

Contingency Deorbit Prep

**Mission Operations Directorate
Operations Division**

**Generic, Rev L
May 8, 2007**

NOTE

For STS-117 and subsequent flights

National Aeronautics and
Space Administration

Lyndon B. Johnson Space Center
Houston, Texas



Verify this is the correct version for the pending operation (training, simulation or flight).
Electronic copies of FDF books are available. URL: <http://mod.jsc.nasa.gov/do3/FDF/index.html>

CONTINGENCY DEORBIT PREP

GENERIC, Rev L (May 8, 2007)

PCN-8 (Jan 16, 2009) Sheet 1 of 1

List of Implemented Change Requests (482s):

C D/O-637
C D/O-640
C D/O-641

NOTE

For STS-119 and subsequent flights

Incorporate the following:

1. Replace iii thru viii
2. Replace 2-5 thru 2-8
3. Replace 8-11 thru 8-14
4. Replace G9-11 and G9-12, H9-11 and H9-12

Prepared by:

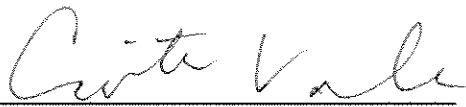

Publication Manager

Approved by:



Manager, Shuttle Procedures Management

Accepted by:



FDF Manager

Encl: 18 pages

File this PCN immediately behind the front cover as a permanent record

CONTINGENCY DEORBIT PREP

GENERIC, Rev L (May 8, 2007)

PCN-7 (Oct 14, 2008) Sheet 1 of 1

List of Implemented Change Requests (482s):

C D/O-636 (S) MULTI-1817
C D/O-638 MULTI-1826
C D/O-639 MULTI-1829
S – Superseded

NOTE

For STS-126 and subsequent flights

Incorporate the following:

1. Replace iii thru viii
2. Delete A5-17 thru B5-18
Add 5-17 and 5-18
3. Delete A7-7 thru B7-8
Add 7-7 and 7-8
4. Delete A8-11 thru B8-12
Add 8-11 and 8-12
5. Delete A9-7 thru B9-8
Add 9-7 and 9-8
Replace A9-11 and A9-12, D9-11 and D9-12
Delete C9-11 and C9-12, F9-11 and F9-12
6. Replace 11-11 and 11-12

Prepared by:



Publication Manager

Approved by:



Manager, Shuttle Procedures Management

Accepted by:



FDF Manager

Encl: 20 pages

File this PCN immediately behind the front cover as a permanent record

CONTINGENCY DEORBIT PREP

GENERIC, Rev L (May 8, 2007)

PCN-6 (July 30, 2008) Sheet 1 of 1

List of Implemented Change Requests (482s):

C D/O-633

C D/O-634

C D/O-635

NOTE

For STS-125 and subsequent flights

Incorporate the following:

1. Replace iii thru viii
2. Replace 1-7 and 1-8, 1-11 and 1-12
3. Replace 2-13 and 2-14, 2-23 and 2-24
4. Replace A9-11 and A9-12, D9-11 and D9-12
Delete E9-11 and E9-12

Prepared by:

Cynthia Simon 7/17/08
Publication Manager

Approved by:

Timberly Johnson 7/22/08
Manager, Shuttle Procedures Management

Accepted by:

Michael T. [Signature]
FDF Manager

Encl: 18 pages

File this PCN immediately behind the front cover as a permanent record

CONTINGENCY DEORBIT PREP

GENERIC, Rev L (May 8, 2007)

PCN-5 (Apr 16, 2008) Sheet 1 of 1

List of Implemented Change Requests (482s):

C D/O-629 MULTI-1816
C D/O-630 MULTI-1818
C D/O-631
C D/O-632

NOTE

For STS-124 and subsequent flights

Incorporate the following:

1. Replace iii thru viii
2. Replace 2-25 and 2-26
3. Replace 3-1 and 3-2, (OV103) A3-29 and (OV103) A3-30, (OV104) B3-29 and (OV104) B3-30, (OV105) C3-29 and (OV105) C3-30
4. Replace 4-5 and 4-6, A4-13 and A4-14, B4-13 and B4-14, 4-17 and 4-18
5. Replace A5-25 and A5-26, B5-25 and B5-26, 5-35 and 5-36
6. Replace 6-1 and 6-2, (OV103) A6-29 and (OV103) A6-30, (OV104) B6-29 and (OV104) B6-30, (OV105) C6-29 and (OV105) C6-30
7. Replace 7-13 and 7-14, 7-19 and 7-20
8. After F9-12, add G9-11 thru I9-12 (6 pages)
Replace A9-17 and A9-18, B9-17 and B9-18
9. Replace 10-3 and 10-4
10. Replace A11-19 and A11-20, B11-19 and B11-20
11. Replace 12-3 thru 12-6

Prepared by:

Condes Simon 4/14/08
Publication Manager

Approved by:

Laura Vaughan
Manager, Shuttle Procedures Management

Accepted by:

Camber Johnson
FDF Manager

Encl: 62 pages

File this PCN immediately behind the front cover as a permanent record

CONTINGENCY DEORBIT PREP

GENERIC, Rev L (May 8, 2007)

PCN-4 (Jan 15, 2008) Sheet 1 of 1

List of Implemented Change Requests (482s):

C D/O-628B

Incorporate the following:

1. Replace iii thru viii
2. Replace 8-13 and 8-14

NOTE

For STS-123 and subsequent flights

Prepared by:

Carole Simon
Publication Manager

Approved by:

Carole Simon
Manager, Shuttle Procedures Management

Accepted by:

Michael T. Holt
FDF Manager

Encl: 8 pages

File this PCN immediately behind the front cover as a permanent record

CONTINGENCY DEORBIT PREP

GENERIC, Rev L (May 8, 2007)

PCN-3 (Nov 2, 2007) Sheet 1 of 1

List of Implemented Change Requests (482s):

C D/O-622
C D/O-626**NOTE**

For STS-122 and subsequent flights

Incorporate the following:

1. Replace iii thru viii
2. Delete TEMP 4-9 and TEMP 4-10
3. Delete TEMP 5-21 and TEMP 5-22
4. Replace B9-11 and B9-12, E9-11 and E9-12

Prepared by:

Lindsey Sumow 10/25/07
Publication Manager

Approved by:

Amberly Johnson 10/26/07
Manager, Shuttle Procedures Management

Accepted by:

Michael E. Shaw
FDF Manager

Encl: 10 pages

File this PCN immediately behind the front cover as a permanent record

CONTINGENCY DEORBIT PREP

GENERIC, Rev L (May 8, 2007)

PCN-2 (Sept 17, 2007) Sheet 1 of 1

List of Implemented Change Requests (482s):

C D/O-620 MULTI-1801
C D/O-621

NOTE

For STS-120 and subsequent flights

Incorporate the following:

1. Replace iii thru viii
2. Replace (OV103) A3-17 and (OV103) A3-18, (OV103) A3-25 and (OV103) A3-26, (OV104) B3-17 and (OV104) B3-18, (OV105) C3-25 and (OV105) C3-26
3. Replace (OV103) A6-25 and (OV103) A6-26, (OV105) C6-25 and (OV105) C6-26
4. Replace F9-11 and F9-12

Prepared by: Andrea Blaylock
Publication Manager

Approved by: Dorothy Johnson
Manager, Shuttle Procedures Management

Accepted by: Michael C. Shaw
FDF Manager

Encl: 20 pages

File this PCN immediately behind the front cover as a permanent record

CONTINGENCY DEORBIT PREP

GENERIC, Rev L (May 8, 2007)

PCN-1 (July 18, 2007) Sheet 1 of 1

List of Implemented Change Requests (482s):

C D/O-615 MULTI-1788
C D/O-618 MULTI-1795
C D/O-619

NOTE
For STS-118 and subsequent flights

Incorporate the following:

1. Replace iii thru viii
2. Replace 2-13 and 2-14
3. Replace (OV103) A3-25 and (OV103) A3-26, (OV105) C3-25 and (OV105) C3-26
4. Replace 5-9 and 5-10
Replace 5-17 and 5-18 with A5-17 thru B5-18 (4 pages)
5. Replace (OV103) A6-25 and (OV103) A6-26, (OV105) C6-25 and (OV105) C6-26
6. Replace 7-7 and 7-8 with A7-7 thru B7-8 (4 pages)
7. Replace 8-9 and 8-10
Replace 8-11 and 8-12 with A8-11 thru B8-12 (4 pages)
8. Replace 9-7 and 9-8 with A9-7 thru B9-8 (4 pages)
After 9-10, add A9-11 and A9-12

Prepared by:

Publication Manager

Approved by:

Manager, Shuttle Procedures Management

Accepted by:

DF Manager

Encl: 38 pages

File this PCN immediately behind the front cover as a permanent record

MISSION OPERATIONS DIRECTORATE

CONTINGENCY DEORBIT PREP

GENERIC, REVISION L

May 8, 2007

PREPARED BY:

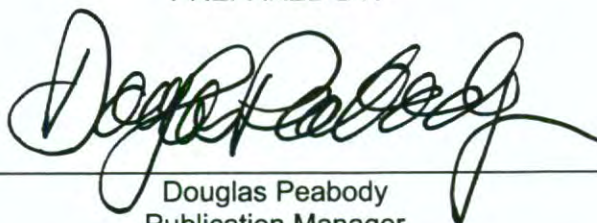

Douglas Peabody
Publication Manager

APPROVED BY:

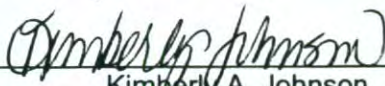

Kimberly A. Johnson
Manager, Shuttle Procedures Management



Michael T. Hurt
FDF Manager

This document is under the configuration control of the Crew Procedures Control Board (CPCB). All proposed changes must be submitted via FDF Workflow Crew Procedure Change Request (CR) to DO3/FDF Manager.

Additional distribution of this book, for official use only, may be requested in writing to DO3/PMO Administrator. The request must include justification and requester's name, organization, position, and phone number. Contractor requests are made through the NASA or DOD organization supported. Deletions, reduction in quantity, or change of address may be submitted to DO3/FDF Management Office, 281-244-1184.

Incorporates the following:		
482#:	C D/O-594	C D/O-608
	C D/O-599	C D/O-609
	C D/O-602	C D/O-610
	C D/O-604	C D/O-611
	C D/O-605	C D/O-612
	C D/O-606	C D/O-613
	C D/O-607A	C D/O-614

AREAS OF TECHNICAL RESPONSIBILITY

Publication Manager	DO3/D. Peabody	281-483-9582
Alternate Publication Manager	DO3/A. Blaylock	281-244-1184
BOOSTER	DF55/M. Patel	281-244-0083
COMM/INCO	DF2/J. King R. Gardner	281-483-0776 281-483-5902
DPS	DF3/J. McDonald	281-483-0793
ECS	DF81/D. Fasbender	281-483-7857
MMACS	DF52/J. Jason K. McCluney	281-483-7575 281-483-0867
GPO	DM/J. Jones	281-483-1170
PROP DATA	DF61/T. Campa	281-244-1002

CONTINGENCY DEORBIT PREP

LIST OF EFFECTIVE PAGES

	GENERIC 04/29/88	PCN-4 01/15/08	
	REV L 05/08/07	PCN-5 04/16/08	
	PCN-1 07/18/07	PCN-6 07/30/08	
	PCN-2 09/17/07	PCN-7 10/14/08	
	PCN-3 11/02/07	PCN-8 01/16/09	
Sign Off	* ALL/GEN L	2-21	ALL/GEN L
ii.....	* ALL/GEN L	2-22	ALL/GEN L
iii.....	* ALL/GEN L,8	2-23	Δ ALL/GEN L,6
iv.....	* ALL/GEN L,8	2-24	Δ ALL/GEN L
v	* ALL/GEN L,8	2-25	Δ ALL/GEN L,5
vi.....	* ALL/GEN L,8	2-26	Δ ALL/GEN L
vii.....	* ALL/GEN L,8	3-1	ALL/GEN L
viii.....	* ALL/GEN L	3-2	ALL/GEN L,5
ix.....	ALL/GEN L	(OV103) A3-3	3/GEN L
x	ALL/GEN L	(OV103) A3-4	ALL/GEN L
1-1	ALL/GEN L	(OV103) A3-5	3/GEN L
1-2	ALL/GEN L	(OV103) A3-6	ALL/GEN L
1-3	ALL/GEN L	(OV103) A3-7	3/GEN L
1-4	ALL/GEN L	(OV103) A3-8	3/GEN L
1-5	ALL/GEN L	(OV103) A3-9	3/GEN L
1-6	ALL/GEN L	(OV103) A3-10	ALL/GEN L
1-7	ALL/GEN L,6	(OV103) A3-11	ALL/GEN L
1-8	ALL/GEN L	(OV103) A3-12	ALL/GEN L
1-9	ALL/GEN L	(OV103) A3-13	ALL/GEN L
1-10	ALL/GEN L	(OV103) A3-14	ALL/GEN L
1-11	Δ ALL/GEN L,6	(OV103) A3-15	3/GEN L
1-12	Δ ALL/GEN L	(OV103) A3-16	3/GEN L
1-13	Δ ALL/GEN L	(OV103) A3-17	3/GEN L
1-14	Δ ALL/GEN L	(OV103) A3-18	3,5/GEN L,2
2-1	ALL/GEN L	(OV103) A3-19	3/GEN L
2-2	ALL/GEN L	(OV103) A3-20	ALL/GEN L
2-3	ALL/GEN L	(OV103) A3-21	3/GEN L
2-4	ALL/GEN L	(OV103) A3-22	3/GEN L
2-5	ALL/GEN L,8	(OV103) A3-23	ALL/GEN L
2-6	ALL/GEN L,8	(OV103) A3-24	3/GEN L
2-7	ALL/GEN L,8	(OV103) A3-25	3/GEN L
2-8	ALL/GEN L,8	(OV103) A3-26	3/GEN L,2
2-9	ALL/GEN L	(OV103) A3-27	3/GEN L
2-10	ALL/GEN L	(OV103) A3-28	3/GEN L
2-11	ALL/GEN L	(OV103) A3-29	3/GEN L
2-12	ALL/GEN L	(OV103) A3-30	ALL/GEN L,5
2-13	ALL/GEN L	(OV103) A3-31	ALL/GEN L
2-14	ALL/GEN L,6	(OV103) A3-32	ALL/GEN L
2-15	ALL/GEN L	(OV104) B3-3	4/GEN L
2-16	ALL/GEN L	(OV104) B3-4	ALL/GEN L
2-17	ALL/GEN L	(OV104) B3-5	4/GEN L
2-18	ALL/GEN L	(OV104) B3-6	ALL/GEN L
2-19	ALL/GEN L	(OV104) B3-7	4/GEN L
2-20	ALL/GEN L	(OV104) B3-8	4/GEN L

* – Omit from flight book

Δ – MS pullout page. Add to MS PAGES in PLT copy only

(OV104) B3-9.....	4/GEN L	4-3	ALL/GEN L
(OV104) B3-10.....	ALL/GEN L	4-4	ALL/GEN L
(OV104) B3-11.....	ALL/GEN L	4-5	ALL/GEN L
(OV104) B3-12.....	ALL/GEN L	4-6	ALL/GEN L,5
(OV104) B3-13.....	ALL/GEN L	4-7	ALL/GEN L
(OV104) B3-14.....	ALL/GEN L	4-8	ALL/GEN L
(OV104) B3-15.....	4/GEN L	4-9	ALL/GEN L
(OV104) B3-16.....	4/GEN L	4-10	ALL/GEN L
(OV104) B3-17.....	4/GEN L	A4-11	3,4/GEN L
(OV104) B3-18.....	4/GEN L,2	A4-12	3,4/GEN L
(OV104) B3-19.....	4/GEN L	A4-13	3,4/GEN L,5
(OV104) B3-20.....	ALL/GEN L	A4-14	ALL/GEN L
(OV104) B3-21.....	4/GEN L	B4-11	5/GEN L
(OV104) B3-22.....	4/GEN L	B4-12	5/GEN L
(OV104) B3-23.....	ALL/GEN L	B4-13	5/GEN L,5
(OV104) B3-24.....	4/GEN L	B4-14	ALL/GEN L
(OV104) B3-25.....	4/GEN L	4-15	ALL/GEN L
(OV104) B3-26.....	4/GEN L	4-16	ALL/GEN L
(OV104) B3-27.....	4/GEN L	4-17	ALL/GEN L,5
(OV104) B3-28.....	4/GEN L	4-18	ALL/GEN L
(OV104) B3-29.....	4/GEN L	5-1	ALL/GEN L
(OV104) B3-30.....	ALL/GEN L,5	5-2	ALL/GEN L
(OV104) B3-31.....	ALL/GEN L	5-3	ALL/GEN L
(OV104) B3-32.....	ALL/GEN L	5-4	ALL/GEN L
(OV105) C3-3.....	5/GEN L	A5-5	3,4/GEN L
(OV105) C3-4.....	ALL/GEN L	A5-6	3,4/GEN L
(OV105) C3-5.....	5/GEN L	B5-5	5/GEN L
(OV105) C3-6.....	ALL/GEN L	B5-6	5/GEN L
(OV105) C3-7.....	5/GEN L	5-7	ALL/GEN L
(OV105) C3-8.....	5/GEN L	5-8	ALL/GEN L
(OV105) C3-9.....	5/GEN L	5-9	ALL/GEN L
(OV105) C3-10.....	ALL/GEN L	5-10	ALL/GEN L,1
(OV105) C3-11.....	ALL/GEN L	5-11	ALL/GEN L
(OV105) C3-12.....	ALL/GEN L	5-12	ALL/GEN L
(OV105) C3-13.....	ALL/GEN L	5-13	ALL/GEN L
(OV105) C3-14.....	ALL/GEN L	5-14	ALL/GEN L
(OV105) C3-15.....	5/GEN L	5-15	ALL/GEN L
(OV105) C3-16.....	5/GEN L	5-16	ALL/GEN L
(OV105) C3-17.....	5/GEN L	5-17	ALL/GEN L,7
(OV105) C3-18.....	3,5/GEN L	5-18	ALL/GEN L,7
(OV105) C3-19.....	5/GEN L	5-19	ALL/GEN L
(OV105) C3-20.....	ALL/GEN L	5-20	ALL/GEN L
(OV105) C3-21.....	5/GEN L	5-21	ALL/GEN L
(OV105) C3-22.....	5/GEN L	5-22	ALL/GEN L
(OV105) C3-23.....	ALL/GEN L	A5-23	ALL/GEN L
(OV105) C3-24.....	5/GEN L	A5-24	3,4/GEN L
(OV105) C3-25.....	5/GEN L	A5-25	3,4/GEN L
(OV105) C3-26.....	5/GEN L,2	A5-26	3,4/GEN L,5
(OV105) C3-27.....	5/GEN L	B5-23	ALL/GEN L
(OV105) C3-28.....	5/GEN L	B5-24	5/GEN L
(OV105) C3-29.....	5/GEN L	B5-25	5/GEN L
(OV105) C3-30.....	ALL/GEN L,5	B5-26	5/GEN L,5
(OV105) C3-31.....	ALL/GEN L	5-27	ALL/GEN L
(OV105) C3-32.....	ALL/GEN L	5-28	ALL/GEN L
4-1	ALL/GEN L		
4-2	ALL/GEN L		

Δ – MS pullout page. Add to MS PAGES in PLT copy only

5-29.....	Δ ALL/GEN L	(OV104) B6-17	4/GEN L
5-30.....	Δ ALL/GEN L	(OV104) B6-18	ALL/GEN L
5-31.....	Δ ALL/GEN L	(OV104) B6-19	4/GEN L
5-32.....	Δ ALL/GEN L	(OV104) B6-20	ALL/GEN L
5-33.....	Δ ALL/GEN L	(OV104) B6-21	4/GEN L
5-34.....	Δ ALL/GEN L	(OV104) B6-22	4/GEN L
5-35.....	Δ ALL/GEN L	(OV104) B6-23	4/GEN L
5-36.....	Δ ALL/GEN L,5	(OV104) B6-24	ALL/GEN L
6-1	ALL/GEN L	(OV104) B6-25	4/GEN L
6-2.....	ALL/GEN L,5	(OV104) B6-26	4/GEN L
(OV103) A6-3.....	3/GEN L	(OV104) B6-27	4/GEN L
(OV103) A6-4.....	ALL/GEN L	(OV104) B6-28	4/GEN L
(OV103) A6-5.....	3/GEN L	(OV104) B6-29	4/GEN L
(OV103) A6-6.....	ALL/GEN L	(OV104) B6-30	ALL/GEN L,5
(OV103) A6-7.....	3/GEN L	(OV104) B6-31	ALL/GEN L
(OV103) A6-8.....	3/GEN L	(OV104) B6-32	ALL/GEN L
(OV103) A6-9.....	3/GEN L	(OV105) C6-3	5/GEN L
(OV103) A6-10.....	ALL/GEN L	(OV105) C6-4	ALL/GEN L
(OV103) A6-11.....	3/GEN L	(OV105) C6-5	5/GEN L
(OV103) A6-12.....	ALL/GEN L	(OV105) C6-6	ALL/GEN L
(OV103) A6-13.....	ALL/GEN L	(OV105) C6-7	5/GEN L
(OV103) A6-14.....	ALL/GEN L	(OV105) C6-8	5/GEN L
(OV103) A6-15.....	3/GEN L	(OV105) C6-9	5/GEN L
(OV103) A6-16.....	3/GEN L	(OV105) C6-10	ALL/GEN L
(OV103) A6-17.....	3/GEN L	(OV105) C6-11	5/GEN L
(OV103) A6-18.....	ALL/GEN L	(OV105) C6-12	ALL/GEN L
(OV103) A6-19.....	3/GEN L	(OV105) C6-13	ALL/GEN L
(OV103) A6-20.....	ALL/GEN L	(OV105) C6-14	ALL/GEN L
(OV103) A6-21.....	3/GEN L	(OV105) C6-15	5/GEN L
(OV103) A6-22.....	3/GEN L	(OV105) C6-16	5/GEN L
(OV103) A6-23.....	3/GEN L	(OV105) C6-17	5/GEN L
(OV103) A6-24.....	ALL/GEN L	(OV105) C6-18	ALL/GEN L
(OV103) A6-25.....	3/GEN L	(OV105) C6-19	5/GEN L
(OV103) A6-26.....	3/GEN L,2	(OV105) C6-20	ALL/GEN L
(OV103) A6-27.....	3/GEN L	(OV105) C6-21	5/GEN L
(OV103) A6-28.....	3/GEN L	(OV105) C6-22	5/GEN L
(OV103) A6-29.....	3/GEN L	(OV105) C6-23	5/GEN L
(OV103) A6-30.....	ALL/GEN L,5	(OV105) C6-24	ALL/GEN L
(OV103) A6-31.....	ALL/GEN L	(OV105) C6-25	5/GEN L
(OV103) A6-32.....	ALL/GEN L	(OV105) C6-26	5/GEN L,2
(OV104) B6-3.....	4/GEN L	(OV105) C6-27	5/GEN L
(OV104) B6-4.....	ALL/GEN L	(OV105) C6-28	5/GEN L
(OV104) B6-5.....	4/GEN L	(OV105) C6-29	5/GEN L
(OV104) B6-6.....	ALL/GEN L	(OV105) C6-30	ALL/GEN L,5
(OV104) B6-7.....	4/GEN L	(OV105) C6-31	ALL/GEN L
(OV104) B6-8.....	4/GEN L	(OV105) C6-32	ALL/GEN L
(OV104) B6-9.....	4/GEN L	7-1	ALL/GEN L
(OV104) B6-10.....	ALL/GEN L	7-2	ALL/GEN L
(OV104) B6-11.....	4/GEN L	A7-3.....	ALL/GEN L
(OV104) B6-12.....	ALL/GEN L	A7-4.....	3,4/GEN L
(OV104) B6-13.....	ALL/GEN L	B7-3.....	ALL/GEN L
(OV104) B6-14.....	ALL/GEN L	B7-4.....	5/GEN L
(OV104) B6-15.....	4/GEN L	7-5	ALL/GEN L
(OV104) B6-16.....	4/GEN L	7-6	ALL/GEN L

Δ – MS pullout page. Add to MS PAGES in PLT copy only

7-7.....	ALL/GEN L,7	H9-11.....	125/GEN L,8
7-8.....	ALL/GEN L,7	H9-12.....	ALL/GEN L,5
7-9.....	ALL/GEN L	I9-11.....	124/GEN L,5
7-10.....	ALL/GEN L	I9-12.....	ALL/GEN L,5
A7-11.....	3,4/GEN L	A9-13.....	ALL/GEN L
A7-12.....	ALL/GEN L	A9-14.....	3,4/GEN L
B7-11.....	5/GEN L	A9-15.....	ALL/GEN L
B7-12.....	ALL/GEN L	A9-16.....	3,4/GEN L
7-13.....	ALL/GEN L	A9-17.....	3,4/GEN L,5
7-14.....	ALL/GEN L,5	A9-18.....	ALL/GEN L
7-15.....	ALL/GEN L	B9-13.....	ALL/GEN L
7-16.....	ALL/GEN L	B9-14.....	5/GEN L
7-17.....Δ	ALL/GEN L	B9-15.....	ALL/GEN L
7-18.....☒Δ	ALL/GEN L	B9-16.....	5/GEN L
7-19.....Δ	ALL/GEN L,5	B9-17.....	5/GEN L,5
7-20.....Δ	ALL/GEN L,5	B9-18.....	ALL/GEN L
7-21.....Δ	ALL/GEN L	10-1.....	ALL/GEN L
7-22.....Δ	ALL/GEN L	10-2.....	ALL/GEN L
8-1.....	ALL/GEN L	10-3.....	ALL/GEN L
8-2.....	ALL/GEN L	10-4.....	ALL/GEN L,5
8-3.....	ALL/GEN L	10-5.....	ALL/GEN L
8-4.....	ALL/GEN L	10-6.....	ALL/GEN L
8-5.....	ALL/GEN L	10-7.....Δ	ALL/GEN L
8-6.....	ALL/GEN L	10-8.....Δ	ALL/GEN L
8-7.....Δ	ALL/GEN L	10-9.....Δ	ALL/GEN L
8-8.....Δ	ALL/GEN L	10-10.....Δ	ALL/GEN L
8-9.....Δ	ALL/GEN L,1	10-11.....	ALL/GEN L
8-10.....Δ	ALL/GEN L	10-12.....	ALL/GEN L
8-11.....	ALL/GEN L,7	10-13.....	ALL/GEN L
8-12.....	ALL/GEN L,8	10-14.....	ALL/GEN L
8-13.....Δ	ALL/GEN L	10-15.....	ALL/GEN L
8-14.....Δ	ALL/GEN L,8	10-16.....	ALL/GEN L
8-15.....Δ	ALL/GEN L	10-17.....	ALL/GEN L
8-16.....Δ	ALL/GEN L	10-18.....	ALL/GEN L
8-17.....Δ	ALL/GEN L	A10-19.....	3,4/GEN L
8-18.....Δ	ALL/GEN L	A10-20.....	3,4/GEN L
9-1.....	ALL/GEN L	B10-19.....	5/GEN L
9-2.....	ALL/GEN L	B10-20.....	5/GEN L
9-3.....	ALL/GEN L	10-21.....	ALL/GEN L
9-4.....	ALL/GEN L	10-22.....	ALL/GEN L
9-5.....Δ	ALL/GEN L	10-23.....	ALL/GEN L
9-6.....Δ	ALL/GEN L	10-24.....	ALL/GEN L
9-7.....	ALL/GEN L,7	11-1.....	ALL/GEN L
9-8.....	ALL/GEN L,7	11-2.....	ALL/GEN L
9-9.....	ALL/GEN L	11-3.....Δ	ALL/GEN L
9-10.....	ALL/GEN L	11-4.....Δ	ALL/GEN L
A9-11.....	126/GEN L,7	A11-5.....Δ	3,4/GEN L
A9-12.....	ALL/GEN L,6	A11-6.....Δ	ALL/GEN L
B9-11.....	123/GEN L,3	B11-5.....Δ	5/GEN L
B9-12.....	ALL/GEN L,3	B11-6.....Δ	ALL/GEN L
D9-11.....	119/GEN L,7	11-7.....	ALL/GEN L
D9-12.....	ALL/GEN L,6	11-8.....	ALL/GEN L
G9-11.....	400/GEN L,8	11-9.....	ALL/GEN L
G9-12.....	ALL/GEN L,5	11-10.....	ALL/GEN L

Δ – MS pullout page. Add to MS PAGES in PLT copy only

☒ – Prelift-off information reqd

11-11.....	ALL/GEN L
11-12.....	ALL/GEN L,7
A11-13.....	ALL/GEN L
A11-14.....	3,4/GEN L
B11-13.....	ALL/GEN L
B11-14.....	5/GEN L
11-15.....	ALL/GEN L
11-16.....	ALL/GEN L
11-17.....	ALL/GEN L
11-18.....	ALL/GEN L
A11-19.....	3,4/GEN L,5
A11-20.....	ALL/GEN L
B11-19.....	5/GEN L,5
B11-20.....	ALL/GEN L
12-1.....	ALL/GEN L
12-2.....	ALL/GEN L
12-3.....Δ	ALL/GEN L,5
12-4.....Δ	ALL/GEN L
12-5.....Δ	ALL/GEN L,5
12-6.....Δ	ALL/GEN L
12-7.....Δ	ALL/GEN L
12-8.....Δ	ALL/GEN L
12-9.....Δ	ALL/GEN L
12-10.....Δ	ALL/GEN L
13-1.....	ALL/GEN L
13-2.....	ALL/GEN L
14-1.....†	ALL/GEN L
14-2.....†	ALL/GEN L
Entry C/L pg.....‡	
Entry C/L pg.....‡	

Δ – MS pullout page. Add to MS PAGES in PLT copy only
† – Flown in PLT copy only
‡ – Landing Site Data Chart from Entry C/L in Flight books only

This Page Intentionally Blank

CONTENTS

	<u>PAGE</u>
LAUNCH DAY DEORBIT PREP (ORBIT 2)	1-1
LAUNCH DAY DEORBIT PREP (ORBIT 3)	2-1
ENTRY SWITCH LIST/VERIFICATION.....	3-1
LOSS OF 2 FC LAUNCH DAY DEORBIT PREP (ORBIT 2 OR ORBIT 3).....	4-1
LOSS OF 2 FUEL CELLS ENTRY MANEUVERS (M = 2.0 $\sqrt{\text{THETA}}$ LIMITS) (CIL)	4-13
LOSS OF 2 FUEL CELLS DEORBIT PREP	5-1
LOSS OF 2 FUEL CELLS ENTRY MANEUVERS (M = 2.0 $\sqrt{\text{THETA}}$ LIMITS) (CIL)	5-26
LOSS OF 2 FC SWITCH VERIFICATION LIST	6-1
LOSS OF FES DEORBIT PREP	7-1
LOSS OF 2 H2O LOOPS	8-1
PART 1: ON-ORBIT WAIT	8-3
PART 2: ON-ORBIT BACKOUT	8-9
20-MINUTE DE/REPRESS	8-17
LOSS OF 2 H2O LOOPS DEORBIT PREP/ENTRY	9-1
LOSS OF 2 H2O LOOPS ENTRY MANEUVERS (M = 2.0 $\sqrt{\text{THETA}}$ LIMITS) (CIL).....	9-17
EMERGENCY DEORBIT PREP/ENTRY	10-1
STOW KU-BD ANTENNA (CIL).....	10-7
(IF NO AIR DATA AND M < 1.5, FLY THETA LIMITS) (CIL).....	10-24
LOSS OF 2 FREON LOOPS DEORBIT PREP/ENTRY	11-1
LOSS OF 2 FREON LOOPS ENTRY MANEUVERS (M = 2.0 $\sqrt{\text{THETA}}$ LIMITS) (CIL).....	11-19
QUICK-RESPONSE JETTISON.....	12-1
POST-JETTISON CLEANUP (CIL).....	12-7
(MCA PWR AC2 3 Φ MID 2, MCA PWR AC3 3 Φ MID 4) (CIL)	12-7
BAILOUT	13-1
MS PAGES	14-1

This Page Intentionally Blank

LAUNCH DAY DEORBIT PREP (ORBIT 2)

This Page Intentionally Blank

LAUNCH DAY DEORBIT PREP (ORBIT 2)

ASSUMPTIONS/INITIAL CONDITIONS

These procedures may be entered directly from ASC

There is no requirement for completion of any Nominal Post Insertion procedures

MSs only will egress seats

Procedures should be started at approximately MET 01:00

PROBLEM DESCRIPTION/RATIONALE

Failure in any system that requires deorbit as soon as possible after last AOA opportunity

LAUNCH DAY DEORBIT PREP (ORBIT 2) SUMMARY TIMELINE

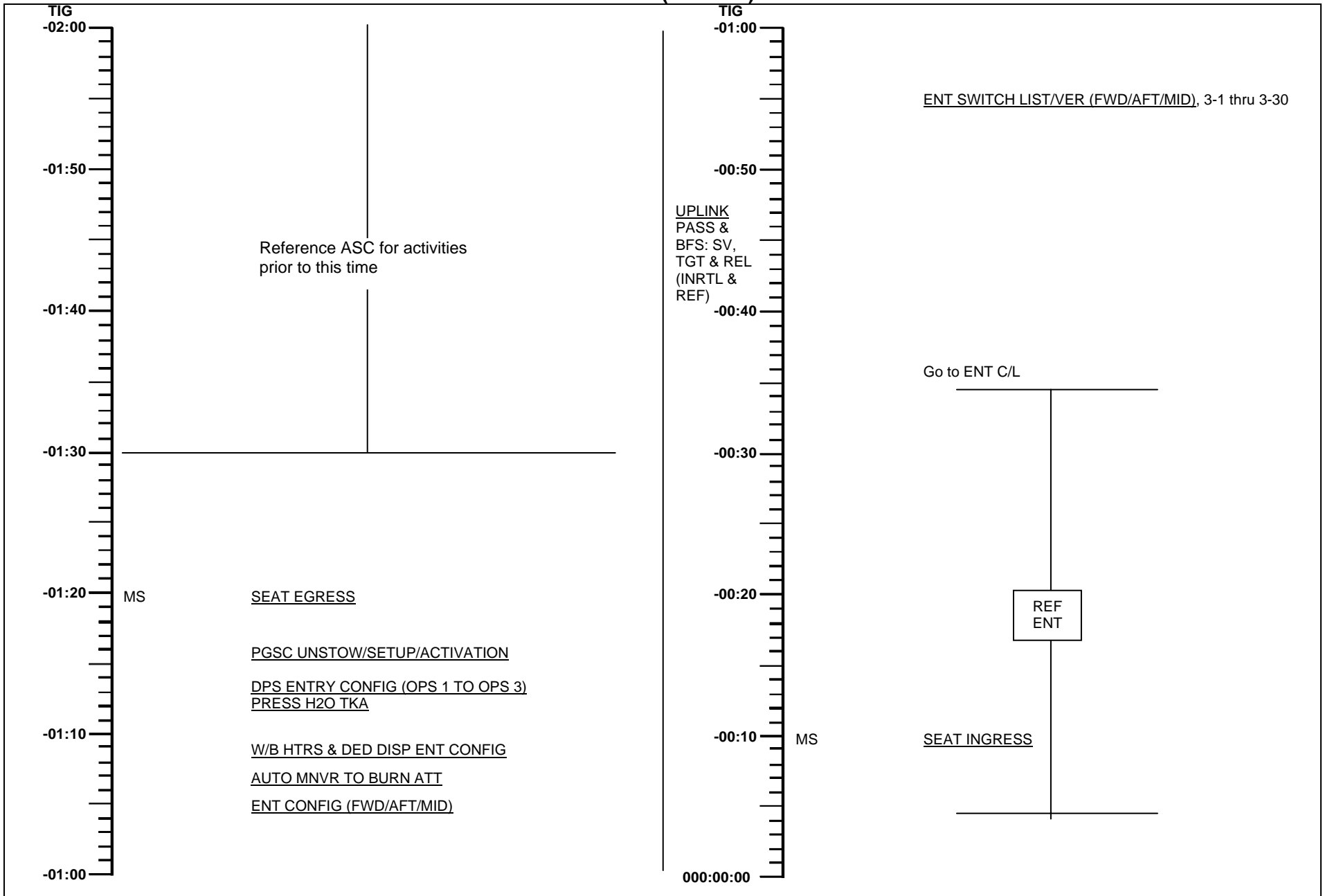

DPS ENTRY CONFIG 1

C,P

C2 1. TRANSITION TO GNC OPS 3
Set event timer to count down to TIG

O14,O15,
O16 √RGA,ACCEL,ASA,IMU (all) – ON

CONFIG – ITEM 1 +3 EXEC
Modify MC 3 per table →

C3 BFC CRT DISP – OFF
GNC, OPS 301 PRO

1: GNC DEORB MNVR COAST

CRT3 BFC CRT DISP – ON
BFS, GNC OPS 000 PRO
301 PRO

CONFIG	3	
GPC	12340	
STR	1	1
	2	2
	3	3
	4	4
PL	1/2	1
CRT	1	1
	2	2
	3	3
	4	0
L	1	0
	2	0
MM	1	1
	2	2

2. LAND SITE UPDATE

1: GNC 50 HORIZ SIT

SEL SITE (See LAND SITE DATA)

3. LOAD IN TGTs

1: GNC DEORB MNVR COAST

* If MCC cannot provide DEORB TGT, use Deorbit Manager on PGSC *

√PASS and BFS TGT per DEORBIT MNVR PAD (ENT, MNVR PADS) or PGSC

LOAD – ITEM 22 EXEC

TIMER – ITEM 23 EXEC

√PASS and BFS solution per DEORBIT MNVR PAD (ENT, MNVR PADS):

BURN ATT

HA

HP

ΔVTOT

TGO

CONFIG	9	
GPC	12340	
STR	1	1
	2	2
	3	3
	4	4
PL	1/2	1
CRT	1	1
	2	2
	3	3
	4	0
L	1	1
	2	2
MM	1	1
	2	2

4. VERIFY MC 9 TABLE (GNC 9) FOR POST LANDING

2: GNC 0 GPC MEMORY

√CONFIG – ITEM 1 +9 EXEC

Modify MC 9 per table →

CONFIG – ITEM 1 +3 EXEC

This Page Intentionally Blank

TIG		
-01:30	TRANS DAP AUTO RT 0.5 DB 3.5	
		NOTE These procedures do not require completion of any nominal Post Insertion procedures
-01:25		
	MS	If reqd, PAYLOAD DEACT (PL OPS, <u>DEORBIT PREP</u>) or PAYLOAD DEACTIVATION (SODF: ASSY OPS: DEORBIT PREP)
-01:20	C	L4:D,E All cbs open L4:B, All cbs closed Q,R
	MS	<u>SEAT EGRESS</u>
UPLINK	MS	<u>PGSC ACT (ORB OPS, PGSC)</u> Use flight deck PGSC
PASS & BFS		Transition to ENT PKT
TGT	C,P	<u>DPS ENTRY CONFIG (OPS 1 to OPS 3)</u> (BFS NOT <u>ENGAGED</u>) [1], 1-5
-01:15	MS	<u>PRESS H2O TK A MS MID ACTIVITIES</u> [2], 1-13
	C,P	GPS INCORPORATION (EPCL, <u>GNC</u>) (Omit if voice or cmd available)
-01:10	C,P	<u>APU HTRS & DED DISP ENT CONFIG</u> [3]
	P	<u>AUTO MNVR TO BURN ATT</u> (MCC update ATT) Mnvr per DEORBIT MNVR PAD (ENT, <u>MNVR PADS</u>): R _____ P _____ Y _____
-01:05	C,P	<u>ENT FWD FLT DECK CONFIG</u> [4]
	MS	<u>ENT AFT FLT DECK CONFIG MS AFT ACTIVITIES</u> [5], 1-11
	MS	<u>ENT MIDDECK CONFIG MS MID ACTIVITIES</u> [6], 1-13
	MS	<u>PAYLOAD ENT SW LIST/VER (PL OPS, DEORBIT PREP)</u> or PAYLOAD DEACTIVATION (SODF: ASSY OPS: DEORBIT PREP)
-01:00		

<u>W/B HTRS & DED DISP ENT CONFIG</u> [3]	
C,P	<u>W/B STEAM VENT HTR ACT</u> BLR CNTLR/HTR (three) – B PWR (three) – ON
F6	<u>DED DISP ENT CONFIG</u> ADI RATE – LO
O7	If OV103,4: TACAN MODE sel (three) – GPC If OV105: √GPS PWR (three) – ON GPS PWRUP (ORB OPS, <u>GNC</u>)
O17:B	EIU (three) – OFF
O8	MLS (three) – ON

<u>ENT FWD FLT DECK CONFIG</u> [4]	
C,P	<u>FES CONFIG</u> FLASH EVAP CNTLR PRI A – OFF B(A) – GPC
R4	<u>FWD SWITCH CONFIG</u> HYD BK HTR (three) – AUTO
L4:J	cb AC3 ΦB SIG CONDR IMU FAN – op
O14:D	MNA CAB VENT – op ISOL – op
O17:D	MEC 1 – OFF, wait 2 sec, then 2 – OFF

This Page Intentionally Blank

TIG

1: GNC DEORB MNVR COAST | 2: GNC 0 GPC MEMORY

3: BFS, GNC DEORB MNVR COAST

-01:00
TRANS DAP
AUTO
RT 0.5
DB 3.5

NOTE

√MCC for unaccounted-for sw or
cb config discrepancies

-00:55
C
P
MS
MS

ENT SWITCH LIST/VER (FWD), 3-3 thru 3-9
ENT SWITCH LIST/VER (FWD), 3-10 thru 3-13
ENT SWITCH LIST/VER (AFT), 3-15 thru 3-26
ENT SWITCH LIST/VER (MID), 3-27 thru 3-30

-00:50

-00:45

UPLINK
PASS &
BFS:
SV & REL
(INRTL &
REF)

-00:40

C,P

Stow ORB PKT,ORBIT Cue Cards, DEORBIT PREP

-00:35

Go to FINAL DEORB UPDATE/UPLINK (ENT, DEORBIT BURN)
with following P&I to ENTRY MANEUVER (Cue Card): V = 12K,
delete: RAD BYP VLV MODE (two) – AUTO CNTLR LOOP
(two) – AUTO B(A)

-00:30

This Page Intentionally Blank

MS LAUNCH DAY DEORBIT PREP AFT DECK CONFIGURATION (ORBIT 2)

MS PULLOUT PAGE

NOTE

Wait for GO from CDR or PLT before starting any activity on this page

TIME (TIG-)	MS AFT ACTIONS
01:23	If reqd, PAYLOAD DEACT (PL OPS, <u>DEORBIT PREP</u>) or PAYLOAD DEACTIVATION (SODF: ASSY OPS: DEORBIT PREP)
01:19	<u>SEAT EGRESS</u>
01:18	<u>PGSC ACT</u> (ORB OPS, <u>PGSC</u>) Use flight deck PGSC
01:05	<u>ENT AFT FLT DECK CONFIG</u> 5
00:54	<u>ENT SWITCH LIST/VER (AFT)</u> , 3-16 thru 3-26

<u>ENT AFT FLT DECK CONFIG</u> 5		
A1L	<u>ENTRY COMM CONFIG</u> S-BD PM MODE – STDN LO NSP CODING RCV – OFF √XMIT – OFF	
A12	<u>HTR CONFIG</u> HYD HTR (eight) – OFF	
ML86B:A R11L	<u>AFT SW CONFIG</u> √cb MNC SPLY H2O XOVR VLV – cl SPLY H2O XOVR VLV – OP (tb-OP) √AFT deck lts as reqd	
	<u>RESET C/W</u>	
	R13U	
	PARAMETER NAME	C/W CH
	FREON LOOP EVAP OUT T1	107
	T2	117
		UPPER LIMIT
		1.90V/64.8 degF
		1.90V/64.8 degF

**Back of LAUNCH DAY DEORBIT PREP AFT DECK CONFIGURATION
(ORBIT 2)**

MS PULLOUT PAGE

I

**MS LAUNCH DAY DEORBIT PREP MIDDECK CONFIGURATION
(ORBIT 2)**

MS PULLOUT PAGE

NOTE

Wait for GO from CDR or PLT before starting any activity on this page

TIME (TIG-)	MS MIDDECK ACTIONS
01:18	<u>SEAT EGRESS</u>
01:15	<u>PRESS H2O TK A</u> [2]
01:04	<u>ENT MIDDECK CONFIG</u> [6]
00:53	<u>ENT SWITCH LIST/VER (MID)</u> , 3-27 thru 3-32

<u>ENT MIDDECK CONFIG</u> [6]	
MS	<u>MIDDECK PCS</u>
MO69M	LEH O2 7,8 vlv (two) – as reqd
MO32M	6 vlv– as reqd
MO13Q	√MIDDECK FLOODS as reqd
	<u>ENTRY COMM CONFIG</u>
ML85E	AC S1 – OFF

<u>PRESS H2O TK A</u> [2]	
ML26C	SPLY H2O GN2 TK VENT vlv – PRESS TKA SPLY vlv – OP
	<u>NOTE</u> Disregard possible 'S66 WASTE H2O PRE' fault msg

**Back of MS LAUNCH DAY DEORBIT PREP MIDDECK ACTIVITIES
(ORBIT 2)
MS PULLOUT PAGE**

I

LAUNCH DAY DEORBIT PREP (ORBIT 3)

This Page Intentionally Blank

LAUNCH DAY DEORBIT PREP (ORBIT 3)

ASSUMPTIONS/INITIAL CONDITIONS

Launch Day Deorbit Prep (Orbit 3) may be entered directly from ascent config (ASC) or orbit config (POST INSERT)

Appropriate PKT or MAL should be accomplished prior to using these procedures

PROBLEM DESCRIPTION/RATIONALE

Any failure that results in a fail-safe condition will be cause for Launch Day Deorbit. Examples include those listed in POST INSERT, plus PLBD problems

NOTE

1. This procedure can be used for an OPS 1 failure or an OPS 2 failure that has occurred prior to GO FOR ORBIT OPS at MET 01:36.
After GO FOR ORBIT OPS, these procedures no longer apply
2. If in OPS 1 or in OPS 2 prior to completion of activities preceding MNVR TO PLBD OPENING ATTITUDE, begin procedure at TIG-2:30.
This will cover necessary Post Insertion procedures not yet accomplished
3. If in OPS 2 after INITIATION OF MNVR TO PLBD OPENING ATTITUDE; begin procedure at TIG-2:00
4. If entering this procedure due to Av Bay Fire and in OPS 1, incorporate AV BAY FIRE CONTINGENCY DELTAS (OPS 1 to OPS 3), 2-5
5. If entering this procedure due to Av Bay Fire and in OPS 2, incorporate AV BAY FIRE CONTINGENCY DELTAS (OPS 2 to OPS 3), 2-7

This Page Intentionally Blank

AV BAY FIRE CONTINGENCY DELTAS (OPS 1 TO OPS 3)

Assumes AV BAY FIRE (ASC PKT, PWRDN) complete

NOTE

Single-fault tolerance used for most cabin air-cooled equipment. Additional LRUs may be activated if reqd and if CABIN PRESS stable \geq 8 psia. Minimize use of IDPs,MDUs,FLT CNTLR PWR, DDU's. Use one PGSC

WARNING

If associated AV BAY AC BUS, FF MDM, or FMCA is unrecoverable, \sqrt MCC for vent door config. Certain failure combinations will cause multiple vent doors to remain open during entry

LAND SITE UPDATE

1: GNC 50 HORIZ SIT
 SEL SITE (See LAND SITE DATA)
 LOAD IN TGTs
1: GNC DEORB MNVR COAST

* If MCC cannot provide DEORB TGT, use Deorbit *
 * Manager on PGSC *

\sqrt PASS and BFS TGT per DEORBIT MNVR PAD
 (ENT, MNVR PADS) or PGSC
 LOAD – ITEM 22 EXEC
 TIMER – ITEM 23 EXEC
 \sqrt PASS and BFS solution per DEORBIT MNVR PAD
 (ENT, MNVR PADS):
 BURN ATT
 HA
 HP
 Δ VTOT
 TGO

1. TIG-2:30
 If AV BAY 1 or 2 FIRE:
 | FCS CH (four) – ORIDE
 If AV BAY 3 FIRE:
 \sqrt FCS CH 1,2,3 (three) – AUTO
 4 – OFF
2. Skip DPS CONFIG 2 and perform following:
DPS CONFIG FOR AV BAY FIRE (OPS 1 to OPS 3)
 Set event timer to count down to TIG
 \sqrt RG,ASA,IMU (all) – ON
 ACCEL, ADTA (all unaffected) – ON

C2
 O14,
 O15,
 O16

3. Replace W/B STEAM VENT HTR ACT 6 with following:
 BLR CNTLR/HTR (three) – B
 If AV BAY 1(2,3) fire:
 BLR CNTLR/HTR 1(2,3) – A
 BLR PWR (three) – ON

R2

TRANSITION GPCs TO GNC OPS 3

1: GNC GPC MEMORY
 CONFIG – ITEM 1 +3 EXEC
 Modify MC 3 per table
 GNC, OPS 301 PRO

3: GNC DEORB MNVR COAST

TRANSITION BFS GPC TO GNC OPS 3

If AV BAY 1 or 3 FIRE:
 GPC MODE 5 – STBY (tb-RUN)
 – RUN (tb-RUN)
 BFC CRT DISP – ON
 \sqrt SEL – 3+1

3: BFS, GNC BFS MEMORY

\sqrt GPC OUTPUT 5 – B/U (tb-bp)
 \sqrt TFL ENA – ITEM 29 (*)
 BFS, GNC OPS 301 PRO

3: BFS GNC DEORB MNVR COAST

If AV BAY 2 FIRE:
 Reassign BFS into GPC 3 via MAL DPS SSR-7 (do not activate MMU2), then take GPC OUTPUT 3 – B/U (tb-bp)
 GPC MODE 3 – RUN (tb-RUN)

CONFIG GPC		LOSS OF		
		BAY 1	BAY 2	BAY 3
	3	3	3	
	02300	10040	12040	
STR	1	3	1	1
	2	2	4	2
	3	3	1	4
	4	2	4	4
PL	1/2	2	1	1
CRT	1	2	1	1
	2	3	4	2
	3	2	1	4
	4	0	0	0
L	1	0	0	0
	2	0	0	0
MM	1	2	1	1
	2	3	4	2

O6

C3

O6

CRT3

O6
 CRT

O6

O14:E,
 O15:E,
 O16:E

L1

4. Deltas to PLBD CLOSING (AUTO SEQ) (if reqd) **8**
 If AV BAY 2 FIRE:
 Perform the following prior to step 1:
 MDM PL2 – ON
 SM (BFS) I/O RESET
 Add the following after step 14:
 MDM PL2 – OFF
5. Deltas to ENT FWD FLT DECK CONFIG 10
 Do not power up MLS
 cb MNA,B,C DDU L,R (four) – cl
 If AV BAY 1 fire:
 FLASH EVAP CNTLR PRI A – GPC

Cont next page

AV BAY FIRE CONTINGENCY DELTAS (OPS 1 to OPS 3) (Cont)

6. Deltas to ENT MIDDECK CONFIG 12
- ML31C √VAC VENT ISOL VLV CNTL – OP (tb-OP)
 √NOZ HTR – ON
7. ENT SWITCH LIST/VERIF
Do not activate pwrdrn items
8. AV BAY FIRE P&I DELTAS TO ENTRY
Deltas to ENT, DEORBIT BURN
At TIG-4:
 If AV BAY 1(2) FIRE:
 GNC DEORB MNVR EXEC
 L(R) OMS GMBL – SEC (*)
 Use two IDP/CRTs with four MDUs
- O14:E,O15:E, √cb MNA,B,C DDU L,R (four) – cl
 O16:E
 F6,F8 FLT CNTLR PWR (two) – ON
- Deltas to ENT, POST BURN:
 Use one IDP/CRT with two MDUs
 FLT CNTLR PWR (two) – OFF
 cb MNA,B DDU L (two) – op
 If AV BAY 1(2) FIRE:
 ENTRY SW CHECK
 Delete: √NWS – 1
 Add: NWS – 2 (OFF)
- O16:F If AV BAY 2 FIRE:
 RJDF 2B F4/F5 LOGIC – ON
 F4 DRIVER – ON
- O8 FWD RCS MANF ISOL 4 – OP (tb-OP)
- Deltas to ENTRY MANEUVERS (Cue Card):
 At EI:
 Use only two IDP/CRTs with four MDUs
 cb MNA,B DDU L (two) – cl
 FLT CNTLR PWR – ON
- O14:E,O15:E, √cb ADTA (all unaffected) – cl
 F6
 O14:E,O15:E, At V = 15K:
 O16:E Activate all unaffected TACANs (OV103,4), RAs, MLSs
 GNC I/O RESET
- At M < 1.0
 Use two IDP/CRTs with five MDUs

AV BAY FIRE CONTINGENCY DELTAS (OPS 2 TO OPS 3)

Assumes AV BAY FIRE (ORB PKT, PWRDN) complete

NOTE

Single-fault tolerance used for most cabin air-cooled equipment. Additional LRUs may be activated if reqd and if CABIN PRESS stable \geq 8 psia. Minimize use of IDPs, MDUs, FLT CNTLR PWR, DDUs. Use one PGSC

CRT
R11L
CRT

VERIFY IDP CONFIG

GPC/CRT 0/4 EXEC
 \sqrt IDP/CRT4 PWR – OFF
GPC/CRT X/3 EXEC

WARNING

If associated AV BAY AC BUS, FF MDM, or FMCA is unrecoverable, \sqrt MCC for vent door config. Certain failure combinations will cause multiple vent doors to remain open during entry

LOAD ENTRY TFL/RECONFIG UPLK

Perform LOAD PDI DECOM FORMAT and LOAD PCMMU FORMAT (ORB OPS FS, COMM/INST) for entry config

TRANSITION GPCs TO GNC OPS 3

1: GNC 0 GPC MEMORY

CONFIG – ITEM 1 +3 EXEC

Modify MC 3 per table

GNC, OPS 301 PRO

1: GNC DEORB MNVR COAST

		LOSS OF		
		BAY 1	BAY 2	BAY 3
CONFIG	3	3	3	3
	02000	10000	12000	
STR	1	2	1	1
	2	2	1	2
	3	2	1	1
	4	2	1	2
PL	1/2	0	0	0
CRT	1	2	1	1
	2	2	1	2
	3	2	1	2
	4	0	0	0
L	1	0	0	0
	2	0	0	0
MM	1	2	1	1
	2	2	1	2

1. TIG -2:30(2:00)
If AV BAY 1 or 2 FIRE:
| FCS CH (four) – ORIDE
If AV BAY 3 FIRE:
 \sqrt FCS CH 1,2,3 (three) – AUTO
4 – OFF
2. Replace W/B STEAM VENT HTR ACT [6] with following:
BLR CNTLR/HTR (three) – B
If AV BAY 1(2,3) fire:
| BLR CNTLR/HTR 1(2,3) – A
BLR PWR (three) – ON

NOTE

Htr reqd to be on prior to APU act

3. Deltas to PLBD CLOSING (AUTO SEQ) (if reqd) [8]
If AV BAY 2 FIRE:
Perform the following prior to step 1:
MDM PL2 – ON
SM (BFS) I/O RESET
Add the following after step 14:
MDM PL2 – OFF
4. Skip OPS 2 TO 3 TRANSITION [9] and perform following:
OPS CONFIG FOR AV BAY FIRE (OPS 2 to OPS 3)
(Omit if BFS engaged or if already configured with G3 set)
 - * If IMU or RHC dilemma, do not proceed with *
 - * OPS 3 transition *

\sqrt Att mnvr complete
 \sqrt RG,ASA,IMU (all) – ON
ACCEL, ADTA (all unaffected) – ON

P R2

O6
CRT

O6

O14,
O15,
O16

Cont next page

AV BAY FIRE CONTINGENCY DELTAS (OPS 2 TO OPS 3) (Cont)

TRANSITION BFS GPC TO GNC OPS 3

O6
C3
If AV BAY 1 or 3 FIRE:
GPC MODE 5 – STBY (tb-RUN)
BFC CRT DISP – ON
√SEL – 3+1

3: BFS, GNC BFS MEMORY

O6
CRT3
GPC OUTPUT 5 – B/U (tb-bp)
√TFL ENA – ITEM 29 (*)
BFS, GNC OPS 301 PRO

3: BFS GNC DEORB MNVR COAST

If AV BAY 2 FIRE:
GPC OUTPUT 3 – B/U (tb-bp)

TRANSITION REMAINING PASS GPCs TO GNC OPS 3

SM, OPS 000 PRO (release payload buses)

X: SM GPC MEMORY

O6
(SM) GPC OUTPUT – NORM (tb-gray)

If AV BAY 1 or 3 FIRE:
GPC MODE 5 – RUN (tb-RUN)
If AV BAY 2 FIRE:
GPC MODE 3 – RUN (tb-RUN)

1: GNC 0 GPC MEMORY

CONFIG – ITEM 1 +3 EXEC

Modify MC 3 per table →
BFC CRT DISP – OFF
GNC, OPS 301 PRO

1: GNC DEORB MNVR COAST

C3
CRT3
BFC CRT DISP – ON
BFS, GNC, OPS 000 PRO
301 PRO

LAND SITE UPDATE

1: GNC 50 HORIZ SIT

SEL SITE (See LAND SITE DATA)

LOAD IN TGTs

1: GNC DEORB MNVR COAST

* If MCC cannot provide DEORB TGT, use Deorbit *
* Manager on PGSC *

√PASS and BFS TGT per DEORBIT MNVR PAD (ENT, MNVR PADS) or PGSC

LOAD – ITEM 22 EXEC
TIMER – ITEM 23 EXEC

√PASS and BFS solution per DEORBIT MNVR PAD (ENT, MNVR PADS):

BURN ATT
HA
HP
ΔVTOT
TGO

	CONFIG GPC	LOSS OF		
		BAY 1	BAY 2	BAY 3
		3	3	3
		02300	10040	12040
STR	1	3	1	1
	2	2	4	2
	3	3	1	4
	4	2	4	4
PL	1/2	2	1	1
CRT	1	2	1	1
	2	3	4	2
	3	2	1	4
	4	0	0	0
L	1	0	0	0
	2	0	0	0
MM	1	2	1	1
	2	3	4	2

5. Deltas to ENT FWD FLT DECK CONFIG 10

Do not power up MLS
cb MNA,B,C DDU L,R (four) – cl

O14:E,
O15:E,O16:E

If AV BAY 1 fire:
FLASH EVAP CNTLR PRI A – GPC

L1

6. Deltas to ENT MIDDECK CONFIG 12

√VAC VENT ISOL VLV CNTL – OP (tb-OP)
√NOZ HTR – ON

ML31C

7. ENT SWITCH LIST/VERIF
Do not activate pwrn items

8. AV BAY FIRE P&I DELTAS TO ENTRY

Deltas to ENT, DEORBIT BURN:

At TIG-4:

If AV BAY 1(2) FIRE:

GNC DEORB MNVR EXEC

L(R) OMS GMBL – SEC (*)

Use two IDP/CRTs with four MDUs for deorbit burn

√cb MNA,B,C DDU L,R (four) – cl

O14:E,O15:E,
O16:E
F6,F8

FLT CNTLR PWR (two) – ON

Deltas to ENT, POST BURN:

Use one IDP/CRT with two MDUs

FLT CNTLR PWR (two) – OFF

cb MNA,B DDU L,R (four) – op

If AV BAY 1(2) FIRE:

ENTRY SW CHECK

Delete: √NWS – 1

Add: NWS – 2 (OFF)

If AV BAY 2 FIRE:

RJDF 2B F4/F5 LOGIC – ON

F4 DRIVER – ON

FWD RCS MANF ISOL 4 – OP (tb-OP)

O16:F

O8

Deltas to ENTRY MANEUVERS (Cue Card):

At EI:

Use two IDP/CRTs with four MDUs

cb MNA,B DDU L,R (four) – cl

O14:E,
O15:E,O16:E
F6

FLT CNTLR PWR – ON

√cb ADTA (all unaffected) – cl

O14:E,O15:E,
O16:E

At V = 15K:

Activate all unaffected TACANs (OV103,4), RAs, MLSS

GNC I/O RESET

At M < 1.0:

Use two IDP/CRTs with five MDUs

LAUNCH DAY DEORBIT PREP (ORBIT 3) SUMMARY TIMELINE

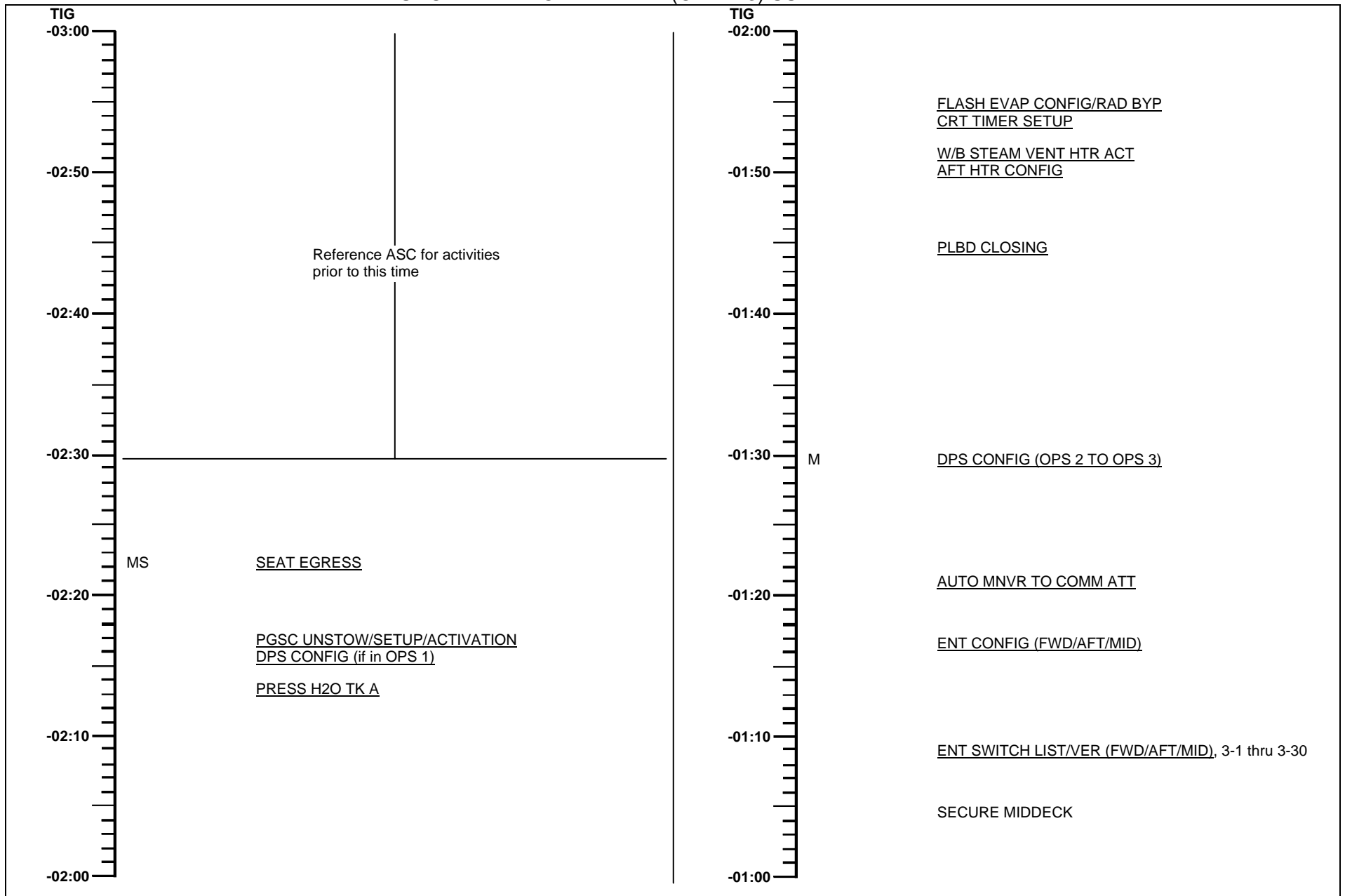

LAUNCH DAY DEORBIT PREP (ORBIT 3) SUMMARY TIMELINE

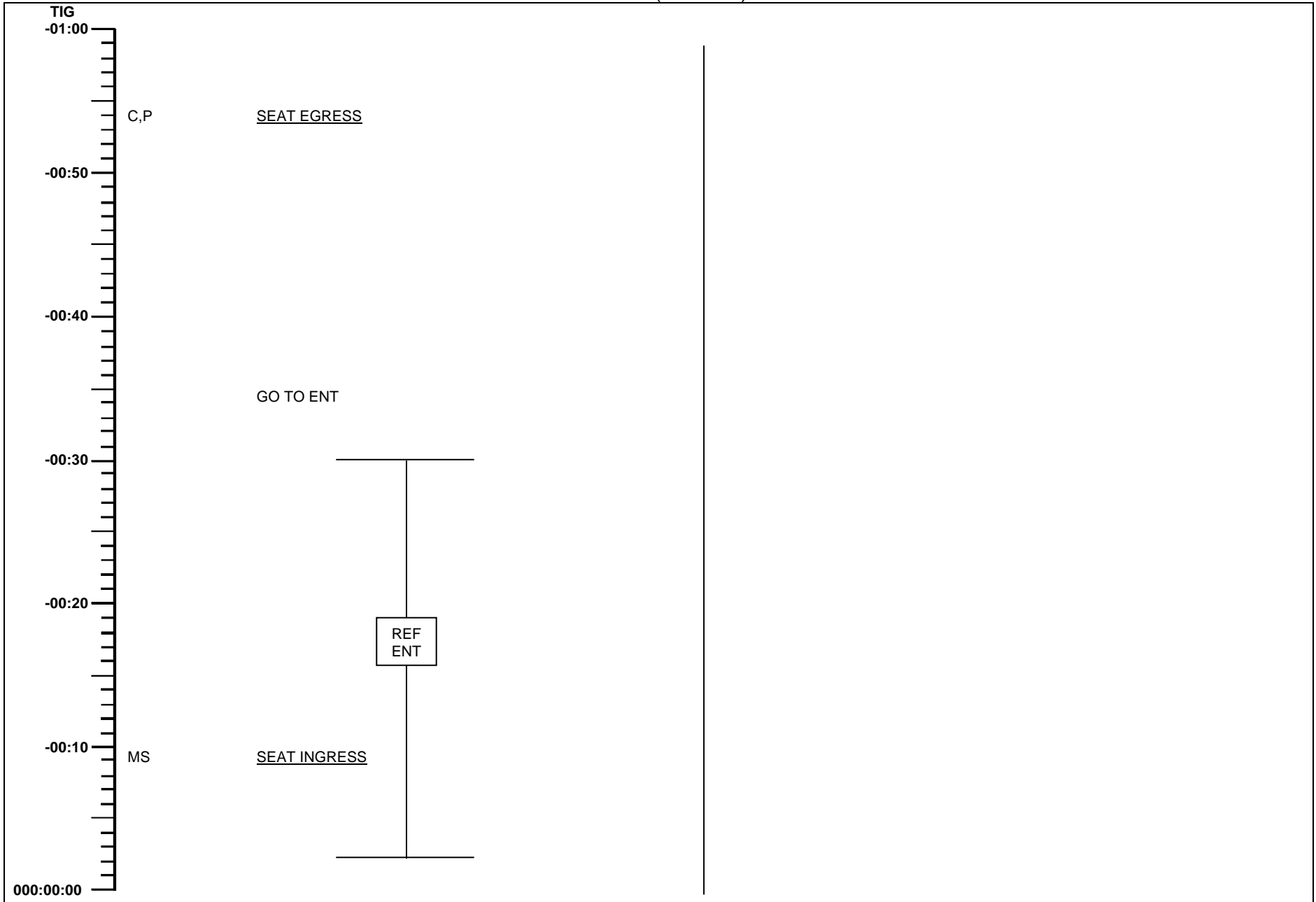

DPS CONFIG 2

C,P

C2
O14,O15,
O16

- TRANSITION TO GNC OPS 3
Set event timer to count down to TIG
√RGA,ACCEL,ASA,IMU (all) – ON

CONFIG – ITEM 1 +3 EXEC
Modify MC 3 per table

C3

BFC CRT DISP – OFF
GNC, OPS 301 PRO

1: GNC DEORB MNVR COAST

CRT3

BFC CRT DISP – ON
BFS, GNC, OPS 000 PRO
301 PRO

- LAND SITE UPDATE

1: GNC 50 HORIZ SIT

SEL SITE (See LAND SITE DATA)

- LOAD IN TGTs

1: GNC DEORB MNVR COAST

* If MCC cannot provide DEORB TGT, use Deorbit Manager on PGSC *

√PASS and BFS TGT per DEORBIT MNVR PAD
(ENT, MNVR PADS) or PGSC
LOAD – ITEM 22 EXEC
TIMER – ITEM 23 EXEC

√PASS and BFS solution per DEORBIT MNVR PAD
(ENT, MNVR PADS):
BURN ATT
HA
HP
ΔVTOT
TGO

- VERIFY MC 9 TABLE (GNC 9) FOR POST LANDING

2: GNC 0 GPC MEMORY

√CONFIG – ITEM 1 +9 EXEC
Modify MC 9 per table
CONFIG – ITEM 1 +3 EXEC

CONFIG	3	
GPC	12340	
STR	1	1
	2	2
	3	3
	4	4
PL	1/2	1
CRT	1	1
	2	2
	3	3
	4	0
L	1	0
	2	0
MM	1	1
	2	2

CONFIG	9	
GPC	12340	
STR	1	1
	2	2
	3	3
	4	4
PL	1/2	1
CRT	1	1
	2	2
	3	3
	4	0
L	1	0
	2	0
MM	1	1
	2	2

TIG		
-02:30	TRANS DAP AUTO RT 0.5 DB 3.5	
		<u>NOTE</u> These procedures do not require completion of any Nominal Post Insertion procedures
		If AV BAY FIRE, check deltas to FCS configuration, 2-5 or 2-7
-02:25		
	C	L4:D,E All cbs open L4:B, All cbs closed Q,R
	<u>UPLINK</u> PASS & BFS TGT	
-02:20	MS	<u>SEAT EGRESS</u>
	MS	PGSC ACT (ORB OPS, <u>PGSC</u>) Use flight deck PGSC
	C,P	<u>DPS CONFIG</u> (if in OPS 1 to OPS 3) (BFS not engaged) <u>2</u> , 2-11. If AV BAY FIRE, check deltas, 2-5
-02:15		
	MS	<u>PRESS H2O TK A MS MID ACTIVITIES</u> <u>3</u> , 2-25
	MS	UNSTOW/DON WIRELESS HEADSETS (if reqd)
-02:10		
-02:05		
-02:00		

RAD BYP (if rads not bypassed) 4

C	L1	RAD BYP VLV MODE (two) – MAN
		MAN SEL (two) – BYP (after ~3 sec, tb-BYP)
		CNTRLR LOOP (two) – OFF
	O1	√FREON EVAP OUT TEMP ind ~39 ± degF (after ~2.5 min)

TIMER SETUP (omit if BFS or OPS 3) 5

GNC 2 TIME

C COUNT TO – ITEM 17 + __ + __ + __ EXEC

W/B STEAM VENT HTR ACT 6 (If AV BAY FIRE, check deltas, 2-5 or 2-7)

P	R2	BLR CNTRLR/HTR (three) – B
		PWR (three) – ON

NOTE
Htr reqd to be on prior to APU act

TIG		
-02:00	MS	If reqd, PAYLOAD DEACT (PL OPS, <u>DEORBIT PREP</u>) or PAYLOAD DEACTIVATION (SODF: ASSY OPS: DEORBIT PREP)
If OPS 2: A1(B1) AUTO PRI RT 0.2 DB 5.0	MS	A15 If SSPTS (OV103,105 only): PTU/MAIN BUS A,B (two) – OFF (tb-OFF) cb CNTL PWR PTU 1,2 (two) – op OPCU 1,2 V-ADJ (two) – OFF
-01:55	C	<u>RAD BYP</u> <u>4</u> , 2-13
If OPS 3: TRANS DAP AUTO RT 0.5 DB 3.5	P	<u>TIMER SETUP</u> (Omit if BFS or OPS 3) <u>5</u> , 2-13
-01:50	P	<u>W/B STEAM VENT HTR ACT</u> <u>6</u> , 2-13
MS		<u>AFT HTR CONFIG MS AFT ACTIVITIES</u> <u>7</u> , 2-23
-01:45	P	<u>AUTO PLBD CLOSING</u> (if reqd) <u>8</u> , 2-15 If AV BAY 2 FIRE, check deltas, 2-5 or 2-7
-01:40		
-01:35		
<u>UPLINK</u> PASS & BFS TGT		
-01:30		

AUTO PLBD CLOSING 8

CAUTION

Verify no obstructions before closing and latching PLBD (Ku ANT, RMS, RAD, etc)

Use MANUAL mode for subsequent BFS PLBD ops if BFS AUTO sequence has been interrupted by reversing latch/door drive direction, or if MANUAL mode has already been used during mission

- R13L
 - * If no motion determined visually or 'OP/CL' not blank *
 - * within 10 sec after cmd: *
 - * PL BAY DR – STOP *
 - * Perform MAL, MECH, 9.1a *
 - * If Latch not 'CL' in single-motor time: *
 - * PL BAY DR – STOP *
 - * Perform MAL, MECH, 9.1e *
 - * If door motion stops and not 'RDY' or 'CL': *
 - * PL BAY DR – STOP *
 - * Perform MAL, MECH, 9.1g *
 - * If SM GPC fails during this operation: *
 - * PL BAY DR SYS (two) – DSBL *
 - * DR – STOP *
 - * Perform PASS SM GPC FAIL (ORB PKT, DPS) *

- R11L
 - 1. √IDP/CRT4 PWR – ON
- CRT4
 - 2. SM, OPS 202 PRO or BFS SM 63 PL BAY DOORS
 - 4: SM PL BAY DOORS

- R13L
 - √PL BAY DR – STOP
- CRT4
 - √PBD SW – STOP
 - √MAN SEL (ten) – (no *)
 - √PBD SW BYPASS – (no *)

- 3. AC POWER ON – ITEM 1 EXEC (*)
 - 4. AUTO MODE SEL – ITEM 3 EXEC (*)
- R13L
 - 5. PL BAY DR SYS (two) – ENA
- CRT4
 - √OP/CL STATUS (ten) – OP

- * If PORT DOOR not 'CL' within 6 sec of 'RDY': *
- * PL BAY DR – STOP *
- * Go to PORT BKHD LATCH TROUBLESHOOTING 8A, *
- * 2-17 *

- R13L
 - 6. PL BAY DR – CL
 - √PORT DOOR – blank, RDY, CL (~63 sec)
 - √FWD, AFT LATCHES – blank, CL (~30 sec)
 - √STBD DOOR – blank
- CRT4
 - 7. When STBD DOOR as close as possible to PORT DOOR before contact, perform PLBD fit check:

- R13L
 - PL BAY DR – STOP
 - Determine C/L Latch clearance on C/L LATCH EXTENDED GUIDE ROLLER TRAJECTORY NO-GO DIAGRAM, 2-16
 - * If NO-GO for PLBD CLOSE: *
 - * If no waveoff capability: Perform MAL, MECH SSR-3 *
 - * (SIMULTANEOUS PLBD CL) *
 - * If waveoff OK: √MCC *
- 8. PL BAY DR – CL
 - * If STBD DOOR not 'CL' within 6 sec of 'RDY': *
 - * PL BAY DR – STOP *
 - * Go to STBD BKHD LATCH TROUBLESHOOTING 8B, *
 - * 2-17 *

- CRT4
 - √STBD DOOR – CL (~63 sec)
 - √FWD, AFT LATCHES (two) – blank, CL (~30 sec)
 - √CENTER LATCHES 1-4, 13-16 (two) – blank, CL (~20 sec)
 - √5-8, 9-12 (two) – blank, CL (~20 sec)

- R13L
 - 9. PL BAY DR – STOP
- CRT4
 - 10. SYS (two) – DSBL
 - √OP/CL STATUS (ten) – CL

- R11L
 - 11. AC POWER OFF – ITEM 2 EXEC (*)
 - 12. GPC/CRT 04 EXEC
- R13L
 - 13. IDP/CRT4 PWR – OFF
- CRT4
 - 14. AFD 1 PWR – OFF

- A7U
 - 15. √PL BAY FLOOD (eight) – OFF

AUTO PLBD CLOSING

PORT AFT BULKHEAD LATCH GO/NO-GO DIAGRAM

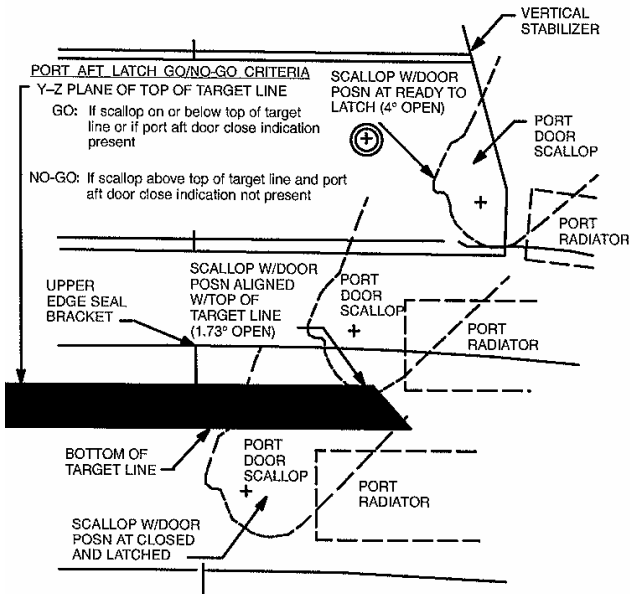

FUNCTION	PLBD CONTROL								PLBD DISPLAY PL MDM								
	Ref: MA73C:C&D for MCA (cb)																
	MTR 1				MTR 2				C	C	O	O	C	R	R	R	O
	AC/MCA	CNTL	MDM	SYS	AC/MCA	CNTL	MDM	SYS	A	B	A	B	A	B	C		
LATCH																	
5-8	1/MID3	AB3/AB2	PL1	2	3/MID2	CA3/CA1	PL2	1	1	2	1	2					
9-12	1/MID1	AB3/AB1	PL1	1	3/MID4	CA3/CA2	PL2	2	1	2	1	2					
1-4	1/MID3	AB3/AB2	PL1	2	3/MID2	CA3/CA1	PL2	1	1	2	1	2					
13-16	3/MID4	CA3/CA2	PL2	2	2/MID2	BC3/BC1	PL1	1	2	1	2	1					
S FWD	1/MID1	AB3/AB1	PL1	1	2/MID4	BC3/BC2	PL2	2	1	2	1	2					
S AFT	3/MID4	CA3/CA2	PL2	2	2/MID2	BC3/BC1	PL1	1	2	1	2	1					
S DOOR	1/MID1	AB3/AB1	PL1	1	2/MID4	BC3/BC2	PL2	2					1	1	2	2	1
													2	1	2	2	2
P FWD	1/MID1	AB3/AB1	PL1	1	2/MID4	BC3/BC2	PL2	2	1	2	1	2					
P AFT	1/MID3	AB3/AB2	PL1	2	3/MID2	CA3/CA1	PL2	1	1	2	1	2					
P DOOR	3/MID4	CA3/CA2	PL2	2	2/MID2	BC3/BC1	PL1	1					2	1	1	2	2
													1	1	1	2	1

C/L LATCH EXTENDED GUIDE ROLLER TRAJECTORY NO-GO DIAGRAM

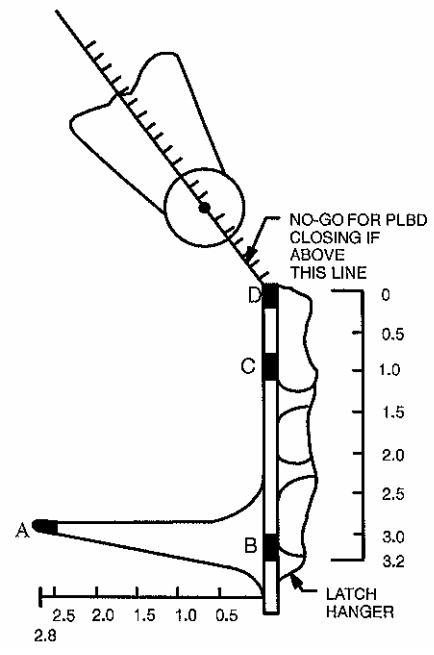

PORT BKHD LATCH TROUBLESHOOTING [8A]

- CRT4 1. √PORT DOOR FWD, AFT MICRO-SW STATs
 If PORT DOOR AFT 'C' = '0':
 : 2. √PORT AFT BULKHEAD LATCH GO/NO DIAGRAM, 2-16
 : If NO-GO:
 L Go to MAL, MECH, SSR-2 (CONTINGENCY PLBD CLOSURE)
- If PORT DOOR FWD 'C' = '0':
 :
 : NOTE
 : Use PLB camera A to view port fwd bkhd latch
 : hook/roller #3 as seen in figures 2-1 and 2-2, 2-18
- R13L 3. PL BAY DR SYS 1 – DSBL
 During the following step, monitor latch hook #3 while driving to
 ensure hook motion and proper roller engagement
- * If latch hook #3 stops moving while commanded, or *
 * it appears that the hook is going to miss or jam *
 * into its roller: *
 * PL BAY DR – STOP *
 * Go to MAL, MECH, SSR-2 (CONTINGENCY *
 * PLBD CLOSURE) *
4. PL BAY DR – CL
5. When proper roller engagement verified for latch #3:
 PL BAY DR – STOP
 L SYS 1 – ENA
6. Go to step 5 of AUTO PLBD CLOSING [8], 2-15 ignoring the starred
 block

STBD BKHD LATCH TROUBLESHOOTING [8B]

- CRT4 1. √STBD DOOR FWD, AFT MICRO-SW STATs
 If STBD DOOR AFT (FWD) 'C' = '0':
 :
 : NOTE
 : Use PLB camera C(D) to view stbd aft (fwd) bkhd latch
 : hook/roller #3 as seen in figures 2-1 and 2-2, 2-18
- R13L 2. PL BAY DR SYS 1(2) – DSBL
- During the following step, monitor latch hook #3 while driving to
 ensure hook motion and proper roller engagement
- * If at any point latch hook #3 stops moving while *
 * commanded, or it appears that the hook is going *
 * to miss or jam into its roller: *
 * PL BAY DR – STOP *
 * Go to MAL, MECH, SSR-2 (CONTINGENCY *
 * PLBD CLOSURE) *
3. PL BAY DR – CL
4. When proper roller engagement verified for latch #3:
 PL BAY DR – STOP
 L SYS 1(2) – ENA
5. Go to step 8 of AUTO PLBD CLOSING [8], 2-15 ignoring the starred
 block

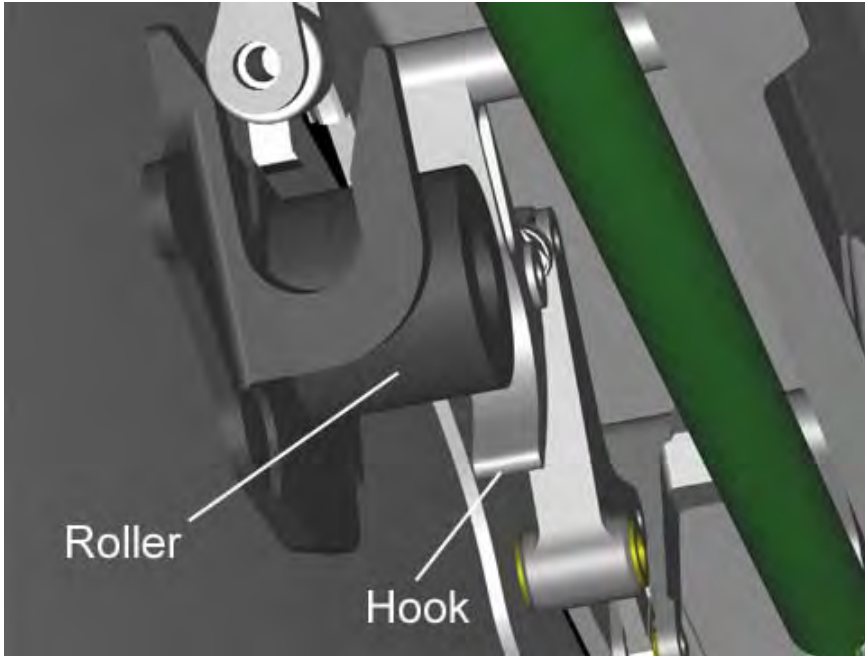

Figure 2-1.- Latch hook/roller #3 typical view from PLB camera

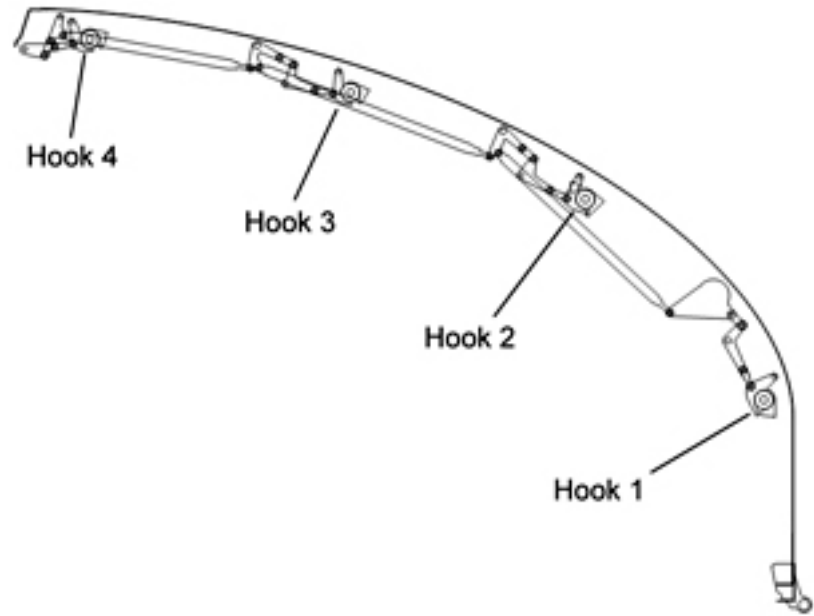

Figure 2-2.- Typical latch hook/roller numbering

OPS 2 TO 3 TRANSITION 9

(Omit if BFS engaged or if already configured with G3 set)

* If IMU or RHC dilemma, do not proceed *
* with OPS 3 transition *

O14,O15,
O16
√Att mnvr complete
√RGA,ACCEL,ASA,IMU (all) – ON

1. VERIFY MEDS CONFIG

C2
R11L
√IDP/CRT PWR (three) – ON
√IDP/CRT4 PWR – OFF

Verify all forward MDUs – ON and selected to primary port

2. VERIFY GPC CONFIG

O6
√GPC MODE 3 – HALT (tb-bp)
√PWR 3,5 – ON
√OUTPUT 1,2 – NORM (tb-gray)
√3,5 – NORM (tb-bp)
√4 – TERM (tb-bp)
√MODE 1,2,4 – RUN (tb-RUN)
3 – STBY (tb-RUN)
5 – STBY (tb-RUN)

3. SM CHECKPOINT/UL CNTL ENA

1: SM 60 SM TABLE MAINT
2: SM 1 DPS UTILITY

CRT2
CRT1
MMU ASSIGN 2 SM – ITEM 4 EXEC
CKPT INITIATE – ITEM 18 EXEC
√Update of CKPT TIME and STATUS GOOD indicated
MMU ASSIGN 1 SM – ITEM 3 EXEC
CKPT INITIATE – ITEM 18 EXEC
√Update of CKPT TIME and STATUS GOOD indicated
CRT2
CRT1
CKPT RETRV ENA – ITEM 12 EXEC (*)
UL CNTL ENA – ITEM 36 EXEC

4. LOAD ENTRY TFL/RECONFIG UPLK

Perform LOAD PDI DECOM FORMAT
and LOAD PCMMU FORMAT
for entry config (ORB OPS FS,
COMM/INST)

5. TRANSITION GPC 1&2 TO GNC OPS 3

1: GNC 0 GPC MEMORY
CONFIG – ITEM 1 +3 EXEC
Modify MC 3 per table
GNC, OPS 301 PRO
3: GNC DEORB MNVR COAST

CONFIG GPC	3	12000
STR 1	1	1
2	2	
3	1	
4	2	
PL 1/2	0	
CRT 1	1	
2	2	
3	2	
4	0	
L 1	0	
2	0	
MM 1	1	
2	2	

C3

6. TRANSITION BFS GPC TO GNC OPS 3

BFC CRT DISP – ON
√SEL – 3+1

3: BFS, GNC BFS MEMORY

O6
CRT3

GPC OUTPUT 5 – B/U (tb-bp)

√TFL ENA – ITEM 29 (*)

BFS, GNC, OPS 301 PRO

3: BFS, GNC DEORB MNVR COAST

7. TRANSITION GPC 1,2,3,4 TO GNC OPS 3
SM, OPS 000 PRO (releases payload buses)

X: SM GPC MEMORY

O6

GPC OUTPUT 4 – NORM (tb-gray)

MODE 3,5 (two) – RUN (tb-RUN)

1: GNC 0 GPC MEMORY

√CONFIG – ITEM 1 +3 EXEC

Modify MC 3 per table

CONFIG GPC	3	12340
STR 1	1	
2	2	
3	3	
4	4	
PL 1/2	1	
CRT 1	1	
2	2	
3	3	
4	0	
L 1	0	
2	0	
MM 1	1	
2	2	

C3

BFC CRT DISP – OFF

GNC, OPS 301 PRO

1: GNC DEORB MNVR COAST

C3
CRT3

BFC CRT DISP – ON

BFS, GNC, OPS 000 PRO

301 PRO

8. LAND SITE UPDATE

1: GNC 50 HORIZ SIT

SEL SITE (See LAND SITE DATA)

9. LOAD IN TGTs

1: GNC DEORB MNVR COAST

* If MCC cannot provide DEORB TGT, use Deorbit *

* Manager on PGSC *

√PASS and BFS TGT per DEORBIT MNVR PAD (ENT,
MNVR PADS) or PGSC

LOAD – ITEM 22 EXEC

TIMER – ITEM 23 EXEC

√PASS and BFS solution per DEORBIT

MNVR PAD (ENT, MNVR PADS):

BURN ATT

HA

HP

ΔVTOT

TGO

CONFIG GPC	9	12340
STR 1	1	
2	2	
3	3	
4	4	
PL 1/2	1	
CRT 1	1	
2	2	
3	3	
4	0	
L 1	1	
2	2	
MM 1	1	
2	2	

10. VERIFY MC 9 TABLE (GNC 9) FOR
POST LANDING

2: GNC 0 GPC MEMORY

√CONFIG – ITEM 1 +9 EXEC

Modify MC 9 per table

CONFIG – ITEM 1 +3 EXEC

		1: SM TABLE MAINT	2: SM ANTENNA
		3: BFS, GNC DEORB MNVR COAST	
-01:30	C,P	<u>OPS 2 TO 3 TRANSITION</u> <u>9</u> , 2-19 (Omit if BFS engaged or if already configured with G3 set) (If AV BAY FIRE, check deltas, 2-7)	
-01:25	C,P	<u>GPS INCORPORATION (EPCL, GNC)</u> Omit if voice or cmd available	
-01:20	P	<u>AUTO MNVR TO COMM ATT</u> Mnvr per MCC: R _____ P _____ Y _____	
-01:15	C,P MS MS MS	<u>ENT FWD FLT DECK CONFIG</u> <u>10</u> <u>ENT AFT FLT DECK CONFIG, MS AFT ACTIVITIES</u> <u>11</u> , 2-23 <u>ENT MIDDECK CONFIG, MS MID ACTIVITIES</u> <u>12</u> , 2-25 <u>PAYLOAD ENT SW LIST/VER (PL OPS, DEORBIT PREP or SODF: ASSY OPS: DEORBIT PREP)</u>	
-01:10	A12	<u>NOTE</u> If AV BAY FIRE, check deltas, 2-5 or 2-8 Deltas to ENT SW LIST/VER <u>APU HTR LUBE OIL LINE (three) – A AUTO</u> <u>NOTE</u> √MCC for unaccounted-for sw or cb config discrepancies	
-01:05	C P MS MS	<u>ENT SWITCH LIST/VER (FWD)</u> , 3-3 thru 3-9 <u>ENT SWITCH LIST/VER (FWD)</u> , 3-10 thru 3-13 <u>ENT SWITCH LIST/VER (AFT)</u> , 3-15 thru 3-26 <u>ENT SWITCH LIST/VER (MID)</u> , 3-27 thru 3-30	
-01:00			

		<u>ENT FWD FLT DECK CONFIG</u> <u>10</u> (If AV BAY FIRE, check deltas, 2-5 or 2-8)
C	L1	<u>FLASH EVAP CONFIG</u> FLASH EVAP CNTLR PRI A – OFF B(A) – GPC
C,P	O5,O9	<u>ENTRY COMM</u> L,R AUD A/G 2 (two) – T/R
	O8	<u>MLS CH</u> √MLS CH tw (three) – See LANDSITE DATA MLS (three) – ON
	O17:A	<u>SSME HYD REPRESS PREP</u> ATVC (four) – ON
	F6 O14:E O16:E	<u>CONTROL FOR ENTRY</u> ADI RATE – LO cb MNA DDU AFT – op MNC DDU AFT – op
	R4 L4:J	<u>HYD HTR/SIG CONDR CONFIG</u> HYD BK HTR (three) – AUTO cb AC3 ΦA SIG CONDR HUM SEP – op ΦB SIG CONDR IMU FAN – op

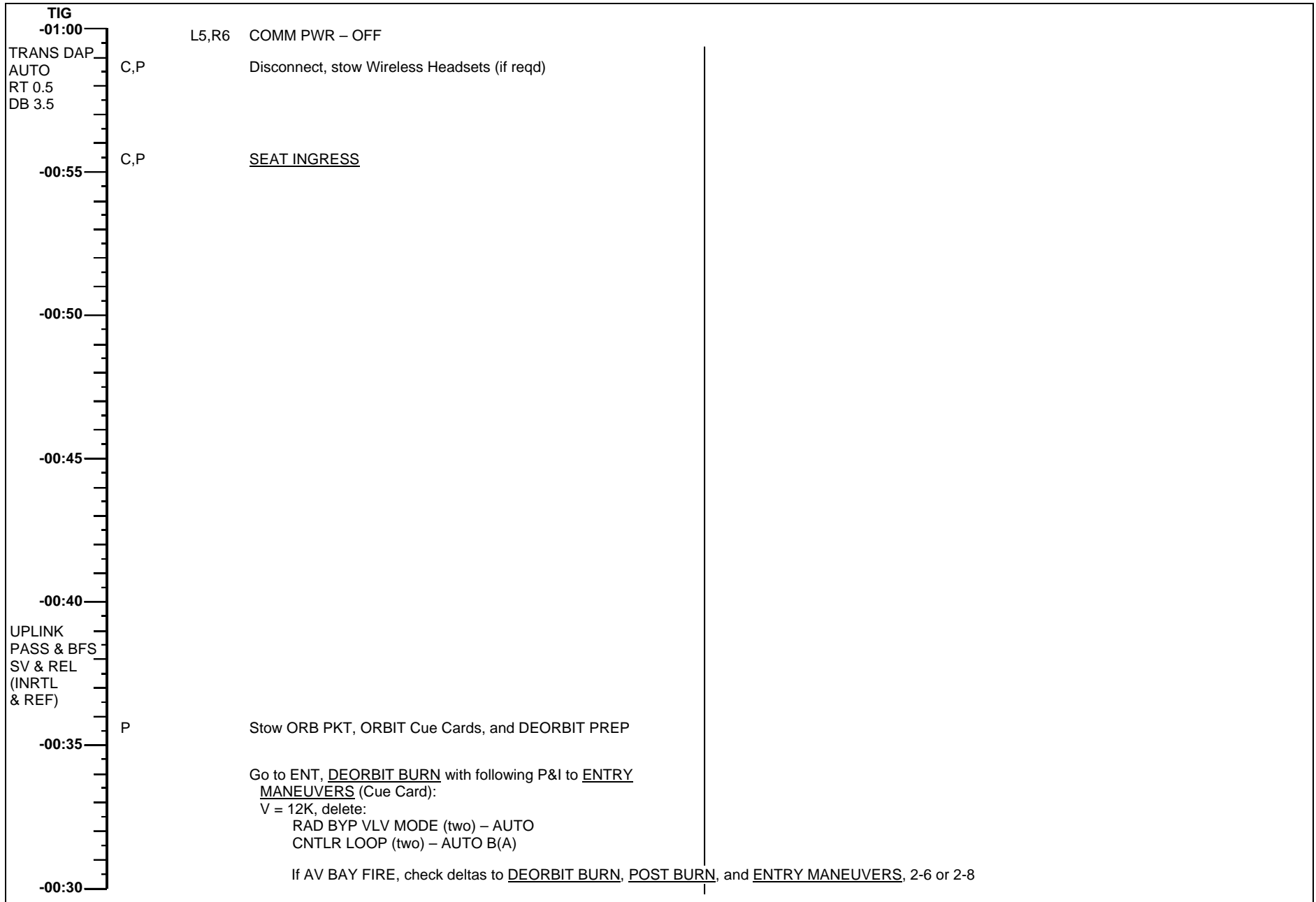

This Page Intentionally Blank

MS LAUNCH DAY DEORBIT PREP AFT DECK ACTIVITIES (ORBIT 3)

MS PULLOUT PAGE

NOTE

Wait for GO from CDR or PLT before starting any activity on this page

TIME (TIG-)	MS AFT ACTIONS
02:22	SEAT EGRESS
02:20	PGSC ACT (ORB OPS, <u>PGSC</u>) Use flight deck PGSC
02:11	UNSTOW/DON WIRELESS HEADSETS (if reqd)
02:00	If reqd, PAYLOAD DEACT (PL OPS, <u>DEORBIT PREP</u>) or PAYLOAD DEACTIVATION (SODF: ASSY OPS: DEORBIT PREP)
01:50	<u>AFT HTR CONFIG</u> 7
01:14	<u>ENT AFT FLT DECK CONFIG</u> 11
01:04	<u>ENT SWITCH LIST/VER (AFT)</u> , 3-15 thru 3-26

<u>AFT HTR CONFIG</u> 7	
A12	HYD HTR (eight) – OFF
A14	RCS/OMS HTR FWD RCS – OFF L POD (two) – A OFF, B OFF R POD (two) – A OFF, B OFF OMS CRSFD LINES (two) – B AUTO, A AUTO √FWD, AFT RCS JET (ten) – AUTO
R11U	√FC PURGE VLVS (three) – GPC √HTR – GPC √H2O LINE HTR – A AUTO
NOTE MCC command FC PURGE HTR off, if reqd	

<u>ENT AFT FLT DECK CONFIG</u> 11		
A1L	<u>ENTRY COMM CONFIG</u> S-BD PM MODE – STDN LO NSP CODING (two) – OFF	
A1R	AUD CTR VOICE RCD SEL CH 1 sel – ICOM A 2 sel – ICOM B	
A13	OS AUD SPKR PWR – OFF	
A15	PS COMM CCU PWR – as reqd	
R14:C	cb MNB KU ANT HTR – op UHF EVA (two) – op	
R10	MS AUD A/G 2 – T/R A/A – T/R	
L9	PS AUD PWR – AUD/TONE A/G 1 – T/R A/A – T/R ICOM (two) – T/R	
ML86B:A R11L	<u>H2O STORAGE SYS CONFIG</u> √cb MNC SPLY H2O XOVR VLV – cl SPLY H2O XOVR VLV – OP (tb-OP)	
<u>RESET C/W</u>		
R13U		
PARAMETER NAME	C/W CH	UPPER LIMIT
FREON LOOP EVAP OUT T1	107	1.90V/64.8 degF
T2	117	1.90V/64.8 degF
A16	√Secure	
R10	√MS LTG FLOOD as reqd	
<u>FOOT LOOP CONFIG</u> Tape Foot Loops in egress routes		

**Back of MS LAUNCH DAY DEORBIT PREP AFT DECK ACTIVITIES
(ORBIT 3)**

MS PULLOUT PAGE

I

**MS LAUNCH DAY DEORBIT PREP MIDDECK ACTIVITIES
(ORBIT 3) MS PULLOUT PAGE**

MS PULLOUT PAGE

NOTE

Wait for GO from CDR or PLT before starting any activity on this page

TIME (TIG-)	MS MIDDECK ACTIONS
02:22	<u>SEAT EGRESS</u>
02:14	<u>PRESS H2O TK A</u> [3]
02:11	UNSTOW/DON WIRELESS HEADSETS (if reqd)
01:14	<u>ENT MIDDECK CONFIG</u> [12]
01:04	<u>ENT SWITCH LIST/VER</u> (MID), 3-27 thru 3-30

<u>PRESS H2O TK A</u> [3]	
ML26C	SPLY H2O GN2 TK VENT vlv – PRESS TKA SPLY vlv – OP
<u>NOTE</u> Disregard possible 'S66 WASTE H2O PRES' fault msg	

<u>ENT MIDDECK CONFIG</u> [12] (If AV BAY FIRE, check deltas, 2-5 or 2-8)	
ML31C	VAC VENT ISOL VLV CNTL – CL (tb-CL) NOZ HTR – OFF
MO42F	<u>ENTRY COMM CONFIG</u> MIDDECK SPKR AUD A/G 2 – T/R Stow: Comm Equip Wireless Headsets
MO13Q	√LOCKERS secure √MIDDECK FLOODS as reqd
ML85E	AC S1 – OFF
MO69M MO32M	<u>MIDDECK PCS</u> LEH O2 7,8 vlv (two) – as reqd LEH O2 6 vlv – as reqd
<u>EGRESS ROUTE CONFIG</u> Tape Foot Loops in egress routes	

**Back of MS LAUNCH DAY DEORBIT PREP MIDDECK ACTIVITIES
(ORBIT 3)
MS PULLOUT PAGE**

I

ENTRY SWITCH LIST/VERIFICATION

LEFT SEAT

L5.....	3-3
L4.....	3-3
L1.....	3-4
F3.....	3-4
L,R HUD.....	3-4
L2.....	3-5
F1.....	3-5
F2.....	3-6
F6.....	3-6
F7.....	3-6
C2.....	3-7
C3.....	3-7
O1.....	3-8
O2.....	3-8
L side OVHD flood...	3-8
O5.....	3-8
O6.....	3-9
O7.....	3-9

RIGHT SEAT

O8.....	3-10
O9.....	3-10
R side OVHD flood ..	3-10
O3.....	3-11
F4.....	3-11
F8.....	3-11
F9.....	3-11







RIGHT SEAT (Cont)

R1.....	3-12
R2.....	3-13
R4.....	3-13
R6.....	3-13

AFT

O13.....	3-15
O14.....	3-15
O15.....	3-15
O16.....	3-16
O17.....	3-16
O19.....	3-17
C6.....	3-17
C5.....	3-17
C7.....	3-17
R10.....	3-18
R11U.....	3-18
R11L.....	3-18
R13U,L.....	3-19
R14.....	3-19
A1U,L,R.....	3-20
A4.....	3-21
A3.....	3-21
A6U.....	3-21
A7U.....	3-21
A7L.....	3-22
A8U,L.....	3-23
A11.....	3-24
A12.....	3-24
A13.....	3-24
A6L.....	3-25
A6.....	3-25
A14.....	3-26
A15.....	3-26
L9.....	3-26

LEGEND

	- left		
	- right		
	- up	R	- as reqd
	- center		- cb close
	- down		- cb open

 indicates switch/display not checked during ENT SWITCH LIST/VERIFICATION

CIRCUIT BREAKER SNAPPING COLOR CODES

<u>COLOR</u>	<u>CONFIGURATION</u>
Red	Open at all times
Green	Open on orbit only
Yellow	Open ascent, close per procedure
Orange	Open orbit through entry
Blank (no ring)	Always closed or as reqd

**ENT SW
LIST/VER**

MIDDECK FWD

MO42F.....	3-27
MO58F.....	3-27
MO32M.....	3-27
MO39M.....	3-27
MO69M.....	3-27
MO29J.....	3-27
MO52J.....	3-27
MO30F.....	3-27
MO62M.....	3-27
MO63P.....	3-27 (OV104)
ML86B.....	3-28

MIDDECK FWD (Cont)

MD44F.....	3-29
MD24K.....	3-29

MIDDECK AFT

MA73C.....	3-28
MO13Q.....	3-29
ML18F.....	3-29
ML26C.....	3-29
ML31C.....	3-29
MO10W.....	3-30
WCS.....	3-30

AIRLOCK

AW18A.....	3-31
AW18D.....	3-31
AW18H.....	3-31
AW82A.....	3-31
AW82B.....	3-31
AW82D.....	3-31
AW82H.....	3-31
INNER HATCH.....	3-32

I

OV103

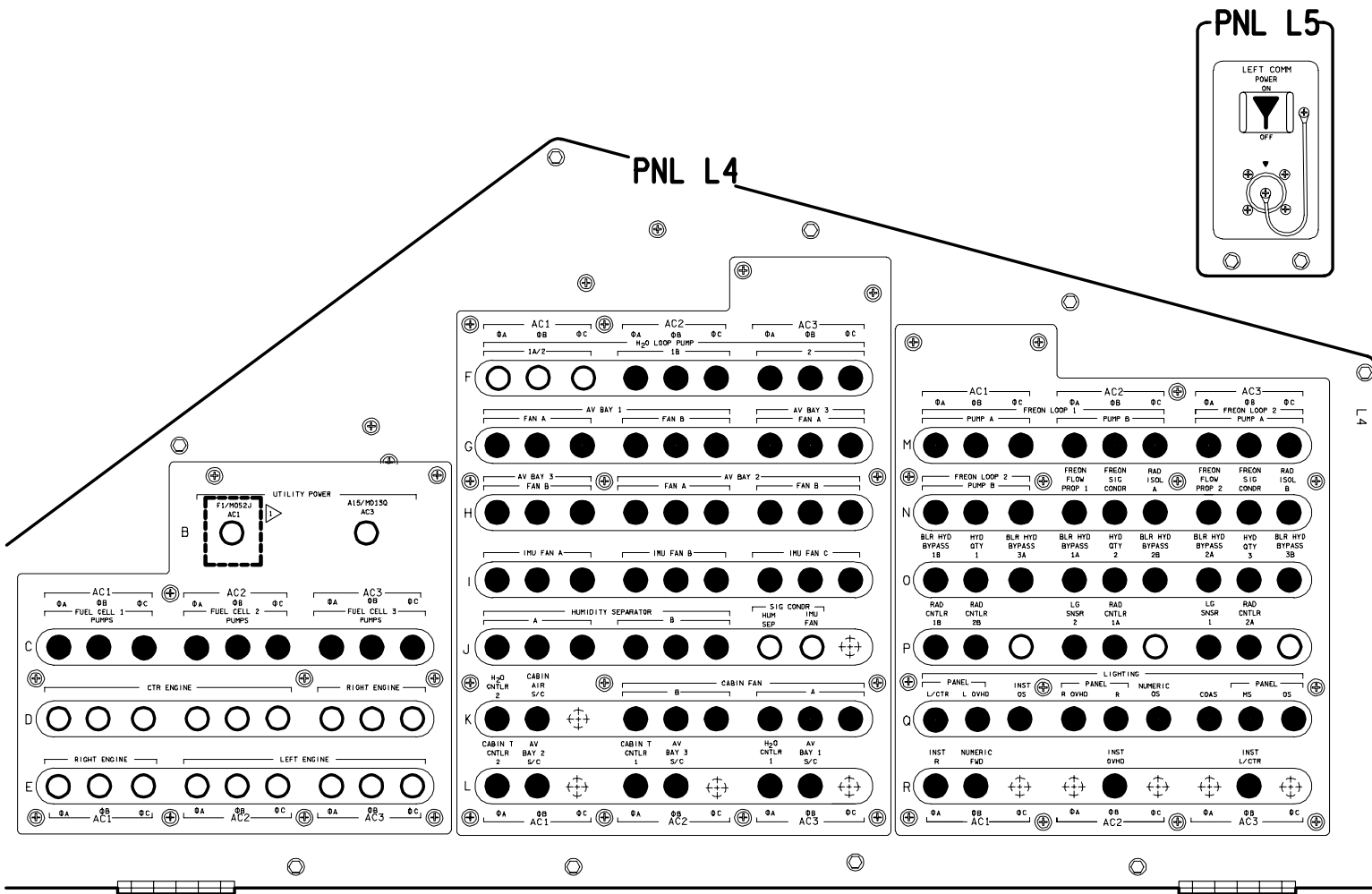

NOTE: ▷ CB CAN REMAIN CLOSED FOR AC PGSC USAGE.
 OPEN WHEN PGSC UNPOWERED/STOWED

OV103

PNL L2

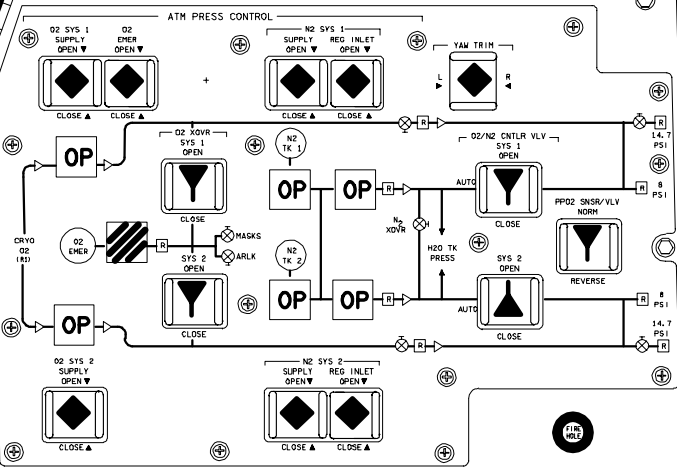
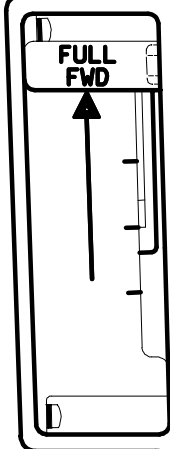
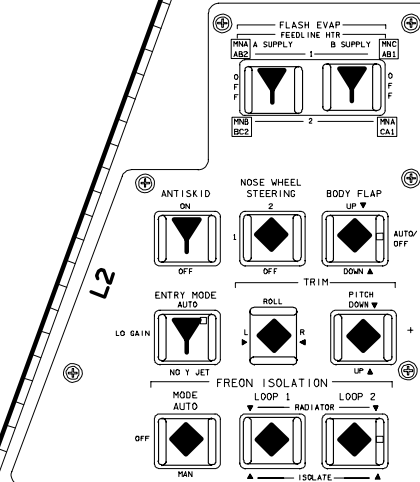
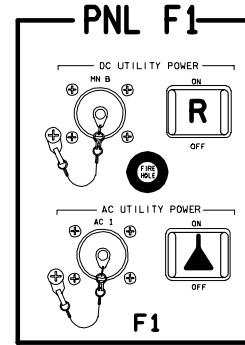
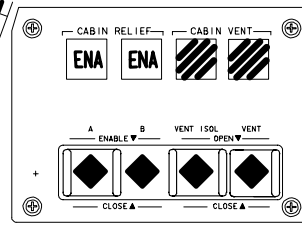

OV103

PNL C2/C3

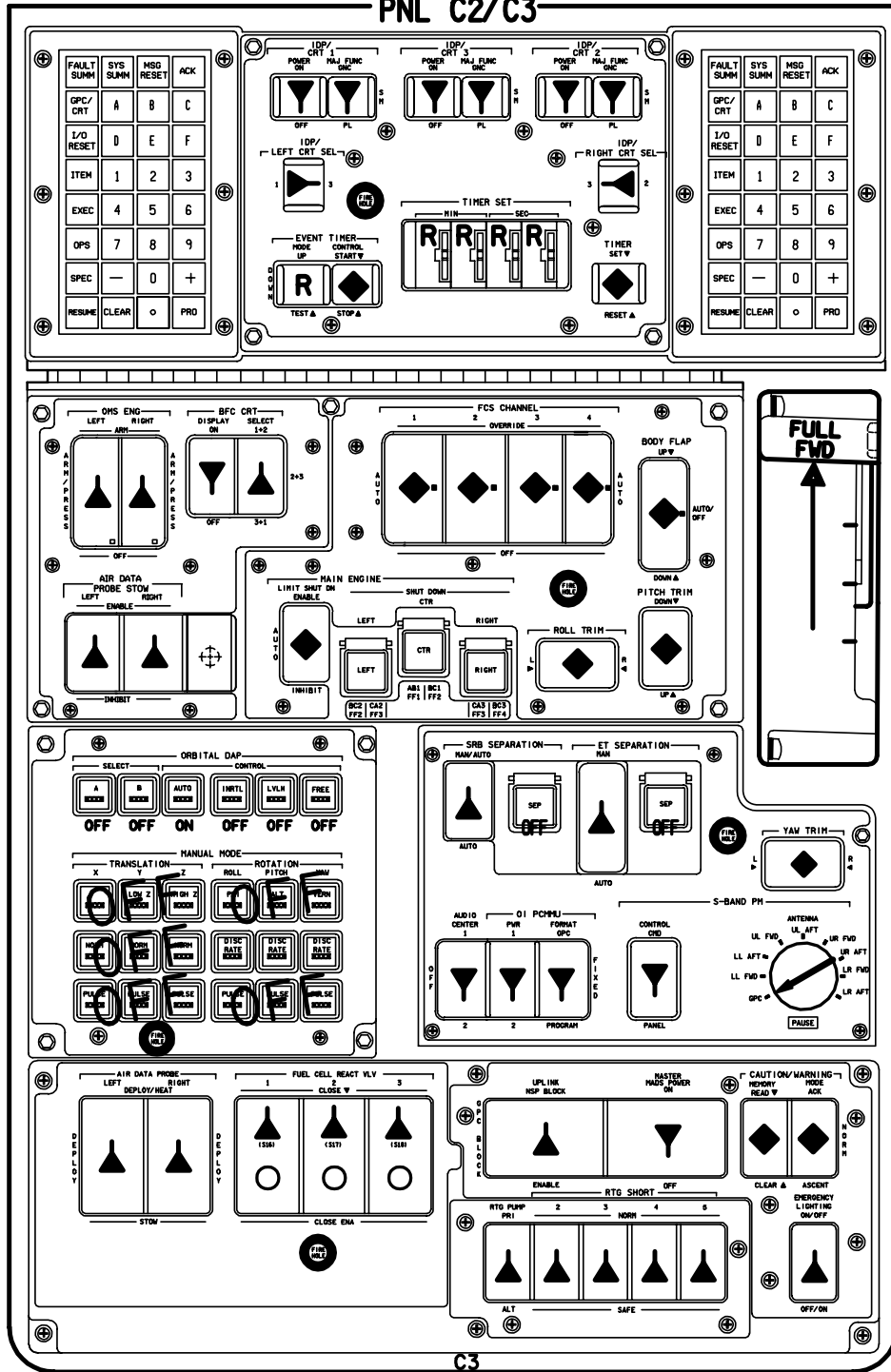

C3

OV103

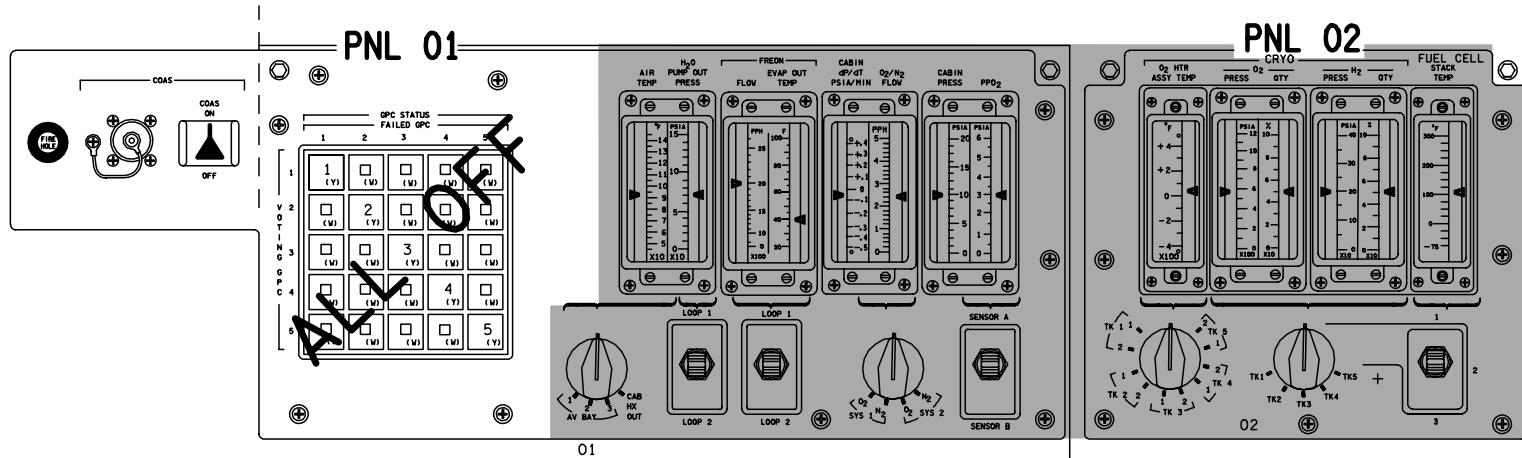

L side OVHD flood - R (MID)

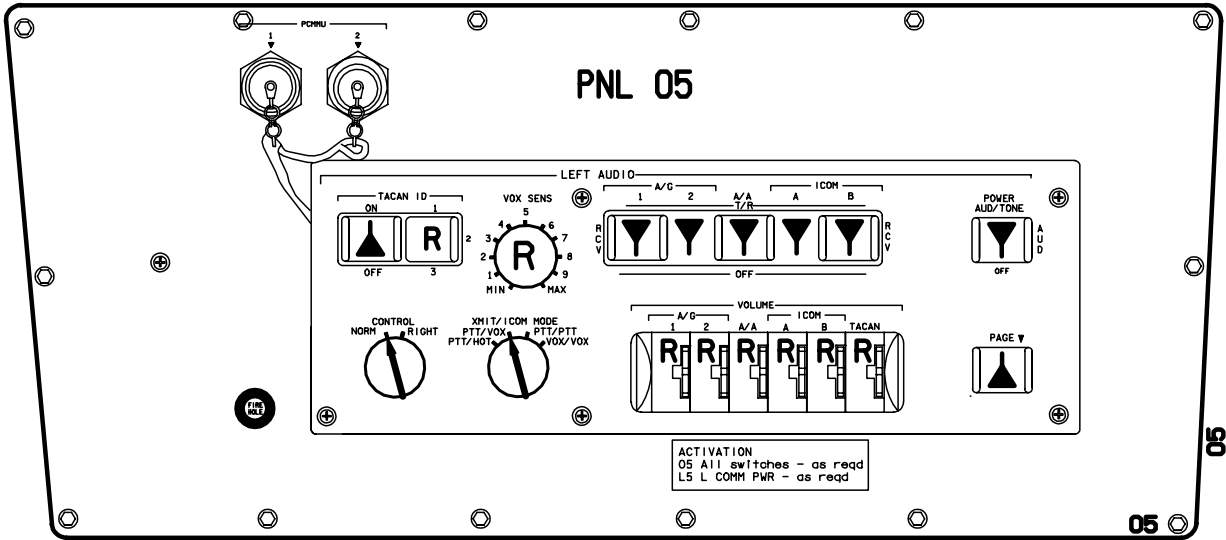

ACTIVATION
 05 All switches - as reqd
 L5 L COMM PWR - as reqd

OV103

PNL 06

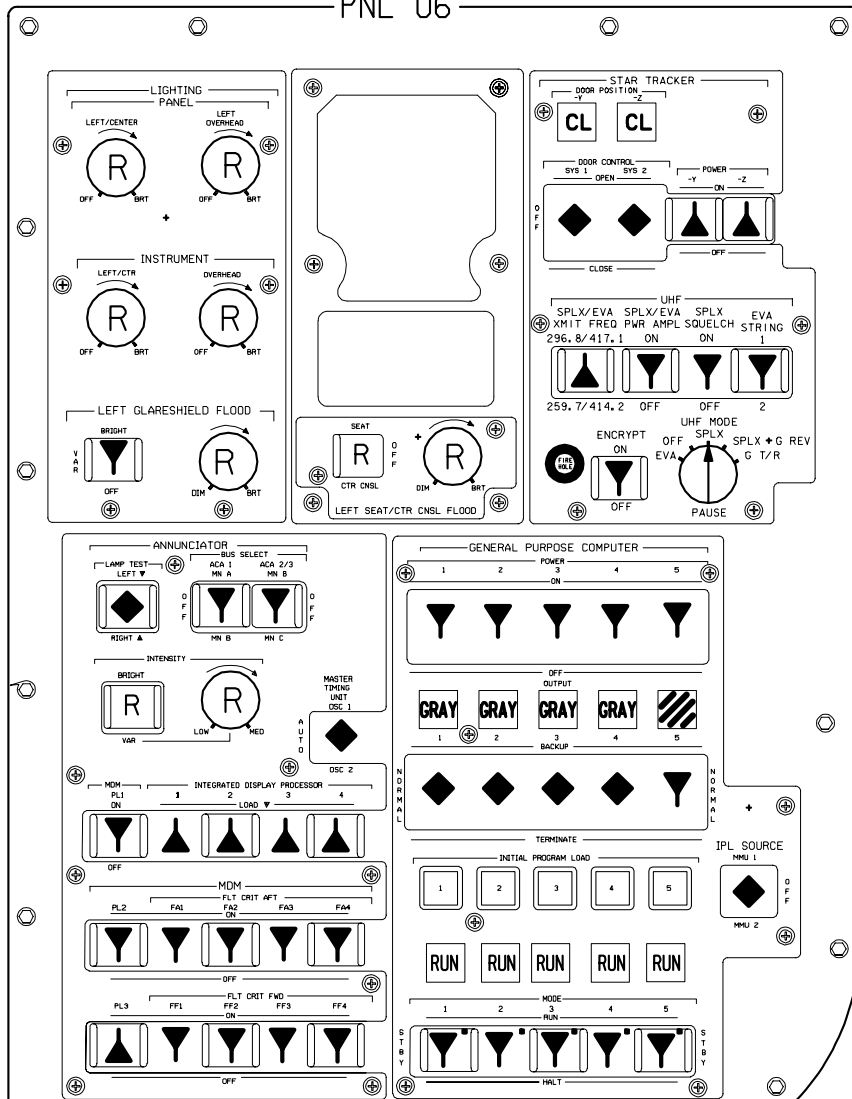

PNL 07

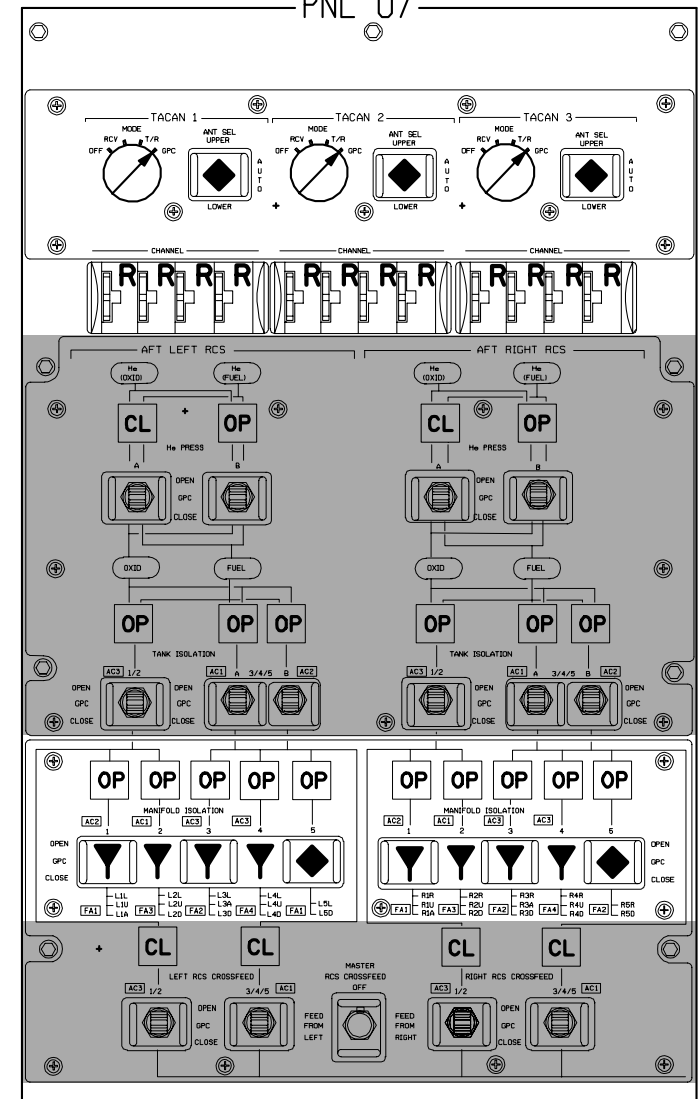

48007E309_114, PNL 2

OV103

OV103/DATE 06/22/05

(OV103) A3-9

C D/O/3/GEN L

OV103

PNL 08

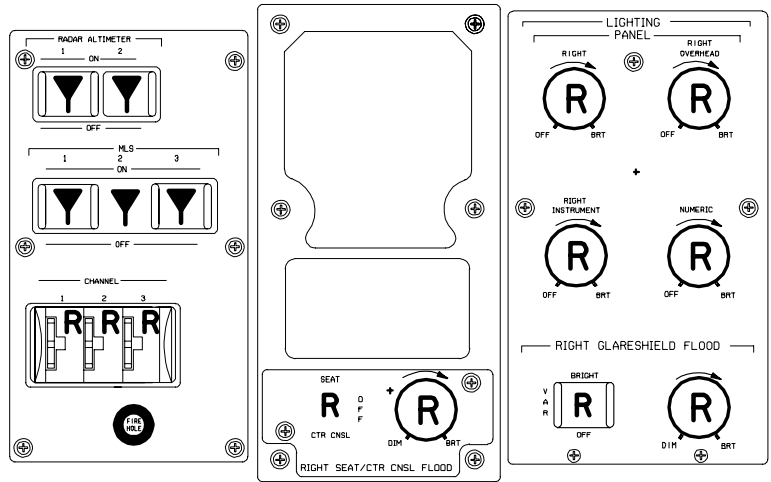

PNL 09

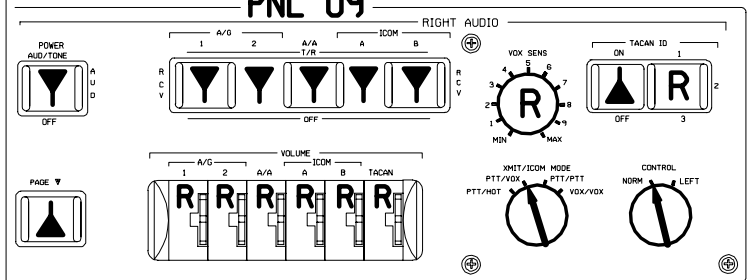

ACTIVATION
 09 R AUD PWR - AUD/TONE
 All other sws - as reqd
 R6 R COMM PWR - as reqd

R side OVHD flood - R (MID)

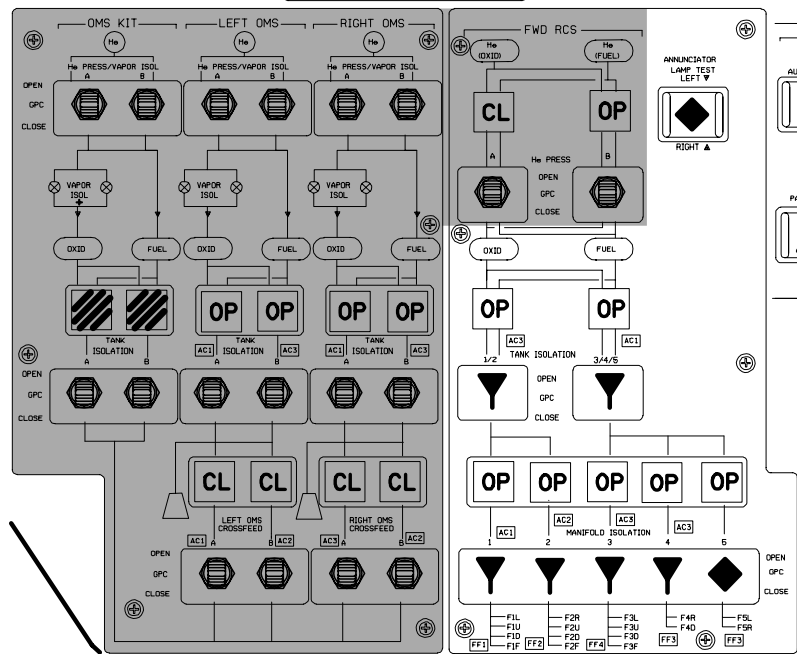

OV103

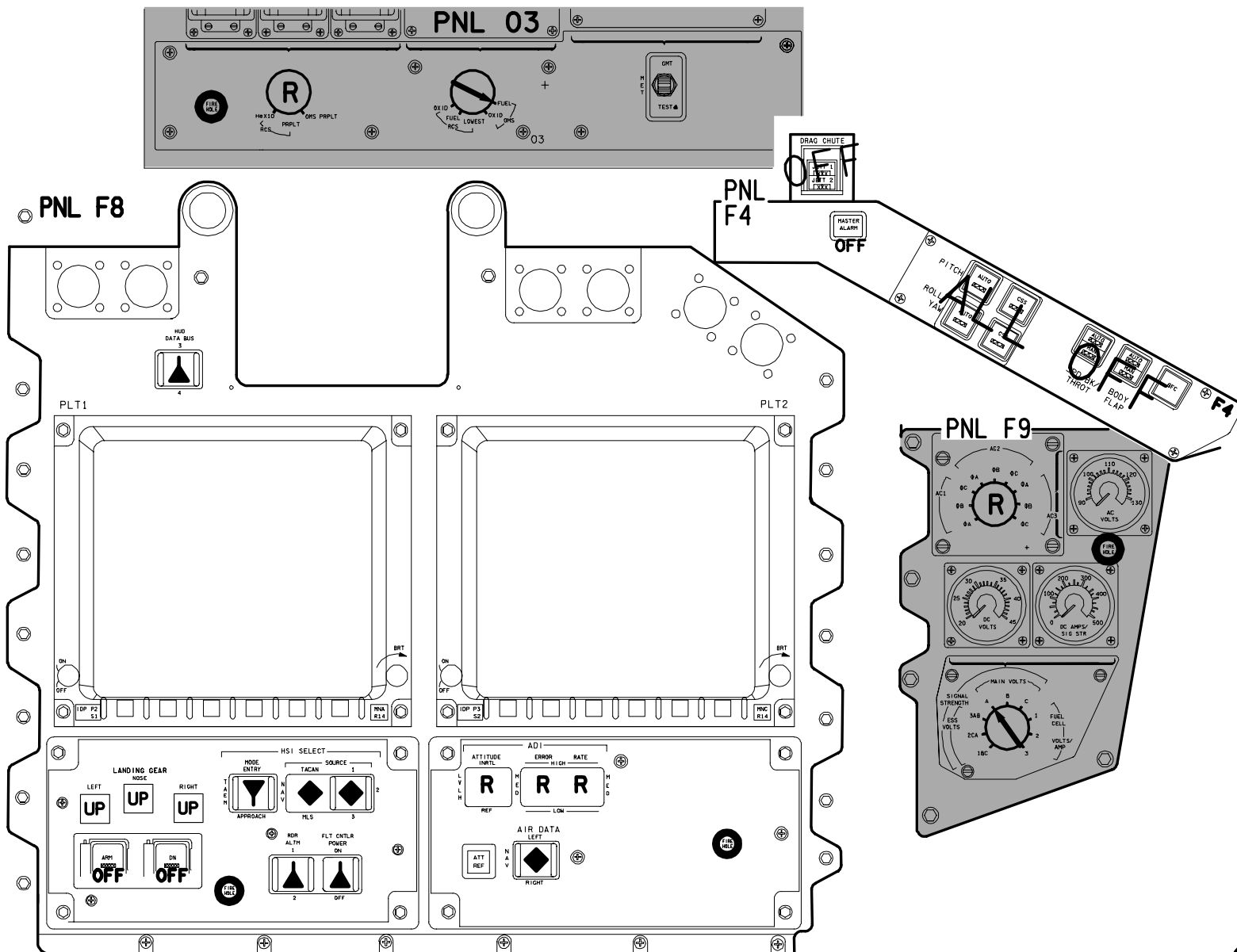

OV103

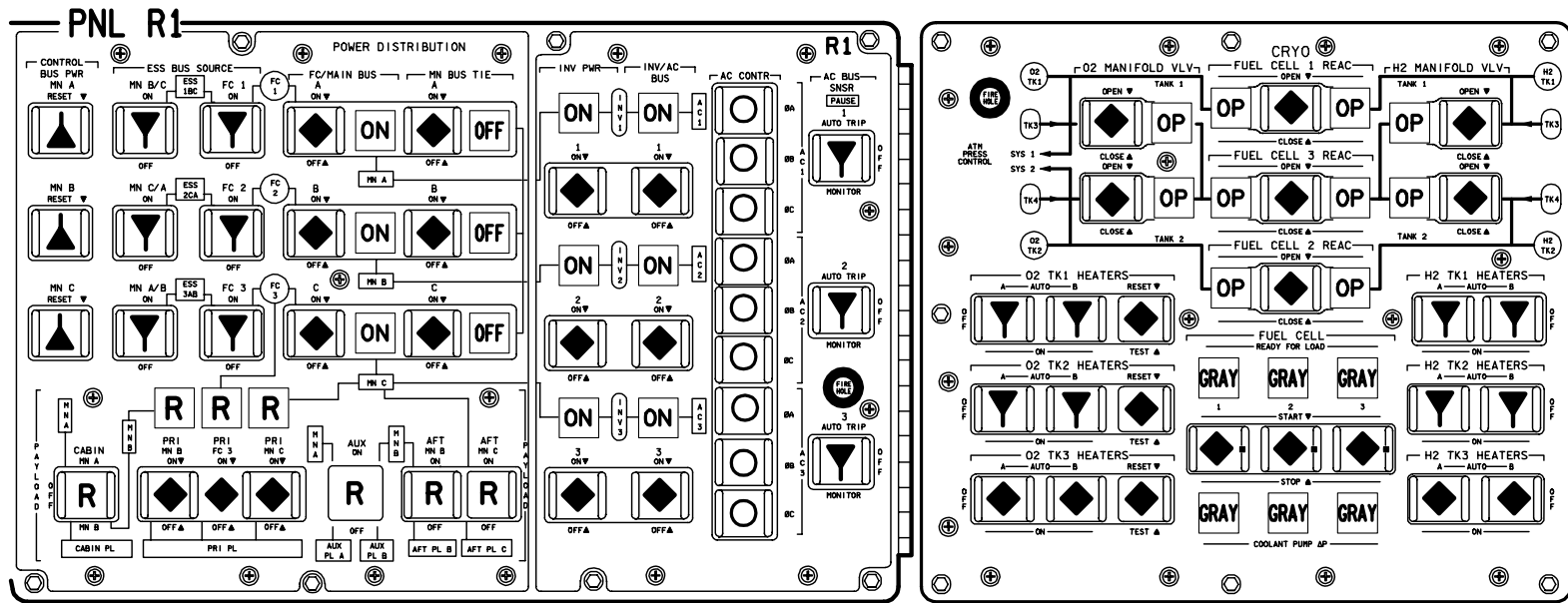

OV103

OV103

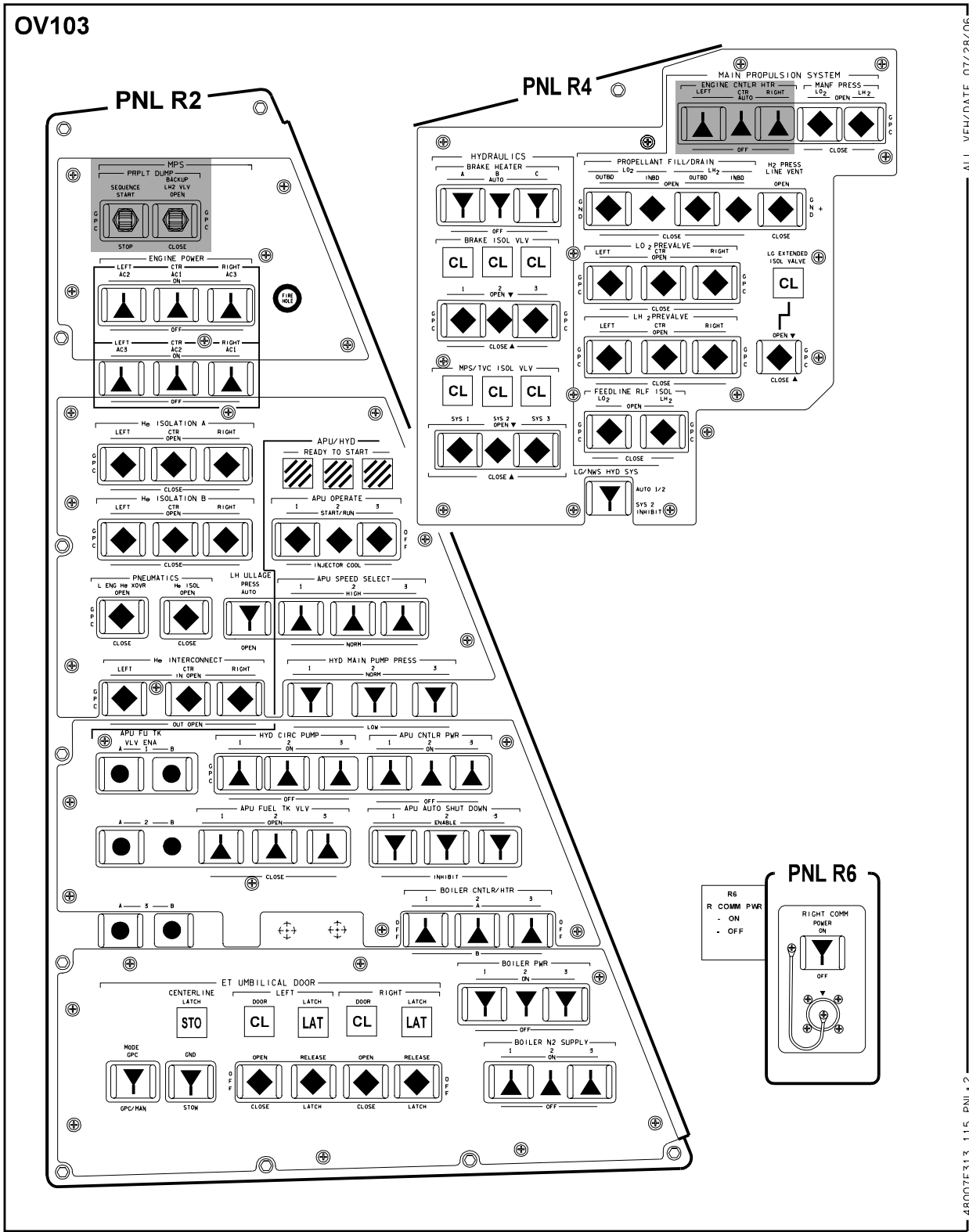

This Page Intentionally Blank

PNL 013

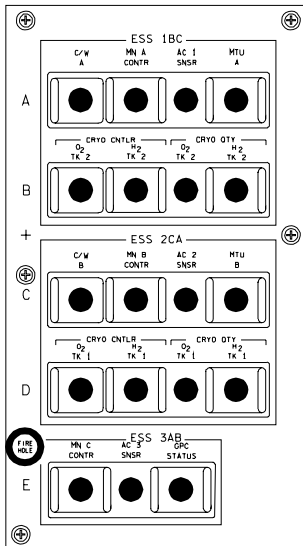

PNL 014

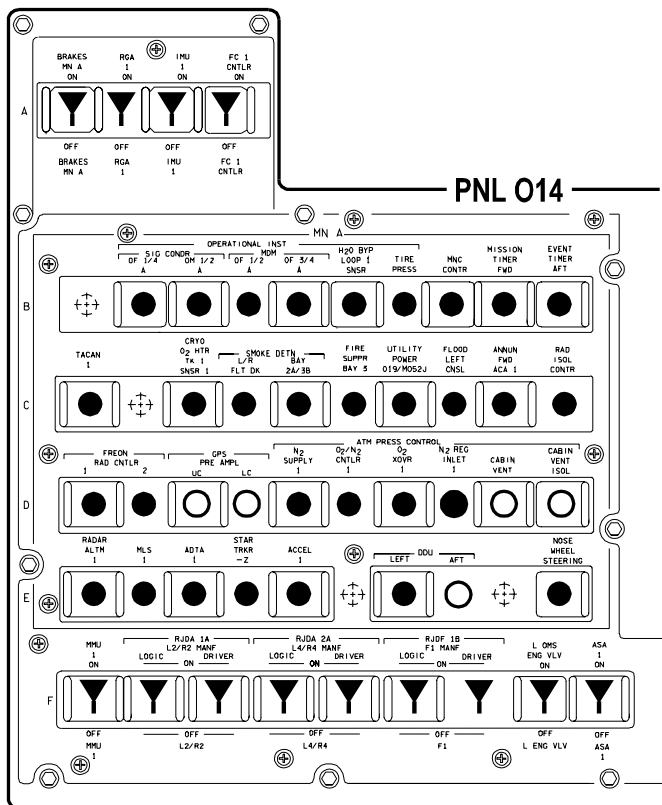

PNL 015

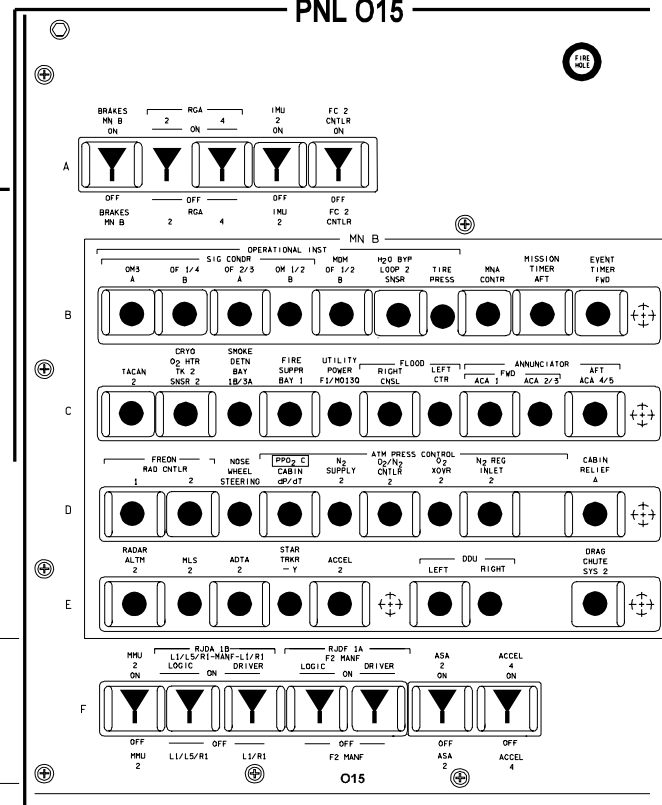

OV103

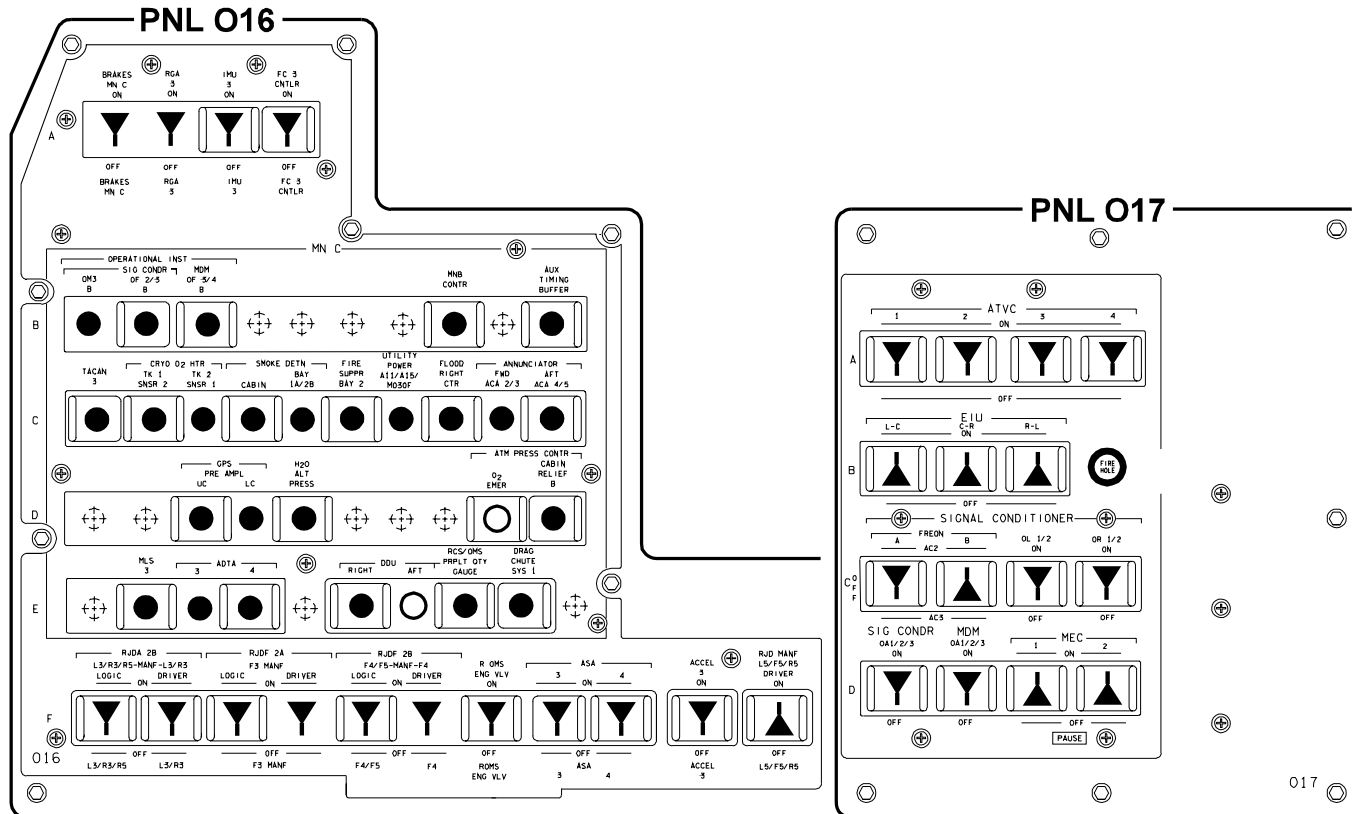

OV103

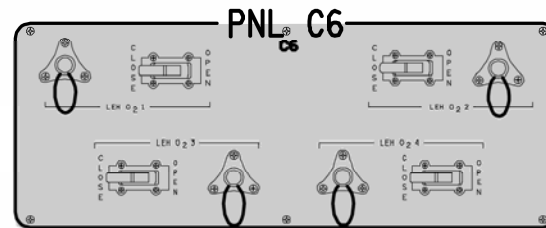
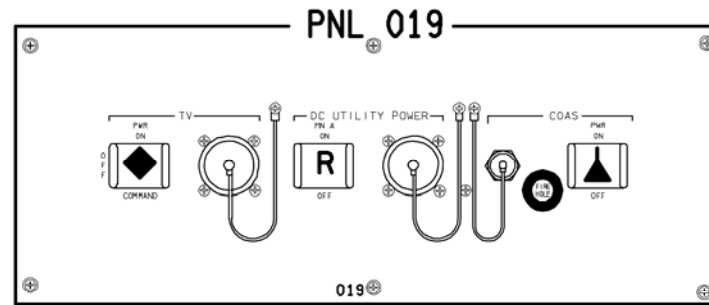

PNL C5



PNL C7

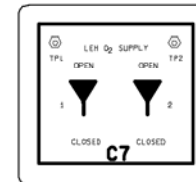

OV103

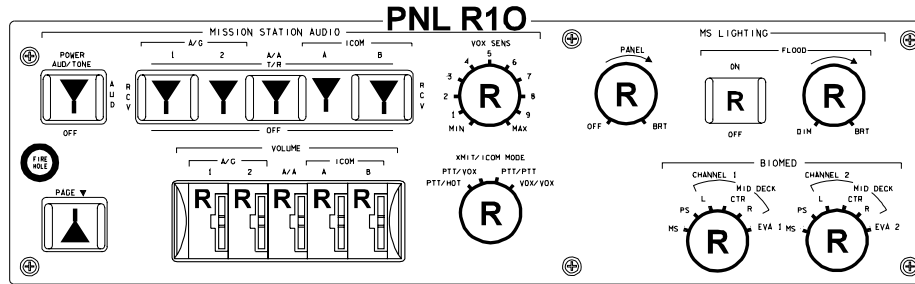

ACTIVATION
 R10 MS AUD PWR - AUD/TONE
 All other sws - as reqd
 R12 MS AUD CNTL - NORM
 A11 MS COMM CCU PWR - ON

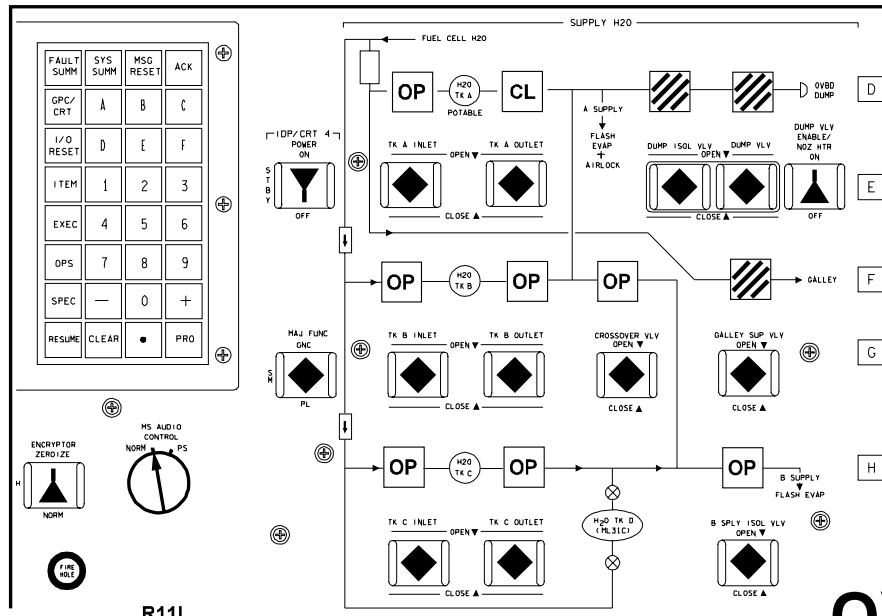
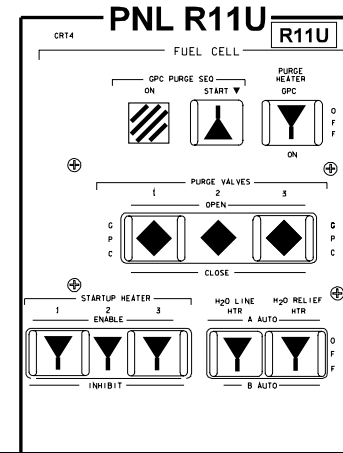

OV103

OV103

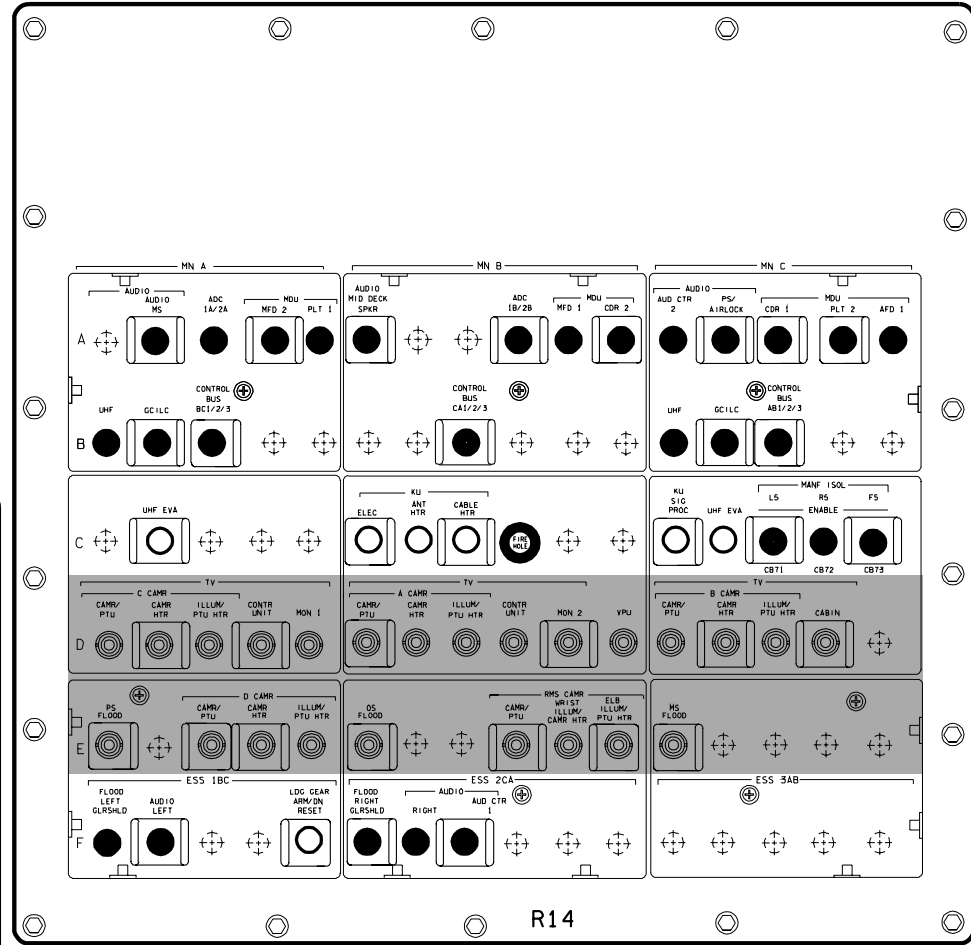
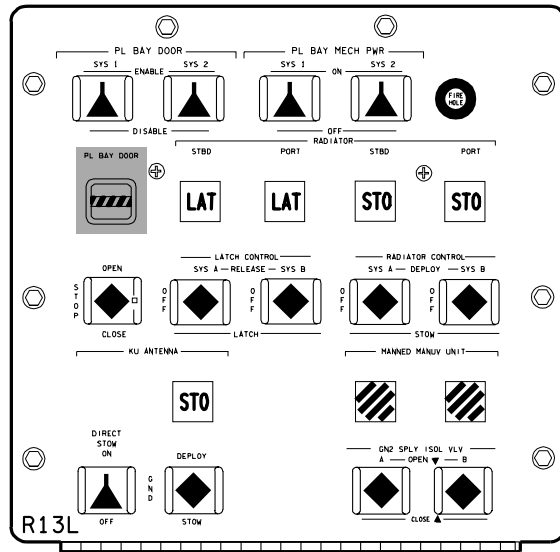
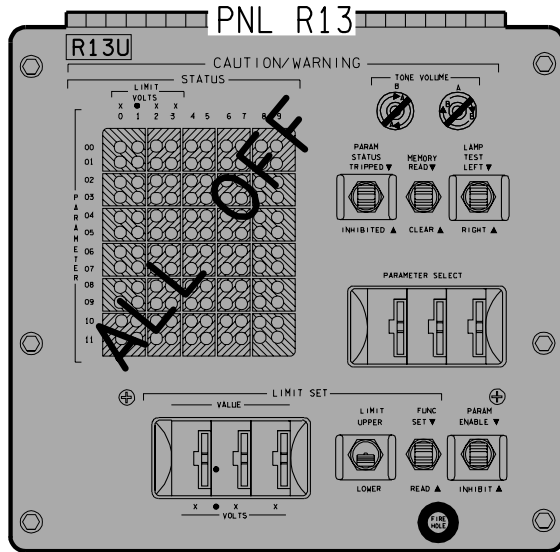

OV103

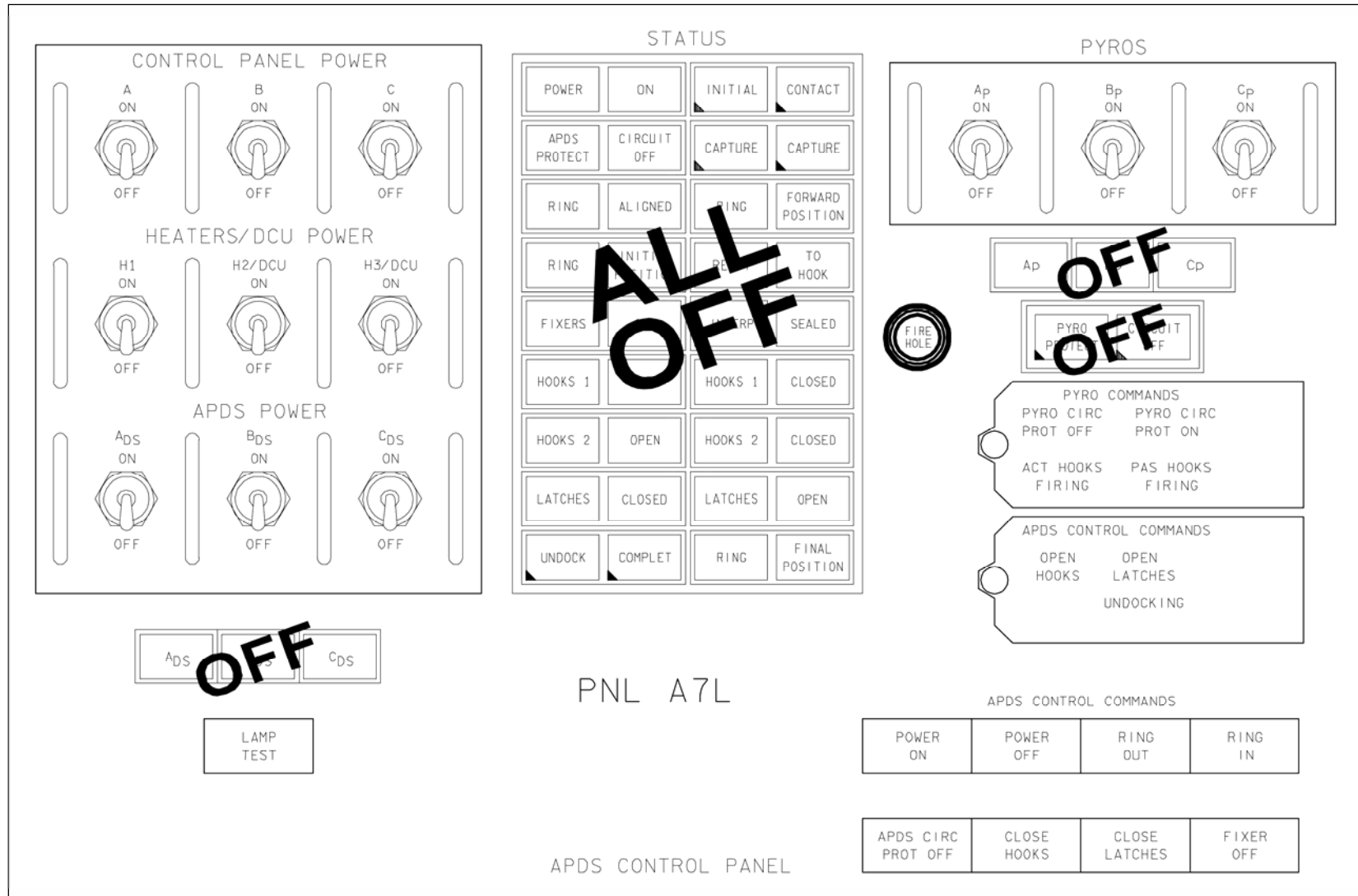

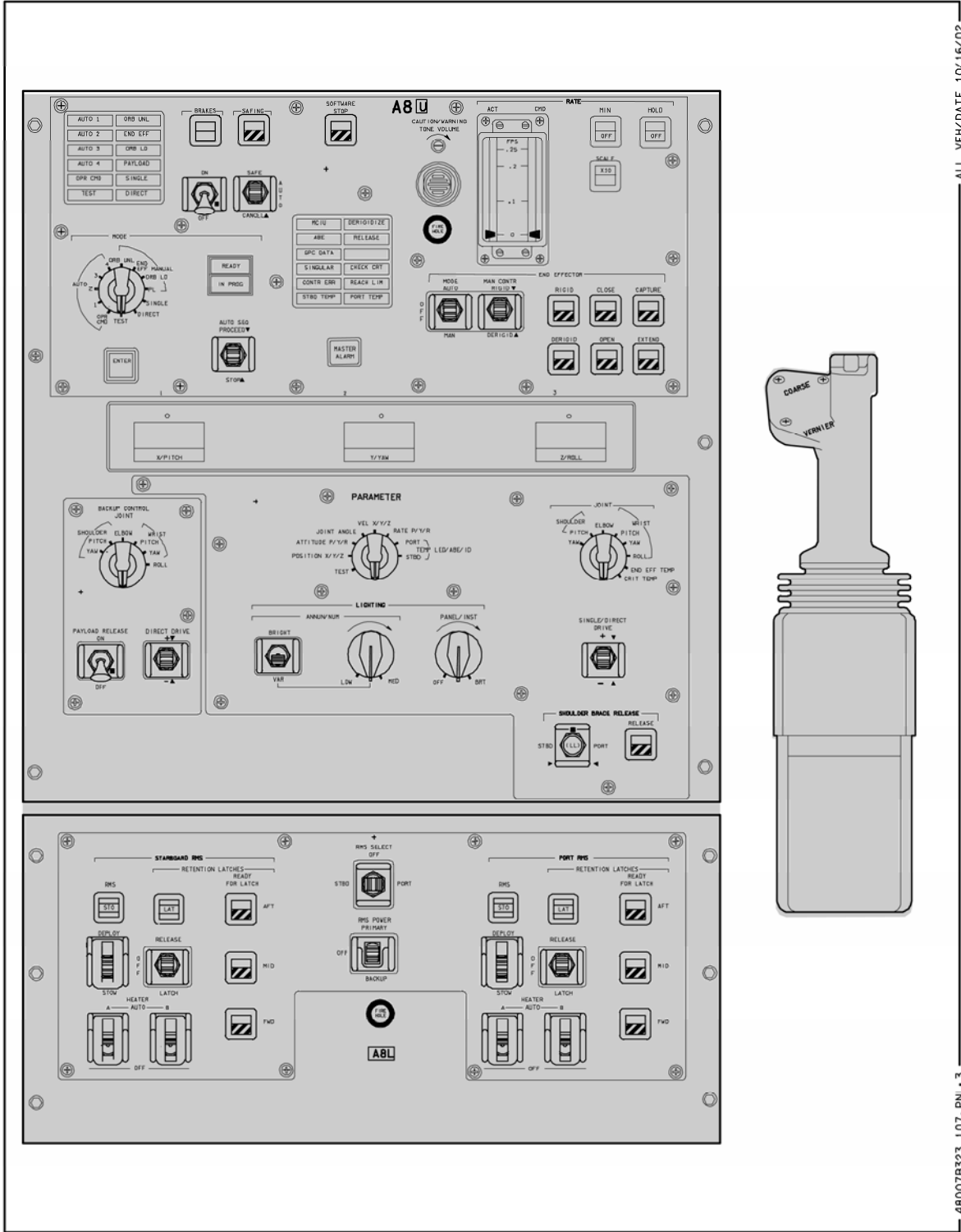

ALL VEH/DATE 10/16/02

48007B323_1107_PN1_3

OV103

A6L

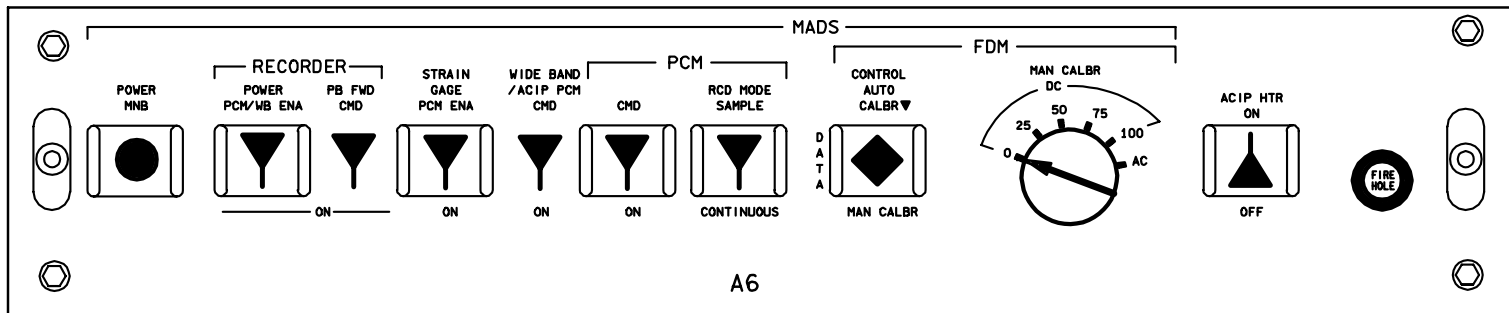
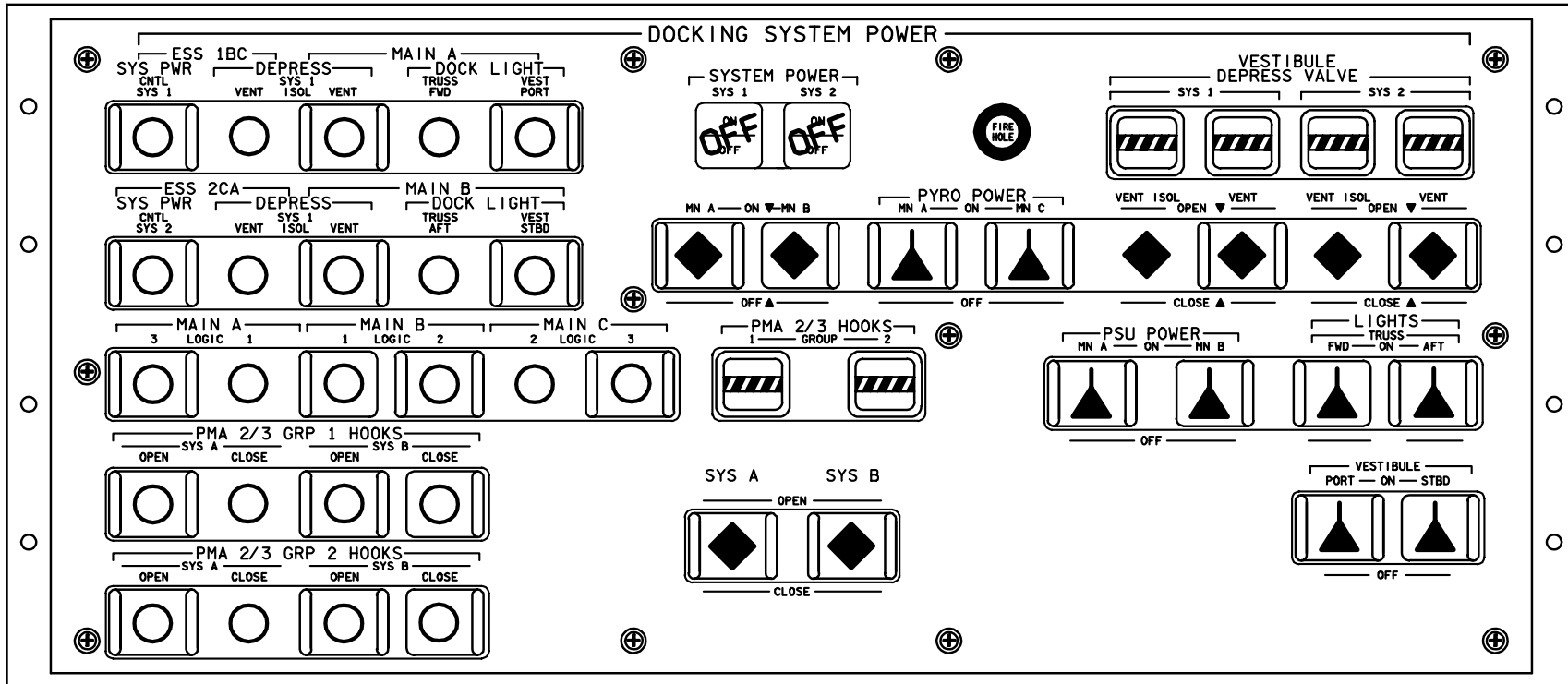

A6

OV103

OV103

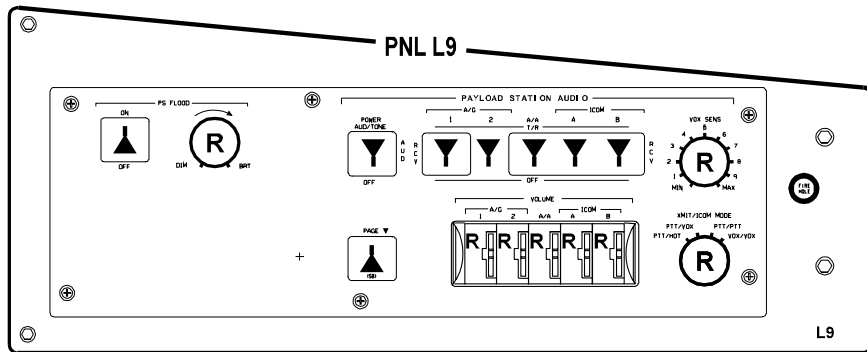
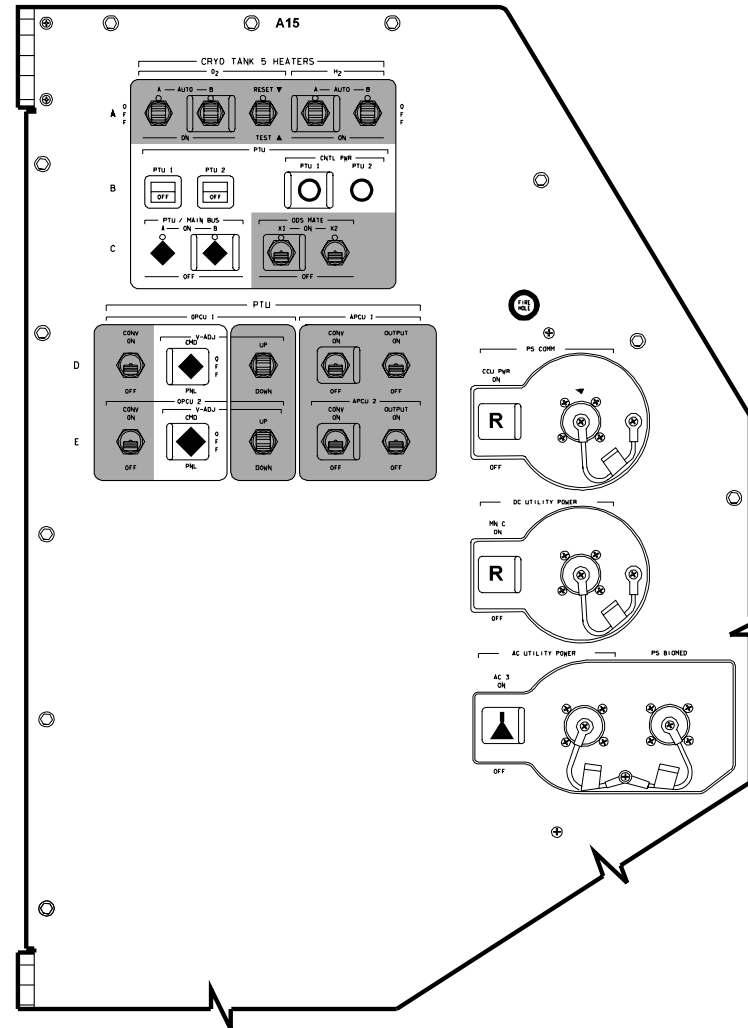
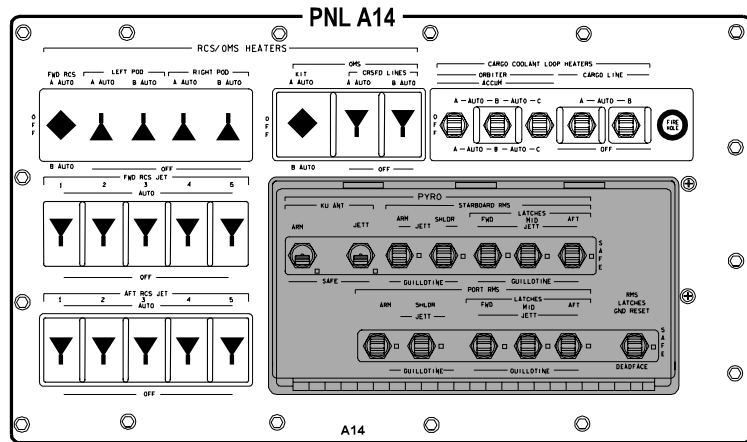

ACTIVATION
 L9 All switches - as read
 A15 PS COMM CCU PWR-ON

OV103

OV103

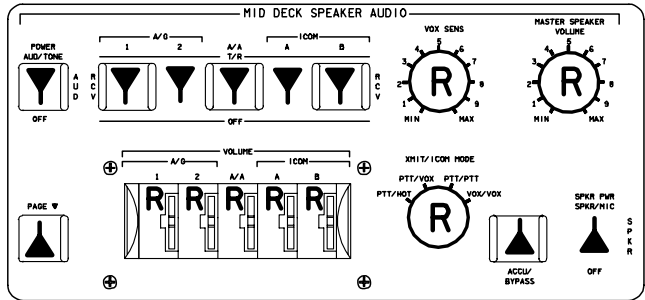

PNL M042F

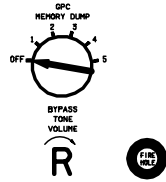

SLEEP STA TONES

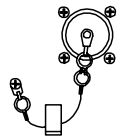

PNL M058F

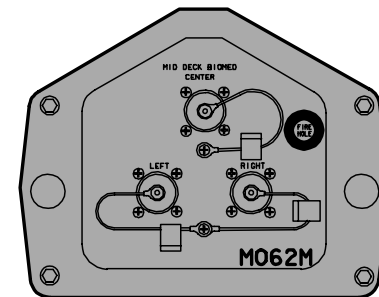
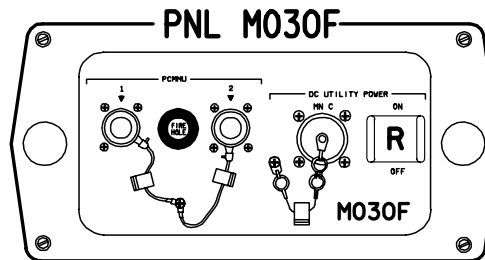
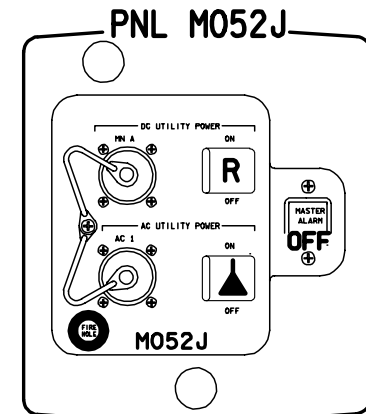
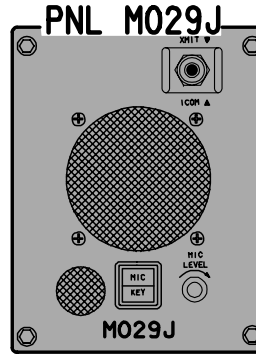
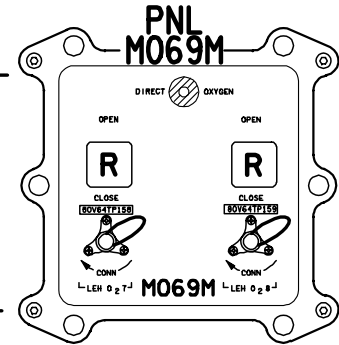
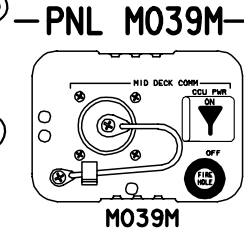
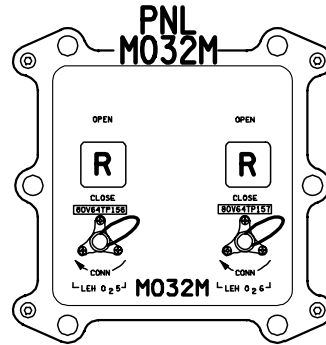
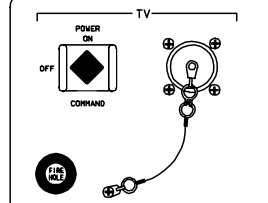

OV103

OV103

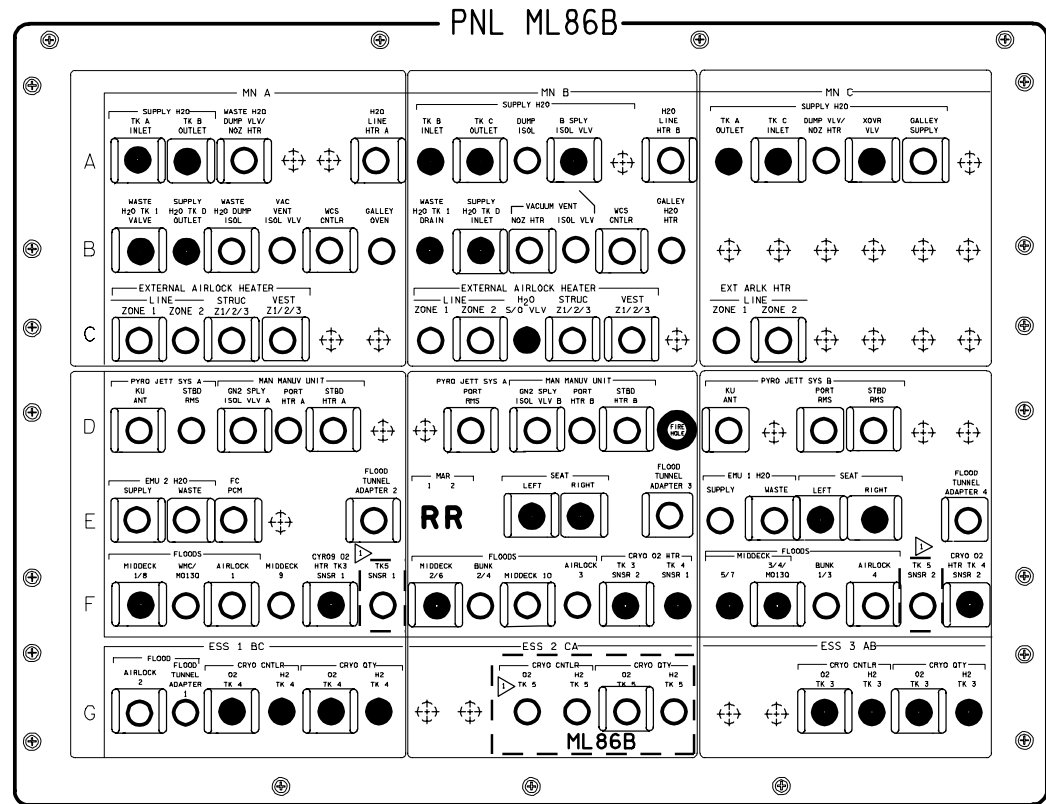
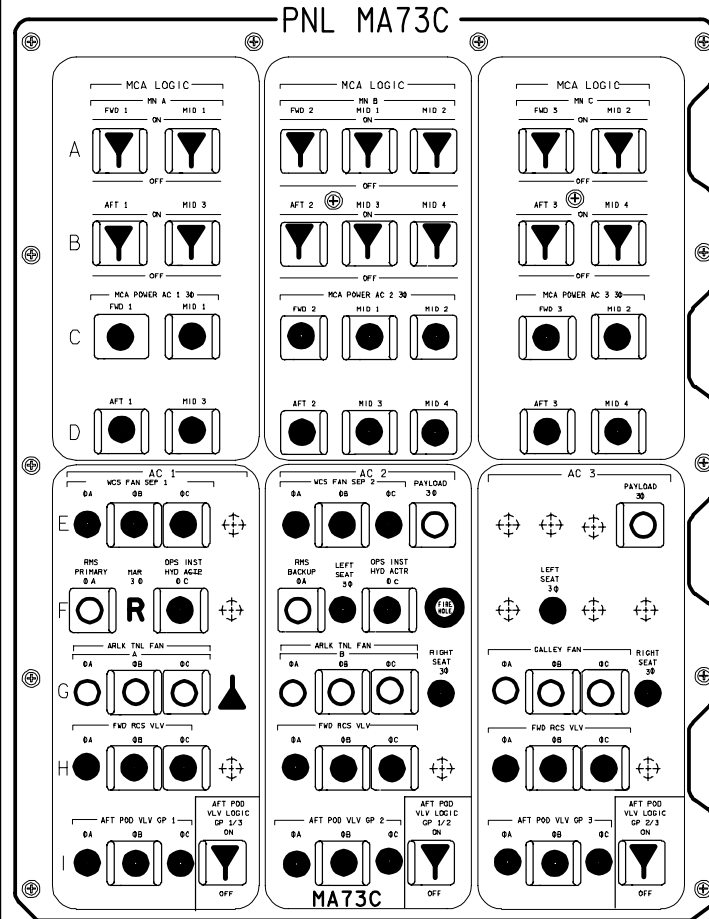

NOTES: ▷ CLOSED IF TK5 FLOWN

OV103

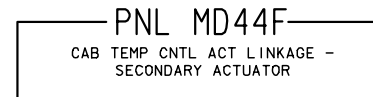
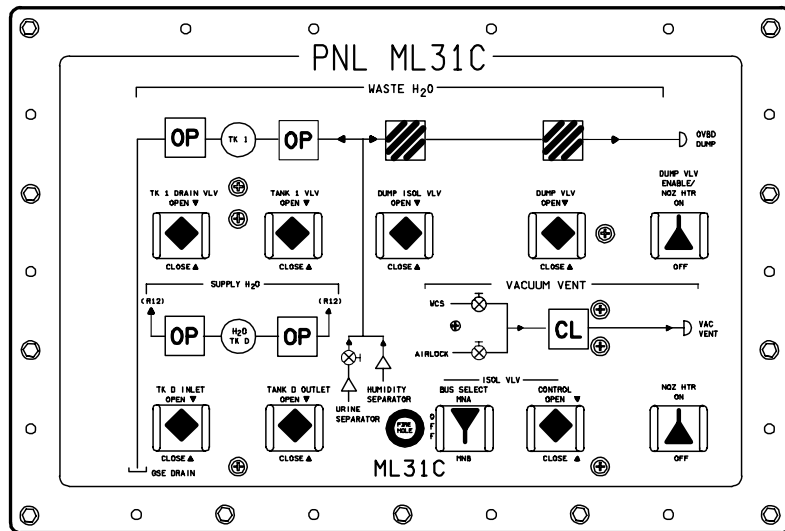
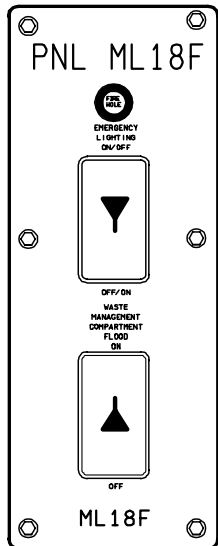
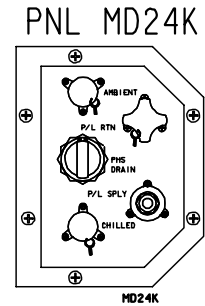
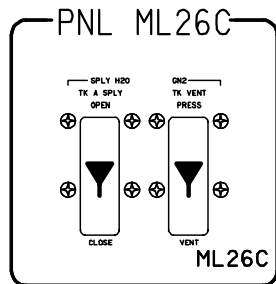
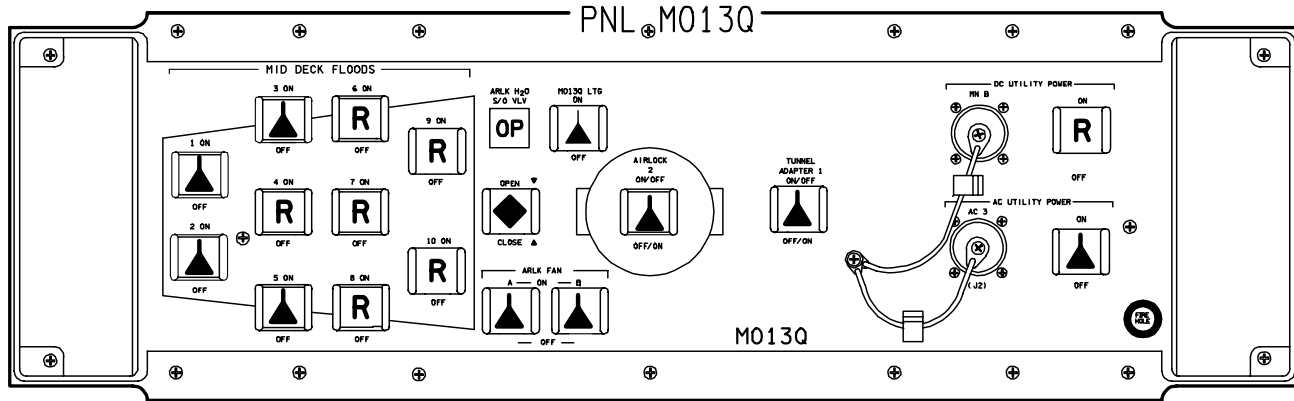

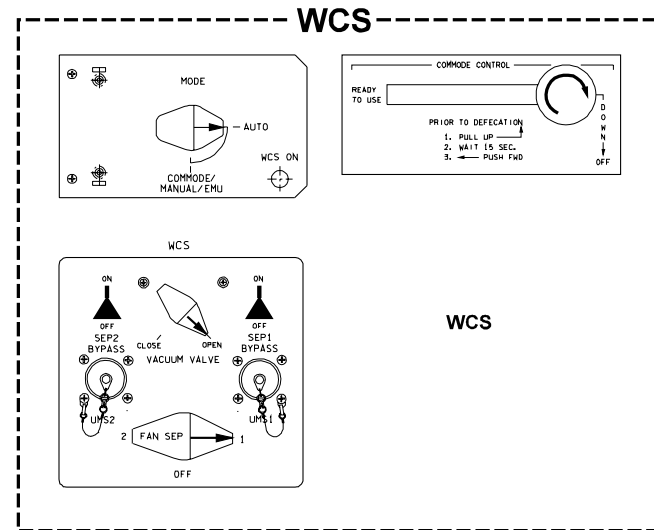
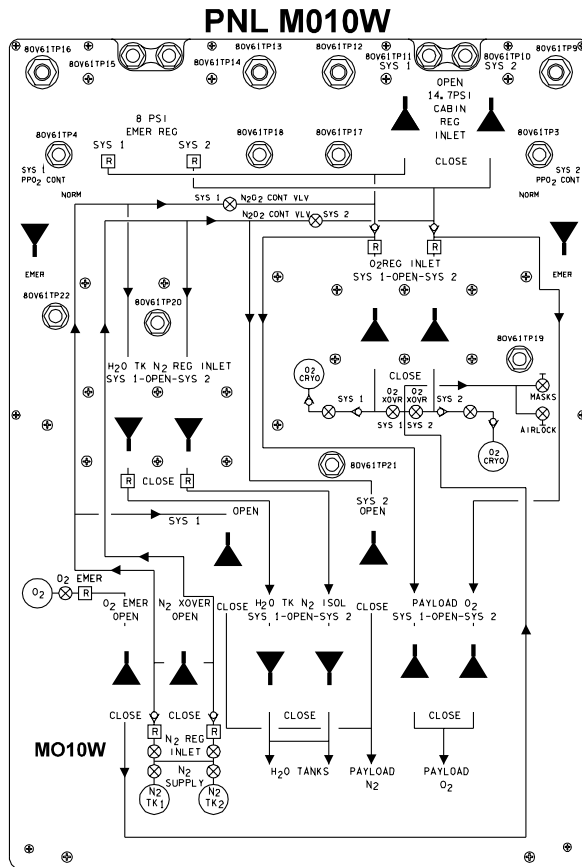

OV103

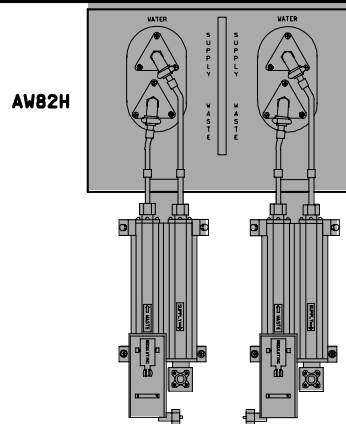
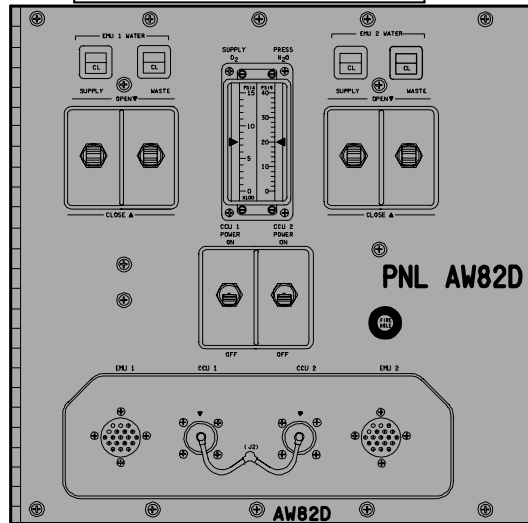
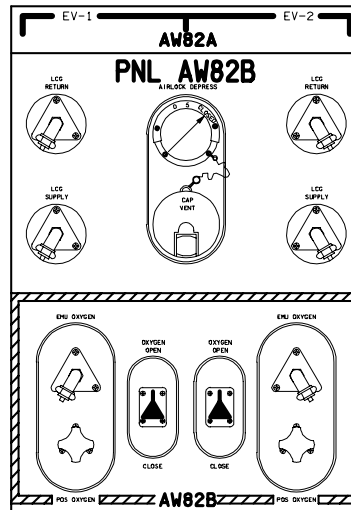
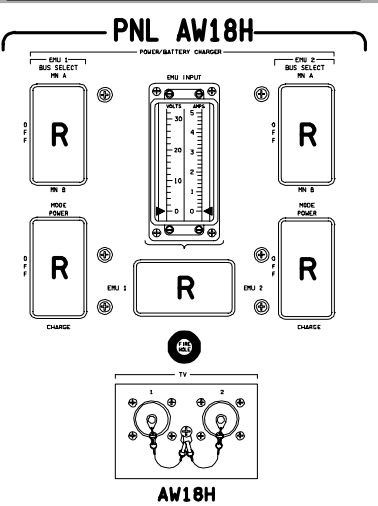
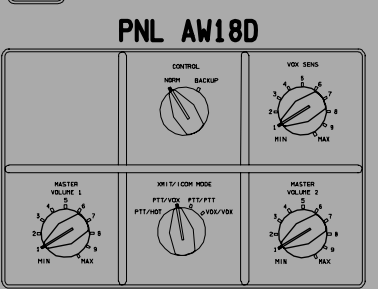
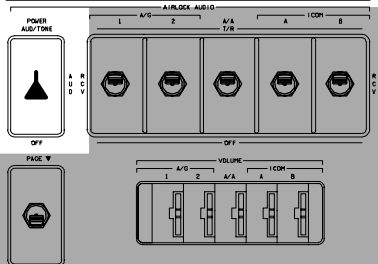
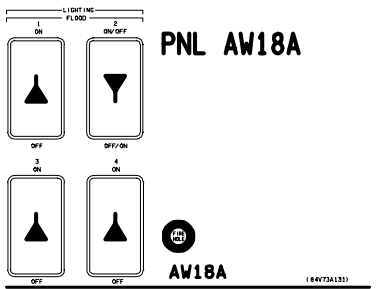

ALL VEH/DATE 04/26/05

4800E331-114; PNL 1

OV103

Inner Hatch

Actuator Handle – LATCHED

Lock Lever – LOCKED

Equalization vlv (two) – NORM, capped

OV104

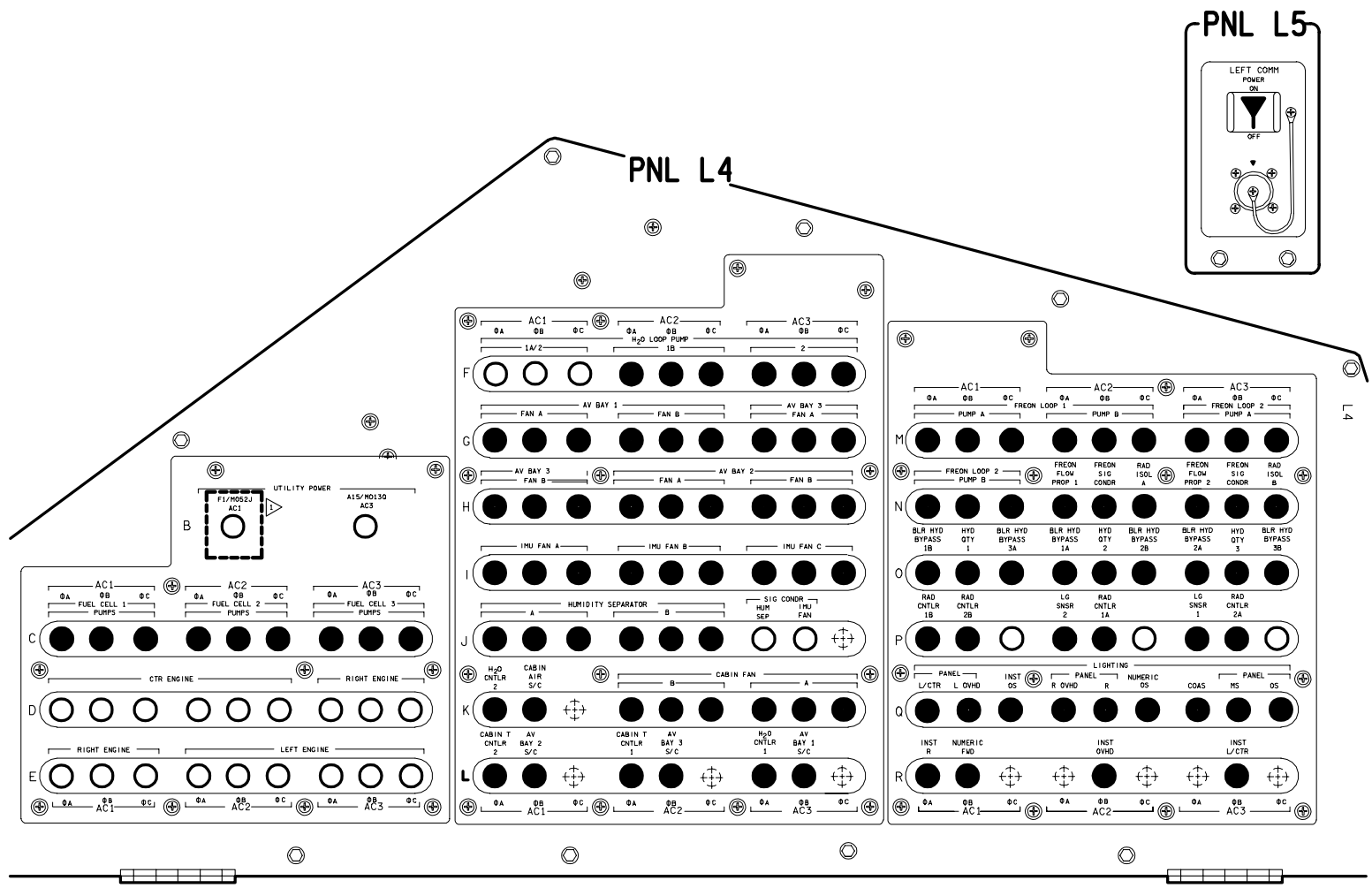

NOTE: ▸ CB CAN REMAIN CLOSED FOR AC PGSC USAGE.
 OPEN WHEN PGSC UNPOWERED/STOWED

OV104

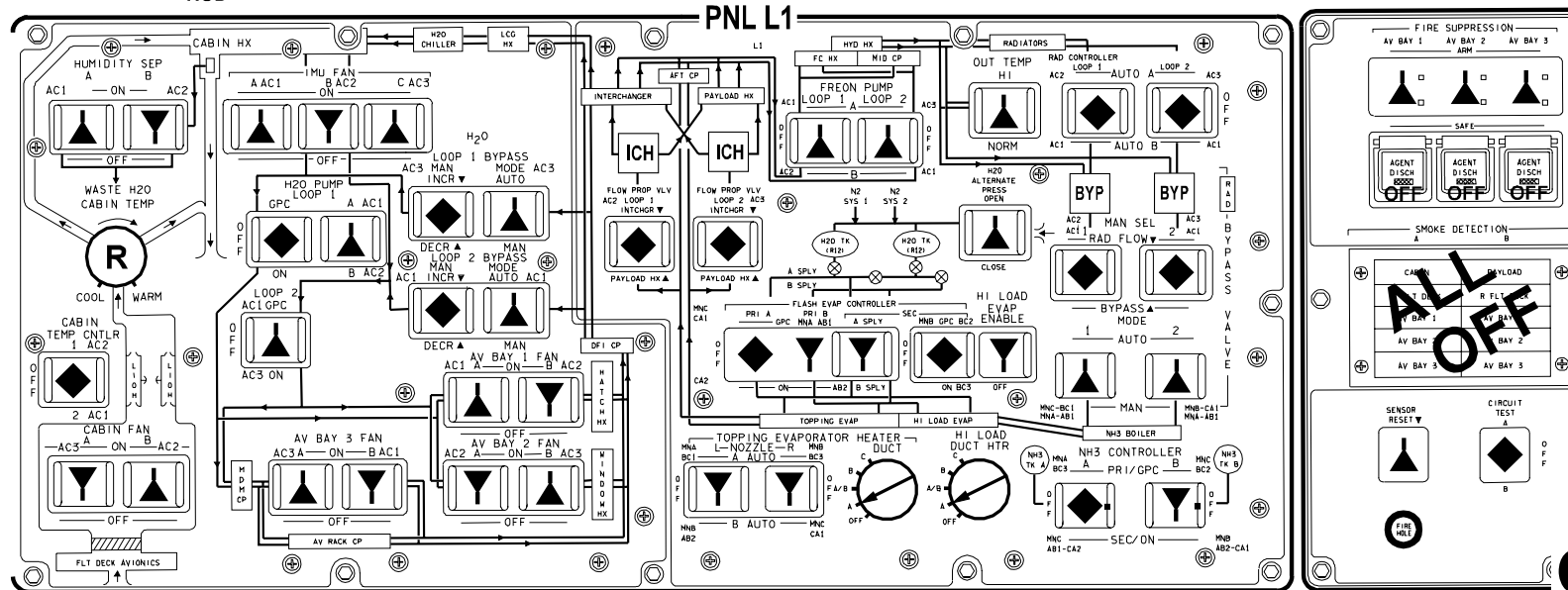
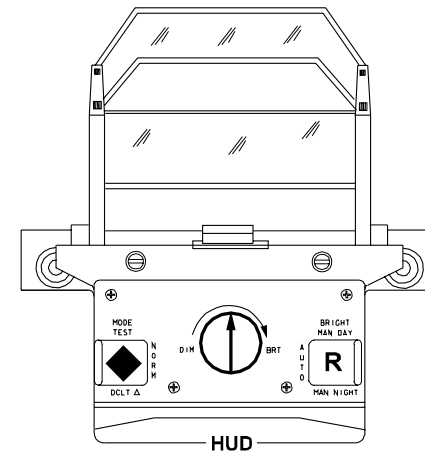
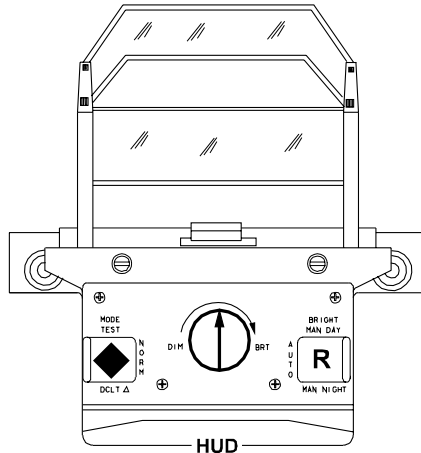
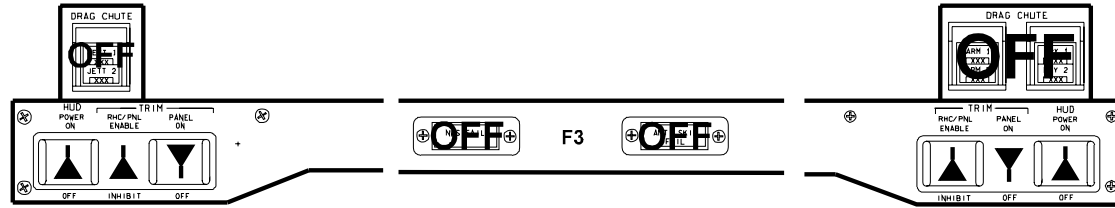

OV104

(OV104) B3-4

C D/O/ALL/GEN L

OV104

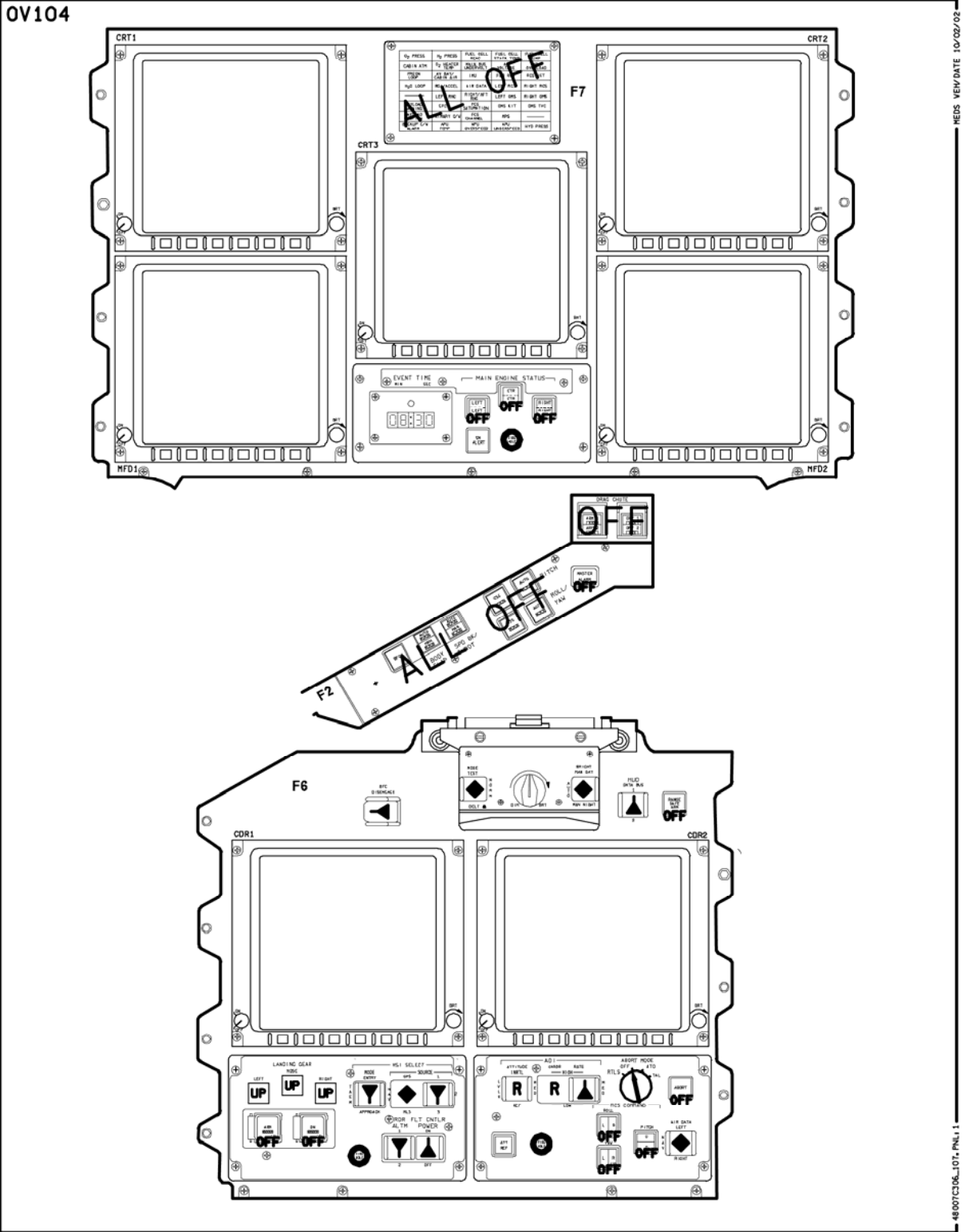

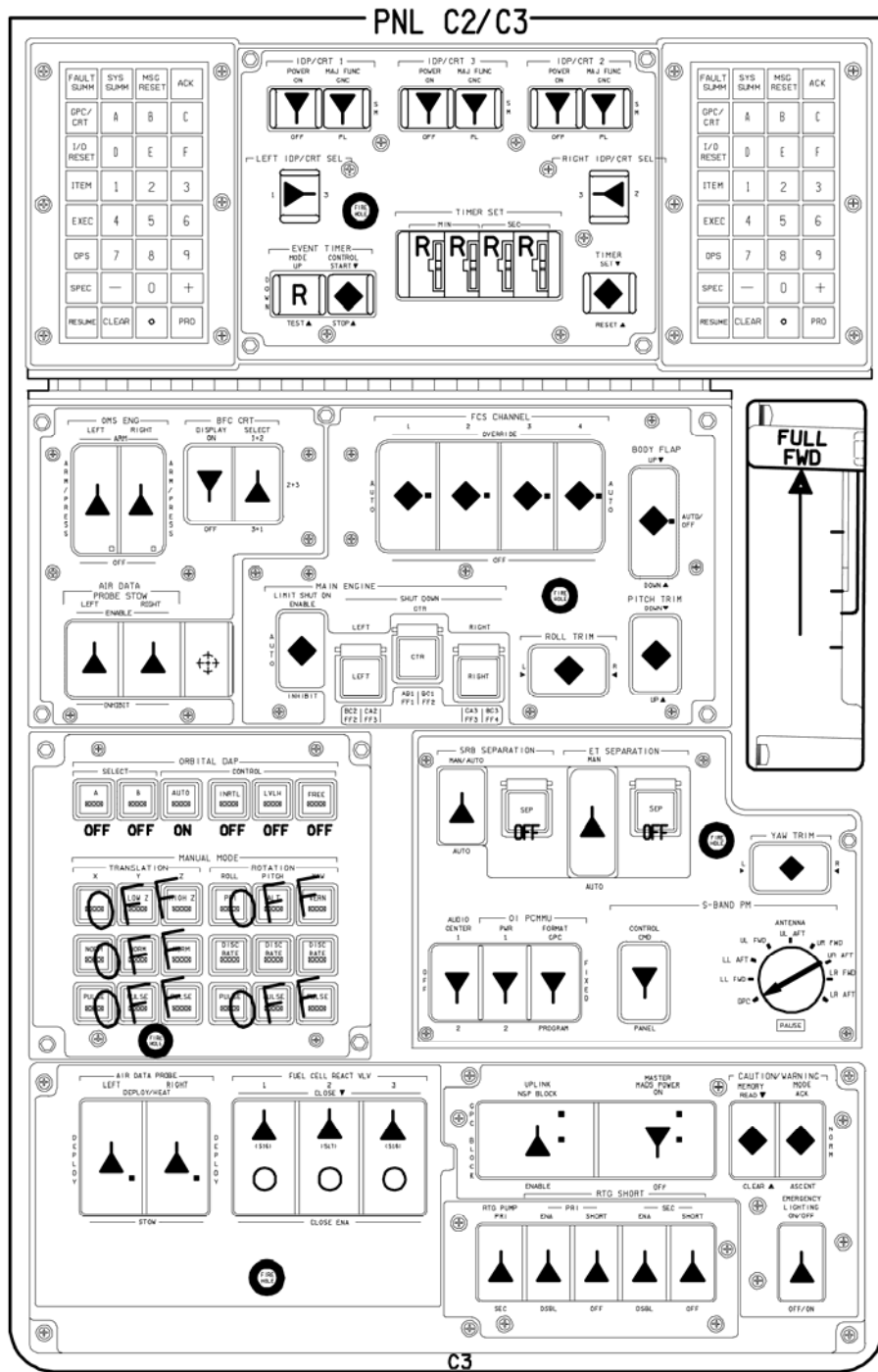

OV104

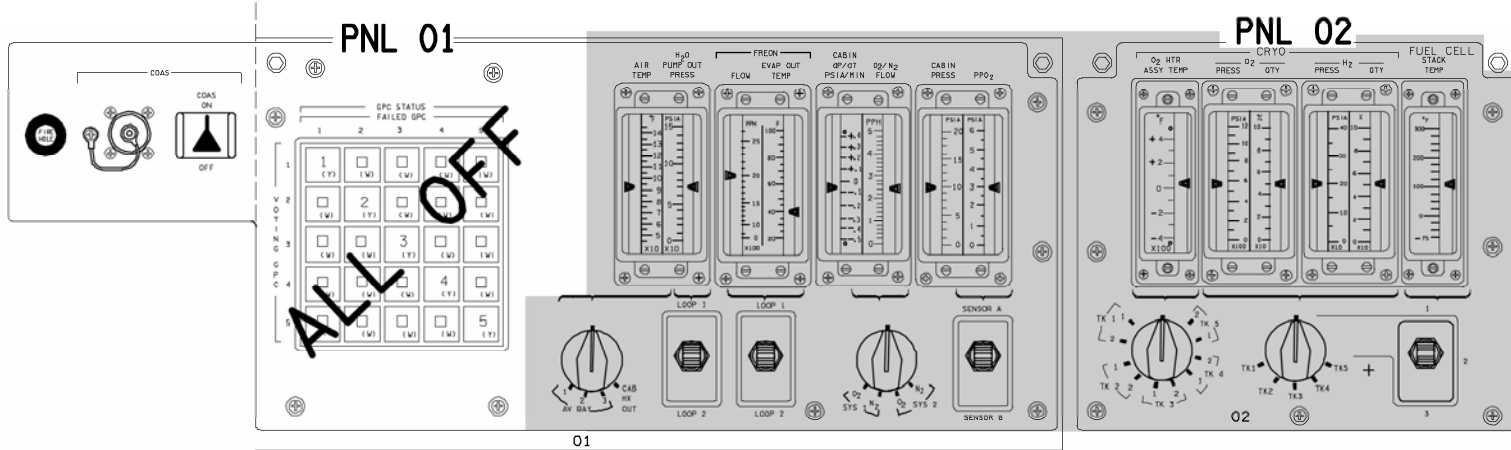

L side OVHD flood - R (MID)

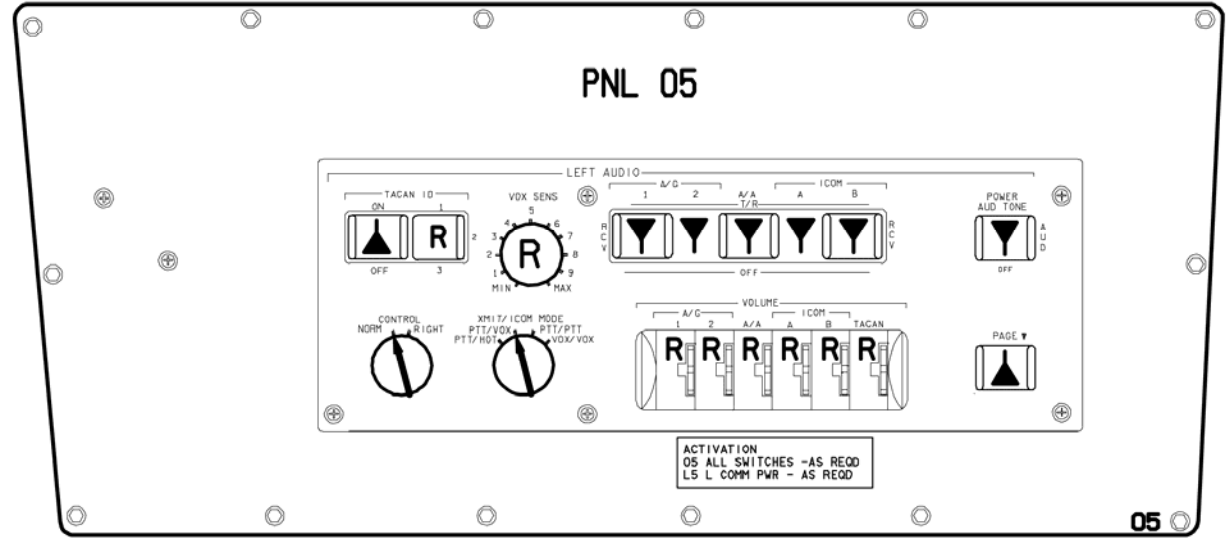

OV104

PNL 06

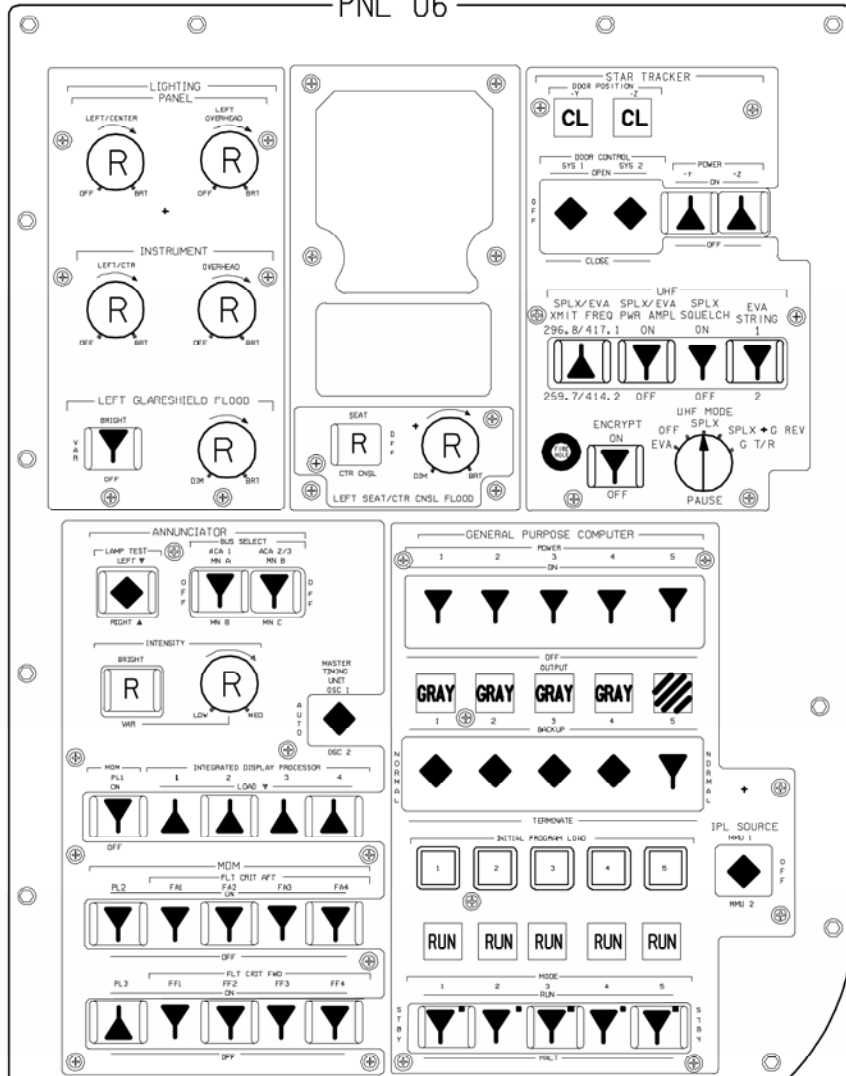

PNL 07

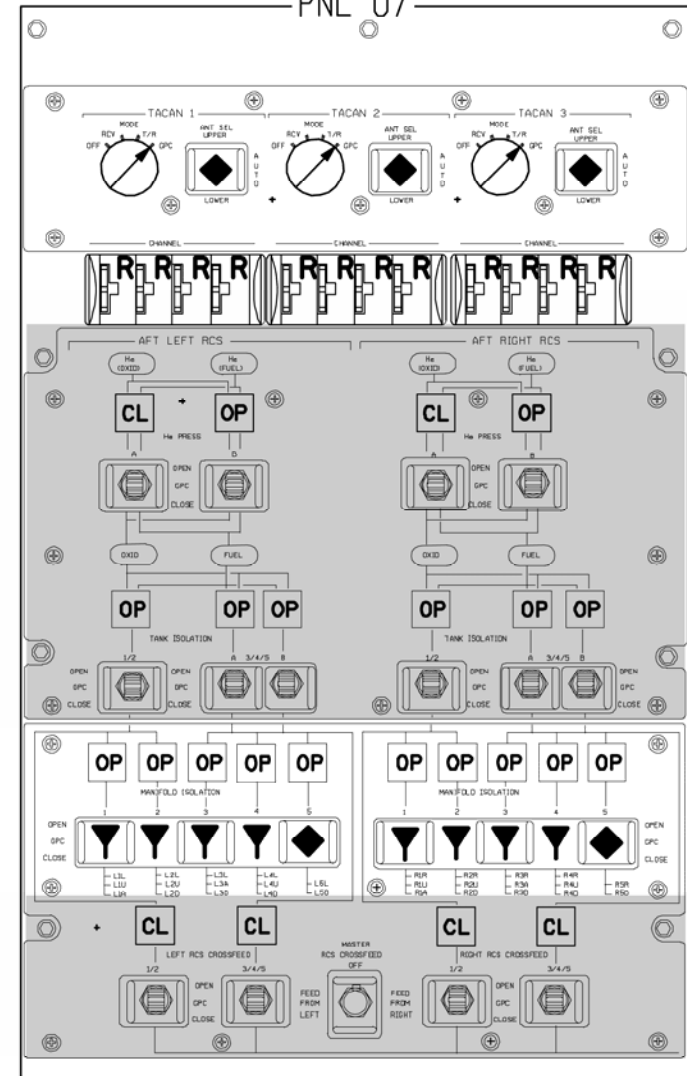

48007C309_114, PNL, 1

OV104

OV104/ DATE 06/30/03

(OV104) B3-9

C D/O/4/GEN L

PNL 08

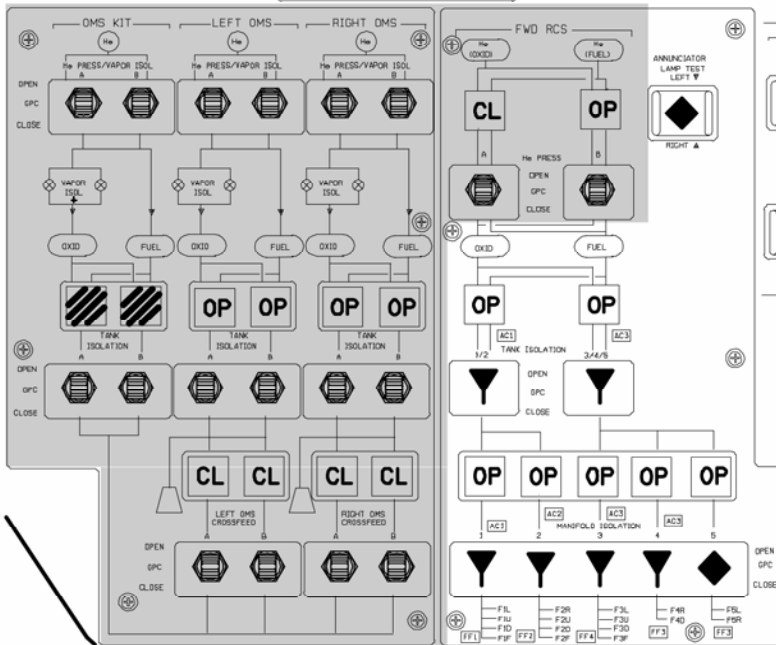
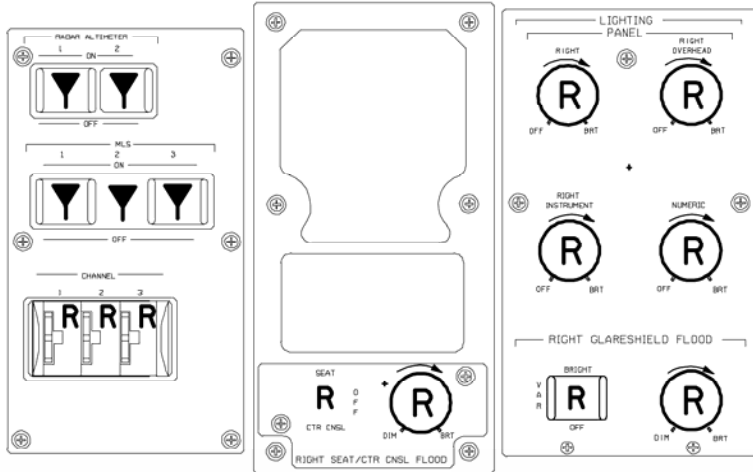

PNL 09

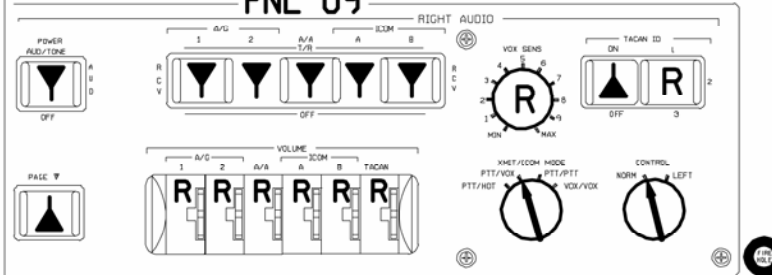

ACTIVATION
 09 R AUD PWR - AUD/TONE
 ALL OTHER SWS- AS REQD
 R6 R COMM PWR - AS REQD

R side OVHD flood - R (MID)

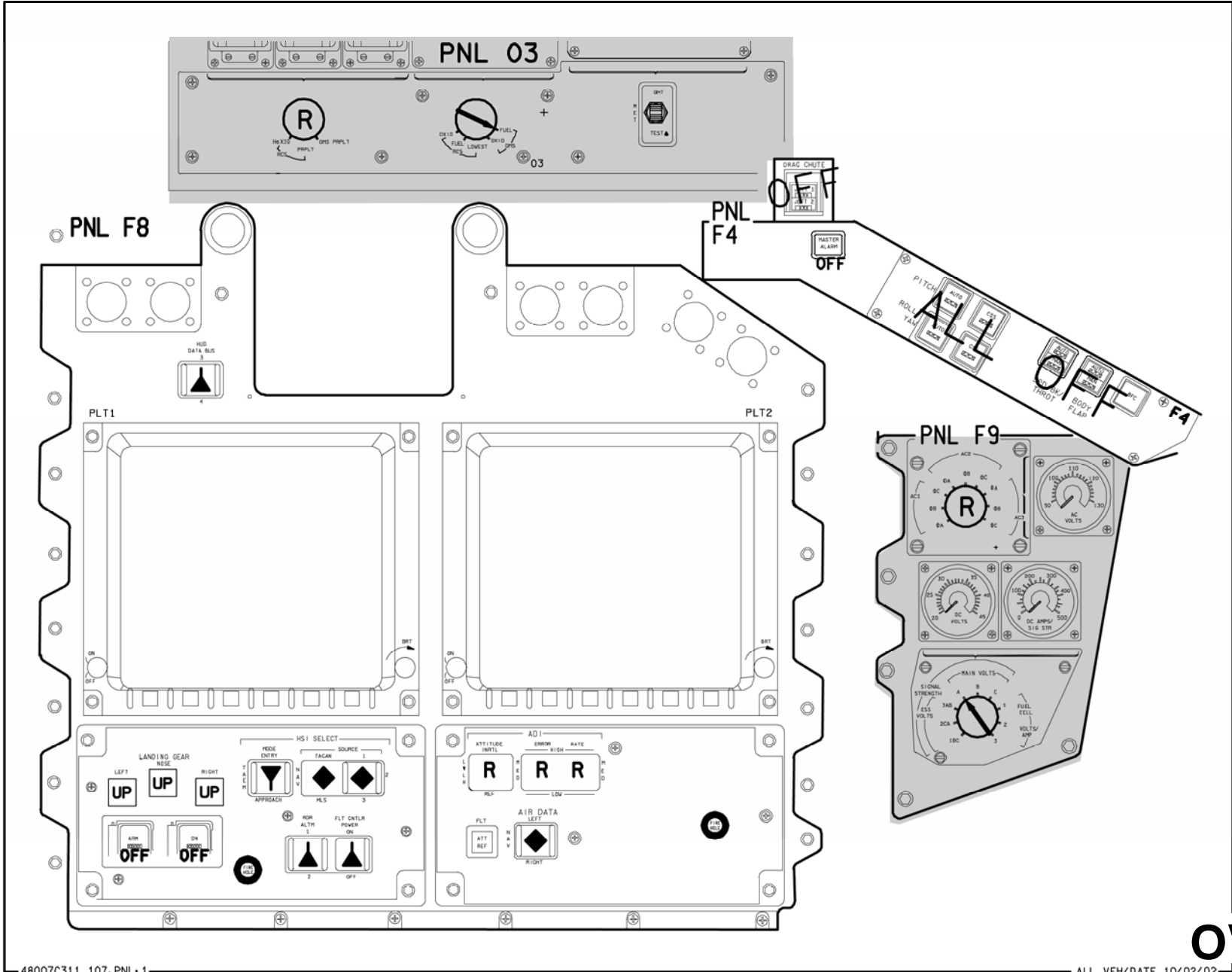

48007C311_107, PNL 1

ALL VEH/DATE 10/02/02

OV104

(OV104) B3-11

C D/O/ALL/GEN L

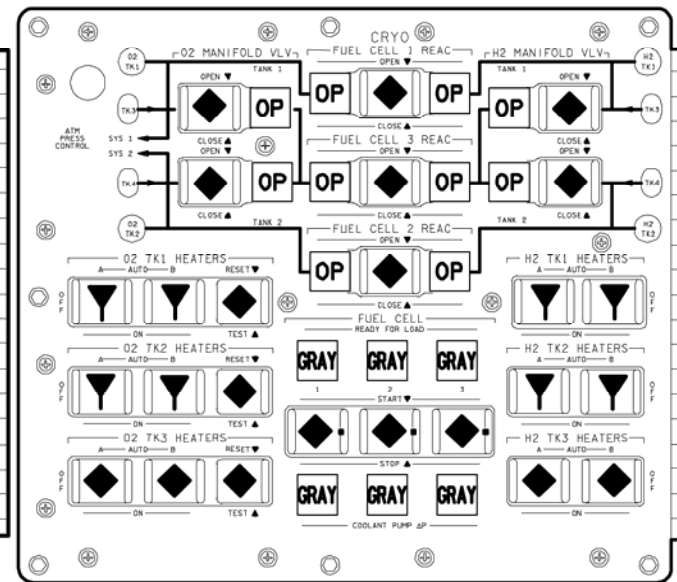
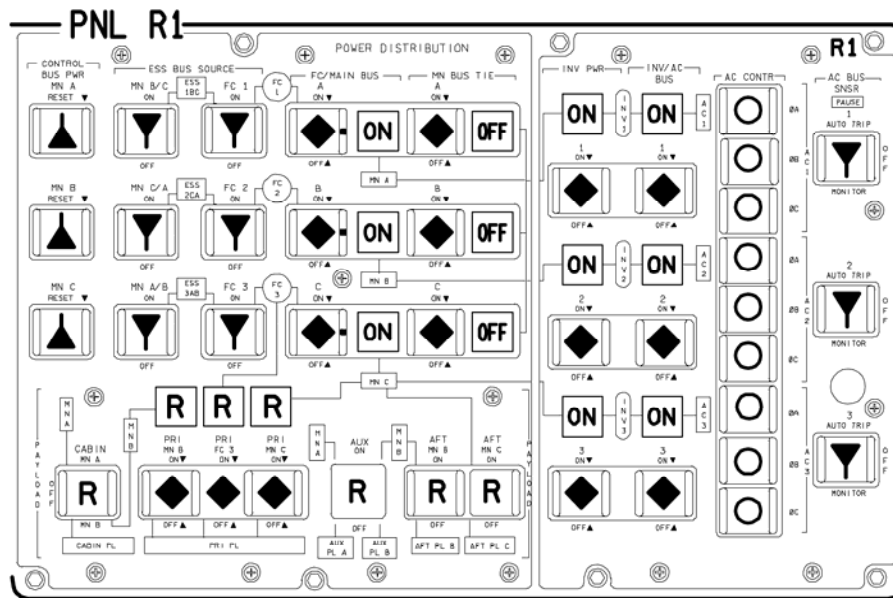

OV104

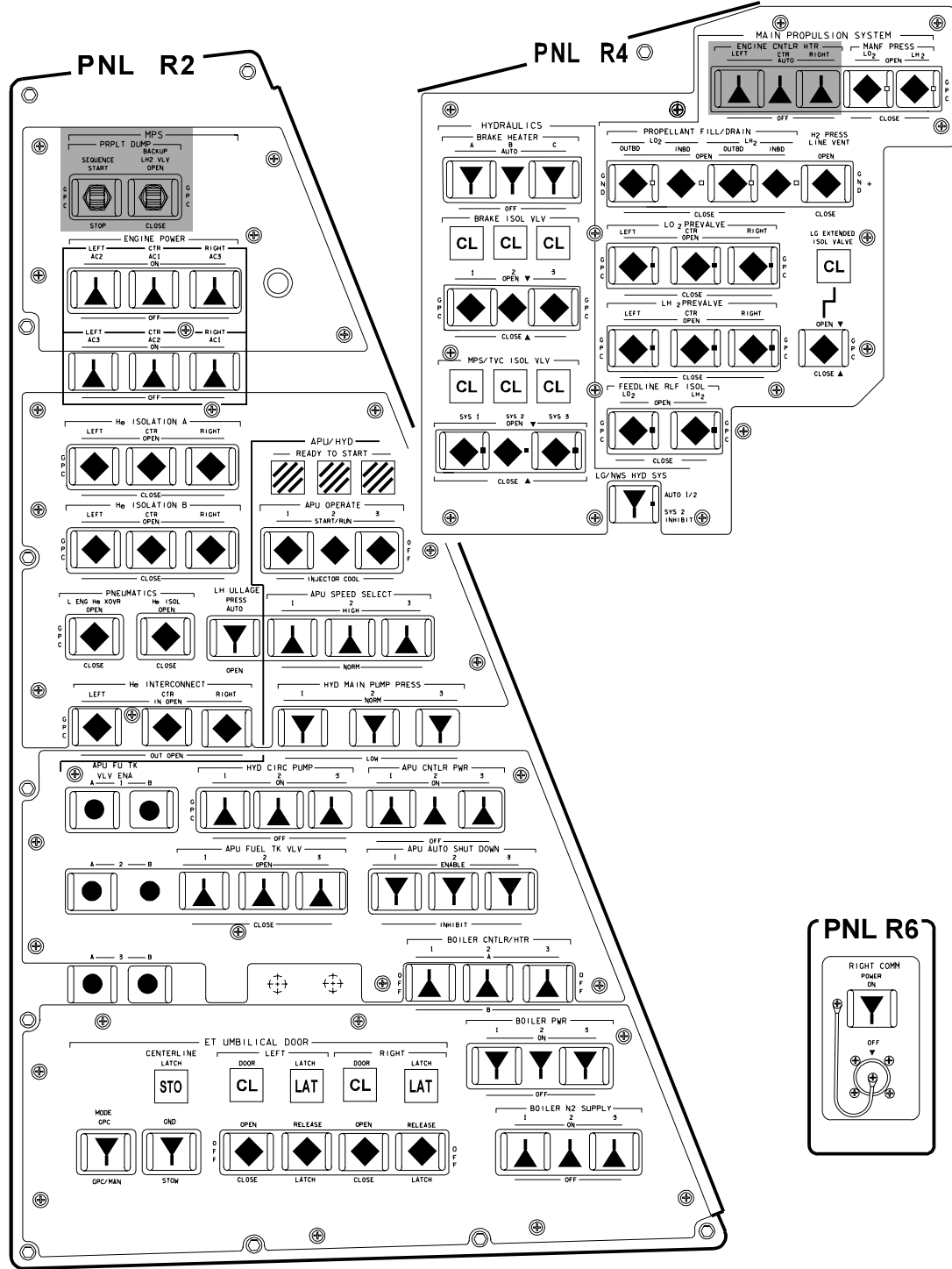

48007313_115_PNL# 2 ALL VEH/DATE 07/26/06

This Page Intentionally Blank

OV104

PNL 013

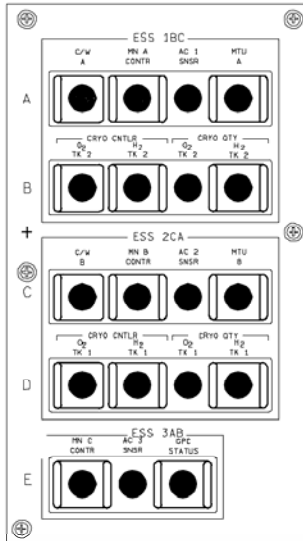

PNL 014

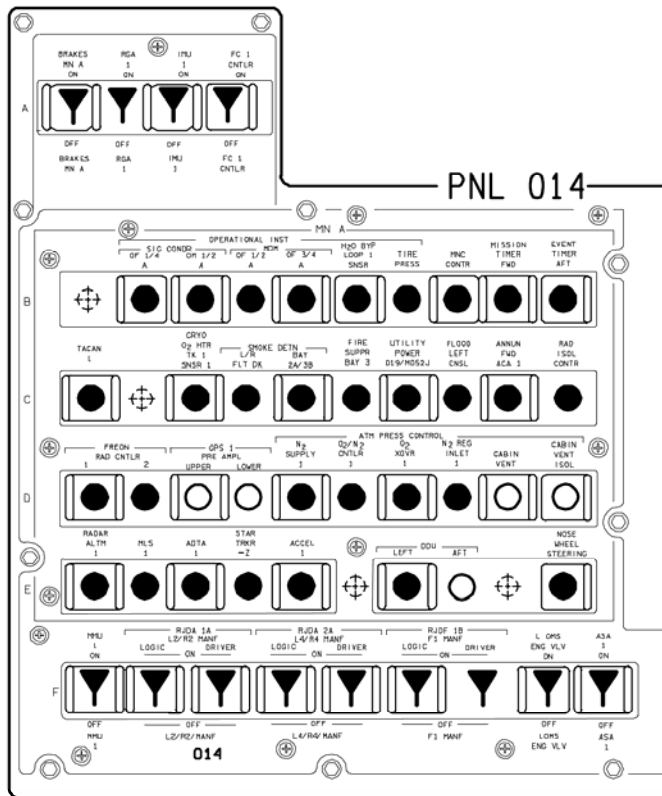

PNL 015

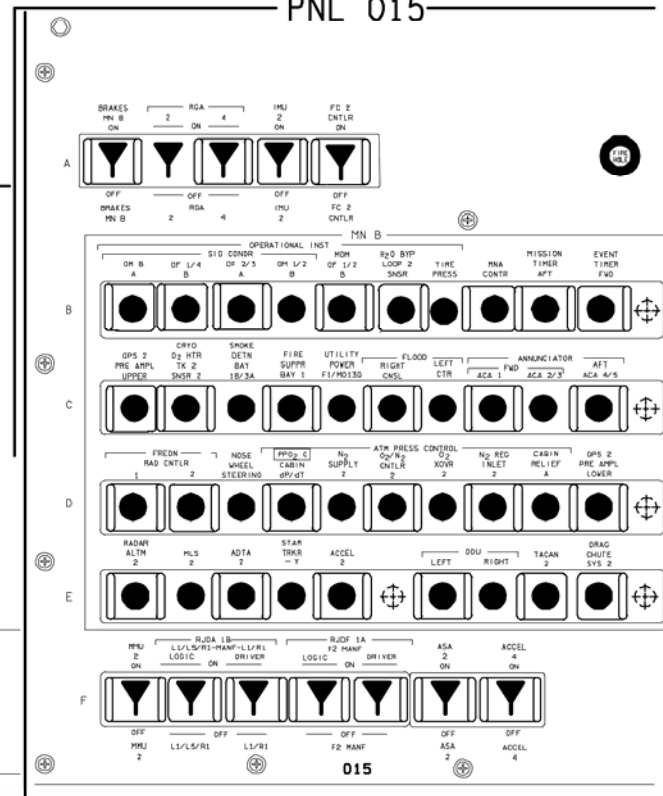

OV104

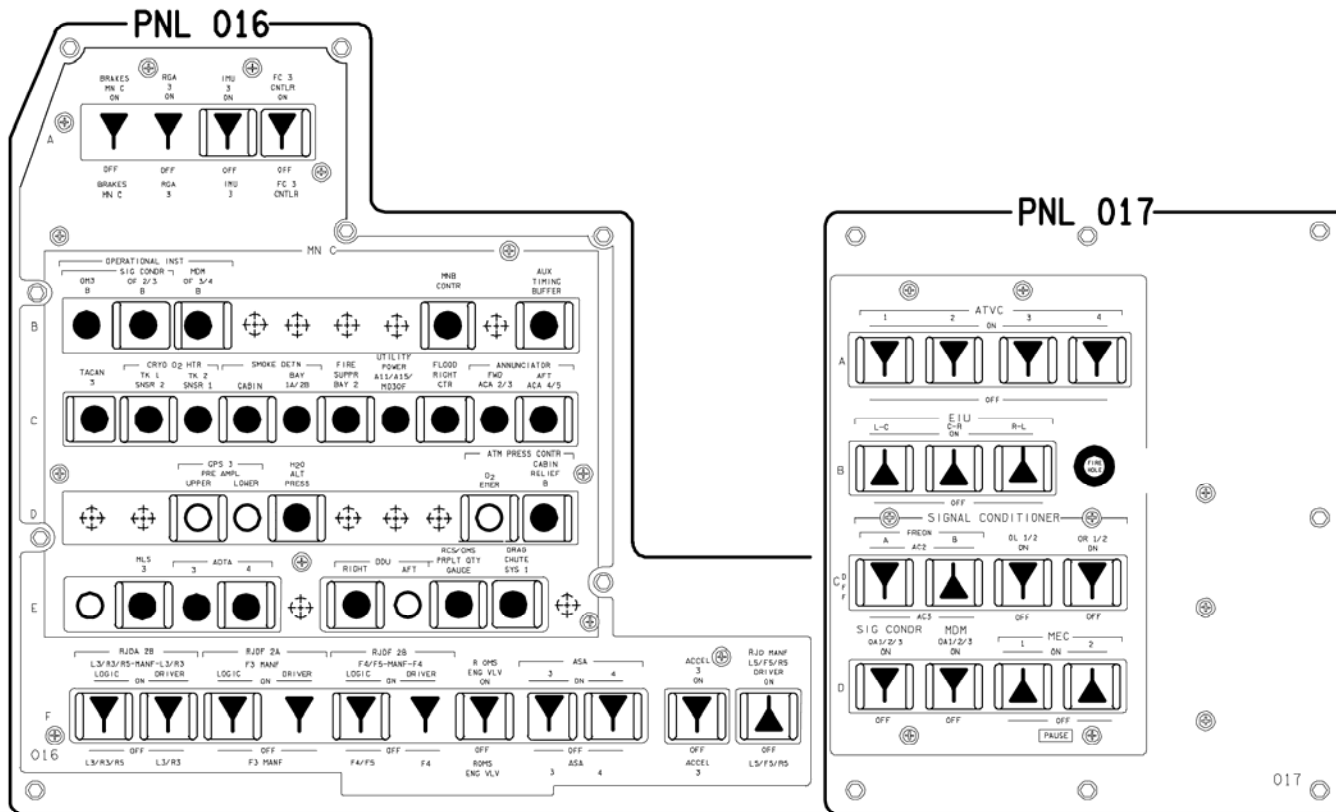

OV104

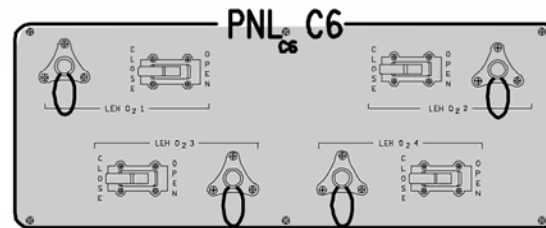
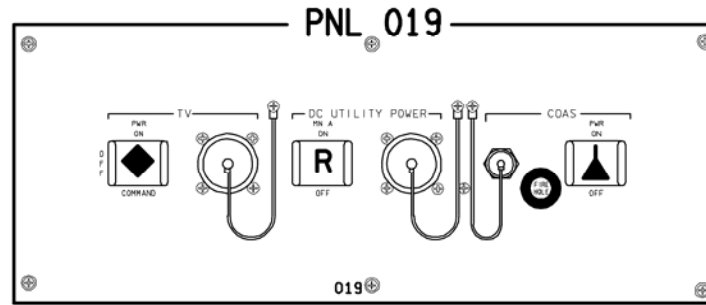

PNL C5



PNL C7

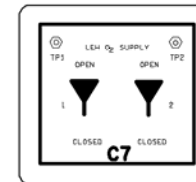

OV104

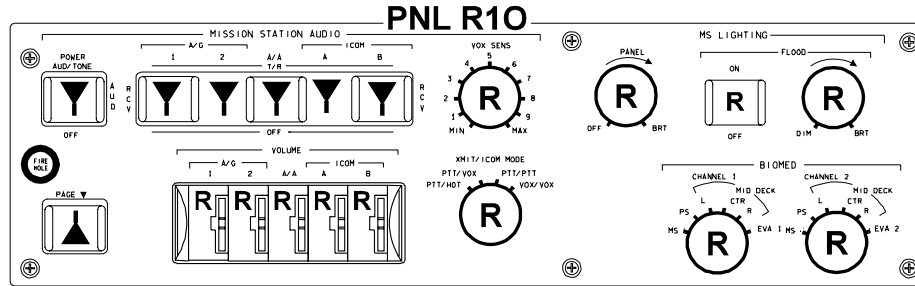

ACTIVATION
 R10 MS AUD PWR - AUD/TONE
 ALL OTHER SWS - AS RECD
 R12 MS AUD CNTRL - NORM
 A11 MS COMM CCU PWR - ON

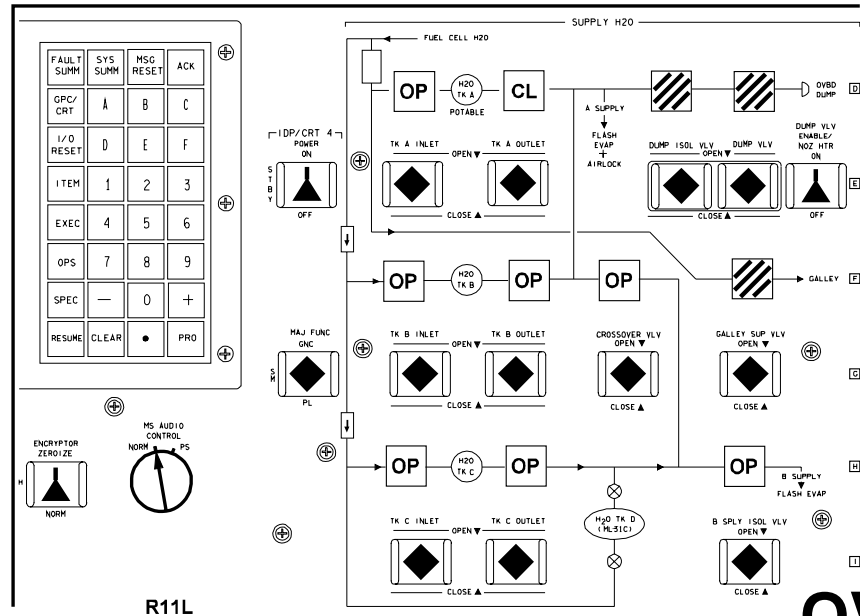
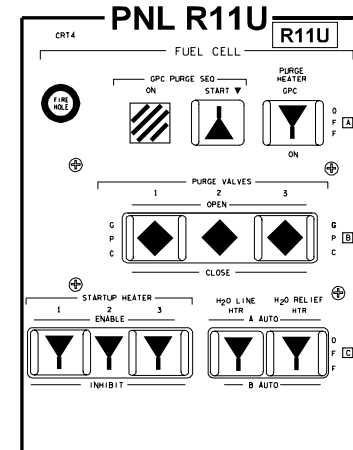

OV104

OV104

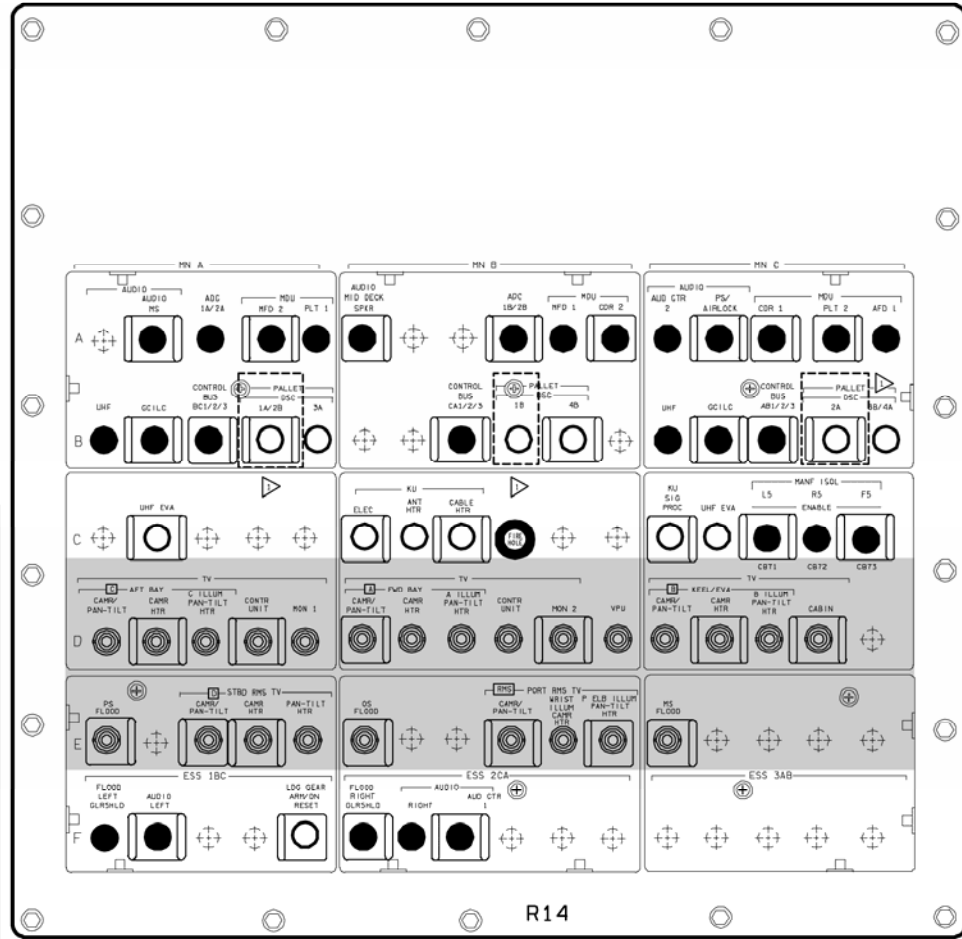
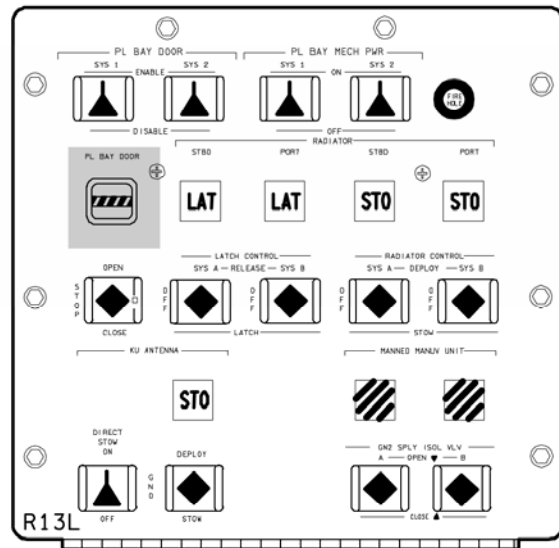
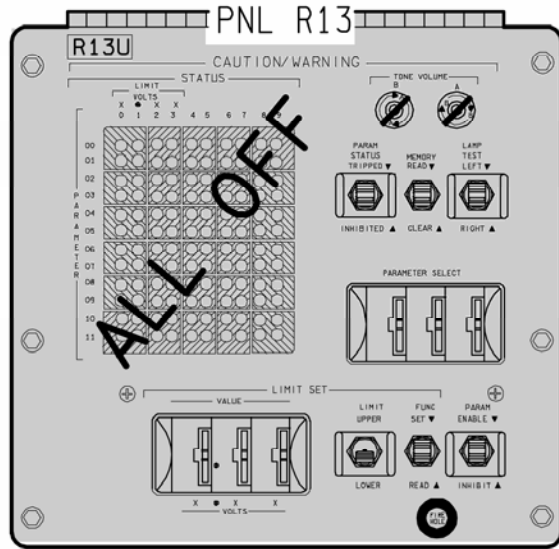

NOTES: > CLOSED IF EDO

OV104

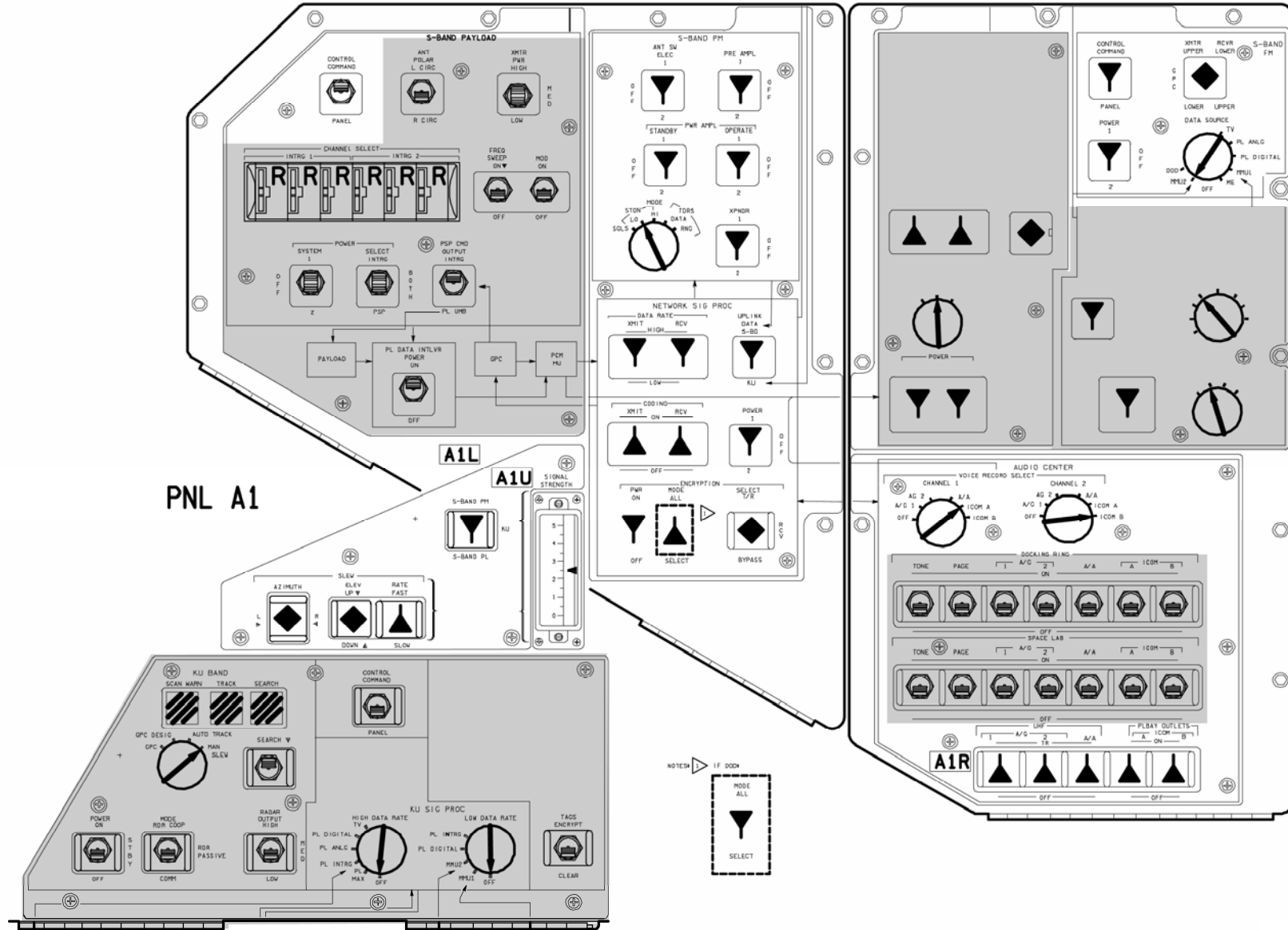

PNL A1

A1L

A1U

A1R

OV104

OV104

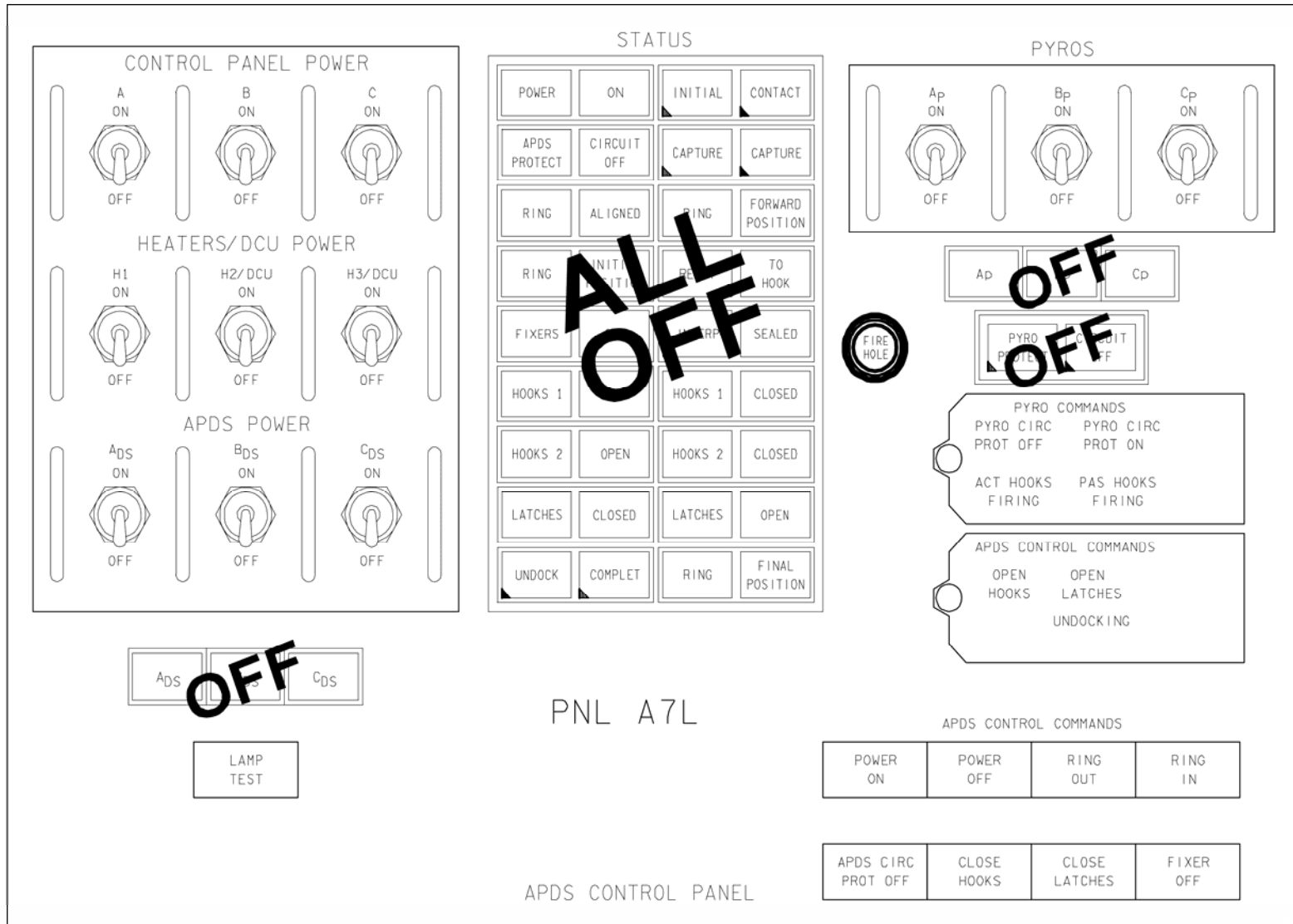

PNL A7L

APDS CONTROL PANEL

OV104

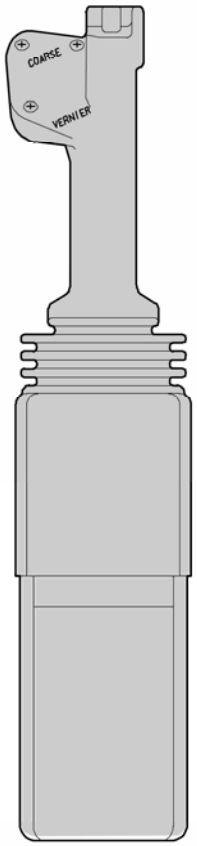
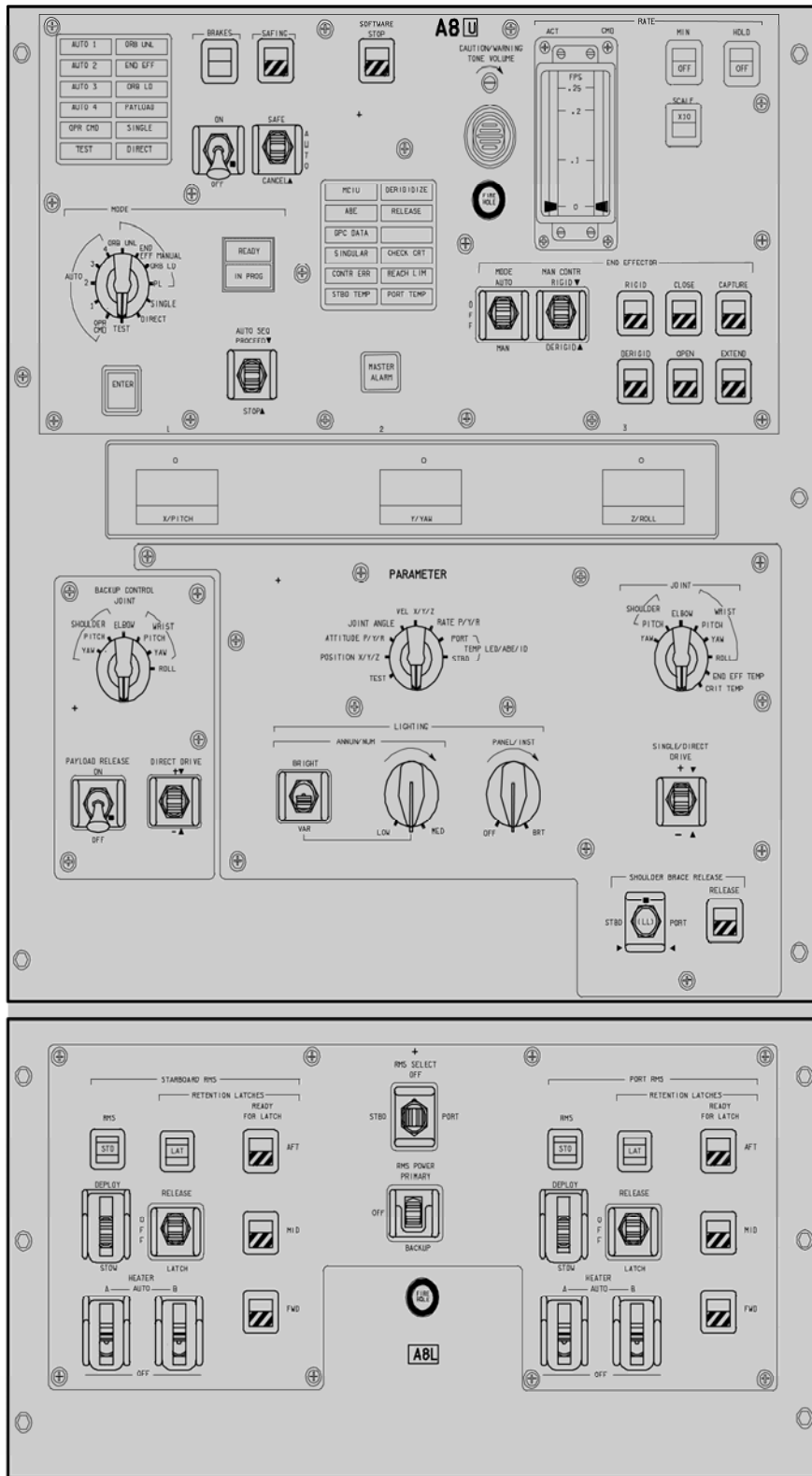

OV104

PNL A13

A11

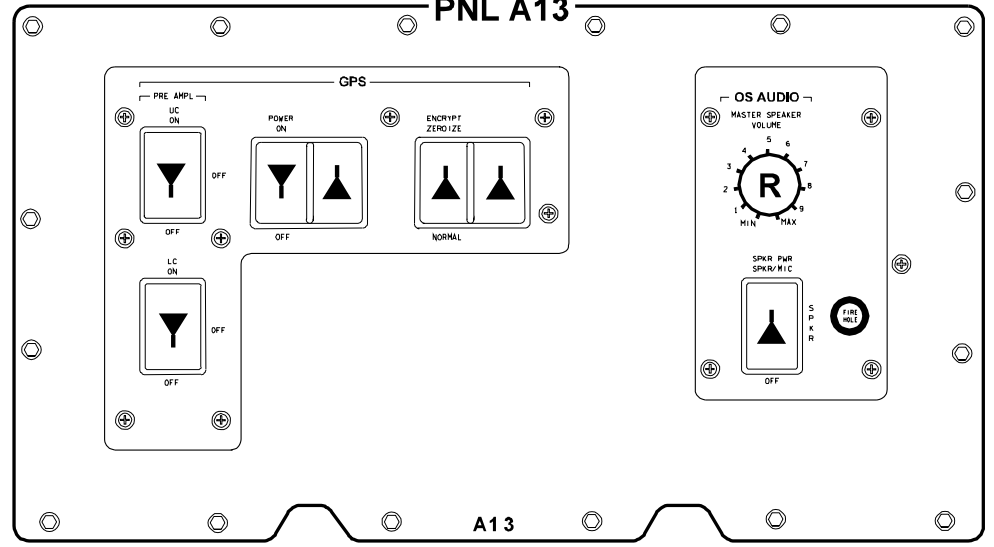
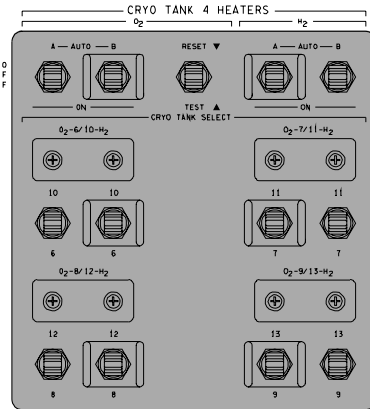

PNL A12

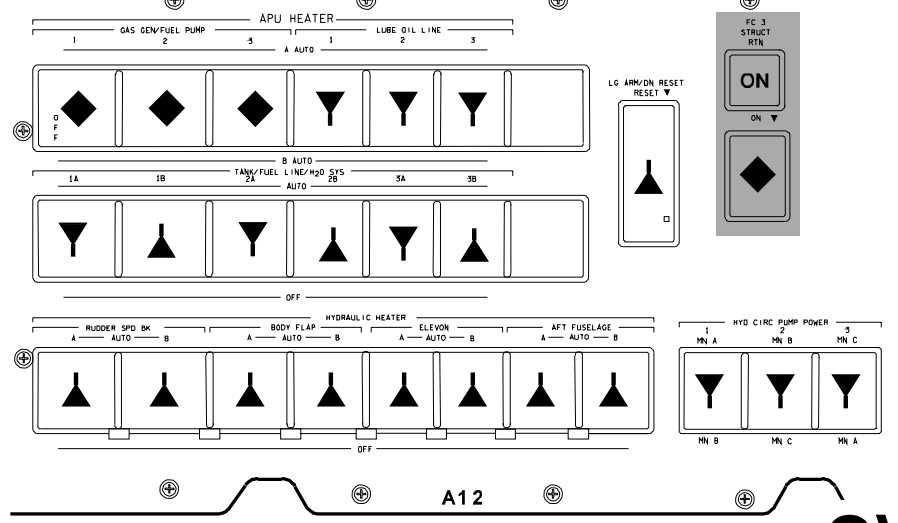

OV104

A6L

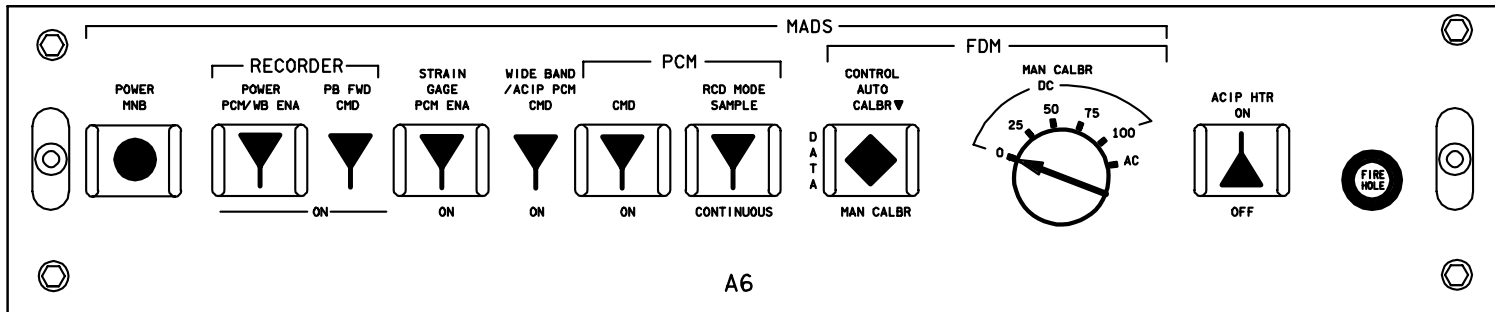
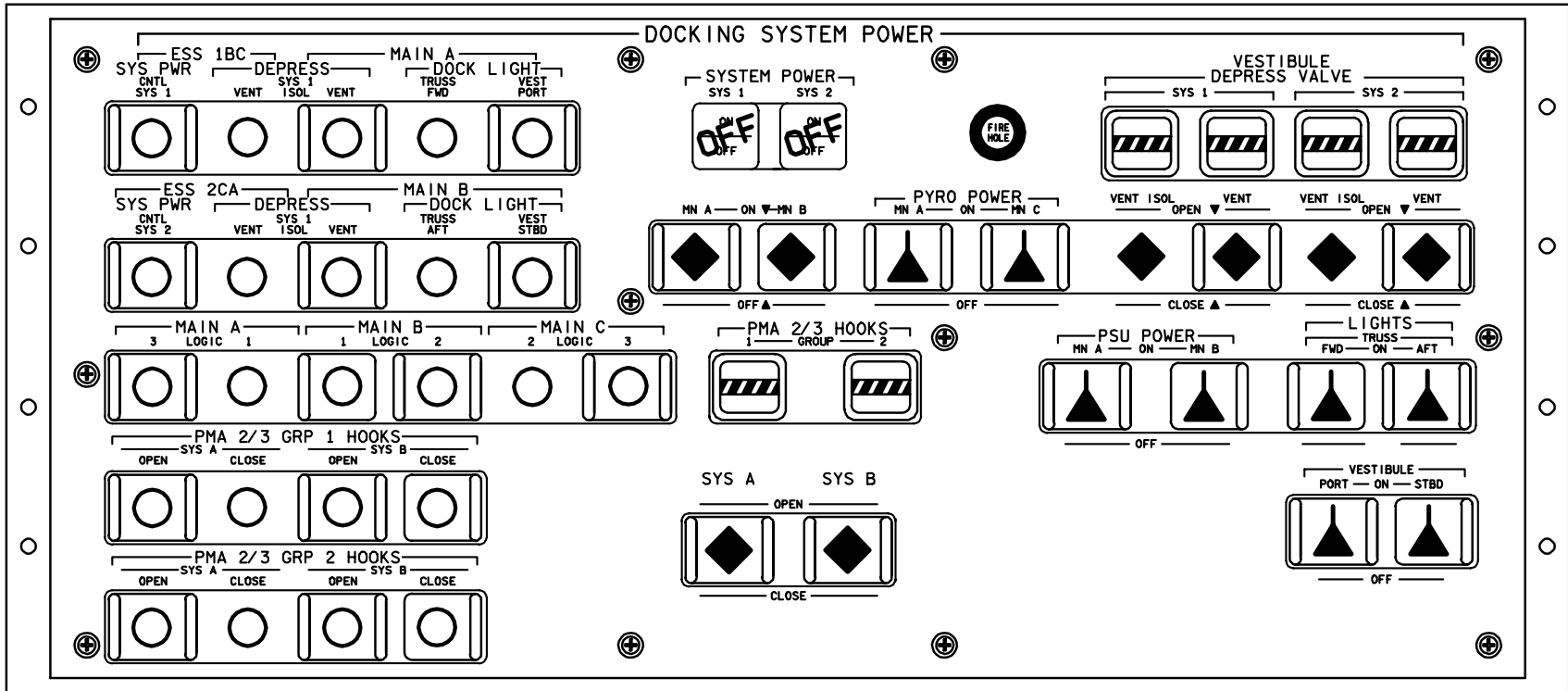

A6

OV104

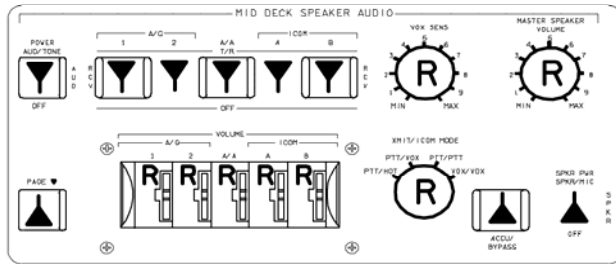

PNL M042F

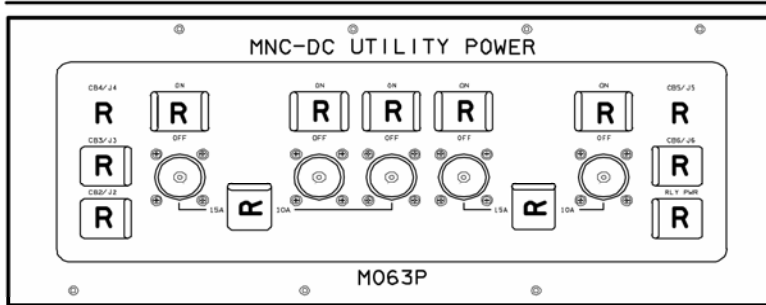
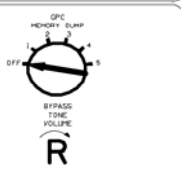

M063P

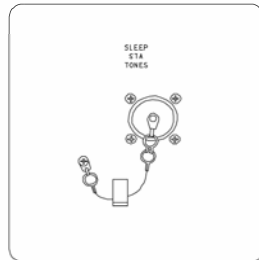

PNL M058F

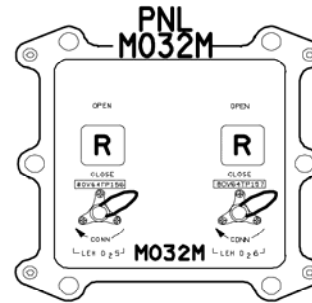

PNL M032M

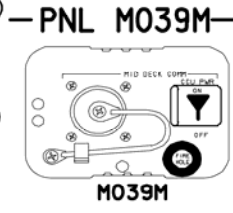

PNL M039M

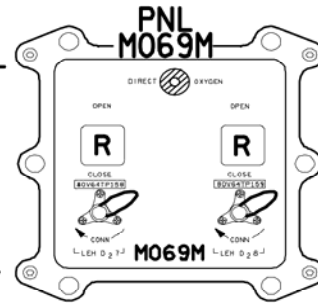

PNL M069M



PNL M029J

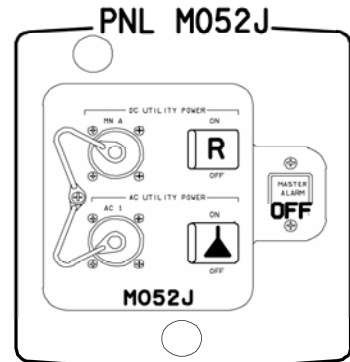

PNL M052J

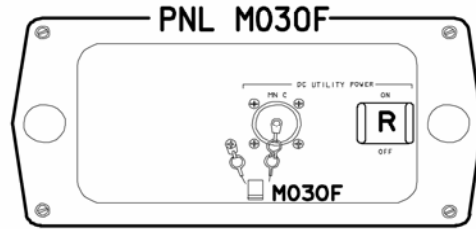

PNL M030F

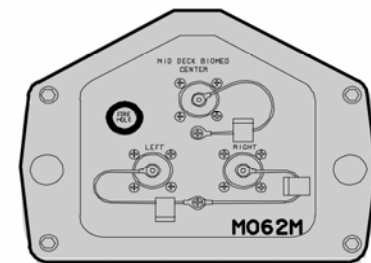

M062M

OV104

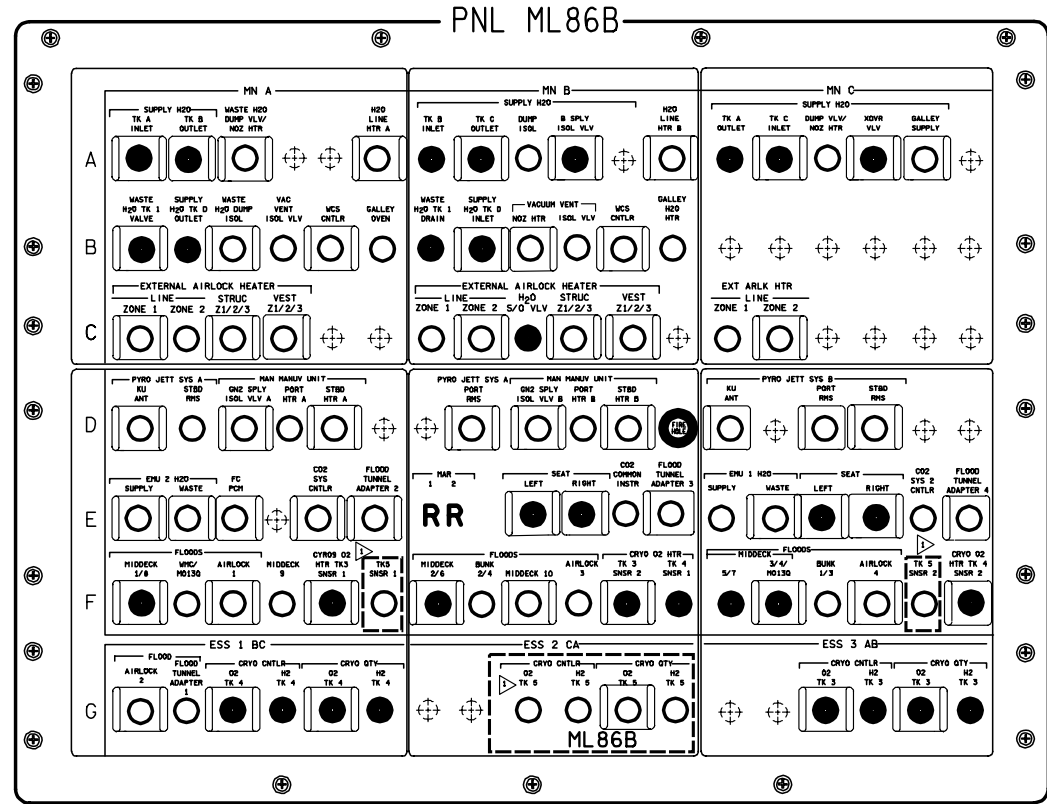
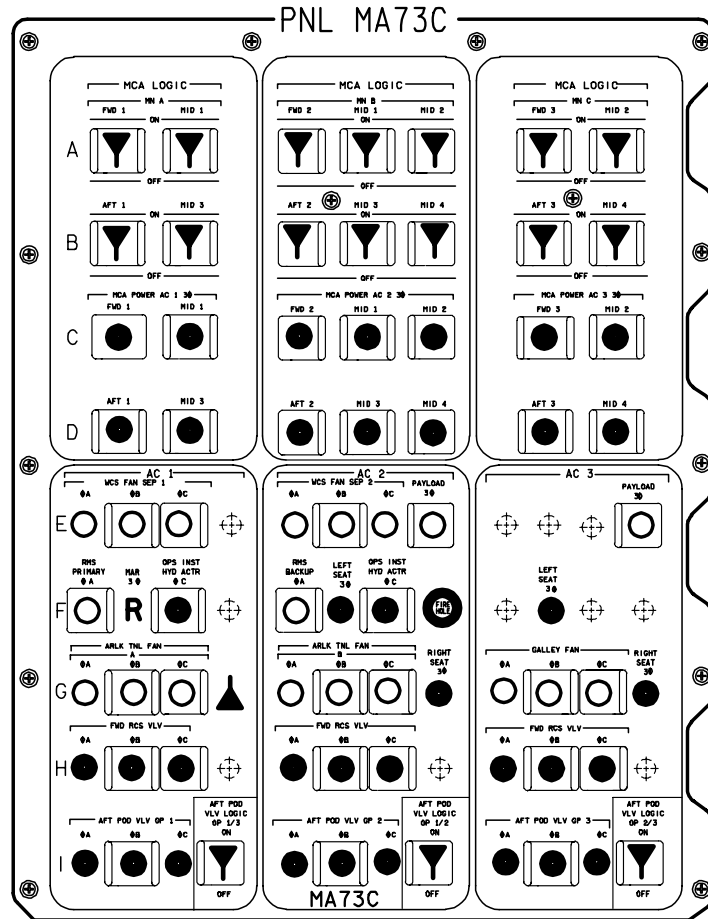

NOTES: ▷ CLOSED IF TK5 FLOWN

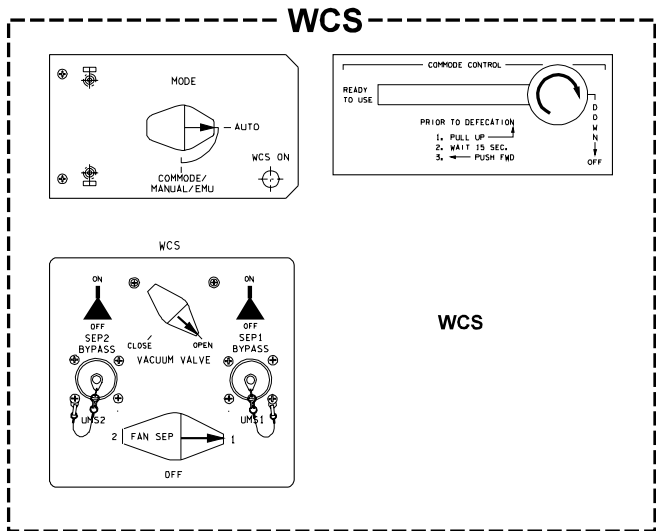
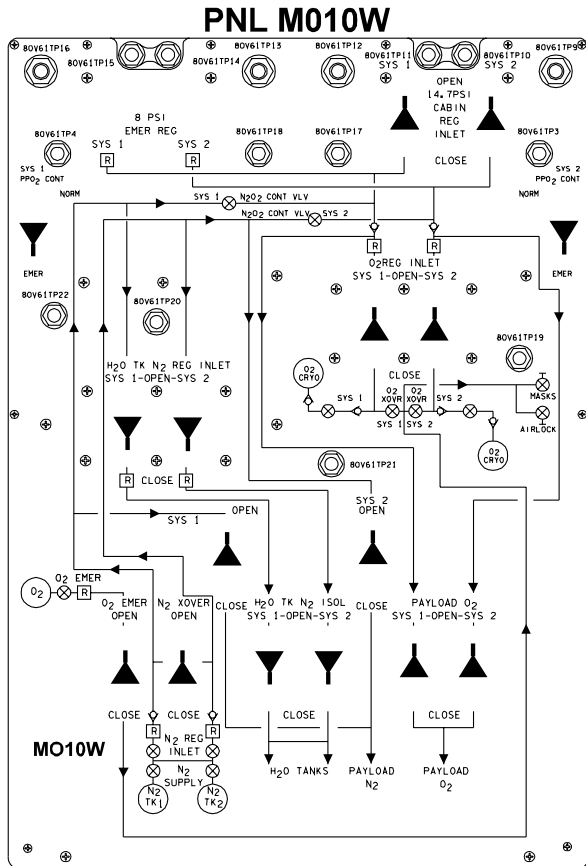

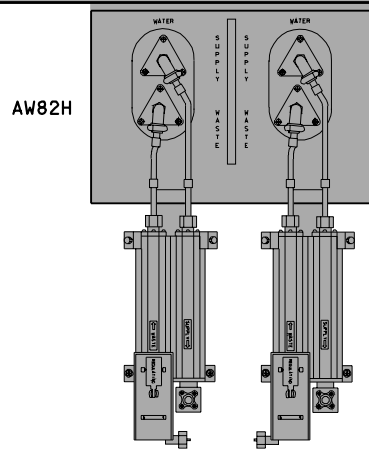
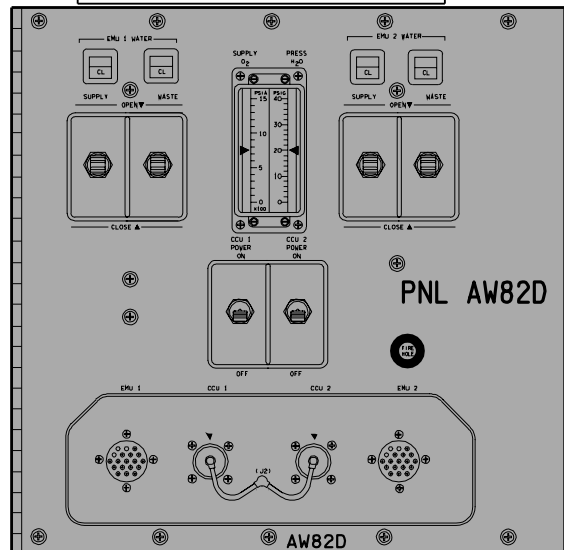
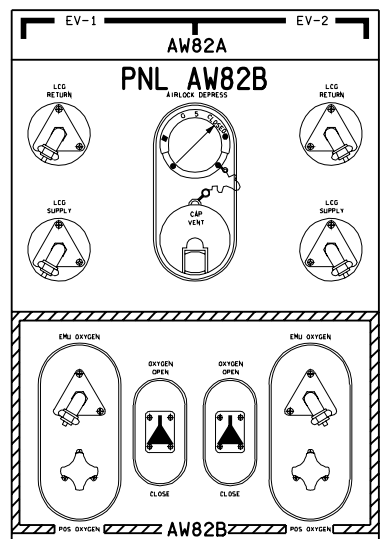
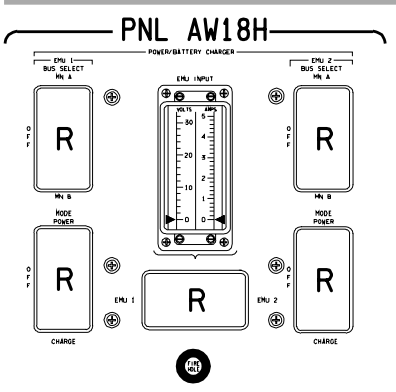
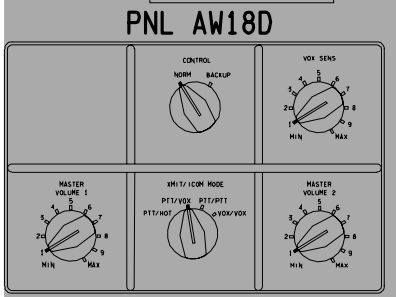
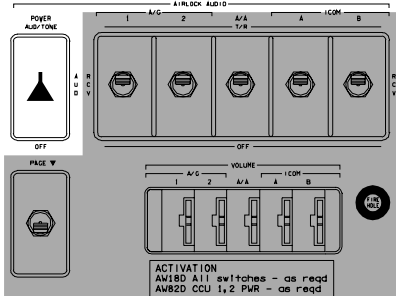
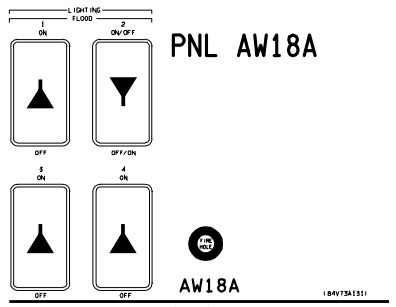

ALL VEH/DATE 07/15/05

48007F331_121_PNL_1

Inner Hatch

Actuator Handle – LATCHED

Lock Lever – LOCKED

Equalization vlv (two) – NORM, capped

OV105

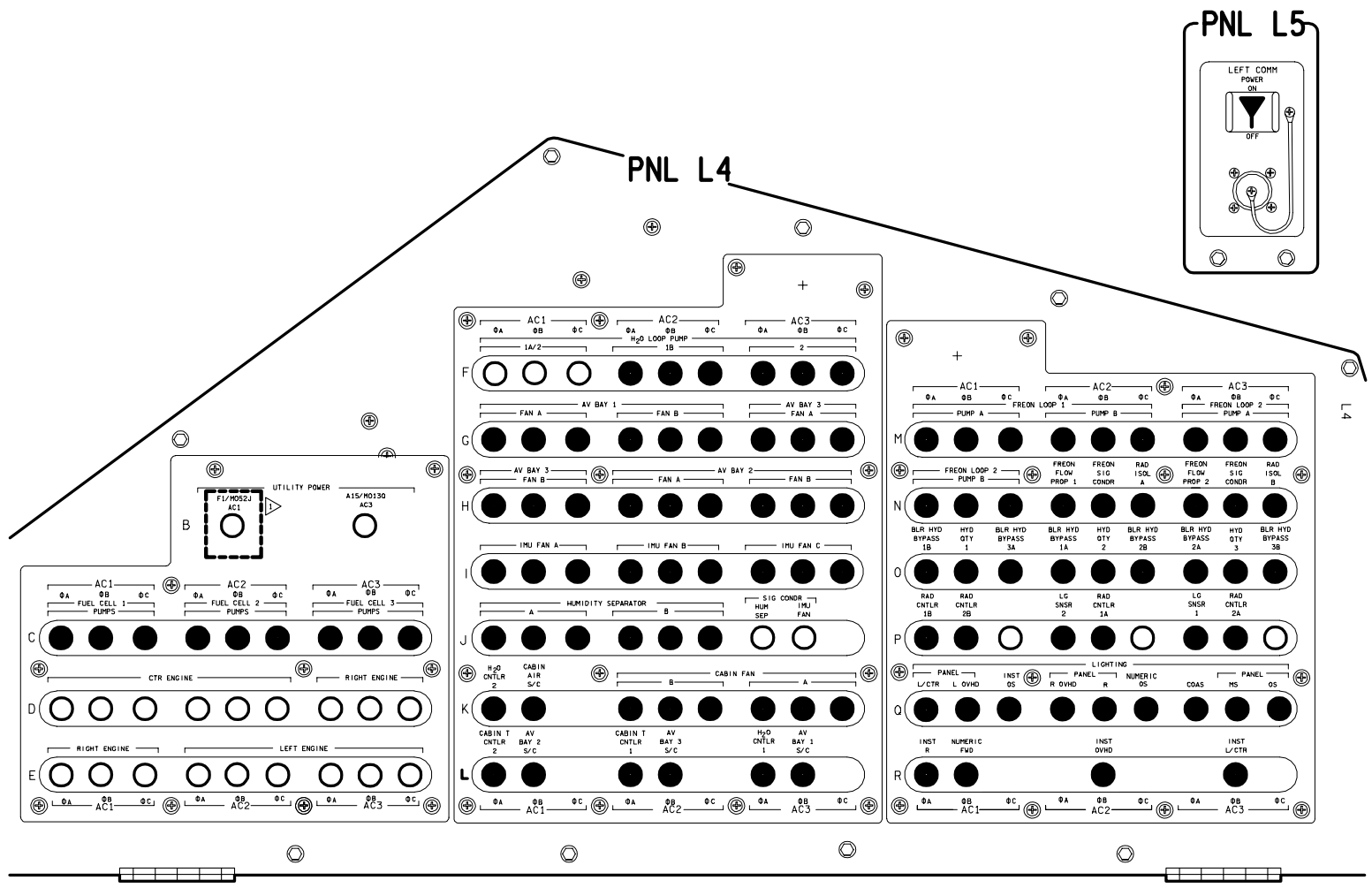

NOTE: ▸ CB CAN REMAIN CLOSED FOR AC PGSC USAGE.
 CLOSED WHEN PGSC UNPOWERED/STOWED

OV105

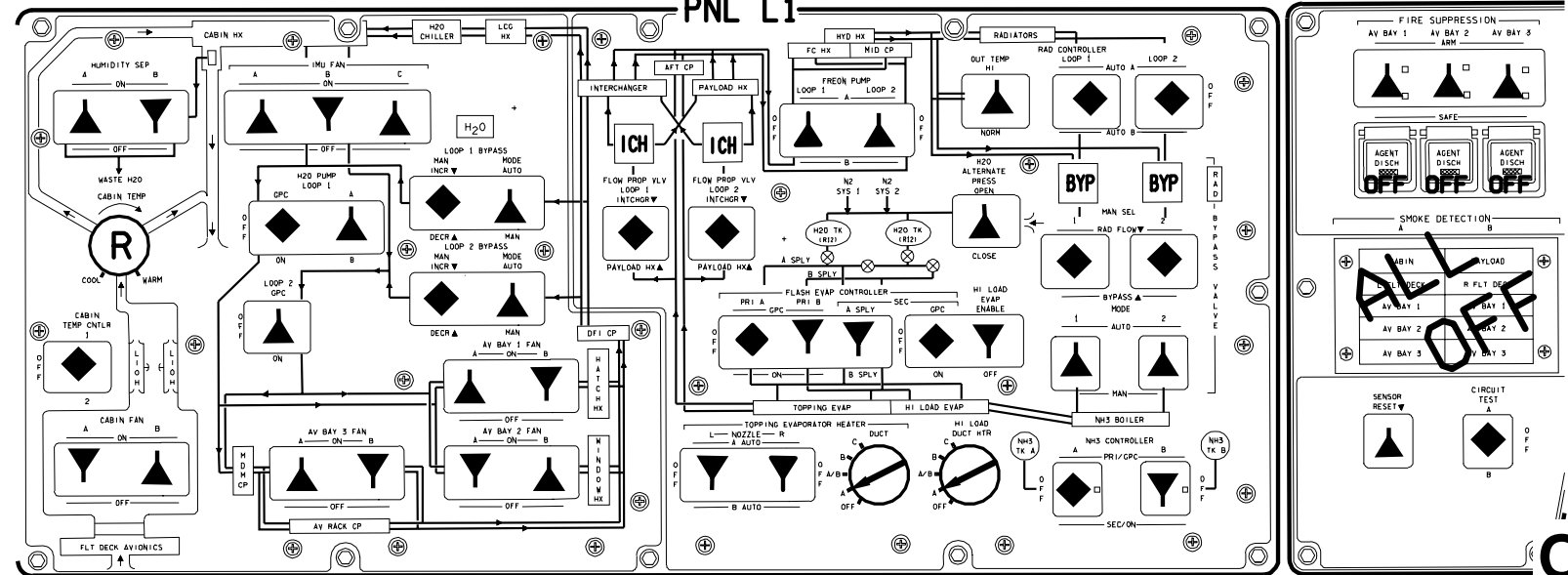
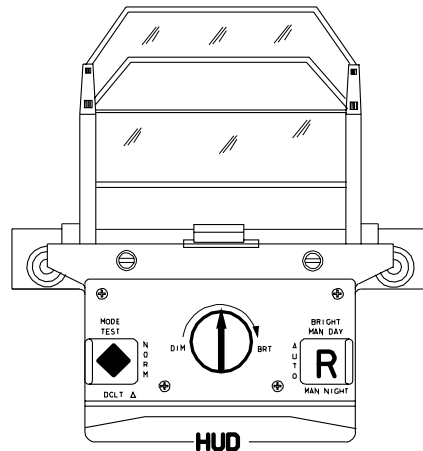
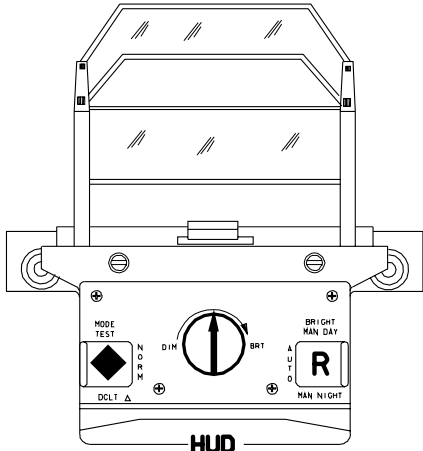
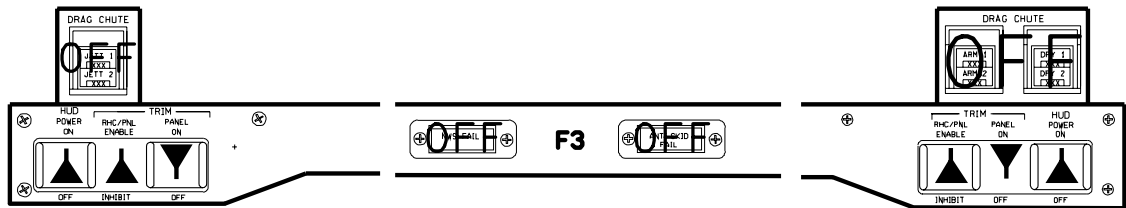

OV105

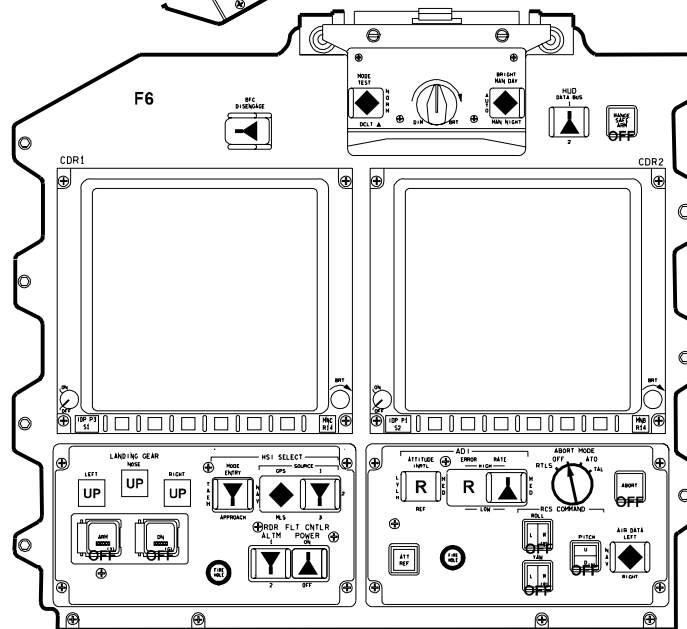
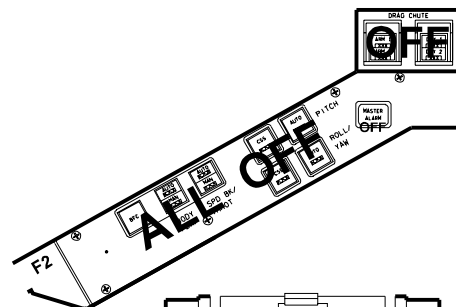
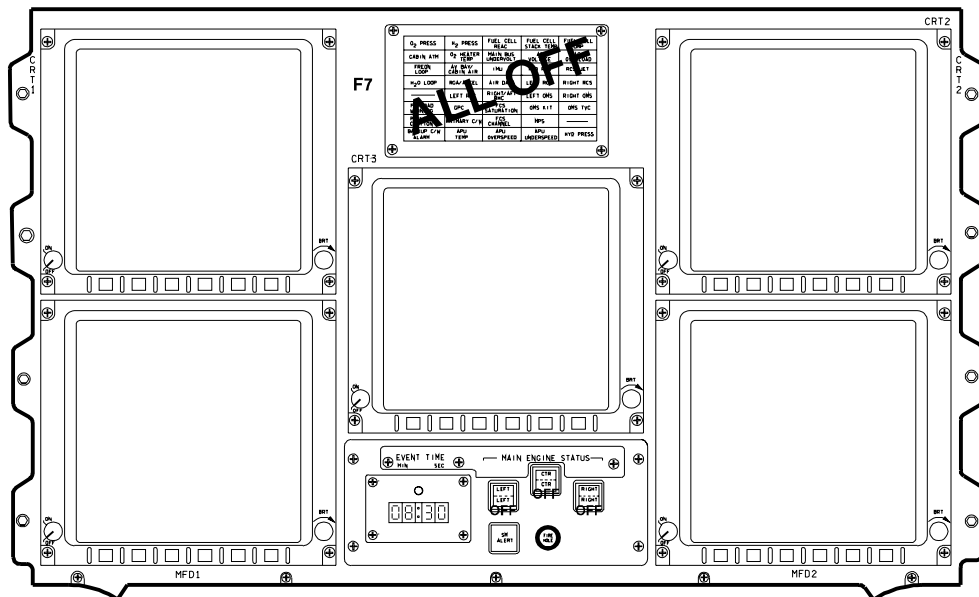

OV105/DATE 04/20/07

480076306-118_PNL2

PNL C2/C3

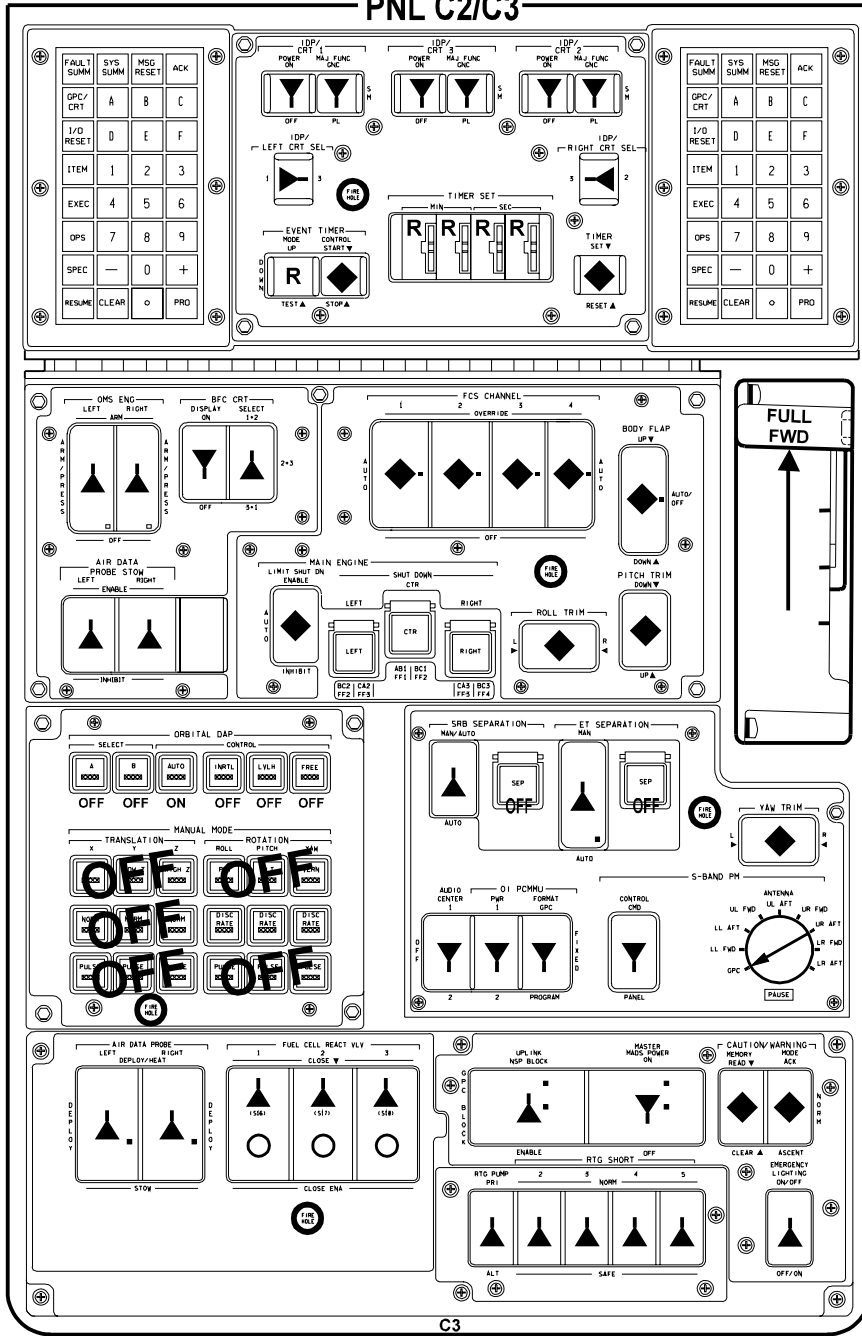

C3

OV105

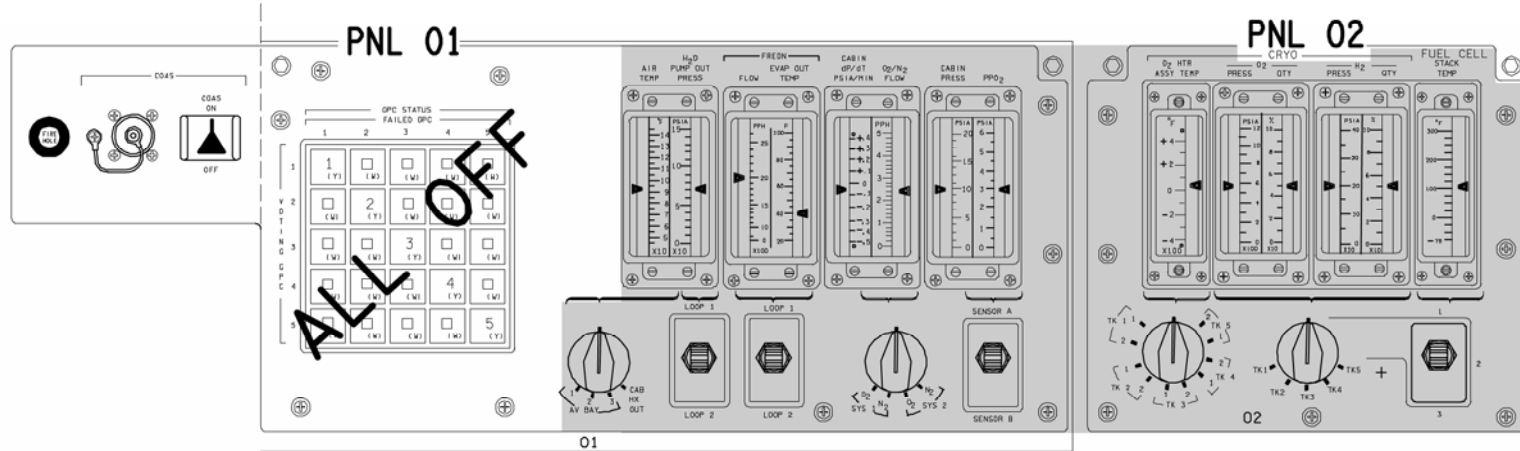

L side OVHD flood - R (MID)

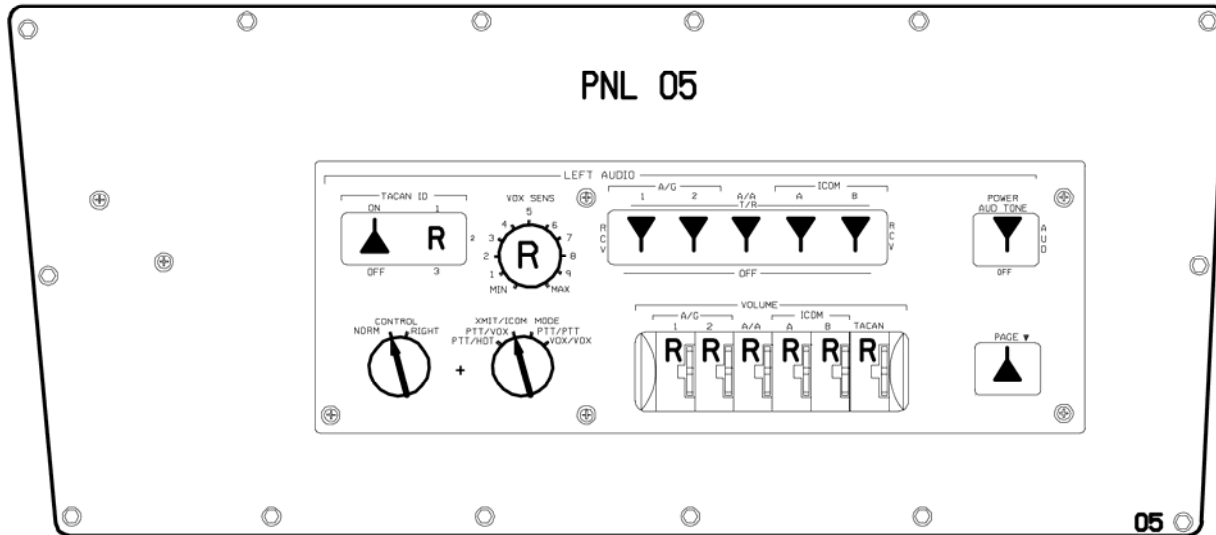

OV105

PNL 06

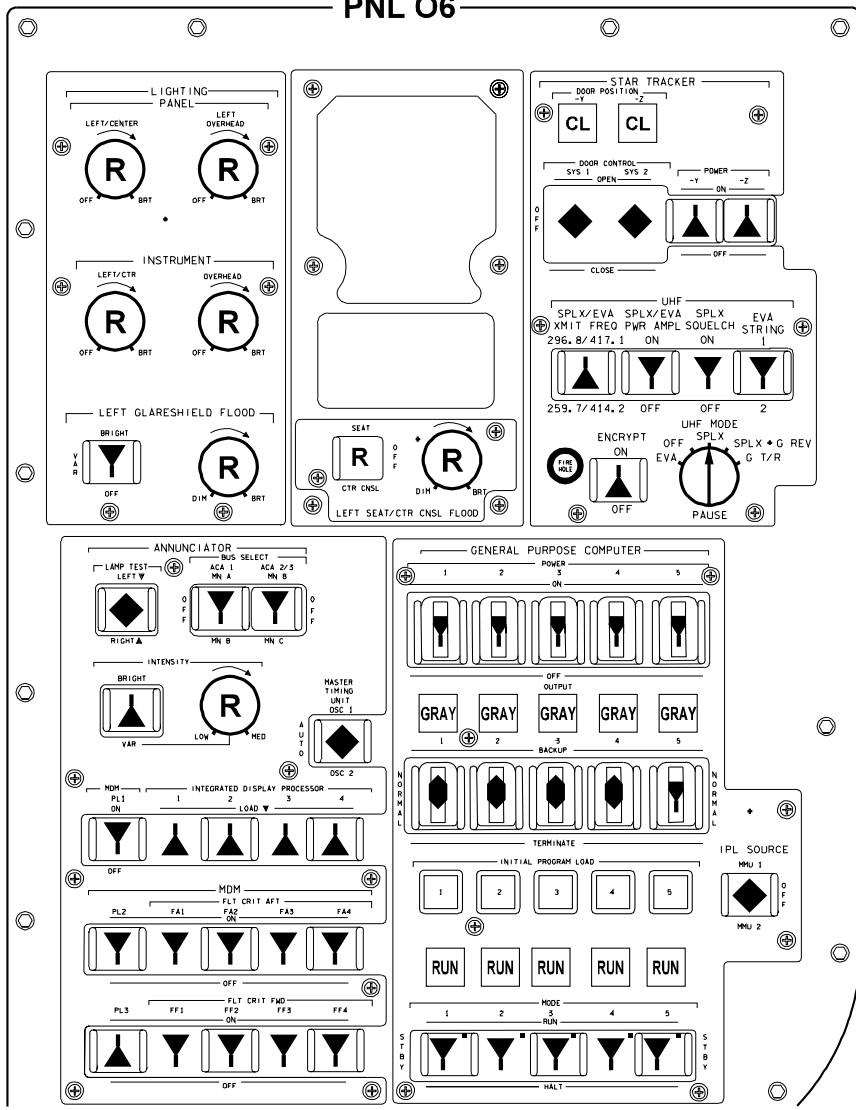

PNL 07

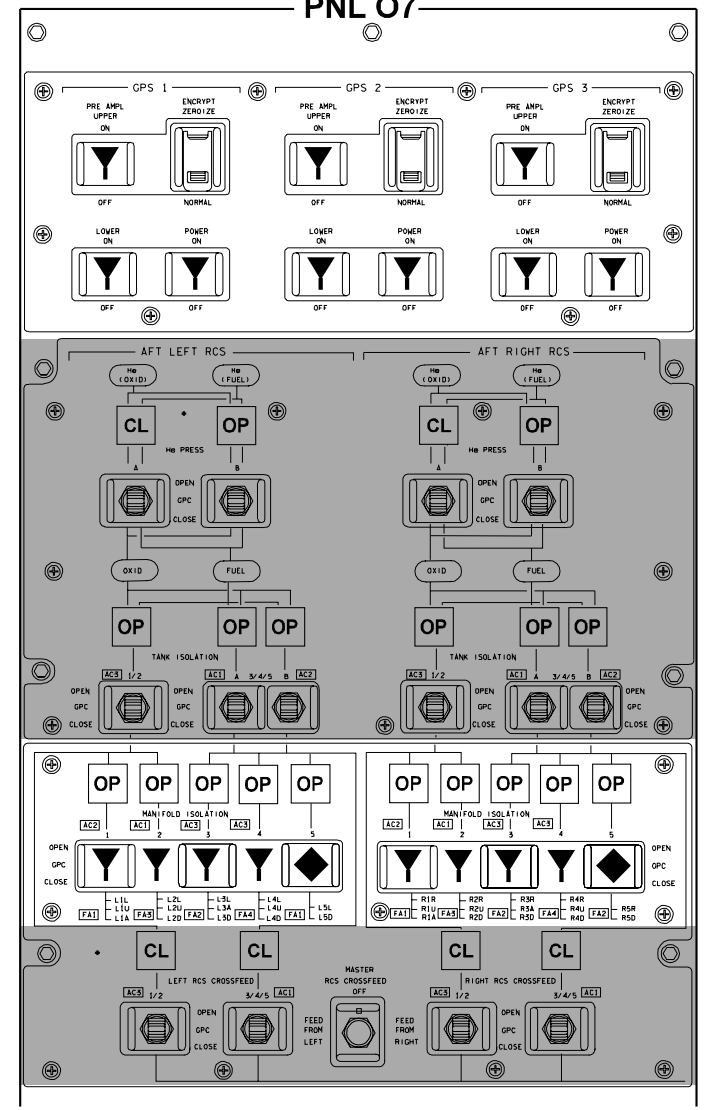

48007G309_118, PNL 2

OV105

OV105/DATE 03/23/07

(OV105) C3-9

C D/O/5/GEN L

PNL 08

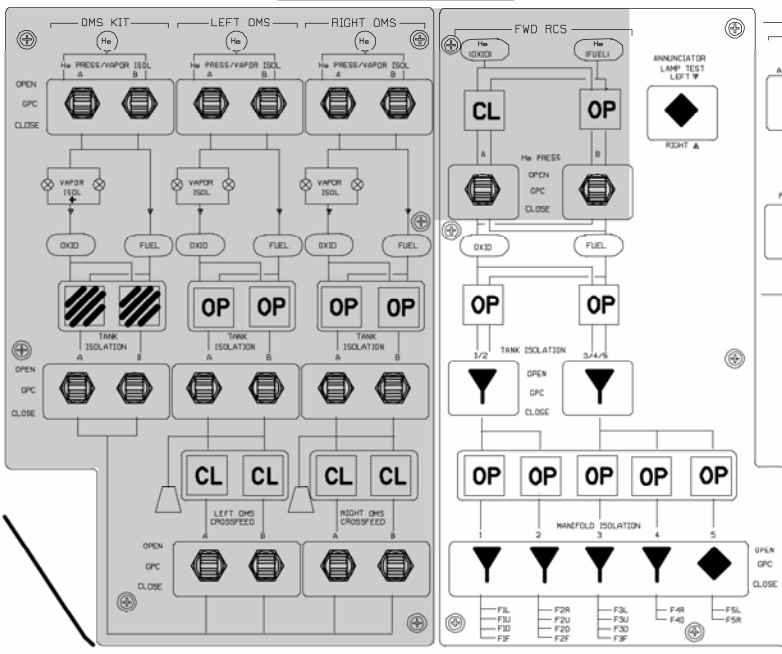
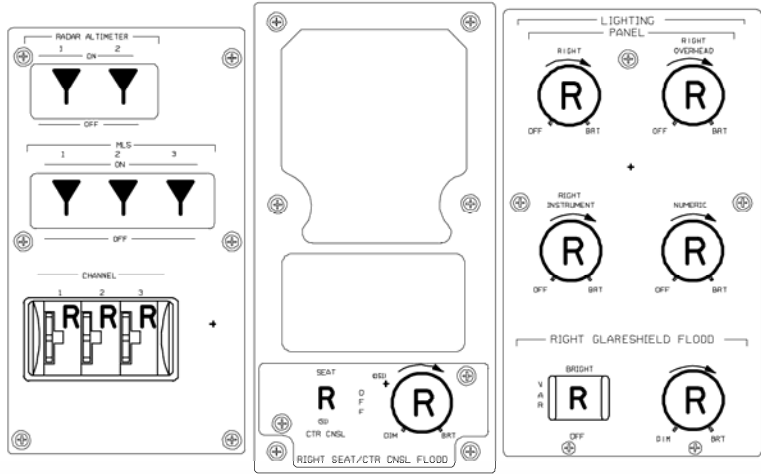

PNL 09

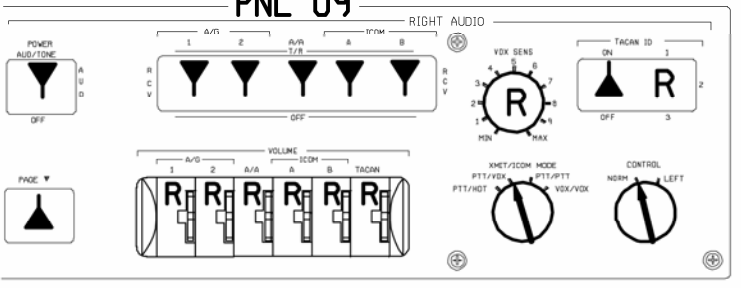

R side OVHD flood - R (MID)

PNL R1

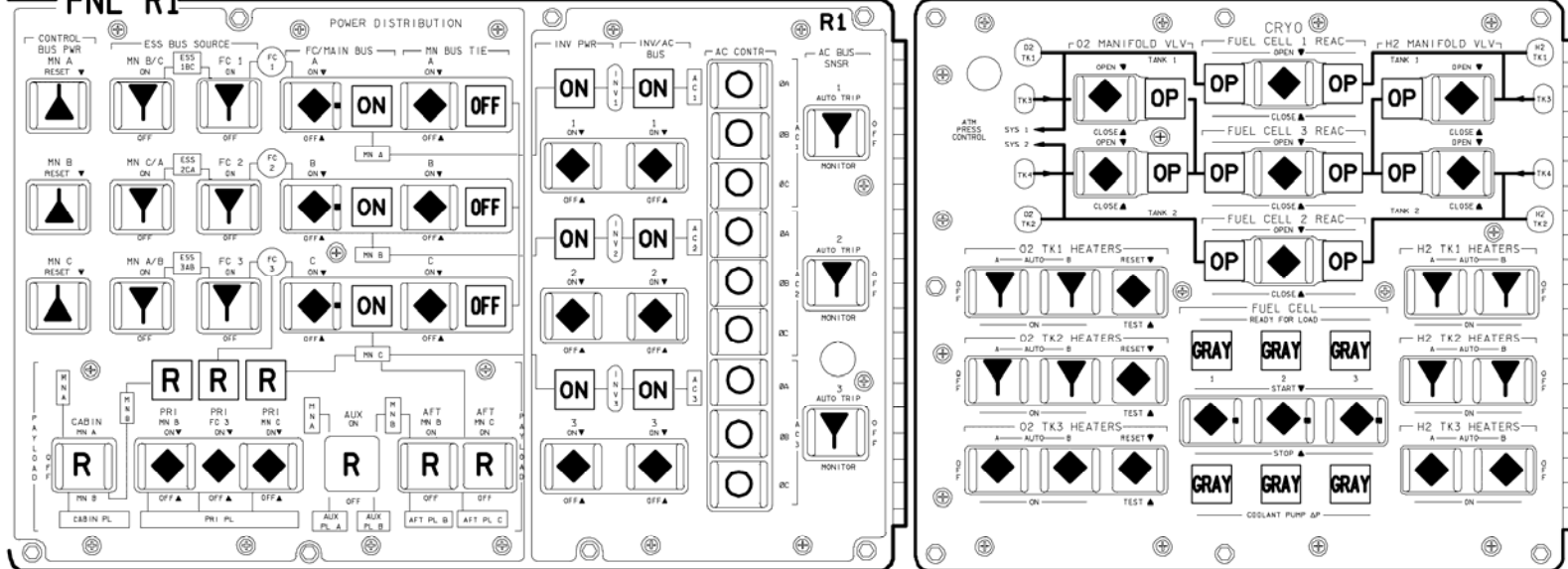

48007D312_107, PNL, 1

OV105

ALL VEH/DATE 10/03/02

(OV105) C3-12

C D/O/ALL/GEN L

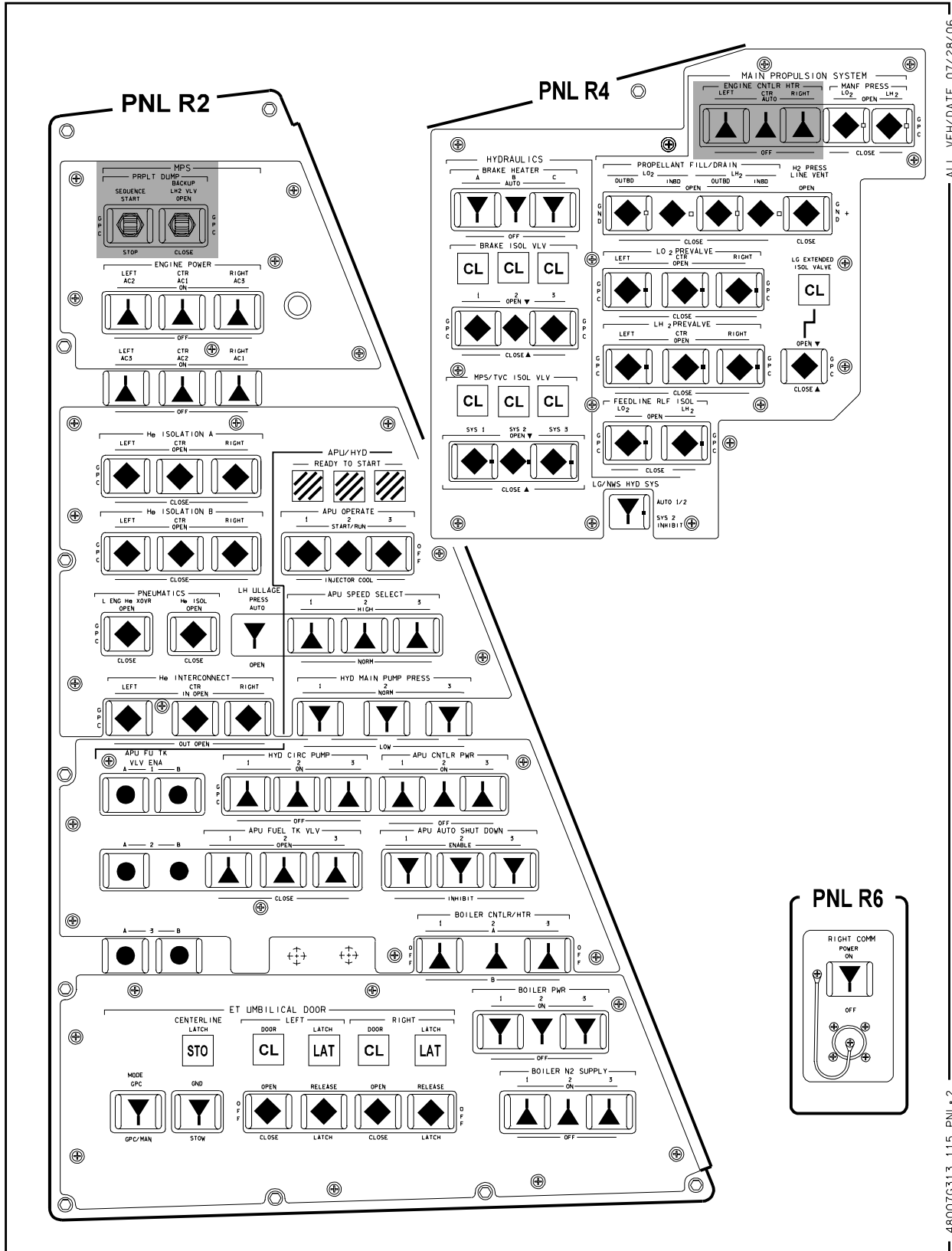

This Page Intentionally Blank

OV105

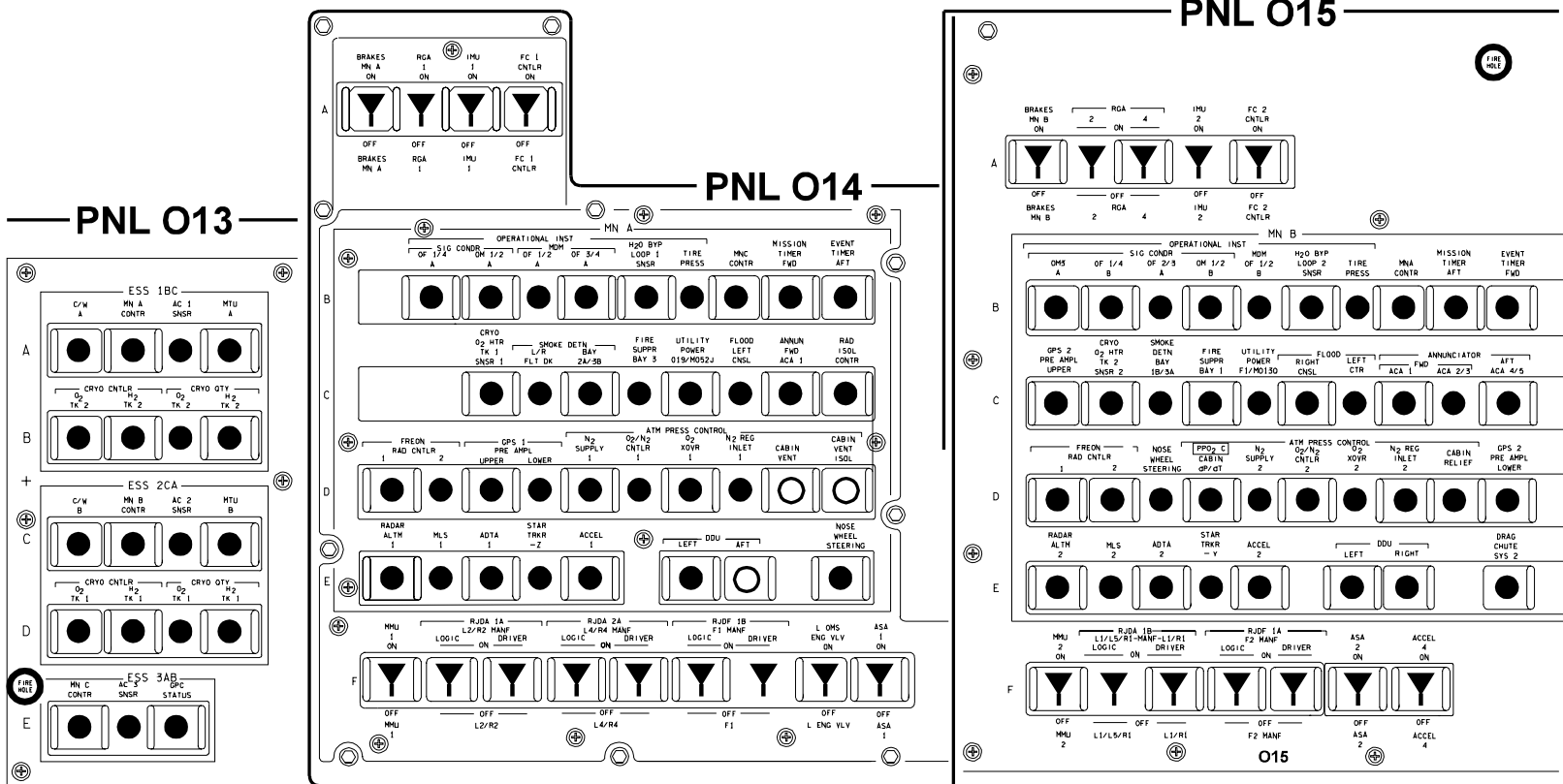

OV105

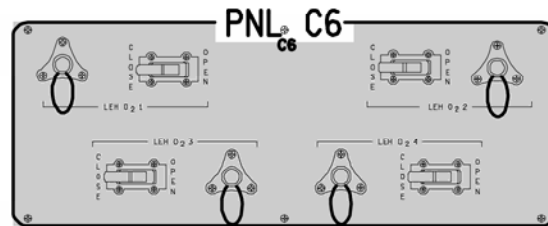
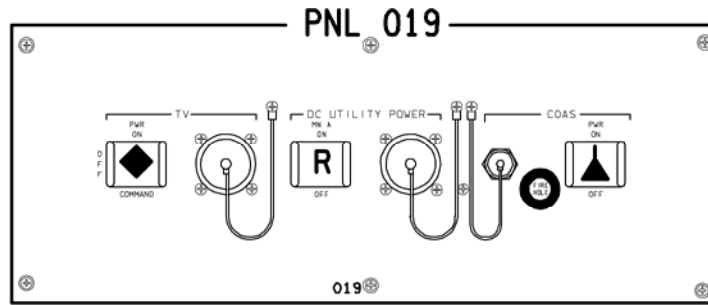

PNL C5



PNL C7

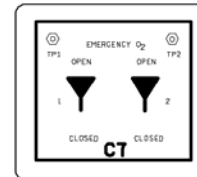

OV105

OV105

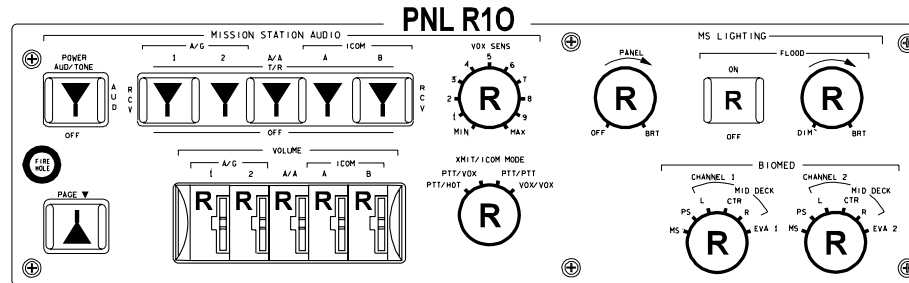

ACTIVATION
 R10 MS AUD PWR - AUD/TONE
 All other sws - as reqd
 R12 MS AUD CNTRL - NORM
 A11 MS COMM CCU PWR - ON

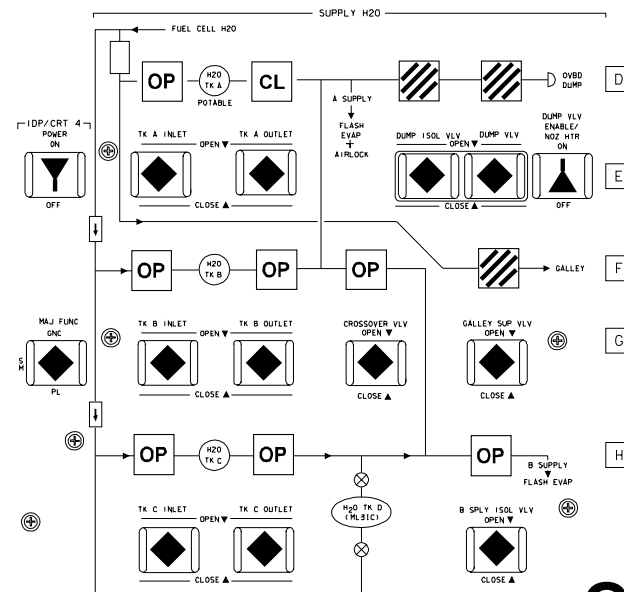
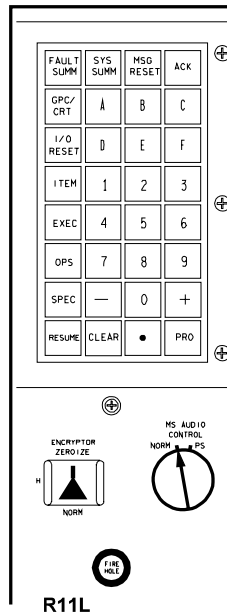
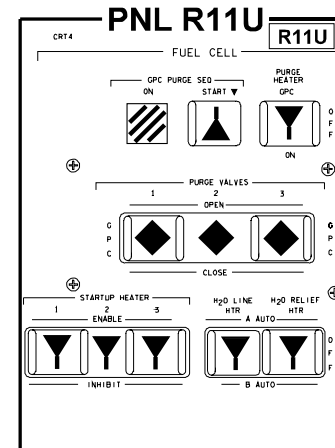

OV105

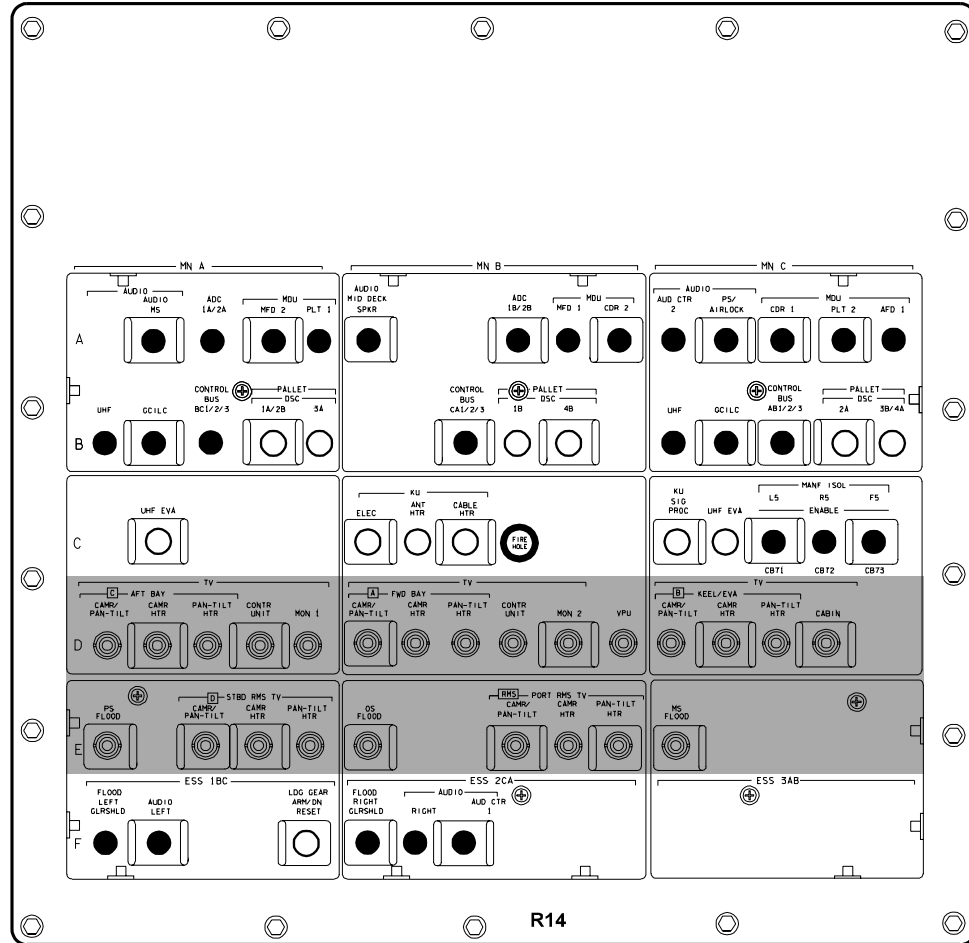
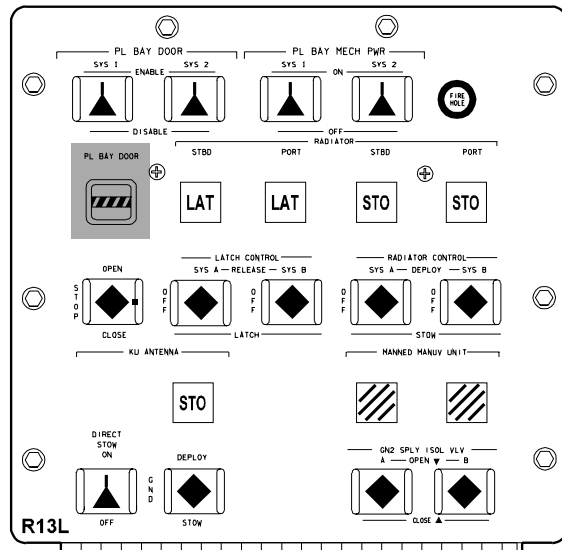
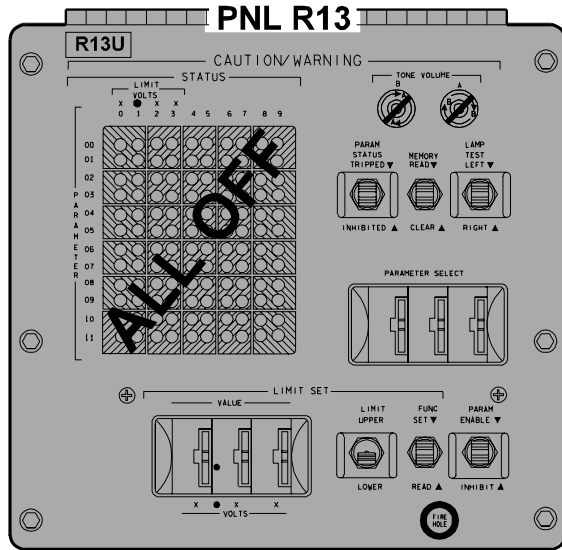

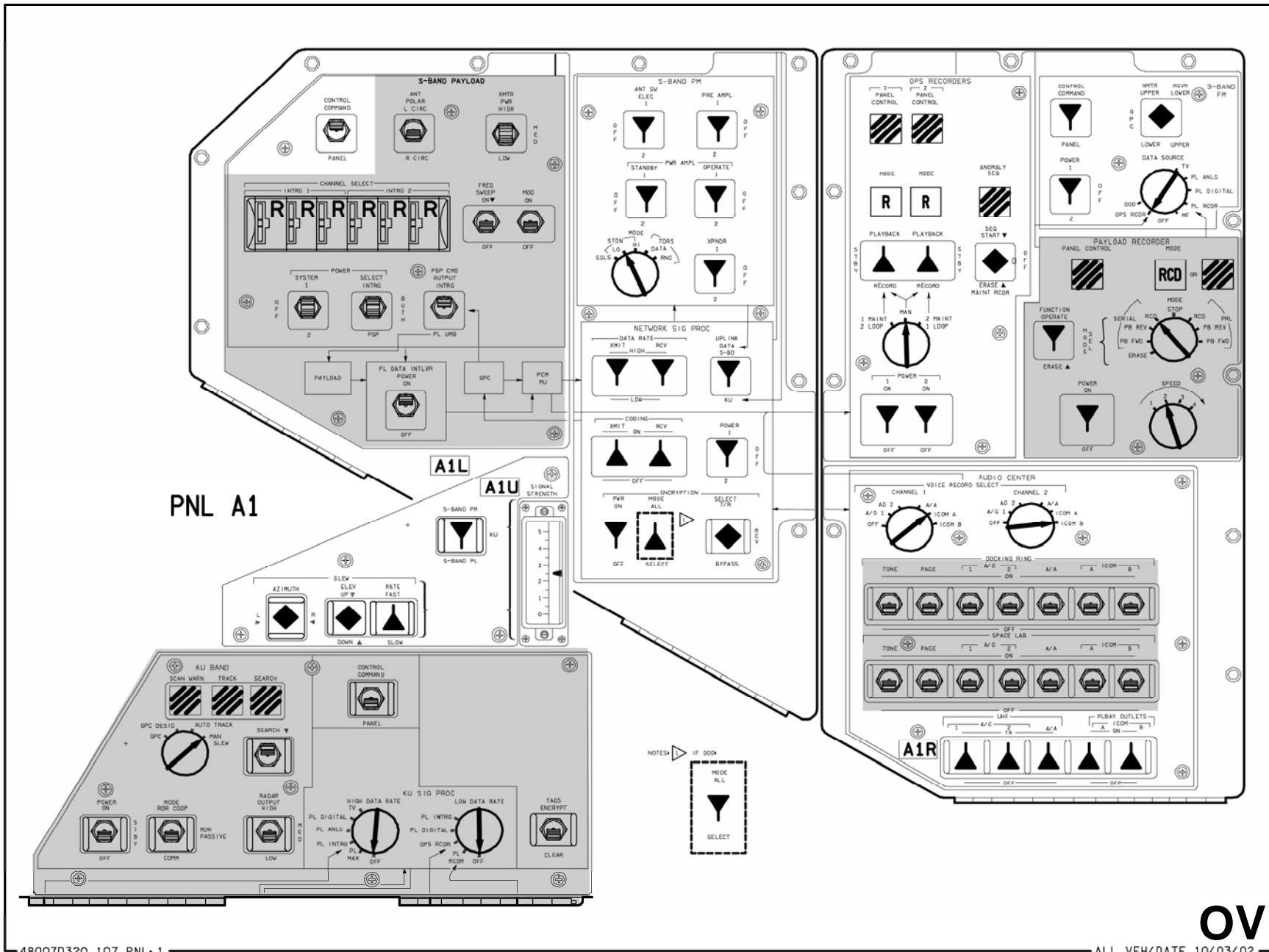

48007D320_107. PNL 1

ALL VEH/DATE 10/03/02

OV105

(OV105) C3-20

C D/O/ALL/GEN L

OV105

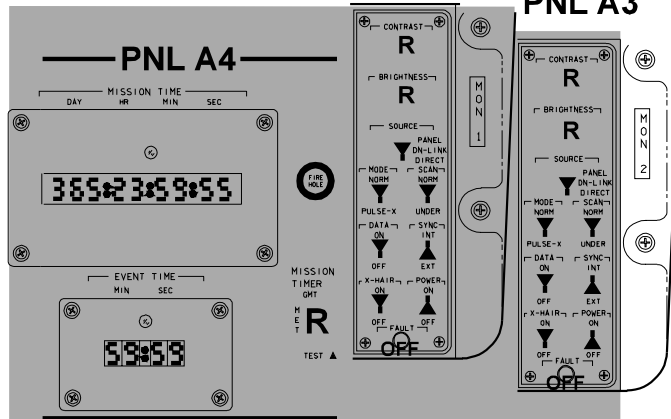

PNL A3

PNL A6U

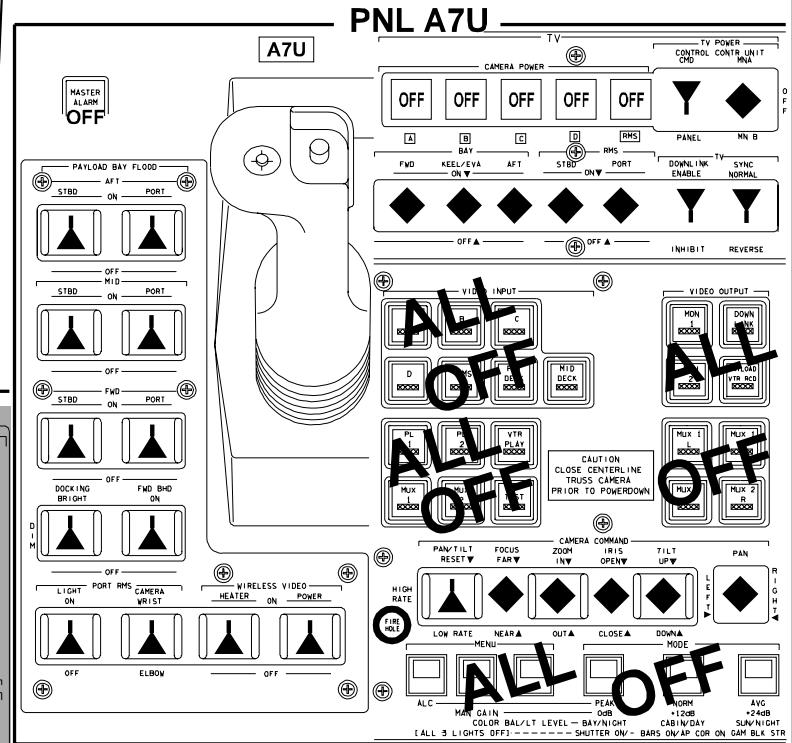
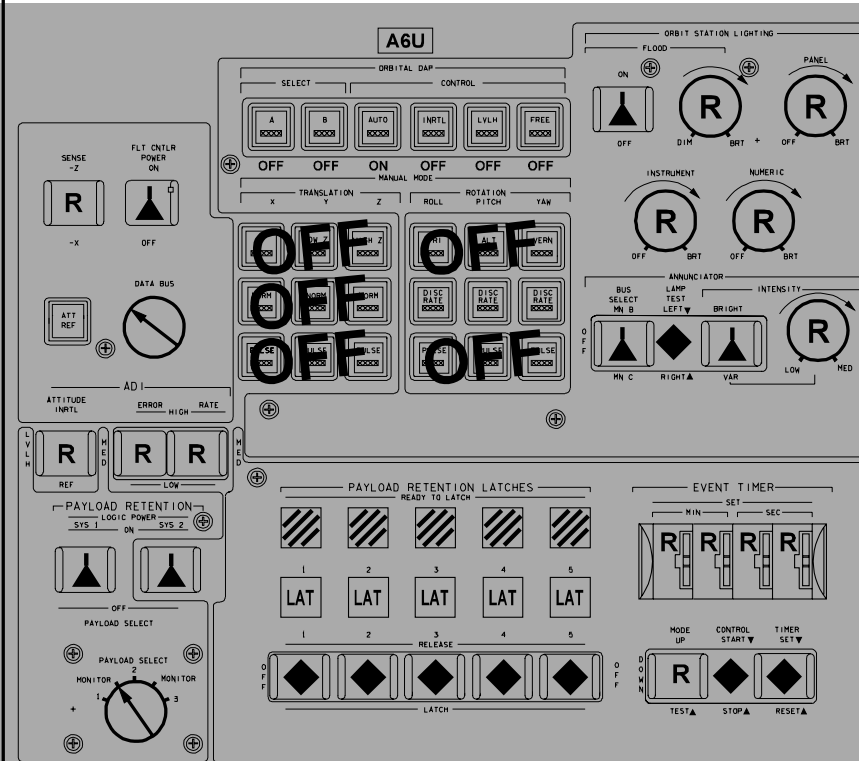

PNL A7U

OV105

OV105

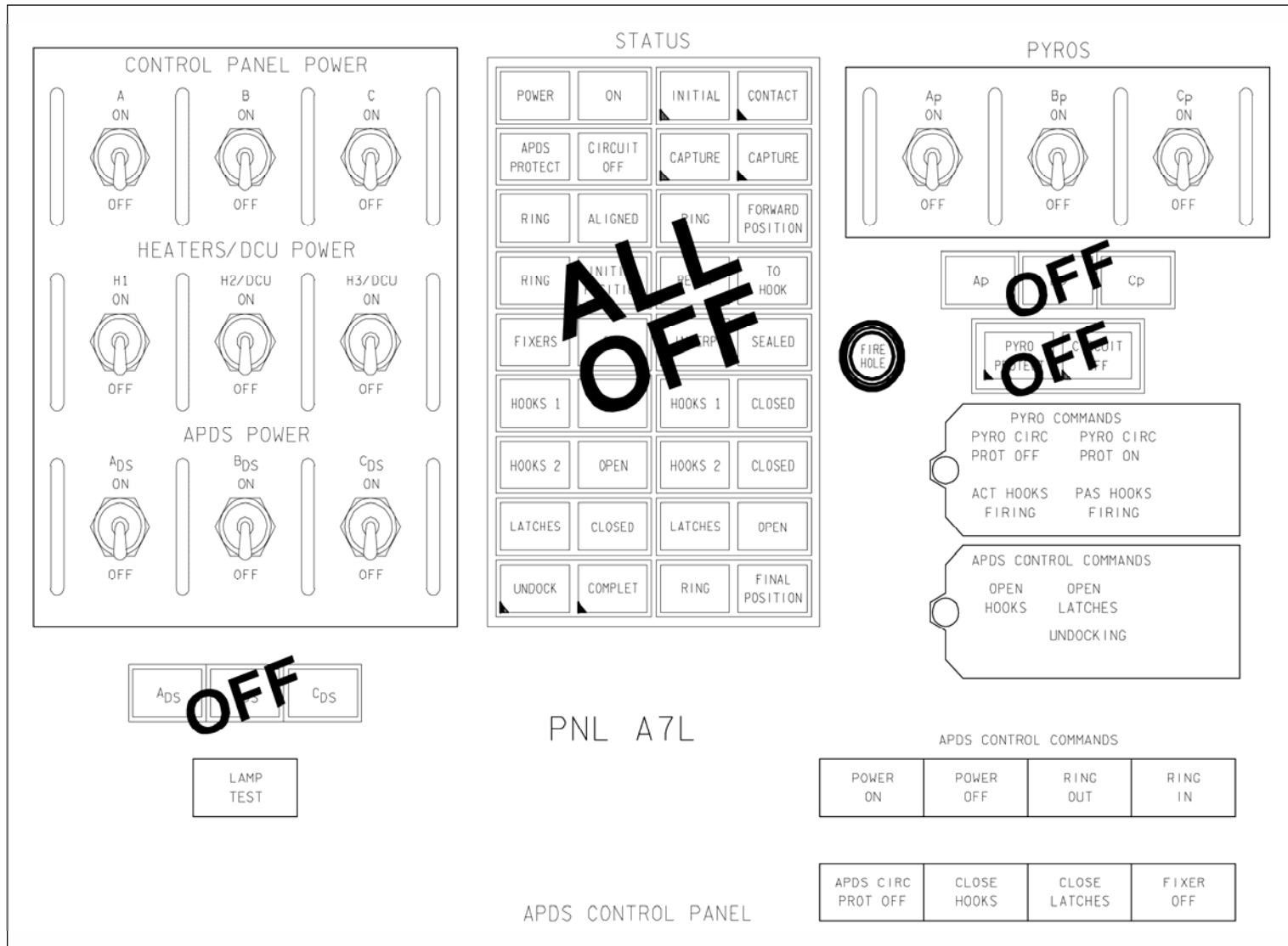

ALL OFF

OFF OFF

OFF

OV105

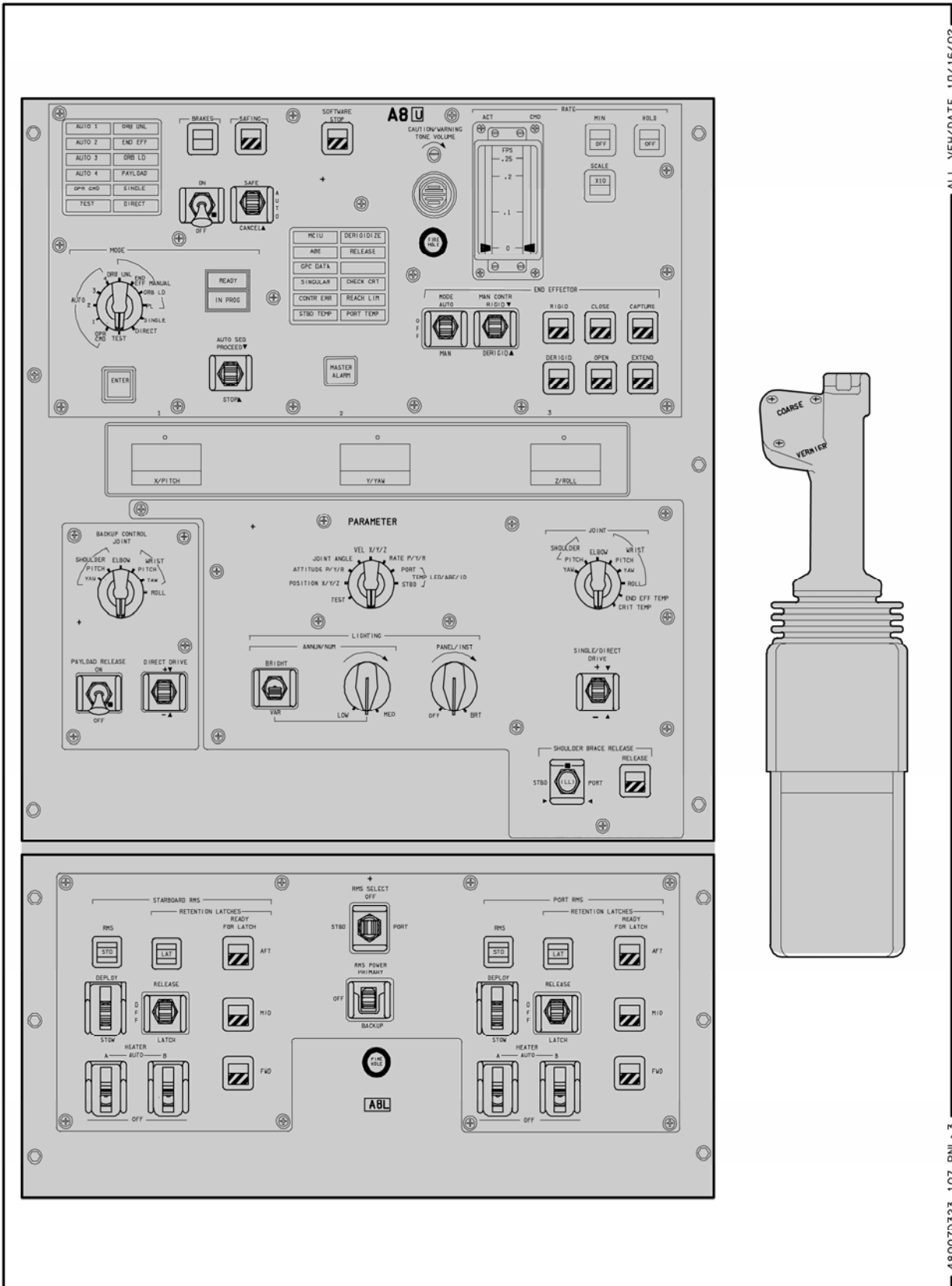

ALL VEH/DATE 10/16/02

48007323_107_PNL 3

OV105

PNL A11

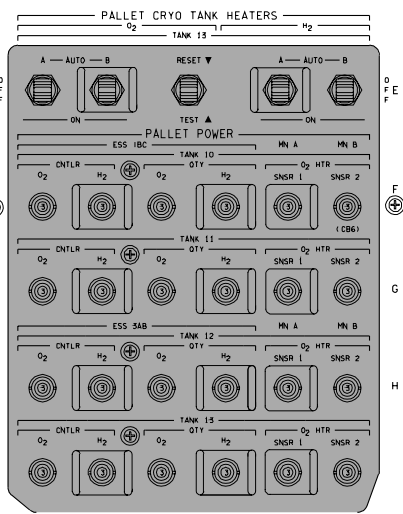
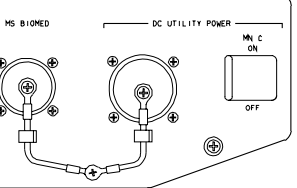
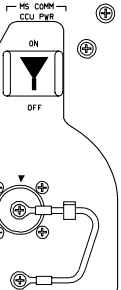
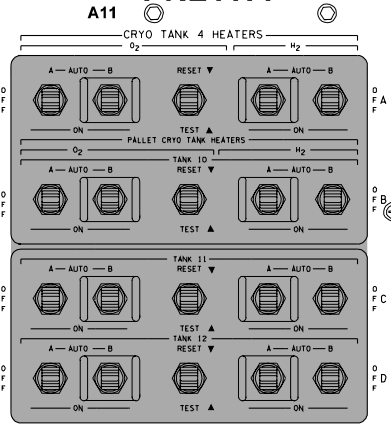

PNL A13

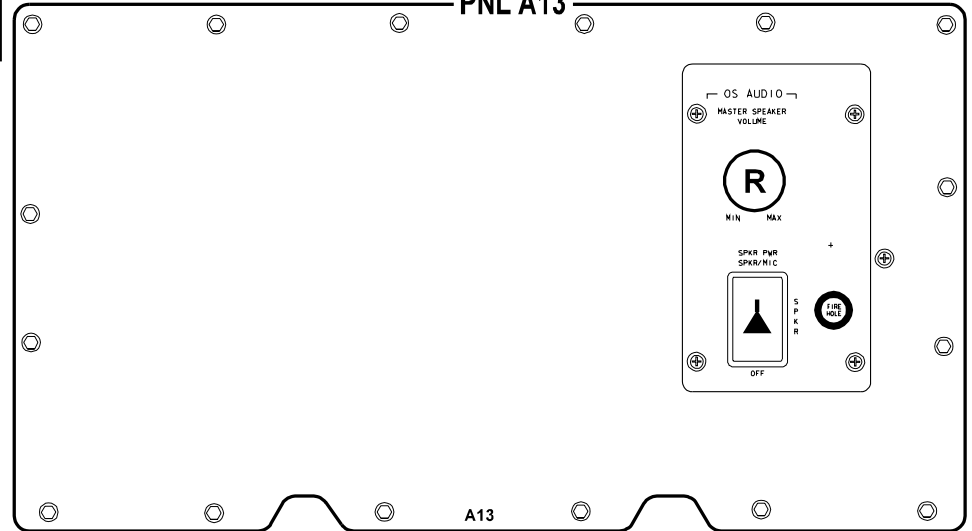

PNL A12

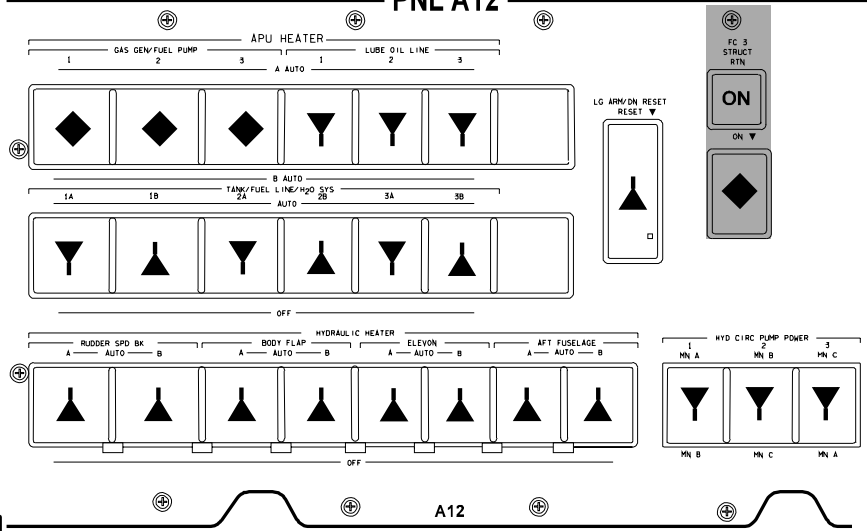

48007G324_115, PNL 1

OV105/DATE 06/21/06

(OV105) C3-24

OV105

C D/O/5/GEN L

A6L

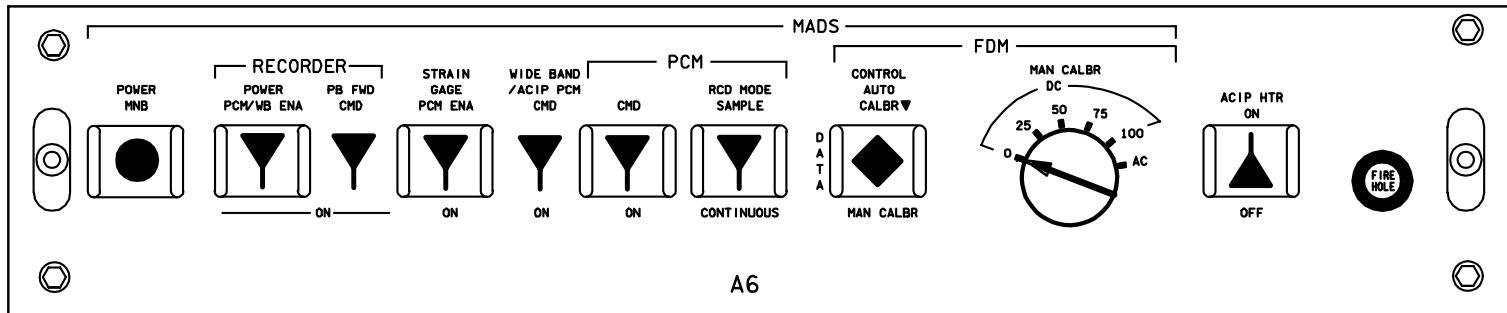
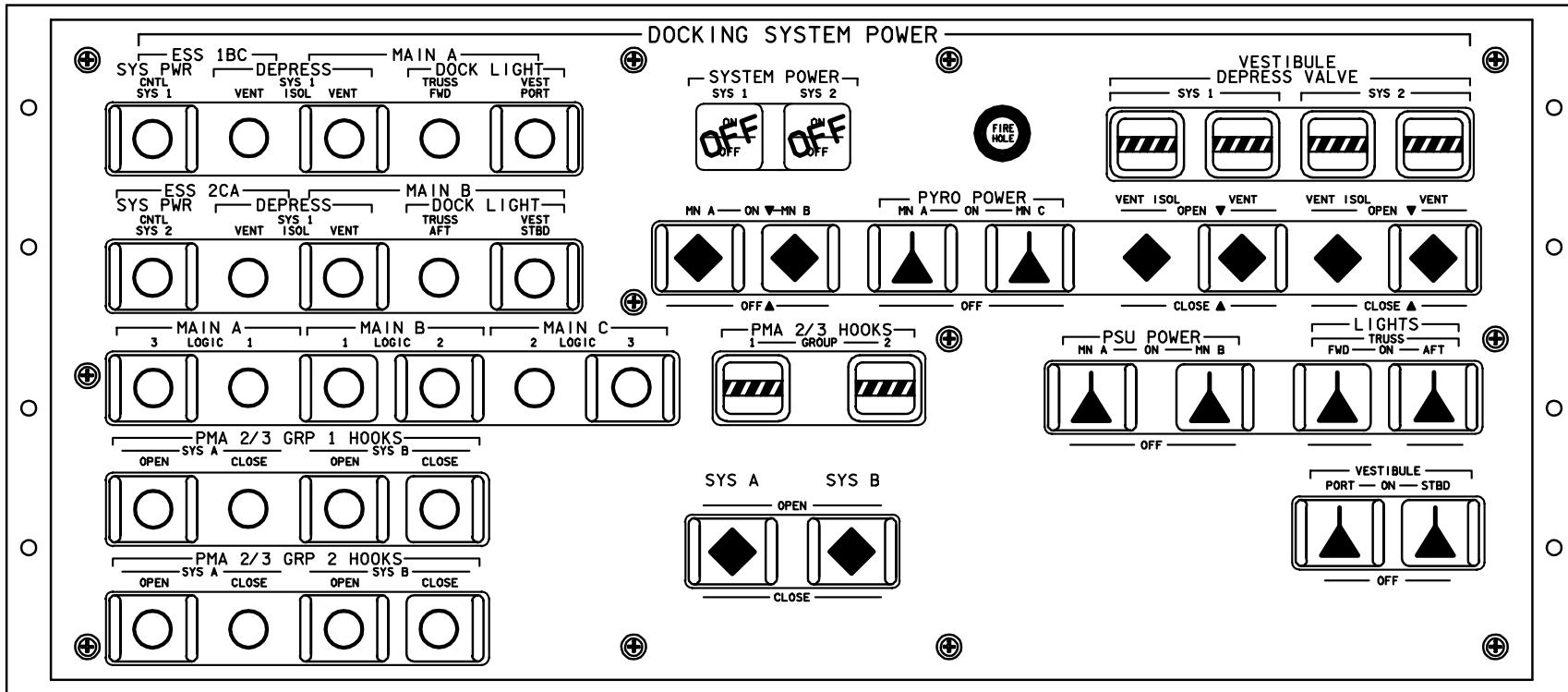

A6

OV105

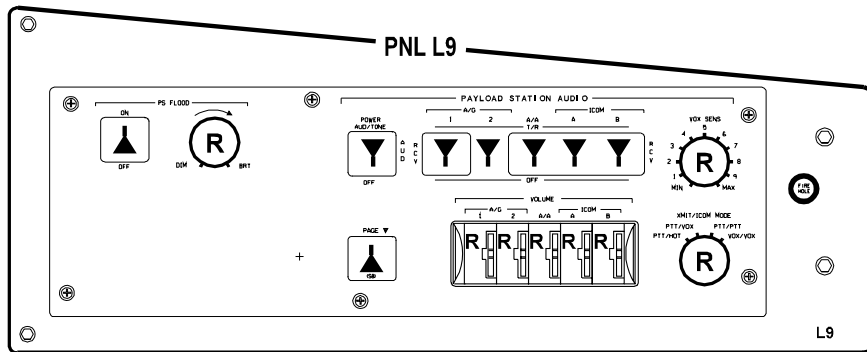
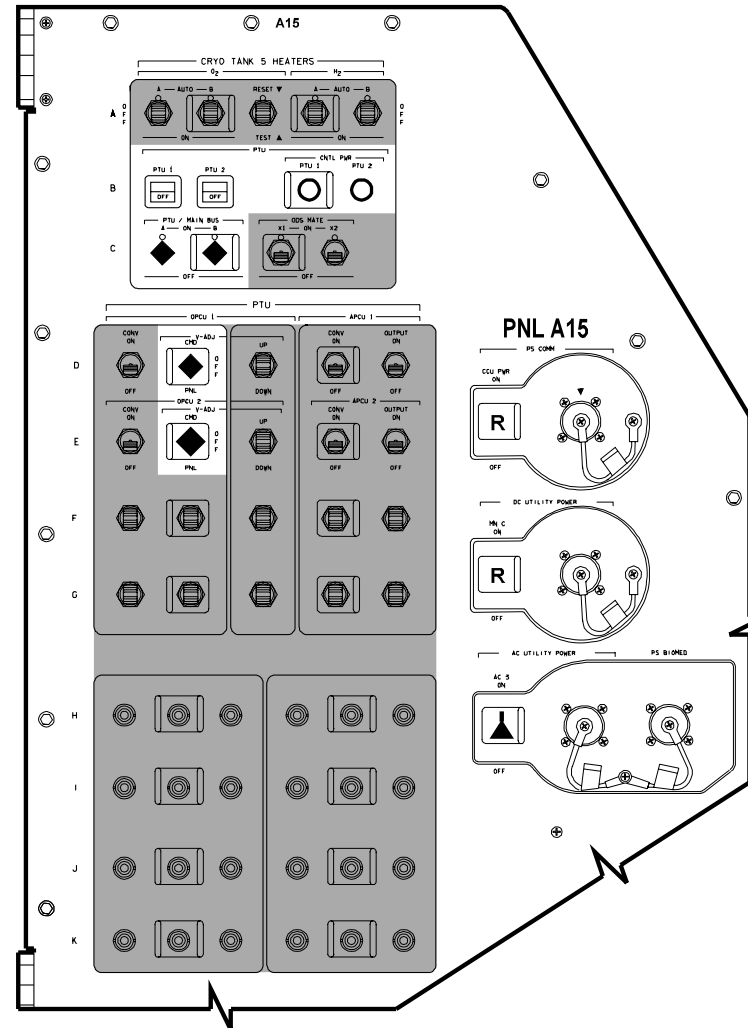
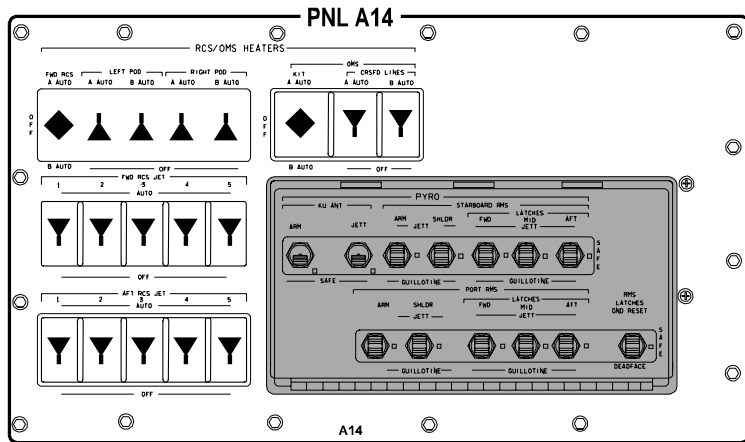

ACTIVATION
L9 All switches - as read
A15 PS COMM CCU PWR-ON

OV105

OV105

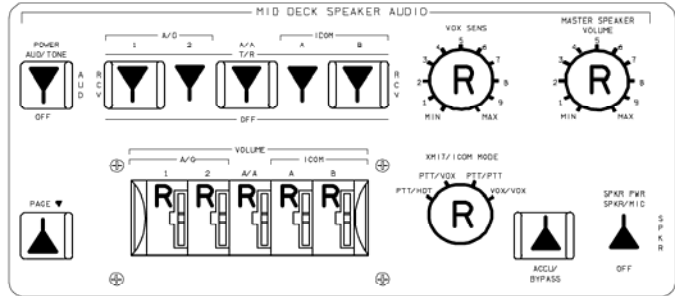

PNL M042F

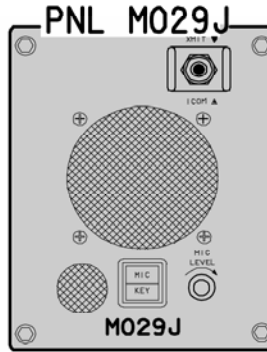
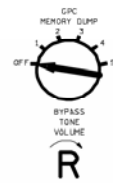

PNL M029J

PNL M058F

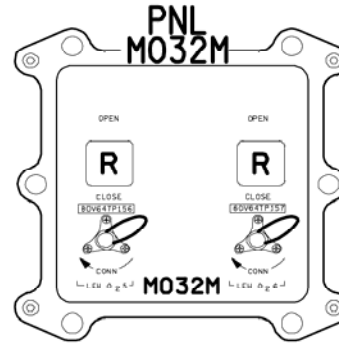
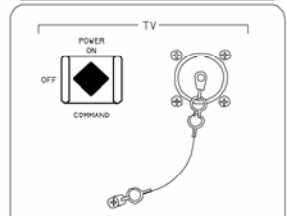
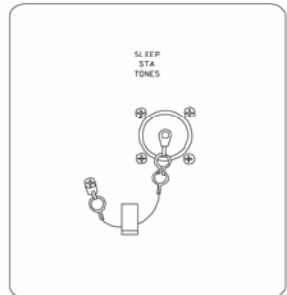

PNL M032M

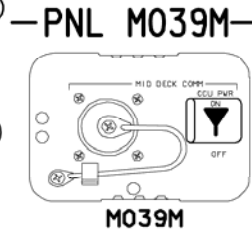

PNL M039M

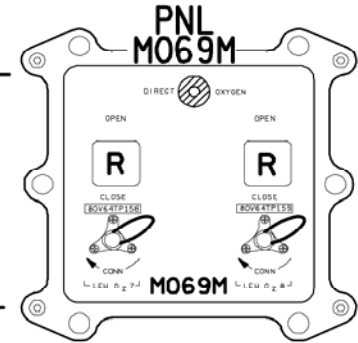

PNL M069M

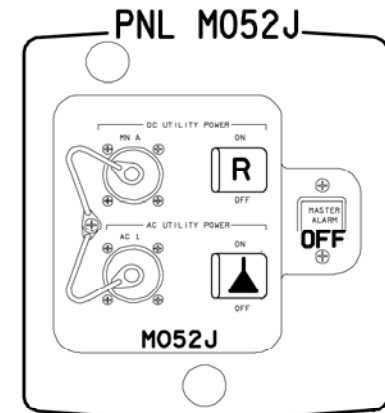

PNL M052J

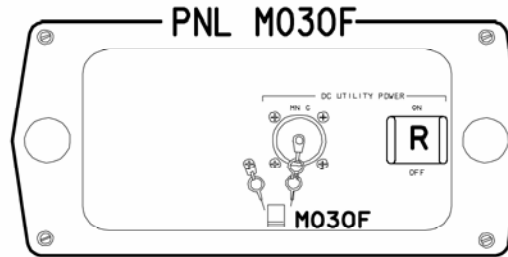

PNL M030F

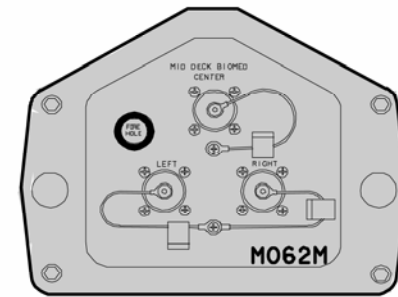

M062M

OV105

OV105

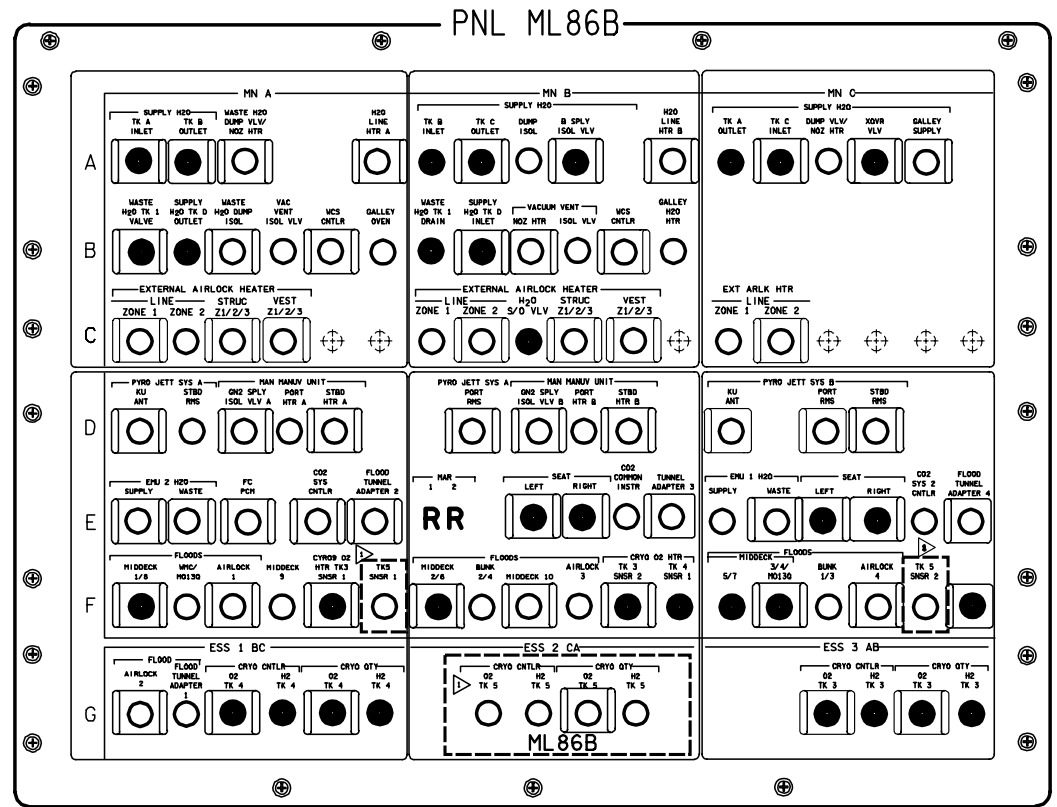
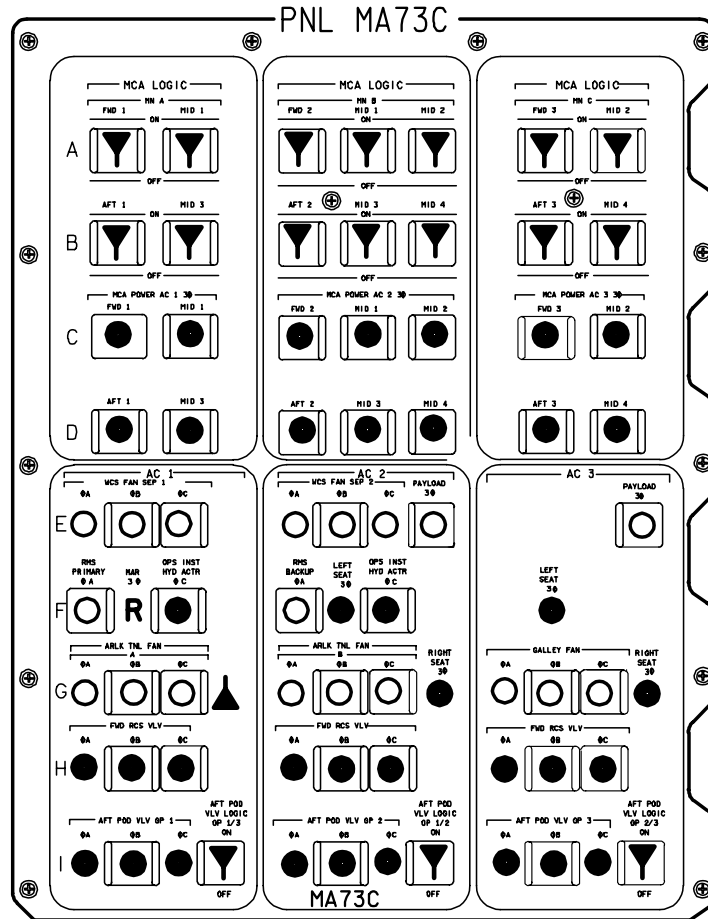

NOTES: ▷ CLOSED IF TK5 FLOWN

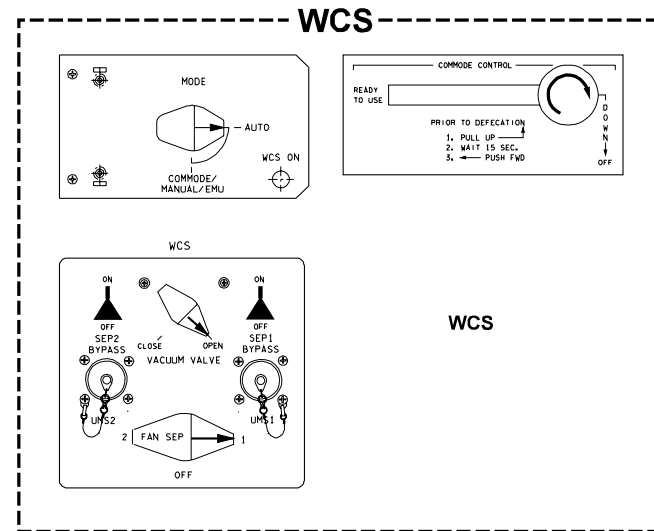
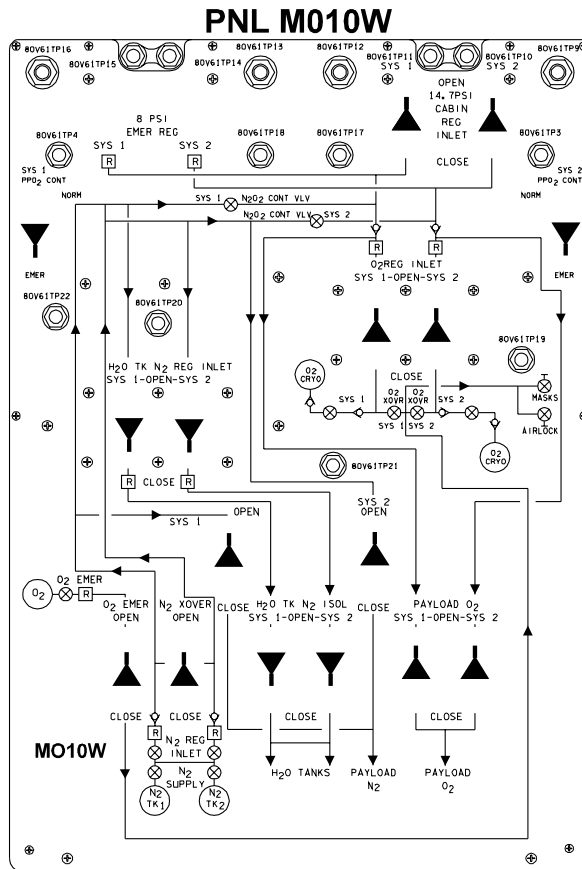

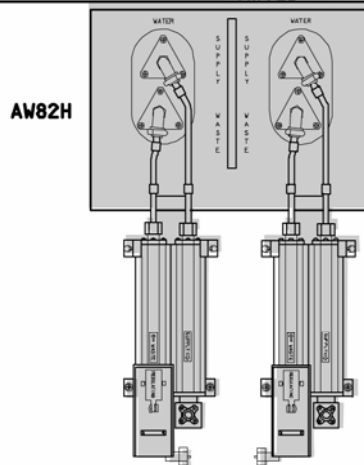
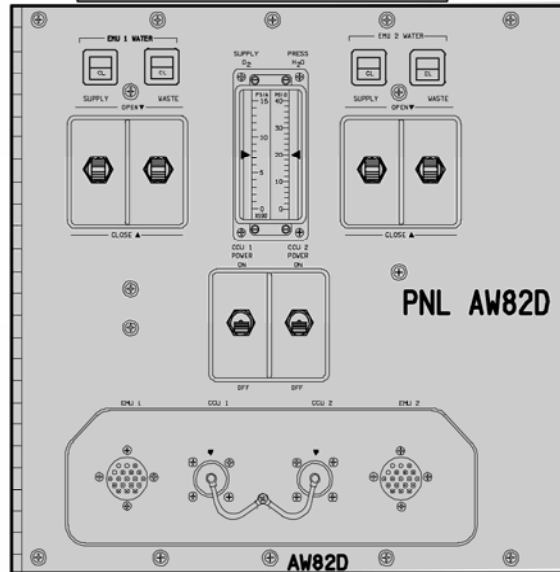
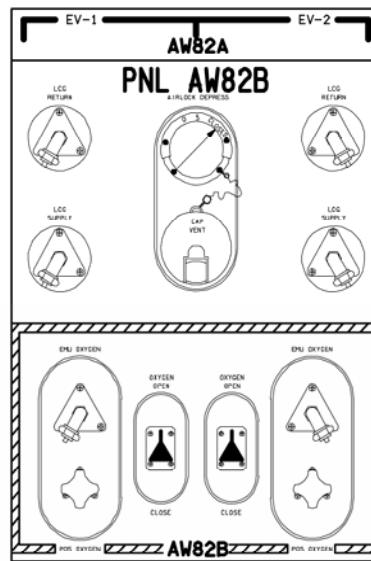
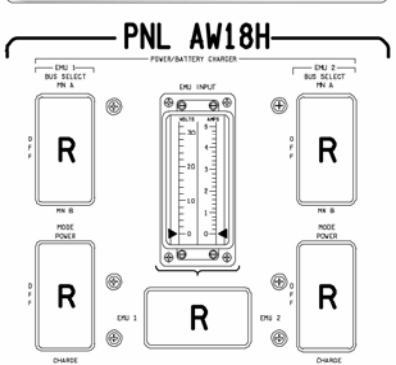
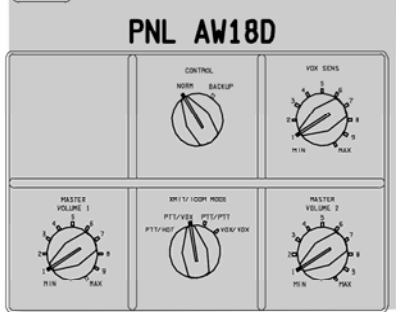
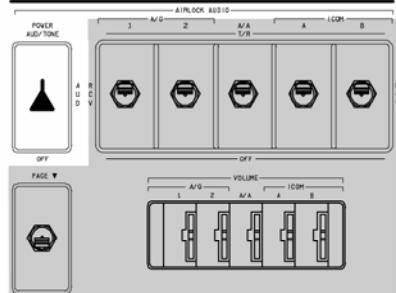
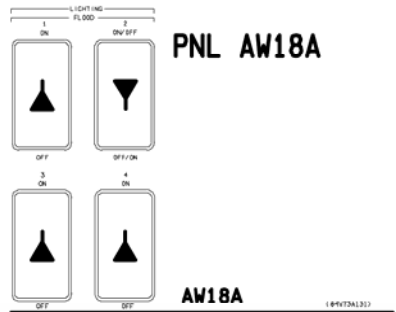

ALL VEH/DATE 10/03/02

480070331_107, PNL_1

Inner Hatch

Actuator Handle – LATCHED

Lock Lever – LOCKED

Equalization vlv (two) – NORM, capped

LOSS OF 2 FC LAUNCH DAY DEORBIT PREP (ORBIT 2 OR ORBIT 3)

LOSS OF 2 FC
ORB 2 OR 3

This Page Intentionally Blank

LOSS OF 2 FC LAUNCH DAY DEORBIT PREP (ORBIT 2 OR ORBIT 3)

ASSUMPTIONS/INITIAL CONDITIONS

LOSS OF 2 FC LAUNCH DAY DEORBIT assumes LOSS OF 2nd FC (ASC PKT, PWRDN) has been accomplished

Electrical load will be 10-12 kW with transients to 14 kW during Deorbit Prep and Entry

This procedure assumes RAD ACT, PLBD OPENING, and subsequent Post Insertion activities have not been accomplished

PROBLEM DESCRIPTION/RATIONALE

Orbiter electrical load carried by one fuel cell; therefore, it is a critical component. LRUs may experience undervoltage with accompanying alarms

LOSS OF 2 FC LAUNCH DAY DEORBIT PREP

NOTE

1. Use one IDP/CRT with two MDUs whenever possible
2. Maintain minimum lighting
3. A second pass GPC (GPC 4) will be activated at ~TIG-20
4. Landing gear will be deployed with pyros due to loss of landing gear extend isolation valve thru MNA AMC1
5. MS procedures are located on MS PULLOUT PAGES, 4-15 thru 4-18. Extra copies are located in back of PLT's book

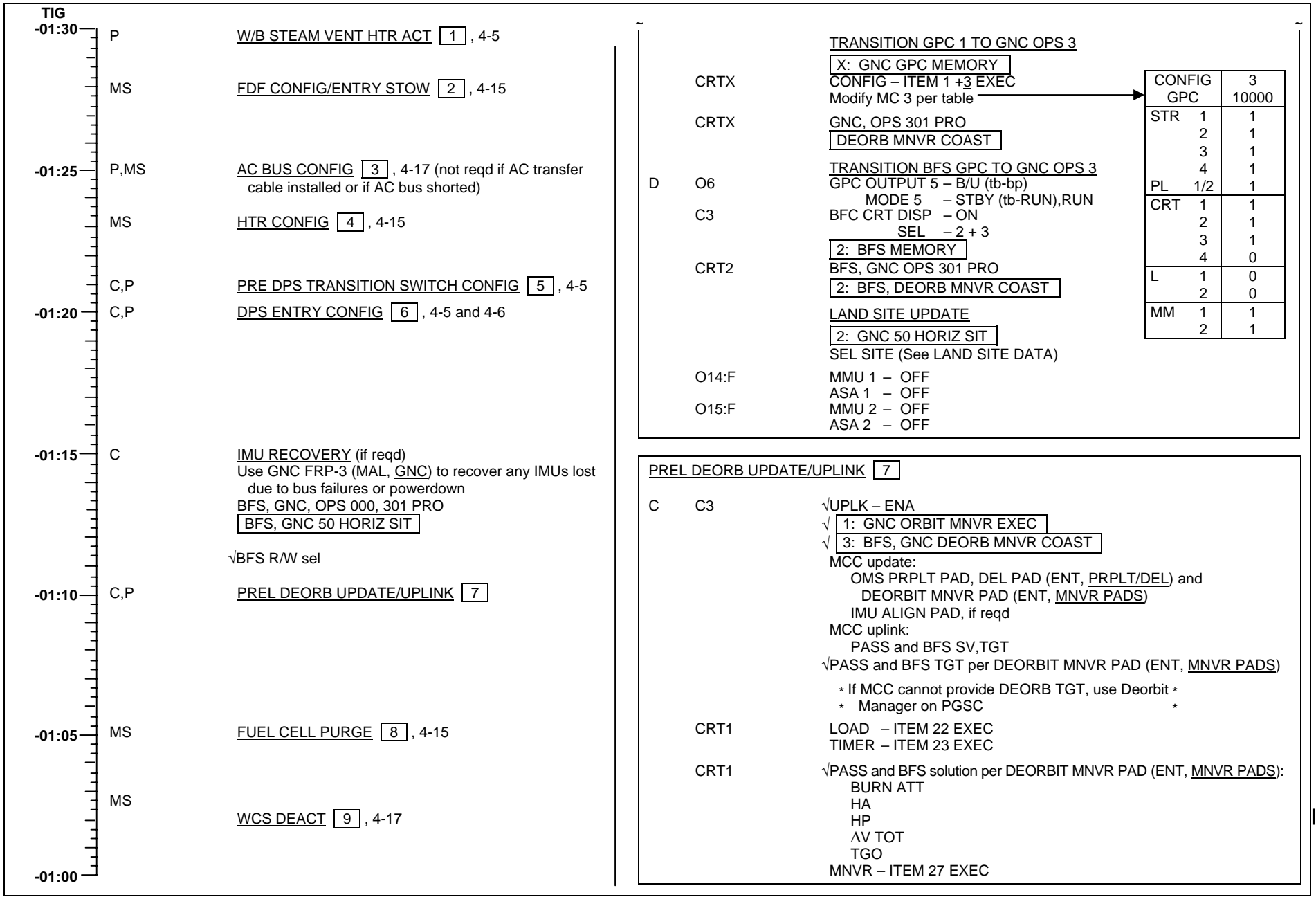

PRE INGRESS CONFIG 12

		<u>MPS/H2 PURGE PREP</u>	
P	R2	MPS He ISOL (six)	- CL
		PNEU He ISOL	- CL
		L ENG He XOVR	- CL
	R4	MANF PRESS (two)	- CL
		<u>ENABLE QTY GAUGE</u>	
C,P	O16:E	cb RCS/OMS PRPLT QTY GAUGE	- cl
		<u>RA CONFIG</u>	
	F8	RDR ALTM	- 1
		<u>MLS CH/TACAN CH/DATA BUS</u>	
	O8	MLS CH tw (three)	- See LAND SITE DATA
		If OV103,4:	
	O7	TACAN CH tw (three)	- See LAND SITE DATA
		<u>ENABLE LG PROXIMITY SENSORS</u>	
C	L4:P	√cb AC2 ΦA LG SNSR 2	- cl
		√AC3 ΦA LG SNSR 1	- cl
		<u>cb CONFIG</u>	
C	L4:J	cb AC3 ΦA SIG CONDR HUM SEP	- op
		ΦB SIG CONDR IMU FAN	- op

TIG	
-01:00	MS <u>COMM CONFIG</u> 10 , 4-16
	MS <u>MCA CONFIG</u> 11 , 4-17
	C,P <u>PRE INGRESS CONFIG</u> 12 , 4-7
-00:55	
	C6 LEH O2 vlv (four) – OP
	C,P <u>SEAT INGRESS</u> Adjust seat (one seat, direction at a time) Exercise brake pedals
-00:50	
	C,P Perform <u>P&I CHANGES TO ENT</u> , 4-9, 4-10
-00:45	A Go to ENT, <u>DEORBIT BURN</u>
-00:40	
-00:35	
-00:30	

LOSS OF 2 FUEL CELLS

P&I Changes to ENTRY

GENERAL

1. AV BAY FANS will be cycled as needed to keep pwr level low
2. GPCs 2,3 remain pwrdn throughout ENTRY

SPECIFIC

TIG-45

Delete: **OMS TVC GMBL CHECK**
HORIZ SIT CONFIG (GNC 51 , BFS GNC 51)

Delete: \sqrt SSME REPOS – ITEM 19 (ENA)
Add: “SSME REPOS – ITEM 19 EXEC (INH)”

TIG-25

Replace VENT DOOR CLOSE with:

“NOTE

VENT DOOR CLOSE must be performed prior to MM302 transition

MA73C:A	MCA LOGIC MNA MID 1 – ON 2: GNC 51 OVERRIDE
CRT 2	VENT DOOR CNTL CLOSE – ITEM 44 EXEC
MA73C:A	MCA LOGIC MNA MID 1 – OFF MNB MID 1 – ON MNC MID 2 – ON MNB AFT 2 – ON
CRT 2	VENT DOOR CNTL CLOSE – ITEM 44 EXEC
MA73C:A	MCA LOGIC MNA MID 1 – ON MNB MID 1 – OFF MNC MID 2 – OFF”

LOSS OF 2 FUEL CELLS
P&I Changes to Entry (Cont)

POST
BURN

Add before PGSC STOW:
 “FLT CNTLR PWR (two) – OFF
 √DAP: AUTO
 cb MNA,B,C DDU L,R (four) – op”

O14:E,
O15:E,
O16:E

L1

Insert after **OMS/RCS POST BURN RECONFIG:**
 “AV BAY FAN 1B,2A,3A [3B vice 3A if FC 1 OK] – ON (3 sec between each start)”

EI-20

C3

SECONDARY ACTUATOR CHECK
 Add: “9. FCS CH (four) – ORIDE”

EI-18

O14:F,
O15:F,
O16:F

If FORWARD RCS DUMP reqd for off-nominal CG, etc,
 insert FORWARD RCS RECOVERY before dump:
“FORWARD RCS RECOVERY
 RJDF LOGIC,DRIVER (eight) – ON”

GNC 23 RCS

“ITEM 1 EXEC (FRCS page)
 OVRD FRCS MANF 1,2,3,4 STAT – OP”

Insert after dump completion:

GNC 23 RCS

“ITEM 1 EXEC (FRCS page)
 OVRD FRCS MANF 1,2,3,4 STAT – CL
 RJDF LOGIC,DRIVER (eight) – OFF”

O14:F,
O15:F,
O16:F

ENTRY SW
CHECK

Delete: √ANTISKID,NWS steps
 Delete: √RADAR ALTM,MLS,TACAN steps

OV103,104

C D/O/3,4/GEN L

LOSS OF 2 FUEL CELLS
P&I Changes to Entry (Cont)

EI-15	A13	GPS PWR – ON If OV103: GPS PRE AMPL (two) – MNC If OV104: GPS PRE AMPL (two) – ON Wait 30 sec GNC I/O RESET GNC 55 GPS STATUS INIT – ITEM 15 EXEC (*) NAV – ITEM 18 EXEC (*)
EI-13		Delete: SSME HYD REPRESS
	ENTRY MNVRS	Replace nominal <u>ENTRY MANEUVERS</u> (Cue Card) with LOSS OF 2 FUEL CELLS ENTRY MANEUVERS, 4-13

LOSS OF 2 FUEL CELLS ENTRY MANEUVERS

FLIGHT CONDITIONS	MANEUVER
EI-5	BRAKES (three) – ON cb ADTA 1,2,3 – cl GNC I/O RESET √cb MNA,B,C DDU L,R (four) – cl (L) FLT CNTLR PWR – ON Use two IDP/CRTs with four MDUs √LVLH ATT GNC, OPS 304 PRO √OPS 304, wait 1 min * If PREBANK: R/Y – CSS * * Roll at 1°/sec to <input type="text"/> <input type="text"/> <input type="text"/> * * Maintain PREBANK ± 5° *
‘Guidance Box’ @ q̄ ~8 or D ~3	CLOSED LOOP GUIDANCE ____:____:____ * If PREBANK: P,R/Y – AUTO * Begin AIL trim monitoring
D = 11	√DRAG H
ΔAz = 10.5°	FIRST ROLL REVERSAL <input type="text"/> <input type="text"/> <input type="text"/> <input type="text"/>
V = 19K	√HYD MPS/TVC ISOL VLV SYS (three) – CL <input type="text"/> G50 √GPS, INCORPORATE
V = 15K	If FC 1 OK: TACAN 1 MODE – GPC If FC 2 or FC 3 OK: TACAN 3 MODE – GPC √TACAN ANT SEL – AUTO
V = 12K	RAD BYP VLV MODE (two) – AUTO CNTLR LOOP (two) – AUTO B(A)
V = 10K	√SPDBK to 81%
V = 7K	√TACAN and GPS status * If ELS,UHF MODE – G T/R *
V = 5K	L AIR DATA PROBE – DPY (Wait 30 sec) R AIR DATA PROBE – DPY (Heat only one probe if reqd) Begin AIL and RUD trim monitoring
M = 3.5	<input type="text"/> G51 VENT DOOR CNTL OPEN – ITEM 43 EXEC

FLIGHT CONDITIONS	MANEUVER
M = 2.9	CAB FAN (two) – OFF AV BAY FAN 2A – OFF 3A(3B) – OFF After ADTA incorporated, TACAN MODE (two) – OFF Use one HUD, one MLS, one RA GNC I/O RESET
M = 2.7	√APUs
	* If M < 2.5, P CSS for ADTA to G&C incorp *
M = 2.0	Ensure ADTA to G&C; else, √theta limits
M < 1.0	* For bailout procedures, go to BAILOUT * P,R/Y – CSS as reqd √SPDBK CMD vs POS MAX Nz <input type="text"/> <input type="text"/> <input type="text"/> (R) FLT CNTLR PWR – ON Use two IDP/CRTs with six MDUs ANTISKID – ON NWS – 1 Lock Inertia Reels
h = 15K	√MLS
h = 10K	√A/L (KSC – Tabs, Visors, Suit O2)
h = 2K	LDG GEAR ARM pb – push (ARM It on)
h = 300	LDG GEAR DN pb – push (DN It on)
MAIN GEAR TD	√SPDBK – 100%
V = 195 KEAS	DRAG CHUTE ARM,DPY pb (two) – push (simo) (All Its on)
V = 185 KEAS	DEROTATE
NOSE GEAR TD	SRB SEP – MAN/AUTO and depress pb √Auto Load Relief √HYD BK ISOL VLV (three) – OP
V < 120 KGS or 5K' remaining	BRAKE as reqd (8-10 fps ² , -0.25 to -0.3G)
	* If 5K' remaining and V > 140 KGS – MAX BRAKING *
V = 60 KGS	DRAG CHUTE JETT pb – push (JETT1, JETT2 It on)
V = 40 KGS	BRAKE < 6 fps ² (-0.2G) (Antiskid cutout)
WHEEL STOP	√All landing/navaids off CAB FAN B – ON (Wait 3 sec, then continue) AV BAY FAN 2A,3A [3B vice 3A if FC1 OK] – ON (3 sec between each start) Go to ENT C/L, <u>POST LDG</u>

OV103,104

This Page Intentionally Blank

LOSS OF 2 FUEL CELLS
P&I Changes to Entry (Cont)

POST
BURN

Add before PGSC STOW:
 “FLT CNTLR PWR (two) – OFF
 √DAP: AUTO
 cb MNA,B,C DDU L,R (four) – op”

O14:E,
O15:E,
O16:E

L1

Insert after **OMS/RCS POST BURN RECONFIG:**
 “AV BAY FAN 1B,2A,3A [3B vice 3A if FC 1 OK] – ON (3 sec between each start)”

EI-20

C3

SECONDARY ACTUATOR CHECK
 Add: “9. FCS CH (four) – ORIDE”

EI-18

O14:F,
O15:F,
O16:F

If FORWARD RCS DUMP reqd for off-nominal CG, etc,
 insert FORWARD RCS RECOVERY before dump:
“FORWARD RCS RECOVERY
 RJDF LOGIC,DRIVER (eight) – ON”

GNC 23 RCS

“ITEM 1 EXEC (FRCS page)
 OVRD FRCS MANF 1,2,3,4 STAT – OP”

Insert after dump completion:

GNC 23 RCS

“ITEM 1 EXEC (FRCS page)
 OVRD FRCS MANF 1,2,3,4 STAT – CL
 RJDF LOGIC,DRIVER (eight) – OFF”

O14:F,
O15:F,
O16:F

ENTRY SW
CHECK

Delete: √ANTISKID,NWS steps
 Delete: √RADAR ALTM,MLS steps

LOSS OF 2 FUEL CELLS
P&I Changes to Entry (Cont)

EI-15	O7	If FC1 OK: GPS 1,2 PWR (two) – ON PRE AMPL (four) – ON If FC2 or FC3 OK: GPS 2,3 PWR (two) – ON PRE AMPL (four) – ON Wait 30 sec GNC I/O RESET GNC 55 GPS STATUS INIT – ITEM 14(15,16) EXEC NAV – ITEM 17(18,19) EXEC
EI-13	ENTRY MNVRS	Delete: SSME HYD REPRESS Replace nominal <u>ENTRY MANEUVERS</u> (Cue Card) with <u>LOSS OF 2 FUEL CELLS ENTRY MANEUVERS</u> , 4-13

LOSS OF 2 FUEL CELLS ENTRY MANEUVERS

FLIGHT CONDITIONS	MANEUVER
EI-5	BRAKES (three) – ON cb ADTA 1,2,3 – cl GNC I/O RESET √cb MNA,B,C DDU L,R (four) – cl (L) FLT CNTLR PWR – ON Use two IDP/CRTs with four MDUs √LVLH ATT GNC, OPS 304 PRO √OPS 304, wait 1 min * If PREBANK: R/Y – CSS * * Roll at 1°/sec to <input type="text"/> <input type="text"/> * * Maintain PREBANK ± 5° *
‘Guidance Box’ @ q̄ ~8 or D ~3	CLOSED LOOP GUIDANCE ____:____:____ * If PREBANK: P,R/Y – AUTO * Begin AIL trim monitoring
D = 11	√DRAG H
ΔAz = 10.5°	FIRST ROLL REVERSAL <input type="text"/> <input type="text"/> <input type="text"/> <input type="text"/>
V = 19K	√HYD MPS/TVC ISOL VLV SYS (three) – CL <input type="text"/> G50 √GPS, INCORPORATE
V = 12K	RAD BYP VLV MODE (two) – AUTO CNTLR LOOP (two) – AUTO B(A)
V = 10K	√SPDBK to 81%
V = 7K	* If ELS,UHF MODE – G T/R *
V = 5K	L AIR DATA PROBE – DPY (Wait 30 sec) R AIR DATA PROBE – DPY (Heat only one probe if reqd) Begin AIL and RUD trim monitoring
M = 3.5	<input type="text"/> G51 VENT DOOR CNTL OPEN – ITEM 43 EXEC

FLIGHT CONDITIONS	MANEUVER
M = 2.9	CAB FAN (two) – OFF AV BAY FAN 2A – OFF 3A(3B) – OFF After ADTA incorporated, Use one HUD, one MLS, one RA GNC I/O RESET
M = 2.7	√APUs
	* If M < 2.5, P CSS for ADTA to G&C incorp*
M = 2.0	Ensure ADTA to G&C; else, √theta limits
M < 1.0	* For bailout procedures, go to BAILOUT * P,R/Y – CSS as reqd √SPDBK CMD vs POS MAX Nz <input type="text"/> <input type="text"/> <input type="text"/> (R) FLT CNTLR PWR – ON Use two IDP/CRTs with six MDUs ANTISKID – ON NWS – 1 Lock Inertia Reels
h = 15K	√MLS
h = 10K	√A/L (KSC – Tabs, Visors, Suit O2)
h = 2K	LDG GEAR ARM pb – push (ARM It on)
h = 300	LDG GEAR DN pb – push (DN It on)
MAIN GEAR TD	√SPDBK – 100%
V = 195 KEAS	DRAG CHUTE ARM,DPY pb (two) – push (simo) (All Its on)
V = 185 KEAS	DEROTATE
NOSE GEAR TD	SRB SEP – MAN/AUTO and depress pb √Auto Load Relief √HYD BK ISOL VLV (three) – OP
V < 120 KGS or 5K' remaining	BRAKE as reqd (8-10 fps ² , -0.25 to -0.3G)
	* If 5K' remaining and V > 140 KGS – MAX BRAKING *
V = 60 KGS	DRAG CHUTE JETT pb – push (JETT1, JETT2 It on)
V = 40 KGS	BRAKE < 6 fps ² (-0.2G) (Antiskid cutout)
WHEEL STOP	√All landing/nav aids off CAB FAN B – ON (Wait 3 sec, then continue) AV BAY FAN 2A,3A [3B vice 3A if FC1 OK] – ON (3 sec between each start) Go to ENT C/L, <u>POST LDG</u>

This Page Intentionally Blank

LOSS OF 2 FC LAUNCH DAY DEORBIT PREP MS AFT FLIGHT DECK ACTIVITIES

MS PULLOUT PAGE

NOTE

Wait for GO from CDR or PLT before starting any activity on this page

TIME (TIG-)	MS ACTIONS (AFT)
1:28	<u>FDF CONFIG/ENTRY STOW</u> [2]
1:23	<u>HTR CONFIG</u> [4]
1:05	<u>FUEL CELL PURGE</u> [8]
1:00	<u>COMM CONFIG</u> [10], 4-16

<p><u>FDF CONFIG/ENTRY STOW</u> [2]</p> <p><u>FDF CONFIG</u> Unstow,install: ENTRY and DEORBIT BURN Cue Cards ENT ENT PKT √AVAILABLE for ENTRY: LDG SITE CHARTS Handheld Radio STAR CHART ORB OPS CONT DEORB ORB PKT REF DATA MAL Stow all other FDF articles</p> <p><u>ENTRY STOW</u> Stow: Flt Deck Camrs,Accessories VTR Cassettes (one in VTR)</p> <p><u>EGRESS ROUTE CONFIG</u> Tape Foot Loops in egress routes</p>

<u>HTR CONFIG</u> [4]	
R11U	FC PURGE HTR – ON
	<u>NOTE</u> Htr must be on 15 min prior to purge
A12	√APU HTR TK/FU LN/H2O SYS 1A,2A,3A (three) – AUTO √1B,2B,3B (three) – OFF
A14	√HYD HTR (eight) – OFF √RCS/OMS HTR FWD RCS – OFF L POD (two) – A OFF,B OFF R POD (two) – A OFF,B OFF OMS CRSFD LINES (two) – A OFF – B OFF √FWD,AFT RCS JET 5 (two) – OFF

<u>FUEL CELL PURGE</u> [8]		
<table border="1" style="margin: auto;"> <tr> <td style="text-align: center;"><u>WARNING</u> Do not purge if FC AMPS > 430</td> </tr> </table>		<u>WARNING</u> Do not purge if FC AMPS > 430
<u>WARNING</u> Do not purge if FC AMPS > 430		
R11U	√FC PURGE HTR ON > 15 min	
	FC PURGE VLV X – OP for 2 min, then – GPC HTR – GPC √VLV – GPC	

**LOSS OF 2 FC LAUNCH DAY DEORBIT PREP
Back of MS AFT FLIGHT DECK ACTIVITIES**

MS PULLOUT PAGE

COMM CONFIG		10
A1L	S-BD PM MODE	- STDN LO
	NSP DATA RATE XMIT,RCV (two)	- HI
	CODING XMIT,RCV (two)	- OFF
A13	OS AUD SPKR PWR	- OFF
A15	PS COMM CCU PWR	- OFF
R14:C	√cb MNB KU ELEC	- op
	√ANT HTR	- op
	√CABLE HTR	- op
	√MNC KU SIG PROC	- op
	√cb UHF EVA (two)	- op
O5,O9	L,R AUD A/G 2	- T/R
	ICOM B	- T/R
	VOX SENS sel	- as reqd
	VOL tw (six)	- as reqd
	XMIT/ICOM MODE sel	- PTT/VOX
MO42F	MIDDECK SPKR AUD PWR	- AUD/TONE
ML85E	AC S1	- OFF
R10,L9	MS,PS AUD PWR	- AUD/TONE
	A/G 1	- T/R
	2	- T/R
	A/A	- T/R
	ICOM A,B	- T/R
	VOX SENS sel	- as reqd
	VOL tw (six)	- as reqd
	XMIT/ICOM MODE sel	- as reqd

LOSS OF 2 FC LAUNCH DAY DEORBIT PREP MS MIDDECK ACTIVITIES

MS PULLOUT PAGE

NOTE

Wait for GO from CDR or PLT before starting any activity on this page

TIME (TIG-)	MS ACTIONS (MID)
1:25	<u>AC BUS CONFIG</u> 3 (Not reqd if AC transfer cable installed or if AC bus shorted)
1:03	<u>WCS DEACT</u> 9
:59	<u>MCA CONFIG</u> 11

<u>AC BUS CONFIG</u> 3 (Not reqd if AC transfer cable installed or if AC bus shorted)	
C	L4:D,E,Q
MS	<ol style="list-style-type: none"> 1. \checkmarkAll cbs (twenty-seven) – op 2. If FC 1 OK: <ul style="list-style-type: none"> Perform AC3 (3Φ) BUS LOSS ACTIONS (ORB PKT, <u>EPS</u>). Do only steps in ORB PKT, do not proceed to MAL AC3 is affected bus in step 3 <li style="padding-left: 20px;">If FC 2 or FC 3 OK: <ul style="list-style-type: none"> Perform AC1 (3Φ) BUS LOSS ACTIONS (ORB PKT, <u>EPS</u>). Do only steps in ORB PKT, do not proceed to MAL AC1 is affected bus in step 3
P	R1
	<ol style="list-style-type: none"> 3. Affected bus: <ul style="list-style-type: none"> cb AC CONTR (three) – cl AC BUS SNSR – OFF INV/AC BUS – OFF (tb-OFF) INV PWR – OFF (tb-OFF) cb AC CONTR (three) – op 4. Connect AC1 to AC3: <ul style="list-style-type: none"> Perform AC POWER TRANSFER CABLE INSTALLATION (IFM, <u>PROCEDURES A THRU F</u>)

<u>WCS DEACT</u> 9	
WCS	VAC VLV – CL \checkmark MODE – AUTO FAN SEP SEL sw – OFF Unstow hose from cradle, attach hose to WCS housing via Velcro straps Remove, stow: WCS Trash Can Mirror Privacy Curtain Foot restraints – up, locked Close, latch door
ML31C	VAC VENT ISOL VLV BUS SEL – MNB CNTL – CL (tb-CL) NOZ HTR – OFF

<u>MCA CONFIG</u> 11	
MA73C:A	MCA LOGIC MID (four) – OFF \checkmark FWD (three) – ON
:B	MCA LOGIC MID (four) – OFF AFT (three) – OFF
:C	If MNB and AC2 powered: cb MCA PWR AC1, AC3 3 Φ FWD 1,3 (two) – op \checkmark Minimum middeck lighting

This Page Intentionally Blank

LOSS OF 2 FUEL CELLS DEORBIT PREP

This Page Intentionally Blank

LOSS OF 2 FUEL CELLS DEORBIT PREP

ASSUMPTIONS/INITIAL CONDITIONS

LOSS OF 2 FUEL CELLS DEORBIT PREP assumes one of following pwrdns has been accomplished:

LOSS OF 2nd FC ON-ORBIT (TIG < 4:00) (ORB PKT, PWRDN)

LOSS OF 2nd FC ON-ORBIT (TIG > 4:00) (ORB PKT, PWRDN)

Electrical load will be 10-12 kW with transients to 14 kW during Deorbit Prep and Entry

IF TIME TO TIG < 4:00

Refer to ACTIVITY PRIORITY TABLE, 5-8

Use EXPEDITED D/O column to determine LOSS OF 2 FC DEORBIT PREP procedures that must be performed (mandatory) and those that should be performed if time permits (optional)

If any portions of Nominal Deorbit Prep have been accomplished, reconfigure systems per LOSS OF 2 FC DEORBIT PREP as reqd

IF TIME TO TIG > 4:00

Perform all LOSS OF 2 FC DEORBIT PREP procedures

PROBLEM DESCRIPTION/RATIONALE

Orbiter electrical load carried by one fuel cell; therefore, it is a critical component. LRUs may experience undervoltage with accompanying alarms

LOSS OF 2 FUEL CELLS DEORBIT PREP

NOTE

1. Use only one IDP/CRT with two MDUs whenever possible
2. Omit all maneuvers prior to TIG-03:36 if GG from powerdown
3. Maintain minimum lighting
4. A second pass GPC (GPC 4) will be activated at ~TIG-20
5. MS procedures are located on MS PULLOUT PAGES, 5-27 thru 5-32. Extra copies are located in back of PLT's book

LOSS OF 2 FUEL CELLS OVERVIEW OF CONFIGURATION MANAGEMENT (Cont)

		SEAT INGRESS					TIG-20					EL-5	V = 15K
DPS													
GPC OPS		1	2	3	4	5	1	2	3	4	5		
		G1	-	-	-	BFS	G3	--	--	G3	BFS		
POWER OUTPUT MODE		ON	OFF	OFF	ON	ON	ON	OFF	OFF	ON	OFF		
		N	N	N	N	B	N	N	N	N	B		
		R	H	H	H	R	R	H	H	R	R		
CONFIG		3					3						
GPC		1	0	0	0	0	1	0	0	4	0		
STR		1	1				1	1					
		2	1				4	1					
		3	1				1	1					
		4	1				4	1					
PL		1/2	1				1	1					
CRT		1	1				1	1					
		2	1				1	1					
		3	1				4	1					
		4	0				0	0					
L		1	0				0	0					
		2	0				0	0					
MM		1	1 (ON)				1 (ON)	1 (ON)					
		2	1 (ON)				4 (ON)	4 (ON)					
MDM		ALL ON except FF4					ALL ON except FF4						
D & C		DDU	L,R				Minimize use						
		MDU	Minimize use				Minimize use						
		IDP	Minimize use				Minimize use						
E C L S		AV BAY FAN	1,2,3				1,2						
		CABIN FAN	A				A						
		IMU FAN	B				B						
		WATER LP	1-OFF,2-ON				1-OFF,2-ON						
		FREON LP	1-A,2-A				1-A,2-A						
		RADIATOR	Stow				Stow						
		FES	ON				ON						
F C S / N A S V O A R I S D S		FCS CH	AUTO				ORIDE						
		ASA	OFF				ON						
		AA	1,2,3				1,2,3						
		RGA	1,2,3				1,2,3						
		ADTA	OFF				ON						
		IMU	1,2,3				1,2,3						
		MLS	OFF				OFF						
		RA	OFF				OFF						
		TACAN	OFF				1, 2 or 2, 3						
R J D		RJDA	1A,1B,2B				1A,1B,2B						
		RJDF	ALL ON				ALL ON						
		VERNIER	ALL ON				ALL ON						

OV103,104

C D/O/3,4/GEN L

LOSS OF 2 FUEL CELLS OVERVIEW OF CONFIGURATION MANAGEMENT

	OPS 1 ASC PKT					OPS 2 ON-ORBIT WAIT					OPS 2 DEORBIT PREP					OPS 3 DEORBIT PREP				
DPS																				
GPC	1	2	3	4	5	1	2	3	4	5	1	2	3	4	5	1	2	3	4	5
OPS	G1	-	-	-	BFS	G2	-	-	SM	-	G2	-	-	SM	-	G3	-	-	-	BFS
POWER	ON	OFF	ON	ON	ON	ON	OFF	OFF	ON	OFF	ON	OFF	ON	ON	OFF	ON	OFF	OFF	ON	ON
OUTPUT	N	N	N	N	B	N	N	N	T	N	N	N	N	T	N	N	N	N	N	B
MODE	R	H	H	H	R	R	H	H	R	H	R	H	H	R	H	R	H	H	H	R
CONFIG																				
GPC	1	2	3	4	0	1	0	0	0	0	1	0	0	0	0	1	0	0	0	0
STR	1	1				1				0	1				0	1				1
	2	1				1				0	1				0	1				1
	3	1				1				0	1				0	1				1
	4	1				1				0	1				0	1				1
PL	1/2	1				0				4	0				4	1				1
CRT	1	1				1				4	1				4	1				1
	2	1				1				4	1				4	1				1
	3	1				0				0	0				0	1				1
	4	0				1				4	1				4	0				0
L	1	1				0				4	0				4	0				0
	2	2				0				0	0				0	0				0
MM	1	1				1 (OFF)				4	1 (ON)				4	1 (OFF)				1 (OFF)
	2	1				1 (OFF)				4	1 (OFF)				4	1 (OFF)				1 (OFF)
MDM						FF3; PL2 – ON					ALL ON except FF4					ALL ON except FF4				
D & C	DDU	MDU	IDP	L,R	Two FWD	ALL	AFT	L												
						Minimize use					Minimize use									
E	AV BAY FAN					1,2,3	1,3	1,2,3					1,2,3							
C	CABIN FAN					A	A													
L	IMU FAN					B	B													
S	WATER LP					2	(A)	1-OFF,2-ON					1-OFF,2-ON							
	FREON LP					1	1-A,2-A													
	RADIATOR					Stow	Stow													
	FES					ON	OFF	ON					ON							
F	FCS CH					AUTO	AUTO													
S	ASA					ON	OFF													
/	AA					ON	OFF	1,2,3					1,2,3							
N	RGA					ON	OFF													
A	ADTA					ON	OFF													
V	IMU					2,3	3	1,2,3					1,2,3							
A	MLS					OFF	OFF													
R	RA					OFF	OFF													
I	GPS					OFF	OFF													
S						OFF	OFF													
R	RJDA ^(B)					ALL ON	OFF	1A,1B,2B												
J	RJDF ^(B)					ALL ON	OFF						ALL OFF							
D	VERNIER					OFF	OFF						ALL OFF							

^(A) Water loops cycled as reqd (950 lb/hr)

^(B) Primary RJDs will be OFF during sleep periods

NOTE: Maintain minimum lighting

LOSS OF 2 FUEL CELLS OVERVIEW OF CONFIGURATION MANAGEMENT (Cont)

		SEAT INGRESS					TIG-20					El-5	V = 15K
DPS													
GPC		1	2	3	4	5	1	2	3	4	5		
OPS		G1	-	-	-	BFS	G3	--	--	G3	BFS		
POWER OUTPUT MODE		ON	OFF	OFF	ON	ON	ON	OFF	OFF	ON	OFF		
		N	N	N	N	B	N	N	N	N	B		
		R	H	H	H	R	R	H	H	R	R		
CONFIG		3					3						
GPC		1	0	0	0	0	1	0	0	4	0		
STR		1	1				1						
		2	1				4						
		3	1				1						
		4	1				4						
PL		1/2	1				1						
CRT		1	1				1						
		2	1				1						
		3	1				4						
		4	0				0						
L		1	0				0						
		2	0				0						
MM		1	1 (ON)				1 (ON)						
		2	1 (ON)				4 (ON)						
MDM		ALL ON except FF4					ALL ON except FF4						
D & C		DDU	L,R			Minimize use	Minimize use						
		MDU	Minimize use			Minimize use							
		IDP	Minimize use			Minimize use							
E C L S		AV BAY FAN	1,2,3			1,2							
		CABIN FAN	A			A							
		IMU FAN	B			B							
		WATER LP	1-OFF,2-ON			1-OFF,2-ON							
		FREON LP	1-A,2-A			1-A,2-A							
		RADIATOR	Stow			Stow							
		FES	ON			ON							
F C S / N A S V O A R I S D S		FCS CH	AUTO			ORIDE							
		ASA	OFF			ON							
		AA	1,2,3			1,2,3							
		RGA	1,2,3			1,2,3							
		ADTA	OFF			ON							
		IMU	1,2,3			1,2,3							
		MLS	OFF			OFF							
		RA	OFF			OFF							
		GPS	OFF			1, 2 or 2, 3							
R J D		RJDA	1A,1B,2B			1A,1B,2B							
		RJDF	ALL ON			ALL ON							
		VERNIER	ALL ON			ALL ON							

LOSS OF 2 FUEL CELLS DEORBIT PREP

MCC	TIG	CDR	PLT	MS(AFT)	MS(MID)
	-04:00	FES HTR ACT	CRT TIMER SETUP	FDf CONFIG/ENT STOW	ENTRY STOWAGE
		MDM CONFIG			
		AC BUS CONFIG	AC BUS CONFIG	AC BUS CONFIG	AC BUS CONFIG
		FES RESTART	SEL AFT RCS JETS		
		PRESS CNTL ENT CONFIG	MNVR TO TAIL SUN	SEAT INSTALLATION	PRESS CNTL ENT CONFIG SEAT INSTALLATION
					MCA CONFIG
	-03:00	RAD BYPASS		KU-BD ANT STOW	
		PRE DPS TRANS SW CONFIG	PRE DPS TRANS SW CONFIG	PLBD CLOSING	
		DPS ENTRY CONFIG	DPS ENTRY CONFIG		
		PREL DEORB UPDATE/UPLINK HORIZ SIT CONFIG	PREL DEORB UPDATE/UPLINK		
		IMU RECOVERY			FLUID LOADING PREP
	-02:00	ACT STR TRK MNVR IMU ALIGN ATT	W/B STEAM VENT HTR	HTR CONFIG	GALLEY/H2O DISP DEACT
		IMU ALIGNMENT			
		MNVR TO BURN ATT DEACT STR TRK		FC PURGE	WCS DEACT
				C/W, COMM CONFIG	MCA RECONFIG
		LOSS OF 2 FC SW VERIF LIST	LOSS OF 2 FC SW VERIF LIST	LOSS OF 2 FC SW VERIF LIST	LOSS OF 2 FC SW VERIF LIST
		CLOTHING CONFIG	CLOTHING CONFIG		
	-01:00	FLUID LOADING PRE INGRESS SEAT INGRESS STOW ORB PKT	FLUID LOADING PRE INGRESS SEAT INGRESS STOW ORB PKT	WIRELESS STOW FLUID LOADING CLOTHING CONFIG STOW ORB PKT	FLUID LOADING CLOTHING CONFIG
	00:00				

**LOSS OF 2 FUEL CELLS DEORBIT PREP
ACTIVITY PRIORITY TABLE**

TIG	ACTIVITY	PAGE	EXPEDITED D/O		TIG	ACTIVITY	PAGE	EXPEDITED D/O	
			Mandatory	Optional				Mandatory	Optional
4:00	TIMER SETUP	5-9	1	--	2:24	IMU RECOVERY	5-16	--	--
3:59	ENTRY STOWAGE	5-35	--	2	2:20	FLUID LOADING PREP	5-36	--	18
3:58	FES HTR ACT	5-9	--	--	2:10	GALLEY DEACT	5-36	--	19
3:57	FDG CONFIG/ENT STOW	5-25	4	--	2:09	HTR CONFIG	5-33	20	--
3:54	RCS/OMS HTR ACT	5-10	--	--	2:08	W/B STEAM VENT HTR ACT	5-15	21	--
3:45	MDM CONFIG	5-9	--	--	2:07	S-TRKR ACT	5-16	T/L	--
3:42	AC BUS CONFIG	5-10	6	--	2:04	MNVR TO IMU ATT	5-16	T/L	--
3:36	SELECT AFT RCS	5-10	--	--	2:00	IMU ALIGNMENT	5-17	22	--
3:32	AIRLOCK SW VERIF	5-10	--	T/L	1:44	WCS DEACT	5-36	23	--
3:30	FES RESTART	5-11	--	--	1:40	FUEL CELL PURGE	5-33	24	--
3:29	MNVR TO TAIL SUN	5-12	T/L	--	1:39	MNVR TO BURN ATT	5-18	T/L	--
3:25	PCS ENT CONFIG	5-11	9	--	1:34	S-TRKR DEACT	5-18	25	--
3:24	SEAT INSTALLATION	5-12	T/L	--	1:29	C/W, COMM CONFIG	5-33	26	--
3:14	MCA CONFIG	5-36	10	--	1:27	MCA RECONFIG	5-36	27	--
3:10	KU-BD ANT STOW	5-12	T/L	--	1:25	SWITCH VERIF	5-19	--	T/L
3:00	RAD BYP	5-14	11	--	1:15	CLOTHING CONFIG (C,P)	5-19	--	28
2:59	PLBD CLOSING	5-29	12	--	1:06	WIRELESS STOW	5-33	29	--
2:49	CRYO QTY CONFIG	5-13	--	13	1:05	BEGIN FLUID LOADING	5-19	--	T/L
2:48	PRE DPS TRANS SW CONFIG	5-13	14	--	1:01	CLOTHING CONFIG (MS,PS)	5-34	--	30
2:45	DPS ENTRY CONFIG	5-13	15	--	1:00	PRE INGRESS CONFIG	5-20	31	--
2:35	PREL DEORB UPDATE/UPLINK	5-14	17	--	:52	SEAT INGRESS	5-21	T/L	--
2:32	HORIZ SIT CONFIG	5-14	--	T/L	:45	GO TO ENT WITH P&Is	5-21	T/L	--

T/L procedure located in timeline vice procedure block

NOTE

1. This table assumes LOSS OF 2nd FC ON-ORBIT (TIG < 4 hr) (ORB PKT, PWRDN) has been performed
2. Procedure blocks listed in mandatory column are only ones that must be performed if failure occurs on orbit with TIG < 4:00 away
3. At least 1.5 hr is reqd to perform all mandatory activities
4. Those in optional column should be performed if time permits
5. If procedure has a dash in both mandatory and optional columns, it is not reqd for expedited case
6. Some procedures may be deleted if any nominal DEORBIT PREP actions have been accomplished

TIMER SETUP 1

P

1: GNC 2 TIME

SET CRT TIMER TO COUNT DOWN TO TIG (perform for GNC and SM)

ENTRY DAY(HR:MIN:SEC – MET)

ITEM 17 + + +

24 HOUR LATE DELAYED DEORBIT

ITEM 17 + + +

1: GNC UNIV PTG

FES HTR ACTIVATION 3

C	L1	TOP EVAP HTR NOZ (two) – B AUTO DUCT – B
	L2	FLASH EVAP FDLN HTR (two) – 2
	R11L	√SPLY H2O TKA OUTLET – CL (tb-CL) √TKB OUTLET – OP (tb-OP) √B SPLY ISOL VLV – OP (tb-OP)

MDM CONFIG 5

C	O6	√MDM PL 1,2 (two) – ON √FF 1,2,3 (three) – ON √FA 1,2,3,4 (four) – ON
	CRTX	GNC I/O RESET SM I/O RESET

TIG GRAVITY GRADIENT	-04:00	P	<u>TIMER SETUP</u> <input type="checkbox"/> 1, 5-9	<u>AC BUS CONFIG</u> <input type="checkbox"/> 6 (Not reqd if AC transfer cable installed or if AC bus shorted) ALL L4:D,E,Q 1. √All cbs (twenty-seven) – op 2. If FC 1 OK: Perform AC3 (3Φ) BUS LOSS ACTIONS (ORB PKT, <u>EPS</u>). Do only steps in ORB PKT, do not proceed to MAL Mark up pictorials in section 6 to match bus loss actions AC3 is affected bus in step 3 If FC 2 or FC 3 OK: Perform AC1 (3F) BUS LOSS ACTIONS (ORB PKT, EPS). Do only steps in ORB PKT, do not proceed to MAL Mark up pictorials in section 6 to match bus loss actions AC1 is affected bus in step 3 R1 3. Affected BUS: cb AC CONTR (three) – cl AC BUS SNSR – OFF INV/AC BUS – OFF (tb-OFF) INV PWR – OFF (tb-OFF) cb AC CONTR (three) – op 4. Connect AC1 to AC3: Go to AC POWER TRANSFER CABLE INSTALLATION (IFM, <u>PROCEDURES A THRU F</u>)
		MS	<u>ENTRY STOWAGE</u> <input type="checkbox"/> 2, 5-35	
		C	<u>FES HTR ACTIVATION</u> <input type="checkbox"/> 3, 5-9	
		MS	<u>FDF CONFIG/ENTRY STOW</u> <input type="checkbox"/> 4, 5-27	
	-03:55	P	A14 √RCS/OMS HTR AFT RCS JET 1,2,3,4 (four) – AUTO	
			A15 If SSPTS (OV103,105 only): PTU/MAIN BUS A,B (two) – OFF (tb-OFF) cb CNTL PWR PTU 1,2 (two) – op OPCU 1,2 V-ADJ (two) – OFF	
	-03:50			
	-03:45	C	<u>MDM CONFIG</u> <input type="checkbox"/> 5, 5-9	
		A	<u>AC BUS CONFIG</u> <input type="checkbox"/> 6, 5-27 (Not reqd if AC transfer cable installed or if AC bus shorted)	
-03:40				
	P	<u>SELECT AFT RCS JETS</u> <input type="checkbox"/> 7 (if GG from pwrn)		
-03:35				
	MS	<u>LOSS OF 2 FC SW VERIF LIST</u> , 6-31, 6-32 (Airlock and Airlock Hatch only)		
-03:30				
			<u>SELECT AFT RCS JETS</u> <input type="checkbox"/> 7 (if GG from pwrn) P O6 √MDM FA 1,2,3,4 (four) – ON <u>GNC 20 DAP CONFIG</u> Select TAIL P,Y OPTION O14:F √RJDA 1A L2/R2 LOGIC, DRIVER – ON O15:F √1B L1/L5/R1 LOGIC – ON √L1/R1 DRIVER – ON O16:F √2B L3/R3/R5 LOGIC – ON √L3/R3 DRIVER – ON <u>X: GNC 23 RCS</u> ITEM 1 EXEC (FRCS page) O7 OVRD FRCS MANF 1,2,3,4 STAT – CL ITEM 2 EXEC (LRCS page) OVRD LRCS MANF 4 STAT – CL ITEM 3 EXEC (RRCS page) OVRD RRCS MANF 4 STAT – CL	

FES RESTART 8

C	L1	RAD CNTLR OUT TEMP – HI
	O1	When FREON EVAP OUT TEMP ind > 50 degF:
	L1	FLASH EVAP CNTLR PRI B(A) – ON
		HI LOAD DUCT HTR sel – B
	ML86B:A	√cb MNC SPLY H2O XOVR VLV – cl
	R11L	SPLY H2O XOVR VLV – OP (tb-OP)

PRESS CNTL SYS ENTRY CONFIG 9

MS	MO10W	14.7 CAB REG INLET SYS 1,2 vlv (two) – CL
		H2O TK N2 REG INLET SYS 1,2 vlv (two) – OP
		O2 REG INLET SYS 1,2 vlv (two) – CL
	MO69M	LEH O2 8 vlv – CL
		Remove, stow O2 Bleed Orifice
		LEH O2 7,8 vlv – OP (if reqd)
	MO32M	5,6 vlv – OP (if reqd)
C	L2	√O2 SYS 1,2 SPLY (two) – OP (tb-OP)
		√XOVR SYS 1,2 (two) – OP
		√N2 SYS 1,2 SPLY (two) – OP (tb-OP)
		√REG INLET (two) – OP (tb-OP)
		O2/N2 CNTLR VLV SYS 1 – OP
		2 – CL

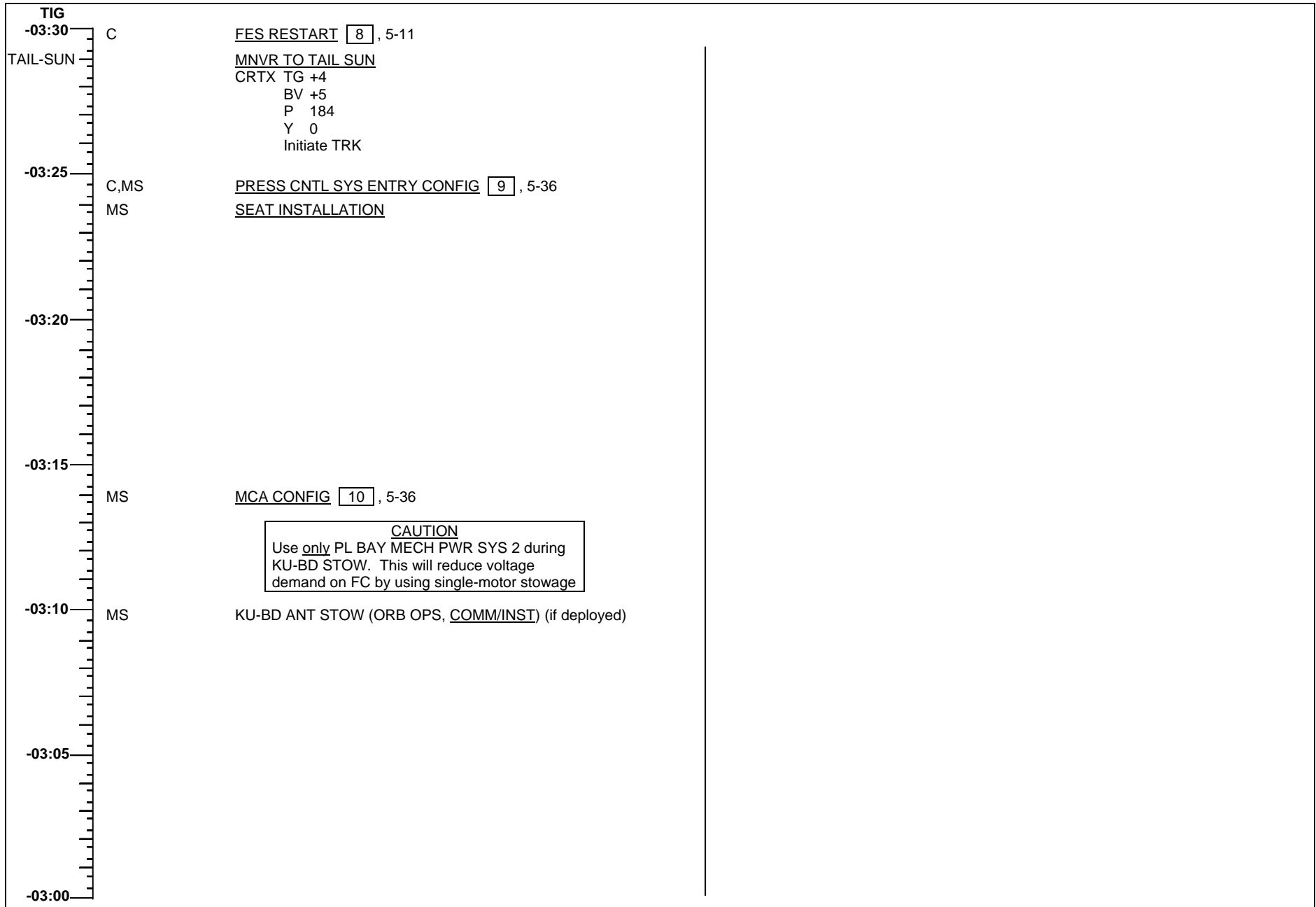

RAD BYP		11
<u>FLASH EVAP CONFIG</u>		
C	L1	√FLASH EVAP CNTLR PRI B(A) – ON √A(B) – OFF √SEC – OFF HI LOAD EVAP – ENA √DUCT HTR sel – B
<u>RAD BYP</u>		
L1		RAD CNTLR OUT TEMP – NORM BYP VLV MODE (two) – MAN MAN SEL (two) – BYP (after 3 sec, tb-BYP) CNTLR LOOP (two) – OFF
L2		FREON ISOL MODE – OFF
O1		√FREON EVAP OUT TEMP ind ~39 ± 1 degF (after 2.5 min)
<u>FREON LOOP CONFIG</u>		
L1		FLOW PROP VLV LOOP (two) – ICH (hold 3 sec, tb-ICH)

CRYO QTY CONFIG		13
C	O13:B	cb ESS 1BC CRYO QTY O2,H2 TK2 (two) – op
	:D	2CA CRYO QTY O2,H2 TK1 (two) – op
MS	ML86B:G	cb ESS 1BC CRYO QTY O2,H2 TK4 (two) – op
		√2CA CRYO QTY O2, H2 TK5 (two) – op
		3AB CRYO QTY O2,H2 TK3 (two) – op

PRE DPS TRANS SWITCH CONFIG		14
C,P	O14:A	RGA 1 – ON
	:E	cb MNA ACCEL 1 – cl
	:F	ASA 1 – ON
	O15:A	RGA 2 – ON
	:E	cb MNB ACCEL 2 – cl
	:F	ASA 2 – ON
	O16:A	RGA 3 – ON
	:F	ACCEL 3 – ON

DPS ENTRY CONFIG		15
C,P	L1	√AV BAY 2 FAN A(B) – ON
	O14:F	√MMU 1 – ON
	O15:F	√2 – ON
	C3	√FCS CH (four) – AUTO
		1. <u>LOAD ENTRY TFL</u> Perform LOAD PDI DECOM FORMAT and LOAD PCMMU FORMAT (ORB OPS FS, <u>COMM/INST</u>) for entry config
		<u>SM CHECKPOINT/UL CNTL ENA</u>
	C2	X: SM 60 SM TABLE MAINT Y: SM 1 DPS UTILITY

CRTY	MMU ASSIGN 2 SM – ITEM 4 EXEC
CRTX	CKPT INITIATE – ITEM 18 EXEC √Update of CKPT TIME and STATUS GOOD indicated
CRTY	MMU ASSIGN 1 SM – ITEM 3 EXEC
CRTX	CKPT INITIATE – ITEM 18 EXEC √Update of CKPT TIME and STATUS GOOD indicated
CRTY	CKPT RETRV ENA – ITEM 12 EXEC (*) UL CNTL ENA – ITEM 36 EXEC
C2	2. <u>DEACT GPC 4</u> IDP/CRT X MAJ FUNC – GNC
	<u>NOTE</u> All MAJ FUNC should be GNC prior to powering down SM GPC
O6	GPC MODE 4 – STBY,HALT – STBY (tb-RUN) – HALT (tb-bp) OUTPUT 4 – NORM
CRT1	GPC/CRT 04 EXEC 13 EXEC
	3. <u>TRANSITION GPC 1 TO GNC OPS 3</u> X: GNC GPC MEMORY
CRTX	CONFIG – ITEM 1 +3 EXEC Modify MC 3 per table
CRTX	GNC, OPS 301 PRO DEORB MNVR COAST
O6	4. <u>TRANSITION BFS GPC TO GNC OPS 3</u> GPC OUTPUT 5 – B/U (tb-bp) MODE 5 – STBY (tb-RUN),RUN BFC CRT DISP – ON SEL – 3 + 1 3: BFS MEMORY BFS, GNC OPS 301 PRO 3: BFS, DEORB MNVR COAST
C3	5. <u>LAND SITE UPDATE</u> X: GNC 50 HORIZ SIT SEL SITE (See LAND SITE DATA)
O14:F	MMU 1 – OFF ASA 1 – OFF
O15:F	MMU 2 – OFF ASA 2 – OFF

CONFIG	3
GPC	10000
STR	1 1
	2 1
	3 1
	4 1
PL	1/2 1
CRT	1 1
	2 1
	3 1
	4 0
L	1 0
	2 0
MM	1 1
	2 1

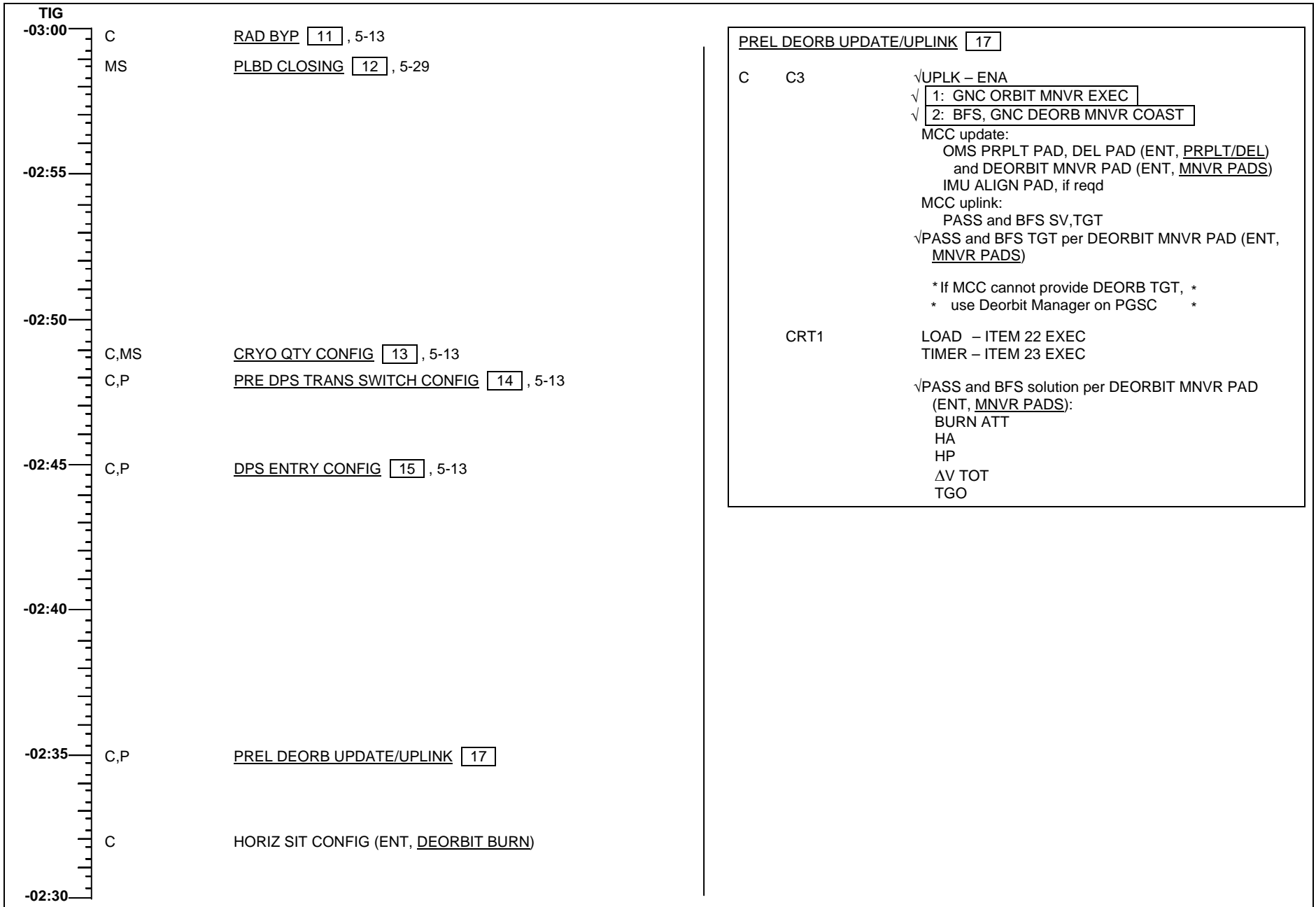

W/B STEAM VENT HTR ACT 21

P R2

If FC 1 OK:

- BLR CNTLR/HTR 1 – A
- 2 – B
- 3 – A

If FC 2 or FC 3 OK:

- BLR CNTLR/HTR 1 – A
- 2 – A
- BLR CNTLR/HTR 3 – B
- BLR PWR (three) – ON

NOTE

Htr reqd to be on 2 hr prior to APU act

TIG
-02:30
-02:25
-02:20
-02:15
-02:10
-02:05
-02:00

C
MS
MS
P
C
C
C

IMU RECOVERY (if reqd)
Use GNC FRP-3 (MAL, GNC) to recover any IMUs lost
due to bus failures or powerdown
BFS, GNC, OPS 000, 301 PRO
BFS, GNC 50 HORIZ SIT
√BFS R/W sel
FLUID LOADING PREP 18, 5-36

GALLEY DEACT 19, 5-36
HTR CONFIG 20, 5-33
W/B STEAM VENT HTR ACT 21, 5-15
ACT STAR TRKR (omit if BFS)
O6 √S TRK PWR -Z - ON
√S TRK PWR -Y - ON
CRT1 GNC I/O RESET
√STAR TRKR doors open
MNVR TO IMU ATT (omit if BFS) use pad on this page
DAP: AUTO

IMU STAR ALIGN PAD

NOTE
For pad data, √MCC or ref STAR PAIRS (ORB OPS, PTG)

STAR ID: -Y _____ (TIG - ____ : ____ TO- ____ : ____)
 -Z _____ (TIG - ____ : ____ TO- ____ : ____)
ANG DIF: _____

ALIGNMENT ATTITUDE (Dual or Single S TRK)	-Z:	2nd ALIGNMENT ATTITUDE (Single S TRK)
R _____		R _____
P _____		P _____
Y _____		Y _____

IMU STAR ALIGN LOG

REQD ID: -Y _____, -Z _____ ANG ERR ____ . ____

ANG	1	2	3
ΔX ()	_____ ()	_____ ()	_____ ()
ΔY ()	_____ ()	_____ ()	_____ ()
ΔZ ()	_____ ()	_____ ()	_____ ()

EXECUTE TIME ____ : ____ : ____ (TIG MINUS)

IMU VERIFICATION PAD

NOTE
For pad data, √MCC or ref STAR PAIRS (ORB OPS, PTG)

STAR ID: -Y _____ (TIG - ____ : ____ TO- ____ : ____)
 -Z _____ (TIG - ____ : ____ TO- ____ : ____)
ANG DIF: _____

ALIGNMENT ATTITUDE (Dual or Single S TRK)	-Z:	2nd ALIGNMENT ATTITUDE (Single S TRK)
R _____		R _____
P _____		P _____
Y _____		Y _____

IMU STAR ALIGN LOG

REQD ID: -Y _____, -Z _____ ANG ERR ____ . ____

ANG	1	2	3
ΔX ()	_____ ()	_____ ()	_____ ()
ΔY ()	_____ ()	_____ ()	_____ ()
ΔZ ()	_____ ()	_____ ()	_____ ()

EXECUTE TIME ____ : ____ : ____ (TIG MINUS)

IMU ALIGNMENT 22

NOTE

Procedure applies for one or two S TRK aligns.
For one S TRK, a second att mnvr reqd between data takes. See pad on 5-16 for att & stars

- C
- C3 1. 1: GNC 22 S TRK/COAS CNTL
- C3 BFC CRT DISP – OFF
- 3: GNC 21 IMU ALIGN
- CRT1 2. √REQD ID – ITEM 11,12 – 0
√STATUS (two) – NO BITE
√SHUTTER (two) – OP
- * If SHUTTER – CL: *
 - * √Att, MET – correct *
 - * Visually verify no bright object in FOV *
 - * After data collected and before changing *
 - * attitude, return shutter to AUTO *
 - * To open shutter: *
 - * MAN OP – ITEM 15(16) EXEC (*) *
 - * To return shutter to AUTO: *
 - * MAN OP – ITEM 15(16) EXEC (no *) *
- CRT3 IMU 1,2,3:
√STAT – blank
√OPER – ITEM 4,5,6 (*)
- CRT1 3. √IMU ALIGN ATT (pad)
- CRT1 4. S TABLE CLR – ITEM 20 EXEC
5. Enable Star Tracker:
√S TRK – ITEM 3,4 EXEC (*)
6. Verify S TABLE:
TRK ID 1,2 = STAR ID (pad)
ANG ERR ≤ 0.08
- Wait approx 1 min for new IMU Δ ANGS
- * If after 3 min no data (or bad data) in S Table: *
 - * √S TRK – ITEM 3,4 (*) *
 - * √ATT/STARS/TIME *
 - * √S TRK: TRK ID = STAR ID (pad) *
 - * Do S TRK Self Test *
 - * If neither tracker fails: *
 - * Mnvr to verification att – repeat steps 3,4,5,6 *
 - * If one tracker fails: *
 - * √TERM/IDLE for failed tracker – ITEM 9(10)(*) *
 - * proceed with one S TRK ALIGN *
 - * If both trackers fail, inform MCC *

For one S TRK align:

S TRK for good tracker – ITEM 3(4) EXEC (*)
TABLE CLR – ITEM 20 EXEC, reacquire star with good tracker
TERM/IDLE for good tracker during maneuvers – ITEM 9(10) EXEC (*)
Mnvr to second att (single S TRK): Do not clear S Table
Repeat steps 3,5,6 with second Star ID

- CRT1 7. √S TABLE SEL – ITEM 17,18 (*)
CRT3 ALIGN IMU 1,2,3 – ITEM 10,11,12, EXEC (*)
√REF STAR – ITEM 13 (*)
√TYPE – ITEM 15 (TORQUE)
√IMU 1,2,3 – ANG ΔX,ΔY,ΔZ < 0.80
- * If ANG ΔX,ΔY,ΔZ > 0.80 for two IMUs, do not torque: *
 - * Mnvr to verification att, repeat steps 3 thru 7 once *
 - * If still > 0.80, report to MCC *
8. Record ANG ΔX,ΔY,ΔZ,ANG ERR, EXECUTE TIME (use log on 5-16)
- EXEC – ITEM 16 EXEC (*)
- Alignment complete when:
EXEC – ITEM 16 (no *)
- IMU ALIGN VERIFICATION
9. Mnvr per IMU VERIFICATION PAD, 5-16
DAP: AUTO
10. Perform steps 3,4,5,6 using appropriate stars (pad)
11. √IMU 1,2,3 ANG ΔX,ΔY,ΔZ < 0.1
- * If ANG ΔX,ΔY,ΔZ > 0.1, perform steps 8 thru 11, *
 - * report to MCC *

NOTE

For alternate stars, √MCC or ref STAR PAIRS (ORB OPS, PTG)

12. Report IMU ALIGN results
- C3 13. BFC CRT DISP – ON
- 3: BFS, GNC DORB MNVR COAST
- 1: GNC DEORB MNVR COAST

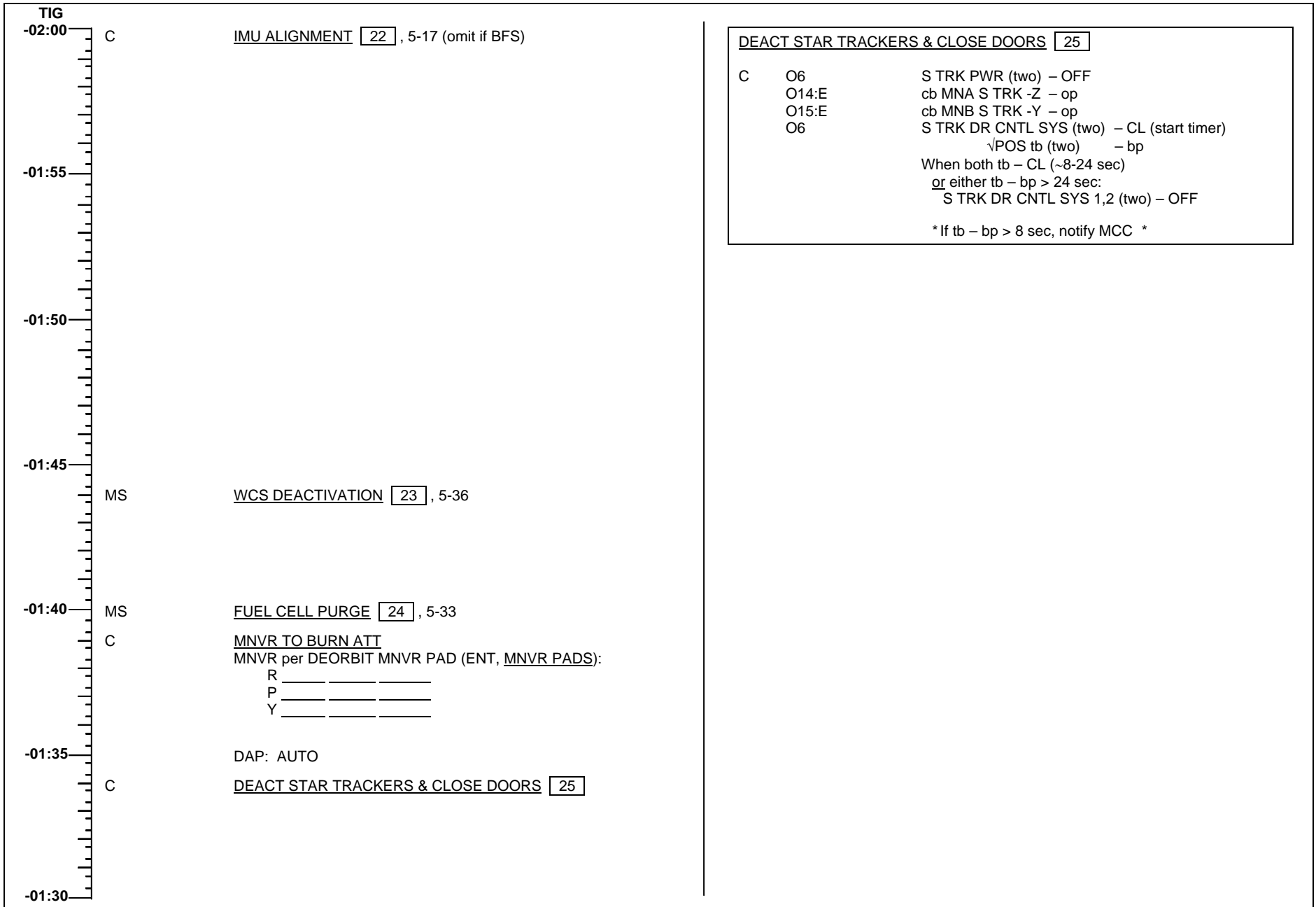

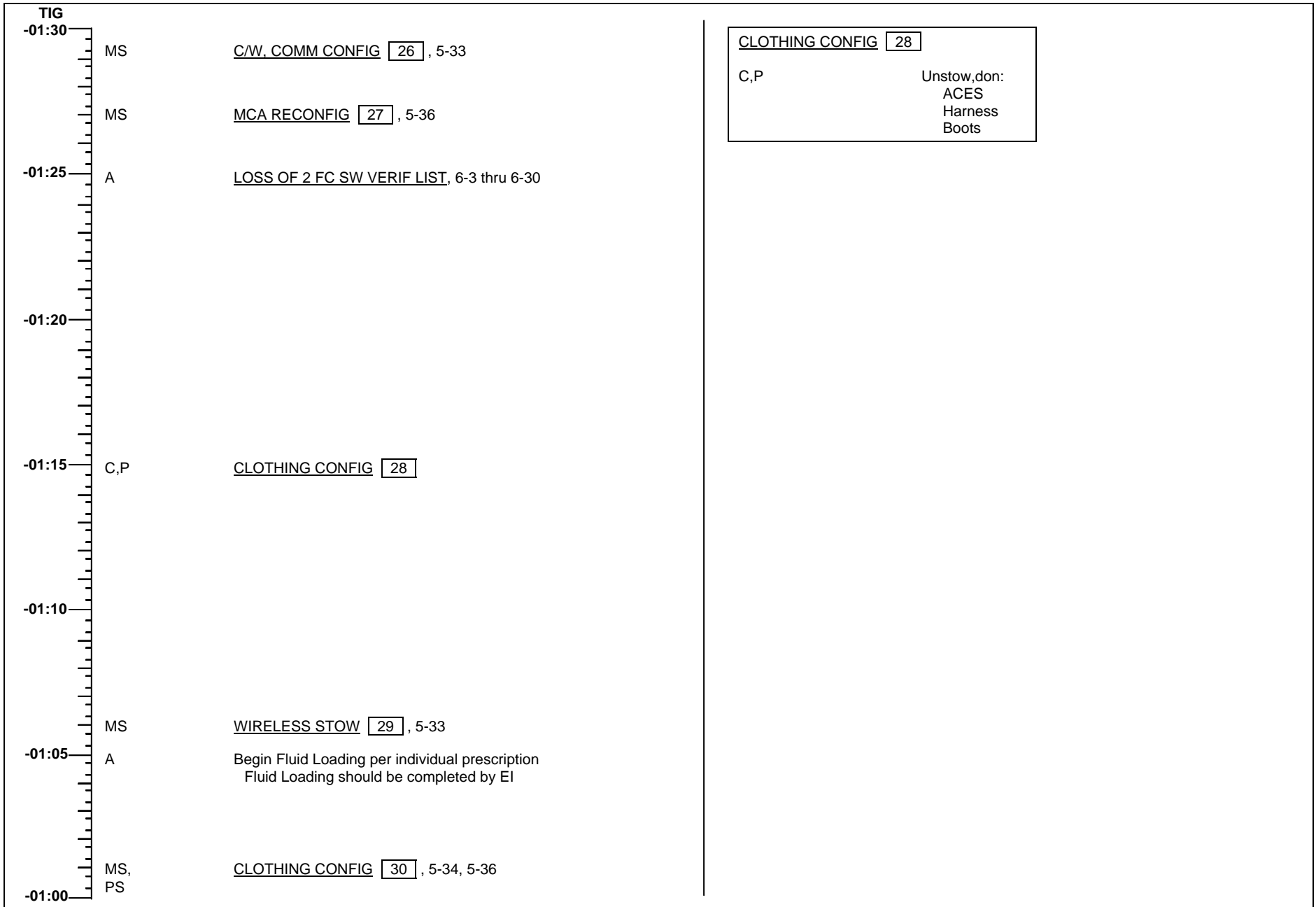

PRE INGRESS CONFIG 31

		<u>MPS/H2 PURGE PREP</u>	
P	R2	MPS He ISOL (six)	- CL
		PNEU He ISOL	- CL
		L ENG He XOVR	- CL
	R4	MANF PRESS (two)	- CL
		<u>ENABLE QTY GAUGE</u>	
C,P	O16:E	cb MNC RCS/OMS PRPLT QTY GAUGE	- cl
		<u>RA CONFIG</u>	
	F8	RDR ALTM	- 1
		<u>MLS CH/TACAN CH/DATA BUS</u>	
	O8	MLS CH tw (three)	- See LAND SITE DATA
	O7	TACAN CH tw (three)	- See LAND SITE DATA
		<u>ENABLE PROXIMITY PACKAGE</u>	
C	L4:P	√cb AC2 ΦA LG SNSR 2	- cl
		√AC3 ΦA LG SNSR 1	- cl
		<u>cb CONFIG</u>	
C	L4:J	cb AC3 ΦA SIG CONDR HUM SEP	- op
		ΦB SIG CONDR IMU FAN	- op
		<u>HUD SETUP</u>	
		Remove, stow HUD covers (two)	
		Ensure cloth cover does not obscure light sensor	

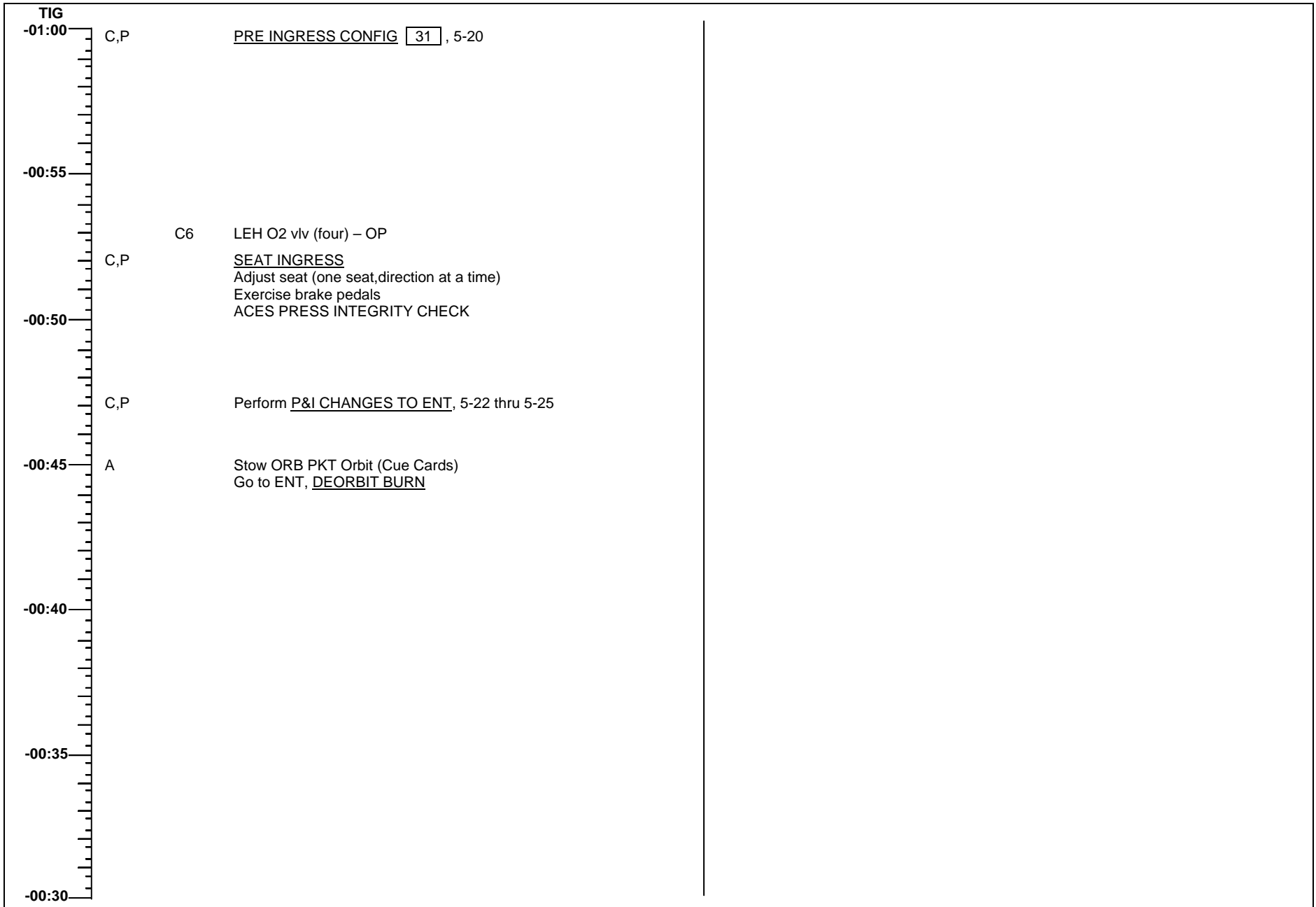

LOSS OF 2 FUEL CELLS

P&I Changes to ENTRY

GENERAL

1. AV BAY FANS cycled as needed to keep power level low
2. GPCs 2,3 remain pwr dn throughout ENTRY

SPECIFIC

TIG-45

R4

Delete: **OMS TVC GMBL CHECK**

Under **APU PRESTART** delete:

√HYD BK ISOL VLV (three) tb – CL

√LG EXTD ISO VLV tb – CL

and associated starred procedures

HORIZ SIT CONFIG (GNC 51, BFS GNC 51)

Delete: √SSME REPOS – ITEM 19 (ENA)

Add: “SSME REPOS – ITEM 19 EXEC (INH)”

I

TIG-25

“NOTE

VENT DOOR CLOSE must be performed prior to MM302 transition

O6

MDM FF4 – ON

GNC I/O RESET

MA73C:A

MCA LOGIC MNA MID 1 – ON

2: GNC 51 OVERRIDE

CRT 2

VENT DOOR CNTL CLOSE – ITEM 44 EXEC

MA73C:A

MCA LOGIC MNA MID 1 – OFF

MNB MID 1 – ON

MNC MID 2 – ON

MNB AFT 2 – ON

CRT 2

VENT DOOR CNTL CLOSE – ITEM 44 EXEC

MA73C:A

MCA LOGIC MNA MID 1 – ON

MNB MID 1 – OFF

MNC MID 2 – OFF”

LOSS OF 2 FUEL CELLS

P&I Changes to ENTRY (Cont)

POST
BURN

Add: "FLT CNTLR PWR (two) – OFF

√DAP: AUTO

cb MNA,B,C, DDU L,R (four) – op"

Insert after **OMS/RCS POST BURN RECONFIG**:

L1

"AV BAY FAN 1B,2A,3A [3B vice 3A if FC 1 OK] – ON (3 sec between each start)"

EI-20

SECONDARY ACTUATOR CHECK

C3

Add: "9. FCS CH (four) – ORIDE"

EI-18

If FORWARD RCS DUMP reqd for off-nominal CG, etc,
insert FORWARD RCS RECOVERY before the dump:

"FORWARD RCS RECOVERY

O14:F,
O15:F,
O16:F

RJDF LOGIC,DRIVER (eight) – ON

GNC 23 RCS

ITEM 1 EXEC (FRCS page)

OVRD FRCS MANF 1,2,3,4 STAT – OP"

Insert after dump completion:

O14:F,
O15:F,
O16:F

"RJDF LOGIC,DRIVER (eight) – OFF

GNC 23 RCS

ITEM 1 EXEC (FRCS page)

OVRD FRCS MANF 1,2,3,4 STAT – cl"

ENTRY SW
CHECK

Delete: √ANTISKID,NWS steps

Delete: √RADAR ALTM,MLS,TACAN steps

OV103,104

C D/O/3,4/GEN L

LOSS OF 2 FUEL CELLS
P&I Changes to ENTRY (Cont)

EI-15	A13	GPS PWR – ON If OV103: GPS PRE AMPL (two) – MNC If OV104: GPS PRE AMPL (two) – ON Wait 30 sec GNC I/O RESET GNC 55 GPS STATUS INIT – ITEM 15 EXEC (*) NAV – ITEM 18 EXEC (*)
EI-13		Delete: SSME HYD REPRESS
	ENTRY MNVRS	Replace nominal <u>ENTRY MANEUVERS</u> (Cue Card) with LOSS OF 2 FUEL CELLS ENTRY MANEUVERS, 5-26

LOSS OF 2 FUEL CELLS ENTRY MANEUVERS

FLIGHT CONDITIONS	MANEUVER
EI-5	BRAKES (three) – ON cb ADTA 1,2,3 – cl GNC I/O RESET cb MNA,B,C DDU L,R (four) – cl (L) FLT CNTLR PWR – ON Use two IDP/CRTs with four MDUs √LVLH ATT GNC, OPS 304 PRO √OPS 304, wait 1 min MDM FF4 – OFF * If PREBANK: R/Y – CSS * * Roll at 1°/sec to <input type="text"/> <input type="text"/> * * Maintain PREBANK ± 5° *
‘Guidance Box’ @ q ~8 or D ~3	CLOSED LOOP GUIDANCE ___ : ___ : ___ * If PREBANK: P,R/Y – AUTO * Begin ALL trim monitoring
D = 11	√DRAG H
ΔAz = 10.5°	FIRST ROLL REVERSAL <input type="text"/> <input type="text"/> <input type="text"/> <input type="text"/> <input type="text"/>
V = 19K	√HYD MPS/TVC ISOL VLV SYS (three) – CL [G50] √GPS, INCORPORATE
V = 15K	If FC 1 OK: TACAN 1 MODE – GPC If FC 2 or FC 3 OK: TACAN 3 MODE – GPC √TACAN ANT SEL – AUTO * If ELS,UHF MODE – G T/R *
V = 12K	RAD BYP VLV MODE (two) – AUTO CNTLR LOOP (two) – AUTO B(A)
V = 10K	√SPDBK to 81%
V = 7K	√TACAN and GPS status
V = 5K	L AIR DATA PROBE – DPY (Wait 30 sec) R AIR DATA PROBE – DPY (Heat only one probe if reqd) Begin AIL and RUD trim monitoring

FLIGHT CONDITIONS	MANEUVER
M = 4	MDM FF4 – ON GNC I/O RESET
M = 3.5	[G51] VENT DOOR CNTL OPEN – ITEM 43 EXEC
M = 2.9	CAB FAN (two) – OFF AV BAY FAN 2A – OFF 3A(3B) – OFF After ADTA incorporated, TACAN MODE (two) – OFF Use one HUD, one MLS, one RA GNC I/O RESET
M = 2.7	√APUs TRIM PANEL (two) – OFF RHC/PNL (two) – ENA
* If M < 2.5, P CSS for ADTA to G&C incorp *	
M = 2.0	Ensure ADTA to G&C; else, √theta limits
M < 1.0	*For bailout procedures, go to BAILOUT * P,R/Y – CSS as reqd √SPDBK CMD vs POS MAX N _z <input type="text"/> <input type="text"/> <input type="text"/> (R) FLT CNTLR PWR – ON Use two IDP/CRTs with six MDUs ANTISKID – ON NWS – 1 Lock Inertia Reels
M = 0.7	√LG EXT D ISO VLV – OP
h = 15K	√MLS
h = 10K	√A/L (KSC – Tabs, Visors, Suit O2)
h = 2K	LDG GEAR ARM pb – push (ARM lt on)
h = 300	LDG GEAR DN pb – push (DN lt on)
MAIN GEAR TD	√SPDBK – 100%
V = 195 KEAS	DRAG CHUTE ARM,DPY pb (two) – push (simo) (All lts on)
V = 185 KEAS	DEROTATE
NOSE GEAR TD	SRB SEP – MAN/AUTO and depress pb √Auto Load Relief √HYD BK ISOL VLV (three) – OP
V < 120 KGS or 5K' remaining	BRAKE as reqd (8-10 fps ² , -0.25 to -0.3G)
* If 5K' remaining and V > 140 KGS – MAX BRAKING *	
V = 60 KGS	DRAG CHUTE JETT pb – push (JETT1, JETT2 lt on)
V = 40 KGS	BRAKE < 6 fps ² (-0.2G) (Antiskid cutout)
WHEEL STOP	√All landing/nav aids off CAB FAN B – ON (Wait 3 sec, then continue) AV BAY FAN 2A,3A [3B vice 3A if FC1 OK] – ON (3 sec between each start) Go to ENT C/L, POST LDG

OV103,104

LOSS OF 2 FUEL CELLS

P&I Changes to ENTRY (Cont)

L1 Insert: "HUM SEP (two) – OFF"

FES HEATER DEACT
TOP EVAP HTR NOZ L,R (two) – OFF
DUCT – OFF
HI LOAD DUCT HTR – OFF

L2 FLASH EVAP FDLN HTR B SPLY – OFF

ASA ACT
ASA (four) – ON"

DEORB
UPDATE/
UPLINK

O14:F,
O15:F,
O16:F

Insert before GNC OPS 302 PRO:

"GPC 4 ACT

- O6 (1) GPC MODE 4 – STBY/RUN
- C3 (2) BFC CRT DISP – OFF
- (3) For OPS 3 TRANS use →
- (4) GNC, OPS 301 PRO
- C3 (5) BFC CRT DISP – ON; BFS I/O RESET
- (6) FCS CH (four) – ORIDE
- (7) G50 √LAND SITE/RWY per DEL PAD"

CONFIG	3	
GPC	10040	
STR	1	1
	2	4
	3	1
	4	4
PL	1/2	1
CRT	1	1
	2	4
	3	1
	4	0
L	1	0
	2	0
MM	1	1
	2	4

TIG-20

Delete: **RCS/OMS HTR** steps

TIG-5

R4 Insert after **SINGLE APU START**:
"√HYD BK ISOL VLV X – GPC (tb-CL)
√LG EXTD ISO VLV – GPC (tb-CL)
GNC DEORB MNVR EXEC
R OMS GMBL – SEC (*)"

TIG-2

L1 Use 2 DDU/FLT CNTLR PWR
Add: "**AV BAY FAN CYCLE**
AV BAY FAN (six) – OFF"

DURING
BURN

If FRCS COMPLETION required during burn, perform EI-18 FORWARD RCS RECOVERY steps below prior to fast flip

LOSS OF 2 FUEL CELLS

P&I Changes to ENTRY (Cont)

POST
BURN

Add: "FLT CNTLR PWR (two) – OFF

√DAP: AUTO

cb MNA,B,C, DDU L,R (four) – op"

Insert after **OMS/RCS POST BURN RECONFIG**:

L1 "AV BAY FAN 1B,2A,3A [3B vice 3A if FC 1 OK] – ON (3 sec between each start)"

EI-20

SECONDARY ACTUATOR CHECK

C3

Add: "9. FCS CH (four) – ORIDE"

EI-18

If FORWARD RCS DUMP reqd for off-nominal CG, etc,
insert FORWARD RCS RECOVERY before the dump:

"FORWARD RCS RECOVERY

O14:F,
O15:F,
O16:F
RJDF LOGIC,DRIVER (eight) – ON

GNC 23 RCS

ITEM 1 EXEC (FRCS page)

OVRD FRCS MANF 1,2,3,4 STAT – OP"

Insert after dump completion:

O14:F,
O15:F,
O16:F
"RJDF LOGIC,DRIVER (eight) – OFF

GNC 23 RCS

ITEM 1 EXEC (FRCS page)

OVRD FRCS MANF 1,2,3,4 STAT – cl"

ENTRY SW
CHECK

Delete: √ANTISKID,NWS steps

Delete: √RADAR ALTM,MLS steps

LOSS OF 2 FUEL CELLS

P&I Changes to ENTRY (Cont)

EI-15	O7	If FC1 OK: GPS 1,2 PWR (two) – ON PRE AMPL (four) – ON If FC2 or FC3 OK: GPS 2,3 PWR (two) – ON PRE AMPL (four) – ON Wait 30 sec GNC I/O RESET <u>GNC 55 GPS STATUS</u> INIT – ITEM 14(15,16) EXEC NAV – ITEM 17(18,19) EXEC
EI-13		Delete: SSME HYD REPRESS
	ENTRY MNVRS	Replace nominal <u>ENTRY MANEUVERS</u> (Cue Card) with LOSS OF 2 FUEL CELLS ENTRY MANEUVERS, 5-26

LOSS OF 2 FUEL CELLS ENTRY MANEUVERS

FLIGHT CONDITIONS	MANEUVER
EI-5	BRAKES (three) – ON cb ADTA 1,2,3 – cl GNC I/O RESET cb MNA,B,C DDU L,R (four) – cl (L) FLT CNTLR PWR – ON Use two IDP/CRTs with four MDUs √LVLH ATT GNC, OPS 304 PRO √OPS 304, wait 1 min MDM FF4 – OFF * If PREBANK: R/Y – CSS * * Roll at 1°/sec to <input type="text"/> <input type="text"/> * * Maintain PREBANK ± 5° *
‘Guidance Box’ @ q ~8 or D ~3	CLOSED LOOP GUIDANCE ___ : ___ : ___ * If PREBANK: P,R/Y – AUTO * Begin ALL trim monitoring
D = 11	√DRAG H
ΔAz = 10.5°	FIRST ROLL REVERSAL <input type="text"/> <input type="text"/> <input type="text"/> <input type="text"/> <input type="text"/>
V = 19K	√HYD MPS/TVC ISOL VLV SYS (three) – CL <input type="text"/> <input type="text"/> √GPS, INCORPORATE
V = 15K	* If ELS,UHF MODE – G T/R *
V = 12K	RAD BYP VLV MODE (two) – AUTO CNTLR LOOP (two) – AUTO B(A)
V = 10K	√SPDBK to 81%
V = 5K	L AIR DATA PROBE – DPY (Wait 30 sec) R AIR DATA PROBE – DPY (Heat only one probe if reqd) Begin AIL and RUD trim monitoring

FLIGHT CONDITIONS	MANEUVER
M = 4	MDM FF4 – ON GNC I/O RESET
M = 3.5	<input type="text"/> <input type="text"/> VENT DOOR CNTL OPEN – ITEM 43 EXEC
M = 2.9	CAB FAN (two) – OFF AV BAY FAN 2A – OFF 3A(3B) – OFF Use one HUD, one MLS, one RA GNC I/O RESET
M = 2.7	√APUs TRIM PANEL (two) – OFF RHC/PNL (two) – ENA
* If M < 2.5, P CSS for ADTA to G&C incorp *	
M = 2.0	Ensure ADTA to G&C; else, √theta limits
M < 1.0	* For bailout procedures, go to BALLOUT * P,R/Y – CSS as reqd √SPDBK CMD vs POS MAX Nz <input type="text"/> <input type="text"/> <input type="text"/> (R) FLT CNTLR PWR – ON Use two IDP/CRTs with six MDUs ANTISKID – ON NWS – 1 Lock Inertia Reels
M = 0.7	√LG EXTD ISO VLV – OP
h = 15K	√MLS
h = 10K	√A/L (KSC – Tabs, Visors, Suit O2)
h = 2K	LDG GEAR ARM pb – push (ARM lt on)
h = 300	LDG GEAR DN pb – push (DN lt on)
MAIN GEAR TD	√SPDBK – 100%
V = 195 KEAS	DRAG CHUTE ARM,DPY pb (two) – push (simo) (All lts on)
V = 185 KEAS	DEROTATE
NOSE GEAR TD	SRB SEP – MAN/AUTO and depress pb √Auto Load Relief √HYD BK ISOL VLV (three) – OP
V < 120 KGS or 5K’ remaining	BRAKE as reqd (8-10 fps ² , -0.25 to -0.3G)
* If 5K’ remaining and V > 140 KGS – MAX BRAKING *	
V = 60 KGS	DRAG CHUTE JETT pb – push (JETT1, JETT2 lt on)
V = 40 KGS	BRAKE < 6 fps ² (-0.2G) (Antiskid cutout)
WHEEL STOP	√All landing/nav aids off CAB FAN B – ON (Wait 3 sec, then continue) AV BAY FAN 2A,3A [3B vice 3A if FC1 OK] – ON (3 sec between each start) Go to ENT C/L, <u>POST LDG</u>

OV105

C D/O/5/GEN L,5

LOSS OF 2 FC Back of MS AFT FLIGHT DECK ACTIVITIES

MS PULLOUT PAGE

NOTE

Wait for GO from CDR or PLT before starting any activity on this page

TIME (TIG-)	MS ACTIONS (AFT)
3:57	<u>FDF CONFIG/ENTRY STOW</u> [4]
3:42	<u>AC BUS CONFIG</u> [6] (Not reqd if AC transfer cable installed or if AC bus shorted)
3:24	<u>SPECIALIST SEAT INSTALLATION</u> Verify Leg Attach Collars (four) – DOWN/LOCKED <div style="border: 1px solid black; padding: 5px; margin: 10px 0;"> <p style="text-align: center;">CAUTION</p> <p>Use <u>only</u> PL BAY MECH PWR SYS 2 during KU-BD STOW. This will reduce voltage demand on FC by using single-motor stowage</p> </div>
3:10	<u>KU-BD ANT STOW</u> (ORB OPS, <u>COMM/INST</u>) (if deployed)
2:59	<u>PLBD CLOSING</u> [12] , 5-29
2:09	<u>HTR CONFIG</u> [20] , 5-33
1:40	<u>FUEL CELL PURGE</u> [24] , 5-33
1:29	<u>C/W, COMM CONFIG</u> [26] , 5-33
1:25	<u>LOSS OF 2 FC SW VERIF LIST</u> , 6-15 thru 6-26
1:06	<u>WIRELESS STOW</u> [29] , 5-33
1:05	Begin Fluid Loading per individual prescription. Fluid Loading should be completed by EI
1:01	<u>CLOTHING CONFIG</u> [30] , 5-34

FDF CONFIG/ENTRY STOW [4]

FDF CONFIG

Unstow,install:

Entry,Deorbit Burn Cue Cards
ENT
ENT PKT

√Available for ENTRY:

LDG SITE CHARTS
Handheld Radio
STAR CHART
ORB OPS
CONT DEORB
ORB PKT
REF DATA
MAL

Stow all other FDF articles

ENTRY STOW

Stow: Flt Deck Camrs,Accessories

Stow VTR Cassettes (one in VTR)
Quick Don Masks

FOOT LOOP CONFIG

Tape Foot Loops in egress routes

AC BUS CONFIG [6]

A L4:D,E,Q

1. √All cbs (twenty-seven) – op

2. If FC 1 OK:

Perform AC3 (3Φ) BUS LOSS ACTIONS (ORB PKT, EPS).
Do only steps in ORB PKT, do not proceed to MAL
Mark up pictorials in section 6 to match bus loss actions
AC3 is affected bus in step 3

If FC 2 or FC 3 OK:

Perform AC1 (3Φ) BUS LOSS ACTIONS (ORB PKT, EPS).
Do only steps in ORB PKT, do not proceed to MAL
Mark up pictorials in section 6 to match bus loss actions
AC1 is affected bus in step 3

R1

3. Affected BUS: cb AC CONTR (three) – cl
AC BUS SNSR – OFF
INV/AC BUS – OFF (tb-OFF)
INV PWR – OFF (tb-OFF)
cb AC CONTR (three) – op

4. Connect AC1 to AC3:

Go to AC POWER TRANSFER CABLE INSTALLATION
(IFM, PROCEDURES A THRU E)

LOSS OF 2 FC
Back of MS AFT FLIGHT DECK ACTIVITIES
MS PULLOUT PAGE

This Page Intentionally Blank

LOSS OF 2 FC MS AFT FLIGHT DECK ACTIVITIES (Cont)

MS PULLOUT PAGE

PLBD CLOSING 12

STOW RADIATOR(S) (if deployed)

CAUTION

Use only PL BAY MECH PWR SYS 2 during RAD STOW. This will reduce voltage demand on FC by using single-motor stowage

Perform RAD STOW (ORB OPS, ECLS)

CONFIG RMS/OBSS (if RMS/OBSS onboard)

√Elbow Camr in aligned posn

- Pan 90° from X-axis
- Tilt per decal

√PORT RMS HTR (two) – OFF

√RMS PWR – OFF

STBD RMS HTR (two) – OFF

RSC PWR – OFF

OBSS SW PWR – OFF

cb OBSS SW PWR CB1 – op

R12 (OBSS)
(OPP)

CAUTION

Verify no obstructions before closing and latching PLBD (Ku ANT, RMS, RAD, etc.)

Use only one PL BAY DR SYS sw during ALL PLBD operations to reduce voltage demand on FC

R13L

- * If SM GPC fails during this operation: *
- * PL BAY DR SYS (two) – DSBL *
- * DR – STOP *
- * Perform PASS SM GPC FAIL (ORB PKT, DPS) *
- * *
- * If no motion determined visually or 'OP/CL' not blank *
- * within 10 sec after cmd, or *
- * *
- * If Latch not 'CL' in single-motor time, or *
- * if door motion stops and not 'RDY' or 'CL': *
- * PL BAY DR – STOP *
- * SYS 1 – DSBL *
- * 2 – ENA *
- * Continue in procedure *

R11L

1. GPC/CRT 44 EXEC
2. IDP/CRT4 PWR – ON
3. SM, OPS 202 PRO

CRT4

4: SM PL BAY DOORS

R13L

√PL BAY DR – STOP

CRT4

√PBD SW – STOP

√MAN SEL (ten) – (no *)

√PBD SW BYPASS – (no *)

4. AC POWER ON – ITEM 1 EXEC (*)

5. AUTO MODE SEL – ITEM 3 EXEC (*)

R13L

6. PL BAY DR SYS 1 – ENA

√2 – DSBL

CRT4

√OP/CL STATUS (ten) – OP

NOTE

Expect single-motor drive time on all actuators

R13L

7. PL BAY DR – CL

CRT4

* If PORT DOOR not 'CL' within 6 sec of 'RDY': *

R13L

* PL BAY DR – STOP *

* Go to PORT BKHD LATCH TROUBLESHOOTING *

12A, 5-31

CRT4

√PORT DOOR – blank, RDY, CL (~126 sec)

√FWD, AFT LATCHES – blank, CL (~60 sec)

√STBD DOOR – blank

8. When Stbd Door as close as possible to Port Door before contact, perform PLBD fit check:

R13L

PL BAY DR – STOP

Determine C/L Latch clearance on C/L LATCH EXTENDED GUIDE ROLLER TRAJECTORY NO-GO DIAGRAM, 5-30

* If NO-GO for PLBD CLOSE: *

* If no waveoff capability: *

* Perform MAL, MECH SSR-3 *

* (SIMULTANEOUS PLBD CL) *

* If waveoff OK: √MCC *

9. PL BAY DR – CL

CRT4

* If STBD DOOR not 'CL' within 6 sec of 'RDY': *

* PL BAY DR – STOP *

* Go to STBD BKHD LATCH TROUBLESHOOTING *

12B, 5-31

√STBD DOOR – CL (~126 sec)

√FWD, AFT LATCHES (two) – blank, CL (~60 sec)

√CENTER LATCHES 1-4, 13-16 (two) – blank, CL (~40 sec)

√5-8, 9-12 (two) – blank, CL (~40 sec)

Cont next page

**LOSS OF 2 FC
MS AFT FLIGHT DECK ACTIVITIES (Cont)**

MS PULLOUT PAGE

PORT BKHD LATCH TROUBLESHOOTING [12A]

- CRT4 1. √PORT DOOR FWD, AFT MICRO-SW STATs
 If PORT DOOR AFT 'C' = '0':
 : 2. √PORT AFT BULKHEAD LATCH GO/NO DIAGRAM, 5-30
 : If NO-GO:
 L Go to MAL, MECH, SSR-2 (CONTINGENCY PLBD CLOSURE)
- If PORT DOOR FWD 'C' = '0':
 :
 : NOTE
 : Use PLB camera A to view port fwd bkhd latch
 : hook/roller #3 as seen in figures 5-1 and 5-2, 5-32
- R13L 3. PL BAY DR SYS 1 – DSBL
 : 2 – ENA
 :
 : During the following step, monitor latch hook #3 while driving to
 : ensure hook motion and proper roller engagement
 :
 : * If at any point latch hook #3 stops moving while commanded, *
 : * or it appears that the hook is going to miss or jam into its *
 : * roller: *
 : * PL BAY DR – STOP *
 : * Go to MAL, MECH, SSR-2 (CONTINGENCY PLBD *
 : * CLOSURE) *
4. PL BAY DR – CL
 :
 : 5. When proper roller engagement verified for latch #3:
 L PL BAY DR – STOP
6. Go to step 7 of PLBD CLOSING [12], 5-29 ignoring the starred block

STBD BKHD LATCH TROUBLESHOOTING [12B]

- CRT4 1. √STBD DOOR FWD, AFT MICRO-SW STATs
 If STBD DOOR AFT (FWD) 'C' = '0':
 :
 : NOTE
 : Use PLB camera C(D) to view stbd aft (fwd) bkhd latch
 : hook/roller #3 as seen in figures 5-1 and 5-2, 5-32
- R13L 2. PL BAY DR SYS 1(2) – DSBL
 : 2(1) – ENA
 :
 : During the following step, monitor latch hook #3 while driving to
 : ensure hook motion and proper roller engagement
 :
 : * If at any point latch hook #3 stops moving while *
 : * commanded, or it appears that the hook is going *
 : * to miss or jam into its roller: *
 : * PL BAY DR – STOP *
 : * Go to MAL, MECH, SSR-2 (CONTINGENCY *
 : * PLBD CLOSURE) *
3. PL BAY DR – CL
 :
 : 4. When proper roller engagement verified for latch #3:
 L PL BAY DR – STOP
5. Go to step 9 of PLBD CLOSING [12], 5-29 ignoring the starred block

**LOSS OF 2 FC
MS AFT FLIGHT DECK ACTIVITIES (Cont)**

MS PULLOUT PAGE

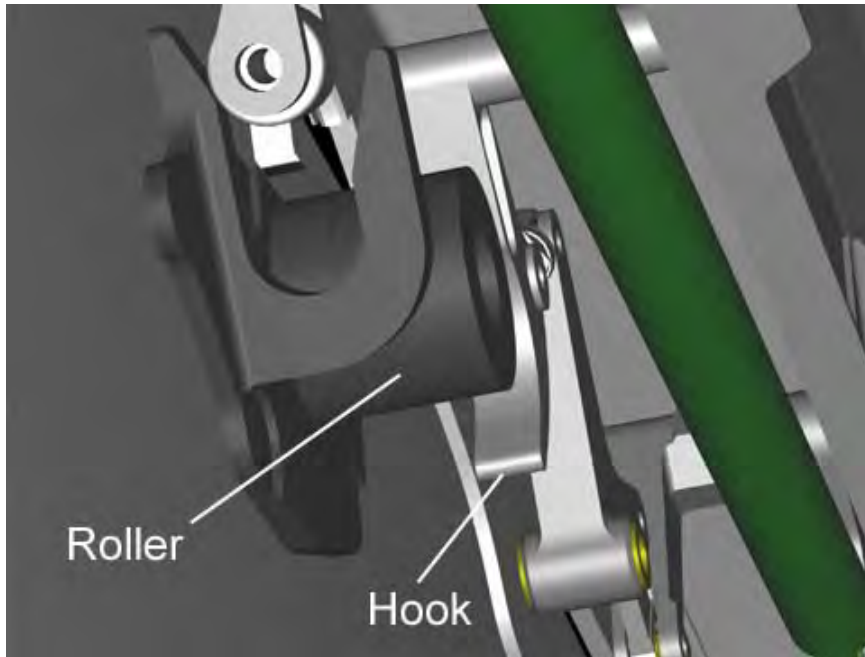

Figure 5-1.- Latch hook/roller #3 typical view from PLB camera

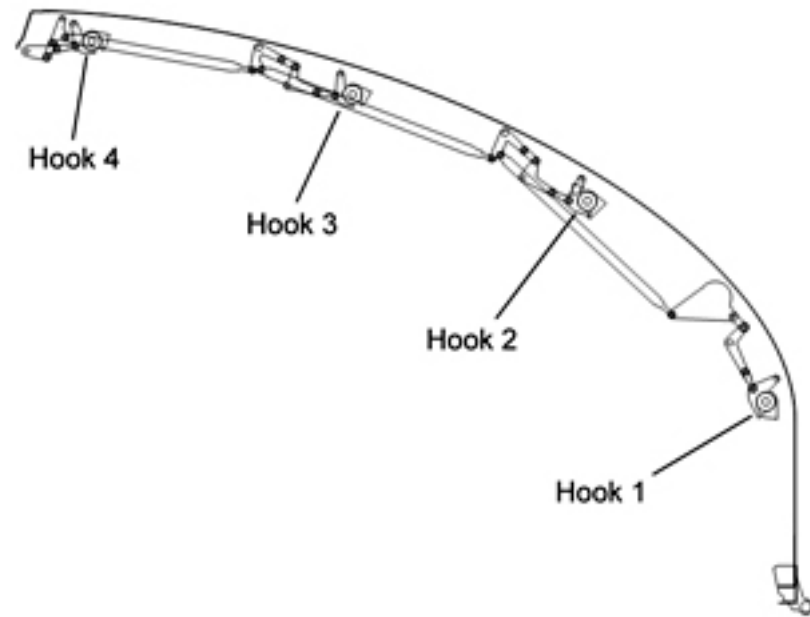

Figure 5-2.- Typical latch hook/roller numbering

LOSS OF 2 FC
Back of MS AFT FLIGHT DECK ACTIVITIES (Cont)

MS PULLOUT PAGE

CLOTHING CONFIG	30
MS,PS	Unstow,don: ACES Harness Boots

LOSS OF 2 FC MS MIDDECK ACTIVITIES

MS PULLOUT PAGE

NOTE

Wait for GO from CDR or PLT before starting any activity on this page

TIME (TIG-)	MS ACTIONS (MID)
3:59	<u>ENTRY STOWAGE</u> [2]
3:42	<u>AC BUS CONFIG</u> [6], 5-36 (Not reqd if AC transfer cable installed or if AC bus shorted)
3:32	<u>SW VERIF</u> (Airlock and Airlock Hatch only), 6-31, 6-32
3:25	<u>PRESS CNTL SYS ENTRY CONFIG</u> [9], 5-36
3:24	<u>SPECIALIST SEAT INSTALLATION</u> Verify Leg Attach Collars (four) – DOWN/LOCKED Verify LiOH Door Latches (four) – ENGAGED
3:14	<u>MCA CONFIG</u> [10], 5-36
2:49	<u>CRYO QTY CONFIG</u> [13], 5-36
2:20	<u>FLUID LOADING PREP</u> [18], 5-36
2:10	<u>GALLEY DEACT</u> [19], 5-36
1:44	<u>WCS DEACTIVATION</u> [23], 5-36
1:27	<u>MCA RECONFIG</u> [27], 5-36
1:25	<u>LOSS OF 2 FC SW VERIF LIST</u> , 6-27 thru 6-30
1:05	Begin Fluid Loading per individual prescription. Fluid Loading should be completed by EI Verify Side Hatch UV Filter, Locking Device, and Pyro Box Safing Pin removed and stowed
1:01	<u>CLOTHING CONFIG</u> [30], 5-36

<p><u>ENTRY STOWAGE</u> [2]</p> <p><u>PERSONAL HYGIENE SYS STOWAGE</u> Stow: Personal Hygiene Kits Hose</p> <p><u>WCS CONFIG</u> Foot restraints – up,locked Privacy Curtain – stow</p> <p><u>AIRLOCK CLOSEOUT</u> Tether soft goods to EVA tether point or A/L Stowage Bag. Gray Tape to floor</p> <p>MO13Q</p> <p>√AIRLK FAN A(B) – OFF if flown Stow all ducts as appropriate</p> <p><u>ESCAPE POLE SETUP</u> Reinstall Stbd Pip Pin Reinstall large Port Pin: Retract and hold Locking Pin (Ring) Reinstall large Pin Release Locking Pin (Ring) Slide forward Safing Latch</p> <p>√Pole Straps secure</p> <p><u>PDF STOWAGE</u> Stow FLIGHT PLAN</p> <p><u>CABIN CONFIG</u> Stow: Backup PGSC Middeck Camrs,Accessories FWD/AFT Shades,Filters,Quick Don Masks Stow Exercise Equipment √Retention net in ASC/ENT config</p> <p><u>EGRESS ROUTE CONFIG</u> Tape Foot Loops in egress routes</p>

LOSS of 2 FC Back of MS MIDDECK ACTIVITIES MS PULLOUT PAGE

<u>AC BUS CONFIG</u> 6 (Not reqd if AC transfer cable installed or if AC bus shorted)		
A	L4:D,E,Q	1. <input checked="" type="checkbox"/> All cbs (twenty-seven) – op 2. If FC 1 OK: Perform AC3 (3Φ) BUS LOSS ACTIONS (ORB PKT, <u>EPS</u>). Do only steps in ORB PKT, do not proceed to MAL Mark up pictorials in section 6 to match bus loss actions AC3 is affected bus in step 3 If FC 2 or FC 3 OK: Perform AC1 (3Φ) BUS LOSS ACTIONS (ORB PKT, <u>EPS</u>). Do only steps in ORB PKT, do not proceed to MAL Mark up pictorials in section 6 to match bus loss actions AC1 is affected bus in step 3
R1		3. Affected BUS: cb AC CONTR (three) – cl AC BUS SNSR – OFF INV/AC BUS – OFF (tb-OFF) INV PWR – OFF (tb-OFF) cb AC CONTR (three) – op 4. Connect AC1 to AC3: Go to AC POWER TRANSFER CABLE INSTALLATION (IFM, <u>PROCEDURES A THRU F</u>)

<u>PRESS CNTL SYS ENTRY CONFIG</u> 9		
MS	MO10W	14.7 CAB REG INLET SYS 1,2 vlv (two) – CL H2O TK N2 REG INLET SYS 1,2 vlv (two) – OP O2 REG INLET SYS 1,2 vlv (two) – CL
	MO69M	LEH O2 8 vlv – CL Remove, stow O2 Bleed Orifice LEH O2 7,8 vlv (two) – OP (if reqd)
	MO32M	5,6 vlv (two) – OP (if reqd)
C	L2	<input checked="" type="checkbox"/> O2 SYS 1,2 SPLY (two) – OP (tb-OP) <input checked="" type="checkbox"/> XOVR SYS 1,2 (two) – OP <input checked="" type="checkbox"/> N2 SYS 1,2 SPLY (two) – OP (tb-OP) <input checked="" type="checkbox"/> REG INLET (two) – OP (tb-OP) O2/N2 CNTLR VLV SYS 1 – OP 2 – CL

<u>MCA CONFIG</u> 10	
MA73C	MCA LOGIC FWD (three) – ON MID (eight) – ON

<u>CLOTHING CONFIG</u> 30	
MS,PS	Unstow, don: ACES Harness Boots

<u>CRYO QTY CONFIG</u> 13		
C	O13:B	cb ESS 1BC CRYO QTY O2,H2 TK2 (two) – op
	O13:D	2CA CRYO QTY O2,H2 TK1 (two) – op
MS	ML86B:G	cb ESS 1BC CRYO QTY O2,H2 TK4 (two) – op
		<input checked="" type="checkbox"/> 2CA CRYO QTY O2,H2 TK5 (two) – op
		3AB CRYO QTY O2,H2 TK3 (two) – op

<u>FLUID LOADING PREP</u> 18	
	Unstow, fill 4 drink containers (per crewmember) with 8 oz of water each; temp stow near seat Unstow 8 salt tablets (per crewmember); temp stow in Flight Suit pocket

<u>GALLEY DEACT</u> 19		
GALLEY		<input checked="" type="checkbox"/> OVEN/RHS – OFF <input checked="" type="checkbox"/> H2O HTRS (two) – OFF <input checked="" type="checkbox"/> OVEN FAN – OFF <input checked="" type="checkbox"/> REHYD STA lever – cl (push in) <input checked="" type="checkbox"/> OVEN DOOR LATCH – latched
MA73C:G		cb AC3 GALLEY FAN (three) – op
ML86B:A		cb MNC SPLY H2O GALLEY SPLY – op
:B		MNA GALLEY OVEN – op
		MNB GALLEY H2O HTR – op

<u>WCS DEACTIVATION</u> 23		
WCS		VAC VLV – CL <input checked="" type="checkbox"/> MODE – AUTO FAN SEP SEL sw – OFF Unstow hose from cradle, attach hose to WCS housing via Velcro straps Remove, stow: WCS Trash Can Mirror Privacy Curtain Foot restraints – up, locked Close, latch door

<u>MCA RECONFIG</u> 27		
MA73C:A		MCA LOGIC MID (four) – OFF <input checked="" type="checkbox"/> FWD (three) – ON MID (four) – OFF AFT (three) – OFF
:B		If MNB and AC2 powered:
		cb MCA PWR AC1, AC3 3Φ FWD 1,3 (two) – op
MA73C:C		<input checked="" type="checkbox"/> Minimum middeck lighting

LOSS OF 2 FC SWITCH VERIFICATION LIST

LEFT SEAT

L5.....	6-3
L4.....	6-3
L,R HUD	6-4
L1.....	6-4
F3	6-4
L2.....	6-5
F1	6-5
F2	6-6
F6	6-6
F7	6-6
C2.....	6-7
C3.....	6-7
O1.....	6-8
O2.....	6-8
L side OVHD flood...	6-8
O5.....	6-8
O6.....	6-9
O7.....	6-9







RIGHT SEAT

O8.....	6-10
O9.....	6-10
R side OVHD flood ..	6-10
O3.....	6-11
F4	6-11
F8	6-11
F9	6-11
R1	6-12
R2.....	6-13
R4.....	6-13
R6.....	6-13

AFT

O13.....	6-15
O14.....	6-15
O15.....	6-15
O16.....	6-16
O17.....	6-16
O19.....	6-17
C6	6-17
C5	6-17
C7	6-17
R10.....	6-18
R11U,L.....	6-18
R13U,L.....	6-19
R14.....	6-19
A1U,L,R	6-20
A4.....	6-21
A3.....	6-21
A6U.....	6-21
A7U.....	6-21
A6L.....	6-22
A6.....	6-22
A7L.....	6-23
A8U,L.....	6-24
A11.....	6-25
A12.....	6-25
A13.....	6-25
A14.....	6-26
A15.....	6-26
L9.....	6-26

LEGEND

	– left		
	– right		
	– up	R	– as reqd
	– center		– cb close
	– down		– cb open

 indicates switch/display not checked during ENT SWITCH LIST/VERIFICATION.

CIRCUIT BREAKER SNAPPING COLOR CODES

<u>COLOR</u>	<u>CONFIGURATION</u>
Red	Open at all times
Green	Open on orbit only
Yellow	Open ascent, close per procedure
Orange	Open orbit through entry
Blank (no ring)	Always closed or as reqd

MIDDECK FWD

MO42F.....	6-27
MO58F.....	6-27
MO32M.....	6-27
MO39M.....	6-27
MO69M.....	6-27
MO29J.....	6-27
MO52J.....	6-27
MO30F.....	6-27
MO62M.....	6-27
MO63P.....	6-27 (OV104)
ML86B.....	6-28
MD24K.....	6-29
MD44F.....	6-29

MIDDECK AFT

MA73C.....	6-28
MO13Q.....	6-29
ML26C.....	6-29
ML18F.....	6-29
ML31C.....	6-29
MO10W.....	6-30
WCS.....	6-30

AIRLOCK

AW18A.....	6-31
AW18D.....	6-31
AW18H.....	6-31
AW82A.....	6-31
AW82B.....	6-31
AW82D.....	6-31
AW82H.....	6-31
INNER HATCH	6-32

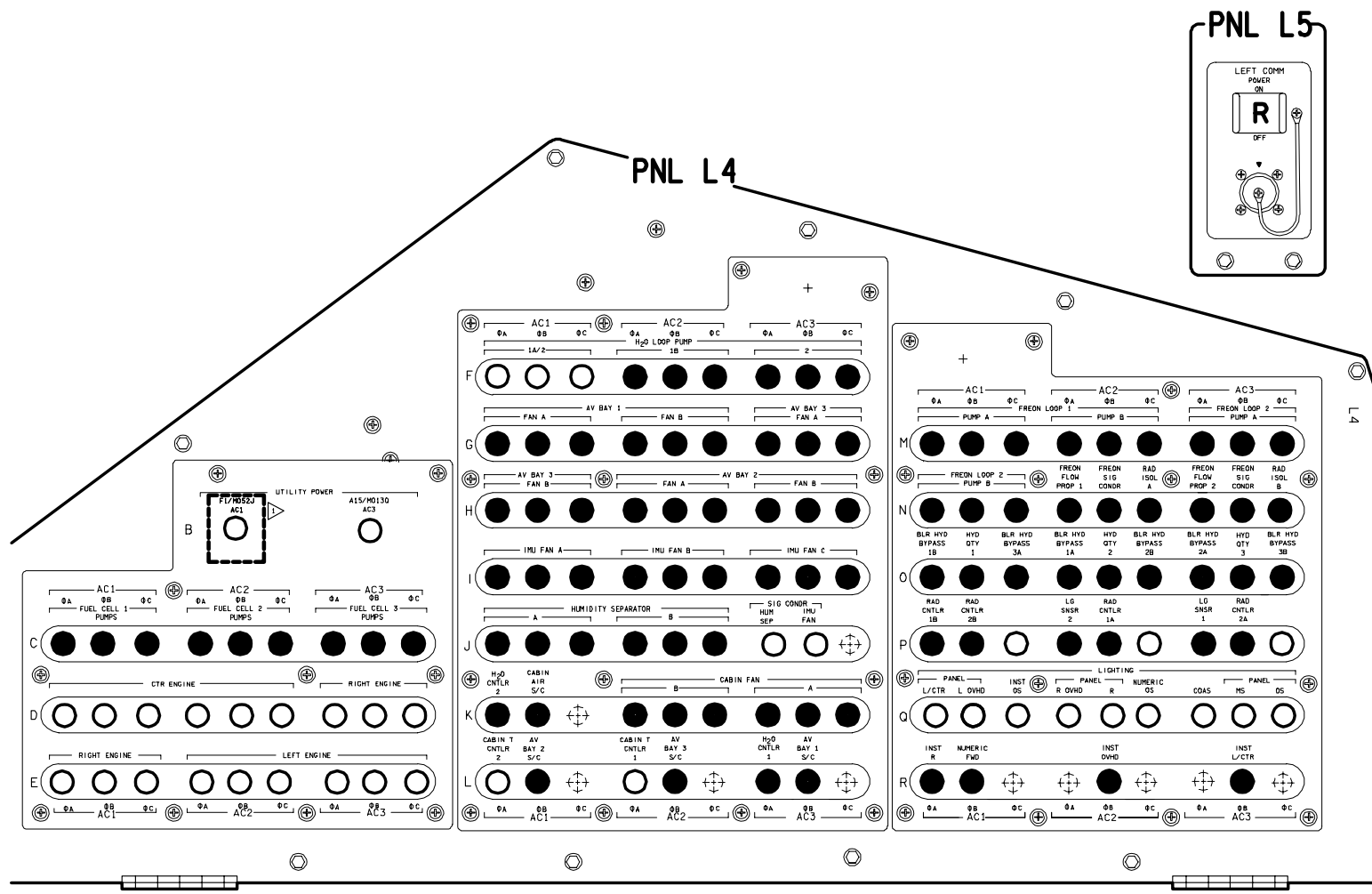

NOTE: ▷ CB CAN REMAIN CLOSED FOR AC PGSC USAGE.
 OPEN WHEN PGSC UNPOWERED/STOWED

OV103

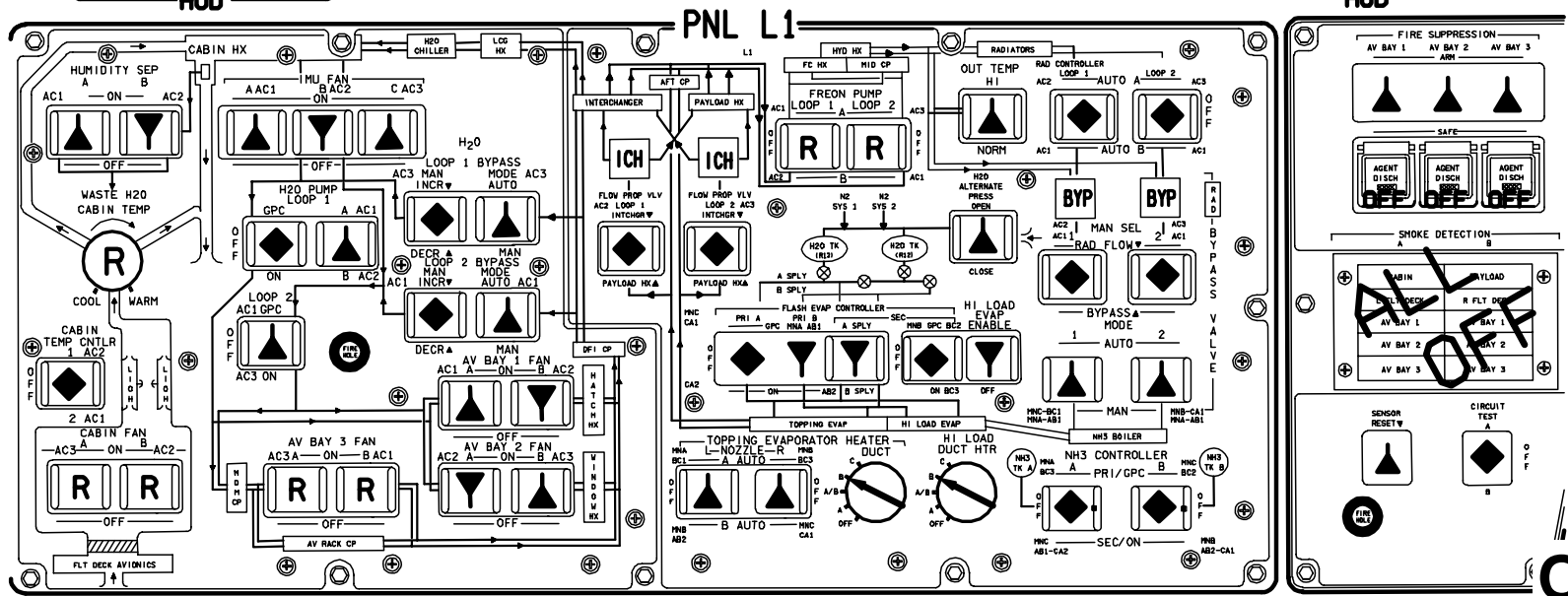
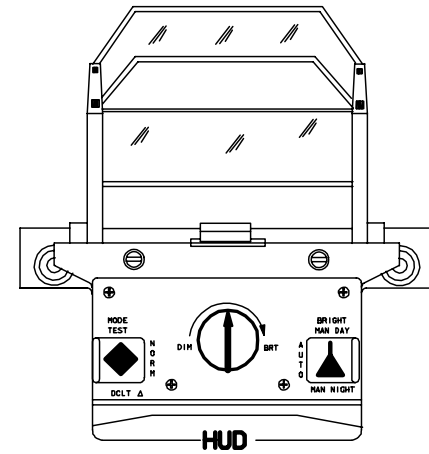
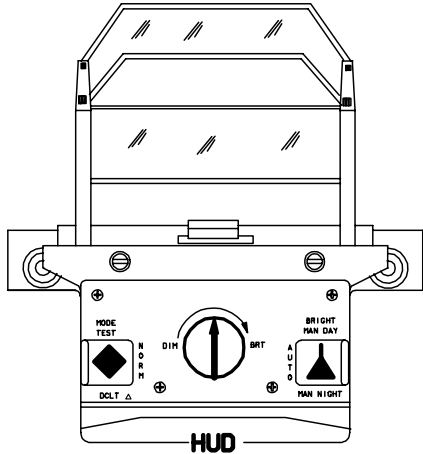
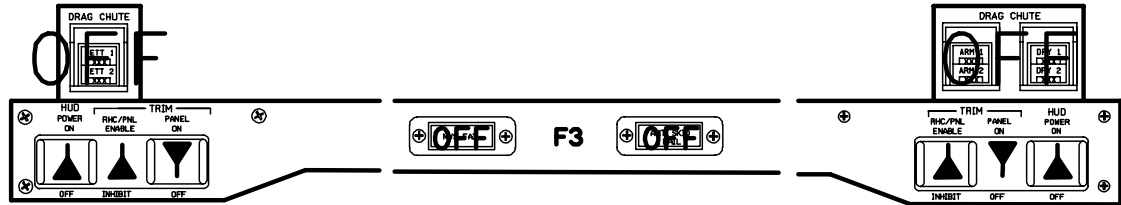

48007E604_114.PNL_1

ALL VEH/DATE 04/26/05

(OV103) A6-4

OV103

C D/O/ALL/GEN L

OV103

48007E605_114. PNL 1

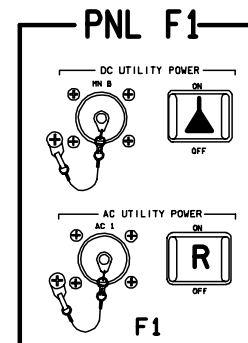
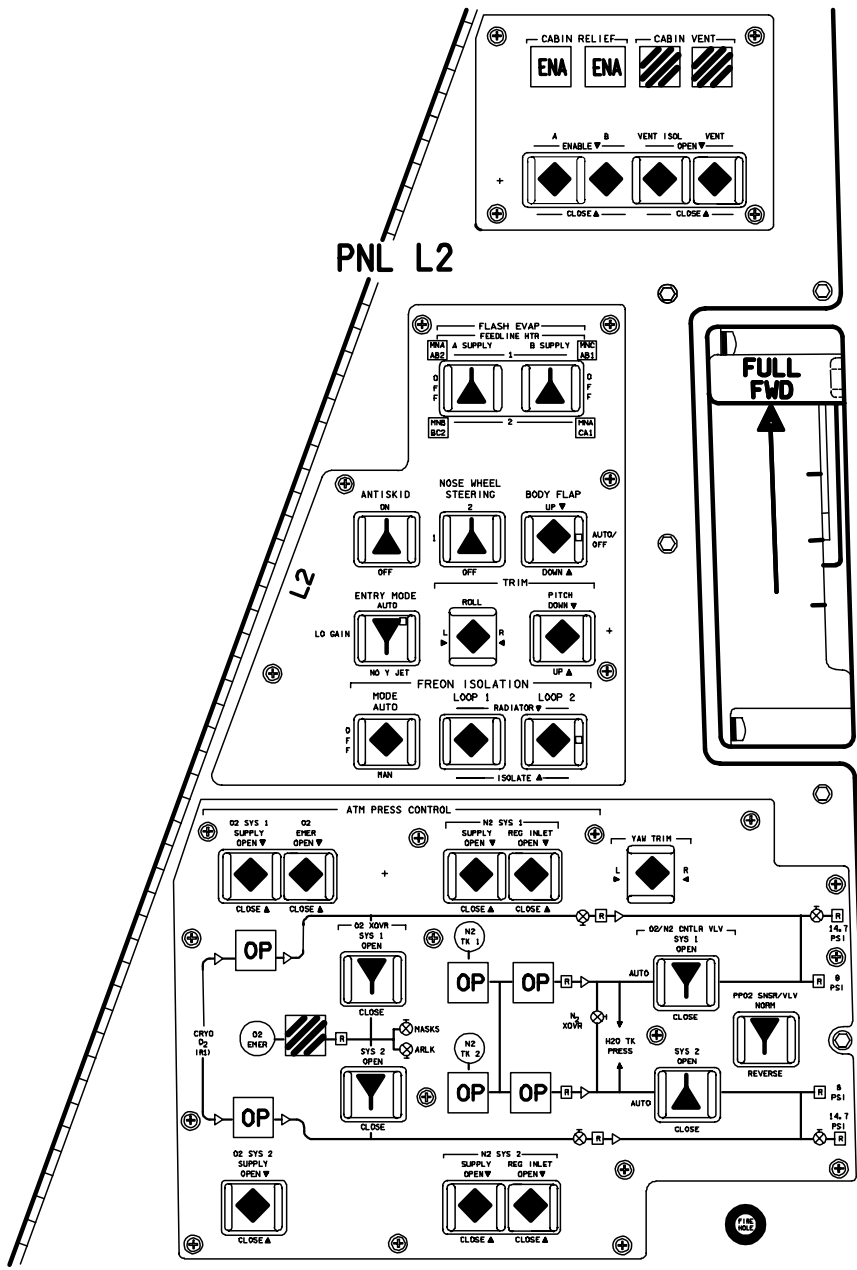

OV103

OV103/DATE 04/26/05

(OV103) A6-5

C D/O/3/GEN L

PNL C2/C3

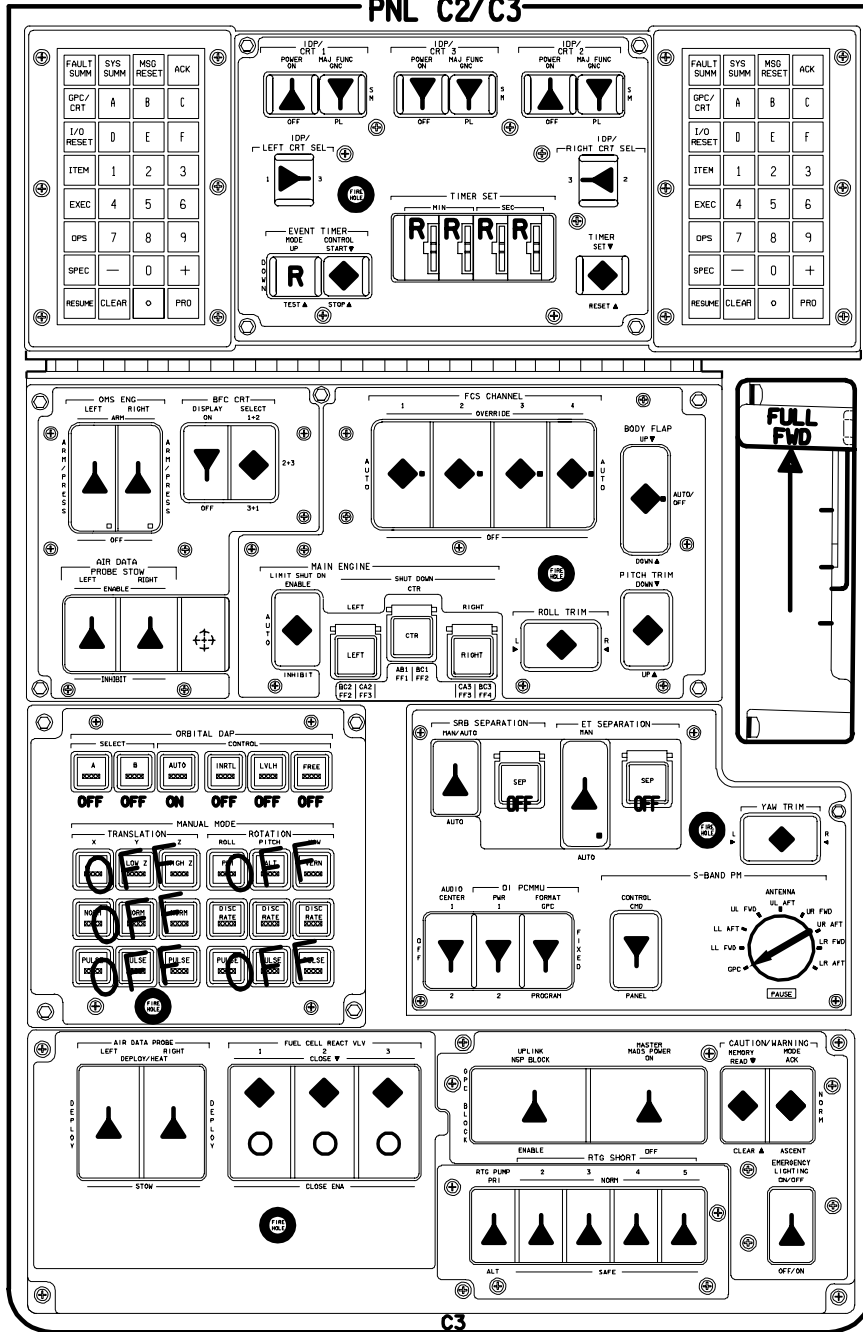

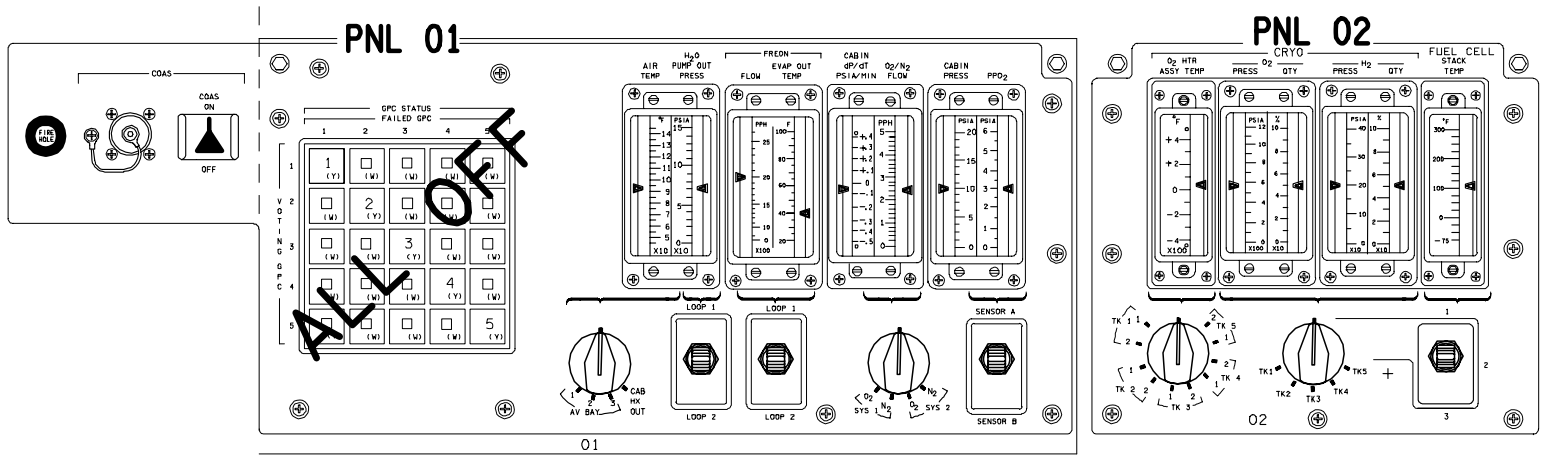

L side OVHD flood - R (MID)

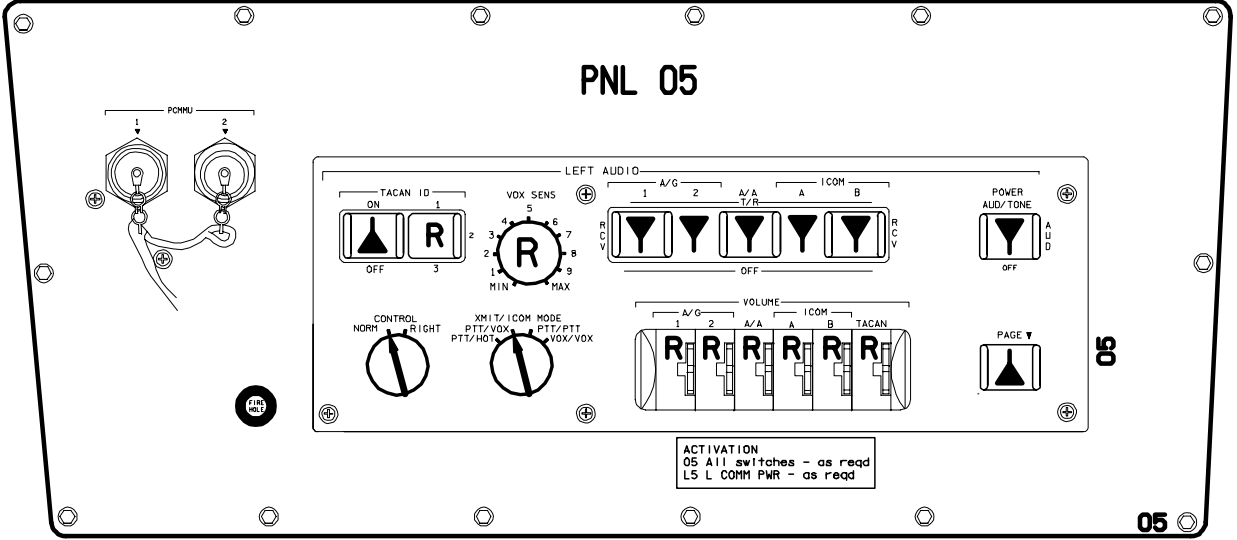

OV103

PNL 06

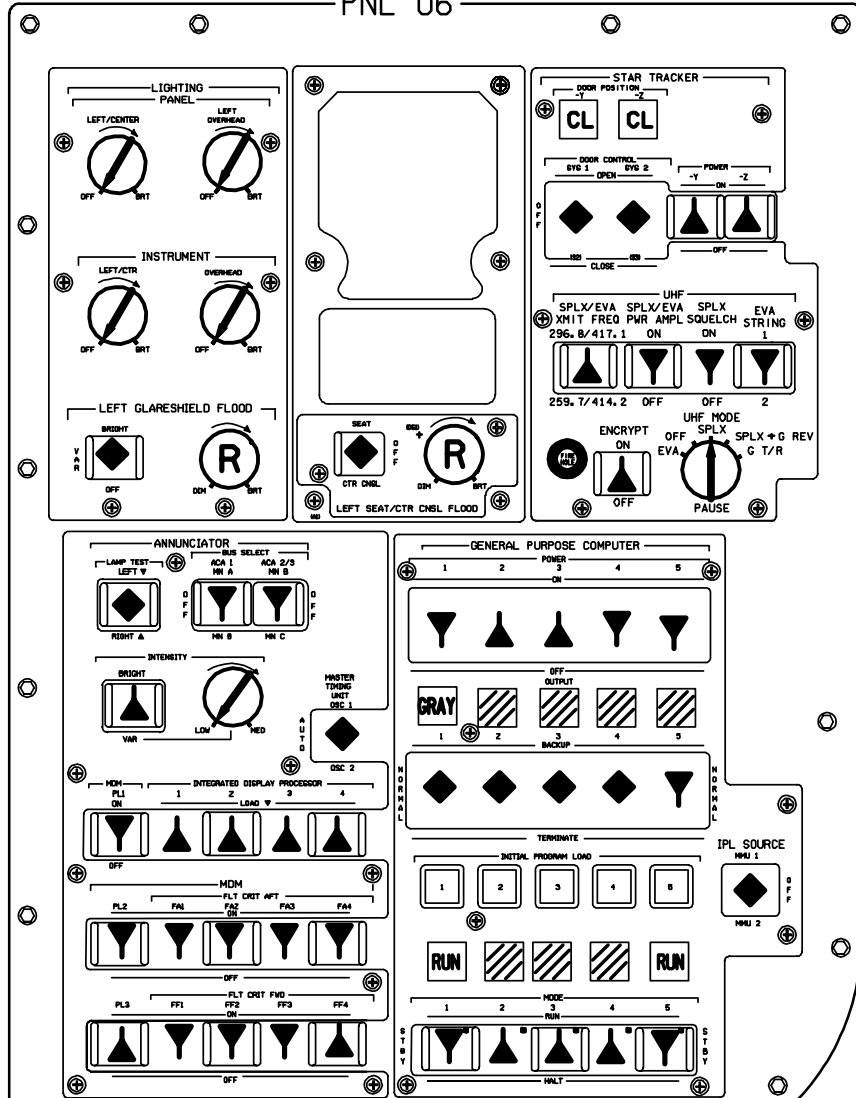

PNL 07

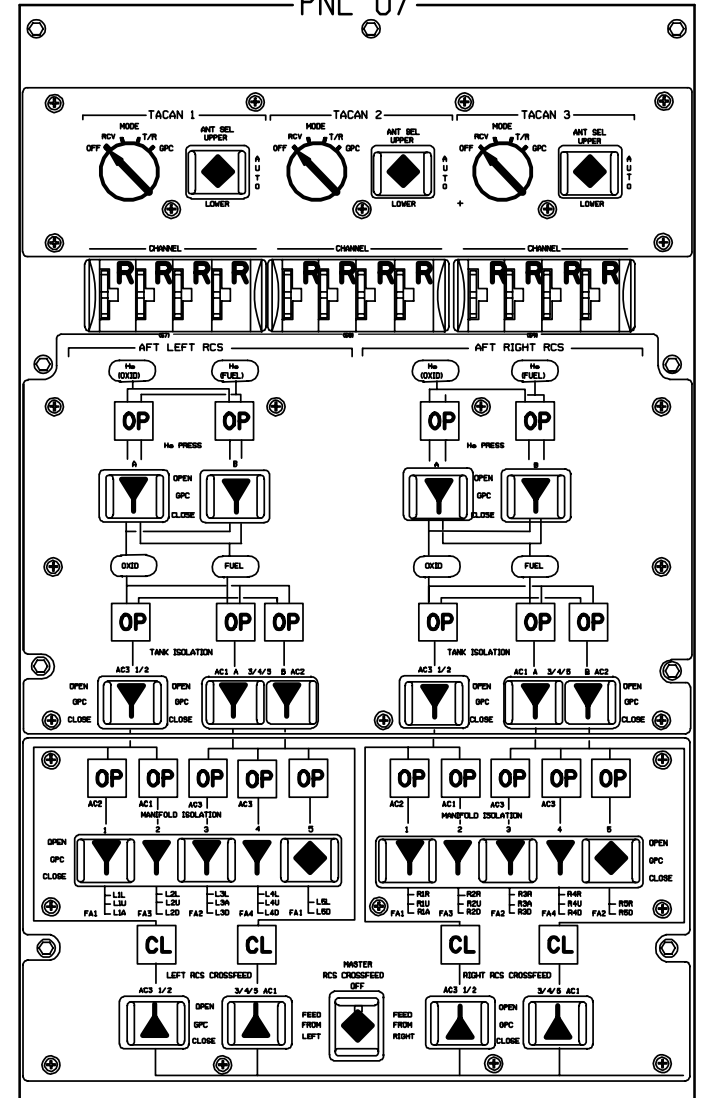

OV103

PNL 08

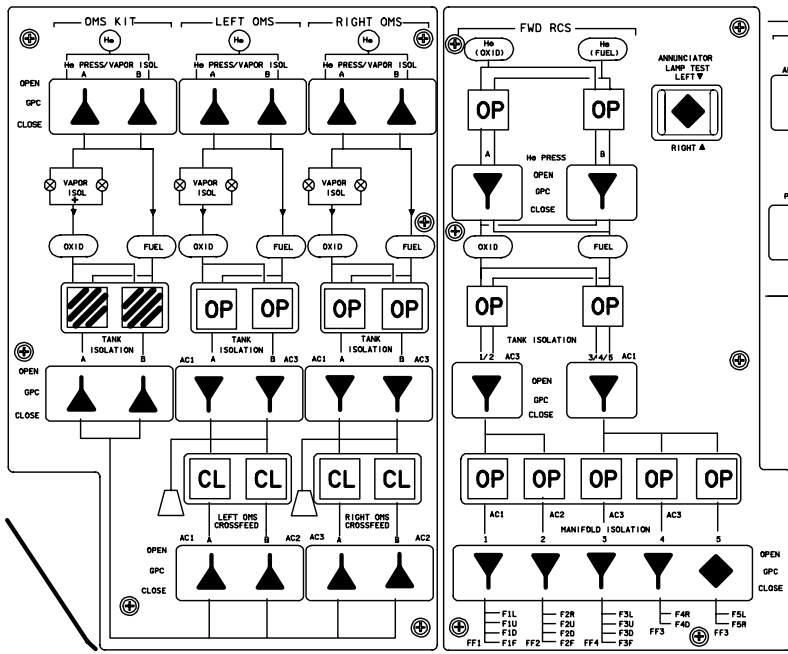
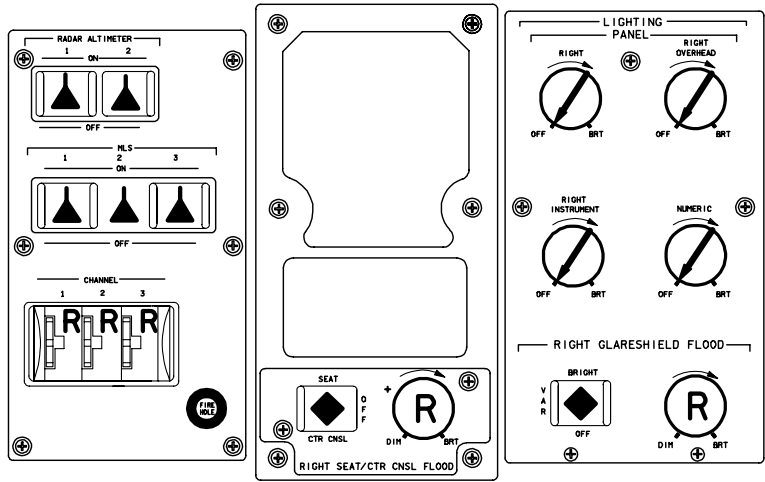

PNL 09

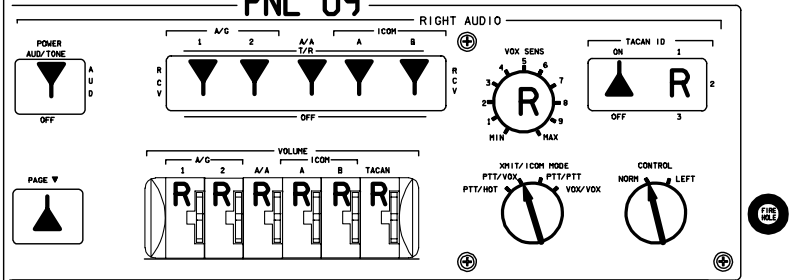

ACTIVATION
09 R AUD PWR-AUD/TONE
All other sws-as reqd
R6 R COMM PWR-as reqd

R side OVHD flood - R (MID)

OV103

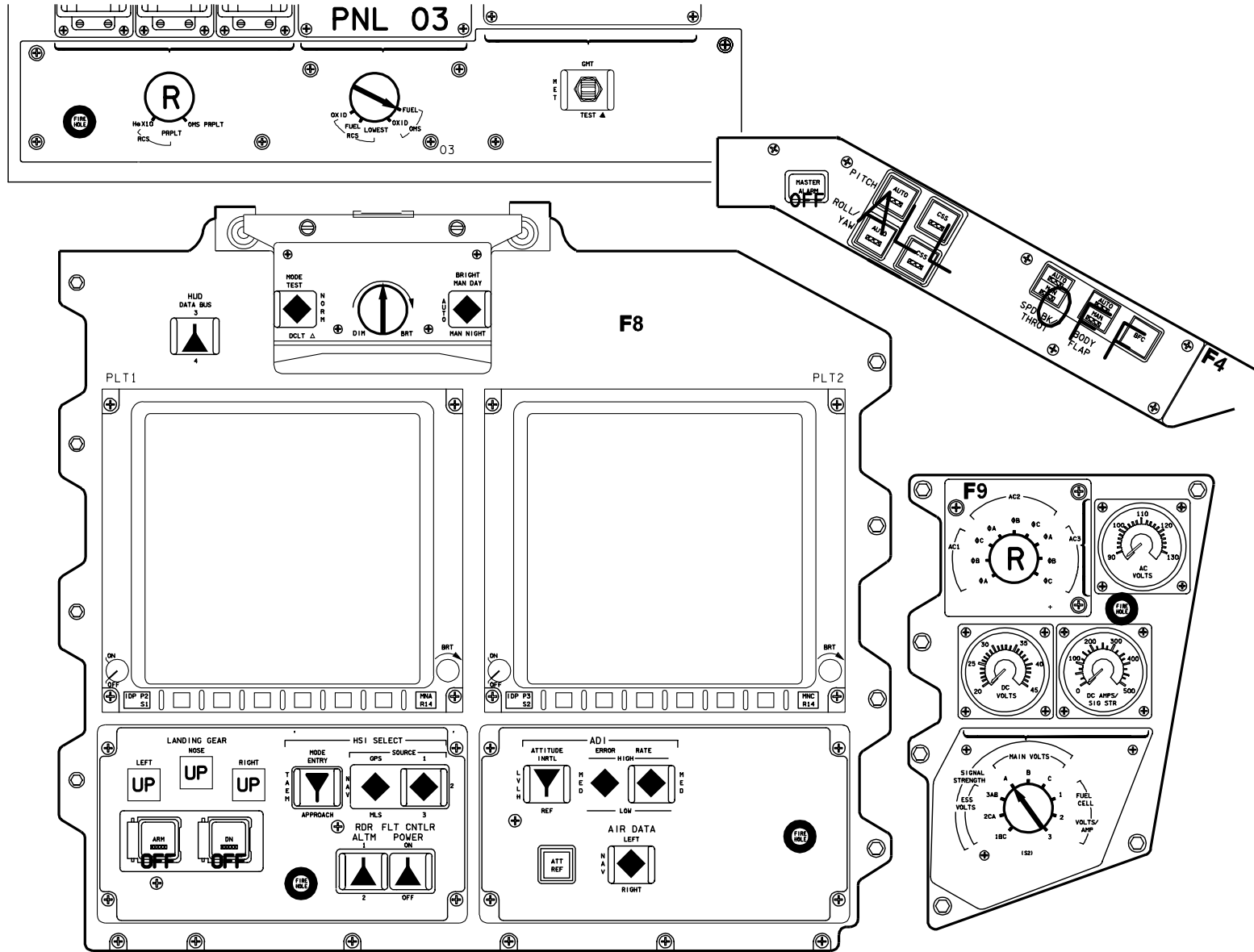

OV103

C D/O/3/GEN L

OV103

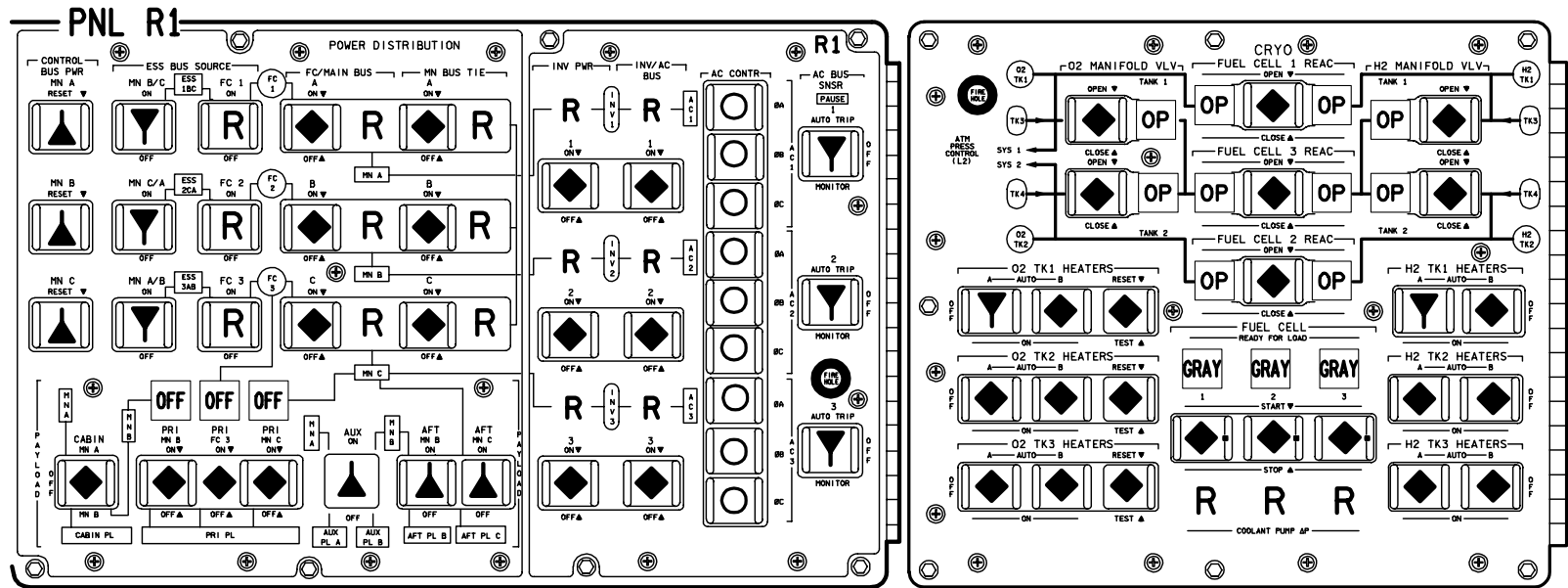

OV103

OV103

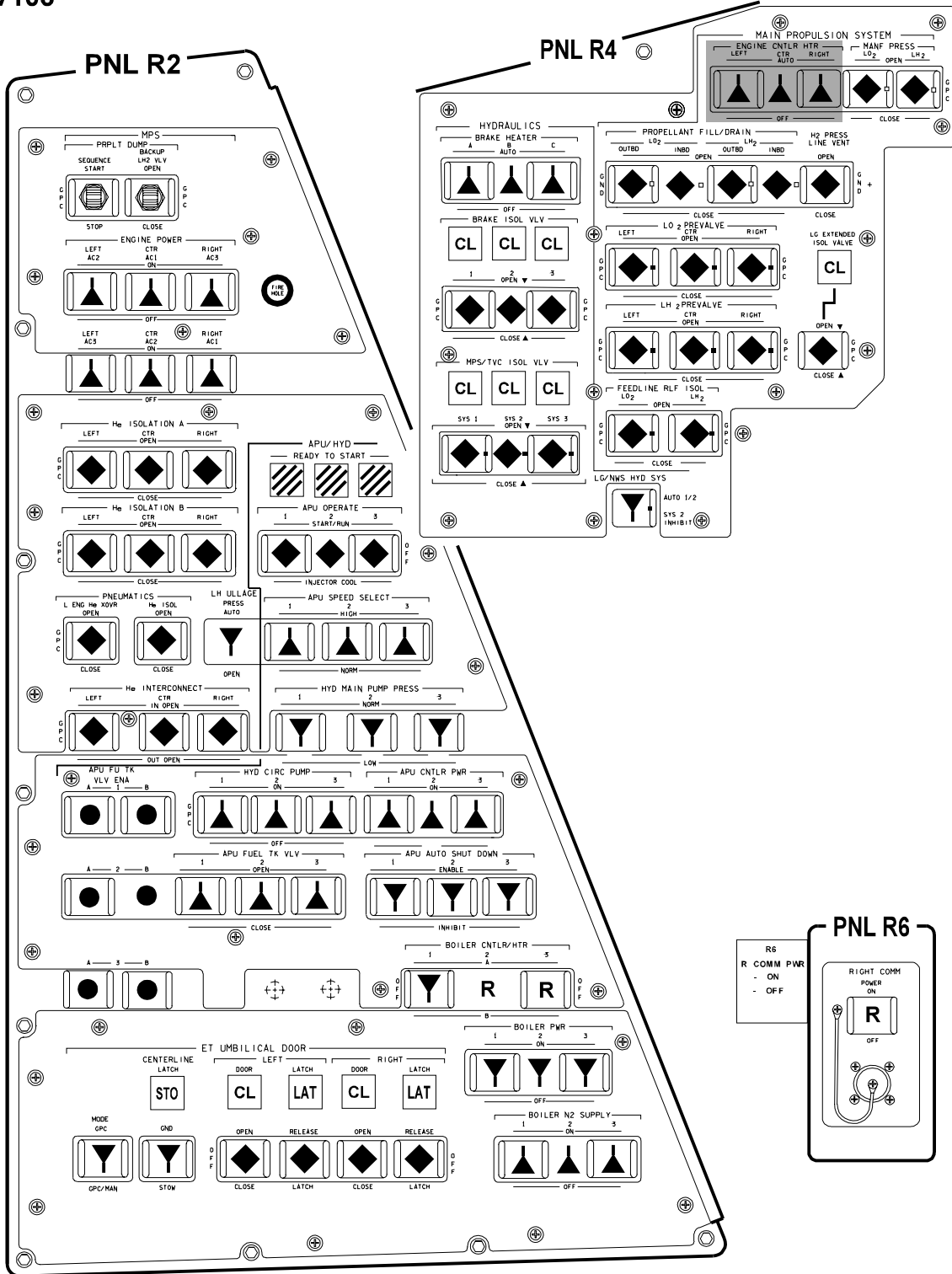

ALL VEH/DATE 06/28/06 48007E6.13_115_PNL R 2

OV103

(OV103) A6-13

C D/O/ALL/GEN L

This Page Intentionally Blank

OV103

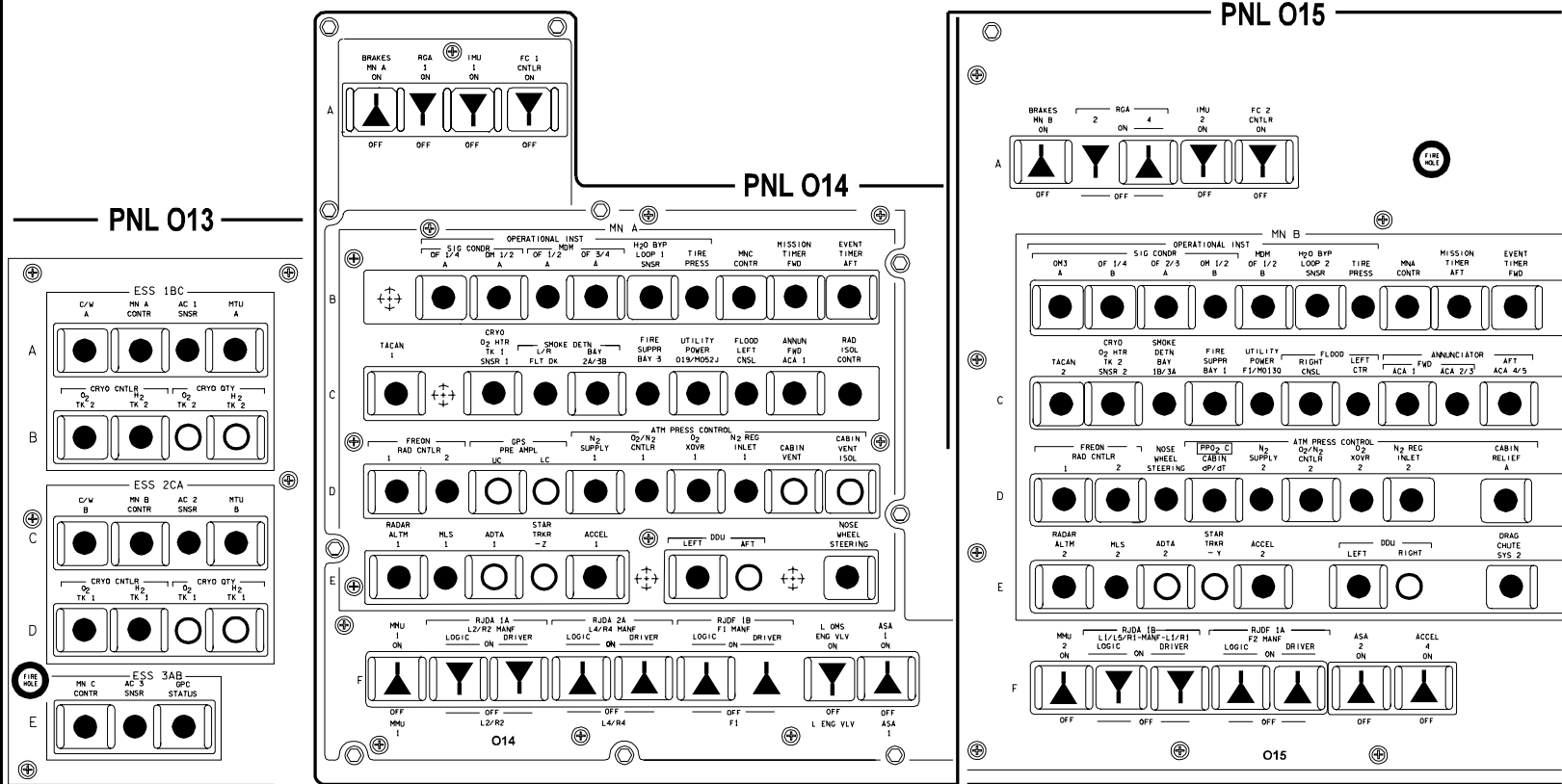

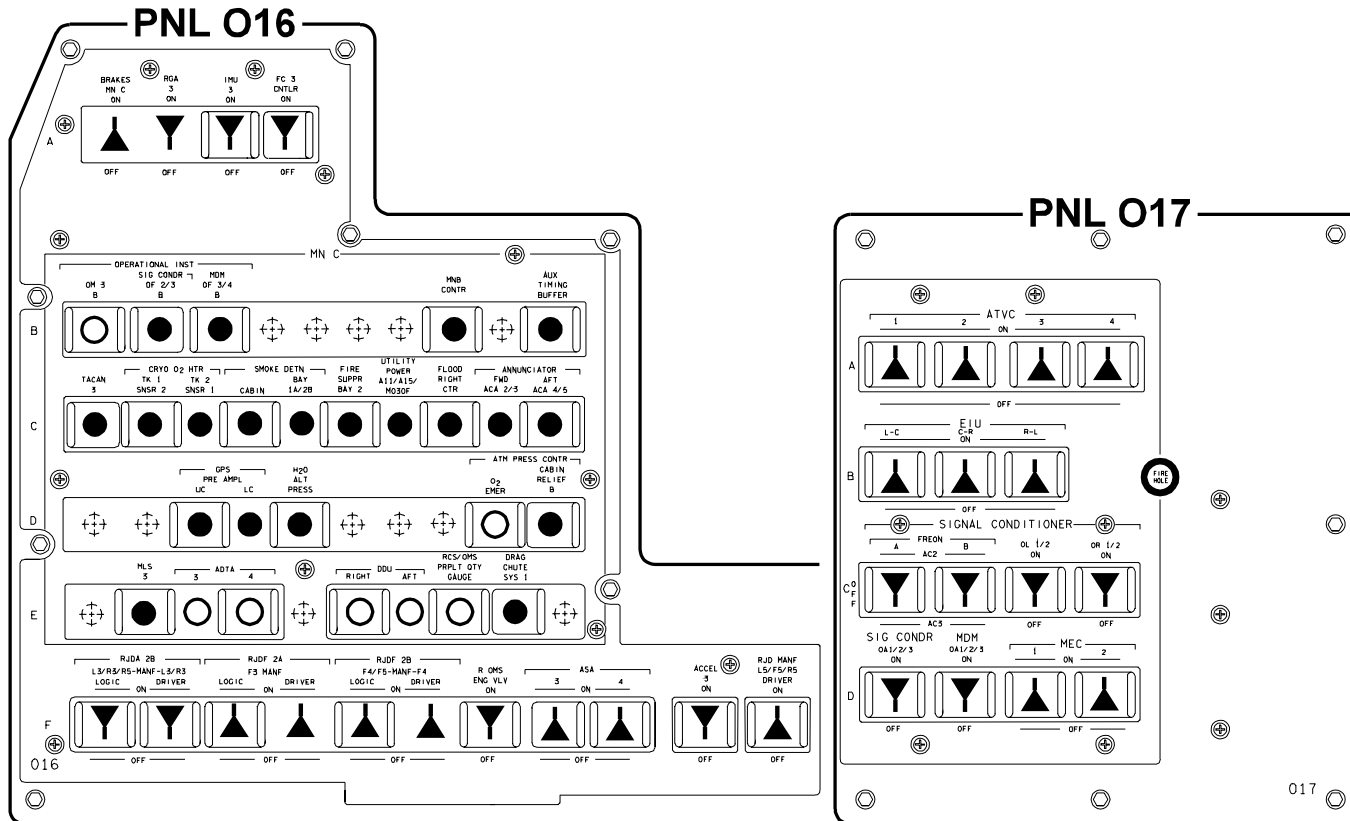

OV103

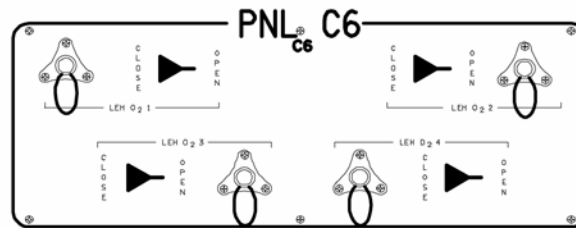
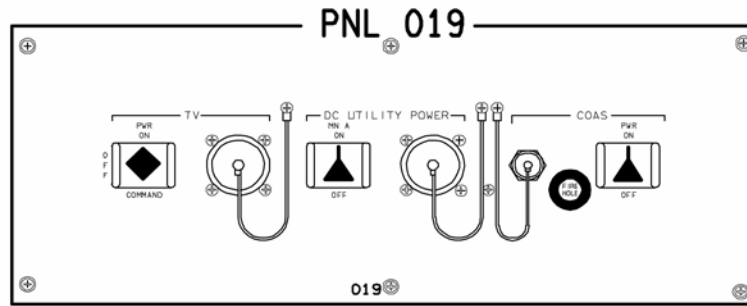

PNL C5



PNL C7

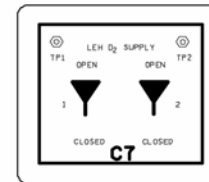

OV103

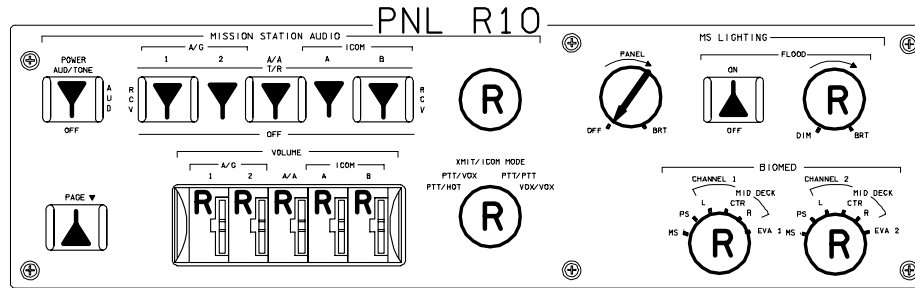

ACTIVATION
 R10 MS AUD PWR - AUD/TONE
 All other sws - as reqd
 R12 MS AUD CONTL - NORM
 A11 MS COMM CCU PWR - ON

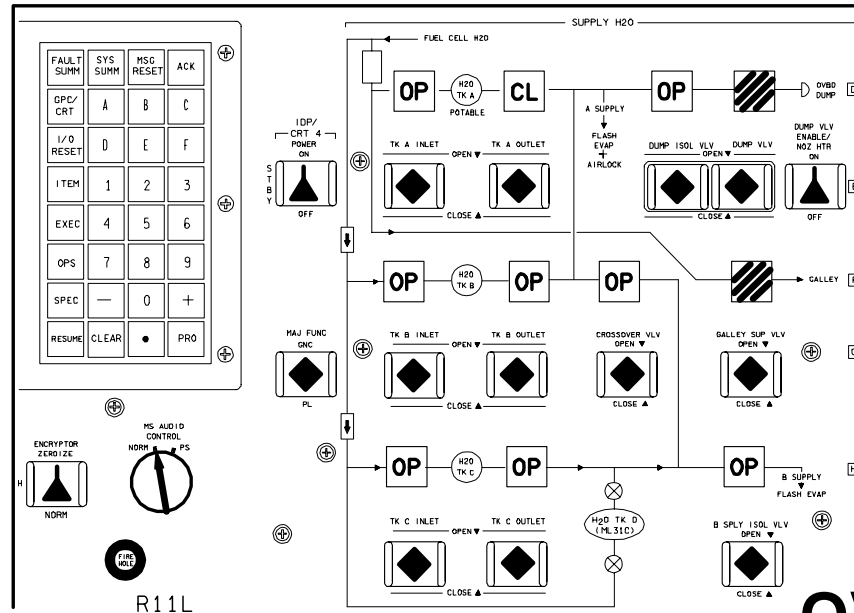
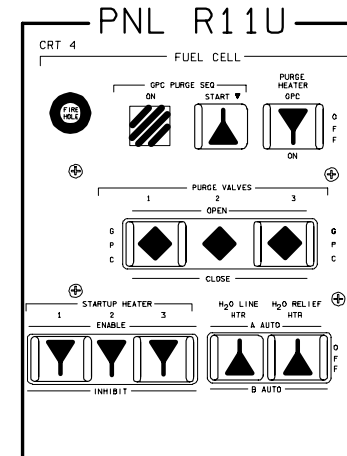

OV103

OV103

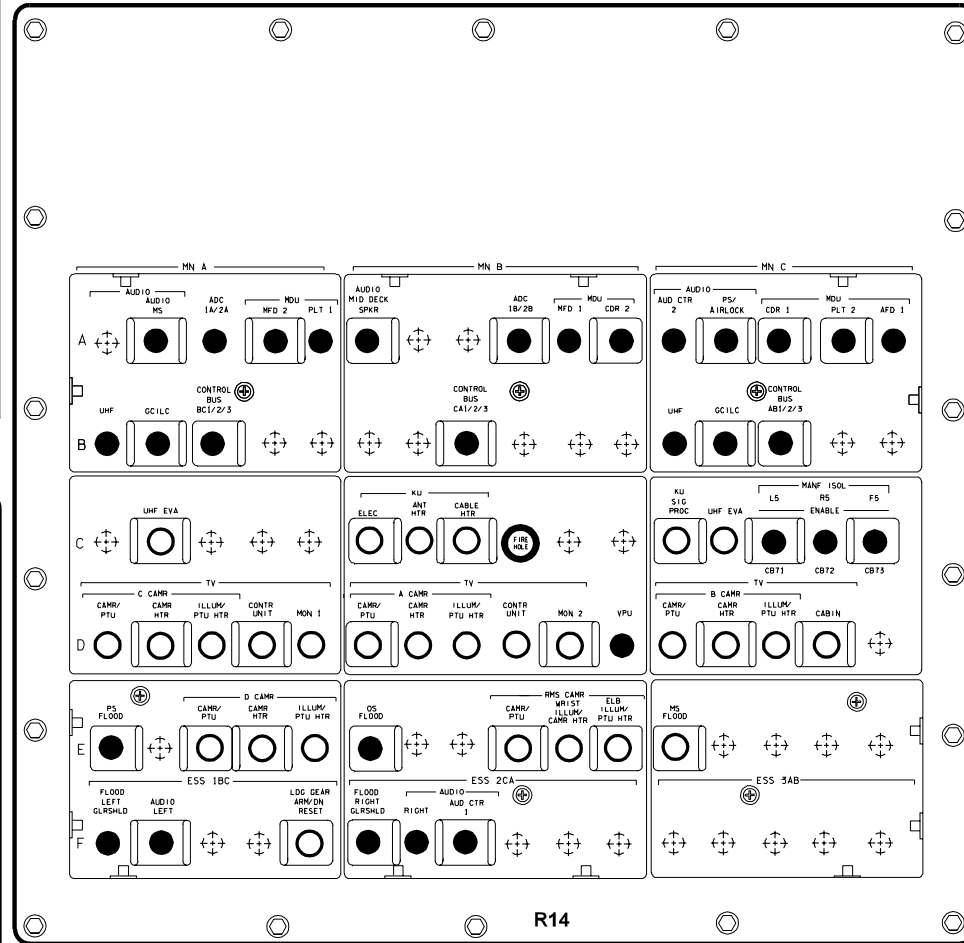
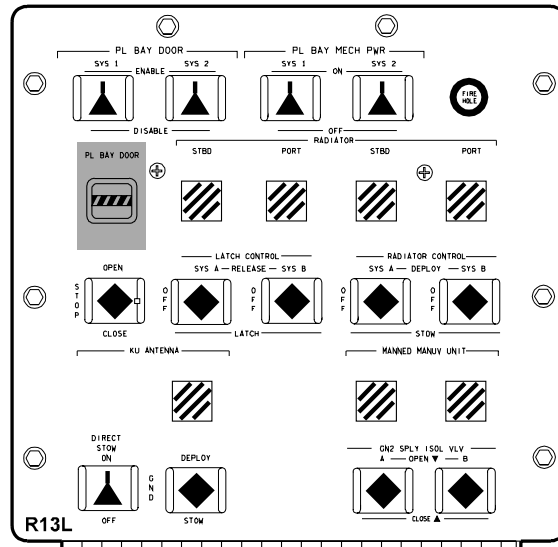
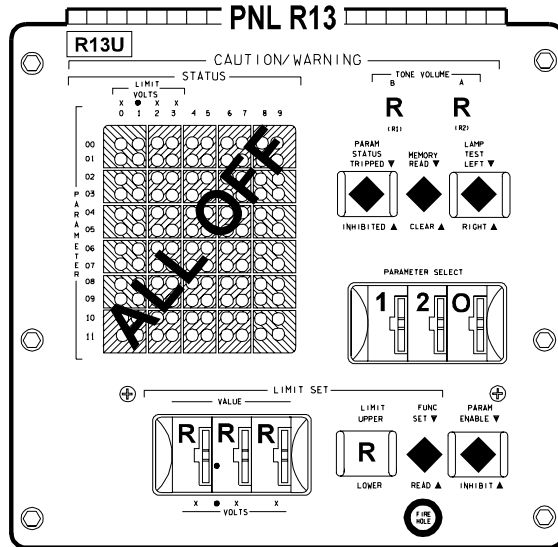

OV103

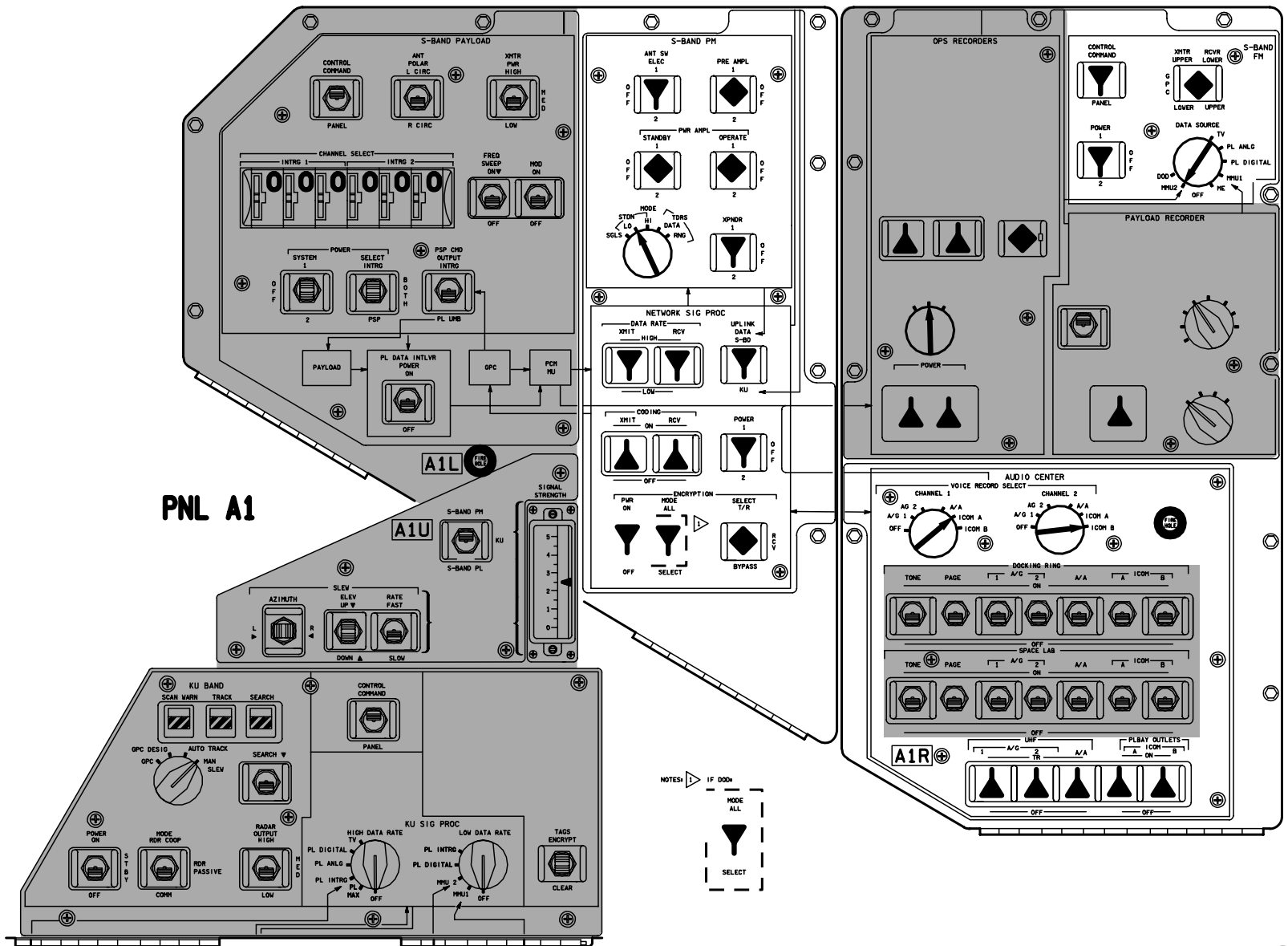

PNL A1

OV103

OV103

PNL A4

MISSION TIME
DAY HR MIN SEC
365:23:59:55

EVENT TIME
MIN SEC
59:59

MISSION TIMER ON
TEST A

PNL A3

MON 1

CONTRAST BRIGHTNESS SOURCE PANEL ON-LINK DIRECT SCAN-NORM

MON 2

CONTRAST BRIGHTNESS SOURCE PANEL ON-LINK DIRECT SCAN-NORM

PNL A6U

A6U

ORBITAL DAP CONTROL

SELECT: A, B, AUTO, INRTL, LVLH, FREE

MANUAL MODE: OFF, OFF, ON, OFF, OFF, OFF

TRANSLATION: X, Z

ROLL, ROTATION, PITCH, YAW

INSTRUMENT, NUMERIC

ANNUNCIATOR: BUS SELECT, LAMP TEST, INTENSITY

PAYLOAD RETENTION LATCHES: 1-5 LAT

EVENT TIMER: MIN, SET, SEC

PAYLOAD SELECT: MONITOR 1, 2, 3

PNL A7U

MASTER ALARM OFF

PAYLOAD BAY FLOOD: STBD, AFT, PORT

DOCKING BRIGHT: FWD, BHD

WIRELESS VIDEO POWER: HEATER, ON

CAMERA POWER: OFF, OFF, OFF, OFF, OFF

VIDEO INPUT: ALL OFF

VIDEO OUTPUT: ALL OFF

CAMERA COMMAND: PAN/TILT, FOCUS, ZOOM, IRIS, TILT, PAN

SHUTTER: ALL OFF

A6L

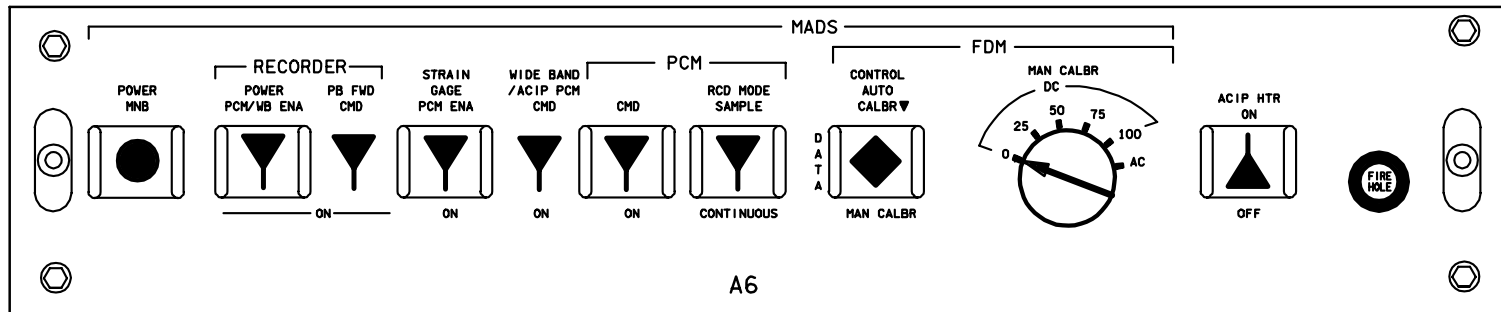
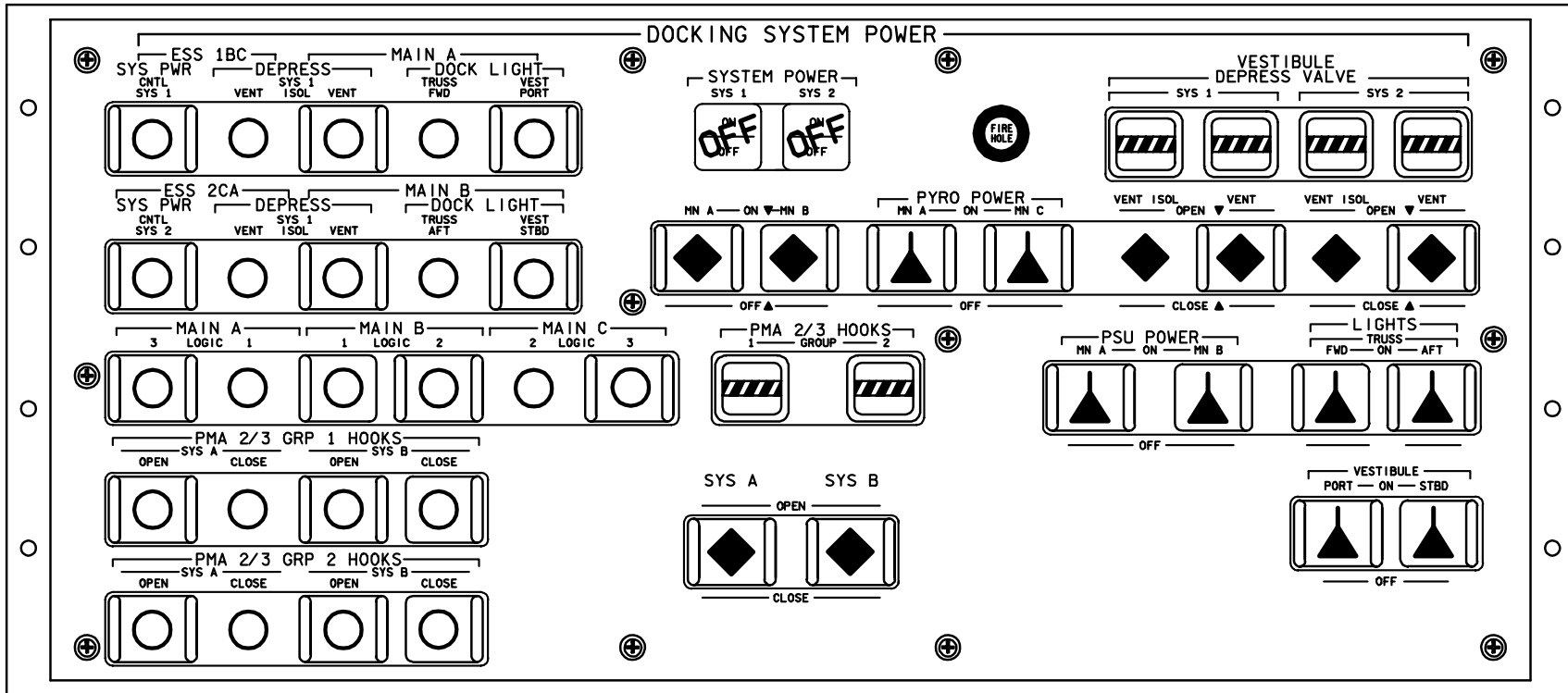

OV103

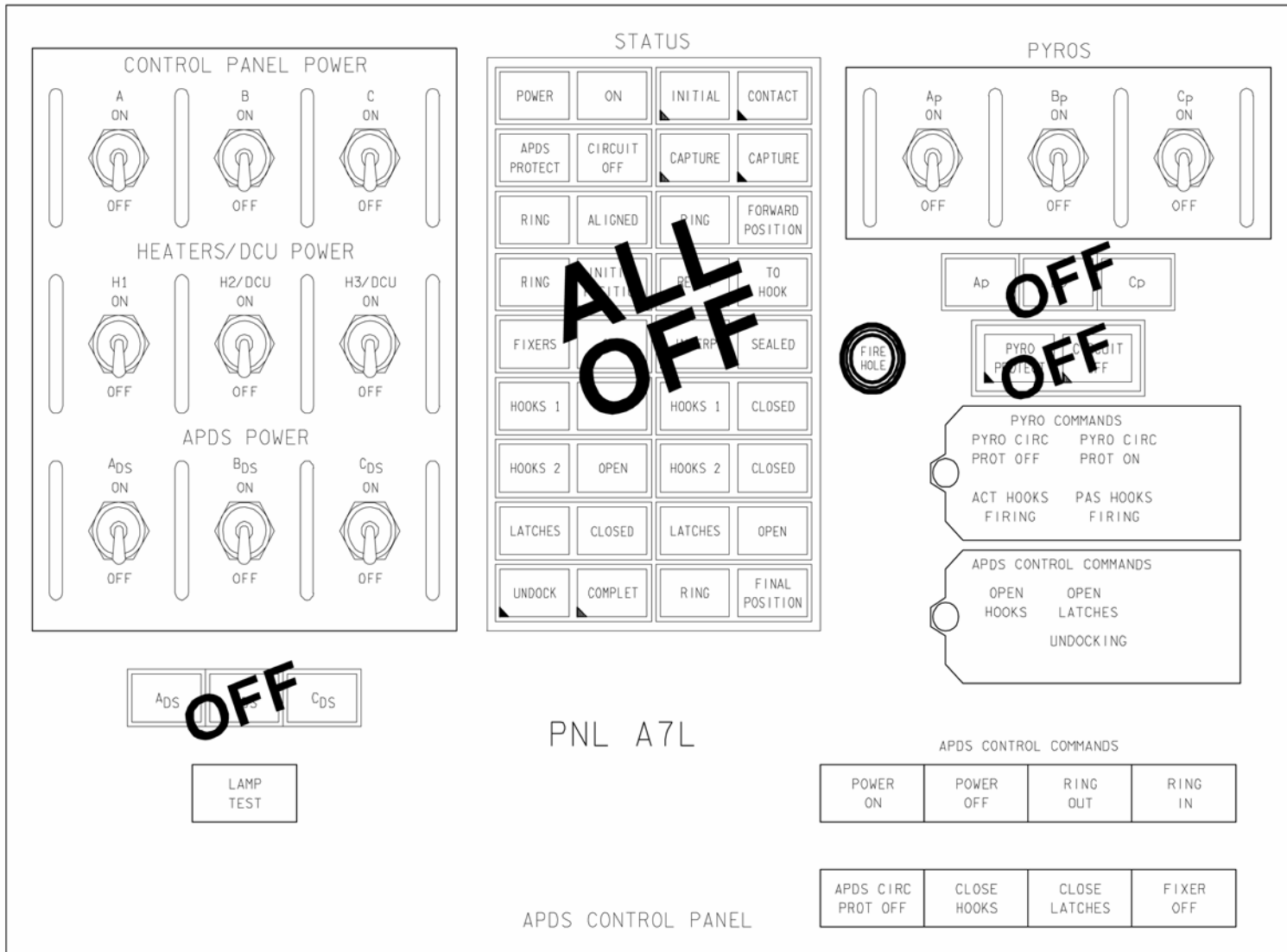

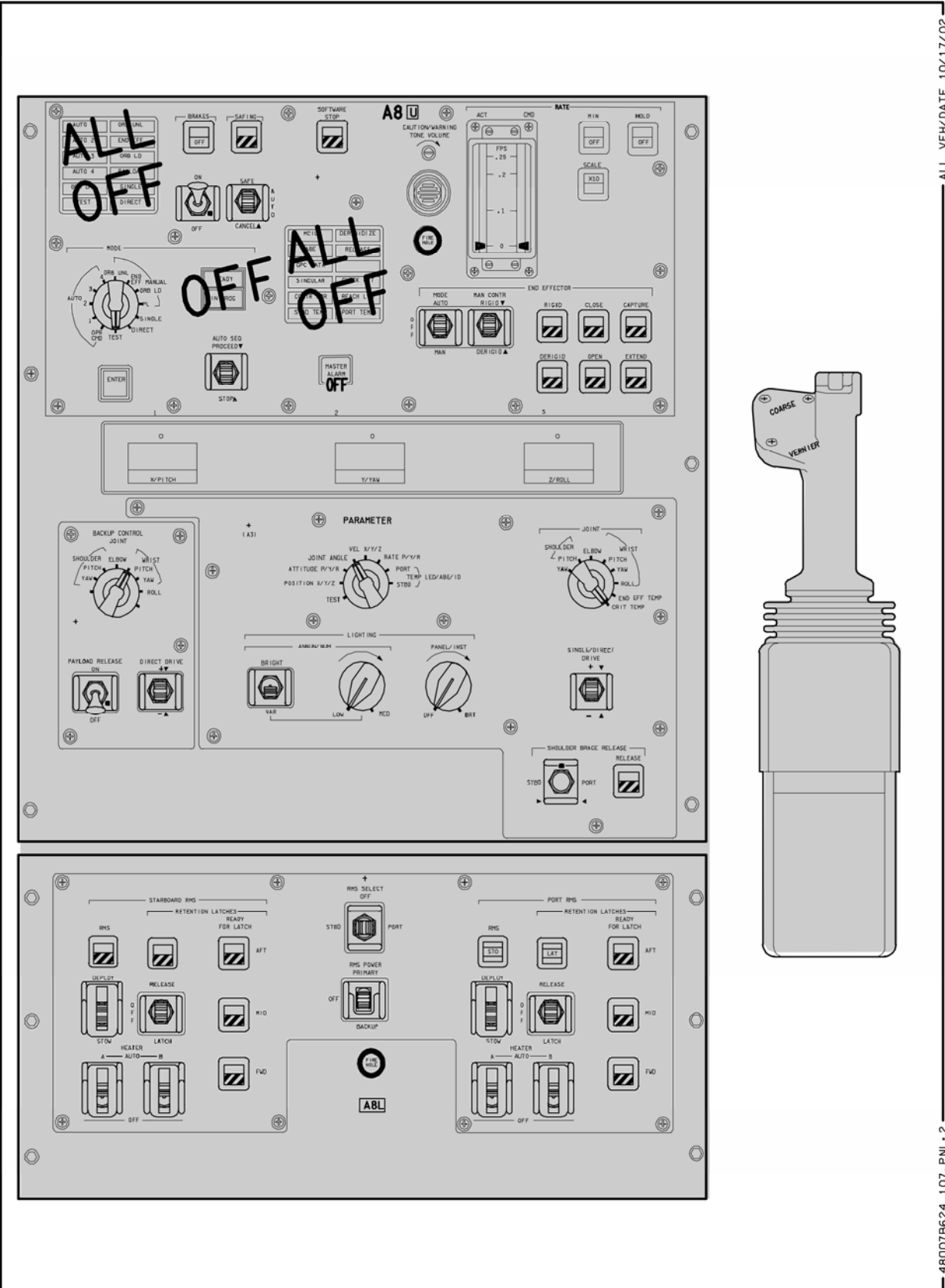

ALL VIEW/DATE 10/17/02

4800TB624_107_PNL_2

OV103

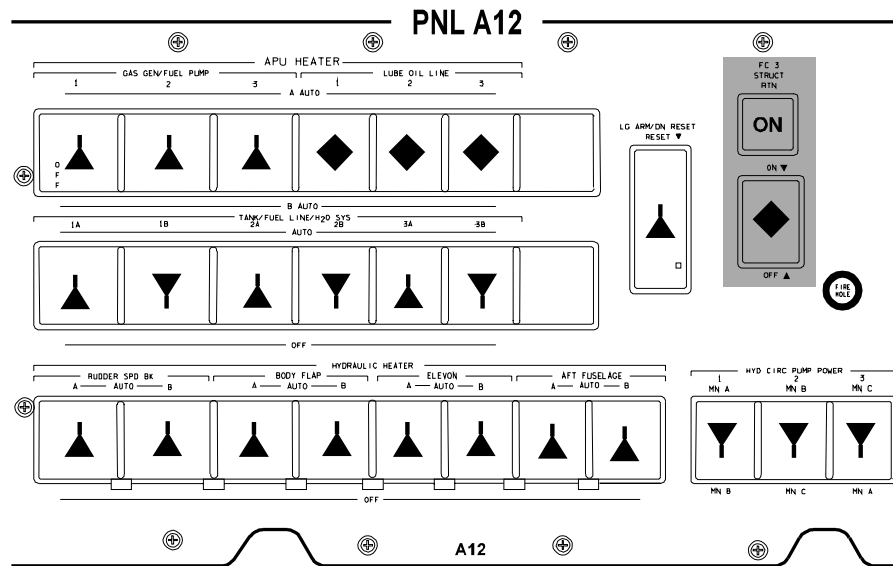
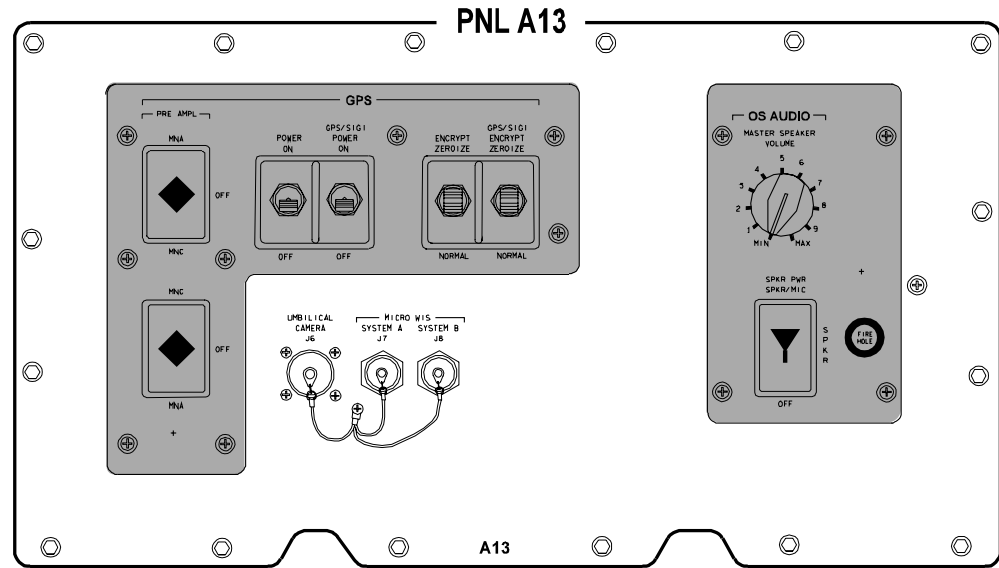
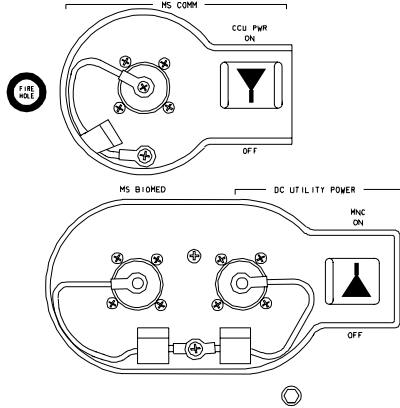
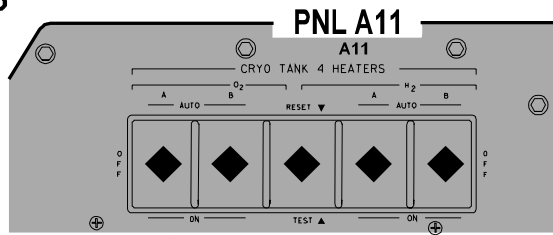

OV103

OV103/DATE 10/05/05

C D/O/3/GEN L

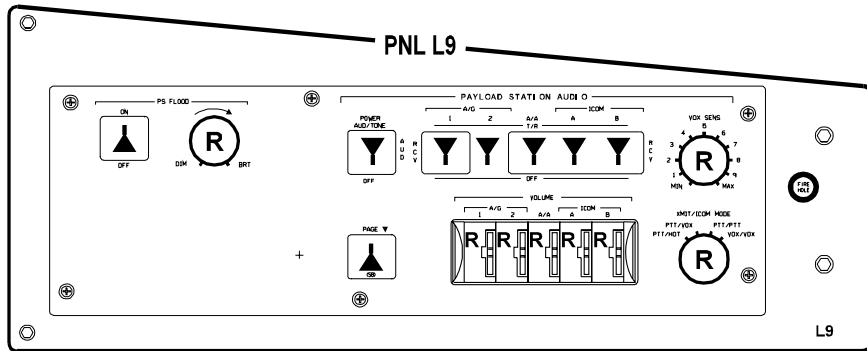
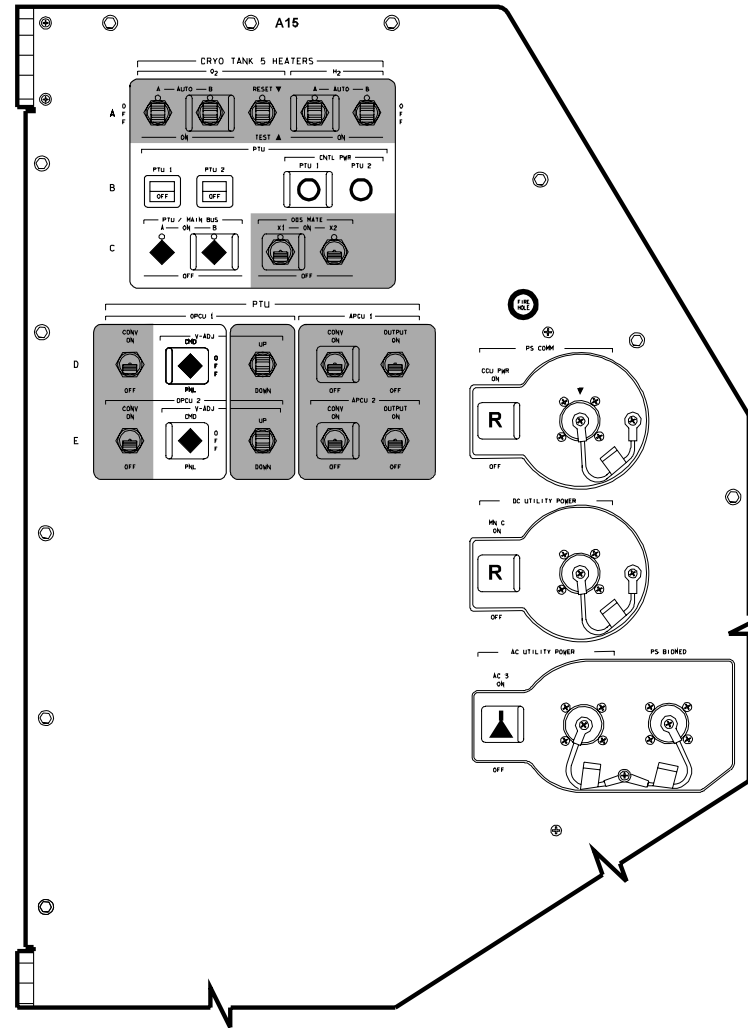
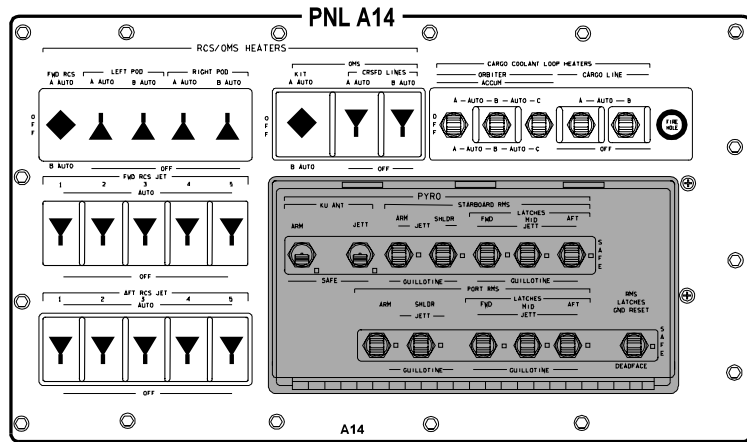

ACTIVATION
L9 All switches - as read
A15 PS COMM CCU PWR-ON

OV103

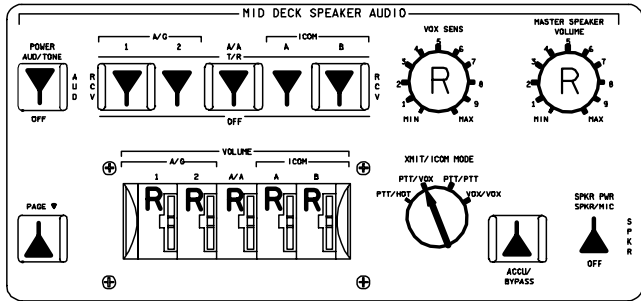

PNL M042F

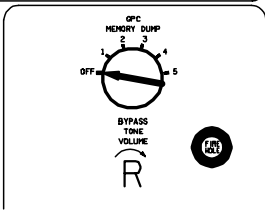

PNL M058F

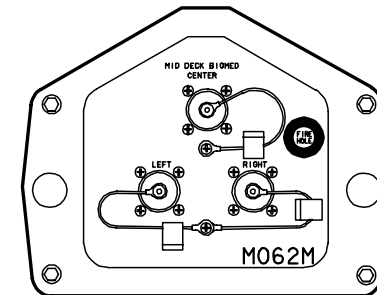
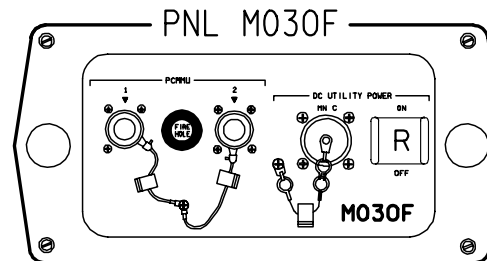
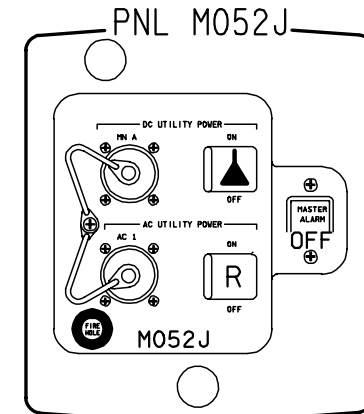
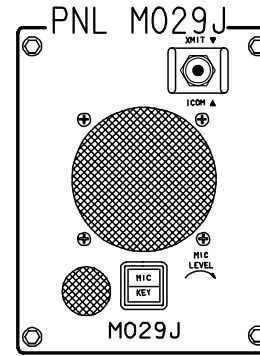
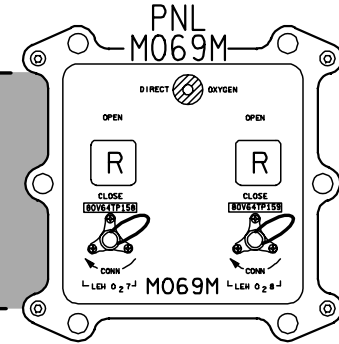
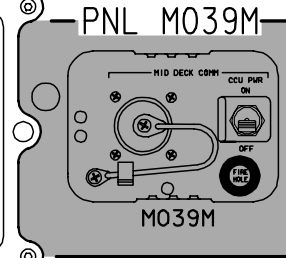
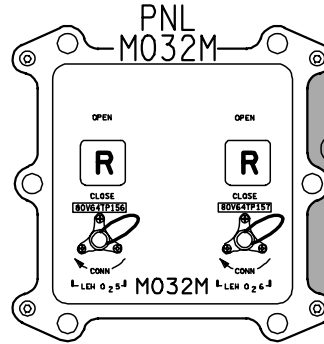
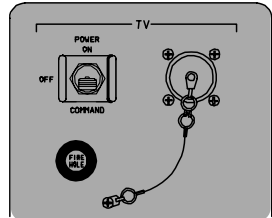
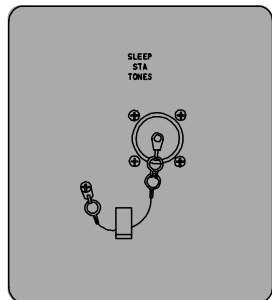

OV103

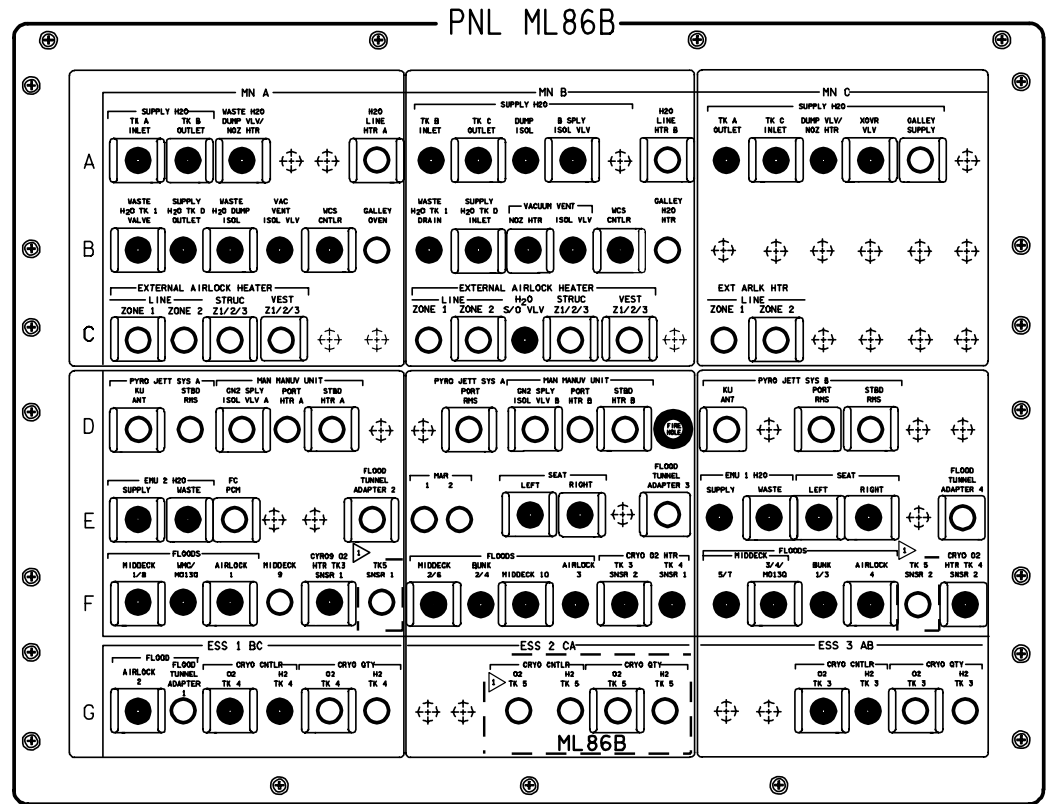
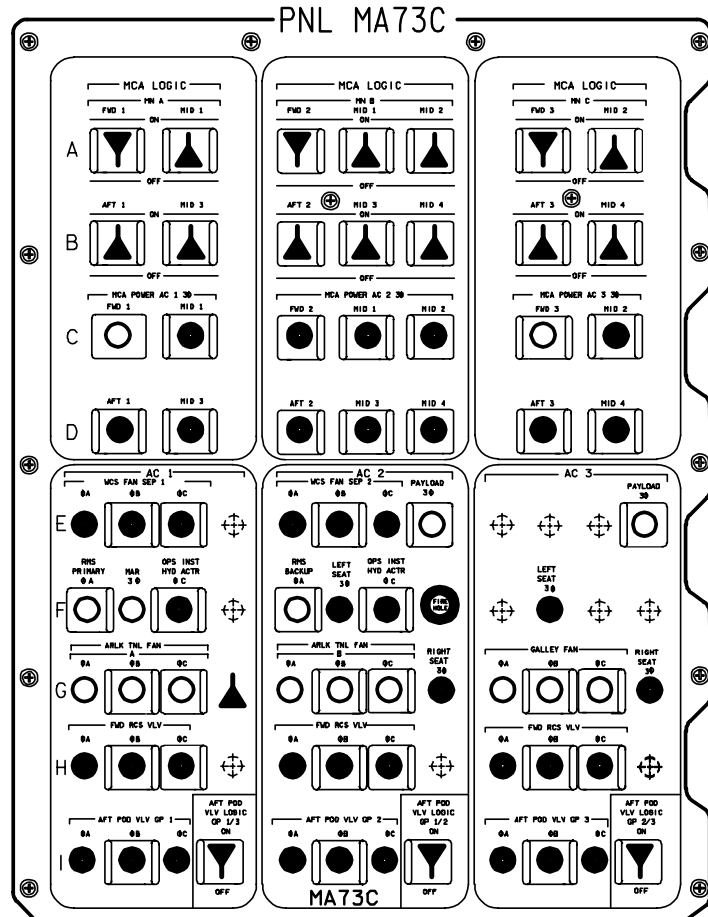

NOTES: ▷ CLOSED IF TK5 FLOWN

OV103

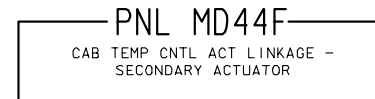
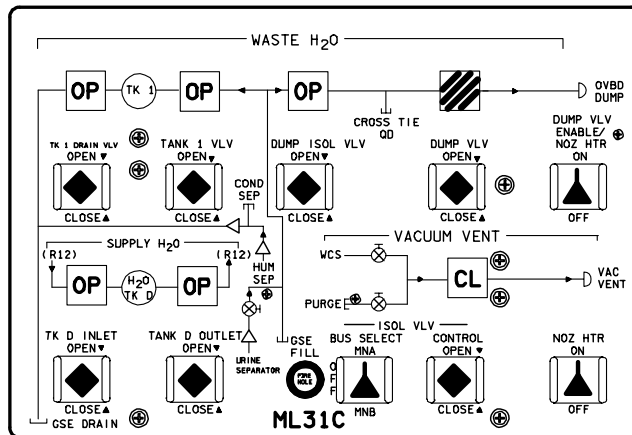
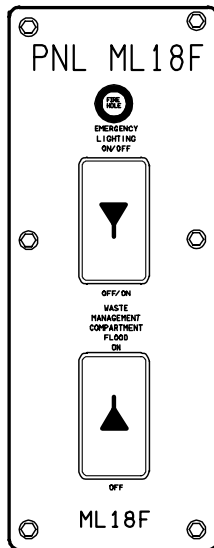
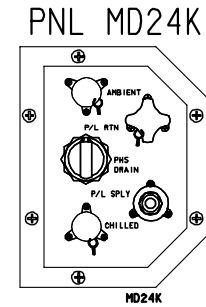
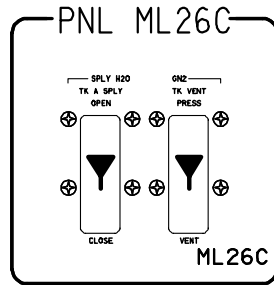
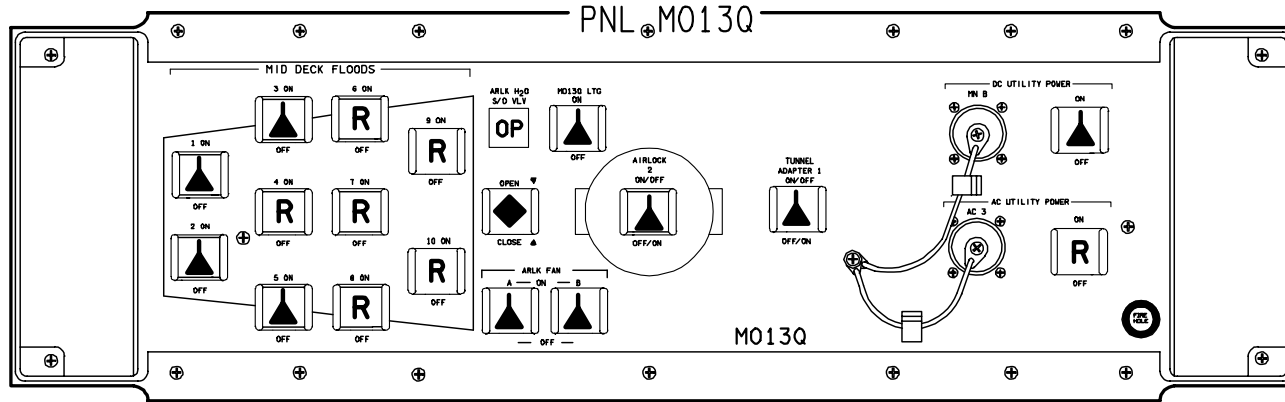

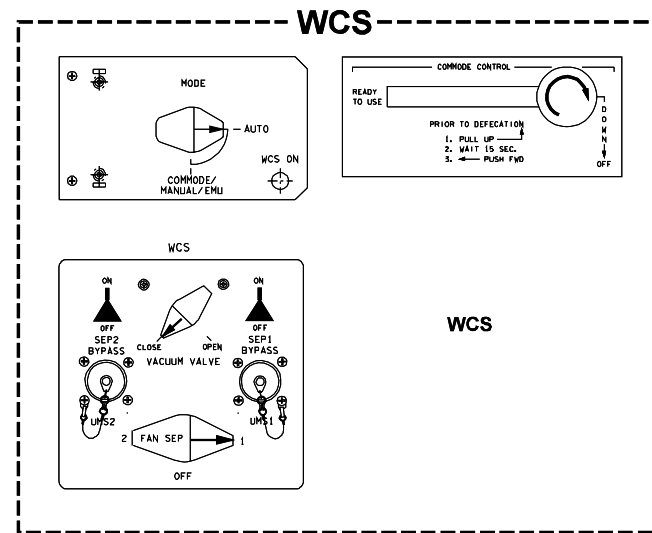
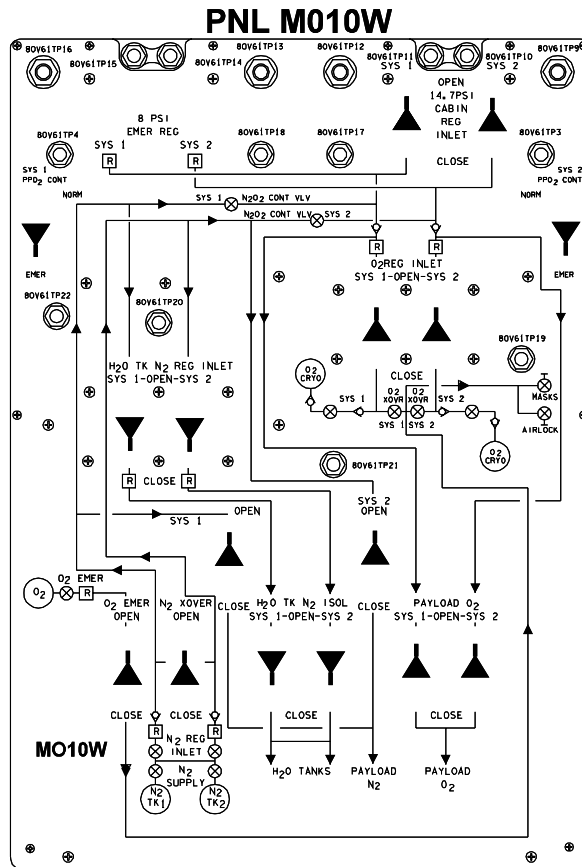

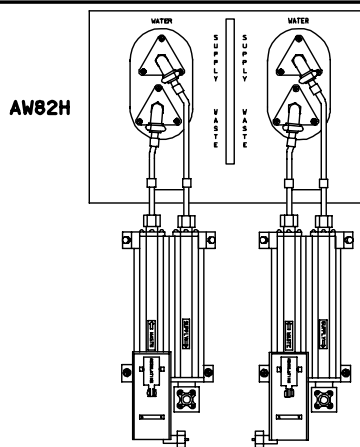
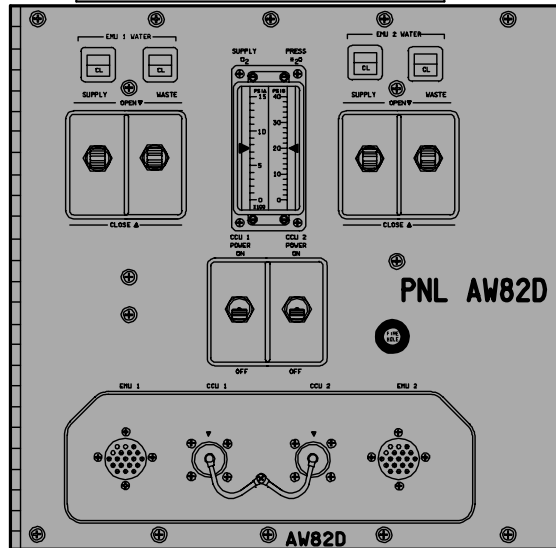
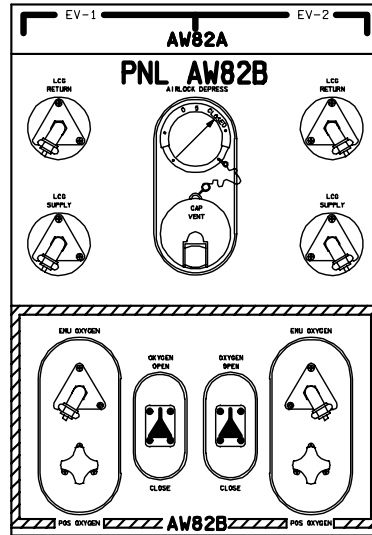
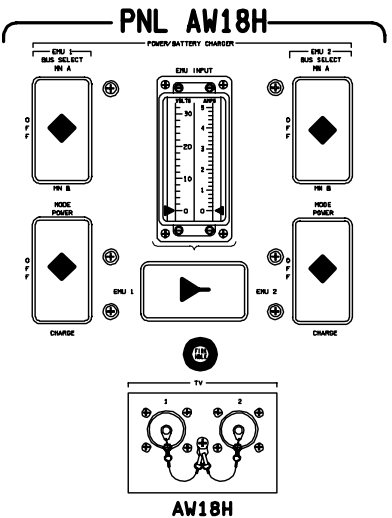
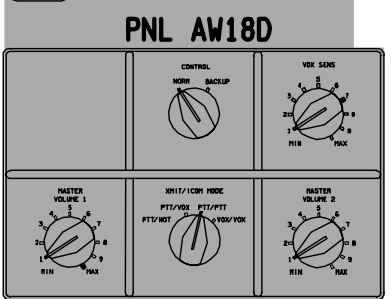
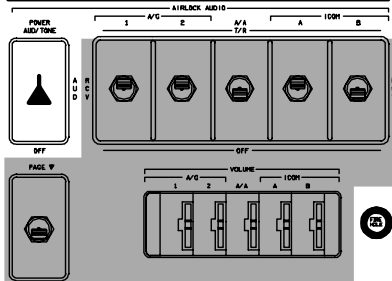
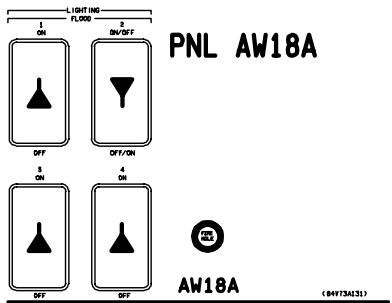

ALL REV/DATE 04/26/05

48007E631_114_PNL_1

Inner Hatch

Actuator Handle – LATCHED

Lock Lever – LOCKED

Equalization vlv (two) – NORM, capped

OV104

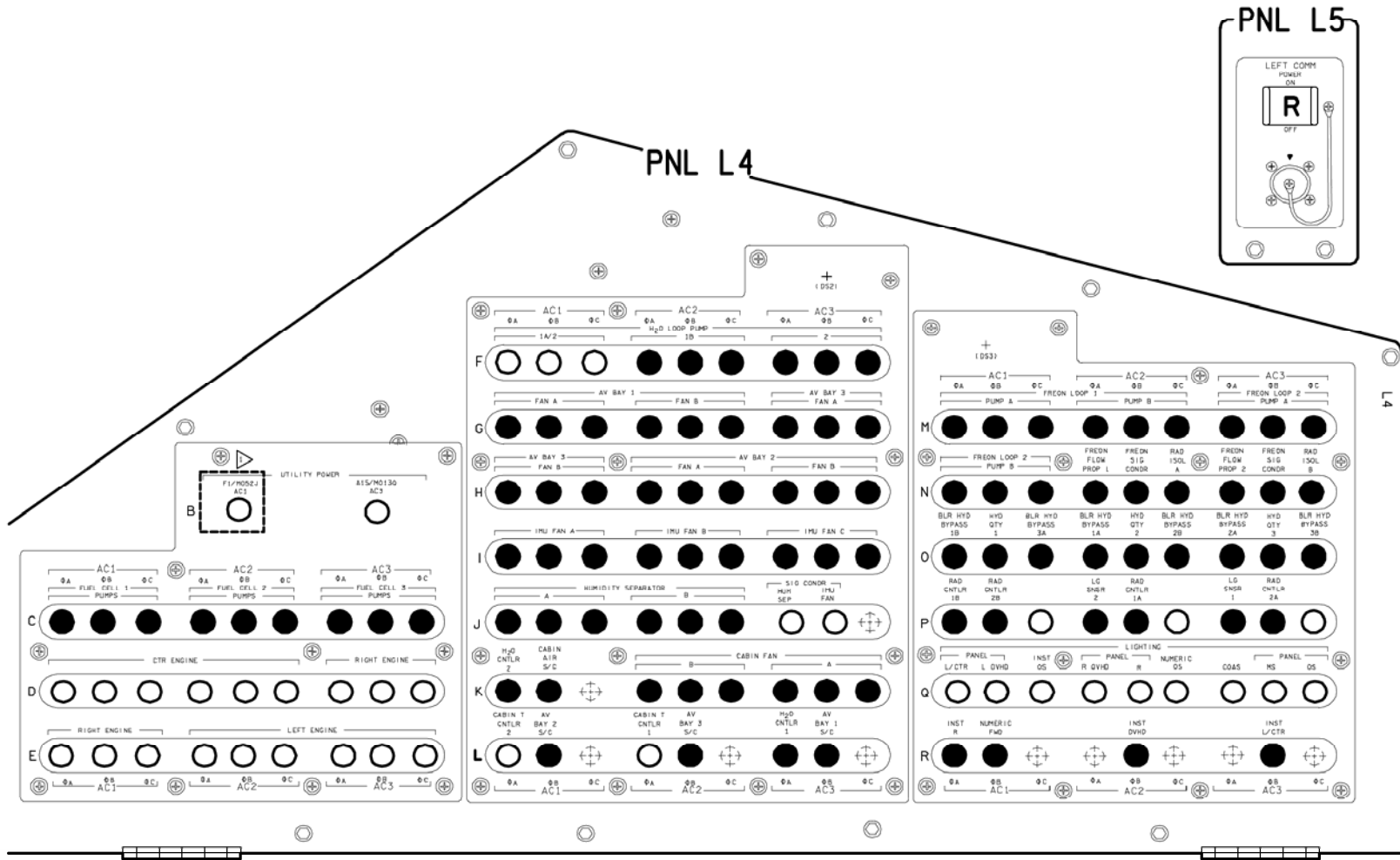

NOTE: ▸ CB CAN REMAIN CLOSED FOR AC PGSC USAGE.
 OPEN WHEN PGSC UNPOWERED/STOWED

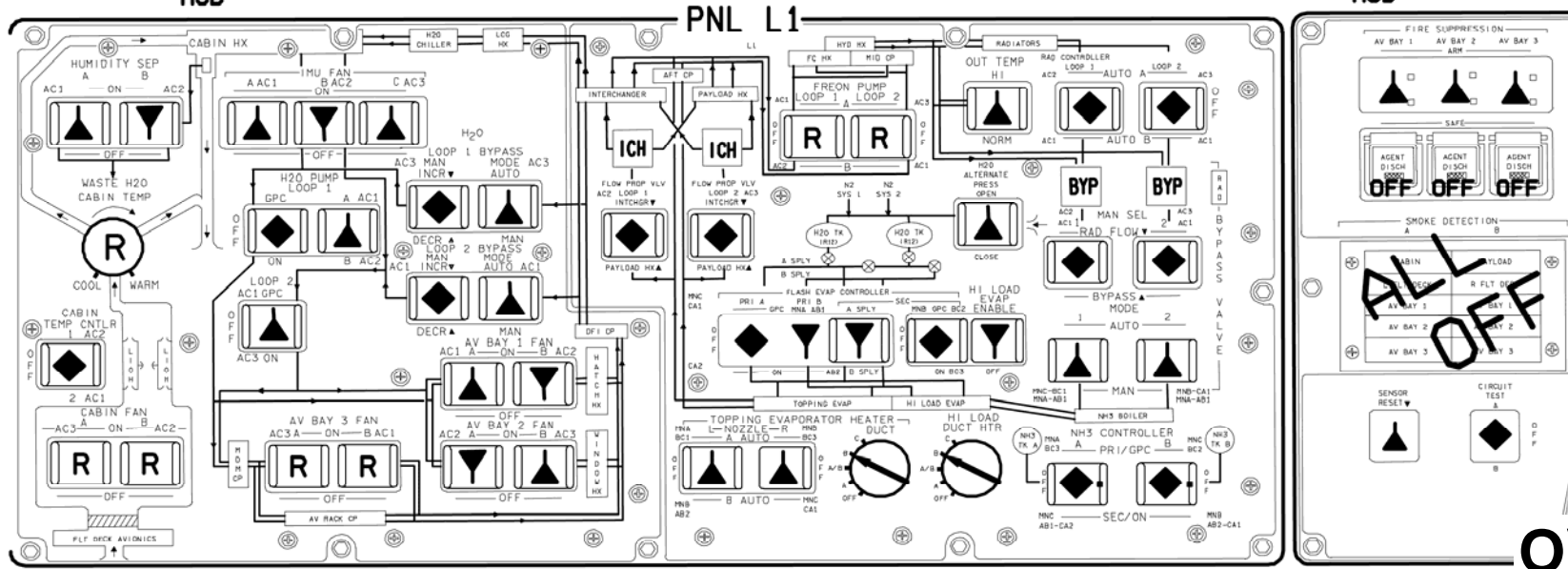
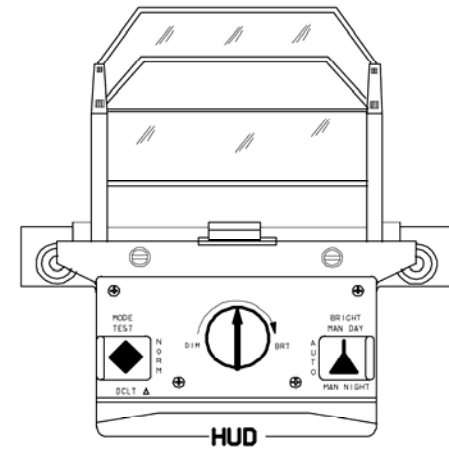
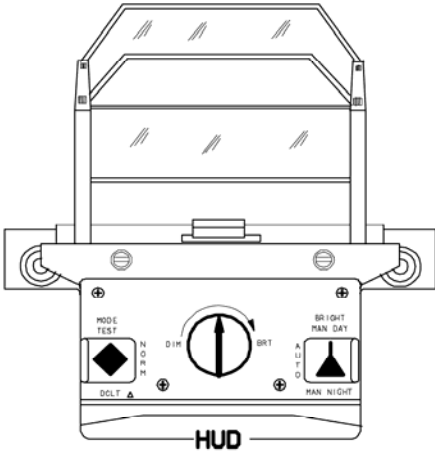
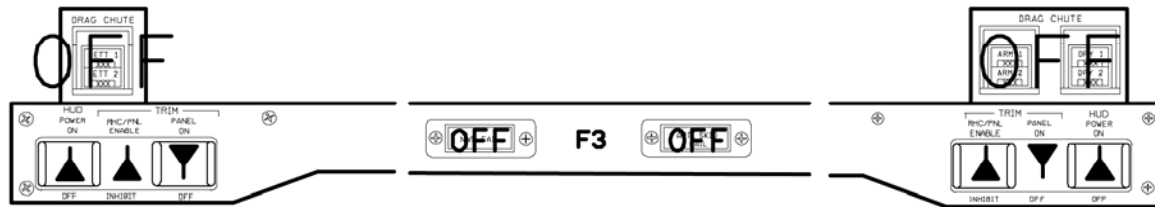

OV104

48007C604_107, PNL, 1

ALL VEH/DATE 10/07/02

(OV104) B6-4

C D/O/ALL/GEN L

OV104

PNL L2

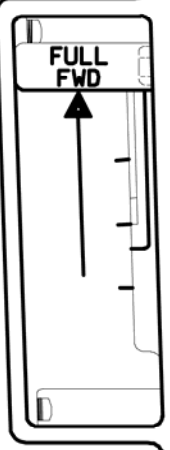
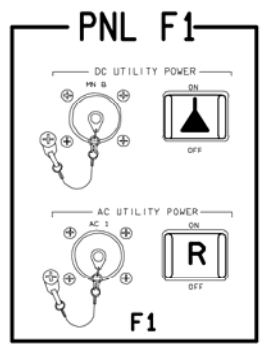
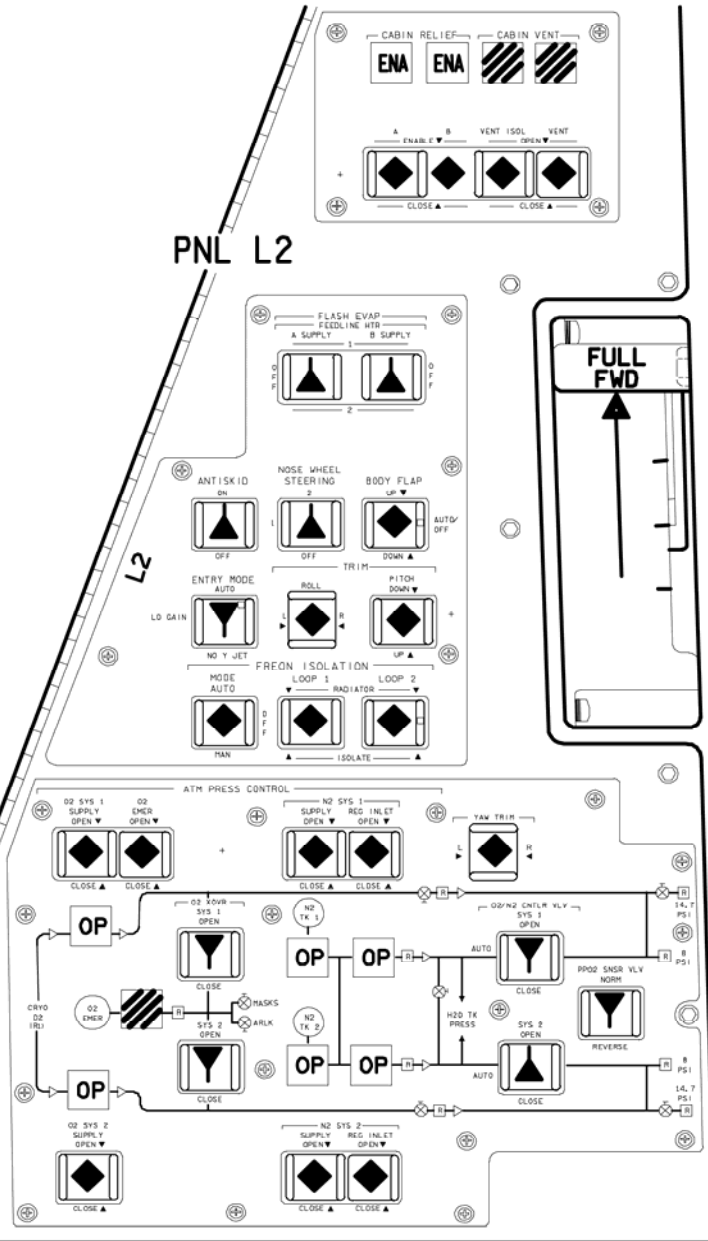

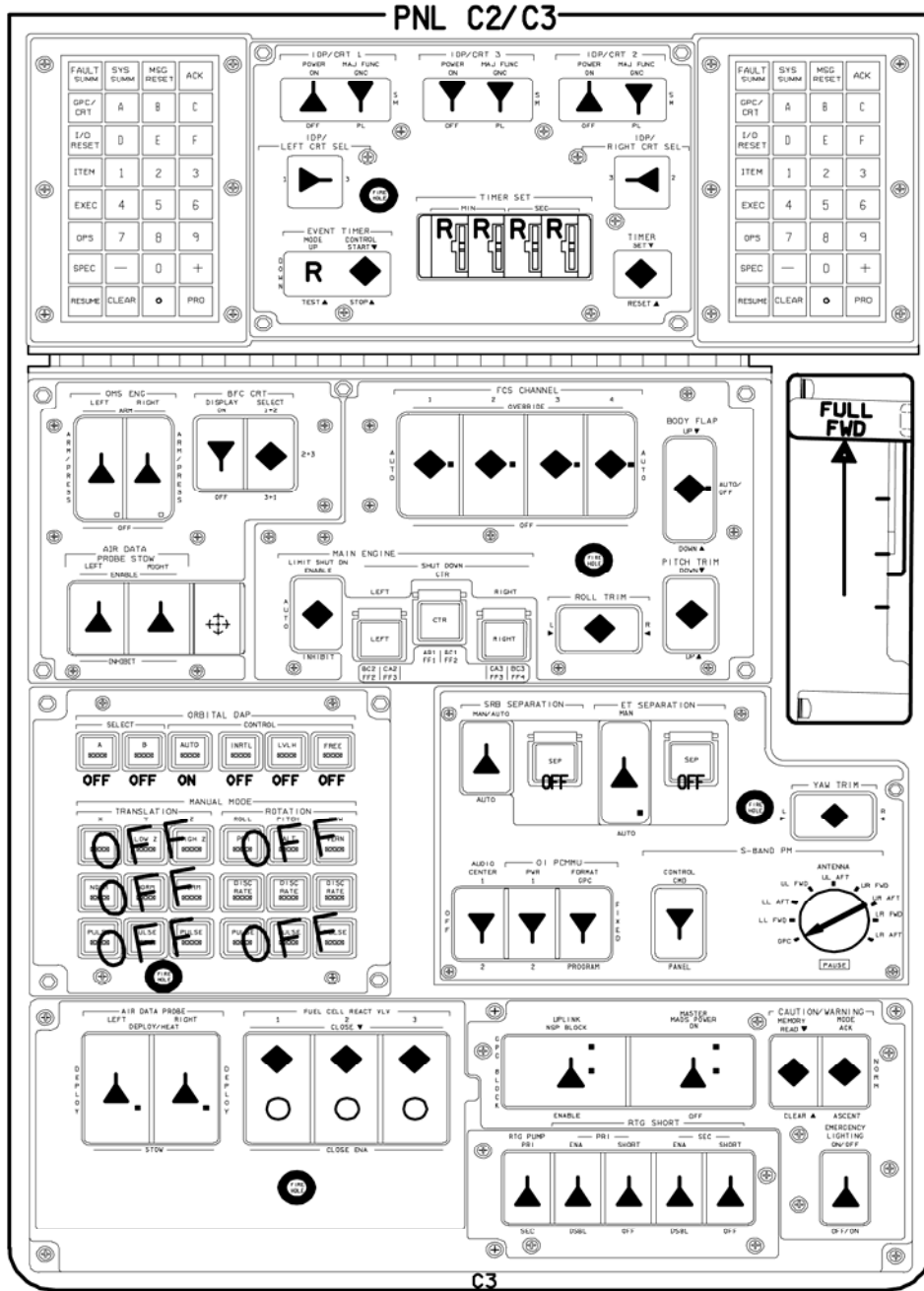

OV104

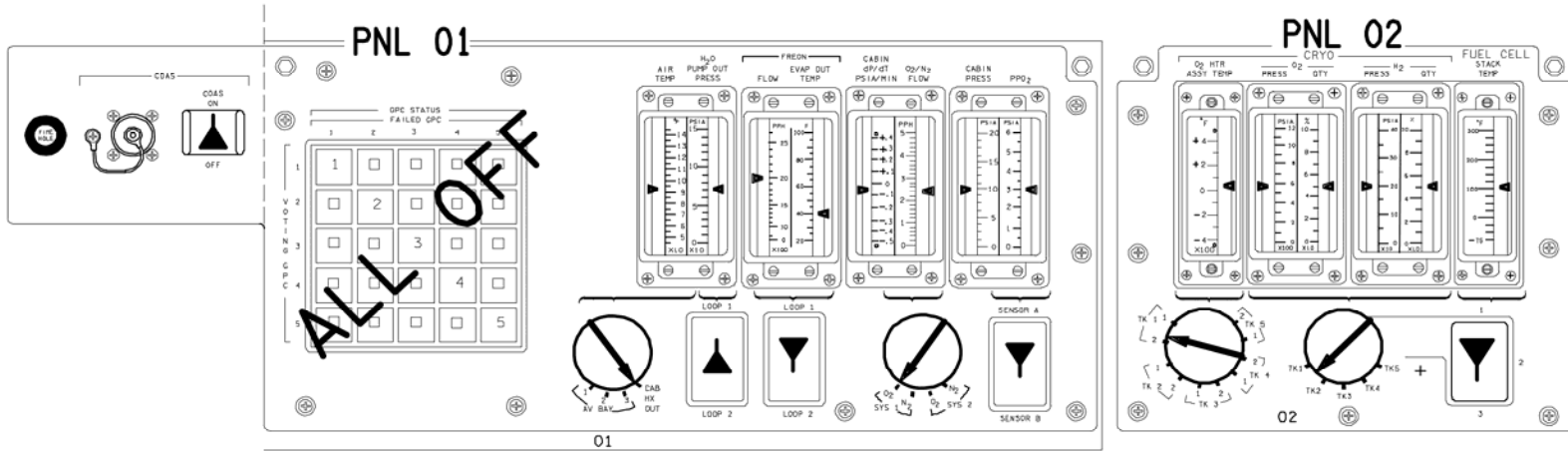

L side OVHD flood - R (MID)

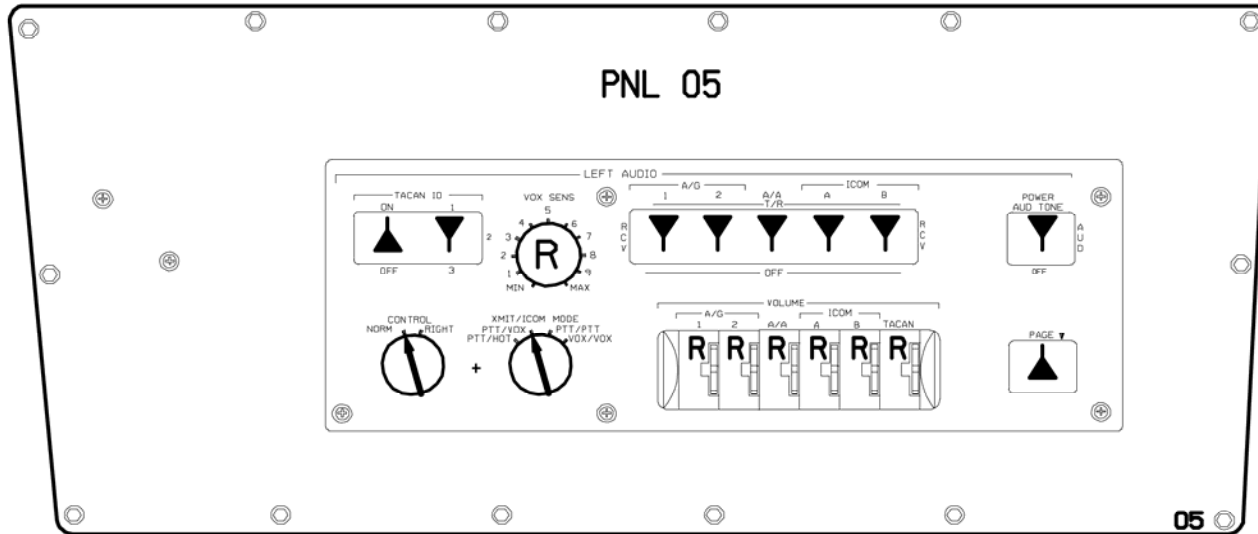

OV104

PNL 06

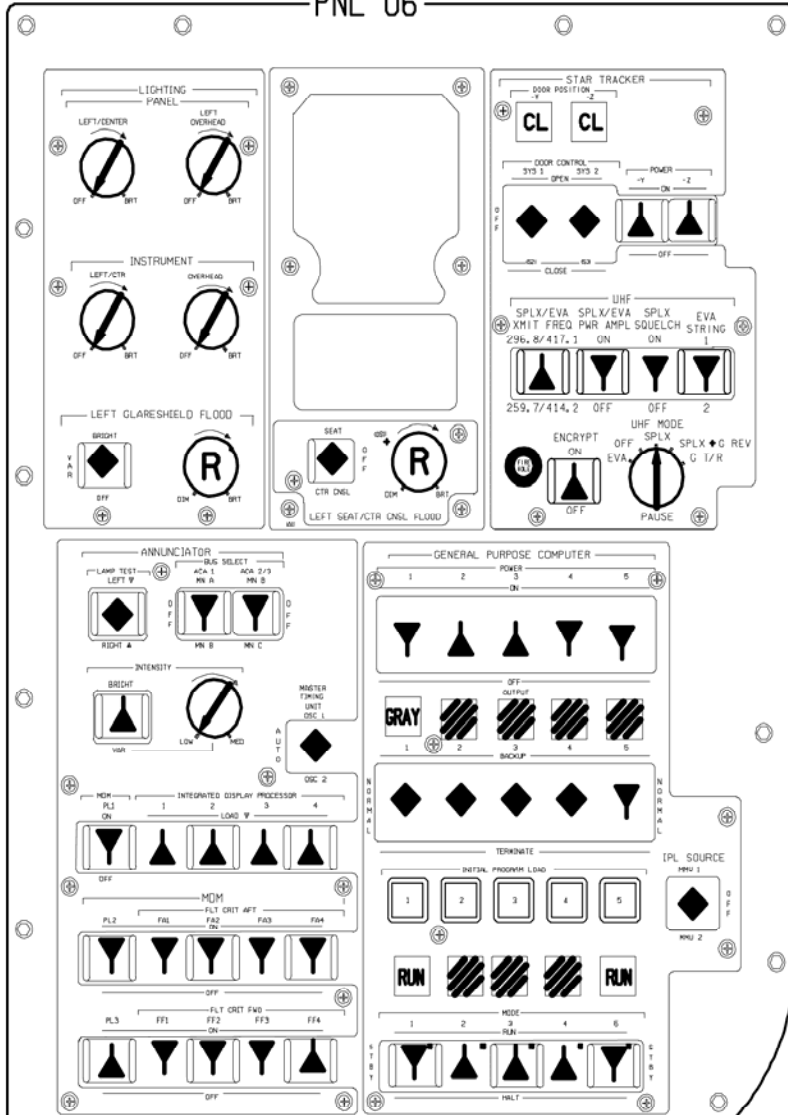

PNL 07

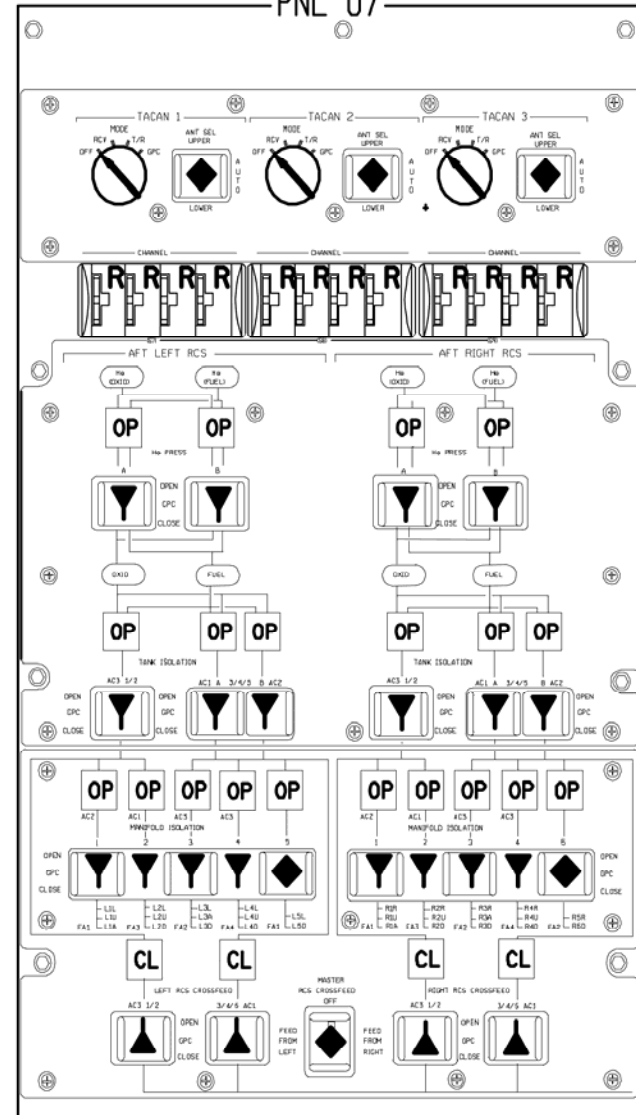

OV104

PNL 08

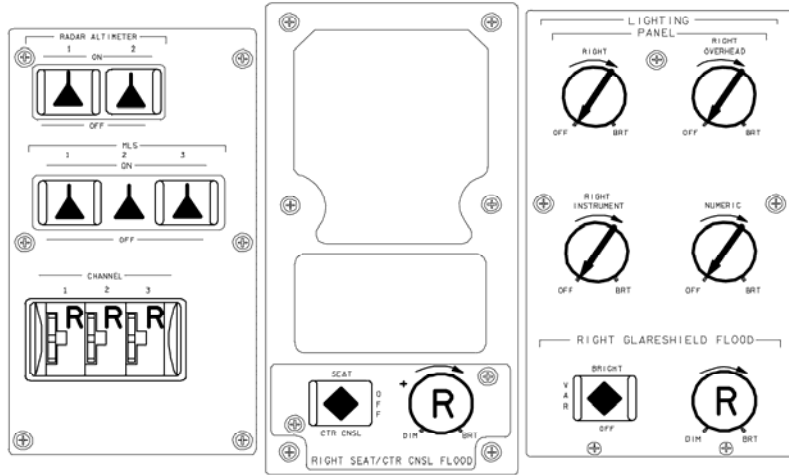

PNL 09

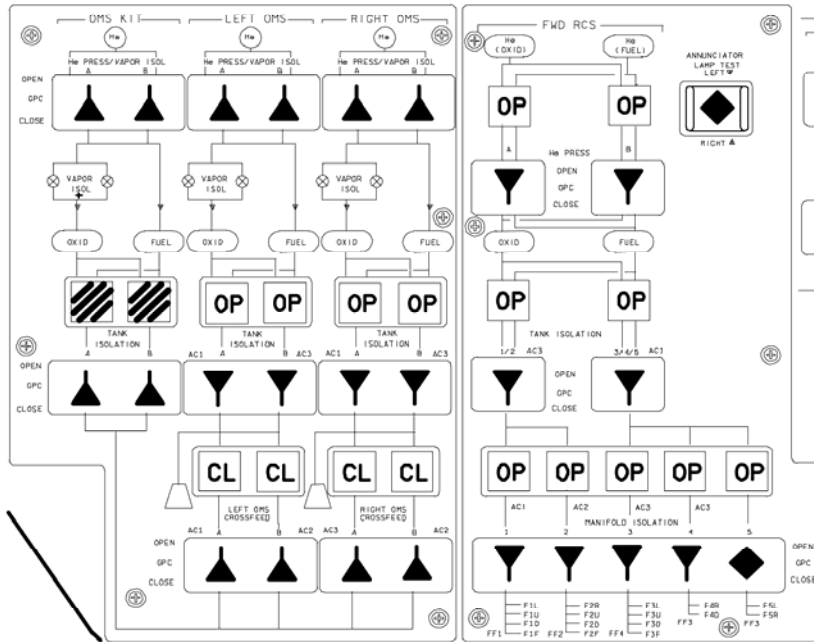
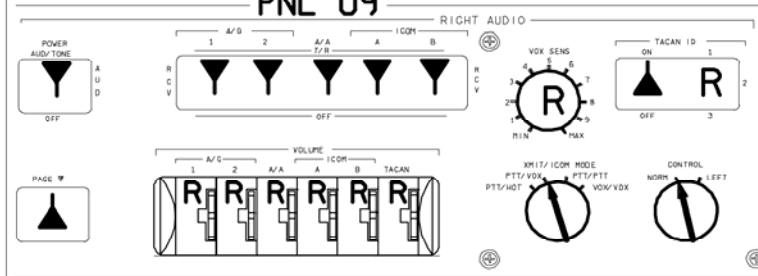

Right OVHD flood - R (MID)

OV104

OV104

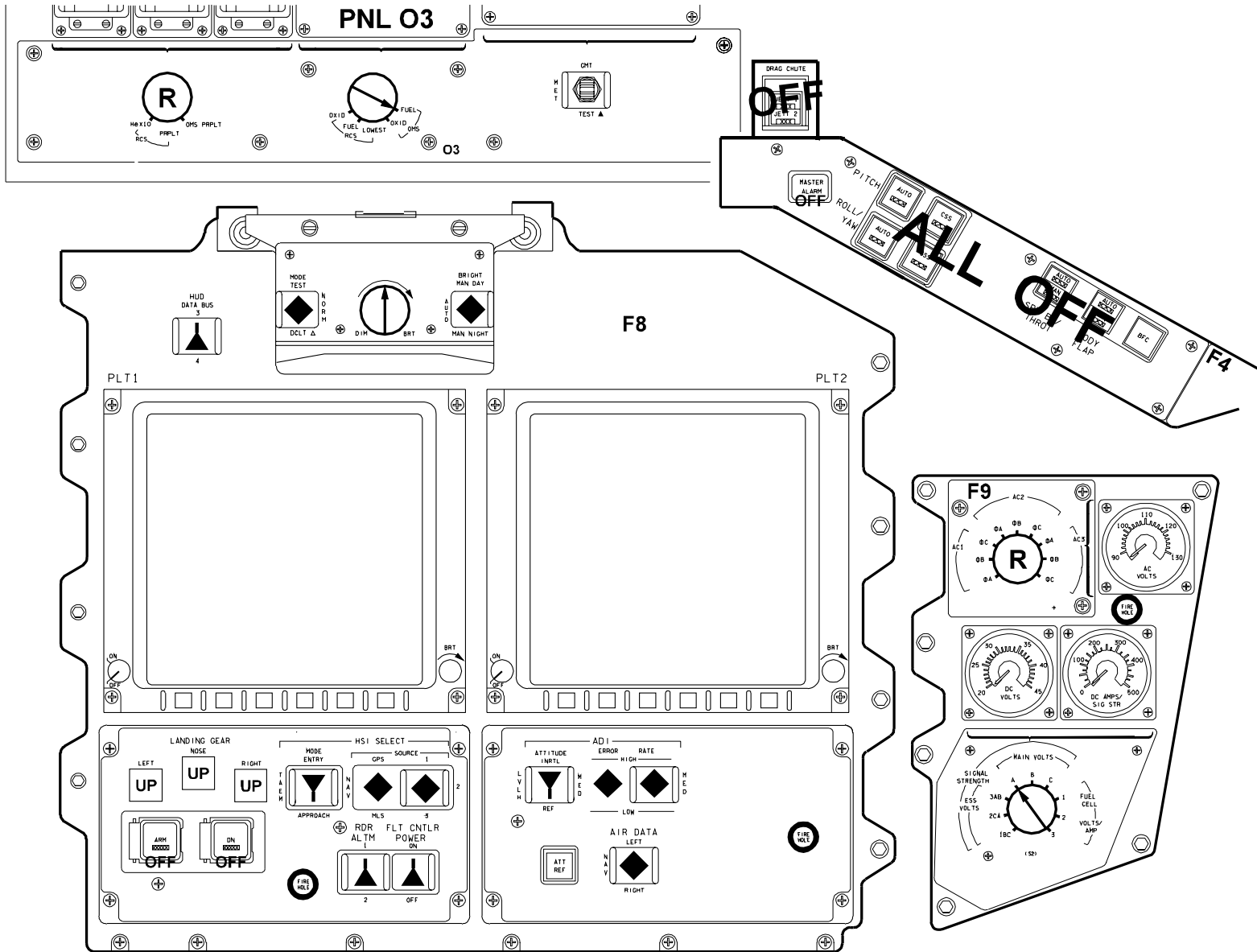

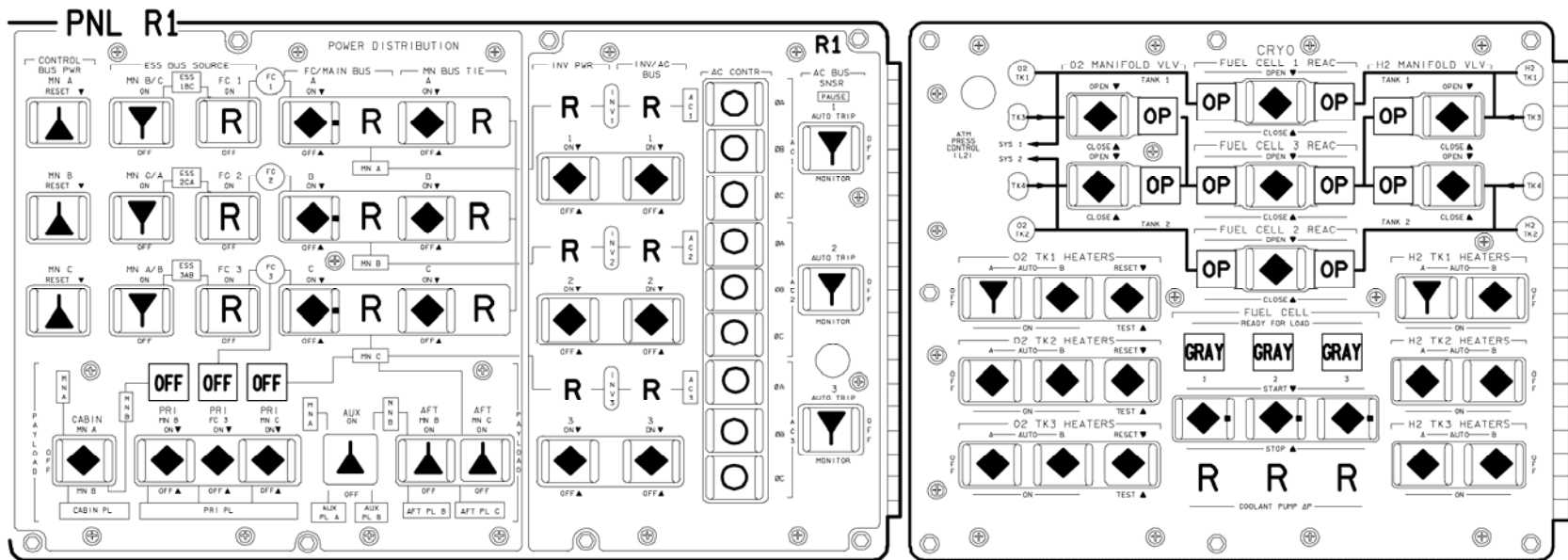

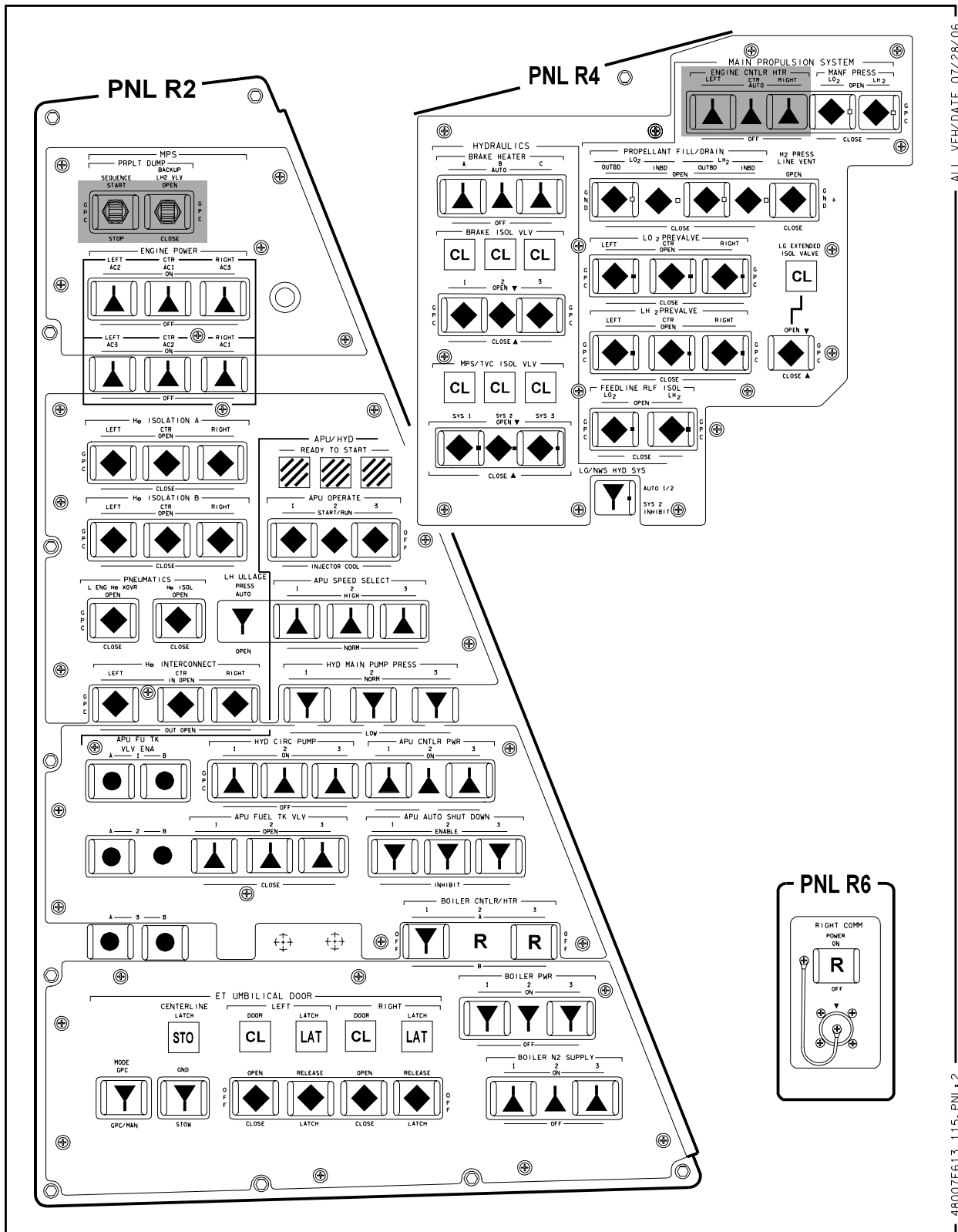

ALL VEH/DATE 07/28/06

48007F613_115, PNLs 2

OV104

(OV104) B6-13

C D/O/ALL/GEN L

This Page Intentionally Blank

(OV104) B6-14

OV104
C D/O/ALL/GEN L

OV104

PNL 013

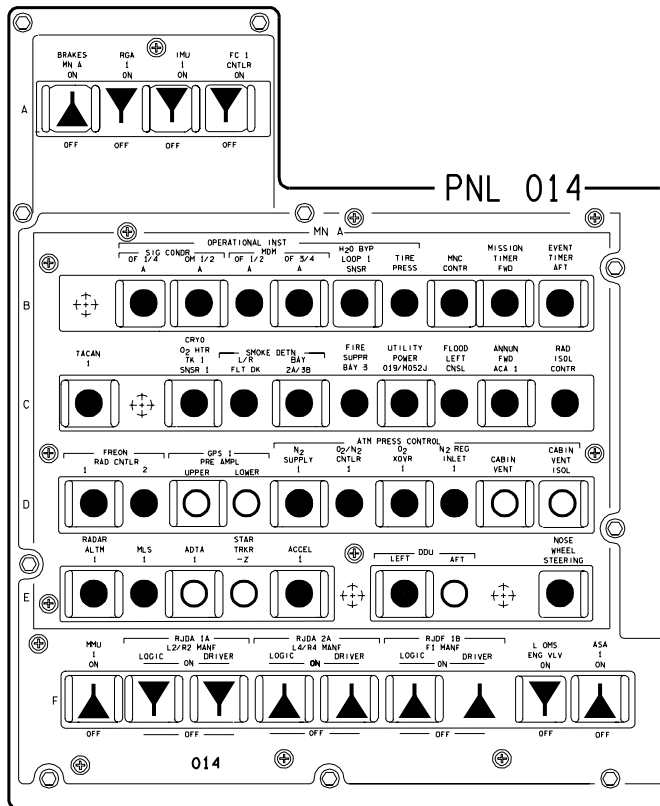
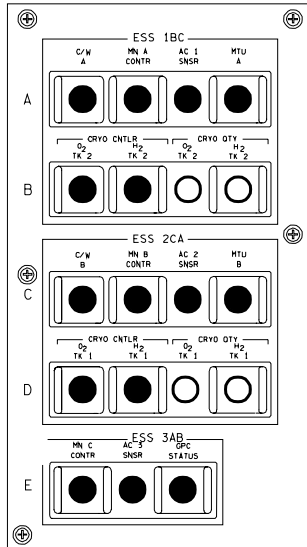

PNL 015

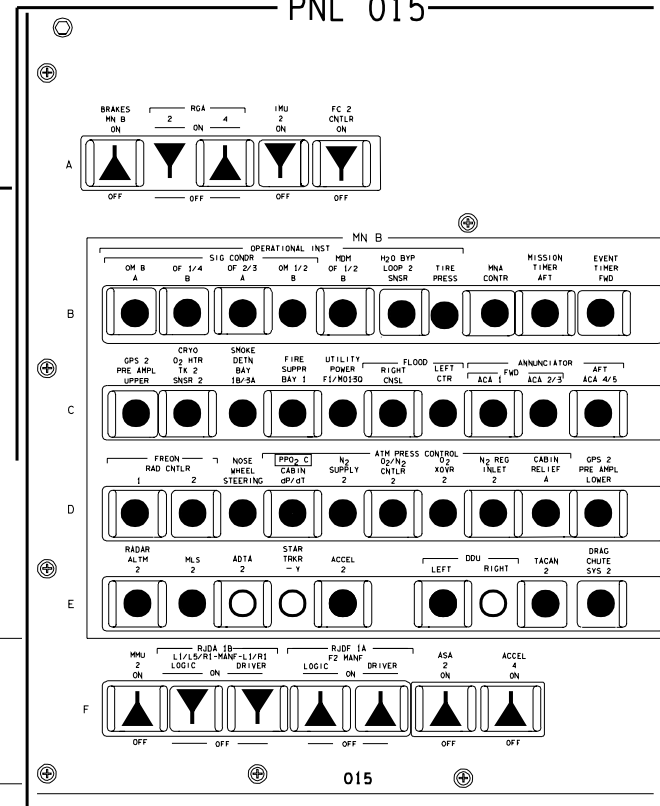

OV104

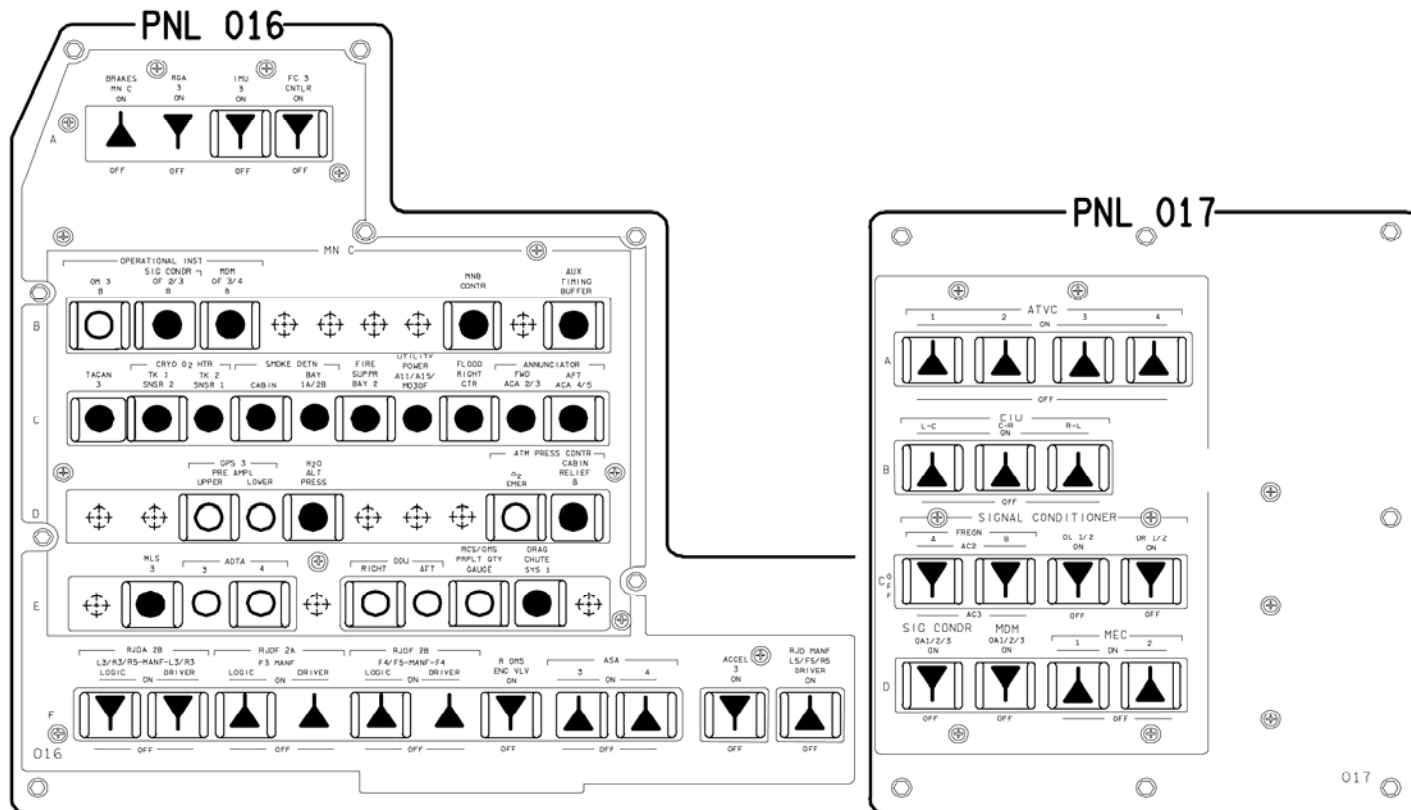

OV104

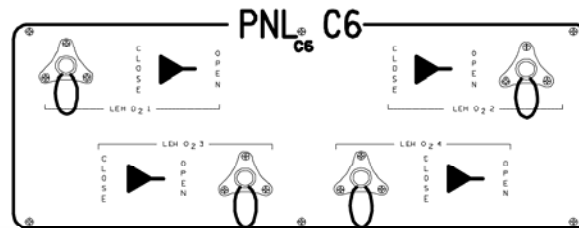
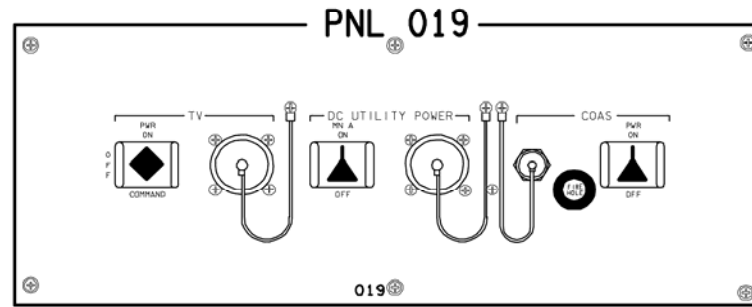

PNL C5



PNL C7

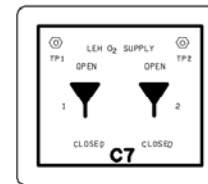

OV104

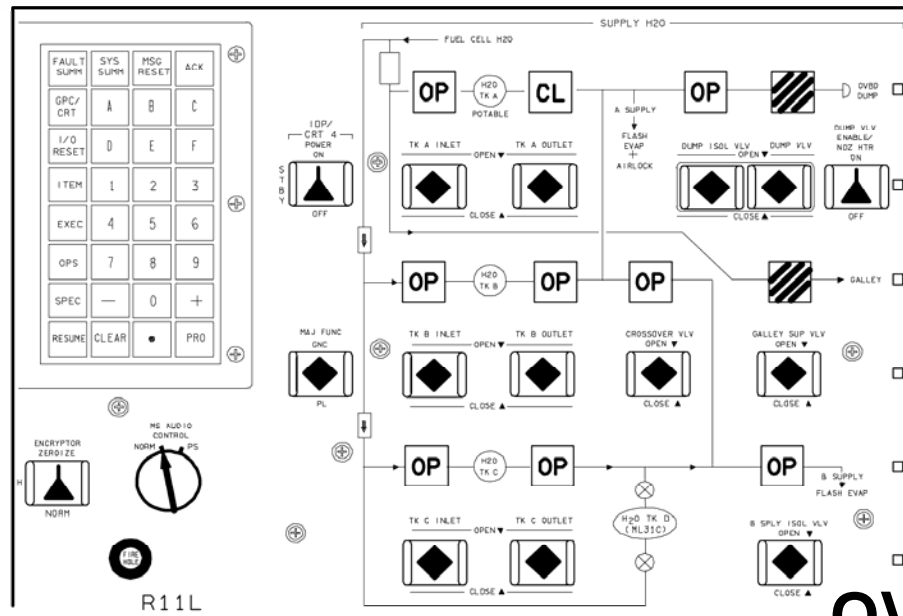
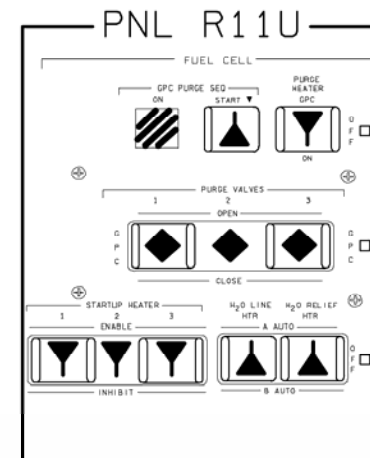
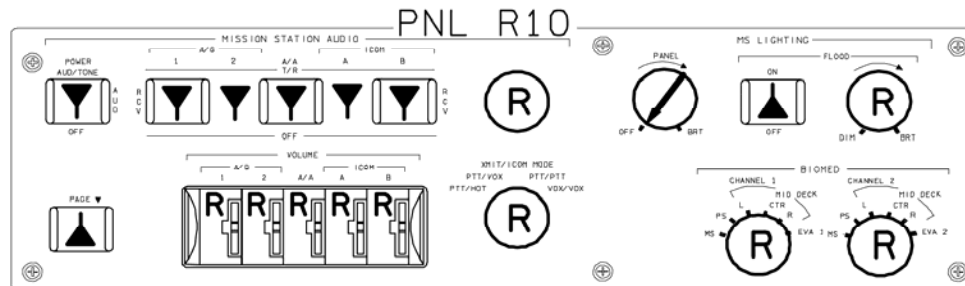

OV104

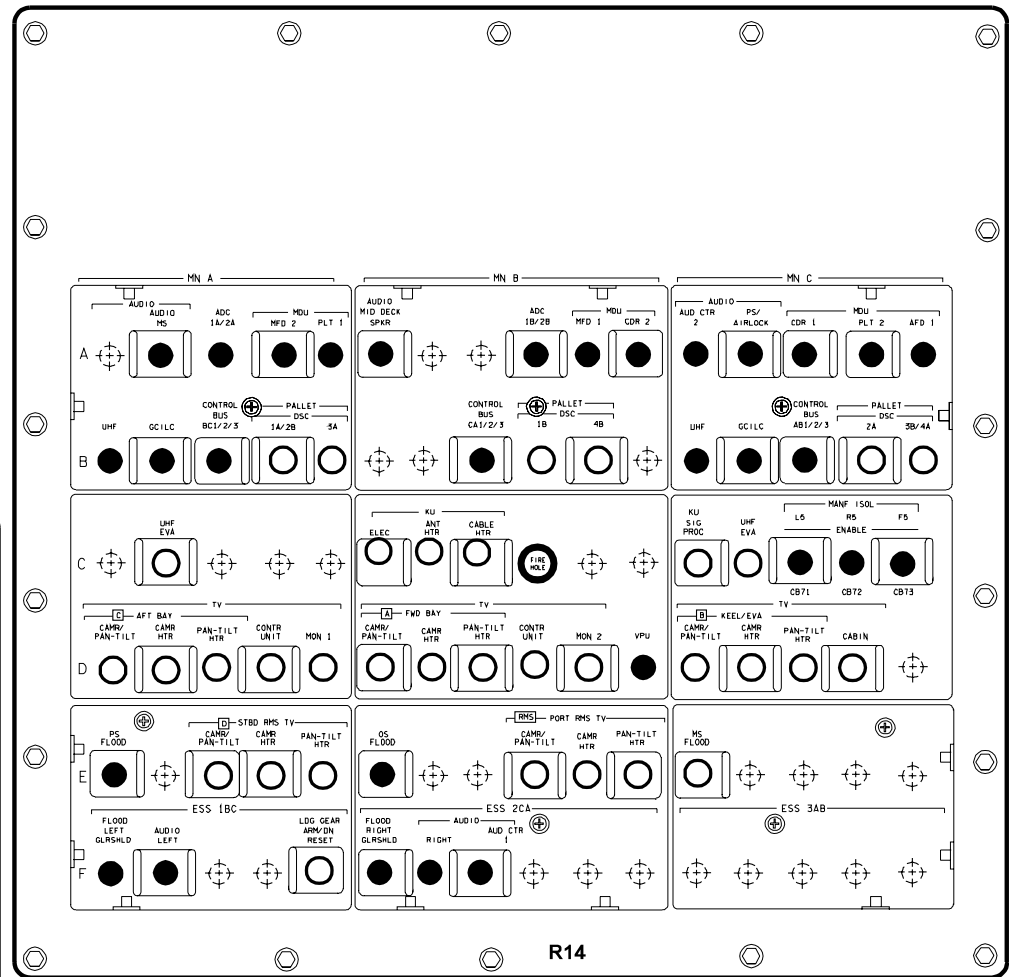
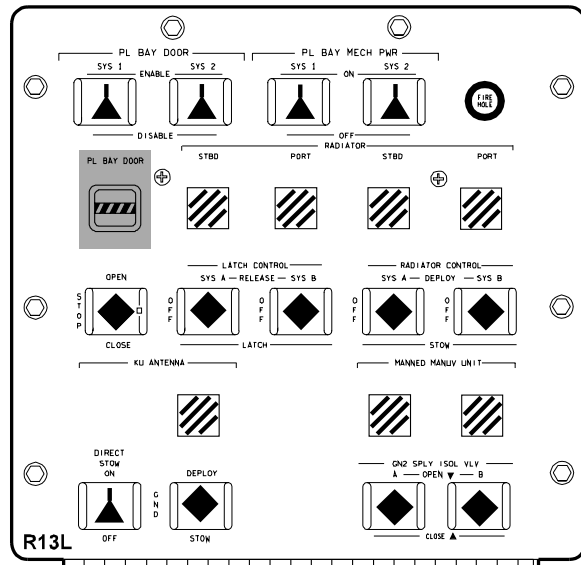
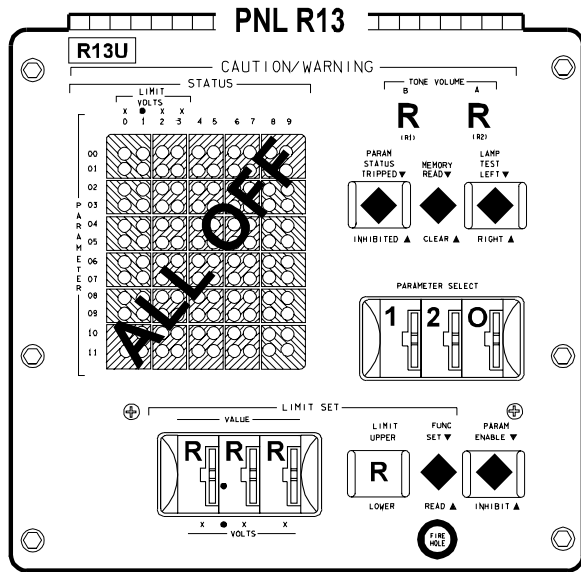

48007F619_121, PNL 3

OV104/DATE 10/05/05

OV104

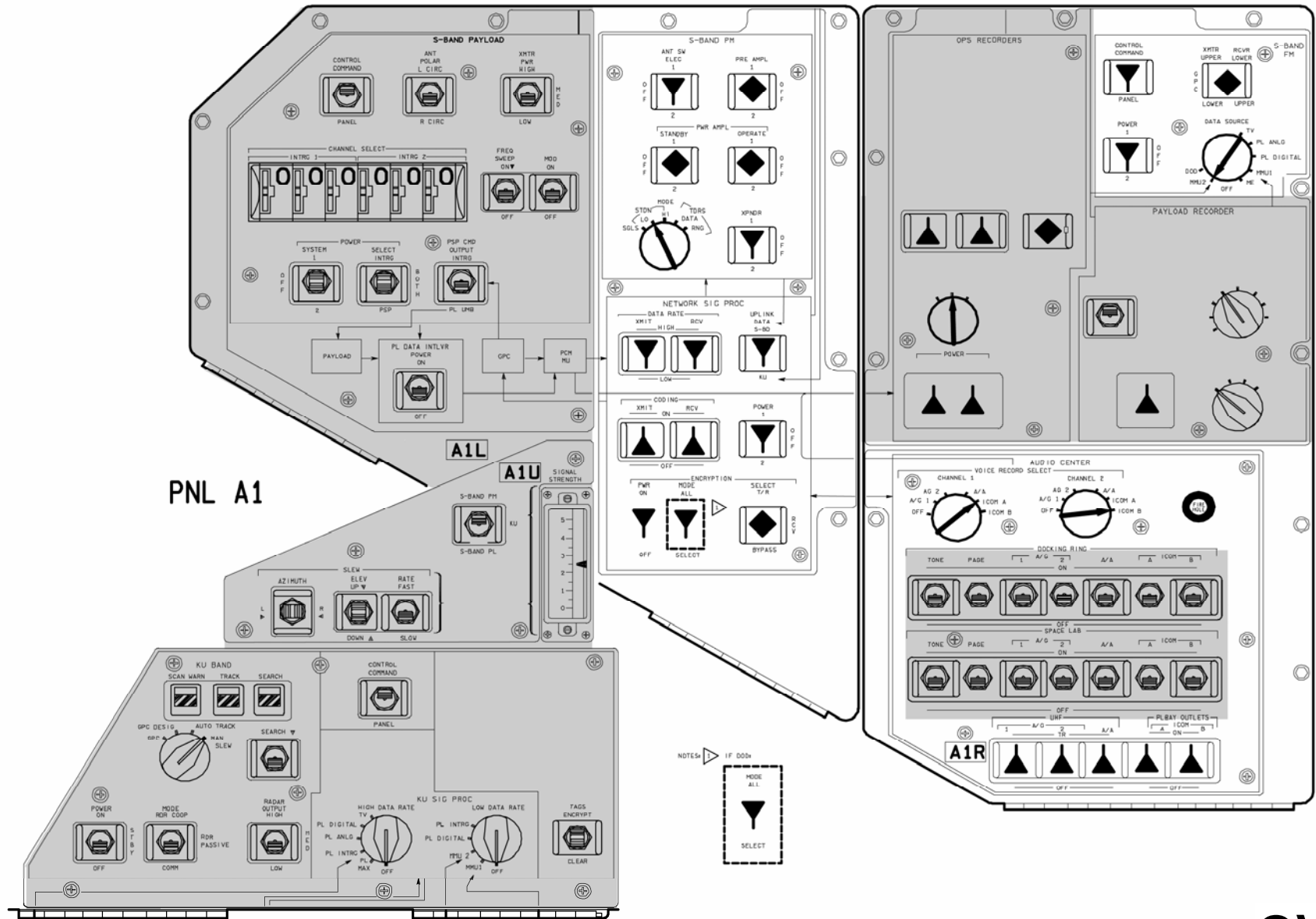

PNL A1

A1L

A1U

A1R

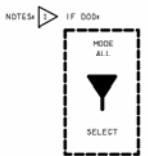

OV104

OV104

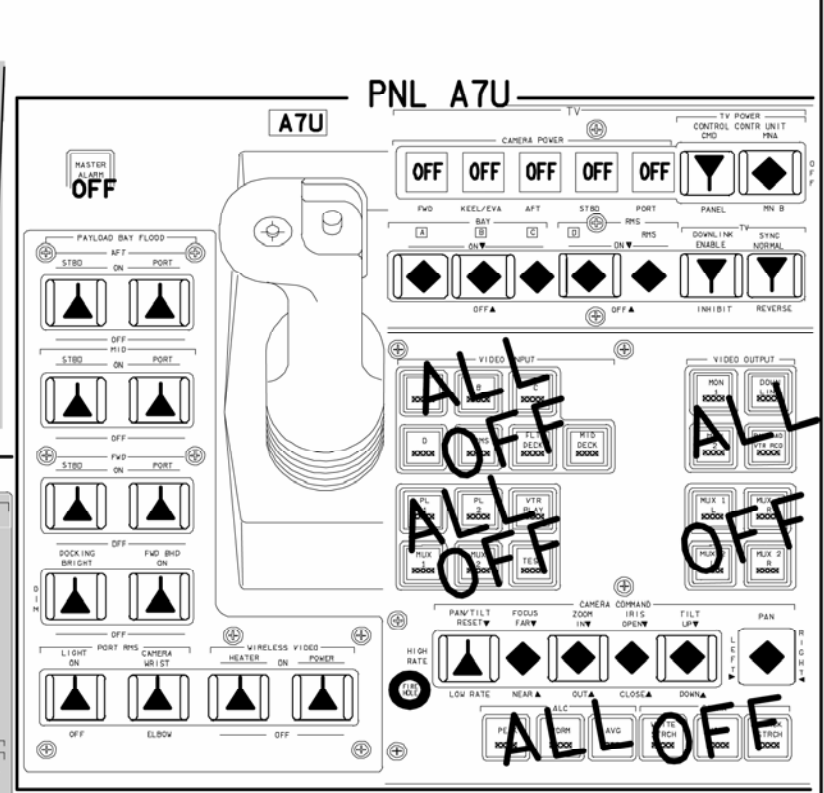
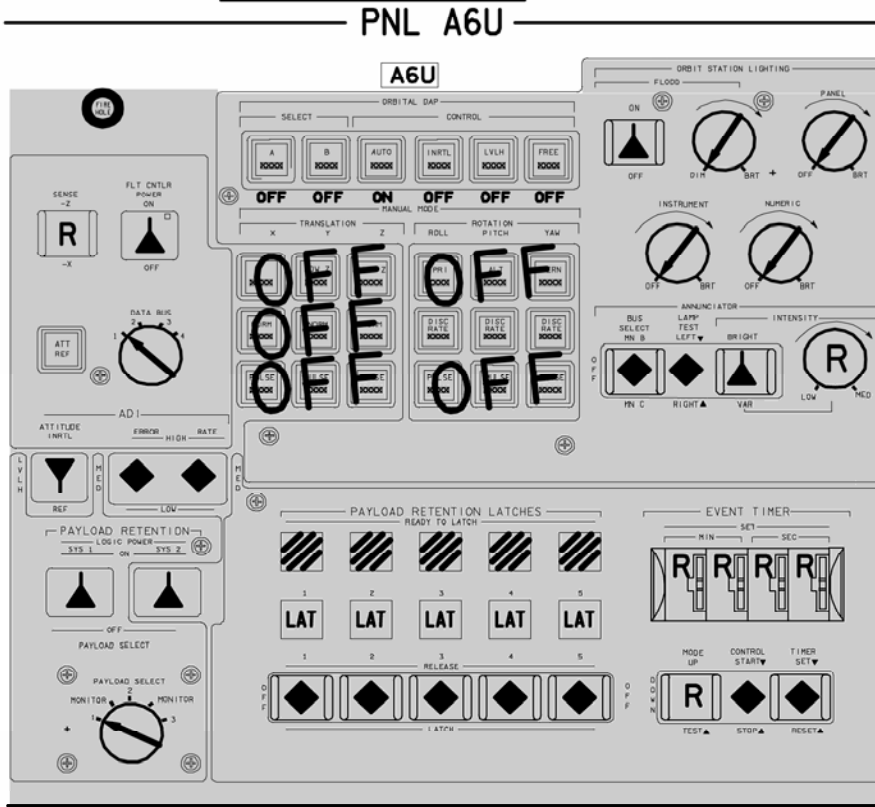
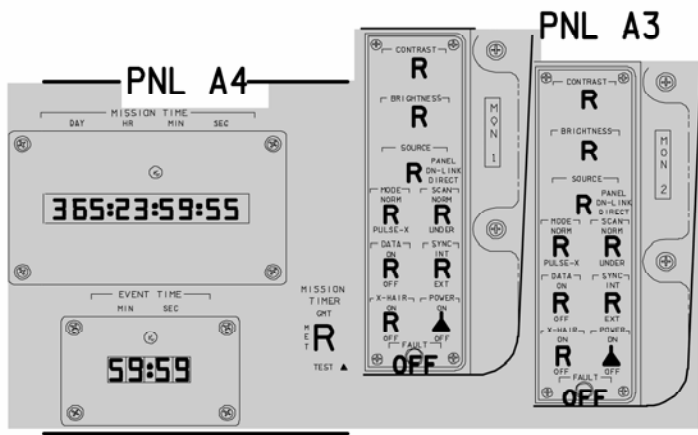

OV104

OV104

A6L

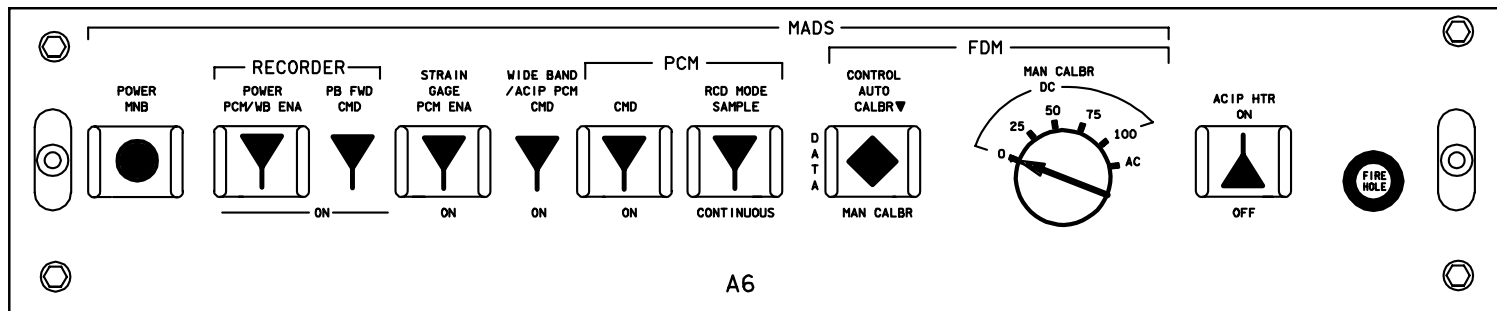
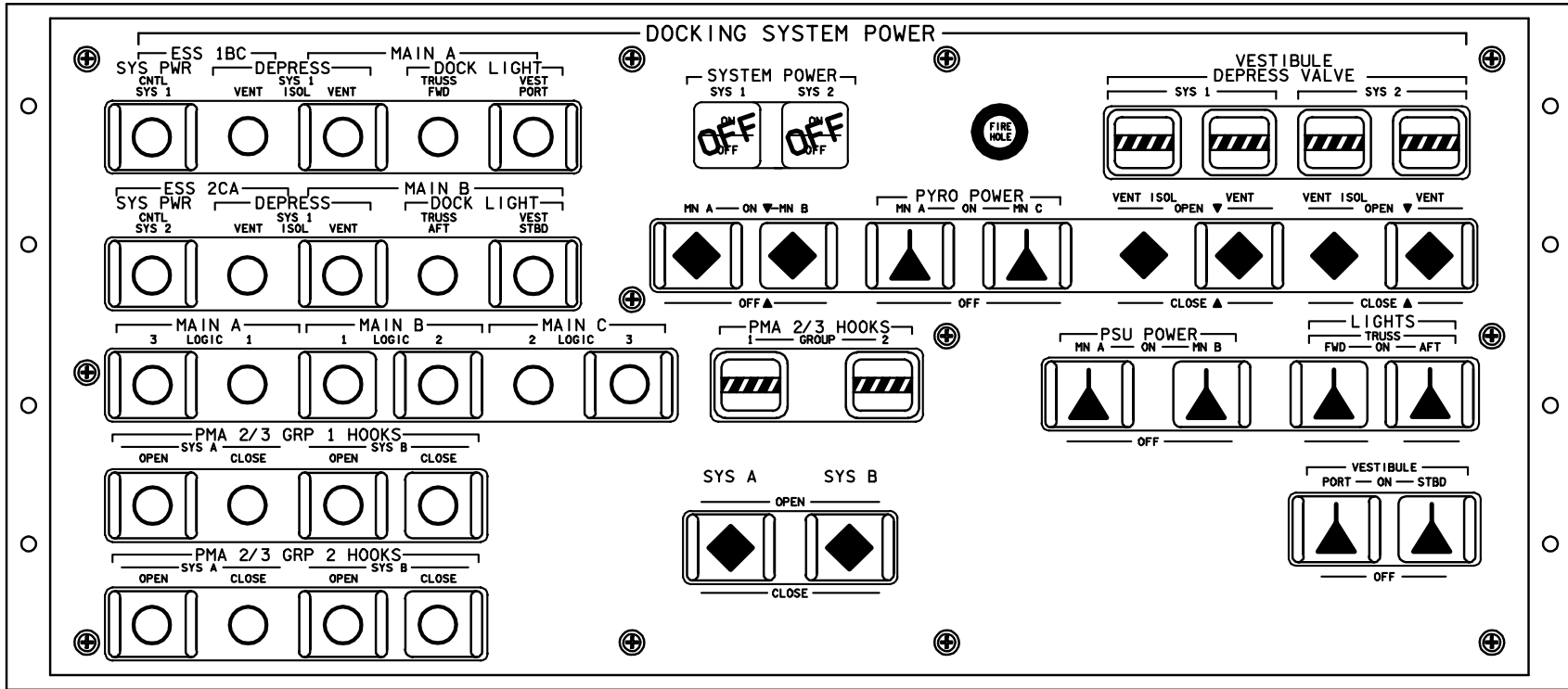

A6

OV104

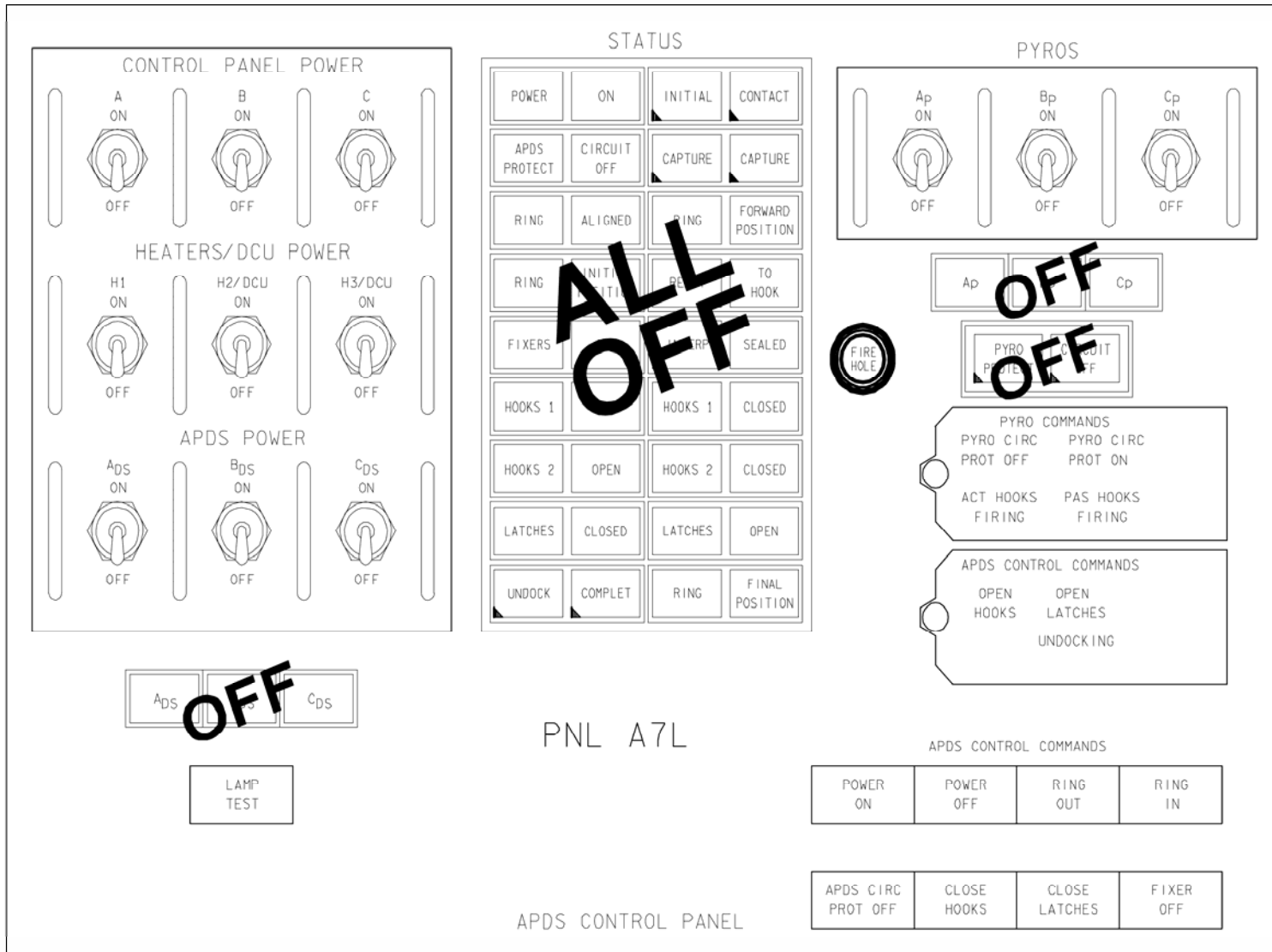

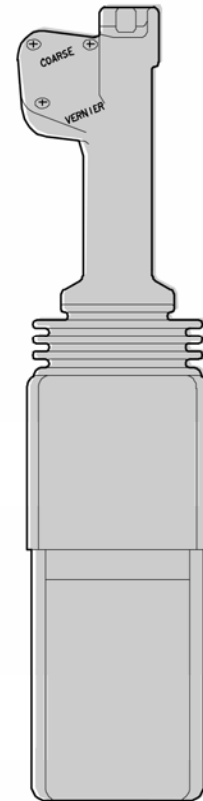
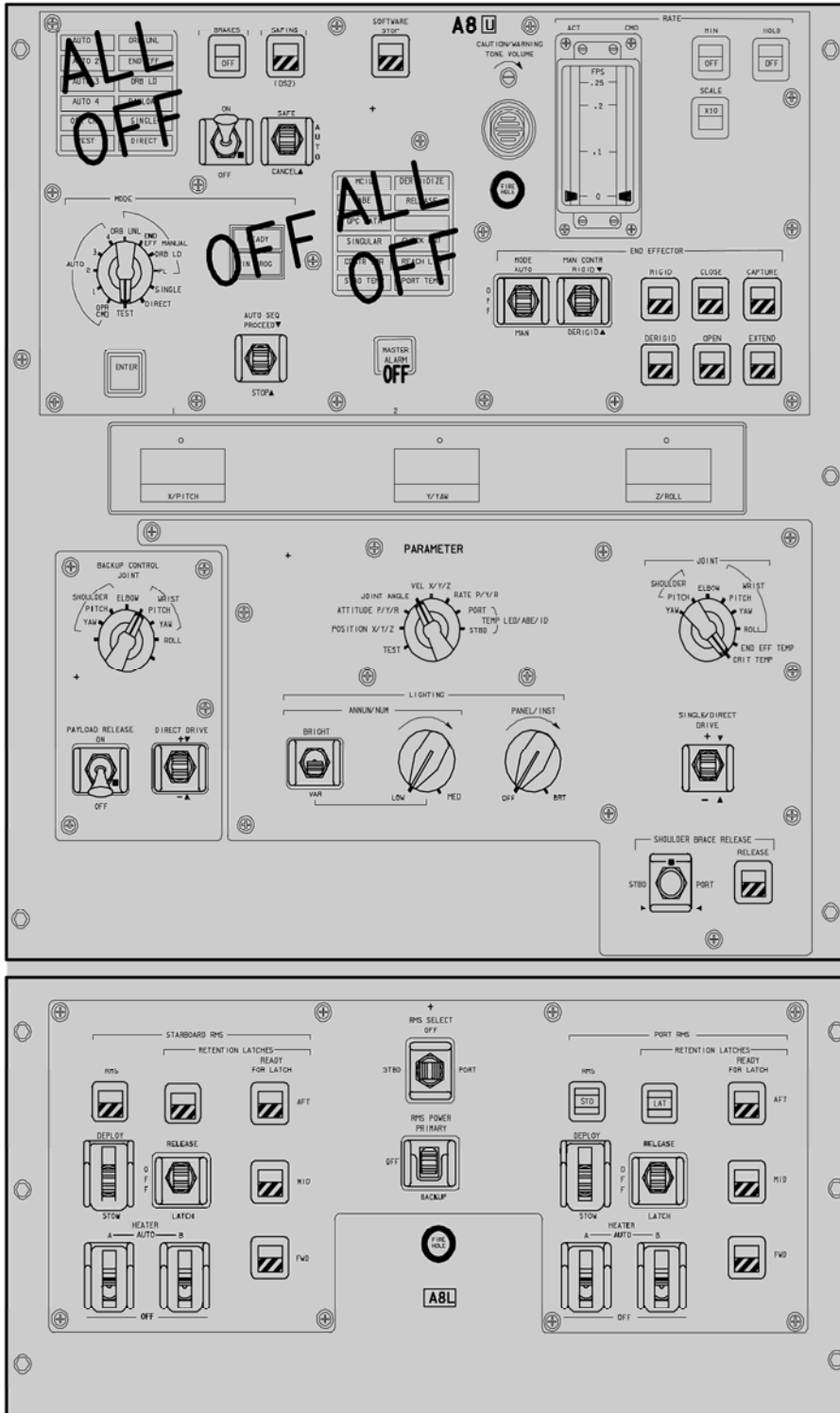

OV104

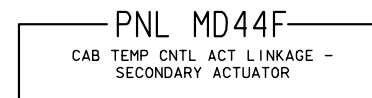
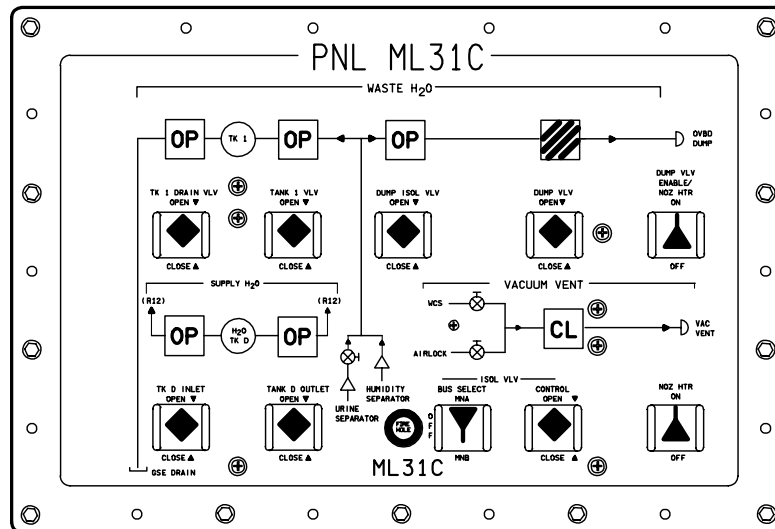
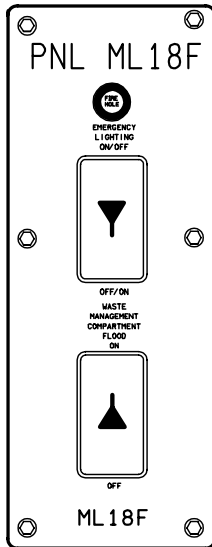
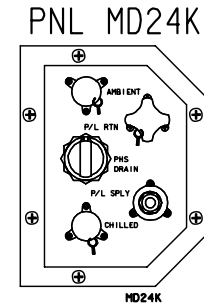
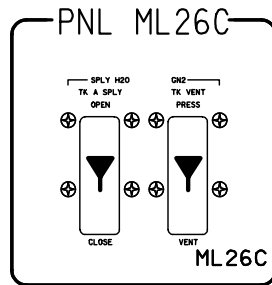
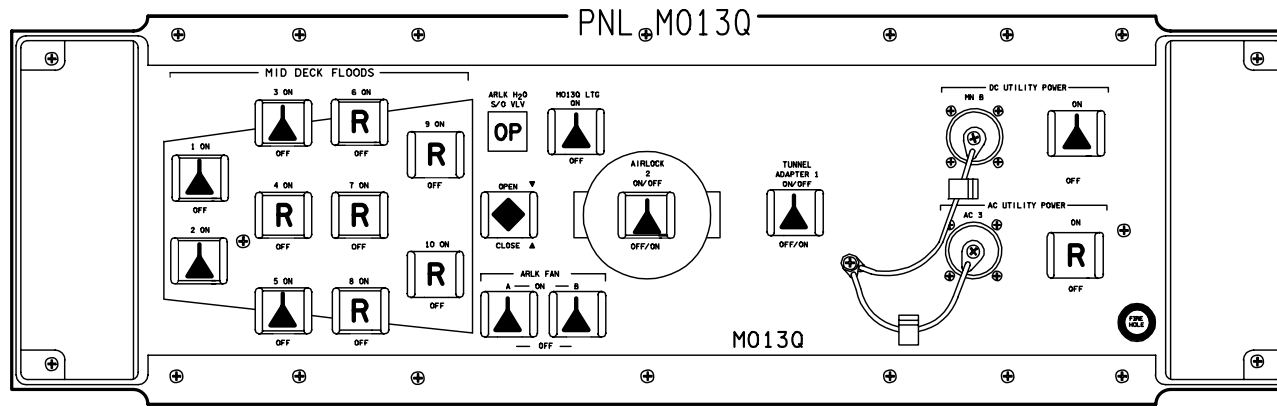

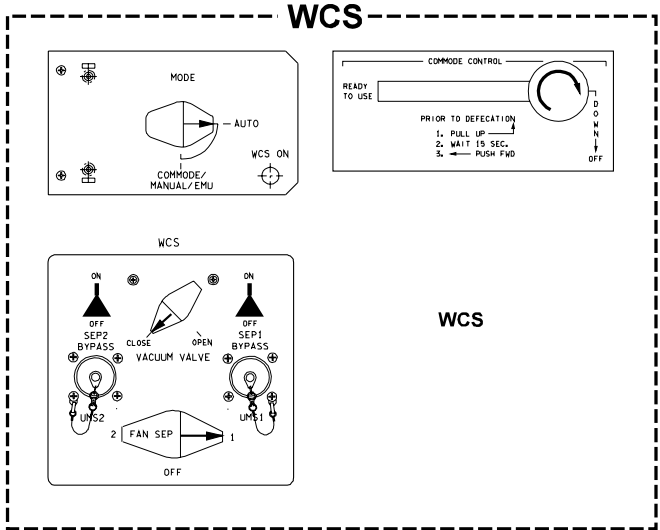
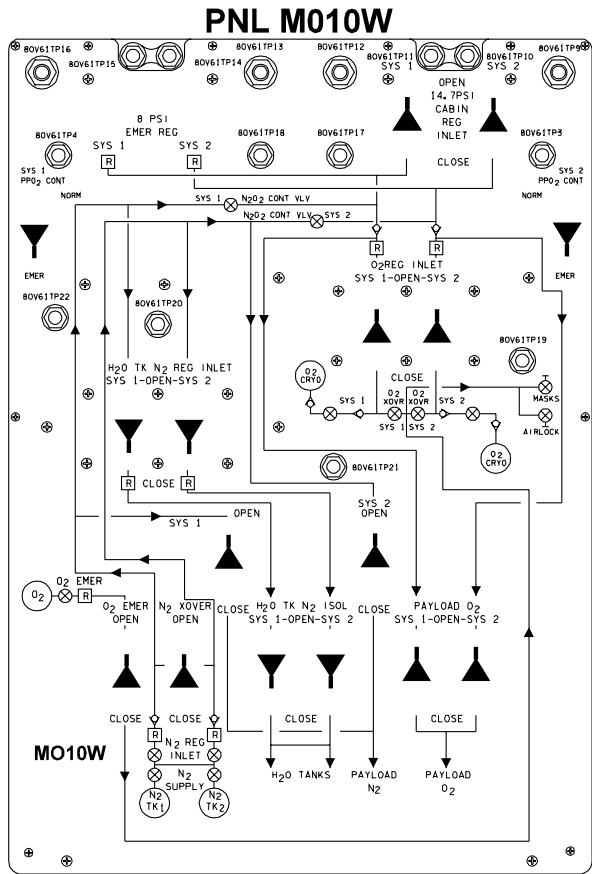

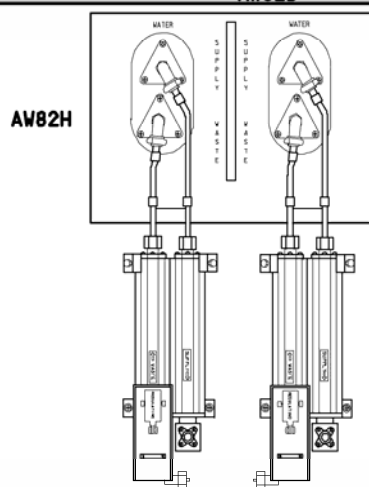
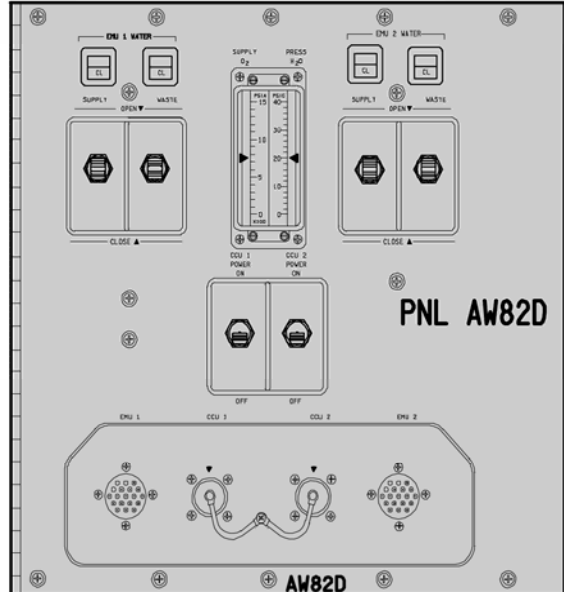
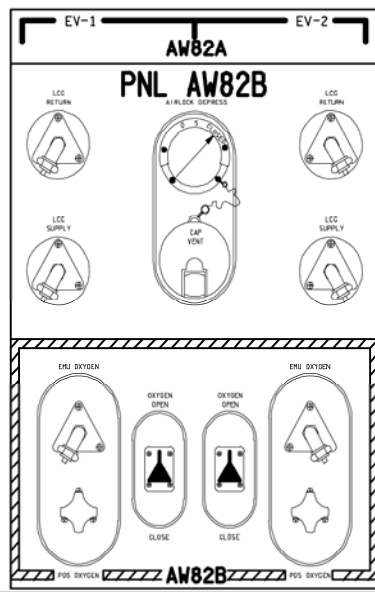
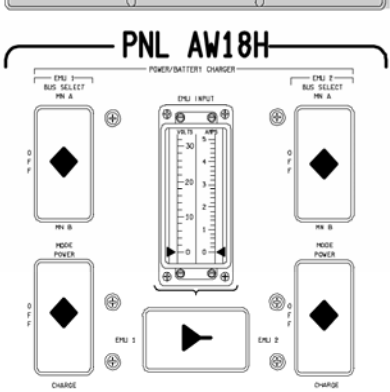
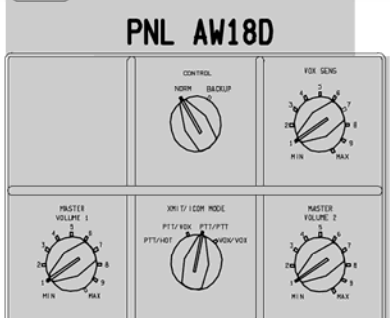
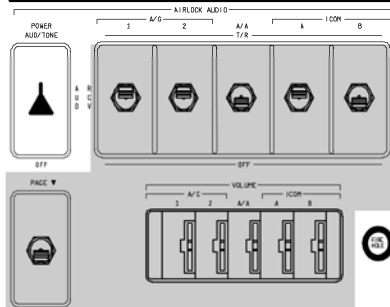
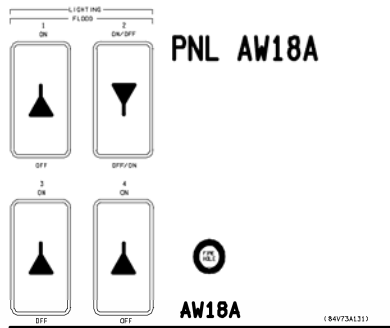

ALL VEH/DATE 10/08/02
48007C631_107_PNL_1

Inner Hatch

Actuator Handle – LATCHED

Lock Lever – LOCKED

Equalization vlv (two) – NORM, capped

OV105

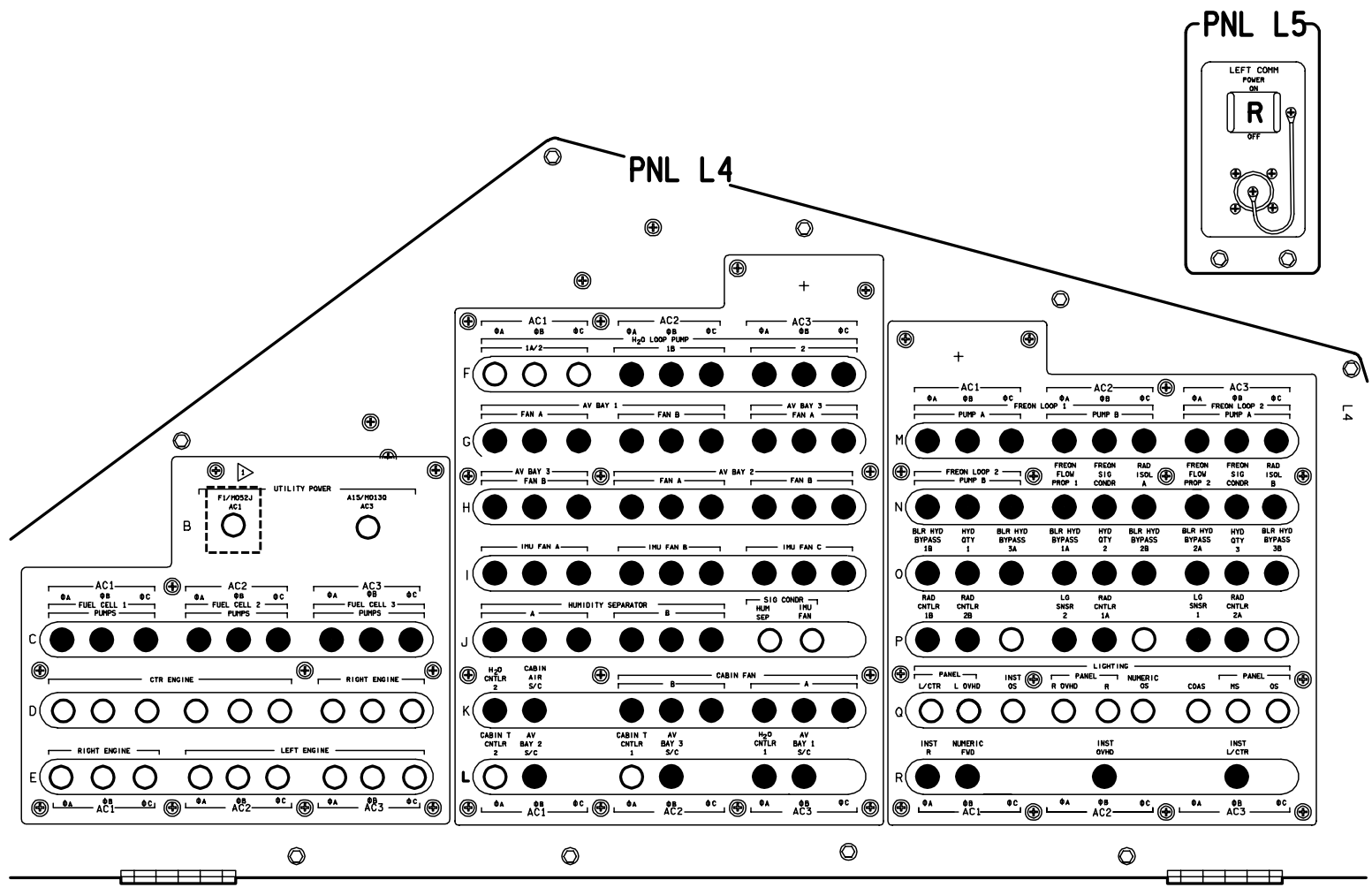

NOTE: ▸ CB CAN REMAIN CLOSED FOR AC PGSC USAGE.
 OPEN WHEN PGSC UNPOWERED/STOWED

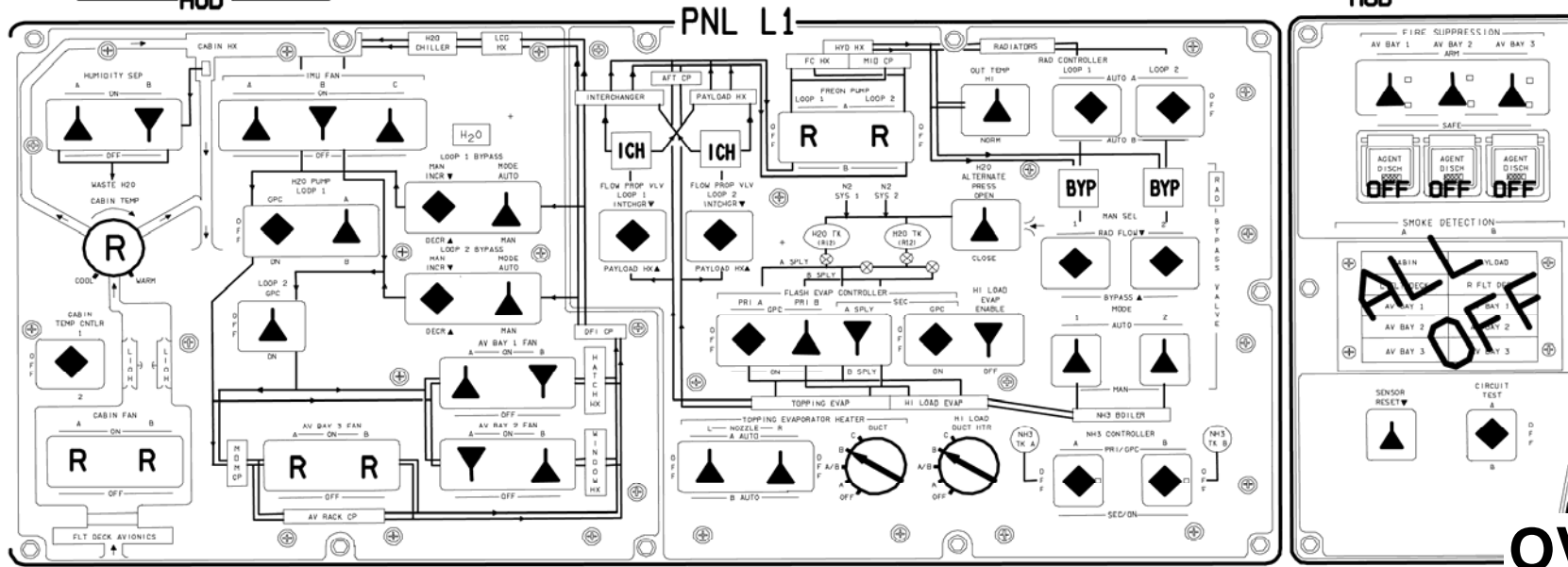
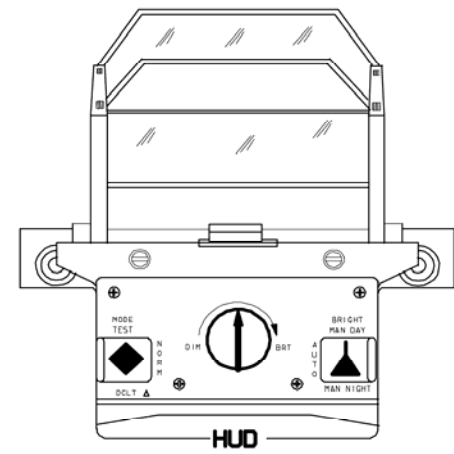
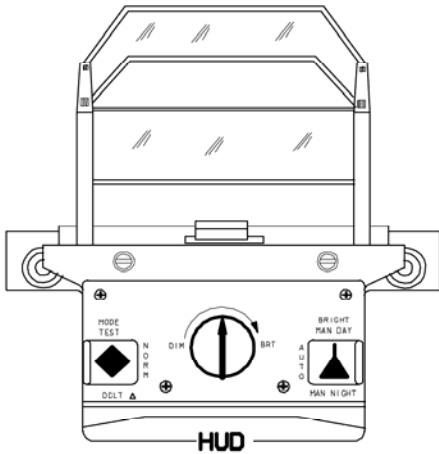
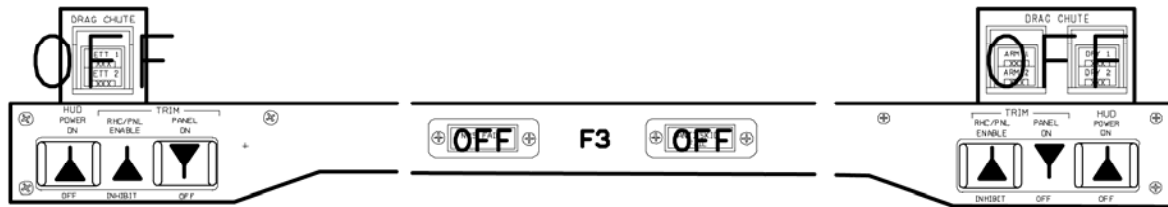

48007D604_107. PNL 1

ALL VEH/DATE 10/08/02

OV105

(OV105) C6-4

C D/O/ALL/GEN L

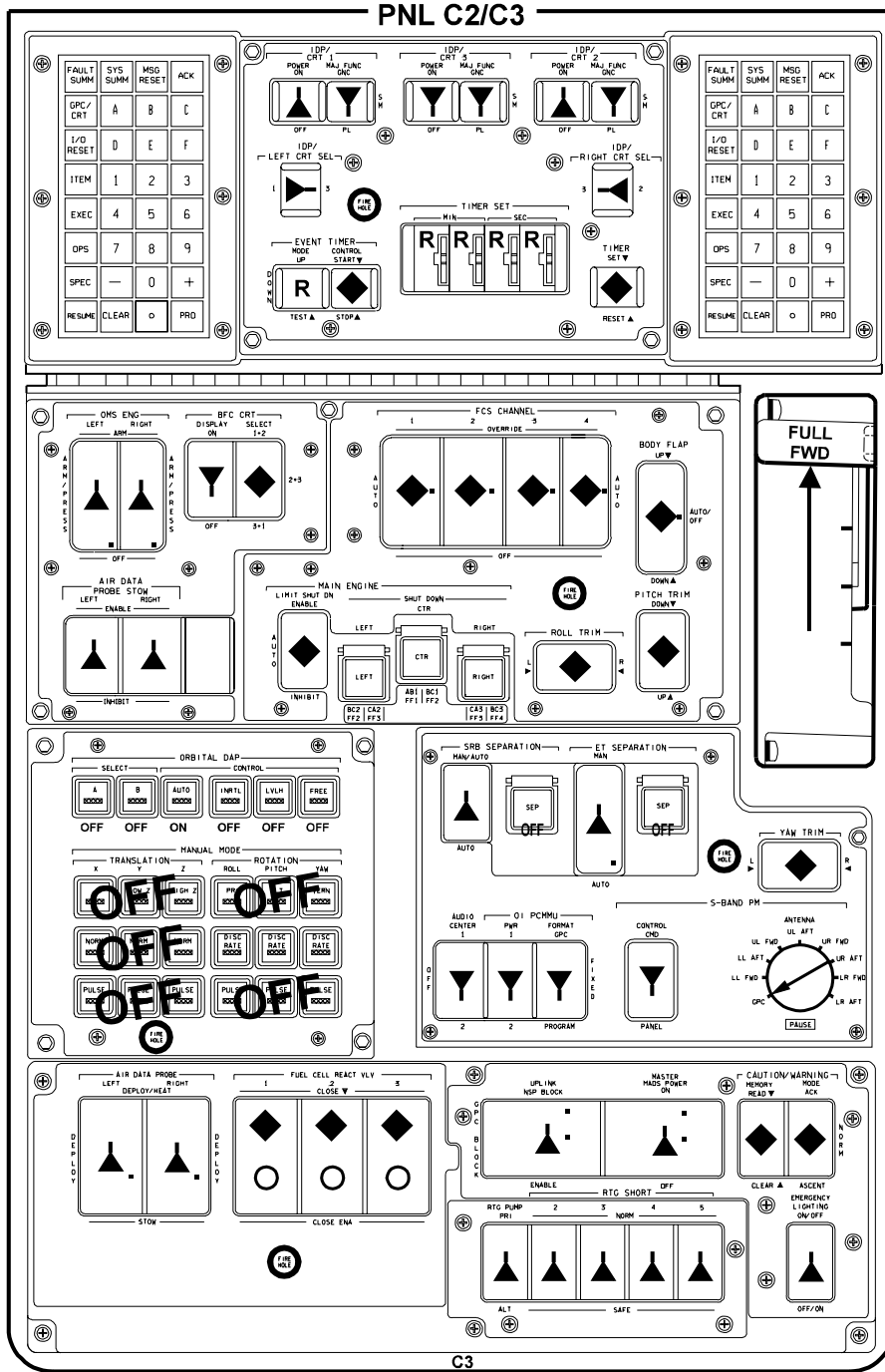

OV105

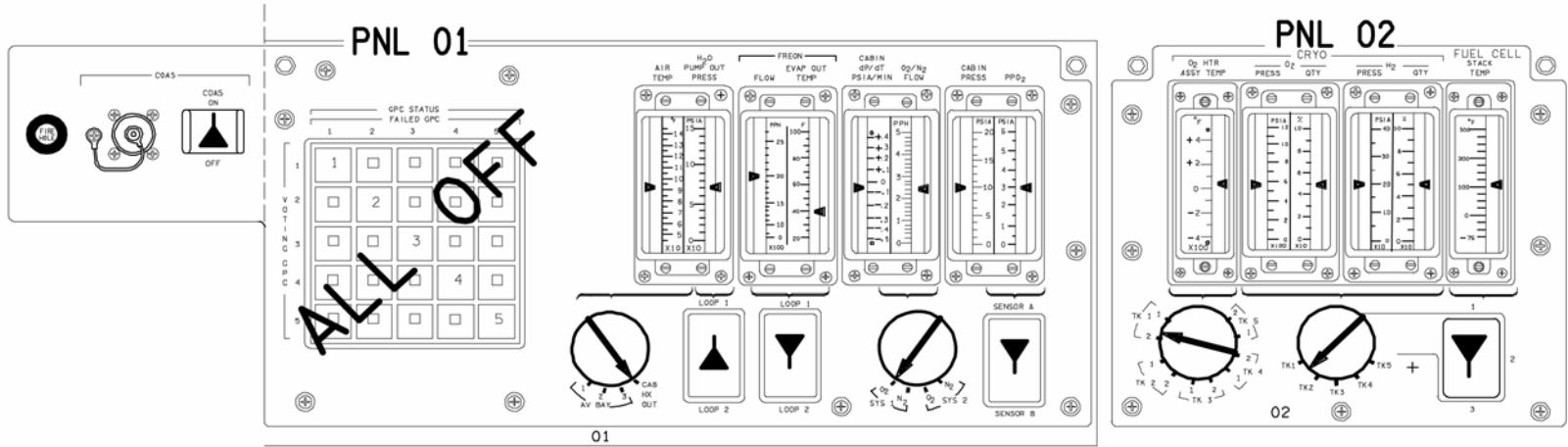

L side OVHD flood - R (MID)

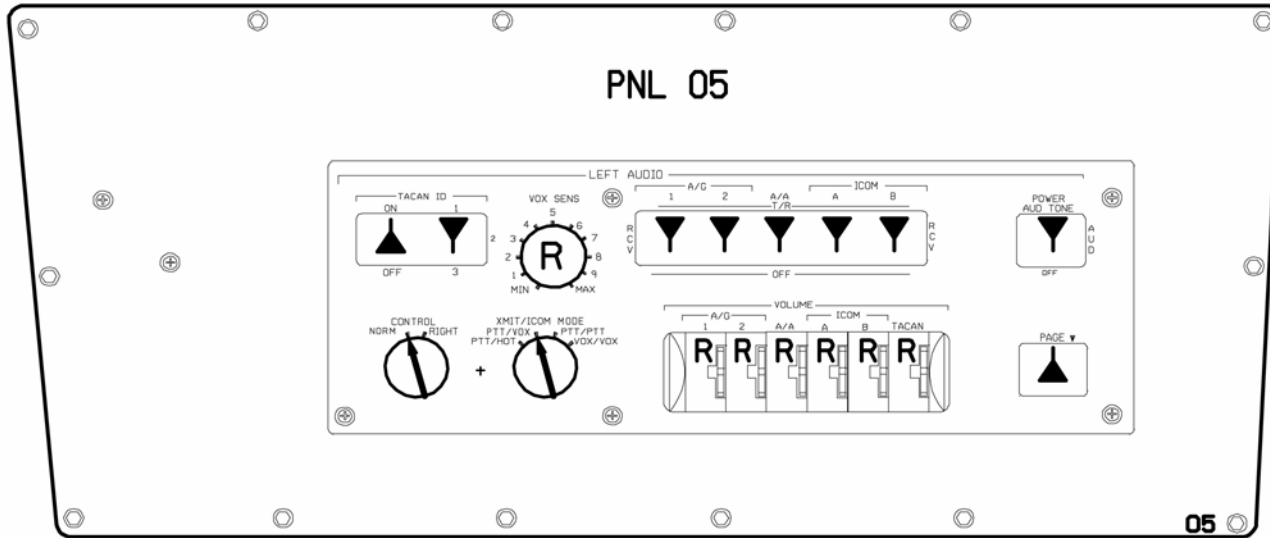

OV105

OV105

PNL 06

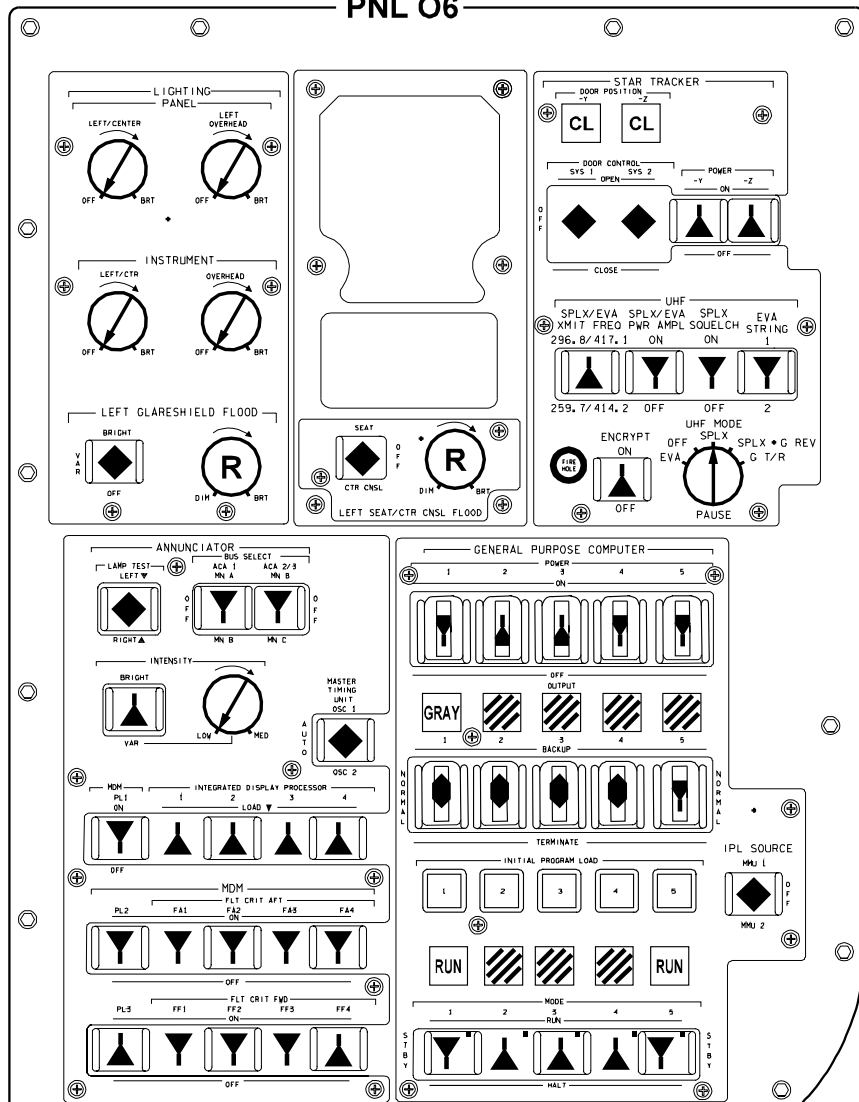

PNL 07

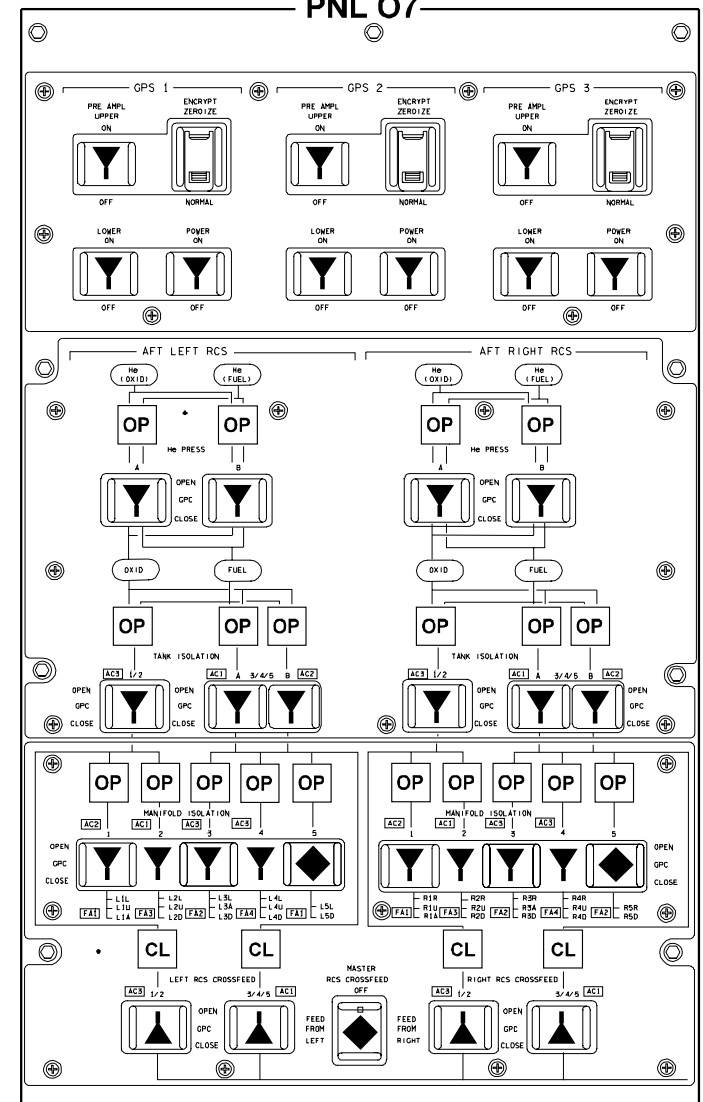

48007G609_118, PNL, 3

OV105

OV105/DATE 05/02/07

(OV105) C6-9

C D/O/5/GEN L

PNL 08

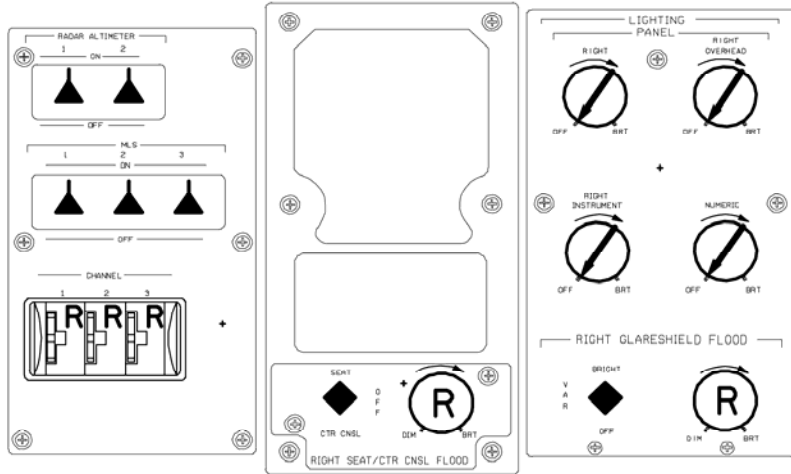

PNL 09

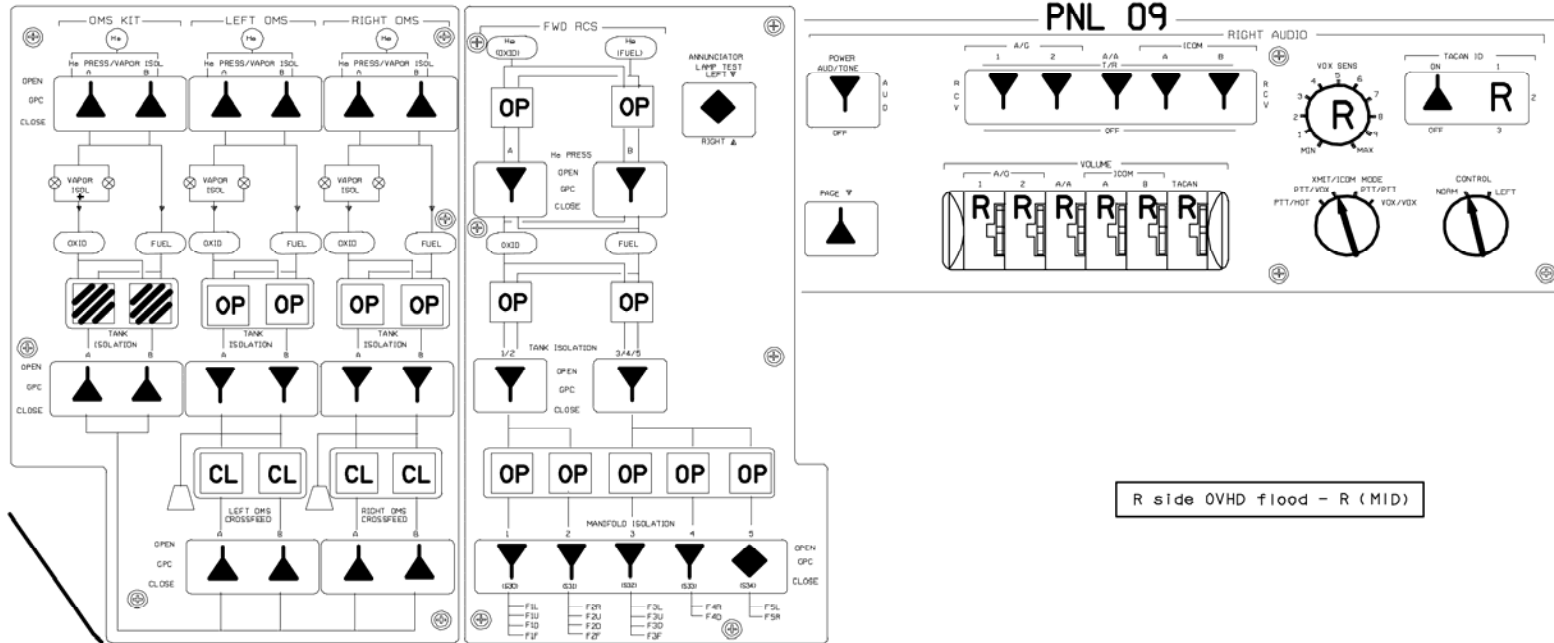

R side OVHD flood - R (MID)

OV105

OV105

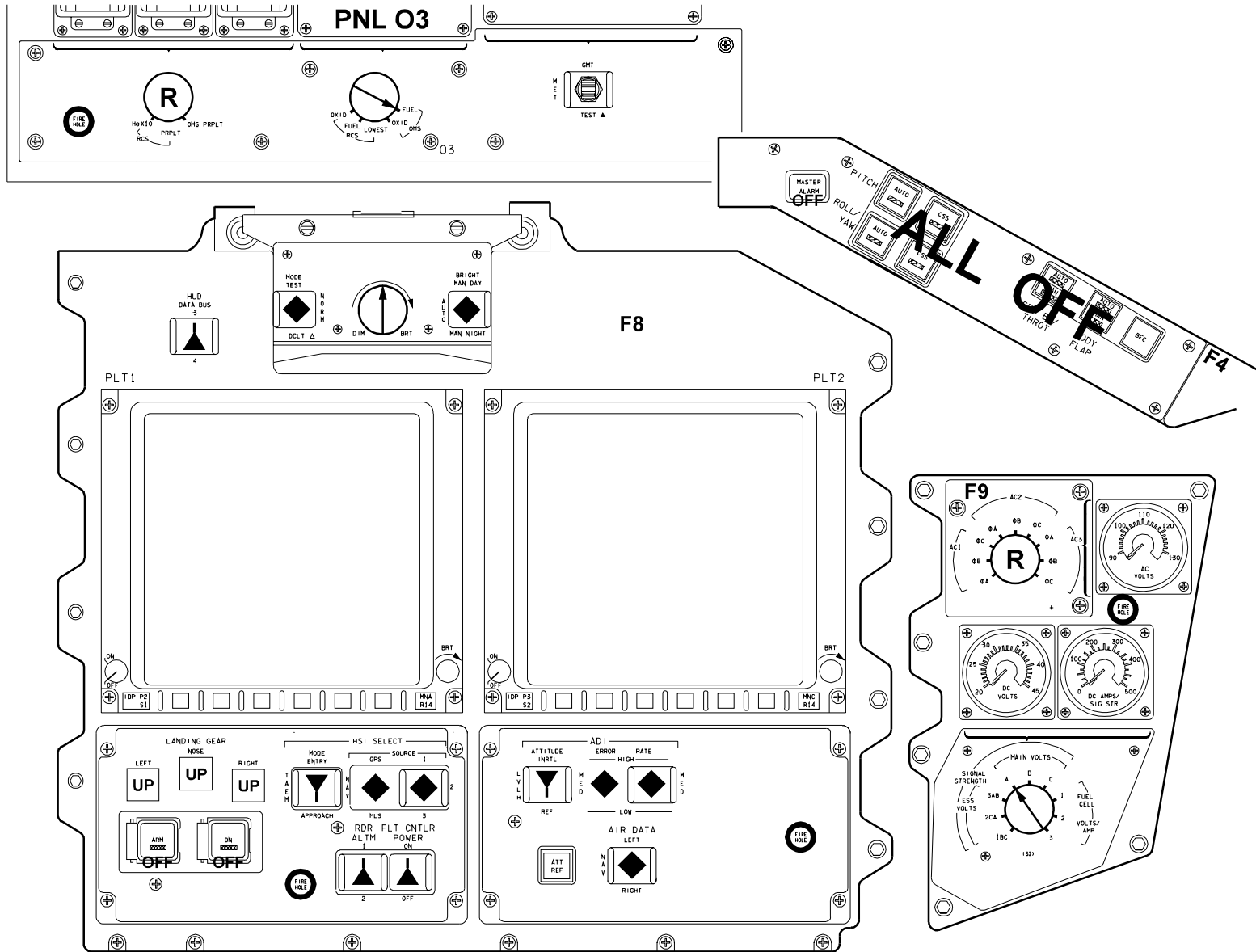

PNL R1

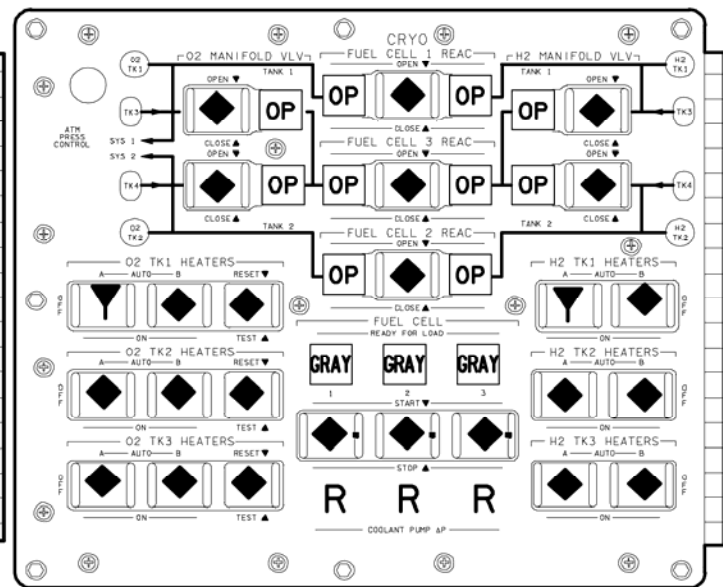
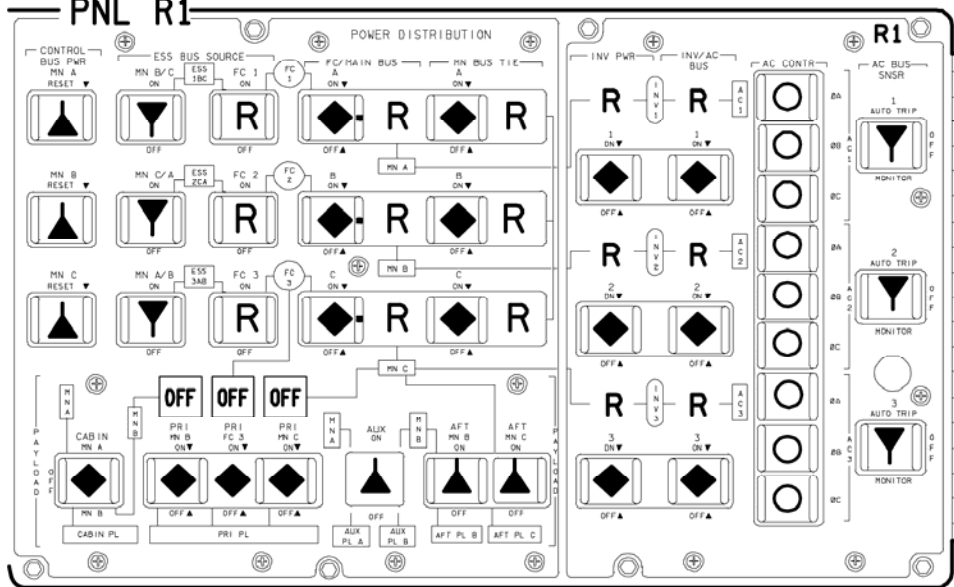

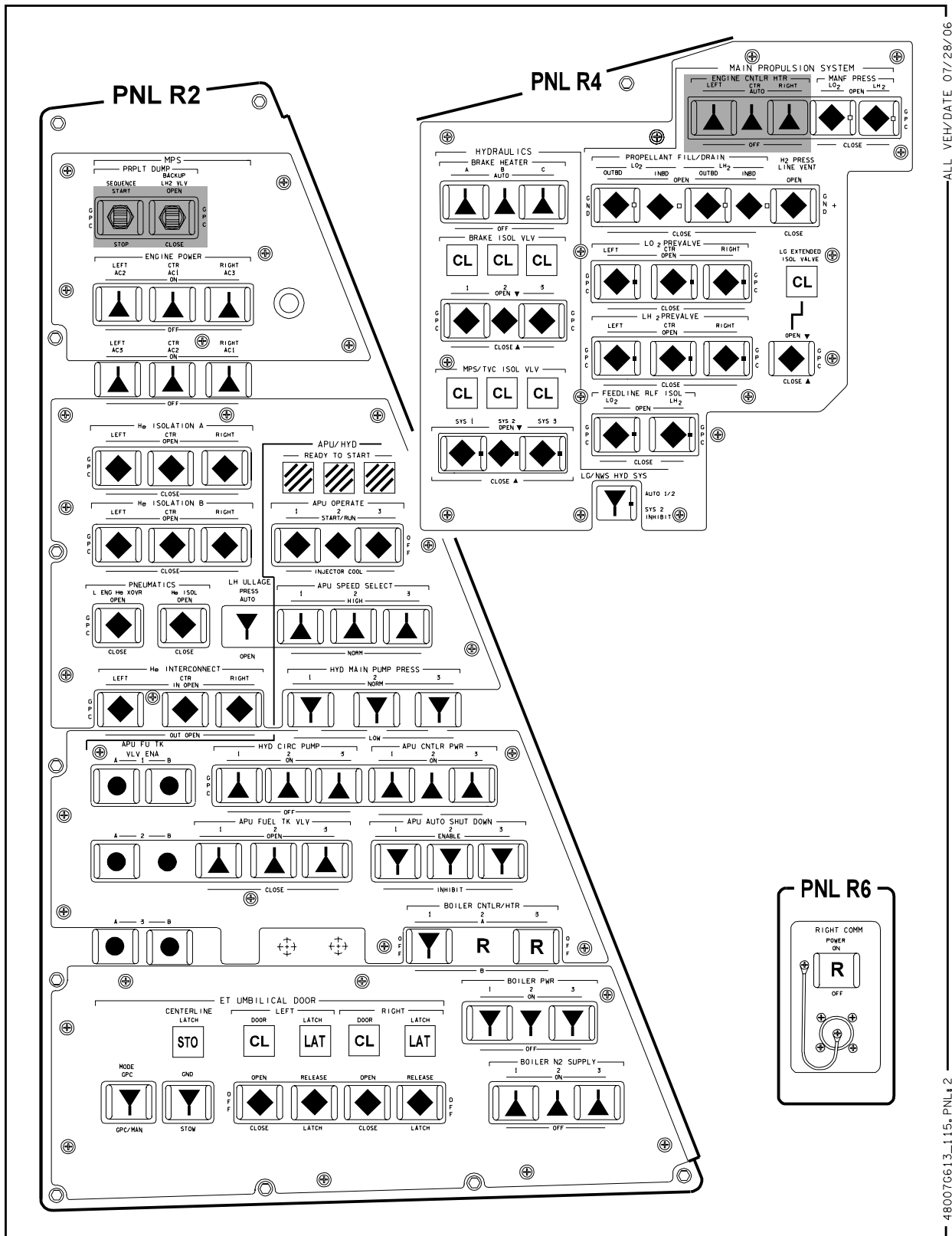

480076613-115, PNLs 2 ALL VEH/DATE 07/28/06

OV105

(OV105) C6-13

C D/O/ALL/GEN L

This Page Intentionally Blank

(OV105) C6-14

OV105
C D/O/ALL/GEN L

OV105

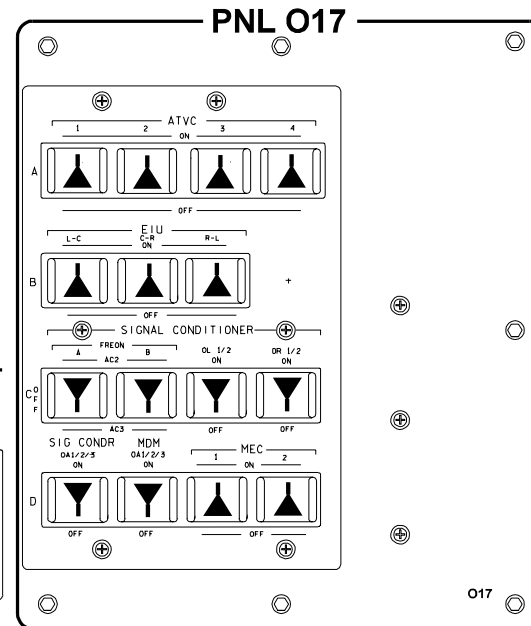
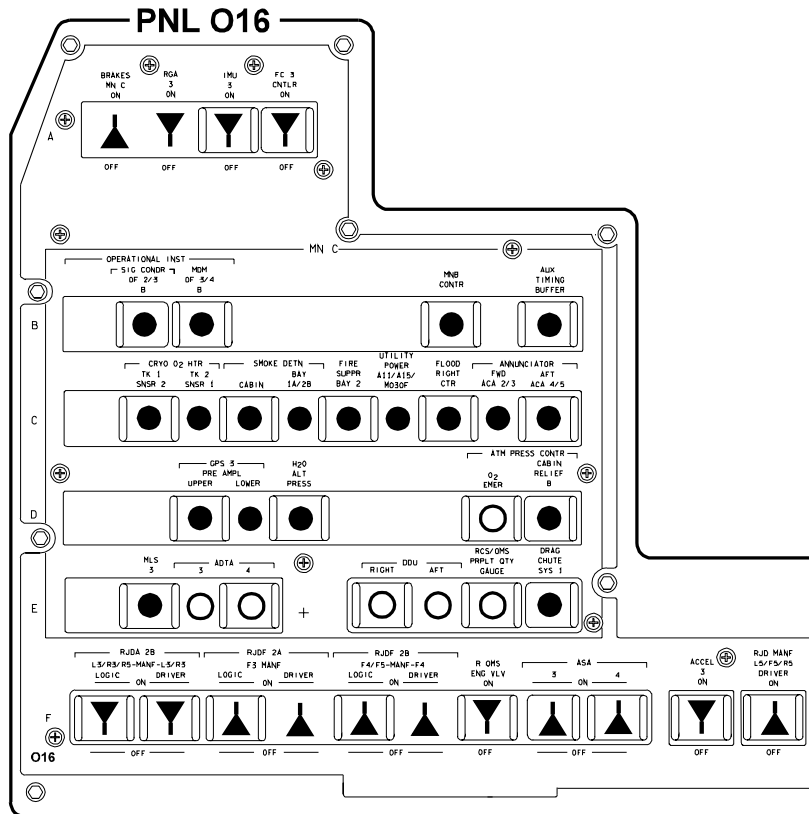

OV105

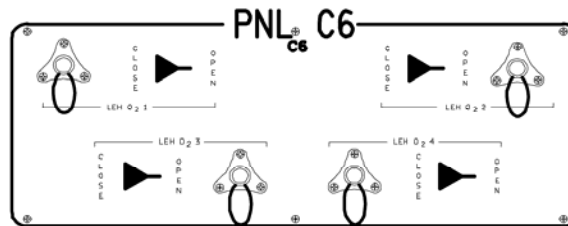
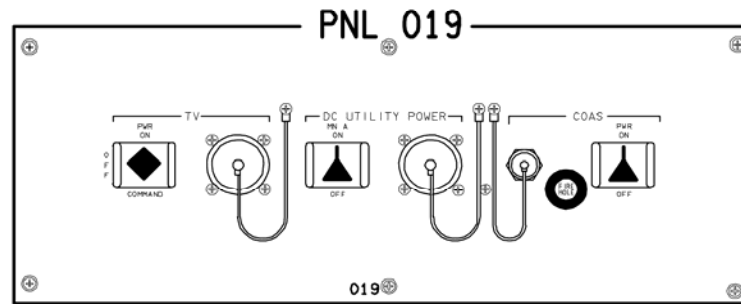

PNL C5



PNL C7

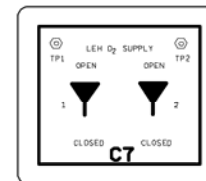

OV105

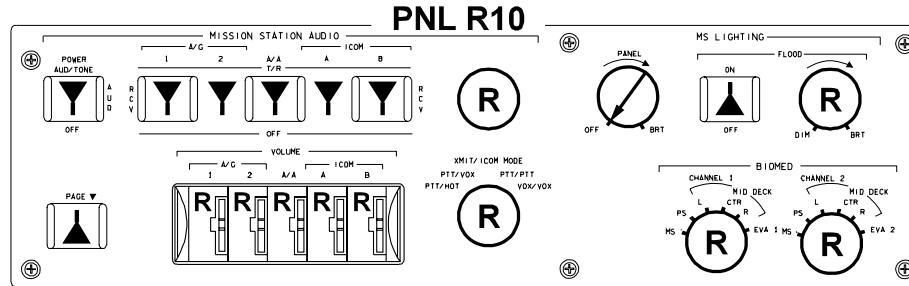

ACTIVATION
 R10 MS AUD PWR - AUD/TONE
 All other sws - as reqd
 R12 MS AUD CONTL - NORM
 A11 MS COMM CCU PWR - ON

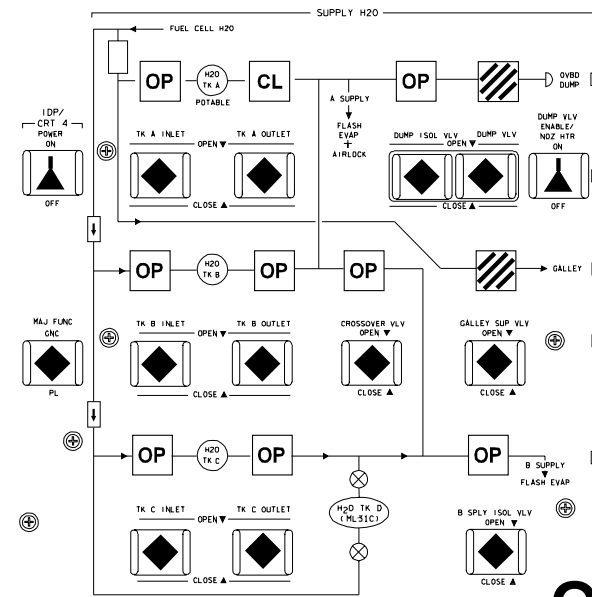
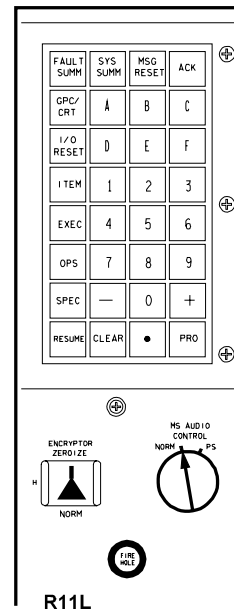
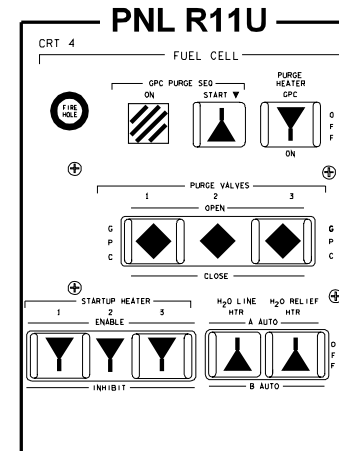

OV105

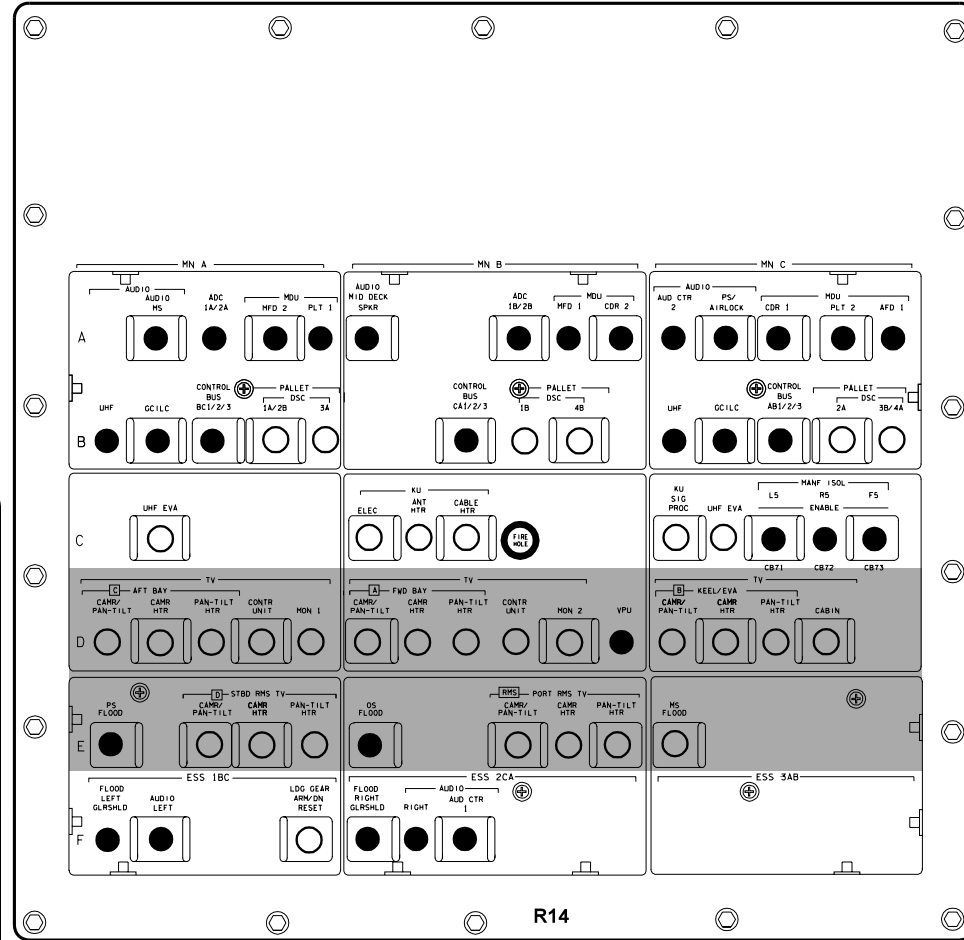
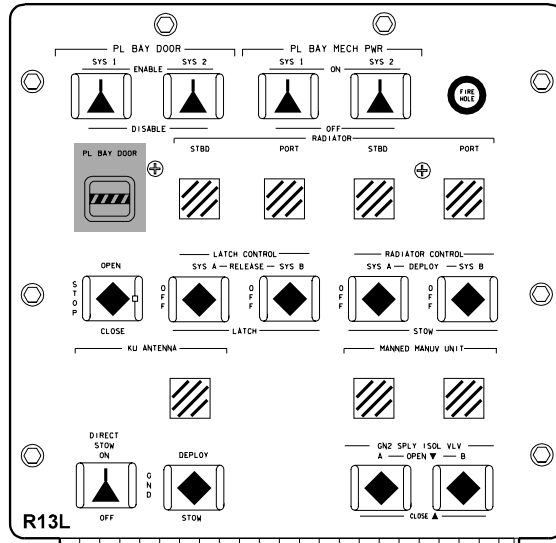
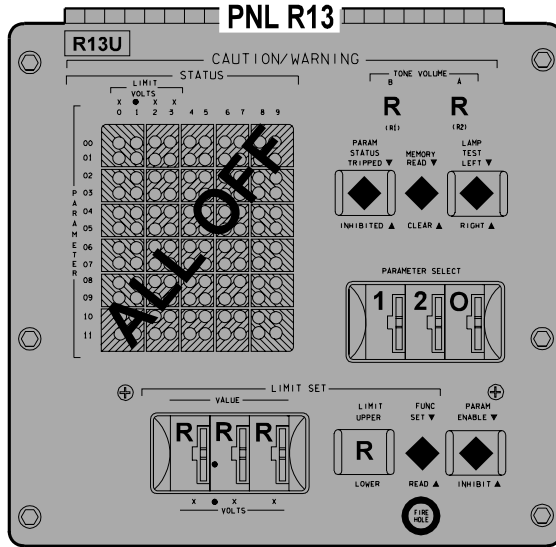

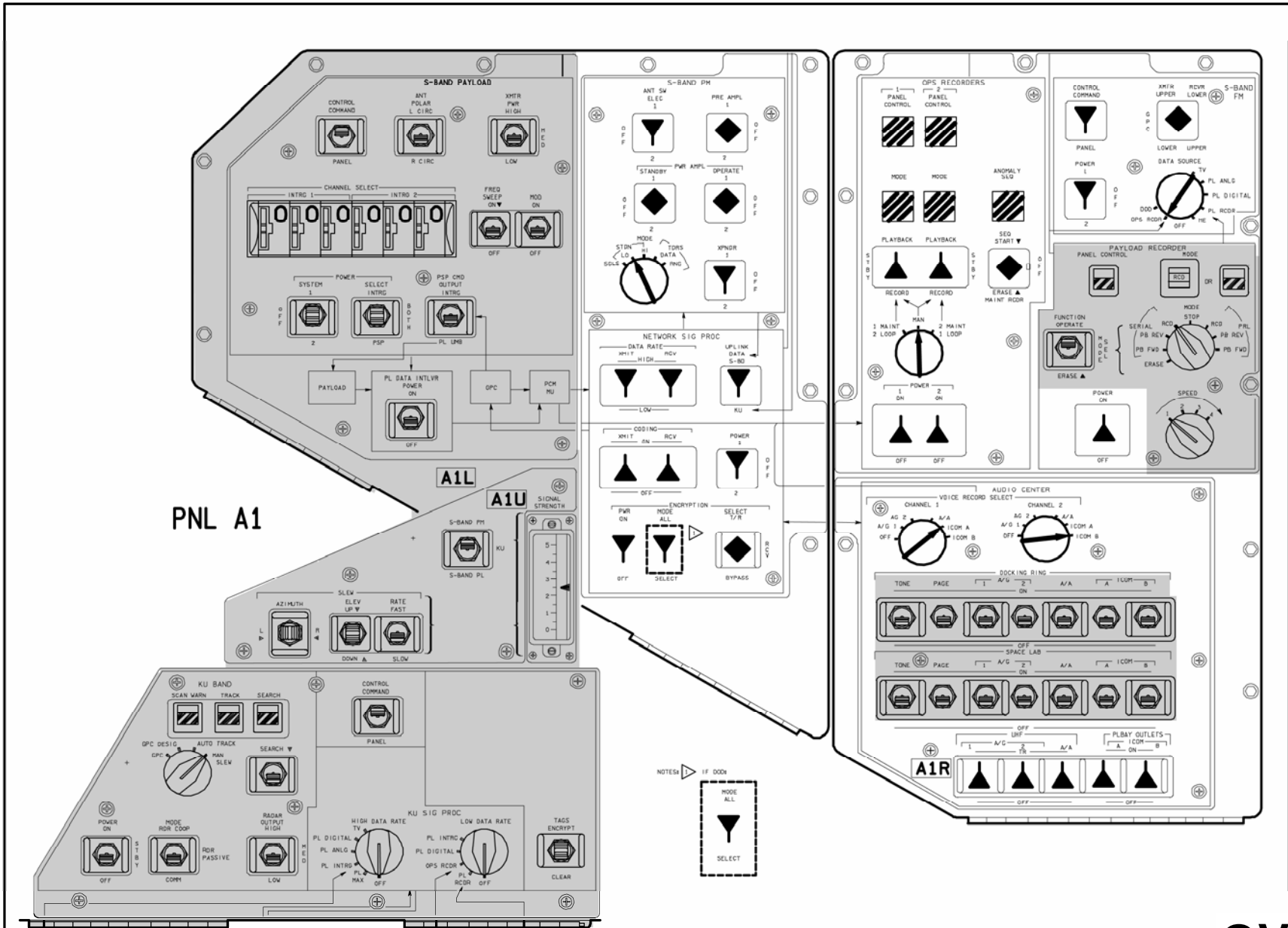

PNL A1

A1L

A1U

A1R

OV105

OV105

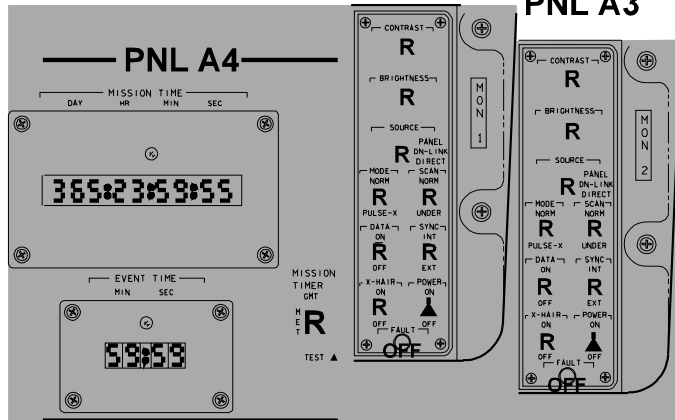

PNL A3

PNL A6U

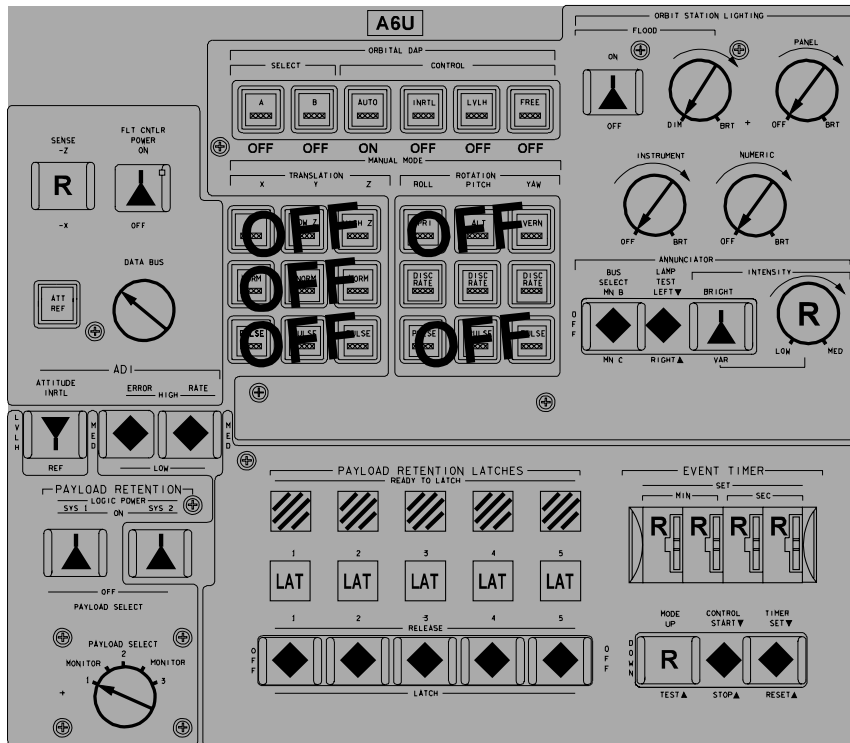

PNL A7U

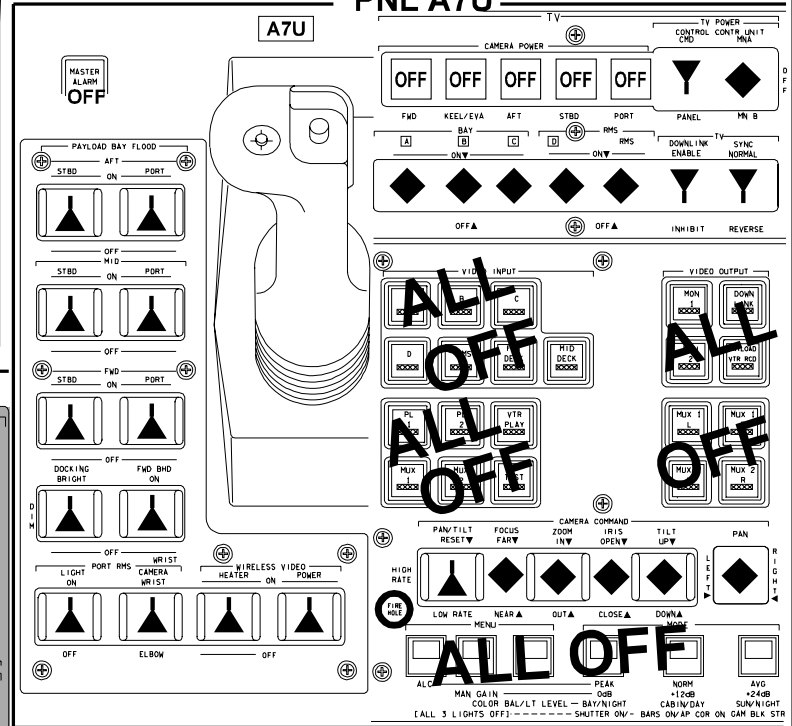

OV105

A6L

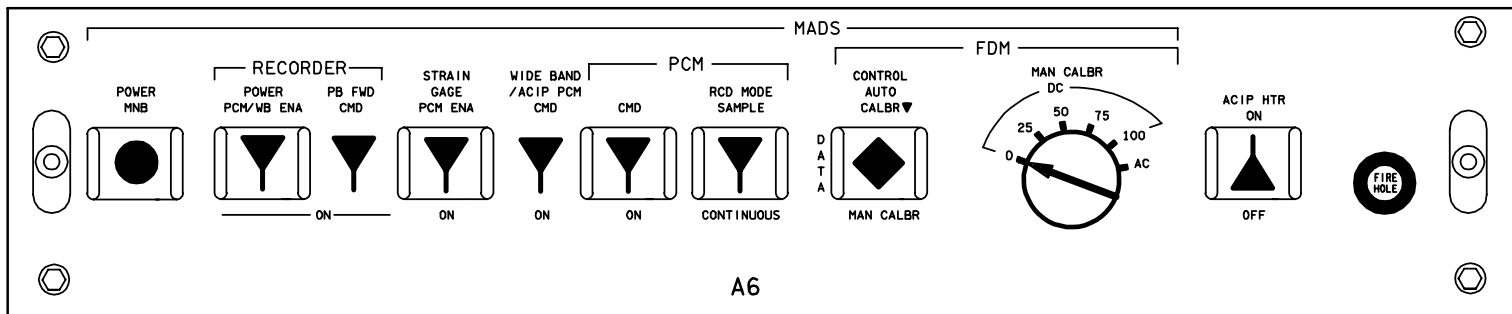
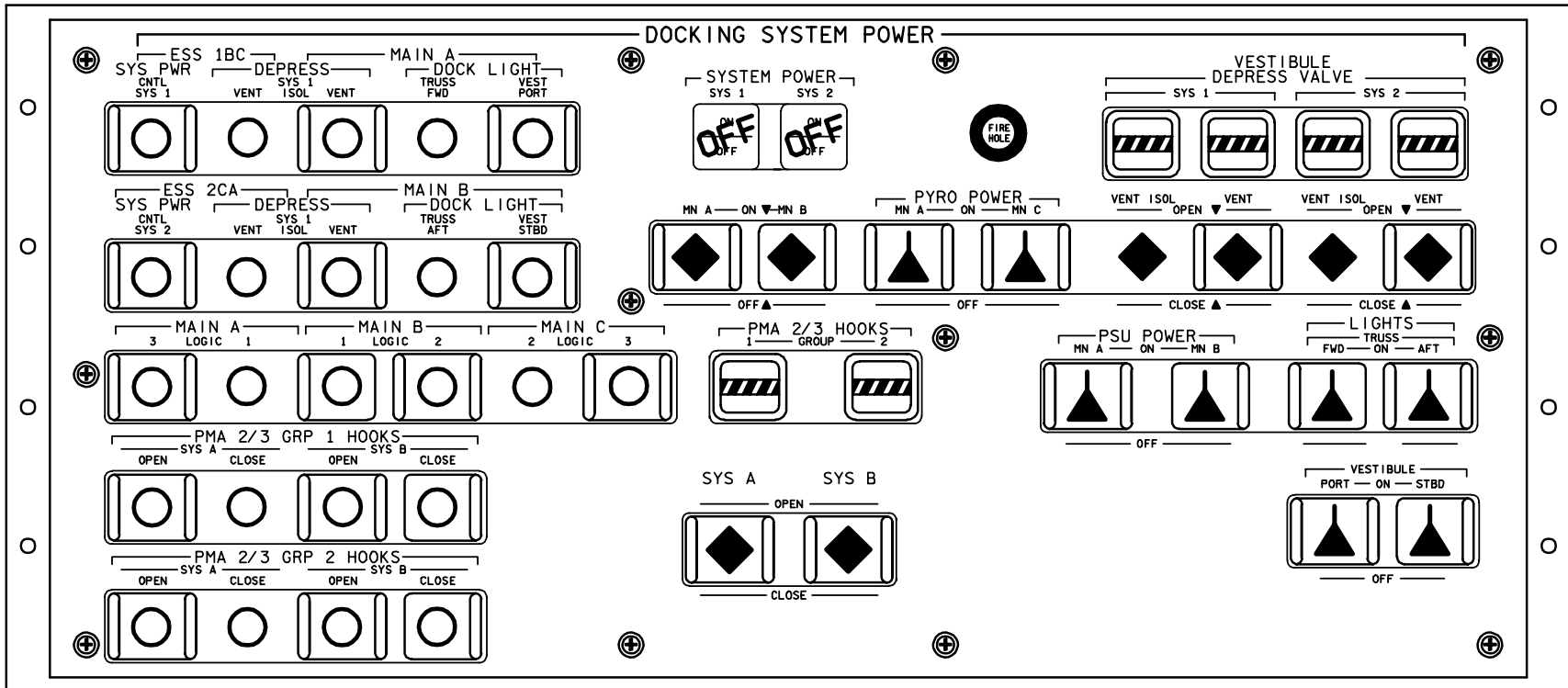

A6

OV105

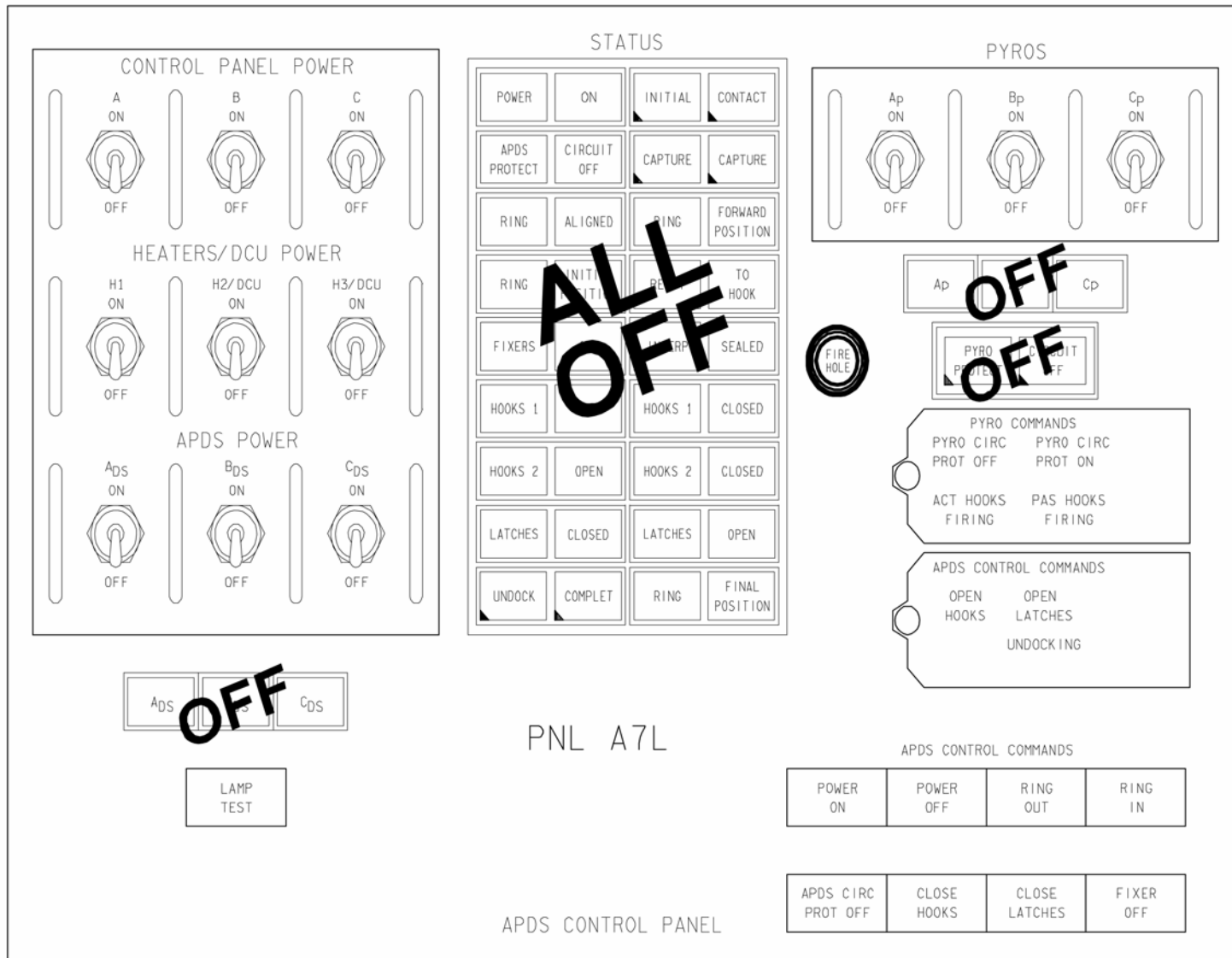

ALL OFF

OFF

OFF

OFF

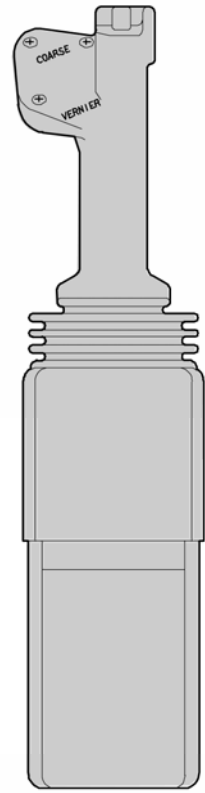
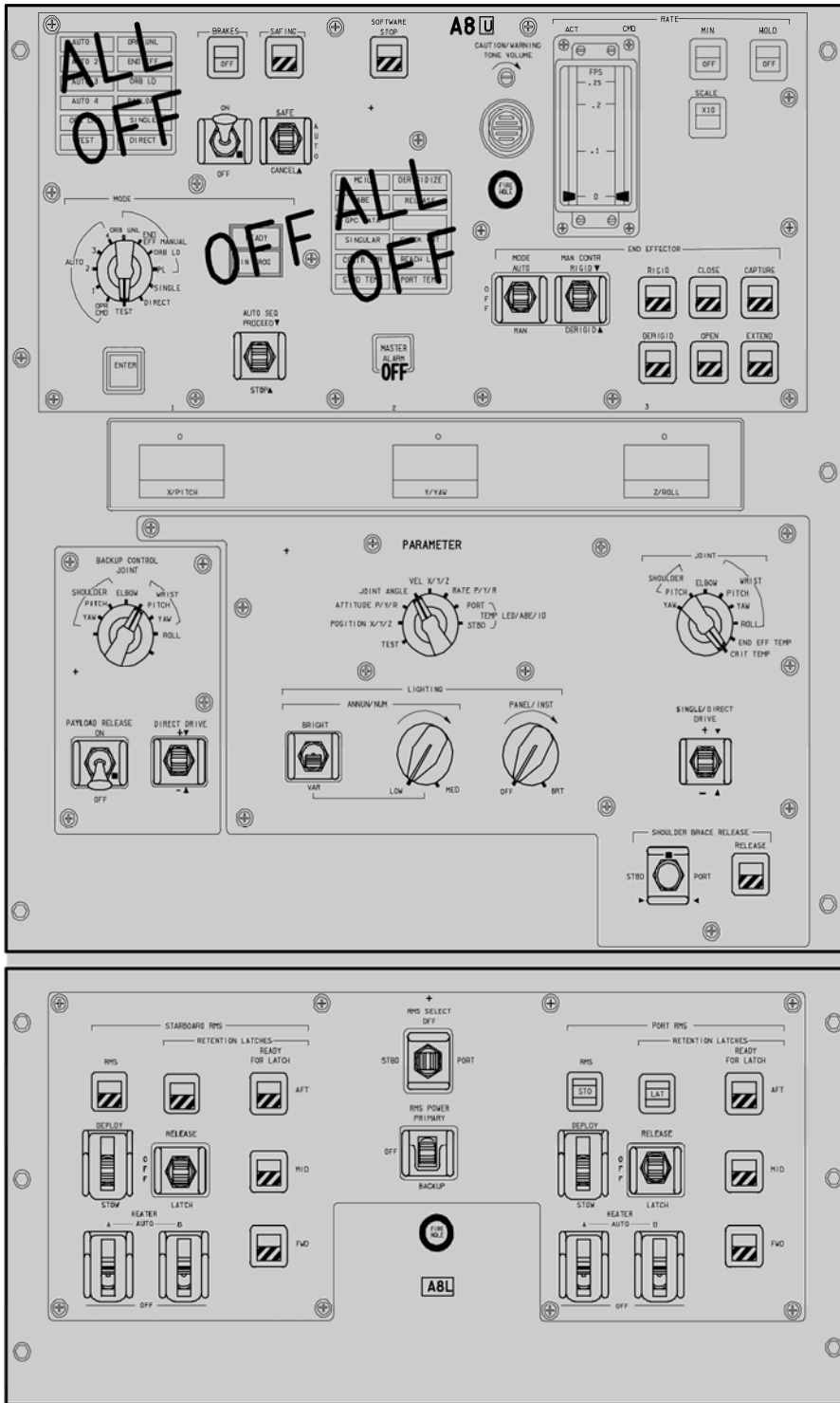

OV105

PNL A11

A11

CRYO TANK 4 HEATERS

A — AUTO — B RESET ▼ A — AUTO — B

ON TEST ▲ ON

PALLET CRYO TANK HEATERS

A — AUTO — B TANK 10 A — AUTO — B

ON TEST ▲ ON

A — AUTO — B TANK 11 A — AUTO — B

ON TEST ▲ ON

A — AUTO — B TANK 12 A — AUTO — B

ON TEST ▲ ON

MS COMM CCU PWR

ON

OFF

MS BIOMED

DC UTILITY POWER

MN C ON

OFF

PALLET CRYO TANK HEATERS

TANK 15

A — AUTO — B RESET ▼ A — AUTO — B

ON TEST ▲ ON

PALLET POWER

ESS 1BC TANK 10 MN A MN B

ONTLR H₂ QTY H₂ SNR 1 SNR 2

ONTLR H₂ QTY H₂ SNR 1 SNR 2

ONTLR H₂ QTY H₂ SNR 1 SNR 2

ESS 3AB TANK 12 MN A MN B

ONTLR H₂ QTY H₂ SNR 1 SNR 2

ONTLR H₂ QTY H₂ SNR 1 SNR 2

ONTLR H₂ QTY H₂ SNR 1 SNR 2

PALLET HEATER

C — AUTO — D

OFF

PNL A13

OS AUDIO

MASTER SPEAKER VOLUME

MIN MAX

SPKR PWR SPKR/MIC

OFF

FIRE HOLE

PNL A12

APU HEATER

1 GAS GEN/FUEL PUMP 2 A AUTO 3 LOBE OIL LINE

1A 1B 2A 2B 3A 3B

TANK/FUEL LINE/H₂O SYS

OFF

HYDRAULIC HEATER

RUDDER SPD BK BODY FLAP ELEVON AFT FUSELAGE

A — AUTO — B A — AUTO — B A — AUTO — B A — AUTO — B

HYD CIRC PUMP POWER

1 MN A 2 MN B 3 MN C

LG ARM/ON RESET

RESET ▼

FC 3 STRUCT RTN

ON

ON ▼

OV105

OV105

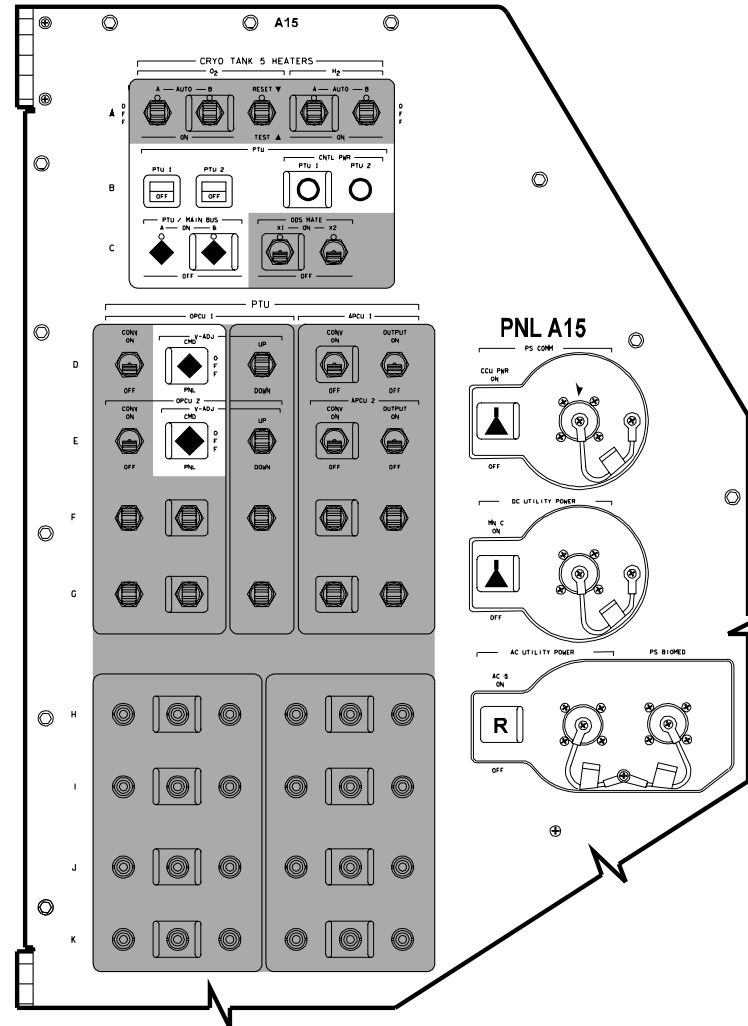
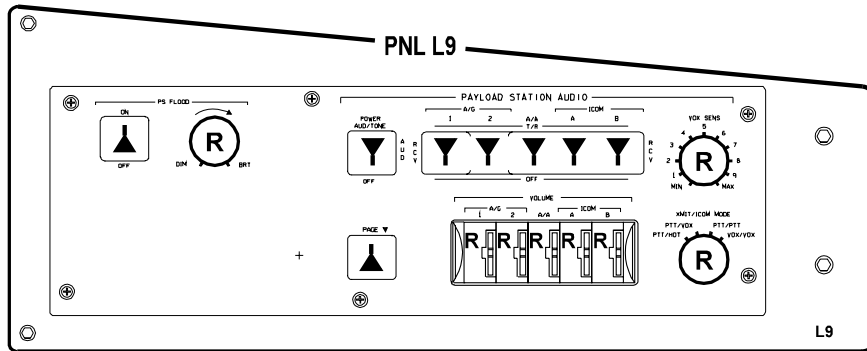
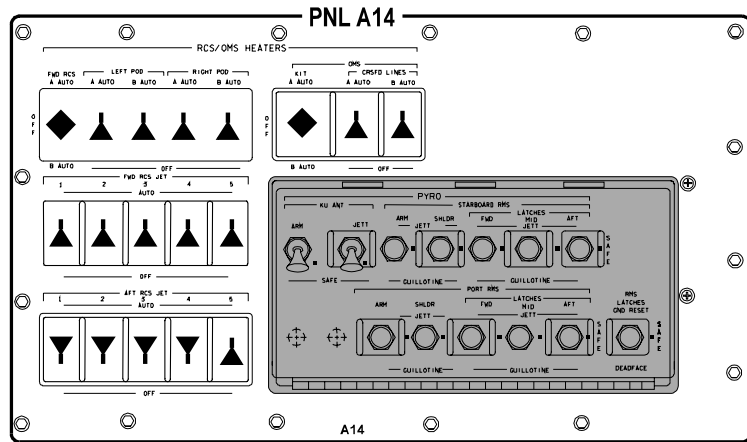

OV105

OV105

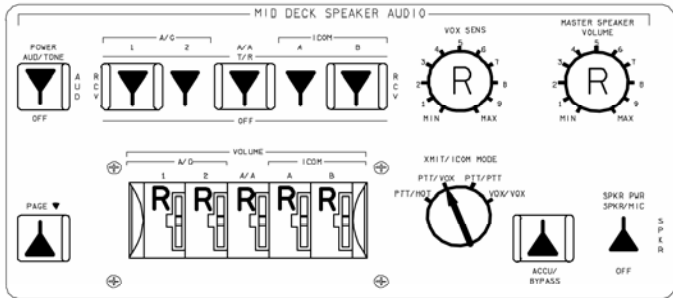

PNL M042F

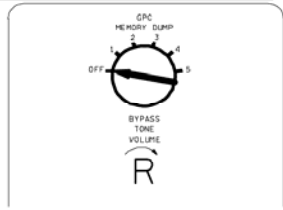

PNL M058F

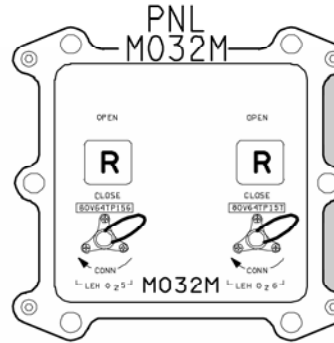
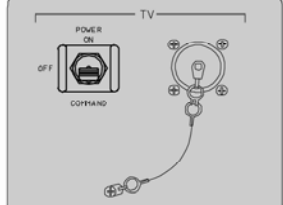
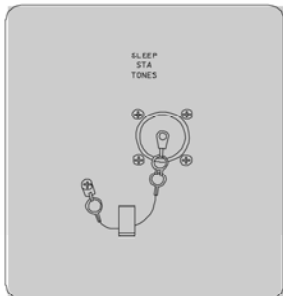

PNL M032M

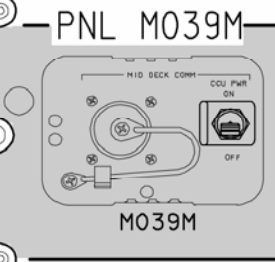

PNL M039M

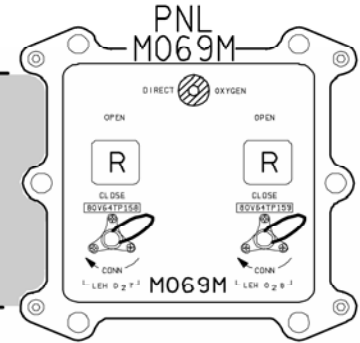

PNL M069M

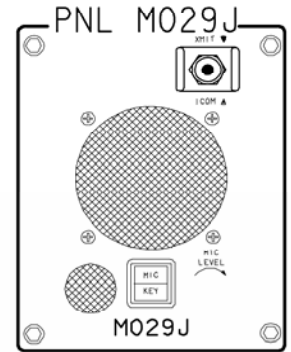

PNL M029J

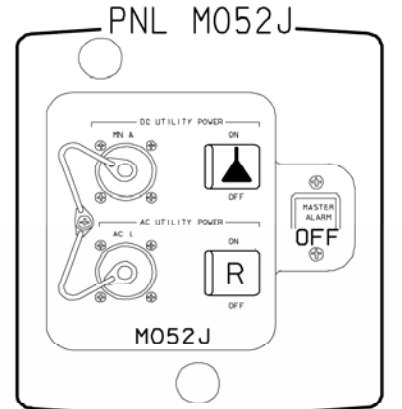

PNL M052J

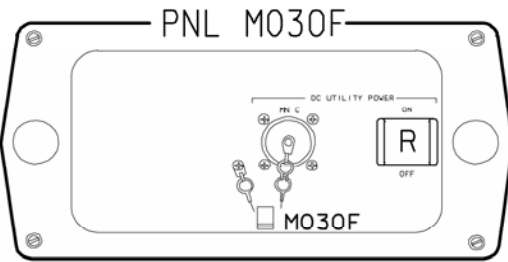

PNL M030F

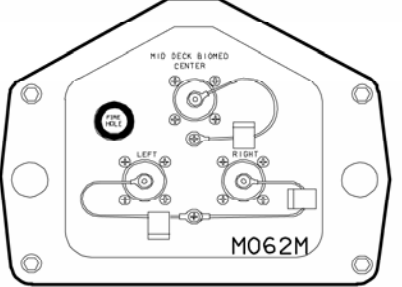

M062M

OV105

OV105

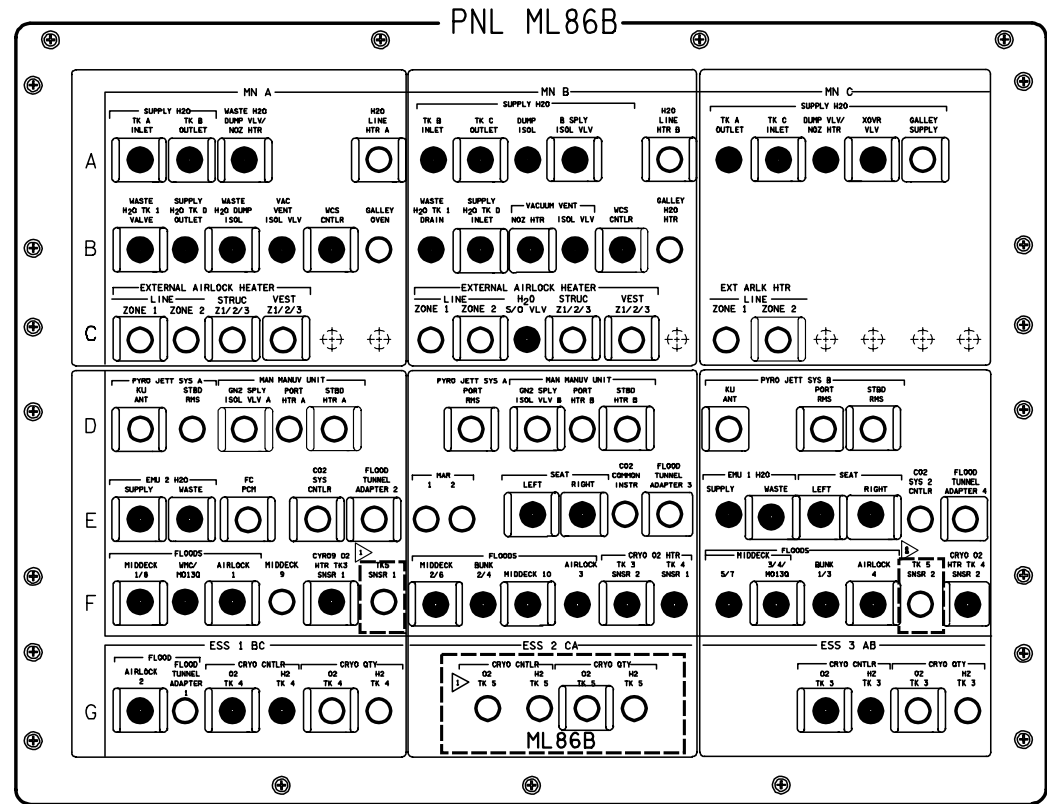
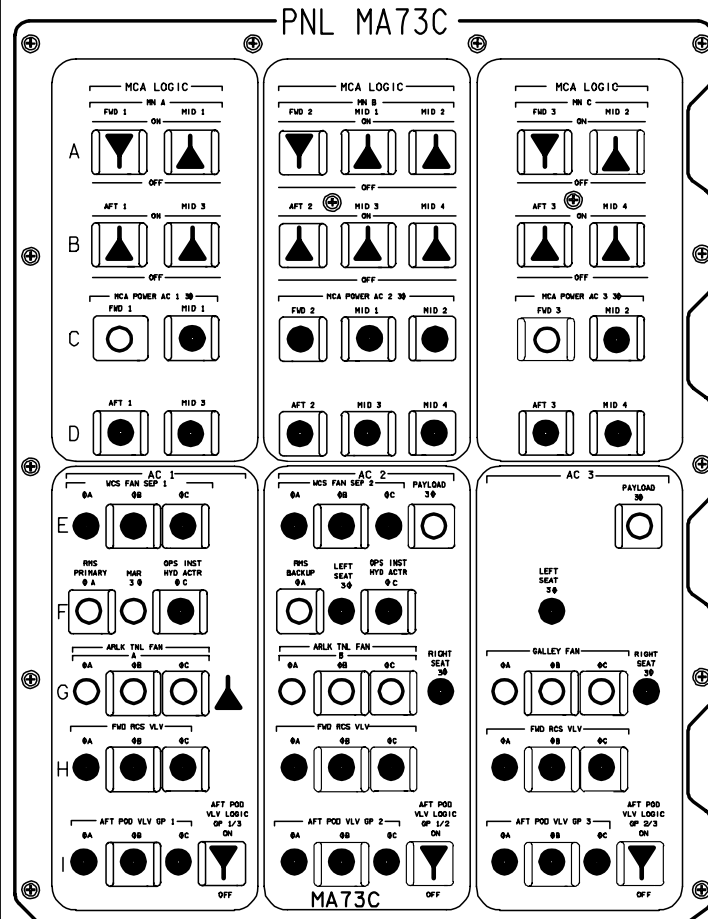

NOTES: ▷ CLOSED IF TK5 FLOWN

OV105

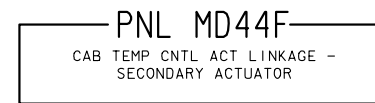
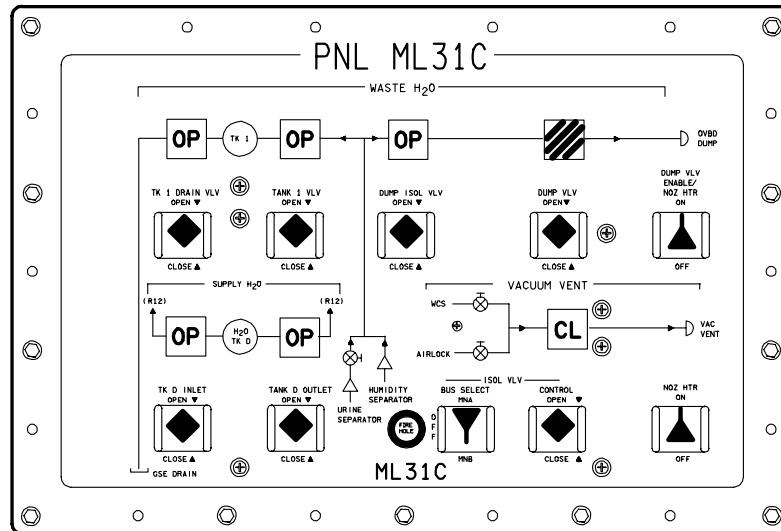
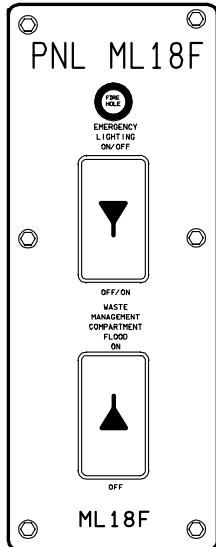
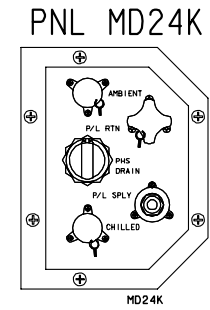
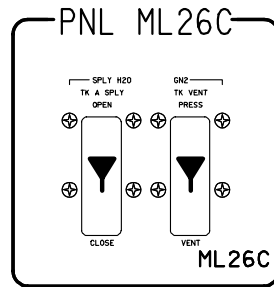
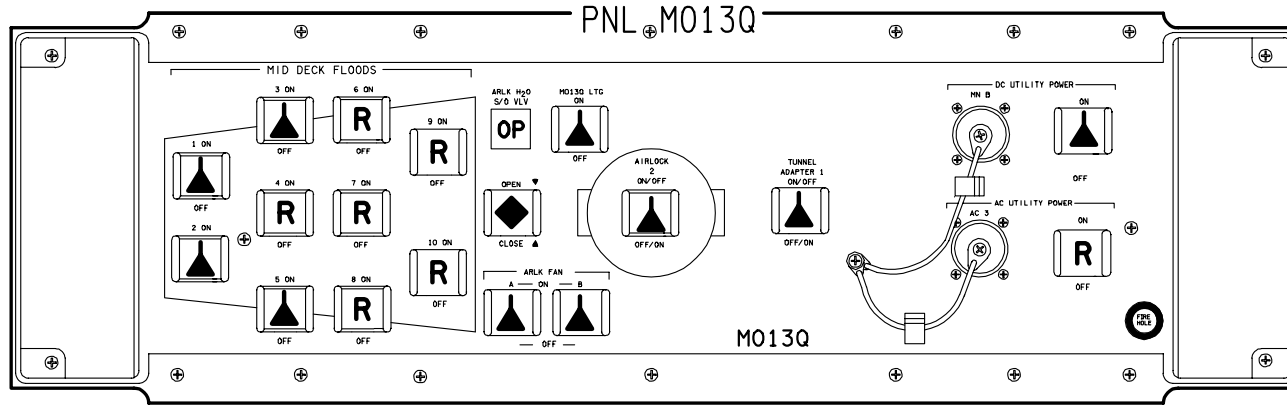

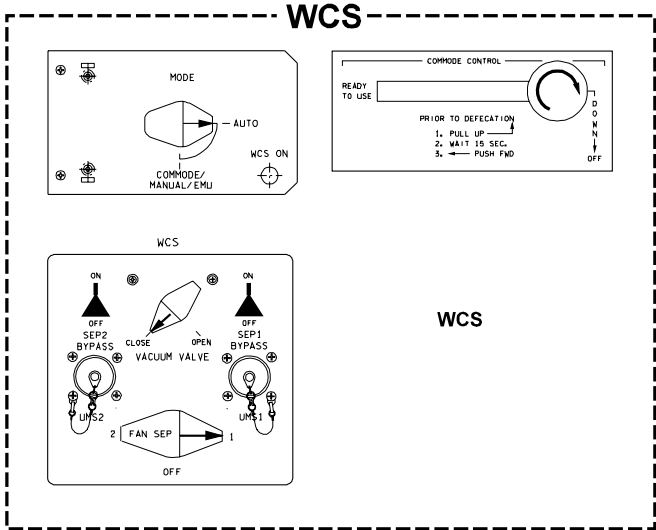
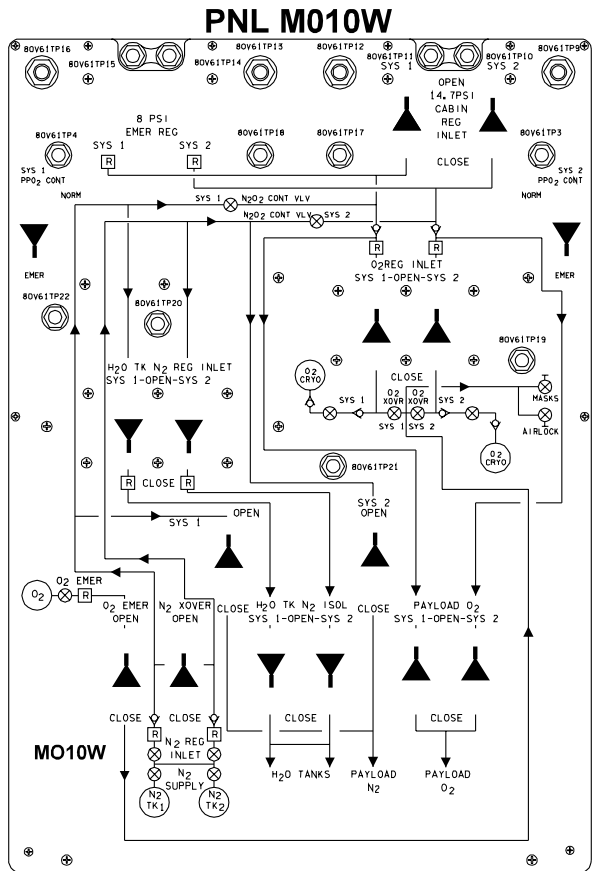

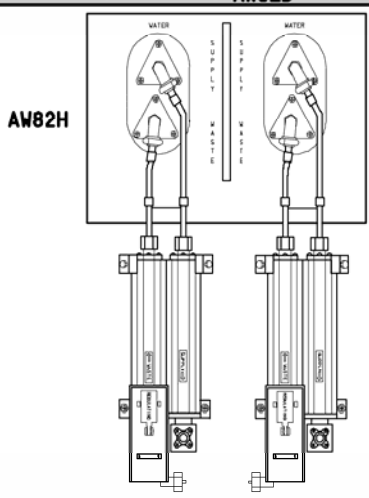
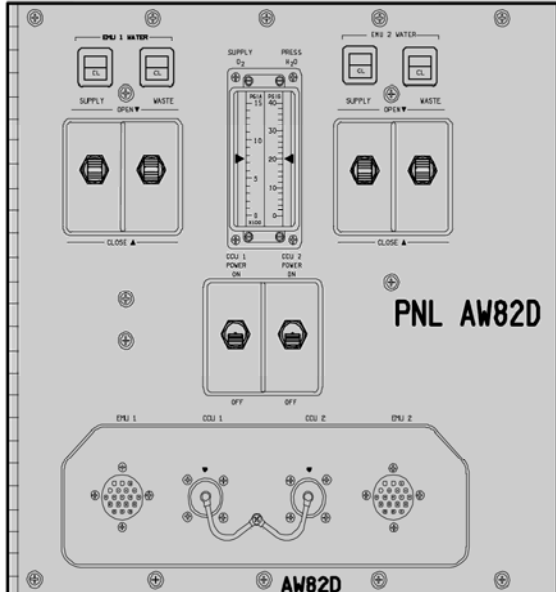
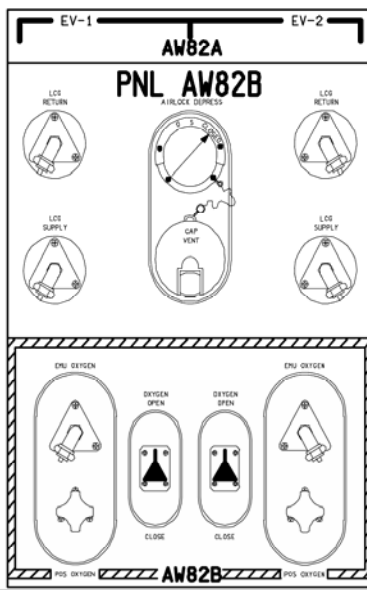
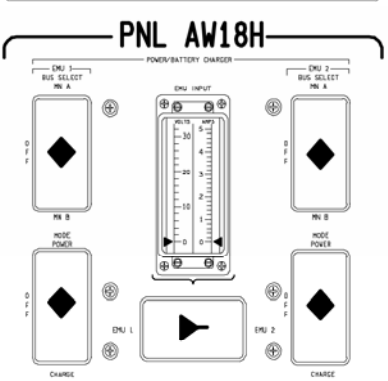
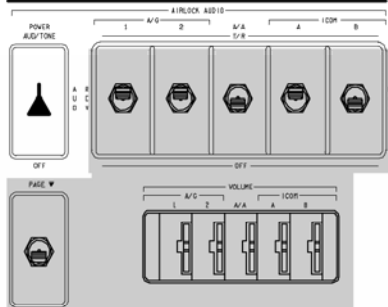
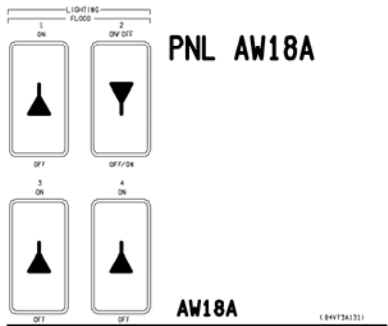

ALL VEH/DATE 10/09/02

48007D631_107_PNL_1

Inner Hatch

Actuator Handle – LATCHED

Lock Lever – LOCKED

Equalization vlv (two) – NORM, capped

LOSS OF FES DEORBIT PREP

This Page Intentionally Blank

LOSS OF FES DEORBIT PREP

ASSUMPTIONS/INITIAL CONDITIONS

This procedure assumes EVAP OUT T HIGH (ORB PKT, ECLS) and LOSS OF FES (ORB PKT, PWRDN) have been performed

If failure occurs after Deorbit Prep entered, compare timeline, beginning at TIG-4 hr, with activities previously accomplished for misconfigurations

PROBLEM DESCRIPTION/RATIONALE

Immediate deorbit not mandatory if both Freon Loops operating and radiator flow has been established

Heat removal capability of radiators allows for normal on-orbit power levels without thermal problems. However, for Deorbit Prep, to allow some coldsoak of the radiators and vehicle, power levels must be limited

NOTE

A near normal deorbit prep and entry performed except that:

1. Nav and landing aids powered when needed during entry
2. Limited use of IDPs,MDUs,Flt Cntrl Pwr,PGSC,lighting
3. GPC entry configuration and OPS 3 transition delayed to TIG-45 min to delay full GPC powerup
4. MS continues deorbit prep activities until TIG. CDR/PLT go to ENT at TIG-30
5. Door closure delayed to TIG-10 min
6. Radiator coldsoak attitude (tail sun) maintained until TIG-15 min except for IMU align attitude
7. Ammonia boiler activated at EI
8. HYD circ pump operated for additional cooling

LOSS OF FES DEORBIT PREP OVERVIEW OF CONFIGURATION MANAGEMENT

	OPS 1 ASC C/L					OPS 2 ON-ORBIT					OPS 2 DEORBIT PREP TIG -03:28					OPS 3 DEORBIT PREP TIG -0:45					TIG					EI-5	V=15K										
DPS																																					
GPC OPS	1 G1	2 G1	3 G1	4 G1	5 BFS	1 G2	2 G2	3 G2	4 SM	5 BFS	1 G2	2 G2	3 G2	4 SM	5 BFS	1 G3	2 G3	3 G3	4 G3	5 BFS	1 G3	2 G3	3 G3	4 G3	5 BFS												
POWER OUTPUT MODE	ON N R	ON N R	ON N R	ON N R	ON B R	ON N R	ON N R	ON N H	ON T R	ON N H	ON N R	ON N R	ON N H	ON T R	ON N S	ON N R	ON N R	ON N R	ON N R	ON N R	ON N R	ON N R	ON N R	ON N R	ON N R	ON N R											
CONFIG GPC	1 1 2 3 4 0					2 1 2 0 0 0					4 (5) 0 0 0 4 0					2 1 2 0 0 0					4 (5) 0 0 0 4 0					3 1 2 3 4 0					3 1 2 3 4 0						
STR	1	1				1	2	3	4	5	1	2	3	4	5	1	2	3	4	5	1	2	3	4	5												
PL	1/2	1				0	0	0	0	0	0	0	0	0	0	1	1	1	1	1	1	1	1	1	1												
CRT	1	1				1	2	3	4	5	1	2	3	4	5	1	2	3	4	5	1	2	3	4	5												
L	1	1				0	0	0	0	0	0	0	0	0	0	0	0	0	0	0	0	0	0	0	0												
MM	1	1				1	2	3	4	5	1	2	3	4	5	1	2	3	4	5	1	2	3	4	5												
MDM	ALL ON					ALL ON					ALL ON					ALL ON					ALL ON																
D & C	DDU MDU IDP		L,R All Forward ALL			L,A ----- Minimize use ----- Minimize use ----- Minimize use -----																															
E C L S	AV BAY FAN CABIN FAN IMU FAN WATER LP FREON LP RADIATOR		1-B,2-A,3-B A ----- B ----- 1-OFF,2-ON 1-B,2-B STOWED ----->			1-GPC,2-ON -----> 1-OFF,2-ON ----- DEPLOY ----->										STOW ----->											1,2 ON										
F C S / N A V A I D S S E N S O R S	FCS ASA AA RGA ADTA IMU RA TACAN UHF MLS		AUTO ----- ALL ON ----- ALL ON ----- ALL ON ----- ALL ON ----- ALL ON ----- ALL ON ----- ALL GPC ----- ON ----- ALL OFF -----			OFF -----> ALL ON ----- OFF -----> ALL ON ----- OFF -----> ALL ON ----- OFF -----> ALL ON ----- OFF -----> ALL ON ----- OFF -----> ALL ON ----- OFF -----> ALL ON ----- OFF -----> ALL ON ----- ON -----> ALL ON ----- ON -----> ALL ON -----										ALL ON -----> ALL ON ----- ALL ON -----> ALL ON ----- ALL ON -----> ALL ON ----- ALL ON -----> ALL ON ----- ALL ON -----> ALL ON ----- ALL ON -----> ALL ON ----- ALL ON -----> ALL ON ----- ALL ON -----> ALL ON ----- ALL ON -----> ALL ON ----- ALL ON -----> ALL ON -----										ALL ON -----> ON ----- ON -----> ON -----											
R J D	RJDA RJDF VERNIER		ALL ON ----- ALL ON ----- OFF ----->			ON ----->										OFF -----> OFF ----->																					

OV103,104

LOSS OF FES DEORBIT PREP

ASSUMPTIONS/INITIAL CONDITIONS

This procedure assumes EVAP OUT T HIGH (ORB PKT, ECLS) and LOSS OF FES (ORB PKT, PWRDN) have been performed

If failure occurs after Deorbit Prep entered, compare timeline, beginning at TIG-4 hr, with activities previously accomplished for misconfigurations

PROBLEM DESCRIPTION/RATIONALE

Immediate deorbit not mandatory if both Freon Loops operating and radiator flow has been established

Heat removal capability of radiators allows for normal on-orbit power levels without thermal problems. However, for Deorbit Prep, to allow some coldsoak of the radiators and vehicle, power levels must be limited

NOTE

A near normal deorbit prep and entry performed except that:

1. Nav and landing aids powered when needed during entry
2. Limited use of IDPs,MDUs,Flt Cntrl Pwr,PGSC,lighting
3. GPC entry configuration and OPS 3 transition delayed to TIG-45 min to delay full GPC powerup
4. MS continues deorbit prep activities until TIG. CDR/PLT go to ENT at TIG-30
5. Door closure delayed to TIG-10 min
6. Radiator coldsoak attitude (tail sun) maintained until TIG-15 min except for IMU align attitude
7. Ammonia boiler activated at EI
8. HYD circ pump operated for additional cooling

LOSS OF FES DEORBIT PREP OVERVIEW OF CONFIGURATION MANAGEMENT

	OPS 1 ASC C/L					OPS 2 ON-ORBIT					OPS 2 DEORBIT PREP TIG -03:28					OPS 3 DEORBIT PREP TIG -0:45					TIG					EI-5	V=15K										
DPS																																					
GPC OPS	1 G1	2 G1	3 G1	4 G1	5 BFS	1 G2	2 G2	3 G2	4 SM	5 BFS	1 G2	2 G2	3 G2	4 SM	5 BFS	1 G3	2 G3	3 G3	4 G3	5 BFS	1 G3	2 G3	3 G3	4 G3	5 BFS												
POWER OUTPUT MODE	ON N R	ON N R	ON N R	ON N R	ON B R	ON N R	ON N R	ON N H	ON T R	ON N H	ON N R	ON N R	ON N H	ON T R	ON N S	ON N R	ON N R	ON N R	ON N R	ON N R	ON N R	ON N R	ON N R	ON N R	ON N R	ON N R											
CONFIG GPC	1 1 2 3 4 0					2 1 2 0 0 0					4 (5) 0 0 0 4 0					2 1 2 0 0 0					4 (5) 0 0 0 4 0					3 1 2 3 4 0					3 1 2 3 4 0						
STR	1	1				1	2	3	4	5	1	2	3	4	5	1	2	3	4	5	1	2	3	4	5												
PL	1/2	1				0	0	0	0	0	0	0	0	0	0	1	1	1	1	1	1	1	1	1	1												
CRT	1	1				1	2	3	4	5	1	2	3	4	5	1	2	3	4	5	1	2	3	4	5												
L	1	1				0	0	0	0	0	0	0	0	0	0	0	0	0	0	0	0	0	0	0	0												
MM	1	1				1	2	3	4	5	1	2	3	4	5	1	2	3	4	5	1	2	3	4	5												
MDM	ALL ON					ALL ON					ALL ON					ALL ON					ALL ON																
D & C	DDU MDU IDP		L,R All Forward ALL			L,A ----- Minimize use ----- Minimize use ----- Minimize use -----																															
E C L S	AV BAY FAN CABIN FAN IMU FAN WATER LP FREON LP RADIATOR		1-B,2-A,3-B A ----- B ----- 1-OFF,2-ON 1-B,2-B STOWED ----->			1-GPC,2-ON -----> 1-OFF,2-ON ----- DEPLOY ----->										STOW ----->											1,2 ON										
F C S / N A V A I D S S E N S O R S	FCS ASA AA RGA ADTA IMU RA GPS UHF MLS		AUTO ----- ALL ON ----- ALL ON ----- ALL ON ----- ALL ON ----- ALL ON ----- ALL ON ----- ALL ON ----- ALL OFF -----			OFF -----> ALL ON ----- OFF -----> ALL ON ----- OFF -----> ALL ON ----- OFF -----> ALL ON ----- OFF -----> ALL ON ----- 2 ON, 1 & 3 OFF -----> ALL ON ----- ON -----> ALL ON ----- ALL OFF -----> ALL ON -----															ALL ON ----->						ON										
R J D	RJDA RJDF VERNIER		ALL ON ----- ALL ON ----- OFF ----->			ON ----->																					OFF OFF										

LOSS OF FES DEORBIT PREP

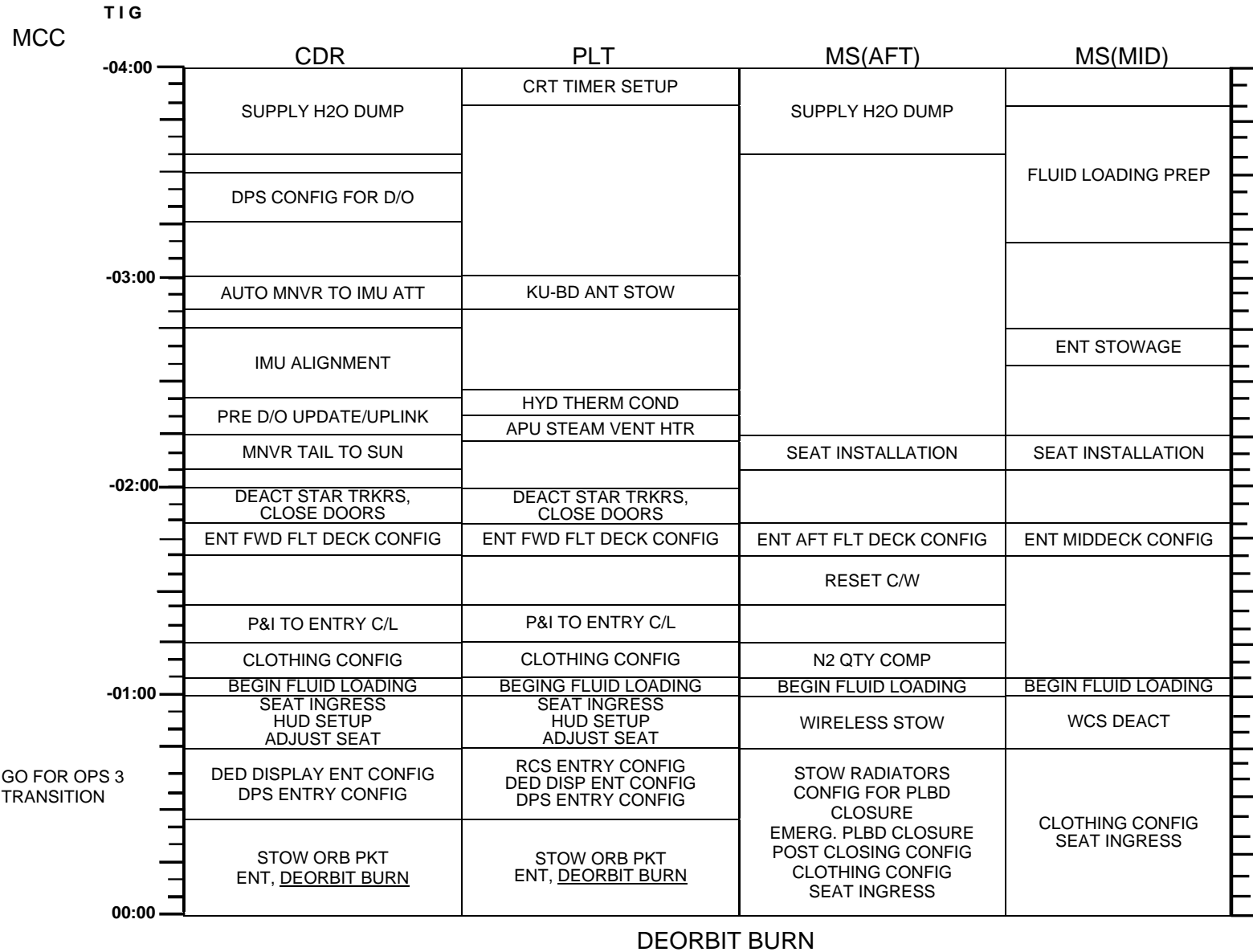

TIG
 -04:00
 A1(B1)
 AUTO
 VERN
 RT 0.2
 DB 1.0

P TIMER SETUP [1]
 L1 √DAP: A1/AUTO/VERN
 √DAP B set to B1

-03:55

C,MS SUPPLY/WASTE WATER DUMP (ORB OPS, ECLS)
 If no MCC, perform supply dump only
 Dump TK B to 50%

-03:50 MS FLUID LOADING PREP MS MID ACTIVITIES [2], 7-19

-03:45

-03:40

-03:35

-03:30

TIMER SETUP [1]

[1: GNC 2 TIME]

SET CRT TIMER TO COUNT DOWN TO TIG (perform for GNC and SM)

ENTRY DAY (HR:MIN:SEC – MET)

ITEM 17 + + +

24 HOUR LATE DELAYED DEORBIT

ITEM 17 + + +

[1: GNC UNIV PTG]

TIG
-03:30

A1(B1)
AUTO
VERN
RT 0.2
DB 1.0

C

DPS CONFIG FOR D/O PREP **3**

MCC: Update IMU ALIGN PAD if reqd (ORB OPS, PTG)

-03:25

-03:20

UPLINK
(over STDN)
(if reqd)
PASS and BFS
SV

-03:15

-03:10

-03:05

P

KU-BD ANT STOW (ORB OPS, COMM/INST) (if deployed)

-03:00

DPS CONFIG FOR D/O PREP **3**

ACTIVATE GPC 2 (if in HALT)

O6 √GPC MODE 2 – HALT (tb-bp)
 √OUTPUT 2 – NORM
 √PWR 2 – ON
 MODE 2 – STBY (tb-RUN), RUN

TRANSITION GPCs 1&2 TO OPS 2
(if GPC 2 just activated)
GNC 0 GPC MEMORY

CONFIG – ITEM 1 +2 EXEC
Modify MC 2 per table →

CONFIG	2
GPC	12000
STR	1
2	2
3	1
4	2
PL	1/2
CRT	1
2	2
3	0
4	2
L	0
2	0
MM	1
2	2

O6 √GPC PWR 5 – ON
 MODE 5 – STBY (tb-RUN)

C3 BFC CRT DISP – ON
 SEL – 2 + 3

2: BFS, GNC BFS MEMORY or SM THERMAL

C3 BFC CRT DISP – OFF
 SEL – 3 + 1

IMU ALIGNMENT 5

NOTE

Procedure applies for one or two S TRK aligns. For one S TRK, a second att mnvr reqd between data takes. Ref STAR PAIRS (ORB OPS, PTG)

C

1. X: GNC 22 S TRK/COAS CNTL
Y: GNC 21 IMU ALIGN

CRTX

2. √REQD ID – ITEM 11,12 – 0
√STATUS (two) – NO BITE
√SHUTTER (two) – OP

* If SHUTTER – CL: *
* √Att,MET – correct *
* Visually verify no bright object in FOV *
* After data collected and before changing *
* attitude, return shutter to AUTO *
* To open shutter: *
* MAN OP – ITEM 15(16) EXEC (*) *
* To return shutter to AUTO: *
* MAN OP – ITEM 15(16) EXEC (no *) *

CRTY

- √IMU 1,2,3:
√STAT – blank
√OPER – ITEM 4,5,6 (*)

CRTX

3. √IMU ALIGN ATT (pad)
4. S TABLE CLR – ITEM 20 EXEC
5. Enable Star Tracker:
S TRK – ITEM 3,4 EXEC (*)
6. Verify S TABLE:
TRK ID 1,2 = STAR ID (pad)
ANG ERR ≤ 0.08

Wait approx 1 min for new IMU Δ ANG S

- * If after 3 min no data (or bad data) in S TABLE: *
- * √S TRK – ITEM 3,4 (*) *
- * √ATT/STARS/TIME *
- * √S TRK: TRK ID = STAR ID (pad) *
- * Do S TRK self-test *
- * If neither tracker fails: *
- * Mnvr to verification att – repeat *
- * steps 3,4,5,6 *
- * If one tracker fails: *
- * √TERM/IDLE for failed tracker – *
- * ITEM 9(10) (*) *
- * Proceed with one S TRK ALIGN *
- * If both trackers fail, √MCC *

For one S TRK align:

- S TRK for good tracker – ITEM 3(4) EXEC (*)
- S TABLE CLR – ITEM 20 EXEC, reacquire star with good tracker
- TERM/IDLE for good tracker during maneuvers – ITEM 9(10) EXEC (*)
- Mnvr to second att (single S TRK): Do not clear S Table
- Repeat steps 3,5,6 with second Star ID

CRTX
CRTY

7. √S TABLE SEL – ITEM 17,18 (*)
ALIGN IMU 1,2,3 – ITEM 10,11,12 EXEC (*)
√REF STAR – ITEM 13 (*)
√TYPE – ITEM 15 (TORQUE)
√IMU 1,2,3 – ANG ΔX,ΔY,ΔZ < 0.80

* If ANG ΔX,ΔY,ΔZ > 0.80 for two IMUs, do not torque: *
* Mnvr to verification att & repeat steps 3 thru 7 once *
* If still > 0.80, report to MCC *
8. Record ANG ΔX,ΔY,ΔZ,ANG ERR,EXECUTE TIME (use log this page)
ITEM 16 – EXEC (*)
Alignment complete when:
ITEM 16 – EXEC (no *)
- IMU ALIGN VERIFICATION
9. Mnvr to IMU VERIFICATION STAR ALIGN ATT (pad):
√DAP: B/AUTO/PRI
10. Perform steps 3,4,5,6 using appropriate stars (pad)
11. √IMU 1,2,3 ANG ΔX,ΔY,ΔZ < 0.1

* If ANG ΔX,ΔY,ΔZ ≥ 0.1, perform steps 8 thru 11; report to MCC *

NOTE

For alternate stars, √MCC or ref STAR PAIRS (ORB OPS, PTG)

12. Report IMU ALIGN results

IMU STAR ALIGN LOG

REQD ID: -Y _____, -Z _____ ANG ERR _____

ANG	1	2	3
ΔX ()	_____	_____	_____
ΔY ()	_____	_____	_____
ΔZ ()	_____	_____	_____

EXECUTE TIME _____: _____: _____ (TIG MINUS)

IMU STAR ALIGN LOG

REQD ID: -Y _____, -Z _____ ANG ERR _____

ANG	1	2	3
ΔX ()	_____	_____	_____
ΔY ()	_____	_____	_____
ΔZ ()	_____	_____	_____

EXECUTE TIME _____: _____: _____ (TIG MINUS)

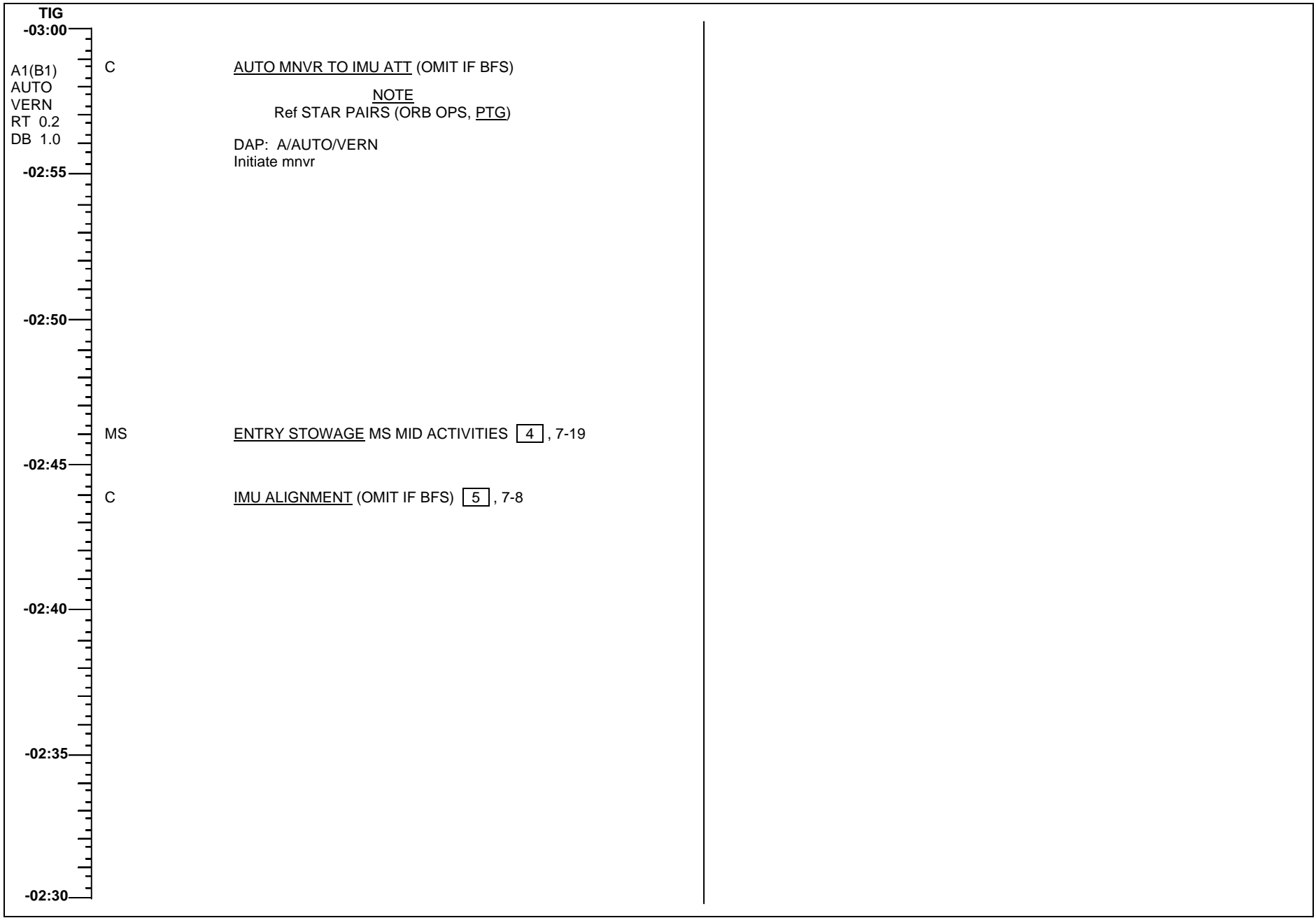

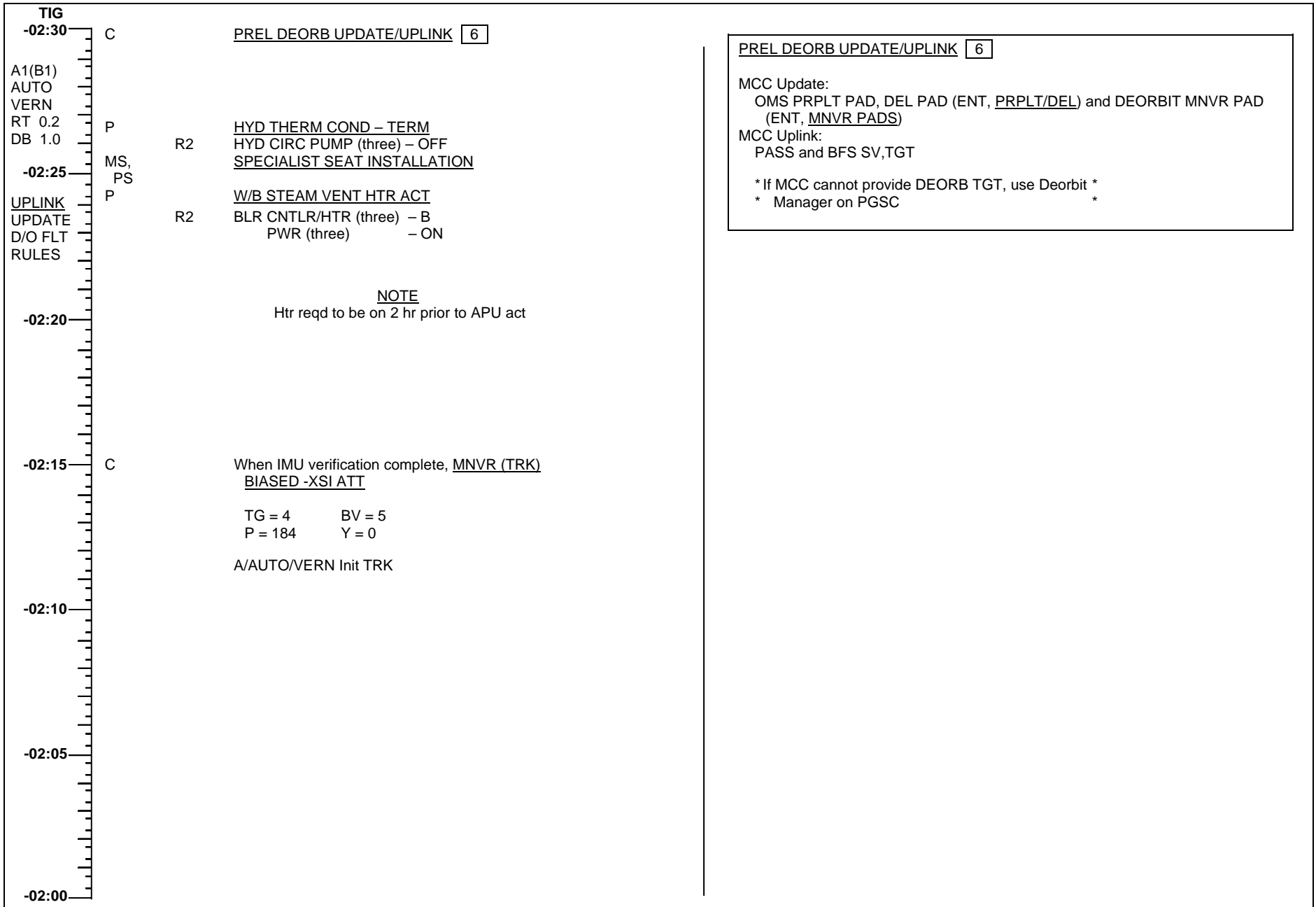

TIG		
-02:00	C,P	<u>DEACT STAR TRKRS & CLOSE DOORS</u> [7]
A1(B1)		
AUTO		
VERN		
RT 0.2		
DB 1.0		
-01:55	C,P	<u>ENT FWD FLT DECK CONFIG</u> [8]
	MS	<u>ENT AFT FLT DECK CONFIG</u>
		MS AFT ACTIVITIES [9], 7-17
	MS	<u>ENT MIDDECK CONFIG</u> MS MID ACTIVITIES [10], 7-20
-01:50		
UPLINK		
TMBU		
-01:45		
-01:40		
-01:35		
-01:30	MS	<u>CW RESET MS AFT ACTIVITIES</u> [11], 7-17

<u>DEACT STAR TRKRS & CLOSE DOORS</u> [7]	
O6	S TRK PWR (two) - OFF
O14:E, O15:E	cb S TRK -Z,-Y (two) - op
O6	S TRK DR CNTL SYS 1,2 (two) - CL (start timer)
	√POS tb (two) - bp
	When both tb - cl (~8-24 sec)
	or either tb - bp > 24 sec:
	S TRK DR CNTL SYS 1,2 (two) - OFF
	* If tb - bp > 8 sec, √MCC *

<u>ENT FWD FLT DECK CONFIG</u> [8]	
	<u>HYD HTR CONFIG</u>
R4	HYD BK HTR (three) - AUTO
	<u>PCS/ARS CONFIG</u>
L2	√O2 SYS 1,2 SPLY (two) - OP (tb-OP)
	√XOVR SYS 1,2 (two) - OP
	√N2 SYS 1,2 SPLY (two) - OP (tb-OP)
	√REG INLET (two) - OP (tb-OP)
	O2/N2 CNTLR vlv SYS 1 - OP
	2 - CL
C7	√LEH O2 SPLY vlv (two) - OP
L4:J	cb AC3 ΦA SIG CONDR HUM SEP - op
	ΦB SIG CONDR IMU FAN - op
	<u>RAD CONFIG</u>
L2	FREON ISOL MODE - OFF
	<u>MLS CH/TACAN CH</u>
O8	√MLS CH tw (three) - see LAND SITE DATA
O7	√TACAN MODE (three) - OFF
	√ANT SEL (three) - AUTO
	<u>ENT COMM</u>
O5,O9	L,R AUD A/G 2 - T/R
	ICOM B - T/R
	XMIT/ICOM MODE - PTT/VOX
O6	√UHF SPLX/EVA PWR AMPL - ON

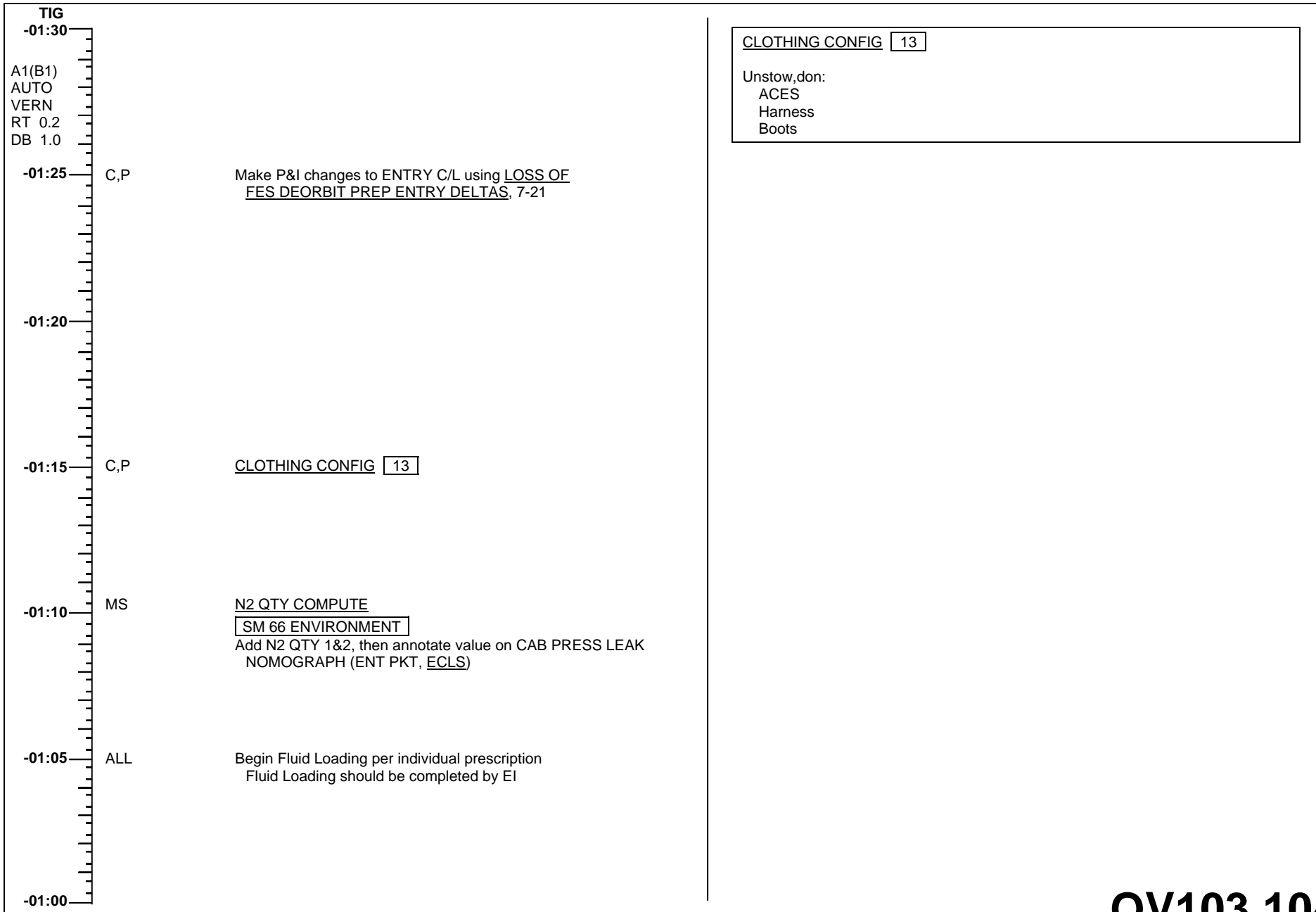

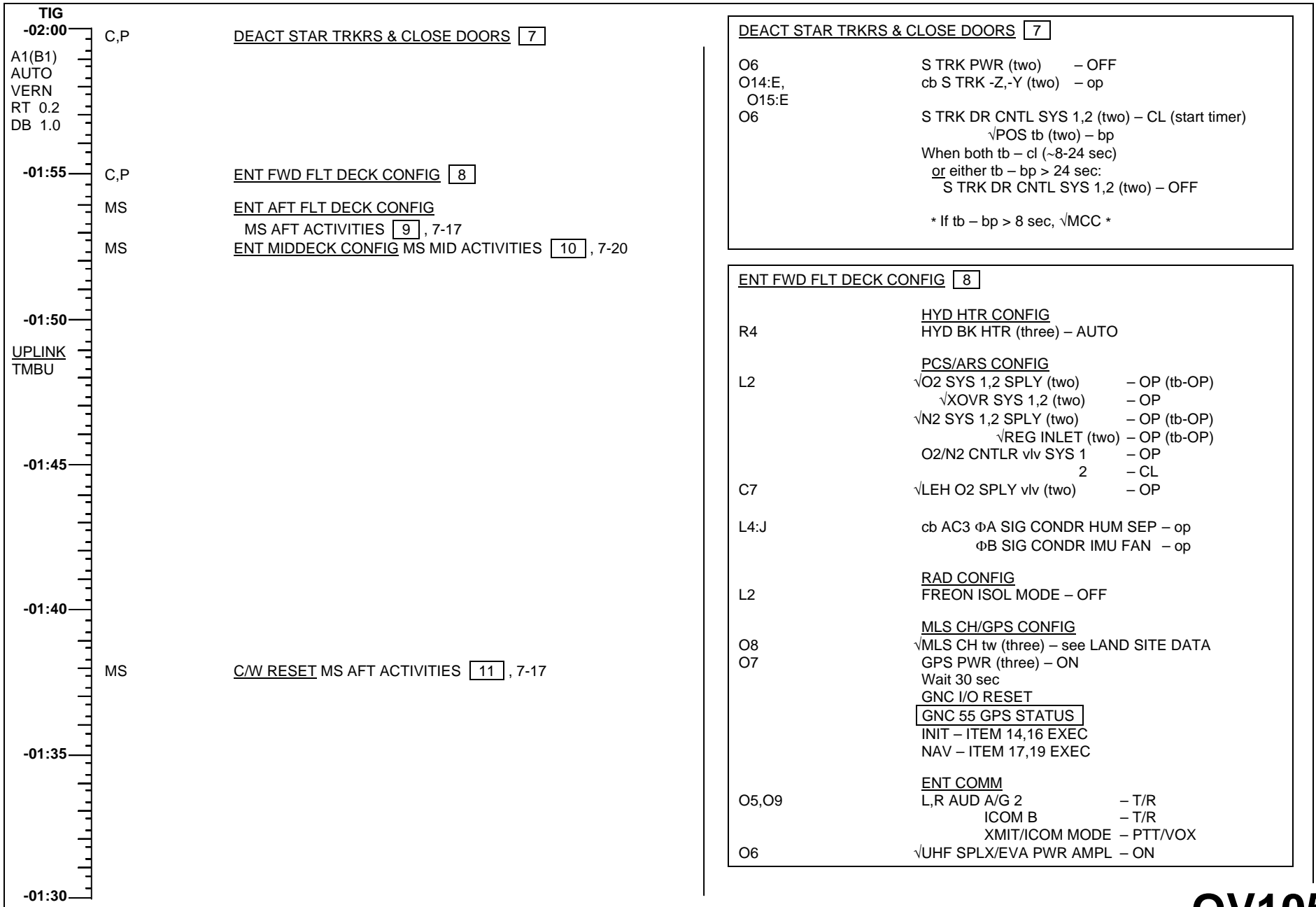

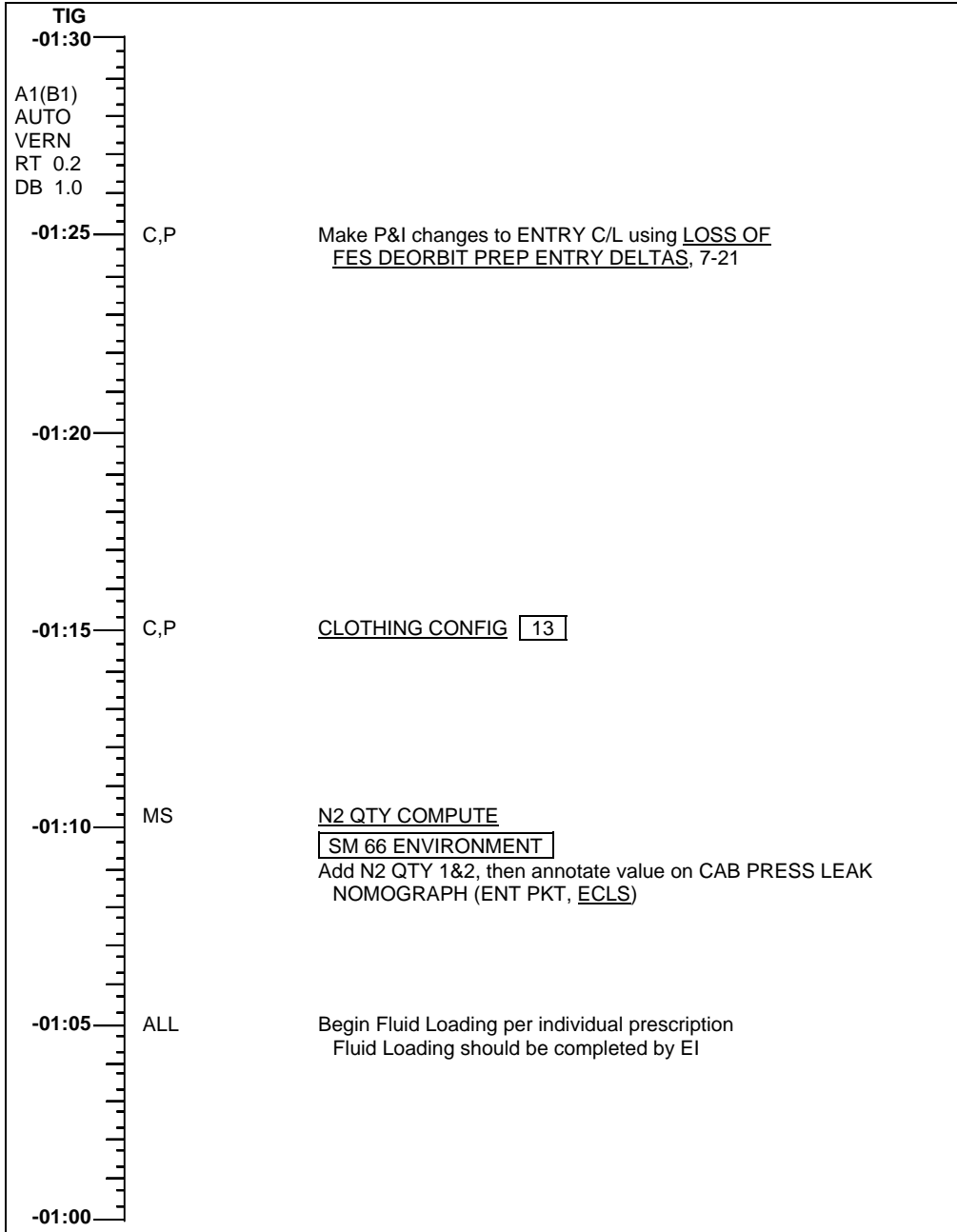

CLOTHING CONFIG 13

Unstow, don:
ACES
Harness
Boots

TIG			
-01:00	C,P	<u>HUD SETUP</u> [14], 7-13	
A1(B1) AUTO RT 0.2 DB 1.0	C	C6	LEH O2 vlv (four) – OP
-00:55	C,P	<u>SEAT INGRESS</u> Adjust seat Exercise brake pedals ACES PRESS INTEGRITY CHECK	
	MS	<u>WIRELESS STOW MS AFT ACTIVITIES</u> [15], 7-17	
-00:50	MS	<u>WCS DEACT</u> MS MID ACTIVITIES [16], 7-20	
	P	<u>RCS ENTRY CONFIG</u> [17], 7-13	
-00:45	C,P	<u>DED DISP ENT CONFIG</u> [18], 7-13 MCC: GO FOR OPS 3 TRANSITION	
-00:40	C,P	<u>DPS ENTRY CONFIG</u> [19], 7-13 and 7-14	
	MS, PS	<u>CLOTHING CONFIG</u> MS AFT,MID ACTIVITIES [20], 7-17 and 7-20	
-00:35			
-00:30	C,P	Stow ORB PKT, Orbit Cue Cards Go to ENT, <u>DEORBIT BURN</u>	
SM CHECKPOINT/UL CNTL ENA			
			[1: SM 60 SM TABLE MAINT 2: SM 1 DPS UTILITY]
CRT2 CRT1			MMU ASSIGN 1 SM – ITEM 3 EXEC CKPT INITIATE – ITEM 18 EXEC
CRT2			√Update of CKPT TIME and STATUS GOOD indicated CKPT RETRV ENA ITEM 12 EXEC (*) UL CNTL ENA – ITEM 36 EXEC
C3			<u>TRANSITION BFS GPC TO GNC OPS 3</u> BFC CRT DISP – ON √SEL – 3 + 1 [3: BFS, GNC BFS MEMORY]
O6 CRT3			GPC OUTPUT 5 – B/U (tb-bp) √TFL ENA – ITEM 29 (*) BFS, GNC OPS 301 PRO [3: BFS, GNC DEORB MNVR COAST]
O6			<u>TRANSITION GPC 1,2,3,4 TO GNC OPS 3</u> SM, OPS 000 PRO [X: SM GPC MEMORY] GPC OUTPUT 4 – NORM (tb-gray) MODE 3,5 (two) – RUN (tb-RUN)
CRT3 C3			[GNC 0 GPC MEMORY] √CONFIG – ITEM 1 +3 EXEC Modify MC 3 per table → GNC, OPS 301 PRO [GNC DEORB MNVR COAST] BFS, GNC OPS 000 PRO BFS, GNC OPS 301 PRO BFC CRT DISP – OFF (GPC 3 commanding IDP 3) BFC CRT DISP – ON
			<u>LAND SITE UPDATE</u> [GNC 50 HORIZ SIT] SEL SITE (See LAND SITE DATA) <u>LOAD IN TGTs</u> [GNC DEORB MNVR COAST]
			√PASS and BFS TGT per DEORBIT MNVR PAD (ENT, MNVR PADS) LOAD – ITEM 22 EXEC TIMER – ITEM 23 EXEC
			√PASS and BFS solution per DEORBIT MNVR PAD (ENT, MNVR PADS): BURN ATT HA HP ΔVTOT TGO
O14:F O15:F			MMU 1 – OFF √2 – OFF

CONFIG	3
GPC	12340
STR	1
	2
	3
	4
PL	1/2
CRT	1
	2
	3
	4
L	1
	2
MM	1
	2

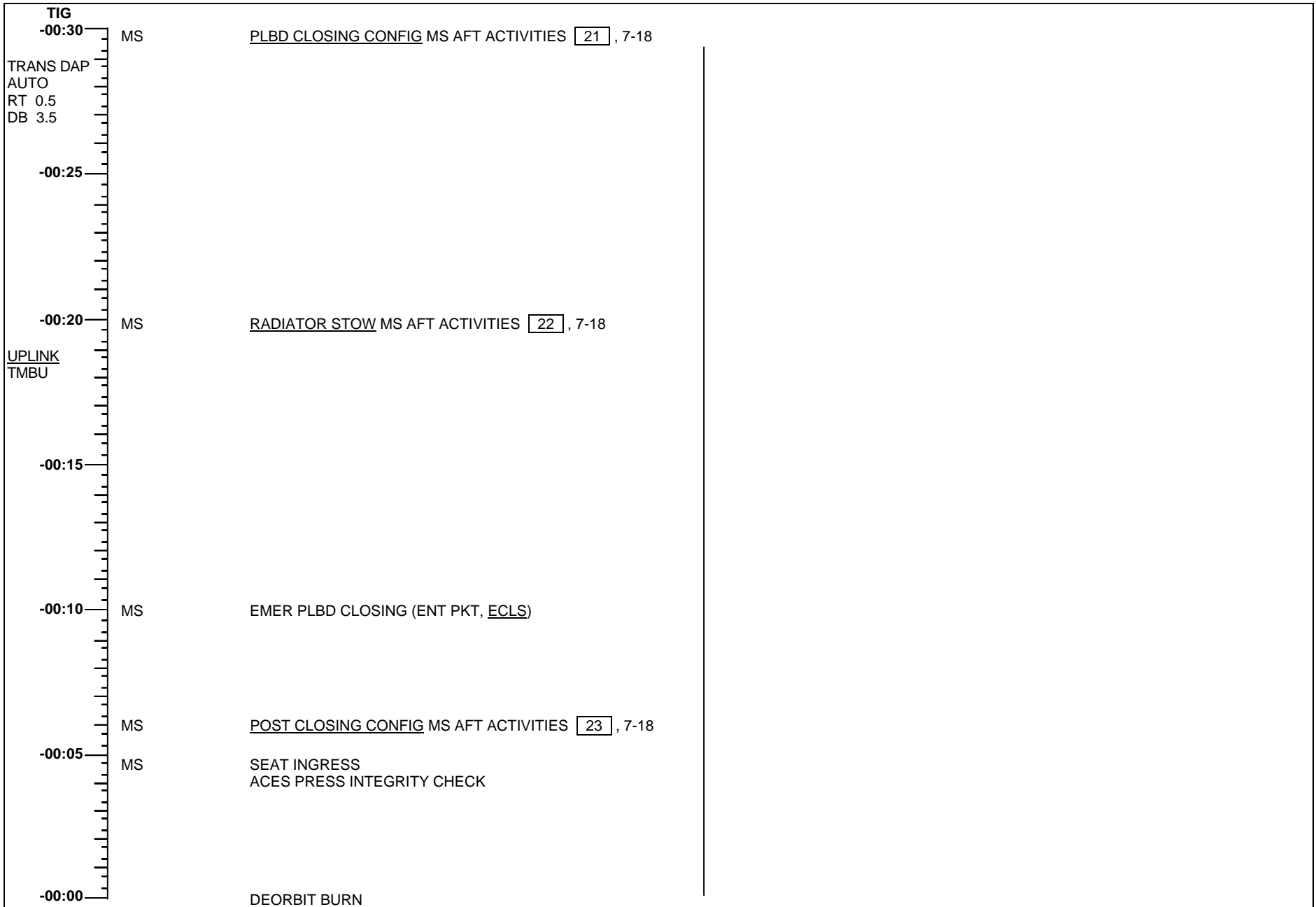

This Page Intentionally Blank

MS AFT FLIGHT DECK ACTIVITIES MS PULLOUT PAGE

NOTE

Wait for GO from CDR or PLT before starting any activity on this page

TIME (TIG-)	MS AFT ACTIONS
2:25	<u>SPECIALIST SEAT INSTALLATION</u> Verify Leg Attach Collars (four) – DOWN/LOCKED
1:55	<u>ENT AFT FLT DECK CONFIG</u> [9]
1:38	<u>C/W RESET</u> [11]
1:10	<u>N2 QTY COMPUTE</u> [24]
1:05	Begin Fluid Loading per individual prescription. Fluid Loading should be completed by EI
0:52	<u>WIRELESS STOW</u> [15]
0:39	<u>CLOTHING CONFIG</u> [20]
0:30	<u>PLBD CLOSING CONFIG</u> [21], 7-18
0:20	<u>RADIATOR STOW</u> [22], 7-18
0:10	<u>EMER PLBD CLOSING</u> (ENT PKT, <u>ECLS</u>)
0:06	<u>POST CLOSING CONFIG</u> [23], 7-18
0:05	<u>SEAT INGRESS</u>

<u>ENT AFT FLT DECK CONFIG</u> [9]	
	<u>ENTRY COMM</u>
A1L	S-BD PM MODE – STDN LO NSP CODING XMIT,RCV (two) – OFF
A1R	AUD CTR VOICE RCD SEL CH 1 sel – ICOM A 2 sel – ICOM B
A13	OS AUD SPKR PWR – OFF
R14:C	cb MNB KU ELEC – op ANT HTR – op √CABLE HTR – op MNC KU SIG PROC – op cb UHF EVA (two) – op
R10,L9	MS,PS AUD PWR – AUD/TONE A/G (two) – T/R √A/A – T/R ICOM (two) – T/R

C/W RESET (Contact CDR for additional parameters) [11]

R13U			
PARAMETER NAME	C/W CH	ENA/ INH	
HYD	P1	99	ENA
	2	109	ENA
	3	119	ENA

WIRELESS STOW [15]

Disconnect, stow Wireless Headsets (if reqd)
√Aft deck lts as reqd (minimize use)

CLOTHING CONFIG [20]

Unstow, don:
ACES
Harness
Boots

N2 QTY COMPUTE [24]

SM 66 ENVIRONMENT

Add N2 Qty 1 and 2, then annotate value on CAB PRESS LEAK nomograph (ENT PKT, ECLS)

Cont next page

MS MIDDECK ACTIVITIES MS PULLOUT PAGE

NOTE

Wait for GO from CDR or PLT before starting any activity on this page

TIME (TIG-)	MS MIDDECK ACTIONS
3:50	<u>FLUID LOADING PREP</u> [2]
2:46	<u>ENTRY STOWAGE</u> [4]
2:25	<u>SPECIALIST SEAT INSTALLATION</u> Verify Leg Attach Collars (four) – DOWN/LOCKED Verify LiOH Door Latches (four) – ENGAGED
1:55	<u>ENT MIDDECK CONFIG</u> [10], 7-20
1:05	Begin Fluid Loading per individual prescription. Fluid Loading should be completed by EI Verify Side Hatch UV Filter, Locking Device, and Pyro Box Safing Pin removed and stowed
0:51	<u>WCS DEACT</u> [16], 7-20
0:39	<u>CLOTHING CONFIG</u> [20], 7-20
0:05	<u>SEAT INGRESS</u>

<u>FLUID LOADING PREP</u> [2]
Unstow,fill 4 drink containers (per crewmember) with 8 oz of water each; temp stow near seat
Unstow 8 salt tablets (per crewmember); temp stow tablets in Flight Suit pocket

<u>ENTRY STOWAGE</u> [4]
<u>PERSONAL HYGIENE SYS STOWAGE</u> Stow: Personal Hygiene Kits Hose
<u>AIRLOCK CLOSEOUT</u> Tether soft goods to EVA tether point or A/L Stowage Bag. Gray Tape to floor
MO13Q
√AIRLK FAN A(B) – OFF if flown Stow all ducts as appropriate Airlock ENT SW VERIF, 3-30 and 3-31

GALLEY

MA73C:G
ML86B:A
:B

ESCAPE POLE SETUP

Reinstall Stbd Pip Pin
Reinstall large Port Pin:
Retract and hold Locking Pin (Ring)
Reinstall large Pin
Release Locking Pin (Ring)
Slide forward Safing Latch

√Pole Straps secure

FDF STOWAGE

Stow FLIGHT PLAN

CABIN CONFIG

Stow: Backup PGSC
Middeck Camrs,Accessories
FWD/AFT Shades,Filters
Quick Don Masks

Stow Exercise Equipment
√Retention net in ASC/ENT config

EGRESS ROUTE CONFIG

Tape Foot Loops in egress routes

GALLEY DEACT

√OVEN/RHS – OFF
H2O HTRS (two) – OFF
√OVEN FAN – OFF
√REHYD STA lever – cl (push in)
√OVEN DOOR LATCH – latched
cb AC3 GALLEY FAN (three) – op
MNC SPLY H2O GALLEY SPLY – op
MNA GALLEY OVEN – op
MNB GALLEY H2O HTR – op

Cont next page

Back of MS MIDDECK ACTIVITIES MS PULLOUT PAGE

ENT MIDDECK CONFIG 10

	<u>ENTRY COMM</u>	
MO42F	MIDDECK SPKR AUD PWR	- AUD/TONE
	A/G (two)	- T/R
	√A/A	- T/R
	ICOM (two)	- T/R
ML85E	AC S1	- OFF
	<u>MIDDECK PCS</u>	
MO10W	14.7 CAB REG INLET vlv (two)	- CL
	H2O TK N2 REG INLET vlv (two)	- OP
	O2 REG INLET vlv (two)	- CL
MO69M	LEH O2 vlv (two)	- as reqd
MO32M	6 vlv	- as reqd
	<u>RMS PNL LIGHTS</u> (If RMS onboard)	
MA73C:F	cb AC1 RMS PRI ΦA	- op
	AC2 RMS B/U ΦA	- op

WCS DEACT 16

WCS	VAC VLV - CL
	√MODE - AUTO
	FAN SEP SEL sw - OFF
	Unstow hose from cradle, attach hose to WCS housing via Velcro straps
	Remove, stow: WCS Trash Can
	Mirror
	Privacy Curtain
	Foot restraints - up, locked
	Close, latch door
ML31C	VAC VENT ISOL VLV BUS SEL - MNB
	CNTL - CL (tb-CL)
	NOZ HTR - OFF
	√Middeck lts as reqd (minimize use)
MO69M	LEH O2 8 vlv - CL
	Remove, stow O2 Bleed Orifice
	LEH O2 8 vlv - as reqd

CLOTHING CONFIG 20

Unstow, don:
ACES
Harness
Boots

LOSS OF FES DEORBIT PREP ENTRY DELTAS MS PULLOUT PAGE

DELTAS TO ENT, DEORBIT BURN

- | | | |
|----|---|-----------|
| 1. | At TIG-30 min, enter ENT, <u>DEORBIT BURN</u>
(do all) | C3
O17 |
| 2. | At TIG-15 min, use two IDP/CRTs with four MDUs as reqd for burn
Minimize use when possible | O17 |
| 3. | At TIG-15, do not perform pnl A14 OMS/RCS heater configurations | |
| 4. | At TIG-5, use MDUs as reqd for APU start, two FLT CNTLR PWR/DDUs as reqd for burn
Minimize use | |

DELTAS TO ENT, POST BURN

- | | | |
|----|---|---------------------|
| 1. | Use one FLT CNTLR PWR, one IDP/CRT with three MDUs only as reqd | |
| 2. | Set event timer counting to EI | |
| 3. | At EI-21:
HYD CIRC PUMP (one of two on non-operating hyd sys) – ON | R2 |
| 4. | At EI-18: If FRCS DUMP reqd:
RJDF LOGIC, DRIVER (eight) – ON
FWD RCS MANF ISOL 1,2,3,4 (four) – OP (tb-OP) | O14,O15,O16:F
O8 |
| 5. | After dump completion:
RJDF LOGIC, DRIVER (eight) – OFF | O14,O15,O16:F |
| 6. | In ENTRY SW CHECK, do not activate ANTISKID, NWS, NAV AIDS | |
| 7. | At EI-13:
Operating HYD CIRC PUMP – OFF
Start second APU (one only)
HYD CIRC PUMP (remaining non-operating hyd sys) – ON | R2
R2 |

- | | |
|----|---|
| 8. | Prior to SSME HYD REPRESS:
√FCS CH (four) – AUTO
ATVC (four) – ON
When SSME REPRESS complete:
ATVC (four) – OFF
√EIU (three) – OFF
√MEC 1,2 (two) – OFF
GNC 51 , BFS GNC 51 SSME
REPOS – ITEM 19 EXEC (INH) |
|----|---|

DELTAS TO ENTRY MANEUVERS CUE CARD

- | | |
|----|--|
| 1. | At EI-5:
Operating HYD CIRC PMP – OFF
Start remaining APU
BRAKES (three) – ON
cb ADTA 1,2,3,4 (four) – cl
GNC I/O RESET |
| 2. | At EI: NH3 CNTLR B – SEC/ON
Use two IDP/CRTs with six MDUs
cb MNA,B,C DDU L,R (four) – cl
FLT CNTLR PWR (two) – ON |
| 3. | If OV103,4:
At V = 15K: TACAN MODE (three) – GPC |
| 4. | At V = 12K: DELETE reference to radiator flow |
| 5. | At V = 6K: NH3 CNTLR B – OFF
A – PRI/GPC |
| 6. | At M = 2.9:
MLS (three) – ON
GNC I/O RESET
RADAR ALTM (two) – ON
HUD PWR (two) – ON
NWS – 1
ANTISKID – ON |
| 7. | Post Wheel-Stop, go to EXPEDITED PWRDN |

This Page Intentionally Blank

LOSS OF 2 H2O LOOPS

PART 1: ON-ORBIT WAIT	8-3
PART 2: ON-ORBIT WAIT BACKOUT	8-9
20-MINUTE DE/REPRESS	8-17



**LOSS OF 2 H2O
LOOPS**

This Page Intentionally Blank

LOSS OF 2 H2O LOOPS

PART 1: ON-ORBIT WAIT

ASSUMPTIONS/INITIAL CONDITIONS

LOSS OF 2 H2O LOOPS assumes one of following pwrdns accomplished:

LOSS OF 2 H2O LOOPS (ORB PKT, PWRDN)

LOSS OF 2 H2O LOOPS (POST OMS-2) (ASC PKT, PWRDN)

IMU 2 and MDM FF2 have been activated

Comm is being cycled per ORB PKT pwrdrn comm pages

PROBLEM DESCRIPTION/RATIONALE

Use of H2O loop or air-cooled equipment is minimized or delayed because heat transfer from crew module is lost

Cabin atmosphere purges are done to aid in reducing cabin humidity and temp. This cycle should be started 1 hr 15 min after failure. Attitude control is reqd during purge because venting is propulsive

Av Bay 1 equipment is used as much as possible to keep Av Bays 2 and 3 cool for entry

LOSS OF 2 H2O LOOPS (Cont)

PART 1: ON-ORBIT WAIT (Cont)

NOTE

1. MS procedures for PART 1: ON-ORBIT WAIT are located on MS PULLOUT PAGES, 8-7. Extra copies are located in back of PLT's book
2. Maintain minimum lighting
3. Use wristwatches for time reference until GMT/MET UPDATE (COARSE) in PART 2: ON-ORBIT WAIT BACKOUT
4. Alternate between GPC 4 and GPC 1 for each Cabin De/Repress cycle. Minimize time that GPCs are on
5. Each GPC will be powered up for 2 sec each cycle to allow error detection and correction logic to scrub memory of any accumulated errors
6. With MDM FF1/off, panel C3 DAP controls are functional even though lights are not on
7. Perform De/Repress during night pass, if possible. De/Repress should occur within 75 min of failure. Subsequent De/Represses at TIG-1:15 and TIG-:20
8. Monitor crew health by applying temp strip (MED Kit) to forehead and trunk of CDR and PLT. Record body temp every 15 min
9. Use Quick Don Mask as needed to provide relief during periods of high cabin temperature and humidity. Do not use Quick Don Mask during cabin repress. Don ACES, activate O2, and close visor if cabin temp > 95 degF and no evaporative cooling is sensed

RJD CONFIG CHECK 1

O6 √MDM FA1,2,3,4 (four) – ON
O14:F,O15:F, √RJDA LOGIC,DRIVER (eight) – ON
O16:F √RJDF LOGIC,DRIVER (eight) – OFF
 √RJD MANF L5/F5/R5 DRIVER – OFF

GNC GPC ACTIVATION 2

Alternate between GPCs 4 and 1
Record MET: 1) ____ / ____ : ____ : ____
 2) ____ / ____ : ____ : ____

C2 IDP/CRT2 PWR – ON
 MAJ FUNC – GNC
L1 AV BAY 1 FAN A(B) – ON
O6 √GPC MODE 4(1) – HALT (tb-bp)
 √OUTPUT 4(1) – NORM (tb-bp)
 PWR 4(1) – ON
 MODE 4(1) – STBY (tb-RUN), RUN

RESTRING TO GNC GPC 3

GNC 0 GPC MEMORY
CONFIG – ITEM 1 +2 EXEC
Assign all strings to GPC 4(1)
GNC, OPS 201 PRO

	ALL	Begin Fluid Loading (one 8 oz container every 15 min, with a salt tablet every other container) and continue through entry
	C,P	Start all <u>CABIN DE/REPRESS</u> cycles approx 20 min before sunrise, if possible
ELAPSED TIME		<u>CABIN DE/REPRESS</u>
	00:00	C,P <u>RJD CONFIG CHECK</u> [1], 8-5
		C <u>PCS SETUP</u> [A] (20 MINUTE DE/REPRESS), 8-17
		C, MS <u>CABIN DEPRESS SETUP</u> [B] (20 MINUTE DE/REPRESS), 8-17
		C,P <u>GNC GPC ACTIVATION</u> [2], 8-5
	00:05	C,P <u>RESTRING TO GNC GPC</u> [3], 8-5
		C,P <u>TAIL SUN ATT MNVR</u> [4]
		MS <u>CABIN DEPRESS</u> [C] (20 MINUTE DE/REPRESS), 8-17
	00:10	
	00:15	C, MS <u>CABIN REPRESS</u> [D] (20 MINUTE DE/REPRESS), 8-17
	C,P <u>ESTABLISH FREE DRIFT</u> [5]	
	C,P <u>GNC GPC POWERDOWN</u> [6]	
00:20		
	MS If MCC requests data on cab temp and humidity, or Av Bay temp, perform <u>CABIN ENVIRONMENT MONITOR</u> [7], 8-7	
	ALL At TIG-1:30, go to PART 2: ON-ORBIT WAIT BACKOUT, 8-9	

TAIL SUN ATT MNVR [4]

WARNING
Do not turn off FF MDM associated with IMU in operate

CRT GNC UNIV PTG

√TGT ID, ITEM 8 +4
BODY VECT – ITEM 14 +5 EXEC
Load Tail Sun Att P = 225, Y = 0, OM = (blank)

C3 DAP: A/AUTO/PRI
TRK – ITEM 19 EXEC (CUR – *)
√ERR TOT – ITEM 23 (*)

ADI √Att mnvr complete

ESTABLISH FREE DRIFT [5]

C3 √CABIN DEPRESS [C] complete
DAP: B/AUTO/PRI
Wait 30 sec
DAP: FREE

NOTE
Deviations from TAIL SUN att are expected during free drift period. No action reqd

GNC GPC POWERDOWN [6]

CRT GNC, OPS 000 PRO

O6 GPC MODE 4(1) – STBY (tb-bp)
– HALT (tb-bp)
– STBY (tb-RUN)
– HALT (tb-bp)

PWR 4(1) – OFF

C2 IDP/CRT 2 PWR – OFF

L1 AV BAY 1 FAN A(B) – OFF
Record MET: 1) ___ / ___ : ___ : ___
2) ___ / ___ : ___ : ___

O6 GPC PWR 1(4) – ON,wait 2 sec,OFF
2 – ON,wait 2 sec,OFF
3 – ON,wait 2 sec,OFF
5 – ON,wait 2 sec,OFF

LOSS OF 2 H2O LOOPS

PART 1: ON-ORBIT WAIT MS ACTIVITIES

MS PULLOUT PAGE

NOTE

Wait for GO from CDR or PLT before starting any activity on this page

<u>CABIN ENVIRONMENT MONITOR</u> 7	
	Perform at GSTDN (SGLS) on MCC call
	<u>NOTE</u> Cab or Av Bay fan must be on for good cab air temp and humidity, or Av Bay temp readings as reqd
	If MCC requests data on cab environ:
L1 O15:B L4:K :L	√CAB FAN A(B) – ON cb MNB OI MDM OF 1/2 B – cl √AC1 φB CAB AIR S/C – cl √AC2 φA CAB T CNTLR 1 – cl
	If MCC requests data on Av Bay 1:
L1 O15:B L4:L	√AV BAY 1 FAN B(A) – ON cb MNB OI MDM OF 1/2 B – cl SIG CONDR OF 2/3 A – cl √AC3 φB AV BAY 1 S/C – cl
	If MCC requests data on Av Bay 2:
L1 O14:B O15:B L4:L	√AV BAY 2 FAN A(B) – ON cb MNA OI MDM OF 3/4 A – cl MNB OI SIG CONDR OF 2/3 A – cl √MNBAC1 φB AV BAY 2 S/C – cl
	If MCC requests data on Av Bay 3:
L1 O15:B L4:L	√AV BAY 3 FAN B(A) – ON cb MNB OI MDM OF 1/2 B – cl SIG CONDR OF 1/4 B – cl √AC2 φB AV BAY 3 S/C – cl
	Perform LOSS OF 2 H2O LOOPS COMM POWERUP, steps 1,4,5,6 (ORB PKT, <u>PWRDN</u>)
C3	OI PCMMU PWR – 1
	After comm/data complete: Go to LOSS OF 2 H2O LOOPS COMM PWRDN (ORB PKT, <u>PWRDN</u>) and pwrdn equipment used in above steps

This Page Intentionally Blank

LOSS OF 2 H2O LOOPS

PART 2: ON-ORBIT WAIT BACKOUT MS PULLOUT PAGE

I

ASSUMPTIONS/INITIAL CONDITIONS

LOSS OF 2 H2O LOOPS (ORB PKT, PWRDN) has been accomplished

Orbiter in On-Orbit Wait config – IMU 2 and MDM FF2 activated

Cabin de/repress cycle has been performed during Part 1

Comm is being cycled per ORB PKT pwrtn comm pages

CONUS TIG available in ≥ 1.5 hr

PROBLEM DESCRIPTION/RATIONALE

IMU reference maintained and heat load minimized during Part 1 by allowing IMU to run uncompensated (GPC off)

During Part 2: ON-ORBIT WAIT BACK OUT, minimum equipment configured to accomplish PLBD closing, IMU alignment, and GMT/MET update. Final powerup to single-fault tolerant entry config initiated at TIG-0:30 min in LOSS OF 2 H2O LOOPS DEORBIT PREP/ENTRY (Sec 9)

NOTE

1. MS procedure located on MS PULLOUT PAGE, 8-15. Extra copies located in back of PLT's book
2. Continue Fluid Loading (8 oz water every 15 min, with a salt tablet every other container)

MS PULLOUT PAGE

FES HTR ACTIVATION		14
C	L1	√TOP EVAP HTR NOZ L,R (two) – B AUTO √DUCT sel – B
	L2	√HI LOAD DUCT HTR sel – A/B
	R11L	√FLASH EVAP FDLN HTR A,B SPLY (two) – 2 SPLY H2O B SPLY ISOL VLV – OP (tb-OP)

RAD BYP CONFIG		15
C	L1	FLASH EVAP CONFIG FLASH EVAP CNTLR SEC – ON PRI B(A) – OFF
	L2	<u>RAD BYP</u> RAD BYP VLV MODE (two) – MAN RAD BYP VLV MAN SEL (two) – BYP (after ~3 sec, tb-BYP)
	O1	RAD CNTLR LOOP 1,2 (two) – OFF FREON ISOL MODE – OFF √FREON EVAP OUT TEMP ind ~62 ± 2 degF (after ~2.5 min)

DEACT GPC 4		16
O6	R11L	√PLBD – closed GPC/CRT – 14 EXEC GPC MODE 4 – STBY (tb-bp),HALT PWR 4 – OFF IDP/CRT4 PWR – OFF

GMT AND MET UPDATE (COARSE)		8
		<u>NOTE</u> This procedure provides for crew autonomous update of onboard GMT and MET. OPS 0 reqd for GMT UPDATE > 15 msec
P	C2 CRT	√PLBD – closed √Depress complete IDP/CRT2 PWR – ON GNC, OPS 000 PRO 2: GNC GPC MEMORY
		<u>NOTE</u> Make no kybd entries during TIME SYNC and UPDATE actions. UPDATE causes reinitialization and TIME SPEC will have to be recalled
		1. 2: GNC 2 TIME TIME SYNC – ITEM 38 EXEC (takes up to 2 min)
		2. <u>GMT UPDATE</u> Calculate GMT Δ for ITEM 24 as follows: GMT Δ = wristwatch GMT – orbiter GMT (DAY/HR:MIN:SEC)
		ITEM 24 <input type="text" value="±"/> <input type="text"/> <input type="text"/> / <input type="text"/> <input type="text"/> : <input type="text"/> <input type="text"/> : <input type="text"/> <input type="text"/> . <input type="text"/> <input type="text"/>
		UPDATE – ITEM 32 EXEC (takes up to 2 min, SPEC 2 resumes at update)
		3. Record GMT when MET RESET occurs: ____/____:____:____ Reset MET to 0 on an even GMT min
		MET RESET – ITEM 33 EXEC
		4. <u>MET UPDATE</u>
		GMT at liftoff = <input type="text" value="±"/> <input type="text"/> <input type="text"/> / <input type="text"/> <input type="text"/> : <input type="text"/> <input type="text"/> : <input type="text"/> <input type="text"/> . <input type="text"/> <input type="text"/>
		Calculate MET Δ for ITEM 28 as follows: MET Δ = GMT recorded in step 3 – GMT at liftoff √ITEM 2 (*)
		ITEM 28 <input type="text" value="±"/> <input type="text"/> <input type="text"/> / <input type="text"/> <input type="text"/> : <input type="text"/> <input type="text"/> : <input type="text"/> <input type="text"/> . <input type="text"/> <input type="text"/>
		UPDATE – ITEM 32 EXEC (takes up to 2 min)
		GNC, OPS 201 PRO
	C2	IDP/CRT2 PWR – OFF

TIG	
-01:30	
C,P	<u>FES HTR ACTIVATION</u> [14], 8-10
-01:25	C,P <u>FES CHECKOUT</u> [17]
C,P	<u>ACTIVATE GPC 1.4</u> [18]
-01:20	
C	<u>RAD BYP CONFIG</u> [15], 8-10
-01:15	C,MS Perform <u>20 MINUTE DE/REPRESS</u> [A] thru [D], 8-17
MS	<u>PLBD CLOSING</u> [19], 8-15
-01:10	
MS	<u>POST CLOSING CONFIG</u> [20], 8-15
C,P	<u>DEACT GPC 4</u> [16], 8-10
P	<u>GMT AND MET UPDATE (COARSE)</u> [8], 8-10
-01:05	
-01:00	

FES CHECKOUT [17]

C L1 FLASH EVAP CNTLR PRI A,B,SEC (three) – OFF
 RAD CNTLR OUT TEMP – HI

O1 When FREON EVAP OUT TEMP ind > 50 degF
 RAD CNTLR OUT TEMP – NORM (then immediately)
 FLASH EVAP CNTLR PRI B(A) – ON

After 1 min:
 √FREON EVAP OUT TEMP ind ~39 degF

ACTIVATE GPC 1.4 [18]

O14:F MMU 1 – ON (wait 34 sec)

C,P GPC 1.4 ACTIVATION
 L1 AV BAY 1 FAN A(B) – ON
 O6 √GPC MODE 1,4 – HALT (tb-bp)
 √OUTPUT 1,4 – NORM (tb-bp)
 PWR 1,4 – ON
 MODE 1,4 – STBY (tb-RUN),RUN

C2 MEDS CONFIG
 IDP/CRT2 PWR – ON
 GPC/CRT 03 EXEC
 44 EXEC
GPC 1(4) TO GNC (SM) OPS 2
GNC 0 GPC MEMORY
 CONFIG – ITEM 1 +2 EXEC
 Deassign GPC4 from target set
 Assign all strings to GPC1
 √PL 1/2 not assigned
 GNC, OPS 201 PRO
 DAP: B/AUTO/PRI
TRANSITION GPC 4 TO SM OPS 2

R11L IDP/CRT4 PWR – ON
 MAJ FUNC – SM

C2 IDP/CRT2 PWR – OFF
 CRT4 SM, GPC/CRT 44 EXEC
 SM, OPS 201 PRO
 Enable Uplink Control
4: SM 1 DPS UTILITY

O14:F ITEM 36 EXEC (*)
 MMU 1 – OFF

O13:A MTU ACTIVATION
 :C cb ESS 1BC MTU A – cl
 2CA MTU B – cl
 (Record MET of cb closure: ___/___:___)

IMU STAR ALIGN PAD

NOTE

For pad data, ref STAR PAIRS (ORB OPS, PTG)

STAR ID: -Y ____, ____ (TIG - ____ : ____ TO - ____ : ____)

-Z ____, ____ (TIG - ____ : ____ TO - ____ : ____)

ANG DIF: _____

ALIGNMENT ATTITUDE
(Dual or Single S TRK)

2nd ALIGNMENT ATTITUDE
(Single S TRK)

-Z: _____ -Y: _____

R _____

R _____

R _____

P _____

P _____

P _____

Y _____

Y _____

Y _____

MNVR TO IMU ALIGN ATT 9

R11L IDP/CRT4 PWR - ON
MAJ FUNC - GNC

C

4: GNC UNIV PTG

Load ALIGN ATT from MCC
or STAR PAIRS (ORB OPS, PTG)

CRT
C3(A6)
L1

ITEM 18 EXEC
DAP: A/AUTO/PRI
HI LOAD EVAP - ENA
FLASH EVAP CNTLR PRI B(A) - ON
SEC - OFF

√Att mnvr complete
DAP: B/AUTO/PRI

IMU ALIGN 10

C O6

MDM FF1 - ON
√FF3 - ON

4: GNC 22 S TRK/COAS CNTL

GNC I/O RESET

1. S TABLE CLR - ITEM 20 EXEC
S TRK - ITEM 3,4 EXEC (*)

2. √S TABLE: TRK ID 1,2 - STAR ID (PAD)
√ANG ERR 1: ≤ 0.08
√SEL ITEM 17,18 (*)

4: GNC 21 IMU ALIGN

√REF STAR - ITEM 13 (*)
√TYPE - ITEM 15 (TORQUE)
√ANG 2 ΔX,ΔY,ΔZ ≤ 2°

3. ALIGN IMU 2 - ITEM 11 EXEC (*)
EXEC - ITEM 16 EXEC (*)
√EXEC - ITEM 16 (no *)

WARNING
Do not turn off FF MDM
associated with IMU just aligned

O6
R11L

MDM FF1,3 - OFF
IDP/CRT4 PWR - OFF

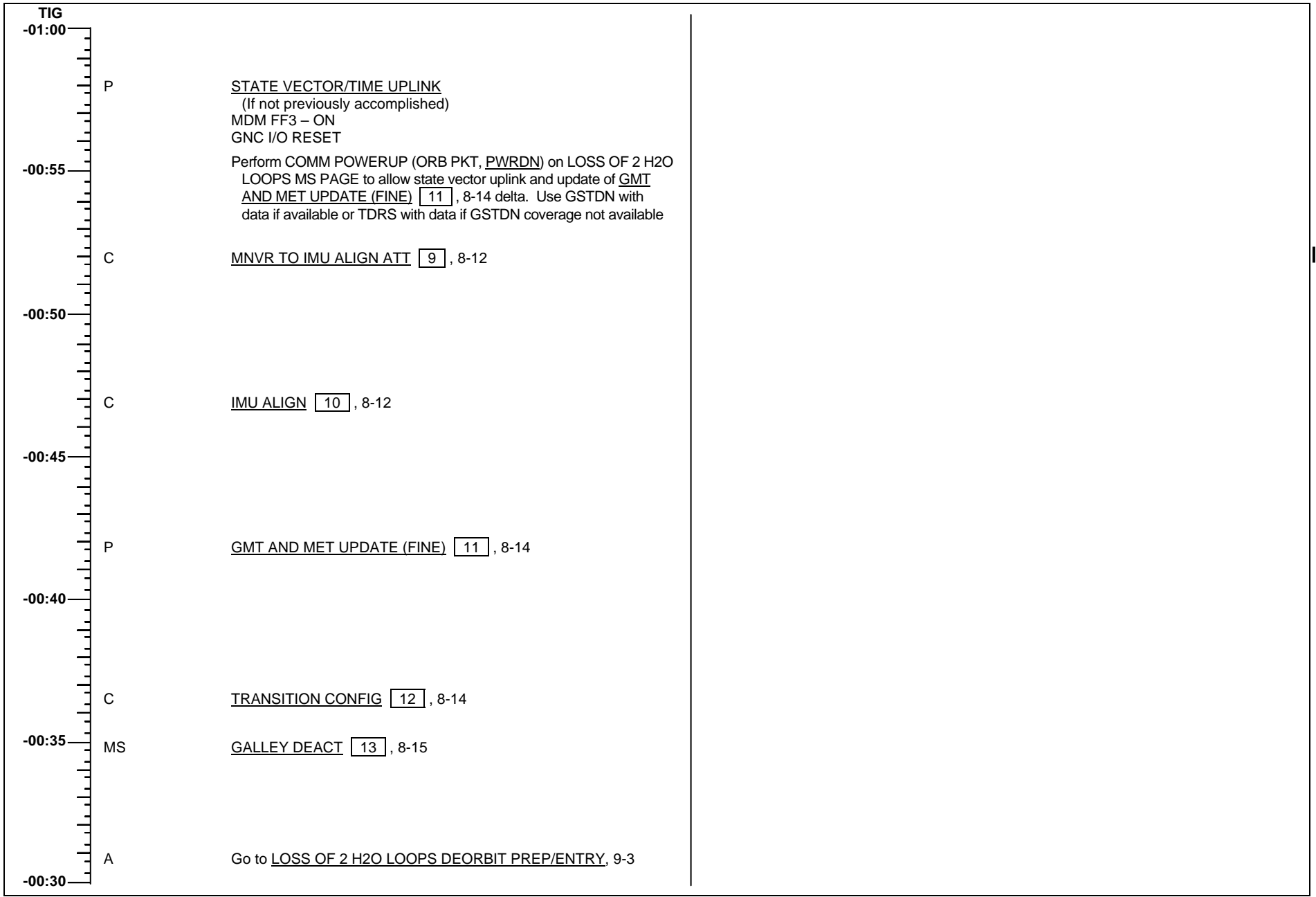

GMT AND MET UPDATE (FINE) 11

NOTE

This procedure is for updating onboard GMT and MET to degree of accuracy reqd for ENTRY. Use deltas provided by MCC. OPS 0 reqd for GMT UPDATE > 15 msec

WARNING

Remaining in OPS 0 longer than 10 min will cause state vector to be lost

P C2

1. IDP/CRT2 PWR – ON
GNC, OPS 000 PRO

NOTE

Make no kybd entries during TIME SYNC and UPDATE actions. GMT UPDATE causes reinitialization and TIME SPEC will have to be recalled

2. 2: GNC 2 TIME
TIME SYNC – ITEM 38 EXEC (takes up to 2 min)

3. GMT UPDATE
Use GMT Δ provided by MCC for ITEM 24 (DAY/HR:MIN:SEC)

ITEM 24 [±] [] [] [] [] / [] [] [] [] : [] [] [] [] : [] [] [] [] . [] [] [] []

UPDATE – ITEM 32 EXEC (takes up to 2 min, SPEC 2 resumes at update)

4. When update complete:
GNC, OPS 201 PRO
5. Calculate MET Δ to be used for ITEM 28 in step 6 as follows:
MET Δ = GMT – GMT at liftoff – MET

6. MET UPDATE
√ITEM 2 (*)

ITEM 28 [±] [] [] [] [] / [] [] [] [] : [] [] [] [] : [] [] [] [] . [] [] [] []

UPDATE – ITEM 32 EXEC (takes up to 2 min)

SET CRT TIMER TO COUNT DOWN TO TIG

(HR:MIN:SEC – MET)

COUNT TO – ITEM 17 + [] [] [] + [] [] [] + [] [] []

C2

TRANSITION CONFIG 12

C O13:E cb ESS 3AB GPC STAT – cl
O14:C MNA SMOKE DETN L/R FLT DK – cl

LOSS OF 2 H2O LOOPS MS ACTIVITIES

Part 2: ON-ORBIT WAIT BACKOUT MS ACTIVITIES MS PULLOUT PAGE

NOTE

Wait for GO from CDR or PLT before starting any activity on this page

TIME (TIG-)	MS ACTIONS
	<p align="center"><u>NOTE</u></p> <p>Prepare ACES for donning. Don ACES if cabin temp > 95 degF and no evaporative cooling sensed. Inflate anti-G suit as needed for circulatory support</p>
1:13	<u>PLBD CLOSING</u> [19]
1:08	<u>POST CLOSING CONFIG</u> [20]
0:42	<u>STOW COAS</u>
0:35	<u>GALLEY DEACT</u> [13]

PLBD CLOSING [19]

MA73C:A MCA LOGIC MID (four) – ON
:B MCA LOGIC MID (four) – ON

O6 CLOSE PLBD
CRT4 MDM PL1,2 (two) – ON
SM I/O RESET
SM, OPS 202 PRO

[4: SM PL BAY DOORS]

CAUTION

Verify no obstructions before closing and latching PLBD (Ku ANT, RMS, RAD, etc.)

R13L PL BAY DR SYS (two) – ENA
CRT4 AC PWR ON – ITEM 1 EXEC
AUTO MODE SEL – ITEM 3 EXEC
PBD SW BYP – ITEM 14 EXEC
CLOSE – ITEM 17 EXEC

* If 'S63 PBD SEQ FAIL' msg, √AUTO SEQ column: *
* If '↓' for CENTER, PORT(STBD) FWD or PORT *
* (STBD) AFT LATCHES, continue in MANUAL *
* mode (skip affected latch gang) *
* If '↓' for PORT(STBD) DOOR: *
* If PORT DOOR, and DOOR SCALLOP on or *
* below target line, continue in MANUAL mode *
* If either AFT LATCHES close MICRO-SW STAT *
* for aff DOOR is '1', continue in MANUAL mode *
* Perform MAL, MECH, SSR-2 CONTINGENCY *
* PLBD CLOSURE *

After PLBD closed:

PBD STOP – ITEM 16 EXEC
AC POWER OFF – ITEM 2 EXEC (*)
PBD SW BYP – ITEM 14 EXEC (no *)
PL BAY DR SYS (two) – DSBL

R13L

POST CLOSING CONFIG [20]

A7U √PL BAY FLOOD (all) – OFF

MA73C:A MCA LOGIC MID (four) – OFF
:B MCA LOGIC MID (four) – OFF
O6 MDM PL1 – OFF

If no data transmission in progress:
MDM PL2 – OFF

GALLEY DEACT [13]

NOTE

Ensure sufficient containers and salt tablets prepared to continue Fluid Loading thru entry

MA73C:G cb AC3 GALLEY FAN (three) – op
ML86B:B cb MNA GALLEY OVEN – op
MNB GALLEY H2O HTR – op
REHYD STA lever – cl (push in)
OVEN DOOR LATCH – latched

This Page Intentionally Blank

20-MIN
DE/REPRESS

MS PULLOUT PAGE
20 MINUTE DE/REPRESS

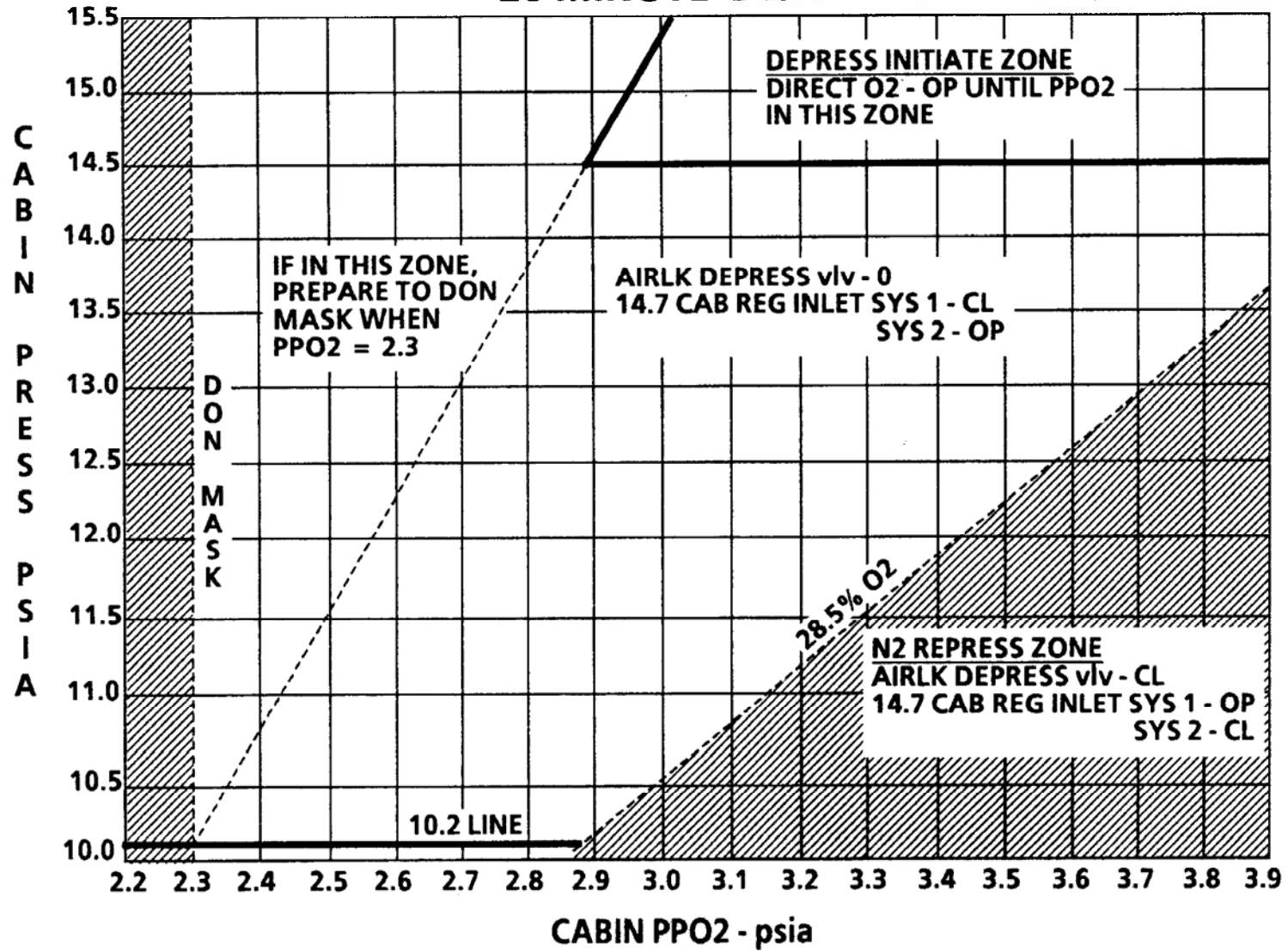

LOSS OF 2 H2O LOOPS DEORBIT PREP/ENTRY

**LOSS OF 2 H₂O
LOOPS D/O PREP**

This Page Intentionally Blank

LOSS OF 2 H2O LOOPS DEORBIT PREP/ENTRY

ASSUMPTIONS/INITIAL CONDITIONS

LOSS OF 2 H2O LOOPS DEORBIT PREP/ENTRY is a **STAND-ALONE procedure** that assumes one of the following has been accomplished:

LOSS OF 2 H2O LOOPS (ORB PKT, PWRDN)

LOSS OF 2 H2O LOOPS (POST OMS-2) (ASC PKT, PWRDN)

LOSS OF 2 H2O LOOPS (ORB PKT, PWRDN) and LOSS OF 2 H2O LOOPS Parts 1 and 2 (Section 8)

This procedure assumes 30 min remaining until deorbit burn

PROBLEM DESCRIPTION RATIONALE

With no H2O loop flow, heat not removed from water and air-cooled equipment. ORB PKT pwrdsn maintained until TIG-30 min to minimize thermal load as long as possible

NOTE

1. LOSS OF 2 H2O LOOPS DEORBIT PREP/ENTRY configures vehicle for entry as quickly as possible and repowers critical equipment as late as possible to single-fault tolerant level
2. MS procedures located on MS PULLOUT PAGE, 9-5. Extra copies located in back of PLT's book
3. CDR and PLT procedures begin on 9-7
4. Use COMM pages from ORB PKT pwrdsn to cycle COMM if necessary
5. This procedure utilizes modified version of DEORBIT BURN MONITOR and ENTRY MANEUVERS Cue Cards located at end of section

This Page Intentionally Blank

**LOSS OF 2 H2O LOOPS DEORBIT PREP/ENTRY
MS PULLOUT PAGE**

NOTE: Wait for GO from CDR before accomplishing any action on this page

TIG-20 MCA CONFIG

MA73C MCA LOGIC (fourteen) – ON

CABIN DE/REPRESS

TIG-20 Perform 20 MINUTE DE/REPRESS, 8-17

TIG-10 AFT PANEL CONFIG FOR ENTRY COMM

NOTE

This procedure configures aft panel for landing site comm coverage at V = 12K. If comm cycled post TIG-10 (using ORB PKT pwrn comm pages), this AFT PANEL CONFIG FOR ENTRY COMM must be reestablished

L9,R10	PS,MS AUD PWR	– AUD
R14:B	cb GCILC (two)	– cl
C3	S-BD PM CNTL	– CMD
A1L	ANT SW ELEC	– 2
	MODE	– STDN LO
	XPNDR	– 2
	NSP PWR	– 2
	DATA RATE XMIT	– HI
	RCV	– HI
	√UPLK DATA	– S-BD
	√CODING XMIT	– OFF
	√RCV	– OFF

(Cont in right column)

TIG-7 AIRLOCK CLOSEOUT (assumes Cabin Depress complete)

Close INNER HATCH:
Position handle to preclosing posn per decal
Hatch – rotate about hinge and push
Handle – CCW to LATCH
Lock lever to LOCKED
Equal vlv – NORM

TIG-5 LEH VLV CONFIG

MO69M	LEH O2 8 vlv – CL
	Remove, stow O2 Bleed Orifice
MO32M	LEH O2 7,8 vlv (two) – OP (if reqd)
	5,6 vlv (two) – OP (if reqd)

CLOTHING CONFIG

	Don: ACES, Harness, Boots
C6	LEH O2 vlv (two) – OP
EI-10	Stow flight deck PGSC

This Page Intentionally Blank

LOSS OF 2 H2O LOOPS DEORBIT PREP/ENTRY

	CDR	PLT
	O6 MDM FF1,3 (two) – ON √FF2 – ON I/O RESET	DEORBIT TARGET Use Deorbit Manager on PGSC to compute targets (record on 9-10)
	F6 HUD DATA BUS – 1	W/B STEAM VENT HTR ACT
	CABIN DE/REPRESS	R2 BLR PWR (three) – ON
		SWITCH CONFIG FOR OPS 3
TIG-20	Perform 20 MINUTE DE/REPRESS, 8-17	O14,O15, O16:A RGA 1,2,3 (three) – ON
	VERIFY DAP/SELECT PRIs	O14,O15:E cb ACCEL 1,2 (two) – cl
	√DAP: A1/AUTO/PRI	O14,O15, O16:F ASA (four) – ON
	B set to B1	O16:F ACCEL 3 – ON
	MCA CONFIG (no earlier than TIG-20)	Verify MCA LOGIC config complete, then:
	Give MS GO for MCA LOGIC config	O8 FWD RCS MANF ISOL 1,2,3,4 (four) – CL (tb-CL)
		IMU ACTIVATION (if IMUs 1,3 off)
		<u>NOTE</u>
		IMU ACT can be performed in OPS 2 or 3
		<u>ACTIVATE IMU 1,3</u>
		O14:A IMU 1 – ON
		O16:A 3 – ON
		GNC 21 IMU ALIGN
		CRT IMU 1,3: OPER, ITEM 4,6 EXEC (*) (wait 90 sec for *)
		I/O RESET
		<u>IMU to IMU ALIGNMENT</u>
		√IMU 1,3: STAT – blank
		REF IMU – ITEM 14 +2 (ref IMU) EXEC
		√TYPE, ITEM 15 – TORQUE
		ALIGN IMU 1,3 – ITEM 10,12 EXEC (*)
		2 – ITEM 11 EXEC (no *)
		EXEC – ITEM 16 EXEC (*)
		(Cont next page)

LOSS OF 2 H2O LOOPS DEORBIT PREP/ENTRY

CDR

PLT

STAR TRKR DEACT

O6 S TRK PWR (two) – OFF
 O14:E,
 O15:E cb S TRK -Z,-Y (two) – op
 O6 S TRK DR CNTL SYS 1,2 (two) – CL (start timer)
 √POS tb (two) – bp
 When both tb – CL (~8-24 sec)
 or either tb – bp > 24 sec,
 S TRK DR CNTL SYS 1,2 (two) – OFF

DPS ENTRY CONFIG (assumes GPC 1 active)

NOTE

Do not perform DPS ENTRY CONFIG
 if IMU Align in progress

O15:F MMU 2 – ON, wait 34 sec
 O6 √GPC MODE 2,3,4,5 (four) – HALT (tb-bp)
 √OUTPUT 2,3,4 (three) – NORM (tb-bp)
 5 – B/U (tb-bp)
 PWR 3,5 (two) – ON
 MODE 3,5 (two) – STBY (tb-RUN)
 – RUN

CRT GNC 0 GPC MEMORY
 CONFIG – ITEM 1 +3 EXEC
 Modify MC3 per table →
 GNC, OPS 301 PRO
DEORB MNVR COAST

CONFIG	3
GPC	10000
STR 1	1
2	1
3	1
4	1
PL 1/2	1
CRT 1	1
2	1
3	1
4	0
L 1	0
2	0
MM 1	1
2	1

(Cont next page)

RESELECT IMU 1,3

√ALIGNMENT COMPLETE – ITEM 16 (no *)
 IMU 1,3: DES – ITEM 7,9 EXEC (no *)

Do not proceed until all DPS ENTRY CONFIG
 steps complete

CLOSE VENT DOORS

O6 MDM FF4 – ON
 GNC I/O RESET
GNC 51 OVERRIDE
 CRT VENT DOOR CNTL CLOSE – ITEM 44 EXEC
 (*), wait 1 min, then
 O6 MDM FF4 – OFF

LANDING SITE UPDATE

1: GNC 50 HORIZ SIT
 SEL SITE, RWY (PASS/BFS)

DRAG ALT ATM SELECTION

SEL ATM: incl ≤ 50° √ITEM 22 (*)
 incl > 50° SEL ITEM NR (table)

Hemi	Jan	Feb	Mar	Apr	May	Jun	Jul	Aug	Sep	Oct	Nov	Dec
N Desc	23	23	23	23	22	24	24	24	22	23	23	23
S Asc	24	24	22	23	23	23	23	23	23	23	22	24
N Asc	22											
S Desc												

CHECK CG

UPDATE PRPLT ITEM 18 as reqd

(Cont next page)

LOSS OF 2 H2O LOOPS DEORBIT PREP/ENTRY

CDR

PLT

GNC 0 GPC MEMORY

CONFIG – ITEM 1 +3 EXEC

Modify MC 3 per table →

GNC, OPS 301 PRO (√DAP)

BFS: GNC, OPS 301 PRO

GNC, OPS 302 PRO

GNC 0 GPC MEMORY

DOWNLIST GPC – ITEM 44

+3 EXEC

CONFIG		3
GPC		10300
STR	1	3
	2	3
	3	3
	4	3
PL	1/2	3
CRT	1	3
	2	3
	3	3
	4	0
L	1	0
	2	0
MM	1	3
	2	3

O6

GPC MODE 1 – STBY (tb-bp)

– HALT

PWR 1 – OFF

GPC/CRT 0/4 EXEC

For any fwd IDP pwrd off:

GPC/CRT 3/X EXEC

O15:F

MMU 2 – OFF

L1

AV BAY 1 FAN (two) – OFF

2 FAN A(B) – ON

(wait 3 sec, then)

3 FAN B(A) – ON

AFT PANEL CONFIG FOR ENTRY COMM

(no earlier than TIG-10 min)

Give MS GO to config AFT panel

Cabin Repress (no earlier than TIG-10)

Give MS GO for CABIN REPRESS

(20 MINUTE DE/REPRESS), 8-17 and

AIRLOCK CLOSEOUT, 9-5

Do not pwr off Cabin Fan A after Repress

complete

OMS BURN PREP

O7

AFT L,R RCS He PRESS (four) – OP (tb-OP)

TK ISOL (six) – GPC (tb-OP)

XFEED (four) – GPC (tb-CL)

√MSTR RCS XFEED – OFF

O8

√L,R OMS He PRESS/VAP ISOL (four) – CL

√TK ISOL (four) – OP

– (tb-OP)

√XFEED (four) – CL (tb-CL)

FWD RCS He PRESS (two) – OP (tb-OP)

Use two IDP/CRTs with four MDUs for deorbit

burn

LOSS OF 2 H2O LOOPS DEORBIT PREP/ENTRY

LOAD TGTs AND MNVR

CRT Enter TGT data from MCC or PGSC → DEORBIT PAD

LOAD – ITEM 22 EXEC
 TIMER – ITEM 23 EXEC

O14:E,
 O15:E,
 O16:E cb MNA,B,C DDU L,R (four) – cl

Mnvr to burn att

Select right sec gimbals
 (because FF4 - OFF)
 RIGHT – ITEM 31 EXEC

CLOTHING CONFIG

Don: ACES,Harness,Boots

C6 LEH O2 vlv (two) – OP

TIG-2 Go to Deorbit Burn Cue Cards

NOTE

If FRCS COMPLETION reqd during burn, perform FRCS RECOVERY prior to fast flip.

Use LOSS of 2 H2O LOOPS DEORBIT BURN MONITOR

RECORD DEORBIT OPPORTUNITIES		
SITE	APPROX TIG	XRNG
_____	____/____:____:____	_____
_____	____/____:____:____	_____
_____	____/____:____:____	_____
_____	____/____:____:____	_____

COMPUTE WEIGHT
 Use Deorbit Manager on PGSC (record below)

COMPUTE TARGET

WT	_____
TIG	____/____:____:____
C1	_____
C2	(-).6000
HT	65.832
θT	_____
ΔVTOT	_____
REI	_____

FRCS RECOVERY (if reqd for FRCS COMPLETION)	
O14,O15,	RJDF LOGIC,DRIVER (eight) – ON
O16:F	
O6	MDM FF4 – ON GNC I/O RESET
O8	FWD RCS MANF ISOL 1,2,3,4 (four) – OP (tb-OP)

LOSS OF 2 H2O LOOPS

DEORBIT BURN MONITOR

OMS TEMP* FU IN P ≥ <table border="1" style="display: inline-table; vertical-align: middle;"><tr><td style="width: 20px; text-align: center;">L</td><td style="width: 20px; text-align: center;">R</td></tr><tr><td style="text-align: center;">219</td><td style="text-align: center;">220</td></tr></table> ≤ <table border="1" style="display: inline-table; vertical-align: middle;"><tr><td style="width: 20px; text-align: center;">201</td><td style="width: 20px; text-align: center;">208</td></tr></table> or No FU IN P	L	R	219	220	201	208	OMS ENG FAIL ----- OMS PRPLT FAIL
L	R						
219	220						
201	208						
OMS PC* & OMS ↓ (BFS: √accel) ENG VLV 1 or 2 < 70 or OX IN P > 227 ----- OX IN P ≤ 227 or No OX IN P	OMS ENG FAIL ----- OMS PRPLT FAIL						
OMS OX/FU TK P (√ENG IN P) OX/FU LOW ----- OX & FU HIGH	He PRESS/VAP ISOL (two) – OP If aff TK P not incr: He PRESS/VAP ISOL (two) – CL At PC < 72 or OMS TEMP: OMS PRPLT FAIL ----- He PRESS/VAP ISOL (two) – CL Cycle He A(B) to maintain TK P 234-284						
OMS GMBL PRI fail ----- SEC fail	L(R) OMS GMBL – SEC ----- If high RCS usage: OMS ENG FAIL						
GPC 3	BFS Engage						
I/O ERROR FA 1 ----- 2 FAs lost	L OMS GMBL – SEC ♦ I/O RESET (if recov: BFS I/O RESET) If high RCS usage: OMS ENG FAIL ----- √MAN SHUTDN						
BCE STRG D 1 ----- 3	I/O RESET (if recov: >>) If high RCS usage: L OMS GMBL – SEC ----- If high RCS usage: R OMS ENG FAIL						
RM DLMA IMU or 2 MN BUSES CUR HP > <table border="1" style="display: inline-table; vertical-align: middle;"><tr><td style="width: 20px; height: 15px;"></td><td style="width: 20px; height: 15px;"></td></tr></table> (safe HP) IMU dilemma			STOP BURN: OMS ENG(s) – OFF >> ----- After C/O: √Timer <table border="1" style="display: inline-table; vertical-align: middle;"><tr><td style="width: 20px; text-align: center;">G21</td></tr></table> If any IMU ACC > 0.03: aff IMU – desel I'cncnt OMS to RCS (√RCS Burn time) THC +X to TGT Hp	G21			
G21							
I/O ERROR PCM	OI PCMMU PWR – 1						

*If XFD, BLDN, or sensor fail, monitor ENG IN P for off-nominal performance

LOSS OF 2 H2O LOOPS DEORBIT PREP/ENTRY

	CDR	POST BURN ACTIVITIES	PLT
	O14:E, cb MNA,B DDU L (two) – op O15:E F6 FLT CNTLR PWR – OFF		O15:E, cb MNB,C DDU R (two) – op O16:E F8 FLT CNTLR PWR – OFF
	C3 √DAP: AUTO		C3 √DAP: AUTO
	MNVR TO EI-5 ATT		OMS/RCS POST BURN RECONFIG
	CRT1 GNC, OPS 303 PRO		O7 √AFT L,R RCS He PRESS (four) – OP (tb-OP) √TK ISOL (six) – GPC (tb-OP) √XFEED (four) – GPC (tb-CL)
TIME TO EI (MIN)	LVLH PITCH (DEG)		O8 √L,R OMS He PRESS/VAP ISOL (four) – CL √TK ISOL (four) – OP (tb-OP) √XFEED (four) – CL (tb-CL)
26	315		
25	319		
24	323		
	327		
	331		
	335		
20	339		
	343		
	347		
	351		
	355		
15	359		
	3		
	7		
	11		
	15		
10	19		
	23		
	27		
	31		
	35		
5	39		
		NOTE Use LVLH table unless INRTL EI-5 attitude (ITEMS 24,25,26) supplied by MCC. Use DDU and FLT CNTLR PWR as reqd for manual mnvr	
		<u>When mnvr complete</u> L4:P cb LG SNSR (two) – cl O14:A, BRAKES (three) – ON O15:A, O16:A	
			APU PRE-START
			R2 BLR N2 SPLY (three) – ON √PWR (three) – ON √CNTLR/HTR (three) – A(B) √cb APU FU TK VLV ENA (six) – cl √APU FU TK VLV (three) – CL √AUTO SHTDN (three) – ENA √SPEED SEL (three) – NORM √OPER (three) – OFF HYD CIRC PUMP (three) – OFF MN PUMP PRESS (three) – LO APU CNTLR PWR (three) – ON

LOSS OF 2 H2O LOOPS

DEORBIT BURN MONITOR

OMS TEMP* FU IN P ≥ <table border="1" style="display: inline-table; vertical-align: middle;"><tr><td style="width: 20px; text-align: center;">L</td><td style="width: 20px; text-align: center;">R</td></tr><tr><td style="text-align: center;">219</td><td style="text-align: center;">220</td></tr></table> ≤ <table border="1" style="display: inline-table; vertical-align: middle;"><tr><td style="width: 20px; text-align: center;">201</td><td style="width: 20px; text-align: center;">208</td></tr></table> or No FU IN P	L	R	219	220	201	208	Oms Eng Fail Oms PRPLT Fail
L	R						
219	220						
201	208						
OMS PC* & OMS ↓ (BFS: √accel) ENG VLV 1 or 2 < 70 or OX IN P > 227 OX IN P ≤ 227 or No OX IN P	Oms Eng Fail Oms PRPLT Fail						
Oms OX/FU TK P (√ENG IN P) OX/FU LOW OX & FU HIGH	He PRESS/VAP ISOL (two) – OP If aff TK P not incr: He PRESS/VAP ISOL (two) – CL At PC < 72 or OMS TEMP: Oms PRPLT Fail He PRESS/VAP ISOL (two) – CL Cycle He A(B) to maintain TK P 234-284						
Oms GMBL PRI fail SEC fail	L(R) Oms GMBL – SEC (twice) If high RCS usage: Oms Eng Fail						
GPC 3	BFS Engage						
I/O ERROR FA 1 2 FAs lost	L Oms GMBL – SEC I/O RESET (if recov: BFS I/O RESET) If high RCS usage: Oms Eng Fail √MAN SHUTDN						
BCE STRG D 1 3	I/O RESET (if recov: >>) If high RCS usage: L Oms GMBL – SEC (twice) If high RCS usage: R Oms Eng Fail						
RM DLMA IMU or 2 MN BUSES CUR HP > <table border="1" style="display: inline-table; vertical-align: middle;"><tr><td style="width: 20px; height: 15px;"></td><td style="width: 20px; height: 15px;"></td></tr></table> (safe HP) IMU dilemma			STOP BURN: Oms Eng(s) – OFF >> After C/O: √Timer G21 If any IMU ACC > 0.03: aff IMU – desel I'cnct Oms to RCS (√RCS Burn time) THC +X to TGT Hp				
I/O ERROR PCM	OI PCMMU PWR – 1						

*If XFD, BLDN, or sensor fail, monitor ENG IN P for off-nominal performance

LOSS OF 2 H2O LOOPS DEORBIT PREP/ENTRY

	CDR	POST BURN ACTIVITIES	PLT
	O14:E, O15:E F7	cb MNA,B DDU L (two) – op,cl as reqd to achieve/maintain EI-5 attitude FLT CNTLR PWR – OFF	O15:E, O16:E F8
	C3	√DAP: AUTO	C3
	MNVR TO EI-5 ATT		OMS/RCS POST BURN RECONFIG
	CRT1	GNC, OPS 303 PRO	O7
			√AFT L,R RCS He PRESS (four) – OP (tb-OP) √TK ISOL (six) – GPC (tb-OP) √XFEED (four) – GPC (tb-CL)
			O8
			√L,R OMS He PRESS/VAP ISOL (four) – CL √TK ISOL (four) – OP (tb-OP) √XFEED (four) – CL (tb-CL)
			APU PRE-START
			R2
			BLR N2 SPLY (three) – ON √PWR (three) – ON √CNTLR/HTR (three) – A(B) √cb APU FU TK VLV ENA (six) – cl √APU FU TK VLV (three) – CL √AUTO SHTDN (three) – ENA √SPEED SEL (three) – NORM √OPER (three) – OFF HYD CIRC PUMP (three) – OFF MN PUMP PRESS (three) – LO APU CNTLR PWR (three) – ON
TIME TO EI (MIN)	LVLH PITCH (DEG)		
26	315		
25	319		
24	323		
	327		
	331		
	335		
20	339		
	343		
	347		
	351		
	355		
15	359		
	3		
	7		
	11		
	15		
10	19		
	23		
	27		
	31		
	35		
5	39		
		<u>NOTE</u> Use LVLH table unless INRTL EI-5 attitude (ITEMS 24,25,26) supplied by MCC. Use DDU and FLT CNTLR PWR as reqd for manual mnvr	
		<u>When mnvr complete</u> L4:P cb LG SNSR (two) – cl O14:A, BRAKES (three) – ON O15:A, O16:A	

LOSS OF 2 H2O LOOPS

DEORBIT BURN MONITOR

OMS TEMP* FU IN P \geq <table border="1" style="display: inline-table; vertical-align: middle;"><tr><td style="width: 20px; text-align: center;">L</td><td style="width: 20px; text-align: center;">R</td></tr><tr><td style="text-align: center;">225</td><td style="text-align: center;">220</td></tr></table> \leq <table border="1" style="display: inline-table; vertical-align: middle;"><tr><td style="width: 20px; text-align: center;">205</td><td style="width: 20px; text-align: center;">204</td></tr></table> or No FU IN P	L	R	225	220	205	204	OMS ENG FAIL ----- OMS PRPLT FAIL
L	R						
225	220						
205	204						
OMS PC* & OMS \downarrow (BFS: $\sqrt{\text{accel}}$) ENG VLV 1 or 2 < 70 or OX IN P > 227 ----- OX IN P \leq 227 or No OX IN P	OMS ENG FAIL ----- OMS PRPLT FAIL						
OMS OX/FU TK P ($\sqrt{\text{ENG IN P}}$) OX/FU LOW ----- OX & FU HIGH	He PRESS/VAP ISOL (two) – OP If aff TK P not incr: He PRESS/VAP ISOL (two) – CL At PC < 72 or OMS TEMP: OMS PRPLT FAIL ----- He PRESS/VAP ISOL (two) – CL Cycle He A(B) to maintain TK P 234-284						
OMS GMBL PRI fail ----- SEC fail	L(R) OMS GMBL – SEC ----- If high RCS usage: OMS ENG FAIL						
GPC 3	BFS Engage						
I/O ERROR FA 1 ----- 2 FAs lost	L OMS GMBL – SEC ----- ♦ I/O RESET (if recov: BFS I/O RESET) If high RCS usage: OMS ENG FAIL ----- $\sqrt{\text{MAN SHUTDN}}$						
BCE STRG D ----- 1 ----- 3	I/O RESET (if recov: >>) ----- If high RCS usage: L OMS GMBL – SEC ----- If high RCS usage: R OMS ENG FAIL						
RM DLMA IMU or 2 MN BUSES CUR HP > <table border="1" style="display: inline-table; vertical-align: middle;"><tr><td style="width: 20px; height: 15px;"></td><td style="width: 20px; height: 15px;"></td></tr></table> (safe HP) IMU dilemma			STOP BURN: OMS ENG(s) – OFF >> ----- After C/O: $\sqrt{\text{Timer}}$ <table border="1" style="display: inline-table; vertical-align: middle;"><tr><td style="width: 20px; text-align: center;">G21</td></tr></table> If any IMU ACC > 0.03: aff IMU – desel I'cncnt OMS to RCS ($\sqrt{\text{RCS Burn time}}$) THC +X to TGT Hp	G21			
G21							
I/O ERROR PCM	OI PCMMU PWR – 1						

*If XFD, BLDN, or sensor fail, monitor ENG IN P for off-nominal performance

LOSS OF 2 H2O LOOPS DEORBIT PREP/ENTRY

	CDR	POST BURN ACTIVITIES	PLT
	O14:E, cb MNA,B DDU L (two) – op O15:E F6 FLT CNTLR PWR – OFF		O15:E, cb MNB,C DDU R (two) – op O16:E F8 FLT CNTLR PWR – OFF
	C3 √DAP: AUTO		C3 √DAP: AUTO
	MNVR TO EI-5 ATT		OMS/RCS POST BURN RECONFIG
	CRT1 GNC, OPS 303 PRO		O7 √AFT L,R RCS He PRESS (four) – OP (tb-OP) √TK ISOL (six) – GPC (tb-OP) √XFEED (four) – GPC (tb-CL)
TIME TO EI (MIN)	LVLH PITCH (DEG)		O8 √L,R OMS He PRESS/VAP ISOL (four) – CL √TK ISOL (four) – OP (tb-OP) √XFEED (four) – CL (tb-CL)
26	315		
25	319		
24	323		
	327		
	331		
	335		
20	339		
	343		
	347		
	351		
	355		
15	359		
	3		
	7		
	11		
	15		
10	19		
	23		
	27		
	31		
	35		
5	39		
		NOTE	
		Use LVLH table unless INRTL EI-5 attitude (ITEMS 24,25,26) supplied by MCC. Use DDU and FLT CNTLR PWR as reqd for manual mnvr	
		<u>When mnvr complete</u>	
		L4:P cb LG SNSR (two) – cl	
		O14:A, BRAKES (three) – ON	
		O15:A,	
		O16:A	
			APU PRE-START
			R2 BLR N2 SPLY (three) – ON √PWR (three) – ON √CNTLR/HTR (three) – A(B) √cb APU FU TK VLV ENA (six) – cl √APU FU TK VLV (three) – CL √AUTO SHTDN (three) – ENA √SPEED SEL (three) – NORM √OPER (three) – OFF HYD CIRC PUMP (three) – OFF MN PUMP PRESS (three) – LO APU CNTLR PWR (three) – ON

LOSS OF 2 H2O LOOPS

DEORBIT BURN MONITOR

OMS TEMP* FU IN P ≥ <table border="1" style="display: inline-table; vertical-align: middle;"><tr><td style="width: 20px; text-align: center;">L</td><td style="width: 20px; text-align: center;">R</td></tr><tr><td style="text-align: center;">219</td><td style="text-align: center;">220</td></tr></table> ≤ <table border="1" style="display: inline-table; vertical-align: middle;"><tr><td style="width: 20px; text-align: center;">201</td><td style="width: 20px; text-align: center;">208</td></tr></table> or No FU IN P	L	R	219	220	201	208	OMS ENG FAIL ----- OMS PRPLT FAIL
L	R						
219	220						
201	208						
OMS PC* & OMS ↓ (BFS: √accel) ENG VLV 1 or 2 < 70 or OX IN P > 227 ----- OX IN P ≤ 227 or No OX IN P	OMS ENG FAIL ----- OMS PRPLT FAIL						
OMS OX/FU TK P (√ENG IN P) OX/FU LOW ----- OX & FU HIGH	He PRESS/VAP ISOL (two) – OP If aff TK P not incr: He PRESS/VAP ISOL (two) – CL At PC < 72 or OMS TEMP: OMS PRPLT FAIL ----- He PRESS/VAP ISOL (two) – CL Cycle He A(B) to maintain TK P 234-284						
OMS GMBL PRI fail ----- SEC fail	L(R) OMS GMBL – SEC (twice) ----- If high RCS usage: OMS ENG FAIL						
GPC 3	BFS Engage						
I/O ERROR FA 1 ----- 2 FAs lost	L OMS GMBL – SEC ----- ♦ I/O RESET (if recov: BFS I/O RESET) If high RCS usage: OMS ENG FAIL ----- √MAN SHUTDN						
BCE STRG D 1 ----- 3	I/O RESET (if recov: >>) ----- If high RCS usage: L OMS GMBL – SEC (twice) ----- If high RCS usage: R OMS ENG FAIL						
RM DLMA IMU or 2 MN BUSES CUR HP > <table border="1" style="display: inline-table; vertical-align: middle;"><tr><td style="width: 20px; height: 15px;"></td><td style="width: 20px; height: 15px;"></td></tr></table> (safe HP) IMU dilemma			STOP BURN: OMS ENG(s) – OFF >> ----- After C/O: √Timer <table border="1" style="display: inline-table; vertical-align: middle;"><tr><td style="width: 20px; text-align: center;">G21</td></tr></table> If any IMU ACC > 0.03: aff IMU – desel I'cnct OMS to RCS (√RCS Burn time) THC +X to TGT Hp	G21			
G21							
I/O ERROR PCM	OI PCMMU PWR – 1						

*If XFD, BLDN, or sensor fail, monitor ENG IN P for off-nominal performance

LOSS OF 2 H2O LOOPS DEORBIT PREP/ENTRY

	CDR	POST BURN ACTIVITIES	PLT
	O14:E, O15:E F7	cb MNA,B DDU L (two) – op,cl as reqd to achieve/maintain EI-5 attitude FLT CNTLR PWR – OFF	O15:E, O16:E F8
	C3	√DAP: AUTO	C3
	MNVR TO EI-5 ATT		OMS/RCS POST BURN RECONFIG
	CRT1	GNC, OPS 303 PRO	O7
			√AFT L,R RCS He PRESS (four) – OP (tb-OP) √TK ISOL (six) – GPC (tb-OP) √XFEED (four) – GPC (tb-CL)
			O8
			√L,R OMS He PRESS/VAP ISOL (four) – CL √TK ISOL (four) – OP (tb-OP) √XFEED (four) – CL (tb-CL)
			APU PRE-START
			R2
			BLR N2 SPLY (three) – ON √PWR (three) – ON √CNTLR/HTR (three) – A(B) √cb APU FU TK VLV ENA (six) – cl √APU FU TK VLV (three) – CL √AUTO SHTDN (three) – ENA √SPEED SEL (three) – NORM √OPER (three) – OFF HYD CIRC PUMP (three) – OFF MN PUMP PRESS (three) – LO APU CNTLR PWR (three) – ON
TIME TO EI (MIN)	LVLH PITCH (DEG)		
26	315		
25	319		
24	323		
	327		
	331		
	335		
20	339		
	343		
	347		
	351		
	355		
15	359		
	3		
	7		
	11		
	15		
10	19		
	23		
	27		
	31		
	35		
5	39		

NOTE

Use LVLH table unless **INRTL**
EI-5 attitude (ITEMS 24,25,26)
supplied by MCC. Use DDU
and FLT CNTLR PWR as reqd
for manual mnvr

When mnvr complete

L4:P cb LG SNSR (two) – cl
O14:A, BRAKES (three) – ON
O15:A,
O16:A

LOSS OF 2 H2O LOOPS

DEORBIT BURN MONITOR

OMS TEMP*	<table border="1" style="margin: auto;"> <tr> <td style="padding: 2px;">L</td> <td style="padding: 2px;">R</td> </tr> <tr> <td style="padding: 2px;">FU IN P ≥</td> <td style="padding: 2px; text-align: center;"> <table border="1" style="display: inline-table;"> <tr> <td style="padding: 2px;">230</td> <td style="padding: 2px;">230</td> </tr> </table> </td> </tr> <tr> <td style="padding: 2px;">≤</td> <td style="padding: 2px; text-align: center;"> <table border="1" style="display: inline-table;"> <tr> <td style="padding: 2px;">214</td> <td style="padding: 2px;">212</td> </tr> </table> </td> </tr> </table>	L	R	FU IN P ≥	<table border="1" style="display: inline-table;"> <tr> <td style="padding: 2px;">230</td> <td style="padding: 2px;">230</td> </tr> </table>	230	230	≤	<table border="1" style="display: inline-table;"> <tr> <td style="padding: 2px;">214</td> <td style="padding: 2px;">212</td> </tr> </table>	214	212	OMS ENG FAIL OMS PRPLT FAIL
L	R											
FU IN P ≥	<table border="1" style="display: inline-table;"> <tr> <td style="padding: 2px;">230</td> <td style="padding: 2px;">230</td> </tr> </table>	230	230									
230	230											
≤	<table border="1" style="display: inline-table;"> <tr> <td style="padding: 2px;">214</td> <td style="padding: 2px;">212</td> </tr> </table>	214	212									
214	212											
or No FU IN P												
OMS PC* & OMS ↓ (BFS: √accel)	ENG VLV 1 or 2 < 70	OMS ENG FAIL										
	or OX IN P > 227											
OX IN P ≤ 227		OMS PRPLT FAIL										
or No OX IN P												
OMS OX/FU TK P (√ENG IN P)	OX/FU LOW	He PRESS/VAP ISOL (two) – OP If aff TK P not incr: He PRESS/VAP ISOL (two) – CL At PC < 72 or OMS TEMP: OMS PRPLT FAIL										
OX & FU HIGH		He PRESS/VAP ISOL (two) – CL Cycle He A(B) to maintain TK P 234-284										
OMS GMBL	PRI fail	L(R) OMS GMBL – SEC (twice)										
	SEC fail	If high RCS usage: OMS ENG FAIL										
GPC 3		BFS Engage										
I/O ERROR FA	1	L OMS GMBL – SEC										
	2 FAs lost	♦ I/O RESET (if recov: BFS I/O RESET) If high RCS usage: OMS ENG FAIL √MAN SHUTDN										
BCE STRG D	1	I/O RESET (if recov: >>) If high RCS usage: L OMS GMBL – SEC (twice)										
	3	If high RCS usage: R OMS ENG FAIL										
RM DLMA IMU	CUR HP >	STOP BURN: OMS ENG(s) – OFF >>										
or	<table border="1" style="margin: auto;"> <tr> <td style="width: 20px; height: 20px;"></td> <td style="width: 20px; height: 20px;"></td> </tr> </table>											
2 MN BUSES	(safe HP)											
	IMU dilemma	After C/O: √Timer G21 If any IMU ACC > 0.03: aff IMU – desel I'cnct OMS to RCS (√RCS Burn time) THC +X to TGT Hp										
I/O ERROR PCM		OI PCMMU PWR – 1										

*If XFD, BLDN, or sensor fail, monitor ENG IN P for off-nominal performance

LOSS OF 2 H2O LOOPS DEORBIT PREP/ENTRY

	CDR	POST BURN ACTIVITIES	PLT
	O14:E, cb MNA,B DDU L (two) – op O15:E		O15:E, cb MNB,C DDU R (two) – op O16:E
	F6 FLT CNTLR PWR – OFF		F8 FLT CNTLR PWR – OFF
	C3 √DAP: AUTO		C3 √DAP: AUTO
	MNVR TO EI-5 ATT		OMS/RCS POST BURN RECONFIG
	CRT1 GNC, OPS 303 PRO		O7 √AFT L,R RCS He PRESS (four) – OP (tb-OP) √TK ISOL (six) – GPC (tb-OP) √XFEED (four) – GPC (tb-CL)
TIME TO EI (MIN)	LVLH PITCH (DEG)		O8 √L,R OMS He PRESS/VAP ISOL (four) – CL √TK ISOL (four) – OP (tb-OP) √XFEED (four) – CL (tb-CL)
26	315		
25	319		
24	323		
	327		
	331		
	335		
20	339		
	343		
	347		
	351		
	355		
15	359		
	3		
	7		
	11		
	15		
10	19		
	23		
	27		
	31		
	35		
5	39		
		<u>NOTE</u> Use LVLH table unless INRTL EI-5 attitude (ITEMS 24,25,26) supplied by MCC. Use DDU and FLT CNTLR PWR as reqd for manual mnvr	
		<u>When mnvr complete</u> L4:P cb LG SNSR (two) – cl O14:A, BRAKES (three) – ON O15:A, O16:A	
			APU PRE-START
			R2 BLR N2 SPLY (three) – ON √PWR (three) – ON √CNTLR/HTR (three) – A(B) √cb APU FU TK VLV ENA (six) – cl √APU FU TK VLV (three) – CL √AUTO SHTDN (three) – ENA √SPEED SEL (three) – NORM √OPER (three) – OFF HYD CIRC PUMP (three) – OFF MN PUMP PRESS (three) – LO APU CNTLR PWR (three) – ON

LOSS OF 2 H2O LOOPS

DEORBIT BURN MONITOR

OMS TEMP* FU IN P \geq <table border="1" style="display: inline-table; vertical-align: middle;"><tr><td style="width: 20px; text-align: center;">L</td><td style="width: 20px; text-align: center;">R</td></tr><tr><td style="text-align: center;">225</td><td style="text-align: center;">220</td></tr></table> \leq <table border="1" style="display: inline-table; vertical-align: middle;"><tr><td style="width: 20px; text-align: center;">205</td><td style="width: 20px; text-align: center;">204</td></tr></table> or No FU IN P	L	R	225	220	205	204	OMS ENG FAIL ----- OMS PRPLT FAIL
L	R						
225	220						
205	204						
OMS PC* & OMS \downarrow (BFS: $\sqrt{\text{accel}}$) ENG VLV 1 or 2 < 70 or OX IN P > 227 ----- OX IN P \leq 227 or No OX IN P	OMS ENG FAIL ----- OMS PRPLT FAIL						
OMS OX/FU TK P ($\sqrt{\text{ENG IN P}}$) OX/FU LOW ----- OX & FU HIGH	He PRESS/VAP ISOL (two) – OP If aff TK P not incr: He PRESS/VAP ISOL (two) – CL At PC < 72 or OMS TEMP: OMS PRPLT FAIL ----- He PRESS/VAP ISOL (two) – CL Cycle He A(B) to maintain TK P 234-284						
OMS GMBL PRI fail ----- SEC fail	L(R) OMS GMBL – SEC (twice) ----- If high RCS usage: OMS ENG FAIL						
GPC 3	BFS Engage						
I/O ERROR FA ----- 1 ----- 2 FAs lost	L OMS GMBL – SEC I/O RESET (if recov: BFS I/O RESET) If high RCS usage: OMS ENG FAIL ----- $\sqrt{\text{MAN SHUTDN}}$						
BCE STRG D ----- 1 ----- 3	I/O RESET (if recov: >>) ----- If high RCS usage: L OMS GMBL – SEC (twice) ----- If high RCS usage: R OMS ENG FAIL						
RM DLMA IMU or 2 MN BUSES CUR HP > <table border="1" style="display: inline-table; vertical-align: middle;"><tr><td style="width: 20px; height: 15px;"></td><td style="width: 20px; height: 15px;"></td></tr></table> (safe HP) IMU dilemma			STOP BURN: OMS ENG(s) – OFF >> ----- After C/O: $\sqrt{\text{Timer}}$ <table border="1" style="display: inline-table; vertical-align: middle;"><tr><td style="width: 20px; text-align: center;">G21</td></tr></table> If any IMU ACC > 0.03: aff IMU – desel I'cnct OMS to RCS ($\sqrt{\text{RCS Burn time}}$) THC +X to TGT Hp	G21			
G21							
I/O ERROR PCM	OI PCMMU PWR – 1						

*If XFD, BLDN, or sensor fail, monitor ENG IN P for off-nominal performance

LOSS OF 2 H2O LOOPS DEORBIT PREP/ENTRY

	CDR	POST BURN ACTIVITIES	PLT	
	O14:E, O15:E F6	cb MNA,B DDU L (two) – op FLT CNTLR PWR – OFF	O15:E, O16:E F8	
	C3	√DAP: AUTO	C3	
	MNVR TO EI-5 ATT		OMS/RCS POST BURN RECONFIG	
	CRT1	GNC, OPS 303 PRO	O7	√AFT L,R RCS He PRESS (four) – OP (tb-OP) √TK ISOL (six) – GPC (tb-OP) √XFEED (four) – GPC (tb-CL)
TIME TO EI (MIN)	LVLH PITCH (DEG)		O8	√L,R OMS He PRESS/VAP ISOL (four) – CL √TK ISOL (four) – OP (tb-OP) √XFEED (four) – CL (tb-CL)
26	315			
25	319			
24	323			
	327			
	331			
	335			
20	339			
	343			
	347			
	351			
	355			
15	359			
	3			
	7			
	11			
	15			
10	19			
	23			
	27			
	31			
	35			
5	39			
		<u>NOTE</u> Use LVLH table unless INRTL EI-5 attitude (ITEMS 24,25,26) supplied by MCC. Use DDU and FLT CNTLR PWR as reqd for manual mnvr		
		<u>When mnvr complete</u> L4:P cb LG SNSR (two) – cl O14:A, BRAKES (three) – ON O15:A, O16:A		
				APU PRE-START
			R2	BLR N2 SPLY (three) – ON √PWR (three) – ON √CNTLR/HTR (three) – A(B) √cb APU FU TK VLV ENA (six) – cl √APU FU TK VLV (three) – CL √AUTO SHTDN (three) – ENA √SPEED SEL (three) – NORM √OPER (three) – OFF HYD CIRC PUMP (three) – OFF MN PUMP PRESS (three) – LO APU CNTLR PWR (three) – ON

LOSS OF 2 H2O LOOPS DEORBIT PREP/ENTRY

CDR	POST BURN ACTIVITIES	PLT
<p>FORWARD RCS DUMP (if reqd) (Use for off-nominal Xcg entry using lowest of OX or FU qty)</p> <p>Perform FRCS dump if reqd to maintain Xcg in box If FRCS dump not reqd, go to 9-12</p> <p>If FRCS dump reqd, perform FOUR JET DUMP FRCS REACTIVATION:</p> <p>MA73C:A √MCA LOGIC FWD (three) – ON O14:B cb OI SIG CONDR OF 1/4 A – cl :F RJDF 1B F1 DRIVER – ON LOGIC – ON</p> <p>O15:B cb OI SIG CONDR OF 2/3 A – cl :F RJDF 1A F2 DRIVER – ON LOGIC – ON</p> <p>O16:F RJDF 2A F3,2B F4 DRIVER (two) – ON F4/F5 LOGIC (two) – ON</p> <p>O6 √MDM FF1,2,3 (three) – ON FF4 – ON GNC I/O RESET</p> <p>O8 FWD RCS MANF ISOL 1,2,3,4 (four) – OP (tb-OP)</p> <p style="border: 1px solid black; display: inline-block; padding: 2px;">GNC 23 RCS</p> <p>CRT JET RESET – ITEM 45 EXEC Reselect deselected FRCS jets JET RESET – ITEM 45 EXEC</p>	<p>APU START</p> <p>C3 OI PCMMU PWR – 1 BFS I/O RESET</p> <p>R2 APU FU TK VLV (three) – OP √APU/HYD RDY tb (three) – gray</p> <p style="text-align: center;">* If tb – bp, attempt normal start *</p> <p> APU OPER (three) – START/RUN</p> <p>MDU √HYD PRESS ind (three) – LO green</p> <p>R2 √APU/HYD RDY tb (three) – bp HYD MN PUMP PRESS (three) – NORM</p> <p>MDU √HYD PRESS ind (three) – HI green</p> <p style="text-align: center;">* If APU OIL OUT P < 25 and APU TEMP * * OIL OUT not increasing after APU start * * or no start, perform APU SHUTDN * * (ENT PKT, <u>APU/HYD</u>) * *</p> <p>R4 √HYD BK ISOL VLV (three) – GPC (tb-CL) √LG EXTD ISO VLV – GPC (tb-CL)</p> <p>C3 OI PCMMU PWR – OFF</p>	

LOSS OF 2 H2O LOOPS DEORBIT PREP/ENTRY

FORWARD RCS DUMP (Cont)

Determine FWD RCS 'DUMP TO %' (calculator, cg wheel, or DEL PAD)

NOTE

During dump, disregard FWD RCS qty

CRT

GNC DEORB MNVR EXEC

 FWD RCS ARM – ITEM 36 EXEC
 DUMP – ITEM 37 EXEC (Start watch)

When dump time achieved:
 FWD RCS OFF – ITEM 38 EXEC

O8

When dump complete:
 FWD RCS MANF ISOL
 1,2,3,4 (four) – CL (tb-CL)

O6

MDM FF4 – OFF
 O14:B cb OI SIG CONDR OF 1/4 A – op
 O14:F RJDF 1B F1 DRIVER, LOGIC – OFF
 O15:B cb MNB OI SIG CONDR OF 2/3 A – op
 O15:F RJDF 1A F2 LOGIC, DRIVER – OFF
 O16:F 2A F3, 2B F4 DRIVER (two) – OFF
 F4/F5 LOGIC (two) – OFF

FOUR JET DUMP

FWD RCS PRPLT TO BE DUMPED (%)

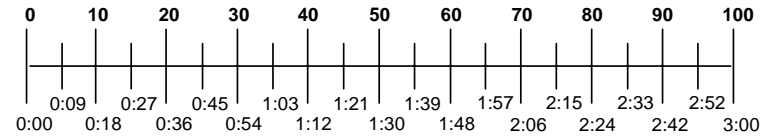

TIME FROM DUMP INITIATION (M:S)

TWO JET DUMP

FWD RCS PRPLT TO BE DUMPED (%)

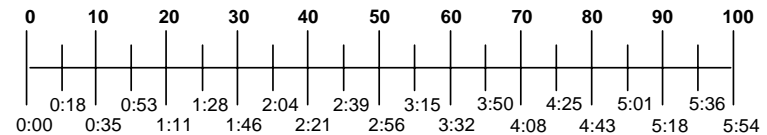

TIME FROM DUMP INITIATION (M:S)

GPS ACTIVATION (EI-15)

MS	A13	GPS PWR – ON
		Wait 30 sec
		GNC I/O RESET
		GNC 55 GPS STATUS
	CRT	INIT – ITEM 15 EXEC (*)
		NAV – ITEM 18 EXEC (*)

OV103,104

C D/O/3,4/GEN L

LOSS OF 2 H2O LOOPS DEORBIT PREP/ENTRY

1: GNC 53 ENTRY CONTROLS	2: BFS, GNC SYS SUMM 2
3: GNC DEORB MNVR COAST	

SECONDARY ACTUATOR CHECK (if not previously performed and time permits)

NOTE

If a port does not bypass during check,
bypass aff port after check:

SEC ACT BYPASS – ITEM 8 +X X
EXEC

If aff port still does not bypass:

SEC ACT RESET – ITEM 9 +X X
EXEC

- | | |
|------|---|
| R2 | 1. √HYD MN PUMP PRESS (three) – NORM |
| CRT3 | SURF DRIVE ON – ITEM 39 EXEC (*), wait at least 5 sec |
| MDU | √SPI: Stop drive test when elevon posns within +12° to -27°:
SURF DRIVE OFF – ITEM 40 EXEC (*) |
| CRT1 | 2. √POS STIM ENA – ITEM 7 (no *) |
| C3 | 3. √FCS CH (four) – AUTO |
| CRT1 | 4. SEC ACT CK, CH 1 – ITEM 1 EXEC (*)
CK START – ITEM 5 EXEC |
| | 5. √All CH 1 ports bypass (↓)
STOP – ITEM 6 EXEC (*) |

- | | |
|------|---------------------------------------|
| C3 | 6. FCS CH 1 – ORIDE |
| CRT1 | √All CH 1 ports reset (no ↓) |
| C3 | FCS CH 1 – AUTO |
| | 7. Repeat steps 5 thru 7 for CH 2,3,4 |

EQUIPMENT STOWAGE AND SEAT INGRESS

If not already accomplished:

- Stow equip
- Seat ingress
- Adjust seat, exercise brake pedals

SPACELAB FINAL DEACT (if flown)

- | | | |
|---|----|--|
| P | R1 | PL PRI MNC,FC3,MNB (three) – OFF (tb-OFF)
AUX – OFF
CAB – OFF
AFT MNB,MNC (two) – OFF |
|---|----|--|

ENTRY SWITCH CHECK

- | | | |
|-----|-------|--|
| C | L1 | NH3 CNTLR B – PRI/GPC |
| | L2 | √CAB RELIEF (two) – ENA (tb-ENA)
√ENTRY MODE – AUTO |
| C,P | C3 | √SBTC – full fwd
√SRB SEP – AUTO
√ET SEP – AUTO |
| | F6/F8 | √AIR DATA – NAV
√ADI ERR – MED
RATE – MED
√HSI SEL MODE – ENTRY
√SOURCE (two) – NAV,1
√ – NAV,2 |
| C,P | F3 | √L,R TRIM RHC/PNL (two) – INH
√PNL (two) – ON |

OV103,104

LOSS OF 2 H2O LOOPS DEORBIT PREP/ENTRY

CDR

PLT

HORIZ SIT CONFIG

ALTM – ITEM 9

--	--	--	--	--

	<u>PASS ITEM</u>		<u>BFS ITEM</u>	
PTI	INH	√1		
LAND SITE (DEL PAD)		√41		√41
RWY (DEL PAD)		√3		√3
		√4		√4
TACAN (DEL PAD)		√5		√5
RA	blank	√46		
TAEM TGT				
G&N	OVHD	√6	blank	
HSI	blank		blank	
XEP	NEP	√7	NEP	√7
AIM (DEL PAD)	NOM	√8	NOM	√8
	(or CLSE)		(or CLSE)	
SPD BK	NOM	√39		
TAC	INH	√20	INH	√20
GPS	INH	√43	INH	√43
DRAG H	AUT	√22	AUT	√22
ADTA H	INH	√26	INH	√26
ADTA TO G&C	INH	√29	AUT	√28
DES any failed TACANs		√		√
TAC	DELTA	√35		
AIF_G	INH	√48		

Stow:

Deorbit Burn Cue Cards (C6)

DEORBIT BURN MONITOR (Cue Card) (C6)

**Go to LOSS OF 2 H2O LOOPS ENTRY MANEUVERS
EI-5, 9-17**

1: GNC DEORB MNVR COAST	2: GNC 50 HORIZ SIT
3: GNC 51 OVERRIDE	

- √ELEVON AUTO – ITEM 17 (*)
- SSME REPOS – ITEM 19 EXEC (INH)
- √WRAP MODE – ITEM 45 (ENA)
- If PLB holding > 10K lb:
- FILTER ALT – ITEM 21 EXEC (*)

3: BFS, GNC 51 OVERRIDE

- √ELEVON AUTO – ITEM 17 (*)
- √SSME REPOS – ITEM 19 (INH)
- √WRAP MODE – ITEM 45 (ENA)
- If PLB holding > 10K lb:
- √FILTER ALT – ITEM 21 EXEC (*)

- * DES any failed/comm faulted IMU, *
- * RGA, AA, or SURF feedback *

G SUIT INFLATION

All Load –1.5

**Go to LOSS OF 2 H2O LOOPS ENTRY
MANEUVERS EI-5, 9-17**

OV103,104

LOSS OF 2 H2O LOOPS ENTRY MANEUVERS

FLIGHT CONDITIONS	MANEUVER
EI-5	cb ADTA 1,2,3 (three) – cl cb MNA,B DDU L (two) – cl (L) FLT CNTLR PWR – ON Use one IDP/CRT with 2 MDUs MDM FF4 – ON GNC I/O RESET √LVLH ATT GNC, OPS 304 PRO * If PREBANK: R/Y – CSS: * * Roll at 1°/sec to <input type="text"/> <input type="text"/> * * Maintain PREBANK ± 5° * *
'Guidance Box' @ Q̄ ~8 or D ~3	CLOSED LOOP GUIDANCE ____:____:____ * If PREBANK: P,R/Y – AUTO * Begin AIL trim monitoring
D = 11	√DRAG H
ΔAz = 10.5°	FIRST ROLL REVERSAL <input type="text"/> <input type="text"/> <input type="text"/> <input type="text"/>
V = 19K	√HYD MPS/TVC ISOL VLV SYS (three) – CL <input type="text"/> G50 √GPS, INCORPORATE
V = 15K	TACAN 1 MODE – GPC
V = 12K	<u>ACTIVATE ENTRY COMM</u> L,R AUD PWR – AUD AUD CTR – 1 UHF SPLX/EVA PWR AMPL – ON UHF MODE – SPLX (G T/R if ELS) S-BD PM CNTL – PNL,CMD OI PCMMU PWR – 1 √FORMAT – FXD MDM PL2 – ON GNC, BFS I/O RESET
V = 10K	√SPDBK to 81%
V = 7K	√TACAN and GPS status
V = 5K	ADTA PROBES – DEPLOY (√HEAT) Begin AIL and RUD trim monitoring

FLIGHT CONDITIONS	MANEUVER
M = 2.9	CAB FAN A(B) - OFF Power one HUD, one MLS, one RA for landing GNC I/O RESET
M = 2.7	√APUs
	* If M < 2.5, P CSS for ADTA to G&C incorp*
M = 2.0	Ensure ADTA to G&C; else, √theta limits
M < 1.0	* For bailout procedures, go to BAILOUT * P,R/Y – CSS as reqd √SPDBK CMD vs POS MAX Nz <input type="text"/> <input type="text"/> <input type="text"/> Use two IDP/CRTs with four MDUs cb MNB,C DDU R (two) – cl (R) FLT CNTLR PWR – ON ANTISKID – ON NWS – 1 Lock Inertia Reels
M = 0.7	√LG EXTD ISO VLV – OP
h = 15K	√MLS (if activated)
h = 10K	√A/L (KSC – Tabs, Visors, Suit O2)
h = 2K	LDG GEAR ARM pb – push (ARM It on)
h = 300	LDG GEAR DN pb – push (DN It on)
MAIN GEAR TD	√SPDBK – 100%
V = 195 KEAS	DRAG CHUTE ARM,DPY pb (two) – push (simo) (All Its on)
V = 185 KEAS	DEROTATE
NOSE GEAR TD	SRB SEP – MAN/AUTO and depress pb √Auto Load Relief √HYD BK ISOL VLV (three) – OP
V < 120 KGS or 5K' remaining	BRAKE as reqd (8-10 fps ² , -0.25 to -0.3G)
	* If 5K' remaining and V > 140 KGS – MAX BRAKING *
V = 60 KGS	DRAG CHUTE JETT pb – push (JETT1, JETT2 It on)
V = 40 KGS	BRAKE < 6 fps ² (-0.2G) (Antiskid cutout)
WHEEL STOP	√All landing/navajds off CAB FAN B – ON (Wait 3 sec, then continue) AV BAY FAN 2A,3A [3B vice 3A if FC1 OK] – ON (3 sec between each start) Go to ENT C/L, <u>POST LDG</u>

OV103,104

This Page Intentionally Blank

LOSS OF 2 H2O LOOPS DEORBIT PREP/ENTRY

FORWARD RCS DUMP (Cont)

Determine FWD RCS 'DUMP TO %' (calculator, cg wheel, or DEL PAD)

NOTE

During dump, disregard FWD RCS qty

CRT

GNC DEORB MNVR EXEC

 FWD RCS ARM – ITEM 36 EXEC
 DUMP – ITEM 37 EXEC (Start watch)

When dump time achieved:
 FWD RCS OFF – ITEM 38 EXEC

O8

When dump complete:
 FWD RCS MANF ISOL
 1,2,3,4 (four) – CL (tb-CL)

O6

MDM FF4 – OFF
 O14:B cb OI SIG CONDR OF 1/4 A – op
 O14:F RJDF 1B F1 DRIVER, LOGIC – OFF
 O15:B cb MNB OI SIG CONDR OF 2/3 A – op
 O15:F RJDF 1A F2 LOGIC, DRIVER – OFF
 O16:F 2A F3, 2B F4 DRIVER (two) – OFF
 F4/F5 LOGIC (two) – OFF

FOUR JET DUMP

FWD RCS PRPLT TO BE DUMPED (%)

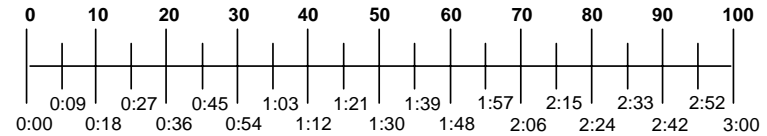

TIME FROM DUMP INITIATION (M:S)

TWO JET DUMP

FWD RCS PRPLT TO BE DUMPED (%)

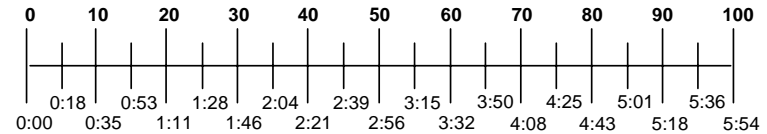

TIME FROM DUMP INITIATION (M:S)

GPS ACTIVATION (EI-15)

O7 GPS 2,3 PWR (two) – ON
 Wait 30 sec
 GNC I/O RESET

GNC 55 GPS STATUS

CRT INIT – ITEM 15,16 EXEC (*)
 NAV – ITEM 18,19 EXEC (*)

LOSS OF 2 H2O LOOPS DEORBIT PREP/ENTRY

1: GNC 53 ENTRY CONTROLS	2: BFS, GNC SYS SUMM 2
3: GNC DEORB MNVR COAST	

SECONDARY ACTUATOR CHECK (if not previously performed and time permits)

NOTE

If a port does not bypass during check,
bypass aff port after check:

SEC ACT BYPASS – ITEM 8 +X X
EXEC

If aff port still does not bypass:

SEC ACT RESET – ITEM 9 +X X
EXEC

- | | |
|------|---|
| R2 | 1. √HYD MN PUMP PRESS (three) – NORM |
| CRT3 | SURF DRIVE ON – ITEM 39 EXEC (*), wait at least 5 sec |
| MDU | √SPI: Stop drive test when elevon posns within +12° to -27°:
SURF DRIVE OFF – ITEM 40 EXEC (*) |
| CRT1 | 2. √POS STIM ENA – ITEM 7 (no *) |
| C3 | 3. √FCS CH (four) – AUTO |
| CRT1 | 4. SEC ACT CK, CH 1 – ITEM 1 EXEC (*)
CK START – ITEM 5 EXEC |
| | 5. √All CH 1 ports bypass (↓)
STOP – ITEM 6 EXEC (*) |

- | | |
|------|---------------------------------------|
| C3 | 6. FCS CH 1 – ORIDE |
| CRT1 | √All CH 1 ports reset (no ↓) |
| C3 | FCS CH 1 – AUTO |
| | 7. Repeat steps 5 thru 7 for CH 2,3,4 |

EQUIPMENT STOWAGE AND SEAT INGRESS

If not already accomplished:

- Stow equip
- Seat ingress
- Adjust seat, exercise brake pedals

SPACELAB FINAL DEACT (if flown)

- | | | |
|---|----|--|
| P | R1 | PL PRI MNC,FC3,MNB (three) – OFF (tb-OFF)
AUX – OFF
CAB – OFF
AFT MNB,MNC (two) – OFF |
|---|----|--|

ENTRY SWITCH CHECK

- | | | |
|-----|-------|--|
| C | L1 | NH3 CNTLR B – PRI/GPC |
| | L2 | √CAB RELIEF (two) – ENA (tb-ENA)
√ENTRY MODE – AUTO |
| C,P | C3 | √SBTC – full fwd
√SRB SEP – AUTO
√ET SEP – AUTO |
| | F6/F8 | √AIR DATA – NAV
√ADI ERR – MED
RATE – MED
√HSI SEL MODE – ENTRY
√SOURCE (two) – NAV,1
√ – NAV,2 |
| C,P | F3 | √L,R TRIM RHC/PNL (two) – INH
√PNL (two) – ON |

LOSS OF 2 H2O LOOPS DEORBIT PREP/ENTRY

CDR

PLT

HORIZ SIT CONFIG

ALTM – ITEM 9

		.		
--	--	---	--	--

	<u>PASS ITEM</u>		<u>BFS ITEM</u>	
PTI	INH	√1		
LAND SITE (DEL PAD)		√41		√41
RWY (DEL PAD)		√3		√3
		√4		√4
TAEM TGT				
G&N	OVHD	√6	blank	
HSI	blank		blank	
XEP	NEP	√7	NEP	√7
AIM (DEL PAD)	NOM	√8	NOM	√8
	(or CLSE)		(or CLSE)	
SPD BK	NOM	√39		
NAV				
GPS	INH	√43	INH	√43
DRAG H	AUT	√22	AUT	√22
ADTA H	INH	√26	INH	√26
MLS	AUT	√50		
G&C				
GPS	INH	√48		
ADTA	INH	√29	AUT	√28

Stow:

- Deorbit Burn Cue Cards (C6)
- DEORBIT BURN MONITOR (Cue Card) (C6)

**Go to LOSS OF 2 H2O LOOPS ENTRY MANEUVERS
EI-5, 9-17**

1: GNC DEORB MNVR COAST	2: GNC 50 HORIZ SIT
3: GNC 51 OVERRIDE	

- √ELEVON AUTO – ITEM 17 (*)
- SSME REPOS – ITEM 19 EXEC (INH)
- √WRAP MODE – ITEM 45 (ENA)
- If PLB holding > 10K lb:
- FILTER ALT – ITEM 21 EXEC (*)

3: BFS, GNC 51 OVERRIDE

- √ELEVON AUTO – ITEM 17 (*)
- √SSME REPOS – ITEM 19 (INH)
- √WRAP MODE – ITEM 45 (ENA)
- If PLB holding > 10K lb:
- √FILTER ALT – ITEM 21 EXEC (*)

- * DES any failed/comm faulted IMU, *
- * RGA, AA, or SURF feedback *

G SUIT INFLATION

All Load –1.5

**Go to LOSS OF 2 H2O LOOPS ENTRY
MANEUVERS EI-5, 9-17**

LOSS OF 2 H2O LOOPS ENTRY MANEUVERS

FLIGHT CONDITIONS	MANEUVER
EI-5	cb ADTA 1,2,3 (three) – cl cb MNA,B DDU L (two) – cl (L) FLT CNTLR PWR – ON Use one IDP/CRT with 2 MDUs MDM FF4 – ON GNC I/O RESET √LVLH ATT GNC, OPS 304 PRO * If PREBANK: R/Y – CSS: * * Roll at 1°/sec to <input type="text"/> <input type="text"/> * * Maintain PREBANK ± 5° * *
'Guidance Box' @ q̄ ~8 or D ~3	CLOSED LOOP GUIDANCE ____:____:____ * If PREBANK: P,R/Y – AUTO * Begin AIL trim monitoring
D = 11	√DRAG H
ΔAz = 10.5°	FIRST ROLL REVERSAL <input type="text"/> <input type="text"/> <input type="text"/> <input type="text"/>
V = 19K	√HYD MPS/TVC ISOL VLV SYS (three) – CL <input type="text"/> G50 √GPS, INCORPORATE
V = 12K	<u>ACTIVATE ENTRY COMM</u> L,R AUD PWR – AUD AUD CTR – 1 UHF SPLX/EVA PWR AMPL – ON UHF MODE – SPLX (G T/R if ELS) S-BD PM CNTL – PNL,CMD OI PCMMU PWR – 1 √FORMAT – FXD MDM PL2 – ON GNC, BFS I/O RESET
V = 10K	√SPDBK to 81%
V = 5K	ADTA PROBES – DEPLOY (√HEAT) Begin AIL and RUD trim monitoring

FLIGHT CONDITIONS	MANEUVER
M = 2.9	CAB FAN A(B) - OFF Power one HUD, one MLS, one RA for landing GNC I/O RESET
M = 2.7	√APUs
	* If M < 2.5, P CSS for ADTA to G&C incorp*
M = 2.0	Ensure ADTA to G&C; else, √theta limits
M < 1.0	* For bailout procedures, go to <u>BAILOUT</u> * P,R/Y – CSS as reqd √SPDBK CMD vs POS MAX Nz <input type="text"/> <input type="text"/> <input type="text"/> Use two IDP/CRTs with four MDUs cb MNB,C DDU R (two) – cl (R) FLT CNTLR PWR – ON ANTISKID – ON NWS – 1 Lock Inertia Reels
M = 0.7	√LG EXTD ISO VLV – OP
h = 15K	√MLS (if activated)
h = 10K	√A/L (KSC – Tabs, Visors, Suit O2)
h = 2K	LDG GEAR ARM pb – push (ARM It on)
h = 300	LDG GEAR DN pb – push (DN It on)
MAIN GEAR TD	√SPDBK – 100%
V = 195 KEAS	DRAG CHUTE ARM,DPY pb (two) – push (simo) (All Its on)
V = 185 KEAS	DEROTATE
NOSE GEAR TD	SRB SEP – MAN/AUTO and depress pb √Auto Load Relief √HYD BK ISOL VLV (three) – OP
V < 120 KGS or 5K' remaining	BRAKE as reqd (8-10 fps ² , -0.25 to -0.3G)
	* If 5K' remaining and V > 140 KGS – MAX BRAKING *
V = 60 KGS	DRAG CHUTE JETT pb – push (JETT1, JETT2 It on)
V = 40 KGS	BRAKE < 6 fps ² (-0.2G) (Antiskid cutout)
WHEEL STOP	√All landing/navaids off CAB FAN B – ON (Wait 3 sec, then continue) AV BAY FAN 2A,3A [3B vice 3A if FC1 OK] – ON (3 sec between each start) Go to ENT C/L, <u>POST LDG</u>

This Page Intentionally Blank

EMERGENCY DEORBIT PREP/ENTRY

STOW KU-BD ANTENNA 10-7

I

This Page Intentionally Blank

EMERGENCY DEORBIT PREP/ENTRY **(20 min < time to TIG < 2 hr 40 min)**

ASSUMPTIONS/INITIAL CONDITIONS

Emergency Deorbit Prep/Entry may be used for any failure case requiring deorbit in less than 2 hr 40 min. For loss of cabin pressure, perform the pwrn on 10-5 if not already completed

This procedure assumes at least 20 min and at most 2 hr 40 min remain until deorbit burn

PROBLEM DESCRIPTION/RATIONALE

Maximum time to TIG (Tmax) is based on cabin pressure, leak rate, and total N2 quantity, and is determined from CAB PRESS LEAK NOMOGRAPH (ORB PKT, ECLS). Tmax can be exceeded, but cabin pressure will drop below 8 psi

Actual time to TIG based on landing site availability

NOTE

1. Procedure designed for worst-case scenario, 20 min until TIG. Any activity not absolutely necessary omitted, and any activity not reqd prior to burn delayed until after burn
2. AFT DECK and MIDDECK MS procedures located on MS PULLOUT PAGES, 10-7 and 10-9, respectively. Extra copies located in back of PLT's book
3. CDR and PLT procedures begin on 10-11
4. Nominal DEORBIT BURN MONITOR Cue Card used
5. If landing site available, this procedure exited on 10-21 and nominal ENTRY MANEUVERS Cue Card with P&Is used
6. If landing site not available, bailout procedures beginning on 10-22 are used
7. This procedure baselines single-fault tolerant configuration on most air-cooled equipment. If cabin pressure stabilizes at 8 psi or greater, additional equipment activated as desired
8. If time available, review NOMINAL DEORBIT PREP (DEORBIT PREP) for any additional activities desired

EMERGENCY DEORBIT PREP/ENTRY MATRIX

The following matrix is for general information only. First and second columns list all nominal deorbit prep activities and times performed, respectively. The third column indicates whether or not activities are performed in emergency deorbit prep, and if so, when performed relative to deorbit burn

ACTIVITY	NOM 4.0 HR D/O PREP	EMERGENCY D/O PREP
FLUID LOADING PREP	FLIGHT PLAN	-√
TIMER SETUP	-03:59	-----
CONFIGURE DAP	-03:58	-√
COLD SOAK INITIATE	-03:56	-----
ENT STOWAGE	-03:52	-----
KU-BD ANTENNA STOW	-03:48	-√
RAD STOW	-03:45	-√
N2 QTY COMPUTE	-03:42	-----
SPECIALIST SEAT INSTALLATION	-03:35	+√
DPS CONFIG FOR D/O PREP	-03:27	-----
APU/HYD CONFIG	-03:25	-√
DED DISP ENT CONFIG	-03:15	+√
AUTO MNVR TO IMU ATT	-02:58	-----
SELECT NORM JETS	-02:56	-√
RAD BYPASS/FES C/O	-02:55	-√
PL DEACT	-02:54	-√
CONFIG FOR PLBD CLOSING	-02:45	-√
IMU ALIGNMENT	-02:44	-----
CLOSE PLBD	-02:40	-√
POST CLOSING CONFIG	-02:25	-----
AUTO MNVR TO COMM ATT	-02:24	-----

ACTIVITY	NOM 4.0 HR D/O PREP	EMERGENCY D/O PREP
SPACELAB FINAL DEACT	-02:19	-----
DPS ENTRY CONFIG	-02:17	-√
DEACT STAR TRKRS & CLOSE DOORS	-01:58	-√
ENT SWITCH CONFIG	-01:55	-√
ENT SWITCH LIST/VER	-01:50	-√
DEORB PAD UPDATE	-01:42	-----
RESET C/W	-01:40	-----
ENTRY REVIEW	-01:39	-----
(C,P) CLOTHING CONFIG	-01:25	+√
(MS) CLOTHING CONFIG	-01:10	+√
IMU/IMU ALIGN	-01:06	-----
FLUID LOADING	-01:04	-√
(C,P) SEAT INGRESS	-00:59	+√
HUD SETUP	-00:57	-----
ADJUST SEAT	-00:55	+√
C6 LEH O2 vlv – OP	-00:53	+√
ACES PRESS INTEGRITY CHECK	-00:52	+√
WIRELESS STOW	-00:50	-----
WCS DEACT, BLEED ORF REMOVAL	-00:49	-----

- √ Indicates accomplished sometime before TIG
- +√ Indicates accomplished sometime between TIG and EI

**EMERGENCY DEORBIT PREP/ENTRY
LOSS OF CABIN PRESSURE**

LOSS OF CAB PRESS PWRDN

Perform following powerdown for loss of cabin pressure:

- C3 MSTR MADS PWR – OFF
Use minimum lighting
Use one IDP/CRT with one MDU (IDP 4 preferable)
Use one PGSC as reqd
- If OV103,4:
- O7 √TACAN MODE sel (three) – OFF
- O8 √MLS (three) – OFF
√RADAR ALTM (two) – OFF
- L1 HUM SEP (two) – OFF
H2O LOOP 2(1) BYP MODE – MAN
MAN – DECR (30 sec)
- If FES not ena:
If EVAP OUT T 41 to 47 degF:
RAD CNTLR OUT TEMP – HI
When EVAP OUT T > 50 degF:
FLASH EVAP CNTLR PRI B(A) – ON,
then immediately
RAD CNTLR OUT TEMP – NORM
If EVAP OUT T < 41 or > 47 degF:
FLASH EVAP CNTLR PRI B(A) – ON
- Go to MS PWRDN (ORB PKT, LOSS OF CAB PRESS PWRDN) if time permits

This Page Intentionally Blank

**EMERGENCY DEORBIT PREP/ENTRY
MIDDECK STATION MS
MS PULLOUT PAGE**

A1R	Begin Fluid Loading (if time available) Ingress seat ACES PRESS INTEGRITY CHECK AUD CTR VOICE RCD SEL CH 1 – ICOM A 2 – ICOM B	MO69M	√Pole Straps secure LEH O2 8 vlv – CL Remove, stow O2 Bleed Orifice LEH O2 7,8 vlv (two) – OP (if reqd) 5,6 vlv (two) – OP (if reqd)
EI-10	Stow flight deck PGSC Fluid Loading Prep (if time available) Remove suits, loose equipment from airlock Close Airlock Hatch: Position handle to preclosing posn per decal Hatch – rotate about hinge and push Handle – CCW to LATCH Lock lever to LOCKED	MO32M	Stow: Exercise Equipment Loose middeck equipment After deorbit targeting complete: Stow backup PGSC Remove, stow side hatch UV Filter, Locking Device, Pyro Box Safing Pin Unstow, install MS Seats Don ACES, Harness, Boots Begin Fluid Loading (if time available) Ingress seat ACES PRESS INTEGRITY CHECK
ENTRY SWITCH LIST/VERIFICATION (MIDDECK) If time available, 3-27 thru 3-30 with following deltas:			
ML31C MO13Q	√VAC VENT ISOL VLV CNTL – CL (tb-CL) √AIRLK FAN A(B) – OFF if flown		
WCS	If not already accomplished Tape Foot Loops in egress routes Foot restraints – up, locked		
<u>ESCAPE POLE SETUP</u>			
Reinstall Stbd Pip Pin Reinstall large Port Pin: Retract and hold Locking Pin (Ring) Reinstall large Pin Release Locking Pin (Ring) Slide forward Safing Latch			
(Cont in right column)			

This Page Intentionally Blank

EMERGENCY DEORBIT PREP/ENTRY

CDR

PLT

VERIFY DAP/SELECT PRI

O14:F, √Pri RJD LOGIC,DRIVER (sixteen) – ON
 O15:F,
 O16:F

√DAP: A1/AUTO/PRI
 √B set to B1

FES HTR ACTIVATION

L1 HI LOAD DUCT HTR sel – A/B
 √TOP EVAP HTR NOZ L,R (two) – B AUTO
 √DUCT – B

STAR TRKR DEACT

O6 S TRK PWR -Y,-Z (two) – OFF

S TRK DR CNTL SYS 1,2 (two) – CL (start timer)

√S TRK DR POS -Y, -Z tb (two) – bp
 When both tb – CL (~8-24 sec)
 or either tb – bp > 24 sec:
 S TRK DR CNTL SYS 1,2 (two) – OFF

DPS ENTRY CONFIG

O14,O15, RGA,ACCEL,ASA,IMU (all) – ON
 O16

UPLINK ENA, GPC DNLIST
X: GNC 1 DPS UTILITY

CRTX UL CNTL ENA – ITEM 36 EXEC
 C3 OI PCMMU FORMAT – FXD

DEORBIT TARGET

Use Deorbit Manager on PGSC to compute targets (record on 10-14)

W/B STEAM VENT HTR ACT

R2 BLR PWR (three) – ON

SWITCH CONFIG

O6 √UHF MODE sel – SPLX

O13,O14, All switches ON and all cbs closed
 O15,O16 except following:

All orange dot – op

O14:E ADTA 1 – op
 DDU L,AFT (two) – op
 STAR TRKR -Z – op

O15:E ADTA 2 – op
 DDU L,R (two) – op
 STAR TRKR -Y – op

O16:E ADTA 3,4 (two) – op
 DDU R,AFT (two) – op
 RCS/OMS PRPLT QTY GAUGE – op

O16:F RJD MANF L5/F5/R5 DRIVER – OFF

DDU ACTIVATION (no earlier than TIG-15)

O14:E, cb DDU L,R (four) – cl
 O15:E,
 O16:E

EMERGENCY DEORBIT PREP/ENTRY

CDR

PLT

CONFIG GPCs

	1	2	3	4	5
PWR	ON	ON	ON	ON	ON
OUTPUT	NORM	NORM	NORM	NORM	B/U
MODE	RUN	RUN	RUN	RUN	RUN

SM, OPS 000 PRO

SM 0 GPC MEMORY

VERIFY MC 3 PER TABLE

CONFIG GPC	3	12340
STR	1	1
	2	2
	3	3
	4	4
PL	1/2	1
CRT	1	1
	2	2
	3	3
	4	0
L	1	0
	2	0
MM	1	1
	2	2

TRANSITION TO OPS 3

GNC, OPS 301 PRO

BFS, GNC OPS 301 PRO

GNC, OPS 302 PRO

Use three IDP/CRTs with five MDUs (six for burn)

CRT3

Do not proceed until all DPS ENTRY CONFIG steps complete

LANDING SITE UPDATE

1: GNC 50 HORIZ SIT

SEL SITE, RWY (PASS/BFS)

DRAG ALT ATM SELECTION

GNC 51 OVERRIDE

SEL ATM: incl $\leq 50^\circ$ $\sqrt{\text{ITEM 22 (*)}}$

incl $> 50^\circ$ SEL ITEM NR (table)

Hemi	Jan	Feb	Mar	Apr	May	Jun	Jul	Aug	Sep	Oct	Nov	Dec
N Desc	23	23	23	23	22	24	24	24	22	23	23	23
S Asc	24	24	22	23	23	23	23	23	23	23	22	24
N Asc	22											
S Desc	22											

CHECK CG

GNC DEORB MNVR EXEC

UPDATE PRPLT ITEM 18 as reqd

EMERGENCY DEORBIT PREP/ENTRY

CDR

PLT

	CDR	PLT
	<p>CLOTHING CONFIG (if time permits)</p> <p>Don: ACES Harness Boots</p> <p>C6 LEH O2 vlv (four) – OP</p> <p>ACES PRESS INTEGRITY CHECK</p> <p>Go to DEORBIT BURN Cue Cards</p>	<p>OMS BURN PREP</p> <p>O7 AFT L,R RCS He PRESS (four) – OP (tb-OP) TK ISOL (six) – GPC (tb-OP) XFEED (four) – GPC (tb-CL) √MSTR RCS XFEED – OFF</p> <p>O8 L,R OMS √He PRESS/VAP ISOL (four) – CL √TK ISOL (four) – OP (tb-OP) √XFEED (four) – CL (tb-CL) FWD RCS He PRESS (two) – OP (tb-OP)</p> <p>CLOTHING CONFIG (if time permits)</p> <p>Don: ACES Harness Boots</p> <p>C6 LEH O2 vlv (four) – OP</p> <p>ACES PRESS INTEGRITY CHECK</p> <p>Go to DEORBIT BURN Cue Cards</p>
TIG-2		TIG-2

EMERGENCY DEORBIT PREP/ENTRY

	CDR	POST BURN ACTIVITIES	PLT
	O14:E, cb MNA,B DDU L (two) – op O15:E		O15:E, cb MNB,C DDU R (two) – op O16:E
	F7 FLT CNTLR PWR – OFF		F8 FLT CNTLR PWR – OFF
	C3 √DAP: AUTO		C3 √DAP: AUTO
	MNVR TO EI-5 ATT		OMS/RCS POST BURN RECONFIG
	CRT1 GNC, OPS 303 PRO		O7 AFT L,R RCS √He PRESS (four) – OP (tb-OP) √TK ISOL (six) – GPC (tb-OP) √XFEED (four) – GPC (tb-CL)
TIME TO EI (MIN)	LVLH PITCH (DEG)		O8 L,R OMS He PRESS/VAP ISOL (four) – CL √TK ISOL (four) – OP (tb-OP) √XFEED (four) – CL (tb-CL)
26	315		
25	319		
24	323		
	327	<u>NOTE</u>	
	331	Use LVLH table unless INRTL	
	335	EI-5 attitude (ITEMS 24,25,26)	
20	339	supplied by MCC. Use DDU	
	343	and FLT CNTLR PWR as reqd	
	347	for manual mnvr	
	351		
	355		
15	359		
	3		
	7		
	11		
	15		
10	19		
	23		
	27		
	31	<u>When mnvr complete</u>	
	35	BRAKES MNA – ON	
5	39	O14:A MNB – ON	
		O15:A MNC – ON	
		O16:A	
			APU PRE-START
			R2 BLR N2 SPLY (three) – ON √PWR (three) – ON √CNTLR/HTR (three) – A(B) √cb APU FU TK VLV ENA (six) – cl √APU FU TK VLV (three) – CL √AUTO SHTDN (three) – ENA √SPEED SEL (three) – NORM √OPER (three) – OFF √HYD CIRC PUMP (three) – OFF MN PUMP PRESS (three) – LO APU CNTLR PWR (three) – ON

EMERGENCY DEORBIT PREP/ENTRY

CDR

PLT

FORWARD RCS DUMP

(Use for off-nominal Xcg entry using lowest of OX or FU qty)
Determine FWD RCS 'DUMP TO %' (DEL PAD)

FOUR JET DUMP:

FWD RCS PRPLT TO BE DUMPED (%)

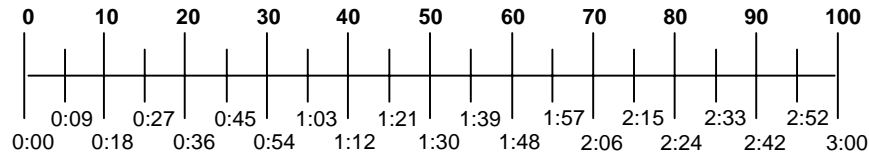

TIME FROM DUMP INITIATION (M:S)

TWO JET DUMP:

FWD RCS PRPLT TO BE DUMPED (%)

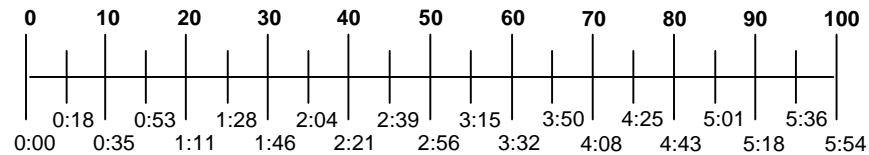

TIME FROM DUMP INITIATION (M:S)

APU START

R2 APU FU TK VLV (three) – OP
 √APU/HYD RDY tb (three) – gray

* If tb – bp, attempt normal start *

APU OPER (three) – START/RUN

MDU √HYD PRESS ind (three) – LO green

R2 √APU/HYD RDY tb (three) – bp
 HYD MN PUMP PRESS (three) – NORM

MDU √HYD PRESS ind (three) – HI green

* If APU OIL OUT P < 25 and APU TEMP *
* OIL OUT not increasing after APU start *
* or no start, perform APU SHUTDN *
* (ENT PKT, APU/HYD) *
* *
* *

R4 √HYD BK ISOL VLV (three) – GPC (tb-CL)
 √LG EXTD ISO VLV – GPC (tb-CL)

EMERGENCY DEORBIT PREP/ENTRY

CDR

PLT

FORWARD RCS DUMP (Cont)

NOTE

During dump, disregard FWD RCS qty

GNC DEORB MNVR EXEC

CRT FWD RCS ARM – ITEM 36 EXEC
 DUMP – ITEM 37 EXEC (start watch)

When dump time achieved:
 FWD RCS OFF – ITEM 38 EXEC

- | | |
|--------------------------|------------------------|
| 1: GNC 53 ENTRY CONTROLS | 2: BFS, GNC SYS SUMM 2 |
| 3: GNC DEORB MNVR COAST | |

SECONDARY ACTUATOR CHECK (if not previously performed and time permits)

NOTE

If port does not bypass during check, bypass affected port after check:
 SEC ACT BYPASS – ITEM 8 +X X EXEC
 If affected port still does not bypass:
 SEC ACT RESET ITEM 9 +X X EXEC

- | | | |
|------|----|---|
| CRT3 | 1. | SURF DRIVE ON, ITEM 39 EXEC – (*), wait at least 5 sec |
| MDU | | SPI: Stop drive test when elevon posns within +12° to -27°:
SURF DRIVE OFF, ITEM 40 EXEC – (*) |
| CRT1 | 2. | √POS STIM ENA, ITEM 7 – (no *) |
| C3 | 3. | √FCS CH (four) – AUTO |
| CRT1 | 4. | SEC ACT CK, CH 1 – ITEM 1 EXEC (*)
– ITEM 5 EXEC (*) |
| | 5. | √All CH 1 ports bypass (↓)
STOP – ITEM 6 EXEC (*) |
| C3 | 6. | FCS CH 1 – ORIDE |
| CRT1 | | √All CH 1 ports reset (no ↓) |
| C3 | | FCS CH 1 – AUTO |
| | 7. | Repeat steps 5 thru 7 for CH 2,3,4 |

This Page Intentionally Blank

EMERGENCY DEORBIT PREP/ENTRY

EQUIPMENT DONNING AND SEAT INGRESS

If not already accomplished:

Stow equip

Don: ACES

Harness

Boots

C6 LEH O2 1,2,3,4 vlv (four) – OP
Begin Fluid Loading (if time available)
Seat ingress
Install Entry Cue Cards
Adjust seat, exercise brake pedals

ENTRY SWITCH CHECK

C	L1	NH3 CNTLR B – PRI/GPC
	L2	√CAB RELIEF A,B (two) – ENA (tb-ENA) ANTISKID – ON NWS – 1
		√ENTRY MODE – AUTO
C,P	C3	√SBTC – full fwd √SRB SEP – AUTO √ET SEP – AUTO
	F6/F8	√AIR DATA – NAV √ADI ERR – MED RATE – MED √HSI SEL MODE – ENTRY √SOURCE (two) – NAV,1 – NAV,2
C,P	F3	√L,R TRIM RHC/PNL (two) – INH √PNL (two) – ON
C	F6	√RADAR ALTM – 1
P	F8	√RDR ALTM – 2

EMERGENCY DEORBIT PREP/ENTRY

CDR

PLT

HORIZ SIT CONFIG

ALTM – ITEM 9

--	--	--	--	--

	<u>PASS ITEM</u>	<u>BFS ITEM</u>
PTI	INH √1	
LAND SITE (DEL PAD)	√41	√41
RWY (DEL PAD)	√3	√3
	√4	√4
TACAN (DEL PAD)	√5	√5
RA	blank √46	
TAEM TGT		
G&N	OVHD √6	blank
HSI	blank	blank
XEP	NEP √7	NEP √7
AIM (DEL PAD)	NOM √8	NOM √8
	(or CLSE)	(or CLSE)
SPD BK	NOM √39	
TAC	INH √20	INH √20
GPS	INH √43	INH √43
DRAG H	AUT √22	AUT √22
ADTA H	INH √26	INH √26
ADTA TO G&C	INH √29	AUT √28
DES any failed TACANs	√	√
TAC	DELTA √35	
AIF_G	INH √48	

1: GNC DEORB MNVR COAST	2: GNC 50 HORIZ SIT
-------------------------	---------------------

3: GNC 51 OVERRIDE

- √ELEVON AUTO – ITEM 17 (*)
- SSME REPOS – ITEM 19 EXEC (INH)
- √WRAP MODE – ITEM 45 (ENA)
- If PLB holding > 10K lb:
- FILTER ALT – ITEM 21 EXEC (*)

3: BFS, GNC 51 OVERRIDE

- √ELEVON AUTO – ITEM 17 (*)
- √SSME REPOS – ITEM 19 (INH)
- √WRAP MODE – ITEM 45 (ENA)
- If PLB holding > 10K lb:
- √FILTER ALT – ITEM 21 EXEC (*)

- * DES any failed/comm faulted IMU, *
- * RGA, AA, or SURF feedback *

EMERGENCY DEORBIT PREP/ENTRY

CDR

PLT

EQUIPMENT DOWNING AND SEAT INGRESS

If not already accomplished:

Stow equip

Don: ACES

Harness

Boots

C6

LEH O2 1,2,3,4 vlv (four) – OP

Begin Fluid Loading (if time available)

Seat ingress

Install Entry Cue Cards

Adjust seat, exercise brake pedals

GPS RECOVERY

P O7

GPS PWR (three) – ON

PRE AMPL (six) – ON

Wait 30 sec

GNC I/O RESET

GNC 55 GPS STATUS

INIT – ITEM 14,15,16 EXEC

NAV – ITEM 17,18,19 EXEC

ENTRY SWITCH CHECK

C L1

NH3 CNTLR B – PRI/GPC

L2

√CAB RELIEF A,B (two) – ENA (tb-ENA)

ANTISKID – ON

NWS – 1

√ENTRY MODE – AUTO

C,P C3

√SBTC – full fwd

√SRB SEP – AUTO

√ET SEP – AUTO

ENTRY SWITCH CHECK (Cont)

C,P

F6/F8

√AIR DATA – NAV

√ADI ERR – MED

RATE – MED

√HSI SEL MODE – ENTRY

√SOURCE (two) – NAV,1

– NAV,2

F3

√L,R TRIM RHC/PNL (two) – INH

√PNL (two) – ON

C

F6

√RADAR ALTM – 1

P

F8

√RDR ALTM – 2

EMERGENCY DEORBIT PREP/ENTRY

CDR

PLT

HORIZ SIT CONFIG

ALTM – ITEM 9

--	--	--	--	--	--

	<u>PASS ITEM</u>		<u>BFS ITEM</u>	
PTI	INH	√1		
LAND SITE (DEL PAD)		√41	√41	
RWY (DEL PAD)		√3	√3	
		√4	√4	
TAEM TGT				
G&N	OVHD	√6	blank	
HSI	blank		blank	
XEP	NEP	√7	NEP	√7
AIM (DEL PAD)	NOM	√8	NOM	√8
	(or CLSE)		(or CLSE)	
SPD BK	NOM	√39		
NAV				
GPS	INH	√43	INH	√43
DRAG H	AUT	√22	AUT	√22
ADTA H	INH	√26	INH	√26
MLS	AUT	√50		
G&C				
GPS	INH	√48		
ADTA	INH	√29	AUT	√28

1: GNC DEORB MNVR COAST	2: GNC 50 HORIZ SIT
-------------------------	---------------------

3: GNC 51 OVERRIDE

√ELEVON AUTO – ITEM 17 (*)

SSME REPOS – ITEM 19 EXEC (INH)

√WRAP MODE – ITEM 45 (ENA)

If PLB holding > 10K lb:

FILTER ALT – ITEM 21 EXEC (*)

3: BFS, GNC 51 OVERRIDE

√ELEVON AUTO – ITEM 17 (*)

√SSME REPOS – ITEM 19 (INH)

√WRAP MODE – ITEM 45 (ENA)

If PLB holding > 10K lb:

√FILTER ALT – ITEM 21 EXEC (*)

- * DES any failed/comm faulted IMU, *
- * RGA, AA, or SURF feedback *

EMERGENCY DEORBIT PREP/ENTRY

Stow:

Deorbit Burn Cue Cards (C6)

DEORBIT BURN MONITOR (Cue Card) (C6)

√Entry Cue Cards installed

If Landing Site available:

Go to ENTRY MANEUVERS (Cue Card) at

EI-5 with following P&I:

NOTE

If cabin pressure stabilizes at 8 psi or greater, activate additional air-cooled equipment as desired

EI-5

cb ADTA 1,2,3 (three) – cl

GNC I/O RESET

cb MNA,B DDU L (two) – cl

(L) FLT CNTLR PWR – ON

If OV103,4:

V = 15K

TACAN MODE 1,2 (two) – GPC

V = 12K

Do not perform RAD ACTIVATION

M = 2.9

Use one HUD, one MLS, one RA

M < 1.0

cb MNB,C DDU R (two) – cl

(R) FLT CNTLR – ON

EMERGENCY DEORBIT PREP/ENTRY

If Landing Site not available, perform following bailout procedures:

EI-5

cb ADTA (four) – cl
MNA,B DDU L (two) – cl
GNC I/O RESET
(L) FLT CNTLR PWR – ON
√ADI ATT – LVLH
MNVR to R 001, P 039, Y 358

C CRT1

GNC, OPS 304 PRO

C ADI

√ENTRY ATT (R 000, P 040, Y 000)

F2

SPDBK/THROT pb – push (AUTO lt on)

√PITCH pb – AUTO lt on (PASS)

√ROLL/YAW pb – AUTO lt on (PASS)
(CSS if PREBANK)

EI

h = 400K
(00:00)

$\bar{q} = .5$

PITCH pb – push (CSS lt on)
ROLL/YAW pb – push (CSS lt on)

EMERGENCY DEORBIT PREP/ENTRY

I

$\dot{H} = -200$ and increasing (D = 5-6)

Start 3°/sec roll to ENTRY ALPHA (Cue Card)
ref bank angle while maintaining alpha = 40°

Approaching ref bank angle, bank as necessary
to center phugoid damper with BIAS = 0

- * Always null alpha errors from ENTRY *
- * TRAJ display or ENTRY ALPHA Cue *
- * Card before nulling bank errors *
- * *
- * When roll reversal reqd or if phugoid *
- * damper becomes overly sensitive, use *
- * alpha and \dot{H} from cue card as primary *
- * fly-to indications *
- * *
- * During roll reversal, if phugoid damper *
- * commands an \dot{H} significantly different *
- * from cue card, establish approximate *
- * cue card \dot{H} with an \ddot{H} of ± 3 to 5 ft/sec² *
- * and wait for phugoid damper to stabilize *
- * before following phugoid damper *

D = 11

√DRAG H UPDATE ACTIVE

- * If editing occurs: *
- * 2: GNC 50 HORIZ SIT *
- * DRAG H FOR – ITEM 24 EXEC *
- * *

If OV103,4:

TACAN MODE 1,2 (two) – GPC

Wings level, follow α sched

V = 15K

M = 6.0

M = 5.0

2: GNC 51 OVERRIDE

AIR DATA PROBES (two) – DEPLOY(√HEAT)

EMERGENCY DEORBIT PREP/ENTRY

I

P

√AIR DATA R,L then NAV

3: GNC 50 HORIZ SIT

RATIO < 1	RATIO > 1	
AUTO	ADTA ERRATIC AUTO	ADTA STEADY FORCE

When ADTA-H AUTO/FORCE:

ADTA to G&C – AUTO

- * If no Air Data and M < 1.5: *
- * Fly theta limits *
- * If PRI DME > 80 nm, theta limits *
- * unavailable: *
- * Maintain theta below limits as *
- * determined by SB posn and roll angle *
- * Supersonic *
- * Theta < -7° for SB = 65% & F = 0° *
- * Supersonic *
- * Theta < -1° for SB = 0% & Φ = 0° *
- * Theta < -12° for SB = 100% & Φ = 0° *

M = 2.5
M < 1.0

FLY $\alpha = 12^\circ$
Go to BAILOUT

LOSS OF 2 FREON LOOPS DEORBIT PREP/ENTRY

This Page Intentionally Blank

LOSS OF 2 FREON LOOPS DEORBIT PREP/ENTRY MS PULLOUT PAGE

I

ASSUMPTIONS/INITIAL CONDITIONS

Loss of Two Freon Loops Deorbit Prep/Entry is a **stand-alone procedure** that assumes FREON FLOW LOW and LOSS OF 2 FREON LOOPS (ORB PKT, PWRDN) or LOSS OF 2 FREON LOOPS (ENTRY) (ENT PKT, PWRDN) accomplished

This failure requires immediate deorbit to first available landing site while powered down to very low level

If landing site not available, bailout procedures will be reqd

All FCs will be on with continuous purge

PROBLEM DESCRIPTION/RATIONALE

Source of orbiter cooling is Freon coolant loops. With no Freon flow, heat not removed from Freon and, hence, from water and air-cooled equipment as well

Orbiter Freon Loops are designed to remove heat from fuel cell coolant (FC-40), maintaining FCs at ~200 degF. When the Freon no longer cools FC-40, fuel cell stack temperature rises and electrolyte concentration drops. Byproduct H₂O not condensed/removed and accumulates in cells, causing fuel cells to flood. Flooding predicted to occur when electrolyte concentration drops below 25% and will result in loss of power to orbiter. Additionally, fuel cell stack can fail allowing mixing and/or escape of reactants if stack temperature becomes excessively high (~250 degF)

If pwrndn accomplished to 8 kW total load immediately following failure of second Freon loop, analysis indicates that with continuous purge, orbiter life extended to 120 min

LOSS OF 2 FREON LOOPS DEORBIT PREP/ENTRY MS PULLOUT PAGE

I

NOTE

1. MS procedures are located on MS PULLOUT PAGE, 11-5. Extra copies located in back of PLT's book
2. Use COMM pages from ORB PKT pwrn to cycle COMM if necessary
3. Maintain minimum lighting
4. Only two APUs used for entry. APUs will be started at EI-5
5. This procedure utilizes modified DEORBIT BURN MONITOR and ENTRY MANEUVERS Cue Cards located in this section
6. Don Quick Don Mask as needed for additional respiratory cooling. If cabin temp > 95 degF and no evaporative cooling sensed, don ACES, activate O2, and close visor

**LOSS OF 2 FREON LOOPS DEORBIT PREP
MS PULLOUT PAGE**

NOTE: Wait for GO from CDR before accomplishing any action on this page

Prepare ACES for donning

~TIG-15 MCA CONFIG

MA73C:A MCA LOGIC FWD (three) – ON
:C cb MCA PWR AC1 3Φ FWD 1 – op
AC3 3Φ FWD 3 – op

~TIG-10 AFT PANEL CONFIG FOR ENTRY COMM

NOTE

This procedure configures aft panel for landing site comm coverage at V = 12K. If comm cycled post TIG-10 (using ORB PKT pwrn comm pages), this AFT PANEL CONFIG FOR ENTRY COMM must be reestablished

R14:B cb GCILC (two) – cl
C3 S-BD PM CNTL – CMD
A1L ANT SW ELEC – 2
MODE – STDN LO
XPNDR – 2
NSP PWR – 2
DATA RATE XMI – HI
RCV – HI
√UPLK DATA – S-BD
√CODING XMIT – OFF
√RCV – OFF

(Cont next column)

TIG-5 LEH VLV CONFIG

MO69M LEH O2 8 vlv – CL
Stow O2 Bleed Orifice
LEH O2 7,8 vlv (two) – OP (if reqd)
MO32M 5,6 vlv (two) – OP (if reqd)

~EI-10

Stow flight deck PGSC

EI GPS POWERUP (OV103,4)

A13 GPS PWR – ON
If OV103:
GPS PRE AMPL (two) – MNC
If OV104:
GPS PRE AMPL (two) – ON
Report Powerup Complete to CDR

CLOTHING CONFIG

Don: ACES
Harness
Boots
C6 LEH O2 vlv (two) – OP

This Page Intentionally Blank

LOSS OF 2 FREON LOOPS DEORBIT PREP

MS PULLOUT PAGE

NOTE: Wait for GO from CDR before accomplishing any action on this page

Prepare ACES for donning

~TIG-15 MCA CONFIG

MA73C:A MCA LOGIC FWD (three) – ON
:C cb MCA PWR AC1 3Φ FWD 1 – op
AC3 3Φ FWD 3 – op

~TIG-10 AFT PANEL CONFIG FOR ENTRY COMM

NOTE

This procedure configures aft panel for landing site comm coverage at V = 12K. If comm cycled post TIG-10 (using ORB PKT pwrn comm pages), this AFT PANEL CONFIG FOR ENTRY COMM must be reestablished

R14:B cb GCILC (two) – cl
C3 S-BD PM CNTL – CMD
A1L ANT SW ELEC – 2
MODE – STDN LO
XPNDR – 2
NSP PWR – 2
DATA RATE XMI – HI
RCV – HI
√UPLK DATA – S-BD
√CODING XMIT – OFF
√RCV – OFF

(Cont next column)

TIG-5 LEH VLV CONFIG

MO69M LEH O2 8 vlv – CL
Stow O2 Bleed Orifice
LEH O2 7,8 vlv (two) – OP (if reqd)
MO32M 5,6 vlv (two) – OP (if reqd)

~EI-10

Stow flight deck PGSC

CLOTHING CONFIG

Don: ACES
Harness
Boots
C6 LEH O2 vlv (two) – OP

This Page Intentionally Blank

This Page Intentionally Blank

LOSS OF 2 FREON LOOPS DEORBIT PREP (Cont)

ENTRY CONFIG

CDR

PLT

3. ASSIGN GPC 3 TO MC3 REDUNDANT SET

CRT GNC 0 GPC MEMORY
 CONFIG – ITEM 1 +3 EXEC
 Modify MC3 per table →
 GNC, OPS 301 PRO
GNC 0 GPC MEMORY
 DOWNLIST GPC – ITEM 44
 +3 EXEC

CONFIG GPC	3 10300
STR 1	3
2	3
3	3
4	3
PL 1/2	3
CRT 1	3
2	3
3	3
4	0
L 1	0
2	0
MM 1	3
2	3

4. DEACT GPC 1, MMU 1, ASAs

O6 GPC MODE 1 – STBY, HALT
 PWR 1 – OFF

O14:F MMU 1 – OFF
 O15:F ASA 2 – OFF
 O16:F 3 – OFF

5. SWITCH AV BAY FANS

L1 AV BAY 1 FAN A – OFF
 3 FAN B – ON

6. ACTIVATE FA4 FOR BURN

O6 MDM FA4 – ON
 GNC I/O RESET

Do not proceed until all DPS ENTRY CONFIG steps complete

ATMOSPHERE SELECT

GNC 51 OVERRIDE

CRT SELECT ATM: incl ≤ 50° √ITEM 22 (*)
 incl > 50° SEL ITEM NR

Hemi	Jan	Feb	Mar	Apr	May	Jun	Jul	Aug	Sep	Oct	Nov	Dec
N Desc	23	23	23	23	22	24	24	24	22	23	23	23
S Asc	24	24	22	23	23	23	23	23	23	23	22	24
N Asc	22											
S Desc												

LAND SITE UPDATE

√LAND SITE UPDATE

GNC 50 HORIZ SIT

CRT SEL SITE (See LAND SITE DATA)

CG CHECK

DEORB MNVR COAST

CRT UPDATE PRPLT, ITEM 18, as reqd

LOSS OF 2 FREON LOOPS DEORBIT PREP

ENTRY CONFIG

LOAD TGTs AND MNVR

CRT Enter TGT DATA from MCC or PGSC →
 LOAD – ITEM 22 EXEC
 TIMER – ITEM 23 EXEC
 DAP: AUTO
 Mnvr to Burn Att

 Select SEC GIMBALS
 (because FF1,FF4 - OFF)
 LEFT – ITEM 30 EXEC
 RIGHT – ITEM 31 EXEC
 GNC, OPS 302 PRO

MEDS CONFIG FOR ENTRY

C2 IDP/CRT3 PWR – ON
 √All other IDP/CRTs – OFF

 Use two MDUs
 O13:A cb ESS 1BC MTU A – op
 O15:E MNB DDU R – cl
 O16:E MNC DDU R – cl

CLOTHING CONFIG

C6 Don: ACES,Harness,Boots
 LEH O2 vlv (two) – OP

~TIG-3 Go to DEORBIT BURN Cue Cards

NOTE
 Use LOSS OF 2 FREON LOOPS
 D/O BURN MONITOR CARD

PGSC DEORBIT PAD		
RECORD DEORBIT OPPORTUNITIES		
SITE	APPROX TIG	XRNG
_____	____/____:____:____	_____
_____	____/____:____:____	_____
_____	____/____:____:____	_____
_____	____/____:____:____	_____
COMPUTE WEIGHT		
Use Deorbit Manager on PGSC (record below)		
COMPUTE TARGET		
WT	_____	_____
TIG	____/____:____:____	_____
C1	_____	_____
C2	(-).6000	_____
HT	65.832	_____
θT	_____	_____
ΔVTOT	_____	_____
REI	_____	_____
LOAD TARGET IN OPS 3		

DEORBIT BURN MONITOR

(LOSS OF 2 FREON LOOPS)

OMS PC & OMS ↓	OMS PRPLT FAIL
OMS OX/FU TK P (√ [OMS/MPS]) OX/FU LOW	He PRESS/VAP ISOL (two) – OP If aff TK P not incr: He PRESS/VAP ISOL (two) – CL At PC < 72: OMS PRPLT FAIL
OX & FU HIGH	He PRESS/VAP ISOL (two) – CL Cycle He A(B) to maintain TK P 234-284
OMS GMBL	If high RCS usage: OMS ENG FAIL
I/O ERROR FA	◆ I/O RESET (if recov: >>) If high RCS usage: OMS ENG FAIL √ MAN SHUTDN
BCE STRG D	I/O RESET (if recov: >>) √ If high RCS usage: OMS ENG FAIL

I

LOSS OF 2 FREON LOOPS

ENTRY

CDR

PLT

MNVR TO EI-5 ATT

O6 MDM FA4 – OFF
 CRT GNC, OPS 303 PRO
 O14:E, cb DDU L (two) – cl, as reqd to reach/
 O15:E maintain EI-5 attitude

TIME TO EI (MIN)	LVLH PITCH (DEG)
26	315
25	319
24	323
	327
	331
	335
20	339
	343
	347
	351
	355
15	359
	3
	7
	11
	15
10	19
	23
	27
	31
	35
5	39

NOTE

Use LVLH table unless **INRTL**
 EI-5 attitude (ITEMS 24,25,26)
 supplied by MCC

F8 FLT CNTLR PWR – OFF
 O15:E, cb DDU R – op
 O16:E

OMS/RCS POST BURN RECONFIG

O7 √AFT L,R RCS He PRESS (four) – OP (tb-OP)
 √TK ISOL (six) – GPC (tb-OP)
 √XFEED (four) – GPC (tb-CL)

O8 L,R OMS
 √He PRESS/VAP ISOL (four) – CL
 √TK ISOL (four) – OP (tb-OP)
 √XFEED (four) – CL (tb-CL)

OMS GIMBAL PWRDN (PASS only)

CRT Verify gimbal posns:

	<u>L</u>	<u>R</u>
P	+5.9	+5.9
Y	+6.4	-6.4

GMBL OFF – ITEM 32 EXEC
 – ITEM 33 EXEC

LOSS OF 2 FREON LOOPS (Cont)

ENTRY

CDR

PLT

Perform FRCS dump if reqd to maintain Xcg in box

If no FRCS dump reqd, go to 11-16

HORIZ SIT CONFIG

ALTM – ITEM 9 +

--	--	--	--	--

	PASS ITEM
PTI	INH √1
LAND SITE (DEL PAD)	√41
RWY (DEL PAD)	√3
	√4
TACAN (DEL PAD)	√5
RA	blank √46
TAEM TGT	
G&N	OVHD √6
HSI	blank
XEP	NEP √7
AIM (DEL PAD)	NOM √8
	(or CLSE)
SPD BK	NOM √39
TAC	INH √20
GPS	INH √43
DRAG H	AUT √22
ADTA H	INH √26
ADTA TO G&C	INH √29
DES any failed TACANs	√
TAC	DELTA √35
AIF_G	INH √48

FWD RCS RECOVERY

- O14:B √cb OI SIG CONDR OF 1/4 A – cl
 :F RJDF 1B F1 DRIVER – ON
 LOGIC – ON
- O15:B √cb OI SIG CONDR OF 2/3 A – cl
 :F RJDF 1A F2 DRIVER – ON
 LOGIC – ON
- O16:F 2A F3,2B F4 DRIVER (two) – ON
 F4/F5 LOGIC (two) – ON
- O6 MDM FF1,4 – ON
 GNC I/O RESET
- O8 Reopen FWD RCS

GNC 23 RCS
- CRTX JET RESET – ITEM 45 EXEC
 Reselect deselected FRCS jets
 JET RESET – ITEM 45 EXEC

FORWARD RCS DUMP (Use for off-nominal Xcg entry using lowest of OX or FU qty)

Determine FWD RCS 'DUMP TO %' (calculator, cg wheel, or DEL PAD)

FOUR JET DUMP:

FRCS PRPLT TO BE DUMPED (%)

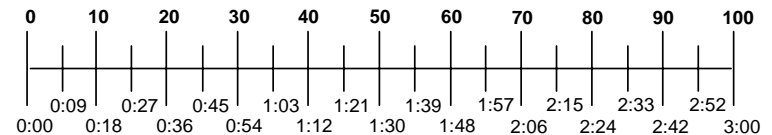

TIME FROM DUMP INITIATION (M:S)

OV103,104

C D/O/3,4/GEN L

LOSS OF 2 FREON LOOPS

ENTRY

CDR

PLT

MNVR TO EI-5 ATT

O6 MDM FA4 – OFF
 CRT GNC, OPS 303 PRO
 O14:E, cb DDU L (two) – cl, as reqd to reach/
 O15:E maintain EI-5 attitude

TIME TO EI (MIN)	LVLH PITCH (DEG)
26	315
25	319
24	323
	327
	331
	335
20	339
	343
	347
	351
	355
15	359
	3
	7
	11
	15
10	19
	23
	27
	31
	35
5	39

NOTE

Use LVLH table unless **INRTL**
 EI-5 attitude (ITEMS 24,25,26)
 supplied by MCC

F8 FLT CNTLR PWR – OFF
 O15:E, cb DDU R – op
 O16:E

OMS/RCS POST BURN RECONFIG

O7 √AFT L,R RCS He PRESS (four) – OP (tb-OP)
 √TK ISOL (six) – GPC (tb-OP)
 √XFEED (four) – GPC (tb-CL)

O8 L,R OMS
 √He PRESS/VAP ISOL (four) – CL
 √TK ISOL (four) – OP (tb-OP)
 √XFEED (four) – CL (tb-CL)

OMS GIMBAL PWRDN (PASS only)

CRT Verify gimbal posns:

	<u>L</u>	<u>R</u>
P	+5.9	+5.9
Y	+6.4	-6.4

GMBL OFF – ITEM 32 EXEC
 – ITEM 33 EXEC

LOSS OF 2 FREON LOOPS (Cont)

ENTRY

CDR

PLT

Perform FRCS dump if reqd to maintain Xcg in box

If no FRCS dump reqd, go to 11-16

HORIZ SIT CONFIG

ALTM – ITEM 9 +

--	--	--	--	--	--

	PASS ITEM
PTI	INH √1
LAND SITE (DEL PAD)	√41
RWY (DEL PAD)	√3
	√4
TAEM TGT	
G&N	OVHD √6
HSI	blank
XEP	NEP √7
AIM (DEL PAD)	NOM √8
	(or CLSE)
SPD BK	NOM √39
NAV	
GPS	INH √43
DRAG H	AUT √22
ADTA H	INH √26
MLS	AUT √50
G&C	
GPS	INH √48
ADTA	INH √29

FWD RCS RECOVERY

- O14:B √cb OI SIG CONDR OF 1/4 A – cl
 :F RJDF 1B F1 DRIVER – ON
 LOGIC – ON
- O15:B √cb OI SIG CONDR OF 2/3 A – cl
 :F RJDF 1A F2 DRIVER – ON
 LOGIC – ON
- O16:F 2A F3,2B F4 DRIVER (two) – ON
 F4/F5 LOGIC (two) – ON
- O6 MDM FF1,4 – ON
 GNC I/O RESET
- O8 Reopen FWD RCS

GNC 23 RCS
- CRTX JET RESET – ITEM 45 EXEC
 Reselect deselected FRCS jets
 JET RESET – ITEM 45 EXEC

FORWARD RCS DUMP (Use for off-nominal Xcg entry using lowest of OX or FU qty)

Determine FWD RCS 'DUMP TO %' (calculator, cg wheel, or DEL PAD)

FOUR JET DUMP:

FRCS PRPLT TO BE DUMPED (%)

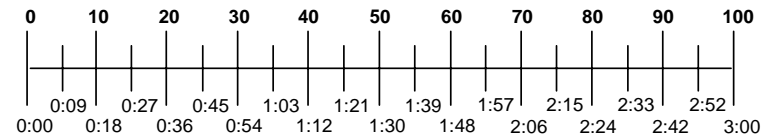

TIME FROM DUMP INITIATION (M:S)

LOSS OF 2 FREON LOOPS (Cont)

ENTRY

CDR

PLT

1: GNC DEORB MNVR COAST | 2: GNC 50 HORIZ SIT

3: GNC 51 OVERRIDE

- √ELEVON AUTO – ITEM 17 (*)
- SSME REPOS – ITEM 19 EXEC (INH)
- √WRAP MODE – ITEM 45 (ENA)
- If PLB holding >10K lb:
- FILTER ALT – ITEM 21 EXEC (*)

TWO JET DUMP:

FRCS PRPLT TO BE DUMPED (%)

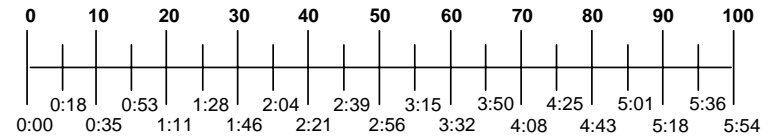

TIME FROM DUMP INITIATION (M:S)

NOTE

During dump, disregard FRCS qty

GNC DEORB MNVR EXEC

- FWD RCS ARM – ITEM 36 EXEC
- DUMP – ITEM 37 EXEC
- (start watch)

When dump time achieved:
OFF – ITEM 38 EXEC

When dump complete:
O8 FWD RCS MANF ISOL 1,2,3,4 (four) – CL (tb-CL)

- O6 MDM FF1,4 (two) – OFF
- O14:F, RJDF LOGIC,DRIVER (eight) – OFF
- O15:F,
- O16:F

LOSS OF 2 FREON LOOPS (Cont)

ENTRY

	CDR	PLT																																																			
	Stow: <u>DEORBIT BURN</u> and <u>DEORBIT BURN MONITOR</u> Cue Cards	FC PERFORMANCE CHECK																																																			
~EI-10	Give MS GO to stow flight deck PGSC	Two FCs reqd for ENTRY/LANDING Monitor FC performance through landing:																																																			
	√ENTRY Cue Cards installed	<table style="width: 100%; border-collapse: collapse;"> <tr> <td style="width: 5%; vertical-align: top;">O2</td> <td style="border-left: 1px solid black; padding-left: 5px;">If any single FC STACK TEMP ≥ 250 degF:</td> <td></td> </tr> <tr> <td style="vertical-align: top;">R1</td> <td style="border-left: 1px solid black; padding-left: 5px;">Affected ESS BUS SOURCE</td> <td></td> </tr> <tr> <td></td> <td style="border-left: 1px solid black; padding-left: 5px;">FC1(2,3) – OFF</td> <td></td> </tr> <tr> <td></td> <td style="border-left: 1px solid black; padding-left: 5px;">Affected FC/MN BUS A(B,C) – OFF</td> <td></td> </tr> <tr> <td style="vertical-align: top;">O2</td> <td style="border-left: 1px solid black; padding-left: 5px;">When FC STACK TEMP within 5 degF of either remaining FC, reconnect FC to buses (MN first, then ESS)</td> <td></td> </tr> <tr> <td></td> <td style="border-left: 1px solid black; padding-left: 5px;">If all three FC STACK TEMPs ≥ 250 degF:</td> <td></td> </tr> <tr> <td></td> <td style="border-left: 1px solid black; padding-left: 5px;">No action</td> <td></td> </tr> </table>	O2	If any single FC STACK TEMP ≥ 250 degF:		R1	Affected ESS BUS SOURCE			FC1(2,3) – OFF			Affected FC/MN BUS A(B,C) – OFF		O2	When FC STACK TEMP within 5 degF of either remaining FC, reconnect FC to buses (MN first, then ESS)			If all three FC STACK TEMPs ≥ 250 degF:			No action																															
O2	If any single FC STACK TEMP ≥ 250 degF:																																																				
R1	Affected ESS BUS SOURCE																																																				
	FC1(2,3) – OFF																																																				
	Affected FC/MN BUS A(B,C) – OFF																																																				
O2	When FC STACK TEMP within 5 degF of either remaining FC, reconnect FC to buses (MN first, then ESS)																																																				
	If all three FC STACK TEMPs ≥ 250 degF:																																																				
	No action																																																				
	SEAT INGRESS																																																				
	Adjust seat (one seat and direction at a time)																																																				
	Exercise brake pedals																																																				
	G-SUIT INFLATION																																																				
	All Load – 1.5	EI-5 APU PRE-START																																																			
EI-7	Go to LOSS OF 2 FREON LOOPS ENTRY MANEUVERS, 11-21	<table style="width: 100%; border-collapse: collapse;"> <tr> <td style="width: 5%; vertical-align: top;">R2</td> <td style="border-left: 1px solid black; padding-left: 5px;">BLR N2 SPLY 1,3 (two)</td> <td style="text-align: right;">– ON</td> </tr> <tr> <td></td> <td style="border-left: 1px solid black; padding-left: 5px;">√PWR 1,3 (two)</td> <td style="text-align: right;">– ON</td> </tr> <tr> <td></td> <td style="border-left: 1px solid black; padding-left: 5px;">√CNTLR/HTR 1,3 (two)</td> <td style="text-align: right;">– A(B)</td> </tr> <tr> <td></td> <td style="border-left: 1px solid black; padding-left: 5px;">√cb APU FU TK VLV ENA 1A,1B (two)</td> <td style="text-align: right;">– cl</td> </tr> <tr> <td></td> <td style="border-left: 1px solid black; padding-left: 5px;">√3A,3B (two)</td> <td style="text-align: right;">– cl</td> </tr> <tr> <td></td> <td style="border-left: 1px solid black; padding-left: 5px;">√APU FU TK VLV 1,3 (two)</td> <td style="text-align: right;">– CL</td> </tr> <tr> <td></td> <td style="border-left: 1px solid black; padding-left: 5px;">√AUTO SHTDN 1,3 (two)</td> <td style="text-align: right;">– ENA</td> </tr> <tr> <td></td> <td style="border-left: 1px solid black; padding-left: 5px;">√SPEED SEL 1,3 (two)</td> <td style="text-align: right;">– NORM</td> </tr> <tr> <td></td> <td style="border-left: 1px solid black; padding-left: 5px;">√OPER 1,3 (two)</td> <td style="text-align: right;">– OFF</td> </tr> <tr> <td></td> <td style="border-left: 1px solid black; padding-left: 5px;">√HYD CIRC PUMP 1,3 (two)</td> <td style="text-align: right;">– OFF</td> </tr> <tr> <td></td> <td style="border-left: 1px solid black; padding-left: 5px;">MN PUMP PRESS 1,3 (two)</td> <td style="text-align: right;">– LO</td> </tr> <tr> <td></td> <td style="border-left: 1px solid black; padding-left: 5px;">APU CNTLR PWR 1,3 (two)</td> <td style="text-align: right;">– ON</td> </tr> <tr> <td></td> <td style="border-left: 1px solid black; padding-left: 5px;">C3</td> <td style="text-align: right;">FCS CH 1,4 (two) – OFF</td> </tr> <tr> <td></td> <td style="border-left: 1px solid black; padding-left: 5px;"></td> <td style="text-align: right;">2,3 (two) – ORIDE</td> </tr> <tr> <td></td> <td style="border-left: 1px solid black; padding-left: 5px;">O14:F,</td> <td style="text-align: right;">ASA (four) – ON</td> </tr> <tr> <td></td> <td style="border-left: 1px solid black; padding-left: 5px;">O15:F,</td> <td></td> </tr> <tr> <td></td> <td style="border-left: 1px solid black; padding-left: 5px;">O16:F</td> <td></td> </tr> </table>	R2	BLR N2 SPLY 1,3 (two)	– ON		√PWR 1,3 (two)	– ON		√CNTLR/HTR 1,3 (two)	– A(B)		√cb APU FU TK VLV ENA 1A,1B (two)	– cl		√3A,3B (two)	– cl		√APU FU TK VLV 1,3 (two)	– CL		√AUTO SHTDN 1,3 (two)	– ENA		√SPEED SEL 1,3 (two)	– NORM		√OPER 1,3 (two)	– OFF		√HYD CIRC PUMP 1,3 (two)	– OFF		MN PUMP PRESS 1,3 (two)	– LO		APU CNTLR PWR 1,3 (two)	– ON		C3	FCS CH 1,4 (two) – OFF			2,3 (two) – ORIDE		O14:F,	ASA (four) – ON		O15:F,			O16:F	
R2	BLR N2 SPLY 1,3 (two)	– ON																																																			
	√PWR 1,3 (two)	– ON																																																			
	√CNTLR/HTR 1,3 (two)	– A(B)																																																			
	√cb APU FU TK VLV ENA 1A,1B (two)	– cl																																																			
	√3A,3B (two)	– cl																																																			
	√APU FU TK VLV 1,3 (two)	– CL																																																			
	√AUTO SHTDN 1,3 (two)	– ENA																																																			
	√SPEED SEL 1,3 (two)	– NORM																																																			
	√OPER 1,3 (two)	– OFF																																																			
	√HYD CIRC PUMP 1,3 (two)	– OFF																																																			
	MN PUMP PRESS 1,3 (two)	– LO																																																			
	APU CNTLR PWR 1,3 (two)	– ON																																																			
	C3	FCS CH 1,4 (two) – OFF																																																			
		2,3 (two) – ORIDE																																																			
	O14:F,	ASA (four) – ON																																																			
	O15:F,																																																				
	O16:F																																																				

LOSS OF 2 FREON LOOPS (Cont)

ENTRY

CDR

PLT

APU START

HYD MN PUMP PRESS 1,3 – NORM

MDU √HYD PRESS 1,3 ind (two) – HI green
INST PWR – OFF

R4 √HYD BRAKE ISOL VLV 1,3 (two) – GPC
 (tb-CL)
 √LG EXTEND ISOL VLV – GPC (tb-CL)

LOSS OF 2 FREON LOOPS ENTRY MANEUVERS

FLIGHT CONDITIONS	MANEUVER
EI-5	MDM FF1,4 – ON CAB FAN B – ON cb MNA,B DDU L (two) – cl cb ADTA 2,3 – cl ACCEL 2 – CL ACCEL 3 – ON GNC I/O RESET * If PREBANK: R/Y – CSS * √LVLH ATT * Roll at 1°/sec to <input type="text"/> <input type="text"/> * GNC, OPS 304 PRO * √OPS 304, wait 1 min * Maintain PREBANK ± 5° * MDM FF1,4 – OFF
EI	After MS reports GPS Powerup complete: GNC I/O RESET <input type="text"/> GNC 55 GPS STATUS INIT – ITEM 15 EXEC (*) NAV – ITEM 18 EXEC (*)
'Guidance Box' @ q ~8 or D ~3	CLOSED LOOP GUIDANCE ____:____:____ * If PREBANK: P,R/Y – AUTO * Begin AIL trim monitoring
D = 11	√DRAG H
ΔAz = 10.5°	FIRST ROLL REVERSAL <input type="text"/> <input type="text"/> <input type="text"/> <input type="text"/>
V = 19K	√HYD MPS/TVC ISOL VLV SYS (three) – CL <input type="text"/> G50 √GPS, INCORPORATE
V = 12K	BRAKES MNB,MNC (two) – ON UHF MODE – SPLX (G T/R if ELS) AUD CTR – 1 √OI PCMMU FORMAT – FXD L,R AUD PWR – AUD If command or data reqd: OI PCMMU PWR – 2 MDM PL2 – ON S-BD PM CNTL – PNL, then CMD GNC I/O RESET ANT SW – Select best ANT On MCC call: MDM PL2 – OFF OI PCMMU PWR – OFF
V = 10K	√SPDBK to 81%
V = 7K	√GPS INCORPORATE
V = 5K	ADTA PROBES – DEPLOY (√HEAT, only one side if reqd) Begin AIL and RUD trim monitoring

FLIGHT CONDITIONS	MANEUVER
M = 4	MDM FF4 – ON MDM FF1 – ON (if NWS reqd) GNC I/O RESET
M = 2.9	RADAR ALTM 2 – ON CAB FAN (two) – OFF Use no landing aids (HUD,MLS) unless reqd to land vehicle safely (L HUD DATA BUS – 2 reqd)
M = 2.7	√APUs APU SPEED SEL (two) – HI * If M < 2.5, P CSS for ADTA to G&C incorp *
M = 2.0	Ensure ADTA to G&C; else, √theta limits
M < 1.0	* For bailout procedures, go to <u>BAILOUT</u> * (L) FLT CNTLR PWR – ON P,R/Y – CSS as reqd √SPDBK CMD vs POS MAX Nz <input type="text"/> <input type="text"/> <input type="text"/> ANTISKID – ON If NWS reqd: cb MNB,C DDU R (two) – cl (R) FLT CNTLR PWR – ON NWS – 1 Lock Inertia Reels Use one IDP/CRT with three MDUs
M = 0.7	LG EXTD ISO VLV – OP HYD BK ISOL VLV 1 – OP
h = 15K	√MLS (if on)
h = 10K	√A/L (KSC – Tabs, Visors, Suit O2)
h = 2K	LDG GEAR ARM pb – push (ARM It on)
h = 300	LDG GEAR DN pb – push (DN It on)
MAIN GEAR TD	√SPDBK – 100%
V = 195 KEAS	DRAG CHUTE ARM,DPY pb (two) – push (simo) (All Its on)
V = 185 KEAS	DEROTATE
NOSE GEAR TD	SRB SEP – MAN/AUTO and depress pb √Auto Load Relief √HYD BK ISOL VLV 1,3 (two) – OP
V < 120 KGS or 5K' remaining	BRAKE as reqd (8-10 fps ² , -0.25 to -0.3G) * If 5K' remaining and V > 140 KGS – MAX BRAKING *
V = 60 KGS	DRAG CHUTE JETT pb – push (JETT1,JETT2 It on)
V = 40 KGS	BRAKE < 6 fps ² (-0.2G) (Antiskid cutout)
WHEEL STOP	Go to <u>EMER PWRDN</u> (Cue Card)

OV103,104

C D/O/3,4/GEN L,5

This Page Intentionally Blank

LOSS OF 2 FREON LOOPS ENTRY MANEUVERS

FLIGHT CONDITIONS	MANEUVER
EI-5	MDM FF1,4 – ON CAB FAN B – ON cb MNA,B DDU L (two) – cl cb ADTA 2,3 – cl ACCEL 2 – CL ACCEL 3 – ON GNC I/O RESET * If PREBANK: R/Y – CSS * √LVLH ATT * Roll at 1°/sec to <input type="text"/> <input type="text"/> <input type="text"/> <input type="text"/> * GNC, OPS 304 PRO * √OPS 304, wait 1 min * Maintain PREBANK ± 5° * MDM FF1,4 – OFF
EI	GPS 2 PWR – ON PRE AMPL (two) – ON Wait 30 sec GNC I/O RESET <input type="text"/> GNC 55 GPS STATUS <input type="text"/> INIT – ITEM 15 EXEC (*) NAV – ITEM 18 EXEC (*)
'Guidance Box' @ q ~8 or D ~3	CLOSED LOOP GUIDANCE ____:____:____ * If PREBANK: P,R/Y – AUTO * Begin AIL trim monitoring
D = 11	√DRAG H
ΔAz = 10.5°	FIRST ROLL REVERSAL <input type="text"/> <input type="text"/> <input type="text"/> <input type="text"/> <input type="text"/>
V = 19K	√HYD MPS/TVC ISOL VLV SYS (three) – CL <input type="text"/> G50 √GPS, INCORPORATE
V = 12K	BRAKES MNB,MNC (two) – ON UHF MODE – SPLX (G T/R if ELS) AUD CTR – 1 √OI PCMMU FORMAT – FXD L,R AUD PWR – AUD If command or data reqd: OI PCMMU PWR – 2 MDM PL2 – ON S-BD PM CNTL – PNL, then CMD GNC I/O RESET ANT SW – Select best ANT On MCC call: MDM PL2 – OFF OI PCMMU PWR – OFF
V = 10K	√SPDBK to 81%
V = 7K	√GPS INCORPORATE
V = 5K	ADTA PROBES – DEPLOY (√HEAT, only one side if reqd) Begin AIL and RUD trim monitoring

FLIGHT CONDITIONS	MANEUVER
M = 4	MDM FF4 – ON MDM FF1 – ON (if NWS reqd) GNC I/O RESET
M = 2.9	RADAR ALTM 2 – ON CAB FAN (two) – OFF Use no landing aids (HUD,MLS) unless reqd to land vehicle safely (L HUD DATA BUS – 2 reqd)
M = 2.7	√APUs APU SPEED SEL (two) – HI * If M < 2.5, P CSS for ADTA to G&C incorp *
M = 2.0	Ensure ADTA to G&C; else, √theta limits
M < 1.0	* For bailout procedures, go to <u>BAILOUT</u> * (L) FLT CNTLR PWR – ON P,R/Y – CSS as reqd √SPDBK CMD vs POS MAX Nz <input type="text"/> <input type="text"/> <input type="text"/> <input type="text"/> ANTISKID – ON If NWS reqd: cb MNB,C DDU R (two) – cl (R) FLT CNTLR PWR – ON NWS – 1 Lock Inertia Reels Use one IDP/CRT with three MDUs
M = 0.7	LG EXTD ISO VLV – OP HYD BK ISOL VLV 1 – OP
h = 15K	√MLS (if on)
h = 10K	√A/L (KSC – Tabs, Visors, Suit O2)
h = 2K	LDG GEAR ARM pb – push (ARM It on)
h = 300	LDG GEAR DN pb – push (DN It on)
MAIN GEAR TD	√SPDBK – 100%
V = 195 KEAS	DRAG CHUTE ARM,DPY pb (two) – push (simo) (All Its on)
V = 185 KEAS	DEROTATE
NOSE GEAR TD	SRB SEP – MAN/AUTO and depress pb √Auto Load Relief √HYD BK ISOL VLV 1,3 (two) – OP
V < 120 KGS or 5K' remaining	BRAKE as reqd (8-10 fps ² , -0.25 to -0.3G) * If 5K' remaining and V > 140 KGS – MAX BRAKING *
V = 60 KGS	DRAG CHUTE JETT pb – push (JETT1,JETT2 It on)
V = 40 KGS	BRAKE < 6 fps ² (-0.2G) (Antiskid cutout)
WHEEL STOP	Go to <u>EMER PWRDN</u> (Cue Card)

This Page Intentionally Blank

QUICK-RESPONSE JETTISON

POST-JETTISON CLEANUP 12-7

I

QUICK-RESPONSE JETTISON

ASSUMPTIONS/INITIAL CONDITIONS

Failed KU-BD and/or RMS (possibly with PL attached) must be jettisoned ASAP

At least one G2 GPC up and running

Full RCS and AFT DDU/FLT CNTLR PWR available for use

Hardware jettison and initial sep mnvr may be done in any attitude

PROBLEM DESCRIPTION/RATIONALE

Integrated, rapidly executable procedure to accomplish time-constrained jettison and sep from failed KU-BD and/or RMS

Designed to be used as reqd during time critical pwrdn and/or deorbit scenario

NOTE

1. Deorbit burn is done in place of third sep mnvr if deorbit TIG < 28 min from initial sep mnvr done in an arbitrary attitude, or if deorbit TIG < 45 min from initial sep mnvr done in $-ZLV \pm 10^\circ$
2. If initial sep mnvr done in $-ZLV \pm 10^\circ$ attitude, out-of-plane sep mnvr not reqd
3. Initial sep mnvr rate must be between 0.7 and 0.9 fps
4. This procedure divided into CDR actions in left column and MS actions in right column

QUICK-RESPONSE JETTISON (Cont)
MS PULLOUT PAGE

1. SET UP FOR JETTISON	1. PREP FOR JETTISON
O14:F, O15:F, O16:F	A8U
O6 MA73C:A O7 O8	A8L
O14:E, O16:E	A7U
A6U	R14:E
DAP: A/LVLH/VERN DAP TRANS: PULSE/PULSE/PULSE, no LO Z	A14
GNC 20 DAP CONFIG √DAP A TRANS PLS ITEM 17 +0.10	ML86B:D
	A14

1. SET UP FOR JETTISON

√Primary RJDs DRIVER,LOGIC (sixteen) – ON

√MDM FF,FA (eight) – ON

√MCA LOGIC FWD (three) – ON

Reopen FWD and AFT RCS if reqd

√cb DDU AFT (two) – cl

SENSE – as reqd

DAP: A/LVLH/VERN

DAP TRANS: PULSE/PULSE/PULSE, no LO Z

GNC 20 DAP CONFIG

√DAP A TRANS PLS ITEM 17 +0.10

1. PREP FOR JETTISON

If only RMS/payload jettison reqd:

MODE – best available

Mnvr RMS/payload clear of upfiring jets and orbiter structure

BRAKES – ON (tb-ON)

PORT RMS HTR A,B (two) – OFF

RMS SEL – OFF

PWR – OFF

TV CAMR PWR RMS – OFF (tb-OFF)

√PORT RMS LT – OFF

cb MNB RMS PORT RMS TV (three) – op

√PL power thru SPEE connector off

PL PWRDN (ORB PKT, PL SAFING)

√PYRO PORT RMS (five)– SAFE

√RMS LAT – SAFE

cb MNB PYRO JETT SYS A PORT RMS – cl

MNC PYRO JETT SYS B PORT RMS – cl

PYRO PORT RMS ARM – GUILLOTINE

Wait 1 sec, then

PYRO PORT RMS SHLDR – GUILLOTINE

– SAFE

ARM – SAFE

Go to step 2, 12-6

QUICK-RESPONSE JETTISON (Cont)
MS PULLOUT PAGE

I

CDR

MS

R14:C

If only KU ANT jettison reqd:
 cb MNB KU ELEC – op
 ANT HTR – op
 √CABLE HTR – op
 MNC KU SIG PROC – op

A1U

√KU BD PWR – OFF
 CNTL – PNL

A14
 MA73C:A
 :B

√PYRO KU ANT (two) – SAFE
 MCA LOGIC MNC MID 2 – OFF
 MNB MID 4 – OFF

ML86B:D

cb MNA PYRO JETT SYS A KU ANT – cl
 MNC PYRO JETT SYS B KU ANT – cl

Go to step 2, 12-6

R14:C

If KU ANT and RMS/payload jettison reqd:
 cb MNB KU ELEC – op
 ANT HTR – op
 √CABLE HTR – op
 MNC KU SIG PROC – op

R14:E
 A1U

cb MNB PORT RMS TV (three) – op
 √KU BD PWR – OFF
 CNTL – PNL

A14

√PYRO KU ANT (two) – SAFE
 √PORT RMS (five) – SAFE
 √RMS LAT – SAFE

QUICK-RESPONSE JETTISON (Cont)
MS PULLOUT PAGE

I

CDR

MS

2. INITIAL SEP MNVR

2. KU/RMS/PAYLOAD JETTISON

WARNING
Initial sep mnvr must be 0.8 ± 0.1 fps

A6U

FLT CNTLR PWR – ON
√DAP TRANS: PULSE/PULSE/PULSE, no LO Z
DAP: A/FREE/PRI

If payload jettison/deploy,
complete jettison/deploy procedure
PL SAFING (ORB PKT)

A14

If KU ANT jettison:
PYRO KU ANT – ARM
Wait 1 sec, then:
PYRO KU ANT – JETT

If RMS/payload jettison:
PYRO PORT RMS ARM – JETT
Wait 1 sec, then:
PYRO PORT RMS SHLDR – JETT

DAP: LVLH

Note MET __/__:__:

THC – +Z 8 PULSES (-X sense – dn)
(-Z sense – out)

DAP: INRTL

QUICK-RESPONSE JETTISON (Cont)
MS PULLOUT PAGE

CDR

MS

3. OUT-OF-PLANE SEP MNVR

If initial sep (step 2) done in $-ZLV \pm 10^\circ$, go to step 4, 12-8

CRT

GNC, OPS 202 PRO

GNC ORB MNVR EXEC

RCS SEL – ITEM 4 EXEC (*)

Set TIG to initial sep mnvr from step 2 +4:00 min

TGT PEG 7 ΔV_x – ITEM 19 +0 EXEC

ΔV_y – ITEM 20 +4 EXEC

ΔV_z – ITEM 21 +0 EXEC

LOAD – ITEM 22 EXEC

TIMER – ITEM 23 EXEC

If VGO Z < 0:

TGT PEG 7 ΔV_y – ITEM 20 -4 EXEC

LOAD – ITEM 22 EXEC

TIMER – ITEM 23 EXEC

$\sqrt{VGO Z} > 0$

Do not mnvr to Burn Att

A6U

\sqrt{DAP} : A/INRTL/PRI

DAP TRANS: as reqd

At TIG, THC – Trim VGO < 0.2 fps

3. POST-JETTISON CLEANUP

A14 PYRO KU ANT (two) – SAFE
PORT RMS SHLDR – SAFE
ARM – SAFE

MA73C:A \sqrt{MCA} LOGIC MNA MID 1 – ON
 \sqrt{MNB} MID 2 – ON
 \sqrt{MNC} MID 2 – ON
:B \sqrt{MNB} MID 4 – ON
 \sqrt{MNC} MID 4 – ON

IF RMS JETTISONED, STOW MPM

WARNING

Payload bay door cannot be closed until MPMs stowed

MA73C:C cb MCA PWR AC2 3 Φ MID 2 – cl
:D AC3 3 Φ MID 4 – cl
R13L PL BAY MECH PWR SYS 1,2 (two) – ON
A8 PORT RMS – STO (tb-STO) (68 sec max)
– OFF
STBD RMS – STO (tb-STO) (68 sec max)
– OFF

R13L PL BAY MECH PWR SYS 1,2 (two) – OFF

ML86B:D cb MNA PYRO JETT SYS A KU ANT – op
MNC PYRO JETT SYS B KU ANT – op
MNB PYRO JETT SYS A PORT RMS – op
MNC PYRO JETT SYS B PORT RMS – op

Go to post jettison/deploy cleanup steps, if reqd (ORB PKT, PL SAFING)

QUICK-RESPONSE JETTISON (Cont)
MS PULLOUT PAGE

I

CDR

MS

4. FINAL (POSIGRADE) SEP MNVR

If Deorbit TIG < 28 min from initial sep done in an arbitrary attitude, go to step 5

If Deorbit TIG < 45 min from initial sep done in -ZLV $\pm 10^\circ$, go to step 5

CRT

If MM 201: GNC, OPS 202 PRO

GNC ORB MNVR EXEC

RCS SEL – ITEM 4 (*)

Set TIG to TIG from previous sep mnvr +4:00 min

TGT PEG 7 ΔV_x – ITEM 19 +3 EXEC

ΔV_y – ITEM 20 +0 EXEC

ΔV_z – ITEM 21 -2 EXEC

LOAD – ITEM 22 EXEC

TIMER – ITEM 23 EXEC

Do not mnvr to Burn Att

A6U

√DAP: A/INRTL/PRI

√DAP TRANS: as reqd

At TIG, THC – Trim VGO < 0.2 fps

If VGO Z is neg, Z,X,Y seq; otherwise, X,Y,Z

QUICK-RESPONSE JETTISON (Cont)
MS PULLOUT PAGE

I

CDR

MS

5. POST-SEP CLEANUP

CAUTION

If Deorbit TIG < 9 min after initial sep,
> 500 ft clearance not guaranteed

A6U CRT	FLT CNTLR PWR – OFF If MM 202: GNC, OPS 201 PRO
O7,O8	Perform RCS SECURE (FWD,AFT) (ORB PKT, <u>RCS</u>) if reqd
MA73C:A O6	MCA LOGIC FWD (three) – as reqd MDM FF,FA (eight) – as reqd
O14:F, O15:F, O16:F	√Primary RJDs DRIVER,LOGIC (sixteen) – as reqd
O14:E, O16:E	cb DDU AFT (two) – op

This Page Intentionally Blank

BAILOUT

BAILOUT

- BAILOUT
MODE 8**
- REPORT POSITION**
- √MACH < 1.0**
- P, R/Y – CSS**
- OPS 305/603 PRO (if reqd)**
- SB – AUTO; BF – AUTO**
- FLY 185-195 KEAS, $\Phi = 0^\circ$**
- ABORT MODE - ATO**
- ABORT PBI – PUSH**
- P,R/Y – AUTO**
- FLT CNTLR PWR (two) – OFF**
- ~50K FT**
- TABS – RELEASE**
- VISOR – CLOSE / LOCK**
- SUIT O2 – ON**
- GREEN APPLE – PULL**
- ~40K FT**
- MS3 – VENT CABIN**
- CDR,PLT SEATS – LOWER**
- KNEEBOARDS – REMOVE**
- COOLING – DISCONNECT**
- SEAT RESTRAINT – RELEASE**
- D-RING – UNCOVER**
- ~30K FT**
- MS3 – JETTISON HATCH**
- COMM – DISCONNECT**
- (G-SUIT CLIP – PULL)**
- SUIT O2 – DISCONNECT**
- EGRESS SEAT**
- POLE – DEPLOY**
- D-RING – HOOK UP**
- BAILOUT**

MS PAGES

This Page Intentionally Blank

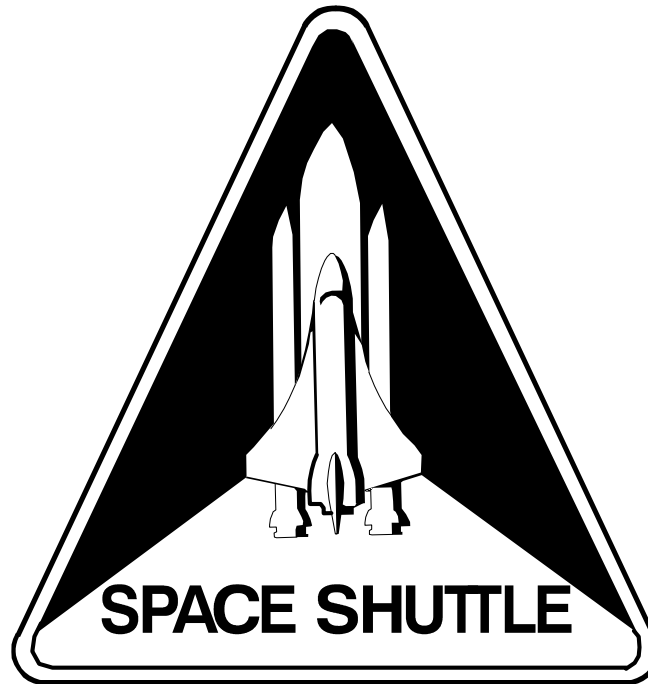

**CONTINGENCY
DEORBIT**

**STS
ALL**