

Shuttle Flight Operations Manual

Volume 12
Crew Systems

Mission Operations Directorate
Training Division

Basic, Revision B
August 14, 1987



National Aeronautics and
Space Administration

Lyndon B. Johnson Space Center
Houston, Texas

SECTION 1 INTRODUCTION

1.1 PURPOSE

The purpose of the Shuttle Flight Operations Manual (SFOM), Vol. 12, Crew Systems, is to provide a single source of general crew systems data. This SFOM is the operational data base for Shuttle Transportation System (STS) crew systems, as applied to console reference, flight design and planning, simulations, and Flight Data File (FDF) development.

1.2 SCOPE

This manual provides data on STS crew systems equipment that is specifically intended for reference by flight crews and flight operations personnel.

This SFOM volume is composed of the following four sections:

Section 1, Introduction - The introduction describes the purpose, scope, authority, control, publication, and revision for this volume.

Section 2, Crew Module - The crew module section contains a configuration overview of the Orbiter crew module, including the (flight deck, middeck, airlock, and docking module).

This section also includes a brief discussion of the crew module location coding system. These data are intended as reference material for use throughout this volume.

Section 3, Orbiter IVA Crew Systems - This section contains data on each of the Orbiter crew systems. Each crew system section contains the following subsections:

- Introduction - a brief description of the system and its operational usage.
- Stowage and Interfaces - defines where the equipment is stowed and any interfaces with the crew module and other systems.
- Systems Functional Description - a description of the system, including operational modes, systems components, and displays and controls (D&C).
- Systems Performance, Limitations, and Constraints - a tabulation of performance data, limitations, and constraints applicable to systems operations.

Section 4, Launch and Landing Site operations

Section 4, Launch and Landing Site Operations - This section contains a description of launch and landing site operations. It is restricted to systems that require flight crew training.

1.3 AUTHORITY

The Systems Division within the Mission Operations Directorate (MOD) has the responsibility to provide documentation necessary to support STS flight operations as defined in the Flight Operations Directorate Program Support and Management Plan (JSC-10750).

This document, SFOM, Vol. 12, is Systems Division partial fulfillment of this responsibility in the crew systems area.

1.4 CONTROL

The general content - subjects covered, level of detail, and format - is under the control of the Systems Division.

1.5 PUBLICATION AND REVISIONS

This document will be published only in Basic editions. Each edition will be revised as required via Page Change Notices (PCN's). If extensive changes are required, the document will be issued again as a revision. The EVA/Crew Systems Section of the Systems Division has the responsibility for preparing, coordinating, and maintaining this document.

Any organization having comments, questions, suggestions, proposed changes, or distribution changes concerning this document should contact G. E. Rains (713-483-2566 or FTS 525-2566).

SECTION 2 CREW MODULE

2.1 CREW MODULE CONFIGURATION

The Orbiter crew module (fig. 2.1-1) is located in the forward portion of the vehicle and provides a pressurized area for working and living. The module consists of the flight deck, middeck, equipment bay, and airlock (fig. 2.1-1). Behind the aft bulkhead of the crew module in the payload bay, provisions exist for a docking module (fig. 2.1-1) and transfer tunnel with adapter to allow crew and equipment access to the Spacelab module and for extravehicular activity (EVA) operations (SFOM, Vol. 15).

2.1.1 Flight Deck

The flight deck contains the displays & controls (D&C) used to pilot, monitor, and control the Orbiter and mission payloads during normal and contingency operations. Seating is provided for four crewmembers. The forward section of the flight deck contains two permanently mounted seats and the aft section contains two removable seats.

The forward flight deck (fig. 2.1-2) contains the commander and pilot stations with the D&C necessary to monitor, command, and control the Orbiter and Orbiter systems. Adjustable seats provide comfortable support for launch, in-flight operations, and landing. Located on the right-hand side of each seat are two permanently mounted flight data file (FDF) containers used to stow flight data file items and emergency equipment.

The aft portion of the flight deck (fig. 2.1-2) contains the mission specialist (MS) and payload specialist (PS) stations as well as the payload handling and vehicle (docking) control stations. Two removable MS seats are located in the aft portion of the flight deck. Items that may need to be readily accessible are found in lockers A16 and A17.

Standard 19-in racks located in the aft portion of the flight deck house the MS and PS stations (fig. 2.1-2) which contain Orbiter and payload-unique D&C. These stations are used to monitor and operate various payloads as well as manage Orbiter subsystems.

Both the MS and PS stations use the vehicle data processing system and the electrical power system to conduct their functions. The MS station includes a caution and warning (C&W) system to monitor payload systems and detect any critical malfunctions.

External viewing on the flight deck is provided by six forward, two aft, and two overhead viewing windows with redundant pressure panes (fig. 2.1-3). In addition, the W8 blowout escape panel provides an emergency egress route, as described in section 3.5, Egress Provisions. The fields of view are illustrated in figure 2.1-3.

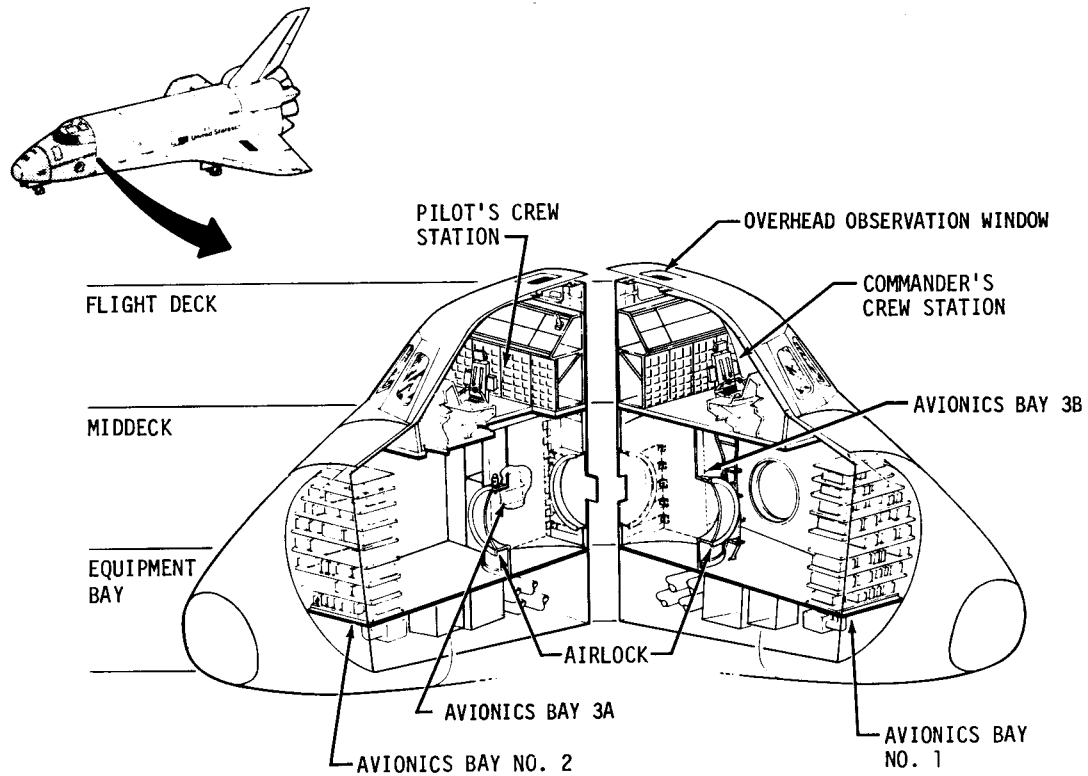
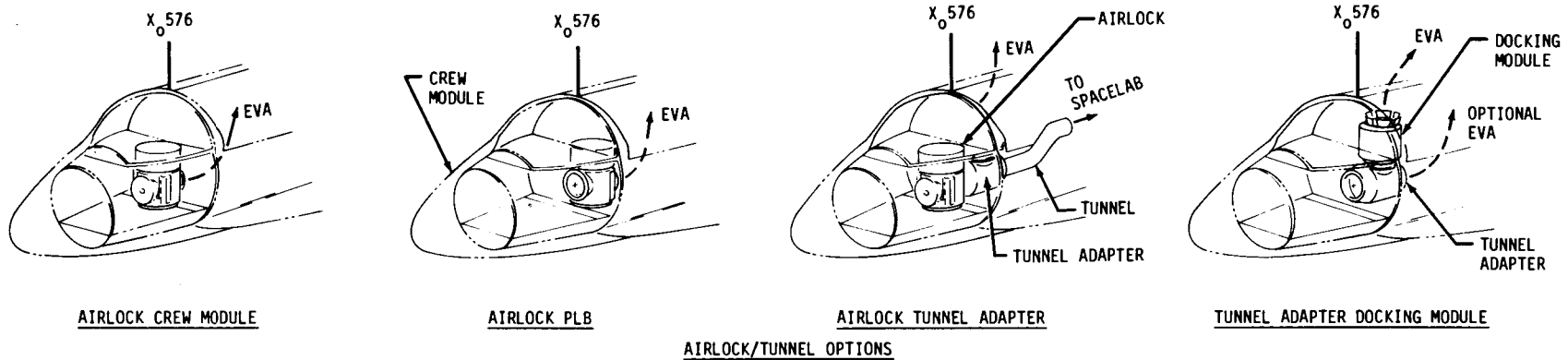


Figure 2.1-1.- Orbiter crew module.

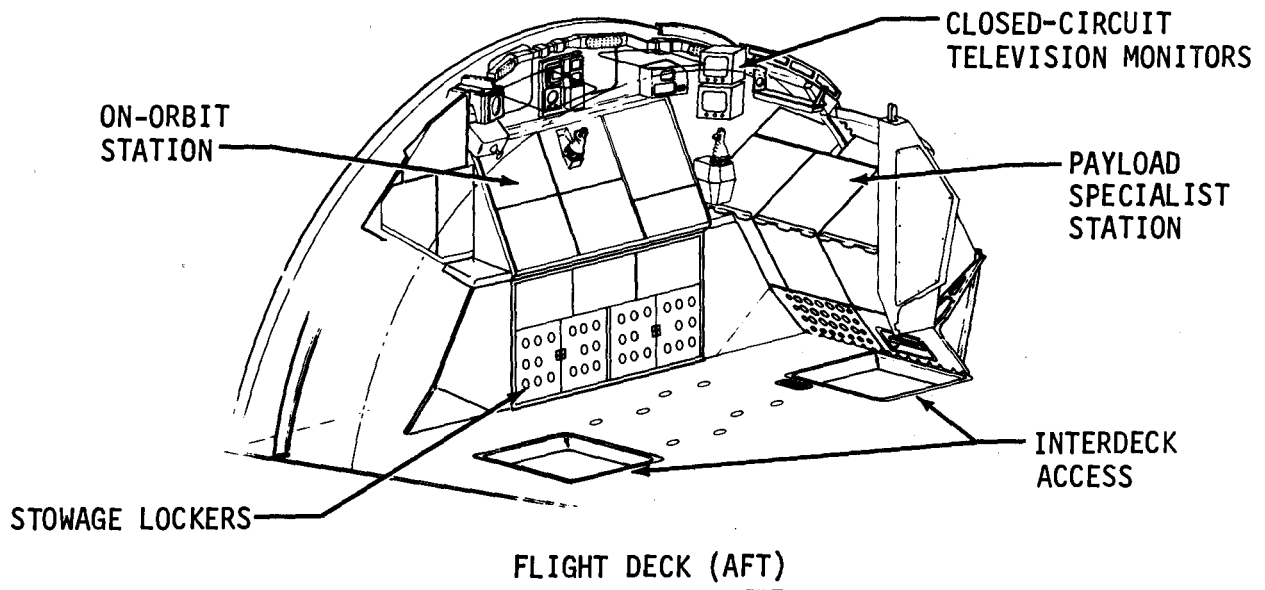
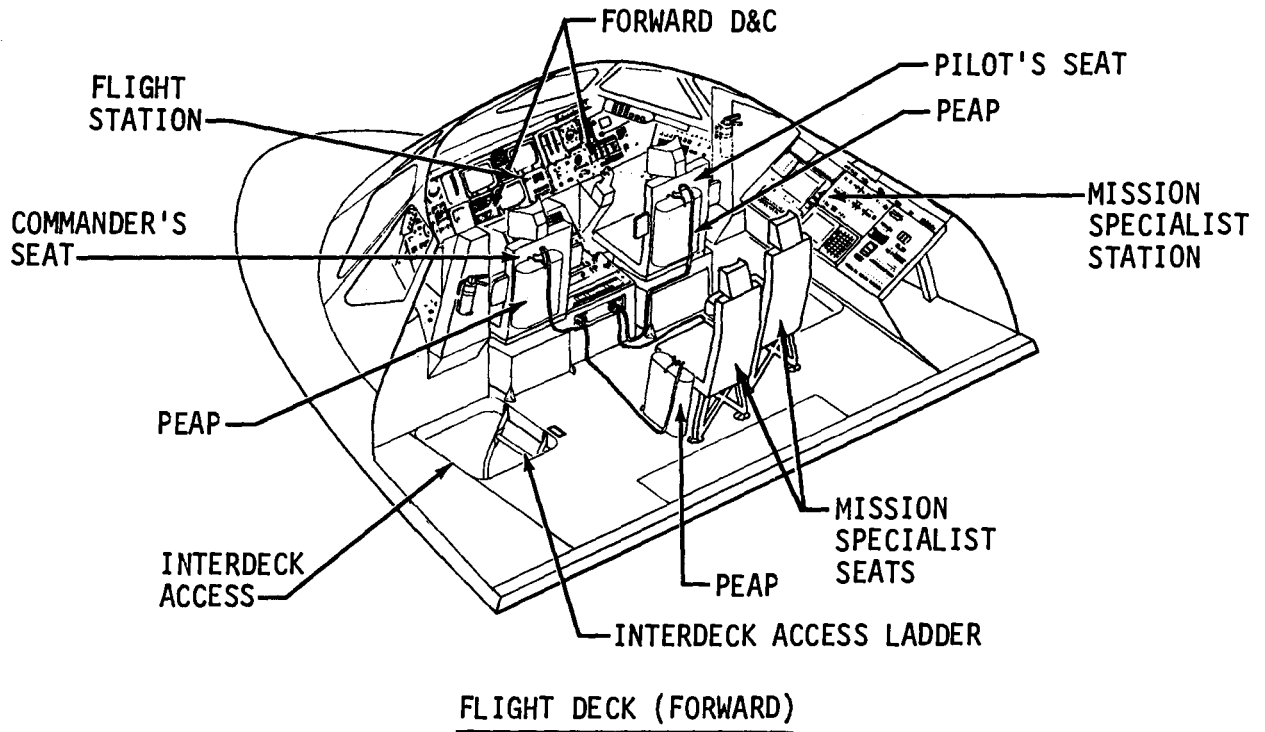


Figure 2.1-2.- Flight deck.

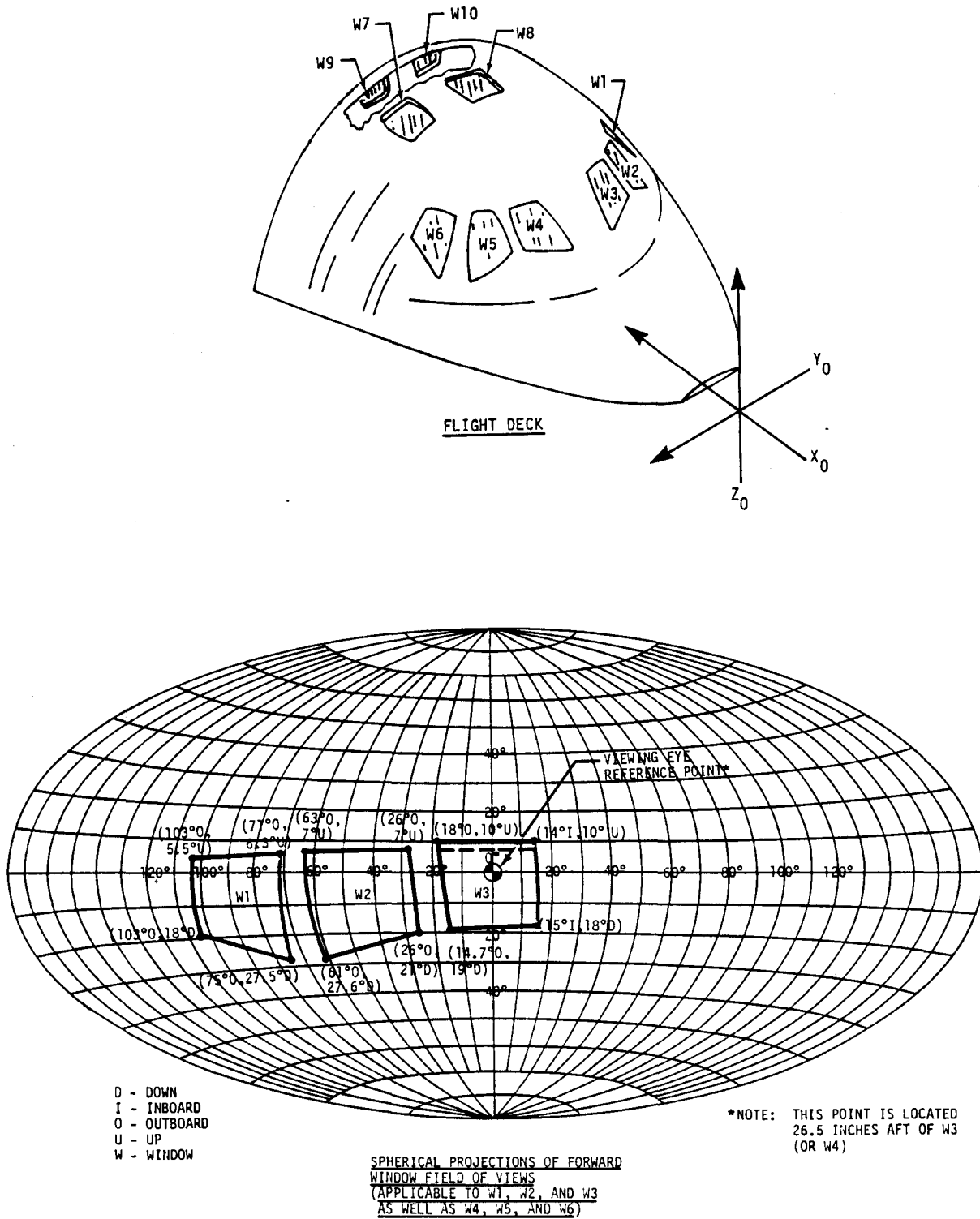
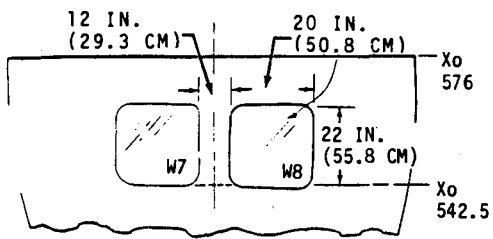
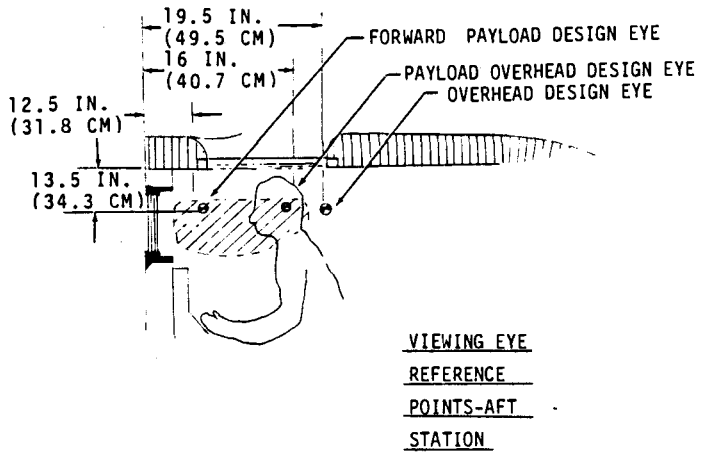
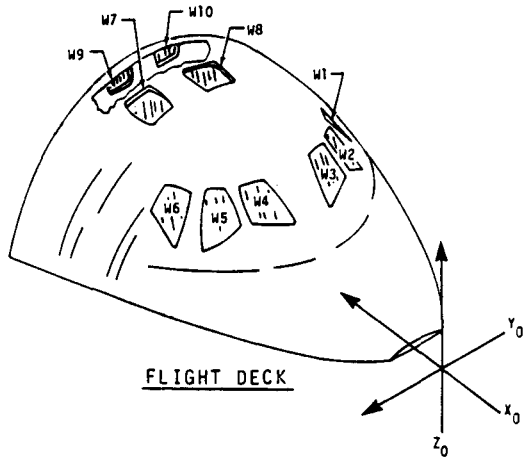
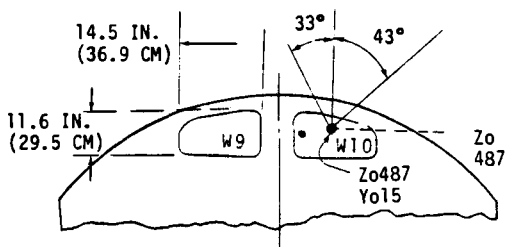


Figure 2.1-3.- Window field of views (sheet 1 of 2).

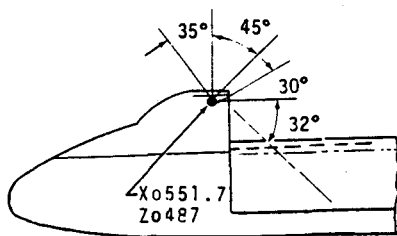
2.1-4



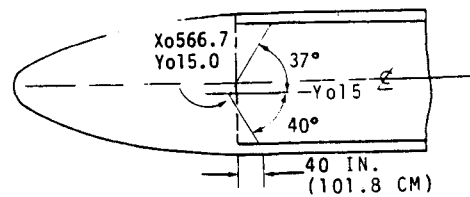
OVERHEAD OBSERVATION WINDOWS, W7 AND W8



PAYLOAD BAY WINDOWS, W9 AND W10



CREW MODULE (AFT SIDE)



CREW MODULE (TOP VIEW)

Figure 2.1-3.- Window field of views (sheet 2 of 2).

Interior lighting, described in section 3.26, Lighting, is provided for D&C and compartment illumination. Both ac and dc utility outlets are provided for accessories such as photo equipment and are located as shown in figure 2.1-4. Communications, crewman optical alignment sight (COAS), TV, and operational bioinstrumentation system (OBS) outlets are shown in figure 2.1-5.

2.1.2 Middeck

The middeck (fig. 2.1-6) has provisions for up to 42 modular lockers each containing such items as experiments, food, and nominal and contingency equipment. In addition, provisions exist for the waste management system (WMS), galley and sleep stations.

Beneath the middeck, and equipment bay (fig. 2.1-1) contains the environmental control and life support system (ECLSS). Contingency access to the ECLSS is provided by means of removable floor panels. LiOH canisters and the wet trash compartment are also located there.

Access between the middeck and flight deck is through two 26- by 28-in. (65- by 70-cm) interdeck access openings. A ladder attached to the port interdeck access allows for easy ingress/egress from the middeck to the flight deck. From the exterior of the Orbiter to the middeck, access is obtained through the Orbiter side hatch (sec. 3.3, Side Hatch). This is the primary means of ingress and egress from the crew module. The airlock (sec. 2.1.3) allows access to the payload bay and Spacelab via the airlock hatches.

2.1.3 Airlock

The airlock (figs. 2.1-1 and 2.1-7) is a modular structure that has an inside diameter of 63 in. (160 cm) and is 83 in. (210.8 cm) long. It has two 40-in. (1.0-m) diameter D-shaped hatches, 36 in. (0.91 m) across the chorded side. These hatches are described in section 3.3.

Although the primary location for the airlock is on the middeck of the crew module, it may be placed in one of three different locations depending on the mission objectives. However, this would require a major modification to the vehicle. The primary purpose of the airlock is to eliminate the need for cabin decompression for EVA and to provide a means for transferring between the crew module and the Spacelab or payload bay. It may also be used to provide additional volume in the Orbiter cabin.

A tunnel adapter which serves as a second airlock provides an alternate route for EVA ingress/egress when carrying manned payloads (Spacelab).

Airlock lighting is described in section 3.26.

2.1.4 Docking Module

For missions requiring direct docking of two vehicles, a docking module can be substituted for the airlock and installed on the tunnel adapter (fig. 2.1-8). The docking module is extendable and provides an airlock function for EVA for two crewmembers when extended or for one crewmember when retracted.

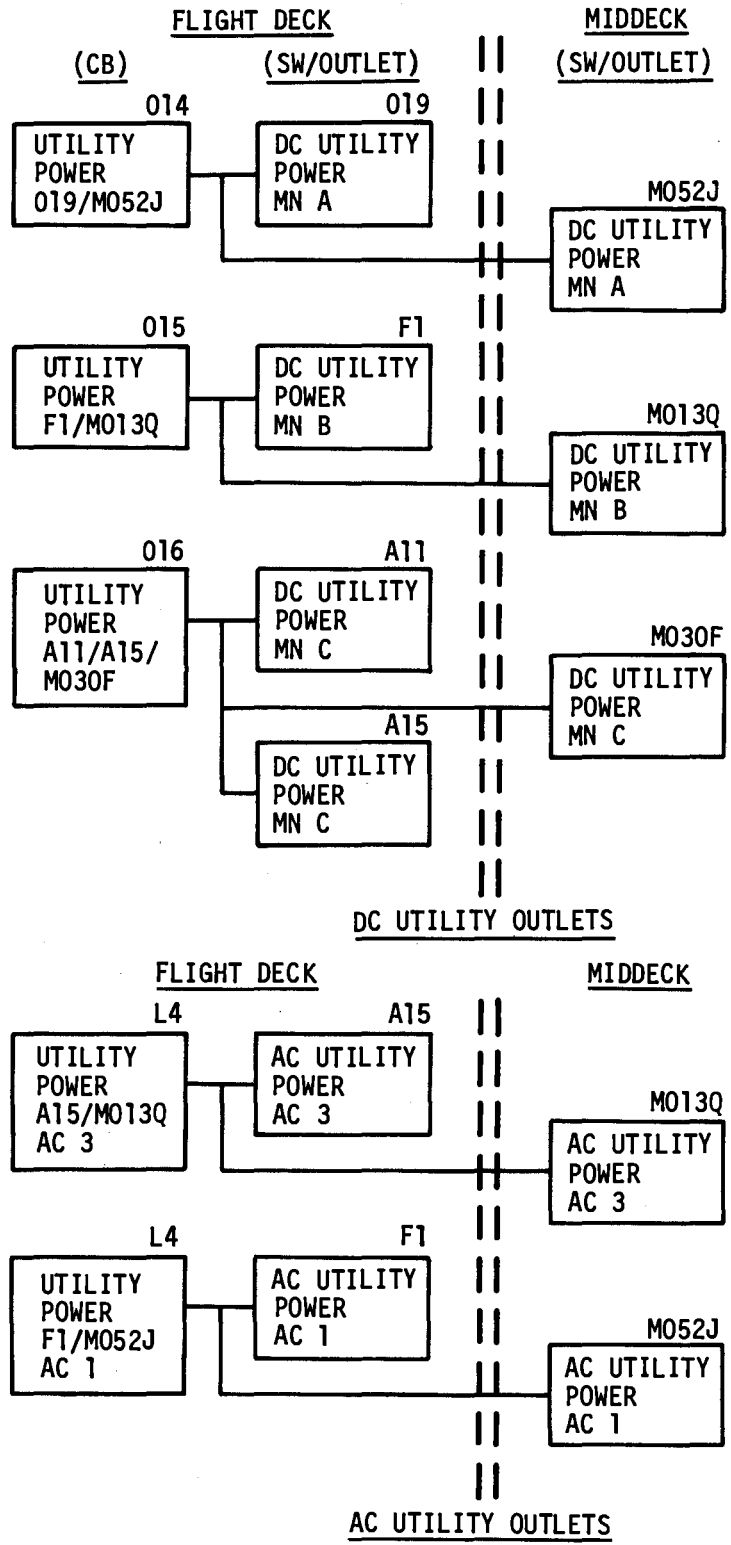


Figure 2.1-4.- DC & AC utility outlets.

2.1-8

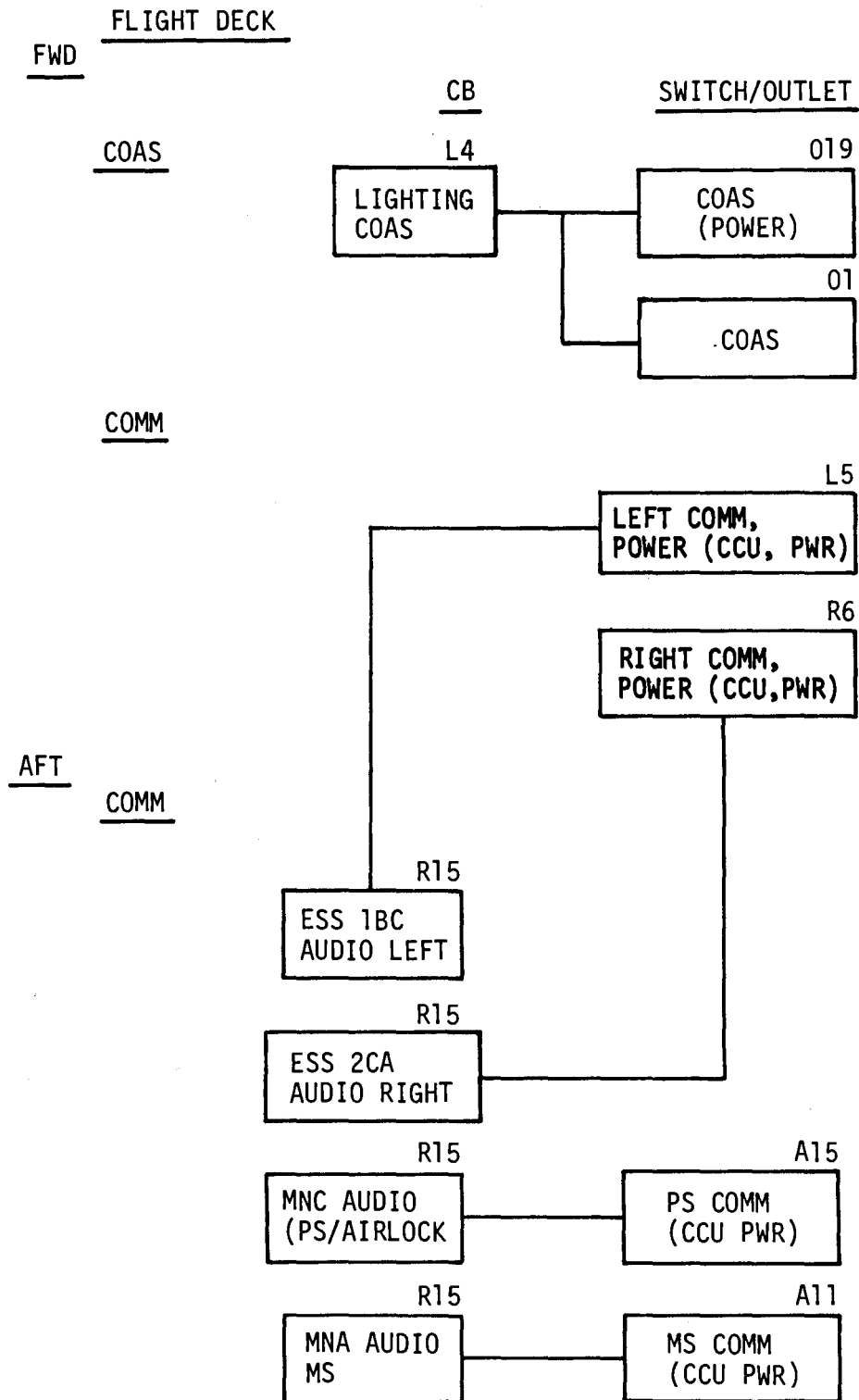


Figure 2.1-5.- COAS, comm and biomed outlet locations (sheet 1 of 2).

2.1-9

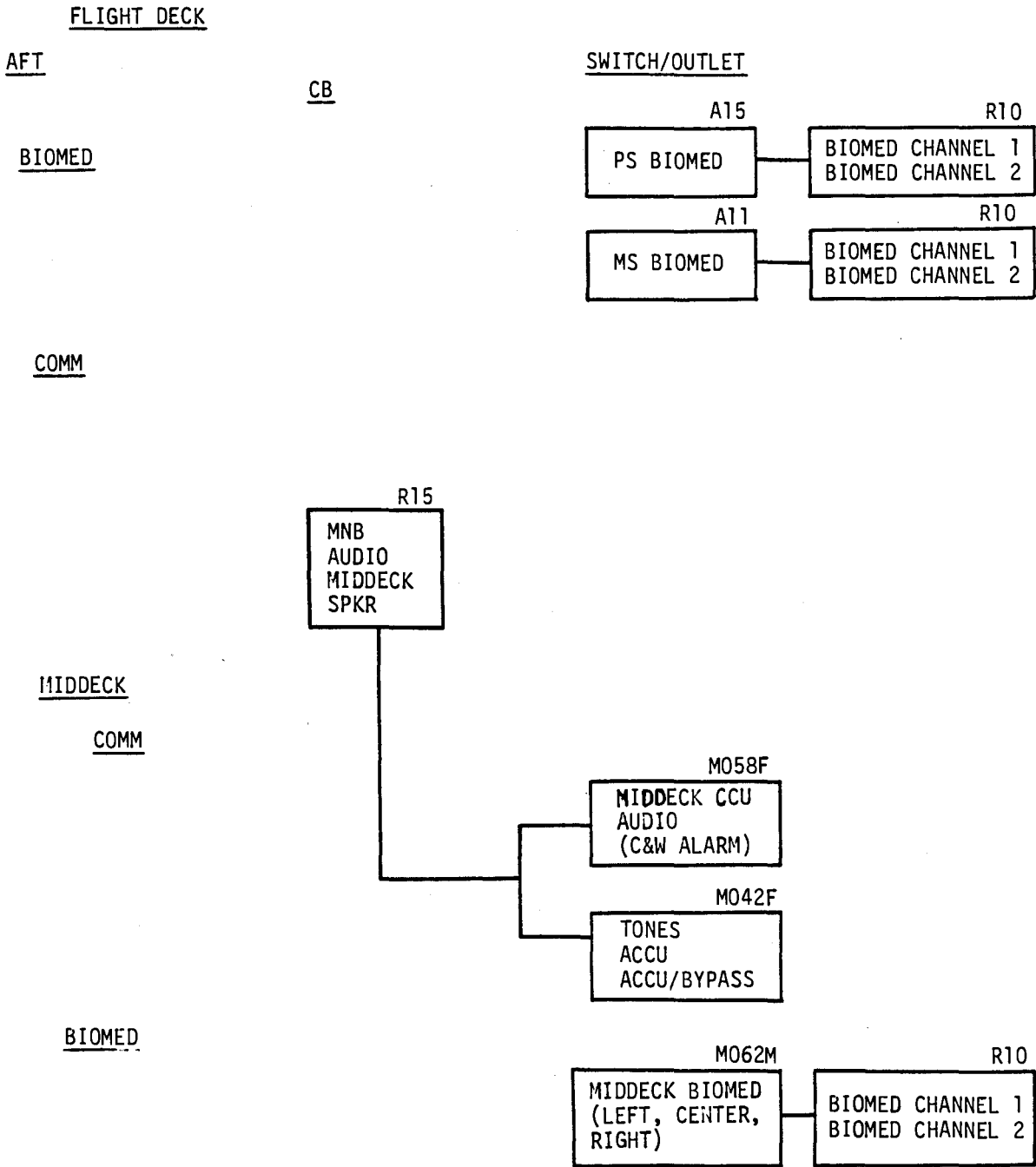
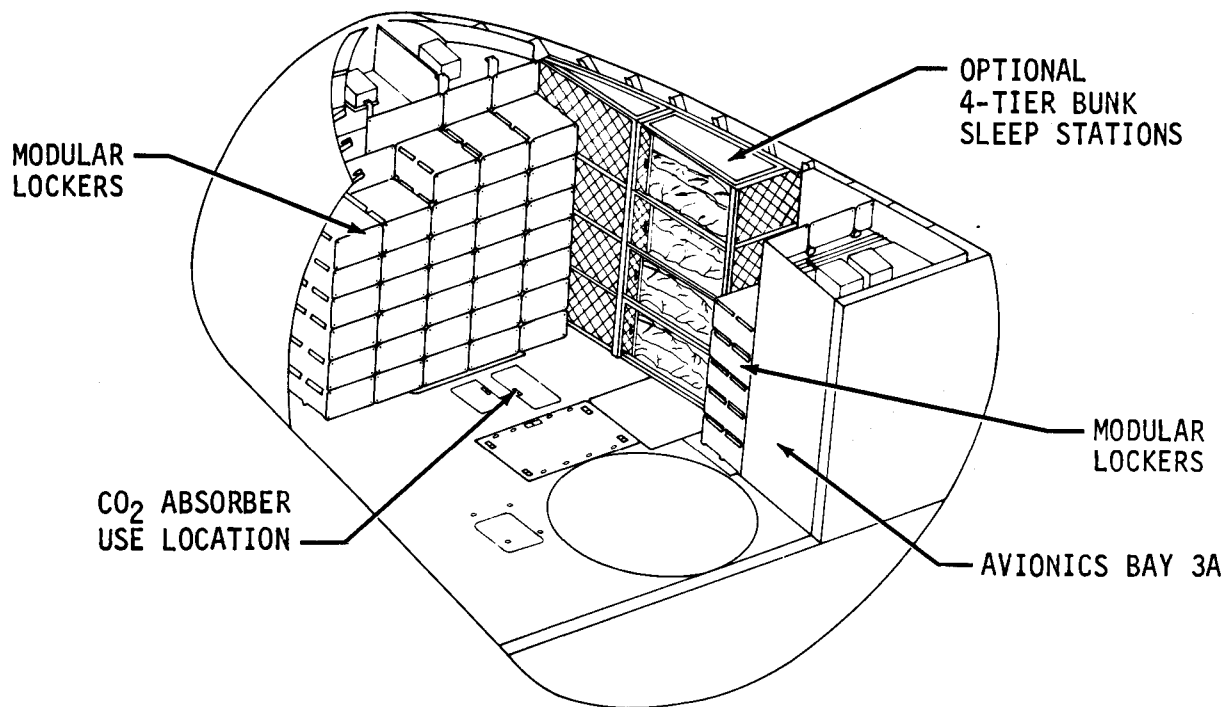


Figure 2.1-5.- COAS, comm and biomed outlet locations (sheet 2 of 2).



MIDDECK (FORWARD)

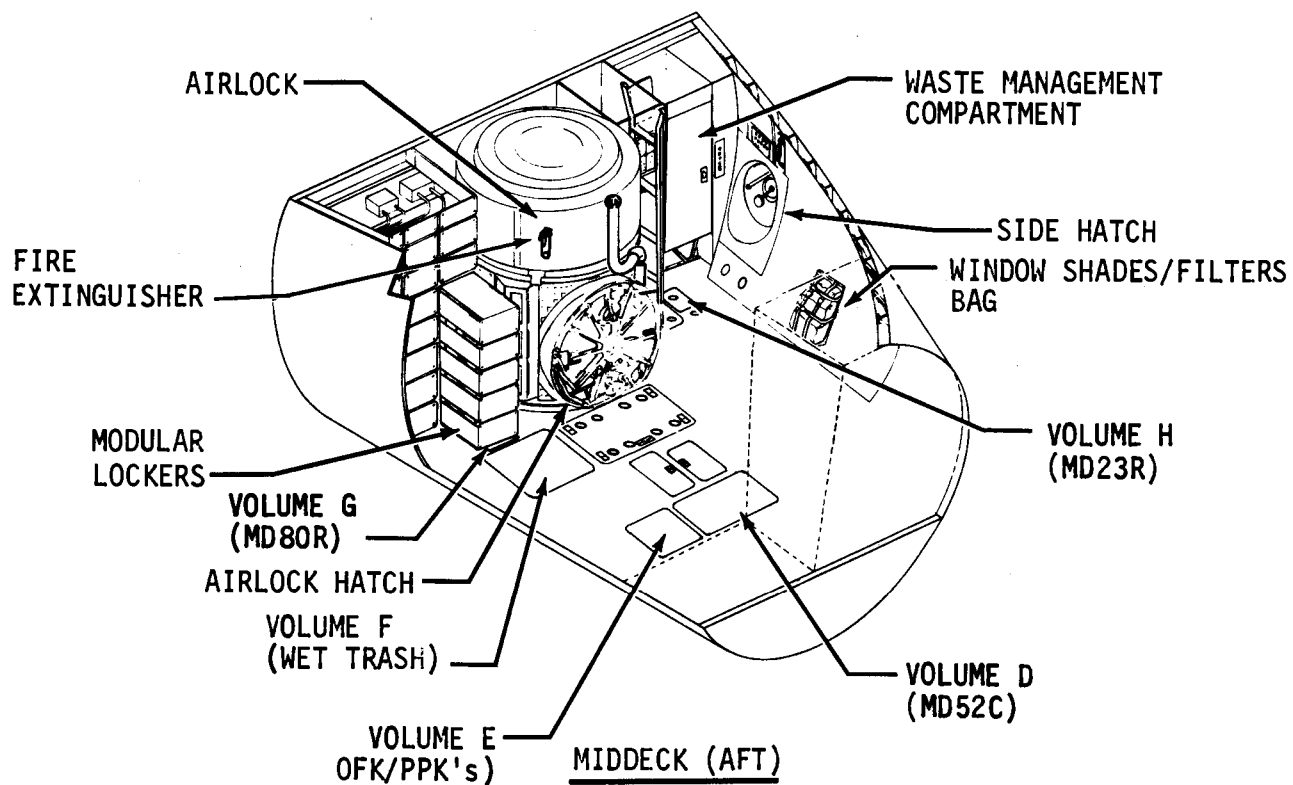


Figure 2.1-6.- Middeck.

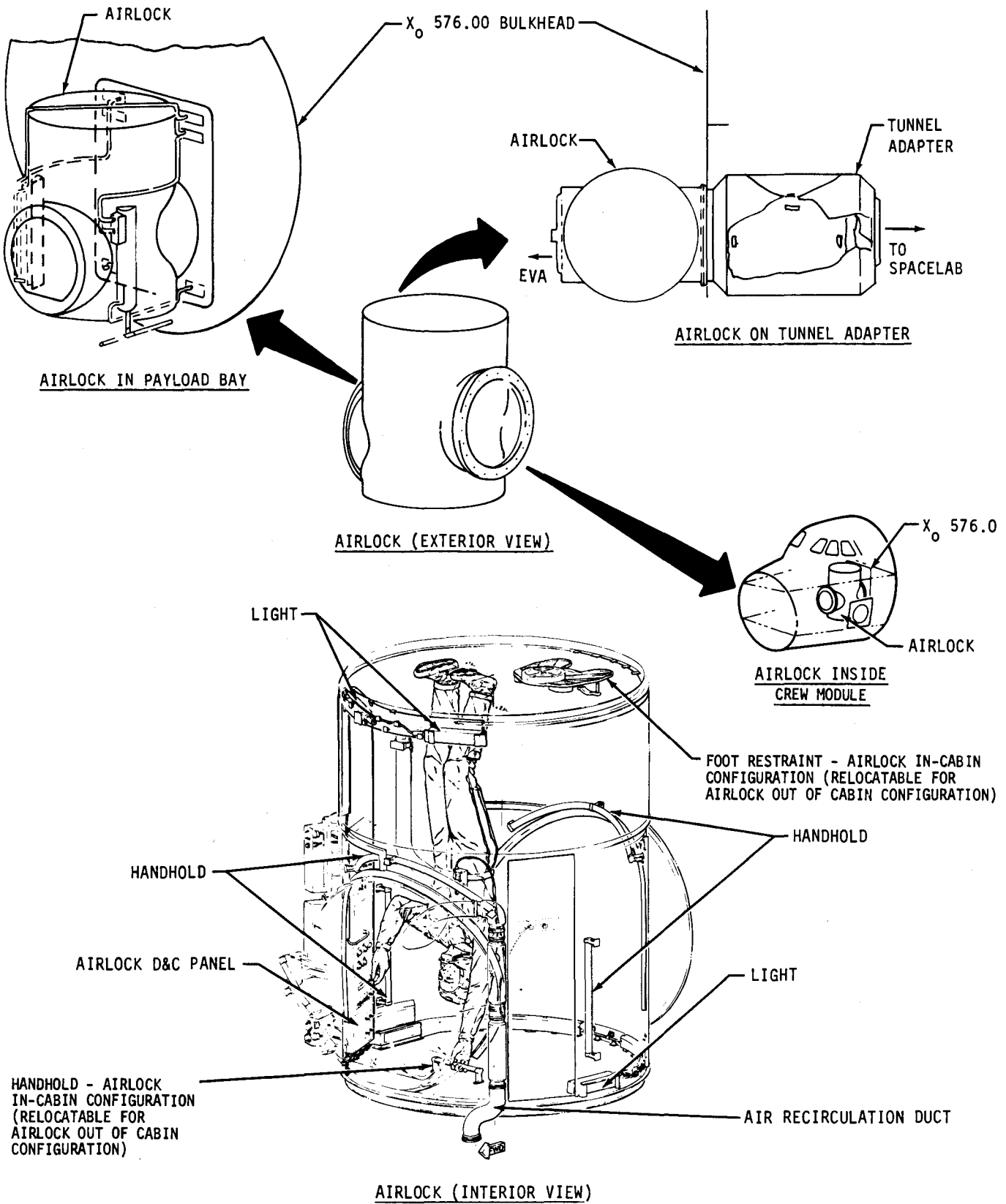


Figure 2.1-7.- Airlock configurations.

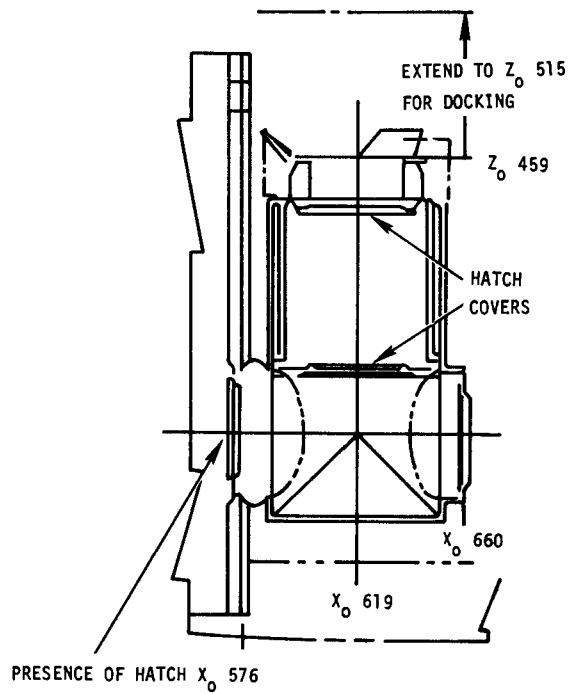
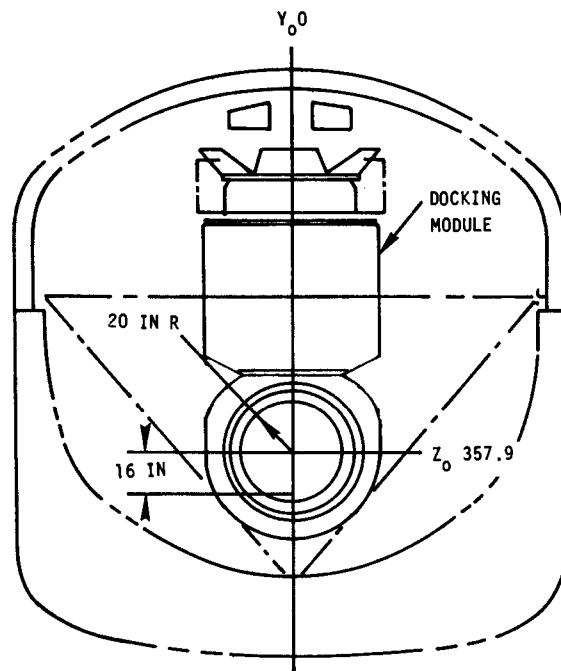


Figure 2.1-8.- Docking module configuration.

2.1-13

2.2 LOCATION CODING

The following section establishes the location coding within the crew module. The Orbiter crew compartments are the flight deck, middeck and airlock (fig. 2.2-1). A fourth compartment, the Spacelab, becomes part of the Shuttle when the Spacelab module is flown. This scheme will be used to designate all areas and locations of D&C panels, hardware, racks, stowage compartments, and other items within those areas. This coding will be displayed on the walls, decks, and ceilings of the crew module, and airlock. It consists of alphanumeric designators as described herein.

2.2.1 Orbiter Crew Module

Each crew compartment (flight deck, middeck, airlock, and Spacelab) has a unique location coding format. The location code formats are

- Flight Deck - A two or three character alphanumeric code. The first character is a letter and the second (and third) are numbers.
- Middeck - A five character alphanumeric code starting with M.
- Airlock - A four or five character alphanumeric code starting with A.
- Spacelab - A three or four character alphanumeric code.

Flight Deck

The coding system for the flight deck utilizes a simple direction and panel numbering system since, for the most part, this area of the vehicle is solely D&C.

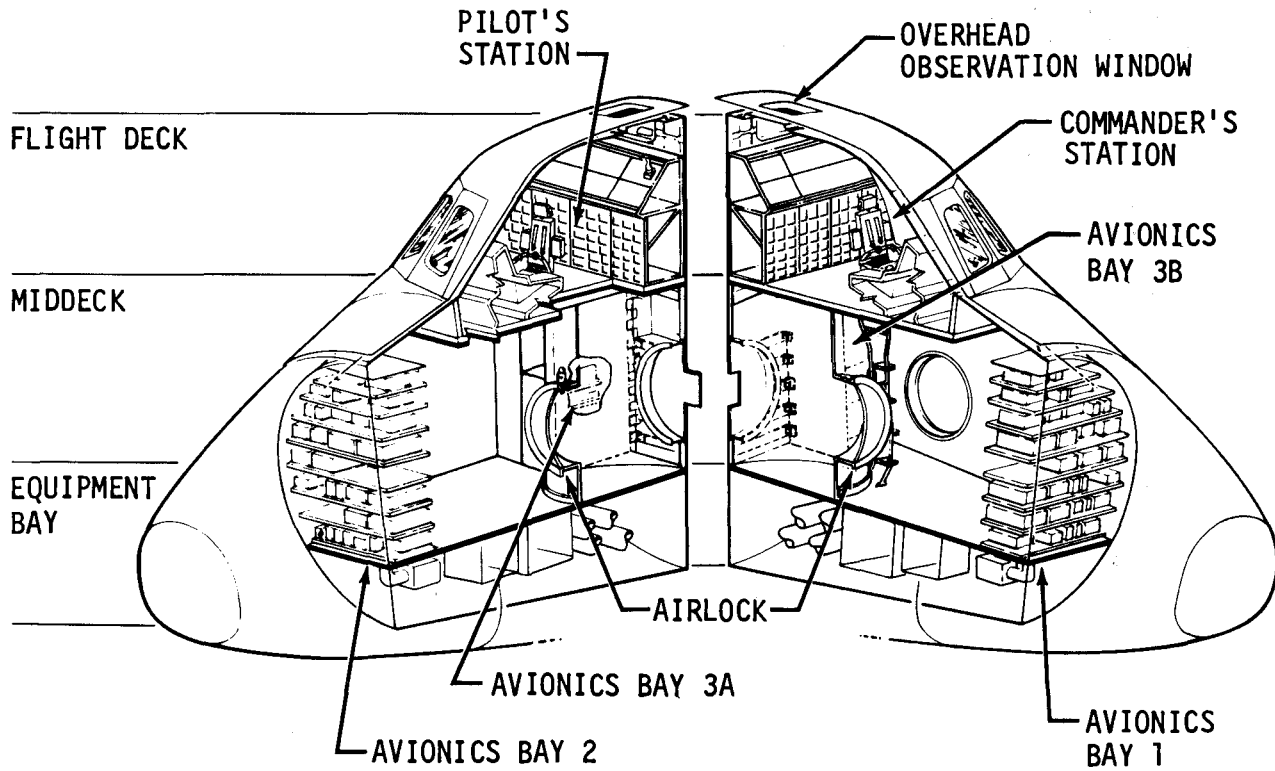


Figure 2.2-1.- Orbiter crew module.

The forward flight deck contains the commander and pilot stations with the D&C necessary to monitor, command, and control the Orbiter and Orbiter systems during normal and contingency operations. The forward flight deck also contains stowage provisions for the flight data file.

The aft flight deck contains D&C required to perform Orbiter systems management, on-orbit maneuvers, payload systems management, and payload handling operations. The aft flight deck also contains stowage provisions for emergency equipment and crew equipment that may be needed during early on-orbit operations.

The following table contains the general numbering philosophy for the flight deck surfaces:

| Surfaces (1st character) | General numbering philosophy (2nd and 3rd character) |
|---|---|
| L - Left R - Right C - Center console | Numbered from top to bottom, forward to aft |
| O - Overhead | Numbered from left to right, forward to aft |
| F - Forward A - Aft | Numbered left to right, top to bottom (facing the surface) |
| W - Windows | The forward windows are numbered left to right (W1 through W6) facing forward The overhead windows are numbered left to right (W7 and W8) facing aft The aft windows are numbered left to right (W9 and W10) facing aft |
| S - Seats | The CDR's seat is <u>S1</u> and the PLT's seat is <u>S2</u> |

(The surfaces are addressed while sitting in the CDR/PLT seats)

The flight deck layout and coding are shown in figures 2.2-2 and 2.2-3.

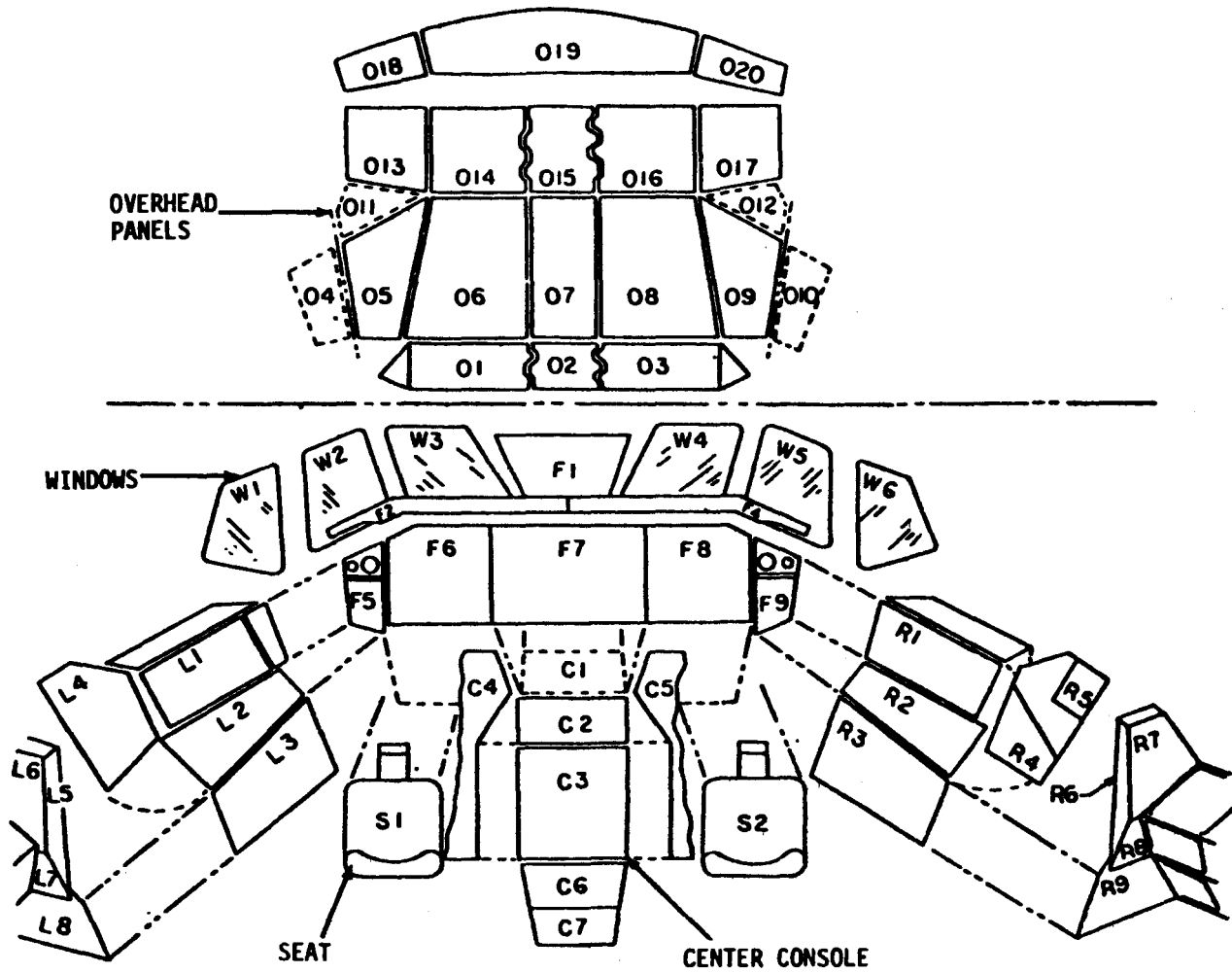


Figure 2.2-2.- Forward flight deck location codes.

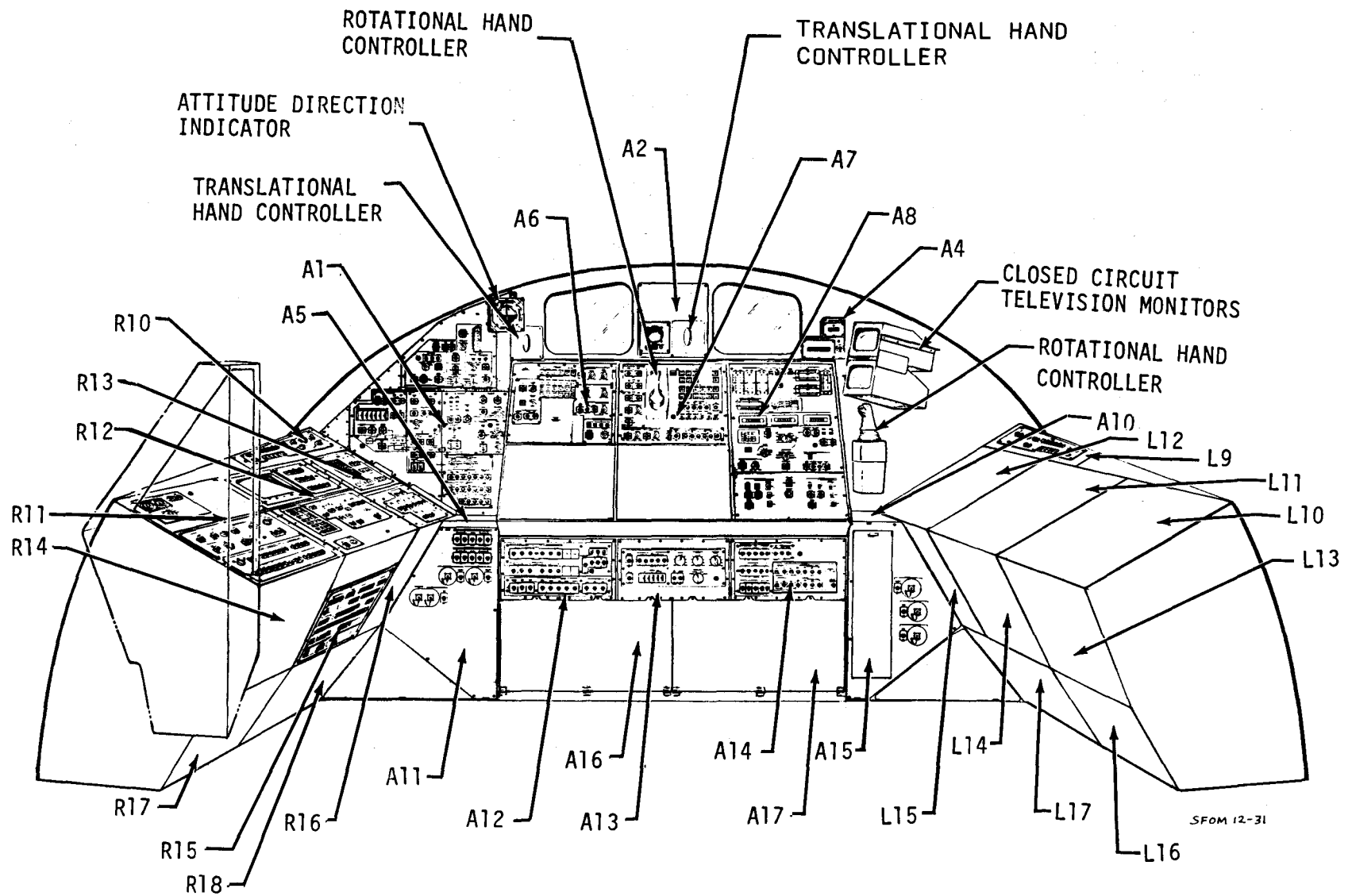


Figure 2.2-3.- Some of the equipment and associated location codes on the aft flight deck.

Middeck

The middeck location codes have five alphanumeric characters and start with M.

The Orbiter middeck contains D&C panels for Orbiter systems control, stowage provisions for most of the crew equipment, the waste management compartment, the airlock, and middeck floor stowage compartments. Beneath the middeck, the lower equipment bay contains ECLSS hardware. Access to equipment in the lower equipment bay is through middeck floor panels which are marked with middeck codes.

The characters in the middeck codes specify the following:

1st character - M for middeck.

2nd character - The first letter of a middeck surface; the characters and surfaces are

| | |
|-------------|--------------|
| L - Left | A - Aft |
| R - Right | D - Deck |
| F - Forward | O - Overhead |

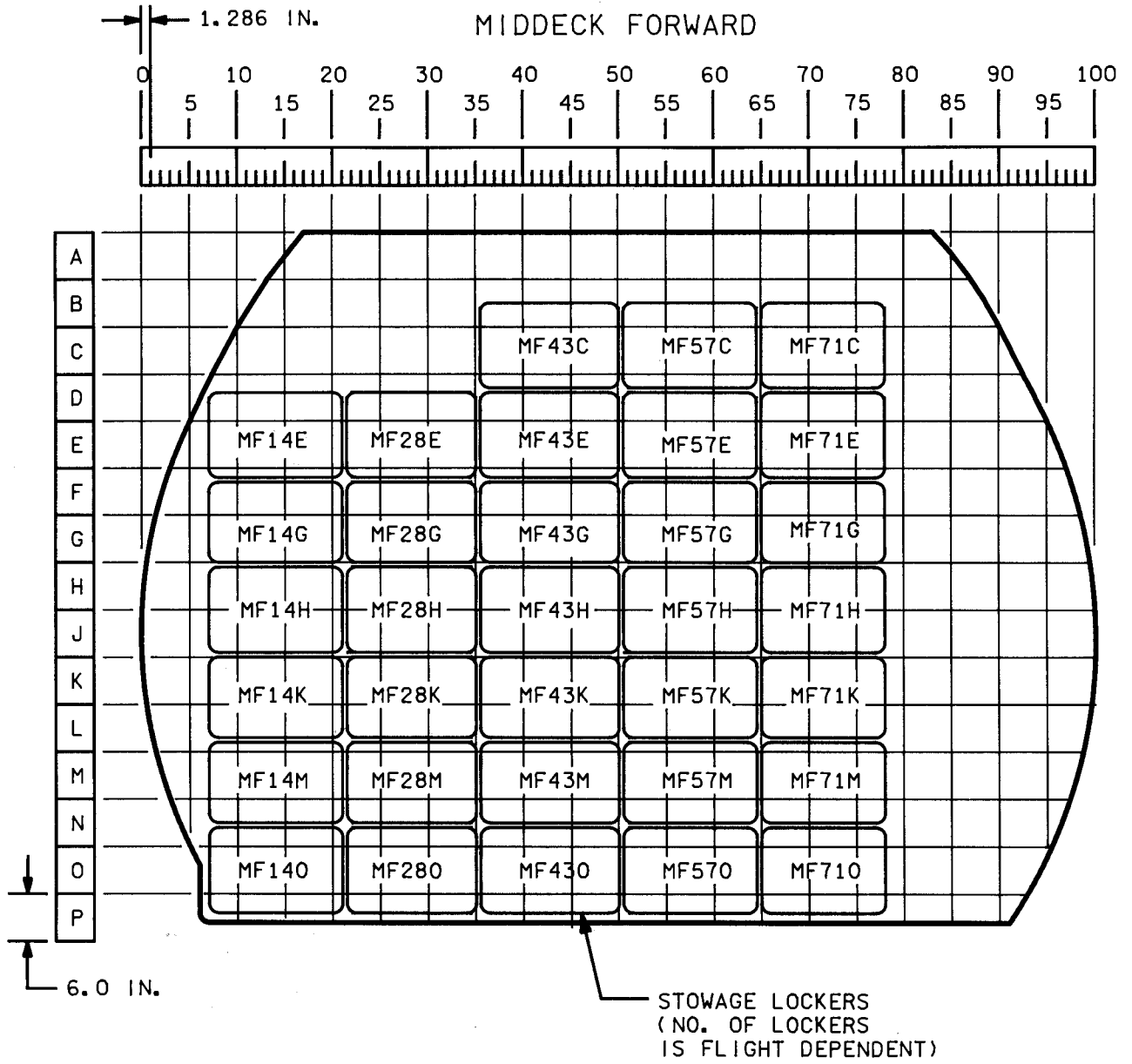
The reference position for identifying the surface is standing on the middeck floor (deck) facing forward.

3rd/4th/5th characters - These characters form a location grid on each mid-deck surface. The 3rd and 4th characters are numerics indicating the distance from the left* side of a surface expressed as a percentage of the total width of the surface (follows the contour of the wall). The 5th character is an alpha character indicating the distance from the top* of a surface expressed alphabetically in increments of 6 inches.

*Each surface is addressed as follows to determine the "left" and "top" sides.

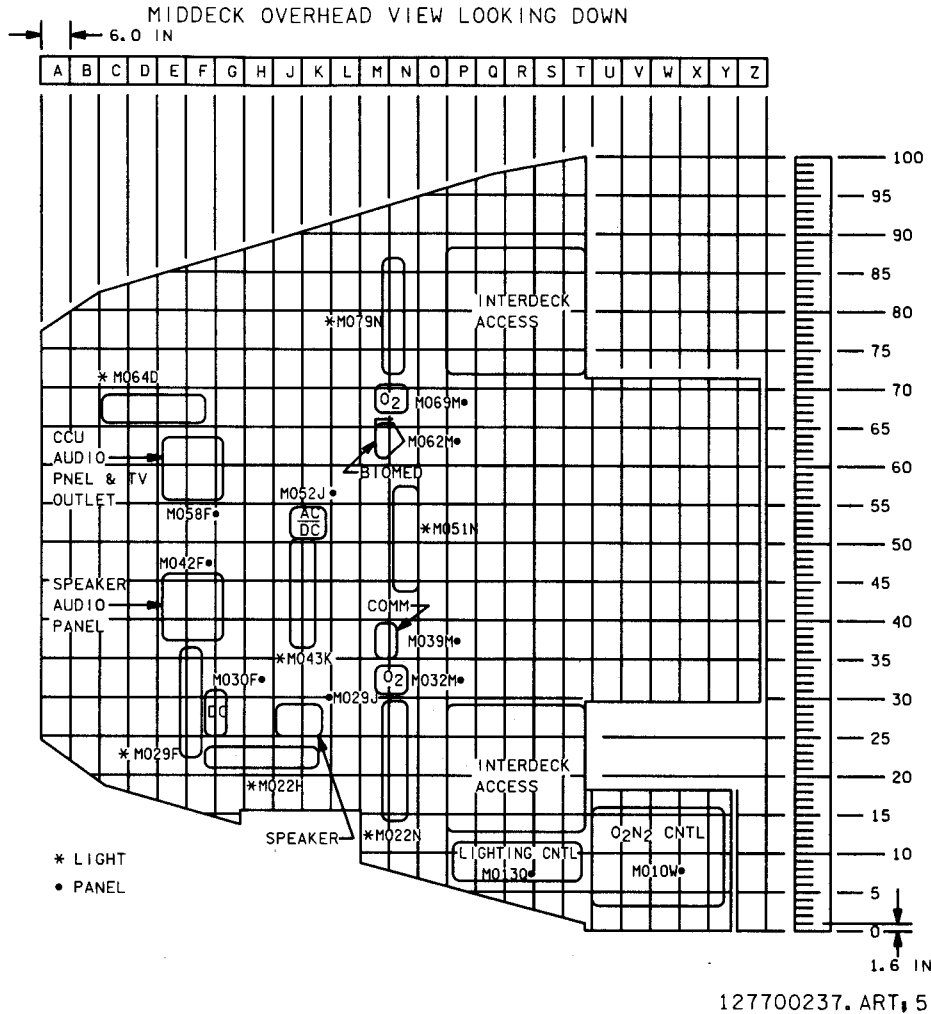
| Surfaces | Reference position |
|------------|---|
| L, R, F, A | Standing on deck facing the surface |
| D | Standing on deck facing forward looking down |
| O | The overhead location grid matches the grid on the deck; i.e., a point on the overhead has the same 3rd, 4th, 5th characters as a point directly below it on the deck |

The middeck layout and coding are shown in figures 2.2-4 through 2.2-10.



127700236. ARTs 1

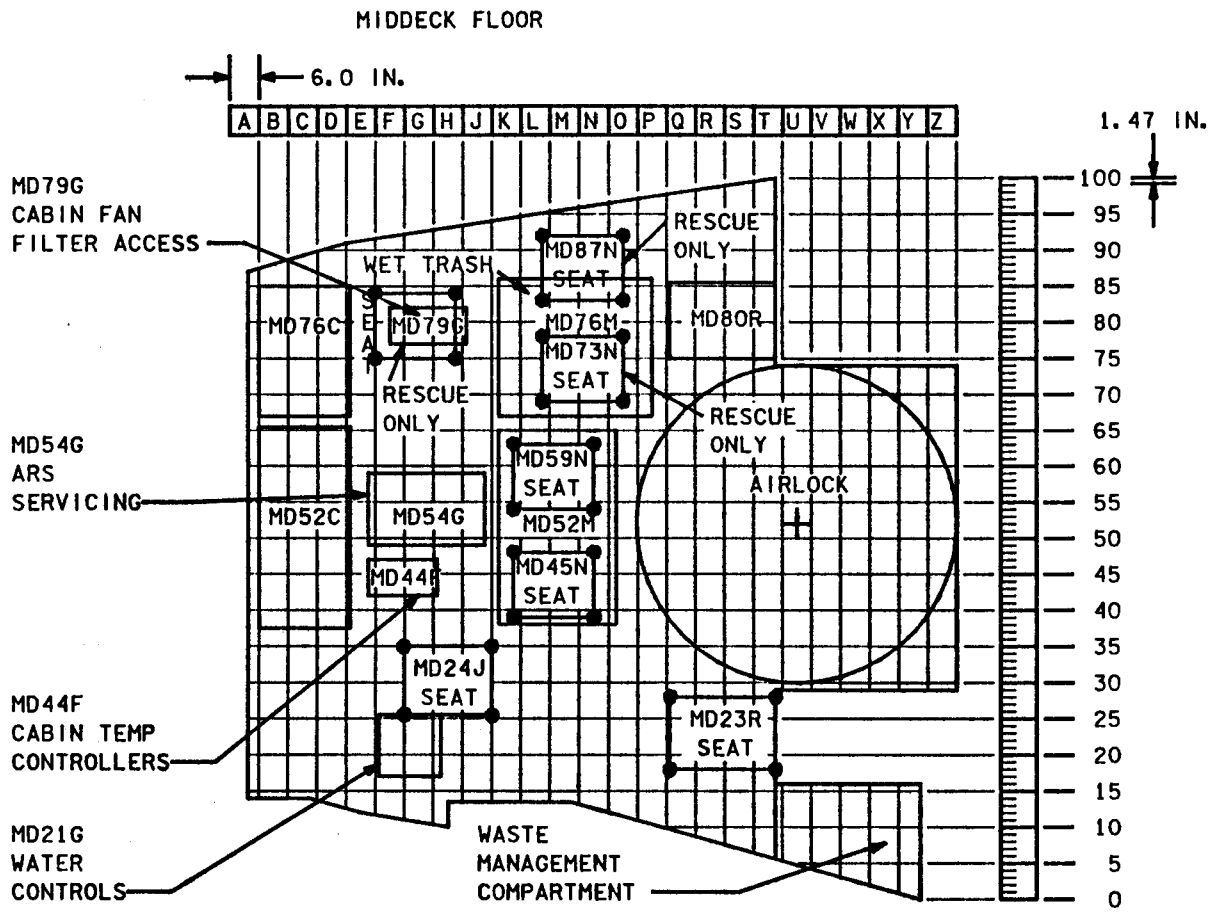
Figure 2.2-4.- Middeck location codes (forward).



NOTE: The panel numbers listed below are not consistent with the location coding system defined here. However, in each case the location coding, as indicated, is in close proximity to the actual location. The panel numbers below were assigned prior to the middeck closeout panel design definition. The starting points for location coding were behind the closeout panels, whereas the starting points used in this document are in front of the closeout panels.

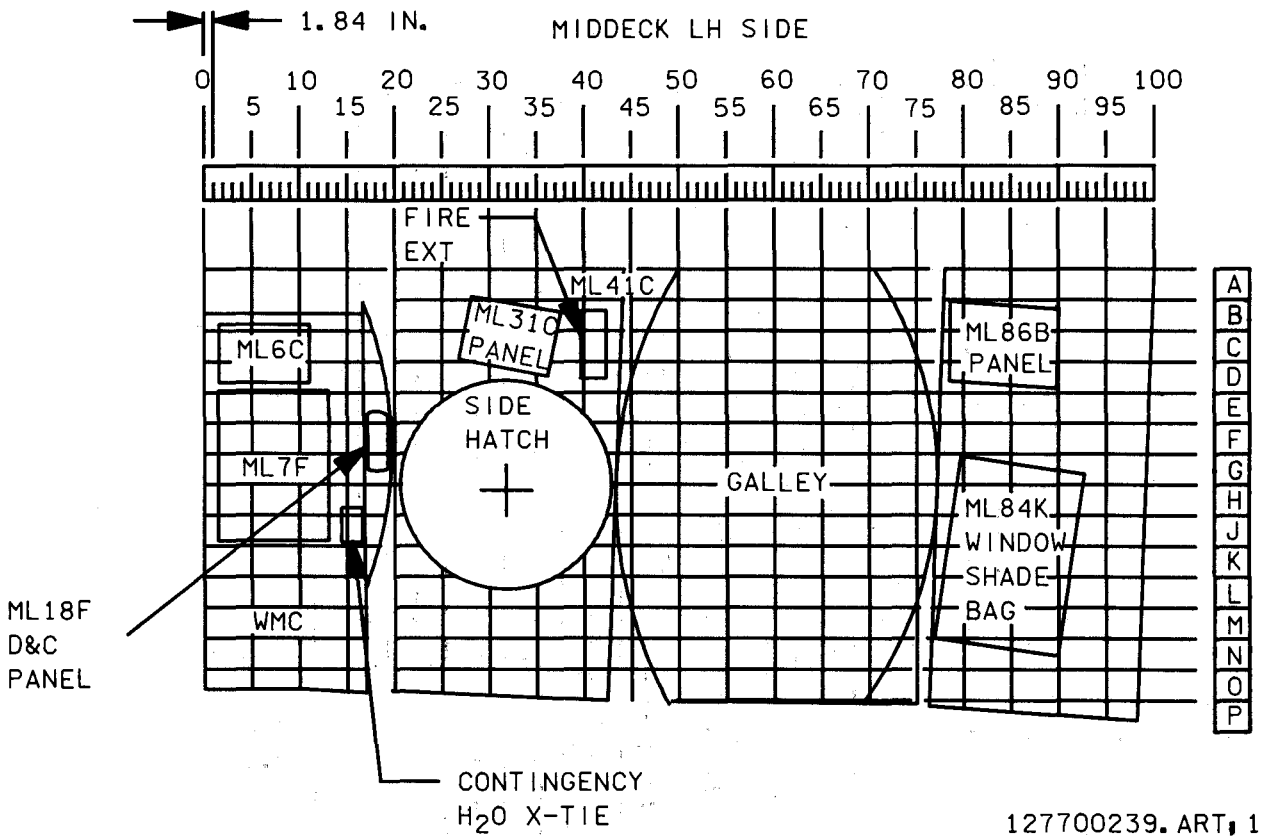
- M058F
- M030F
- M052J
- M029J
- M039M
- M062M
- M013Q

Figure 2.2-5.- Middeck overhead view looking down.



127700238. ART, 2

Figure 2.2-6.- Middeck location codes (floor).



NOTE: The panel numbers listed below are not consistent with the location coding system defined by this document. However, in each case the location coding, as indicated, is in close proximity to the actual location. The panel numbers below were assigned prior to the middeck closeout panel design definition. The starting points for location coding were behind the closeout panels, whereas the starting points used in this document are in front of the closeout panels.

ML31C
ML86B

Figure 2.2-7.- Middeck location codes (LH side).

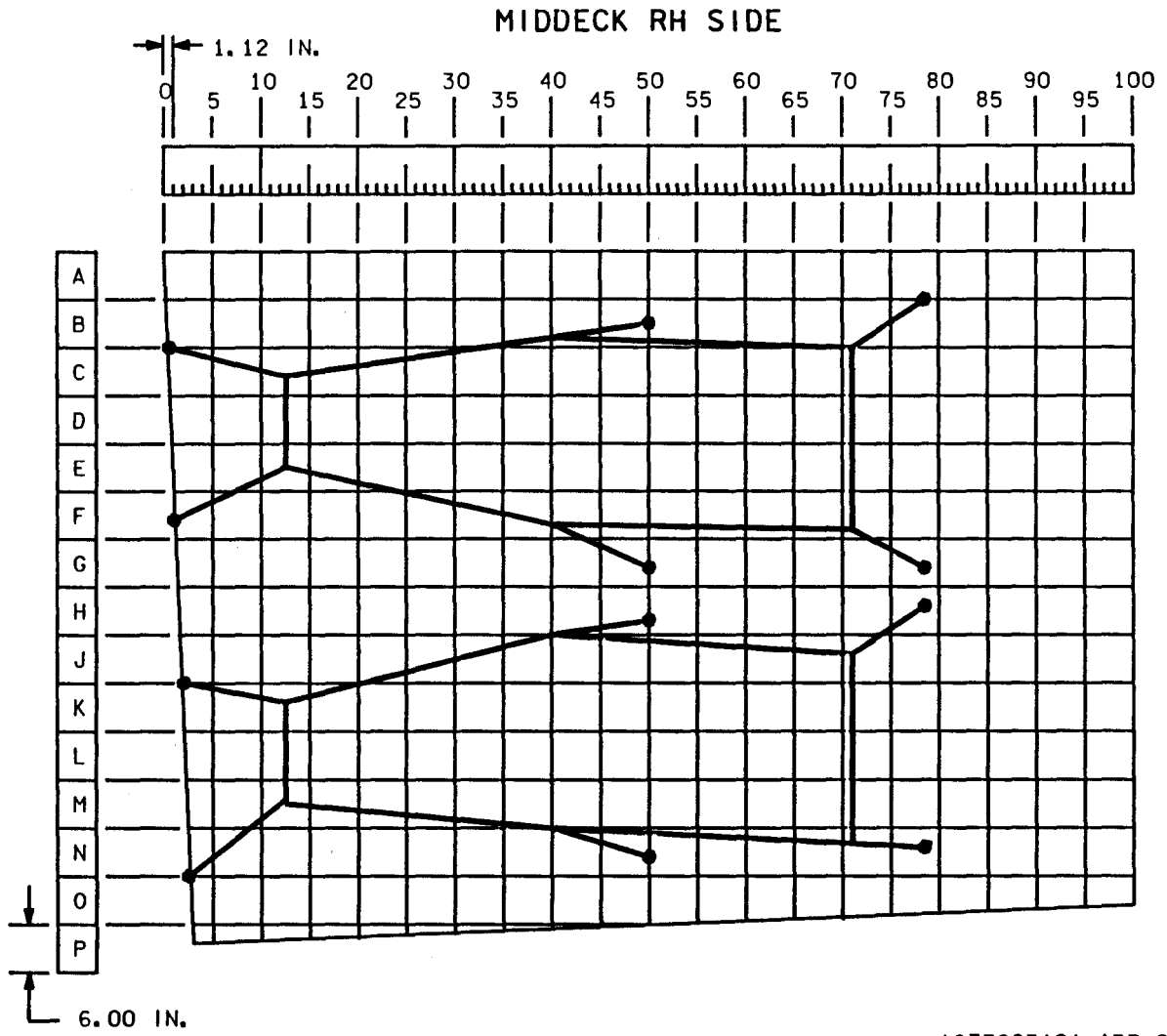


Figure 2.2-8.- Middeck location codes Rh side (sheet 1 of 2).

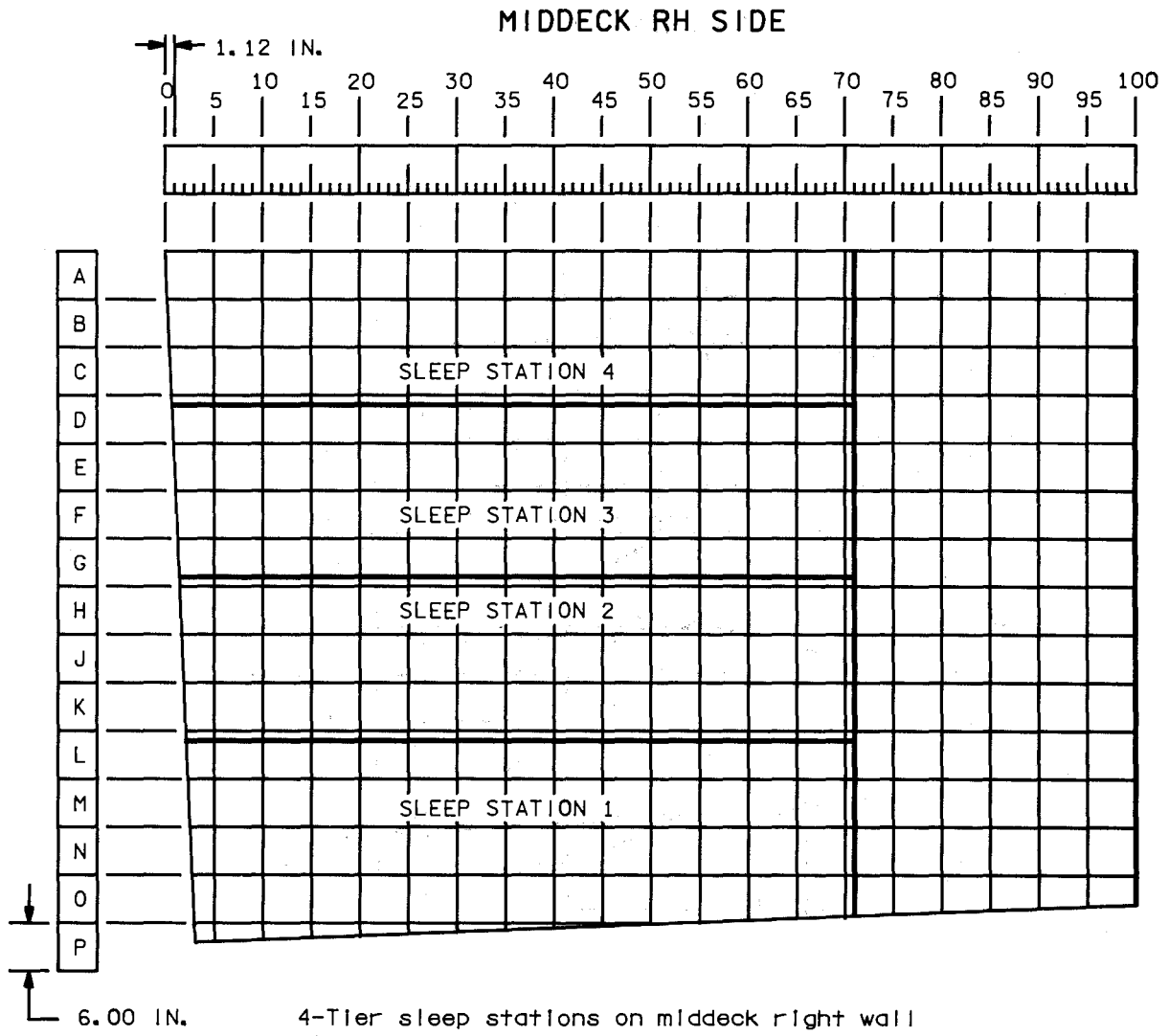
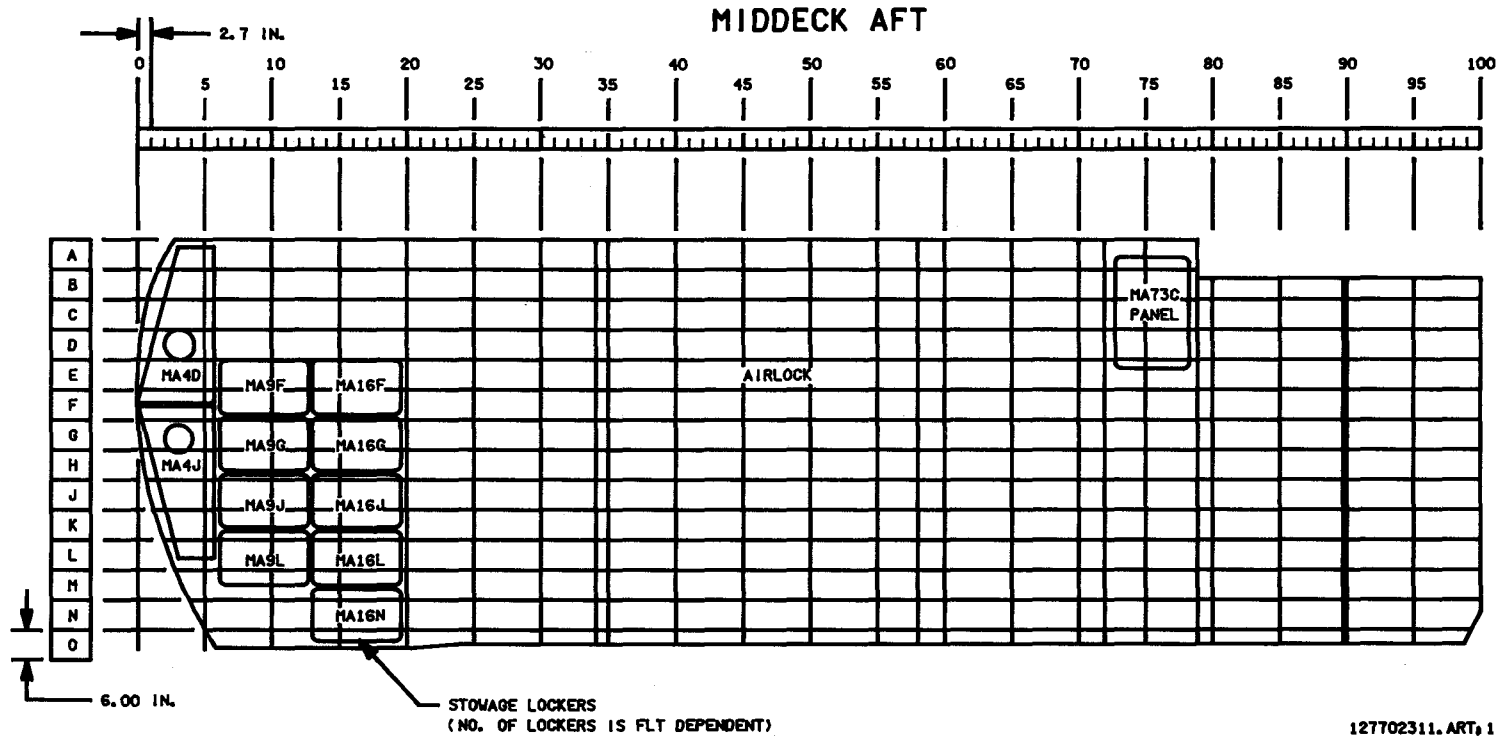


Figure 2.2-8.- Middeck location codes - RH side (sheet 2 of 2).

28

2.2-13



NOTE: The panel number listed below is not consistent with the location coding system defined by this document. However in each case the location coding, as indicated, is in close proximity to the actual location. The panel number below was assigned prior to the middeck closeout panel design definition. The starting points for location coding were behind the closeout panels, whereas the starting points used in this document are in front of the closeout panels.

MA73C

Figure 2.2-9.- Middeck location codes (aft).

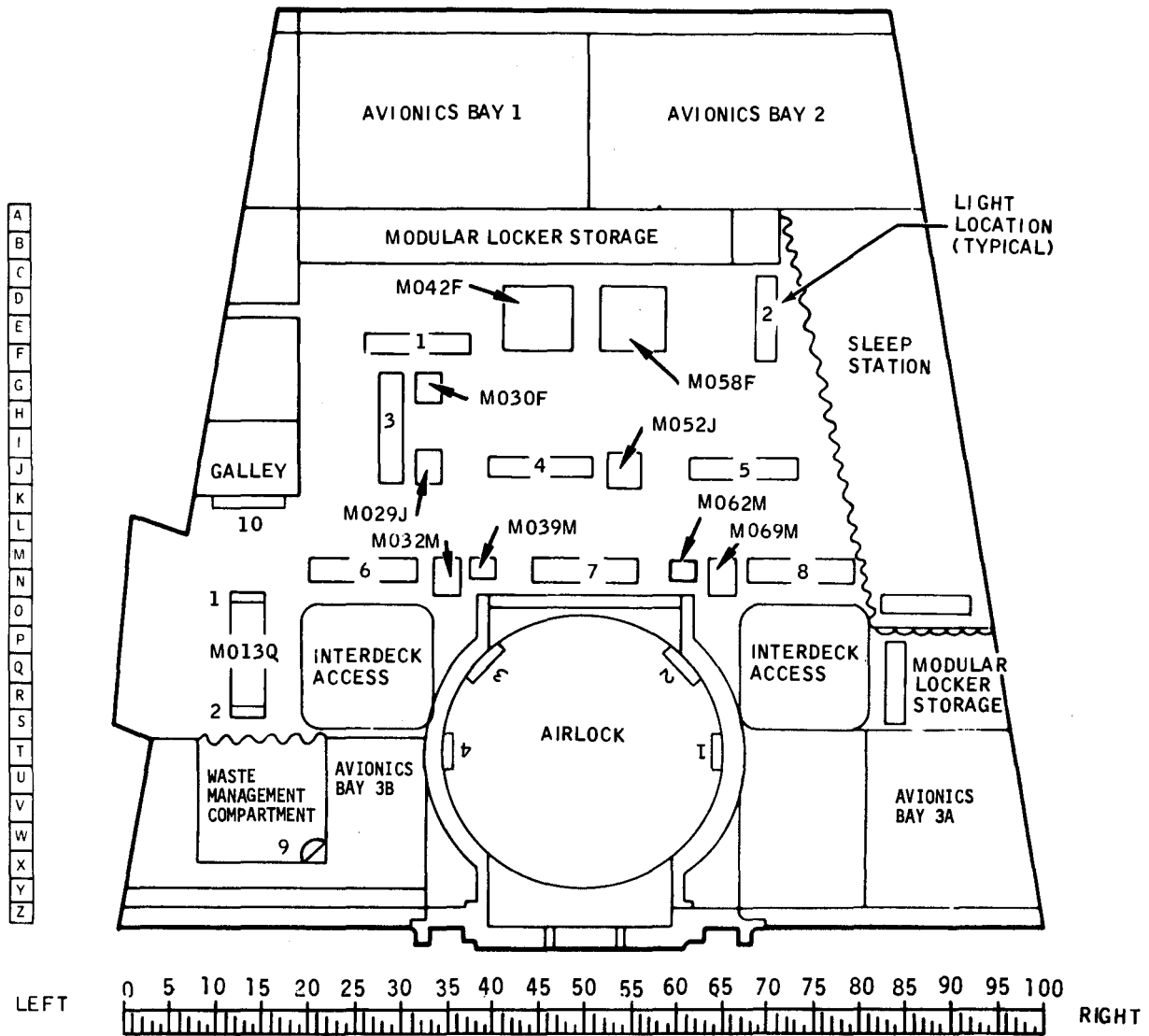


Figure 2.2-10.- Middeck (looking down).

Airlock

An airlock code consists of four or five alphanumeric characters.

An airlock provides the capability to transfer from the middeck to the payload bay for EVA, without depressurizing the Orbiter cabin. The airlock has D&C panels for airlock systems control and stowage provisions for most of the crew equipment necessary to perform an EVA.

The characters in the airlock codes specify the following:

1st character - A for airlock

2nd character - The first letter of an airlock surface; the characters and surfaces are

W - Wall
O - Overhead
D - Deck

The "wall" is the inner wall of the cylindrical airlock. The "overhead" and "deck" are flat surfaces at each end of the cylinder. The overhead is the surface nearest the airlock hatches. The wall location codes have five characters and the overhead/deck codes have four characters.

3rd/4th/5th characters (wall only) - These characters form a location grid on the airlock wall. The 3rd and 4th characters are numerics indicating the distance (clockwise) from the vertical centerline of the forward hatch (airlock in) expressed as a percentage of the total airlock circumference. The 5th character is an alpha character indicating the distance from the overhead surface expressed alphabetically in increments of 6 inches.

3rd/4th characters (overhead/deck only) - These alpha (A through K) numeric (0 through 10) characters form location grids on the deck and overhead surfaces. Since these surfaces are small, items can be easily located without the aid of the location grids.

The airlock layout and coding are shown in figures 2.2-11 and 2.2-12.

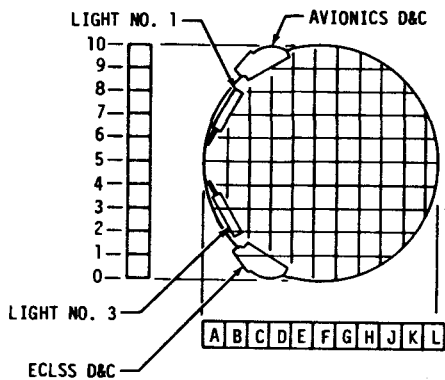
2.2.2 Orbiter Payload Bay

The standard spacecraft X, Y, Z grid will be used for payload bay location coding.

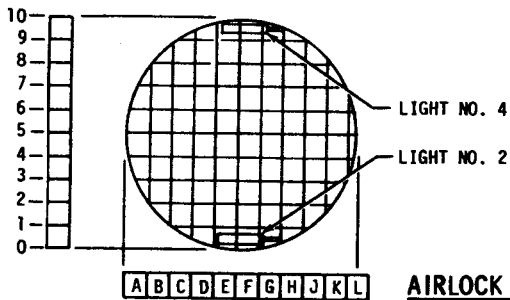
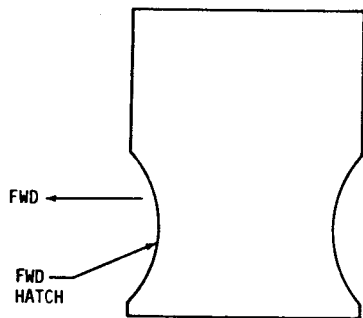
AIRLOCK SURFACES

AIRLOCK LOCATION CODES (1 of 1)

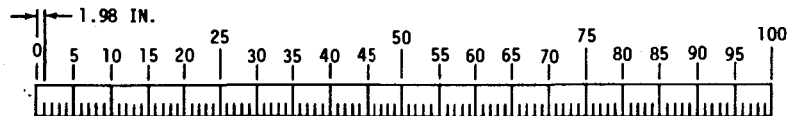
The airlock is shown in the middeck (inside) configuration. The location codes do not change if the airlock is moved to the payload bay. In the 'Airlock In' configuration the airlock overhead aligns with the middeck floor.



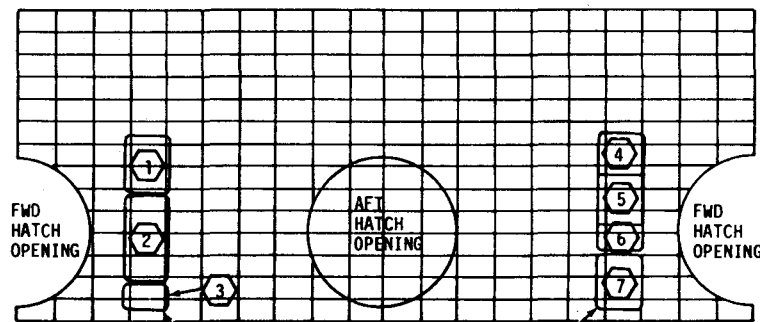
AIRLOCK DECK



AIRLOCK OVERHEAD



6.0 IN.



AVIONICS D&C

- ① AW18H
- ② AW18D
- ③ AW18B

ECLSS D&C

- ④ AW82H
- ⑤ AW82F
- ⑥ AW82D
- ⑦ AW82B

AIRLOCK WALL

Figure 2.2-11.- Airlock surface location codes.

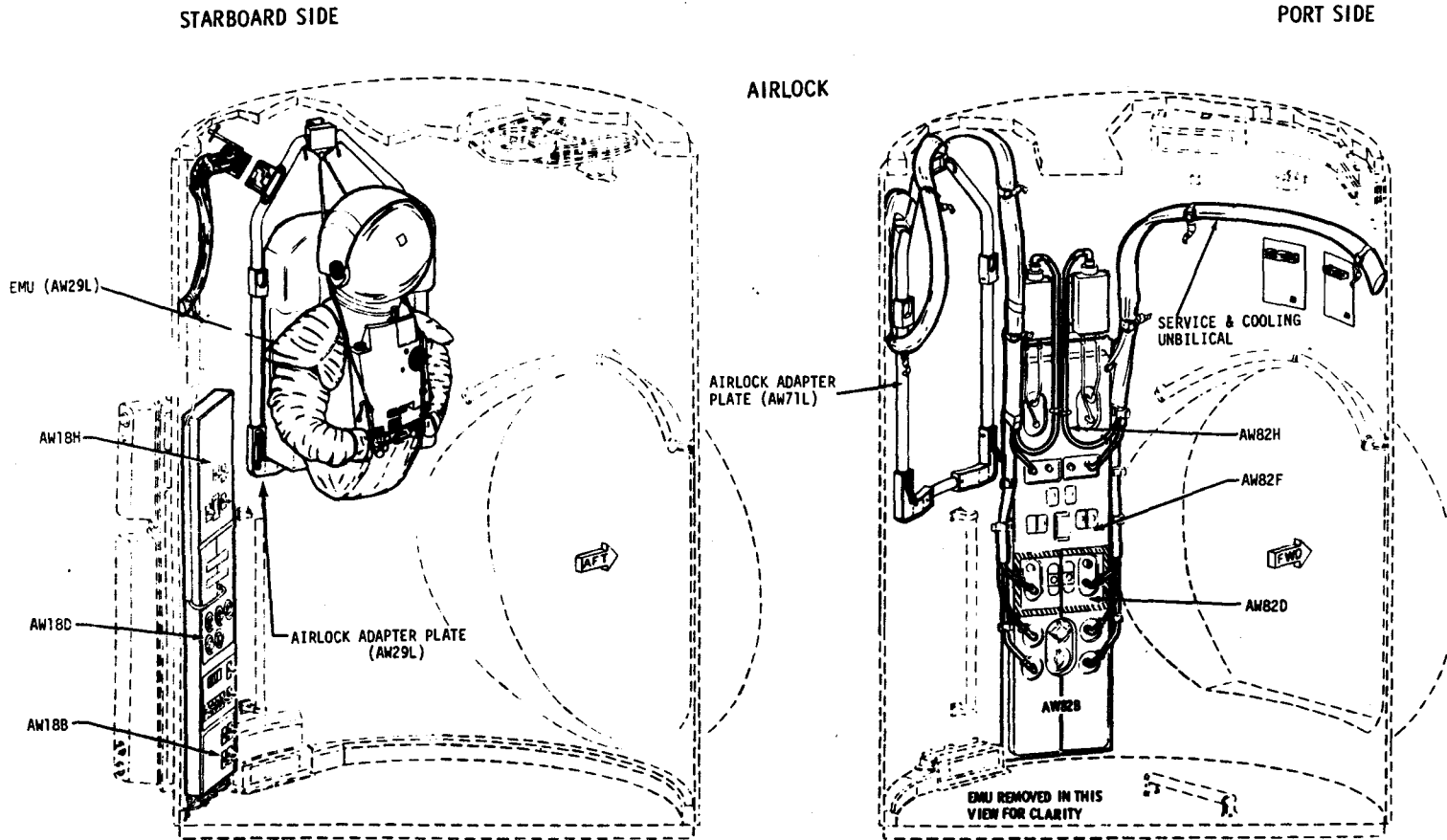


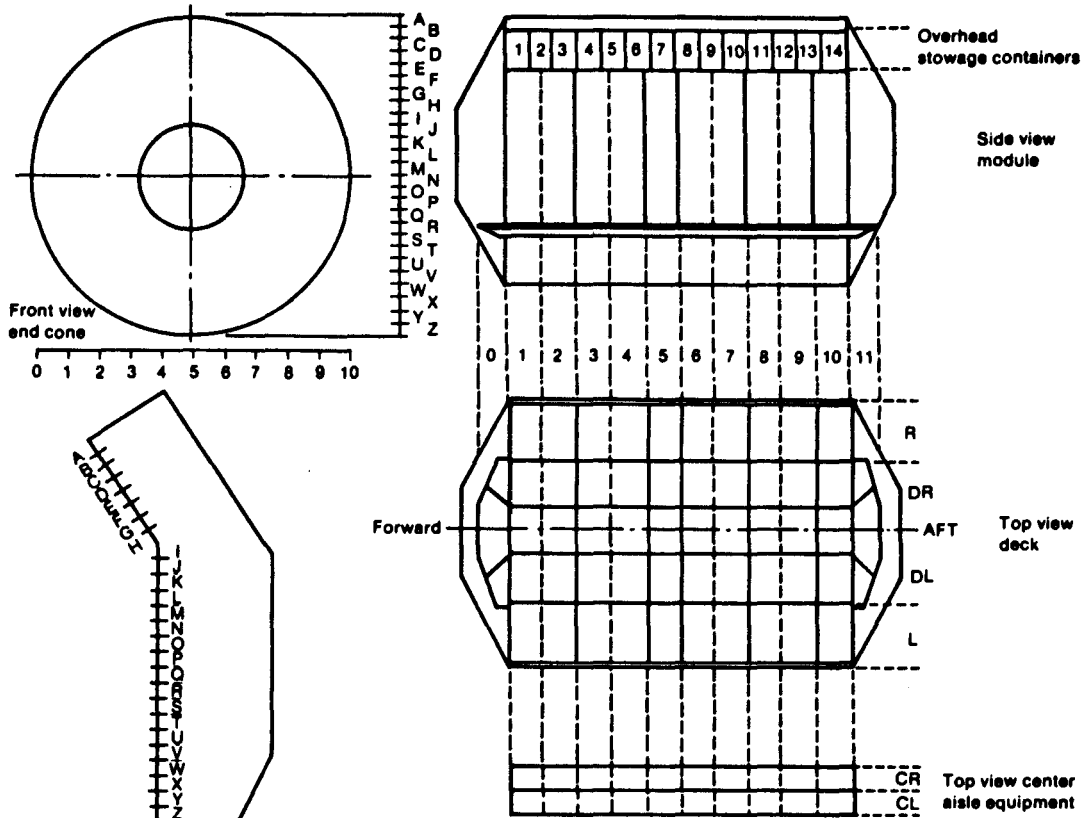
Figure 2.2-12.- Airlock control panels and stowed equipment location codes.

Spacelab

Locations in the Spacelab are identified by alphanumeric codes as depicted in figure 2.2-13 and are based on the following guidelines:

- The forward end cone (F) and aft end cone (A) locations are identified by an alphanumeric coordinate system giving a letter from A to Z indicating position from top to bottom. A number from 0 to 10 denotes the distance from left to right when viewed from the front of the end cone.
- Overhead stowage containers (O) are numbered 1 through 14 from forward to aft.
- The remainder of the module is divided into 12 sections along the cylinder axis starting with 0 for the forward end cone volume, followed by 1 through 10 representing sections of single rack thickness and 11 being the aft end cone volume.

Racks on the left and right side are codes L and R, respectively. An alphabetical letter A through Z determines the height from top to bottom. The left and right sides of the deck (main floor) are coded DL and DR. The left and right sides of the center aisle equipment are coded CL and CR. The left and right sides of the underfloor area are coded UL and UR.



The example alphanumeric code identifies the location of one of the Intercom Remote Stations.

| Example | R | 9 | G |
|-------------------------|--------|------------------------|-----------------------|
| | Prefix | Number | Suffix |
| O = Overhead container | | 1 ... 14 fore to aft | - |
| F = Forward end cone | | 1 ... 10 left to right | A ... Z top to bottom |
| A = Aft end cone | | | |
| R = Rack right side | | 1 ... 10 fore to aft | A ... Z top to bottom |
| L = Rack left side | | | |
| DR = Deck right side | | 0 ... 11 fore to aft | - |
| DL = Deck left side | | | |
| CR = Center aisle right | | 0 ... 11 fore to aft | - |
| CL = Center aisle left | | | |
| UR = Underfloor right | | 0 ... 11 fore to aft | - |
| UL = Underfloor left | | | |

The example alphanumeric code identifies the location of one of the Intercom Remote stations.

Figure 2.2-13.- Spacelab location codes.

SECTION 3.0 ORBITER IVA CREW SYSTEMS

3.1 STOWAGE PROVISIONS

3.1.1 Introduction

Various stowage containers are provided for storing loose on-board equipment and trash/waste materials during different phases of the flight. The major stowage containers and their locations are as follows:

- Flight deck - Aft compartments and Flight Data File (FDF) containers
- Middeck - Modular lockers, Volume A and B, waste management compartment (WMC), galley stowage compartments, airlock and floor compartments

Certain items, because of their usage or their size, are mounted on brackets or in bags for launch and entry. Some examples are extravehicular activity (EVA) hardware in the airlock, personnel egress air packs (PEAP's), and the window shade bag. The detailed stowage of these items is discussed in the appropriate SFOM sections. On-orbit temporary stowage provisions (snaps, Velcro, etc.) are discussed in section 3.4, Seats, Restraints, and Mobility Aids.

3.1.2 Systems Functional Description

Flight Deck Stowage

The flight deck stowage provisions are shown in figure 3.1-1.

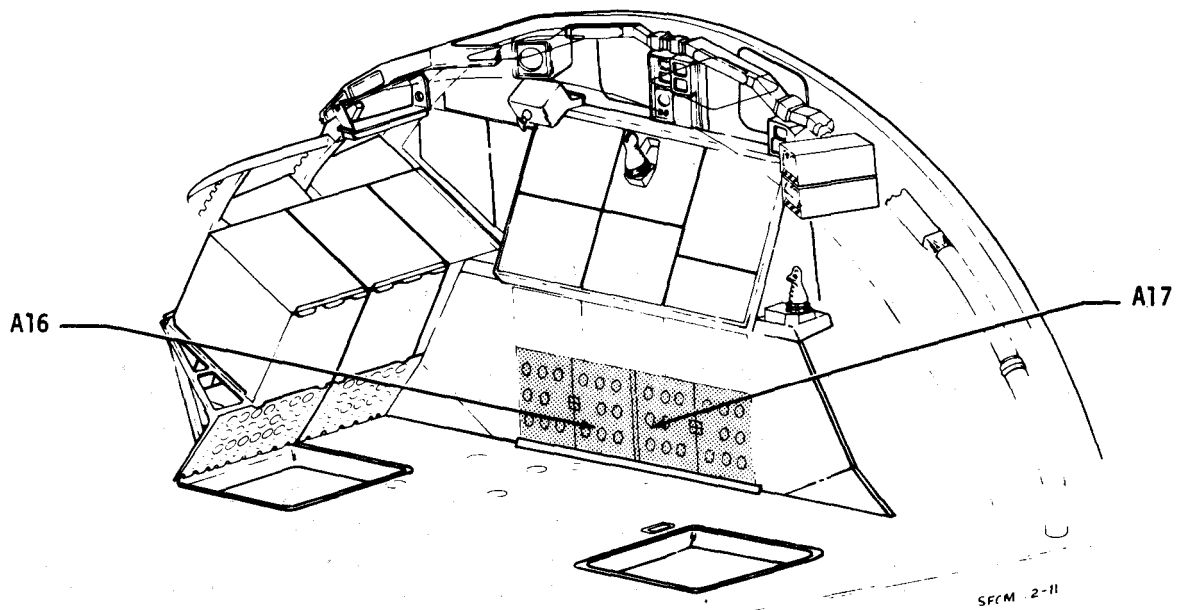
- **Aft Compartments**

The aft flight deck stowage compartments contain binoculars, cameras, video tapes, and other items frequently used on the flight deck. In addition, the survival kit used in a contingency situation is stowed there. The doors to the compartments are opened by squeezing together the latch mechanism between thumb and forefinger.

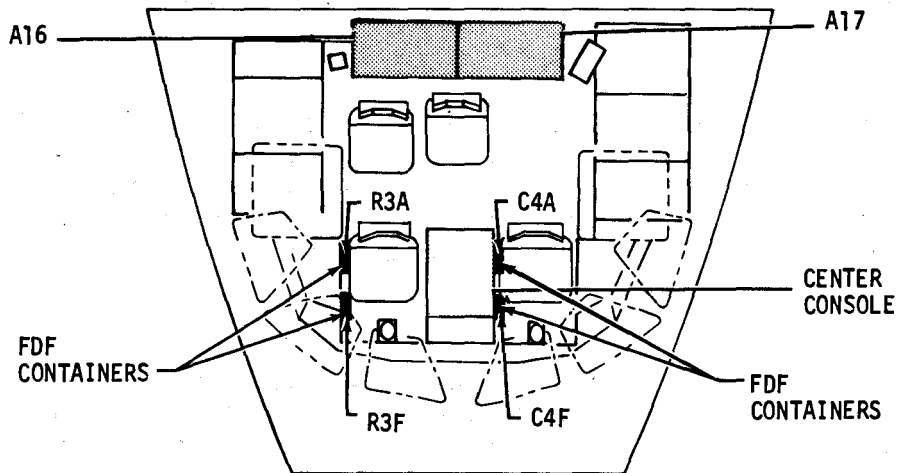
- **Flight Data File Lockers**

Four permanently mounted lockers located on the right-hand side of the CDR and PLT seats are used to store Flight Data File and contingency equipment. Each locker has a usable volume of 0.19 ft³ (0.005 m³). These lockers are described in detail in section 3.2, Flight Data File.

In addition, each specialist seat except S5, has an FDF stowage container installed on the right side of the seat. This may be used for storing Flight Data File and other small loose items such as tape, kneeboards, side hatch locking device, etc.



FLIGHT DECK (LOOKING AFT)



FLIGHT DECK (LOOKING DOWN)

Figure 3.1-1.- Flight deck stowage lockers.

Middeck Stowage

The middeck stowage provisions are shown in figure 3.1-2.

- **Modular lockers**

Each modular locker provides 2 ft³ (0.0566 m³) of stowage volume with the maximum weight no greater than 70 lb each (fig. 3.1-3). The lockers are attached to the avionics bay by four fasteners and can be removed in flight by the use of an extension drive and ratchet assembly (sec. 3.23.1). Hinged doors with two magnetic on-orbit latches and two captive wingnut locks secure the doors during launch and entry. The corners of the locker doors are configured with a standard hole pattern used when restraining equipment. Four types of reusable trays with foam inserts are available. An avionics bay closeout panel is used for structural continuity when modular lockers are not flown.

Up to 42 modular lockers can be flown.

- **Volume A and B Compartments**

- Volume A - Located on the forward upper middeck, just above the middeck modular lockers. This area provides 3 ft³ of usable stowage volume for contingency and pantry food/dining items.
- Volume B - Located in the aft left-hand side of the middeck, this volume is for dry trash stowage. Volume B has a usable stowage volume of 7 ft³.

- **Waste Management Compartment (WMC) Stowage Compartments**

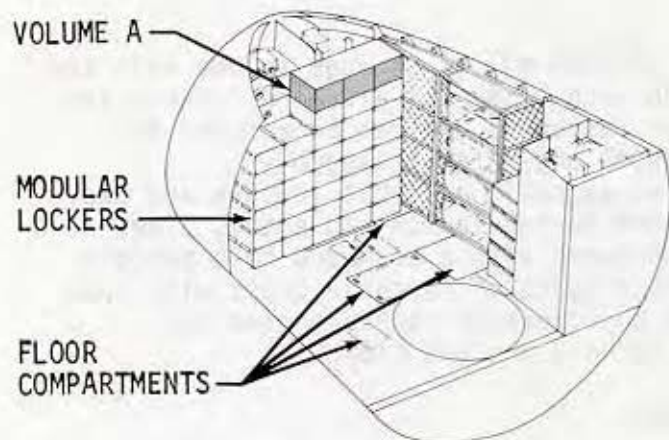
The WMC stowage compartment details are discussed in section 3.17, Waste Collection System (WCS).

- **Galley Stowage Compartments**

Details of the galley stowage compartments are in section 3.16, Food Preparation and Dining.

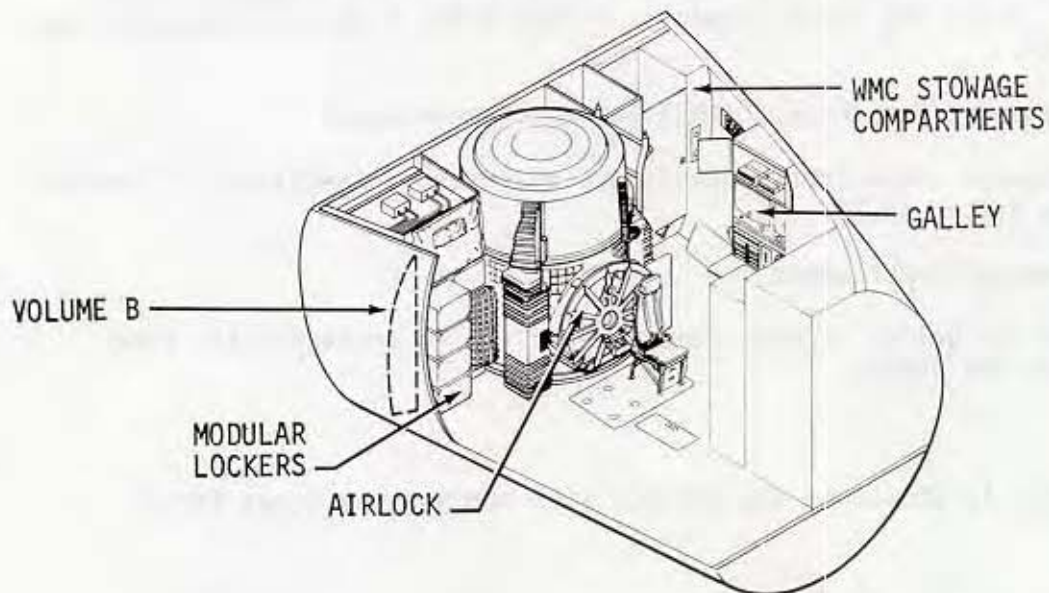
- **Airlock**

EVA hardware is stowed in the airlock with contingency items found in Vol. H.



SLEEPING BAGS ON STARBOARD WALL-
WHEN 4-TIER BUNK SLEEP
STATIONS NOT FLOWN

MIDDECK
(LOOKING FWD)



MIDDECK
(LOOKING AFT)

Figure 3.1-2.- Middeck stowage compartments.

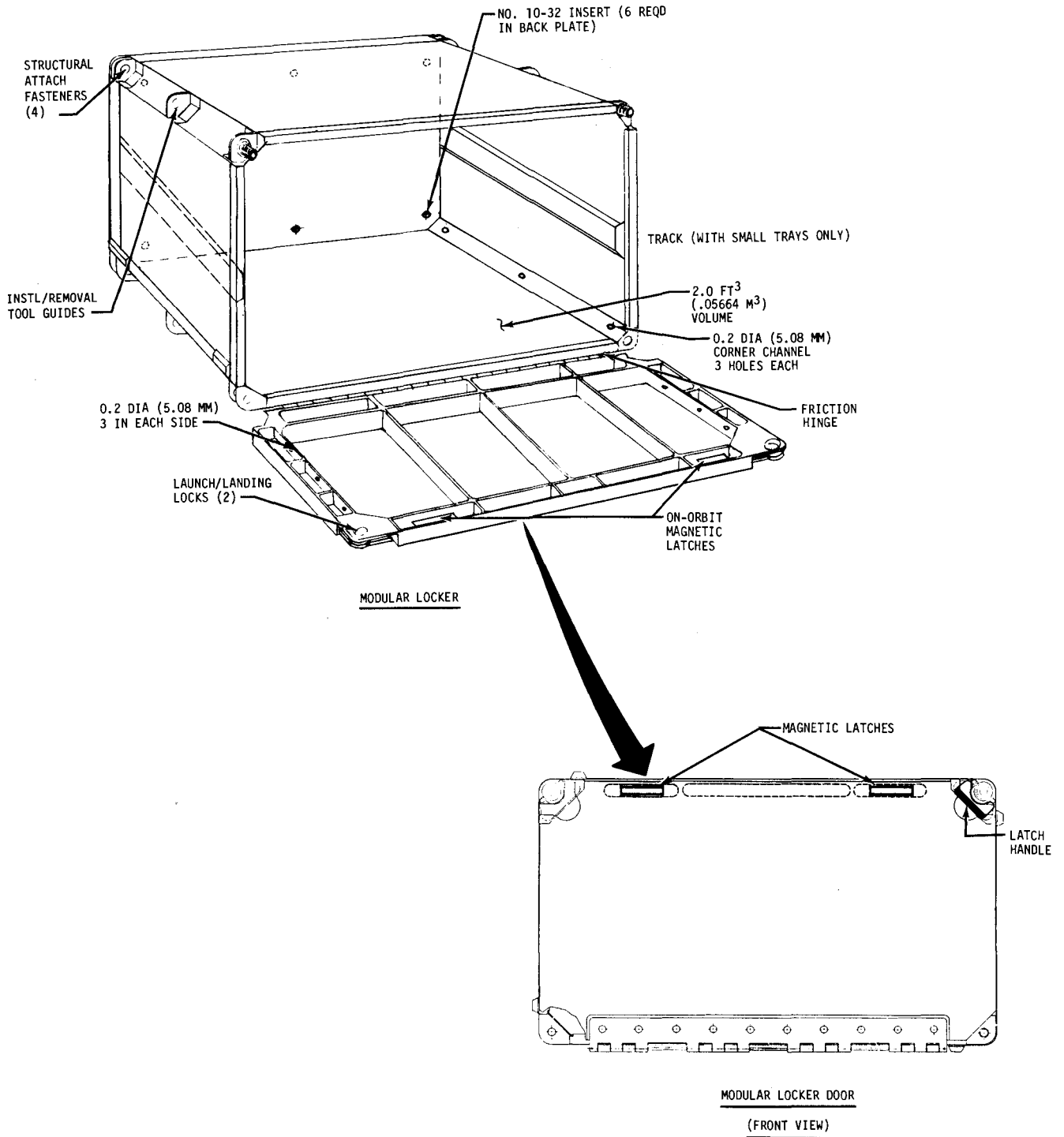
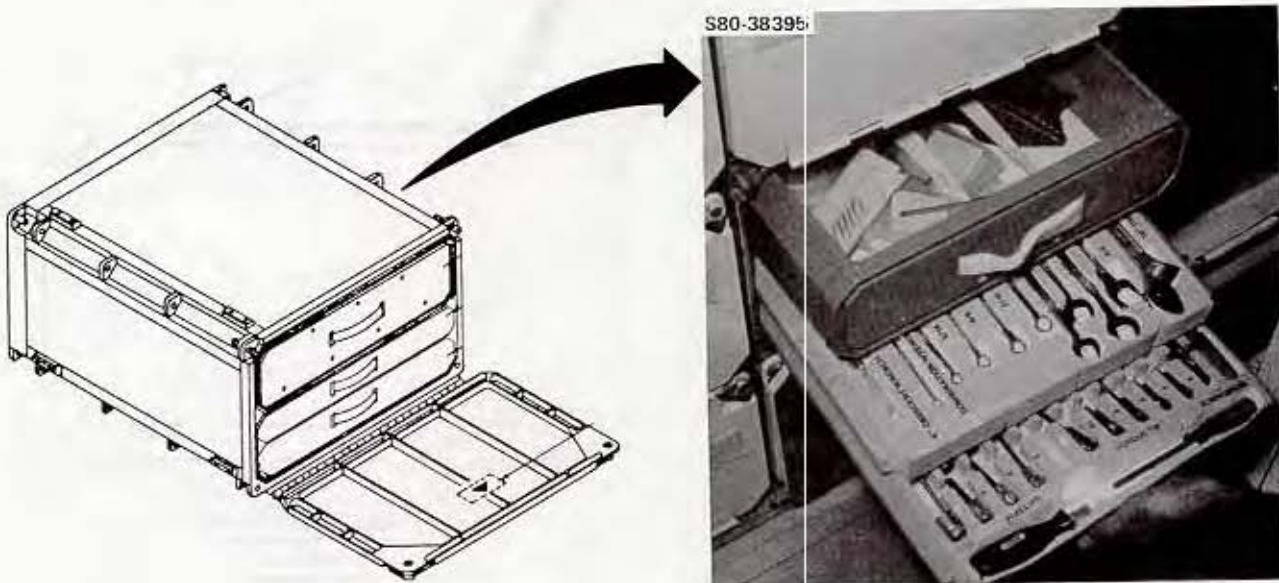
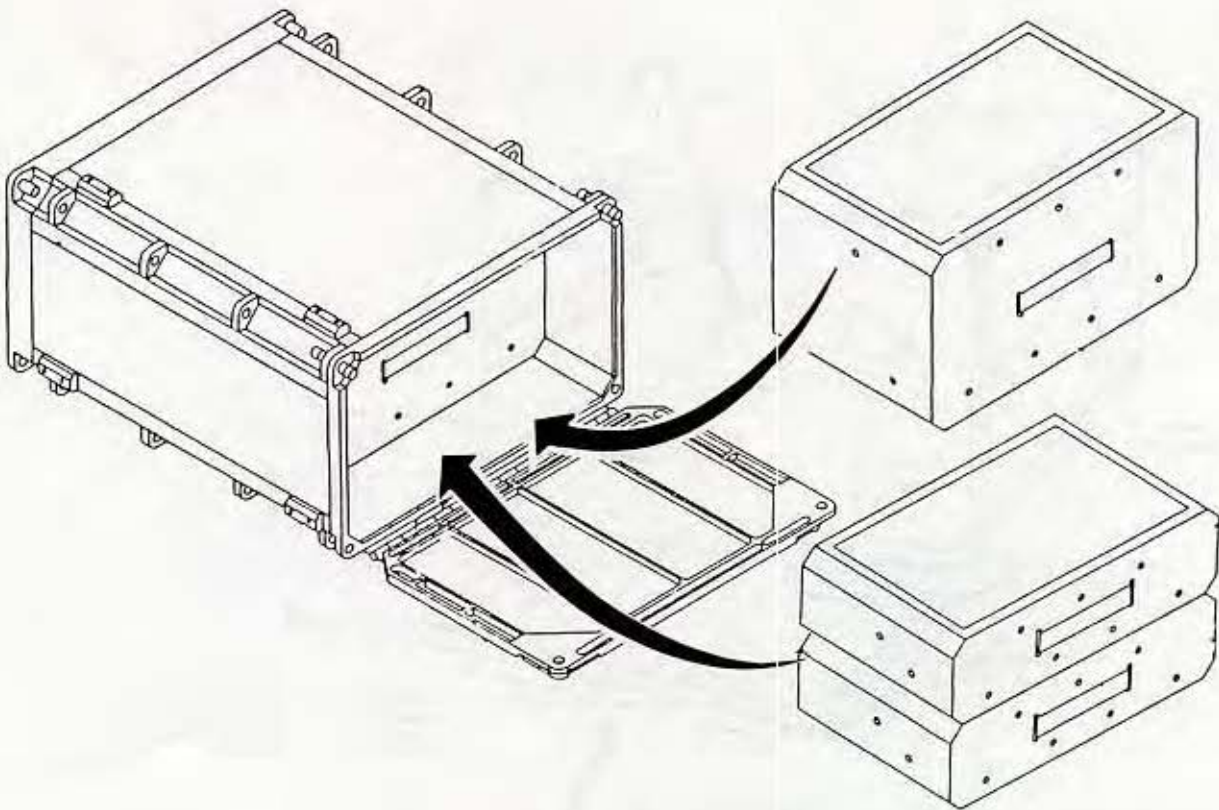


Figure 3.1-3.- Middeck modular locker (sheet 1 of 5).

3.1-5



INFLIGHT MAINTENANCE
LOCKER ASSEMBLY

Figure 3.1-3.- Middeck stowage locker (sheet 2 of 5).

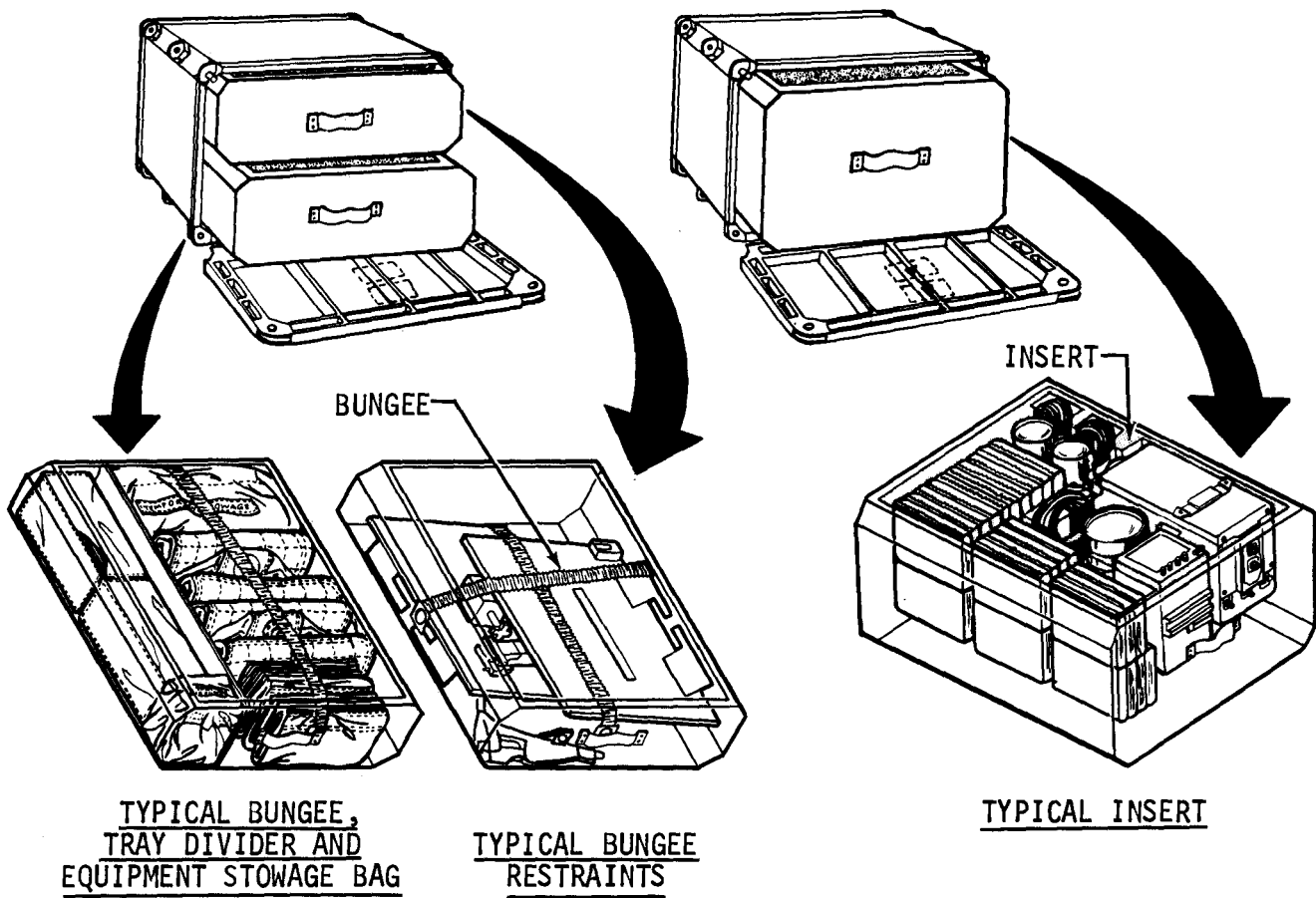
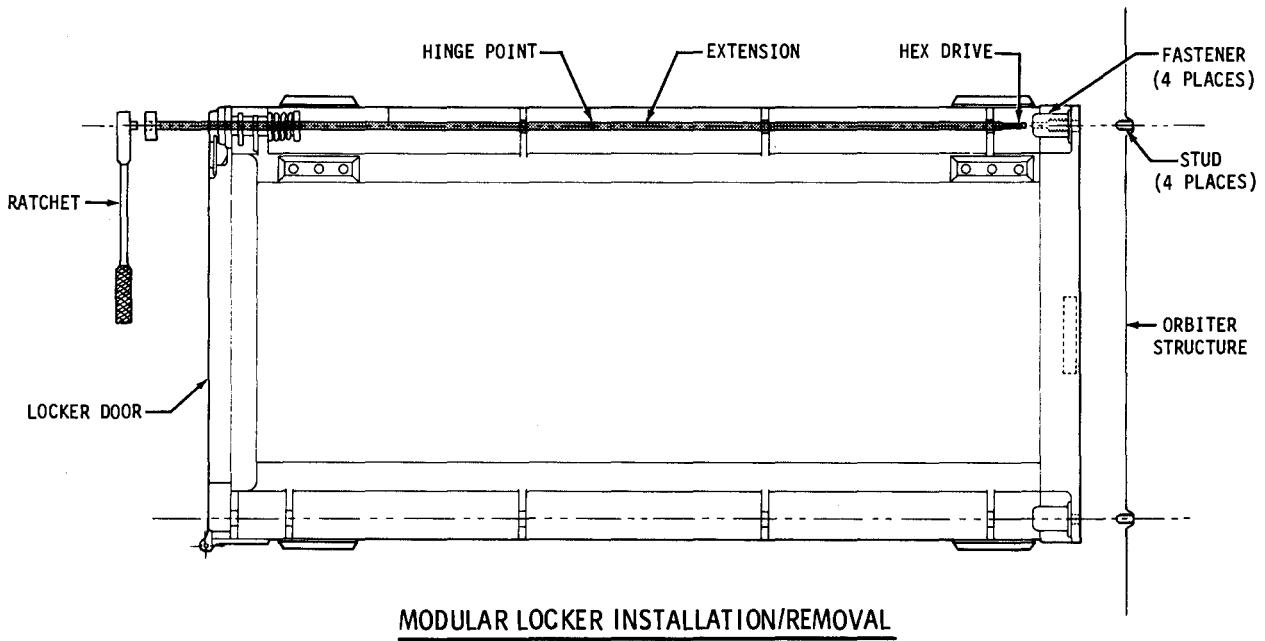


Figure 3.1-3.- Middeck modular storage locker (sheet 3 of 5).



| Procedure | Remarks |
|---|---|
| <u>MODULAR LOCKER/LOCKER CLOSEOUT REMOVAL/INSTALLATION</u> | |
| 1 Unstow, assemble Ratchet/torque wrench Locker tool. | |
| 2 To remove, loosen fasteners (4). | Turn tool ccw 3-1/2 to 4 turns. |
| 3 To install, hand tighten fasteners, torque (30 in-lb) top right, bottom left, top left, bottom right. | Locker must be seated on alignment pin. Push in, turn tool cw 3-1/2 to 4 turns. Torque specs are 30 in-lb |
| 4 Stow tools | |

Figure 3.1-3.- Middeck modular stowage locker (sheet 4 of 5).

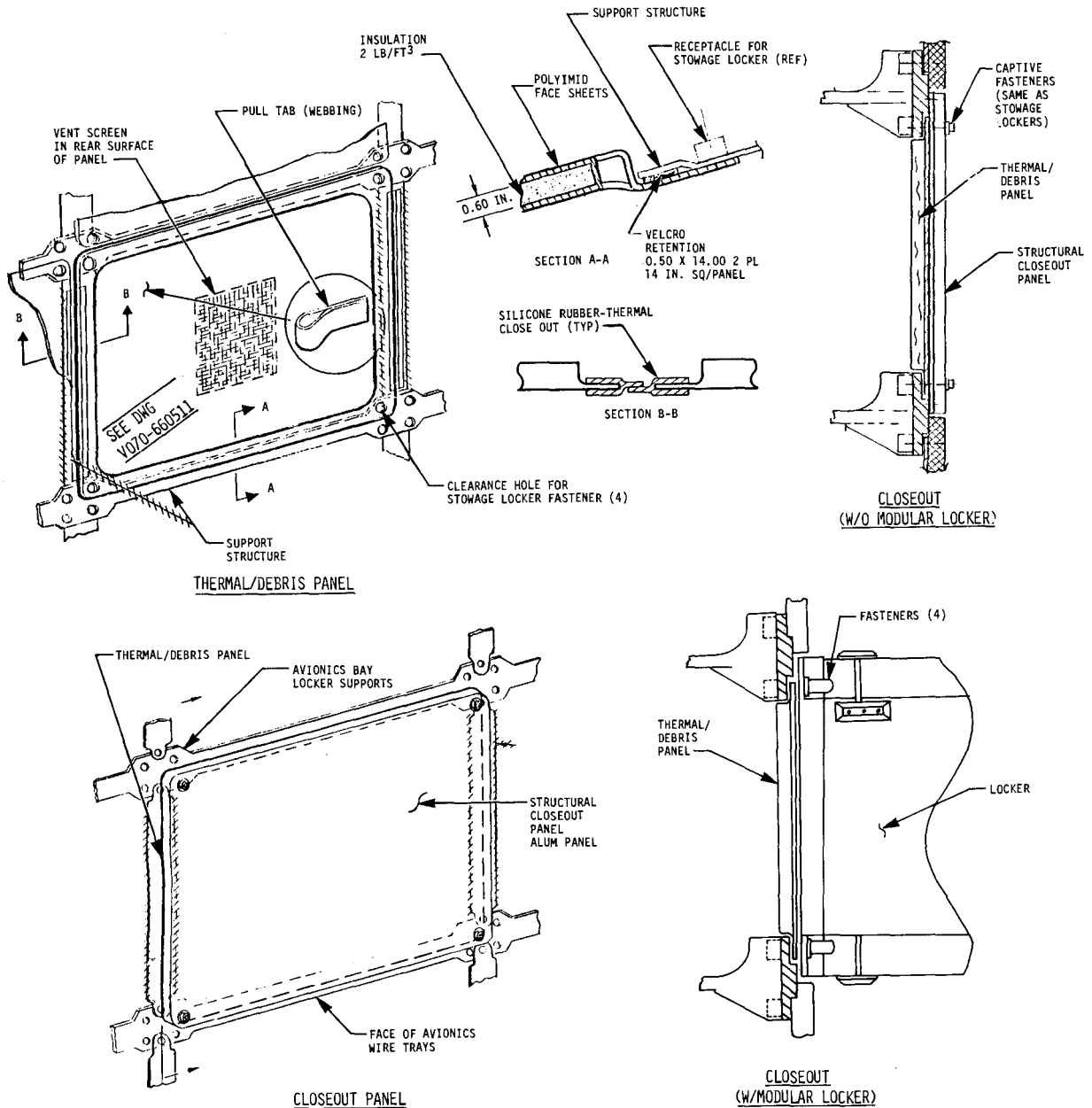


Figure 3.1-3.- Middeck modular locker (sheet 5 of 5).



S83-25275

MIDDECK STOWAGE BAG



S85-28236

FLIGHT DECK STOWAGE BAG

S85-28233



JETTISON BAG

S79-25283



HELMET STOWAGE BAG

S85-28234



INFLIGHT STORAGE BAG

S79-31402



TRASH CONTAINER

S79-31450



TEMPORARY STOWAGE BAG

Figure 3.1-4.- Stowage bags.

- Floor Compartments

The middeck floor has six floor stowage compartments. The CO₂ absorber compartments and the wet trash compartment are discussed in section 3.22. Two other compartments (Volume G (MD80R) and H (MD23R)) are used to store contingency items and EVA equipment respectively. The remaining compartment (volume E (MD76C)) is used to store items, such as OFK and PPK's. The volume for floor compartments E, G and H is 6.5 ft³. The wet trash compartment volume is 8 ft³. Procedures for accessing volume E or G are shown in table 3.1-1. The doors are opened by squeezing spring-loaded fasteners together using the thumb and first finger (fig. 3.1-5).

Stowage volumes for the flight deck and middeck are listed in table 3.1-2.

Miscellaneous Stowage

Loose onboard equipment and dry trash may be temporarily stowed in flexible stowage containers. These include flight deck stowage bags, middeck stowage bag, temporary stowage bags, inflight stowage bags, jettison stowage bags, helmet bags, and trash containers (fig. 3.1-4).

- Flight Deck Stowage Bag

For flight deck stowage, a bag is mounted on the back of the CDR and PLT seats. Each bag has pockets with flaps for stowing loose items on orbit. These bags are stowed in a middeck locker and are transferred to the flight deck during postinsertion.

- Middeck Stowage Bag

A fabric bag with pockets is provided for stowing loose items on the middeck. The bag is attached with four hooks usually above the airlock hatch. This bag is stowed in a middeck locker and is deployed during postinsertion.

- Temporary Stowage Bag

One temporary stowage bag (TSB) is normally installed on the aft flight deck. The bag is used to hold loose equipment for temporary restraining, stowage, or transporting. An additional TSB is stowed in a middeck locker.

- Inflight Stowage Bag

Seven color-coded mesh fabric bags are stowed in a middeck stowage locker. These bags are used for storing the crewmember's launch equipment, such as helmets, harnesses, boots, and PEAP's. Each bag has a drawstring for sealing the opening.

TABLE 3.1-1.- PROCEDURES FOR ACCESSING VOLUME E OR G

| Procedure | Remarks |
|--|---|
| <u>ACCESS TO VOLUME E (MD76C)</u> | |
| 1 Unstow, assemble Ratchet/torque wrench Locker tool | |
| 2 Loosen MF71M and MF710 four fasteners | Turn tool ccw 3-1/2 to 4 turns |
| 3 Remove MF71M and MF710 and stow | |
| 4 Remove required items from MD76C | |
| 5 Install MF71M and MF710 - hand tighten fasteners, torque (30 in-lb) top right, bottom left, top left, bottom right | Locker must be seated on alignment pin. Push in and turn tool cw 3-1/2 to 4 turns. If three fasteners can be secured in place, continue nominal use of lockers. If only two fasteners can be engaged, locker can be left in place but contents must be removed from locker and stowed elsewhere. If less than two fasteners can be engaged, the locker can be stowed in the 4-tier bunk sleep station (sleeping bags) |
| 6 Stow tools | |

TABLE 3.1-1 .- Concluded

| Procedure | Remarks |
|--|---|
| <u>ACCESS TO VOLUME G (MD80R)</u> | |
| 1 Unstow, assemble Ratchet/torque wrench Locker tool | |
| 2 Loosen MA16N four fasteners | Turn tool ccw 3-1/2 to 4 turns |
| 3 Remove MA16N and stow | |
| 4 Remove required items from MD80R | Remove locker MA16L (if required) |
| 5 Install MA16N - hand tighten fasteners, torque (30 in-lb) top right, bottom left, top left, bottom right | Locker must be seated on alignment pin. Push in and turn tool cw 3-1/2 to 4 turns. If three fasteners can be secured in place, continue nominal use of lockers. If only two fasteners can be engaged, locker can be left in place but contents must be removed from locker and stowed elsewhere. If less than two fasteners can be engaged, the locker can be stowed in the 4-tier bunk sleep station (sleeping bags) |
| 6 Stow tools | |

TABLE 3.1-2.- STOWAGE VOLUMES

| Location | Locker/container/ compartment | Stowage volumes | |
|-------------|---|-----------------|----------------|
| | | ft ³ | m ³ |
| Flight deck | Aft compartments | 4.31 | 0.122 |
| | FDF container (C4F, C4A, R3F, R3A) | 0.76 | 0.022 |
| Middeck | Modular Lockers 2 ft ³ | 84.00 | 2.379 |
| | Floor compartments | 34.08 | 0.965 |
| | Volume A and B | 10.00 | 0.283 |
| | WMC stowage compartments | 5.00 | 0.142 |
| | Specialist seat stowage (per seat) ^a | 0.22 | 0.006 |
| | Galley stowage compartments | 0.46 | .013 |
| Total | | 138.83 | 3.932 |

^aVolume per Specialist seat.

- Jettison Stowage Bag

Jettison bags are used for stowing dry trash. Each bag has a drawstring for sealing the opening of the bag. In addition, at least one bag is labeled "Return to Houston" and items stowed in this bag are flight data file, film, cassettes and other early return items.

- Helmet Stowage Bag

A meshed-fabric bag with a drawstring is provided for stowing flight data file or other onboard loose equipment. The bag is stowed in the Commander's FDF stowage container. In addition, one helmet bag is provided to each crewmember for stowing their helmet and gloves.

- Trash Bags

Three trash bags are normally flown. One is mounted on the inside surface of the WMC door, one is located on the aft flight deck, and one is installed on avionics bay IIIB door (MA73G). Each bag contains a disposable trash bag plastic liner. Spare liners are flown in a middeck locker.

3.1.3 Systems Performance, Limitations, and Constraints

Compartments

- The maximum density for stowage compartments is 30 lb/ft³.
- Capacity of Volume E (MD76C), G (MD80R) and H (MD23R) is 6.5 ft³.
- Capacity of the wet trash compartment is 8 ft³.

Modular Lockers

- Foam inserts off-gas at about 500° F.
- Maximum density for modular lockers (if all lockers are flown) is 20 lb/ft³.
- Stowed items must not be free to shift in the locker.
- The c.g. of stowed items must not extend farther than 14 in. (two-thirds of the depth) from the locker attachment face.
- Packing must not allow high single-point loading onto any surface of the locker.
- Hard items are to be packed with padding between the items and the locker surface.
- Dimensions (inside): 21.062 by 18.125 by 10.757 in. (53.5 by 46.0 by 27.3 cm)

A16 and A17 Lockers

- Dimensions (inside): L by W by H = 27.87 by 10.125 by 14.75 in. (70.8 by 25.7 by 37.5 cm) each

C4 and R3 Lockers

● Dimensions (inside):

- Forward container: L by W by H = 9.5 by 3.0 by 11.5 in. (24.13 by 7.62 by 29.21 cm)
- Aft container: L by W by H = 11.5 by 3.0 by 9.5 in. (29.21 by 7.62 by 24.13 cm)

3.2 FLIGHT DATA FILE

3.2.1 Introduction

The Flight Data File (FDF) is the onboard complement of documentation available to crewmembers during flight. FDF items are used throughout the mission from prelaunch use of the Ascent Checklist to postlanding use of the Entry Checklist. The FDF is composed of, but not limited to the following:

- Documentation
 - Procedural checklists (normal, backup, and emergency procedures)
 - Integrated timelines
 - Malfunction procedures
 - Reference data book
 - Crew activity plans
 - Schematics
 - Photos
 - Cue cards
 - Star charts
 - Earth maps
 - Decals
- Stowage containers
- Accessories
 - Tethers
 - Clamps
 - Clips
 - Tape
 - Rubber bands
 - Pencils
 - Switch caps
 - Crew notebooks

3.2.2 Systems Functional Description

FDF Documentation

FDF documentation includes reference data (books, cards, maps, etc.) and related aids that are required onboard the Orbiter for the conduct of each flight. The specific documents and quantities carried vary from flight to flight, since specific flight documentation requirements are published in the FDF Manifest Document (JSC-19542).

Description

There are four types of articles in the FDF, Control, Support, Off-nominal and Reference.

- Control documents are those articles containing nominal timelines and covering a specific flight phase. These documents are as follows:
 - Ascent Checklist
 - Postinsertion
 - Crew Activity Plan
 - Deorbit Prep
 - Entry Checklist
- Support documents contain the detailed procedures required to support nominal operations. These include
 - Cue Cards
 - EVA Checklist
 - EVA Cuff Checklist
 - Orbit Ops Checklist
 - Payload Deployment Checklist (as required)
 - Payload Ops Checklist (as required)
 - PDRS Checklist (as required)
 - Rendezvous/Prox Ops (as required)
 - Landing Site Charts
- Off-nominal articles contain detailed procedures to support unplanned activities when needed and include
 - Pocket Checklist (Ascent Orbit Entry)
 - Ascent/Entry Systems Procedures (Flight Deck Cue Cards/Flip Books)
 - Contingency Deorbit Prep
 - Contingency EVA
 - IFM Checklist
 - Med Checklist
 - Malfunction Procedures
- Reference documents contain additional data/schematics needed to support either nominal or off-nominal operations such as
 - Reference Data
 - System Data
 - DPS Dictionary

For a more detailed description of each individual document refer to the Flight Data File Workbook (FDF 2102).

FDF Stowage Containers

- Middeck FDF locker (fig. 3.2-1)

The middeck FDF locker is a modular locker tray that serves as a "central library". Typically, the middeck FDF locker contains the Orbiter and Crew Systems Procedures handbooks, Crew Activity Plans, malfunction and reference data books, maps, and other specialized articles. In addition,

53

3.2-3

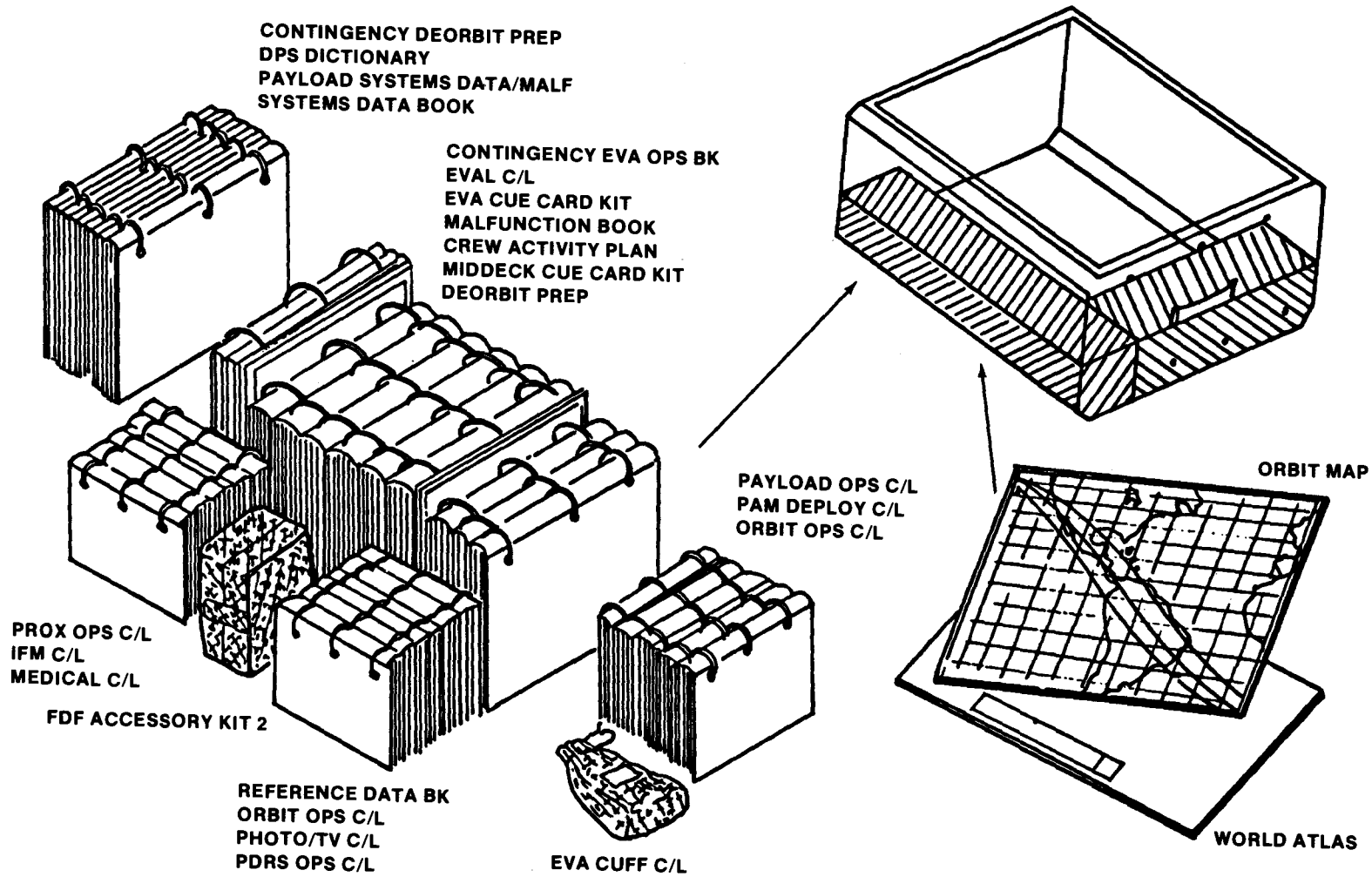


Figure 3.2-1.- Representative middeck FDF locker.

other supporting items such as book clamps and clips, pencils and short tethers, are stowed within an FDF accessory kit in the locker.

If the flight carries a Spacelab module, many Spacelab books are stowed for launch in an additional middeck locker tray and transferred in flight to a location in the Spacelab.

- Lockers C4F and C4A

Lockers C4F and C4A are permanently mounted lockers located on the right-hand side of the CDR seat and provide stowage of the CDR's FDF documentation. The lockers can hold both small and large checklists as well as star charts, OMS/RCS slide rule and non-FDF items (helmet bag, switchguard).

- Lockers R3F and R3A (fig. 3.2-2)

Lockers R3F and R3A are permanently mounted lockers located on the right side of the PLT seat and provide stowage for the PLT's FDF documentation. The lockers are similar in size to lockers C4F and C4A. Like the CDR, the PLT carries some non-FDF items in these containers including a switchguard and handheld VHF radio.

- Specialist Seat FDF Container (MS bags) (fig. 3.2-3)

These containers are soft fabric bags which can be attached via a bracket to the right side of the seat for storing FDF or other small loose items. Specific details on this container are discussed in section 3.4, Seat, Restraints, and Mobility Aids.

- Data Card Kits

The Cue Cards are carried in data card kit bags and are configured as follows:

- The Cue Cards used for flight-deck operations during orbit, deorbit, and entry are contained in data card kit 1 (fig. 3.2-4) stowed in R3A
- Cue Cards used for EVA and middeck operations are located in the mid-deck FDF locker
- For off-nominal operations of the RCS and OMS, the OMS/RCS slide rule kit is provided in flight deck locker C4F.

The nominal contents of each data card kit are listed in table 3.2-1.

TABLE 3.2-1.- REPRESENTATIVE FDF KITS

| Kit | Contents |
|-----------------|--|
| Accessory kit 1 | Binder clip Book clips Book clamps FDF pencils with Velcro Rubber bands Switch caps Short tethers Tape dispenser and extra roll Yellow tape |
| Accessory kit 2 | Short tethers Book clips Book clamps FDF pencils with Velcro FDF grease pencils (red and black) |
| Data card kit 1 | Orbit cards DAP BOOK ORBIT SPEC/SM CHECKPOINT ORBIT SPEC (R11)/C&W MATRIX TV-VTR ORB VTR FUEL CELL PURGE CARD LEAKING OMS PRPLT BURN (2) SPOC (WITH FUSE) EARTH OBS GO/NO GO Deorbit cards (9) CDR pouch: DEORB BURN (2 ENG)/DEORB BURN (1 ENG) DEORB BURN MONITOR/OMS FAILURES DEORB BURN (RCS) UNBAL PRPLT BURN/DEORB (MIXED FEED) |

TABLE 3.2-1.- Concluded

| Kit | Contents |
|------------------------|--|
| | PLT pouch: DEORB BURN FLIGHT RULES DEORB BURN (2 ENG)/DEORB BURN (1 ENG) DEORB BURN MONITOR/OMS FAILURES DEORB BURN (RCS) UNBAL PRPLT BURN/DEORB (MIXED X FEED) Entry cards (4) ENTRY MNVRS/(CONT) (2) ENTRY NO-GO CHECKLIST (2) |
| EVA cue card kit | DEPRESS/REPRESS/FAILED LEAK CHECK |
| Middeck cue card kit | TREADMILL/CONT WCS/SUPPLY H2O FOOD PREP POST/FOOD WARMER/GALLEY URINE COLLECTION/APOLLO BAG PROCEDURE CO2 ABSORBER REPLACEMENT CREW MODULE MEASUREMENTS w/GAP TOOL MIDDECK TAPE MEASUREMENTS/CARD/PHOTO |
| OMS/RCS slide rule kit | OMS/RCS SLIDE RULE 1ST FAILURE INSERTS (2) 2ND FAILURE INSERTS (2T*) 3RD FAILURE INSERTS (1T*) FWD RCS INSERTS (1 + 2T*) |

* T = Transparency

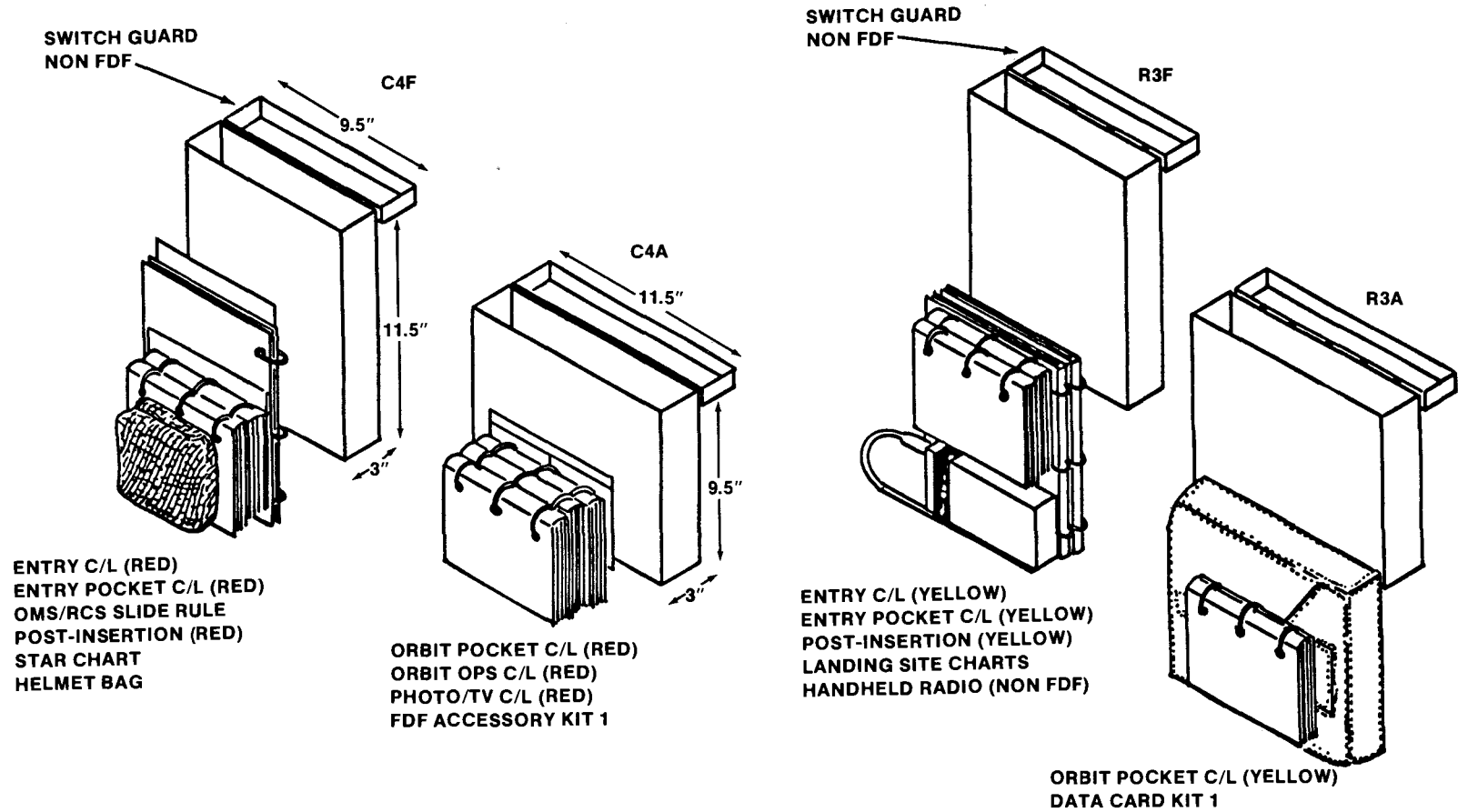


Figure 3.2-2.- Flight deck FDF containers and representative items.

S83-25263

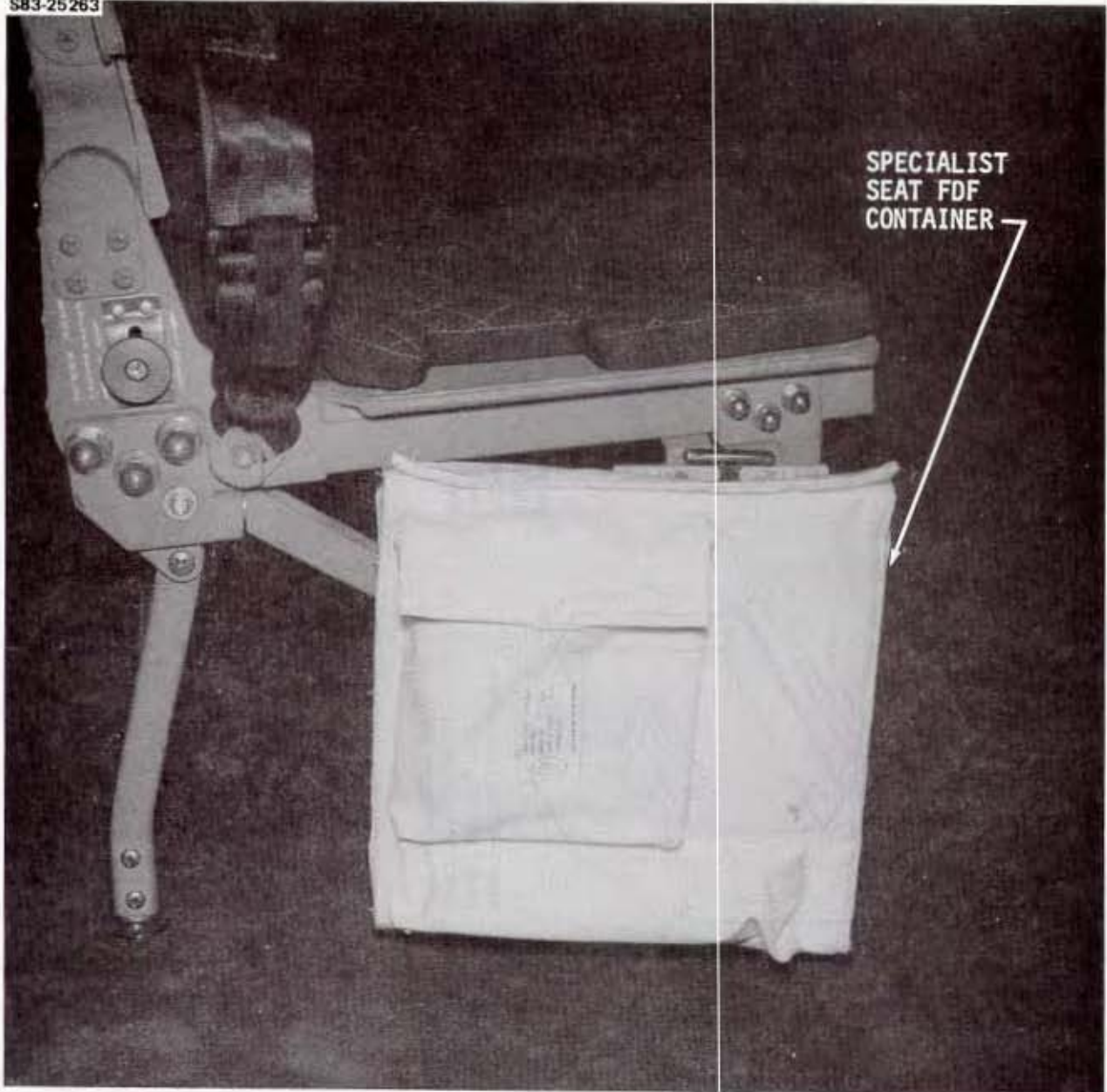


Figure 3.2-3.- Flight Data File container - specialist seat (MS bag).

3.2-8

S-79-39302



Figure 3.2-4.- Data card kit.

FDF Accessories

The FDF accessories (fig. 3.2-5) include zero-g restraints (tethers, book clamps, and clips), tape, rubber bands, switch caps, grease pencils, and pencils. These items are stored in two soft FDF accessory kits, one of which is stowed in the middeck locker and the other in C4A. For many of the items, quantities are not fixed and will vary with preference of the crewmembers. A representative list of accessory kit contents is presented in table 3.2-1.

- Tethers

Two different lengths of braided fabric tethers with a metal snaphook on each end are provided. The short tethers are 16 in. long (40.64 cm) and the long ones are 40 in. long (101.60 cm). The quantity will vary with crew preference.

- Book clamps/clips (with Velcro)

Book clamps and clips are provided to hold documents open to specific pages and to secure the documents with Velcro to various locations in the vehicle.

- Binder clips

Binder clips are used to secure or hold small documents open to specific pages. The clips are generally stowed in accessory kit 1 in locker C4A but this location may vary.

- Tape

Two types of tape are provided with the FDF.

Transparent tape - A dispenser and a spare roll of tape are stowed in accessory kit 1 (C4A).

Yellow tape - A roll of yellow tape is provided to mark malfunctioning switches. The yellow tape is stowed in accessory kit 1 (C4A).

- Switch caps

Accessory kit 1 also contains 20 yellow vinyl switch caps. These are supplied to cover malfunctioning switches so the crew will not reconfigure them.

- Grease pencil assembly

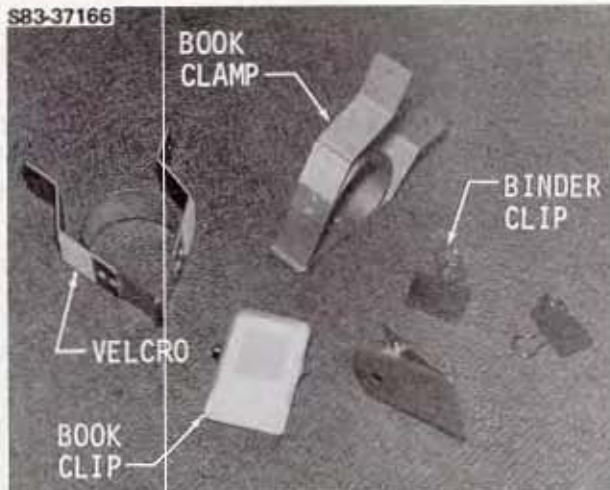
Red and black grease pencils are supplied for marking the orbit maps. Velcro is placed around the tops of the pencils to indicate the color of the lead and to allow for temporary stowage. These pencils are located in accessory kit 1 (C4A).

- FDF pencil

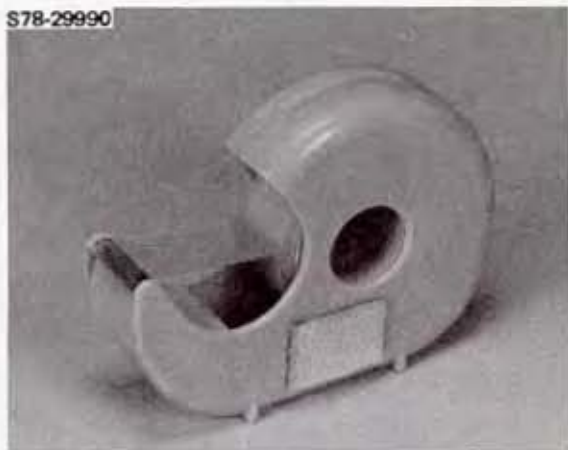
Sixteen pencils are provided, eight in accessory kit 1 and eight in kit 2. The pencils, GSA stock mechanicals, have Velcro at the top. One piece of lead is left in the pencil cartridge with a spare in the holder at the end of the pencil.



TETHER



BOOK CLAMPS AND CLIPS



TAPE DISPENSER



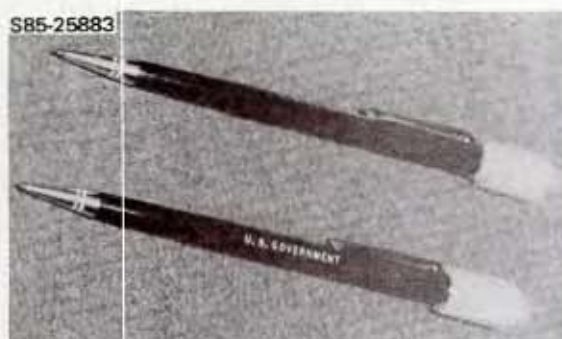
YELLOW TAPE



GREASE PENCILS



SWITCHCAPS



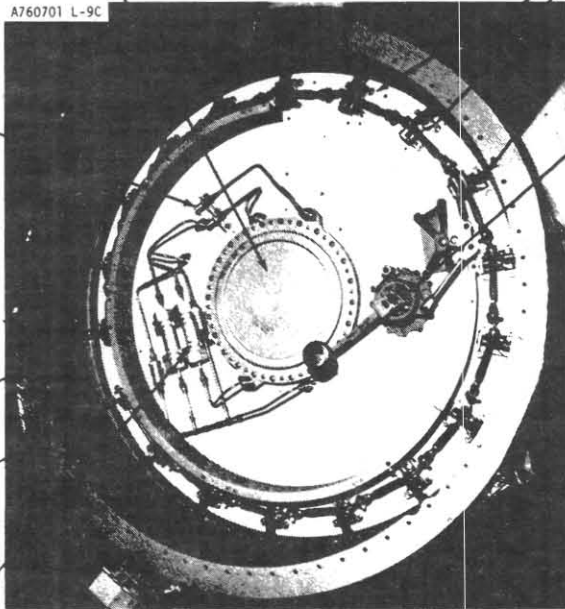
FDF PENCILS

Figure 3.2-5.- FDF accessories.

| | | |
|---------------|-------------|----------------|
| DATE: 3/19/80 | NAME: V.S.D | VERSION: BPT12 |
| DATE: 5/23/80 | NAME: V.S.D | VERSION: BPT13 |

WINDOW CAVITY
 • SEALED BY 3 PANES:
 2 PRESSURE PANES (INBOARD)
 1 THERMAL PANE (OUTBOARD)

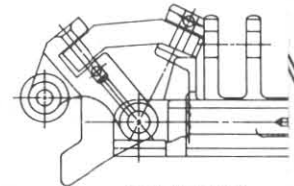
HATCH MECHANISMS



DOUBLE ACTING LATCHES (LATCH 11 AND 12)

ACTUATOR INTERFACE LATCH (LATCH 10)

ACTUATOR
 • 450° ROTATION OF THE ACTUATOR HANDLE TURNS THE ACTUATOR OUTPUT ARM ≈ 41°



DOUBLE ACTING LATCH
 • HAS RICKER CAN TO BREAK
 • USED FOR LATCHES 11 AND 12

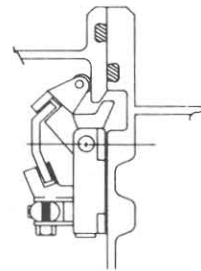
WINDOW CAVITY PURGE PORTS

LATCH 18

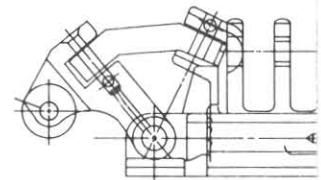
LATCH 01

DESICCANT CONTAINERS

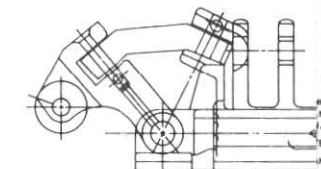
HATCH/TUNNEL (LOOKING OUTWARD)



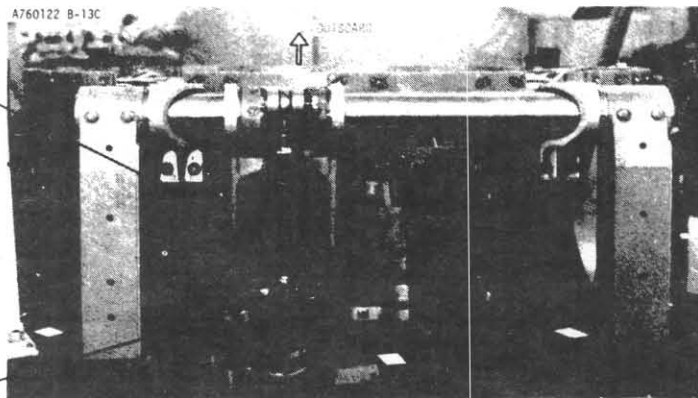
APPLYING LOAD TO BREAK SEALS



ACTUATOR INTERFACE LATCH
 • USED FOR LATCH 10



SINGLE ACTING LATCH
 • USED FOR LATCHES 1-9 AND 13



HYDRAULIC ATTENUATOR
 • HYDRAULICALLY CONTROLS THE OPENING RATE OF THE HATCH

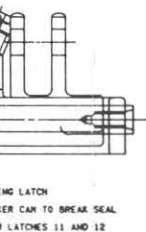
VENT AND DRAIN LINE (OVERBOARD)

HATCH/TUNNEL (LOOKING UP)

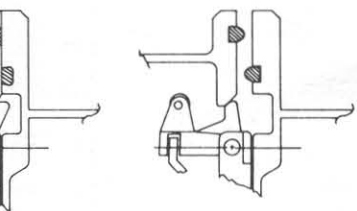
5 HATCH 1

62A

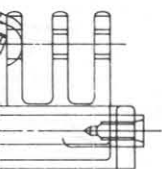
| | | | |
|--|--|-----------------------|---------|
| NATIONAL AERONAUTICS AND SPACE ADMINISTRATION JOHN B. JOHNSON SPACE CENTER HOUSTON, TEXAS | | SIGNATURE | DATE |
| HATCHES (SIDE) | | DSGH VICKI S. DODGETT | 2/19/80 |
| DWG NO 15.5 | | DR | |
| SPACE SHUTTLE | | ENGR R.S. H... 5/1/81 | |
| OV 102 | | ENGR M.K. ... 5/4/81 | |
| 104.5 X 34 | | APP V.D. ... 2/24/81 | |
| LTR B | | PCN | 6/1/81 |



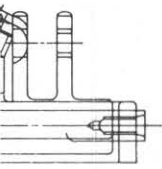
ING LATCH
ER CAN TO BREAK SEAL
LATCHES 11 AND 12



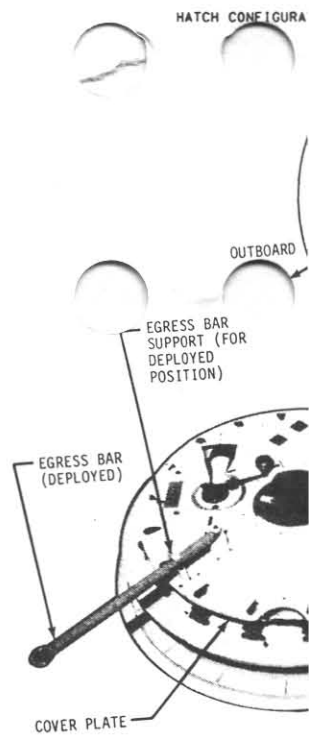
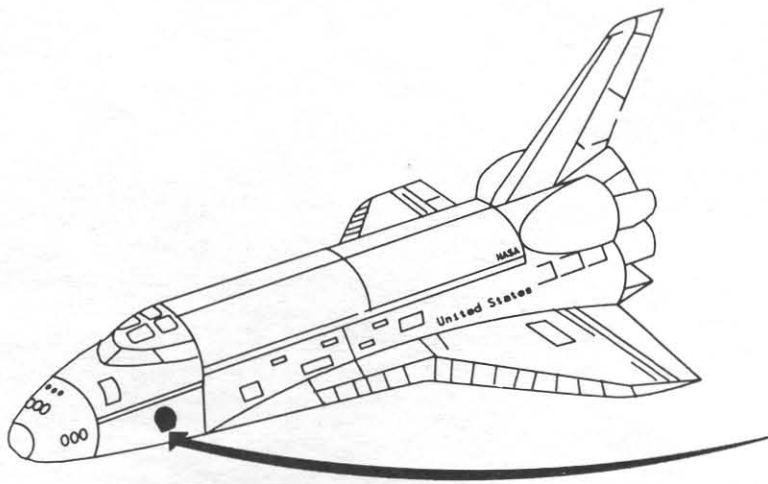
TO BREAK SEALS



INTERFACE LATCH
FOR LATCH 10



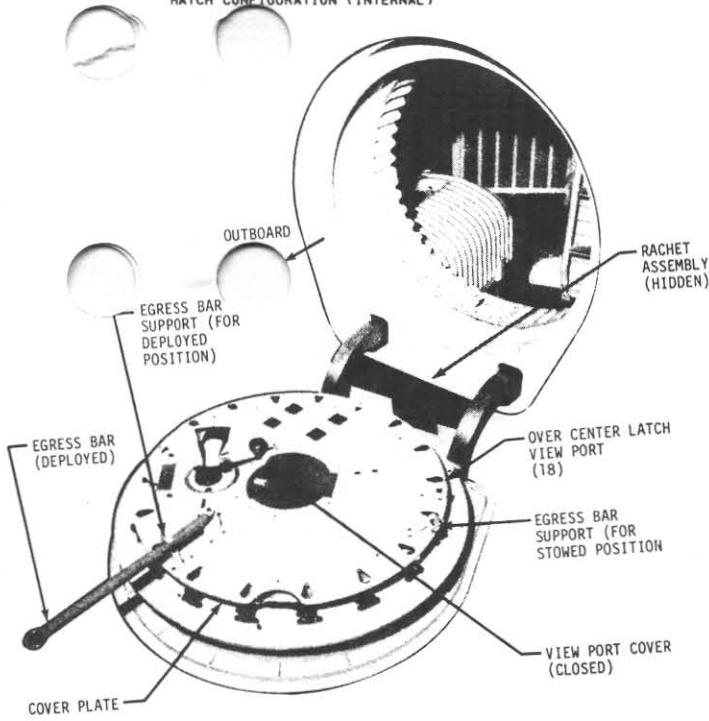
LATCH
LATCHES 1-9 AND 13-18



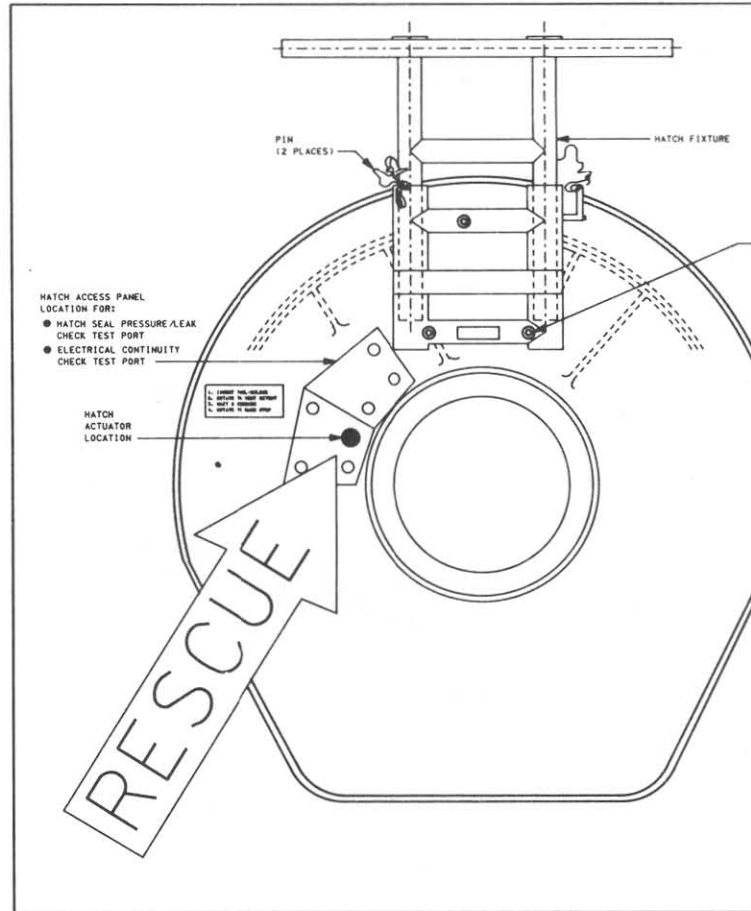
- NORMAL CLOSING
- WITH HATCH OPEN, LATCH AND LOCK HATCH USING HATCH ACTUATOR HANDLE
 - REMOVE TPS PLUGS AND ACCESS DOOR
 - ATTACH HATCH FIXTURE
 - INSERT HATCH T-HANDLE, LOCK IN PLACE
 - WITH HATCH T-HANDLE UNLOCK/UNLATCH HATCH
 - USING HATCH FIXTURE, CLOSE HATCH
 - LATCH/LOCK HATCH
 - VERIFY HATCH LOCKED AND LATCHED
 - UNLOCK AND REMOVE T-HANDLE
 - REMOVE HATCH FIXTURE
 - REPLACE ACCESS DOOR AND TPS PLUGS



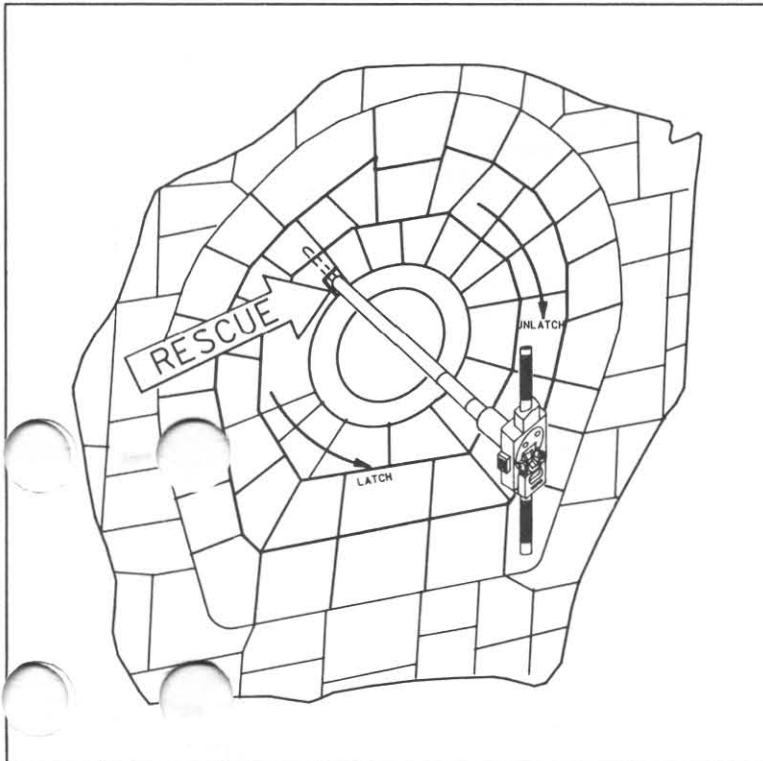
HATCH CONFIGURATION (INTERNAL)



HATCH CONFIGURATION (EXTERNAL)

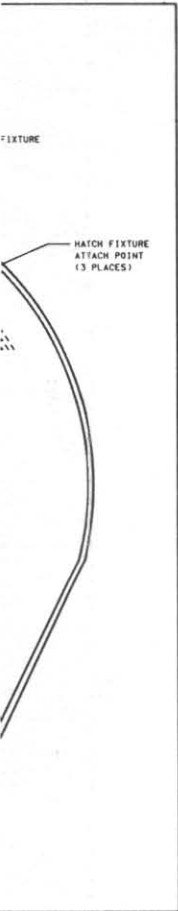


NORMAL SIDE HATCH OPENING/CLOSING (EXTERNAL)

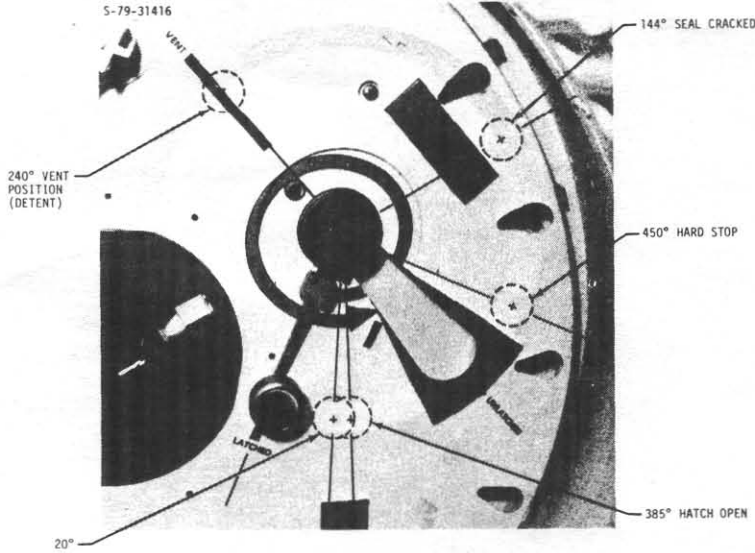


- NORMAL OPENING**
- REMOVE TPS PLUGS (6 FOR HATCH ACCESS PANEL, 3 FOR HATCH FIXTURE)
 - REMOVE HATCH ACCESS PANEL (6 SCREWS)
 - ATTACH HATCH FIXTURE
 - INSERT T-HANDLE, LOCK IN PLACE
 - UNLOCK/UNLATCH HATCH
 - PULL ON HATCH FIXTURE TO OPEN

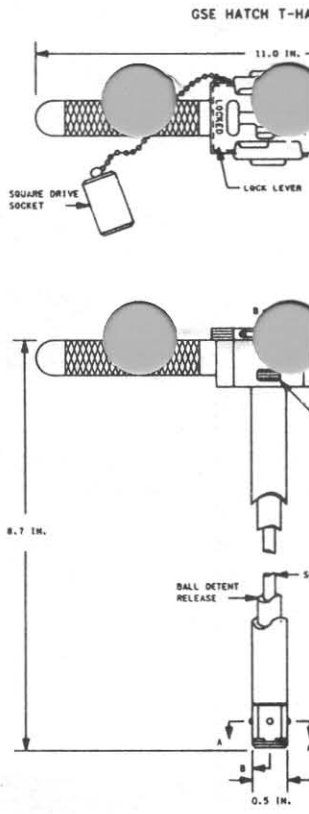
- IN A POST LANDING ACCESS COVER USE DRIVE WITH 12 1/4"
- INSERT DRIVE EX
- PUSH TO UNLOCK
- PULL HATCH TO OPEN



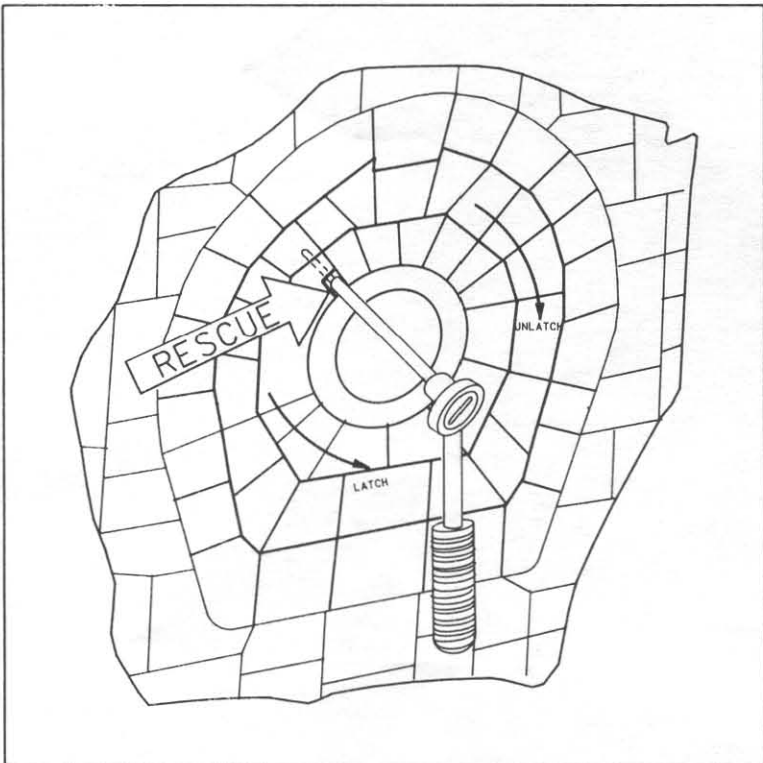
SIDE HATCH OPENING (INTERNAL)



- TO OPEN HATCH
- ACTUATOR HANDLE SHOWN IN LATCHED/LOCKED POSITION
 - FLIP LOCK LEVER OVER 180° TO UNLOCK
 - GRASP KNOB ON ACTUATOR HANDLE AND ROTATE CCW
- ≈20° ROTATION THE TWO LATCH KICKER CANS START TO DISENGAGE THE SEALS
- ≈144° ROTATION THE SEAL IS CRACKED
- ≈240° ROTATION VENT DETENT POSITION (EQUALIZES HATCH ΔP)
- ≈450° ROTATION END OF ACTUATOR TRAVEL AND HARD STOP. HATCH OPEN



EMERGENCY SIDE HATCH OPENING (EXTERNAL)

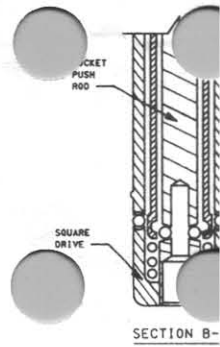
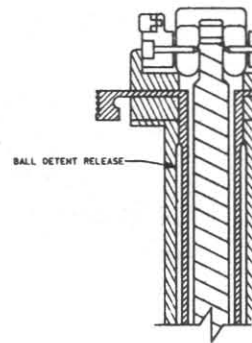


EMERGENCY OPENING

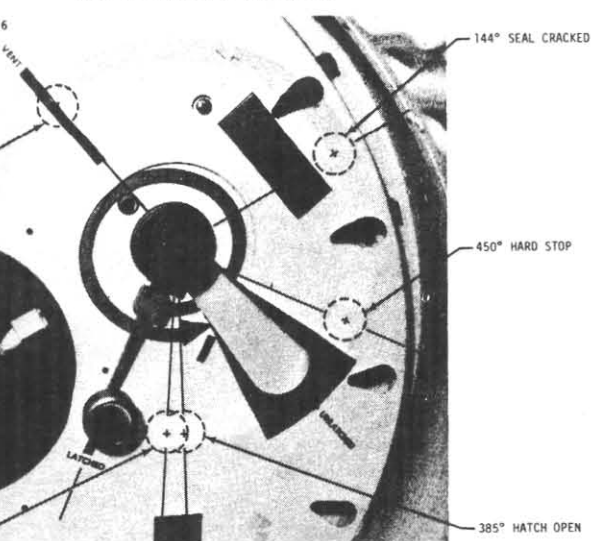
POST LANDING EMERGENCY, PUNCH THROUGH SMALL TILE ON T-HANDLE COVER USING T-HANDLE OR 1/2 IN. OR 5/8 IN. SQUARE SOCKET WITH 12 IN. EXTENSION

GRASP T-HANDLE AND DRIVE EXTENSION IN SIDE HATCH RELEASE SOCKET

TO UNLOCK AND ROTATE 1 1/4 TURNS CCW TO UNLATCH HATCH TO OPEN



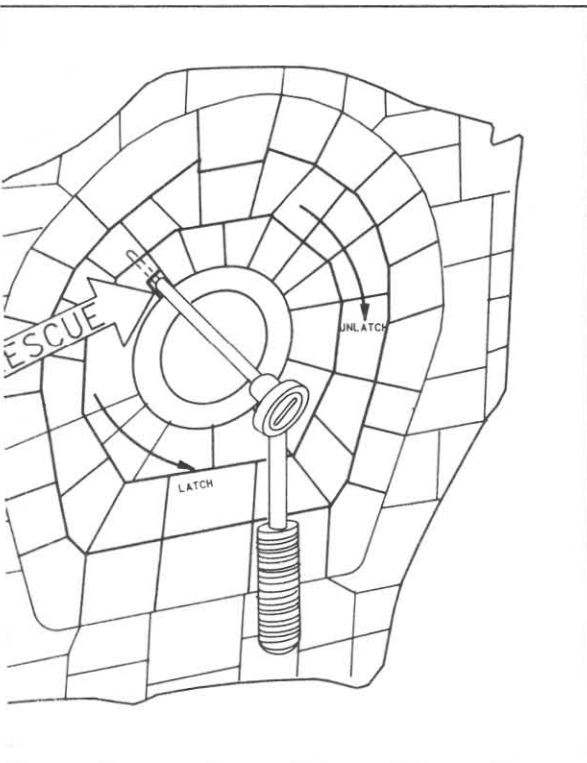
SIDE HATCH OPENING (INTERNAL)



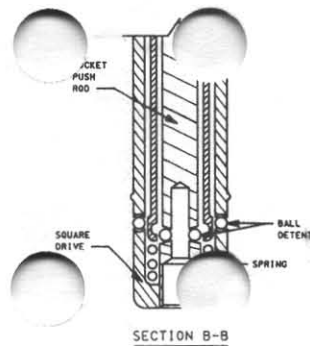
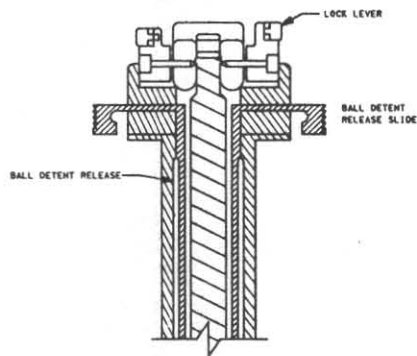
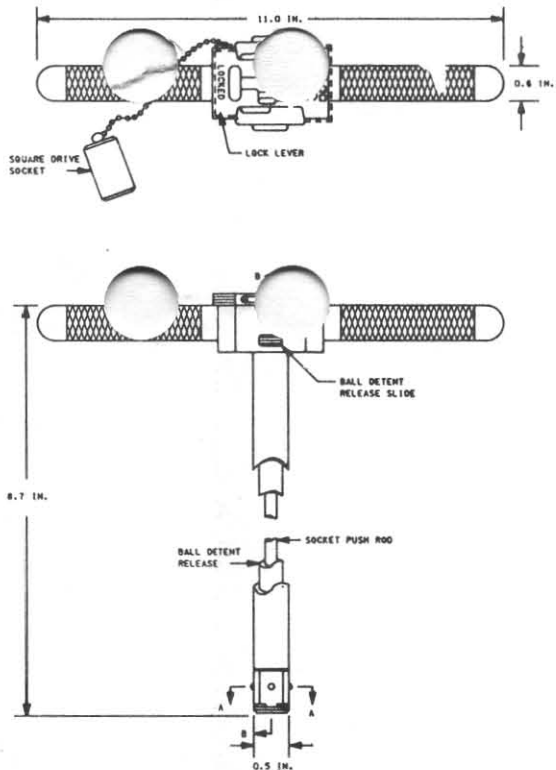
TO OPEN HATCH

- ACTUATOR HANDLE SHOWN IN LATCHED/LOCKED POSITION
- FLIP LOCK LEVER OVER 180° TO UNLOCK
- GRASP KNOB ON ACTUATOR HANDLE AND ROTATE CCW
- 20° ROTATION THE TWO LATCH KICKER CAMS START TO DISENGAGE THE SEALS
- 144° ROTATION THE SEAL IS CRACKED
- 240° ROTATION VENT DETENT POSITION (EQUALIZES HATCH ΔP)
- 450° ROTATION END OF ACTUATOR TRAVEL AND HARD STOP. HATCH OPEN

EMERGENCY SIDE HATCH OPENING (EXTERNAL)



GSE HATCH T-HANDLE



8
7
6
5
4
3
2
1

3.3 SIDE HATCH

3.3.1 Introduction

Side Hatch

The side hatch provides access to the interior of the crew module for normal crew ingress and egress and for on-orbit extravehicular activity (EVA) rescue. The side hatch also provides the primary emergency egress route. This hatch is located on the left-hand (port) side of the vehicle, forward of the wing (fig. 3.3-1).

The side hatch opens outward, and is equipped with hydraulic brakes to prevent damage to the vehicle when the hatch is allowed to free fall on opening. The hatch is also equipped with a ratchet assembly that holds the hatch open while on the pad.

The hatch is held in the closed/sealed position by a series of over-center latches, driven by a series of links from the hatch latch actuator. The hatch latch actuator is capable of being driven manually either from within the crew module or from the exterior after removal of an access panel. The latches can be visually inspected from inside the vehicle to ensure they are over center. The hatch also has test ports for electrically verifying that the latches are over center (external) and for verifying proper hatch seal (internal and external).

The hatch itself includes two seals, an outer thermal seal and a pressure seal. There is another pressure seal that is part of the Orbiter.

The side hatch locking device is a small clamp which fits over the locking lever on the hatch handle. It is held in place with a pip pin and prevents the hatch from being inadvertently unlocked while on orbit.

3.3.2 Systems Functional Description

Side Hatch

The hatch has a diameter of 40 inches. It contains 18 latches, an actuator mechanism (fig. 3.3-2) with provisions for both interior and exterior operation, a viewport window, hatch coverplate, ratchet assembly, egress bar, and access panels (fig. 3.3-1).

- Operational Modes

The actuator is equipped with a hand crank on the interior side for operation by the crew. Two separate actions are required in order to open the hatch. The locking lever (fig. 3.3-3) on the handle must first be unlocked, and then the handle must be rotated counterclockwise to unlatch the hatch (clockwise to latch). On unlatching, the hatch seal is cracked at 144° of crank rotation, the vent position detent is reached at 240°, and the hatch is fully unlatched and ready to open between 385° and 450°. Once the hatch is opened, the crew will egress by standing on the interior hatch coverplate which protects the hatch mechanisms from damage. For emergency egress, the crew will deploy the egress bar and descend (fig. 3.3-4). Refer to section 3.5.

A ground support equipment (GSE) T-handle hatch tool is provided for exterior ground operation (figs. 3.3-1 and 3.3-5), and may be used to operate the latch mechanism after removal of an access panel. A GSE hatch fixture (figs. 3.3-1 and 3.3-5) is provided to pull (push) the side hatch open (closed).

- Components

Latches - The side hatch is held in the latched/locked position by 18 over-center latches 6 connected by a linkage system to a common actuator. The latches may be visually inspected from inside the Orbiter to ensure they are over center (fig. 3.3-7). Two upper latches contain an additional cam feature used to break the hatch seal against external pressure during the first stage of unlatching (fig. 3.3-1).

S86-31235

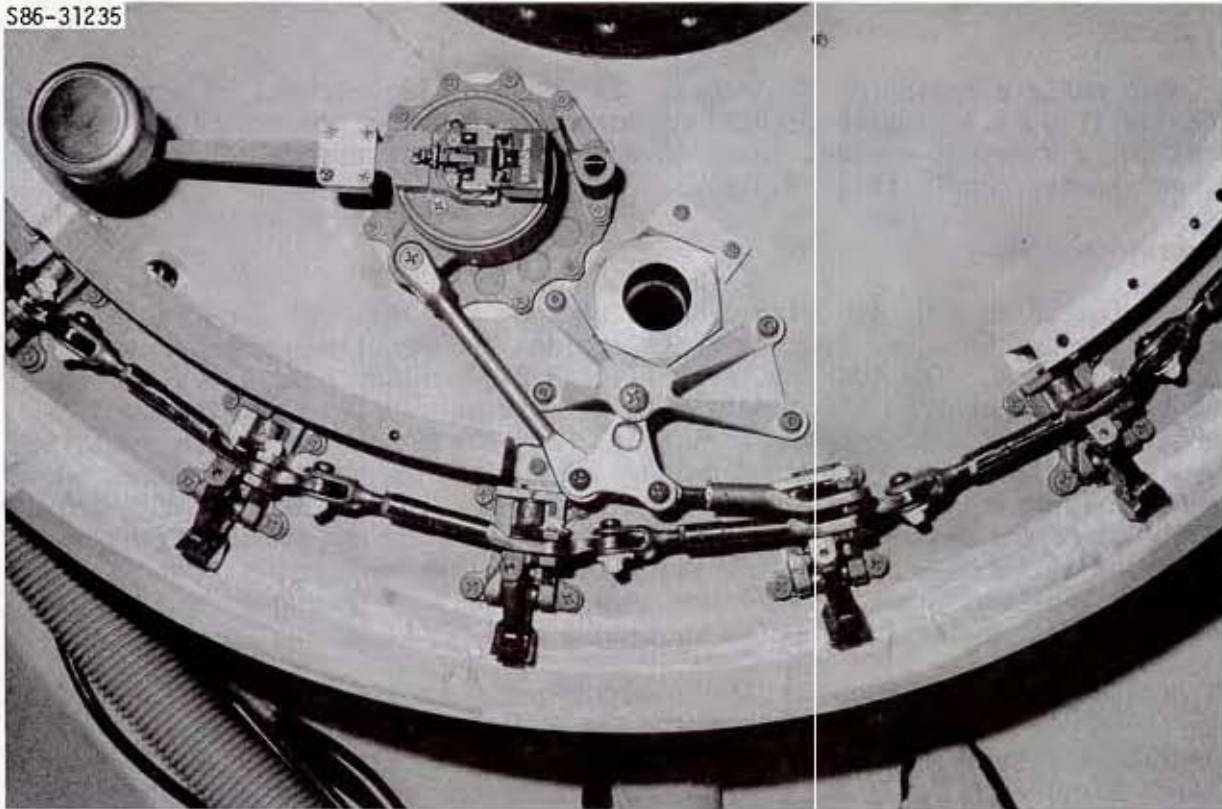


Figure 3.3-2.- Side hatch actuator and over-center latches.

S85-44075

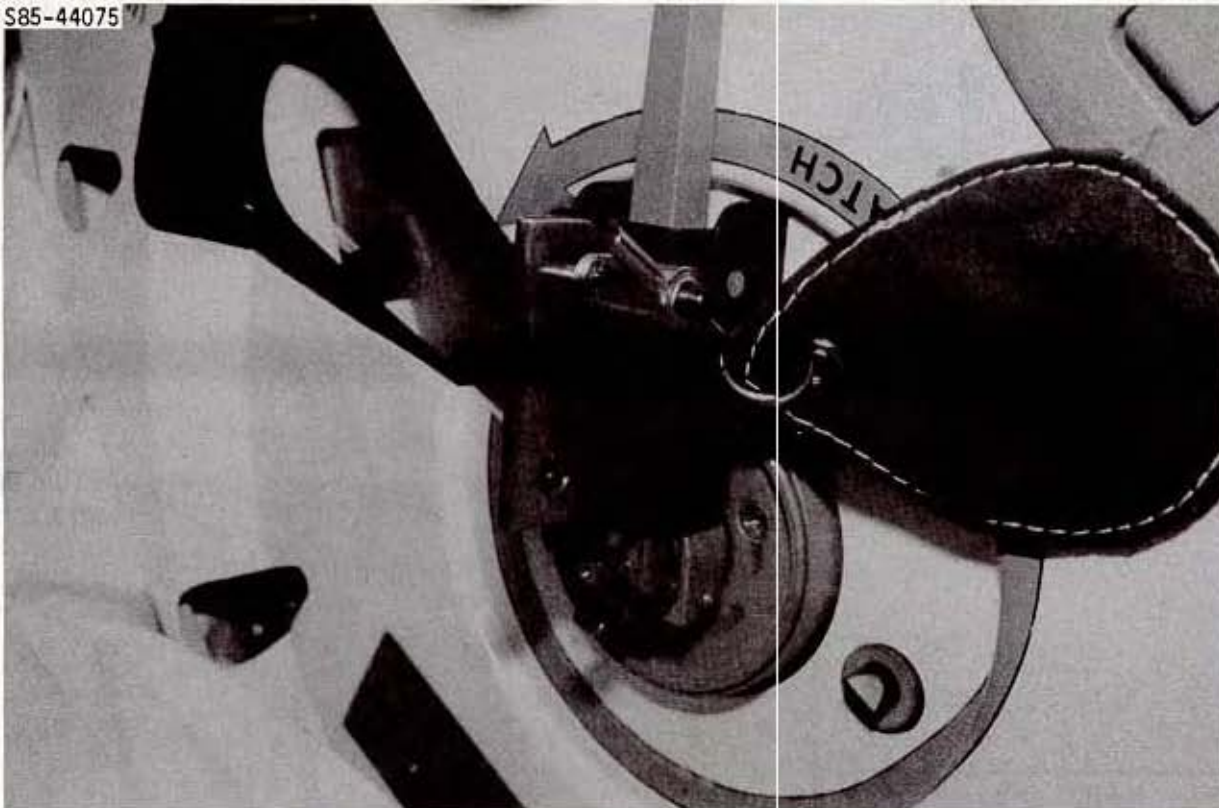


Figure 3.3-3.- Side hatch locking device.

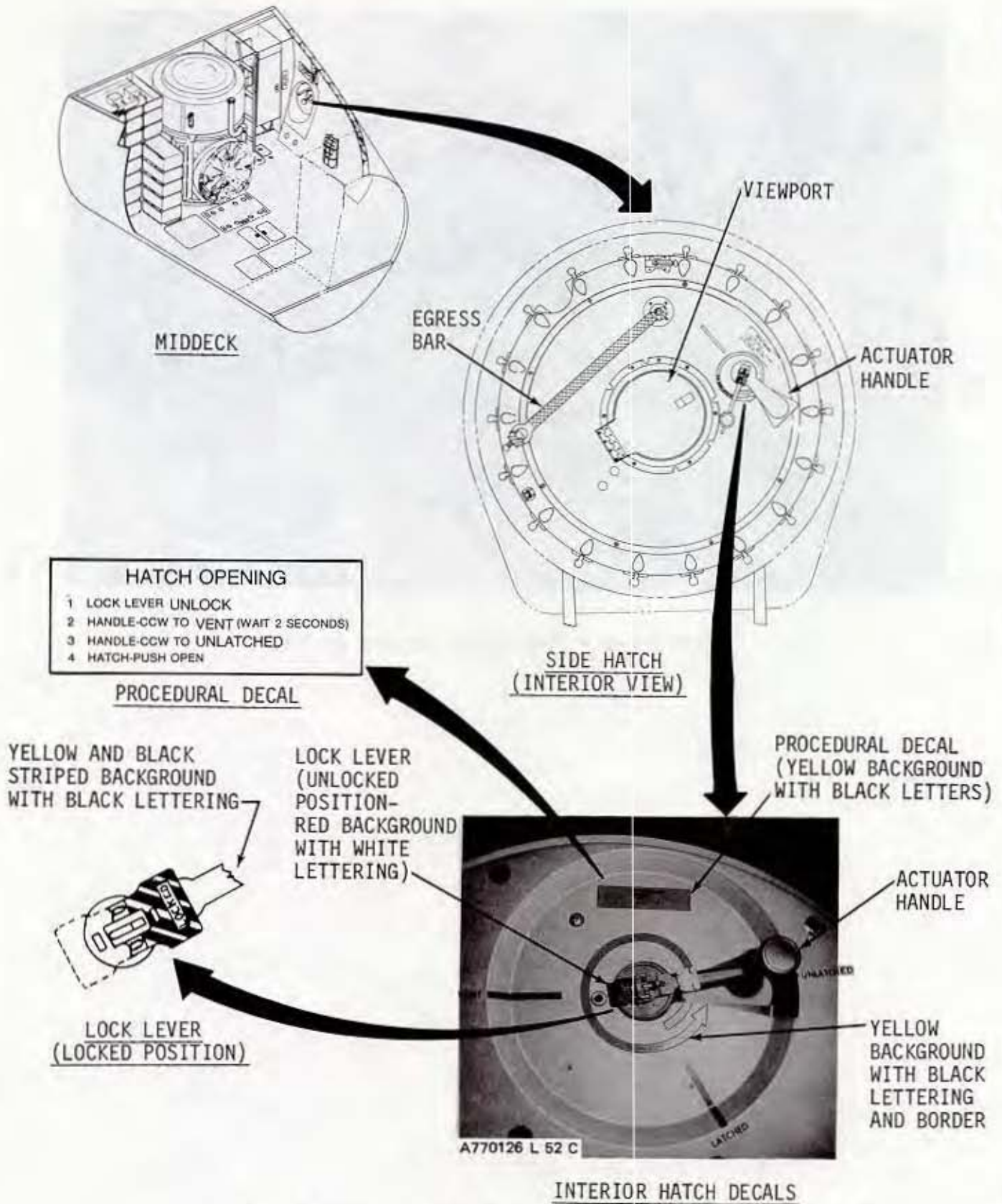
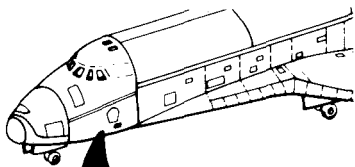


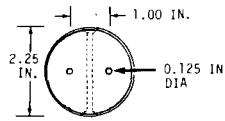
Figure 3.3-4.- Side hatch decals - internal.



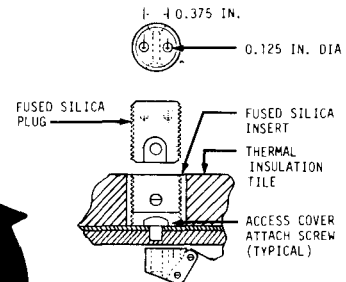
SIDE HATCH
(EXTERIOR VIEW)

① REMOVE HATCH RELEASE ACCESS COVER

- REMOVE SIX THREADED 3/4-INCH DIAMETER INSULATION PLUGS
- REMOVE SIX ACCESS COVER ATTACH SCREWS
- REMOVE ACCESS COVER



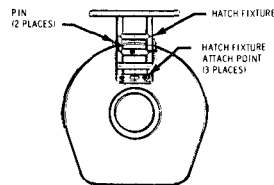
HATCH FIXTURE
ATTACH POINT
INSULATION PLUG
(1 PLACE)



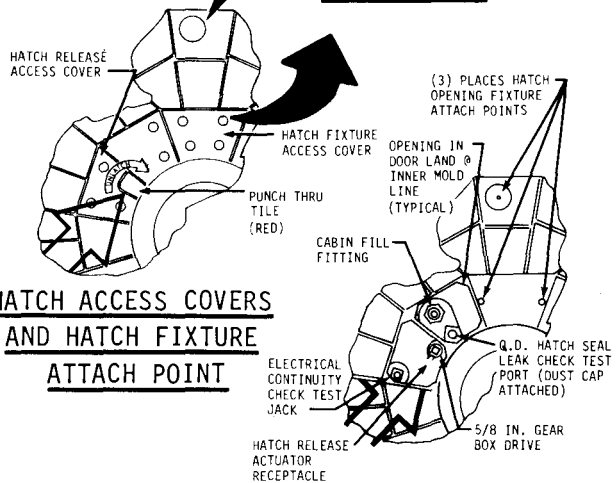
ACCESS COVER
INSULATION PLUG
(10 PLACES)

② INSTALL HATCH FIXTURE

- REMOVE FOUR (4) THREADED INSULATION PLUGS FROM HATCH FIXTURE ACCESS COVER
- REMOVE FOUR (4) SCREWS FROM HATCH FIXTURE ACCESS COVER
- REMOVE ONE THREADED INSULATION PLUG (2-INCH DIA) FROM TILE AT UPPER END OF HATCH
- REMOVE ACCESS COVER
- INSTALL HATCH FIXTURE



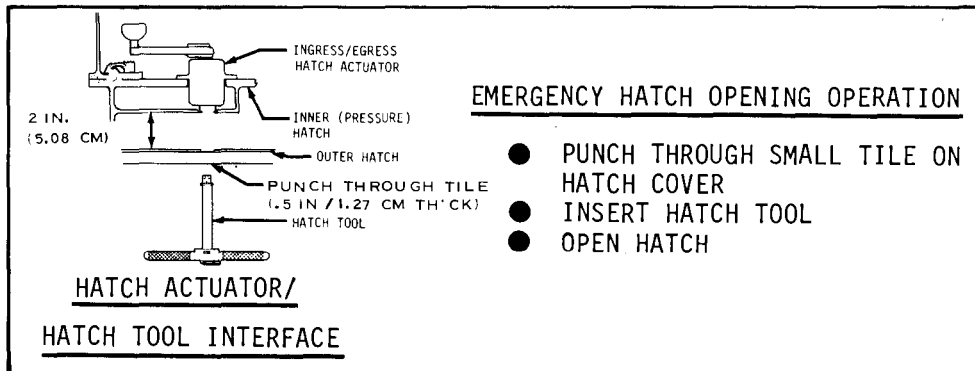
HATCH FIXTURE



HATCH ACCESS COVERS
AND HATCH FIXTURE
ATTACH POINT

HATCH ACCESS
COVERS REMOVED

③ ENGAGE HATCH TOOL IN HATCH RELEASE ACTUATOR RECEPTACLE. OPEN HATCH.



EMERGENCY HATCH OPENING OPERATION

- PUNCH THROUGH SMALL TILE ON HATCH COVER
- INSERT HATCH TOOL
- OPEN HATCH

Figure 3.3-5.- Side hatch external opening/closing.

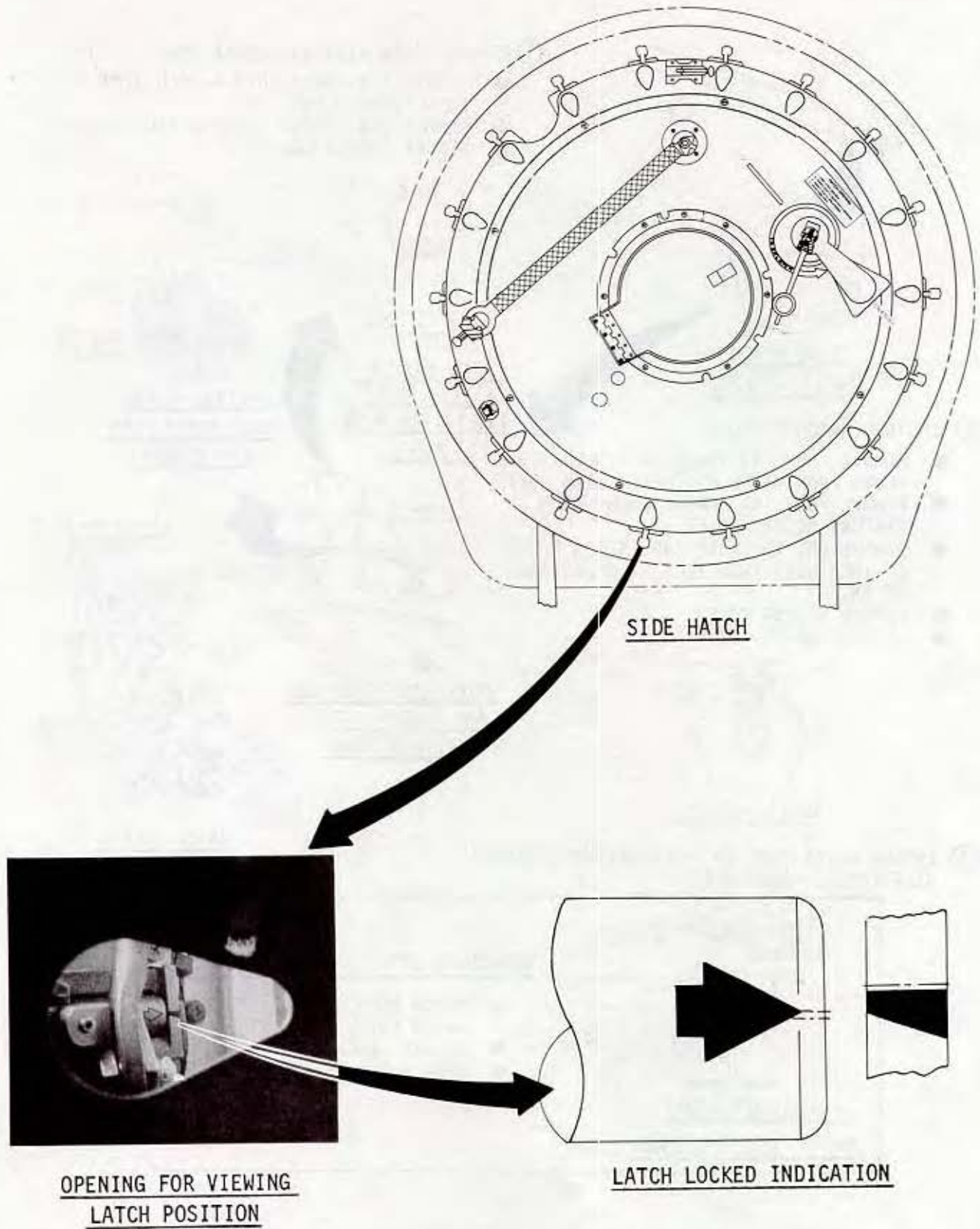


Figure 3.3-6.- Side hatch latch visual check.

S86-31238

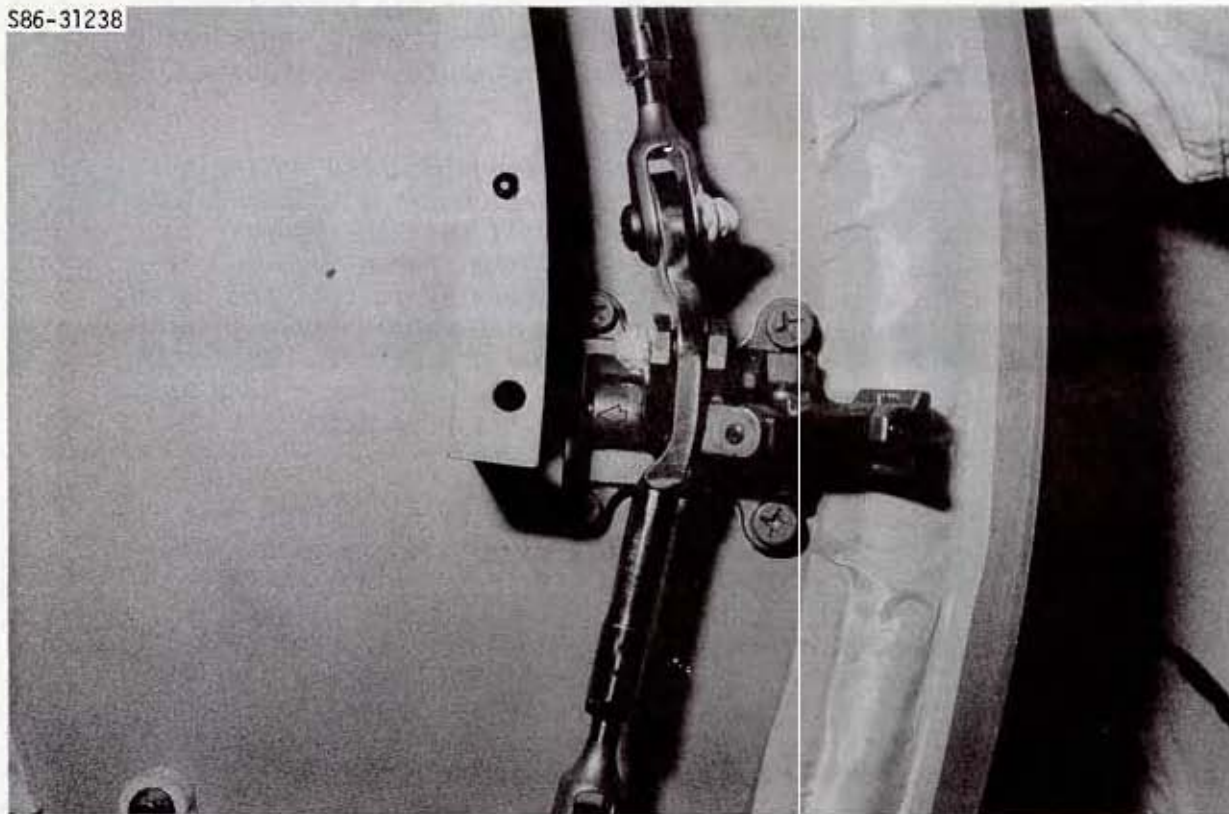


Figure 3.3-7.- Detail of over-center latch.

Hatch Actuator - The hatch actuator is a manually operated gearbox that drives a lever, allowing the crew to latch or unlatch the hatch (table 3.3-1). The actuator can be operated by the internal handle, as already described, as well as by a GSE tool inserted through the access panel opening on the outside of the Orbiter (figs. 3.3-1 and 3.3-5).

The hatch actuator detent is a spring-loaded plunger mounted on the surface of the hatch coverplate. A cam is installed on the actuator handle which, when operated to unlatch the hatch, travels over the plunger to compress the plunger and the spring. The additional force required to rotate the handle past the plunger allows the operator to feel the hatch vent position. Operation of the hand crank requires approximately 16 lb of force to rotate and 25 lb of force to overcome the detent. The actuator is designed with an anti-back mechanism so that the force tending to open the latches locks the hatch actuator. The actuator mechanism details for all hatches are shown in figure 3.3-8.

Viewport - The 10-in.-diameter window provides a viewing port through the hatch. The window cavity is covered by three panes - two pressure panes inboard and one thermal pane outboard. The side hatch viewport is the only optical quality window on the Orbiter. Consequently, UV rays are not filtered and a removable UV filter is required for on-orbit operations for vehicles 103 and 104. Dessicant containers, located near the window cavity, prevent moisture buildup on the window panes. A viewport cover acts as a window shade and provides protection for the viewport. The cover is opened by a finger-operated catch and held open by a friction hinge (fig. 3.3-9).

Hatch Coverplate - The interior hatch coverplate provides protection for the latches, latch linkages, actuator mechanism, dessicant containers, and the window during crew ingress/egress. Openings in the coverplate allow visual observation of the over-center positions of the latches (fig. 3.3-7). The internal hatch decals on the hatch coverplate are shown in figure 3.3-4.

Ratchet Assembly - A ratchet assembly device (figs. 3.3-1 and 3.3-10) is provided to prevent the hatch from inadvertently swinging closed during vertical launch pad operations.

Side Hatch Locking Device - This is a small clamp which fits over the locking lever on the hatch handle. It is held in place with a pip pin and prevents the hatch from being inadvertently unlocked while on orbit. It is normally launched in the MS3 Flight Data File bay and installed during postinsertion. It must be removed during deorbit prep, as the hatch cannot be opened if the locking device is in place.

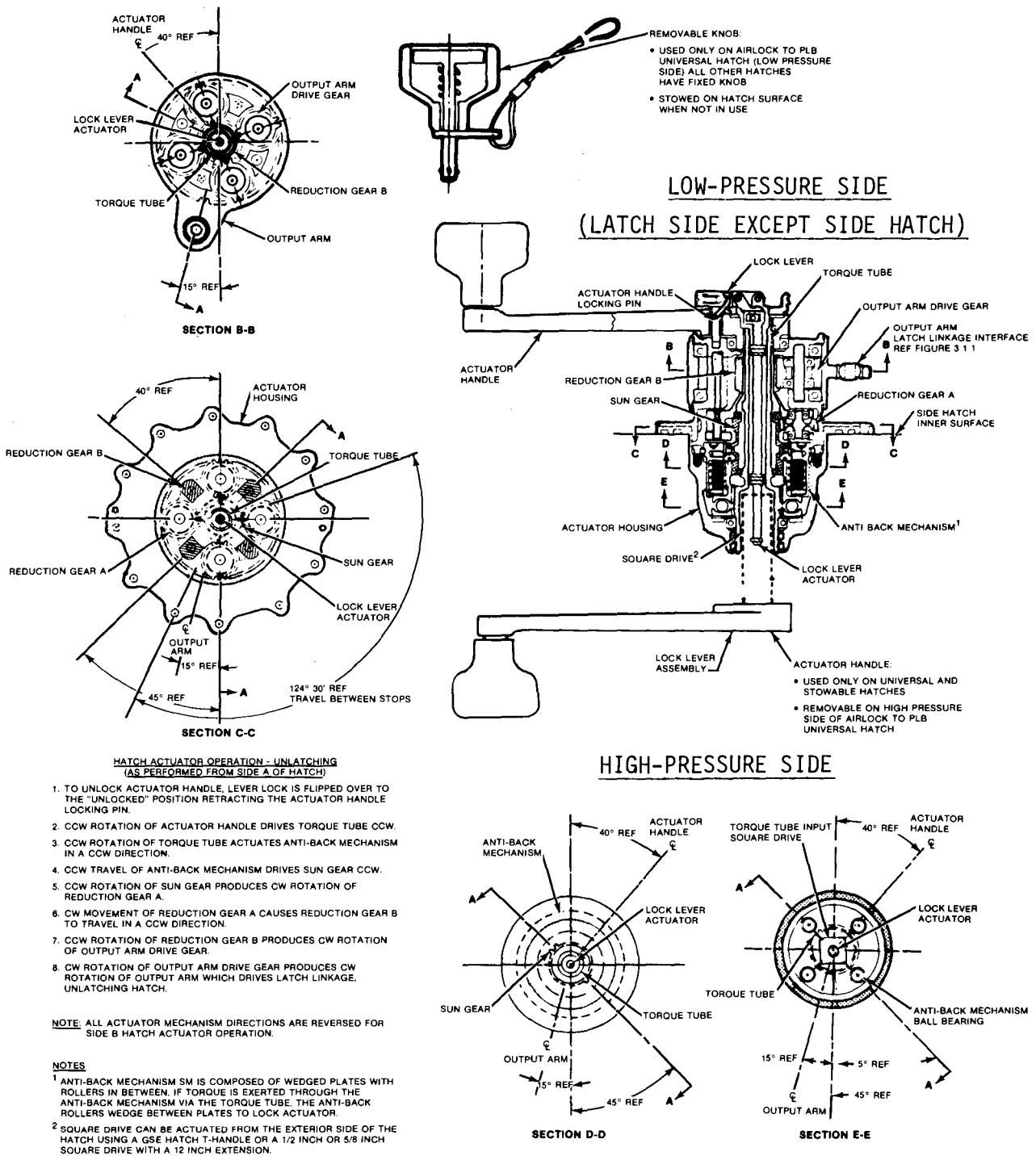


Figure 3.3-8.- Hatch actuator (all hatches).

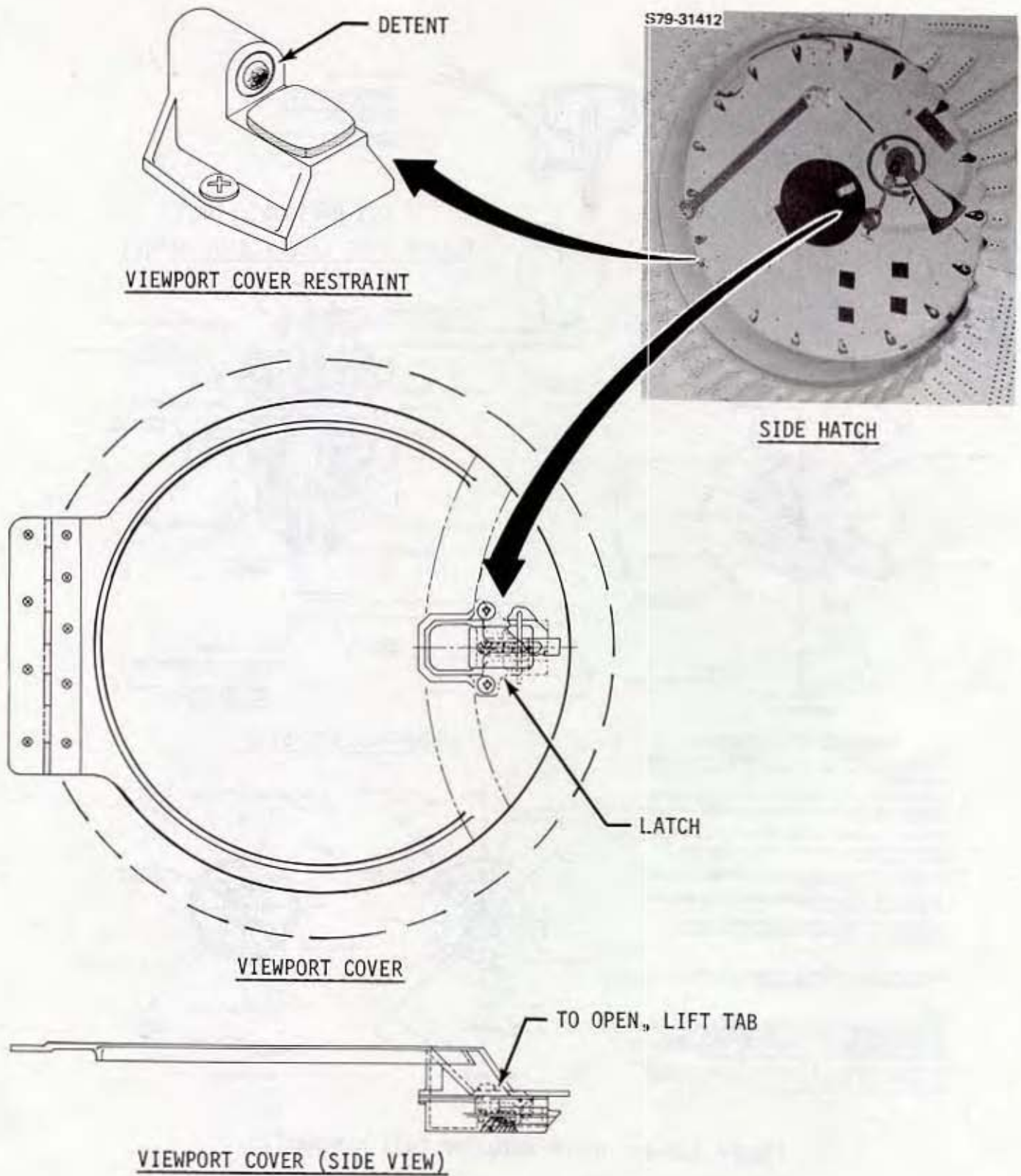


Figure 3.3-9.- Side hatch viewport cover.

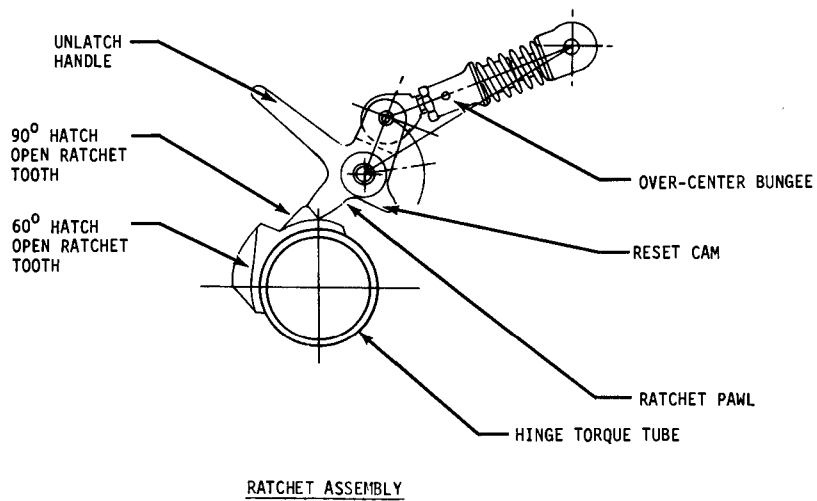
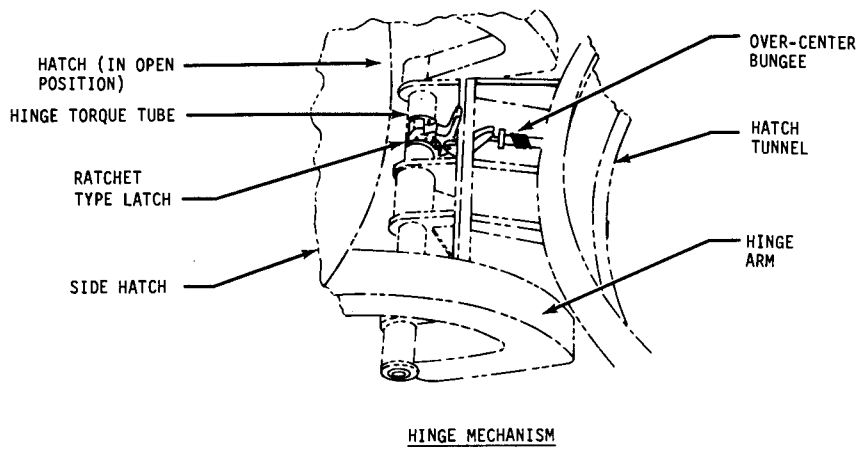
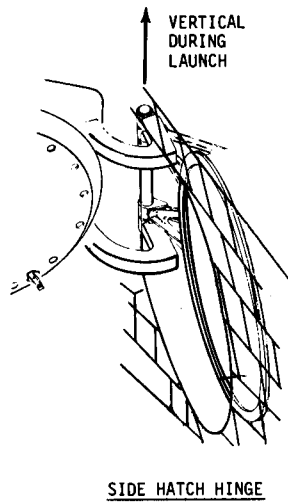


Figure 3.3-10.- Side hatch ratchet assembly.

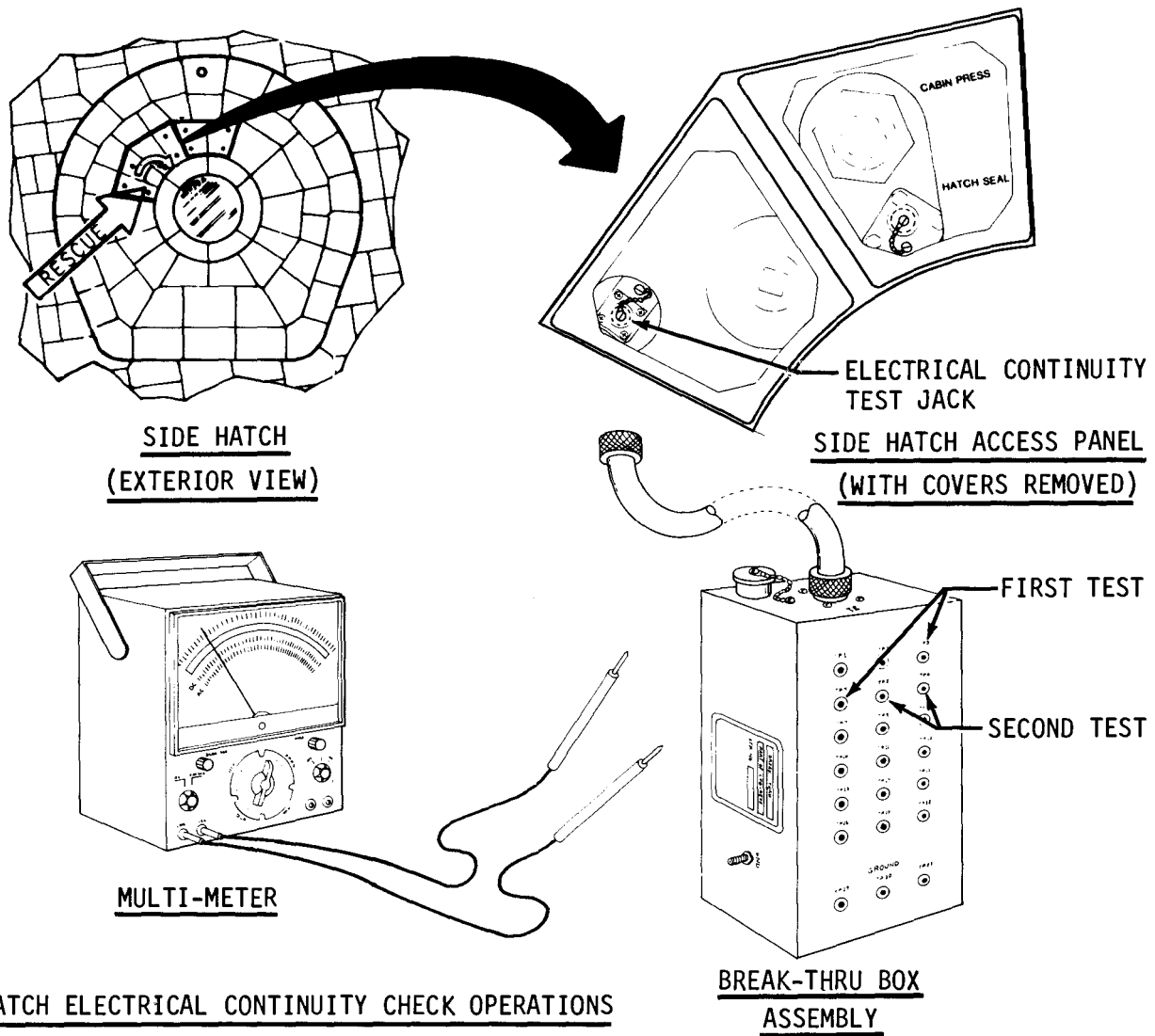
3.3-15

Egress Bar - See section 3.4.

External Access Panels - Two access panels are used for ground operations and emergency crew-aided egress. They are located on the outside of the hatch (fig. 3.3-1) and provide thermal protection for cavities in the hatch. The panels are opened by removing the 10 thermal protection system (TPS) plugs and fasteners. If the hatch is opened in an emergency, the GSE T-handle or its equivalent is used to break a hole in the access panel at the breakthrough tile which exposes the hatch actuator socket; the hatch can then be opened without taking out the TPS plugs. The breakthrough tile is marked by a red 1-1/8-in. disk (fig. 3.3-3).

An access panel covers two cavities in the hatch which contain the socket for the GSE T-handle, a hatch seal integrity test port, a crew compartment pressurization port, and an electrical test port. The electrical test port is used for a determination of the closed latch configuration by checking the status of limit switches installed on the two end latches (fig. 3.3-11). An adapter cable, attached to the electrical test port, is connected to a breakout box and ohm meter (or multimeter) to check the electrical continuity. The pneumatic test and fill ports are used to check the entire crew module for leakage and to test the hatch seals. A GSE test kit is provided to check for a 4-psi pressure drop after pressurization (fig. 3.3-12).

Exterior Decals - Exterior side hatch decals on the access panels and hatch are shown in figure 3.3-13.



HATCH ELECTRICAL CONTINUITY CHECK OPERATIONS

- REMOVE ACCESS PANEL (REF. FIGURE 3.3-4)
- REMOVE DUST COVER FROM ELECTRICAL CONTINUITY TEST JACK
- CONNECT CABLE TO JACK (ASSUMES THE CABLE IS CONNECTED TO BREAK-THRU BOX)
- CHECK RESISTANCE ACROSS TEST POINTS THREE AND FOUR (TP3, TP4) AND ACROSS TEST POINTS FIVE AND SIX (TP5, TP6) (A MULTI-METER IS USED FOR THIS)
- RESISTANCE FOR BOTH TESTS < 2 OHMS - HATCH CLOSED, OTHERWISE - HATCH OPEN
- DISCONNECT CABLE FROM ELECTRICAL CONTINUITY TEST JACK
- REINSTALL DUST COVER

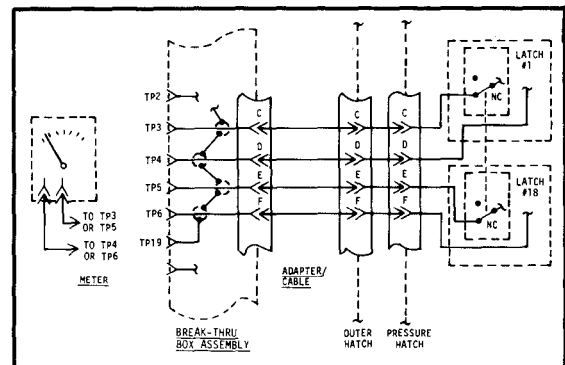
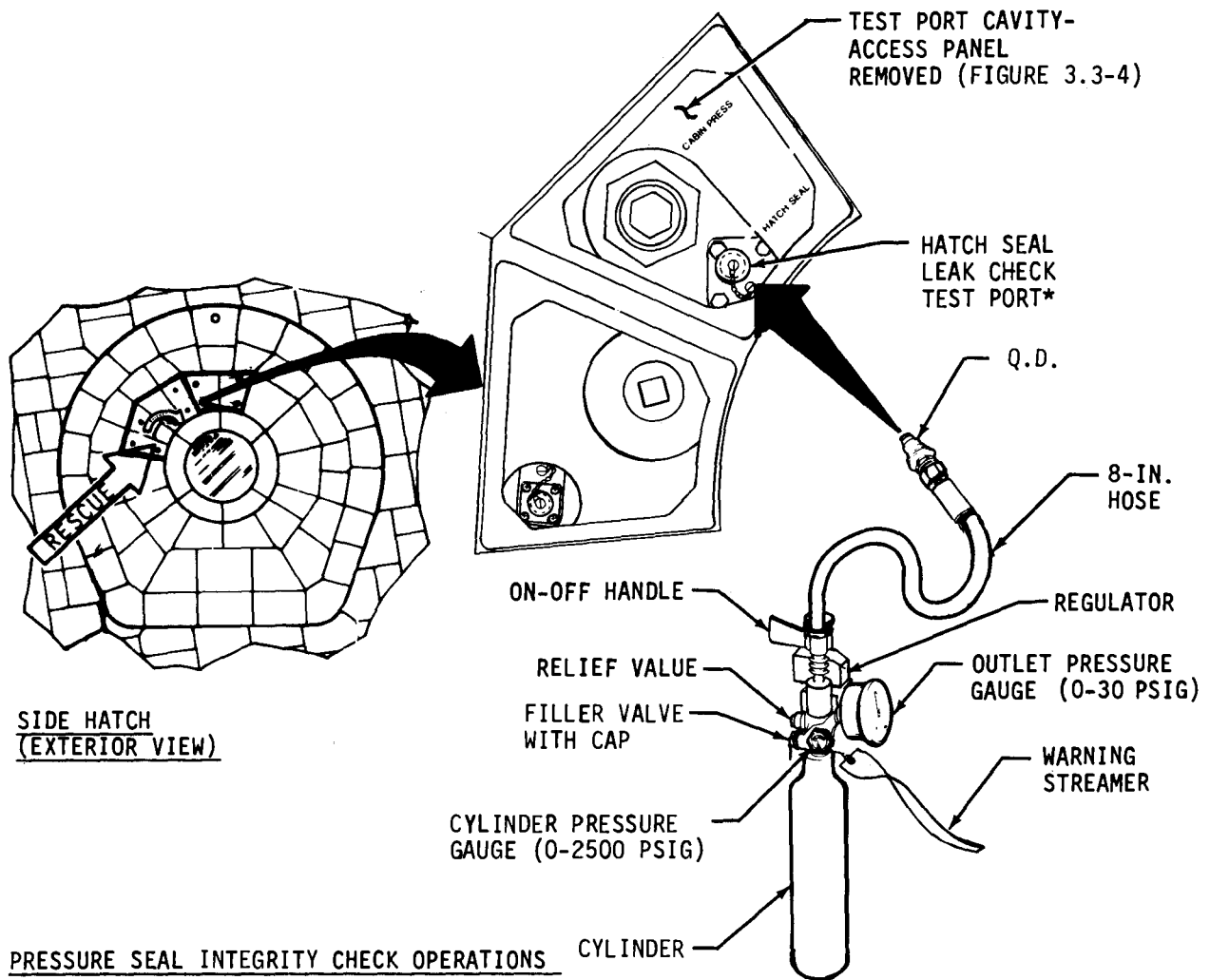


Figure 3.3-11.- Side hatch electrical continuity check.



SIDE HATCH
(EXTERIOR VIEW)

PRESSURE SEAL INTEGRITY CHECK OPERATIONS

- REMOVE ACCESS PANEL (FIGURE 3.3-4)
- REMOVE DUST CAP FROM LEAK CHECK TEST PORT
- CONNECT TEST KIT Q.D. TO TEST PORT Q.D.
- ON-OFF HANDLE - ON, UNTIL PRESSURE (BETWEEN SEALS) IS 14.7 PSIG ON OUTLET PRESSURE GAUGE
- LOCK OFF PRESSURE AND HOLD FOR 60 SECONDS
- CHECK FOR PRESSURE DROP (4 PSI MAX. ALLOWABLE)

NOTE: IF PRESSURE DROP GREATER THAN 4 PSIG ,
OPEN HATCH AND INSPECT/CLEAN SEALS;
CLOSE HATCH AND RETEST.

- REMOVE TEST KIT
- REINSTALL DUST CAP

PORTABLE PNEUMATIC TEST KIT

*NOTE: ADDITIONAL TEST PORTS ARE LOCATED ON:

- INSIDE SIDE HATCH
- MANUFACTURING ACCESS PANEL
- STAR TRACKER
- AIRLOCK HATCHES

Figure 3.3-12.- Side hatch pressure seal integrity check (external).

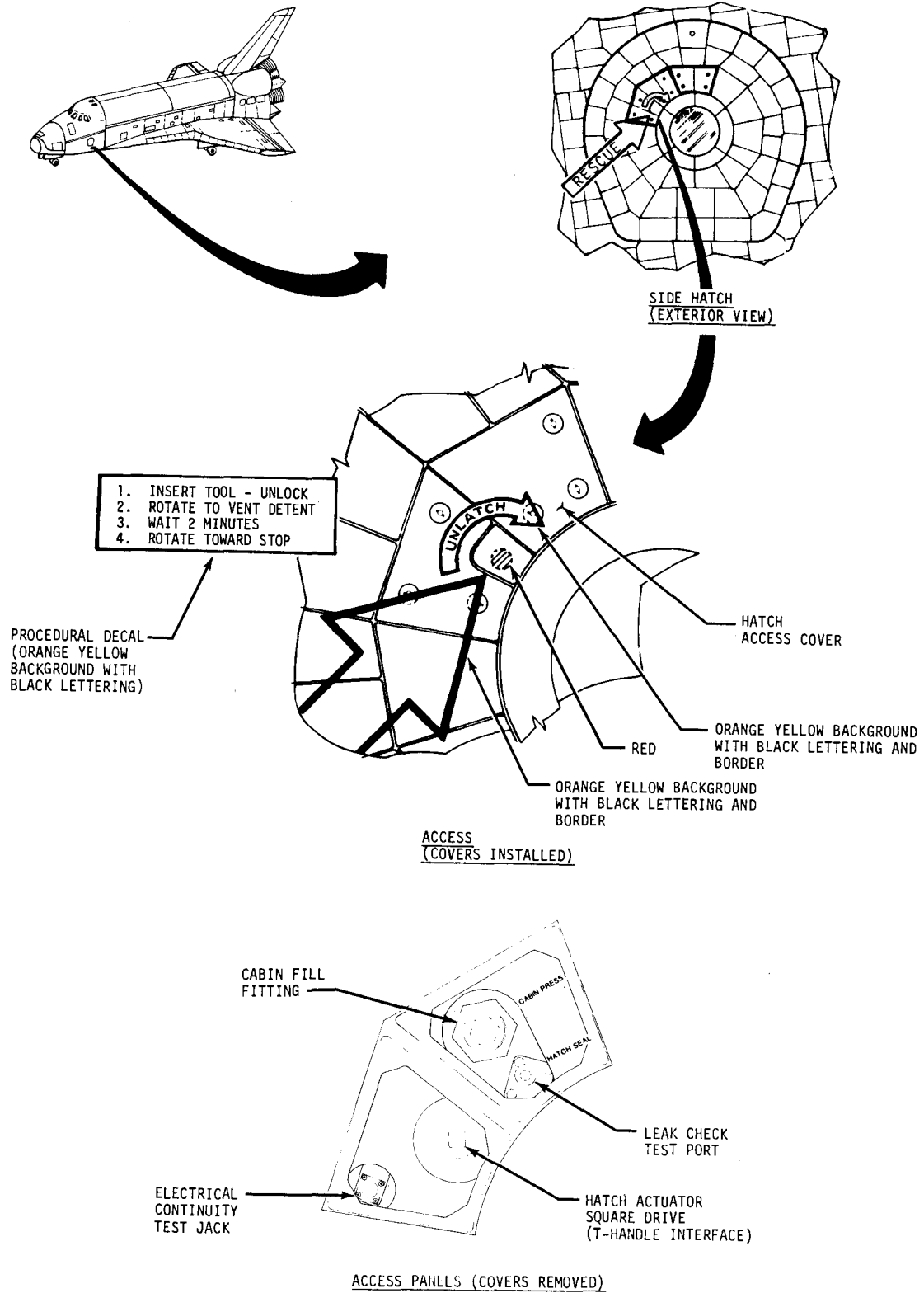


Figure 3.3-13.- Side hatch decals (external).

3.3-19

3.3.3 Systems Performance, Limitations, and Constraints

Side Hatch

- Physical characteristics
 - Diameter:
 - Total: 40 in. (103 cm)
 - Cover plate: 36 in. (91.5 cm)
 - Weight:
 - Total: 294 lb (129 kg)
 - Latching mechanism: 80 lb (36.4 kg)
- Lock lever
 - Unlocking force: 12 to 16 lb (53 to 71 N)
 - Travel: 180°
- Actuator handle
 - Rotation force: 16 lb (71 N)
 - Travel: 385° to 450°
 - Vent position: 250°
 - Vent force: 25 lb (111 N)
- Opening force
 - Prelaunch: 34 lb (151 N)
 - Postlanding: Gravity fall open
- Temperature limits (due to attenuator fluid)
 - Operating: -65° to +275° F (-54° to +135° C)
 - Nonoperating: 275° F (max.)
- Pressure limits (due to environmental control and life support system (ECLSS) tolerances)
 - Maximum differential pressures (cabin - ambient): +2.0, -0.4 psid (for pressures outside this range, pressures must be vented)
- Leak rate (allowable): 1 psi in 60 sec at 15 ± psig.
- Viewport
 - Size: 10-in.-diameter (25.4-cm)
 - No. panes: 3 (2 pressure - inboard, 1 thermal - outboard)
 - Type glass: Alumino silicate with IR coating (inboard side)

Tables 3.3-2 through 3.3-6 detail the hatch operating procedures for the internal and external side hatch openings and closings and emergency openings.

TABLE 3.3-1.- HATCH DISPLAY AND CONTROL FUNCTIONS

| Location | Type | Nomenclature/ position | Function | Remarks |
|----------------|---------------|---|---|---|
| <u>Hatches</u> | | | | |
| All | Lever | Actuator lock lever | | Rotates 180° |
| | | UNLOCKED | Unlocks hatch actuator handle | Flip lock lever to UNLOCKED. Allows rotation of actuator handle/hatch opening |
| | LOCKED | Locks actuator handle in latched position | Actuator handle must be in LATCHED posi- tion. Flip lock lever to LOCKED | |
| | Hand crank | Actuator handle | | |
| | | UNLATCHED | Relieves delta pres- sure across hatch and releases the latches to permit hatch opening | Rotate 240° ccw (latch side of hatch per figure 3.3-6) and stop at vent position (approx. 2 min) (side hatch only) to avoid damage to hatch/ hatch actuator. After vent, con- tinue rotation another 210° (total approx. 450°) to hard stop. Open hatch |

TABLE 3.3-1.- Concluded

| Location | Type | Nomenclature/ position | Function | Remarks |
|----------|------|---------------------------|---|--|
| | | LATCHED | Actuates latches to latch and seal side hatch | Rotate approx. 450° cw (latch side of hatch per figure 3.3-6) to hard stop to latch/seal hatch |

TABLE 3.3-2.- SIDE HATCH OPENING (INTERNAL)

| Procedure | Remarks |
|--|--|
| <div style="border: 2px solid black; padding: 5px; margin: 10px auto; width: fit-content;"> <p style="text-align: center;"><u>WARNING</u></p> <p>If external atmosphere contaminated or unknown, do not open hatch until all crewmembers breathing supplemental air/O₂</p> </div> | |
| <p>1 Lock lever to UNLOCKED (flip over past detent)</p> | <p>1 Lock lever requires 6- to 13-lb force to unlock. Flip over past detent</p> |
| <div style="border: 2px solid black; padding: 5px; margin: 10px auto; width: fit-content;"> <p style="text-align: center;"><u>WARNING</u></p> <p>Stop at VENT position 2 minutes to avoid rapid hatch opening</p> </div> | |
| <p>2 Handle - ccw to VENT</p> | <p>2,4 Handle requires approx. 16-lb force to rotate</p> |
| <p>3 Wait 2 minutes</p> | <p>and 25-lb force to overcome detent</p> |
| <p>4 Handle - ccw to UNLATCHED</p> | <p>4 Ratchet has two positions (60° & 90°). Either position gives sufficient clearance for ingress/egress in the vertical position</p> |
| | <p style="text-align: center;"><u>NOTE</u></p> <p><u>TIME</u></p> <ul style="list-style-type: none"> ● Steps 1-2: ~10 sec ● Step 3: 2 min ● Steps 4-5: ~5 sec |

TABLE 3.3-2.- Concluded

| Procedure | Remarks |
|---------------------|--|
| 5 Hatch - Push open | <p data-bbox="899 394 1305 520">5 If Orbiter vertical, push outward on hatch until ratchet engages</p> <p data-bbox="964 554 1305 932">Hatch hydraulic attenuator controls rate of hatch opening; however, if interior pressure not equalized, excessive opening rate may occur. Personal injury and/or hatch/hatch actuator damage may result</p> <p data-bbox="964 966 1289 1092">If Orbiter horizontal, push outward on hatch, let free fall to full open</p> |

TABLE 3.3-3.- SIDE HATCH OPENING (EXTERNAL)

| Procedure | Remarks |
|---|--|
| 1 Remove hatch fixture attach point TPS plug (1) with 1-in. spanner wrench | |
| 2 Remove hatch access panels (2) Remove screws (10) Pull out panel | |
| 3 Attach GSE hatch fixture | |
| 4 Configure GSE hatch T-handle Actuator locking lever - LOCKED Ball detent release slide - unlock (away from handle) | 4,6 Ball detent release slide is spring-loaded to lock position |
| 5 Insert GSE hatch T-handle | |
| 6 Ball detent release slide - lock (toward handle) | |
| 7 GSE hatch T-handle actuator locking lever - UNLOCKED | 7 Lock lever requires 12- to 16-lb force to unlock |
| <div style="border: 2px solid black; padding: 5px; width: fit-content; margin: 0 auto;"> <p>WARNING To avoid rapid hatch opening, stop at VENT position 2 minutes</p> </div> | <p>NOTE</p> <p><u>TIME:</u> TBD</p> |
| | <p>If GSE hatch T-handle is not available, a 5/8- or 1/2-in.-square drive with a 12-in. extension can be used to open side hatch. Insert drive, strike sharply to unlock, rotate cw to vent position, wait 2 minutes and rotate cw to hardstop</p> |

TABLE 3.3-3.- Concluded

| Procedure | Remarks |
|---|---|
| 8 GSE hatch T-handle - Rotate cw to vent detent | 8 GSE hatch T-handle requires aprox. 16-lb force to rotate and 25-lb force to over-come VENT detent |
| 9 Wait 2 minutes | |
| 10 Rotate cw to UNLATCH (hard stop) | |
| 11 Remove tool | 8 Hatch hydraulic attenuator controls rate of opening; however, if interior pressure is not equalized, excessive opening rates may occur and crewmember or ground crewman could be injured if in hatch opening envelope |
| 12 If Orbiter vertical, pull on GSE hatch T-handle until ratchet engages | 12 Ratchet has two positions (60° to 90°). Either position gives sufficient clearance for ingress/egress in the vertical position |
| 13 If Orbiter horizontal, pull GSE hatch T-handle, let hatch free fall to full open | |

TABLE 3.3-4.- SIDE HATCH CLOSING (EXTERNAL)

| Procedure | Remarks |
|--|---|
| 1 Side hatch actuator handle - LATCH (cw to hard stop - 1-1/4 turns) | 1 Steps 1, 2, 9, and 10 performed to assure hatch fully unlocked and unlatched before closing |
| 2 Side hatch actuator lock lever - LOCKED (flip over) | |
| 3 Remove hatch fixture attach point TPS plug (1) with 1-in. spanner wrench | |
| 4 Remove hatch access panels (2) Remove screws (10) Pull out panel | |
| 5 Attach GSE hatch fixture | |
| 6 Configure GSE hatch T-handle Actuator locking lever - LOCKED Ball detent release slide - unlock (away from handle) | 6,8 Ball detent release slide is spring loaded to lock position |
| 7 Insert GSE hatch T-handle | <p style="text-align: center;"><u>NOTE</u></p> Side hatch normally closed by closeout crew |
| 8 Ball detent release slide - lock (toward handle) | |
| 9 GSE hatch T-handle actuator locking lever - UNLOCKED | |
| 10 GSE hatch T-handle - UNLATCH (cw to hard stop + 1/4 turn) | |
| 11 ✓Latches fully retracted | |
| <p><u>NOTE</u></p> Kicker latches prevent full closing of hatch | |

TABLE 3.3-4.- Concluded

| Procedure | Remarks |
|--|--|
| 12 Close hatch Unlock ratchet Push (using GSE hatch fixture) | |
| 13 GSE hatch T-handle - LATCHED (ccw past detent to hard stop - 1-1/4 turns) | 13 GSE hatch T-handle requires approx. 16-lb force to rotate and 25-lb force to overcome VENT position |
| 14 Hatch T-handle actuator locking lever - LOCKED (flip over) | 14 Lock lever requires 15- to 16-lb force to lock |
| 15 ✓ Hatch latched - pull GSE hatch fixture (no hatch movement if latched) | |
| 16 ✓ Hatch locked - attempt to rotate GSE hatch T-handle cw (no rotation if locked) | |
| 17 Ball detent release slide - unlock (away from handle) | 17 Ball detent release slide is spring-loaded to lock position |
| 18 Remove GSE hatch T-handle | |
| 19 Remove GSE hatch fixture | |
| 20 If prelaunch Perform hatch seal pressure integrity check Perform hatch latch electrical check | |
| 21 Install hatch access panel Insert TPS carrier panel Install screws (10) | |
| 22 Install hatch fixture TPS plugs (1) with 1-in. spanner wrench | |

TABLE 3.3-5.- EMERGENCY SIDE HATCH OPENING (INTERNAL)

| Procedure | Remarks |
|---|--|
| <div style="border: 1px solid black; padding: 5px; margin-bottom: 10px;"> <p style="text-align: center;">WARNING</p> <p>Do not open hatch until all crewmembers breathing on supplemental air/O₂</p> </div> | |
| <p>1 Lock lever to UNLOCKED (flip over past detent)</p> | <p>1 Lock lever requires 6- to 13-lb force to unlock. Flip over past detent</p> |
| <div style="border: 1px solid black; padding: 5px; margin-bottom: 10px;"> <p style="text-align: center;">WARNING</p> <p>Stop at VENT position 30-60 sec to avoid rapid hatch opening</p> </div> | |
| <p>2 Handle ccw to VENT</p> | <p>2 Handle requires approx. 16-lb force to rotate and 25-lb force to overcome VENT detent</p> |
| <p>3 Wait 30-60 sec</p> | <p>2,3 Steps not required if prelaunch</p> |
| <p>4 Handle - ccw to UNLATCHED</p> | <p>3 Vent times are worst case and may be reduced if speed of egress higher priority than risk of damage</p> |
| <p>5 Hatch - push open</p> | <p>5 If Orbiter vertical, push outward on hatch until ratchet engages. Ratchet has two positions (60° to 90°). Either position gives sufficient clearance for egress</p> |

TABLE 3.3-5.- Concluded

| Procedure | Remarks |
|-----------|--|
| | <p data-bbox="1063 409 1388 535">If Orbiter horizontal, push outward on hatch, let free fall to full open</p> <p data-bbox="1063 567 1372 661">Hatch hydraulic attenuator controls rate of opening</p> <p data-bbox="1177 724 1242 756"><u>NOTE</u></p> <p data-bbox="998 787 1079 819"><u>TIME:</u></p> <ul data-bbox="998 850 1307 955" style="list-style-type: none">● Steps 1,2: 3 sec● Step 3: 30-60 sec● Steps 4,5: 5 sec <p data-bbox="998 976 1356 1050">Procedure is for emergency egress</p> |

TABLE 3.3-6.- EMERGENCY SIDE HATCH OPENING (EXTERNAL)

| Procedure | Remarks |
|--|--|
| 1 Using GSE handle T-handle or 5/8- or 1/2-in. sq drive, punch through TPS plug over hatch actuator | 1 Rescue team will use 1/2-in. sq drive with 12-in. extension and ratchet handle. Approx. 16-lb force on tool required to unlock hatch. Approx. 16-lb force on tool required to unlock hatch. Approx. 16-lb force required to rotate tool and 25-lb force required to overcome VENT detent |
| 2 Configure GSE hatch T-handle Actuator locking lever - LOCKED Ball detent release slide - UNLOCK (away from handle) <ul style="list-style-type: none"> * If GSE hatch T-handle not available, * * use a 5/8- or 1/2 in. sq drive with a * * 12-in. extension and open hatch: * * Insert tool, push to unlock * * * * * * <div style="border: 1px solid black; padding: 5px; width: fit-content; margin: 5px auto;"> WARNING To avoid rapid hatch opening, stop at VENT position 30-60 sec </div> * * * * Rotate cw to VENT detent * * Wait 30-60 sec * * Rotate cw to UNLATCH (hard stop) * * Remove tool * * Pull on hatch, let free fall * * to full open * | 2,3 Ball detent releasing slide is spring-loaded to lock position 2,7 Wait at VENT detent not reqd if pre-launch |
| 3 Insert GSE hatch T-handle into actuator | |
| 4 Ball detent release slide - Lock (toward handle) | |

3.4 SEATS, RESTRAINTS, AND MOBILITY AIDS

3.4.1 Introduction

Seats, restraints, and mobility aids are provided in the Orbiter to enable the crew to perform all tasks safely and efficiently and to provide them with proper body positioning. They include the following:

- Operational seats (Commander/Pilot (CDR/PLT)) and specialist seats)
- Foot loop restraints/airlock foot restraint
- Seat restraint kits
- Inflight restraints: temporary stowage bags (TSB's), specialist seat Flight Data File container, Velcro, tape, snaps, cable restraint clips, bungees, tethers (SFOM, Vol. 15), and sleep restraints (sec. 3.18, Sleeping Provisions)
- Mobility aids

The CDR/PLT seats provide proper body positioning and restraint so that control of the vehicle can be maintained throughout the flight. They provide comfortable support and proper body positioning during launch, entry, and orbital flight.

The specialist seats are similar to the CDR/PLT seats and are required to provide support and restraint during launch and entry. On orbit these seats may be removed and stowed. Restraints used in conjunction with the seats consist of two shoulder harnesses and a lap belt.

The foot loop restraints are placed on the Orbiter middeck and flight deck to provide stabilization in zero-g.

The airlock foot restraint provides stabilization for EVA crewmembers in the airlock hatch opening.

The seat restraint kits provide a way to secure the folded seats on orbit.

Inflight restraints include TSB's, Velcro, snaps, straps, and bungees. A specialist seat Flight Data File container is also available. These restraints are provided to assist in securing various items of inflight equipment and are depicted in figure 3.4-1.

Mobility aids are provided for all movement pathways within the crew module, docking module, airlock, and Spacelab. These features include

- Handholds
- Footholds
- Handrails
- Ladders

Mobility aids within the crew module are designed primarily for one-g operations such as ingress/egress.



S-79-31450
TEMPORARY STOWAGE BAG



S-78-37400
TAPE



S-79-31454 S-79-31455
CABLE RESTRAINT CLIPS (TYPICAL)



S-79-37377
PILE VELCRO KIT HOOK



S-79-39262
STRAP (TYPICAL)



S-83-25291
METAL SPRING
BUNGEEES



S-83-25292
ELASTIC CORD
BUNGEEES

OTHER RESTRAINTS

- LOCATED THROUGHOUT THE VEHICLE FOR EQUIPMENT STOWAGE/RESTRAINT
- TETHERS: SEE SFOM, VOLUME 15, EVA.

Figure 3.4-1.- Restraints (typical).

3.4.2 Interfaces

Operational Seats

The CDR and PLT seats are permanently installed, while the specialist seats may be removed and stowed during orbital flight. The specialist seats are anchored by connecting the quick disconnects (1 on each leg) to their corresponding studs on the Orbiter deck (fig. 3.4-2). Currently the CDR, PLT, and up to six specialist seats can be installed in the locations shown in figure 3.4-3. Eventually provisions may be made for three additional seats to support a rescue crew.

Airlock Foot Restraint

The airlock foot restraint is bolted to the airlock deck by four bolts and is located in one of two places for the duration of the flight (SFOM, Volume 15 and fig. 3.4-4).

Foot Loop Restraints

Foot loop restraints (fig. 3.4-4) are cloth loops attached to the Orbiter decks by adhesive. Crewmembers can stabilize themselves by placing one or both feet in the foot loops during on-orbit tasks. Foot loop restraints are launched installed in the areas of the aft flight deck workstations, middeck lockers, personal hygiene station, Waste Collection System (WCS), and galley/CFES. Spares are stowed in a middeck locker. The use of these restraints on the flight deck, middeck, and Spacelab is a crew option.

Seat Restraint Kits

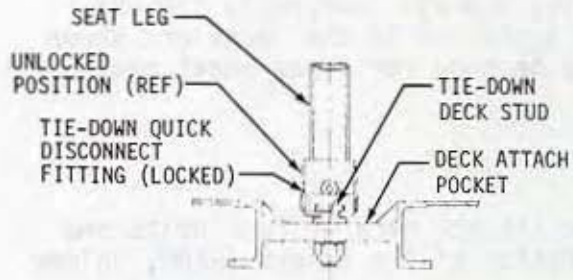
The seat restraint kits consist of two adhesive squares connected by a cloth strap (fig. 3.4-4). The adhesive squares may be attached to the Orbiter in any convenient location, and the strap is attached over a stowed specialist seat to restrain it during on-orbit operations.

Additional Inflight Restraints

- Specialist seat Flight Data File containers attach to the PEAP bracket and leg structure on the right side of the specialist seats (fig. 3.4-5).
- TSB's, vehicle-installed snaps, clips, straps, Velcro, and bungee restraints attach to the Orbiter at the standard snap and Velcro pattern locations (figs. 3.4-6 and 3.4-7).

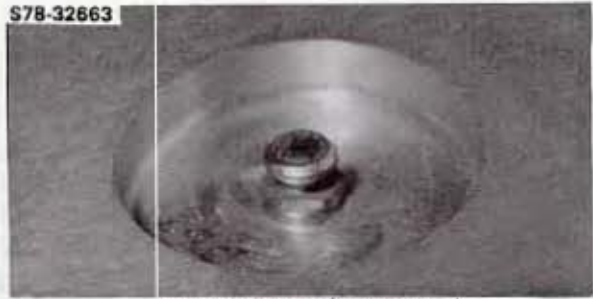
Mobility Aids

Mobility aids (handholds, footholds, handrails, and the interdeck access ladder) are permanently attached to the Orbiter.



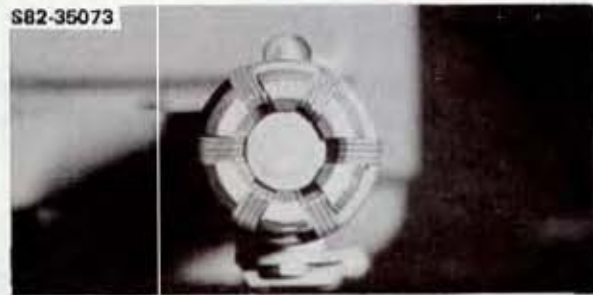
SEAT QUICK DISCONNECT

S78-32663



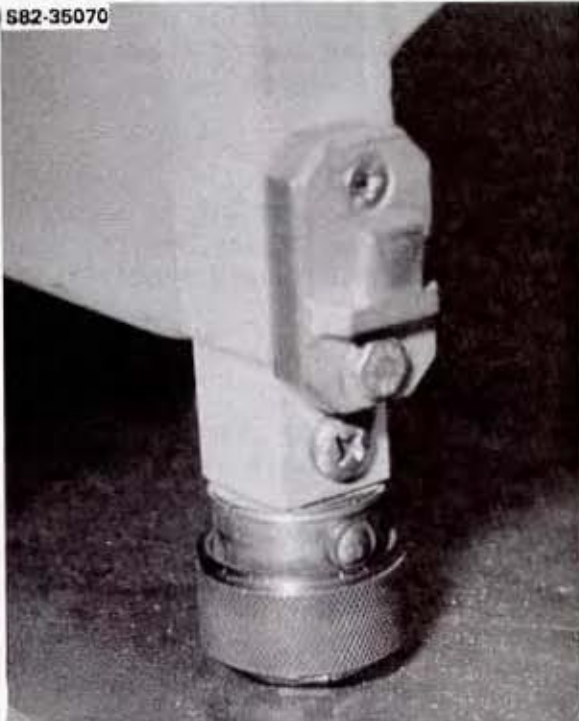
DECK STUD (TYPICAL)

S82-35073



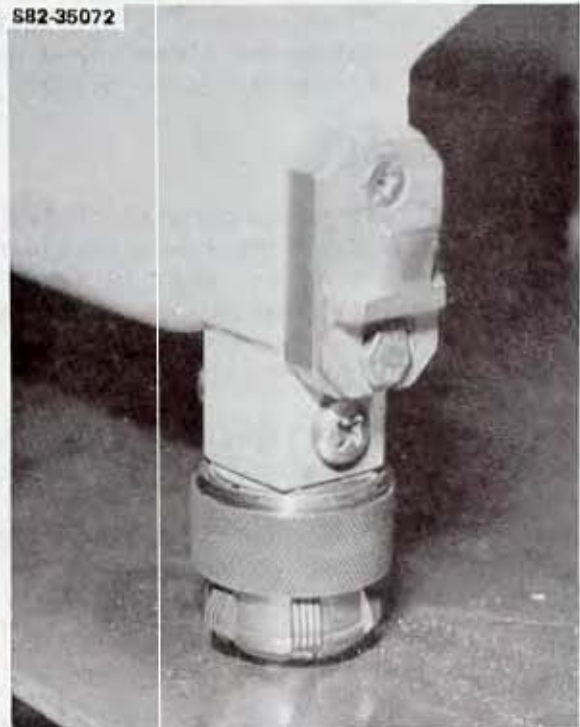
QUICK-DISCONNECT FITTING
(BOTTOM VIEW)

S82-35070



QUICK-DISCONNECT FITTING (LOCKED)

S82-35072



QUICK-DISCONNECT FITTING (UNLOCKED)

Figure 3.4-2.- Specialist seat quick disconnect fitting.

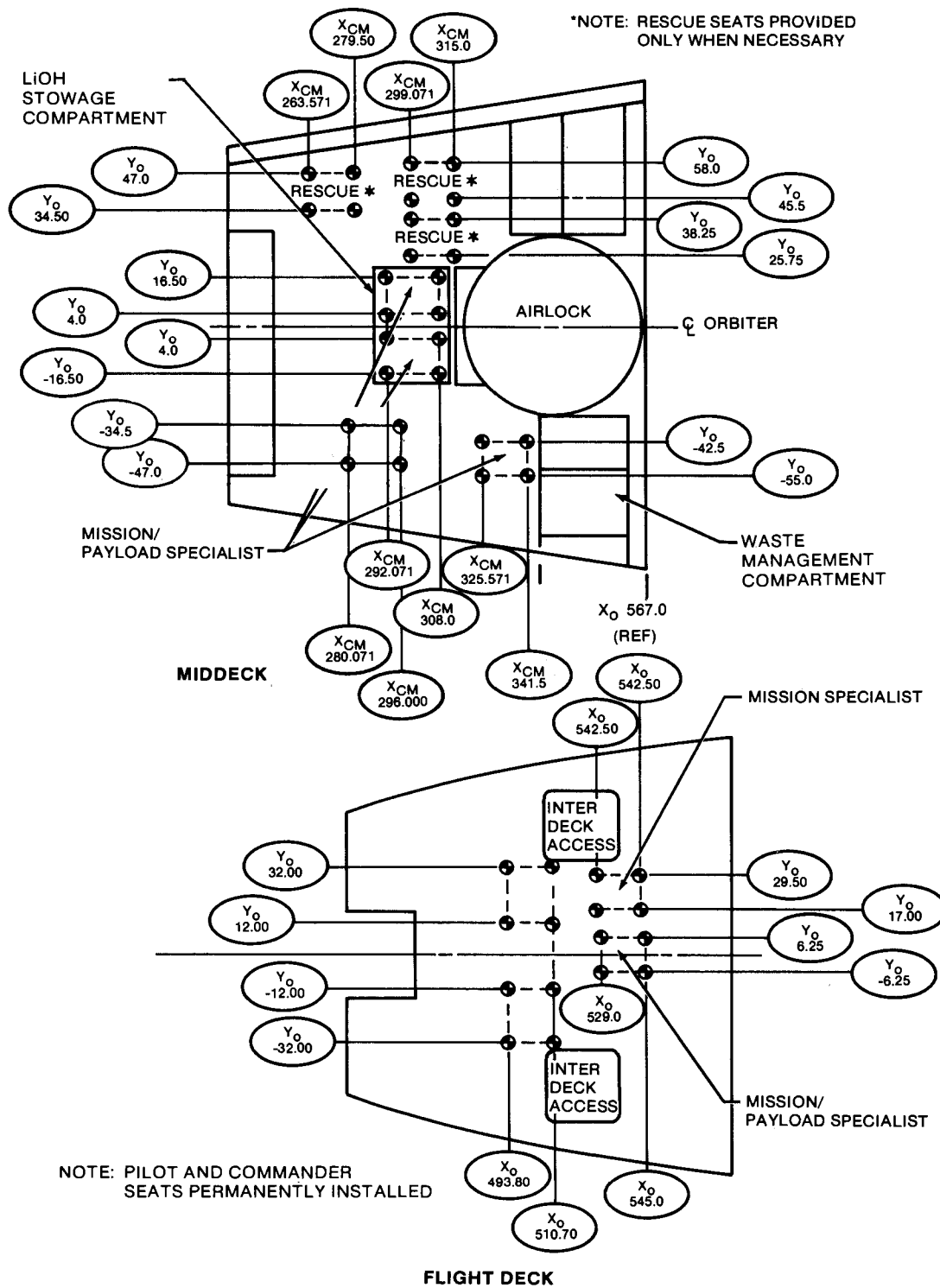
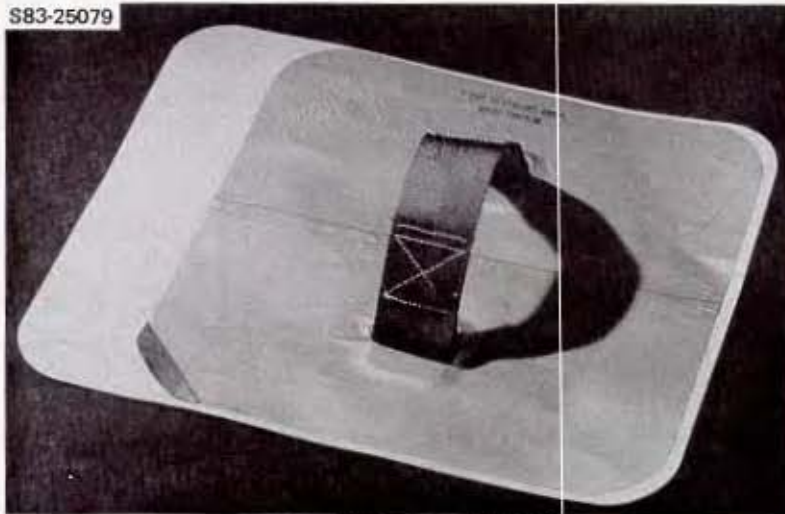
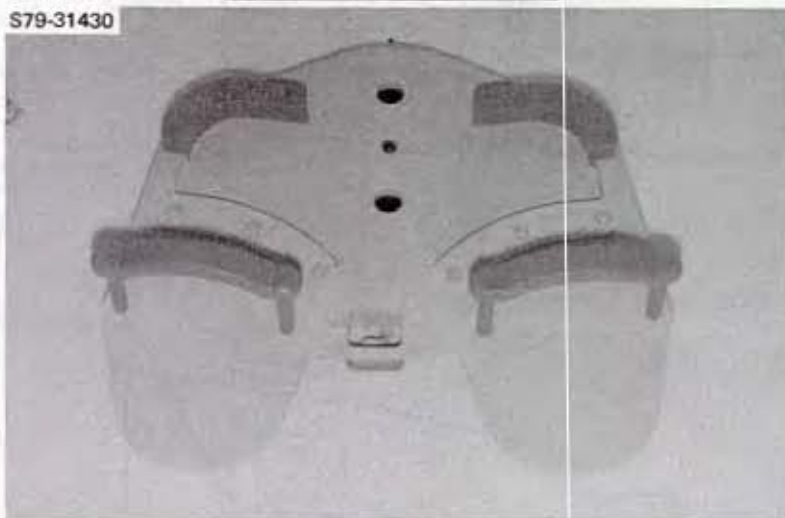


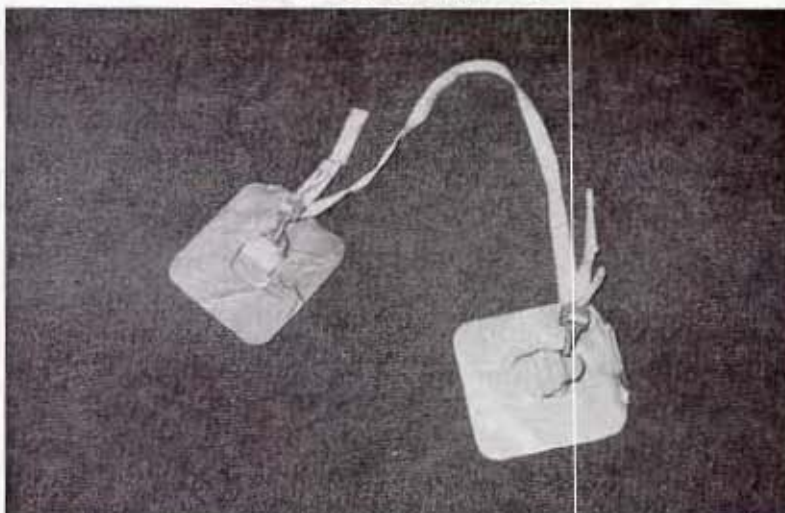
Figure 3.4-3.- Seat attach points.



FOOT LOOP RESTRAINT



AIRLOCK RESTRAINT

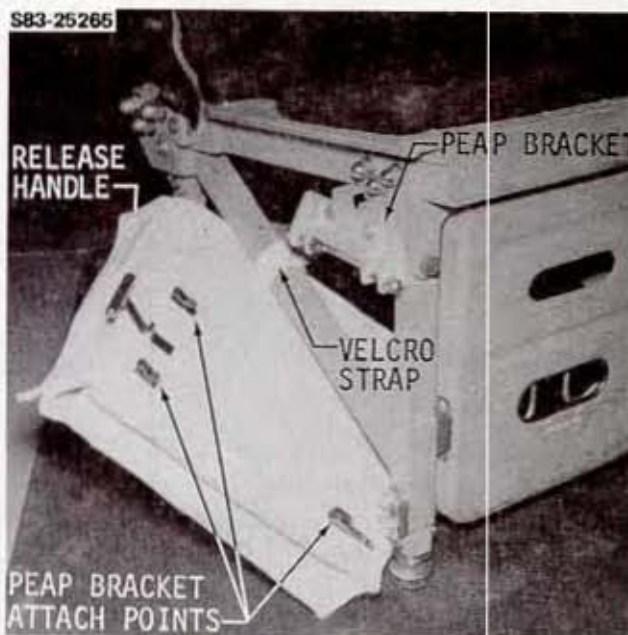


SEAT RESTRAINT KIT

Figure 3.4-4.- Restraints.

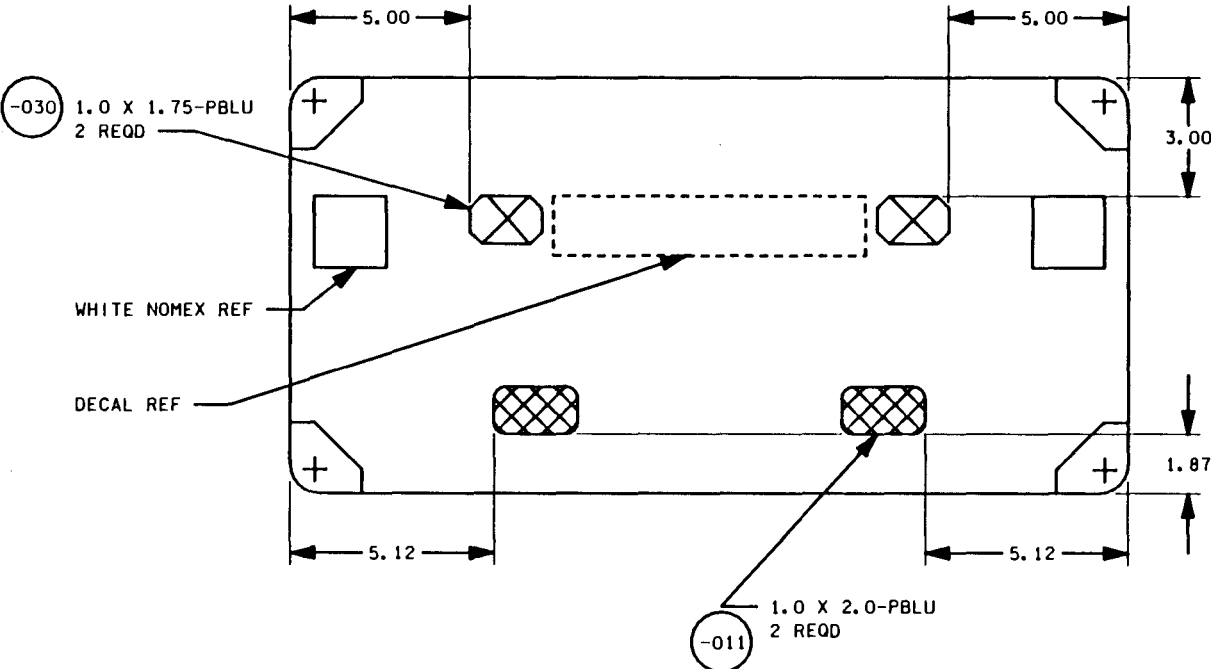


SPECIALIST FLIGHT DATA FILE CONTAINER (INSTALLED)



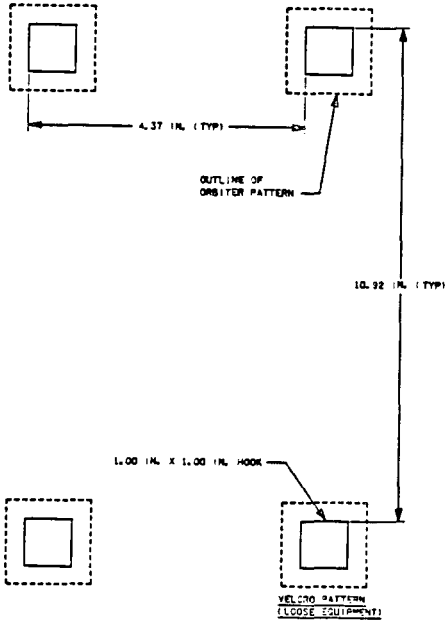
SPECIALIST FLIGHT DATA FILE CONTAINER (ATTACH POINTS)

Figure 3.4-5.- Specialist seat Flight Data File container.



DETAIL 'DC'
TYP ALL MIDDECK LOCKER DOORS

12770346A. V12; 2



12770346A. V12; 2

Figure 3.4-6.- Standard velcro patterns.

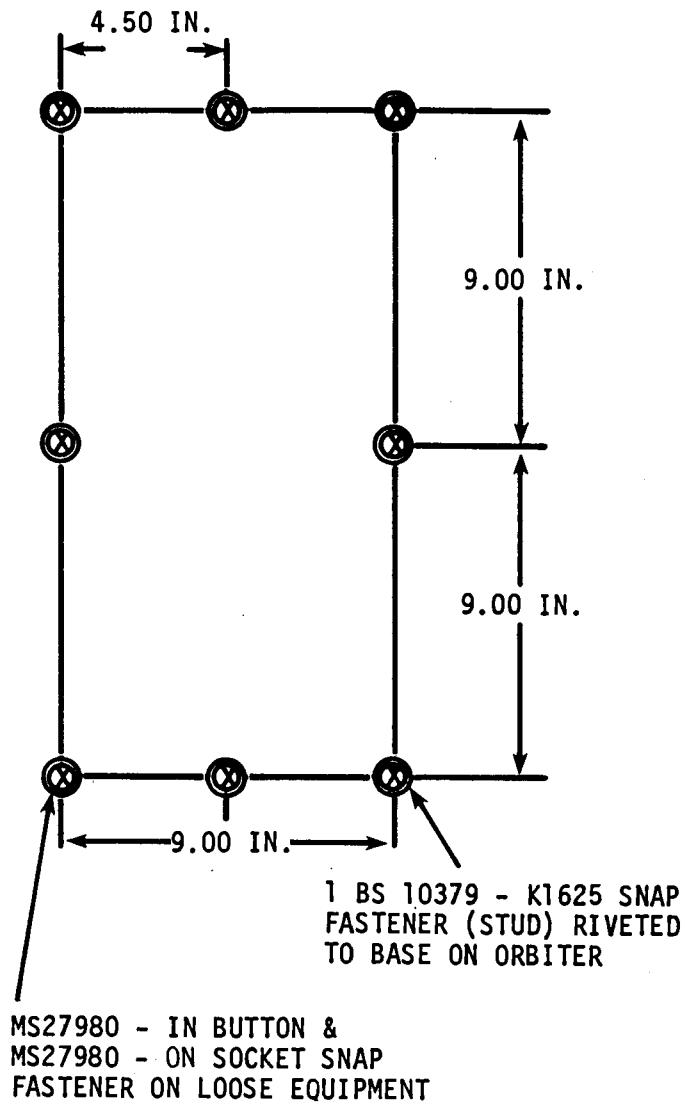


Figure 3.4-7.- Standard snap pattern.

3.4.3 Systems Functional Description

Operational Seats

In order to ensure proper body positioning so that control of the vehicle can be maintained, adjustable seats (fig. 3.4-8) for the CDR and PLT are provided in the locations shown in figure 3.4-3. The seat control mechanism allows movement of the CDR/PLT seat 10 in. (25.4 cm) along the longitudinal and 5 in. (12.7 cm) along the vertical planes of the Orbiter. This movement is of sufficient magnitude to accommodate all except the shortest and tallest 5 percent of American males, and the shortest 45 percent and tallest 5 percent of American females. To provide proper body positioning during vertical launch and horizontal flight conditions, these seats also include adjustments to provide separate back angle positions for the launch and entry phases of flight.

The specialist seats are designed to accommodate all except the shortest and tallest 5 percent of American males, and the shortest 45 percent and tallest 5 percent of American females (figs. 3.4-3 and 3.4-8). The seats include a shoulder harness and lap belt, and controls are provided to lock and unlock the seat back for back angle adjustments. The specialist seats may be removed and reinstalled without the use of tools by means of a quick disconnect (QD) fitting on each seat leg. Once the seat is detached from the deck, it may be folded and stowed.

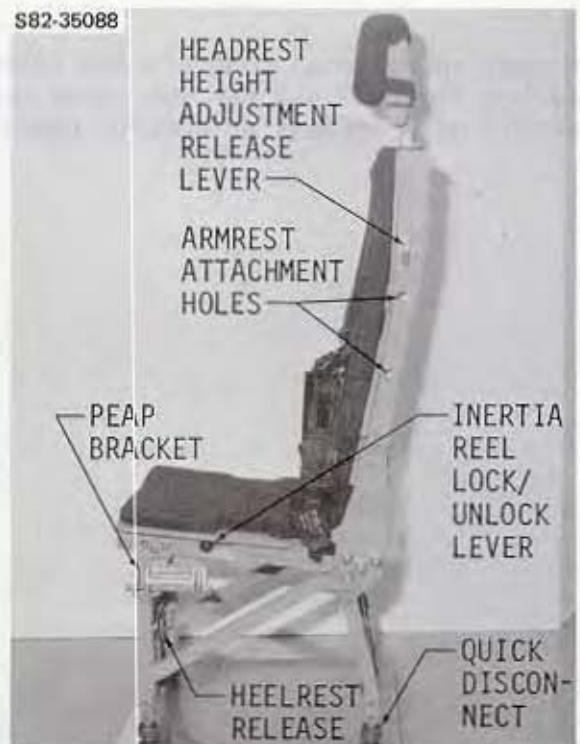
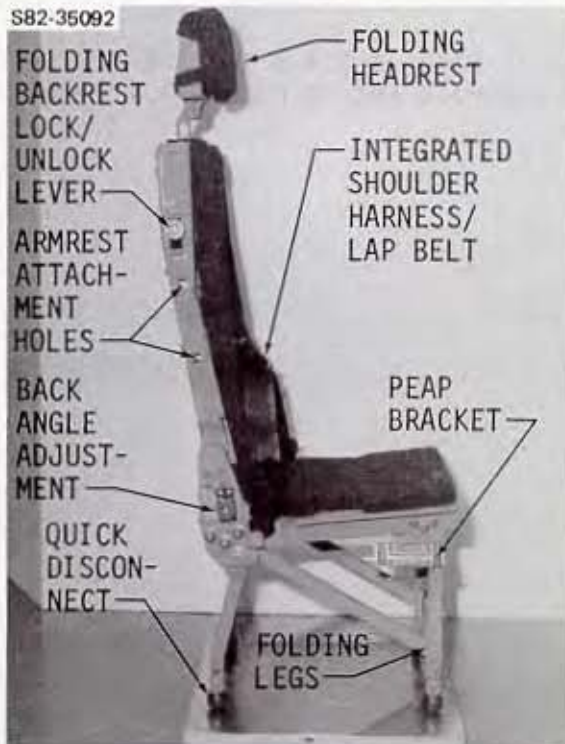
The Specialist seat installation and removal procedures are as follows:

Seat Removal Procedures

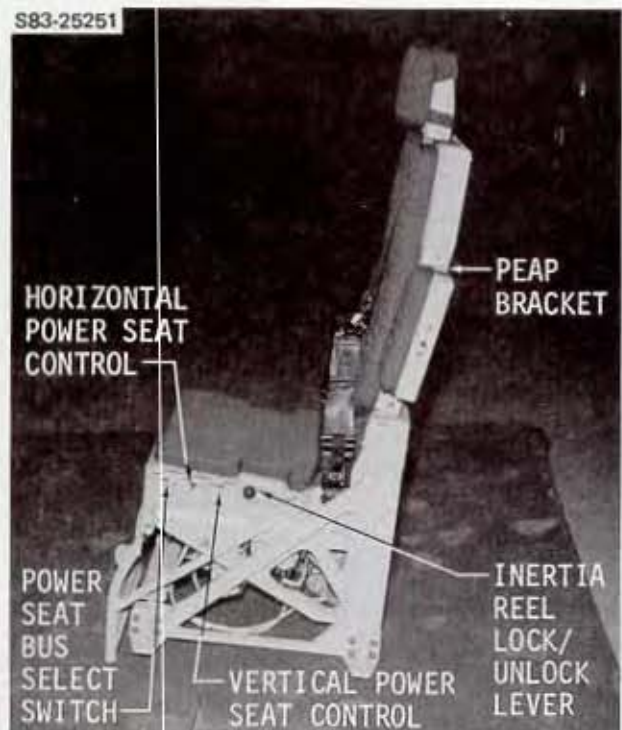
1. Release Biomed, Comm and O₂ cables from seat legs
2. Remove/stow PEAP and FDF container
3. Connect lap belt
4. Headrest - pull down and fold forward
5. Backrest - entry position, fold forward
6. Release seat QD's (four)
7. Heelrest - unlock, fold
8. Fold legs and stow

Seat Installation Procedures

1. Unstow seat
2. Deploy legs
3. Deploy heelrest and lock in position
4. Connect seat to floor studs
 - QD's (four) unlocked
 - Install rear legs first
 - QD's (four) locked
5. Unfold, adjust back to entry position and position headrest
6. Unstow, attach PEAP and FDF container



SPECIALIST SEATS



CDR and PLT SEATS

Figure 3.4-8.- Operational seats.

Folding backrest lock/unlock lever - pull out then down to fold or unfold the seat back. Seats should be in the entry position (backrest in farthest back position) before folding the backrest. If seats are folded while in launch position they will jam.



Armrest attachments holes - the armrest is mandatory on the left side of seat four (S4), but is optional on all other seats. The armrest is required on S4 to act as a step during an overhead window emergency egress. The armrest can be removed by the "pull to unlock" ring on its underside and is compatible with any seat.

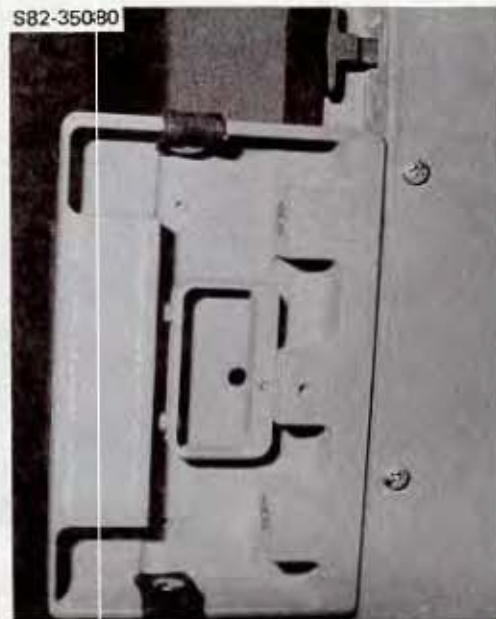
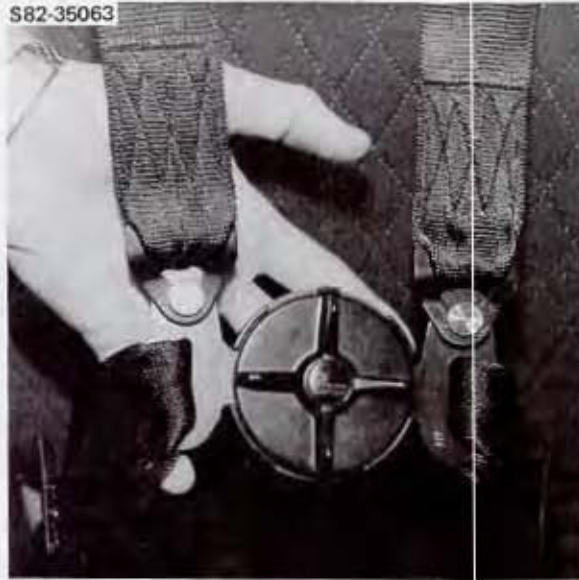


Figure 3.4-9.- Seat OPS (sheet 1 of 5).

Shoulder harness/lap belt - the lap belt is adjustable and the shoulder harness is on an inertial reel to accommodate various size crewmembers. The lap belt connector control can be rotated in either direction to release. A connection is made by simply inserting the loose end of the lap belt into the connector control.

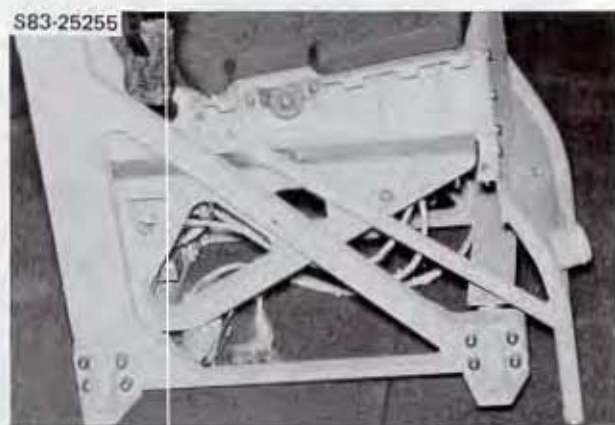


SHOULDER HARNESS/LAPBELT

Back angle adjustment - this knob adjusts the seat back angle to either the launch or entry position. The specialist seat control is located in the starboard aft side of the seat pan, and is activated by pulling out, then up. The CDR and PLT seats controls are located about midway on the starboard side of the seat pan and are activated by pulling out, then aft. Once the seat back is in the desired position it can be locked in place by placing the back angle adjustment knob in its original position.



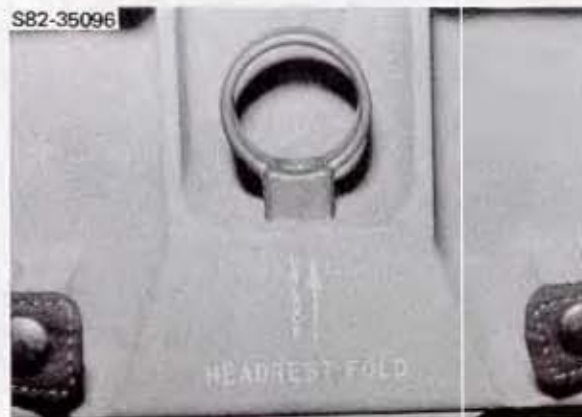
BACK ANGLE ADJUSTMENT
SPECIALIST SEATS



BACK ANGLE ADJUSTMENT
CDR AND PLT SEATS

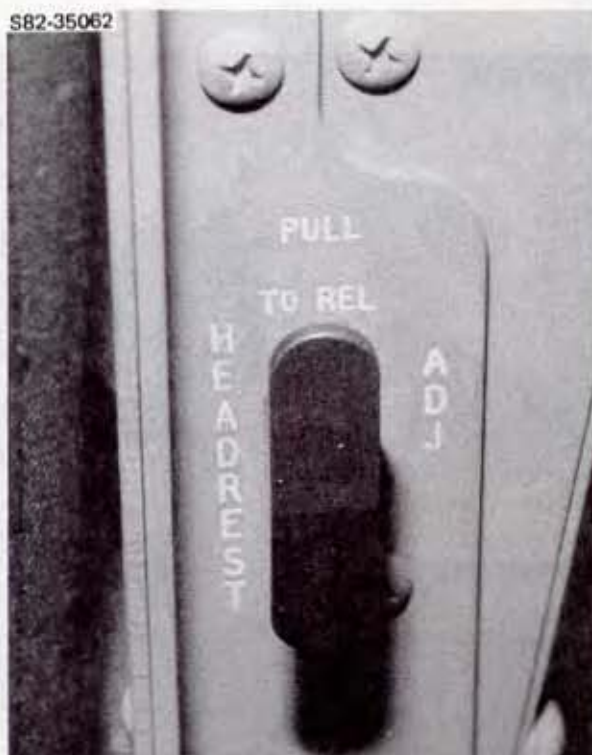
Figure 3.4-9.- Seat OPS (sheet 2 of 5).

Folding headrest - the headrest fold lever is located on the back of the headrest. The lever is pulled up to unlock the headrest so it can be folded forward 90°. This provides a more compact seat for stowage on orbit.



HEADREST FOLD

Headrest height adjustment - to adjust the headrest to the desired height, pull the headrest adjustment control out and hold it while sliding the headrest up or down. When the lever is released, the headrest is locked in the desired position.



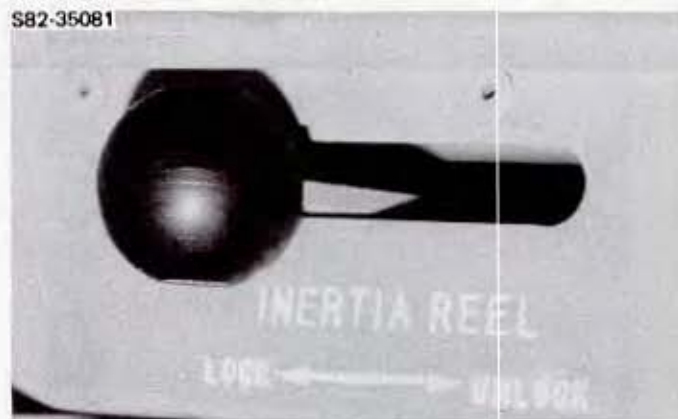
HEADREST HEIGHT ADJUSTMENT



HEADREST HEIGHT

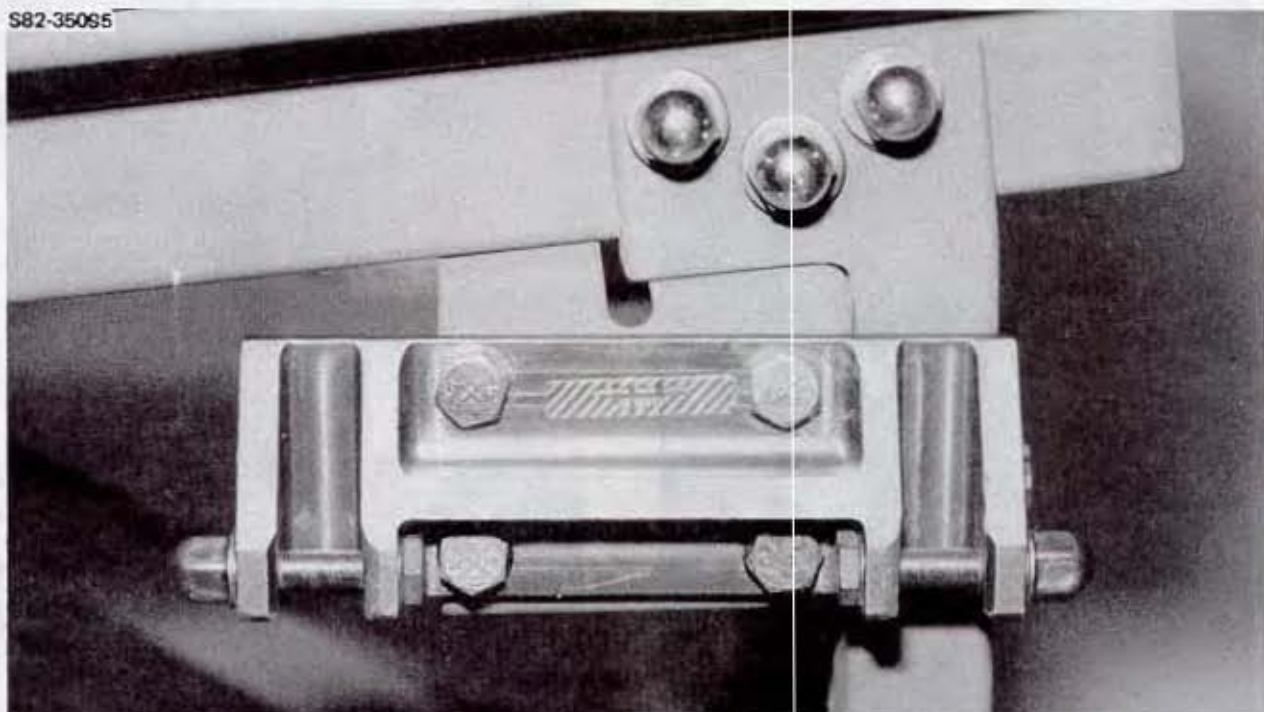
Figure 3.4-9.- Seat OPS (sheet 3 of 5).

Inertia reel lever - the inertial reel lever either locks or unlocks the shoulder harness.



INERTIA REEL LEVER

PEAP bracket - PEAP brackets are located on both sides of all specialist seats and on the back of the CDR and PLT seats. The PEAP's are mounted on the left side of the specialist seats and the back of the CDR and PLT seats. Flight Data File bags are normally attached to the PEAP brackets on the right side of the specialist seats.

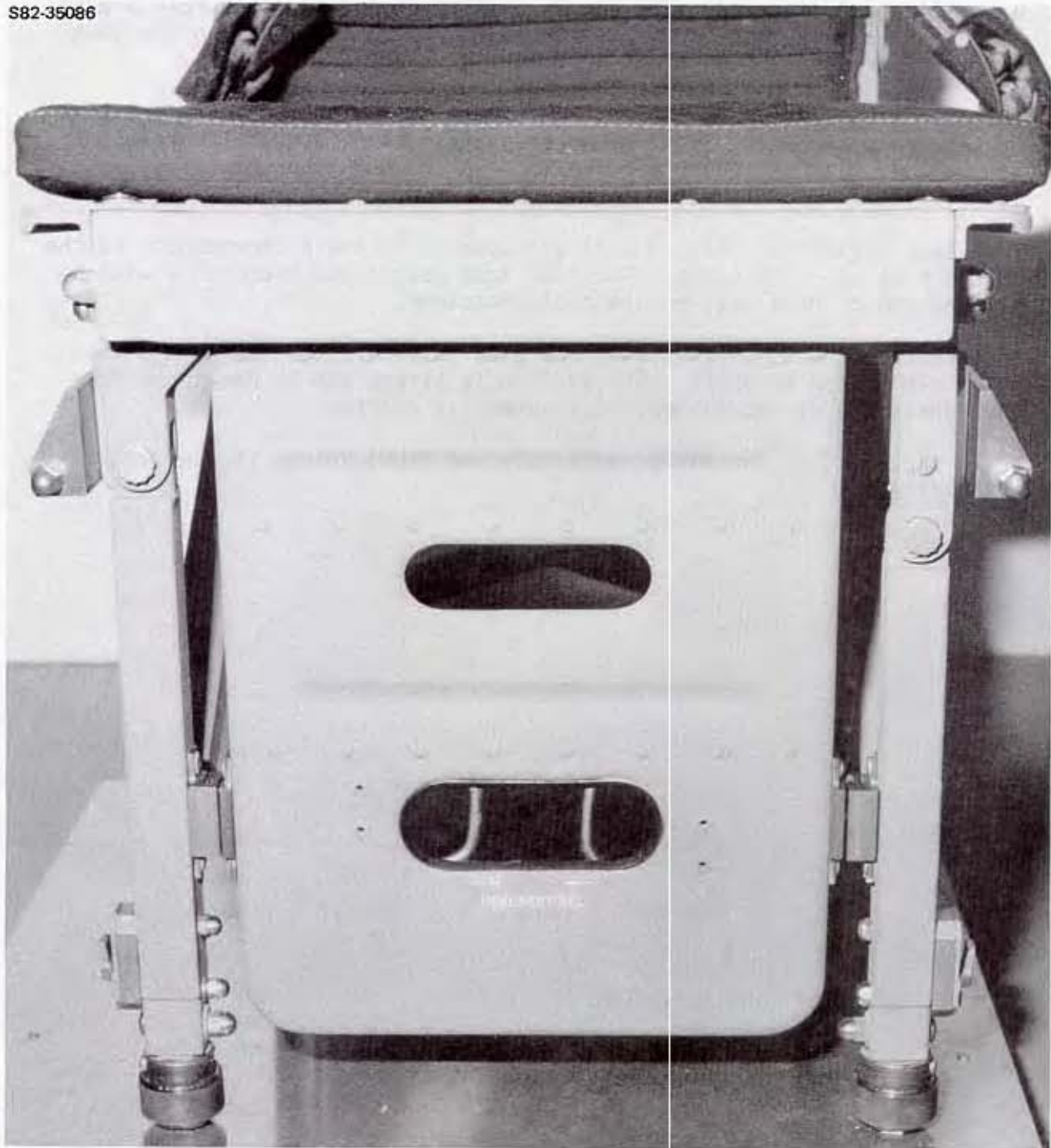


PEAP BRACKET

Figure 3.4-9.- Seat OPS (sheet 4 of 5).

Heelrest release - the heelrest provides support for the two front seat legs and must be folded prior to folding the seat. This is done by squeezing the heel rest release handles and pushing the heel rest (hinged at the top) up under the seat bottom.

S82-35086

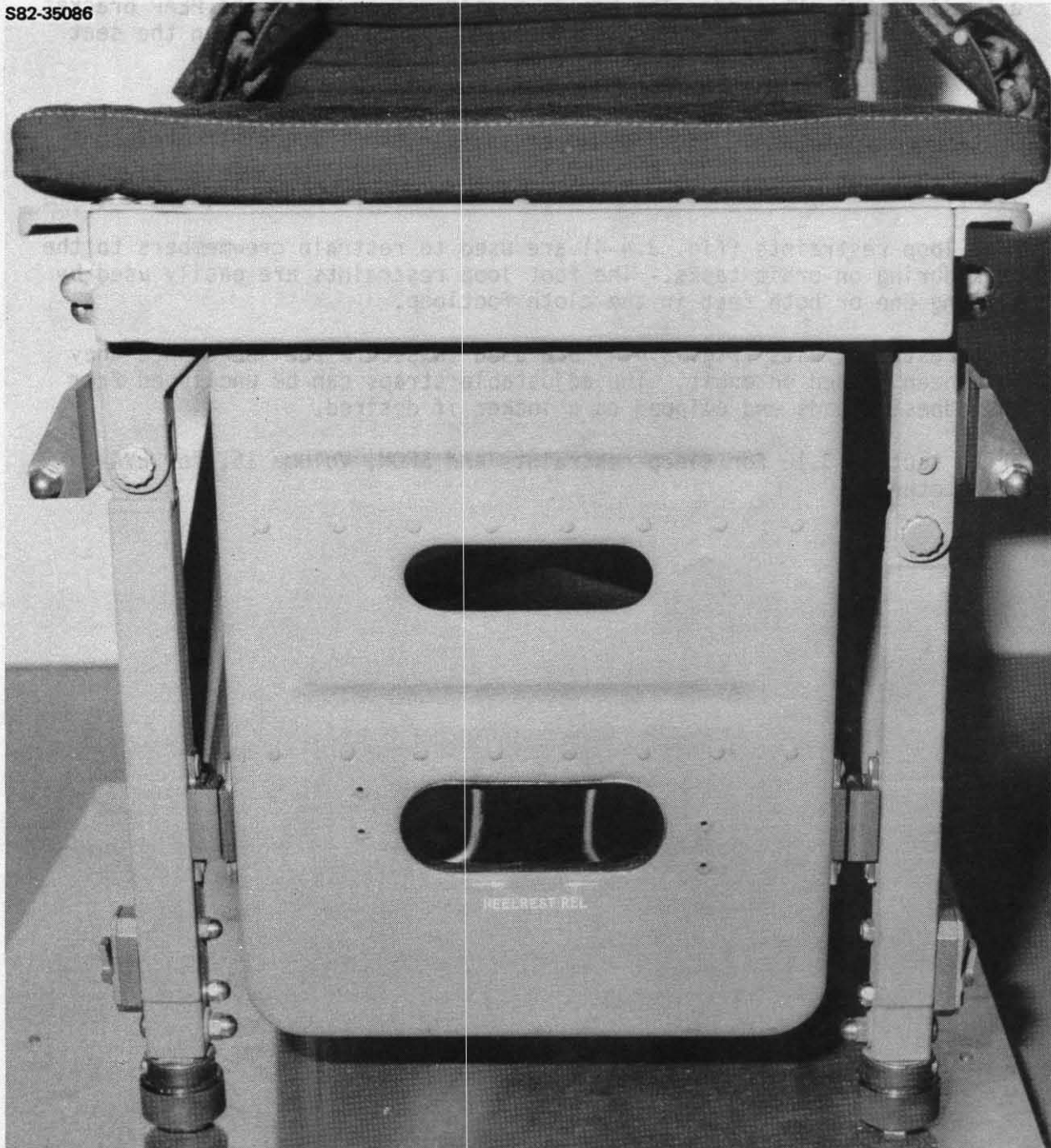


HEELREST RELEASE

Figure 3.4-9.- Seat OPS (sheet. 5 of 5).

Heelrest release - the heelrest provides support for the two front seat legs and must be folded prior to folding the seat. This is done by squeezing the heel rest release handles and pushing the heel rest (hinged at the top) up under the seat bottom.

S82-35086



HEELREST RELEASE

Figure 3.4-9.- Seat OPS (sheet 5 of 5).

Inflight Restraints

- Specialist Flight Data File bags are used to hold FDF and small loose items during launch and entry. The bags have one large compartment with a small pocket attached. The bag is easily removed from the PEAP bracket by pulling the release handle and removing the Velcro strap on the seat leg structure (fig. 3.4-5).
- The TSB (fig. 3.4-10) is used to hold loose equipment for transportation or temporary stowage. The TSB can be snapped or attached with Velcro to many places within the cabin. The TSB has an inside pocket to hold small items.
- Foot loop restraints (fig. 3.4-4) are used to restrain crewmembers to the deck during on-orbit tasks. The foot loop restraints are easily used by placing one or both feet in the cloth footloop.
- Seat restraint kits (fig. 3.4-4) are used to secure the seats once they have been folded on orbit. The adjustable straps can be unclipped from the adhesive pads and clipped to a locker if desired.

Refer to section 3.18 for sleep restraints and SFOM, Volume 15, for EVA-related tethers.

Mobility Aids

Mobility aids are located to facilitate movement of the flightcrew during ingress (one-g, Orbiter vertical), egress (one-g, Orbiter horizontal), and orbital flight (zero-g, Orbiter orientation arbitrary) (fig 3.4-11).

Mobility aids are located within the crew module as shown in figures 3.4-12 and 3.4-13. These include

- Handholds for ingress/egress to crew seats for launch and landing configurations
- Handholds in the area of the primary interdeck access opening for ingress and egress in launch and landing configurations
- A platform in front of the airlock for ingress/egress to/from the middeck seats when the Orbiter is in the launch position
- An interdeck access ladder for egress from the flight deck to the middeck after landing

Handholds are provided on the interior of the airlock and the tunnel adapter (sec. 3.4-14) for IVA and extravehicular activity (EVA) operations.

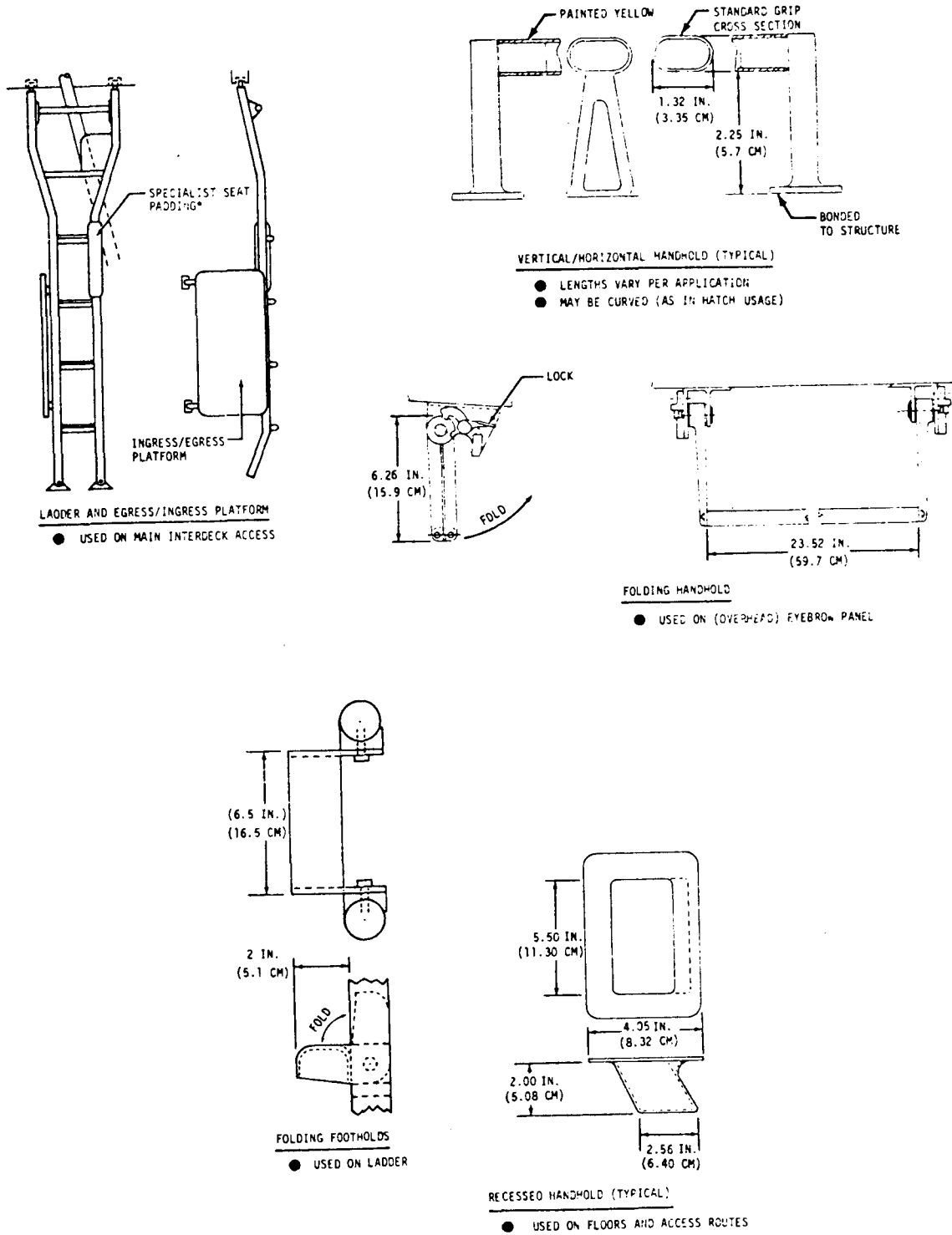
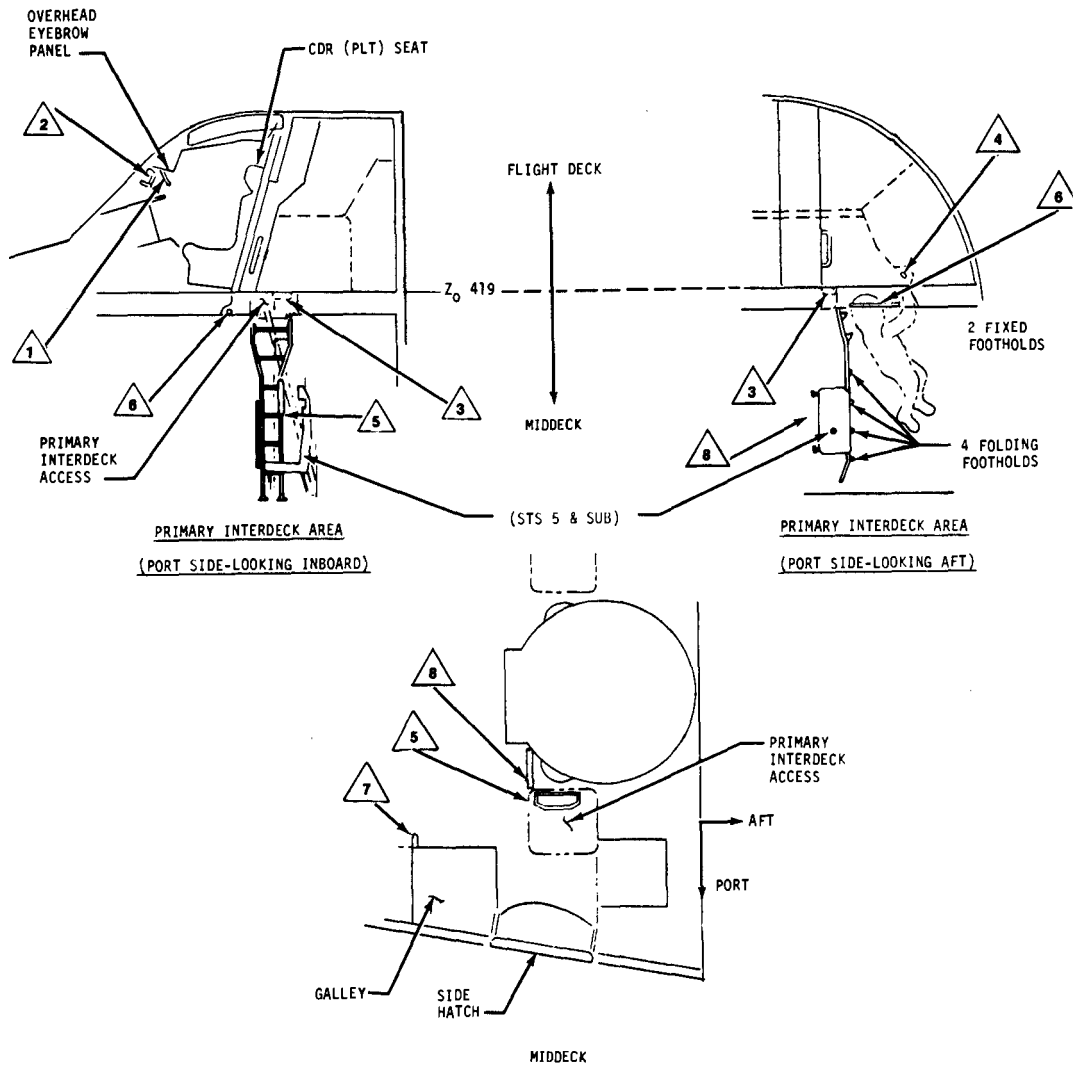
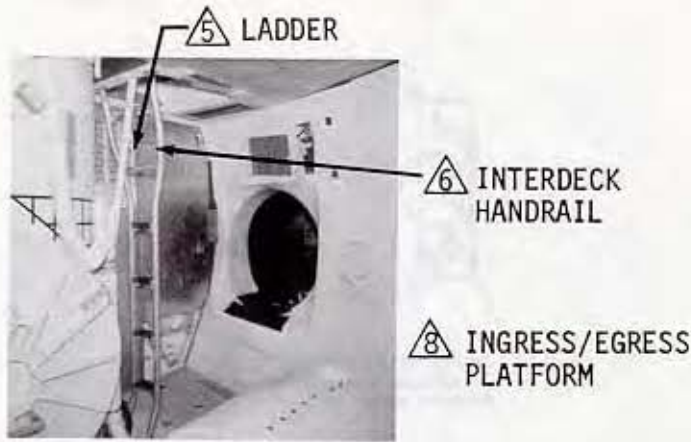


Figure 3.4-11.- Mobility aids (typical).

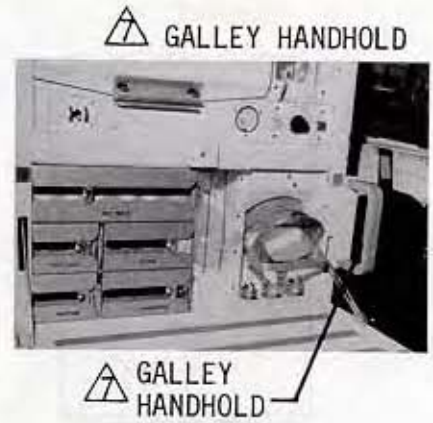


| NO. | NAME | LOCATION | PRIMARY USE |
|-----|---|--------------------------|---------------------|
| 1 | EYEBROW HANDHOLD (FOLDING) | OVERHEAD EYEBROW PANEL | SEAT INGRESS/EGRESS |
| 2 | WINDOW POST HANDHOLD | WINDOW POSTS | SEAT INGRESS/EGRESS |
| 3 | FLIGHT DECK FLOOR HANDHOLD | FLIGHT DECK FLOOR | INTERDECK ACCESS |
| 4 | PRIMARY INTERDECK ACCESS HANDHOLD | ABOVE ACCESSWAY | INTERDECK ACCESS |
| 5 | INTERDECK ACCESS LADDER (4 FOLDING AND 2 FIXED FOOTHOLDS) | BELOW ACCESSWAY | INTERDECK ACCESS |
| 6 | INTERDECK ACCESS HANDRAIL | ACCESSWAY | INTERDECK ACCESS |
| 7 | GALLEY HANDHOLD | FOOD PREPARATION STATION | PAD EGRESS |
| 8 | INGRESS/EGRESS PLATFORM | FORWARD OF LADDER | PAD INGRESS/EGRESS |

Figure 3.4-12.- Mobility aids and locations - crew module.



MIDDECK (LOOKING PORT AND AFT)



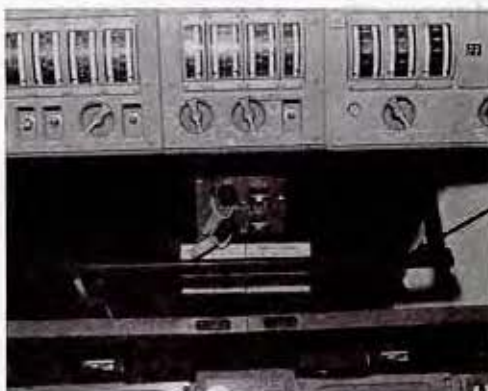
GALLEY



FLIGHT DECK FLOOR



LOOKING THROUGH INTERDECK ACCESS FROM MIDDECK

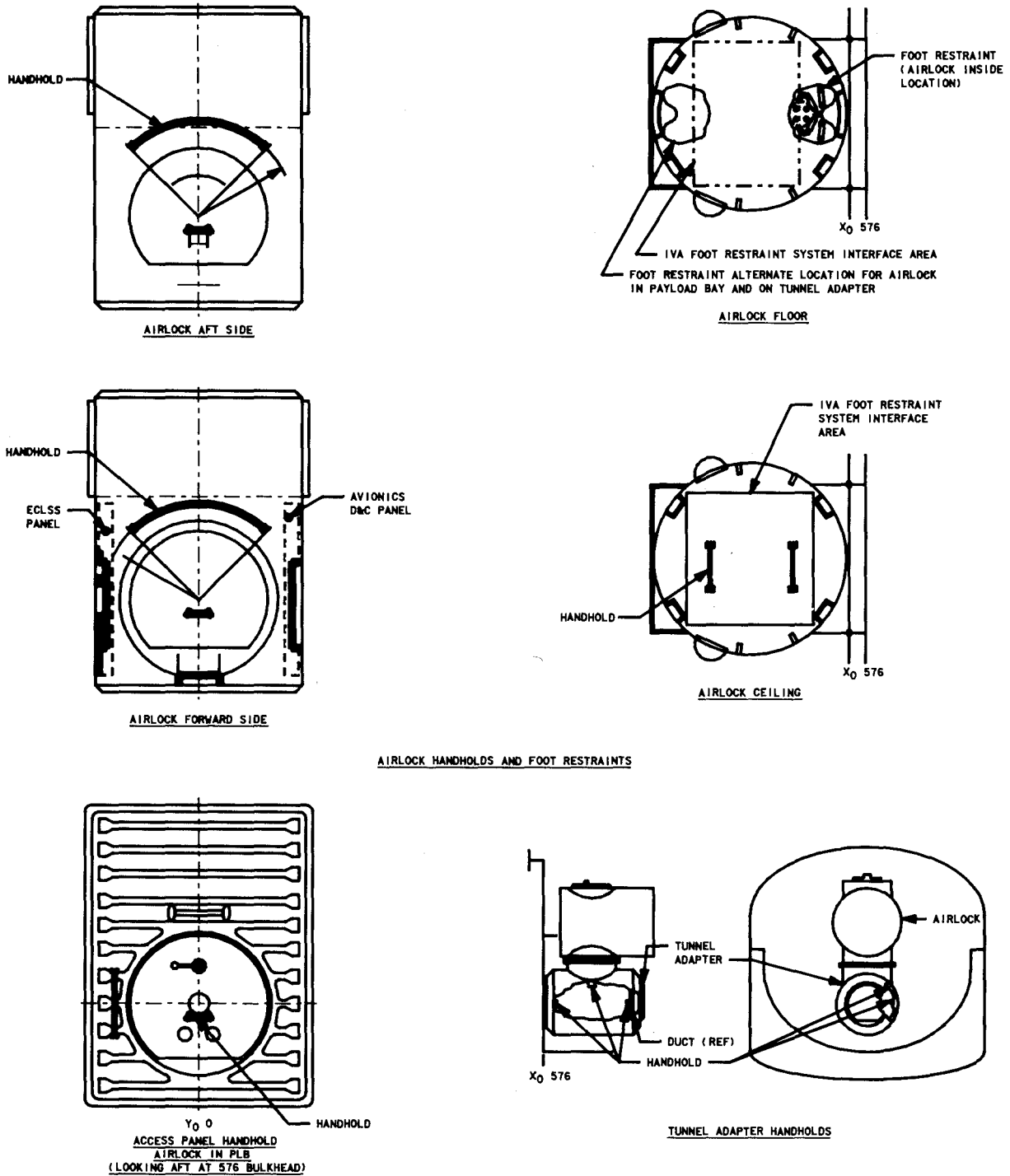


FOWARD FLIGHT DECK CENTER



FLIGHT DECK FORWARD (STARBOARD AND PORT)

Figure 3.4-13.- Mobility aids and locations - crew module



127703414, V12, 2

Figure 3.4-14.- Mobility aids and locations (airlock and tunnel adapter).

3.4.4 Systems Performance, Limitations, and Constraints

Seats

- Back angle:
 - Launch: 2° forward of seat-back (Z-axis) pivot
 - Entry: 10° aft of seat-back (Z-axis) pivot
- Weight:
 - CDR-PLT Seat: 166 lb (75.3 kg)
 - MS seat: 92 lb (41.7 kg)
 - Armrests: 5 lb (2.3 kg) each
- Dimensions:
 - MS seat (folded): 25 by 16.5 by 14 in. (63.5 by 41.9 by 35.6 cm)
- Construction:
 - Body: Aluminum and steel
 - Cushion: Tompstoxx foam covered with Nomex
 - Lapbelt and shoulder harness: Nylon webbing
- Seat travel (CDR-PLT seat only)
 - 5 in. (12.7 cm) along Orbiter X-axis (forward-rear)
 - 10 in. (25.4 cm) along Orbiter Z-axis (up-down)
 - Travel speed: 0.75 in. \pm 0.25 in./sec (1.9 cm \pm .6 cm/sec)

Seat Restraint Kits

- Construction:
 - 2 adhesive pads tethered by an adjustable nylon strap
- Weight: 1.5 lb each
- Number flown:
 - Standard amount is 5 however 6 will be flown on 8 crewmember flights

Foot Loop Restraint

- Construction: Adhesive backing with nylon foot loop
- Weight: 0.37 lb (.17 kg) each
- Number flown: 16
 - Launch: 17 installed on mid deck and flight deck
 - On-Orbit: 6 extras stowed in a middeck locker for on-orbit installation
 - Entry: May be removed for entry

Temporary Stowage Bag

- Construction:
 - Bag: Two layer's of 7.5-oz Nomex
 - Window: Two layers of 5-mil Teflon FEP
- Dimensions:
 - Folded: approx. 15 by 7 by 2 in. (38 by 17.7 by 5 cm)
 - Inside volume: 26 by 12 by 10 in. (66 by 30.5 by 25.4 cm)
- Weight: 1.67 lb (.765 kg)
- Number flown: 2

Velcro Kit

- Construction: Adhesive-backed nylon hook and pile Velcro
- Dimensions: 2 by 2 in. (5.08 by 5.08 cm)
- Packaging: Each square individually heat sealed in a plastic bag.
All bound by a ring binder.
- Weight: 0.42 lb/set (0.19 kg/set)
- Number flown: 1 set 2x2 (20 squares of hook and 20 squares of pile)
1 set 1x1 (20 squares of hook and 20 squares of pile)

Bungees

- Metal spring bungees with switch guard hooks and snaps (two sizes)
 - Length 5.75 in. (14.61 cm) and 8.75 in. (22.23 cm)
 - Number flown: 9 of each size
 - Weight: TBD
- Braided elastic cord bungee with locker door hooks and snaps (two sizes)
 - Length: 8.75 in. (22.23 cm) and 15 in. (38.1 cm)
 - Number flown: 6 of each size
 - Weight: 0.04 lb each (0.018 kg each)
- Braided elastic cord bungee with switch guard hooks and snaps (two sizes)
 - Length: 8.75 in. (22.23 cm) and 15 in. (38.1 cm)
 - Number flown: 12 of each size
 - Weight: 0.04 lb each (0.018 kg each)
- Specialist Seat Flight Data File Container
 - Material: Nomex
 - Weight: 1.75 lb (0.79 kg)
 - Dimensions: 11.5 by 3.0 by 11.0 in. (28.5 by 7.6 by 27.9 cm)

Utility Straps

- Length:
 - Overall: 13 in. (33 cm)
 - Between snaps: 10.5 in. (26.7 cm)
- Weight: TBD

Velcro/Snap/Clip Patterns

- Pattern details: See drawing number V070-650501 (OV102).

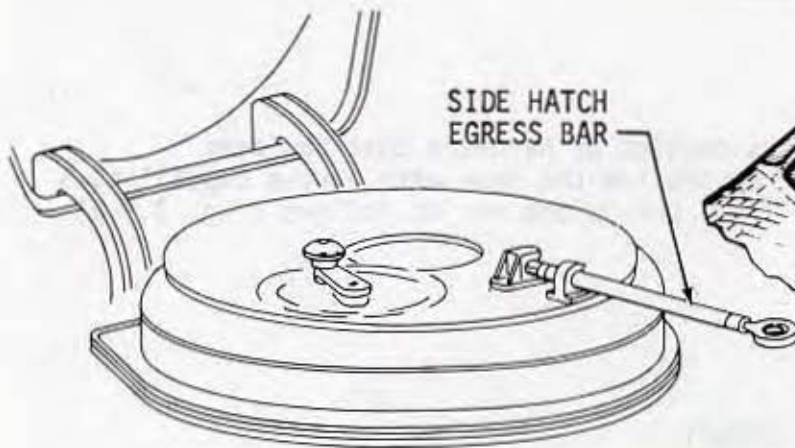
3.5 EMERGENCY EGRESS PROVISIONS

3.5.1 Introduction

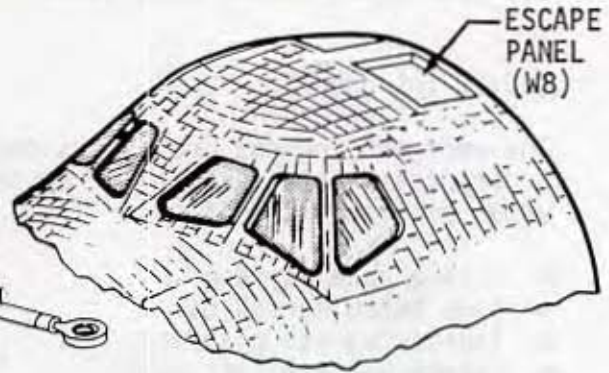
The emergency egress provisions consist of hardware that has been incorporated into the Orbiter to provide the crew with egress capabilities under emergency conditions. These provisions are as follows (fig. 3.5-1):

- Escape panel system
- Side hatch egress bar
- Ingress/egress platform
- Egress harness/life vest
- Descent devices
- Personnel egress air pack (PEAP)
- Survival equipment
- Emergency egress prybar

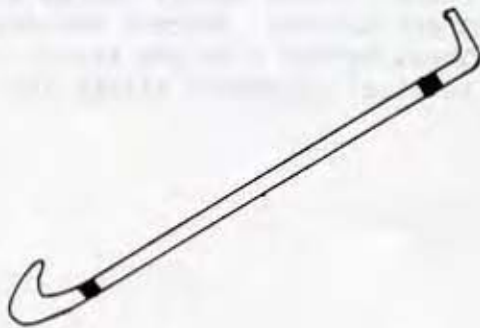
The primary mode of emergency egress is through the side hatch. The escape panel system provides the secondary egress route. These egress routes are depicted in figures 3.5-2 and 3.5-3. The egress harness, descent devices, egress bar, emergency egress prybar, and ingress/egress platform assist the crew during egress. The life vest and the survival equipment assist the crew after egress.



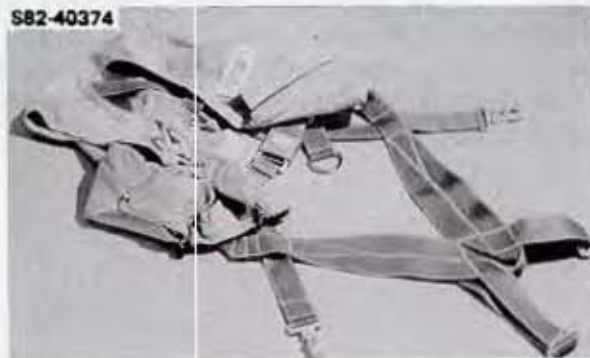
SIDE HATCH



ESCAPE PANEL



EMERGENCY EGRESS PRYBAR



EGRESS HARNESS WITH LIFE VEST



SURVIVAL KIT



PEAP



DESCENT DEVICE

Figure 3.5-1.- Egress provisions.

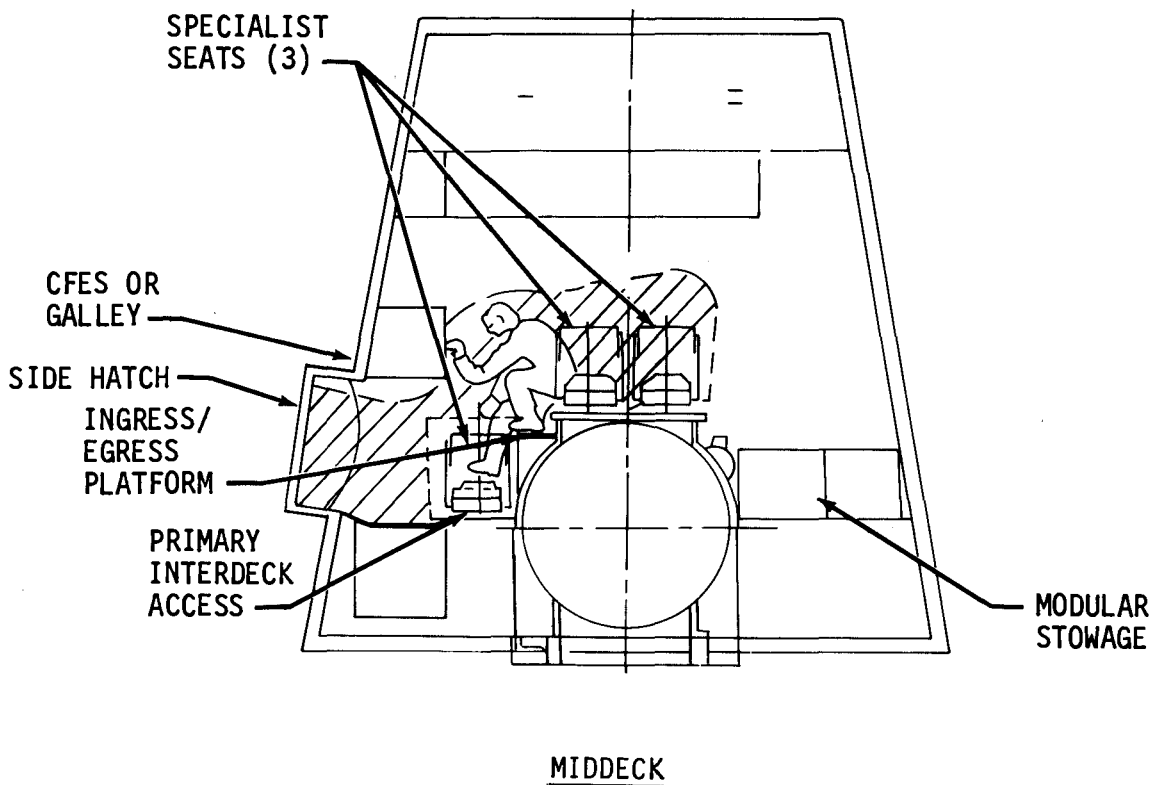
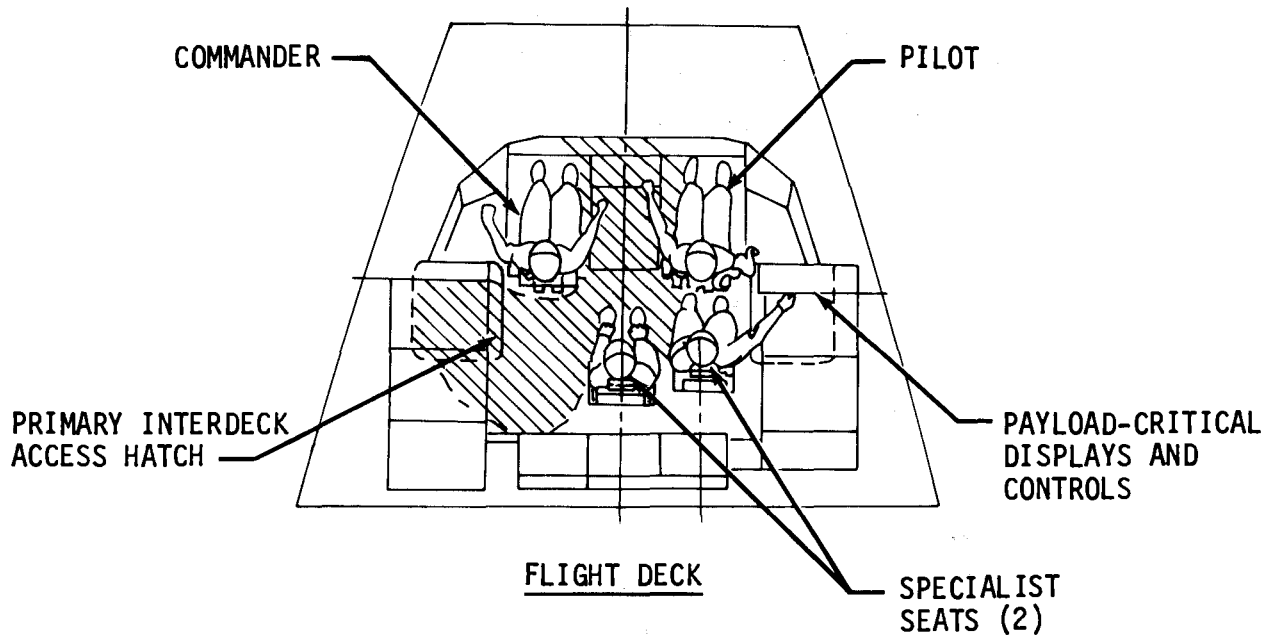


Figure 3.5-2.- Vertical (launch pad) egress routes.

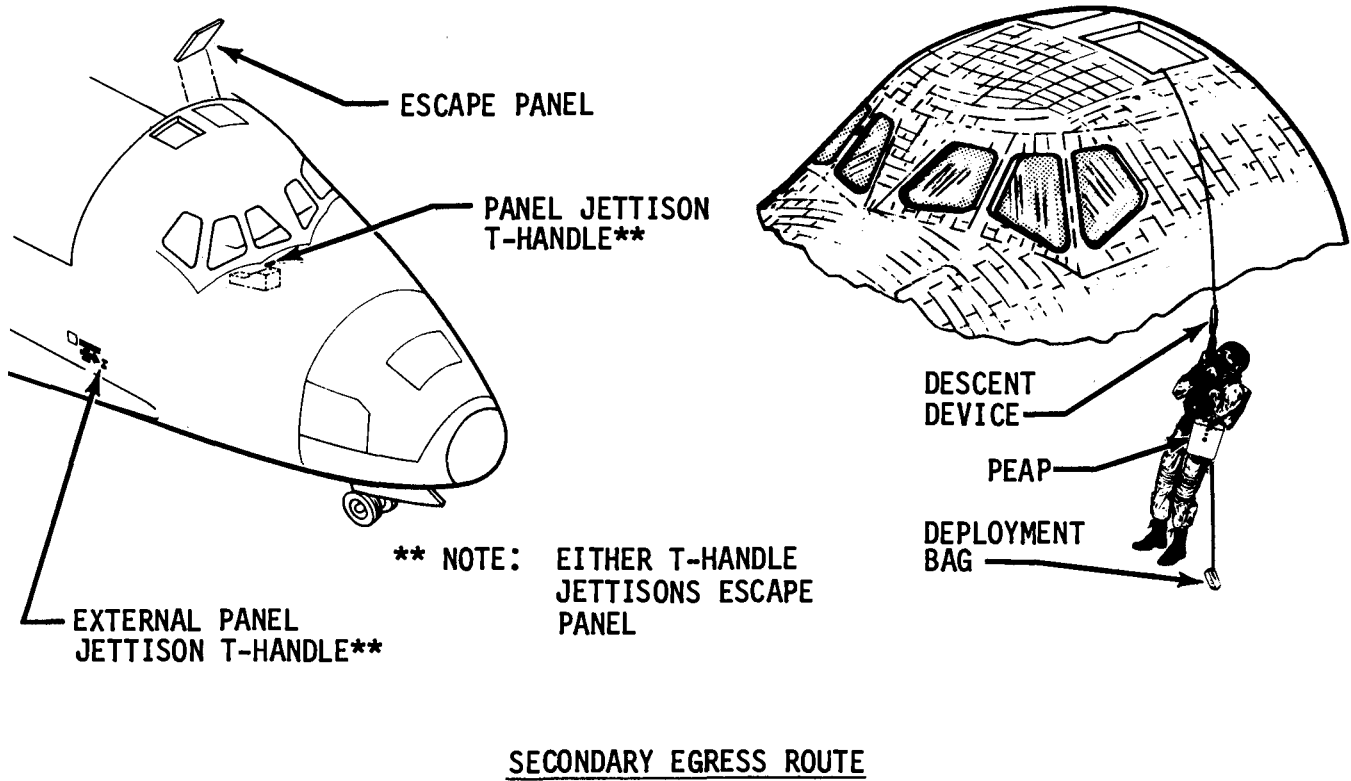
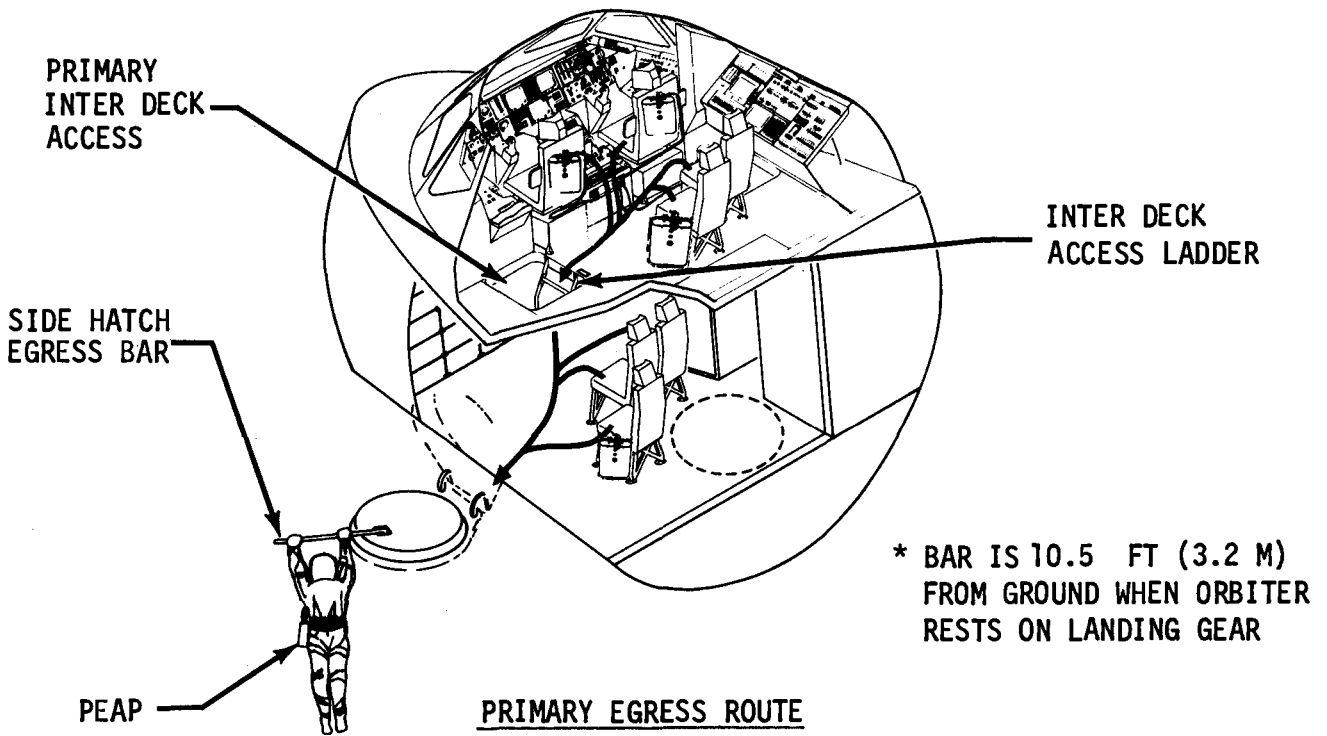


Figure 3.5-3.- Postlanding egress routes.

3.5.2 Interfaces

Escape Panel System

The outer window assembly in the escape panel (W8) can be jettisoned by a pyrotechnic system. The inner assembly is attached directly to the crew module below the outer window and is also fitted with a pyrotechnic system. The aft edge of the inner window is hinged so that it will swing down and rest on the aft panels.

Side Hatch Egress Bar

The egress bar is attached on the cover plate inside of the side hatch (fig. 3.5-4).

Ingress/Egress Platform

The ingress/egress platform is attached to the forward rail of the middeck ladder (fig. 3.5-5).

3.5-5

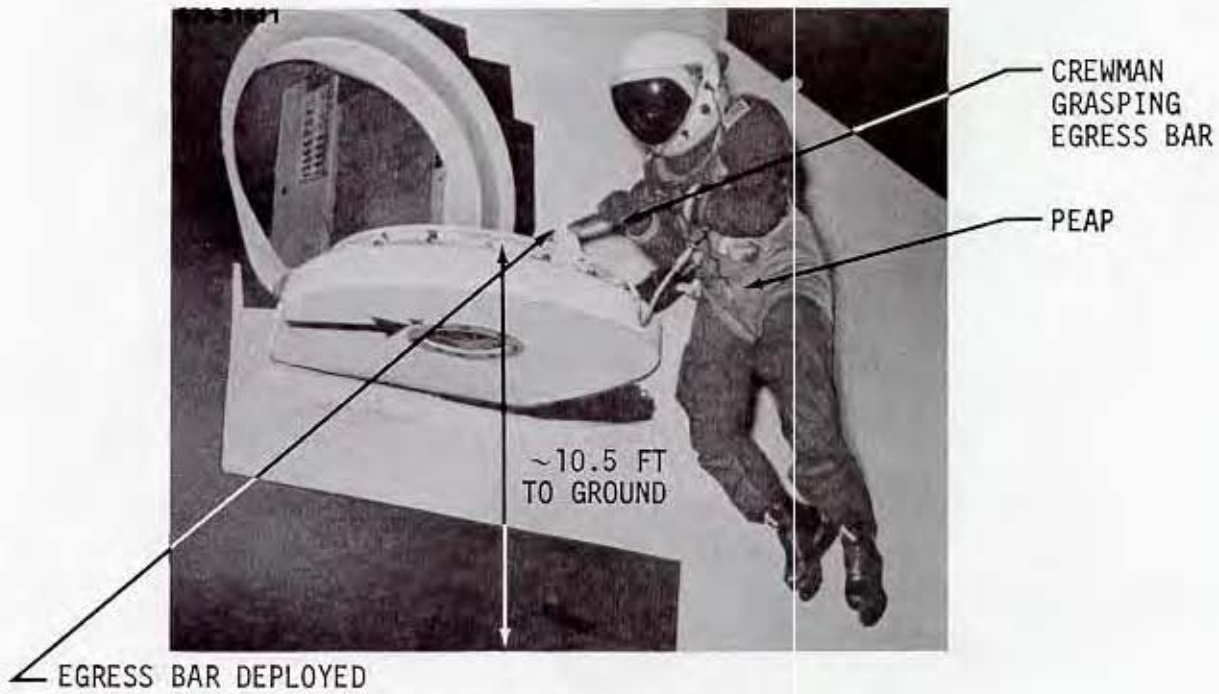
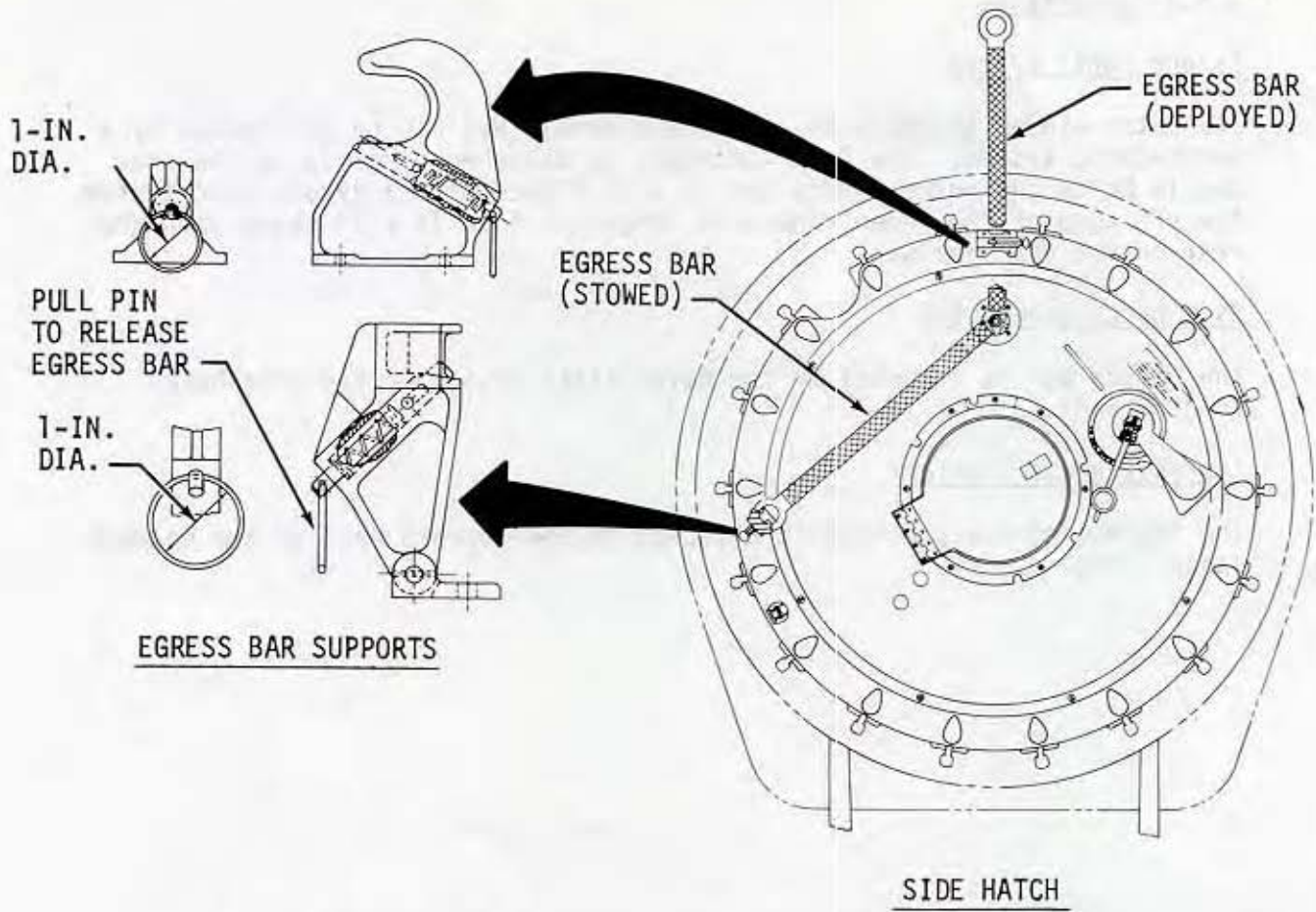


Figure 3.5-4.- Side hatch egress bar.

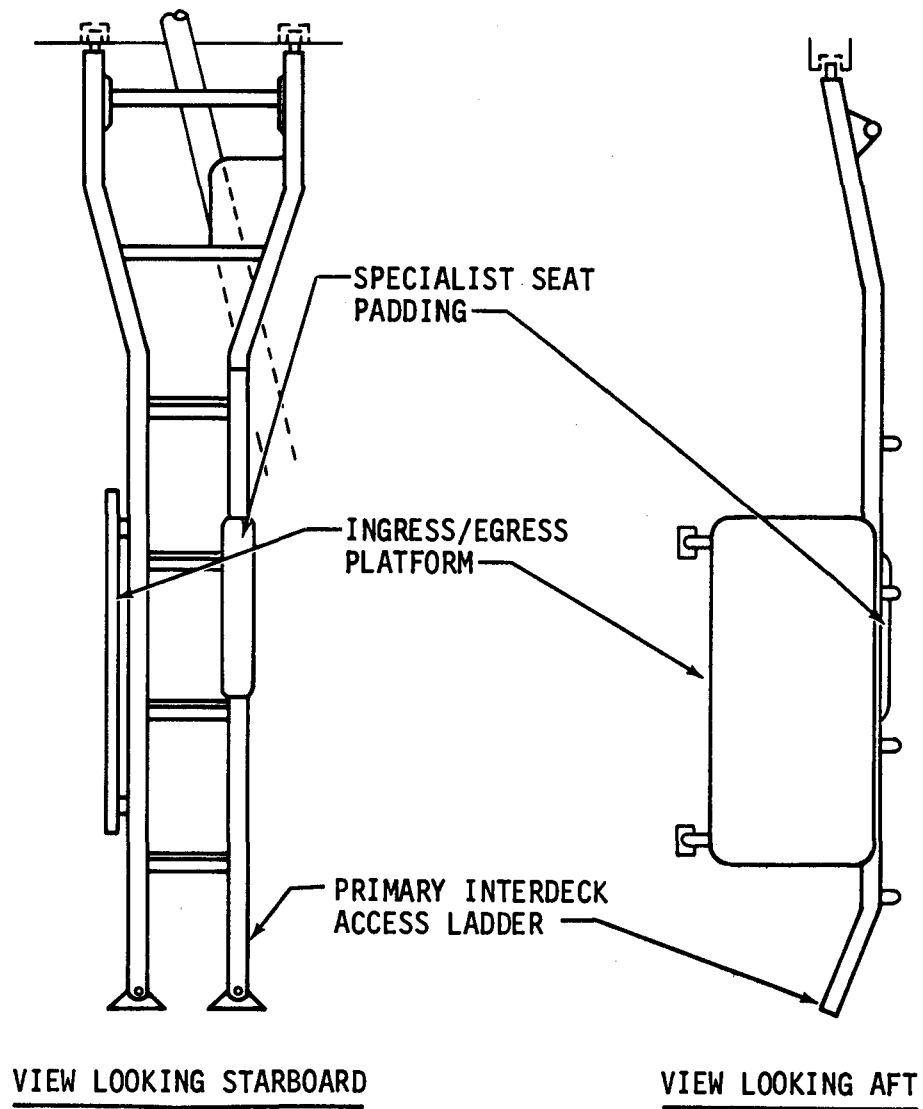


Figure 3.5-5.- Ingress/egress platform.

Egress Harness/Life Vest

The egress harness/life vest assembly attaches to the descent device by means of a carabiner on the egress harness and a snap shackle on the descent device. The egress harness/life vest assembly must be worn for launch and entry (figs. 3.5-6 and 3.5-7).

Descent Devices

A descent device for each crewmember is stowed in an individual bag located on the flight deck ceiling outboard of windows W7 and W8. Each descent device cable is permanently attached to a support bracket forward of the escape panel (W8). The cables are individually routed through recessed channels in the ceiling to each descent device (fig. 3.5-7). The descent devices are numbered sequentially to assist in preventing descent device cable and line entanglement during emergency egress. The snap shackle on each descent device attaches to each carabiner on the crewmembers egress harness.



EXPOSE HARNESS D-RING

S83-31659



CONNECT TETHER



TETHER EMERGENCY RELEASE TAB

Figure 3.5-6.- Descent device connection.

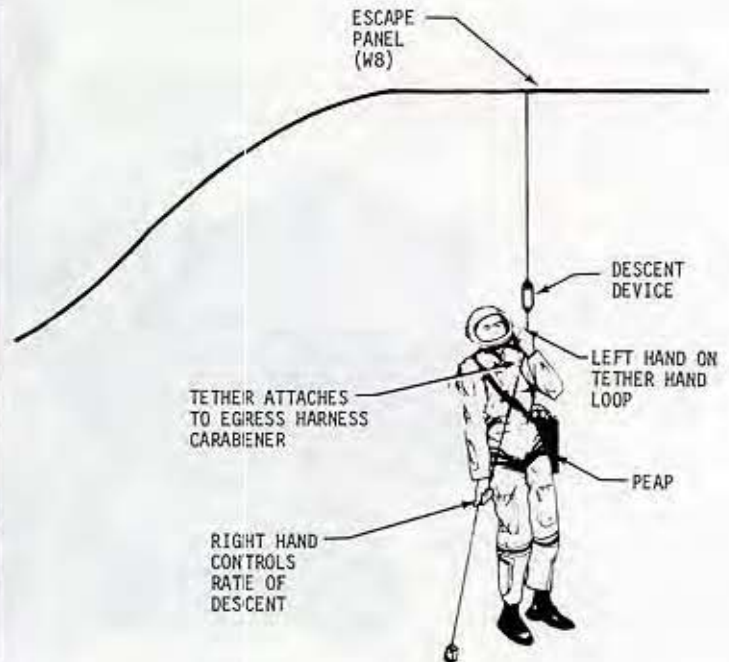
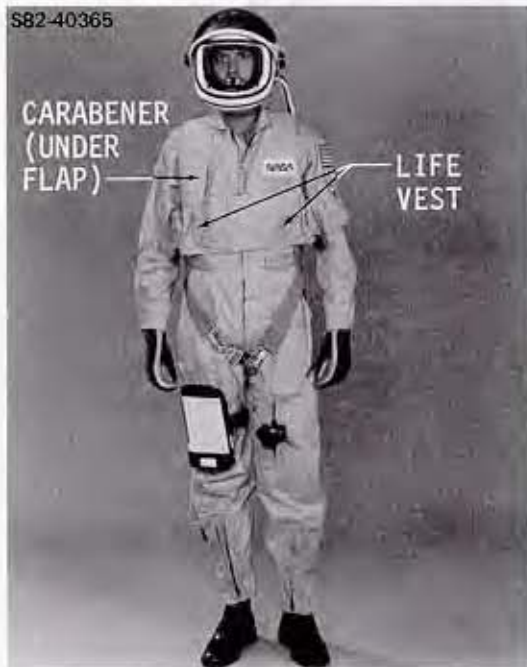
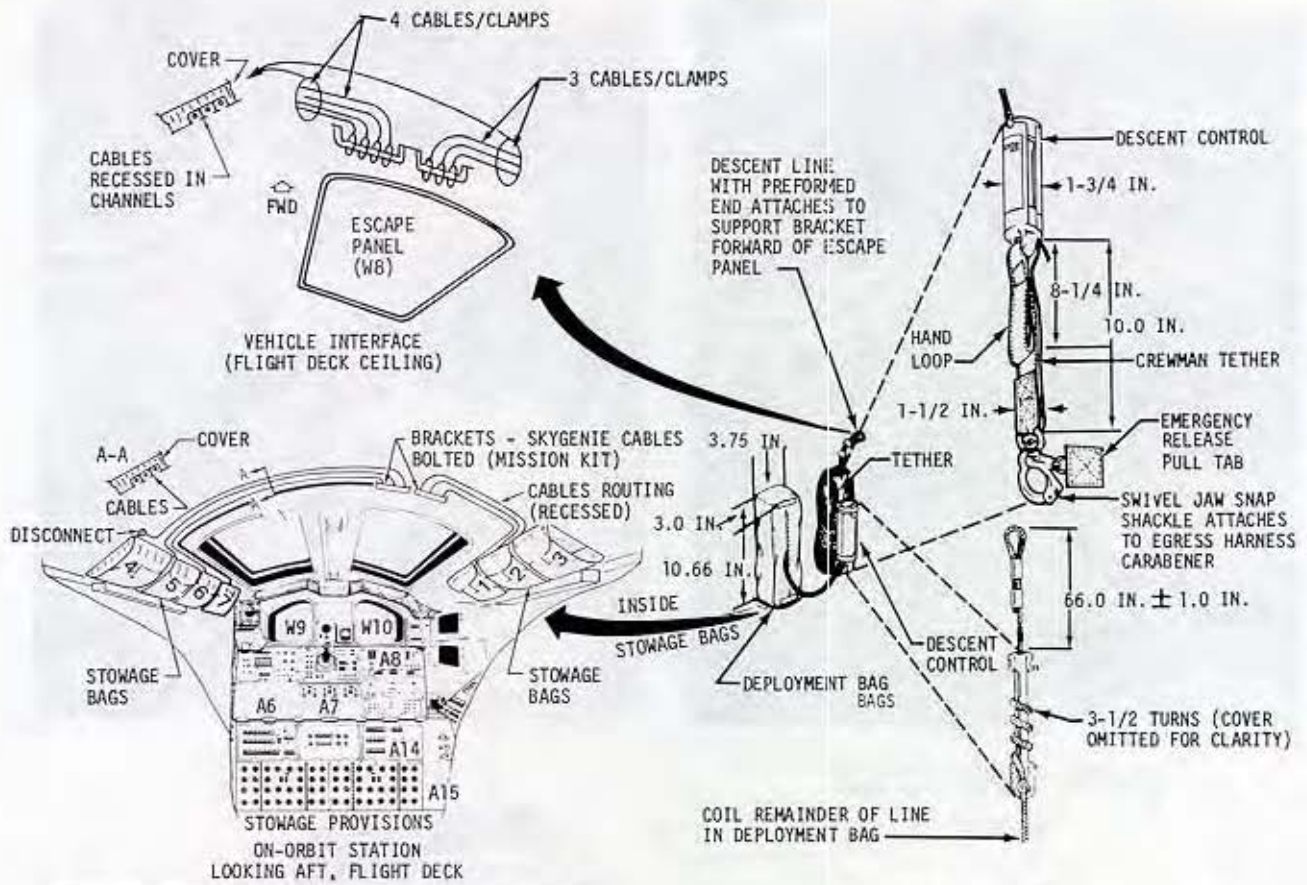


Figure 3.5-7.- Descent device - with operational seats

PEAP

Each crewmember has a PEAP for oxygen distribution during launch and entry and also for air supply during emergency egress. The PEAP contains a manifold which distributes Orbiter oxygen to the LEH and g-suit. The PEAP's are mounted on the seats for launch and entry (figs. 3.5-8 and 3.5-9). If needed for an emergency egress the PEAP is taken off the seat and attached to the D-ring on the crewmembers egress harness (fig. 3.5-8).

Survival Equipment

The Orbiter survival kit is stowed on the aft flight deck in stowage locker A17.

Emergency Egress Prybar

The emergency egress prybar is attached to the outside of the survival kit and stowed in locker A17. The ends of the prybar are color coded for primary and backup use. Because the air pressure inside the cabin is normally greater than that outside, use of the prybar will probably be required to force the emergency egress panel open.

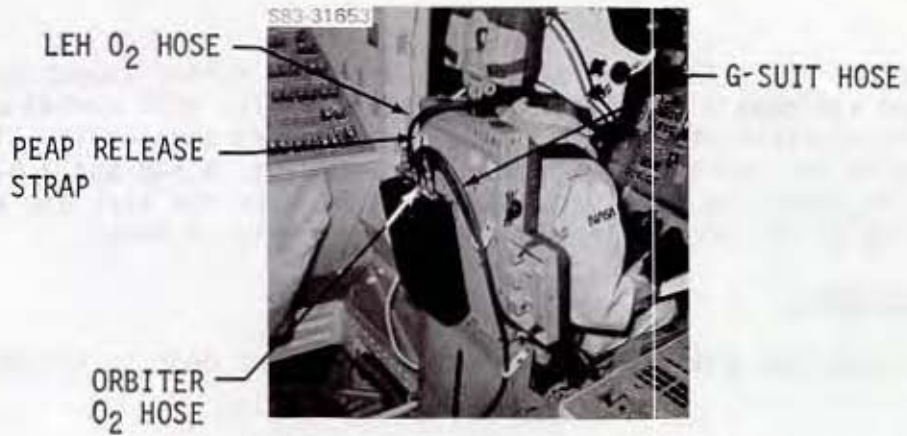
3.5.3 System Functional Description

Escape Panel System

The escape panel (W8) (fig. 3.5-3) has a pyrotechnic system which jettisons the exterior portion of the panel. This system consists of a manual percussion initiator assembly that is activated by squeezing and pulling either of two panel jettison T-handles. Upon activation, a dual strand of mild detonating fuse is fired in the outer window assembly shearing the external panel and propelling it away from the vehicle. At the same time, an expanding tube assembly is activated in the inner window, shearing it and forcing it inward. A capture device keeps the inner window panel from opening with too much force and holds it open.

The escape panel system can be activated by the crew from inside the vehicle via the panel jettison T-handle located on the center console above panel C2. In the event the crew is partially or completely disabled, ground rescue forces can activate the system from outside the vehicle via the external panel jettison T-handle located behind an access door situated below window W6 and above the leading edge of the right wing. This access door is clearly marked with a rescue arrow and instructions. To prevent inadvertent activation of the system, the panel jettison T-handle has a safing pin which must be removed before the T-handle can be pulled.

Prior to jettisoning the escape panel, all crewmembers must be breathing from their PEAP's and be clear of the window opening path.



CDR AND PLT ENTRY CONFIGURATION



DISCONNECT G-SUIT HOSE



ACTIVATE PEAP



DISCONNECT ORBITER O2 HOSE



UNSTOW, DON PEAP

Figure 3.5-8.- Personnel egress air pack (PEAP) CDR AND PLT.



SPECIALIST ENTRY CONFIGURATION



ACTIVATE PEAP



DISCONNECT ORBITER O₂ HOSE



UNSTOW PEAP



DON PEAP

Figure 3.5-9.- Personnel egress air pack (PEAP) specialist.

Under most conditions, the Orbiter cabin pressure is higher than the atmospheric pressure at the landing site. This results in a high probability that the inner window will initially open then be forced closed again. To prevent window closure, a no-back device (fig. 3.5-10) is attached to the Orbiter structure forward of the window edge. This device is spring-loaded to follow the initial window opening, engage a ratchet, and prevent subsequent window closing.

It is possible that the pressure differential between the cabin and the outside atmosphere will be so great that it precludes adequate window opening to engage the first ratchet of the no-back device. This required opening distance for the no back device to engage is 0.18 in. (0.46 cm). Until corrective measures can be incorporated, an emergency egress prybar will be flown that can be used by the crew to pry the window open to a point where the no-back device will engage. Once the no-back device is engaged, 34 sec will be required for cabin pressure equalization prior to window opening for egress. Emergency egress prybar operations are shown in figure 3.5-11.

The procedure for egress via the escape panel is shown in table 3.5-1.

Side Hatch Egress Bar

The side hatch egress bar is permanently attached to the side hatch and serves as a handhold for jumping off the side hatch. It reduces the drop distance to the ground from 10.5 ft to 3 or 4 ft (3.2 to 0.9 or 1.2 m).

For egress out the side hatch, the crew must deploy the 1.25-in. (3.18 cm) diameter egress bar. The bar rotates from its stowage position and swings out and locks into its use position (fig. 3.5-4).

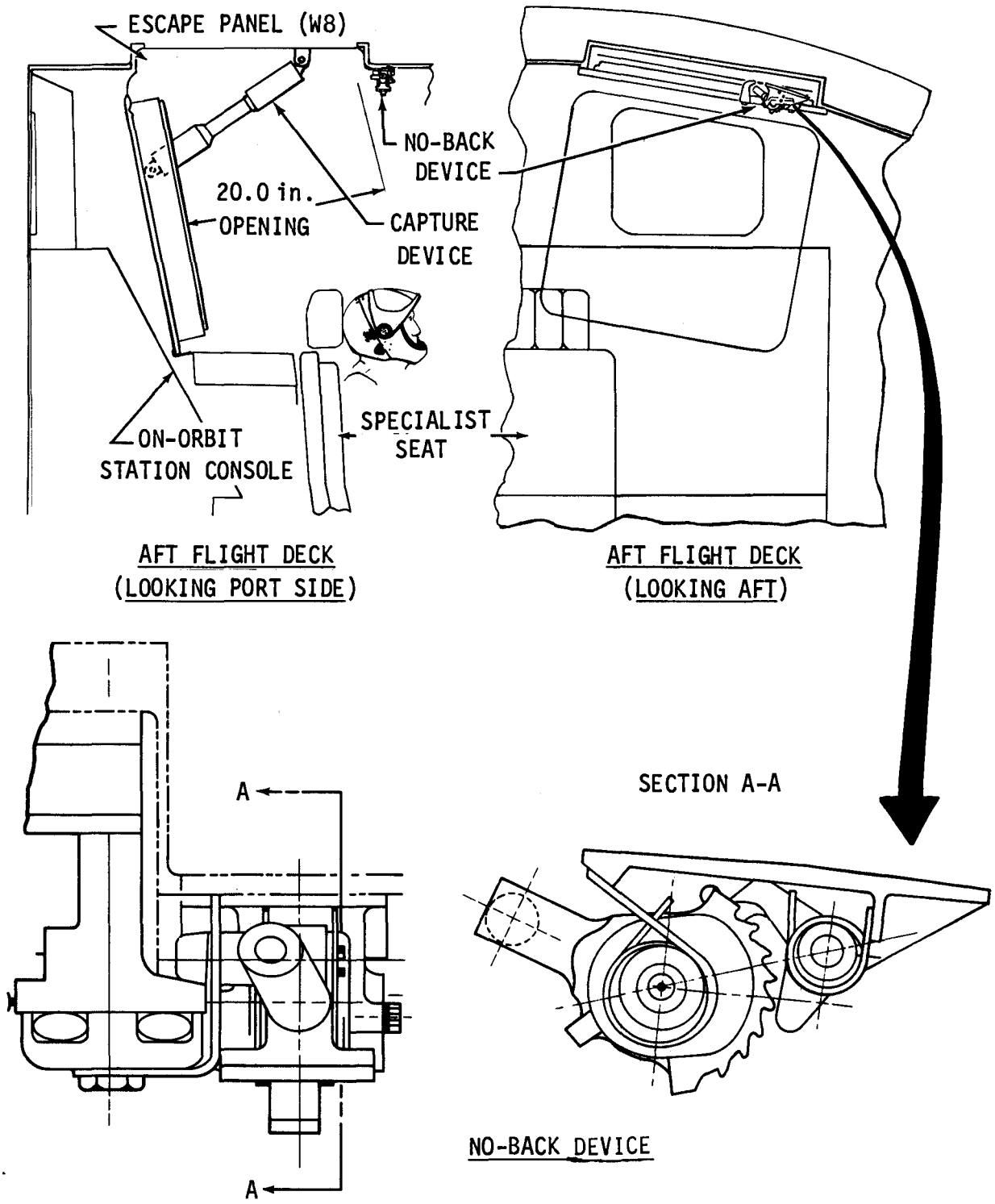


Figure 3.5-10.- Escape panel (W8) envelope.

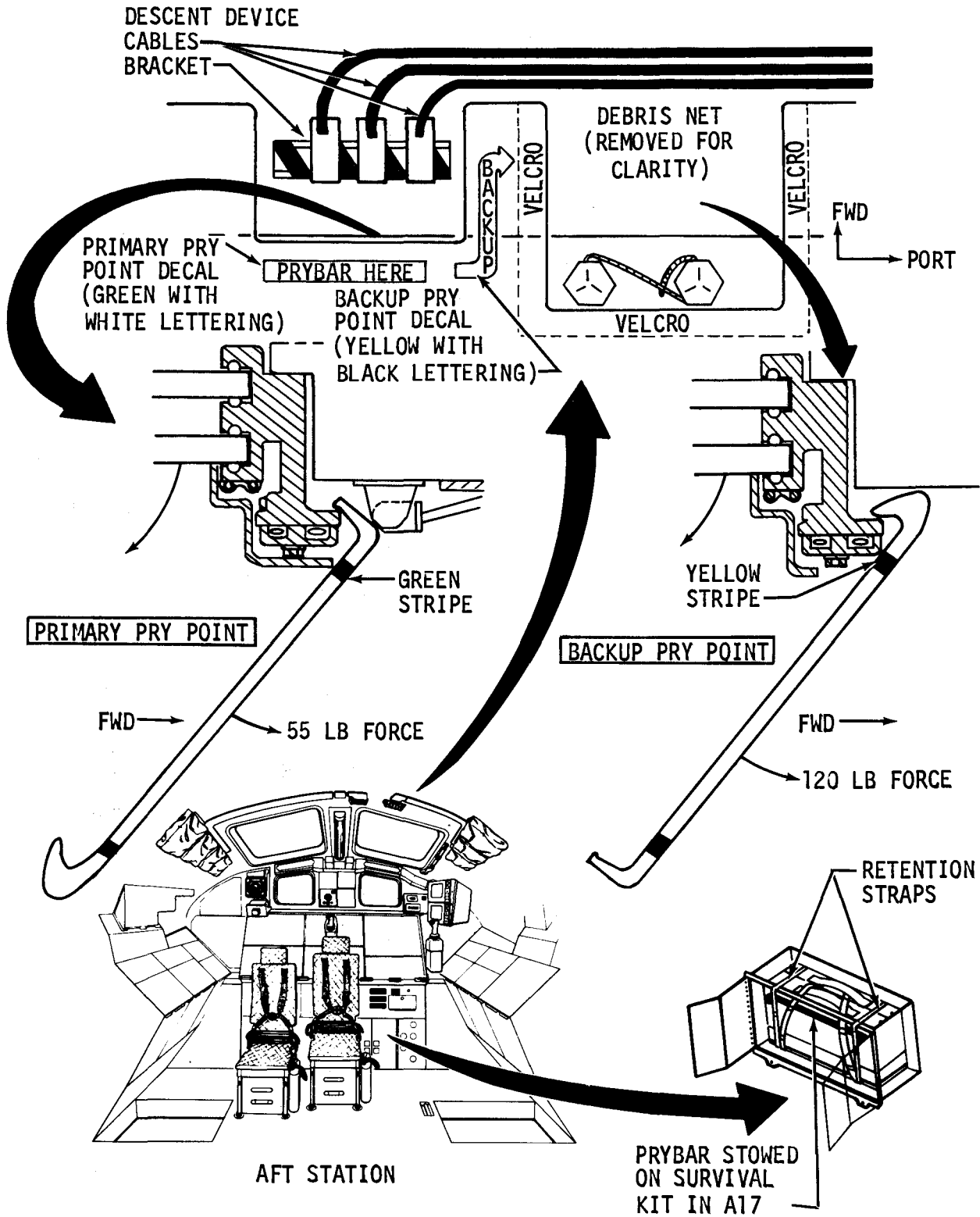


Figure 3.5-11.- Emergency egress prybar.

TABLE 3.5-1.- EGRESS PROCEDURE VIA ESCAPE PANEL*

| Procedure | Remarks |
|--|---|
| <u>DESCENT DEVICE OPERATION</u> | |
| 1 Expose harness D-ring <u>NOTE</u> Descent device stowage bags are numbered to indicate sequence of use. | 1 To expose harness D-ring, pull down on Velcroed cover |
| 2 Unstow descent device, tether, and rope deployment bag from stowage bag | 2 Do not wrap rope around descent device |
| 3 Throw rope bag overboard | |
| 4 Attach tether to harness D-ring | 4 To attach tether to harness, snap D-ring through tether snap shackle |
| 5 Pull steel cable free from plastic molding <u>NOTE</u> Keep steel cable and rope over right shoulder during escape panel egress. | |
| 6 Climb specialist seat to egress through escape panel | 6 Use left foot for first step. Seat must have arm rest installed on left side |
| <u>WARNING</u> Crewmembers should stay clear of previous crewmember's steel cable and rope until previous crewmember's rope is taut. | <u>NOTES</u> <u>TIME:</u> ~30 sec/crewmember Procedure performed sequentially, one crewmember at a time |

*Procedure assumes that escape panel has been jettisoned.

TABLE 3.5-1.- Concluded

| Procedure | Remarks |
|--|--|
| <div style="border: 2px solid black; padding: 5px; text-align: center;"> <p>WARNING Slow descent immediately before reaching the ground.</p> </div> | |
| <p>7 Descend to ground with one hand on rope (to control descent rate) and other through tether hand loop (to hold descent device in front)</p> | <p>7 Descent is approx. 23 ft (7m)</p> |
| <div style="border: 2px solid black; padding: 5px; text-align: center;"> <p>WARNING Do not release tension on rope during emergency release or free fall will result.</p> </div> | |
| <p>8 If rope becomes wrapped around descent device or if it locks - perform emergency release</p> <ul style="list-style-type: none"> * Loop free end of rope * * through D-ring (2 turns) * * Hold tension on rope * * Emergency release tab - pull * * Descend to ground * | <p>8 Control descent rate by hand tension on free end of rope</p> |
| <p>9 When on ground, disconnect rope from harness</p> | <p>9 Depress side of D-ring and unhook from rope or pull emergency release tab while holding tension on the rope</p> |

Ingress/Egress Platform

The ingress/egress platform is provided to aid crewmembers in ingress and egress from the middeck specialist seats while the vehicle is in the vertical (launch) position (figs. 3.5-2 and 3.5-7).

Egress Harness/Life Vest

The descent device attaches to the crewmember's carabiner (fig. 3.5-6) located on the right chest of the egress harness.

The life vest (fig. 3.5-12) provides 24-hour flotation capability for a maximum-size crewmember. The crewmember inflates the vest by pulling two inflation tabs which activate the CO₂ bottles. The vest can also be inflated orally.

Descent Device

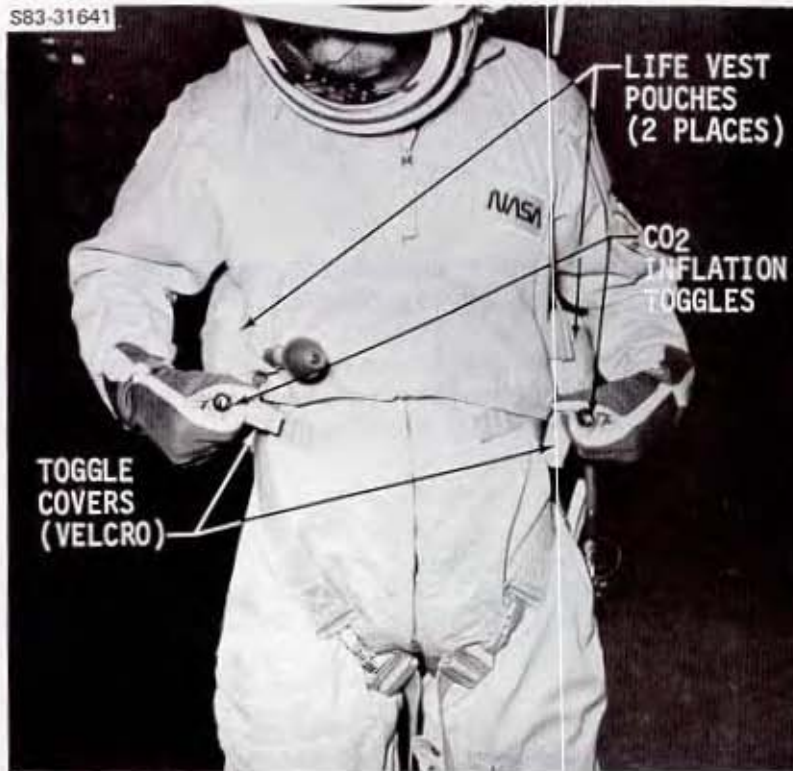
Descent devices permit emergency egress over the side of the vehicle at a controlled rate of descent (fig. 3.5-7). Each descent device consists of the following:

- Nylon rope
- Tether with emergency release tab
- Descent control assembly
- Deployment bag

During emergency egress, each crewmember, one at a time, must remove a descent device from its stowage bag on the ceiling (numbered for correct sequential use); unstow and attach the tether snap shackle to the egress harness carabiner; throw the deployment bag out the escape panel and over the side of the Orbiter; then, using the specialist seat as a step, egress out the escape panel and descend using the descent device.

The ropes are 3/8-in.-diameter (9.5-mm) 50-ft-long (15.24-m) nylon lines with 3-1/2 turns around the descent control. A preformed loop on one end is used to attach the rope to a steel cable that is anchored to the vehicle on the flight-deck ceiling forward of the escape panel. The tether is attached directly to the descent control and connects to the crewmember's egress harness carabiner by means of a snap shackle. The descent control assembly allows the crewmember to lower himself to the ground at a controlled rate of descent. The deployment bag contains the rope and prevents it from becoming entangled before deployment. The descent devices are stowed on the flight-deck ceiling outboard of windows W7 and W8.

The descent device tether includes an emergency release pull tab. In the event that the descent device becomes jammed, the crewmember can loop the rope through the egress harness carabiner (two turns), hold tension on the rope, then pull the emergency release tab that will disengage the tether snap shackle from the carabiner (fig. 3.5-6). After release, the crewmember can control his descent in the same manner as the descent device. The critical difference between using the carabiner instead of the descent device



LIFE VEST ACTIVATION



INFLATED LIFE VEST

Figure 3.5-12.- Life vest.

is that if the crewmember releases tension on the rope free fall will result.

PEAP

Each crewmembers PEAP functions as an oxygen distribution manifold during ascent and entry, and provides air for emergency egress. The PEAP consists of the following components (fig. 3.5-13):

- Two air bottles/protective cover/mounting bracket
- Pressure regulator
- Pressure gage
- Relief valve
- Shutoff valve
- Air/oxygen distribution manifold
- LEH O2 hose connector
- G-suit O2 hose connector
- Orbiter Oxygen inlet connector (QD)
- Restraint hook
- Release strap

When the PEAP is used for emergency egress, the internal air supply must first be activated by means of the shutoff valve. Then, the Orbiter oxygen supply QD is disconnected, and the PEAP is released from the seat mounting bracket. The restraint hook on the PEAP is then attached to the egress harness D-ring and the crewmember conducts an emergency egress. A check valve in the air/oxygen distribution manifold prevents airflow from the PEAP to the g-suit.

Survival Equipment

- Orbiter Survival Kit

The Orbiter survival kit provides land and sea survival capability for eight crewmembers for 48 hr. The kit is packaged in a single container which can be deployed through the side hatch or the escape panel (W8) by a single crewmember. The kit is stowed on the flight deck in compartment A17, and consists of the following components (figs 3.5-14 through 3.5-16):

- Life raft (eight-person), consisting of
 - CO2 inflation assembly
 - Mooring lanyard assembly
 - Oral inflation tube
 - Bellows pump
 - Bailing bucket
 - Sea anchor
 - CO2 valve cover

- Signaling equipment
 - Personnel distress signal kit (A/P 25S-5A, launcher and 7 flares)
 - Smoke/illumination flare (2) (MK 13, MOD 0, day/night)
 - Sun mirror, large (2) (MK 13, type II, 3 by 5 in. (7.6 by 12.7 cm))
 - Radio/beacon with spare batteries (PRC-96)
 - Sea dye marker (2)

- Other survival equipment
 - Survival first aid kit
 - Survival blanket
 - Survival knife assembly (A1 pocket knife)
 - Desalter bags (7) and chemical packets (14)
 - Drinking water cans (8)
 - Survival manual
 - Matches with waterproof container

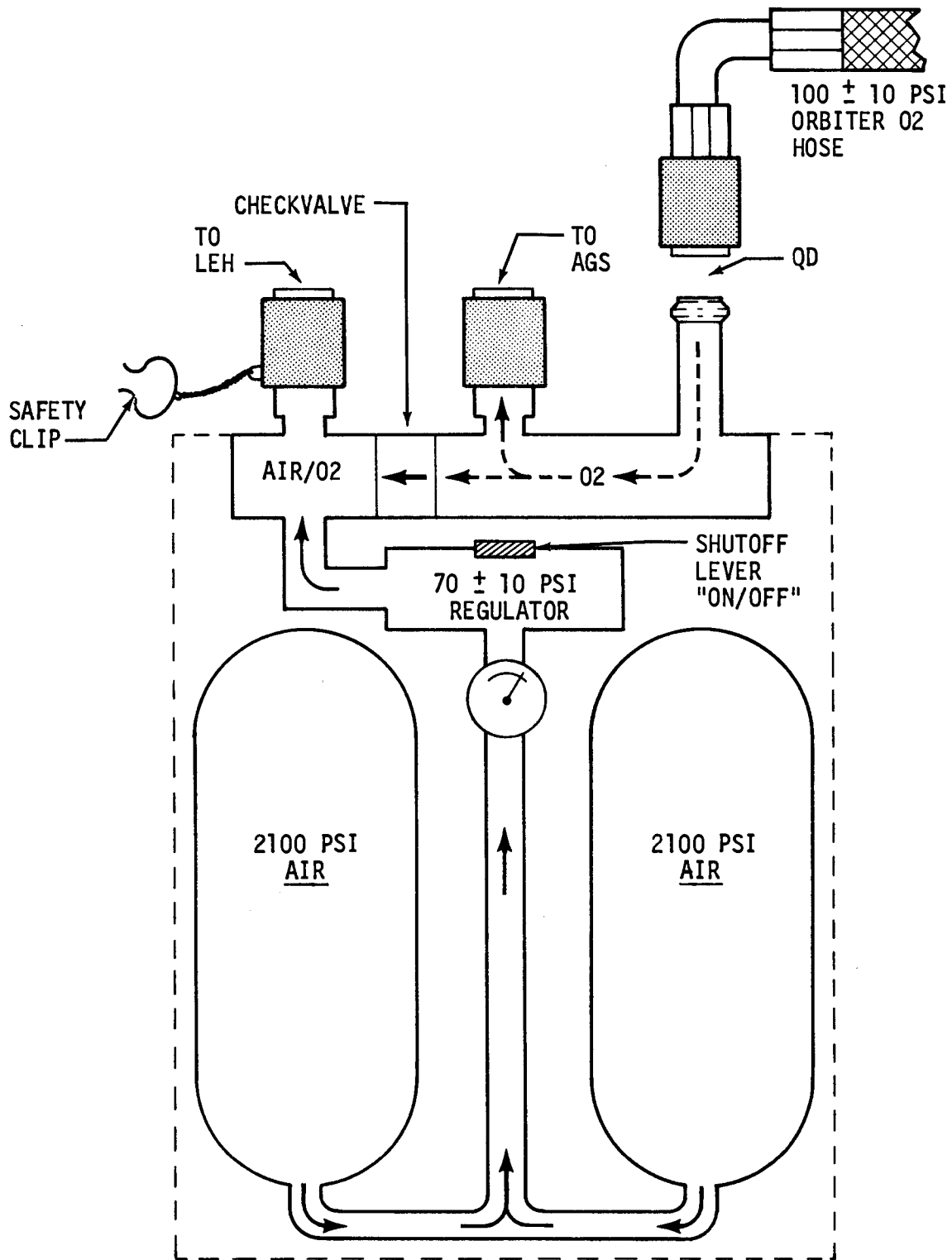
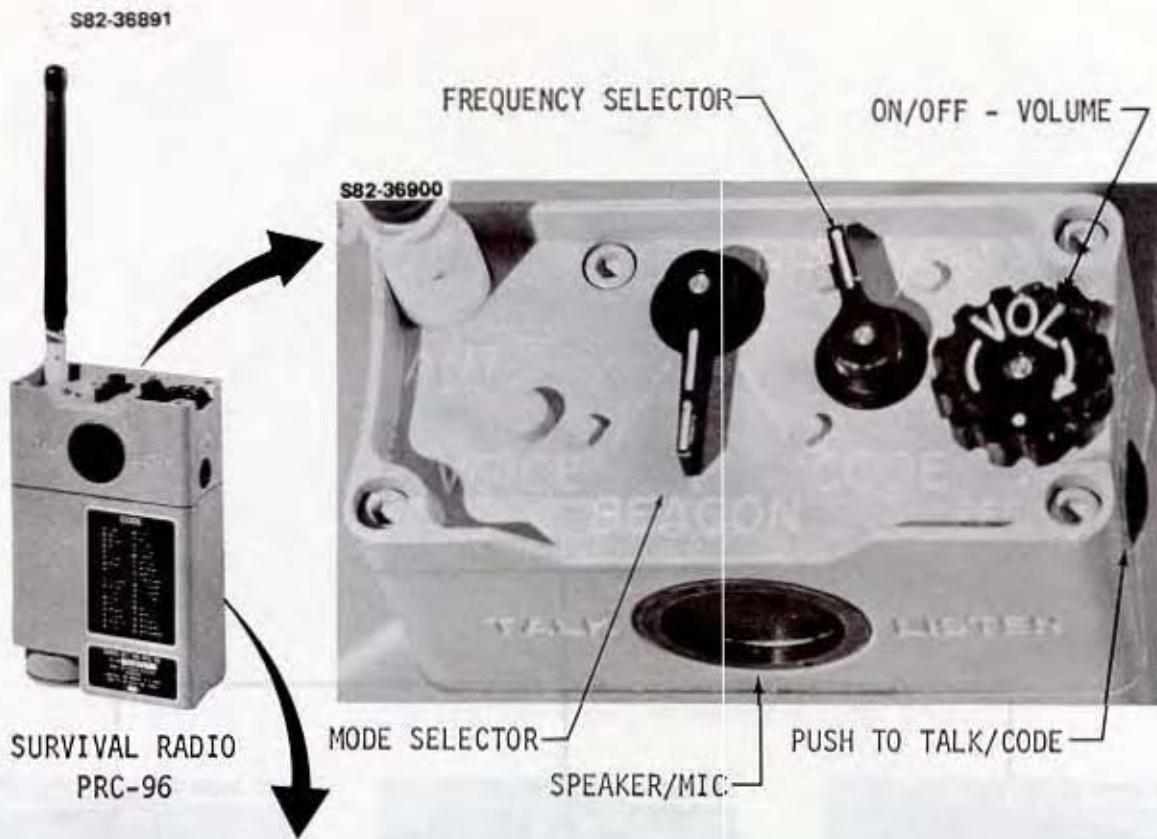


Figure 3.5-13.- Personnel egress air pack (PEAP) schematic.

3.5-23



S82-36888

OPERATING INSTRUCTIONS

A. TRANSMIT

1. VOICE: SELECT "VOICE" MODE. PRESS "PUSH TO TALK/CODE" BUTTON AND SPEAK INTO "TALK" MIKE.
2. BEACON: SELECT "BEACON" MODE. TRANSMISSION IS AUTOMATIC.
3. CODE: SELECT "CODE" MODE. PRESS "PUSH TO TALK/CODE" BUTTON TO SEND DOTS AND DASHES PER CODE CHART.

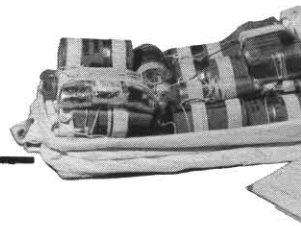
B. RECEIVE

1. VOICE: SELECT "VOICE" MODE. SELECT DESIRED FREQUENCY AND ADJUST VOLUME TO DESIRED LEVEL. (DO NOT DEPRESS "PUSH TO TALK/CODE" BUTTON.)

OPERATING INSTRUCTIONS (BACK)

Figure 3.5-15.- Orbiter survival kit - survival radio.

S-82-36899



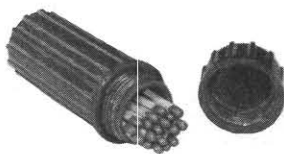
SIGNALING

S-75-31770



SEA DYE MARKER

S-76-28597



MATCHES

S-75-31761



SUN MIRROR

SURVIVAL EQUI

1

S-82-36891



SURVIVAL RADIO AND SPARE BATTERY

S-75-31756



SIGNAL, SMOKE AND ILLUMINATION

2

OPERATING INSTRUCTIONS

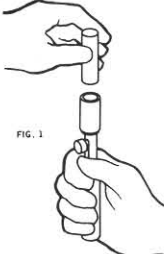


FIG. 1

1. DO NOT POINT LOADED LAUNCHER AT SELF OR OTHERS.
2. INSERT NOZZLE END OF SIGNAL INTO LAUNCHER FIRMLY UNTIL SIGNAL BOTTOMS OUT (FIGURE 1).
3. HOLD SIGNAL ABOVE HEAD AND AIM IN DESIRED DIRECTION.

WARNING

DO NOT HOLD SIGNAL IN FRONT OF FACE BEFORE FIRING


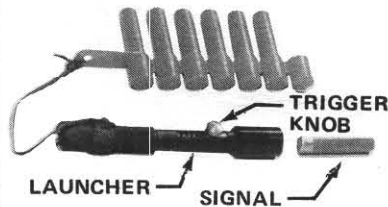


FIG. 2

4. PULL TRIGGER KNOB TO THE REAR OF SLOT WITH THUMB AND RELEASE QUICKLY (FIGURE 2).
5. IF SIGNAL DOES NOT FIRE, REPEAT THE ABOVE STEPS AND BE SURE THE THUMB DOES NOT DRAG ON THE KNOB DURING RELEASE.

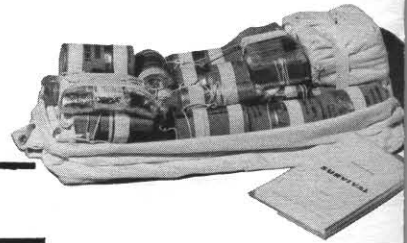
SIGNAL KIT, PERSONNEL, DISTRESS, A/P255-SA
PSN 1370-490-7302 (L-119)
LOT NO. MBA 5-5
12-1974
MEG. IDENT. 27934
CONTRACT NO. F33657-74-C-0424

S-75-31772



SIGNAL KIT, PERSONNEL DISTRESS

S-82-36899



SIGNALING

S-76-28597

S-75-31761

SURVIVAL EQUIPMENT



DYE MARKER



MATCHES



SUN MIRROR

S-75-31756



SIGNAL, SMOKE AND ILLUMINATION

**IO AND
TERY**

OPERATING INSTRUCTIONS




FIG. 1

- DO NOT POINT LOADED LAUNCHER AT SELF OR OTHERS.
- INSERT NOZZLE END OF SIGNAL INTO LAUNCHER FIRMLY UNTIL SIGNAL BOTTOMS OUT (FIGURE 1).
- HOLD SIGNAL ABOVE HEAD AND AIM IN DESIRED DIRECTION.

WARNING
DO NOT HOLD SIGNAL IN FRONT OF FACE BEFORE FIRING


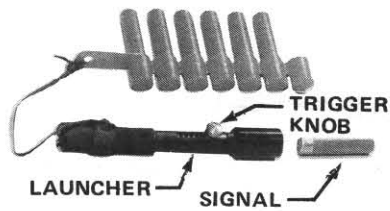


FIG. 2

- PULL TRIGGER KNOB TO THE REAR OF SLOT WITH THUMB AND RELEASE QUICKLY (FIGURE 2).
- IF SIGNAL DOES NOT FIRE, REPEAT THE ABOVE STEPS AND BE SURE THE THUMB DOES NOT DRAG ON THE KNOB DURING RELEASE.

SIGNAL KIT, PERSONNEL, DISTRESS, A/P255-SA
FSN 3370-490-7362 (L-119)
LOT NO. MBA 5-5
12-1974
MEG. IDENT. 27934
CONTRACT NO. F33657-74-C-0424

S-75-31772



SIGNAL KIT, PERSONNEL DISTRESS

FIRST AID

S-76-28607



KNIFE

S-75-31771



EMERGENCY DRINKING WATER

S-82-36893



FIR

S-82-36890



SURVIVAL BLANKET

S-82-36892

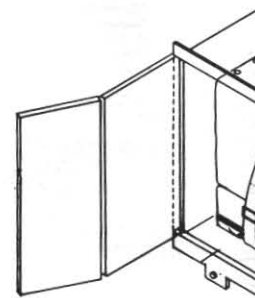


DESALTER KIT

S-76-28593



SURVIVAL MANUAL



SURVIVAL KIT STOWE

ORBITER SURVIVAL KIT



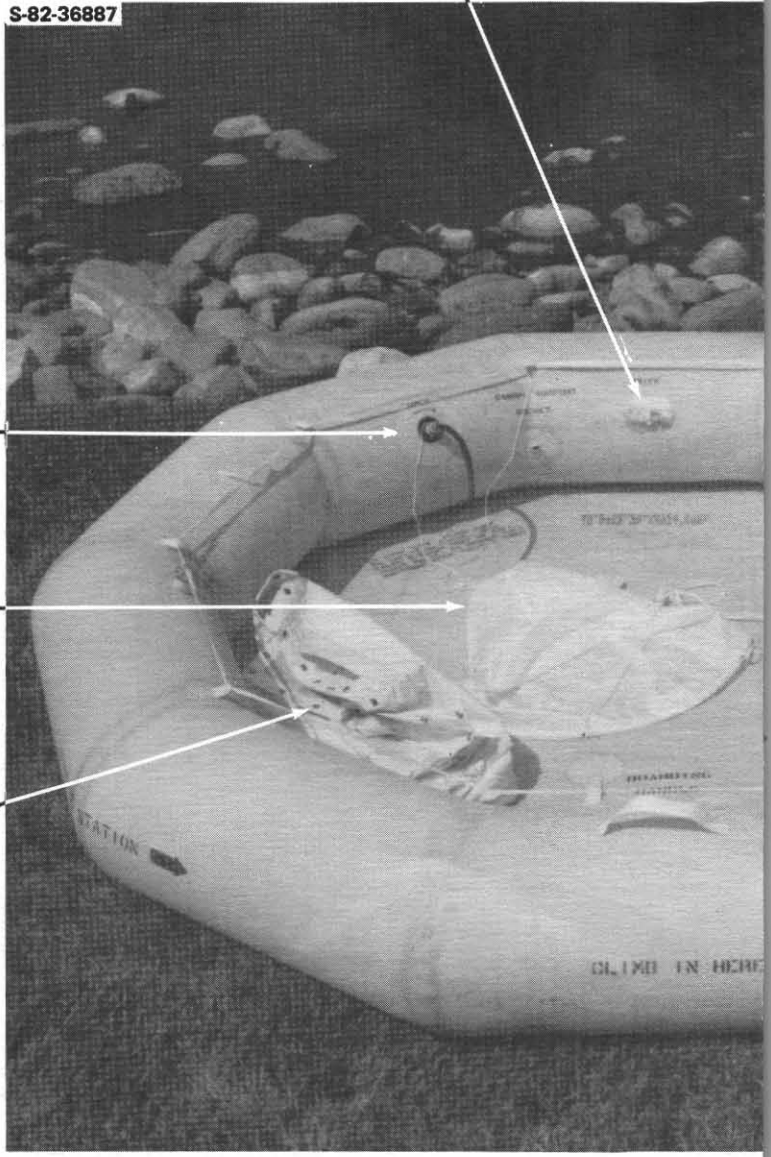
S-82-36893



FIRST AID KIT

KNIFE

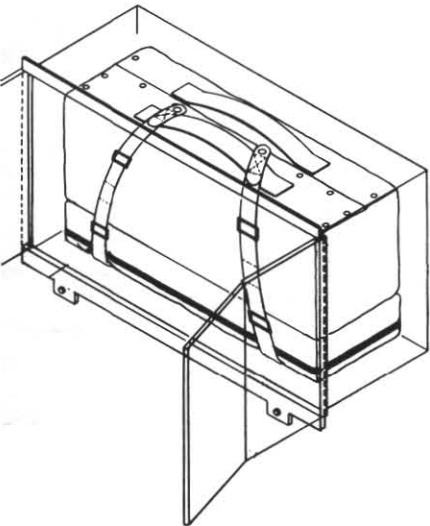
S-82-36887



ORAL INFLATION
TUBE

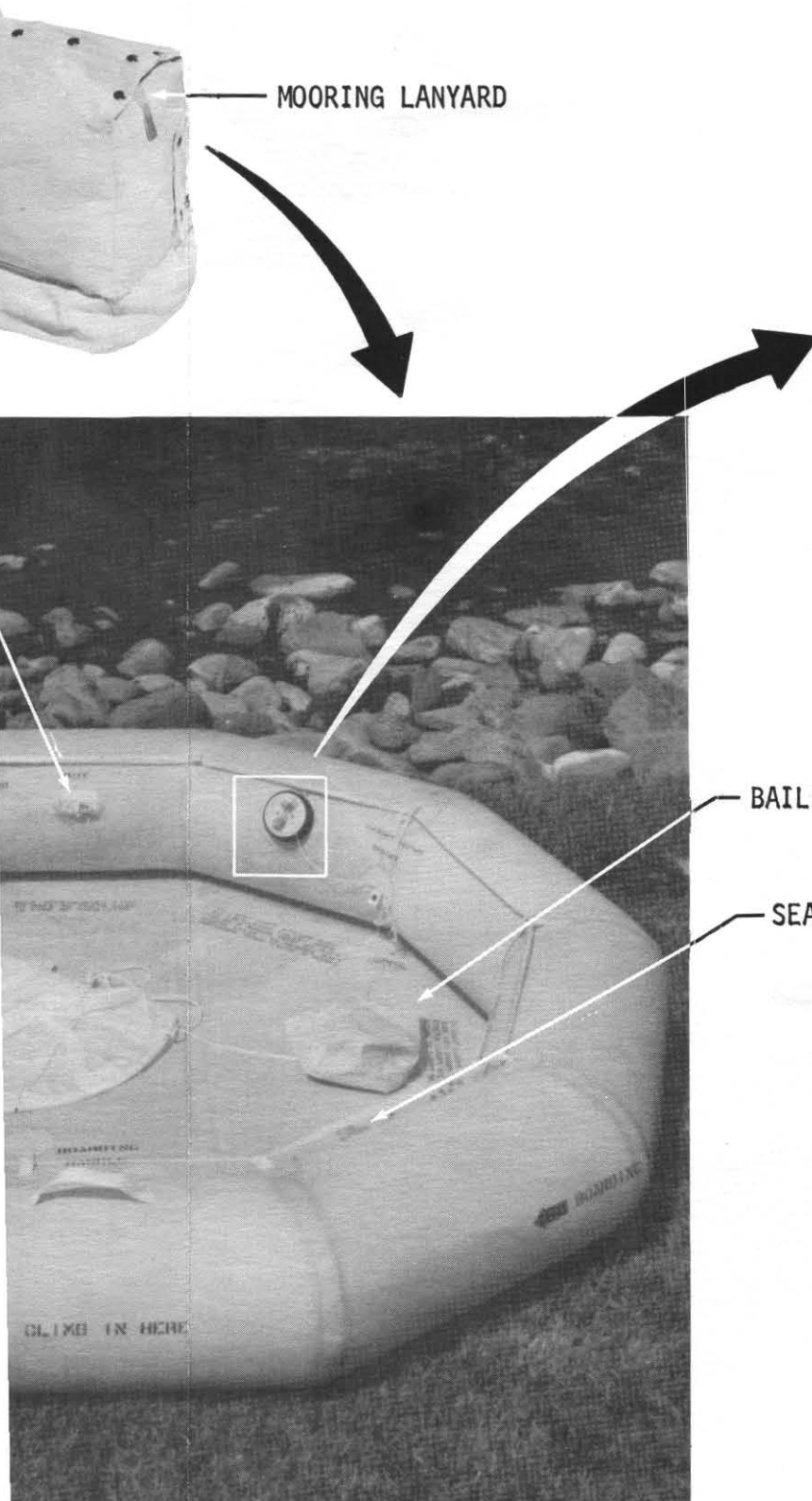
SEA ANCHOR

SURVIVAL KIT
CONTAINER

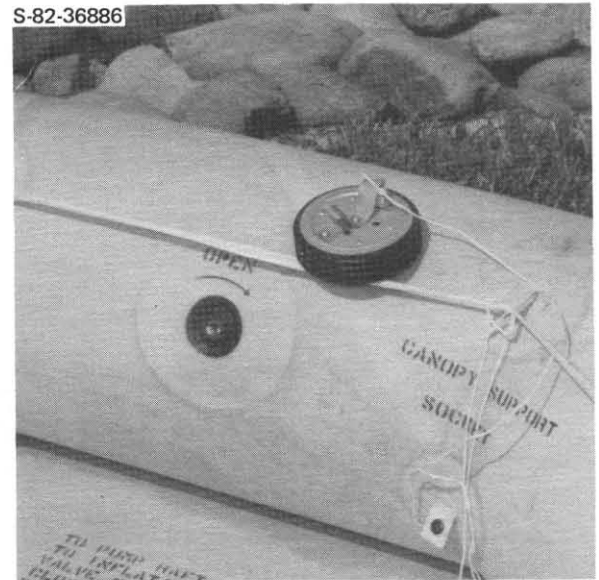


STOWED IN AFT FLIGHT DECK(A17)

LIFE RAFT



MOORING LANYARD



S-82-36886

BELLOWS PUMP

BAILING BUCKET

SEA DYE MARKERS

- 5 SEE TABLE 3.5-2 FOR DETAIL
- 4 MOORING LANYARD EXPOSED ON END OF SURVIVAL KIT USED TO TETHER KIT TO ORBITER AUTOMATICALLY INFLATES LIFE RAFT AFTER DEPLOYED 20 FT
- 3 SEE FIG 3.5-16 FOR DETAIL
- 2 SEE FIG 3.5-15 FOR DETAIL
- 1 ATTACHED TO LIFE RAFT

LIFE RAFT

Figure 3.5-14.- Orbiter survival kit.

140A

S82-36893



SURVIVAL FIRST AID KIT

S82-36896



S82-36897



S82-36898



CONTENTS LIST

ADHESIVE TAPE
 AMPHETAMINE (20)
 ANTIBIOTIC TABLET (30)
 ANTIMOTION SICKNESS TABLET (20)
 ANTISEPTIC PAD (12)
 ASPIRIN TABLETS (20)
 BANDAGE - 37 IN. BY 37 IN. BY 52 IN. (2)
 BANDAID - 3/4 IN. (8)
 BANDAID - 1 IN. (8)

COMPRESS - 4 IN. BY 4 IN. (4)
 EYE OINTMENT
 EYE PAD (8)
 LIP OINTMENT (3)
 MORPHINE INJECTABLE (4)
 NAUSEA SUPPOSITORY (7)
 PAIN TABLETS (10)
 SUNSCREEN (2)
 SYRINGE

Figure 3.5-16.- Orbiter survival kit - first aid kit.

TABLE 3.5-2.- DESALTER KIT OPERATION

| Procedure | Remarks |
|--|--|
| 1 Fill bag with sea water | |
| 2 Turn vlv cw to close | 2 Make sure valve is closed |
| 3 Take out one pack of chemical and reclose container | |
| 4 Remove outer wrapping and place chemical in bag filled with sea water to heavy line near 16-ounce mark | 4 Kit does not remove all salt. If less salty water desired, fill bag to ~1 in. below filling line |
| 5 Fold top of bag down tightly, roll toward fastener, and snap securely to make water tight seal | |
| 6 Let chemical stand in bag for a few minutes, and it will disintegrate | |
| 7 If necessary, pulverize chemical by kneading gently until dissolved | |
| 8 Agitate bag gently for 60 minutes | |
| 9 To drink water unscrew valve at bottom of bag without squeezing bag. Put valve in mouth and gently squeeze bag or suck on valve. Spit out first few drops if too salty | |
| 10 When finished drinking, close valve. Any remaining water can be left in bag until wanted | |

TABLE 3.5-2.- Concluded

| Procedure | Remarks |
|--|--|
| 11 When all water is drawn from bag, rinse out chemical with sea water. Bag is then ready for next batch | |
| 12 In case the bag develops a puncture or tear, carefully dry the affected part and then apply a patch of mending tape | 12 Mending tape not part of the survival kit |
| | <p data-bbox="1062 661 1146 695"><u>NOTES</u></p> <p data-bbox="997 695 1078 728"><u>TIME:</u></p> <ul data-bbox="997 728 1341 793" style="list-style-type: none"><li data-bbox="997 728 1341 762">● Steps 1-6: 5 min<li data-bbox="997 762 1341 793">● Step 7: 1 hr <p data-bbox="997 825 1406 888">Kit will not purify fresh water.</p> |

3.5.4 Systems Performance, Limitations, and Constraints

Escape Panel System

- Escape panel

- Dimensions of opening: 19.8 by 19.5 in. (50.3 by 49.5 cm)

Descent Device

- Diameter of rope: 3/8-in. (9.5-mm)
- Length of rope: 50 ft (15.2-m)
- Descent device proof loading: 4000 ± 100 lb ($17,800 \pm 445$ N)
- Rope assembly proof loading: 1250 ± 50 lb (5500 ± 220 N)
- Rope strength: 2500 lb (11,000 N)
- Maximum load rope is subjected to 576 lb (2560 N) for a 240-lb (109-kg) man using 3-1/2 turns on the descent device, with a spring constant of 0 at the attach point
- Safety factor: 2.2

PEAP

- Weight: 7.6 lb (3.45 kg)
- Maximum crewmember work rate: 1500 Btu/hr (378 kcal/hr)
- Flow capability
 - 7 lb/hr (3.2 kg/hr) instantaneous
 - 2.2 lb/hr (1.0 kg/hr) average
- Use time: 6 min under emergency conditions
- Cylinder size: 45 in.³ (0.73 liter), 3.25-in. (8.25-cm) diameter (two)
- Regulator output: 70 ± 10 psid (483 ± 70 kN/m²)
- Pressure relief valve assembly relief pressure: 130 ± 10 psi (897 ± 69 KN/m²) (keeps air above this pressure from entering the breathing hose)

Survival Equipment

- Orbiter Survival Kit

- Size: 12 by 16 by 30 in. (30.5 by 40.6 by 76.2 cm)
- Weight: 47 lb (21.3 kg)
- Life raft:
 - Inflation time: <30 sec
 - Capacity: 8-persons
- Mooring lanyard assembly:
 - Length: 50 ft (15.25 m)
 - Raft length (inflated): 20 ft (6.1 m)
 - Raft inflation force: 25 lb (111 N)
 - Breakaway force: 200 lb (890 N) (force required to part mooring lanyard)
 - Sea anchor: PER MIL-A 3339

- Radio (PRC-96) with spare battery set
 - Operating modes
 - 121.5 or 243.0 MHz voice (transmit/receive)
 - 121.5 or 243.0 MHz AM-MCW (transmit)
 - 121.5 and 243.0 MHz beacon (alternating transmit)
 - Battery
 - Type: Lithium
 - Life: (per battery set) 42 hr continuous beacon, 60 hr at 30-percent voice transmit/70-percent voice receive
 - Range
 - Beacon: 50 n. mi. (92 km)
 - Voice: 30 to 40 n. mi. (55 to 74 km)
- Signal Kit, personnel distress (A/P 25S-5A)
 - PER NSN 1370-00-490-7362
 - Launcher, seven flares
 - Altitude above ground level: 700 to 1400 ft (213 to 427 m)
 - Flare duration: 9 sec
 - Visibility range: 18 to 20 n. mi. (33 to 37 km)
- Signal, smoke and illumination (MK13-MOD 0)
 - PER NSN 1370-00-309-5028
 - Modes (opposite ends of signal):
 - Day operation: Smoke
 - Night operation: Flare
 - Signal duration: 18 sec
 - Visibility range: 7 n. mi. (13 km)
- Sea dye marker
 - PER MIL-A-17980
 - Produces yellow-green slick
 - Duration: Short duration (used for visual aid after the aircraft is in vicinity)
 - Visibility range: 2 to 3 n. mi. 3.7 to 5.6 km)
- Sun mirror (large, MK 13 type II)
 - PER NSN 6350-00-299-6198
 - Size 3 by 5 in. (7.6 by 12.7 cm)
 - Visibility range: 18 n. mi. (33 km) under ideal conditions
- Survival knife: PER MIL-K-818
- Desalter kit: PER NSN 4610-001372-0592
- Drinking water (can):
 - Volume: 10 oz. (380 ml)
 - Quantity stowed: 8

3.6 EMERGENCY BREATHING PROVISIONS

3.6.1 Introduction - Orbiter Emergency Breathing Provisions

Emergency breathing provisions for all crewmembers consist of the Launch and Entry Helmet (LEH) connected to the Personnel Egress Air Pack (PEAP) for prelaunch or postlanding emergency egress and the LEH connected to Orbiter oxygen for on-orbit emergency breathing.

For launch and entry (fig. 3.6-1), all crewmembers wear LEH's that are connected to seat-mounted PEAP's. During nominal operations, the PEAP receives Orbiter oxygen through a supply hose and distributes it to the LEH for breathing and to the g-suit for inflation (entry only). For emergency egress, the PEAP provides a regulated air supply to the LEH only for a period of 6 minutes (fig. 3.6-2 and Table 3.6-1).

Since an independent oxygen supply does not exist for on-orbit emergency breathing, all crewmembers are provided with a minimum of 7 ft (2.1 m) of oxygen hose for mobility table 3.6-2. This length combined with the existing hose on the LEH results in a mobility range of 11 ft (3.35 m) from the Orbiter oxygen supply outlets.

Hardline communication capability is provided using the Headset Interface Unit (HIU) and comm cables. Each crewmember has a sufficient length of comm cable to enable communication while wearing the LEH throughout the full range of mobility afforded by the oxygen hose. In addition, the LEH is compatible with the wireless crew communications system (WCCS).

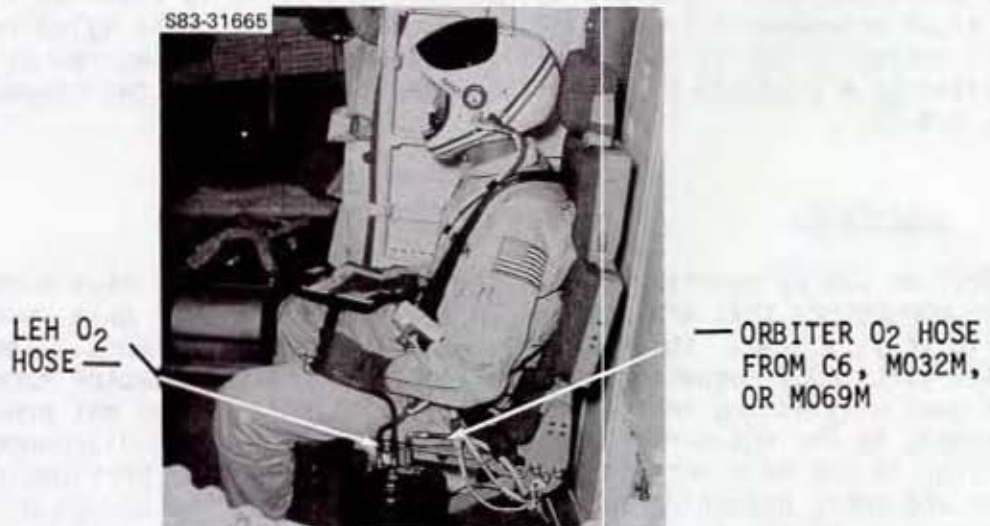
Since there are only eight LEH O₂ outlets, a T-valve is flown on flights with eight crewmembers to provide a redundant outlet. The valve remains stowed unless an LEH O₂ outlet fails. If needed, the valve can be connected to a good LEH O₂ outlet and provide oxygen for two crewmembers (fig. 3.6-3).

3.6.2 Interfaces

All Orbiter LEH O₂ panels, PEAP's, and oxygen hoses are fitted with female oxygen connectors that are compatible with the LEH oxygen hose connector or T-valve (fig. 3.6-4). The PEAP has two additional connectors. The anti-gravity suit (AGS) connector is identical to the LEH connector except that it is used only during entry for g-suit inflation and will not provide an air supply to the AGS during emergency egress. The quick-disconnect (QD) connector is the male interface for the oxygen hose that provides nominal launch and entry breathing supply through the PEAP. The design of the PEAP enhances crew emergency egress by eliminating the requirements for crewmembers to transfer hose connections from Orbiter supply to PEAP supply or to disconnect the g-suit hose.



CDR AND PLT CONFIGURATION



SPECIALIST CONFIGURATION

Figure 3.6-1.- Launch and entry configuration.

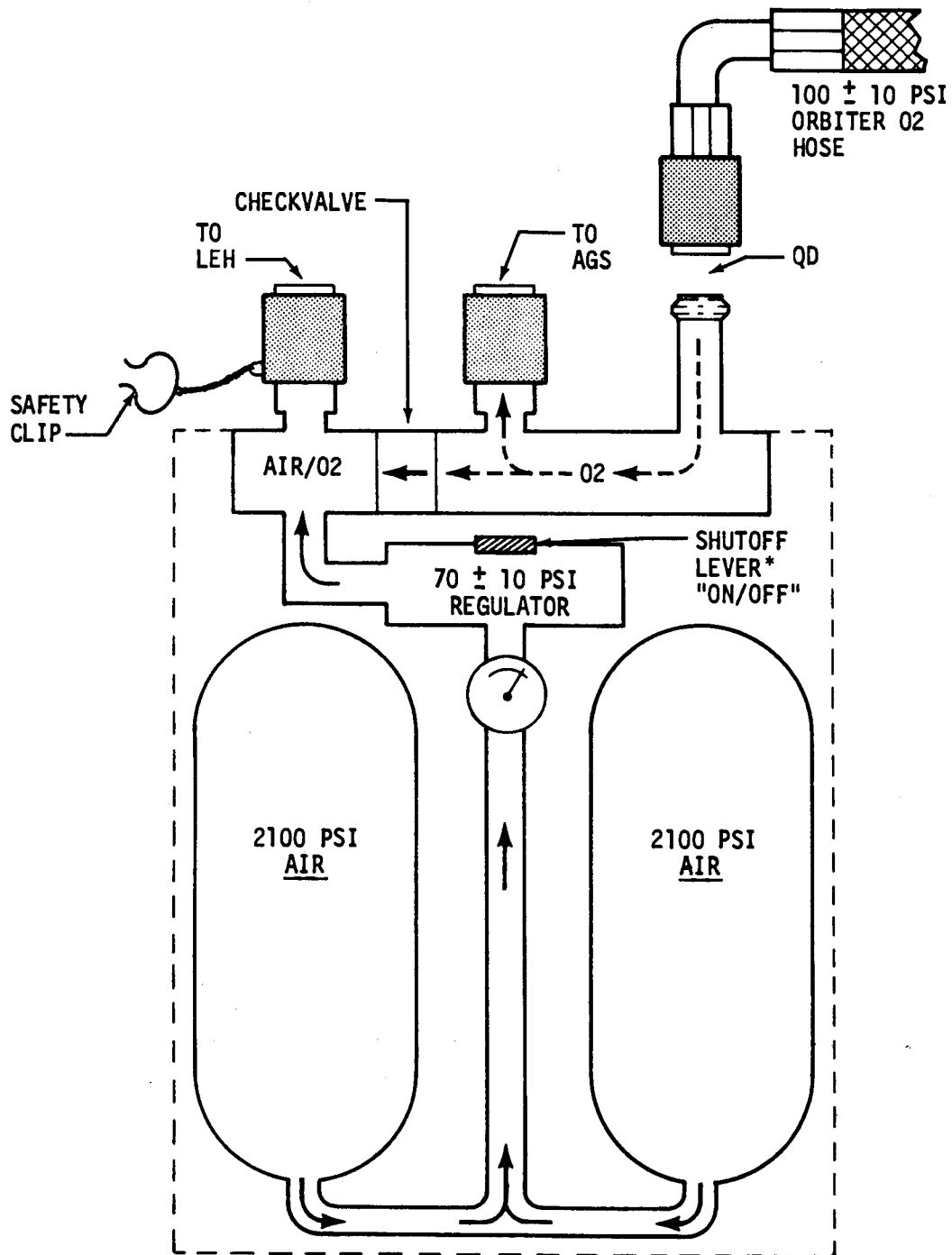
TABLE 3.6-1.- COMPOSITION OF PEAP AIR

| Component | Quantity |
|-----------------|----------------------------|
| O ₂ | 20 to 23% (by volume) |
| N ₂ | 75.2 to 79% (by volume) |
| Moisture | 0.02 mg/l (26.3 ppm) (max) |
| CO | 10 ppm (max) |
| CO ₂ | 500 ppm (max) |

TABLE 3.6-2.- LEH O₂ HOSE AND COMM CABLE CONFIGURATIONS

| Seat/ crewmember | O ₂ hose length, ft | LEH O ₂ panel/outlet | Comm cable length, ft | Comm outlet |
|------------------------|-----------------------------------|------------------------------------|--------------------------|----------------|
| S1/CDR | 7 | C6/1 | 8 | L5 |
| S2/PLT | 7 | C6/2 | 8 | R6 |
| S3/MS1 ^a | 7 | C6/4 | 8 | A11 |
| S4/MS2 ^a | 14 | C6/3 | 18 | A11 |
| S5/PS, MS ^a | 14 | M069M/7 | 14 | M039M |
| S6/PS, MS ^a | 14 | M069M/8 | 14 | M039M |
| S7/MS, PS | 14 | M032M/6 | 14 | A15 |

^aMultiple headset adapter at M039M and A11



*Nominal position for lever is "OFF". If accidentally turned to "ON", O₂ will continue flowing from the Orbiter O₂ hose because of the pressure differential until the orbited O₂ hose is disconnected.

Figure 3.6-2.- Personnel egress air pack (PEAP) schematic.

3.6-4

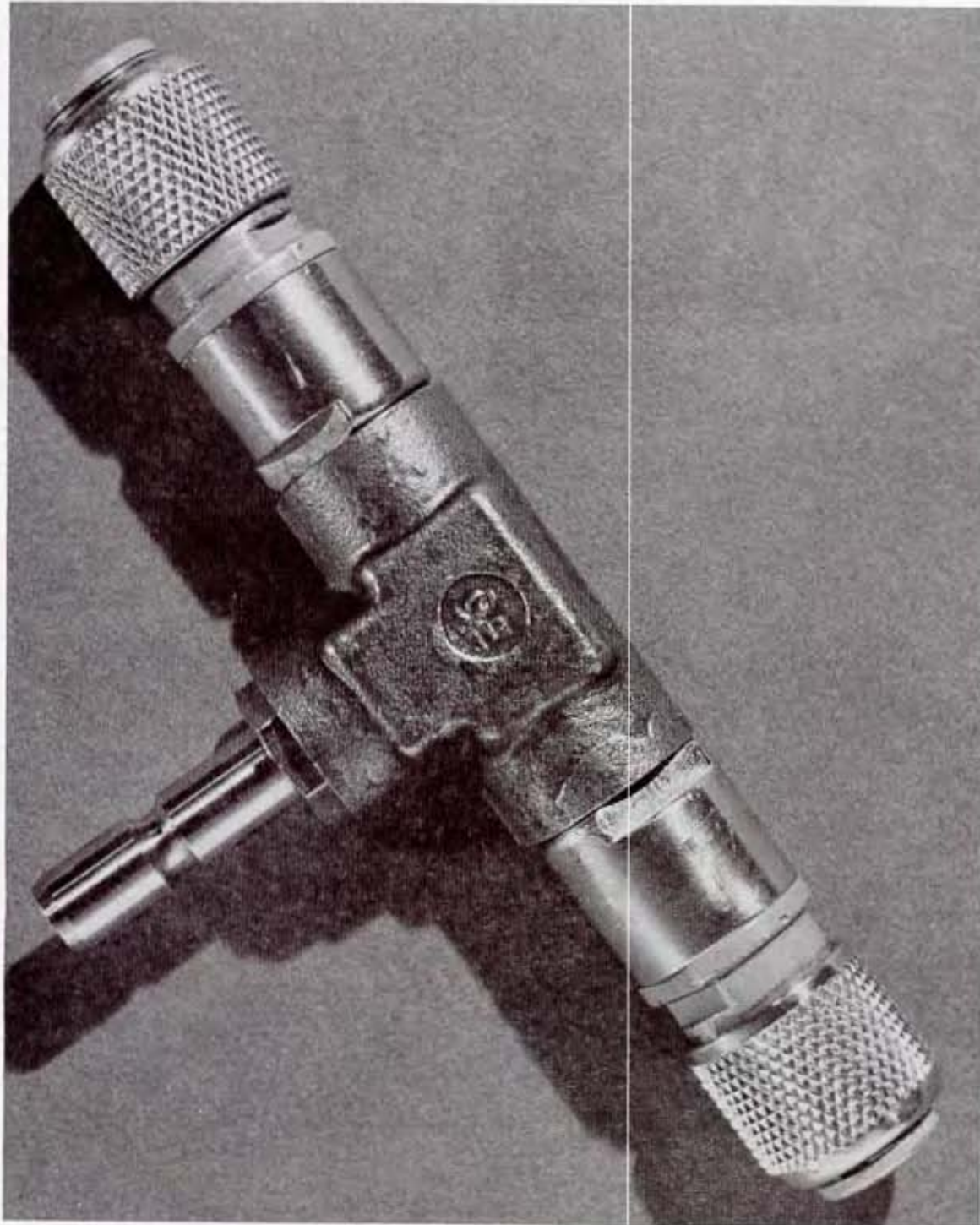


Figure 3.6-3.- T-valve.

160

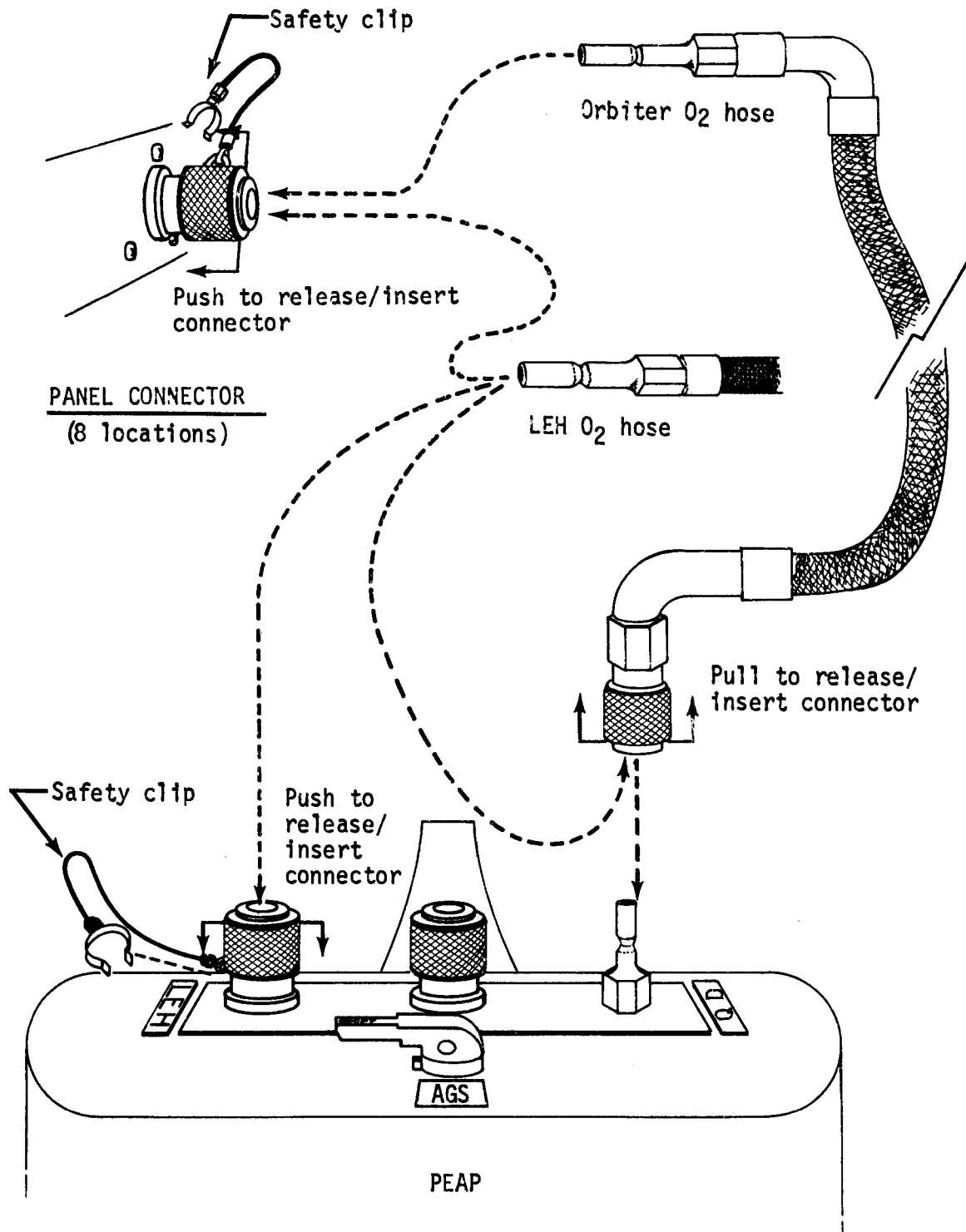


Figure 3.6-4.- LEH O₂ connections and controls - connectors (Sheet 1 of 3).

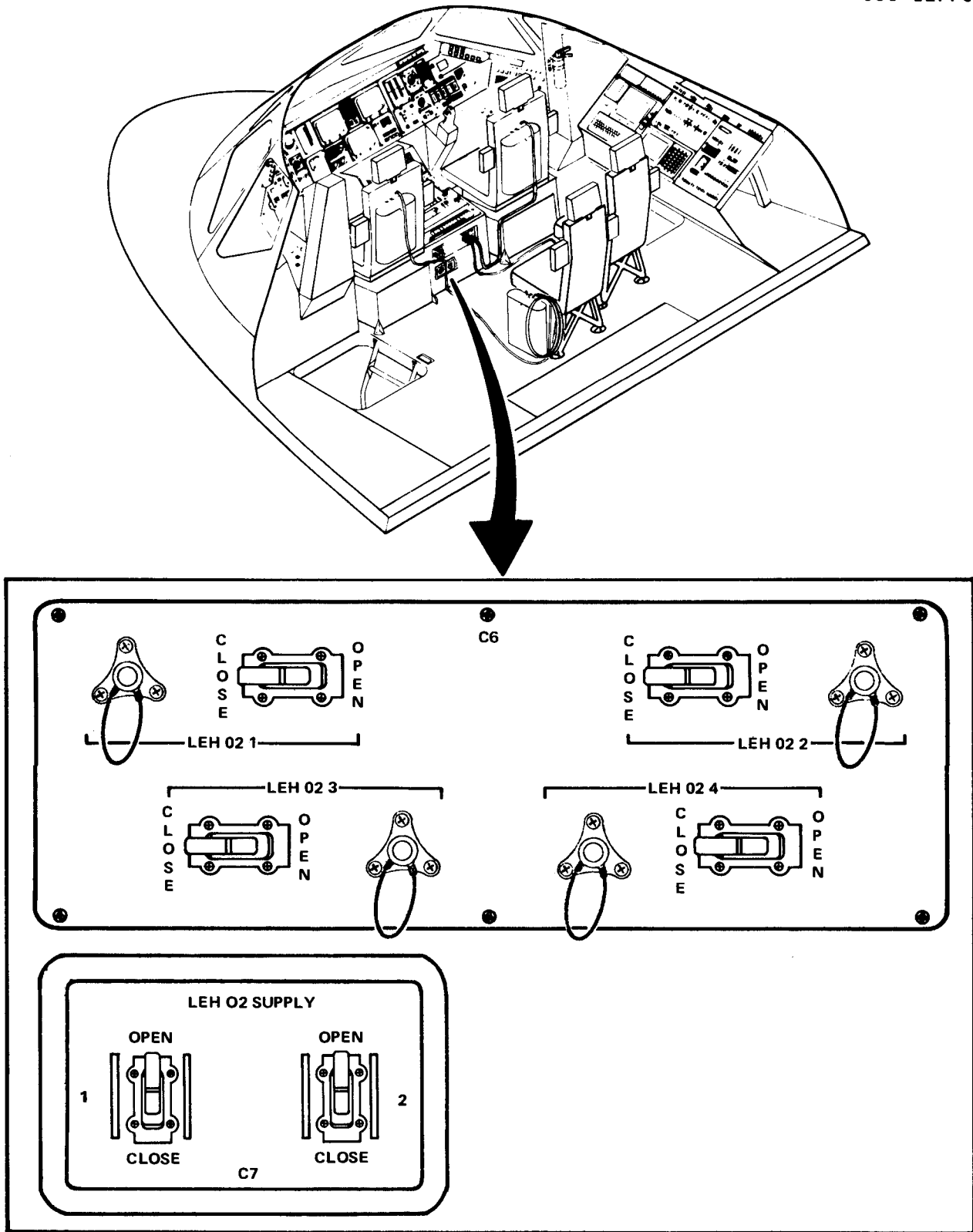


Figure 3.6-4.- LEH O₂ connections and controls - flight deck (sheet 2 of 3).

3.6-7

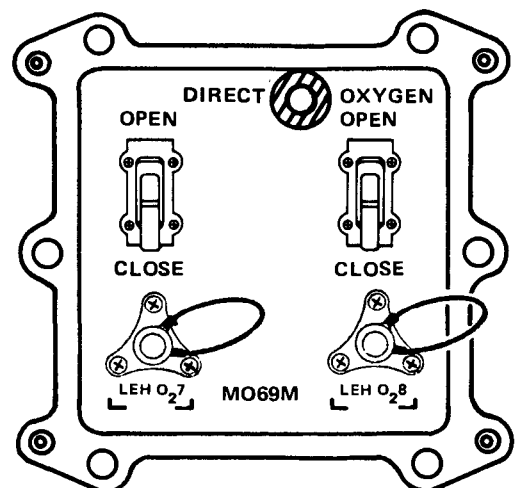
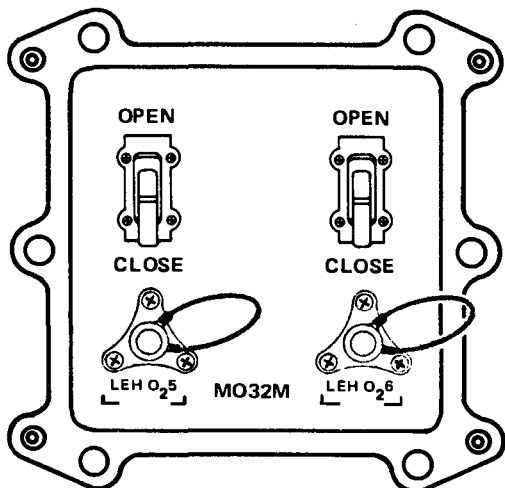
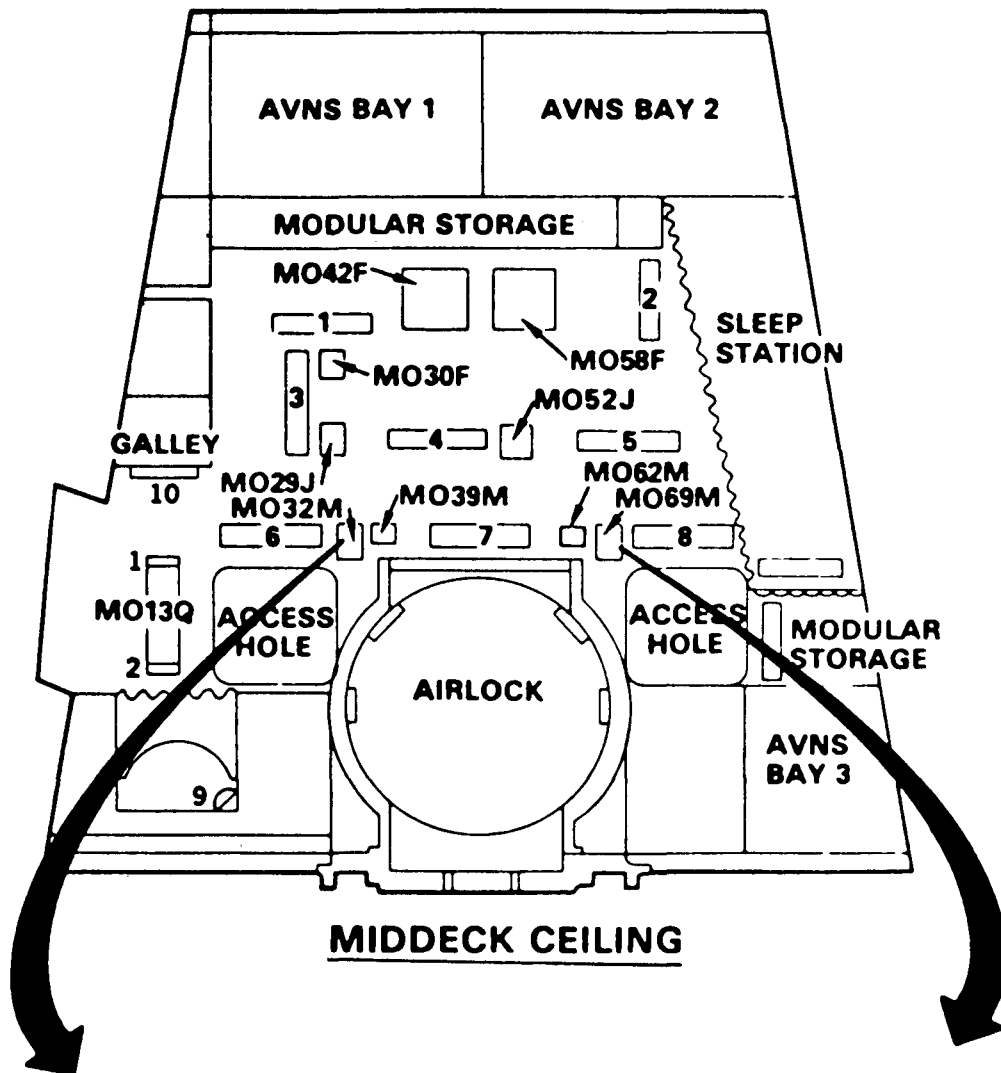


Figure 3.6-4.- LEH O₂ connections and controls connectors - middeck (Sheet 3 of 3).

3.6.3 Systems Functional Description

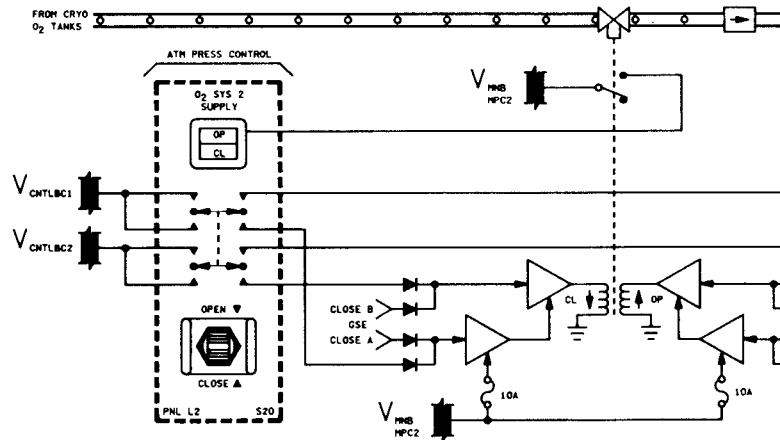
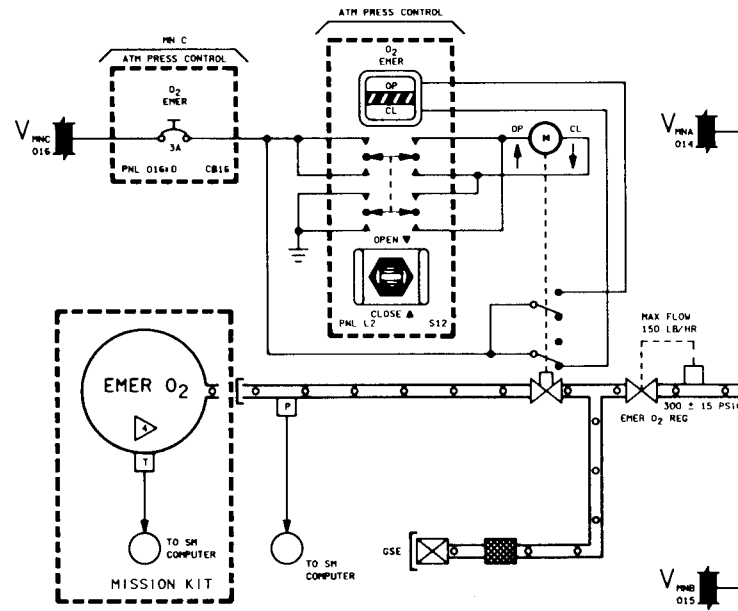
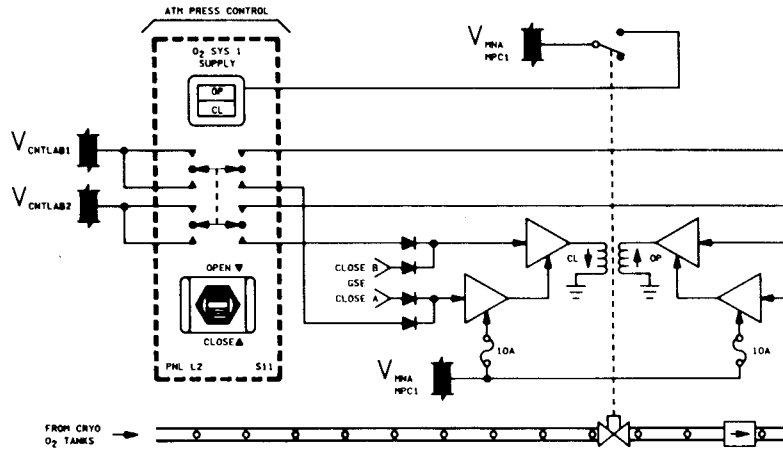
The eight Orbiter LEH O₂ outlets are supplied with regulated (100 ± 10 psi (690 ± 69 kN/m²)) oxygen. Figure 3.6-5 shows the Orbiter oxygen system in simplified form to depict the switch configurations required to enable LEH O₂ supply. The LEH O₂ regulators obtain oxygen from the crossover line between oxygen systems 1 and 2. This crossover is pressurized and both LEH O₂ supply valves are open throughout the mission. This configuration is mandatory to ensure that the regulated oxygen is available at the LEH O₂ outlets for launch, on-orbit emergency, and entry.

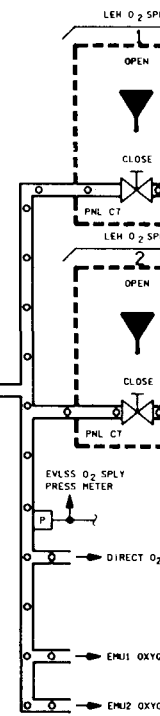
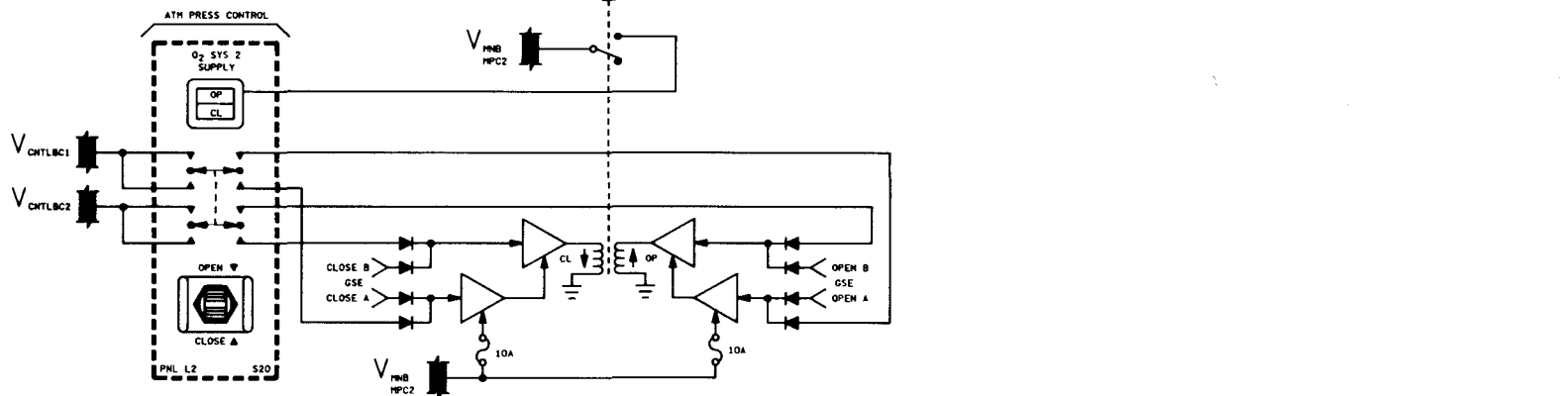
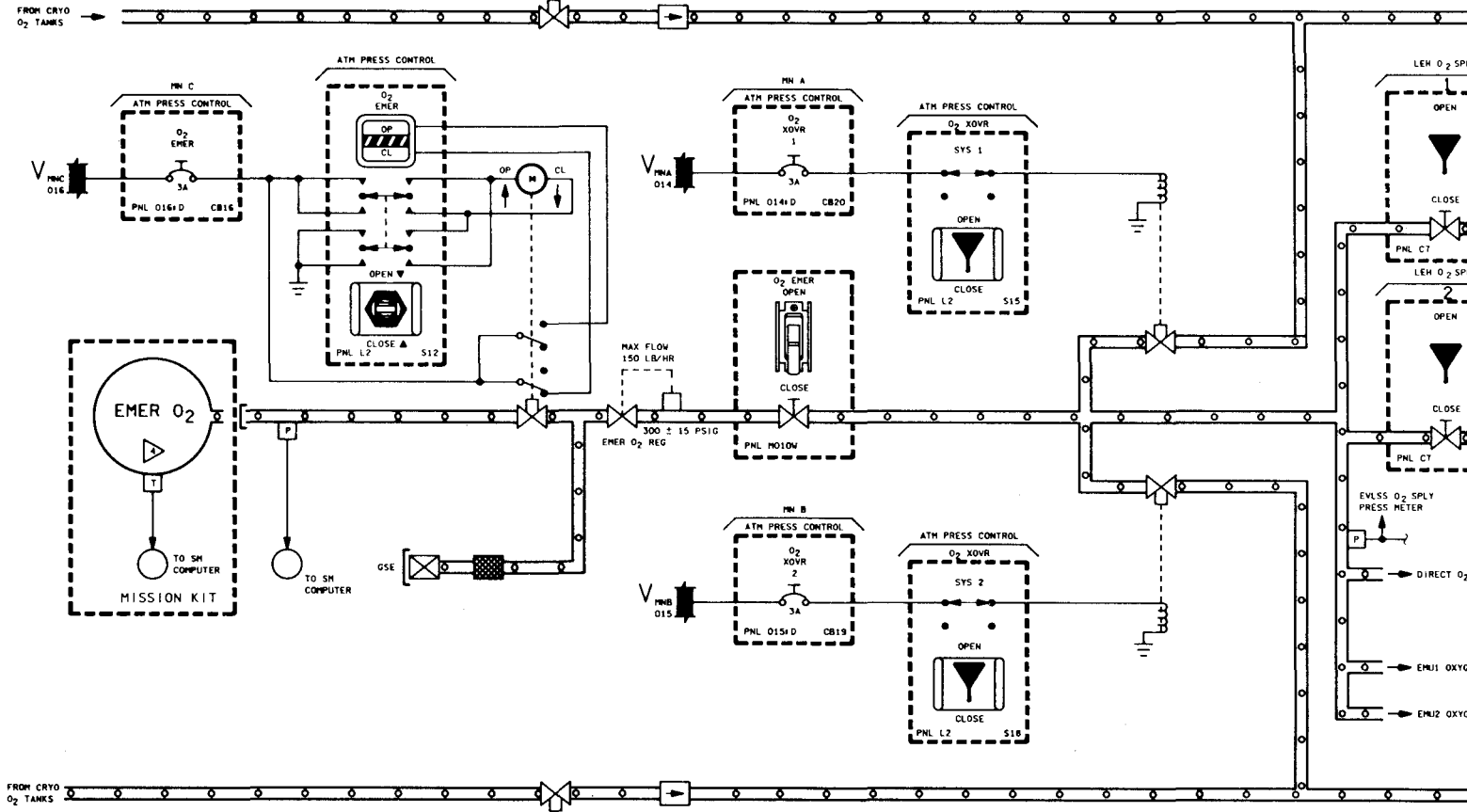
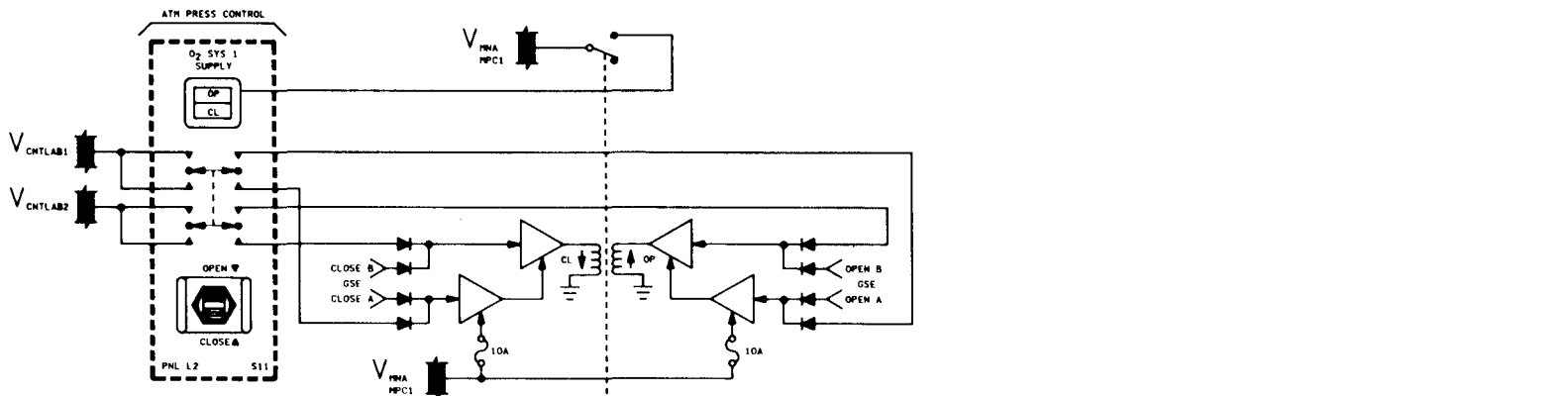
Fire, smoke or contamination within the crew module would require the crewmembers to open LEH O₂ valves (1, 2, 3, 4, 5, 6, 7, 8), don LEH's (visors closed), and reconfigure comm. The PEAP's should not be used in this situation, they are primarily for emergency egress. Once the crewmembers are on oxygen they can take the necessary actions to correct the problem.

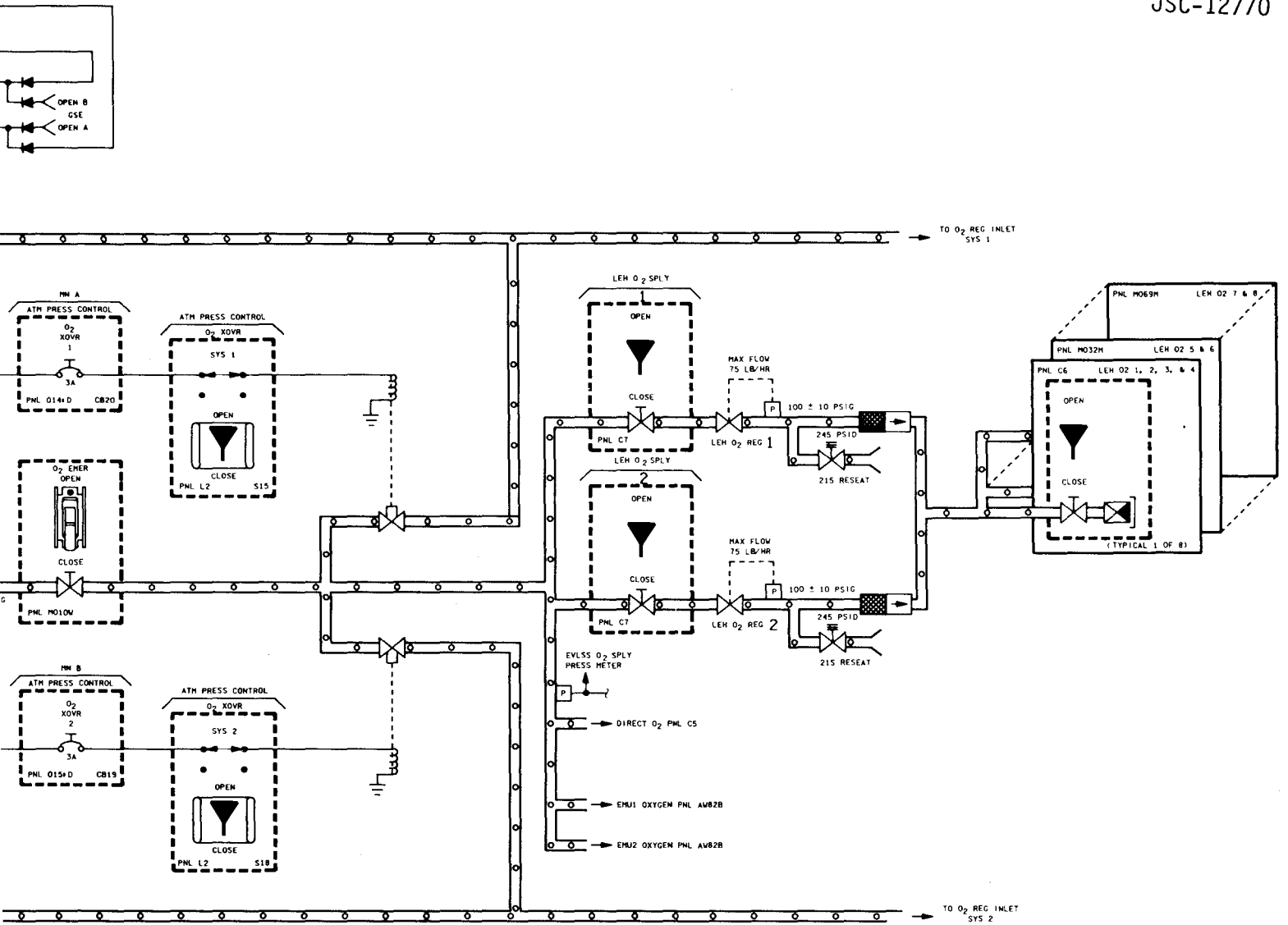
Unless an emergency oxygen tank is installed for the mission, all the LEH O₂ supply will be lost during prelaunch and postlanding emergency egress when Orbiter emergency powerdown occurs. The oxygen crossover valves are solenoid operated and require electrical power to hold them open. With the loss of MNA and MNB power, the crossover valves will close and stop the flow of oxygen from systems 1 and 2, respectively.

3.6.4 Systems Performance and Limitations

- LEH - See section 3.13
- PEAP - See section 3.5
- Orbiter oxygen supply
 - Pressure: 300 to 900 psi (2068 to 6205 kN/m²)
 - Minimum flow rate: 150 lb/hr (68 kg/hr)
- LEH oxygen supply
 - Pressure: 100 ± 10 psi (690 ± 69 kN/m²)
 - Maximum flow rate:
 - One regulator, 75 lb/hr (34 kg/hr)
 - Two regulators, 150 lb/hr (68 kg/hr)
 - Outlet locations:
 - Center console C6 (4)
 - Middeck M032M (2), M069M (2)
 - Oxygen hose and comm cable lengths: See table 3.6-1







2034, ART 1

Figure 3.6-5.- Orbiter oxygen system.

154A

3.7 COMMUNICATIONS LOOSE EQUIPMENT

3.7.1 Introduction

Communications loose equipment consists of the comm equipment used by the crew for voice communications during all phases of flight. Extravehicular Activity (EVA) use of comm equipment is included in the EVA Console Handbook. The Orbiter comm system is addressed in SFOM, Vol. 4A.

The comm equipment consists of the following (fig. 3.7-1):

- Wireless crew comm system (WCCS)
 - Audio interface unit (AIU)
 - Crew remote unit (CRU)
- Communications carrier assembly (CCA)
- Very lightweight headset (VLHS)
- Launch and entry helmet (LEH)
- Headset interface unit (HIU)
- Communications cable
- Multiple headset adapter (MHA)
- Handheld microphone (HHM)
- Audio distribution system/video tape recorder (ADS/VTR) cable

3.7.2 Stowage and Interfaces

All comm equipment used on orbit is stowed in lockers except for the very lightweight headset which is stowed in each crewmember's flight suit pocket.

Some comm equipment is used during launch and entry and either stowed or reused on orbit. The LEH's, HIU 's and MHA's are normally used only for launch and entry and are stowed during postinsertion audio reconfiguration. The wireless comm equipment, VLHS and handheld mike are used primarily on orbit; comm cables and the HIU's are available for backup comm.

The loose equipment connects with the Orbiter comm system via crew communication umbilical (CCU) outlets controlled by audio terminal units (ATU's). Audio is also carried over the speaker microphone units (SMU's) which are controlled by the ATU's. The SMU's do not connect to comm loose equipment.

The CCA interfaces with the extravehicular mobility unit (EMU) comm system for EVA communications.

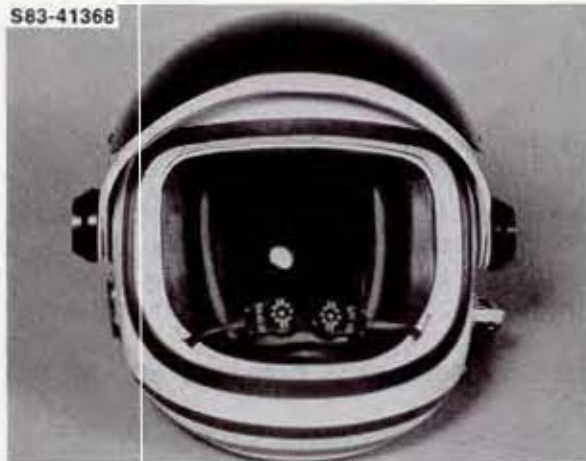
The ADS/VTR cable is used for audio recording and dubbing.

S77-22510



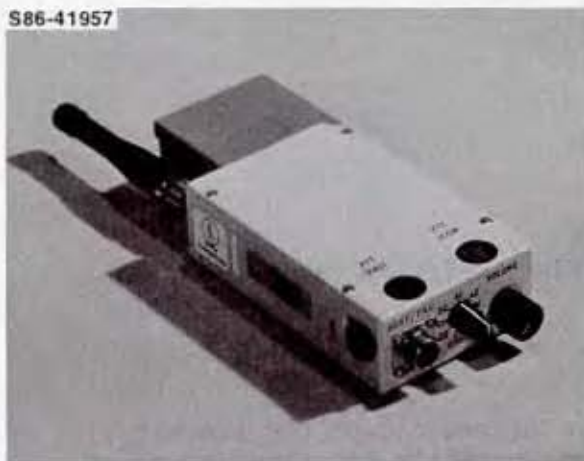
COMMUNICATIONS CARRIER ASSEMBLY

S83-41368



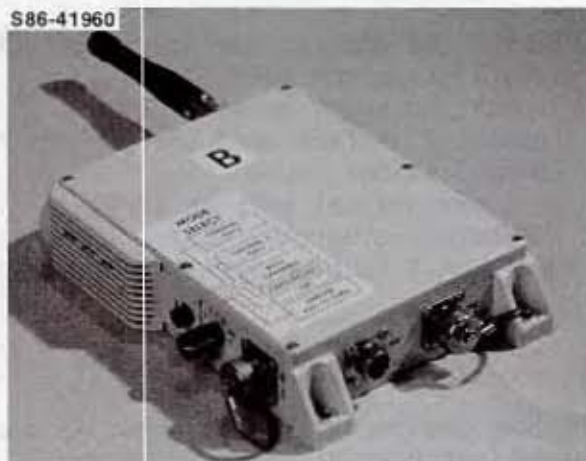
LAUNCH AND ENTRY HELMET

S86-41957



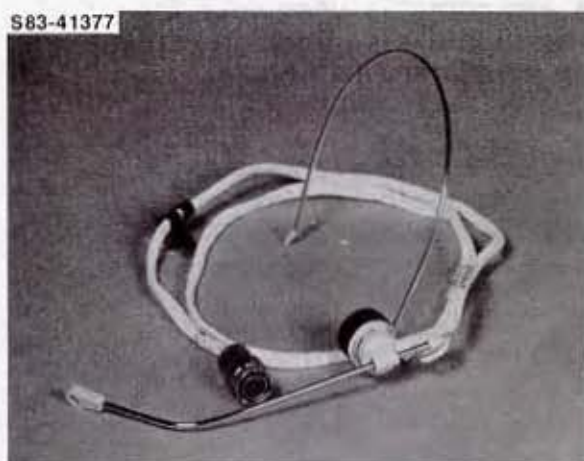
WIRELESS CREW COMM SYSTEM (WALL)

S86-41960



WIRELESS CREW COMM SYSTEM (LEG)

S83-41377



VERY LIGHTWEIGHT HEADSET

S83-41374



HEADSET INTERFACE UNIT

Figure 3.7-1.- Communications loose equipment (sheet 1 of 2).

S87-28758



COMMUNICATION (COMM) CABLE

S87-28159



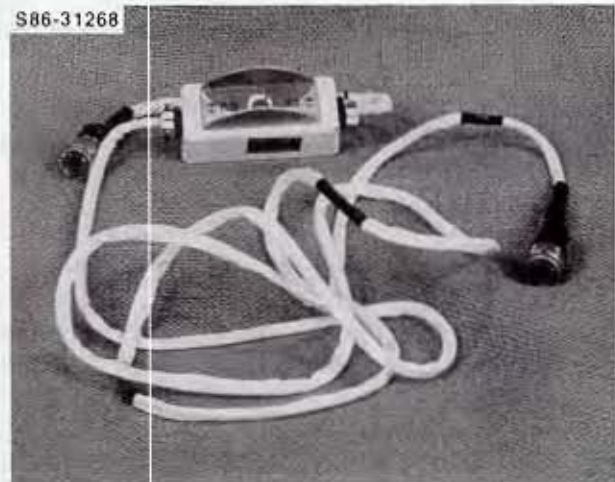
MULTIHEADSET ADAPTER (MHA)

S86-31267



HANDHELD MICROPHONE

S86-31268



ADS/VTR CABLE

Figure 3.7-1.- Communications loose equipment (sheet 2 of 2).

3.7.3 Systems Functional Description

There are various modes of operating the Orbiter comm system in conjunction with the comm equipment. Each of these modes and the associated audio control panel Display and Control (D&C) functions are discussed in SFOM, Vol. 4A.

The ATU and CCU locations are given in table 3.7-1.

TABLE 3.7-1.- ATU AND CCU LOCATIONS

| CCU | Primary ATU | Backup ATU | Audio station |
|-----------|-------------|-------------------------------|---------------|
| L5 | 05 | 09 | CDR |
| R6 | 09 | 05 | PLT |
| A11 | R10 | L9 (switch on R12) | MS1,2 |
| A15 | L9 | None | MS3 |
| M039M | M042F | None | PS1,2,3 |
| AW82D (2) | AW18D | M042F (CCU #2) L9 (CCU #1) | EVA |

On OV102 there is an orbit station (OS) CCU. It is located at A11 and is configured from an ATU at A13. Also specific to OV102 is an extra ATU located on panel M058F. It serves solely as a backup ATU (instead of L9) for airlock comm.

Power for the comm loose equipment comes from the Orbiter audio system via the CCU outlet. Equipment plugged into an unpowered outlet is in a "listen only" mode; power is required for keying a microphone (or, in the case of the WCCS, for wireless comm) and for amplification of the signal. Audio modes are XMIT (air/air or air/ground transmissions) and ICOM (intercom), and are selected via the ATU's. Available modes are push-to-talk manual microphone keying (PTT), voice-actuated keying (VOX), and open microphone (HOT). PTT and HOT are self-explanatory; VOX keys the mike only when voice level reaches a preset VOX sensitivity limit, in order to screen out breathing or background noises.

For operations, the crew unstows, assembles and dons the equipment; plugs it into the appropriate comm outlet; and configures the ATU's for the desired comm loop. Displays and controls for the loose comm equipment are summarized in table 3.7-2.

TABLE 3.7-2.- COMMUNICATIONS LOOSE EQUIPMENT D&C FUNCTIONS

| Location | Type | Nomenclature/ position | Function | Remarks |
|-------------|--------|---|---|---|
| WCCS CRU | rotary | PWR | On/off/volume | Full counter-clockwise detent is OFF. Rotating clockwise past detent begins volume control, with clockwise rotation increasing volume |
| | rotary | CHANNEL A1, A2, B1, B2 C1, C2, D1, D2 | Channel selection | |
| | pb | XMIT ICOM | When depressed, enables voice channel on respective comm loops | XMIT pb has raised piece of plastic for tactile identification |
| | pb | ZERO | Permanently zeroizes (erases) key to COMSEC encryptor module (if installed) | Switch is covered to prevent accidental activation |
| AIU | rotary | MODE SEL 1, 2, B | Selects one or both of the CRU's associated with this AIU | Switch positions are detented; Z can be reached only after knob is pulled up. Hardline comm is active in modes 1, 2, B, and HL |
| | | HL | Selects hardline comm only | |
| | | OFF | Powers down AIU | |
| | lit | Z PWR | Encryptor zeroize When lit, indicates AIU power is on | Green |

TABLE 3.7-2.- Concluded

| Location | Type | Nomenclature/ position | Function | Remarks |
|-----------------------------|--------|--|--|---|
| HIU | rotary | Volume control 0, 1, 2, 3, 4 5, 6, 7, 8, 9 | Provides earphone volume control | Clockwise rotation of the knob increases volume from min. (0) to max. (9) |
| | pb | XMIT ICOM | When depressed, enables voice channel on res- pective comm loops | XMIT pb is raised for tactile iden- tification |
| Handheld micro- phone | pb | XMIT ICOM | Same as above | |
| ADS/VTR cable | toggle | PLBK/RCD | Configures ADS/VTR interface for playback or recording | |

WCCS

The WCCS (fig. 3.7-2) functionally replaces the HIU/MHA audio configuration and consists of sets of wall-mounted Audio Interface Units (AIU's) and crew-worn leg units, or crew remote units (CRU's). A set consists of two CRU's and one AIU and operates on two duplex channels. Each duplex channel is supported by a designated UHF transmit and receive pair. AIU's are designated A, B, C, or D. CRU channel selection determines with which AIU the CRU communicates. For example, a CRU using channel A1 or A2 communicates with AIU A.

The system has a frequency range of 340.0-389.9 MHz; channels are assigned according to one of seven available frequency plans. The primary flight frequency plan is given in table 3.7-3.

Three AIU's are mounted in the vehicle prior to launch. The two flight deck AIU installation sites are at L5 (CDR) (fig 3.7-3) and A11 (MS). The remaining AIU is located on the middeck ceiling just aft of panel M029J (middeck CCU).

Each flight deck AIU is launched with its 22-in. cable in place but not connected to the CCU outlet until postinsertion reconfiguration. The middeck AIU is launched in the OFF setting with its 48-in. cable connected to the middeck overhead multiheadset adapter (MHA). It is turned on at postinsertion reconfiguration. Also during postinsertion, the CRU's are unstowed and the antennas and batteries attached. The CRU's are worn on a leg strap (stowed with the units) with the antenna pointing towards the feet (fig. 3.7-3).

Each CRU is powered by zinc-air batteries which can provide approximately 28 hours of operation. The battery pack has holes in the covering to expose the zinc to air. Indication of battery depletion (approximately fifteen minutes of power remaining) is by a beep audible through the headset. The battery pack slides onto the CRU and is held in place by a spring-loaded clip with sufficient force to prevent the battery pack from sliding off by itself. For training purposes a NiCad battery pack is used. It has no holes in the covering and lasts only four hours but is otherwise identical to the flight battery pack.

The AIU receives its power (28-V dc) from an Orbiter CCU outlet. On the side of the unit is a connector, labeled CCU/HIU, that allows the use of communication umbilical equipment, such as the HIU or the HHM, with the AIU. AIU functions are controlled by a single rotary selector see figure 3.7-3. There are six detented positions: 1, 2, B, HL, OFF, and Z. The first three select RF channels: 1, 2, and both (B). The fourth position, HL, disables the RF channels while leaving the CCU/HIU connector active. The CCU/HIU connector is active when the selector is in the 1, 2, B, or HL position. "Z" stands for "zeroize" and is used on DOD missions. Neither wireless nor umbilical communication is possible when the selector is in the OFF position. The nominal selector position is B. A green light indicates that power is on.

CRU controls consist of a rotary ON/OFF/volume knob (fig. 3.7-4), rotary channel, PTT pushbuttons and a zeroize pushbutton. The PTT pushbuttons are located on the front of the unit. The XMIT PTT has a raised surface to allow immediate tactile differentiation.

TABLE 3.7-3.- WCCS PRIMARY FLIGHT FREQUENCY PLAN*

| Channel designator | CRU mode | AIU mode | Frequency (Mhz) |
|--------------------|----------|----------|-----------------|
| A1 | RCV | XMIT | 340.7 |
| A1 | XMIT | RCV | 374.7 |
| A2 | RCV | XMIT | 343.6 |
| A2 | XMIT | RCV | 376.3 |
| B1 | RCV | XMIT | 345.8 |
| B1 | XMIT | RCV | 377.7 |
| B2 | RCV | XMIT | 347.2 |
| B2 | XMIT | RCV | 380.0 |
| C1 | RCV | XMIT | 349.3 |
| C1 | XMIT | RCV | 383.4 |
| C2 | RCV | XMIT | 351.0 |
| C2 | XMIT | RCV | 386.1 |
| D1 | RCV | XMIT | 359.7 |
| D1 | XMIT | RCV | 388.3 |
| D2 | RCV | XMIT | 372.7 |
| D2 | XMIT | RCV | 389.6 |

*There are a total of seven frequency plans available for flight and training.

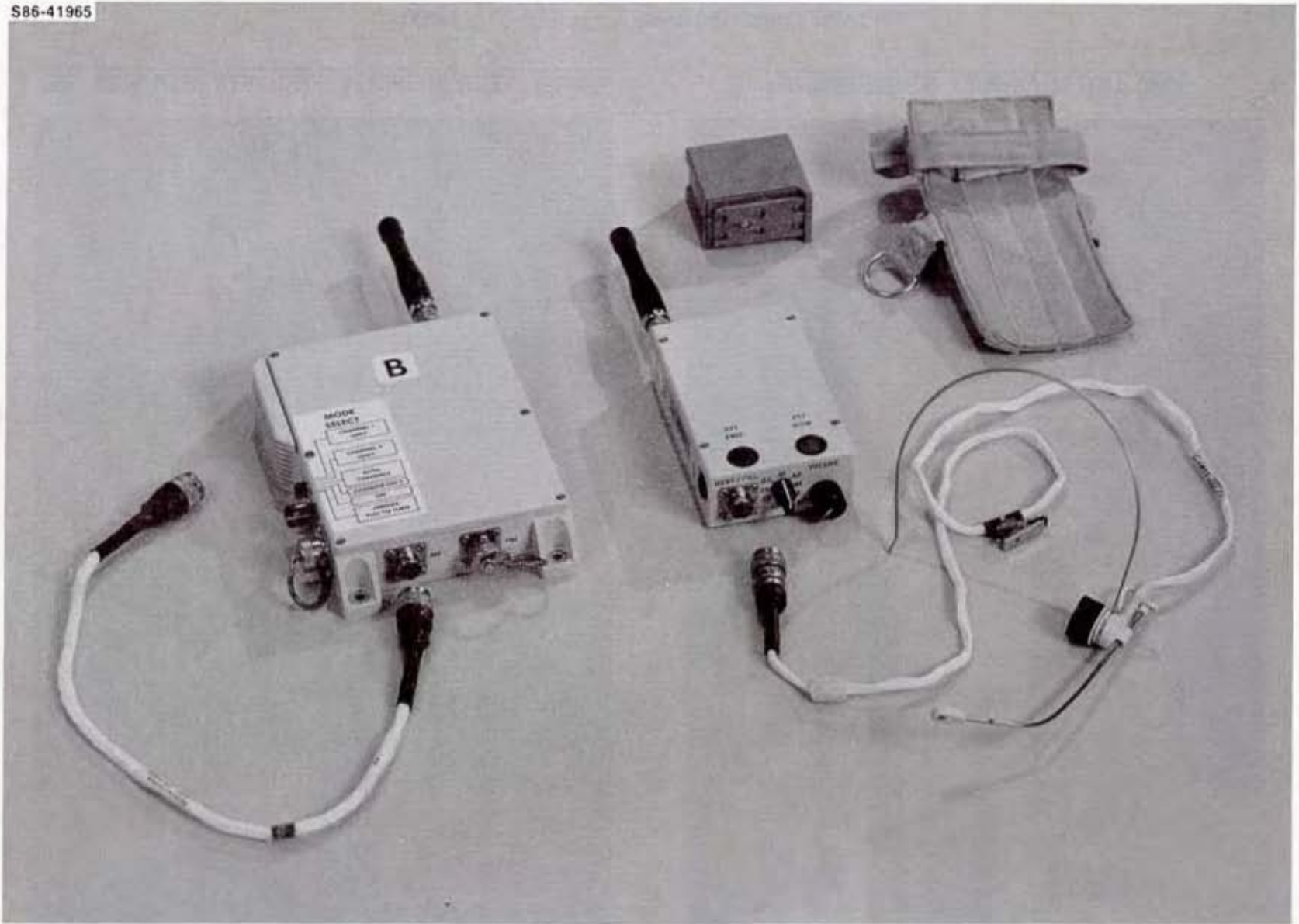


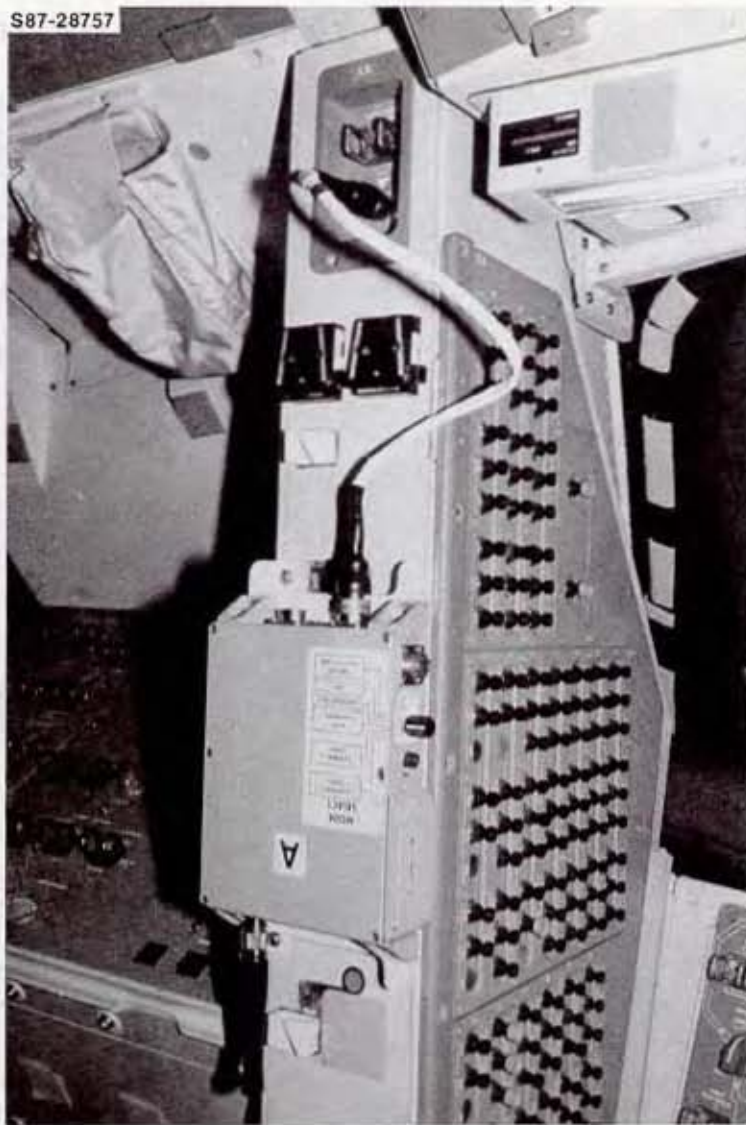
Figure 3.7-2.- Wireless crew comm system (WCCS).

S86-41958



CRU WORN WITH VERY LIGHTWEIGHT HEADSET (VLHS)

S87-28757



AIU MOUNTED ON FORWARD FLIGHT DECK

Figure 3.7-3.- WCCS on-orbit configuration.

JSC-12770

The rotary channel selector has eight detented positions - one for each channel. On the side is a small covered "zeroize" button for use on DOD missions (fig. 3.7-4).

For nominal operation, the VLHS is connected to the CRU at the HDST/FILL port, and channel selection is verified and the volume control rotated clockwise.

Each AIU can support two CRU's on separate RF channels (1 and 2) so three AIU's will provide wireless communication for a crew of six. A handheld microphone or a headset with attached HIU can be plugged into the AIU and operated as long as both CCU and AIU power are on. More AIU's and CRU's are flown as needed. Mounting provisions for additional AIU's are available at the PLT (R6) and PS (A15) CCV panels.

For DOD missions plug-in Communications Security (COMSEC) encryption modules are installed in the AIU's and CRU's. These modules receive an encryption key through the FILL and HDST/FILL connectors on each AIU and CRU, respectively. These units are filled at KSC, 48 hours before launch. As a security measure the modules will zeroize, or erase the key, on command or if the AIU or CRU COMSEC modules are tampered with. This will result in loss of wireless communication with the units containing the zeroized modules, because the modules cannot be "refilled" inflight. Upon mission completion, the closeout crew will zeroize all encryption keys. To deliberately zeroize the key on the AIU, turn the selector to OFF, pull up, and turn to "Z." To zeroize the CRU key, swing away the small spring-loaded cover on the side of the CRU and push the little button (fig. 3.7-4). The zeroizing procedures described above are designed to require the use of two hands to prevent unintentional zeroizing. Small batteries installed in both the AIU and CRU provide power for the COMSEC module memory when the CRU battery pack is removed or AIU power is interrupted. Decals placed on the units indicate that COMSEC modules have been installed and filled. See figure 3.7-4.

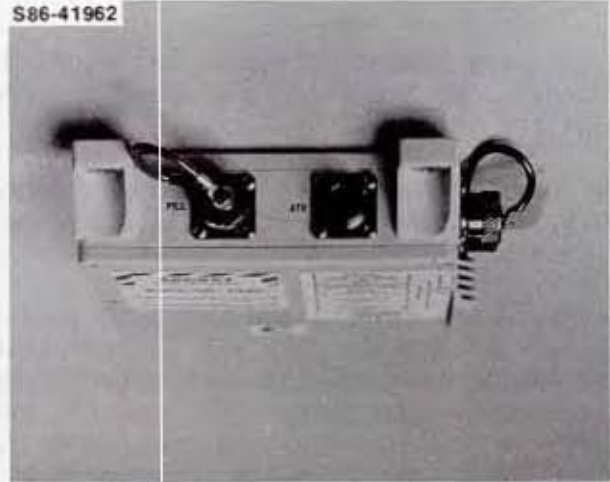
CCA

The CCA is a headset integrated into a skull cap, often referred to as a 'Snoopy hat' (fig. 3.7-5). The CCA is identical to the Skylab and the Apollo Soyuz Test Project CCA. The unit contains padded ear muff-type earphones, two microphones - one on the right and one on the left, and a connector and cable. The microphones and earphones in the CCA incorporate transducer assemblies for voice transmission.

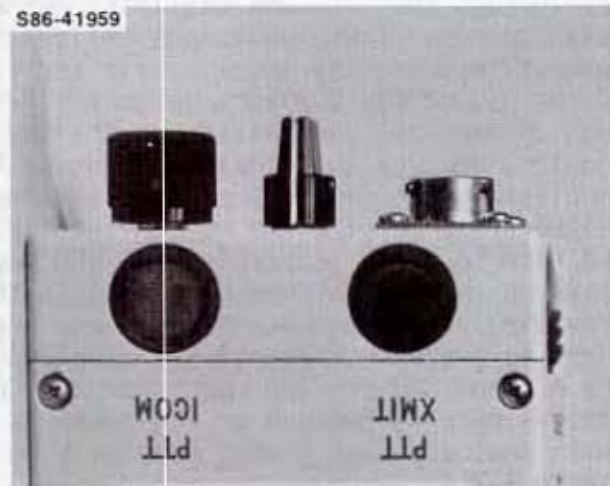
The CCA is used primarily for EVA.

VLHS

The VLHS (fig. 3.7-6) uses a wire headband to secure the headset. The foam cushioned earphone can be used in either ear. The microphone is mounted at the end of a molded, L-shaped extension.

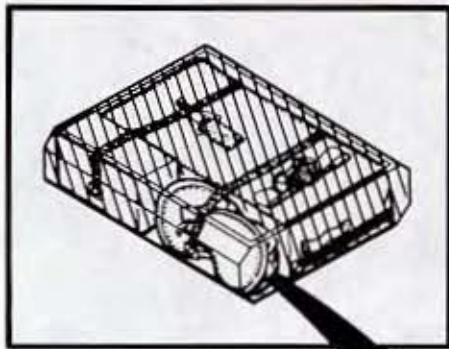


AIU CONTROLS

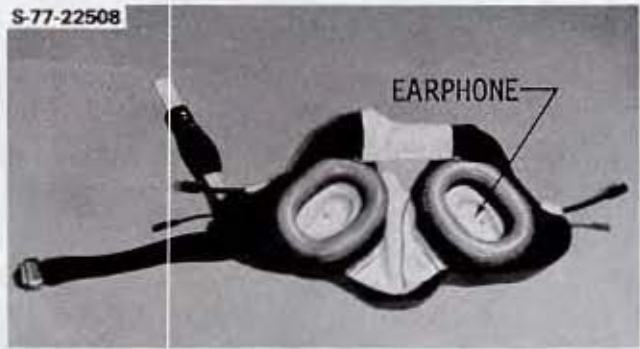


CRU CONTROLS

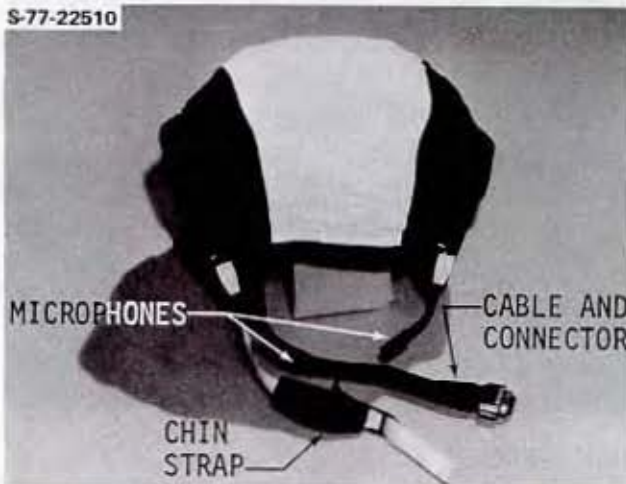
Figure 3.7-4.- WCCS displays and controls.



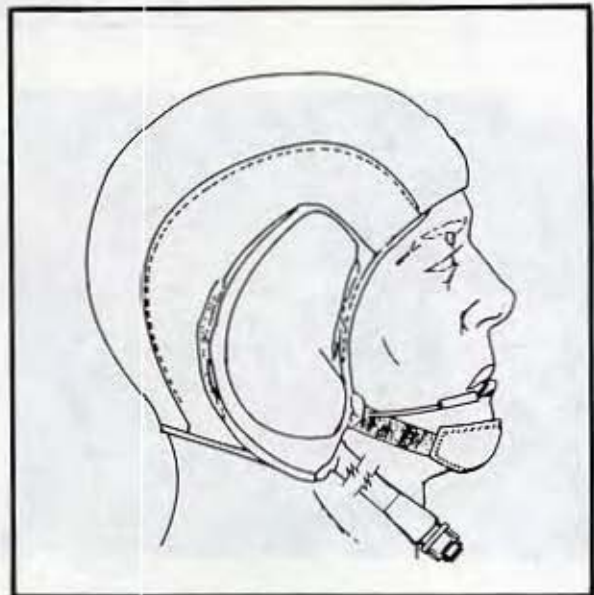
LOCKER STORAGE
(TYPICAL)



CCA
(INSIDE OUT)



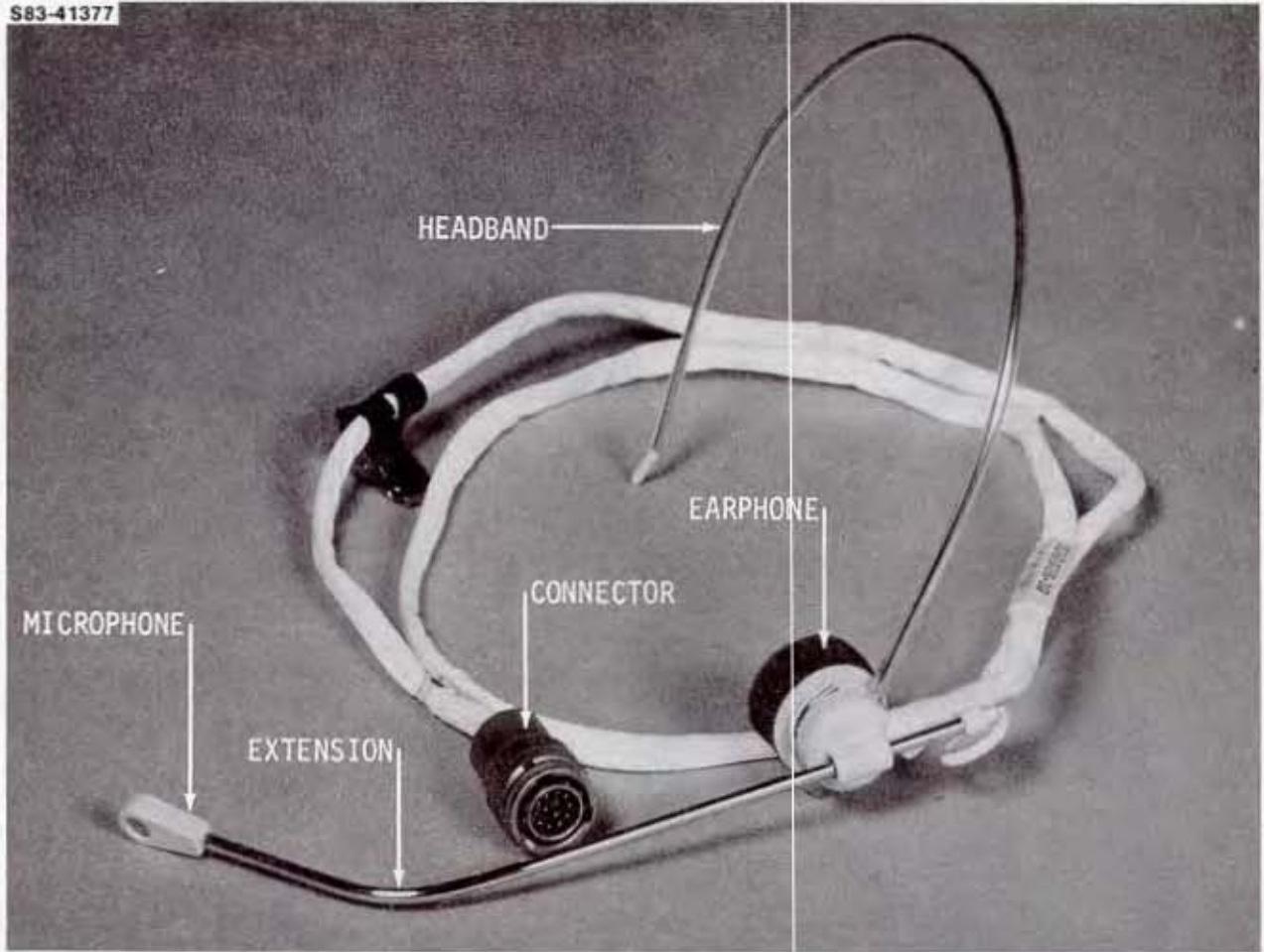
COMMUNICATIONS CARRIER ASSEMBLY (CCA)
(FRONT VIEW)



CCA DONNED

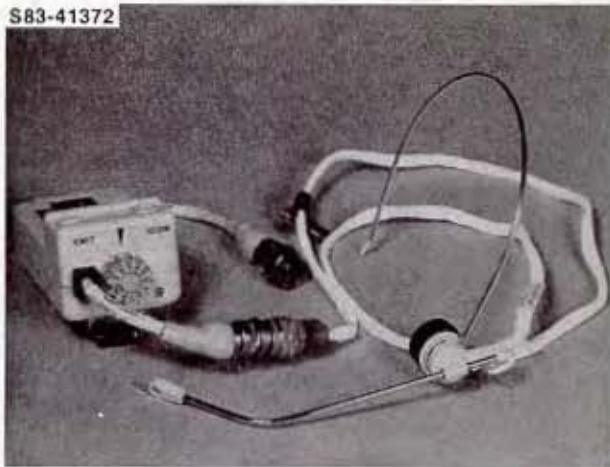
Figure 3.7-5.- Communications carrier assembly.

S83-41377



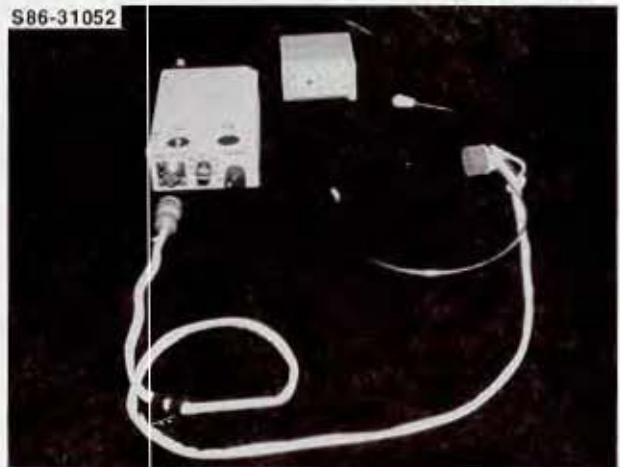
VERY LIGHTWEIGHT HEADSET

S83-41372



VERY LIGHTWEIGHT HEADSET W/HIU

S86-31052



VERY LIGHTWEIGHT HEADSET W/LEG UNIT

Figure 3.7-6.- VLHS.

There are three ways to adjust the microphone to get it positioned correctly. First, the wire extension slides forward and back. It also rotates up and down. Finally, one can slide the free end of the headband forward and back to adjust the distance between the mouth and microphone. It is vital to remember that the wire extension may never be bent to adjust the microphone.

The headset can be used with either the HIU or the WCCS leg unit.

LEH

The LEH is a head protection device that provides the crewmember with face protection, light and sound attenuation, and comm capabilities (fig. 3.7-7). The enclosed environment of the helmet attenuates the severe noise levels encountered at launch and allows intelligible air-to-ground communication (sec. 3.25, Acoustics Provisions).

To provide comm capabilities, the helmet contains two noise-cancelling, redundant microphones and two redundant earphones. The microphones are built into the helmet and can be positioned to suit the individual crewmember. The earphones are integrated into the helmet's padded ear muffs. A cable (with a quick-disconnect feature) from the LEH connects to the HIU.

HIU

The HIU provides volume control and PTT capabilities to the CCA, the VLWH, and the LEH.

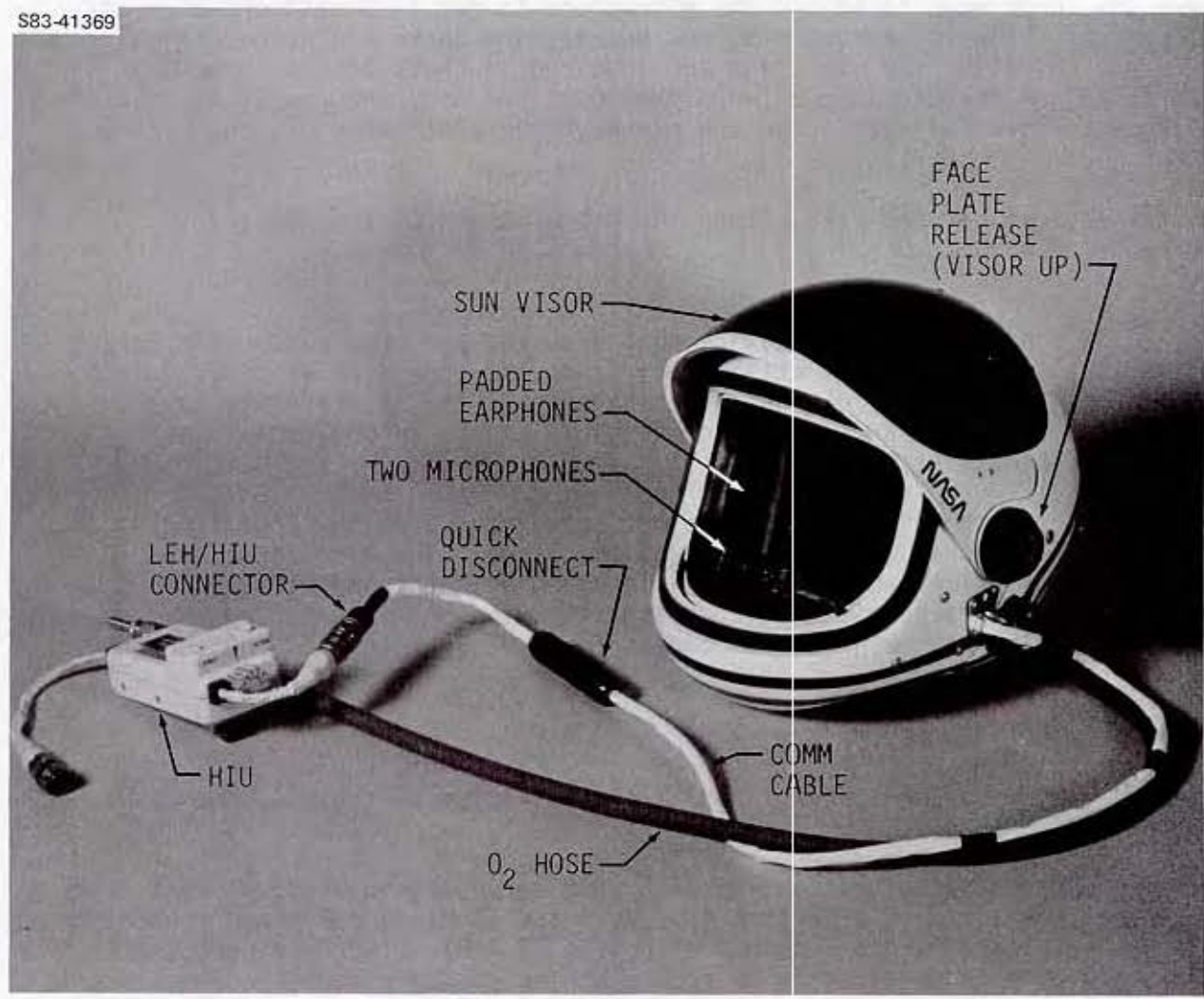
The unit contains a volume control knob (for earphones in the equipment mentioned above), two PTT buttons (for XMIT and ICOM), a cable and connector for comm interface, and a retainer clip (fig. 3.7-8). The retainer clip allows the unit to be attached to crew clothing during on-orbit operations. Care should be taken to ensure the retainer clip is attached to the crewmember's lap belt or shoulder harness prior to launch and entry for proper operation of the quick disconnect feature in case of emergency egress.

The HIU is a preamplifier; without it, the microphone signal from the CCA, VLHS, or LEH is too weak for the Orbiter comm system to pick up (unless the VLHS is connected to a CRU).

Comm Cable

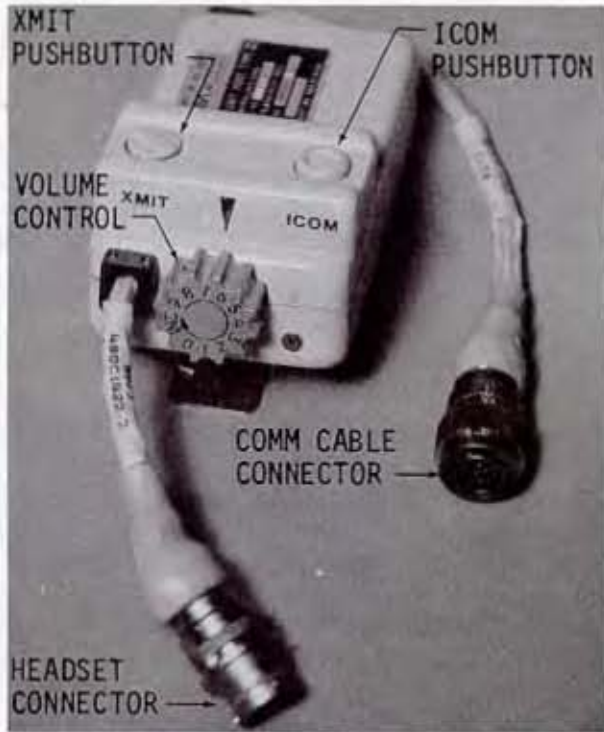
The comm cable is available in 4-ft (1.2-m) and 14-ft (4.2-m) sections and can connect the HIU or a HHM with the CCU outlets directly or through a MHA (fig. 3.7-8). Additional sections of cable can be connected together to extend the length of the cable.

S83-41369



LAUNCH AND ENTRY HELMET W/HIU

Figure 3.7-7.- Launch and entry helmet (LEH).



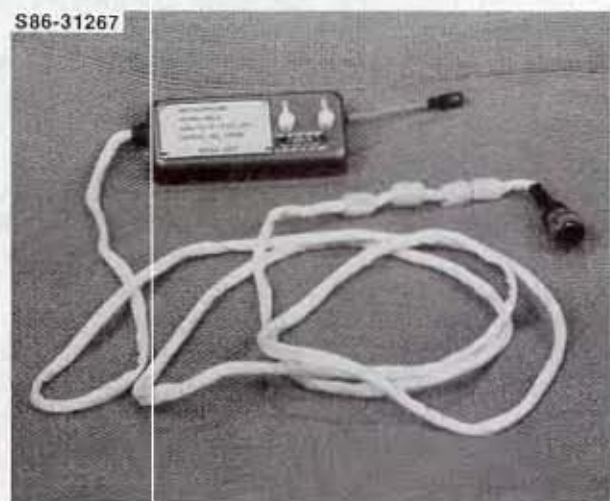
HEADSET INTERFACE UNIT



MULTIPLE HEADSET ADAPTER



COMM CABLE



HANDHELD MICROPHONE

Figure 3.7-8.- Loose comm equipment.

MHA

The multiple headset adapter (fig. 3.7-8) is used to allow up to three crewmembers to use one CCU outlet. One is permanently installed on the middeck ceiling at M039M and another is flown for MS ascent/entry comm and stowed for use on orbit. When in any PTT or VOX mode, activation of one voice circuit will activate the microphones of any other headset sharing the MHA. Also, when one voice circuit is activated, the others using the MHA will hear the activated voice circuit at a side tone level.

HHM

The HHM (fig. 3.7-8) is a noise-cancelling microphone that connects directly to any CCU outlet. The HHM is primarily used with the speaker microphone units located at A2 and M029J. To avoid feedback when using the speakers, one ATU and its corresponding CCU outlet on the aft flight deck, and one ATU and its corresponding CCU outlet on the middeck are equipped with a speaker muting capability. On OV103, OV104, and subsequent vehicles the muting-capable ATU controls are located at R10 and M042F. On OV102 the muting-capable ATU controls are located at A13 at M042F.

Two PTT pushbuttons are provided for XMIT and ICOM audio modes. When used to record audio on the VTR either pb can be used. The HHM is equipped with a foam windscreen over the mouthpiece. To maintain clear transmissions, the windscreen should barely touch the corner of the operator's mouth. The pb's should face the operator to ensure that the noise-cancelling feature of the microphone remains functional. The HHM is equipped with a 7-ft. (2.13 m) cable which can connect at any CCU or to other comm cables.

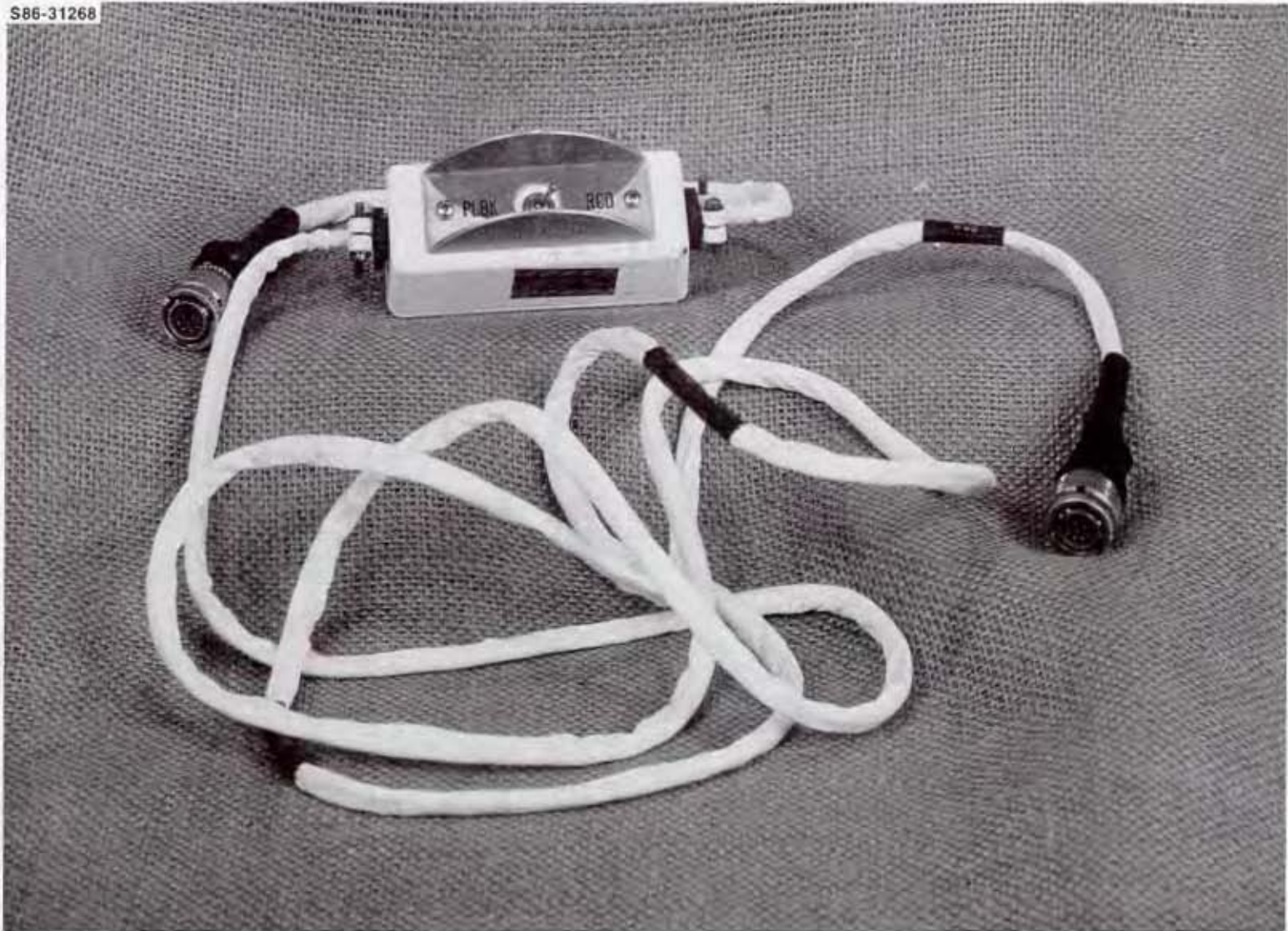
ADS/VTR Cable

The ADS/VTR cable (fig. 3.7-9) is used for recording and dubbing audio on the VTR when the audio source is Orbiter comm. It has a plug at each end. One plug is labeled "VTR" for connection to the VTR CCU; the other, "ORB," connects to any Orbiter CCU outlet. The audio input is determined by the configuration of the ATU associated with the CCU to which the ADS/VTR cable is connected. A playback/record (PLBK/RCD) switch is located on the cable, near the VTR end. Recording while the switch is in the PLBK position will result in audio feedback on the videotape and on the Orbiter comm system. Playback while the switch is in RCD will result in no audio output to Orbiter comm.

3.7.4 Systems Performances, Limitations, and Constraints

- CCA
 - Noise attenuation: 10 dB
 - Ear and microphone impedance: 600Ω

S86-31268



173

3.7-19

Figure 3.7-9.- ADS/VTR cable.

JSC-12770

- VLHS
 - Noise attenuation: 15 dB
 - Earphone impedance: 7400 Ω
 - Microphone impedance: 120 Ω
- LEH
 - Noise attenuation: 10 dB
 - Earphone impedance: 1200 Ω
 - Microphone impedance: 350 Ω
- HHM
 - Microphone impedance: 600 Ω
- WCCS
 - Size
 - AIU: 7.13 x 5.50 x 1.62 in. (18.1 x 14.0 x 4.11 cm)
 - CRU: 7.75 x 3.50 x 1.62 in. (19.7 x 8.89 x 4.11 cm)
- Power
 - AIU: 28-V dc Orbiter power
 - CRU: 28 hr. primary zinc-air battery (flight); Rechargeable Ni-Cad battery (training)
 - COMSEC encryptor module (DOD flights only - installed in both AIU and CRU): 7.2-V dc - 3 series-connected silver oxide cells
- Frequency range: 340.0 to 389.9 MHz
- Channel select
 - CRU: 8 operator selectable preset channels
 - AIU: Internal frequency switches for both transceivers
- Transmit/receive audio response (AIU and CRU): 300-2700 Hz
- Transmit tone (CRU): 94.8 Hz (PTT ICOM), 79.7 Hz (PTT XMIT)
- Low battery beeper
 - Tone: 1 kHz
 - Rate: 1.3 sec

3.8 TELEVISION

3.8.1 Introduction

The Orbiter closed circuit television (CCTV) system includes both interior and exterior cameras. In this section, the television (TV) system is limited to a discussion of crew cabin operations. The overall Orbiter system is presented in SFOM, Vol. 4D. The CCTV system discussions unique to remote manipulator system (RMS) operations are contained in SFOM, Vol. 16. Those discussions relative to extravehicular activities (EVA) are contained in SFOM, Vol. 15.

The TV system is used to document a wide variety of on orbit activities and events inside the crew cabin. These activities and events include crew activities and operations, experiment observations, inspections and data retrieval, hardware observations and inspections, and crew compartment areas and configurations. The system consists of the following (figs. 3.8-1 and 3.8-2):

- TV camera (TVC)
- TV color lens assembly (CLA) (if flown)
- TV wide-angle lens assembly (WLA)
- TV monochrome lens assembly (MLA) (if flown)
- TV viewfinder monitor (VFM)
- TV cable, 10 and 20 ft
- TV Viewfinder Monitor Cable
- TV console monitor (MON)
- Video tape recorder (VTR)
- VTR cassette
- TV system displays and controls (D&C)

The CCTV system also includes other components that are discussed in more detail in SFOM, Vol. 4D. These components include those not used in crew cabin operations, such as the pan/tilt unit (PTU). Also addressed are components used by the cabin TV system to control, route, and handle TV signals; for example the video control unit (VCU), which consists of the video switching unit (VSU) and the remote control unit (RCU).

TV operations involving uplink commands and data downlinks are accomplished via S-band coverage and the Tracking and Data Relay Satellite (TDRS). After the TDRS is fully operational, Ku-band and S-Band coverage will determine TV operations requiring uplink and downlink capabilities.

3.8.2 Interfaces

For launch and entry, the TV system components are stowed in lockers, with the exception of the VTR (which is launched installed in panel R11) and MON's 1 and 2, which are launched installed on panel A3.

S-79-39297



TV CAMR (FRONT)

S-79-39298



TV CAMR (BACK)

S-79-39287



TV LENS (FRONT)

S-79-39288



TV LENS (BACK)

S-79-39292



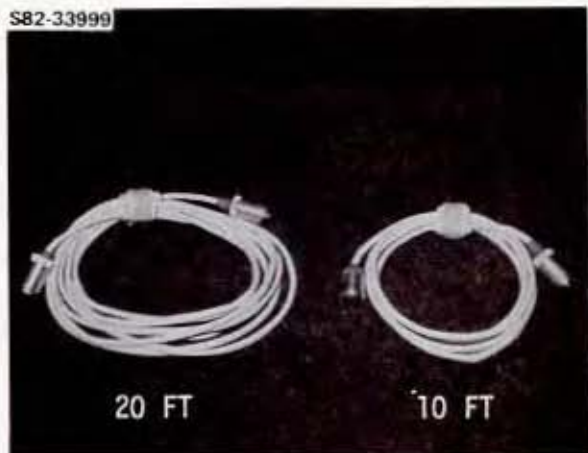
TV VIEWFINDER MON (FRONT)

S-79-39286



TV VIEWFINDER MON (BACK)

Figure 3.8-1.- TV system (sheet 1 of 2).



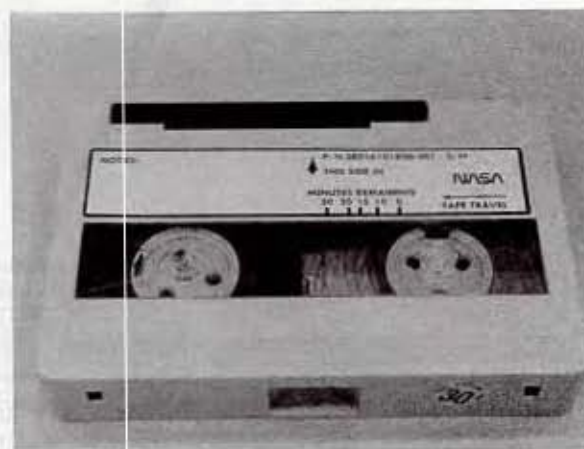
TV CAMR CABLES



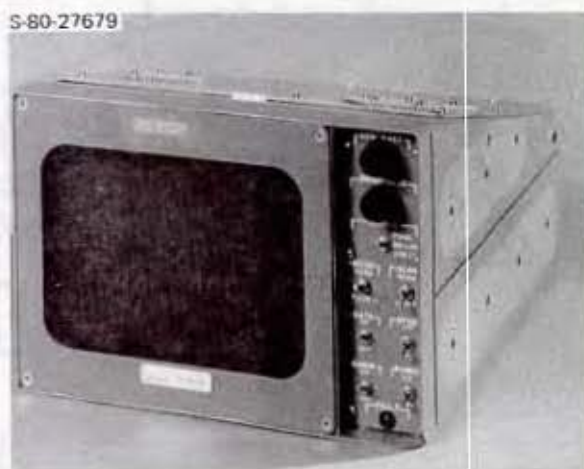
VIEWFINDER MON CABLE



VTR ASSEMBLY

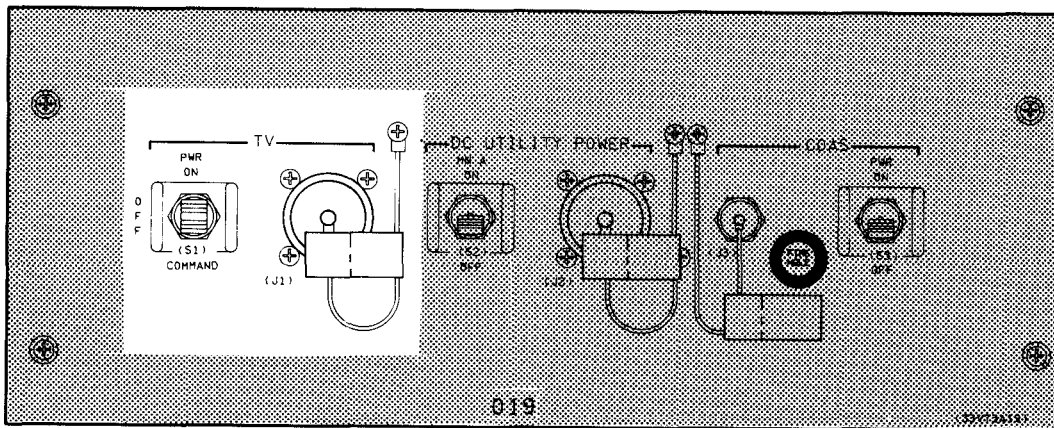


VTR CASSETTE

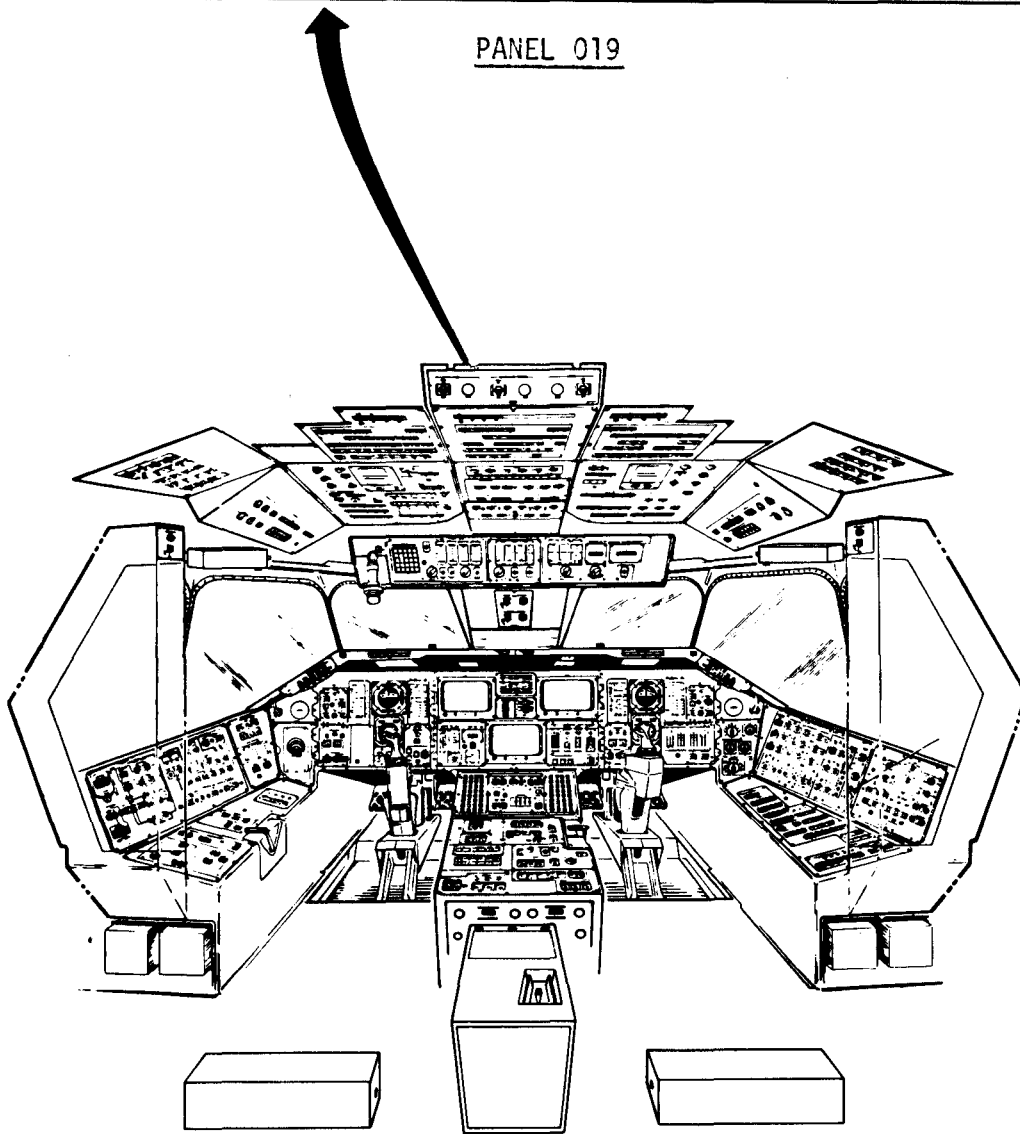


TV CONSOLE MON

Figure 3.8-1.- TV system (sheet 2 of 2).

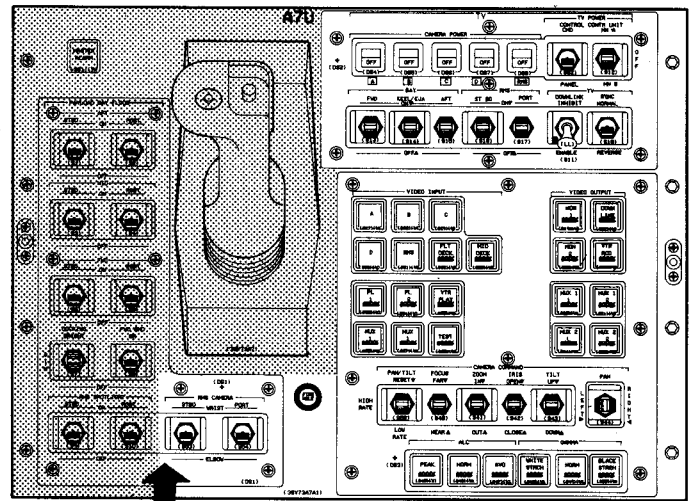
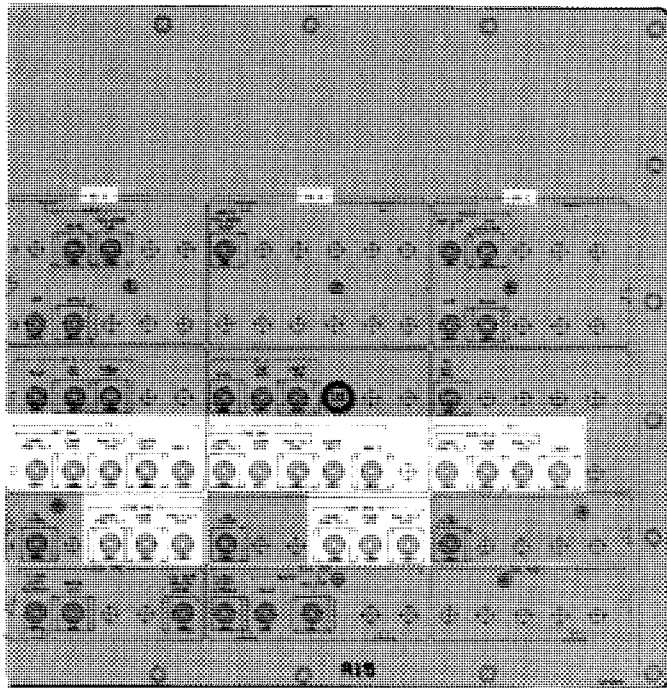


PANEL 019



FWD FLIGHT DECK

Figure 3.8-2.- TV system D&C (sheet 1 of 3).



PANEL A7

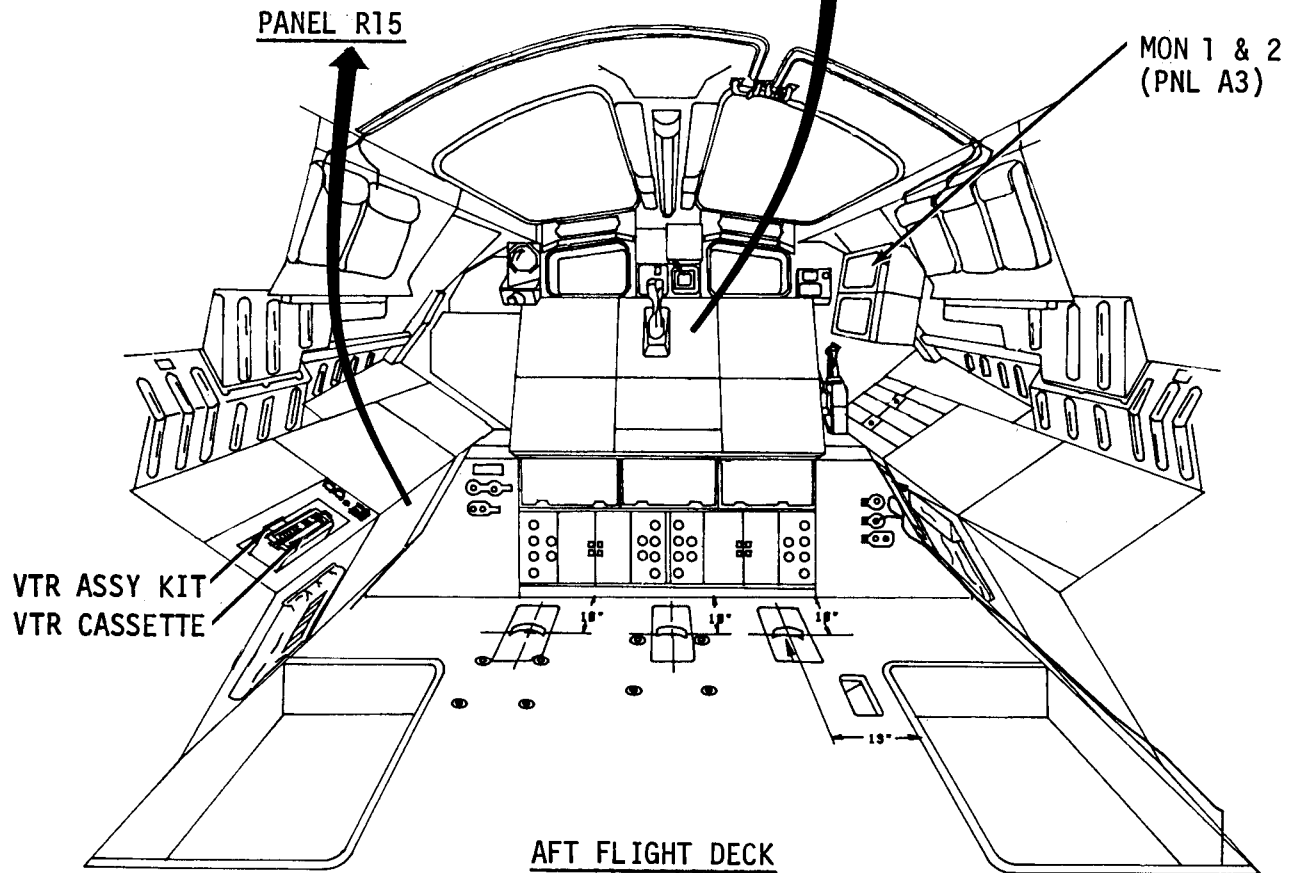


Figure 3.8-2.- TV system D&C (sheet 2 of 3).

For operations, the system requires the support of the following vehicle systems:

- Electrical power system - 28 V dc
- Communications/instrumentation system - CCTV uplink commands, telemetry downlink, and video and audio downlink
- Environmental control and life support system (ECLSS) - cooling (MON only)
- Structural system - mounting locations

During operations, the TVC attaches directly to the multi-use arm (fig. 3.8-3) used with photo equipment (sec. 3.9, Photography).

3.8.3 Systems Functional Description

The crew is required to unstow, set up, and stow the cabin TVC's and support equipment. Control of the system is possible either from the ground (through uplink commands) or from onboard from panel A7 and the camera assembly. Onboard control is also possible through the data processing system (DPS) keyboards. Detailed uplink commands and keyboard inputs are covered in SFOM, Vol 4D. The ground and crew can both control the system power, camera and lens functions, and input/output video configuration selection. Only the crew can determine control mode (ground and/or onboard) and assign the input to MON's 1 and 2. The ground can affect the MON 1 or 2 display if a split screen display from a multiplexer is the input to the monitor. In this case, the ground can change the camera inputs assigned to the multiplexer. Also, the ground can simultaneously downlink a camera selected for MON 1 or 2 and adjust the camera settings (i.e., zoom) and affect the MON display. The VTR record and playback operations can be controlled only by the crew.

All interior cameras are equipped with a color wide-angle lens. MON 1 and 2 and the TV VFM provide a monochrome (black and white) picture regardless of the lens assembly used. When viewing interior camera scenes, a flicker will be noticed. The flicker is caused by the rotating color wheel used to generate the field-sequential-color (FCS) signal that allows color outputs on the ground. The color conversion process on the ground eliminates the flicker before the color signal is distributed.

A block diagram of the TV system is shown in figure 3.8-4.

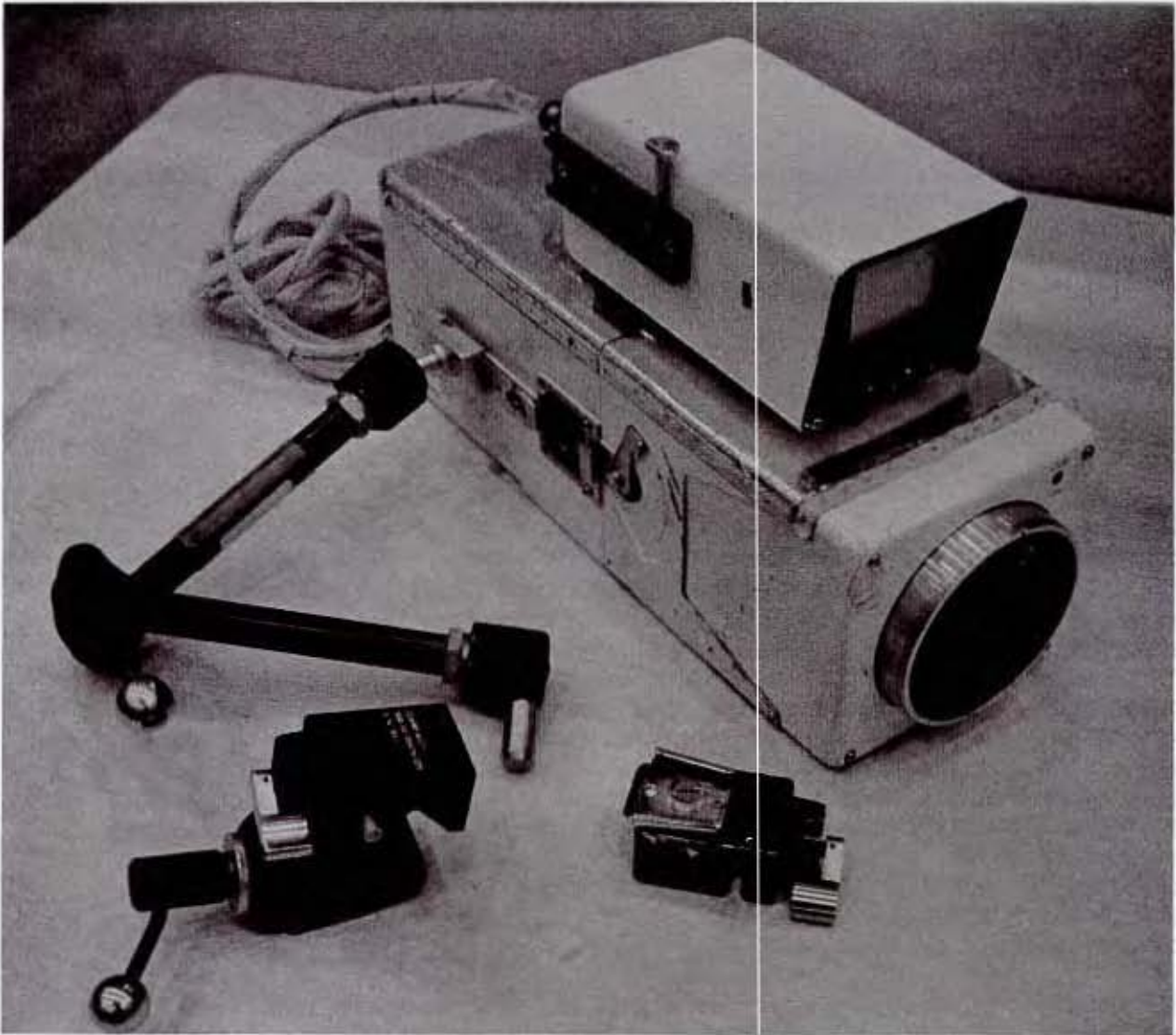


Figure 3.8-3.- TV Camera assembly with multi-use arm attached.
(Multi-use clamp and multi-use mount separate.)

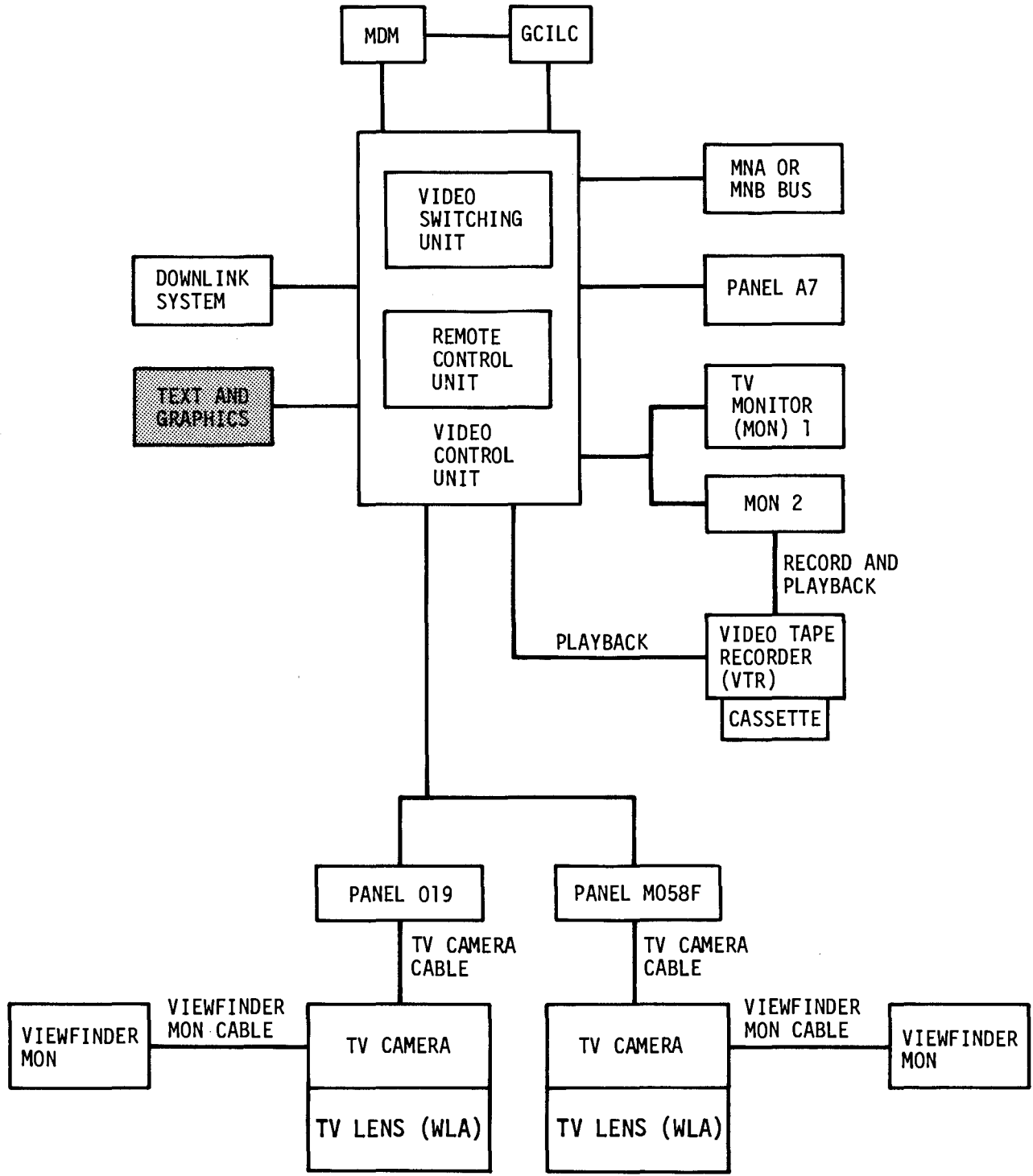


Figure 3.8-4.- TV system interface diagram.

TVC

The camera (fig. 3.8-5) used by the system is a basic monochrome camera that converts light images into a composite video signal (picture plus sync). The camera can produce either a B&W or a color image depending on the lens assembly used.

For mounting purposes, the camera is equipped with three dovetail mounts for attaching the camera to the camera mount and the VFM. For heat dissipation, the top of the camera contains a highly reflective surface. The connector that is used to attach the TV cable to the camera is on the right side of the camera. The back of the camera contains the camera controls and a connector for attaching the Viewfinder Mon Cable.

Both sides of the camera have decals that indicate the relative positions of the ALC and GAMMA pushbutton controls on the back of the camera. These aid local operations when the controls cannot be viewed directly. Two camera/lens latch catches, which secure the lens to the camera, are located on either side of the camera.

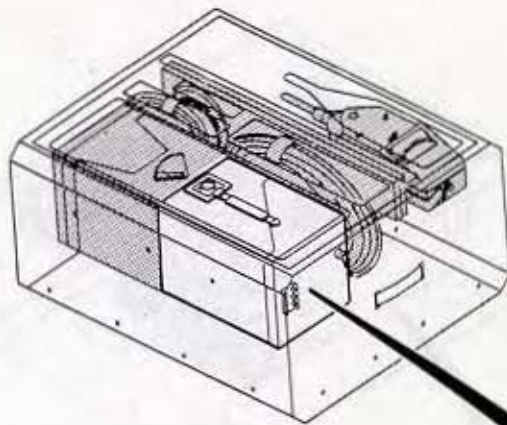
Specific operating characteristics are detailed in section 3.8.4.

TV Wide Angle Lens Assembly (WLA)

The TV lens provided with the cabin TV system is a color lens. This lens is an F/3.5 zoom lens (fig. 3.8-6). The lens is equipped with a six-segment, three-color rotating filter wheel that produces sequential red, green, and blue color fields. On MON 1 and 2 and the VFM, the output appears in B&W with a flicker due to the rotating filter wheel. On the ground, the output can be converted to a color image. The lens is equipped with motorized lens control functions for varying the zoom, iris, and focus. These lens functions are controlled manually via lens switches, remotely via panel A7, or via ground command. The iris is also controlled automatically through the camera ALC circuits.

The top of the lens contains a highly reflective radiator surface to dissipate heat. Located on the front of the lens is the red cue light that illuminates when the camera video output is selected for downlink. The three lens control switches are located on the upper left-hand corner of the lens. The side under the controls as well as the front of the lens contain decals which indicate the relative positions of the controls and aid operations when the switches cannot be viewed directly. Two overcenter lens/camera lock latches which secure the lens to the camera are located on either side of the lens.

Specific operating characteristics are provided in section 3.8.4.



LOCKER STORAGE
(TYPICAL)

LATCH CATCH
(2 places)

S79-39297

DOVETAIL
MOUNT

CONTROL
DECAL

TV CAMERA

S80-27681

CONTROLS

LENS

VIEWFINDER
MON CABLE
CONNECTOR

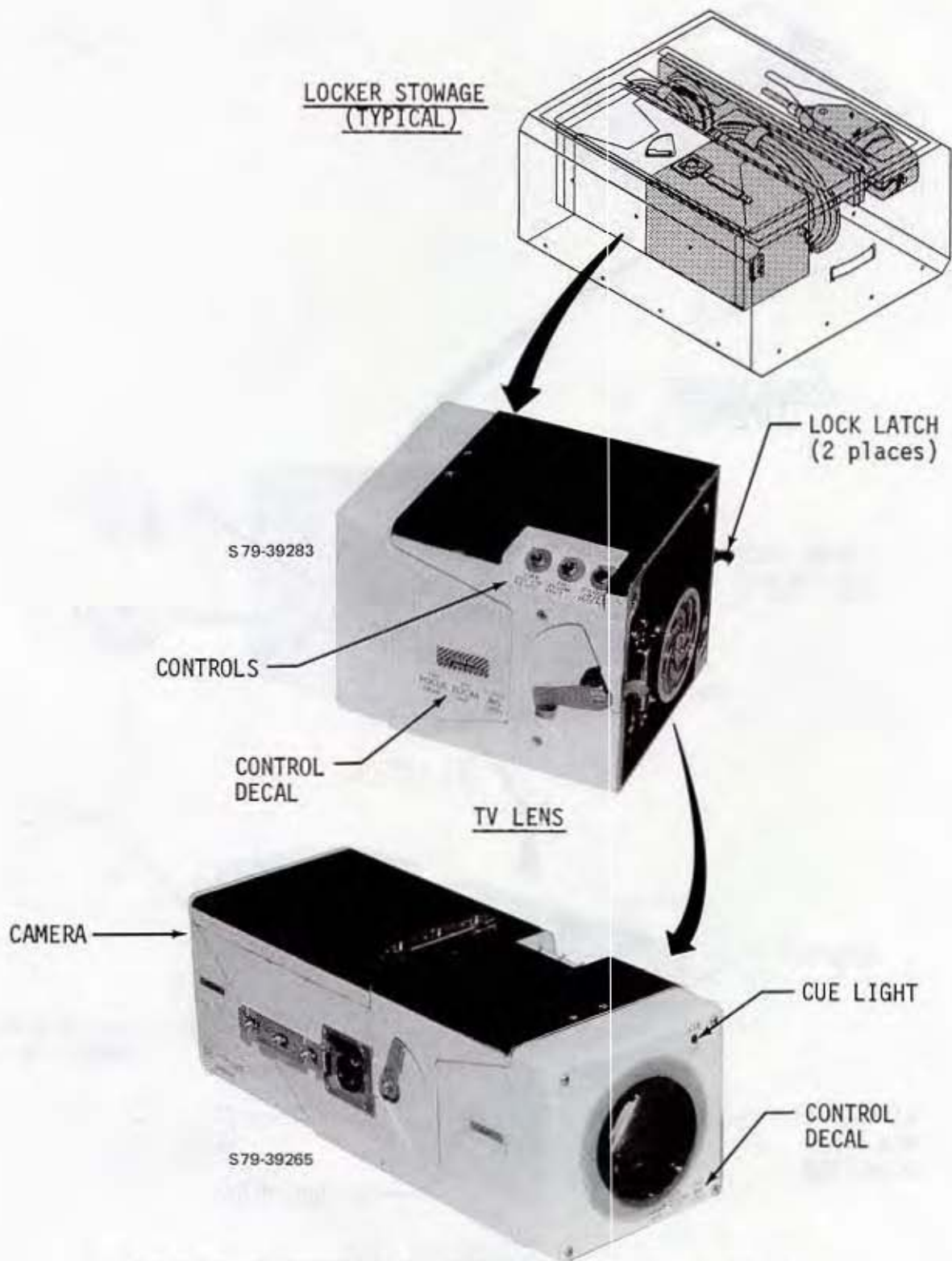
CAMERA CABLE
CONNECTOR

DOVETAIL
MOUNT

CONTROL DECAL

TV CAMERA AND LENS
(LAUNCH AND ENTRY CONFIGURATION)

Figure 3.8-5.- TV camera.



TV LENS AND CAMERA (LAUNCH AND ENTRY CONFIGURATION)

Figure 3.8-6.- TV lens.

TV Color Lens Assembly (CLA)

The TV CLA is identical in function and control to the TV lens discussed above except for lens size and field of view. This lens is an F/1.4 zoom lens with about a half-width field of view compared to the other lenses.

Specific operating characteristics are provided in section 3.8.4.

TV Monochrome Lens Assembly (MLA)

The MLA is identical in function to the CLA except for the color wheel assembly, hence, it has no flicker when viewed on B&W TV console monitors. Although MLA, like CLA, is nominally not flown for in-cabin use, it is available if there is a need or requirement for these lens assemblies.

Specific operating characteristics are provided in section 3.8.4.

VFM

The VFM is a small portable monochrome monitor that enables the crew to view camera video output for scene verification when MON 1 or 2 is not accessible or available (fig. 3.8-7). The monitor is equipped with a D&C to control the display. Aside from the D&C, the VFM contains a connector located on the back to attach the Viewfinder Mon Cable which then connects the monitor to the camera. The bottom and left sides of the monitor (when viewed from front) contain dovetail mounting shoes that mate to dovetail mounts on the camera.

Specific operating characteristics are provided in section 3.8.4.

TV Cable - 10 and 20 ft

The TV cable connects the camera to either of the two TV system input stations located in the cabin on panels 019 and M058F, (fig. 3.8-2). The cable provides the camera with 28-V dc power and command/sync signals, and provides camera video and data signals to the VCU for distribution.

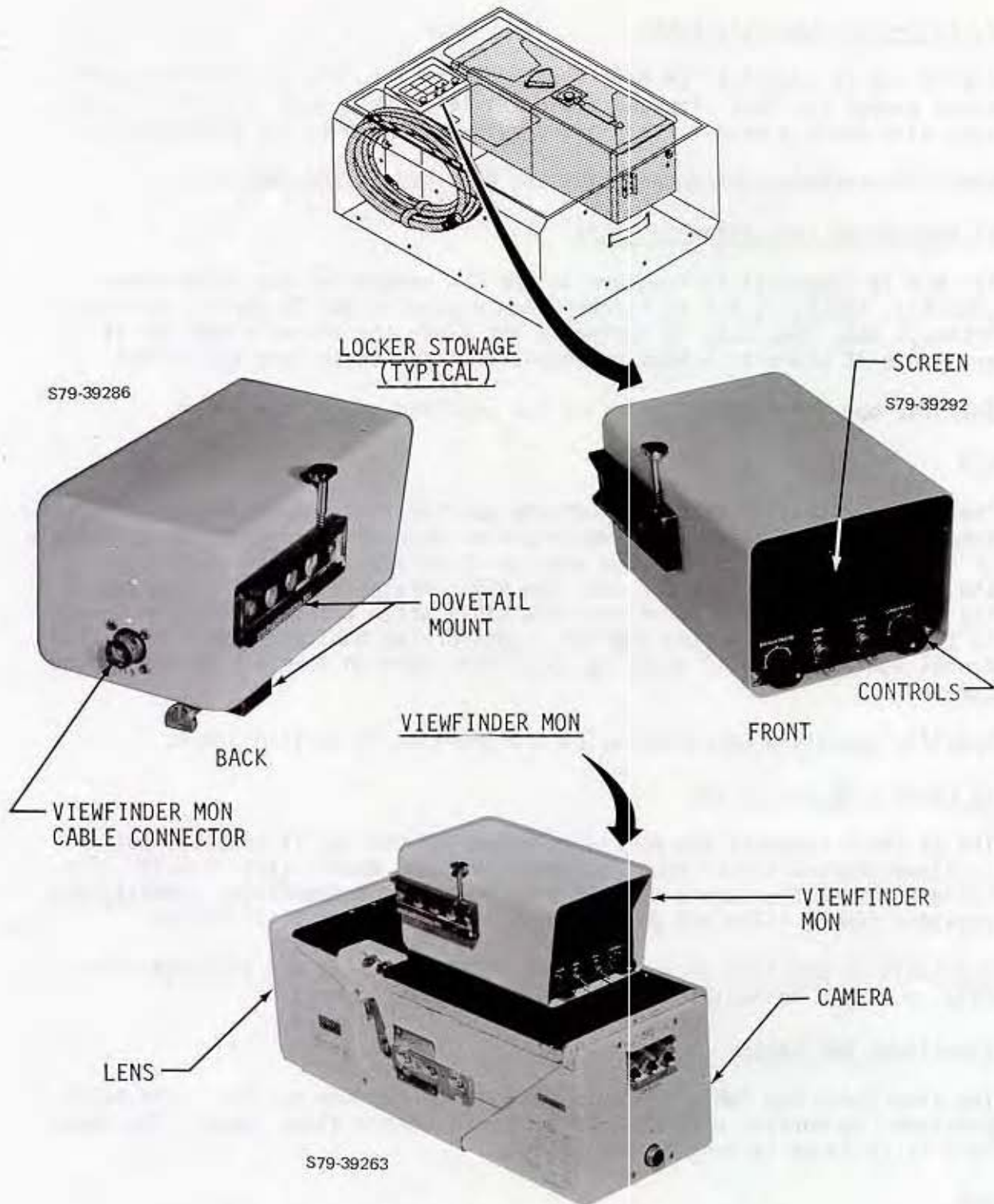
The cable is provided in two lengths: 10 ft (3.05 m) and 20 ft (6.10 m) (fig. 3.8-8). Normally, two 20-ft lengths are flown.

Viewfinder Mon Cable

The Viewfinder Mon Cable connects the camera with the monitor. The cable provides the monitor with 28-V dc power and camera video input. The cable is 9 ft (2.74 m) in length (fig. 3.8-8).

MON

Two monitors are fixed in the aft station on panel A3. The monitors are identical (fig. 3.8-9) and are arranged one over the other - the top one is referred to as MON 1 and the bottom as MON 2. The monitors are used



VIEWFINDER MON, CAMERA, AND LENS ASSEMBLY

Figure 3.8-7.- Viewfinder monitor.

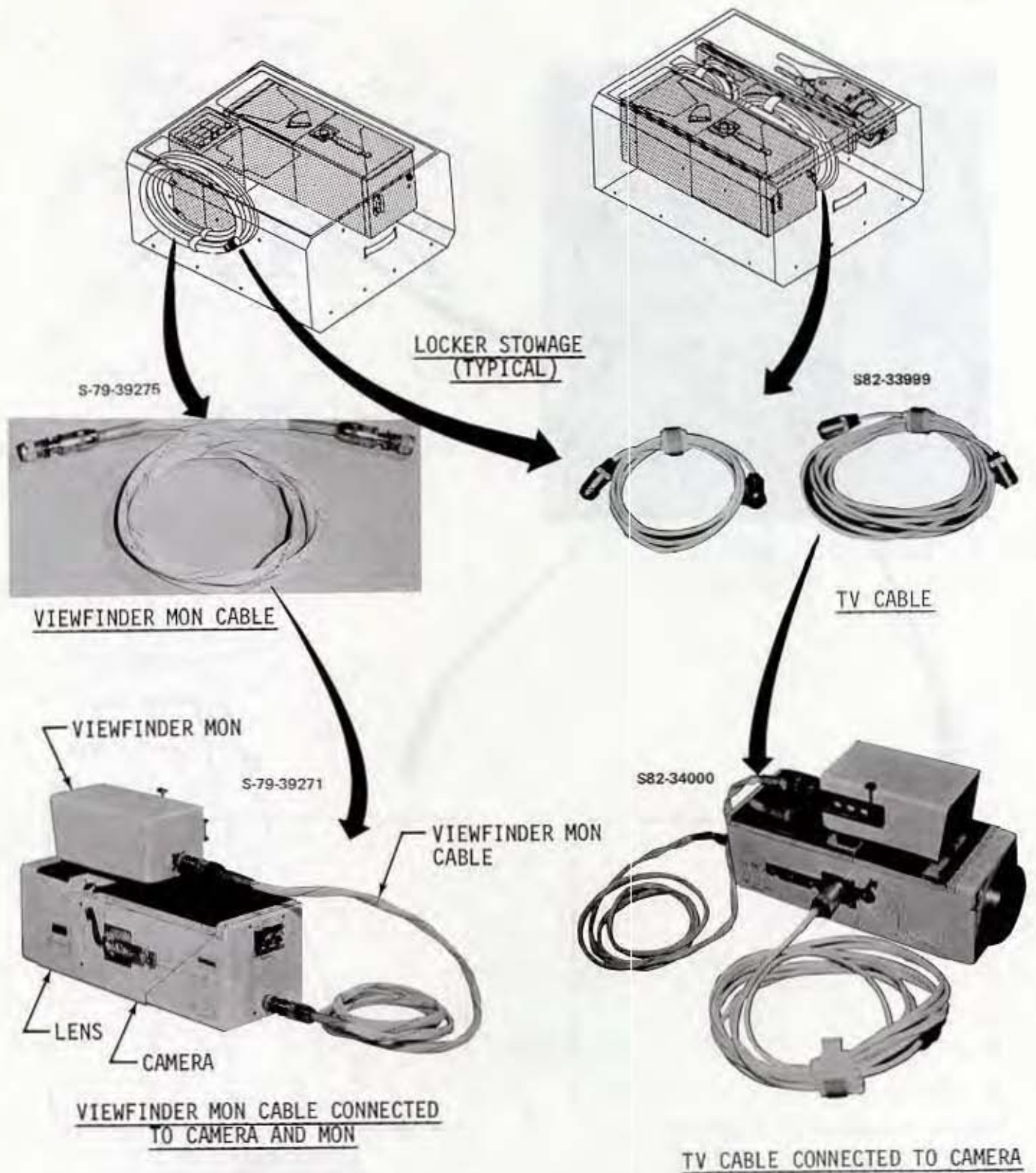
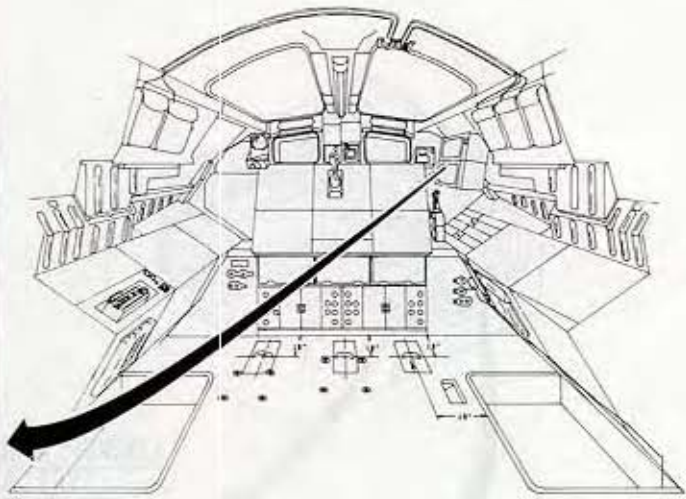


Figure 3.3-8.- TV and viewfinder monitor cables.

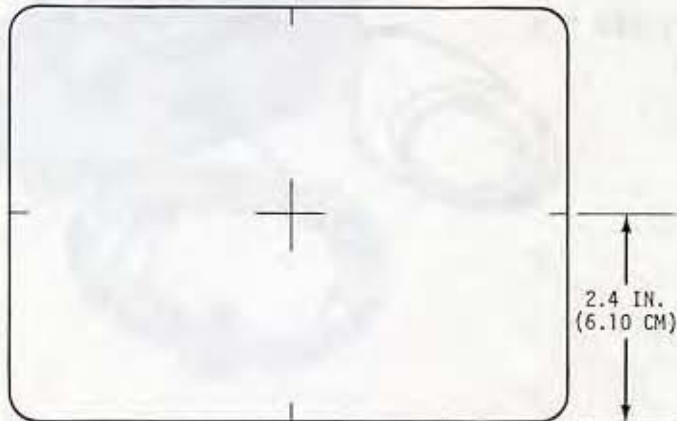
S-79-39240



AFT FLIGHT DECK

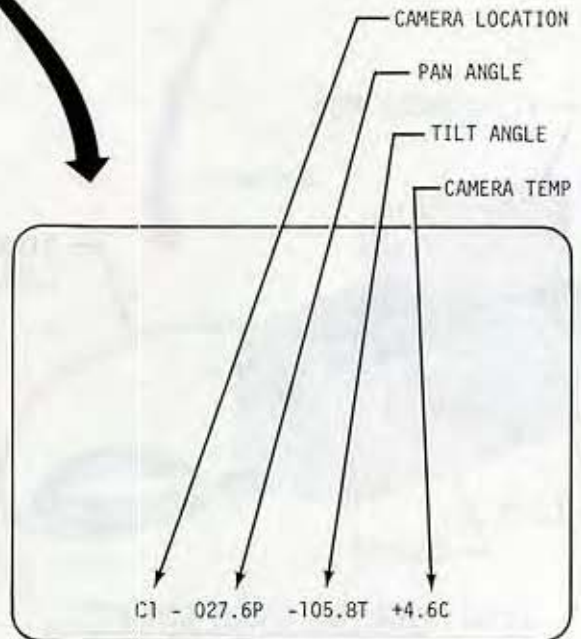
MON
(PANEL A3)

3.2 IN.
(8.13 CM)



CROSSHAIR PATTERN
(X-HAIR SW IN "ON" POSITION)

2.4 IN.
(6.10 CM)



ALPHANUMERIC DATA
(DATA SW IN "ON" POSITION)

C1 - 027.6P -105.8T +4.6C

Figure 3.8-9.- Console monitor (MON).

primarily to provide the crew with a means of viewing camera outputs for picture quality and scene verification and to conduct camera operations. Each MON is a monochrome monitor and has the capability of displaying any of the camera inputs available. Each includes a split screen image from any two cameras. This feature is generated by the VCU and selected via panel A7 commands. The video source may be selected from the panel A7 selection, the downlink signal, and a direct VTR video playback. The monitors are capable of displaying a set of crosshairs for camera pointing alignment and superimposing alphanumeric camera data on the screen. The data consist of a camera location ID number, camera pan and tilt angles, and camera temperatures if any camera is in an overtemperature condition.

The monitors are equipped with D&C to directly control most monitor operations; however, the assignment of an input source to the monitor is controlled by panel A7.

Specific operating characteristics are provided in section 3.8.4.

VTR

The VTR is a modified off-the-shelf video recorder that is normally used to record CCTV system video (fig. 3.8-10). The VTR has the capability of also recording audio with the video through the CCU connector on the VTR housing. This connector only interfaces the VTR and does not allow the crewmember to access the vehicle communications system. The VTR uses 30-min tape cassettes that can be played back for downlink via a combination of crew and ground operations. Both recorded video and audio can be downlinked. All actual VTR operations must be performed by the crew. These operations include everything from tape change-out to VTR activation.

The VTR is configured to receive its video input from PLB and cabin cameras and MUX's. For onboard playback, the recorded video can be reviewed on either monitor through the A7 panel when a VTR playback is initiated. For downlink purposes, the A7 panel is configured to downlink the VTR playback and the VTR is configured in a playback mode. The audio portion of the recorded video can be hardwired into a CCU and downlinked via A/G 2.

In addition to the D&C, the VTR has two connectors on one of its panels. One of these connectors is an audio input (CCU) that interfaces directly with crew comm equipment. The other connector is a direct output (VIDEO OUTPUT) for playback purposes through OI9, since VTR playback PBI on A7 is dedicated to an experiment on most Spacelab flights.

Specific operating characteristics are provided in section 3.8.4.

VTR Cassette

The VTR uses off-the-shelf 30-min tape cassettes (fig. 3.8-11). The VTR is equipped with a NO VIDEO light that illuminates when there is no video source present at the recorder. When recording, a check should be made to verify that the NO VIDEO light is off. Also, an end-of-tape (EOT) light indicates when the cassette is out of tape. When this occurs, the VTR will automatically stop.

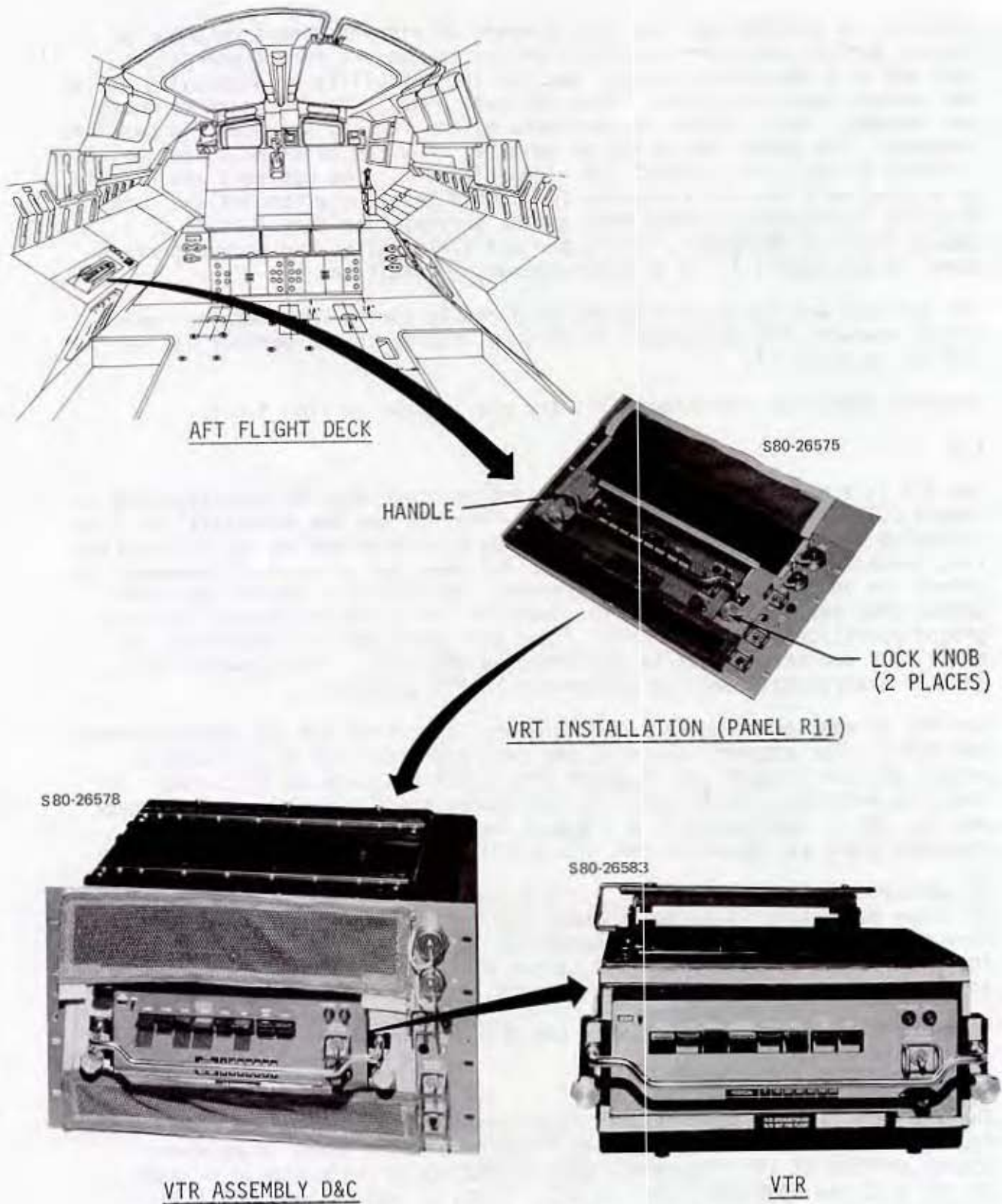
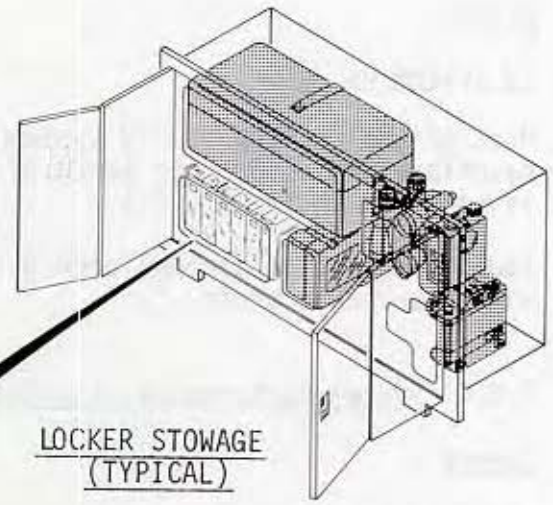
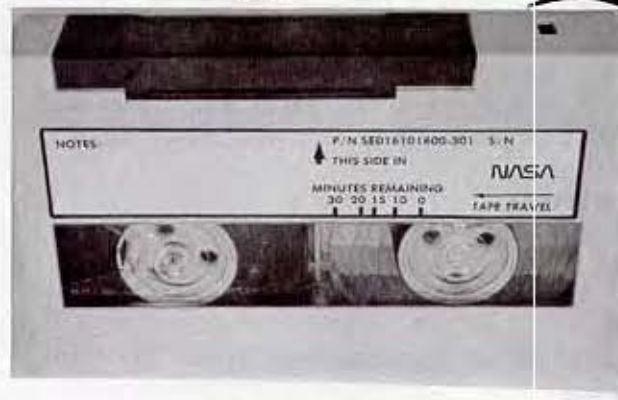


Figure 3.8-10.- Video tape recorder.



LOCKER STORAGE
(TYPICAL)

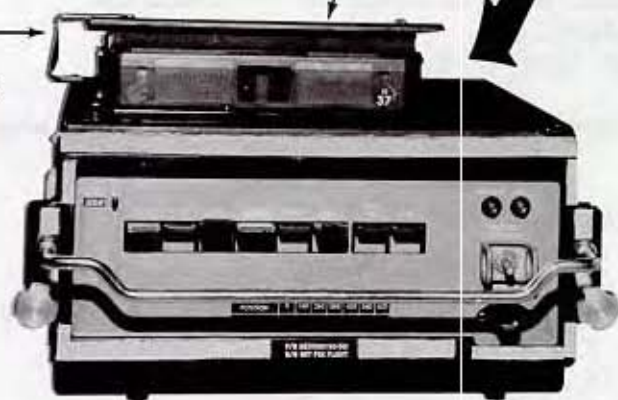


VTR HEAD INTERFACE
(THIS SIDE GOES INTO VTR)

VTR CASSETTE

CARRIAGE RETRACT
LEVER

S80-26584



CASSETTE CARRIAGE
(DEPLOYED)

VTR CASSETTE INSTALLED

Figure 3.8-11.- VTR cassette.

TV System D&C

Most of the D&C for the TV system is located on the hardware previously described and on Orbiter panel A7. A listing of the specific D&C functions is provided in table 3.8-1.

Tape changeout is accomplished by ejecting the cassette from the VTR like any cassette recorder.

3.8.4 System Performance, Limitations, and ConstraintsCamera

- Weight: 9.7 lb (4.4 kg)
- Dimensions: 9.14 by 6.32 by 5.75 in. (23.2 by 16.1 by 14.6 cm)
- Power: 28 V dc, 20.5 W
- Heater power: 28 V dc, 19.6 W*
- Signal-to-noise ratio: 35 dB
- Dynamic light range: 5×10^6 to 1 in. @6.0 sec
- Video output: nominal 1 V peak-to-peak into 75- Ω load
- Resolution: 350 TV lines
- Frame rate: 60 fields/sec
- Scan lines: 525 lines/frame
- Video bandwidth: #4.5 MHz
- Gray scale response: 10 log steps (32:1 contrast ratio)
- Power-on conditions
 - 50 μ sec reset pulse to clear command register
 - Inhibits the following
 - Focus-zoom clock
 - Iris clock
 - Converter sync
 - Initializing states
 - ALC: PEAK
 - GAMMA: NORM
 - Manual iris (lens fully closed)
 - No focus, zoom, or iris motor drive commands
- Power-off conditions:
 - 4-sec delay for lens iris closing

*The heater is thermostatically controlled and is off when the camera is powered.

TV Lens (CLA and MLA)

- Weight: 7.7 lb (3.49 kg)
- Dimensions: 7.41 by 5.75 by 5.43 in. (18.4 by 14.6 by 13.8 cm)
- Power: 28 V dc, 5.4 W (8.0 W max.)
- Focus: 30 in. (76.2 cm) to infinity
- Aperture: F/1.6 to F/16
- Zoom: 18 to 108 mm

- Field of view: 6.8° to 39.4° (horizontal); 5.1° to 29.9° (vertical); 8.5° to 48.0° (diagonal)
- Time for lens to focus from one extreme to the other
Manual: 15 ± 2 sec
- Time for lens to zoom from one extreme to the other
Manual: 7.0 ± 2 sec
- Time for lens to close iris from full open
Powerdown: 2 ± 1 sec
Auto: 4 ± 1 sec
Manual: 10 ± 1 sec
- Latch closing pressure: 60 lb
- If the camera is in the auto mode and the iris is changed, the camera goes into a manual mode (panel A7 will automatically illuminate the two ALC pbi's not associated with the ALC mode indicating the manual iris mode is in effect). Depressing any one of the ALC pbi's will automatically put the camera in an auto mode (panel A7 will go back and illuminate only the selected ALC pbi indicating the auto mode is in effect).

WLA

- All aspects of the wide-angle lens are the same as the TV lens except for the following.
Weight: 8.3 lb (3.7 kg)
Focus: 24 in. (61 cm) to infinity
Aperture: F/3.5 to F/22
Zoom: 9 to 27 mm
Field of view: 29° to 82° (horizontal); 22° to 62° (vertical); 36° to 103° (diagonal)

VFM

- Weight: 4.0 lb (1.81 kg)
- Dimensions: 8.00 x 4.25 x 3.60 in. (20.3 x 14.8 x 9.1 cm)
- Power: 28 V dc, 7.0 W
- Brightness: 50 ft-L
- Signal-to-noise ratio: 50 dB
- Resolution: 400 TV lines
- Image display area: 3.8 in. (diagonal)
- Scope: Kine with P-4 Phosphor

MON

- Weight: 21 lb (9.52 kg)
- Dimensions: 12.5 by 10 by 7 in. (31.7 by 25.4 by 17.8 cm)
- Power: 28 V dc, 40 W
- Brightness: 50 ft-L
- Signal-to-noise ratio: 50 dB
- Resolution: 600 TV lines
- Image display area: 8 in.
- Scope: Kine with P-4 Phosphor
- Gray shades: 10 (EIA logarithmic) in 25 ft-c ambient

VTR

- Power: 28 V dc
 - Stop: 12.0 W
 - Record: 42.6 W
 - Playback: 39.8 W
 - Standby: 32.2 W
 - Rewind/fast fwd: 16.0 W
- Signal-to-noise ratio
 - Video: #43 dB
 - Audio: #40 dB
- Video output: 1 V peak-to-peak into 75- Ω (unbalanced) load
- Audio output: -6 dB at 100-k Ω load with an impedance of 2 k Ω or less
- Horizontal resolution: #340 lines
- Tape speed: 3-3/4 in/sec (95.3 mm/sec)
- Rewind and fast forward time: 3 min
- To downlink recorded video, the TV system must be in an asynchronous mode (ground function) and the PL 1 input selected for the DOWNLINK output.
- To record video on the VTR, the desired camera output must be selected for display on MON 2 (VTR video input tied directly to MON 2).
- To record audio with the video, voice must be input directly into the recorder via crew comm equipment which interfaces directly with the VTR CCU connector.
- To place the VTR in a record mode, the RCD and PLAY pushbuttons have to be depressed simultaneously.
- If the STOP pushbutton is used before ejecting a tape cassette, allow 10 sec for tape to unthread before depressing the EJECT pushbutton.

TABLE 3.8-1.- TV DISPLAY AND CONTROL FUNCTIONS

| Location | Type | Nomenclature/ position | Function | Remarks | |
|----------|------|--|--|---|---|
| TVC | pb | Automatic light control(ALC) pushbutton | Automatic image tube protection circuit that compensates for scene brightness levels. The circuit controls the tube high voltage, lens aperture (IRIS), and automatic gain control (AGC) | Panel A7 and the ground have the same remote control functions | |
| | | | PEAK | Eliminates 0.5 percent of the brightest portion of the scene and adjusts to the remaining scene light level | This mode provides more detail or contrast in the bright areas of the scene |
| | | | NORM | Same as PEAK except it eliminates 2.5 percent | |
| | AVG | Same as PEAK except it eliminates 10 percent | | | |
| | pb | GAMMA push-button | A shade correction circuit that enhances and subdues light and dark areas of the scene in the video output signal. The circuit controls the video voltage level | Panel A7 and the ground have the same remote control functions | |

TABLE 3.8-1.- Continued

| Location | Type | Nomenclature/ position | Function | Remarks |
|----------|--|---------------------------|--|--|
| TV lens | sw | WHITE STRCH | Enhances light areas and subdues dark areas within the scene to allow more contrast within the light areas | Panel A7 and the ground have the same remote control functions |
| | | NORM | Maintains a linear relationship between light and dark areas within the scene to allow equal contrast of both dark and light areas | |
| | | BLACK STRCH | Enhances dark areas and subdues light areas within the scene to allow more contrast within the dark areas | |
| | | FOCUS switch | Controls the focus lens to obtain a clear sharp image | |
| | | FAR | Drives the focus motor, positioning the lens so the scene is focused on distant objects (out to infinity) | |
| NEAR | Drives the focus motor, positioning the lens so the scene is focused on closed objects (down to 30 in. from front of lens) | | | |

TABLE 3.8-1.- Continued

| Location | Type | Nomenclature/ position | Function | Remarks |
|----------|------|---------------------------|---|--|
| | sw | ZOOM switch | Controls the zoom lens in order to magnify or reduce objects in the scene | |
| | | IN | Drives the zoom motor, positioning the lens to a longer focal length, thus magnifying an object in the field of view (maximum focal length - 108 mm (CLA), 27 mm (WLA)) | Panel A7 and the ground have the same remote control functions |
| | | OUT | Drives the zoom motor, positioning the lens to a shorter focal length, thus reducing an object in the field of view (minimum focal length - 18 mm (CLA), 9 mm (WLA)) | |
| | sw | IRIS switch | Controls the iris diaphragm, adjusting the aperture and controlling the amount of light entering the lens | Panel A7 and the ground have the same remote-control functions |
| | | CLOSE | Drives the iris motor, closing the diaphragm and decreasing the light through the aperture | The iris can be closed down to F/16 and opened to F/1.6 |

TABLE 3.8-1.- Continued

| Location | Type | Nomenclature/ position | Function | Remarks |
|------------------------|-------|---|--|---|
| View- finder Mon | lt | OPEN | Drives the iris motor, opening the diaphragm and increasing the light through the aperture | There are two latches on the lens, one on either side |
| | | CUE light | | |
| | latch | on (red) | Indicates, for interior cameras only, the camera video has been selected for downlink | |
| | | off | Indicates camera not selected for downlink | |
| | sw | TV lens/TVC lock latch | | |
| | | close (cw) | Secures TV lens to the camera | |
| | sw | open (ccw) | Releases TV lens from the camera | |
| | | PWR switch | | |
| sw | ON | Applies power to the monitor electronics, if the camera is on | | |
| | OFF | Removes power from the electronics | | |
| | sw | PEAK switch | | |

TABLE 3.8-1.- Continued

| Location | Type | Nomenclature/ position | Function | Remarks |
|----------|--------------|-------------------------------|--|---------|
| MON1(2) | knob | ON | Increases frequency response of monitor providing a greater contrast level than normally attained by the maximum setting on the CONTRAST control | |
| | | OFF | Returns monitor frequency response level to the normal limits of the CONTRAST control | |
| | | BRIGHTNESS control knob | Controls CRT bias level | |
| | | cw rotation | Increases tube image brightness level | |
| | | ccw rotation | Decreases tube image brightness level | |
| | | knob | CONTRAST control knob | |
| | cw rotation | Increases tube image contrast | | |
| | ccw rotation | Decreases tube image contrast | | |
| | knob | CONTRAST control knob | Controls monitor gain | |
| | cw rotation | Increases tube image contrast | | |
| | ccw rotation | Decreases tube image contrast | | |

TABLE 3.8-1.- Continued

| Location | Type | Nomenclature/ position | Function | Remarks |
|----------|------|----------------------------|---|--|
| | knob | BRIGHTNESS control knob | Controls CRT bias level | |
| | | cw rotation | Increases tube image brightness level | |
| | | ccw rotation | Decreases tube image brightness level | |
| | sw | SOURCE switch | | |
| | | PANEL | Selects the video input source as- signed to MON 1(2), defined by panel A7 for dis- play on the moni- tor | |
| | | DN-LINK | Selects the video input source as- signed to downlink for display on the monitor | This is not the nominal config- uration. It is only used to verify the signal being downlinked |
| | | DIRECT | Selects direct input of VTR video for display on moni- tors | Normally not used |
| | sw | MODE switch | | |
| | | NORM | Enables the normal display mode, al- lowing video se- lected by the SOURCE sw to be output on the monitor | Momentary sw spring-loaded to the NORM position. This sw is used for ground checkout and is not planned for in- flight use |

TABLE 3.8-1.- Continued

| Location | Type | Nomenclature/ position | Function | Remarks |
|----------|------|---------------------------|---|---|
| | sw | SCAN switch | <p>PULSE-X Activates a vertical test pattern in the internal MON electronics and outputs it on the monitor</p> <p>NORM Selects a 5 percent overscan mode of the monitor display, where the total image viewed by the camera is displayed</p> <p>UNDER Selects a 5 percent underscan mode of the monitor display where the total image viewed by the camera is displayed</p> | |
| | sw | DATA switch | <p>ON Superimposes an alphanumeric display of camera location, pan and tilt angles, and temperature data for the camera whose output is being viewed on the monitor</p> | <p>The data are provided at the base of the display</p> <p>Temperature data are displayed for all cameras only when an overtemp condition exists for any camera</p> |

TABLE 3.8-1.- Continued

| Location | Type | Nomenclature/ position | Function | Remarks |
|----------|------|---------------------------|--|--|
| | sw | SYNC switch | <p>OFF Disables alpha-numeric display capabilities</p> <p>INT Selects monitor's internal sync generator as its sync source</p> <p>EXT Selects VCU master sync generator as the monitor sync source</p> | <p>Also displayed when an asynchronous source is being played back through a monitor. This causes erroneous overtemp displays</p> <p>INT is used when VTR recorded data are played back to a MON</p> <p>EXT is nominally not used unless INT fails. It is unable to monitor asynchronous sources; e.g., VTR playback</p> |
| | sw | X-HAIR switch | <p>ON Superimposes a crosshair and tick marks in the field of view of the monitor display</p> <p>OFF Disables crosshair display capabilities</p> | <p>This feature is provided for aligning the camera with objects in the field of view during payload bay and RMS operations</p> |

TABLE 3.8-1.- Continued

| Location | Type | Nomenclature/ position | Function | Remarks | |
|----------|--------------------------|---|--|---|--|
| VTR | sw | POWER switch | ON | Applies power to the monitor electronics | Light will come on when no video source is assigned to a monitor. This is caused by a drop in power supply voltage |
| | | | OFF | Removes power from the monitor | |
| | lt | FAULT light | on (red) | Indicates a monitor overtemp or under-voltage condition | |
| | | | off | Indicates normal monitor temperature and voltage conditions | |
| | cb | VTR | close (push) | Provides power to the VTR | |
| | | | open (pull) | Removes power from the VTR | |
| | sw | POWER switch | ON | Applies power to the VTR | |
| | | | OFF | Removes power from the VTR | |
| screw | COLOR LOCK control screw | Adjusts the recorder housing NTSC color electronics to match recorder electronics | Normally a ground function to adjust out variations that exist from VTR to VTR | | |

TABLE 3.8-1.- Continued

| Location | Type | Nomenclature/ position | Function | Remarks |
|----------|------|----------------------------|--|--|
| | sw | AUDIO MODE switch | | PTT requires activation of the rocker arm- switch on the HIU to record audio |
| | | HOT MIKE | Configures VTR comm interface for a hot mike mode | |
| | | PTT | Configures VTR comm interface for a PUSH-TO-TALK mode | |
| | pb | MARK TAPE push- button | Inserts a 1-kHz event marker tone in with the re- corded video | The tone aids in returning to specific video data after re- cording |
| | ind | TAPE POSITION indicator | Displays the number of revolutions to provide an indi- cation of tape position | A decal on the face of the recorder indi- cates TAPE PO- SITION vs. TIME REM - MIN; 620 revolutions equals 30 min |
| | pb | RESET pushbutton | Zero's TAPE POSITION indicator | The tape is threaded when the recorder is in PLAY, RCD, RWND, or STBY. |
| | pb | EJECT push- button | Ejects tape cassette from recorder if the tape is un- threaded | The STOP pb must be depressed to unthread the tape and eject it properly |

TABLE 3.8-1.- Continued

| Location | Type | Nomenclature/ position | Function | Remarks |
|----------|------|---------------------------|---|---|
| | pb | F FWD push- button | Moves the tape in the forward direction at 10 times the normal play speed | The tape takes 3 min from BOT to EOT |
| | pb | PLAY push- button | Threads the tape on the tape head and starts the tape moving for the record and play- back modes | The RCD pushbut- ton must also be depressed when recording video |
| | pb | STOP push- button | Stops tape motion, unthreads tape from tape head, and releases any depressed push- button | |
| | pb | RWND push- button | Starts tape moving in the reverse direction at 10 times the normal play speed | The tape takes 3 min from EOT to BOT. The re- corder performs an automatic STOP when this rewind is complete |
| | pb | RCD pushbutton | Enables recording of video and audio on the tape cassette | The PLAY pushbut- ton must also be depressed in order to record |
| | pb | AUDIO DUB pushbutton | Enables voice annotation and event mark to be recorded without affecting video while in the playback mode | Previous recorded audio (but not video) will be recorded over or erased when the pushbutton is depressed |

TABLE 3.8-1.- Continued

| Location | Type | Nomenclature/ position | Function | Remarks |
|----------|------|---------------------------|--|--|
| | pb | STBY pushbutton | Stops the tape without unthreading it and releases the tension around the head. In the playback mode, the frame is frozen | The PLAY pushbutton must be depressed first and held down while the AUDIO DUB pushbutton is depressed Depressing the pushbutton enables the <u>standby mode</u> (<u>PAUSE</u>)* and a subsequent depression disables it (<u>RUN</u>)* |
| | lt | NO VIDEO light | <p>on (yellow) Indicates no video input is present at the VTR when the recorder is powered</p> <p>off Indicates video input is present</p> | |
| | lt | EOT light | <p>on (yellow) Indicates the cassette is at the end of usable tape</p> <p>off Indicates the cassette has not reached the EOT</p> | The EOT light also indicates the recorder has performed an automatic STOP function. |
| | | | | *Box indicates panel decal next to this position |

TABLE 3.8-1.- Continued

| Location | Type | Nomenclature/ position | Function | Remarks |
|----------|------|----------------------------------|---|--|
| | sw | VIDEO MODE switch | | FUTURE consid- erations are to use a NTSC cam- era, but pres- ently only B&W and FSC cameras are available |
| | | NTSC COLOR | Modes the recorder to be compatible with NTSC color signals for the record and play- back modes | |
| | | B&W/FSC | Modes the recorder to be compatible with B&W and FSC signals | |
| | ind | HOURS AND TENTHS indicator | Indicates total VTR record and play- back time (head wheel motion) | Not used for flight. The maximum readout is 999.9 hr |
| | sw | VIDEO SELECT switch | | The sw is located on the back of the assembly and set preflight to J2 by ground. The J3 position was originally intended for downlinking VTR recorded vido through the pan- el 019 FLT DECK input using a TVC cable |
| | | | J2 Routes the VTR video output to the J2 connector on the back of the VTR assembly, which interfaces the Payload 1 (PL 1) into the VCU | |
| | | | J3 Routes the output to the J3 connec- tor on the face of the VTR assembly | |

TABLE 3.8-1.- Continued

| Location | Type | Nomenclature/ position | Function | Remarks |
|-------------------------------|------|---------------------------|---|---------|
| Panels 019 and M058F | sw | TV PWR switch | ON Applies power to the cabin cameras and disables ground control of the power function only | |
| | | | OFF Opens the power circuit to the cabin cameras preventing either crew or ground control of the function | |
| | | | COMMAND Enables ground control of power to the cabin cameras | |
| Panel A7 | sw | TV POWER CONTROL switch | CMD Enables the ground to control power to the VCU and disables the POWER CONTR UNIT sw. Allows the crew or ground to control input/output selection and any camera | |

TABLE 3.8-1.- Continued

| Location | Type | Nomenclature/ position | Function | Remarks |
|----------|------|----------------------------|--|---|
| | | PANEL | Enables the POWER CONTR UNIT sw, allowing the crew to control power to the VCU. Disables all ground control; therefore, only the crew can control the system | This position is used for initial TV system activation to eliminate a ground coverage constraint when powering the system |
| | sw | TV POWER CONTR UNIT switch | | For sw to function, TV POWER CONTROL sw must be in PANEL position |
| | | MNA | Applies MN BUS A power to the VCU | |
| | | OFF | Removes power from the VCU. | The VCU may still be powered if the CONTROL sw is in CMD and the ground has commanded it on |
| | | MNB | Applies MN BUS B power to the VCU | |
| | sw | TV SYNC switch | | |
| | | NORMAL | Configures the system so that oscillator A is operational when MNA is the VCU power source; oscillator B is operational when MNB is the source | |
| | | REVERSE | Configures the system so that oscillator A is operational when MNB is the power source; oscillator B is operational when MNA is the source | |

TABLE 3.8-1.- Continued

| Location | Type | Nomenclature/ position | Function | Remarks |
|----------|------|------------------------------|---|---|
| | sw | TV DOWNLINK switch | | |
| | | ENABLE | Allows video and audio to be output from the VCU to the downlink system | |
| | | INHIBIT | Disables the output to the downlink system | |
| | tb | CAMERA POWER talkback (5) | | There are five such indicators on the panel: one above each respective power ON/OFF sw for each of the camera locations |
| | | ON (blk on wht) | Indicates the respective camera has been issued a POWER ON command | |
| | | OFF (wht on blk) | Indicates the respective camera is powered down | |
| | sw | TV CAMERA POWER A switch | | |
| | | ON | Applies power to the A camera assembly | |
| | | OFF | Removes power from the assembly | |
| | sw | TV CAMERA POWER B switch | Same as A pwr sw except the B camera | |
| | sw | TV CAMERA POWER C switch | Same as A pwr sw except the C camera | |
| | sw | TV CAMERA POWER D switch | Same as A pwr sw except the D camera | |

TABLE 3.8-1.- Continued

| Location | Type | Nomenclature/ position | Function | Remarks |
|----------|------|---|--|---------|
| | sw | CAMERA POWER RMS PORT switch | Same as A pwr sw ex- cept the PORT RMS camera | |
| | sw | RMS CAMERA PORT switch WRIST | Configures the RMS video switcher so that the wrist camera provides the video input when the RMS PORT input has been selected for output | |
| | | ELBOW | Configures the sys- tem for the elbow camera | |
| | sw | RMS CAMERA STBD switch | Same as the PORT sw except the STBD RMS | |
| | pbi | VIDEO OUTPUT pushbutton indicator DOWNLINK | Initiates or re- activates an in- put/output con- figuration selec- tion specifying the S-band FM or Ku-band downlink system as the out- put to which the assigned input is routed | |

TABLE 3.8-1.- Continued

| Location | Type | Nomenclature/ position | Function | Remarks |
|----------|------|---------------------------|---|---|
| | | MON 1 | Same as DOWNLINK except specifies MON 1 (top monitor) as the output | |
| | | PAYLOAD/ VTR RCD | Same as DOWNLINK except specifies a payload or video record as the output | |
| | | MON 2 | Same as DOWNLINK except specifies MON 2 (bottom monitor) as the output | |
| | | MUX 1 R | Same as DOWNLINK except specifies multiplexer 1 as the output. This will compose the right half of a split screen image | MUX 1 as an input can be assigned to any of the four outputs terminals (DNLK, MON 1, MON 2, OR PAYLOAD/VTR RCD) |
| | | MUX 1 L | Same as DOWNLINK except specifies multiplexer 1 as the output. This will compose the left half of a split screen image | The split screen image is composed of the center portion of the field of view of each camera |
| | | MUX 2 R | Same as DOWNLINK except specifies multiplexer 2 as the output. This will compose the right half of a split screen image | |

TABLE 3.8-1.- Continued

| Location | Type | Nomenclature/ position | Function | Remarks |
|----------|------|--|---|---------|
| | pbi | VIDEO INPUT pushbutton indicator | MUX 2 L Same as DOWNLINK except specifies multiplexer 2 as the output. This will compose the right half of a split screen image A Assigns the A camera to the illuminated OUTPUT pbi termi- nal and interfaces the camera with the panel A7 CAMERA COMMAND switches B Same as A pbi except the B camera C Same as A pbi except the C camera D Same as A pbi except the D camera RMS Same as A pbi except the RMS PORT cam- era specified by the RMS CAMERA PORT switch | |

TABLE 3.8-1.- Continued

| Location | Type | Nomenclature/ position | Function | Remarks |
|----------|------|---------------------------|--|--|
| | | MIDDECK | Same as A pbi except the MID DECK (connected to panel M058F) camera | |
| | | FLT DECK | Same as A pbi except the FLT DECK (connected to panel 019) camera | |
| | | PL 1 | Same as A pbi except the PL 1 camera | |
| | | PL 2 | Same as A pbi except the PL 2 camera | |
| | | VTR PLAY | Same as A pbi except assigns VTR PLAY to indicated output | VTR PLAY is for both playback of recorded video and recording of video |
| | | TEST | Assigns the test pattern to the illuminated OUTPUT pbi terminal | |
| | | MUX 2 | Assigns the MUX 2 split screen image as an input video source to the illuminated OUTPUT pbi terminal | |
| | | MUX 1 | Assigns the MUX 1 split screen image as an input video source to the illuminated OUTPUT pbi terminal | |

TABLE 3.8-1.- Continued

| Location | Type | Nomenclature/ position | Function | Remarks |
|----------|------|-------------------------------|--|--|
| | sw | CAMERA COMMAND PAN switch | | |
| | | RIGHT | Activates the PTU azimuth drive assembly to rotate the camera to the right (clockwise) | |
| | | LEFT | Activates the azimuth drive assembly rotate the camera to the left (counter-clockwise) | |
| | sw | CAMERA COMMAND TILT switch | | |
| | | UP | Activates the elevation drive assembly to rotate the camera up | |
| | | DOWN | Activates the elevation drive assembly to rotate the camera down | |
| | sw | CAMERA COMMAND IRIS switch | Duplicates same function as lens IRIS sw | The panel A7 iris, zoom, and focus switches interface with the VCU which issues the commands to the camera associated with the illuminated input pbi |
| | | OPEN | | |
| | | CLOSE | | |

TABLE 3.8-1.- Continued

| Location | Type | Nomenclature/ position | Function | Remarks |
|----------|------|---|---|---|
| | sw | CAMERA COMMAND ZOOM switch IN OUT | Duplicates same function as lens ZOOM sw | Electronic com- pensation for reduced light. With modified manual iris there's no elec- tronic compen- sation for re- duced light, hence it is a "true" manual |
| | sw | CAMERA COMMAND FOCUS switch FAR NEAR | Duplicates same function as lens FOCUS sw | |
| | sw | CAMERA COMMAND PAN/TILT switch RESET | Changes the PTU azimuth and eleva- tion axis zero reference point to the present camera position | |
| | | HIGH RATE | Sets the PTU azimuth and elevation drive assemblies to drive at a rate of 12 deg/sec | The azimuth and elevation angles may be displayed on MON 1 or 2. Both readouts change to all zeros when the reset is per- formed, but the camera position does not change |
| | | LOW RATE | Sets the PTU azimuth and elevation drive assemblies to drive at a rate of 1.2 deg/sec | |
| | pbi | CAMERA COMMAND GAMMA BLACK STRCH pushbutton indicator | Duplicates same function as camera GAMMA BLACK STRCH pushbutton | |

TABLE 3.8-1.- Concluded

| Location | Type | Nomenclature/ position | Function | Remarks |
|----------|------|---|--|---------|
| | pbi | CAMERA COMMAND GAMMA NORM pushbutton indicator | Duplicates same function as camera GAMMA NORM push- button | |
| | pbi | CAMERA COMMAND GAMMA WHITE STRCH push- button indi- cator | Duplicates same function as camera GAMMA WHITE STRCH pushbutton | |
| | pbi | CAMERA COMMAND ALC AVG push- button indi- cator | Duplicates same function as camera ALC AVG pushbutton | |
| | pbi | CAMERA COMMAND ALC NORM pushbutton indicator | Duplicates same function as camera ALC NORM push- button | |
| | pbi | CAMERA COMMAND LC PEAK pushbutton indicator | Duplicates same function as camera ALC PEAK push- button | |

3.9 PHOTOGRAPHY

3.9.1 Introduction to 16 mm Photographic Equipment

This section describes the 16 mm photographic equipment used during on-orbit operations. On-orbit operations consist of unstowing and assembling the required camera hardware, setting the camera controls, exposing the proper film footage, and disassembling and stowing the camera hardware. Details of these operations are provided in the 16 mm Photo Equipment Workbook.

The 16 mm camera system consists of the following components:

- Camera body
- Film magazine
- Lenses (5.9 mm, 10 to 100 mm zoom)
- Daylight color correction filters
- Camera battery
- Camera handgrip

See figure 3.9-1.

3.9.1.1 Stowage and Use Locations

For launch and entry, the 16 mm camera system and associated equipment are stowed in the middeck 16 mm camera bag locker. Additional film magazines and batteries are stowed in other middeck lockers as center of gravity and stowage constraints permit.

The 16 mm camera can be used as a handheld system or as a stationary system mounted to the vehicle. The multiuse arm, mount, and baseplate adapter are used to anchor the camera to the vehicle.

3.9.1.2 Systems Functional Description

The 16 mm camera is a battery powered, rotating-mirror, through-the-lens viewing, parallax free, professional motion picture camera. The modular design of this system allows the camera to be configured as needs dictate. In addition to basic camera attachments such as lenses, batteries, film magazines, and the handgrip, the special attachments such as the data module and the tachometer can be easily attached when necessary.

The camera has a through-the-lens automatic exposure system available when using the 10 to 100 mm zoom lens. A manual match-needle exposure system is available when using the manual 5.9 mm lens or when the 10 to 100 mm lens is operated in the nonautomatic mode.

The following is a description of the 16 mm camera system components and their functions. In addition to the following discussion, D&C information can be found in table 3.9-1.

586-38012

221

3.9-2



Figure 3.9-1.- 16 mm photographic equipment.

JSC-12770

The camera body is the major component of the camera system. The working camera is built upon this component. The lens, battery, and film magazine can be attached to the body quickly and easily (fig. 3.9-2).

The camera body is made of the following components.

The centrally mounted viewfinder system provides through-the-lens viewing. This adjustable finder can be rotated in three axes for unrestricted viewing from the right or the left side of the camera. The finder image always remains upright and correct left to right. The viewfinder image can be focused for correction from +4 to -4 diopters. The finder has a 10X magnification.

The activation system allows the operation of the metering system and the film transport system. These functions are initiated by either the camera operate lever or the camera operate lever in conjunction with the handgrip trigger. An in-flight maintenance procedure exists for off-nominal camera activation due to a failure of the camera operate lever.

The through-the-lens metering system allows automatic exposure or manual exposure depending upon lens choice. The 10 to 100 mm zoom lens can be operated in an automatic or a manual mode. With this lens in the automatic mode the camera meter will select the appropriate aperture for proper exposure. With the 10 to 100 mm lens in the manual mode the operator can adjust the exposure using the match-needle exposure system. This is usually accomplished by viewing through the viewfinder and adjusting the lens aperture ring until the metering needle is centered on the exposure scale. The 5.9 mm wide-angle lens does not have an automatic mode. The 5.9 mm lens aperture must be manually adjusted while viewing through the viewfinder.

The film transport system is controlled by a 12-V Hall-effect dc brushless motor which is permanently built into the body. At 24 frames per second the motor rotation is 1440 rpm. The optional tachometer or data module can vary the frame rate from 5 to 75 frames per second or can operate in the single frame mode. The standard 400-foot film loads give a total operating time of 11-1/2 minutes at 24 frames per second.

A rotating mirror-shutter is run by the same motor that runs the film transport system. The standard shutter speed is 1/48 of a second with 24 frames per second. The exposure time can be varied by changing the frame rate with the tachometer or the data module. The exposure time can also be changed by a preflight changeout of the mirror-shutter. The standard mirror-shutter has a 180° open sector. The optional mirror-shutter has a 45° open sector for use when a frame rate of 6 frames per second is required and the 1/48 of a second shutter speed must be maintained.

Plug-in fuses are incorporated in the body to prevent damage to the electronics. The fuses are housed under a clear plastic cover that can be removed and replaced with a coin. Spare fuses are stored within the plastic cover. If fuse replacement is necessary, the ends of the spare fuse must be bent at right angles so that the replacement will fit properly. A 10-amp

586-37990

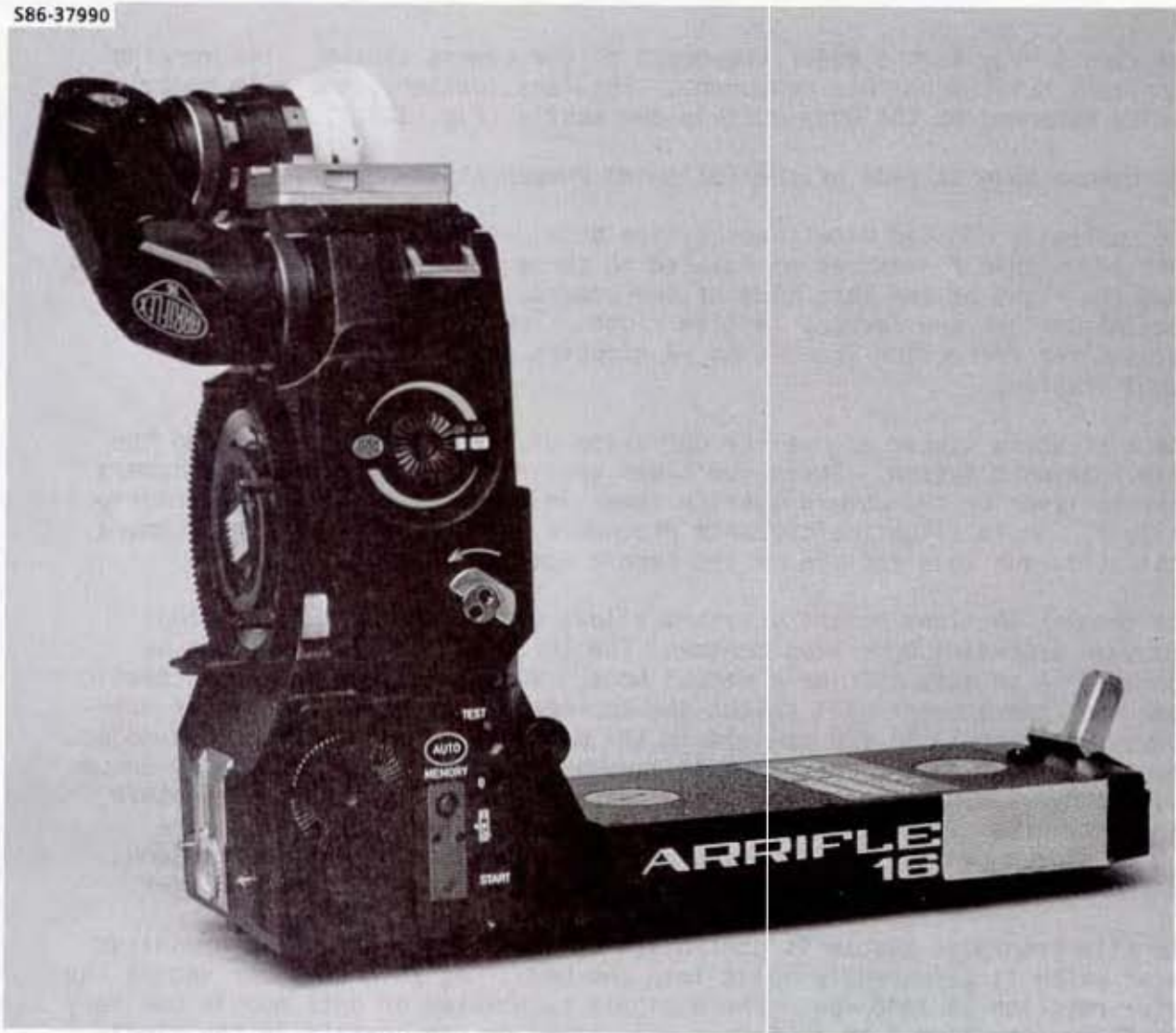


Figure 3.9-2.- 16 mm camera body.

fuse is used to protect the main power circuit. The 0.75-amp fuse protects the camera motor.

The film magazine houses a standard daylight load of 400 ft of 16 mm perforated motion picture film (fig. 3.9-3). In this context, daylight load refers to a film load that can be handled in daylight without fear of excessive light contamination. This is accomplished by winding the film on reels with solid metal sides that prevent light from exposing the film. Using daylight loads greatly reduces bulk and weight and, as a result, more film can be flown.

The right side of the magazine is the supply side. The left side of the magazine is the take-up side. Two latches are provided for securing the sides of the magazine. A red latch release pushbutton positioned next to each latch must be depressed in order to turn the latch to open the side.

An additive magazine footage counter counts from 0 to 360. One complete revolution of the counter dial (from 0 to 0) represents 400 ft. This counter must be manually reset after film changeout by turning the knurled magazine counter reset knob to the 0 position.

The magazine is attached to the camera body by engaging the hinge pin in the snap catch and pushing the magazine downward until a click is heard. The magazine safety lock is then locked to prevent accidental magazine detachment. To remove the magazine from the camera body, the magazine safety lock is pulled back and the release lever is pushed down while the magazine is lifted away.

A protective cover is placed over the end of each spare magazine. The hard plastic cover can be removed by pushing up on the cover and then lifting the cover away from the magazine.

The 16 mm camera system is equipped with a 10 to 100 mm T/2 (f/1.8) zoom and a 5.9 mm f/1.8 wide-angle lens (fig. 3.9-4).

The 10 to 100 mm zoom lens and the 5.9 mm lens attach to the camera body via bayonet mounts. Caution must be used when installing or removing the 10 to 100 mm zoom lens. The 10 to 100 mm zoom lens must be set at T/2 for installation or removal. If the lens is not set to T/2, a metal portion of the lens can make contact with a plastic part in the camera body and cause damage. The 5.9 mm lens does not have a potential interface problem and can be mounted and removed in any f setting.

The 10 to 100 mm zoom lens is capable of macrophotography. For macrophotography the lens must be focused at infinity and the zoom ring rotated to the 10 mm focal length. The green macro focus locking pb must then be depressed and the zoom ring simultaneously rotated into the macro range. Focusing is now accomplished by adjusting the zoom ring within the macro range or by changing the camera-to-subject distance. The closest focusing distance is approximately 1 in. from the front lens element.



Figure 3.9-3.- 16 mm film magazine.

586-37987



10 to 100 mm T/2 (f/1.8) ZOOM

586-37982



5.9 mm f/1.8 WIDE-ANGLE

Figure 3.9-4.- 16 mm lenses.

Daylight color correction filters are necessary when using tungsten film with daylight illumination to ensure correct exposure and color rendition.

Both of the 16 mm lenses have a color correction filter to be used when the scene is illuminated by daylight. The filter supplied for the 5.9 mm lens is a number 85 color correction filter. The filter supplied for the 10 to 100 mm lens is a number 85 ND 3 filter having both color correction and neutral density qualities. One f-stop of neutral density is necessary in the 10 to 100 mm lens to allow the lens to close down to an equivalent of f/22 when the lens is set on f/16. On-orbit exterior photography such as payload bay scenes illuminated by direct sunlight may need the capability offered by using f/22. The 5.9 mm lens has an f/22 setting and does not require the neutral density addition.

The 16 mm camera system is powered by a rechargeable 12-V 1.2 amp-hour Ni-Cad battery (fig. 3.9-5). The battery is used to operate all camera electrical functions. The battery attaches to the battery adapter located on the rear of the camera body. The battery swings forward and secures to the film magazine with a magnetic catch. Each battery supplies electrical power for two film magazines prior to recommended battery changeout. Recharging the batteries is not done on orbit.

The handgrip is mounted on the right side of the camera body and is fastened to the rosette (fig. 3.9-6). The grip can be moved vertically, parallel to the camera for ease of operation. After setting the camera operate lever to the standby position, the handgrip trigger can activate the camera. The handgrip trigger is a three-position switch: off and two operating modes. Depressing the trigger half-way puts the camera in the momentary run mode. Upon releasing the trigger the camera will stop running. The second mode of operation is the continuous run mode. Upon depressing the trigger completely, the camera is locked in the run mode. Fully depressing the trigger completely, the camera is locked in the run mode. Fully depressing the trigger a second time and releasing it will cause the camera to stop running and remove the camera from the continuous run mode.

The handgrip is electrically connected to the camera with a four-pole plug.

TABLE 3.9-1.- 16 mm CAMERA SYSTEM DISPLAYS AND CONTROL FUNCTIONS



| Location | Nomenclature | Function | Remarks | |
|-------------|---|--|--|--|
| Camera body | Viewfinder | Provides through-the-lens viewing | Upright image correct left to right | |
| | Eyepiece shutter lever | Prevents stray light from entering eyepiece and effecting exposure | Inadvertent closure prevents viewing | |
| | Diopter adjustment | Allows adjustment of +4 to -4 diopters | Diopter adjustment provided by rotating ring for clear focus on ground glass | |
| | Diopter adjustment lock | Locks diopter correction ring | | |
| | Ground glass display | Displays crop marks for framing, exposure information, and multifunction LED | | |
| | Crop marks | | | |
| |  | Normal image area | | |
| |  | Image area for TV dupes | | |
| | Exposure information | | | |
| | -0 | Marks needle location for two stops underexposure | In auto operation needle will be centered for proper exposure. In manual operation, the operator must adjust aperture to center needle for proper exposure | |
| | 0 | Marks needle location for one stop underexposure | | |
| | • | Marks needle location for proper exposure | | |
| 0 | Marks needle location for one stop overexposure | | | |
| +0 | Marks needle location for two stops over exposure | | | |

TABLE 3.9-1.- Continued

| Location | Nomenclature | Function | Remarks |
|--------------|--|---|--|
| Camera body | Multifunction LED | Indicates low battery power and run status | During camera startup and shutdown light will illuminate to indicate insufficient frame rate. Light will also illuminate to indicate low battery power |
| | Lens release pb (2) | Allows lens removal | |
| | Front connector plate | Allows bypass of the camera operate lever for mechanical activation | Three position switch; off, standby and run |
| | ASA (ISO) dial | Allows setting of proper ASA for metering system | Range from ASA (ISO) 16 to 1000 |
| | Battery test button | Allows momentary test of battery power | |
| | Camera operate lever | Sets camera operation to off, standby, and run | |
| | 0 | Camera in OFF position | |
| | Standby | Activates camera exposure system and allows filming with the handgrip trigger | <p style="text-align: center;">CAUTION</p> <p>Battery depletion will occur if lever is left in stand-by</p> |
| Start | Allows full camera operations | Handgrip trigger not necessary | |
| Memory slide | Locks lens aperture for subsequent exposures | Meter needle continues to operate | |

TABLE 3.9-1.- Continued

| Location | Nomenclature | Function | Remarks |
|----------|----------------------------|---|--|
| | Memory lock lever | Prevents accidental memory dump by preventing camera operate lever from returning to off position | |
| | Fuses | Prevent damage to the camera electrical system | Spare fuses located in clear plastic cover |
| | 10 amp | Protects main power circuit | |
| | 0.75 amp | Protects motor circuit | |
| | Run lights (green) | Indicates nominal camera operation | Green lights flash when camera is operating |
| | Battery test light (green) | Indicates battery has sufficient power to operate camera | Illuminates when test button is depressed |
| | Pilot tone connector | Not used for flight | |
| | Accessory connector | Electrical interface for attachments such as tachometer and IFM pin kit | |
| | Battery connector | Allows attachment of battery adapter and IFM pin kit | |
| | Battery adapter | Electrical interface for battery | Installed preflight and not normally removed |
| | Handgrip connector | Electrical interface for handgrip trigger | |
| | Snap catch | Mechanical interface for magazine hinge pin | |

TABLE 3.9-1.- Continued

| Location | Nomenclature | Function | Remarks |
|---------------|----------------------------|--|---|
| Film magazine | Supply side latch | Allows access to film supply reel and secures supply side door | CCW rotation opens door. CW rotation locks door |
| | Supply side latch release | Allows CCW rotation of supply side latch | Red pb must be pushed in and held in order to turn supply side latch |
| | Film guides (4) | Maintain precise film position on pressure plate | Film edges must be placed under hooks during film changeout |
| | Take-up side latch | Allows access to film take-up reel and secures take-up side door | CCW rotation opens door. CW rotation locks door |
| | Take-up side latch release | Allows CCW rotation of take-up side latch | Red pb must be pushed in and held in order to turn take-up side latch |
| | Magazine footage counter | Indicates quantity of exposed film | Counts in feet from 0 to 360 |
| | Magazine counter reset | Allows counter to be reset | |
| | Manual film advance | Allows manual film advancement | Used during film loading only |
| | Magazine safety lock | Prevents magazine detachment | Forward position locks; aft position unlocks |
| | Magazine release lever | Allows detachment of magazine | Downward motion on lever allows magazine to be lifted away from camera body |
| | Magazine hinge pin | Ensures proper alignment between magazine and body | Magazine hinges on this pin during installation and removal |

TABLE 3.9-1.- Continued

| Location | Nomenclature | Function | Remarks |
|---|--|--|---|
| Lenses 5.9 mm 10 to 100 mm zoom | White loop length mark | Ensures correct length of film for magazine loading | |
| | Aperture ring 1.8, 4, 5.6, 8, 11, 16, 22 | Allows operator to set lens aperture | Continuously variable from f/1.8 to f/22 |
| | Aperture ring 2, 2.8, 4, 5.6, 8, 11, 16, A | Allows operator to set lens aperture in manual or automatic | Continuously variable from f/2 to f/16 |
| | Aperture ring lock | Enables placement of aperture ring in the automatic setting | |
| | Aperture ring coupler | No function for flight | |
| | Zoom ring macro, 10, 16, 25, 32, 50, 75, 100 | Allows selectable focal length | Variable from 10 to 100 mm |
| | Macro focus locking pushbutton | Enables zoom ring to be placed in or released from the macro range | |
| | Focus ring 5 ft to in- finity | Allows operator to adjust focus | |
| Zoom lever | Provides operator with handle to aid smooth zoom technique | Optional attachment | |

TABLE 3.9-1.- Concluded

| Location | Nomenclature | Function | Remarks |
|----------|---------------------|--|---|
| Battery | Battery connector | Attach to camera body to supply 12-V dc | |
| | Magnetic catch | Secures battery to film magazine | |
| Handgrip | Handgrip thumbscrew | Allows attachment of handgrip to camera body | |
| | Handgrip plug | Provides electrical interface between handgrip and camera body | Safety bail should be latched to prevent loss of trigger function |
| | Handgrip trigger | Allows remote camera operation | Three position switch operated with camera operate lever in standby position. Off; depressed half-way provides momentary run mode; full depression provides continuous run mode |

586-38004

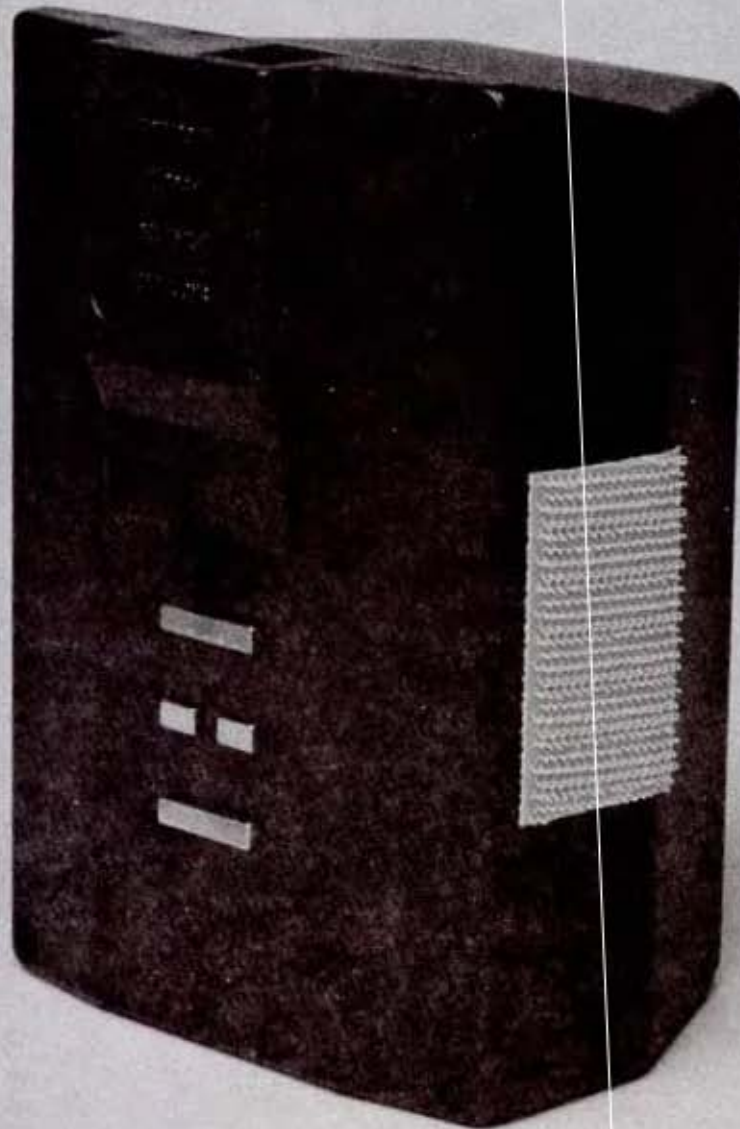


Figure 3.9-5.- Ni-Cad battery.

586-38002



Figure 3.9-6.- Handgrip.

3.9.1.3 Systems Performance, Limitations, and Constraints

16 mm camera body

- Type: Single lens reflex
- Format: Standard 11 mm; image area approx. 7 mm x 10 mm
- Transport system: Motor driven at normal frame rate of 24 frames per second but variable with the optional tachometer or the data module
- Electrical requirement: 12-V dc, approx. 1 amp. Fuses required are one 10 amp and one 0.75 amp
- Viewfinder: Through-the-lens type; eyepiece allows +4 to -4 diopters of correction
- Exposure system: Meter is centered-weighted with 60 percent of the exposure information measured from 30 percent of the metered area.
- Film ISO (ASA) range: 16 to 1000
- Shutter: 180° one piece mirror-shutter

Film magazine

- Type: 400-foot coaxial quick-change
- Footage counter: Additive type from 0 to 360. One revolution from 0 to 0 represents 400 ft

5.9 mm lens

- Type: Fixed focal length
- Aperture range: f/1.8 through f/22
- Focus range: Approximately 5 in. to infinity at f/22 measured from the film plane
- Field of view: 82° horizontal, 64° vertical, 104° diagonal

10 to 100 mm lens

- Type: Variable focal length (zoom)
- Aperture range: T 2 to T 16
- Focus range: Approximately eight inches to infinity measured from the film plane

- Field of view: 53 to 6° horizontal, 40 to 4.5° vertical, 64 to 7° diagonal

Daylight color correction filters

- 5.9 mm lens filter: Number 85 used to color correct daylight for tungsten film. Filter factor equals 2/3 of a stop.
- 10 to 100 mm lens filter: Number 85 ND 3 used to add neutral density in conjunction with color correction. Filter factor equals 1 2/3 stops.

Battery 12 volt, 1.2 amp-hour rechargeable NiCad. Recharged on ground only.

Handgrip

- Trigger: Equipped with three position switch: off, momentary run, and continuous run
- Power connection: One four-pole plug

3.9.2 Introduction to 35 mm Photographic Equipment

This section describes the 35 mm photographic equipment used onboard the Orbiter. On-orbit operations consist of unstowing and assembling the required camera hardware, setting the camera controls, taking the required exposures, and disassembling and stowing the camera hardware. Details of these operations are provided in the Photo Equipment Workbook 2102.

The 35 mm camera system consists of the following components:

- Camera body
- Lenses (35 mm, 28 mm, 35 to 70 mm zoom,)
- Flash
- Film cartridge

Accessories

- Lenses (16 mm, 180 mm, 500 mm, others available on request)
- Intervalometer
- Cable release

3.9.2.1 Stowage and Use Locations

For launch and entry, two 35 mm cameras and associated equipment are stowed in the flight deck (A16) camera bag and the middeck 35 mm camera bag. Figure 3.9-7 shows representative contents of the 35 mm bag.

Additional 35 mm equipment may be stowed in the middeck camera accessory bag or other middeck lockers.

587-32769



Figure 3.9-7.- Representative contents of the 35 mm camera bag.

The 35 mm camera may be handheld or mounted to the vehicle with a multiuse arm, mount, clamp, and baseplate adapter. The 35 mm camera can also be activated by an integral self-timer, cable release, or intervalometer.

3.9.2.2 Systems Functional Description

The camera is a modified preproduction version of the Nikon F-3. The significant modifications include a nondetachable NASA-unique motor drive, removal of the camera shutter release on/off switch, deletion of the exposure memory and double exposure functions, and removal of the leatherette. Figure 3.9-8 shows the front and back of the 35 mm camera.

The 35 mm camera is a battery-powered, motor-driven, through-the-lens metering, single lens reflex camera with an integral data back. The camera body, motor drive and data back make up the 35 mm camera. Interchangeable lenses and an attachable flash complete the standard 35 mm system.

The following is a description of the 35 mm camera system components and their functions. In addition to the following discussion, D&C information can be found in table 3.9-2.

The 35 mm camera has an automatic mode (with or without flash) and a manual mode. The automatic mode is aperture priority. For photos without flash, the photographer chooses the aperture and the camera selects the shutter speed from the full range available (8 sec through 1/2000 sec). With the flash activated, the photographer chooses the aperture and the camera sets the shutter speed at approximately 1/80 sec. The automatic mode is selected by placing the shutter speed dial to the "A" position.

The manual mode is selected by placing the shutter speed dial in any position other than "A". The manual mode is not normally used.

Both the automatic and manual modes require battery power. The camera has a limited backup mechanical capability. Activation of the mechanical release lever trips the shutter at approximately 1/60 of a second (except in the "T" position on the shutter speed scale).

The exposure meter is a silicon photo diode (SPD) located below the camera mirror. The SPD receives light reflected off the secondary mirror (without flash) or film (with flash). In "A" the exposure system utilizes this reflected light to adjust the shutter speed for correct exposure of a subject reflecting 18 percent of the light falling on it. With manual shutter speeds the exposure system provides indications of over, under, or correct exposure for the speed selected.

The viewfinder incorporates exposure data, focusing aids, a flash "ready" light, an exposure meter reference circle, and the image seen by the lens. Figure 3.9-9 illustrates the items that appear in the display. Exposure data is read on a liquid crystal display (LCD). In the automatic mode the LCD displays the shutter speed selected by the camera and an over or under exposure (+,-) indication if the speed exceeds the camera's capabilities.



Figure 3.9-8.- Front and back of the 35 mm camera.

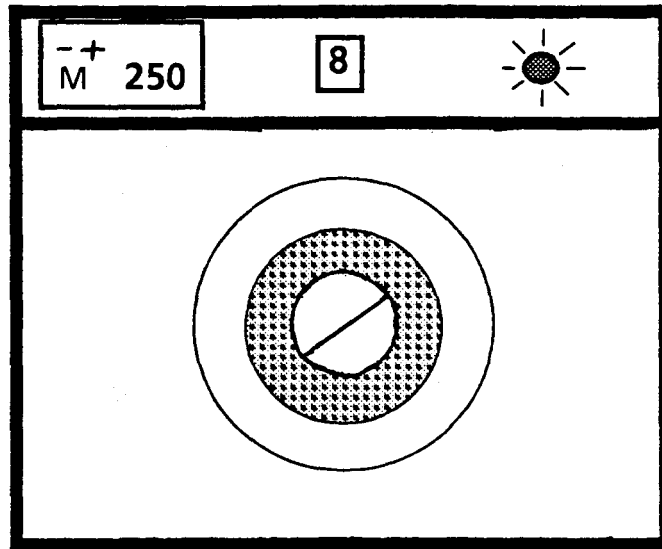


Figure 3.9-9.- Viewfinder images.

In the manual mode the LCD indicates the speed the photographer has selected and over, under, or correct exposure. A prism permits viewing the selected aperture directly off the lens. The viewfinder contains a light for illumination of the LCD and aperture display.

The focusing aids include a fine matte/fresnel surface, a microprism collar, and a split-image rangefinder. The matte/fresnel surface makes up most of the viewing screen and is useful for quick general focusing. Through the microprism the image will appear to shimmer until good focus is achieved. The split image will yield the best focus for subjects with any linear features. Vertical or horizontal lines will be separated along the 45° junction of the prisms. The image is sharply focused when the separated lines become one.

The flash "ready" light illuminates to indicate the flash is approximately 80 percent charged. The light will blink indicating the flash is not properly attached, or the ISO/ASA dial is set for a film incompatible with the flash. The light will also blink briefly following complete discharge of the flash capacitor.

A 12 mm reference circle surrounds the focusing aids indicating the area from which 80 percent of the exposure data is derived.

Virtually 100 percent of the image that will appear on the film is visible in the viewfinder.

The motor drive mode selector has three positions: Off, S (single), C (continuous). In the off position the motor drive is inactive as is the motor drive shutter release. The camera body shutter release is active and manual film advance must be used. The "S" position energizes the motor drive shutter release and causes the film to advance after either shutter release is pressed. The "C" position allows continuous shooting at a rate of 3 frames per second only with the motor drive release. The camera body release will remain in a single frame mode.

The camera utilizes standard 35 mm 36 exposure film cassettes. The cameras are launched with ISO 64 Ektachrome (slide) film loaded. This film is the standard 35 mm film, but several rolls of 160 and 400 ISO film are flown. A special ISO 64 Ektachrome film yielding 65 exposures per roll is flown for scheduled EVA's. Special purpose film is flown as required. A standard film cassette and container are illustrated in figure 3.9-10.

The camera and motor drive are powered by eight 1.5-V AA batteries in a sealed pack. The camera is launched with a battery pack installed. Spare packs are nominally flown plus additional ones for scheduled EVA's. The battery is illustrated in figure 3.9-11.

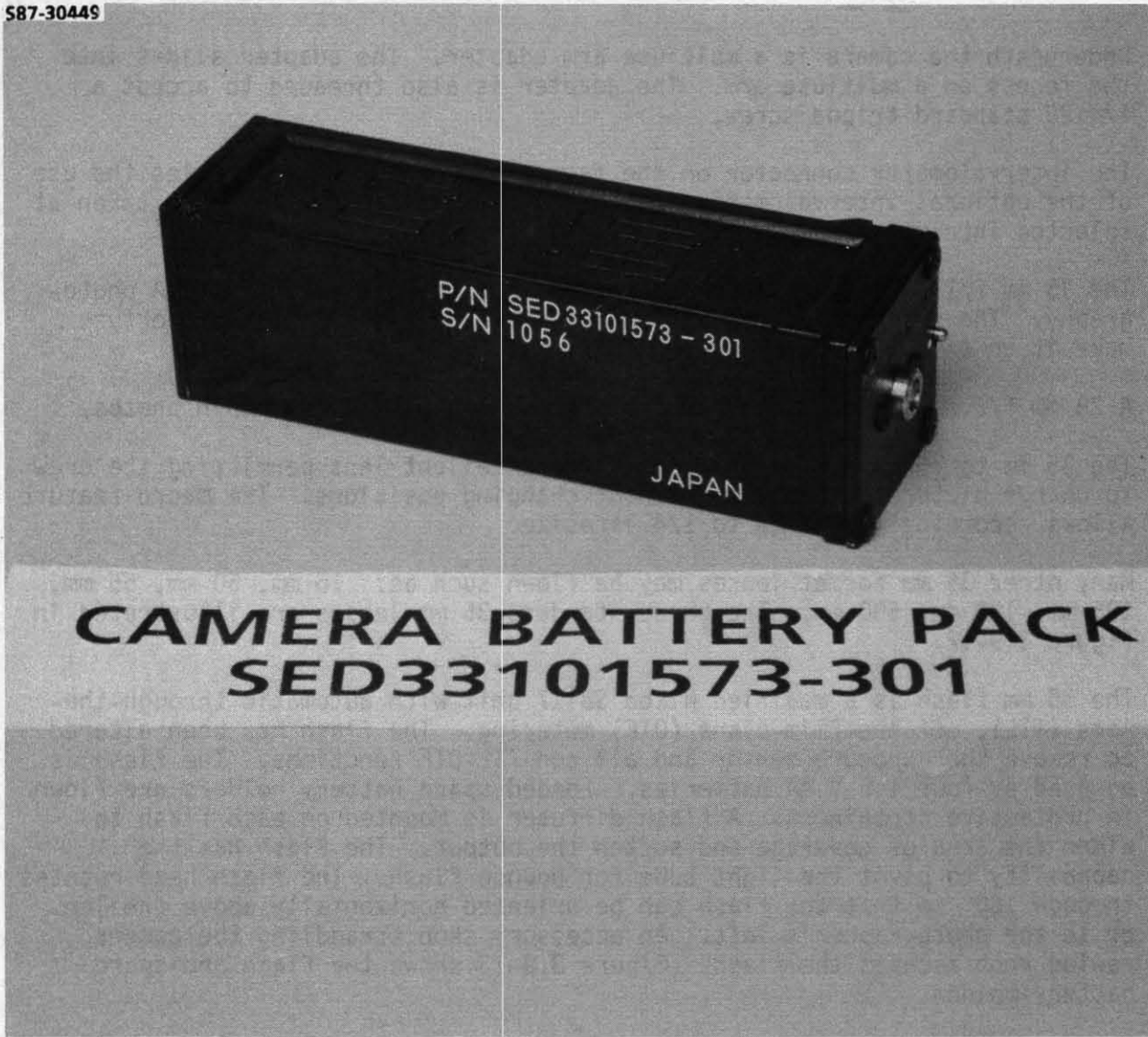
The camera circuitry is protected by a 12-V, 2 amp fuse. Although the fuse is replaceable, no spares are flown.

587-30437



Figure 3.9-10.- Standard film cassette and container.

587-30449



**CAMERA BATTERY PACK
SED33101573-301**

Figure 3.9-11.- Camera battery.

Underneath the camera is a multiuse arm adapter. The adapter slides into the recess on a multiuse arm. The adapter is also threaded to accept a 1/4-20 standard tripod screw.

The intervalometer connector on the face of the motor drive enables the use of the optional intervalometer. This device allows pictures to be taken at selected intervals.

The 35 mm f/1.4 lens is the standard lens for both in-cabin and EVA photography. The slight wide-angle field-of-view and large relative aperture make it an excellent general use lens.

A 28 mm f/2.0 lens is flown for group shots and wide-angle cabin photos.

The 35 mm to 70 mm f/3.5 zoom lens is an excellent lens permitting the crew to change picture composition without changing positions. The macro feature allows recording images up to 1/4 lifesize.

Many other 35 mm format lenses may be flown such as: 16 mm, 50 mm, 55 mm, 135 mm, 180 mm, 500 mm. The three standard 35 mm lenses are illustrated in figure 3.9-12.

The 35 mm flash is a modified Nikon SB-17 unit with automatic through-the-lens (TTL), off-the-film-plane (OTF) metering. The flash has been altered to remove the exposure sensor and all non-TTL-OTF functions. The flash is powered by four 1.5-V AA batteries. Loaded spare battery holders are flown in protective containers. A flash diffuser is mounted on each flash to widen the area of coverage and soften the output. The flash has the capability to pivot the light tube for bounce flash. The flash head rotates through 180° so that the flash can be oriented horizontally above the lens or to the photographer's left. An accessory shoe straddling the camera rewind knob accepts the flash. Figure 3.9-13 shows the flash and spare battery holder.

Activation of the flash on/off switch automatically sets the camera shutter speed at 1/80 of a second (in "A" or manual 1/125 to 1/2000).

The flash "ready" light duplicates the functions of the light in the viewfinder. The light is also a flash test button.

The flash can be operated in a manual mode only in conjunction with the camera mechanical shutter.

S87-32768



Figure 3.9-12.- Standard 35 mm lenses.

587-30368

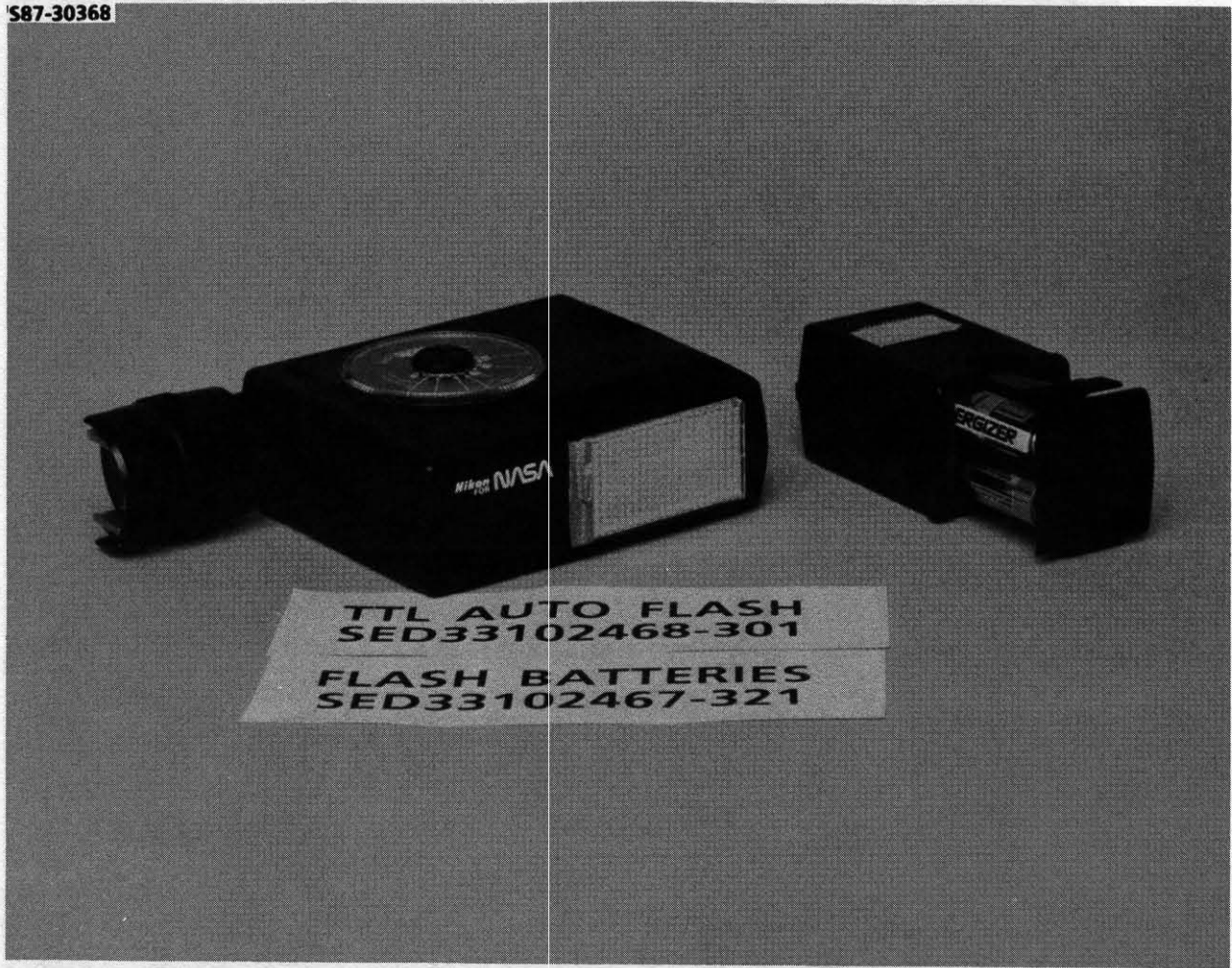


Figure 3.9-13.- Flash and battery holder.

Figure 3.9-13.- Flash and battery holder.

TABLE 3.9-2.- 35 mm CAMERA SYSTEM DISPLAYS AND CONTROLS

| Location | Nomenclature | Function | Remarks |
|-----------------------|---|---|--|
| Camera body Top | Frame counter ..0...5 ...10 - thru 70.. | Indicates amount of exposed film from -2 to 72 | Resets to -2 each time camera back is opened |
| | Film advance lever | Manually advances film with one 140° rotation or a series of shorter strokes | Not usually needed if motor drive mode switch is in "S" or "C" |
| | Shutter release pb | Electromechanical pb that activates the exposure meter with partial depression and fires the shutter when fully depressed | Always ON when battery power is available; threaded to accept cable release |
| | Shutter Speed Dial "A", 2000, 1000, 500, 250, 125, 60, 30, 15, 8, 4, 2, 1, 2, 4, 8, B, T, X | Selects camera automatic exposure system (aperture priority) or manual shutter speeds | "A" is nominal mode; dial locks in "A" and "X" |
| | Shutter speed dial lock | Locks shutter speed dial in "A" and "X" | Pb must be depressed to exit "A" or "X" |
| | Self-timer lever | Enables 10 second self-timer function | Timer is activated by depression of either shutter release; timer must be deselected when not required |

TABLE 3.9-2.- Continued

| Location | Nomenclature | Function | Remarks |
|--------------------|--|--|---|
| Camera body Top | Viewfinder | Permits viewing the field of view of the camera lens, exposure meter data, and flash "Ready" light | Interchangeable with EVA viewfinder |
| | Flash ready light | Illuminates to indicate 80% charge in flash capacitor; flashes to indicate improper flash mounting, unuseable ISO or capacitor dump (following flash firing) | |
| | Illuminator pb | Illuminates exposure meter LCD and f/stop | Only functional when exposure meter is activated |
| In viewfinder | Eyepiece shutter lever | Prevents light from entering viewfinder | Bright light in the viewfinder can affect the exposure meter data |
| | Exposure meter LCD | Displays camera selected or manual shutter speeds and over (+), under (-), or correct exposure (- +) | Absence of + or - in "A" indicates correct exposure for normal scenes |
| | 2000, 1000, 500, 250, 125, 80, 60, 30, 15, 8, 4, 2, 1, 2, 4, 8, +, -, M | | |
| | Viewfinder releases (2) | Unlocks viewfinder for EVA conversion | |
| | Rewind knob | Houses rewind crank, rotates CCW to indicate film transport; lifts to unlock camera back | Camera back safety lock must be released to lift knob |

TABLE 3.9-2.- Continued

| Location | Nomenclature | Function | Remarks |
|-------------|---|---|---|
| Camera body | Rewind crank | Manually rewinds film | Crank unfolds from rewind knob |
| Top | Rewind index arrow | Indicates direction rewind crank is turned to rewind film | |
| | Back lever lock | Prevents inadvertent lifting of rewind knob | Lever is pushed toward viewfinder |
| | ISO dial | Programs camera exposure meter for the film in use | Dial housing is lifted slightly for rotation |
| | 12..25..64 .. 100.. 160..320 ..500.. 1000..2000 ..4000.. 6400 | | |
| | Exposure compensation dial | Biases exposure meter for under or overexposure | Setting for 64 ISO film is -2/3 |
| | +2..+1..0 ..-1..-2 | | |
| | Exposure compensation dial lock | Locks dial at desired setting | Depress pb to unlock |
| Motor drive | | | |
| Side | Battery check pb | Checks condition of motor drive/camera battery pack | |
| | Battery check lights (2) | Indicate motor drive/-camera battery pack condition or motor drive cycle interruption | Battery check: Red and green light = nominal; Red only = low battery; constant red indicates incomplete cycle of motor drive, i.e., end of film |

TABLE 3.9-2.- Continued

| Location | Nomenclature | Function | Remarks |
|-------------|-----------------------|--|--|
| Camera body | Data back | Optional imprinting of selected data | Models 302 and 303 print data in lower right of picture; Model 304 prints between frames |
| Back | Data back LCD | Displays data to be printed if "Print" function is selected | |
| | ASA/ISO pb H, M, L | Selects data imprint intensity based on film ISO | H is nominal for flight films |
| | Adjust pb | Changes data within an LCD display | Enabled only after actuation of No. reset/select pb |
| | No reset/ select | Enables adjust pb, selects data within a display to be changed and resets data back to normal function | Actuation of pb stops clock until full display is selected |
| | Mode pb | Selects date, time or frame number | |
| | Print pb | ON/OFF for "print" function | "Print" LCD flashes when ON, data is printed at shutter actuation |
| | Alarm pb | ON/OFF for alarm and enables alarm time changes | Must be held depressed to adjust alarm time; functional on 303 model only |
| Motor drive | | | |
| Back | Rewind slide | Enables film rewinding | Slide locks to left and disables both shutter releases |
| | Rewind reset pb | Resets rewind slide to nominal position | |

TABLE 3.9-2.- Continued

| Location | Nomenclature | Function | Remarks |
|-------------|--|---|--|
| Motor drive | | | |
| Back | Motor drive frame counter 72.70. 68.+0 | Indicates frames remaining when properly adjusted | Must be adjusted to correspond to film length |
| | Motor drive counter reset | Adjusts motor drive frame counter to desired number | |
| Side | Battery release | Unlocks battery pack | |
| Top | Mode select SW | "OFF" - disables motor drive and motor drive shutter release "S" (single) - Enables motor drive shutter release and provides automatic film advance following each shutter actuation "C" (continuous) - Enables motor drive shutter release for continuous operation at 3 frames per second with shutter speeds of 1/125 second or faster | Nominal mode that works in conjunction with both shutter releases Camera shutter release still operates as if "S" were selected |
| | Motor drive shutter release pb | Electromechanical pb that activates the exposure meter with partial depression and fires the shutter when fully depressed | Powered only when motor drive mode SW is in "S" or "C" position |
| Camera body | | | |
| Front | Depth-of-field preview pb | Mechanically closes lens iris to the user selected f/stop | Not normally used |

TABLE 3.9-2.- Continued

| Location | Nomenclature | Function | Remarks |
|-------------------------|---|--|---|
| Camera body Front | Mirror lockup lever | Locks the reflex viewing mirror in the up position | Not normally used |
| | Mechanical shutter release | Fires shutter at approxi- mately 1/60 second | Not normally used; requires no battery power |
| | Lens mounting index | Provides alignment index for mounting lenses | |
| Motor drive Front | Self-timer LED | Blinks to indicate 10 second self-timer is operating | Blinks rapidly 2 seconds prior to shutter actuation |
| 35 mm lens | Central index | Aligns with camera index for lens installation, indexes distance from subject to film plane when lens is focused and indexes selected f/stop | |
| | Depth-of- field scale | Indicates the region of acceptable focus for f/5.6 - f/16 | Used in conjunction with focus ring |
| | Focus ring ∞ , 15, 5, 3, 2, 1.5, 1.25, 1 ft | Focuses image on film and viewfinder ground glass; indicates distance from film plane to focused object in feet | Detent at 15 ft for general EVA photography |
| | Aperture ring f/16, 11, 8, 5.6, 4, 2.8, 2, 1.4 | Selects various diameter lens iris openings | Automatically wide open to f/1.4 until shutter is tripped; small f/stop scale is visible in viewfinder |

TABLE 3.9-2.- Continued

| Location | Nomenclature | Function | Remarks |
|--------------------------------|--|--|--|
| 28 mm lens | Central index | Aligns with camera index for lens installation, indexes distance from subject to film plane when lens is focused and selected f/stop | Used in conjunction with focus ring |
| | Depth-of-field scale | Indicates the region of acceptable focus for f/5.6 - f/22 | |
| | Focus ring ∞ , 15, 5, 3, 2, 1.5, 1.25, 1, 0.9 ft | Focuses image on film and viewfinder ground glass; indicates distance from film plane to focused object in ft | |
| | Aperture ring f/22, 16, 11, 8, 5.6, 4, 2.8, 2 | Selects various diameter lens iris openings | |
| 35 mm 70 mm zoom lens | Central index | Aligns with camera index for lens installation; indicates selected f/stop | Focus region 0.7 meters and closer is available only in macro focusing |
| | Focus ring | Focuses image on film and viewfinder ground glass | |
| | Feet: 30, 10, 7, 5, 4, 3, 2.5, 2, 1.75, 1.5, 1.3, 1.2 | | |

TABLE 3.9-2.- Continued

| Location | Nomenclature | Function | Remarks |
|--------------------------------|--|---|---|
| 35 mm 70 mm zoom lens | Meters: 5, 3, 2, 1.5, 1.2, 1, 0.8, 0.7, 0.6, 0.5, 0.4, 0.35 | | |
| | Focus index/ IR indexes | Indicates distance to subject from film plane in feet and meters. | |
| | 35 , 70 | IR indexes align with subject distance to focus infrared image on film for 35 mm to 70 mm focal lengths | IR scale is not used |
| | Macro focus locking button | Enables focusing in the macro region | Lens must be at 70 mm focal length to engage macro button |
| | Zoom ring 35, 50, 70 | Selects continuously variable focal lengths | |
| 16 mm lens | Aperture ring f/22, 16, 11.8, 5.6, 3.5 | Selects various diameter lens iris openings | Automatically wide open to f/3.5 until shutter is tripped; small f/stop is visible in viewfinder |
| | Central index | Aligns with camera index for lens installation; indexes distance from subject to film plane when lens is focused and selected f/stop | |
| | Depth-of- field scale | Indicates the region of acceptable focus for f/5.6- f/22 | Used in conjunction with focus ring |

TABLE 3.9-2.- Concluded

| Location | Nomenclature | Function | Remarks |
|------------|--|---|--|
| 16 mm lens | Focus ring Feet: 5, 3, 2, 1.5, 1.25, 1 Meters: ∞ , 2, 1, 0.7, 0.5, 0.4, 0.3 | Focuses image on film and viewfinder ground glass; indicates distance from film plane to focused object in feet and meters | Detent at ∞ for general EVA photograph |
| Flash | On/off sw | Enables flash operation and initiates flash capacitor charging | |
| | Ready light/test pb | Illuminates to indicate 80% charge in flash capacitor; flashes to indicate improper flash mounting, unusable ISO or capacitor dump (following flash firing) | Identical to "Ready Light" in viewfinder except pressing flash ready light will fire flash |
| | Locking collar | Secures flash to camera | Flash "Ready light" flashes if ring is not locked |
| Flash | Bounce flash lock | Unlocks flash tube to enable bounce flash | Detents at 15°, 30°, 60°, and 90° rotation |
| | Battery releases (2) | Unlocks battery holder | |
| | Manual flash calculator dial | Enables calculation of lens aperture for manual flash | Not used |

3.9.2.3 Systems Performance, Limitations, and Constraints

- 35 mm camera and motor drive
 - Power requirement: 8 AA 1.5-V dc batteries
 - Shutter speeds: (sec) 8, 4, 2, 1, 1/2, 1/4, 1/8, 1/15, 1/30, 1/60, 1/125, 1/250, 1/1000, 1/2000, A (Automatic), 8-1/2000, B (bulb) user controlled, T (time) user controlled, X (sync) 1/80
 - The motor drive "C" mode will give 1-3 exposures per second based on shutter speed. Three frames per second are available with shutter speeds of 1/125 and faster.
 - A mechanical shutter speed of 1/60 sec is available with no power required.
- 35 mm film cassette
 - (5017) Ektachrome 64 ISO: 36 exposures usable
 - (5026) Vericolor III 160 ISO: 36 exposure usable
 - (5020) Ektachrome 800/1600 (400 ISO): 36 exposure usable
 - (QX824) Ektachrome 64 ISO: 65 exposures usable (EVA)
- 35 mm f/1.4 lens
 - Field of view: 37° X 53° (62° diagonally)
 - Focus: 1 ft to ∞
 - Aperture: f/1.4 to f/16
- 28 mm f/2 lens
 - Field of view: 45° X 64° (74° diagonally)
 - Focus: 10 in. to ∞
 - Aperture: f/2 to f/22
- 35 mm - 70 mm f/3.5 zoom lens
 - Field of view: (35 mm) 37° X 53° (62° diagonally) - (70 mm) 19° X 29° (34° diagonally)
 - Focus: 2.5 ft to ∞, macro 13 in to ∞ (1/4 life-size)
- 16 mm f/2.8 full frame fisheye lens

- Field of view: 100° X 147° (180° diagonally)
- Focus: 10 in. to ∞
- Aperture: f/2.8 to f/22
- 180 mm f/2.8 lens
 - Field of view: 7° X 11° (13° diagonally)
 - Focus: 2.75 ft to ∞
 - Aperture: f/2.8 to f/32
- 35 mm camera flash
 - Power requirement - 4 AA 1.5-V dc batteries
 - Angle of coverage
 - Without diffuser: Horizontal - 60°, vertical - 45°
 - With diffuser: Horizontal - 70°, vertical - 53°
 - Flash duration: 1/1,429 sec to 1/20,000 sec
 - Recycle time: < 1 sec to > 30 sec
 - ISO/ASA range: 25 to 400 (with 0 exposure compensation)

3.9.3 Introduction to 70 mm Photographic Equipment

This section describes the 70 mm photographic equipment used during on-orbit operations. On-orbit operations consist of unstowing and assembling the required camera hardware, setting the camera controls, taking the required exposures, and disassembling and stowing the camera hardware. Details of these operations are provided in the 70 mm Photo Equipment Workbook 2102.

The 70 mm camera system consists of the following components (fig. 3.9-14):

- 70 mm camera body (including batteries and fuse)
- 70 mm camera data magazine
- 70 mm camera lenses (50 mm, 100 mm, 250 mm)
- 70 mm remote ON/OFF switch
- Spotmeter
- Dual camera bracket

3.9.3.1 Stowage and Use Locations

For launch and entry, the 70 mm camera system and associated equipment are stowed in the middeck 70 mm camera bag locker and flight deck A16 locker.

586-37988



Figure 3.9-14.- 70 mm camera system.

The 70 mm camera can be used as a handheld system or as a stationary system mounted to the vehicle. The multiuse arm, mount, and baseplate adapter are used by the remote ON/OFF switch.

3.9.3.2 Systems Functional Description

The 70 mm camera is a battery-powered motor-driven single lens reflex camera.

The 70 mm camera system is a commercially available system that has undergone minor modifications to certify it for spaceflight. One modification is the removal of the leatherette on the body and data magazine to prevent outgassing problems. Another modification is the installation of a capacitor in the motor to prevent electromagnetic interference. The remote control connector on the body has been modified to accept the remote ON/OFF switch. The time exposure lever has been removed. The operate pushbutton has been enlarged. The 250 mm lens has been modified so that it cannot be focused beyond the infinity setting.

In addition to the D&C noted in table 3.9-3, information on the 70 mm camera body is as follows:

- The camera body viewfinder provides through-the-lens viewing (fig. 3.9-15). The image viewed through the viewfinder is magnified 4X. The ground glass is equipped with a split-screen focusing aid.
- The camera body includes a remote control connector. This connector allows the remote ON/OFF switch to be attached for remote activation of the camera (fig. 3.9-16).
- Power to the camera is provided by two rechargeable (on the ground only) 6-V nickel-cadmium batteries. Each battery can provide power for 1000 exposures. The camera is capable of operating with only one battery in either position. The batteries operate in parallel within a battery compartment located at the base of the camera. Batteries are installed with the positive end (narrow end) in first. When the battery compartment cover is attached, electrical continuity is achieved. Spare batteries are stowed in the 70 mm camera bag.
- Within the battery compartment, one 1.7 amp medium slow-blow fuse is housed. Spare fuses are taped to the spare batteries (fig. 3.9-17).

The camera is provided with interchangeable 70 mm data magazines preloaded with film. Each magazine provides approximately 95 exposures.

In addition to the D&C noted in table 3.9-3, each data magazine is provided with a dark slide which protects the film within the magazine when the magazine is off the camera. Once the magazine is installed on the camera, the slide must be removed before the camera will operate. In order to remove the data magazine, the dark slide must first be fully inserted.

586-37954

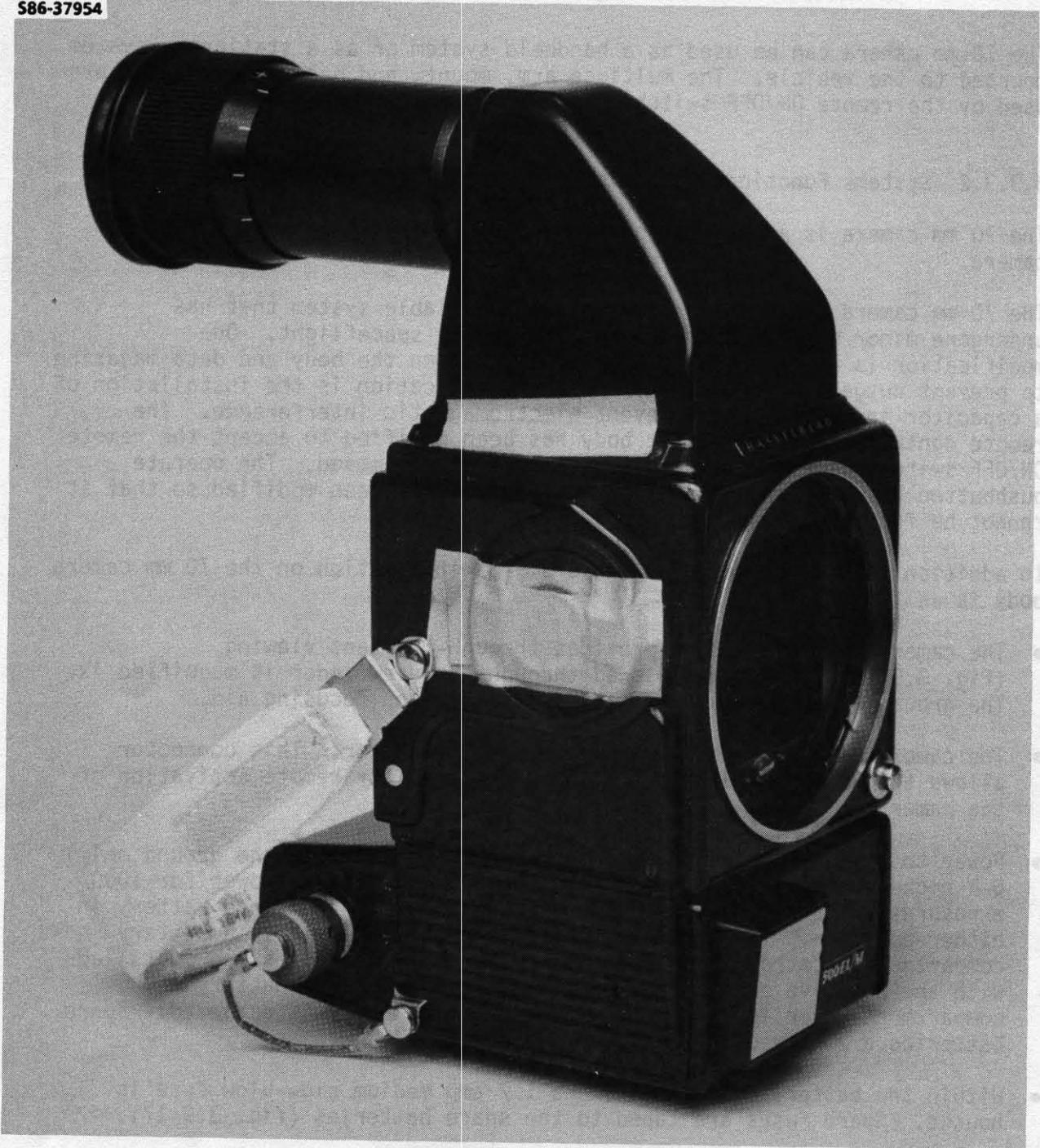


Figure 3.9-15.- Viewfinder.

586-37943

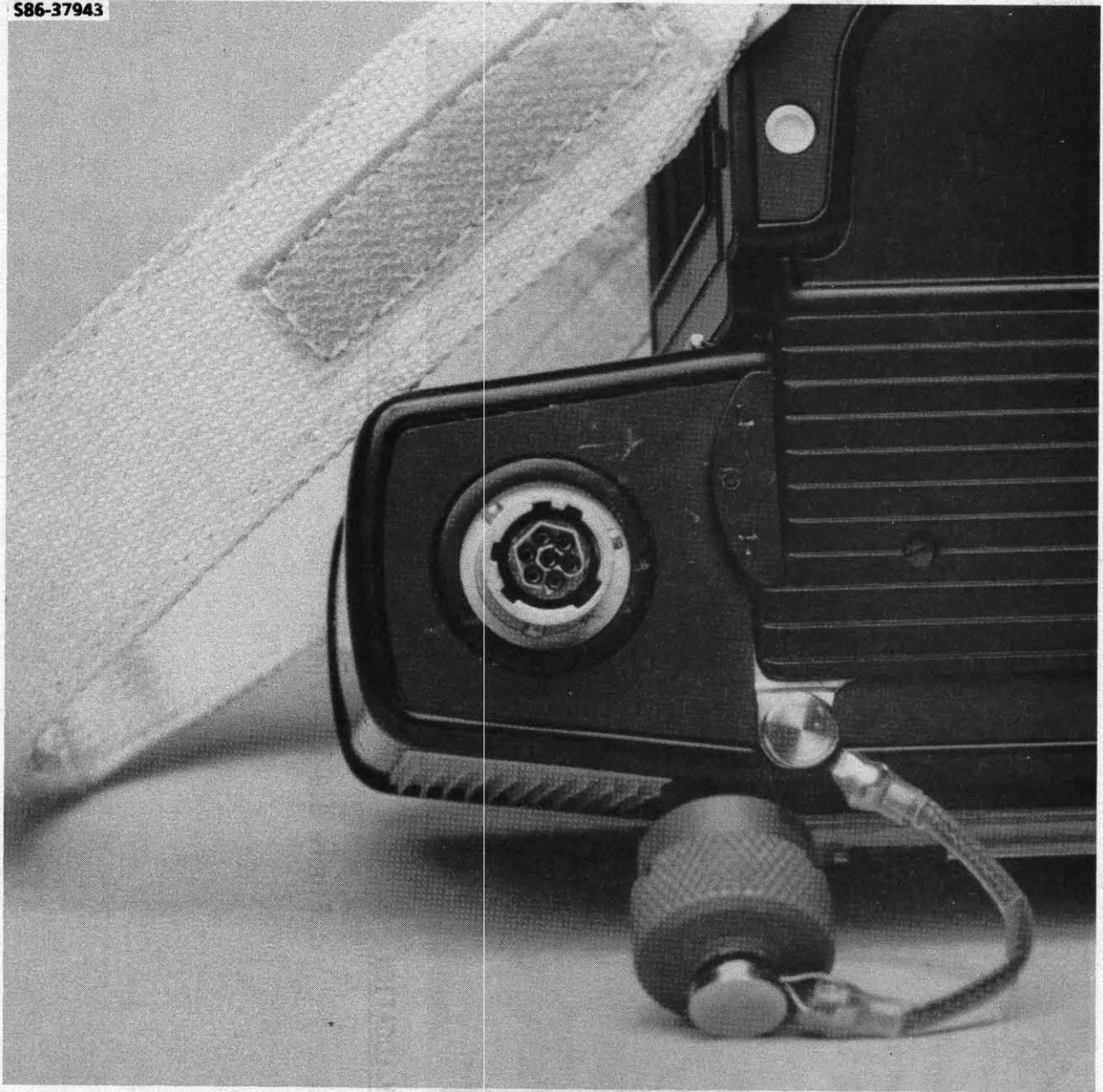


Figure 3.9-16.- Remote control connector.

586-37942



FUSE AND BATTERY LOCATION

586-37941



SPARE BATTERY AND FUSE CONFIGURATION

Figure 3.9-17.- Fuses.

263

3.9-44

JSC-12770

The data magazine is capable of recording various information on the film edge. Data information to be imprinted on the film edge is programmed into the data module preflight. The information that can be imprinted includes such data as mission number, date, GMT, and roll and frame numbers (fig. 3.9-18).

The 70 mm camera system is equipped with a 50 mm f/4 lens, a 100 mm f/3.5 lens, and a 250 mm f/5.6 lens (fig. 3.9-19). The lenses attach to the camera body via a bayonet mount. The lens and camera body have a mechanical interface which allows the motor drive to recock the shutter and reposition the aperture after each exposure. Each lens has a depth-of-field preview lever. The lens controls are illustrated in figure 3.9-20.

The 250 mm lens is an apochromatic lens corrected so that the three primary colors of light focus on the same plane. This is accomplished by the use of glass made of calcium fluoride. This type of glass is very sensitive to temperature changes. The commercial lens can be focused beyond the infinity setting at certain temperatures. The flight 250 mm lens has been modified with a hard stop at infinity based on an Orbiter cabin temperature of $75^{\circ} \pm 7^{\circ}$.

Additional D&C information is included in table 3.9-3.

A remote ON/OFF switch is supplied as part of the system (fig. 3.9-21). The switch cable attaches to the camera body to allow remote operations when the camera is mounted in an Orbiter window.

The 70 mm camera does not have an automatic exposure capability. Consequently, the spotmeter is used to determine the proper exposure. The spotmeter is a handheld reflected-light meter with a 1° angle of acceptance. The meter is capable of determining correct exposure settings for average, shadow, or highlight areas within a scene. The meter has both analog and digital display capabilities. The exposure can be read in any one of three places; the digital display on the face of the meter, the analog scale above the digital readout on the face of the meter, on the digital display located in the viewfinder. The location of all displays and controls can be found in figure 3.9-22.

The dual camera bracket (fig. 3.9-23) allows two 70 mm cameras to be mounted side-by-side for special photographic situations. The cameras are activated simultaneously by a common operate pb on the handgrip of the dual camera bracket. Power cables are attached between the bracket and the remote ON/OFF connector located on the right side of the camera body.

586-37928

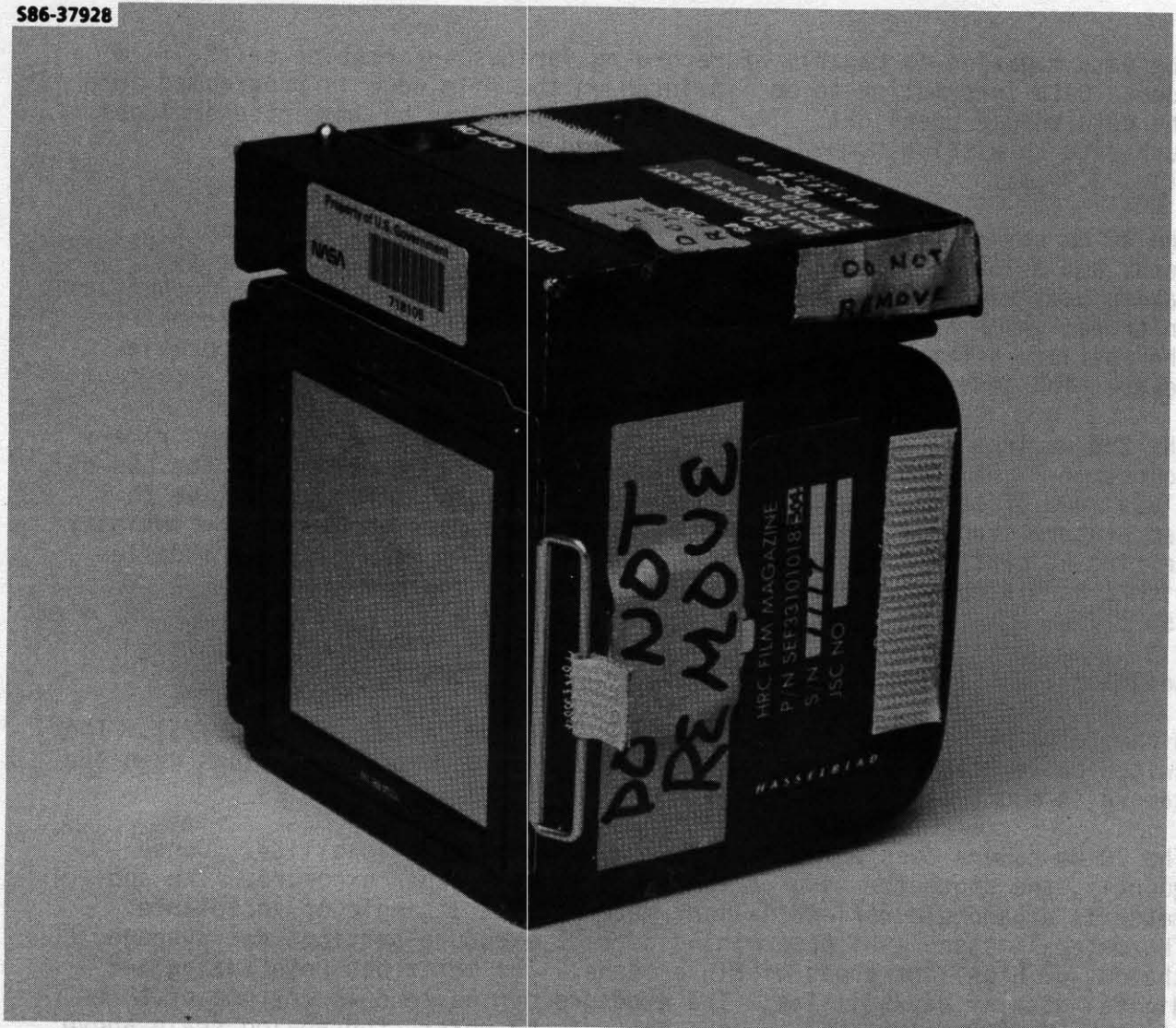


Figure 3.9-18.- Data magazine.

586-37939

266

3.9-47



01151-021

JSC-12770

Figure 3.9-19.- Lenses.

S86-37935

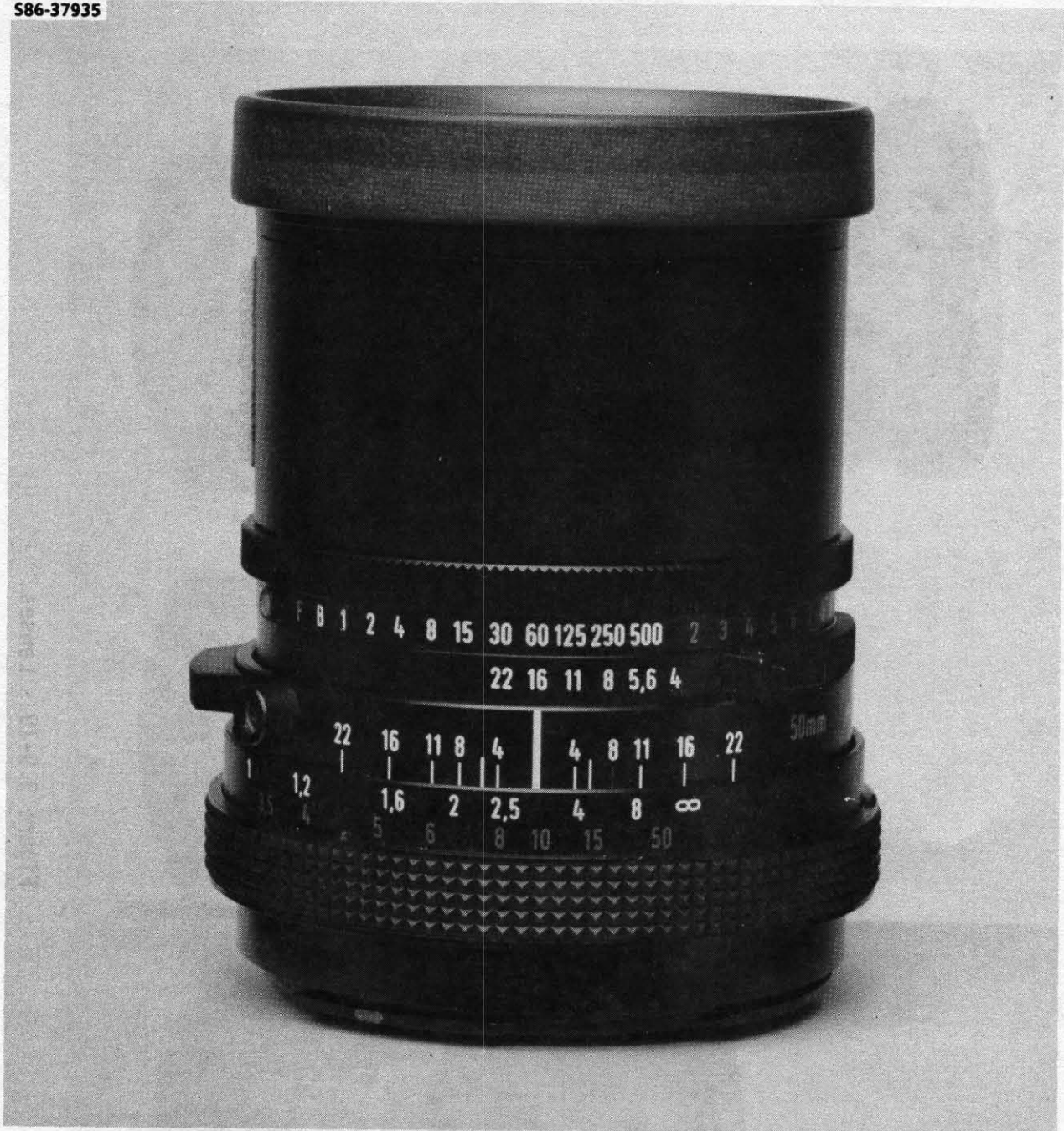
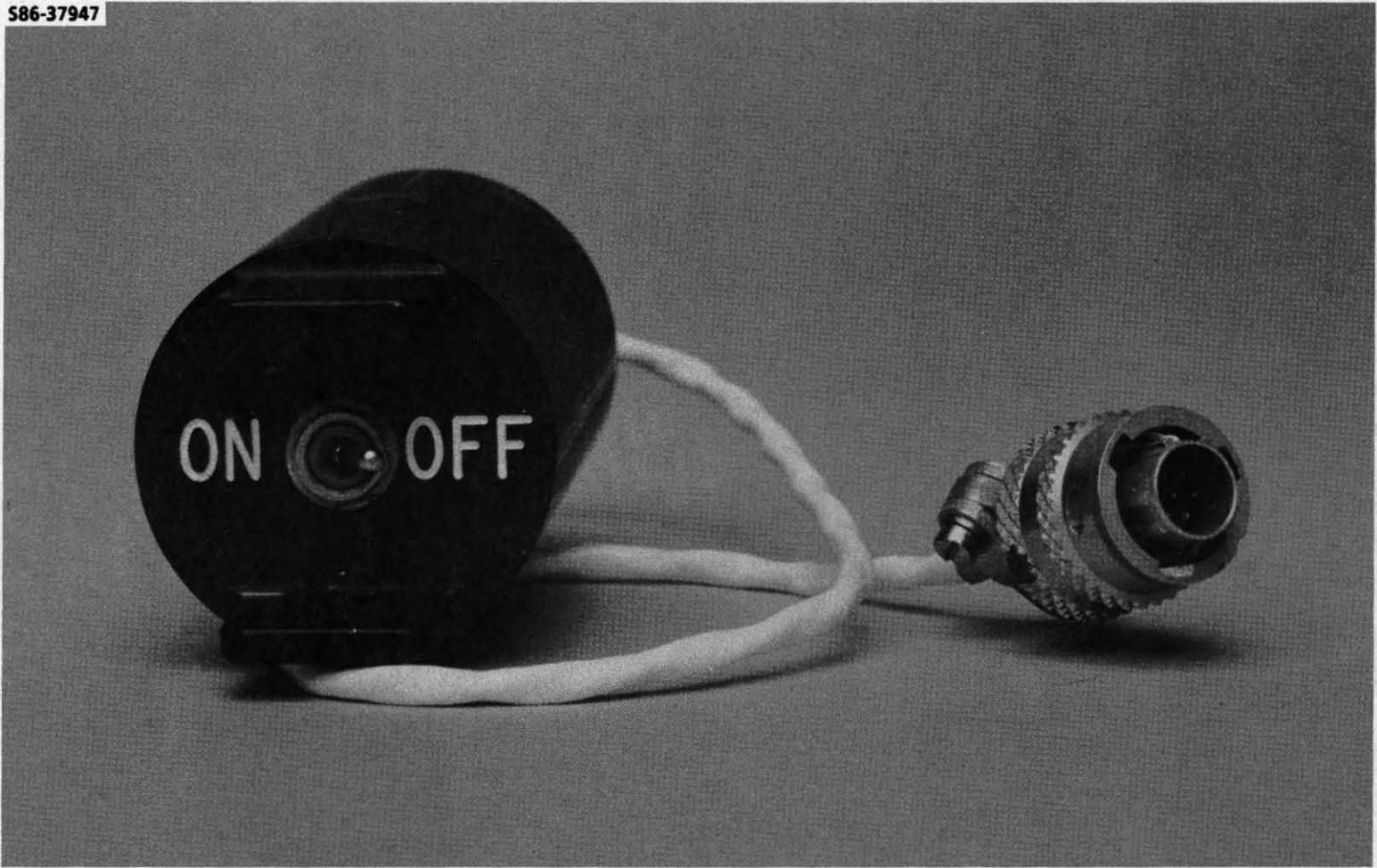


Figure 3.9-20.- Lens controls.

586-37947



268

3.9-49

Figure 3.9-21.- Remote ON/OFF switch.

JSC-12770

586-37946

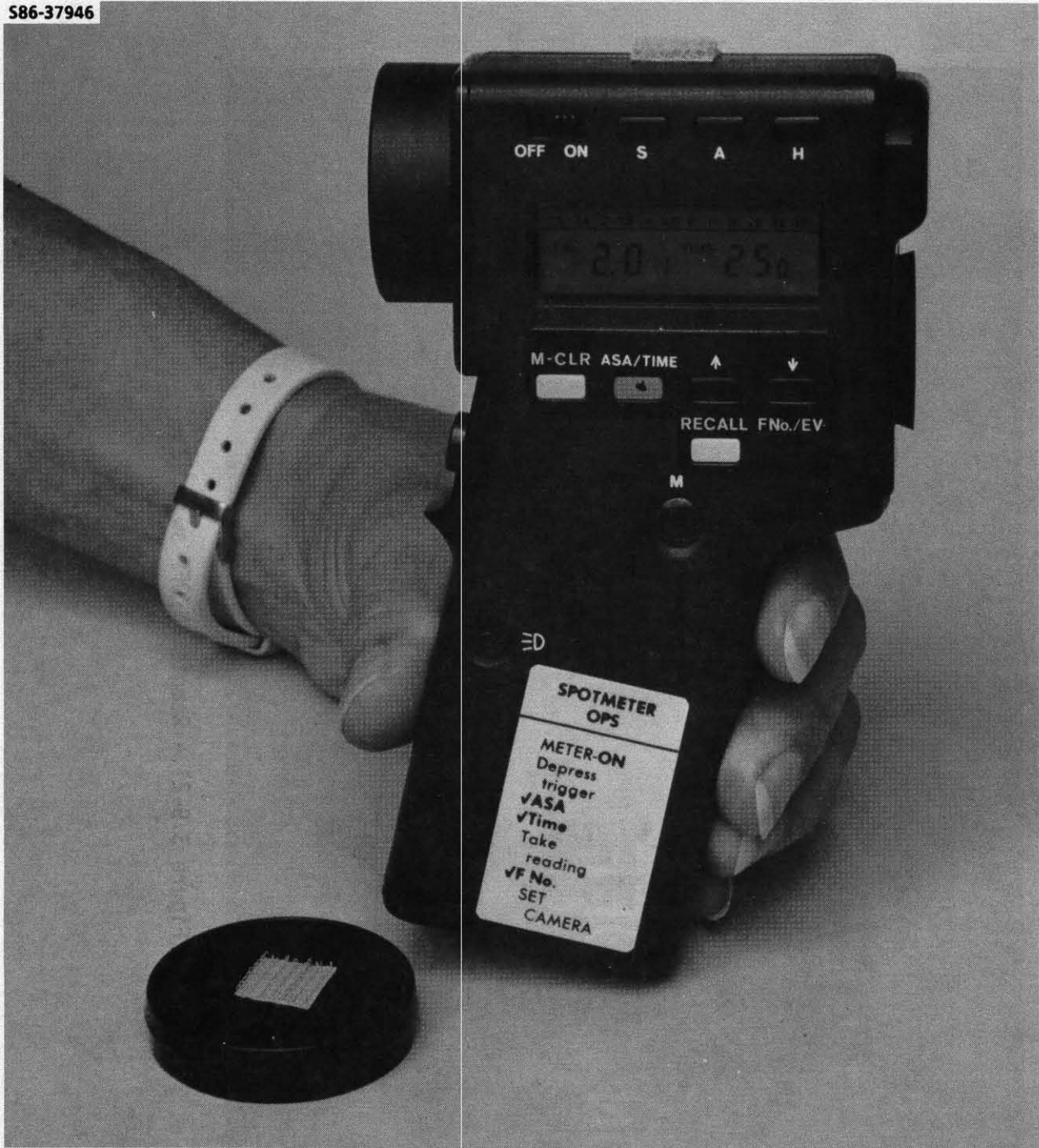


Figure 3.9-22.- Spotmeter.

585-28286

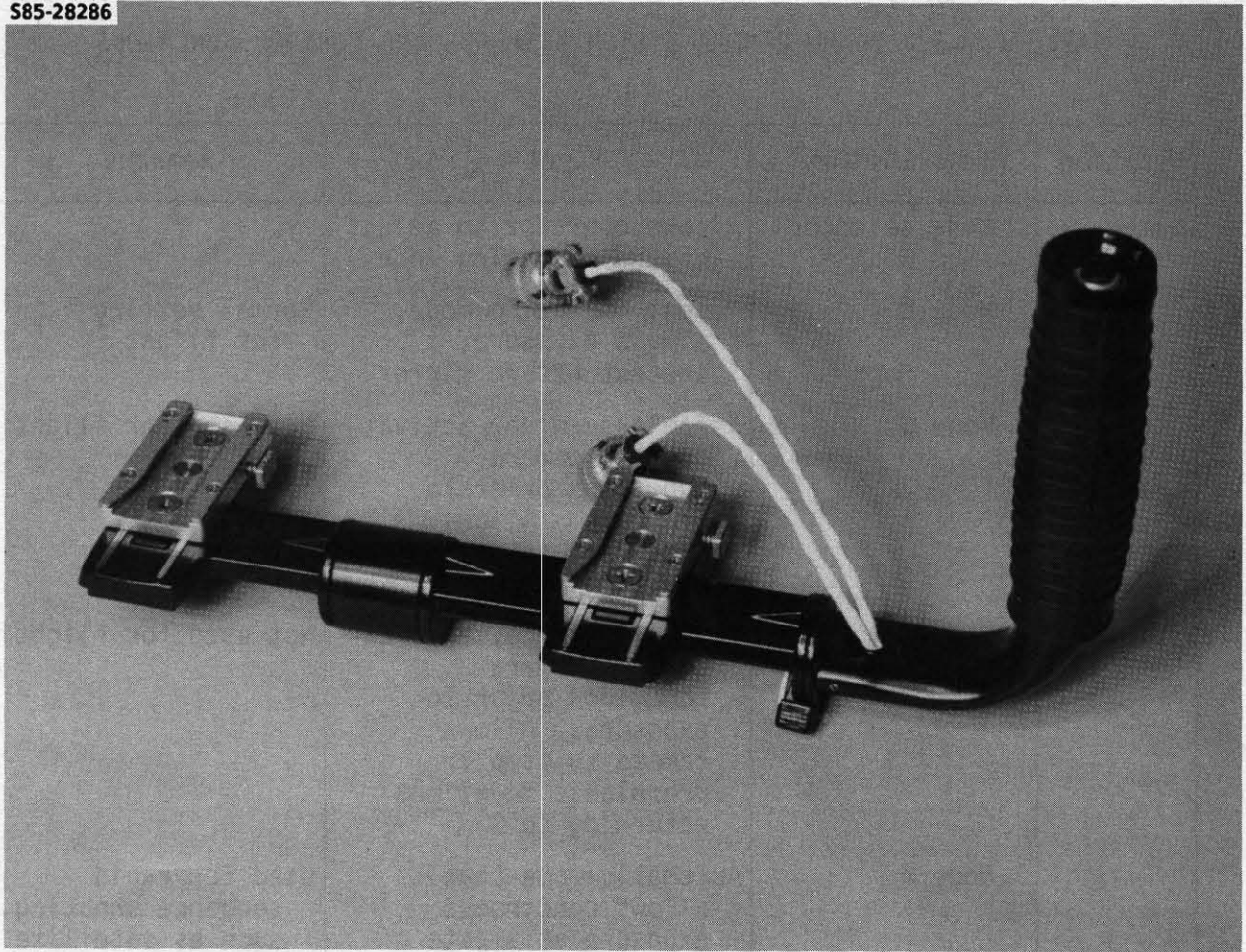


Figure 3.9-23.- Dual camera bracket.

TABLE 3.9-3.- 70 MM CAMERA SYSTEM DISPLAYS AND CONTROL FUNCTIONS

| Location | Nomenclature | Function | Remarks |
|-------------|----------------------------|--|--|
| Camera body | Mode selector | Allows operator to select camera operating mode | |
| | Mode 0 | Normal operating mode, single exposure, instant return mirror | Normal setting for flight |
| | Mode S | Prerelease mode, activating all camera functions prior to exposure. Allows camera to return to 0 mode after exposure | Not used for flight |
| | Mode SR | Prerelease mode, activating all camera functions prior to exposure. Allows camera to stop in prerelease mode, not returning to 0 | Not used for flight |
| | Mode A | Automatic mode that allows continuous exposure at a rate of approximately one frame per second | Used for rapid sequence shooting such as satellite deployments |
| | Mode AS | Automatic sequence mode starting and ending in the prerelease mode (S) | Not used for flight |
| | Shutter release pushbutton | Allows operator to actuate the camera | |
| | Lens release pushbutton | Releases lens latch to allow lens removal. Not used for installation | CCW turn for removal; CW turn for lens installation |
| | Battery compartment lock | Secures battery compartment cover | CCW 1/4 turn to open, CW 1/4 turn to close |
| | Diopter adjustment | Diopter adjustment possible by rotating eyepiece. Correction available ± 5 diopters | Allows operator to adjust focus on ground glass to compensate for vision |

TABLE 3.9-3.- Continued

| Location | Nomenclature | Function | Remarks |
|---------------|------------------------------------|--|---|
| Data magazine | Frame counter | Indexes with each frame and counts up from 0 to 200 (numbered every 5 frames) | 95 exposures normal for flight |
| | Film advance indicator | Monitors film advancement | |
| | Red | Indicates incomplete film advancement, film jam, or out-of-film condition | For normal camera operation the indicator should go from white to red and back to white |
| | White | Normal film advance | |
| | End-of-film indicator | Indicates film availability | |
| | Red | Indicates magazine is out of film | |
| | White | Indicates magazine contains film | |
| | Manual film advance knob | Film can be advanced by turning knob CW | |
| | Magazine insert lock | Secures insert to magazine | Not used for flight |
| | Release magazine lock lever | Secures magazine to camera. Magazine is released by sliding lock lever to left | |
| | ISO select switch | Adjusts brightness of data imprint to match film sensitivity | Set preflight |
| | ON/OFF switch | Supplies power to enable data imprinting on edge of film | Normally turned ON when mag is installed and left on until mag is replaced |
| LED's | Indicates status of magazine power | | |

TABLE 3.9-3.- Continued

| Location | Nomenclature | Function | Remarks |
|---------------|---|--|--|
| Data magazine | Green | Indicates battery power sufficient for data recording upon powerup. Indicates data has been imprinted on film during normal operations | Comes on momentarily when ON/OFF switch is placed in the ON position. Comes on momentarily after each exposure |
| | Red | Indicates insufficient battery power to record data on film | Battery needs replacement (ground only) |
| Lenses | | | |
| 50 mm | Aperture ring 4, 5, 6, 8, 11, 16, 22 | Allows operator to set lens aperture (detents every half f-stop) | |
| | Focus ring 19 inches to infinity | Allows operator to adjust focus | |
| | Shutter speed ring F, B, 1, 2, 4, 8, 15, 30, 60, 125, 250, 500 | Allows operator to set shutter speed | F setting designed for cameras with focal plane shutters (not used). B used for shutter speeds longer than 1 sec (time exposures). Shutter remains open as long as operate pb is depressed. Shutter speed settings correspond to fractions of a second |
| | Depth-of-field preview lever | Allows aperture to stop down to selected f-stop for a preview of scene depth of field | |

TABLE 3.9-3.- Continued

| Location | Nomenclature | Function | Remarks |
|----------|---|---|--|
| 50 mm | Depth-of-field indicators | Indicates depth-of-field range in relation to f-number | Indicators located between aperture ring and focus ring |
| | Shutter/aperture -coupling button | Button for locking aperture ring and shutter speed ring together | |
| | Coupling shaft | Allows proper attachment to camera body for normal lens operation | Attaching lens to camera can only be accomplished if coupling shaft is aligned with red dot on rear of lens |
| 100 mm | Aperture ring 3, 5, 4, 5.6, 8, 11, 16, 22 | Allows operator to set lens aperture (detents every half f/stop) | |
| | Focus ring 3 ft to infinity | Allows operator to adjust focus | |
| | Shutter speed ring F, B, 1, 2, 4, 8, 15, 30, 60, 125, 250, 500 | Allows operator to set shutter speed | F-setting designed for cameras with focal plane shutters (not used). B used for shutter speeds longer than 1 sec (time exposures). Shutter remains open as long as operate pb is depressed. Shutter speed settings correspond to fractions of a second |
| | Depth-of-field preview tab | Allows aperture to stop down to selected f/stop for a preview of scene depth-of-field | |

TABLE 3.9-3.- Continued

| Location | Nomenclature | Function | Remarks |
|----------|---|---|---|
| 100 mm | Depth-of-field indicators | Indicates depth-of-field range in relation to f-number | Indicators located between aperture ring and focus ring |
| | Cross-coupling button | Button for locking aperture ring and shutter speed ring together | |
| | Coupling shaft | Allows proper attachment to camera body for normal lens operation | |
| 250 mm | Aperture ring 5.6, 8.11, 16, 22, 32, 45 | Allows operator to set lens aperture (detents every half f/stop) | F-setting designed for cameras with focal plane shutters (not used). B used for shutter speeds longer than 1 sec, (time exposures). Shutter remains open as long as operate pb is depressed. Shutter speed settings correspond to fractions of a second |
| | Focus ring 10 feet to infinity | Allows operator to adjust focus | |
| | Shutter speed ring F, B, 1, 2, 4, 8, 15, 30, 60, 125, 250, 500 | Allows operator to set shutter speed | |
| | Depth-of-field preview lever | Allows aperture to stop down to selected f/stop for a preview of scene depth-of-field | |

TABLE 3.9-3.- Continued

| Location | Nomenclature | Function | Remarks |
|------------|-------------------------------|---|---|
| 250 mm, | Depth-of-field indicators | Indicates depth-of-field range in relation to f-number | Indicators located between aperture ring and focus ring |
| | Cross-coupling button | Button for locking aperture ring and shutter speed ring together | |
| | Coupling shaft | Allows proper attachment to camera body for normal lens operation | Attaching lens to camera can only be accomplished if coupling shaft is aligned with red dot on rear of lens |
| Spot-meter | ON/OFF switch | Provides power for spotmeter operations | |
| | S | Allows exposure adjustment for shadow areas (decreases f/stop 2 1/2 stops) | Not normally used for flight |
| | A | Allows averaging of two meter readings placed in memory | Not normally used for flight |
| | H | Allows exposure adjustment for highlight areas (increases f/stop 2 1/2 stops) | Not normally used for flight |
| | LCD window 1 through 45 scale | Analog scale with moving pointer to indicate appropriate f/stop | F numbers from 1 to 45 in 1/2-stop increments |
| | F-number | Digital display indicates appropriate f/stop | Has provision for displaying tenths of a stop. Range from 0.7 to 64 |

TABLE 3.9-3.- Continued

| Location | Nomenclature | Function | Remarks |
|------------|---------------------|--|--|
| Spot-meter | Time | Digital display indicates selected shutter speed | Exposure times range from 30 min to 1/2000 sec in 1-stop increments (interruption of battery power automatically defaults meter to 1/60 sec) |
| | ASA | Digital display indicates programmed ASA | ASA range from 12 to 6400 in 1/3-stop increments (interruption of battery power automatically defaults meter to ASA 100) |
| | M-CLR pushbutton | Allows operator to clear meter memory | |
| | ASA/time pushbutton | Allows operator to access ASA or time settings | Display must be in time mode for proper meter use |
| | ↑ Pushbutton | Allows operator to increase ASA or time values | |
| | ↓ Pushbutton | Allows operator to decrease ASA or time values | |
| | Recall pushbutton | Allows operator to recall entries placed in memory | |

TABLE 3.9-3.- Concluded

| Location | Nomenclature | Function | Remarks | |
|------------|------------------------|---|--|--|
| Spot-meter | F-number/EV pushbutton | Allows operator to select either the f/stop or EV scale | Not used for flight. Ball-point pen can reset to f-number position if EV scale is inadvertently selected (interruption of battery power automatically defaults meter to EV mode) | |
| | M pushbutton | Allows operator to enter meter reading to memory | | |
| | * pushbutton | Illuminates viewfinder LCD | Operable only in time display mode | |
| | Trigger | Provides meter reading with each trigger activation | | |
| | Eyepiece adjustment | Allows operator to adjust variable diopter for best focus | | Adjusts -2.5 to +1.2 diopters |
| | Viewfinder LCD | Digital display indicating proper f/stop | | Capable of indicating tenths of a stop |

3.9.3.3 Systems Performance, Limitations, and Constraints

70 mm camera body

- Type: single lens reflex
- Format: 2 1/4 x 2 1/4 in.
- Transport system: motor driven single frame or continuous up to approximately 1 frame per second
- Electrical requirement: 6-V, (two 6-V batteries standard per camera)
- Battery duration: approximately 2000 exposures with two batteries
- Finder type: interchangeable prism finder with eyepiece adjustment of +5 to -5 diopters. Finder magnification of 4X

70 mm film data magazine

- Type: 100/200 core load (can only be opened in darkroom)
- Frames available: approximately 95 exposures
- Film type and size: 70 mm perforated type II
- Frame counter: additive from zero to 200
- Electrical requirement: 4, E90 1.5-V battery
- Data control: ON/OFF switch
- Imprint intensity: controlled by selecting ASA setting that approximates the film ASA (64, 200, 400)
- Power verification: green LED
- Data provided: flight specific information such as date, time and mission designator is programmed into the data module preflight. Red LED light indicates battery voltage too low to actuate system

50 mm lens

- Type: fixed focal length
- Aperture range: f/4.0 through f/22
- Focus range: 19 inches to infinity
- Shutter speed: B, 1 to 1/500 of a sec

- Field of view: diagonal-75°, horizontal and vertical -58°

100 mm lens

- Type: fixed focal length
- Aperture range: f/3.5 through f/22
- Focus range: 2.5 ft to infinity
- Shutter speed: B, 1 to 1/500 of a sec
- Field of view: diagonal-42°, horizontal and vertical-30°

250 mm lens

- Type: fixed focal length, Superachomat
- Aperture: f/5.6 through f/45
- Focus range: 10 ft to infinity
- Shutter speed: B, 1 to 1/500 of a sec
- Field of view: diagonal-17°, horizontal and vertical-13°

3.11 SIGHTING AIDS

3.11.1 Introduction

Sighting aids include all items used to aid crew and passenger visibility within and outside the crew module. Sighting aids include

- Crewman optical alignment sight (COAS) - fig. 3.11-1
- Binoculars - figs. 3.11-2, 3.11-3 and 3.11-4
- Spotlight - fig. 3.11-5

The COAS is used on orbit for the following functions:

- Provides range and range rate during rendezvous and docking.
- Provides fixed line-of-sight attitude reference for verification of inertial measurement unit (IMU) and star tracker performance.
- Provides capability for backup IMU alignment.
- Provides backup attitude check prior to any major burn.

The binoculars can be used to view objects in the payload bay and remote to the Orbiter.

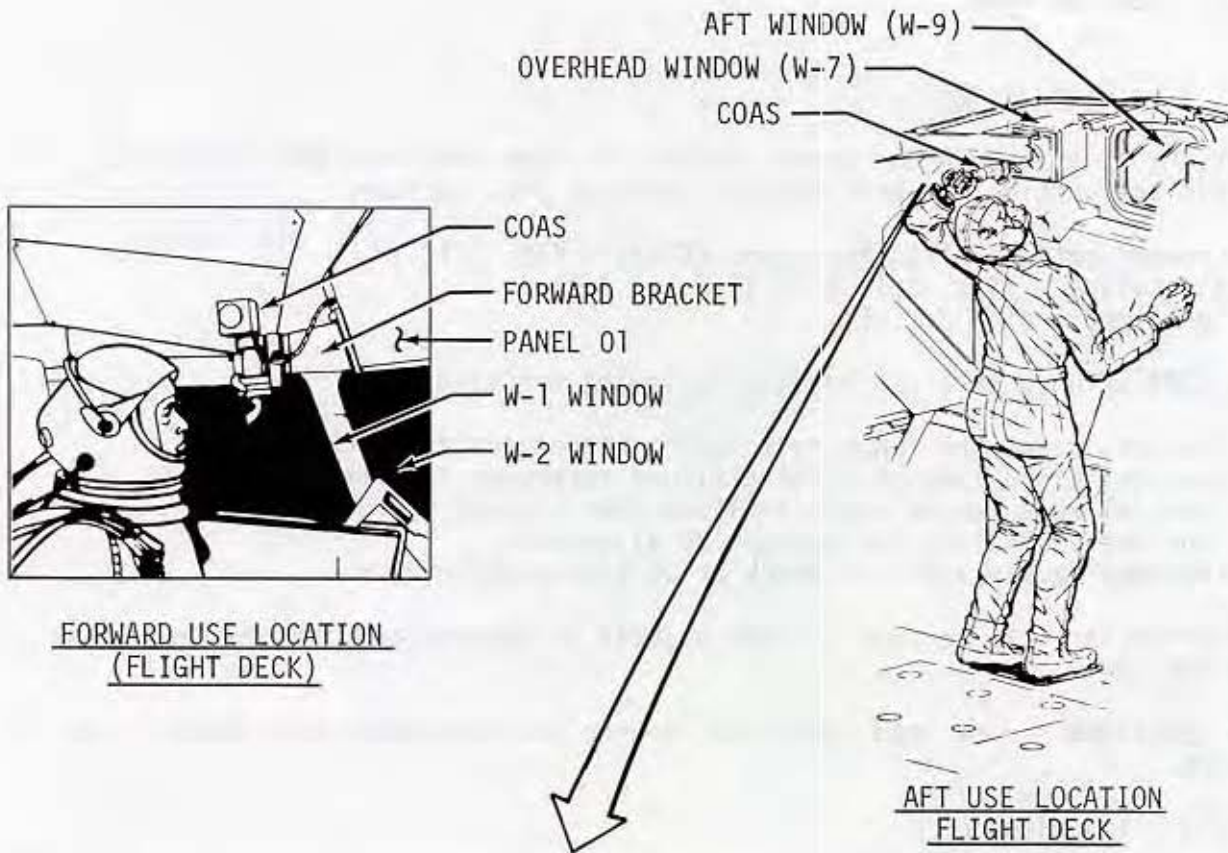
The spotlight can be used as a light source in contingency situations such as IFM.

3.11.2 Installation

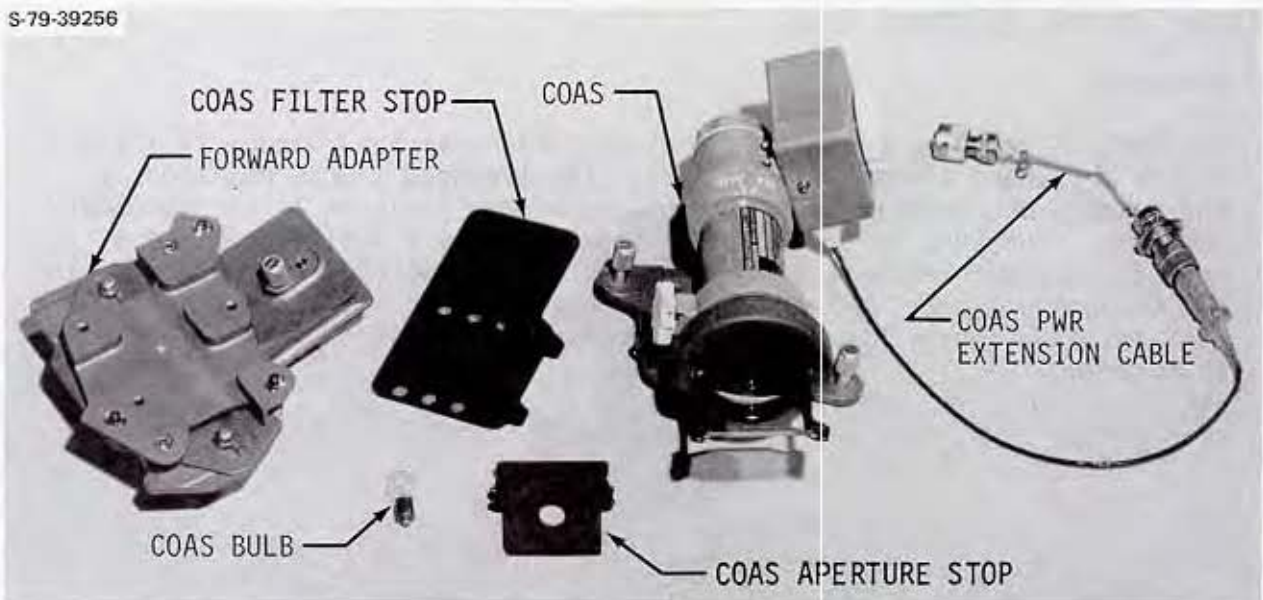
Crewman Optical Alignment Sight

- Mounting

The COAS is designed for use in the right-hand overhead window (W7) and in the left-hand forward window (W3). The overhead window position is the primary use location and the forward window position is the secondary location. The COAS is installed as shown in figure 3.11-1 by using a mounting bracket which is locked in position by two COAS thumbscrews. In the forward position, a forward mounting adapter is installed prior to COAS installation. This adapter is locked into position with a single thumbscrew.



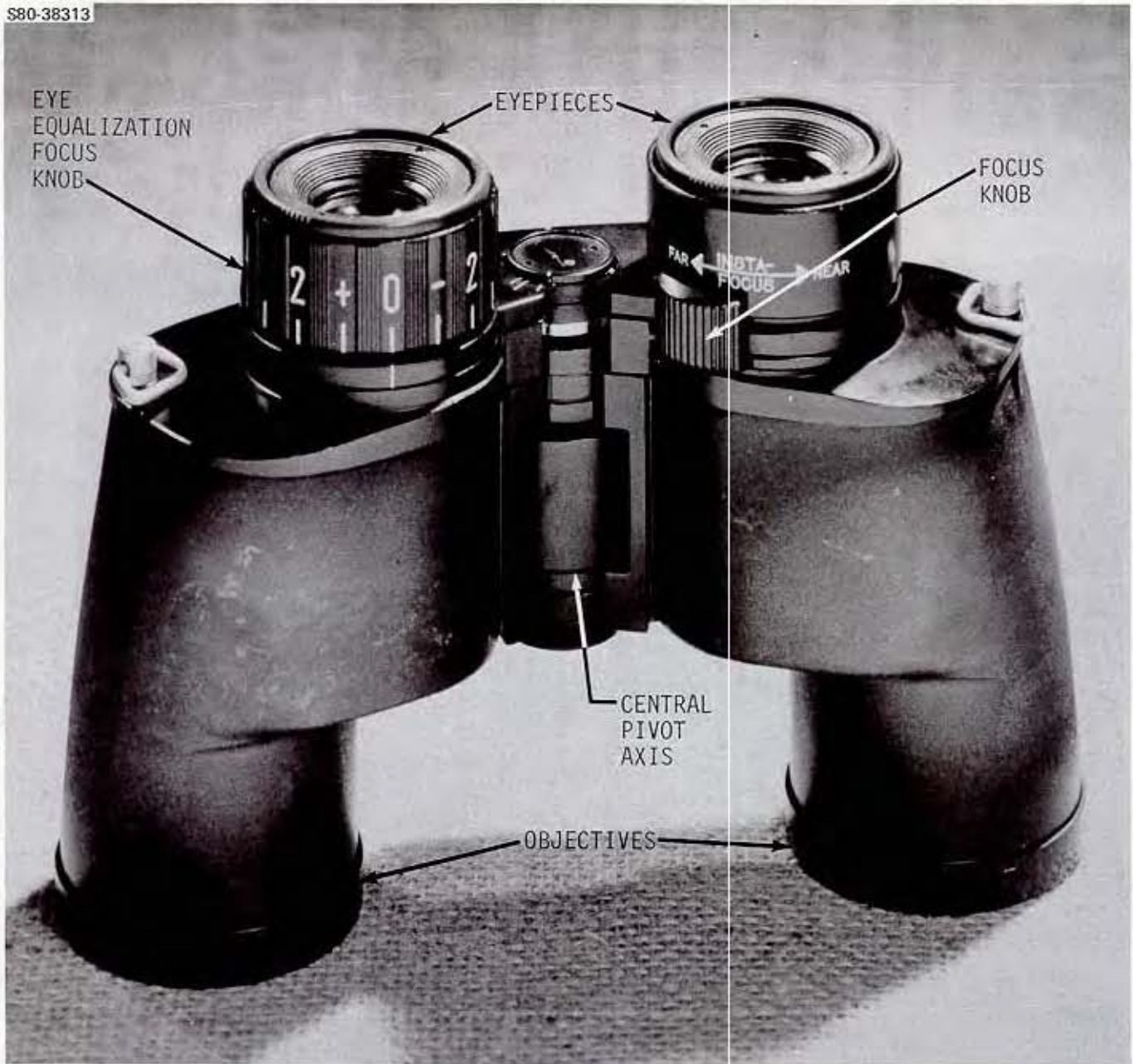
S-79-39256



COAS AND COMPONENTS

Figure 3.11-1.- Crewman optical alignment sight components and use locations.

S80-38313



7 X 35 BINOCULARS

Figure 3.11-2.- Binoculars.



Figure 3.11-3.- 8 X 30 binoculars.

285

3.11-5

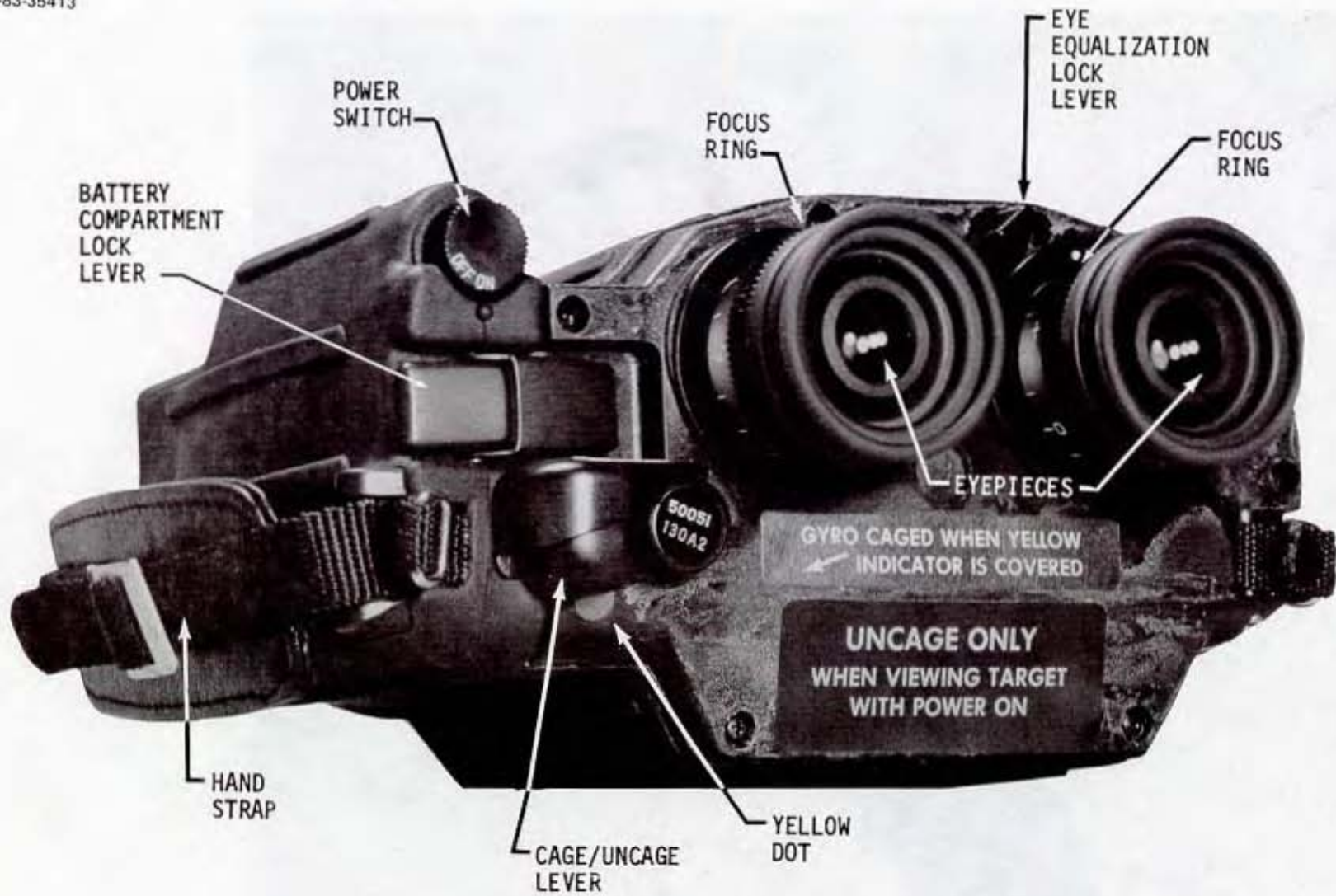


Figure 3.11-4.- Gyrostabilized binoculars.

S83-35410

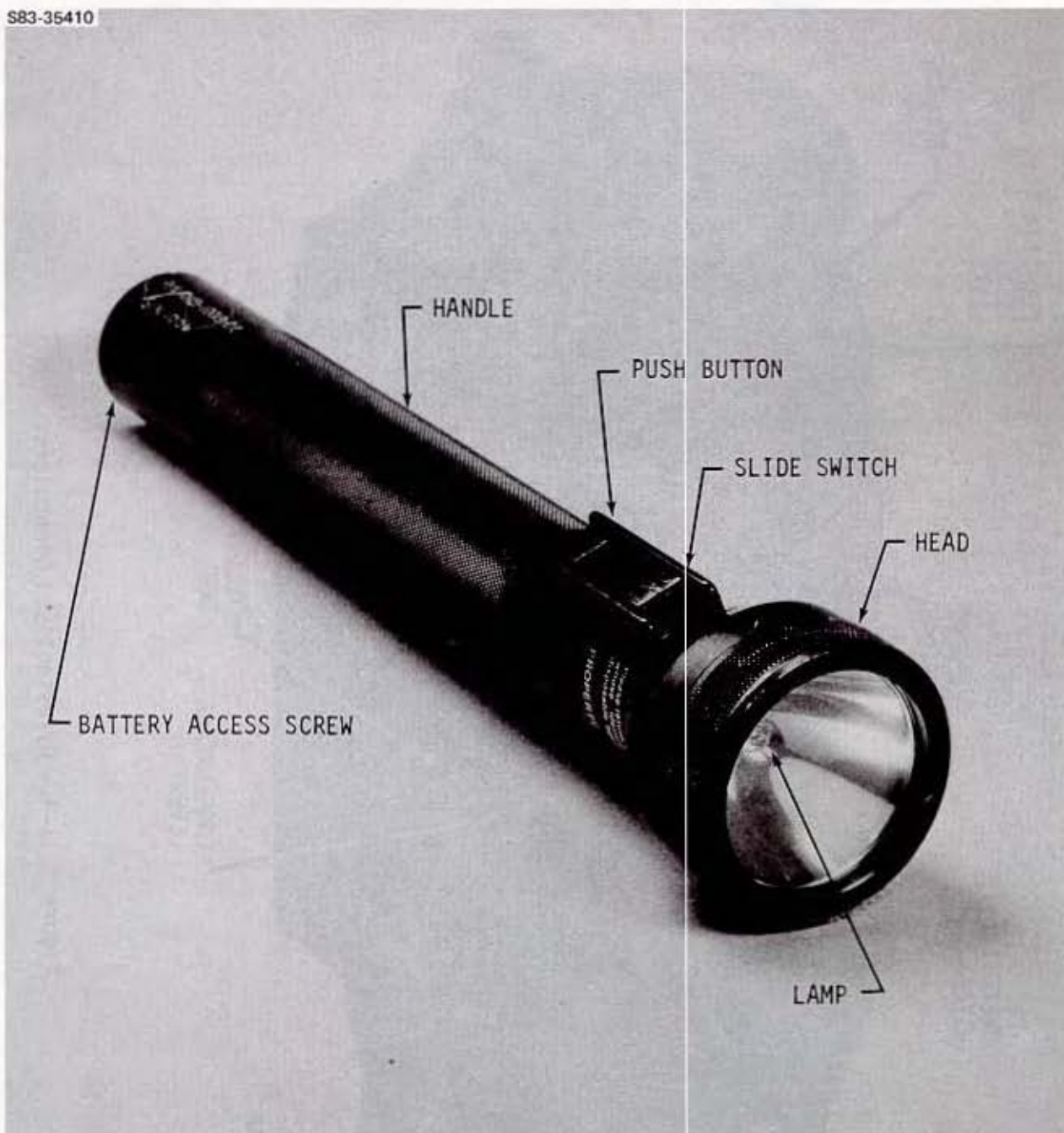


Figure 3.11-5.- Spotlight.

TABLE 3.11-1.- SIGHTING AIDS DISPLAY AND CONTROL FUNCTIONS

| Location | Type | Nomenclature/ position | Function | Remarks |
|-----------------------------|------|---------------------------|--|---|
| <u>COAS</u> | | | | |
| COAS | knob | Intensity control | Varies intensity of COAS reticle pattern | Full bright power - 11.5 V ac Minimum power - 4.2 V ac Maximum reticle illumination - 4860 ft - Lamberts |
| | ring | Barrel | OW Position for overhead window COAS operations FW Positions for forward and aft window COAS operations | Rotates 10°; positions are detented |
| | knob | Barrel lock | Unlocks COAS barrel for rotation | Pull knob to unlock; push in to lock position |
| Pnl 01 & 19 | SW | COAS | ON Supplies 1 ϕ 115 V ac power for COAS operation OFF Removes power | Panel 01 controls left-hand forward window mounting position. Panel 019 controls right-hand overhead and aft window mounting position |
| <u>BINOCULARS</u> 7 x 35 | knob | Focus | Focuses binoculars | Closest focus approx. 36 ft (11 m) |
| | knob | Right eyepiece adjustment | Adjusts right eyepiece for viewing equalization | |

TABLE 3.11-1.- Continued

| Location | Type | Nomenclature/ position | Function | Remarks | |
|--|-------|------------------------------|--|---|---|
| 8 x 30 14 x 40 gyrosta- bilized | knob | Left eyepiece adjustment | Focuses left eyepiece | Closest focus approx. 18 ft. (5.5 m) | |
| | knob | Right eyepiece adjustment | Focuses right eyepiece | | |
| | knob | Right eyepiece ±5 | Adjusts right eye- piece to ±5 di- opters for indi- vidual operator vision | Approximately 1 minute is needed for the gyros to reach a full image stabi- lizing speed of 12,000 to 15,000 rpm | |
| | lever | Left eyepiece ±5 | Adjusts left eye- piece to ±5 di- opters for indi- vidual operator vision | | |
| | SW | Interpupillary adjustment | Adjusts the distance between two eye- pieces | | |
| | lever | Power | ON | | Activates the gyros |
| | | | OFF | | Deactivates gyros |
| | | Cage/uncage lever | Uncage | | After the warm- up period the cage/uncage lever is pushed up (exposing yellow dot) to stabilize the image |

TABLE 3.11-1.- Concluded

| Location | Type | Nomenclature/ position | Function | Remarks |
|--------------------------------|-------|--|--|---|
| 14 X 40 gyrosta- bilized | | Cage | The lever is pushed up to cover the yellow dot | The gyrostabilized binoculars should be caged (yellow dot covered) before turning power off |
| | lever | Battery com- partment lock lever | Lifting up lever al- lows access to the battery com- partment | |
| <u>SPOTLIGHT</u> | SW | Barrel | Supplies 6-V dc power to quartz- halogen lamp | Five 1.2 V nonstandard batteries for 1 hr continuous operation |

- Electrical Connections

For the forward position, ac power is supplied for COAS operation from a receptacle on panel 01. For the overhead position, ac power is supplied from panel 019. The switch functions are identified in table 3.11-1.

3.11.3 Systems Functional Description

COAS

The COAS is utilized in the right-hand overhead window (W7) to provide range and range rate for rendezvous/docking, for IMU backup alignment, and Z-axis sighting (fig. 3.11-6). The crewmember sights through the COAS while maneuvering the Orbiter with the aft station controls. The COAS on orbit D&C location is shown in figure 3.11-7.

In the left-hand forward window (W3), the COAS is used for stationkeeping/tracking, miscellaneous Orbiter alignment tasks, and as a backup location for IMU alignment. The COAS provides the crewman a fixed line-of-sight attitude reference image that appears to be the same distance away as the target. This image is boresighted (by means of a sight mount) parallel to the X-axis (centerline of the Orbiter). The COAS on orbit use location is shown in figure 3.11-8.

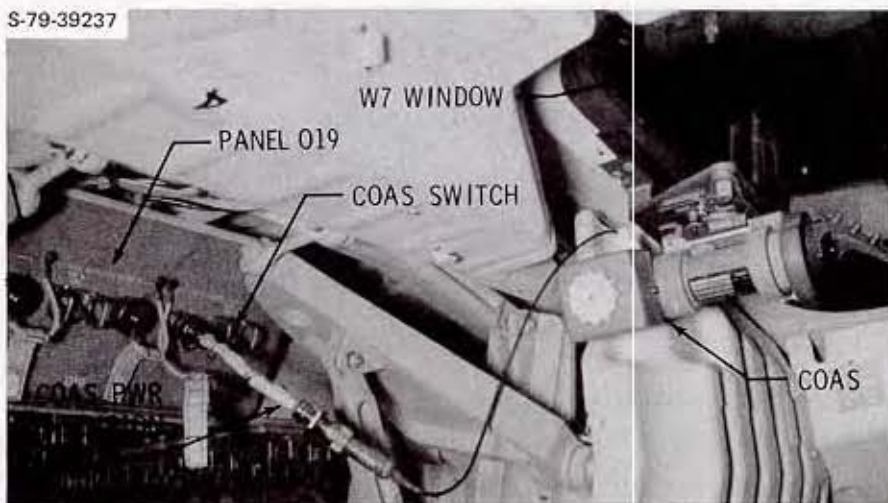
The COAS is a collimator device similar to a heads-up display. The COAS weighs approximately 2-1/2 lb (1.13 kg), is 9.5 in. (24 cm) long, and requires Orbiter 115 ± 5 V ac power. The COAS consists of a lamp with an intensity control, reticle, barrel-shaped housing, mount, combiner lens assembly, and a power cable (fig. 3.11-9). The reticle consists of a 10° circle, vertical and horizontal cross hairs with 1° marks, and an elevation scale on the right side of -10° to 0° to +31.5° (fig. 3.11-10). The combiner lens assembly is a half-silvered mirror that allows the crewmember to see the target on the reticle.

- COAS Aperture Stop

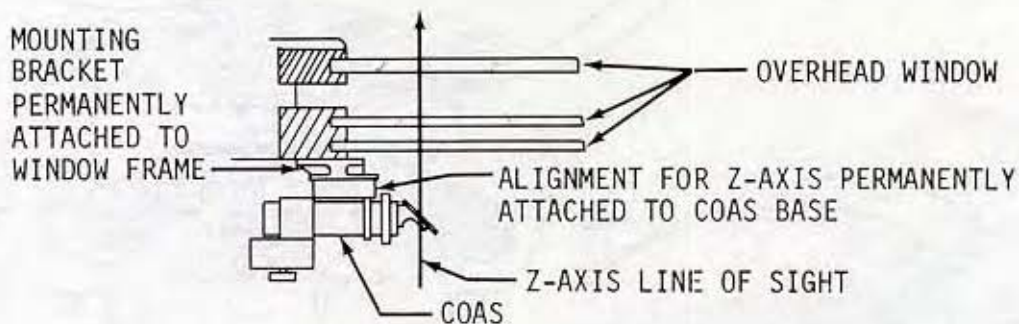
The COAS aperture stop is affixed to the arms supporting the combiner lens. The aperture stop covers most of the viewing optics on the COAS except for a centrally located 0.50-in. (1.27-cm) diameter hole for viewing conditions. Its purpose is to limit the amount of side-to-side head movement (3/4 in.) when observing the projected reticle image through the small aperture

- COAS Filter

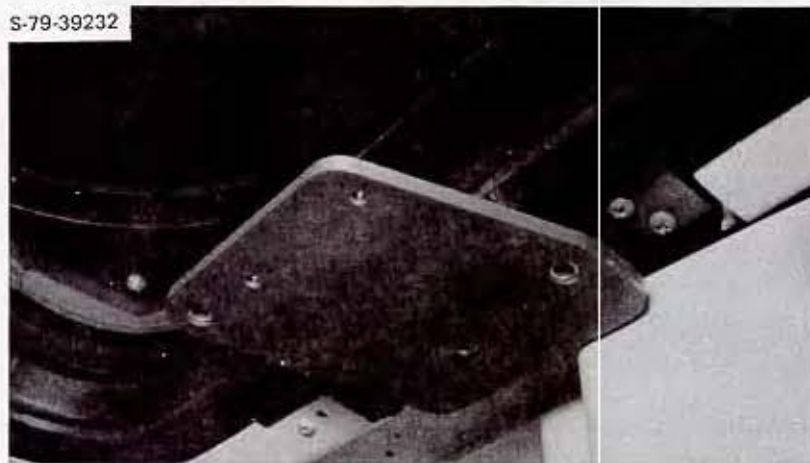
The COAS filter is affixed to the bracket behind the combiner lens. Its purpose is to filter out bright glare areas when viewing the reticle image on the lens during full sunlight conditions.



AFT FLIGHT DECK MOUNTING



COAS MOUNTING (SIDE VIEW)



OVERHEAD MOUNTING BRACKET

Figure 3.11-6.- COAS - aft station.

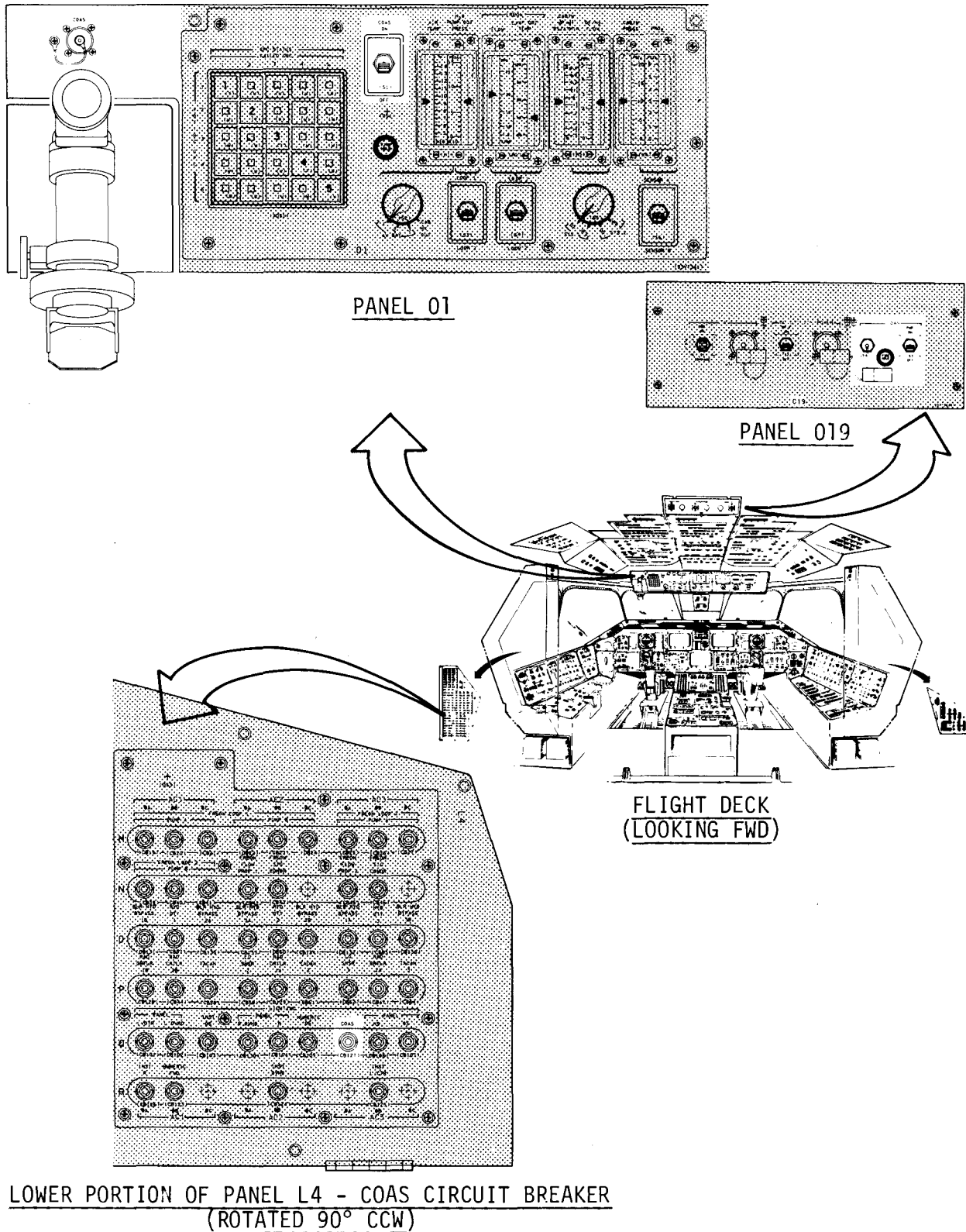
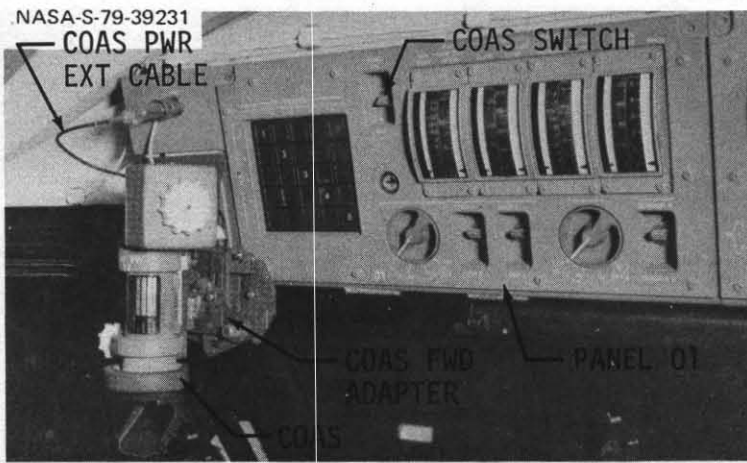
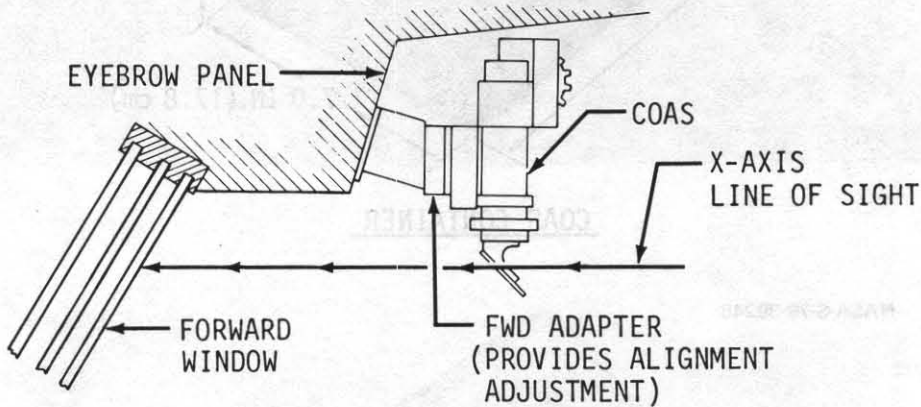


Figure 3.11-7.- Orbiter D&C for COAS operations.

3.11-12

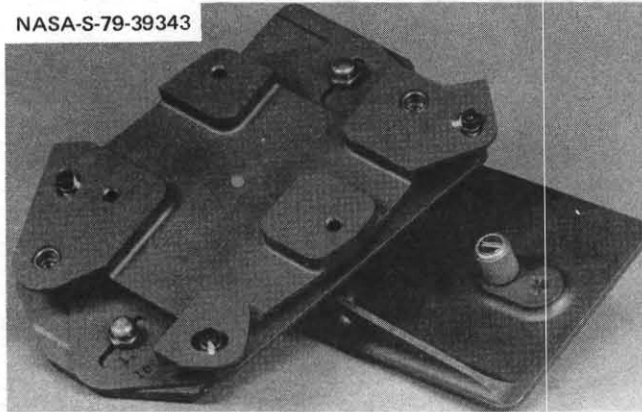


FWD FLIGHT DECK MOUNTING



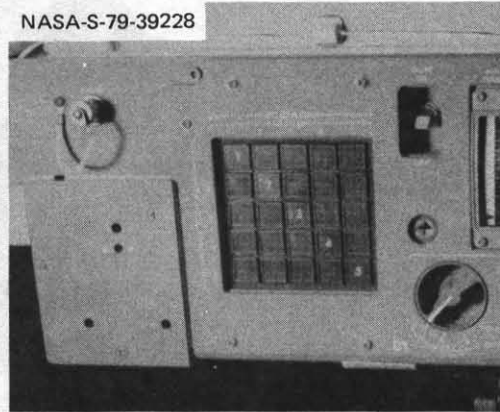
COAS MOUNTING (SIDE VIEW)

NASA-S-79-39343



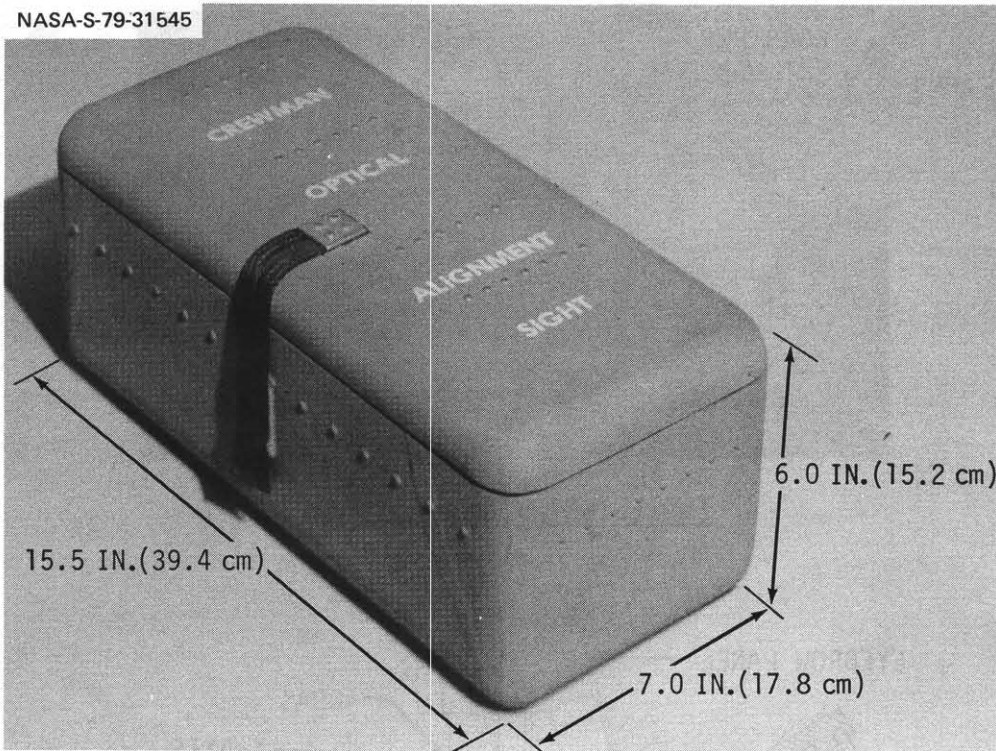
FWD ADAPTER

NASA-S-79-39228

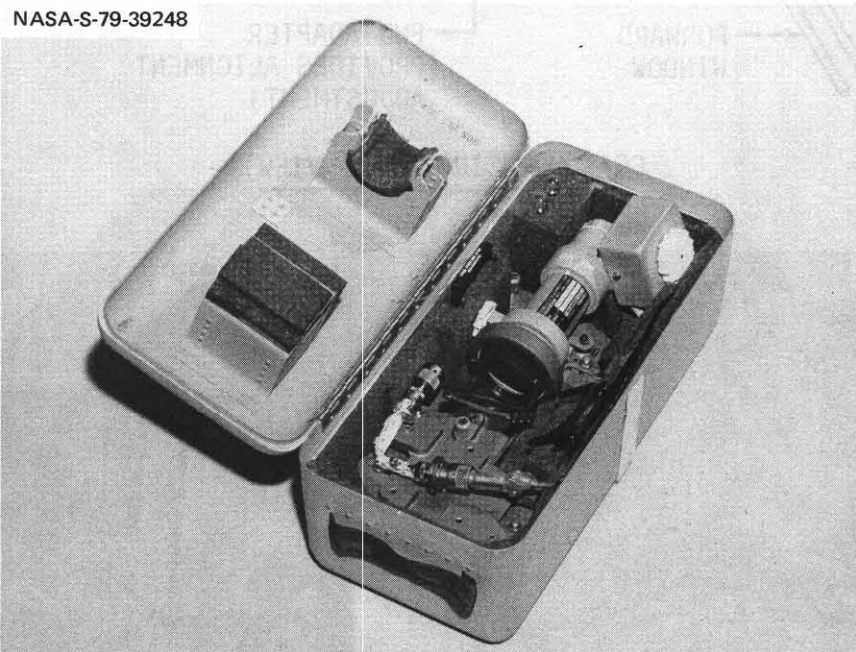


FWD MOUNTING BRACKET

Figure 3.11-8.- COAS operations - forward flight deck.

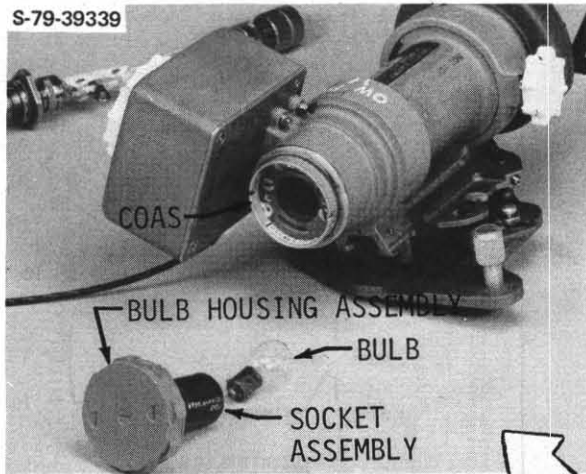


COAS CONTAINER



COAS CONTAINER CONTENTS

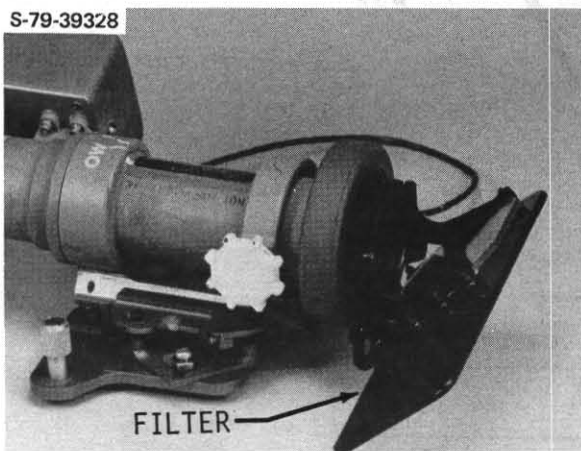
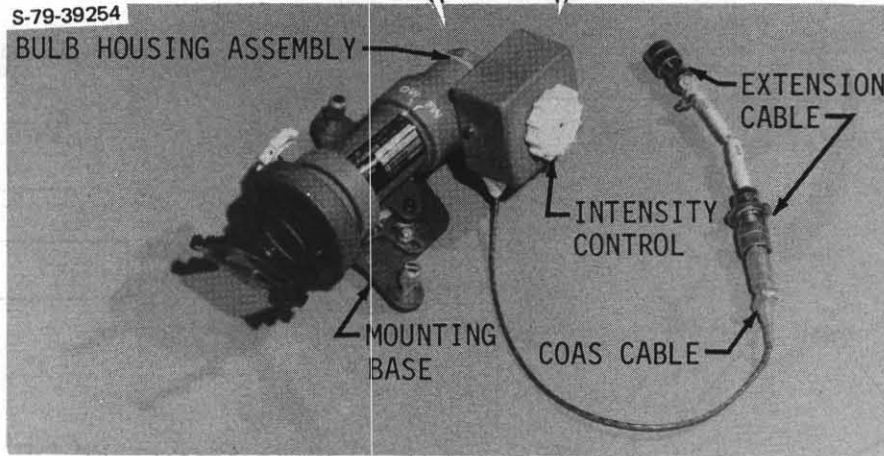
Figure 3.11-9.- COAS operations (sheet 1 of 2).



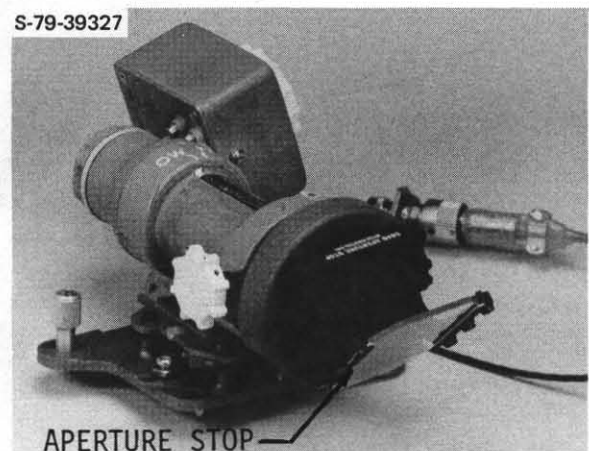
COAS BULB CHANGE OUT



COAS INTENSITY CONTROL



COAS WITH FILTER



COAS WITH APERTURE STOP

Figure 3.11-9.- COAS operations (sheet 2 of 2).

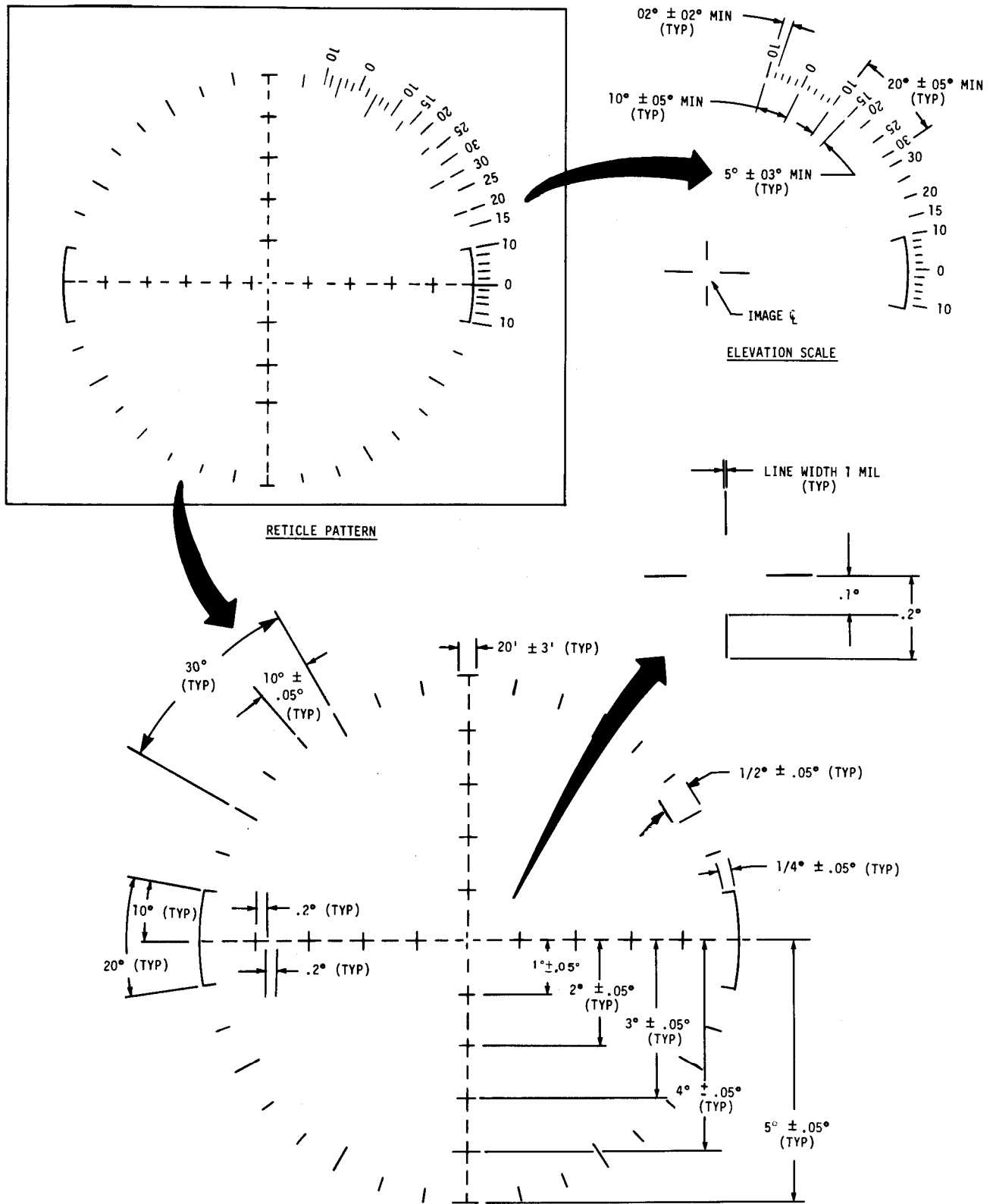


Figure 3.11-10.- COAS reticle.

3.11-16

- COAS Power Extension Cable

The power extension cable is an extension of the COAS cable which remains attached to the COAS and is not to be removed at any time. It permits connection to the aft COAS power outlet. A COAS wiring diagram is shown in figure 3.11-11.

Binoculars

The 7 x 35 binoculars are a modified version of the commercial Bushnell 7 x 35 binoculars (fig. 3.11-2). This unit is noted especially for its minimum focal distance at high magnification and rugged sealed construction.

The focus of the binoculars is adjusted by moving the knob on the right eyepiece. Left eyepiece adjustment for viewing equalization is provided by turning the left eyepiece.

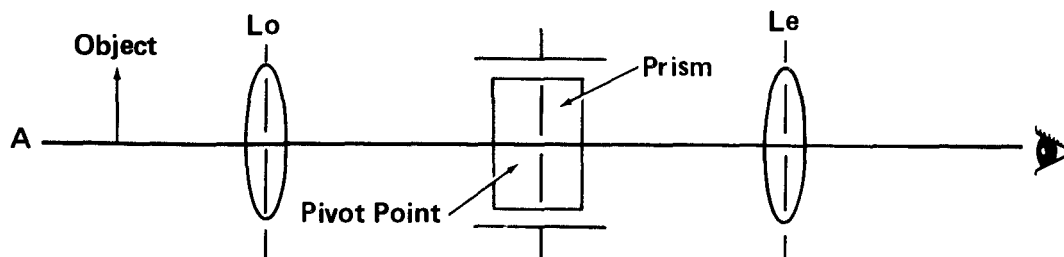
The 8 x 30 binoculars are a modified version of those manufactured by Tasco (fig. 3.11-3). This unit has features similar to those of the 7 x 35, as well as a built-in measuring scale.

The focus of the binoculars is found by separate adjustments of the left and right eyepieces.

The measuring scale is based on the NATO military reticle. It consists of a horizontal line that would be 90 yards long at a distance of 1000 yards and is bisected by a vertical line covering 20 yards at the same distance. The scale is graduated in 5-yard increments.

The 14 x 40 gyrostabilized binoculars are a modified version of the Fujinon Stabiscopes (fig 3.11-4). This unit contains a gyrostabilizing system which enhances target acquisition and retention. The difficulty in maintaining a steady image because of normal body or hand tremor is amplified when the magnification increases. When the operator is subjected to ambient vibration or hand tremor while using the gyrostabilized binoculars, the target image remains clear and stable.

As shown below, the objective lens L_o , the eyepiece L_e , and the erecting prism cluster are arranged on the same axis. The prism is fixed to gimbals with a gyromotor and the pivot point is in the middle point of L_o and L_e .



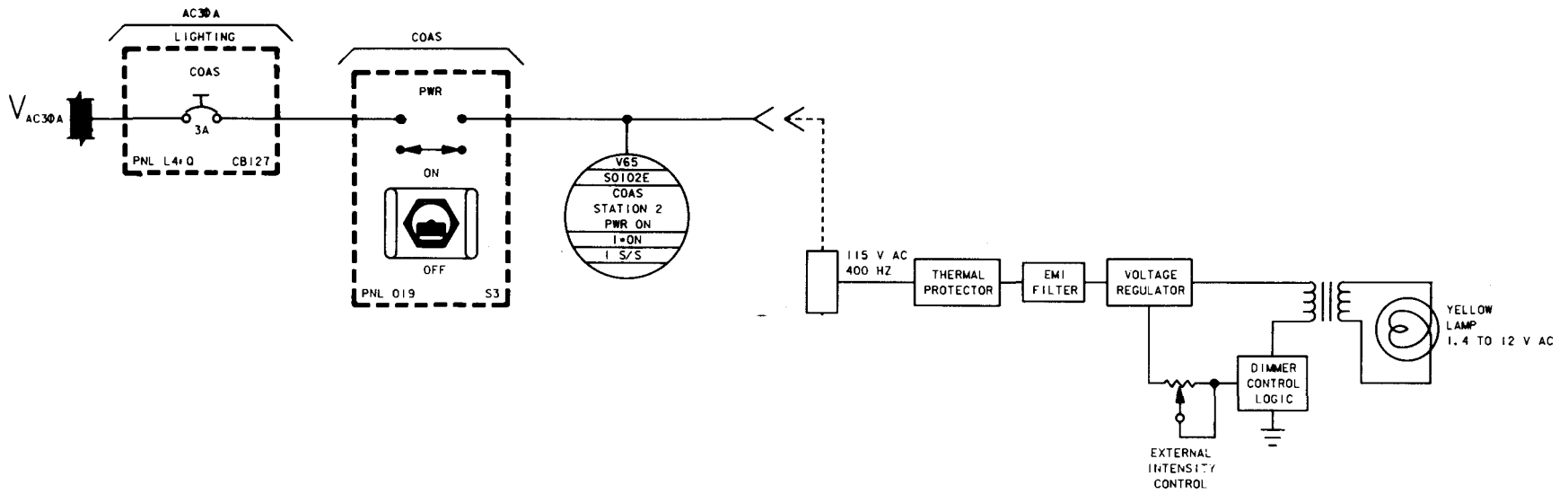
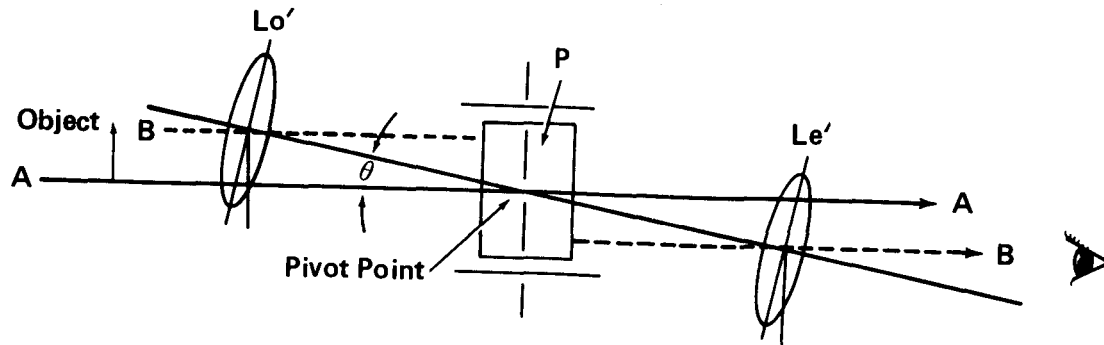
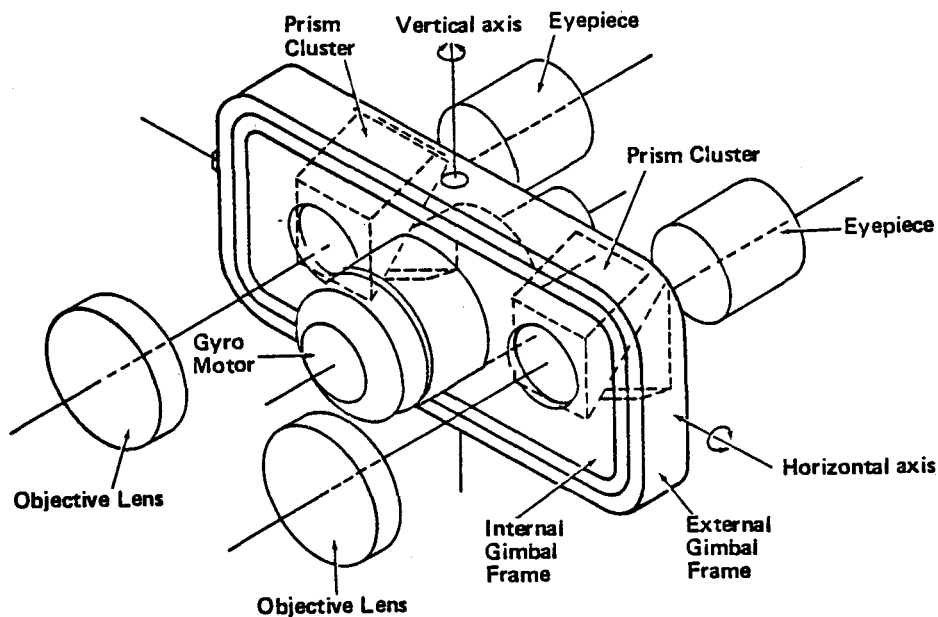


Figure 3.11-11.- COAS wiring diagram.

When vibration is applied, Lo and Le will slant together by \ominus degrees, and come to the position of Lo' and Le' . Because the prism is fixed to the gimbals with a gyromotor, the prism maintains its initial position despite vibration. Light B , which comes through the center of Lo in parallel to the optical axis A , passes through the prism and goes through the center of Le' .



Light B then comes to the eye in parallel with the optical axis A because the pivot point of the gimbals is located in the middle of Lo and Le . A more detailed illustration is shown below.



To operate the gyrostabilized binoculars, the power switch is rotated clockwise to the ON position. A warmup period of ~ 1 minute is needed for the gyros to reach a full image stabilizing speed of 12 000 to 15 000 rpm. After the warmup period, the cage/uncage lever is pushed up (exposing yellow dot) to stabilize the image. Individual eyepieces can be focused for individual operator vision by rotating the knurled focus rings on each eyepiece. Interpupillary adjustment is controlled by an adjustment lever located between the two eyepieces. The gyrostabilized binoculars should be caged (yellow dot covered) before turning power off.

The gyrostabilized binoculars will operate continuously for up to 3 hours with one battery pack. The battery pack contains six alkaline-type AA batteries. To change out the battery pack, the lock lever is pulled up and released from the metal hook on the binoculars' main body. The battery pack is contained within the battery pack housing which is attached to the bottom of the binoculars' main body via hinges. After the battery pack housing is swung away from the binoculars' main body, the battery pack can be removed by pulling up on a small tab attached to the pack. The battery pack is designed so that it will only go into the housing one way. There are also arrow indicators labeling correct orientation. One spare battery pack will be flown for each pair of binoculars flown. The batteries within the pack can also be changed out by releasing the battery pack clips, removing old batteries, and installing the new batteries. The proper terminal orientation is imprinted in the plastic pack. The old battery terminals should be covered with gray tape and stowed where the new batteries came from.

Spotlight

The spotlight (fig. 3.11-5) is a high intensity, handheld flashlight and is powered by a battery pack consisting of five 1.2-volt 1/2-D nonstandard size nickel-cadmium batteries. A spare battery pack will normally be flown. The spotlight produces a 20 000 candlepower output with a continuous running time of 1.5 hours. The lamp is a 6-volt tungsten filament and cannot be replaced in flight.

To change out the batteries, the end of the flashlight is removed by unscrewing counterclockwise. The batteries are bound together in series with a plastic wrap. The stick battery pack is inserted into the spotlight handle with the positive terminal pointing to the lamp. The spotlight is activated by a combination pushbutton/slide switch. To temporarily activate the spotlight, the pushbutton is depressed and held down. The spotlight will deactivate when the pushbutton is released. To lock the spotlight in the on position, the slide switch is moved towards the lamp. The spotlight will remain on until the slide switch is pushed back toward the handle to the off position.

3.11.4 Systems Performance, Limitations, and Constraints

COAS

- Stowed for launch and entry
- Weight
 - COAS: Approx. 2.5 lb (1.13 kg)
 - COAS with bracket assembly: 3.45 lb (1.56 kg)
- Envelope
 - COAS: 9.5 x 6.0 x 4.3 in. (24.1 x 15.2 x 10.9 cm)
 - COAS with bracket: 9.5 x 6.5 x 6.5 in. (24.1 x 16.5 x 16.5 cm)
 - Container: 6 x 15.5 x 7 in. (15.2 x 39.4 x 17.8 cm)
- Barrel rotation: 10°
- Power
 - Source: 1 ϕ 115 \pm 5 V ac
 - Full bright: 11.5 V ac; 12 watts
 - Full dim: 4.2 V ac; 6 watts
- Reticule luminance (max.): 4860 ft-Lamberts
- Cables
 - COAS power cable
 - Length: 15.2 in. (38.6 cm)
 - Connector type: 3-pin male (NBS6GE8-3PN)
 - COAS power extension cable
 - Length: 6.2 in. (15.7 cm)
 - Connector types: 3-pin male (NBS6GE8-3PN);
3-socket female (NBS7E8-3SN)

7 x 35 Binoculars

- Stowed for launch and entry
- Weight: 1.85 lb (0.84 kg)
- Envelope: 5 x 6 x 2.8 in. (12.7 x 15.2 x 7.1 cm)
- Magnification: 7X
- Focal distance (min.): 12.5 ft (3.8 m)
- Objective diameter: 35 mm
- Field-of-view: 8°; 420 ft at 1000 yd

8 X 30 Binoculars

- Stowed for launch and entry
- Weight: 1.66 lb (0.75 kg)
- Envelope: 5.0 x 7.0 x 2.9 in. (12.7 x 17.8 x 7.4 cm)
- Magnification: 8X
- Focal distance (min.): 16 ft. (4.9 m)
- Objective diameter: 30 mm
- Field-of-view: 8.5°; 446 ft at 1000 yd
- Features range-finding scale

14 x 40 Gyrostabilized Binoculars

- Stowed for launch and entry
- Weight: 4.6 lb (2.1 Kg)
- Envelope: 7.9 x 7.1 x 3.8 in. (20 x 18 x 9.6 cm)
- Magnification: 14 x \pm 5 percent
- Focal distance (min.): 52 ft (15.9 m)
- Field of view: 4° dia.
- Objective diameter: 40 mm
- Exit pupil diameter: 2.8 mm \pm 5 percent
- Eyepiece focus adjustment: \pm 5° diopters
- Interpupillary adjustment: 60 - 70 mm
- Power: Six type AA nickel-cadmium batteries

Spotlight

- Stowed for launch and entry
- Weight: 1.8 lbs (0.8 kg) - with batteries
- Envelope: 12 x 1.5 x 2.5 in. (30.5 x 3.8 x 6.4 cm)
- Luminance: 20 000 candle power
- Power: Five 1.2-volt 1/2 D (nonstandard) size nickel-cadmium batteries (series)
- Lamp: 6 volt, 10 watt, tungsten filament, quartz-halogen

3.12 WINDOW SHADES, FILTERS, EMI SHIELDS AND INTERDECK LIGHT SHADES

3.12.1 Introduction

The Orbiter windows are designed to provide external visibility for a wide variety of tasks. Rendezvous, docking, payload handling, entry, atmospheric flight, and landing all require adequate external visibility which will often expose the crew to Sun glare. Therefore, window shades and filters are provided and may be installed by the crew when necessary to minimize or prevent Sun glare. All shades, filters, and shields may be used while on orbit. Window shades, filters, EMI shields, and the windows they cover are shown in figure 3.12-1.

The aft window shades (W-9 and W-10) are installed preflight for launch in order to protect the aft windows from falling objects while the Orbiter is in a vertical position; they are stowed for entry.

Electromagnetic interference (EMI) shields have a triple purpose. First, they serve as window shades for the overhead windows (W-7 and W-8). In addition, they will be installed for launch and entry to protect Orbiter overhead electronics from lightning and electromagnetic interference when the Orbiter has been certified to fly in the vicinity of thunderstorms. Last, the W8 EMI shield is always installed for launch and entry to provide protection from flying debris during blowout of the emergency egress panel in case of postlanding emergency egress.

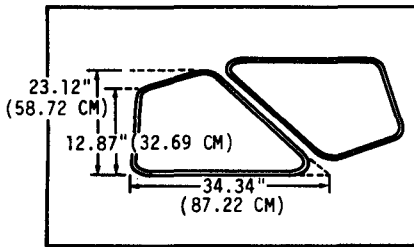
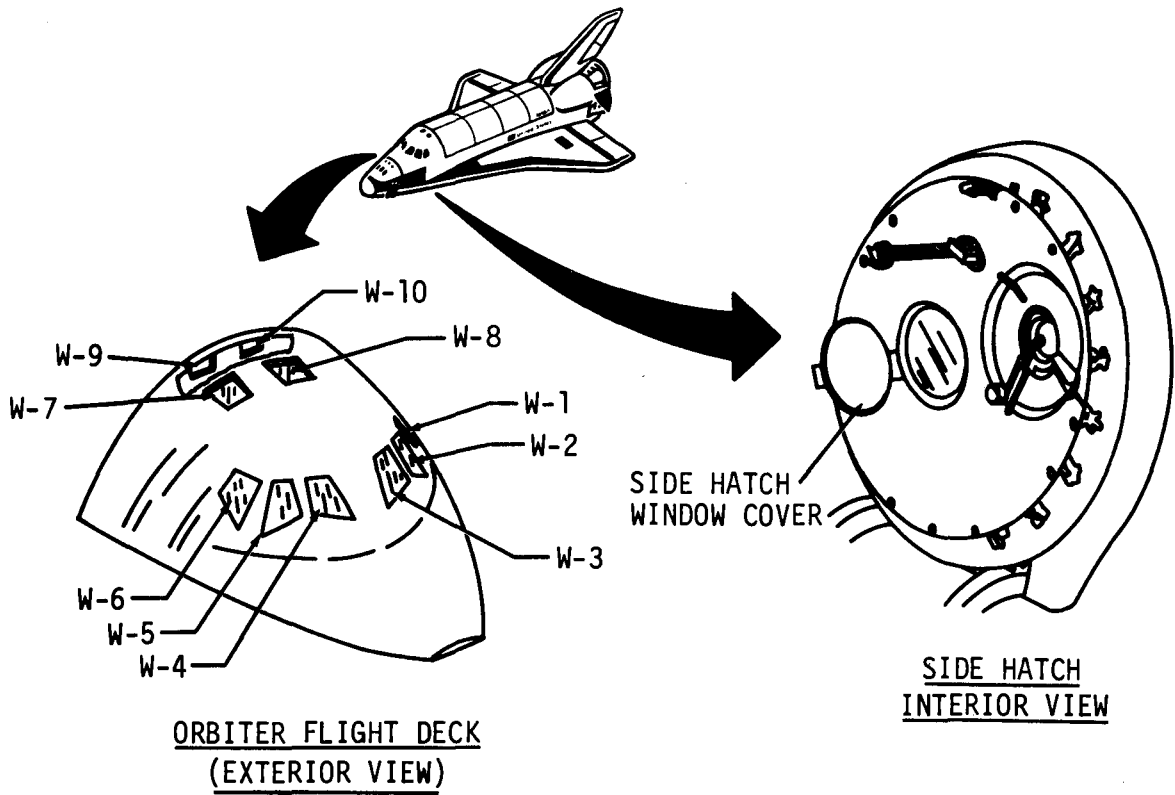
Interdeck light shades are provided in order to minimize light leakage and window reflections between the flight deck and middeck during night out-the-window photography, rendezvous, or stationkeeping. Figure 3.12-2 shows a drawing of the interdeck light shades.

The only window on the Orbiter middeck is a 10 in. diameter circular window in the side hatch. This window is provided with a cover that is permanently attached to the window frame. The side hatch window cover acts as a window shade and also provides protection for the window. The cover is hinged to allow opening and closing (fig. 3.12-1).

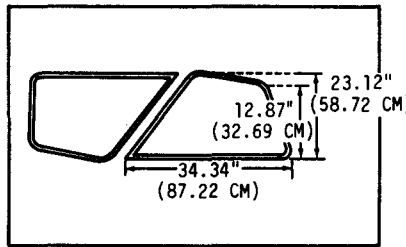
3.12.2 Stowage

When not in use, window shades, filters, and EMI shields are stowed in the window shade bag at ML84K (fig. 3.12-3). The bag is fastened to a metal frame on the bulkhead by snaps and snap-connected straps and may be removed from the frame if required.

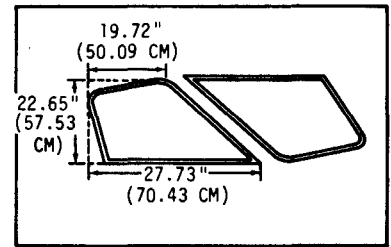
The window shade bag has labeled compartments for each window shade, filter, and EMI shield. Each compartment has a Velcro-restrained closure panel. In addition to the compartment identification labels on the bag, each shade, filter, and shield is labeled, with the markings close enough to the edge



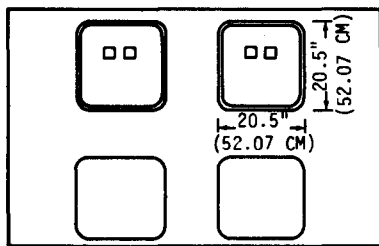
W-1 AND W-6
WINDOW SHADES



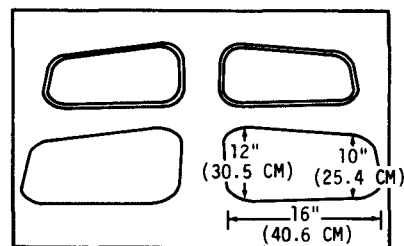
W-2 AND W-5
WINDOW SHADES



W-3 AND W-4
WINDOW SHADES

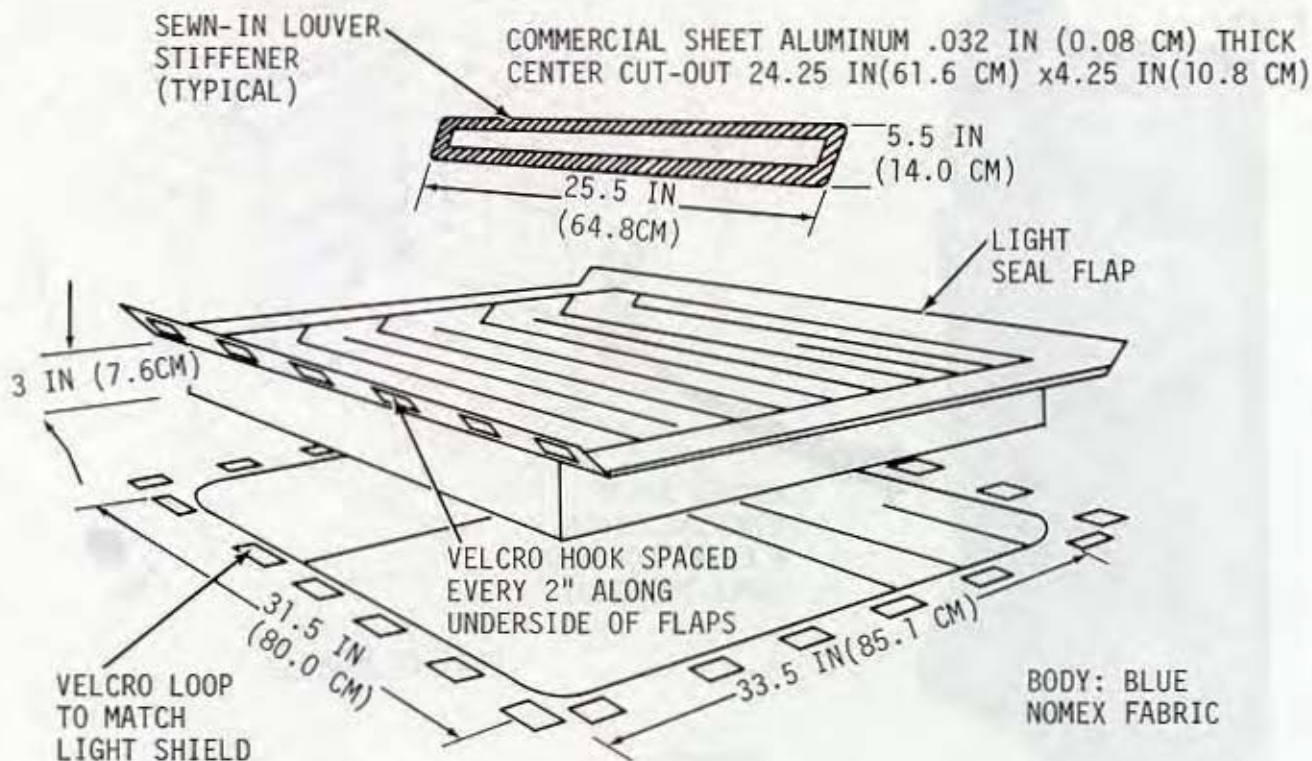


W-7 AND W-8
EMI SHIELDS AND FILTERS



W-9 AND W-10
WINDOW SHADES AND FILTERS

Figure 3.12-1.- Window shades/filters.



INTERDECK LIGHT SHADE-VELCRO ATTACHING



INTERDECK LIGHT SHADE STOWAGE

Figure 3.12-2.- Interdeck light shade installation/stowage.

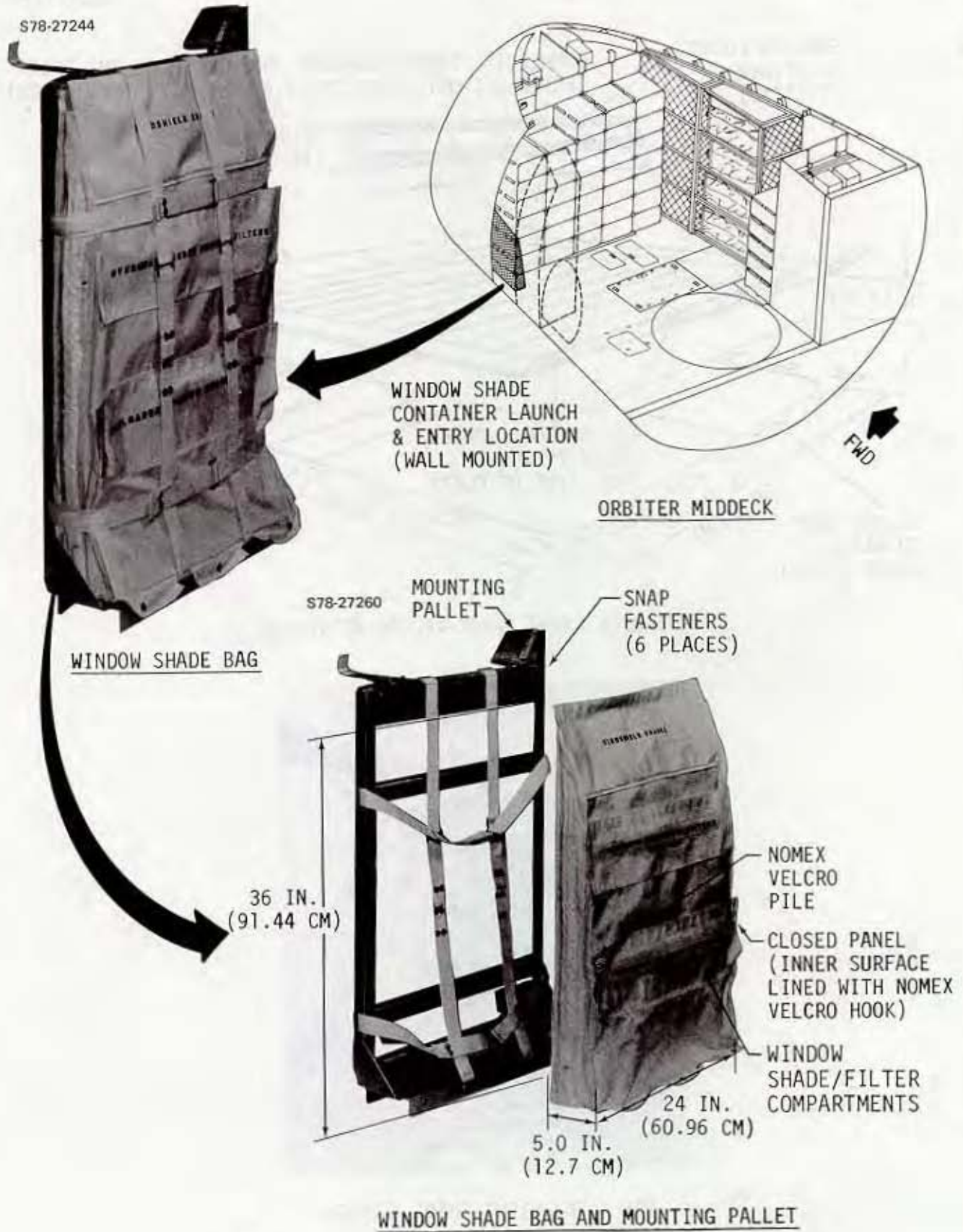
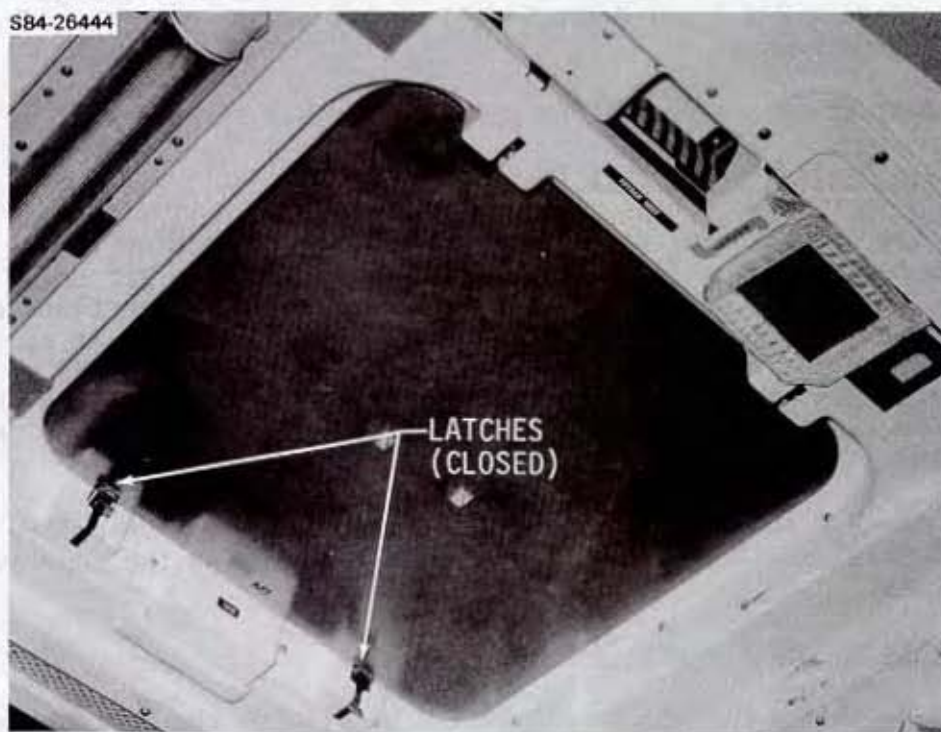


Figure 3.12-3.- Window Shade/Filter stowage.



W8 EMI SHIELD INSTALLATION/REMOVAL



W8 EMI SHIELD (INSTALLED)

Figure 3.12-4.- EMI shield installation and removal.

of the shade, filter, or shield so as to be readily visible when the stowage bag is opened.

The interdeck light shades are stowed on the outside front of the window shade bag, and are held in place against the bag by the snap-connected straps attached to the mounting frame (fig. 3.12-2).

3.12.3 Installation and Removal

Forward Station Window Shades (W-1 through W-6)

To install the W-1 through W-6 window shades, first open the two hinge plates, one each on the left and right sides of the window frame. Next, place the shade (reflective surface outboard) into the positioning slots on the window and press the rubber seal on the edge of the shade against the window frame to prevent light leakage. Installation is completed by closing the hinge plates against the shade.

To remove the W-1 through W-6 window shades, open the two hinge plates and pull the Nomex tab to remove the shade from the window.

Note that installation and removal of the W-3 and W-4 shades requires that the shade be inserted between the window and the Heads-Up Display. The handhold between W-2/W-3 and W-4/W-5 will rotate outboard to facilitate installation and removal.

Note also that there are no filters provided for W-1 through W-6.

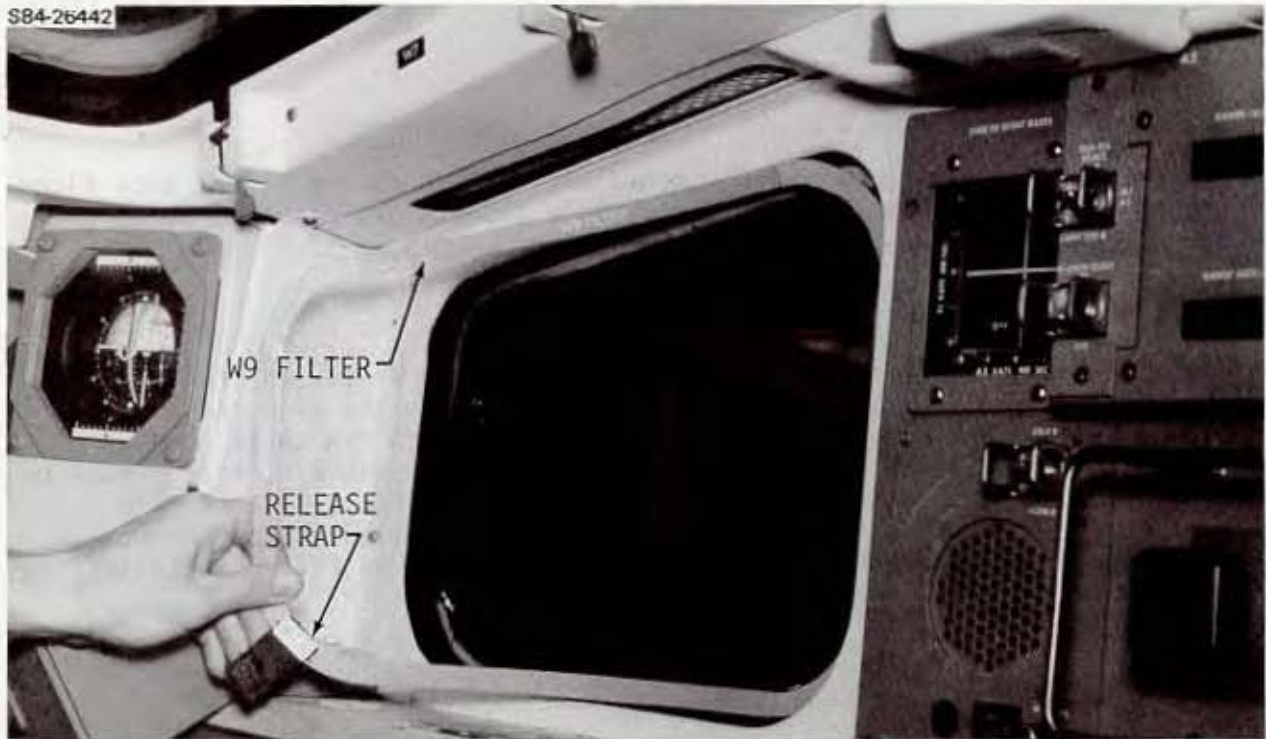
Overhead EMI Shields and Filters (W-7 and W-8)

To install the overhead EMI shields, first hold the shield up to the window so that the partitioned side is outboard. The forward and aft edges of the shield are labeled and correspond to the forward and aft directions on the Orbiter. Insert the forward end of the shield first, placing it against the window and above the two forward latches. Then push the aft edge of the shield against the window and close all four latches to retain the shield in place. To remove the shield, simply reverse the above procedure. EMI shield installation/removal is illustrated in figure 3.12-4.

To install the W-7 and W-8 filters, use the same procedure described above for the EMI shields. The filters are held in place using the four overhead window latches.

Aft Window Shades and Filters (W-9 and W-10)

Aft window shades and filters are installed by placing the correct shade or filter in the appropriate window (reflective side outboard in the case of shades) and securing it to the mating Velcro on the window ledges. Figure 3.12-5 illustrates W-9 shade and filter installation and removal.



W9 FILTER INSTALLATION/REMOVAL



W9 SHADE INSTALLATION/REMOVAL



W9 SHADE (INSTALLED)

Figure 3.12-5.- W-9 window filter and shade installation/removal (W-10 similar).

Interdeck Light Shades

The interdeck light shades are attached with Velcro to the flight deck floor around the interdeck access. Nonadjustable louvers are provided to allow air circulation between flight deck and middeck (fig. 3.12-2).

Side Hatch UV Filter

The side hatch viewport is the only optical quality window on Orbiters 103 and 104. Unlike the ten windows on the flight deck, the side hatch viewport does not provide protection from solar UV rays, which can cause serious injury in as little as 10 seconds. Therefore, a removable UV filter must be placed on the side hatch viewport for on-orbit operations. It is held against the viewport by Velcro and is normally installed at postinsertion and removed during deorbit preparations. Side hatch UV filter installation and removal is illustrated in figure 3.12-6.

3.12.4 Systems Performance, Limitations, and Constraints

● Window Shades

- Reflect ~ 90 percent of solar energy
- Light transmittance: ~1 percent
- Light leakage around edges: ~10 percent
- Electrically nonconductive
- Material: One piece Kevlar epoxy glass fabric with outside surface of silver-and Inconel-coated Teflon tape and painted inside. The edge seal is silicone rubber.
- Total surface thickness: 0.06 in. (0.152 cm)

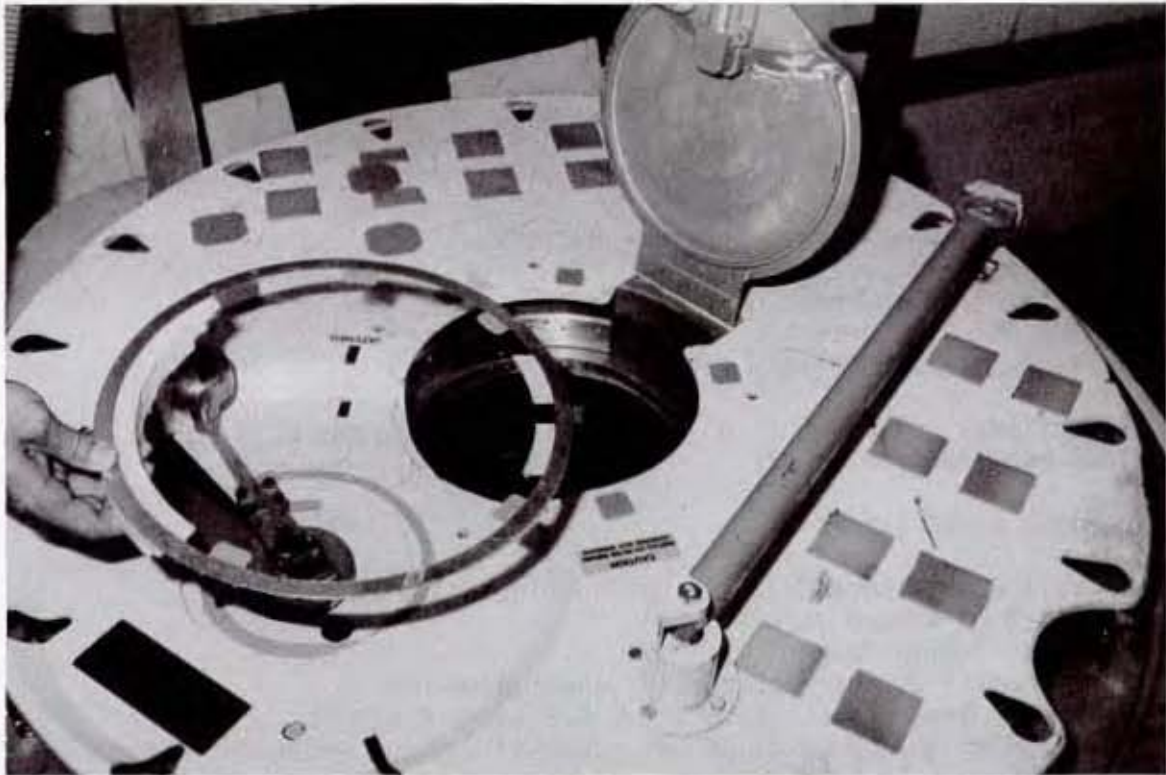
● W-7, W-8 EMI Shields

- Material: Standard commercial annealed aluminum
- Thickness: 0.04 in. (.102 cm)

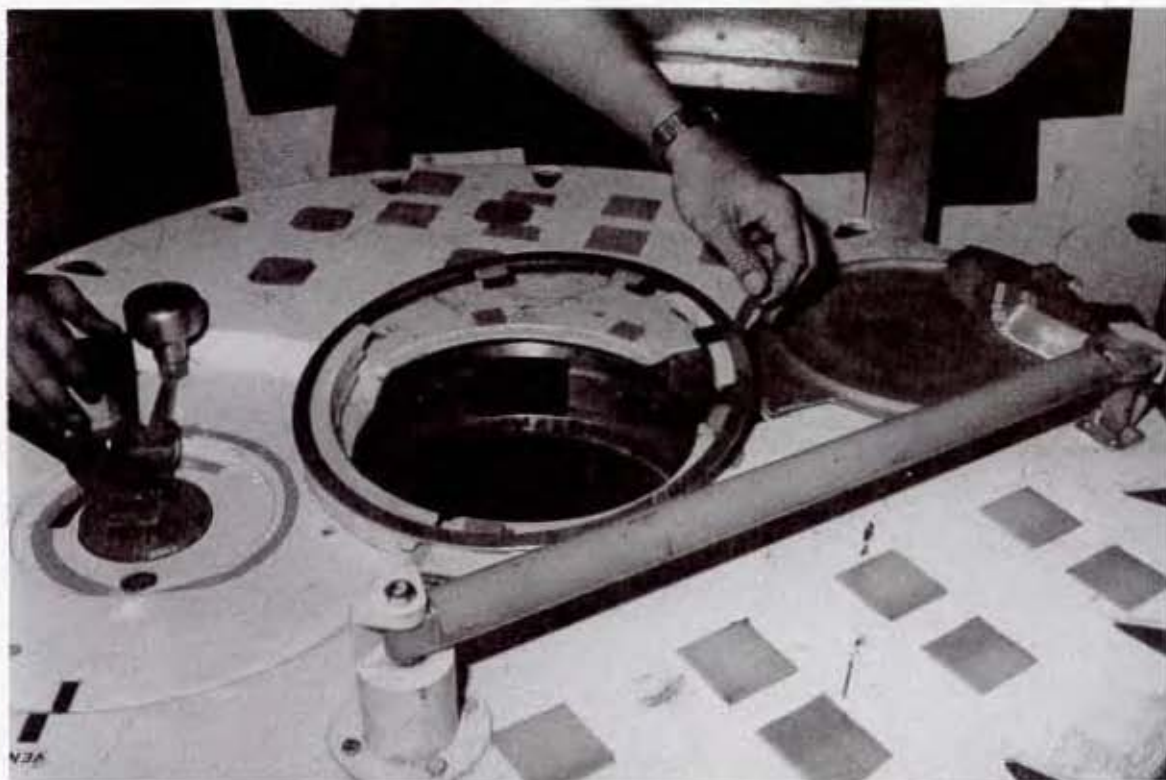
Provides protection from 50,000 ampere lightning strike, and from magnetic fields within 5 n. mi. of thunderstorm activity. Does not provide protection from electric fields associated with thunderstorms.

● W-7, -8, -9, -10 Filters

- Light transmittance: 18 + 2 percent
- Light leakage around edges: ~ 10 percent
- Material: Lexan
- Thickness: 0.06 in. (0.152 cm)



SIDE HATCH UV FILTER INSTALLATION



SIDE HATCH UV FILTER REMOVAL

Figure 3.12-6.- Side hatch UV filter installation/removal.

- Side Hatch UV Filter
 - Material: Acrylic Plexiglas UF3, Nomex Velcro
 - Light Transmittance
 - Wavelength > 475 nanometers: 92 percent
 - 450 nm: 90 percent
 - 425 nm: 80 percent
 - 400 nm: 35 percent
 - <375 nm: effectively zero
 - Dimensions: diameter 12.8 in. (32.5 cm), thickness 0.10 in. (.25 cm)
(not required for OV102)

- Interdeck Light Shades
 - Overall Dimensions: 33.5 in. x 31.5 in. x 3.0 in.
(85.1 cm x 80.0 cm x 7.6 cm)
 - Material: Blue Nomex
 - Stiffeners: Standard commercial sheet aluminum
 - Stiffener Dimensions: 25.5 in. x 5.5 in. x 0.032 in.
(64.8 cm x 14.0 cm x .08 cm). Center cut-out 24.25 in. x 4.25 in.
(61.6 cm x 10.8 cm)

3.13 CREW CLOTHING/WORN EQUIPMENT

3.13.1 Introduction

The crew clothing/worn equipment provides for the personal needs of all crewmembers. Prior to flight each crewmember selects clothing and worn equipment from a list of required and optional flight equipment.

Coveralls, gloves, boots, the life vest harness assembly (LVHA) and the launch and entry helmet (LEH) are required for launch and entry. The g-suit is required to be worn on entry only. These items are shown in figures 3.13-1 and 3.13-5 and are discussed in detail below:

- Coverall

The coverall is a full length garment made of flame retardant Nomex. The arm and leg pockets hold worn/carry-on equipment and the openings on the left thigh allows access to the g-suit controls on entry.

- Gloves

The crewmembers may wear either the short or long cuff deerskin or Nomex knit gloves.

- Flight boots

The crewmembers have the option of wearing NASA supplied flight boots or their personal T-38 boots.

- Life vest harness assembly (LVHA)

The LVHA is made of flame-retardant cotton and features a nylon strap assembly interwoven through the harness which provides complete body support for crewmembers during emergency egress or rescue operations. The descent device from the Orbiter attaches to a carabiner located under a Velcro-restrained patch on the right vest of the harness. The PEAP ring allows for the retention of the PEAP during emergency egress. A flotation device located under each arm provides 24-hour flotation capability in the event of an Orbiter ditching (fig. 3.13-2).

07751-020

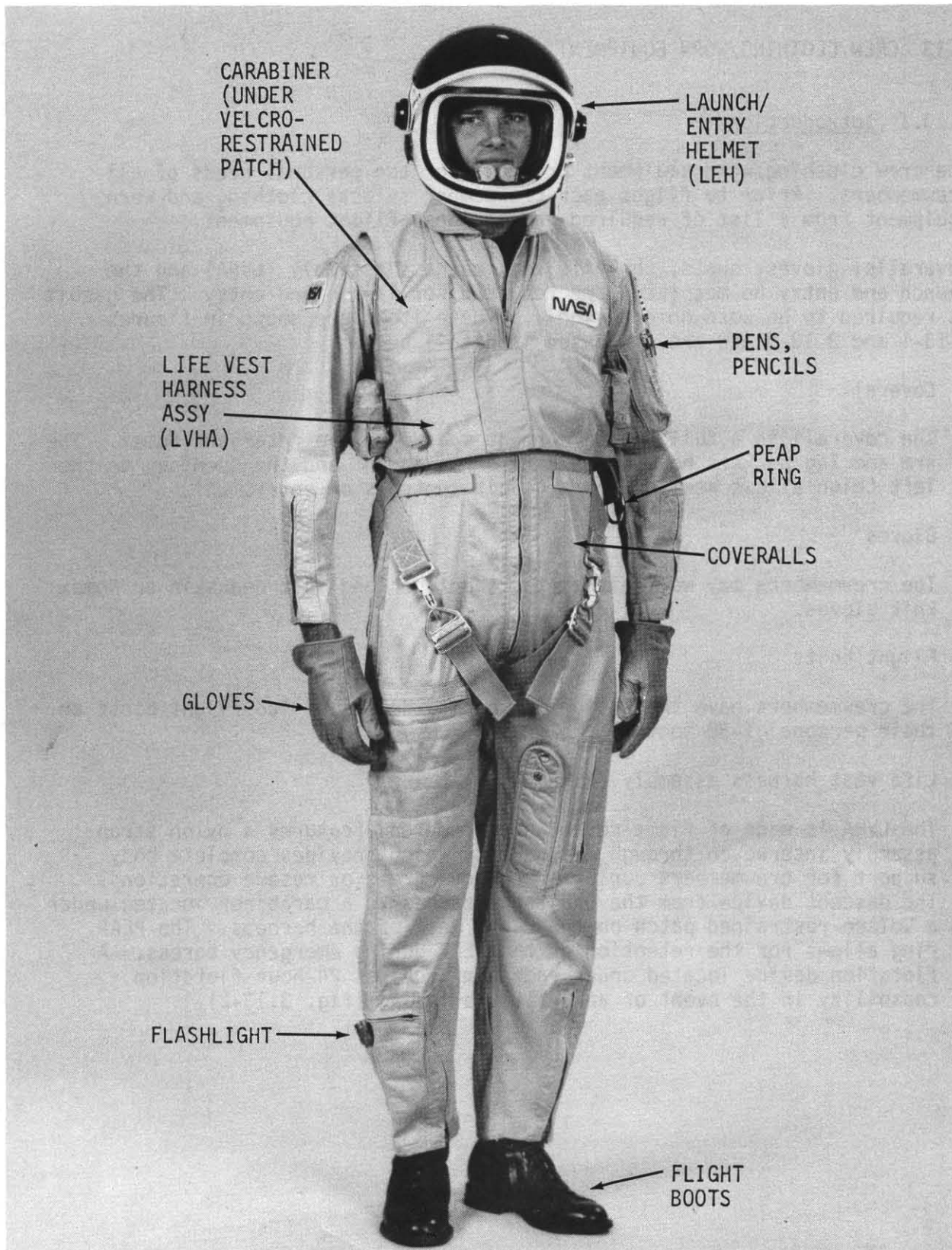


Figure 3.13-1.- Crew clothing configuration (launch and entry).

Q7757-02L

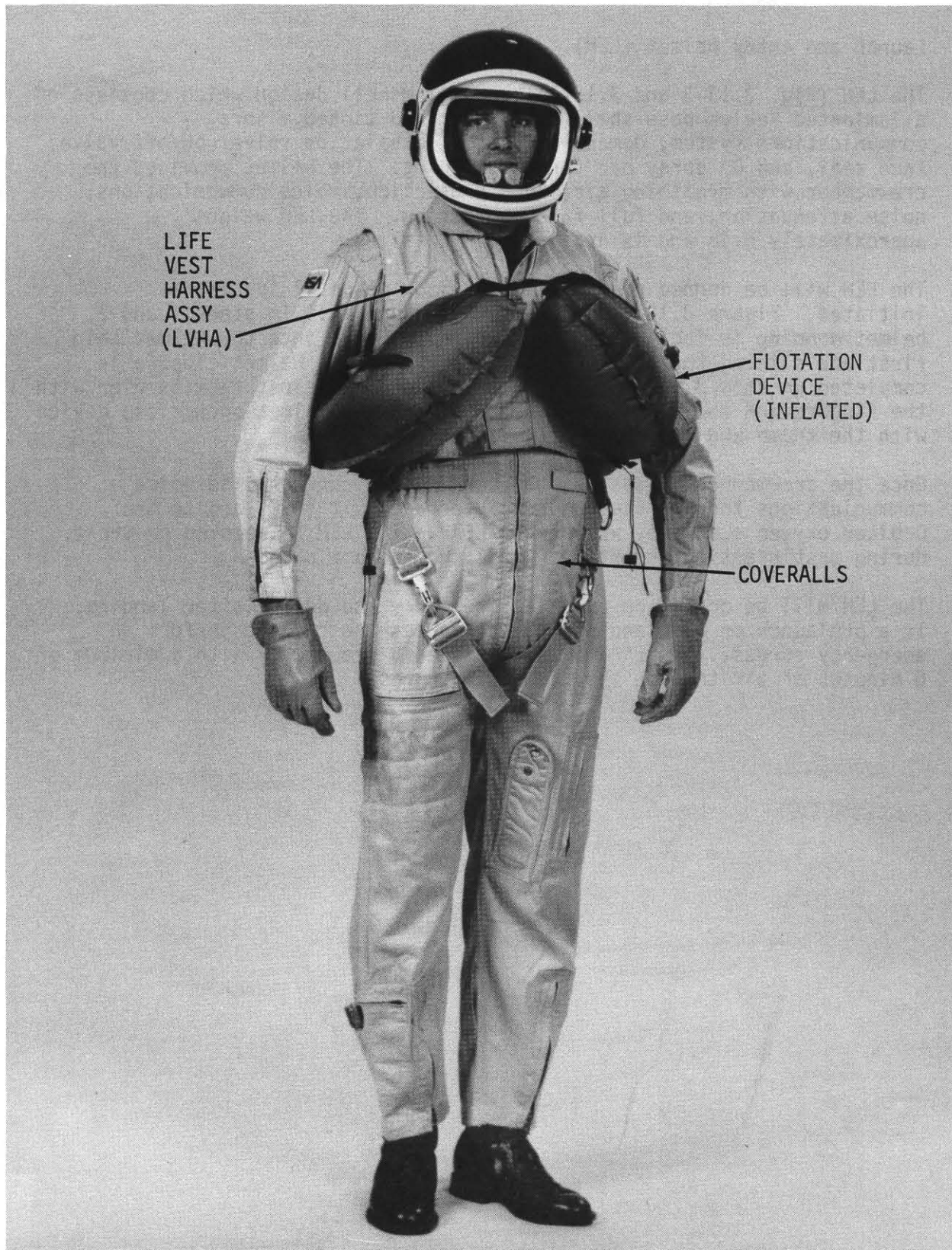


Figure 3.13-2.- LVHA flotation device inflated.

- Launch and entry helmet (LEH)

The LEH (fig. 3.13-3 and 3.13-4) has a clamshell design which consists of a laminated Kevlar base shell with clear and tinted visors, communications system, demand regulator, exhalation valve, on/off valve, face seal, and O₂ spray bar for antifogging. The helmet provides the crewmember with breathing air, bump protection, voice communications, noise attenuation, and full face protection. The LEH weighs approximately 6 lb and is available in 12 sizes.

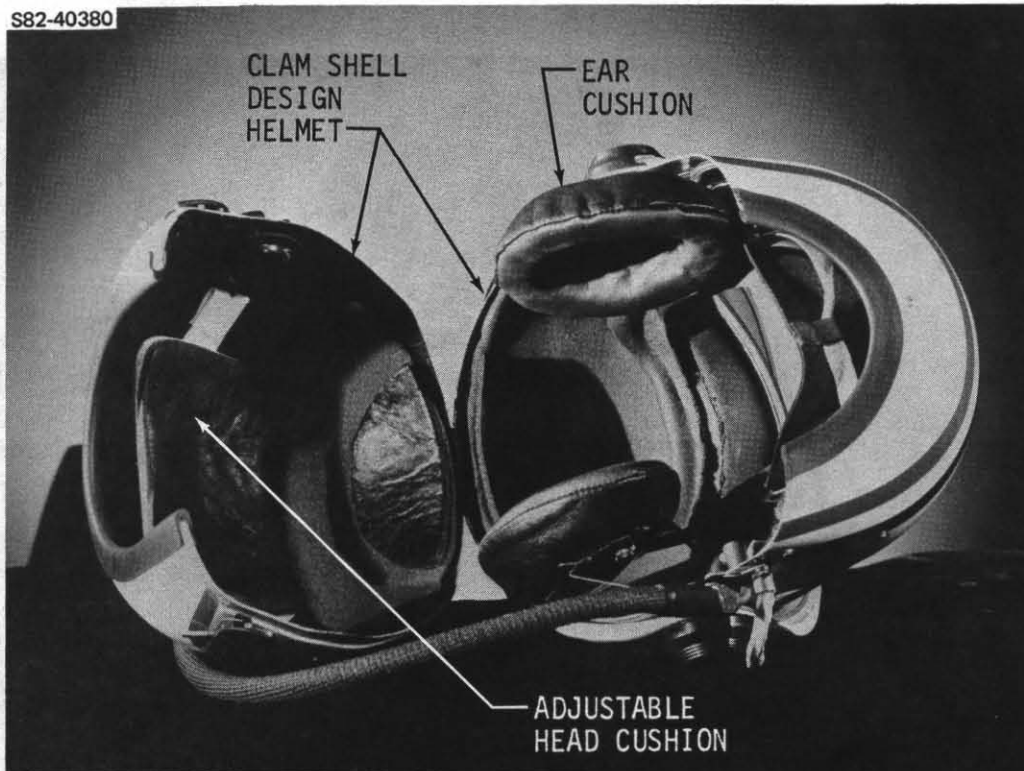
The LEH will be donned preflight with visor up until ingress is initiated. Figure 3.13-4 illustrates LEH donning. In steps 1 and 2, helmet donning is facilitated by leading the head into the helmet chin first and sliding the ear cushions onto the ears. Helmet closure is completed in step 3 by grasping the front of the helmet face barrier with the fingers and the back of the helmet below the helmet open/close device with the thumb and squeezing both together.

Once the crewmember is seated, the LEH will be connected to voice communications through the headset interface unit (HIU) and to the Orbiter oxygen supply by way of the PEAP. The LEH is removed on orbit during postinsertion and stowed until the deorbit prep.

The LEH will be donned on orbit before entry and doffed after landing. If a prelaunch or postlanding failure forces the crew to perform an emergency egress, the PEAP would supply each crewmember with a minimum of 6 minutes of air through the LEH during egress.

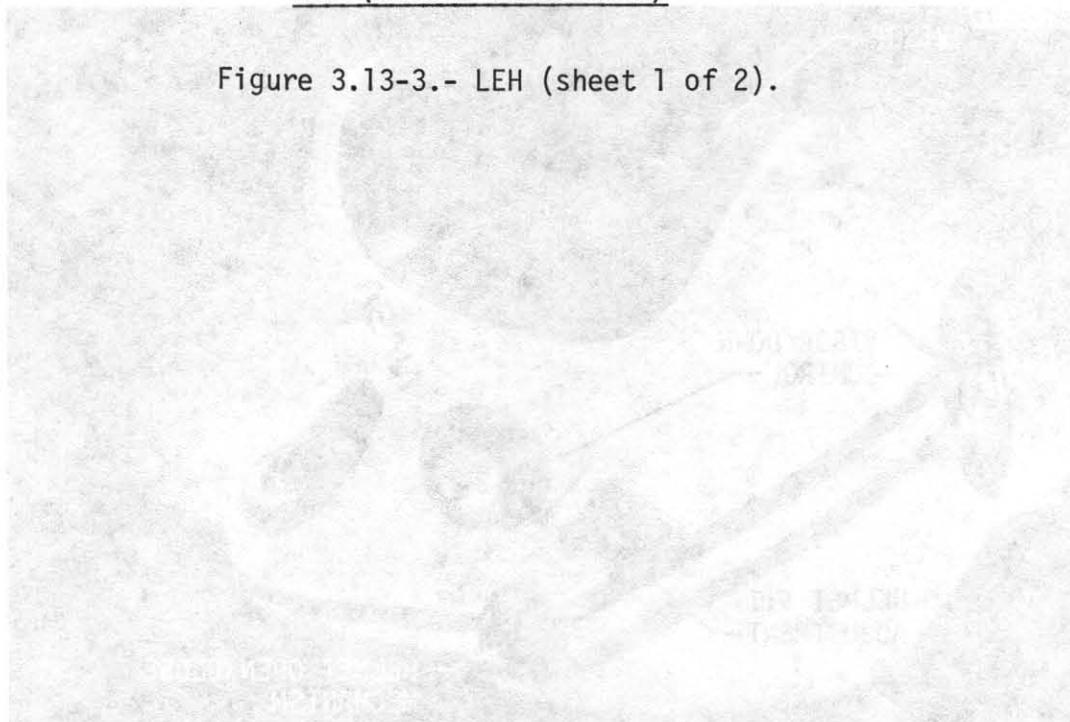
01187-320

S82-40380

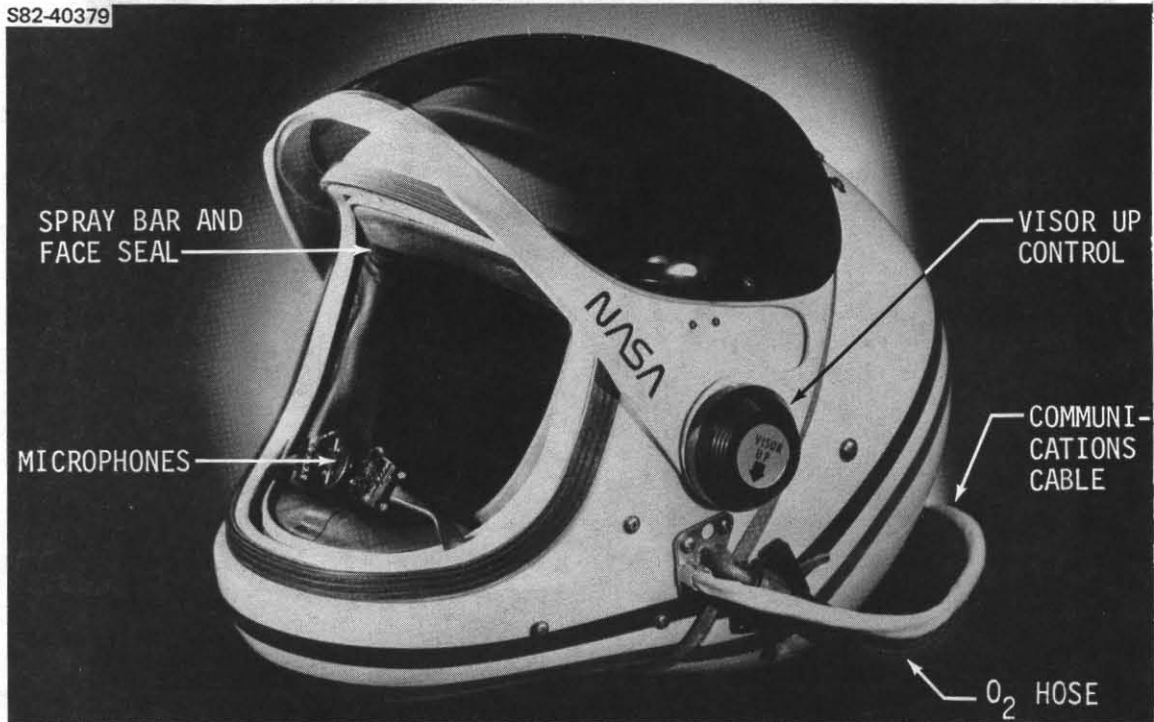


LEH (INSIDE COMPONENTS)

Figure 3.13-3.- LEH (sheet 1 of 2).

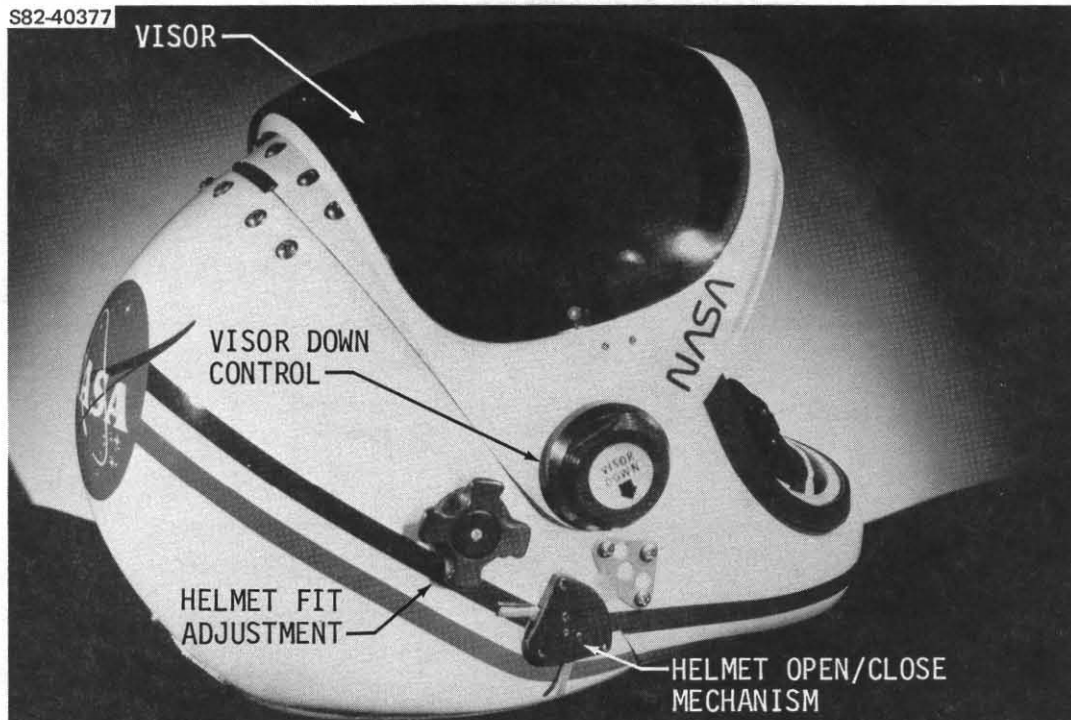


S82-40379



LAUNCH AND ENTRY HELMET (LEFT-SIDE VIEW)

S82-40377



LAUNCH AND ENTRY HELMET (RIGHT-SIDE VIEW)

Figure 3.13-3.- Launch and entry helmet (sheet 2 of 2).

S82-40372



LEH DONNING (STEP 1)

S82-40371



LEH DONNING (STEP 2)

S82-40373



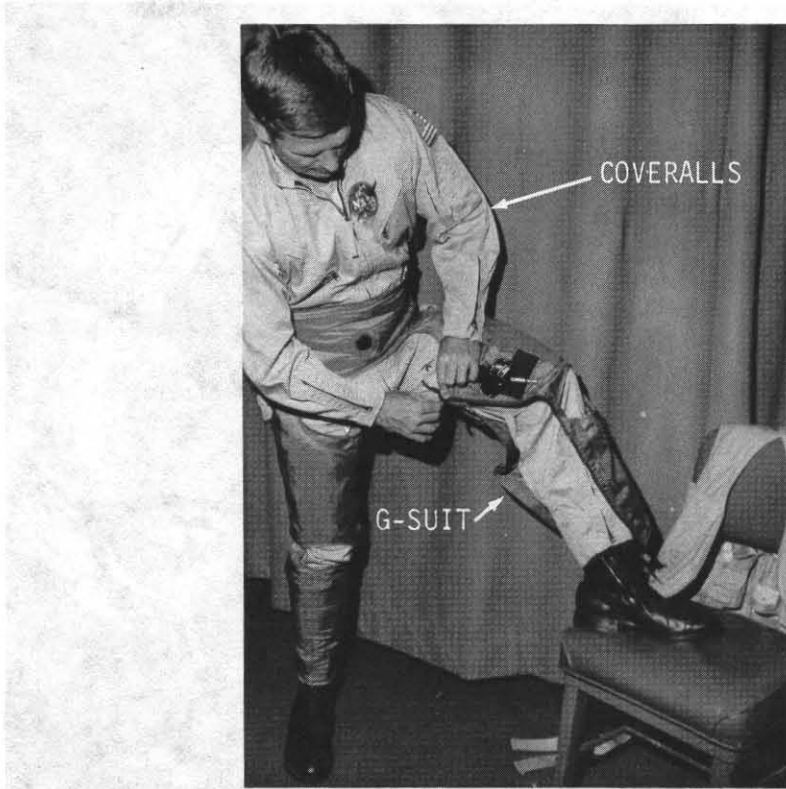
LEH DONNING (STEP 3)

Figure 3.13-4.- LEH donning.

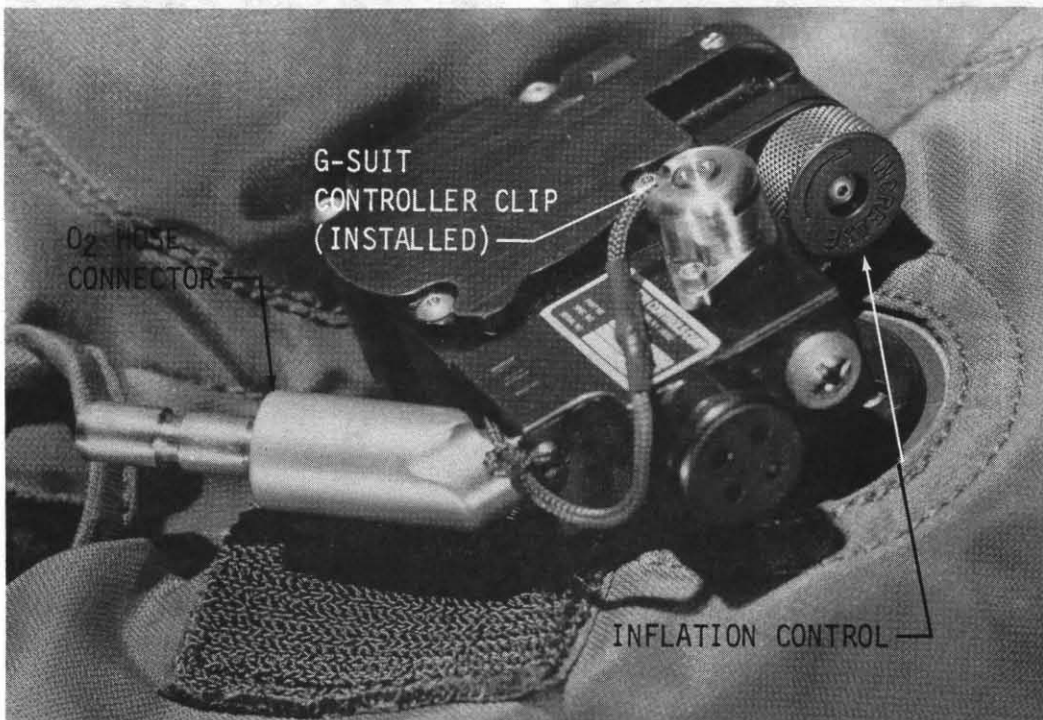
- G-suit

The g-suit (fig. 3.13-5) is made of Fypro and is a one-piece garment that extends from the ankles to the abdomen. It may be worn either over or under the coveralls. It is donned on orbit prior to entry and worn through the entry and postlanding flight phases. Bladders incorporated in the g-suit may be actuated to apply pressure to the crewmember's lower extremities and abdomen to prevent the pooling of blood and to aid in maintaining circulating blood volume. Pooling of blood can occur when high-g loads are imposed on the body and is particularly noticeable after the crewmember has had more than 3 days of zero-g.

Inflation of the g-suit is controlled at the g-suit controller (fig. 3.13-5). The g-suit controller consists of a male O₂ hose connector, inflation control, and g-suit controller clip. The g-suit inflation control when rotated clockwise (in the direction of arrow) inflates the g-suit bladders 0.5 psi per complete turn to a maximum pressure of 2.5 psi. Rotation of the inflation control counterclockwise will deflate the g-suit bladders 0.5 psi per complete turn. Each complete revolution of the inflation control is signified by a detent. The g-suit controller clip, when pulled free, traps the volume of O₂ inside the g-suit and prohibits any O₂ loss. Reinstallation of the clip will allow a controlled bleeddown of the suit. The g-suit is supplied Orbiter O₂ through a hose between the PEAP and the g-suit O₂ hose connector. The location of the CDR/PLT PEAP (fig. 3.13-6) on the back of the seat requires a 50-in. O₂ hose to reach the g-suit controller (fig. 3.13-7). The g-suit hose leaves the center hose connection of the PEAP and is routed through the intersection of the seat pan and seat back to the left side of the seat. It may also be routed across the body. It is then connected to the g-suit controller on the left thigh pocket. Figure 3.13-8 illustrates the PEAP to g-suit O₂ hose routing for the MS/PS. Due to the location of the PEAP on the left side of the specialist seat, only an 18-in. hose is required for connection of the PEAP to the g-suit controller.



G-SUIT CONFIGURATION



G-SUIT CONTROLLER

Figure 3.13-5.- G-suit.

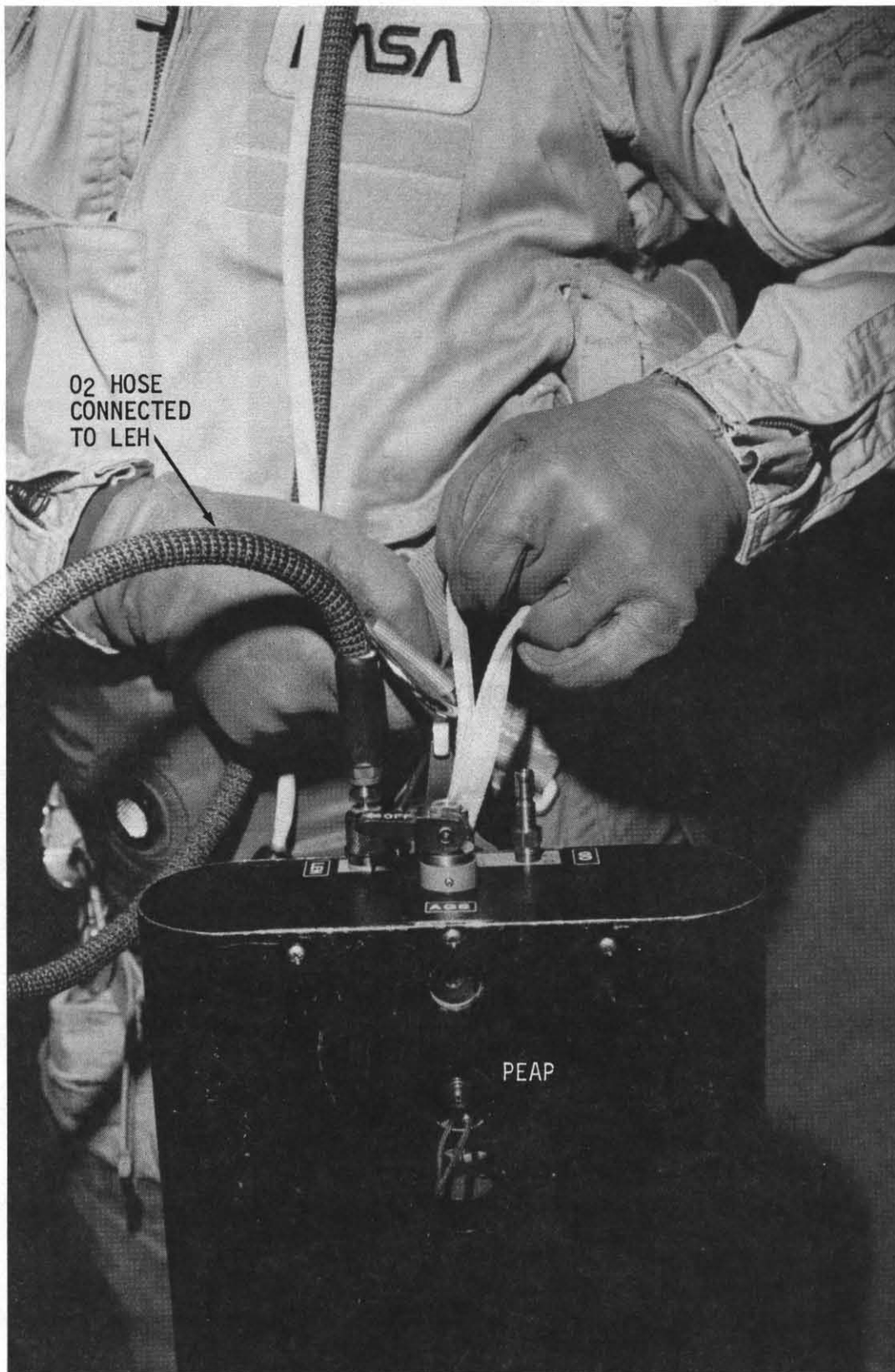


Figure 3.13-6.- PEAP.

S83-31653

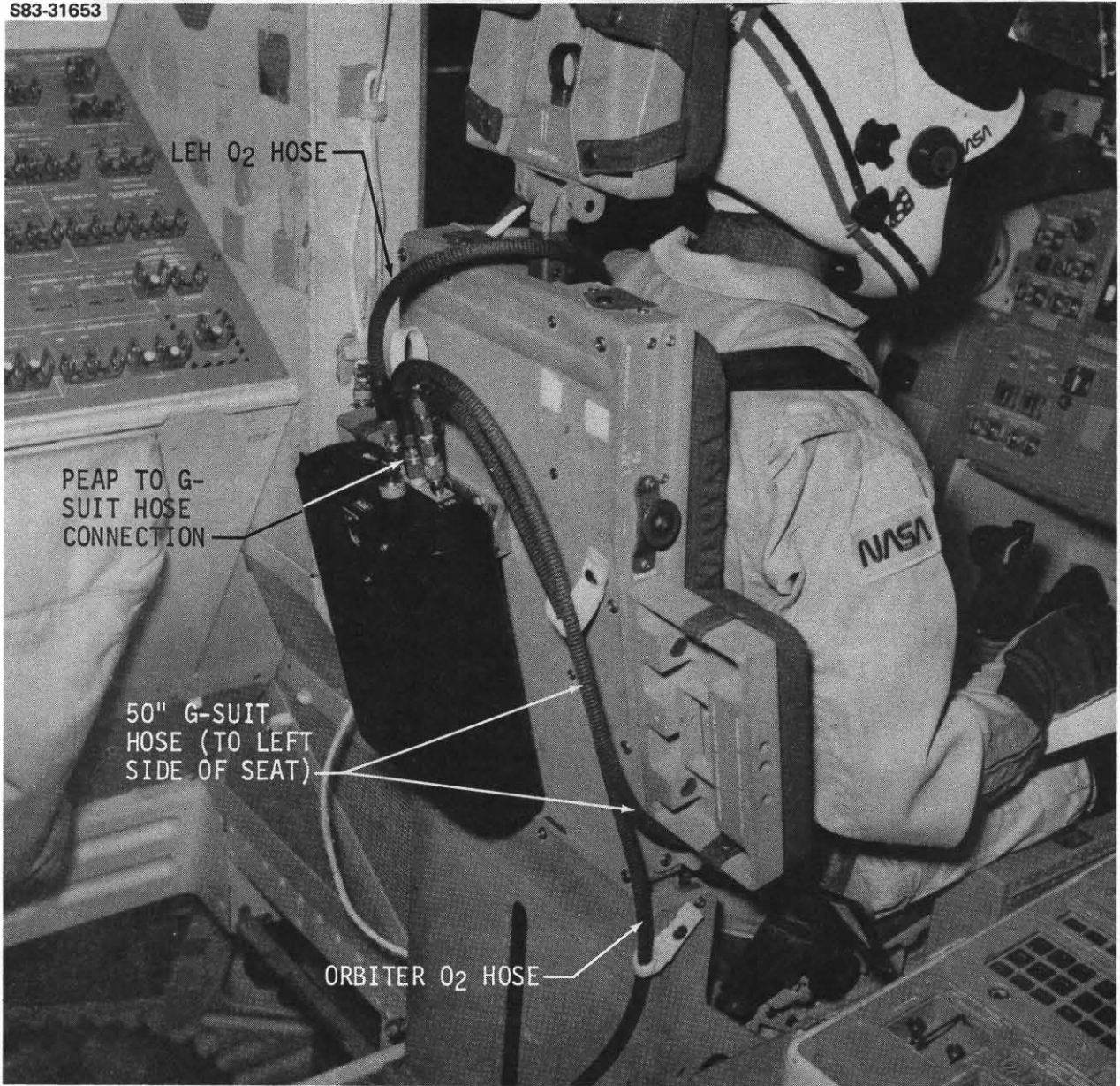


Figure 3.13-7.- CDR/PLT g-suit hose routing.

01751-320

S83-31665



Figure 3.13-8.- Specialist g-suit hose routing.

Figure 3.13-8.- Specialist g-suit hose routing.

3.13.2 IVA Crew Clothing (fig. 3.13-9)

- Jacket

The jacket is a contoured waist-length jacket fabricated from flame-retardant cotton. It has an adjustable waistband, collar, full-length front zipper, and pockets for stowage.

- IVA shirt

The shirt is a short-sleeved pullover with a collar.

- Trousers

The trousers are made from flame-retardant cotton and have 4 in. of adjustment in the waistband that accommodates for fluid shifts on orbit. The trousers have several pockets and Velcro strips to hold equipment.

- Sleep shirt

The sleep shirt is a heavyweight, cotton T-shirt.

- Sleep shorts

The sleep shorts are jogging-type shorts fabricated from flame-retardant cotton with removable pockets.

- Underwear

Underwear consists of T-shirt, shorts, socks and long underwear. The T-shirt is a standard white pullover fabricated from 100-percent cotton or cotton blend. The shorts are standard white jockey or boxer shorts fabricated from cotton or blended cotton fabric. The socks are standard white stretch-top reinforced-heel "one-size-fits-all" fabricated from cotton or a blended cotton fabric. The long underwear is worn underneath the g-suit during entry (per crew option). For female crewmembers, the shorts are replaced with panties and brassieres.

- Soft shoe slippers

The soft shoe slippers are made of wool with leather soles and are worn during on-orbit activities.

07131-326

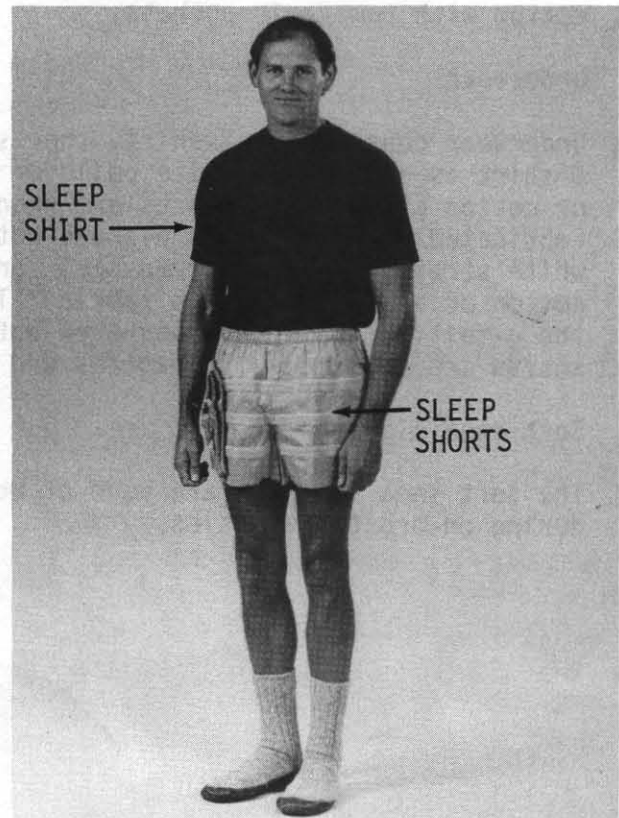
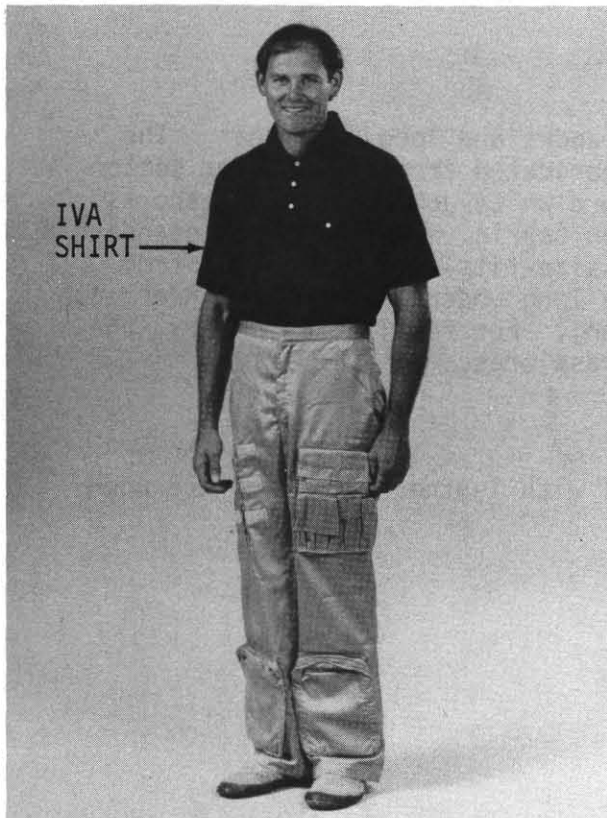
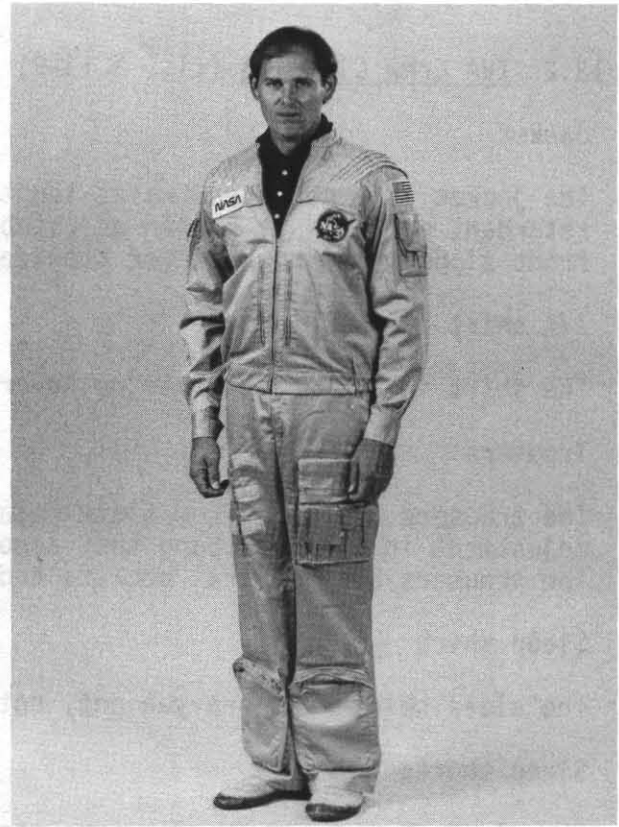
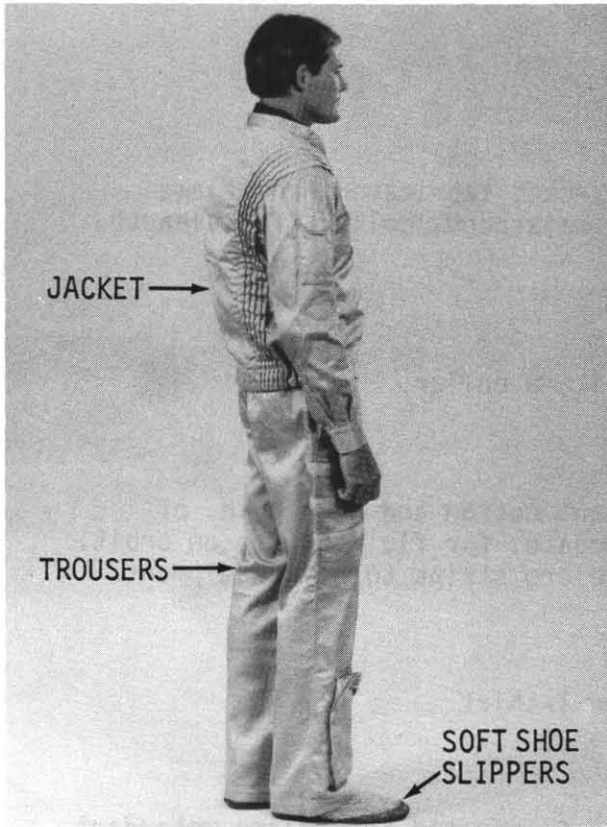


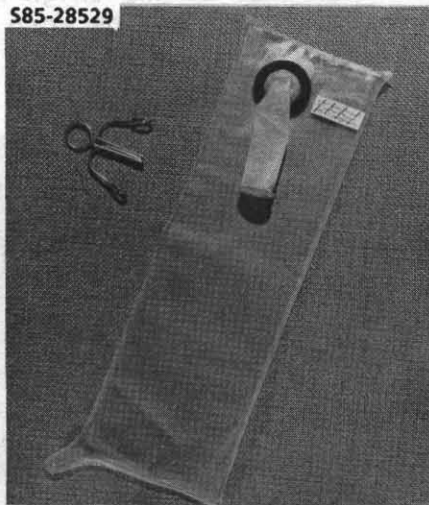
Figure 3.13-9.- IVA crew clothing.

Contingency UCD's are disposable urine collection systems used during a WCS failure. These UCD's should be stowed in the wet trash after use.

The male contingency UCD (fig. 3.13-11) consists of a ziplock bag, UCD, cuff and clamp. Each UCD may be used for two urinations. Once full it should be clamped, sealed in the ziplock bag and stowed in the wet trash. The contingency UCD may be used during launch and entry.

The female contingency urine absorption system (UAS) consists of a ziplock bag, UAS and wet wipes (fig. 3.13-11). The UAS contains wicking to disperse the urine and a moisture-sensitive powder which absorbs the urine. Once used the UAS should be sealed in a ziplock bag and stowed in the wet trash.

585-28529

MALE

584-47384

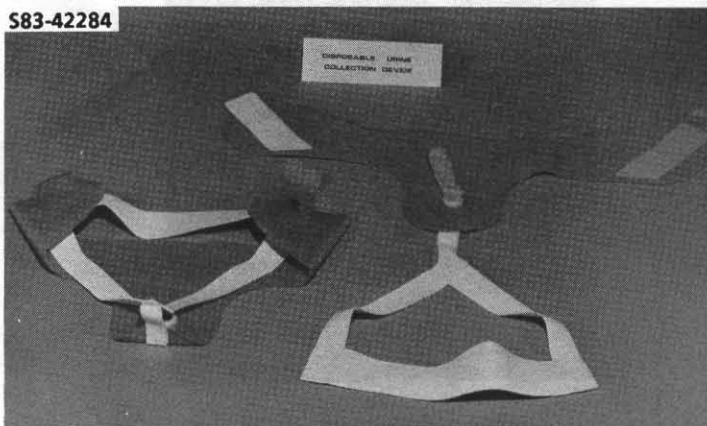
FEMALE

Figure 3.13-11.- Contingency urine collection devices.

3.13.3 Urine Collection Devices (UCD's)

The male disposable UCD (DUCD) consists of a collection bag, a restraint assembly, and a roll-on cuff (fig. 3.13-10). The DUCD may be worn for launch and entry and is required for EVA. When removed, the DUCD should be stowed in the wet trash whether or not it contains urine.

The female disposable absorption containment trunk (DACT) (fig. 3.13-10) consists of multiple layers of material designed to rapidly absorb and store urine. The inner layer is tricot and the middle layers use directional wicking to disperse urine to the outer layers which contain the moisture-sensitive powder that absorbs the urine. The outside plastic layer prevents moisture from coming in contact with garments worn over the DACT. Lycra stretch panels extending from the waist to the thigh hold the DACT close to the body and prevents slippage. The DACT may be worn for launch and entry and is required for EVA.



MALE



FEMALE

Figure 3.13-10.- Urine collection devices.

3.13.4 Worn/Carry-On Equipment

- Flashlight

The flashlight is an individual portable light source for use during both intravehicular activities (IVA) and extravehicular activities (EVA). It has an operating life of less than 7 hours and a minimum illumination of 10 ft-c (86 lm/m²). It is also used for handheld illumination of poorly lighted areas, maintenance tasks, and as a light source in the event of cabin lighting failure.

- Swiss army knife

The Swiss army knife is a multiple-purpose stainless steel general-utility knife.

- Scissors

The scissors are standard metal surgical scissors with Velcro.

- Sunglasses and pouch

The sunglasses are HGU-4/P-type sunglasses and are used by the crewmembers for general eye protection during unhelmeted flight operations. A pouch is provided for protecting the glasses when not in use. In addition, the crewmembers have the option of flying regular glasses.

- Chronograph

Major features of the chronograph are as follows:

- General timing function based on a 12-hr cycle
- Hour, minute, and second hands independent of stopwatch functions
- Hour, minute, and second dials for elapsed time (stopwatch)
- Start/stop button for stopwatch operation
- Reset button for stopwatch operation
- Maximum elapsed time possible with stopwatch function is 12 hr
- Manual winding
- Antimagnetic and shock protected in a waterproof stainless steel case
- Watchband: Nomex with strips of Velcro for restraint

- Ballpoint pen

A retractable ballpoint pen with a pressurized ink cartridge is provided for use in zero-g environment. The cartridge contains 0.042 in.³ (0.69 cm³) of ink, pressurized with nitrogen gas to 50 psia (3.45 x 10⁵ N/m²). The ink supply provides approximately 15,000 ft (4600 m) of writing. The ink is thixotropic (semisolid gel) and liquifies only when the revolving ball shears its polymer bonds. A small patch of Velcro hook and a standard metal clip are provided for restraint of the pen.

- Pencil

The pencil is a mechanical metal pencil that uses standard commercial graphite lead 2.75 in. (6.99 cm) long by 0.036 in. (0.91 mm) in diameter. A small patch of Velcro hook and a standard metal clip are provided for restraint of the pencil.

- Marker pen

The marker pen is a general purpose felt-tip marking pen with a metallic exterior and a marking ink capacity that provides 1515 ft (460 m) of writing. A small patch of Velcro hook and a standard metal clip are provided for restraint of the pen.

3.13.5 Systems Performance Limitations and Constraints

- Coveralls

- Fabric: flame-retardant cotton

- LEH

- Breathing system

- Gas type: O₂

- Normal Orbiter O₂ supply pressure: 100 psig

- Emergency PEAP supply: 70 psig, air

- Flow capacities

- Normal operating conditions: 135 slpm (135 x 10⁻³ m³/min)

- Emergency conditions: 135 slpm (135 x 10⁻³ m³/min)

- Communication system

- Earphone: H43 1200-L earphones; isolation module provided for redundant earphone operation

- Microphone: Dual M101 50-L microphones; isolation module provided for redundant microphone operation

- Helmet sizes: Small, medium, and large

- Helmet weight: Approximately 6 lb

- LVHA

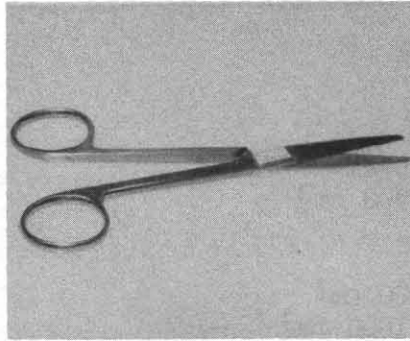
- Fabric: Cotton mountain cloth and 5000 lb parachute webbing

- Weight: 7 lb

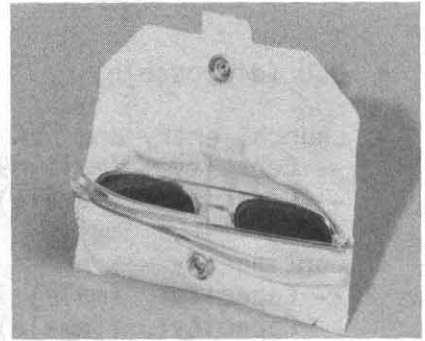
- Life vest: Urethane coated nylon



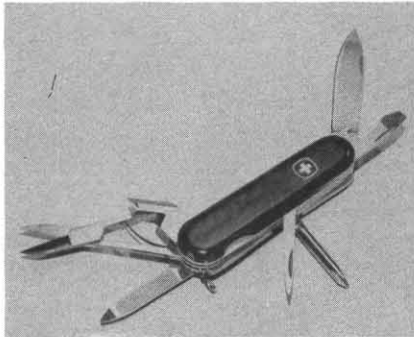
POCKET FOOD ITEMS



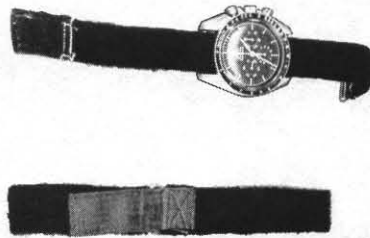
SCISSORS



SUNGLASSES AND POUCH



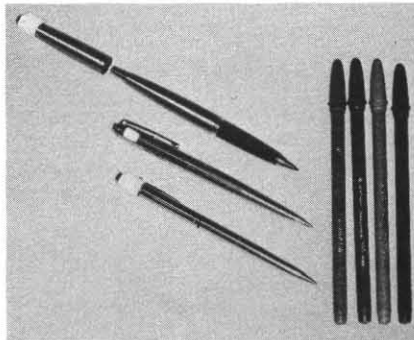
SWISS ARMY KNIFE



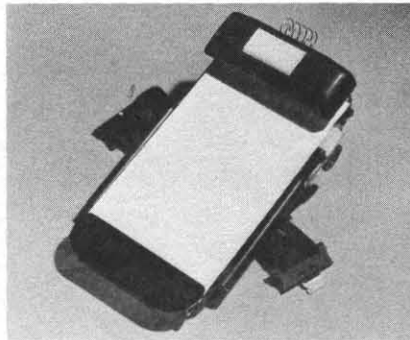
WATCH AND WATCHBAND



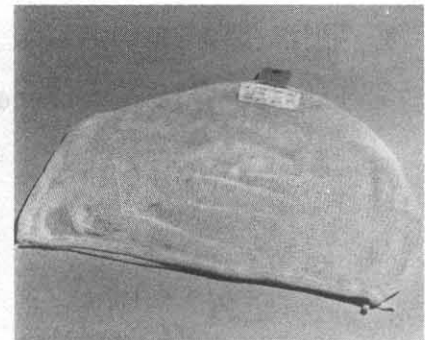
FLASHLIGHT



PENS AND PENCILS



KNEEBOARD



HELMET BAG



GLOVES



FLIGHT BOOTS



SLEEP KIT

Figure 3.13-12.- Crew equipment.

- UCD (disposable)
 - Launch, entry and EVA
 - Capacity: (male) 950 cm³
 - Capacity: (female) 900 cm³
 - Contingency
 - Capacity: (male) 1200 cm³
 - Capacity: (female) 1000 cm³
- G-Suit
 - Fabric: Fypro
 - Bladder: Neoprene
 - Weight: 3.5 lb
- Flight Boots
 - Construction
 - Lightweight leather
 - Neoprene nonskid soles
 - Weight (per pair): 3 lb (1.36 kg)
 - Sizes available: 5 to 13 (B, D, and E width)
- Shirt-Sleeve Clothing
 - Fabric: flame-retardant cotton

3.14 EXERCISE EQUIPMENT

3.14.1 Introduction

The exercise equipment consists of a treadmill used with a restraint system for running in place (fig. 3.14-1). The treadmill is an in-flight exerciser used to minimize muscle loss in the legs and maintain cardiovascular fitness in a zero-g environment. The treadmill consists of a conveyor running track with force cords, waistbelt, and shoulder straps. The force cords, waistbelt, and shoulder straps restrain the crewmember to the running track. A physiological monitor is used to watch heart rate, distance run, and time run while exercising. Extension hooks can be used to provide additional adjustment for taller crewmembers.

3.14.2 Stowage and Installation

The treadmill is attached to the middeck floor for launch, on-orbit use, and entry (fig. 3.14-2). The treadmill kit contains the waistbelt, shoulder straps, physiological monitor, and extension hooks. When the treadmill kit is restrained to the treadmill running track by the force cords. The base of the treadmill is equipped with quick disconnect attachment fittings which fit onto deck studs located on the middeck floor. The crewmember dons the waistbelt and shoulder straps, attaches the force cords, to the front and rear buckles, and steps onto the treadmill to begin running. The physiological monitor provides heart rate data by attaching an infrared sensor to the earlobe. Distance run is determined by a mechanical sensor attached to the conveyor running track. Time run is displayed in minutes.

3.14.3 Systems Functional Description

The treadmill exercise system consists of the following components:

- Treadmill with force cords
- Waistbelt
- Shoulder straps (2)
- Physiological monitor
- Extension hooks (2)

Treadmill

The treadmill consists of a conveyor running track contained in a metal housing. The running track is coupled to a rapid onset braking system which is regulated by a speed control knob (fig. 3.14-3). When the preset speed is attained, the rapid onset braking system applies increased drag to the running track and consequently limits the speed of the runner. To increase the drag, the speed control knob can be dialed to a lower number from 7 to 1.

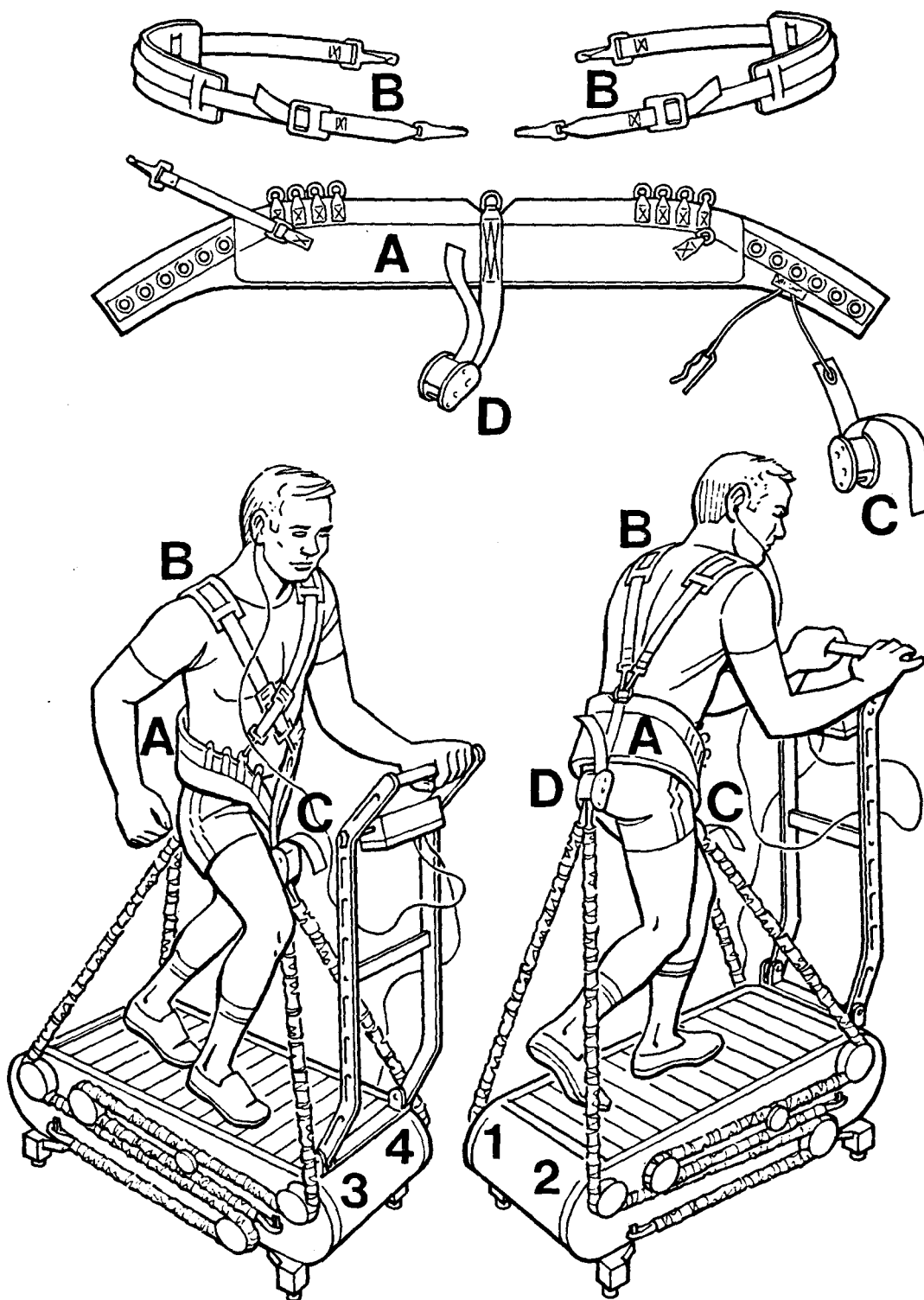


Figure 3.14-1.- Treadmill system.

335

3.14-3

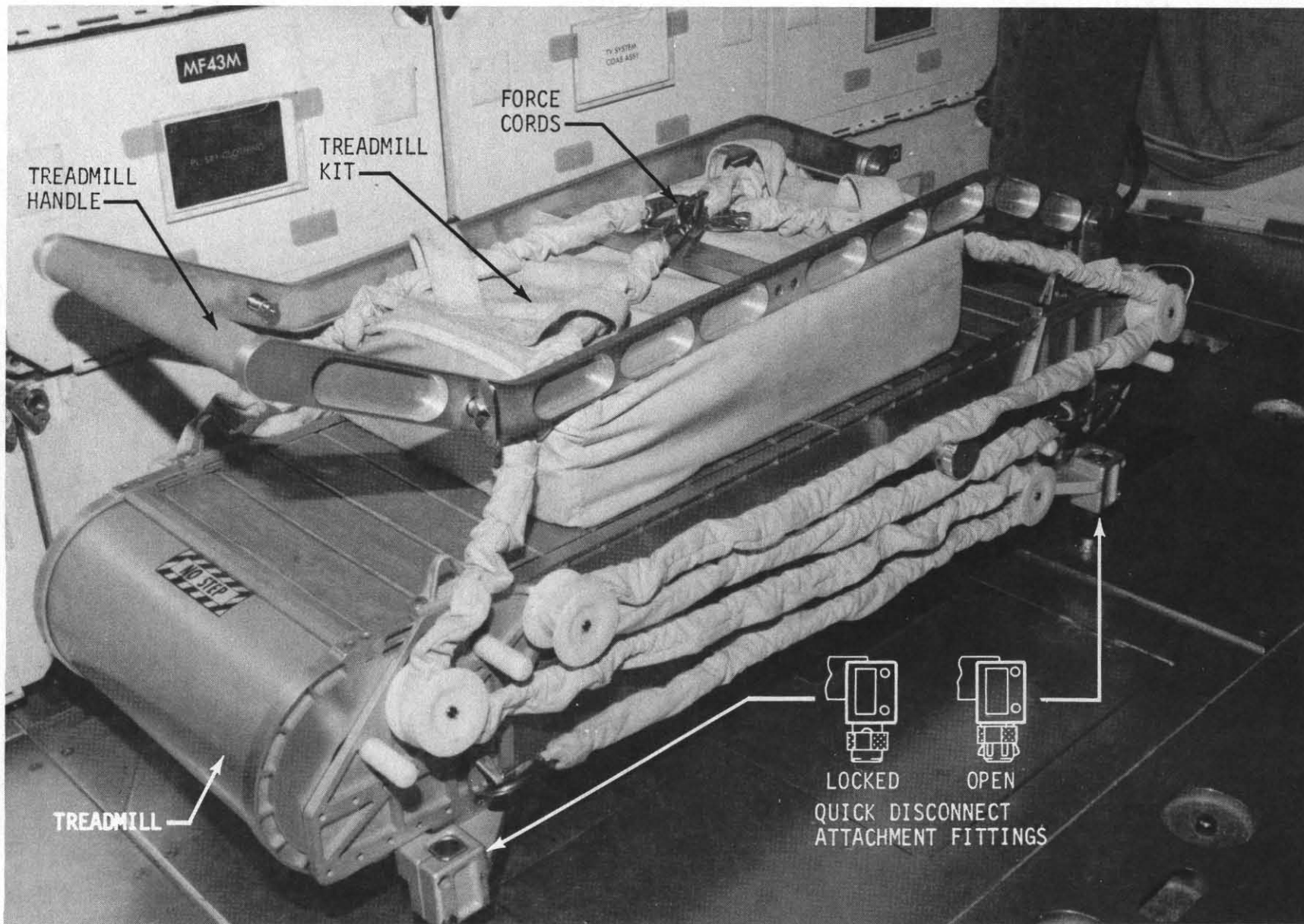


Figure 3.14-2.- Treadmill stowage.

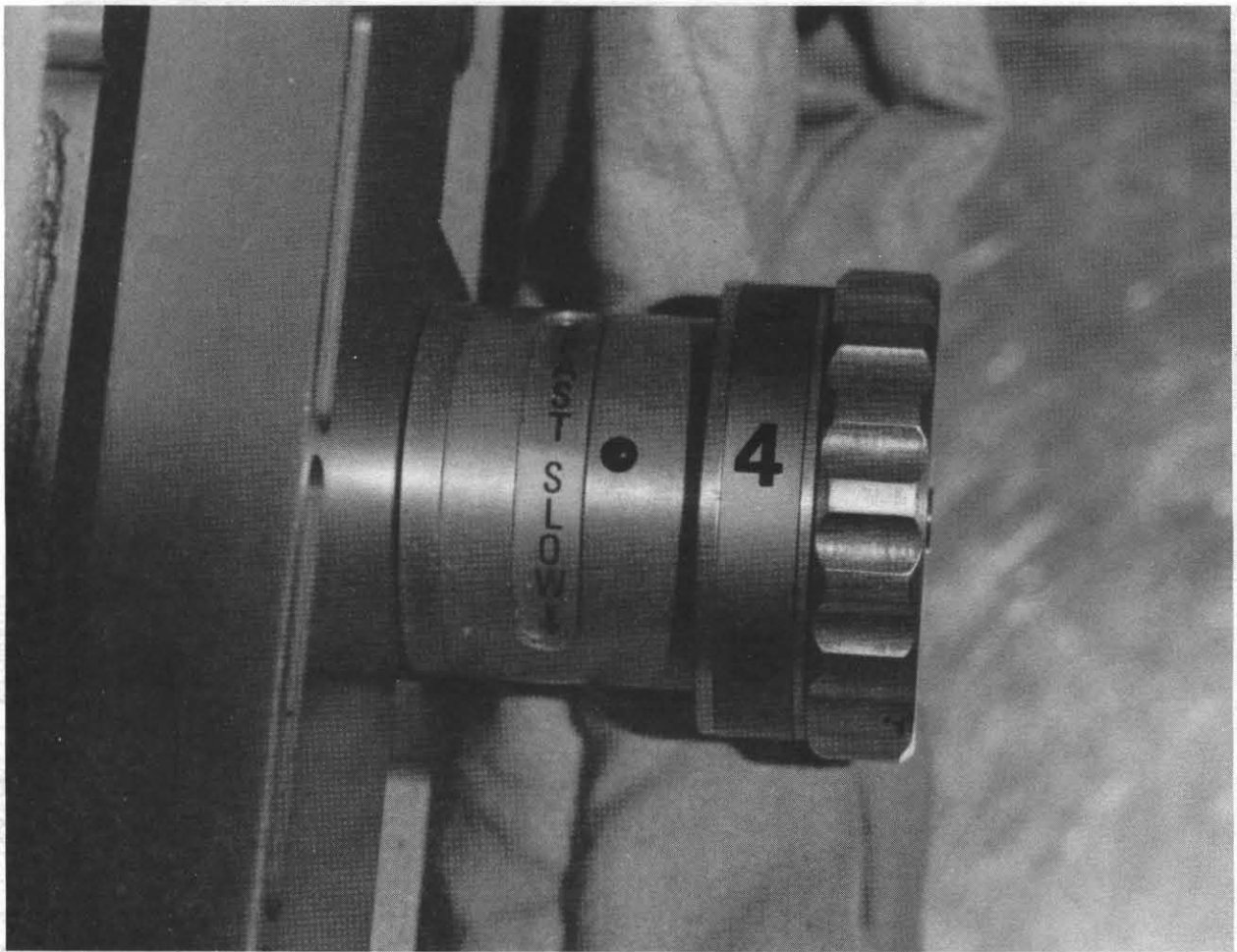


Figure 3.14-3.- Speed control knob.

The increased drag requires additional muscular work to run at the slower speed. For exercise in zero-g, a restraint system is used to apply near one-g forces to the body. Four force cords are routed near the four corners of the treadmill to restrain the body to the running track. The force cords are routed through a series of pulley wheels to provide a more constant force delivered to the body. The force cords attach to the slip buckles which are attached to the adjustment straps on the waistbelt.

Waistbelt

The waistbelt is a large padded belt designed to fit snugly on the upper hip/waist area (fig. 3.14-4). Adjustment is made by pinning the waistbelt together in the front. A series of brass rings are crimped into the fabric in the front of the waistbelt. The metal cone is inserted into the brass rings and pinned in place by inserting a large cotter pin into a hole in the end of the cone. The pin is attached to the front adjustment strap which has a slip buckle. The force cords attach to the slip buckle and the force is regulated by adjusting the length of the adjustment strap. The adjustment strap has markings numbered to facilitate quick individual readjustments. The rear of the waistbelt also has an adjustment strap with a slip buckle. The rear force cords attach to the rear slip buckle, which is attached to the rear adjustment strap and is also adjusted to control the force delivered to the body. Additional adjustment can be made for taller crewmembers by connecting extension hooks between the force cords and slip buckles.

Shoulder Straps

Two shoulder straps are attached to the top of the waistbelt at two locations in the front and one location in the back (fig. 3.14-5). Four sets of rings are located in the front of the waistbelt to provide individual comfort. The shoulder straps are adjustable and help distribute the force applied to the body delivered by the force cords.

Physiological Monitor

The physiological monitor (fig. 3.14-6) is an off the shelf unit which displays heart rate, distance run and time run. To monitor heart rate an ear clip is worn on the ear lobe. The clip contains an infrared sensor which senses an increased blood volume in the ear lobe. The increased blood volume causes an electrical signal to be generated and the physiological monitor computes the heart rate which is displayed in beats per minute on the LED. The distance run is determined by a mechanical sensor inserted into the side of the treadmill and data is displayed in kilometers and miles.

82-32633

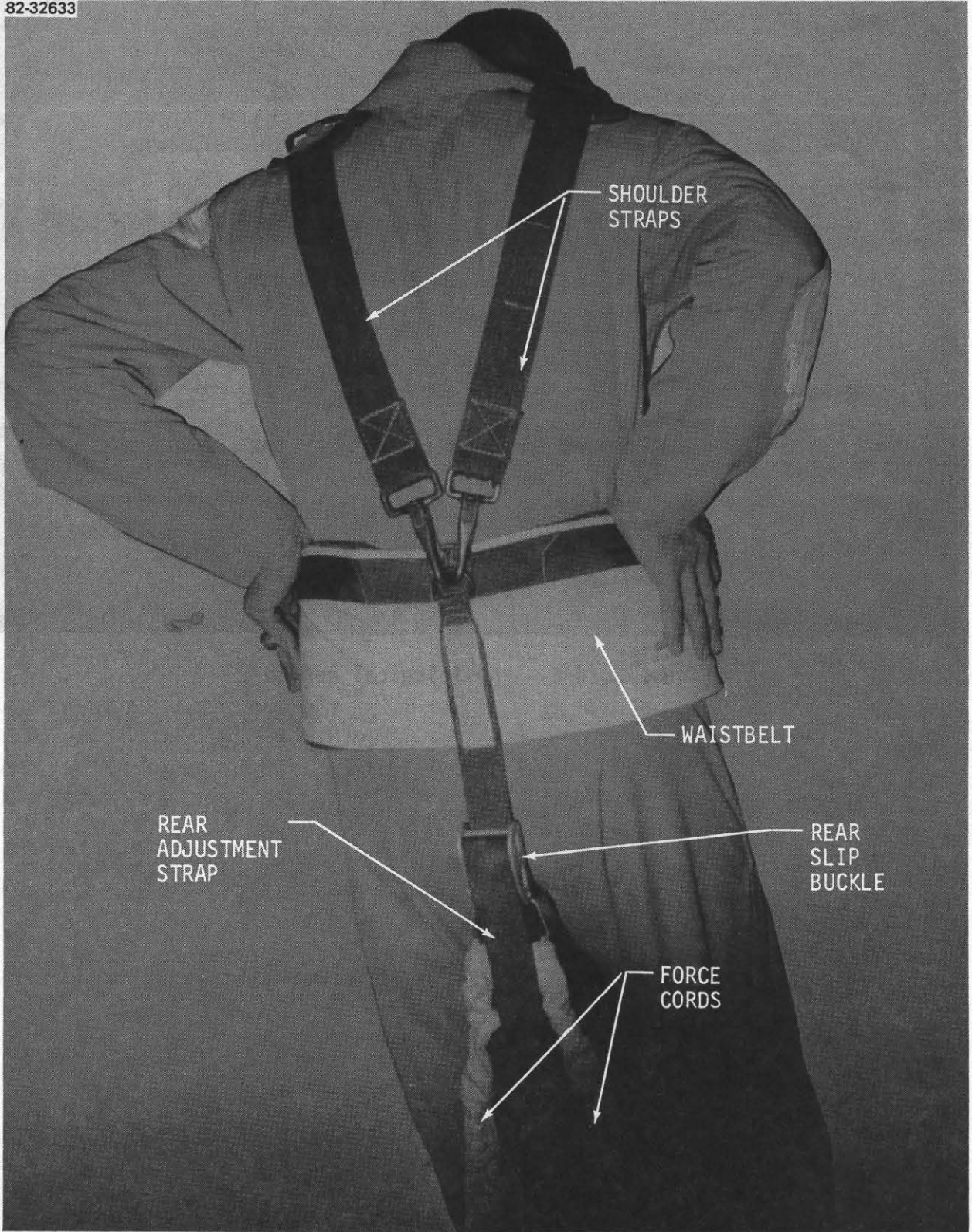


Figure 3.14-5.- Shoulder straps.

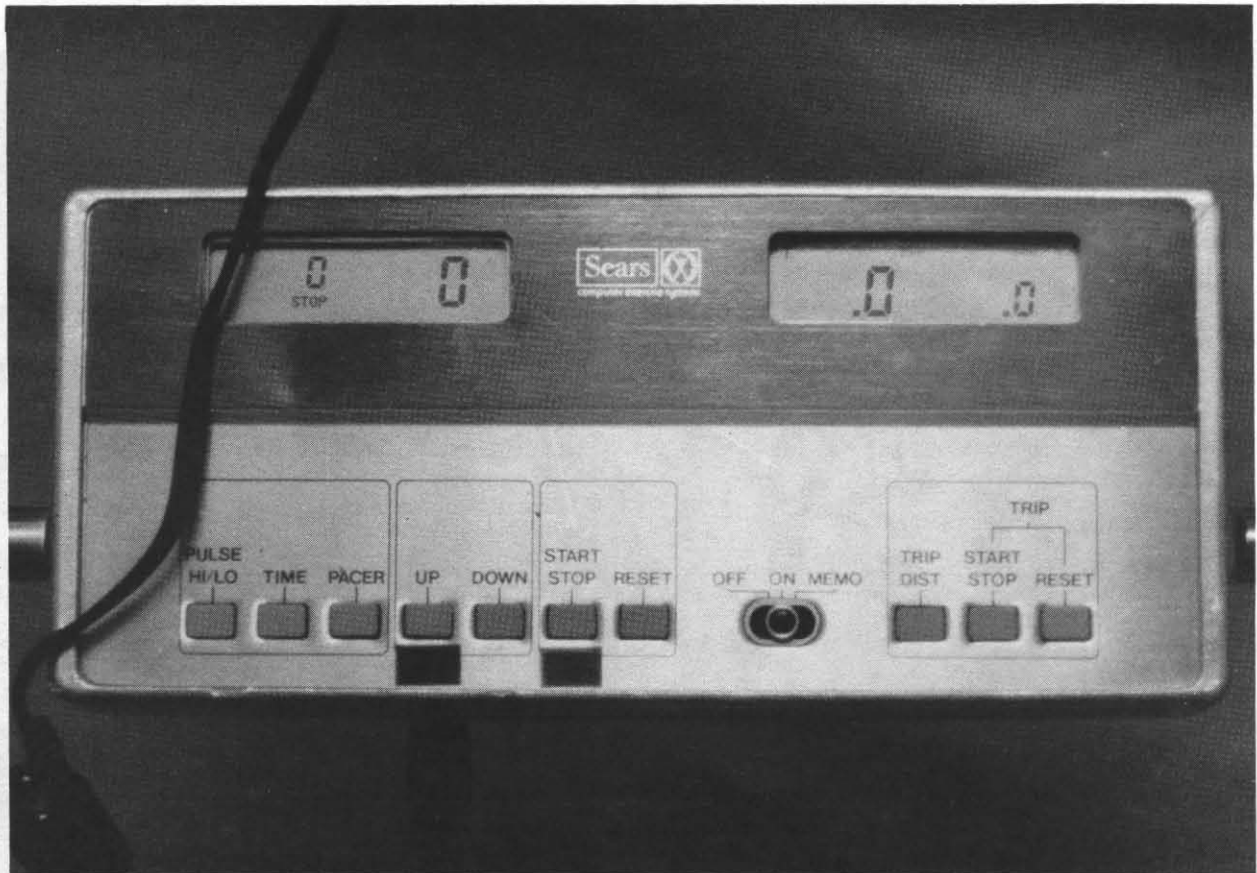


Figure 3.14-6.- Physiological monitor.

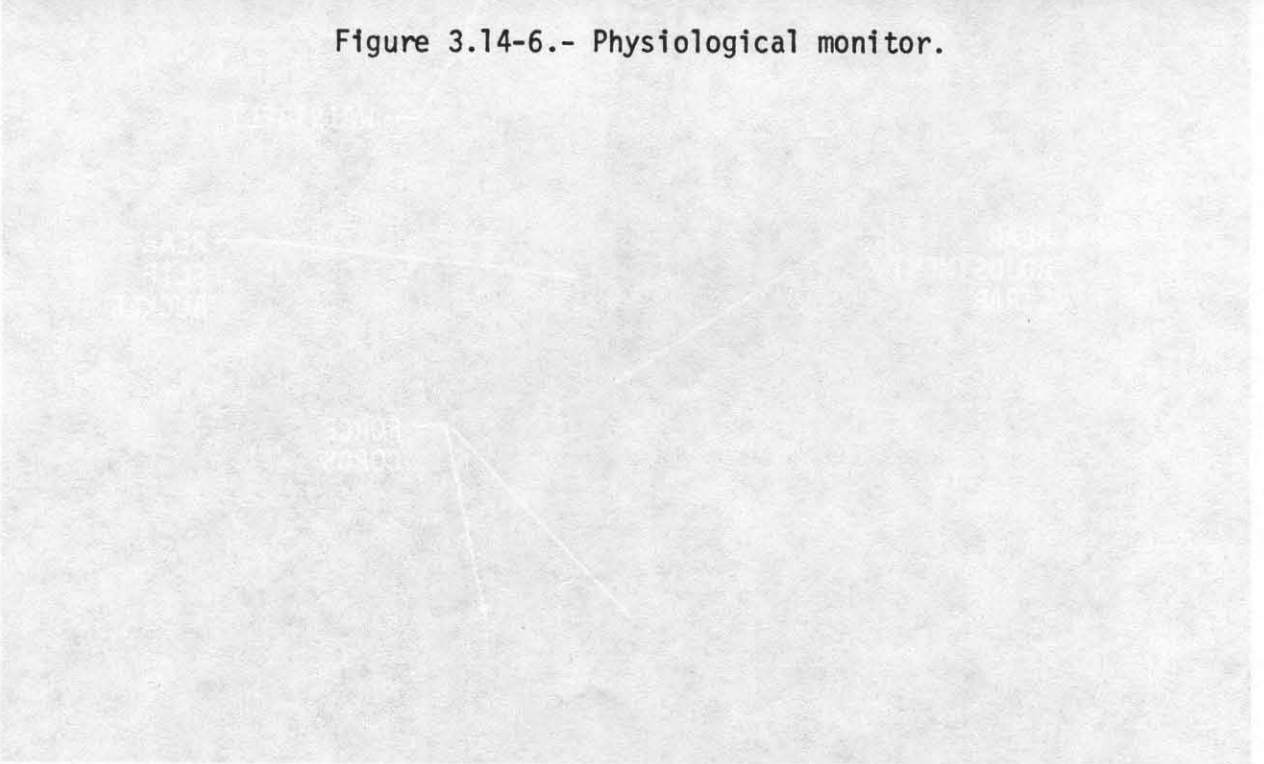


Figure 3.14-6.- Physiological monitor.

3.14.4 Systems Performance, Limitations, and Constraints

- Treadmill

- Envelope: 43.8 X 18.1 X 14.0 in. (111.2 X 46.0 X 36.0 cm)
- Weight: 61.9 lb (28.1 kg)

- Force Cords

- Weight: 2.9 lb (1.3 kg)

- Waistbelt

- Weight: 4.7 lb (2.1 kg)

- Shoulder Straps

- Weight: 1.6 lb (0.7 kg)

- Physiological Monitor

- Weight: 1.7 lb (0.8 kg)

- Extender hooks

- Weight: 0.6 lb (0.3 kg)

- Treadmill Kit

- Weight: 1.6 lb (0.7 kg)

Systems Procedures

Check procedures on new cue card. The following is a detailed procedure for operation of the treadmill. Figure 3.14-7 is a duplication of the Cue Card flown each mission in the middeck Cue Card Kit:

- 1) Relocate treadmill to floor in front of airlock (if needed) with handle base closest to port.
- 2) Verify treadmill is locked to deck studs by pulling up on treadmill body

CAUTION

The treadmill force cords are stretched and hooked together to restrain the treadmill kit and handle. Exercise care when unhooking.

- 3) Raise treadmill handle, lock in upright position (depress lock bar to lower).

- 4) Unstow physiological monitor (if desired) from treadmill kit, install on treadmill handle by turning winged bolts ccw, installing monitor, and tighten bolts (cw). Unstow distance cable (left side of treadmill), plug into monitor (yellow to yellow). Unstow pulse cable (treadmill kit), plug into monitor (green to green).
- 5) Unstow waistbelt.
- 6) Connect rear bungees to rear load strap buckle.
- 7) Facing port, sit down on treadmill running track.
- 8) Don belt, insert front load cone into brass grommets (maintaining symmetry), secure in place with cotter pin.
- 9) Connect front bungees to front load strap buckle.
- 10) Don shoulder straps crossing chest and clipping onto left and right rings on top of waistbelt (maintaining symmetry).
- 11) Carefully stand up on running track, pull load adjustment straps to adjust load, and adjust shoulder straps to place majority of load on hips.
- 12) Position shoulder strap cushions for comfort.
- 13) To use the Physiological Monitor (optional)
 - Power switch - ON
 - ✓Battery indication light - ON
 - Reset key - depress
 - Don ear restraint, ear clip with light side on back of ear lobe
 - Start key - depress
 - Pulse, time, distance, speed keys - depress to observe the desired parameter
- 14) Disconnect front shoulder strap connections, doff equipment, leave assembled for later use or stow for entry.

TOP

+ TREADMILL (T/M)

| |
|----------------|
| HOOK VELCRO |
|----------------|

CUE/ALL/O/BAS B,4 +

- ✓Treadmill locked onto deck studs
- Raise, lock Treadmill handle, (depress push bar), unstow waistbelt/shoulder straps, physiological monitor (if required)
- Install physiological monitor, (see reverse), connect electrical cables
- Adjust front, rear load straps (C, D) to maximum length
- Connect rear force cords (1, 2) to waistbelt (A) rear load strap buckle (D)
- While sitting on Treadmill don waistbelt/shoulder straps (B), pin in place
- Connect front force cords (3, 4) to front load strap buckle (C)
- Carefully stand on Treadmill, adjust front, rear load straps to desired force

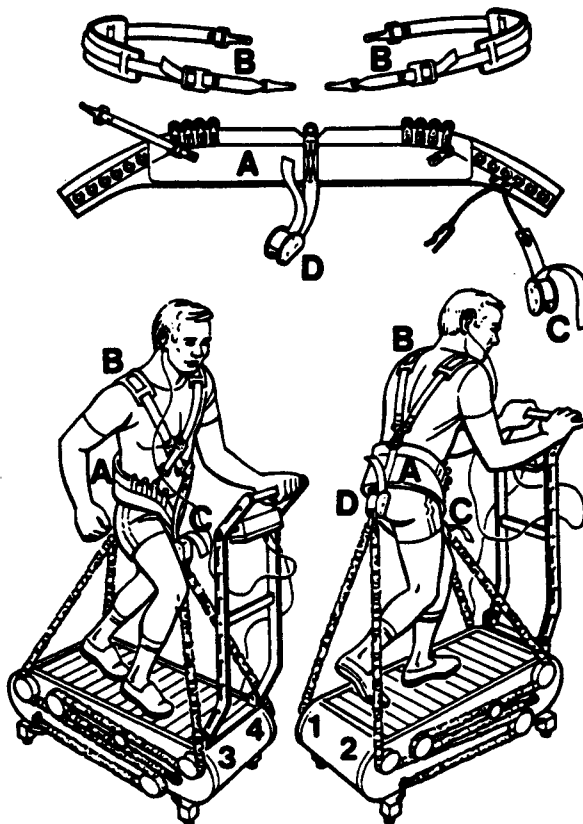


Figure 3.14-7.- Treadmill cue card.

TOP
BACK OF 'TREADMILL (T/M)'



CUE/ALL/O/BAS B,4



INSTALLATION OF TREADMILL MONITOR

Screw threaded side of treadmill monitor bracket into wingnut
first until firm

Screw other wingnut until firm

Reverse procedure to remove

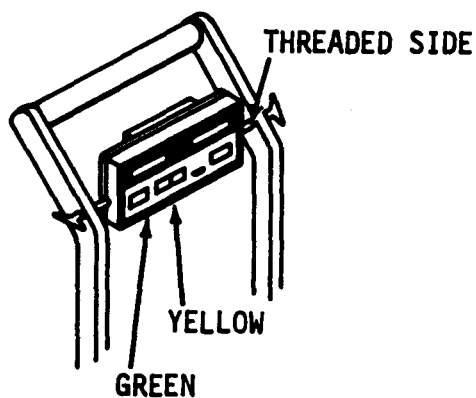


Figure 3.14-8.- Treadmill monitor installation cue card.

3.15 PERSONAL HYGIENE PROVISIONS

3.15.1 Introduction

Personal hygiene provisions include the following equipment (fig. 3.15-1):

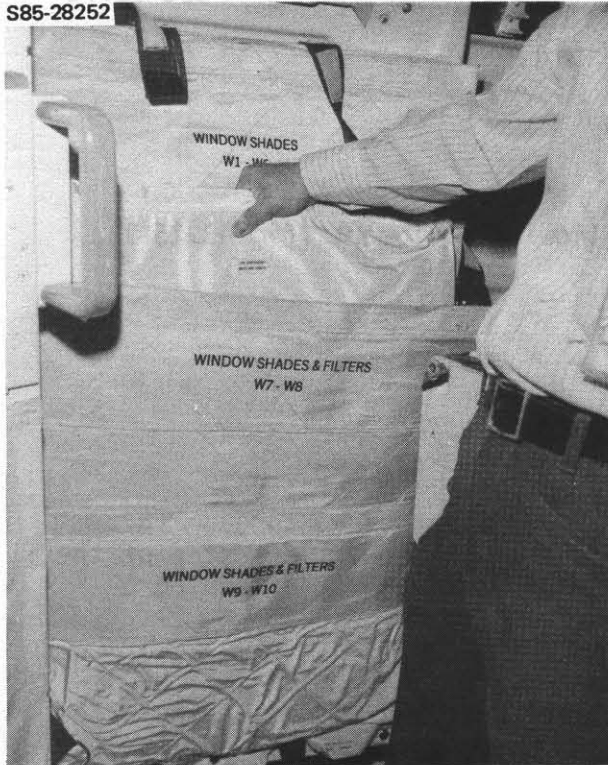
- Personal hygiene hose
- Personal hygiene kit (PHK)
- Female preference kits
- Towels and washcloths
- Tissue dispenser
- Wet wash dispenser

When the galley is flown, personal hygiene water is provided through the galley auxiliary port potable water QD located on the lower left side of the galley. The crewmember obtains ambient water from the QD by attaching a 12-ft flex hose with a mating QD.

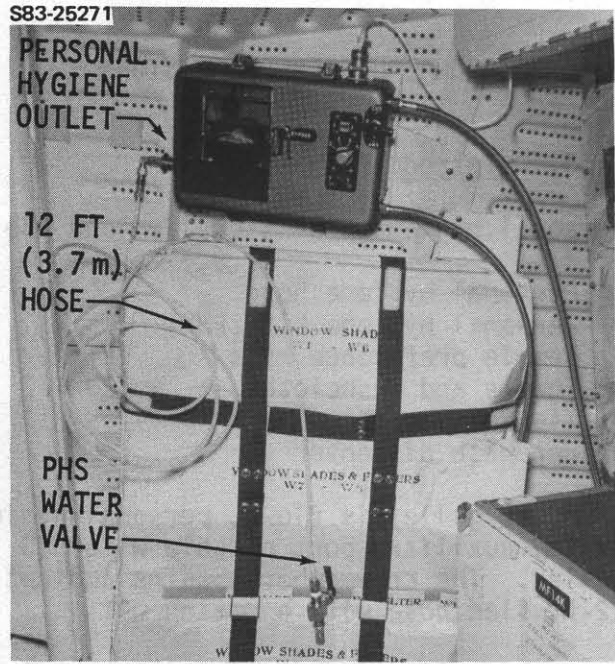
When the galley is not flown, personal hygiene water is provided by the water dispenser which is located on the port side of the middeck. The water dispenser provides ambient water through a quick disconnect (QD) on its left side. The crewmember obtains water from this QD with the same 12-ft flex hose with a valve and nozzle used on galley flights. On the opposite end of the flex hose is a valve and nozzle.

PHK's and female preference kits are stowed in a middeck locker. Disposables (gloves, tissues, wet washes, and dry wipes) are stowed in dispensers located inside the WMC. Towels and washcloths are stored in the WMC and in a middeck locker.

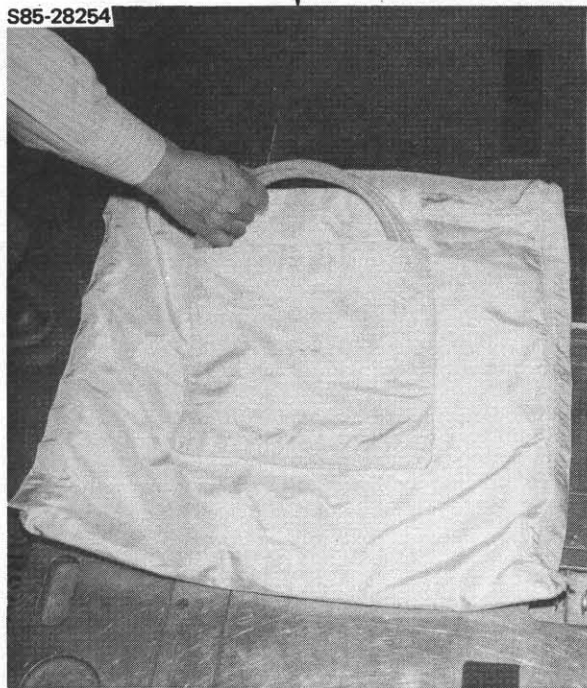
These items must be transferred from stowage to use locations on orbit (fig. 3.15-2).



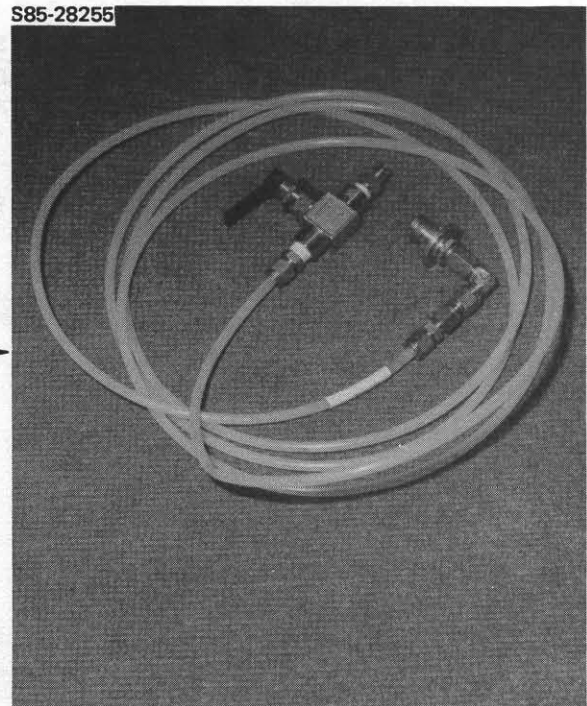
STOWAGE OF IFM HOSES AND CABLE BAG



WATER DISPENSER - PERSONAL HYGIENE WATER VALVE



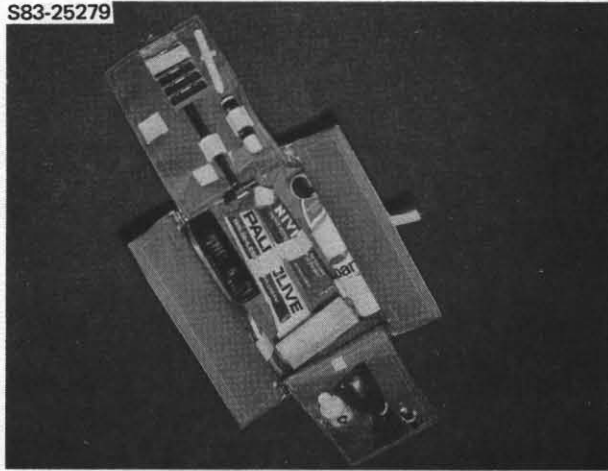
IFM HOSES AND CABLE BAG



PERSONAL HYGIENE HOSE/VALVE

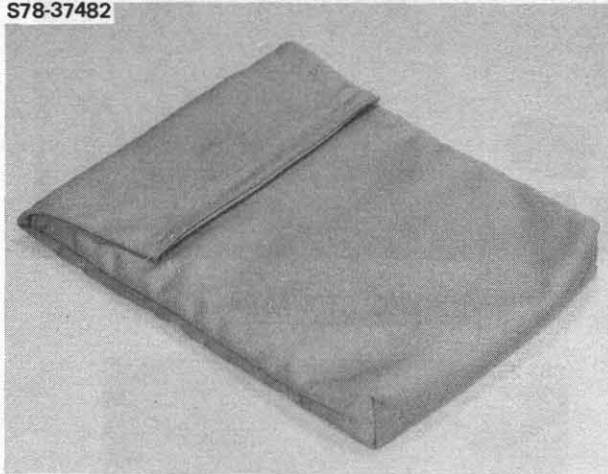
Figure 3.15-1.- Personal hygiene provisions (sheet 1 of 2).

S83-25279



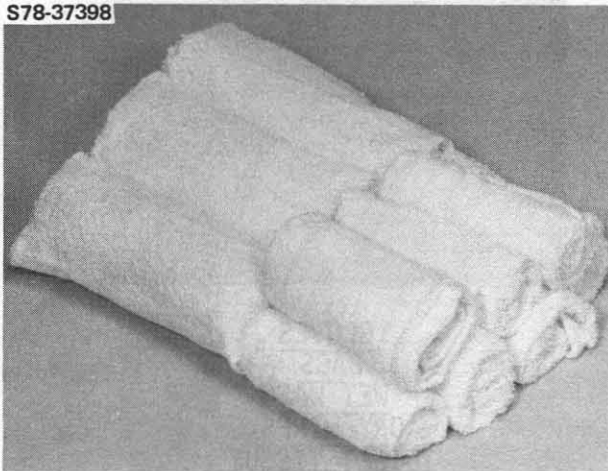
PHK

S78-37482



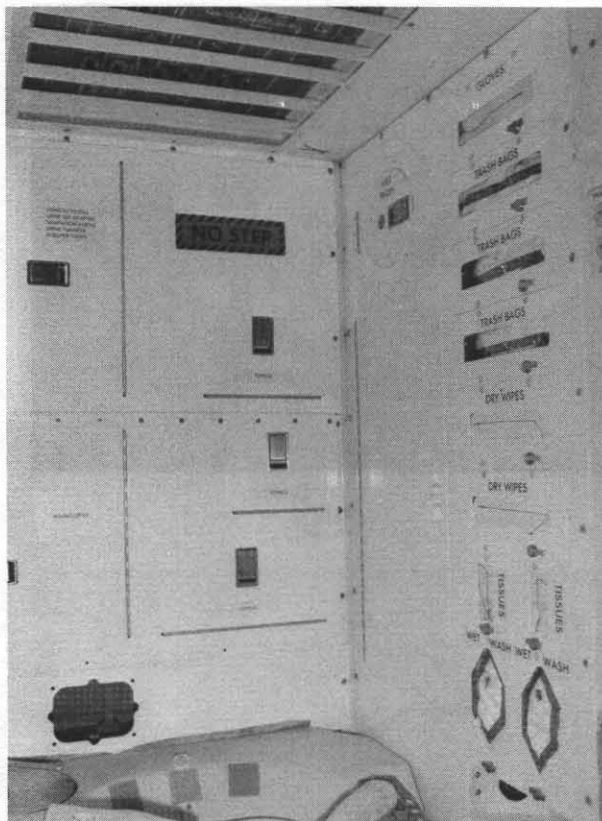
PERSONAL HYGIENE MIRROR BAG

S78-37398

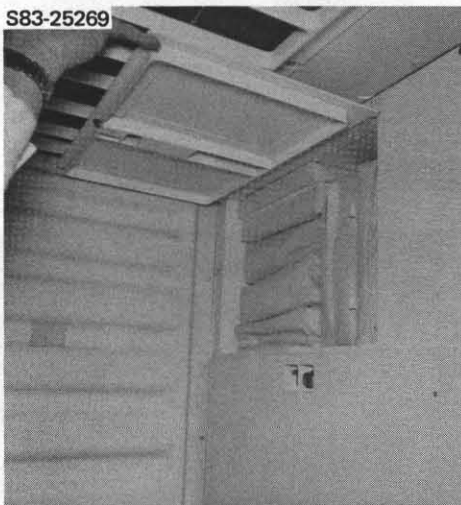


TOWELS AND WASHCLOTHS

Figure 3.15-1.- Personal hygiene provisions (sheet 2 of 2).



WMC STOWAGE



S83-25269

GLOVES
BAGS
WET WASH
DRY WIPES
TOILET TISSUE
DISPENSERS
STOWAGE

Figure 3.15-2.- Personal hygiene equipment on-orbit locations - with galley.

3.15.2 Systems Functional Description

Most personal hygiene items are stowed for launch in the Orbiter middeck area and must be moved for use on orbit. Waste management accessories are stowed in wall compartments in the WMC. A 12-ft flexible hose and valve are used for personal hygiene water and are connected to the Orbiter potable water system via the galley or water dispenser.

Personal Hygiene Station

The personal hygiene hose consists of a hygiene water valve with a 12-ft (3.7-m) flexible plastic line which is connected to the water outlet. The hygiene water valve is a manually-operated valve that can be activated by either squeezing or lifting the handle. It provides ambient water at 65° to 75° F (18° to 24° C). When the handle is lifted to the "up" locked-open position, a continuous flow of water is provided.

On galley flights the personal hygiene hose is connected to the auxiliary port potable water QD located on the lower left side of the galley. On nongalley flights the hose attaches to the left side of the operational water dispenser assembly. In each case a microbial check valve is located upstream of the personal hygiene hose to prevent microbial back contamination. The plumbing details are shown in figure 3.15-3. A list of displays and controls is provided in table 3.15-1.

In addition, a 9 x 12-in. (22.9 x 30.5 cm) stainless steel mirror and light are provided on the left side of the galley structure (fig. 3.15-4). The light has a single light brightness control switch. On nongalley flights a Mylar mirror can be mounted by means of Velcro for use on orbit. It is the same size as the steel mirror and is stowed for launch and entry in the middeck locker containing hygiene equipment.

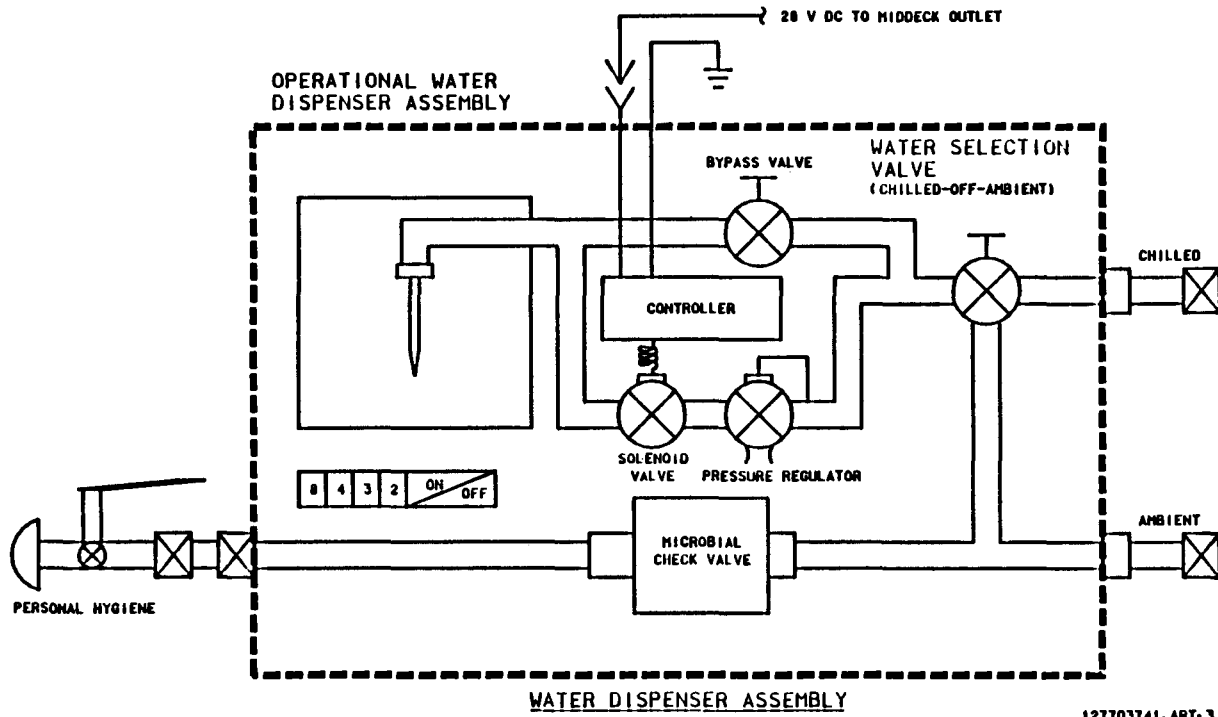
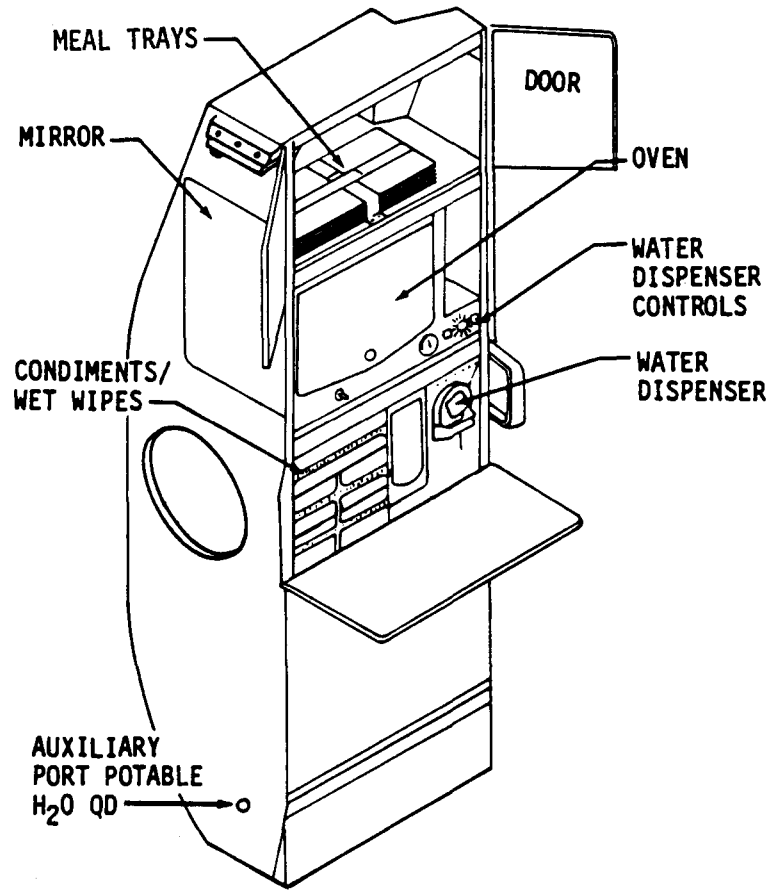
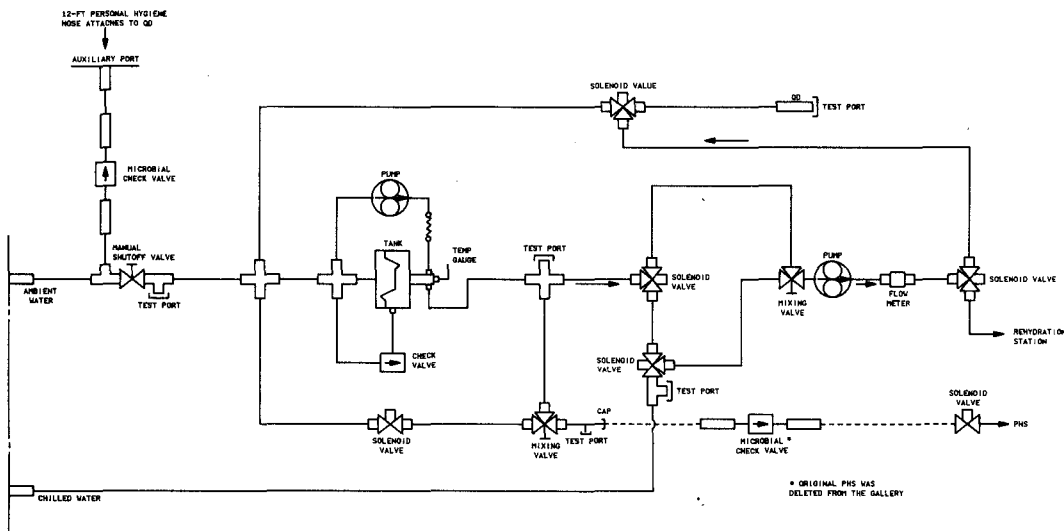


Figure 3.15-3.- Personal hygiene schematic (sheet 1 of 2).



GALLEY



127703742.ARI.2

GALLEY WATER SYSTEM

Figure 3.15-3.- Personal hygiene schematic (sheet 2 of 2).

12C-12770

S84-34160

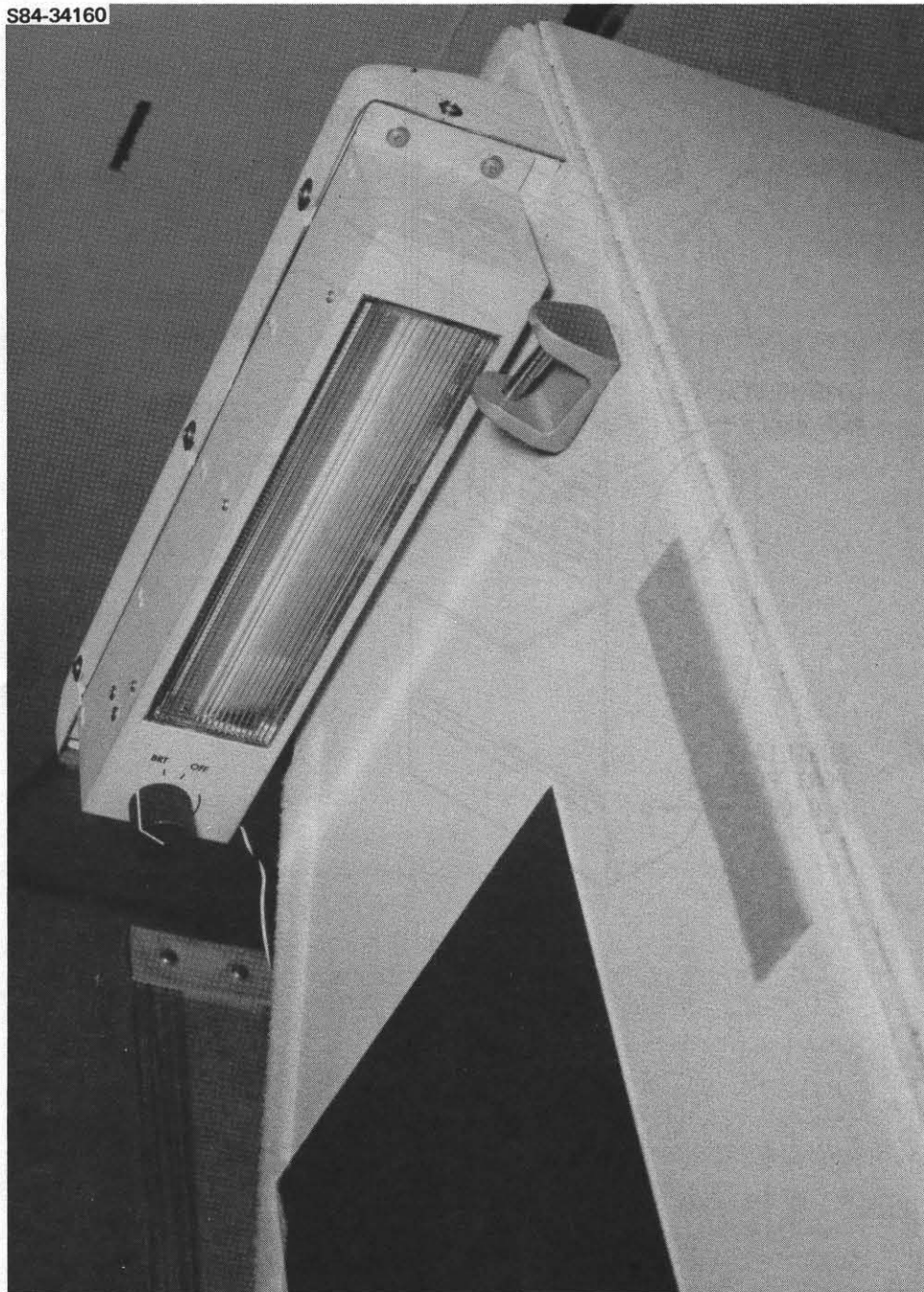


Figure 3.15-4.- Light and stainless steel mirror on galley.

GALLEY WATER SYSTEM

Figure 3.15-2.- Personnel hygiene schematic (sheet 2 of 2)

TABLE 3.15-1.- PERSONAL HYGIENE STATION DISPLAY AND CONTROL FUNCTIONS

| Location | Type | Nomenclature/ position | Function | Remarks |
|--|---------------|---------------------------------|---|---|
| Twelve ft flexible plastic hose w/valve used with galley/water dispenser | Valve | Hygiene water valve | | |
| | | Closed | Prevents flow of water from hygiene water valve | Two-position handle; spring-loaded to stay in closed position |
| Galley | Rotary switch | Open | Allows flow of water from hygiene water valve | Squeeze with hand to open valve or lift handle to 'UP' (locked-open) position to provide continuous flow of water |
| | | Light brightness control switch | | |
| | | BRT OFF | Remove power from galley light Moving knob cw from OFF applies power to the light and provides variable brightness control | |

WMC Door/Compartment Privacy Curtains

Two privacy curtains are attached with snaps to the inside of the WMC compartment door (fig. 3.15-5). One is attached to the top of the door and fastens to the outer edge of the interdeck access by Velcro. The other is attached to the side of the door and fastens to the galley, Continuous Flow Electrophoresis System (CFES), or to the Orbiter port wall structure with Velcro. The WMC door is held in place by two telescoping rods. Each rod has a spring latch on one end which locks onto a bracket on the galley/CFES/Orbiter port structure to secure the door in position. The curtains are constructed of Nomex fabric.

The deployed curtains serve to isolate the WMC compartment from the rest of the Orbiter middeck.

Personal Hygiene Kits (PHK)

A PHK is furnished for each crewmember to provide for brushing teeth, hair care, shaving, nail care, etc. (fig. 3.15-6). The contents of a typical PHK are as follows:

- Soap (bar or liquid)
- Shaving cream
- Stick deodorant
- Styptic pencil
- Skin moisturizer
- Nail clippers
- Hair comb or brush
- Double edge safety razor, twin-blade razor, or choice of two electric razors with batteries
- Dental floss
- Toothbrush (disposable toothbrush with toothpaste can be substituted at crew's option)
- Toothpaste
- Antichap lipstick
- Disposable gloves (1 pair)

Pockets, loops, and Velcro are provided in the PHK containers to maintain articles in an orderly manner and to permit efficient removal, use, and replacement of components in flight. The maximum weight of the PHK will be 5.0 lb (2.3 kg). Each PHK is color coded (with a Velcro patch on the side) for each crewmember. PHK's are launched in the middeck locker with other personal hygiene accessories.

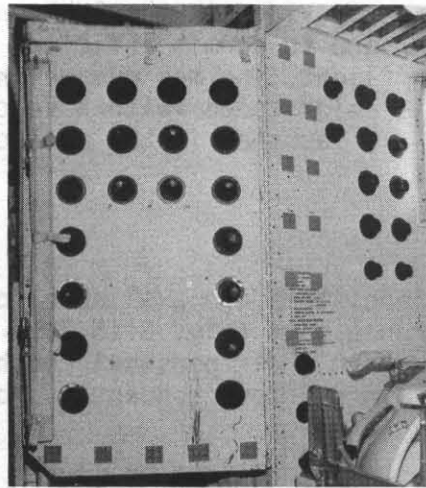
Female Preference Kits

Additional grooming and hygiene items are available for the female crewmembers in the female preference bags (fig. 3.15-7). Each female crewmember has the option of flying these in their personal clothing lockers. Each kit contains the following items in sufficient quantity for a minimum of 7 flight days:

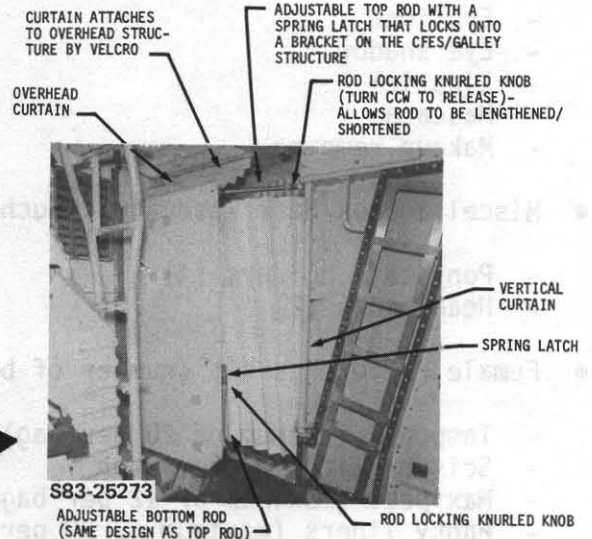
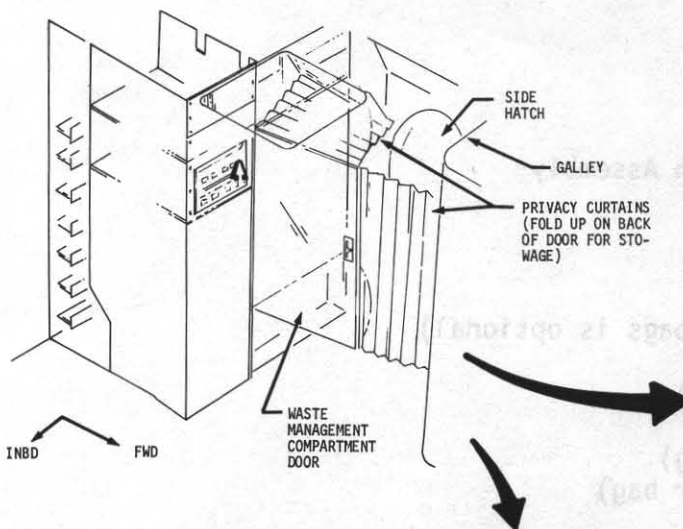
- Roll Out Makeup Assembly
 - Blush
 - Eyeliner
 - Eye shadow
 - Lipstick
 - Mascara
 - Makeup remover
- Miscellaneous Hair Restraint Pouch Assembly
 - Pony tail holders (4)
 - Head bands (2)
- Female Preference Kit (number of bags is optional)
 - Tampons (maximum of 20 per bag)
 - Scissor with Velcro patch
 - Maxipads (maximum of 12 per bag)
 - Panty liners (maximum of 20 per bag)

Towels and Washcloths

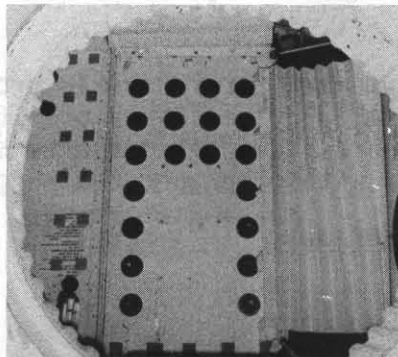
A quantity of towels sufficient for each crewmember for 7 days is provided. The washcloths are 12 x 12 in. (30.5 x 30.5 cm) and the towels are 16 x 27 in. (40.6 x 68.6 cm). Towels and washcloths are stowed in dispensers in the aft wall of the WMC and in the middeck locker with other personal hygiene accessories (fig. 13.15-8).



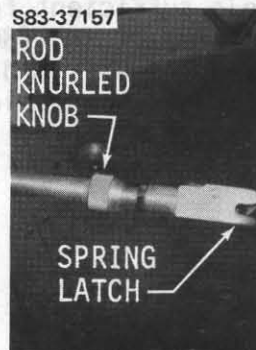
PRIVACY CURTAIN - STOWED POSITION



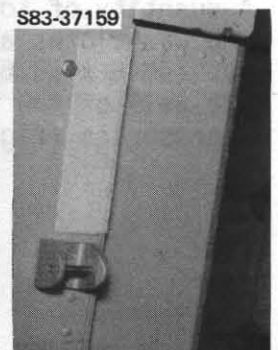
**PRIVACY CURTAIN - INSTALLED
LOOKING OUTBOARD**



**PRIVACY CURTAIN - INSTALLED
(LOOKING INBOARD)**



ROD CONTROLS



LATCH BRACKET

Figure 3.15-5.- Personal hygiene compartment privacy curtains.

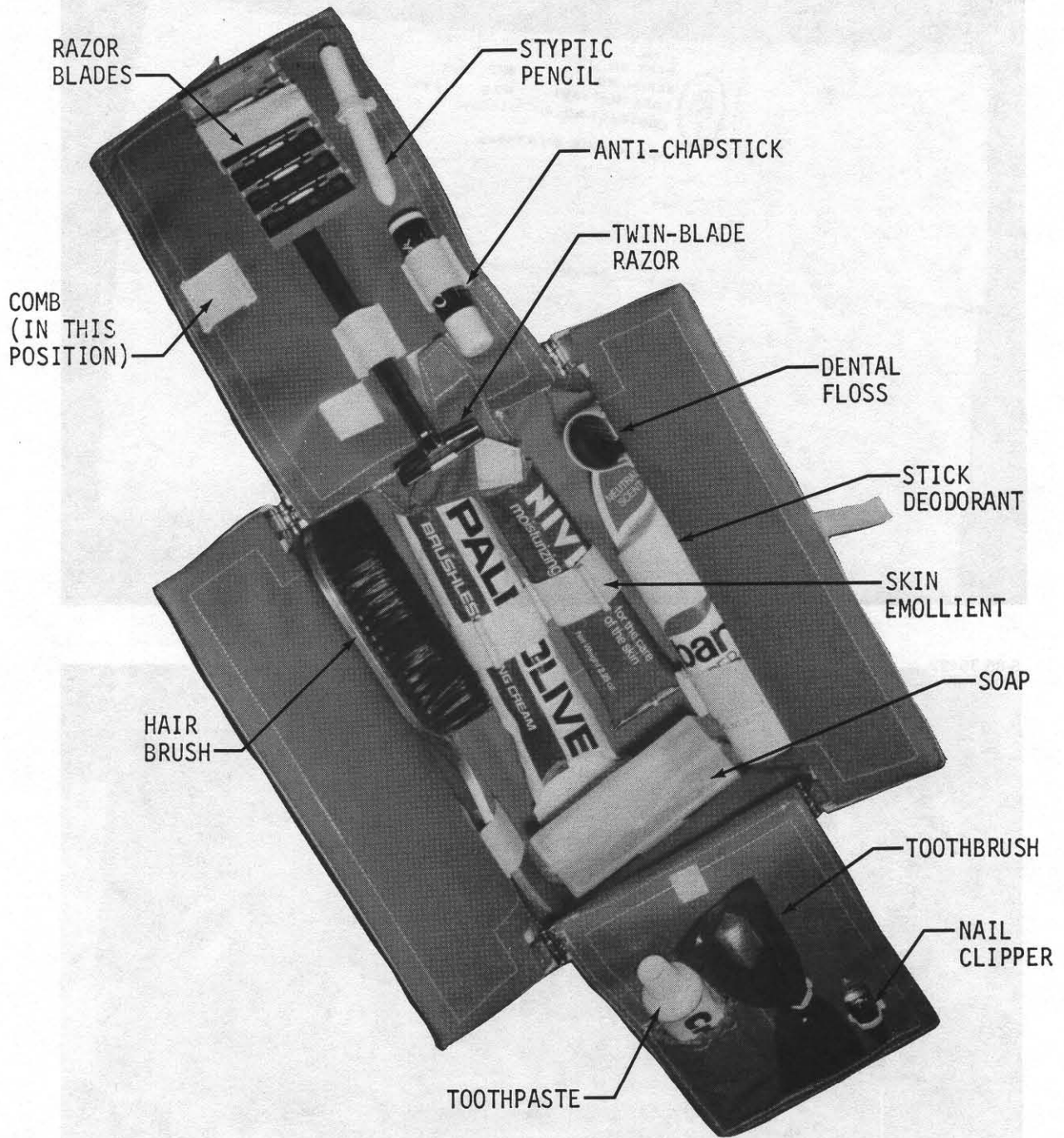
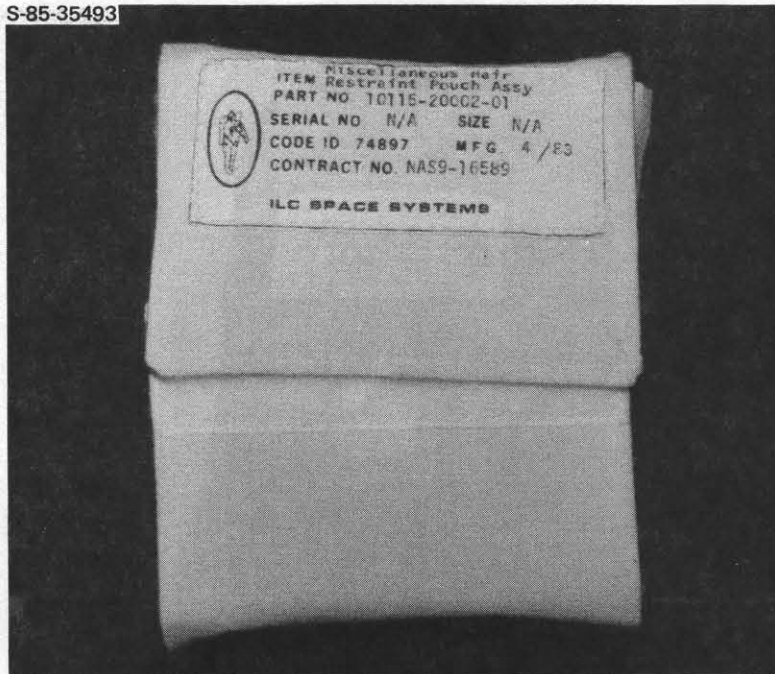
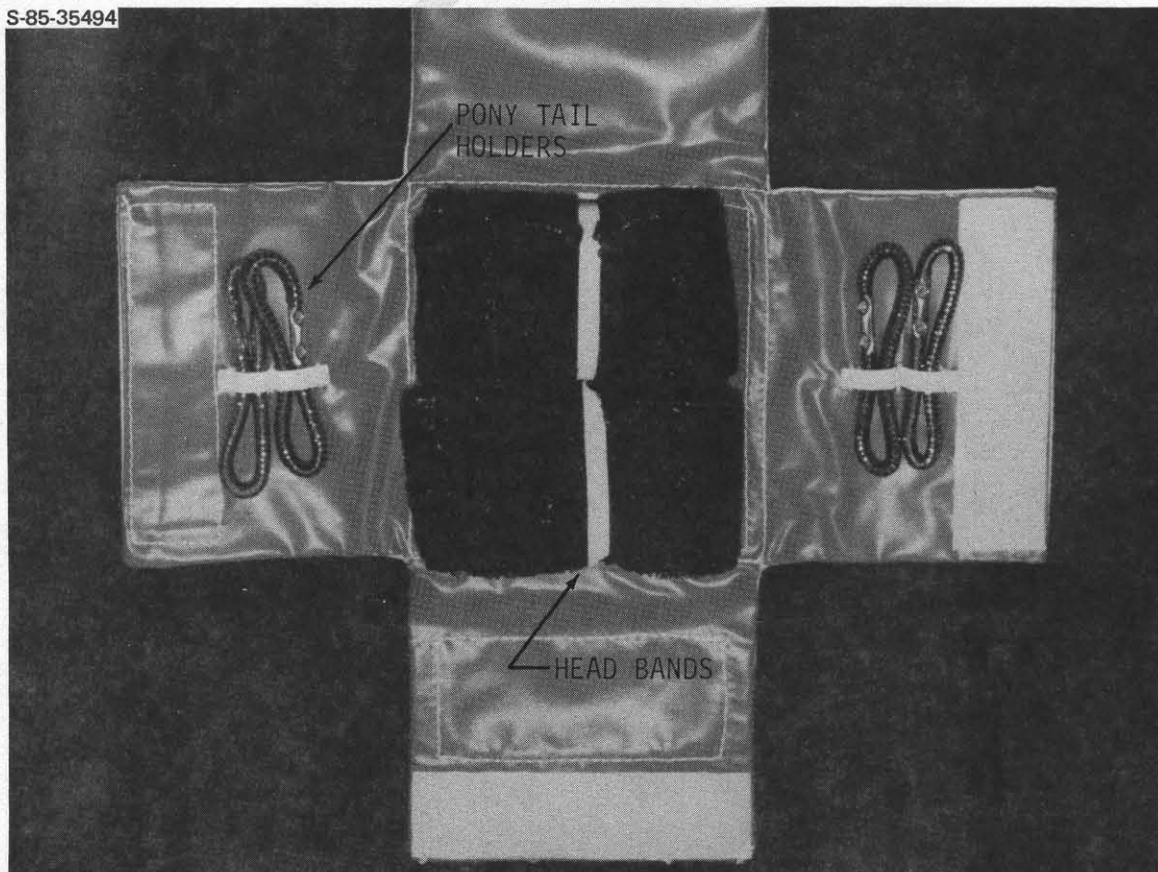


Figure 3.15-7.- Personal hygiene kit.

S-85-35493



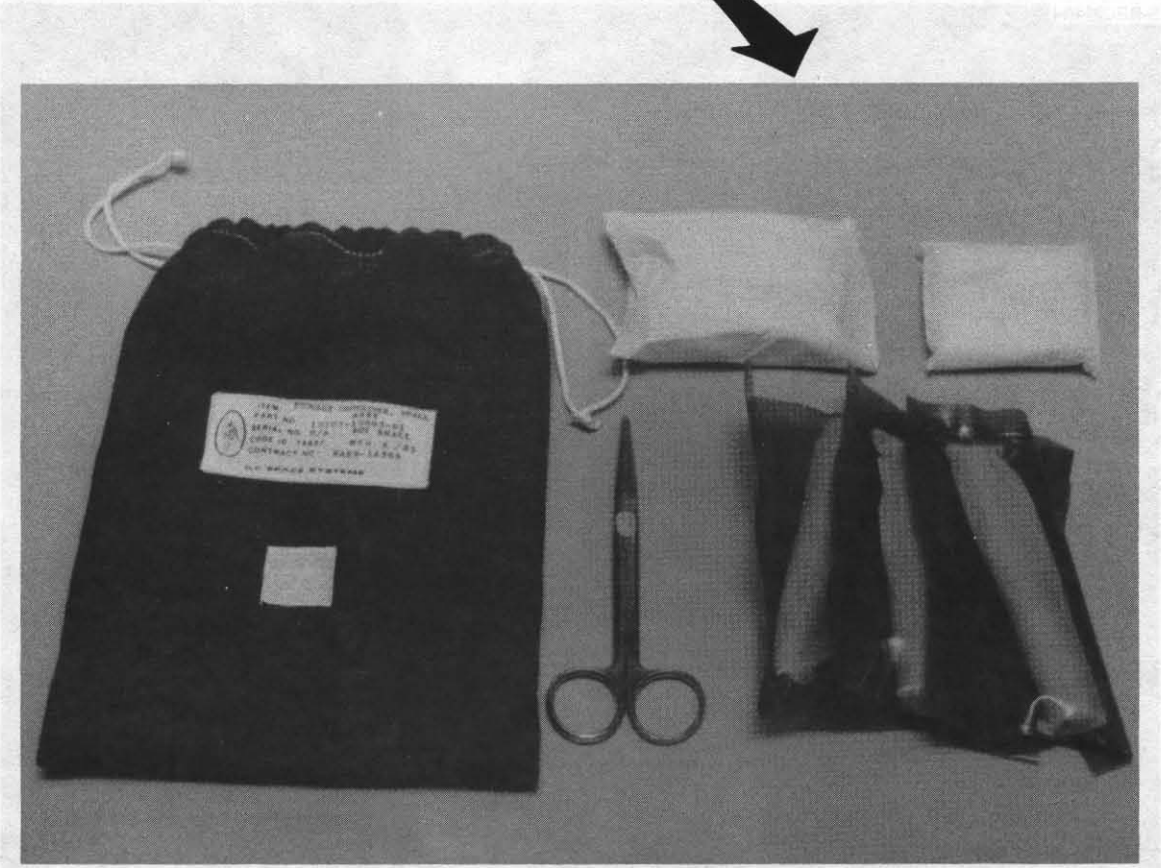
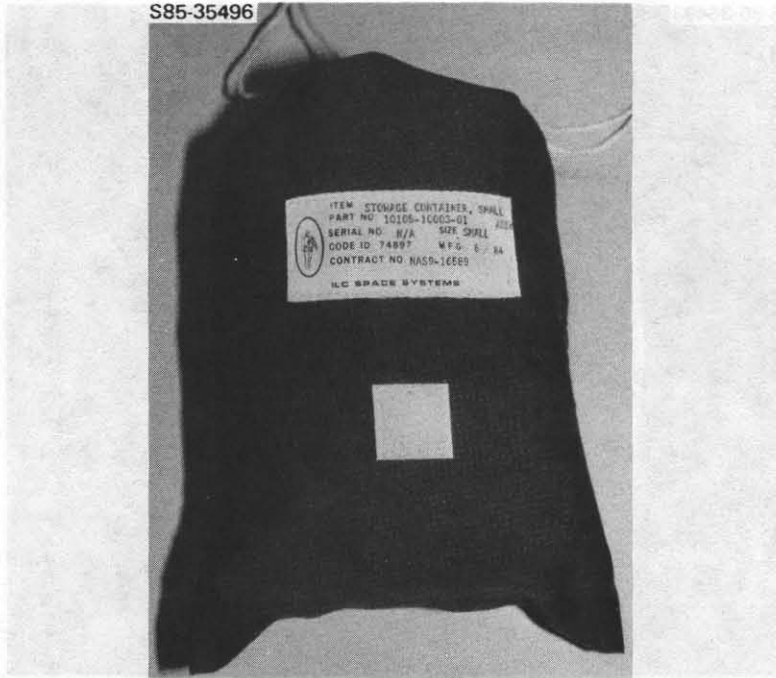
S-85-35494



MISCELLANEOUS HAIR RESTRAINT POUCH ASSEMBLY

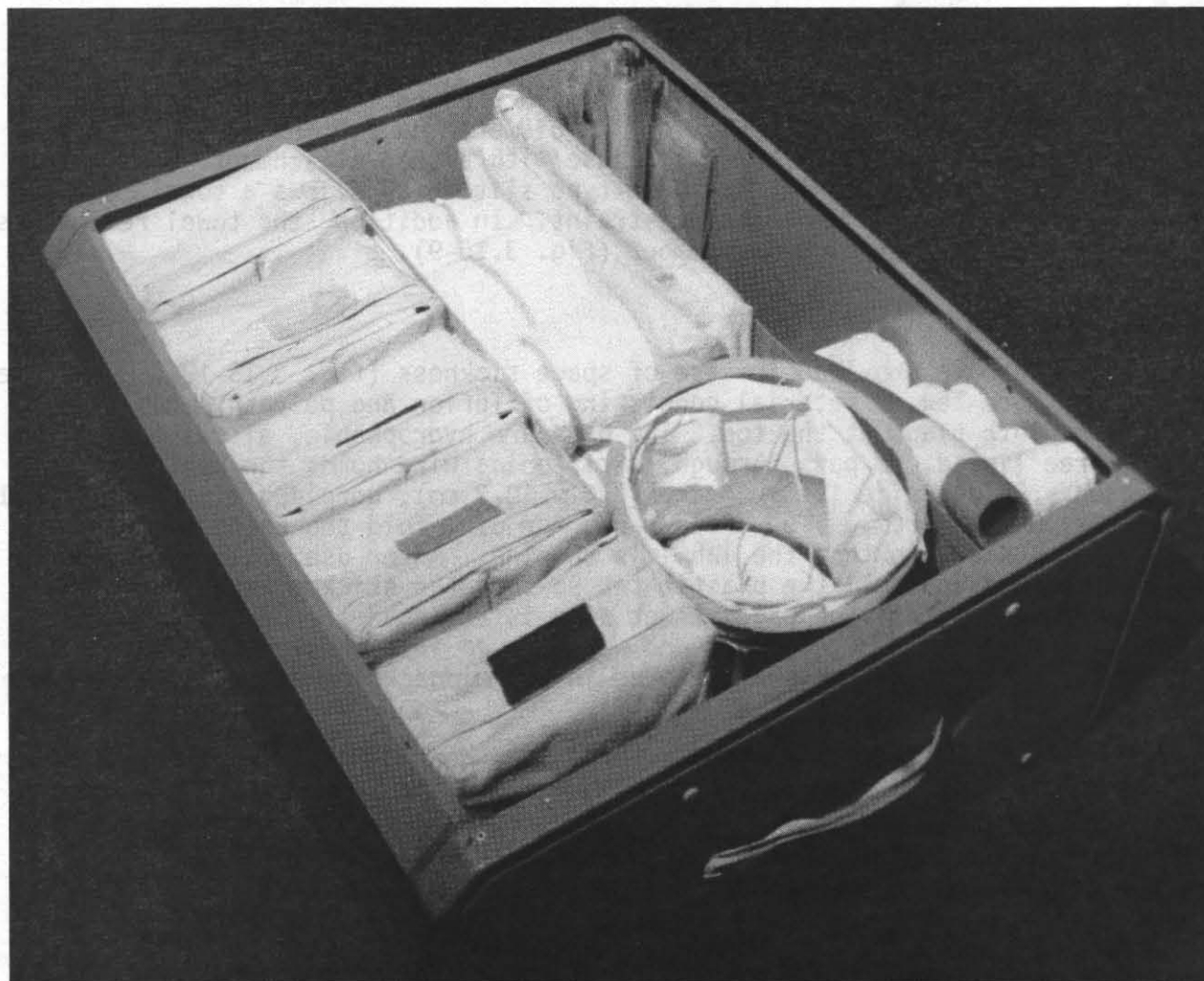
Figure 3.15-7.- Female preference items (sheet 2 of 3).

S85-35496



FEMALE HYGIENE ITEMS

Figure 3.15-7.- Female preference items (sheet 3 of 3).



Small wet paper tissues measuring 3.87 x 5.8 in. (10 x 15 cm) are provided for minor body cleanliness. They are sealed individually in packets and soaked with a mixture of benzalkonium chloride (0.13%), alcohol (40%), propylene glycol, and water. These are stored in the galleys for use in which they are used for sanitary purposes and in volume 2.

Large paper towels measuring 16.5 x 7.5 in. (41.5 x 19 cm) are provided for general cleaning. They are stored in dispensers located in the port wall of the WMC.

The toilet tissues are paper and are absorbent, soft-ply and low linting. They measure 5.87 in. (14.7 x 14.8 cm) and are stored in dispensers located in the port wall of the WMC.

Figure 3.15-8.- Towel and tissue dispenser.

Towel Restraints

A number of rubber towel restraints are located on the inside of the WMC. Each restraint is 1.75 in. (4.4 cm) in diameter by 1.0 in. (2.5 cm) in height and has a 2.75-in. (7.0-cm) base with a snap attachment. The rubber top of the towel restraint has an X-type slit which allows a towel to be inserted by the crewmember for restraint. In addition, the towel restraints are color coded for each crewmember (fig. 3.15-9).

Emesis bags

Emesis bags are provided in case of space sickness (fig. 3.15-10). They are made of Gore-Tex, a material consisting of Teflon and polyethylene, with cotton cloth flaps at the top. The bags are hydrophobic, allowing air, but not free liquid, to pass through. Stiffening wire holds the bags open or closed. Folded size is 3 x 4 in. (7.6 x 10.2 cm); unfolded size is 8.5 x 11 in. (21.6 x 27.9 cm). To unfold a bag for use, fold the cotton flaps down on the outside, so that the label is showing. After use, fold the flaps into the bag and pull the plastic tab so that the stickum layer underneath can be used to seal the bag. A wet wipe is attached to the outside of the bag for cleaning up. Both bag and wet wipe go into the wet trash compartment. Emesis bags are stowed in the middeck locker with the other hygiene accessories.

Wet washes

Large wet wash cloths measuring 6.5 x 6.2 in. (16.51 x 15.75 cm) are provided for body cleansing. A quantity sufficient for the entire crew is stowed in dispensers located in the port wall of the WMC.

Wet wipes

Small wet paper tissues measuring 7.87 x 5.5 in. (20 x 14 cm) are provided for minor body cleansing. They are sealed individually in packets and soaked with a mixture of benzalkonium chloride (.013%), alcohol (40%), propylene glycol, and water. These are stowed in the galley (or in a middeck locker with food for nongalley flights) and in volume G.

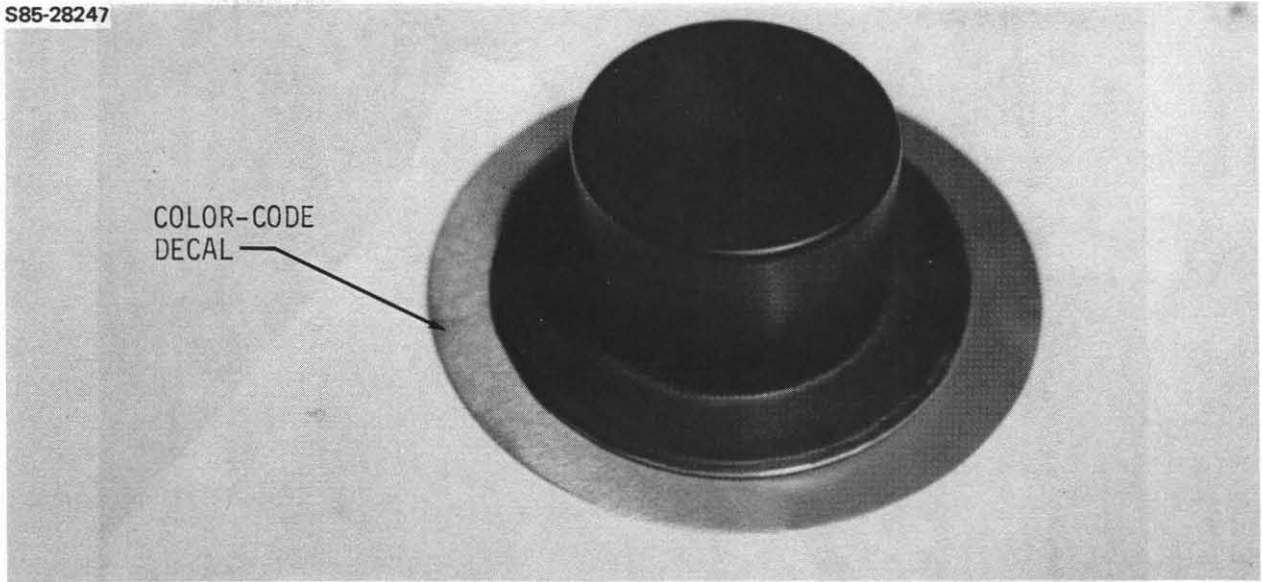
Dry wipes

Large paper towels measuring 16.5 x 7.5 in. (41.5 x 19 cm) are provided for general cleaning. They are stowed in dispensers located in the port wall of the WMC.

Toilet tissues

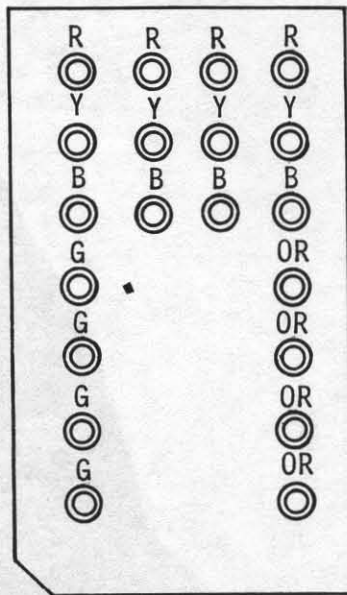
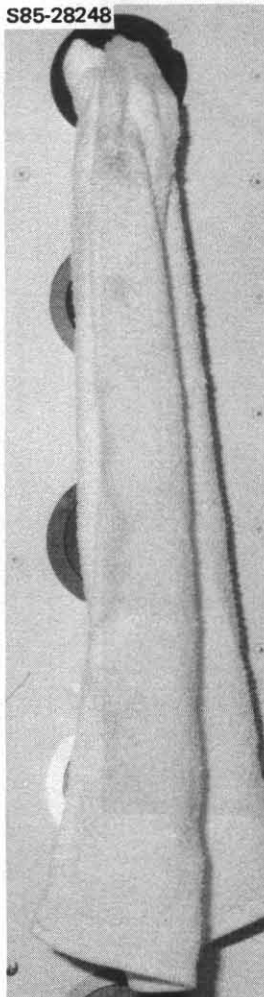
The toilet tissues are paper and are absorbent, multi-ply and low linting. They measure 5 x 8.5 in. (12.7 x 21.6 cm) and are stowed in dispensers located in the port wall of the WMC.

S85-28247



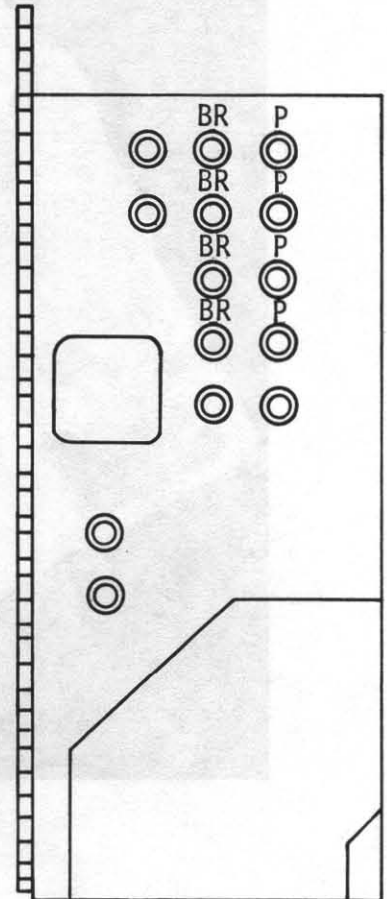
COLOR-CODE
DECAL

S85-28248



WMC DOOR

NOTE: UNMARKED TOWEL
RESTRAINTS ARE
FOR THE 8th
CREWMEMBER.



WMC STBD WALL

Figure 3.15-9.- Towel restraints and installation.
363



NOTE: UNMARKED TOWEL
 RESTRAINTS ARE
 FOR THE 25H
 CREWMEMBER

MMT 2500 WALL

Figure 3.15-10.- Emesis bag.

Gloves

Disposable polyethylene gloves are provided for general hygiene needs. They are dispensed singly from a dispenser in the port wall of the WMC and can be worn on either hand.

3.15.3 Inventory of Stowed Hygiene Items for a Typical Flight

| <u>WMC</u> | <u>Middeck locker</u> |
|----------------------------|---------------------------|
| Contingency scraper tool | Emesis bags (20) |
| Dry wipes (360) | Mirrors (2) |
| Gloves (50) | Personal hygiene kits (7) |
| Sanitation agent | Towels (10) |
| Toilet tissues (400) | Washcloths (49) |
| Towels (39) | WCS canister |
| Trash bags (70) | WCS airvent hoses |
| Urinal funnels, female (3) | Ziplock bags (6 in.) (20) |
| Urinal funnels, male (7) | Ziplock bag (8 in.) (1) |
| Conical prefilter (20) | |
| QD adapter (2) | |
| Washcloths (49) | |
| Wet washes (360) | |
| Ziplock bag (8 in.) (1) | |

3.15.4 Systems Performance, Limitations, and ConstraintsPersonal hygiene water

- Temperature range
 - Ambient: 65° to 75° F (18° to 24° C)
- Rate of supply: No more than 130 lb/hr (59 kg/hr)
- Pressure: 17 psig (12 N/cm²)

Personal hygiene hose/valve

- Length of hose: 12 ft (365.76 cm)
- Type of valve: squeeze handle, springloaded closed, locks open

PHK

- Size: 3.25 x 5.5 x 9.75 in. (8.26 x 13.97 x 24.77 cm)
- Weight: 4 lb (1.8 kg) (max.)
- Construction (container): Nomex
- Contents
 - Bar Soap
 - Soap holder
 - Size: 1.44 x 2.31 x 3.72 in. (3.66 x 5.87 x 9.45 cm)
 - Construction: flexible plastic
 - Type: Ivory
 - Liquid Soap
 - Soap dispenser
 - Size: 4.0 x 1.5625 in (10.16 x 3.97 cm)
 - Construction: flexible plastic
 - Type: nonfoaming soap
 - Quantity: 2 oz bottle
 - Shaving cream
 - Type: Gillette or Palmolive
 - Stick deodorant
 - Type: Ban, Dial, Mitchum, Mennen Speed Stick
 - Styptic pencil
 - Skin emollient
 - Type: Keri Dri or Nivea
 - Nail clippers
 - Hair comb or brush
 - Razor and blades
 - Type: Gillette or Schick (twin blade)

- Norelco or Remington (electric razor with batteries)
- Dental floss
 - Type: POH (nylon, unwaxed)
 - Length: 100 yd (91 m)
- Toothbrush
 - Type: Oral B
- Toothpaste
 - Type: Crest
- Disposable toothbrushes with toothpaste
 - Type: Cutee
 - Quantity: Crew optional
- Antichap lipstick
 - Type: Chap Stick
- Disposable gloves
 - Material: Polyethylene

Female preference items

- Roll Out Makeup Assembly
 - Blush
 - Type: Revlon, Young blush, rose blush
 - Eyeliner
 - Type: Revlon, Fabuliner
 - Eye shadow
 - Type: Revlon, Professional Eye Coloring Stick Skyblue frost
 - Lip gloss
 - Type: Revlon, Colorless Lipsheen
 - Mascara
 - Type: Aziza, extra length mascara with sealer

- Eye Makeup remover
 - Type: Revlon, 30 second eye makeup remover
- Miscellaneous Hair Restraint Pouch Assembly
 - Pony tail holders (4)
 - Head bands (2 - blue)
- Female Preference Kit
 - Tampons
 - Type: Playtex Super
 - Quantity: 20
 - Scissors with Velcro patch
 - Maxipads
 - Type: Maxithins
 - Quantity: Optional, up to 12 per bag
 - Pantyliners
 - Type: Maxithins
 - Quantity: Optional, up to 20 per bag

Towels and washcloths

- Size
 - Towels: 15 x 26.5 in. (38.1 x 67.3 cm)
 - Washcloths: 12 x 12 in. (30.5 x 30.5 cm)
- Weight
 - Towels: ~0.4 lb (~0.18 kg)
 - Washcloths: ~0.1 lb (~0.045 kg)
- Material: white cotton
- Quantity
 - Towels: 1 per crewmember per day (exact quantities are crew optional)
 - Washcloths: 2 per crewmember per day (quantities are crew optional)
 - Tissues/dispenser: 28 (min.), 30 (max.)

Wet wash dispenser

- Size: 6.5 x 6.2 in. (16.51 x 15.75 cm)
- Quantity flown
 - Dispensers/flight: 1 per crewmember per 7 days (quantities are crew optional)
 - Washcloths

Toilet tissue

- Size: 5 x 8.5 in. (12.7 x 21.6 cm)
- Material: low-linting paper tissue
- Quantity: 400 sheets stowed in 2 dispensers in the port wall of the WMC

Wet wash

- Size: 6.5 x 6.2 in. (16.5 x 15.75 cm)
- Material: low-linting wet paper tissue
- Quantity: 360 sheets stowed in 2 dispensers in the port wall of the WMC

Dry wipes

- Size: 16.5 x 7.5 in. (41.5 x 19 cm)
- Material: absorbent paper towel
- Quantity: 360 stowed in 2 dispensers in the port wall of the WMC

Wet wipes

- Size: 7.85 x 5.5 in. (20 x 14 cm)
- Material: low-linting wet paper tissue
- Quantity
 - 264 packets in volume G
 - 230 packages in galley
 - 6 dispensers of 42 packets in middeck locker with food when galley is not flown

Emesis bags

- Size
 - 3 x 4 in. (7.6 x 10.2 cm) folded
 - 8.5 x 11 in. (21.6 x 27.9 cm) unfolded
- Material: Gore-Tex with cotton cloth flaps
- Quantity: 20 in middeck locker with personal hygiene equipment

3.16 FOOD PREPARATION AND DINING

3.16.1 Introduction

The Orbiter is equipped with food preparation and dining facilities to provide each crewmember with three meals per day plus snacks, two meals on launch day, two meals on reentry day, and an additional 48 hr of contingency food. The food supply and food preparation facilities are designed to accommodate variations in the number of crewmembers and flight durations.

The food preparation system consists of the following (fig. 3.16-1):

- Food (menu and pantry/contingency)
- Food system accessories
- Galley
- Water dispenser (if no galley)
- Food warmer (if no galley)
- Food trays

The food consists of individually packaged portions of fresh, dehydrated, thermostabilized, irradiated, intermediate moisture, and natural form foods, and beverages, providing an average energy intake of approximately 2700 cal per crewmember of menu food in the daily meals and 2100 cal per day of contingency and snack food items.

The food system accessories consist of the following:

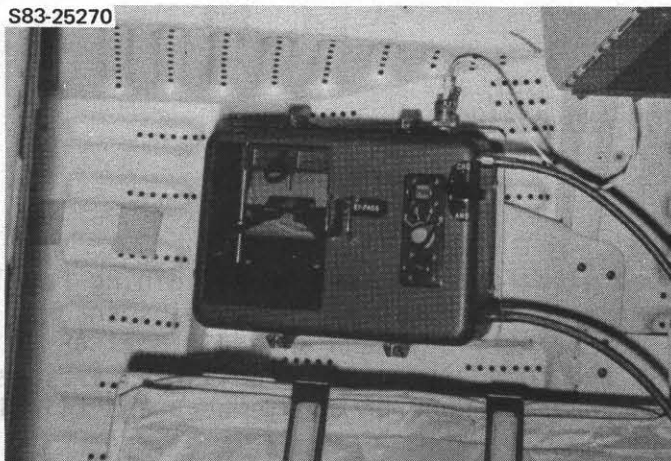
- Condiments (salt, pepper, sauces, etc.)
- Gum/candy
- Vitamins
- Wet wipes
- Dry wipes (sec. 3.22)
- Utensils
- Drinking containers

The galley is the standard means of meal preparation. The galley includes food preparation and heating facilities as well as stowage for meal accessories and food trays. It also has temporary stowage areas for menu food and drinking straws.

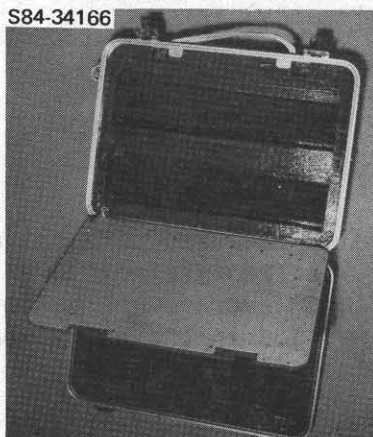
The water dispenser provides the crew with a source of ambient and chilled water for drinking and food reconstitution when the galley is not flown. A source of ambient water for personal hygiene is also provided and is discussed in section 3.15, Personal Hygiene Station.

The food warmer is a portable electrically powered device that can simultaneously warm meals for four crewmembers.

The food trays provide each crewmember with a dining surface with restraints for food items and associated dining accessories.



WATER DISPENSER (if no galley)



FOOD WARMER (if no galley)



FOOD TRAY

Figure 3.16-1. Food preparation and dining provisions-
(sheet 1 of 3).



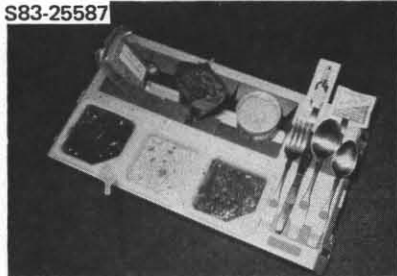
FOOD



WET AND DRY WIPES

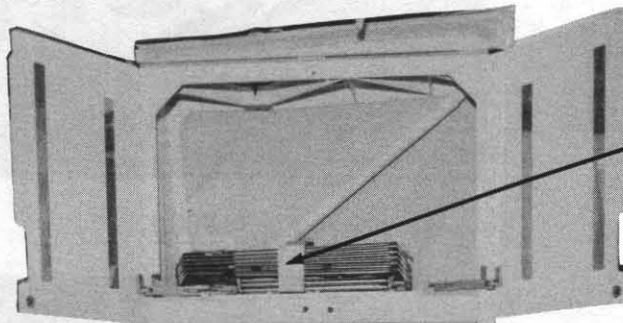


Figure 3.16-1.- Food preparation and dining provisions-
without galley (sheet 2 of 3).



FOOD TRAY WITH FOOD

S85-25891



FOOD TRAY STORAGE



OVEN

WET WIPES

CONDIMENTS

S82-26422



REHYDRATION STATION

Figure 3.16-1.- Food preparation and dining provisions- with galley (sheet 3 of 3).

3.16.2 Stowage and Interfaces

Food preparation and dining systems interfaces are identified in figure 3.16-2.

3.16.2.1 Food

All food is stowed in forward middeck lockers for launch and entry. Unused food items remain there throughout the flight.

3.16.2.2 Food System Accessories

With Galley

Food system accessories are stowed in the galley or in forward middeck lockers.

Without Galley

Food system accessories are stowed in forward middeck lockers.

3.16.2.3 Food Trays

With Galley

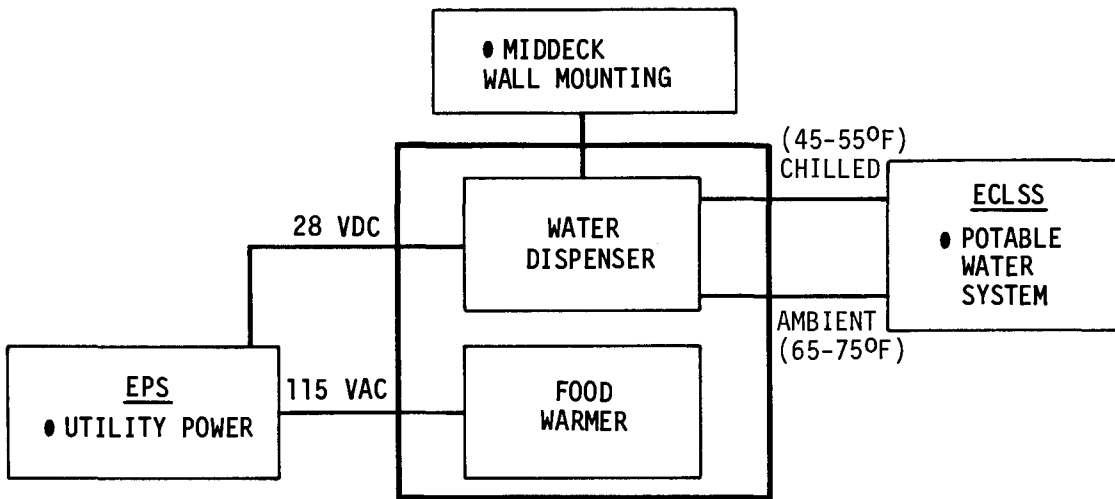
When not in use, the food trays (fig. 3.16-3) are stowed in the upper compartment of the galley. During use, the trays can be restrained to the galley doors, middeck locker doors, or to the crewmember's leg by the Velcro straps on the food tray.

Without Galley

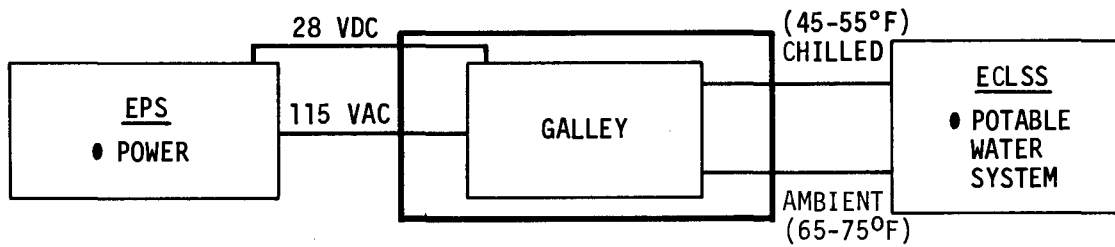
The food trays are stowed in a forward middeck locker for launch and entry. On orbit, the food trays (fig. 3.16-3) may be attached to a locker door with Velcro, or to a crewmember's leg by the Velcro straps on the bottom of tray.

3.16.2.4 Galley

The galley is connected to the Orbiter electrical power system and the ambient and chilled potable water system. The galley is mounted on the middeck floor and wall or the port side of the vehicle forward of the side hatch.

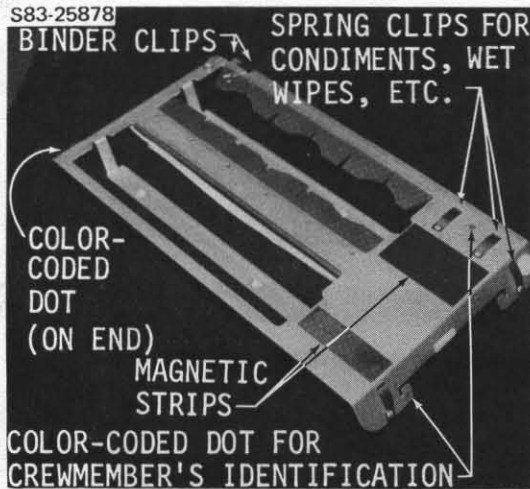


Without Galley

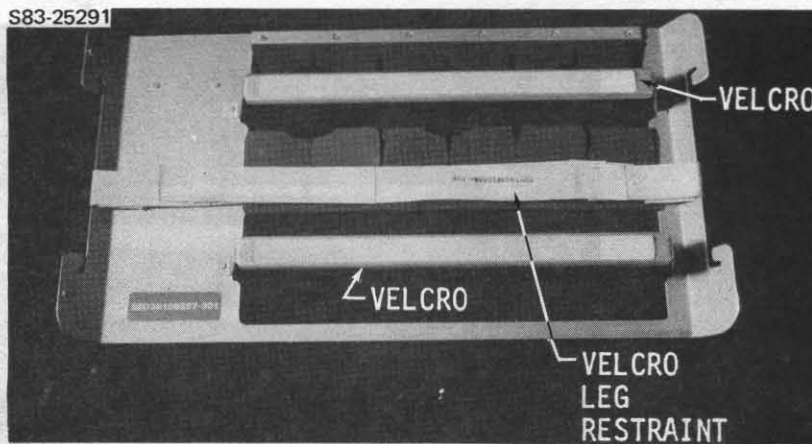


With Galley

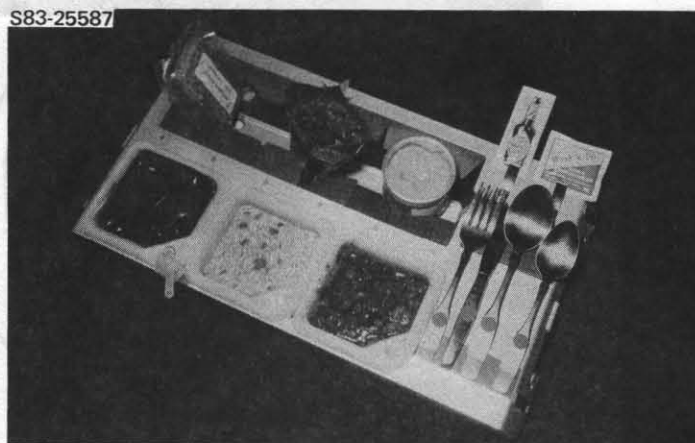
Figure 3.16-2.- Food preparation and dining interfaces.



FOOD TRAY (TOP)

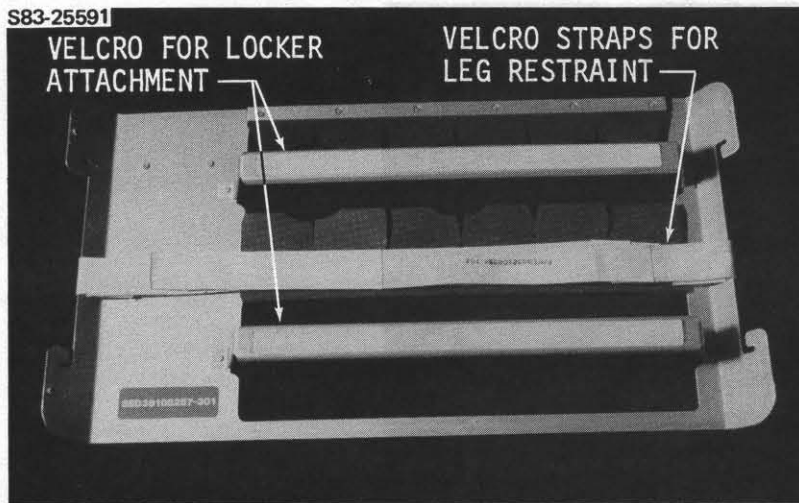


FOOD TRAY (BOTTOM)



FOOD TRAY WITH FOOD

Figure 3.16-3.- Food tray configuration (sheet 1 of 3).



FOOD TRAY (BOTTOM)

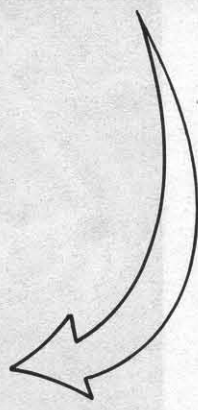
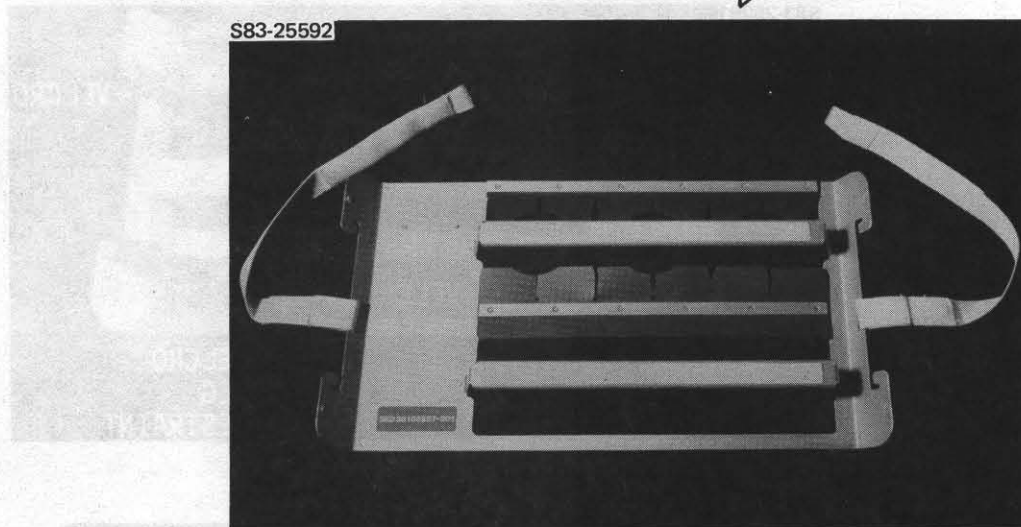
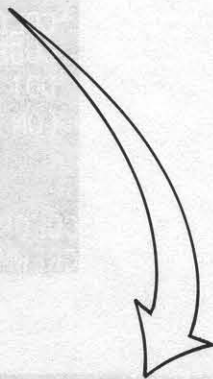
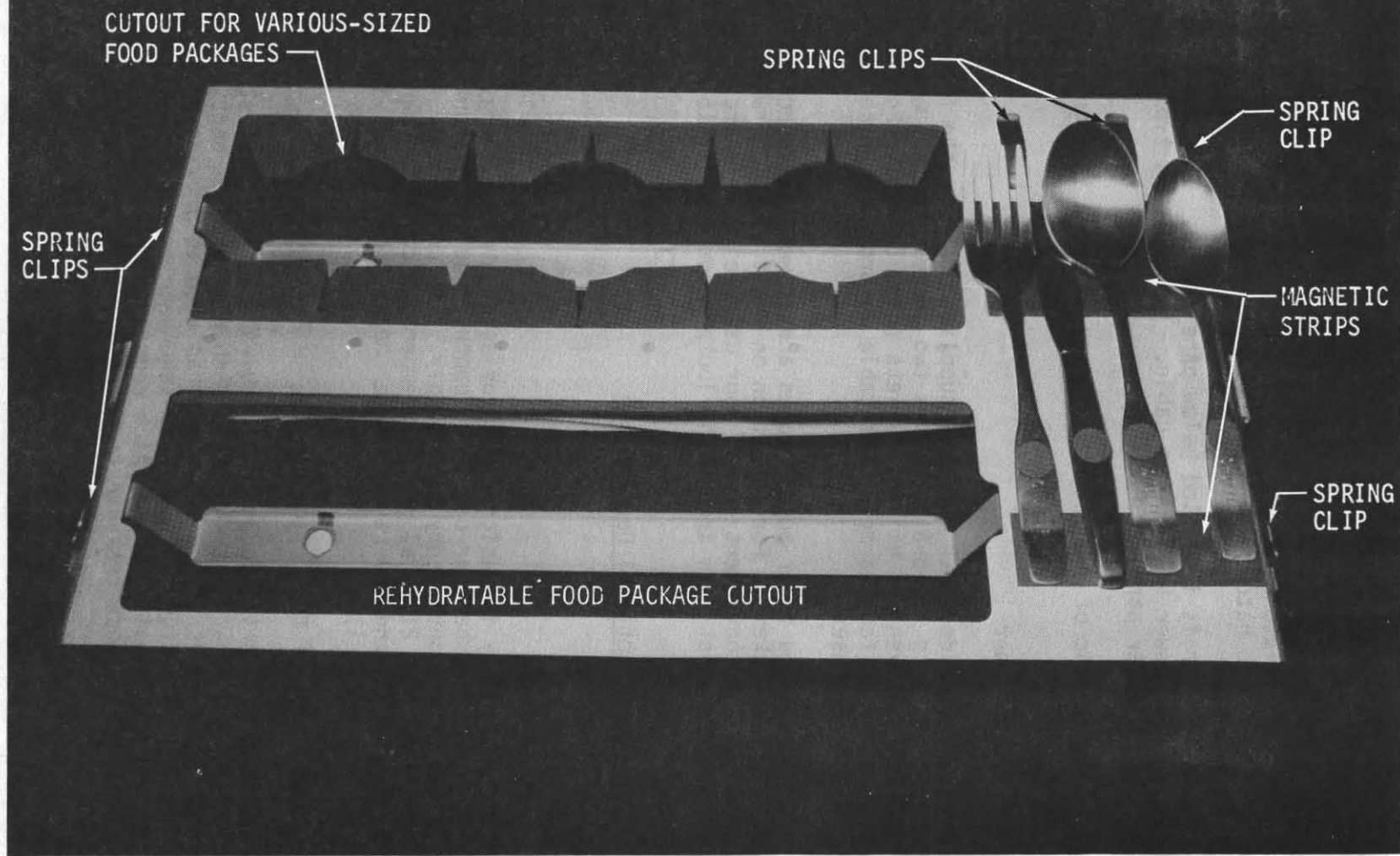


Figure 3.16-3.- Food tray configuration (sheet 2 of 3).



379

3.16-9

033

Figure 3.16-3.- Food tray configuration (sheet 3 of 3).

3.16.2.5 Water Dispenser

This unit is connected to the Orbiter ambient and chilled potable water system via quick disconnects (QD's) located on the Orbiter middeck floor forward of the side hatch.

The water dispenser is installed below panel M686B. The water dispenser requires 28-V dc power via a power cable. The cable is typically attached to the utility power panel M030F.

A plumbing schematic of the water dispenser is shown in figure 3.16-4.

3.16.2.6 Food Warmer

A power cable provided with the unit supplies power to the food warmer. The food warmer (fig. 3.16-5) requires two phases (phase A and C) of the ac power provided by vehicle utility outlets (fig. 3.16-6). For those missions using two food warmers, a Y cable is provided which shares loads among all three phases.

The food warmers and their power cables are stowed for launch and entry in forward middeck lockers. For operation on orbit, the food warmers can be restrained on any convenient locker door using either Velcro or a strap restraint system that fits around the locker door (fig. 3.16-7).

3.16.3 Systems Functional Description

3.16.3.1 Food

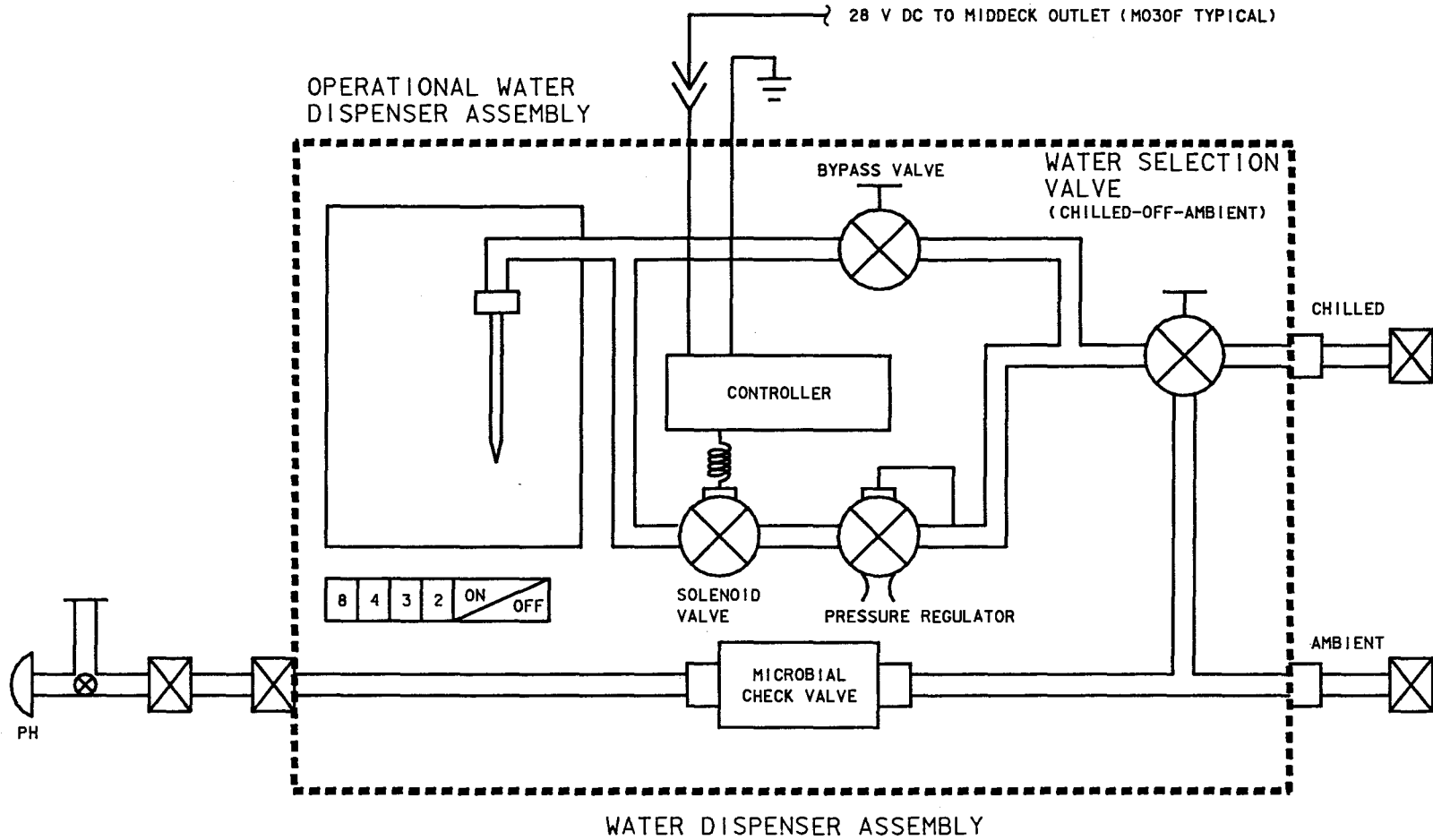
The menu food supply is designed to provide an average energy intake of 2700 cal per crewmember per day. The pantry food supply contains snack items and a 2-day contingency food supply. The contingency food supply is designed to provide 2100 cal per crewmember per day. The pantry food can be used for snacks and beverages between meals and for individual menu changes (table 3.16-1).

The food consists of the following:

- Rehydratables - dried foods that require water for reconstitution
- Thermostabilized - foods that have been preserved by heat processing
- Irradiated - foods that have been irradiated to provide preservation
- Intermediate moisture - foods that have been preserved by restricting the available moisture and which require no reconstitution
- Ready to eat - foods that are to be eaten without reconstitution
- Beverages - powders that require water for reconstitution
- Fresh - unprocessed foods, such as bread and fruits

381

3.16-11



127703163.V12, 1

Figure 3.16-4.- Water dispenser schematic.

JSC-12770

S-79-31543

382

3.16-12



FOOD WARMER (CLOSED)

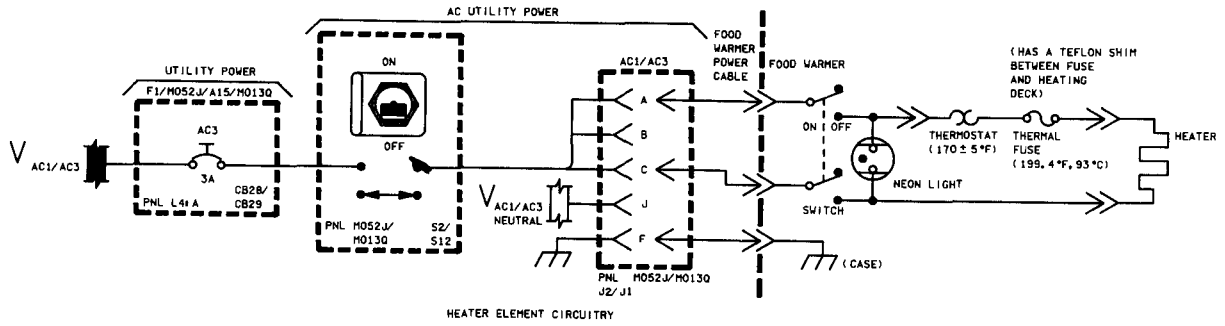
Figure 3.16-5.- Food warmer configuration - without galley (sheet 1 of 2).

DTICSL-121

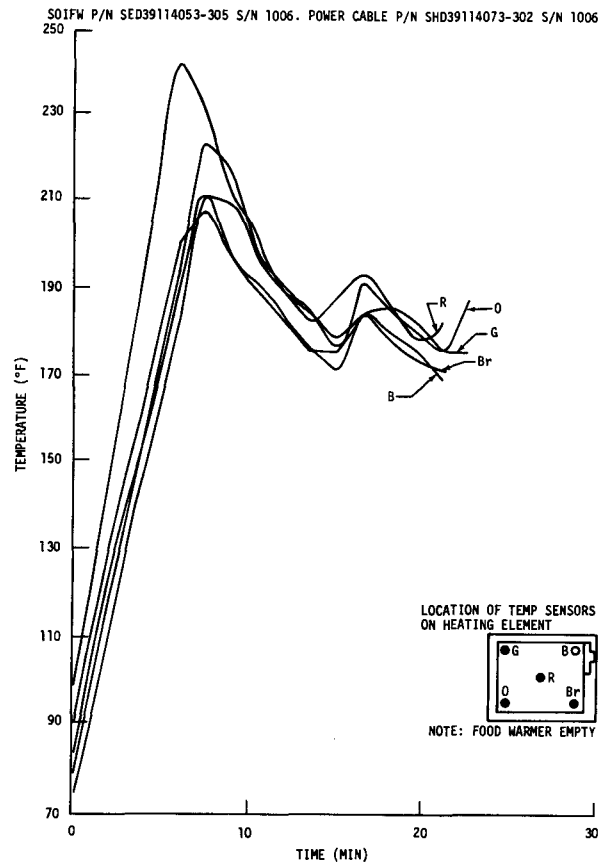
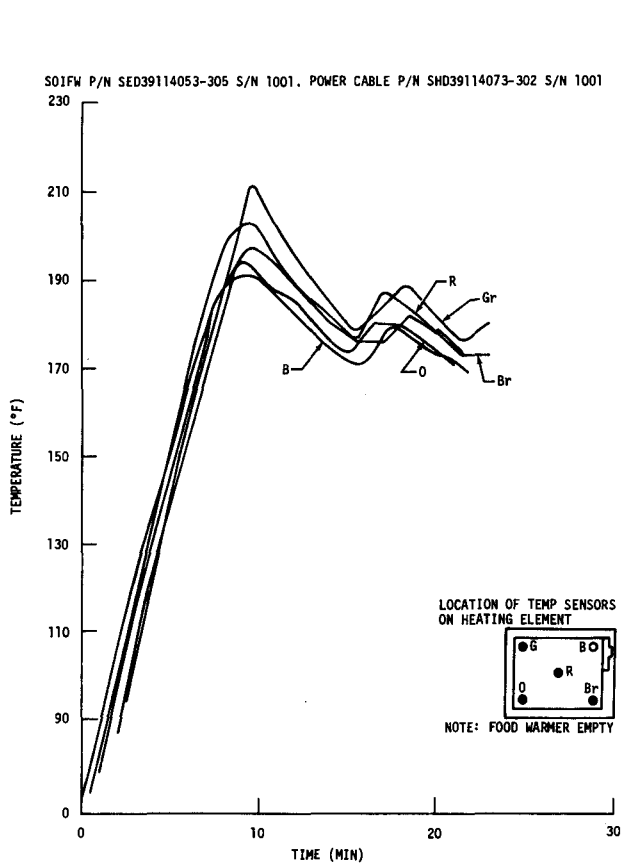
JSC-12770



Figure 3.16-5.- Food warmer configuration-
without galley (sheet 2 of 2).



127703166, V12.2



FOOD WARMER P/N SED39114053-305 S/N 1001

FOOD WARMER SED39114053-305 S/N 1006

TYPICAL HEATER ELEMENT TEMPERATURE PROFILE

Figure 3.16-6.- Food warmer electrical schematic and temperature profiles.

S85-25884



Figure 3.16-7.- Food warmer installation.

TABLE 3.16-1.- FOOD AND BEVERAGE LIST^a

| Foods | |
|--|--------------------------------------|
| Applesauce (T) | Corn, green beans and pasta (R) |
| Apricots, dried (IM) | Crackers, graham (NF) |
| Asparagus (R) | Crackers, soda (NF) |
| Beef almondine (R) | Eggs, scrambled (R) |
| Beef, barbecue w/sauce (R) | Eggs, seasoned scrambled (R) |
| Beef, dried (TM) | Eggs, Mexican scrambled (R) |
| Beef and gravy (T) | Food bar, granola (NF) |
| Beef, ground w/spice sauce (T) | Food bar, peanut butter/granola (NF) |
| Beef pattie (R) | Frankfurters (T) |
| Beef, slices w/BBQ sauce (T) | Fruit bars in suit (for EVA) (IM) |
| Beef steak (T) | Fruitcake (NF) |
| Beef stroganoff w/noodles (R) | Fruit cocktail (T) |
| Bread (NF) | Green beans and broccoli (R) |
| Breakfast roll (NF) | Green beans, french w/mushrooms (R) |
| Broccoli au gratin (R) | Ham (T) |
| Brownies (NF) | Ham salad sandwich spread (T) |
| Candy, Lifesavers, assorted flavors (NF) | Italian vegetables (R) |
| Candy coated chocolates (NF) | Jam/jelly (IM) |
| Candy coated peanuts (NF) | Macaroni and cheese (R) |
| Carrot sticks (F) | Meatballs w/BBQ sauce (T) |
| Cauliflower w/cheese (R) | Nuts, almonds (NF) |
| Cereal, bran flakes (R) | Nuts, cashews (NF) |
| Cereal, cornflakes (R) | Nuts, macadamia (NF) |
| Cereal, granola (R) | Nuts, peanuts (NF) |
| Cereal, granola w/blueberries or raisins (R) | Oatmeal w/raisins & spice (R) |
| Cereal, rice krispies (R) | Peach ambrosia (R) |
| Cheese spread (T) | Peaches diced (T) |
| Chicken a la king (T) | Peaches, dried (IM) |
| Chicken consomme (R) | Peanut butter (T) |
| Chicken and noodles (R) | Pears, diced (T) |
| Chicken and rice (R) | Pears, dried (IM) |
| Chicken salad spread (T) | Pineapple (T) |
| Chili mac w/beef (R) | Potato au gratin (R) |
| Chocolate mints (NF) | Potato patties (R) |
| Cookies, butter (NF) | Pudding, butterscotch (T) |
| Cookies, chocolate covered (NF) | Pudding, chocolate (T) |
| Cookies, pecan (NF) | Pudding, lemon (T) |
| Cookies, shortbread (NF) | Pudding, vanilla (T) |
| | Rice pilaf (R) |

^aAbbreviations in parentheses indicate type of food: T = thermostabilized, IM = intermediate moisture, F = fresh food, crew preference carry-on, R = rehydratable, I = irradiated, and NF = natural food.

TABLE 3.16-1.- Continued^a

| Foods | |
|-----------------------------|-------------------------------|
| Salmon (T) | Teriyaki chicken (R) |
| Sausage pattie (R) | Trail mix (NF) |
| Shrimp cocktail (R) | Tuna (T) |
| Shrimp Creole (R) | Tuna salad spread (T) |
| Soup, cream of mushroom (R) | Turkey and gravy (T) |
| Spaghetti w/meat sauce (R) | Turkey salad spread (T) |
| Spinach, creamed (R) | Turkey tetrazzini (R) |
| Strawberries (R) | Vegetables, mixed Italian (R) |

^aAbbreviations in parentheses indicate type of food: T = thermostabilized, IM = intermediate moisture, F = fresh food, crew preference carry-on, R = rehydratable, I = irradiated, and NF = natural food.

| Beverages | |
|---|---------------------------------------|
| Apple drink | Lemon-lime drink |
| Cherry drink w/artificial sweetener | Orange drink |
| Citrus drink | Orange drink w/artificial sweetener |
| Cocoa | Orange-grapefruit drink |
| Coffee w/artificial sweetener | Orange juice mix |
| Coffee, black | Orange-mango drink |
| Coffee w/cream | Orange-pineapple drink |
| Coffee w/cream and artificial sweetener | Peach drink |
| Coffee w/cream and sugar | Pineapple drink |
| Coffee w/sugar | Strawberry drink |
| Grape drink | Tea |
| Grape drink w/artificial sweetener | Tea w/artificial sweetener |
| Grapefruit drink | Tea w/cream |
| Instant breakfast, chocolate | Tea w/lemon |
| Instant breakfast, strawberry | Tea w/lemon and artificial sweetener |
| Instant breakfast, vanilla | Tea w/lemon and sugar |
| Lemonade | Tea w/sugar |
| Lemonade w/artificial sweetener | Tropical punch |
| | Tropical punch w/artificial sweetener |

TABLE 3.16-1.- Concluded

| Condiments |
|------------------|
| Catsup |
| Mustard |
| Pepper |
| Salt |
| Hot pepper sauce |
| Mayonnaise |
| Taco Sauce |

The daily menu for a typical crewmember consists of approximately 20 packages as follows

- Four to seven rehydratable foods
- One to four thermostabilized/irradiated foods
- Eight beverages
- Four ready-to-eat foods
- Three hot items per crewmember per meal (maximum)

Food Packaging.— Nonrehydratable foods are packaged in cans and flexible pouches (fig. 3.16-8). Cans are provided with easy-open pull-out lids. The pouches are cut open with scissors. Foods can be eaten directly from the packages. Each package is clearly marked with its contents. All food packages have a Velcro patch for on-orbit restraint.

Rehydratable foods are packaged in containers that must be rehydrated using the galley rehydration station or the water dispenser. Plastic straws with on/off clips are provided for beverage containers. The food cans come in three sizes: 3 in. (7.62 cm) in diameter by 1-3/8-in. (3.49 cm) high, 2-1/2 in. (3.81 cm) in diameter by 2-3/16 in. (5.56 cm) high, and 2-5/8 in. (6.67 cm) in diameter by 1-9/16 in. (3.97 cm) high. All of the cans (except the 3-in. diameter size) have an easy-open pullout lid. The 3-in. diameter can containing salmon requires the use of the can opener to open the lid. The contents of the different sizes of cans are

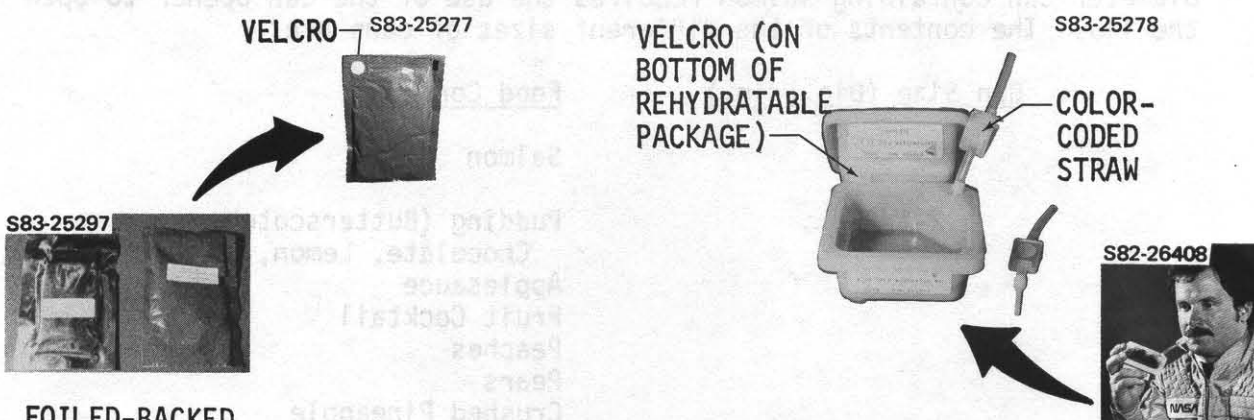
| <u>Can Size (Dia., in.)</u> | <u>Food Content</u> |
|-----------------------------|--|
| 3 | Salmon |
| 2-1/2 | Pudding (Butterscotch, Chocolate, Lemon, or Vanilla) Applesauce Fruit Cocktail Peaches Pears Crushed Pineapple |
| 2-5/8 | Tuna |



FOOD IN CANS

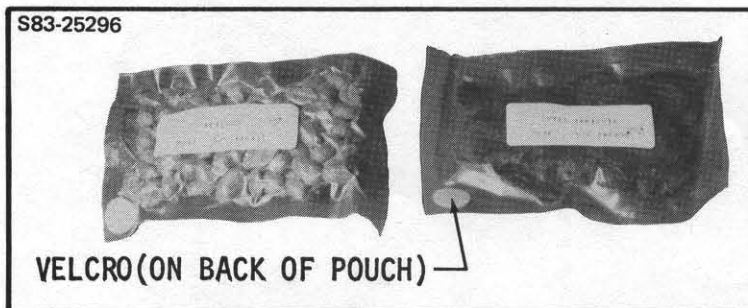


RIGID CONTAINER (REHYDRATABLE)



FOILED-BACKED PLASTIC BAGS

DRINKING CONTAINER



INDIVIDUAL SERVINGS IN PLASTIC POUCHES

Figure 3.16-8.- Food packaging.

3.16.3.2 Food System Accessories

Food system accessories include a number of items that are used during food preparation or during dining (fig. 3.16-9). These include the following items:

- Condiments, including hot pepper sauce, taco sauce, salt, pepper, cat-sup, mayonnaise, and mustard. Condiments are packaged in individual plastic packets. For galley flights, condiment dispensers are provided on the galley.
- Candy and gum, for snacks.
- Vitamins, to supplement dietary requirements.
- Wet wipes, for cleaning utensils after dining. The wipes are packaged 21 per dispenser. Additional wet wipes are stored on the galley wet wipe dispenser.
- Dry wipes, for dining and postdining cleanup. The dry wipes are the same as those used for housekeeping.
- Color-coded utensils, including a knife, two spoons (soup spoon and teaspoon), a fork, and a can opener are provided for each crewmember. The utensils are stowed in a reusable plastic bag (fig. 3.16-10). The utensils are magnetized to adhere to the magnetic strips on the food trays.
- Drinking containers, for storing and drinking water. Normally one full plastic drinking container will be launched on each crewmember. These containers can be refilled from the water dispenser for later consumption. In addition, extra empty water containers with color-coded straws (one per man day) are provided.

3.16.3.3 Food Trays

The food tray (fig. 3.16-3) is a clear anodized aluminum sheet with two cutouts, one designed to hold up to three rehydratable food packages and the other provided with rubber strips to adapt various-sized food packages and cans. The tray has a number of spring clips and two 3/4 in. wide binder clips to retain condiment packets, wipes, etc. Two magnetic strips hold the stainless steel eating utensils (fig. 3.16-10). The bottom of the tray has Velcro strips that are used to hold the trays against the galley/locker door during meal preparation and to hold the trays in place for storage by stacking the trays on top of each other (fig. 3.16-1). In addition, two Velcro straps on the bottom of the tray provide the capability of restraining the food tray to the crewmember's leg for dining purposes (fig. 3.16-3). Finally, the trays are color-coded with color dots for each crewmember.

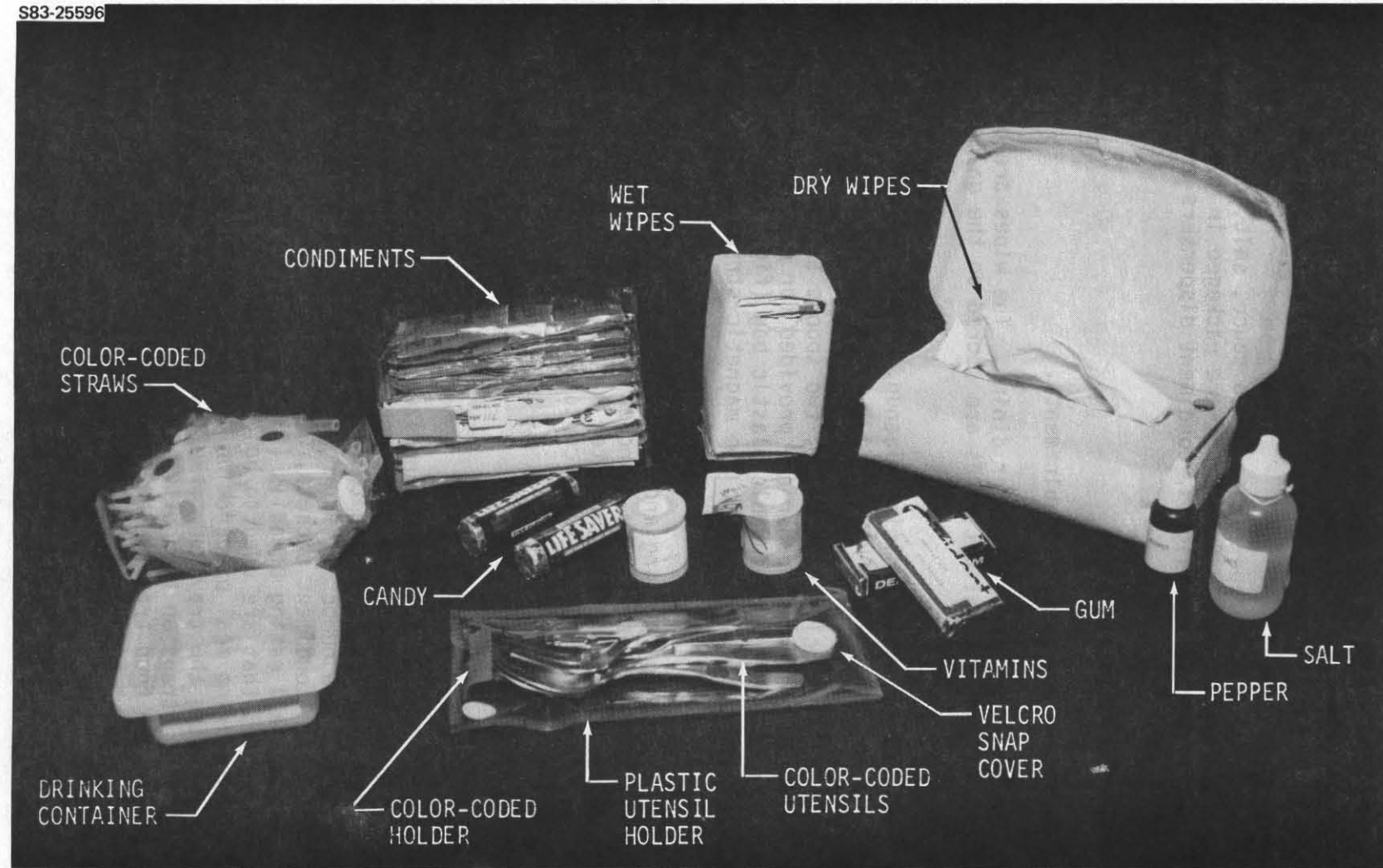


Figure 3.16-9.- Food system accessories.

S83-25595

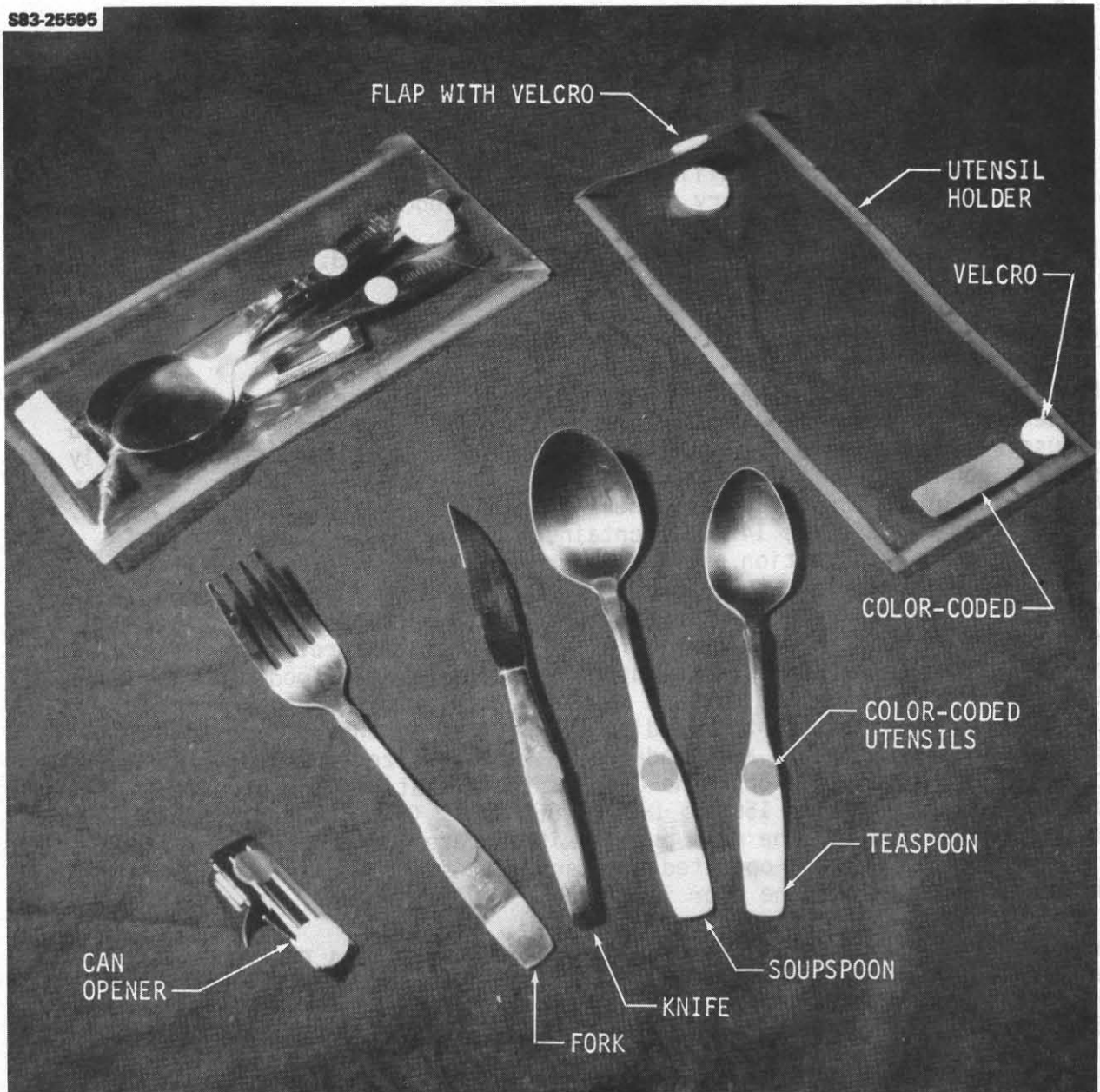


Figure 3.16-10.- Utensil holder and utensils.

The rehydrator station (fig. 3.16-10) is used to rehydrate measured amounts of hot or cold water at 50 ± 5°C or 100 ± 5°F (10 or 10°C) into the rehydrable food container. The mechanism used by the crewmember is the rehydrator and the cup-rehydrator. The needle is a small diameter stainless steel tube used to penetrate the rubber septum of the rehydrable food container and to discharge the water from the system. The cup rehydrator is basically a drawer with a cutter that automatically rehydrates the food container with the needle. The rehydrator is attached to the

3.16.3.4 Galley

The galley provides a centralized location for one individual to handle all food preparation activities for a meal. Food system accessories and food trays are stowed in this unit.

The galley also provides facilities for heating food, dispensing water, personal hygiene and temporary stowage of menu food items (fig. 3.16-11).

The galley consists of the following components (figs. 3.16-12 and 3.16-13):

Oven

The oven is contained within the upper midsection of the galley and is divided into two principal compartments. The lower compartment is designed for use with rehydrated food packages and an upper compartment is primarily used for pouches. In the lower compartment, the containers are retained by seven pairs of tracks. Two containers fit in each pair of tracks so that the maximum capacity is 14 food containers. Heating is accomplished mainly by forced convection provided by three fans that circulate the air over a finned heat sink at the top of the oven and down over the food packages. A perforated plate separates the food packages from the air inlet. The plate acts as a debris filter and provides protection if one of the food packages breaks. In the upper compartment, the food packages are retained against the lower surface of the heat sink by a set of four spring-loaded plates. Spring loading is required to ensure good contact with the heat sink and to accommodate the various-sized packages. Heating occurs mainly by conduction. The oven is thermostatically controlled to operate at approximately 150° to 180° F (66° to 82° C). The heaters are always powered (unless the main power switches are turned off); the fans are normally off and are operated by a separate switch only after food is placed in the oven and the door is closed.

The oven door is hinged at the top and can be stowed in a recessed compartment above the oven. The door is kept closed by a latch that is operated by squeeze action with one hand. For launch and entry, a strap with a snap is used to secure the oven door in the closed position (fig. 3.16-14).

Galley electrical system details are shown in figure 3.16-15.

Rehydration Station

The rehydration station (fig. 3.16-16) is used to inject measured amounts of hot or cold water at 50° ± 5° F or 160° ± 5° F (10° or 70° C) into the rehydratable food containers. The mechanisms used by the crewmember are the 'needle' and the cup retainer. The needle is a small diameter stainless steel tube used to penetrate the rubber septum of the rehydratable food containers and to discharge the water from the system. The cup retainer is basically a drawer with a cutout that automatically aligns the food container with the needle. The retainer is attached to the

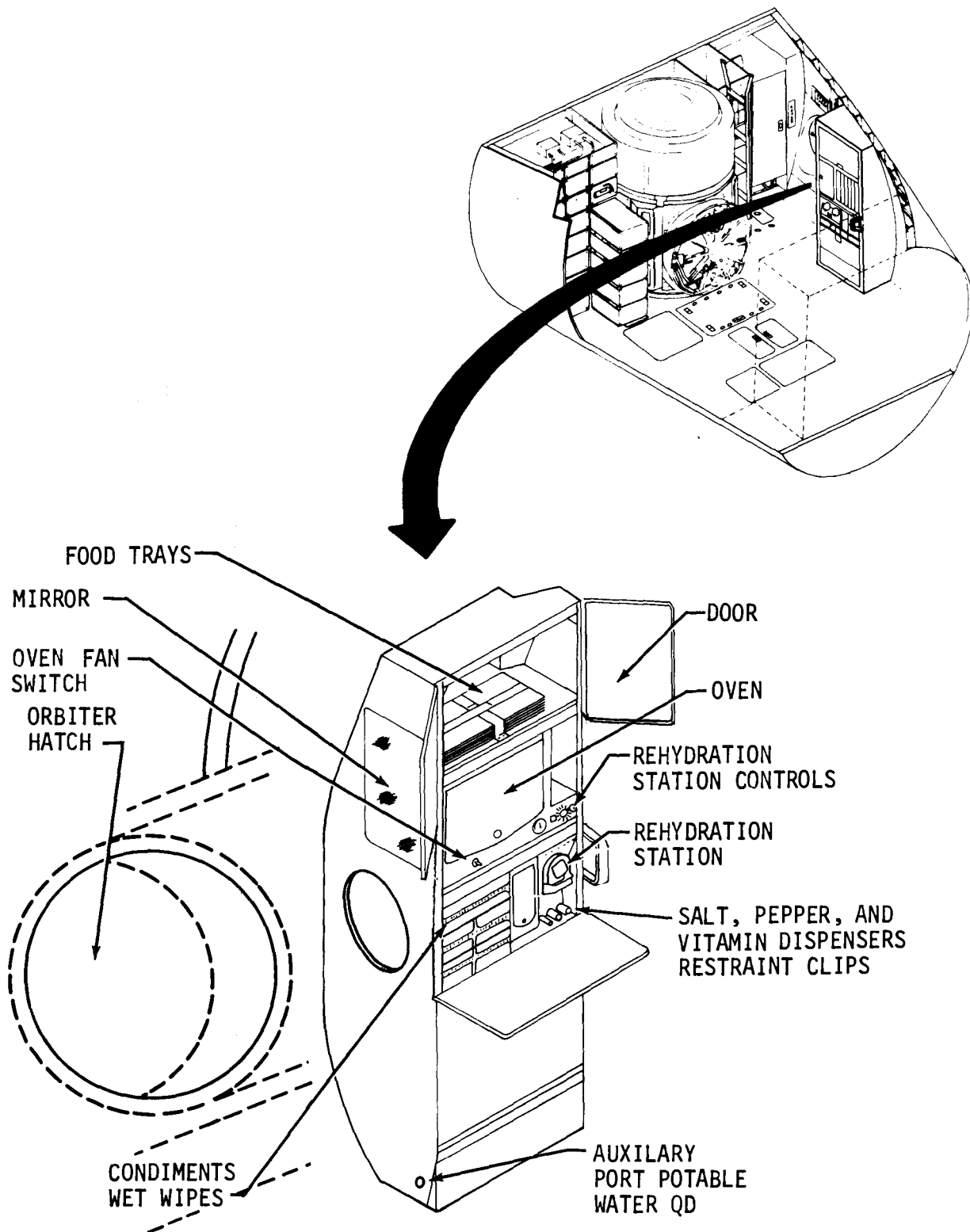


Figure 3.16-11.- Galley configuration (sheet 1 of 3)

S85-25891

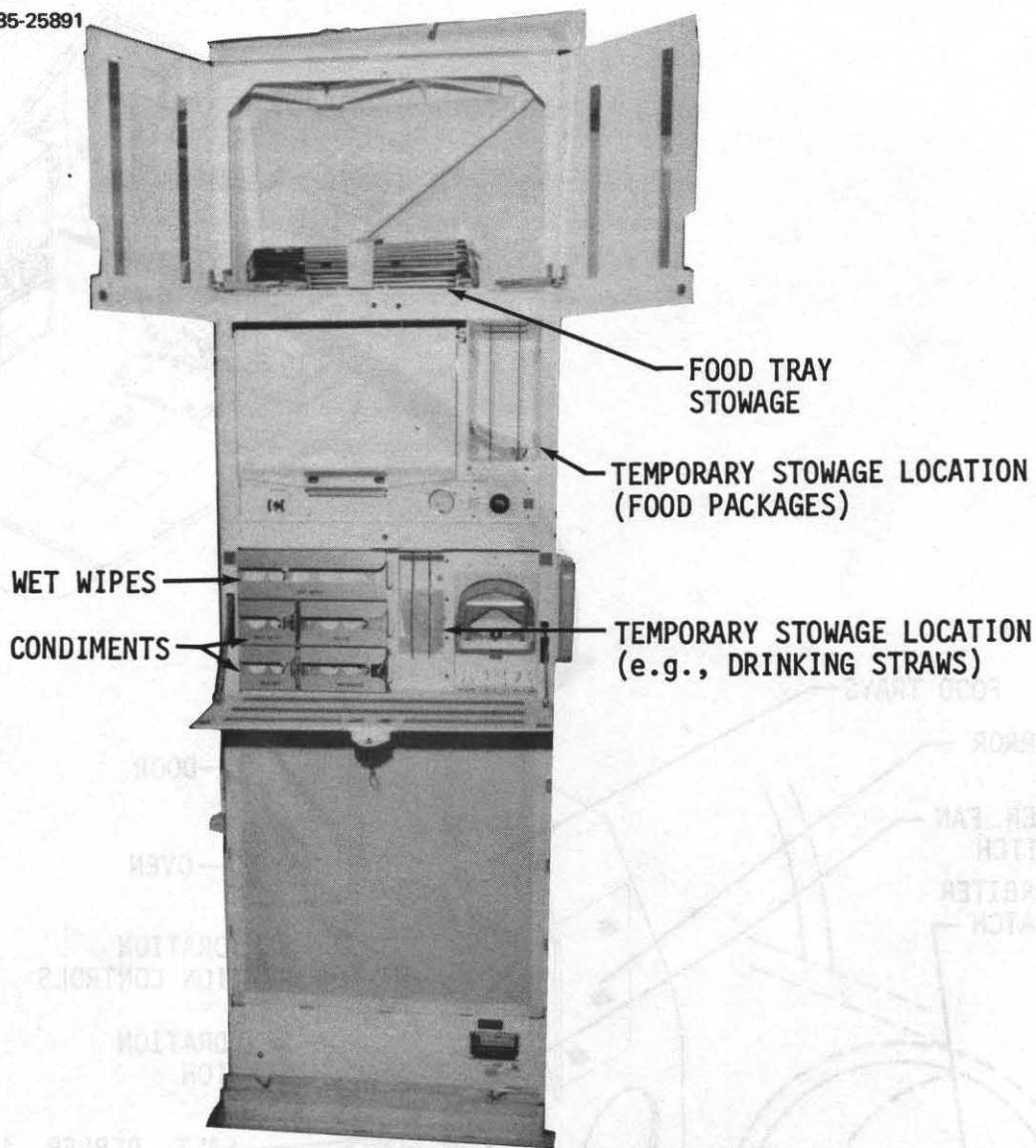


Figure 3.16-11.- Galley configuration (sheet 2 of 3).

S84-34159

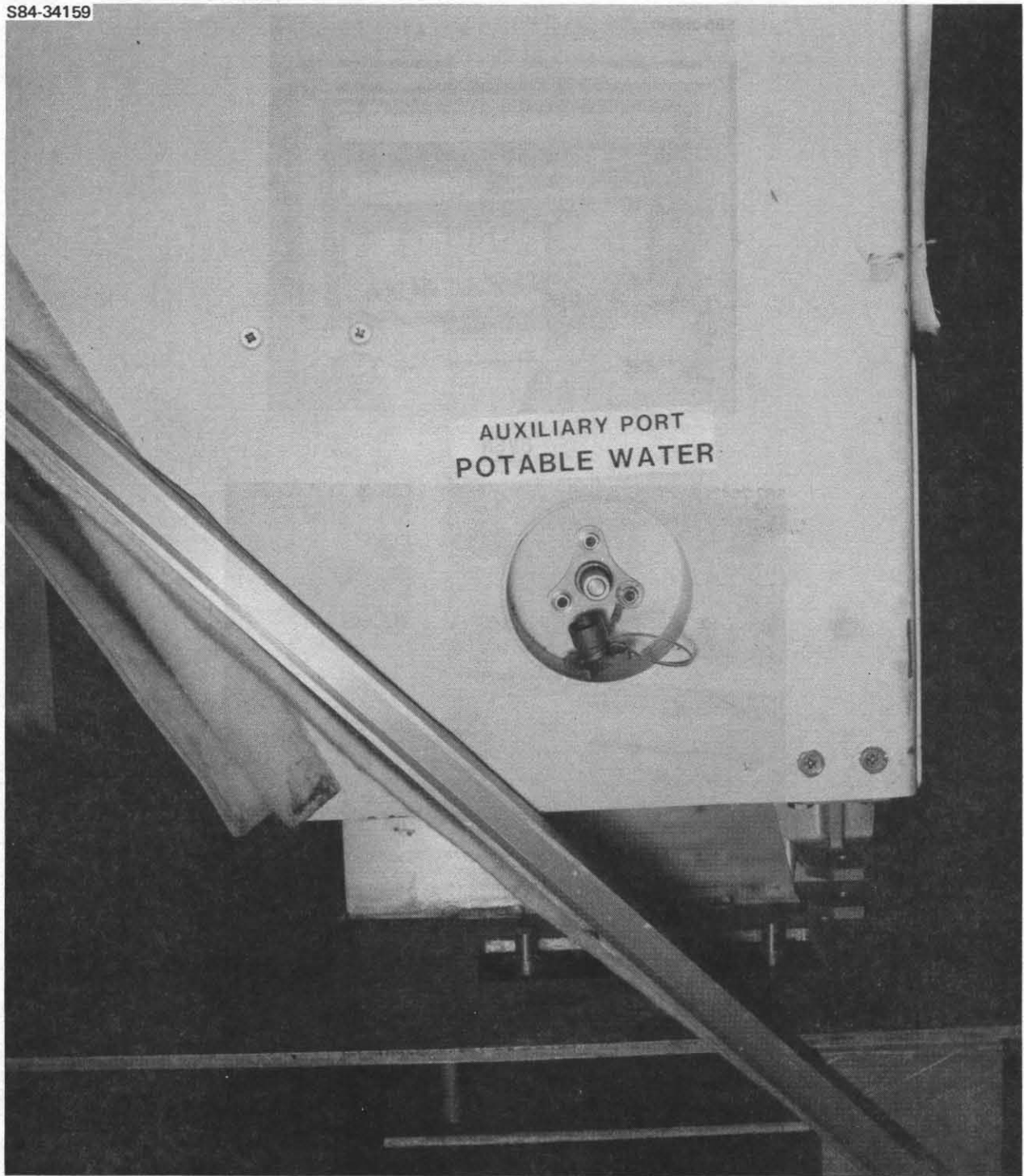
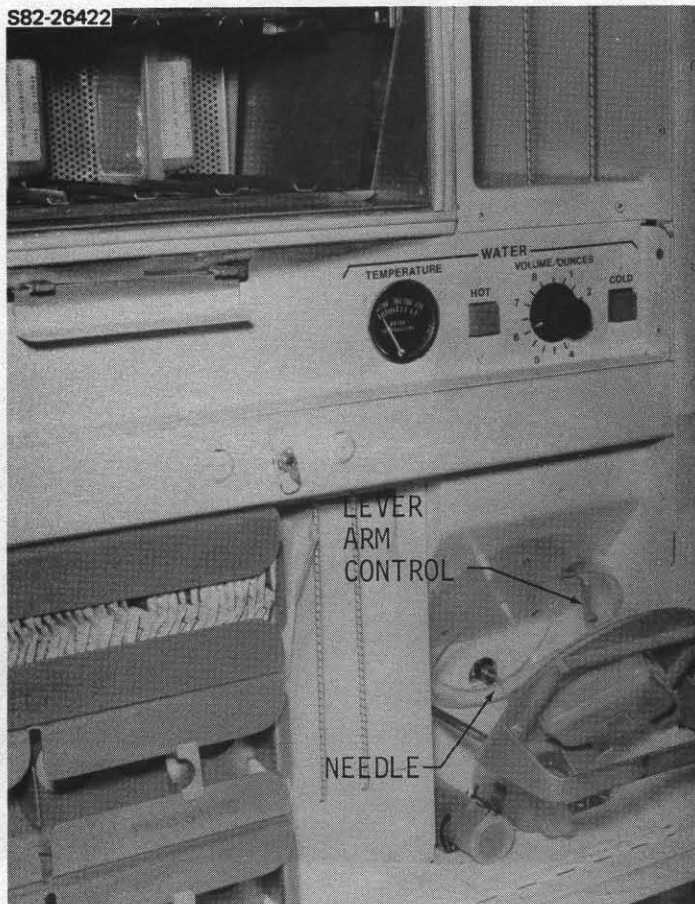


Figure 3.16-11.- Galley configuration (sheet 3 of 3).



OVEN



REHYDRATION STATION

Figure 3.16-12.- Galley D&C.

399

3.16-29

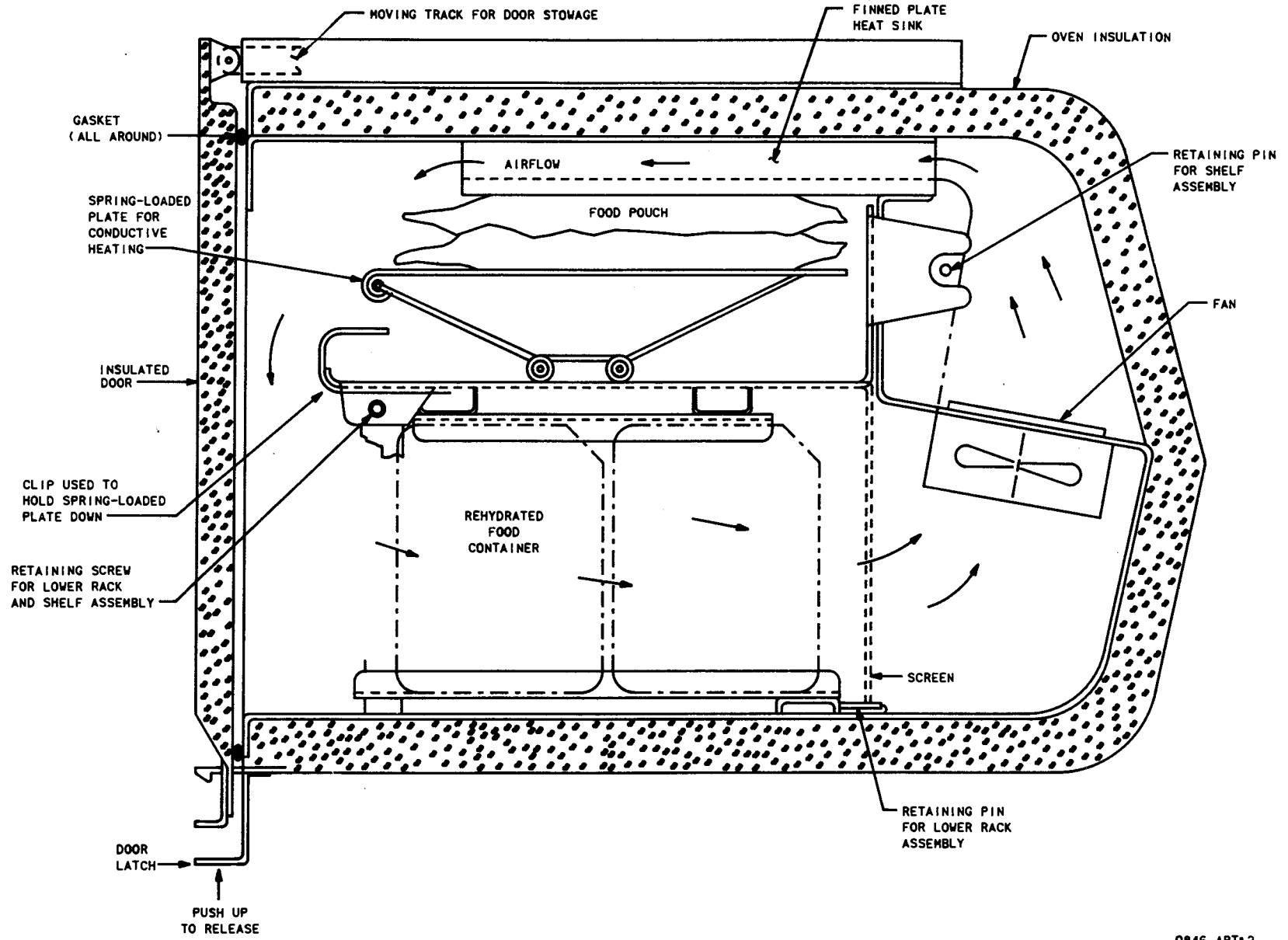
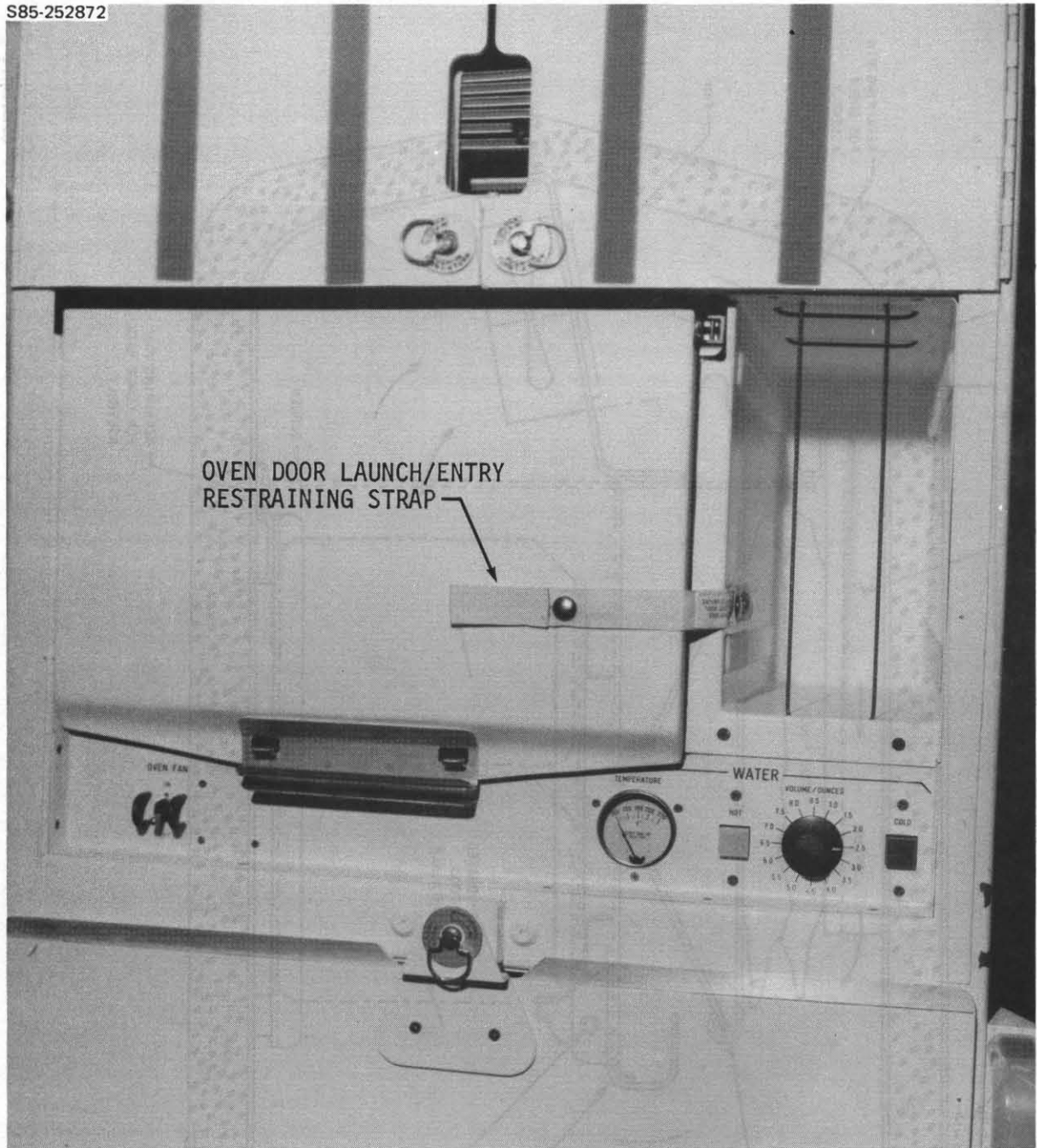


Figure 3.16-13.- Sideview of oven.

0846. ART; 2

JSC-12770

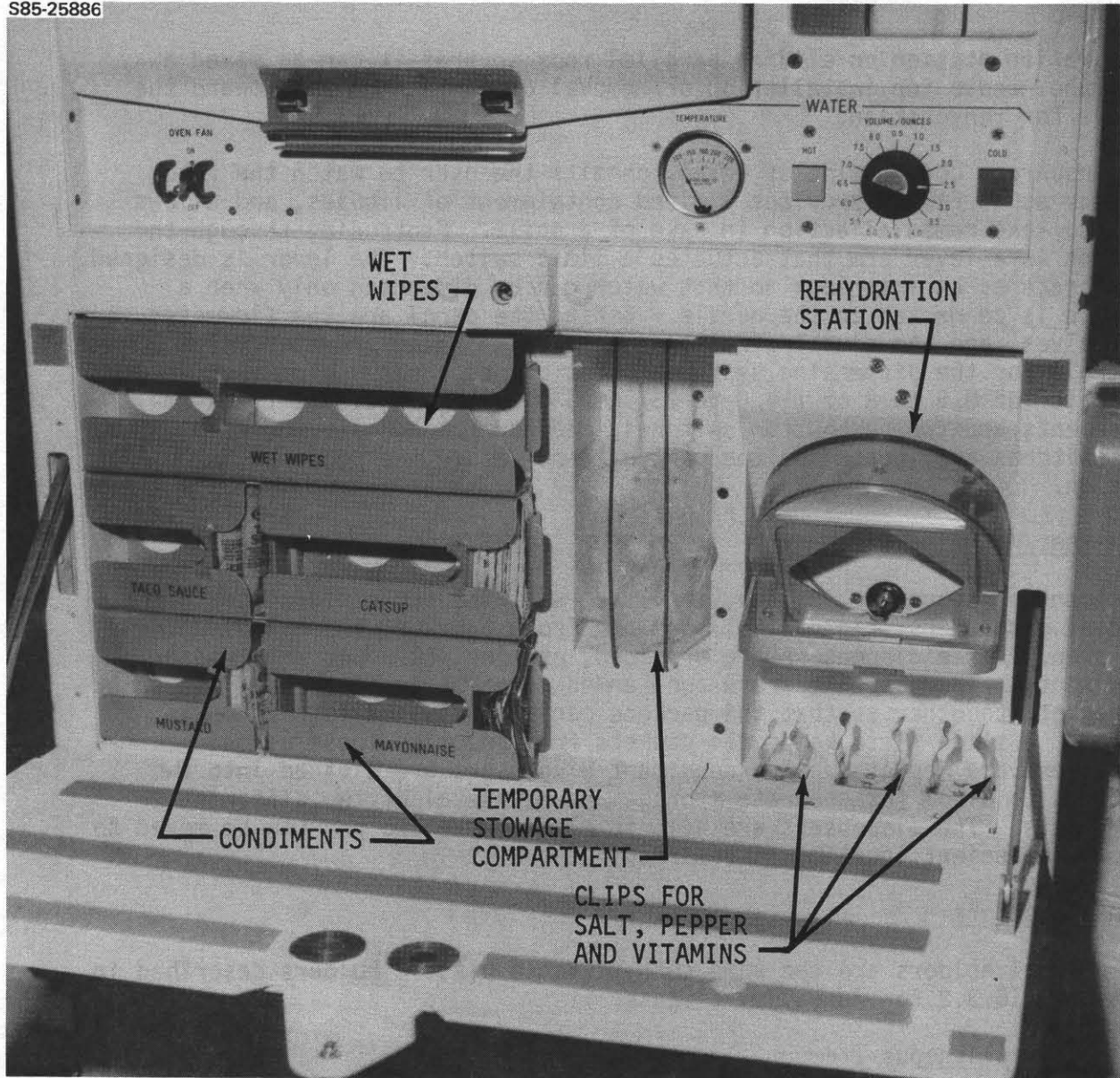
S85-252872



OVEN DOOR LAUNCH/ENTRY
 RESTRAINING STRAP

Figure 3.16-14.- Oven launch/entry strap.

S85-25886



REHYDRATION STATION

Figure 3.16-16.- Galley rehydration station.

rehydration station on sliding parallel rods so that it can be moved away from the needle for installation or removal of containers and toward the needle for rehydration.

A transparent cover, made of Lexan, permits the user to watch the food package as it fills, provides limited containment of liquids, and allows time to take remedial action in case of a spill. Protruding through the chamber is a lever arm that actuates a limit switch. The lever is designed to operate as an interlock so that water can be dispensed only when a package is connected to the needle. Behind the panel are the flowmeter, the valves, and the plumbing related to the dispensing of water. The controls for the dispensing system consist of one rotary switch for volume selection of 0.5 to 8 oz (14.8 to 237 cm³) of water in 0.5-oz (14.8-cm³) increments and two pushbutton switches, one for hot and one for cold water. The switches are located on the control panel above the rehydration station.

Condiment/Wet Wipe Dispensers

Condiments (mayonnaise, catsup, etc.) and wet wipe packets are stored in special dispensers (fig. 3.16-17) on the front panel of the galley below the oven. Three dispensers are provided, one for wet wipes and two for condiments. The dispensers are open-ended boxes designed to hold the stack of packets together so that the packets can be individually removed as needed. A slide plate keeps the packets from becoming loose as the dispensers are depleted. The condiment dispensers are divided into two sections to allow for separate storage and retrieval of two different condiments. The dispensers are held in place by Velcro and can be moved to a more convenient location if desired.

Utensil Holders

The utensil holders are the same soft reusable plastic holders described in section 3.16.3.2 for nongalley flights.

Galley Miscellaneous Items

The galley also provides a means for storing or restraining food items and accessories. The provisions are as follows:

- Restraint clips for salt, pepper, and vitamin dispensers are provided below the rehydration station.
- A temporary stowage compartment 3.5 in. wide × 7.75 in. high × 4.5 in. deep (8.89 × 19.69 × 11.43 cm) is located between the rehydration station and the condiment dispensers. Items such as drinking straws may be retained in this area by bungee cords.

- Another temporary stowage compartment 5.5 in. wide by 10.125 in. high by 12 in. deep (13.97 by 25.72 by 30.48 cm) is provided on the right side of the oven (fig. 3.16-17). Food packages may be temporarily stowed here.

Water Heater System

The galley includes a hot water system that supplies the galley rehydration station. The water heater draws ambient water from the Orbiter ambient potable water system. The water heater system is an integral part of the oven assembly and is thermally and mechanically connected and controlled at the same temperature. This system is made up of two components, the water tank and the heating coil assembly. The water tank is made of stainless steel, has a capacity of 12 lb (5.5 kg or 1.5 gallons) of water, and is fitted with a silicone rubber bladder. The tank has no vents, so that as hot water is discharged, cold water is drawn into the tank. The rubber bladder separates cold and hot water.

The coil assembly is made from stainless steel tubing, tightly wound and brazed in a 12-in. (30.5-cm) diameter coil. The coil has six strip heaters bonded on the outside of the cylindrical surface and is held by three brackets that are used to connect the tank to the oven. The system uses 540 W of power to activate the heating elements. The water heater provides water at a temperature of 160° F (71° C). A maximum of 30 min is required for a complete water reheat cycle after heating a complete meal. The unit includes a water temperature gauge located on the front of the galley.

3.16.3.5 Water Dispenser

The water dispenser provides the crew with ambient and chilled water for food rehydration, drinking, and hygiene whenever the galley is not flown. The water dispenser provides ambient water of 65° to 75° F (18° to 24° C) and chilled water of 45° to 55° F (7° to 13° C) directly from the Orbiter ambient and chilled waterlines.

The system consists of the following components (fig. 3.16-18).

Housing Assembly.- The housing assembly, which is 12.75 by 8.6 by 3.75 in. (32.4 by 21.8 by 9.53 cm), contains other components of the water dispenser. The assembly is clamped to a mounting plate which is permanently attached to the vehicle wall.

Rehydration Unit. - The rehydration unit is an electronic system for dispensing 2, 3, 4, and 8 oz (56.7, 85.1, 113.4, and 226.8 g) of water (± 15 percent) into the food and beverage containers. A spare needle is stowed at the rear of the rehydration unit (fig. 3.16-18).

S83-37172

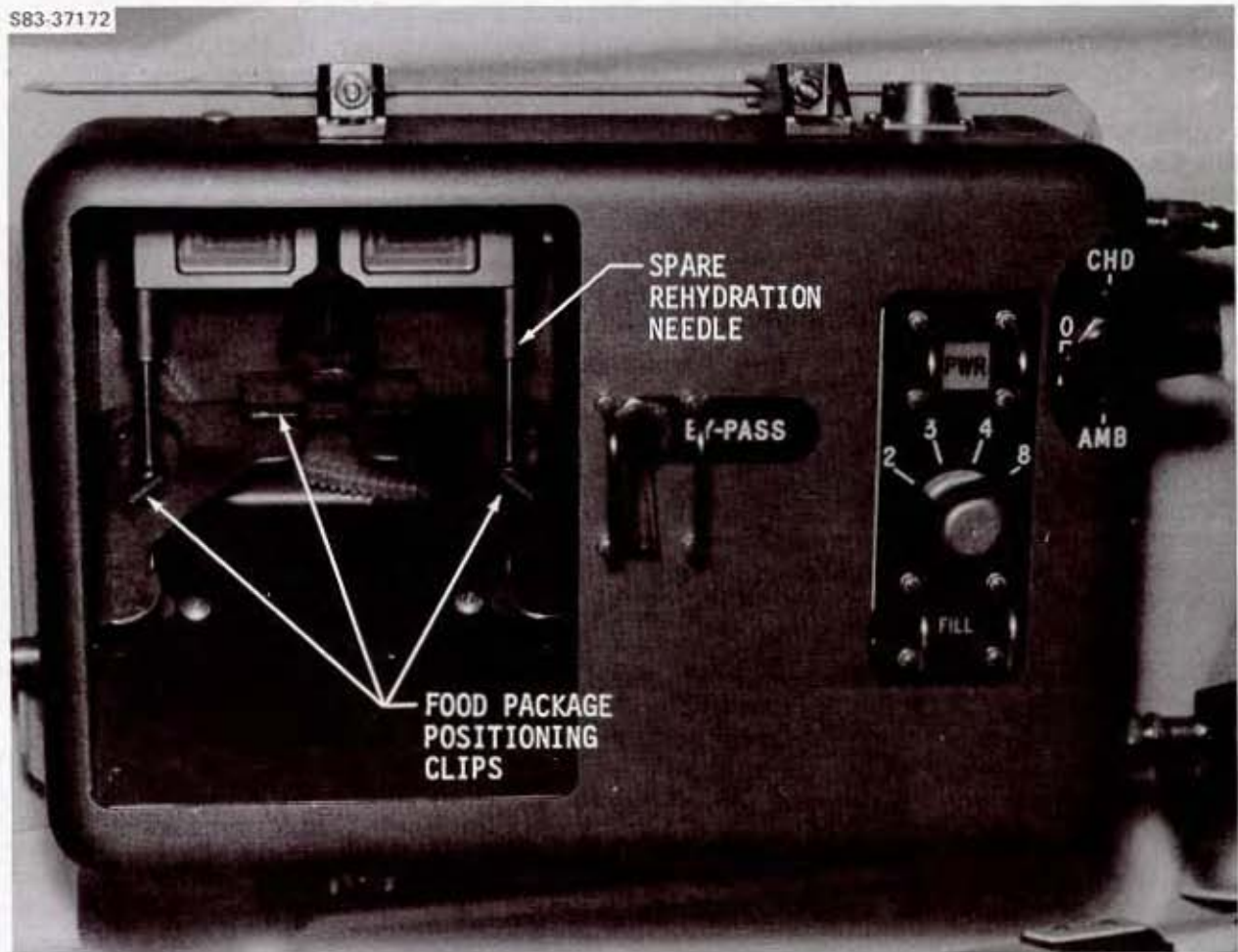


Figure 3.16-18.- Water dispenser.

The needles may be removed and replaced with a 3/8-in. (.97 cm) open end wrench. Another needle is stowed in the water equipment bay in the IFM locker. The water lines from the Orbiter have a nominal system pressure of 12.0 to 22.0 psi (0.84 to 1.55 kg/cm²) which is reduced to a constant pressure of 12.0 psi (0.84 kg/cm²) by regulator. Downstream of the solenoid valve, an electronic controller governs the time of flow. This timed shut-off after constant flow translates to specific water quantities for accurate rehydration.

A mechanical bypass line with a continuous flow capability is also provided in the event failure occurs in the solenoid valve or in the pressure regulator.

The rehydration unit consists of

- Power switch.— The power switch provides power to the electronic food rehydration system. Activation of this switch is not required when using the personal hygiene hose. To engage, push the button. An indicator light within the switch will come on. To deactivate the switch, push the button again.
- H₂O quantity selector.— The selector is a four-position rotary switch that provides for 2-, 3-, 4-, and 8-oz (56.7-, 85.1-, 113.4- and 226.8-g) water quantity selections. After choosing a selection on the dial, push the fill switch.
- Fill switch.— The fill switch activates the electronic filling mechanism after a water quantity selection has been made. The fill switch illuminates while the water is being dispensed. When filling is complete, the light turns off automatically and the system is deactivated.
- Bypass valve.— The bypass valve is a toggle switch which provides a continuous flow of water to the dispenser needle. This valve can be used to supply varying amounts of water to food or beverage packages in quantities other than the preselected values. It also serves as a contingency bypass to supply water if the electronic filling mechanism fails. To activate the valve, depress the handle or lift it to the up position. This valve is identical to the personal hygiene valve.
- Waterlines.— Two flexible steel lines feed the dispenser housing from the Orbiter potable water system. There is an ambient and a chilled water line, each of which is 10 ft. (304.8 cm) in overall length. The Orbiter interface end of each of these lines is a female QD. The lines consist of 1/4-in. (0.64-cm) stainless steel tubing. All line fittings and connections are stainless steel. On the left side of the dispenser is a personal hygiene QD for connecting the 12-ft (365.76 cm) plastic personal hygiene hose with dispensing valve.

- Microbial check valve.- The system contains one microbial check valve for the hygiene dispenser line. The check valve prevents water system back contamination. It is contained in the assembly housing and it is held in place by a set of clips. The check valve is refurbished after approximately four to five flights.
- Hygiene water valve.- The hygiene water valve is a two-position manual valve located on the end of the personal hygiene hose. It provides ambient water for hygienic purposes (sec. 3.15).
- Ambient/chilled water valve.- The ambient/chilled water valve is a three-position manual valve that controls water flow to the rehydration unit. This stainless steel valve is mounted within the housing assembly. The valve selector lies outside the housing assembly and has the following labeled positions: AMB, OFF, and CHD.

The display and control functions of the water dispenser are listed in table 3.16-2.

3.16.3.6 Food Warmer

The food warmer is a portable heating unit that can warm a meal for four crewmembers within 1 hr. On food warmer flights with more than four crewmembers a second food warmer is normally flown. A Y-cable allows both food warmers to be powered from one AC power outlet. The warmer heats food items by thermal conduction. Foods can be heated to 170° F (76° C).

The food warmer consists of the following components (fig. 3.16-19):

- Case

The outer case is constructed of aluminum and has exterior dimensions of 13 × 18 × 6-in. (33 × 45.7 × 15.2-cm). The case provides an interior heating volume of ~334 in³ (~5633 cm³). The lid of the case contains a friction hinge. The inner surface of the case is lined with urethane foam insulation coated with clear room temperature vulcanizing (RTV) compound. The exterior of the case contains the controls and displays for the operation of the warmer and a power connector which attaches to the power cable.

- Heating element

The heater assembly for the warmer consists of a 12.3 × 17.2 × 0.063-in. (31.2 × 43.7 × 0.16-cm) plate of laminated plastic and aluminum. The heating element is mounted on a friction hinged aluminum substrate. The heating element provides a heating capacity of 400 W when spacecraft ac power is applied. The heating element is thermostatically controlled to within a 170° ± 5° F (77° ± 2° C).

- Displays and controls

The warmer contains one control and one display on the exterior of the case: an ON/OFF switch and a heating element ON indicator light. The control and display functions are defined in table 3.16-2.

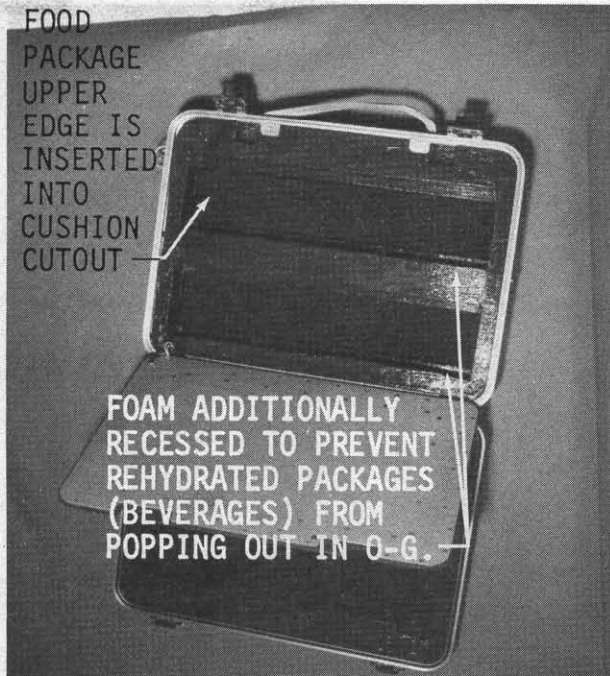
- Power cable

The power cable is a 20-gauge Teflon insulated cable that is 13 ft (3.96 m) long. It has a male connector at both ends. The cable is stowed inside the food warmer case for launch and entry.

The food warmer has two spring bungees attached to one side of the heating element. On each side of the heating element are urethane foam insulation cutouts coated with clear RTV compound. At the bottom are recessed cutouts to retain rehydratable food packages by friction fit. In addition, at the bottom of the cutouts is 1/2 inch thick uncoated foam to absorb moisture of spilled liquids. The upper surface of the rehydratable food package is inserted into the recessed cutouts with the base of the package facing the heating element. A maximum of 14 packages can be installed in the food warmer. In this configuration, six rehydratable packages can be installed on the side of the spring bungees and eight on the other side. Rehydratable beverages should be placed in the side opposite the spring bungees. The foam on this side is additionally recessed to prevent the packages from popping out in zero-g (fig. 3.16-19). When 14 rehydratable packages are heated, no foil-backed food pouches can be heated. A maximum of six foil-backed food pouches can be heated in conjunction with 12 rehydratable packages. When foil-backed pouches are heated, only four rehydratable packages can be heated on the side of the spring bungees. The foil-backed pouches may be stacked up to three deep. In addition, the four rehydratable packages are inserted with two packages each on the outside recessed foam cutouts (fig. 3.16-20).

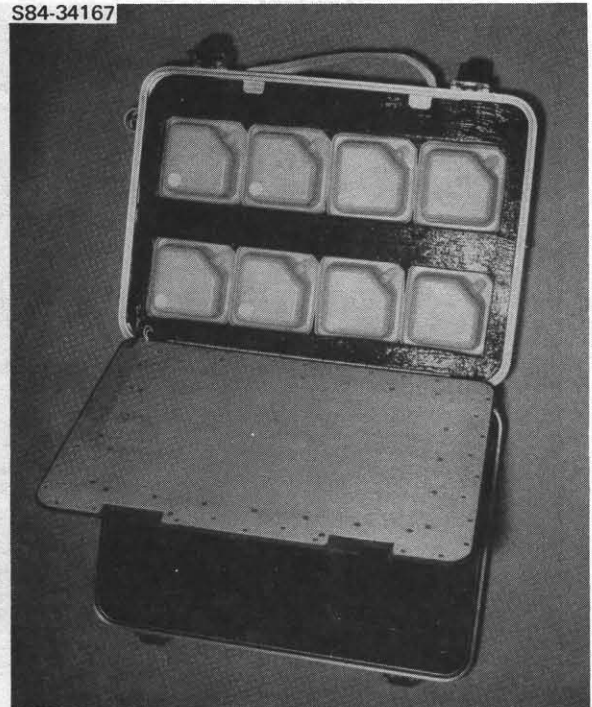
FOOD PACKAGE UPPER EDGE IS INSERTED INTO CUSHION CUTOUT

FOAM ADDITIONALLY RECESSED TO PREVENT REHYDRATED PACKAGES (BEVERAGES) FROM POPPING OUT IN O-G.



VIEW ON SIDE OF SPRING BUNGEEES SHOWING CUTOUTS

S84-34167



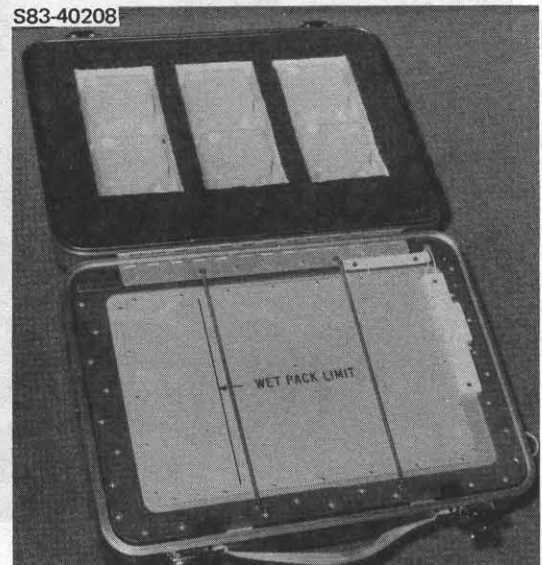
VIEW OPPOSITE SPRING BUNGEEES WITH EIGHT PACKAGES (MAX)

S84-34168



VIEW OPPOSITE SPRING BUNGEEES SHOWING CUTOUTS

S83-40208



VIEW ON SIDE OF SPRING BUNGEEES WITH SIX PACKAGES (MAX)

Figure 3.16-19.- Food warmer.

S84-34164

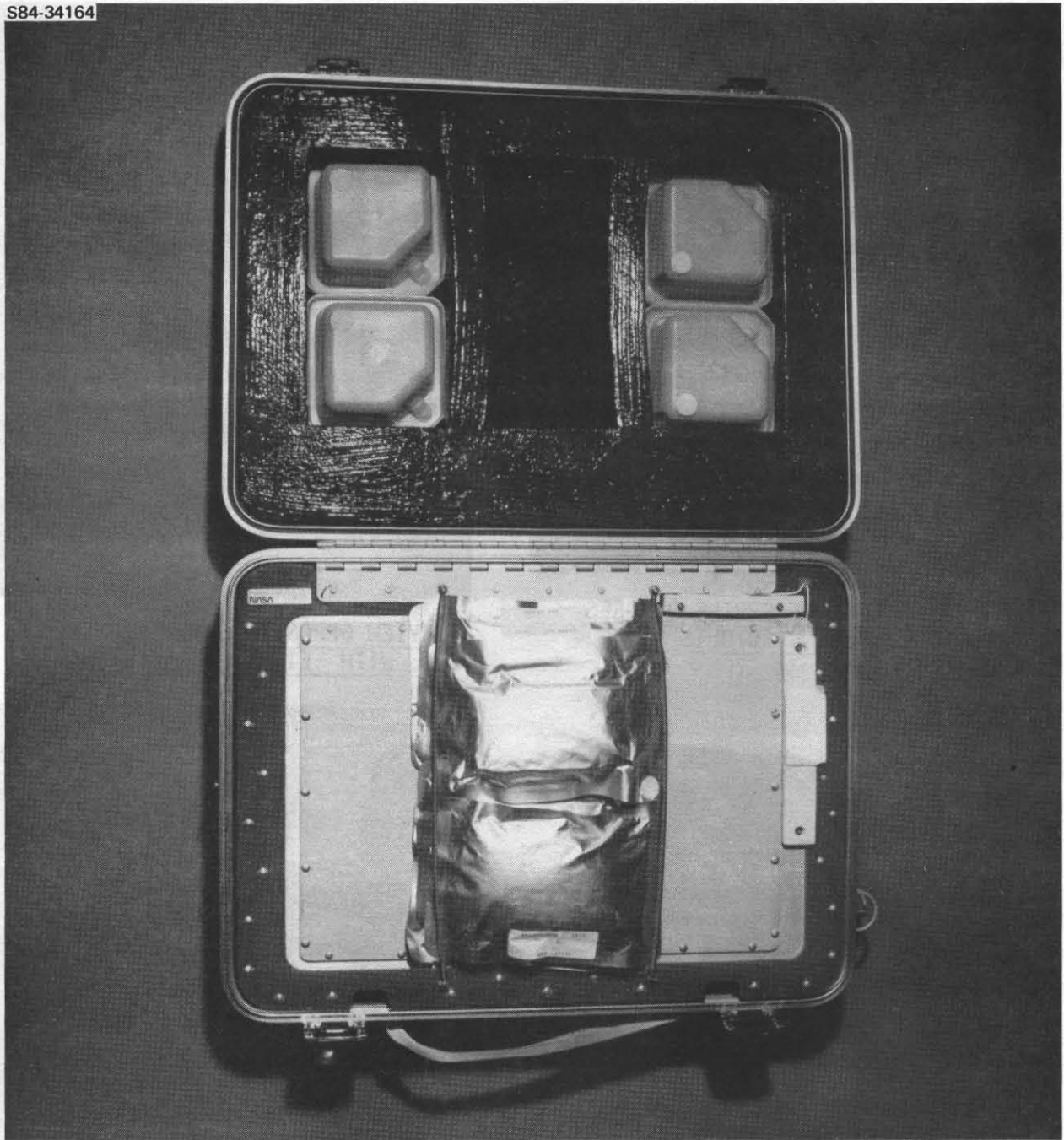


Figure 3.16-20.- Food warmer-food pouches and packages.

VIEW OR SIDE OF SPRING BUDGES
WITH SIX PACKAGES (MAX)

TABLE 3.16-2.- FOOD PREPARATION AND DINING DISPLAY AND CONTROL FUNCTIONS

| Location | Type | Nomenclature/ position | Function | Remarks | |
|----------|-------|----------------------------------|--|---|--|
| Galley | sw | Oven fan | ON | Enables power to the three fans | |
| | | | OFF | Disables power to the three fans | |
| | gauge | Temperature | Indicates the hot water temperature | Water temperature at 100° to 220° F (37.8° to 104.4° C) | |
| | sw | Volume, oz | Selects the volume of water to be dispensed by the rehydration station | Volume selection of 0.5 to 8 oz (14.8 to 237 c cm ³) in 1/2-oz (14.8-cm ³) increments | |
| pb/lt | Hot | Allows hot water to be dispensed | Yellow HOT push button will light when pushed. When the selected volume of water has been dispensed, the push-button will begin to flash on and off. The light will go out when the food package is retracted and the lever arm/limit switch is released | | |

TABLE 3.16-2.- Continued

| Location | Type | Nomenclature/ position | Function | Remarks |
|----------|-------|--|--|--|
| Galley | pb/lt | Cold | Allows cold water to be dispensed | Blue COLD push-button will light when pushed. When the selected volume of water has been dispensed, the push-button will begin to flash on and off. The light will go out when the food package is retracted and the lever arm/limit switch is released. |
| | sw | Rehydration station lever arm/limit switch | Serves as an interlock so that water can be dispensed only when a food container is connected to the needle. | Food container makes contact with rehydration station lever. Crewmember does not physically actuate lever. |
| | vlv | MV3 Ambient H2O supply OFF | Serves as a manual ambient supply shutoff valve, if the galley water system leaks ambient/hot water on orbit. Valve shuts off only the ambient water supply to the galley. | Valve is located behind the Teflon cloth panel on the upper lefthand corner. The Teflon cloth panel is attached with Velcro. |

TABLE 3.16-2.- Continued

| Location | Type | Nomenclature/ position | Function | Remarks | |
|----------|------|--------------------------------|--|---|--|
| Galley | conn | ON | Serves as the nominal open position of the manual shutoff valve | Test connectors J104 and J105, DC power Bus A and Bus B switches, and flush port TP4 connector are located behind the Teflon panel on the upper right-hand corner | |
| | | Test connectors | | | |
| | | J104 | Serves as a GSE test connector | | |
| | J105 | Serves as a GSE test connector | | | |
| | sw | DC power | | | |
| | | Over/RHS | ON | | Activates the galley oven heaters and the rehydration station system |
| | | OFF | Deactivates the galley oven heaters and the rehydration station system | | |
| | | Water Heaters | ON | Activates the six galley water tank strip heaters | |

TABLE 3.16-2.- Concluded

| Location | Type | Nomenclature/ position | Function | Remarks |
|--------------------|------|------------------------------|--|--|
| Water dispenser | | OFF | Deactivates the six galley water tank strip heaters | |
| | QD | Flush port TP4 | Serves as the galley water system GSE flushing port | |
| | QD | Auxiliary port potable water | Allows crewmembers to obtain ambient potable water in event the MV3 valve is shut off (fig. 3.16-14) | Provides personal hygiene water to crew |
| | vlv | Ambient/chilled water valve | | |
| | | AMB | Provides ambient water to the food rehydration unit | Water temp. at 65° to 75° F (18° to 24° C) |
| | | OFF | Main shutoff of water to dispenser assembly | Will not shutoff the water supply to the personal hygiene QD |
| | | CHD | Provides chilled water to the food rehydration unit | Water temp. at 45° to 55° F (7° to 13° C) |

TABLE 3.16-2.- Continued

| Location | Type | Nomenclature/ position | Function | Remarks |
|-----------------|--------|--|---|--|
| Water dispenser | sw | Water quantity selector 2,3,4,8 | Four-position rotary dial provides for 2-, 3-, 4-, and 8-oz water quantity selections | Not required to be on when using the personal hygiene system FILL switch automatically deactivates; does not require pushing the button to shut off |
| | sw/ind | PWR | Provides power to the electronic food rehydration system. To engage, the button is pushed and an indicating light within the switch illuminates. To turn off, the button is pushed again | |
| | sw/ind | FILL | Activates the electronic filling mechanism once a water quantity selection has been made on the rotary switch. During filling, a light comes on within the FILL switch. When filling is complete, the light automatically turns off | |

TABLE 3.16-2.- Continued

| Location | Type | Nomenclature/ position | Function | Remarks |
|-----------------------------|------|---------------------------|--|--|
| Water dispenser | vlv | BYPASS | Provides a continuous flow of water to the food rehydration unit by depressing the handle, or lifting the handle in the up position (the valve will be in the locked-open position) | Can be used to supply varying amounts of water to food or beverage packages. Can serve as a contingency bypass station to supply water if the electronic filling mechanism fails |
| 12 ft personal hygiene hose | vlv | Personal hygiene | Two-position manual valve that provides ambient water for hygienic purposes by depressing the handle, or lifting the handle in the up position (the valve will be in the locked-open position) | |
| Food warmer | sw | Power | ON | Enables power to the heater assembly |
| | | | OFF | Disables power to the heater assembly |

3.16.4 Systems Performance, Limitations, and Constraints

3.16.4.1 Galley

- Oven
 - Heating range: 145° to 185°F (63° to 85°C) - approximately 20 min required to heat a meal for up to seven crewmembers
 - Heaters: 4 each 45 watts, 28-V dc heaters
 - Fans: 3 each 22 watts, 115-V ac fans
- Hot and chilled water dispensers
 - Temperatures: 50° ± 5°F and 160° ± 5°F (10° ± 2° and 71° C ± 2°)
 - Volume dispensed: 0.5 to 8 oz
- Hot water tank
 - Tank capacity: 12 lb (5.5 kg or 1.5 gallons)
 - Temperature: 160°F (71°C)
 - Heaters: 6 - strip heaters, 90 watts each
 - Maximum time for reheat cycle: 30 min
 - Power: 540 W, 28-V dc
- Wet wipes dispenser
 - Quantity: 1
 - Wipes packages: 115
 - Construction: Aluminum
- Condiment dispensers
 - Quantity: 2
 - Construction: Aluminum
 - Condiment packages: 20 mayonnaise, 30 mustard, 25 catsup, and 20 taco sauce

3.16.4.2 Water Dispenser

- Temperature range
 - Ambient: 65° to 75°F (18° to 24°C)
 - Chilled: 45° to 55°F (7° to 13°C)
 - Rate of supply: No more than 130 lb/hr (59 kg/hr)
 - Rate of flow: ~1/2 oz/sec (14.8 cm³/sec)
 - Pressure: 12 psig (843.7 g/cm²)
 - Dimensions: 12.75 by 8.6 by 3.75 in. (32.4 by 21.8 by 9.53 cm)
 - Microbial check valve: Treat minimum of 8640 lb H₂O equal to 30-day mission
 - Power: 0.1 amp (standby); 0.5 amp (operating)

3.16.4.3 Food Warmer

- Maximum temperature range: 157° to 165°F (69° to 73°C)
- Approximately 1 hr required to heat a meal for four crewmembers
- Weight: 12 lb (5.5 kg)
- Power: 203 VAC, 400 Hertz, 2.0 A (max)

3.16.4.4 Food Systems Accessories

3.16.4.4.1 Wet wipes

- Quantity
 - Wipes/dispenser: 21
 - Dispensers/flight: 3 per 14 crewmember days (w/o galley), 1 per 14 crewmember days (with galley)
- Construction
 - Material: 7.5-oz (212.6-g) Nomex exterior, Urethane-coated nylon interior
 - Light spring that provides pressure to retain and position wipes for dispensing
- Size
 - Dispenser: 4.5 × 2.75 × 2.25 in. (11.43 × 6.98 × 5.7 cm)
 - Tissue: 7.87 × 5.5 in. (20 × 14 cm)

3.16.4.4.2 Dry wipes

- Quantity
 - Wipes/dispenser: 30
 - Dispenser/flight: 1 per 7 crewmember days
- Construction
 - Material: Nomex
- Size
 - Dispenser: 7.75 × 4.63 × 2 in. (19.69 × 11.76 × 5.08 cm)
 - Tissue: 16.5 × 7.5 in. (41.9 × 19 cm)

3.17 WASTE COLLECTION SYSTEM

3.17.1 Introduction

The Waste Collection System (WCS) collects and transports biological wastes from crewmembers in a zero-g environment. The system performs the following general functions:

- Collecting, storing, and drying fecal wastes and associated toilet paper
- Transferring extravehicular mobility unit (EMU) water from the airlock to waste storage tanks
- Transferring urine to waste storage tanks
- Venting air and vapors from the middeck and waste management wet trash stowage compartments (sec. 3.22, Housekeeping Systems)
- Transferring waste water overboard, as a contingency

The WCS is a part of the Waste Management System (WMS). The WMS also includes the following:

- Waste water storage tanks (refer to SFOM, Vol. 3)
- Waste water overboard dump system (refer to SFOM, Vol. 3)
- Wet trash stowage compartment for stowage of emesis bags, trash can (coffee can) liners, and other wet trash generated during WMS OPS.
- Vacuum vent system (refer to SFOM, Vol. 3)

3.17.2 Interfaces

The WCS interfaces with the Orbiter systems as shown in figure 3.17-1.

The vacuum vent system provides venting for the wet trash stowage compartments, airlock vent, Air Revitalization System (ARS), water loop relief vent, and the commode (for solid waste drying).

The middeck wet trash stowage compartment vents through a flow restrictor quick disconnect (QD) to the vacuum vent line downstream of the contingency shutoff valve. It provides venting for 8 ft³ (0.23 m³) of wet trash stowage. The WMS wet trash compartment also vents through this line. Gases are vented overboard at a constant flow of about 3 ± 0.4 lb/ day (~750 scc/min).

Condensate water from the EMU is dumped through fittings in the airlock and routed through lines to the fan separator portion of the WCS to the waste water tanks.

The Orbiter electrical power system provides 28-V dc and 115-V ac power for system operation.

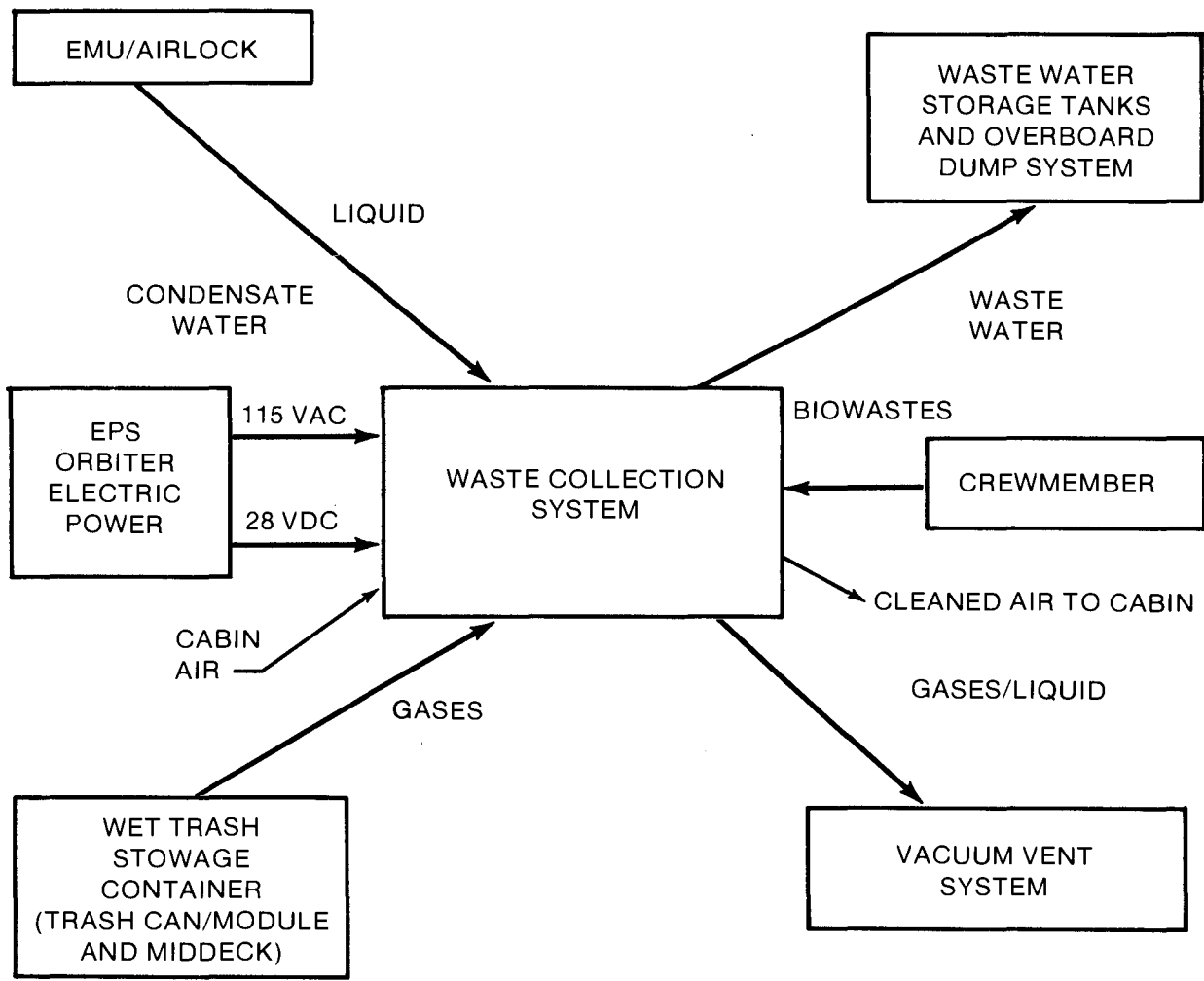


Figure 3.17-1.- Waste Collection System interfaces.

3.17.3 Systems Functional Description

The WCS collects and transports biological wastes from the crewmembers, gases from wet trash stowage, and waste water from the EMU/airlock support station.

The WCS accommodates both male and female crewmembers and consists of the commode assembly, urinal assembly, instrumentation, interconnecting plumbing, mounting framework, and restraints.

The WCS is located on the middeck of the Orbiter in a 29-in. (74-cm) wide compartment immediately aft of the side hatch. The unit is approximately 27 by 27 by 29 in. (69 by 69 by 74 cm). It has two major independent and interconnected assemblies: one, the urinal, is designed to handle fluids and the other (the commode) handles solid waste. Certain components, such as some controls, the odor/bacteria filter, and the fan separators, are common to both assemblies.

A set of controls is used to configure the WCS system for various modes of operation. These controls are shown in figure 3.17-2 and defined in table 3.17-1.

The WCS electrical system is shown schematically in figure 3.17-3.

The major assemblies and components of the WCS are discussed below.

3.17.3.1 Fluid Processing Assembly

The fluid processing assembly consists of the urinal, fan separator, controls, and interconnections. This assembly is used to collect liquid waste from the urinal or the EMU. An airflow of 15 ft³/min (0.23 m³/min) is used to entrain the liquid in the zero-g environment at a maximum urine flow rate of 0.09 lb/sec (0.04 kg/sec).

The urinal consists of a flexible hose and a urine funnel. The hose attaches to the front of the unit and can be positioned to direct fluid flow to one of two fan separators. Urine funnels are conical in shape for males and elongated for females. Each crewmember is provided with a funnel which is stowed in the WCS wall volume.

See figure 3.17-4 for urinal operation.

During urination, the air/liquid mixture is drawn into the fan separator where the air is returned to the cabin through the odor/bacteria filter and the liquid is pumped to the vehicle waste water storage tanks.

Fan Separator Assembly

The operation of the fan separator is common to both the fluid processing assembly and the solids processing assembly.

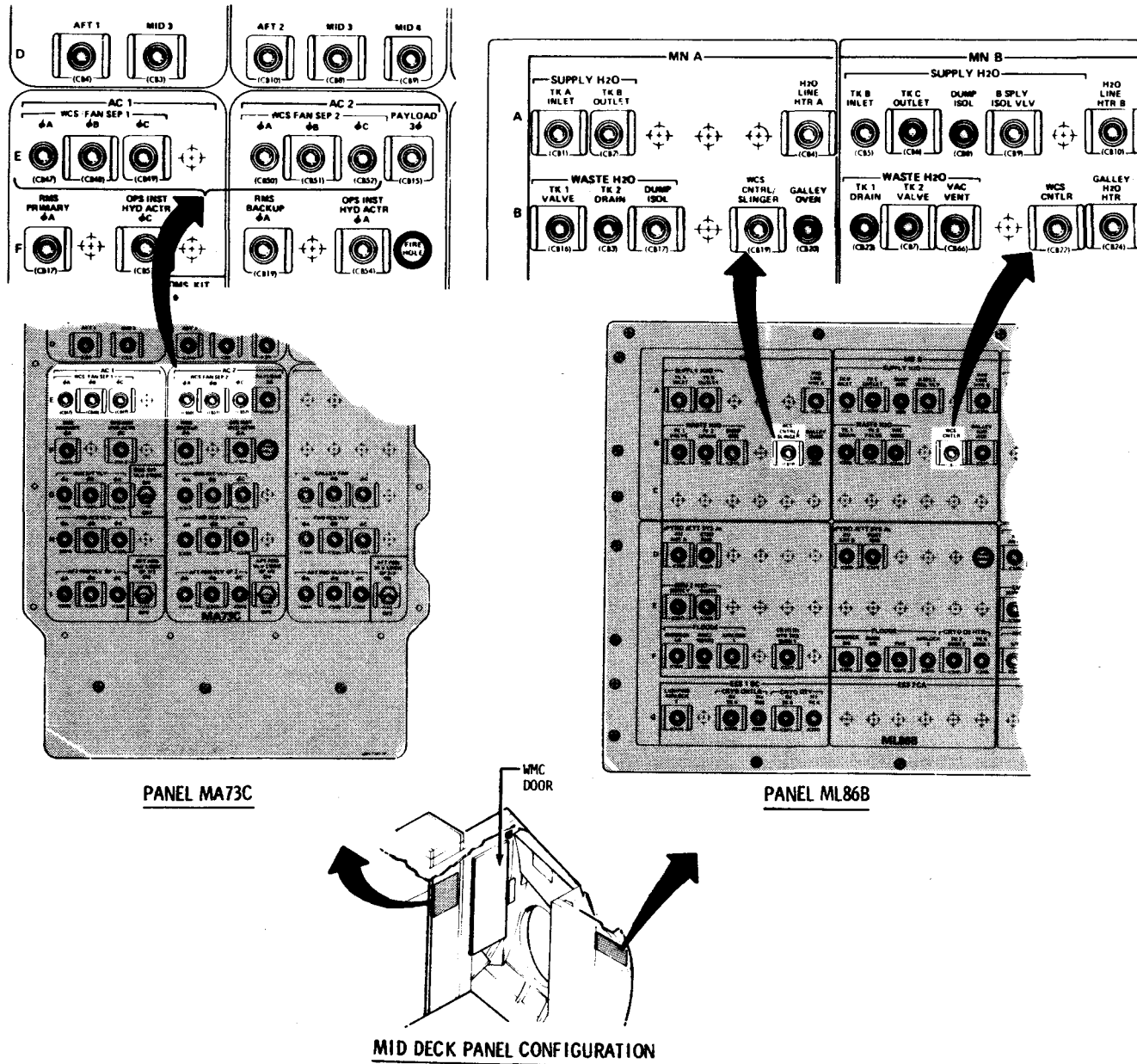


Figure 3.17-2.- Waste Collection System displays and controls (sheet 1 of 2).

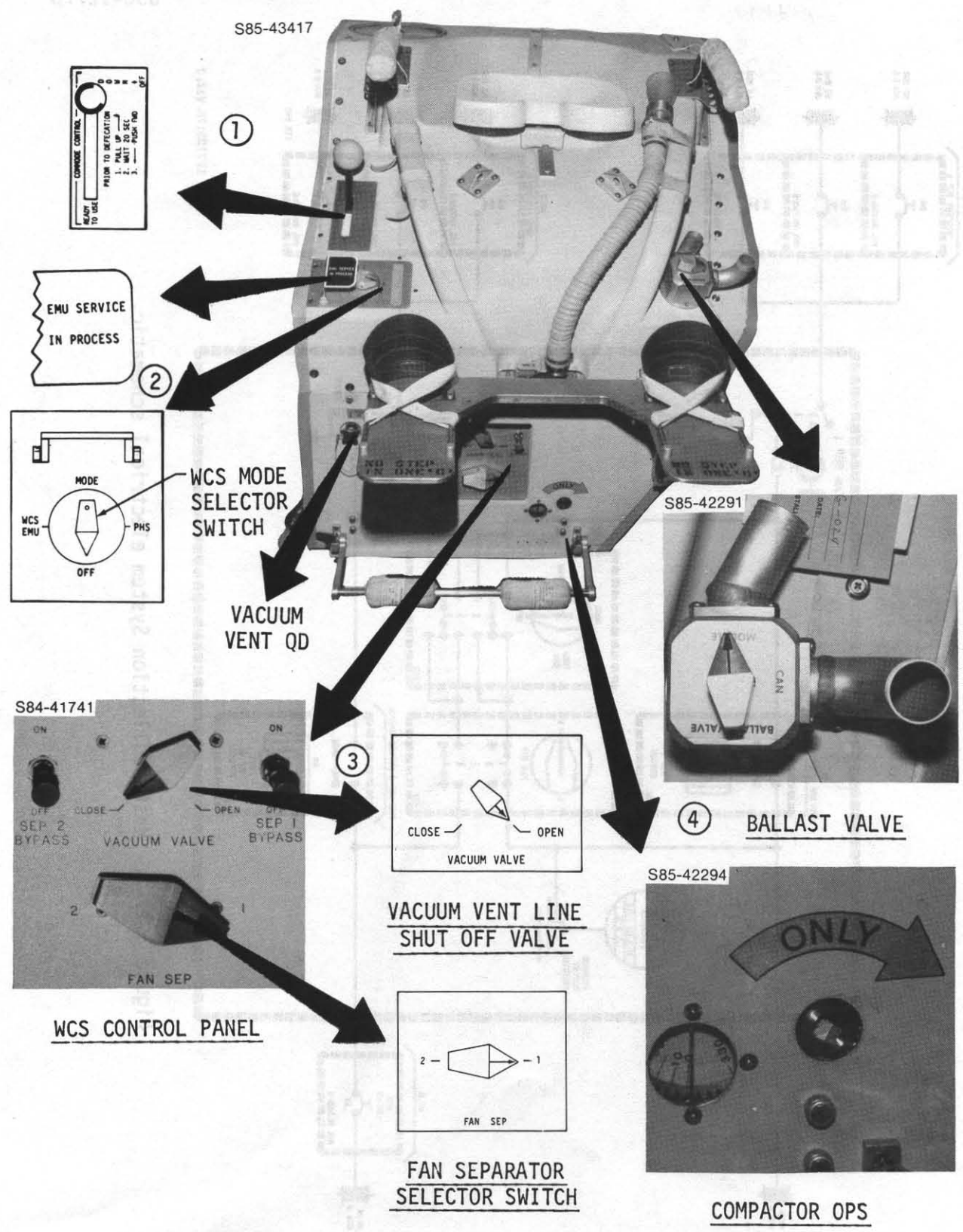
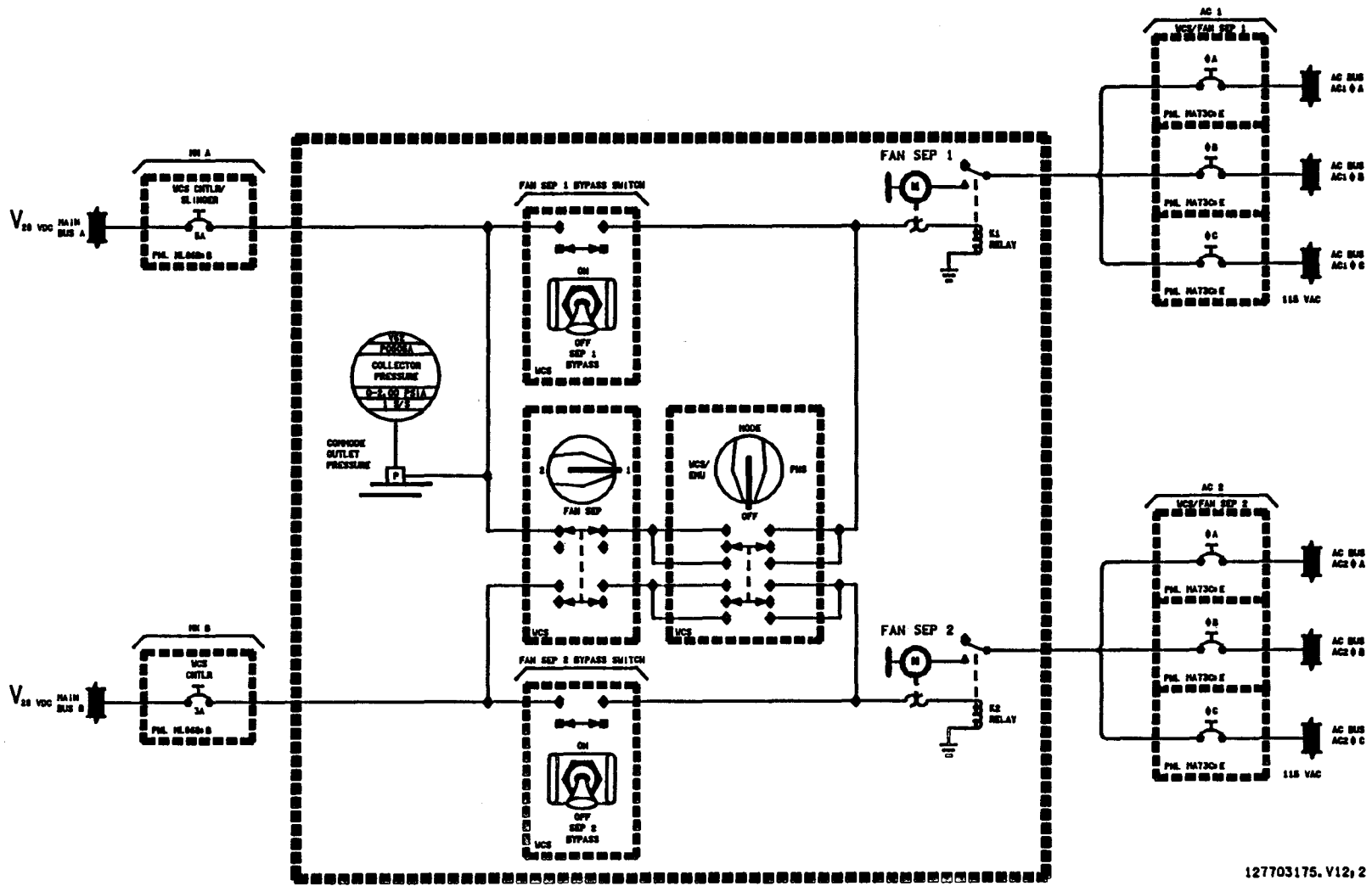


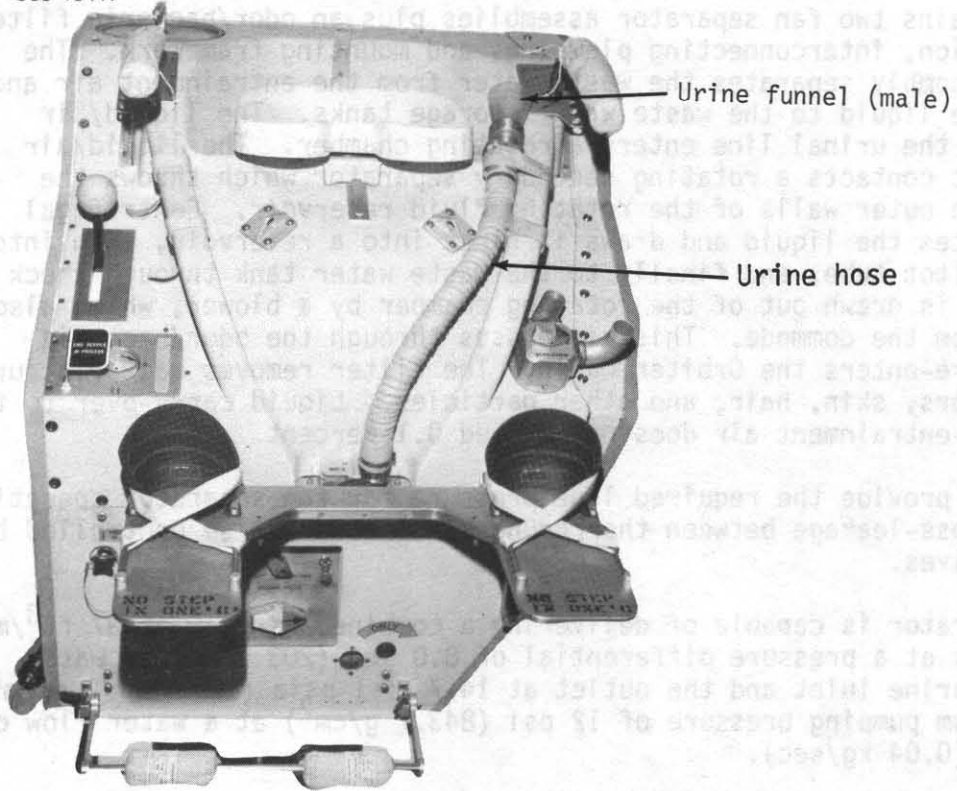
Figure 3.17-2. - Waste Collection System displays and controls (sheet 2 of 2).



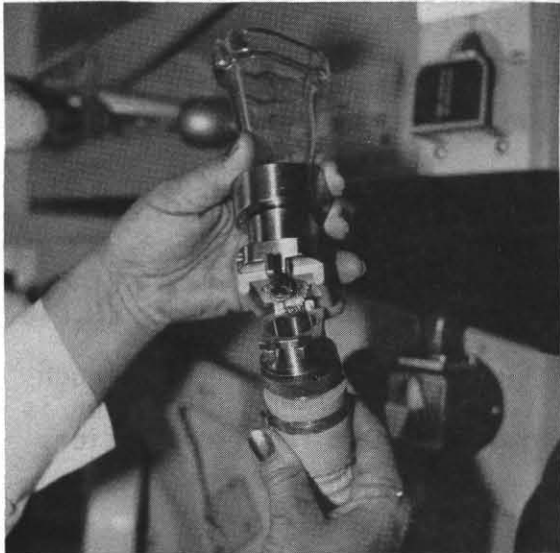
127703175, V12, 2

Figure 3.17-3.- Waste Collection System electrical schematic.

S85-43417



URINAL



REMOVAL OF CONICAL PREFILTER

Figure 3.17-4.- Urinal operations.

The WCS contains two fan separator assemblies plus an odor/bacteria filter, instrumentation, interconnecting plumbing, and mounting framework. The separator assembly separates the waste water from the entrainment air and transfers the liquid to the waste water storage tanks. The liquid/air mixture from the urinal line enters a rotating chamber. The liquid/air mixture first contacts a rotating secondary separator which throws the liquid to the outer walls of the rotating fluid reservoir. Centrifugal force separates the liquid and draws it first into a reservoir, then into a stationary Pitot tube, and finally to the waste water tank through check valves. Air is drawn out of the rotating chamber by a blower, which also draws air from the commode. This air passes through the odor/bacteria filter, and re-enters the Orbiter cabin. The filter removes bacteria, urine and fecal odors, skin, hair, and other particles. Liquid carry-over to the cabin by the entrainment air does not exceed 0.1 percent.

Check valves provide the required line pressure for fan separator operation. Back- and cross-leakage between the redundant lines are also controlled by the check valves.

The fan separator is capable of delivering a combined airflow of 37 ft³/min (1.08 m³/min) at a pressure differential of 8.0 in. (203.2 mm) of water between the urine inlet and the outlet at 14.7 ± 1 psia (1030 ± 70 g/cm²), with a minimum pumping pressure of 12 psi (843.7 g/cm²) at a water flow of 0.09 lb/sec (0.04 kg/sec).

Urinal Prefilter

A conical disposable prefilter located at the base of the urinal funnel is used to capture air-entrained debris. This prefilter consists of a 40-mesh by 0.0065 in. (0.0165-cm) diameter stainless steel conical wire screen contained within a rubber pad. The prefilters should be changed at least once each day and more often, if needed. The filters are stowed in the WMC stowage volume. The urinal prefilter location and replacing operations are shown in figure 3.17-5.

Ballast Air Flow Screen

An air flow screen is located inside the ballast air (diverter) valve (fig. 3.17-2). The screen consists of 20 by 20 mesh stainless steel screen (0.018 in. diameter wire) for capturing air-entrained debris. The screen is checked and cleaned preflight. The screen allows cabin air to pass through for fan separator ballast air flow (30 cu. ft./min) when fecal collection is not required, and for repressurizing the commode prior to fecal collection.

Commode Pressure Transducer

The vacuum condition of the commode is monitored for leakage by a pressure transducer. The transducer is installed between the waste collector and the vacuum valve, and has a range of 0-2 psia.

Odor/Bacteria Filter

The odor/bacteria filter prevents odors and bacteria from entering the cabin air. The filter is cylindrical, 10 in. (25.4 cm) in length and 7 in. (17.8 cm) in diameter (fig. 3.17-5). It is constructed of anodized aluminum, perforated on the sides to allow airflow, and provides a filtering function by means of activated charcoal and a filter media rated for removal of 99.999 percent of all particles above 0.45 μm . The filter is ordinarily changed on the ground after each flight, but it can be changed out on orbit. A spare filter is carried in a mid-deck floor compartment.

Waste Management Compartment Door and Compartment Privacy Curtains

A description of the waste management compartment (WMC) door and compartment privacy curtains for the middeck use location is found in section 3.15.

Restraints

Commode restraints consist of foot restraints, thigh bars, and the commode handholds (fig. 3.17-6). Descriptions of these restraints are as follows.

Foot Restraints

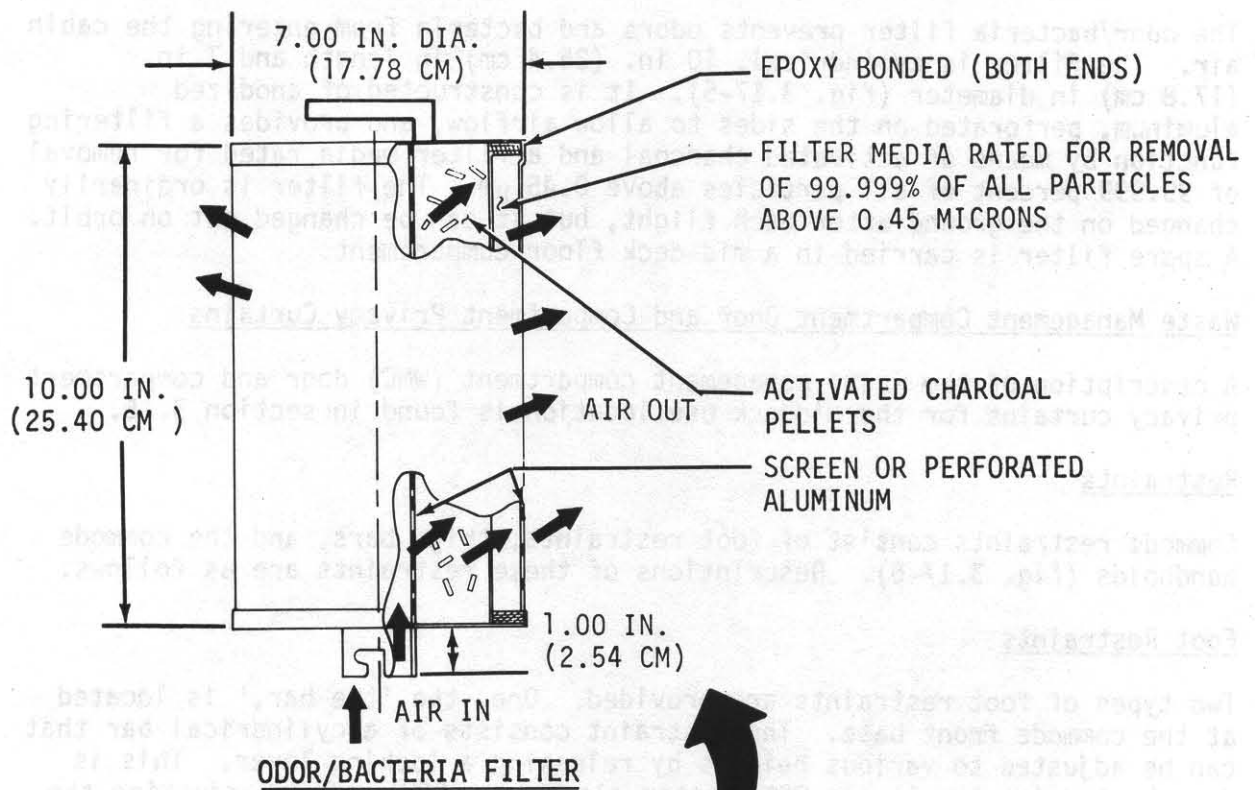
Two types of foot restraints are provided. One, the 'toe bar,' is located at the commode front base. The restraint consists of a cylindrical bar that can be adjusted to various heights by releasing a locking lever. This is done by turning the levers 90° counter clockwise (CCW). Once adjusting the restraint to the proper height, the levers are locked in place by turning them 90° clockwise (CW). The crewmember can restrain himself in the standing position by slipping his feet under the restraint.

The second foot restraint (the footrest) allows the crewmember's feet to be restrained while sitting on the commode. The restraint consists of detachable Velcro straps which are wrapped cross-wise over each foot. The foot restraint can also be adjusted to various angles and heights. To adjust the angle, both locking handles are pulled outward to release the foot restraint platform. The platform is positioned as required and the handles are locked by releasing. The height is then adjusted by lifting the two locking levers and moving the restraint to the desired height.

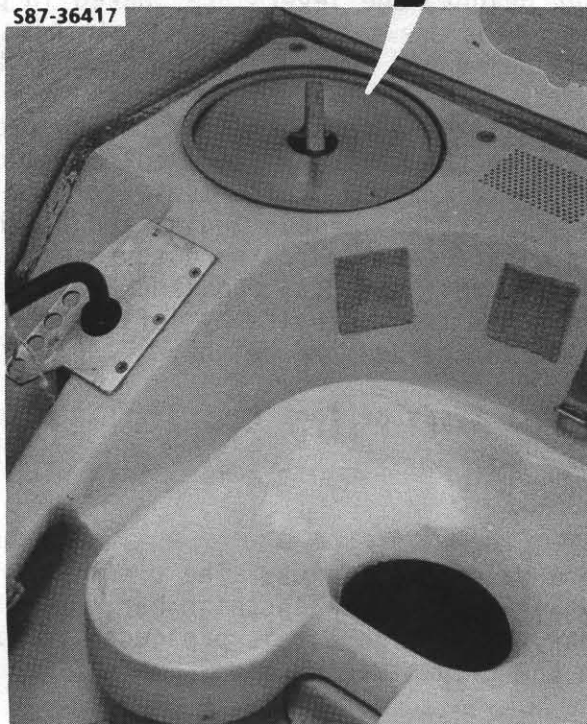
For launch and entry, both types of foot restraints are folded up and secured.

Thigh Bar

The thigh bar is also a padded restraint. The crewmember's position on the commode is secured by lifting up on each thigh bar, rotating over thigh and releasing the thigh bar. The thigh bar is preloaded to exert approximately 10 pounds of force on the crewmember's thigh.



587-36417



428 Figure 3.17-5.- Odor/bacteria filter.

587-36414

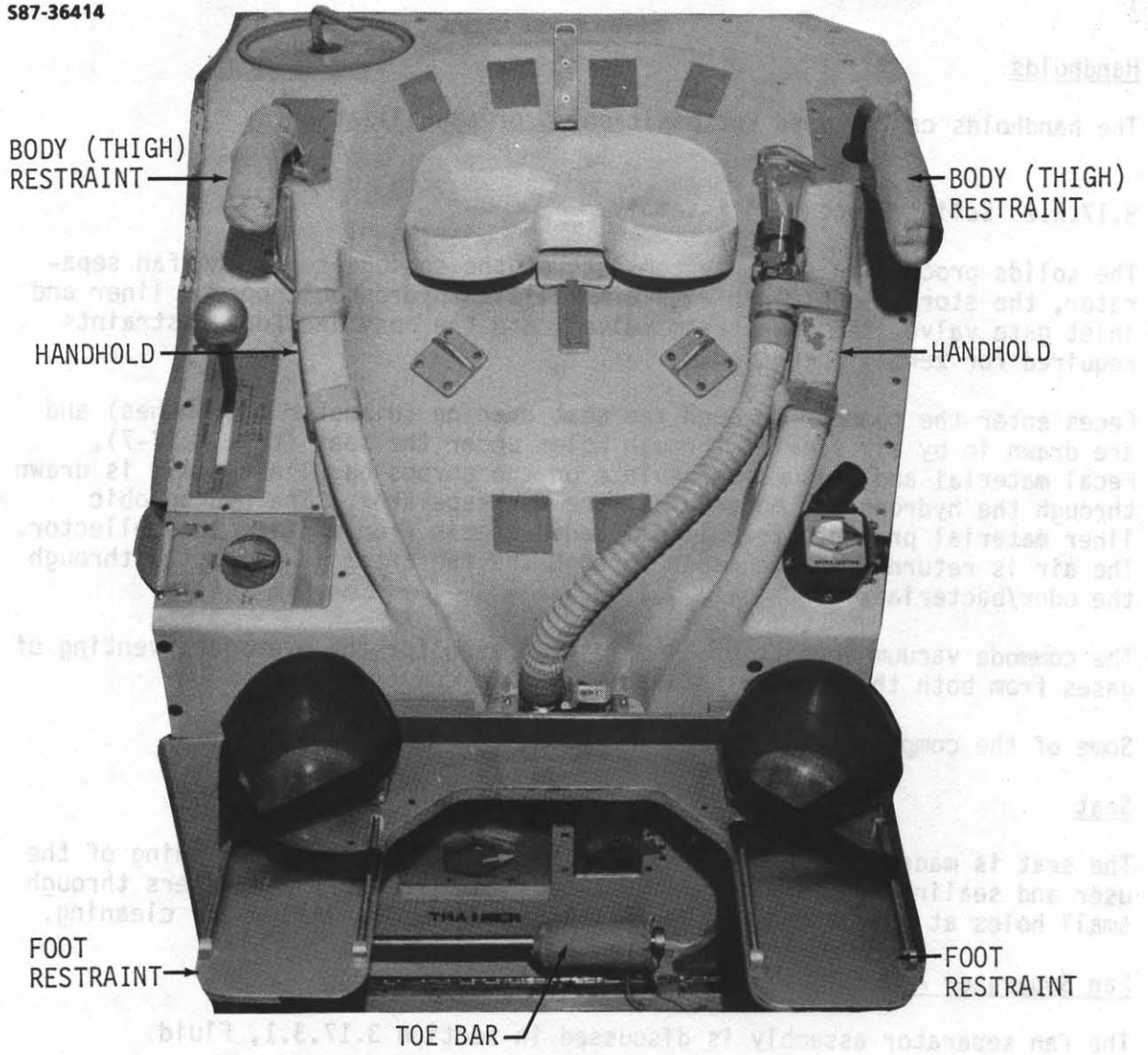


Figure 3.17-6.- Commode restraints.

Handholds

The handholds can be used for positioning or stabilization.

3.17.3.2 Solids Processing Assembly

The solids processing assembly consists of the commode seat, the fan separator, the storage container with a multilayer hydrophobic porous liner and inlet gate valve, the downstream valves, and the body and foot restraints required for zero-g operation.

Feces enter the commode through the seat opening (diameter 4.0 inches) and are drawn in by air flowing through holes under the seat (fig. 3.17-7). Fecal material and tissues accumulate on the porous bag liner. Air is drawn through the hydrophobic material to the fan separator. The hydrophobic liner material prevents free liquid and bacteria from exiting the collector. The air is returned to the cabin through the fan after it is ducted through the odor/bacteria filter (sec. 3.17.31).

The commode vacuum connection line is also used for the overboard venting of gases from both the middeck and WMC wet trash compartments.

Some of the components of the assembly are as follows:

Seat

The seat is made of a soft plastic, which ensures proper positioning of the user and sealing to minimize air leakage. The transport air enters through small holes at the base of the seat. The seat can be lifted for cleaning.

Fan Separator Assembly

The fan separator assembly is discussed in section 3.17.3.1, Fluid Processing Assembly.

WMC Door and Compartment Privacy Curtains

The WMC door and compartment privacy curtains are discussed in section 3.15, Personal Hygiene Provisions.

3.17.3.3 Vacuum Vent QD

The vacuum vent QD provides the capability to dump Air Revitalization System (ARS) waste water overboard through the vacuum vent line. This procedure is performed if the waste water tank 1 valve failed closed or if the waste tank had a leak that cannot be isolated. This is accomplished by utilizing a water transfer hose which is connected to the waste water crosstie QD located on the outboard WCS wall inside the WCS compartment (fig. 3.17-8). The VACUUM VENT QD is on the vertical panel on the left front side of WCS.

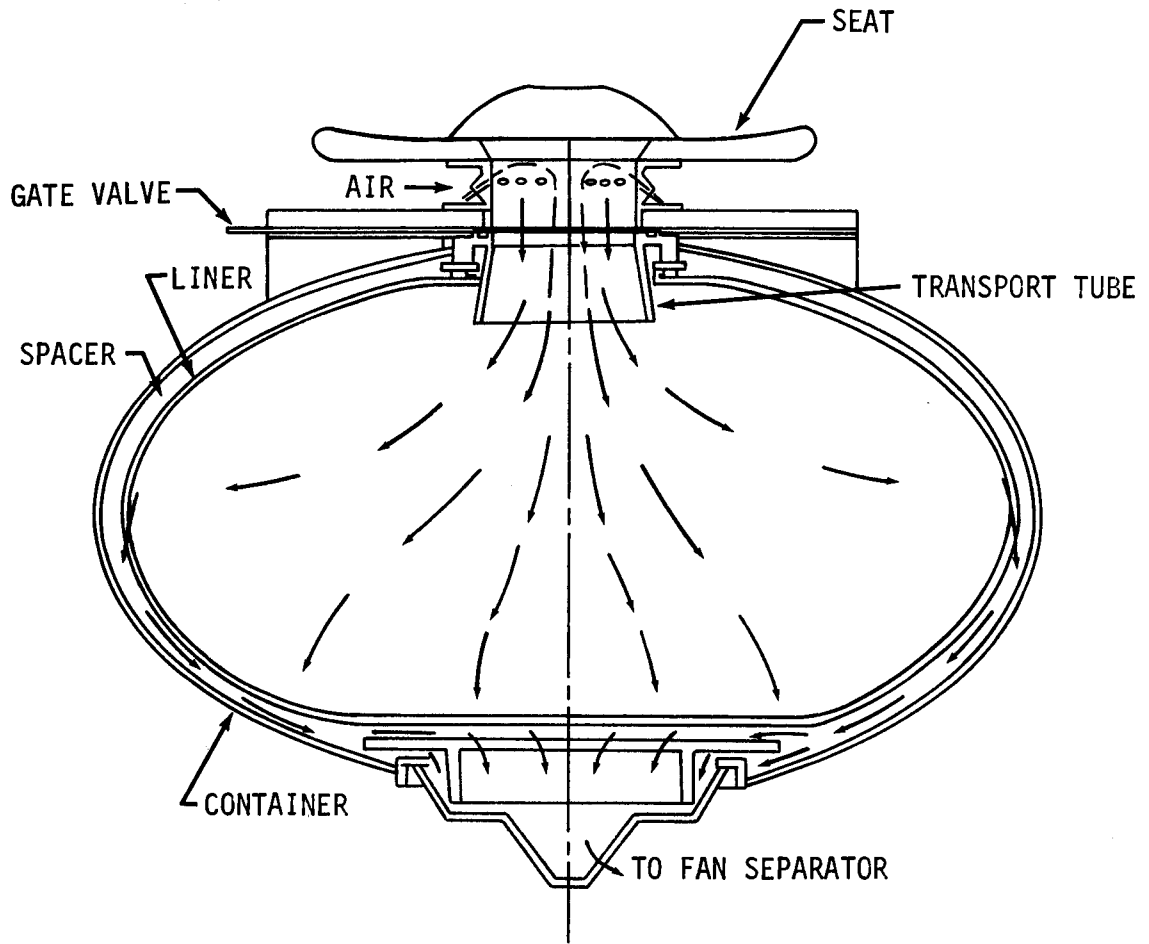
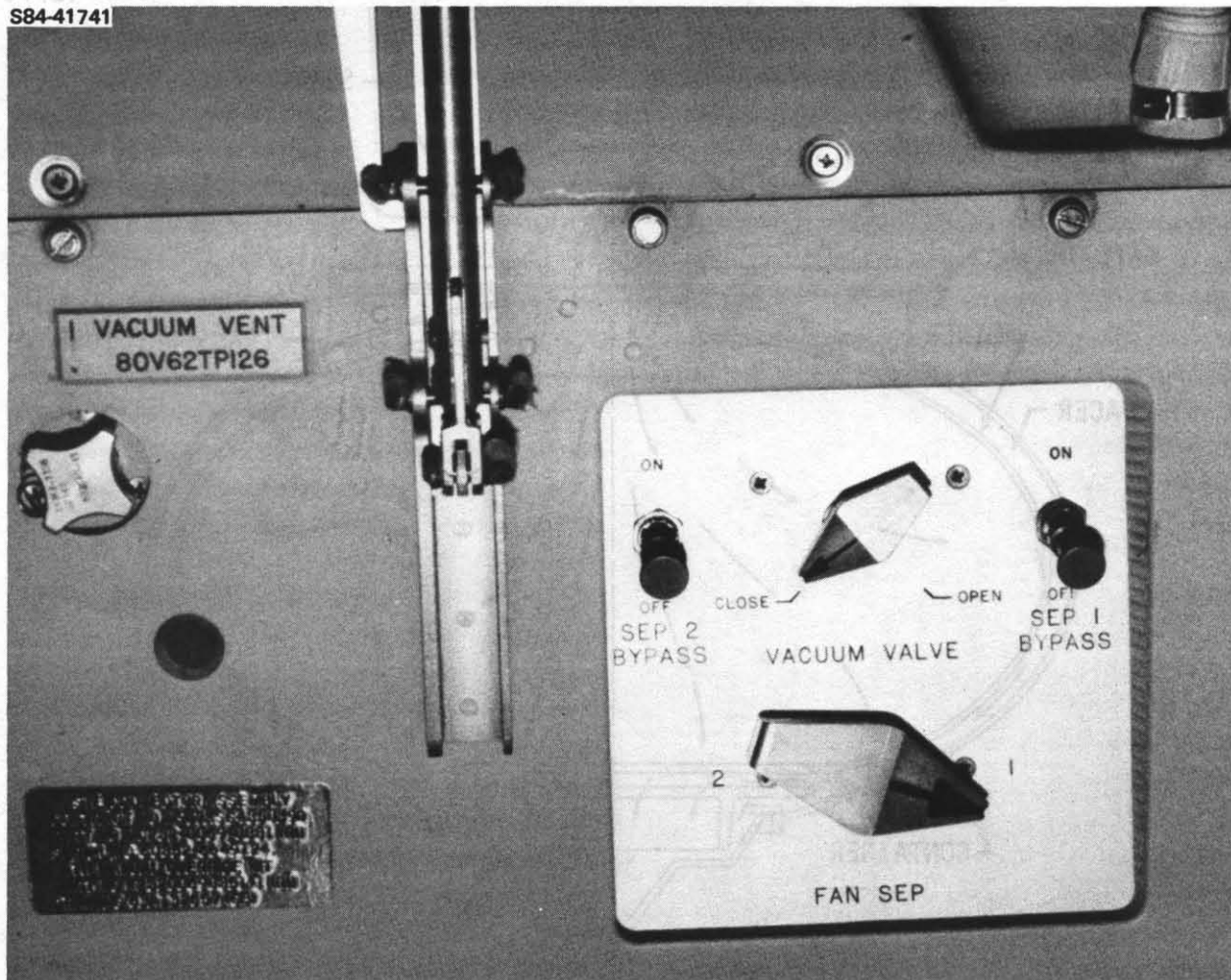
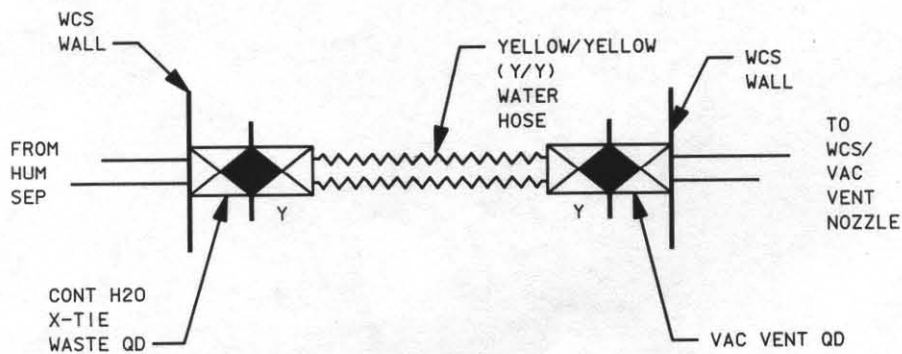


Figure 3.17-7.- Waste storage container.

S84-41741



(Reference IFM Procedure: ARS Condensate Disposal-Failed Waste H2O TK.)



127703172.V12,2

Figure 3.17-8.- Vacuum vent QD.

3.17.3.4 WCS Operating Modes

The operating modes for the WCS are discussed below.

Deactivated Mode

When the WCS is not in use by the crew, the commode (waste collector) storage compartment is opened to vacuum by means of the vacuum vent system (fig. 3.17-9). The vacuum accomplishes drying and disinfecting of wastes stored in the waste collector. In this mode, the COMMODE CONTROL handle is in the OFF position (back and down); the FAN SEPARATOR switch is set on 1; the MODE switch is set in the OFF position, closing the urine collection valve; SEP 1 and 2 BYPASS switches in the OFF position; and the vent line VACUUM VALVE is turned to OPEN, opening the vacuum vent line to vacuum.

Commode Repressurization

Before use, the ΔP between the cabin and the commode must be equalized. This repressurization is accomplished through the ballast valve and calibrated orifice. The pressurization valve and the commode outlet control valve (fig. 3.17-10) are linked to the commode gate valve and are controlled by pulling up on the COMMODE CONTROL handle. The calibrated orifice is sized so that repressurization takes less than 20 sec. Equilibration of ΔP must be accomplished before the commode can be used for collection of feces.

Urine Collection Mode

The user installs the urinal funnel and positions the WCS control panel MODE switch to the WCS/EMU position. The COMMODE CONTROL handle is in the OFF position and the VACUUM VALVE is in the OPEN position. The user positions the urinal and urinates. The subsystem configuration for this mode of operation is shown in figure 3.17-11.

In this mode, an airflow of 15 scfm ($0.23 \text{ m}^3/\text{min}$) enters the urinal and a ballast airflow of 22 scfm ($0.85 \text{ m}^3/\text{min}$) enters the system through the ballast valve. The ballast air mixes with the urine transport airflow in the fan separator to ensure that moisture in the warm urine transport air does not condense in the cooler outlet line.

The WCS requires daily cleaning of the urinal with biocide and dry wipes. The wipes are disposed of in the wet trash compartment.

Urine and Feces Collection Mode

In this mode, the user installs the urine funnel and turns the WCS control panel MODE switch to the WCS/EMU position. The user should place his feet into the foot restraints and restrain himself on the seat using the thigh bar restraints. Then he should maintain a proper seal between his buttocks and the commode seat. After he is satisfactorily restrained, the user operates the COMMODE CONTROL handle to repressurize the commode (PULL UP) (fig. 3.17-12) and, after 20 sec, opens the gate valve by pushing the COMMODE CONTROL handle FORWARD (fig. 3.17-13). The user proceeds to use the

equipment as a normal toilet. Waste volume should be minimized by putting slightly soiled wipes in the trash can. Toilet tissue is the only permissible paper item that can be disposed of in the commode. General purpose dry wipes or wet wipes should not be put into the commode. The urine is processed as described in the urine collection mode, while the feces and WCS tissue are conveyed into the WCS via a 22-scfm (0.85- m³/min) airflow. The solid wastes are deposited on the multilayer hyperphobic porous liner. Air flows through the liner, and is drawn through the three control valves into the fan separator.

The deactivation of the WCS requires reversing the above procedure. Closing the gate control and interlocking control valves with the VACUUM VALVE open opens the commode volume to vacuum for drying via the vacuum vent line.

EMU/Airlock Water Collection Mode

The EMU/airlock water collection mode permits dumping of EMU condensate water through the airlock support system to the waste management system. The commode remains exposed to vacuum.

An airflow of 15 ft³/min enters the urinal, and a ballast airflow of 22 ft³/min enters the system via the ballast valve. The EMU waste water is dumped through the waste water valves in the airlock, through the WCS fan separator, and into the waste tank. The WCS urinal cannot be used during the EMU dump due to possible separator flooding.

The user rotates the MODE switch to WCS/EMU; rotates the guard down (90°) over the MODE switch, switches the airlock waste valve to OPEN, and checks hose block and fan sep settings. Deactivation requires reversing the above procedure.

While servicing the EMU, a warning on the guard precludes a user from using the commode in the WCS mode, with the words: EMU SERVICE IN PROGRESS. Upon condensate drain completion, this guard is rotated back to the 'up' position.

This operation is covered in detail in the EVA All Vehicles Checklist.

Backup Urine/Feces Collection - Failed Fan Separator

Failure of the fan separator (if the primary fan separator fails to achieve proper operational speed) can be verified by a reduced noise level and by physically sensing a lack of airflow. The alternate fan separator is then switched on by moving the control knob labeled FAN SEP (on the WCS unit) from position 1 to position 2 and repositioning the hose block for SEP 2 (fig. 3.17-14).

The failed fan separator can be checked for a malfunctioning limit switch located within the FAN SEP and MODE switches. This is done by using SEP 1 (2) BYPASS switch to override the fan separator limit switch failure.

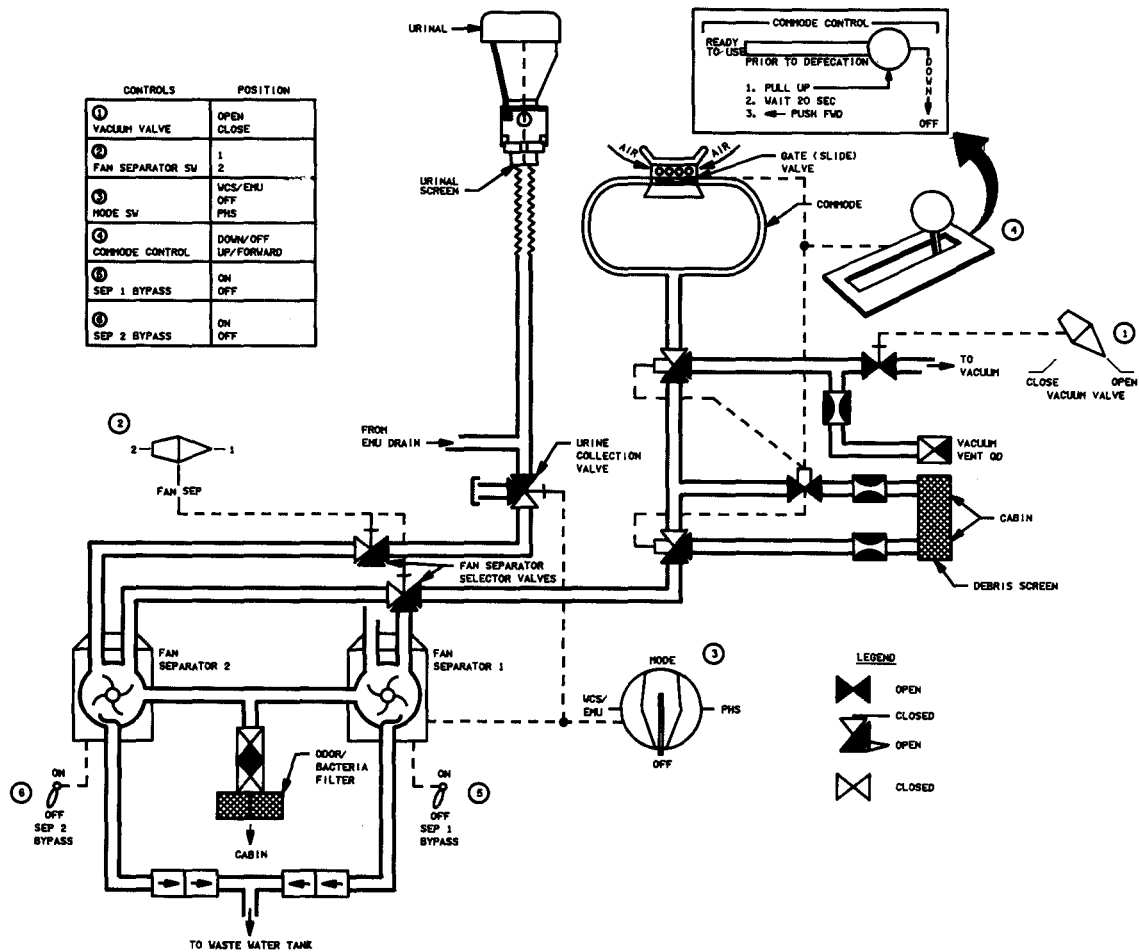
Before activating the lever-locked Fan SEP 1 or 2 BYPASS switch, the hose block and fan sep SW should be positioned to the corresponding fan separator bypass position.

When a FAN SEP BYPASS switch is used, the following WCS controls must be completed first:

- FAN SEP - 1 (2). This will position the fan separator selector valves.
- MODE - WCS/EMU. This will open the urine collection valve line to the fan separator.

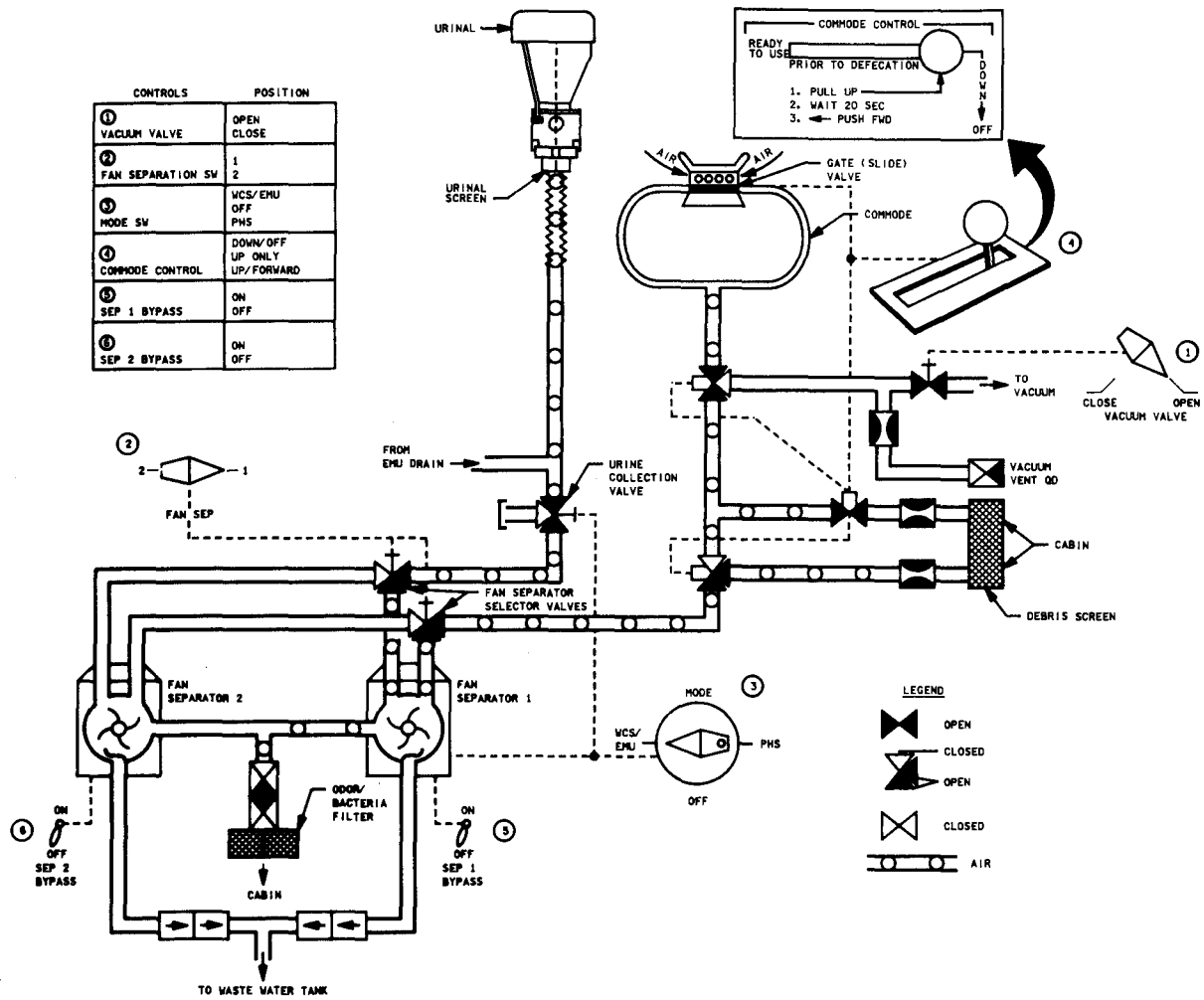
Backup Urine Collection - Use of Contingency Urine Collection Device (UCD)

If both fan separators fail and urine cannot be dumped overboard, urine may be collected in a contingency urine collection device (UCD) (fig. 3.17-15).



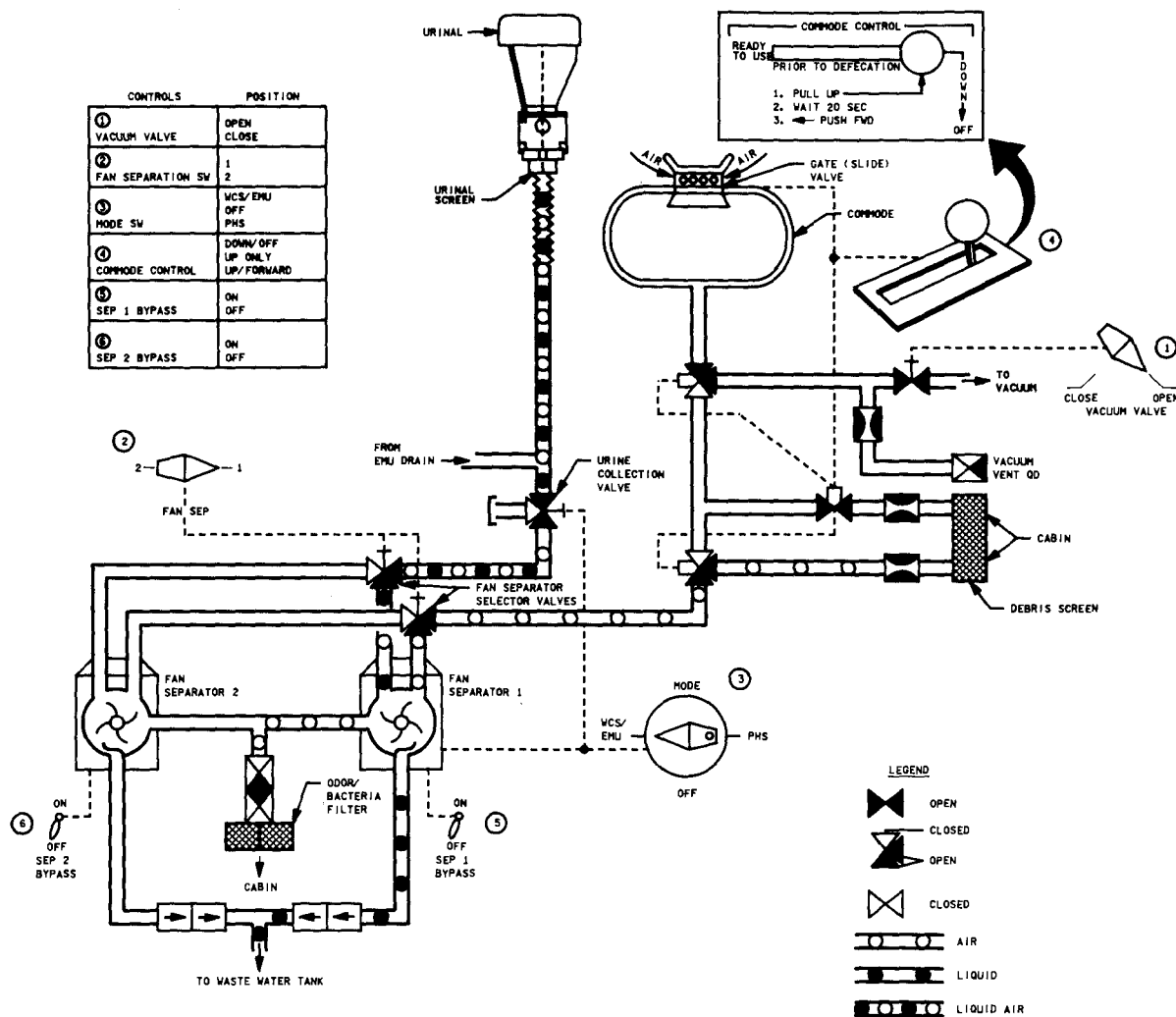
127703173, V12, 2

Figure 3.17-9.- Waste Collection System, deactivated mode.



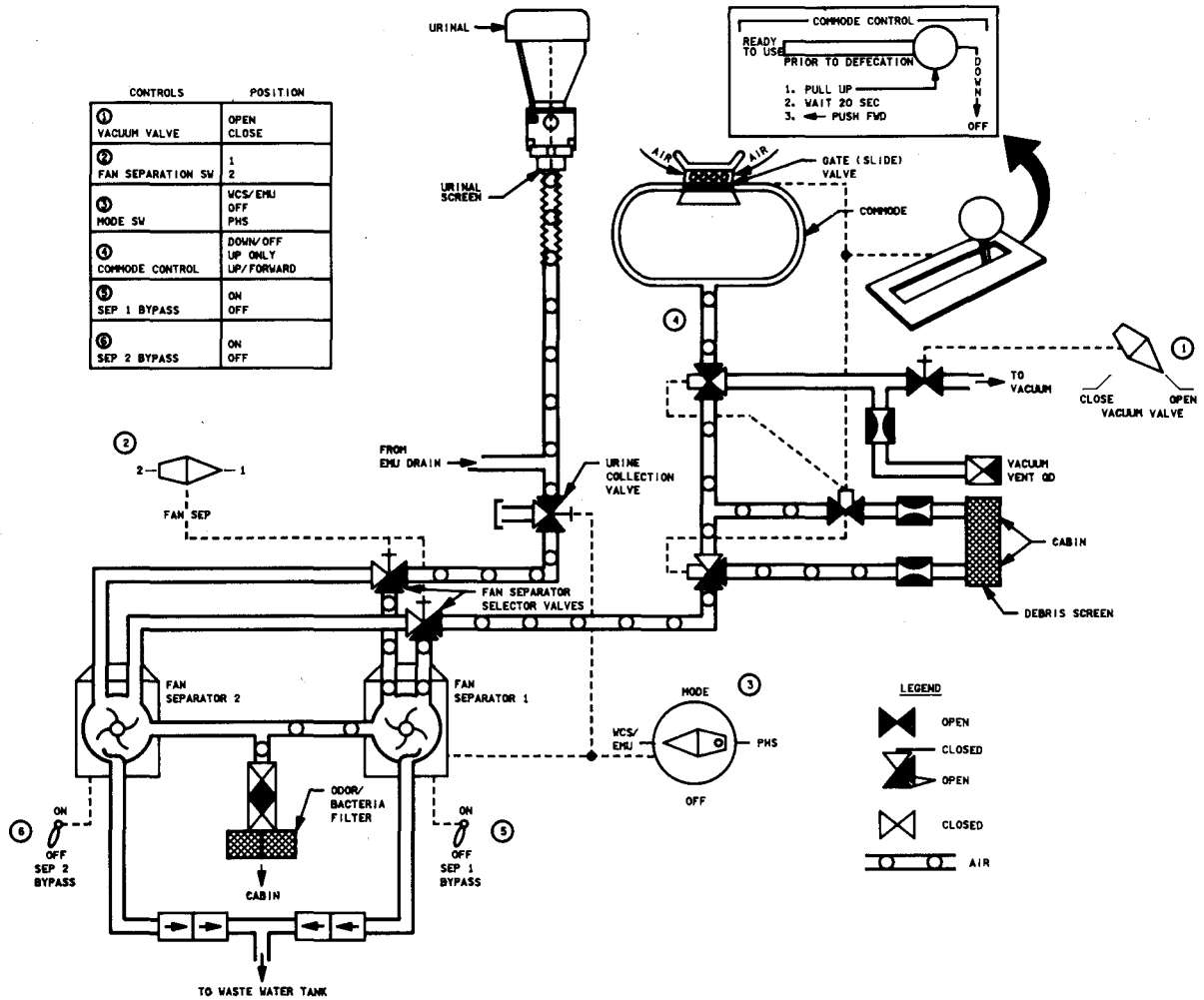
127703174, V12x3

Figure 3.17-10.- Waste Collection System, commode pressurization mode.



127703176, V12, 4

Figure 3.17-11.- Waste Collection System, urine collection mode.

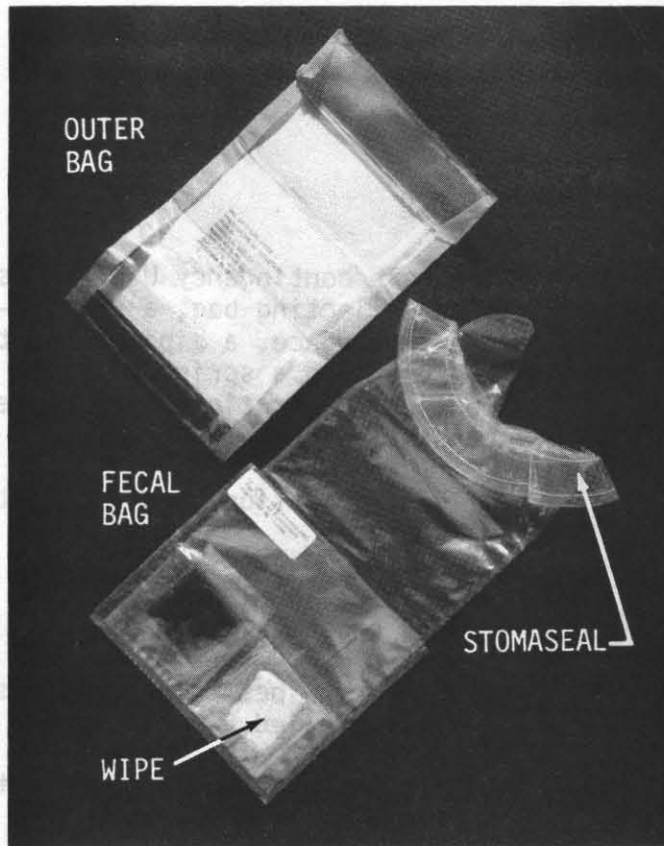


127703177, V12, 5

Figure 3.17-12.- Waste Collection System, urine and feces collection mode-commode pressurization

NOTE:

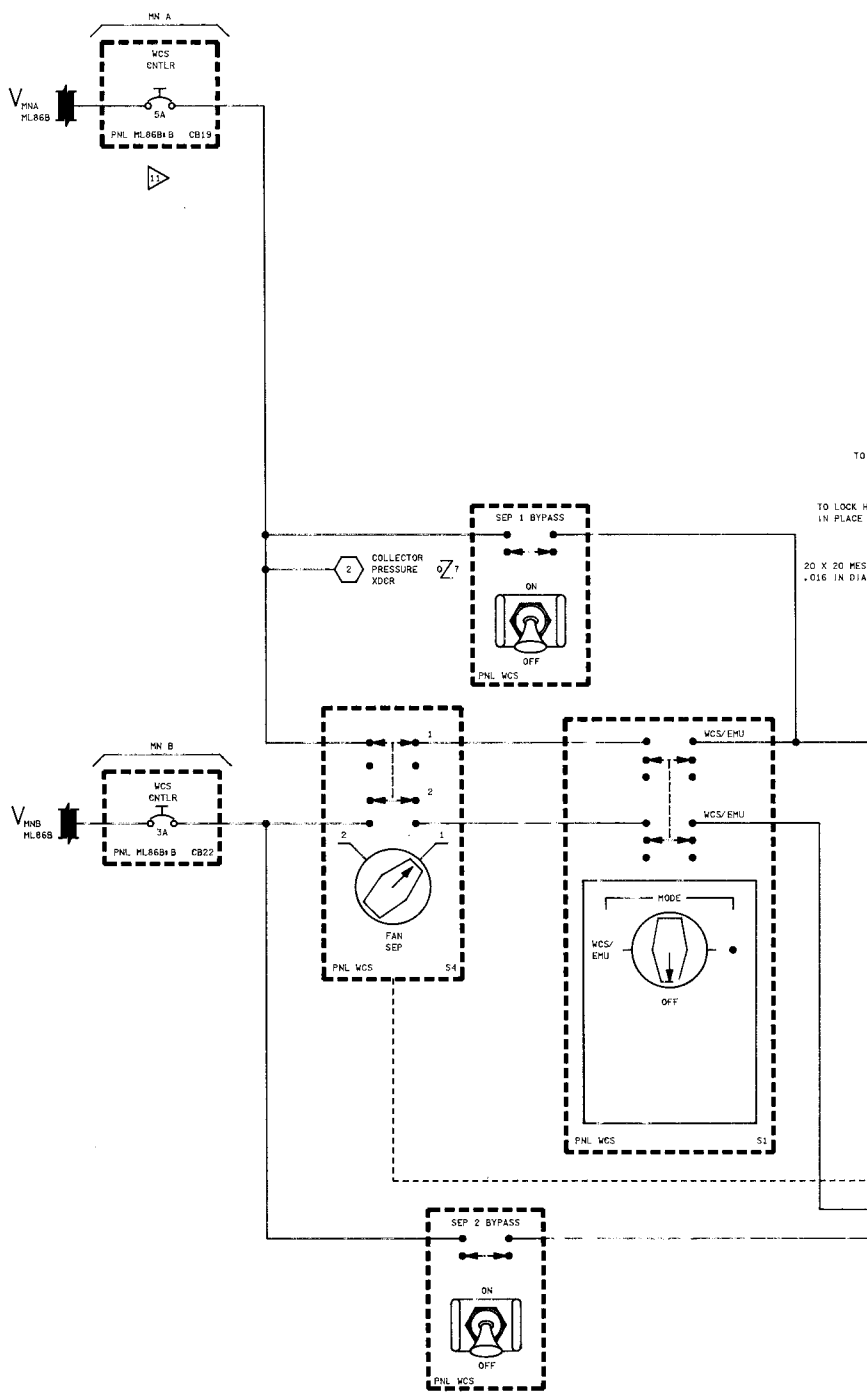
Crewmember should urinate before defecation.

APOLLO FECAL BAG PROCEDURE

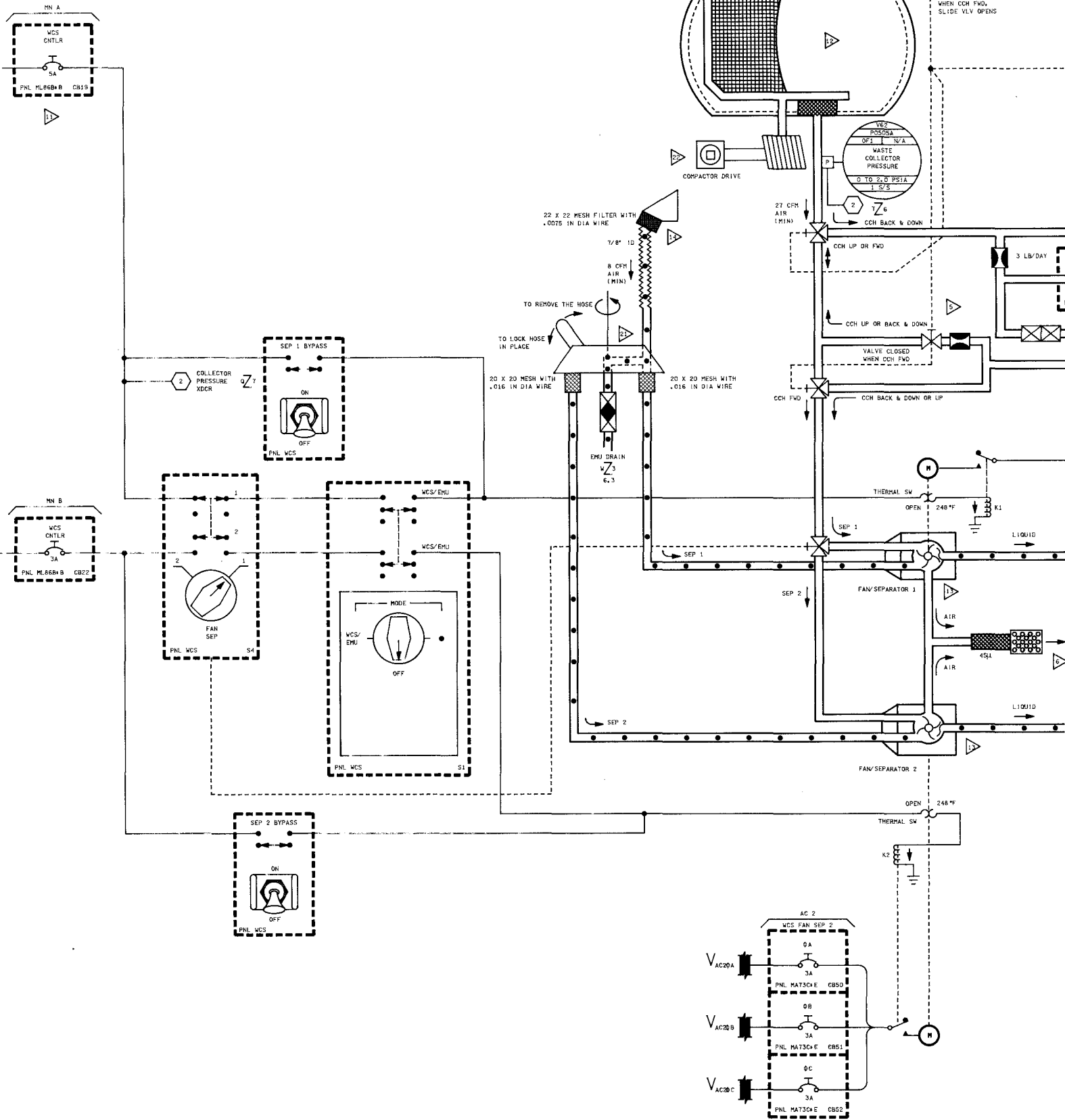
- Complete urination (in urinal per IFM WCS-failed urinal procedures).
- Remove protective strips covering the Stomaseal on the flanges of the fecal bag.
- Seal to buttocks and defecate.
- Gently force gas out of the bag and seal the flange opening.
- Place fecal bag into outer bag.
- Remove outer bag internal seal cover.
- Force gas out and seal.
- Remove outer bag external seal cover.
- Fold and seal.
- Stow in wet trash.

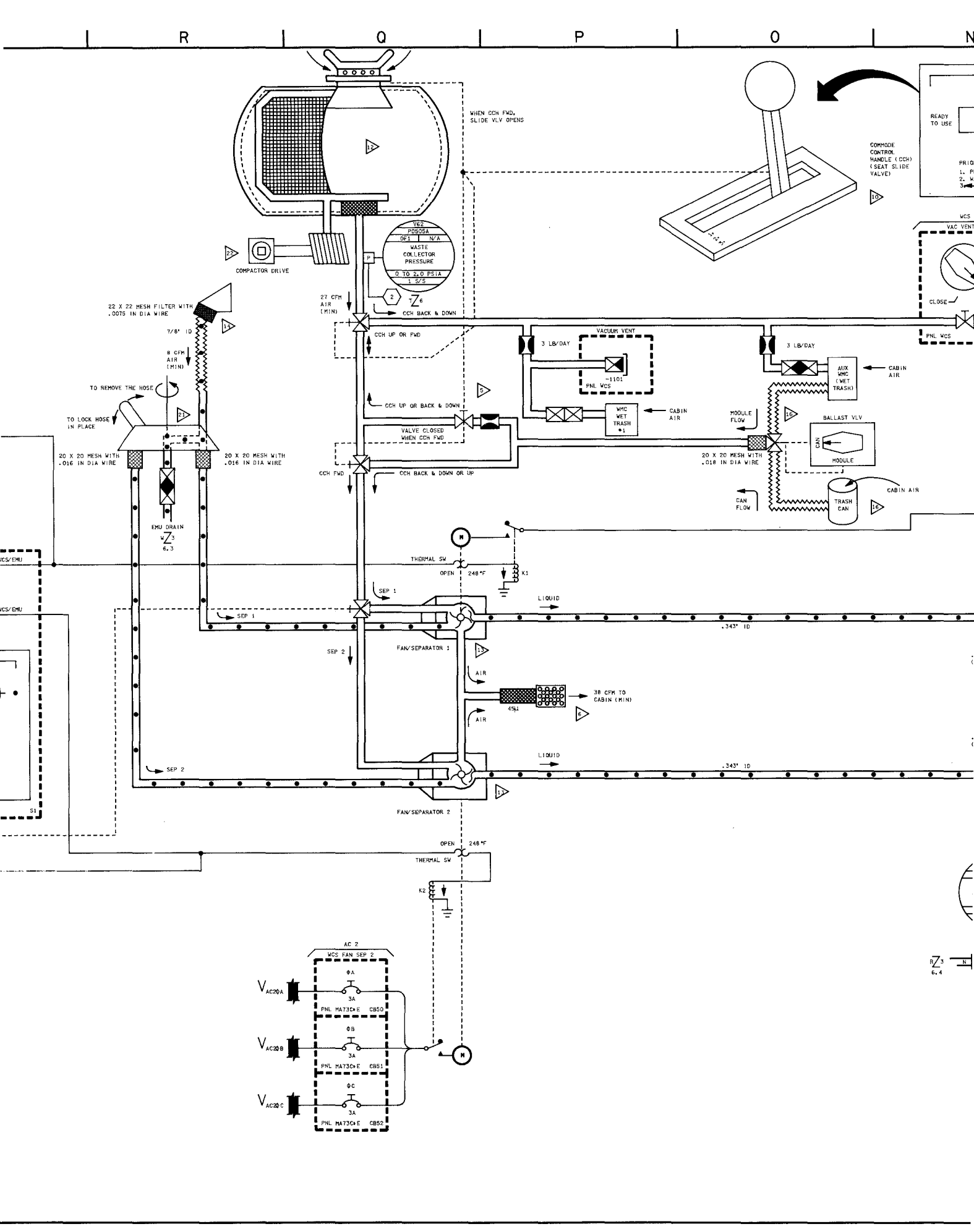
Figure 3.17-14.- Backup feces collection - failed fan separators.

8
7
6
5
4
3
2
1

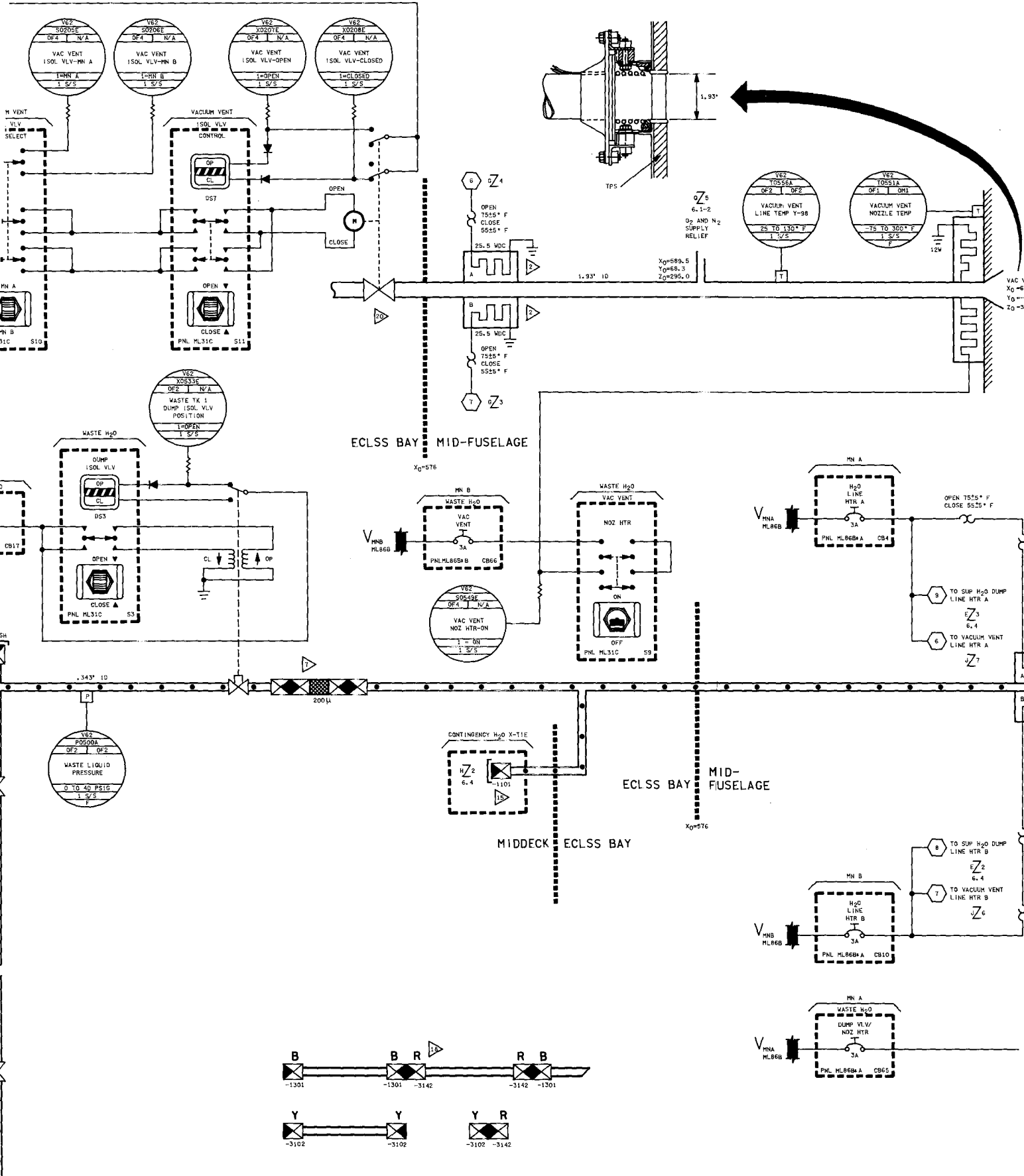


TO R
TO LOCK HO
IN PLACE
20 X 20 MESH
.016 IN DIA



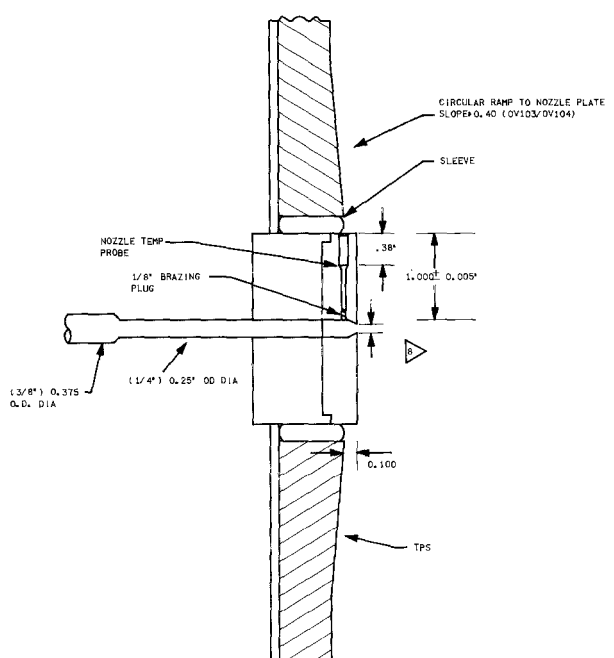
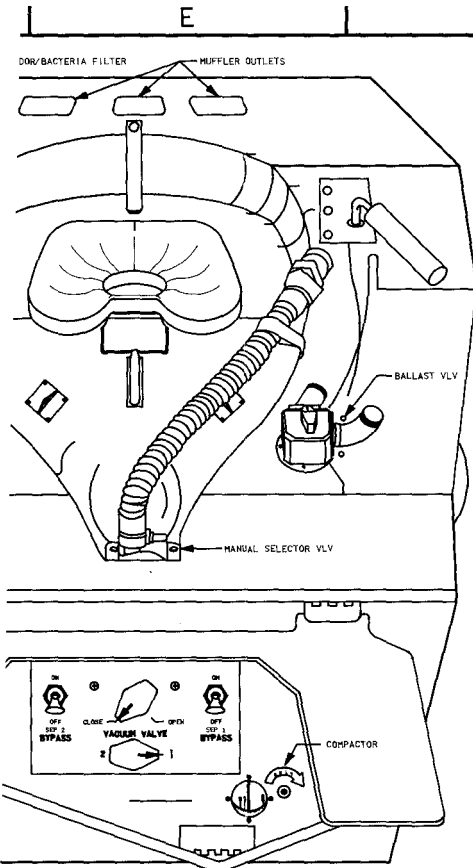


K | J | I | H | G



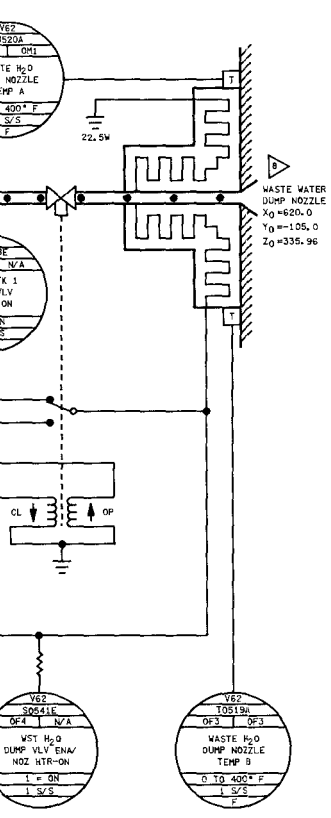
ECLS H₂O
SYSTEM FWD
FUSELAGE

| DATE | NAME | VER | VERSION |
|---------|------|-----|---------|
| 6/24/87 | VOC | | 1NK1 |
| 7/08/87 | MDU | | 1NK2 |
| 8/24/87 | MDU | | 1NK1 |



ACTUAL NOZZLE DIAMETER (ALL VEH)

| | OV-102 | OV-103 | OV-104 |
|-------------------|--------|--------|--------|
| WASTE DUMP NOZZLE | 0.0565 | 0.056 | 0.0555 |



- 22 THE COMPACTOR DRIVE AND ELASTIC NET SHOULD ONLY BE USED ONCE. IT MAKES ROOM IN THE COMMODE BY COMPACTING THE FECAL MATTER INTO A SMALL AREA. COMPACTOR CRANK FITTING (3/8" SQUARE DRIVE), USE TORQUE WRENCH AND 8" EXT. SET TO 150 IN-LB. 5 TURNS CW-360°
- 23 TO USE THE OTHER SEPARATOR LIFT LEVER ARM UP, ROTATE THE MANUAL SELECTOR VALVE 180° AND LOCK IN PLACE
- 24 VAC VENT 150L VLV ORIFICE IN VLV PLATE
FLOW 3,000-25 LBS/HR @ 14.7 PSIA
DELTA P 6.7 PSID
ORIFICE DIA. 0.0635 TO 0.0638 INCHES
DISCHARGE COEFF. (C_d) 0.8
KSC TESTING 4,3750.36 LBS/HR @ 6.7 PSID

- 25 SPARE
- 26 CONTINGENCY VACUUM HOSES
 - LENGTH
 - BLU/BLU - 10 FT
 - RED/RED - 10 FT
 - YELLOW/YELLOW - 8 FT
 - MATERIAL - TEFLON
 - DIAMETER - 1/4 IN OD
 - VACUUM NOZZLE (NOT SHOWN)
 - LENGTH ~1 FT

OD COMPATIBILITY

| | |
|-------|--------------|
| -1101 | -3102 |
| -1141 | -3142 |
| -1201 | -3142, -3302 |
| -1301 | -3142, -3302 |

- 27 SPARE
- 28 TRASH CAN AND HOSES INSTALLED DURING POST INSERTION AND STOWED DURING DEORBIT PREP
- 29 ALLOWS WASTE TANK TO BE SUPPLIED TO FES IN A CONTINGENCY BY CONNECTING WASTE OD TO CONTINGENCY WATER X-11E SUPPLY
OD SHOWN ON H/Z ALSO ALLOWS DUMP NOZZLES TO BE CROSS-TIED 6.4
- 30 FILTER IS REMOVABLE IN FLIGHT
- 31 FAN SEPARATOR SPEED 5800 RPM, 200 WATTS AC, MIN AIR FLOW 35 CFM, MAX WST WATER FLOW 0.09 LB/SEC
- 32 COMMODE
 - VOLUME 2.5 FT³
 - WEIGHT 135 LBS
 - COLLECTOR AIR OUTLET IS THROUGH A 0.45μM HYDROPHOBIC FILTER WHICH PREVENTS FREE LIQUID FROM EXITING COLLECTOR
 - COLLECTOR AIR OUTLET HAS 20 X 20 MESH FILTER WITH .018 IN OIA WIRE, WHICH PREVENTS SOLID WASTE FROM EXITING COLLECTOR
- 33 THE 5A CB AND WIRING IS A HOLD-OVER FROM WHEN THE COMMODE HAD A SLINGER
- 34 COMMODE CONTROL HANDLE CONTROLS MECHANICAL LINKAGE THAT ACTIVATES 4 VALVES AND S3 MICROSWITCH. COMMODE CONTROL HANDLE NOT OPERABLE IF MODE SWITCH IS IN OFF POSITION OR IN THE "M" POSITION. MODE SWITCH NOT OPERABLE IF COMMODE CONTROL HANDLE IS IN READY TO USE POSITION
- 35 SPARE
- 36 DUMP NOZZLE
 - MAX FLOW RATE 185-195 LB/HR FLUID
 - 1.5-2.0 LB/HR AIR
- 37 FILTER IS NOT REPLACEABLE IN FLIGHT
- 38 SEPARATOR OUTLET CABIN ODOR/BACTERIA FILTER. CAN BE CHANGED IN FLIGHT, BUT ONLY ONE SPARE IS CARRIED ONBOARD
- 39 COMMODE REPRESS SCREEN
SCREEN 40 MESH, 0.0065 WIRE
RESTRICTOR ENSURES COMMODE REPRESS >10 SEC
FILTER 0.45μM ABSOLUTE
MAX FLOW 30 CFM
- 40 SPARE
- 3 REFER TO TABLE 6.1 FOR DRAWING REFERENCES
- 41 THE A AND B (REDUNDANT) LINE HEATERS ARE CONTINUOUSLY WRAPPED TOGETHER THE FULL LENGTH OF THE LINE FROM X₀ = 576

- NOTES
- 42 WASTE WATER STORAGE TANK
 - USABLE CAPACITY 165 LBS
 - LENGTH 35.5 IN
 - DIAMETER 15.90 IN
 - DRY WEIGHT 39.5 LBS
 - 43 HYDROPHOBIC FILTER PRECLUDES WATER FROM EXITING TANK TO H₂ SUPPLY LINES IN EVENT OF BELLOWS LEAK, BUT WATER WILL BREAK THROUGH THE HYDROPHOBIC FILTER IF THE PRESSURE IS 5 PSID ACROSS IT

***5 WMS**

440A

| SIGNATURE | DATE | NATIONAL AERONAUTICS AND SPACE ADMINISTRATION |
|-------------------|--------------|---|
| DSGN LINDA DUPUIS | 10/10/78 | LINDA B. JOHNSON SPACE CENTER HOUSTON, TEXAS |
| DR | | |
| ENGR D. WILLIAMS | | |
| ENGR | | |
| APP | | |
| APP | SFORM VOL 12 | DWG NO |
| OWN/PLAN | ALL | FIGURE 3.17- |
| CTR | PCN | 121 X 34 PAGE 3.17-23 SHEET 1 OF |

NOTE:

Crewmember should urinate before defecation.

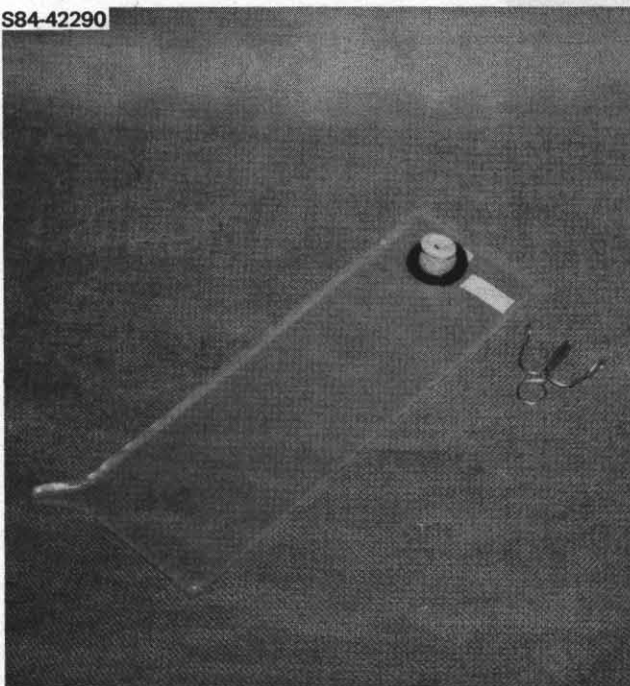
APOLLO FECAL BAG PROCEDURE

- Complete urination (in urinal)
- per ILM HCS-failed urinal
- procedures.

Remove protective strips covering the stomach on the flanges of the fecal bag.

CONTINGENCY MALE UCD

S84-42290



The male contingency UCD consists of a collecting bag, a roll-on-cuff crew interface, a ziplock plastic overbag, and a spring clip for sealing. Operational procedures consist of:

- Post-urination, apply clip to cuff.
- Push residual urine in cuff past bag check valve.
- Use dry wipes to dry cuff as cuff is re-rolled.
- Stow in overbag and into wet trash.
- For re-use of UCD, clean cuff with wet wipes.

Figure 3.17-15.- Male Urine Collection Device

URINE ABSORPTION SYSTEM (UAS)

The UAS consists of wicking material and moisture-sensitive powder which absorbs urine. After use, the UAS is placed in a plastic ziplock bag and stowed in the wet trash (fig. 3.17-16).

S85-25873

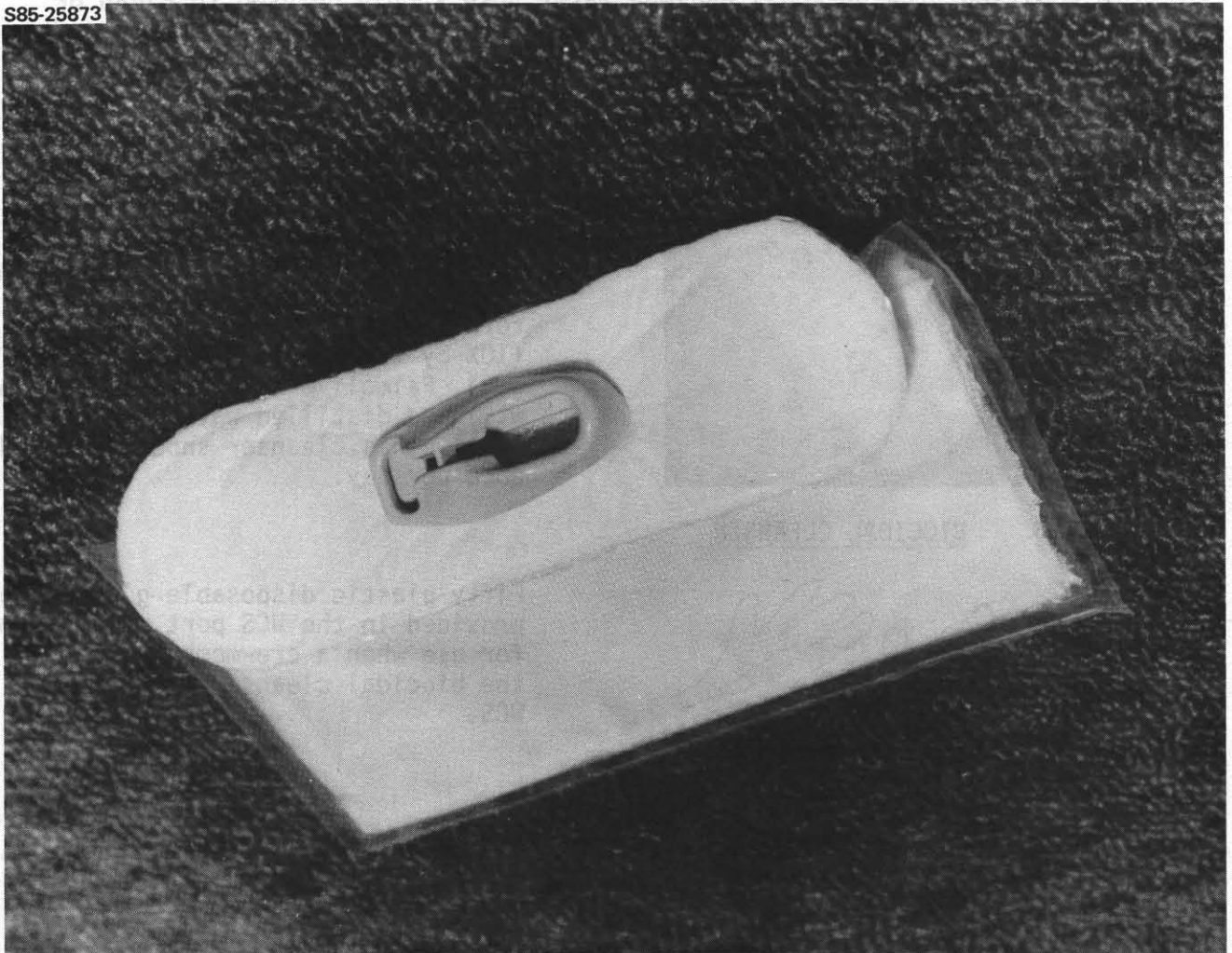


Figure 3.17-16.- Urine Absorption System.

3.17.3.5 WCS Inflight Cleaning/Maintenance

WCS cleaning is done as a daily inflight activity. Sanitation agent, disposable gloves, general purpose dry wipes, small wet wipes, and a contingency scraper tool (CST) are provided for cleaning the WCS. The urinal prefilter, located at the base of the urinal funnel, captures air entrained debris and should be replaced as required. In addition, the debris screen located in the hose block should be periodically checked and cleaned if clogged with debris. The odor/bacteria filter can be removed and replaced with a spare filter if excessive odors are present.

In addition, the personal hygiene water hose should be used to clean or flush areas of the urinal with water at least once per day.

The following equipment is provided to clean the WCS:



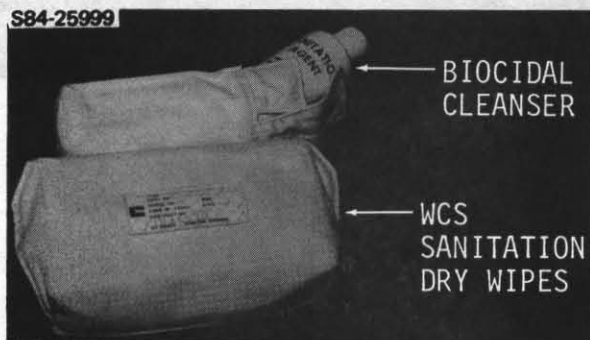
BIOCIDAL CLEANSER

The sanitation agent is a liquid biocidal detergent formulation in squeeze-bottle container (approximately 2 inches in diameter and 6 inches in length) with a dispensing valve and nozzle. The chemical formulation is denatured ethanol (10% by wt.), Lysol liquid (5% by wt.), Palmolive liquid soap (1.5% by wt.) and distilled water (83.5% by wt.). This cleanser should be used once per day.



DISPOSABLE GLOVES

Fifty plastic disposable gloves are provided in the WCS port wall volume for use when a crewmember is using the biocidal cleanser to clean the WCS.



GENERAL PURPOSE DRY WIPES

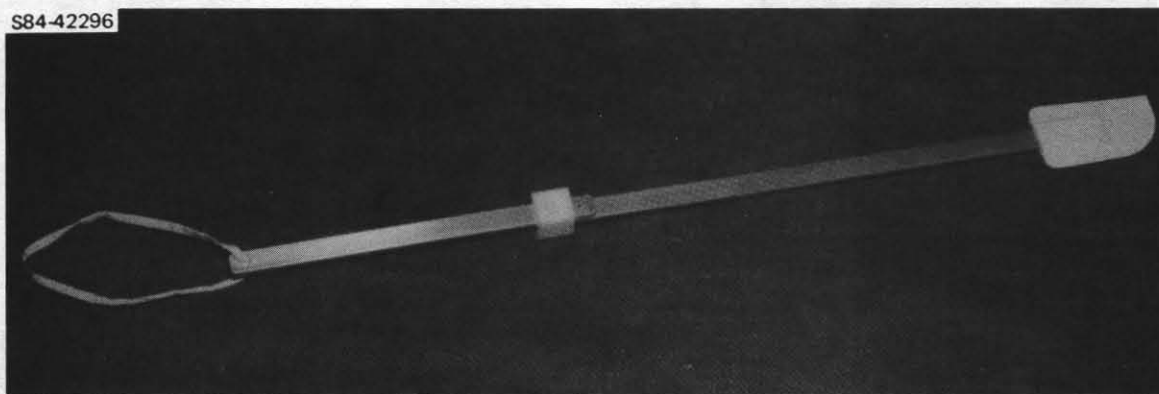
General purpose dry wipes are packaged 45 per pack. The wipes are used to spread the biocidal cleanser and to dry the cleaned surface. They are discarded either in the WCS wet trash module or Vol. F after use.



Wet Wipes (Small)

Small wet wipes are stowed in the WMC wall volume. The wipes contain Benzalkonium Chloride with alcohol and can be used to do general WCS cleaning.

S84-42296

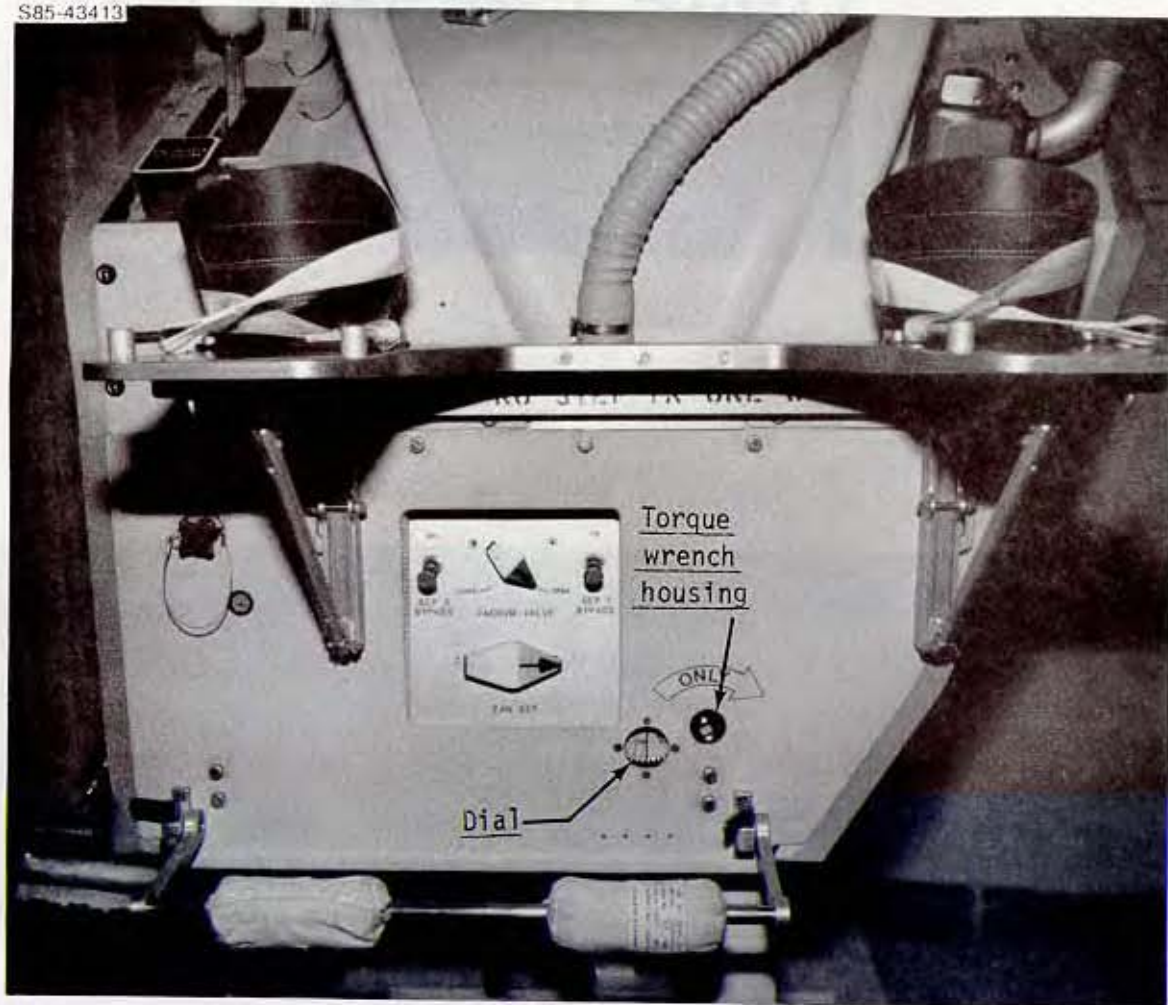


Contingency Scraper Tool (CST)

The contingency scraper tool (CST) is used to clean off excessive waste material buildup from the transport tube.

Excess buildup of waste material in the console may be minimized by using the manual compactor. The compactor consists of two vanes, one stationary and one movable, with a net connected between them. The 1/4" drive wrench, set to 150 ft-lb, is inserted into a housing located on the lower front of the WCS. Cranking the wrench clockwise causes the waste vanes to travel around the circumference of the console, carrying the net with it. Debris is captured by the net and pulled to one side of the console. A full sweep of the compactor is approximately 30" and measured by a rotary dial. If the net becomes stuck under the transport tube, scissors or cutters can be used to clear the tube.

S85-43413

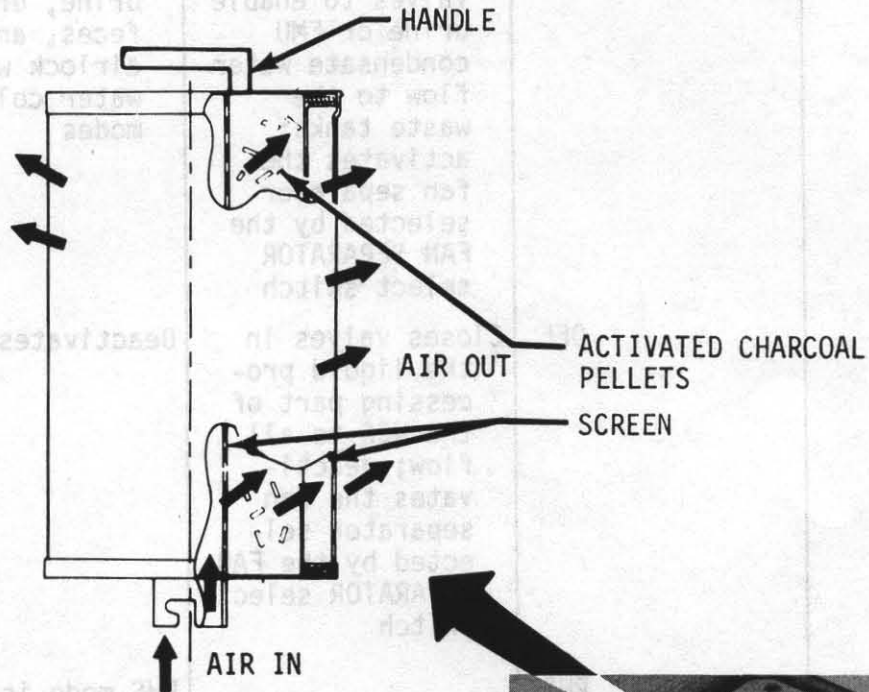


Manual Compactor

Excess buildup of waste materials in the commode may be minimized by using the manual compactor. The compactor consists of two vanes, one stationary and one moveable, with a net connected between them. The IFM torque wrench, set to 150 ft-lb, is inserted into a housing located on the lower front of the WCS. Cranking the wrench clockwise causes the mobile vane to travel around the circumference of the commode, carrying the net with it. Debris is captured by the net and pulled to one side of the commode. A full sweep of the compactor is approximately 330° as measured by a rotary dial. If the net becomes stuck under the transport tube, scissors or cutters can be used to clear the tube.

ODOR/BACTERIAL FILTER REPLACEMENT

Excessive waste odors may indicate an expended or failed odor/bacteria filter.



To replace odor/bacteria filter:

- Remove soft rubber gasket
- Grasp handle, turn filter 1/4 turn CW and remove
- Dispose of used filter in a dry trash bag liner, then deposit into wet trash compartment
- Install new filter
- Install soft rubber gasket

TABLE 3.17-1.- WCS DISPLAY AND CONTROL FUNCTIONS

| Location | Type | Nomenclature/ Position | Function | Remarks |
|----------|------|---------------------------|---|--|
| WCS unit | vlv | MODE Switch | | |
| | | WCS/EMU | Positions the WCS valves to enable urine or EMU condensate water flow to the waste tanks; activates the fan separator selected by the FAN SEPARATOR select switch | Position used for urine, urine/feces, and EMU/airlock waste water collection modes |
| | | OFF | Closes valves in the liquid processing part of the WCS to all flow; deactivates the fan separator selected by the FAN SEPARATOR select switch | Deactivates WCS |
| cover | | PHS | | PHS mode is no longer used |
| | | MODE Guard | Protects MODE switch in WCS/EMU position during EMU draining | Guard has the words: 'EMU SERVICE IN PROCESS'. Cannot use the 'WCS' during EMU use |

TABLE 3.17-1.- Continued

| Location | Type | Nomenclature/ Position | Function | Remarks |
|----------|--------|---------------------------|--|---|
| | handle | COMMODE CONTROL handle | | Requires an operating torque of 25 in-lb or less. |
| | | PULL UP | Positions interconnected valves to pressurize the commode. | Commode pressurization takes approximately 20 sec. The handle cannot be removed if the MODE switch is in the OFF position (mechanical interlock). |
| | | PUSH FORWARD | Opens the gate valve exposing the collector for use. | The MODE switch cannot be turned OFF when the handle is in the forward position (mechanical interlock). |
| | | OFF (Back/Down) | Closes gate valve, and exposes the collector to a vacuum for solid waste drying. | Vacuum valve must be open to obtain vacuum. |
| | v1v | VACUUM VALVE | | |
| | | OPEN | Opens vacuum vent line to commode. | Ordinarily left open for on orbit, closed for launch, reentry, and in contingency situations such as air leaks in WCS unit. |
| | | CLOSE | Closes vacuum vent line to commode. | |

TABLE 3.17-1.- Continued

| Location | Type | Nomenclature/ Position | Function | Remarks |
|----------|------|---------------------------|--|--|
| | vlv | FAN SEP Switch | | Switch is rotated CW from position 1 to 2 and vice versa |
| | | 1 | Enables operation of fan separator 1 (primary) on MN A DC BUS. Positions fan separators inlet valves for fan separator 1 operation | In general SW will be set on SEP 1 for launch and will remain in this position unless SEP 1 fails |
| | | 2 | Switches to redundant fan separator 2 and redundant power from MN B DC BUS. Positions fan separator inlet valves for fan separator 2 operation | Generally, will not use SEP 2 except in the case of SEP 1 failure |
| | sw | SEP 1 BYPASS | | |
| | | ON | Allows a manual override of a fan separator limit (control) switch failure located either in the FAN SEP or MODE switches. The lever-locked switch will activate (by providing dc control power) fan separator 1 as long as the fan separator ac circuit breakers are closed | Before activating the SEP 1 BYPASS switch, the FAN SEP switch should be positioned to 1 and the MODE switch be placed on WCS/EMU to position the inlet valves to the fan separator |

TABLE 3.17-1.- Continued

| Location | Type | Nomenclature/ Position | Function | Remarks | |
|----------|------|---------------------------|--|--|--|
| | | OFF | Deactivates manual override capability of a fan separator limit switch failure | | |
| | sw | SEP 2 BYPASS | ON | Allows a manual override of a fan separator limit (control) switch failure located either in the FAN SEP or MODE switches. The lever-locked switch will activate (by providing dc control power) fan separator 2 as long as the fan separator ac circuit breakers are closed | Before activating the SEP 2 bypass SW, the FAN SEP SW should be positioned to 2 and the MODE SW be placed on WCS/EMU to position the inlet valves to the fan separator |
| | | OFF | Deactivates the manual override capability of a fan separator limit switch failure | | |
| | qd | VACUUM VENT | Allows overboard venting through the vacuum vent line | Also, allows hook-up of waste water transfer hose for contingency | |

TABLE 3.17-1.- Continued

| Location | Type | Nomenclature/ Position | Function | Remarks |
|------------------------------------|-------|--|---|---------|
| Airlock waste water panel | vlv | WASTE WATER | | |
| | | OPEN | Allows flow of EMU waste water from airlock to WCS | |
| Panel ML86B | cb | MN A WCS CNTRL | | |
| | | OPEN | Disables power to fan separator 1 control functions | |
| | CLOSE | Enables power to fan separator 1 control functions | | |
| | cb | MN B WCS CNTRL | | |
| OPEN | | Disables power to fan separator 2 control func- tions | | |
| Panel MA73C | cb | AC1 WCS FAN SEP 1 ØA | | |
| | | OPEN | Disables ØA power to fan separator 1 control functions | |
| | | CLOSE | Enables ØA power to fan separator 1 control functions | |

TABLE 3.17-1.- Continued

| Location | Type | Nomenclature/ Position | Function | Remarks |
|----------------|------|---------------------------|----------|---|
| Panel MA73C | cb | AC1 WCS FAN SEP 1 ØB | OPEN | Disables ØB power to fan separator 1 control functions |
| | | | CLOSE | Enables ØB power to fan separator 1 control functions |
| | cb | AC1 WCS FAN SEP 1 ØC | OPEN | Disables ØC power to fan separator 1 control functions |
| | | | CLOSE | Enables ØC power to fan separator 1 control functions |
| | cb | AC2 WCS FAN SEP 2 ØA | OPEN | Disables ØA power to fan separator 2 control functions |
| | | | CLOSE | Enables ØA power to fan separator 2 control functions |

TABLE 3.17-1.- Concluded

| Location | Type | Nomenclature/ Position | Function | Remarks |
|----------|------|--|---|---------|
| | cb | AC2 WCS FAN SEP 2 ØB OPEN CLOSE | Disables ØB power to fan separator 2 control functions Enables ØB power to fan separator 2 control functions | |
| | cb | AC2 WCS FAN SEP 2 ØC OPEN CLOSE | Disables ØC power to fan separator 2 control functions Enables ØC power to fan separator 2 control functions | |

3.17.4 Systems Performance, Limitations, and Constraints

3.17.4.1 Commode Interlocks

- COMMODE CONTROL handle cannot be moved until the MODE switch is taken out of the OFF position (mechanical).
- COMMODE CONTROL handle cannot be moved forward (opening the gate valve) until the commode is pressurized (pneumatic).

3.17.4.2 Waste Production Quantities

- Urine

- Flow rate

- Nominal: 0.05 lb/sec (0.02 kg/sec)
- Maximum: 0.09 lb/sec (0.04 kg/sec)

- Quantity

- Maximum: 1.8 lb (0.82 kg) per urination
- Maximum: 8.8 lb/man-day (4.0 kg)

- Nominal quantity

- Water: 3.31 lb/man-day (1.50 kg)
- Solids: 0.13 lb/man-day (0.059 kg)

- Quantity range

- Water: 1.26 to 5.29 lb/man-day (0.57 to 2.40 kg)
- Solids: 0.06 to 0.22 lb/man-day (0.027 to 0.10 kg)

- Feces

- Nominal quantity

- Water: 0.2 lb/man-day (0.09 kg)
- Solids: 0.07 lb/man-day (0.03 kg)

- Quantity range

- Water: 0.13 to 0.44 lb/man-day (0.059 to 0.20 kg)
- Solids: 0.04 to 0.15 lb/man-day (0.018 to 0.068 kg)

- Wash water
 - Flow rate
 - Maximum: 0.09 lb/sec (0.04 kg/sec)
 - Quantity per wash
 - Maximum: 0.51 lb (0.23 kg)
 - Quantity per man-day
 - Average: 2.55 lb (1.16 kg)
- EMU water
 - Flow rate
 - Maximum: 0.09 lb/sec (0.04 kg/sec)
 - Quantity per use
 - Maximum: 10.0 lb (4.54 kg)
 - Uses per mission
 - Maximum: 6

3.17.4.3 Metabolic Waste Collection

- Waste collector (commode/urinal)
 - Location: WMC
 - Airflows required
 - Commode: 30 ft³/min (0.85 m³/min)
 - Urinal: 8 ft³/min (0.23 m³/min)
 - Storage volume: 2.4 ft³ (0.07 m³)
 - System leakage through vacuum vent: 0.0985 lb/man-day (0.045 kg)(max.)
 - Gate valve
 - Type: slide

- Waste collector control valves
 - Number: 2
 - Flow capacity: 30 ft³/min at 10 in. H₂O (0.85 m³/min at 254 mm H₂O)
 - Operating pressure: 14.7 to 8 psia (1033.5 to 562.5 g/cm²)

3.17.4.4 Metabolic Waste Processing

- Vacuum drying (for metabolic solid wastes)
 - Vacuum vent
 - Number: 1
 - Operating pressure range: 0 to 14.9 psia (0 to 1048 g/cm²)
 - ΔP : 14.7 to 0.2 psia (1034 to 14 g/cm²)
 - Controlled temperature range: 55° to 75° F (12.77° to 23.88° C)
 - Heater
 - Type: 2-element
 - Voltage range: 24 to 32 V dc
 - Heater capacity: 22.5 W
 - Temperature limits: 32° to 350° F (0° to 176.66° C)
 - Vacuum vent manual shutoff valve
 - Number: 1
 - Operating pressure range: 0 to 14.9 psia (0 to 1048 g/cm²)
 - ΔP : 14.7 \pm 0.2 psia (1034 \pm 14 g/cm²)
 - Leakage: 0.0985 lb/man-day (0.045 kg) (max.)
- Fan/water separator
 - Number: 2
 - Flow rate
 - Air: 38 ft³/min (1.08 m³/min)
 - Waste water (max.): 0.09 lb/sec (0.04 kg/sec)
 - ΔP
 - Air: 8 in. H₂O (203 mm H₂O)
 - Waste water at maximum H₂O flow minimum: 12 psid (843.7 g/cm²)
 - Maximum: 21 psi (1476.4 g/cm²)

- Separator capacity: 0.09 lb/sec (0.04 kg/sec)
- Inlet temperature range: 40° to 100° F (4.4° to 38° C)
- Quantity of liquid in discharged air (max.): 0.1 percent
- Quantity of air in discharged liquid (max.): 5 percent
- Input voltage range: 115 ± 5 V ac per phase (3 phase)
- Overload protection (circuit breaker): 3 A
- Thermal overload protection: 248° F (120° C)
- Minimum operating temperature: 32° F (0° C)
- Maximum operating temperature
 - Long term: 90° F (32.22° C)
 - Short term: 90° F (32.22° C)
 - Rotating chamber speed: 5800 rpm
- Fan/water separator check valves
 - Discharged water check valves
 - Number per separator: 2
 - Flow capacity: 0.09 lb/sec (0.04 kg/sec)
 - Operating pressure range: 0 to 30 psi (0 to 2109.2 g/cm²)
 - Leakage: Zero liquid
 - Pressure drop thru two valves: 2 ± 0.5 psi
- Odor/bacteria filter
 - Number: 1 + 1 spare
 - Flow rate (to cabin): 38 ft³/min (1.08 m³/min)
 - Operating pressure range: 14.7 ± 0.2 psia (1034 ± 14 g/cm²)
 - Maximum ΔP: 1 in. H₂O (25.4 mm H₂O)
 - Filter medium: Activated charcoal
 - Operating temperature range: 65° to 90° F (18.3° to 32.2° C)
 - Mesh
 - Nominal: 0.45 μm absolute

- Characteristics: Filter media rated for removal of 99.999 percent of all particles above 0.45 μm ; filter medium treated to provide hydrophobic characteristics
- Plastic zip-lock bags: 20 in hygiene locker
- Urinal Prefilter
 - Quantity: 10 spares
 - Material: Stainless steel
 - Opening: 40 mesh by 0.0065 in. (0.0165 cm) diameter wire
- Urinal Hose
 - Material: Stainless steel
 - Opening: 0.093 in. (0.236 cm)
- Ballast Air Flow Screen
 - Material: Stainless steel (type 304)
 - Opening: 20 x 20 mesh (0.018 in. diameter wire) - 1.5 in. effective open area

3.18 SLEEPING PROVISIONS

3.18.1 Introduction

Two sleeping systems are available on the Orbiter: the sleeping bag, and the three- and four-tier rigid sleep stations (fig. 3.18-1). Sleeping bags are flown on all missions. The sleep stations are also flown for large crews with two shift operations or Spacelab.

There are two types of sleeping bags available: the operational sleeping bag and the Apollo-type sleeping bag (fig. 3.18-2). The operational sleeping bags are made primarily of flame retardant cotton material, while the Apollo-type sleeping bag is made of Beta material perforated for thermal comfort. The operational sleeping bags are normally flown mounted on the starboard wall (in two groups of two), or in the four-tier bunk sleep stations. For sleeping bag flights when the crew size exceeds four, the remaining crewmembers use operational sleeping bag liner (fig. 3.18-3) and/or the Apollo-type sleeping bag. Only one Apollo-type sleeping bag can be flown per flight due to limited supply.

For Spacelab and other missions requiring two-shift operations either the three-tier or the four-tier rigid sleep stations are provided. Each bunk is provided with a sleeping bag, personal stowage, light, ventilation inlet and outlet, and overhead light shields. In the top three bunks of the four-tier sleep station (and in the top two of the three-tier sleep station) the sleeping bag faces the overhead. In the bottom bunk the sleeping bag can face the overhead or be installed so that it faces the deck. The light in the bottom bunk can be moved up or down the bunk depending on the location of the sleeping bag.

To facilitate sleeping, each crewmember has a sleep kit (fig. 3.18-4). Each kit contains eye covers and ear plugs for use as needed during the sleep period. The kits are stored in the crewmember's personal clothing locker.

3.18.2 Stowage and Installation

When the rigid sleep stations are not flown, four operational sleeping bags are launched on the starboard wall in two groups of two. The top two cotton sleeping bags have six adjustable straps (three on each side) with a spring clip on each end. Six pip pins (twelve are located in the IFM locker tray) can be attached to the spring clips for installing two of the sleeping bags to the middeck lockers. The other two sleeping bags are left on the starboard wall for use. For entry, all four sleeping bags are re-installed on the starboard wall. When the crew size exceeds four, the extra crewmembers use operational sleeping bag liners and a maximum of one Apollo sleeping bag all launched in a middeck stowage locker. The operational sleeping bag liners can be restrained in any convenient Orbiter location (e.g., airlock) with the two 36 in. long (1 1/8 in. wide) straps located on back of the liner. The Apollo sleeping bag has four adjustable straps with pip pins that allow it to be attached to the middeck lockers.

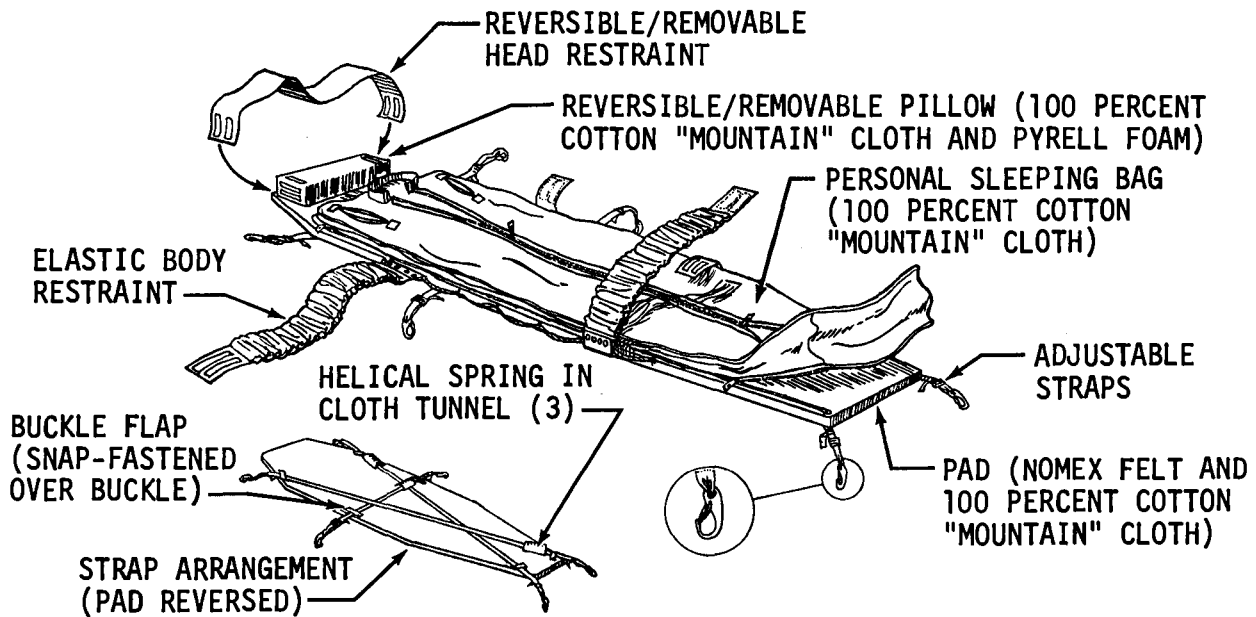
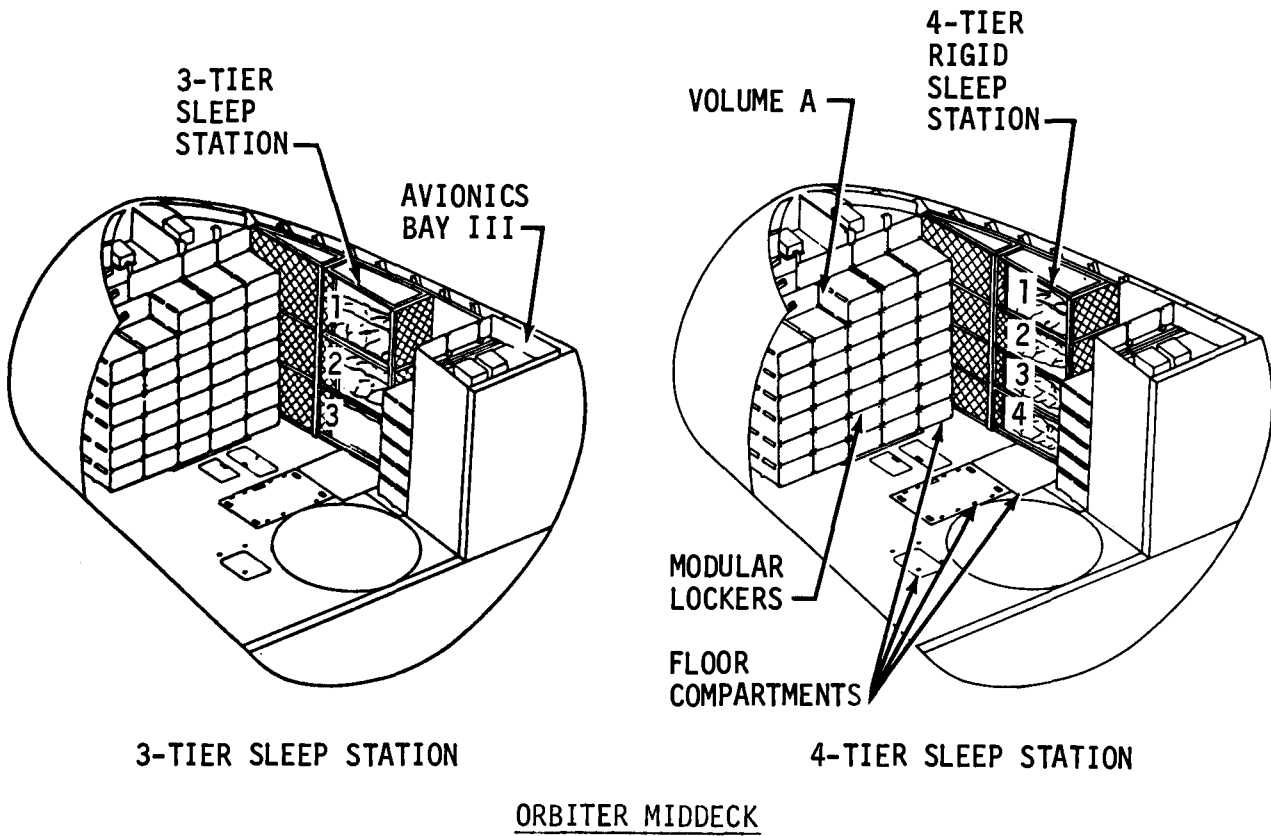


Figure 3.18-1.- Rigid sleep stations and operational sleeping bag.

S-78-27258



Figure 3.18-2.- Apollo sleeping bag.

LINER BACK VIEW

LINER FRONT VIEW

Figure 3.18-3 - Operational Sleeping Bag Liner.

S85-32280



SLEEPING BAG ASSY W/LINER

S85-32281



LINER FRONT VIEW

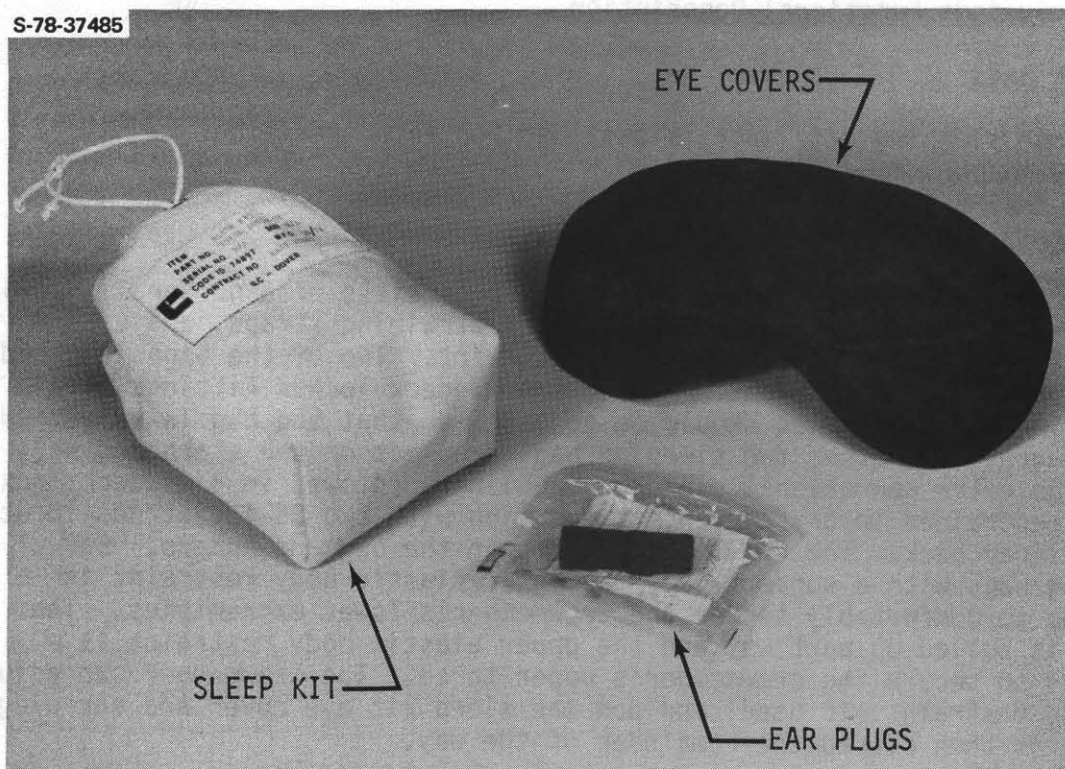
S85-32282



LINER BACK VIEW

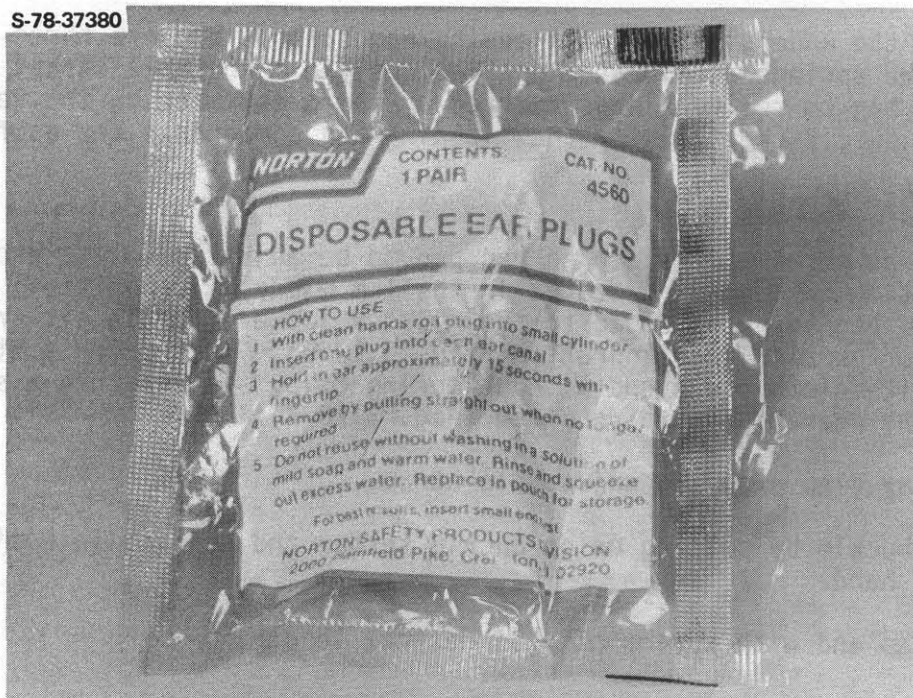
Figure 3.18-3.- Operational Sleeping Bag Liner.

S-78-37485



SLEEP KIT CONTENTS

S-78-37380



EAR PLUGS (BACKSIDE)

Figure 3.18-4.- Sleep kit (stowed in personal clothing lockers).

3.18.3 Systems Functional Description

Sleeping Bags

A separate sleeping bag/liner is provided for each crewmember.

Operational Sleeping Bag

The operational sleeping bag (figs. 3.18-5) consists of a personal sleeping bag liner, a support pad with adjustable restraining straps, and a reversible/removable pillow and head restraint. Two of the bags launched on the starboard wall can be attached to the middeck locker fittings by pip pins. The six pad straps should be adjusted so that the bag is stretched to full length. The other two sleeping bags are left on the starboard wall for use. The extra operational sleeping bag liners (stowed in a middeck locker) can be restrained in any convenient location with two 36-in. straps located on the liner back. The crewmember zips open the bag and enters. For sleeping bags with a support pad, the lower elastic body restraint is adjusted to comfortably secure the crewmember's lower extremities. The zipper is pulled up part way and the upper elastic body restraint is adjusted to secure the crewmember's upper torso. The crewmember can adjust the head restraint (if used) and don the sleep kit eye cover and ear plugs. The bag is then closed the remainder of the way.

The personal sleeping bag liner is made primarily of 100-percent cotton 'mountain' cloth. The inner padding for the pillow and pad is Pyrell foam and Nomex felt, respectively.

Included on the underside of the sleeping bag support pad are three helical springs. The springs are located upstream of the adjustable straps on one side of the bag to relieve loads exerted by the crewmember on the vehicle structure. Specific details on the sleeping bag components are as follows

Six Adjustable Straps

The six straps permit the sleeping bag pad to be adjusted to its proper configuration. Pip pins (located in the IFM middeck locker tray) allow the sleeping bag to be attached to the middeck locker face in either a horizontal or vertical configuration (fig. 3.18-6). To shorten a strap, pull the white cloth strap end without spring clip. To lengthen a strap, the following operations are required (fig. 3.18-7):

- Lift cover flap exposing adjustable strap.
- Release buckle by pulling up on buckle tether and holding in position with one hand.
- Pull strap end with spring clip to desired length.
- Release tether and close cover flap.

S83-25266



Figure 3.18-5.- Operational sleeping bags - launch/entry position.

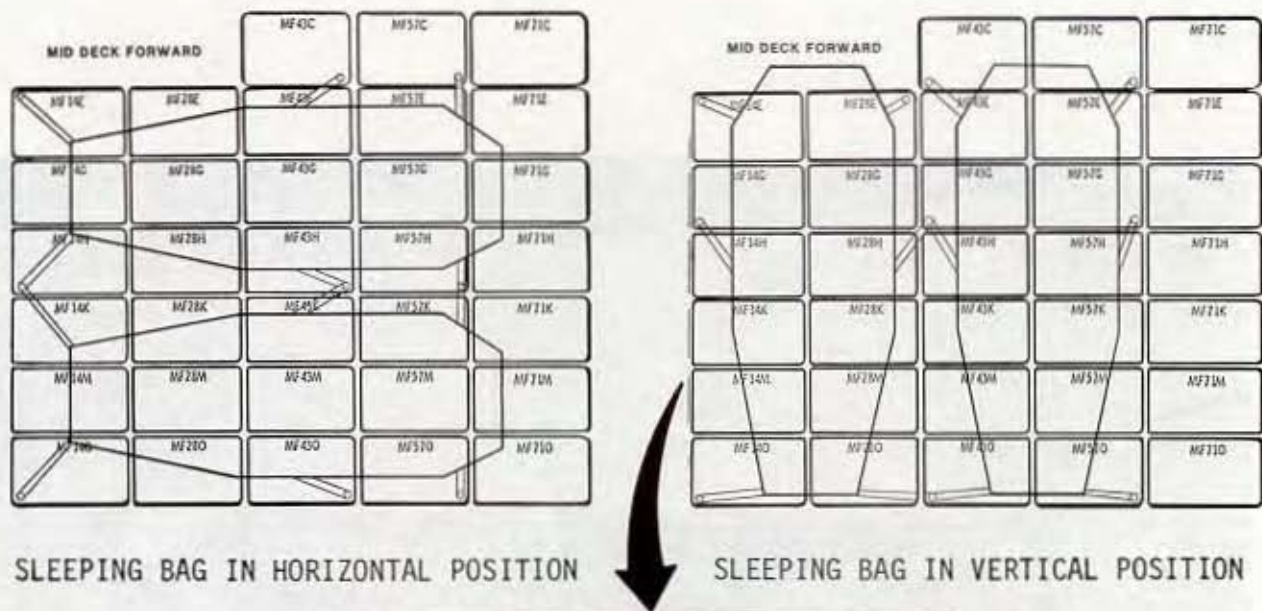


Figure 3.18-6.- Operational sleeping bags use location - two on starboard wall, two on middeck lockers

S-82-35029

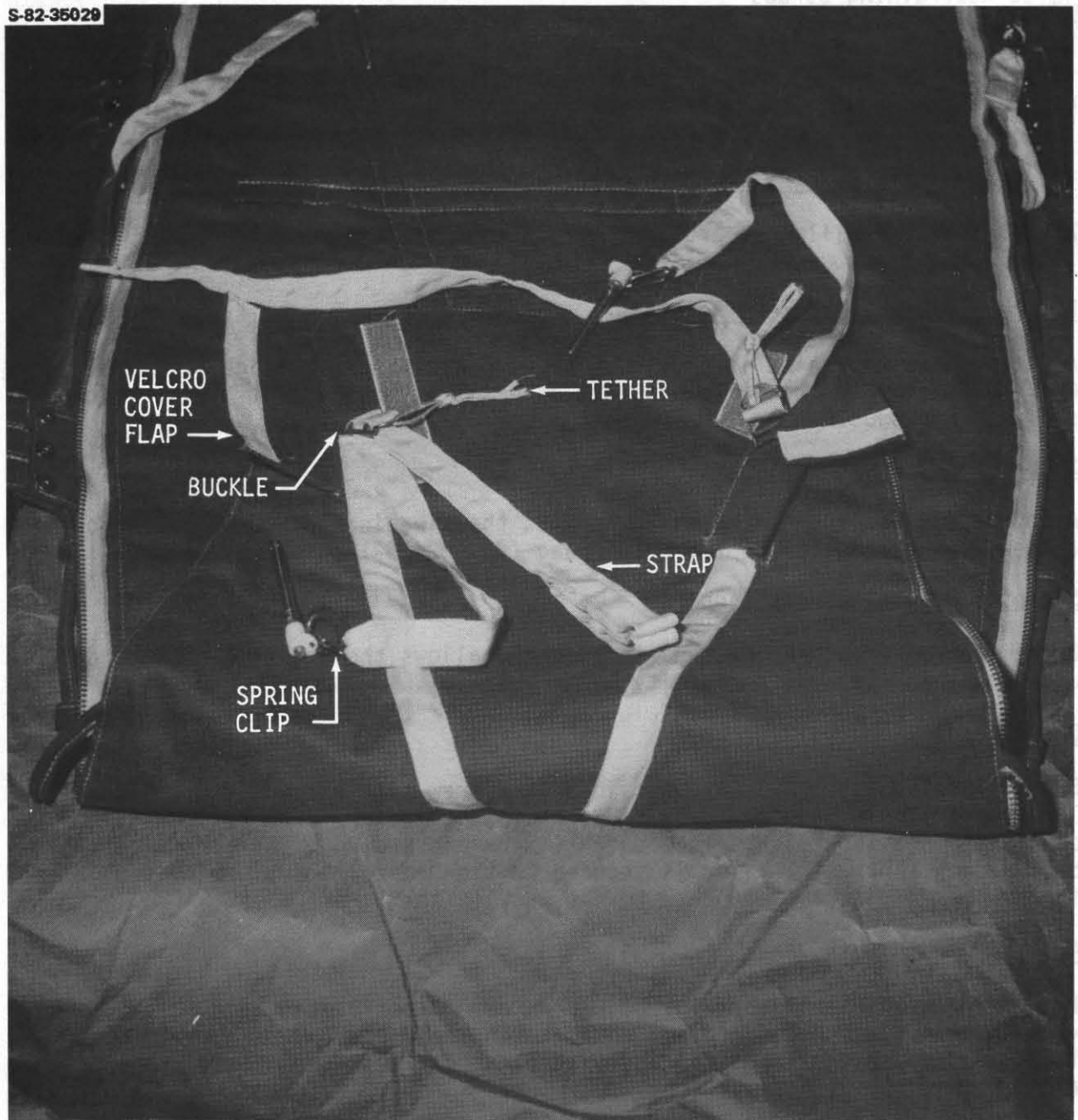


Figure 3.18-7.- Adjustable straps.

Torso Restraining Straps

Two elastic adjustable body restraints are provided to restrain the upper and lower part of the body (fig. 3.18-8). The adjustable straps can be moved up or down the sides of the sleeping bag by unsnapping the snaps (fig. 3.18-9). Once properly positioned, the straps are attached by Velcro.

Reversible/Removable Pillow

A cotton padded pillow is provided to position the crewmember's head (fig. 3.18-10).

Reversible/Removable Head Restraint

A cotton head restraint is provided for each sleeping bag (fig. 3.18-11). One end is sewn to the pillow and the other is attached to it by two Velcro strips, for adjustment.

Sleeping Bag Closure Zipper

A double zipper arrangement which permits the sleeping bag to be opened or closed from the bottom or top of the bag (fig. 3.18-12) is provided.

Sleeping Bag Attachment Zippers

One zipper on each side of the sleeping bag allows the bag to be attached to a support pad for better rigidity (fig. 3.18-13).

Operational Sleeping Bag Liner

Extra sleeping bag liners are provided when crew size exceeds four. The liners are either launched in a middeck stowage locker, or, for four-tier bunk sleep station flights, the extra liners are stowed within the sleeping bag in each bunk. The liner is secured to the Orbiter structure by two 36 in. x 1 1/8 in. straps attached to the back of the liner.

Apollo-type Sleeping Bags

The Apollo-type sleep restraint bags are made of perforated Beta material, with Armalon stiffening material added to the back for firmness. A zipper is used to close the front, and a torso strap is used to encircle the midsection (fig. 3.8-14).

S-82-35023

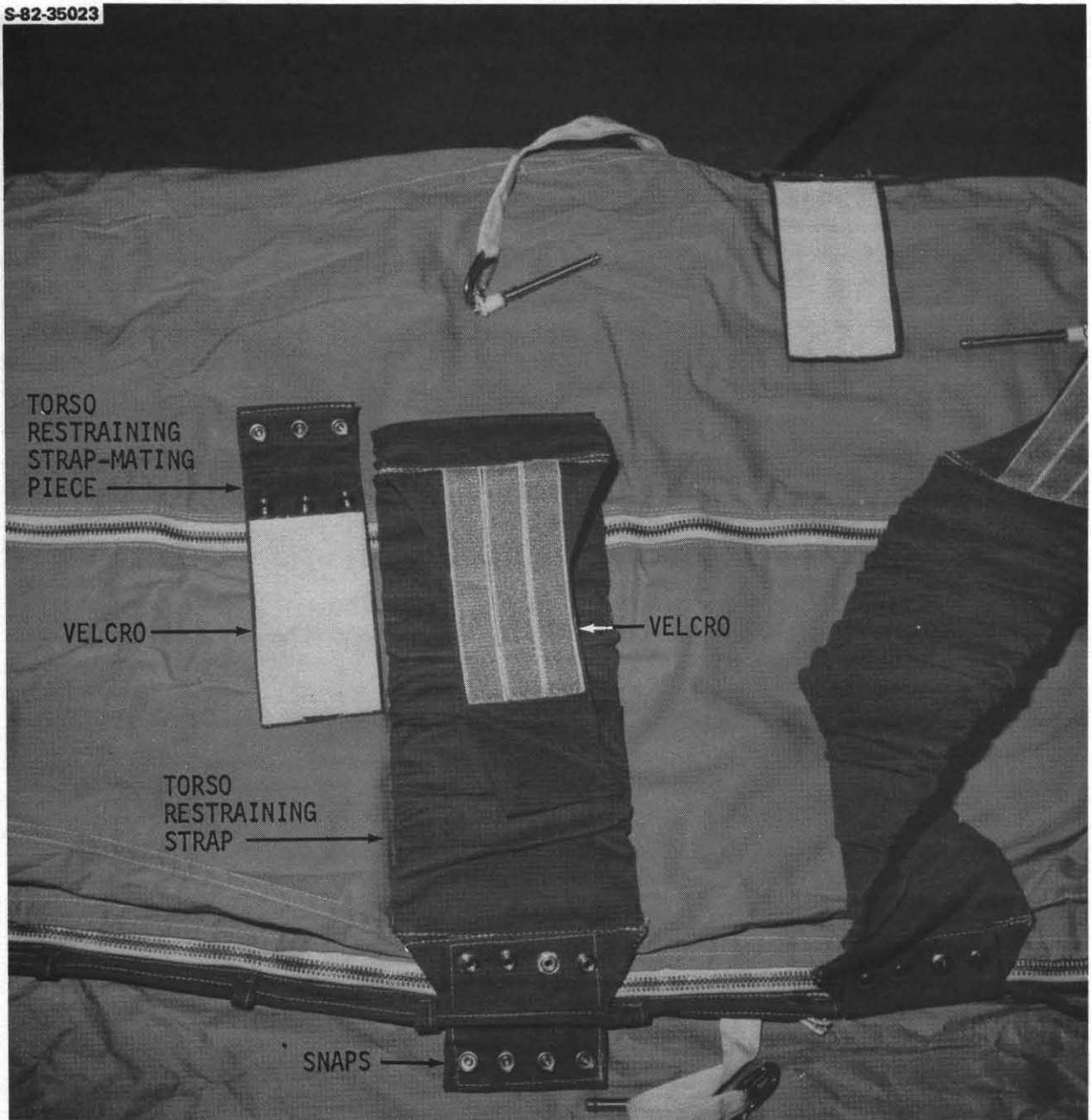


Figure 3.18-8.- Torso restraining straps.

S-82-35018

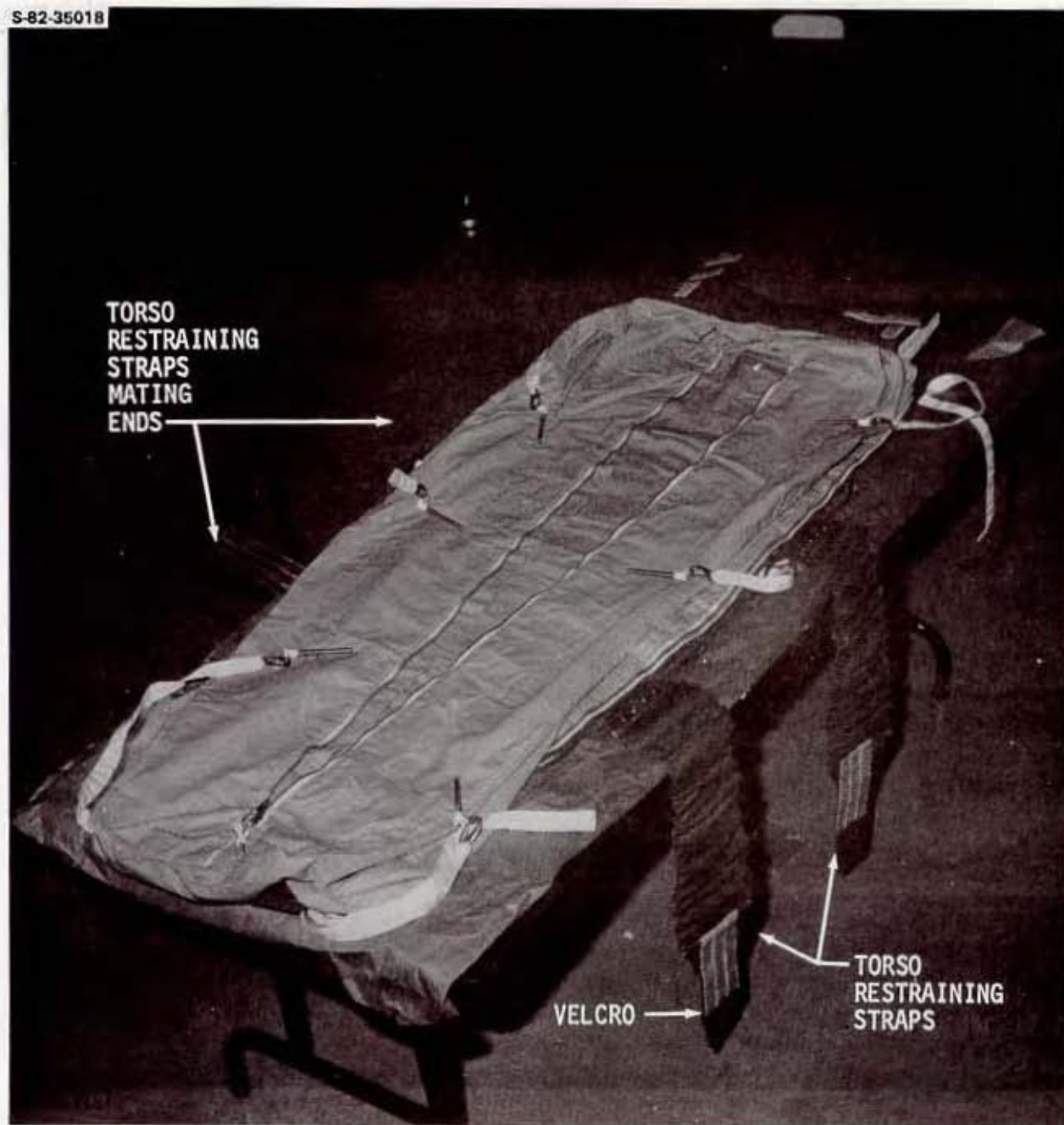


Figure 3.18-9.- Torso restraining straps.

S-82-35026



Figure 3.18-10.- Reversible/removable pillow.

S-82-35025

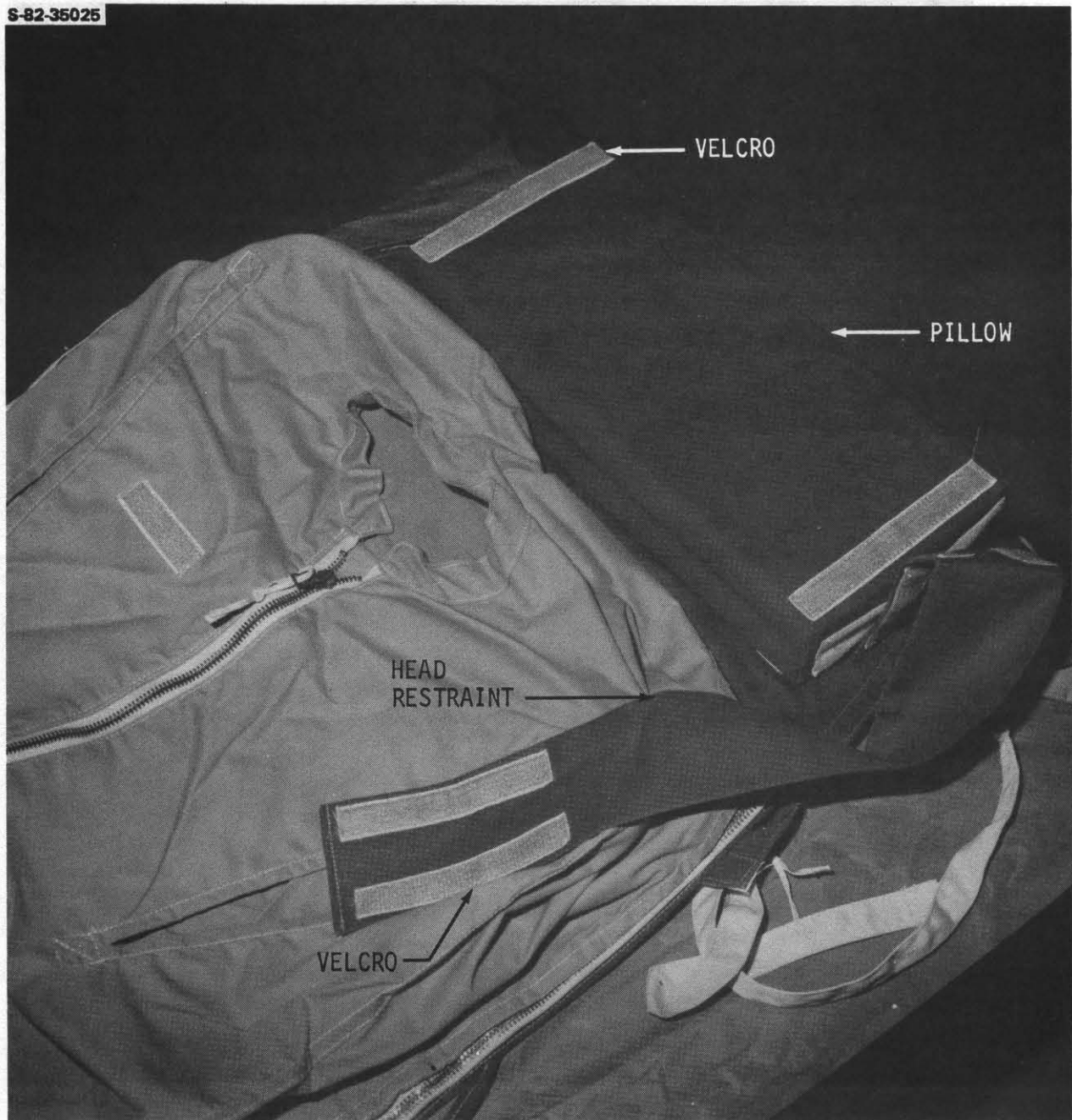


Figure 3.18-11.- Reversible/removable head restraint.

S82-35024

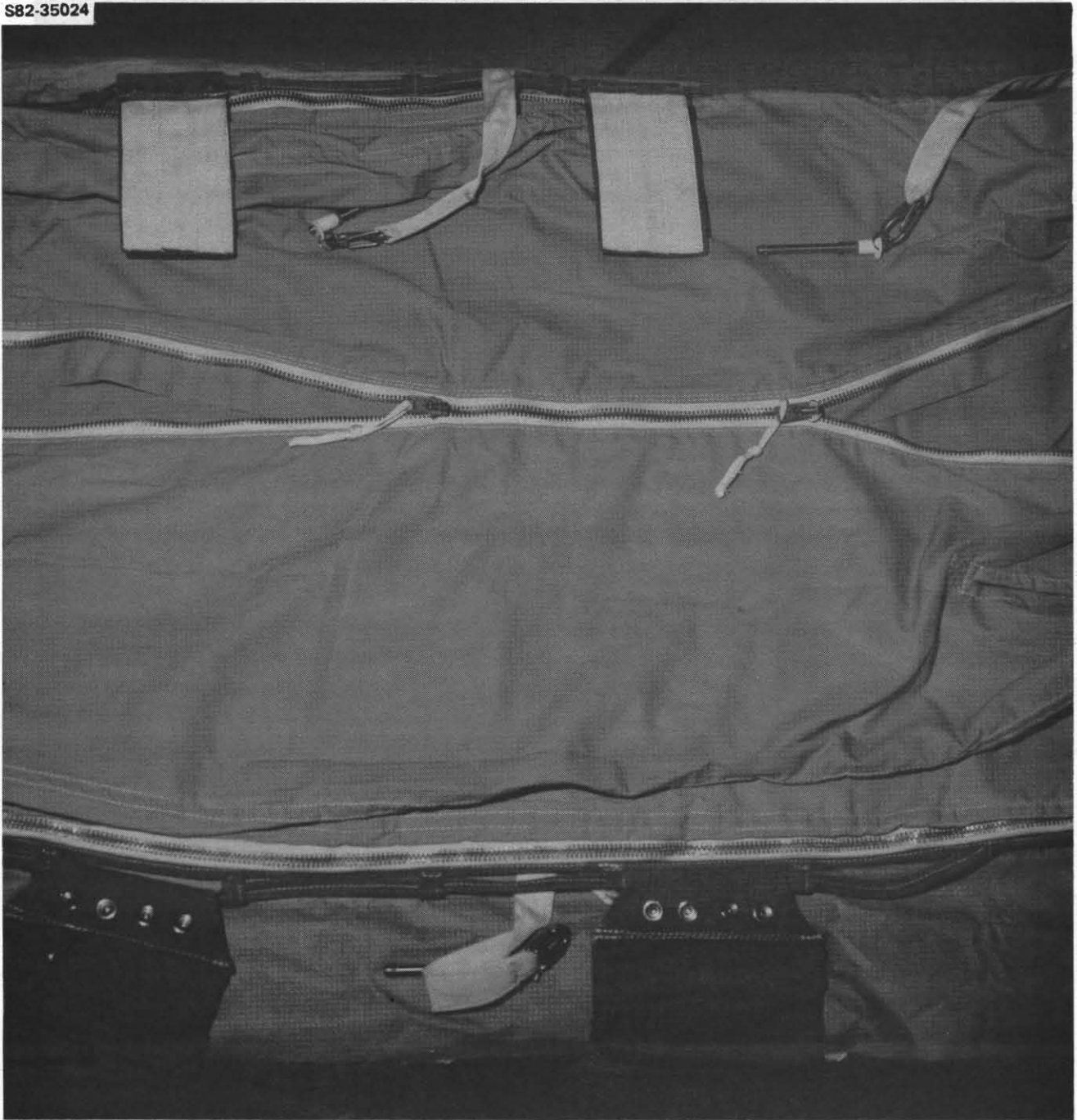


Figure 3.18-12.- Sleeping bag closure zipper.

S-82-35027

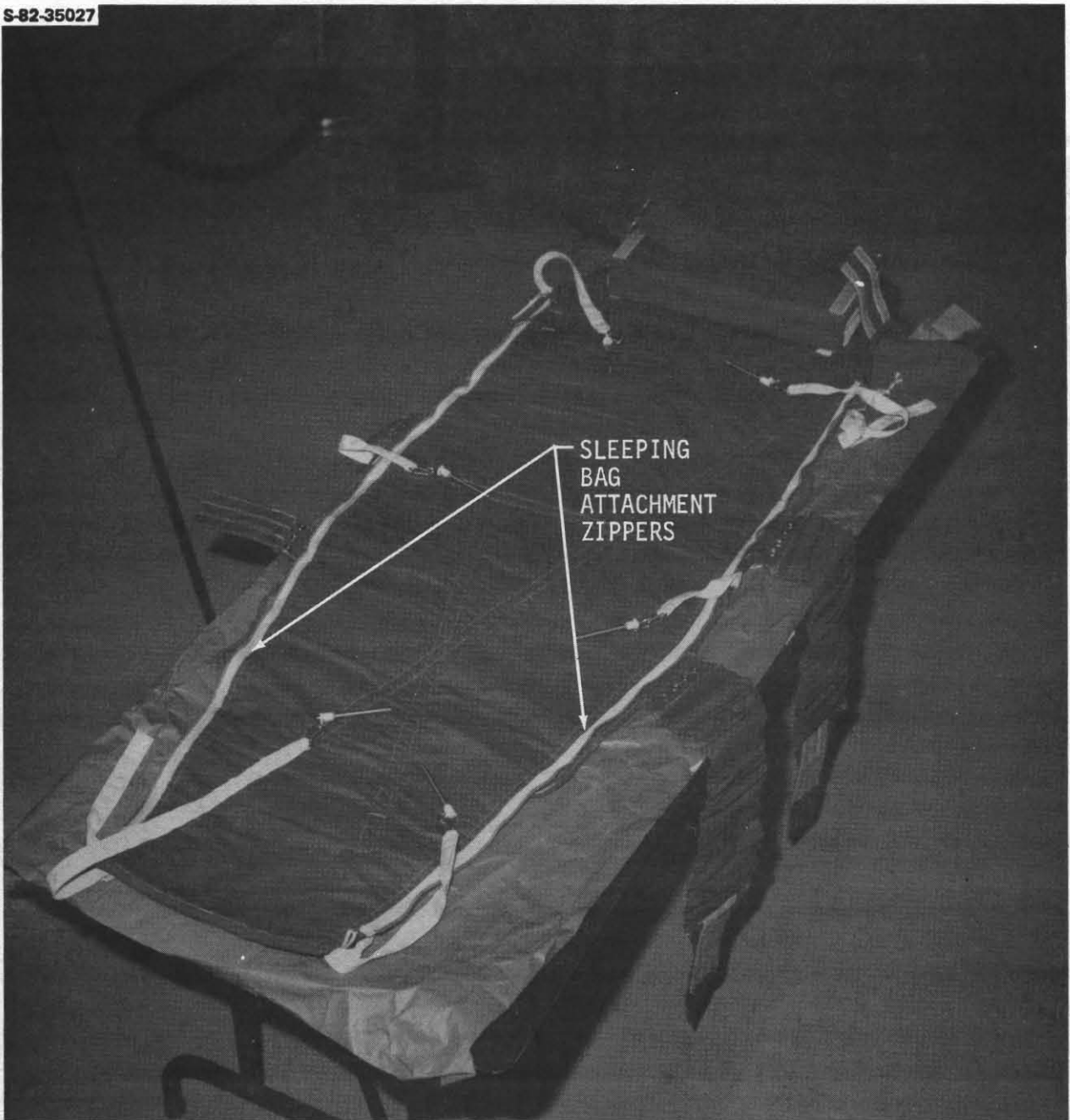


Figure 3.18-13.- Sleeping bag attachment zippers.

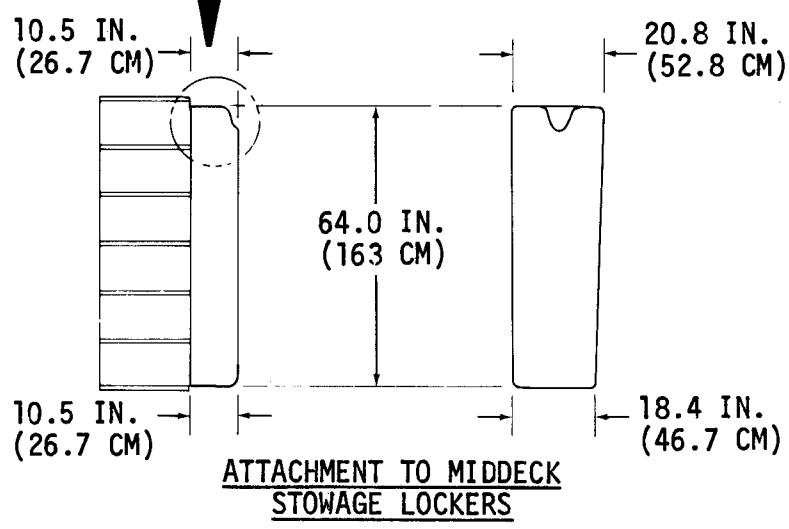
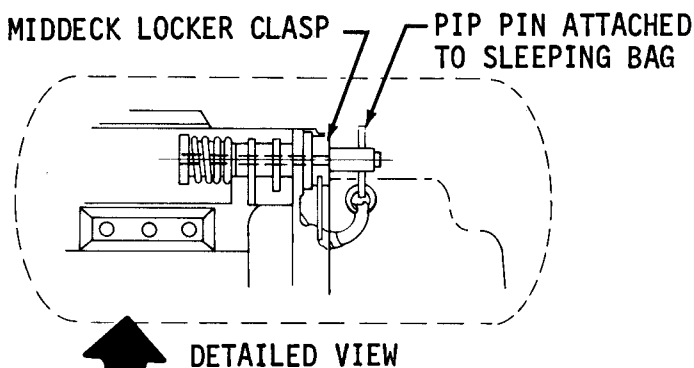
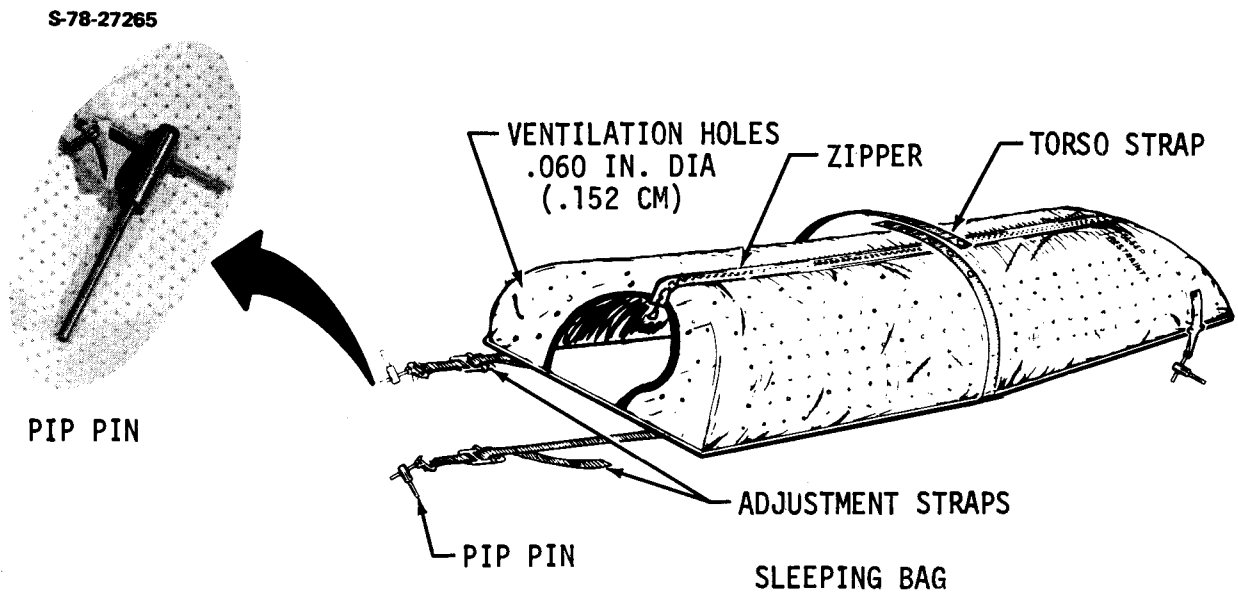


Figure 3.18-14.- Apollo-type Beta cloth sleeping bag configuration.

Sleep Kit

The sleep kit contains eye covers and ear plugs. The sleep kit is stowed in each crewmember's personal clothing locker.

- Eye covers

The eye covers (fig. 3.18-4) are soft fabric eyeshields. The eye covers attenuate light that might be objectionable to a sleeping crewmember. One set of eye covers is provided for each crewmember per flight.

- Ear plugs

The ear plugs (fig. 3.18-4) attenuate normal cabin environment noises to a level that will not awaken a sleeping crewmember. One pair of ear plugs is provided for each crewmember per 2 flight days. The ear plugs can be reused if required.

Four-Tier Sleep Station

The four-tier sleep station consists of four horizontal bunks each of which contains an operational sleeping bag. The bunks are constructed of machined aluminum and Kevlar and provide for light and sound attenuation and privacy. The sliding doors allow ingress/egress into the bunks. The side panels, door and support for the bottom bunk are removable for access to under-floor stowage. To gain access to floor compartment volume E (MD76C), the crewmember needs to remove the bottom bunk side panel and door. (See IFM Checklist)

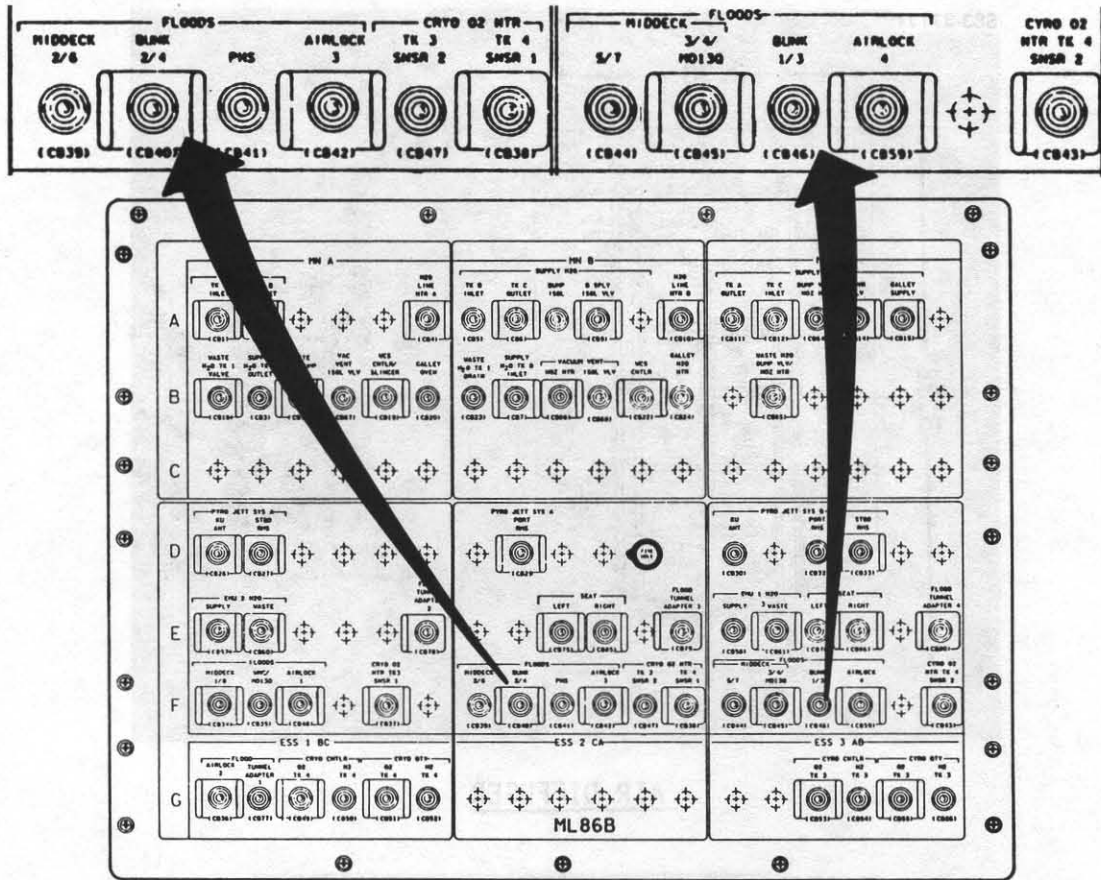
For ground servicing or contingency on-orbit access to under-floor compartment F (the wet trash compartment MD76M), the individual needs to remove the bottom bunk lower aft inboard panel at the middeck floor (see IFM Checklist). To achieve this, the following procedure must be performed:

- Open the bottom sleep station door past the center vertical support beam.

Three-Tier Sleep Station

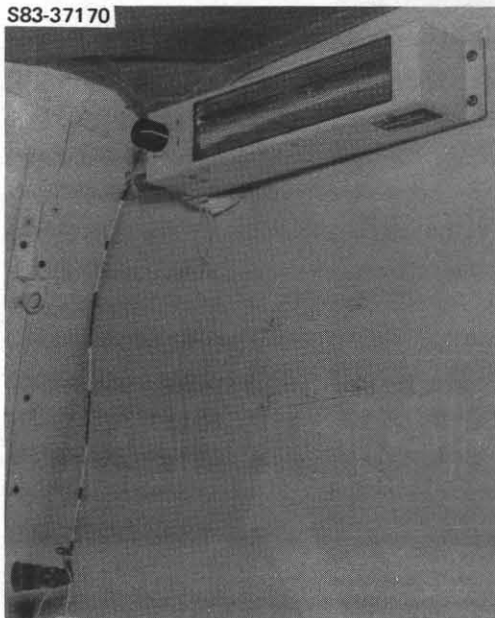
The three-tier sleep station consists of three horizontal bunks. The components of the three-tier sleep station are the same as those of the four-tier sleep station.

Lights are provided at the head of each sleep station (fig. 3.18-15). Ventilating air enters through an air diffuser (fig. 3.18-16) at the head of each station and exits into the Orbiter cabin (fig. 3.18-16) through a grille at the foot of each station. The adjustable air diffuser will permit a ventilation airflow of up to 20 ft³/min (0.57 m³/min). Personal stowage provisions are also provided on the starboard wall of each sleep station (fig. 3.18-17). Sleep station displays and controls (D&C) are listed in table 3.18-1.



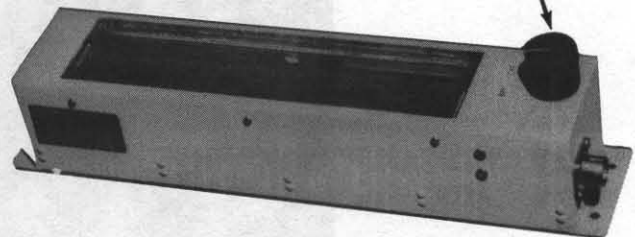
PANEL ML86B

S83-37170



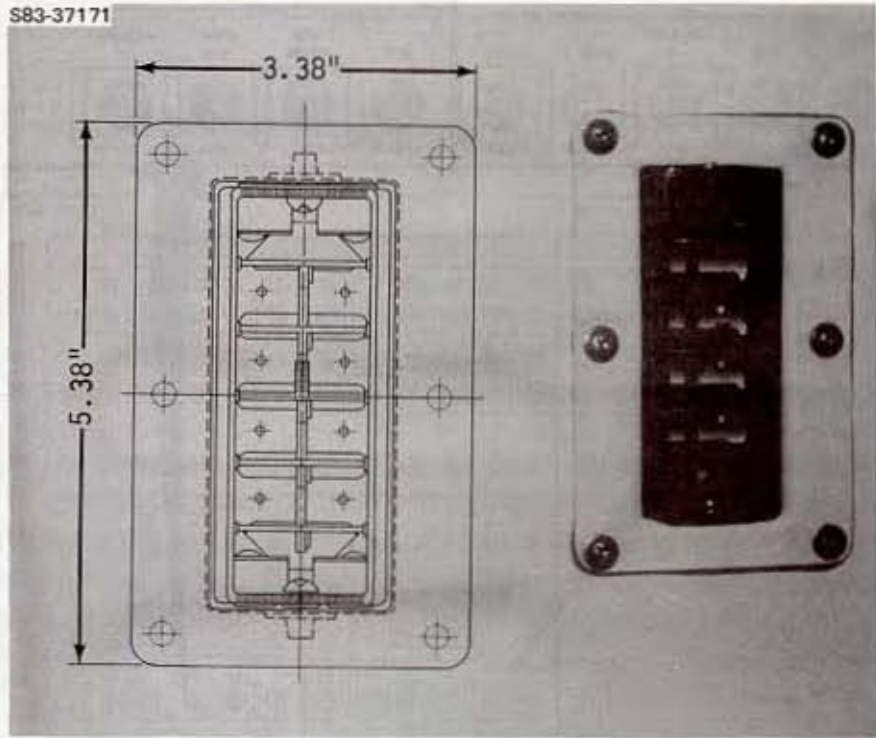
LIGHT BRIGHTNESS CONTROL SWITCH

S80-39628

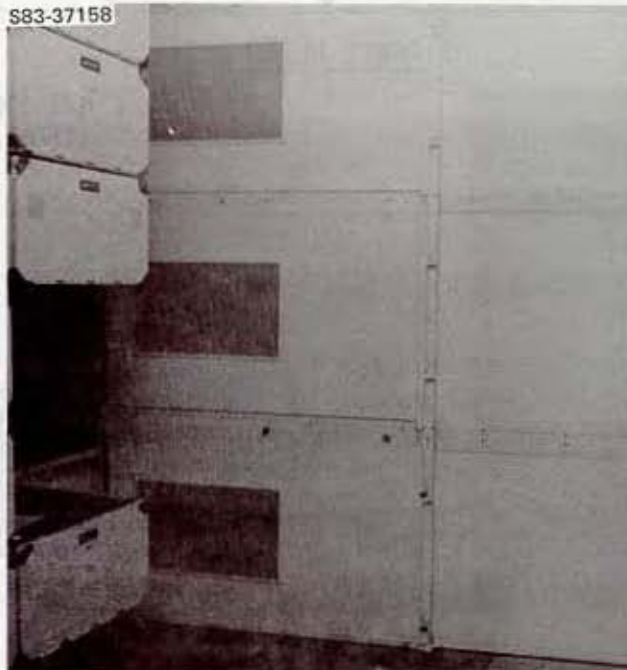


FOUR-TIER SLEEP STATION LIGHT

Figure 3.18-15.- Sleep station light and circuit breakers (three and four-tier)



AIR DIFFUSER



GRILLE ON SIDE PANEL OF EACH SLEEP STATION

Figure 3.18-16.- Sleep station ventilation system.

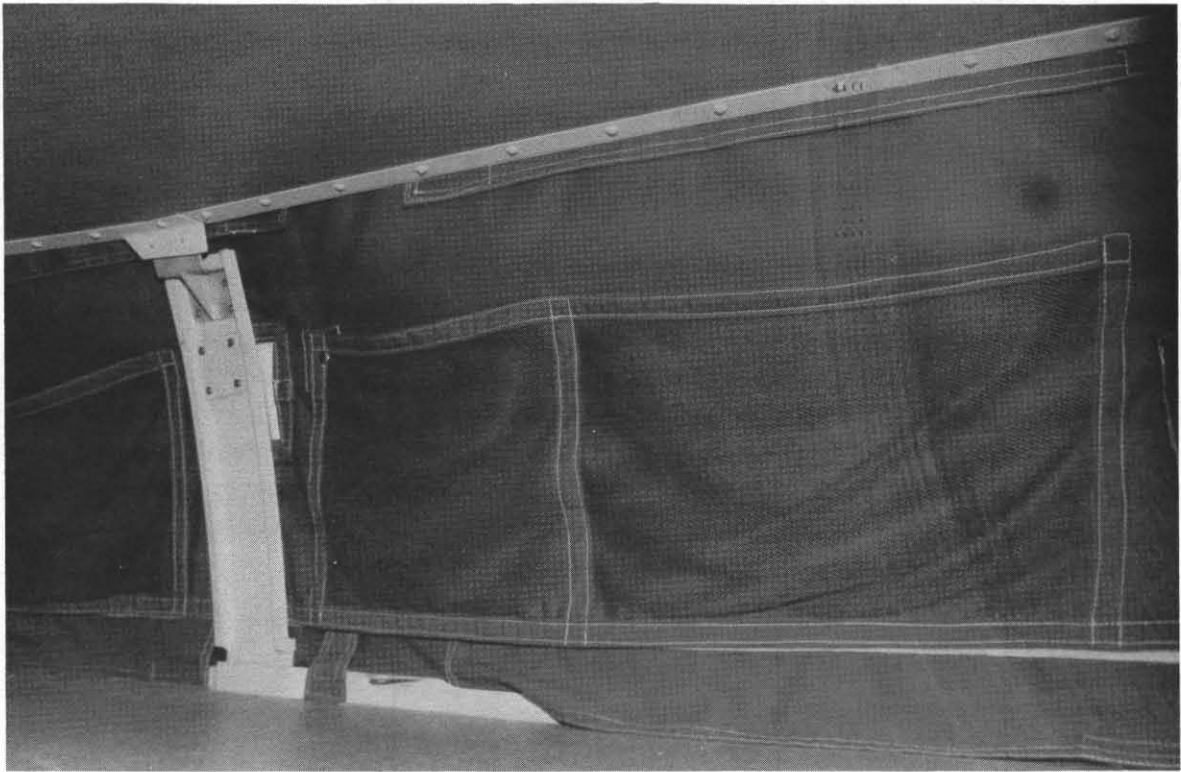
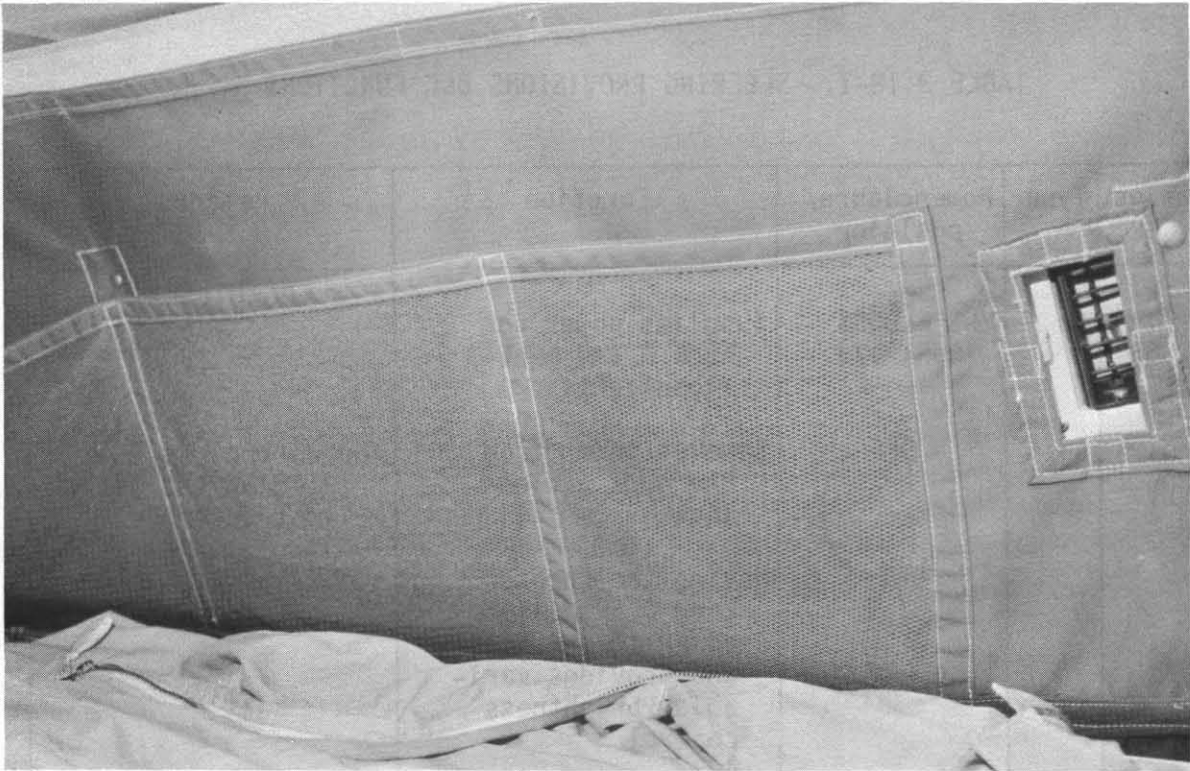



Figure 3.18-17.- Personal stowage provisions in rigid sleep stations.

TABLE 3.18-1.- SLEEPING PROVISIONS D&C FUNCTIONS

| Location | Type | Nomenclature/ position | Function | Remarks |
|---------------|------|---|--|---|
| Pn1 ML86B | cb | MNC FLOODS BUNK 1/3 | Supplies power for bunk 1 and bunk 3 floodlights | |
| Pn1 Bunk 1 | sw | OFF  BRT | Removes power from the bunk 1 flood- light Moving the knob cw from OFF applies power to the light and provides vari- able brightness control | The control is lo- cated on the flood- light assembly |
| Pn1 Bunk 3 | sw | | Same as bunk 1 sw except bunk 3 | |
| Pn1 ML86B | cb | MNB FLOODS BUNK 2/4 | Same as bunk 1/3 cb except bunk 2 and bunk 4 | When three-tier sleep station is flown, cb controls bunk 2 floodlight only |
| Pn1 Bunk 2 | sw | | Same as bunk 1 sw except bunk 2 | |
| Pn1 Bunk 4 | sw | | Same as bunk sw except bunk 4 | |

3.18.4 Systems Performance, Limitations, and Constraints

Sleeping Bag System

- If all crewmembers are sleeping simultaneously, at least two crewmembers will wear a headset. To ensure reception of ground calls and caution and warning (C&W) alarms, one headset will be connected to the SLEEP STA TONES outlet (M058F) and the other to any other comm outlet.
- Operational sleeping bag 100-percent cotton 'mountain' cloth
 - Bag: 64 x 26 x 14 in. (162 x 66 x 36 cm); weight 3 lb
 - Pad: 74 x 26 x 1/2 in. (188 x 66 x 1.27 cm); weight 6.5 lb
 - Body straps: 29 x 6 in. (73.7 x 15.2 cm)
 - Pillow: 18 x 8 x 3 in. (45.6 x 20.3 x 7.6 cm); weight 1 lb
 - Head restraint: 30 x 4 in. (76 x 10.2 cm)
- Apollo-type Beta cloth bag
 - Length: 64 in. (162 cm)
 - Width (head end): 20.8 in. (52.8 cm)
 - Width (foot end): 18.4 in. (46.7 cm)
 - Height: 10.5 in. (26.7 cm)
 - Neck opening diameter: 7 in. (18 cm)
 - Weight: 3.5 lb

Eye Covers

- Quantity: 1/crewmember
- Weight: 0.3 lb (0.14 kg)

Ear Plugs

- Material: Polyurethane foam
- Mean attenuation (dB): 24.5 at 125 Hz
32.1 at 500 Hz
34.0 at 1000 Hz
38.4 at 2000 Hz
- Quantity: 2 plugs/2 days/crewmember

Rigid Sleep Station System

If all crewmembers are sleeping simultaneously, at least two crewmembers will wear headsets. To ensure reception of ground calls and C&W alarms, one headset will be connected to the SLEEP STA TONES outlet (M058F) and the other to any other comm outlet.

- Four-tier

- Length

- Station 1: 76 in. (193 cm)
- Station 2: 77 in. (195.6 cm)
- Station 3: 77 in. (195.6 cm)
- Station 4: 79.4 in. (201.7 cm)

- Width (max.)

- Station 1: 28.9 in. (73.4 cm)
- Station 2: 32.7 in. (83.1 cm)
- Station 3: 32.6 in. (82.8 cm)
- Station 4: 31.3 in. (79.5 cm)

- Width (min.)

- Station 1: 24.95 in. (63.4 cm)
- Station 2: 30.5 in. (67.3 cm)
- Station 3: 26.5 in. (67.3 cm)
- Station 4: 19.4 in. (49.3 cm)

- Height

- Station 1: 20.8 in. (52.8 cm)
- Station 2: 20.9 in. (53.1 cm)
- Station 3: 20.9 in. (53.1 cm)
- Station 4: 19.5 in. (49.5 cm)

- Three-tier

- Length

- Station 1: 76 in. (193 cm)
- Station 2: 77 in. (196 cm)
- Station 3: 80 in. (203 cm)

- Width (max.)

- Station 1: 28.9 in. (73.4 cm)
- Station 2: 30.9 in. (78.4 cm)
- Station 3: 31.8 in. (80.8 cm)

- Width (min.)

- Station 1: 24.9 in. (63.4 cm)
- Station 2: 26.2 in. (66.5 cm)
- Station 3: 20.9 in. (53.1 cm)

- Height

- Station 1: 29.1 in. (73.9 cm)
- Station 2: 26.0 in. (66.0 cm)
- Station 3: 26.3 in. (66.8 cm)

3.19 SHUTTLE ORBITER MEDICAL SYSTEM

3.19.1 Introduction

The Shuttle Orbiter Medical System (SOMS) consists of two kits containing medical provisions for on-orbit diagnosis and treatment.

The SOMS is flown on every mission and is designed to meet the following needs:

- Medical care for minor illnesses and injuries
- Stabilization of severely injured or ill personnel until return to Earth
- Obtaining information for ground personnel to assist in the diagnosis and treatment of injuries and illnesses
- Appropriate medical support for individual crewmembers; e.g., allergy medication, etc.

Additional medically-related equipment, such as the G-suit (sec. 3.13), radiation dosimeters (sec. 3.20), and Operational Bioinstrumentation System (OBS) (sec. 3.21) can be used to supplement the SOMS; for example, the OBS can be used to obtain an electrocardiogram.

3.19.2 Stowage

The SOMS is stowed in a middeck locker. For on-orbit use, the kit may be attached with Velcro to any locker door.

3.19.3 Systems Functional Description

SOMS

The SOMS (fig. 3.19-1) weighs 10.5 lb (4.8 kg), will fit into a 0.6-ft³ (0.02-m³) volume, and consists of two packages (fig. 3.19-1). These packages are the Emergency Medical Kit (EMK), which contains four pallets, and the Medications and Bandage Kit (MBK), which contains three pallets. The EMK includes pallet A, injectables; pallet B, injection accessories and surgical items; pallet C, diagnostic/therapeutic items; and pallet G, microbiological test items. The MBK contains pallet D, oral medications; pallet E, bandage items; and pallet F, other medications, (fig. 3.19-2). Each is constructed in the form of a pallet with a fabric covered stiffener and pockets on each side. Each has a number '1' or '2' with its designator; for example, pallet A1 and A2 indicate the front and back sides of pallet A. The All Flights MEDICAL CHECKLIST will specify the location of medical equipment and supplies in the two medical kits by an alphanumeric code as follows:

- 1st Character - Alpha code of the pallet (A to G)
- 2nd Character - Pallet side (1 or 2)
- 3rd, 4th Character(s) - Number of the specified pocket on the pallet

Example: Aspirin MBK (D1-5)

Location: Medications and Bandage Kit, Pallet D, Side 1, Pocket 5

In addition to pallets, each medical kit contains a pocket sewn onto the inside back of each kit. The MBK is blue, and the EMK is blue with red Velcro.

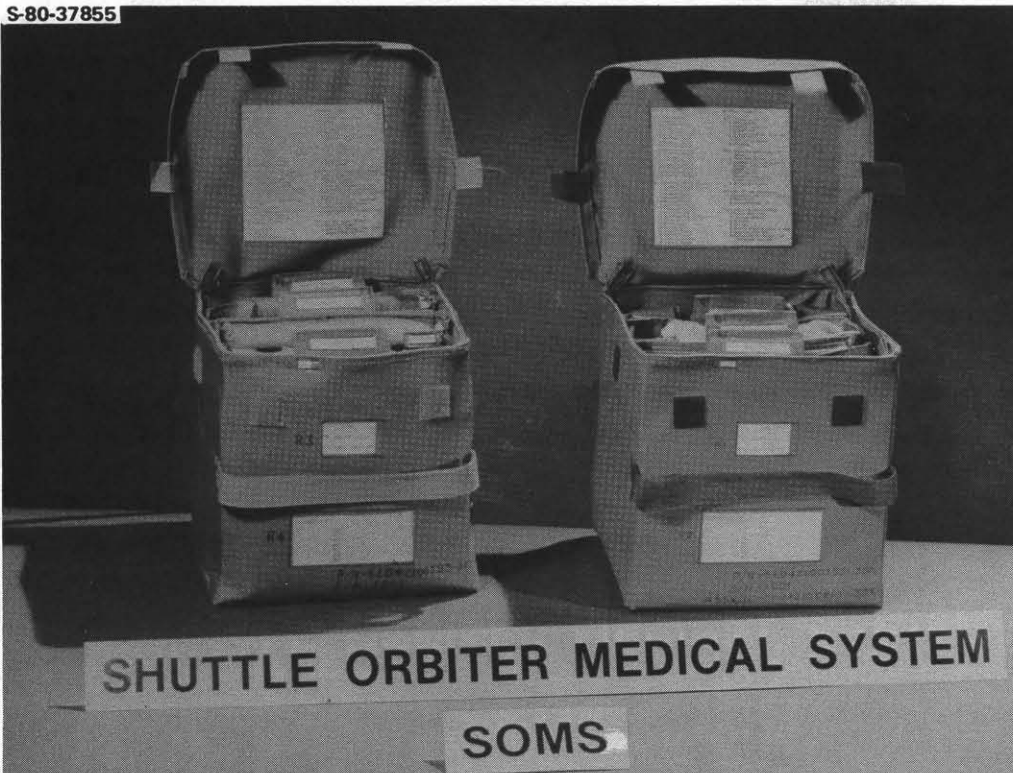
The following medical equipment and the corresponding locations are typical examples only. The technically correct locations are flight specific and will be supplied in the MEDICAL CHECKLIST.

Typical contents of the SOMS are as follows:

- Pallet A, Injectables (fig. 3.19-2)

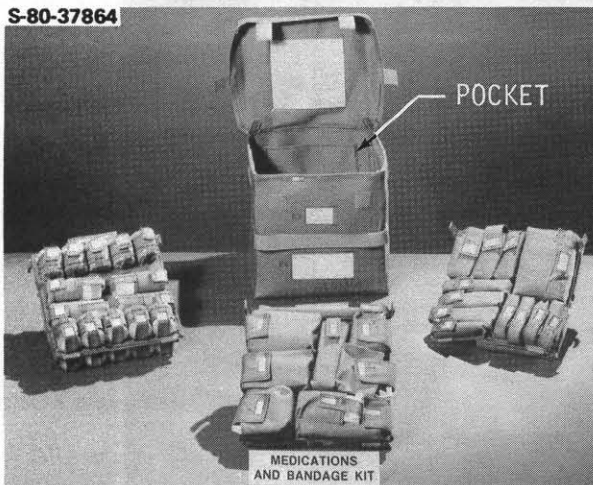
| <u>Location</u> | <u>Item</u> |
|-----------------|--|
| A1-1 | Epinephrine, 1/1000 |
| 2 | Epinephrine, 1/1000 |
| 3 | Epinephrine, 1/1000 |
| 4 | Epinephrine, 1/1000 |
| 5 | Benadryl, 50 mg/cc |
| 6 | Benadryl, 50 mg/cc |
| 7 | Isoproterenol, 1/5000 |
| 8 | Atropine, 4 mg/cc |
| 9 | Lasix, 10 mg/cc |
| 10 | Amikacin, 250 mg/cc |
| 11 | Calcium chloride (10%) |
| 12 | Lidocaine, 40 mg/cc |
| 13 | Lidocaine, 40 mg/cc |
| 14 | Lidocaine, 40 mg/cc |
| 15 | Xylocaine, 2 percent with Epinephrine |
| 16 | Xylocaine, 2 percent without Epinephrine |
| 17 | Heparin, 1000 units/cc |
| A2-1 | Morphine sulfate, 10 mg/cc |
| 2 | Morphine sulfate, 10 mg/cc |
| 3 | Morphine sulfate, 10 mg/cc |
| 4 | Decadron, 4 mg/cc |
| 5 | Decadron, 4 mg/cc |
| 6 | Decadron, 4 mg/cc |
| 7 | Demerol, 25 mg/cc |
| 8 | Demerol, 25 mg/cc |
| 9 | Verapamil, 2.5 mg/cc |
| 10 | Verapamil, 2.5 mg/cc |
| 11 | Valium, 5 mg/cc |
| 12 | Valium, 5 mg/cc |
| 13 | Compazine, 5 mg/cc |
| 14 | Compazine, 5 mg/cc |
| 15 | Compazine, 5 mg/cc |
| 16 | Phenergan, 50 mg/cc |
| 17 | Phenergan, 50 mg/cc |

S-80-37855



SHUTTLE ORBITER MEDICAL SYSTEM (SOMS)

S-80-37864



MEDICATIONS AND BANDAGE KIT (MBK) PALLETS

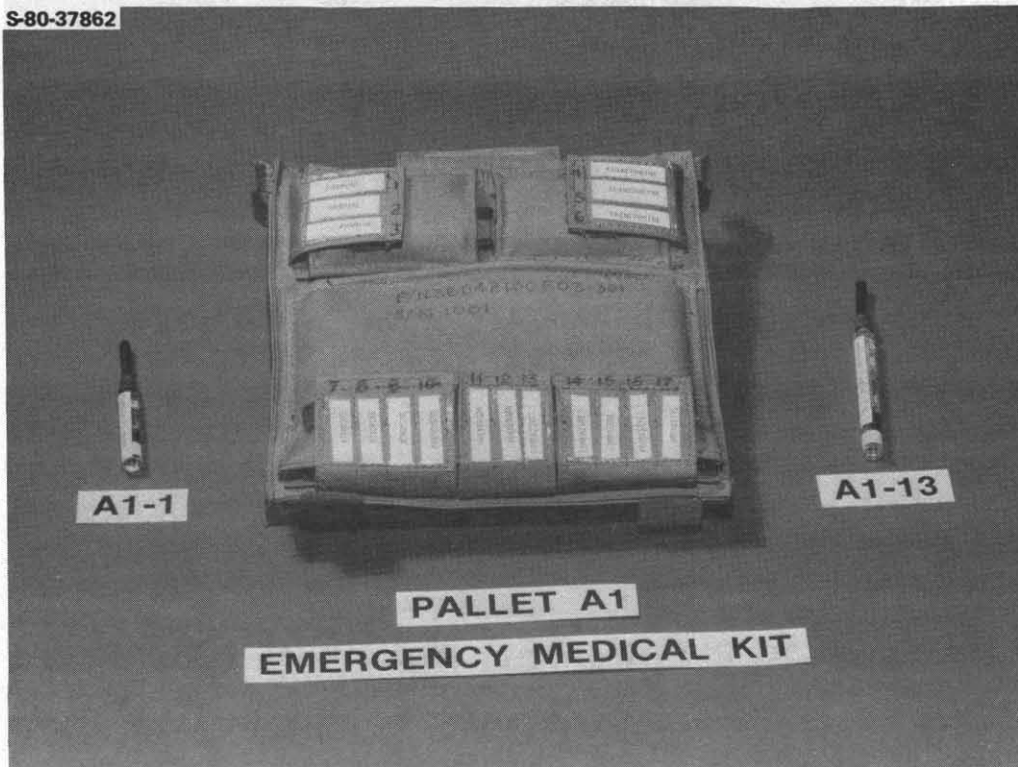
S-81-35740



EMERGENCY KIT (EMK) PALLETS

Figure 3.19-1.- SOMS

S-80-37862



S-80-37868

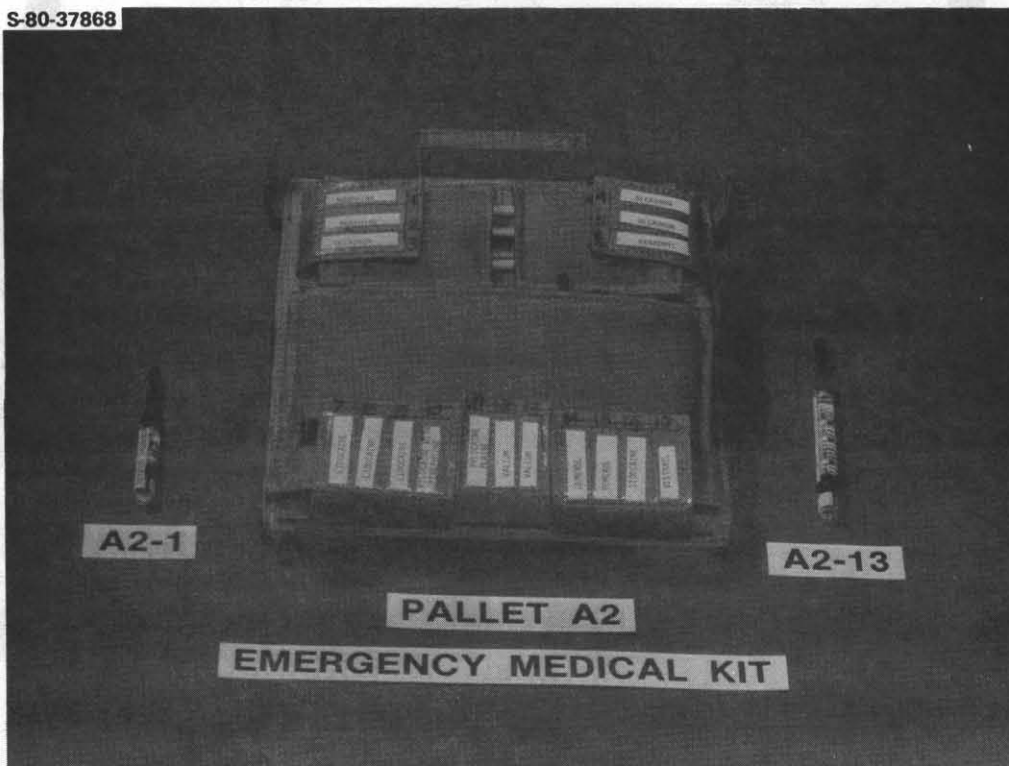


Figure 3.19-2.- SOMS, pallet A - injectables.

- Pallet B, injection accessories and surgical items (fig. 3.19-3)

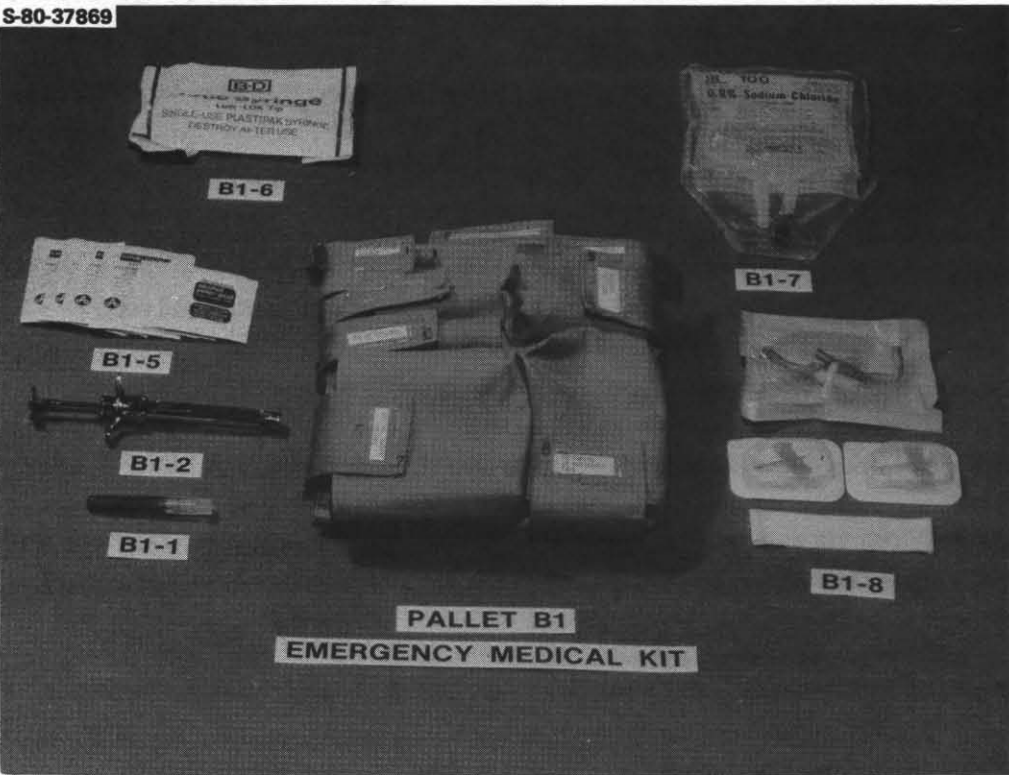
| <u>Location</u> | <u>Item</u> |
|-----------------|--|
| B1-1 | Needle, 22 gauge, 1.5 in.* |
| 2 | Tubex injector |
| 3 | Needle, 18 gauge, 1.5 in.* |
| 4 | Syringe, 10 cc |
| 5 | Alcohol wipes*, Povidone iodine swabs |
| 6 | Syringe, 10 cc* |
| 7 | Irrigation solution, 100 cc and valve |
| 8 | Ace bandage, tape, Heparin locks* |
| B2-1 | Suture: 4-0 Dexon*, 4-0 Ethilon* |
| 2 | Urine test package with forceps* |
| 3 | Surgical instrument assembly: forceps*, tweezers*, hemostats*, scissors*, needle holder* |
| | Sterile drape* |
| 4 | Scalpels, no. 10 and no. 11* |

- Pallet C, Diagnostic/Therapeutic Items (fig. 3.19-4)

| <u>Location</u> | <u>Item</u> |
|-----------------|-------------------------------------|
| C1-1 | Blood pressure cuff and stethoscope |
| 2 | Tourniquet and cotton balls |
| 3 | Airway*, nasostat |
| 4 | Cricothyrotomy setup* |
| C2-1 | Disposable thermometer* |
| 2 | Tongue depressor* |
| 3 | Otoscope speculum |
| 4 | Otoscope (ear viewer) |
| 5 | Penlight |
| 6 | Sterile gloves* |
| 7 | Blue filter (for penlight) |
| 8 | Flourescein strips, Ophthalmoscope |

* Indicates sterile items. Any use of these items other than medical procedures is not allowed without direct approval from the crew surgeon.

S-80-37869



S-80-37859



Figure 3.19-3.- SOMS pallet B injection accessories and surgical items.

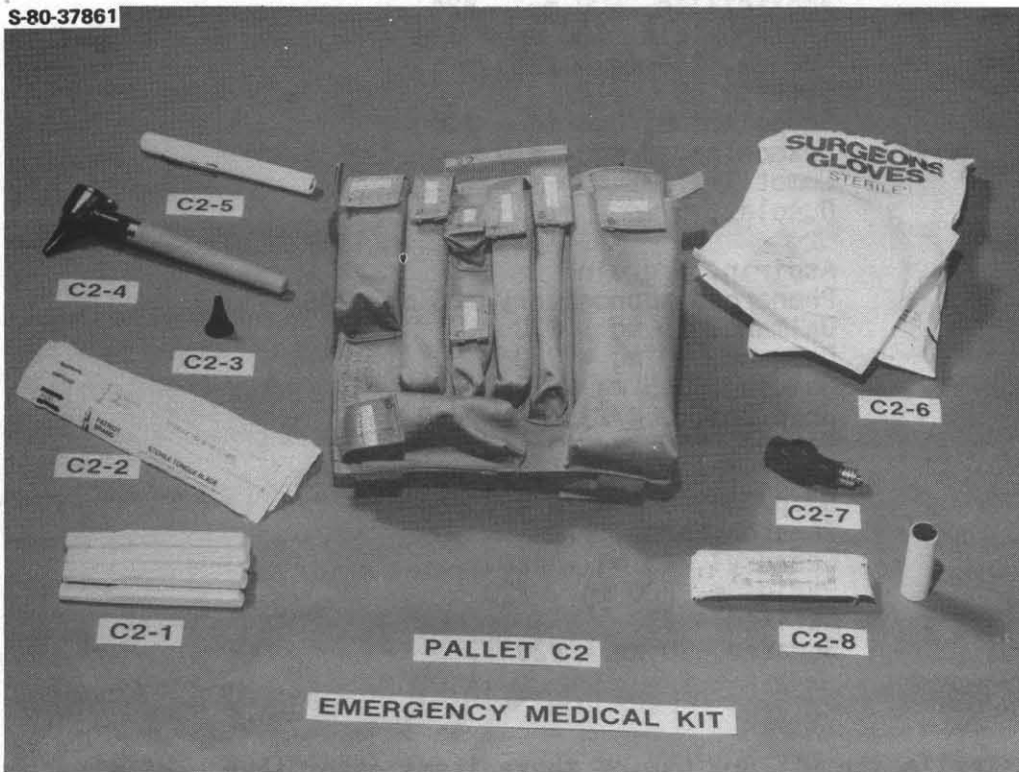
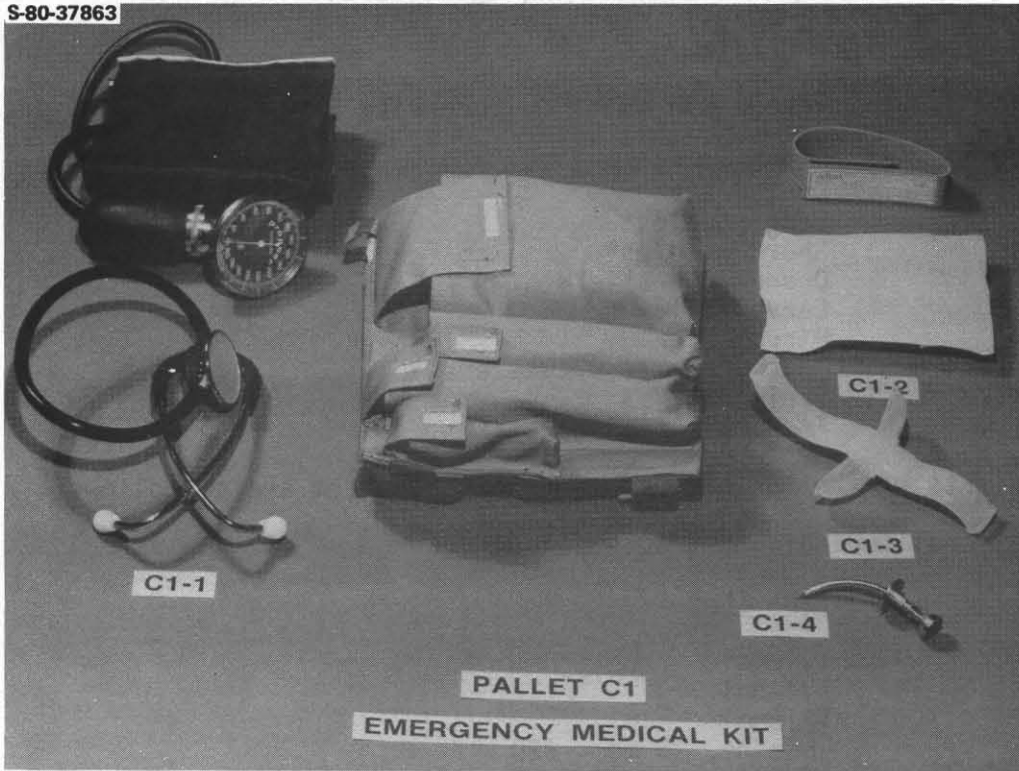


Figure 3.19-4.- SOMS, pallet C - diagnostic and therapeutic items.

- Pallet G, Microbiological test items (fig. 3.19-5)

| <u>Location</u> | <u>Item</u> |
|-----------------|-------------------------------|
| G1-1 | Throat and wound culture kits |
| 2 | Urine culture kit |
| G2-(2-9) | Dental kit |
| 2 | Long needles* |
| 3 | Short needles* |
| 4 | Orangewood sticks |
| 5 | Carver/file |
| 6 | Mirror |
| 7 | Toothache kit w/tweezers* |
| 8 | Syringe* |
| 9 | Temporary filling* |

Typical contents of the MBK and locations of each item are as follows:

- Pallet D, oral medications (fig. 3.21-6)

| <u>Location</u> | <u>Item</u> |
|-----------------|-----------------------------------|
| D1-1 | Tylenol |
| 2 | Tylenol |
| 3 | Tylenol |
| 4 | Codeine, 15 mg - #20 |
| 5 | Aspirin, 5 grain |
| 6 | Bactrim DS - #28 |
| 7 | Amoxicillin, 500 mg - #24 |
| 8 | Erythromycin, 250 mg - #48 |
| 9 | Keflex, 250 mg - #35 |
| 10 | Bactrim DS - #12 |
| 11 | Scopolamine, 0.4 mg - #40 |
| 12 | Dexedrine, 5 mg - #10 |
| 13 | Lomotil - #32 |
| 14 | Ducolax, 5 mg - #10 |
| D2-1 | Aspirin, 5 grain |
| 2 | Phenergan suppository, 25 mg - #8 |
| 3 | Dalmane, 15 mg - #30 |
| 4 | Dalmane, 30 mg - #30 |
| 5 | Halcion, 0.5 mg - #30 |
| 6 | Scop/Dex, 0.4/2.5 mg - #40 |
| 7 | Flagyl, 250 mg, #45 |
| 8 | Compazine suppository, 25 mg - #8 |
| 9 | Scop/Dex, 0.4 mg/5 mg, #54 |
| 10 | Parafon Forte, #20 |
| 11 | Benadryl, 25 mg - #20 |
| 12 | Pyridium, 200 mg - #20 |
| 13 | Actifed - #30 |
| 14 | Sudafed, 30 mg - #20 |

*Indicates sterile items. Any use of these items other than medical procedures is not allowed without direct approval from the crew surgeon.

07191-326

S-81-35743

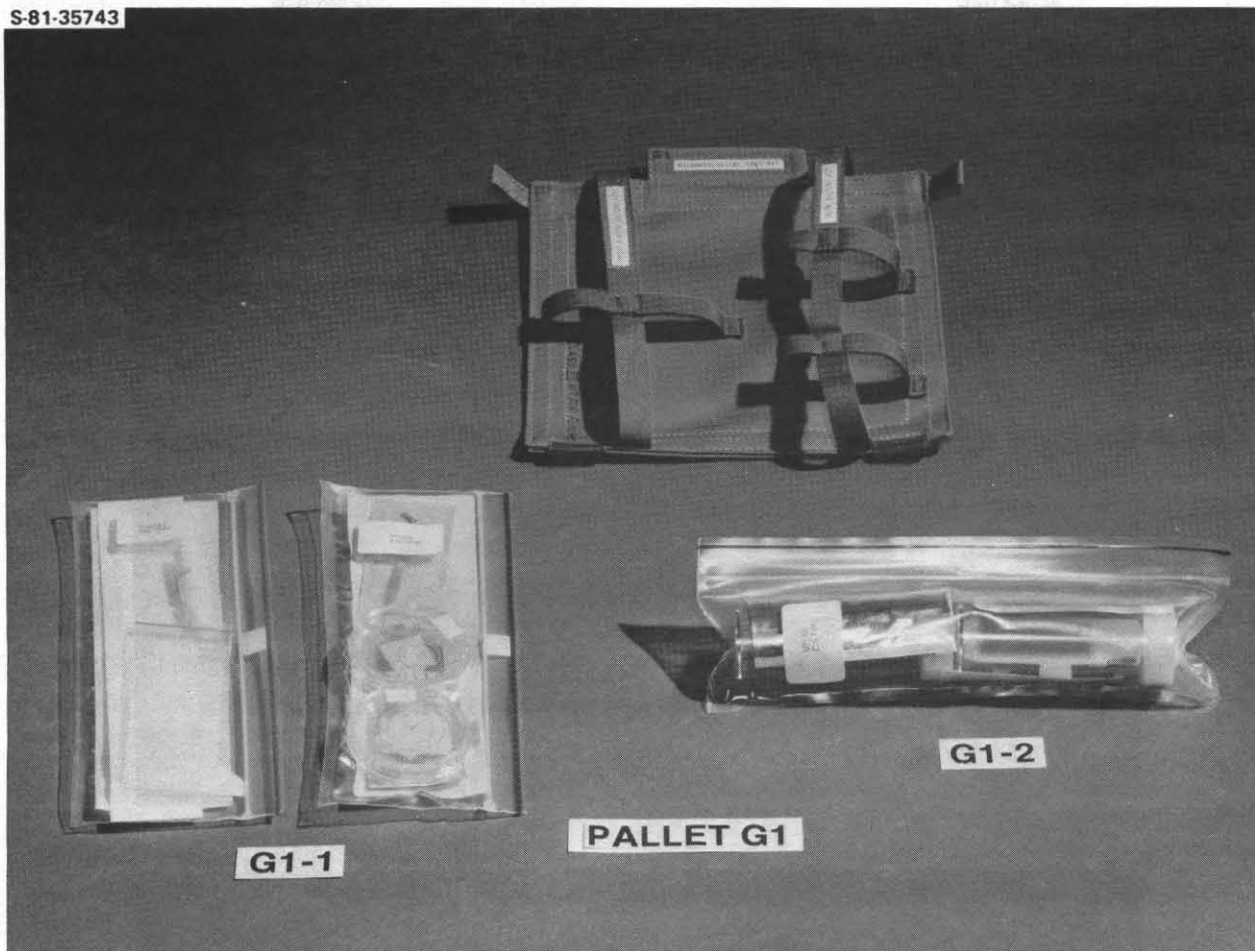


Figure 3.19-5.- SOMS, pallet G - microbiological test items.

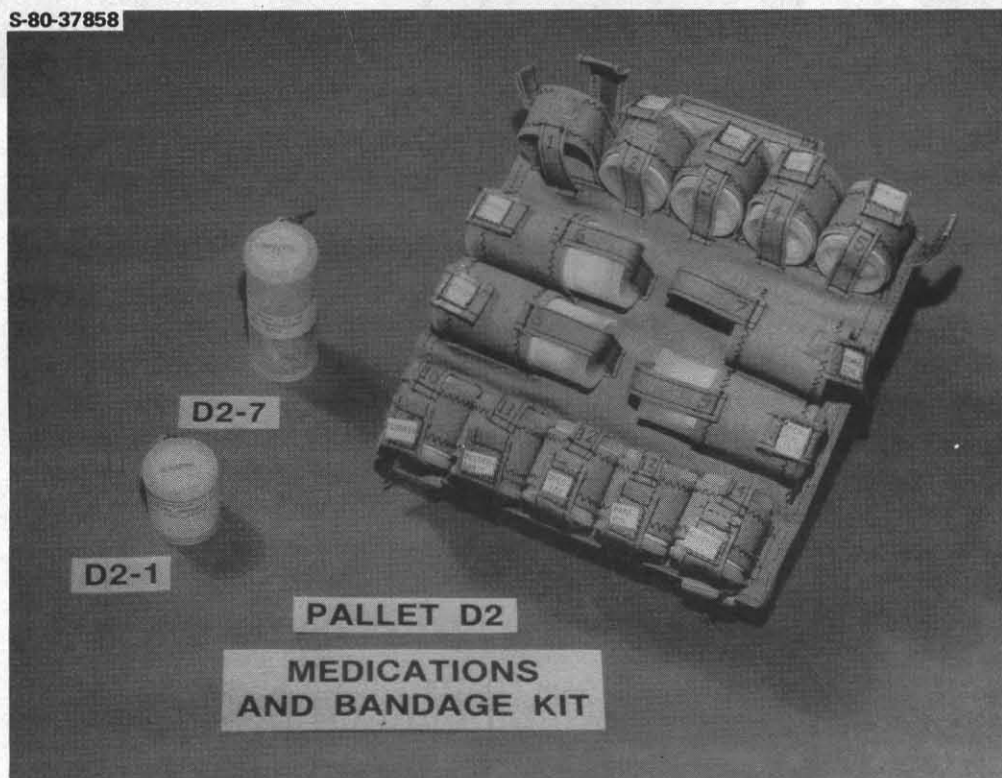
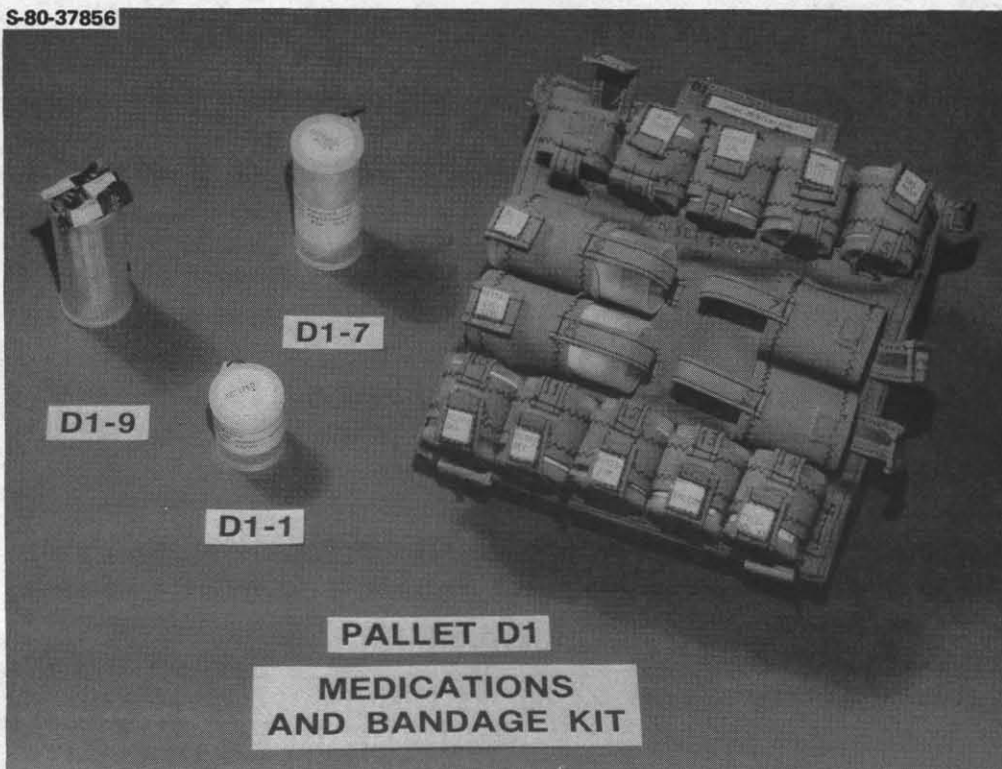


Figure 3.19-6.- SOMS, pallet D - oral medications.

• Pallet E, bandage items (fig. 3.19-7)

| <u>Location</u> | <u>Item</u> |
|-----------------|---|
| E1-1 | Cotton swabs, silver nitrate sticks* |
| 2 | 3-in. Kling dressing |
| 3 | Mylanta - #24 |
| 4 | Tape, Dermicel |
| 5 | 3-in. Kling dressing* |
| 6 | 3-in. Kling dressing* |
| 7 | Alcohol wipes, Povidone iodine swabs* |
| 8 | Band-aids (1-in. x 3-in.)* |
| 9 | Steri-strips, finger splint, and Benzoin swabs* |
| E2-1 | Gauze (4-in. x 4-in.) |
| 2 | Gauze (4-in. x 4-in.) |
| 3 | Eye pads |
| 4 | |
| 5 | Ace bandage (3-in. wide) |
| F1-1 | Afrin nasal spray |
| 2 | Afrin nasal spray |
| 3 | Vo Sol Otic Soln |
| 4 | Kerlix dressing |
| 5 | Silvadene Cream |
| 6 | Lotrimin Cream/Anusol Cream |
| 7 | Polysporin |
| 8 | Kenalog Cream; Mycolog Cream |
| 9 | Garamycin; Sulfacetamide Optalmic |
| F2-1 | Kling* |
| 2 | Binocular loupe |
| 3 | Elastoplast tape; Telfa pads;* |
| | Magnifying glass |

Specific information on SOMS kit drugs and other medications are presented in table 3.19-1.

* Indicates sterile items. Any use of these items other than medical procedures is not allowed without direct approval from the crew surgeon.

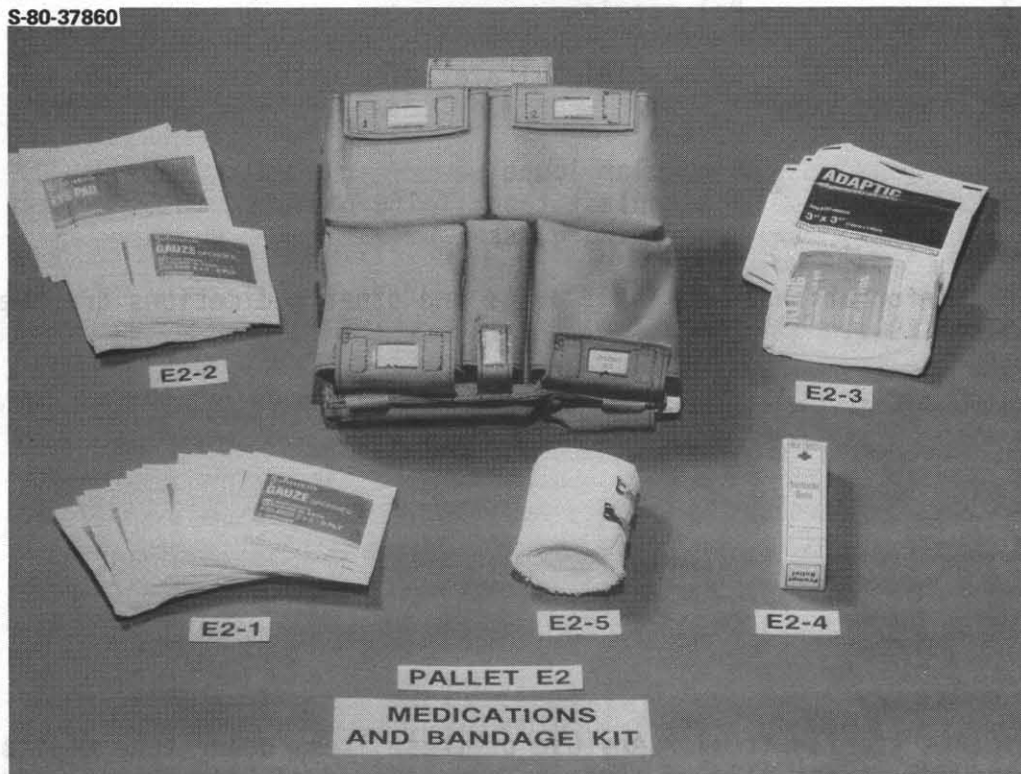
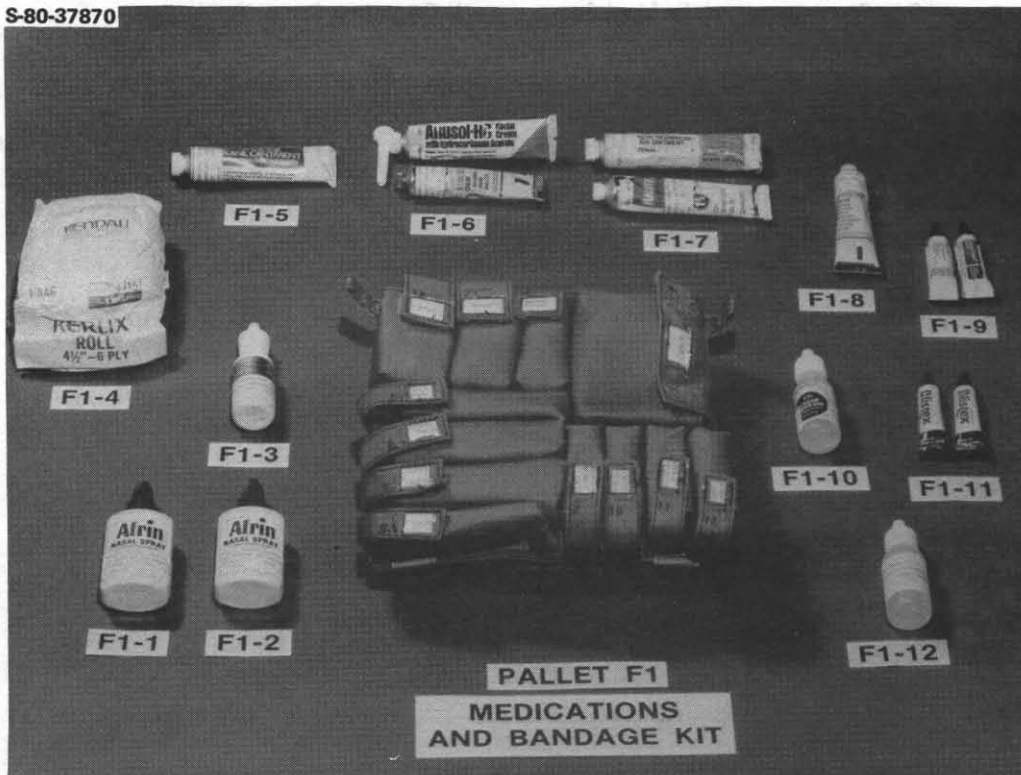


Figure 3.19-7.- SOMS, pallet E - bandage items.

S-80-37870



S-80-37857



Figure 3.19-8.- SOMS, pallet F - topical drugs.

3.19.4 Systems Performance, Limitations, and Constraints

General

- Usage and side effects information on the SOMS medications are presented in table 3.19-1.

TABLE 3.19-1.- SOMS A MEDICATIONS

| Medical kit contents | Type | Unit | Strength | Use | Dose | Side effects/ Contraindications |
|----------------------|------|------------------------------------|--|---|---------------------------|---|
| Actifed | O | Tablet | 2.5 mg Tripro- lidine, 60 mg Pseudophe- drine | Antihistamine and decon- gestant; cold symptoms, hay fever, runny nose, itchiness, asthma, sinus- itis, inflammation of eustachian tubes, inner ear congestion, croupy breathing, aerotitis media (aviator's ear) | 1 tablet every 8 hr | Drowsiness, fatigue, dizziness, dry mouth, blurred vision, rapid heart rate, excitability, agitation |
| Afrin spray | T | 15-cc plastic squeeze bottle | 0.05% | Topical liquid nasal decon- gestant; constricts smaller arterioles of nasal passages in nasal congestion from allergies or infection | 1-2 sprays every 6 hr | Burning, stinging, sneezing or increased nasal discharge |
| Amikcin ^a | I | 2 cc | 250 mg/cc | Intravenous antibiotic | Up to 2 cc | Nausea, diarrhea and rash WARNING Do not use on indi- viduals with history of allergic reactions to penicillins or cephalosporins |
| Amoxicillin | O | Tablet | 500 mg | Antibiotic | 1 tablet every 8 hr | |
| Anusol-HC cream | T | 4.5-g tube | N/A | Hemorrhoids, inflammation of the rectum, ulcer of the anus | N/A | Discontinue if condition worsens |
| Aspirin | O | Tablet | 5 grains/tablet | A pain reliever and anti- inflammatory | 2 tablets every 4-6 hr | Do not use in patients w/asthma, aspirin allergy, or bleeding problems |

T = Topical I = Injectable O = Oral

^aSurgeon should be contacted before drug is given; if LOS treatment should be started and surgeon contacted ASAP at AOS.

496

3.19-15

JSC-12770

TABLE 3.19-1.- Continued

| Medical kit contents | Type | Unit | Strength | Use | Dose | Side effects/ Contraindications |
|-----------------------|------|-----------|--|---|--------------------------------|--|
| Atropine ^a | I | 2-cc unit | 1.0 mg/cc | | Up to 2 cc | Use only in cardio-pulmonary arrest after contacting surgeon |
| Bactrim-DS | O | Tablet | N/A | Bladder infection, otitis media | 1 tablet every 12 hours | A skin rash, headache, stomach upset |
| Benadryl | O | Capsule | 25 mg | Antihistamine for allergic reactions or drug-induced muscle spasm | Oral - 1 capsule every 6 hr | Drowsiness, inability to concentrate, blurry vision, dry mouth, dizziness, headache, photosensitivity, rapid heart rate, fatigue |
| Benadryl | I | 1-cc unit | 50 mg/cc | | Injectable - 1 cc | |
| Blistex | T | Tube | N/A | Prevent and/or treat dry chapped lips | As required | None |
| Bupivacaine | I | 2-cc unit | 0.5 percent with Epinephrine 1:200,000 | Dental anesthetic | 2 cc | Hypotension, nausea, nervousness, and depression |
| Calcium Chloride | I | 2-cc unit | 10% | Cardiopulmonary arrest | Up to 2 cc | Use only after contacting surgeon |
| Codeine ^b | O | Tablet | 15 mg | A narcotic pain reliever | 1 to 2 tablets every 4 to 6 hr | Lightheadedness, dizziness, nausea, vomiting |

T = Topical I = Injectable O = Oral

^aSurgeon should be contacted before drug is given; if LOS, treatment should be started and surgeon contacted ASAP at AOS.^bMedical Officers may administer 2 doses of these drugs; For more than 2 doses contact surgeon.

TABLE 3.19-1.- Continued

| Medical kit contents | Type | Unit | Strength | Use | Dose | Side effects/ Contraindications |
|--------------------------|------|-------------|----------|---|--|--|
| Compazine | I | 2-cc unit | 5 mg/cc | Control of severe nausea and vomiting | 2 cc | Drowsiness, dizziness, skin rashes, blurred vision <div style="border: 2px solid black; padding: 5px; width: fit-content; margin: 5px auto;">WARNING Do not use with Phenergan or Scop/Dex. May cause spasms of the neck or head</div> |
| Compazine | T | Suppository | 25 mg | Moderate nausea | 1 every 12 hr | Do not take with Phenergan or Scop/Dex |
| Dalmane | O | Capsule | 15-30 mg | Treatment of insomnia | 15-30 mg before retiring | Dizziness, lightheadedness |
| Decadron ^a | I | 1-cc unit | 4 mg/cc | Steroid to treat severe allergic reactions | Individualized by physician | Contact surgeon before use |
| Demerol | I | 2-cc unit | 25 mg/cc | Pain relief | 50 mg every 3-4 hr | Dizziness, lightheadedness, sedation, nausea, vomiting, sweating, dry mouth, blurred vision, constipation |
| Dexadrine | O | Tablet | 5 mg | Stimulant usually used to counteract effects to Scopolamine | 5 mg | Overstimulation, restlessness, insomnia, diarrhea, rapid heart rate |
| Dulcolax | O | Tablet | 5 mg | Treatment of constipation | 5 mg | Abdominal cramps |
| Epinephrine ^a | I | 1-cc unit | 1:1000 | Treatment for acute shock due to allergy or drug reaction | 1 cc initially. If no improvement in 15 min repeat 1-cc dose | Use only in cardiopulmonary arrest or severe allergic reactions |

T = Topical I = Injectable O = Oral

^aSurgeon should be contacted before drug is given; if LOS, treatment should be started and surgeon contacted ASAP at AOS

TABLE 3.19-1.- Continued

| Medical Kit contents | Type | Unit | Strength | Use | Dose | Side effects/ Contraindications |
|----------------------------|------|-----------|---|---|--|--|
| Erythromycin | O | T | 250 mg | Antibiotic | 1 tab every 6 hr for 10 days | Abdominal cramping, nausea, vomiting, diarrhea, rash |
| Flagyl | O | T | 250 mg | Antibiotic | | Seizures, cramps, nausea |
| Garamycin ointment | T | 8 oz tube | N/A | Antibiotic eye ointment | Every 12 hr for 3 days | Burning, stinging, eye irritation |
| Halcion | O | T | 0.5 mg | Treatment for insomnia | 1/2-1 tablet 1 hr prior to sleep | Excess drowsiness, headache, dizziness, nausea, vomiting, coordination problems |
| Heparina | I | 2-cc unit | 1000 units/cc | Anticoagulant used when giving IV meds | 1 cc | |
| Isoproterenol ^a | I | 2-cc unit | 1:5000 | Treatment of cardiopulmonary arrest | Up to 2-cc intravenous | Contact surgeon before use |
| Keflex | O | Capsule | 250 mg | Antibiotic | 250 mg every 6 hr | Diarrhea, nausea, vomiting, abdominal pain. Do not use w/penicillin or cephalosporin allergy |
| Kenalog cream | T | 15-g tube | N/A | For skin rashes | Apply thin coat as needed, 2 times daily | |
| Lidocaine ^a | I | 2-cc unit | 40 mg/cc | Treatment of cardiac arrhythmias, or cardiopulmonary arrest | 2-cc intravenous | |
| Lomotil ^b | O | Tablet | Diphenoxylate 2.5 mg and Atropine 0.025 mg | To slow intestinal activity in diarrhea | 1-2 tablets every 6 hr | Nausea, sedation, dizziness, vomiting |

NOTE

Avoid if diarrhea due to bacterial infection or antibiotic use

T = Topical I = Injectable O = Oral

^aSurgeon should be contacted before drug is given; if LOS, treatment should be started and surgeon contacted ASAP at AOS.

^bMedical officer may administer 2 doses of these drugs; For more than 2 doses, contact surgeon

TABLE 3.19-1.- Continued

| Medical kit contents | Type | Unit | Strength | Use | Dose | Side effects/ Contraindications | |
|--------------------------------|------|--------------|----------|--|--|---|--|
| Lotrimin cream | T | 15-g tube | N/A | Antifungal skin medications | 2 applications daily | Allergic rash, burning itching, skin dryness, atrophy | |
| Morphine sulfate ^a | I | 1-cc unit | 10 mg/cc | Pain relief | 1/2 cc every 3-4 hours as needed | | |
| Mycolog cream | T | 15-g tube | N/A | Treatment of skin problems | Rub into affected area 2 or 3 times daily | | |
| Mylanta | O | Tablet | N/A | Antacid/antiflatalent | 1 or 2 tablets 1 and 3 hr after meals and at bedtime | | |
| Nitrobid ointment ^a | T | 1 unit doses | N/A | Only for pain associated with heart attack and only as directed by surgeon | | | Contact surgeon |
| Parafon forte | O | Tablet | N/A | Relief of muscle spasms, pain | 1-2 tablets, 4 times daily | | Stomach upset, drowsiness, dizziness, lightheadedness. Do not take in combination with Tylenol |
| Phenergan ^b | I | 2-cc unit | 50 mg/cc | Treatment of severe motion sickness and nausea | 1/2 to 1 cc intramuscular | | Sedation, inability to concentrate, drowsiness, dizziness, blurred vision |

| |
|--|
| <p>WARNING Do not take with Scop/Dex or Compazine</p> |
|--|

T = Topical I = Injectable O = Oral

^aSurgeon should be contacted before drug is given; if LOS, treatment should be started and surgeon contacted ASAP at AOS.

^bMedical officer may administer 2 doses of these drugs; For more than 2 doses, contact surgeon.

500

3.19-19

JSC-12770

TABLE 3.19-1.- Continued

| Medical kit contents | Type | Unit | Strength | Use | Dose | Side effects/ Contraindications |
|----------------------------------|------|--------------|-------------------------------|---|---|---|
| Polysporin | T | 1.0-oz tube | N/A | Topical antibiotic | Apply 4 times a day | Allergic reactions |
| Proparacaine eye drops | T | 15-ml bottle | N/A | Anesthetic eye drops | 1 to 2 drops in affected eye | Corneal damage may occur with repetitive use |
| Pyridium | O | Tablet | 200 mg | To relieve pain or burning due to urinary tract infection | 1 tablet, 2 times a day | Occasional stomach or gastrointestinal upset. Produces reddish-orange urine |
| Scop/Dex (Scopolamine/Dexedrine) | O | Capsule | 0.4 mg/2.5 mg and 0.4 mg/5 mg | Prevention of motion sickness | 1 capsule before expected stimulus to motion sickness. 1 capsule every 6 hr during exposure to stimulus | Drowsiness, dry mouth, blurred vision, and urine retention |
| Silvadene cream | T | 20-g tube | | Minor burns, lacerations | | |
| Sodium Bicarbonate | I | 50 cc | | Only used in cardio-pulmonary arrest | | |

WARNING
Do not take with Phenergen or Compazine

T = Topical I = Injectable O = Oral

501

3.19-20

JSC-12770

TABLE 3.19-1.- Continued

| Medical kit contents | Type | Unit | Strength | Use | Dose | Side effects/ Contraindications |
|-------------------------------|------|--------------|--------------------------------------|--|--|--|
| Sulfacetamide ointment | T | Tube | N/A | Antibacterial eye ointment | As directed | |
| Tears Naturale eye drops | T | 15-ml bottle | N/A | Artificial tears for minor eye irritation, dryness of eyes, or removing foreign body from surface of eye | 1 to 2 drops every 4 hr | None |
| Tylenol | O | Tablet | N/A | Pain relief | 1 or 2 tablets every 4-6 hr as needed | |
| Valium ^a | I | 2-cc unit | 5 mg/cc | Sedative anticonvulsant | | Low blood pressure, slow heart rate, fatigue, nausea, blurred vision |
| Verapamil ^a | I | 2-cc unit | 2.5 mg/cc | Only for very rapid heart rates which do not resolve with other therapy | Up to 2 cc (2.5 mg) Ir | Contact surgeon |
| Vo Sol Otic | T | 0 ml bottle | N/A | Ear canal infection | 2-4 drops in affected ear 4 times each day | Do not use if a ruptured eardrum is suspected |
| Xylocaine with Epinephrine | I | 2-cc unit | 2 percent with 1:000,000 Epinephrine | Local anesthetic | Solution for nerve block as required | Shock (anaphylaxis) <div style="border: 2px solid black; padding: 5px; width: fit-content; margin: 5px auto;"> <p style="text-align: center;">WARNING Do not use on fingers, toes or nose</p> </div> |
| Xylocaine without Epinephrine | I | 2-cc unit | 2 percent | Local anesthetic | For nerve block | Shock |

T = Topical I = Injectable O = Oral

^aSurgeon should be contacted before drug is given; if LOS, treatment should be started and surgeon contacted ASAP at AOS

3.20 RADIATION INSTRUMENTATION

3.20.1 Introduction

The radiation instrumentation system consists of the following components:

- Crew passive dosimeter (CPD)
- Passive radiation dosimeter (PRD)
- Area passive dosimeter (APD) (mid rate)
- 0 to 200 millirad pocket dosimeter (low rate)
- 0 to 100 rad pocket dosimeter (mid rate)
- 0 to 600 rad pocket dosimeter (high rate)
- Dosimeter pouch

3.20.2 Stowage

Each crewmember will carry a CPD somewhere on his person at all times. The passive radiation dosimeters are attached throughout the Orbiter prelaunch. The remainder of the dosimeters are stowed preflight in a middeck locker and do not need to be moved or inspected by the crew unless requested by MCC.

3.20.3 Systems Functional Description

The types and use locations of dosimeters are shown in table 3.20-1. Quantities are flight specific and will be included in the stowage list in the FDF Reference Data book. Configurations are shown in figure 3.20-1.

Dosimeter Pouch

The design of the dosimeter pouch is such that it can contain all dosimeters other than the CPD's and PRD's. The flaps of the pouch are fitted with Velcro for closing, and the back of the pouch contains Velcro for mounting on the wall. The pouch and contents together form a dosimeter assembly as shown in figure 3.20-2. The PRD's are stowed throughout the Orbiter (fig. 3.20-3) and remain there during the entire mission.

Pocket Dosimeters

The operation of the pocket dosimeters is the same, differing only in quantity of radiation measured. The units contain a quartz fiber which is electrostatically charged and calibrated to zero preflight. The fiber discharges according to the amount of ionizing radiation received, and the quartz fiber moves as it discharges. The position of the fiber is a function of the amount of radiation received and can be read by visual inspection, as if looking through a small telescope.

CPD's and PRD's

These badge-type dosimeters are squares of fine-grained photo film sandwiched between plastic separators in a lightproof package. Radiation which strikes the silver halide causes spots on the film which can be measured postflight. Included in the badge dosimeters are thermoluminescent dosimeter (TLD) chips. When radiation strikes the chip, it causes electrons to jump to a higher orbit where they remain until the chip is heated. After return to Earth, the chips are heated in a laboratory, and the emitted light caused by electrons returning to their original orbits is detected by light sensors. Also included in the package are sandwiched pieces of plastic which aid in determining radiation.

APD's

These units are functionally similar to the CPD units, but are much larger. The size of the APD units may be as much as 5 X 5 X 2 in. (12.7 X 12.7 X 5.08 cm).

3.20.4 Systems Performance, Limitations, and Constraints

Passive Dosimeter (CPD, APD, and PRD)

These TLD chips begin luminescence at 120° F (48.89° C), and consequently must be operated below this temperature.

Pocket Dosimeters

These quartz-fiber units will be precharged to the zero position preflight. They may be reused.

General

Calibration of the dosimeters is accomplished by using data from Skylab D008 Units and the Shuttle TLD chips from early flights.

TABLE 3.20-1.- RADIATION INSTRUMENTATION DATA

| Type | Purpose | Range | On-orbit location |
|-----------|-----------------------------|------------|---|
| CPD | Crew passive dosimeter | NA | In crewmembers worn clothes at all times. Also worn during EVA. |
| PRD | Passive radiation dosimeter | NA | Stowed throughout Orbiter (fig. 3.20-3) |
| APD | Area passive dosimeter | NA | Stowed in locker |
| Low-rate | Pocket dosimeter | 0-200 mrad | Stowed in locker |
| Mid-rate | Pocket dosimeter | 0-100 rad | Stowed in locker |
| High-rate | Pocket dosimeter | 0-600 rad | Stowed in locker |

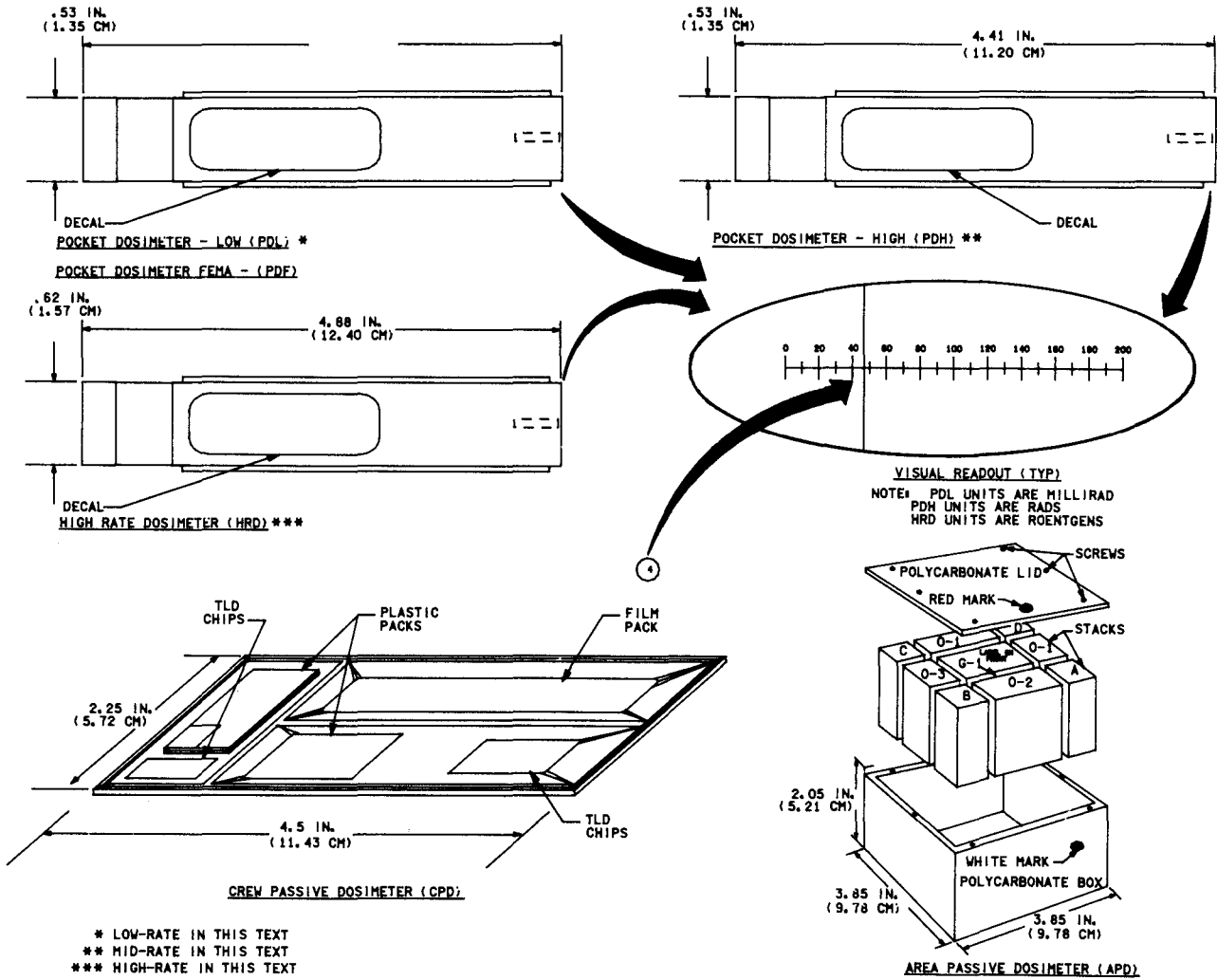


Figure 3.20-1.- Radiation instrumentation.

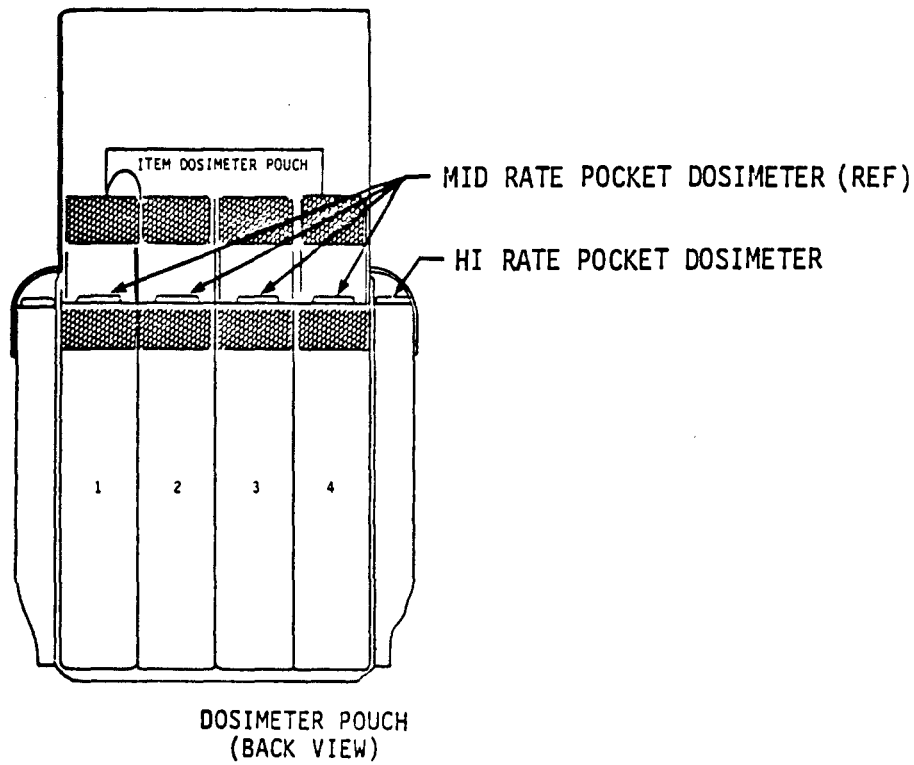
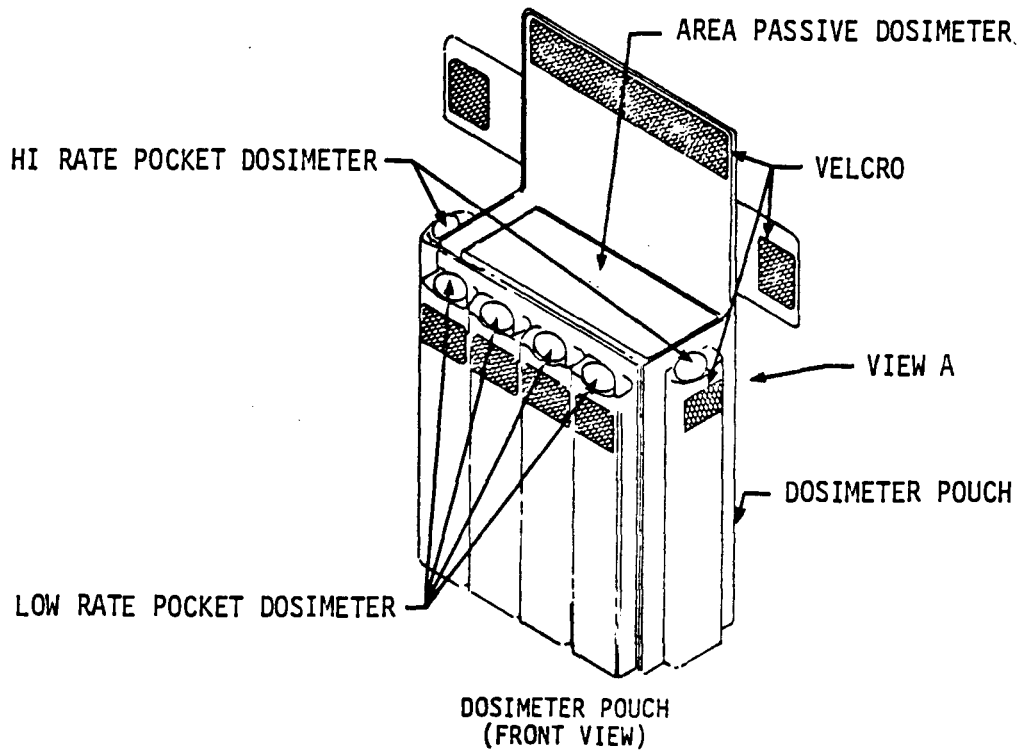


Figure 3.20-2.- Dosimeter assemblies.

3.20-5

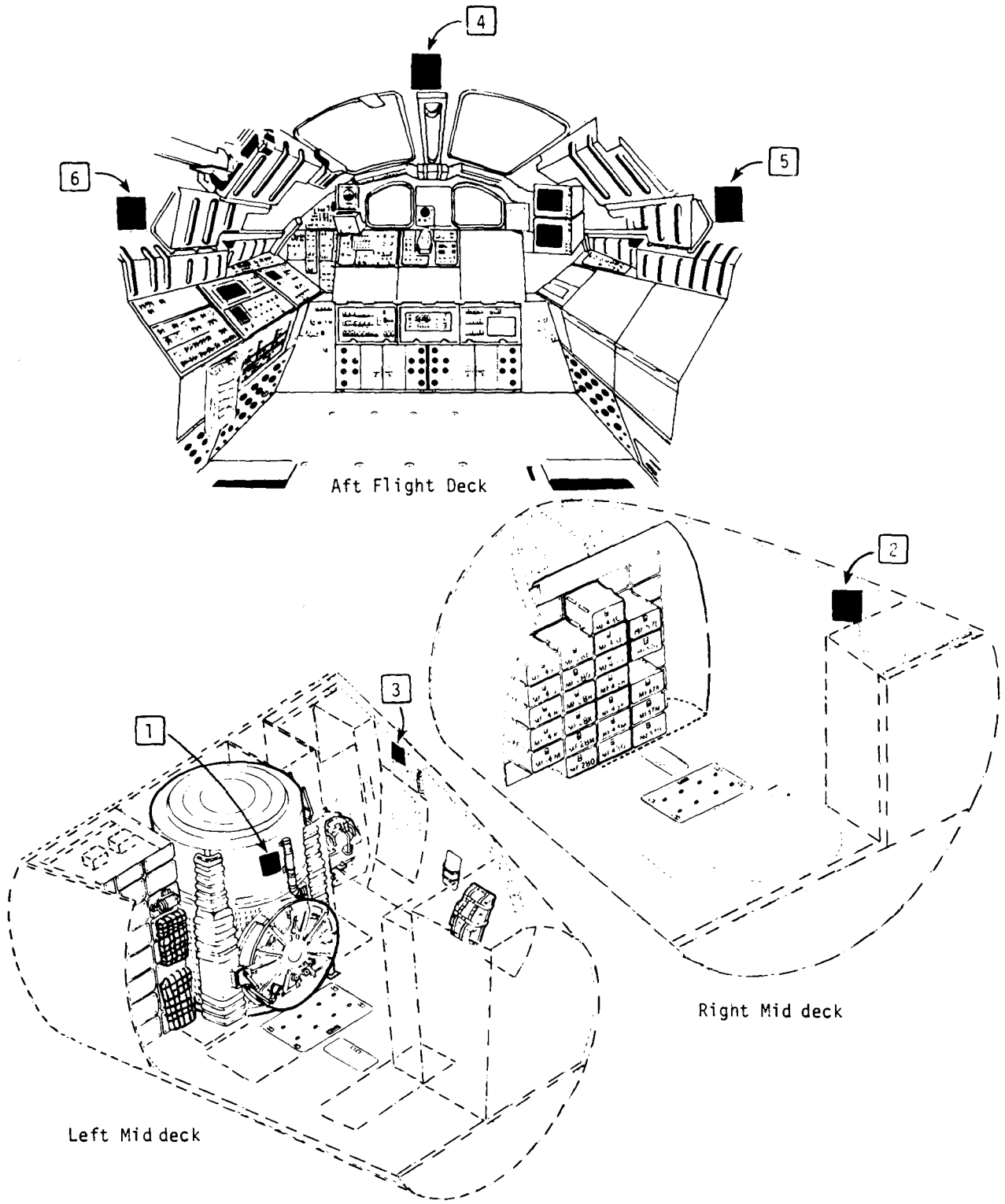


Figure 3.20-3.- On-orbit passive radiation dosimeter locations.

3.21 OPERATIONAL BIOINSTRUMENTATION

3.21.1 Introduction

The Operational Bioinstrumentation System (OBS) provides an amplified Electrocardiogram (ECG) analog signal from crewmembers aboard the Shuttle to the Shuttle avionics multiplexer/demultiplexer (MDM) where it is converted from analog to digital data and is transmitted to the ground in real time or stored on tape for dump or postflight return. The major components of the OBS are a biomed belt with signal conditioner, electrode harness, cables and electrode donning kit (fig. 3.21-1).

Use of OBS is limited to extravehicular activity (EVA) unless intravehicular activity (IVA) use is requested by the Flight Surgeon.

3.21.2 Interfaces

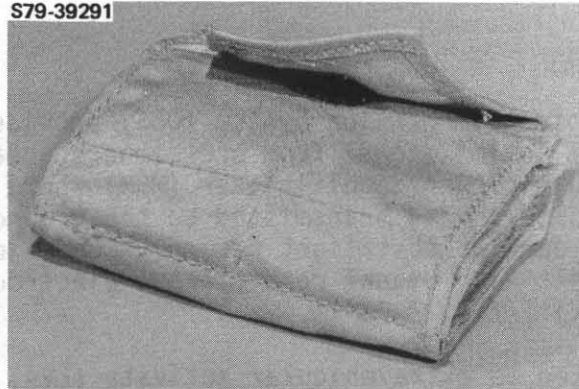
The signal conditioner is located in a pocket on the biomed belt. The biomed belt is secured by Velcro around the waist with the signal conditioner on the left side. The biomed IVA cable is routed under the T-shirt and through the waist opening of the flight suit. The biomed IVA cable connects to the biomed panel cable which is routed from the seat to the nearest biomed outlet (fig. 3.21-2).

The EVA OBS signal will be sent to the Orbiter by UHF transmission.

3.21.3 Systems Functional Description

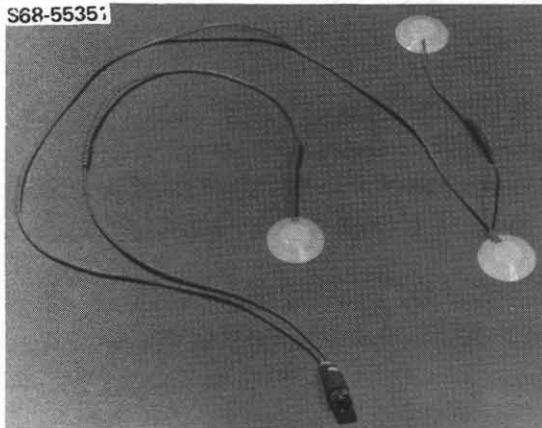
Three electrodes are placed on the skin in the standard OBS configuration (one sternal, one right chest, and one lateral lead) fig. 3.21-3. Each of the three electrodes connects to the amplifier through an electroshock protection (ESP) circuit. The electrodes detect the moving electric field generated by heart muscle depolarization and repolarization, and this electric signal is amplified and conditioned by the signal conditioner. The OBS control functions are shown in table 3.21-1. An internal on/off switch exists for the signal conditioner. The unit is activated when the biomed IVA cable is connected to the signal conditioner.

S79-39291



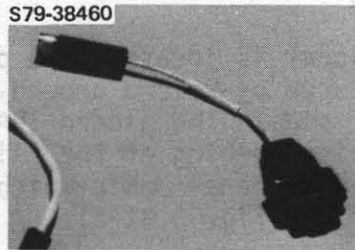
ELECTRODE DONNING KIT

S68-55351



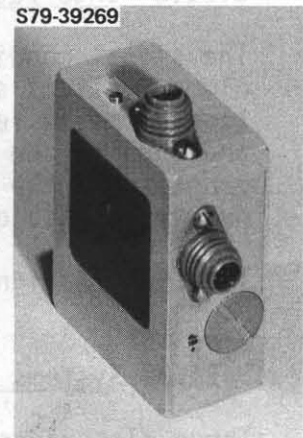
ELECTRODE HARNESS

S79-38460



EVA BIOMED CABLE

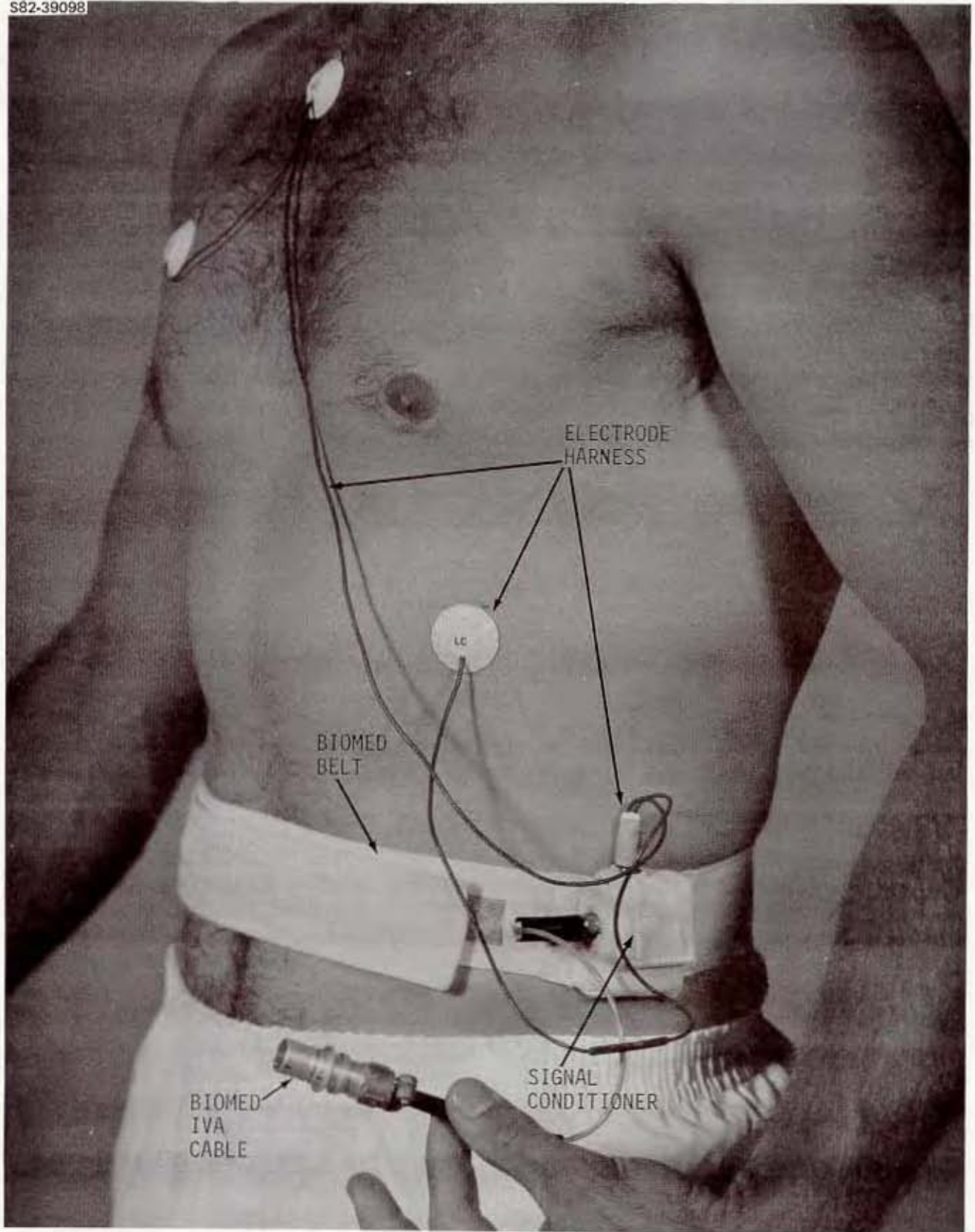
S79-39269



SIGNAL CONDITIONER

Figure 3.21-1.- OBS components (sheet 1 of 2).

S82-39098

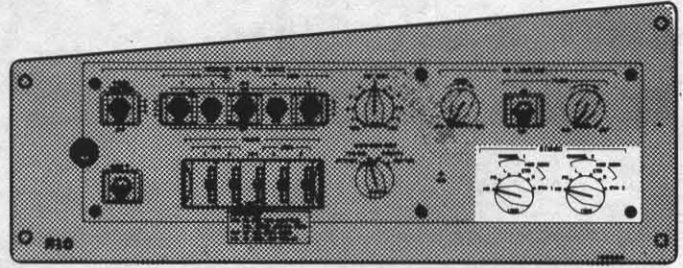


3.21-1.- OBS components (sheet 2 of 2).

S82-35608

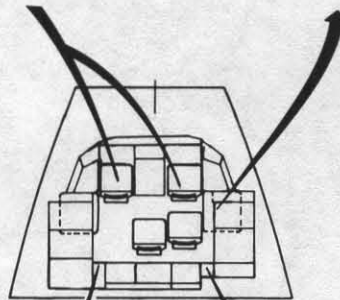


BIOMED CABLE
INTERFACE IS
AT LEFT HIP
(CONCEALED BY HIU/LAP BELT)

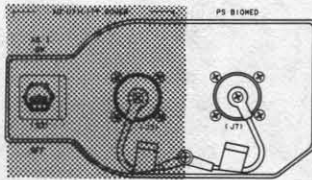


PANEL R10

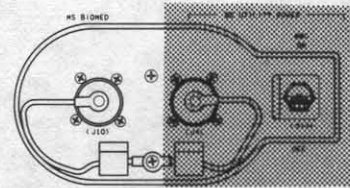
ENTRY
CONFIGURATION



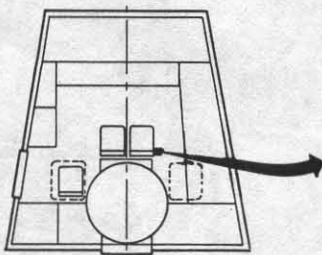
FLIGHT DECK
(LOOKING DOWN)



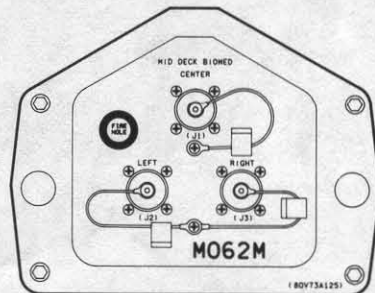
PANEL A15



PANEL A11



MIDDECK
(LOOKING DOWN)



PANEL M062M (ON CEILING)

Figure 3.21-2.- Shuttle biomed interfaces (sheet 1 of 2).

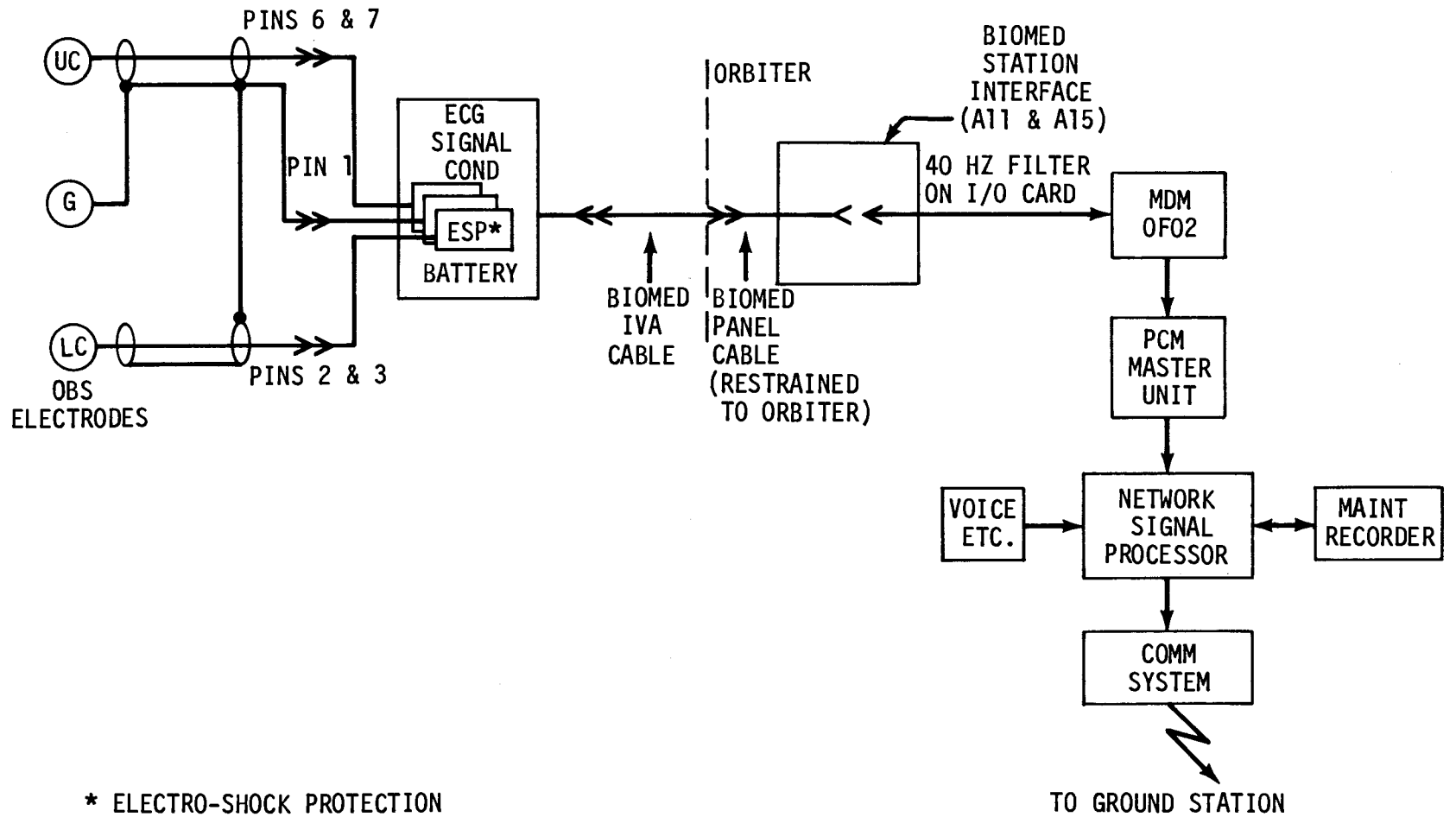


Figure 3.21-2.- Shuttle biomed interfaces (sheet 2 of 2).

S82-39097

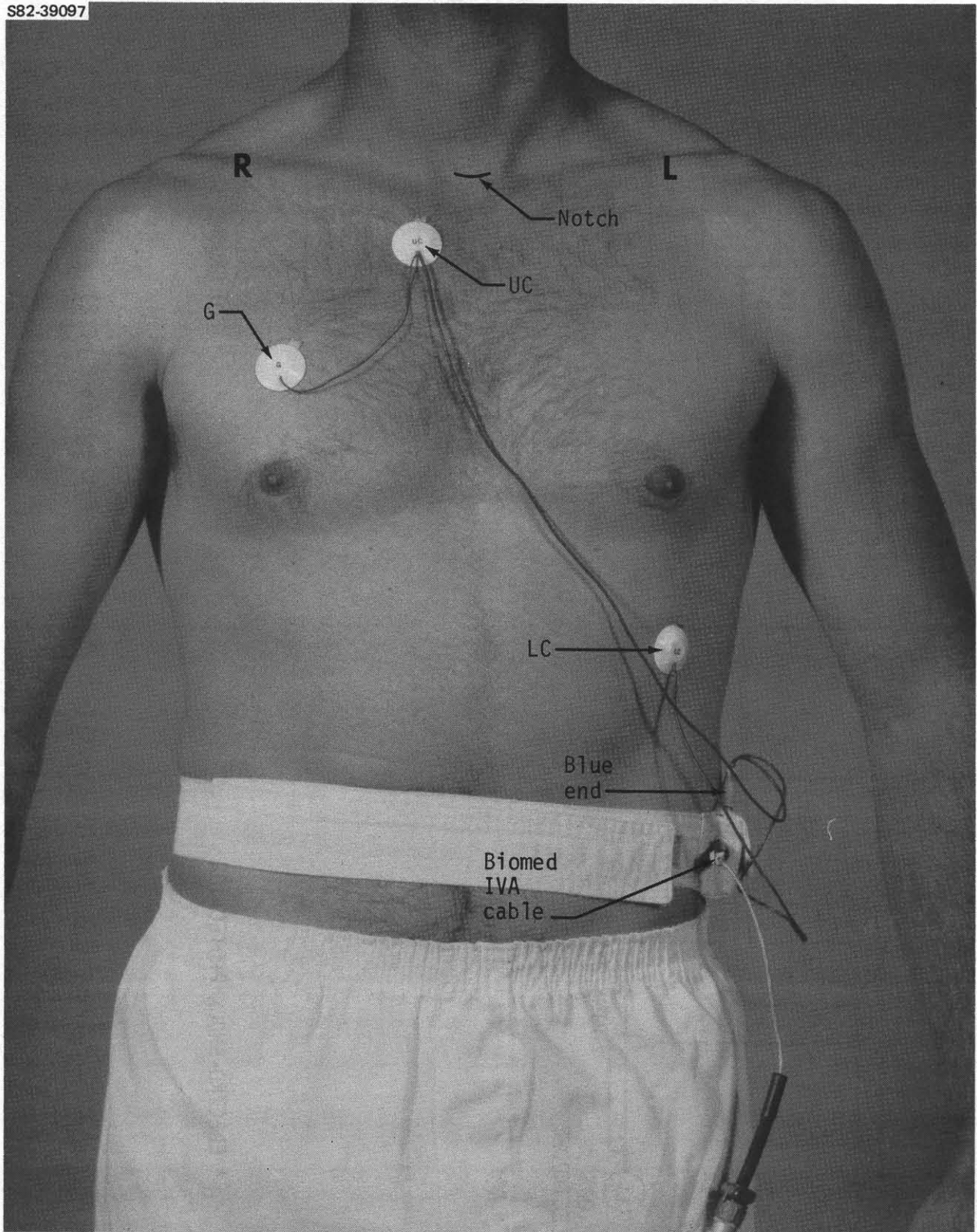


Figure 3.21-3.- Electrode donning.

TABLE 3.21-1.- OBS CONTROL FUNCTIONS

| Location | Type | Nomenclature/ position | Function | Remarks |
|----------|------|---------------------------|--|--------------------------------|
| Pnl R10 | sw | BIOMED CHANNEL 1 | | The sw is a rotary-type sw. |
| | | MS | Selects and activates MS BIOMED connector (panel A11) | |
| | | PS | Selects and activates PS BIOMED connector (panel A15) | |
| | | MIDDECK L | Selects MIDDECK LEFT connector (panel M062M) | |
| | | MIDDECK CTR | Selects MIDDECK CENTER connector (panel M062M) | |
| | | MIDDECK R | Selects MIDDECK RIGHT connector (panel M062M) | |
| | | EVA 1 | Selects EVA 1 crewmember's EMU for electrocardio- gram data sampling by UHF. | |

TABLE 3.21-1.- Concluded

| Location | Type | Nomenclature/ position | Function | Remarks |
|-----------------------------------|-------|---|------------------------------------|--------------------------------|
| Pn1 R10 | sw | BIOMED CHANNEL 2 | | The sw is a rotary-type sw. |
| | | MS | Same as for CHANNEL 1 selector | |
| | | PS | Same as for CHANNEL 1 selector | |
| | | MIDDECK L | Same as for CHANNEL 1 selector | |
| | | MIDDECK CTR | Same as for CHANNEL 1 selector | |
| | | MIDDECK R | Same as for CHANNEL 1 selector | |
| | EVA 2 | Selects EVA 2 crew- members EMU for electrocardiogram data sampling by UHF. | | |
| OBS Signal Condi- tioner | ctl | Gain control | Adjusts output amplitude of ECG | Adjustment made preflight. |

On-Orbit IVA Operations

In case of illness, the Flight Surgeon may request that the OBS be donned for observation or diagnostic purposes. In this event, the OBS will be donned (fig. 3.21-3) and the data will be transmitted in real time or recorded and dumped in near real time. A spare OBS system including a panel cable is always flown in the medical kit locker.

EVA

The ECG data on two EVA crewmembers can be transmitted in real time to the ground during flights in which an EVA transmitter is carried (fig. 3.21-4).

Electrodes

The electrodes are used with electrolyte gel to provide better electrical contact. The electrode is composed of a plastic housing containing a non-polarizable Ag/AgCl pressed pellet. The housing is attached to the skin with a stomaseal (double-sided adhesive tape) and the pellet contacts the skin. There are three electrodes on the harness which are designated as upper chest (UC), ground (G), and left chest (LC). The UC and G electrodes are connected together on a single wire; one electrode uses the center conductor and the other uses the shield. The LC electrode attaches to the connector by the center conductor of another shielded wire. The shields from both wires tie together on a connector pin.

Signal Conditioner

The ECG signal conditioner (fig. 3.21-5) is a hybrid microcircuit with a differential input and single-ended output, a variable gain, and an on/off switch internal to the output plug which is turned on by plugging in the IVA cable. It is battery operated and batteries will not nominally be replaced during the flight.

Cables

A short biomed IVA cable is provided for connecting to the biomed panel cables. The biomed panel cables are routed from the seats to the closest available biomed outlets (fig. 3.21-2). For EVA a cable is provided which connects to the extravehicular mobility unit (EMU).

Electrode Donning Kit

The electrode donning kit (fig. 3.21-6) contains alcohol wipes, overtapes, and stomaseals in strips of three.

00751-026

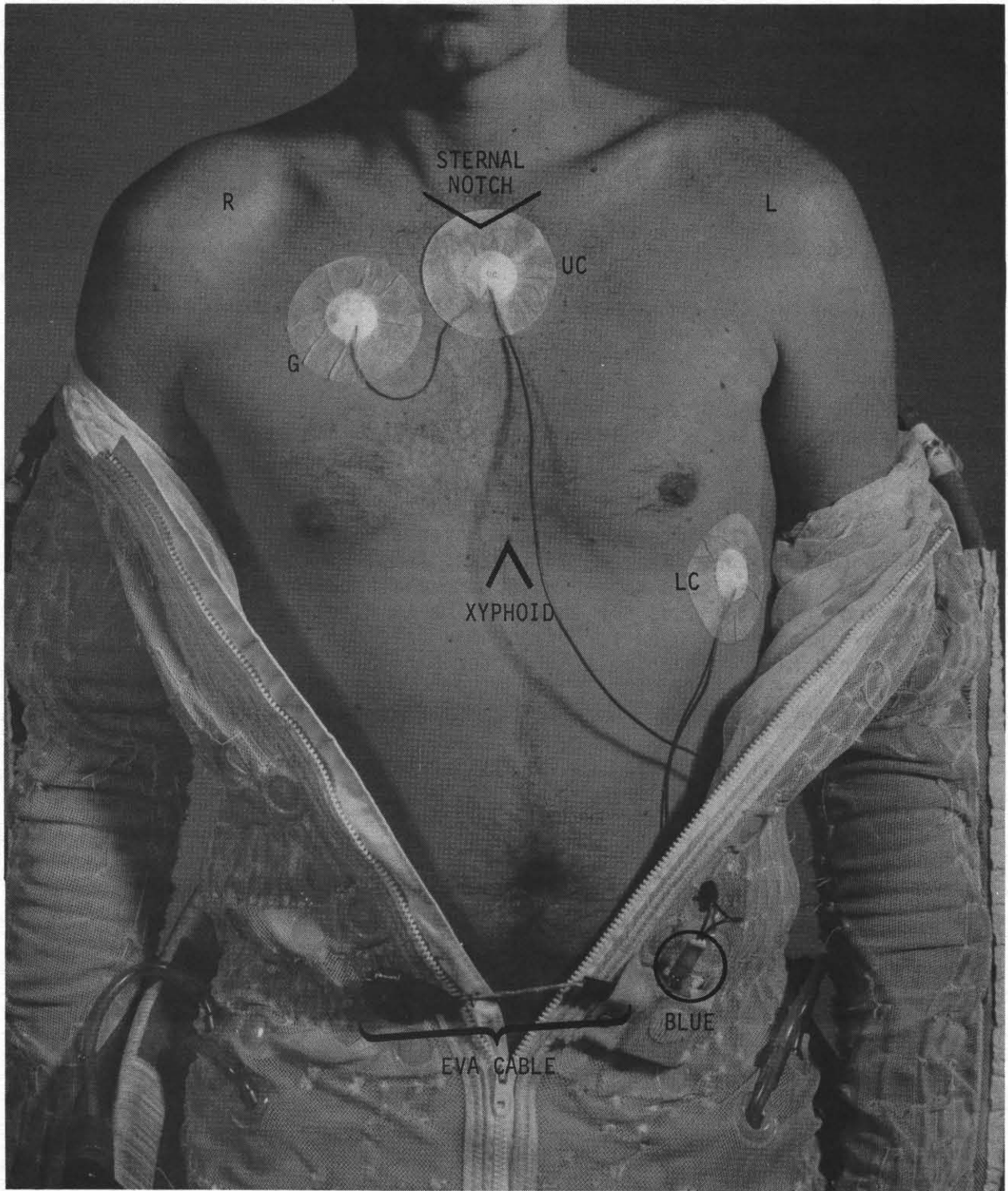
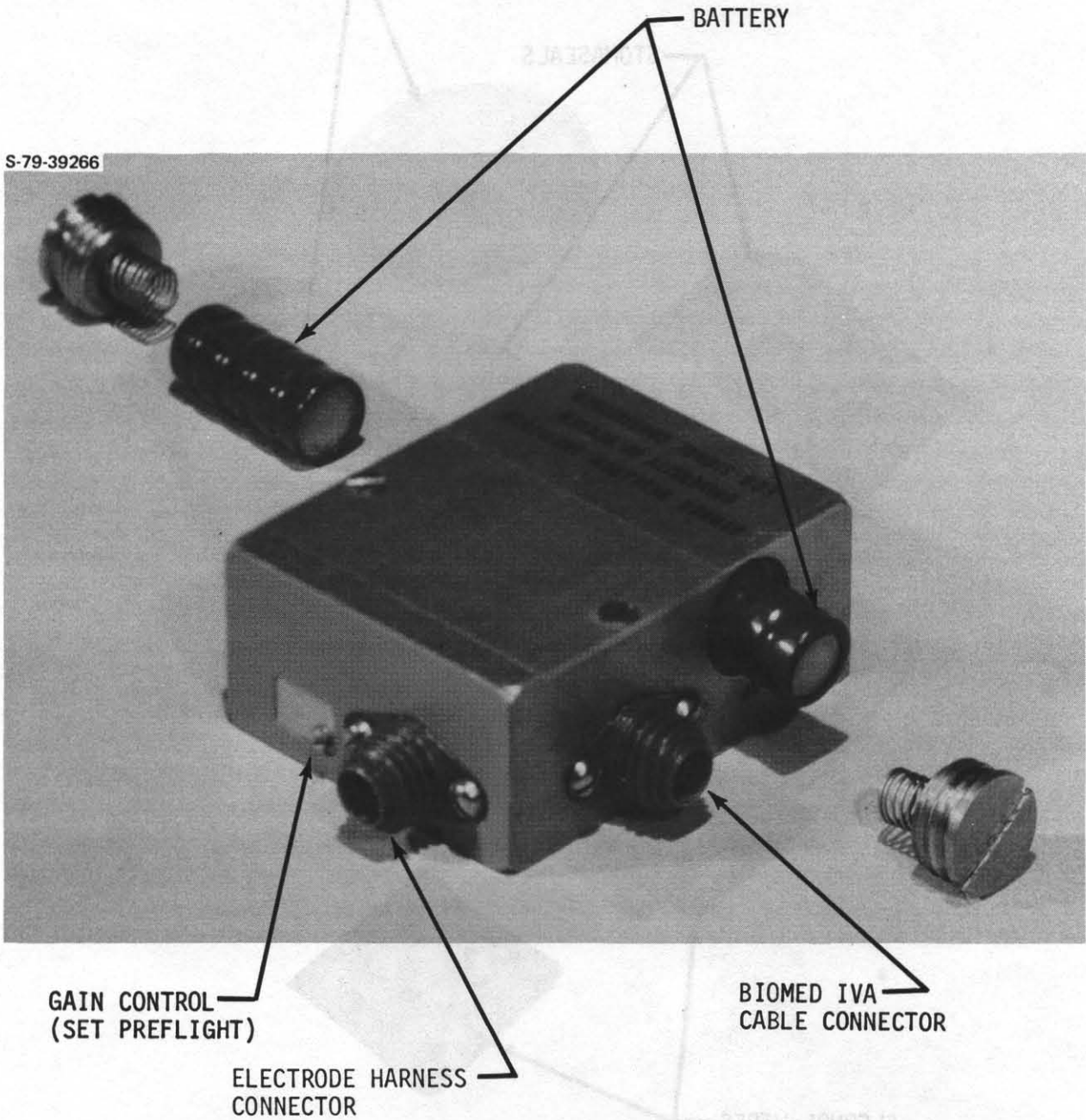


Figure 3.21-4.- ECG in position for EVA transmission.

S-79-39266



GAIN CONTROL
(SET PREFLIGHT)

ELECTRODE HARNESS
CONNECTOR

BIOMED IVA
CABLE CONNECTOR

Figure 3.21-5.- Signal Conditioner.

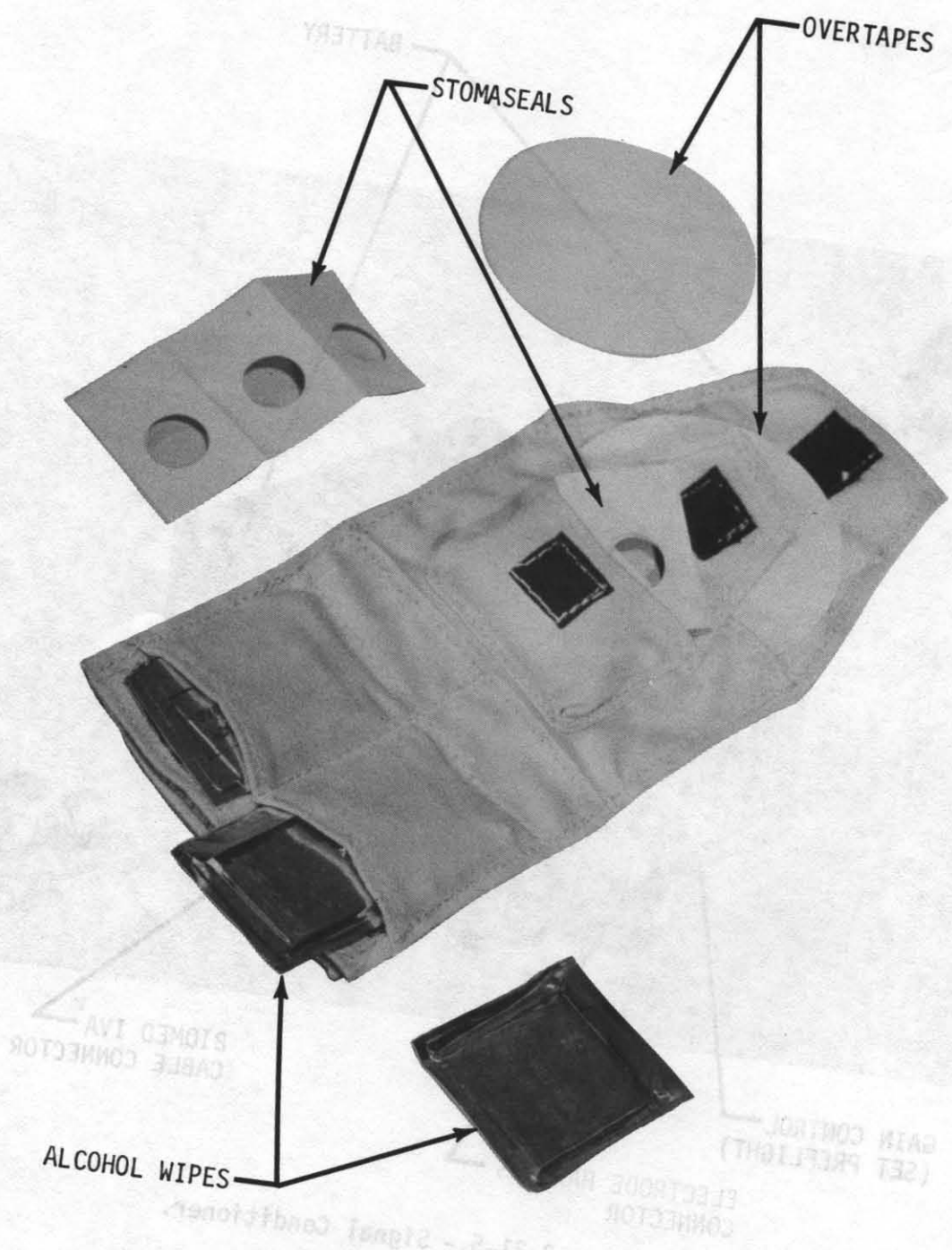


Figure 3.21-6.--Electrode donning kit.

3.21.4 Systems Performance, Limitations, and Constraints

General

- Data can be recorded or transmitted simultaneously from only two subjects. If data are required from more than two crewmembers, sequential sampling is necessary.
- Biomed data:
 - High data rate (HDR): 100 sps
 - On-orbit: Available real time and recorded
 - Entry: Recorded, available postflight

Signal Conditioner

- Signal output: 0 to 5 V
- Output bias: 2.5 V dc
- Impedance:
 - Input: 40 M Ω
 - Output: <200 Ω
- ESP: 100 μ A, dc to 2 kHz
- Battery:
 - Type: 5 series silver oxide cells
 - Life: 380 hr minimum
 - Capacity: 38 mA-h
 - Voltage: 7.5 V nominal
- Connector type: MIK0-1-7SH80
- Size: 1.25 by 1.57 by 0.63 in. (3.18 by 3.97 by 1.59 cm)

Electrode Harness

- Type: Ag/AgCl pressed pellet
- Harness length:
 - UC and G wire: 17.5 in. (44.45 cm)
 - LC wire: 21 in. (53.34 cm)
- Connector type: MIK6-1-7PH102

Cables

- Biomed panel cable:
 - Cable length: 180 in. (4.57 m)
 - Connector type:
 - Seat biomed cable end: A43-AJ-17S-N(046)
 - Orbiter panel end: NB6GE10-6PNT2
- Biomed IVA Cable:
 - Cable length: 1 ft (30.48 cm)
 - Connector type:
 - Signal conditioner end: ME-95184
 - Biomed cable end: A43-AJ-17P-N(046)

Panel Connectors

- Location: Panels A15, A11, M062M
- Connector type: NBOE10-6SNT

3.21.5 Systems Procedures

The procedure in the medical checklist, CPR STATION, ELECTROCARDIOGRAPH (EKG) - CONTINGENCY procedure includes the correct stowage location, panel configurations and cable connections required to configure an on-orbit contingency Electrocardiograph (fig. 3.21-7). This procedure utilizes the contingency biomed system found in the Emergency Medical Kit.

ELECTROCARDIOGRAPH (EKG)- CONTINGENCY

Donning

- | | |
|--------------|---|
| EMK (red) | <ol style="list-style-type: none"> 1 Unstow Operational Bioinstrumentation System: Biomed belt w/Signal Conditioner (Pocket 1) Electrode Harness (Pocket 1) Biomed IVA Cable (Pocket 1) Biomed Cable (if needed - same locker as Med Kit) Electrode Donning Kit - same locker as Med Kit 2 Swab electrode sites with alcohol wipe, let dry 3 Connect Biomed IVA Cable to side of Signal Conditioner 4 Connect blue end of Electrode Harness to top of Signal Conditioner 5 Don Belt w/Signal Conditioner 6 Apply small amount of electrode gel to electrodes 7 Remove stomaseal protective coverings from electrodes 8 Attach electrodes to chest; secure with tape |
|--------------|---|

Operation

- | | |
|-----|---|
| R10 | <ol style="list-style-type: none"> 1 BIOMED CH 1(2) - PS (for CDR, MS2 seats; connect Biomed Cable to A15) - MS (for PLT, MS1 seats; connect Biomed Cable to A11) - MIDDECK L (for middeck port seat S7; connect Biomed Cable to M062M; LEFT) - MIDDECK CTR (for middeck center seat S5; connect Biomed Cable to M062M; CENTER) - MIDDECK R (for middeck stbd seat S6; connect Biomed Cable to M062M; RIGHT) 2 Connect Biomed IVA cable to Biomed Cable |
|-----|---|

Doffing and Stowage

- | | |
|--------------|---|
| EMK (red) | <ol style="list-style-type: none"> 1 Remove electrodes, doff Belt, discard stomaseals (3) 2 Disconnect Biomed IVA Cable from Signal Conditioner, Biomed Cable 3 Using alcohol wipes, clean electrodes, air dry or wipe dry 4 Apply stomaseals to electrodes (3) 5 Stow Operational Bioinstrumentation System Biomed Belt w/Signal Conditioner (Pocket 1) Electrodes Harness (Pocket 1) Biomed IVA Cable (Pocket 1) Biomed Cable (same locker as Med Kit) |
|--------------|---|

S-82-39097

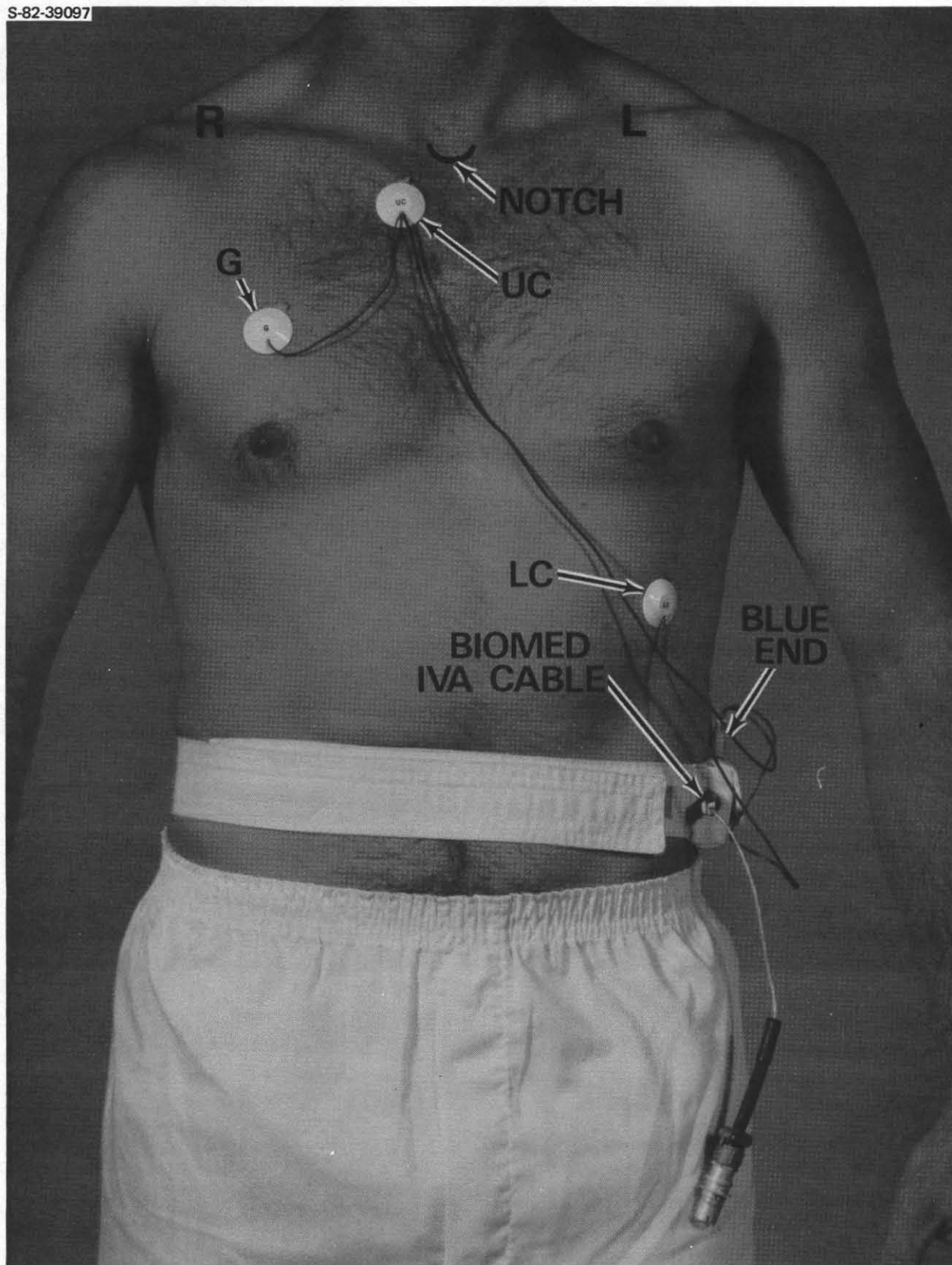


Figure 3.21-7.- Electrocardiograph in position.

3.22 HOUSEKEEPING

3.22.1 Introduction

The housekeeping systems provide the components necessary for both periodic and nonperiodic maintenance and cleaning activities in the Orbiter crew station.

The major housekeeping categories are

- Cleaning equipment
- Atmosphere revitalization and cooling system
- Trash management
- Replacement parts/units
- Water system
- Communications/electrical

The use of the housekeeping systems is applicable, to some degree, for all flights. All housekeeping functions are performed during the orbital flight phase.

3.22.2 Interfaces

There are three trash bags for dry trash. They attach to the Orbiter with snaps or Velcro at their use locations, and are launched in position. The materials used in cleaning operations are stowed in lockers. The CO₂ Absorbers (LiOH canisters) are stowed in a middeck floor stowage compartment and are replaced in the environmental control system downstream of the fans on a periodic basis. The vacuum cleaner is stowed in a modular locker and requires Orbiter electrical power. Procedures are listed in the In-flight Maintenance Checklist for the changeout of all replaceable units and parts. The water hoses connect by means of QD's with the water system for draining, flushing, or X-TIES as outlined in the IFM Checklist. The communications/electrical equipment draws power from the Orbiter electrical power system.

3.22.3 Systems Functional Description

Cleaning Equipment

The cleaning operations include the following activities:

- Clean Waste Collection System (WCS) (urinal and seat) (sec. 3.17)
- Clean dining area and equipment
- Clean floors and walls (as required)
- Clean air filters

The materials and equipment available for cleaning operations are listed below.

- WCS cleanser and wipes

The WCS cleanser is a liquid biocidal detergent in a squeeze-bottle container, with a built-in bladder, dispensing valve, and nozzle. The cleanser is sprayed on the surface, which is then wiped clean with dry wipes. The cleanser and wipes are packaged together and stowed in the WCS compartment (fig. 3.22-1).

The cleanser is used for periodic cleansing of the WCS urinal and seat. It can also be used, as required, to clean walls and floors.

- Dry wipes

The dry wipes are packaged 30 per dispenser. The wipes are the same as those used in the WCS wipes/cleanser package and are used for meal clean-up and for general purpose cleaning.

- Disposable gloves

Plastic disposable gloves are provided for use when a crewmember is using the biocidal cleanser (fig. 3.22-2).

- Vacuum Cleaner

The vacuum cleaner (fig. 3.22-3) is provided for general housekeeping and for cleaning Orbiter air filters and the Spacelab Environmental Control System (ECS) filters.

The vacuum cleaner is stowed in a modular locker. Vacuum cleaner details for housekeeping procedures are given in the IFM checklist.

S79-31524



Figure 3.22-1.- The WCS cleanser and dry wipes.

S78-37481

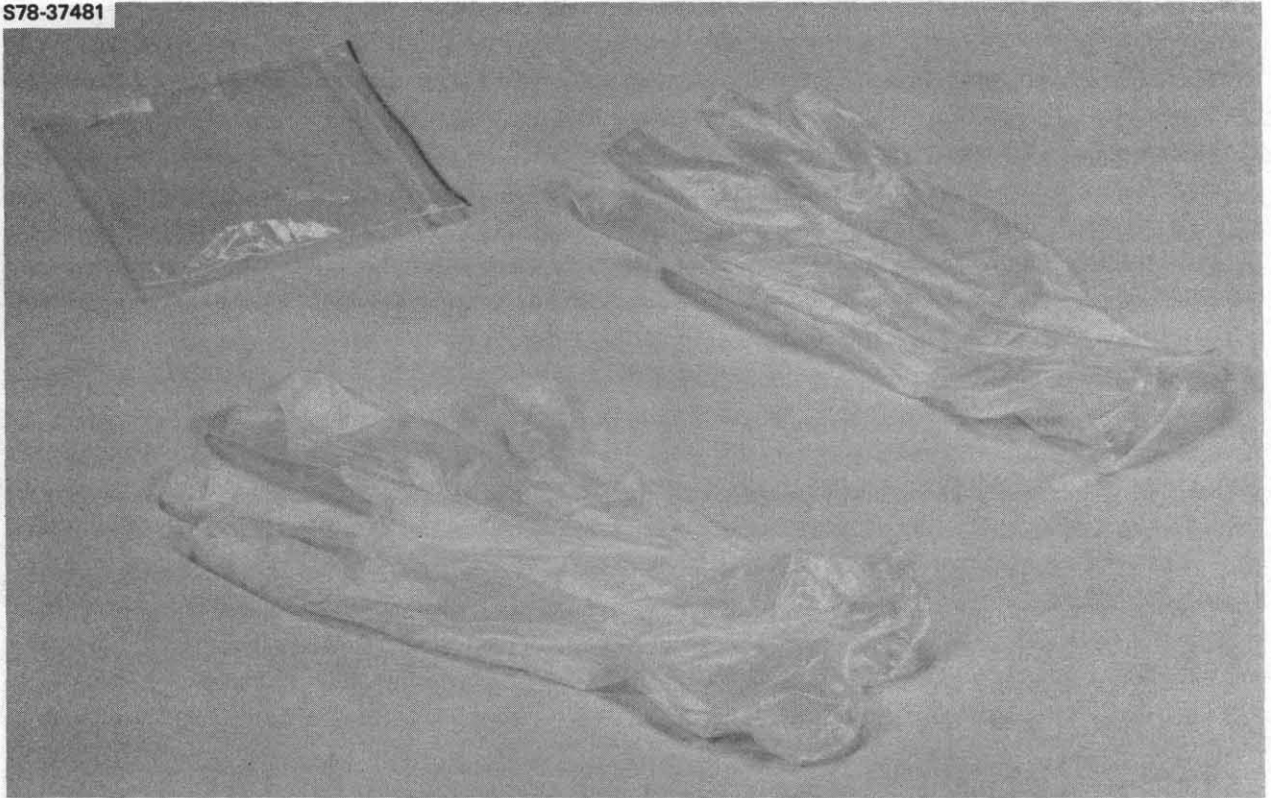
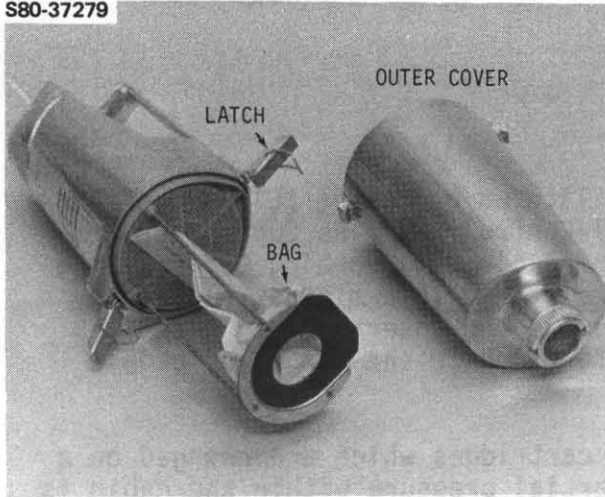


Figure 3.22-2.- Disposable gloves.

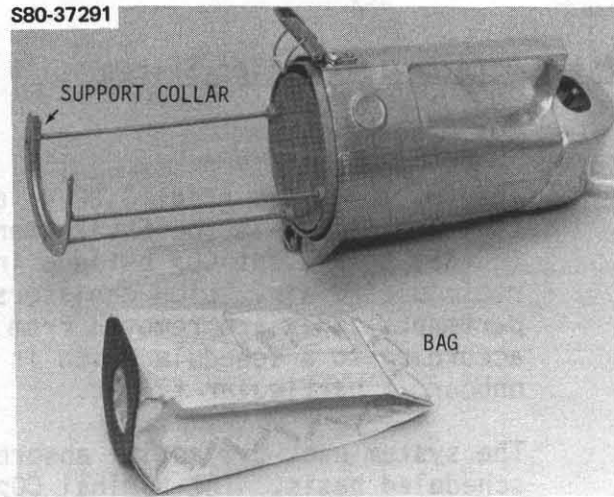
Figure 3.22-1.- The HCS cleaner and dry wipes.

S80-37279



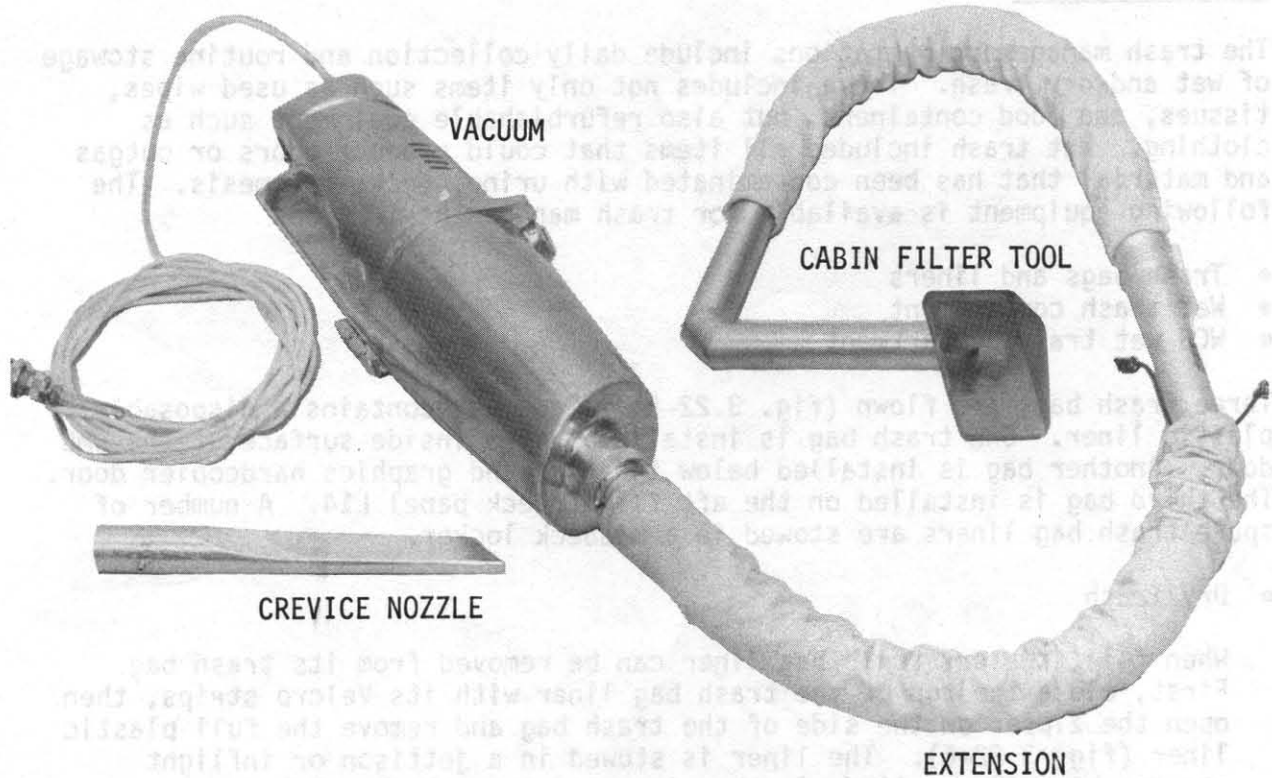
REMOVE OUTER COVER

S80-37291



REPLACE VACUUM BAG

S80-37290



VACUUM WITH ATTACHMENTS

Figure 3.22-3.- Vacuum cleaner.

Atmosphere Revitalization System

- CO₂ Absorbers

The CO₂ absorbers (fig. 3.22-4) are lithium hydroxide (LiOH) canisters that are placed in the Environmental Control and Life Support System (ECLSS) to prevent CO₂ buildup in the cabin by absorbing CO₂ from the recirculated air. LiOH canisters are stowed in a middeck floor compartment. They are removed from stowage and inserted into the ECLSS according to a schedule which is a function of the number of people onboard a particular flight.

The system uses two active absorber cartridges which are changed on a scheduled basis. The nominal CO₂ partial pressure within the cabin is less than 5.0 mmHg and varies within a range of 0 to 7.6 mmHg.

The procedures for atmosphere revitalization are covered in the In-Flight Maintenance checklist.

Trash Management

The trash management operations include daily collection and routine stowage of wet and dry trash. Trash includes not only items such as used wipes, tissues, and food containers, but also refurbishable equipment such as clothing. Wet trash includes all items that could produce odors or outgases and material that has been contaminated with urine, feces or emesis. The following equipment is available for trash management includes

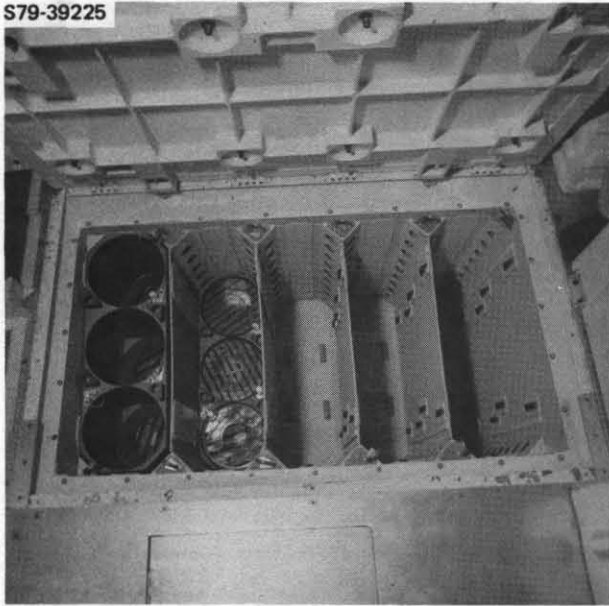
- Trash bags and liners
- Wet trash compartment
- WCS wet trash compartment

Three trash bags are flown (fig. 3.22-5). Each bag contains a disposable plastic liner. One trash bag is installed on the inside surface of the WMC door. Another bag is installed below the text and graphics hardcopier door. The third bag is installed on the aft flight deck panel L14. A number of spare trash bag liners are stowed in a middeck locker.

- Dry Trash

When full, the dry trash bag liner can be removed from its trash bag. First, close the top of the trash bag liner with its Velcro strips, then open the zipper on the side of the trash bag and remove the full plastic liner (fig. 3.22-6). The liner is stowed in a jettison or inflight stowage bag. A new liner is then inserted into the trash bag.

S79-39225



LiOH CANISTER STOWAGE

S79-39257



LiOH CANISTER

S79-39208



LiOH CANISTER INSERTION INTO ARS

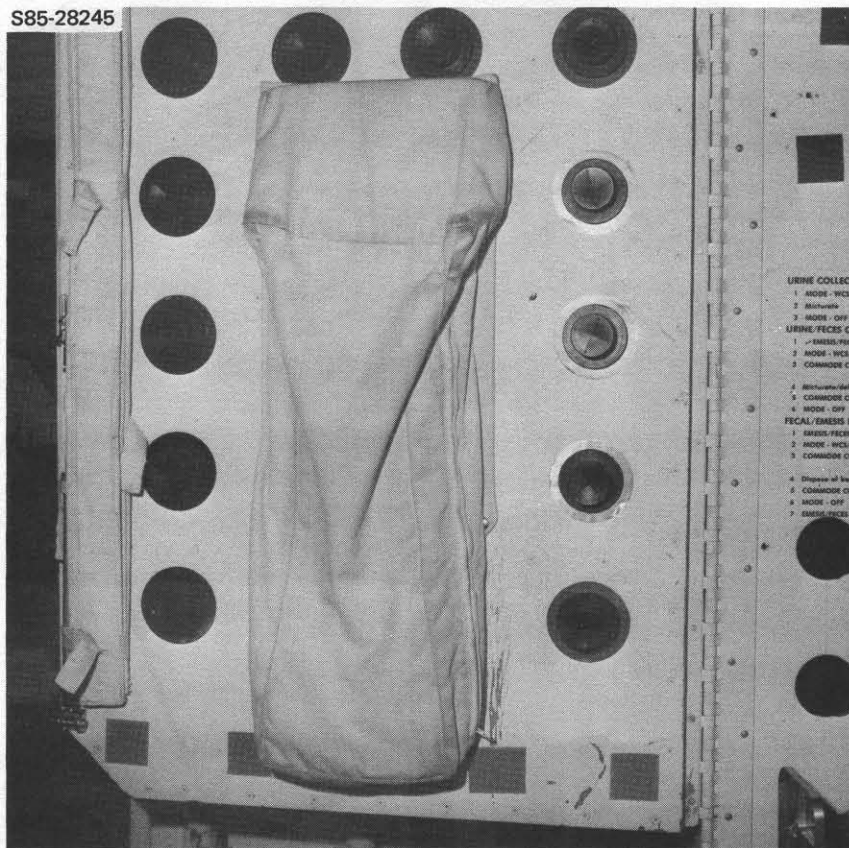
Figure 3.22-4.- LiOH canisters



AFT FLIGHT DECK



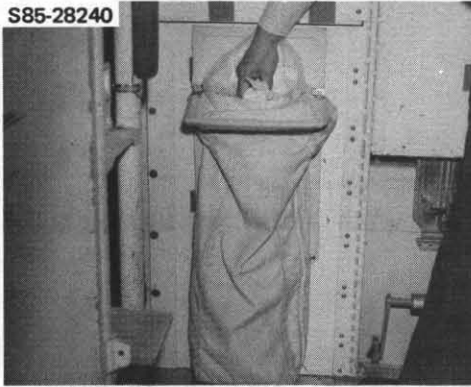
AFT MIDDECK BELOW TAGS DOOR



ON INSIDE SURFACE OF WCS DOOR

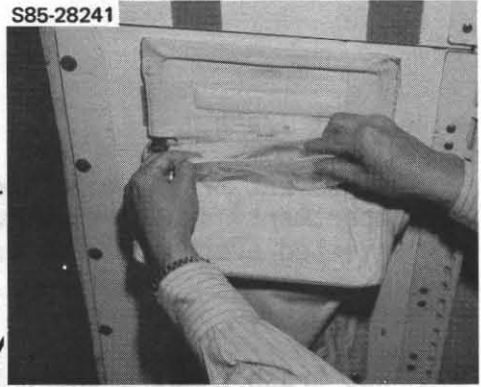
Figure 3.22-5.- Trash bag locations.

S85-28240



DEPOSITING TRASH

S85-28241



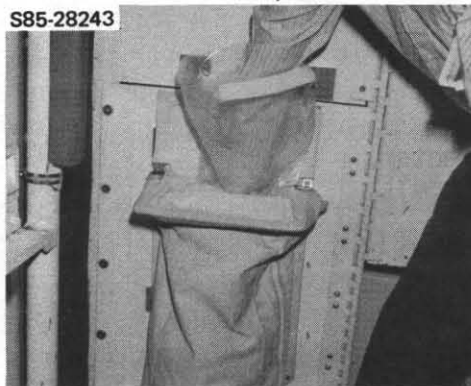
SEAL FULL LINER

S85-28242



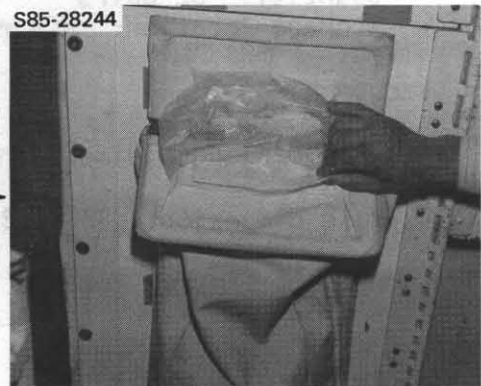
REMOVE LINER FROM SIDE
AND STOW IN JETTISON BAG, ETC.

S85-28243



INSERT NEW LINER

S85-28244



ATTACH LINER VELCRO

Figure 3.22-6.- Trash bag operations.

- WCS Wet Trash

The WCS wet trash compartment is located on the WMC port wall. This compartment is used to stow material contaminated with fecal or urine and is vented overboard at a rate of 3 ± 0.4 lb/day.

- Wet Trash Compartment

A wet trash compartment (fig. 3.22-7) providing 8 ft³ of stowage volume is located under the middeck floor. The compartment is vented overboard through the vacuum vent line. The compartment is vented at a rate of approximately 3 ± 0.4 lb/day (~750 scc/min).

3.22.4 System Performance, Limitations, and Constraints

Cleaning Equipment

- WCS Cleanser

- Composition - Denatured Ethanol, Technical - (10% by wt), Lysol liquid (containing o-phenylphenol (2.8%), o-benzyl-p-chlorophenol (2.7%), ethanol (1.8%), xylene (1.5%), isopropanol (0.9%), tetrasodium ethylene diamine tetraacetate (0.76%), soap (16.5%), inert (73.04%) - (5% by wt), Palmolive liquid soap (containing alkyl-benzene sulfonate, alkyl-ether sulfate, fatty acid amide, sodium cumene sulfonate, ethanol) - (1.5% by wt), distilled water (83.5% by wt)

- Quantity: 105 ml (approx 5 oz)

- Disposable gloves

- Quantity: 32 pairs
- Storage location: WCS restraint bag

- Vacuum cleaner

- Vacuum cleaner dimension: 19" long x 6" diameter
(48.26 cm x 15.24 cm)
- Hose dimension: 36" x 3" diameter
(91.44 cm x 7.62 cm)
- Weight: Approx 20 lbs.

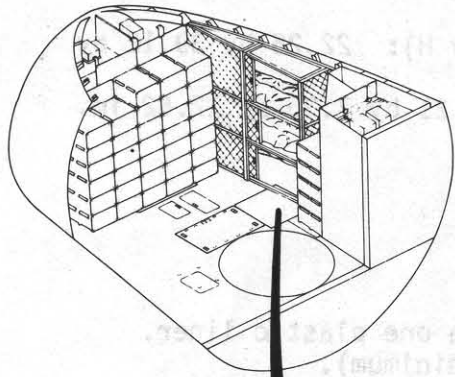
LiOH Canister

- LiOH canister dimensions/weight: 6.68-in.-diameter (16.97-cm) by 11.3 in. (28.70 cm)/6.73 lb

- LiOH canister compartment dimensions (L by W by H): 22.25 by 39.12 by 30.08 in. (56.51 by 99.36 by 76.40 cm)
- Stowage rack dimensions/weight (L by W by H): 21 by 7.30 by 12.52 in. (53.34 by 18.54 by 31.80 cm)/28 lb

Trash Management

- Dry trash
 - Number of bags flown: 3 (nominal) each with one plastic liner.
 - Number of replaceable plastic liners: 20 (minimum).
- Wet trash compartment
 - Volume: 8 cu ft
 - Vented rate (overboard): 3 ± 0.4 lb/day (~750 scc/min)
- WCS wet trash
 - Volume: 1.85 cu ft
 - Vented rate (overboard): 3 ± 0.4 lb/day



MID DECK

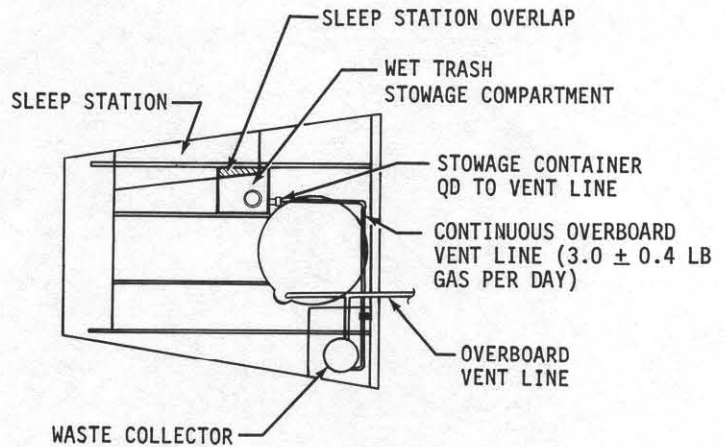
S8528256



S85-28232



WET TRASH STOWAGE COMPARTMENT



EQUIPMENT BAY VENT LINES

Figure 3.22-7.- Wet trash stowage compartment.

3.23 TOOLS

3.23.1 Introduction

Two standard tool kits are flown on every flight: the intravehicular activity (IVA) tool kit stowed in a middeck locker and the extravehicular activity (EVA) tool kit stowed in the payload bay. This section identifies the tools available. Activities associated with these tools are described in the appropriate systems section and the IFM checklist. Associated procedures are listed in the Inflight Maintenance Checklist (JSC-17321) document.

3.23.2 Stowage

The tool kits are stowed in a middeck locker and in the payload bay tool box.

3.23.3 Systems Functional Description

IVA Tool Kit

The contents of the IVA tool kit are shown in table 3.23-1 and in figure 3.23-1.

EVA Tool Kit

The EVA tool kit is stowed in the payload bay tool box, (reference SFOM, Volume 15).

3.23.4 Systems Performance, Limitations, and Constraints

Not applicable

TABLE 3.23-1.- IVA TOOL KIT

| Contents | Remarks |
|--|---|
| ACCU bypass connecter Adapter 3/8 in. to 1/4 in. Allen head drivers 1/8 in. 5/32 in. (2) 3/16 in. 1/4 in. 5/16 in. 5/16 in. long 7/64 in. Allen wrenches 0.028 in. 0.035 in. 3/64 in. 1/16 in. 5/64 in. 3/32 in. 7/64 in. 1/8 in. 9/64 in. 5/32 in. 3/16 in. 7/32 in. 1/4 in. Breakout box cb override Connector strap wrench Cables AC power transfer (15 ft) DC extension (24 ft) DC extension pigtails (1 ft) Driver handles Small Impact | Stowed in vacuum cleaner locker 1 is stowed in vacuum cleaner locker Seat adjustment tool 1/4 in. drive-stowed in small tool pouch. L-shaped - stowed in pouch. Stowed in IFM contingency hose and cable kit. Adapts 24-ft extensions into true dc extension cables |

TABLE 3.23-1.- Continued

| Contents | Remarks |
|--|--|
| Electric screwdriver | Stowed in vacuum cleaner locker with spare batteries |
| Extensions 1/4 in. drive-4 in., 6 in., 10 in. 3/8 in. drive-4 in., 8 in., 12 in. | Stowed in small tool pouch 12 in. is in small tool pouch |
| Forceps | For TAGS paper removal |
| Hammer, (ballpeen-deadblow) | Shot-filled head reduces bounce |
| High data rate recorder - tape leader repair kit | |
| Hoses blue/blue red/red yellow/yellow VACHS QD adapter | Stowed in IFM contingency hose and cable kit A yellow/red adapter |
| Locker tool | |
| Measuring tape | |
| Mechanical fingers | |
| Mirror | With telescopic handle |
| Multimeter | With a spare battery |
| Patch kit Bone saw Dux seal Lubricant Safety wire Valve foam applicator | |
| Pinch bar | |
| Pin kit Alligator clips (4) Banana jack adapter Crimping tool 16 gauge 20 gauge 22 gauge Fresnel lens, 10 power | |

TABLE 3.23-1.- Continued

| Contents | Remarks |
|--|---------|
| <p>Pin kit (cont.)</p> <p>Fuse cap test leads 8 ft, 22 gauge (2)</p> <p>Fuses</p> <p>1-A, pin (5)</p> <p>3-A, pin (5)</p> <p>5-A, pin (5)</p> <p>1/2-A, inline (2)</p> <p>1-A, inline (2)</p> <p>2-A, inline (2)</p> <p>3-A, inline (2)</p> <p>5-A, inline (5)</p> <p>6-A, inline (2)</p> <p>8-A, inline (2)</p> <p>10-A, inline (2)</p> <p>Insulated pin/pin test jump leads, 5 in.</p> <p>12 gauge (4)</p> <p>16 gauge (4)</p> <p>20 gauge (4)</p> <p>22 gauge (4)</p> <p>Insulated pin/socket test jumper leads, 5 in.</p> <p>12 gauge (4)</p> <p>16 gauge (4)</p> <p>20 gauge (4)</p> <p>22 gauge (4)</p> <p>Insulated pin/socket test jumper leads, 24 in.</p> <p>12 gauge (6)</p> <p>16 gauge (6)</p> <p>20 gauge (6)</p> <p>22 gauge (6)</p> <p>Insulated socket/socket test jumper leads, 5 in.</p> <p>12 gauge (4)</p> <p>16 gauge (4)</p> <p>20 gauge (4)</p> <p>22 gauge (4)</p> <p>Insulation tubing</p> <p>16 gauge (2)</p> <p>20 gauge (2)</p> <p>22 gauge (2)</p> | |

TABLE 3.23-1.- Continued

| Contents | Remarks |
|---|---------|
| Pin kit (cont) Ku-band antenna cable Minigrabbers 24 in. (2) 48 in. (2) Pins 16 gauge (12) 20 gauge (12) 22 gauge (12) PLBD motor ops cables (4) Sockets 16 gauge (12) 20 gauge (12) 22 gauge (12) Splice crimp tool Test adapter pin 12 gauge 16 gauge 20 gauge 22 gauge Test adapter socket 12 gauge 16 gauge 20 gauge 22 gauge Wire, electrical 16 gauge, 10 ft 20 gauge, 10 ft 22 gauge, 10 ft Wire splices Large (Red-4) Small (Blue-4) Wire stripper Pip pins Pliers Electrical connector Needle nose Vise grip Protective covers Cold plate Wireway Punch-8 in. | |

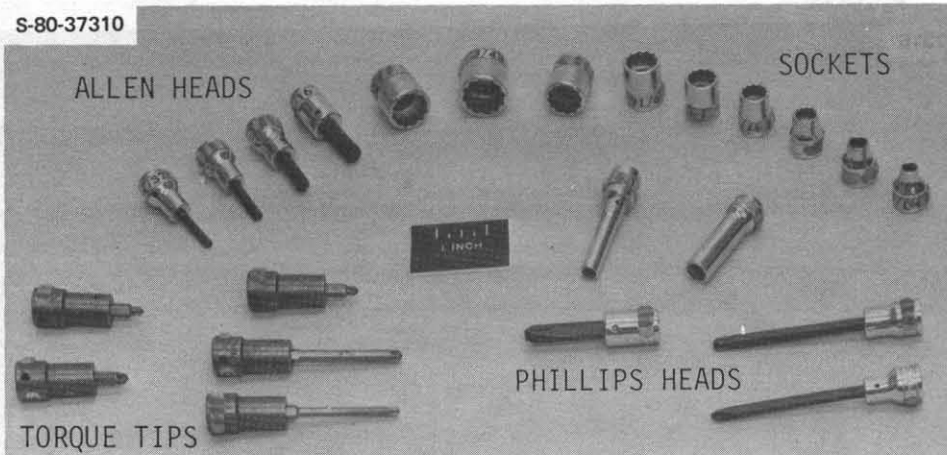
TABLE 3.23-1.- Continued

| Contents | Remarks |
|--|---|
| Screwdrivers Small slotted Large slotted Phillips Phillips bits #2,3,4 Torque tip #6,8,10 Torque tip bits #2,4,6,8,10 | For TAGS repair |
| Small tool pouch Allen head driver 7/64 in. Adapter 1/4 to 3/8 in. Driver handle Extensions 4 in., 6 in., 10 in., 12 in. Jewelers screwdrivers (6 sizes) Needle nose pliers Ratchet wrench Sockets Standard 1/4, 5/16, 3/8, 7/16, 1/2, 9/16 Deep 1/4, 5/16, 11/32, 3/8, 7/16 | All tools 1/4-in. drive unless noted 12 in. is 3/8-in. drive |
| Sockets 1/4, 5/16, 3/8, 7/16, 1/2, 9/16, 5/8, 11/16, 3/4 | 3/8 in. drive |
| Speed handle | |
| Tape Aluminum Gray | 2 in. wide 1 in. and 2 in. wide |
| Tool pouch | Empty |
| Torque wrench | |
| Universal joint | |
| Velcro kits 1 in. square 2 in. square | 50 each hook and pile 50 each hook and pile |
| Velcro strap kit | |

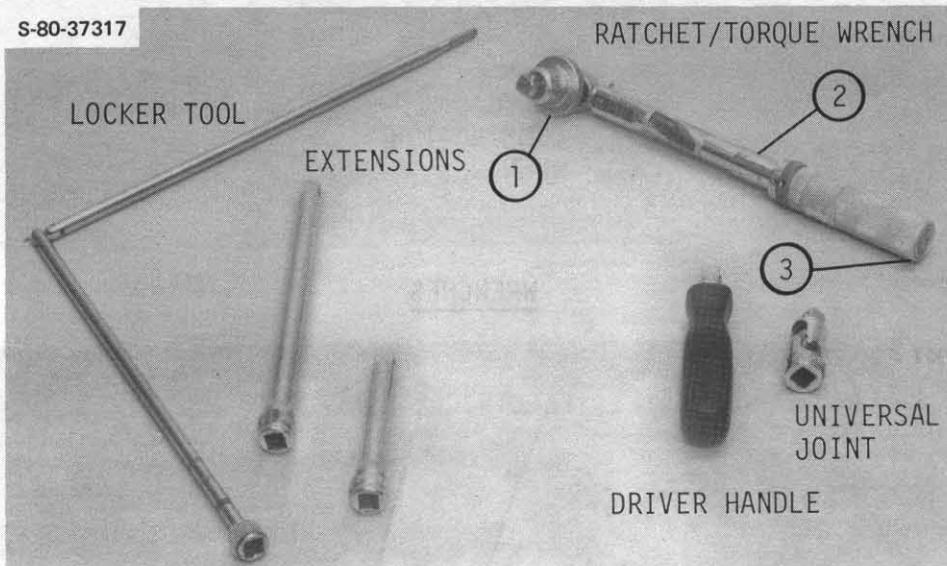
TABLE 3.23-1.- Concluded

| Contents | Remarks |
|--|-----------------|
| Water equipment assy Contingency water dispenser Free fluid vacuum Needles (spare) (2) Gas separator Wicket safety caps Wrenches Adjustable - 4 in., 10 in. Combination 1/4, 5/16, 3/8, 7/16, 1/2, 9/16, 5/8, 11/16, 3/4 | Galley and OWDA |

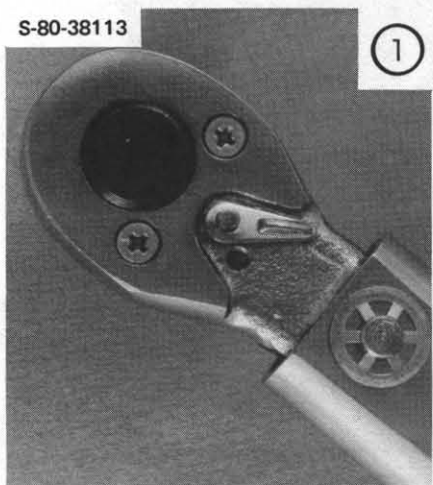
S-80-37310



S-80-37317

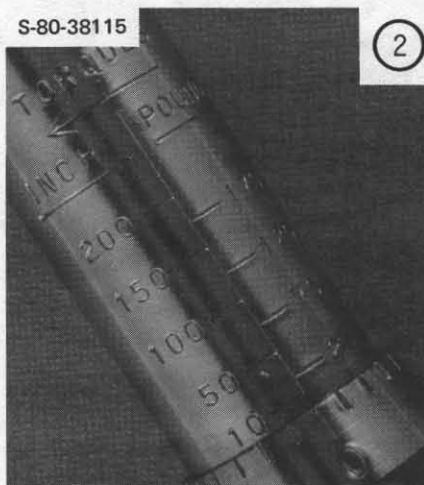


S-80-38113



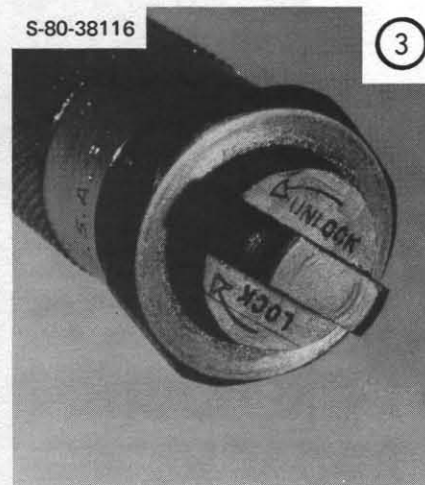
RATCHET HEAD SELECTOR

S-80-38115



SCALE, IN-LB

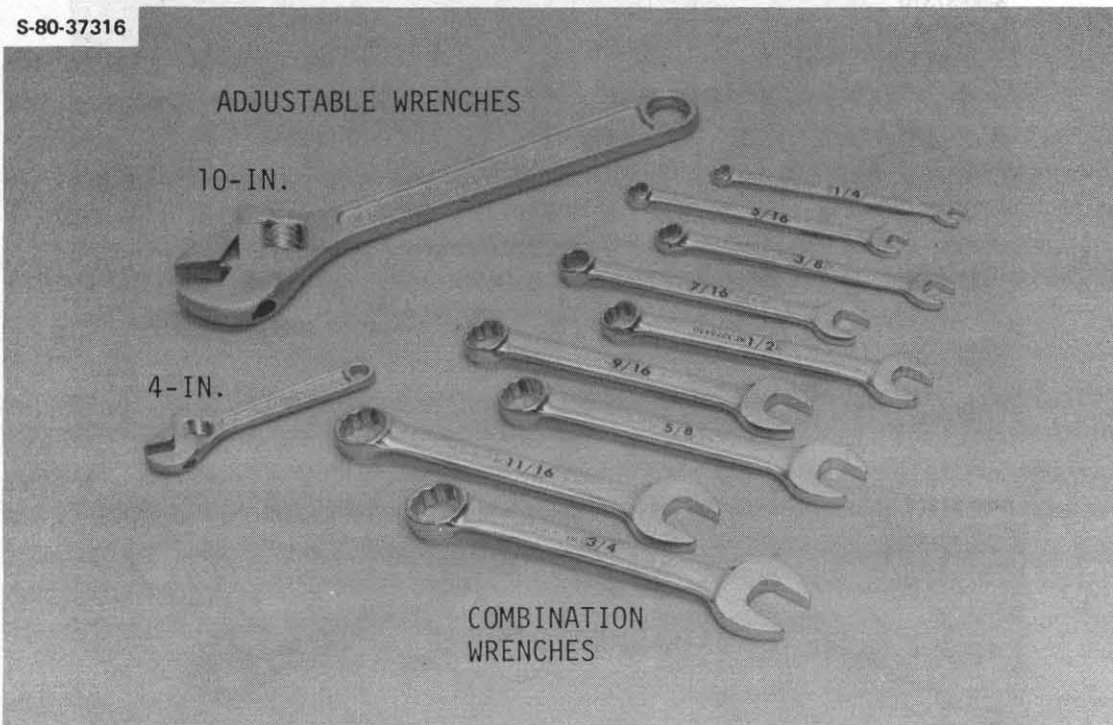
S-80-38116



ADJUSTMENT LOCK

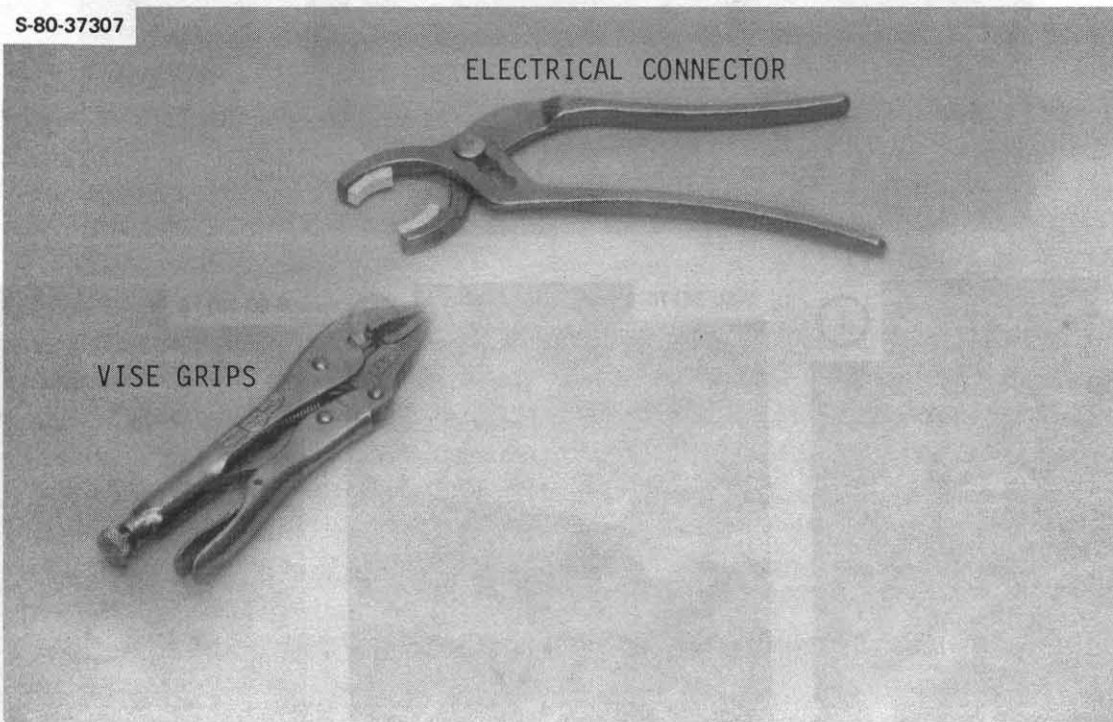
Figure 3.23-1.- IVA Tools (sheet 2 of 9).

S-80-37316



WRENCHES

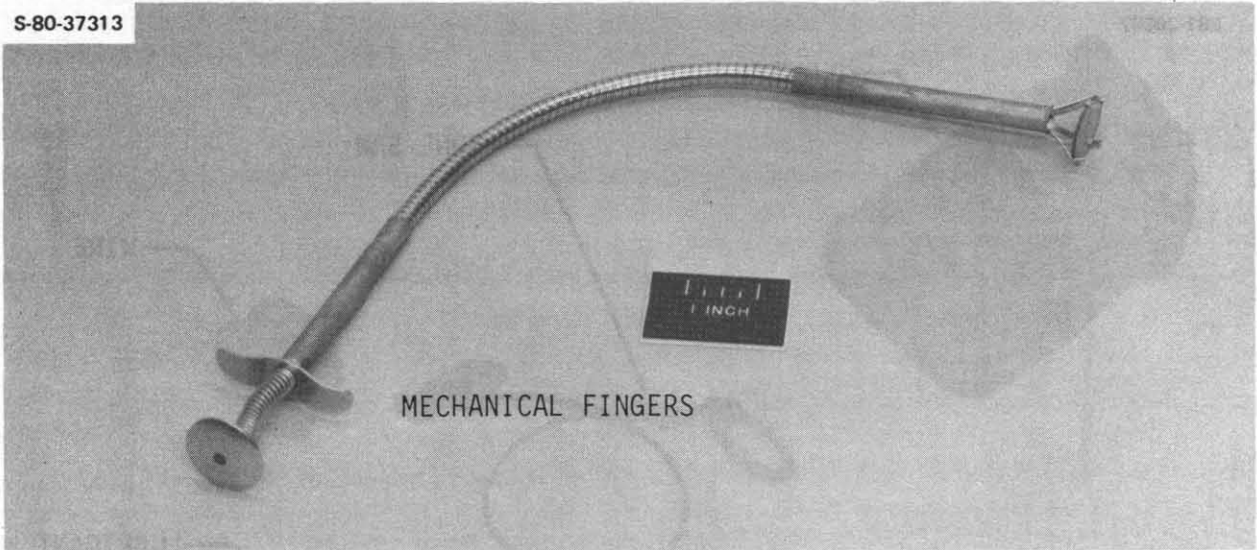
S-80-37307



PLIERS

Figure 3.23-1.- IVA Tools (sheet 3 of 9).

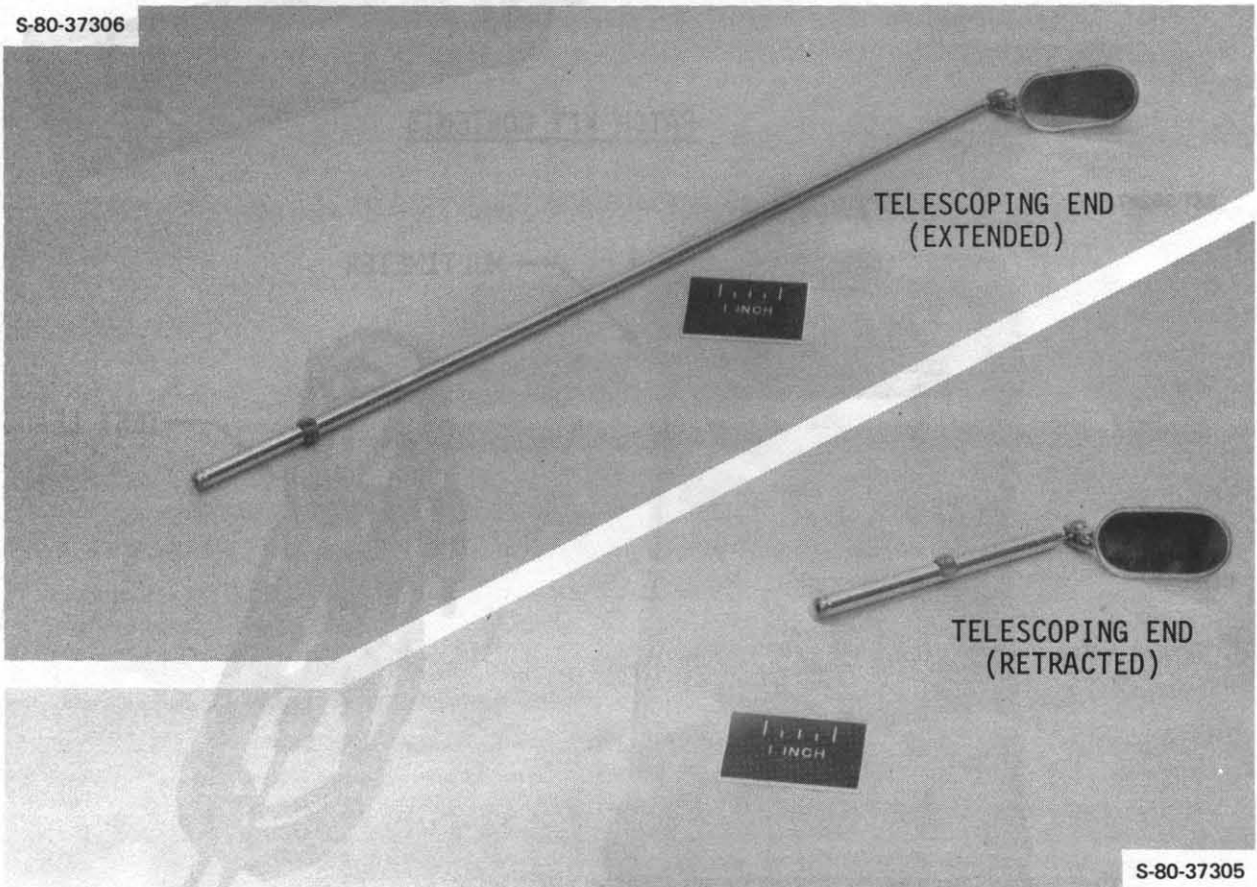
S-80-37313



MECHANICAL FINGERS

MECHANICAL FINGERS

S-80-37306



TELESCOPING END (EXTENDED)

TELESCOPING END (RETRACTED)

S-80-37305

INSPECTION MIRROR

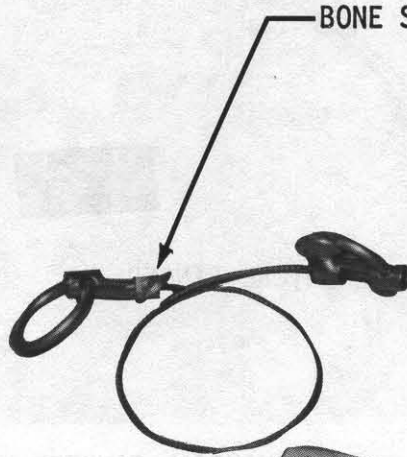
Figure 3.23-1.- IVA Tools (sheet 4 of 9).

S81-26997



DUXSEAL

BONE SAW



WIRE



LUBRICANT



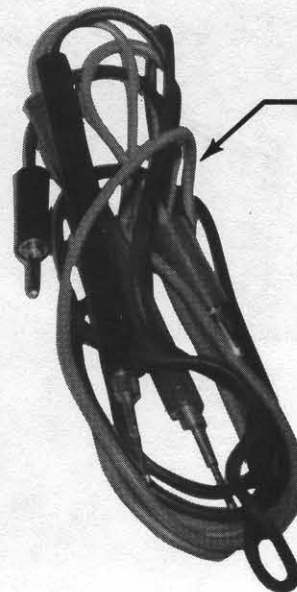
PATCH KIT CONTENTS

S81-36297



MULTIMETER

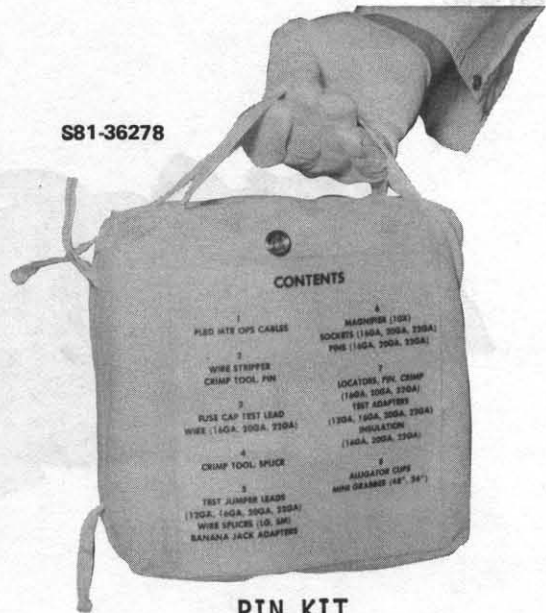
TEST LEADS



MULTIMETER KIT

Figure 3.23-1.- IVA Tools (sheet 5 of 9).

S81-36278



PIN KIT

S81-36292



PIN KIT - OPENED (VIEW 1 OF 4)

S81-36293



PIN KIT - OPENED (VIEW 2 OF 4)

Figure 3.23-1.- IVA Tools (sheet 6 of 9).

S81-36294



PIN KIT - OPENED (VIEW 3 OF 4)

S81-36295

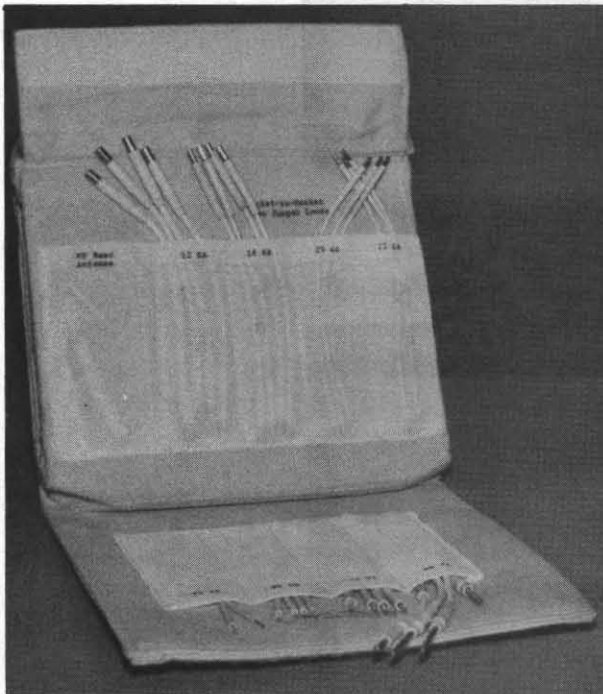


PIN KIT - OPENED (VIEW 4 OF 4)

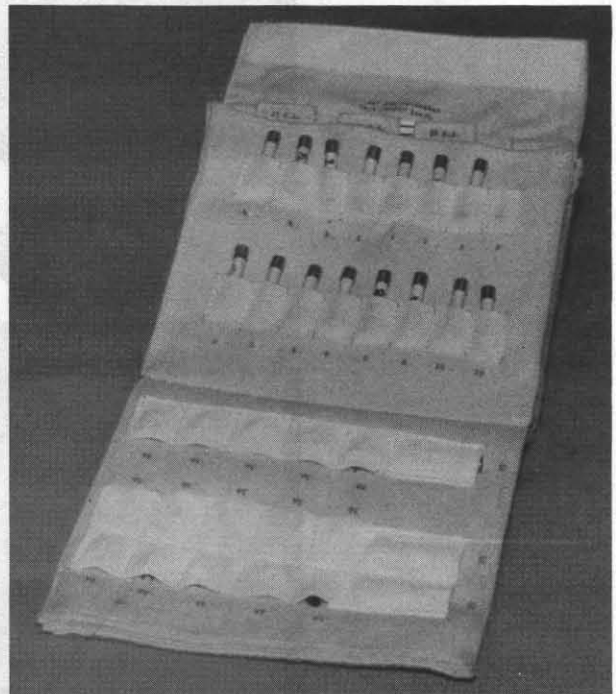
Figure 3.23-1.- IVA Tools (sheet 7 of 9).



FUSE AND TEST JUMPER LEAD KIT



FUSE AND TEST JUMPER LEAD KIT OPENED



FUSE AND TEST JUMPER LEAD KIT OPENED

Figure 3.23-1.- IVA Tools (Sheet 8 of 9).

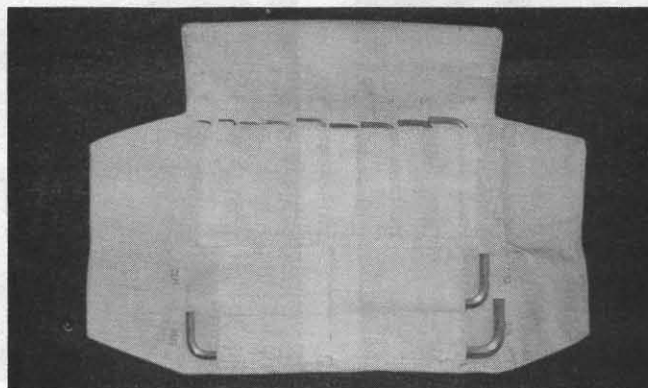
S83-42490



TOOL POUCH



EMPTY TOOL POUCH



ALLEN WRENCH POUCH

FUSE AND TEST JUMPER LEAD KIT OPENED

Figure 3.23-1.- IVA Tools (Sheet 9 of 9).

3.24 FIRE EXTINGUISHER

3.24.1 Introduction

Three portable fire extinguishers (fig. 3.24-1) are located within the crew module, two on the middeck and one on the flight deck. These fire extinguishers are used to suppress open fires in the crew compartment and enclosed fires behind the Display and Control (D&C) panels.

3.24.2 Stowage and Use

Extinguishers are stowed on mounting brackets in the locations shown in figure 3.24-2. Each is held by a single retention strap with a quick-release over-center lock. Pulling on the handloop allows the extinguisher to be released and removed in one motion.

Each extinguisher contains a nozzle which can be inserted into the fire ports located on the avionics bays, the galley, the CFES, the WCS, and most D&C panels. This allows the crewmember to combat enclosed fires. Fire port locations are shown in figures 3.24-3 through 3.24-6.

3.24.3 Systems Functional Description

The extinguisher is designed for one-handed operations. These operations include removing the extinguisher from the mounting bracket and activating the extinguisher. The extinguisher can be released within 2 sec by a single hand motion with 2- to 5-lb (8.9- to 22.2-N) force.

The ring pin prevents inadvertent activation and must be removed before the extinguisher can be used. With the ring pin removed, the extinguisher is activated by squeezing the trigger down against the handle (table 3.24-1).

Care should be taken to anchor oneself before discharging the extinguisher in zero g. The extinguisher produces a thrust of 2.4 lb, which is sufficient to push an unanchored crewmember about the cabin.

For a fire behind a D&C panel, the extinguisher nozzle is inserted into one of the panel fire ports before extinguisher activation. For open fire suppression, the extinguisher nozzle is pointed at the base of the flame and discharged. Many D&C panels are partitioned and care should be taken to point the extinguisher nozzle into the correct fire port.

A fire in one of the avionics bays would be suppressed with one of the remote controlled fire bottles operated from panel L1. In this case, just prior to reentry, a portable fire extinguisher should be discharged into the appropriate avionics bay.

If the fire occurs before or during zero-g conditions, the extinguisher should be restrained after use at some convenient location or restowed on

its mounting bracket. Stowage of the extinguisher after use is not required if the fire occurs after reentry. In this case, the extinguisher can be left on the floor or in any suitable location.

The fire extinguisher consists of the following major components (fig. 3.24-1):

- Cylinder
- Nozzle
- Ring pin
- Handle
- Trigger
- Handloop
- Procedural decal

Each fire extinguisher is approximately 13.3 in. (33.8 cm) long and 3.5 in. (8.9 cm) in diameter, and contains approximately 3.75 lb (1.25 kg) of pressurized suppressant. The fire suppressant is Halon 1301 (Bromotrifluoromethane, CBrF_3), a halogenated fire-extinguishing agent. The prompt suppressing action of Halon 1301 minimizes the major hazards of a conflagration; i.e., smoke, heat, oxygen depletion, and formation of pyrolysis products such as carbon monoxide.

3.24.4 Systems Performance, Limitations, and Constraints

- Suppressant: Halon 1301
- Suppressant quantity: 3.75 lb
- Extinguisher discharge
 - 1g: 18 \pm 2 sec
 - Zero-g: 30 \pm 5 sec
- Propulsion effect (zero-g): 2.4-lb thrust



Figure 3.24-1.- Fire extinguisher.

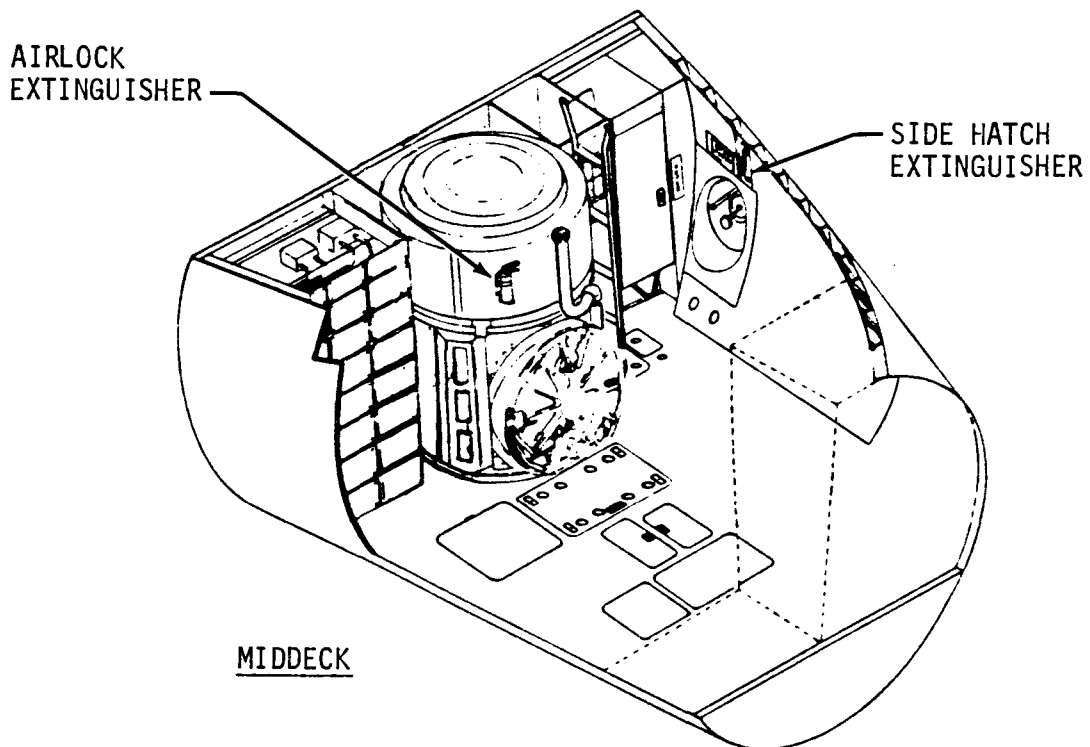
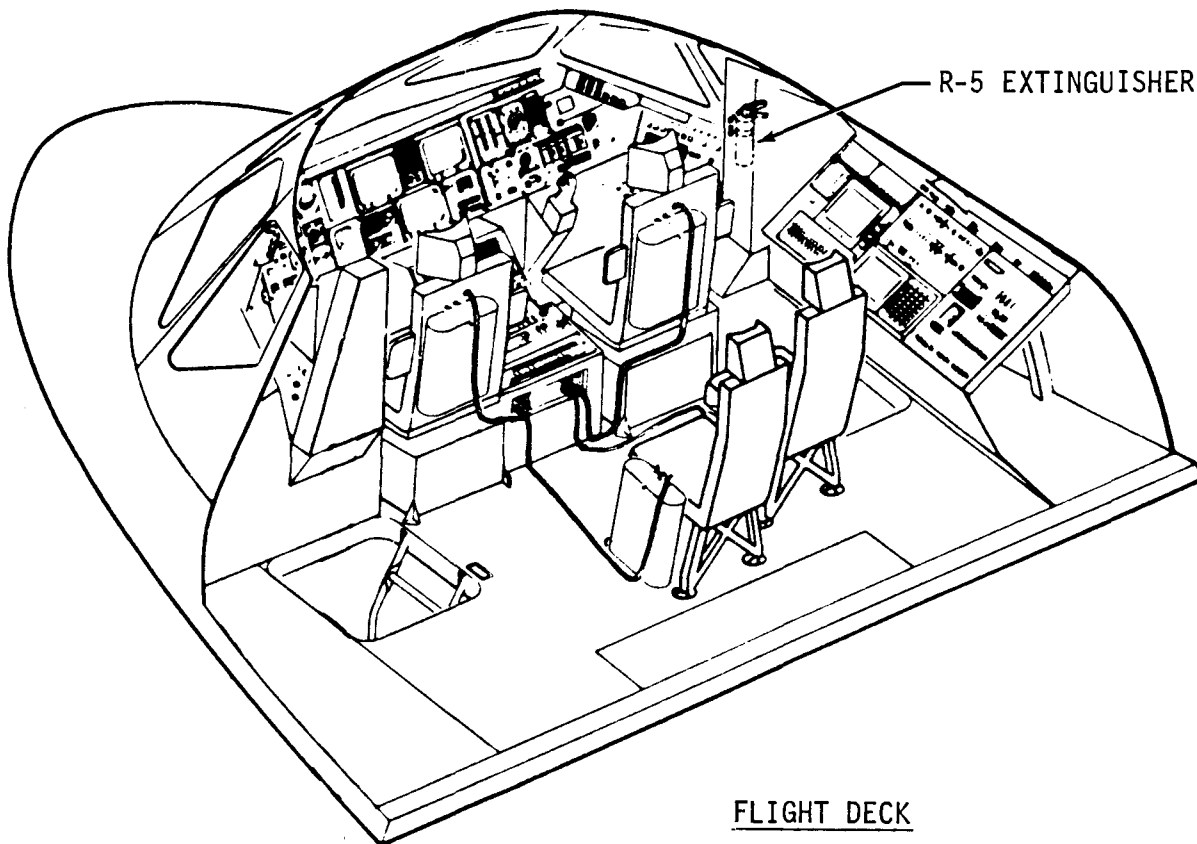
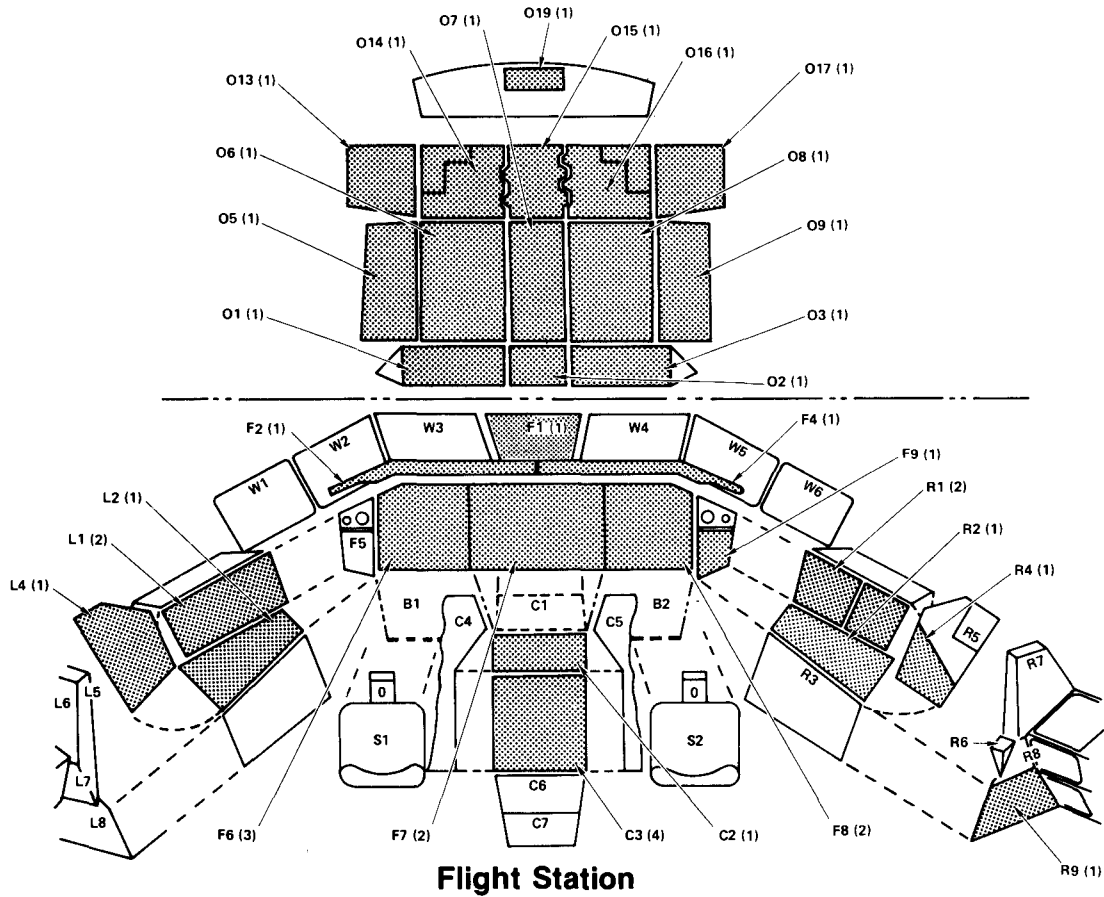
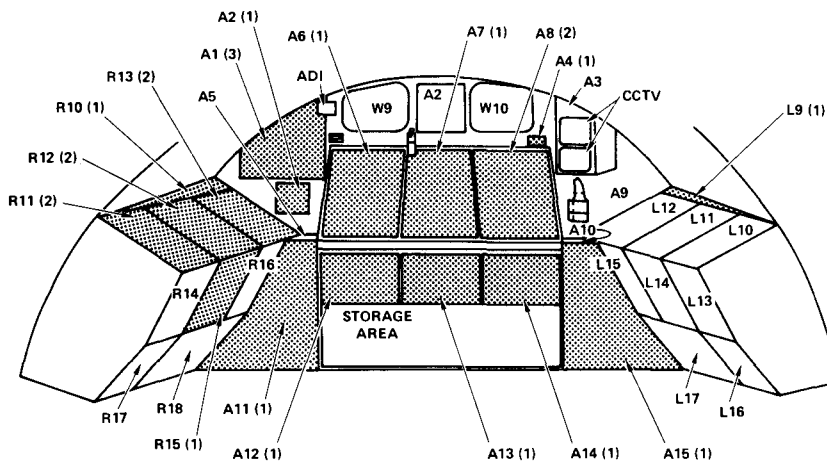


Figure 3.24-2.- Fire extinguisher stowage locations.



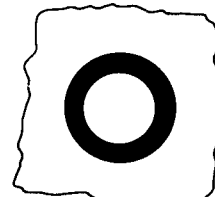
Flight Station



Aft Station

Note

- FIRE PORTS PROVIDE ACCESS TO AREAS BEHIND CONTROL AND DISPLAY PANELS.
- FIRE PORTS ARE SIZED TO FIT PORTABLE FIRE EXTINGUISHER NOZZLE.
- PANELS CONTAINING FIRE PORTS ARE SHADED AND IDENTIFIED BY PANEL NO. (EXAMPLE: R1 (1), R1 = PANEL NUMBER AND (1) = NUMBER OF FIRE PORTS ON PANEL.)
- PNLS R11, L12, L11, L10 ARE PAYLOAD SPECIFIC. THEY MAY OR MAY NOT HAVE FIRE PORTS



FIRE (EXTINGUISHER) PORT (TYPICAL)

Figure 3.24-3.- Fire port locations (sheet 1 of 3).

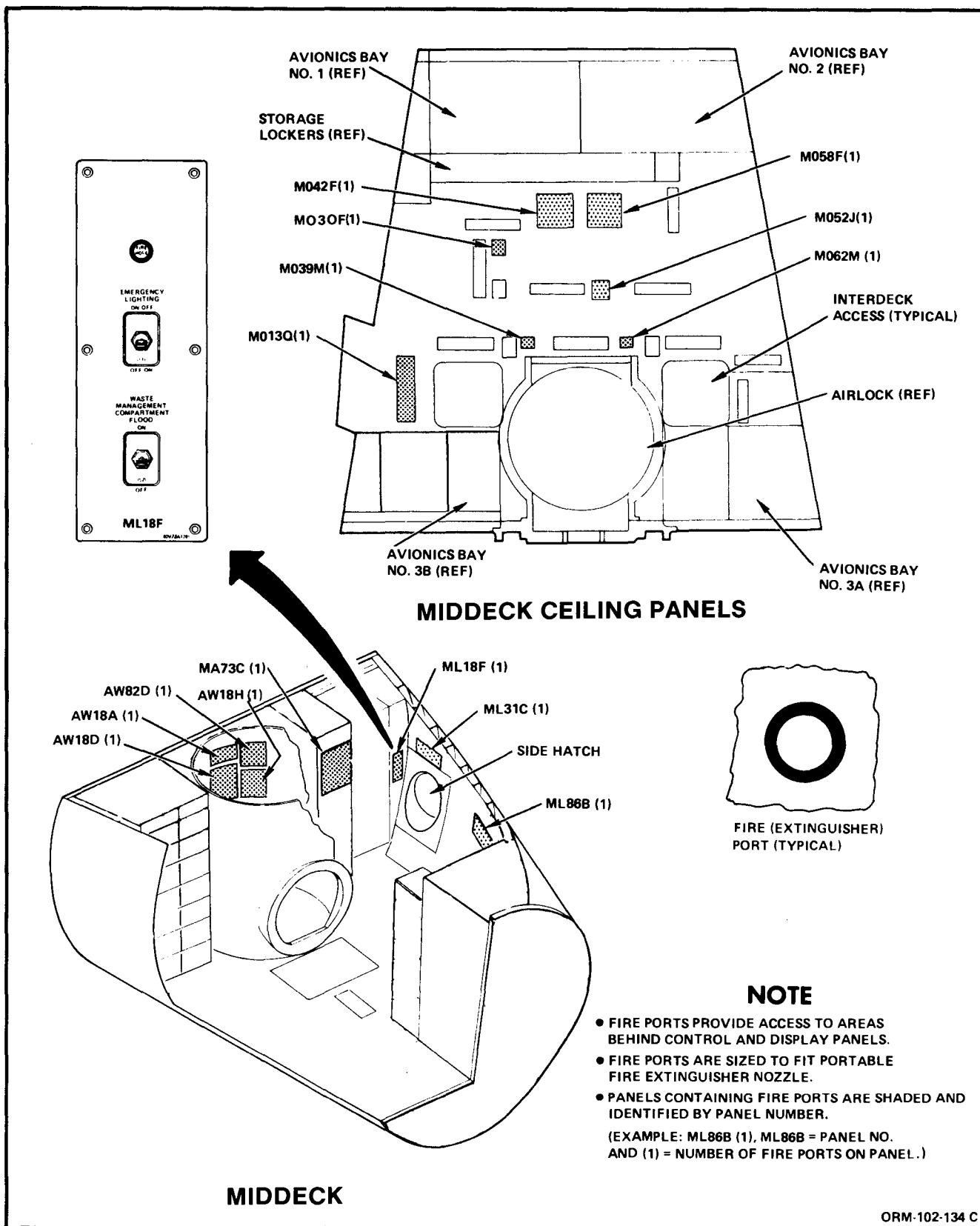
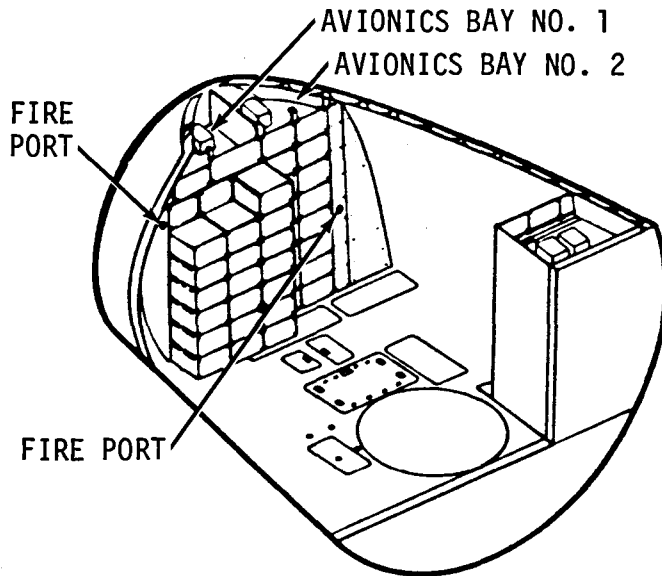
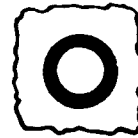


Figure 3.24-3.- Fire port locations (sheet 2 of 3).



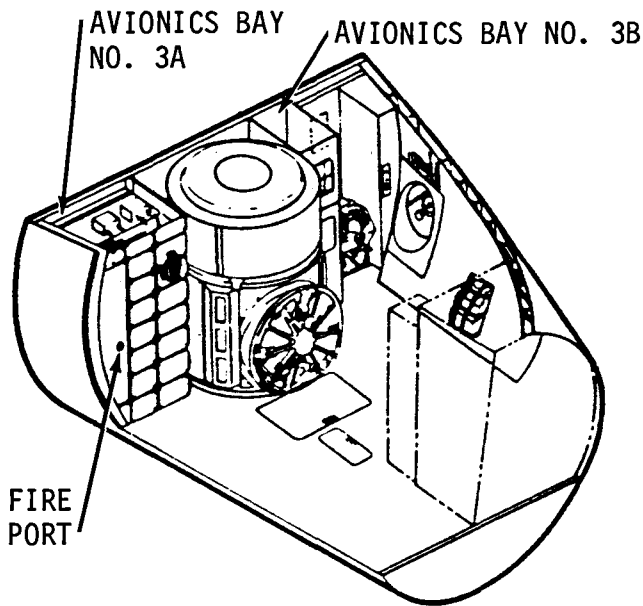
AVIONICS BAYS NO.1 AND NO. 2



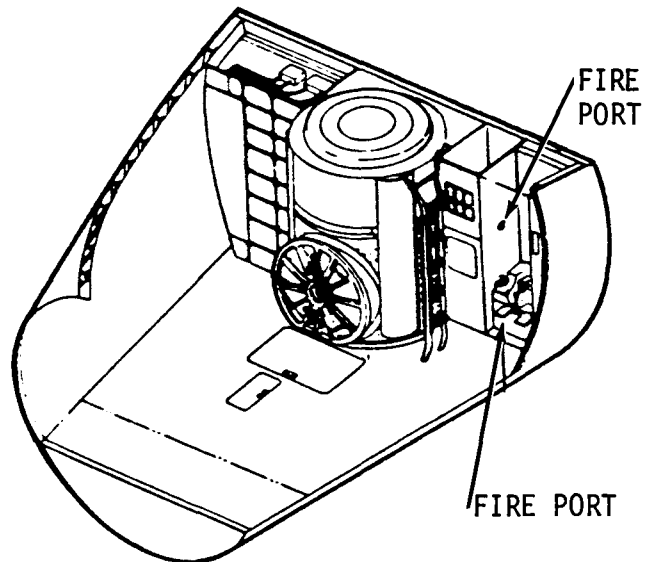
FIRE PORT/GUIDE
(TYPICAL)

NOTE

- FIRE PORTS PROVIDE ACCESS TO AVIONICS BAYS
- FIRE PORTS SIZED TO FIT PORTABLE FIRE EXTINGUISHER NOZZLE



AVIONICS BAYS NO. 3A AND 3B



PERSONAL HYGIENE STATION

Figure 3.24-3.- Fire port locations (sheet 3 of 3).

108-KSC-384C-2526/2

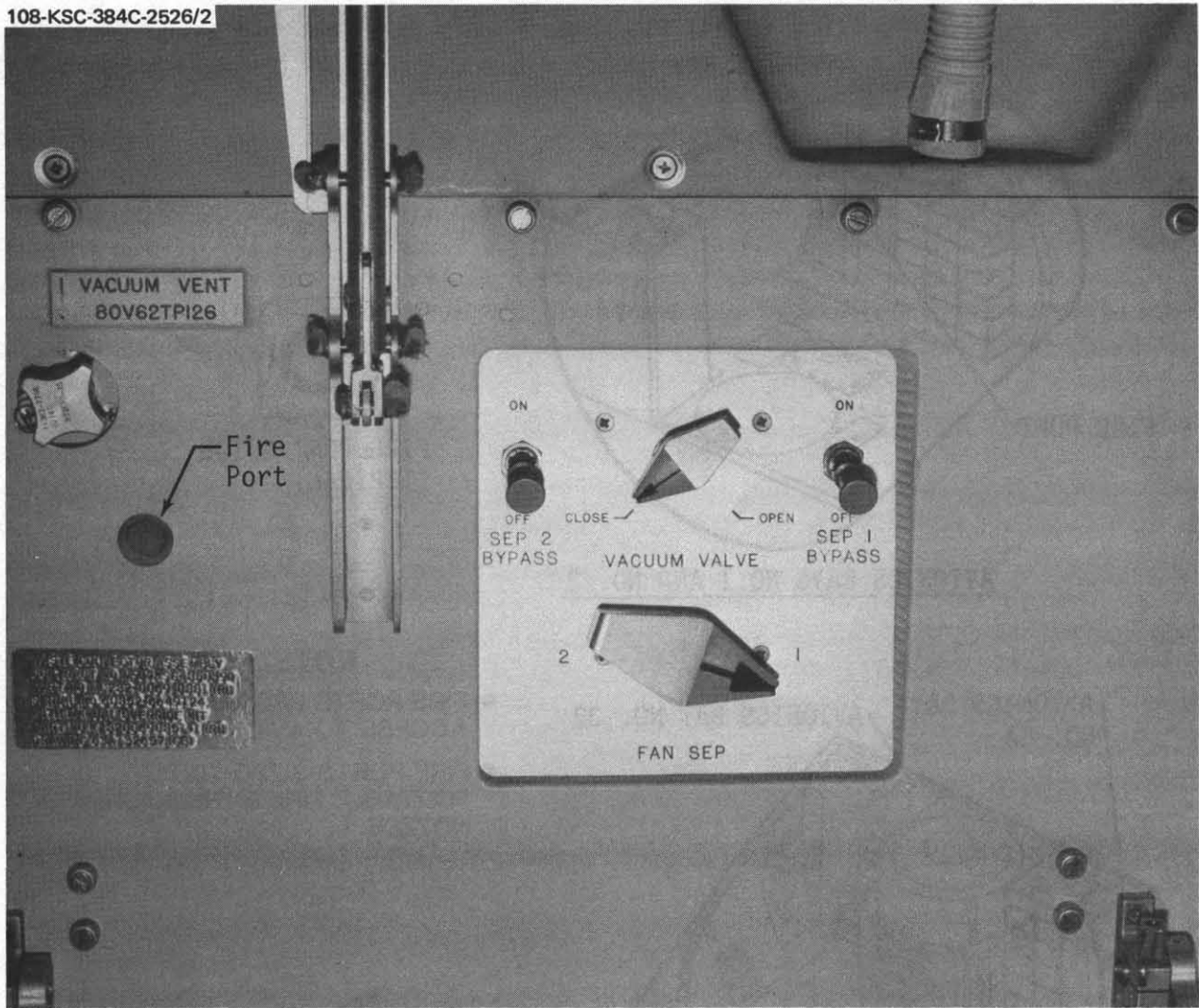
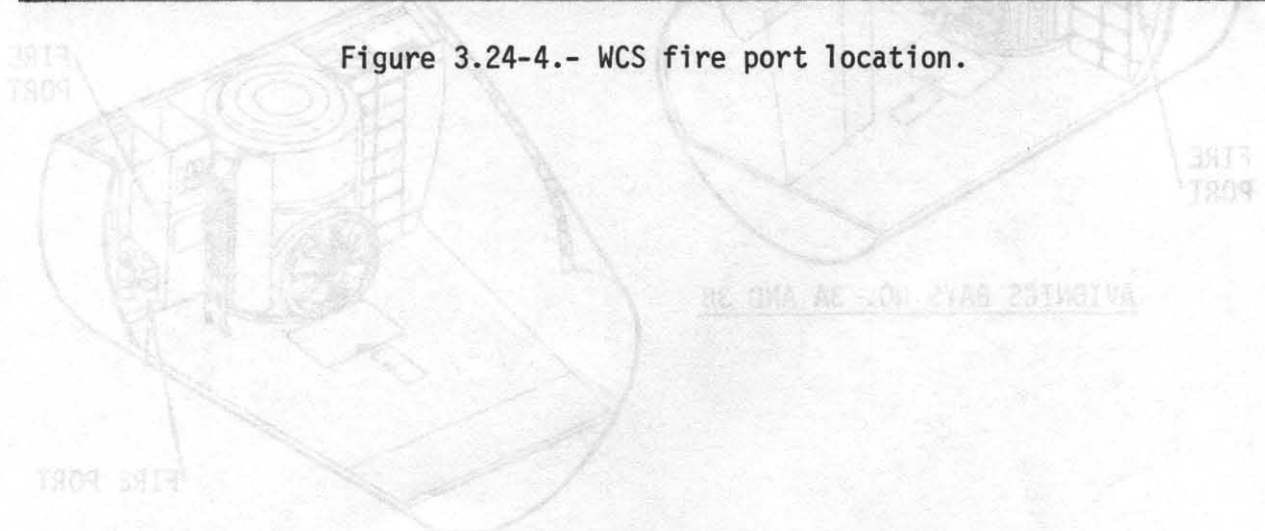
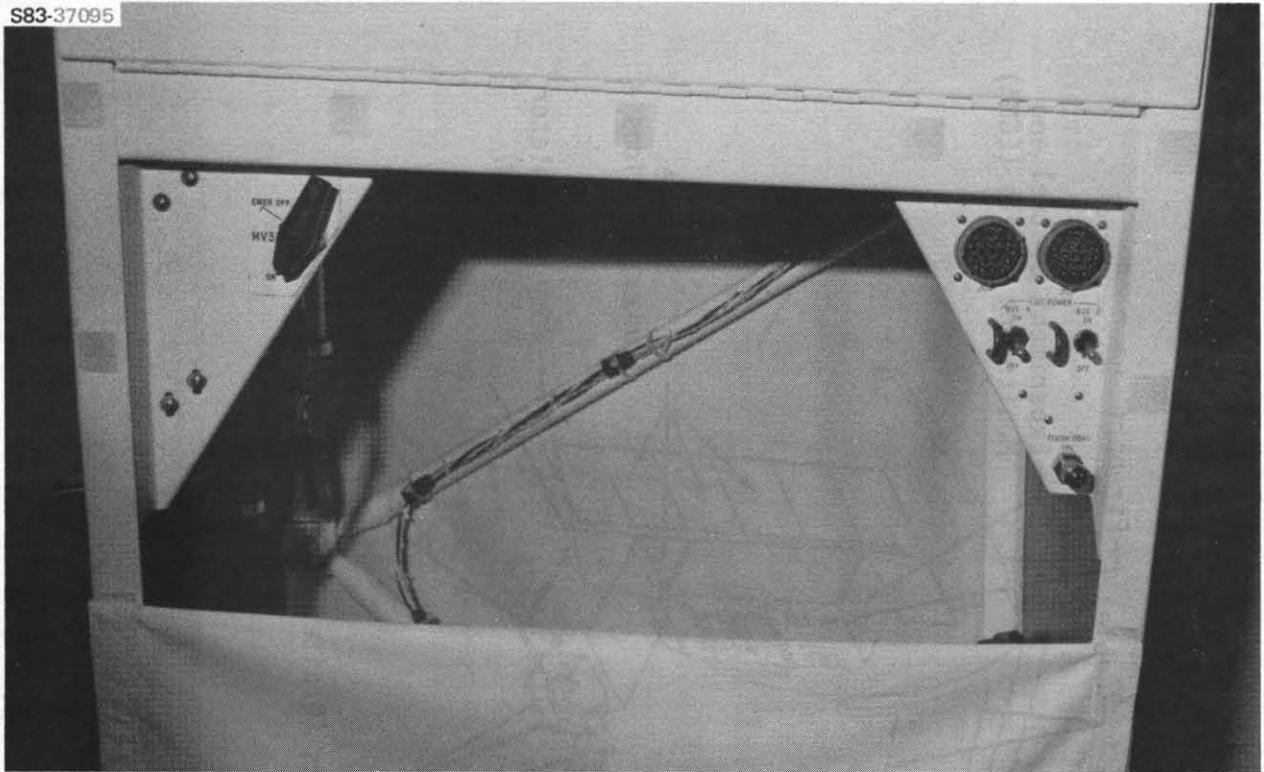


Figure 3.24-4.- WCS fire port location.



S83-37095



Access to galley wiring for fire suppression

108-KSC-383C-535/4

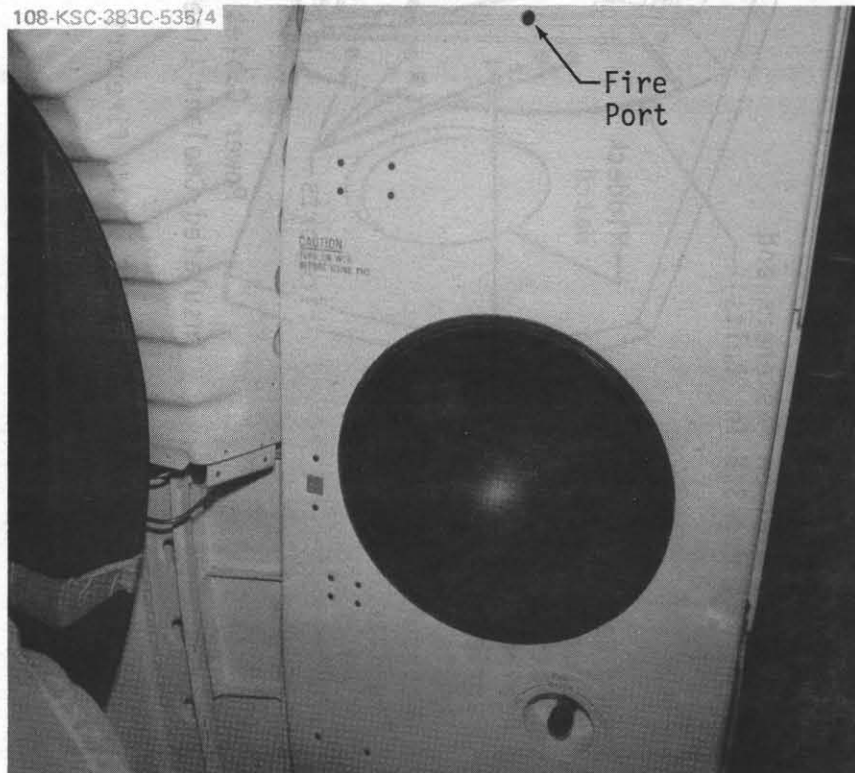


Figure 3.24-5.- Galley fire port location (side closest to hatch).
560

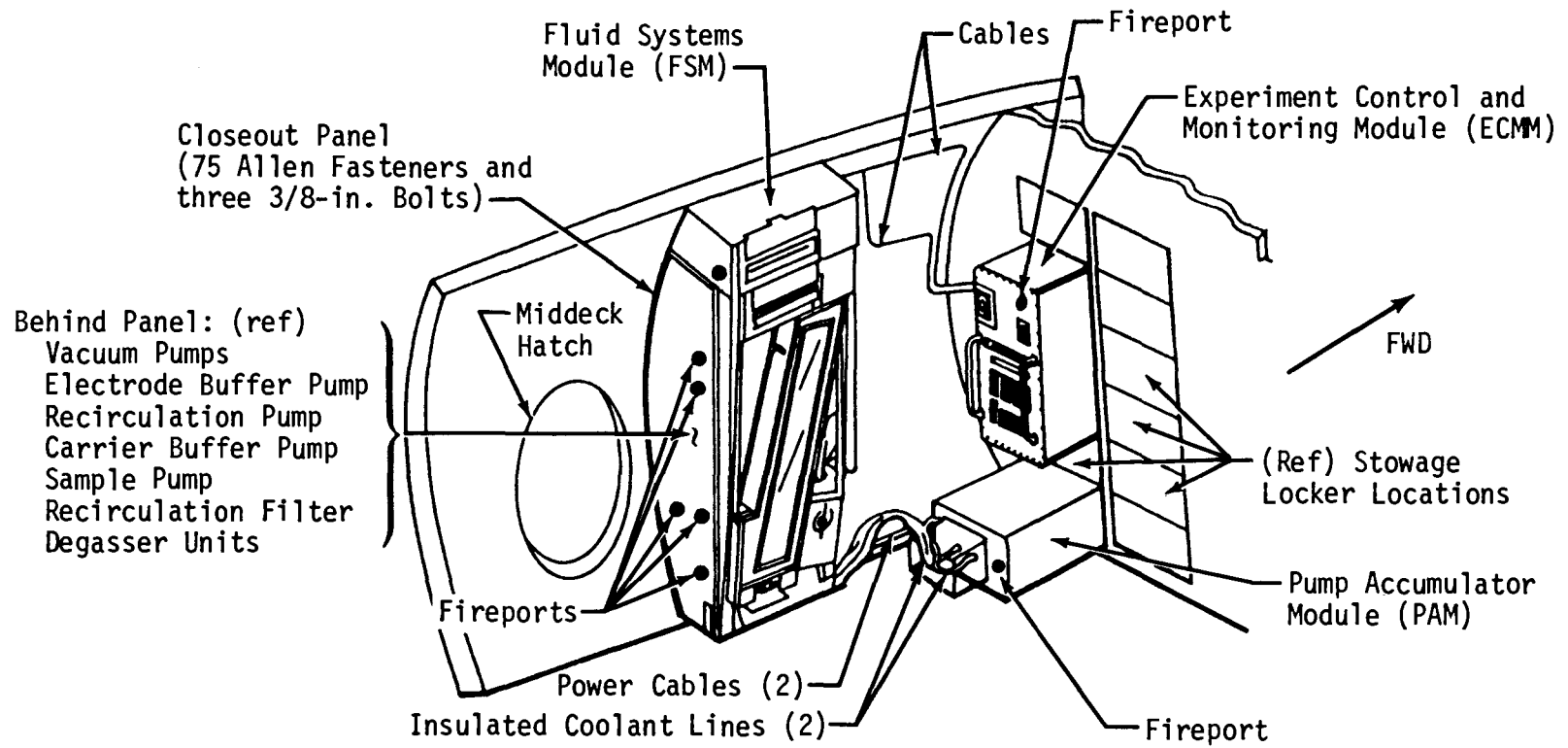


Figure 3.24-6.- CFES, ECMM fireport locations (Orbiter middeck - left side).

TABLE 3.24-1 - FIRE EXTINGUISHER OPERATIONS

| Procedure | Remarks |
|--|---|
| <p><u>Fire extinguisher operation</u></p> <p><u>To operate</u></p> <p>For panel fire</p> <ol style="list-style-type: none"> 1 Pull ring pin. 2 Insert nozzle tip into fire hole. <div style="border: 1px solid black; padding: 5px; margin: 10px 0;"> <p style="text-align: center;">CAUTION</p> <p style="text-align: center;">0-G DISCHARGE RESULTS IN PROPULSIVE EFFECT</p> <p style="text-align: center;">>0-G: EXTINGUISHER SHOULD BE HELD UPRIGHT FOR MAX DISCHARGE RATE</p> </div> <ol style="list-style-type: none"> 3 Depress trigger to discharge (extinguisher discharges in 18-30 sec). <p><u>To operate</u></p> <p>For open fire</p> <ol style="list-style-type: none"> 1 Pull ring pin. 2 Point nozzle close to base of fire. 3 Depress trigger to discharge and keep base of flames covered (extinguisher discharges in 18-30 sec). | <p><u>TIME:</u> Discharge rate:</p> <p style="padding-left: 40px;">One g: 18 ± 2 sec</p> <p style="padding-left: 40px;">Zero g: 55 percent in 30 ± 5 sec</p> <p>Orbiter smoke detection D&C located on panel L1</p> <p>Spacelab smoke detection D&C located on panel R7</p> |

NOTE: This procedure is used if the remote-controlled (fixed) fire suppression equip is insufficient or fire is not in Av Bay 1, 2, or 3

3.25 SOUND LEVEL METER

3.25.1 Introduction

Although not normally flown, a sound level meter (fig. 3.25-1) is available that can be used to measure cabin noise levels while on-orbit.

When the meter is flown, the crew is required to take specific meter readings at certain specified vehicle and equipment locations. The data obtained by the crew will be logged and/or voice recorded.

3.25.2 Stowage

For launch and entry, the sound level meter is stowed in a middeck locker (fig. 3.25-2).

3.25.3 Systems Functional Description

The sound level meter is a standard commercially available Bruel and Kjaer Type 2215 sound level meter and octave analyzer. The meter comes equipped with a condenser microphone which gives it a frequency range of 20 Hz to 20 kHz and an overall dynamic range of 26 to 140 dB (A weighted). The meter provides direct sound level and frequency readings via a meter-type display (fig. 3.25-2).

The meter is operated by four 1.5 volt size AA batteries. There are no provisions to provide spares for on-orbit battery changeout. The meter contains a battery voltage status circuit which can be activated by the crewman to check battery voltage levels.

The meter is equipped with built-in A- and C-weighting networks and 10 octave filters. This allows the meter to analyze a signal in each of 10 octave bands with or without a weighting factor. The 10 octave filters give the meter a center frequency range of 31.5 Hz to 16 kHz. Of the two weighting factors available, only the A-weighting factor will be used.

The C-weighting factor is not used. Signal analysis with A-weighting causes the signal to be evaluated relative to the standard weighting curve used for Occupational Safety and Health Activities (OSHA). This weighting factor takes into account the physiological filtering and the sound transduction properties of the human ear. Both weighting factor and octave filter are selected by the crewman.

The meter is calibrated pre- and postflight, and on-orbit calibration is not required.

The meter has other features and associated displays and controls as noted in section 3.25.4 and table 3.25-1.

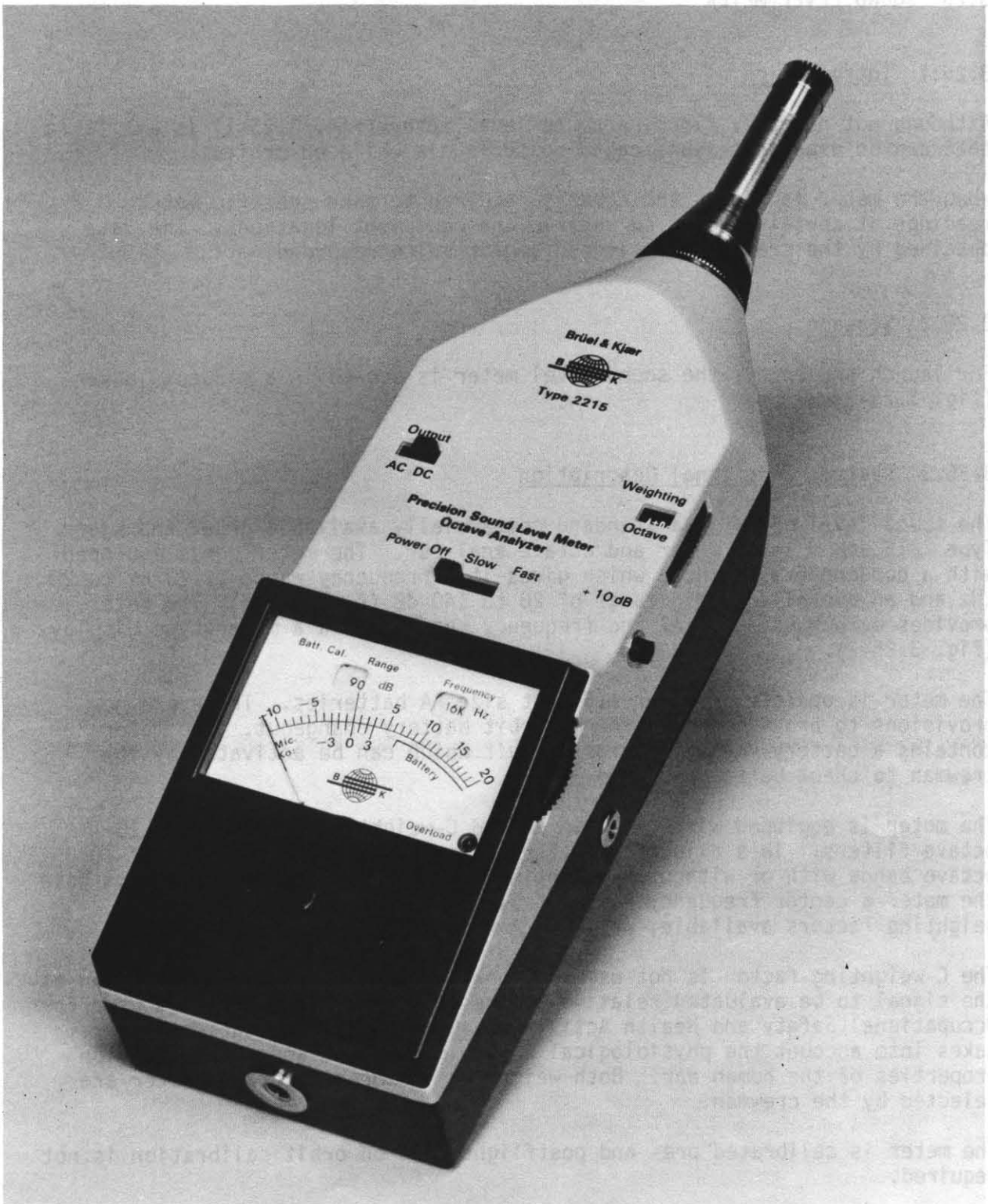
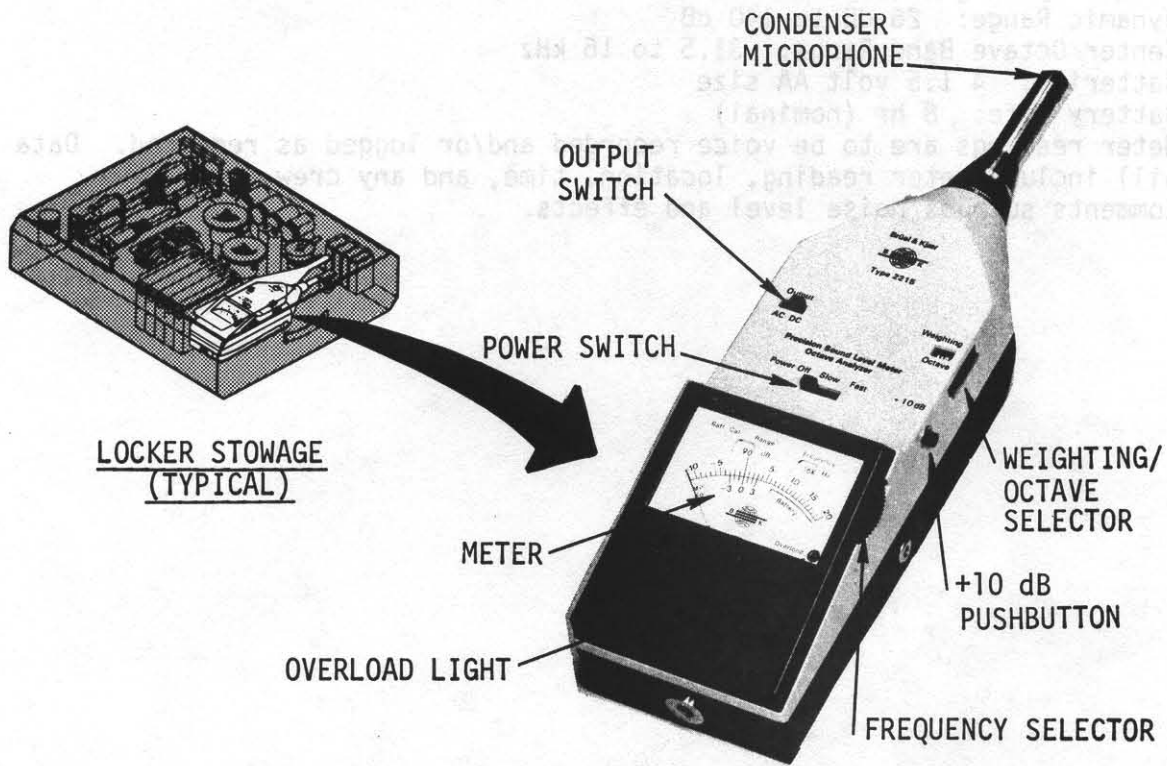
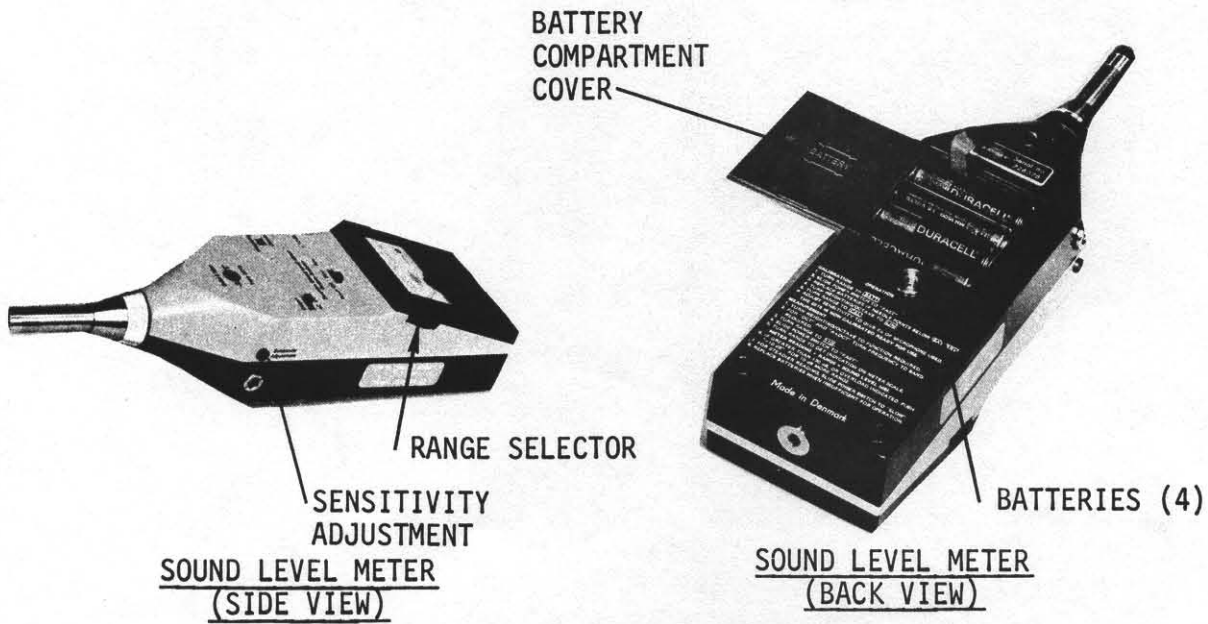


Figure 3.25-1.- Sound level meter.

3.25-2



SOUND LEVEL METER
(FRONT VIEW)



SOUND LEVEL METER
(SIDE VIEW)

SOUND LEVEL METER
(BACK VIEW)

Figure 3.25-2.- Sound level meter operations.

3.25.4 Systems Performance, Limitations, and Constraints

- Frequency Range: 20 Hz to 20 kHz
- Dynamic Range: 26 dB to 140 dB
- Center Octave Band Range: 31.5 to 16 kHz
- Batteries: 4 1.5 volt AA size
- Battery Life: 8 hr (nominal)
- Meter readings are to be voice recorded and/or logged as required. Data will include meter reading, location, time, and any crew subjective comments such as noise level and effects.

TABLE 3.25-1.- SOUND LEVEL METER DISPLAY AND CONTROL FUNCTIONS

| Location | Type | Nomenclature/ position | Function | Remarks | |
|----------------------------------|------|---|---|----------------------|---|
| <u>Sound Level meter</u> | sw | Power switch | | | |
| | | OFF | Removes power from meter. | | |
| | | SLOW | Dampens meter needle movement for easier measurement reading. | | |
| | sel | WEIGHTING/OCTAVE selector | | | Selector setting is displayed in the display window next to selector. |
| | | A + OCT | Performs an A-weighted measurement at the selected octave band (frequency). | | |
| | | OCT | Performs a non-weighted measurement at the selected octave band. | | |
| | | LIN | Sets meter in a linear mode for calibration purposes. | Not used for flight. | |
| | C | Performs an overall C-weighted measurement over the entire frequency range of the source and limits of the meter. | Not used for flight. | | |

TABLE 3.25-1.- Continued

| Location | Type | Nomenclature/ position | Function | Remarks |
|----------|------|--|---|--|
| | sw | OUTPUT switch | <p>A Performs an overall A-weighted measurement over the entire frequency range of the source and limits of the meter</p> <p>AC Selects meter output which is ac compatible</p> <p>DC Selects meter output which is dc compatible</p> | Not used for flight. |
| | pb | +10 dB push-button | Instantly adds a +10 dB shift in meter range to compensate for an overload condition | Used when the OVERLOAD light illuminates. |
| | adj | SENSITIVITY ADJUSTMENT | Allows meter to be set to condenser microphone correction factor (k_0) during meter calibration | Microphone k_0 is -0.6 dB. This adjustment is not used for flight. |
| | lt | OVERLOAD light | Indicates meter has exceeded range setting | Upon illumination, the +10 dB pb should be depressed. |
| | sel | FREQUENCY selector | Selects one of ten octave filters | Selector is located on right-hand side of meter; selector setting is displayed in the display window on meter scale. |
| | | 31.5, 63, 125, 250, 500, 1K, 2K, 4K, 8K, 16K | | |

TABLE 3.25-1.- Concluded

| Location | Type | Nomenclature/ position | Function | Remarks |
|----------|------|--|--|--|
| | sel | RANGE selector CAL BATT 20, 30, 40, 50, 60, 70, 80, 90, 100, 110 | Activates meter calibration sequence Activates battery voltage status circuit to check battery voltage level Selects meter range | Selector is located on the left-hand side of the meter; selector setting is displayed in the display window on the meter scale. |
| | disp | Meter -10 to 20 BATTERY | Indicates sound level range above or below RANGE setting Indicates good battery voltage level range | Actual measurement is the sum of the RANGE setting and meter reading of this scale. A needle reading outside the battery scale indicates batteries need to be replaced. |

3.26 LIGHTING

3.26.1 Introduction

The lighting system provides interior and exterior lighting. The interior lighting provides illumination for display and control visibility and for general crew station/crew equipment operations. It allows the crewmembers to locate, operate, and read all displays, controls, and nomenclature. It also provides visibility for interior compartment surfaces, for stowage and retrieval of all articles of crew equipment, and for location and orientation of the crewmembers within the cabin compartment. The exterior lighting provides illumination for payload bay door operations, extravehicular activities (EVA's), remote manipulator system (RMS) operations, and for station keeping/docking.

The lighting system is divided into the following major categories:

- Interior Lighting
 - Floodlights
 - Panel lights
 - Instrument lights
 - Numeric lights
 - Annunciator lights
- Exterior Lighting
 - Overhead docking light
 - Payload bay lights
 - RMS light

3.26.2 Interfaces

The Orbiter lighting system is powered by the electrical system. It also interfaces various other systems by providing annunciation of parameters within these systems.

3.26.3 Functional Description

Interior Lighting

The interior lighting system uses both fluorescent and incandescent lamps. The fluorescent lamps start within 1 second after being energized. The fixtures are recessed where possible and they are located to provide even illumination.

- Floodlights

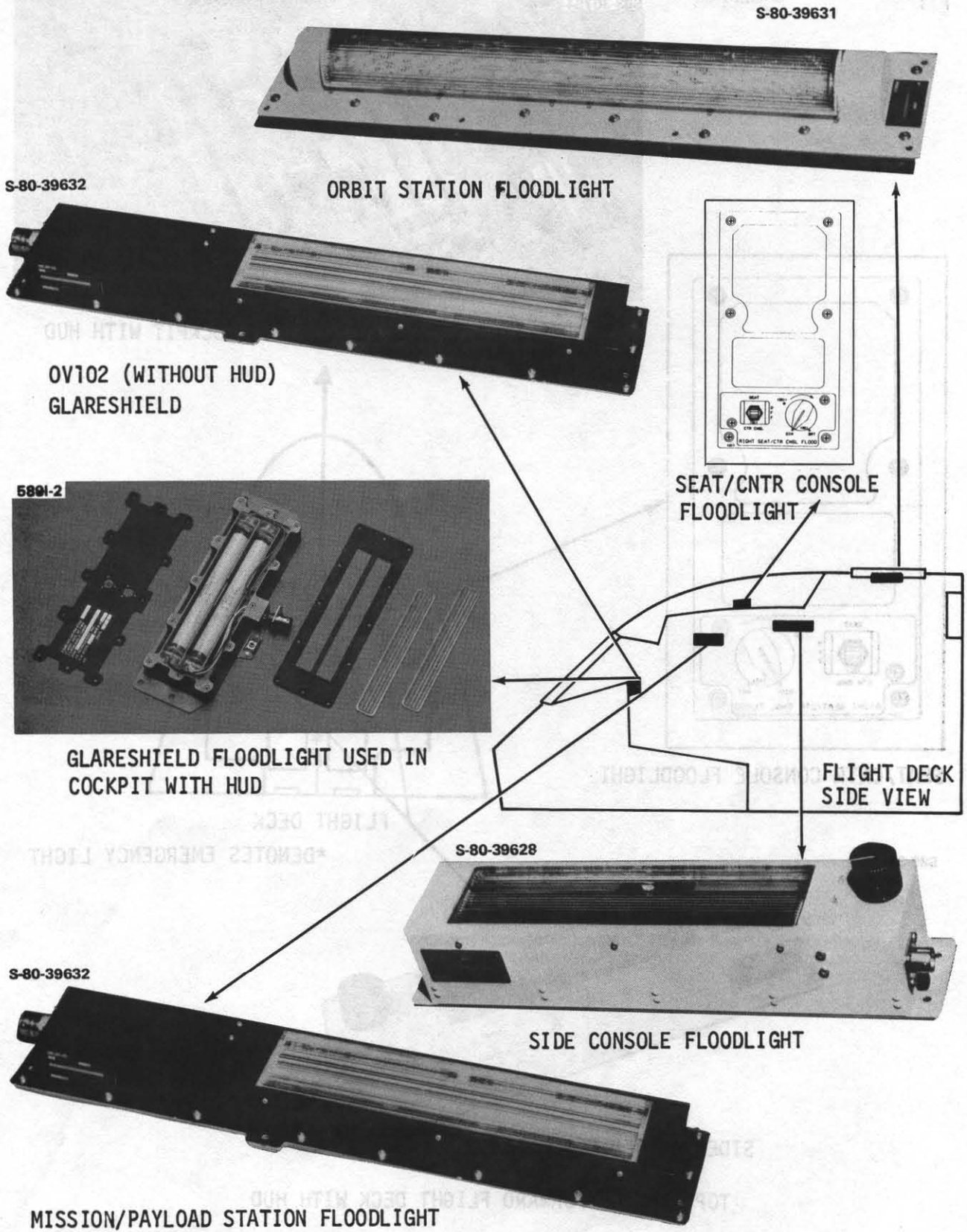
The lighting system provides broad-beam-type floodlights that illuminate the overall crew station areas and surfaces (figs. 3.26-1 through 3.26-3, flight deck; fig. 3.26-4 through 3.26-13, middeck and airlock) for required visual monitoring during the flight. Floodlights provide the following:

- Optimum visibility
- Aid in rapid location and recognition of the overall forms of controls and equipment
- Sufficient background lighting to ensure optimum orientation
- Emergency lighting
- Redundancy to the integral lighting

Provisions have been made to actuate selected 'emergency' floodlights (figs. 3.26-14 and 3.26-15) in the event of a power failure. The minimum brightness of the emergency lights at the major control panels is 5 ft-L. The minimum brightness along passage ways, exits, and work areas is 2 ft-L.

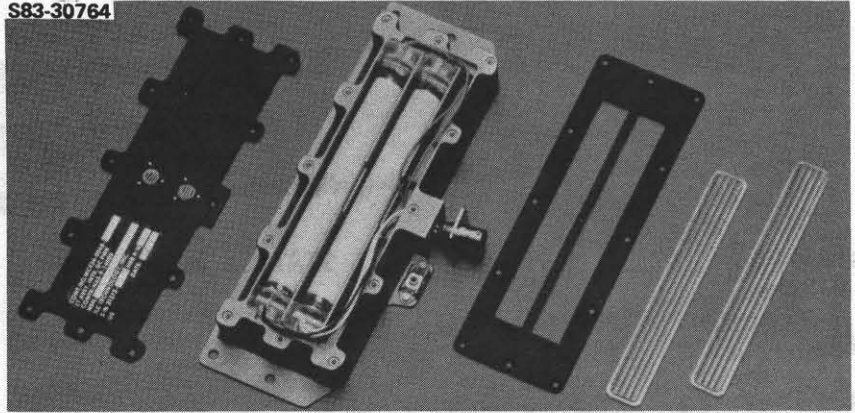
The emergency floodlight system operates from an essential bus which is active as long as any fuel cell is operating. The emergency floodlight system makes use of several of the normal floodlights along with an independent power circuit that is in parallel to the circuits which are normally used to provide power for lighting.

Interior floodlight control functions are presented in table 3.26-1.

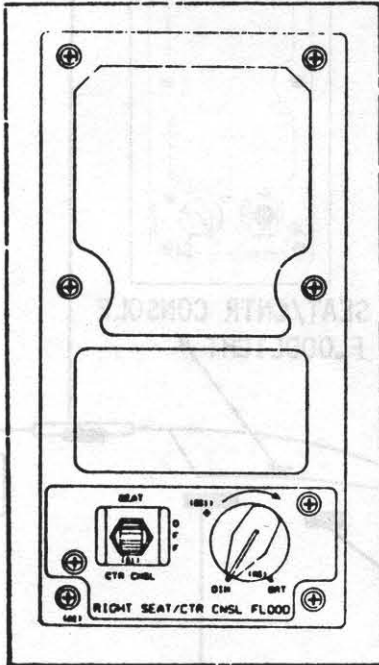


(Figure 3.26-1.- Flight deck side view (sheet 1 of 4).)

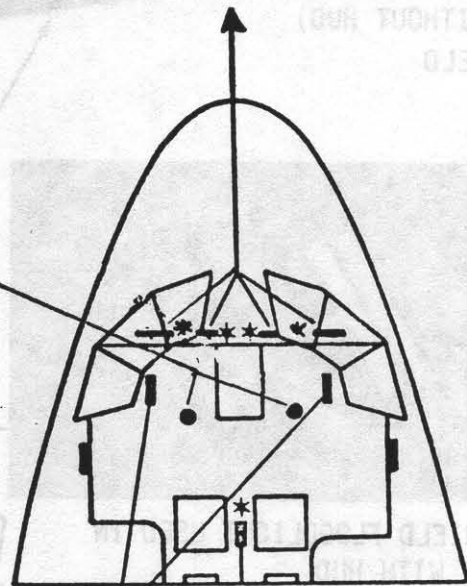
S83-30764



GLARESHIELD FLOODLIGHT USED IN COCKPIT WITH HUD



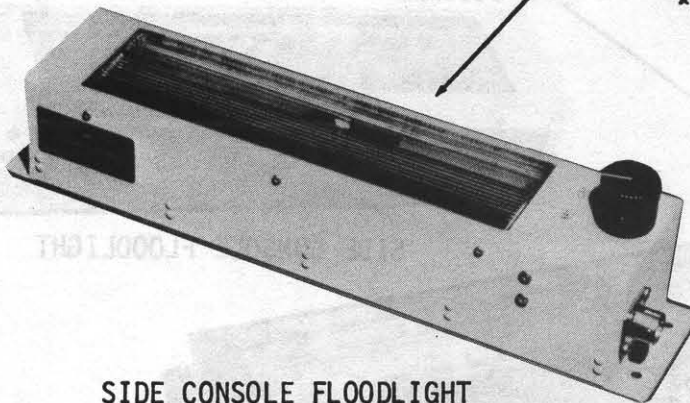
SEAT/CNTR CONSOLE FLOODLIGHT



FLIGHT DECK

*DENOTES EMERGENCY LIGHT

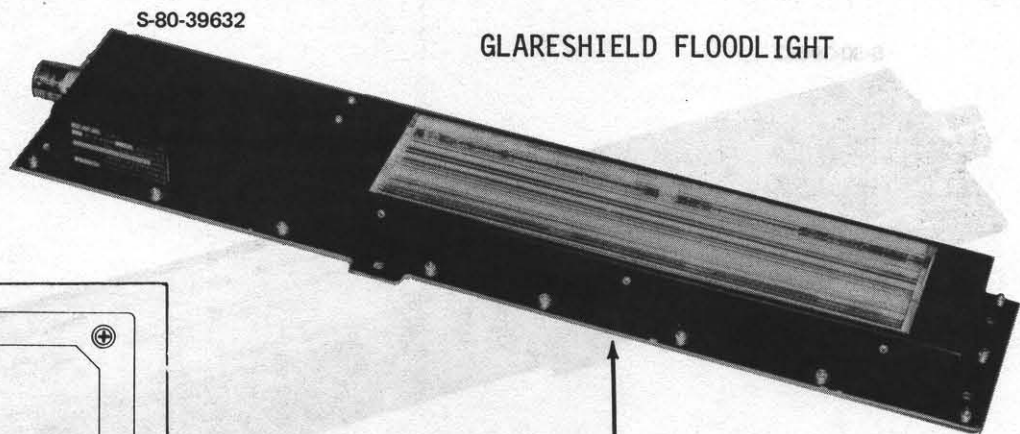
S80-39628



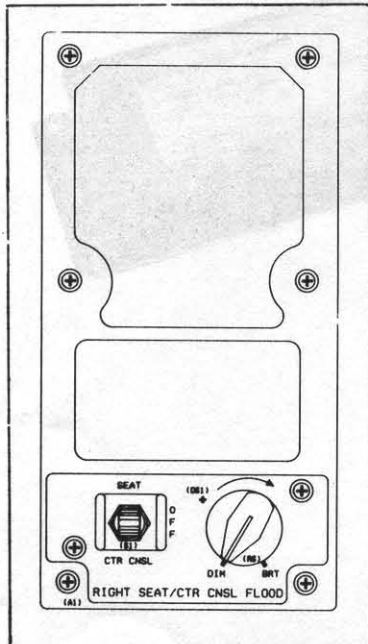
SIDE CONSOLE FLOODLIGHT

TOP VIEW OF FORWARD FLIGHT DECK WITH HUD

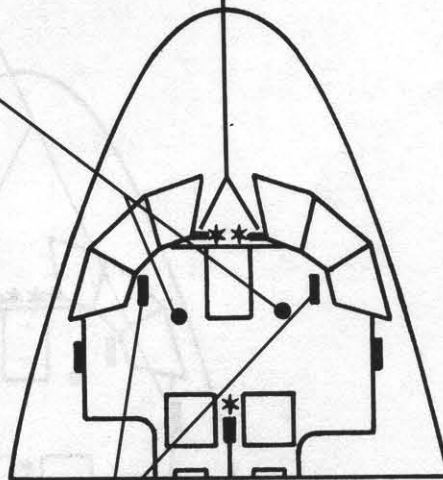
Figure 3.26-1.- Flight deck floodlights (sheet 2 of 4).



GLARESHIELD FLOODLIGHT

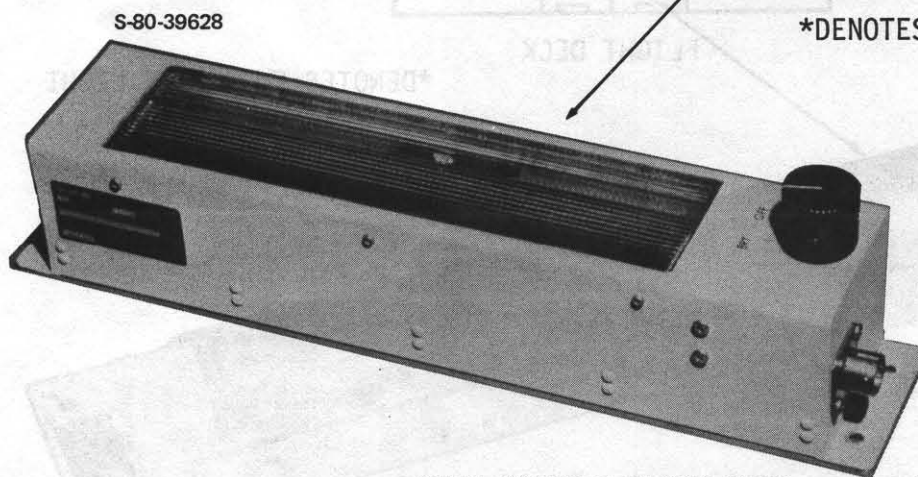


SEAT/CNTR CONSOLE FLOODLIGHT



FLIGHT DECK

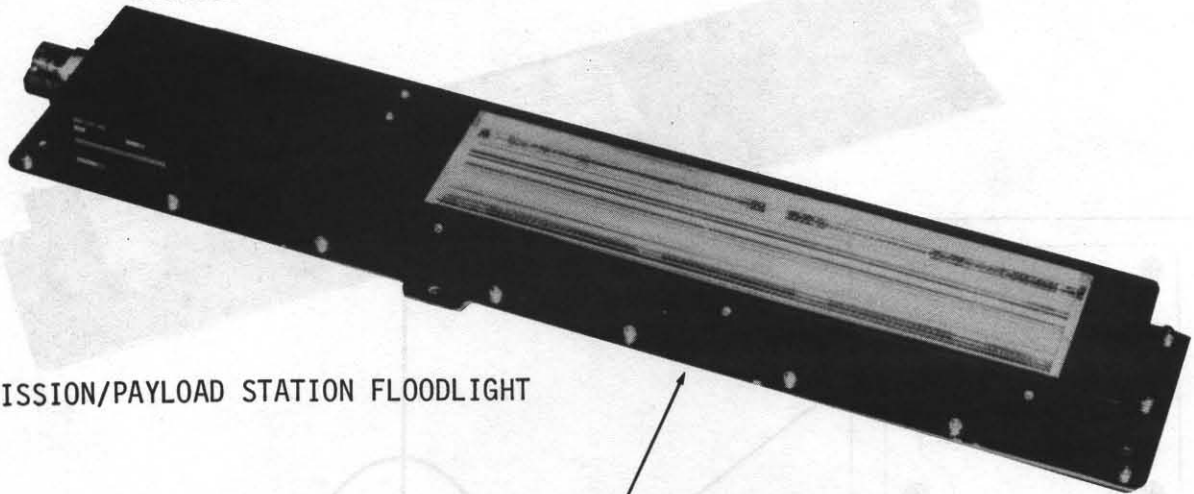
*DENOTES EMERGENCY LIGHT



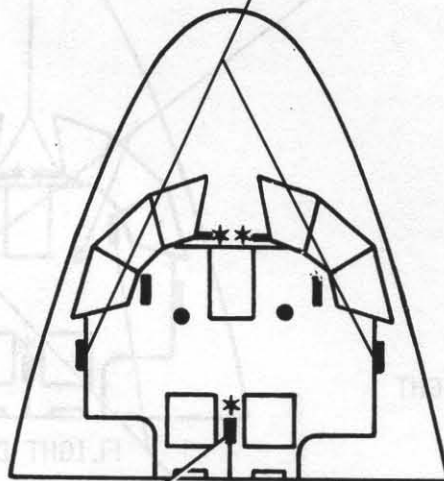
SIDE CONSOLE FLOODLIGHT

TOP VIEW OF FORWARD FLIGHT DECK WITHOUT HUD
Figure 3.26-1.- Flight deck floodlights (sheet 3 of 4).

S-80-39632



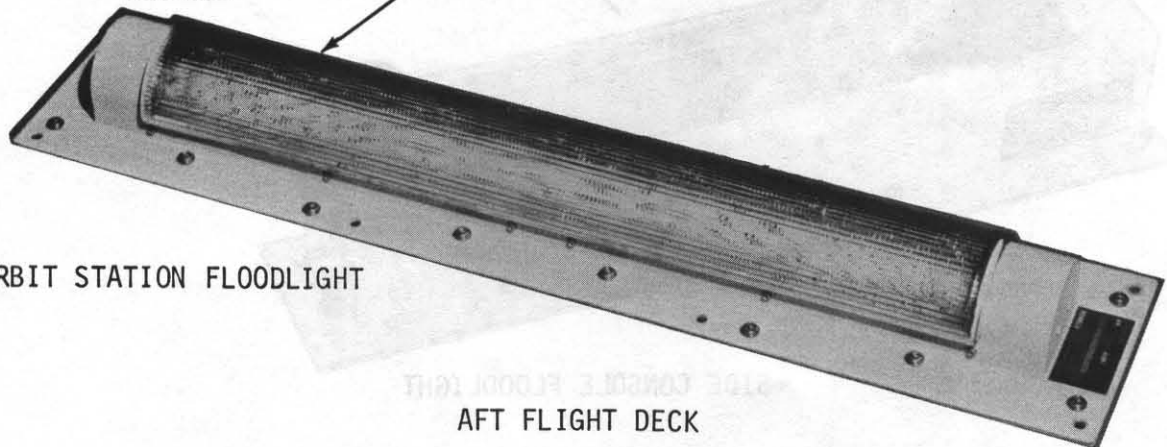
MISSION/PAYLOAD STATION FLOODLIGHT



FLIGHT DECK

*DENOTES EMERGENCY LIGHT

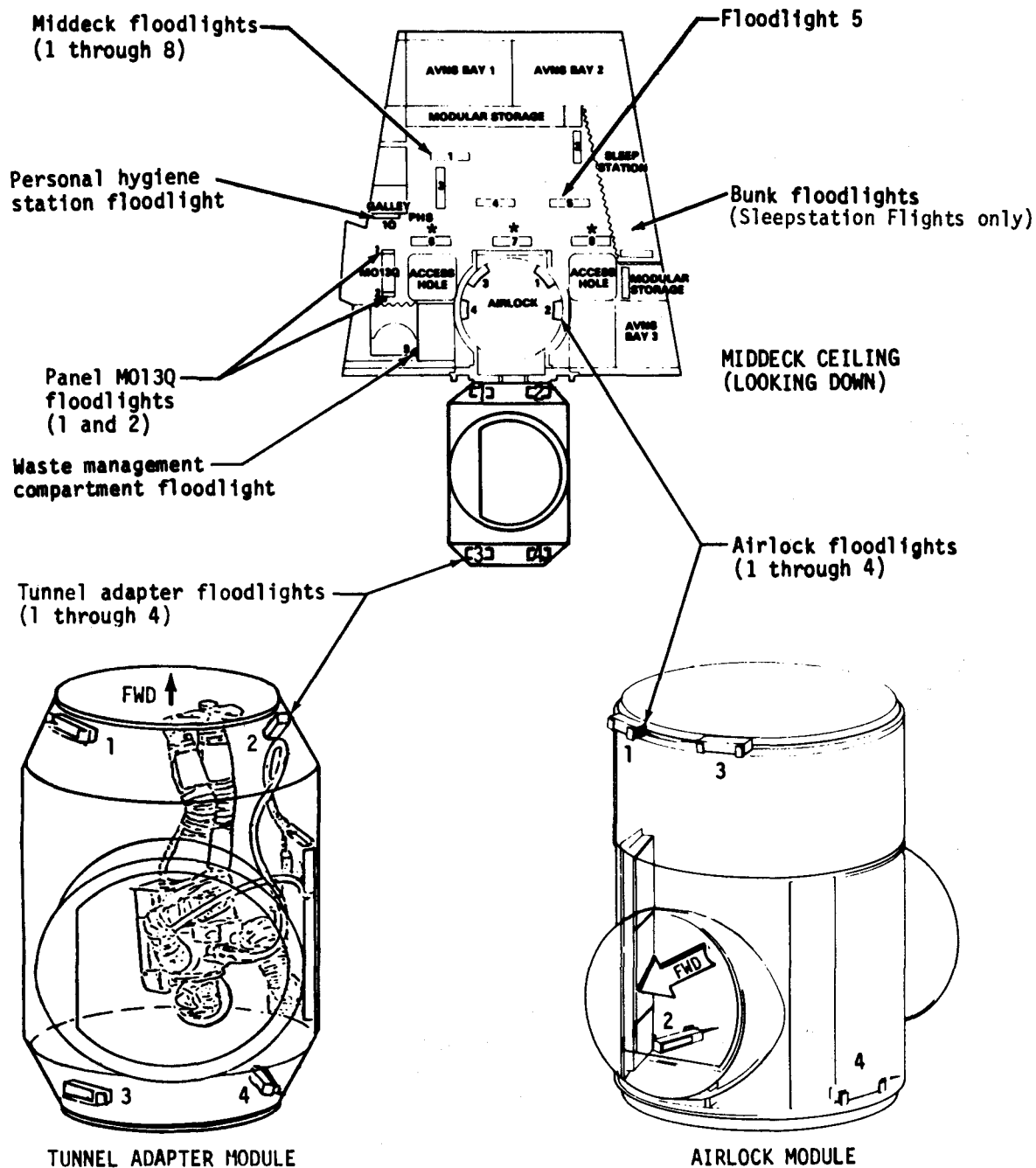
S-80-39631



ORBIT STATION FLOODLIGHT

AFT FLIGHT DECK

Figure 3.26-1.- Flight deck floodlights (sheet 4 of 4).



All floodlights shown are fluorescent

* Indicates an emergency light

Figure 3.26-4.- Floodlight locations middeck and airlock.

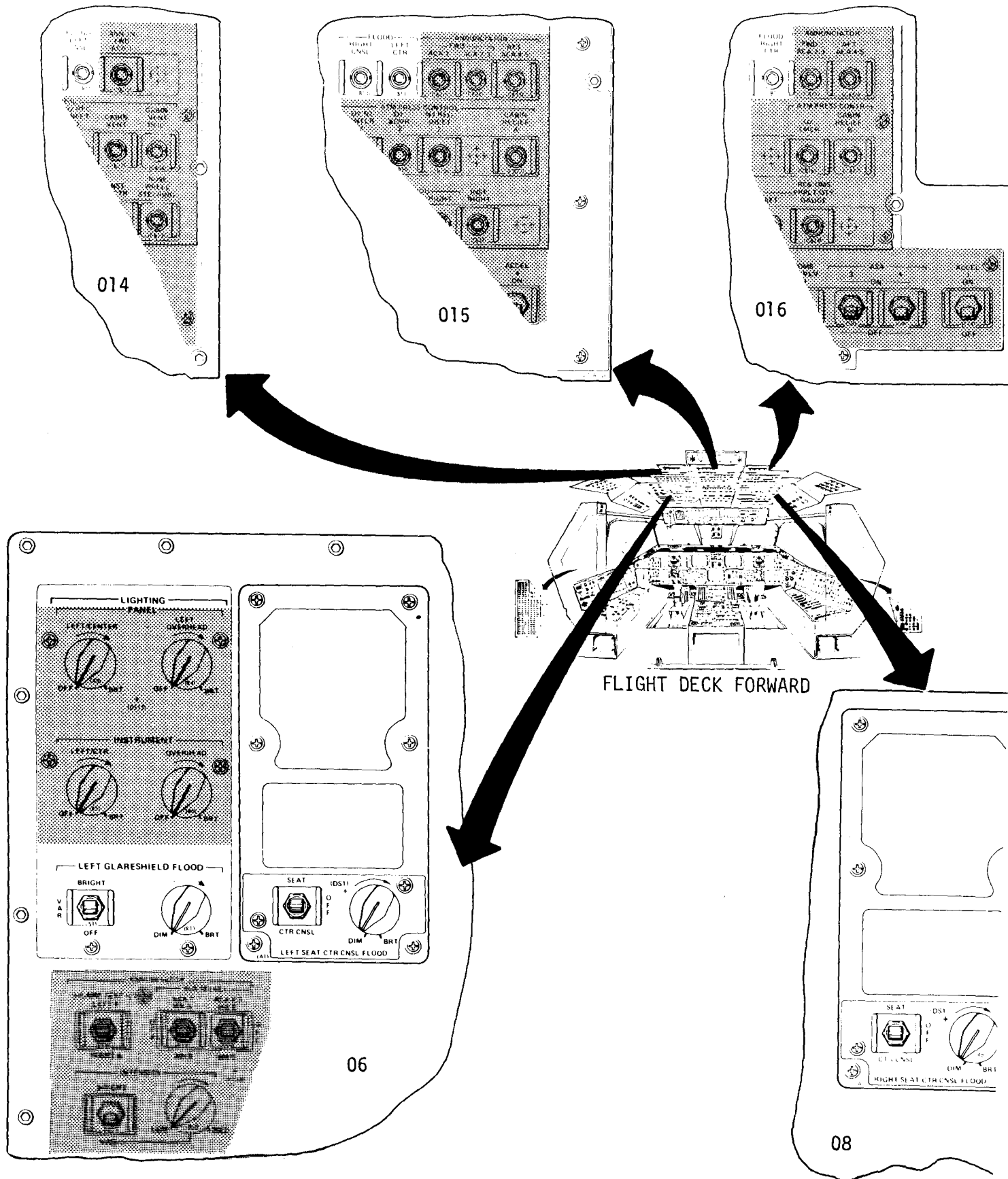
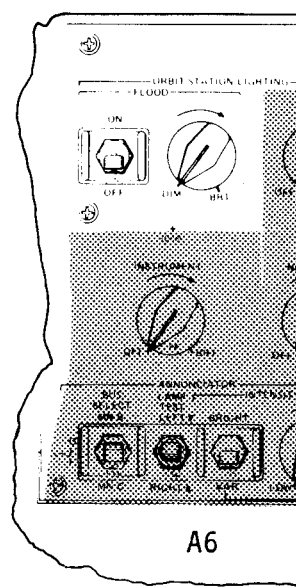
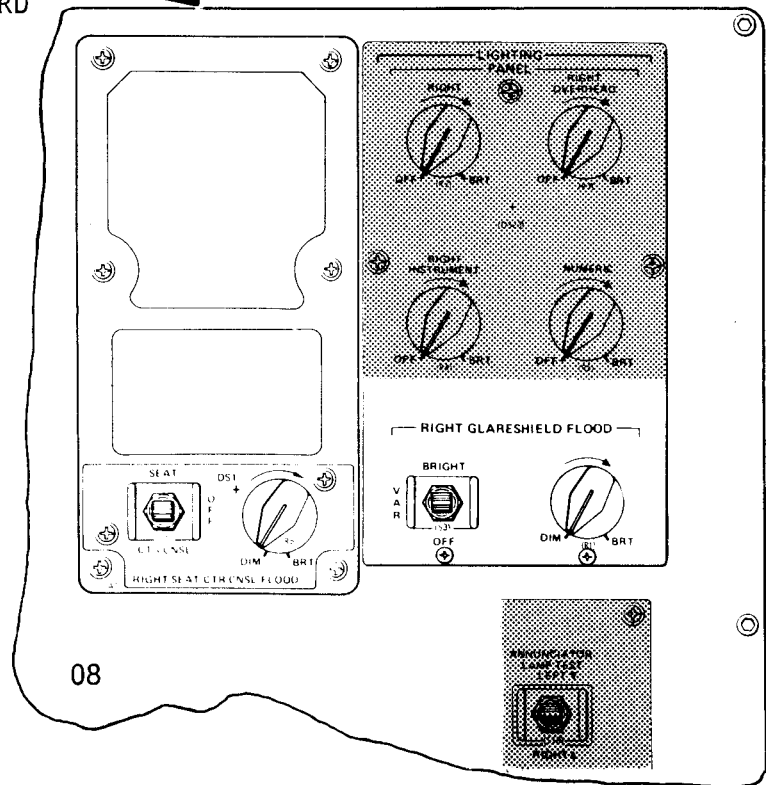
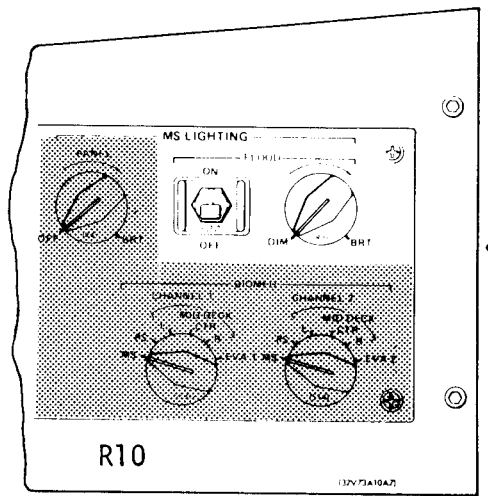
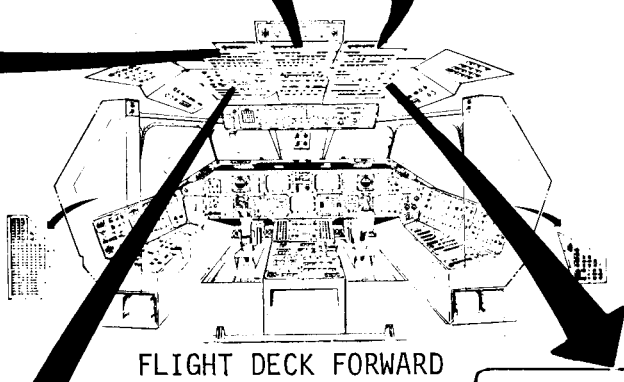
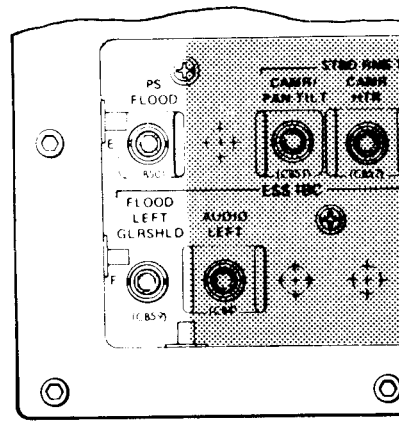
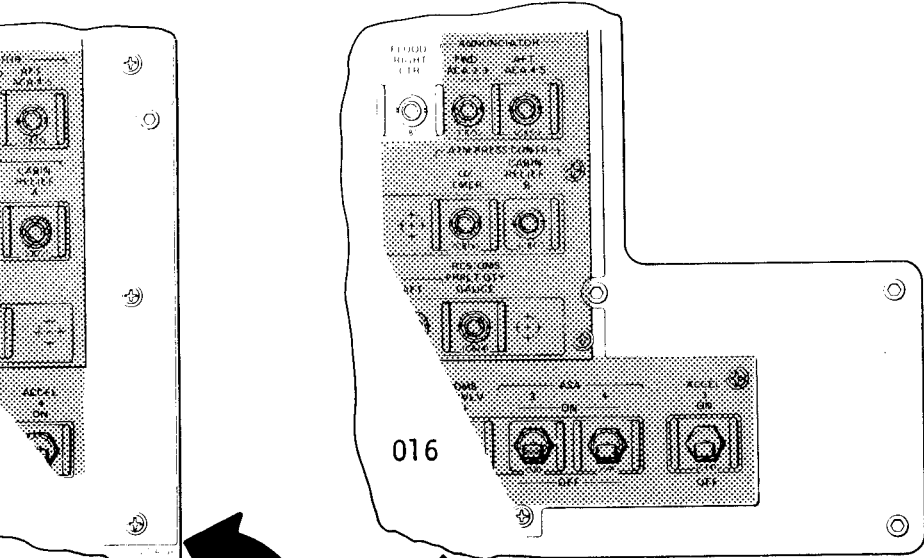
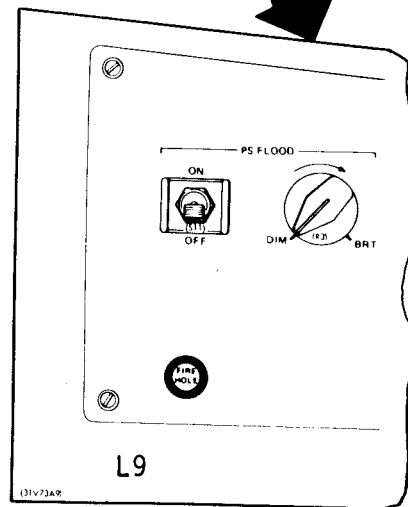
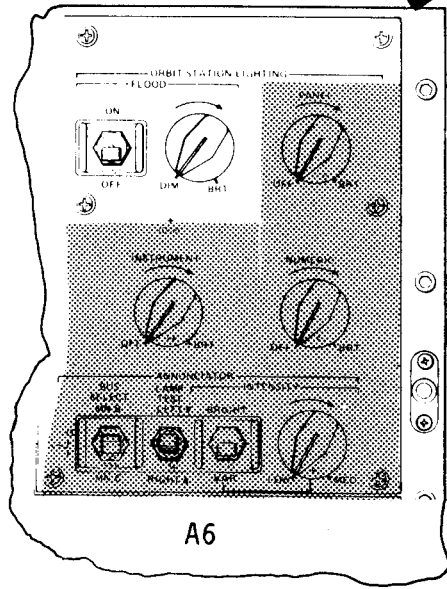
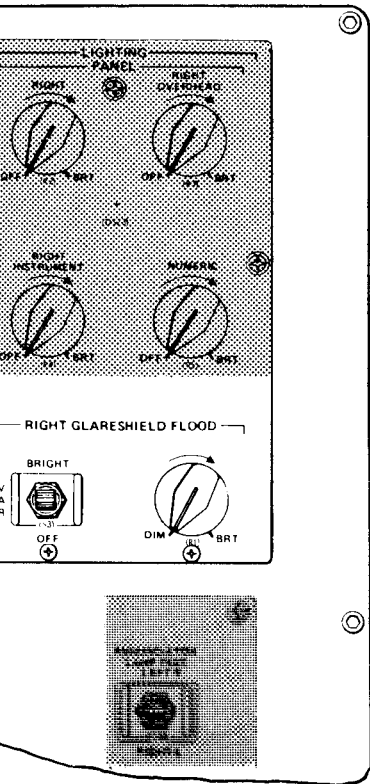
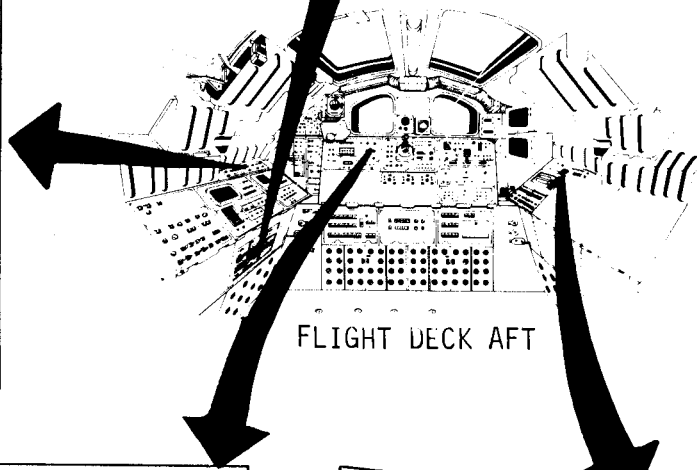
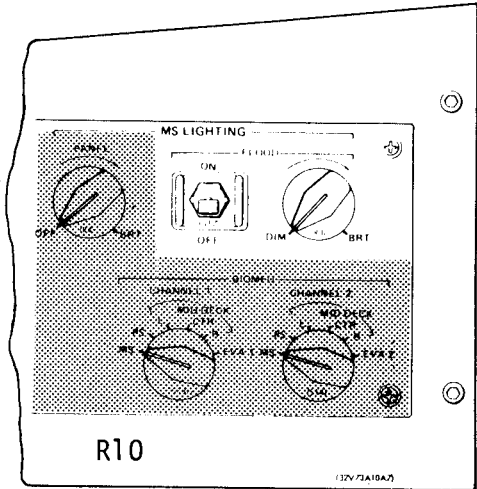
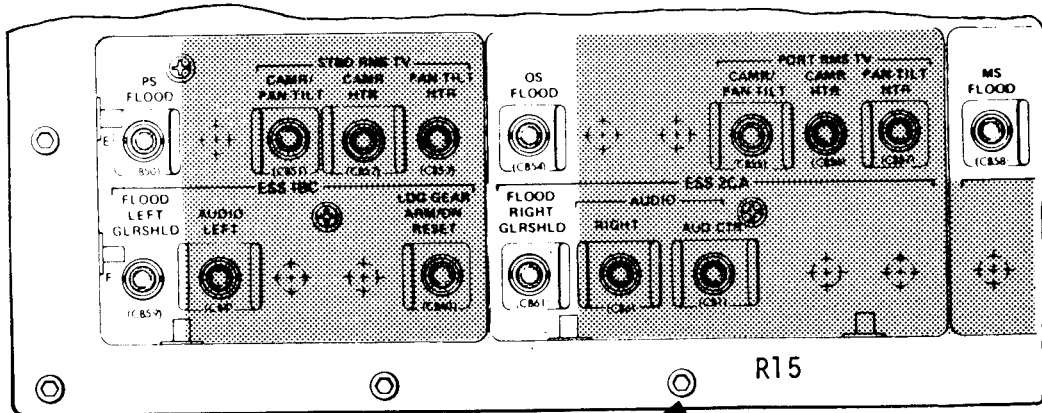


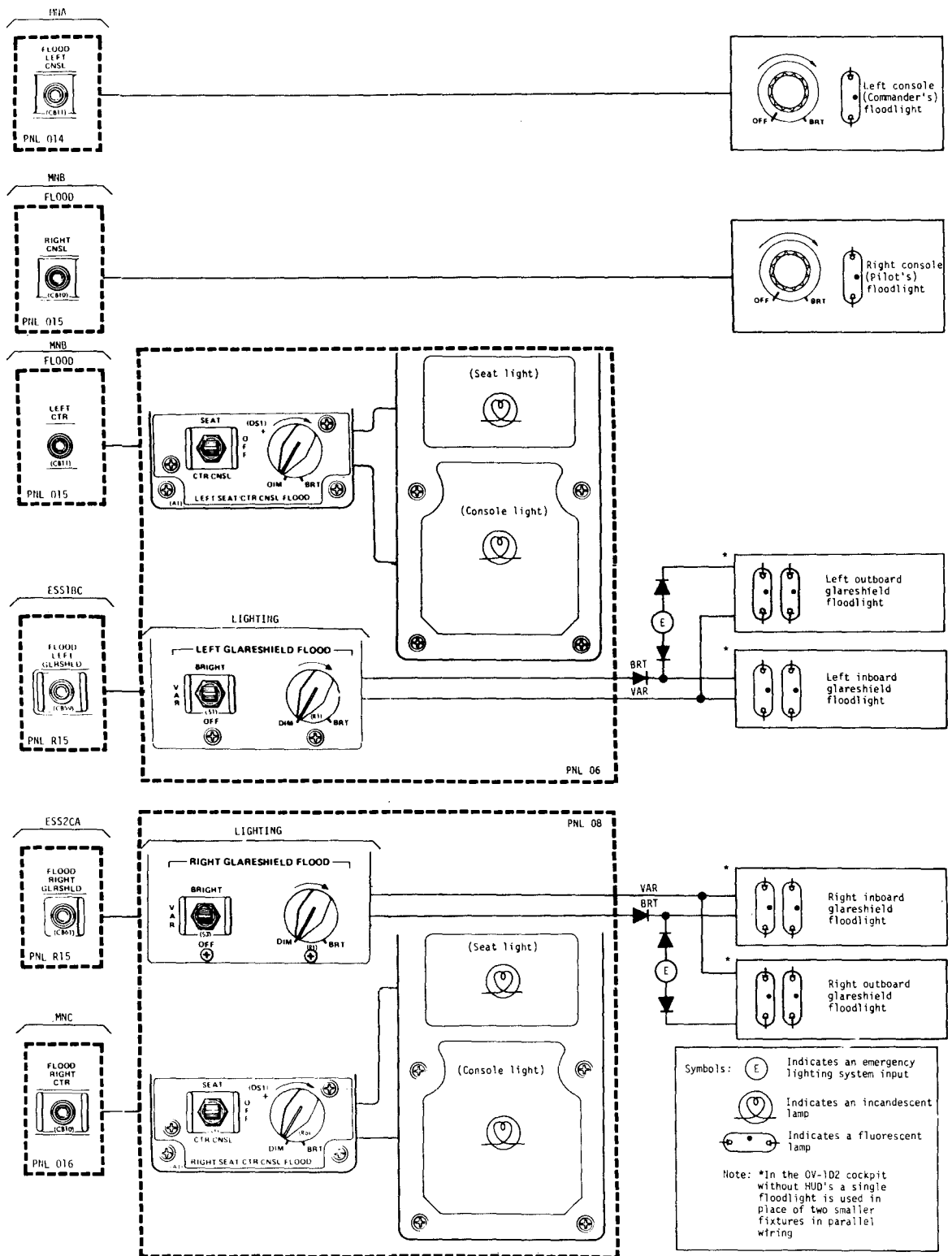
Figure 3.26-2.- Flight deck floodlight control locations.

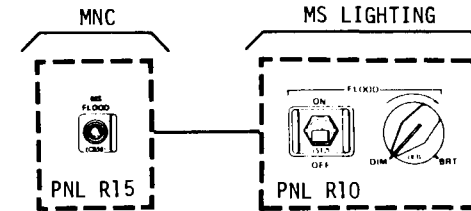
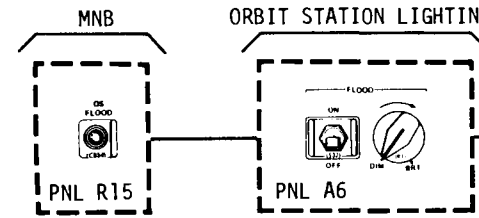
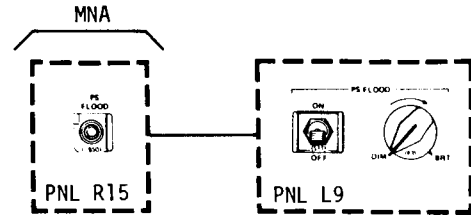
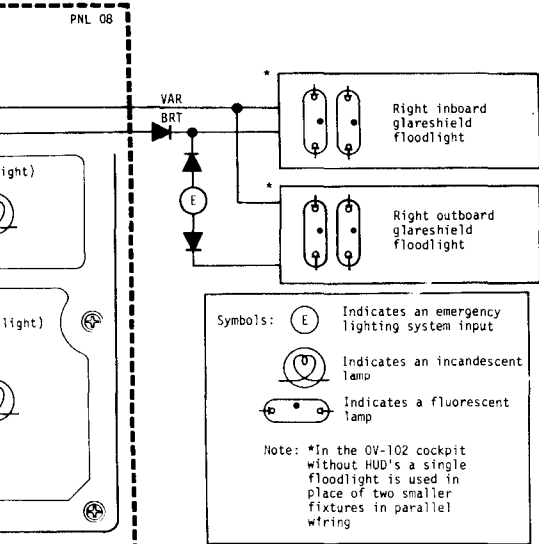
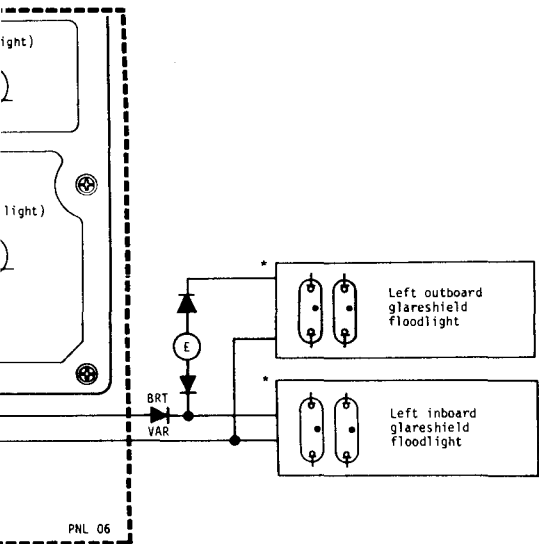
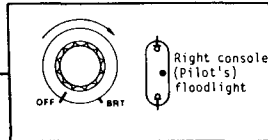
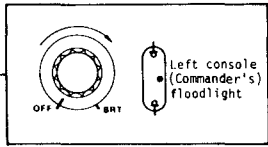
576A



576A







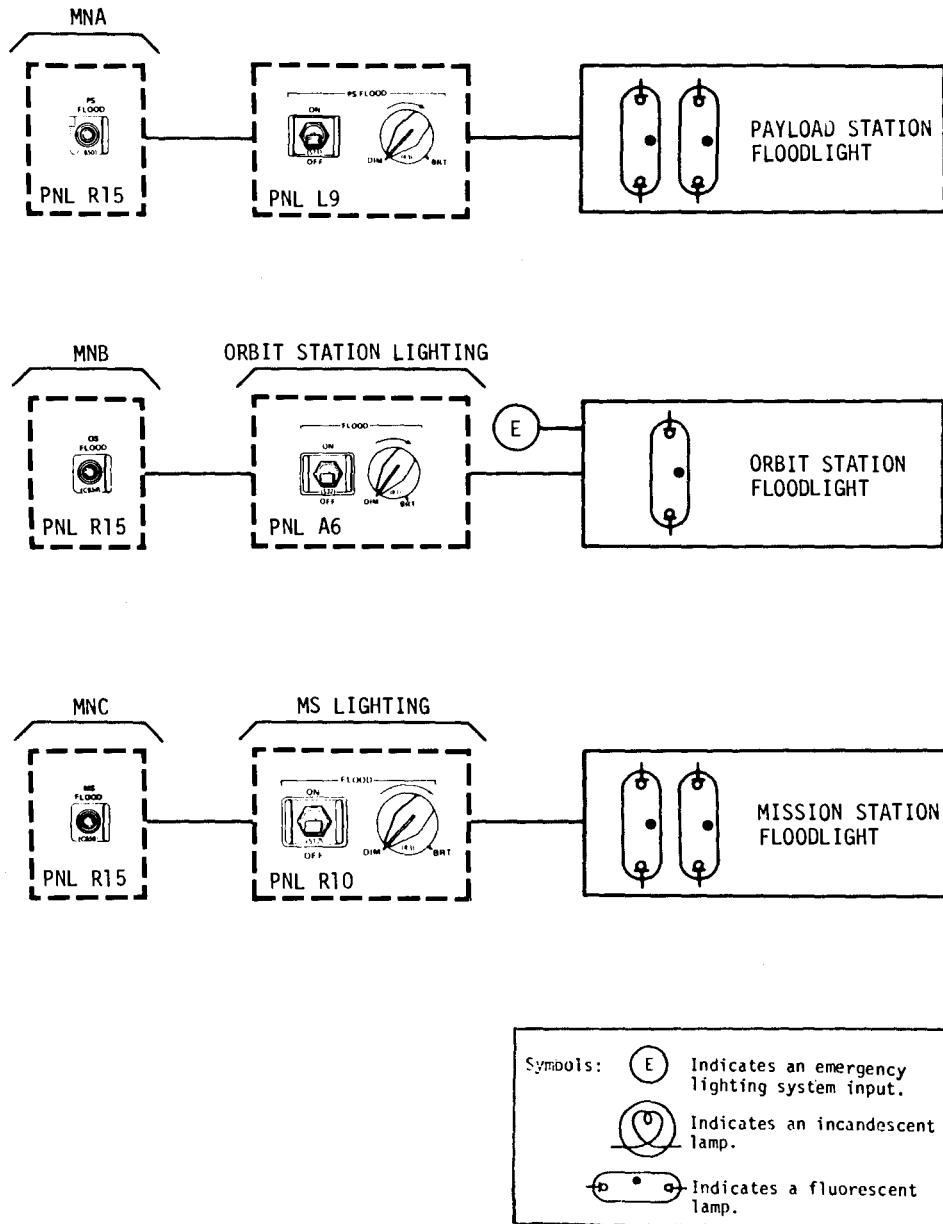


Figure 3.26-3.- Flight deck floodlight operations.

576 B

- Middeck and airlock floodlight configurations

The middeck (ceiling) and waste management compartment (WMC) floodlights have the same fixture configuration as the orbit station floodlight previously shown. The ceiling fixtures are covered by a translucent plastic (lexan) material. The personal hygiene station (PHS) and bunk floodlights use the same fixture as the side console floodlights.

The panel M013Q floodlights use a small fluorescent lamp located at each end of the recessed panel. The figure below shows locations of each lamp.

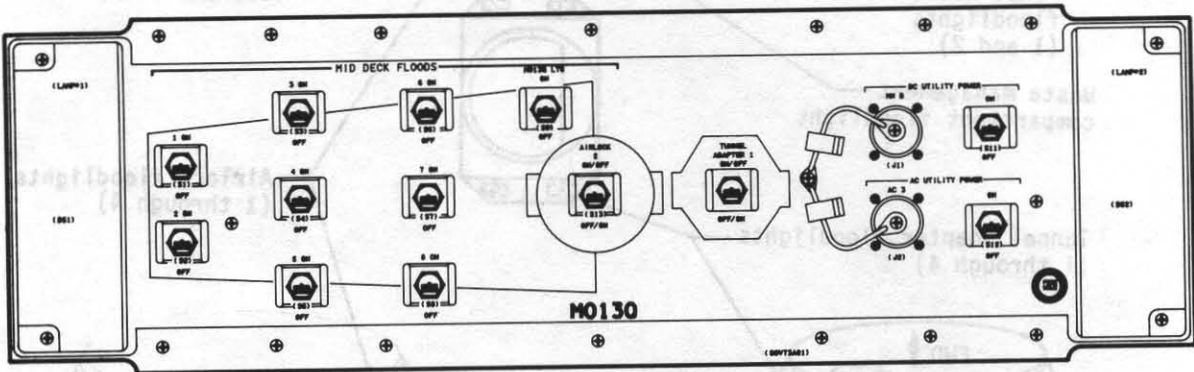


Figure 3.26-5.- Panel M013Q floodlights.

The airlock module floodlights are a single lamp fluorescent fixture like the side console floodlights except for the integral control. The fixture, shown below, is controlled by a switch on a remote panel.

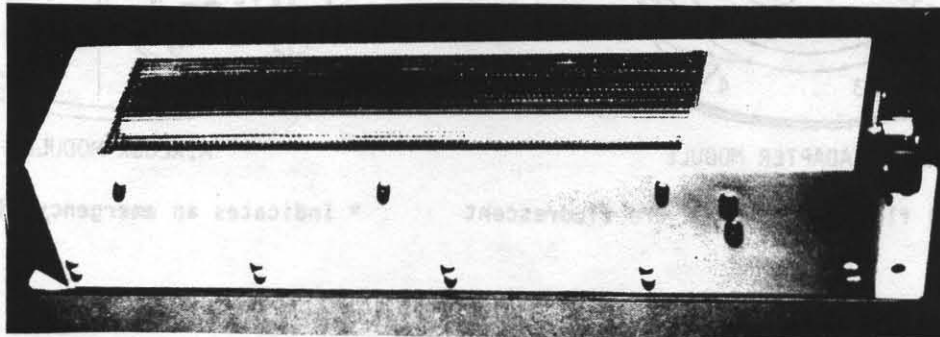


Figure 3.26-6.- Airlock floodlight.

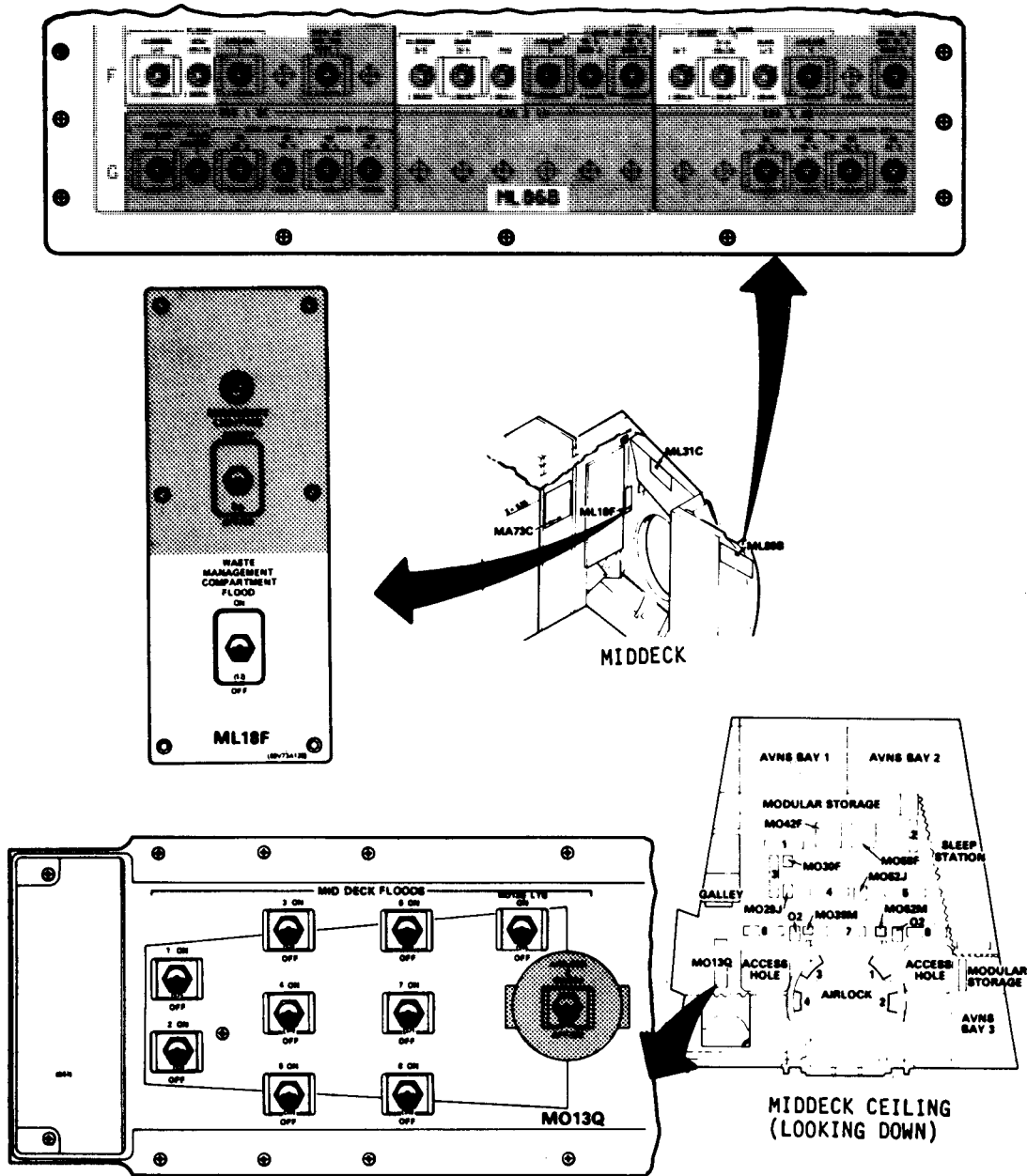


Figure 3.26-7.- Control locations middeck floodlights.

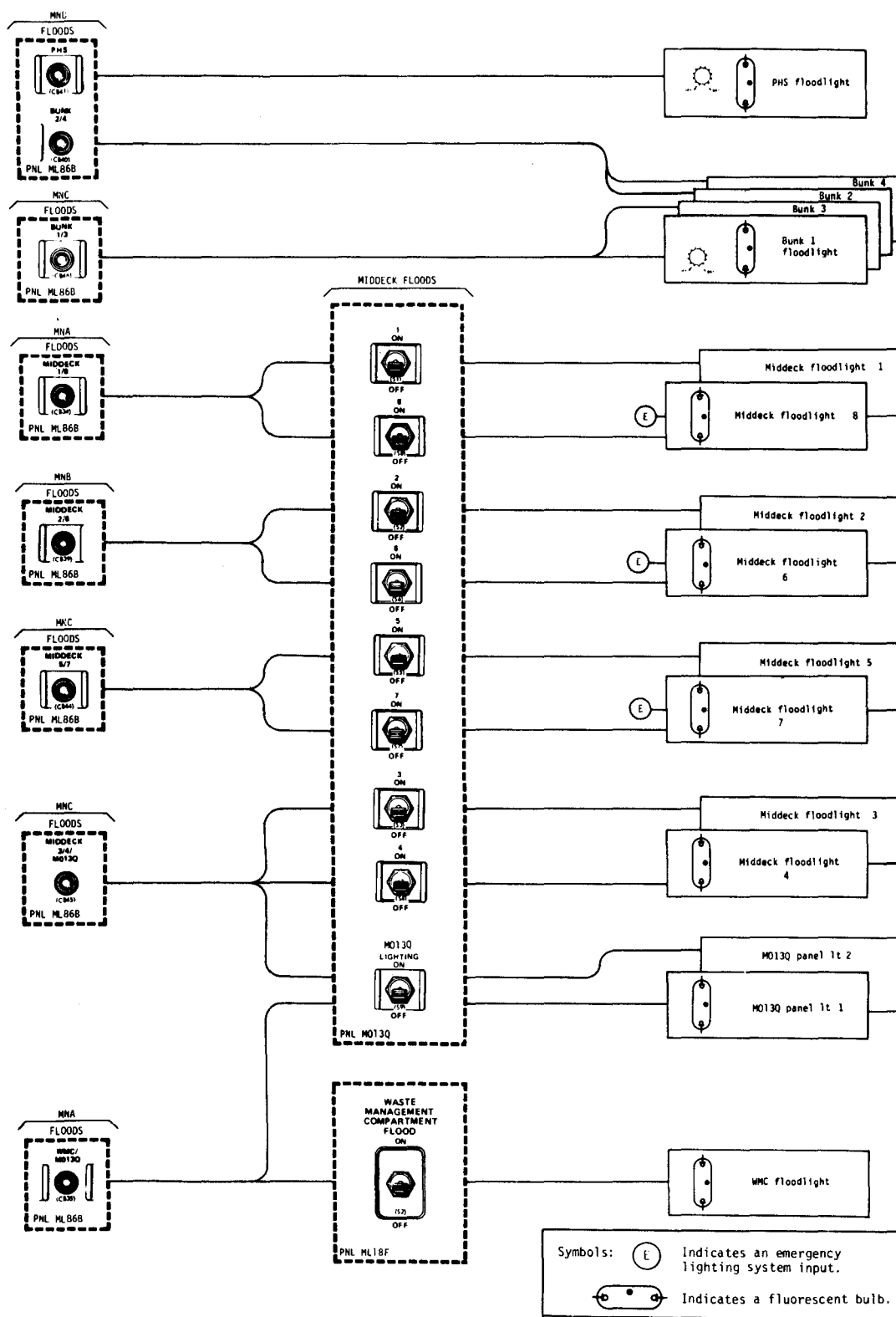


Figure 3.26-8.- Functional schematic-middeck floodlights.

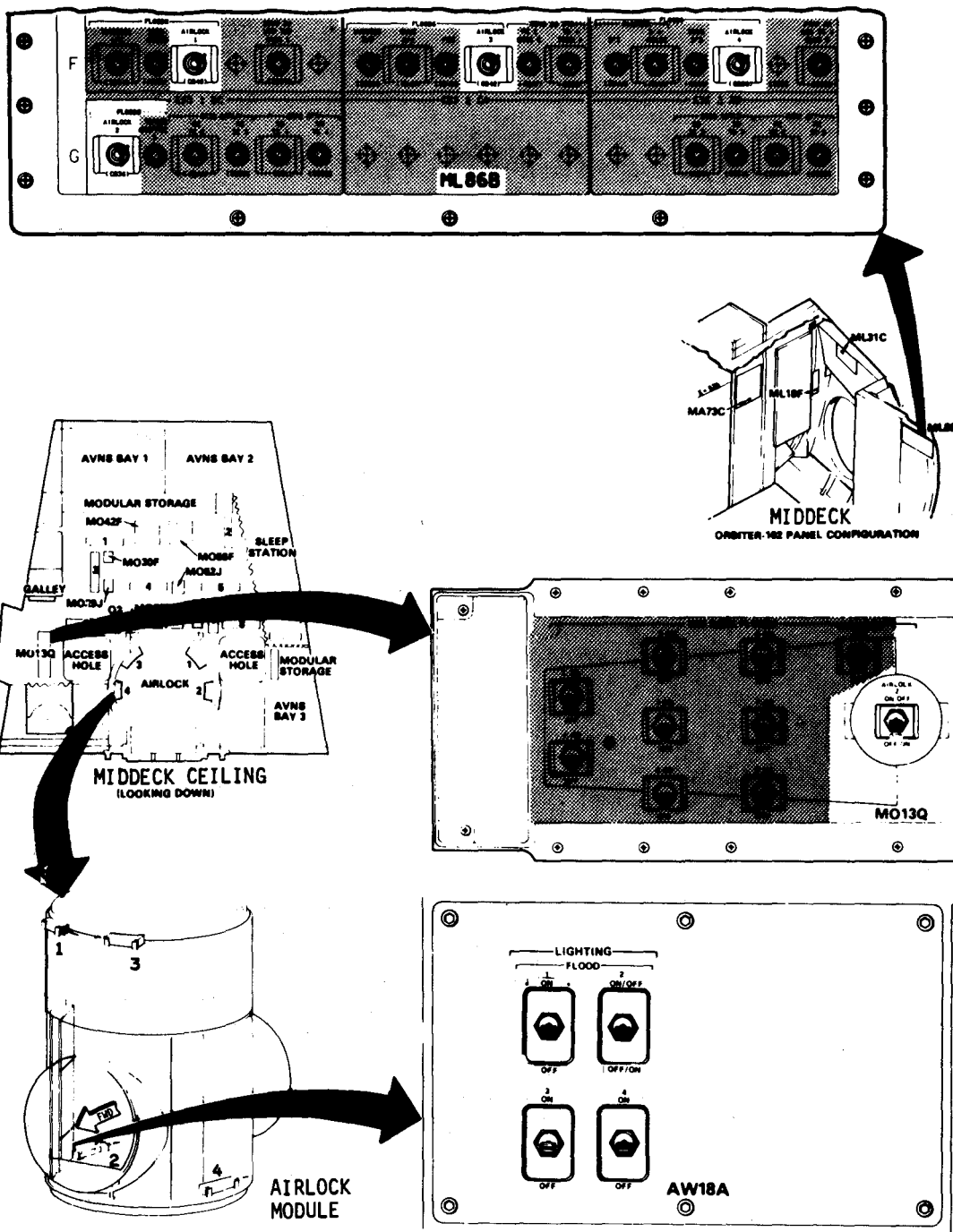


Figure 3.26-9.- Control locations - airlock floodlights.

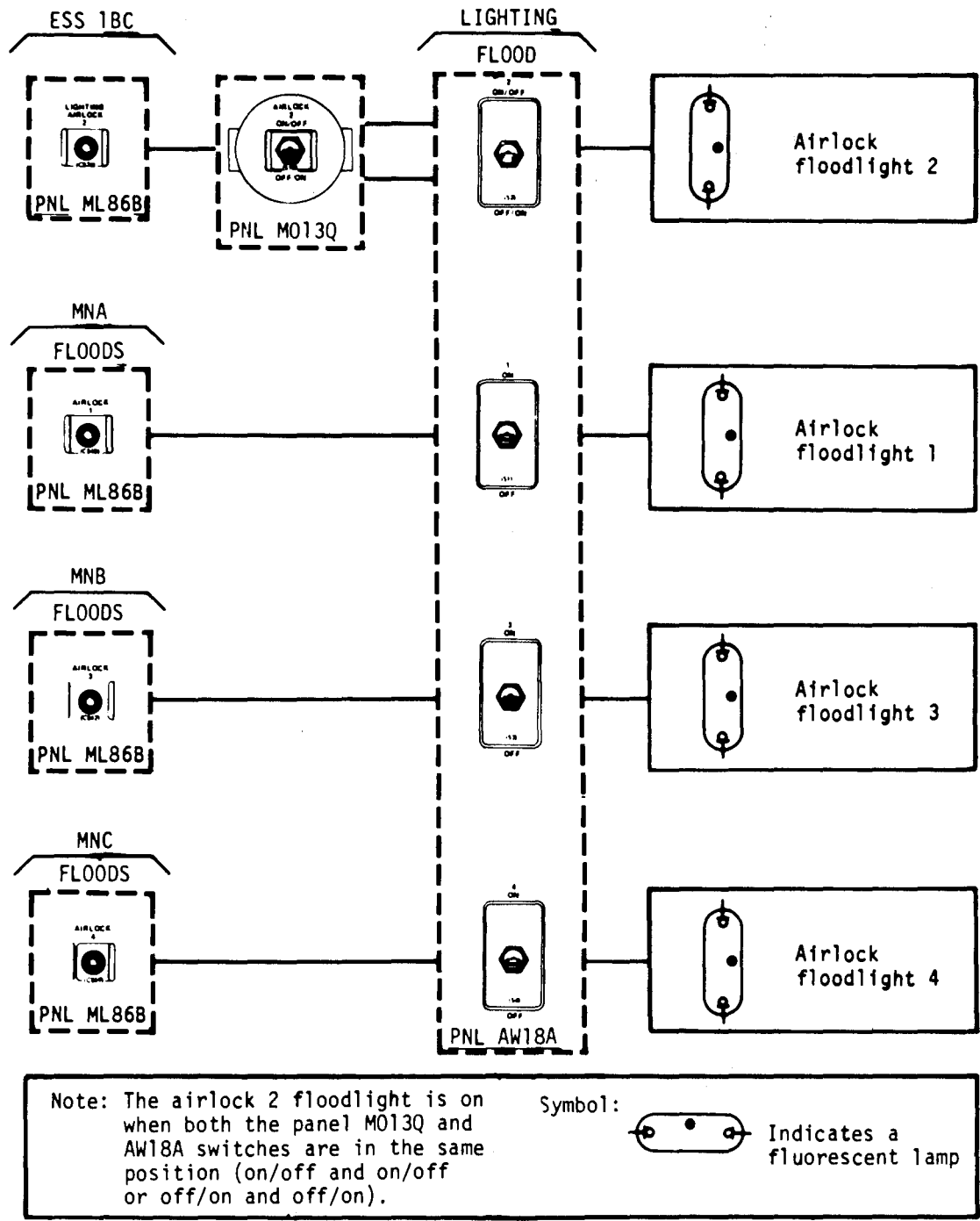
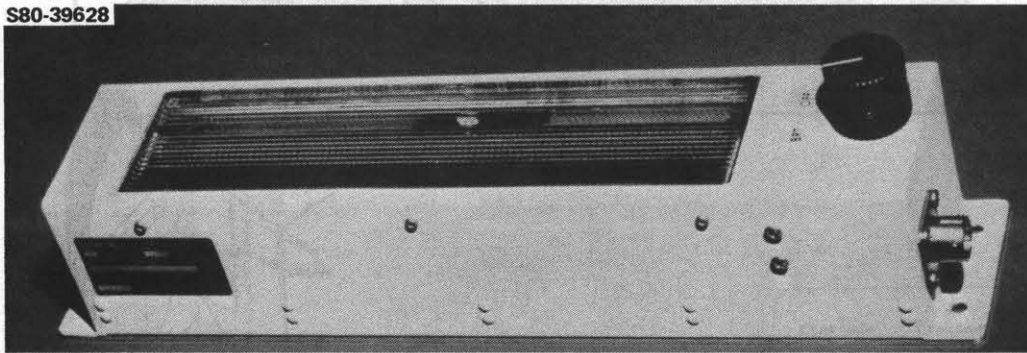


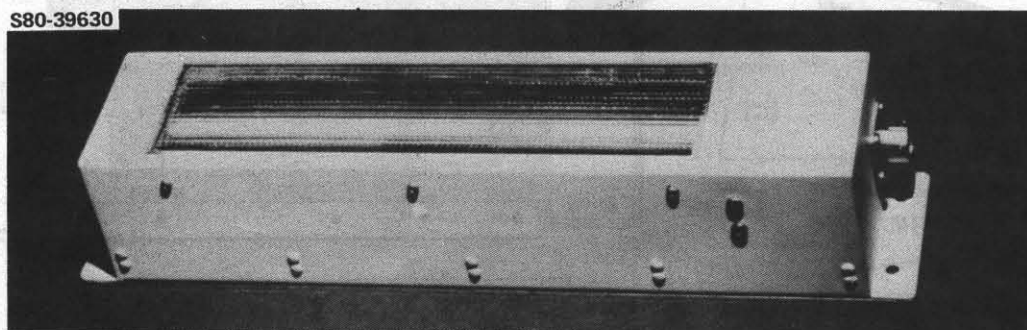
Figure 3.26-10.- Functional schematic - airlock floodlights.

- Tunnel adapter floodlight configurations

The tunnel adapter floodlights are single lamp fluorescent fixtures. They are the same type of fixture used on the flight deck side panels. Two of the four tunnel adapter floodlights lack integral switch controls, like the airlock floodlights.



TUNNEL ADAPTER FLOODLIGHT WITH INTEGRAL CONTROL



TUNNEL ADAPTER FLOODLIGHT WITHOUT INTEGRAL CONTROL

Figure 3.26-11.- Tunnel adapter floodlight.

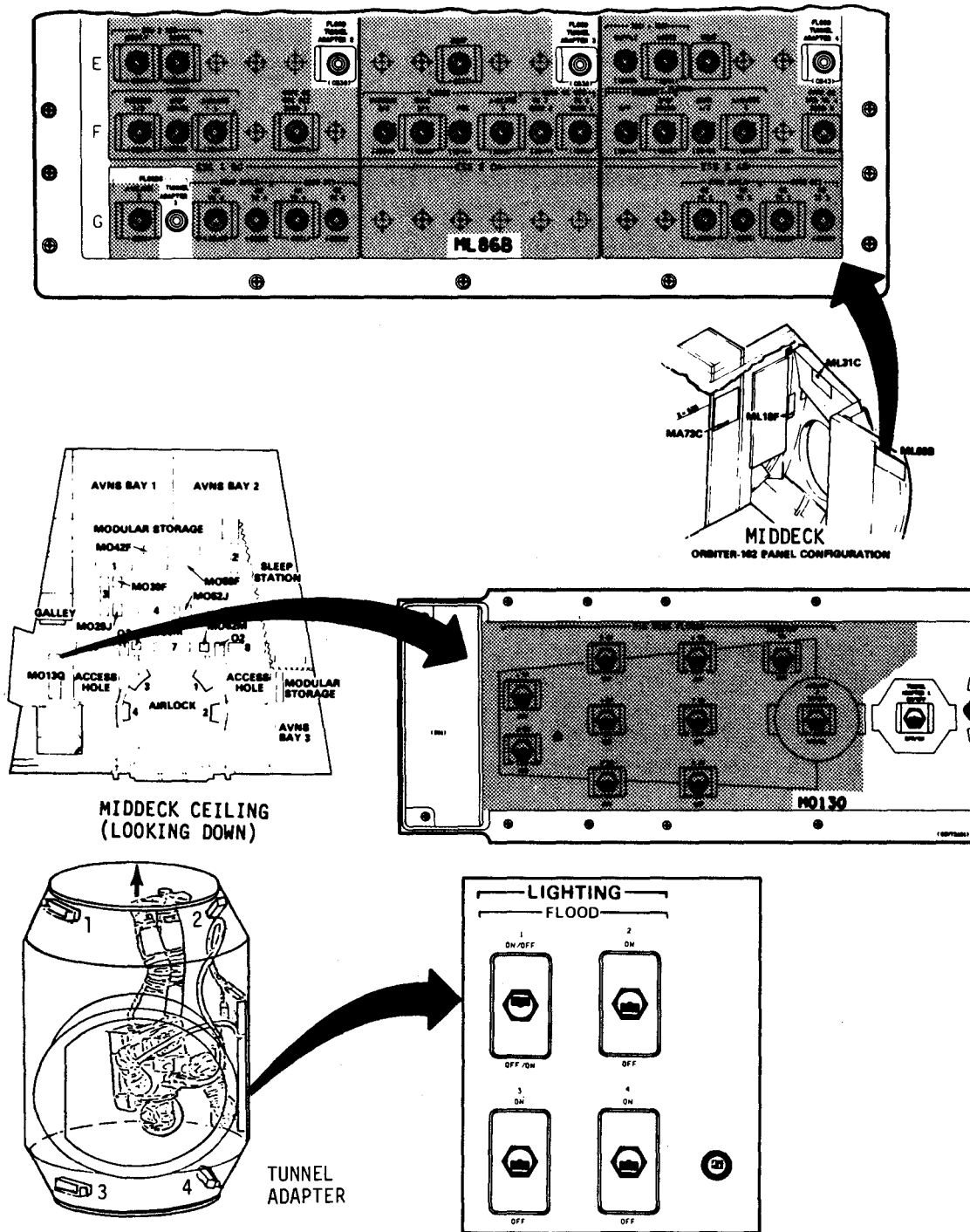
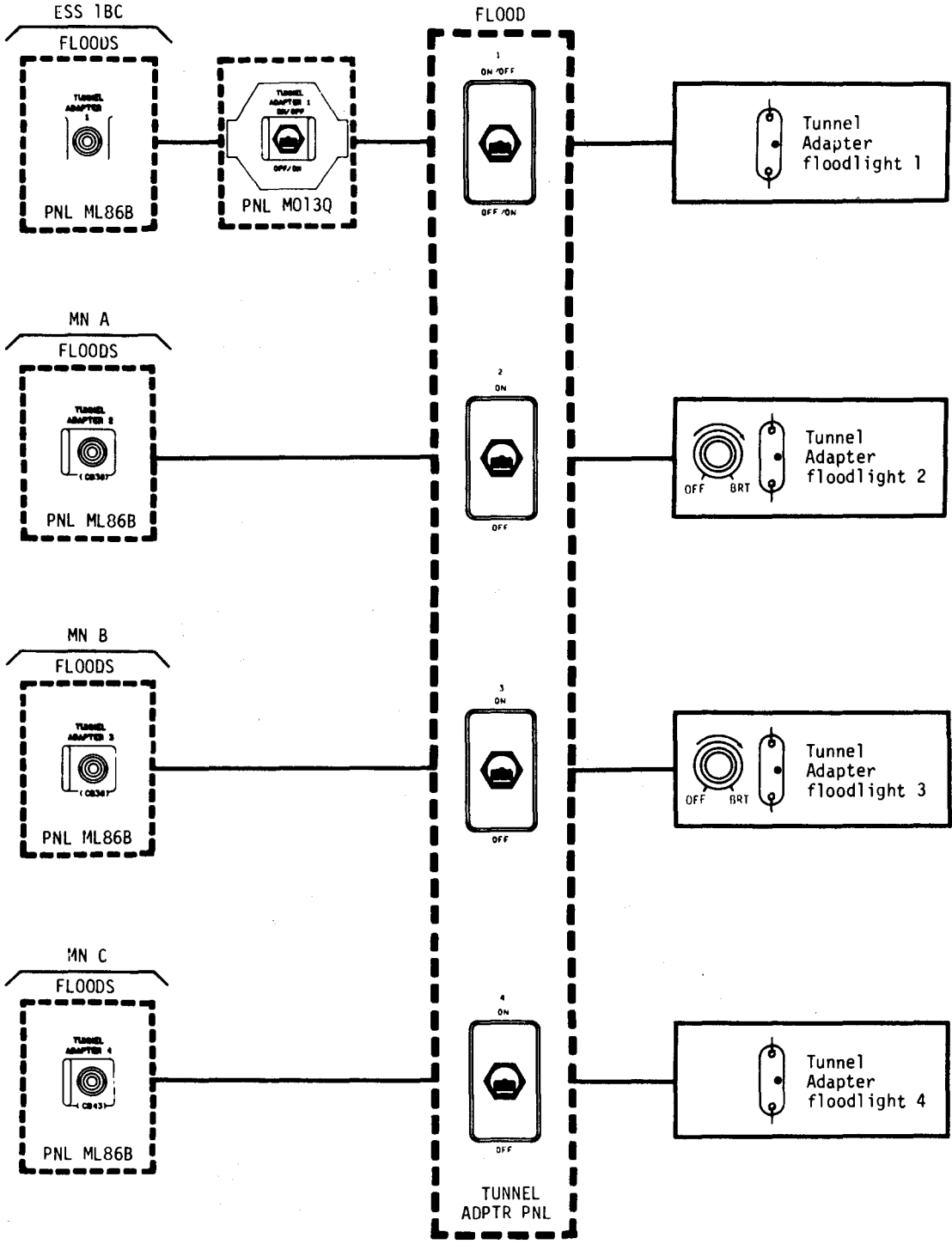


Figure 3.26-12.- Control locations - tunnel adapter floodlights.



Note: The tunnel adapter floodlight 1 is on when both the panel M013Q and the tunnel adapter panel switches are in the same position (on/off and on/off or off/on and off/on)


Symbol:  Indicates fluorescent lamp

Figure 3.26-13.- Functional schematic tunnel adapter.

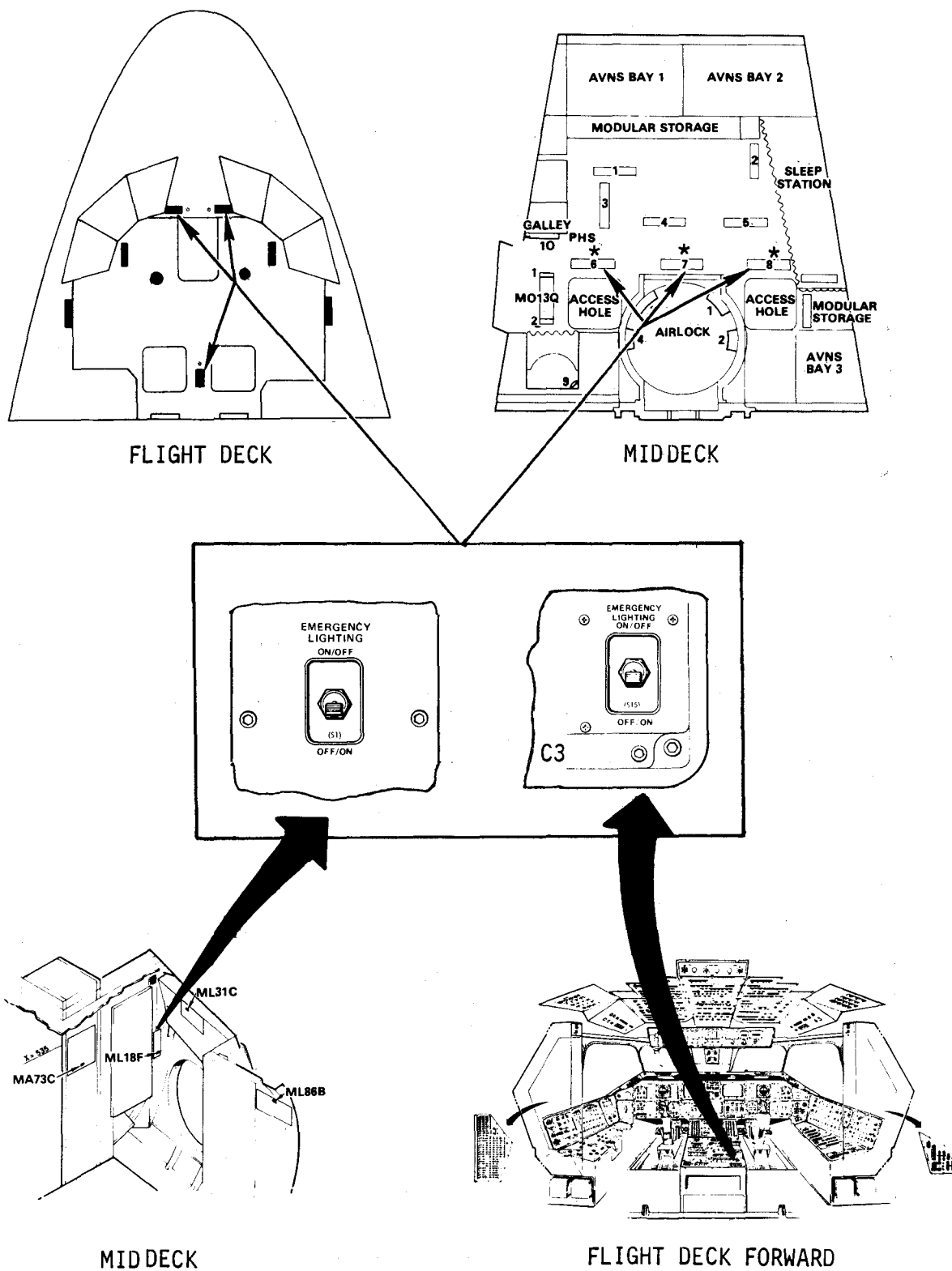
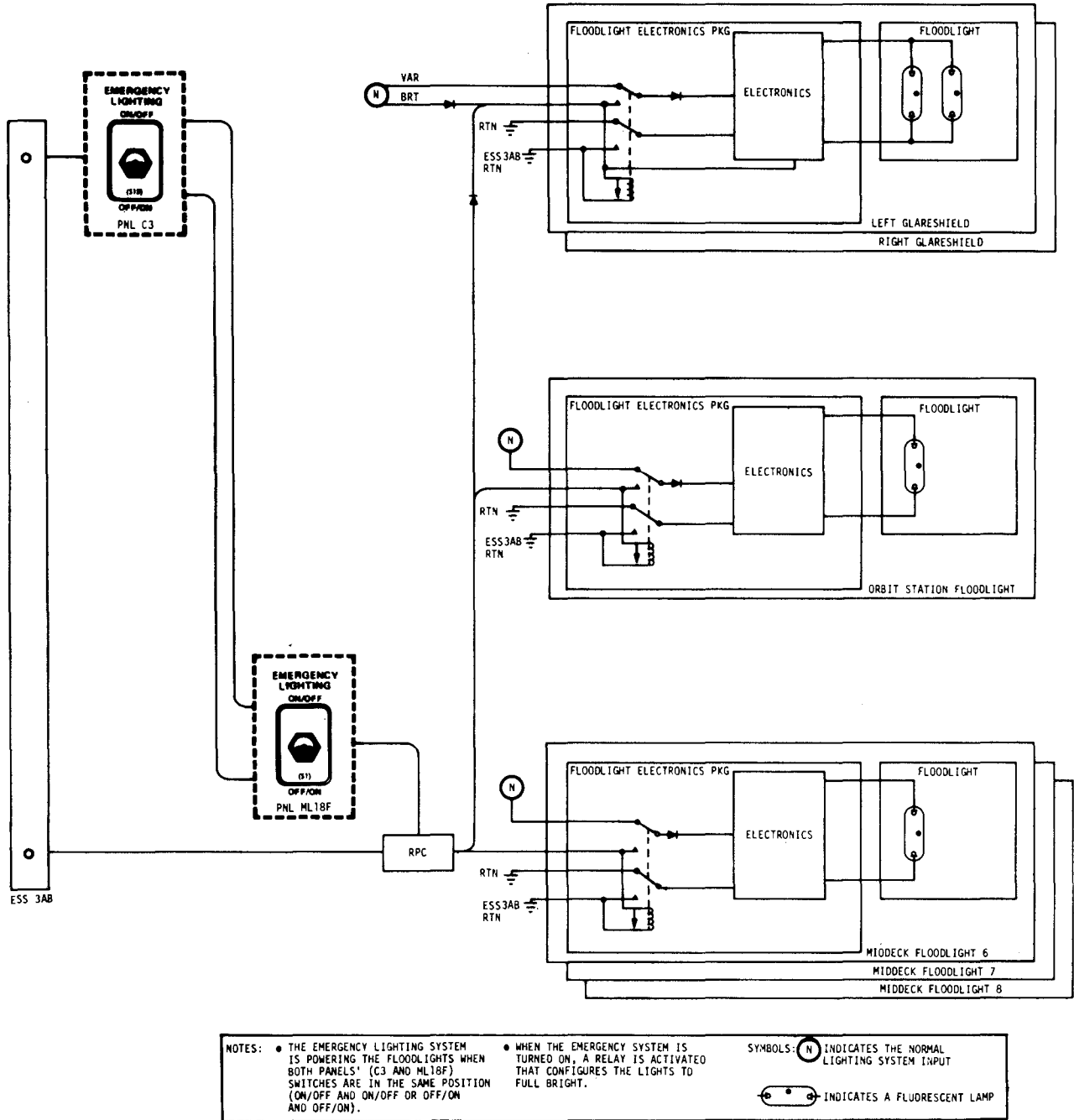


Figure 3.26-14.- Emergency floodlight and control locations.



NOTES: • THE EMERGENCY LIGHTING SYSTEM IS POWERING THE FLOODLIGHTS WHEN BOTH PANELS' (C3 AND ML18F) SWITCHES ARE IN THE SAME POSITION (ON/OFF AND ON/OFF OR OFF/ON AND OFF/ON). • WHEN THE EMERGENCY SYSTEM IS TURNED ON, A RELAY IS ACTIVATED THAT CONFIGURES THE LIGHTS TO FULL BRIGHT.


SYMBOLS: (N) INDICATES THE NORMAL LIGHTING SYSTEM INPUT
 INDICATES A FLUORESCENT LAMP

Figure 3.26-15.- Emergency floodlight operations.

TABLE 3.26-1.- INTERIOR FLOODLIGHT CONTROL FUNCTIONS

| Location | Type | Nomenclature/ position | Function | Remarks |
|----------------------------|------|---|---|--|
| <u>L glare- shield</u> | | | | |
| Pnl R15 | cb | ESS 1 BC FLOOD LEFT GLRSHLD | Supplies power for the left glare- shield floodlight during normal operations | |
| Pnl 06 | sw | LIGHTING LEFT GLARESHIELD FLOOD | <p>BRT Applies full power to the left glare- shield floodlights bypassing the variable control</p> <p>VAR Applies power to the left glareshield floodlights through the variable control</p> <p>OFF Removes power from the left glare- shield flood- lights</p> | The glareshield flood illumi- nates the for- ward flight deck instru- ment panels. When this sw is OFF, the light may still be powered if the emergency lighting system is on |
| | cont | <p>LIGHTING LEFT GLARESHIELD FLOOD</p> <p>DIM ↘ BRT ↙</p> | <p>Moving the knob cw from DIM to BRT increases the floodlight inten- sity when the LIGHTING LEFT GLARESHIELD FLOOD sw is in the VAR position</p> | |

TABLE 3.26-1.- Continued

| Location | Type | Nomenclature/ position | Function | Remarks |
|---------------------------------------|------|--|--|---------|
| <u>R glare- shield</u> | | | | |
| Pnl R15 | cb | ESS 2CA FLOOD RIGHT GLRSHLD | Supplies power for the right glare- shield floodlight during normal operations | |
| Pnl 08 | sw | LIGHTING RIGHT FLARESHIELD FLOOD | Same as the LIGHTING LEFT GLARESHIELD FLOOD sw above except the right glareshield floodlight | |
| Pnl 06 | cont | LIGHTING RIGHT GLARESHIELD FLOOD | Same as the LIGHTING LEFT GLARESHIELD FLOOD cont above except the right glare- shield floodlight | |
| <u>L Seat/ Center Console</u> | | | | |
| Pnl 015 | cb | MNB FLOOD LEFT CTR | Supplies power for the CDR's over- head (seat/ctr cns1) floodlight | |

TABLE 3.26-1.- Continued


| Location | Type | Nomenclature/ position | Function | Remarks |
|----------|------|---|--|---|
| Pn1 06 | sw | LEFT SEAT/CTR CNSL FLOOD | <p>SEAT Applies power to the portion of the left overhead floodlight which illuminates the left seat area</p> <p>OFF Removes power from both portions of the left overhead floodlight</p> <p>CTR CNSL Applies power to the portion of the left overhead floodlight which illuminates the center console area</p> | The overhead floodlight assembly contains two bulbs. Only one is operational at a time. The seat bulb illuminates the seat occupant's lap and the center console bulb illuminates the center console instrument panel |
| | cont | <p>LEFT SEAT/CTR CNSL FLOOD</p> <p>DIM </p> <p>BRT</p> | Moving the knob cw from DIM to BRT increases the selected floodlight's intensity when the LEFT SEAT/CTR CNSL FLOOD sw is not OFF | |

TABLE 3.26-1.- Continued


| Location | Type | Nomenclature/ position | Function | Remarks |
|--------------------------------------|------|---|---|--|
| <u>R Seat Center Console</u> | | | | |
| Pnl 016 | cb | MNC FLOOD RIGHT CTR | Supplies power for the PLT's over- head (seat/ctr cns1) flood- lights | |
| Pnl 08 | sw | RIGHT SEAT/CTR CNSL FLOOD | Same as the LEFT SEAT/CTR CNSL FLOOD sw control above except the right overhead floodlight | |
| | cont | RIGHT SEAT/CTR CNSL FLOOD | Same as the LEFT SEAT/CTR CNSL FLOOD control above except the right overhead floodlight | |
| <u>L Side Console</u> | | | | |
| Pnl 014 | cb | MNA FLOOD LEFT CNSL | Supplies power for the CDR's side- console flood- light assembly | The floodlight illuminates the left-side instrument panels |
| Pnl R side ovhd flood | sw | OFF  BRT | Removes power from the CDR's side- console flood- light Moving the knob cw from OFF applies power to the light and pro- vides variable brightness control | The control is located on the floodlight assembly |

TABLE 3.26-1.- Continued


| Location | Type | Nomenclature/ position | Function | Remarks |
|-------------------------------------|------|---|---|---|
| <u>R Side Console</u> | | | | |
| Pn1 015 | cb | MNB FLOOD RIGHT CTR | Supplies power for the PLT's side- console flood- light assembly | The floodlight illuminates the right-side instrument panels |
| Pn1 L side ovhd flood | sw | OFF  BRT | Removes power from the PLT's side console flood- light Moving the knob cw from OFF applies power to the lights and provides variable brightness control | The control is located on the floodlight assembly |
| <u>Payload Station (PS)</u> | | | | |
| Pn1 R15 | cb | MNA PS FLOOD | Supplies power for the PS flood- light | |
| Pn1 L9 | sw | PS FLOOD | ON Applies power to the PS flood- light OFF Removes power from the PS flood- light | The PS flood- light illumi- nates the left side of the aft flight deck |

TABLE 3.26-1.- Continued

| Location | Type | Nomenclature/ position | Function | Remarks | | |
|-------------------------------------|---------|--|---|---------------------------------------|---------------------------------------|--|
| <u>Mission Station (MS)</u> | cont | PS FLOOD DIM ↘ BRT ↘ | Moving the knob cw from DIM to BRT increases light intensity when the PS FLOOD sw is in the ON position | | | |
| | Pn1 R15 | cb | MNC MS FLOOD | Supplies power for the MS flood-light | | |
| | Pn1 R10 | sw | MS LIGHTING FLOOD | ON | Applies power to the MS flood-light | The MS flood-light illuminates the right side of the aft flight deck |
| | | | | OFF | Removes power from the MS flood-light | |
| | cont | MS LIGHTING FLOOD DIM ↘ BRT ↘ | Moving the knob cw from DIM to BRT increases the floodlight intensity when the MS LIGHTING FLOOD sw is in the ON position | | | |

TABLE 3.26-1.- Continued

| Location | Type | Nomenclature/ position | Function | Remarks |
|--------------------------|------|--|---|--|
| Orbit Station (OS) | | | | |
| Pnl R15 | cb | MNB OS FLOOD | Supplies power for the OS flood- light | |
| Pnl A6 | sw | ORBIT STATION LIGHTING FLOOD ON OFF | Applies power to the OS flood- light Removes power from the OS flood- light | The OS flood- light illumi- nates the cen- ter and aft portion of the aft flight deck. When this sw is OFF, the light may still be powered if the emergency lighting system is on |
| | cont | ORBIT STATION LIGHTING FLOOD DIM BRT | Moving the knob cw from DIM to BRT increases the floodlight inten- sity when the ORBIT STATION LIGHT FLOOD sw is in the ON position | |

TABLE 3.26-1.- Continued

| Location | Type | Nomenclature/ position | Function | Remarks |
|----------------|------|---------------------------|--|--|
| <u>Middeck</u> | | | | |
| Pn1 ML86B | cb | MNA FLOODS MIDDECK 1/8 | Supplies power for middeck flood- lights 1 and 8 | |
| Pn1 M013Q | sw | MIDDECK FLOODS 1 | ON Applies power to middeck flood- light 1. | |
| | | | OFF Removes power from middeck flood- light 1 | |
| | sw | MIDDECK FLOODS 8 | ON Applies power to middeck flood- light 8 | When this sw is OFF, the light may still be powered if the emergency lighting system is on |
| | | | OFF Removes power from middeck flood- light 8 | |
| Pn1 ML86B | cb | MNB FLOODS MIDDECK 2/6 | Supplies power for middeck flood- lights 2 and 6 | |
| Pn1 M013Q | sw | MIDDECK FLOODS 2 | Same as MIDDECK FLOODS 1 sw above except floodlight 2 | |
| | sw | MIDDECK FLOODS 6 | SAME AS MIDDECK FLOODS 8 sw above except floodlight 6 | |

TABLE 3.26-1.- Continued

| Location | Type | Nomenclature/ position | Function | Remarks |
|-----------|------|------------------------------------|--|---------|
| Pn1 ML86B | cb | MNC FLOODS MIDDECK 5/7 | Supplies power for middeck flood- lights 5 and 7 | |
| Pn1 M013Q | sw | MIDDECK FLOODS 5 | Same as MIDDECK FLOODS 1 sw above except floodlight 5 | |
| | sw | MIDDECK FLOODS 7 | Same as MIDDECK FLOODS 8 sw above except floodlight 7 | |
| Pn1 ML86B | cb | MNC FLOODS MIDDECK 3/4/M013Q | Supplies power for middeck flood- lights 3 and 4 and M013Q panel light 1 | |
| | cb | MNA FLOODS WMC/ M013Q | Supplies power to the WMC flood- light and M013Q panel light 2 | |
| Pn1 M013Q | sw | MIDDECK FLOODS 3 | Same as MIDDECK FLOODS 1 sw above except floodlight 3 | |
| | sw | MIDDECK FLOODS 4 | Same as MIDDECK FLOODS 1 sw above except floodlight 4 | |

TABLE 3.26-1.- Continued

| Location | Type | Nomenclature/ position | Function | Remarks | | |
|---|------|--|--|--|---|---|
| Pn1 ML18F <u>Sleep Station</u> | sw | MIDDECK FLOODS M013Q LTR | ON | Applies power to panel M013Q lights 1 and 2 | The M013Q flood- lights illumi- nate the face of panel M013Q | |
| | | | OFF | Removes power from panel M013Q lights 1 and 2 | | |
| | sw | WASTE MANAGEMENT COMPARTMENT FLOOD | ON | Applies power to the WMC flood- light | | The waste management compartment (WMC) floodlight provides general illumination for the WMC |
| | | | OFF | Removes power from the WMC flood- light | | |
| Pn1 ML86B | cb | MNC FLOODS BUNK 1/3 | Supplies power for bunk 1 and bunk 3 floodlights | | | |
| Pn1 bunk 1 | sw | | OFF | Removes power from the bunk 1 floodlight. | The control is located on the floodlight assembly | |
| | | | BRT | Moving the knob cw from OFF applies power to the light and provides vari- able brightness control | | |

TABLE 3.26-1.- Continued

| Location | Type | Nomenclature/ position | Function | Remarks | |
|----------------|------|-------------------------------|---|--|---|
| Pn1 bunk 3 | sw | | Same as bunk 1 sw except bunk 3 | | |
| Pn1 ML86B | cb | MNB FLOODS BUNK 2/4 | Same as bunk 1/3 cb except bunks 2 and 4 | | |
| Pn1 bunk 2 | sw | | Same as bunk 1 sw except bunk 2 | | |
| Pn1 bunk 4 | sw | | Same as the bunk 1 sw except bunk 4 | | |
| <u>Airlock</u> | | | | | |
| Pn1 ML86B | cb | MNA FLOODS AIRLOCK 1 | Supplies power for airlock flood- light 1 | The airlock floodlights provide gene- ral illumina- tion of the airlock module | |
| Pn1 AW18A | sw | LIGHTING FLOOD 1 | ON | | Applies power to airlock flood- light 1 |
| | | | OFF | | Removes power from airlock flood- light 1 |
| Pn1 ML86B | cb | ESS 1BC LIGHTING AIRLOCK 2 | Supplies power for airlock flood- light 2 | | |

TABLE 3.26-1.- Continued

| Location | Type | Nomenclature/ position | Function | Remarks |
|-----------|------|---------------------------|---|---------|
| Pn1 AW18A | sw | LIGHTING FLOOD 2 | Opens or closes a circuit to the MID DECK FLOODS AIRLOCK sw. When both sw's are in the same position, power is provided to the airlock 2 floodlight. Opposite positions remove power from the light | |
| | | ON/OFF | | |
| Pn1 M013Q | sw | MIDDECK FLOODS AIRLOCK 2 | Same as the LIGHTING FLOOD 2 sw above except it opens or closes a circuit to the LIGHTING FLOOD 2 sw on pn1 AW18A | |
| | | OFF/ON | | |
| Pn1 ML86B | cb | MNB FLOODS AIRLOCK 3 | Supplies power for airlock floodlight 3 | |
| Pn1 AW18A | sw | LIGHTING FLOOD 3 | Same as the LIGHTING FLOOD 1 sw above except floodlight 3 | |
| Pn1 ML86B | cb | MNC FLOODS AIRLOCK 4 | Supplies power for airlock floodlight 4 | |

TABLE 3.26-1.- Continued

| Location | Type | Nomenclature/ position | Function | Remarks |
|---------------------------|------|--------------------------------|--|---------|
| Pn1 AW18A | sw | LIGHTING FLOOD 4 | Same as the LIGHT- ING FLOOD 4 sw above except floodlight 4 | |
| <u>Tunnel Adapter</u> | | | | |
| Pn1 ML86B | cb | TUNNEL ADAPTER 1 | Supplies power for tunnel adapter floodlight 1 | |
| Pn1 M013Q | sw | TUNNEL ADAPTER 1 ON/OFF | Opens or closes a circuit to the tunnel adapter FLOOD 1 sw. When both sw's are in the same posi- tion, power is provided to the tunnel adapter 1 flood. Opposite positions remove power from the light | |
| Pn1 Tunnel Adapter | sw | FLOOD 1 | Same as the TUNNEL ADAPTER 1 sw above except it opens or closes a circuit to the TUNNEL ADAPTER 1 sw | |
| Pn1 ML86B | cb | TUNNEL ADAPTER 2 | Supplies power for tunnel adapter floodlight 2 | |

TABLE 3.26-1.- Continued


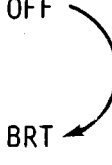
| Location | Type | Nomenclature/ position | Function | Remarks |
|---------------------------------|------|---|---|---------|
| Pnl Tunnel Adapter | sw | FLOOD 2 | Supplies power for tunnel adapter floodlight 2 | |
| Pnl Tunnel Adapter Floodlight 2 | sw | OFF  BRT | Removes power from the tunnel adapter floodlight 2 Moving the knob cw from OFF applies power to the light and provides variable brightness control | |
| Pnl ML86B | cb | TUNNEL ADAPTER 3 | Supplies power for tunnel adapter floodlight 3 | |
| Tunnel Adapter Pnl | sw | FLOOD 3 | Supplies power for tunnel adapter floodlight 3 | |
| Pnl tunnel adapter Floodlight 3 | sw | OFF  BRT | Removes power from the tunnel adapter floodlight 3 Moving the knob cw from OFF applies power to the light and provides variable brightness control | |
| Pnl ML86B | cb | TUNNEL ADAPTER 4 | Supplies power for tunnel adapter floodlight 4 | |
| Pnl tunnel adapter | sw | FLOOD 4 | Supplies power for tunnel adapter floodlight 4 | |

TABLE 3.26-1.- Concluded

| Location | Type | Nomenclature/ position | Function | Remarks |
|---------------------------------------|------|---------------------------|----------|---|
| <u>Emerg Lights</u> Pn1 C3 | sw | EMERGENCY LIGHTING | ON/OFF | Opens or closes a circuit to the EMERGENCY LIGHTING sw (ML18F). When both sw's are in the same position, power is provided to the emergency lighting circuit. Opposite positions remove power |
| | | | OFF/ON | Same as the ON/OFF position |
| Pn1 ML18F | sw | EMERGENCY LIGHTING | ON/OFF | Opens or closes a circuit to the EMERGENCY LIGHTING sw (C3). When both sw's are in the same position, power is provided to the emergency lighting circuit. Opposite positions remove power |
| | | | OFF/ON | Same as the ON/OFF position |

- Panel Lights

Many flight deck instrument panels have integral lighting (figs. 3.26-16 through 3.26-20) that illuminates the panel nomenclature and markings and the display and controls (D&C's). This illumination aids the crew in locating D&C while operating the Orbiter.

Panel lighting is transmitted from behind a panel overlay through the panel nomenclature making it appear white lighted. It is also transmitted to the edges of the D&C for general illumination. The lighting source consists of small, incandescent 'grain-of-wheat' lamps mounted between the metal panel face and the plastic panel overlay. The overlay has a layer of white paint and a layer of gray paint on the top surface. The panel nomenclature is formed by etching the letters and symbols into the gray paint leaving the white layer underneath.

A typical panel lighting configuration is shown in figure 3.26-16.

Panel lighting control functions are presented in table 3.26-2.

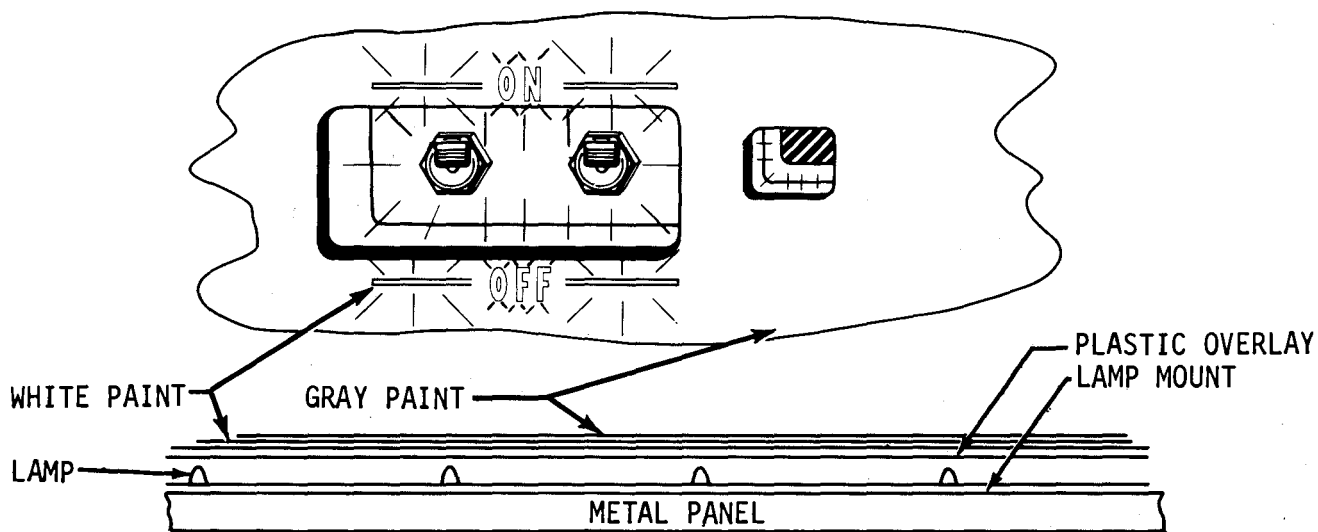


Figure 3.26-16.- Panel lighting configuration.

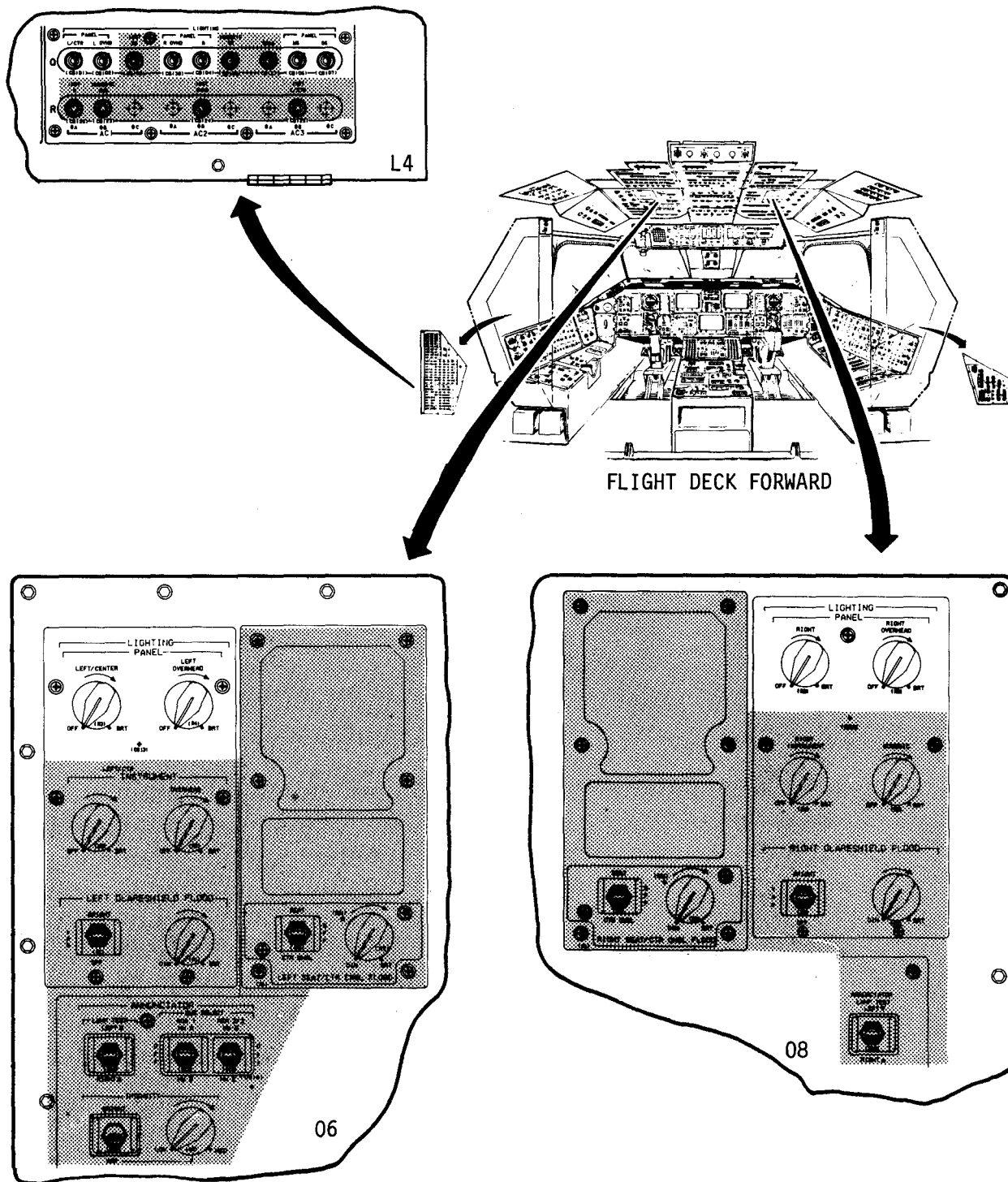


Figure 3.26-17.- Panel lighting control locations - forward flight deck.

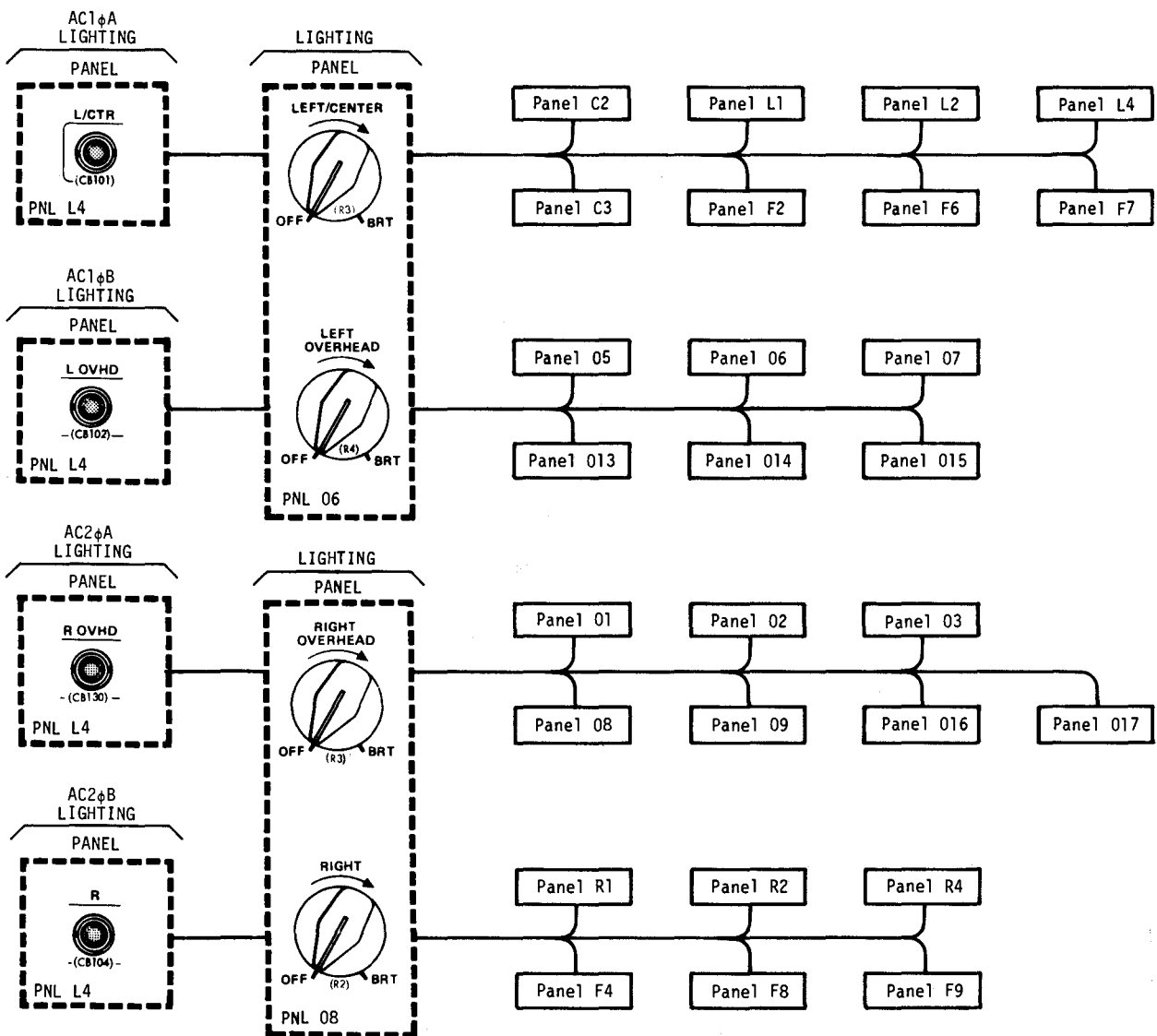


Figure 3.26-18.- Panel lighting operations - forward flight deck.

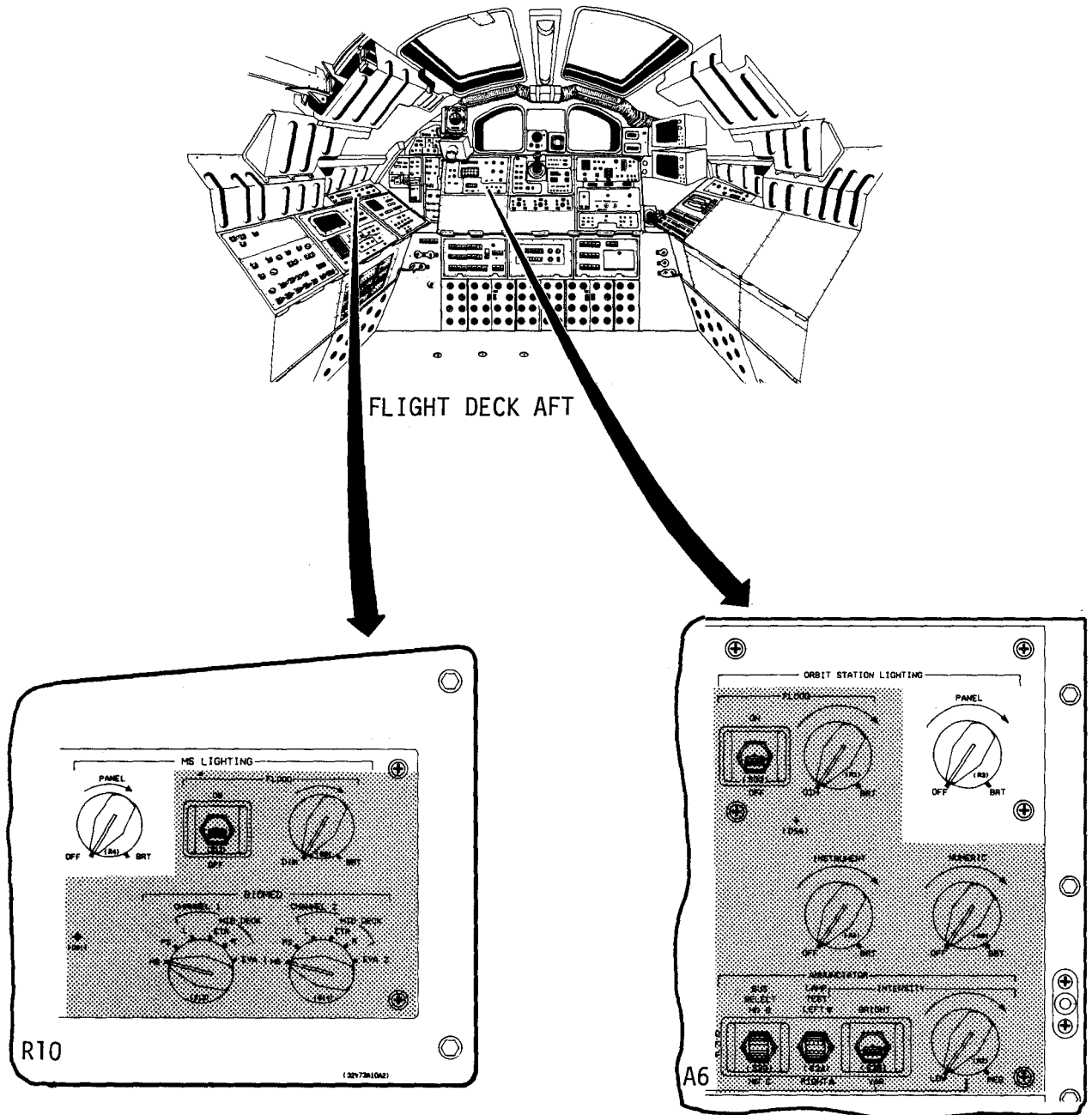


Figure 3.26-19.- Panel lighting control locations - aft flight deck.

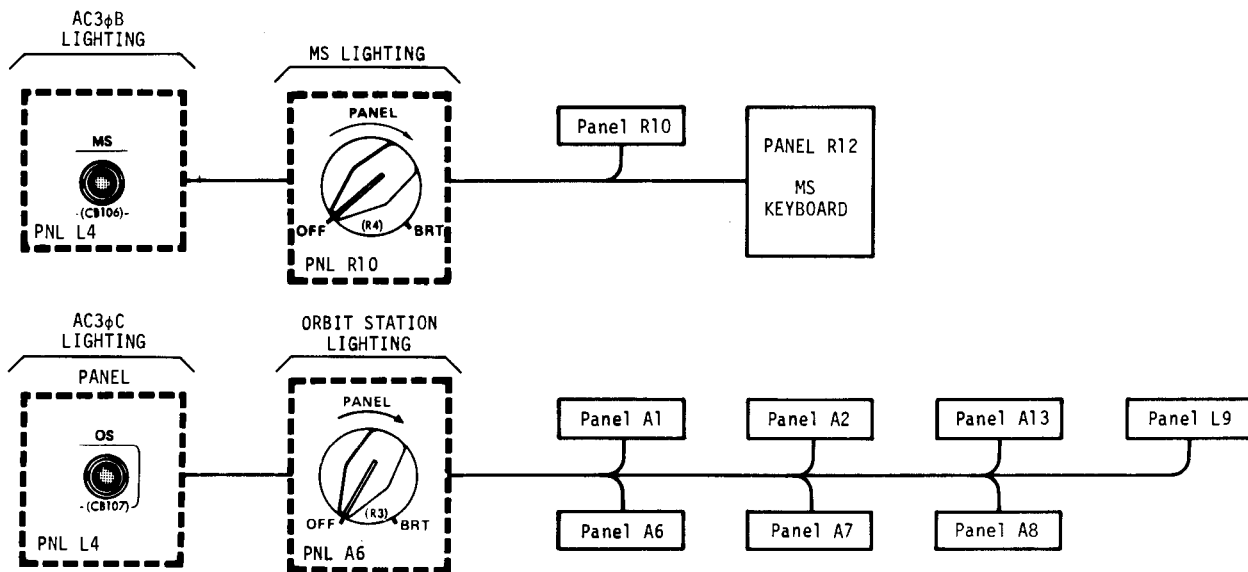


Figure 3.26-20.- Panel lighting operations: aft flight deck.

TABLE 3.26-2.- PANEL LIGHTING CONTROL FUNCTIONS


| Location | Type | Nomenclature/ position | Function | Remarks |
|---|-----------------------|---|--|---------|
| <p><u>Left Overhead</u></p> <p>Pn1 L4</p> <p>Pn1 06</p> | <p>cb</p> <p>cont</p> | <p>AC1ΦB LIGHTING PANEL L OVHD</p> <p>LIGHTING PANEL LEFT OVERHD</p> <p>OFF</p>  <p>BRT</p> | <p>Supplies power for illuminating left overhead panels 05, 06, 07, 013, 014, and 015 edge lights.</p> <p>Removes power from the panel edge lights for left overhead panels 05, 06, 07, 013, 014, and 015.</p> <p>Moving the control cw from OFF applies power to the lights and provides variable brightness control.</p> | |

TABLE 3.26-2.- Continued




| Location | Type | Nomenclature/ position | Function | Remarks |
|---------------------------|------|--|--|---------|
| <u>Right Overhead</u> | | | | |
| Pnl L4 | cb | AC2ΦA LIGHTING PANEL R OVHD | Supplies power for illuminating right overhead panels 01, 02, 03, 08, 09, 016, and 017 edge lights. | |
| Pnl 08 | cont | LIGHTING PANEL RIGHT OVERHEAD OFF  BRT | Removes power from panel lights for right overhead panels 01, 02, 03, 08, 09, 016, and 017. Moving the control cw from OFF applies power to the lights and provides variable brightness control. | |

TABLE 3.26-2.- Concluded

| Location | Type | Nomenclature/ position | Function | Remarks |
|--|------|---|--|---------|
| Pnl R10 <u>Orbit Station (OS)</u> | cont | MS LIGHTING PANEL | | |
| | | <p>OFF </p> <p>BRT</p> | <p>Removes power from the MS panel R10 edge lights, and the MS keyboard lights on R12.</p> <p>Moving the control cw from OFF applies power to the lights and provides variable brightness control.</p> | |
| Pnl L4 | cb | AC3ΦC LIGHTING PANEL OS | Supplies power for illuminating aft panels A1, A2, A6, A7, A8, A13, and L9 edge lights. | |
| Pnl A6 | cont | ORBIT STATION LIGHTING PANEL | | |
| | | <p>OFF </p> <p>BRT</p> | <p>Removes power from the edge lights on orbit station panels A1, A2, A6, A7, A8, A13, and L9.</p> <p>Moving the control away from OFF applies power to the lights and provides variable brightness control.</p> | |

- Instrument lights

The flight deck instruments have integral lighting (figs. 3.26-21 through 3.26-23) which illuminates the instrument face to enable the user to read the displayed data. The illumination comes from incandescent lamps located behind the instrument face. Prisms are utilized to distribute the light evenly over the instrument face.

Parallax, distortion, and unwanted reflections from instruments, windows, and similar surfaces are kept to a minimum. Antireflection techniques are used in order to reduce reflections.

Instrument lighting control functions are presented in table 3.26-3.

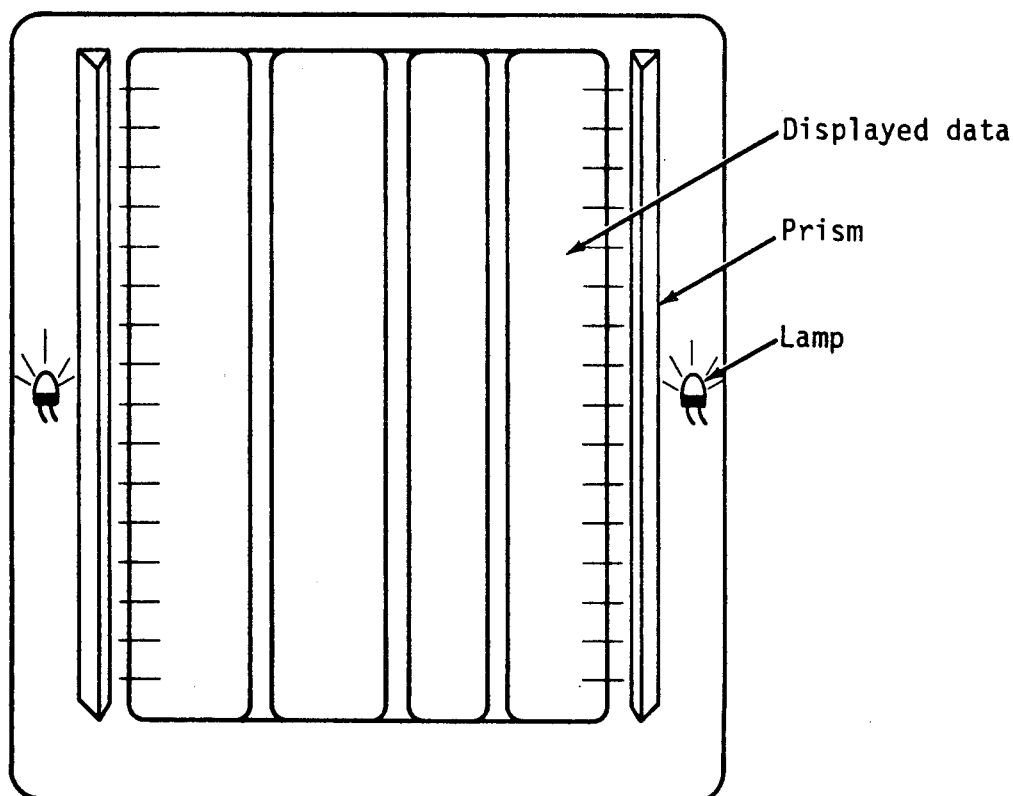
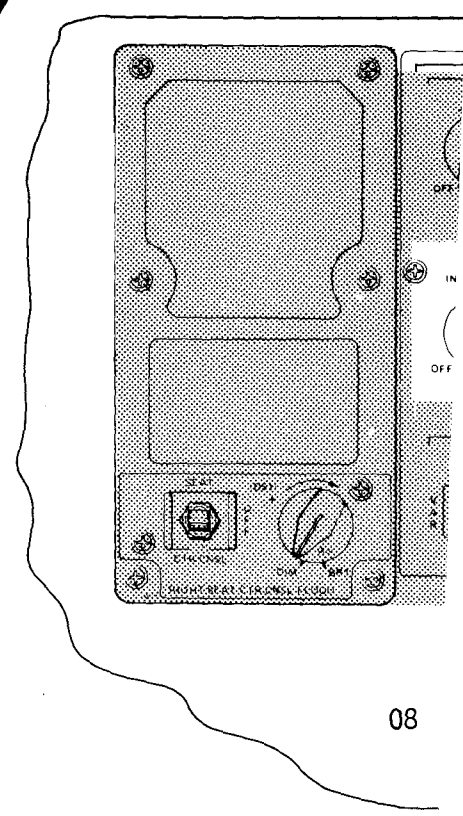
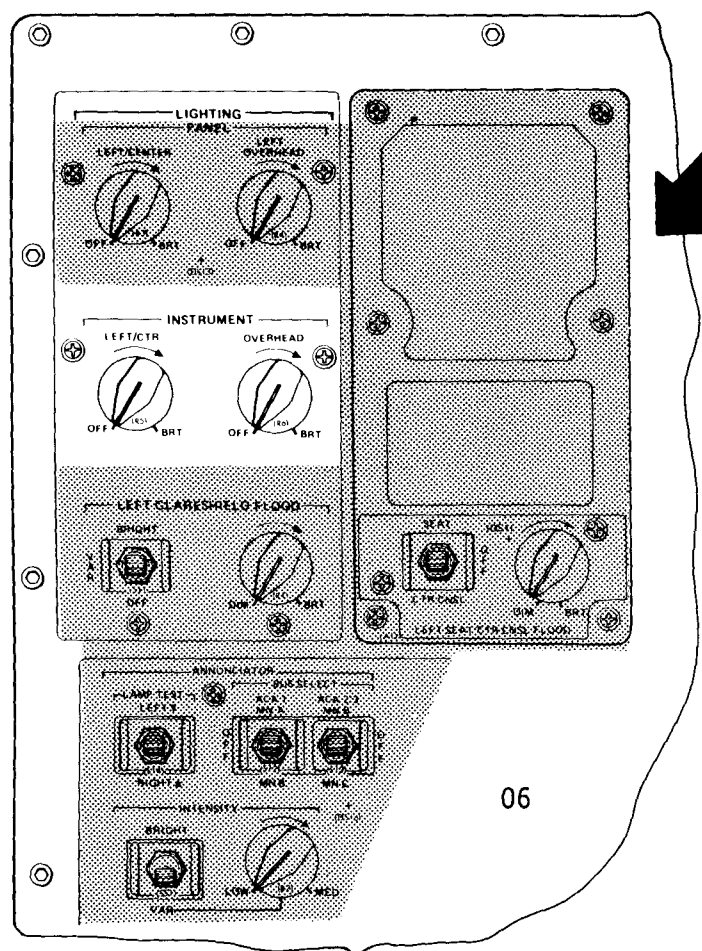
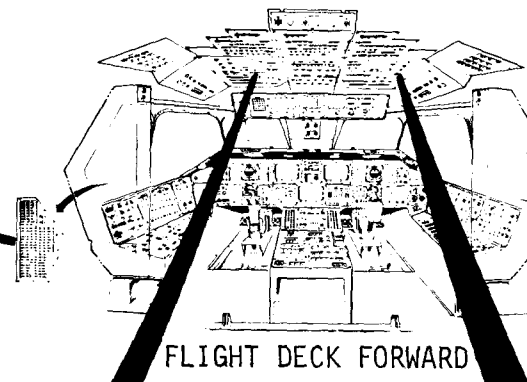
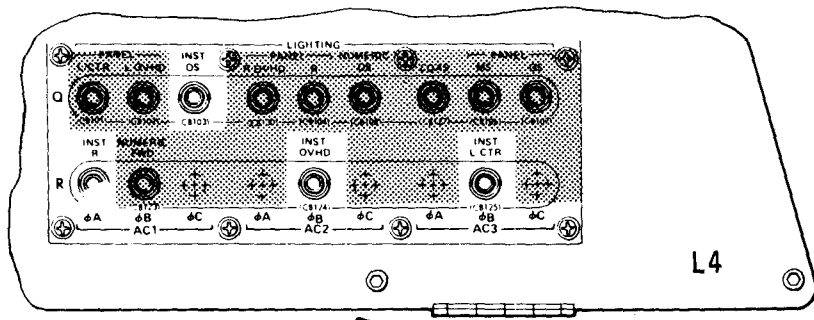
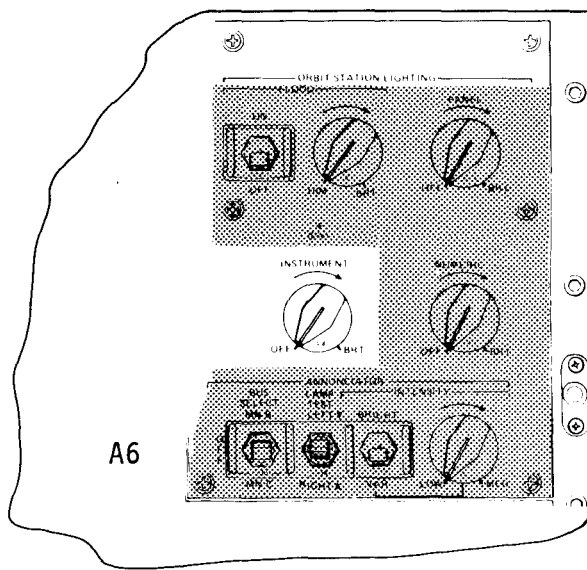
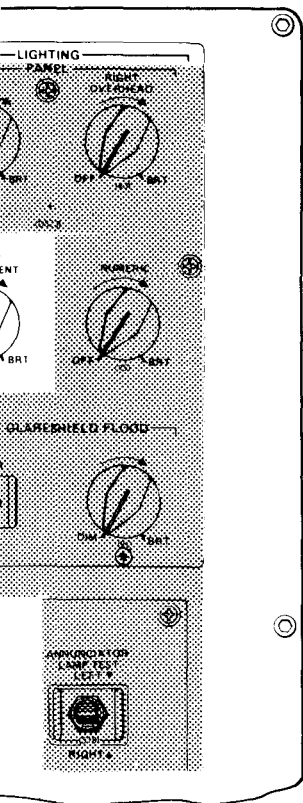
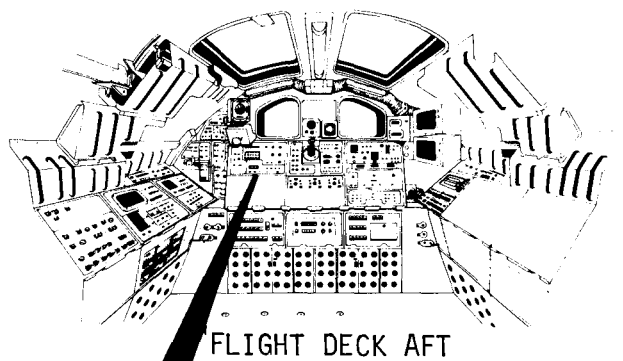


Figure 3.26-21.- Instrument lighting configuration.





612 A

Figure 3.26-22- Instrument lighting control locations.

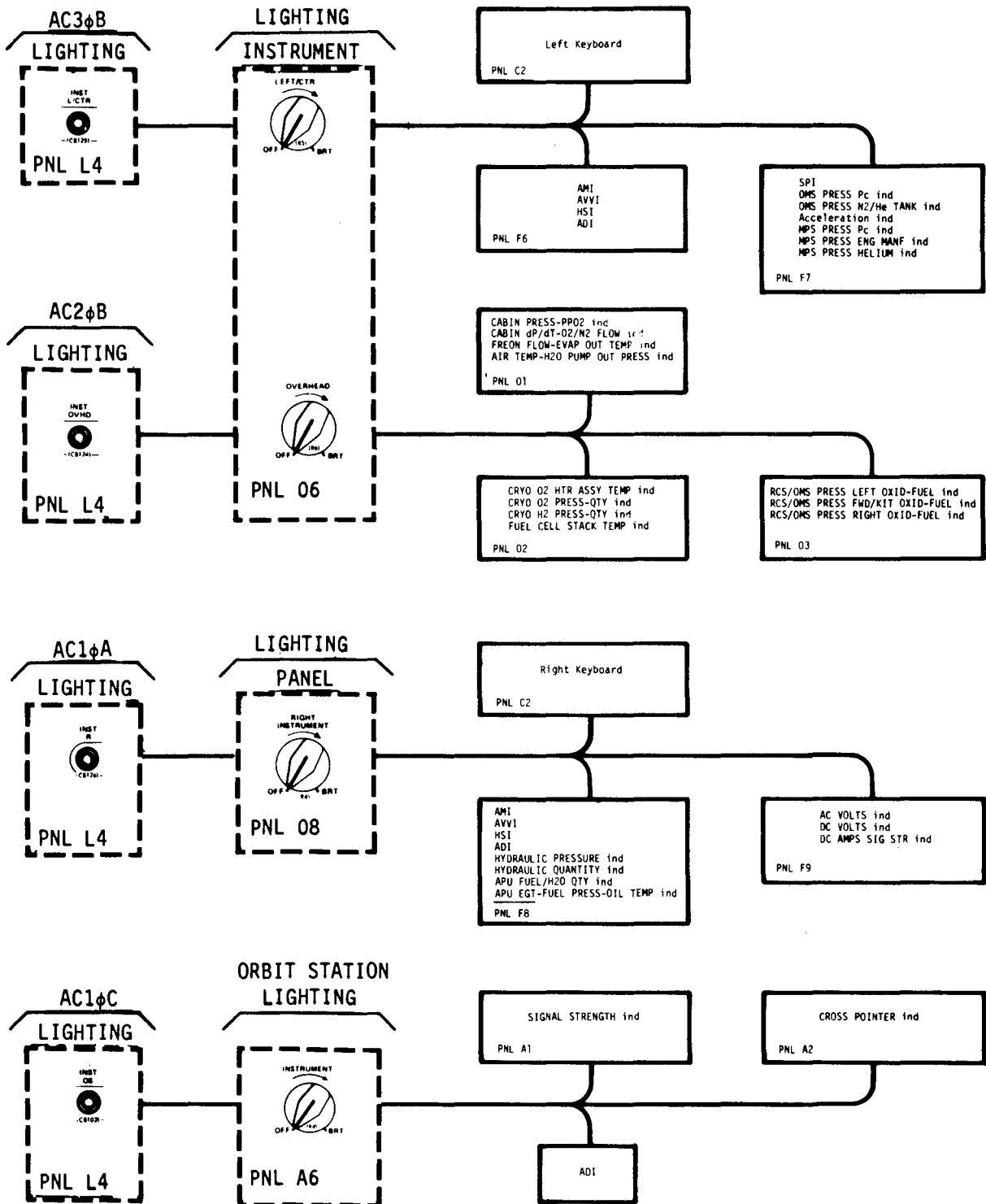


Figure 3.26-23.- Instrument lighting operations.

TABLE 3.26-3.- INSTRUMENT LIGHTING CONTROL FUNCTIONS


| Location | Type | Nomenclature/ position | Function | Remarks |
|---|------|--|--|---|
| <p><u>Overhead</u></p> <p>Pnl L4</p> <p>Pnl 06</p> | cb | AC2ΦB LIGHTING INST OVHD | Supplies power for illuminating the instrument lights on overhead panels 01, 02, and 03. | The specific instruments illuminated are as fol- lows: |
| | cont | <p>LIGHTING INSTRU- MENT OVERHEAD</p> <p>OFF</p>  <p>BRT</p> | <p>Removes power from the instrument lights on overhead panels 01, 02, and 03.</p> <p>Moving the control cw from OFF ap- plies power to the lights and provides variable brightness con- trol.</p> | <p><u>PANEL 01</u> CABIN PRESS PPO₂ ind. CABIN dp/dT O₂/N₂ FLOW FREON FLOW-EVAP OUT ind. AIR TEMP - H₂O PUMP OUT PRESS ind.</p> <p><u>PANEL 02</u> CRYO O₂ HTR ASY TEMP ind. CRYO O₂ PRESS- QTY ind. CRYO H₂ PRESS- QTY ind. FUEL CELL STACK TEMP ind.</p> <p><u>PANEL 03</u> RCS/OMS PRESS LEFT OXID-FUEL ind. RCS/OMS PRESS FWD/KIT OXID- FUEL ind. RCS/OMS PRESS RIGHT OXID-FUEL ind.</p> |

TABLE 3.26-3.- Continued

| Location | Type | Nomenclature/ position | Function | Remarks |
|---------------------------------------|------|--|--|--|
| <u>Left/ Center</u> Pnl L4 | cb | AC3ΦB LIGHTING INST L/CTR | Supplies power for illuminating the instrument lights on forward panels F6 and F7 center panel C2. | The specific instruments illuminated are as fol- lows: <u>PANEL C2</u> Left keyboard <u>PANEL F6</u> AMI AVVI HSI ADI <u>PANEL F7</u> SPI OMS PRESS Pc ind. OMS PRESS N2/He TANK ind. Acceleration ind. MPS PRESS Pc ind. MPS PRESS ENG MANF ind. MPS PRESS HELIUM ind. |
| Pnl 06 | cont | LIGHTING INSTRU- MENT LEFT/ CENTER | Same as the LIGHT- ING INSTRUMENT OVERHEAD cont above except forward panels F6 and F7 and center panel C2. | |

TABLE 3.26-3.- Concluded

| Location | Type | Nomenclature/ position | Function | Remarks |
|-----------------------------------|------|---|---|---|
| <u>Right</u> | | | | |
| Pnl L4 | cb | AC1ΦA LIGHTING INST R | Supplies power for illuminating the instrument lights on forward panels F8 and F9, and the center panel C2. | The specific instruments il- luminated are as follows: <u>PANEL C2</u> Right keyboard <u>PANEL F8</u> AMI AVVI HSI ADI HYDRAULIC PRES- SURE ind. HYDRAULIC QUANTITY ind. APU FUEL/H ₂ O QTY ind. APU EGT-FUEL PRESS-OIL TEMP ind. |
| Pnl 08 | cont | LIGHTING PANEL RIGHT INSTRU- MENT | Same as the LIGHT- ING INSTRUMENT OVERHEAD cont above except for- ward panels F8 and F9, and cen- ter panel C2. | |
| <u>Orbit Station (OS)</u> | | | | |
| Pnl L4 | cb | AC1ΦC LIGHTING INST OS | Supplies power for illuminating the instrument lights on aft panels A1, A2, and the ADI. | <u>PANEL F9</u> AC VOLTS ind. DC VOLTS ind. DC AMPS SIG STR ind. |
| Pnl A6 | cont | ORBIT STATION LIGHTING INSTRUMENT | Same as the LIGHT- ING INSTRUMENT OVERHEAD cont above except aft panels A1 and A2 and the ADI. | The specific instruments il- luminated are as follows: <u>PANEL A1</u> SIGNAL STRENGTH ind. <u>PANEL A2</u> LINE-OF-SIGHT RATES ind. <u>PANEL (AFT)</u> ADI |

- Numeric lights

Six indicators on the flight deck use illuminated numeric (digital) read-outs (figs. 3.26-24 through 3.26-26) to display data. Numeric indicators are generally used for quick or precise display of quantitative data or alphanumeric codes. The illumination is provided by incandescent lamps used to form the numerics. A single incandescent lamp is used for each segment of a digit. Seven segments are required to generate the numbers zero through nine. Each numeric indicator has a red light to indicate failures in the indicator. The light will illuminate for the failure of any lamp in the indicator.

The typical numeric lighting configuration is shown in figure 3.26-24.

Numeric lighting control functions are presented in table 3.26-4.

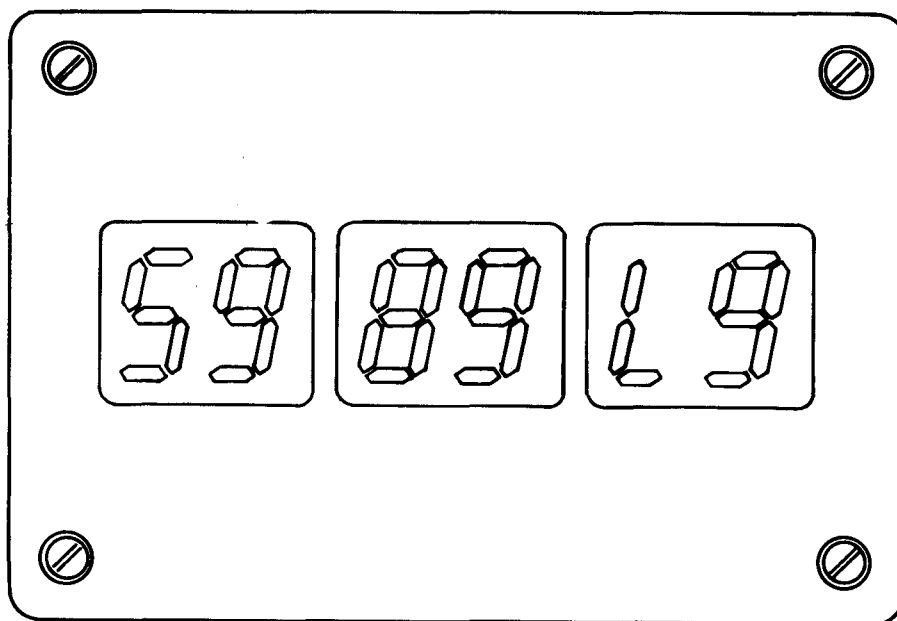


Figure 3.26-24.- Numeric lighting configuration.

There are six numeric (digital) indicators in the Orbiter

| <u>Panel</u> | <u>Indicator</u> |
|--------------|-------------------------|
| F7 | EVENT TIME |
| O3 | MISSION TIME |
| O3 | RCS/OMS PRPLT QTY |
| A2 | DIGI (Rendezvous radar) |
| A4 | EVENT TIME |
| A4 | MISSION TIME |

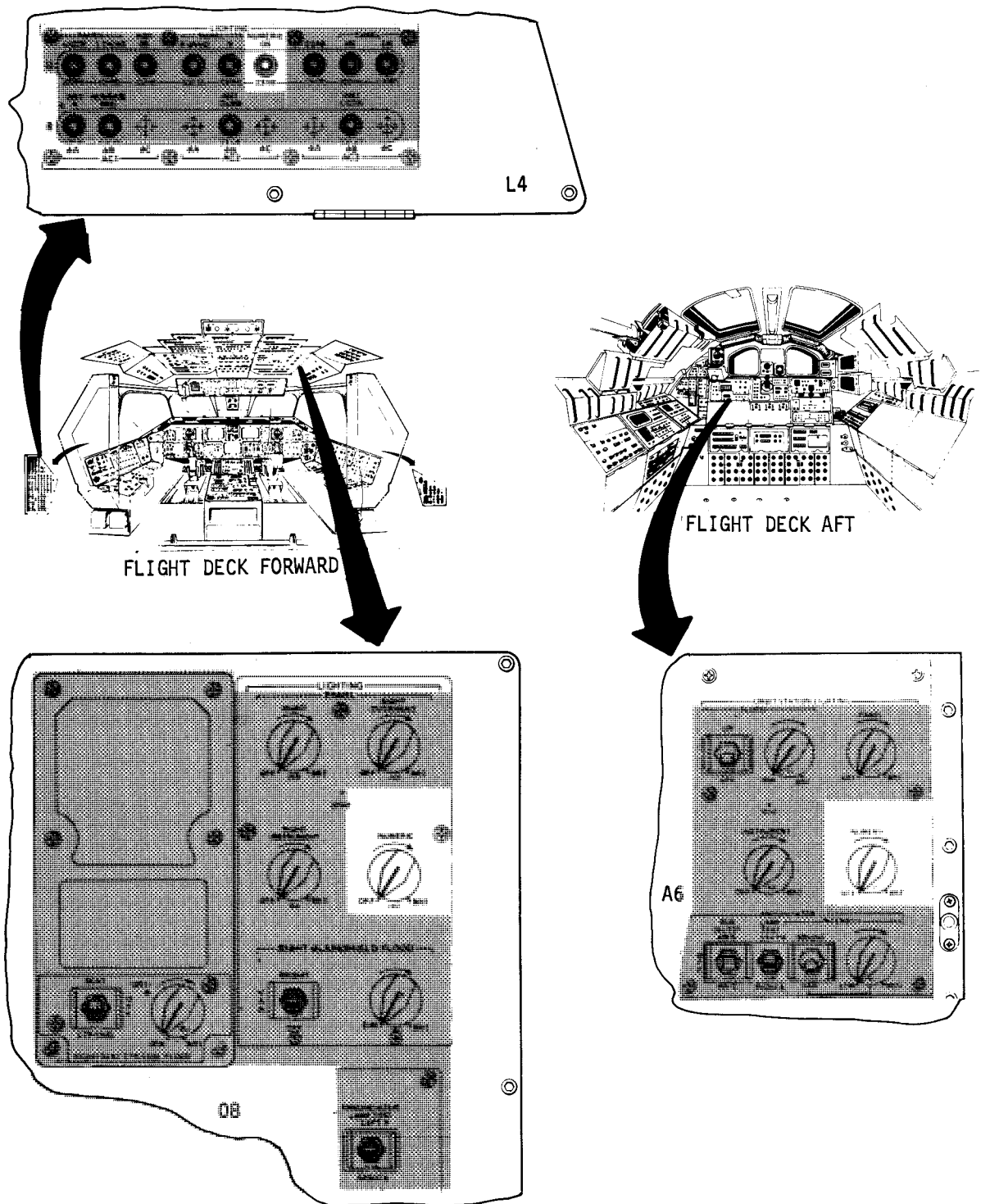


Figure 3.26-25.- Numeric lighting control locations.

3.26-56

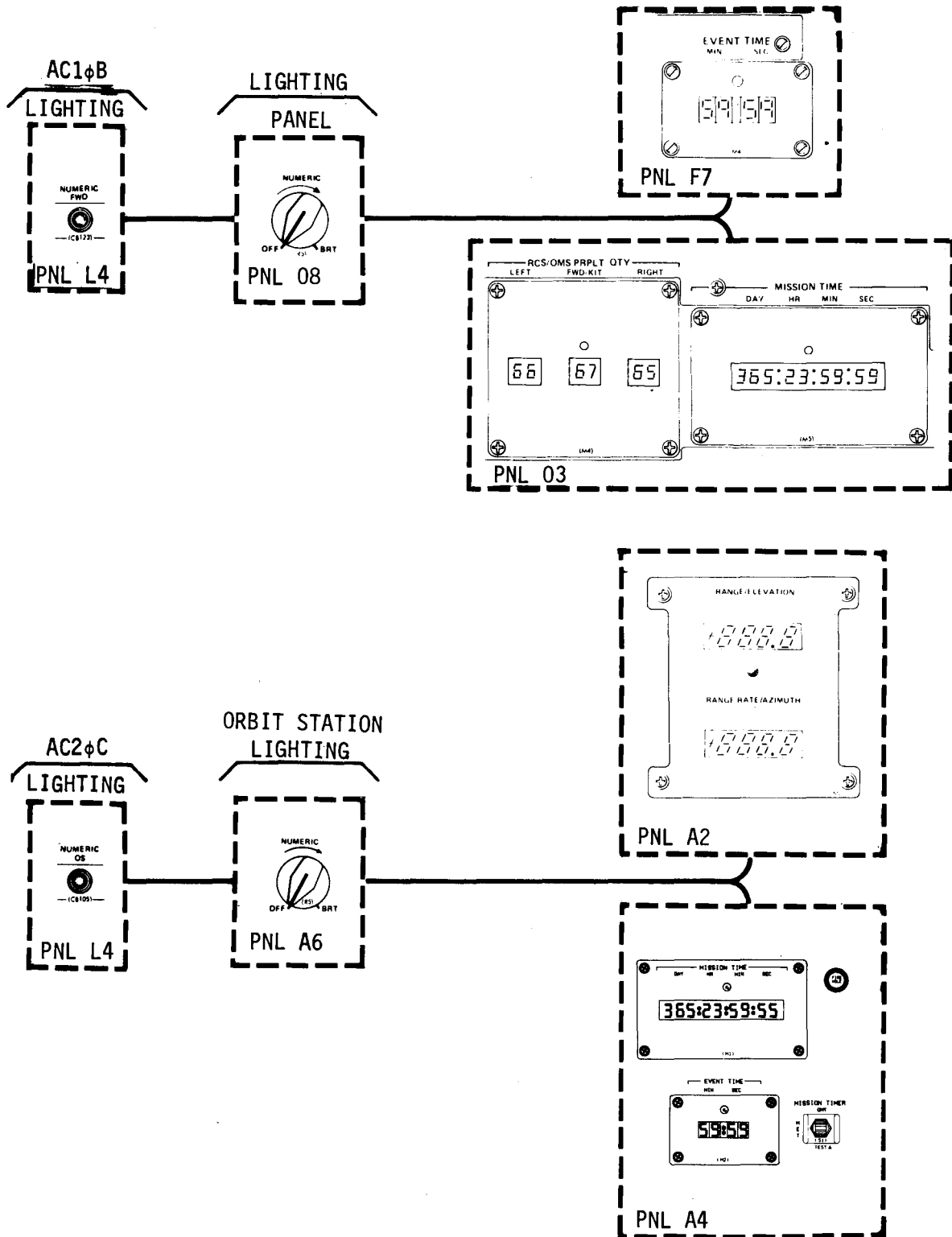



Figure 3.26-26.- Numeric lighting operations.

3.26-57

TABLE 3.26-4.- NUMERIC LIGHTING CONTROL FUNCTIONS

| Location | Type | Nomenclature/ position | Function | Remarks |
|-----------------------------------|------|--|--|---|
| <u>Forward</u> | | | | |
| Pnl L4 | cb | AC1ΦB LIGHTING NUMERIC FWD | Supplies power for illuminating the numeric lighting on forward panels 03 and F7. | The specific numeric indi- cators illumi- nated are as follows: <u>PANEL 03</u> MISSION TIME ind. RCS/OMS PRPLT QTY ind. |
| Pnl 08 | sw | LIGHTING PANEL NUMERIC OFF  BRT | Removes power from the numeric lighting on for- ward panels 03 and F7. Moving the control cw from OFF applies power to the lights and provides variable brightness control. | <u>PANEL F7</u> EVENT TIME ind. |
| <u>Orbit Station (OS)</u> | | | | |
| Pnl L4 | cb | AC2ΦC LIGHTING NUMERIC OS | Supplies power for illuminating the numeric lighting on aft panels A2 and A4. | The specific numeric indi- cators illumi- nated are as follows: <u>PANEL A2</u> RANGE/RATE AZIMUTH ind. |
| Pnl A6 | sw | ORBIT STATION LIGHTING NUME- RIC | Same as the light- ing panel numer- ics cont above except orbit sta- tion panels A2 and A4. | <u>PANEL A4</u> EVENT TIMER ind. MISSION TIMER ind. |

- Annunciator lights

The annunciator lights (figs. 3.26-27 through 3.26-29) provide visual indications of vehicle and payload systems status and configurations in the following areas:

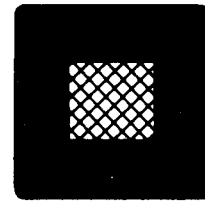
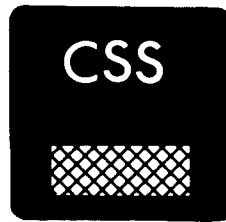
- Range safety
- Abort
- Smoke detection and fire suppression
- Caution and warning (C/W)
- Systems management (SM) alert
- General purpose computers (GPC's)
- Flight Control System (FCS)
- Main engines
- Landing gear
- Communications and video
- Payloads

The lights are classified as emergency/warning, caution, and advisory. The classifications are associated with the following colors:

- Emergency/warning - red
- Caution - yellow
- Advisory - white (status)
 - green (normal configuration)
 - yellow (alternate configuration)
 - blue (special applications)

Annunciator lighting is provided by incandescent lamps which illuminate the lens area of the annunciator or by light emitting diodes (LED's). Most lamps are controlled through electronic circuits in the five annunciator control assemblies (ACA's). Individual inputs to the ACA's illuminate the annunciators when the associated system initiates the function. The C/W and GPC status lights have separate electronics units for lighting control. Lamp test functions are provided through switches (two for the forward flight deck and two for the aft flight deck and mid-deck) which are used to verify that the annunciators are operational. Each area also has a potentiometer control and switch to vary the intensity of the lamps during a normal or test input.

The incandescent lamps include pushbutton indicators (pbi's) and indicator lights. Three different lens configurations exist for the pbi's and indicator lights. One configuration has illuminated nomenclature in the appropriate color on an opaque black background. The nomenclature cannot be seen until it is illuminated. Another configuration has non-illuminated white nomenclature on an opaque black background and a bar that illuminates in the appropriate color. The nomenclature in this configuration is always visible. The third configuration has a bar that illuminates on an opaque black background and no nomenclature on the lens, but nomenclature is available as part of the panel. The configurations are shown in figure 3.26-27.



ILLUMINATED NOMENCLATURE
(NOMENCLATURE IS BLACK
WHEN NOT ILLUMINATED)

ILLUMINATED BAR -
WHITE NOMENCLATURE
(BARS APPEAR BLACK WHEN NOT ILLUMINATED)

ILLUMINATED BAR -
NO NOMENCLATURE
(BARS APPEAR BLACK WHEN NOT ILLUMINATED)

* ALL BACKGROUNDS ARE OPAQUE BLACK

Figure 3.26-27.- Typical annunciator configurations.

Both the PBI's and indicator lights have a minimum of two 2.2-watt bulbs per annunciator with the critical function indicators having four bulbs.

A tone from the C/W system and the master alarm annunciator light accompany an annunciator in the emergency/warning or caution classification. The SM tone and light accompany many of the other annunciators.

The LED annunciators are used for payload annunciator functions and are driven directly. Test functions, if provided, are independent of the vehicle systems annunciators.

Annunciator lighting control functions are presented in table 3.26-6 and ACA channel assignments in table 3.26-6.

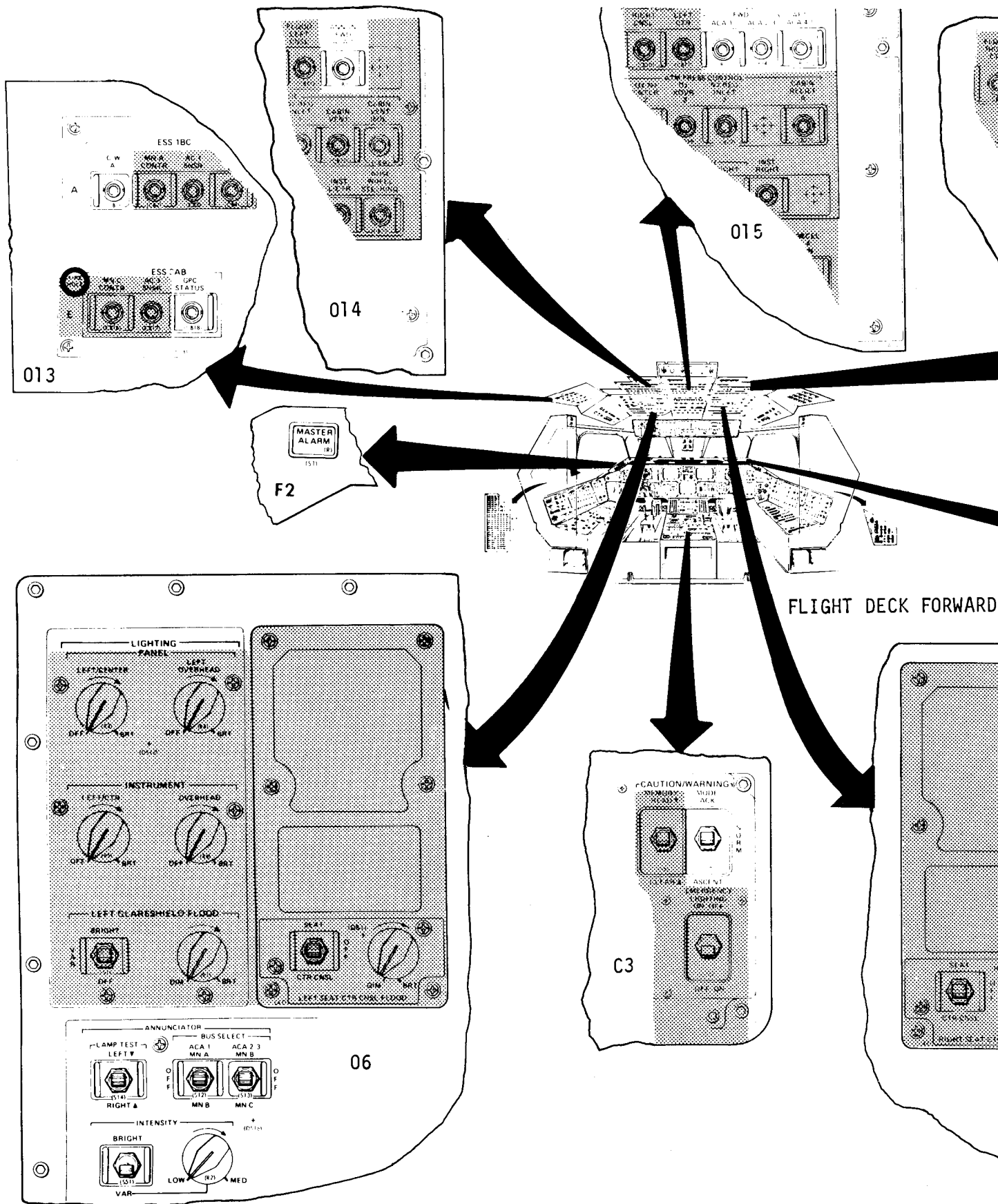
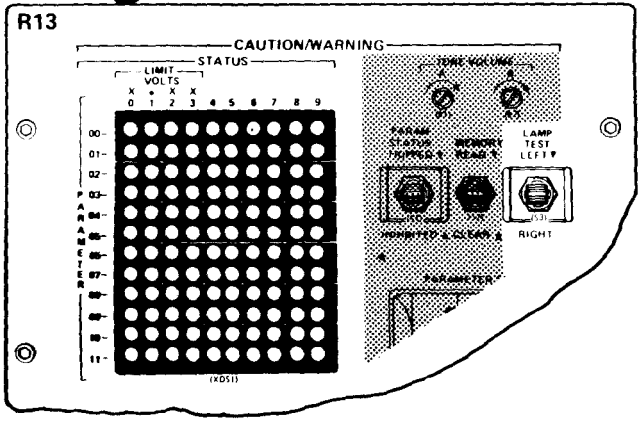
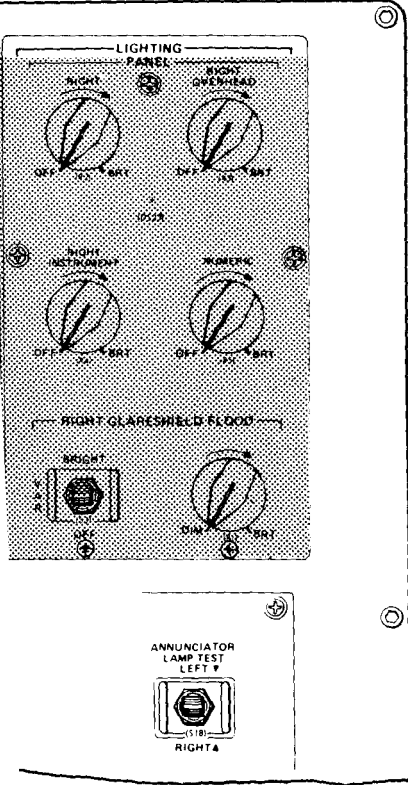
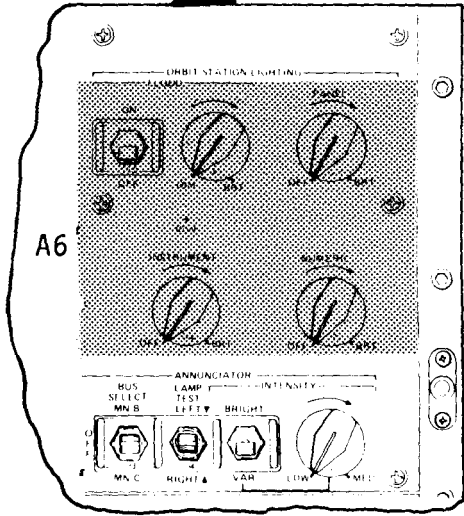
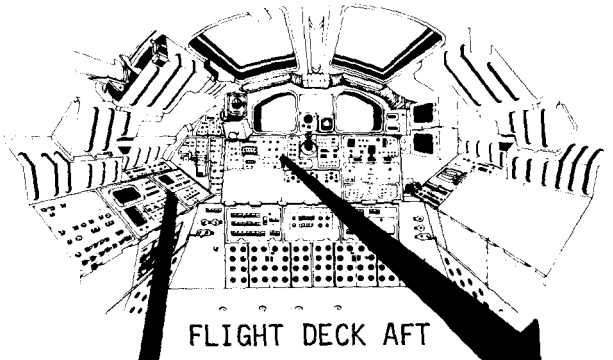
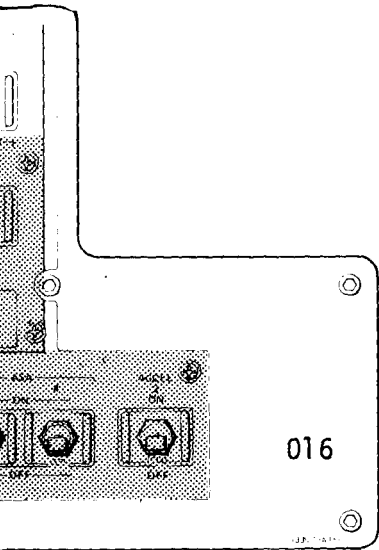


Figure 3.26-28.- Annunciator lighting control locations.



622A

TABLE 3.26-5.- ANNUNCIATOR LIGHTING CONTROL FUNCTIONS

| Location | Type | Nomenclature/ position | Function | Remarks |
|------------------|------|---------------------------|---|---|
| <u>C/W Annun</u> | | | | |
| Pn1 013 | cb | ESS 1BC C/W A | Applies power to the C/W electronics unit A power supply and supplies power for the C/W annunciator (F7) power supply and C/W master alarm relay circuitry | |
| Pn1 C3 | sw | CAUTION/WARNING MODE | <p>ACK Removes power from the C/W annunciator (F7) power supply and enables circuits for illuminating the F2 master alarm PBI</p> <p>NORM Applies power to the C/W annunciator (F7) power supply and enables the circuit for illuminating the F2 master alarm PBI</p> | <p>ACK establishes a mode where the lights for out-of-limit parameters are only allowed to illuminate when the master PBI's on F2 and F4 are depressed</p> <p>Allows lights to illuminate if a parameter is out-of-limits and not inhibited</p> |

TABLE 3.26-5.- Continued

| Location | Type | Nomenclature/ position | Function | Remarks |
|----------|------|-------------------------------|---|--|
| Pn1 F2 | pb | ASCENT | Applies power to the C/W annunciator (F7) power supply and disables the circuit for illuminating the F2 master alarm pbi | The master alarm light was disabled to avoid mistaking it for the range safety light when the range safety light was located on F2 |
| | | MASTER ALARM | | |
| | | DEPRESS | Resets the C/W system for another input, turns off the tone, and extinguishes all master alarm lights. Applies power to the C/W light matrix to illuminate out-of-limit parameter lights when the system is in the ACK mode | |
| Pn1 F4 | pb | MASTER ALARM | LT (red) Indicates a fault detected in the C/W category Same as the pn1 F2 MASTER ALARM pb | The light is accompanied by appropriate C/W lights and C/W tone |
| Pn1 F7 | lts | C/W LT MATRIX | | |
| | | O ₂ PRESS (yellow) | Indicates O ₂ tank pressure <540 or >985 psia | |

TABLE 3.26-5.- Continued

| Location | Type | Nomenclature/ position | Function | Remarks |
|----------|------|--|---|---------|
| | | H ₂ PRESS (yellow) | Indicates H ₂ tank pressure <153 or >293.8 psia | |
| | | FUEL CELL REACT (red) | Indicates O ₂ or H ₂ fuel cell 1, 2, or 3 reactant valve is closed | |
| | | FUEL CELL STACK TEMP (yellow) | Indicates fuel cell 1, 2, or 3 stack temp <172.5° or >243.7° F | |
| | | FUEL CELL PUMP (yellow) | Indicates fuel cell 1, 2, or 3 pump $\Delta P < 2 \pm 1$ psid | |
| | | CABIN ATM (red) | Indicates cabin pressure <14.1 or >15.3 psia, PPO ₂ <2.8 or >3.6 psia, O ₂ flow rate >5 lb/hr, or GN ₂ flow rate >5 lb/hr | |
| | | O ₂ HEATER TEMP (yellow) | Indicates O ₂ tank heater temp >349° F | |
| | | MAIN BUS UNDERVOLT (red) | Indicates main BUS A, B, or C vol- tage <25.2 V dc | |
| | | AC VOLTAGE (yellow) | Indicates AC BUS 1, 2, or 3 phase A, B, or C <108 or >123 V ac | |

TABLE 3.26-5.- Continued

| Location | Type | Nomenclature/ position | Function | Remarks |
|----------|------|---------------------------------|--|---------|
| | | AC OVERLOAD (yellow) | Indicates inverter 1, 2, or 3 phase A, B, or C output of 225 percent O/L for 15 to 20 sec or 300 percent for 4 to 6 sec. | |
| | | FREON LOOP (red) | Indicates Freon loop 1 or 2 sink temp <32° F or >50° F, or a flow rate <1200 lb/hr | |
| | | AV BAY/CABIN AIR (yellow) | Indicates cabin HX out temp >65° F, cabin fan ΔP <0.1 or >0.3 psid or AV BAY 1, 2, or 3 air out temp >139° F | |
| | | IMU (red) | Indicates detection of an IMU failure or dilemma | |
| | | FWD RCS (red) | Indicates detection of FWD RCS fuel tank ullage pres- sure <200 psia or >312 psia, oxidi- zer tank ullage pressure <200 psia or >312 psia, or FWD fuel oxidizer leak (13 percent Δ qty) | |

TABLE 3.26-5.- Continued

| Location | Type | Nomenclature/ position | Function | Remarks |
|----------|------|-----------------------------------|--|---------|
| | | RCS JET (yellow) | Indicates detection of RCS thruster failed ON, failed OFF, or leaking | |
| | | H ₂ O LOOP (yellow) | Indicates loop 1 H ₂ O pump out pressure >79 psia or loop 2 >80 psia | |
| | | RGA/ACCEL (yellow) | Indicates detection of RGA 1, 2, 3, or 4 failure, or accelerometer 1, 2, 3, or 4 failure | |
| | | AIR DATA (red) | Indicates detection of ADTA dilemma | |
| | | LEFT RCS (red) | Indicates detection of left RCS fuel tank ullage pressure <200 psia or >312 psia, oxidizer tank ullage pressure <200 psia or >312 psia, left fuel or oxidizer leak (13 percent Δ qty) | |

TABLE 3.26-5.- Continued

| Location | Type | Nomenclature/ position | Function | Remarks |
|----------|------|---------------------------|--|---------|
| | | RIGHT RCS (red) | Indicates detection of right RCS fuel tank ullage pressure <200 psia or >312 psia, oxidizer tank ullage pressure <200 psia or >312 psia, right fuel or oxidizer leak (13 percent Δ qty) | |
| | | LEFT RHC (red) | Indicates detection of left RHC pitch, roll, or yaw disagree | |
| | | RIGHT/AFT RHC (red) | Indicates detection of right or aft RHC pitch, roll, or yaw disagree | |
| | | LEFT OMS (red) | Indicates detection of left OMS pod fuel or oxidizer ullage pressure <212 psia or >284 psia or engine abnormal (OMS engine fail to cutoff, fail to ignite, or early shutdown) condition | |

TABLE 3.26-5.- Continued

| Location | Type | Nomenclature/ position | Function | Remarks |
|----------|------|---------------------------|--|---------------------------------------|
| | | RIGHT OMS (red) | Indicates detection of right OMS pod fuel or oxidizer tank ullage pressure <212 psia or >284 psia, or engine abnormal (OMS engine fail to cutoff, fail to ignite, or early shutdown) condition | The parameters vary with each mission |
| | | PAYLOAD WARNING (red) | Indicates detection of up to five out-of-limits payload parameter inputs | |
| | | GPC (red) | Indicates GPC 1, 2, 3, 4, or 5 has determined itself failed | |
| | | FCS SATURATION (red) | Indicates detection of elevon position or hinge moment saturation | |
| | | OMS KIT (red) | Indicates detection of OMS kit fuel or oxidizer tank ullage pressure <212 psia or >284 psia | |
| | | OMS TVC (red) | Indicates detection of OMS pitch or yaw gimbal failure | |

TABLE 3.26-5.- Continued

| Location | Type | Nomenclature/ position | Function | Remarks |
|----------|------|--------------------------------|---|---|
| | | PAYLOAD CAUTION (yellow) | Indicates detection of out-of-limit payload parameter input | The failures include the loss of power supply A or B, loss of A or B timing, or that a C/W self-test parameter is out of limit |
| | | PRIMARY C/W (yellow) | Indicates detection of C/W system failure via the C/W electronics unit | |
| | | FCS CHANNEL (yellow) | Indicates detection of an elevon, rudder, or speed brake actuator failure, SRB rock or tilt actuator failure, or MPS engine pitch and yaw actuator failure | |
| | | MPS (red) | Indicates detection of MPS engine He tank press <1150 psia, He reg out press <550 psia, LH2 manifold press <25 psia or >60 psia, or L02 manifold press >249 psia | |
| | | BACKUP C/W ALARM (red) | Indicates detection of C/W alarm via software monitor- ing | |

TABLE 3.26-5.- Continued

| Location | Type | Nomenclature/ position | Function | Remarks |
|-----------------------|------|----------------------------|---|---------|
| <u>GPC</u> Pn1 013 | cb | APU TEMP (yellow) | Indicates APU 1, 2, or 3 exhaust gas temp >1260° F, or lube oil temp <45° F or >265° F | |
| | | APU OVERSPEED (yellow) | Indicates APU 1, 2, or 3 speed >129 percent of design speed | |
| | | APU UNDERSPEED (yellow) | Indicates APU 1, 2, or 3 speed <80 percent of design speed | |
| | | HYD PRESS (yellow) | Indicates hydraul- ics system 1, 2, or 3 supply pres- sure <2760 psia | |
| | | ESS 3AB GPC STATUS | Applies power to the computer in- terface condi- tioning unit (CICU) and GPC annunciator dis- play unit for il- luminating the GPC status light matrix | |

TABLE 3.26-5.- Continued

| Location | Type | Nomenclature/ position | Function | Remarks |
|----------------|------|---------------------------------|---|---|
| Pn1 01 | 1ts | GPC STATUS 1t matrix | A five-by-five light matrix that provides an indication of failed GPC as determined by each computers vote | The diagonal yellow lights indicate a computer has determined itself failed and the non- diagonal white lights indi- cate a GPC has been voted failed by the voting GPC |
| <u>Forward</u> | | | | The specific communicator lights are as follows: |
| Pn1 014 | cb | MNA ANNUN FWD ACA 1 | Supplies power for the ACA 1 elec- tronics and lights | <u>PANEL C3</u> ORBITAL DAP CONTROL MAN 1t ORBITAL DAP RCS JET 1ts (2) MANUAL MODE ROTATION 1ts (9) |
| Pn1 015 | cb | MNB ANNUNCIATOR FWD ACA 1 | Supplies power for the ACA 1 elec- tronics and lights | <u>PANEL F2</u> PITCH 1ts (3) ROLL/YAW 1ts (3) SPD BR/THROT 1t BODY FLAP 1t BFC 1t MASTER ALARM 1t |
| Pn1 06 | sw | ANNUNCIATOR BUS SELECT ACA 1 | MNA Applies MNA bus power to ACA 1 to enable annuncia- tor lights on panels C2, F2, F4, F6, F7, L1, and M052J | <u>PANEL F4</u> MASTER ALARM 1t |
| | | | Also provides power for the lamp test and intensity functions | <u>PANEL F6</u> ABORT 1t RNG SAF ARM 1t |

TABLE 3.26-5.- Continued

| Location | Type | Nomenclature/ position | Function | Remarks | |
|----------|------|-----------------------------------|--|---|---|
| Pnl 015 | cb | MNB ANNUNCIATOR FWD ACA 2/3 | OFF | Removes power from ACA 1 disabling the lights listed above | <u>PANEL F7</u> MAIN ENGINE STATUS LEFT 1t |
| | | | MNB | Same as MNA posi- tion except power source is MNB | <u>PANEL L1</u> SMOKE DETECTION 1ts (5) <u>PANEL M052J</u> MASTER ALARM 1t |
| Pnl 016 | cb | MNC ANNUNCIATOR FWD ACA 2/3 | Supplies power for the ACA 2 and ACA 3 electronics and lights | The specific communicator lights are as follows: | |
| Pnl 06 | sw | ANNUNCIATOR BUS SELECT ACA 2/3 | | Supplies power for the ACA 2 and ACA 3 electronics and lights | <u>PANEL C3</u> ORBITAL DAP SELECT 1ts (2) ORBITAL DAP CONTROL AUTO 1t MANUAL MODE TRANSLATION 1ts (9) |
| | | | MNB | Applies MNB bus power to ACA 2 and ACA 3 to en- able the annunci- ator lights on panels C3, F2, F4, F6, F7, F8, L1, M029J and M052J | <u>PANEL F2</u> NWS FAIL 1t <u>PANEL F4</u> PITCH 1ts (3) ROLL/YAW 1ts (3) SPD BK/THROT 1t BODY FLAP 1t BFC 1t MASTER ALARM 1t ANTISKID FAIL 1t |
| | | | OFF | Removes power from ACA 2 and ACA3 disabling the lights listed above | |

TABLE 3.26-5.- Continued

| Location | Type | Nomenclature/ position | Function | Remarks |
|----------|------|---------------------------|--|---|
| | | MNC | Same as MNB position except power source is MNC | <p><u>PANEL F6</u> LANDING GEAR 1ts (2) ABORT 1t RCS COMMAND 1ts (6) RNG SAF ARM 1t</p> <p><u>PANEL F7</u> SM ALERT 1t MAIN ENGINE STATUS CTR 1t MAIN ENGINE STATUS RIGHT 1t</p> <p><u>PANEL F8</u> LANDING GEAR 1ts (2)</p> <p><u>PANEL L1</u> SMOKE DETECTION B 1ts (5) AGENT DISCH 1ts (3)</p> <p><u>PANEL M029J</u> MIC/KEY 1ts (2)</p> <p><u>PANEL M052J</u> MASTER ALARM 1t</p> |

TABLE 3.26-5.- Continued

| Location | Type | Nomenclature/ position | Function | Remarks |
|----------|------|---------------------------|--|---|
| Pnl 06 | sw | ANNUNCIATOR INTENSITY | <p data-bbox="651 555 1066 913">BRIGHT Applies signals to the intensity circuit so that any position of the cont will provide 100 percent brightness for the ACA 1, ACA 2, ACA 3, C/W, and GPC annunciator lights</p> <p data-bbox="699 1203 1082 1624">VAR Grounds the intensity circuit so that adjusting the cont varies the annunciator lamp intensity. The brightness ranges from 30 to 67 percent for the ACA 1, ACA 2, ACA 3, C/W, and GPC annunciator lights</p> | <p data-bbox="1118 462 1369 685">ACA 1, 2, and 3 annunciator lights not affected by the intensity switch are as follows:</p> <p data-bbox="1118 721 1385 851"><u>PANEL F6</u> RNG SAF ARM 1t (Brt only, 100 percent)</p> <p data-bbox="1118 886 1369 1017"><u>PANEL M029J</u> MIC/KEY 1ts (2) Med only, 67 percent)</p> <p data-bbox="1118 1052 1369 1176"><u>PANEL M052J</u> Master Alarm 1t (Med only, 67 percent)</p> <p data-bbox="1118 1203 1353 1363">The lights affected by the BRIGHT position are as follows:</p> <p data-bbox="1118 1404 1369 1570"><u>PANEL C3</u> ORBITAL DAP 1ts (6) MANUAL MODE 1ts (18)</p> <p data-bbox="1118 1597 1305 1659"><u>PANEL F2</u> NWS FAIL 1t</p> |

TABLE 3.26-5.- Continued

| Location | Type | Nomenclature/ position | Function | Remarks |
|----------|------|---------------------------|----------|---|
| | | | | <p><u>PANEL F2 & F4</u> PITCH 1ts (3) ROLL/YAW 1ts (3) SPD BK/THROT 1t BODY FLAP 1t BFC 1t MASTER ALARM 1t EVENT SEQUENCE 1ts (5)</p> <p><u>PANEL F4</u> ANTISKID FAIL 1t</p> <p><u>PANEL F6</u> RCS COMMAND 1ts (6) ABORT 1t</p> <p><u>PANEL F6 & F8</u> LANDING GEAR 1ts (2)</p> <p><u>PANEL F7</u> SM ALERT 1t CW 1ts (4) MAIN ENGINE STATUS 1ts (3)</p> <p><u>PANEL L1</u> SMOKE DETECTION 1ts (10) AGENTS DISCH 1ts (3)</p> <p><u>PANEL O1</u> GPC STATUS 1ts (25)</p> |

TABLE 3.26-5.- Continued


| Location | Type | Nomenclature/ position | Function | Remarks |
|----------|------|---|--|--|
| | cont | ANNUNCIATOR INTENSITY  | Provides a signal to the annunciator cont assembly such that a cw rotation varies the intensity from 30 (low) to 67 percent (med) when the INTENSITY sw is in the VAR position | The lights affected by the VAR position are as follows: Same as BRIGHT position except <u>PANEL F2 & F4</u> MASTER ALARM lt (Med only, 67 percent) <u>PANEL F6</u> ABORT lt (Med only, 67 percent) |
| Pnl 06 | sw | ANNUNCIATOR LAMP TEST LEFT | Applies a test signal to the annunciator lights on panels F2, F6, F7, L1, 01, and M029J | |

TABLE 3.26-5.- Continued

| Location | Type | Nomenclature/ position | Function | Remarks |
|------------------------------|------|-----------------------------|--|--|
| | | CENTER | Removes test signal allowing normal annunciator light operation | |
| | | RIGHT | Applies a test signal to the annunciator lights on panels C3, F4, F7, F8, and M052J | |
| Pnl 08 | sw | ANNUNCIATOR LAMP TEST | Same as the pnl 06 sw | |
| <u>Orbit Station</u> (OS) | | | | The specific annunciator lights are as follows: |
| Pnl 015 | cb | MNB ANNUNCIATOR AFT ACA 4/5 | Supplies power for ACA 4 and ACA 5 electronics and lights | <u>PANEL A2</u> MIC/KEY lts (2) |
| Pnl 016 | cb | MNC ANNUNCIATOR AFT ACA 4/5 | Supplies power for ACA4 and ACA 5 electronics and lights | <u>PANEL A6</u> ORBITAL DAP SELECT lts (6) MANUAL MODE lts (18) |
| Pnl A6 | sw | ANNUNCIATOR BUS SELECT | | <u>PANEL A7</u> MASTER ALARM 1t VIDEO INPUT lts (13) VIDEO OUTPUT lts (8) ALC lts (3) GAMMA lts (3) |
| | | MNB | Applies MNB bus power to ACA 4 and ACA 5 to enable the annunciator lights on panels A2, A6, and A7 | |

TABLE 3.26-5.- Continued

| Location | Type | Nomenclature/ position | Function | Remarks |
|----------|------|---------------------------|--|---|
| Pnl A6 | sw | ANNUNCIATOR INTENSITY | <p>OFF Removes power from ACA 4 and ACA 5 disabling the lights on panels A2, A6, and A7</p> <p>MNC Same as MNB position except power source is MNC</p> <p>BRIGHT Applies a signal to the intensity circuit so that any position of the cont will provide 100 percent brightness for the ACA 4 and ACA 5 annunciator lights</p> <p>VAR Grounds the intensity circuit so that adjusting the cont varies the annunciator lamp intensity. The brightness ranges from 30 to 67 percent for the ACA 4 and ACA 5 annunciator lights</p> | <p>The lights affected by the BRIGHT position are as follows:</p> <p><u>PANEL A2</u> MIC/KEY 1ts (2)</p> <p><u>PANEL A6</u> ORBITAL DAP 1ts (6) MANUAL MODE 1ts (18)</p> <p><u>PANEL A7</u> MASTER ALARM 1t VIDEO INPUT 1ts (13) VIDEO OUTPUT 1ts (8) ALC 1ts (3) GAMMA 1ts (3)</p> |

TABLE 3.26-5.- Continued


| Location | Type | Nomenclature/ position | Function | Remarks |
|----------|------|---|--|---|
| | cont | <p>ANNUNCIATOR INTENSITY</p>  | <p>Provides a signal to the annunciator cont assembly such that a cw rotation varies the intensity from 30 (low) to 67 percent (med), when the INTENSITY sw is in the VAR position</p> | <p>The lights affected by the VAR position are as follows: Same as the BRIGHT position except</p> <p><u>PANEL A7</u> MASTER ALARM lt (Med only, 67 percent)</p> <p>ACA 4 and 5 annunciator lights not affected by the intensity control are as follows:</p> <p><u>PANEL A7</u> MASTER ALARM lt (Brt and Med only, 100 and 67 percent)</p> |

TABLE 3.26-5.- Concluded

| Location | Type | Nomenclature/ position | Function | Remarks |
|----------|------|---------------------------|--|---------|
| Pn1 A6 | sw | ANNUNCIATOR LAMP TEST | <p data-bbox="683 555 1066 714">LEFT Applies a test signal to the annunciator lights on panels A2 and A6</p> <p data-bbox="651 747 1082 876">CENTER Removes test signal allowing normal annunciator light operation</p> <p data-bbox="667 909 1082 1038">RIGHT Applies a test signal to the annunciator lights on panel A7</p> | |

TABLE 3.26-6.- ANNUNCIATOR CONTROL ASSEMBLY CHANNEL ASSIGNMENTS

ACA NO. 1

| Panel number | Light title | Lamp test | Color | Channel | No. bulbs | Redundant bulb pwr | Brightness control |
|--------------|---------------------------------------|-----------|-------|---------|-----------|--------------------|--------------------|
| L1 | SMOKE DETECTION A - CABIN | Left | R | 1 | 2 | | B&V |
| | L FLT DECK | Left | R | 3 | 2 | | B&V |
| | AV BAY 1 | Left | R | 5 | 2 | | B&V |
| | AV BAY 2 | Left | R | 7 | 2 | | B&V |
| | AV BAY 3 | Left | R | 9 | 2 | | B&V |
| F2 | PITCH - AUTO | Left | W | 13 | 2 | | B&V |
| | CSS | Left | W | 15 | 2 | | B&V |
| | GAIN ENA | Left | W | 17 | 2 | | B&V |
| | ROLL/YAW - AUTO | Left | W | 19 | 2 | | B&V |
| | CSS | Left | W | 21 | 2 | | B&V |
| | DIR | Left | W | 23 | 2 | | B&V |
| | SPD BK/THROT - AUTO | Left | W | 25 | 2 | | B&V |
| | MAN | Left | W | 27 | 2 | | B&V |
| | BODY FLAP - AUTO | Left | W | 29 | 2 | | B&V |
| | MAN | Left | W | 11 | 2 | | B&V |
| | BFC | Left | Y | 37 | 2 | | B&V |
| MASTER ALARM | Left | R | 33 | 2 | ACA2 | B&M | |
| F6 | ABORT | Left | R | 31 | 2 | ACA2 | B&M |
| | RANGE SAFE ARM | Left | R | 35 | 2 | ACA2 | BO |
| | RANGE SAFE ARM | Left | R | 39 | 2 | ACA3 | BO |
| C3 | ORBITAL DAP CONTROL - MAN | Right | W | 2 | 2 | | B&V |
| | RCS JETS - NORM | Right | W | 4 | 2 | | B&V |
| | VERN | Right | W | 6 | 2 | | B&V |
| | MANUAL MODE ROTATION - ROLL DISC RATE | Right | W | 10 | 2 | | B&V |
| | PITCH DISC RATE | Right | W | 12 | 2 | | B&V |
| | YAW DISC RATE | Right | W | 14 | 2 | | B&V |
| | ROLL ACCEL | Right | W | 18 | 2 | | B&V |
| | PITCH ACCEL | Right | W | 20 | 2 | | B&V |
| | YAW ACCEL | Right | W | 22 | 2 | | B&V |
| | ROLL PULSE | Right | W | 26 | 2 | | B&V |
| | PITCH PULSE | Right | W | 28 | 2 | | B&V |
| YAW PULSE | Right | W | 30 | 2 | | B&V | |
| F4 | MASTER ALARM | Right | R | 32 | 2 | ACA3 | B&M |
| F7 | MAIN ENGINE STATUS - LEFT | Right | R | 8 | 2 | | B&V |
| | LEFT | Right | Y | 16 | 2 | | B&V |
| M052J | MASTER ALARM | Right | R | 36 | 2 | ACA3 | MO |
| -- | SPARE | - | - | 24 | - | | B&V |
| -- | SPARE | - | - | 34 | - | | BO |
| -- | SPARE | - | - | 38 | - | | MO |
| -- | SPARE | - | - | 40 | - | | MO |

TABLE 3.26-6.- Continued

ACA NO. 2

| Panel number | Light title | Lamp test | Color | Channel | No. bulbs | Redundant bulb pwr | Brightness control | |
|--------------|--|-----------|-------|---------|-----------|--------------------|--------------------|-----|
| L1 | SMOKE DETECTION B - PAYLOAD R FLT DECK AV BAY 1 AV BAY 2 AV BAY 3 | Left | R | 1 | 2 | | B&V | |
| | | Left | R | 3 | 2 | | B&V | |
| | | Left | R | 5 | 2 | | B&V | |
| | | Left | R | 7 | 2 | | B&V | |
| | | Left | R | 9 | 2 | | B&V | |
| F2 | MASTER ALARM | Left | R | 33 | 2 | ACA1 | B&M | |
| F6 | ABORT RANGE SAFE ARM RCS COMMAND - ROLL L ROLL R PITCH U PITCH D YAW L YAW R | Left | R | 31 | 2 | ACA1 | B&M | |
| | | Left | R | 39 | 2 | ACA1 | BO | |
| | | Left | W | 17 | 1 | ACA3 | B&V | |
| | | Left | W | 19 | 1 | ACA3 | B&V | |
| | | Left | W | 21 | 1 | ACA3 | B&V | |
| | | Left | W | 23 | 1 | ACA3 | B&V | |
| | | Left | W | 25 | 1 | ACA3 | B&V | |
| Left | W | 27 | 1 | ACA3 | B&V | | | |
| F7 | SM ALERT | Left | B | 29 | 2 | ACA3 | B&V | |
| MO29J | MIC KEY | Left | W | 35 | 2 | | MO | |
| | | Left | W | 37 | 2 | | MO | |
| -- | SPARE | | - | 11 | - | | B&V | |
| -- | SPARE | | - | 13 | - | | B&V | |
| -- | SPARE | | - | 15 | - | | B&V | |
| F4 | ANTISKID FAIL PITCH - AUTO CSS GAIN ENA ROLL/YAW - AUTO CSS DIR SPD BK/THROT - AUTO MAN BODY FLAP - AUTO MAN | Right | Y | 12 | 2 | | | B&V |
| | | Right | W | 14 | 2 | | | B&V |
| | | Right | W | 16 | 2 | | | B&V |
| | | Right | W | 18 | 2 | | | B&V |
| | | Right | W | 20 | 2 | | | B&V |
| | | Right | W | 22 | 2 | | | B&V |
| | | Right | W | 24 | 2 | | | B&V |
| | | Right | W | 26 | 2 | | | B&V |
| | | Right | W | 28 | 2 | | | B&V |
| | | Right | W | 30 | 2 | | | B&V |
| | | Right | W | 34 | 2 | | | B&V |
| F7 | MAIN ENGINE STATUS - RIGHT RIGHT | Right | R | 32 | 2 | | B&V | |
| | | Right | Y | 38 | 2 | | B&V | |
| F8 | LANDING GEAR - ARM DOWN | Right | Y | 36 | 2 | | B&V | |
| | | Right | G | 40 | 2 | | B&V | |

TABLE 3.26-6.- Continued

ACA NO. 3

| Panel number | Light title | Lamp test | Color | Channel | No. bulbs | Redundant bulb pwr | Brightness control |
|--------------|---|-----------|-------|---------|-----------|--------------------|--------------------|
| F1 | NWS FAIL | Left | Y | 35 | 2 | | B&V |
| L1 | FIRE SUPPRESSION AV BAY 1 - AGENT DISCH | Left | Y | 11 | 2 | | B&V |
| | 2 - AGENT DISCH | Left | Y | 13 | 2 | | B&V |
| | 3 - AGENT DISCH | Left | Y | 15 | 2 | | B&V |
| F6 | LANDING GEAR - ARM | Left | Y | 31 | 2 | | B&V |
| | DOWN | Left | G | 33 | 2 | | B&V |
| | RCS COMMAND - ROLL L | Left | W | 17 | 1 | ACA2 | B&V |
| | ROLL R | Left | W | 19 | 1 | ACA2 | B&V |
| | PITCH U | Left | W | 21 | 1 | ACA2 | B&V |
| | PITCH D | Left | W | 23 | 1 | ACA2 | B&V |
| | YAW L | Left | W | 25 | 1 | ACA2 | B&V |
| | YAW R | Left | W | 27 | 1 | ACA2 | B&V |
| | RANGE SAFE ARM | Left | R | 39 | 2 | ACA1 | BO |
| F7 | SM ALERT | Left | B | 29 | 2 | ACA2 | B&V |
| -- | SPARE | | - | 37 | - | | MO |
| F4 | BFC | Right | Y | 24 | 2 | | B&V |
| | MASTER ALARM | Right | R | 32 | 2 | ACA1 | B&M |
| F7 | MAIN ENGINE STATUS - CTR | Right | R | 8 | 2 | | B&V |
| | CTR | Right | Y | 16 | 2 | | B&V |
| C3 | ORBITAL DAP SELECT - A | Right | W | 2 | 2 | | B&V |
| | B | Right | W | 4 | 2 | | B&V |
| | CONTROL - AUTO | Right | W | 6 | 2 | | B&V |
| | MANUAL MODE TRANSLATION - X HIGH | Right | W | 10 | 2 | | B&V |
| | Y HIGH | Right | W | 12 | 2 | | B&V |
| | Z HIGH | Right | W | 14 | 2 | | B&V |
| | X NORM | Right | W | 18 | 2 | | B&V |
| | Y NORM | Right | W | 20 | 2 | | B&V |
| | Z NORM | Right | W | 22 | 2 | | B&V |
| | X PULSE | Right | W | 26 | 2 | | B&V |
| | Y PULSE | Right | W | 28 | 2 | | B&V |
| | Z PULSE | Right | W | 30 | 2 | | B&V |
| M052J | MASTER ALARM | Right | R | 36 | 2 | ACA1 | MO |
| -- | SPARE | | - | 34 | - | | BO |
| -- | SPARE | | - | 38 | - | | MO |
| -- | SPARE | | - | 40 | - | | MO |

TABLE 3.26-6.- Continued

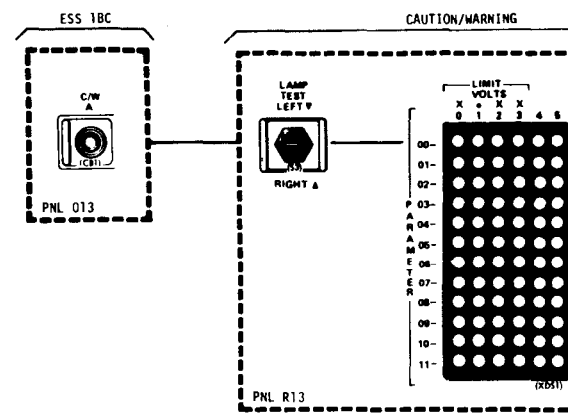
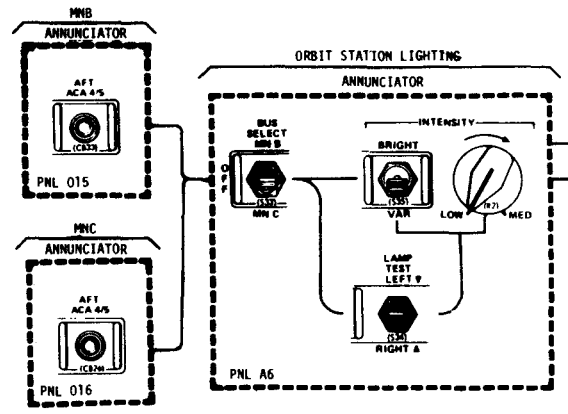
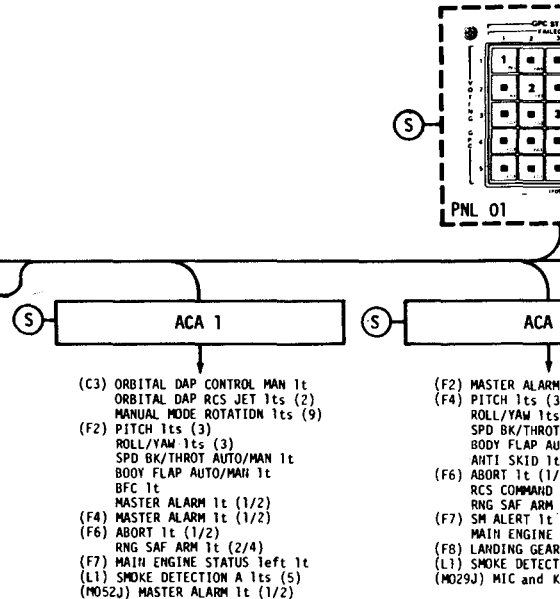
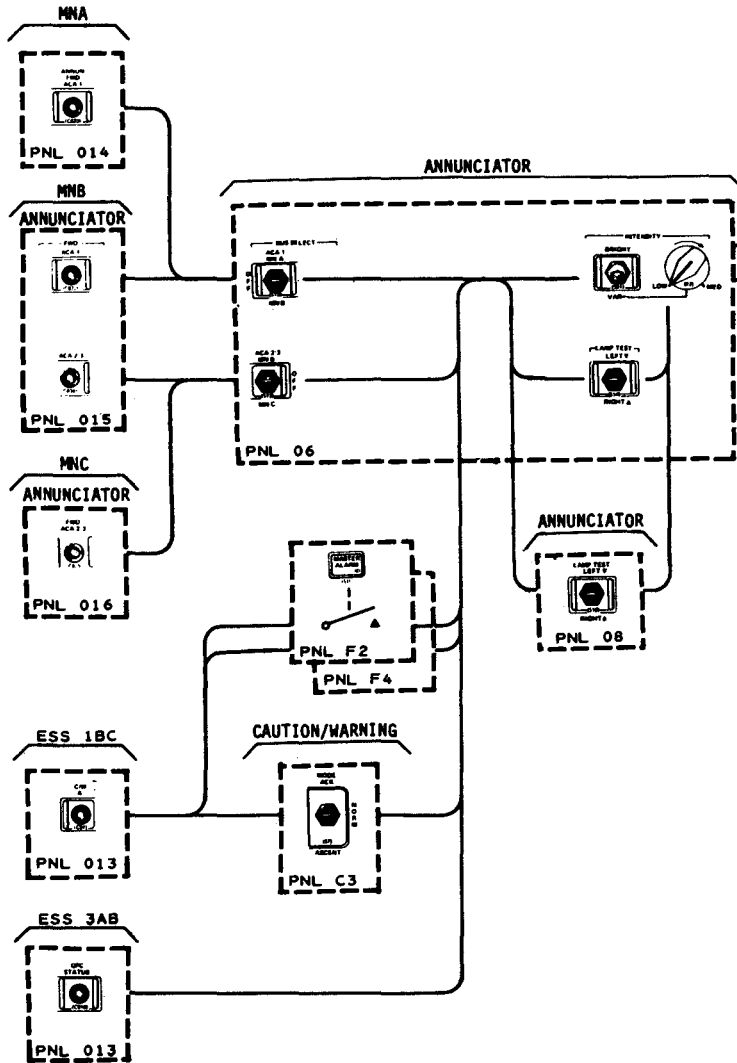
ACA NO. 4

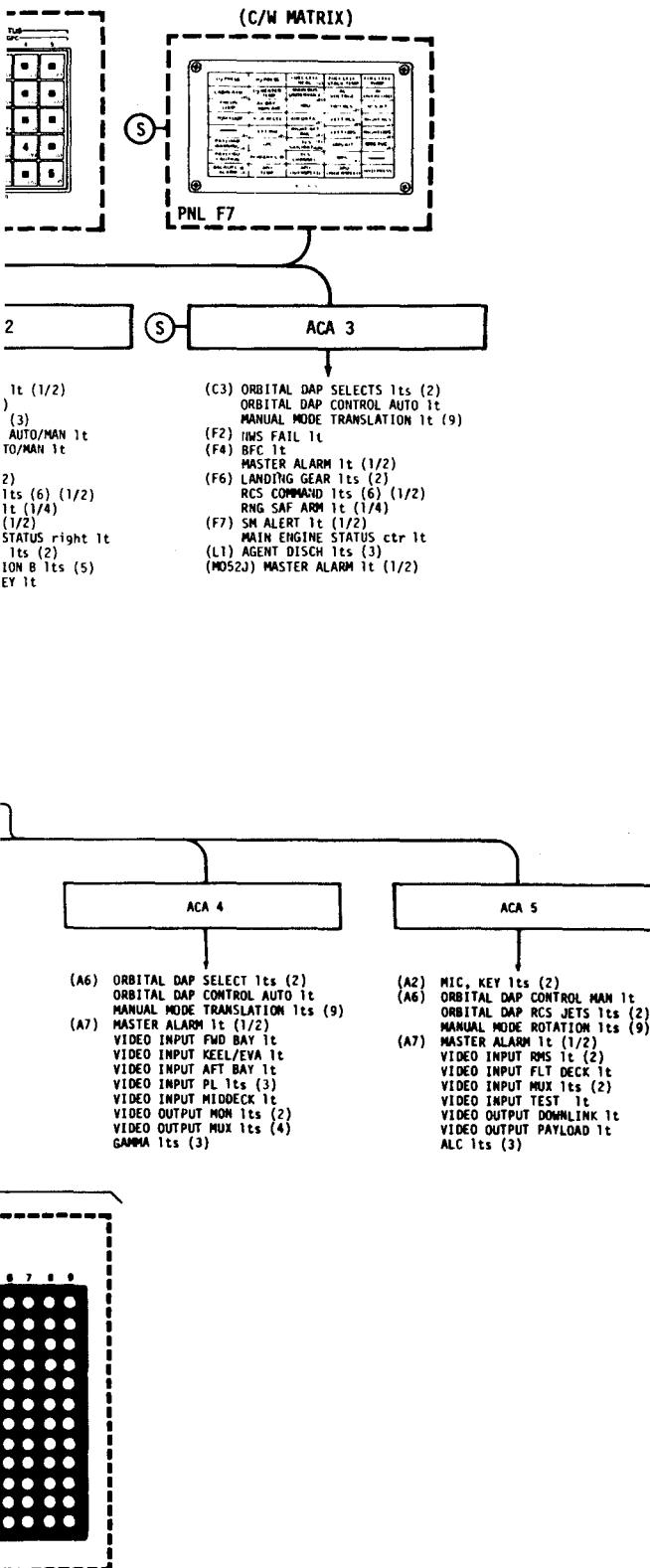
| Panel number | Light title | Lamp test | Color | Channel | No. bulbs | Redundant bulb pwr | Brightness control | |
|---------------------|----------------------------------|-----------------------|-------|---------|-----------|--------------------|--------------------|-----|
| A6 | ORBITAL DAP SELECT - A | Left | W | 1 | 2 | | B&V | |
| | B | Left | W | 3 | 2 | | B&V | |
| | CONTROL - AUTO | Left | W | 5 | 2 | | B&V | |
| | MANUAL MODE TRANSLATION - X HIGH | Left | W | 9 | 2 | | B&V | |
| | Y HIGH | Left | W | 11 | 2 | | B&V | |
| | Z HIGH | Left | W | 13 | 2 | | B&V | |
| | X NORM | Left | W | 17 | 2 | | B&V | |
| | Y NORM | Left | W | 19 | 2 | | B&V | |
| | Z NORM | Left | W | 21 | 2 | | B&V | |
| | X PULSE | Left | W | 25 | 2 | | B&V | |
| | Y PULSE | Left | W | 27 | 2 | | B&V | |
| | Z PULSE | Left | W | 29 | 2 | | B&V | |
| | -- SPARE | | | - | 7 | - | | B&V |
| | -- SPARE | | | - | 15 | - | | B&V |
| | -- SPARE | | | - | 23 | - | | B&V |
| | -- SPARE | | | - | 31 | - | | B&M |
| | -- SPARE | | | - | 33 | - | | B&M |
| | -- SPARE | | | - | 35 | - | | BO |
| | -- SPARE | | | - | 37 | - | | MO |
| | -- SPARE | | | - | 39 | - | | MO |
| | | VIDEO OUTPUT - MON 1 | Right | W | 2 | 2 | | B&V |
| | | MON 2 | Right | W | 8 | 2 | | B&V |
| | | MUX 1L | Right | W | 4 | 2 | | B&V |
| | | MUX 1R | Right | W | 6 | 2 | | B&V |
| | | MUX 2L | Right | W | 10 | 2 | | B&V |
| | | MUX 2R | Right | W | 12 | 2 | | B&V |
| | A7 | VIDEO INPUT - FWD BAY | Right | W | 14 | 2 | | B&V |
| | | KEEL/EVA | Right | W | 16 | 2 | | B&V |
| | | AFT BAY | Right | W | 18 | 2 | | B&V |
| PL 1 | | Right | W | 20 | 2 | | B&V | |
| PL 2 | | Right | W | 22 | 2 | | B&V | |
| PL 3 | | Right | W | 24 | 2 | | B&V | |
| MIDDECK | | Right | W | 34 | 2 | | B&V | |
| GAMMA - WHITE STRCH | | Right | W | 26 | 2 | | B&V | |
| NORM | | Right | W | 28 | 2 | | B&V | |
| BLACK STRCH | | Right | W | 30 | 2 | | B&V | |
| MASTER ALARM | | Right | R | 32 | 2 | ACA5 | B&M | |
| -- SPARE | | | | - | 36 | - | | BO |
| -- SPARE | | | | - | 38 | - | | MO |
| -- SPARE | | | - | 40 | - | | MO | |

TABLE 3.26-6.- Concluded

ACA NO. 5

| Panel number | Light title | Lamp test | Color | Channel | No. bulbs | Redundant bulb pwr | Brightness control | |
|--------------|---------------------------------------|-----------|-------|---------|-----------|--------------------|--------------------|-----|
| A2 | MIC | Left | W | 37 | 2 | | B&V | |
| | KEY | Left | W | 35 | 2 | | B&V | |
| A6 | ORBITAL DAP CONTROL - MAN | Left | W | 1 | 2 | | B&V | |
| | RCS JETS - NORM | Left | W | 3 | 2 | | B&V | |
| | VERN | Left | W | 5 | 2 | | B&V | |
| | MANUAL MODE ROTATION - ROLL DISC RATE | Left | W | 9 | 2 | | B&V | |
| | PITCH DISC RATE | Left | W | 11 | 2 | | B&V | |
| | YAW DISC RATE | Left | W | 13 | 2 | | B&V | |
| | ROLL ACCEL | Left | W | 17 | 2 | | B&V | |
| | PITCH ACCEL | Left | W | 19 | 2 | | B&V | |
| | YAW ACCEL | Left | W | 21 | 2 | | B&V | |
| | ROLL PULSE | Left | W | 25 | 2 | | B&V | |
| | PITCH PULSE | Left | W | 27 | 2 | | B&V | |
| | YAW PULSE | Left | W | 29 | 2 | | B&V | |
| | --- | SPARE | | - | 7 | - | | B&V |
| | --- | SPARE | | - | 15 | - | | B&V |
| | --- | SPARE | | - | 23 | - | | B&V |
| | --- | SPARE | | - | 31 | - | | B&M |
| --- | SPARE | | - | 33 | - | | B&M | |
| --- | SPARE | | - | 39 | - | | MO | |
| A7 | VIDEO OUTPUT - DOWNLINK | Right | W | 6 | 2 | | B&V | |
| | PAYLOAD | Right | W | 12 | 2 | | B&V | |
| | VIDEO INPUT - RMS STBD | Right | W | 14 | 2 | | B&V | |
| | RMS PORT | Right | W | 16 | 2 | | B&V | |
| | FLT DECK | Right | W | 18 | 2 | | B&V | |
| | MUX 1 | Right | W | 20 | 2 | | B&V | |
| | MUX 2 | Right | W | 22 | 2 | | B&V | |
| | TEST | Right | W | 24 | 2 | | B&V | |
| | ALC - PEAK | Right | W | 26 | 2 | | B&V | |
| | NORM | Right | W | 28 | 2 | | B&V | |
| | AVG | Right | W | 30 | 2 | | B&V | |
| | MASTER ALARM | Right | R | 32 | 2 | ACA4 | B&M | |
| | --- | SPARE | | - | 2 | - | | B&V |
| | --- | SPARE | | - | 4 | - | | B&V |
| --- | SPARE | | - | 8 | - | | B&V | |
| --- | SPARE | | - | 10 | - | | B&V | |
| --- | SPARE | | - | 34 | - | | BO | |
| --- | SPARE | | - | 36 | - | | BO | |
| --- | SPARE | | - | 38 | - | | MO | |
| --- | SPARE | | - | 40 | - | | MO | |





- Notes:**
- The lamp test (panels 06 and 08) illuminates the following lights:
LEFT - Panels F2, F6, F7 (SM ALERT and 20 C/W), L1, O1, and M029J (MIC and KEY).
RIGHT - Panels C3, F4, F7 (Main Engine and 20 C/W), F8 and M052J.
 - The C/W annunciators are not active when the system is in the ACK mode, until the panel F2 or F4 master alarm is depressed.
 - The master alarm light (panel F2) does not illuminate when the system is in the ASCENT mode.
 - (1/2) indicates one of two bulbs illuminated.
 - The intensity control determines the illumination levels during a lamp test.
 - The intensity control (panel 06) does not affect the following lights:
100% Brightness only
(F6) RNG SAF ARM
67% Brightness only
(M029J) MIC and KEY
(M052J) MASTER ALARM
 - The intensity variable control (panel 06) does not affect the following lights which operate only at 100% or 67%:
(F2) MASTER ALARM
(F4) MASTER ALARM
(F6) ABORT
 - The lamp test (panel A6) illuminates the following lights:
LEFT - Panels A2 and A6
RIGHT - Panel A7
 - The C/W lamp test (panel R13) illuminates the following lights:
LEFT - Columns 0 through 4
RIGHT - Columns 5 through 9
- Symbol: (S) Indicates the systems inputs that activate the individual lights.

646 A

Figure 3.26-29.- Annunciator lighting operations.

Exterior Lighting

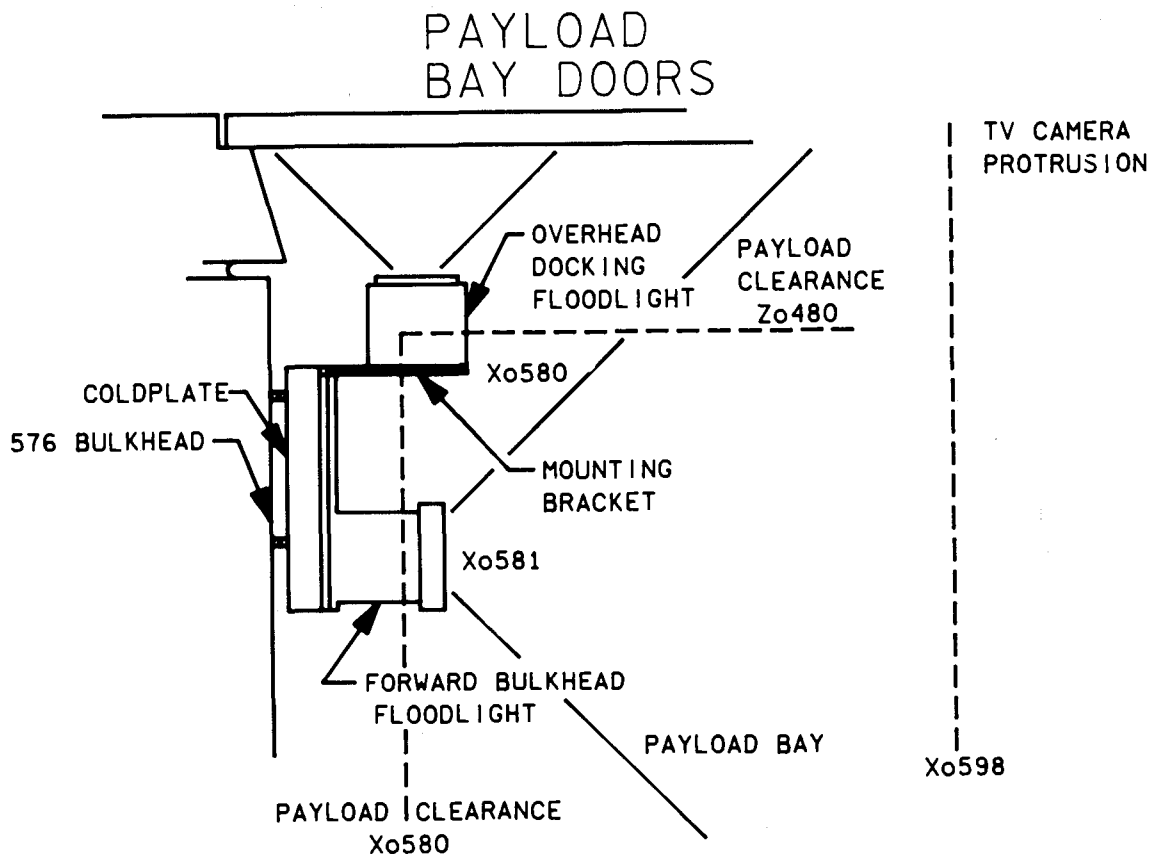
Exterior lighting consists of both incandescent and high-intensity discharge (metal halide) lamps. The system provides broad-beam-type floodlights (figs. 3.26-30 through 3.26-36) that illuminate another vehicle during rendezvous, the payload bay area, and any object toward which the RMS is pointed.

- Overhead Docking Light

The overhead docking light (fig. 3.26-30) is used during the rendezvous stationkeeping (formation) and docking phase to provide the crew perspective viewing of the passive vehicle.

Initially, the docking light was intended to be inset into the cockpit ceiling with the lamp face flush to the outer skin surface of the Shuttle. This design was changed when a major TPS redesign was found to be required.

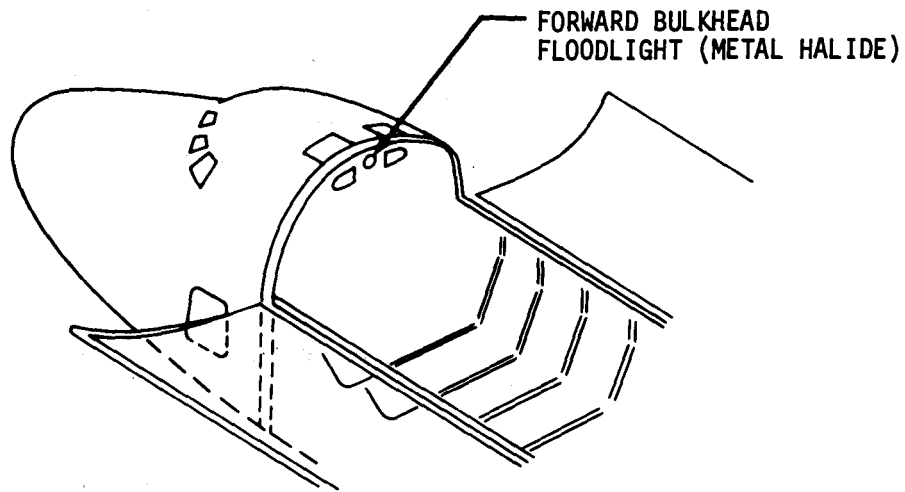
The docking light is now mounted on a bracket that is located on the forward bulkhead in the payload bay. The forward bulkhead floodlight is also mounted on the bracket as noted in figures 3.26-30 and 3.26-31.



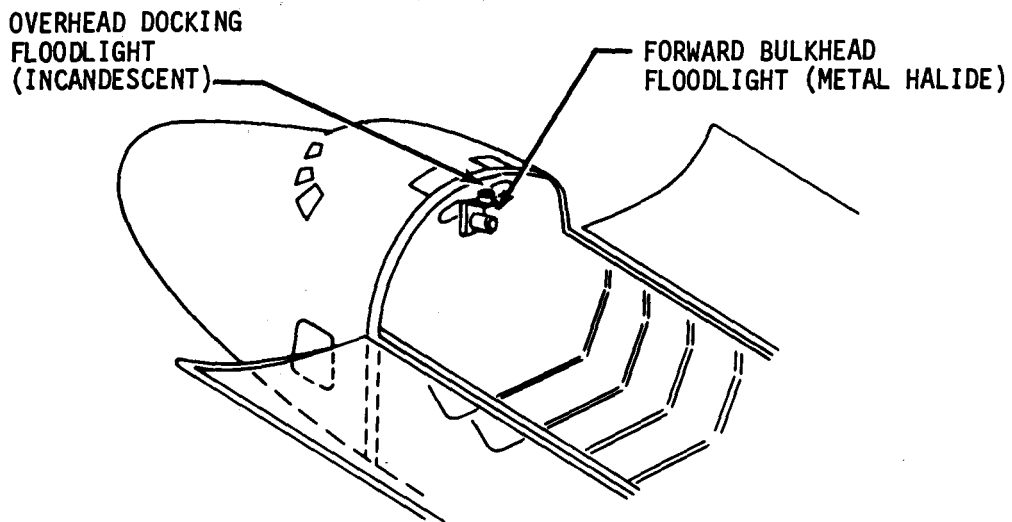
2203. ART, 2

Figure 3.26-30.- Overhead docking and forward bulkhead lamp assembly.

3.26-89



BULKHEAD FLOODLIGHT



DOCKING AND BULKHEAD FLOODLIGHT

Figure 3.26-31.- Bulkhead floodlight assembly.

- Payload Bay Lights

The payload bay worksite lights (fig. 3.26-32) provide illumination for the exterior work stations and traverse routes during EVA.

The payload bay lights are metal halide-type lamps. The lights have a luminous intensity (candle power) sufficient to illuminate the surface of the vehicle for the crew to perform their task.

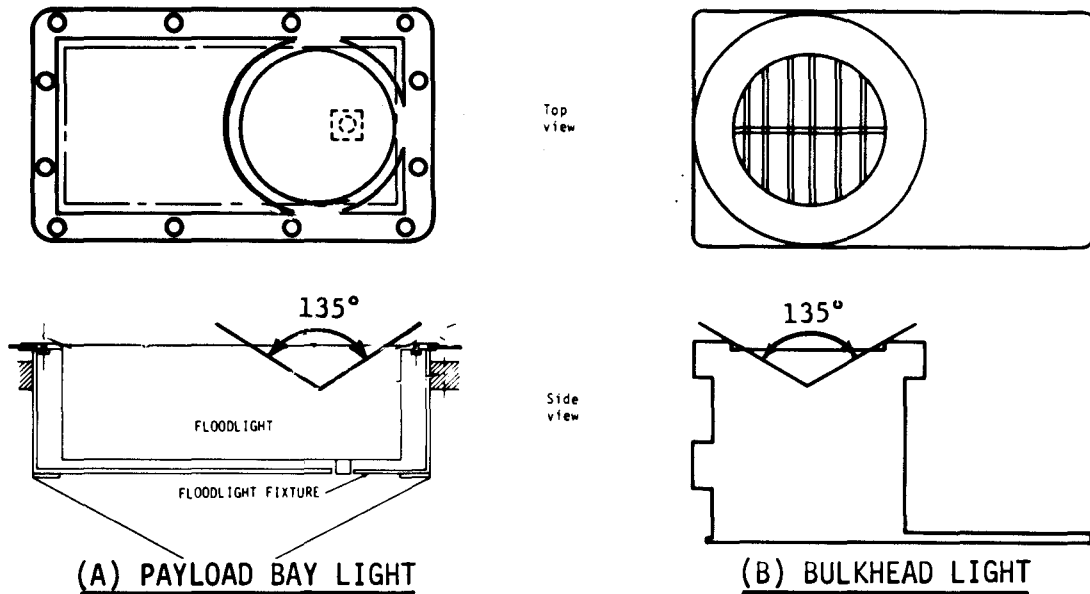


Figure 3.26-32.- Payload bay lights.

- RMS Light

The RMS light (fig. 3.26-33) is mounted in close proximity to a television camera to provide visual alignment information between the RMS and payloads for deployment and retrieval operations. For additional information on RMS lighting, see SFOM, volume 16.

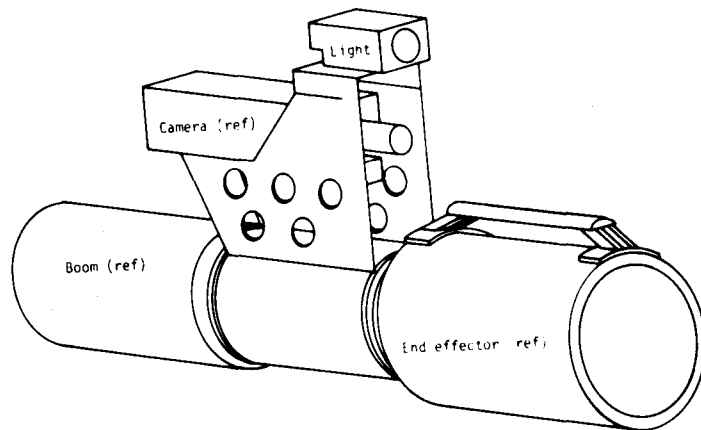


Figure 3.26-33.- Remote manipulator system lights.

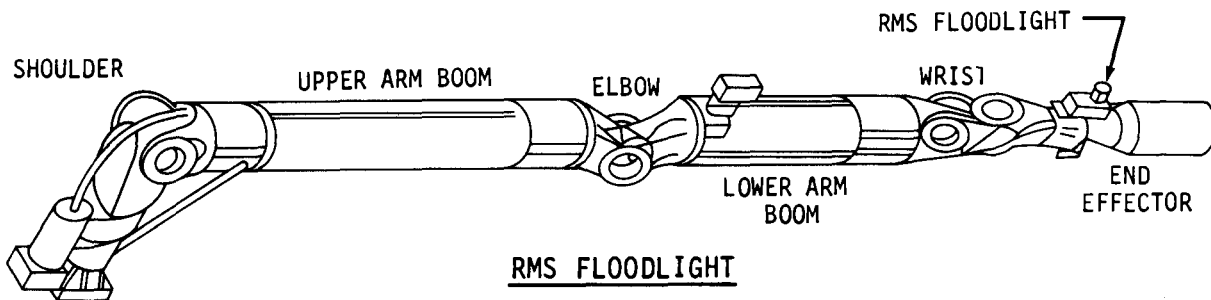
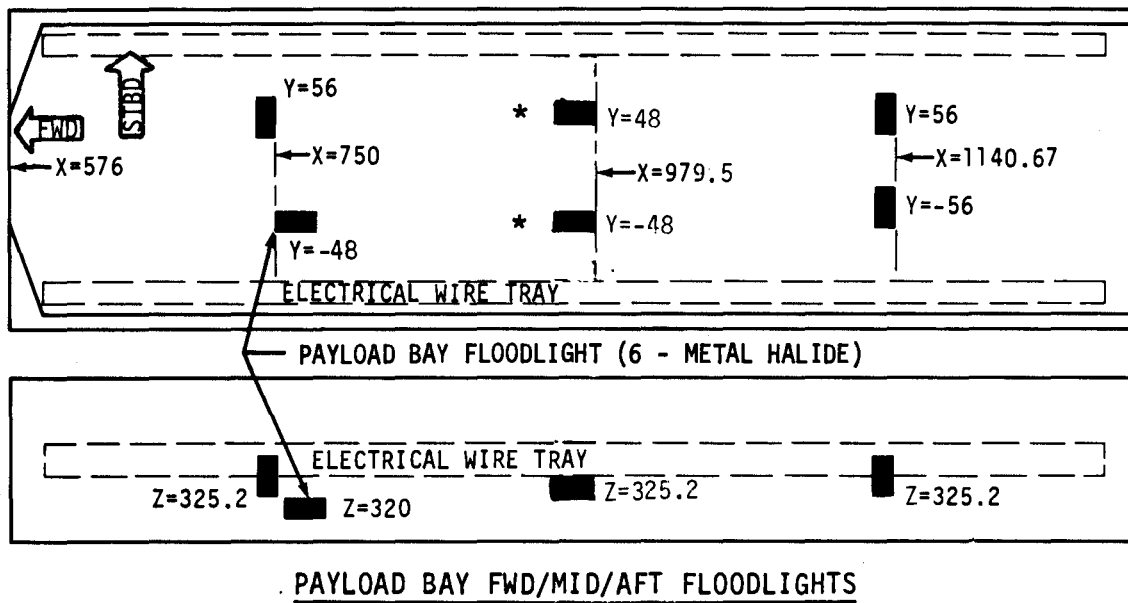


Figure 3.26-34.- RMS/payload bay floodlights.

Exterior lighting control functions are presented in table 3.26-7.

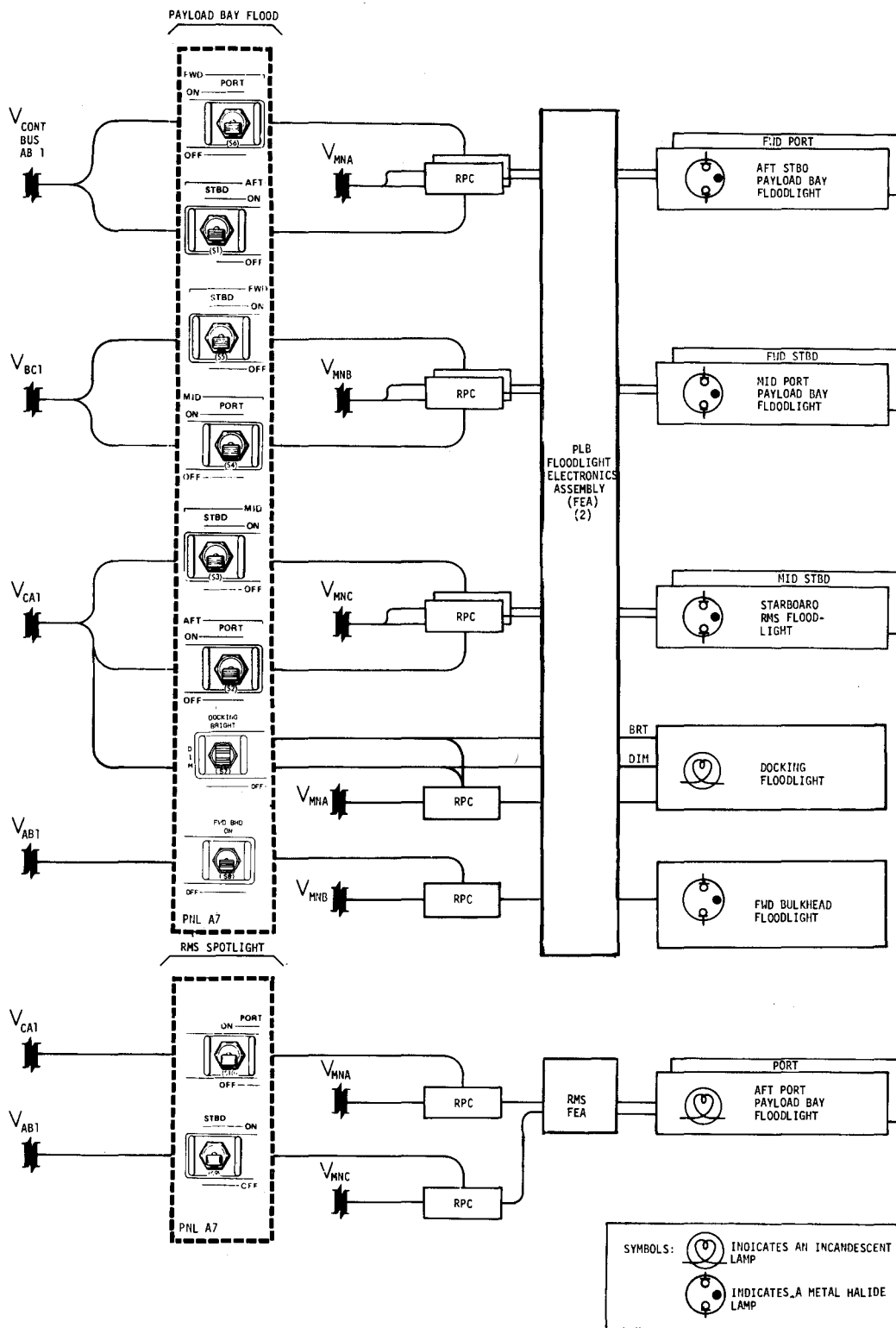


Figure 3.26-36.- Exterior floodlight operations.

TABLE 3.26-7.- EXTERIOR LIGHTING CONTROL FUNCTIONS

| Location | Type | Nomenclature/ position | Function | Remarks |
|---|------|-------------------------------|---|--|
| <u>Payload Bay Lights</u> Pn1 A7 | sw | PAYLOAD BAY FLOOD AFT STBD | ON | Provides a signal to an RPC which illuminates the forward starboard payload bay floodlight |
| | | | OFF | Removes the signal from the floodlight, turning it off |
| | sw | PAYLOAD BAY FLOOD AFT PORT | Same as the PAYLOAD BAY FLOOD AFT STBD sw except the port floodlight | |
| | sw | PAYLOAD BAY FLOOD MID STBD | Same as the PAYLOAD BAY FLOOD AFT STBD sw except the midstarboard floodlight | |
| | sw | PAYLOAD BAY FLOOD MID PORT | Same as the PAYLOAD BAY FLOOD AFT STBD sw except the midport floodlight | |
| | sw | PAYLOAD BAY FLOOD FWD STBD | Same as the PAYLOAD BAY FLOOD AFT STBD sw except the forward starboard floodlight | |

TABLE 3.26-7.- Continued

| Location | Type | Nomenclature/ position | Function | Remarks |
|---|------|--|--|---------|
| <p><u>Docking Light</u></p> <p>Pn1 A7</p> | SW | PAYLOAD BAY FLOOD FWD PORT | Same as the PAYLOAD BAY FLOOD AFT STBD sw except the for- ward port flood- light | |
| | SW | PAYLOAD BAY FLOOD FWD BULKHEAD | Same as the PAYLOAD BAY FLOOD AFT STBD sw except the for- ward bulkhead floodlight | |
| | SW | PAYLOAD BAY FLOOD FWD DOCKING BRIGHT DIM | Provides a signal to an RPC which illuminates the overhead docking floodlight and a signal to the floodlight elec- tronics assembly which allows full intensity Provides a signal to an RPC which illuminates the overhead docking floodlight and a signal to the floodlight elec- tronics assembly which reduces the intensity | |

TABLE 3.26-7.- Concluded

| Location | Type | Nomenclature/ position | Function | Remarks | |
|----------------------------|------|---------------------------|--|---------|--|
| <u>RMS Light</u> Pn1 A7 | sw | OFF | Removes power from the overhead docking floodlight, turning it off | | |
| | | RMS SPOTLIGHT STBD | ON | | Applies power to the starboard RMS spotlight, illuminating the light |
| | sw | OFF | Removes power from the port RMS spotlight, turning it off | | |
| | | RMS SPOTLIGHT PORT | Same as the RMS SPOTLIGHT STBD sw except the port RMS | | |

3.26.4 Systems Performance, Limitations, and Constraints

Interior Lighting

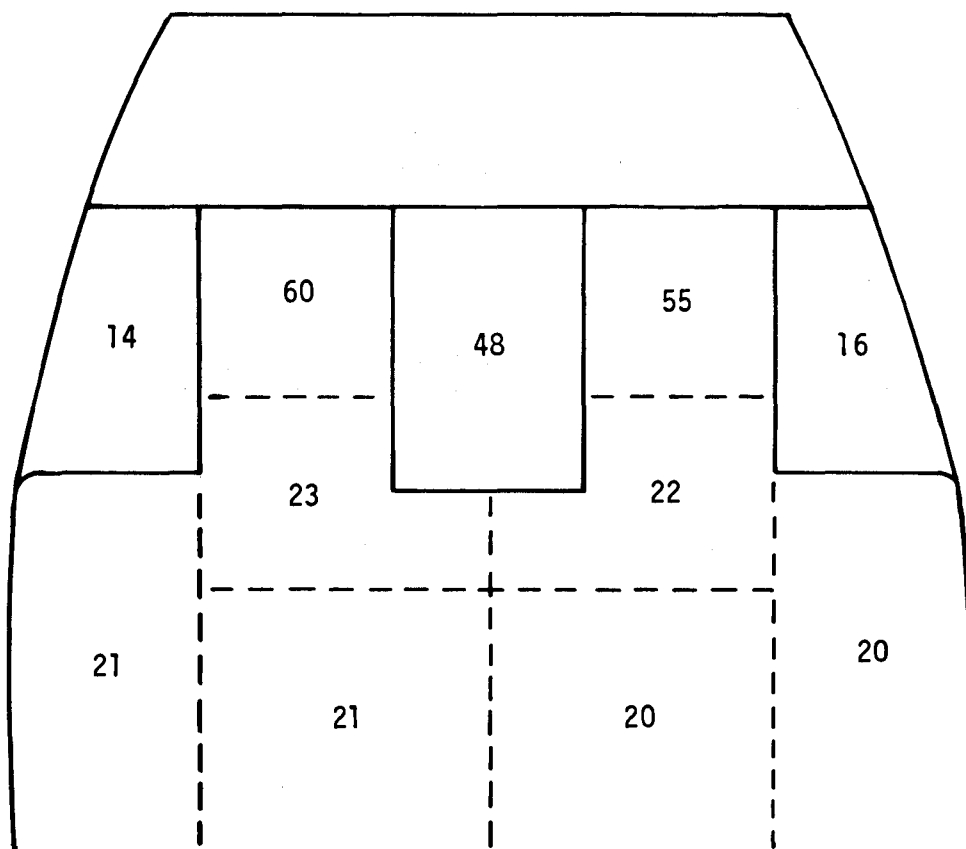
- Flight deck illumination levels: ref. figure 3.26-37.
- Middeck illumination levels: ref. figure 3.26-38.
- Lighting characteristics (type light, overall color, rated brightness level, brightness adjustment, and power requirements): ref. table 3.26-8.

Exterior Lighting

- Lighting characteristics (type light, overall color, rated brightness level, brightness adjustment, and power requirements): ref. table 3.26-9.

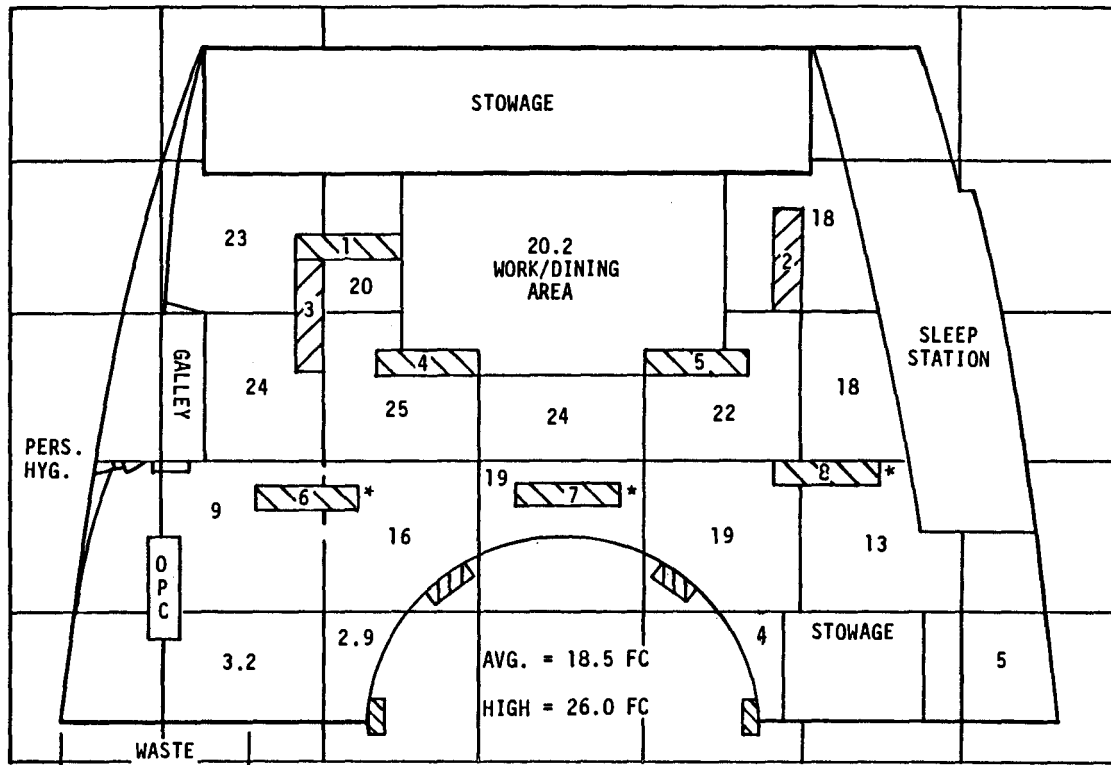
Lighting Power Sources

- Lighting losses vs. bus failure: ref. table 3.26-10.



NOTE: Numbers are foot candles at 3 feet above the floor.

Figure 3.26-37.- Flight deck illumination levels.



* DENOTES EMERGENCY LIGHT

NOTE: Numbers are foot-candles at 3 feet above the floor.

Figure 3.26-38.- Middeck illumination levels.

TABLE 3.28-8.- INTERIOR LIGHTING

| Component | Lighting method | Illumination color | Brightness/intensity (rated capacity) | Adjustment | Power 28 V dc | Remarks |
|---|-----------------|---|---|------------------------------------|---------------------|---|
| Glareshield, MS, and PS floodlights | Fluorescent | White unfiltered | 200 ft-c max. | Continuous from 0 ft-L | 33.0 watts | The fixture contains two redundant bulbs. |
| Seat/center console floodlights | Incandescent | White unfiltered | 20 ft-c max. | Continuous from 0 ft-L | 22.0 watts | The fixture contains two bulbs, but only one can be active at a time. |
| Side console, sleep station floodlights | Fluorescent | White unfiltered | 25 ft-c max. | Continuous from 0 ft-L | 16.5 watts | The adjustment pot is an integral part of the lighting assembly. |
| OS floodlights | Fluorescent | White unfiltered | 25 ft-c max. | Continuous from 0 ft-L | 19.0 watts | |
| Middeck, WMC, and PHS floodlights | Fluorescent | White unfiltered | 22 ft-c max. | Fixed | 16.5 watts | |
| Airlock lights | Fluorescent | White unfiltered | 60 ft-c max. | Fixed | 16.5 watts | |
| Panel lights (flight deck) | Incandescent | White - lunar white | 1.8 ± 0.6 ft-L max. | Continuous from 0 ft-L | 16.0 to 177.0 watts | The power values are per panel. |
| Panel lights (mid-deck - MO13Q) | Fluorescent | White unfiltered | 3.5 ft-c max. | Fixed | 6.6 watts | |
| Instrument lights | Incandescent | White | 1.8 ± 0.6 ft-L max. | Continuous from 0 ft-L | 13.5 to 57.8 watts | The power values are per unit. |
| Numeric lights | Incandescent | Aviation yellow | 10 ft-L max. | Continuous from 0 ft-L | 17.5 to 20.0 watts | |
| Master alarm lights | Incandescent | Aviation red | 150 ± 50 ft-L | Fixed | 8.8 watts | |
| C&W annunciator lights | Incandescent | Warning: aviation red Caution: aviation yellow | 60 ± 5 ft-L max. 25 ± 5 ft-L max. var. | Continuous from 1.5 ± 0.5 ft-L | 8.0 to 88.0 watts | |

660

3.26-102

JSC-12770

TABLE 3.26-8.- Concluded

| Component | Lighting method | Illumination color | Brightness/intensity (rated capacity) | Adjustment | Power 28 V dc | Remarks |
|--|-----------------|--|---------------------------------------|----------------------------------|---------------|--|
| C&W status lights | LED's | Aviation red | 10 ± 3 ft-L | Continuous from 0.02 ± 0.01 ft-L | 20.0 watts | |
| Computer status annunciator assy. lights | Incandescent | Aviation white Aviation yellow | 10 ± 3 ft-L | TBD | 23.75 watts | The diagonal lights are yellow and the nondiagonal lights are white. |
| Advisory annunciator lights | Incandescent | Aviation red Aviation yellow Aviation white Aviation green Aviation blue | 5 ± 2 ft-L | Continuous from 0.02 ± 0.01 ft-L | TBS | -Color Examples- RNG SAF ARM, ABORT LDG ARM, NWS FAIL RCS COMMAND, BODY FLAP LDG DN, SM ALERT |

TABLE 3.26-9.- EXTERIOR LIGHTING

| Component | Lighting method | Illumination color | Brightness/intensity (rated capacity) | Adjustment | Power 28 V dc | Remarks |
|-------------------------|-----------------|--------------------|---|------------|---------------|---------|
| Overhead docking light | Incandescent | White unfiltered | 15 000 cdp at centerline 10 000 cdp 10° off centerline | Fixed | 200 watts | |
| Payload bay floodlights | Metal haloid | White | 30 ft-c at centerline >1 ft-c on transfer route >5 ft-c at work station | Fixed | 200 watts | |
| Forward bulkhead light | Metal haloid | White | 30 ft-c at 30 ft | Fixed | 175 watts | |
| RMS light | Incandescent | White unfiltered | 4.0 ft-c at 30 ft | Fixed | 170 watts | |

662 3.26-104

JSC-12770

TABLE 3.26-10.- LIGHTING LOSSES VS BUS FAILURE

| <u>ESS 1BC</u> | <u>ESS 2CA</u> | <u>ESS 3AB</u> |
|---|--|---|
| LEFT GLARESHIELD (N) C/W STATUS AIRLOCK 2 | RIGHT GLARESHIELD (N) | LEFT GLARESHIELD (E) RIGHT GLARESHIELD (E) ORBIT STATION (E) MIDDECK FLOOD 6 (E) MIDDECK FLOOD 7 (E) MIDDECK FLOOD 8 (E) GPC STATUS |
| <u>MNA</u> | <u>MNB</u> | <u>MNC</u> |
| LEFT CONSOLE PAYLOAD STATION MIDDECK FLOOD 1 MIDDECK FLOOD 8 (N) MO13Q #2 WMC AIRLOCK 1 ANNUN FWD ACA 1 PL BAY AFT STBD (P) PL BAY FWD PORT (P) DOCKING (P) RMS PORT (P) | LEFT SEAT/CTR CNSL RIGHT CONSOLE ORBIT STATION (N) MIDDECK FLOOD 2 MIDDECK FLOOD 6 (N) BUNK 2 BUNK 4 PHS AIRLOCK 3 ANNUN FWD ACA 1 ANNUN FWD ACA 2/3 ANNUN AFT ACA 4/5 PL BAY FWD STBD (P) PL BAY MID PORT (P) PL BAY FWD BULKHEAD (P) | RIGHT SEAT/CTR CNSL MISSION STATION MIDDECK FLOOD 3 MIDDECK FLOOD 4 MIDDECK FLOOD 5 MIDDECK FLOOD 7 (N) MO13Q Q1 AIRLOCK 4 BUNK 1 BUNK 3 ANNUN FWD ACA 2/3 ANNUN AFT ACA 4/5 PL BAY MID STBD (P) PL BAY AFT PORT (P) RMS STBD (P) |
| <u>AC1 φA</u> | <u>AC2 φA</u> | <u>AC3 φA</u> |
| PANEL L/CTR INST R | PANEL R OVHD | |
| <u>AC1 φB</u> | <u>AC2 φB</u> | <u>AC3 φB</u> |
| PANEL L/OVHD NUMERIC FWD | PANEL R INST OVHD | PANEL MS INST L/CTR |
| <u>AC1 φC</u> | <u>AC2 φC</u> | <u>AC3 φC</u> |
| INST OS | NUMERIC OS | PANEL OS |
| <u>CNTL AB1</u> | <u>CNTL BC1</u> | <u>CNTL CA1</u> |
| PL BAY AFT STBD (C) PL BAY FWD PORT (C) PL BAY FWD BULKHEAD (C) RMS STBD C | PL BAY FWD STBD (C) PL BAY MID PORT (C) | PL BAY MID STBD (C) PL BAY AFT PORT (C) DOCKING (C) RMS PORT (C) |

SYMBOLS

- SYSTEM: (N) - NORMAL SYSTEM (E) - EMERGENCY SYSTEM
- SOURCE: (P) - POWER BUS (C) - CONTROL BUS

3.27 AIR SAMPLING SYSTEMS

3.27.1 Introduction

The air sampling system provides a method of obtaining samples of cabin atmosphere. This allows postflight evaluation of the gases for trace contaminants within the Orbiter crew compartment. The following hardware may be used for air sampling:

- Air bottles
- Microbial air sampler

3.27.2 Stowage

Both types of air sampling hardware are stowed in a middeck locker for launch and entry. Usually only one air bottle is flown for contingency air sampling or to be used prior to entry. The microbial air sampler is mission specific.

3.27.3 Systems Functional Description

Air Bottle

The air bottle (fig. 3.27-1) is designed to obtain whole, instantaneous gas samples. The air bottle consists of a stainless steel cylinder equipped with a shut-off valve and a tethered cap. The screw cap covers the air inlet to prevent dust from contaminating the air sample. The air bottle is evacuated preflight to approximately 10^{-7} mm Hg. To collect a sample, the tethered cap is removed from the valve assembly by rotating CCW. The valve is opened by rotating the green knurled knob CCW until a hard stop is reached (table 3.27-1). When opening the valve, a hissing noise may not always be heard due to cabin noise. The time it takes to fully open the valve (CCW) and fully close the valve (CW) is sufficient to collect the sample. The tethered cap is then put back on the valve assembly.

The number of bottles flown is flight specific. Normally, one bottle is flown for contingency purposes.

Microbial Air Sampler

If flown, the microbial air sampler is used on orbit to evaluate the microbial buildup in the crew cabin during flight. The microbial air sampler (fig. 3.27-2) consists of a metal tube with an open end centrifugal fan drum that has a slot for inserting an agar strip. The agar strip is composed of 34 individual agar wells and is a nutritional media which supports the growth of many micro-organisms. The agar strip is opened by pulling the plastic covering down no more than one third of the total length, as marked.

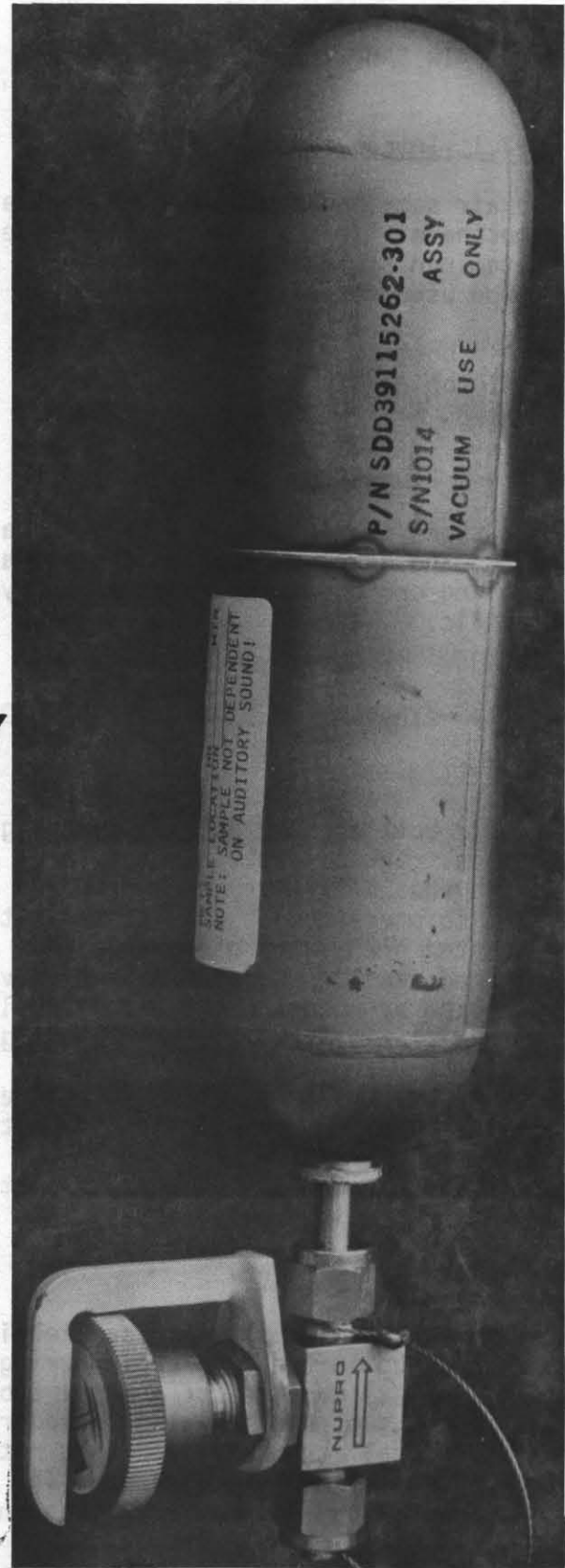
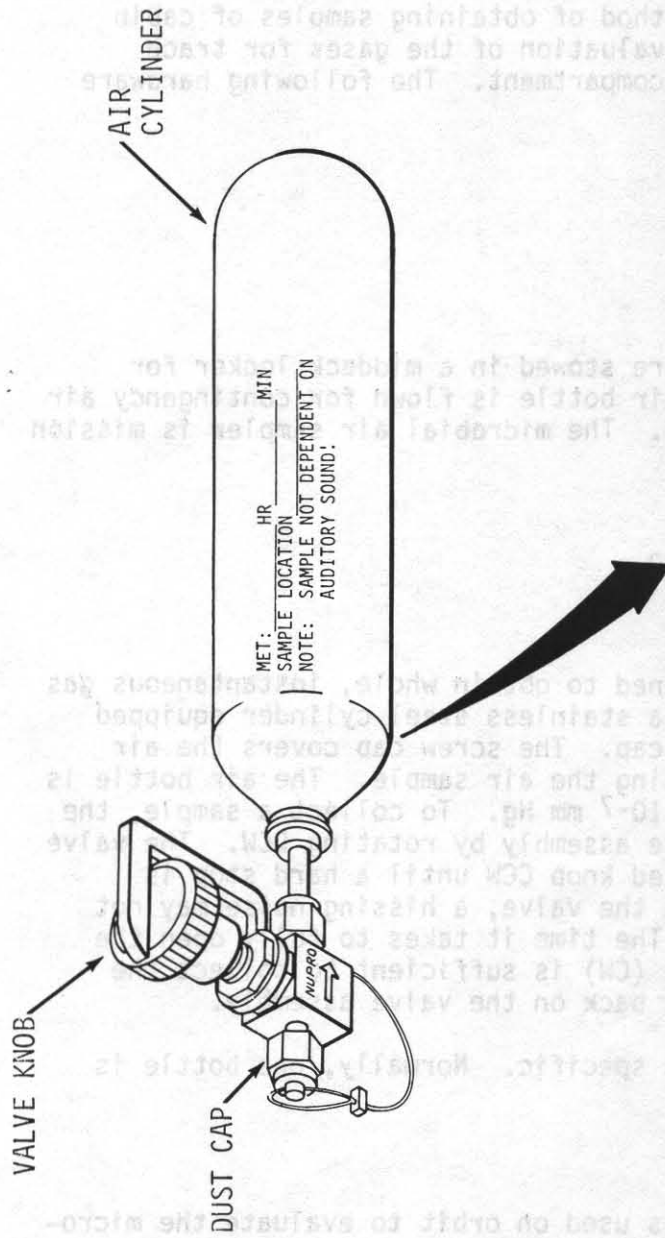
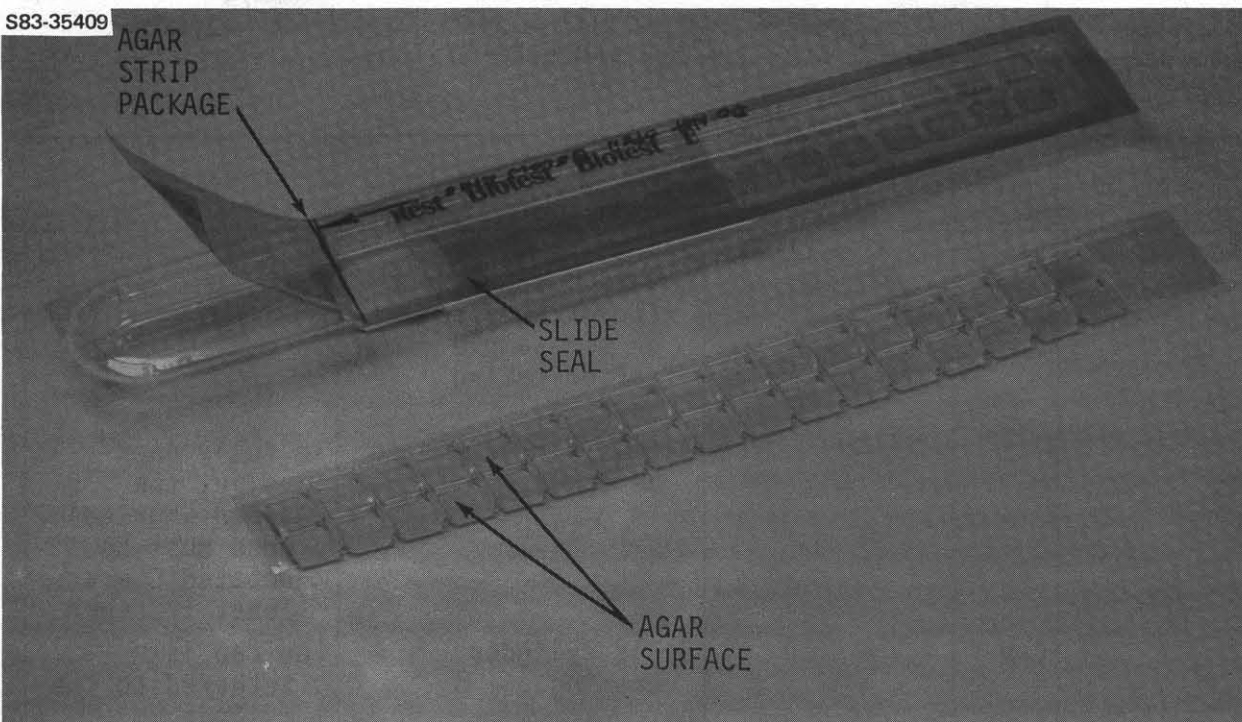


Figure 3.27-1.- Air bottle.

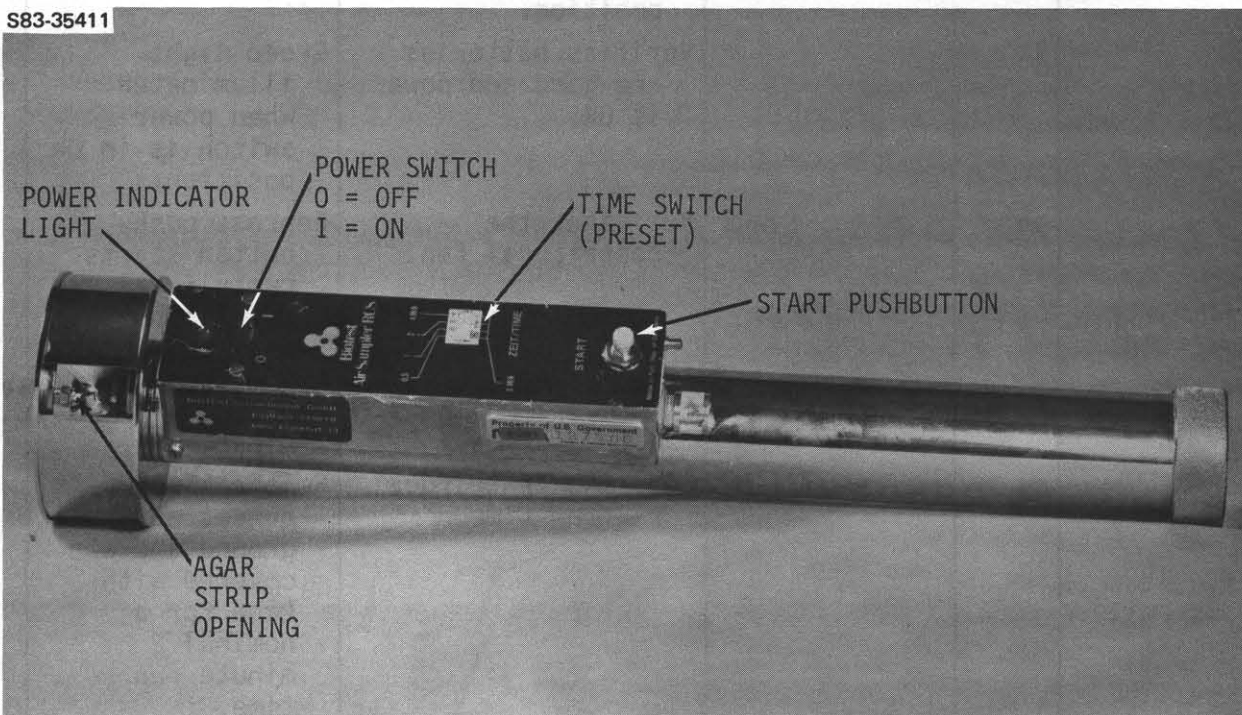
12C-15570

S83-35409



AGAR STRIP

S83-35411



MICROBIAL AIR SAMPLER

Figure 3.27-2.- Microbial air sampling system.

TABLE 3.27-1.- AIR SAMPLING SYSTEMS

| Location | Type | Nomenclature/ Position | Function | Remarks |
|-----------------------|-------|---------------------------|--|---|
| Air bottle | Valve | CLOSED | Maintains cylinder vacuum conditions (prior to opening) or air sample (after taking sample). | To fully open valve, the green knurled knob must be rotated CCW at least 1/2 turn. |
| | | OPEN | Allows air sample to be taken. | |
| | Cap | | Seals cylinder opening. | The cap is tethered to the cylinder. |
| Microbial air sampler | sw | 0 | Power switch OFF position. | Green light illuminated when power switch is in ON position. Depress push-button starts centrifugal fan operation. Fan will run a preset time period of 2 minutes. Switches are preset on ground and are covered with tape for a nominal 2 minute run time. |
| | | 1 | Power switch ON position. | |
| | lt | | Verifies batteries are good and power is ON. | |
| | pb | START | Activates the centrifugal fan. | |
| | sw | ZEIT/TIME | Sets the centrifugal fan run time. | |

This is to prevent contamination after repackaging. Upon inserting the agar strip into the drum (agar facing inward), care must be taken to avoid touching, and consequently contaminating, the agar wells. The microbial air sampler power is turned on and the START button depressed (table 3.27-1). The power switch allows current to flow from the 4 D-cell batteries to an indicator light which verifies that the batteries are good. When the START pushbutton is depressed, the centrifugal air fan within the drum will operate for 2 minutes. The micro-organisms are drawn into the drum by the centrifugal air fan and are deposited onto the agar surface. After the centrifugal air fan stops, the agar strip is removed from the drum and placed back into its' original package. After placing the the agar strip back into the original package, the plastic slide seal is slid up over the area that was pulled down for removing the agar strip. The MET is then recorded on the outside of the agar strip package. The total number of strips flown is mission specific and sample time is scheduled in the Crew Activity Plan.

3.27.4 Systems Performance, Limitations, and Constraints

Air Bottle

- Dimensions: 10.75 x 3.44 in. (27.31 by 8.74 cm)
- Weight : 0.71 lb (322.3 g)
- Evacuated pressure: 10^{-7} mm Hg

Microbial Air sampler

- Dimension:
 - Sampler : 13.5 x 2.63 in. dia. (34.3 x 6.7 cm)
 - Agar strip: 1.38 x 9.5 in. long (3.5 x 24.1 cm long)
- Weight : 1.52 lb empty (689.93 gm); 2.61 lb with batteries (1184.73 g)
- Airflow : 40 liters per minute
- Operating speed : 4092 RPM
- Run time : 2 minutes (standard)

3.28 VISIBILITY AND REACH PROVISIONS

3.28.1 Introduction

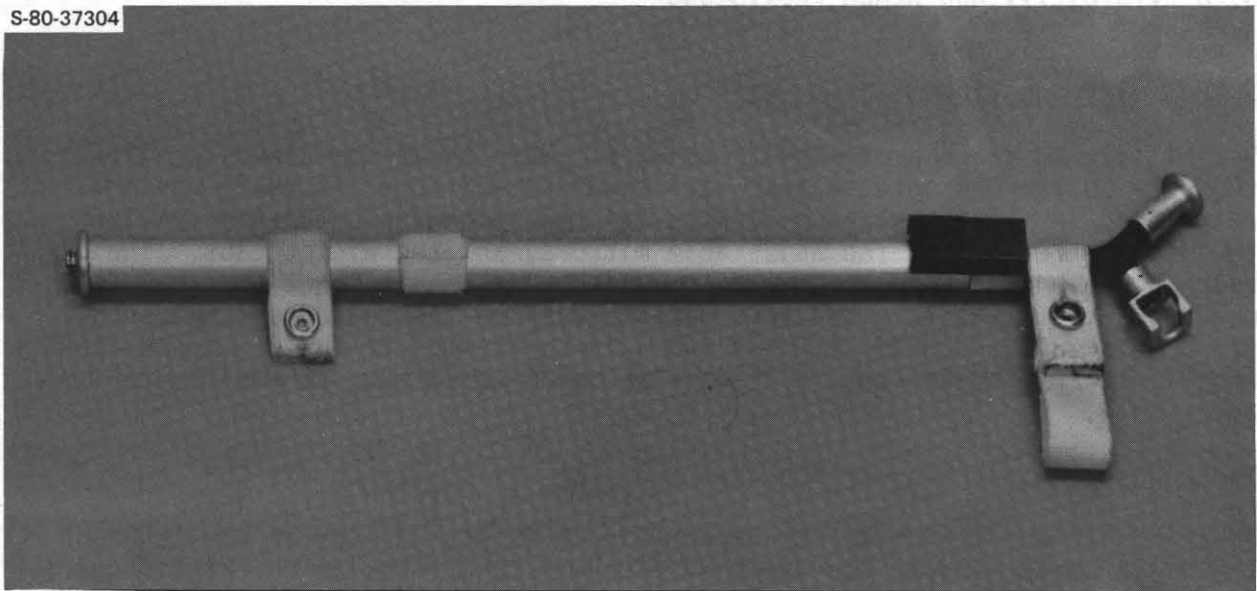
Visibility and reach provisions consist of those items necessary to allow the crew to see and actuate essential displays and controls (D&C) while restrained in their seats during critical flight phases. These provisions include the reach aid, the adjustable mirrors, and the wicket tabs. The reach aid (sometimes known as the 'swizzle stick') is a short bar that is used to actuate controls that are out of reach of the seated crewmember (figures 3.28-1 and 3.28-2). The two-axis adjustment of the Commander (CDR) and Pilot (PLT) seats (sec. 3.4) is also intended to make controls more accessible.

Two adjustable mirrors provide rear and side visibility to the CDR and PLT for assessing separation of the external tank from the Orbiter and for checking D&C and man/seat interfaces (fig. 3.28-3). Fields of view through the flight deck windows are shown in figure 3.28-5. Vision restrictions are usually more severe than reach restrictions; therefore, certain switches can be operated in the blind (by feel) if necessary. Wicket tabs have been developed to aid the crew in the operation of controls by touch (fig. 3.28-4). The wicket tabs may be used as reference points for actuating controls, permitting visual freedom for concentrating on other flight phases.

It is important to note the full meaning of the words 'see' and 'actuate' when discussing the crewmember-control interface on the Orbiter. 'See' defines the ability of the crewmember to read nomenclature on controls, discern the positions of circuit breakers and toggle switches, read numbers on rotary detent switches and CRT displays, discern colors on warning lights, read gages, and determine if particular lights are on or off. 'Actuate' refers to the ability of the crewmember to flip toggle switches, turn knobs, pull circuit breakers, push detent buttons, and make manual inputs into CRT keysets and other related controls. 'See' and 'actuate' refer to the vision and reach envelopes (respectively) of the crewmember at his crew station during particular phases of flight.

The limitations of the CDR's and PLT's reach and vision envelopes are functions of the crewmember's anthropometry, helmet, seat adjustability, seat back angle, Orbiter orientation, and acceleration forces. The reach and vision limitations in table 3.28-1 and in figures 3.28-6 through 3.28-11 describe envelopes (without the reach aid) determined in a JSC mockup review of NASA astronauts wearing flight suits. It should be understood that this study was done in a 1g situation, and therefore is only a simulated measure of launch g-loading. Furthermore, the definition of 'see' and 'actuate' were not rigorously enforced throughout the test. Discretion should be used interpreting these results and applying them to real-time Shuttle reach and vision envelopes for ascent loads over 1.5g. Reach envelopes in figures 3.28-6 through 3.28-11 are omitted where there are no limitations.

S-80-37304



REACH AID

S-80-37303

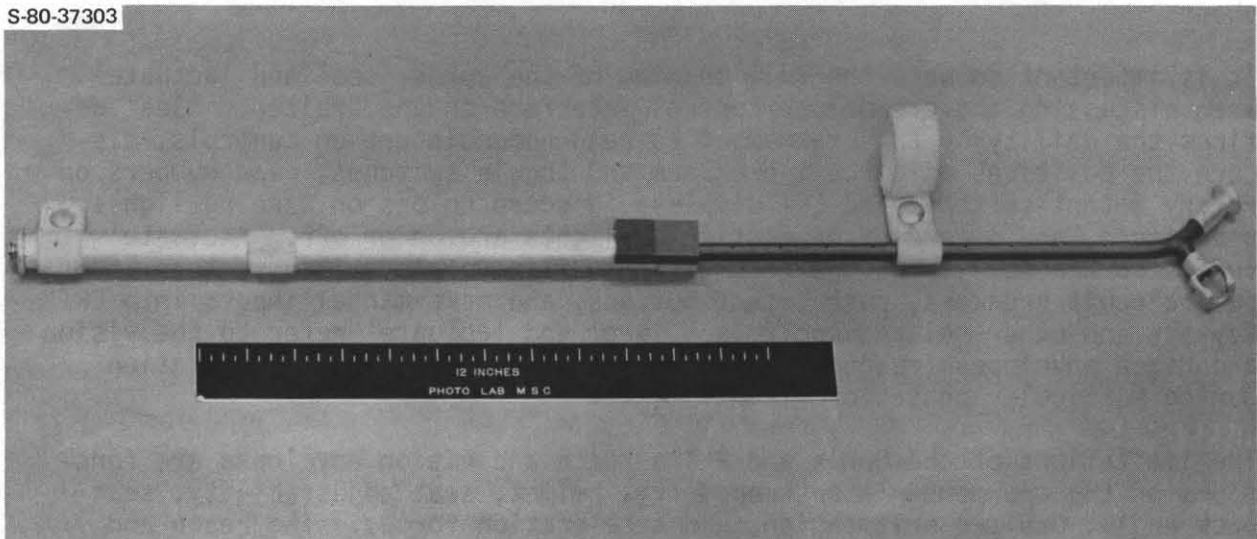
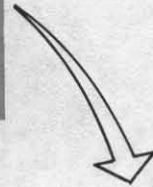
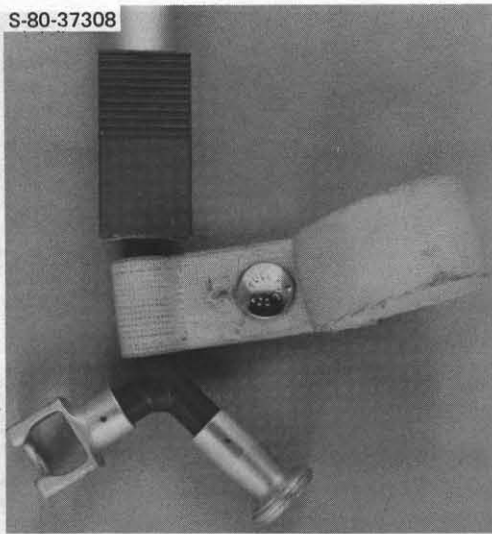


Figure 3.28-1.- Length adjustment of reach aid.

S-80-37308



S-80-37327



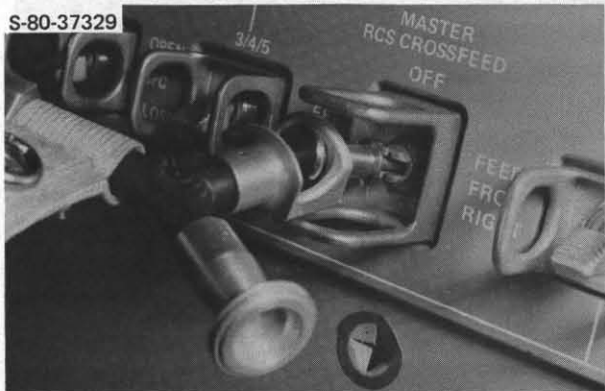
PULLING CIRCUIT BREAKER

S-80-37328



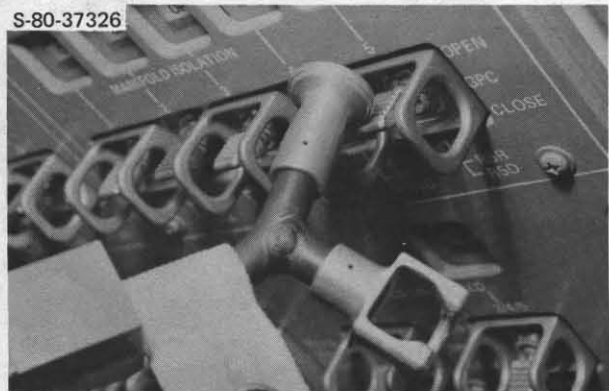
PUSHING CIRCUIT BREAKER

S-80-37329



FLIPPING-LEVER LOCK SWITCH

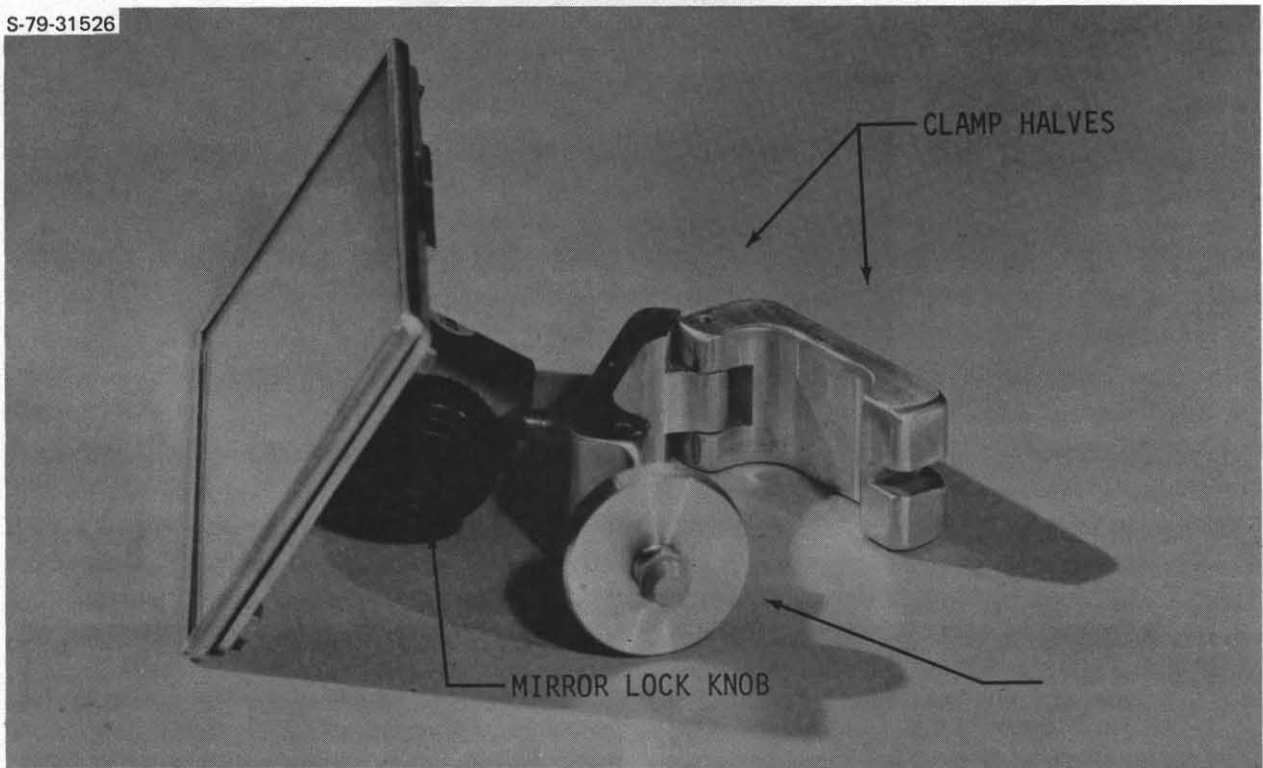
S-80-37326



FLIPPING SWITCH

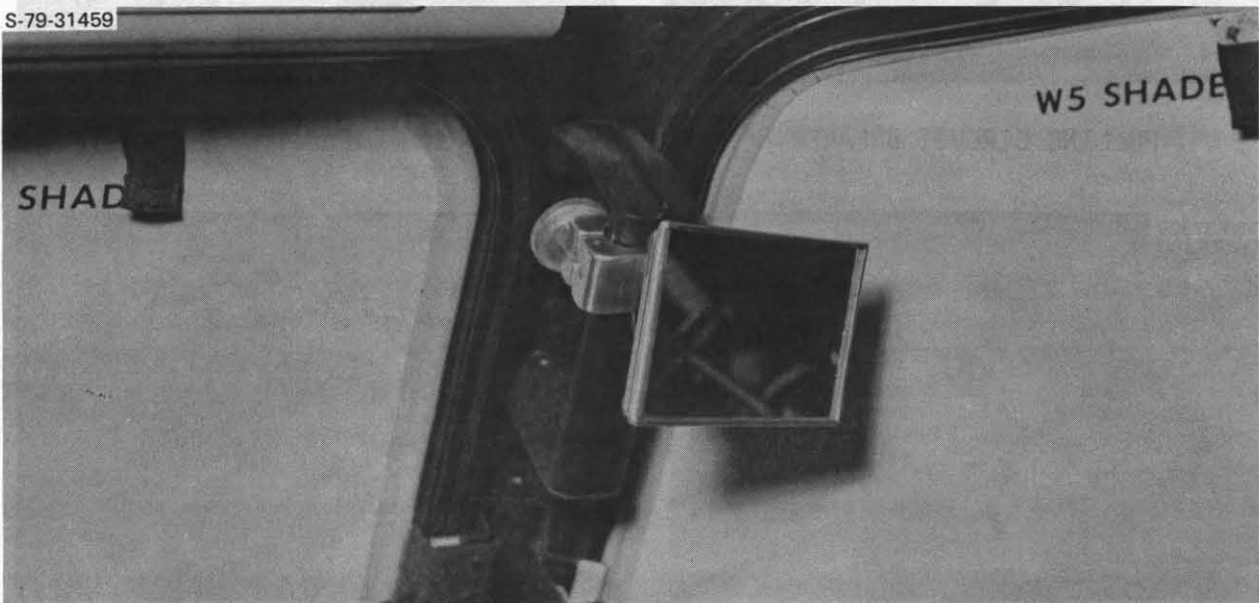
Figure 3.28-2.- Reach aid use.

S-79-31526



ADJUSTABLE MIRROR

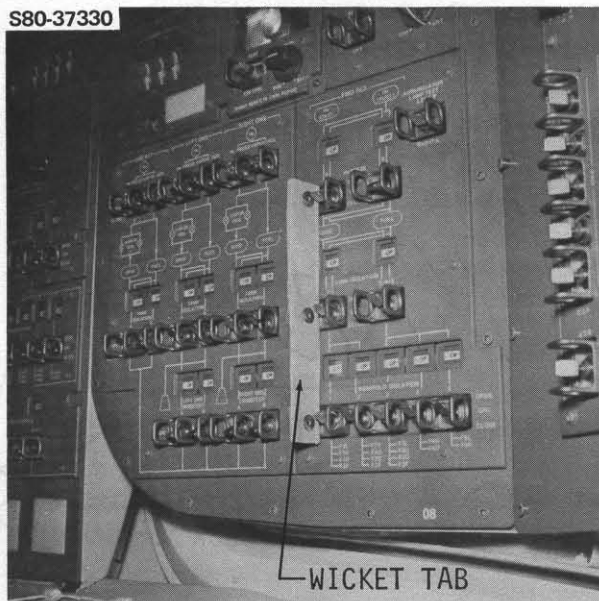
S-79-31459



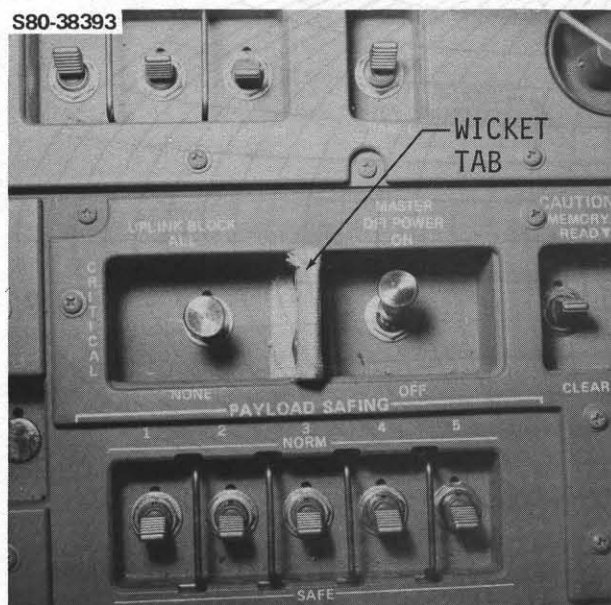
ADJUSTABLE MIRROR INSTALLED ON FLIGHT DECK

Figure 3.28-3.- Adjustable mirror.

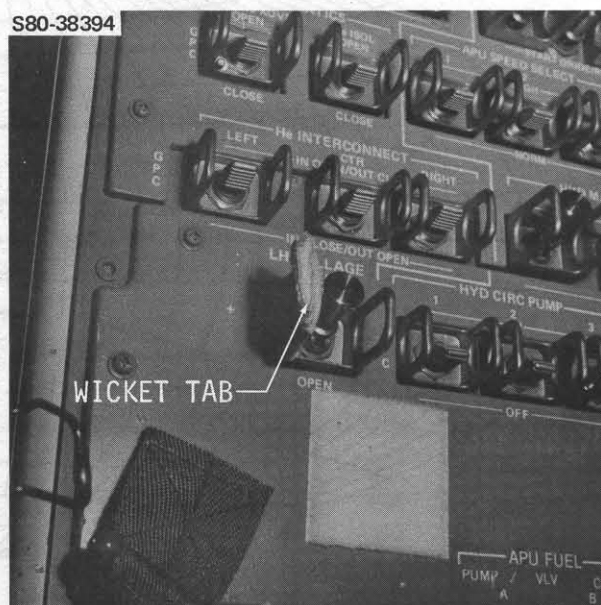
07751-020



PANEL 08

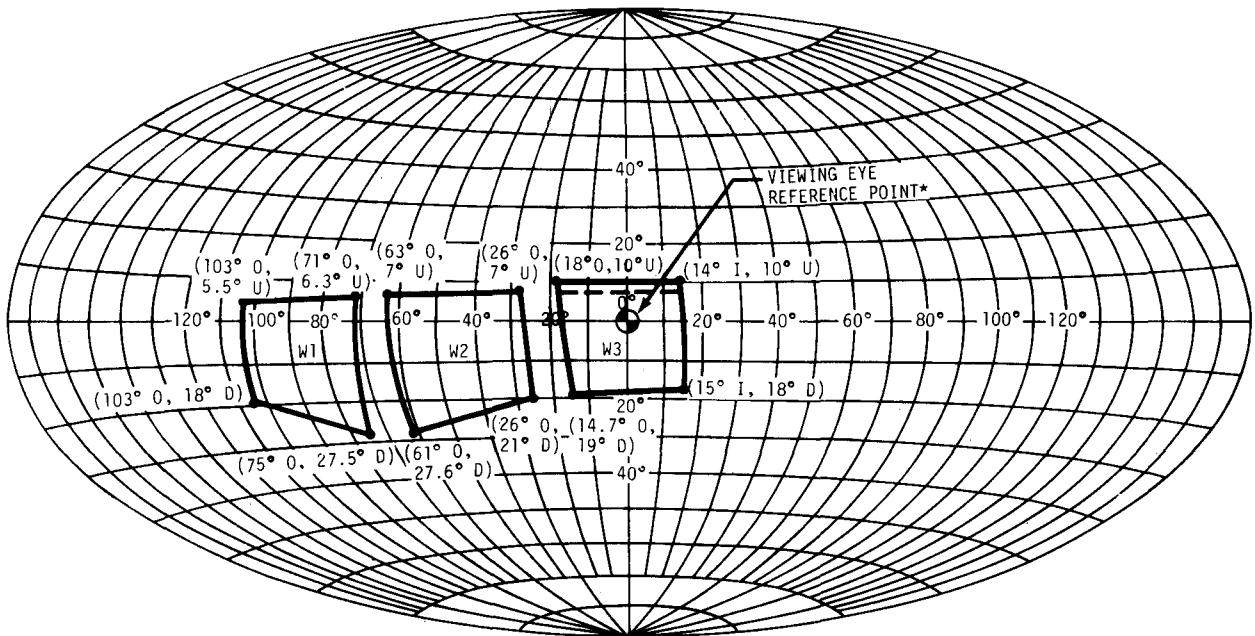
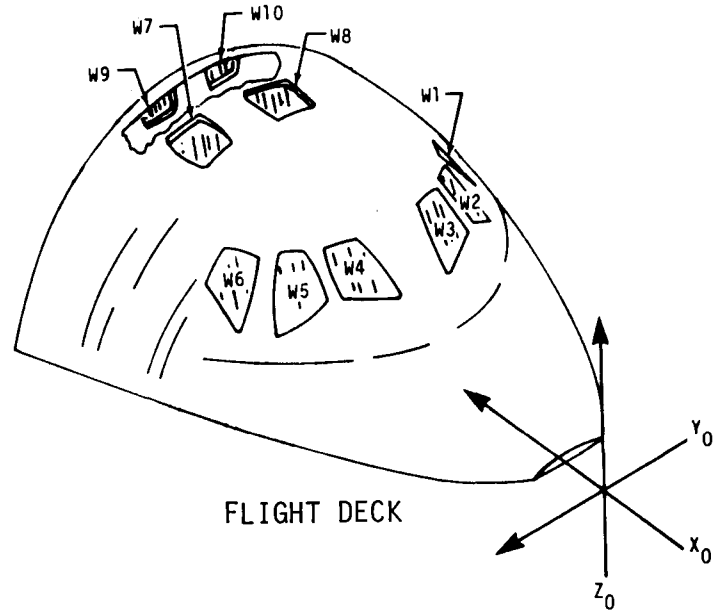


PANEL C3



PANEL R2

Figure 3.28-4.- Wicket tabs.

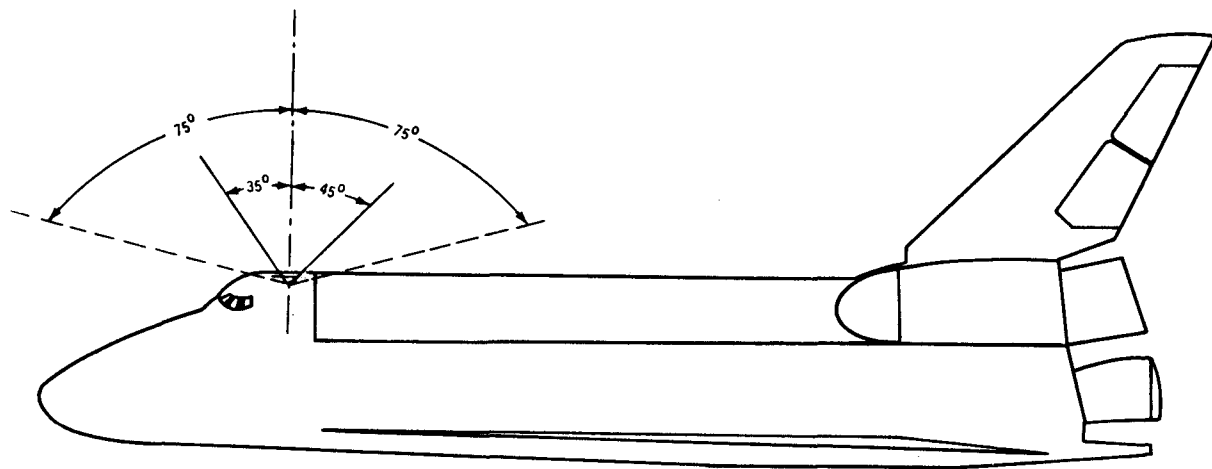


- D - DOWN
- I - INBOARD
- O - OUTBOARD
- U - UP
- W - WINDOW

*NOTE: THIS POINT IS LOCATED 26.5 INCHES AFT OF W3 (OR W4)

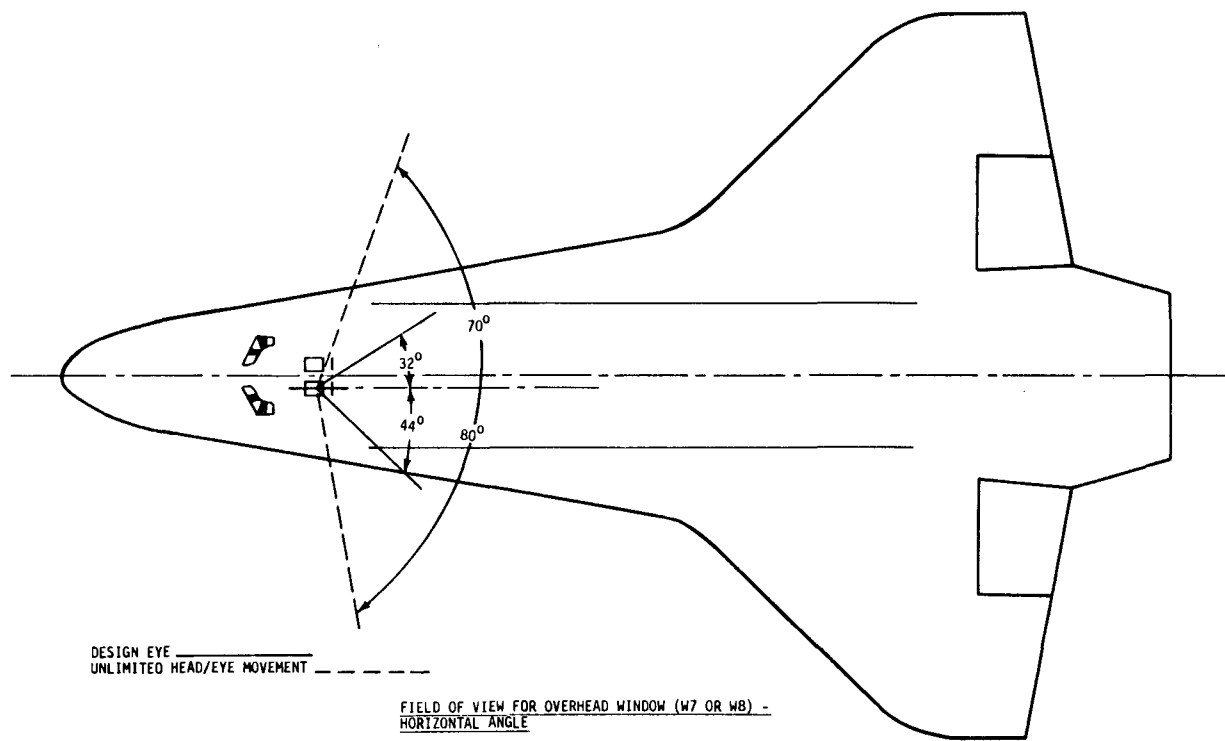
SPHERICAL PROJECTIONS OF FORWARD WINDOW FIELD OF VIEWS (APPLICABLE TO W1, W2, AND W3 AS WELL AS W4, W5, AND W6)

Figure 3.28-5.- Window field of views (sheet 1 of 3).



DESIGN EYE _____
UNLIMITED HEAD/EYE MOVEMENT - - - - -

FIELD OF VIEW FOR OVERHEAD WINDOW (W7 OR W8) -
VERTICAL ANGLE

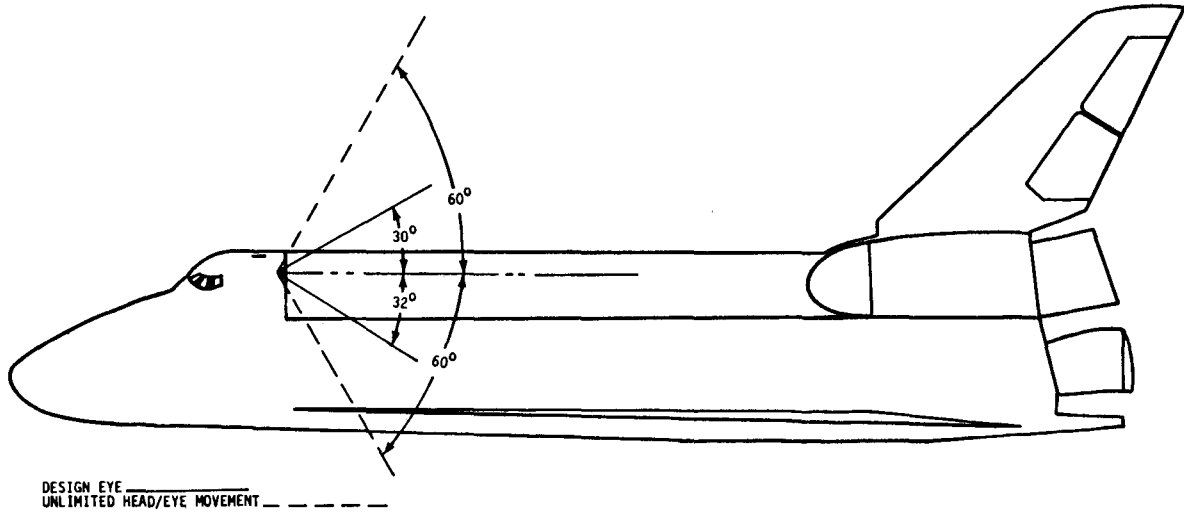


DESIGN EYE _____
UNLIMITED HEAD/EYE MOVEMENT - - - - -

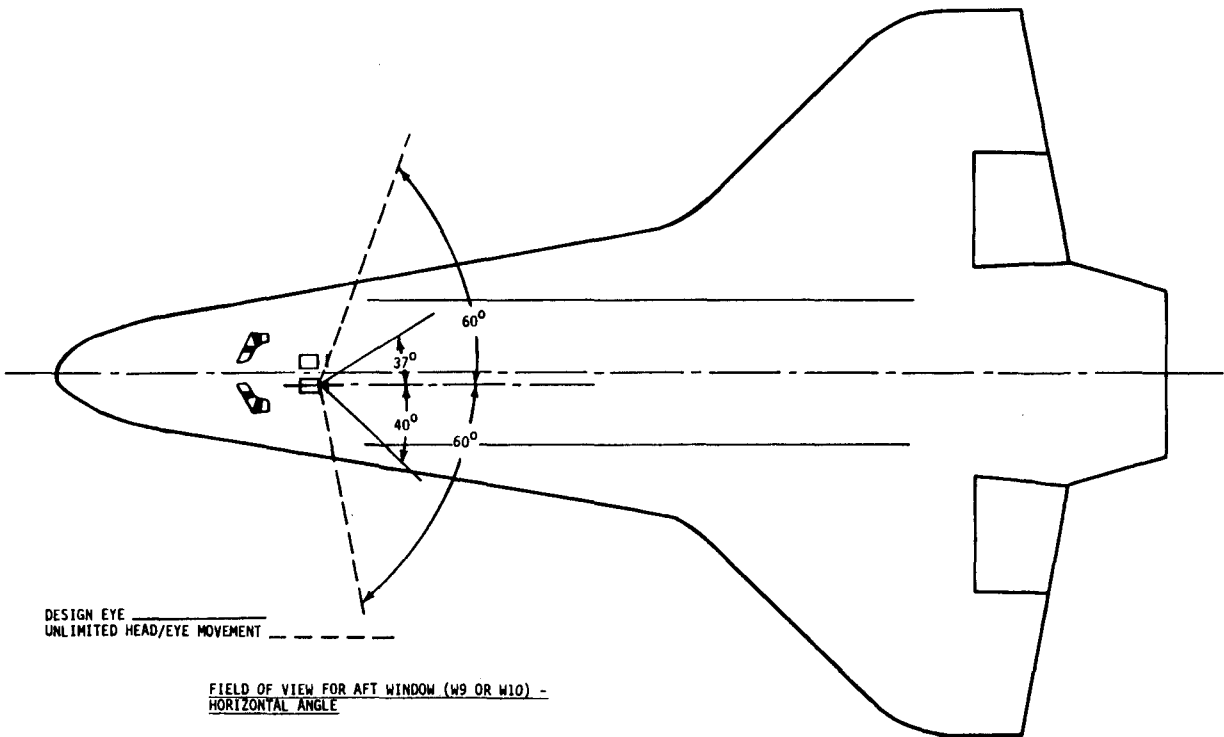
FIELD OF VIEW FOR OVERHEAD WINDOW (W7 OR W8) -
HORIZONTAL ANGLE

Figure 3.28-5.- Window field of views (sheet 2 of 3).

3.28-7



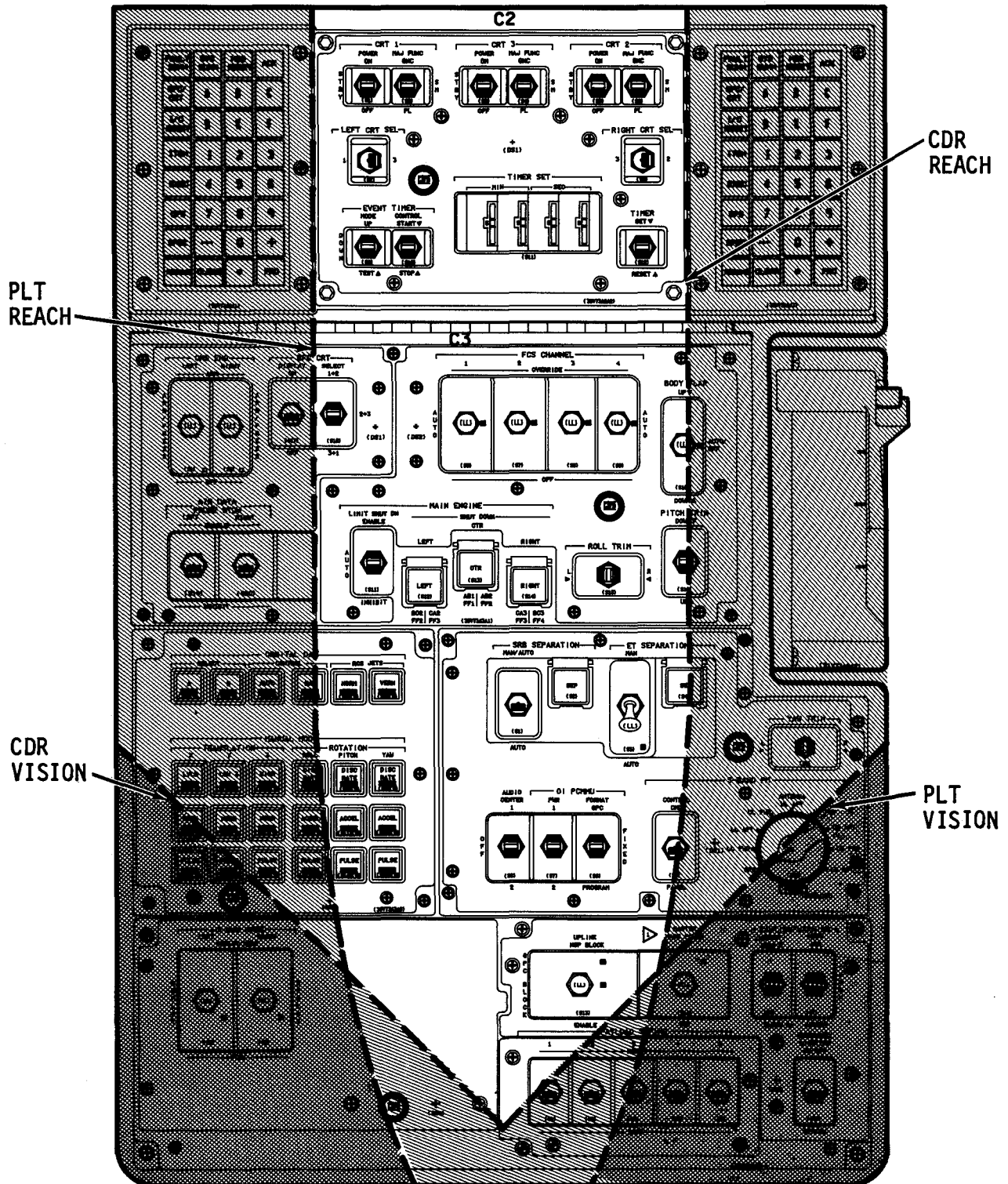
FIELD OF VIEW FOR AFT WINDOW (W9 OR W10) -
VERTICAL ANGLE



FIELD OF VIEW FOR AFT WINDOW (W9 OR W10) -
HORIZONTAL ANGLE

Figure 3.28-5.- Window field of views (sheet 3 of 3).

3.28-8



REACH AND VISIBILITY FOR PANELS C2 AND C3
 Figure 3.28-6.- Reach and vision limitations.

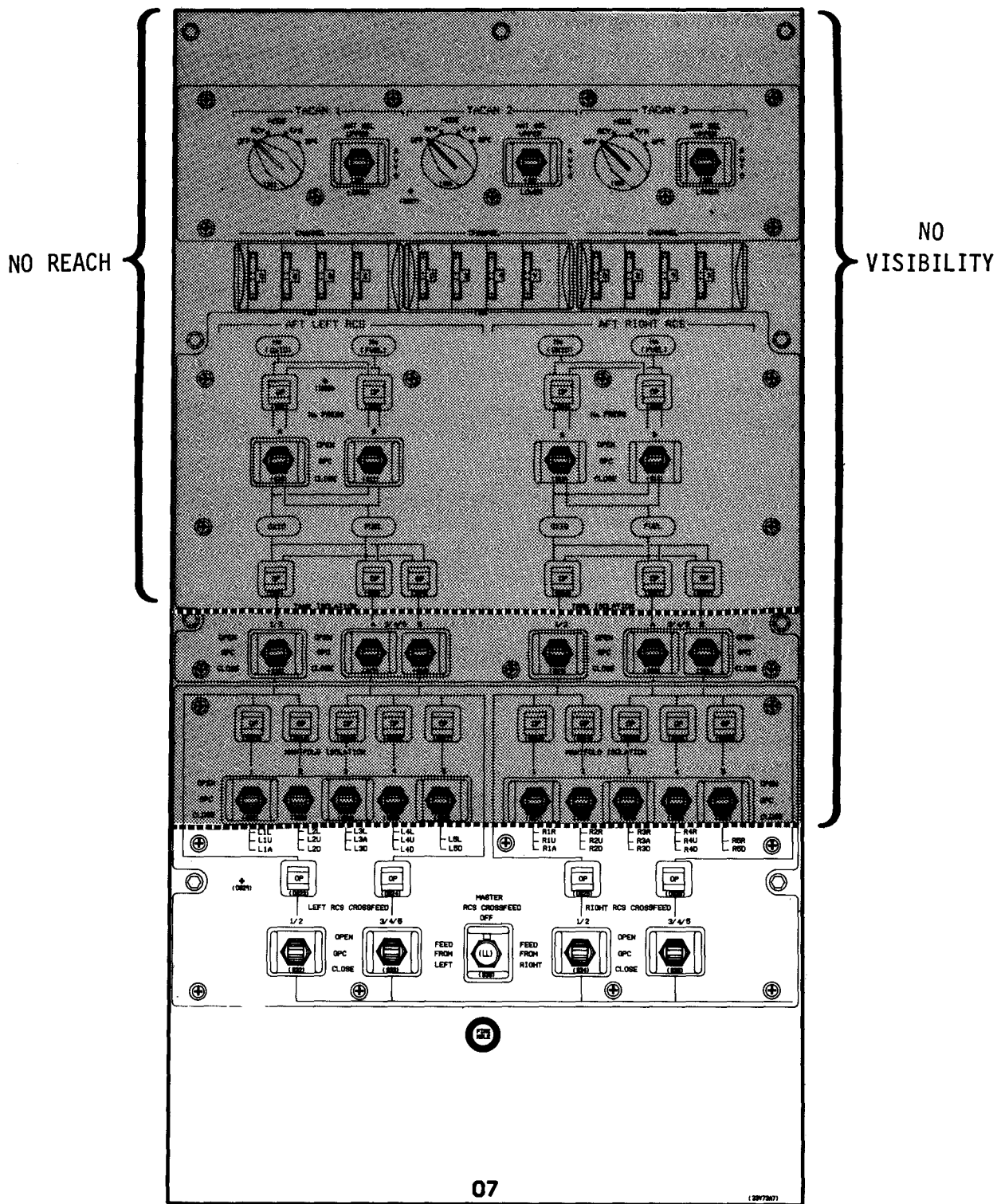


Figure 3.28-7.- Prelaunch, ascent, and entry reach/visibility for panel 07.

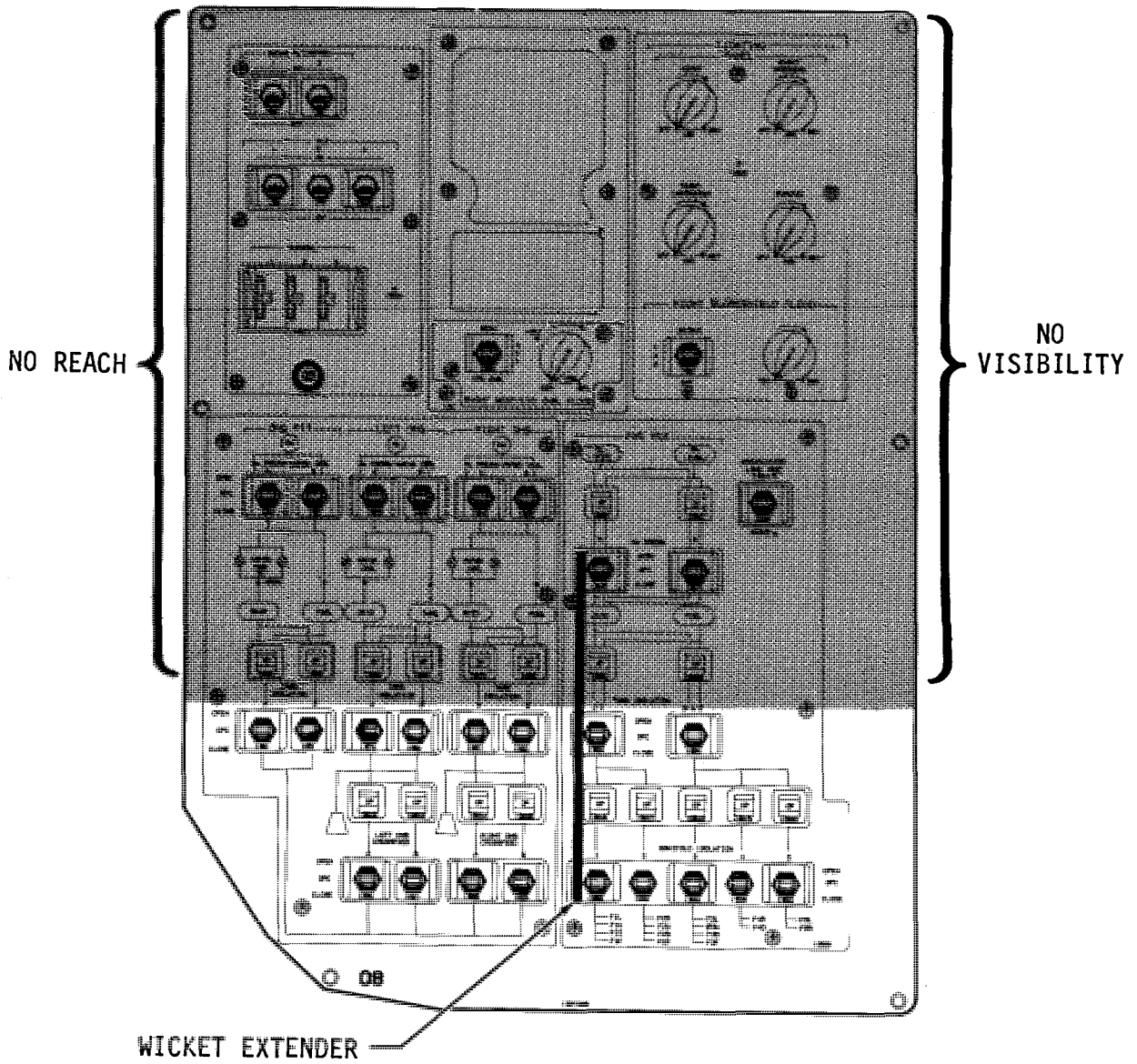


Figure 3.28-8.- Prelaunch and powered ascent (<1.5g) reach/visibility for panel 08.

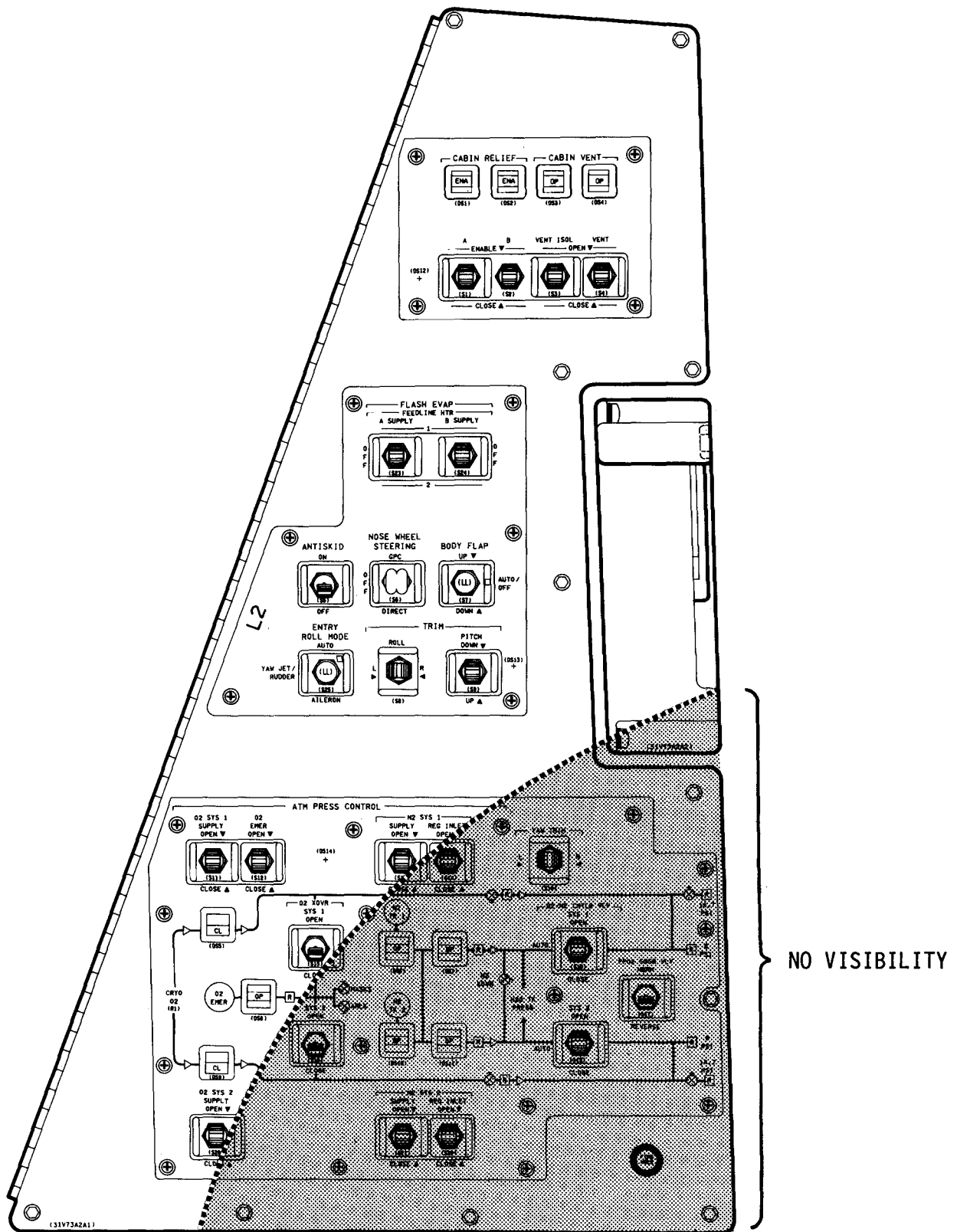
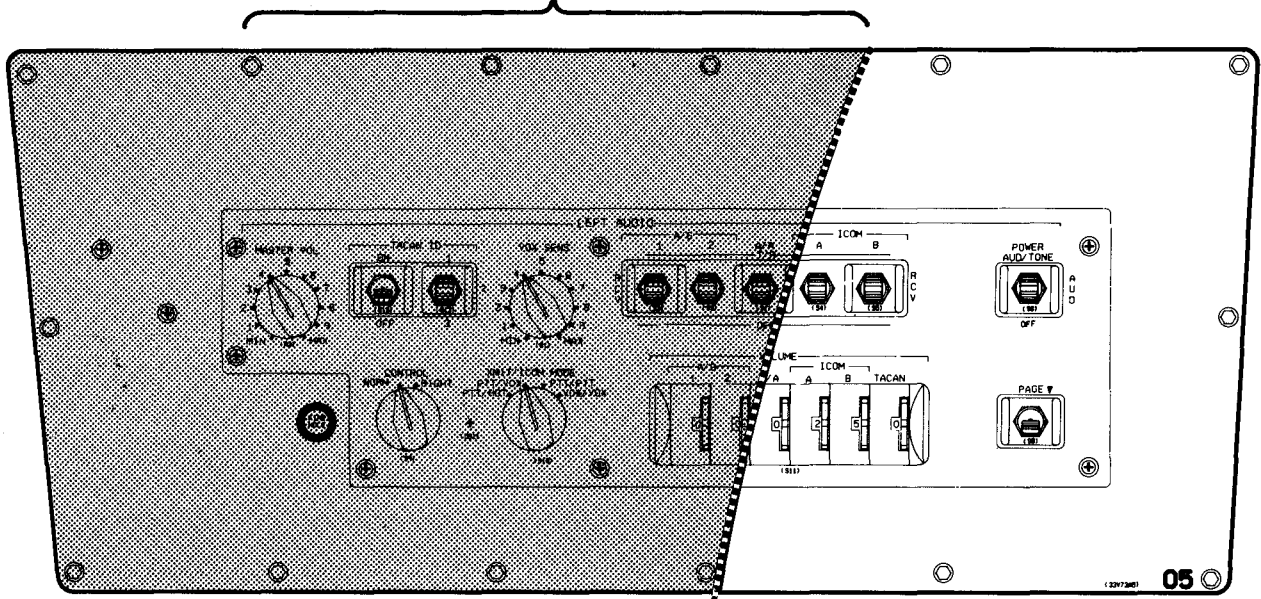


Figure 3.28-9.- Powered ascent (<1.5g) reach/visibility for panel L2.

NO VISIBILITY



Powered ascent (<1.5g) reach/visibility for panel 05.

NO VISIBILITY

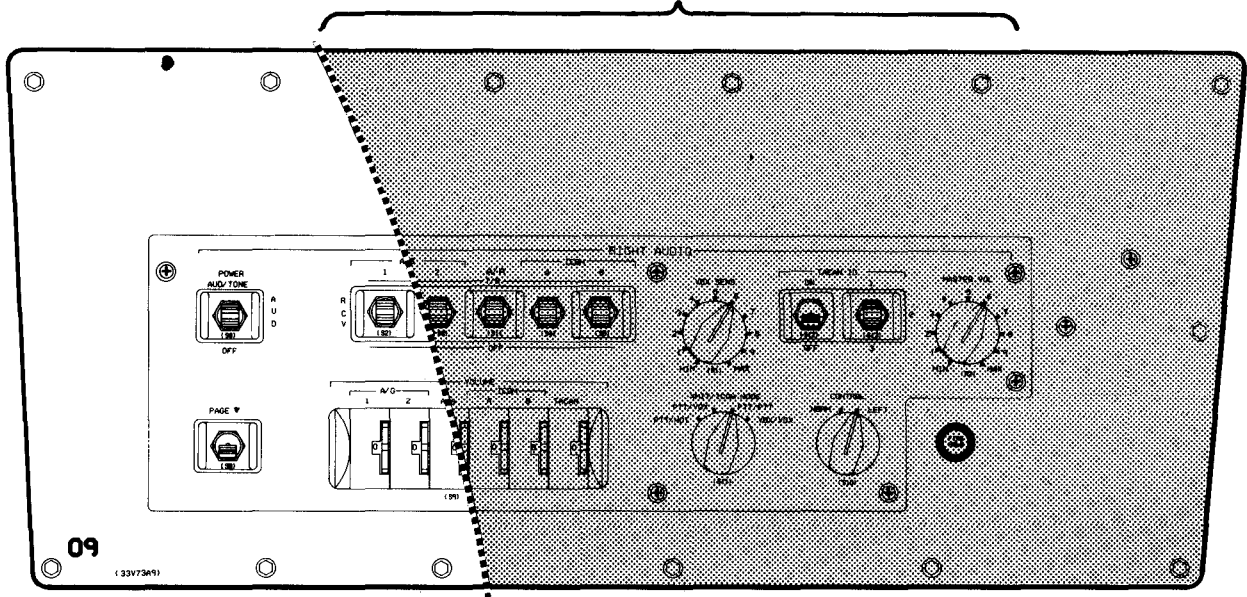


Figure 3.28-10.- Powered ascent (<1.5g) reach/visibility for panel 09.

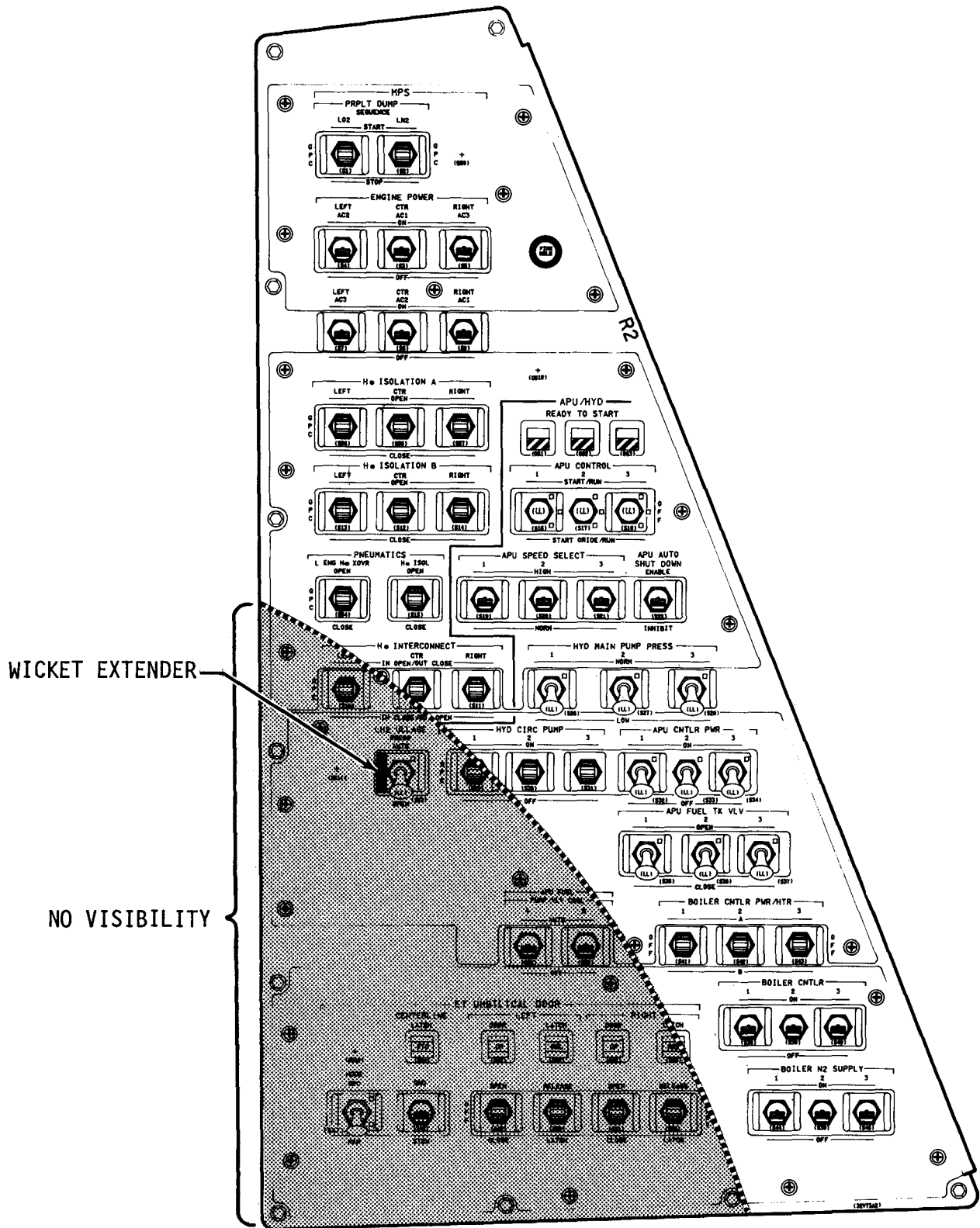


Figure 3.28-11.- Powered ascent (<1.5g) reach/visibility for panel R2.

TABLE 3.28-1.- OPERATIONAL REACH/VISIBILITY ENVELOPE

| Prelaunch and powered ascent (<1.5g) | | Powered ascent (>2gx) | | Ascent (after MECO) and entry | |
|--------------------------------------|---------------|-----------------------|---------------|-------------------------------|------------|
| Panel | Visibility | Panel | Visibility | Panel | Visibility |
| L5 | All | L5 | None | L5 | All |
| L4 | All | L4 | None | L4 | All |
| L1 | All | L1 | All | L1 | All |
| L2 | All | L2 | Partial, Okay | L2 | All |
| F1 | All | F1 | None | F1 | All |
| F2 | All | F2 | All | F2 | All |
| F6 | All | F6 | All | F6 | All |
| F7 | All | F7 | All | F7 | All |
| C2 | All | C2 | All | C2 | All |
| C3 | All | C3 | Partial, Okay | C3 | All |
| 01 | All | 01 | | 01 | All |
| 02 | All | 02 | All | 02 | All |
| 05 | All | 05 | All | 05 | All |
| 06 | Partial, Okay | 06 | Partial, Okay | 06 | All |
| 07 | Partial, Okay | 07 | Inaccessible | 07 | All |
| 013 | None | 013 | Inaccessible | 07 | Partial |
| 014 | None | 014 | | 013 | None |
| 015 | None | 015 | None | 014 | None |
| 016 | None | 016 | None | 015 | None |
| 017 | None | 017 | None | 016 | None |
| 08 | Partial, Okay | 08 | None | 017 | None |
| 09 | All | 09 | Inaccessible | 08 | All |
| 03 | All | 03 | | 09 | All |
| F4 | All | F4 | Partial, Okay | 03 | All |
| F8 | All | F8 | All | F4 | All |
| F9 | All | F9 | All | F8 | All |
| R1 | All | R1 | All | F9 | All |
| R2 | All | R2 | All | R1 | All |
| | | | All | R2 | All |
| R4 | All | R4 | Partial, Okay | R4 | All |
| R6 | None | R6 | | R6 | None |
| | | | None | | |
| | | | None | | |

Note: All - All of the panel is accessible.
None - None of the panel is accessible.
Partial - Some of the panel is accessible without seat movement.
Okay - Accessibility of panel achieved by seat movement or panel not critical to ascent phase.
Inaccessible - Degraded vision makes switch activations hazardous.

3.28.2 Systems Functional Description

Reach Aid

The reach aid is a short rod used to actuate switches and circuit breakers that are out of arm's reach. The value of the reach aid to crewmembers during powered flight has yet to be determined. This value of the reach aid is dependent on ascent acceleration loads, spacecraft vibration (may prevent tip of reach aid from cueing on desired control), length of reach aid, visual envelope, and crewmember anthropometry.

The reach aid has two effectors: one for pulling circuit breakers and lever-lock switches, the other for pushing circuit breakers and flipping switches (fig. 3.28-2). The reach aid is stowed on R6 by means of two snap fasteners. Additionally, a strip of Velcro hook surrounds the handle and a male snap fastener is mounted on the opposite end from the actuators.

The length of the reach aid is adjustable in approximately 1-in. increments. It can be adjusted by depressing the length lock lever (red anodized), sliding the smaller tube into or out of the handle to the desired length, and then releasing the lock lever and sliding the small tube until the lock actuates (fig. 3.28-1).

Wicket Tabs

The wicket tabs consist of strips of Armalon that are doubled over the affected switch guard and riveted through the hole in the switch guard. They are installed on certain switching guards on panels R2, O8, and C3 and remain in place for the duration of the flight.

Adjustable Mirrors

The adjustable mirrors (one each for the CDR and PLT) are mounted on the forward flight deck vertical handholds throughout the flight (fig. 3.28-3).

The adjustable mirrors provide the CDR and PLT views of D&C panels that cannot be seen because of constraints on their visual envelope during flight. The amount of visible area available to a crewmember through the flight mirror is small. Furthermore, the mirror face causes a reversal of D&C nomenclature when viewed by CDR or PLT. Both these constraints imposed by the flight mirror can make control actuation difficult when depending on it to provide visual cues for hand and control location. The adjustable mirror is mounted on the forward vertical handhold on the CDR and PLT sides by closing the split clamp halves around the handhold, swinging the handwheel (connected to one clamp half) over the slot in the other clamp half, and then tightening the assembly by rotating the handwheel clockwise. The mirror is mounted to the base by a ball joint. The position of the mirror is changed by rotating the mirror lock knob counter-clockwise to loosen the joint, repositioning the mirror, and tightening the lock knob (clockwise rotation) (fig. 3.28-3). Adjustable mirror control function data are provided in table 3.28-2.

3.28.3 Systems Performance, Limitations, and Constraints

Reach Aid

- Stowed on R6
- Weight: approximately 7 oz (220 g)
- Dimensions
 - Length: 17.5 to 28.5 in. (43.5 to 71.3 cm) in 1-in. (2.5-cm) increments
 - Diameter: 0.75 in. (1.9 cm)
 - Width across end effectors: approximately 3.3 in. (8.1 cm)
- Construction: Aluminum with Nomex straps

Wicket Tab

- Installed on panels C3, 08, R2
- Construction: Armalon with stainless steel rivets

Adjustable Mirrors

- Installed on forward vertical handholds
- Weight: <1 lb (0.45 kg)
- Envelope: 3 by 5 by 5 in. (7.6 by 12.7 by 12.7 cm)
- Construction: Aluminum and mirrorized Lexan

TABLE 3.28-2.- VISIBILITY AND REACH PROVISIONS CONTROL FUNCTIONS

| Location | Type | Nomenclature/ position | Function | Remarks |
|-------------------|------------|---------------------------|---|--|
| Reach aid | Lever | Length lock lever | Locks reach aid length at 1-in. increments | Press to disengage lock; release, then adjust length slightly to engage lock |
| Adjustable mirror | hand-wheel | Mount lock | Locks and unlocks mirror mount to vertical handhold | Turn cw to lock |
| | Knob | Mirror Lock | Locks and unlocks mirror orientation ball joint | Turn cw to lock |

3.29 MICROCASSETTE RECORDERS

3.29.1 Introduction

The Microcassette Recorders are off-the-shelf tape recorders which are flown primarily for the voice recording of data, but may also be used to play prerecorded tapes. The equipment flown includes (fig. 3.29-1)

- Microcassette Recorder
- Microcassettes
- Batteries

Quantities are flight specific.

3.29.2 Stowage

The Microcassette Recorders, spare batteries, and microcassettes are normally stowed in a middeck locker. They may also be carried as part of the crew launch/worn equipment.

3.29.3 Systems Functional Description

Microcassette Recorder operations include the following (table 3.29-1 and fig. 3.29-2):

- Recording on a microcassette
- Playing a microcassette
- Repositioning the tape within the microcassette

Recording on a Microcassette

Recording is accomplished by ensuring that the POWER switch is in the ON position, selecting the tape speed, sliding the function lever to the dictate (DICT) position, and speaking into the built-in microphone. The dictate/ battery (DICT/BATT) indicator flickers during recording if the batteries are good. The internal microphone is protected by a small grille and is located above the function lever. The recording level is controlled automatically and the volume (VOL) control is used only during playback.

Tape recordings can be made at either of two speeds (2.4 or 1.2 cm/sec). However, better frequency response is produced when recording at the higher speed. When the recorder is in the DICT mode and the microcassette reaches the end-of-tape (EOT), the function lever is not repositioned automatically but a continuous audio tone is generated until the function lever is moved to STOP.

TABLE 3.29-1.- MICROCASSETTE RECORDER DISPLAY AND CONTROL FUNCTIONS

| Location | Type | Nomenclature/ position | Function | Remarks | |
|-------------------|--------|---------------------------|--|--|--|
| Recorder (top) | sw | SPEED | 2.4 | Tape is recorded or played at 2.4 cm/sec | Allows 30 min recording time per microcassette side. Produces best frequency response |
| | | | 1.2 | Tape is recorded or played at 1.2 cm/sec | |
| | tw | VOL | Varies the audio level during playback only | | |
| | socket | MIC | Provision for external microphone | | Not used |
| | socket | EAR | Provision for external earphone | | Earphones provided with personal entertainment (Walkman) tape player can be used |
| | lt | DICT/BATT | Illuminates when recorder is ON and the function lever is in a position other than STOP and batteries are good | | May flicker during recording. Is illuminated when fast forwarding. Grows dim as batteries weaken |

TABLE 3.29-1.- Continued

| Location | Type | Nomenclature/ position | Function | Remarks |
|-----------------------------|------|---------------------------|--|--|
| Recorder (right side) | sw | Function sw | | |
| | | DICT | Records audio onto micro- cassette | |
| | | STOP | Secures recorder from DICT, LISTEN or BACK SPACE modes | |
| | | LISTEN | Playback mode | |
| Recorder (back side) | sw | LTR, SEC | | Not used |
| | sw | FF/CUE | Permits fast forward when the function sw is in STOP po- sition. Per- mits searching for selected portion of tape when the func- tion sw is in LISTEN position | Spring-loaded to the normal position |
| Recorder (front) | pb | N/A | Resets tape counter | |
| | sw | EJECT | Allows insertion or removal of microcassette | |

TABLE 3.29-1.- Concluded

| Location | Type | Nomenclature/ position | Function | Remarks | |
|----------------------|--------|---------------------------|---|--|---|
| Recorder (bottom) | sw | Release | Unlocks battery compartment cover | Battery compart- ment cover slides off | |
| | socket | DC IN 3V | Provision for external power | Not used | |
| | sw | POWER | ON | Supplies battery power | Should be turned OFF manually to avoid battery drain |
| | | | OFF | Interrupts battery power | |

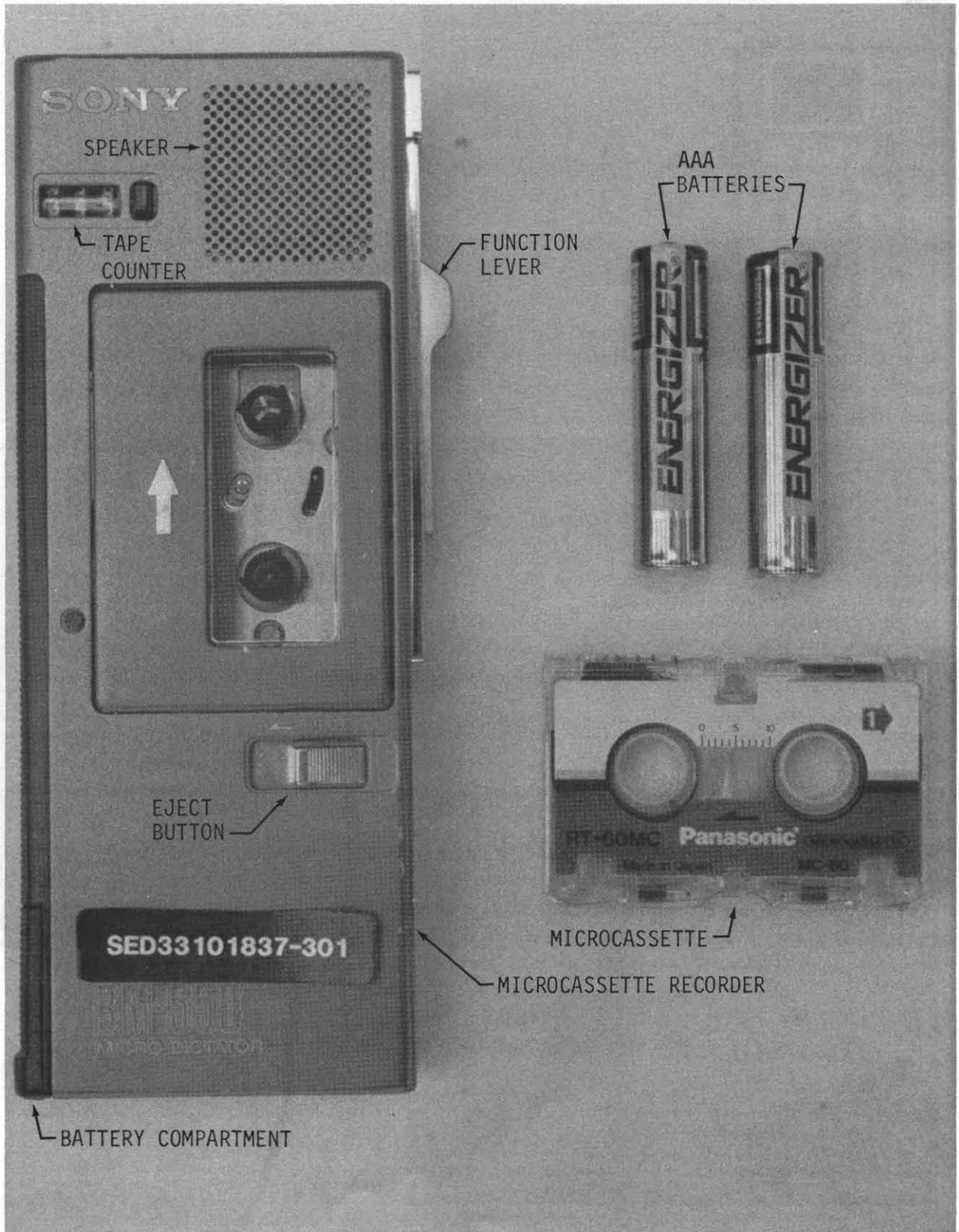


Figure 3.29-1.- Microcassette recorder.

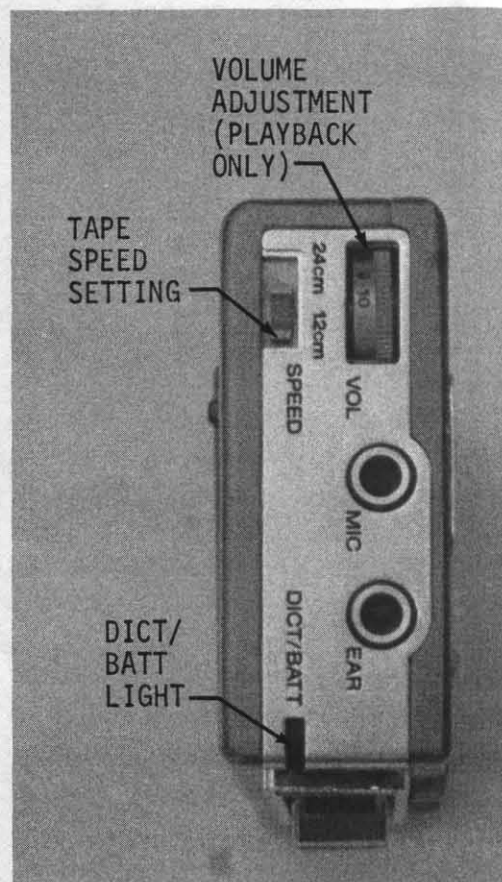
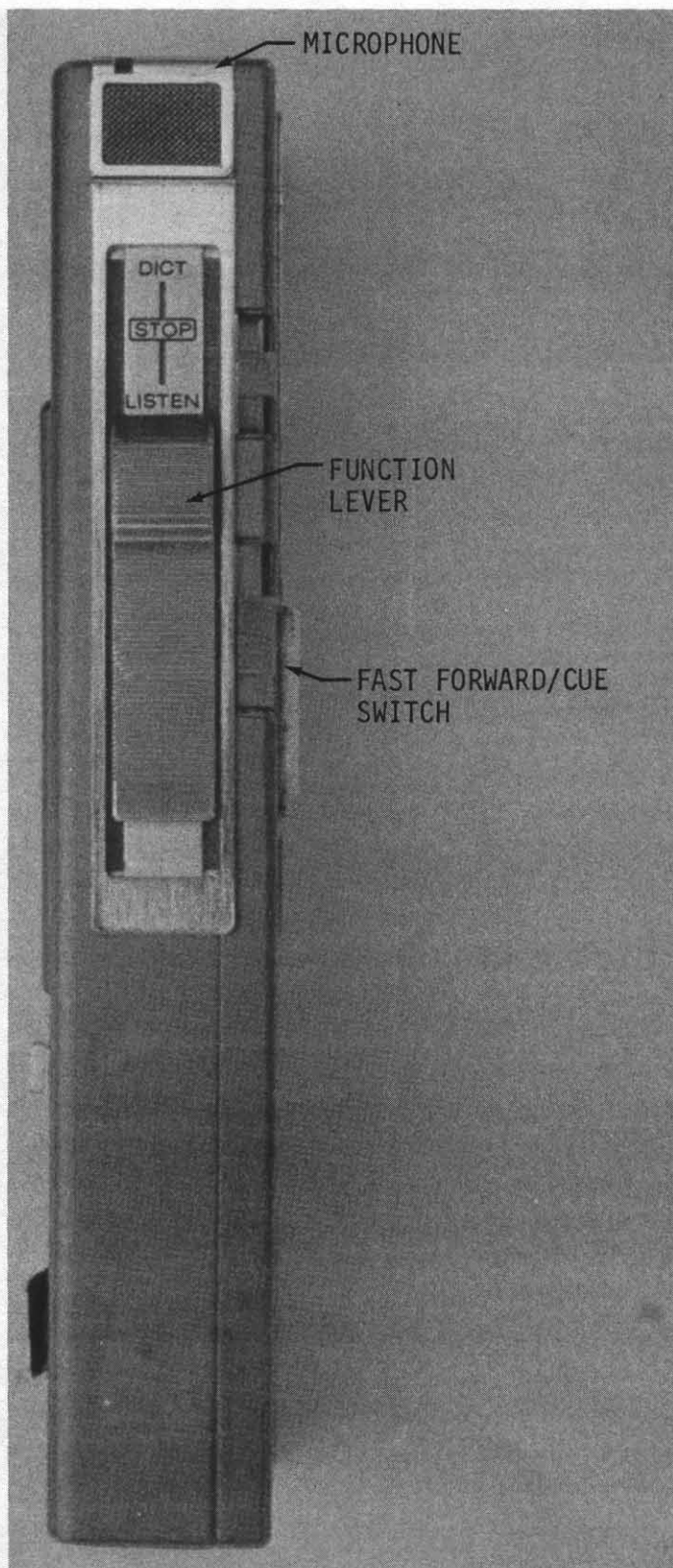


Figure 3.29-2.- Microcassette recorder displays and controls.

Playing a Prerecorded Microcassette

The microcassette recorder features a small speaker for audio output. To enter the playback mode, ensure that the POWER switch is ON, select the tape speed, slide the function lever to the LISTEN position, and adjust the volume with the thumbwheel labeled VOL. The correct playback speed can be found through the use of the SPEED switch. The recorder does not have to be in the STOP position to change speeds.

Repositioning the tape within a Microcassette

The microcassette recorder has rewind and fast forward capabilities. In order to rewind, place the function lever in the BACK SPACE position. To initiate fast forward place the FF/CUE momentary contact switch to FF/CUE. The microcassette can be searched for a certain recording by sliding the function lever to LISTEN and the FF/CUE switch to FF/CUE.

3.29.4 Systems Performance, Limitations, and Constraints

Microcassette Recorder

- Tape speed: 2.4 or 1.2 cm/sec
- Speaker: ~1-1/8 in (2.8 cm) diameter
- Power output: 250 mW (at 10 percent harmonic distortion)
- Power requirements: 3-V dc, two AAA batteries
- Battery life: continuous recording with built in microphone; ~6.5 hours with alkaline batteries
- Physical dimensions: 2 x 5-9/32 x 13/16 in. (5.0 x 13.4 x 2.02 cm)
- Weight: 6.9 oz (195 g) including batteries

Microcassette

- Recording length
 - 30 min per Microcassette side at 2.4 cm/s
 - 60 min per Microcassette side at 1.2 cm/s
- Physical dimensions: 2 x 1.3 x 0.3 in. (5.1 x 3.3 x 0.76 cm)
- Weight: 1 oz (28.35 g)

Batteries

- Type: AAA, 1.5 V (2 required)
- Physical dimensions: 1-3/4 x 3/8 in
- Weight: 1 oz
- Battery life: ~6.5 hr

SECTION 4.0
LAUNCH AND LANDING SITE OPERATIONS

This section covers flight activities at the launch and landing sites for the pretransfer through postlanding periods. It provides a description and layout of the support and services available to the flight crew at the launch and landing sites. It also provides a general overview of these sites (figs. 4.0-1 thru 4.0-6).

The launch and landing site operations can be categorized as follows:

- Pretransfer Operations
 - Preflight medical evaluation
 - Preflight briefing
 - Preflight meal
 - Equipment donning
- Transfer to pad and Orbiter ingress
 - Ingress transfer van
 - Transfer to pad apron
 - Transfer from pad apron to Orbiter hatch
 - Ingress Orbiter
- Ingress to Lift-off Operations
 - Seat ingress
 - System functional checks
 - Perform leak checks
 - Verify all systems 'GO' for launch
 - Lift-off
- Pad Emergency Operations
 - Seat egress
 - Orbiter egress
 - Escape
- Normal Postlanding Operations
 - Power down
 - Seat egress
 - Orbiter egress
 - Postflight operations

- Emergency Postlanding Operations

- Power down
- Seat egress
- Orbiter egress
- Escape
- Postflight operations

- Postditching Operations

- Seat egress
- Orbiter egress
- Escape
- Post-egress activities
- Return to CONUS (if applicable)

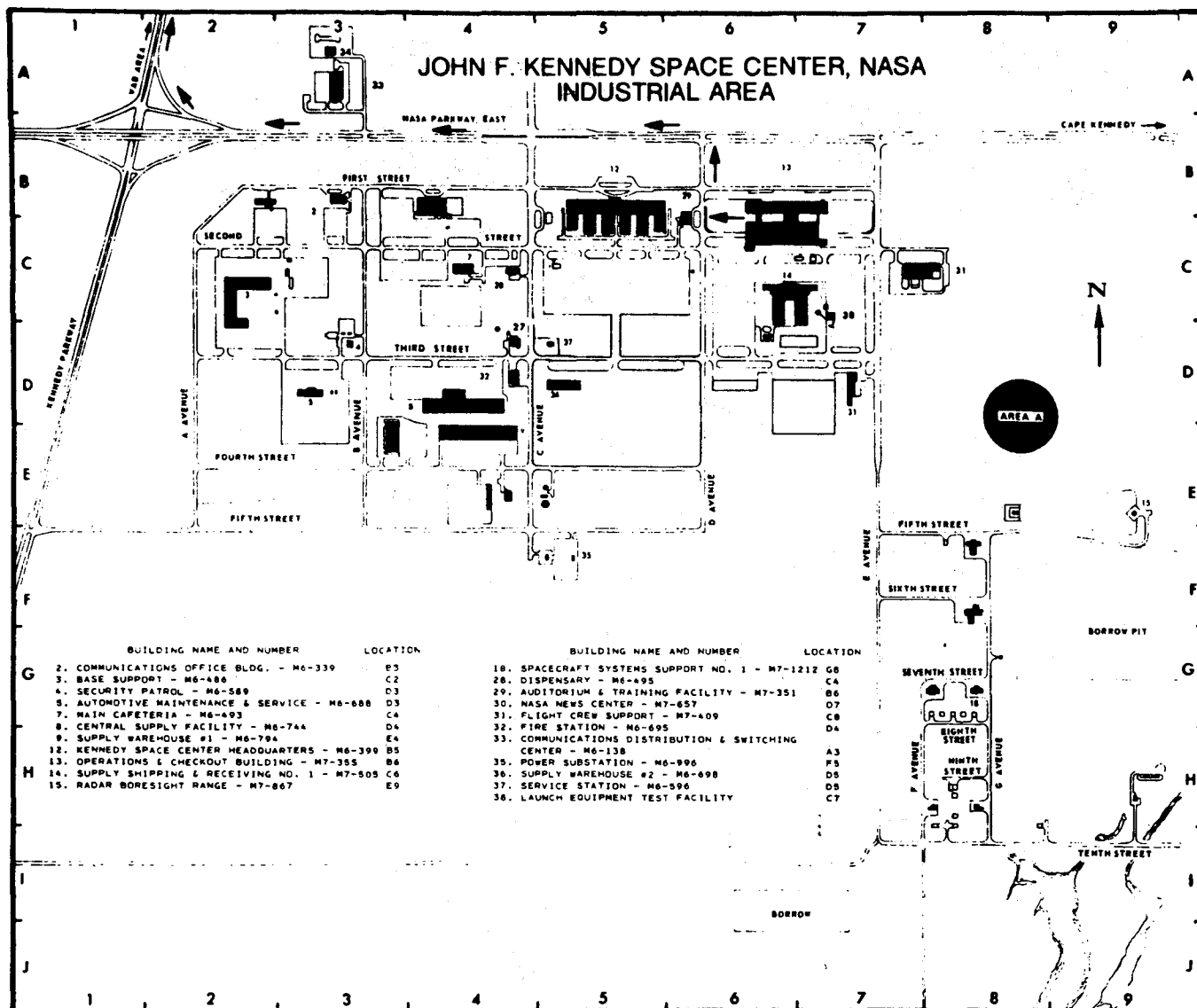


Figure 4.0-1.- John F. Kennedy Space Center-NASA industrial area.

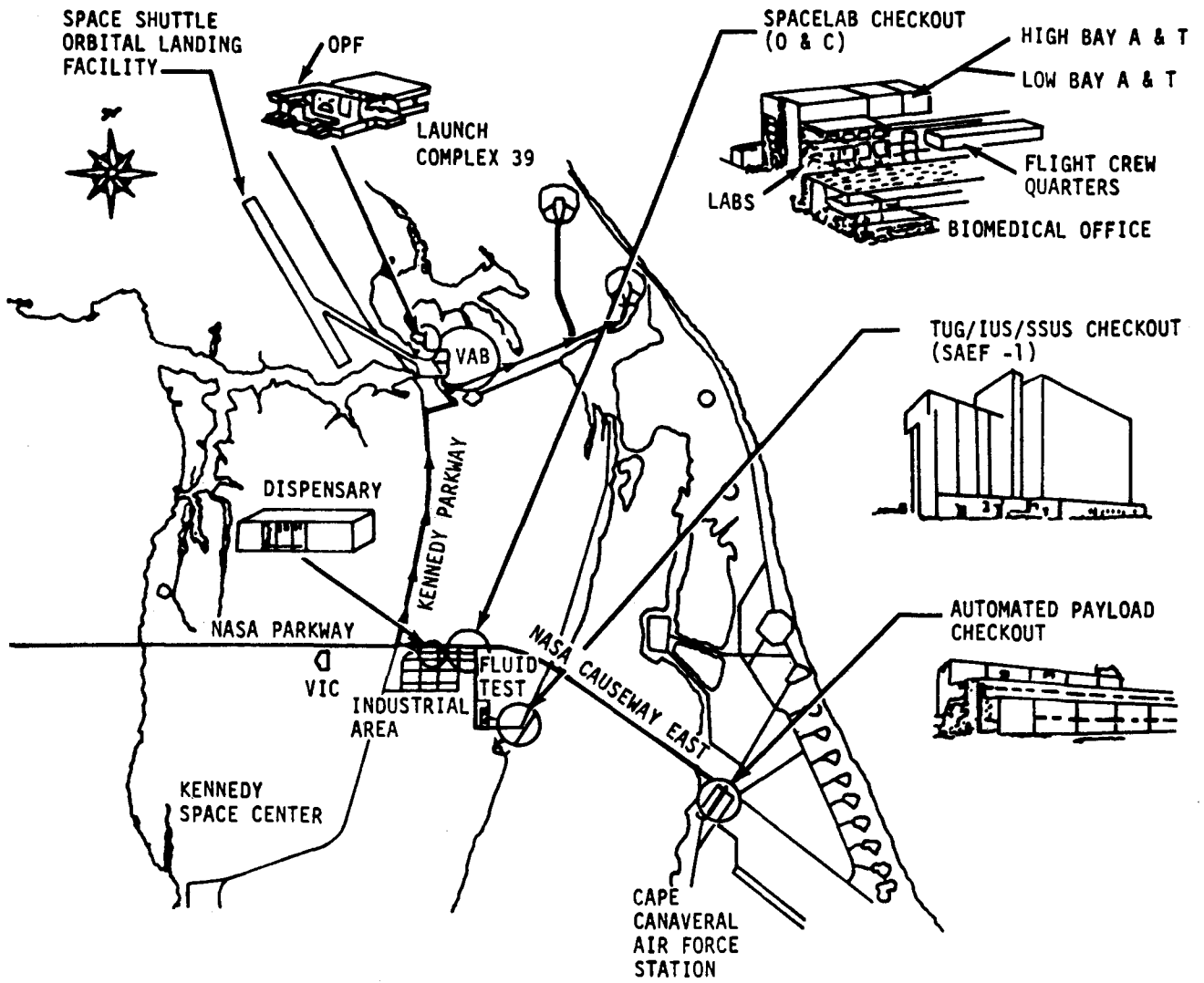
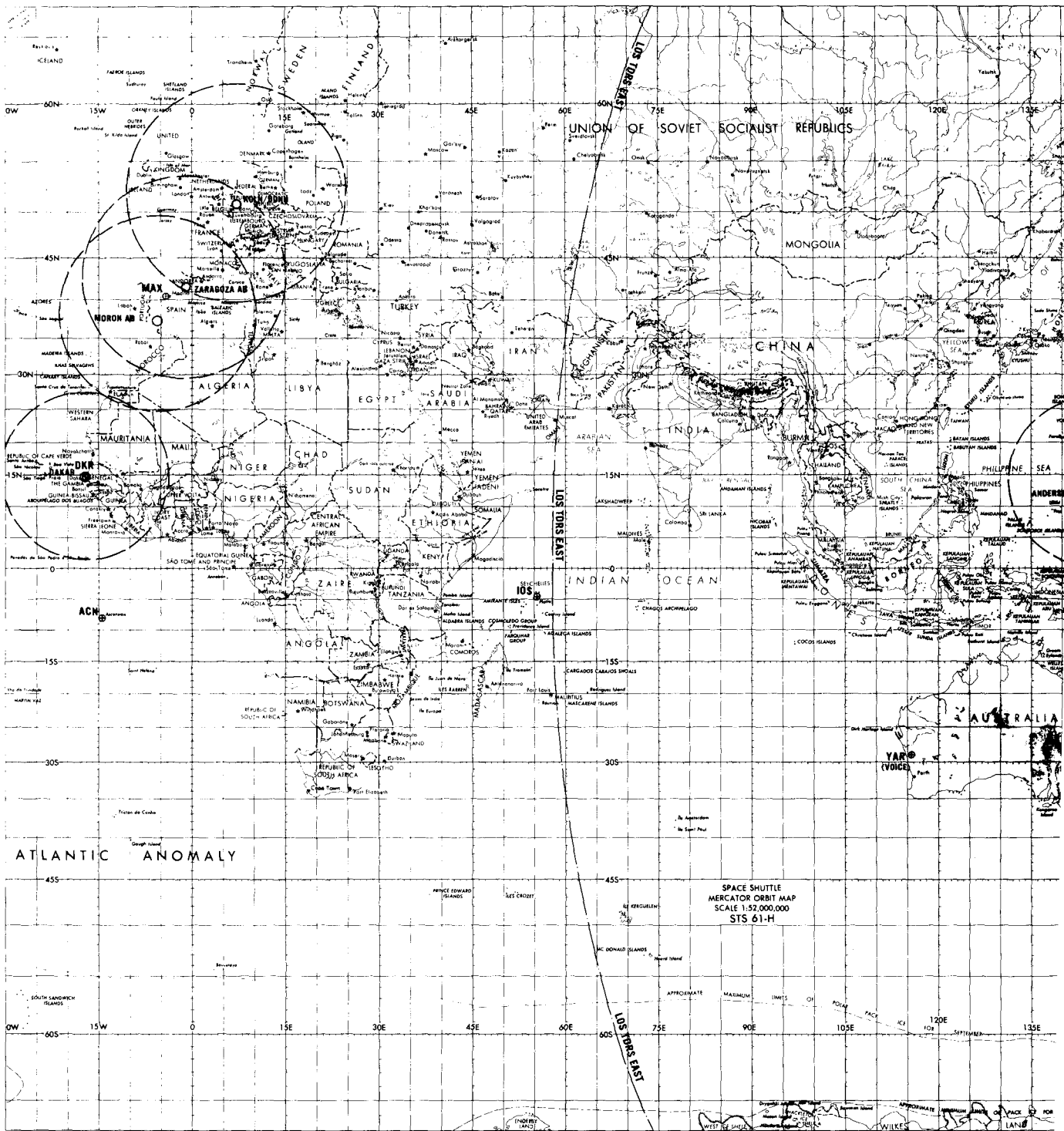


Figure 4.0-2.- Overview of KSC facility locations.



ATLANTIC ANOMALY

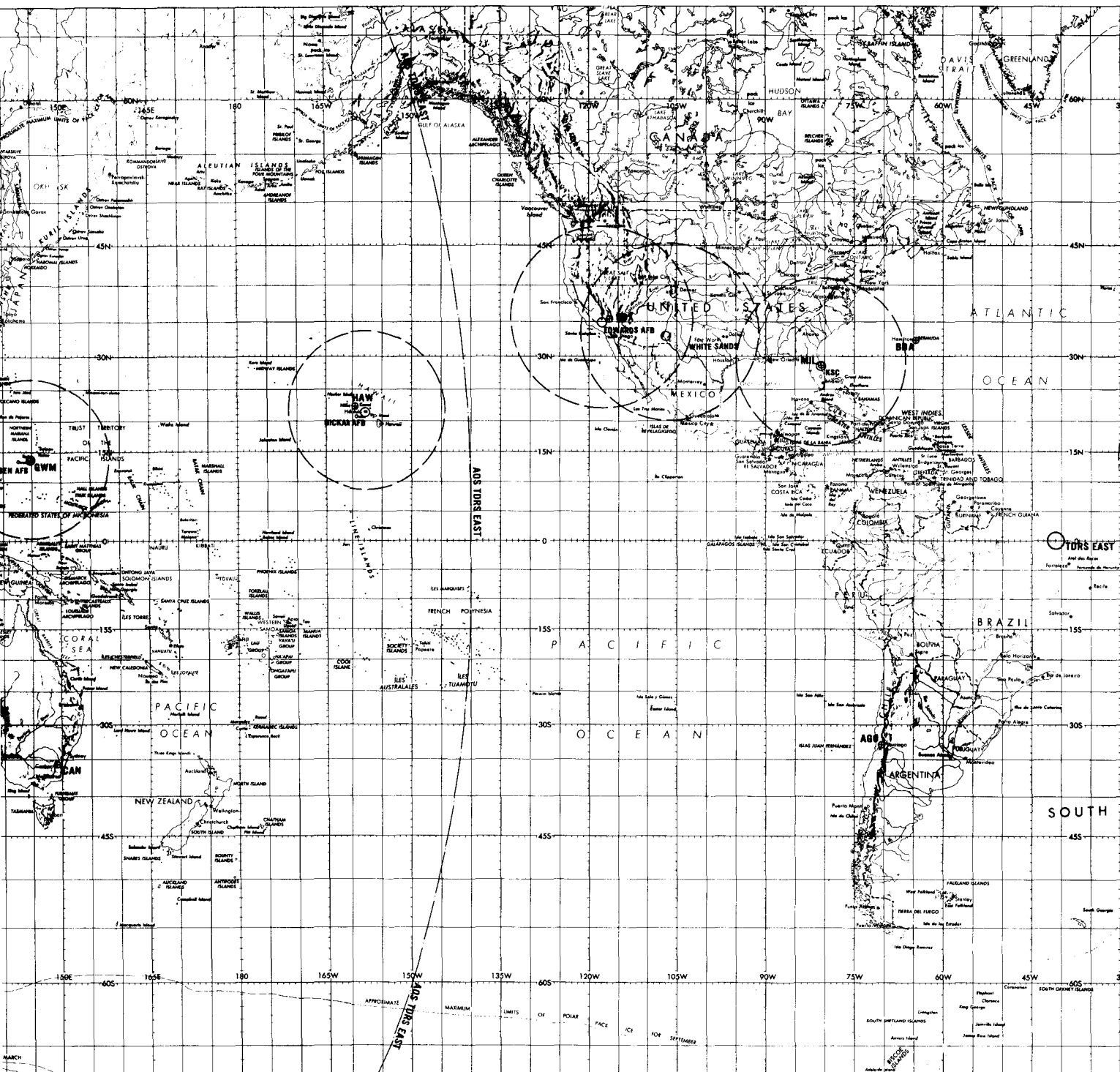
SPACE SHUTTLE
MERCATOR ORBIT MAP
SCALE 1:52,000,000
STS 61-H

PREPARED AND PUBLISHED BY THE DEFENSE MAPPING AGENCY AEROSPACE
CENTER, 3200 SOUTH SECOND STREET, ST. LOUIS, MISSOURI, 63118-3399
FOR THE NATIONAL AERONAUTICS AND SPACE ADMINISTRATION

NOTE:
The representation of international boundaries on this chart is not necessarily
authoritative.

LEGEND
 International boundary
 Capital cities
 Other cities
 Airfields
 Crossrange limits for 750 n.m. altitude
 South Atlantic Anomaly for 190 n.m. altitude

MERCATOR PROJECT
SCALE 1:52,000,000 AT THE



TRACKING AND DATA RELAY SATELLITE SYSTEM (TDRSS) SPACEFLIGHT TRACKING AND DATA NETWORK (STDN)

AOS, LOS Antenna location symbols and call letters MIL

Sub-orbital point Tracking limits (● N.M. altitude)

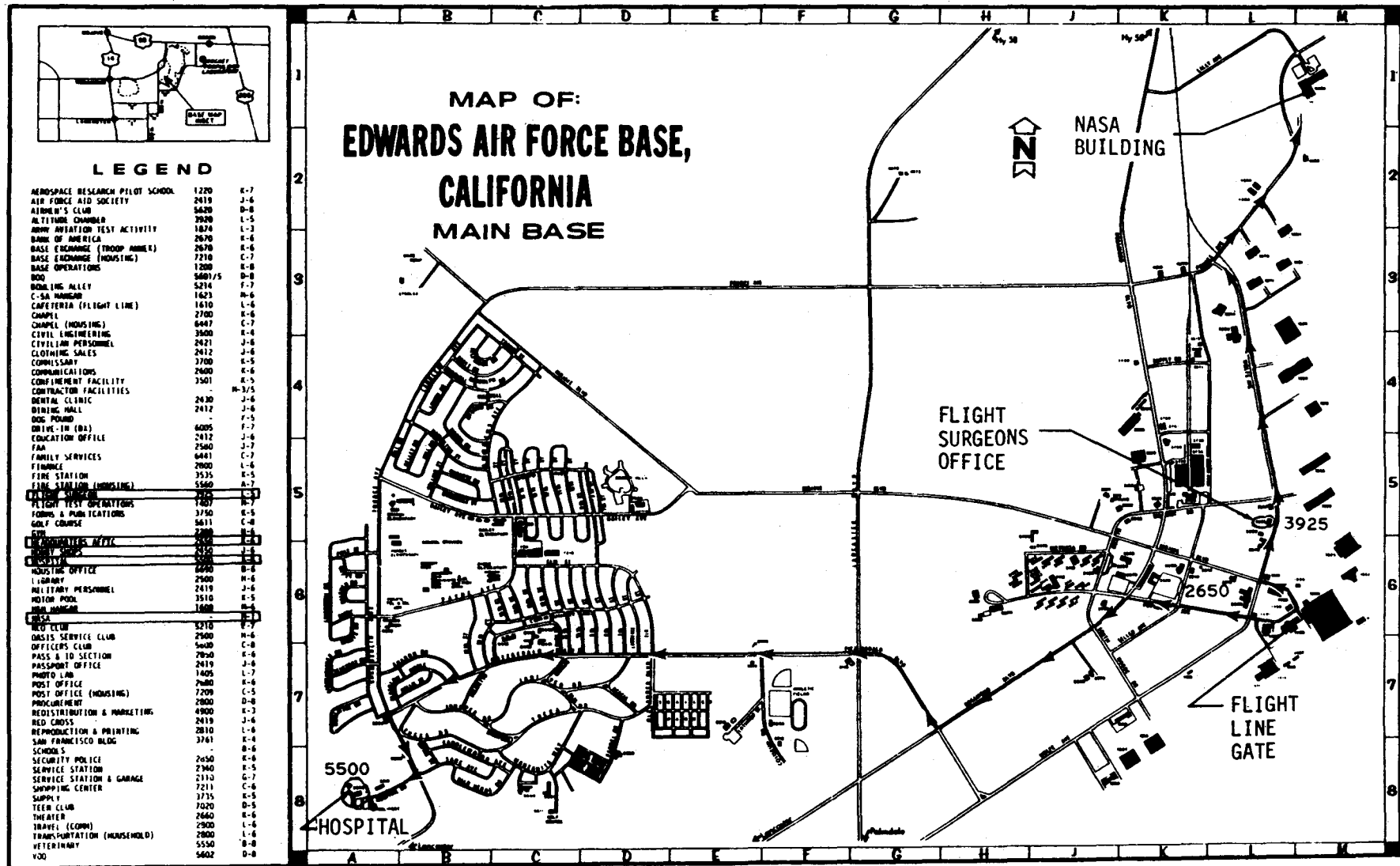
SPACE SHUTTLE
 MERCATOR ORBIT MAP
 STS 61-H

Figure 4.0-3.- Contingency landing sites.

698 A

700

4.0-8



NOTE: FSO to flight line gate- .5 mile Hosp to flight line main gate- 4.1 miles

Figure 4.0-5.- Edwards Air Force Base, California - main base.

JSC-12770

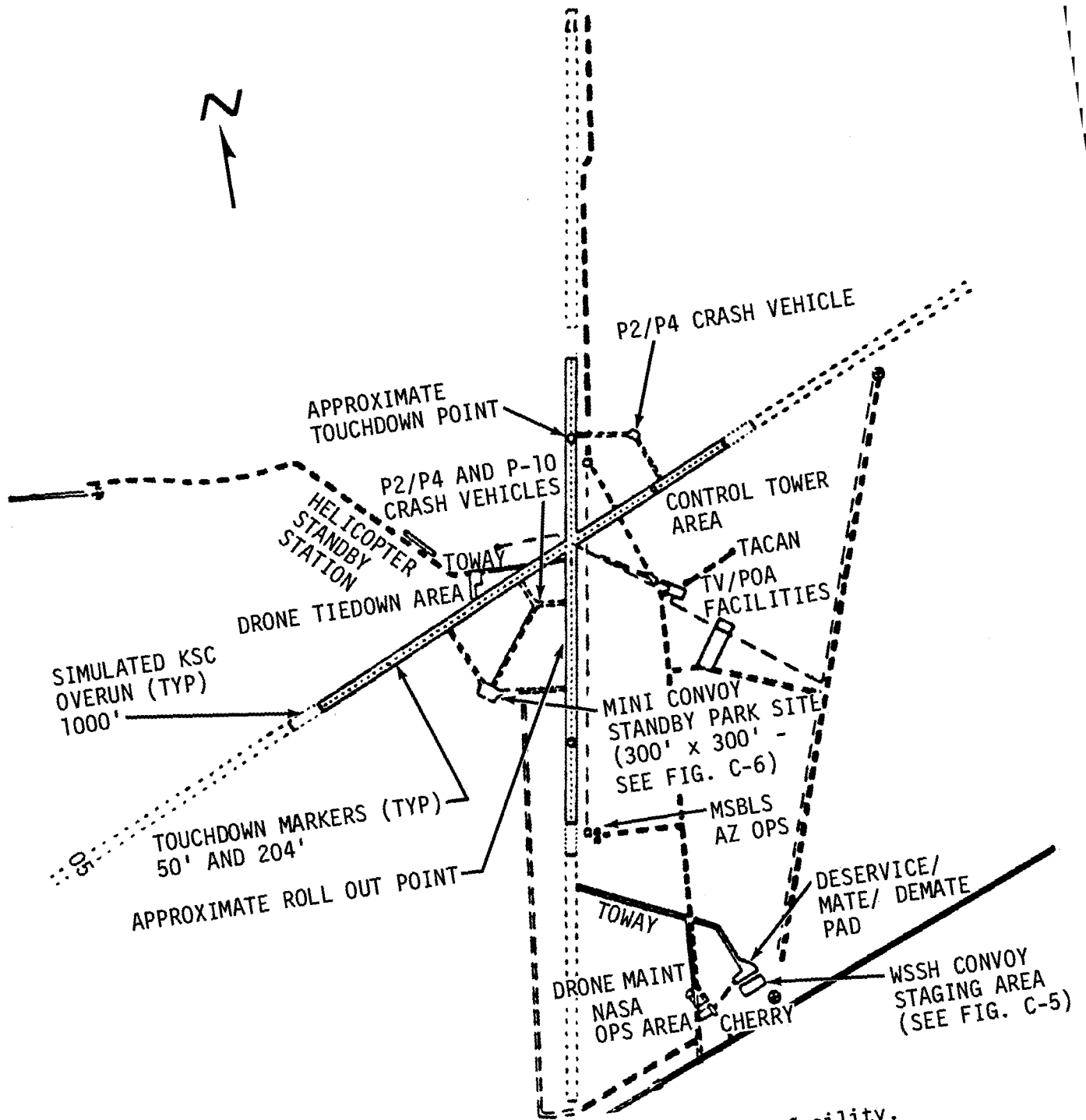


Figure 4.0-6.- Northrup strip landing facility.

4.1 PRETRANSFER OPERATIONS

The pretransfer operations include

- Preflight medical evaluation
- Preflight briefing
- Preflight meal
- Suit/equipment donning

These operations are conducted in the flight crew quarters (figs. 4.1-1 and 4.1-2), medical suite (figs. 4.1-1 and 4.1-4), and Orbiter flight crew equipment (FCE) laboratory (figs. 4.1-1 and 4.1-3). The Orbiter FCE clean room facility is the primary FCE work area, with peripheral and outlying facilities designated as the secondary work area. It provides an environmentally clean area for the storage, preparation, and issuing of FCE for tests and launch support.

The major activities are discussed below.

Preflight Medical Evaluation

There are three preflight examinations on or about F-30 days, F-7 days, and F-0 (prelaunch check).

The preflight medical evaluation is conducted in the medical suite of the operation and checkout (O&C) building (figs. 4.1-1 and 4.1-4) approximately 4 hours before equipment donning. The F-0 day medical evaluation includes the following:

- Vital signs (blood pressure, pulse, temperature) and weight
- Interim medical history
- Physical examination - skin (and hydration), eye, ear, nose, and throat (EENT), chest, abdomen, extremities, neurological
- Laboratory

Preflight Briefing

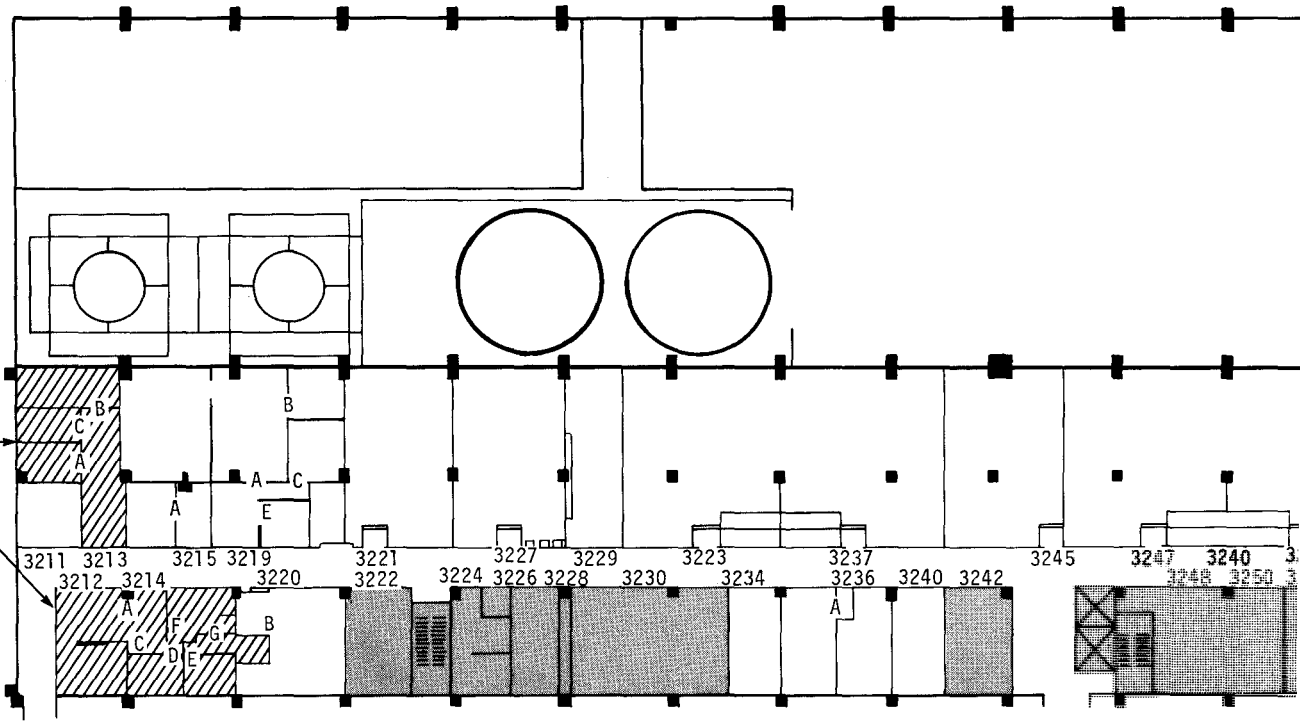
The preflight briefing is conducted in the crew quarters conference and ready room on the third floor of the O&C building (figs. 4.1-1 and 4.1-2). Approximately 15 minutes is allowed to perform this activity.

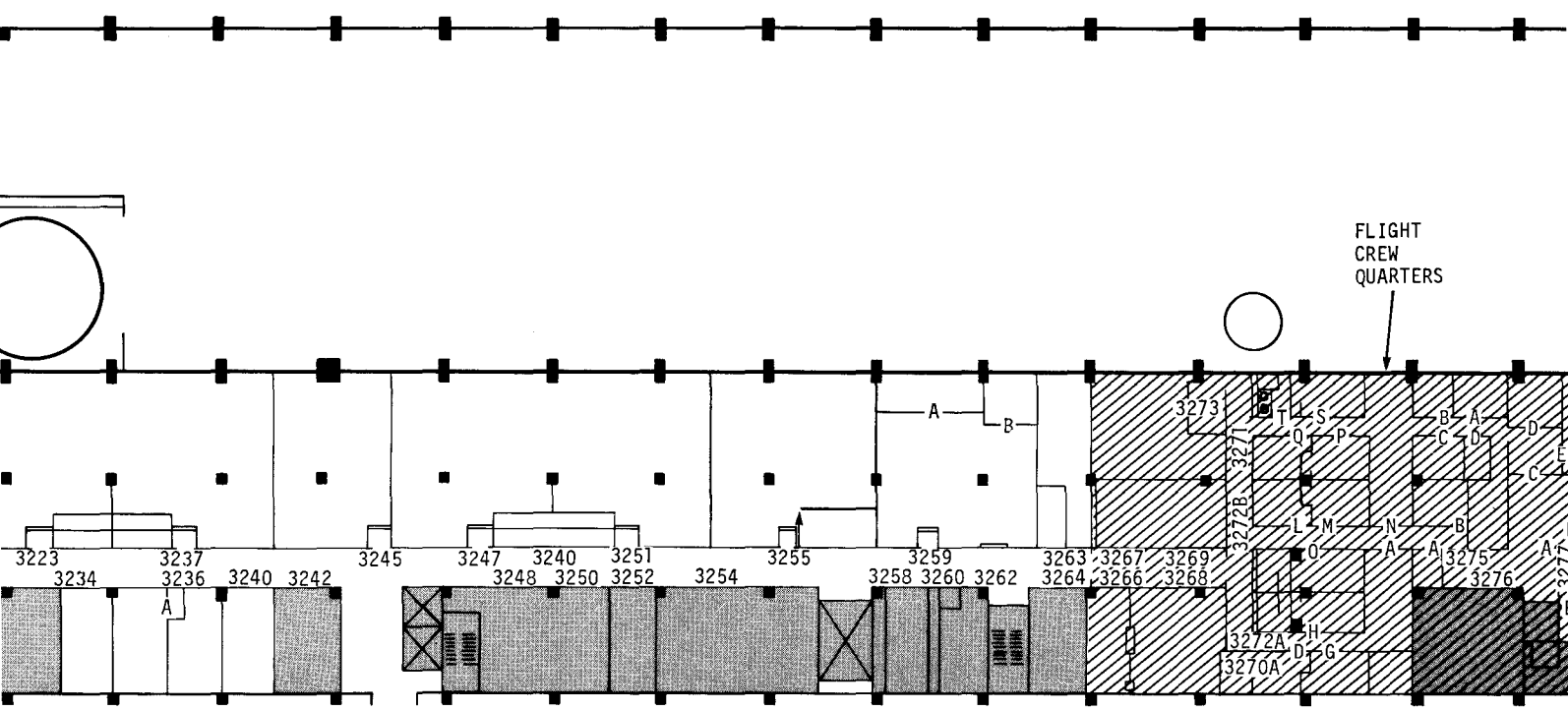
A KSC engineering-type individual will conduct the preflight briefing. Usually, last minute changes are passed on to the crewmembers at this time.

Preflight Meal

Food for the crewmembers is provided from F-7 until launch completion. All preflight foods, including off-the-shelf processed ambient, refrigerated, fresh, fresh frozen, and precooked frozen foods are purchased, stored, and prepared under controlled conditions.

MEDICAL SUITE





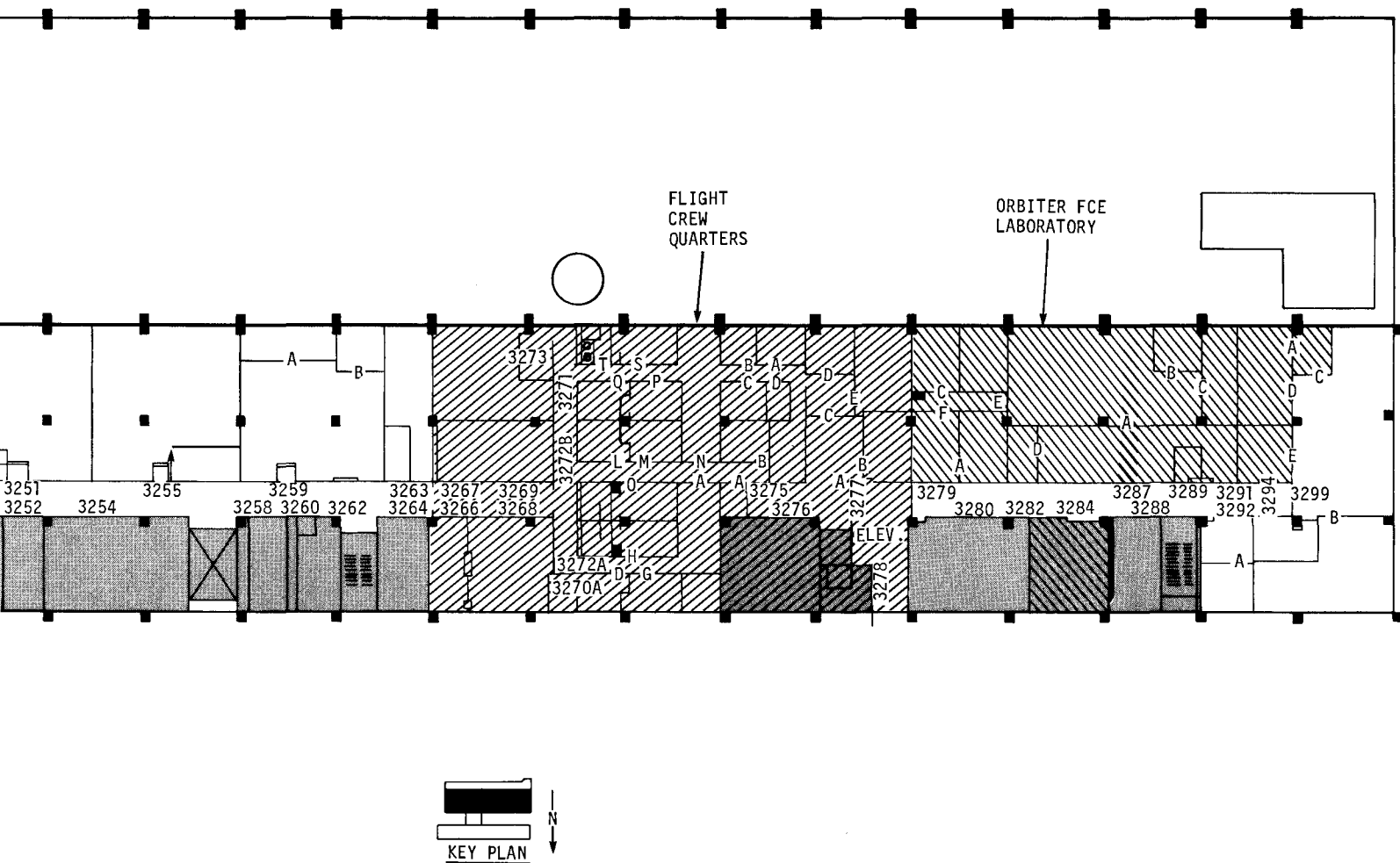
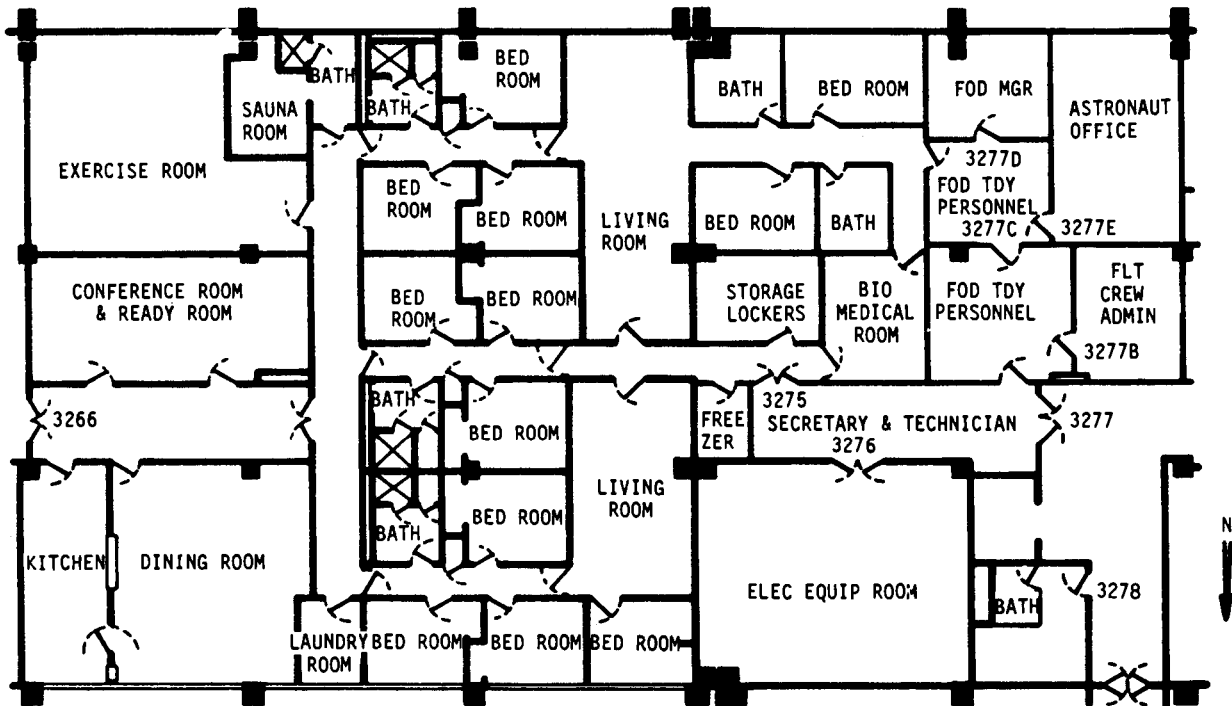


Figure 4.1-1.- O&C building floor plan (3rd floor).

702 A 4.1-3



O&C BUILDING
3RD FLOOR
SOUTHWEST WING

Figure 4.1-2.- Flight crew quarters (KSC).

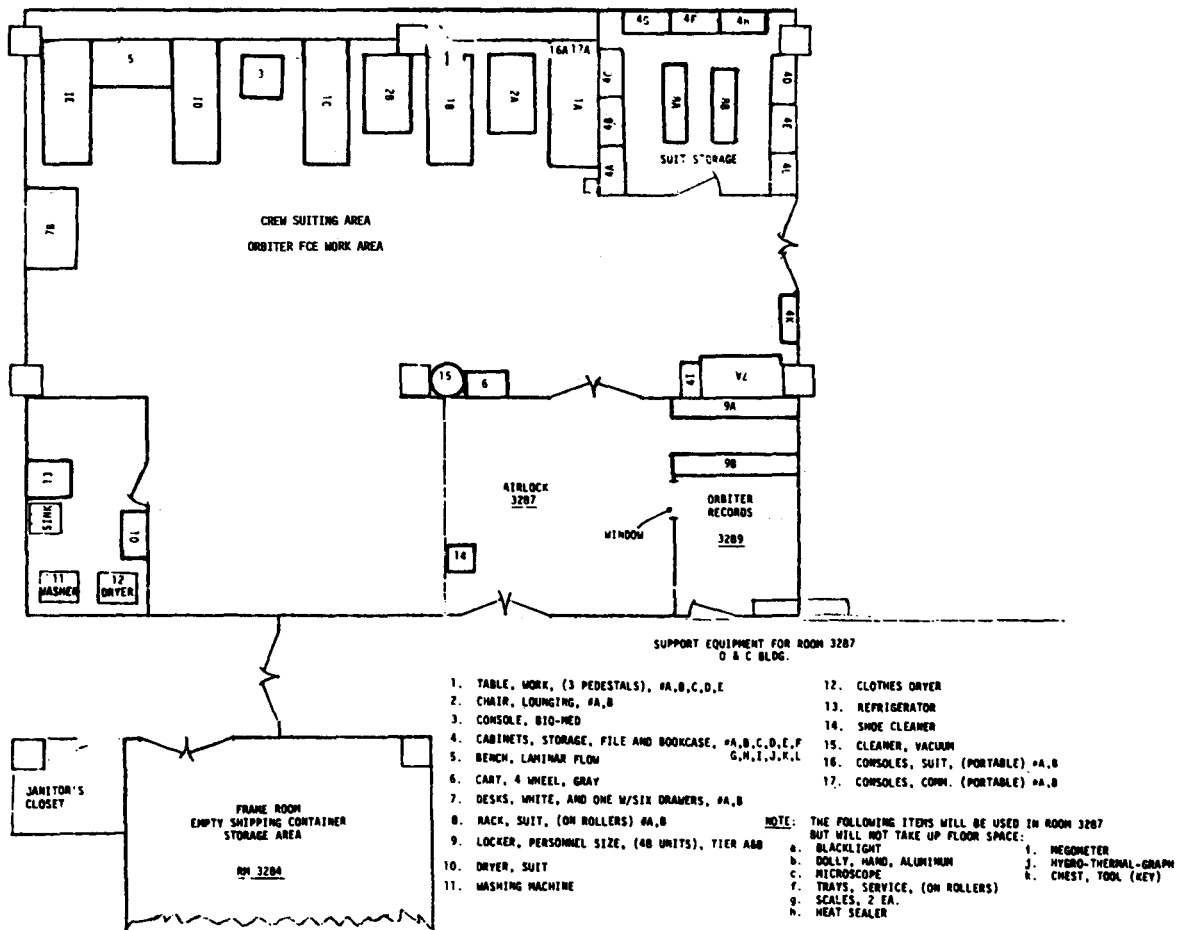
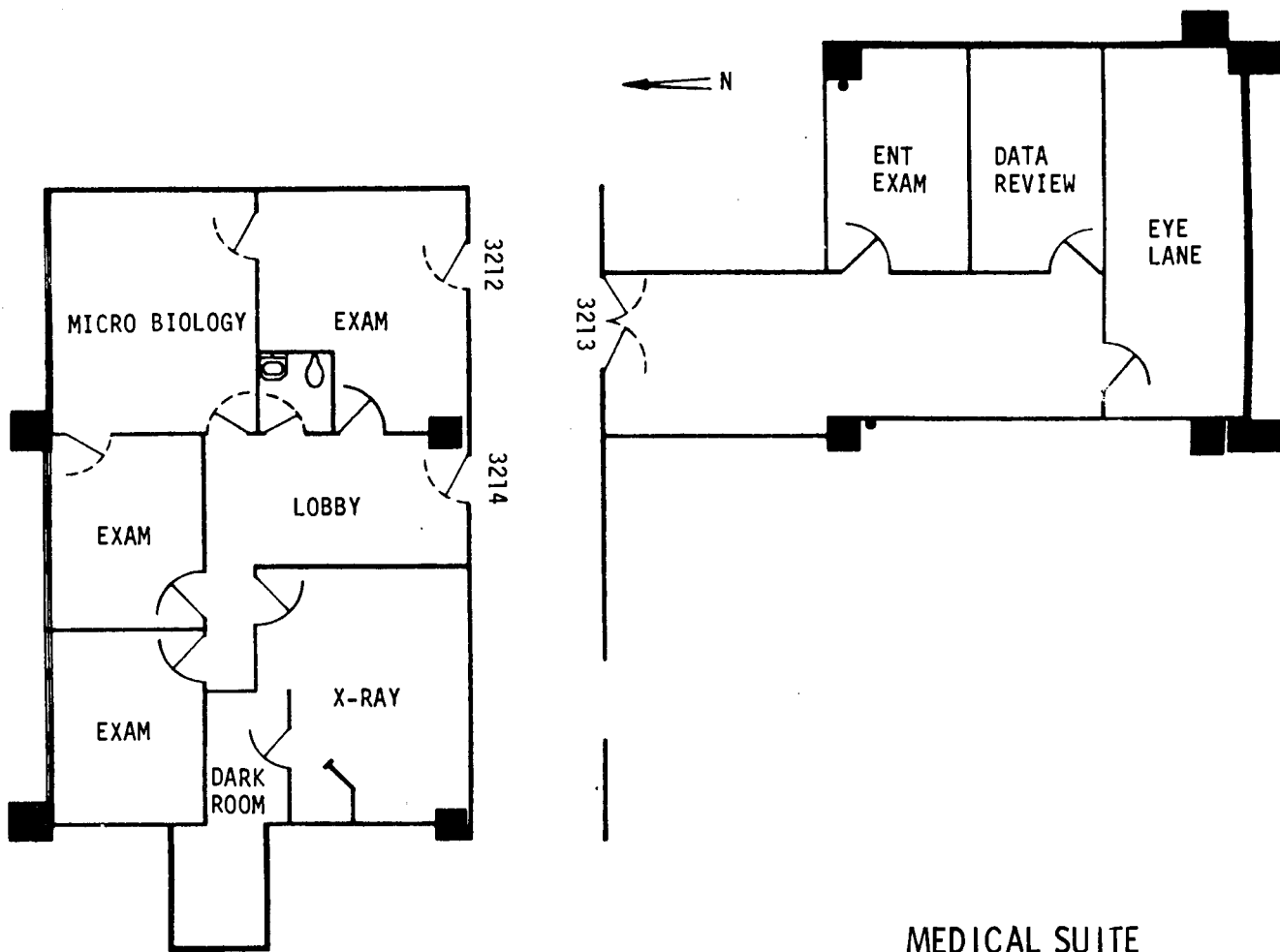


Figure 4.1-3.- O&C Orbiter FCE laboratory (KSC).



MEDICAL SUITE

Figure 4.1-4.- Medical Suite (KSC).

JSC provides a preflight food service for flight crews. Balanced menus that are flexible and offer a variety of commercially available foods are emphasized.

The preflight meal is served in the crew quarters dining room on the third floor of the O&C building (figs. 4.1-1 and 4.1-2). A standard breakfast meal is available for crewmembers, but additional or unusual items can be accommodated. Approximately 45 minutes is allocated for the flight crew to complete their meal.

Equipment Donning

Equipment donning is performed in the suit room area of the O&C building (fig. 4.1-3). Each crewmember requires approximately 20 minutes for donning operations.

4.2 TRANSFER TO PAD AND ORBITER INGRESS

The transfer to pad and Orbiter ingress operations include

- Ingress transfer van
- Transfer to pad apron
- Transfer from pad apron to Orbiter hatch
- Ingress Orbiter

The major phases of this operation are discussed below.

Ingress Transfer Van

To exit the O&C building at KSC, the crewmembers transfer from the third floor to the first floor by utilizing the protected elevator adjacent to the crew quarters. After reaching the first floor, the crew exits through the side door and enters the astronaut transfer van (fig. 4.2-1).

The van accommodates the following personnel and equipment:

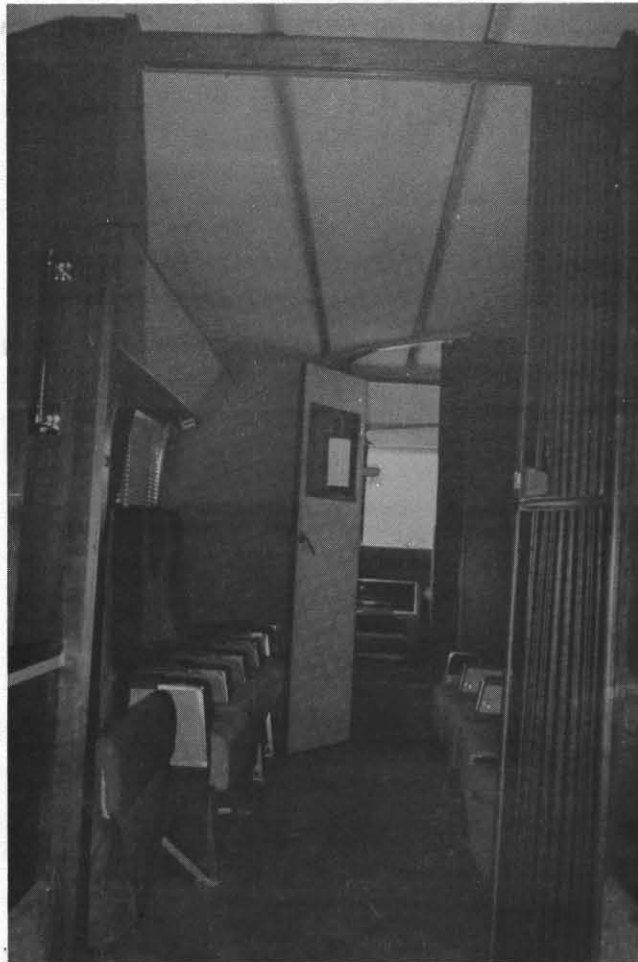
- One security representative
- Vehicle operators as required
- One suit technician
- Seven crewmembers

Transfer to Pad Apron

Approximately 30 minutes is required to transfer the crew from the O&C building to the launch pad (fig. 4.2-2).



TRANSFER VAN



TRANSFER VAN INTERIOR
(LOOKING FORWARD)

Figure 4.2-1.- Transfer van.

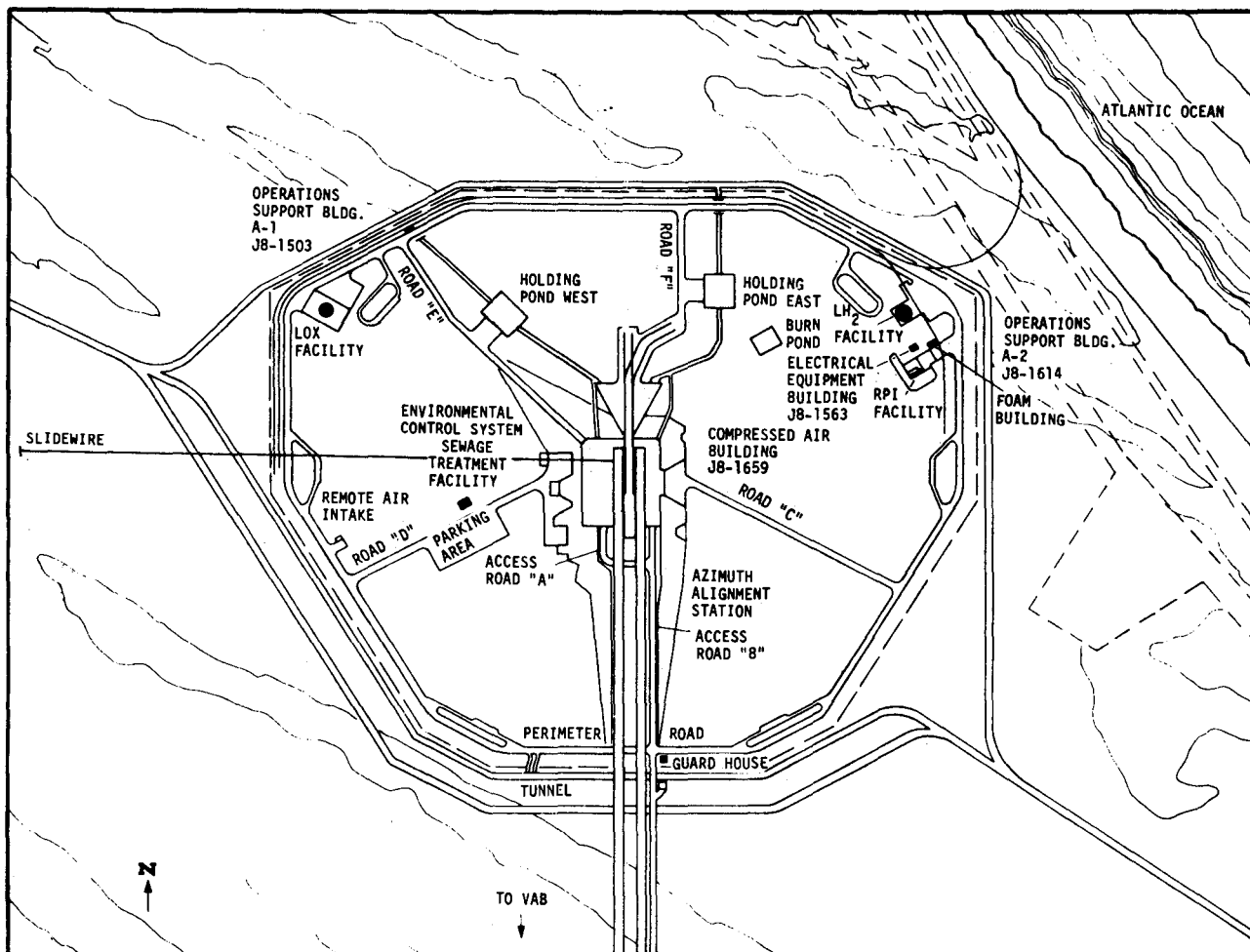


Figure 4.2-2.- Launch pad, 39A (sheet 1 of 2).

S80-33605

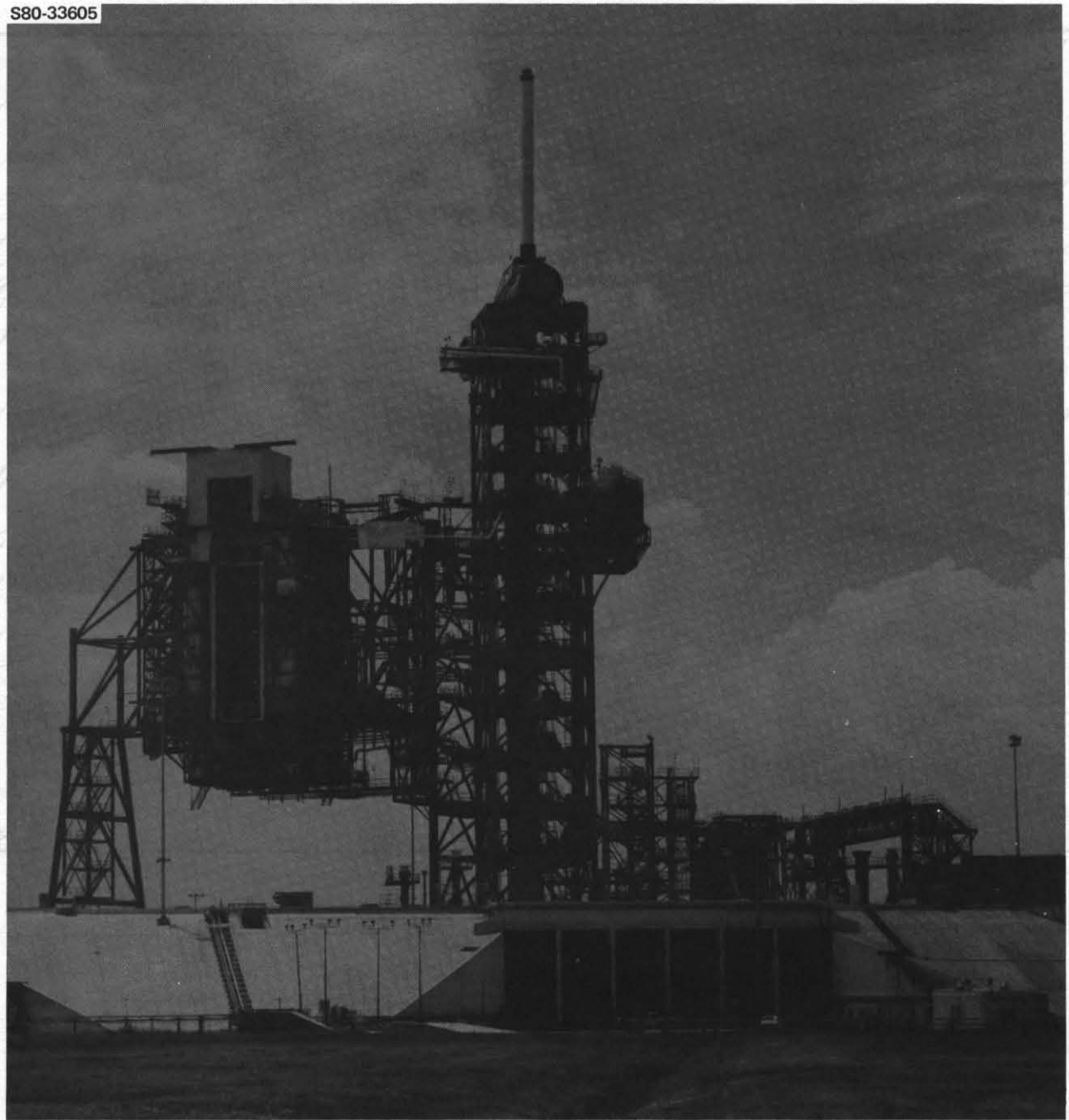


Figure 4.2-2.- Launch pad, 39A (sheet 2 of 2).

Transfer from Pad Apron to Orbiter Hatch

The crewmembers enter the elevator and ascend to the 195-ft level (fig. 4.2-3). Upon reaching the 195-ft level, the crewmembers walk across the swing arm (fig. 4.2-4), and enter the white room (fig. 4.4-1).

Ingress Orbiter

Crew ingress to the Orbiter occurs through the white room and the Orbiter side hatch. (fig. 4.2-4).



ELEVATORS - GROUND LEVEL

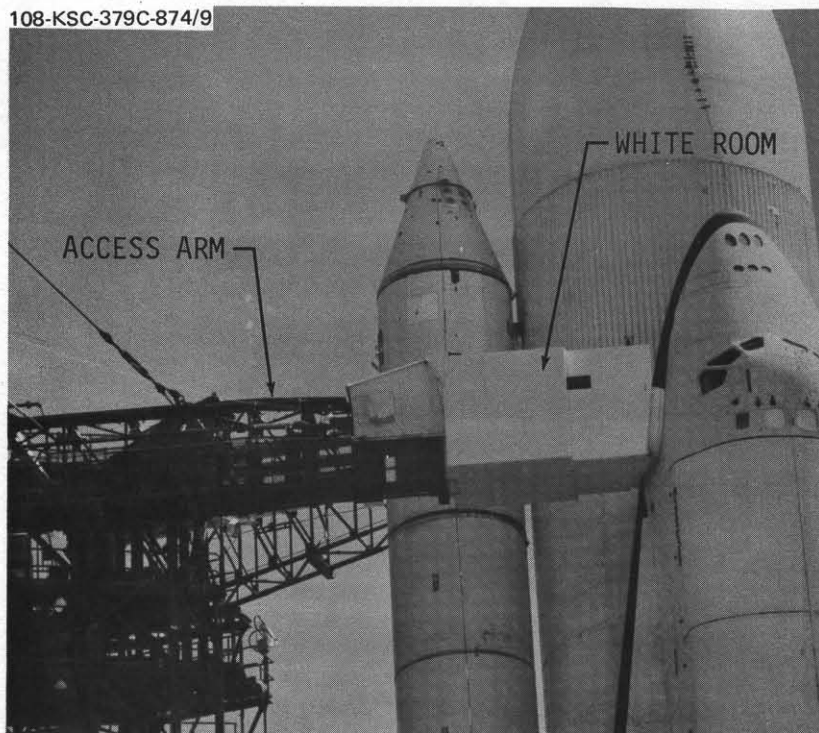


ELEVATORS - 195 FT. LEVEL

Figure 4.2-3.- Elevators.



ACCESS ARM



ACCESS ARM WITHDRAWN

Figure 4.2-4.- Access arm.

4.3 INGRESS TO LIFT-OFF OPERATIONS

The major operations from Orbiter ingress to lift-off are

- Seat ingress
- Systems functional checks
- Perform leak checks
- Verify all systems 'GO' for launch
- Lift-off

The crew is assisted in these activities by the closeout crew. The closeout crew consists of

- One closeout crew leader
- Two mechanical technicians
- One astronaut support person (ASP)
- One suit technician
- One NASA QC

The ASP and the suit technician are responsible for assisting the crew inside the vehicle.

The time required from Orbiter ingress to lift-off is approximately 2 hours (fig. 4.3-1). During this time the crew adjusts their rotational hand controllers and rudder pedals (fig. 4.3-2 and 4.3-3).

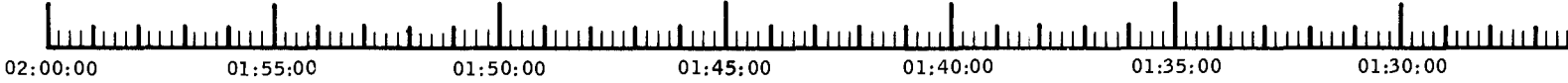
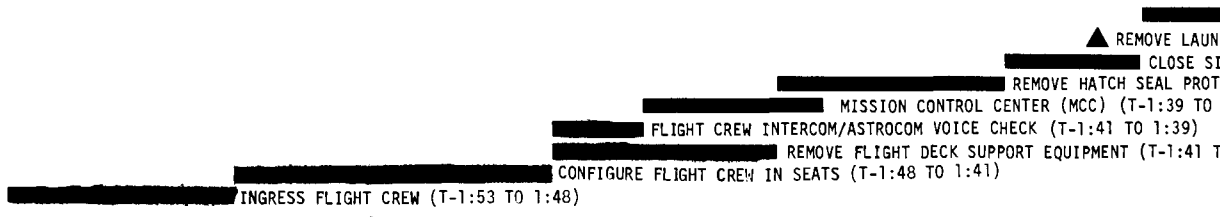
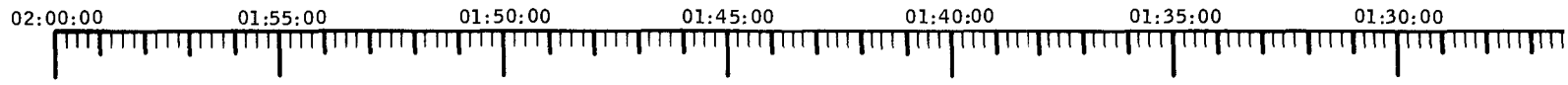
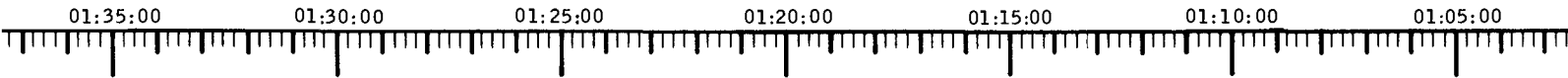


Figure 4.3-1.- Crew ingress to lift-off sequence (sheet 1 of 2).

714 B



START ORBI

FLIGHT CONTR
 DISPLAY DRIVER UNIT/DATA ENTRY AND DISPL
 INERTIAL MEASUREMENT UNIT PREFLIGHT

▲ SOLID ROCK
 HATCH

ABORT ADVISORY CHECK & MCC COMMAND

DISCONNECT HATCH LEAK CHECK SUPPORT EQUIPMENT
 CABIN TEMPERATURE STABILIZATION (T-1:19 TO 1:13)

DISCONNECT CABIN LEAK CHECK SUPPORT EQUIPMENT (T-1:21 TO 1:18)

PERFORM HATCH SEAL LEAK CHECK (T-1:21 TO 1:15)

PRESSURIZE CABIN TO 16.7 PSIA (T-1:25 TO 1:19)

CONNECT HATCH SEAL LEAK TEST SUPPORT EQUIPMENT (T-1:25 TO 1:21)

CONNECT CABIN LEAK TEST SUPPORT EQUIPMENT (T-1:28 TO 1:25)

▲ REMOVE LAUNCH PROCESSING SYSTEM AUXILIARY POWER UNIT- PREACTIVATION PREPARATION (T-1:29:00)
 CLOSE SIDE HATCH (T-1:31 TO 1:28)

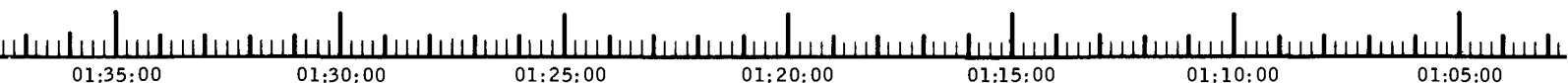
REMOVE HATCH SEAL PROTECTION (T-1:36 TO 1:31)

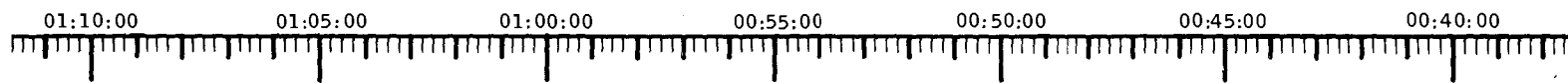
MISSION CONTROL CENTER (MCC) (T-1:39 TO 1:35) (S-BAND, UHF)

CREW INTERCOM/ASTROCOM VOICE CHECK (T-1:41 TO 1:39)

REMOVE FLIGHT DECK SUPPORT EQUIPMENT (T-1:41 TO 1:36)

CREW IN SEATS (T-1:48 TO 1:41)





FORWARD REACTION CONTROL
 LOWER RIGHT OUTER MARKER A

CREW OVERRIDE MAIN PROPULSION SY
 AUXILIARY POWER UNIT CREW PREP-OVERRIDE LAUNCH PROCESSING SYSTEMS P
 FIRST STAGE GUIDANCE PO
 R

SOLID ROCKET BOOSTER GYRO
 GROUND CREW TO FALL BACK AREA (T-0.3

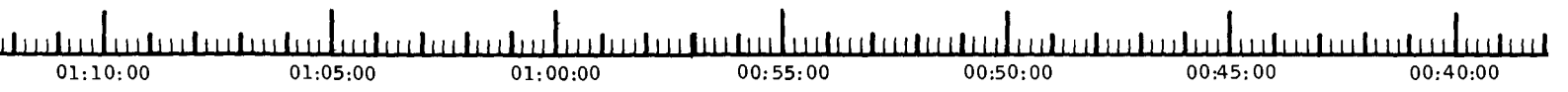
DEVELOPMENT FLIGHT INSTRUMENTATION FM WIDEBAND MISSION RECORDER OFF ▲
 DEVELOPMENT FLIGHT INSTRUMENTATION FM WIDEBAND ASSENT RECORDER OFF ▲
 ORBITAL DEVELOPMENT FREQUENCY DIVISION MULTIPLEX CALIBRATION ▲
 DEVELOPMENT FLIGHT INSTRUMENTATION FM WIDEBAND MISSION RECORDER ON ▲
 DEVELOPMENT FLIGHT INSTRUMENTATION FREQUENCY MODULATION (FM) ASSENT RECORDER ON ▲
 ORBITER DEVELOPMENT INSTRUMENTATION RECORDER CALIBRATION [REDACTED]
 ORBIT INSERTION OPERATIONAL SEQUENCE #2 RECORDER ON (T-0:40:00) ▲

SECURE WHITE ROOM (T-48 TO 36) [REDACTED]
 BLEED CABIN THRU AFT BULKHEAD (T-48 TO 45) [REDACTED]
 START ORBITAL MANEUVERING SYSTEM THRUST VECTOR CONTROL GIMBAL PROFILE [REDACTED]
 RADAR ALTITUDE POWER ON & EXTERNAL TANK READOUT CHECK ▲
 RADAR CONTROL SYSTEM POWER UP [REDACTED]
 ORBITAL MANEUVERING SYSTEM POWER UP [REDACTED]

FLIGHT CONTROL POWER UP [REDACTED]
 DISPLAY DRIVER UNIT/DATA ENTRY AND DISPLAY POWER UP [REDACTED]
 INERTIAL MEASUREMENT UNIT PREFLIGHT ALIGNMENT [REDACTED]

▲ VERIFY MASTER TIME UNIT GREENWICH MEAN TIME CORRECT (T-1:00:00)
 ▲ SOLID ROCKET BOOSTER RATE GYRO POWER UP & MONITOR (T-01:05:00)
 [REDACTED] HATCH THERMAL PROTECTION SYSTEM CLOSE OUT (T-1:12 TO 1:04)

[REDACTED] MONITOR CABIN PRESSURE (T-1:13 TO 48)
 [REDACTED] ABORT ADVISORY CHECK & MCC COMMAND CHECK
 [REDACTED] DISCONNECT HATCH LEAK CHECK SUPPORT EQUIPMENT (T-1:16 TO 1:12)
 CABIN TEMPERATURE STABILIZATION (T-1:19 TO 1:13)
 [REDACTED] SUPPORT EQUIPMENT (T-1:21 TO 1:18)
 HATCH SEAL LEAK CHECK (T-1:21 TO 1:15)
 [REDACTED] (T-1:25 TO 1:19)
 [REDACTED] (T-1:25 TO 1:21)
 [REDACTED] (T-1:29:00)



00:45:00 00:40:00 00:35:00 00:30:00 00:25:00 00:20:00 00:15:00

VERIFY AUXILIARY POWER UNIT 1, 2, 3 SPEED SELE

HYDRAULIC WATER BOILE

HYDRAULIC

AUXILIARY POWER U

LEAK CHECK POWER REACTANT SUPPLY AND DIS

PRESSURIZE MAIN PROPULSION SYSTEM HELIUM TANKS FROM STANDBY T

MAIN PROPULSION SYSTEM/TSM LIQUID OXYGEN UNIT LINE

MAIN PROPULSION SYSTEM LIQUID OXYGEN INBOARD FILL VALVE CL

MISSION CONTROL CENTER

RANGE SAFETY 'GO' FOR LA

LOAD SOLID ROCKET MOT

MISSION CONTROL CENTER "GO" FOR

VENT POWER REACTANT SUPPLY AND DISTRIBUTION SUPPLY LINES

POWER REACTANT SUPPLY AND DISTRIBUTION OXYGEN/HYDROGEN GROUND GAS SUPPLY VALVES CLOSE (T-0:11:00) ▲

ARMED REACTANT CONTROL SYSTEM DRIVER & LOGIC [REDACTED]

LAUNCH PROCESSING SYSTEM SWITCH TO N:ILA RFTM ▲

INERTIAL MEASUREMENT UNIT TILT CORRECTION [REDACTED]

LOAD DUMP AND VERIFY FLIGHT PROGRAM (PRIMARY SET) [REDACTED]

FORWARD REACTION CONTROL SYSTEM (FRCS) MANIFOLD/HELIUM ISOLATION VALVES OPEN-VERIFY TANK AT FLIGHT PRESSURE [REDACTED]

AFT REACTION CONTROL SYSTEM (ARCS) [REDACTED]

LOWER RIGHT OUTER MARKER AND PRESSURE OPERATED DISCONNECT HELIUM VALVES OPEN-VERIFY TANKS AT FLIGHT PRESSURE [REDACTED]

AUTOMATIC THRUST VECTOR CONTROL POWER ON (T-0:20:00) ▲

GENERAL PURPOSE COMPUTER BACKUP TO RUN (T-0:21:00) ▲

CREW OVERRIDE MAIN PROPULSION SYSTEM ENGINES & HELIUM ISOLATION VALVE CONTROL (T-0:25:00) ▲

UNIT CREW PREP-OVERRIDE LAUNCH PROCESSING SYSTEMS PRE-ACTIVATION PREPARATIONS (T-0:29:00) ▲

FIRST STAGE GUIDANCE POLYNOMIAL UPDATE FROM MCC TO MEMORY [REDACTED]

RANGE SAFETY CLOSE LOOP CHECK S1002 [REDACTED]

ABORT LITE CHECK [REDACTED]

SOLID ROCKET BOOSTER GYRO TEST B1007 [REDACTED]

GROUND CREW TO FALL BACK AREA (T-0:36:00) [REDACTED]

NTATION FM WIDEBAND MISSION RECORDER OFF ▲

ENTATION FM WIDEBAND ASSENT RECORDER OFF ▲

REQUENCY DIVISION MULTIPLEX CALIBRATION ▲

TION FM WIDEBAND MISSION RECORDER ON ▲

Y MODULATION (FM) ASSENT RECORDER ON ▲

INSTRUMENTATION RECORDER CALIBRATION [REDACTED]

SEQUENCE #2 RECORDER ON (T-0:40:00) ▲

[REDACTED]

[REDACTED]

[REDACTED]

[REDACTED]

[REDACTED]

[REDACTED]

[REDACTED]

[REDACTED]

[REDACTED]

[REDACTED]

[REDACTED]

[REDACTED]

[REDACTED]

[REDACTED]

[REDACTED]

[REDACTED]

[REDACTED]

[REDACTED]

[REDACTED]

[REDACTED]

[REDACTED]

[REDACTED]

[REDACTED]

[REDACTED]

[REDACTED]

[REDACTED]

[REDACTED]

[REDACTED]

[REDACTED]

[REDACTED]

[REDACTED]

[REDACTED]

[REDACTED]

[REDACTED]

[REDACTED]

[REDACTED]

[REDACTED]

[REDACTED]

[REDACTED]

[REDACTED]

[REDACTED]

[REDACTED]

[REDACTED]

[REDACTED]

00:45:00 00:40:00 00:35:00 00:30:00 00:25:00 00:20:00 00:15:00

00:00)

MONITOR CABIN PRESSURE (T-1:13 TO 48)

00:20:00 00:15:00 00:10:00 00:05:00 00:00:00

VERIFY AUXILIARY POWER UNIT 1, 2, 3 SPEED SELECT HIGH/LOW COMMAND A (T-0:05:30) ▲
 HYDRAULIC WATER BOILER VENT LINE HEATER ON (T-0:05:30) ▲
 HYDRAULIC CIRCULATION PUMP OFF (T-0:05:30) ▲
 AUXILIARY POWER UNIT READY FOR START (T-0:06:00) ▲
 LEAK CHECK POWER REACTANT SUPPLY AND DISTRIBUTION SUPPLY VALVE [REDACTED]
 PROPULSION SYSTEM HELIUM TANKS FROM STANDBY TO FLIGHT PRESSURE [REDACTED]
 PROPULSION SYSTEM/TSM LIQUID OXYGEN UNIT LINE DRAIN (OMI-S1003) [REDACTED]
 LIQUID OXYGEN INBOARD FILL VALVE CLOSED (T-0:09:00) ▲
 MISSION CONTROL CENTER "GO" FOR LAUNCH ▲
 RANGE SAFETY "GO" FOR LAUNCH (T-0:09:00) ▲
 LOAD SOLID ROCKET MOTOR CONSTANTS [REDACTED]
 MISSION CONTROL CENTER "GO" FOR FLIGHT LOAD ▲
 REACTANT SUPPLY AND DISTRIBUTION SUPPLY LINES (V1040) [REDACTED]
 INBOARD GAS SUPPLY VALVES CLOSE (T-0:11:00) (V1040) ▲
 PROPULSION CONTROL SYSTEM DRIVER & LOGIC [REDACTED]
 PRESSURE SYSTEM SWITCH TO MILA RFTM ▲
 CORRECTION [REDACTED]
 PRIMARY SET [REDACTED]
 FLIGHT PRESSURE [REDACTED]
 TEMPERATURE (ARCS) [REDACTED]
 FLIGHT PRESSURE [REDACTED]
 (T-0:20:00) ▲
 (T-0:11:00) ▲

00:20:00 00:15:00 00:10:00 00:05:00 00:00:00



Figure 4.3-2.- Rotational hand controller.

4.3-7

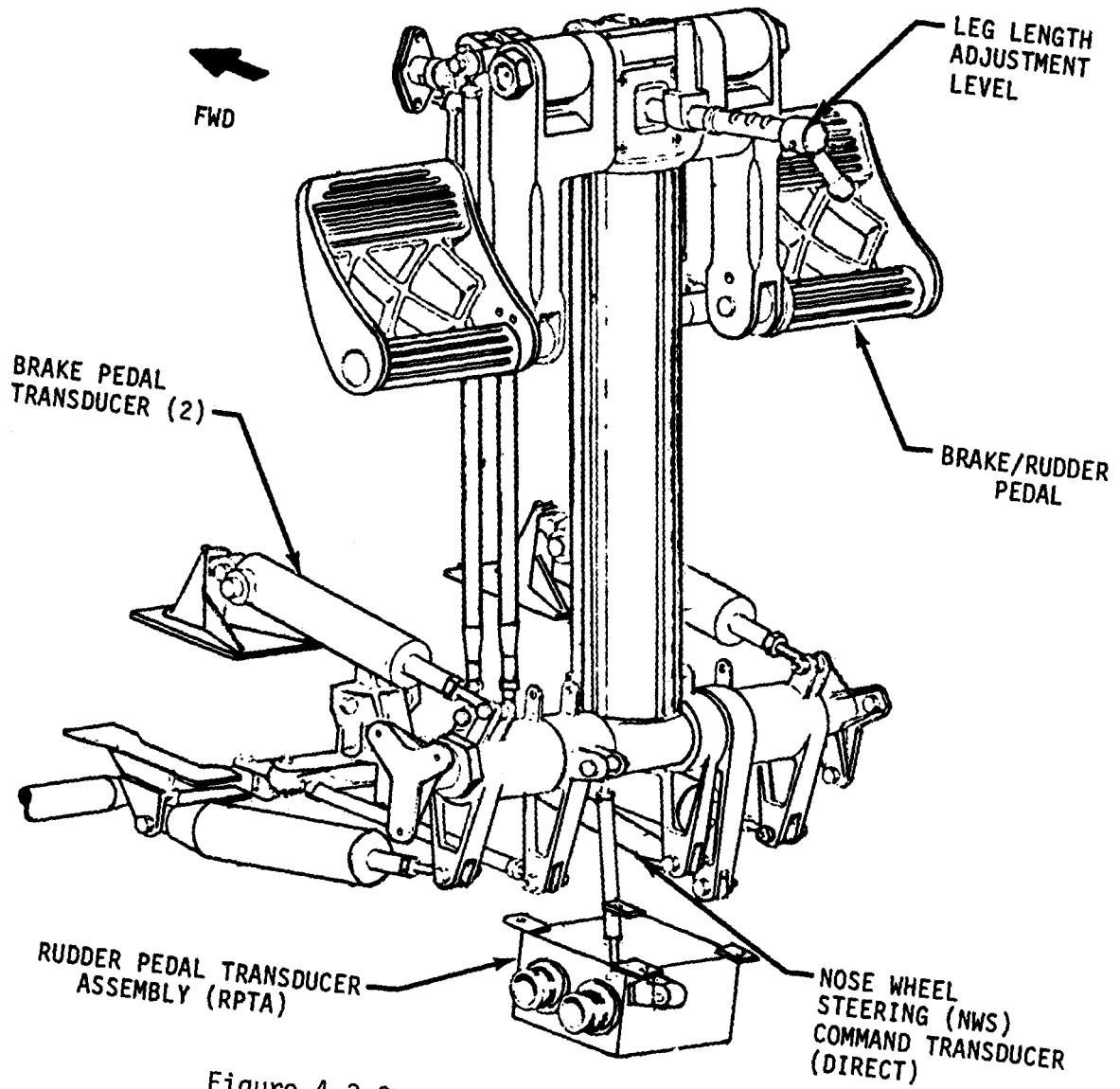


Figure 4.3-3.- Rudder/brake pedal assembly.

4.4 PAD EMERGENCY OPERATIONS

The pad emergency operations include

- Seat egress
- Orbiter egress
- Escape

There are two possible types of crew seat and Orbiter egress

- Aided egress - flight crew egress to the outside of the Orbiter cabin requiring assistance of ground rescue personnel.
- Unaided egress - flight crew egress to the outside of the Orbiter cabin without assistance.

Seat Egress

See seat egress cue card, mode 1 (fig. 4.6-2).

Orbiter Egress

The only egress route when the vehicle is on the pad is the side hatch.

For Aided Egress

Immediately following hatch opening, the rescue crew will ascertain the condition of the middeck and, after clearing debris and extinguishing fires as necessary, will proceed to the flight deck. If the crew is conscious and mobile, the rescue crew will provide necessary assistance to expedite egress. If a crewmember is incapacitated, the rescue crew will remove him from his seat, transfer him to the middeck and out the side hatch.

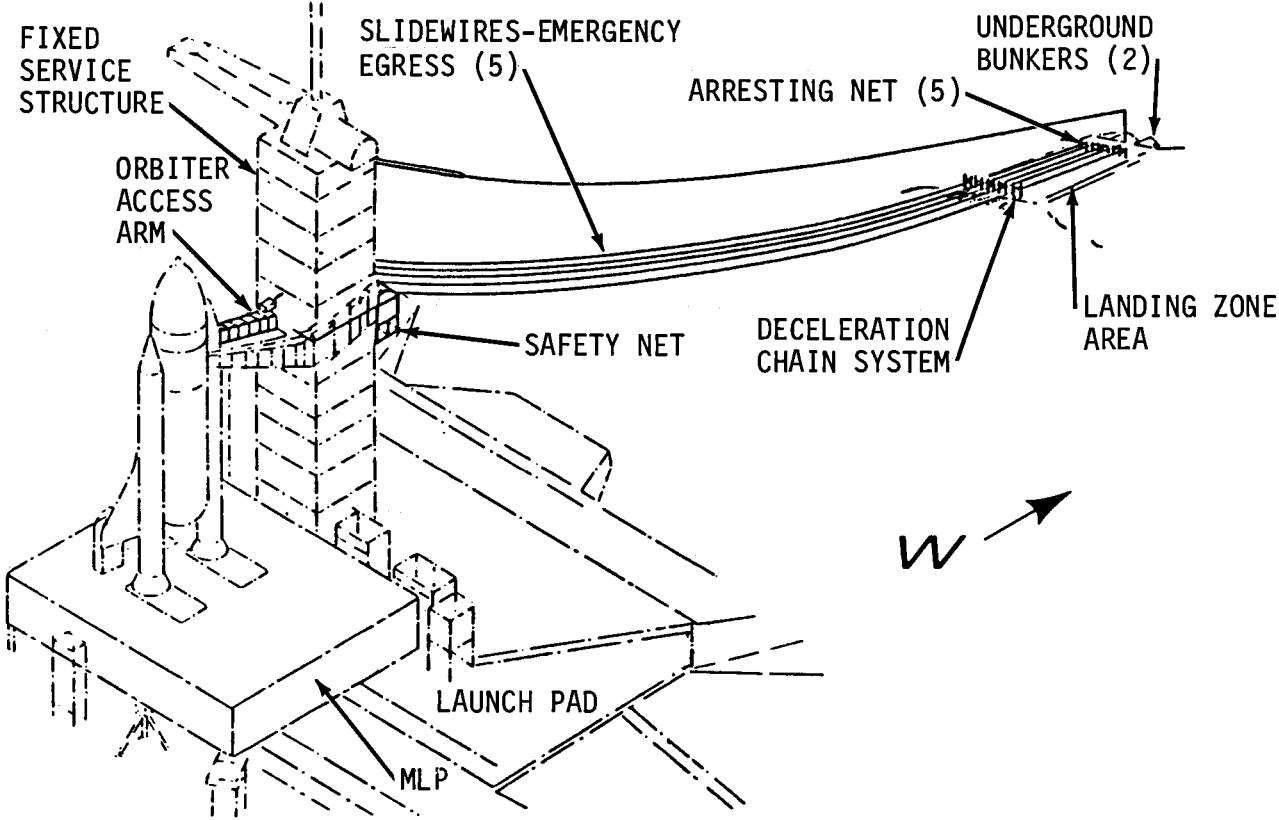
Unaided emergency egress is discussed in section 3.5.

Emergency egress for additional ground operations personnel located on the fixed service structure (FSS) in the area of the egress arm is also provided, and is available up to SRB ignition.

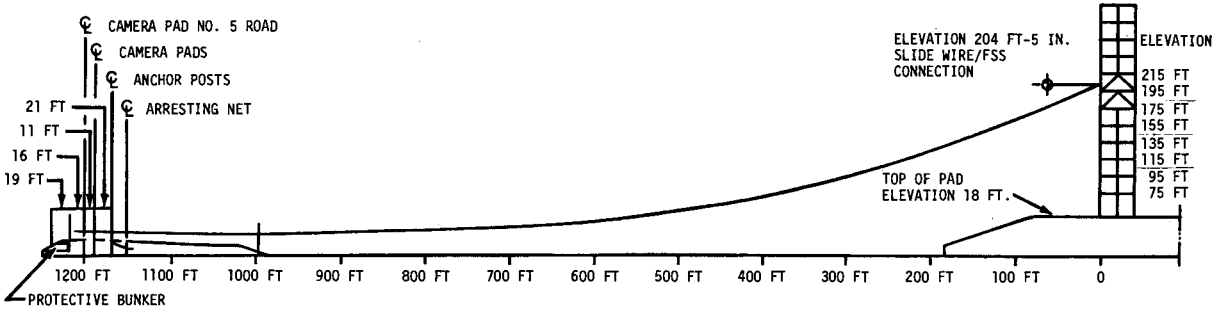
Escape

Four possible modes of flight crew escape can be performed during a pad emergency.

- Mode I Unaided Escape - In an emergency operation in which the flight crew is ambulatory and the closeout crew is not on station, the flight crew either (1) proceeds to the pad surface by elevator/stairs (fig. 4.2-3) where they are met by overland transportation or (2) to the ground bunker via slidewire (fig. 4.4-1 through 4.4-2) where they may remain in the protective bunker or use the M-113 (fig. 4.4-3) to continue escape to a safe area.

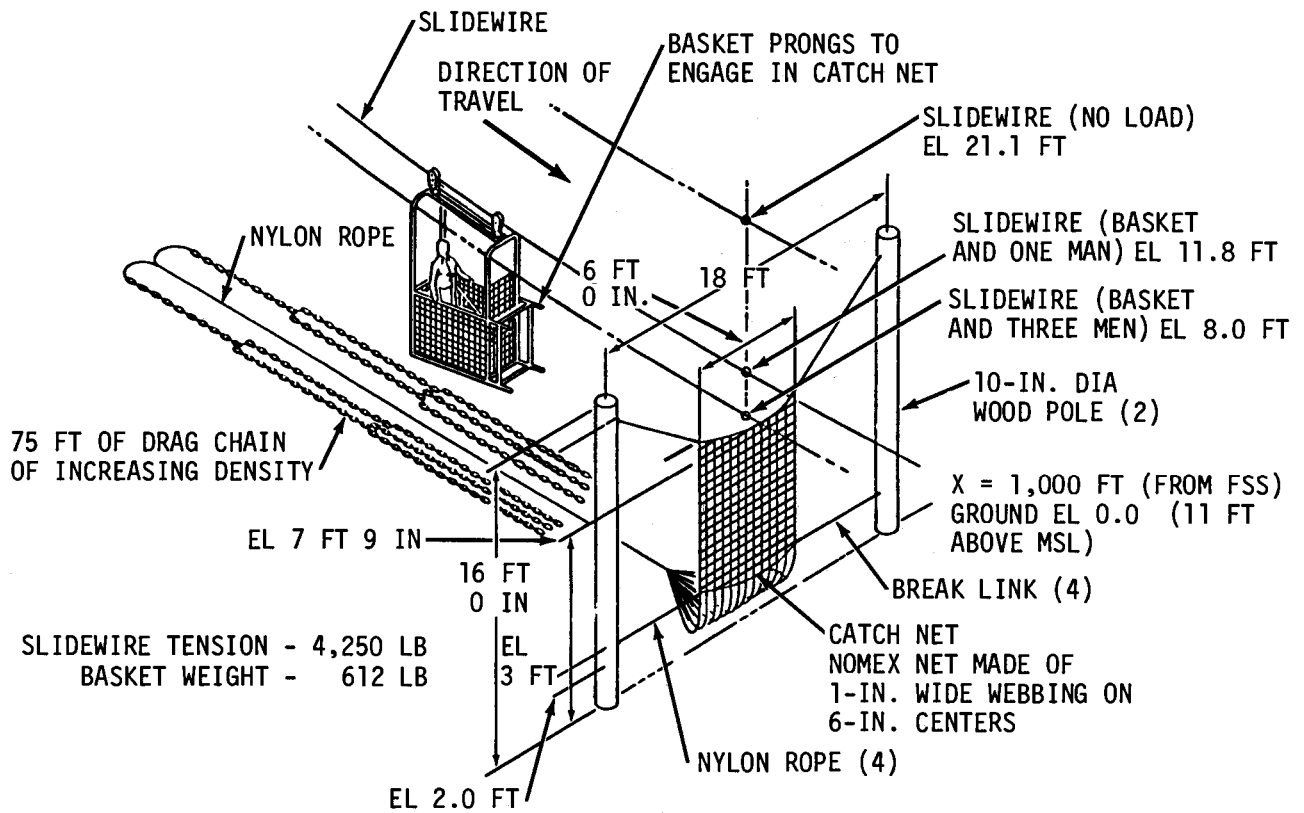


EMERGENCY EGRESS SYSTEM, LAUNCH PAD - COMPLEX 39A

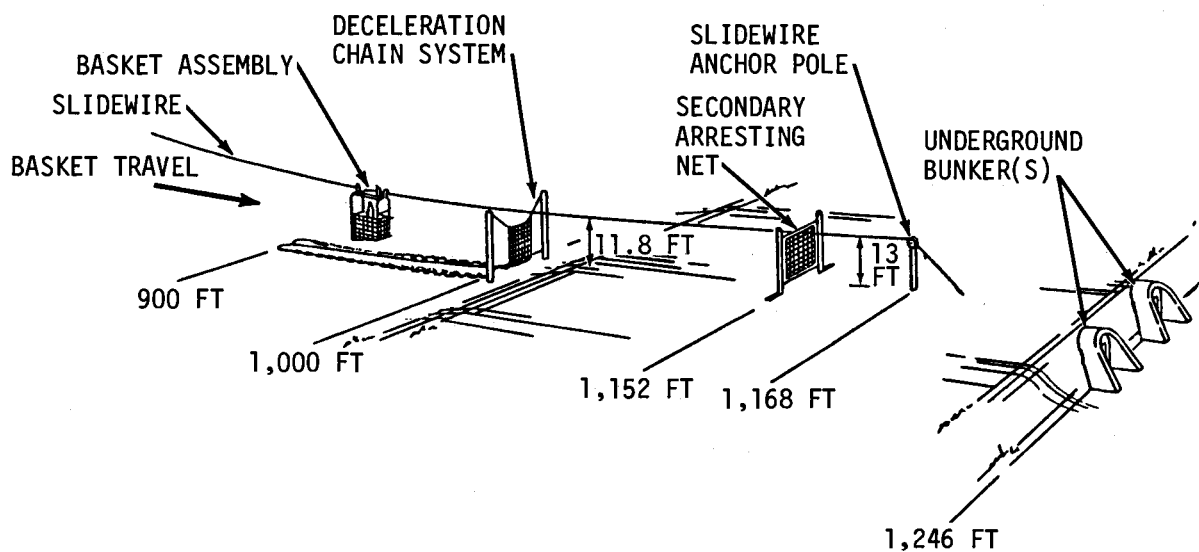


FSS SLIDEWIRE SYSTEM

Figure 4.4-1.- Slidewire system (Sheet 1 of 2).

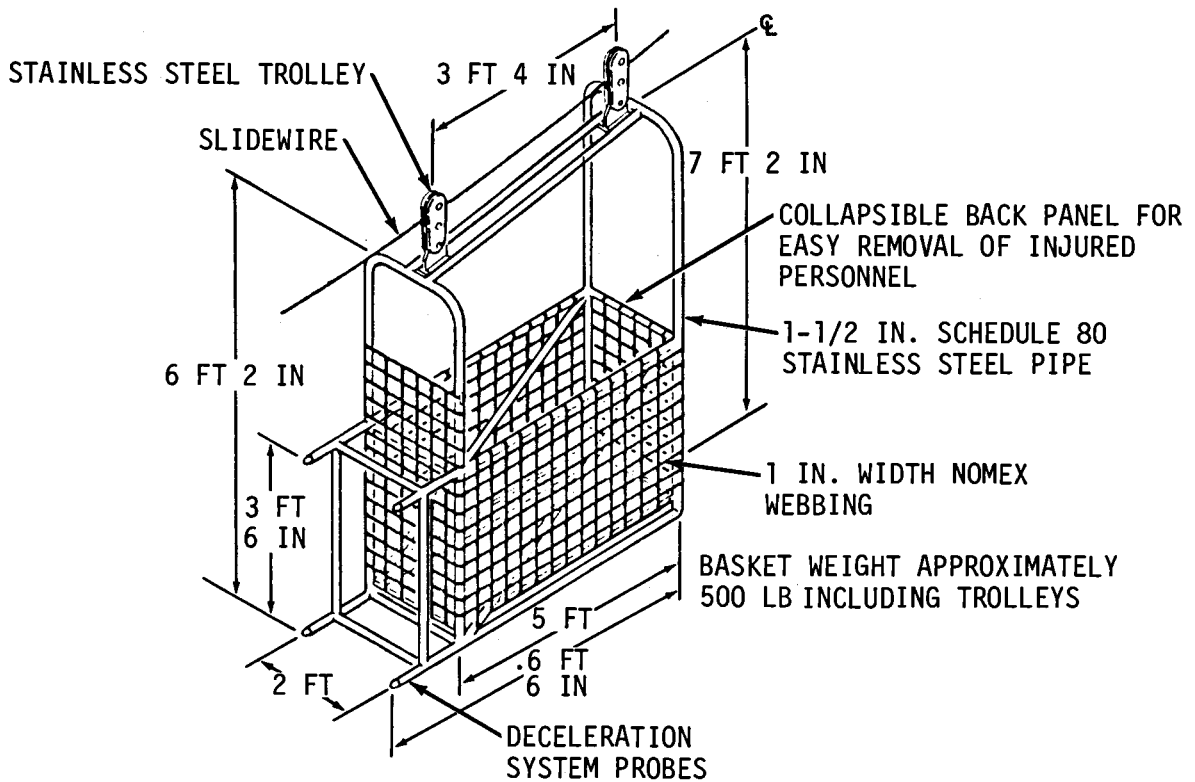


SLIDEWIRE EMERGENCY EGRESS DECELERATION SYSTEM

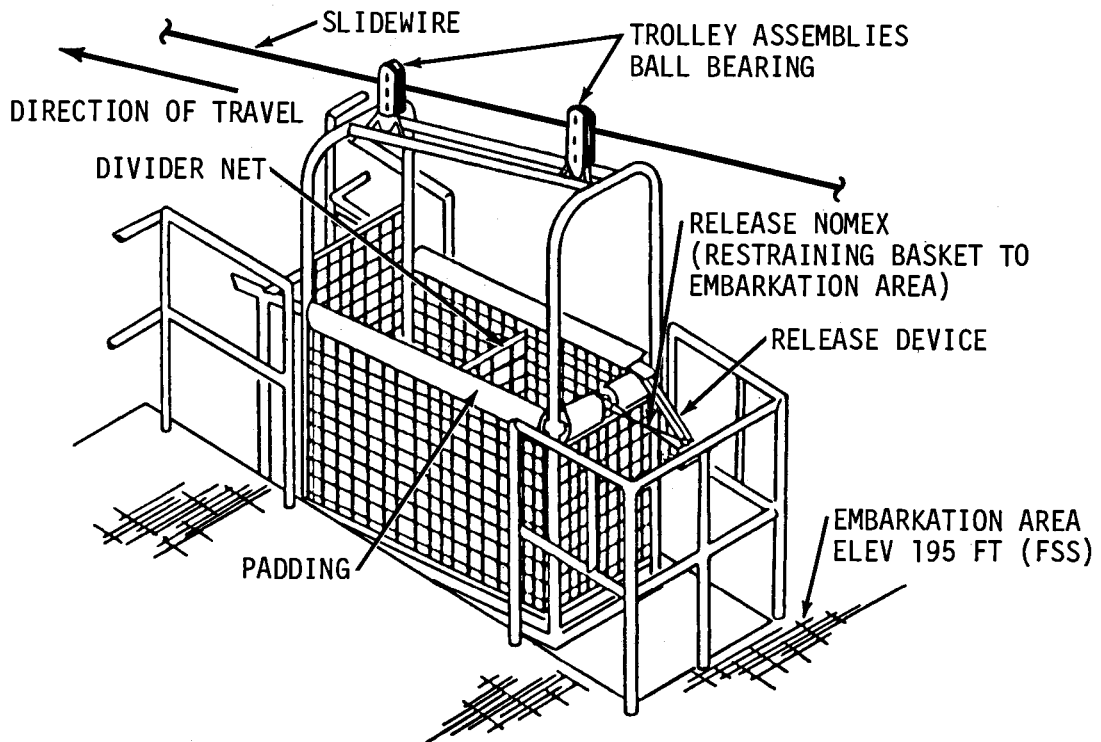


SLIDEWIRE EMERGENCY EGRESS LANDING ZONE

Figure 4.4-1.- Slidewire system (Sheet 2 of 2).



SLIDEWIRE BASKET DIMENSIONS



SLIDEWIRE EMERGENCY EGRESS BASKETS AT THE EMBARKATION AREA

Figure 4.4-2.- Slidewire basket.

- Mode II-Aided Escape - In an emergency operation in which the closeout crew is on station, the closeout crewmembers perform all tasks necessary to aid the flight crew to escape from the environmental chamber either to (1) the pad surface via FSS elevator/stairs where they will be met by overland transportation or (2) to a ground bunker (fig. 4.4-3) via the slidewire system.
- Mode III-Aided Escape - In an emergency operation in which the closeout crew is not on station, the fire/rescue crew is required to move from their fall-back station to the environmental chamber to effect the rescue of the flight crew.
- Mode IV-Aided Escape - In an emergency operation in which the closeout crew as well as the flight crew are on station, the fire/rescue crew proceeds from their fall-back station to the crew module level of the FSS to assist or to rescue both the closeout crew and the flight crew.

Escape from the Orbiter hatch is via the Orbiter access arm (OAA) (fig. 4.4-4). The arm consists of a modified Apollo servicing arm with a White Room attached to the end of the arm. The White Room is provided with a fire detection and alarm system (fig. 4.4-5). The alarm signal is sent to the fire services.

Once the OAA has been traversed, the primary route is via the emergency escape (slidewire). A secondary route via an escape stairway is also available.

In addition to the fire protection system, the white room is provided with portable fire suppression equipment for use within the Orbiter cabin. This portable equipment consists of three fire extinguishers stored on the wall within the white room, and one water hose reel outside the entrance. The arm walkway is also protected with a water spray system.

As stated earlier, the primary route for emergency escape is via the OAA to the FSS to the Shuttle slidewire system (fig. 4.4-4).

The slidewire system consists of five slidewires with one basket per slidewire. The basket is secured to the FSS by a 3/8 in. diameter rope. The basket is released by manually operating a guillotine-type device which cuts the rope. The basket descends to ground level where it hits the breakaway catch net. The net is connected to 75 ft. of chain which is dragged along the ground until the basket stops. The crewmembers then leave the basket and enter either the protective bunker or M113. A basket can safely accommodate a maximum of four people.

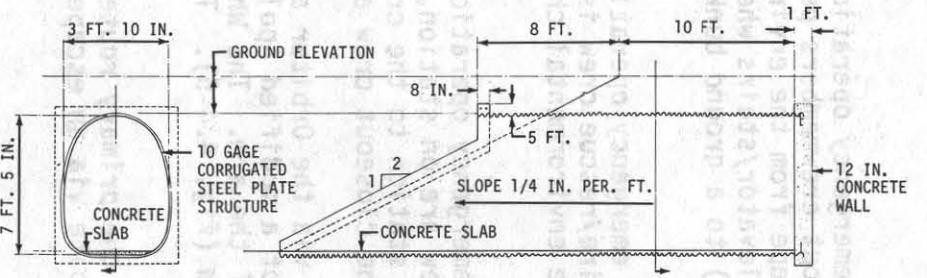
The M-113 armored personnel carrier (APC) will be parked at the slidewire bunker area to provide a protected means of transportation of personnel from the slidewire bunker area to a safe area.



M113 PERSONNEL CARRIER (FRONT VIEW)



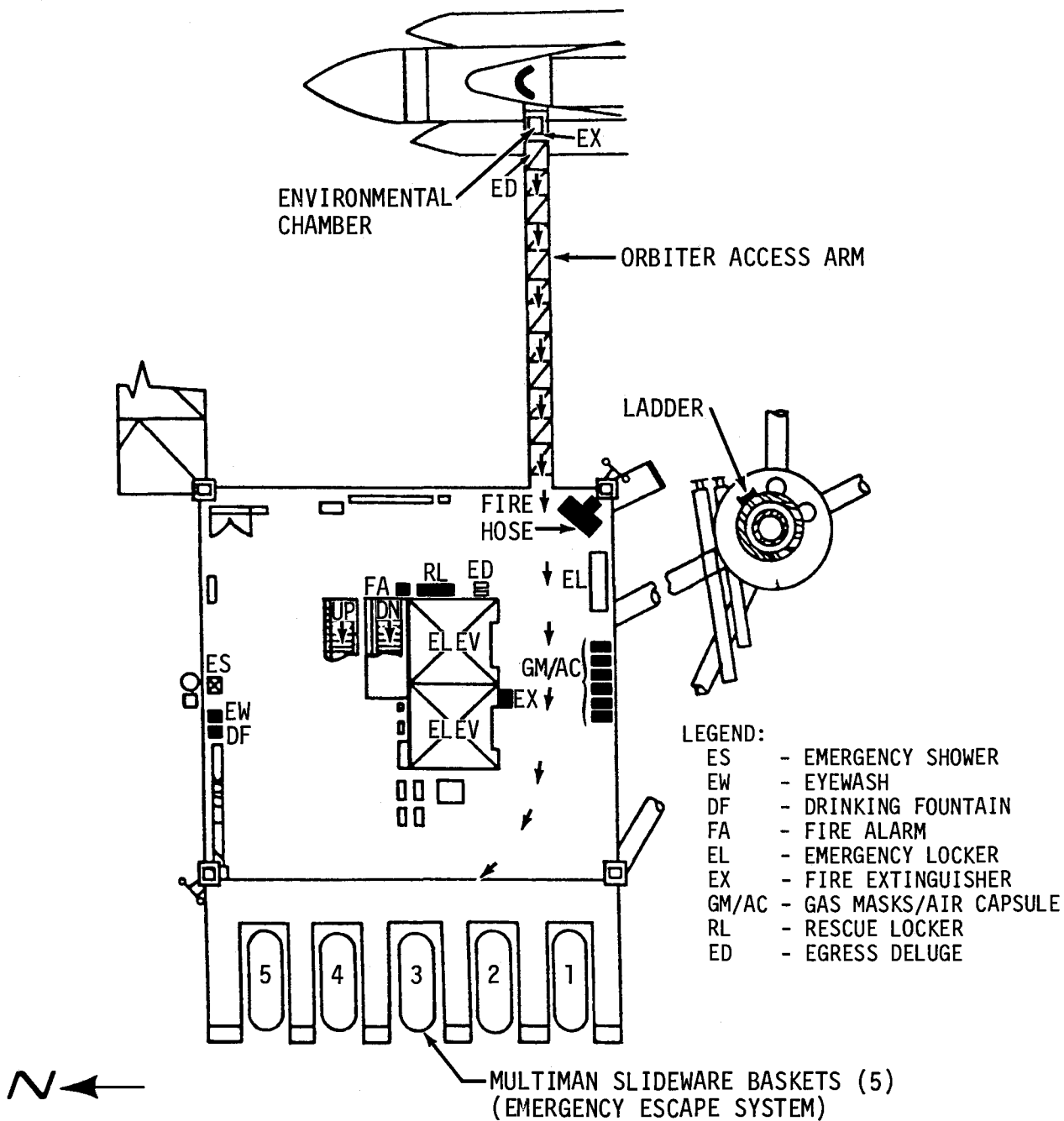
M113 PERSONNEL CARRIER (BACK VIEW)



PROTECTIVE BUNKER

Figure 4.4-3.- Protective devices.

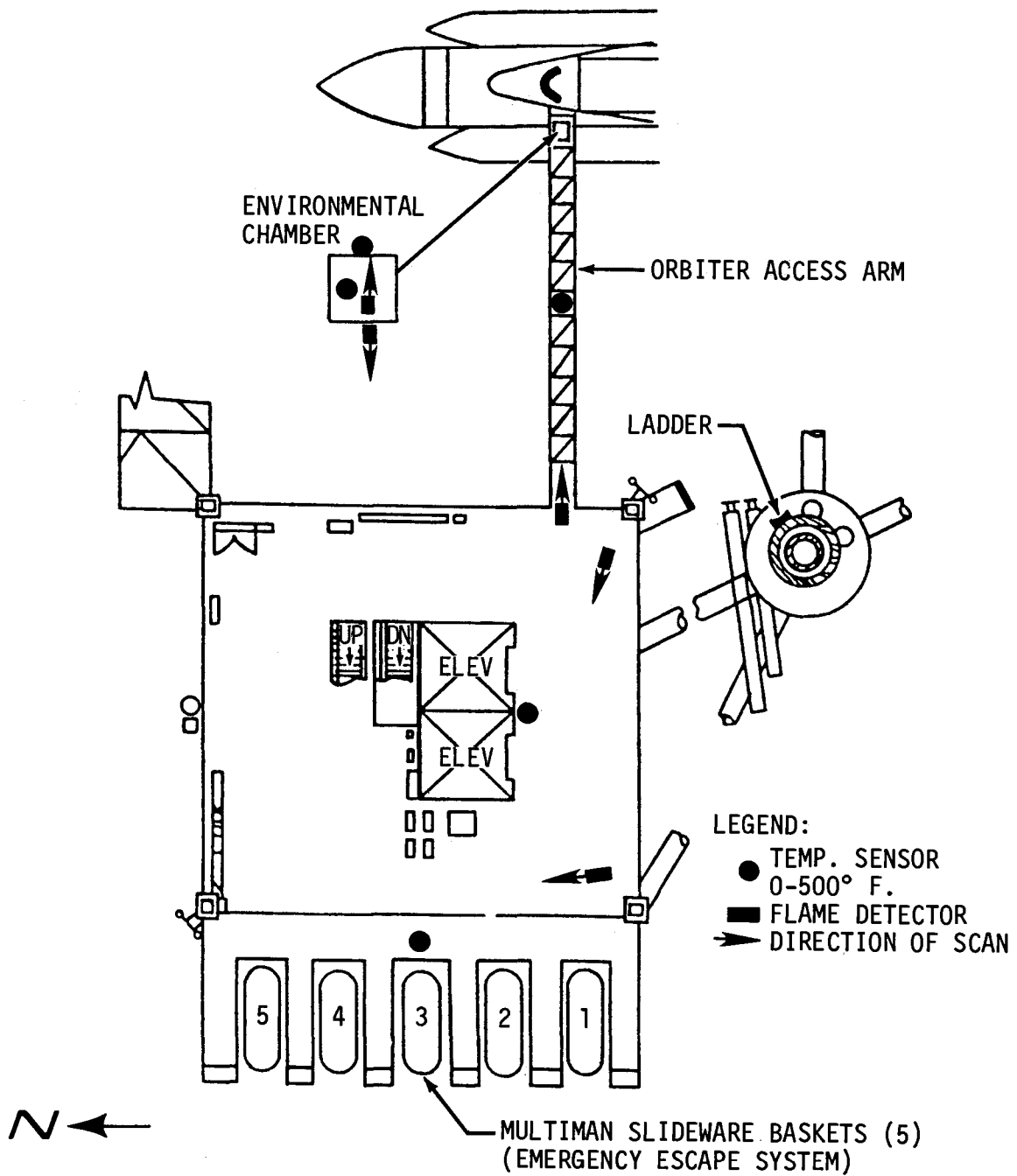
NOTE: SHUTTLE SYSTEM AND ORBITER
SHOWN ROTATED 90 DEG FOR
CLARITY.



FSS, 195' LEVEL SHOWING ORBITER ACCESS ARM AND EMERGENCY ESCAPE SYSTEM LOCATIONS (LC-39) (FOR REFERENCE ONLY)

Figure 4.4-4.- Escape route.

NOTE: SHUTTLE SYSTEM AND ORBITER
SHOWN ROTATED 90 DEG FOR
CLARITY.



FSS 195' LEVEL, OAA AND WHITE ROOM TEMPERATURE SENSOR, FLAME DETECTOR
LOCATIONS (FOR REFERENCE ONLY)

Figure 4.4-5.- Fire Detection System.

4.5 NORMAL POSTLANDING OPERATIONS

The following activities take place during normal postlanding operations:

- Power down
- Seat egress
- Orbiter egress
- Postflight operations
- Return to JSC

Powerdown

- KSC, EAFB, and Northrup Strip

After a normal landing at KSC, EAFB, or Northrup Strip the crew transfers power to the ground. Powerdown is performed under ground control.

- Contingency Landing Site (CLS)

After a normal landing at a CLS, the crew performs the powerdown. The powerdown includes APU hydraulics deactivation, hydraulic circulation pump activation, RCS and OMS safing, GPC deactivation, ammonia system deactivation, and fuel cell shutdown.

Seat Egress

- The crewmembers egress their seats and doff their LEH and Emergency Egress Harnesses.

Orbiter Egress

- KSC, EAFB, and Northrup Strip

After a normal landing at KSC (fig. 4.0-1), EAFB (fig. 4.0-3), or Northrup Strip (fig. 4.0-6), the crew leaves the Orbiter via the routes illustrated on figure 3.5-3. The crew leaves through the side hatch, which will normally be opened from outside by the ground crew utilizing normal hatch opening procedures as described in section 3.3. The Orbiter egress vehicle (fig. 4.5-1) is used to assist the Orbiter flight crew and ground personnel during Shuttle postlanding egress operations at the Shuttle landing facility (SLF) runway.

- CLS

After a normal landing at a CLS (fig. 4.0-2), the crew leaves the Orbiter via the routes illustrated on figure 3.5-3. The crew uses the side hatch, which will normally be opened by the flight crew utilizing normal hatch opening procedures as described in section 3.3.

The crew descends to the ground using the egress bar. Available equipment at the CLS's will be used to assist the Orbiter flight crew and ground personnel during Shuttle postlanding egress operations.

Postflight Operations

- Welcome back ceremony

A very brief welcome back ceremony (handshake) is conducted immediately after Orbiter egress.

- Suit doffing

Suit doffing is conducted in the transfer van at DFRC or Northrup Strip. For a landing at KSC, the crew will be transported back to the O&C building for suit doffing in the suit room.

- Postflight Medical Evaluation

Postflight medical evaluations will be conducted on each crewmember. The first examination will be conducted as soon as possible in the transfer van at DFRC or Northrup Strip or in the medical suite at KSC. If a more extensive examination is required, it will be conducted in the landing sites medical facility. A second evaluation will be performed on the morning of L + 1 day in the medical facility at JSC. The following evaluations will be performed (except as noted) on landing day, landing plus 1 day, and landing plus 3 days.

- Medical debriefing
- Vital signs (blood pressure, pulse, and temperature)
- Weight (except in transport van at DFRC & Northrup Strip)
- Physical examination - skin (and hydration), EENT (eyes, ears, nose and throat), chest, abdomen, extremities, neurological, orthostatic tolerance test
- Laboratory - urinalysis, blood, microbiology, audiometry (L + 3 days only), dental (L + 3 days only)

- Departure from landing strip

- KSC: The flight crew is carried via the transfer van to the O&C building for suit doffing, postflight medical evaluations, and to await departure to JSC.
- DFRC: The flight crew is carried via the transfer van to the astronaut trailer to await departure to JSC.
- Northrup Strip: The flight crew is carried via the transfer van or in a helicopter to the return aircraft.

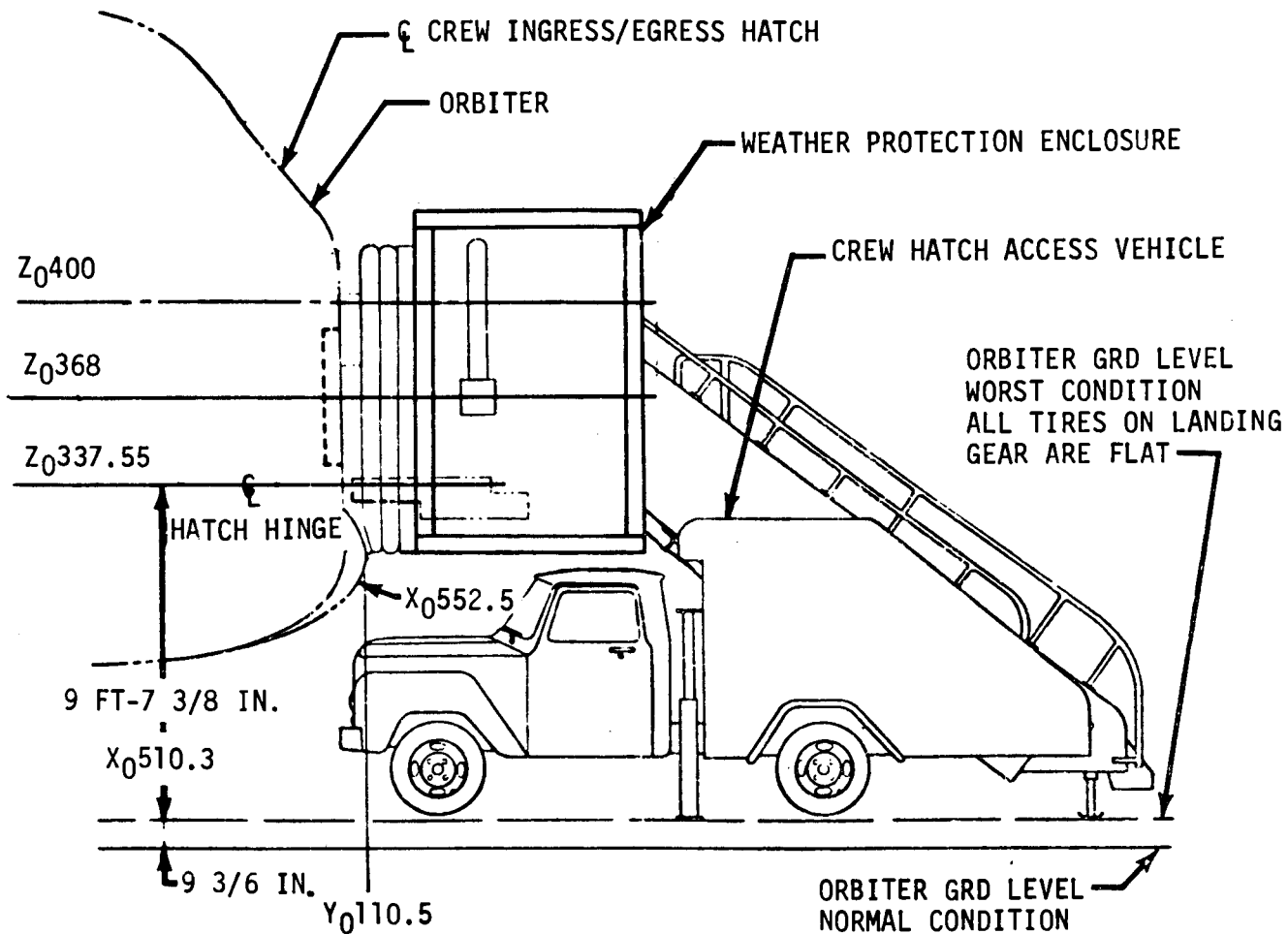


Figure 4.5-1.- Orbiter egress vehicle.

4.6 EMERGENCY POSTLANDING OPERATIONS

The following activities will generally take place during emergency post-landing operations:

- Powerdown
- Seat egress
- Orbiter egress
- Escape
- Postflight operations

For an emergency landing (collapsed gear, blown tires, fire, etc.) at KSC on the SLF runway, emergency vehicles and fire rescue personnel located at the SLF fallback area will respond to the emergency.

Fire rescue personnel are prepositioned on the access routes along the SLF runway. They will be alerted for any contingency landing condition and will respond to the emergency with preplanned fire/rescue procedures.

A contingency team exists for landing emergencies at EAFB or Northrup Strip. The team is directed by the Convoy Commander (reporting to the STS Director at KSC) who is the designated NASA Center Operations Director (COD) for contingency operations on the runway/dry lakebed area. The COD communicates with the Air Force Flight Test Center (AFFTC) commander who is responsible for all AFFTC resources (i.e., fire, rescue, and medical). For remote site contingencies, the role of COD will be filled by the designated NASA representative aboard the Department of Defense (DOD) rescue helicopter until arrival of a ground party headed by the Convoy Commander.

Powerdown

Emergency powerdown is described in figure 4.6-1.

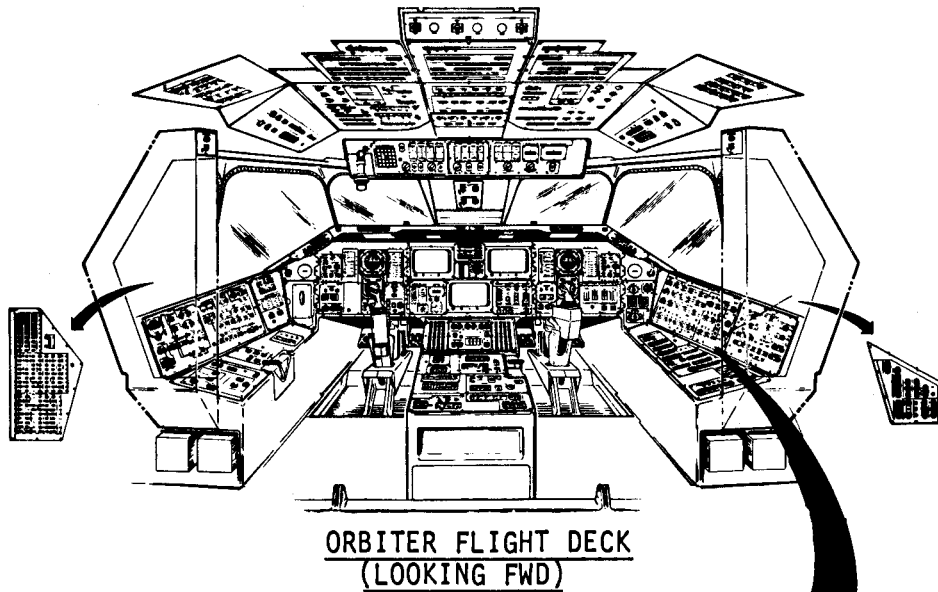
Seat Egress

See Seat Egress Cue Card, Mode 5 (fig. 4.6-2).

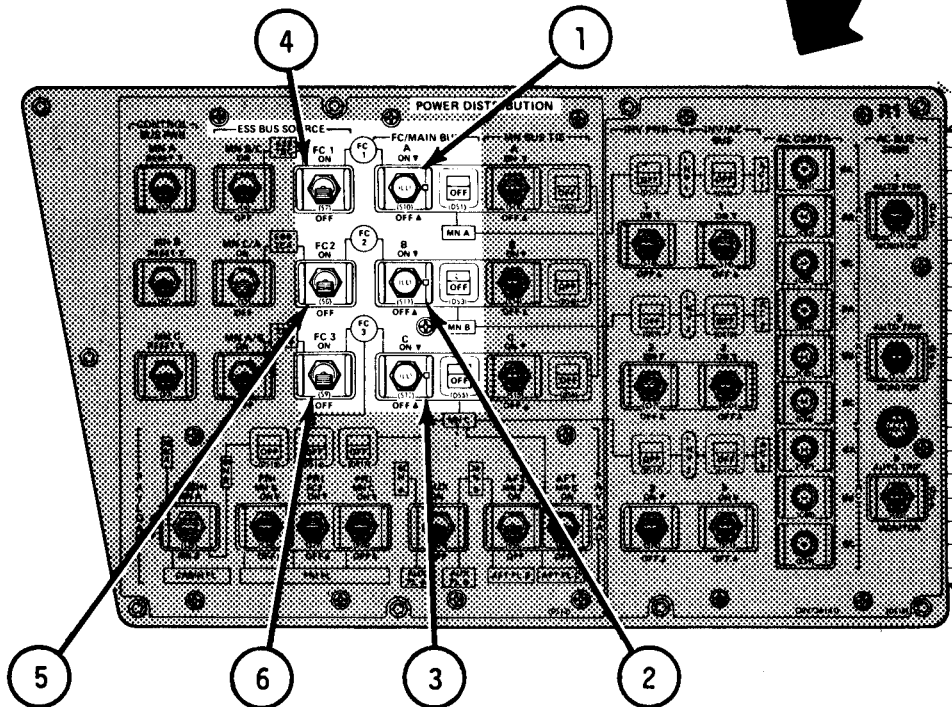
Orbiter Egress

Postlanding emergency egress routes are described in section 3.5. A snorkel truck is available to the crew at the Orbiter landing site in the event an immediate postlanding egress is required.

The primary mode of emergency egress is through the side hatch (sec. 3.3). The secondary emergency exit is via the left-hand overhead window escape panel (W8). Egress routes are shown in figure 3.5-3.



ORBITER FLIGHT DECK
(LOOKING FWD)



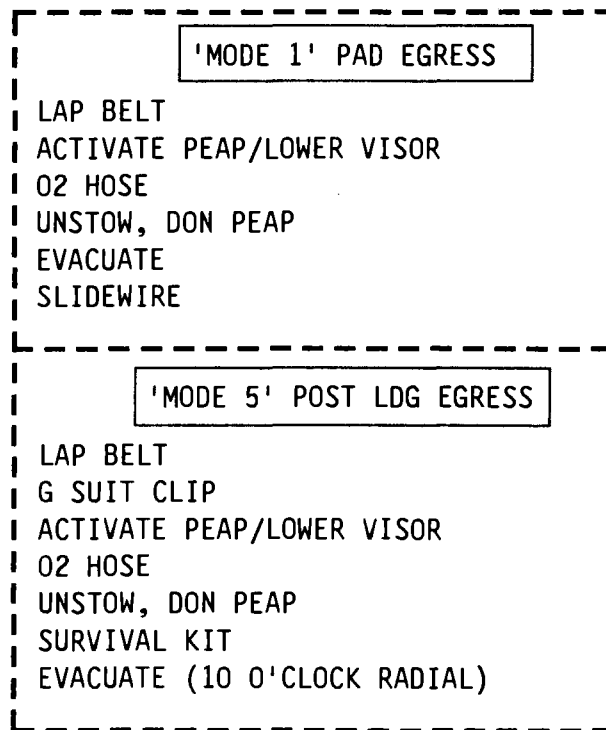
Warning

RESCUE PERSONNEL SHALL NOT DEVIATE FROM THESE PROCEDURES. POSITIONING OF SWITCHES/CIRCUIT BREAKERS OTHER THAN THOSE SPECIFIED COULD JEOPARDIZE CREW AND RESCUE PERSONNEL SAFETY.

SET PANEL R1 FC/MAIN BUS A, B, & C AND ESS BUS SOURCE FC1, FC2 & FC3 TO "OFF" IN THE SEQUENCE SHOWN ABOVE. BE SURE TO HOLD FC/MAIN BUS A, B & C EACH FOR TWO SECONDS AND VERIFY EACH INDICATOR READS "CL".

Figure 4.6-1.- Emergency powerdown.

4.6-2



SPECIALIST SEAT EGRESS CUE CARD

Mode 1 - Prelaunch

- 1) Disconnect lap belt.
- 2) Activate PEAP ("ON")/lower visor (right side knob down).
- 3) Disconnect orbiter O₂ hose.
- 4) Unstow PEAP (up and out on lanyard).
- 5) Don PEAP (clips to ring on harness left side).
- 6) Evacuate through side hatch.
- 7) Take slidewire basket to ground.

Mode 5 - Post landing

- 1) Disconnect lap belt.
- 2) Pull G-suit clip if G-suit inflated.
- 3) Activate PEAP ("ON")/lower visor (right side knob down).
- 4) Disconnect orbiter O₂ hose.
- 5) Unstow PEAP (up and out on lanyard).
- 6) Don PEAP (clips to ring on harness left side).
- 7) Deploy survival kit if required.
- 8) Egress through side hatch (overhead window if necessary).

Figure 4.6-2.- Emergency seat egress.

Escape

M-113's with fire/rescue crews will proceed to the location of the downed Orbiter and assist in fire fighting and/or rescue of the flight crew as required.

The flight crew will be transported by the fire/rescue crew to the medical ambulance for treatment/transportation, or to a safe location for air evacuation to the hospital via the medical helicopter.

4.7 POSTDITCHING OPERATIONS

The following activities take place during postditching operations:

- Seat egress
- Orbiter egress
- Postegress activities
- Return to continental United States (if applicable)

The Orbiter should be ditched in a medium nose up attitude of about 12° at as light a mass as possible and as slow as is consistent with adequate aerodynamic control. Considerable fuselage damage is expected. Duration of flotation is dependent on the integrity of the wing. If the wing remains relatively damage free, the vehicle will float for a reasonable length of time. Once in the water, the vehicle can be expected to sink at approximately 0.7 ft/sec to 6.6 ft/sec depending on landing attitude, elevon setting, landing mass, and landing speed.

Seat Egress

See Seat Egress Cue Card, Mode 5 (fig. 4.6-2).

Orbiter Egress

For a landing mishap off the SLF runway, predesignated equipment and fire/rescue personnel located at the SLF fallback area will respond to the emergency.

Because flotation is dependent on the wing integrity and the expected fuselage damage, the crewmembers should egress the vehicle as rapidly as possible and proceed to a safe distance from the vehicle.

Post Egress Activities

After egress from the Orbiter, the crewmembers will deploy and enter the life raft. Attached to the life raft is a survival kit capable of keeping seven people alive for 24 hours. Section 3.5 illustrates the survival equipment packed in the survival kit.

Return to Continental United States

At the fallback area, the helicopters will take off and proceed to the location of the water impact. Upon arrival at the scene, the helicopter will hover as close as possible and debark the para-rescue jumpers (PJ) into the water to rescue/assist the flight crew as required. The flight crew will be taken aboard the medical helicopter via the hoist/sling. Once aboard the helicopter, they will depart the area to meet the ambulance at KSC or be airlifted to a predesignated hospital.