

Deorbit Prep

Mission Operations Directorate Operations Division

Generic, Rev Q
July 1, 2009

NOTE

For STS-128 and subsequent flights

National Aeronautics and
Space Administration

Lyndon B. Johnson Space Center
Houston, Texas



Verify this is the correct version for the pending operation (training, simulation or flight).
Electronic copies of FDF books are available. URL: <http://mod.jsc.nasa.gov/do3/FDF/index.html>

DEORBIT PREP

GENERIC, REV Q (July 1, 2009)

PCN-5 (Mar 2, 2011) Sheet 1 of 1

List of Implemented Change Requests (482s):

D/O-00899

D/O-00902

NOTE

For STS-134 and subsequent flights

Incorporate the following:

1. Replace iii and iv
2. Replace 1-29 and 1-30

Prepared by:

Publication Manager

Approved by:

Manager, Flight Procedures

Accepted by:

FDF Manager

Encl: 4 pages

File this PCN immediately behind the front cover as a permanent record

DEORBIT PREP	GENERIC, REV Q (July 1, 2009)
---------------------	--------------------------------------

PCN-4 (Feb 11, 2011) Sheet 1 of 1

List of Implemented Change Requests (482s):

ASC-01955

Incorporate the following:

- 1. Replace iii and iv
- 2. Replace 1-15 and 1-16

<p align="center">NOTE For STS-133 and subsequent flights</p>
--

Prepared by: 
Publication Manager

Approved by: 
Manager, Flight Procedures

Accepted by: 
FDF Manager

Encl: 4 pages

File this PCN immediately behind the front cover as a permanent record

DEORBIT PREP	GENERIC, REV Q (July 1, 2009)
--------------	-------------------------------

PCN-3 (Feb 7, 2011) Sheet 1 of 1

List of Implemented Change Requests (482s):

ASC-01953B

NOTE
For STS-133 and subsequent flights

Incorporate the following:

1. Replace iii and iv
2. Replace 1-15 and 1-16
3. Replace 2-9 and 2-10
4. Replace A3-15 and A3-16, B3-15 and B3-16, C3-15 and C3-16

Prepared by: Andrea Blaylock
Publication Manager

Approved by: Carolee Pasenucci
Manager, Flight Procedures

Accepted by: Michael J. Holt
FDF Manager

Encl: 12 pages

File this PCN immediately behind the front cover as a permanent record

DEORBIT PREP	GENERIC, REV Q (July 1, 2009)
---------------------	--------------------------------------

PCN-2 (Jun 11, 2010) Sheet 1 of 1

List of Implemented Change Requests (482s):

D/O-00895

Incorporate the following:

1. Replace iii thru vi
2. Replace 1-31 and 1-32
3. Replace 2-17 and 2-18
4. Replace 8-1 and CC 8-2, CC 8-5 and 8-6

<p align="center">NOTE For STS-133 and subsequent flights</p>
--

Prepared by: *Curtis Moe 6/14/10*
Publication Manager

Approved by: *Lyndberg Johnson*
Manager, Flight Procedures

Accepted by: *Michael T. Holt*
FDF Manager

Encl: 12 pages

File this PCN immediately behind the front cover as a permanent record

DEORBIT PREP

GENERIC, REV Q (July 1, 2009)

PCN-1 (Oct 8, 2009) Sheet 1 of 1

List of Implemented Change Requests (482s):

D/O-888

D/O-889

NOTE

For STS-129 and subsequent flights

Incorporate the following:

1. Replace iii thru vi
2. Replace 1-31 and 1-32
3. Replace 5-3 and 5-4, 5-7 thru 5-10
4. Replace 8-1 and CC 8-2

Prepared by:



Publication Manager

Approved by:



Manager, Flight Procedures

Accepted by:



FDF Manager

Encl: 14 pages

File this PCN immediately behind the front cover as a permanent record

MISSION OPERATIONS DIRECTORATE

DEORBIT PREP

GENERIC, REVISION Q

July 1, 2009

PREPARED BY:



Anita Valle
Publication Manager

APPROVED BY:



Manager, Flight Procedures

ACCEPTED BY:



Michael T. Hurt
FDF Manager

This document is under the configuration control of the Crew Procedures Control Board (CPCB). All proposed changes must be submitted via Change Request Workflow (CRW) to DO3/FDF Manager.

Additional distribution of this book, for official use only, may be requested in writing to DO3/PMO Administrator. The request must include justification and requester's name, organization, position, and phone number. Contractor requests are made through the NASA or DOD organization supported. Deletions, reduction in quantity, or change of address may be submitted to DO3/FDF Management Office, 281-244-1184.

Incorporates the following:
482#: PI-00866

AREAS OF TECHNICAL RESPONSIBILITY

Publication Manager	DO3/A. Valle	281-244-6401
Alternate Book Manager	DO3/A. Blaylock	281-244-1184

DEORBIT PREP

LIST OF EFFECTIVE PAGES

GENERIC	09/16/87	PCN-3	02/07/11
REV Q	07/01/09	PCN-4	02/11/11
PCN-1	10/08/09	PCN-5	03/02/11
PCN-2	06/11/10		

Sign Off	*	ALL/GEN Q	2-3	ALL/GEN Q
ii	*	ALL/GEN Q	2-4	ALL/GEN Q
iii	*	ALL/GEN Q,5	2-5	ALL/GEN Q
iv	*	ALL/GEN Q,3	2-6	ALL/GEN Q
v	*	ALL/GEN Q,2	2-7	ALL/GEN Q
vi	*	ALL/GEN Q	2-8	ALL/GEN Q
vii		ALL/GEN Q	2-9	ALL/GEN Q,3
viii		ALL/GEN Q	2-10	ALL/GEN Q
1-1		ALL/GEN Q	2-11	ALL/GEN Q
1-2		ALL/GEN Q	2-12	ALL/GEN Q
1-3		ALL/GEN Q	2-13	ALL/GEN Q
1-4		ALL/GEN Q	2-14	ALL/GEN Q
1-5		ALL/GEN Q	2-15	☒† ALL/GEN Q
1-6		ALL/GEN Q	2-16	† ALL/GEN Q
1-7		ALL/GEN Q	2-17	ALL/GEN Q
1-8		ALL/GEN Q	2-18	ALL/GEN Q,2
1-9		ALL/GEN Q	3-1	ALL/GEN Q
1-10		ALL/GEN Q	3-2	ALL/GEN Q
1-11		ALL/GEN Q	(OV103) A3-3	3/GEN Q
1-12		ALL/GEN Q	(OV103) A3-4	3/GEN Q
1-13		ALL/GEN Q	(OV103) A3-5	3/GEN Q
1-14		ALL/GEN Q	(OV103) A3-6	3/GEN Q
1-15		ALL/GEN Q,4	(OV103) A3-7	3/GEN Q
1-16		ALL/GEN Q	(OV103) A3-8	ALL/GEN Q
1-17		ALL/GEN Q	(OV103) A3-9	‡ 3/GEN Q
1-18		ALL/GEN Q	(OV103) A3-10	‡ 3/GEN Q
1-19		ALL/GEN Q	(OV103) A3-11	‡ 3/GEN Q
1-20		ALL/GEN Q	(OV103) A3-12	‡ 3/GEN Q
1-21		ALL/GEN Q	(OV103) A3-13	3/GEN Q
1-22		ALL/GEN Q	(OV103) A3-14	ALL/GEN Q
1-23		ALL/GEN Q	(OV103) A3-15	3/GEN Q,3
1-24		ALL/GEN Q	(OV103) A3-16	3/GEN Q
1-25		ALL/GEN Q	(OV103) A3-17	3/GEN Q
1-26		ALL/GEN Q	(OV103) A3-18	3/GEN Q
1-27		ALL/GEN Q	(OV103) A3-19	3/GEN Q
1-28		ALL/GEN Q	(OV103) A3-20	3/GEN Q
1-29	†	ALL/GEN Q	(OV103) A3-21	ALL/GEN Q
1-30	†	ALL/GEN Q,5	(OV103) A3-22	3/GEN Q
1-31		ALL/GEN Q,2	(OV103) A3-23	3/GEN Q
1-32		ALL/GEN Q	(OV103) A3-24	3/GEN Q
1-33	☒	ALL/GEN Q	(OV103) A3-25	3/GEN Q
1-34		ALL/GEN Q	(OV103) A3-26	3/GEN Q
2-1		ALL/GEN Q	(OV103) A3-27	3/GEN Q
2-2		ALL/GEN Q	(OV103) A3-28	3/GEN Q

* – Omit from flight book
 † – MS pullout page. Add in MS2 copy only, in back of book
 ☒ – Prelift – off information reqd
 ‡ – Add extra copies in back of all books

(OV103) A3-29.....	‡	3/GEN Q	(OV105) C3-23.....		5/GEN Q
(OV103) A3-30.....	‡	3/GEN Q	(OV105) C3-24.....		5/GEN Q
(OV103) A3-31.....	‡	3/GEN Q	(OV105) C3-25.....		5/GEN Q
(OV103) A3-32.....	‡	3/GEN Q	(OV105) C3-26.....		5/GEN Q
(OV104) B3-3.....		4/GEN Q	(OV105) C3-27.....		5/GEN Q
(OV104) B3-4.....		4/GEN Q	(OV105) C3-28.....		5/GEN Q
(OV104) B3-5.....		4/GEN Q	(OV105) C3-29.....	‡	5/GEN Q
(OV104) B3-6.....		4/GEN Q	(OV105) C3-30.....	‡	5/GEN Q
(OV104) B3-7.....		4/GEN Q	(OV105) C3-31.....	‡	5/GEN Q
(OV104) B3-8.....		ALL/GEN Q	(OV105) C3-32.....	‡	5/GEN Q
(OV104) B3-9.....	‡	4/GEN Q	4-1.....		ALL/GEN Q
(OV104) B3-10.....	‡	4/GEN Q	4-2.....		ALL/GEN Q
(OV104) B3-11.....	‡	4/GEN Q	5-1.....		ALL/GEN Q
(OV104) B3-12.....	‡	4/GEN Q	5-2.....		ALL/GEN Q
(OV104) B3-13.....		4/GEN Q	5-3.....		ALL/GEN Q
(OV104) B3-14.....		ALL/GEN Q	5-4.....		ALL/GEN Q,1
(OV104) B3-15.....		4/GEN Q,3	5-5.....		ALL/GEN Q
(OV104) B3-16.....		4/GEN Q	5-6.....		ALL/GEN Q
(OV104) B3-17.....		4/GEN Q	5-7.....		ALL/GEN Q
(OV104) B3-18.....		4/GEN Q	5-8.....		ALL/GEN Q,1
(OV104) B3-19.....		4/GEN Q	5-9.....		ALL/GEN Q,1
(OV104) B3-20.....		4/GEN Q	5-10.....		ALL/GEN Q
(OV104) B3-21.....		ALL/GEN Q	6-1.....		ALL/GEN Q
(OV104) B3-22.....		4/GEN Q	6-2.....		ALL/GEN Q
(OV104) B3-23.....		4/GEN Q	6-3.....		ALL/GEN Q
(OV104) B3-24.....		4/GEN Q	6-4.....		ALL/GEN Q
(OV104) B3-25.....		4/GEN Q	7-1.....		ALL/GEN Q
(OV104) B3-26.....		4/GEN Q	7-2.....		ALL/GEN Q
(OV104) B3-27.....		4/GEN Q	7-3.....		ALL/GEN Q
(OV104) B3-28.....		4/GEN Q	7-4.....		ALL/GEN Q
(OV104) B3-29.....	‡	4/GEN Q	8-1.....	*	ALL/GEN Q
(OV104) B3-30.....	‡	4/GEN Q	CC 8-2.....	*	ALL/GEN Q,2
(OV104) B3-31.....	‡	4/GEN Q	CC 8-3.....	*	ALL/GEN Q
(OV104) B3-32.....	‡	4/GEN Q	CC 8-4.....	*	ALL/GEN Q
(OV105) C3-3.....		5/GEN Q	CC 8-5.....	*	ALL/GEN Q,2
(OV105) C3-4.....		5/GEN Q	8-6.....	*	ALL/GEN Q
(OV105) C3-5.....		5/GEN Q			
(OV105) C3-6.....		5/GEN Q			
(OV105) C3-7.....		5/GEN Q			
(OV105) C3-8.....		ALL/GEN Q			
(OV105) C3-9.....	‡	5/GEN Q			
(OV105) C3-10.....	‡	5/GEN Q			
(OV105) C3-11.....	‡	5/GEN Q			
(OV105) C3-12.....	‡	5/GEN Q			
(OV105) C3-13.....		5/GEN Q			
(OV105) C3-14.....		ALL/GEN Q			
(OV105) C3-15.....		5/GEN Q,3			
(OV105) C3-16.....		5/GEN Q			
(OV105) C3-17.....		5/GEN Q			
(OV105) C3-18.....		5/GEN Q			
(OV105) C3-19.....		5/GEN Q			
(OV105) C3-20.....		5/GEN Q			
(OV105) C3-21.....		ALL/GEN Q			
(OV105) C3-22.....		5/GEN Q			

‡ – Add extra copies in back of all books

* – Omit from flight book

DEORBIT CUE CARDS

<u>Title</u>	<u>Ref. Page</u>	<u>Card No.</u>	
MS MIDDECK ACTIVITIES (Front)	CC 8-2	D/O-1a/E/C	
(Back).....	CC 8-3	D/O-1b/E/A	
MS MIDDECK BACKOUT ACTIVITIES (Front).....	CC 8-4	D/O-2a/E/A	
(Back).....	CC 8-5	D/O-2b/E/B	

This Page Intentionally Blank

CONTENTS

PAGE

NOMINAL DEORBIT PREP PROCEDURES 1-1

DEORBIT PREP BACKOUT PROCEDURES 2-1

ENTRY SWITCH LIST/VERIFICATION..... 3-1

BFS DEORBIT PREP NOTES..... 4-1

CONTINGENCY DELTAS TO NOMINAL DEORBIT PREP 5-1

PLBD CONTINGENCY EVA TIMELINE 6-1

HARDWARE CONTINGENCY EVA TIMELINE..... 7-1

CUE CARD CONFIGURATION 8-1

This Page Intentionally Blank

NOMINAL DEORBIT PREP PROCEDURES

This Page Intentionally Blank

NOMINAL DEORBIT PREP SUMMARY TIMELINE

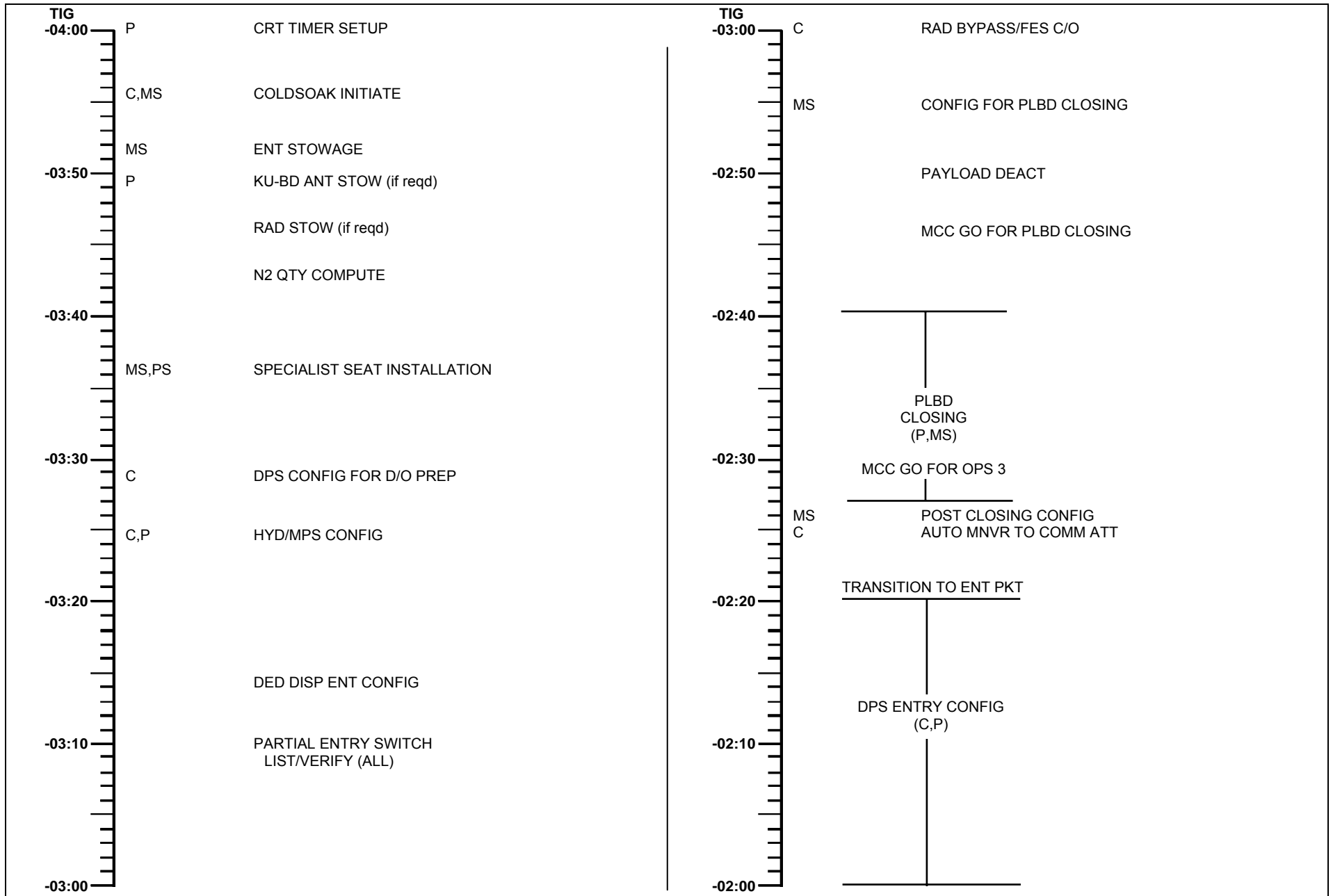

NOMINAL DEORBIT PREP SUMMARY TIMELINE (Cont)

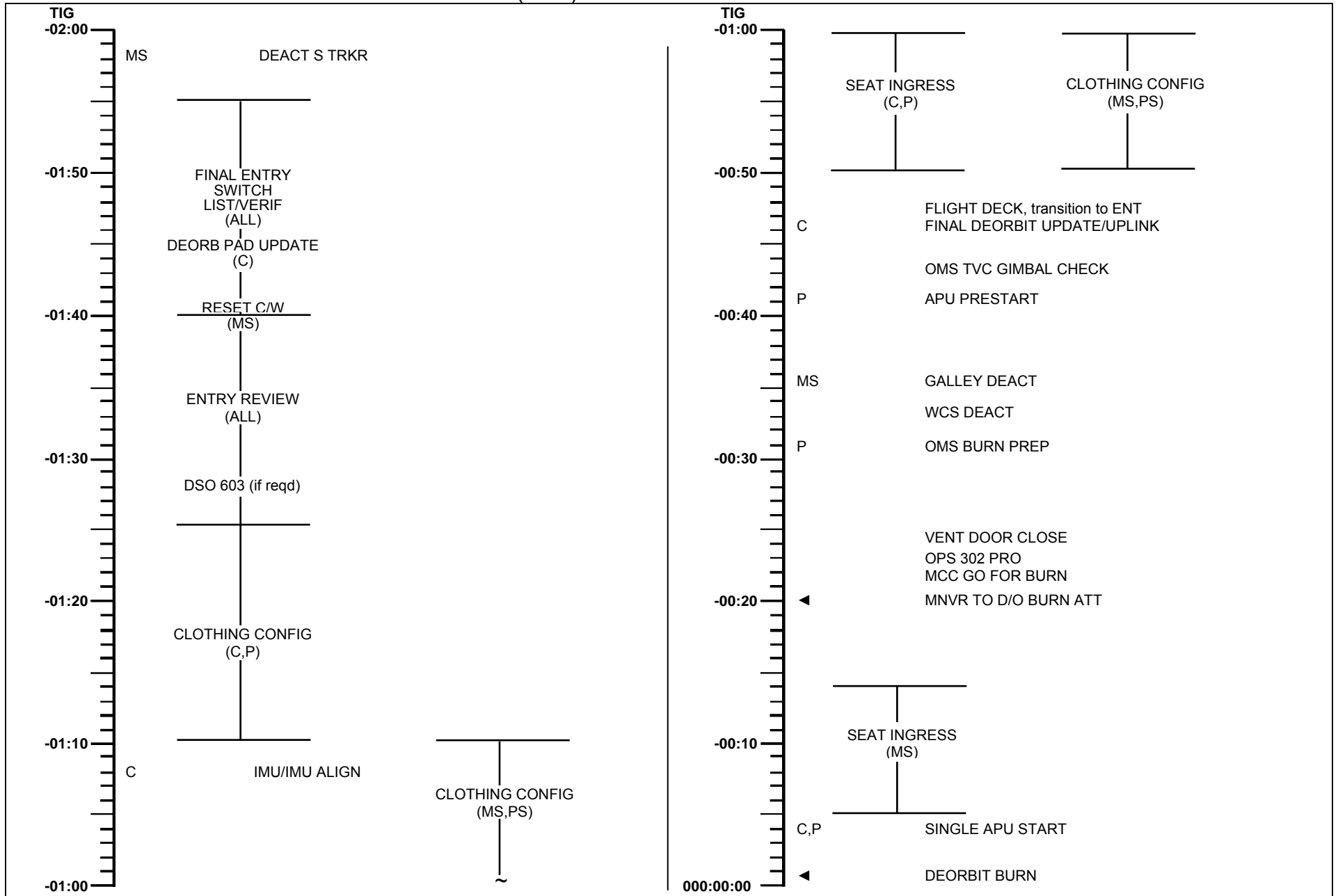

NOMINAL DEORBIT PREP

For cabin temperature management, use maximum of 25% on backlit panel lighting unless reqd for visibility

- * If TIME to TIG < 4 hr and > 2 hr 40 min: *
- * 1. ACCOMPLISH IMMEDIATELY: *
- * MNVR (TRK) BIASED -XSI (if not already in TAIL SUN) *
- * CRTX TGT ID +4 (blanks OM) *
- * BODY VECT +5 *
- * P +184 *
- * √OM (blank) *
- * Initiate TRK *
- * 2. Back out of PRIORITY PWRDN as reqd (ORB PKT, PRIOR PWRDN) *
- * 3. If previous FC PURGE was not accomplished within last 6 hr: *
- * Accomplish FC PURGE (ORB OPS, EPS) during D/O Prep prior to DPS ENTRY *
- * CONFIG *
- * 4. MS accomplish CABIN CONFIG/STOW (FLIGHT PLAN) during D/O Prep timeframe *
- * 5. Begin Deorbit Prep timeline immediately and perform procedure as rapidly as possible *

VERIFY THAT FOLLOWING ACTIVITIES HAVE BEEN ACCOMPLISHED:

FCS CHECKOUT (ORB OPS, GNC)

RCS HOT FIRE TEST (ORB OPS, RCS)

CABIN CONFIG/STOW (FLIGHT PLAN)

IMU ALIGN – S TRK (ORB OPS, GNC)

MNVR (TRK) BIASED – XSI (FLIGHT PLAN, DETAILED TIMELINE)

FC PURGE (ORB OPS, EPS)

Back out of PRIORITY PWRDN as reqd (ORB PKT, PRIOR PWRDN)

		1: GNC UNIV PTG	2: SM SYS SUMM 1	
<p>TIG -04:00</p> <p>A5(B1) AUTO VERN RT 0.2 DB 1.0</p>	<p>P</p> <p>C,MS</p> <p>-03:55</p> <p>MS</p> <p>-03:50</p> <p>P</p> <p>-03:45</p> <p>S66</p> <p>-03:40</p> <p>S68, 168</p> <p>MS, PS</p> <p>-03:35</p> <p>-03:30</p>	<p><u>CRT TIMER SETUP</u> [1]</p> <p><u>COLDSOAK INITIATE</u> [2]</p> <p>Verify in ATT: DAP: A5/AUTO/VERN(ALT) If no FWD RCS: √A6/AUTO/ALT √DAP: B set to B1</p> <p><u>ENT STOWAGE</u> [3], 1-31 <u>ENT AIRLOCK CONFIG</u> [3A], 1-32</p> <p>KU-BD ANT STOW, if deployed (ORB OPS, <u>COMM/INST</u>)</p> <p>RAD STOW, if reqd (ORB OPS, <u>ECLS</u>)</p> <p><u>N2 QTY COMPUTE</u> Add N2 QTY 1 + 2 Then annotate CABIN PRESS LEAK NOMOGRAPH (ENT PKT, <u>ECLS</u>)</p> <p><u>DETERMINE H2 DEPLETED TANKS</u> Note all H2 tanks with Qty < 3% Then annotate DEORBIT BURN FLIGHT RULES, ELEC section (step 8) for depleted tanks (ENT, <u>BURN CARDS</u>)</p> <p><u>SPECIALIST SEAT INSTALLATION</u></p>	<div style="border: 1px solid black; padding: 5px;"> <p><u>CRT TIMER SETUP</u> [1]</p> <p>1: GNC 2 TIME <u>SET CRT TIMER TO COUNT DOWN TO TIG</u> (perform for GNC & SM)</p> <p>ENTRY DAY (HR:MIN:SEC – MET)</p> <p>ITEM 17 + <input type="text"/> <input type="text"/> + <input type="text"/> <input type="text"/> + <input type="text"/> <input type="text"/></p> <p>24 HR LATE DELAYED DEORBIT</p> <p>ITEM 17 + <input type="text"/> <input type="text"/> + <input type="text"/> <input type="text"/> + <input type="text"/> <input type="text"/></p> <p>1: GNC UNIV PTG</p> </div> <div style="border: 1px solid black; padding: 5px; margin-top: 10px;"> <p><u>COLDSOAK INITIATE</u> [2]</p> <p>C L1 <u>FES CONFIG</u> FLASH EVAP CNTLR PRI A,B, SEC (three) – OFF RAD CNTLR OUT TEMP – HI When FREON EVAP OUT TEMP > 50 degF, FLASH EVAP CNTLR PRI B(A) – ON HI LOAD DUCT HTR – B</p> <p><u>H2O LOOP C/O AND CONFIG</u> <u>SM 88 APU/ENVIRON THERM</u></p> <p><u>NOTE</u> INCR decreases ICH FLOW</p> <p>L1 H2O LOOP 2 BYP MODE – MAN MAN – INCR or DECR (adjust until ICH FLOW ~950 ± 50)</p> <p>If first Deorbit Prep:</p> <p>L1 H2O PUMP LOOP 1 – ON √LOOP 1 BYP MODE – MAN MAN – DECR (hold 5 sec)</p> <p>CRT √H2O LOOP 1 ICH FLOW – increasing</p> <p>L1 H2O LOOP 1 BYP MAN – INCR (Adjust until ICH FLOW ~950 ± 50) H2O PUMP LOOP 1 (two) – OFF,B</p> </div>	

HYD/MPS CONFIG 5

W/B STEAM VENT HTR ACT

R2 √BLR CNTLR/HTR (three) – B
 PWR (three) – ON

NOTE

HTR reqd to be on 2 hr prior to APU act

HYD CIRC PUMP TERM

R2 HYD CIRC PUMP (three) – OFF

SSME HYD REPRESS PREP

C3 √FCS CH (four) – AUTO
 O17 ATVC (four) – ON

DED DISP ENT CONFIG 6

O14, RGA (four) – ON
 O15, cb MNA,B,C ADTA (four) – cl
 O16 MNA,B ACCEL 1, 2 (two) – cl
 DDU L (two) – cl
 √MNA, C DDU AFT (two) – op
 MNB, C DDU R (two) – cl
 ASA (four) – ON
 MDU ACCEL 4,3 (two) – ON
 AFD1 – OFF

O7 If OV105:
 GPS 1,3 PRE AMPL (four) – ON
 GPS 1,3 PWR (two) – ON
 Wait at least 30 sec
 GNC I/O RESET
 1: GNC 55 GPS STATUS
 √NAV – ITEM 17,19 EXEC (*)
 INIT – ITEM 14,16 EXEC (*)
 √MODE – INIT
 NAV – ITEM 17,19 EXEC (*)
 √MODE – INS
 If OV103,4:
 TACAN MODE (three) – GPC
 ANT SEL (three) – AUTO

O8 RADAR ALTM (two) – ON
 MLS (three) – ON
 CH tw (three) – See DEL PAD (ENT), PRPLT/DEL PADS

F3 TRIM PNL (two) – ON

Block deleted

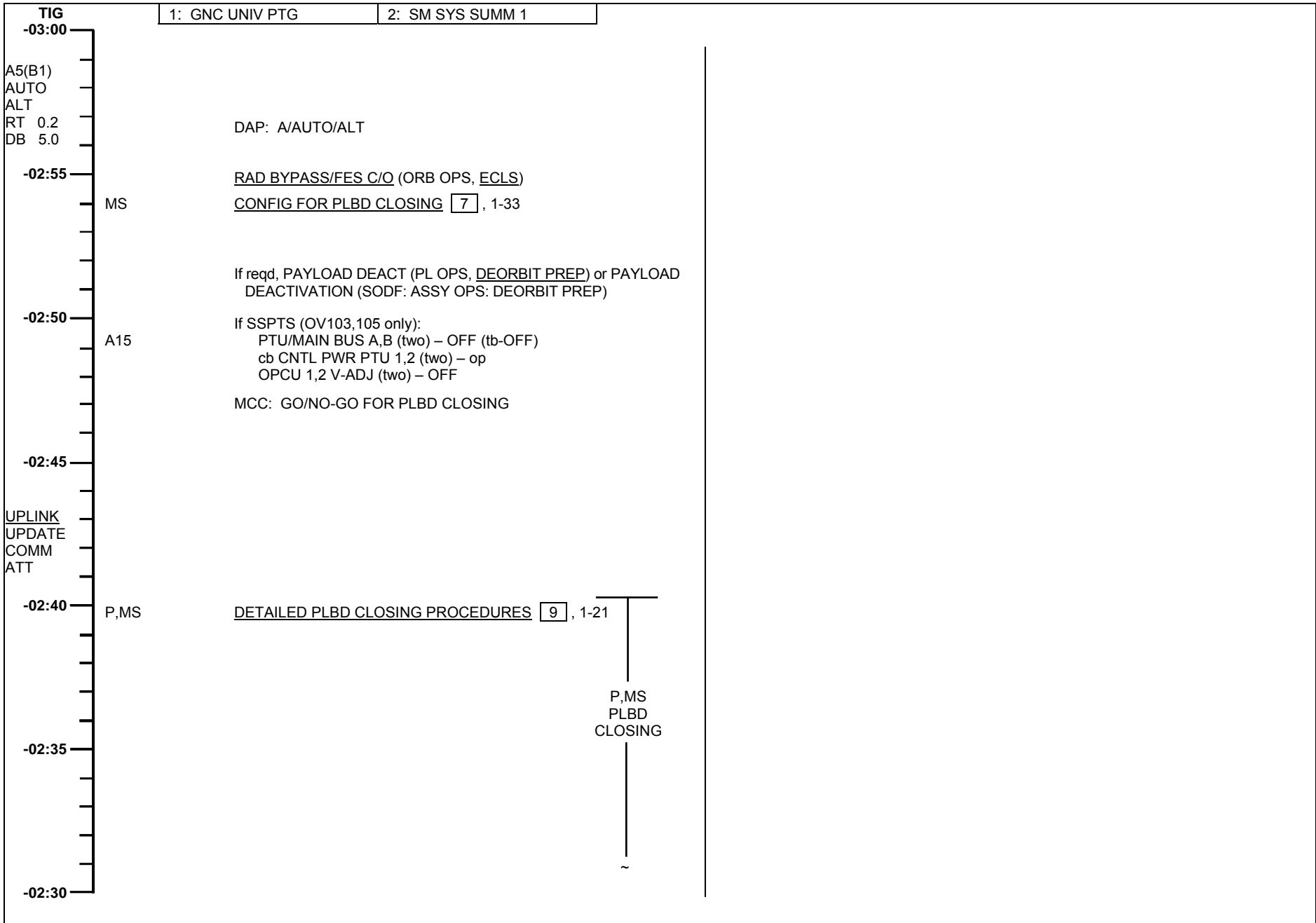

DPS ENTRY CONFIG 12

* If IMU or RHC dilemma, do not proceed with OPS 3 transition *

√Att mnvr complete
 √RGA,AA,ASA,IMU (all) – ON

NOTE

No keyboard entries or sw throws 10 sec:
 Before and after moding PASS GPCs to RUN
 Before OPS transition or set expansion/contraction requests until new OPS base page is displayed

1. MEDS CONFIG
 C2 IDP/CRT 3 PWR – ON
 CRTX GPC/CRT 2/3 EXEC
 F6,F7,F8 √All forward MDUs ON and selected to primary port
2. VERIFY GPC CONFIG
 O6 √GPC MODE 3 – HALT (tb-bp)
 √PWR 3 – ON
 √OUTPUT 1,2 – NORM (tb-gray)
 √3,5 – NORM (tb-bp)
 √4 – TERM (tb-bp)
 √MODE 1,2,4 – RUN (tb-RUN)
 3 – STBY (tb-RUN)
 √5 – STBY (tb-RUN)
3. SM CHECKPOINT/UL CNTL ENA
 1: SM 60 SM TABLE MAINT
 2: SM 1 DPS UTILITY
 CRT2 MMU ASSIGN 2 SM – ITEM 4 EXEC
 CRT1 CKPT INITIATE – ITEM 18 EXEC
 √Update of CKPT TIME and STATUS GOOD indicated
 CRT2 MMU ASSIGN 1 SM – ITEM 3 EXEC
 CRT1 CKPT INITIATE – ITEM 18 EXEC
 √Update of CKPT TIME and STATUS GOOD indicated
 CRT2 CKPT RETRV ENA – ITEM 12 EXEC (*)
 UL CNTL ENA – ITEM 36 EXEC
4. LOAD ENTRY TFL/RECONFIG UPLK
 Perform LOAD PDI DECOM FORMAT and LOAD PCMMU FORMAT for entry config (ORB OPS FS, COMM/INST)
- C2 Set event timer to count down to TIG
5. TRANSITION GPC 1&2 TO GNC OPS 3
 1: GNC 0 GPC MEMORY
 CONFIG – ITEM 1 +3 EXEC

	CONFIG GPC	3
C3	STR	1
	2	2
	3	1
	4	2
O6	PL	1/2
	CRT	1
	2	2
	3	2
CRT3	4	0
	L	1
	2	0
	MM	1
	2	2

Modify MC 3 per table →
 GNC, OPS 301 PRO
 1: GNC DEORB MNVR COAST

6. TRANSITION BFS GPC TO GNC OPS 3
 BFS CRT DISP – ON
 √SEL = 3+1
 3: BFS, GNC BFS MEMORY

GPC OUTPUT 5 – B/U (tb-bp)
 √TFL ENA – ITEM 29 (*)
 BFS, GNC OPS 301 PRO
 3: BFS, GNC DEORB MNVR COAST

7. TRANSITION GPC 1,2,3,4 TO GNC OPS 3
 SM, OPS 000 PRO
 X: SM GPC MEMORY
 GPC OUTPUT 4 – NORM (tb-gray)
 MODE 3,5 (two) – RUN (tb-RUN)
 If no comm, sel best antenna
 1: GNC 0 GPC MEMORY
 √CONFIG – ITEM 1 +3 EXEC
 Modify MC 3 per table →
 GNC OPS 301 PRO
 1: GNC DEORB MNVR COAST

	CONFIG GPC	3
O6	STR	1
	2	2
	3	3
	4	4
CRT3	PL	1/2
	CRT	1
	2	2
	3	3
C3	4	0
	L	1
	2	0
	MM	1
	2	2

BFS, GNC OPS 000 PRO
 BFS, GNC OPS 301 PRO
 BFS CRT DISP – OFF
 (GPC 3 commanding IDP 3)
 BFS CRT DISP – ON
 * If any IMU failed or not aligned: *
 * 3: BFS, GNC 51 OVERRIDE *
 * Aff IMU – desel *

8. MNVR BACK TO COMM ATT

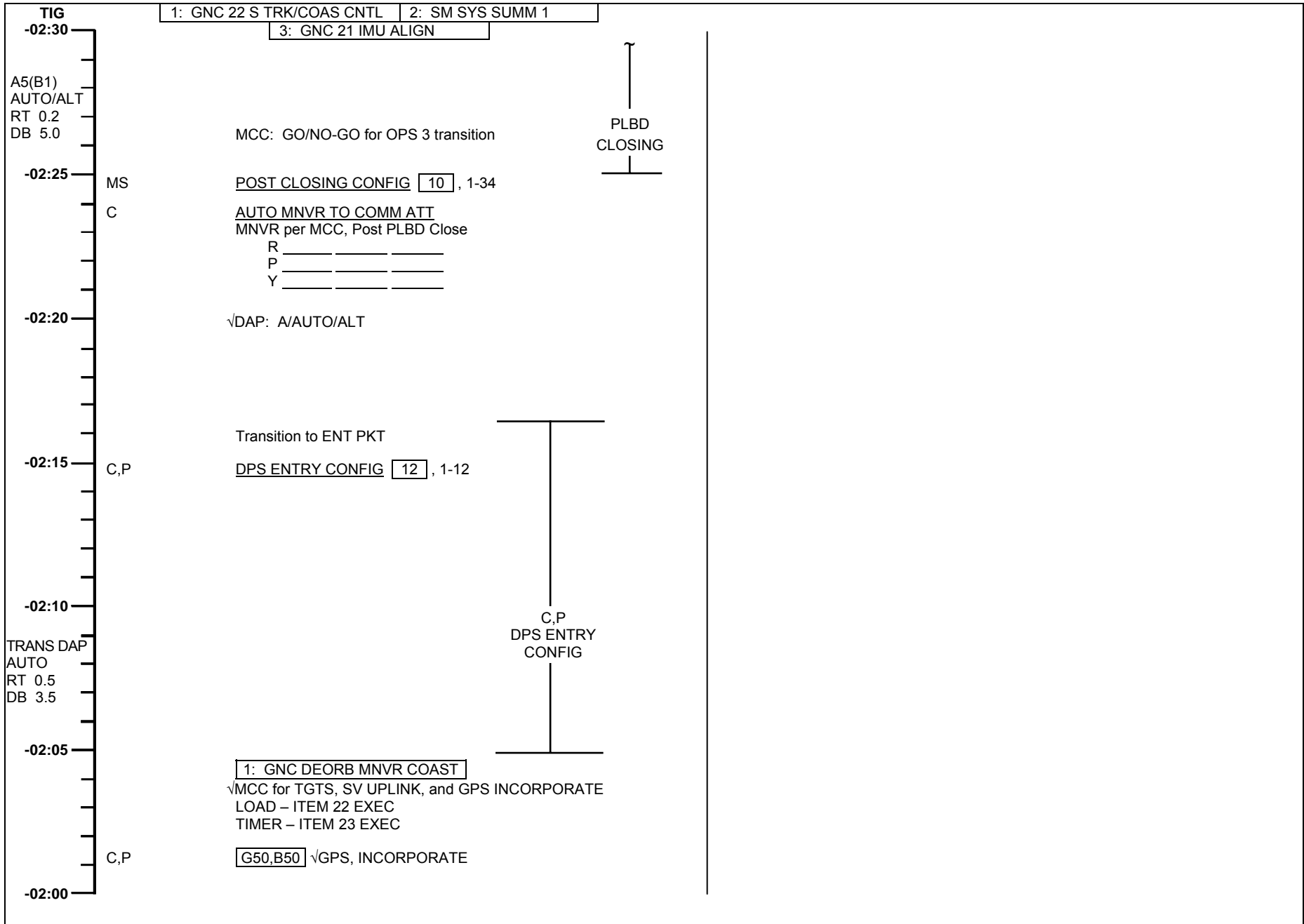

DEORB PAD UPDATE 17

MCC update:

OMS PRPLT PAD, DEL PAD (ENT, PRPLT/DEL PADS) and DEORBIT
MNVR PAD (ENT, MNVR PADS)

* If MCC cannot provide DEORB TGT, use Deorbit Manager on PGSC *

LANDING SITE UPDATE

1: GNC 50 HORIZ SIT

SEL SITE see DEL PAD (ENT, PRPLT/DEL PADS)

CHECK TGTs

1: GNC DEORB MNVR COAST

√PASS and BFS TGT per DEORBIT MNVR PAD (ENT, MNVR PADS)

√PASS and BFS solution per DEORBIT MNVR PAD (ENT, MNVR PADS)

BURN ATT, HA HP

Δ VTOT

TGO

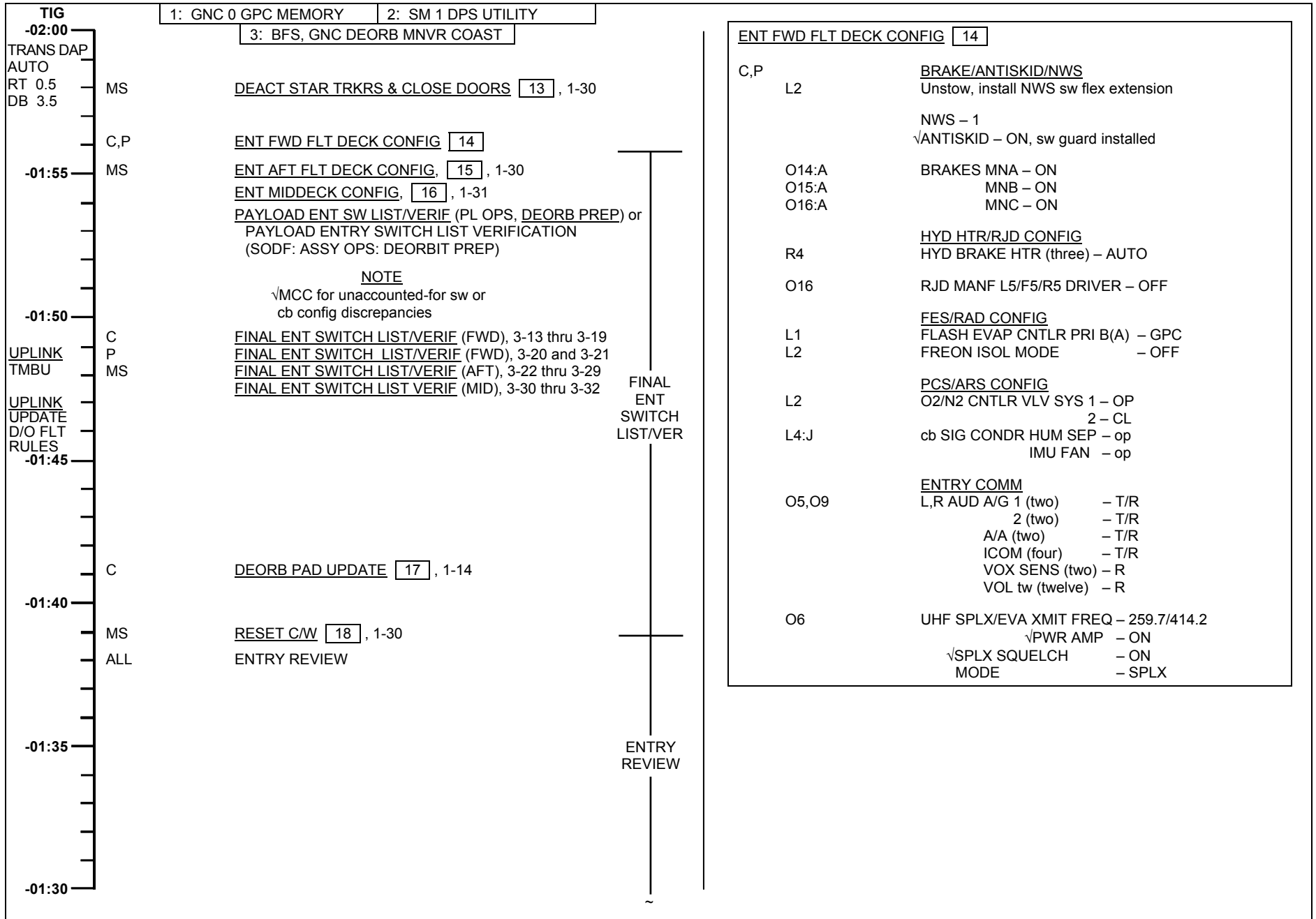

This Page Intentionally Blank

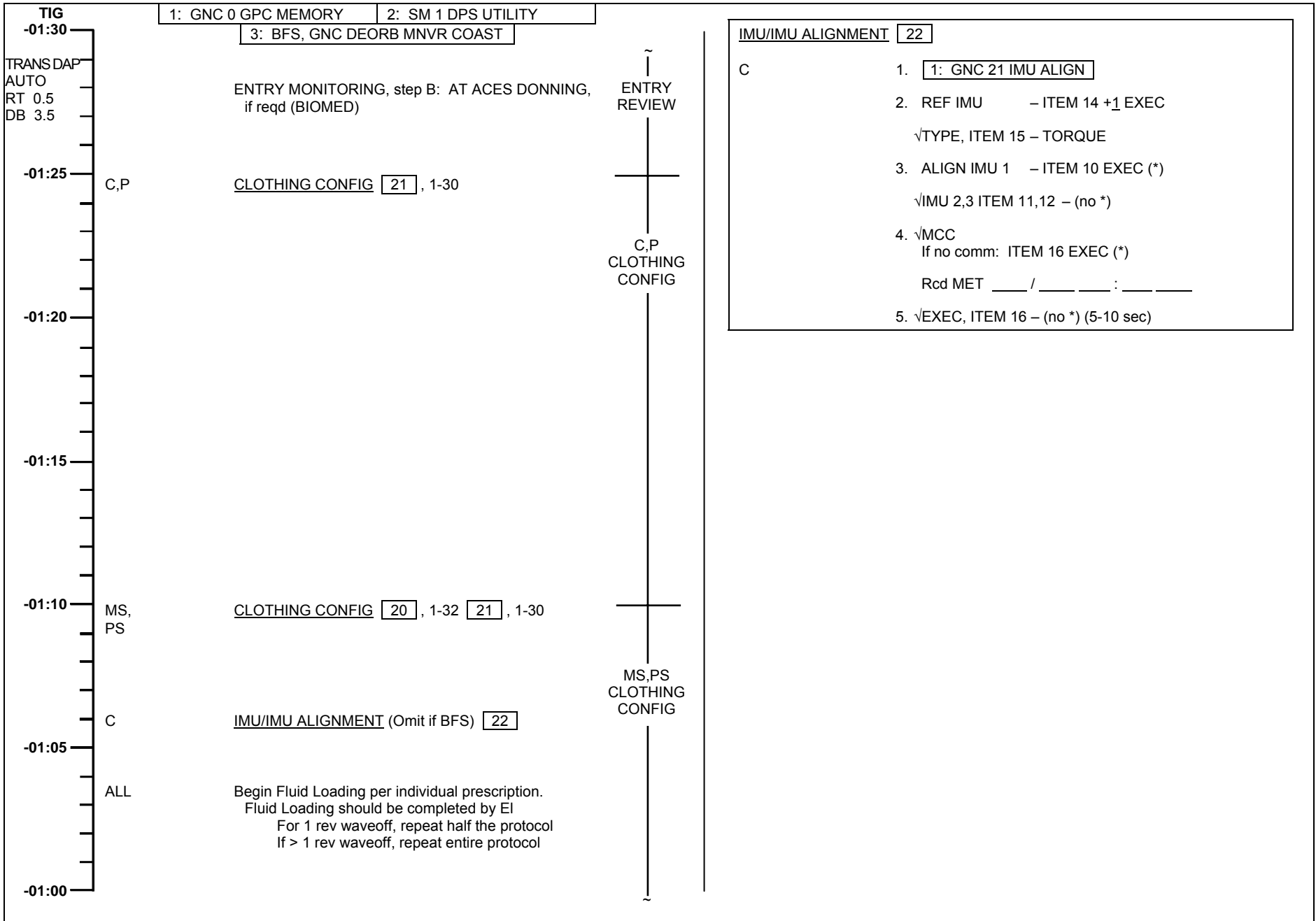

This Page Intentionally Blank

TIG		1: GNC DEORB MNVR COAST	2: GNC DEORB MNVR COAST	
-01:00		3: BFS, GNC DEORB MNVR COAST		
TRANS DAP	C,P	SEATS	CDR SEAT PWR BUS SEL – AC2 (up)	MS,PS CLOTHING CONFIG
AUTO			PLT SEAT PWR BUS SEL – AC3 (dn)	
RT 0.5	C,P		<u>SEAT INGRESS</u>	
DB 3.5	C,P		<u>HUD SETUP</u> [23]	
	C,P		Adjust seat	
			Exercise brake pedals	
-00:55	C	C6	LEH O2 vlv (four) – OP	
	C,P		<u>ACES PRESS INTEGRITY CHECK</u>	
	MS		Dual Suit Controller, Dial-To-Test Knob – full cw	
	MS		<u>AFD AUD SPKR CONFIG</u> [28], 1-29	
			<u>WIRELESS STOW</u> , if flown [24]	
-00:50				
	C,P		Stow all unnecessary FDF articles	
			FLIGHT DECK, go to ENT, <u>DEORBIT BURN</u>	
-00:45				
-00:40				
-00:35	MS		<u>GALLEY DEACT</u> [26], 1-31	
			<u>NOTE</u>	
			WCS must be deactivated prior to EI	
	MS		<u>WCS DEACT MS</u> [27], 1-32	
	MS		<u>MD AUD SPKR CONFIG</u> [29], 1-32	
-00:30				

HUD SETUP [23]
Remove, stow HUD Covers (two)
Ensure Cloth Cover does not obscure light sensor

WIRELESS STOW, if flown [24]
Disconnect, stow Wireless Comm (if reqd)
√Aft deck lts as reqd

This Page Intentionally Blank

AUTO PLBD CLOSING

DETAILED PLBD CLOSING PROCEDURES 9

CAUTION

Verify no obstructions before closing and latching PLBD (Ku ANT,RMS,RAD,etc)

Use MANUAL mode for subsequent BFS PLBD ops if BFS AUTO sequence has been interrupted by reversing latch/door drive direction or if MANUAL mode has already been used during mission

- R13L
- * If no motion determined visually or 'OP/CL' *
 - * not blank within 10 sec after cmd: *
 - * PL BAY DR – STOP *
 - * Perform MAL, MECH, 9.1a *
 - * If Latch not 'CL' in single-motor time: *
 - * PL BAY DR – STOP *
 - * Perform MAL, MECH, 9.1e *
 - * If door motion stops and not 'RDY' or 'CL': *
 - * PL BAY DR – STOP *
 - * Perform MAL, MECH, 9.1g *

- * If SM GPC fails during this operation: *
- * PL BAY DR SYS (two) – DSBL *
- * DR – STOP *
- * Perform PASS SM GPC FAIL (ORB PKT, DPS) *

NOTE

Note any single-motor operations (continue ops)
(single-motor times = 2x listed dual-motor times)

RECORD MUXED PORT RAD RETRACT HOSE VIEWS (A and C)

- L10 (VTR)
1. √Muxed scene displayed on VTR LCD
REC pb – push, hold
PLAY pb – push
√Red dot displayed on LCD

CONFIGURE FOR AUTO MODE

- CRT4
2. SM, OPS 202 PRO or BFS, SM 63 PL BAY DOORS

4: SM PL BAY DOORS

- R13L
- CRT4
- √PL BAY DR – STOP
 - √PBD SW – STOP
 - √MAN SEL (ten) – (no *)
 - √PBD SW BYPASS – (no*)
3. AC POWER ON – ITEM 1 EXEC (*)
 4. AUTO MODE SEL – ITEM 3 EXEC (*)
- R13L
- CRT4
5. PL BAY DR SYS (two) – ENA
 - √OP/CL STATUS (ten) – OP

CLOSE PLBDs USING AUTO MODE

- R13L
6. PL BAY DR – CL
- CRT4
- * If PORT DOOR not 'CL' within 6 sec of 'RDY': *
 - * PL BAY DR – STOP *
 - * Go to PORT BKHD LATCH TROUBLESHOOTING *
 - * (AUTO MODE) 9A, 1-23 *

- CRT4
- √PORT DOOR – blank,RDY,CL (~63 sec)

RECORD MUXED STBD RAD RETRACT HOSE VIEWS (D and B)

- A7
7. VID IN MUX 2 pb – push
- L10 (VTR)
- √Muxed scene displayed on VTR LCD
- CRT4
- √PORT FWD, AFT LATCHES – blank, CL (~30 sec)
 - √STBD DOOR – blank

8. When Stbd Door as close as possible to Port Door before contact, perform PLBD fit check:

- R13L
- PL BAY DR – STOP
 - Determine C/L Latch clearance on C/L LATCH EXTENDED GUIDE ROLLER TRAJECTORY NO-GO DIAGRAM, 1-22

- * If NO-GO for PLBD CLOSE: *
- * If no waveoff capability: *
- * Perform MAL, MECH, SSR-3 (SIMULTANEOUS *
- * PLBD CL) *
- * If waveoff OK: *
- * √MCC *

9. PL BAY DR – CL

- CRT4
- * If STBD DOOR not 'CL' within ~6 sec of 'RDY': *
 - * PL BAY DR – STOP *
 - * Go to STBD BKHD LATCH TROUBLESHOOTING *
 - * (AUTO MODE) 9B, 1-23 *
- R13L

- CRT4
- √STBD DOOR – CL (~63 sec)
 - √FWD,AFT LATCHES (two) – blank,CL (~30 sec)
 - √CENTER LATCHES 1-4,13-16 (two) – blank,CL (~20 sec)
 - √5-8, 9-12 (two) – blank,CL (~20 sec)

- R13L
10. PL BAY DR – STOP

POST-PLBD CLOSING CLEANUP

- CRT4
11. PL BAY DR SYS (two) – DSBL
 - √OP/CL STATUS (ten) – CL
 12. AC POWER OFF – ITEM 2 EXEC (*)
 13. GPC/CRT 54 EXEC

MARK AND STOW RAD RETRACT HOSE RECORDING

- L10 (VTR)
14. STOP pb – push, Eject tape, mark as PLBD Closure, stow in RTH bag (L10A1 foam)

AUTO PLBD CLOSING (Cont)

PORT AFT BULKHEAD LATCH GO/NO-GO DIAGRAM

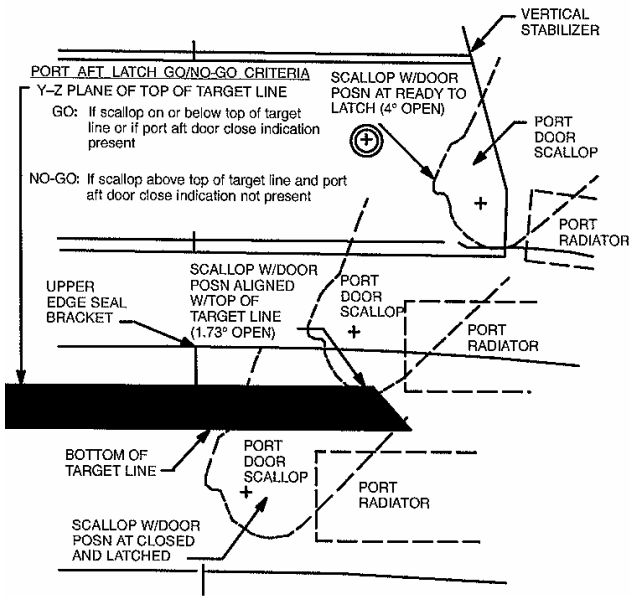

FUNCTION	PLBD CONTROL								PLBD DISPLAY PL MDM								
	Ref: MA73C:C&D for MCA (cb)																
	MTR 1				MTR 2				C	C	O	O	C	R	R	R	O
	AC/MCA	CNTL	MDM	SYS	AC/MCA	CNTL	MDM	SYS	A	B	A	B	A	B	C		
LATCH																	
5-8	1/MID3	AB3/AB2	PL1	2	3/MID2	CA3/CA1	PL2	1	1	2	1	2					
9-12	1/MID1	AB3/AB1	PL1	1	3/MID4	CA3/CA2	PL2	2	1	2	1	2					
1-4	1/MID3	AB3/AB2	PL1	2	3/MID2	CA3/CA1	PL2	1	1	2	1	2					
13-16	3/MID4	CA3/CA2	PL2	2	2/MID2	BC3/BC1	PL1	1	2	1	2	1					
S FWD	1/MID1	AB3/AB1	PL1	1	2/MID4	BC3/BC2	PL2	2	1	2	1	2					
S AFT	3/MID4	CA3/CA2	PL2	2	2/MID2	BC3/BC1	PL1	1	2	1	2	1					
S DOOR	1/MID1	AB3/AB1	PL1	1	2/MID4	BC3/BC2	PL2	2					1	1	2	2	1
													2	1	2	2	2
P FWD	1/MID1	AB3/AB1	PL1	1	2/MID4	BC3/BC2	PL2	2	1	2	1	2					
P AFT	1/MID3	AB3/AB2	PL1	2	3/MID2	CA3/CA1	PL2	1	1	2	1	2					
P DOOR	3/MID4	CA3/CA2	PL2	2	2/MID2	BC3/BC1	PL1	1					2	1	1	2	2
													1	1	1	2	1

C/L LATCH EXTENDED GUIDE ROLLER TRAJECTORY NO-GO DIAGRAM

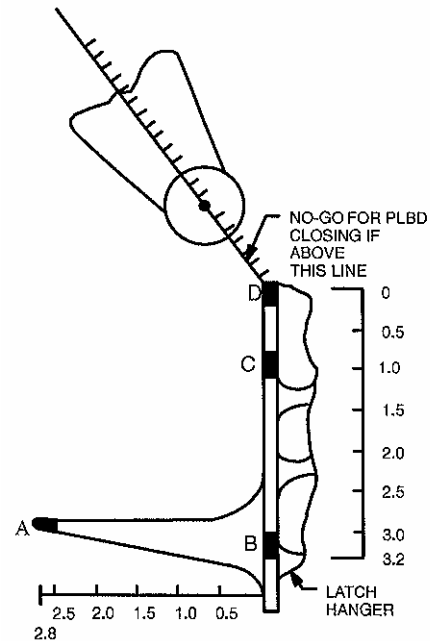

PORT BKHD LATCH TROUBLESHOOTING (AUTO MODE) [9A]

- CRT4 1. √PORT DOOR FWD, AFT MICRO-SW STATs
 If PORT DOOR AFT 'C' = '0':
 : 2. √PORT AFT BULKHEAD LATCH GO/NO DIAGRAM, 1-22
 : If NO-GO:
 L Go to MAL, MECH, SSR-2 (CONTINGENCY PLBD CLOSURE)
- If PORT DOOR FWD 'C' = '0':
 :
 : NOTE
 : Use PLB camera A to view port fwd bkhd latch
 : hook/roller #3 as seen in figures 1-1 and 1-2, 1-24
- R13L 3. PL BAY DR SYS 1 – DSBL
 :
 : During the following step, monitor latch hook #3 while driving to
 : ensure hook motion and proper roller engagement
 :
 : * If latch hook #3 stops moving while commanded, or *
 : * it appears that the hook is going to miss or jam *
 : * into its roller: *
 : * PL BAY DR – STOP *
 : * Go to MAL, MECH, SSR-2 (CONTINGENCY *
 : * PLBD CLOSURE) *
4. PL BAY DR – CL
 :
 : 5. When proper roller engagement verified for latch #3:
 L PL BAY DR – STOP
 SYS 1 – ENA
6. Go to step 6 of AUTO PLBD CLOSING [9], 1-21 ignoring the starred
 block

STBD BKHD LATCH TROUBLESHOOTING (AUTO MODE) [9B]

- CRT4 1. √STBD DOOR FWD, AFT MICRO-SW STATs
 If STBD DOOR AFT (FWD) 'C' = '0':
 :
 : NOTE
 : Use PLB camera C(D) to view stbd aft (fwd) bkhd latch
 : hook/roller #3 as seen in figures 1-1 and 1-2, 1-24
- R13L 2. PL BAY DR SYS 1(2) – DSBL
 :
 : During the following step, monitor latch hook #3 while driving to
 : ensure hook motion and proper roller engagement
 :
 : * If at any point latch hook #3 stops moving while *
 : * commanded, or it appears that the hook is going *
 : * to miss or jam into its roller: *
 : * PL BAY DR – STOP *
 : * Go to MAL, MECH, SSR-2 (CONTINGENCY *
 : * PLBD CLOSURE) *
3. PL BAY DR – CL
 :
 : 4. When proper roller engagement verified for latch #3:
 : PL BAY DR – STOP
 L SYS 1(2) – ENA
5. Go to step 9 of AUTO PLBD CLOSING [9], 1-21 ignoring the starred
 block

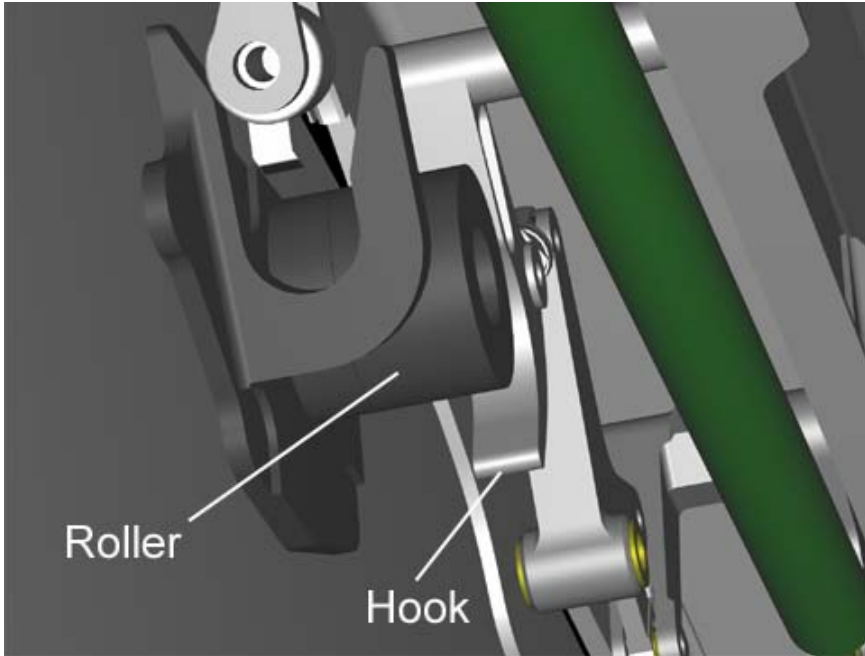

Figure 1-1.- Latch hook/roller #3 typical view from PLB camera

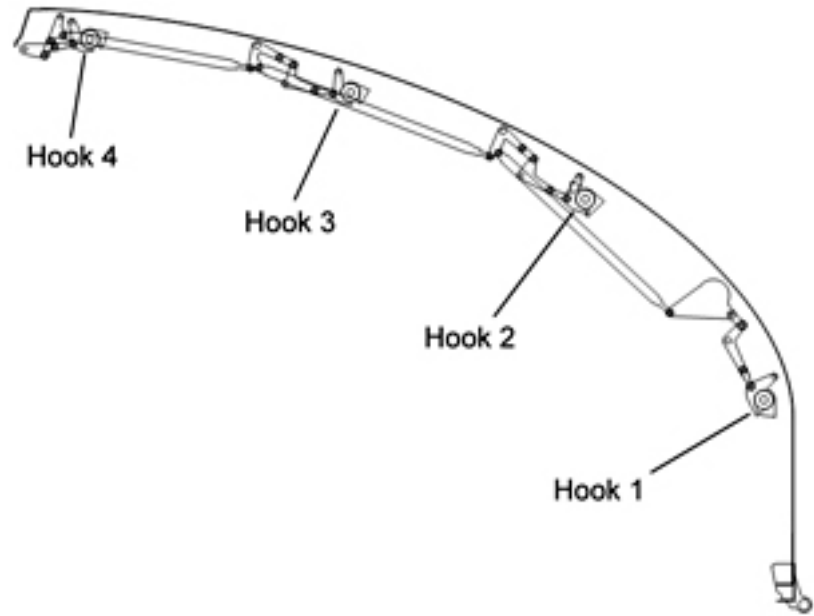

Figure 1-2.- Typical latch hook/roller numbering

MANUAL PLBD CLOSING

DETAILED PLBD CLOSING PROCEDURES

CAUTION

Verify no obstructions before closing and latching PLBD (Ku ANT,RMS,RAD,etc)

Use MANUAL mode for subsequent BFS PLBD ops if BFS AUTO sequence has been interrupted by reversing latch/door drive direction or if MANUAL mode has already been used during mission

- R13L
- * If no motion determined visually or 'OP/CL' *
 - * not blank within 10 sec after cmd: *
 - * PL BAY DR – STOP *
 - * Go to MAL, MECH, 9.1a *
 - * If Latch not 'CL' in single-motor time: *
 - * PL BAY DR – STOP *
 - * Go to MAL, MECH, 9.1e *
 - * If door motion stops and not 'RDY' or 'CL': *
 - * PL BAY DR – STOP *
 - * Go to MAL, MECH, 9.1g *
 - * If SM GPC fails during this operation: *
 - * PL BAY DR SYS (two) – DSBL *
 - * DR – STOP *
 - * Go to PASS SM GPC FAIL (ORB PKT, DPS) *

NOTE

Note any single-motor operations (continue ops) (single-motor times = 2x listed dual-motor times)

- L10 (VTR) 1. RECORD MUXED PORT RAD RETRACT HOSE VIEWS (A and C)
 √Muxed scene displayed on VTR LCD
 REC pb – push, hold
 PLAY pb – push
 √Red dot displayed on LCD
- CRT4 2. CONFIGURE FOR MANUAL MODE
 SM, OPS 202 PRO or BFS, SM 63 PL BAY DOORS
4: SM PL BAY DOORS
- R13L √PL BAY DR – STOP
 CRT4 √PBD SW – STOP
 √MAN SEL (ten) – (no *)
 √PBD SW BYPASS – (no *)
3. AC POWER ON – ITEM 1 EXEC (*)
 √AUTO MODE SEL – (no *)
- R13L 4. PL BAY DR SYS (two) – ENA
 CRT4 √OP/CL STATUS (ten) – OP
- CLOSE PORT DOOR, FWD & AFT LATCHES
 CRT4 5. Select PORT DOOR – ITEM 13 EXEC (*)
 R13L 6. PL BAY DR – CL
- CRT4 * If PORT DOOR not 'CL' within 6 sec of 'RDY': *
 R13L * PL BAY DR – STOP *
 * Go to PORT BKHD LATCH TROUBLESHOOTING *
 * (MANUAL MODE) 9C, 1-27 *
- CRT4 √PORT DOOR – blank,RDY,CL (~63 sec)
 R13L 7. PL BAY DR – STOP

- CRT4 8. Select PORT FWD,AFT LATCHES – ITEM 11, 12 EXEC (*)
 R13L 9. PL BAY DR – CL
 CRT4 √PORT DOOR – CL
 √FWD,AFT LATCHES (two) – blank, CL (~30 sec)
- R13L 10. PL BAY DR – STOP
 CRT4 11. Deselect PORT FWD,AFT LATCHES, & DOOR – ITEM 11,12,13 EXEC (no *)
RECORD MUXED STBD RAD RETRACT HOSE VIEWS (D and B)
- A7 12. VID IN MUX 2 pb – push
 L10 (VTR) √Muxed scene displayed on VTR LCD
CLOSE STBD DOOR, FWD & AFT LATCHES
- R13L 13. Select STBD DOOR – ITEM 10 EXEC (*)
 CRT4 14. PL BAY DR – CL
 √STBD DOOR – blank
15. When Stbd Door as close as possible to Port Door before contact, perform fit check:
 PL BAY DR – STOP
 Determine C/L Latch clearance on C/L LATCH EXTENDED GUIDE ROLLER TRAJECTORY NO-GO DIAGRAM, 1-26
 * If NO-GO for PLBD CLOSE: *
 * If no waveoff capability: *
 * | Go to MAL, MECH SSR-3 (SIMULTANEOUS PLBD CL) *
 * If waveoff OK: *
 * √MCC *
16. PL BAY DR – CL
 * If STBD DOOR not 'CL' within 6 sec of 'RDY': *
 * PL BAY DOOR – STOP *
 * Go to STBD BKHD LATCH TROUBLESHOOTING *
 * (MANUAL MODE) 9D, 1-27 *
- CRT4 √STBD DOOR – RDY,CL (~63 sec)
 R13L 17. PL BAY DR – STOP
 CRT4 18. Select STBD FWD,AFT LATCHES – ITEM 8,9 EXEC (*)
 R13L 19. PL BAY DR – CL
 CRT4 √STBD DR – CL
 √FWD AFT LATCHES (two) – blank, CL (~30 sec)
- R13L 20. PL BAY DR – STOP
 CRT4 21. Deselect STBD FWD,AFT LATCHES & DOOR – ITEM 8,9,10 EXEC (no *)
CLOSE C/L LATCHES
- R13L 22. Select CENTER LATCHES 1-4,13-16 – ITEM 6,7 EXEC (*)
 CRT4 23. PL BAY DR – CL
 √CENTER LATCHES 1-4,13-16 (two) – blank,CL (~20 sec)
- R13L 24. PL BAY DR – STOP
 CRT4 25. Deselect CENTER LATCHES 1-4,13-16 – ITEM 6,7 EXEC (no *)
 26. Select CENTER LATCHES 5-8,9-12 – ITEM 4,5 EXEC (*)
- R13L 27. PL BAY DR – CL
 CRT4 √CENTER LATCHES 5-8,9-12 (two) – blank,CL (~20 sec)
- R13L 28. PL BAY DR – STOP
 CRT4 29. Deselect CENTER LATCHES 5-8,9-12 – ITEM 4,5 EXEC (no *)
POST-PLBD CLOSING CLEANUP
- R13L 30. PL BAY DR SYS (two) – DSBL
 CRT4 √OP/CL STATUS (ten) – CL
31. AC POWER OFF – ITEM 2 EXEC (*)
 32. GPC/CRT 54 EXEC
- L10 (VTR) 33. MARK AND STOW RAD RETRACT HOSE RECORDING
 STOP pb – push, Eject tape, mark as PLBD Closure, stow in RTH bag (L10A1 foam)

MANUAL PLBD CLOSING (Cont)

PORT AFT BULKHEAD LATCH GO/NO-GO DIAGRAM

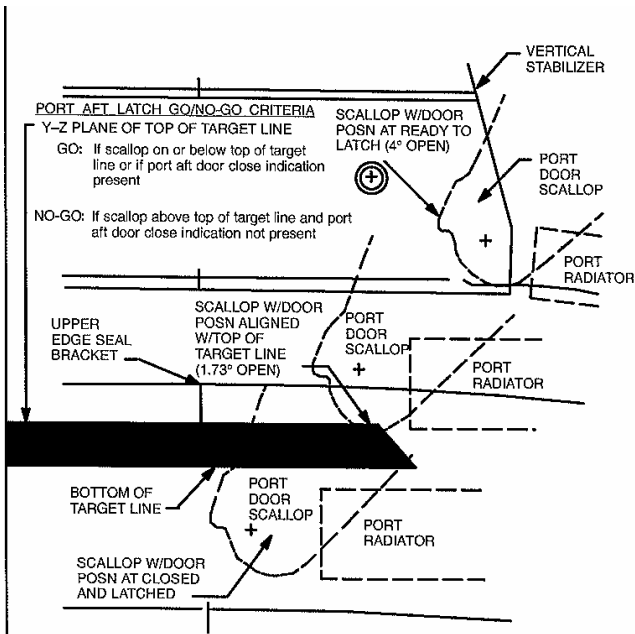

FUNCTION	PLBD CONTROL								PLBD DISPLAY PL MDM								
	Ref: MA73C:C&D for MCA (cb)																
	MTR1				MTR2				C C O O C R R R O		A B A B		A B C				
	AC/MCA	CNTL	MDM	SYS	AC/MCA	CNTL	MDM	SYS	A	B	A	B	A	B	C		
LATCH																	
5-8	1/MID3	AB3/AB2	PL1	2	3/MID2	CA3/CA1	PL2	1	1	2	1	2					
9-12	1/MID1	AB3/AB1	PL1	1	3/MID4	CA3/CA2	PL2	2	1	2	1	2					
1-4	1/MID3	AB3/AB2	PL1	2	3/MID2	CA3/CA1	PL2	1	1	2	1	2					
13-16	3/MID4	CA3/CA2	PL2	2	2/MID2	BC3/BC1	PL1	1	2	1	2	1					
S FWD	1/MID1	AB3/AB1	PL1	1	2/MID4	BC3/BC2	PL2	2	1	2	1	2					
S AFT	3/MID4	CA3/CA2	PL2	2	2/MID2	BC3/BC1	PL1	1	2	1	2	1					
S DOOR	1/MID1	AB3/AB1	PL1	1	2/MID4	BC3/BC2	PL2	2					1	1	2	2	1
P FWD	1/MID1	AB3/AB1	PL1	1	2/MID4	BC3/BC2	PL2	2	1	2	1	2					
P AFT	1/MID3	AB3/AB2	PL1	2	3/MID2	CA3/CA1	PL2	1	1	2	1	2					
P DOOR	3/MID4	CA3/CA2	PL2	2	2/MID2	BC3/BC1	PL1	1					2	1	1	2	2
													1	1	1	2	1

C/L LATCH EXTENDED GUIDE ROLLER TRAJECTORY NO-GO DIAGRAM

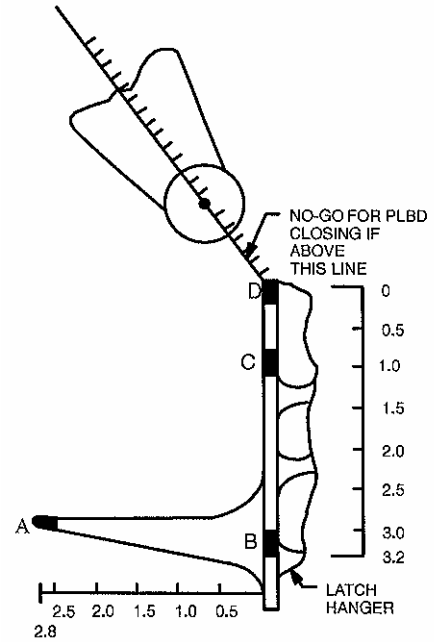

PORT BKHD LATCH TROUBLESHOOTING (MANUAL MODE) [9C]

- CRT4 1. √PORT DOOR FWD, AFT MICRO-SW STATs
 If PORT DOOR AFT 'C' = '0':
 : 2. √PORT AFT BULKHEAD LATCH GO/NO DIAGRAM, 1-26
 : If NO-GO:
 L Go to MAL, MECH, SSR-2 (CONTINGENCY PLBD CLOSURE)
- If PORT DOOR FWD 'C' = '0':
 :
 : NOTE
 : Use PLB camera A to view port fwd bkhd latch
 : hook/roller #3 as seen in figures 1-3 and 1-4, 1-28
- R13L 3. PL BAY DR SYS 1 – DSBL
 :
 : During the following step, monitor latch hook #3 while driving to
 : ensure hook motion and proper roller engagement
 :
 : * If at any point latch hook #3 stops moving while *
 : * commanded, or it appears that the hook is going *
 : * to miss or jam into its roller: *
 : * PL BAY DR – STOP *
 : * Go to MAL, MECH, SSR-2 (CONTINGENCY *
 : * PLBD CLOSURE) *
- CRT4 4. Select PORT FWD,AFT LATCHES – ITEM 11,12 EXEC (*)
 R13L 5. PL BAY DR – CL
 :
 : 6. When proper roller engagement verified for latch #3:
 : PL BAY DR – STOP
 : SYS 1 – ENA
 L Go to step 9 of MANUAL PLBD CLOSING [9], 1-25
7. Go to step 8 of MANUAL PLBD CLOSING [9], 1-25

STBD BKHD LATCH TROUBLESHOOTING (MANUAL MODE) [9D]

- CRT4 1. √STBD DOOR FWD, AFT MICRO-SW STATs
 If STBD DOOR AFT (FWD) 'C' = '0':
 :
 : NOTE
 : Use PLB camera C(D) to view stbd aft (fwd) bkhd latch
 : hook/roller #3 as seen in figures 1-3 and 1-4, 1-28
- R13L 2. PL BAY DR SYS 1(2) – DSBL
 :
 : During the following step, monitor latch hook #3 while driving to
 : ensure hook motion and proper roller engagement
 :
 : * If at any point latch hook #3 stops moving while *
 : * commanded, or it appears that the hook is going *
 : * to miss or jam into its roller: *
 : * PL BAY DR – STOP *
 : * Go to MAL, MECH, SSR-2 (CONTINGENCY *
 : * PLBD CLOSURE) *
- CRT4 3. Select STBD FWD,AFT LATCHES – ITEM 8,9 EXEC (*)
 : 4. PL BAY DR – CL
 :
 : 5. When proper roller engagement verified for latch #3:
 : PL BAY DR – STOP
 L SYS 1(2) – ENA
6. Go to step 19 of MANUAL PLBD CLOSING [9], 1-25

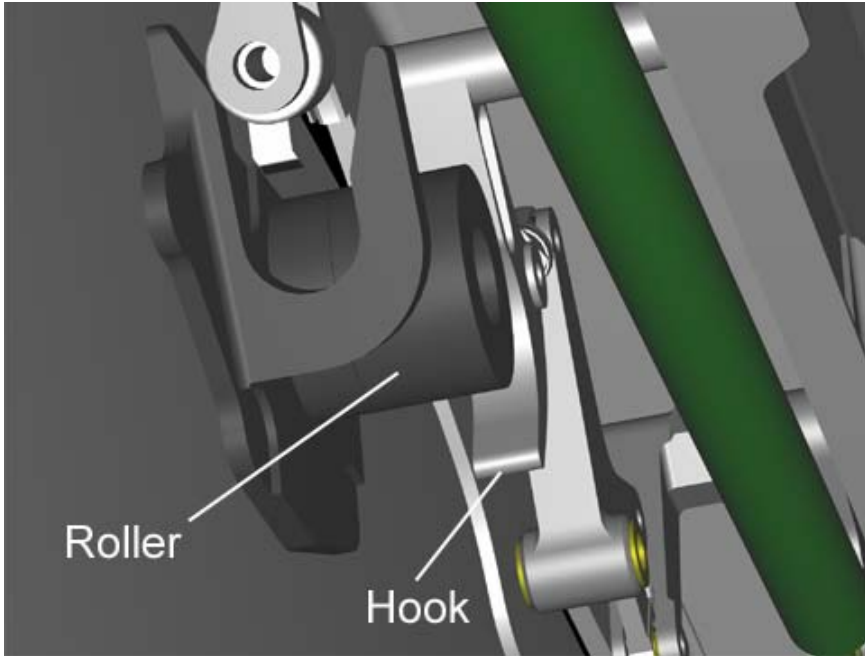

Figure 1-3.- Latch hook/roller #3 typical view from PLB camera

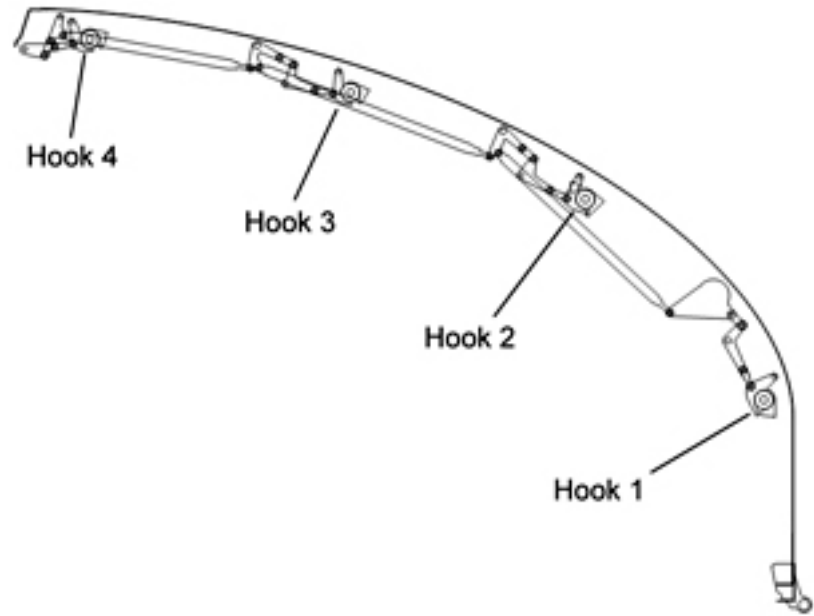

Figure 1-4.- Typical latch hook/roller numbering

MS AFT FLIGHT DECK ACTIVITIES

NOTE

WAIT FOR GO FROM CDR OR PLT BEFORE STARTING ANY ACTIVITY ON THIS PAGE

TIME (TIG-)	MS AFT DECK ACTIONS
3:35	<u>SPECIALIST SEAT INSTALLATION</u> Verify Leg Attach Collars (four) – DOWN/LOCKED
3:10	<u>PARTIAL ENT SWITCH LIST/VERIF (AFT)</u>
2:55	<u>CONFIG FOR PLBD CLOSING [7]</u> , 1-33
2:51	If reqd, PAYLOAD DEACT, (PL OPS, <u>DEORB PREP</u>) or PAYLOAD DEACTIVATION (SODF: ASSY OPS: DEORBIT PREP)
2:40	<u>DETAILED PLBD CLOSING PROCEDURES [9]</u> , 1-21
2:25	<u>POST CLOSING CONFIG [10]</u> , 1-34
1:56	<u>DEACT STAR TRKRS & CLOSE DOORS [13]</u> , 1-30 <u>ENT AFT FLT DECK CONFIG [15]</u> , 1-30
1:55	<u>PAYLOAD ENT SW LIST/VERIF (PL OPS, DEORB PREP or PAYLOAD ENTRY SWITCH LIST VERIFICATION (SODF: ASSY OPS: DEORBIT PREP)</u>
1:50	<u>FINAL ENT SWITCH LIST VERIF (AFT), 3-22 thru 3-33</u>
1:41	<u>RESET C/W [18]</u> , 1-30
1:40	<u>ENTRY REVIEW</u>
1:28	DSO 603, if reqd (BIOMED, <u>BIOMED DSOs</u>)
1:10	<u>CLOTHING CONFIG [21]</u> , 1-30
1:00	Begin Fluid Loading per individual prescription. Fluid Loading should be completed by EI For 1 rev waveoff, repeat half the protocol If > 1 rev waveoff, repeat entire protocol
0:53	<u>AFT AUD SPKR CONFIG [28]</u>
0:52	<u>WIRELESS STOW</u> , if flown <u>[24]</u> , 1-19

Block [11] deleted

<u>AFT AUD SPKR CONFIG [28]</u>	
	Verify CDR,PLT on headsets
A13	OS AUD SPKR PWR – OFF MS COMM CCU PWR – OFF Disconnect and stow Handheld Mic Configure MHA to MS CCU per entry plug-in plan Connect Lightweight Headsets or ACES Comm Cap MS COMM CCU PWR – ON

(Cont next page)

Back of MS AFT FLIGHT DECK ACTIVITIES

DEACT STAR TRKRS & CLOSE DOORS 13

- O6 STAR TRKR PWR (two) – OFF
- O14:E, cb STAR TRKR -Z,-Y (two) – op
O15:E
- O6 STAR TRKR DR CNTL SYS (two) – CL (start timer)
√POS tb (two) – bp
When both tb – cl (~8-24 sec) or either tb – bp > 24 sec:
STAR TRKR DR CNTL SYS (two) – OFF
* If tb – bp > 8 sec, notify MCC *

RESET C/W (Contact CDR for additional parameters) 18

NOTE
Expect 'MPS' light and 'HYD PRESS' light and master alarm. 'MPS' light will extinguish at OPS 303 PRO

R13U		
PARAMETER NAME	C/W CH	ENA/INH
MPS He REG P C	39	ENA
L	49	ENA
R	59	ENA
MANF P LO2	69	INH
LH2	79	INH
HYD P 1	99	ENA
2	109	ENA
3	119	ENA

CLOTHING CONFIG 21

- Stow:
QDMs
- Unstow, don:
ACES
Harness
Boots
- Verify ACES Gloves (Spare) available. Relocate as reqd
- Remove radiation dosimeter from inflight garments and insert in ACES
- Connect flight deck cooling units per
PWR/DATA/VIDEO: ASCENT/ENTRY CONFIG
(REF FS, UTIL PWR)
- A11,A15, DC UTIL PWR MNA(B,C) – ON as reqd
F1,O19 Cooling units – Hose Jumper Plug installed
Pre-chill cooling units 10 min prior to seat ingress

ENT AFT FLT DECK CONFIG 15

- DSP
- A6L SYS PWR MN A,MN B (two) – OFF (hold 5 sec)
√SYS 1,SYS 2 tb (two) – OFF
cb ESS 1BC SYS PWR CNTL SYS 1 – op
2CA SYS PWR CNTL SYS 2 – op
MN A,B DOCK LIGHT (four) – op
MN A,B,C LOG (six) – op
- HYD HTR**
- A12 HYD HTR (eight) – OFF
- ENTRY COMM**
- A1L S-BD PM MODE – STDN LO
NSP CODING (two) – OFF
S-BAND PAYLOAD
S-BD PL CH SEL INTRG 1,2 tw (six) – 910,910
PWR SYS – OFF
SEL – PSP
ANT POLAR – L CIRC
PSP CMD OUTPUT – PL UMB
- A1R AUD CTR VOICE RCD SEL CH1 – ICOM A
CH2 – ICOM B
- If WVS installed:
- A7 √WIRELESS VIDEO PWR – OFF
√WIRELESS VIDEO HTR – OFF
- R14:C cb MNB KU ANT HTR – op
UHF EVA (two) – op
:D Open all cbs except TV CABIN (14)
:E Open all D CAMR and RMS CAMR cbs (6)
:F √cb MN A ESS 1BC LDG GEAR ARM/DN RESET – op
- NOTE**
Review or mark cb location for ease of finding during post landing procedures
- VPU √VPU POWER – OFF
R10 MS AUD A/G 1 – T/R
A/G 2 – T/R
A/A – T/R
ICOM (two) – T/R
VOX SENS – R
VOL tw (five) – R
XMIT/ICOM MODE – R
- L9 PS AUD PWR – AUD TONE
A/G 1 – T/R
A/G 2 – T/R
A/A – T/R
ICOM (two) – T/R
AUD VOX SENS – R
XMIT/ICOM MODE – R
VOL tw (five) – R
- O19 TV PWR – ON
- L10 (MUX) VTR/CC PWR – ON (LED on)
(VIP) PWR – ON (LED on, DATA FLOW LED flashes twice)
(VTR) √ON/STANDBY LED – green
TIMER – REC
Install VIP, VTR covers
- R1 PL AUX – OFF

MS MIDDECK ACTIVITIES

NOTE

WAIT FOR GO FROM CDR OR PLT BEFORE STARTING ANY ACTIVITY ON THIS PAGE

TIME (TIG-)	MS MIDDECK ACTIONS
3:50	<u>ENT STOWAGE</u> [3]
3:50	<u>ENT AIRLOCK CONFIG</u> [3A], 1-32
3:35	<u>SPECIALIST SEAT INSTALLATION</u> Verify Leg Attach Collars (four) – DOWN/LOCKED Verify LiOH Door Latches (four) – ENGAGED
3:10	<u>PARTIAL ENT SWITCH LIST/VERIF (MID)</u> , 3-10 thru 3-12
1:55	<u>ENT MIDDECK CONFIG</u> [16]
1:50	<u>FINAL ENT SWITCH LIST/VERIF (MID)</u> , 3-30 thru 3-32
1:40	<u>ENTRY REVIEW</u>
1:28	DSO 603, if reqd (BIOMED, <u>BIOMED DSOs</u>)
1:10	<u>CLOTHING CONFIG</u> [20], 1-32
1:00	Begin Fluid Loading per individual prescription. Fluid Loading should be completed by EI For 1 rev waveoff, repeat half the protocol If > 1 rev waveoff, repeat entire protocol
0:55	Remove, stow Side Hatch UV Filter, Locking Device, and Pyro Box Safing Pin
0:35	<u>GALLEY DEACT</u> [26]
0:33	<u>WCS DEACT</u> [27], 1-32
0:31	<u>MD AUD SPKR CONFIG</u> [29], 1-32

<u>ENT MIDDECK CONFIG</u> [16]	
MO42F	<u>ENTRY COMM</u> MIDDECK SPKR AUD A/G 1 – T/R A/G 2 – T/R A/A – T/R ICOM (two) – T/R VOX SENS – R VOL tw (five) – R XMIT/ICOM MODE – R
MO10W	<u>MIDDECK PCS</u> 14.7 CAB REG INLET vlv (two) – CL H2O TK N2 REG INLET vlv (two) – OP O2 REG INLET vlv (two) – CL
MO32M	LEH O2 vlv (two) – R
MO69M	LEH O2 8 vlv – CL Remove, stow O2 Bleed Orifice LEH O2 8 vlv – R 7 vlv – R
SIDE HATCH	NEG PRESS RLF VLV COVER (two) – pull open to vent; push firmly to close
MA73C:F	<u>RMS PNL LTS</u> (if RMS onboard) cb RMS PRI ΦA – op B/U ΦA – op <u>AC UTILITY OUTLET</u> cb AC1 MAR 3Φ – op

<u>ENT STOWAGE</u> [3]
<u>PERSONAL HYGIENE SYS STOWAGE</u> Stow: Personal Hygiene Kits Hose
<u>AIRLOCK CLOSEOUT</u> Tether soft goods to EVA tether point or A/L Stowage Bag. Gray Tape to floor
<u>POLE SETUP</u> Reinstall Stbd Pip Pin Install Pip Pin Install Hitch Pin in Pip Pin Reinstall large Port Pin: Retract and hold Locking Pin (Ring) Reinstall large Pin Release Locking Pin (Ring) Slide forward Safing Latch
√ Pole Straps secure
<u>FDF STOWAGE</u> Stow FLIGHT PLAN <u>CABIN CONFIG</u> Stow: Backup PGSC Middeck Camrs, Accessories FWD/AFT Shades, Filters Exercise Equipment
√ Retention net is in ASC/ENT config
<u>EGRESS ROUTE CONFIG</u> Tape Foot Loops in egress routes
NOTE Chemlights are middeck carry-on items. Activate green chemlights after TIG. Do not activate orange chemlights (slide ops only)
Install green chemlights (8 ea) near egress hdw and egress routes Install orange chemlights (2 ea) above side hatch

<u>GALLEY DEACT</u> [26]	
GALLEY	OVEN/RHS – OFF H2O HTRS (two) – OFF √OVEN FAN – OFF √REHYD STA lever – cl (push in) √OVEN DOOR LATCH – latched
MA73C:G	cb AC3 GALLEY FAN (three) – op
ML86B:A	MNC SPLY H2O GALLEY SPLY – op
:B	MNA GALLEY OVEN – op MNB GALLEY H2O HTR – op

(Cont next page)

Back of MS MIDDECK ACTIVITIES

ENT AIRLOCK CONFIG 3A

- | | |
|-------------|---|
| MO13Q | 1. √AIRLK FAN A(B) – OFF |
| TNL EXT | 2. Disconnect A/L Fan Inlet Duct from aft middeck floor fitting and A/L Fan Inlet and strap to Tunnel Extension wall |
| MA73C:G | 3. cb AC1,2 ARLK TNL FAN A,B (six) – op |
| EXT A/L | 4. Unstow,install diffuser cap on aft middeck floor fitting |
| AW18A | 5. NEG PRESS RLF vlv cover (two) – pull open to vent; push firmly to close |
| INNER HATCH | 6. LTG FLOOD 1(3,4) – OFF |
| | 7. Perform AIRLOCK ENTRY SWITCH LIST/VERIFICATION, 3-3 |
| | 8. Close hatch:
Position handle to preclosing posn per decal
Hatch – rotate about hinge and push
Handle – CCW to LATCH
Lock lever to LOCKED |
| | 9. Equal vlv (two) – NORM, install caps |
| MIDDECK FLR | 10. √EMU O2 ISOL vlv – CL |
| MO13Q | 11. AIRLK 2 – OFF/ON |
| | 12. √AIRLK H2O S/O vlv – OP (tb-op) |
| ML86B:C | 13. cb MNB EXT ARLK HTR VEST Z1/2/3 – op |
| | If TNL ADAPT flown: |
| :E | 14. cb MNA FLOOD TNL ADAPT 2 – op
cb MNB FLOOD TNL ADAPT 3 – op
cb MNC FLOOD TNL ADAPT 4 – op |
| :F | 15. cb MNA FLOODS AIRLK 1 – op
MIDDECK 9 – op
cb MNB FLOODS MIDDECK 10 – op
AIRLK 3 – op
cb MNC FLOODS AIRLK 4 – op |
| :G | 16. cb ESS 1BC FLOOD AIRLK 2 – op |
| | If TNL ADAPT flown:
17. cb ESS 1BC FLOOD TNL ADAPT 1 – op |

CLOTHING CONFIG 20

Unstow,don:
ACES
Harness
Boots

Verify ACES Gloves (Spare) available. Relocate as reqd

Remove radiation dosimeter from inflight garments and insert in ACES; if waveoff, remove radiation dosimeter from ACES and insert in inflight garments

NOTE

Refer to flight specific utility outlet plug-in plan if reqd

Connect middeck cooling units per PWR/DATA/VIDEO:
ASCENT/ENTRY CONFIG (REF FS, UTIL PWR)

MO13Q,	DC UTIL PWR MNA(B,C) – ON as reqd
MO30F,	Cooling units – Hose Jumper Plug installed
MO52J,	Pre-chill cooling units 10 min prior to seat ingress
PDB J2(3,4),	
ML85E (MUP)	

WCS DEACT 27

- | | |
|-------|---|
| WCS | VAC VLV – CL
√MODE sel – AUTO
FAN SEP sel – OFF
Unstow hose from cradle, attach hose to WCS housing via Velcro straps
Stow:
WCS Trash Can
Mirror
Privacy Curtain |
| | Foot/toe restraints – up,latched |
| | Close and latch door |
| ML31C | VAC VENT ISOL VLV BUS SEL – MNB
CNTL – CL (tb-CL)
NOZ HTR – OFF |
| | √Middeck lts as reqd |

MD AUD SPKR CONFIG 29

- | | |
|-------|---|
| MO42F | MIDDECK AUD SPKR PWR – OFF |
| MO39M | MIDDECK COMM CCU PWR – OFF |
| | Disconnect and stow Handheld Mic |
| | Configure MHA to MID CCU per entry plug-in plan |
| | Connect Lightweight Headsets or ACES Comm Cap |
| | MIDDECK COMM CCU PWR – ON |

CONFIG FOR PLBD CLOSING 7

CONFIG RMS/OBSS (if RMS/OBSS onboard)

- 1. ✓ Elbow Camr in aligned position
 - Pan 90° from X-axis
 - Tilt per decal
- A8L 2. RMS PWR – OFF (SM ALERT, BCE BYP MCIU)
PORT RMS HTR (two) – OFF
- R11L SET UP LIGHTS
- MDU 3. IDP/CRT4 PWR – ON
- A6U ✓ CRT 4 PWR – ON
✓ ANNUN BUS SEL – MNC

NOTE

Minimum operating time for PLB
Floodlights: 10 min ~3 min to full bright

- A7U PL BAY FLOOD AFT STBD –
- PORT –
- MID STBD –
- PORT –
- FWD STBD –
- PORT –
- BHD –

Record MET ____ / ____ : ____ : ____

- * If PLB floodlight not ON to full bright within 5 min: *
- * (Aff) PL BAY FLOOD – OFF *

TV ACT

- 4. Perform ACTIVATION, OPERATION (Cue Card, TV) to activate camrs A, B, C, D (ALC-AVG with Illuminators on)
- 5. ✓ MCC for rad hose camr pointing and composed MUX1(A,C) and MUX2(D,B) camr views (see fig 1-5)

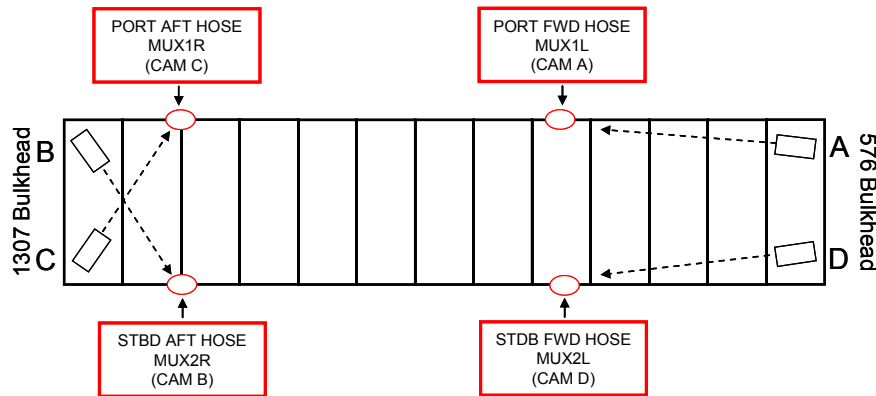

Figure 1-5. RAD hose camera muxing

If camr pointing and muxing required for rad retract hose recording:

Point Camrs A and C at PORT FWD and AFT rad retract hose:

- 6. VID OUT MON 1 pb – push
IN A pb – push
PAN/TILT, ZOOM, FOCUS as reqd to center PORT FWD rad retract hose in FOV
- 7. VID IN C pb – push
PAN/TILT, ZOOM, FOCUS as reqd to center PORT AFT rad retract hose in FOV

Point Camrs D and B at STBD FWD and AFT rad retract hose:

- 8. VID OUT MON 2 pb – push
IN D pb – push
PAN/TILT, ZOOM, FOCUS as reqd to center STBD FWD rad retract hose in FOV
- 9. VID IN B pb – push
PAN/TILT, ZOOM, FOCUS as reqd to center STBD AFT rad retract hose in FOV

MUX Camrs A and C:

- 10. VID OUT MON 1 pb – push
IN MUX 1 pb – push
OUT MUX 1 L pb – push
IN A pb – push
OUT MUX 1 R pb – push
IN C pb – push

- 11. Verify both rad retract hoses are centered in each MUX half views; adjust accordingly

MUX Camrs D and B:

- 12. VID OUT MON 2 pb – push
IN MUX 2 pb – push
OUT MUX 2 L pb – push
IN D pb – push
OUT MUX 2 R pb – push
IN B pb – push

- 13. Verify both rad retract hoses are centered in each MUX half views; adjust accordingly

Route MUXED video to DTV

- A7 14. ✓ PL AUX – ON
✓ cb AC2 PL 3Φ – cl
- R1 15. Reinstall VIP OUT-to-VTR IN jumper cable
- MA73C 16. VTR/CC PWR – on (LED on)
- L10 (MUX) 17. ✓ ATU – REC
✓ CCTV VID IN – J3
PWR – on (LED on, DATA FLOW flashes twice)
- (VIP) 18. ✓ ON/STANDBY LED – green
✓ Switches set to white dot (seven)
Insert new tape (tape icon LED on)
- (VTR) 19. VID OUT DTV pb – push
IN MUX 1 pb – push
- A7 20. ✓ MUX scene displayed on VTR LCD
- L10 (VTR)

POST CLOSING CONFIG 10

If radiator hose exhibits bend,
 : RADIATOR HOSE STILL PHOTOS

- Vol 3B : Unstow, Configure Hardware
- 400mm lens : 1. Unstow D2Xs, 400mm lens
- D2Xs : √400mm lens attached to D2Xs
- : Aperture - Min, locked
- : Lens Focus Mode - M
- : Body Focus Mode - S
- : √Batt installed
- : √Flash Card installed
- : Pwr - ON
- : Top LCD
- : √Batt
- : √Frames remaining sufficient
- : Exp Comp () - 0.0
- : Exp Mode - A
- : f/stop - f/2.8
- : Meter - Matrix ()
- : Diopter - Adjust
- : Frame Rate - S
- : √BKT disabled - 0 F
- : Rear LCD
- : ISO - 800
- : √QUAL - RAW
- : √WB 0,A
- : AF Area Mode - [[]]
- : √Focus Area - Center
- : √Focus Selector Lock - L

W9, W10

D2Xs

Vol 3B

A8L
 R12 (OBSS)
 (OPP)

A7U
 L10 (VTR)

Photograph Bent Radiator Hose(s)

- 2. √Camr A,B,C,D illuminators,PLB lights are ON
- Remove window shield(s)
- Frame radiator hose while stabilizing lens on window frame
- Focus on hose
- Take images, one hose at a time
- Reinstall window shield

Deactivate,Stow Hardware

- 3. Exp Mode - P
- Rear LCD
- ISO - 100
- Turn Camr Pwr - OFF
- L 4. Stow D2Xs, 400mm lens

CONFIG STBD RMS/OBSS

- STBD RMS HTR (two) – OFF
- RSC PWR – OFF
- OBSS SW PWR – OFF
- cb OBSS SW PWR CB1 – op

NOTE

PLB Floodlights must be off for minimum of 10 min
 UNBLOCKED, 16 min BLOCKED prior to reuse

After floodlights ON > 10 min:

- PL BAY FLOOD (all) – OFF
- Install fresh 3-hr tape for entry video
- Reconnect Mini-Cam AVIU J1 video output to VTR IN, as reqd
- Perform DEACTIVATION (Cue Card, TV), then:
- Stow Flight Deck Camrs, Accessories

FOOT LOOP CONFIG

Tape Foot Loops in egress routes

DEORBIT PREP BACKOUT PROCEDURES

This Page Intentionally Blank

DEORBIT PREP BACKOUT SUMMARY TIMELINES

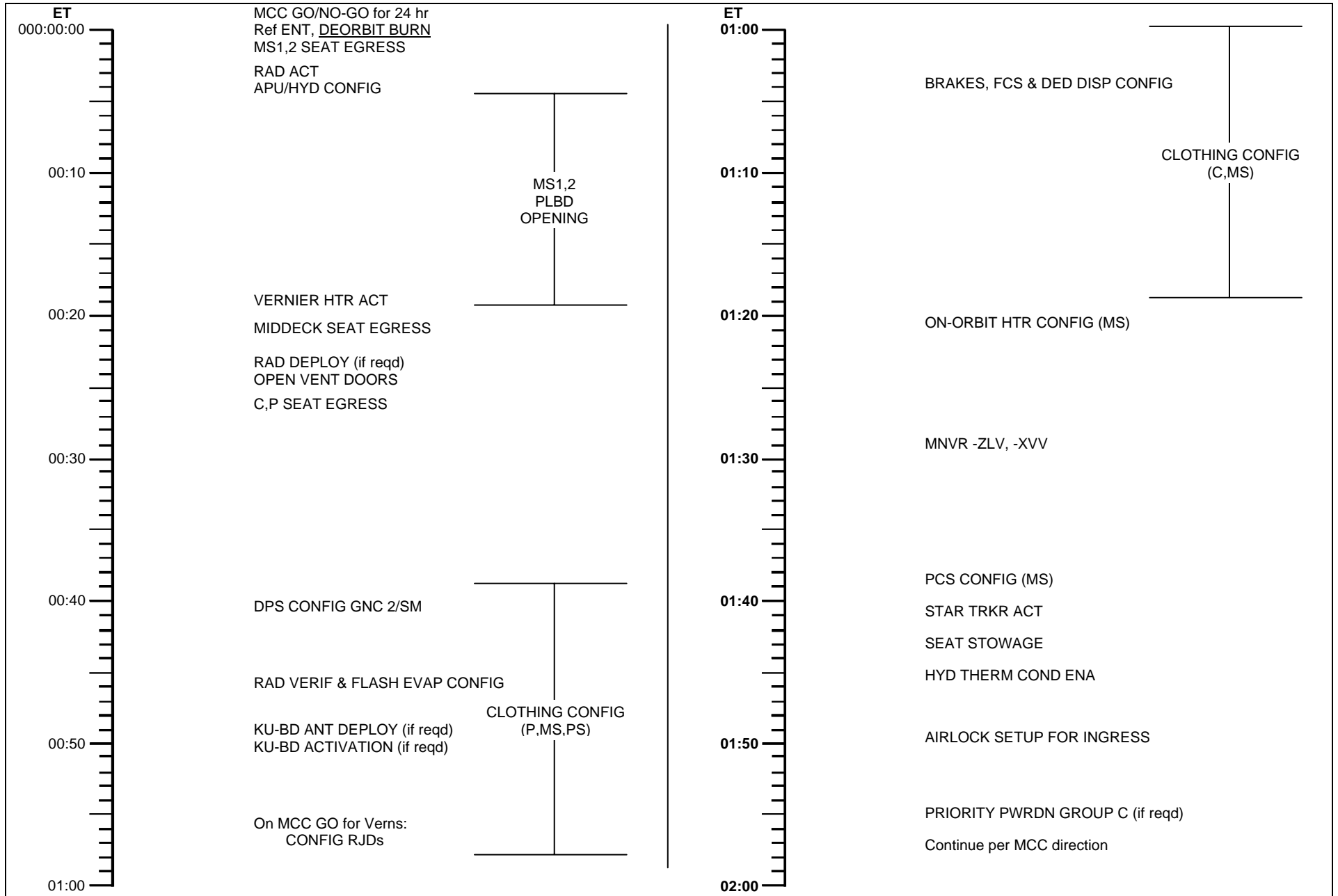

This Page Intentionally Blank

ET		1: GNC DEORB MNVR COAST	2: GNC DEORB MNVR COAST	3: BFS, GNC DEORB MNVR COAST
00:00:00	MCC/CREW GO/NO-GO FOR 24 HR	MS1,2	C6	Ref ENT, DEORBIT BURN LEH O2 vlv (four) – CL FLT DECK SPECIALIST SEAT EGRESS (all others remain seated) CONFIG FOR PLBD OPENING [1], 2-15
	TRANS DAP AUTO RT 0.5 DB 3.5	C		RAD ACT [2]
		P		APU/HYD CONFIG [3]
		MS		PLBD OPENING [5], 2-13
00:10				MS1,2 PLBD OPENING
		C,P	O5,O9	MCC: GO/NO-GO for PRIORITY PWRDN GROUP C scheduled at ET 02:00 L,R AUD A/G 2 (two) – RCV XMIT/ICOM MODE – PTT/VOX (recommended)
			O6	UHF MODE – OFF
00:15		C	L1	CAB TEMP CNTLR – 2 TEMP – adj rotary as reqd
		C	L4:J	cb SIG COND HUM SEP – cl IMU FAN – cl
		MS		VERNIER HTR ACT [6]
00:20		MS,PS		WHEN PLBD OPENING COMPLETE: SEAT EGRESS (all middeck)
		MS	MO32M	LEH O2 vlv (two) – CL
			MO69M	– CL
		MS		RAD DEPLOY, if reqd (ORB OPS, ECLS)
		MS		PRELIM MIDDECK CONFIG [7], 2-17
		P		OPEN VENT DOORS 1: GNC 51 OVERRIDE
00:25		C,P		VENT DOOR CNTL OPEN – ITEM 43 EXEC (*) Unstow/install HUD covers (two) SEAT EGRESS
00:30		MS		PDF/COMM CONFIG MS AFT ACTIVITIES [8], 2-15

RAD ACT [2]

C L1

√RAD CNTLR OUT TEMP – NORM
BYP VLV MODE (two) – AUTO
CNTLR LOOP (two) – AUTO A(B)

After ~90 sec,
√RAD BYP VLV tb (two) – RAD

* If tb(s) remain in BYP or return to BYP: *

- * Use alternate RAD CNTLR *
- * Do not drive BYP VLV(s) manually *
- * If tb(s) bp: *
- * Do not select alternate RAD CNTLR *
- * Do not drive BYP VLV(s) manually *
- * If EVAP OUT T low or H2O ICH OUT T low: *
- * RAD BYP VLV MODE (two) – MAN *
- * MAN SEL (two) – BYP *
- * (after ~3 sec tb-BYP) *

APU/HYD CONFIG [3]

P R2

APU SHUTDOWN (EPCL, APU/HYD)

BLR N2 SPLY (three) – OFF
HYD MN PUMP PRESS (three) – NORM

VERNIER HTR ACT [6]

P A14

RCS/OMS HTR FWD RCS JET 5 – AUTO
AFT RCS JET 5 – AUTO

NOTE
Delay use of verniers until MCC GO in GNC OPS 2

CLOTHING CONFIG 9

Doff/Stow:
Harness,Boots,ACES,UCD (if not used)

Remove radiation dosimeter from ACES and insert in inflight garments

Doff/Stow in Wet Trash (if used):
UCD (clamp)
Emesis Bag (unstow new Bag)

DPS CONFIG TO GNC2/SM 11

NOTE

No keyboard entries or sw throws 10 sec:
Before and after moding PASS GPCs to RUN
Before OPS transition or set expansion/contraction requests until new OPS base page is displayed

1. TRANSITION TO GNC OPS 201

GNC 0 GPC MEMORY

√CONFIG – ITEM 1 +2 EXEC

Config for single G2 GPC ops unless directed otherwise by MCC:

Modify MC 2 per table →

		DUAL G2	SINGLE G2
CONFIG GPC		2	2
STR	1	1	1
	2	2	1
	3	1	1
	4	2	1
PL	1/2	0	0
CRT	1	1	1
	2	2	1
	3	0	0
	4	2	1
L	1	0	0
	2	0	0
MM	1	1	1
	2	2	1

C3

Modify MC 2 per table →

BFC CRT DISP – OFF

GNC, OPS 201 PRO

GNC UNIV PTG

DAP: B/AUTO/PRI

GNC 1 DPS UTILITY

√CKPT RETRV ENA – ITEM 12 EXEC (*)

BFC CRT DISP – ON

C2 BFS, MSG RESET (√BFC It off)

CRT

GNC, GPC/CRT 04 EXEC

If single G2 GPC ops:

CRTX

MAJ FUNC – PL

GPC/CRT 2/X EXEC

X: PL GPC MEMORY

CONFIG ITEM 45 +2 EXEC

GPC ITEM 46 +2 EXEC

STORE ITEM 47 EXEC

Store complete when MC = 02

√All IDPs deassigned from FD GPC

O6

GPC MODE 2 – STBY (tb-bp)

– HALT (tb-bp)

– STBY (tb-RUN)

– HALT (tb-bp)

C3
CRTX

2. FREEZE DRY GPC 3

BFC CRT DISP – OFF

MAJ FUNC – PL

GPC/CRT 3/X EXEC

X: PL GPC MEMORY

CONFIG – ITEM 45 +2 EXEC

GPC – ITEM 46 +3 EXEC

STORE – ITEM 47 EXEC

Store complete when MC = 02 (~16 sec)

√All IDPs deassigned from FD GPC

O6

GPC MODE 3 – STBY (tb-bp)

– HALT (tb-bp)

– STBY (tb-RUN)

– HALT (tb-bp)

CRTY

3. TRANSITION GPC 4 TO SM OPS 201(401)

MAJ FUNC – SM

GPC/CRT 4/X EXEC

X: SM GPC MEMORY

CONFIG – ITEM 1 +4 EXEC

√MC 4(5) per table →

CRTX

SM, OPS 201(401) PRO

X: SM ANTENNA

DAP: B/AUTO/PRI

SM 1 DPS UTILITY

UL CNTL AUTO – ITEM 35 EXEC

	CONFIG GPC	4(5) 00040
STR	1	0
	2	0
	3	0
	4	0
PL	1/2	4
CRT	1	4
	2	4
	3	0
	4	4
L	1	4
	2	0
MM	1	4
	2	4

C3
CRT3

4. RECONFIG GPCs

BFC CRT DISP – ON

BFS, GNC OPS 000 PRO

3: BFS, GNC GPC MEMORY

C3

BFC CRT DISP – OFF

O6

√All IDPs deassigned from BFS

GPC MODE 5 – STBY (tb-RUN)

(releases payload buses 1,2)

then HALT (tb-bp)

OUTPUT 4 – TERM (tb-bp)

5 – NORM (tb-bp)

P/I Locker

Unstow and install GPC Mode Switch Guard

C2

5. MEDS RECONFIG

GPC/CRT 03 EXEC

44 EXEC

IDP/CRT3 PWR – OFF

ET		1: GNC 51 OVERRIDE	2: GNC DEORB MNVR COAST	
00:30	TRANS DAP		3: BFS, GNC DEORB MNVR COAST	
	AUTO			
	RT 0.5			
	DB 3.5			
00:35				
	P	<u>CLOTHING CONFIG</u> [9], 2-6		
	MS,PS	<u>CLOTHING CONFIG</u> [10], 2-15		
00:40				
	C	If reqd, <u>PAYLOAD REACT (PL OPS, DEORB PREP)</u> or <u>PAYLOAD REACTIVATION (SODF: ASSY OPS: DEORBIT PREP)</u>		
(A1) B1	C	<u>DPS CONFIG TO GNC2/SM</u> [11], 2-6 and 2-7		
AUTO/PRI				
RT 0.5				
DB 3.0				
00:45				
	P	<u>RAD VERIF & FLASH EVAP CONFIG</u> [12]		
	MS	<u>RMS PNL LT, TEMP MON, HTR ACT, OBSS,</u> <u>C/W</u> [13], 2-16	CLOTHING CONFIG (P,MS,PS)	
	C	<u>KU-BD ANT DEPLOY</u> , if reqd (ORB OPS, <u>COMM/INST</u>) <u>KU-BD ACTIVATION</u> , if reqd (ORB OPS, <u>COMM/INST</u>)		
00:50				
	MS	<u>MIDDECK CONFIG</u> [14], 2-17 and 2-18		
	C,P	If MCC GO for use of verniers: <u>CONFIG RJDs</u> O16:F RJD MANF L5/F5/R5 DRIVER – ON, wait 5 sec DAP: A/AUTO/VERN Else, load DAP A5 (Nose and Tail) or A6 (Tail) <u>GNC 20 DAP CONFIG</u> ITEM 10 +0.1 EXEC 11 +1 0 EXEC 22 +1 EXEC DAP: A/AUTO/ALT		
00:55				
A1 (B1)				
AUTO				
VERN				
RT 0.2				
DB 1.0				
01:00				

6. TFL/DFL FOR ON-ORBIT OPS
√MCC for TFL/DFL config
Perform LOAD PCMMU FORMAT (ORB OPS FS, COMM/INST) and LOAD PDI DECOM FORMAT (ORB OPS FS, COMM/INST)

7. ERROR LOG RESET
After MCC GO:
SM 0 GPC MEMORY
ERR LOG RESET – ITEM 48 EXEC
GNC 0 GPC MEMORY
ERR LOG RESET – ITEM 48 EXEC

RAD VERIF & FLASH EVAP CONFIG [12]

L1 √RAD BYP VLV tb (two) – RAD FLOW
CRT2 When FREON LOOP RAD OUT T < 60 degF:
L1 HI LOAD EVAP – OFF
FLASH EVAP CNTLR PRI B(A) – OFF
L2 FREON ISOL MODE – AUTO
2: SM SYS SUMM 1

This Page Intentionally Blank

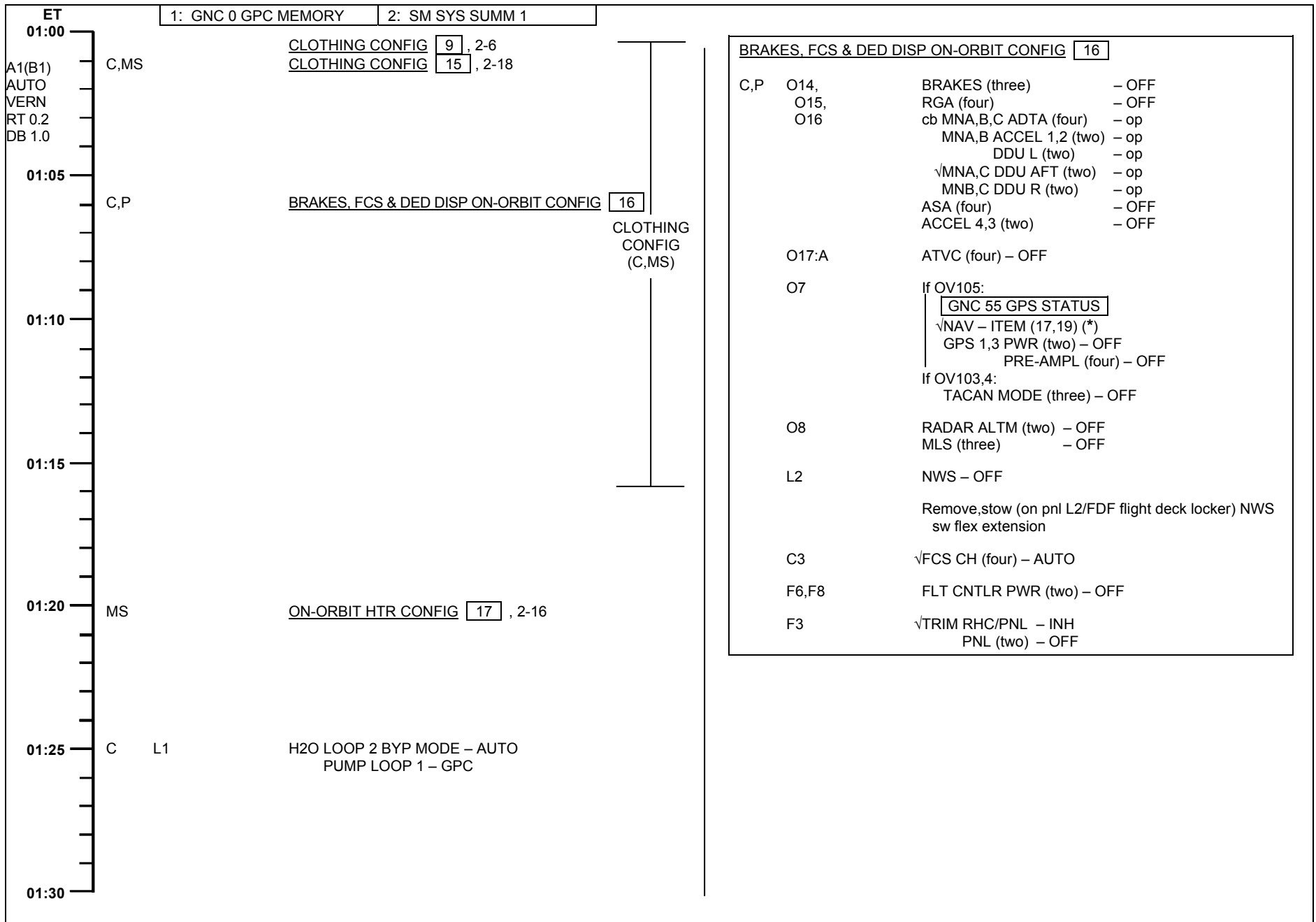

This Page Intentionally Blank

ET		1: GNC 0 GPC MEMORY	2: SM SYS SUMM
01:30	C		<u>AUTO MNVR -ZLV, -XVV</u> √TGT ID +2 BODY VECT +3 OM +0 DAP: A/AUTO/VERN Initiate TRK
01:35			
01:40	C,MS P		<u>ON-ORBIT PCS2(1) CONFIG</u> <input type="checkbox"/> 19, 2-18 <u>STAR TRKR ACT</u> <input type="checkbox"/> 20
	MS,PS		<u>SPECIALIST SEAT REMOVAL/STOWAGE</u>
01:45	P R2		<u>HYD THERM COND ENA</u> HYD CIRC PUMP (three) – GPC
01:50	MS		<u>AIRLOCK SETUP FOR INGRESS</u> <input type="checkbox"/> 21, 2-18
01:55			
02:00			On MCC call: PRIORITY PWRDN GROUP C, if reqd (ORB PKT, <u>PRIORITY PWRDN</u>) Continue per MCC direction

<u>STAR TRKR ACT</u> <input type="checkbox"/> 20	
O14:E, O15:E	cb STAR TRKR -Z,-Y (two) – cl
O6	STAR TRKR PWR (two) – ON
C2	GNC I/O RESET
O6	STAR TRKR DR CNTL SYS (two) – OP (start timer) √POS tb (two) – bp When both tb – OP (~8-24 sec) <u>or either tb – bp > 24 sec:</u> STAR TRKR DR CNTL SYS (two) – OFF
	<input type="checkbox"/> X: GNC 22 S TRK/COAS CNTL
	S TRK -Y,-Z: STAR TRK – ITEM 3,4 (*)
	<input type="checkbox"/> X: GNC 21 IMU ALIGN
	RESUME
	* If tb – bp > 8 sec, notify MCC *

This Page Intentionally Blank

PLBD OPENING

DETAILED PLBD OPENING PROCEDURES 5

CAUTION

Use MANUAL mode for subsequent BFS PLBD ops if BFS AUTO sequence has been interrupted by reversing latch/door drive direction or if MANUAL mode has already been used during mission

- | | |
|------|---|
| R13L | * If no motion determined visually or 'OP/CL' * |
| | * not blank within 10 sec after cmd: * |
| | * PL BAY DR – STOP * |
| | * Go to MAL, MECH, 9.1a * |
| | * If Latch not 'OP' in single-motor time: * |
| | * PL BAY DR – STOP * |
| | * Go to MAL, MECH, 9.1d * |
| | * If door motion stops and not 'OP': * |
| | PL BAY DR – STOP * |
| | * Go to MAL, MECH, 9.1f * |
| O6 | * If BFS GPC fails during operation: * |
| | * PL BAY DR SYS (two) – DSBL * |
| | * DR – STOP * |
| | * MDM PL1,2 (two) – OFF * |
| | * GPC MODE 5 – STBY, HALT * |
| | * MDM PL1,2 (two) – ON * |
| | * Proceed with DPS CONFIG TO GNC2/SM 11, then * |
| | * continue in MANUAL PLBD OPENING PROCEDURE, * |
| | * as reqd * |
| R13L | * If SM GPC fails during this operation: * |
| | * PL BAY DR SYS (two) – DSBL * |
| | * DR – STOP * |
| | * Go to PASS SM GPC FAIL (ORB PKT, DPS) * |

NOTE

Note any single-motor ops (continue ops)
(single-motor times = 2x listed dual-motor times)

AUTO PLBD OPENING PROCEDURE

- | | |
|-----------|--|
| MS CRTX | 1. SM, OPS 202 PRO or BFS, SM 63 PL BAY DOORS |
| | X: SM PL BAY DOORS |
| R13L CRTX | √PL BAY DR – STOP |
| | √PBD SW – STOP |
| | √MAN SEL (ten) – (no *) |
| | √PBD SW BYPASS – (no *) |
| R13L CRTX | 2. AC POWER ON – ITEM 1 EXEC (*) |
| | √AUTO MODE SEL – (no *) |
| | 3. PL BAY DR SYS (two) – ENA |
| | √OP/CL STATUS (ten) – CL |
| | √AOS |
| | OPEN C/L LATCHES 5-8 (MANUAL MODE) |
| R13L CRTX | 4. Select CENTER LATCHES 5-8 – ITEM 4 EXEC (*) |
| R13L CRTX | 5. PL BAY DR – OP |
| | √CENTER LATCHES 5-8 – blank, OP (~20 sec) |
| R13L | 6. PL BAY DR – STOP |

OPEN REMAINING LATCHES/DOORS (AUTO MODE)

- | | |
|-----------|--|
| R13L CRTX | 7. AUTO MODE SEL – ITEM 3 EXEC (*) |
| | 8. PL BAY DR – OP |
| | √CENTER LATCHES 9-12 – blank, OP (~20 sec) |
| | √CENTER LATCHES 1-4,13-16 (two) – blank, OP (~20 sec) |
| | √STBD FWD,AFT LATCHES (two) – blank, OP (~30 sec) |
| | √DOOR – RDY, blank, OP (~63 sec) |
| | √PORT FWD,AFT LATCHES (two) – blank, OP (~30 sec) |
| | √DOOR – RDY, blank, OP (~63 sec) |
| R13L | 9. PL BAY DR – STOP |
| | POST-PLBD OPENING CLEANUP |
| R13L CRTX | 10. PL BAY DR SYS (two) – DSBL |
| | √OP/CL STATUS (ten) – OP |
| | 11. AC POWER OFF – ITEM 2 EXEC (*) |
| | 12. SM, OPS 201 PRO (if PASS SM) |
| | X: SM ANTENNA |
| A7U | 13. After floodlights ON > 10 min:
PL BAY FLOOD (all) – OFF |

MANUAL PLBD OPENING PROCEDURE

- | | |
|-----------|--|
| MS CRTX | 1. SM, OPS 202 PRO or BFS, SM 63 PL BAY DOORS |
| | X: SM PL BAY DOORS |
| R13L CRTX | √PL BAY DR – STOP |
| | √PBD SW – STOP |
| | √MAN SEL (ten) – (no *) |
| | √PBD SW BYPASS – (no *) |
| R13L CRTX | 2. AC POWER ON – ITEM 1 EXEC (*) |
| | √AUTO MODE SEL – (no *) |
| | 3. PL BAY DR SYS (two) – ENA |
| | √OP/CL STATUS (ten) – CL |
| | √AOS |
| | OPEN C/L LATCHES |
| R13L CRTX | 4. Select CENTER LATCHES 5-8 – ITEM 4 EXEC (*) |
| R13L CRTX | 5. PL BAY DR – OP |
| | √CENTER LATCHES 5-8 – blank, OP (~20 sec) |
| R13L CRTX | 6. PL BAY DR – STOP |
| | 7. Deselect CENTER LATCHES 5-8 – ITEM 4 EXEC (no *) |
| | 8. Select CENTER LATCHES 9-12 – ITEM 5 EXEC (*) |
| R13L CRTX | 9. PL BAY DR – OP |
| | √CENTER LATCHES 9-12 – blank, OP (~20 sec) |
| R13L CRTX | 10. PL BAY DR – STOP |
| | 11. Deselect CENTER LATCHES 9-12 – ITEM 5 EXEC (no *) |
| | 12. Select CENTER LATCHES 1-4,13-16 – ITEM 6,7 EXEC (*) |
| R13L CRTX | 13. PL BAY DR – OP |
| | √CENTER LATCHES 1-4,13-16 (two) – blank, OP (~20 sec) |
| R13L CRTX | 14. PL BAY DR – STOP |
| | 15. Deselect CENTER LATCHES 1-4,13-16 – ITEM 6,7 EXEC (no *) |

PLBD OPENING (Cont)

- R13L 16. OPEN STBD FWD, AFT LATCHES & DOOR
 CRTX 17. Select STBD FWD, AFT LATCHES – ITEM 8,9 EXEC (*)
 R13L 17. PL BAY DR – OP
 CRTX √STBD FWD, AFT LATCHES (two) – blank, OP (~30 sec)
 R13L 18. PL BAY DR – STOP
 CRTX 19. Deselect STBD FWD, AFT LATCHES – ITEM 8,9 EXEC (*)
 R13L 20. Select STBD DOOR – ITEM 10 EXEC (*)
 CRTX 21. PL BAY DR – OP
 R13L √STBD DOOR – RDY, blank, OP (~63 sec)
 CRTX 22. PL BAY DR – STOP
 R13L 23. Deselect STBD DOOR – ITEM 10 EXEC (*)
 CRTX
- R13L 24. OPEN PORT FWD, AFT LATCHES & DOOR
 CRTX 25. Select PORT FWD, AFT LATCHES – ITEM 11,12 EXEC (*)
 R13L 25. PL BAY DR – OP
 CRTX √PORT FWD, AFT LATCHES (two) – blank, OP (~30 sec)
 R13L 26. PL BAY DR – STOP
 CRTX 27. Deselect PORT FWD, AFT LATCHES – ITEM 11,12 EXEC (no *)
 R13L 28. Select PORT DOOR – ITEM 13 EXEC (*)
 CRTX 29. PL BAY DR – OP
 R13L √PORT DOOR – RDY, blank, OP (~63 sec)
 CRTX 30. PL BAY DR – STOP
 R13L 31. Deselect PORT DOOR – ITEM 13 EXEC (no *)
 CRTX

- R13L 32. POST-PLBD OPENING CLEANUP
 CRTX 32. PL BAY DR SYS (two) – DSBL
 √OP/CL STATUS (ten) – OP
 33. AC POWER OFF – ITEM 2 EXEC (*)
 34. SM, OPS 201 PRO (if PASS SM)
 X: SM ANTENNA
 A7U 35. After floodlights ON > 10 min:
 PL BAY FLOOD (all) – OFF

FUNCTION	PLBD CONTROL								PLBD DISPLAY PL MDM								
	Ref: MA73C:C&D for MCA cbs																
	MTR 1				MTR 2				C	C	O	O	C	R	R	R	O
	AC/ MCA	CNTL	MDM	SYS	AC/ MCA	CNTL	MDM	SYS	A	B	A	B	A	B	C		
LATCH																	
5-8	1/MID3	AB3/AB2	PL1	2	3/MID2	CA3/CA1	PL2	1	1	2	1	2					
9-12	1/MID1	AB3/AB1	PL1	1	3/MID4	CA3/CA2	PL2	2	1	2	1	2					
1-4	1/MID3	AB3/AB2	PL1	2	3/MID2	CA3/CA1	PL2	1	1	2	1	2					
13-16	3/MID4	CA3/CA2	PL2	2	2/MID2	BC3/BC1	PL1	1	2	1	2	1					
S FWD	1/MID1	AB3/AB1	PL1	1	2/MID4	BC3/BC2	PL2	2	1	2	1	2					
S AFT	3/MID4	CA3/CA2	PL2	2	2/MID2	BC3/BC1	PL1	1	2	1	2	1					
S DOOR	1/MID1	AB3/AB1	PL1	1	2/MID4	BC3/BC2	PL2	2					1	1	2	2	1
													2	1	2	2	2
P FWD	1/MID1	AB3/AB1	PL1	1	2/MID4	BC3/BC2	PL2	2	1	2	1	2					
P AFT	1/MID3	AB3/AB2	PL1	2	3/MID2	CA3/CA1	PL2	1	1	2	1	2					
P DOOR	3/MID4	CA3/CA2	PL2	2	2/MID2	BC3/BC1	PL1	1					2	1	1	2	2
													1	1	1	2	1

MS AFT DECK BACKOUT ACTIVITIES

NOTE

WAIT FOR GO FROM CDR OR PLT BEFORE STARTING ANY ACTIVITY ON THIS PAGE

TIME (ET)	MS AFT ACTIONS
00:01	C6 LEH O2 vlv (four) – CL
00:02	<u>CONFIG FOR PLBD OPENING</u> [1]
00:20	<u>SPECIALIST SEAT EGRESS</u>
00:30	<u>FDF/COMM CONFIG</u> [8]
00:38	<u>CLOTHING CONFIG</u> [10]
00:40	If reqd, PAYLOAD REACT (PL OPS, <u>DEORBIT PREP</u>) or PAYLOAD REACTIVATION (SODF: ASSY OPS: <u>DEORBIT PREP</u>)
00:47	<u>RMS PNL LT, TEMP MON, HTR ACT, OBSS, C/W</u> [13], 2-16
01:20	<u>ON-ORBIT HTR CONFIG</u> [17], 2-16
01:42	<u>SPECIALIST SEAT REMOVAL/STOWAGE</u>

<u>CONFIG FOR PLBD OPENING</u> [1]	
	<u>4: BFS, SM 63 PL BAY DOORS</u>
	<u>SET UP LIGHTS</u>
A6U	ANNUN BUS SEL – MNC
	NOTE
	Minimum operating time for PLB Floodlights: 10 min. Lights must be off for minimum of 10 min UNBLOCKED, 16 min BLOCKED prior to reuse. ~3 min to full bright
A7U	PL BAY FLOOD AFT STBD – <input type="checkbox"/>
	PORT – <input type="checkbox"/>
	MID STBD – <input type="checkbox"/>
	PORT – <input type="checkbox"/>
	FWD STBD – <input type="checkbox"/>
	PORT – <input type="checkbox"/>
	BHD – <input type="checkbox"/>
	Record MET ____ / ____ : ____ : ____
	* If PLB Floodlight not ON to full bright within 5 min: *
	* (Aff) PL BAY FLOOD – OFF *
	<u>CONFIG STBD RMS/OBSS</u>
A8L	STBD RMS HTR (two) – AUTO
R12 (OPP)	cb OBSS SW PWR CB1 – cl
	OBSS SW PWR – ON
(OBSS)	RSC PWR – ON

<u>FDF/COMM CONFIG</u> [8]	
	<u>COMM CONFIG</u>
	Unstow: Headsets, Handheld Mics and/or Wireless Comm if flown
	If WCCS, perform STD WCCS CONFIG (ORB OPS, <u>COMM/INST</u>) or see <u>WCCS COMM PLAN</u> (Cue Card)
	If flight deck Handheld Mic/speaker operation:
R10	MS AUD PWR – AUD/TONE
	A/G 1 – T/R, tw-2
	A/G 2 – RCV, tw-2
	A/A – RCV, tw-2
	ICOM A – T/R, tw-2
	ICOM B – RCV, tw-2
	XMIT/ICOM MODE – PTT/PTT
A13	OS AUD SPKR PWR – SPKR/MIC
	MSTR SPKR VOL – 8
A11	MS COMM CCU PWR – OFF
	Connect Handheld Mic to CCU
	MS COMM CCU PWR – ON
R6,L5	CCU PWR – OFF
A1L	S-BD PM MODE – TDRS DATA
	NSP CODING (two) – ON
	OCA SETUP (ORB OPS, <u>PGSC</u>) A/G 2 MODE
	OCA S-BAND MODEM (MFX) ACTIVATION (ORB OPS, <u>PGSC</u>)
	COLOR PRINTER UNSTOW AND ASSEMBLE (ORB OPS, <u>PGSC</u>)
O19	TV PWR – OFF
L10 (VTR)	ON/STANDBY – PRESS (red LED on)
(VIP)	PWR – OFF (LED off)
(MUX)	VTR/CC PWR – OFF (LED off)
	<u>FDF CONFIG</u>
	Stow:
	ENT
	ENT PKT
	ENT Cue Cards
	Unstow (if reqd):
	Deploy Orbit Cue Cards

<u>CLOTHING CONFIG</u> [10]	
	Doff/stow:
	Harness, Boots, ACES, UCD (if not used)
	Remove radiation dosimeter from ACES and insert in inflight garments
	Doff, stow in Wet Trash (if used):
	UCD (clamp)
	Emesis Bag (unstow new bag)

(Cont next page)

Back of MS AFT DECK BACKOUT ACTIVITIES

RMS PNL LTS, TEMP MON, HTR ACT, C/W 13

MA73C:F RMS PNL LTS, TEMP MON, HTR ACT (if RMS on board)
 A8L cb RMS PRI Φ A – cl
 RMS PWR – PRI (MA tone)
 SM 94 PDRS CONTROL (MA, GPC DATA It on)
 I/O ON – ITEM 5 EXEC (*)
 A8U SAFING – CANCEL (tb-bp) (\sqrt GPC DATA It off)
 A8L PORT RMS HTR A – AUTO

C/W

R13U		
PARAMETER NAME	C/W CH	ENA/INH
MPS He REG P C	39	INH
L	49	INH
R	59	INH
HYD P 1	99	INH
2	109	INH
3	119	INH

ON-ORBIT HTR CONFIG 17

R2 BLR PWR (three) – OFF
 R4 HYD BK HTR (three) – OFF
 L1 \sqrt HI LOAD EVAP – OFF
 DUCT HTR sel – OFF
 A12 HYD HTR RUD SPD BK B – AUTO
 \sqrt A – OFF
 BDY FLP B – AUTO
 \sqrt A – OFF
 ELEV B – AUTO
 \sqrt A – OFF
 AFT FUS B – AUTO
 \sqrt A – OFF
 A14 RCS/OMS HTR FWD RCS – B AUTO
 \sqrt L POD – A OFF
 L POD – B AUTO
 \sqrt R POD – A OFF
 R POD – B AUTO
 OMS CRSFD LINES – A OFF
 \sqrt OMS CRSFD LINES – B AUTO
 R14:C cb KU ANT HTR – cl
 :D Close left to right all cbs
 :E Close left to right all cbs

Block 4 deleted

Block 18 deleted

MS MIDDECK BACKOUT ACTIVITIES

NOTE

WAIT FOR GO FROM CDR OR PLT BEFORE STARTING ANY ACTIVITY ON THIS PAGE

TIME (ET)	MS MIDDECK ACTIONS
00:20	<u>SPECIALIST SEAT EGRESS</u>
00:21	MO32M LEH O2 vlv (two) – CL MO69M LEH O2 vlv (two) – CL
00:22	<u>PRELIM MIDDECK CONFIG</u> 7
00:40	If reqd, PAYLOAD REACT, (PL OPS, <u>DEORB PREP</u>) or PAYLOAD REACTIVATION (SODF: ASSY OPS: DEORBIT PREP)
00:52	<u>MIDDECK CONFIG</u> 14
01:00	<u>CLOTHING CONFIG</u> 15 , 2-18
01:40	<u>ON-ORBIT PCS 2(1) CONFIG</u> 19 , 2-18
01:42	<u>SPECIALIST SEAT REMOVAL/STOWAGE</u>
01:50	<u>AIRLOCK SETUP FOR INGRESS</u> 21 , 2-18

<u>PRELIM MIDDECK CONFIG</u> 7	
	<u>INSTALL FILTERS</u> Unstow,install: Side Hatch UV Filter and Locking Device Pyro Box Safing Pin
	<u>COMM CONFIG</u> Unstow: Headsets, Handheld Mics and/or Wireless Comm if flown (see <u>WCCS COMM PLAN</u> (Cue Card))
	If WCCS perform STD WCCS CONFIG (ORB OPS, <u>COMM/INST</u>) or see <u>WCCS COMM PLAN</u> (Cue Card)
MO42F	If middeck Handheld Mic/speaker operation: MIDDECK SPKR AUD SPKR PWR – SPKR/MIC A/G 1 – T/R, tw-2 A/G 2 – RCV, tw-2 A/A – RCV, tw-2 ICOM A – T/R, tw-2 ICOM B – RCV, tw-2 XMIT/ICOM MODE – PTT/PTT MSTR SPKR VOL – 8
MO39M	MIDDECK COMM CCU PWR – OFF Connect Handheld Mic to CCU MIDDECK COMM CCU PWR – ON
ML31C	<u>HTR CONFIG</u> VAC VENT ISOL VLV BUS SEL – MNA NOZ HTR – ON ISOL VLV CNTL – OP (tb-OP)
	* If VAC VENT ISOL VLV CNTL tb – CL or bp: * * VAC VENT ISOL VLV BUS SEL – MNB * * CNTL – OP (tb-OP) * * If VAC VENT ISOL VLV CNTL tb still CL or bp: * * √MCC for further actions *

<u>MIDDECK CONFIG</u> 14	
ML86B:A	<u>GALLEY ACTIVATION</u> cb MNC SPLY H2O GALLEY SPLY – cl :B cb MNA GALLEY OVEN – cl cb MNB GALLEY H2O HTR – cl
R11L:G	√SPLY H2O GALLEY SPLY VLV – OP (tb-OP)
GALLEY	H2O HTRS (two) – ON OVEN/RHS – ON
MA73C:G	cb AC3 GALLEY FAN (three) – cl Unstow,install Personal Hygiene Hose
WCS	<u>WCS ACTIVATION</u> VAC VLV – OP Unstow Urinal Hose from Velcro strap, install hose in cradle √MODE – AUTO √CRADLE – AUTO FAN SEP SEL sw – 1 Unstow hose from cradle (√airflow) √WCS ON It – ON Stow hose in cradle √WCS ON It – OFF Unstow,install: WCS Trash Can Mirror Urine Collection Cue Card Foot/Toe Restraint – down,locked (Cont next page)

AIRLOCK ENTRY SWITCH LIST/VERIFICATION (TIG-3:50)

AIRLOCK

AW18A.....	3-3
AW18D	3-3
AW18H	3-3
AW82B.....	3-3

PARTIAL ENTRY SWITCH LIST/VERIFICATION (TIG-3:10)

LEFT SEAT

F3.....	3-4
F7.....	3-4
L,R HUD	3-4
F2.....	3-5
O7	3-5
O13.....	3-5
L side OVHD flood ...	3-5
F1.....	3-6
F6.....	3-6
L5.....	3-6

RIGHT SEAT

O8.....	3-7
R side OVHD flood ..	3-7
F4.....	3-7
F8.....	3-7
R2	3-8
R6	3-8
O17	3-8

AFT

C5	3-9
C7	3-9
A11	3-9









MIDDECK-FWD

MO58F.....	3-10
MO39M.....	3-10
MO52J.....	3-10
MO30F.....	3-10
MD44F.....	3-10
MD24K.....	3-10
A/L HATCH.....	3-10
MO63P	
(OV103,OV104)	3-10
ML86B	3-11

MIDDECK-AFT

MO13Q	3-12
ML18F.....	3-12
ML26C	3-12
ML31C	3-12

LEGEND

 - left	 - right
 - up	R - as reqd
 - center	 - cb close
 - down	 - cb open
 - indicates switch/display not checked during ENT SWITCH LIST/VERIFICATION.	
Switch/display pictorials are generic representations and are not intended to depict actual switch positions. √MCC if additional clarification reqd	

CIRCUIT BREAKER SNAP RING

COLOR CODES

<u>COLOR</u>	<u>CONFIGURATION</u>
Red	Open at all times
Green	Open on orbit only
Yellow	Open ascent, close per procedure
Orange	Open orbit through entry
Blank (no ring)	Always closed or as reqd

ENT SWITCH LIST/VERIF

FINAL ENTRY SWITCH LIST/VERIFICATION (TIG-1:50)

LEFT SEAT

L4.....	3-13
L1.....	3-14
L2.....	3-15
C2/C3.....	3-16
O1.....	3-17
O5.....	3-17
O6.....	3-18
O14.....	3-19
O15.....	3-19

RIGHT SEAT

O19.....	3-20
O16.....	3-20
O9.....	3-20
R1.....	3-21
R4.....	3-21

AFT









R10.....	3-22
R12U.....	3-22
R11L.....	3-22
R13L.....	3-23
R14.....	3-23
A1L,R.....	3-24
A12.....	3-25
A13.....	3-25
L9.....	3-26
A6L.....	3-27
A7L.....	
(APDS CNTL PNL) .	3-28
A15.....	3-29

MIDDECK-FWD

MO42F.....	3-30
MO32M.....	3-30
MO69M.....	3-30
MO51F.....	3-30

MIDDECK-AFT

MA73C.....	3-31
MO10W.....	3-32
WCS.....	3-32

<u>LEGEND</u>	
 – left	 – right
 – up	R – as reqd
 – center	 – cb close
 – down	 – cb open
 – indicates switch/display not checked during ENT SWITCH LIST/VERIFICATION. Switch/display pictorials are generic representations and are not intended to depict actual switch positions. √MCC if additional clarification reqd	

<u>CIRCUIT BREAKER SNAP RING COLOR CODES</u>	
<u>COLOR</u>	<u>CONFIGURATION</u>
Red	Open at all times
Green	Open on orbit only
Yellow	Open ascent, close per procedure
Orange	Open orbit through entry
Blank (no ring)	Always closed or as reqd

OV103

PNL AW18A

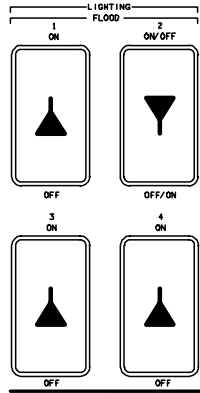

AW18A

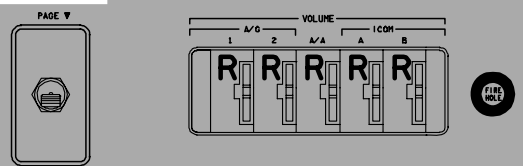
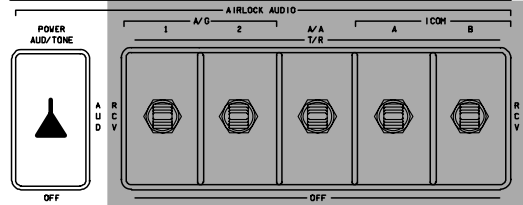

PNL AW18D

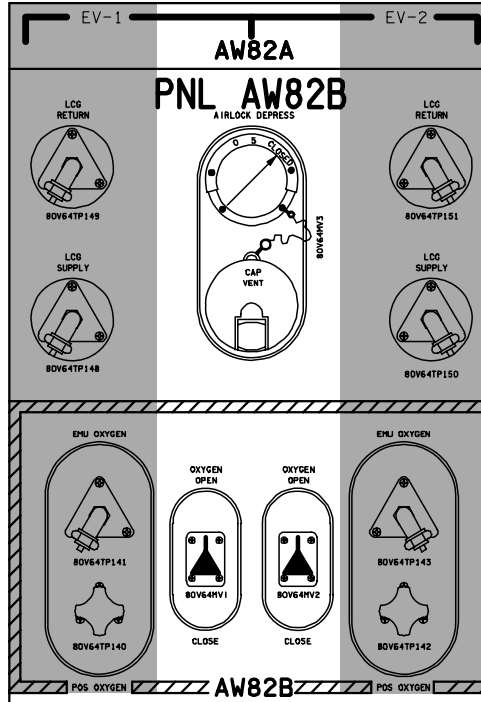
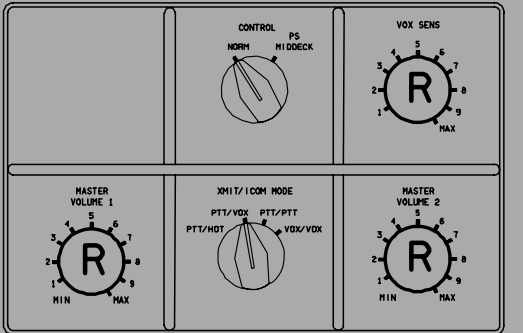

PNL AW18H

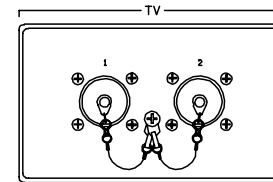
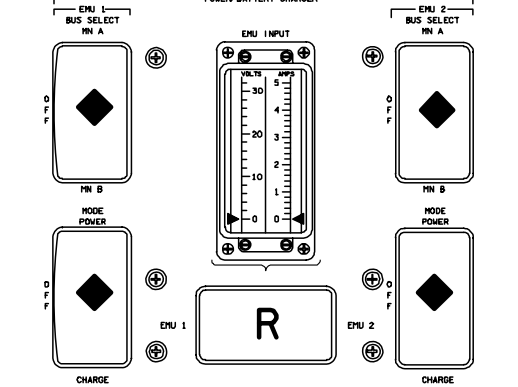

PNL AW18H

OV103

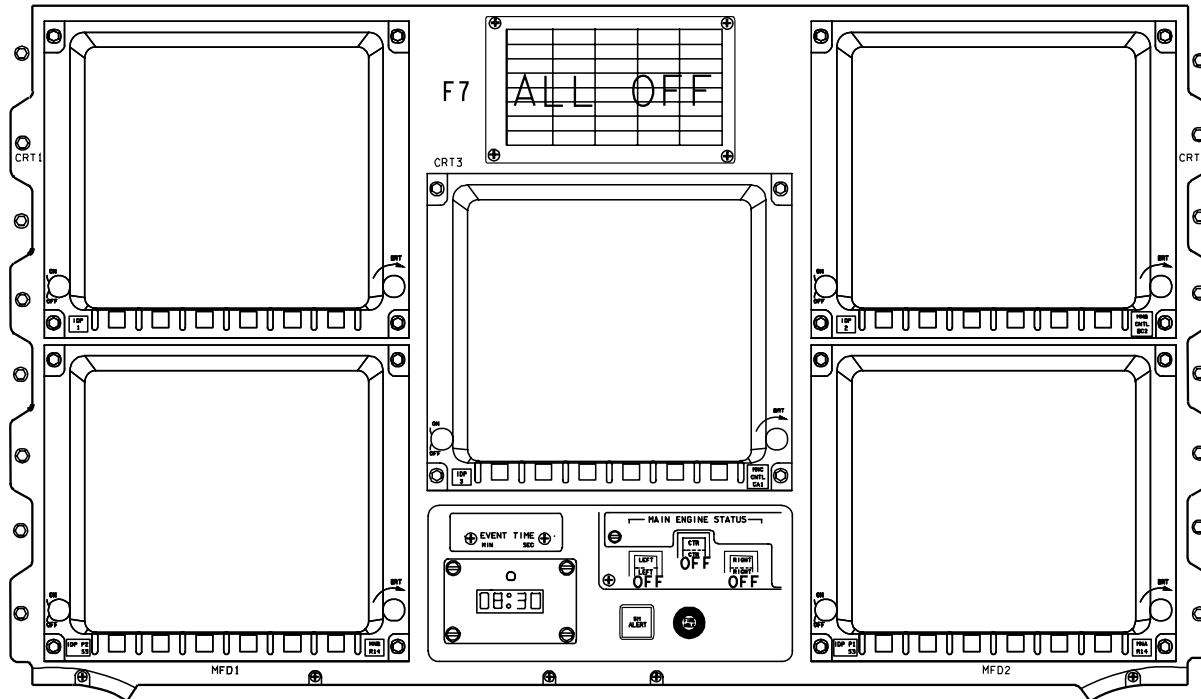
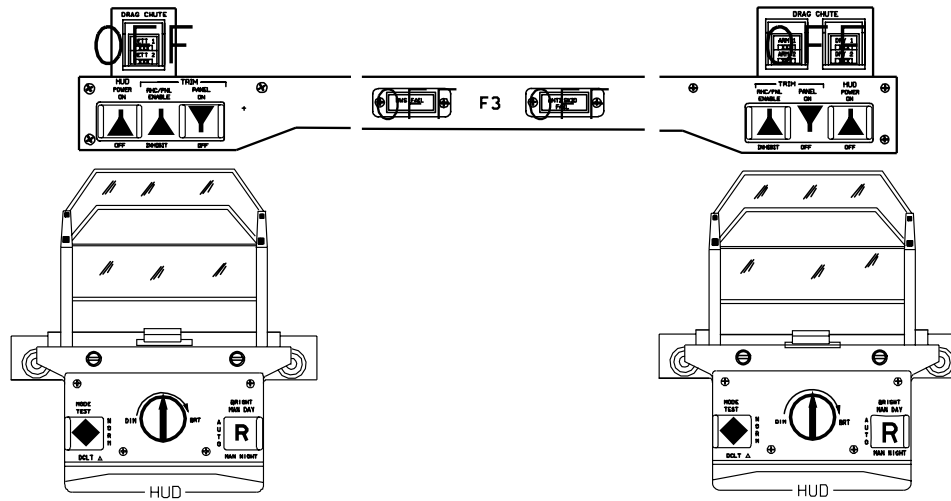

OV103

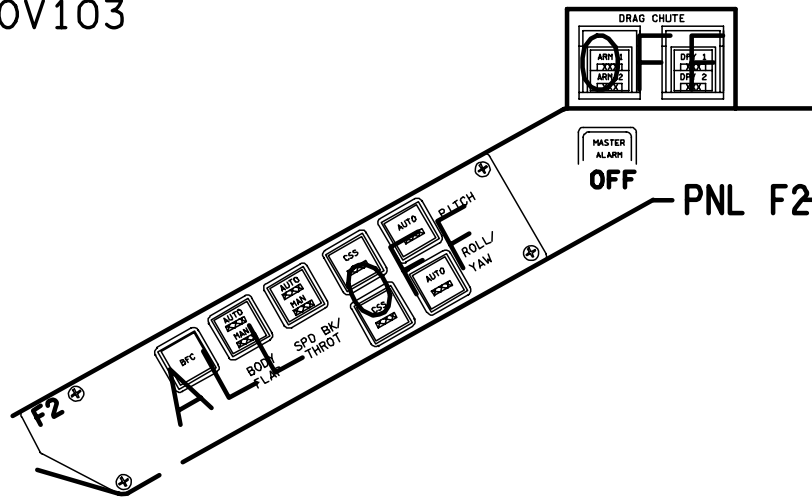

PNL 013

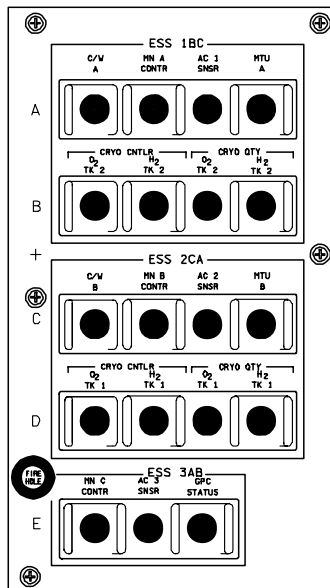

L side OVHD flood - R (MID)

PNL 07

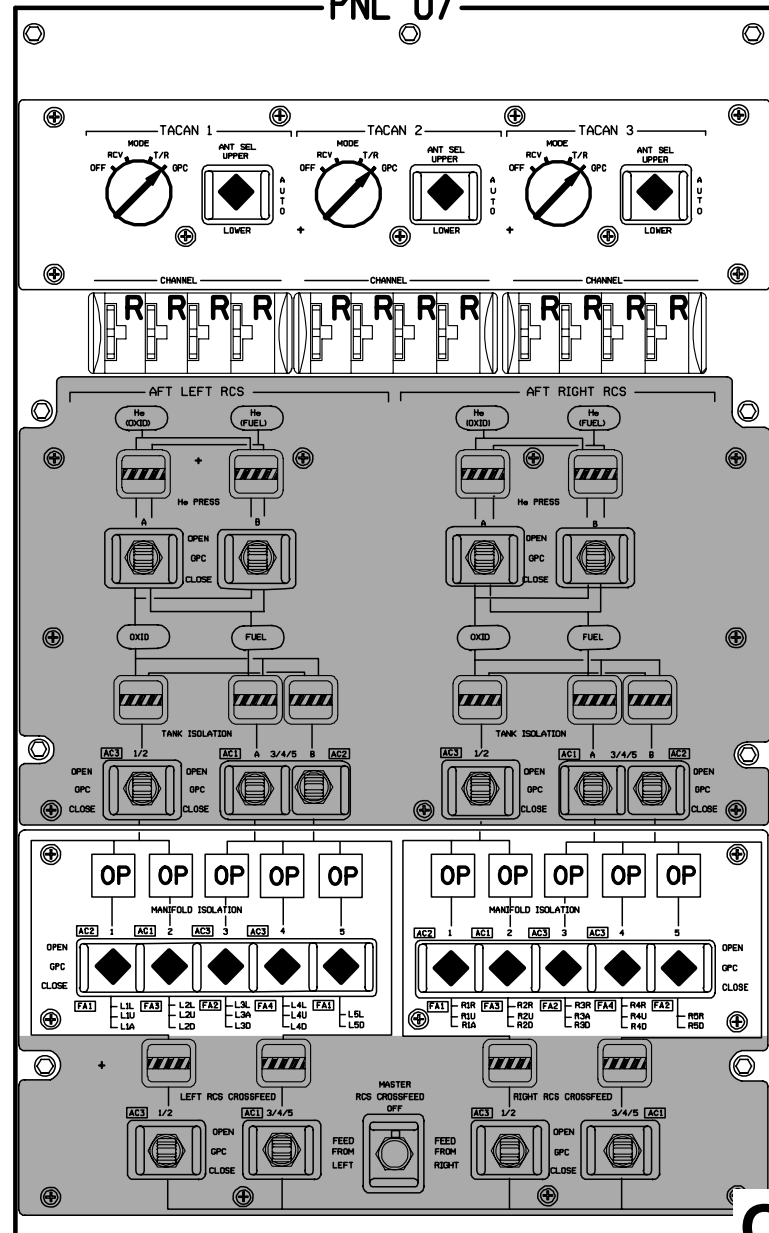

OV103

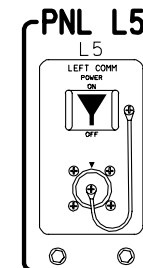
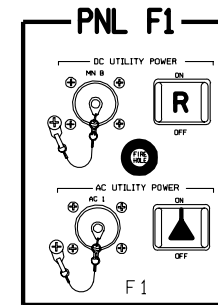
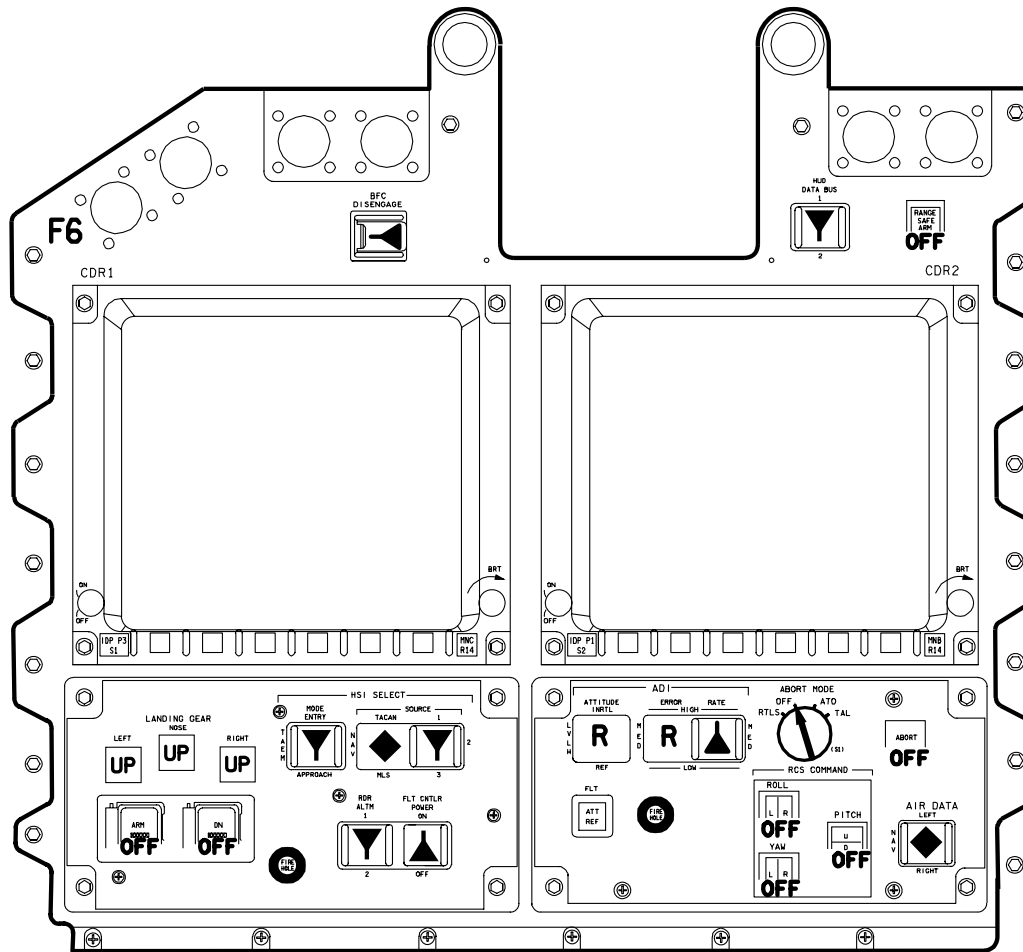

OV103

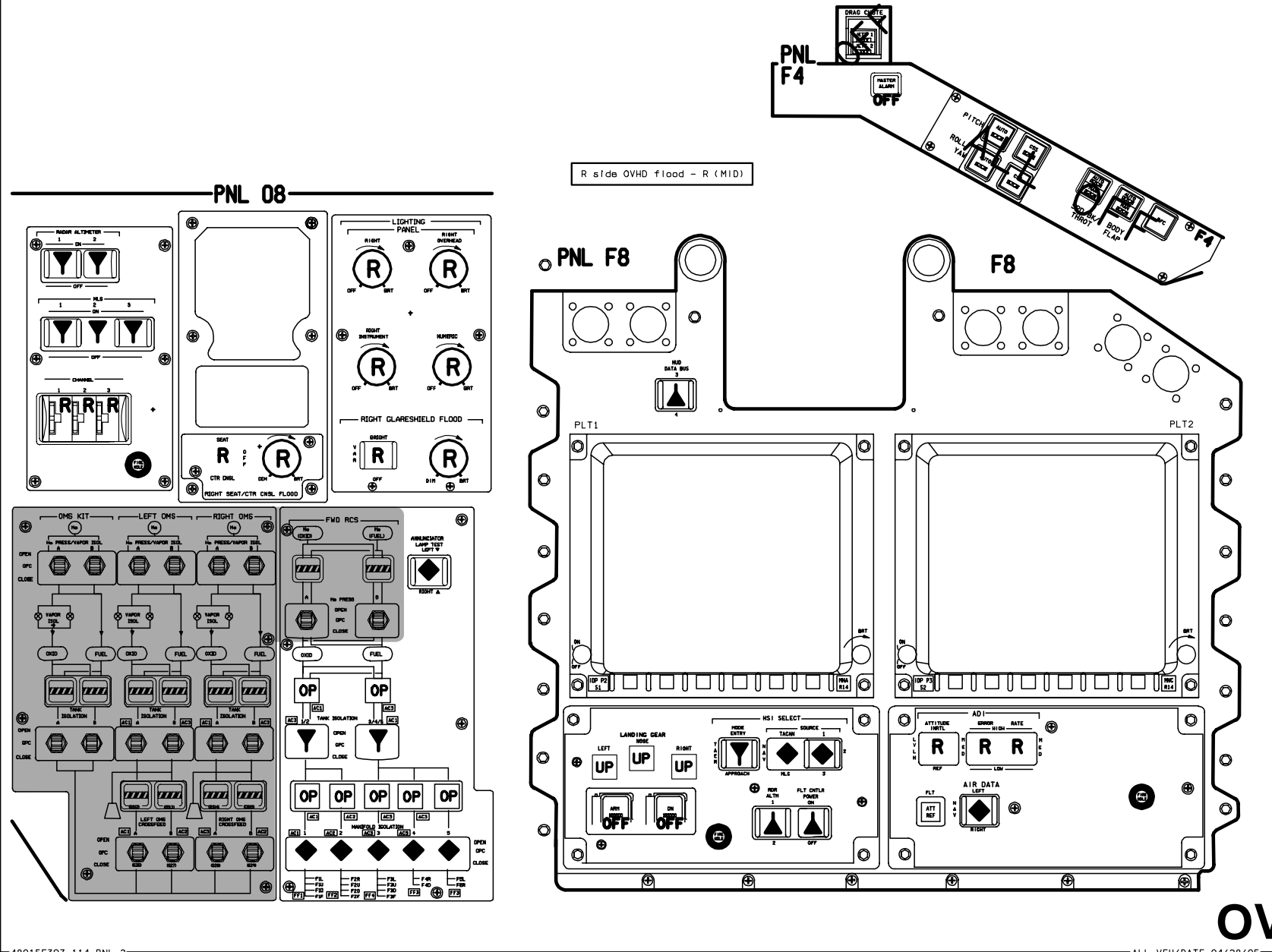

48015E307_114. PNL: 2

ALL VEH/DATE 04/28/05

OV103

(OV103) A3-7

D/O/3/GEN Q

OV103

PNL R2

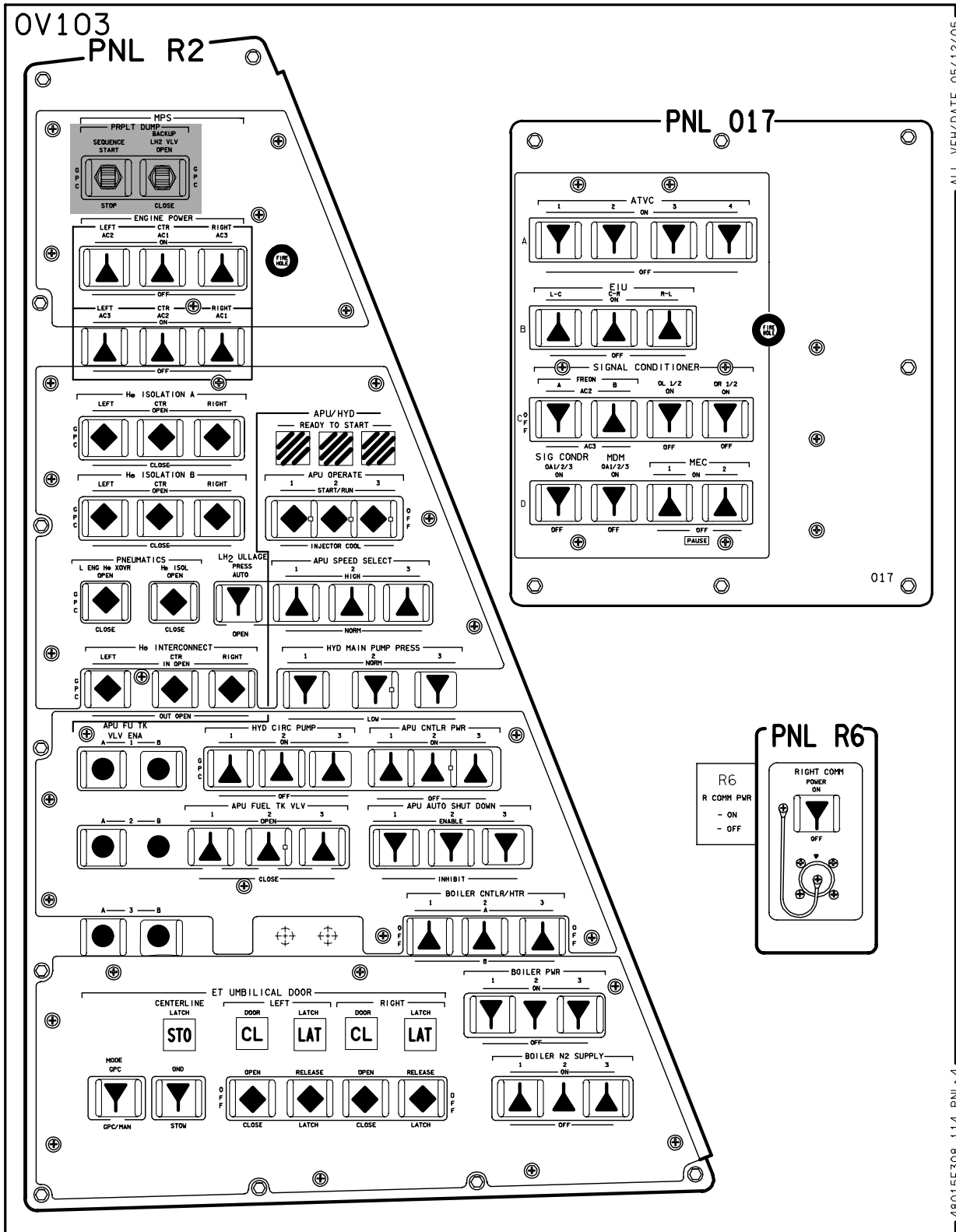

PNL 017

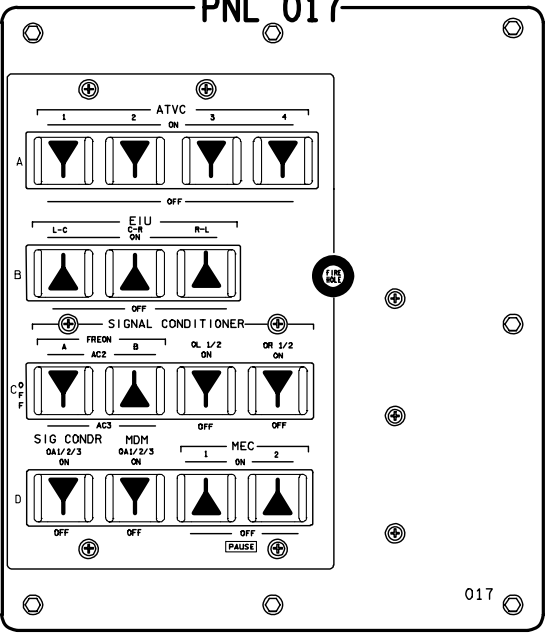

PNL R6

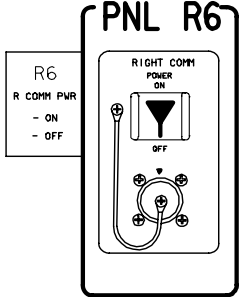

480.15E308_114, PNL R4 ALL VEH/DATE 05/12/05

OV103

(OV103) A3-8

D/O/ALL/GEN Q

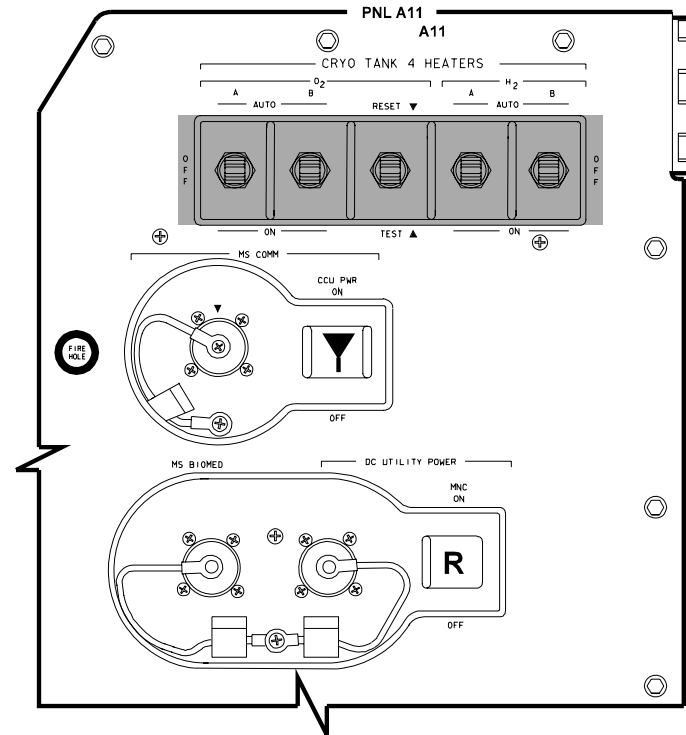
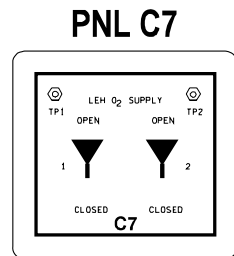
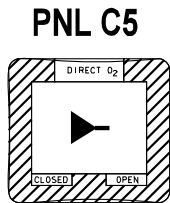

OV103

AIRLOCK HATCH

ACTUATOR HANDLE - LATCHED
 LOCK LEVER - LOCKED
 EQUALIZATION VLV (TWO) - NORM
 -CAPS INSTALLED

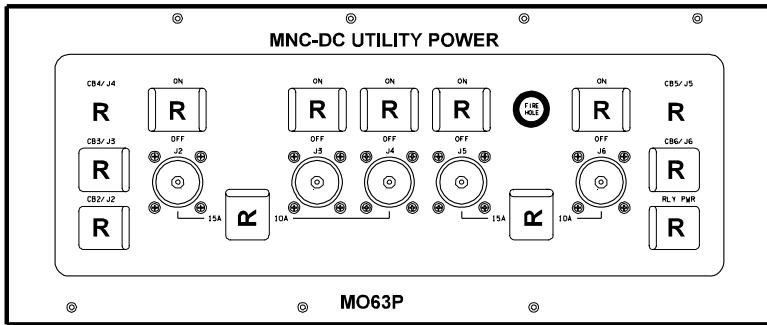

PNL MO58F

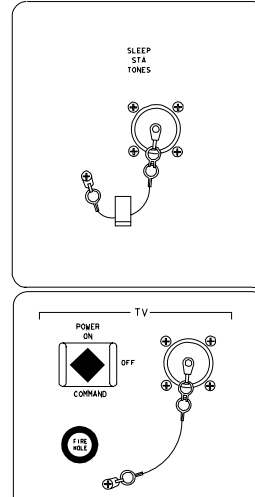

PNL MO30F

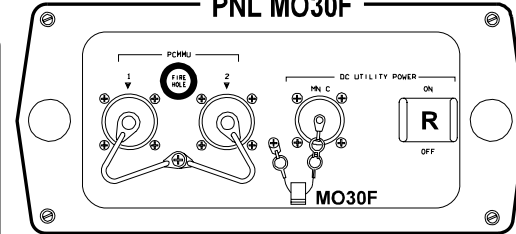

PNL MO52J

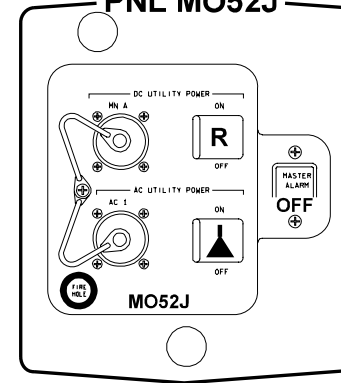

PNL MO39M

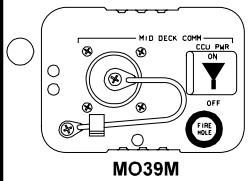

PNL MD24K

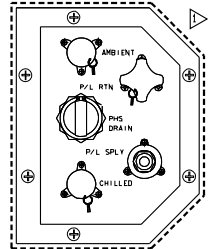

PNL MD44F

CAB TEMP CNTL ACT LINKAGE - SECONDARY ACTUATOR

PNL ML85E

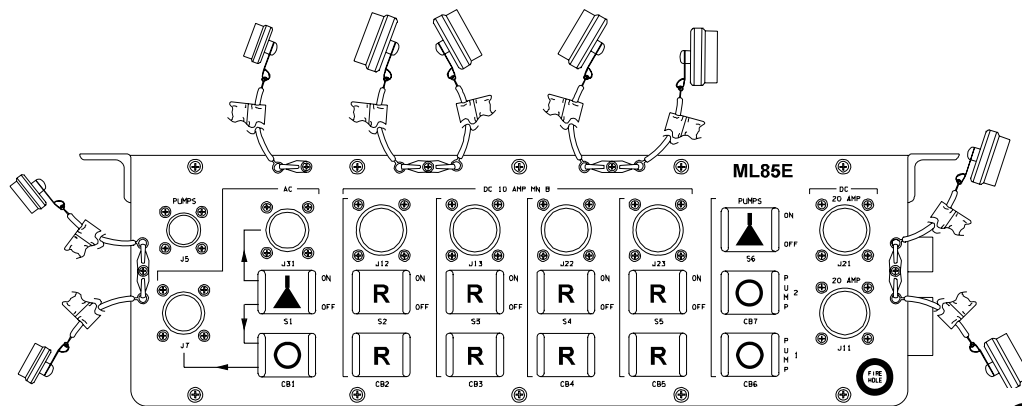

OV103

OV103

PNL ML86B

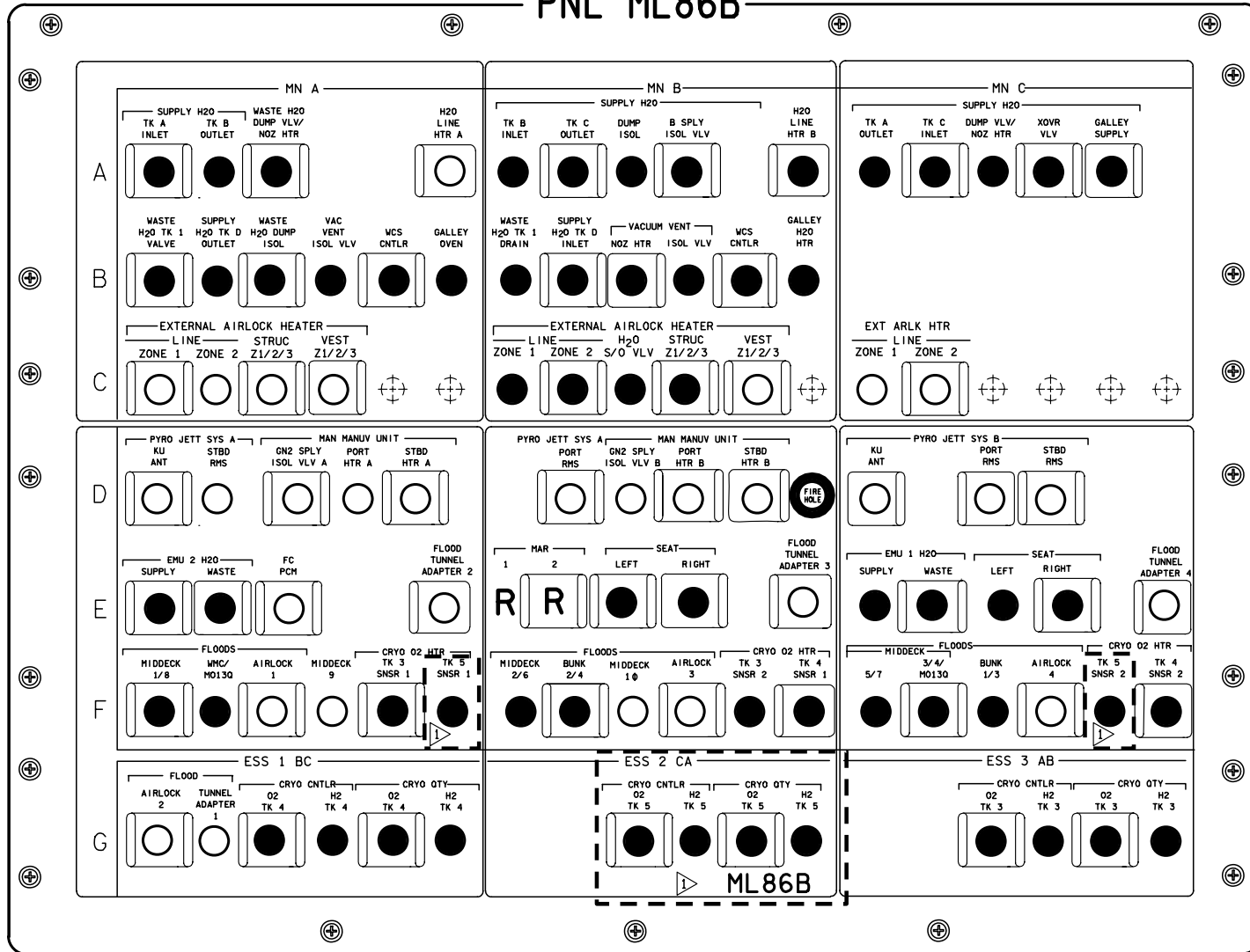

NOTE: ▷ OPEN IF TK 5 NOT FLOWN

OV103

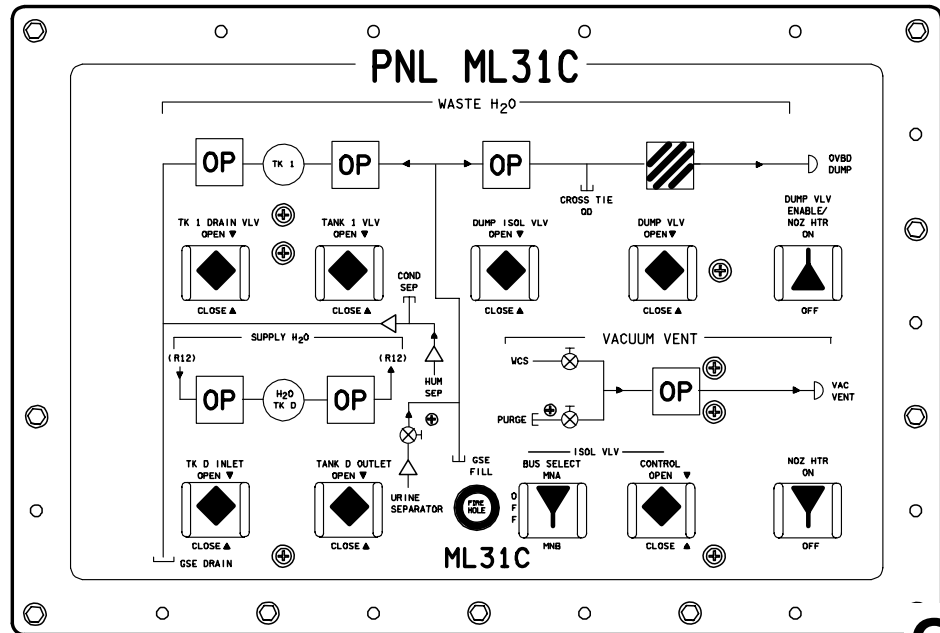
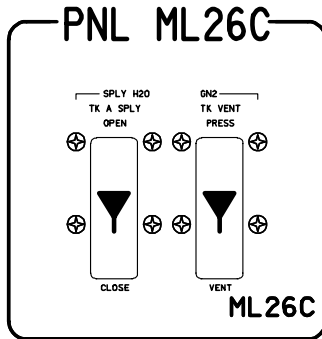
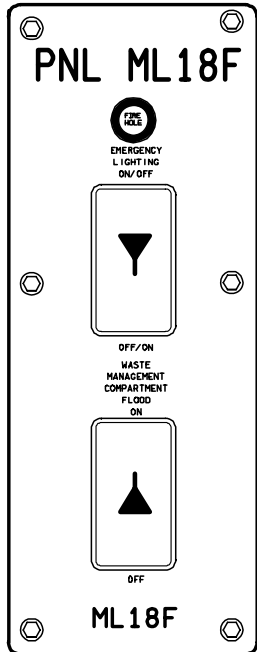
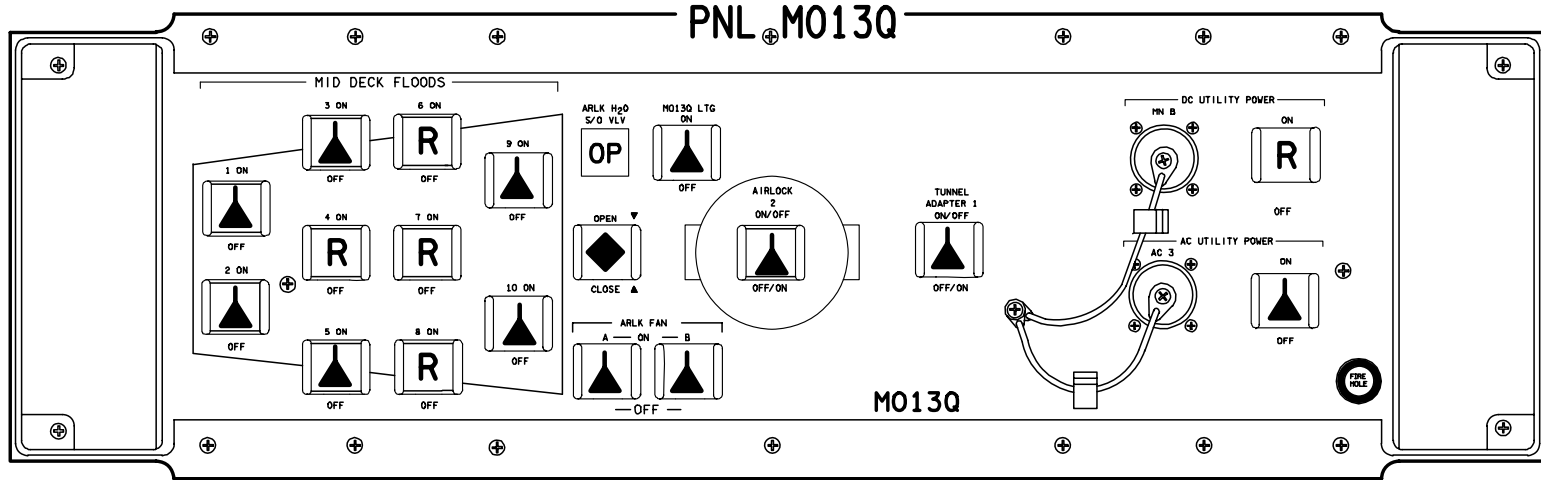

OV103

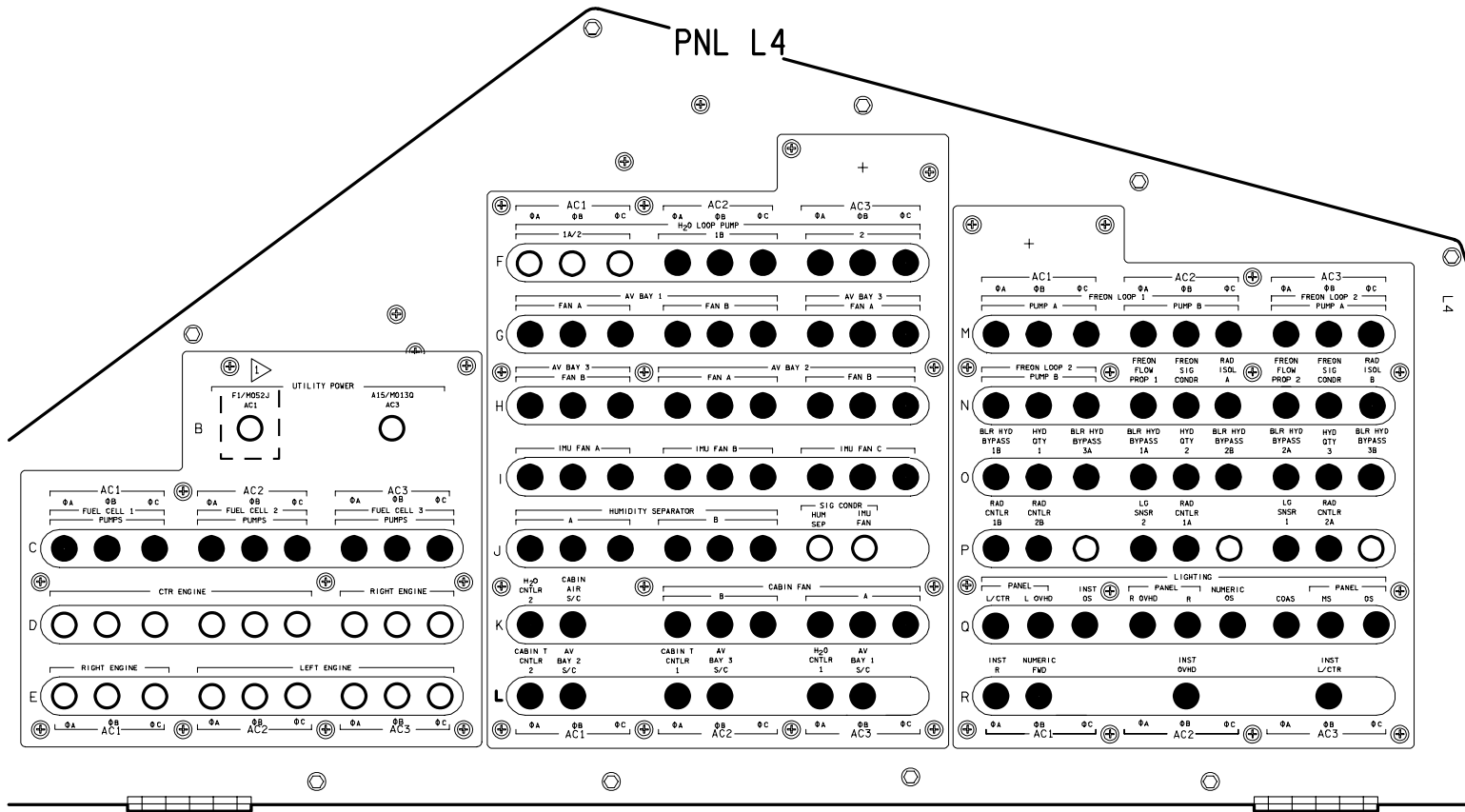

NOTE: ▷ CB CAN REMAIN CLOSED FOR AC PGSC USAGE.
 OPEN WHEN PGSC UNPOWERED/STOWED

OV103

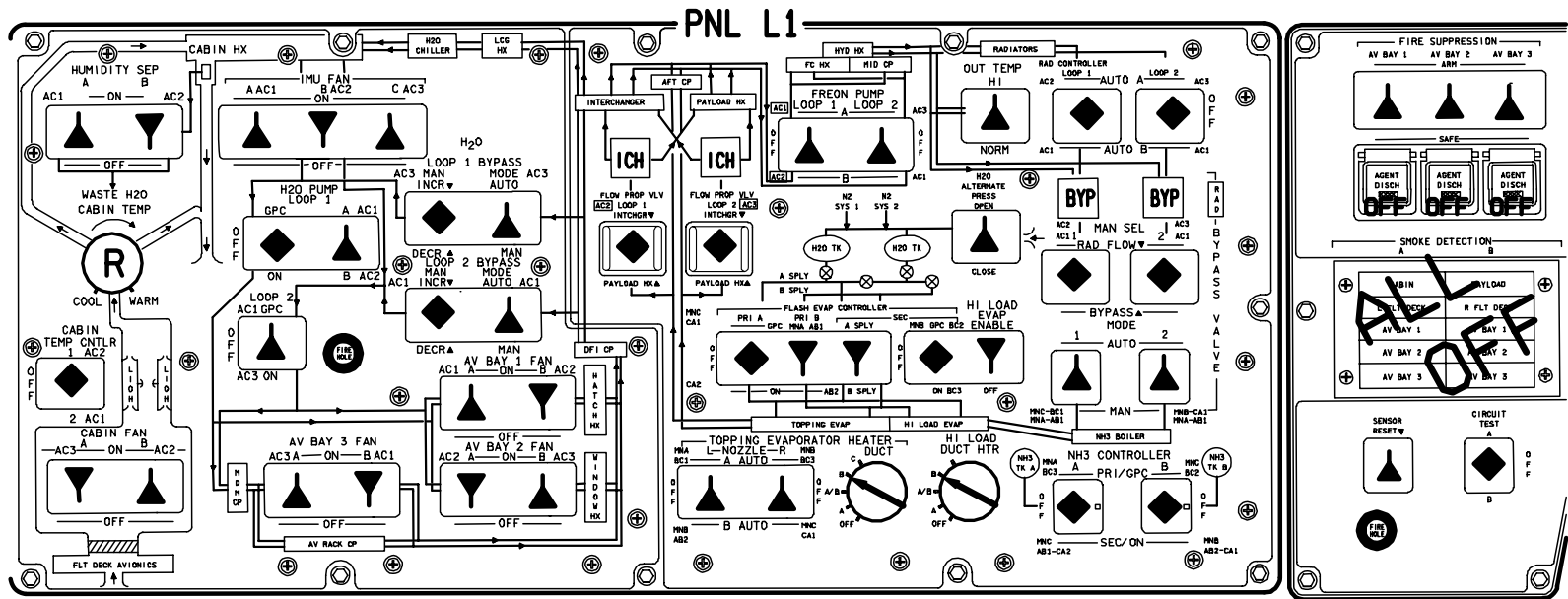

48015E314_114, PNL 2

ALL VEH/DATE 04/28/05

OV103

(OV103) A3-14

D/O/ALL/GEN Q

OV103

PNL L2

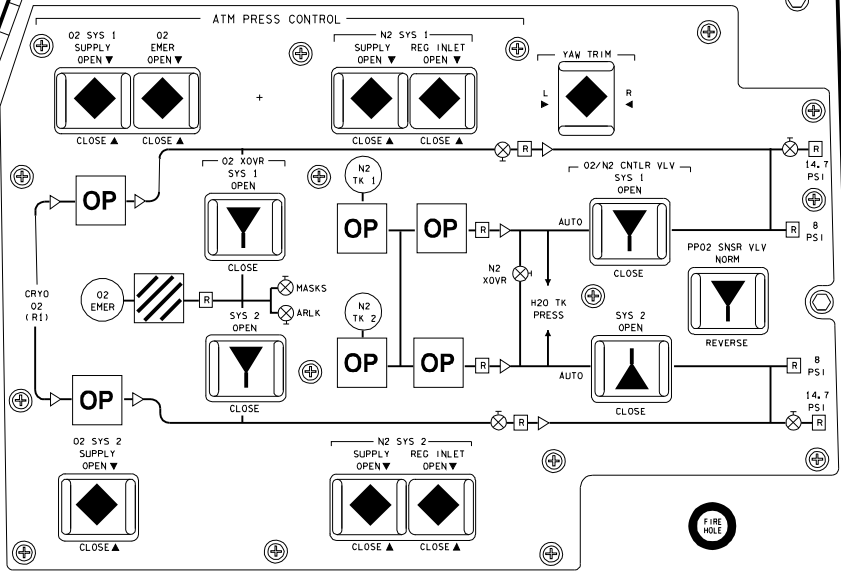
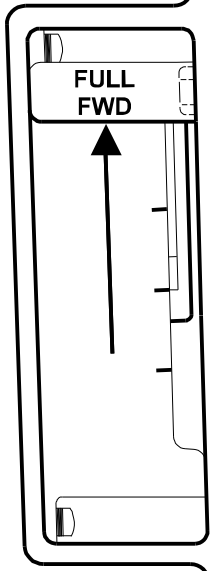
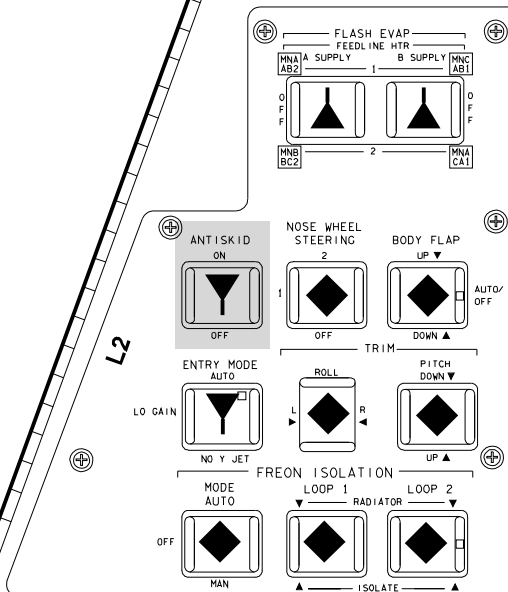
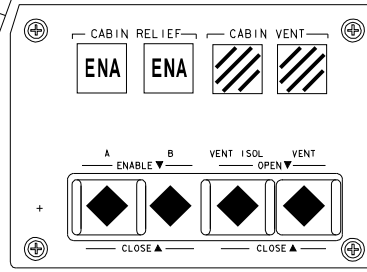

OV103/DATE 01/28/11 48015B315_133_PNL 1

OV103

PNL C2/C3

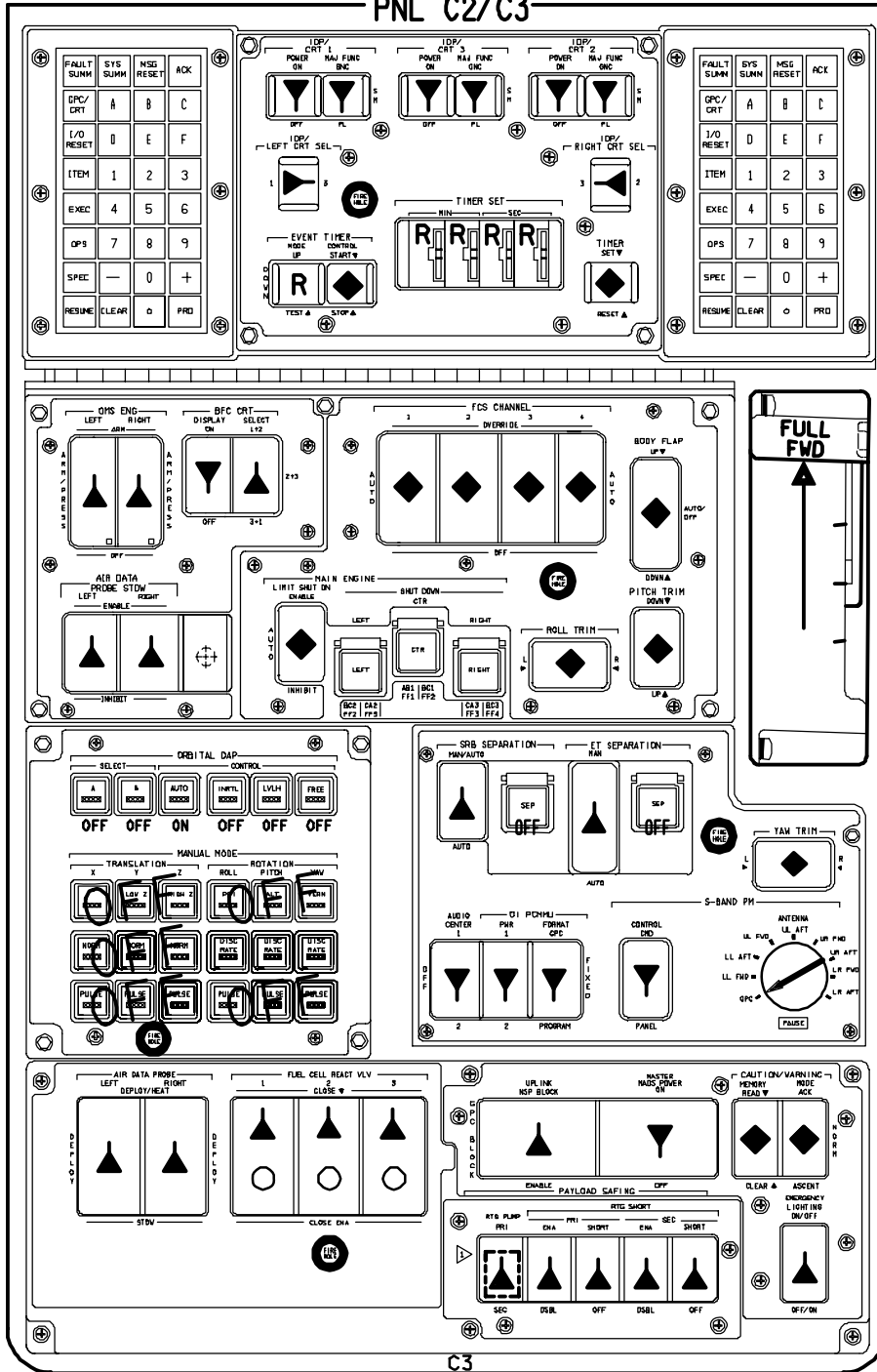

POSSIBLE CONFIGURATION

OV103/DATE 05/02/05
48015E316_1.14_PNL C2

OV103

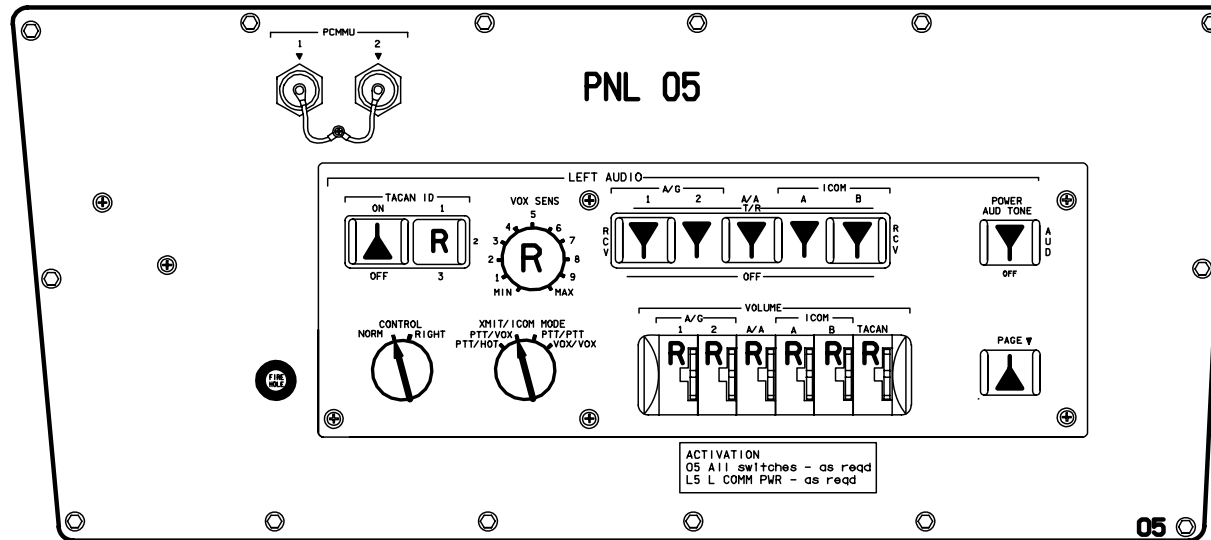
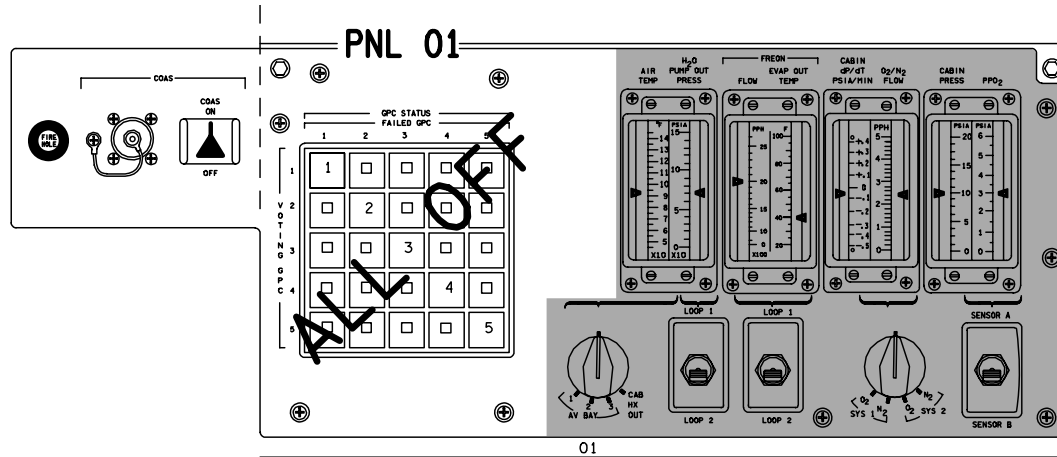

OV103

PNL 06

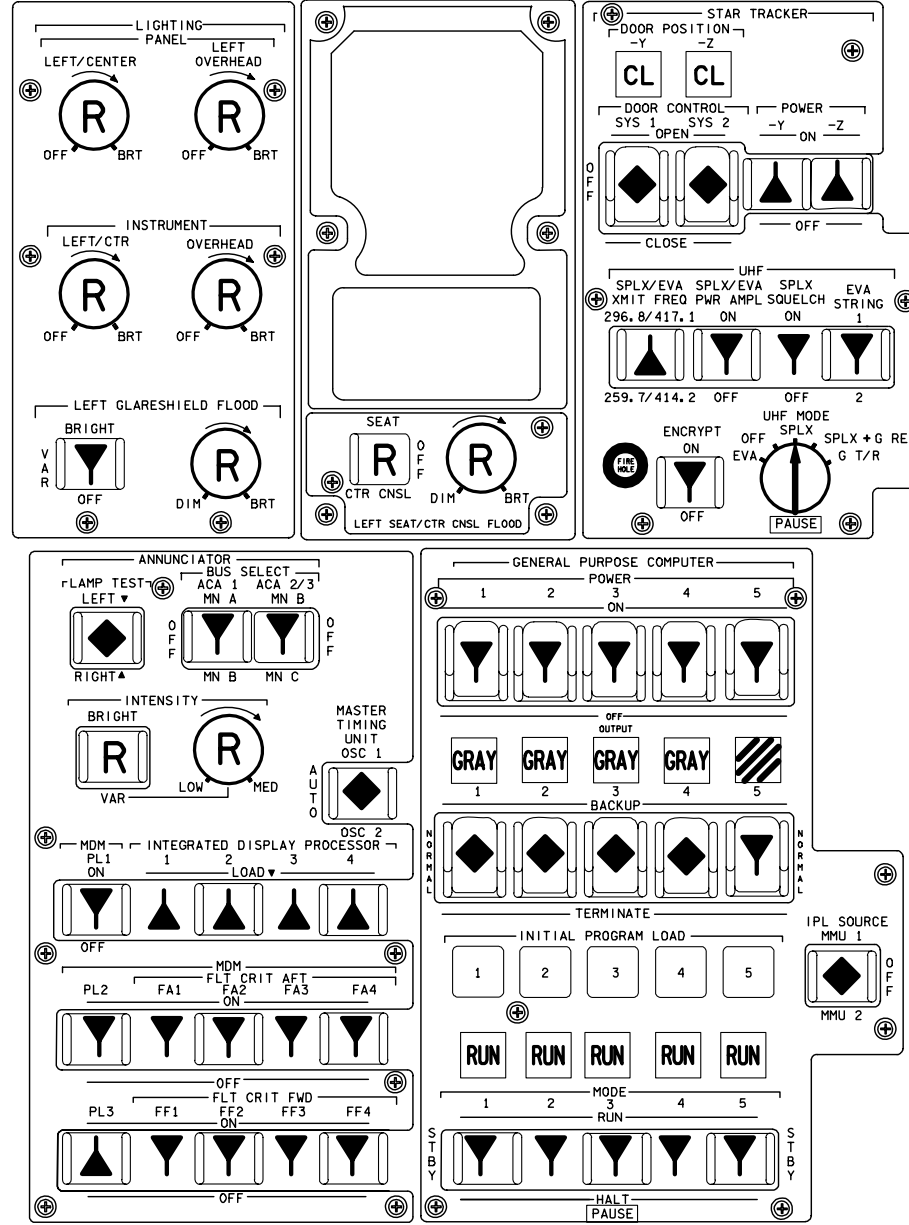

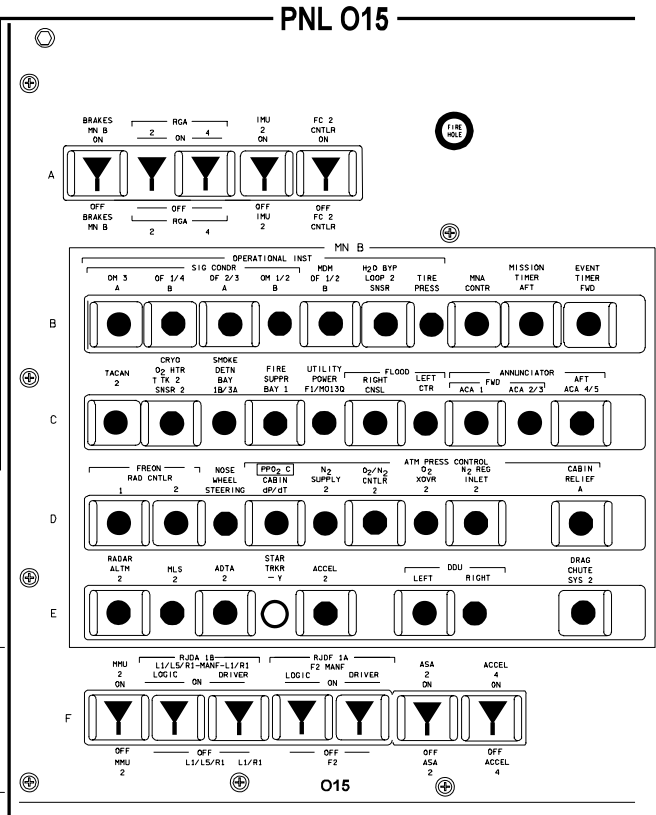
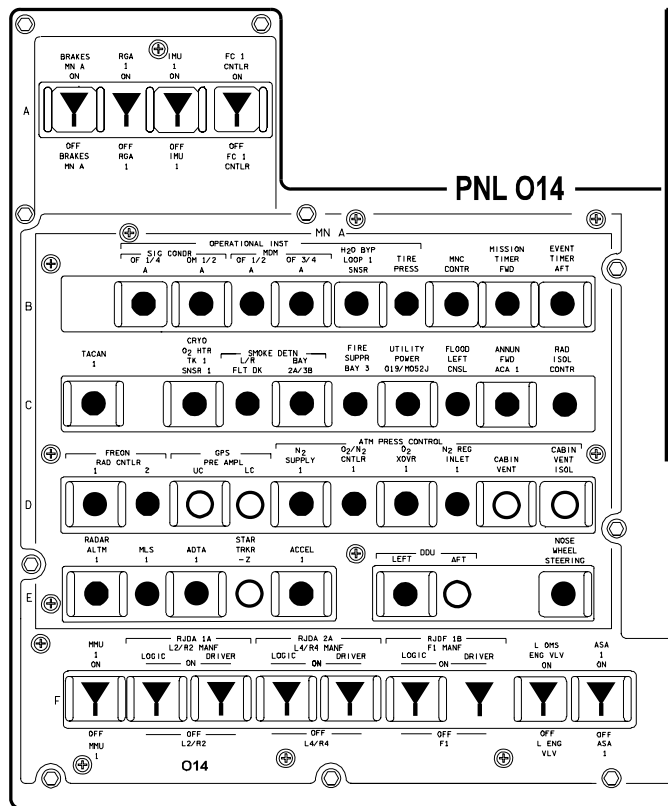

OV103

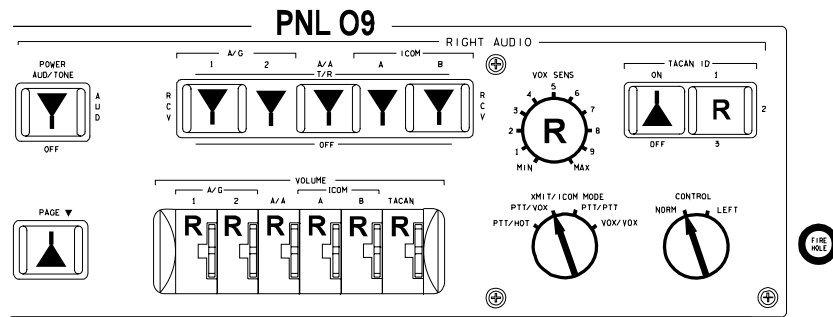
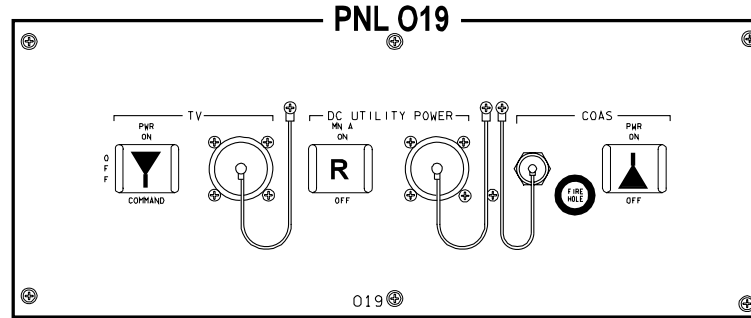
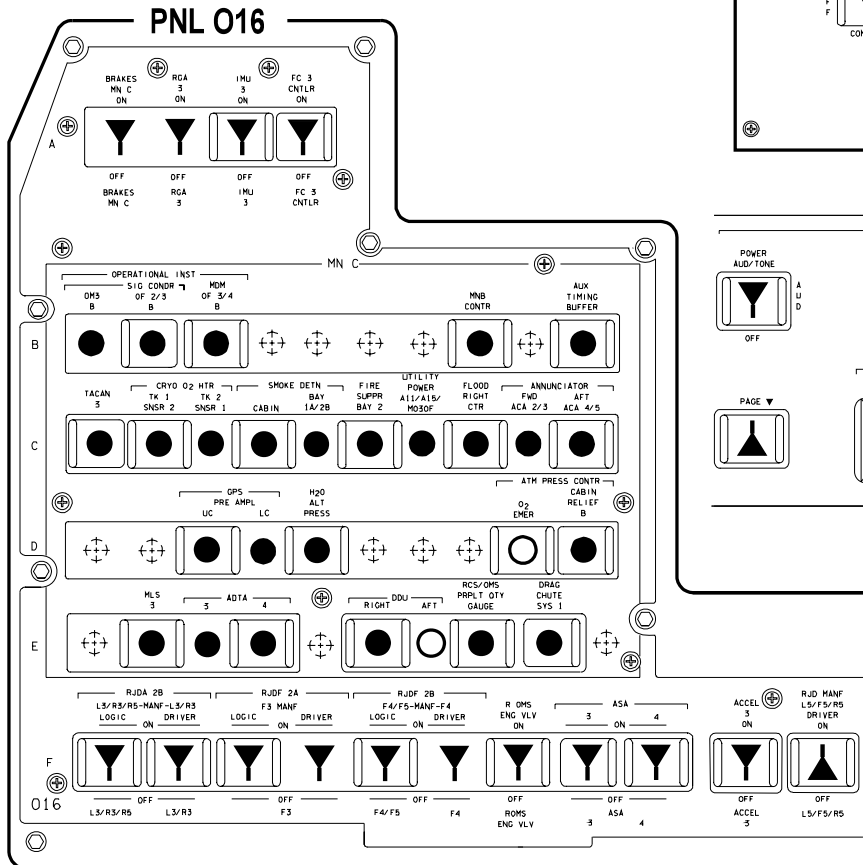

ACTIVATION
09 R AUD PWR - AUD/TONE
All other sws - as reqd
R6 R COMM PWR - as reqd

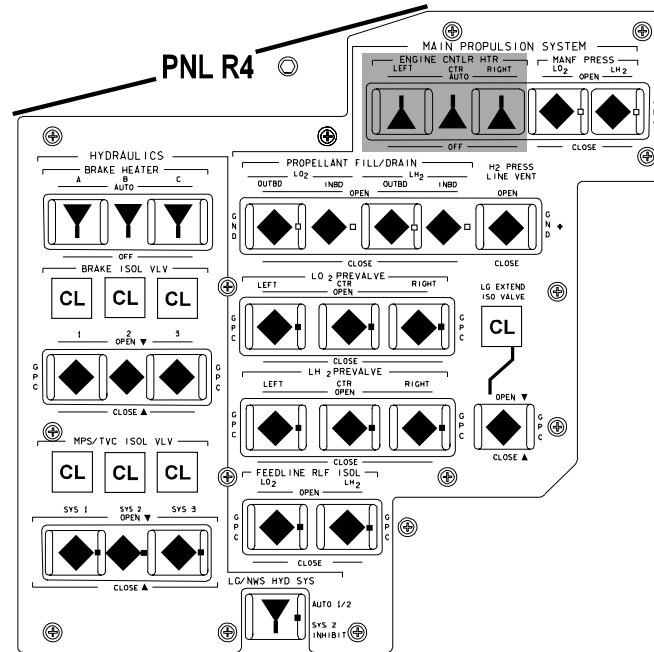
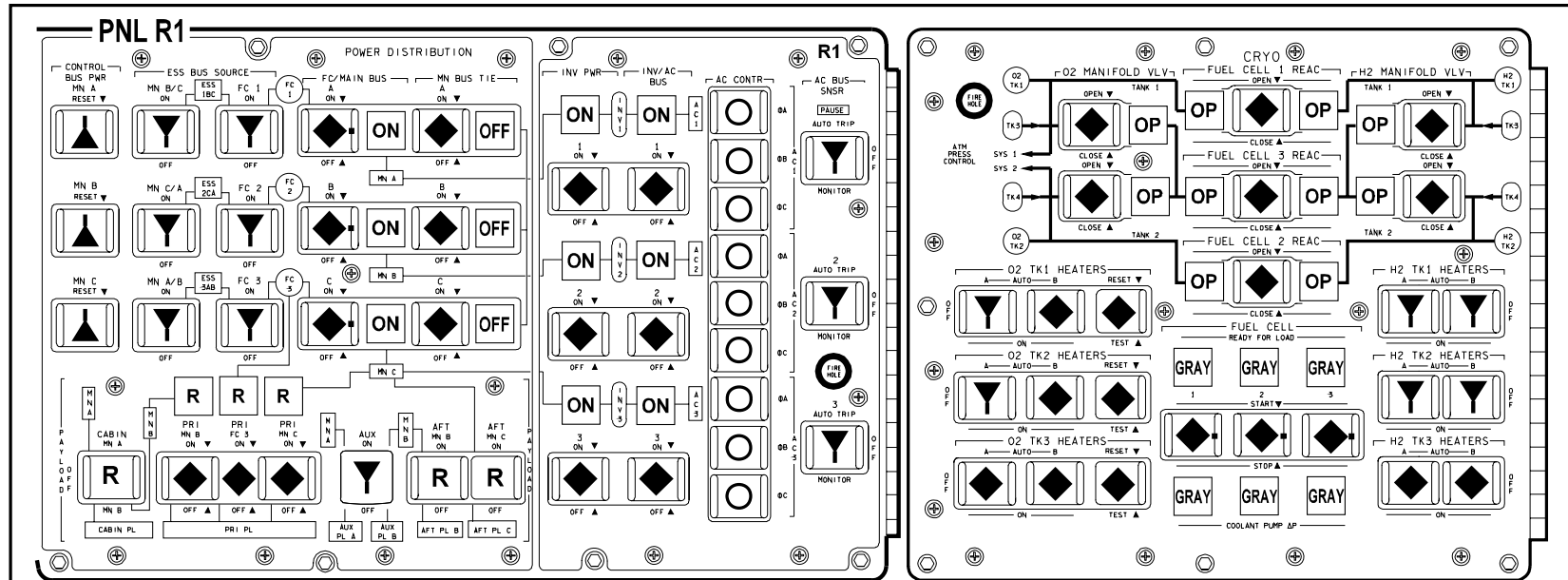

OV103

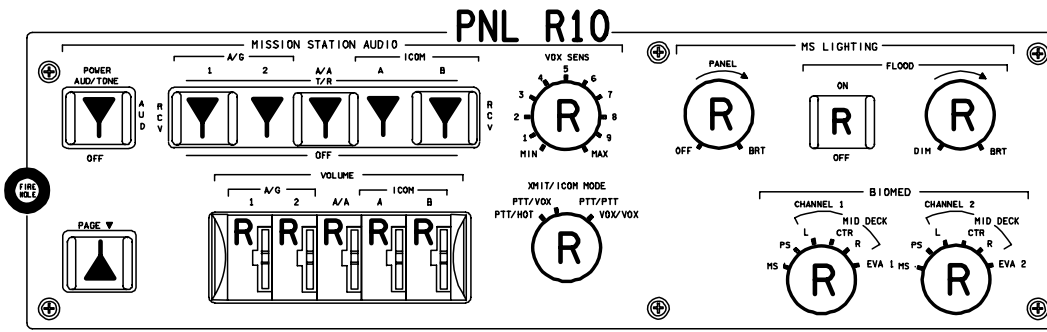

ACTIVATION
 R10 MS AUD PWR - AUD/TONE
 All other sws - as reqd
 R12 MS AUD CONTL - NORM
 A11 MS COMM CCU PWR - ON

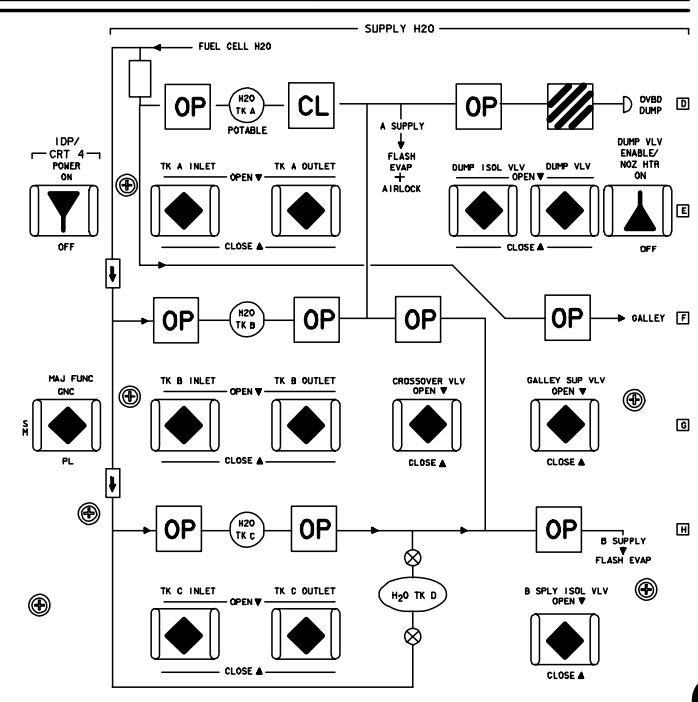
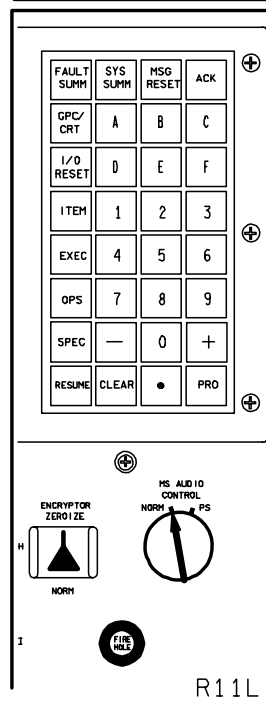
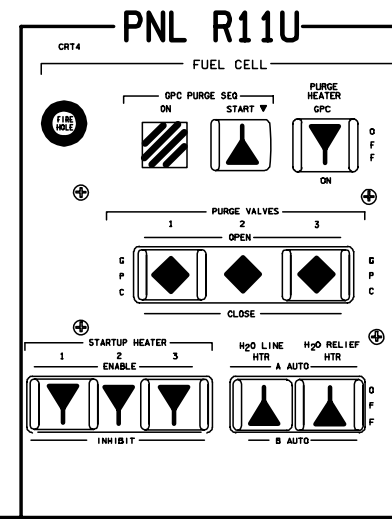

OV103

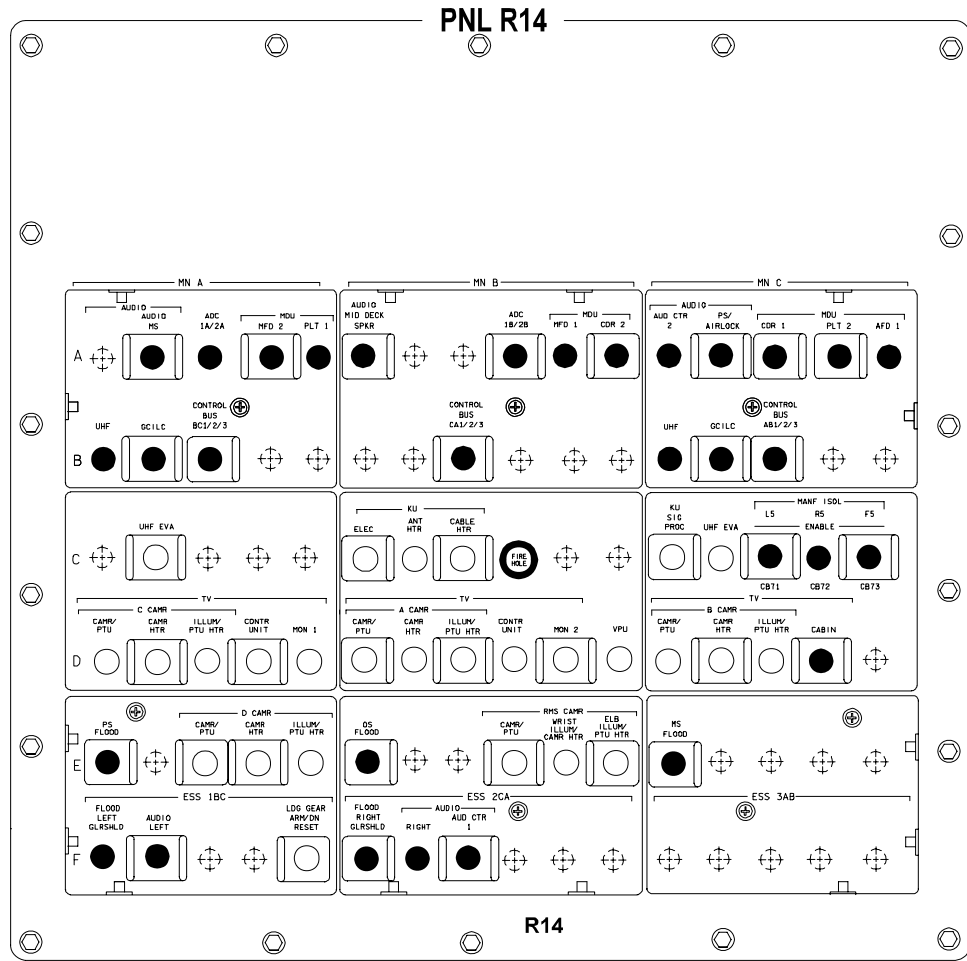
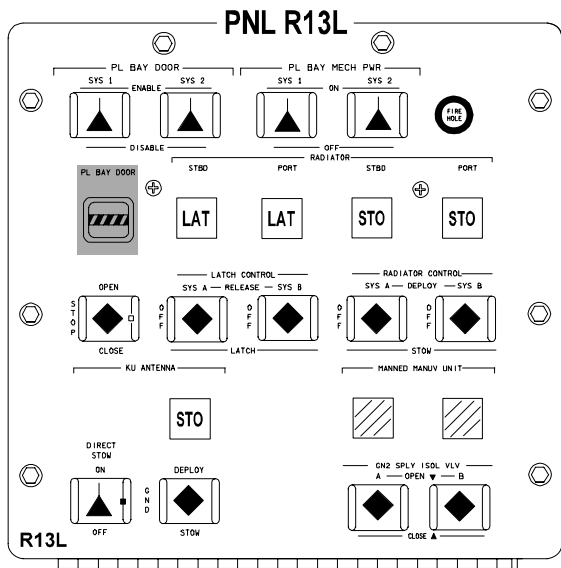

OV103

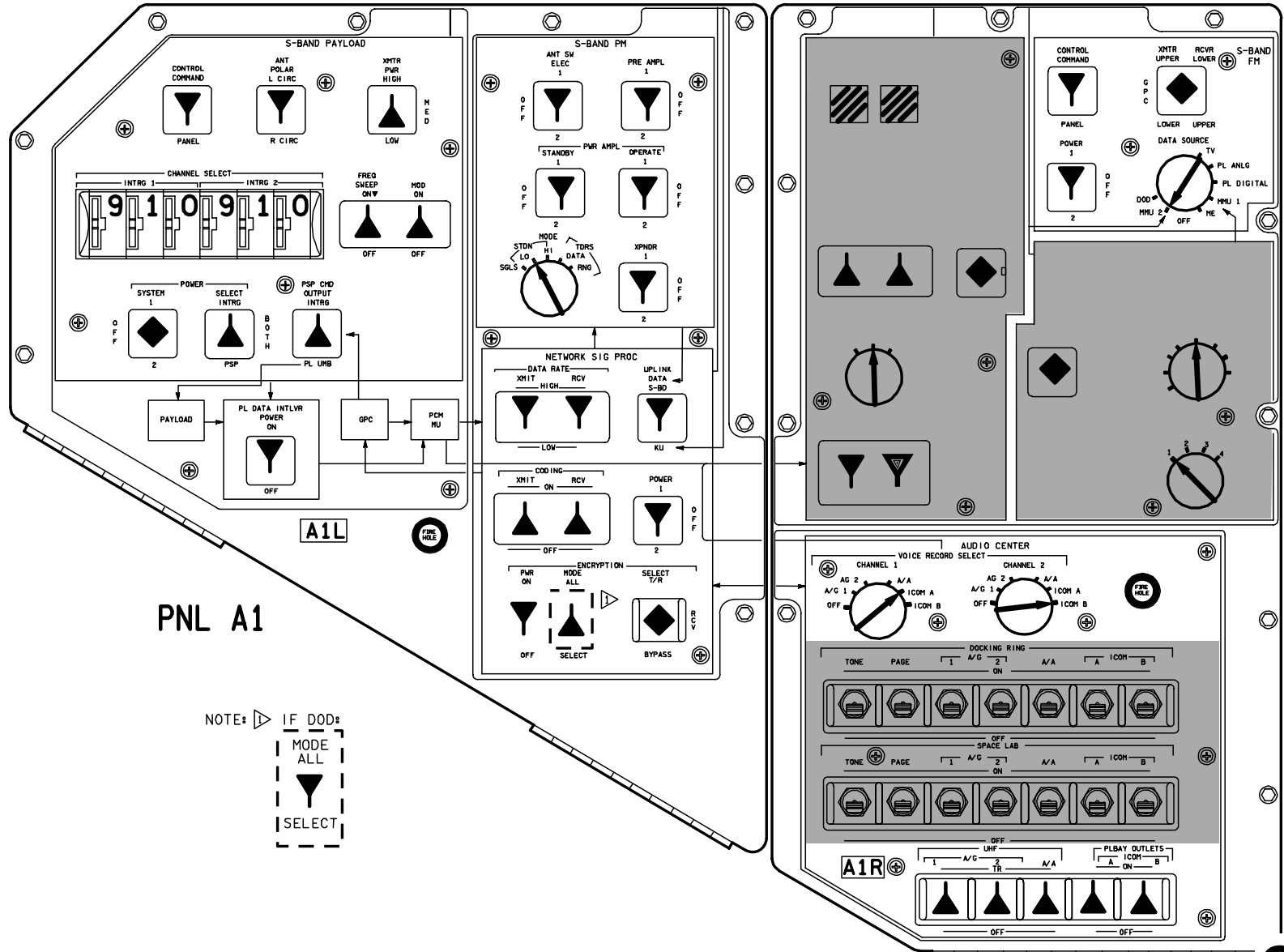

OV103

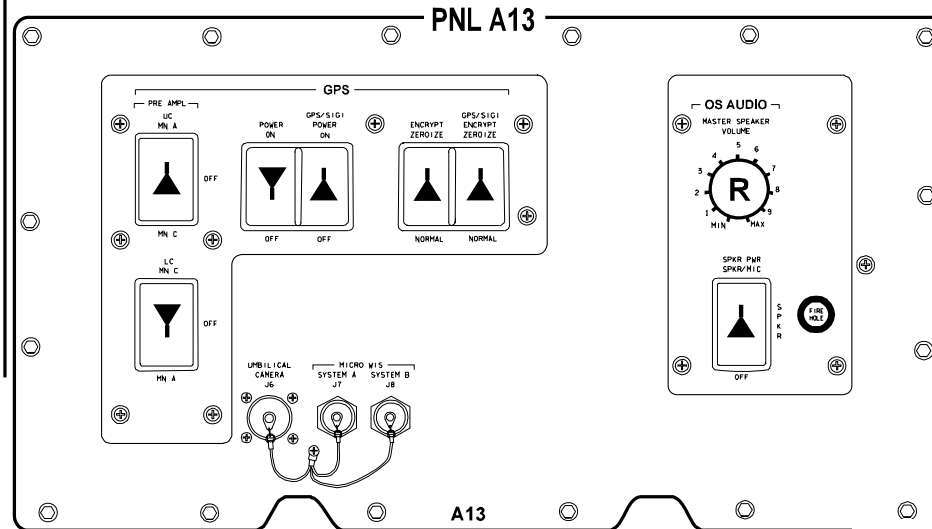
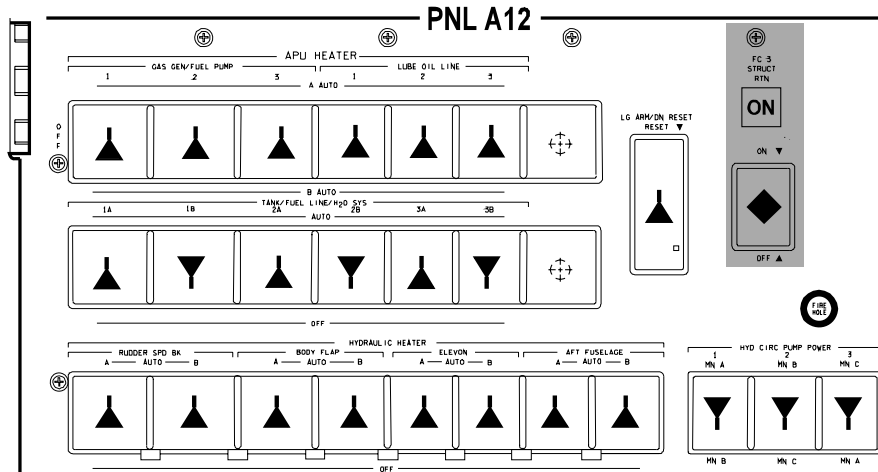
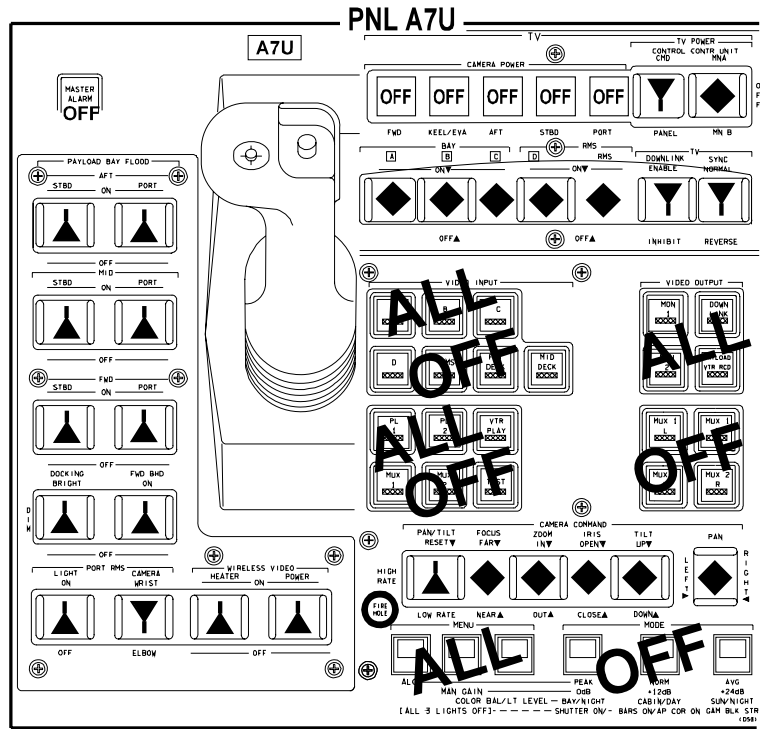

OV103

PNL L9

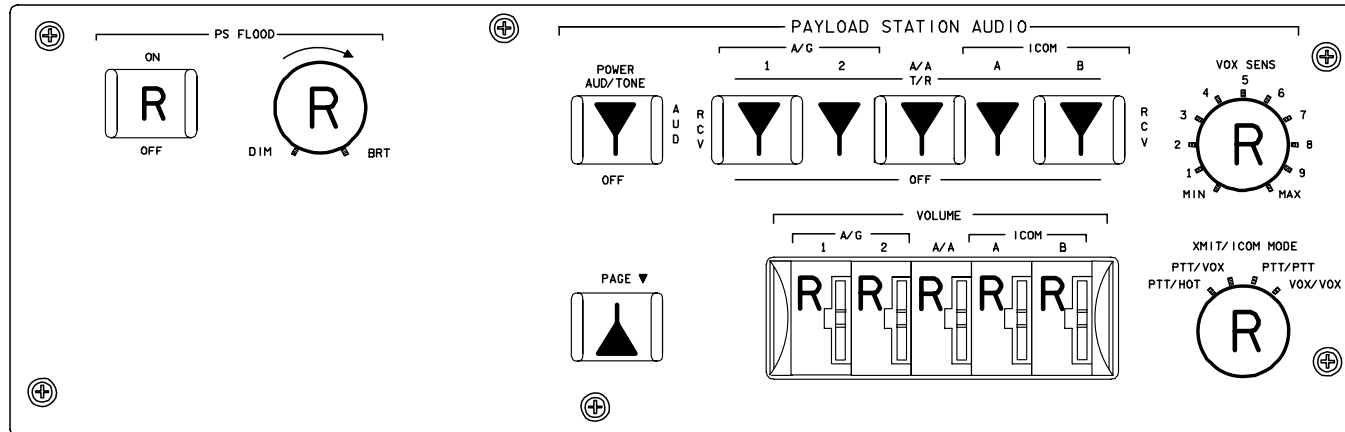

ACTIVATION
 L9 All switches - as reqd
 A15 PS COMM CCU PWR - ON

L9

OV103

PNL A6L

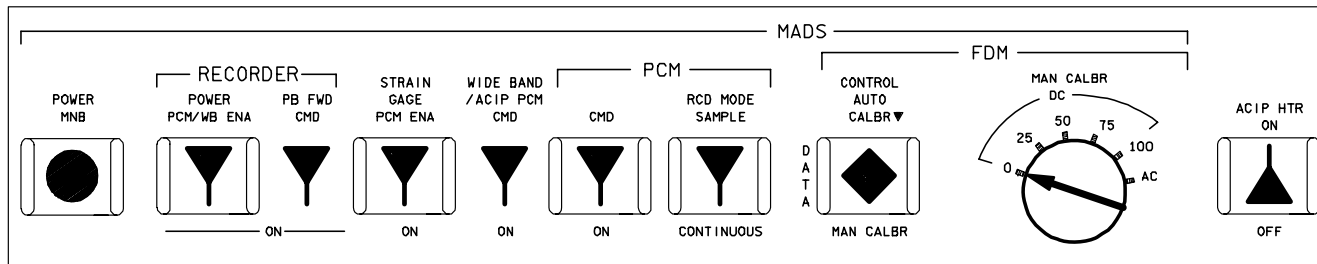
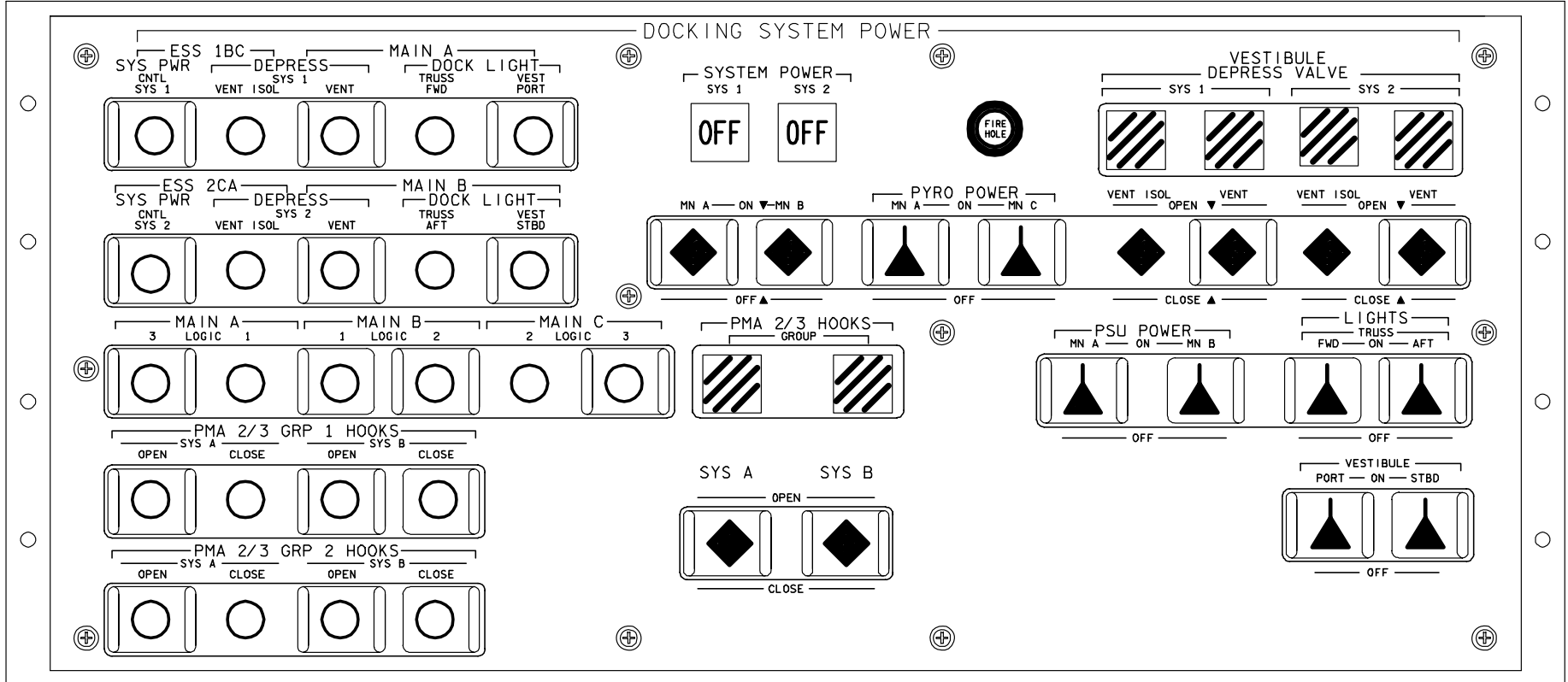

48015E327_114. PNL 1

OV103/DATE 04/28/05

OV103

OV103

CONTROL PANEL POWER

A ON OFF B ON OFF C ON OFF

HEATERS/DCU POWER

H1 ON OFF H2/DCU ON OFF H3/DCU ON OFF

APDS POWER

A_{DS} ON OFF B_{DS} ON OFF C_{DS} ON OFF

STATUS

POWER	ON	INITIAL	CONTACT
APDS PROTECT	CIRCUIT OFF	CAPTURE	CAPTURE
RING	ALIGNED	RING	FORWARD POSITION
RING	INITIAL POSITION	TO HOOK	
FIXERS	OFF	INTER	SEALED
HOOKS 1	OPEN	HOOKS 1	CLOSED
HOOKS 2	OPEN	HOOKS 2	CLOSED
LATCHES	CLOSED	LATCHES	OPEN
UNDOCK	COMPLET	RING	FINAL POSITION

PYROS

A_p ON OFF B_p ON OFF C_p ON OFF

A_p C_p

FIRE HOLE

OFF

OFF

PYRO COMMANDS

PYRO CIRC PROT OFF PYRO CIRC PROT ON

ACT HOOKS FIRING PAS HOOKS FIRING

APDS CONTROL COMMANDS

OPEN HOOKS OPEN LATCHES

UNDOCKING

A_{DS} B_{DS} C_{DS}

OFF

LAMP TEST

PNL A7L

APDS CONTROL COMMANDS

POWER ON	POWER OFF	RING OUT	RING IN
APDS CIRC PROT OFF	CLOSE HOOKS	CLOSE LATCHES	FIXER OFF

APDS CONTROL PANEL

OV103

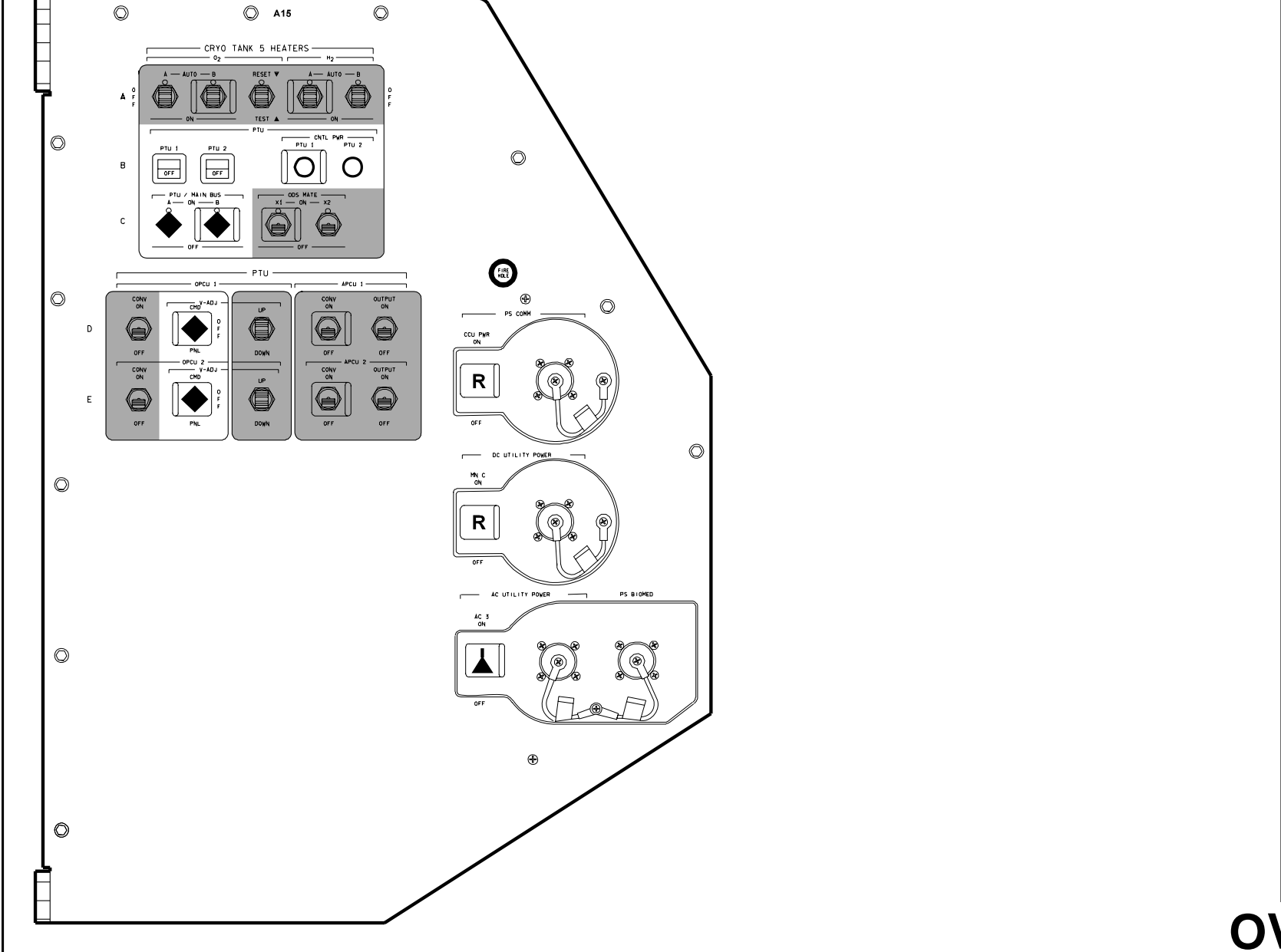

48015E329_120, PNL 1

OV103/DATE 09/10/07

(OV103) A3-29

OV103

D/O/3/GEN Q

OV103

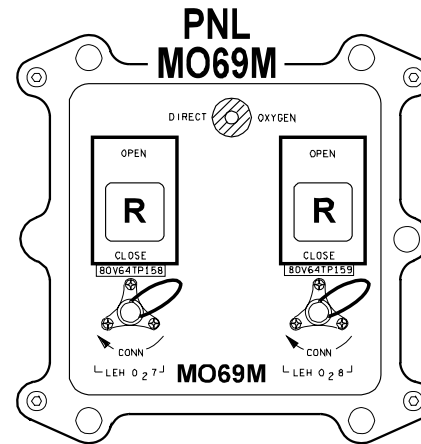
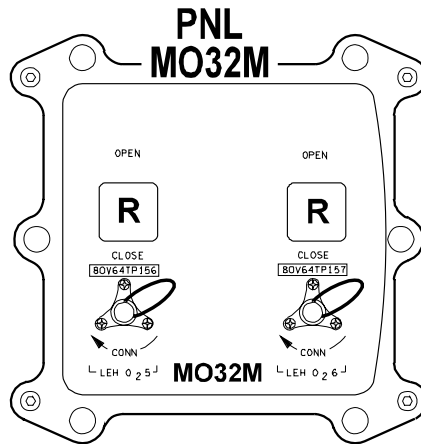
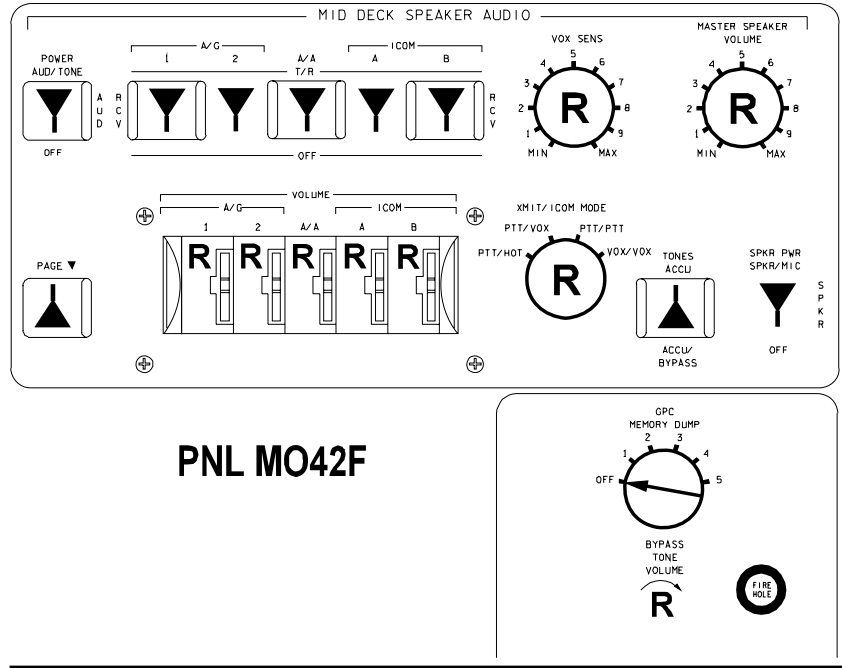

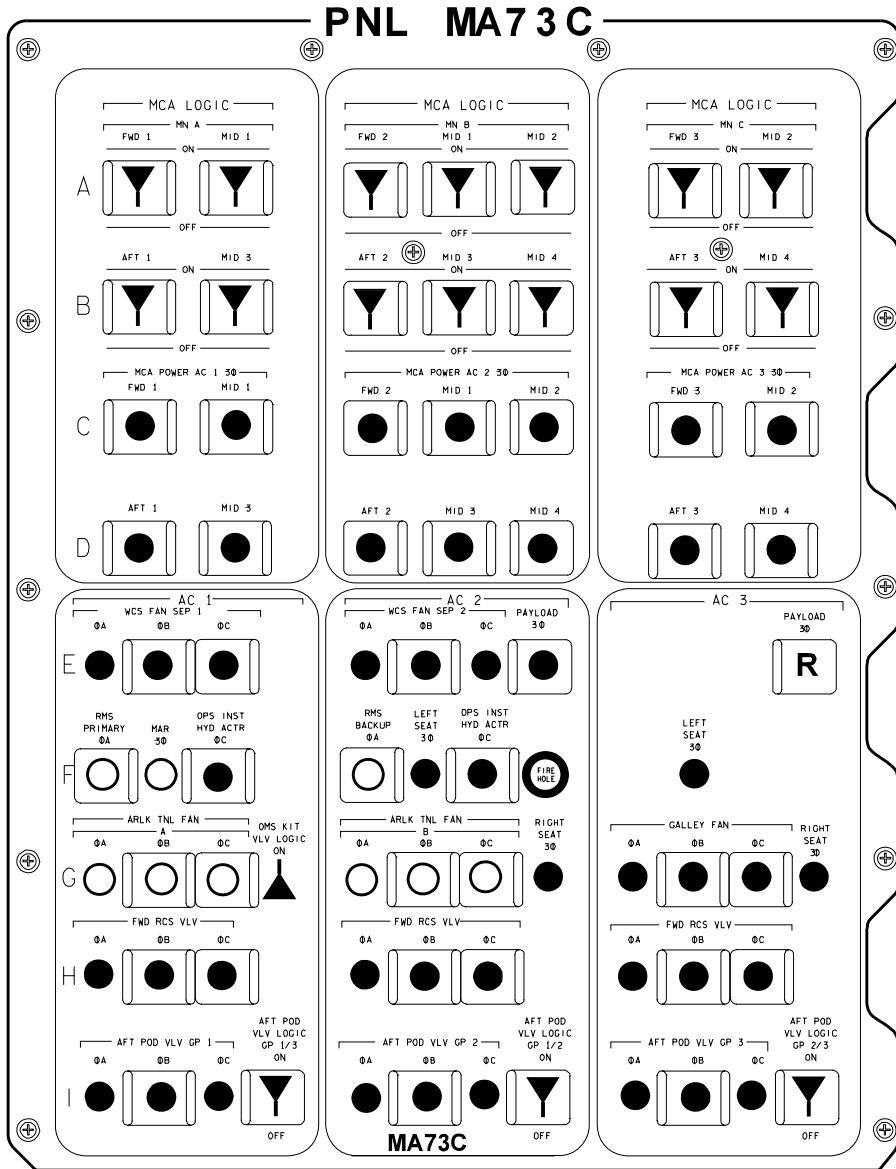

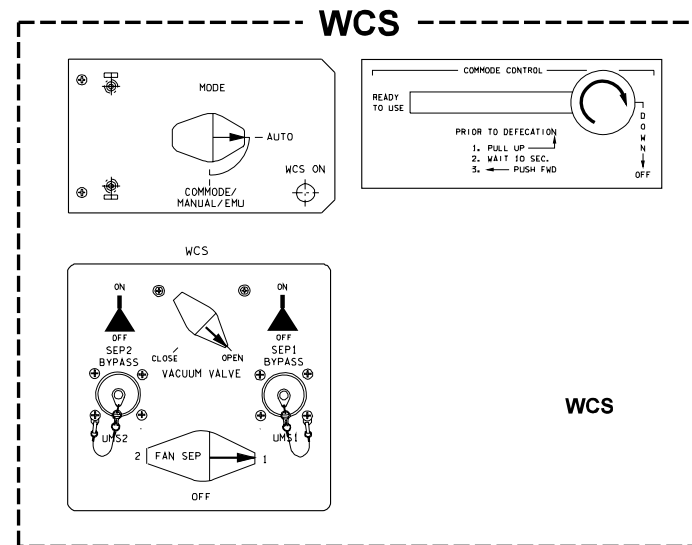
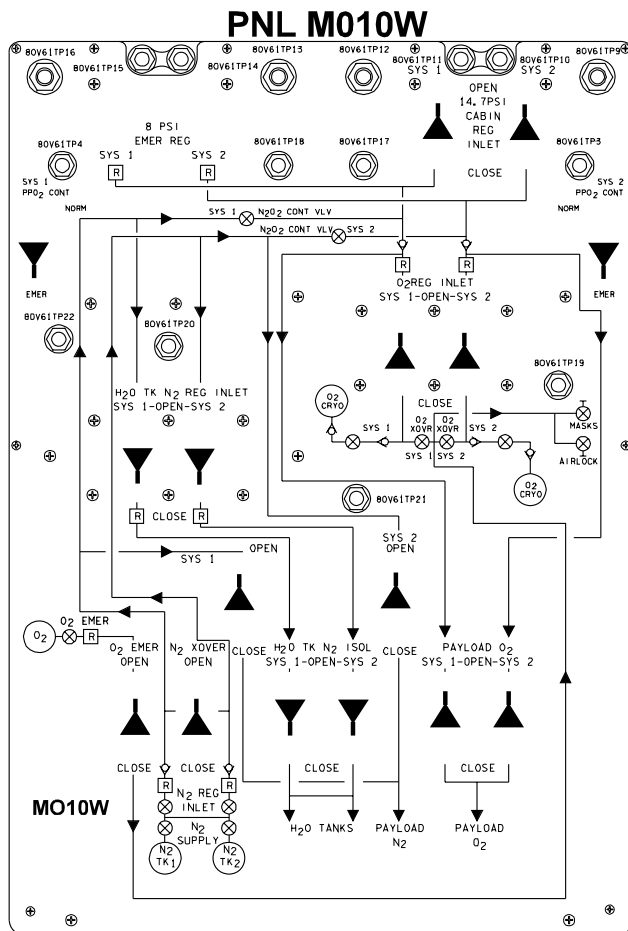

LIGHTING
FL DOOR

1 ON
2 ON/OFF

PNL AW18A

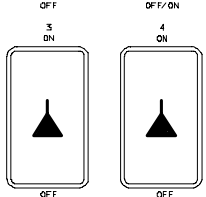
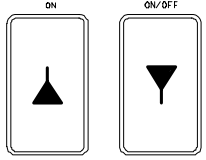

AW18A

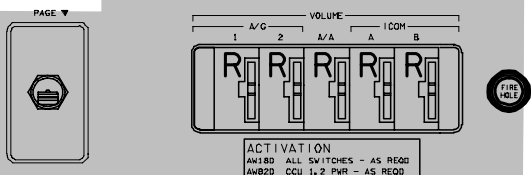
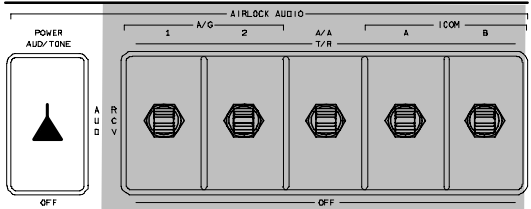

ACTIVATION
AW18D ALL SWITCHES - AS REQD
AW82D CCL 1, 2 PWR - AS REQD

PNL AW18D

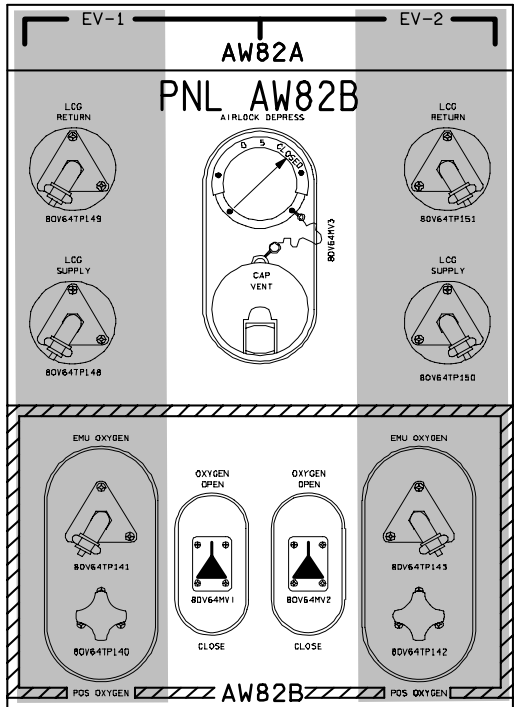
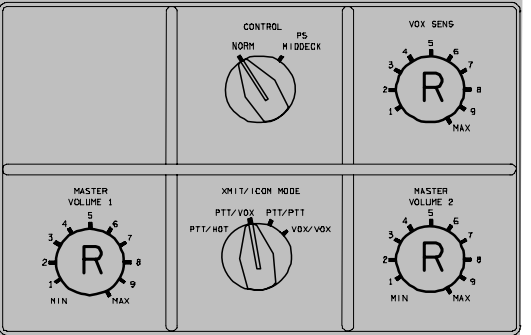

PNL AW18H

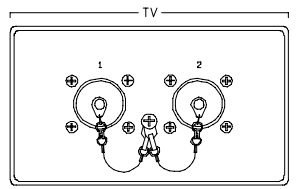
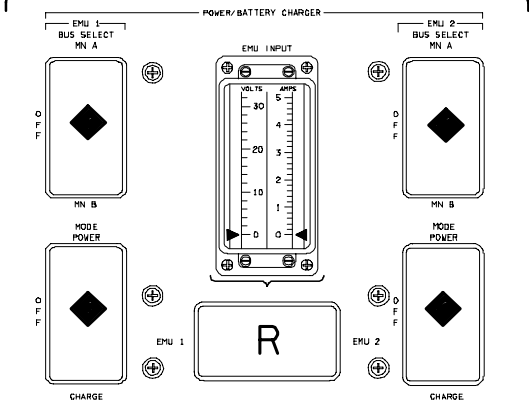

PNL AW18H

OV104

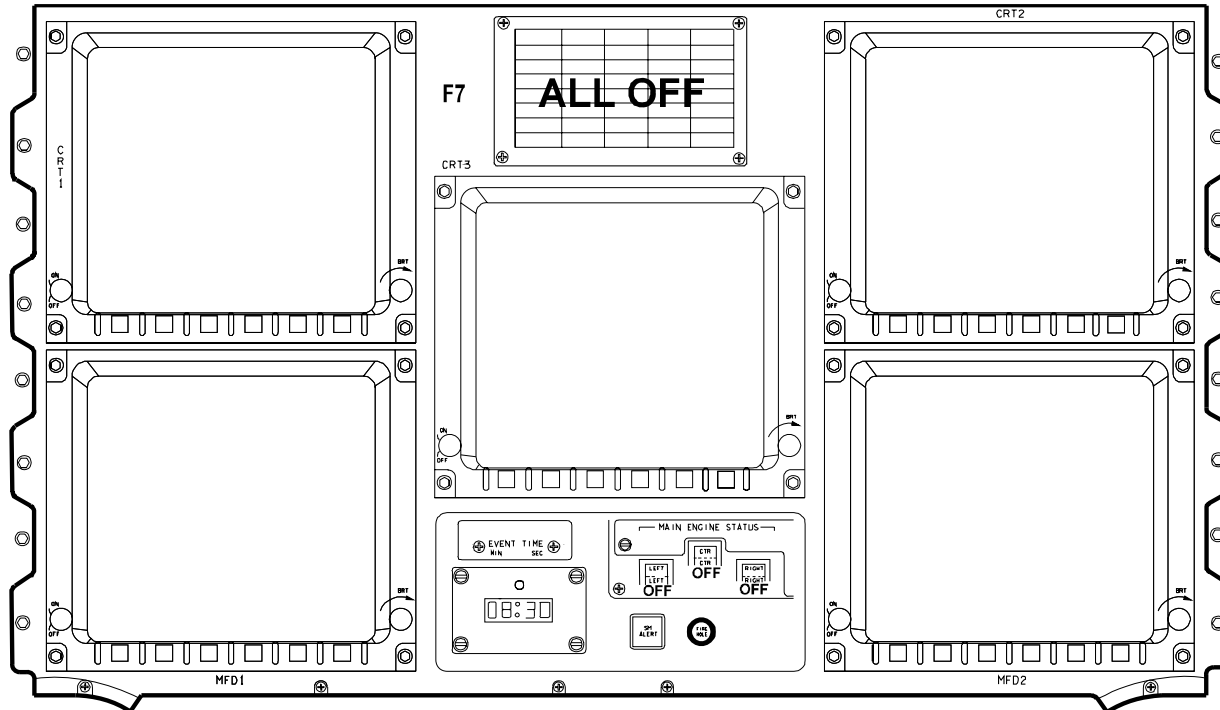
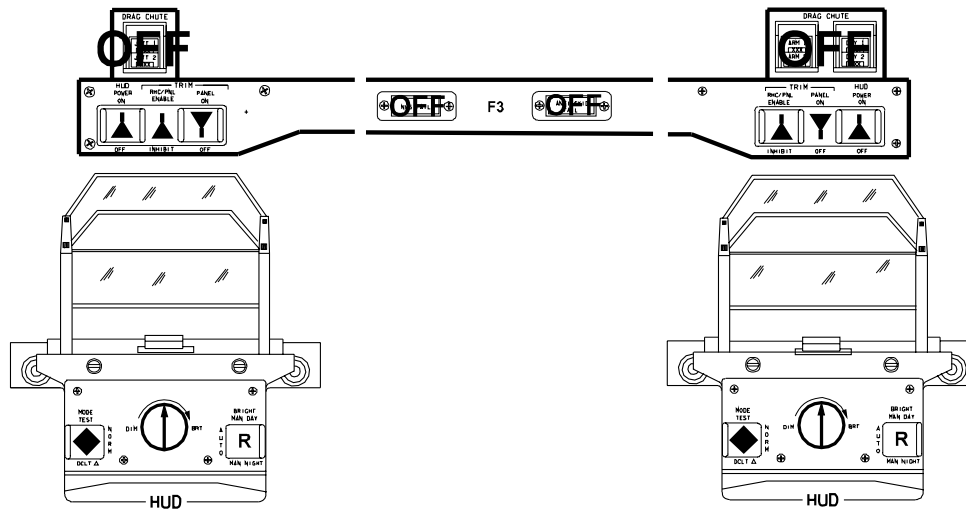

48015F304_121.PNL# 3

ALL VEH/DATE 09/28/05

(OV104) B3-4

OV104
D/O/4/GEN Q

OV104

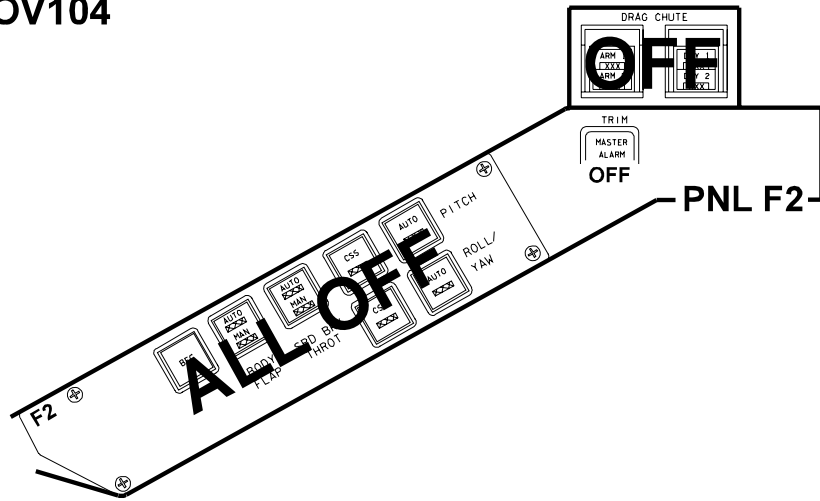

PNL O13

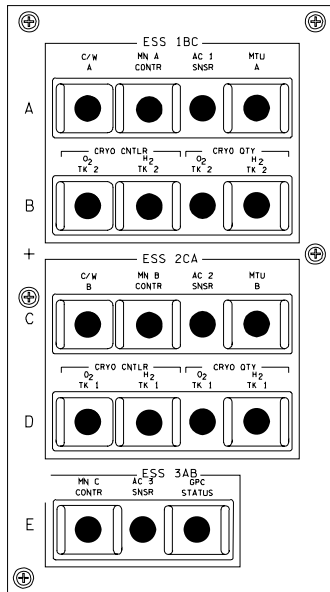

L side OVHD flood - R (MID)

PNL O7

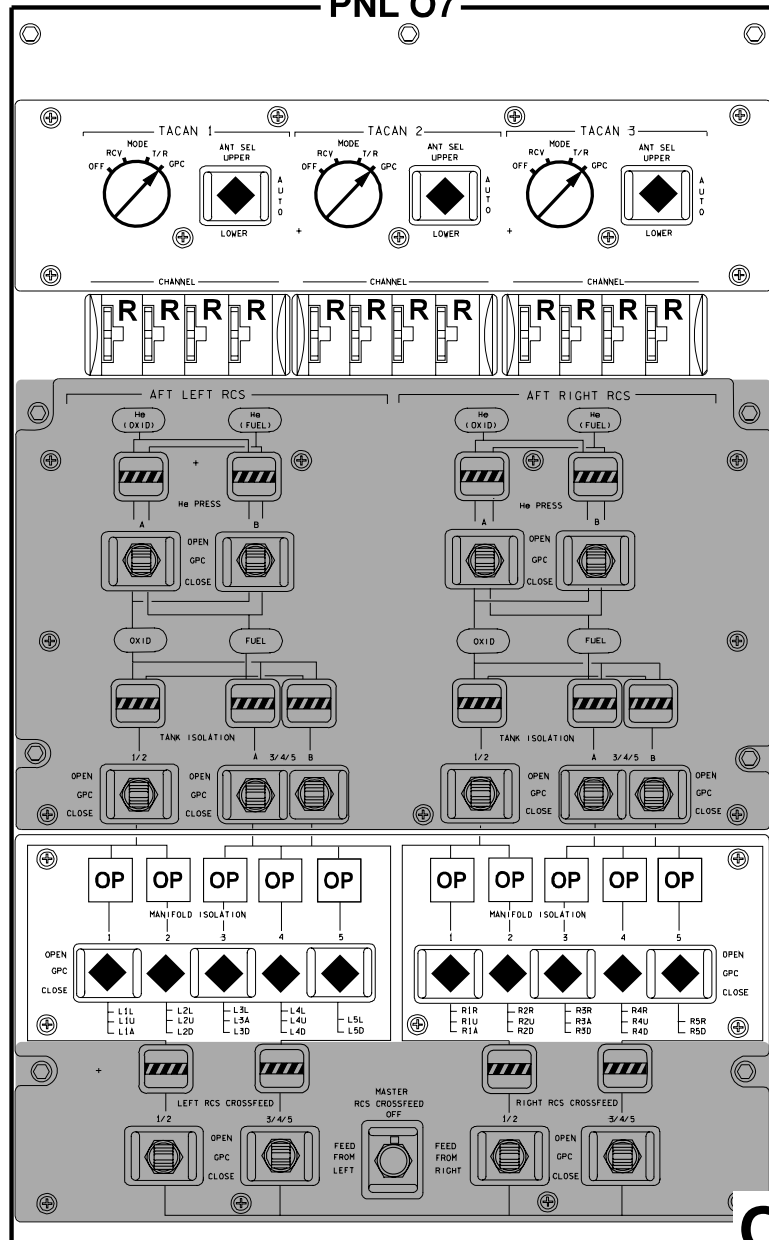

OV104

OV104

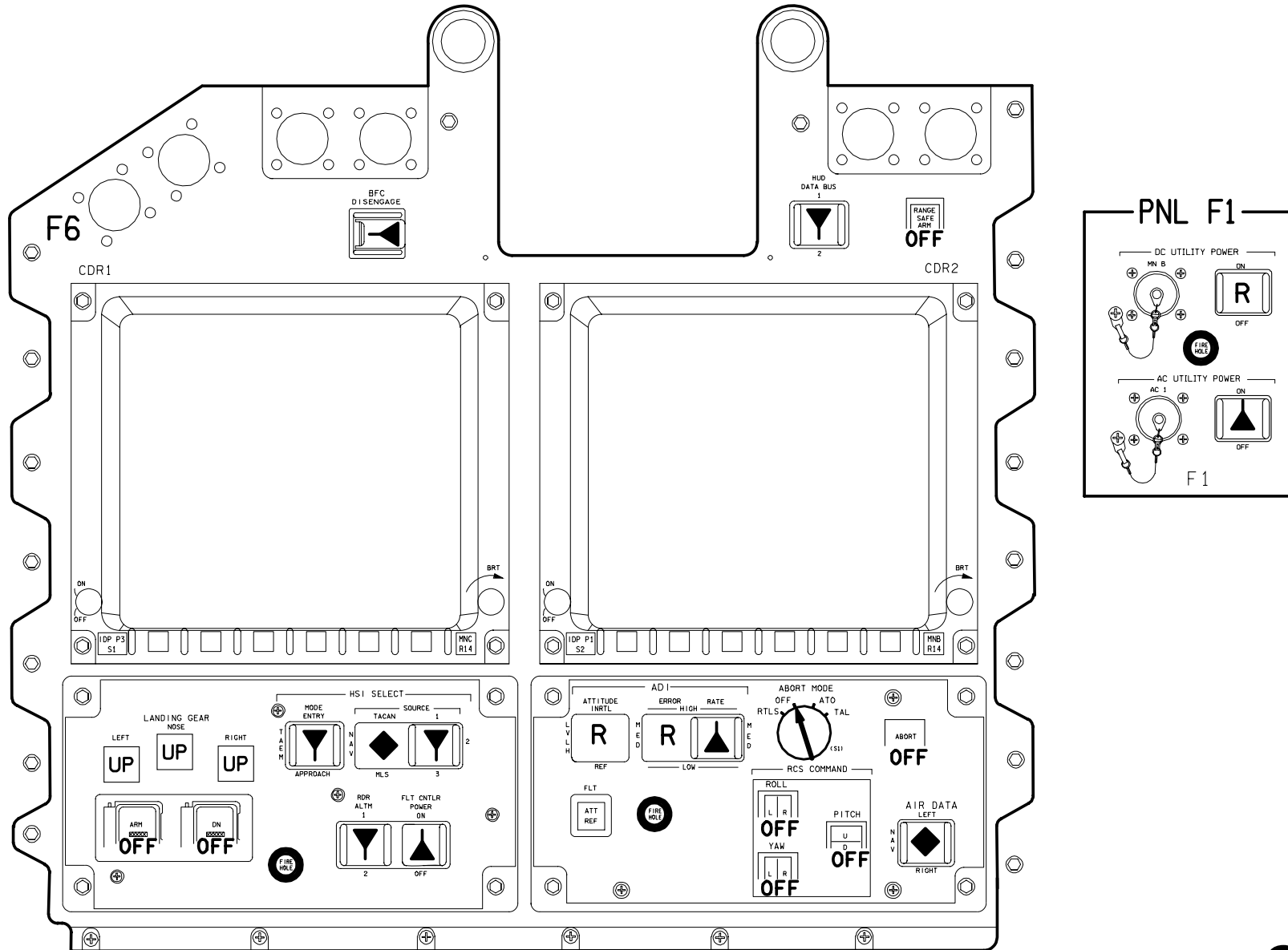

OV104

(OV104) B3-6

D/O/4/GEN Q

OV104

PNL 08

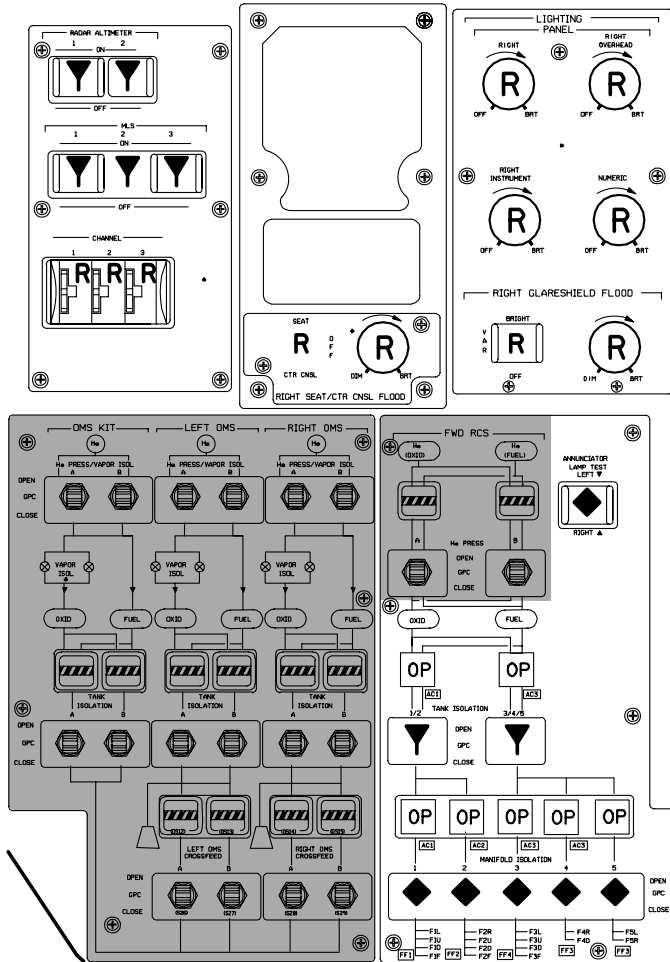

R side OVHD flood - R (MID)

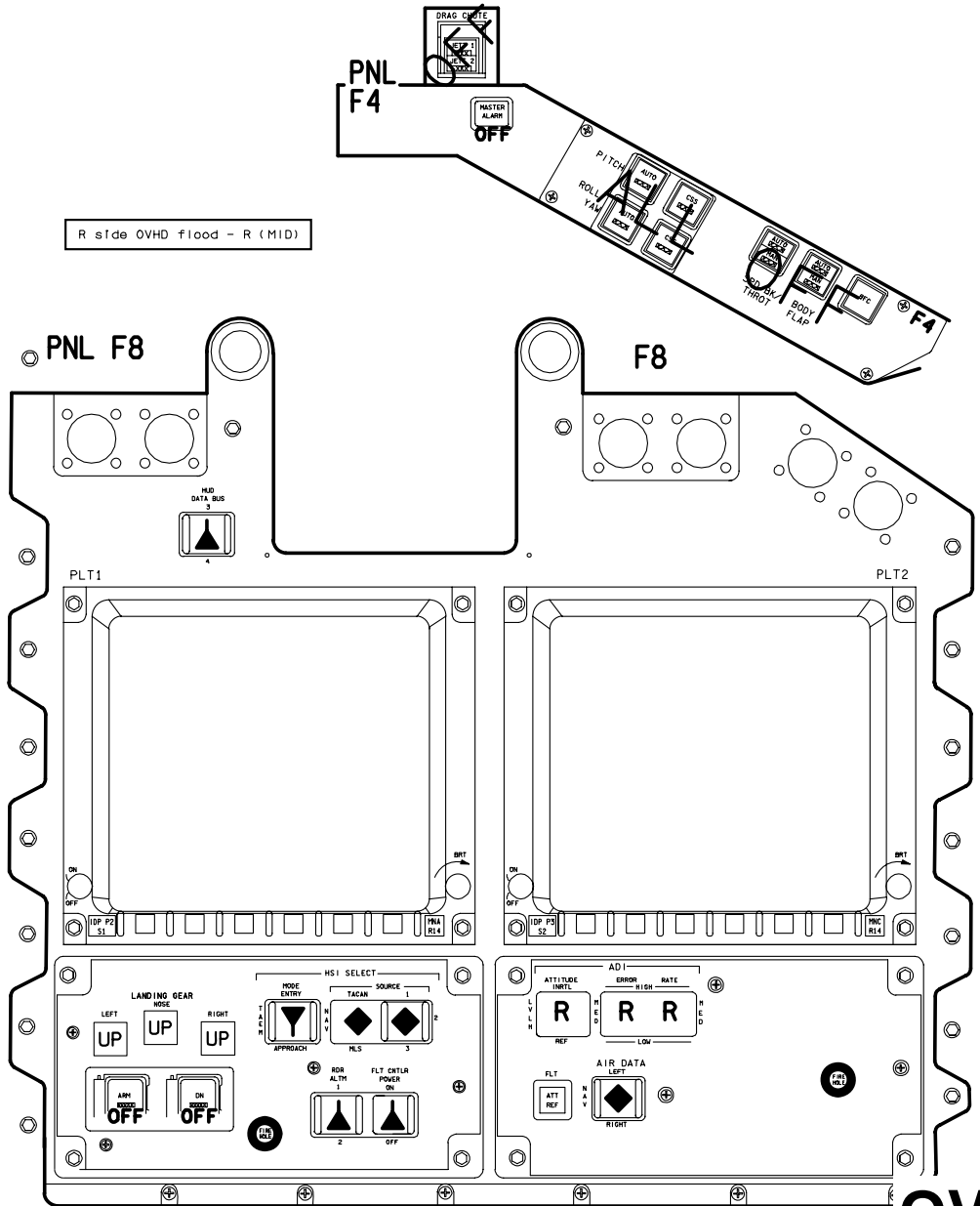

OV104
PNL R2

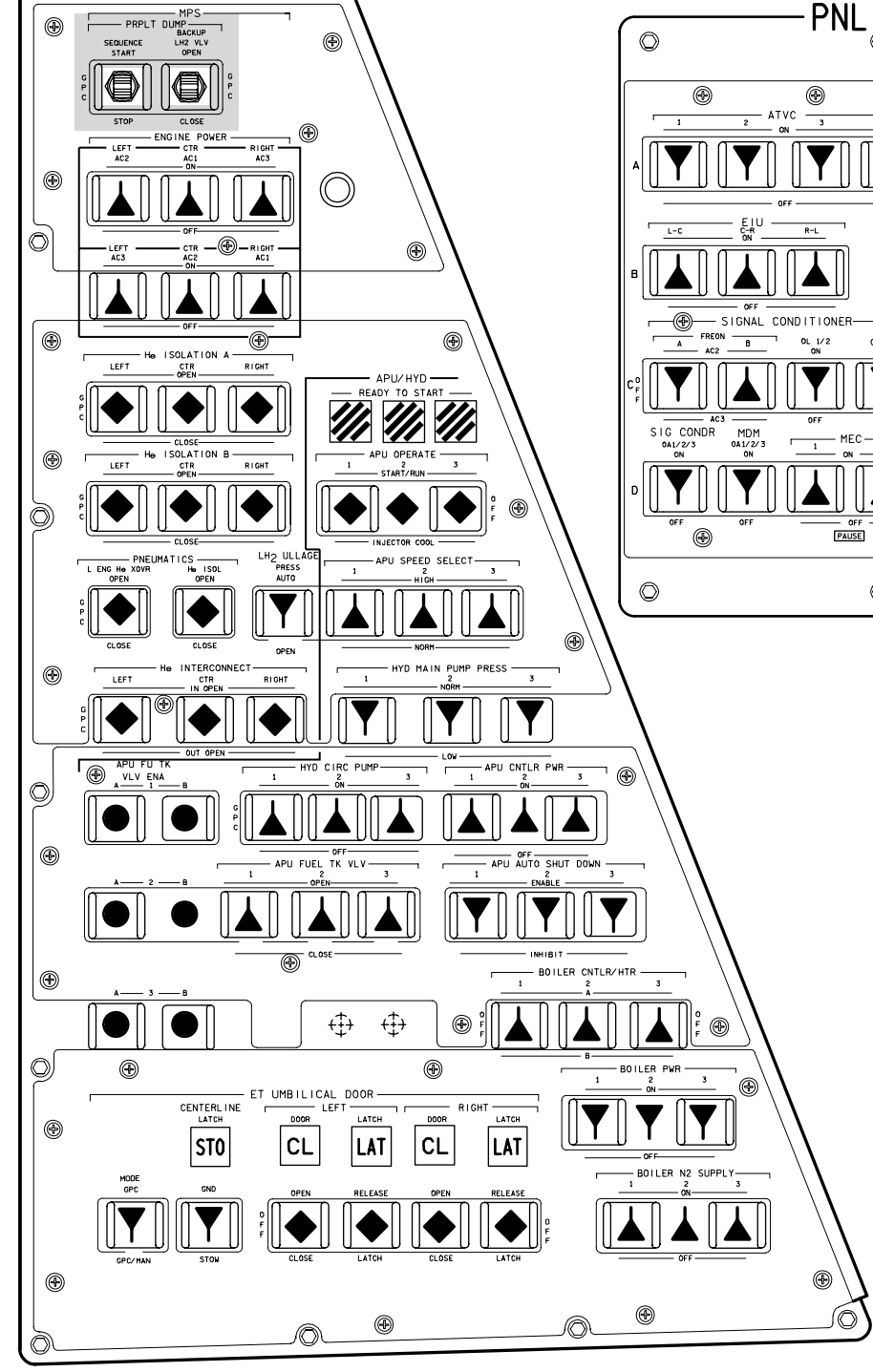

PNL 017

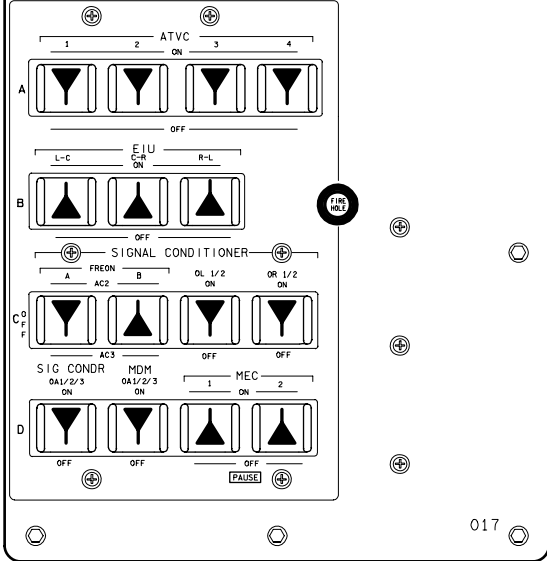

017

ALL VEH/DATE 11/29/04
48015C308_114, PNL, 5

OV104

(OV104) B3-8

D/O/ALL/GEN Q

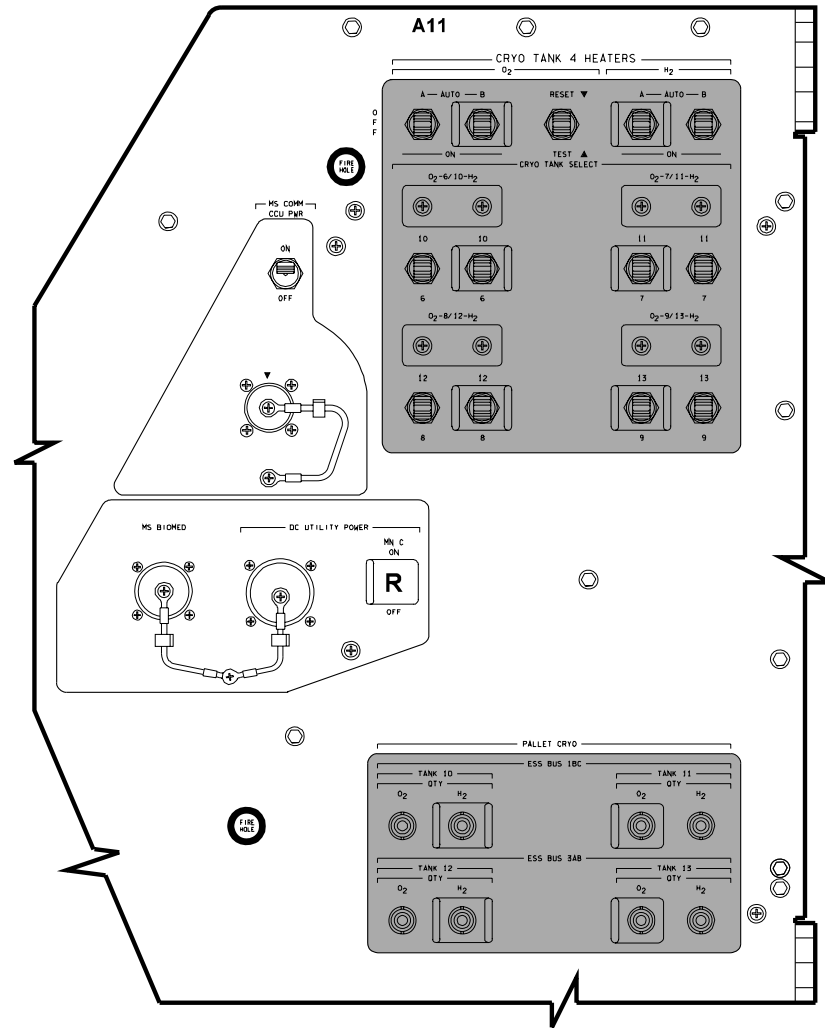
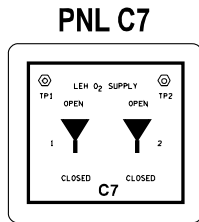

OV104

AIRLOCK HATCH

ACTUATOR HANDLE - LATCHED
 LOCK LEVER - LOCKED
 EQUALIZATION VLV (TWO) - NORM
 -CAPS INSTALLED

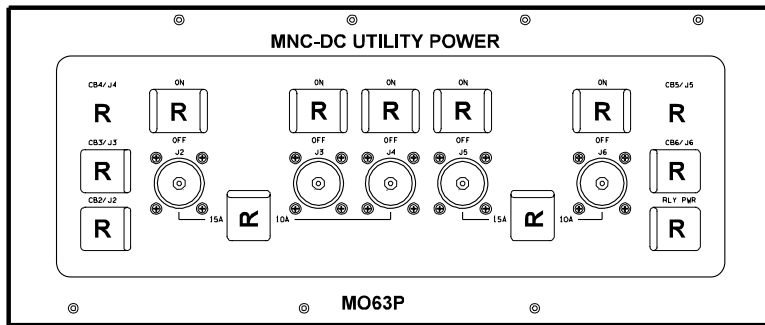

PNL MO58F

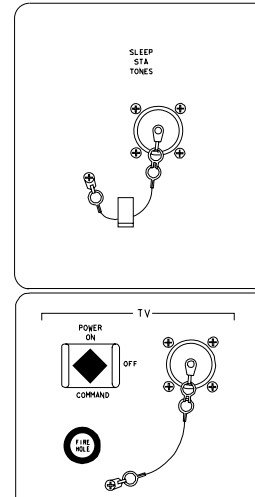

PNL MO30F

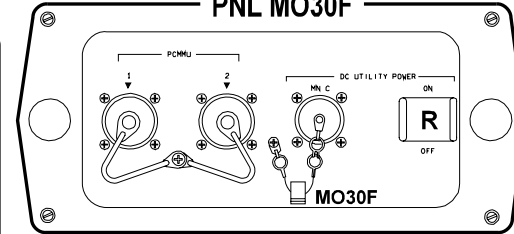

PNL MO52J

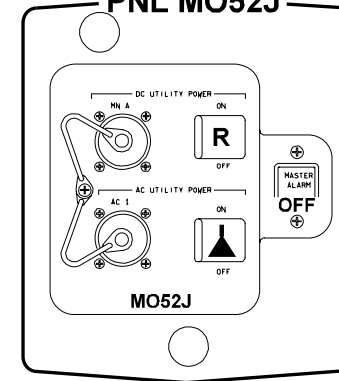

PNL MO39M

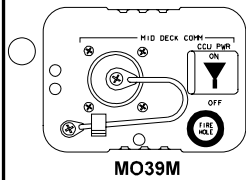

PNL MD24K

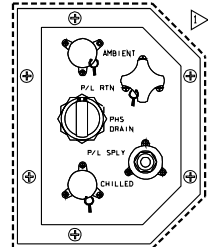

NOTE: NOT VISIBLE IF MAR FLOWN

PNL MD44F

CAB TEMP CNTL ACT LINKAGE - SECONDARY ACTUATOR

PNL ML85E

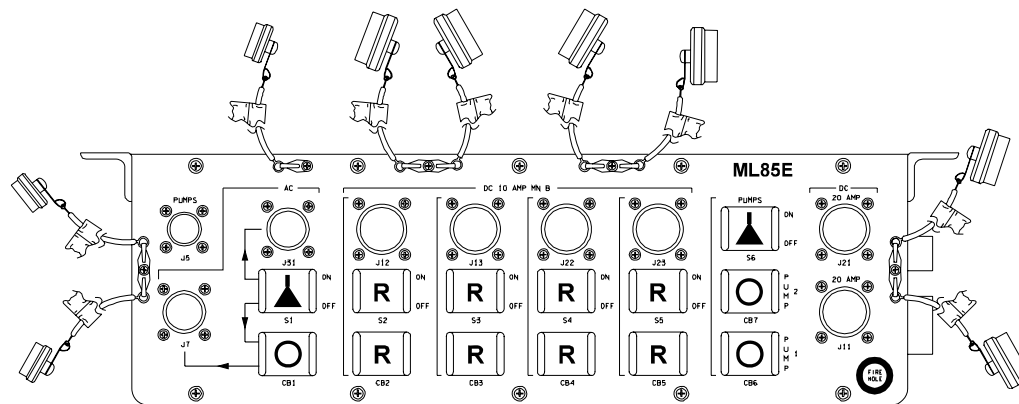

OV104

OV104

PNL ML86B

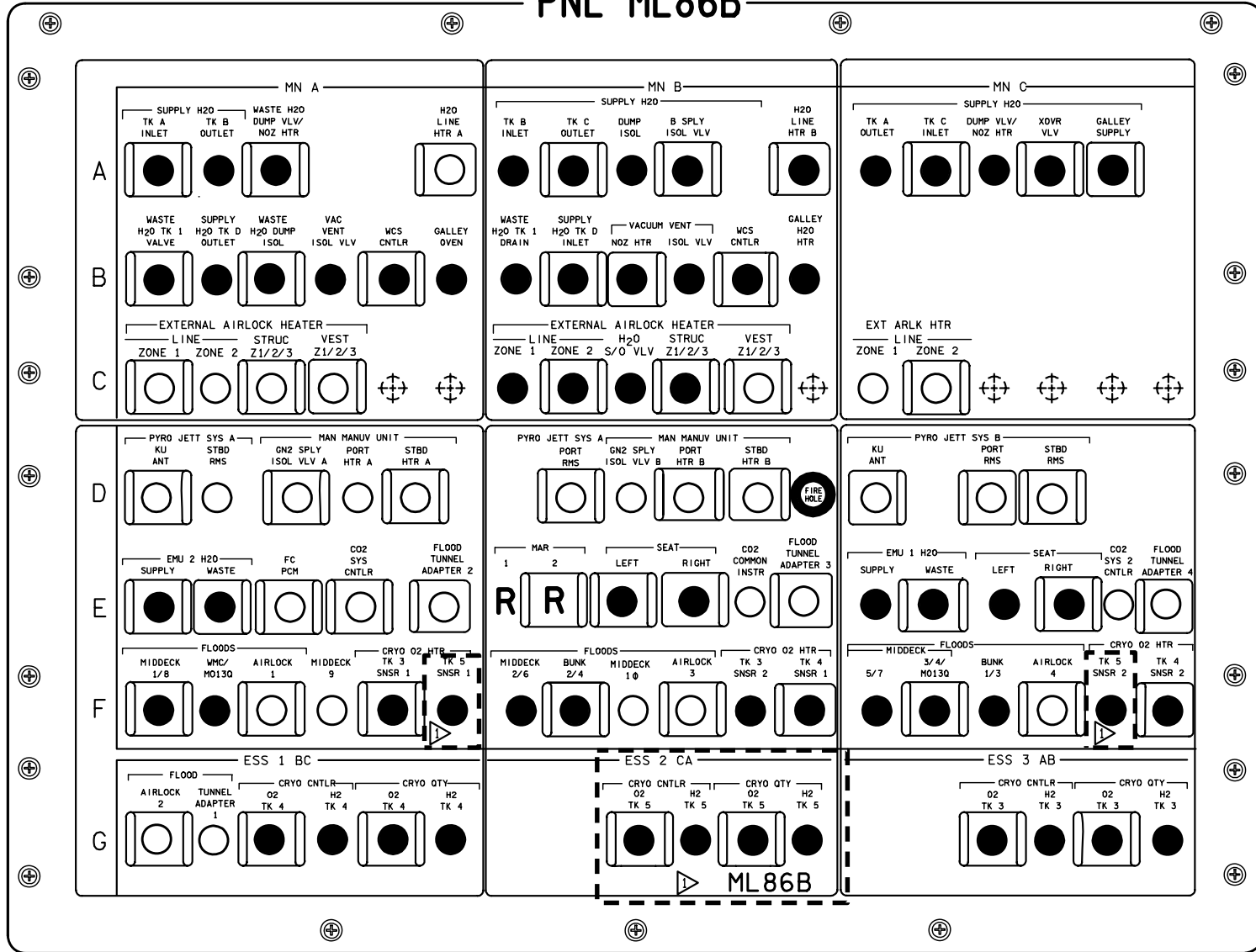

NOTE: ▷ OPEN IF TK 5 NOT FLOWN

OV104

OV104

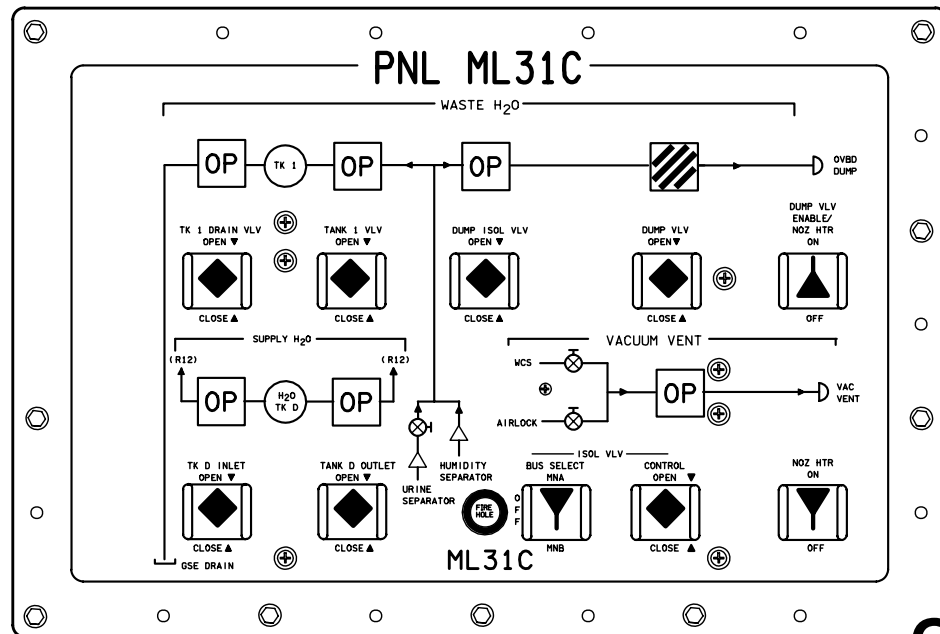
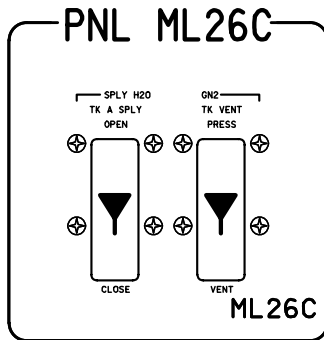
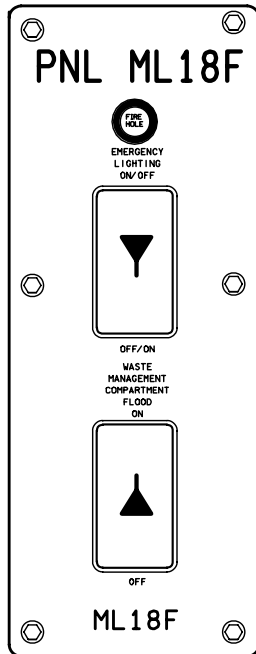
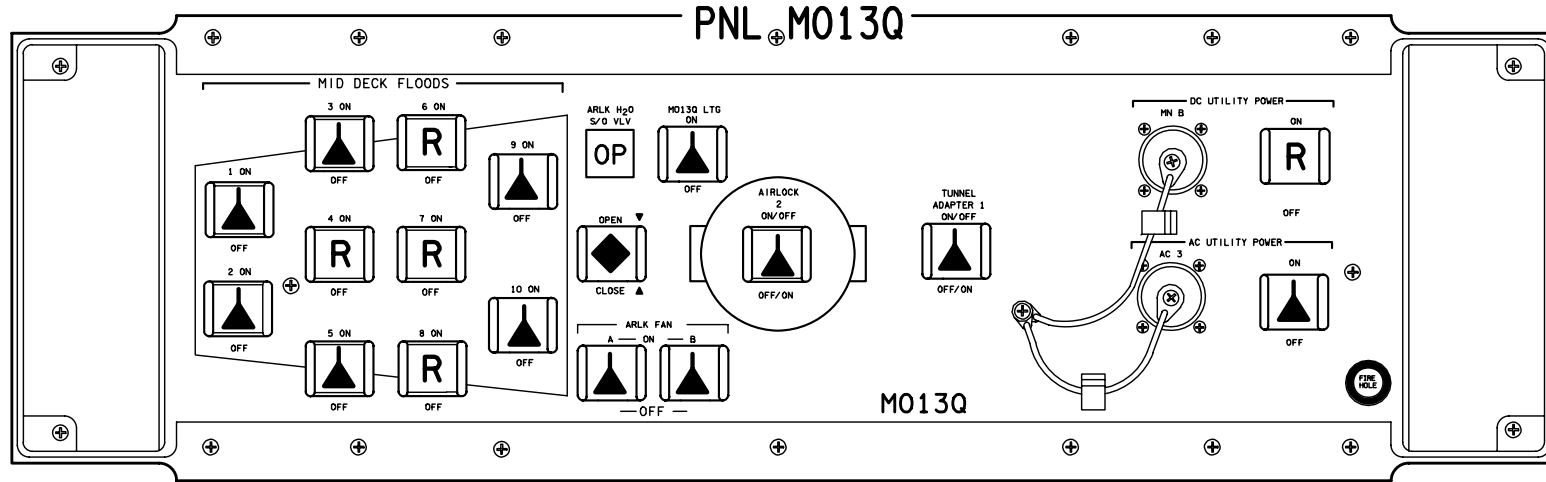

OV104

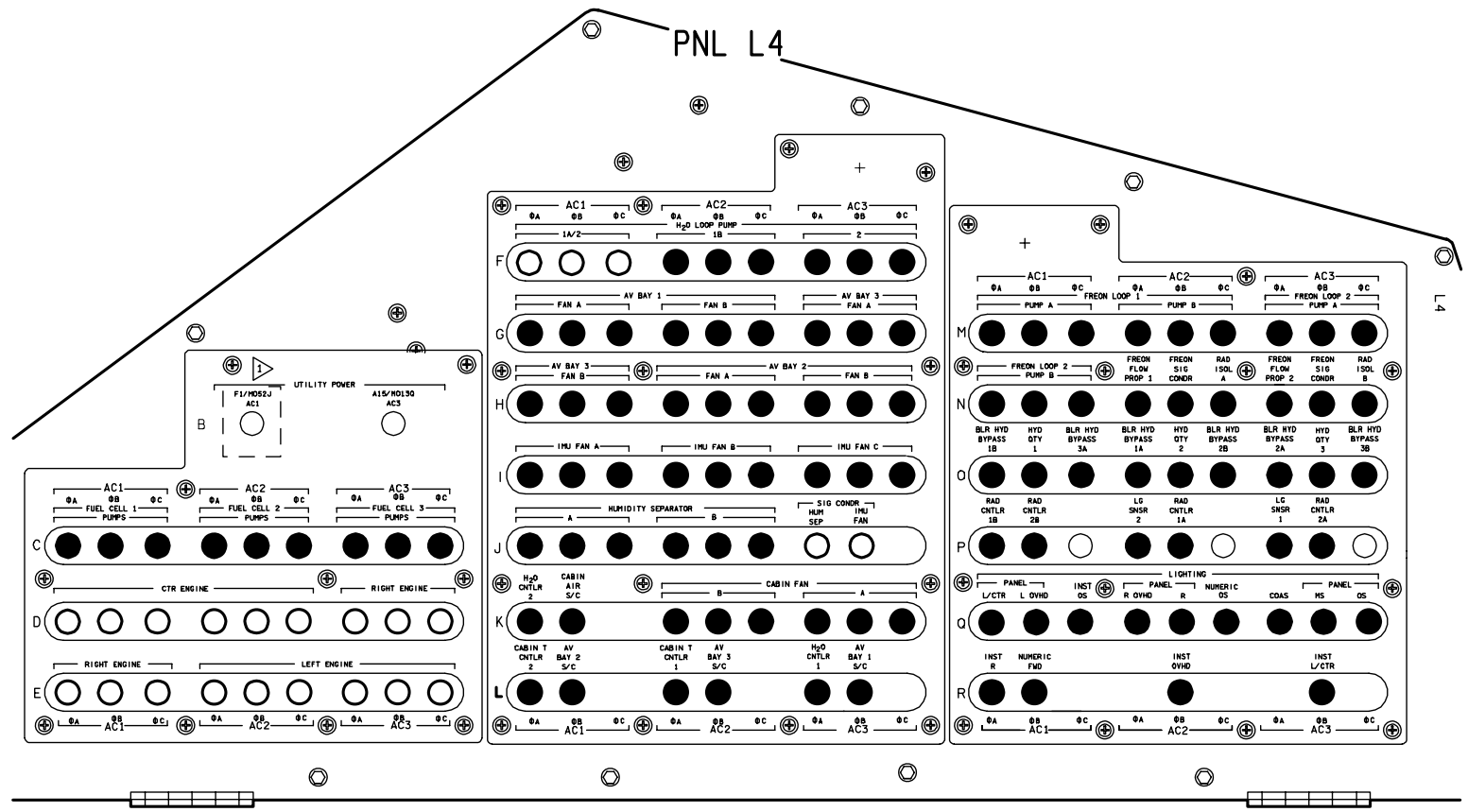

NOTE:  CB CAN REMAIN CLOSED FOR AC PGSC USAGE.
 OPEN WHEN PGSC UNPOWERED/STOWED

OV104

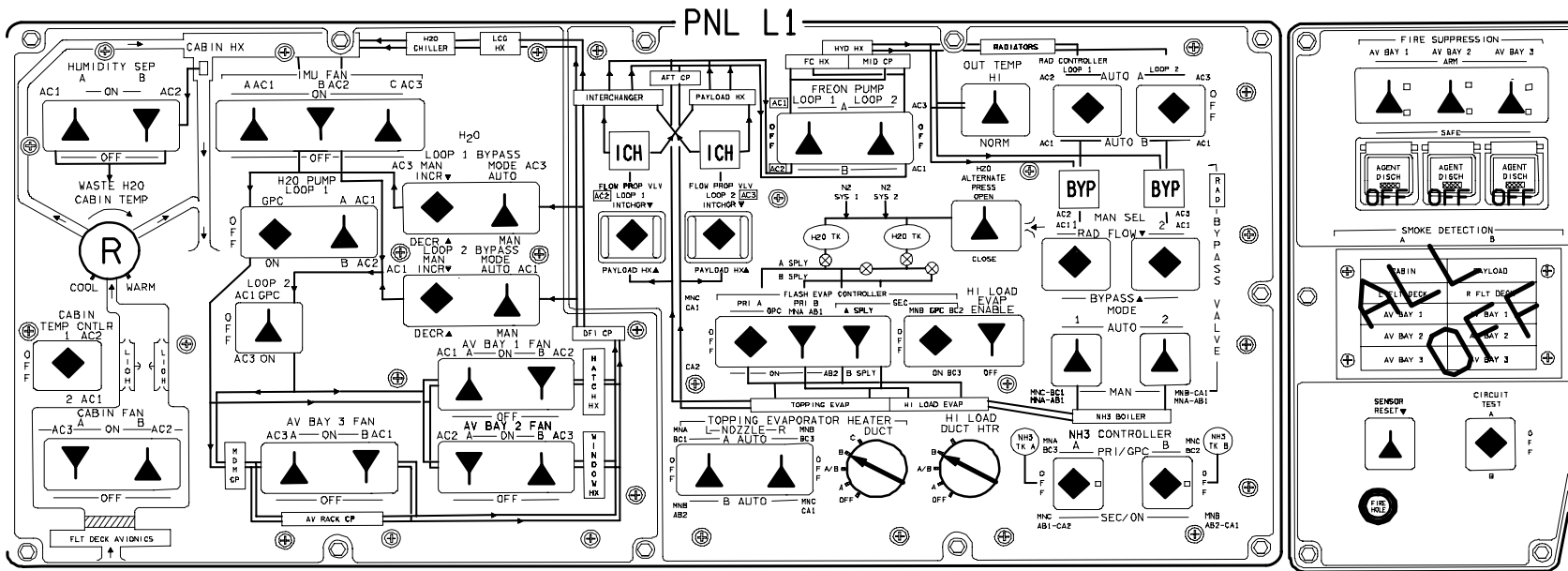

OV104

OV104/DATE 01/28/11

PNL L2

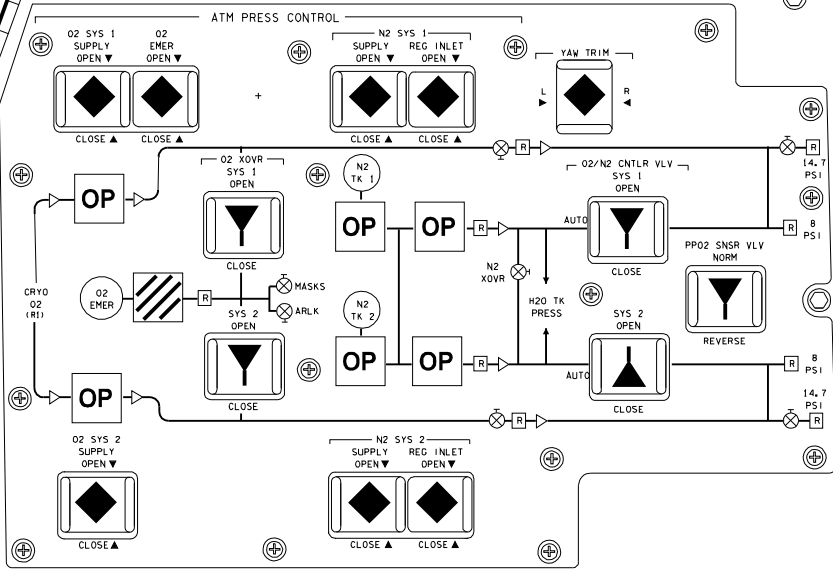
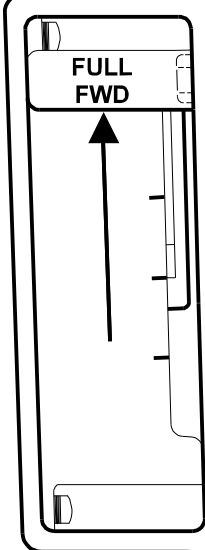
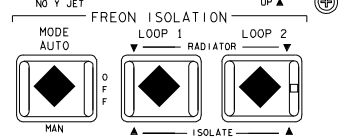
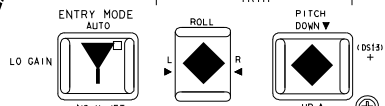
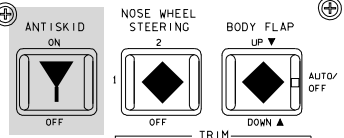
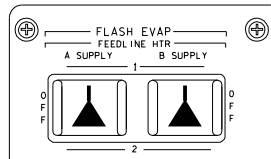
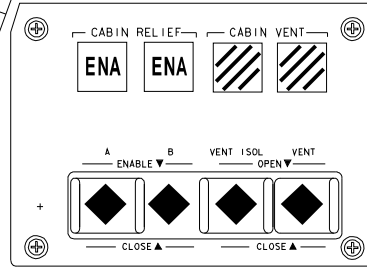

48015C315_135_PNL_1

OV104

PNL C2/C3

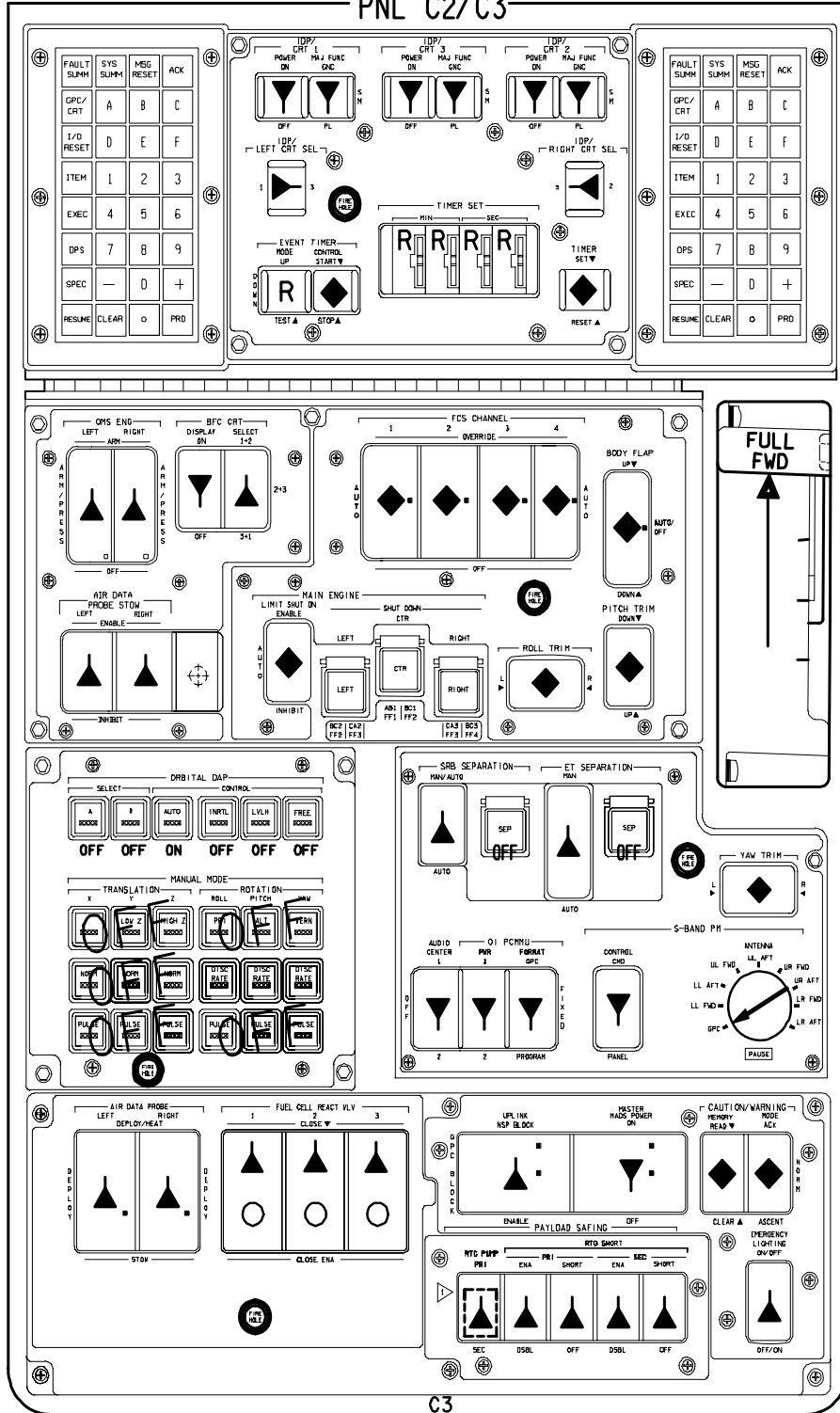

C3

OV104

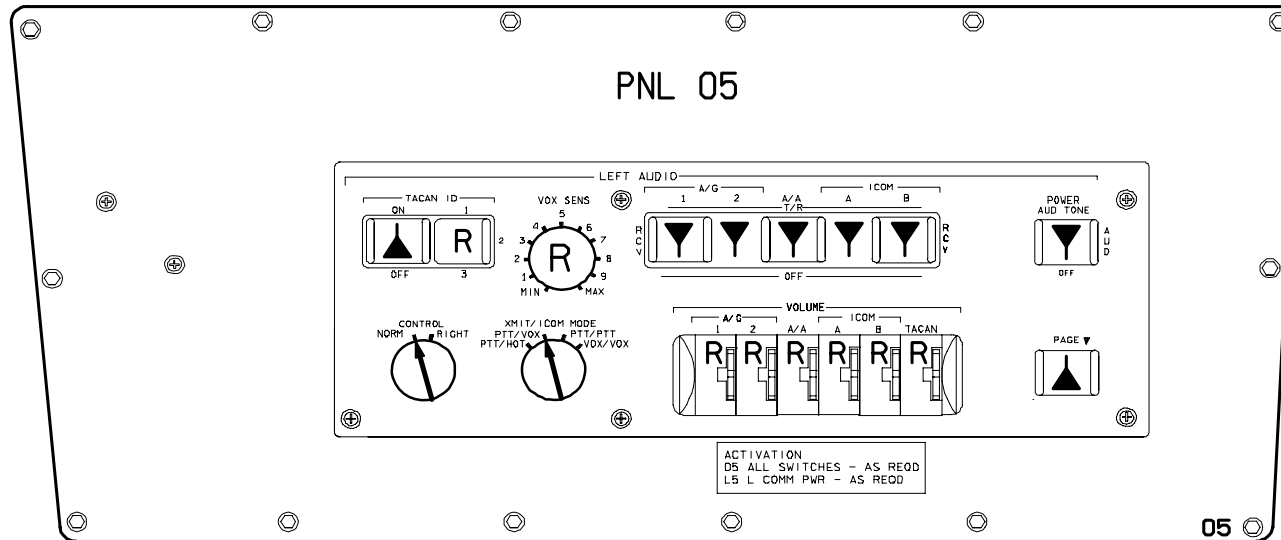
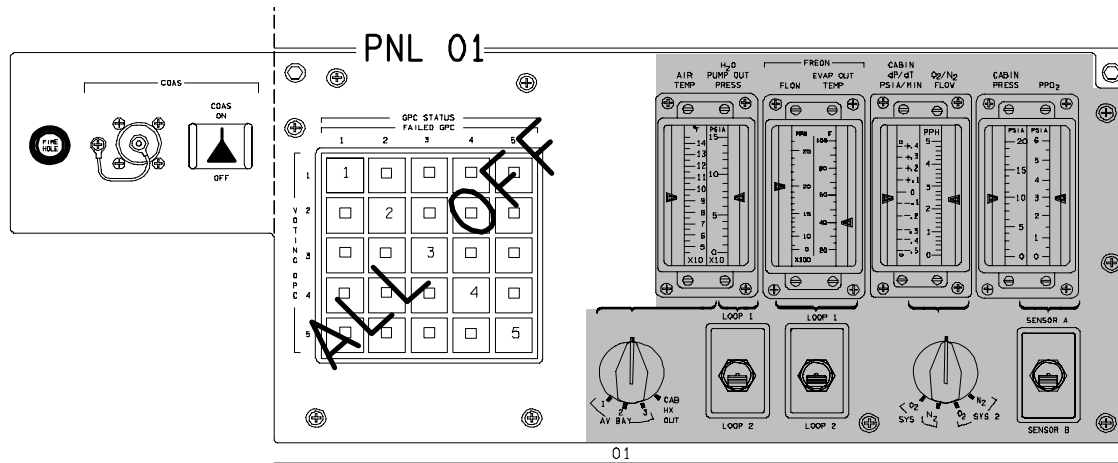

PNL 06

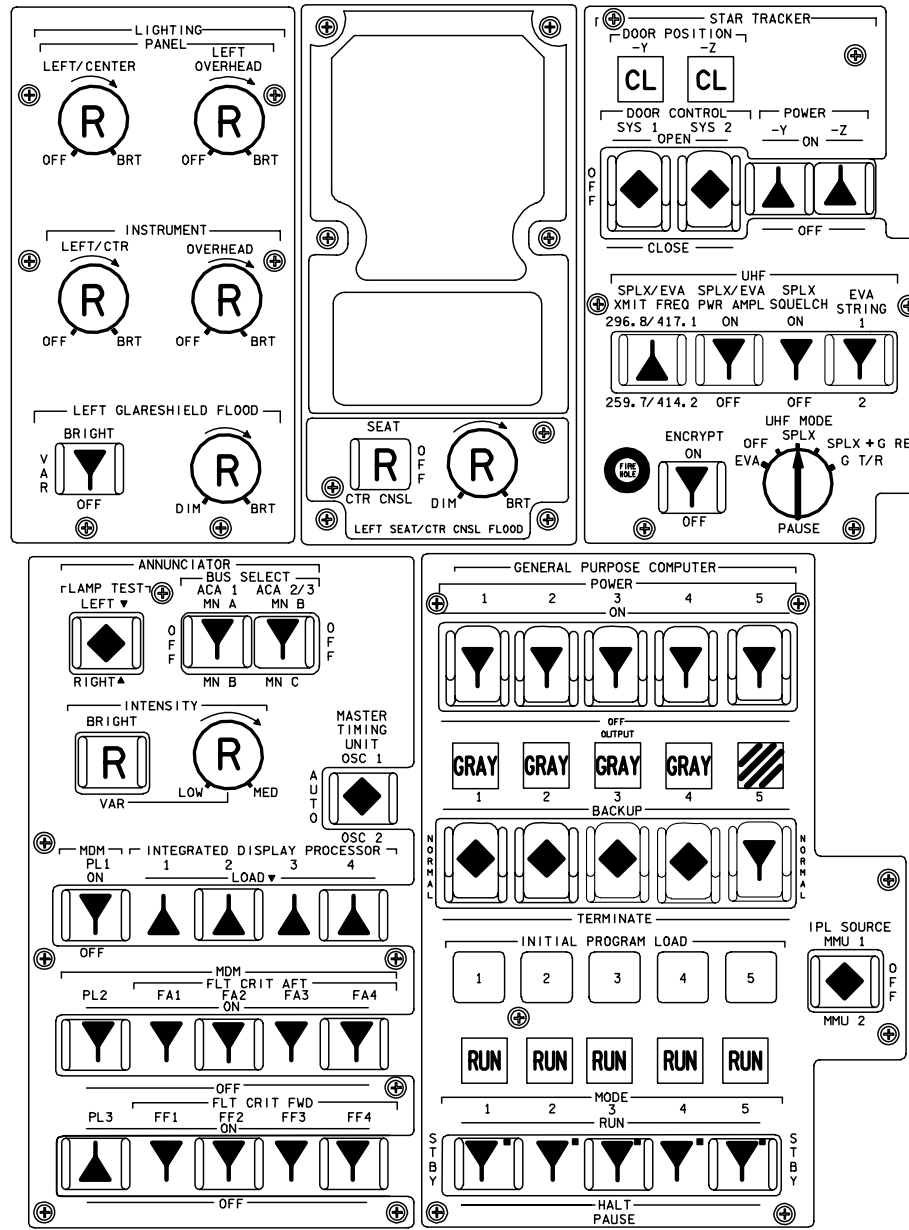

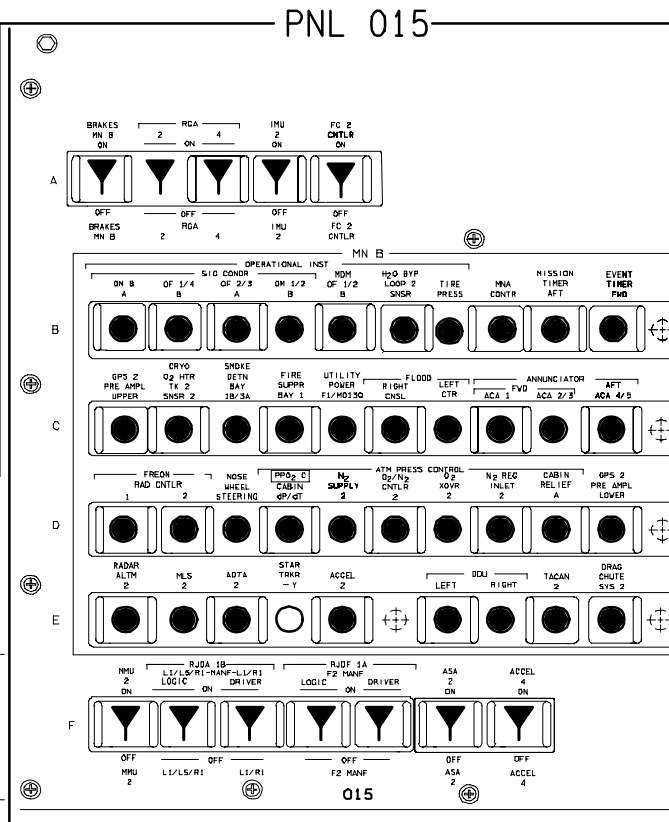
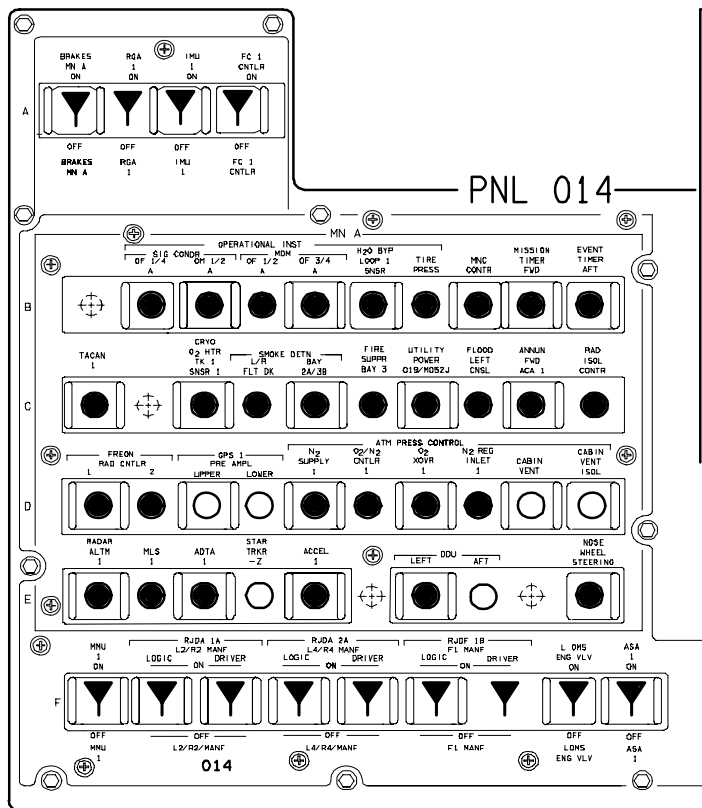

OV104

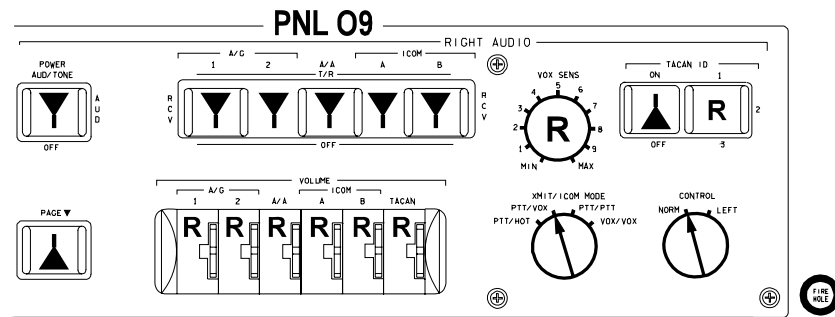
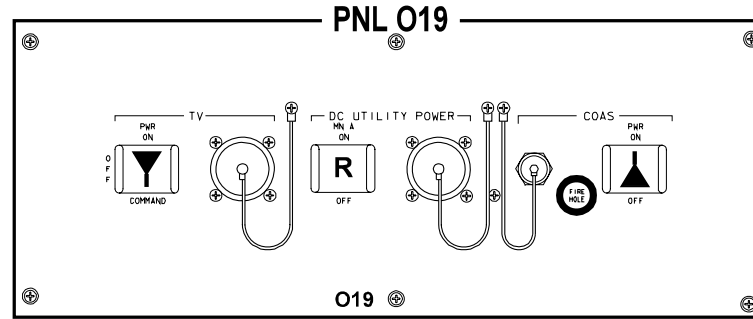
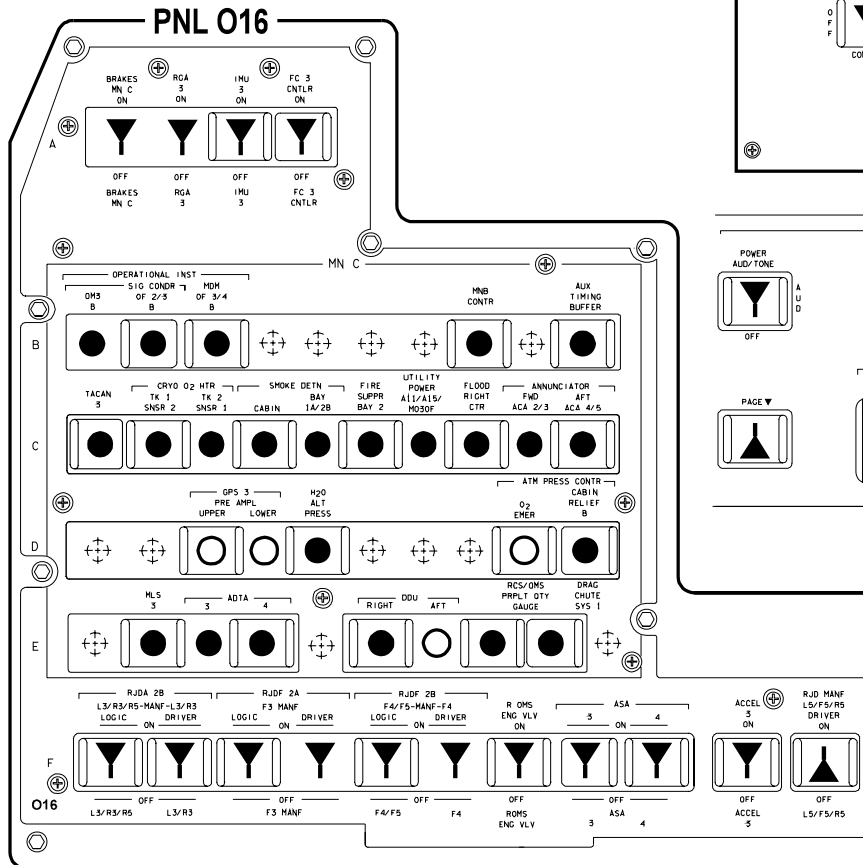

ACTIVATION
 09 R AUD PWR - AUD/TONE
 ALL OTHER SWS - AS REQD
 R6 R COMM PWR - AS REQD

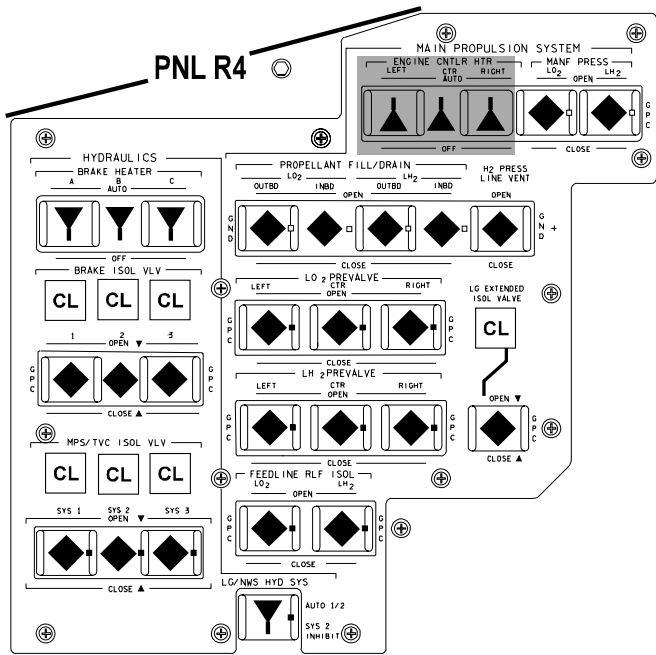
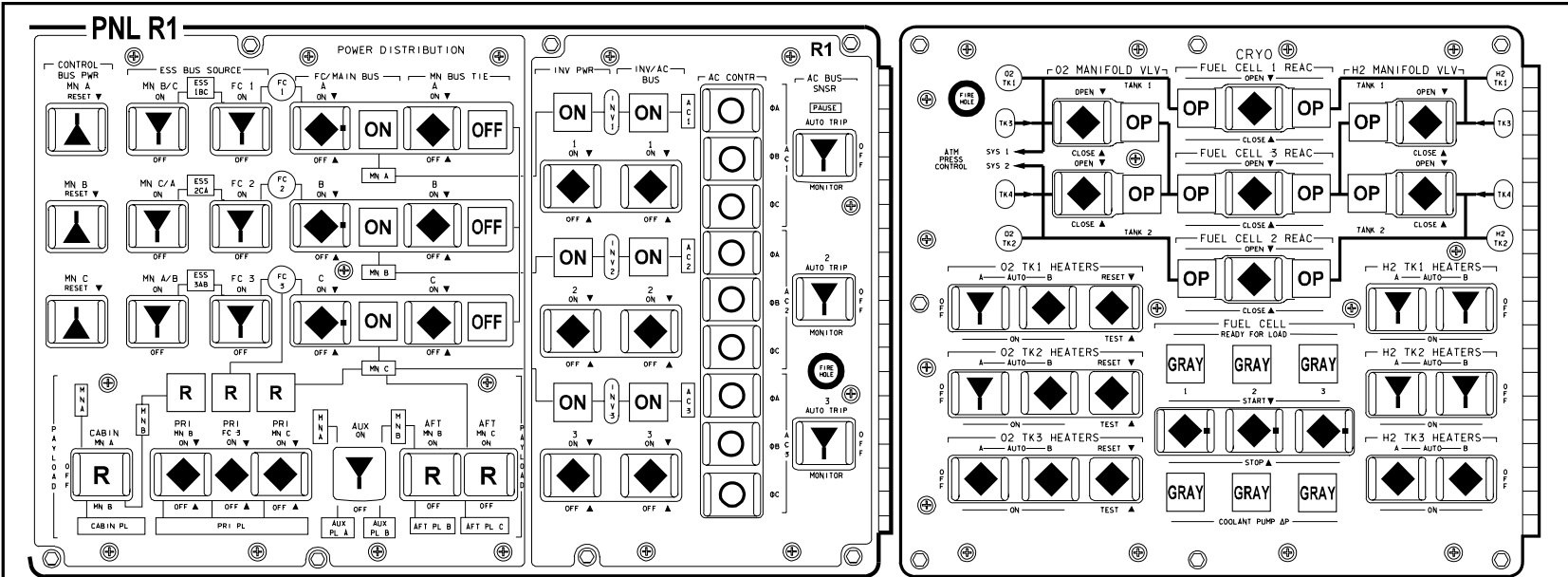

48015F321_115, PNL 1

ALL VEH/DATE 06/27/06

(OV104) B3-21

OV104

D/O/ALL/GEN Q

OV104

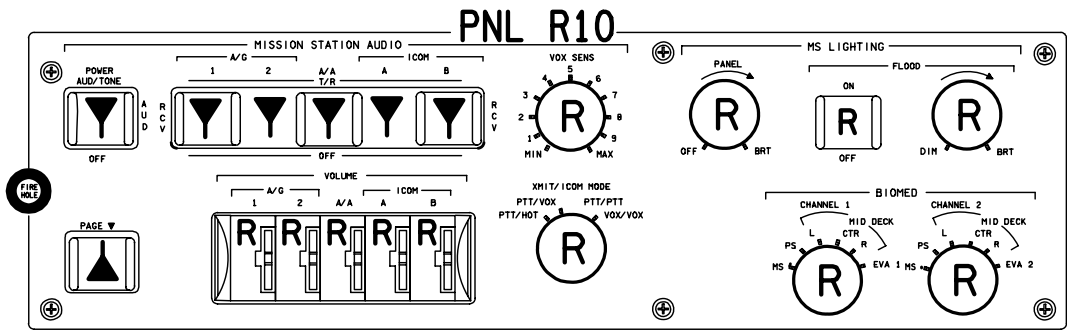

ACTIVATION
 R10 MS AUD PWR - AUD/TONE
 ALL OTHER SWS - AS REQD
 R12 MS AUD CONTL - NORM
 A11 MS COMM CCU PWR - ON

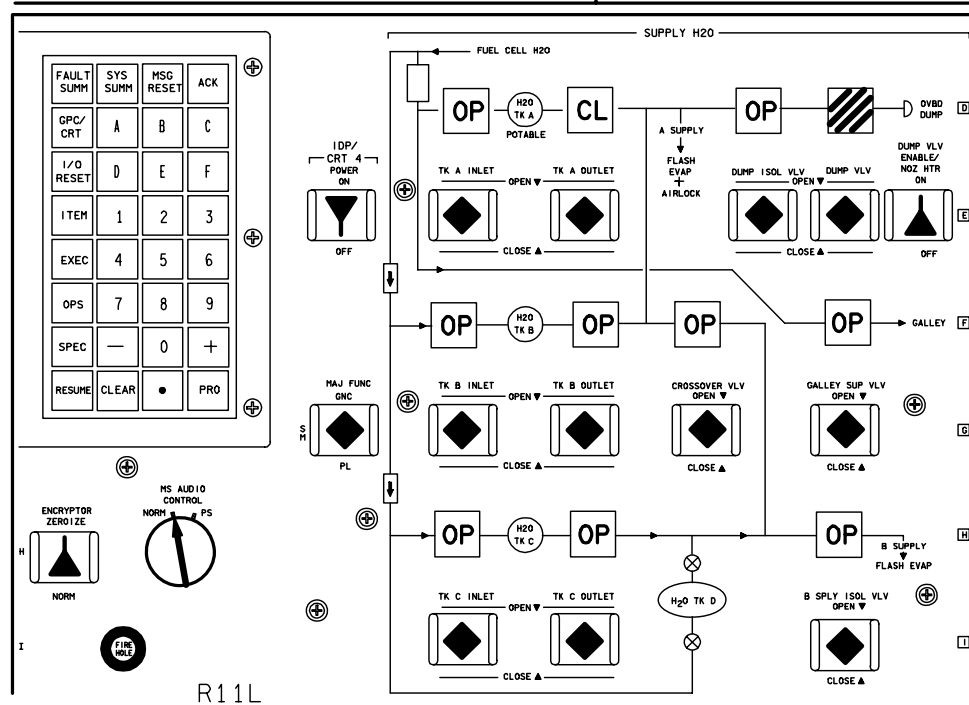
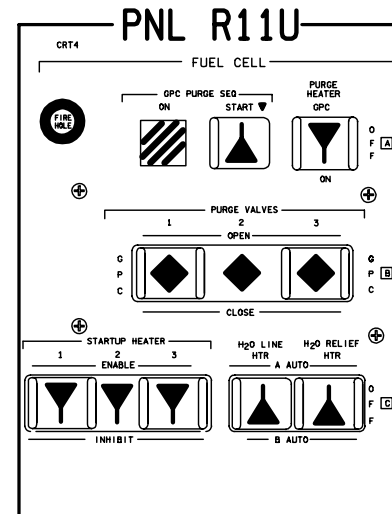

OV104

OV104

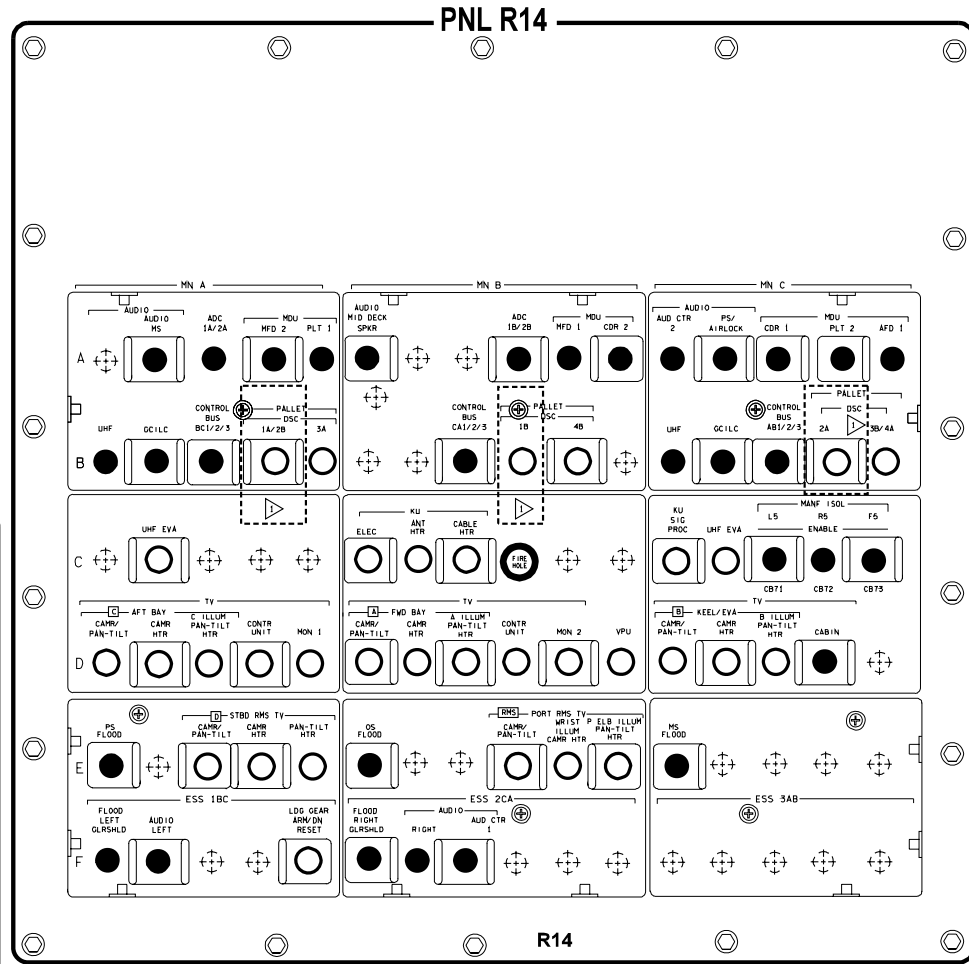
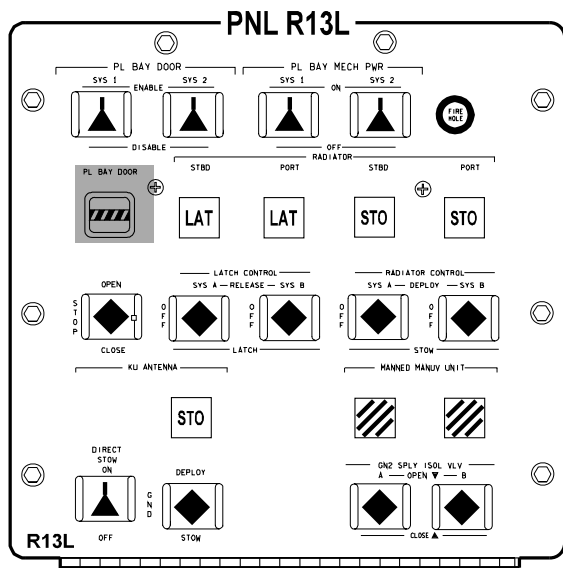

NOTE: ▷ CLOSED IF EDO

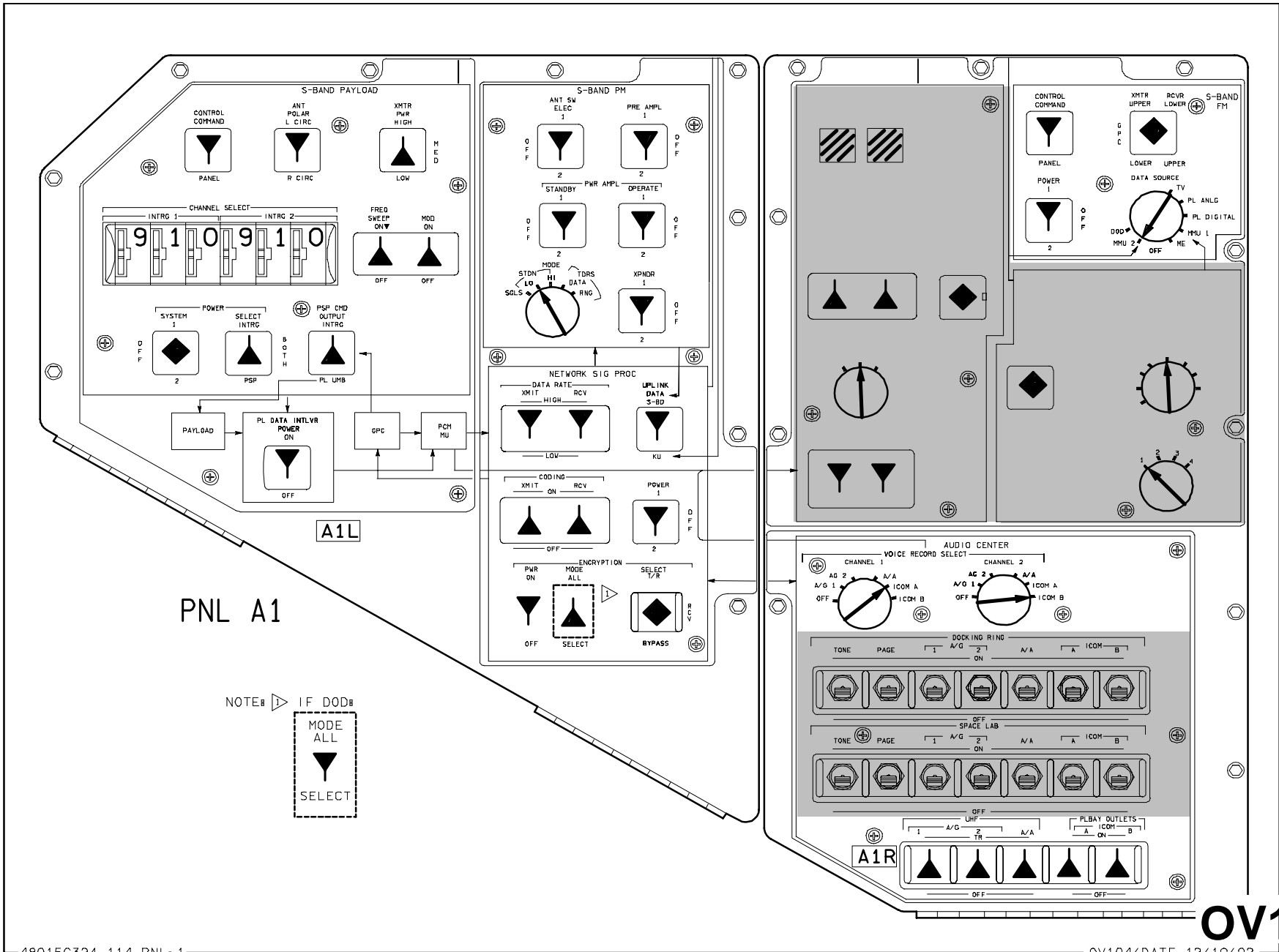

PNL A1

NOTE: IF DOD:
 MODE ALL
 SELECT

OV104

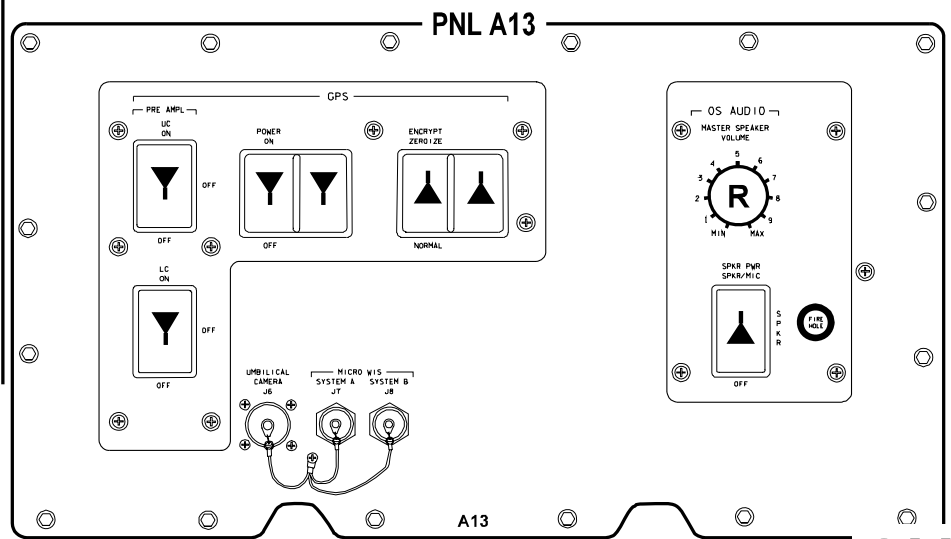
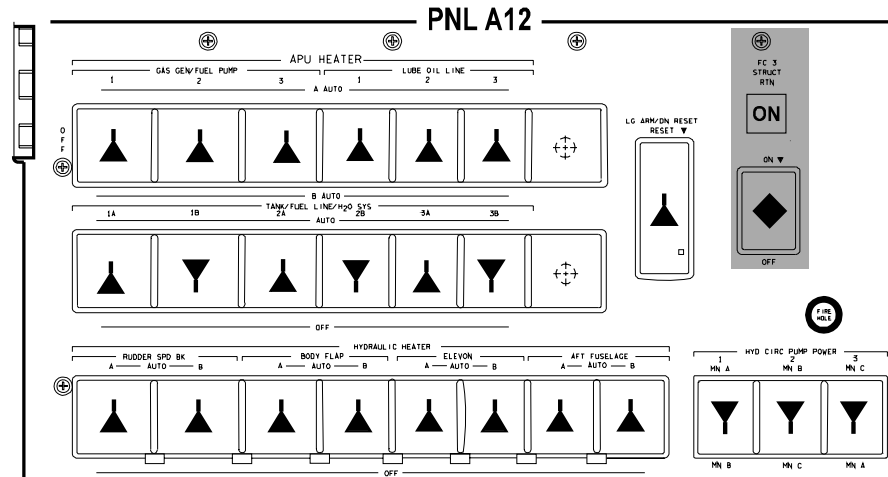
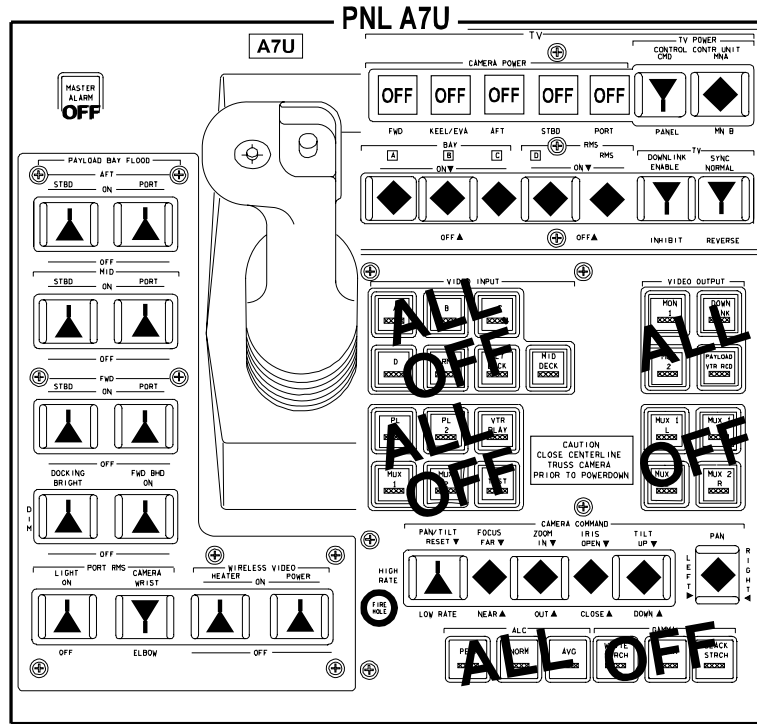

OV104

PNL L9

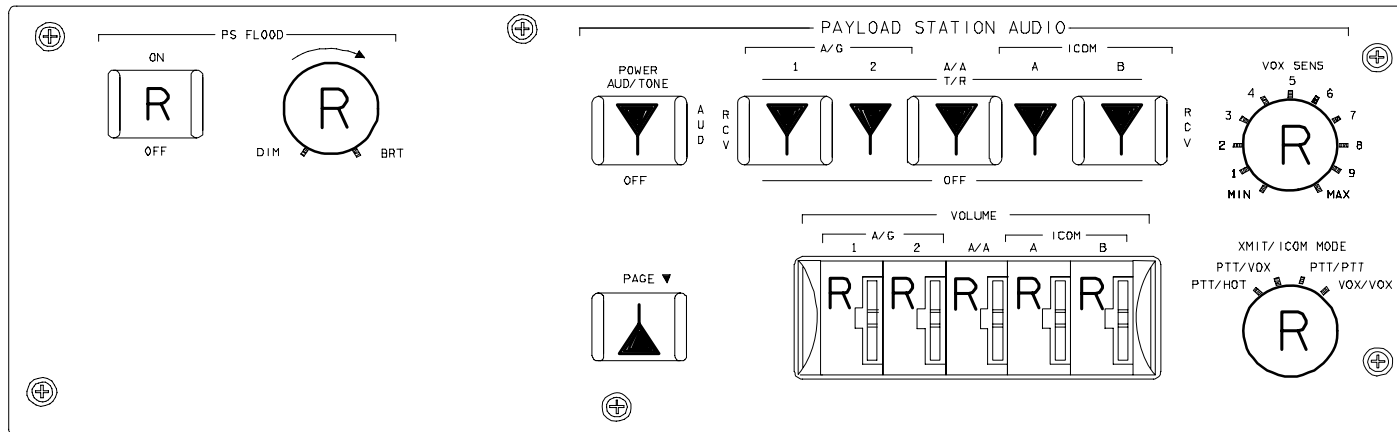

ACTIVATION
L9 ALL SWITCHES - AS REQD
A15 PS COMM CCU PWR - ON

L9

OV104

PNL A6L

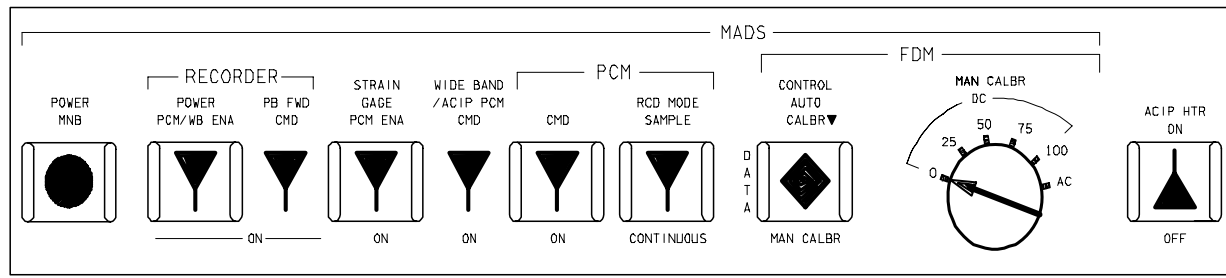
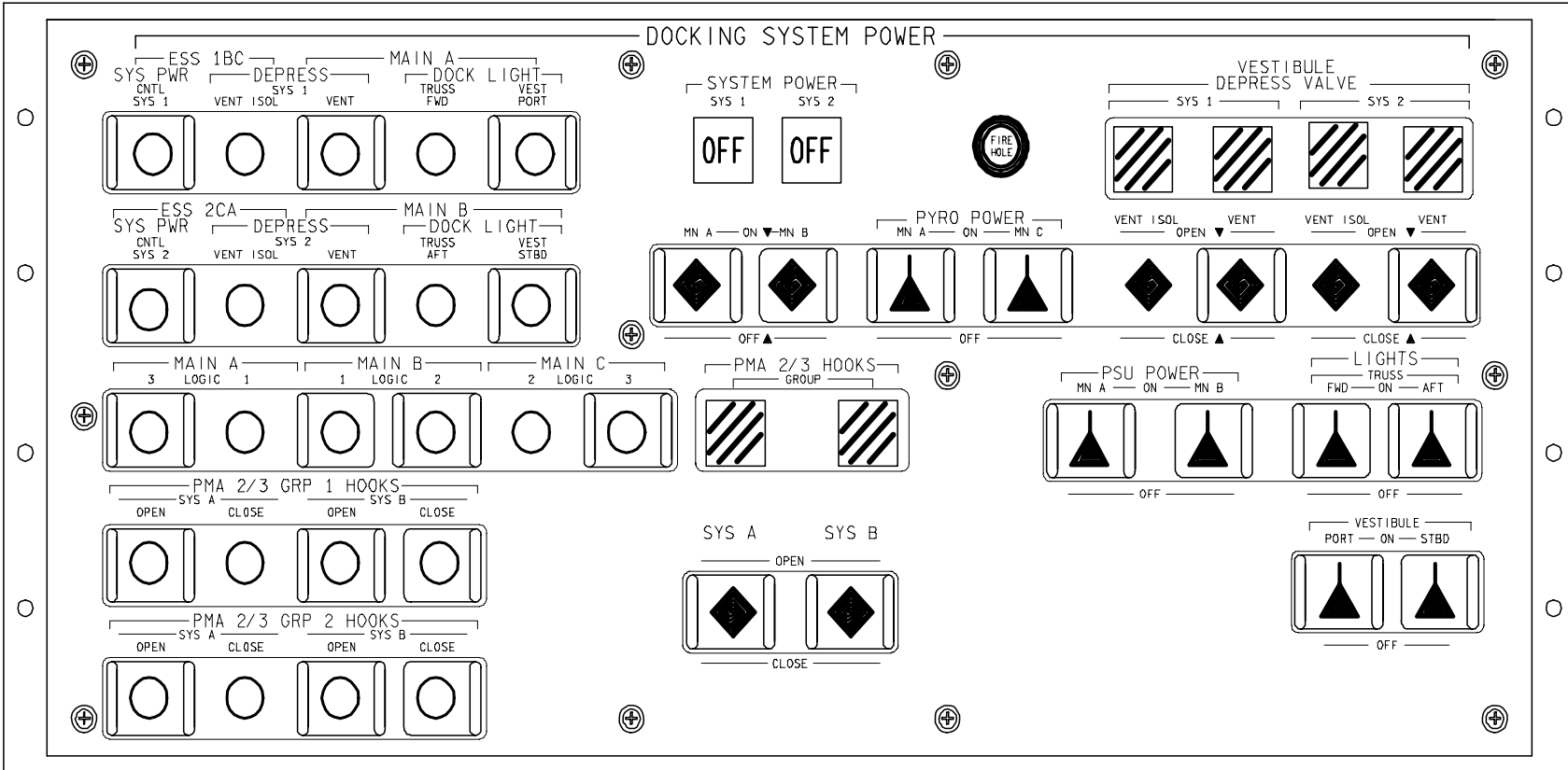

OV104

CONTROL PANEL POWER

A ON OFF B ON OFF C ON OFF

HEATERS/DCU POWER

H1 ON OFF H2/DCU ON OFF H3/DCU ON OFF

APDS POWER

A_{Ds} ON OFF B_{Ds} ON OFF C_{Ds} ON OFF

STATUS

POWER	ON	INITIAL	CONTACT
APDS PROTECT	CIRCUIT OFF	CAPTURE	CAPTURE
RING	ALIGNED	RING	FORWARD POSITION
RING	INITIAL POSITION	TO HOOK	
FIXERS	OFF	INTER	SEALED
HOOKS 1	OPEN	HOOKS 1	CLOSED
HOOKS 2	OPEN	HOOKS 2	CLOSED
LATCHES	CLOSED	LATCHES	OPEN
UNDOCK	COMPLET	RING	FINAL POSITION

PYROS

A_p ON OFF B_p ON OFF C_p ON OFF

Ap OFF Cp

FIRE HOLE

PYRO PROTECT **CIRCUIT OFF**

PYRO COMMANDS

PYRO CIRC PROT OFF PYRO CIRC PROT ON

ACT HOOKS FIRING PAS HOOKS FIRING

APDS CONTROL COMMANDS

OPEN HOOKS OPEN LATCHES

UNDOCKING

A_{Ds} OFF B_{Ds} C_{Ds}

LAMP TEST

PNL A7L

APDS CONTROL COMMANDS

POWER ON	POWER OFF	RING OUT	RING IN
APDS CIRC PROT OFF	CLOSE HOOKS	CLOSE LATCHES	FIXER OFF

APDS CONTROL PANEL

OV104

A15

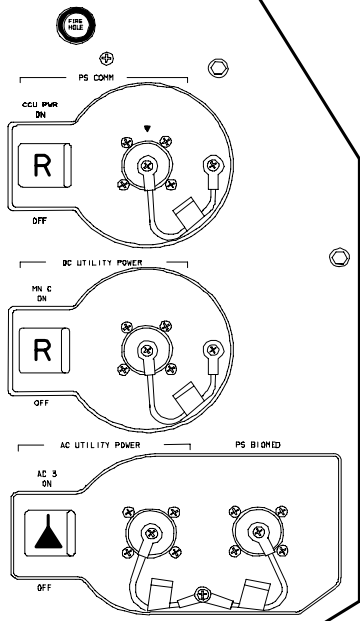
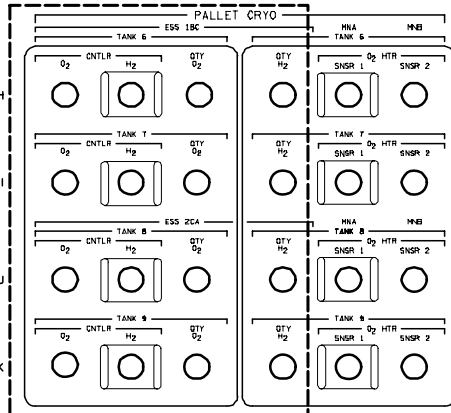
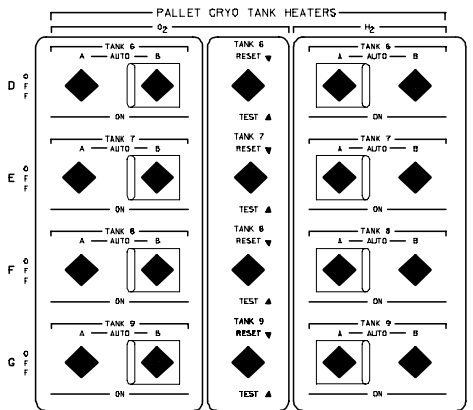
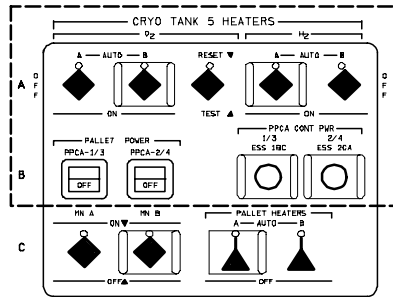

▶ cbs CLOSED FOR EDO MISSIONS

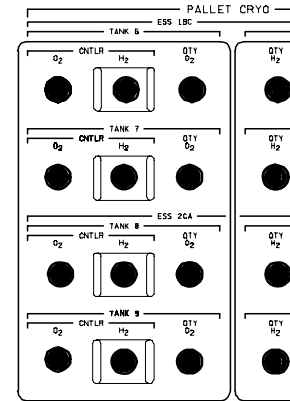

OV104

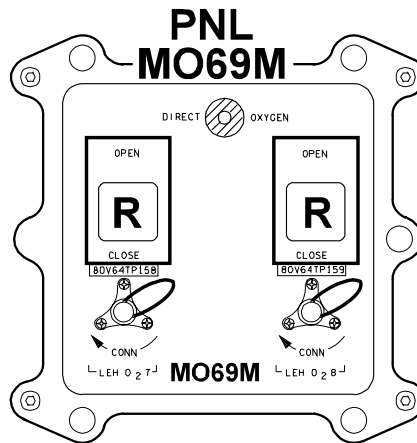
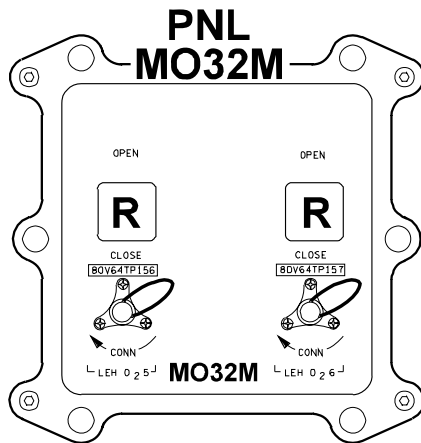
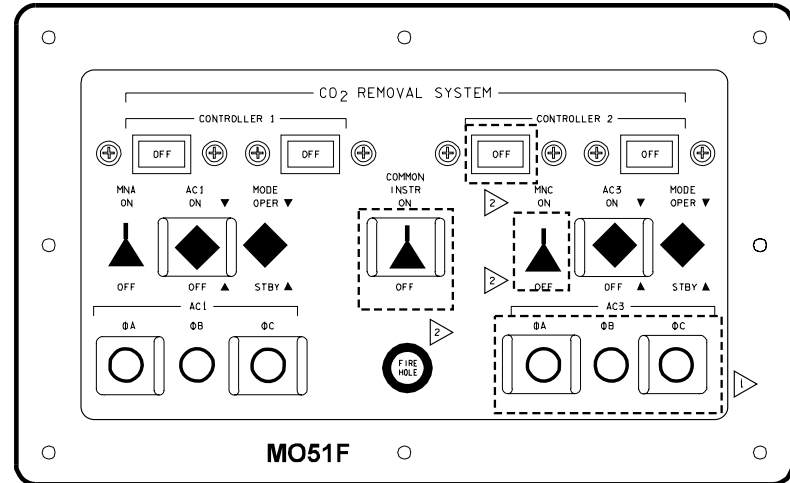
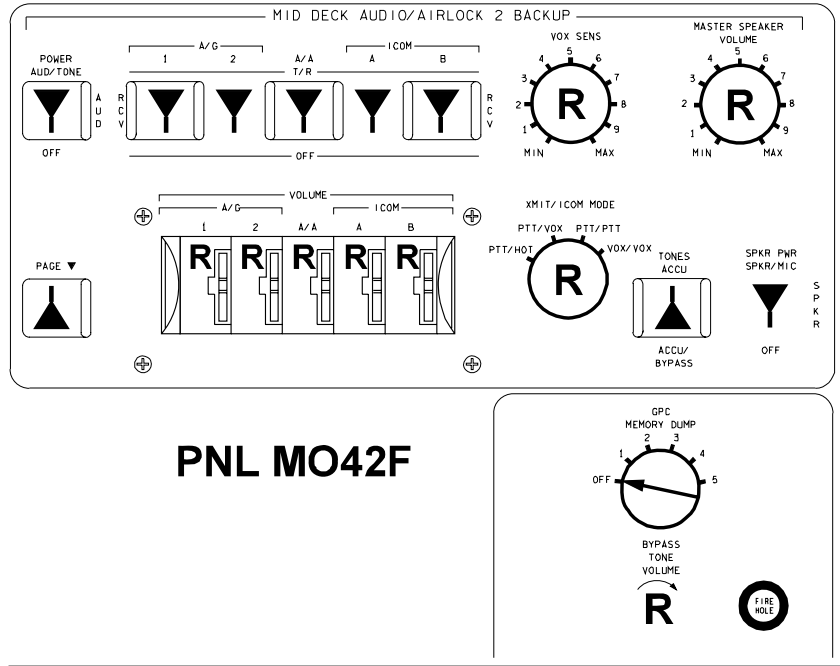

NOTES: ▷ CLOSED IF CO2 RMVL SYS FLOWN
▷ ON IF CO2 RMVL SYS FLOWN

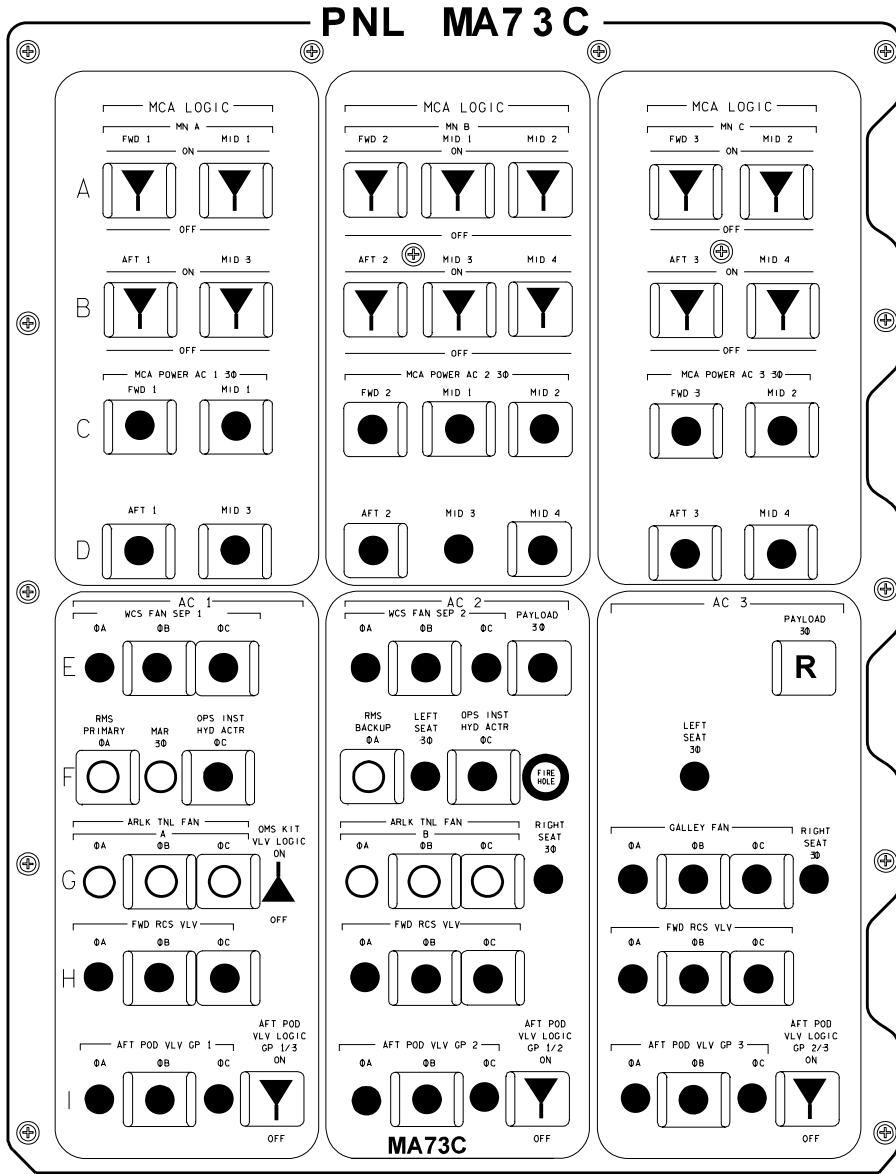

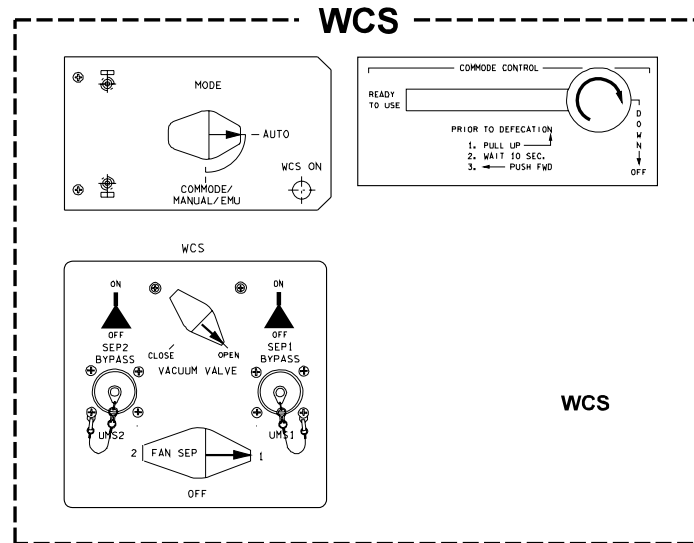
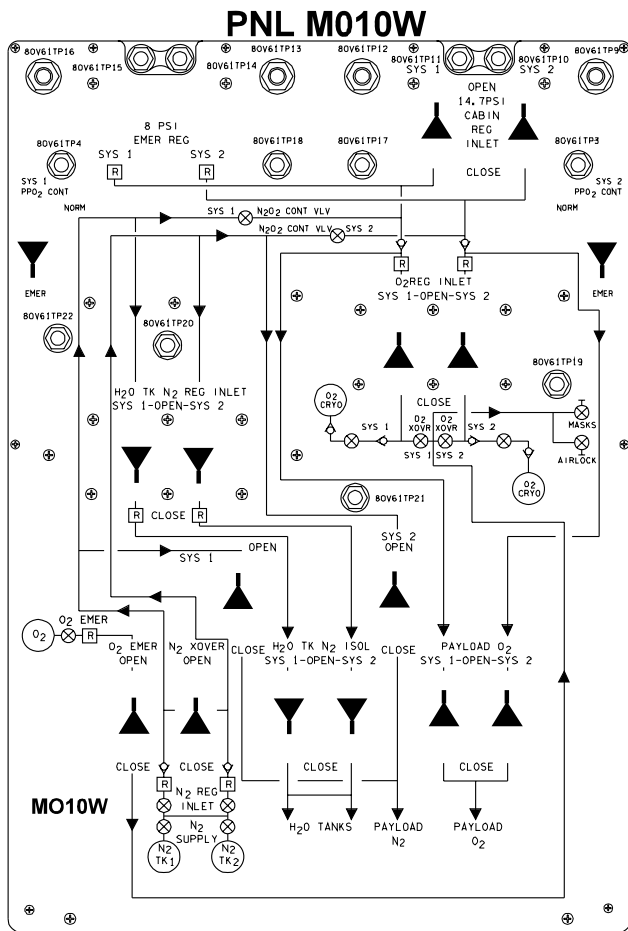

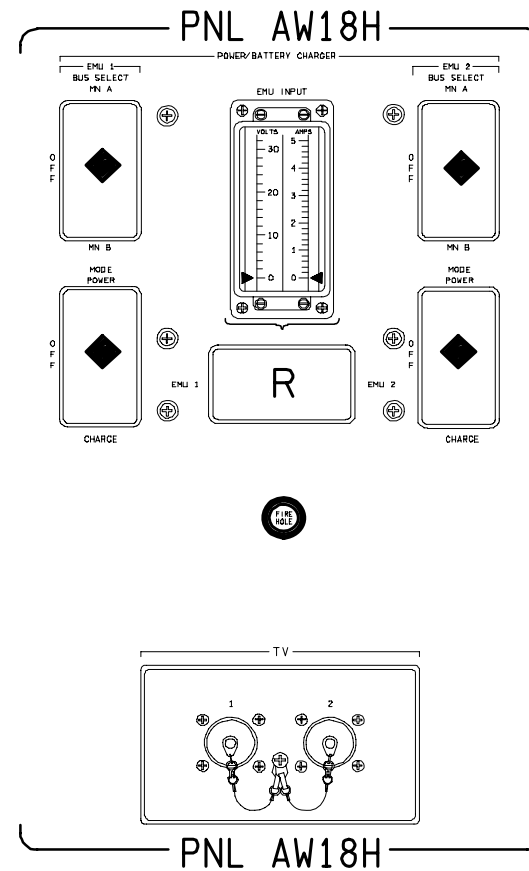
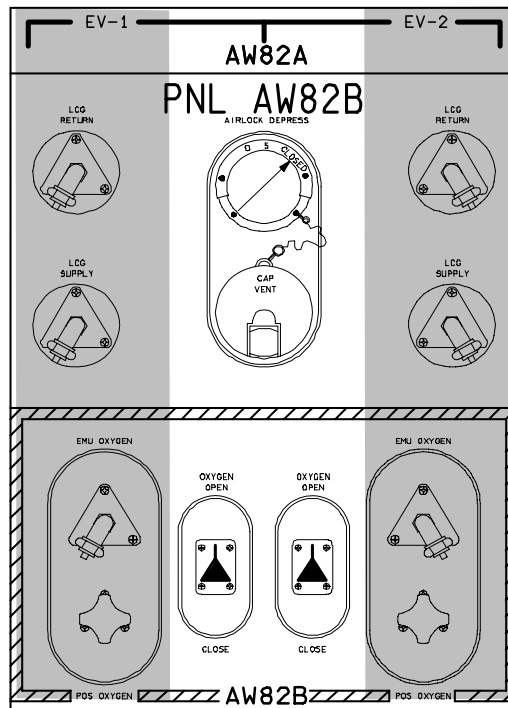
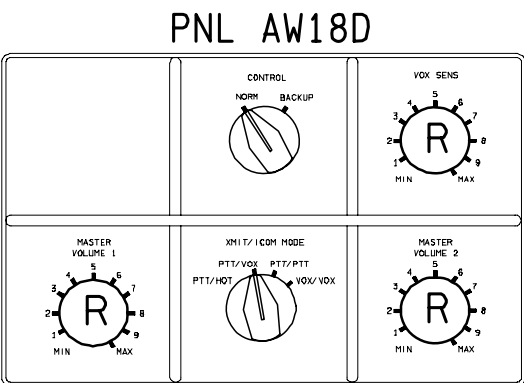
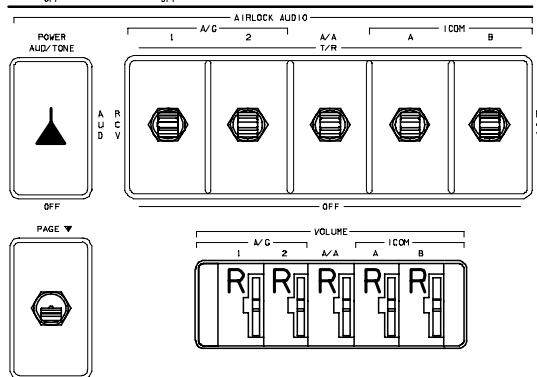
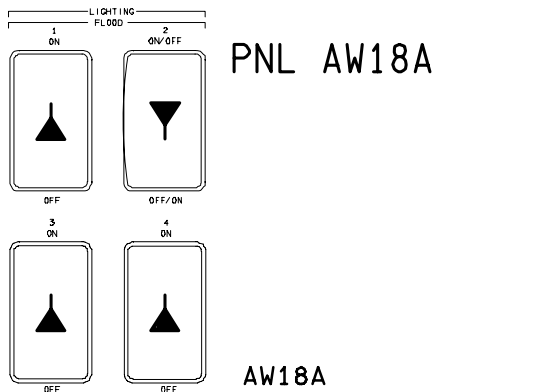

OV105

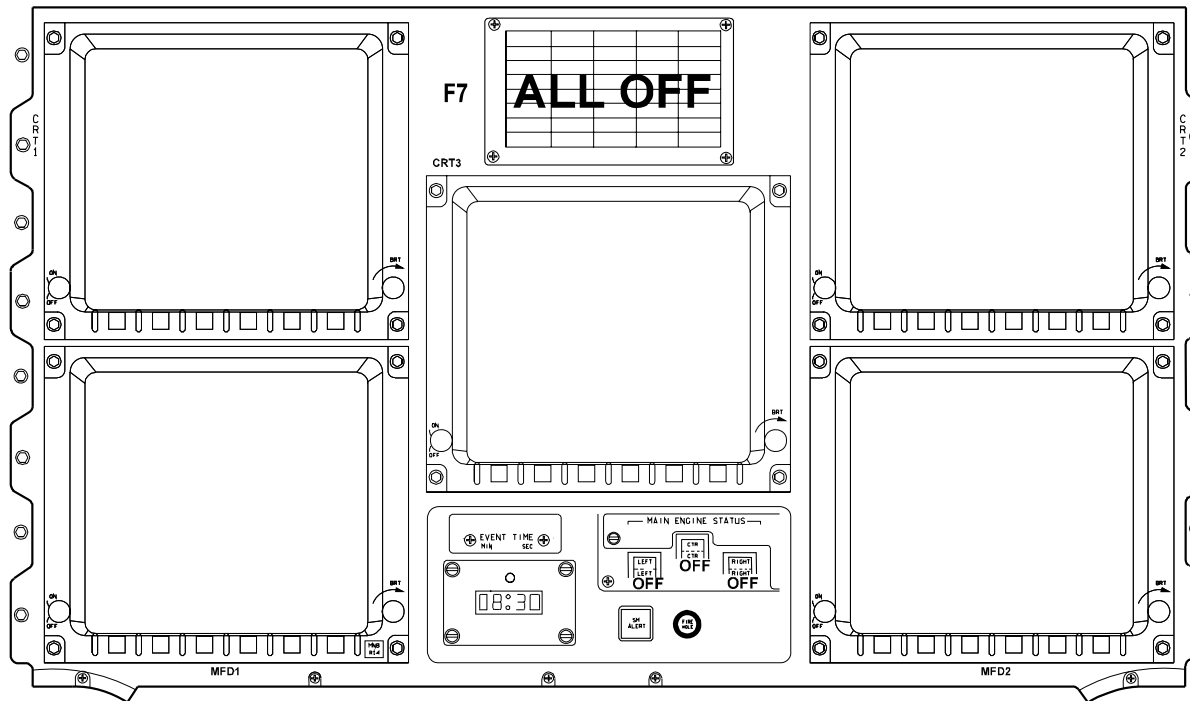
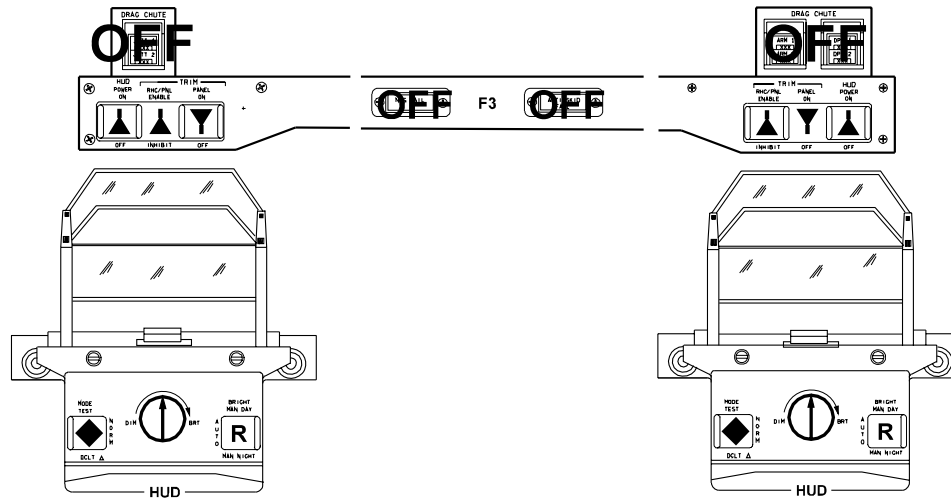

OV105

OV105

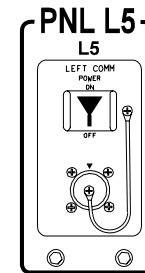
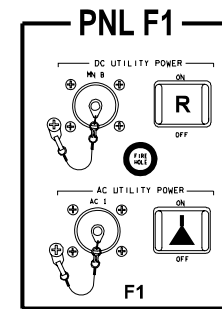
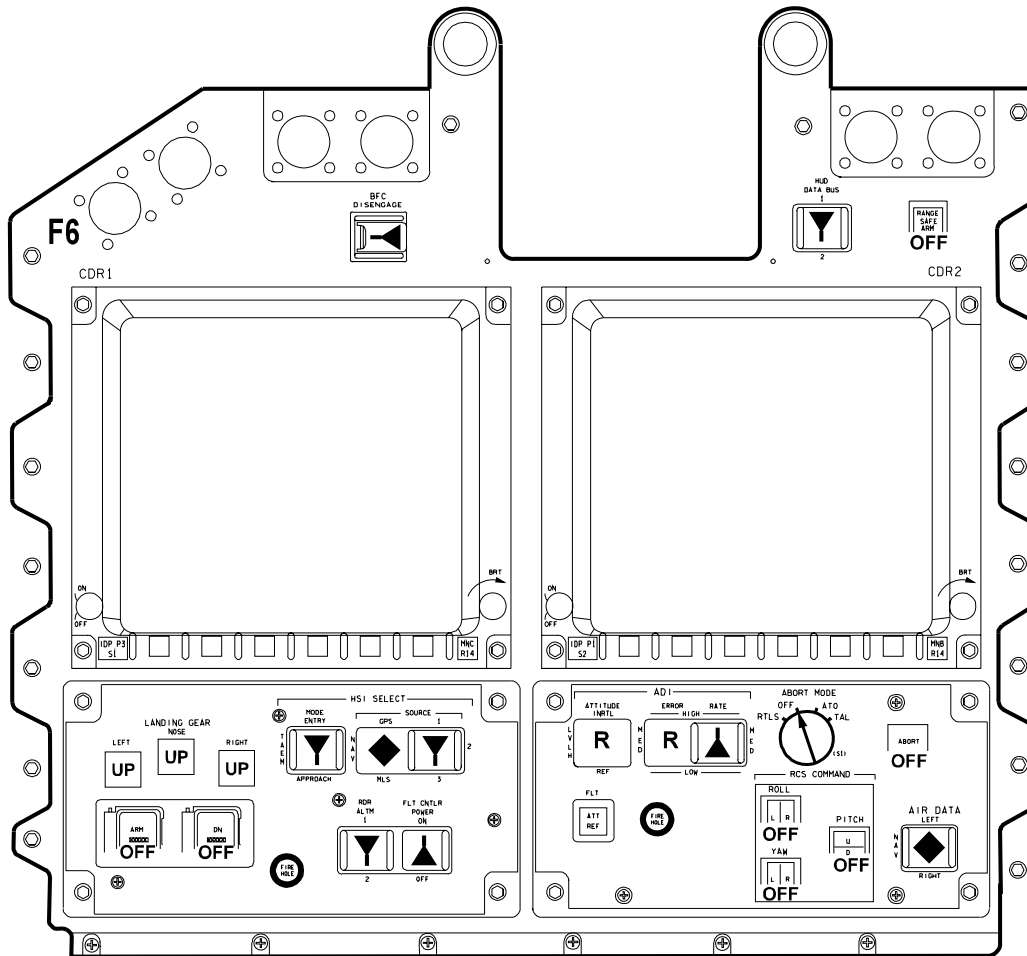

OV105

PNL O8

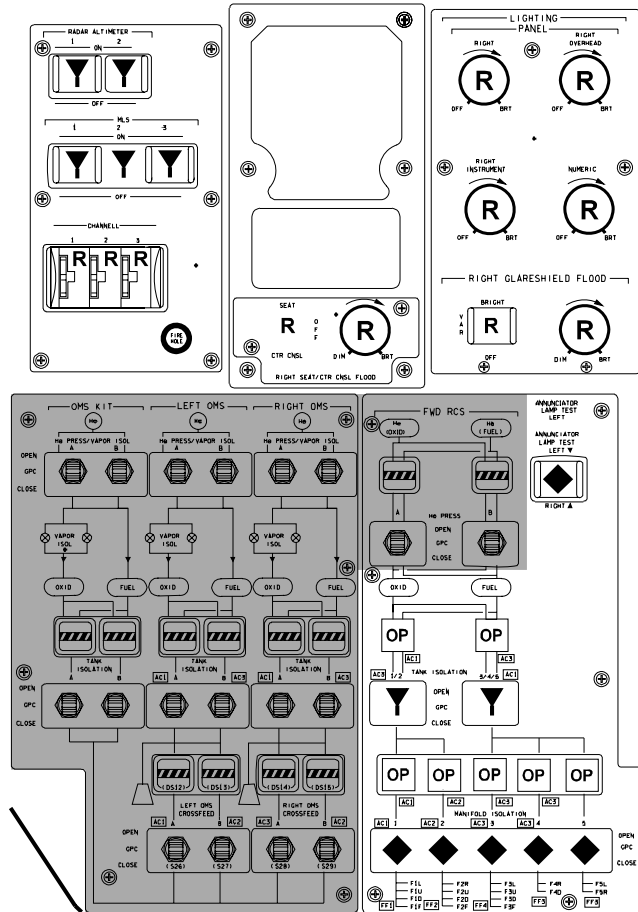

R side OVHD flood - R (MID)

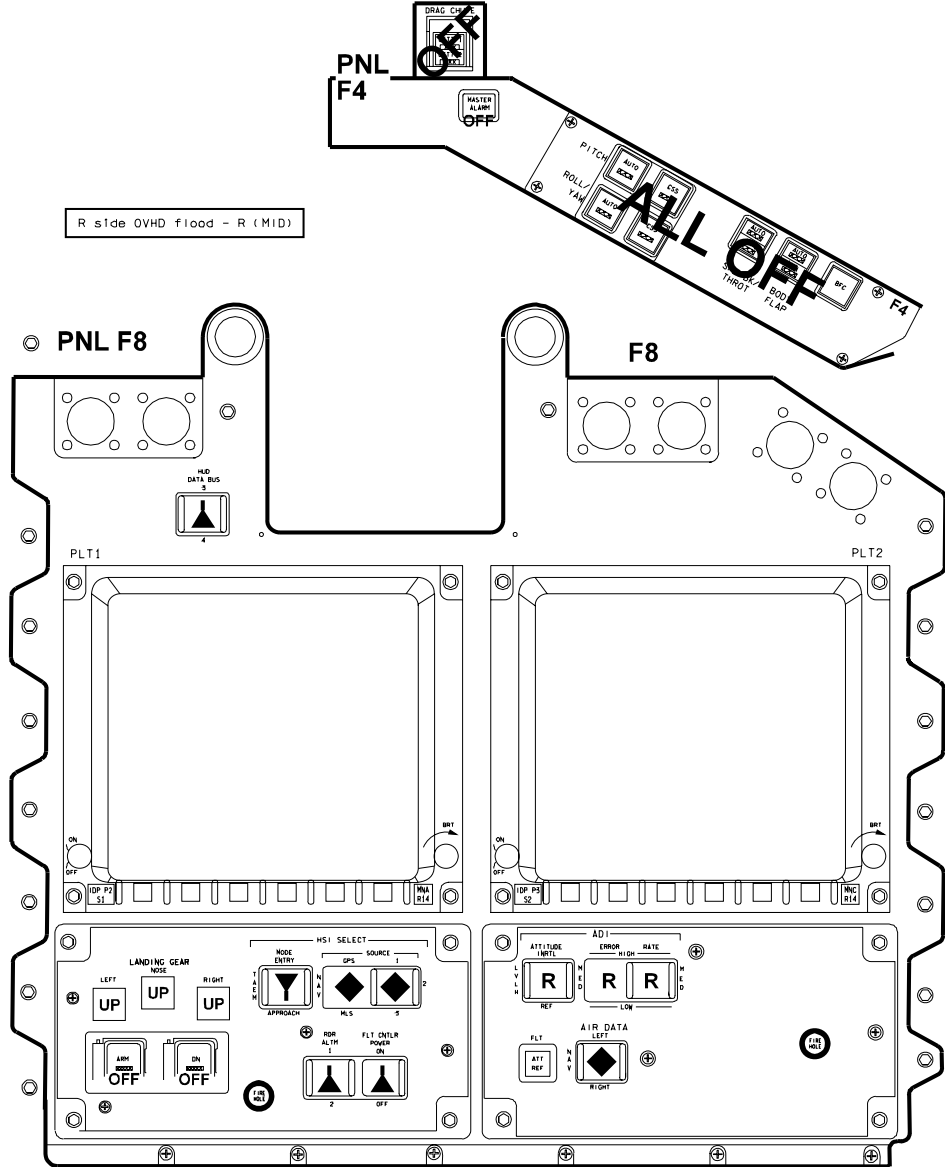

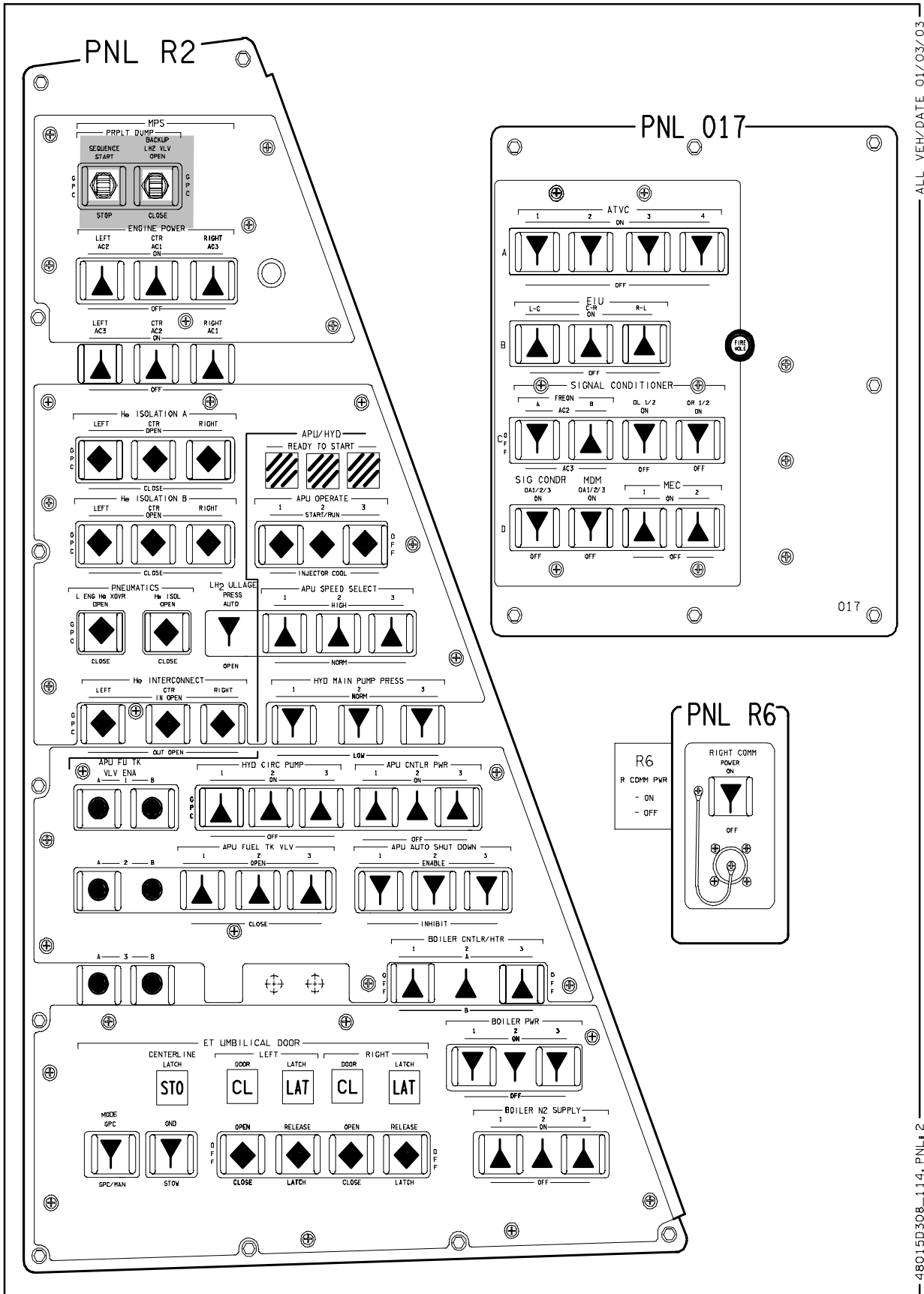

ALL VEH/DATE 01/03/03

48015D308_114, PNL 2

OV105

(OV105) C3-8

D/O/ALL/GEN Q

OV105

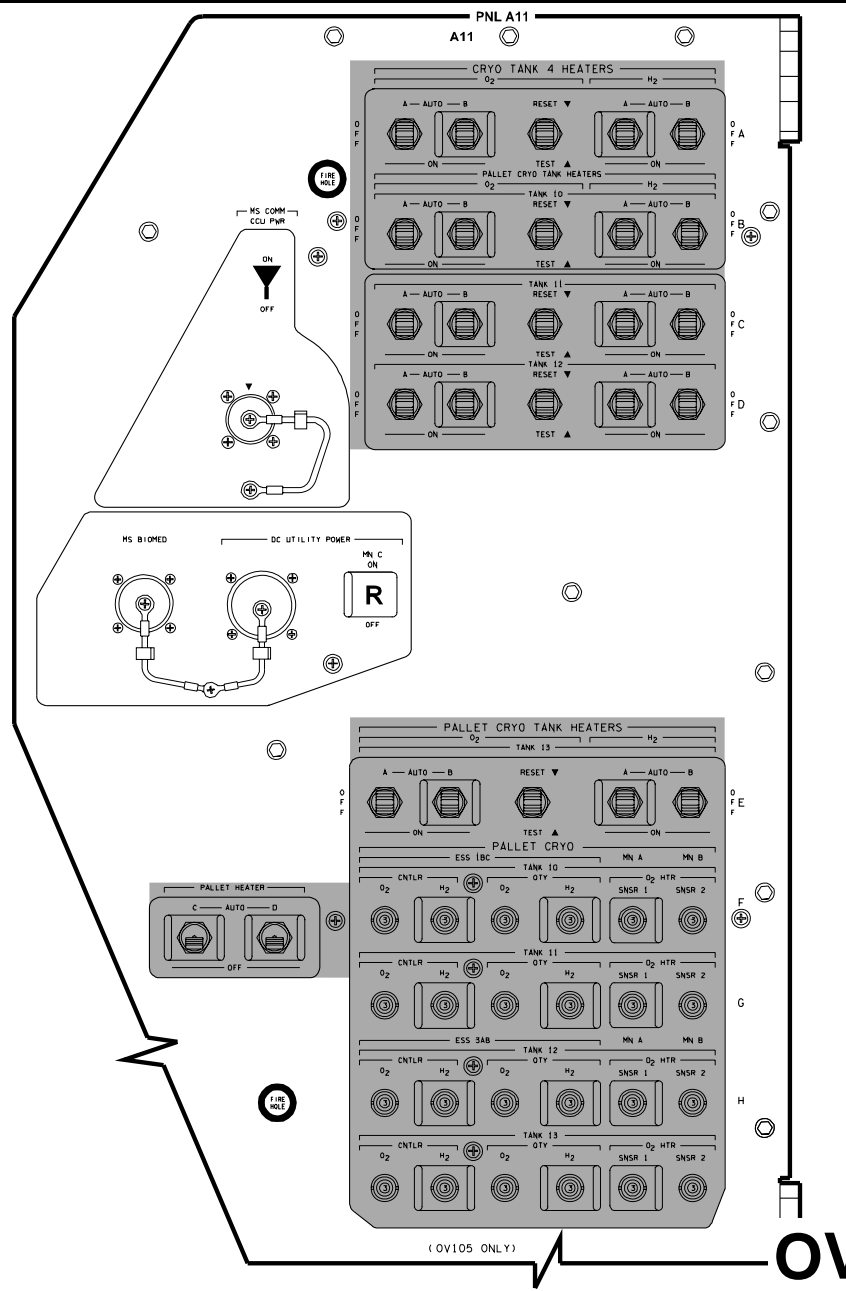
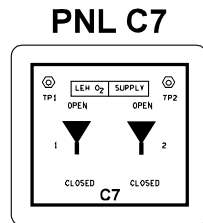
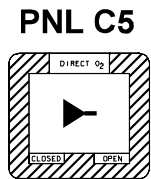

OV105

PNL MO58F

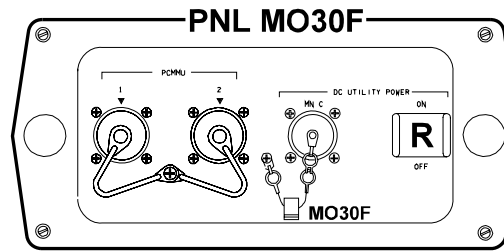
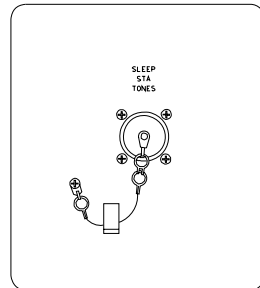

AIRLOCK HATCH

ACTUATOR HANDLE - LATCHED
 LOCK LEVER - LOCKED
 EQUALIZATION VLV (TWO) - NORM
 -CAPS INSTALLED

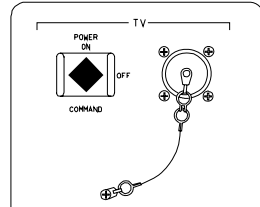

PNL MD24K

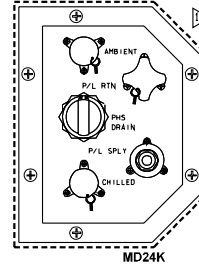

PNL MD44F

CAB TEMP CNTL ACT LINKAGE - SECONDARY ACTUATOR

NOTE: NOT VISIBLE IF MAR FLOWN

PNL MO39M

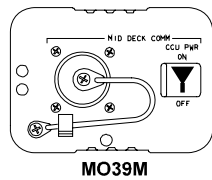

PNL MO52J

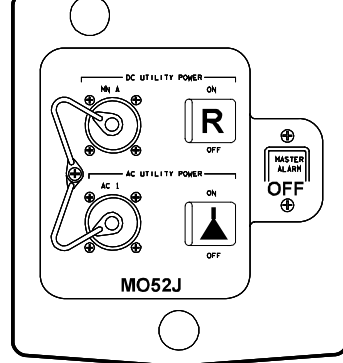

PNL ML85E

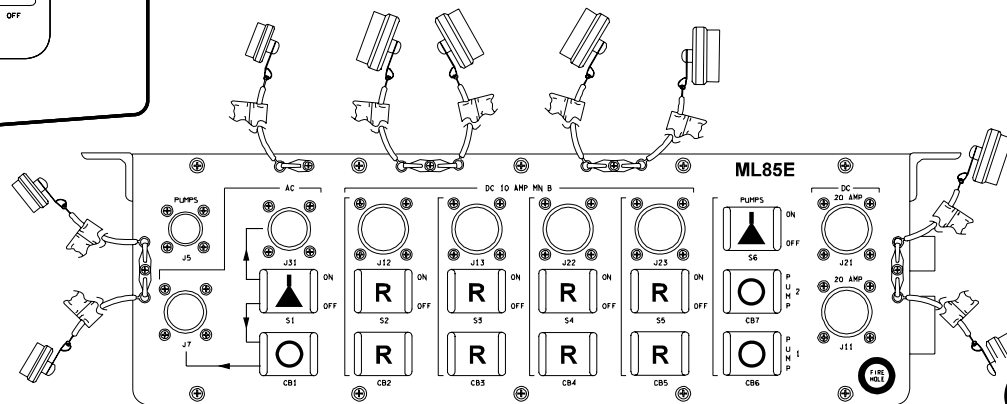

OV105

OV105

PNL ML86B

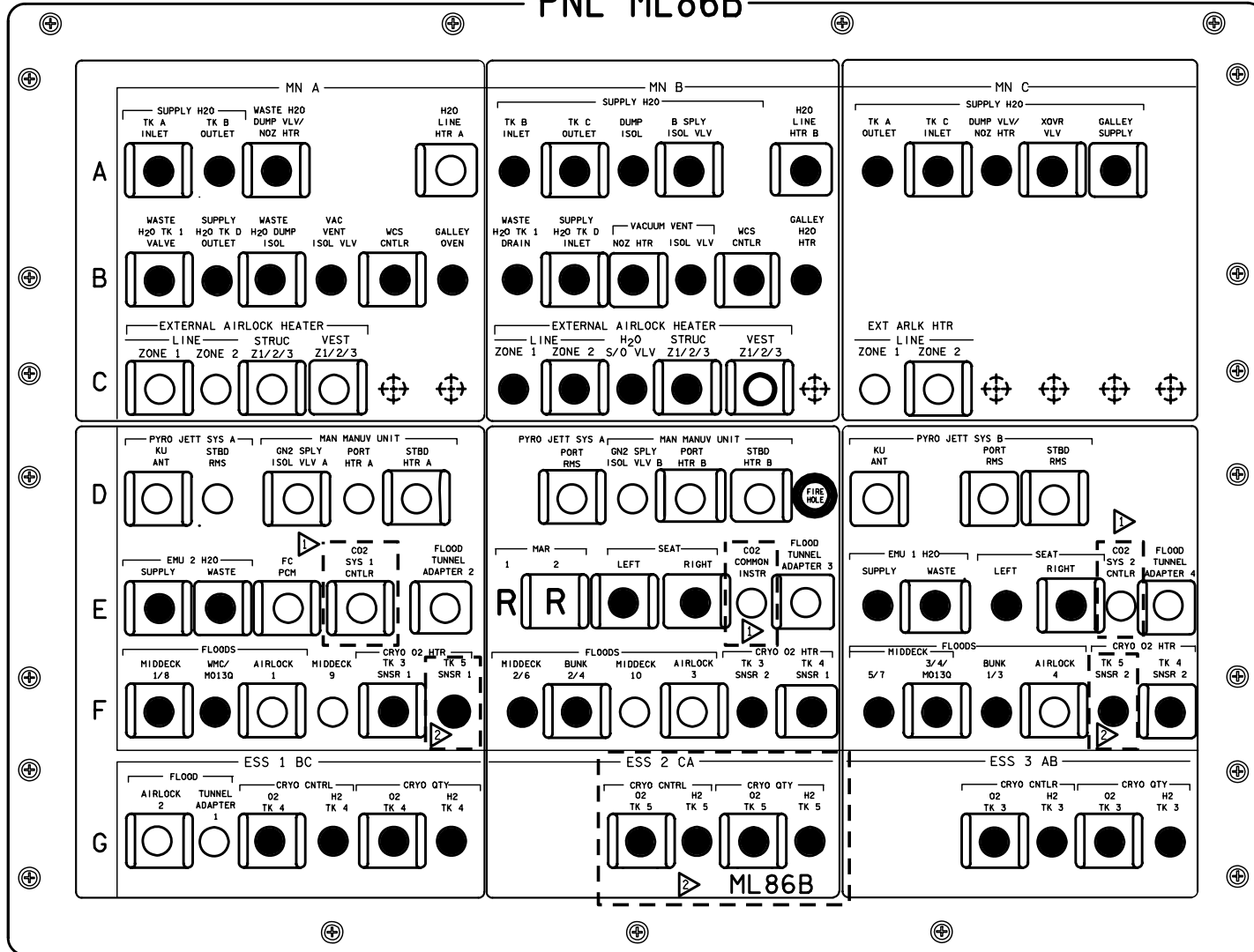

NOTES: ▷ CLOSED IF CO2 RML SYS FLOWN

▷ OPEN IF TK 5 NOT FLOWN

OV105

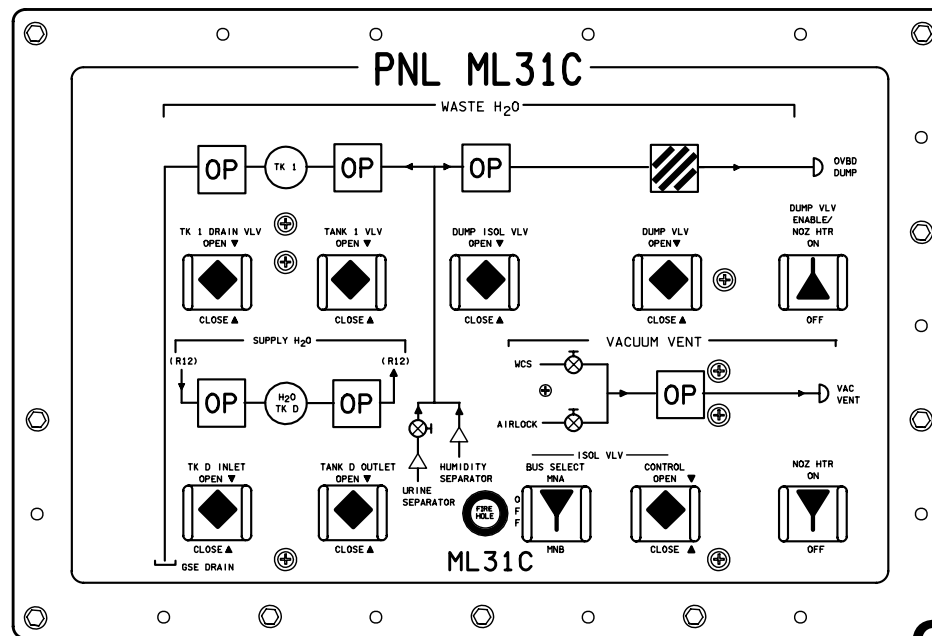
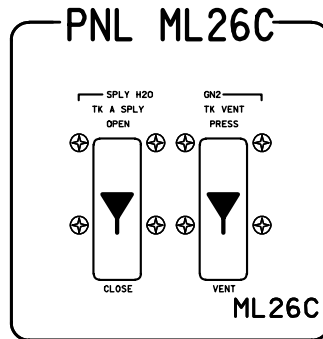
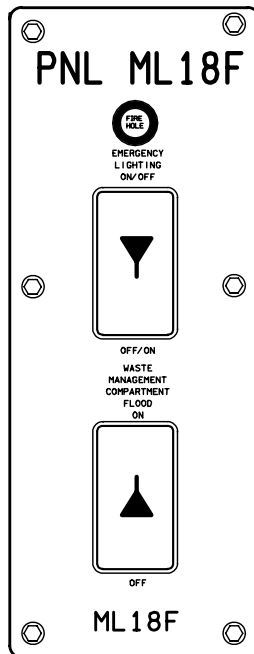
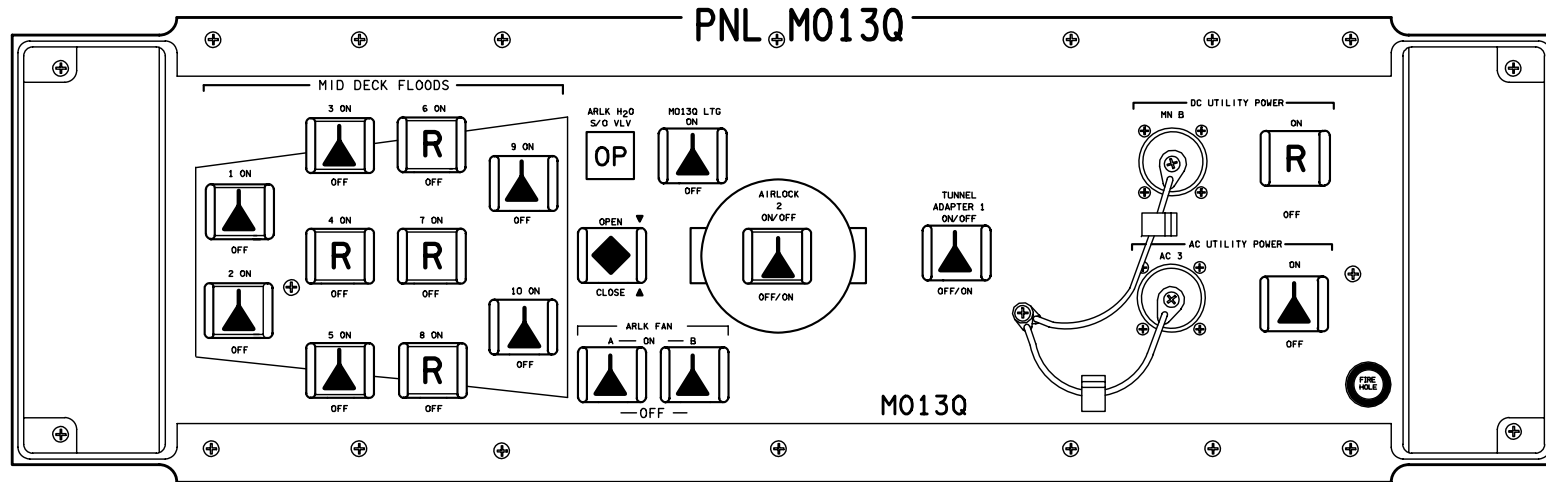

OV105

PNL L4

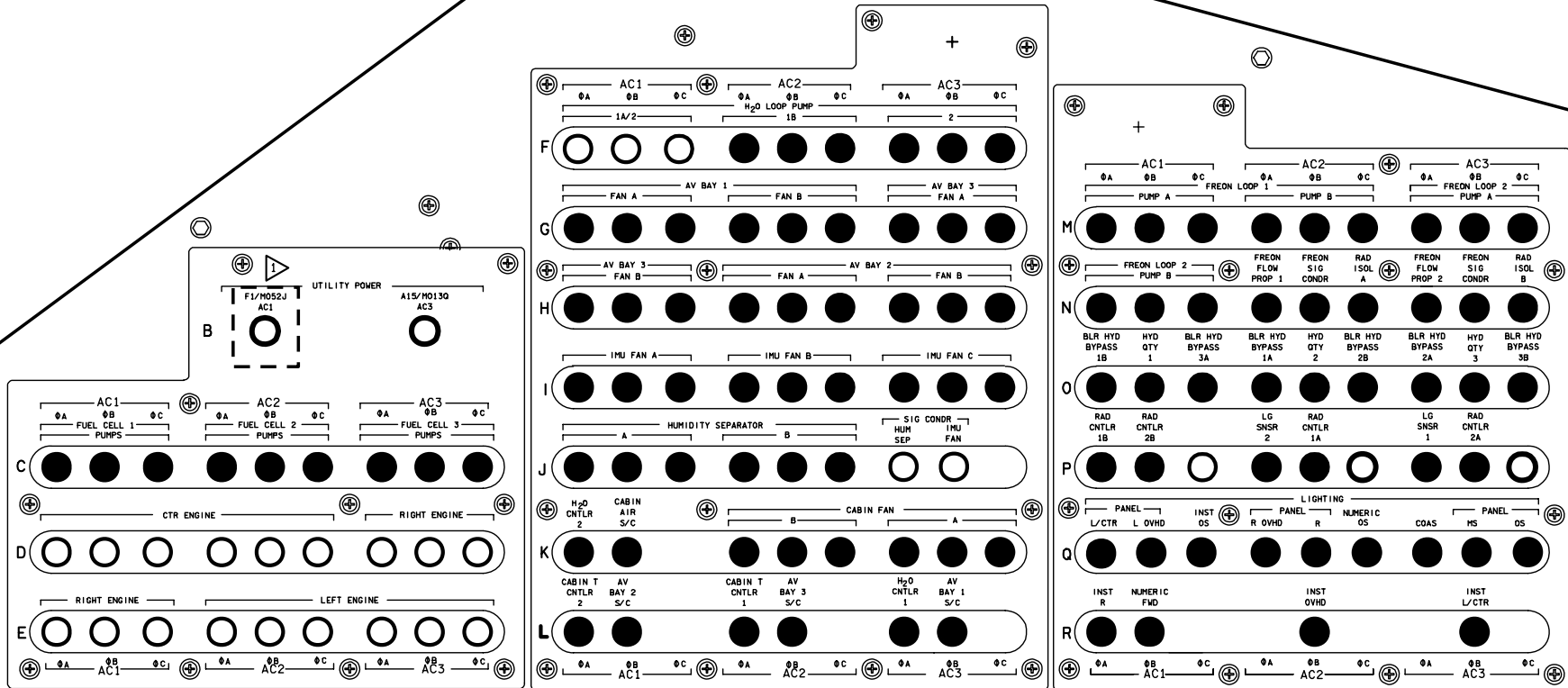

NOTE: CB CAN REMAIN CLOSED FOR AC PGSC USAGE. OPEN WHEN PGSC UNPOWERED/STOWED

48015D313_114. PNL 3

OV105/DATE 11/23/04

(OV105) C3-13

OV105
D/O/5/GEN Q

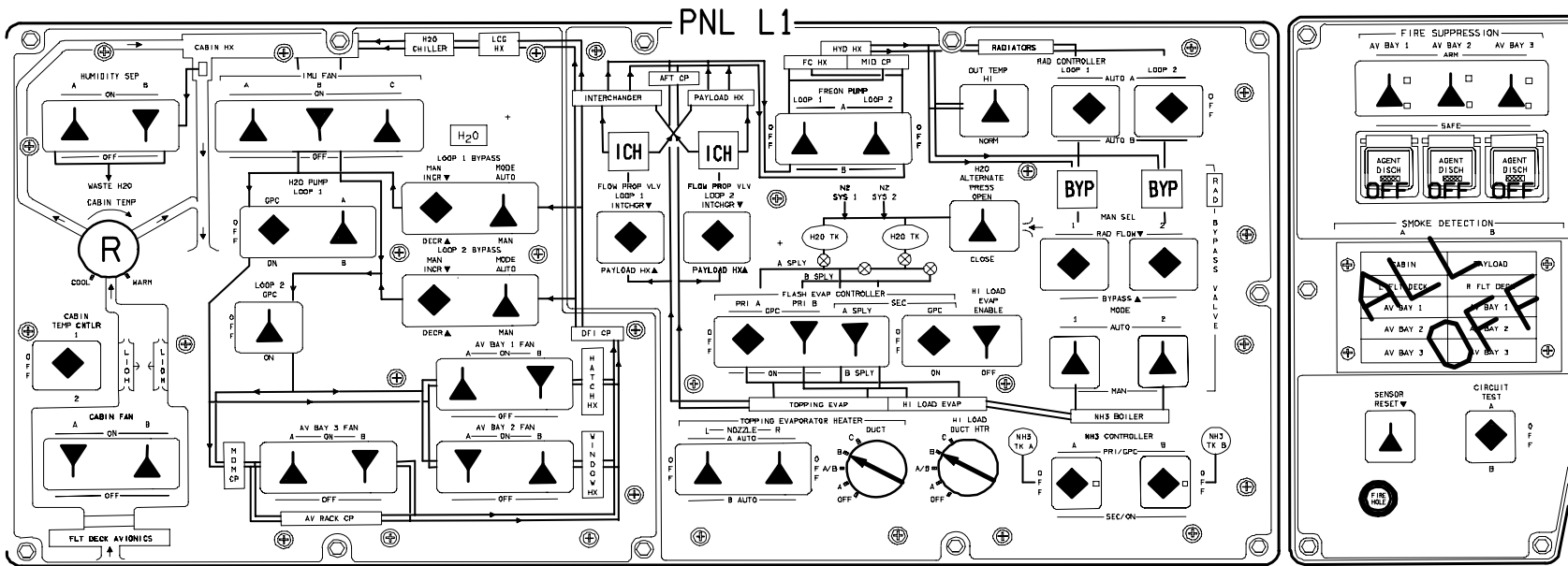

OV105

OV105/DATE 01/28/11

PNL L2

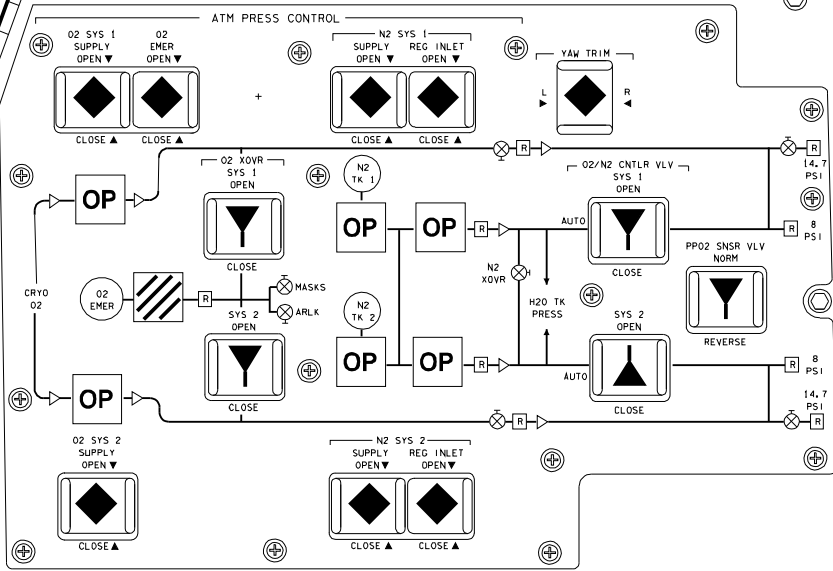
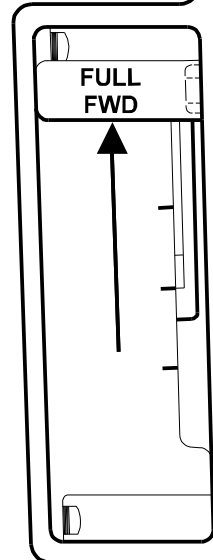
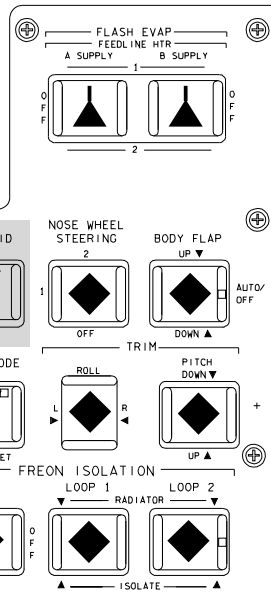
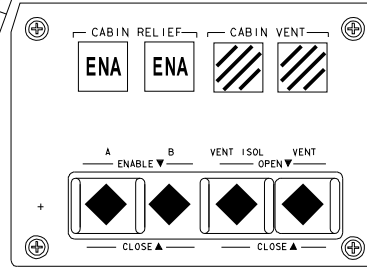

48015D315_134_PNL# 1

OV105

PNL C2/C3

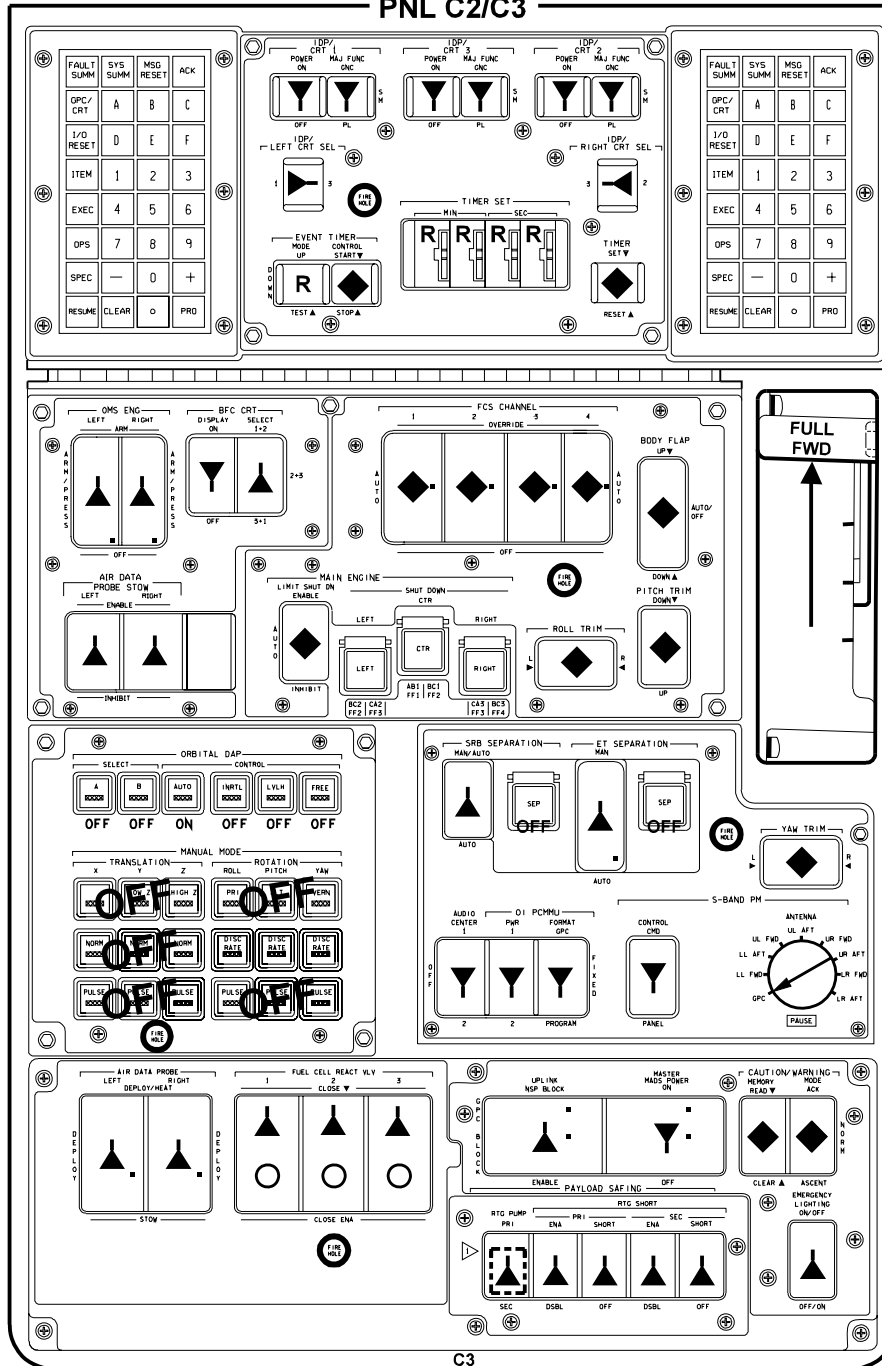

C3

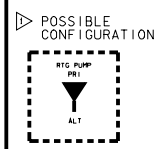

OV105/DATE 03/26/07
48015G316_118_PNL 2

OV105

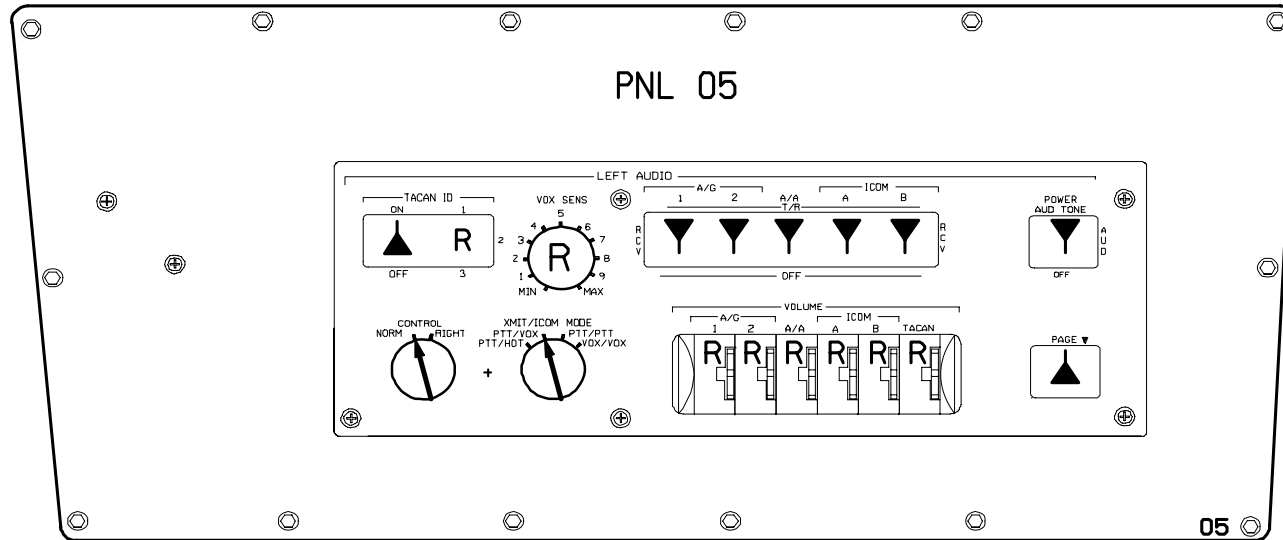
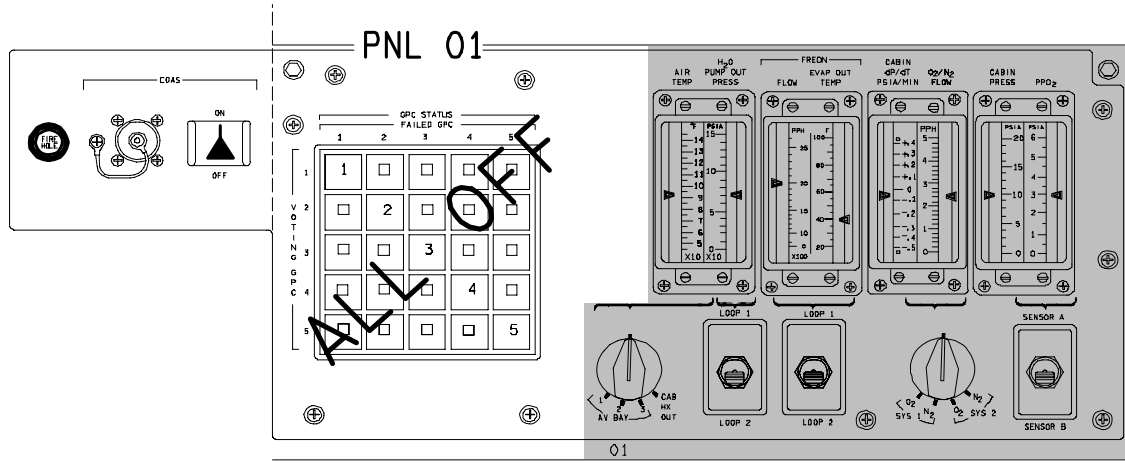

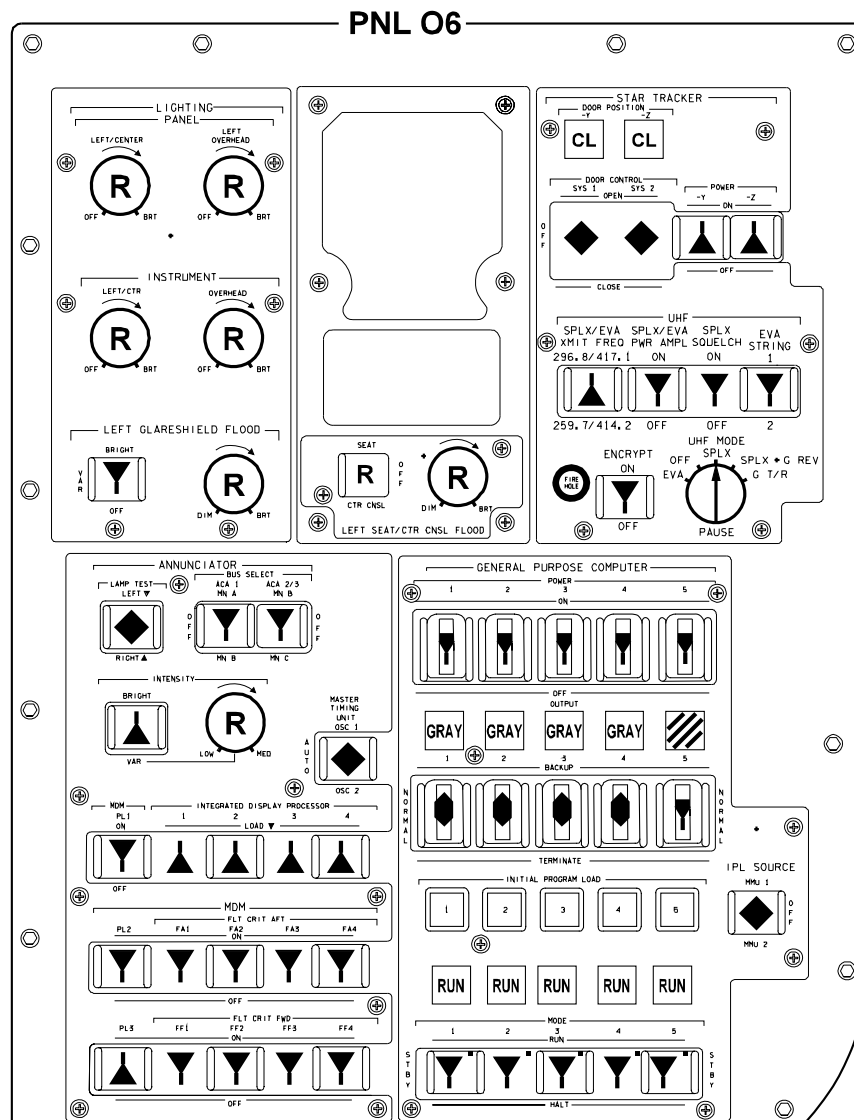

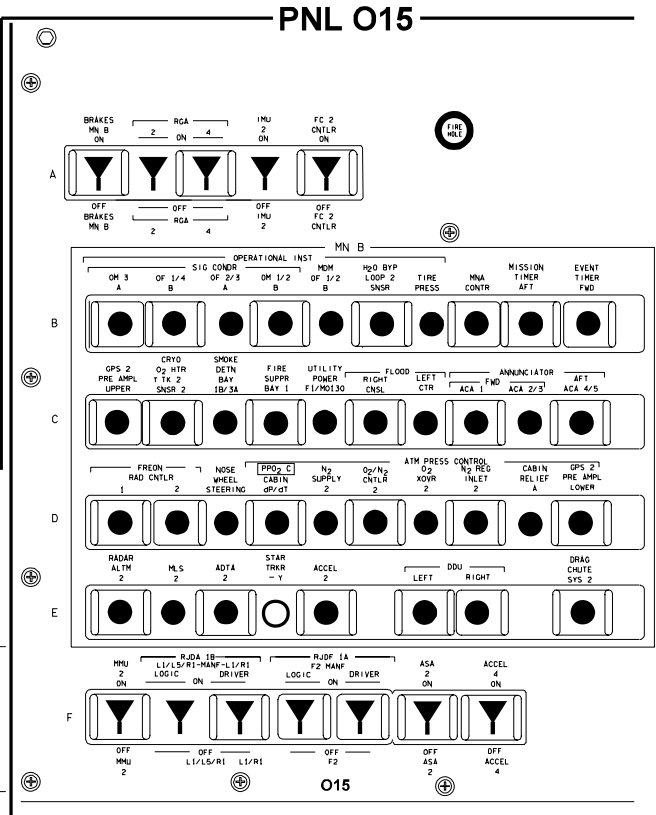
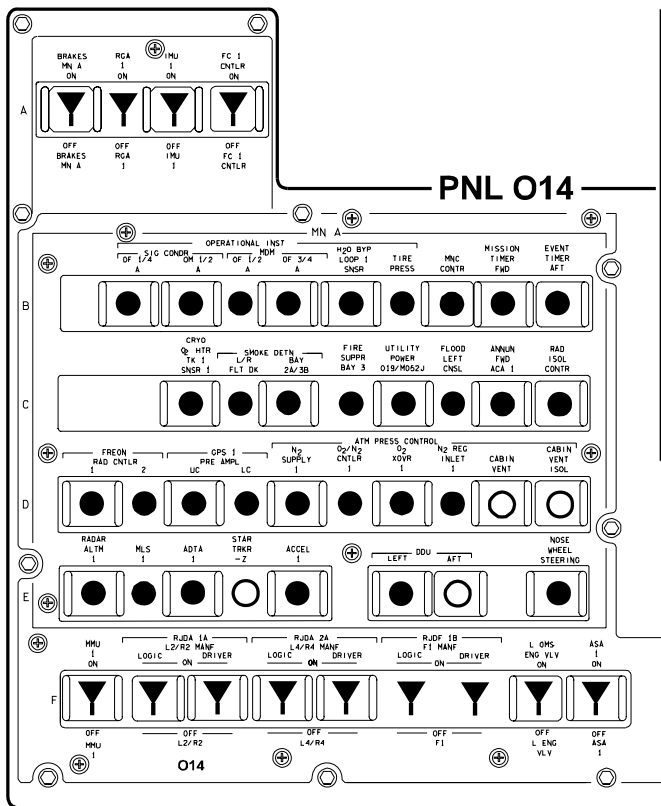

OV105

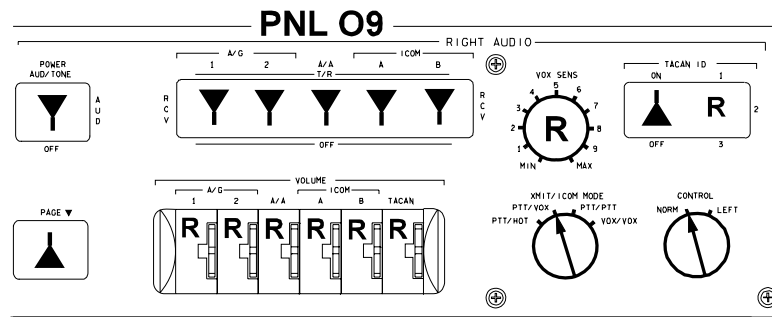
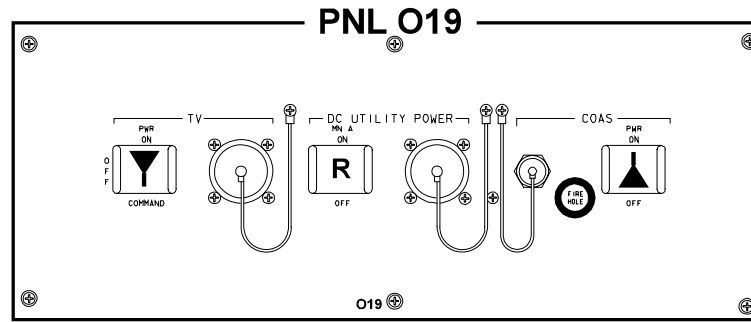
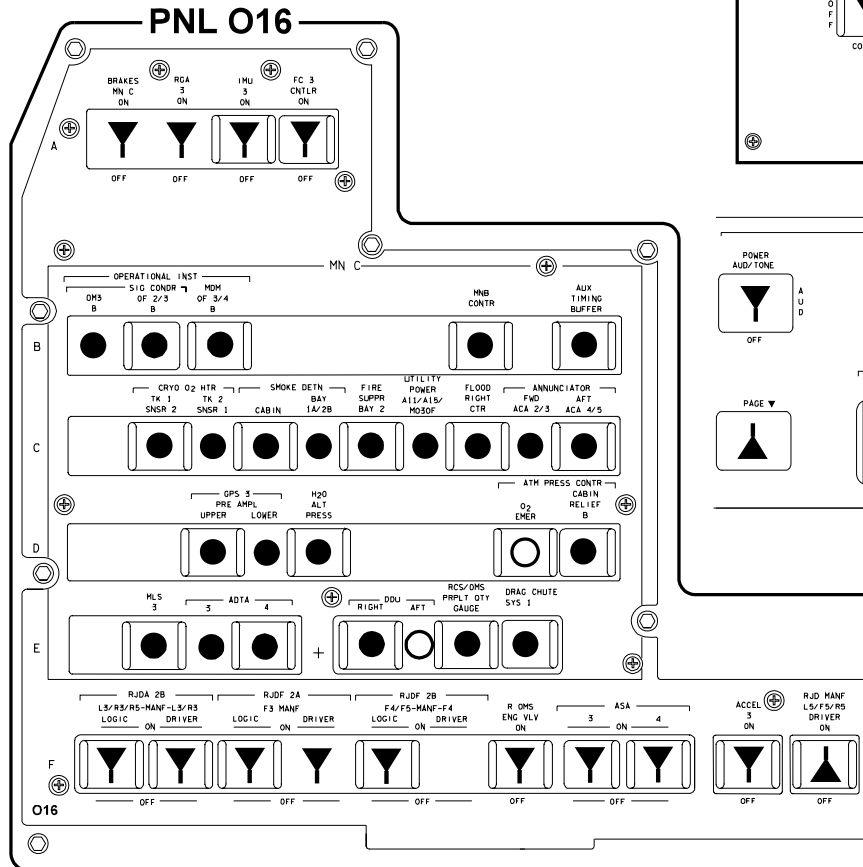

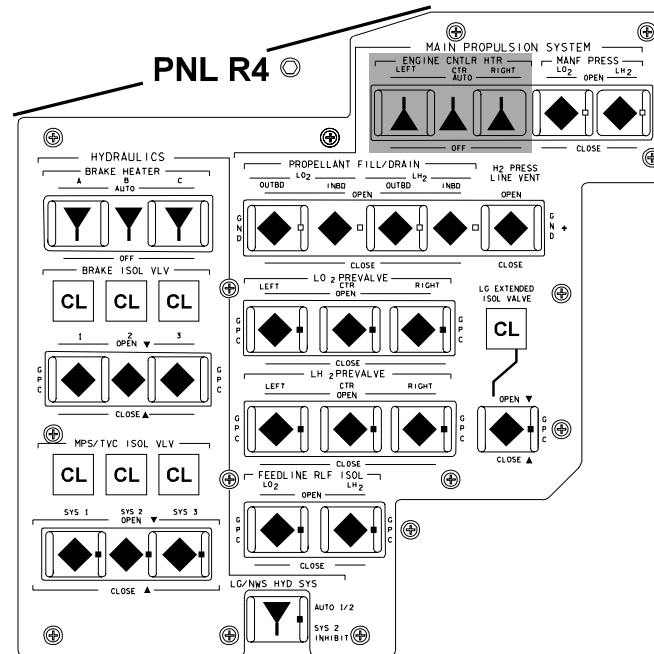
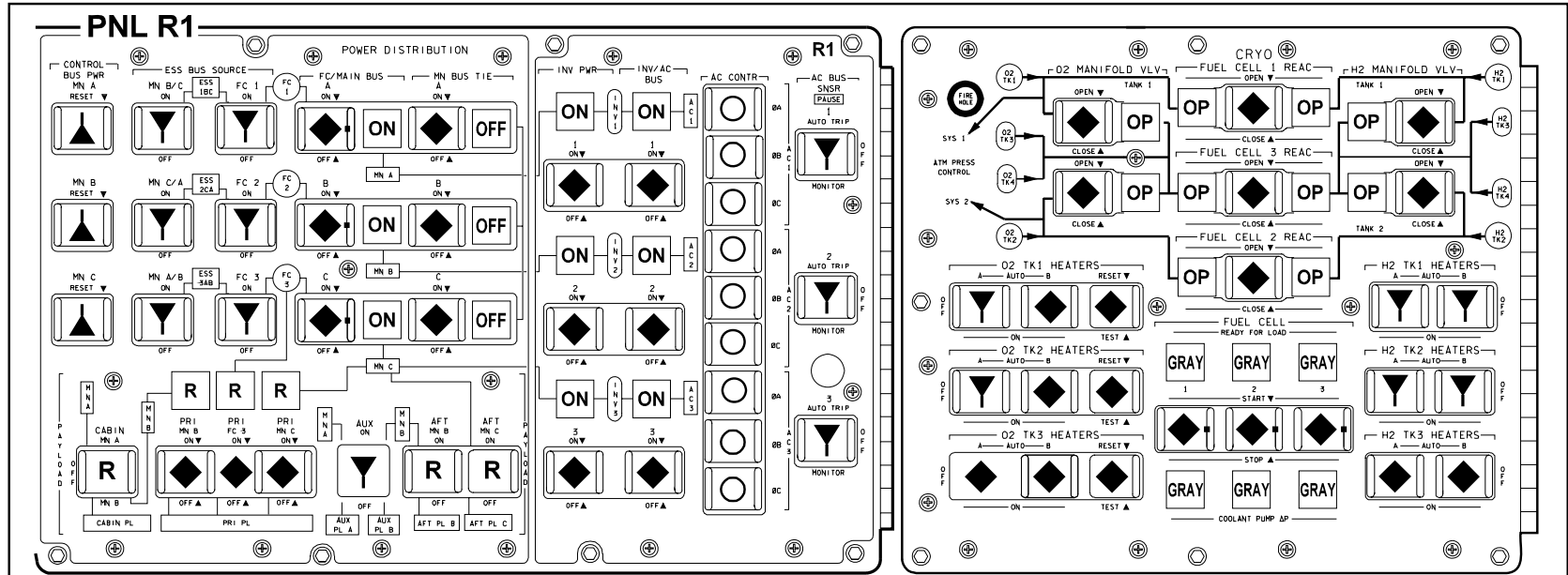

OV105

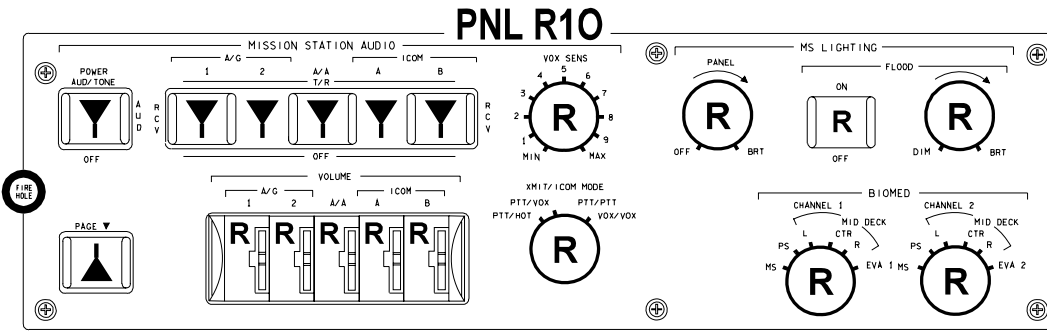

ACTIVATION
 R10 MS AUD PWR - AUD/TONE
 All other sws - as reqd
 R12 MS AUD CONTL - NORM
 A11 MS COMM CCU PWR - ON

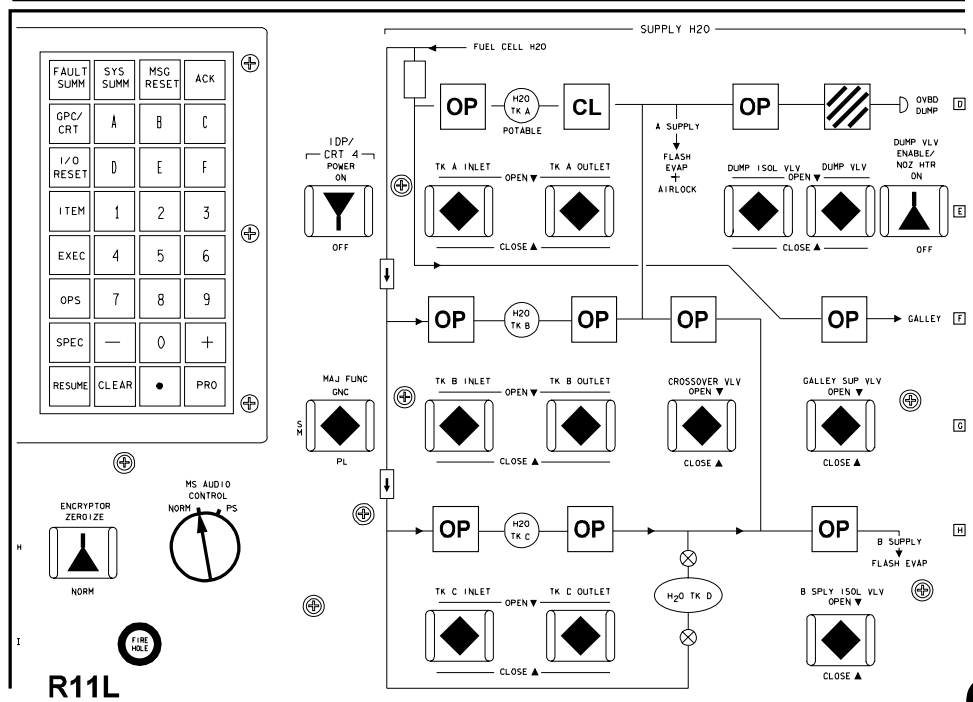
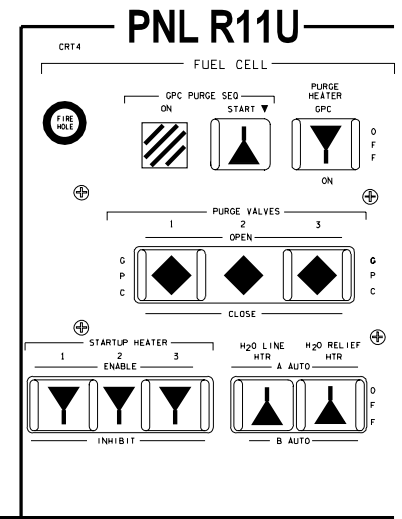

OV105

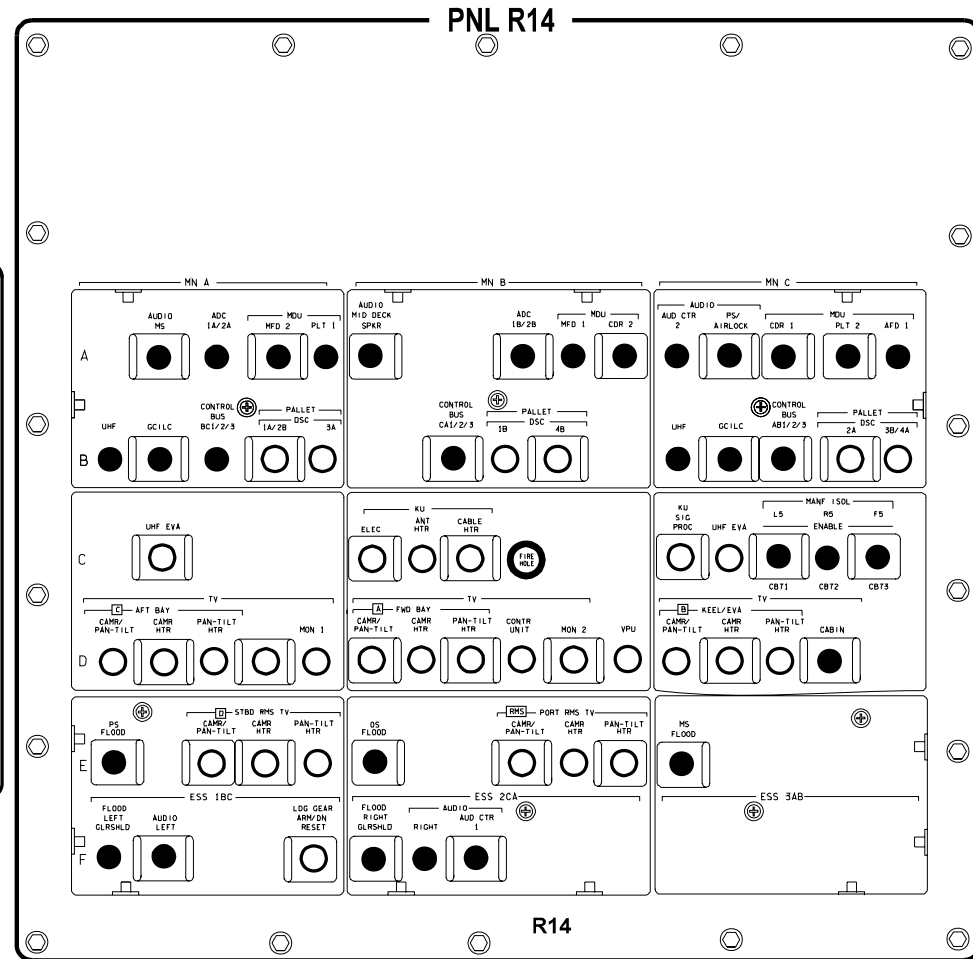
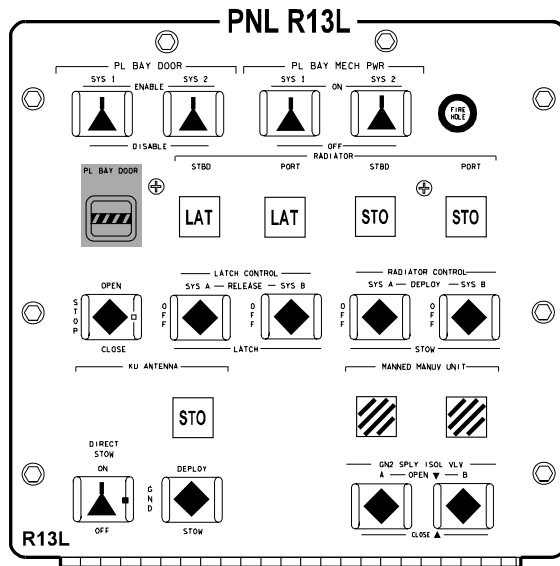

OV105

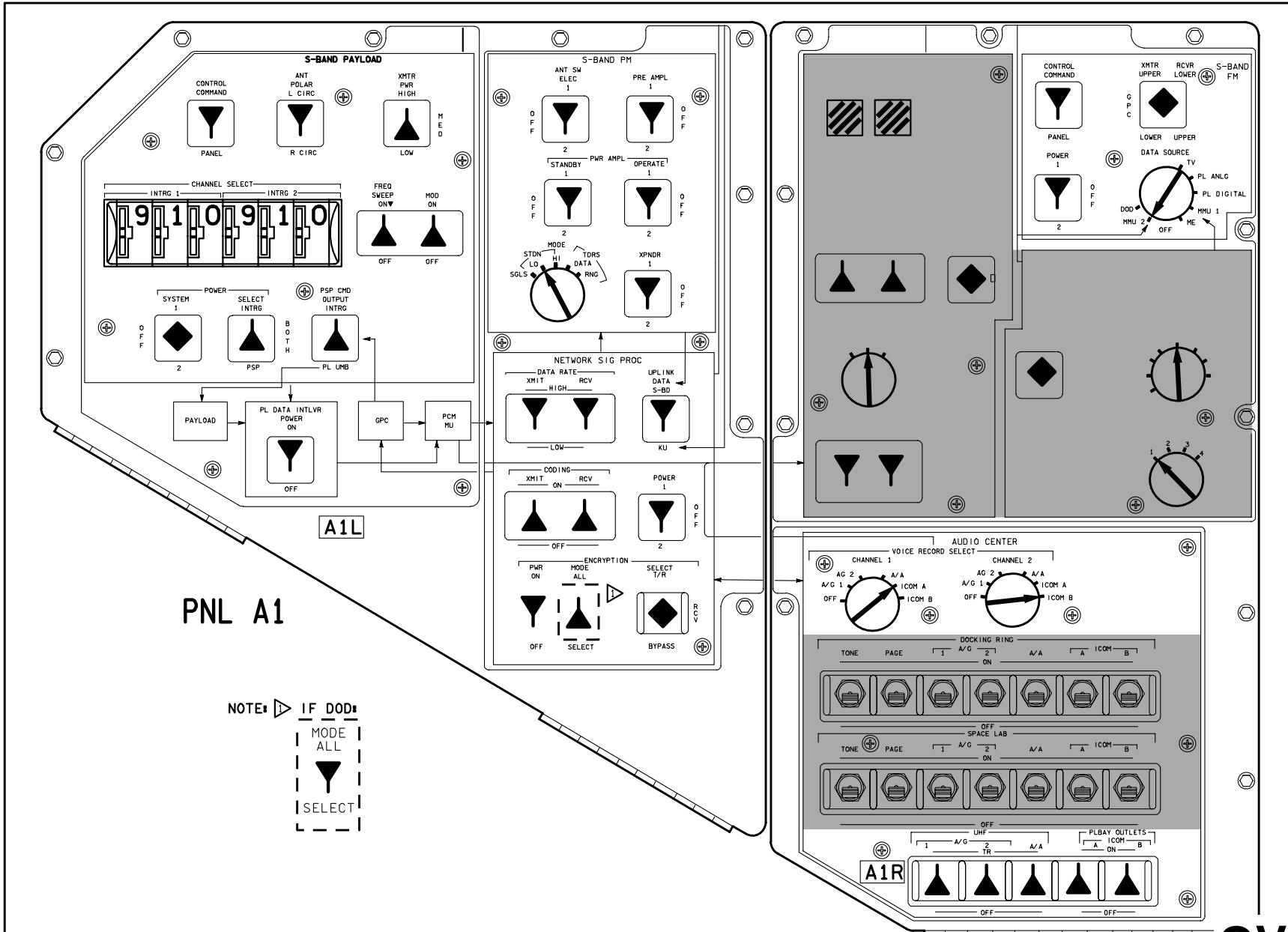

PNL A1

NOTE: IF DOD:
 MODE ALL
 SELECT

OV105

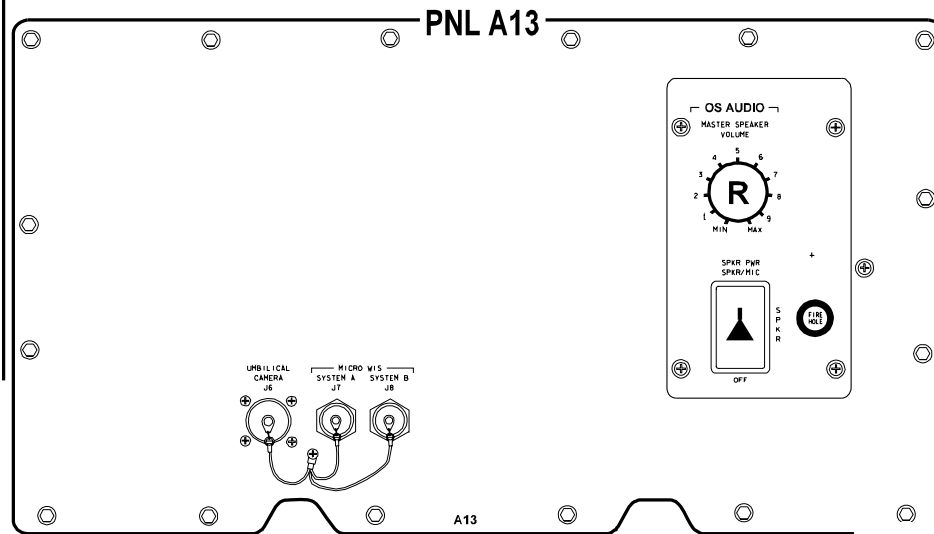
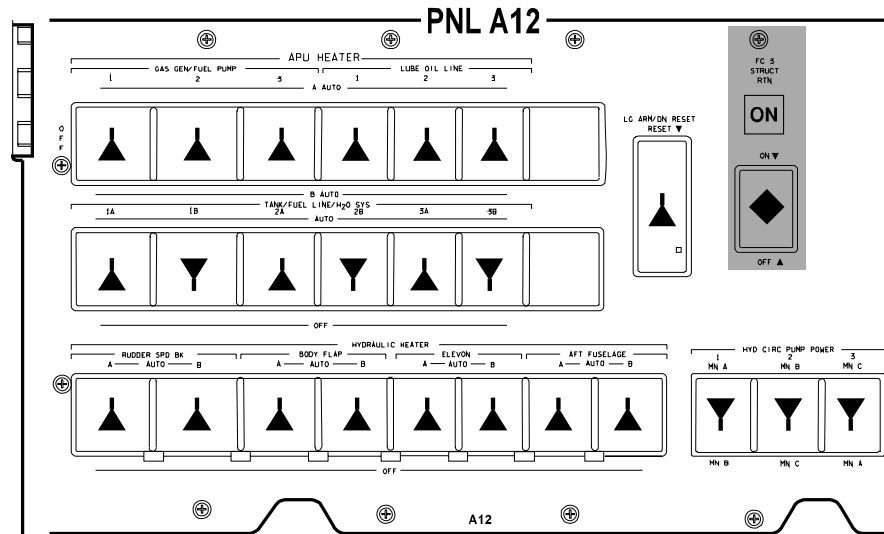
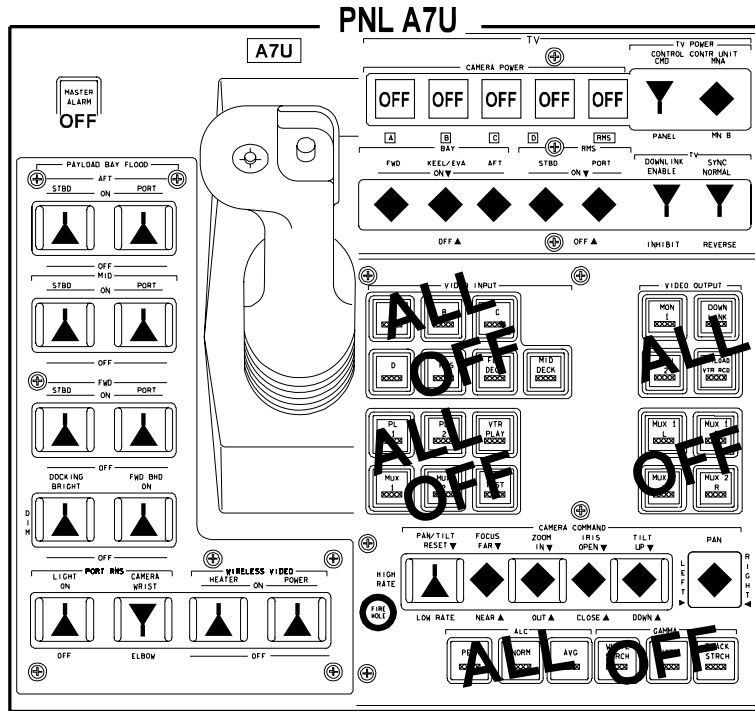

OV105

PNL L9

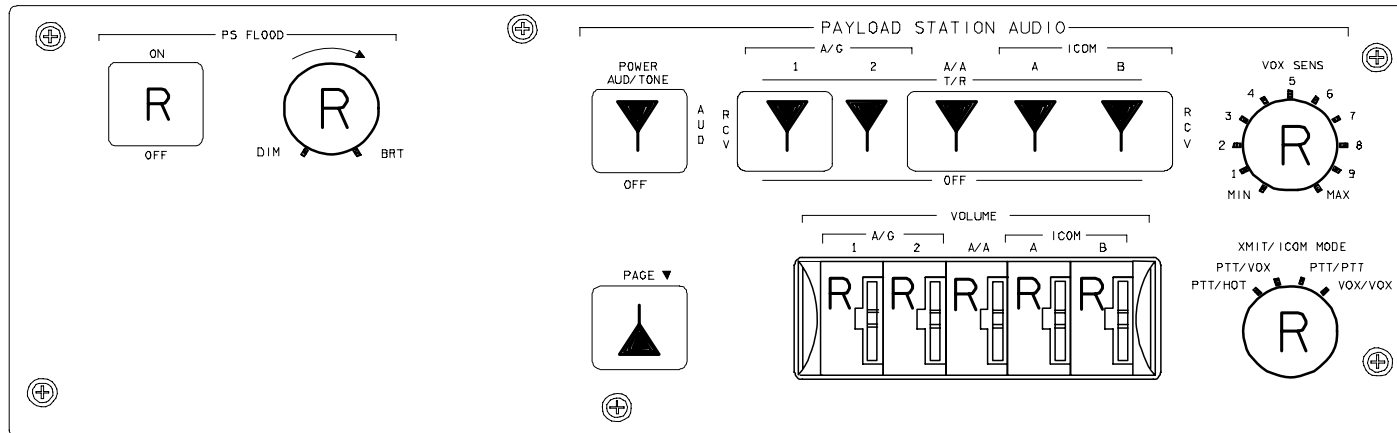

L9

OV105

PNL A6L

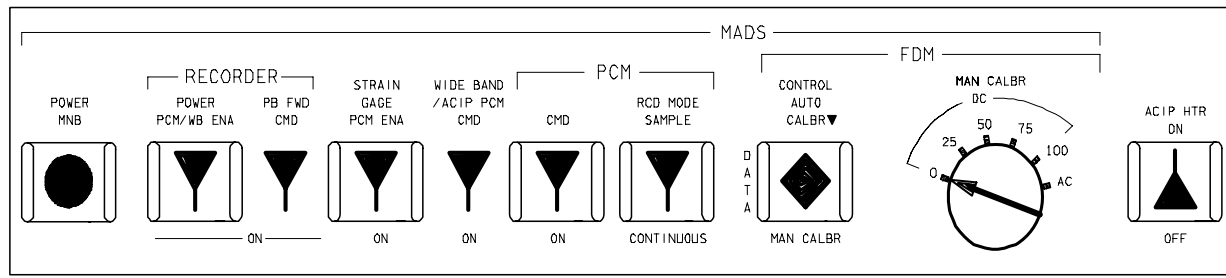
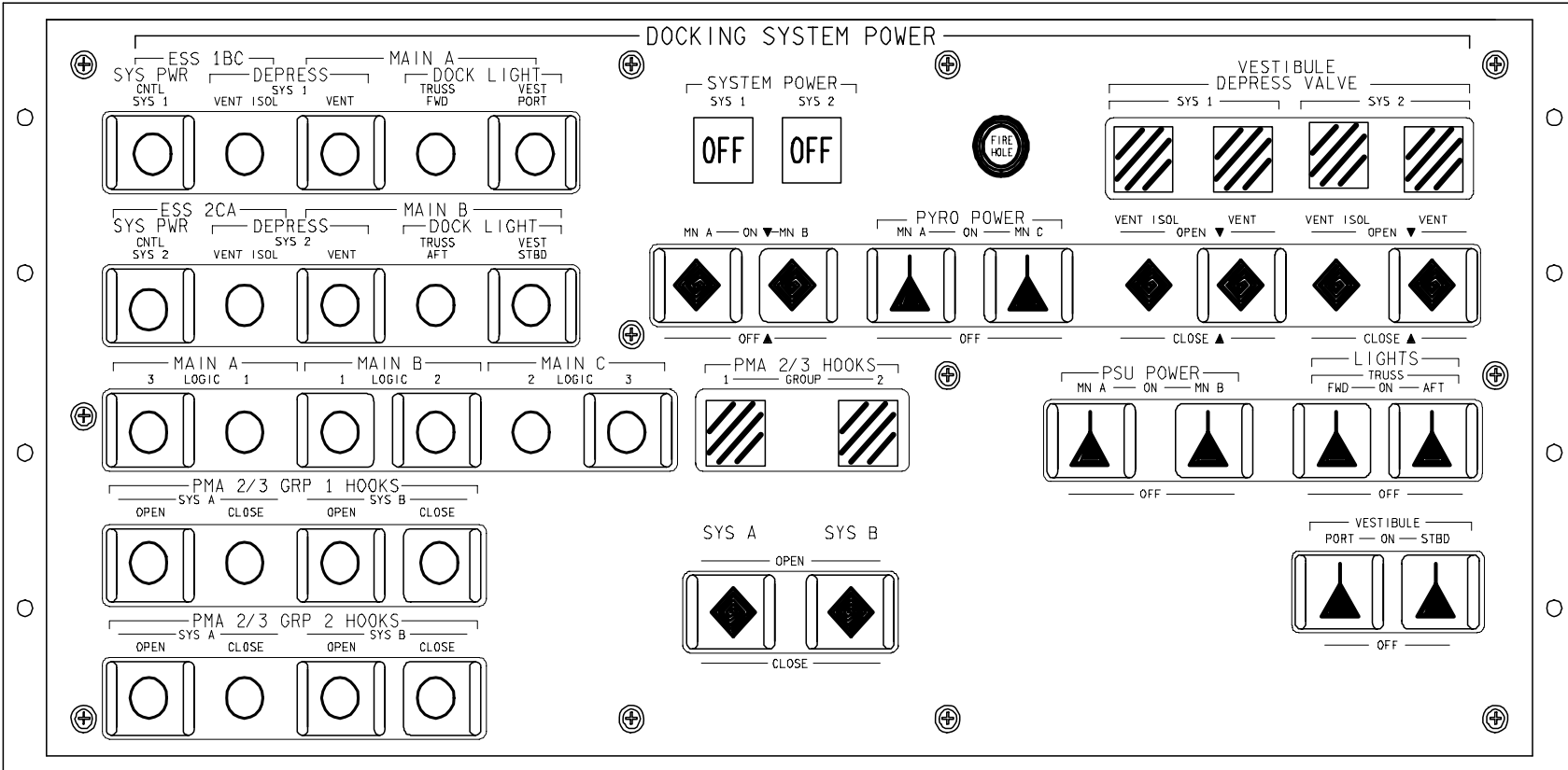

OV105

OV105

CONTROL PANEL POWER

A ON OFF B ON OFF C ON OFF

HEATERS/DCU POWER

H1 ON OFF H2/DCU ON OFF H3/DCU ON OFF

APDS POWER

A_DS ON OFF B_DS ON OFF C_DS ON OFF

STATUS

POWER	ON	INITIAL	CONTACT
APDS PROTECT	CIRCUIT OFF	CAPTURE	CAPTURE
RING	ALIGNED	RING	FORWARD POSITION
RING	INITIAL POSITION	RING	TO HOOK
FIXERS	OFF	INTER	SEALED
HOOKS 1	OPEN	HOOKS 1	CLOSED
HOOKS 2	OPEN	HOOKS 2	CLOSED
LATCHES	CLOSED	LATCHES	OPEN
UNDOCK	COMPLET	RING	FINAL POSITION

PYROS

A_p ON OFF B_p ON OFF C_p ON OFF

Ap OFF Cp

OFF

PYRO CIRC PROT OFF

OFF

PYRO COMMANDS

PYRO CIRC PROT OFF PYRO CIRC PROT ON

ACT HOOKS FIRING PAS HOOKS FIRING

APDS CONTROL COMMANDS

OPEN HOOKS OPEN LATCHES

UNDOCKING



A_DS OFF C_DS

LAMP TEST

PNL A7L

APDS CONTROL COMMANDS

POWER ON POWER OFF RING OUT RING IN

APDS CIRC PROT OFF CLOSE HOOKS CLOSE LATCHES FIXER OFF

APDS CONTROL PANEL

OV105

OV105

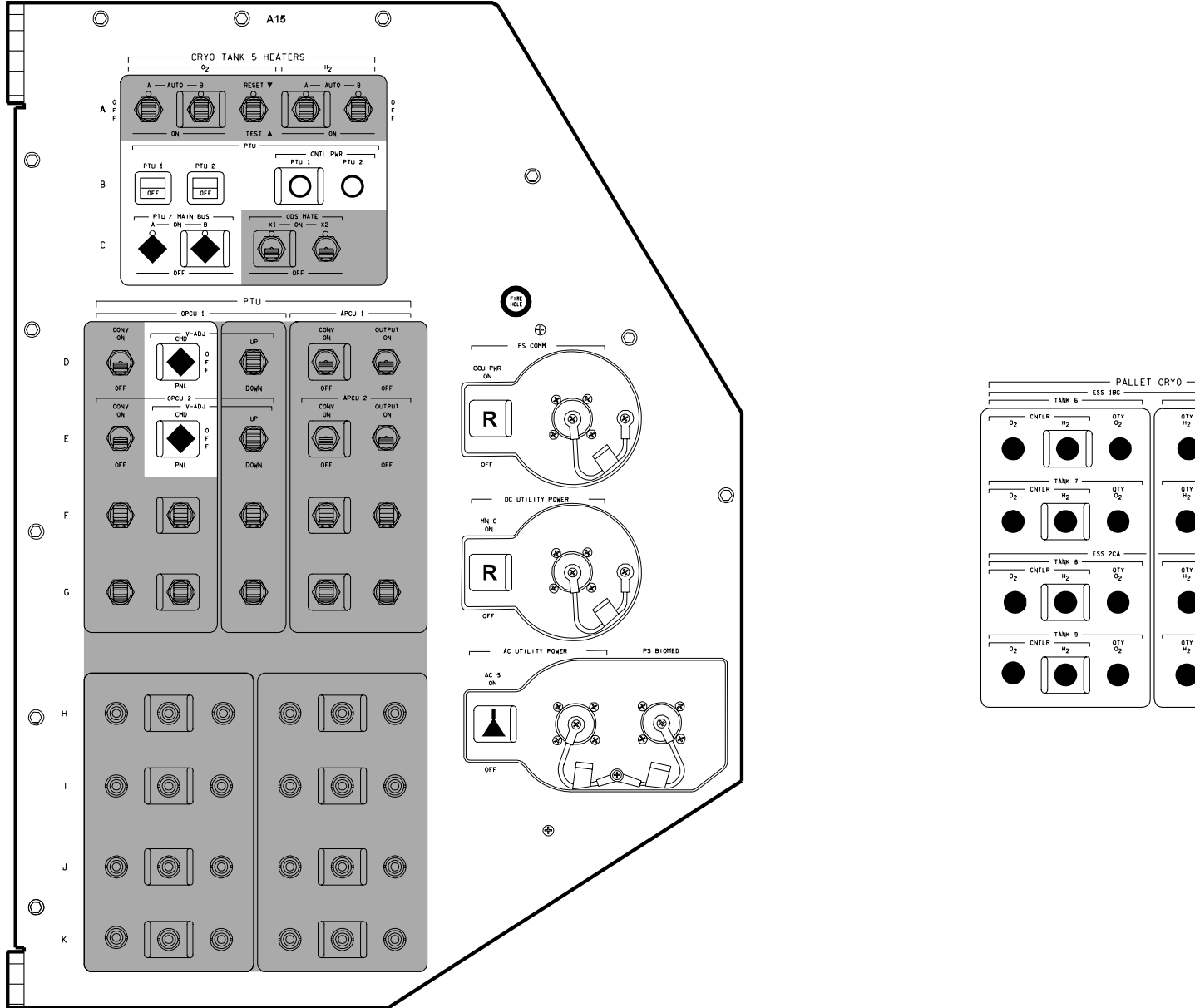

OV105

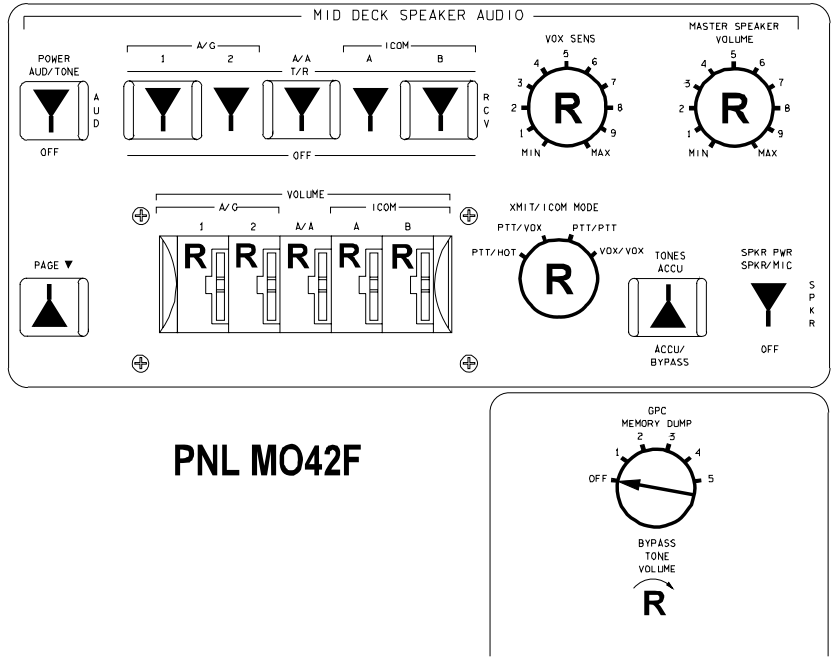

PNL MO42F

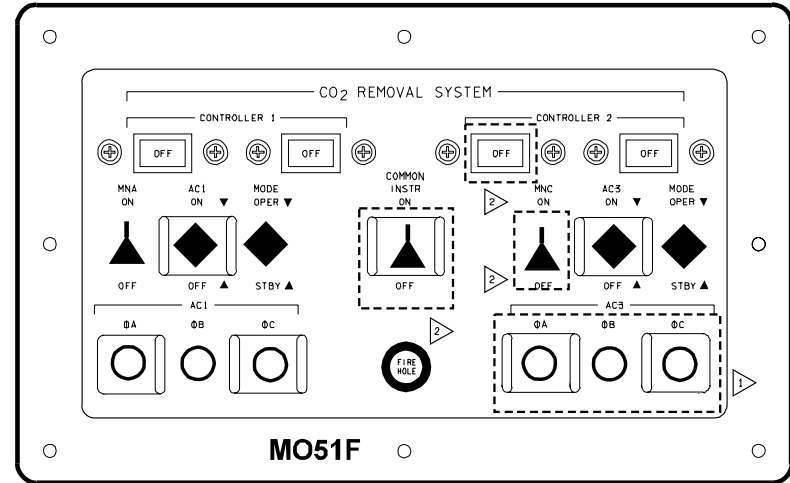

MO51F

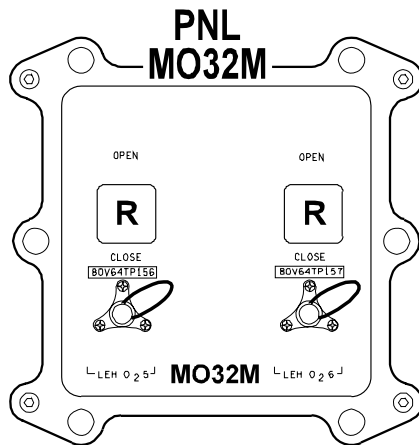

PNL MO32M

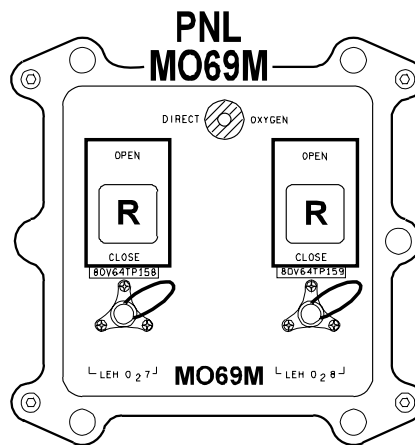

PNL MO69M

NOTES: CLOSED IF CO2 RMVL SYS FLOWN
 ON IF CO2 RMVL SYS FLOWN

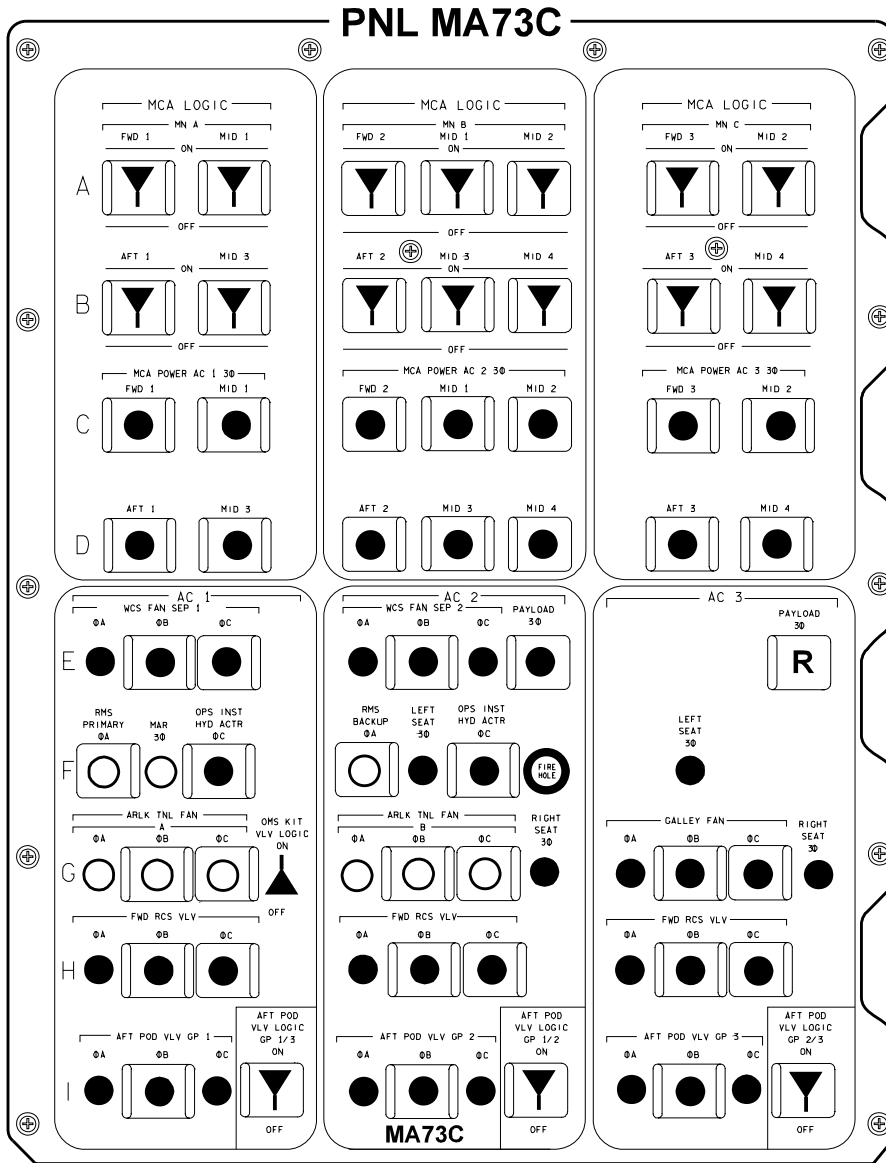

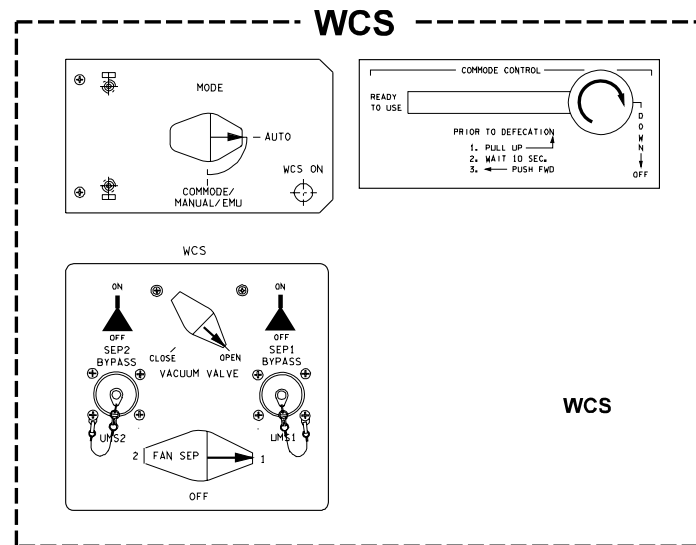
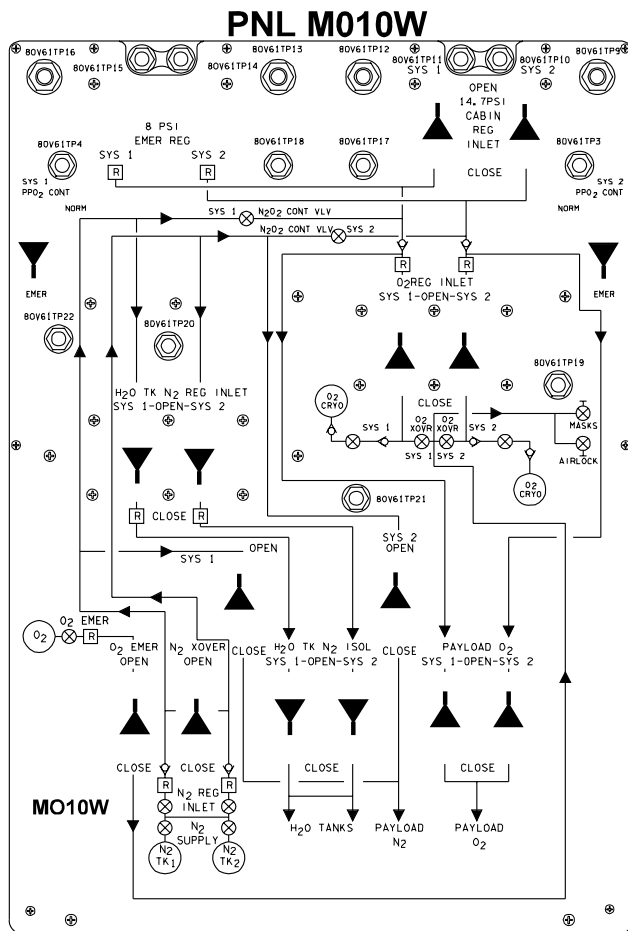

BFS DEORBIT PREP NOTES

BFS DEORBIT PREP NOTES

BFS DEORBIT PREP NOTES

- 1) BFS cannot support COAS Cal or an IMU Align
- 2) No AUTO DAP or AUTO TVC is available with BFS.
After OPS 304 Transition, CSS must be used
- 3) BFS does not support MSN TIMER updates
- 4) BFS supports manual RCS to RCS Xfeed only
- 5) BFS follows PASS port moding via BFS I/O RESET
- 6) BFS does not support the following switches:

NOTE

Boldface indicates items affected during Entry (MM 304)

LEFT SEAT

- | | | |
|------|----|--|
| C | L1 | H2O PUMP LOOP 1 (GPC pos only) |
| F6 | | ADI ERR
RATE
HSI SEL MODE
SOURCE 1, 2, 3
RDR ALTM |
| C, P | C3 | DAP pb (six)
MAN MODE TRANSLATION pb (eight)
jet option PRI,ALT,VERN pb |
| O7 | | MSTR RCS XFEED
AFT L,R RCS TK ISOL (six) (GPC pos only)
XFEED (four) (GPC pos only) |

RIGHT SEAT

- | | | |
|------------|-----------|---|
| P | F8 | AIR DATA (slaved to CDRs)
ADI ERR
RATE
ATT (slaved to CDRs)
ATT REF pb
HSI SEL MODE
HSI SEL SOURCE TACAN (OV103,4),
GPS (OV105), MLS, NAV
(slaved to CDRs) |
| | F3 | RDR ALTM
R TRIM RHC/PNL |
| | R2 | HYD CIRC PUMP (three) (GPC pos only) |
| <u>AFT</u> | <u>MS</u> | R12U FC PURGE VLV (three) (GPC pos only)*
HTR (GPC pos only)*
GPC PURGE SEQ |

* FC PURGE valve and heater functions can be ground-commanded through BFS when switches are in GPC position. Therefore, place these switches in GPC for entry

CONTINGENCY DELTAS TO NOMINAL DEORBIT PREP

NOTE

Perform NOMINAL DEORBIT PREP procedure with
CONTINGENCY DELTAS for specific case

LOSS OF 2 CAB FANS 5-3

LOSS OF AV BAY AIR COOLING 5-4

8 PSI DEORBIT PREP 5-6

AV BAY FIRE 5-8

This Page Intentionally Blank

LOSS OF 2 CAB FANS

Assumes LOSS OF 2 CAB FANS (ORB PKT, PWRDN) accomplished

1. Minimize use of IDPs,MDUs,FLT CNTLR PWR,DDUs to reduce cabin heat load and to save for use during entry
2. Minimize lighting
3. Wipe off any visible moisture with towels
4. Use IDP/CRT 4 when possible. Use one IDP/CRT with two MDUs as reqd. Use two IDP/CRTs with two MDUs for DPS ENTRY CONFIG. Save two forward IDP/CRTs with four MDUs that interface with those IDPs for entry
5. In DED DISP ENT CONFIG, do not power DDUs unless reqd. Minimize use
6. In DPS ENTRY CONFIG, skip SM CKPT except UL CNTL ENA – ITEM 36 EXEC. Skip MC9 RECONFIG
7. In CLOTHING CONFIG, prepare ACESs for donning. Don QDM if cabin temp > 90 degF and discomfort occurs. If cabin temp > 95 degF and no evaporative cooling, don ACES, activate O2, and close visor. Inflate Anti-G Suit as needed for circulatory support
8. ENTRY SWITCH LIST/VER will not reflect pwrdrn items
9. FLUID LOADING: Continue drinking 8 oz container of water every 15 min with salt tablets every other 8 oz container through entry
10. Maintain tail Sun attitude/leave window shades installed until TIG-15 min

For ENTRY C/L deltas, go to LOSS OF 2 CAB FANS (ENT PKT, PWRDN)

LOSS OF AV BAY AIR COOLING

Assumes MAL, DPS, GPC FRP-7 accomplished

1. For Av Bay 1 or 2 loss, skip DPS CONFIG FOR D/O PREP [4a], but perform ENSURE BFS GPC CAN COMMAND AN IDP [4b]
 If Av Bay 3 loss, perform both DPS CONFIG FOR D/O PREP [4a] and ENSURE BFS GPC CAN COMMAND AN IDP [4b]
2. In HYD/MPS CONFIG [5]:
 - If AV BAY 1 or 2 air cooling lost:
 - | FCS CH (four) – ORIDE
 - If AV BAY 3 air cooling lost:
 - √FCS CH 1,2,3 (three) – AUTO
 - 4 – OFF
3. In DED DISP ENT CONFIG [6], delay activation of affected GPS,TACANs,MLSs,AAs,ADTAs (EQUIP COOLING MATRIX, ORB PKT, I ECLS); deactivate if already activated
4. During DPS ENTRY CONFIG [12]
 - a. If loss of AV BAY 3, do not activate GPC 3
 - b. In all cases, substitute appropriate NBAT in following activities:

TRANSITION GPC 1 & 2 TO GNC OPS 3

CONFIG GPC	LOSS OF		
	BAY 1	BAY 2	BAY 3
	3	3	3
	02000	10000	12000
STR 1	2	1	1
2	2	1	2
3	2	1	1
4	2	1	2
PL 1/2	0	0	0
CRT 1	2	1	1
2	2	1	2
3	2	1	2
4	0	0	0
L 1	0	0	0
2	0	0	0
MM 1	2	1	1
2	2	1	2

TRANSITION GPC 1,2,3,4 TO GNC OPS 3

CONFIG GPC	LOSS OF		
	BAY 1	BAY 2	BAY 3
	3	3	3
	02300	10040	12040
STR 1	3	1	1
2	2	4	2
3	3	1	4
4	2	4	2
PL 1/2	2	1	1
CRT 1	2	1	1
2	3	4	2
3	2	1	4
4	0	0	0
L 1	0	0	0
2	0	0	0
MM 1	2	1	1
2	3	4	2

Cont next page

LOSS OF AV BAY AIR COOLING (Cont)

RECONFIG MC 9 TABLE (GNC 9) FOR POST LANDING →

5. In C,P ENT FWD FLT DECK CONFIG:

- O14:A If AV BAY 1 air cooling lost:
 O15:A √BRAKES MNA – OFF
 O16:A MNB – ON
 √MNC – OFF
 O14:A If AV BAY 2 air cooling lost:
 O15:A BRAKES MNA – ON
 O16:A √MNB – OFF
 MNC – ON

6. ENT SWITCH LIST/VERIF will not reflect pwrn items

7. Incorporate following pen and inks to ENT MNVR

Cue Cards:

- El: Power up affected air-cooled equipment
 except affected TACAN (OV103,4) (EQUIP COOLING
 MATRIX, ENT PKT, ECLS)

If OV103,4:

- V = 10K: If unaffected TACAN failed,
 Affected TACAN MODE – GPC

O7

8. If just prior to OPS 302 TRANSITION, affected GPCs have
 been in HALT for ≥ 3.5 hr, add to RS as follows:

- a. Modify MC3 per table →
 b. MODE affected GPCs to RUN
 c. BFC CRT DISP – OFF
 OPS 301 PRO
 BFC CRT DISP – ON
 BFS GNC I/O RESET
 d. FCS CH (four) – AUTO

9. Update GPC/FCS CHANNEL CONFIGURATION (Cue Card)

CONFIG	LOSS OF		
	BAY 1	BAY 2	BAY 3
GPC	9	9	9
	02300	10040	12040
STR 1	3	1	1
2	2	4	2
3	3	1	4
4	2	4	2
PL 1/2	2	1	1
CRT 1	2	1	1
2	3	4	2
3	0	0	4
4	3	4	0
L 1	0	0	1
2	0	0	2
MM 1	2	1	1
2	3	4	2

CONFIG	LOSS OF		
	BAY 1	BAY 2	BAY 3
GPC	3	3	3
	12340	12045	12340
STR 1	1	1	1
2	2	2	2
3	3	4	4
4	4	5	3
PL 1/2	2	1	1
CRT 1	2	1	1
2	1	2	2
3	3	4	4
4	0	0	0
L 1	0	0	0
2	0	0	0
MM 1	2	1	1
2	3	4	2

8 PSI DEORBIT PREP (Cont)

9. In DED DISP ENT CONFIG, delay activation of ADTAs, GPS, TACANs, MLS, RAs, and DDU's
10. In ENT FWD FLT DECK CONFIG block 14, skip panel L2 actions under PCS/ARS CONFIG
11. In ENT MIDDECK CONFIG block 16, skip all of MIDDECK PCS
12. Continue to manage cabin atmosphere per O2(N2) FLOW HIGH/CABIN P LOW/dP/dT (OPCL, ECLS) as reqd until just prior to WCS DEACT block 27. When ready to perform WCS DEACT, config PCS as follows:

MO10W	14.7 CABIN REG INLET SYS 1,2 – CL
	O2 REG INLET SYS 1,2 – CL
	H2O TK N2 REG INLET 1,2 VLV – OP
MO69M	LEH O2 8 VLV – CL
	Remove, stow Bleed Orifice
L2	O2/N2 CNTRL VLV SYS 1,2 – OP
	O2 XOVR SYS 1,2 – OP
C5	DIRECT O2 VLV – CL
	When PPO2 < 2.2
	DON ACES, open LEH O2 vlvs
	check tabs, visors – CL, Suit O2 – ON
13. ENTRY SWITCH LIST/VER will not reflect pwrdn items

IN ENT CL

14. At TIG-4, activate DDU's
15. At EI-15, activate unpowered GPS. Work star block in step 2a of GPS TROUBLESHOOTING (EPCL, GNC) (any vehicle)
16. At EI, activate ADTAs
17. At V=15K, activate TACANs (except OV105), MLSs, RAs

AV BAY FIRE

Assumes AV BAY FIRE (ORB PKT, PWRDN) and MAL, ECLS SSR-12, AV BAY FIRE RECOVERY/RECONFIG accomplished

1. For Av Bay 1 or 2 loss, skip DPS CONFIG FOR D/O PREP [4a], but perform ENSURE BFS GPC CAN COMMAND AN IDP [4b]
If Av Bay 3 loss, perform both DPS CONFIG FOR D/O PREP [4a] and ENSURE BFS GPC CAN COMMAND AN IDP [4b]
2. In HYD/MPS CONFIG [5]:
If AV BAY 1 or 2 air cooling lost:
| FCS CH (four)–ORIDE
If AV BAY 3 air cooling lost:
√FCS CH 1,2,3 (three)–AUTO
4–OFF
3. During DED DISP ENT CONFIG [6], power up only three ADTAs, three AAs, two MLSs, and two GPS (OV105) or two TACANs (OV103,4)

AV BAY FIRE (Cont)

4. During DPS ENTRY CONFIG 12
 - a. If loss of Av Bay 3, do not pwrap GPC 3
 - b. During SM CHECKPOINT, skip MMU 1 (if Av Bay 1) or MMU 2 (if Av Bay 2)
 - c. Using column for affected Av Bay, substitute appropriate NBAT in following activities

TRANSITION GPC 1 & 2 TO OPS 3

CONFIG GPC	LOSS OF		
	BAY 1	BAY 2	BAY 3
	3 02000	3 10000	3 12000
STR 1	2	1	1
2	2	1	2
3	2	1	1
4	2	1	2
PL 1/2	0	0	0
CRT 1	2	1	1
2	2	1	2
3	2	1	2
4	0	0	0
L 1	0	0	0
2	0	0	0
MM 1	2	1	1
2	2	1	2

TRANSITION GPC 1,2,3,4 TO OPS 3

CONFIG GPC	LOSS OF		
	BAY 1	BAY 2	BAY 3
	3 02300	3 10040	3 12040
STR 1	3	1	1
2	2	4	2
3	3	1	4
4	2	4	2
PL 1/2	2	1	1
CRT 1	2	1	1
2	3	4	2
3	2	1	4
4	0	0	0
L 1	0	0	0
2	0	0	0
MM 1	2	1	1
2	3	4	2

**RECONFIG MC 9 TABLE (GNC 9)
FOR POST LANDING**

CONFIG GPC	LOSS OF		
	BAY 1	BAY 2	BAY 3
	9 02300	9 10040	9 12040
STR 1	3	1	1
2	2	4	2
3	3	1	4
4	2	4	2
PL 1/2	2	1	1
CRT 1	2	1	1
2	3	4	2
3	0	0	4
4	3	4	0
L 1	0	0	1
2	0	0	2
MM 1	2	1	1
2	3	4	2

5. ENT SWITCH LIST/VERIF pictorials will not reflect pwrn items

This Page Intentionally Blank

PLBD CONTINGENCY EVA TIMELINE

This Page Intentionally Blank

PLBD CONTINGENCY EVA NOTES

1. This timeline is an overview template that covers a payload bay door contingency EVA with a 10.2 cabin depress. The scenario starts from a closure failure 1.5 hr into the deorbit prep followed by a D/O PREP BACKOUT and cabin depress activities. The EVA and landing will occur on the EOM + 1 day
2. The timeline assumes that a two-crewmember 3.5 hr EVA to repair the problem is immediately followed by an entry to the prime landing site
3. Specific procedure block callouts for the EV and IV crewmembers during the EVA will be coordinated in real time
4. RCS hot fire testing, FCS C/O, and CABIN STOW are assumed to be previously accomplished
5. The timeline utilizes minimum activity durations for POST/PRE SLEEPS, EMU C/O, and DEORBIT PREP
6. The crew will be reqd to perform A/L PREP during Mask Pre-Breathe prior to cabin depress
7. Due to necessity of performing the EVA on the same day as landing, the crew is reqd to start their sleep period 3.5 hr earlier than the previous day
8. This template can be adapted for dual-shift timelines by scheduling Non-Entry team sleep with Entry team sleep in order to modify the timeline to single-shift operations
9. The MET scale on this timeline is actually a PET scale counting down to nominal deorbit TIG

HARDWARE CONTINGENCY EVA TIMELINE

This Page Intentionally Blank

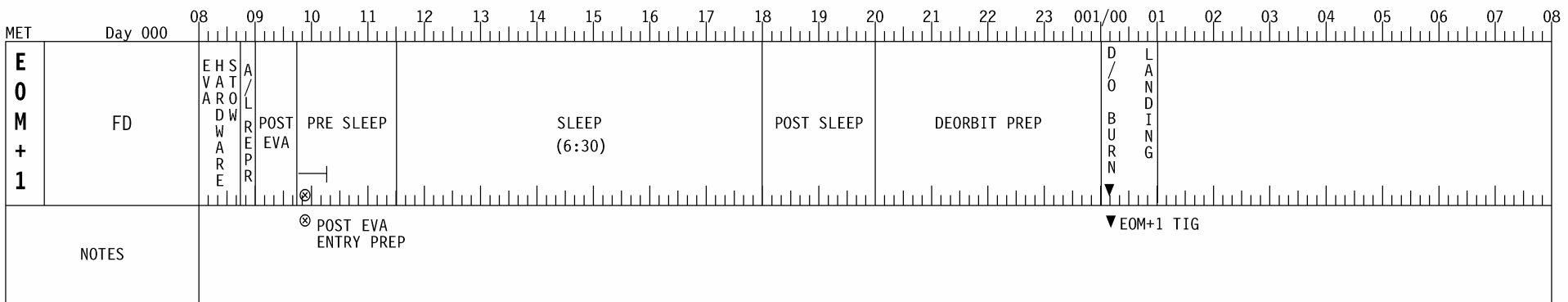
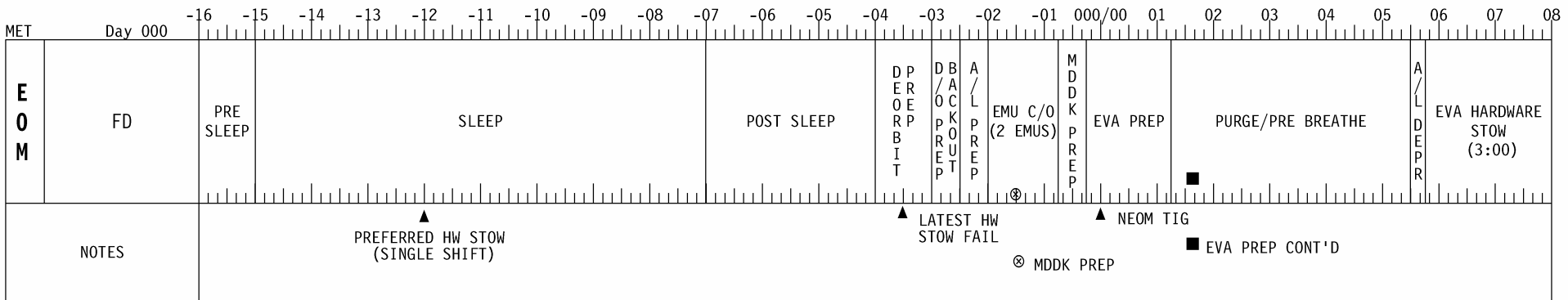
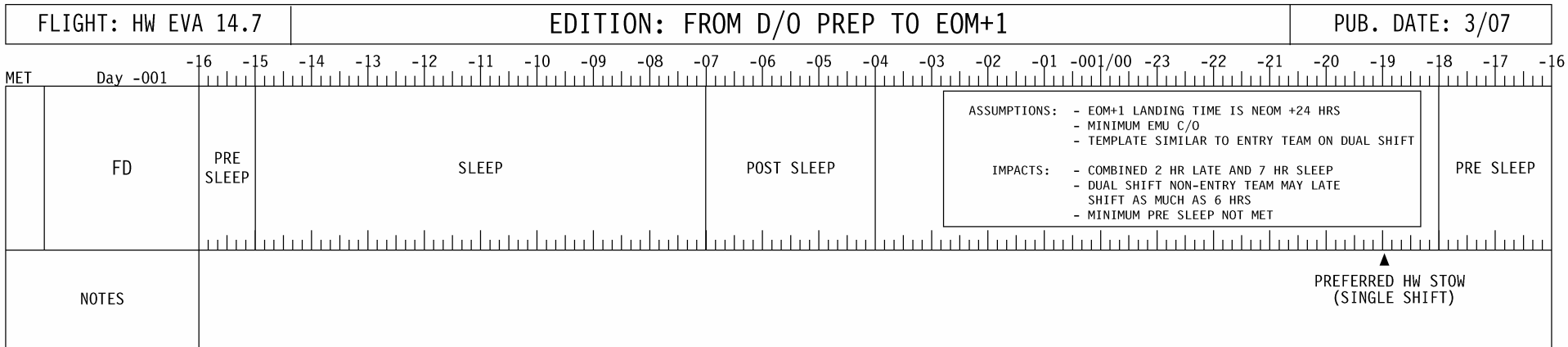

HARDWARE CONTINGENCY EVA NOTES

1. This timeline is an overview template that covers KU antenna, RMS, and RAD stow contingency EVAs with a “no cabin depress” scenario starting from a stow failure as late as 30 min into deorbit prep. The Pre-Breathe and EVA will be performed after D/O BACKOUT is complete and a landing will occur on the EOM + 1 day
2. The timeline assumes a two-crewmember 3 hr EVA to repair the problem
3. Specific procedure block callouts for the EV and IV crewmembers during the EVA will be coordinated in real time
4. RCS hot fire testing, FCS C/O, and CABIN STOW are assumed to be previously accomplished
5. The timeline utilizes minimum activity durations for EMU C/O and PRE/POST SLEEP
6. Due to the necessity of the timeline, the crew is reqd to shorten their sleep to 7 hr and shift the sleep late by 2 hr
7. This template can be adapted for dual-shift timelines by scheduling Non-Entry team sleep with Entry team sleep in order to modify the timeline to single-shift operations
8. The MET scale on this timeline is actually a PET scale counting down to nominal deorbit TIG

CUE CARD CONFIGURATION

MS MIDDECK ACTIVITIES (Front).....	CC 8-2
(Back).....	CC 8-3
MS MIDDECK BACKOUT ACTIVITIES (Front)	CC 8-4
(Back).....	CC 8-5

CUE CARD
CONFIG

CUE CARD CONFIG

TOP

MS MIDDECK ACTIVITIES

NOTE

WAIT FOR GO FROM CDR OR PLT BEFORE STARTING ANY ACTIVITY ON THIS PAGE

TIME (TIG-)	MS MIDDECK ACTIONS
3:50	<u>ENT STOWAGE</u> [3]
3:50	<u>ENT AIRLOCK CONFIG</u> [3A], 1-32
3:35	<u>SPECIALIST SEAT INSTALLATION</u> Verify Leg Attach Collars (four) – DOWN/LOCKED Verify LiOH Door Latches (four) – ENGAGED
3:10	<u>PARTIAL ENT SWITCH LIST/VERIF (MID)</u> , 3-10 thru 3-12
1:55	<u>ENT MIDDECK CONFIG</u> [16]
1:50	<u>FINAL ENT SWITCH LIST/VERIF (MID)</u> , 3-30 thru 3-32
1:40	<u>ENTRY REVIEW</u>
1:28	DSO 603, if reqd (BIOMED, BIOMED DSOs)
1:10	<u>CLOTHING CONFIG</u> [20], 1-32
1:00	Begin Fluid Loading per individual prescription. Fluid Loading should be completed by EI For 1 rev waveoff, repeat half the protocol If > 1 rev waveoff, repeat entire protocol
0:55	Remove, stow Side Hatch UV Filter, Locking Device, and Pyro Box Safing Pin
0:35	<u>GALLEY DEACT</u> [26]
0:33	<u>WCS DEACT</u> [27], 1-32
0:31	<u>MD AUD SPKR CONFIG</u> [29], 1-32

<u>ENT MIDDECK CONFIG</u> [16]	
MO42F	<u>ENTRY COMM</u> MIDDECK SPKR AUD A/G 1 – T/R A/G 2 – T/R A/A – T/R ICOM (two) – T/R VOX SENS – R VOL tw (five) – R XMIT/ICOM MODE – R
MO10W	<u>MIDDECK PCS</u> 14.7 CAB REG INLET vlv (two) – CL H2O TK N2 REG INLET vlv (two) – OP O2 REG INLET vlv (two) – CL
MO32M	LEH O2 vlv (two) – R
MO69M	LEH O2 8 vlv – CL Remove, stow O2 Bleed Orifice LEH O2 8 vlv – R 7 vlv – R
SIDE HATCH	NEG PRESS RLF VLV COVER (two) – pull open to vent; push firmly to close
MA73C:F	<u>RMS PNL LTS</u> (if RMS onboard) cb RMS PRI ΦA – op B/U ΦA – op <u>AC UTILITY OUTLET</u> cb AC1 MAR 3Φ – op

<u>ENT STOWAGE</u> [3] <u>PERSONAL HYGIENE SYS STOWAGE</u> Stow: Personal Hygiene Kits Hose <u>AIRLOCK CLOSEOUT</u> Tether soft goods to EVA tether point or A/L Stowage Bag. Gray Tape to floor <u>POLE SETUP</u> Reinstall Stbd Pip Pin Install Pip Pin Install Hitch Pin in Pip Pin Reinstall large Port Pin: Retract and hold Locking Pin (Ring) Reinstall large Pin Release Locking Pin (Ring) Slide forward Safing Latch √ Pole Straps secure <u>PDF STOWAGE</u> Stow FLIGHT PLAN <u>CABIN CONFIG</u> Stow: Backup PGSC Middeck Camrs, Accessories FWD/AFT Shades, Filters Exercise Equipment Quick Don Masks √ Retention net is in ASC/ENT config <u>EGRESS ROUTE CONFIG</u> Tape Foot Loops in egress routes <p style="text-align: center;">NOTE</p> Chemlights are middeck carry-on items. Activate green chemlights after TIG. Do not activate orange chemlights (slide ops only) Install green chemlights (8 ea) near egress hdw and egress routes Install orange chemlights (2 ea) above side hatch

<u>GALLEY DEACT</u> [26]	
GALLEY	OVEN/RHS – OFF H2O HTRS (two) – OFF √ OVEN FAN – OFF √ REHYD STA lever – cl (push in) √ OVEN DOOR LATCH – latched
MA73C:G	cb AC3 GALLEY FAN (three) – op
ML86B:A	MNC SPLY H2O GALLEY SPLY – op
:B	MNA GALLEY OVEN – op
	MNB GALLEY H2O HTR – op

D/O-1a/E/C

HOOK
VEL-
CRO

HOOK
VEL-
CRO

HOOK
VEL-
CRO

(reduced copy)

CC-8-2

D/O/ALL/GEN Q.2

TOP
BACK OF "MS MIDDECK ACTIVITIES"

ENT AIRLOCK CONFIG 3A	
MO13Q	1. √AIRLK FAN A(B) – OFF
TNL EXT	2. Disconnect A/L Fan Inlet Duct from aft middeck floor fitting and A/L Fan Inlet and strap to Tunnel Extension wall
MA73C:G	3. cb AC1,2 ARLK TNL FAN A,B (six) – op
EXT A/L	4. Unstow,install diffuser cap on aft middeck floor fitting
AW18A	5. NEG PRESS RLF vlv cover (two) – pull open to vent; push firmly to close
INNER HATCH	6. LTG FLOOD 1(3,4) – OFF
	7. Perform AIRLOCK ENTRY SWITCH LIST/VERIFICATION, 3-3
	8. Close hatch: Position handle to preclosing posn per decal Hatch – rotate about hinge and push Handle – CCW to LATCH Lock lever to LOCKED
	9. Equal vlv (two) – NORM, install caps
MIDDECK FLR	10. √EMU O2 ISOL vlv – CL
MO13Q	11. AIRLK 2 – OFF/ON
	12. √AIRLK H2O S/O vlv – OP (tb-op)
ML86B:C	13. cb MNB EXT ARLK HTR VEST Z1/2/3 – op If TNL ADAPT flown: :E 14. cb MNA FLOOD TNL ADAPT 2 – op cb MNB FLOOD TNL ADAPT 3 – op cb MNC FLOOD TNL ADAPT 4 – op :F 15. cb MNA FLOODS AIRLK 1 – op MIDDECK 9 – op cb MNB FLOODS MIDDECK 10 – op AIRLK 3 – op cb MNC FLOODS AIRLK 4 – op :G 16. cb ESS 1BC FLOOD AIRLK 2 – op If TNL ADAPT flown: 17. cb ESS 1BC FLOOD TNL ADAPT 1 – op

CLOTHING CONFIG 20	
	Unstow, don: ACES Harness Boots
	Verify ACES Gloves (Spare) available. Relocate as reqd
	Remove radiation dosimeter from inflight garments and insert in ACES; if waveoff, remove radiation dosimeter from ACES and insert in inflight garments
	NOTE
	Refer to flight specific utility outlet plug-in plan if reqd
	Connect middeck cooling units per PWR/DATA/VIDEO: ASCENT/ENTRY CONFIG (REF FS, UTIL PWR)
MO13Q, MO30F, MO52J, PDB J2(3,4), ML85E (MUP)	DC UTIL PWR MNA(B,C) – ON as reqd Cooling units – Hose Jumper Plug installed Pre-chill cooling units 10 min prior to seat ingress

WCS DEACT 27	
WCS	VAC VLV – CL √MODE sel – AUTO FAN SEP sel – OFF Unstow hose from cradle, attach hose to WCS housing via Velcro straps Stow: WCS Trash Can Mirror Privacy Curtain Foot/toe restraints – up,latched Close and latch door
ML31C	VAC VENT ISOL VLV BUS SEL – MNB CNTL – CL (tb-CL) NOZ HTR – OFF √Middeck lts as reqd

MD AUD SPKR CONFIG 29	
MO42F MO39M	MIDDECK AUD SPKR PWR – OFF MIDDECK COMM CCU PWR – OFF Disconnect and stow Handheld Mic Configure MHA to MID CCU per entry plug-in plan Connect Lightweight Headsets or ACES Comm Cap MIDDECK COMM CCU PWR – ON

HOOK
VEL-
CRO

HOOK
VEL-
CRO

HOOK
VEL-
CRO

D/O-1b/E/A

CC-8-3
(reduced copy)

D/O/ALL/GEN Q

TOP

MS MIDDECK BACKOUT ACTIVITIES

NOTE
WAIT FOR GO FROM CDR OR PLT BEFORE STARTING ANY ACTIVITY ON THIS PAGE

TIME (ET)	MS MIDDECK ACTIONS
00:20	<u>SPECIALIST SEAT EGRESS</u>
00:21	MO32M LEH O2 vlv (two) – CL MO69M LEH O2 vlv (two) – CL
00:22	<u>PRELIM MIDDECK CONFIG</u> [7]
00:40	If reqd. PAYLOAD REACT, (PL OPS, DEORB PREP) or PAYLOAD REACTIVATION (SODF: ASSY OPS: DEORBIT PREP)
00:52	<u>MIDDECK CONFIG</u> [14]
01:00	<u>CLOTHING CONFIG</u> [15], 2-18
01:40	<u>ON-ORBIT PCS 2(1) CONFIG</u> [19], 2-18
01:42	<u>SPECIALIST SEAT REMOVAL/STOWAGE</u>
01:50	<u>AIRLOCK SETUP FOR INGRESS</u> [21], 2-18

<u>PRELIM MIDDECK CONFIG</u> [7]	
	<u>INSTALL FILTERS</u> Unstow,install: Side Hatch UV Filter and Locking Device Pyro Box Safing Pin
	<u>COMM CONFIG</u> Unstow: Headsets, Handheld Mics and/or Wireless Comm if flown (see <u>WCCS COMM PLAN</u> (Cue Card))
	If WCCS perform STD WCCS CONFIG (ORB OPS, COMM/INST) or see <u>WCCS COMM PLAN</u> (Cue Card)
MO42F	If middeck Handheld Mic/speaker operation: MIDDECK SPKR AUD SPKR PWR – SPKR/MIC A/G 1 – T/R, tw-2 A/G 2 – RCV, tw-2 A/A – RCV, tw-2 ICOM A – T/R, tw-2 ICOM B – RCV, tw-2 XMIT/ICOM MODE – PTT/PTT MSTR SPKR VOL – 8
MO39M	MIDDECK COMM CCU PWR – OFF Connect Handheld Mic to CCU MIDDECK COMM CCU PWR – ON
ML31C	<u>HTR CONFIG</u> VAC VENT ISOL VLV BUS SEL – MNA NOZ HTR – ON ISOL VLV CNTL – OP (tb-OP)
	* If VAC VENT ISOL VLV CNTL tb – CL or bp: *
	* VAC VENT ISOL VLV BUS SEL – MNB *
	* CNTL – OP (tb-OP) *
	* If VAC VENT ISOL VLV CNTL tb still CL or bp: *
	* √MCC for further actions *

<u>MIDDECK CONFIG</u> [14]	
ML86B:A :B	<u>GALLEY ACTIVATION</u> cb MNC SPLY H2O GALLEY SPLY – cl cb MNA GALLEY OVEN – cl cb MNB GALLEY H2O HTR – cl
R11L:G	√SPLY H2O GALLEY SPLY VLV – OP (tb-OP)
GALLEY	H2O HTRS (two) – ON OVEN/RHS – ON
MA73C:G	cb AC3 GALLEY FAN (three) – cl Unstow,install Personal Hygiene Hose
WCS	<u>WCS ACTIVATION</u> VAC VLV – OP Unstow Urinal Hose from Velcro strap, install hose in cradle √MODE – AUTO √CRADLE – AUTO FAN SEP SEL sw – 1 Unstow hose from cradle (√airflow) √WCS ON It – ON Stow hose in cradle √WCS ON It – OFF Unstow,install: WCS Trash Can Mirror Urine Collection Cue Card Foot/Toe Restraint – down,locked (Cont next page)

HOOK
VEL-
CRO

HOOK
VEL-
CRO

HOOK
VEL-
CRO

CC 8-4
(reduced copy)

D/O/ALL/GEN Q

D/O-2a/E/A

TOP
BACK OF "MS MIDDECK BACKOUT ACTIVITIES"

If PRIORITY PWRDN GROUP C not reqd:
PGSC ACTIVATION (backup PGSC) PGSC
ACTIVATION (ORB OPS, PGSC)

POLE STOWAGE

Remove large Port Pin:
Slide back Safing Latch
Retract and hold Locking Pin (Ring)
Remove large Pin
Release Locking Pin (Ring)
Remove Stbd Pip Pin
Remove Hitch Pin
Remove Pip Pin
Stow Pole

FLOODLIGHT CONFIG

If TNL ADAPT flown:

ML86B:E	cb MNA FLOOD TNL ADAPT 2 – cl
	cb MNB FLOOD TNL ADAPT 3 – cl
	cb MNC FLOOD TNL ADAPT 4 – cl
ML86B:F	cb MNA FLOODS AIRLK 1 – cl
	MIDDECK 9 – cl
	cb MNB FLOODS MIDDECK 10 – cl
	AIRLK 3 – cl
	cb MNC FLOODS AIRLK 4 – cl
ML86B:G	cb ESS 1BC FLOOD AIRLK 2 – cl

If TNL ADAPT flown:
cb ESS 1BC FLOOD TNL ADAPT 1 – cl

CLOTHING CONFIG 15

DoFF/stow:
Harness, Boots, ACES, UCD (if not used)

Remove radiation dosimeter from ACES and insert in inflight garments

DoFF, stow in Wet Trash (if used):
UCD (clamp)
Emesis Bag (unstow new bag)

ON-ORBIT PCS 2(1) CONFIG 19

C	L2	√O2 XOVR SYS (two) – OP
		O2/N2 CNTLR VLV SYS 1(2) – CL
		2(1) – AUTO
	O1	O2/N2 FLOW sel – SYS 2(1) O2
	C7	√LEH O2 SPLY vlv (two) – OP
		Expect possible 'S66 CAB O2(N2) FLO 2(1)' msg
MS	MO10W	14.7 CAB REG INLET SYS 2(1) vlv – OP
		H2O TK N2 REG INLET SYS 1(2) vlv – CL
		O2 REG INLET SYS 2(1) vlv – OP
	MO69M	√LEH O2 8 vlv – CL
		Insert O2 Bleed Orifice Assembly into LEH O2 8 QD
		LEH O2 8 vlv – OP

AIRLOCK SETUP FOR INGRESS 21

INNER	1. Equal vlv caps (two) – remove, stow
HATCH	2. √Equal vlv (two) – NORM
	3. Open hatch per decal
AW18A	4. LTG FLOOD 1(3,4) – ON (as reqd)
MO13Q	5. AIRLK 2 – ON/OFF
	6. √AIRLK H2O S/O vlv – OP (tb-op)
MIDDECK FLR	7. √EMU O2 ISOL vlv – CL
	8. Remove, stow diffuser cap on middeck floor air fitting (mark)
	9. Unstow, install bypass duct to middeck floor fitting
	10. √Airflow at top of external airlock halo
	If Spacehab flown and reingress desired:
	11. Go to SPACEHAB INGRESS AFTER WAVEOFF (SH OPS, <u>ON-ORBIT</u>)
	If orbiter only and Spacehab reingress not desired:
	12. Unstow bypass duct from Tunnel Extension wall and install on middeck floor fitting

HOOK
VEL-
CRO

HOOK
VEL-
CRO

HOOK
VEL-
CRO

D/O-2b/E/B

CC-8-5
(reduced copy)

D/O/ALL/GEN Q,2

This Page Intentionally Blank

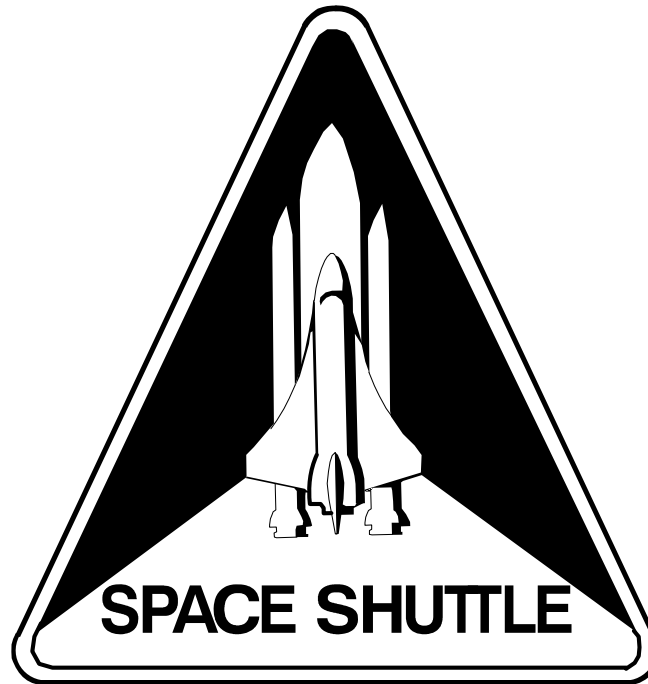

DEORBIT PREP

**STS
ALL**