

Ascent/Entry Systems Procedures

Volume II: OV102,4

Mission Operations Directorate
Systems Division

Generic, Rev J
September 3, 1999

NOTE
For STS-108 and subsequent OV102,4 flights
Cover replaced in PCN-11
Also see note #6 on page iii

National Aeronautics and
Space Administration

Lyndon B. Johnson Space Center
Houston, Texas



Verify this is the correct version for the pending operation (training, simulation or flight).
Electronic copies of FDF books are available. URL: <http://fltproc.jsc.nasa.gov/dfd>

ASC/ENT SYSTEMS PROCEDURES

GENERIC, Rev J (Sept 3, 1999)

PCN-14 (Feb 11, 2002) Sheet 1 of 1

List of Implemented Change Requests (482s):
A/E SYS-621 MULTI-1592

NOTE
For STS-109 flight and subsequent
generic training using OI-28 software load

Incorporate the following changes to Volume I (OV103,5):

1. Replace v thru xii
2. Replace MS A4-1 and MS A4-2
3. Replace MS A6-1 and MS A6-2
4. Replace MS E4-1 and MS E4-2
5. Replace FB A11-1 and FB A11-2
6. Replace FB A13-5 and FB A13-6
7. Replace FB E13-9 and FB E13-10

Incorporate the following changes to Volume II (OV102,4):

1. Replace v thru xii
2. Replace MS A4-1 and MS A4-2 with MS (A)A4-1 thru MS (B)A4-2 (4 pages)
3. Replace MS A6-1 and MS A6-2
4. Replace MS E4-1 and MS E4-2 with MS (A)E4-1 thru MS (B)E4-2 (4 pages)
5. Replace FB A11-1 and FB A11-2
6. Replace FB A13-5 and FB A13-6 with FB (A)A13-5 thru FB (B)A13-6 (4 pages)
7. Replace FB E13-9 and FB E13-10 with FB (A)E13-9 thru FB (B)E13-10 (4 pages)

Prepared by: _____
Book Manager

Approved by: _____
Manager, Shuttle Procedures Management (USA)

Accepted by: _____
FDF Subsystem Manager (NASA)

Encl: Volume I – 20 pages; Volume II – 28 pages

File this PCN immediately behind the front cover as a permanent record

MISSION OPERATIONS DIRECTORATE

ASCENT/ENTRY SYSTEMS PROCEDURES

GENERIC, REVISION J
September 3, 1999

PREPARED BY:

Jerome W. Gourdine, Sr.
Book Manager

APPROVED BY:

ACCEPTED BY:

Paul D. Hancock
Supervisor,
Procedures Management
(USA)

John W. Bearley
FDF Subsystem Manager
(NASA)

This document is under the configuration control of the Crew Procedures Control Board (CPCB). All proposed changes must be submitted on JSC Form 482 to DO3/FDF Manager.

Additional distribution of this book for official use must be requested in writing to DO3/FDF Manager. The request must include justification and requester's name, organization, position, and phone number. Contractor requests are made through the NASA or DOD organization supported. Deletions, reduction in quantity, or change of address may be submitted to DO3/FDF Management Office, 281-244-1184.

AESP/ALL/GEN J

Incorporates the following:		
482#:	A/E SYS-579	MULTI-1443
	A/E SYS-580	MULTI-1448A
	A/E SYS-582	MULTI-1466
	A/E SYS-583	
	A/E SYS-584	

AREAS OF TECHNICAL RESPONSIBILITY

Book Manager	DO35/J. Gourdine	281-244-1189
Alternate	DO35/C. Simon	281-483-0656
APU/HYD	DF05/R. Doremus	281-483-0680
COMM	DF2/S. Murray	281-483-4061
DPS	DF2/T. Murphy	281-483-3290
ECLS	DF8/P. Hasbrook	281-483-0768
EPS	DF7/J. Azbell	281-483-0742
GNC	DF6/K. Dwyer	281-483-2476
OMS/RCS	DF6/C. Koerner	281-483-2617
MPS	DF5/N. Knight	281-483-4899
PWRDN	DF7/J. Azbell	281-483-0742

NOTES

1. Sections 1 through 8 of this book are inserted in the front of the Mission Specialist copies of the Ascent and/or Entry Pocket Checklists.
2. Sections 10 thru 13 are the Multiphase Cue Cards, the Pilot's Overhead Flip Book, the Pilot's Window Flip Book, and the Commander's Window Flip Book which are printed in this book for documentation and control purposes only. They will be removed from Simulator and Flight copies.
3. The Mission Specialist book and all flip books will each be separated into two divisions, Powered Flight (A) and Glided Flight (E).
4. Icons will be used in the following manner:
 - '⇒' At the end of a procedure line indicates a choice to continue to either the Glided Flight division of the AESP and/or to the ASC PKT C/L as dictated by the prevailing flight phase.
 - '⇒G' At the end of a procedure line indicates one should continue to the Glided Flight division of the AESP.
 - '⇒A' At the end of a procedure line indicates one should continue to the ASC PKT C/L.
 - '⇒' Preceding a line indicates the starting point of the procedure if coming from a procedure with a continue (⇒) icon.
 - '◇' Indicates one should ✓MCC and if no comm continue with the procedure.
5. The content (text) flight phase notation and page coding are controlled by the Ascent/Entry Systems Procedures Book Manager. The size, shape, and Velcro location of the cue cards are controlled by the Cue Card Book Manager.
6. This document (Ascent/Entry Systems Procedures Checklist) is published in multiple volumes to accommodate vehicle configuration differences. Volume I is dedicated to

OV103 and OV105; Volume II is dedicated to OV102 and OV104. Pages which contain procedures that are applicable to all vehicles are duplicated in each volume. The number of volumes and vehicles covered by a particular volume will change as required to keep pace with hardware and/or software upgrades. Only the applicable volume will be manifested on a given flight.

Although published with separate covers, the volumes will be considered together as one book for configuration control, review, and sign-off purposes. This is to ensure that all vehicle configurations are considered when individual procedure changes are made. Updates to all the various affected volumes will be made at the same time regardless of the flights to which the vehicles are assigned.

ASCENT/ENTRY SYSTEMS PROCEDURES – Vol II

LIST OF EFFECTIVE PAGES

GENERIC	07/02/87	PCN-7	12/12/00
REV J	09/03/99	PCN-8	02/12/01
PCN-1	12/09/99	PCN-9	04/24/01
PCN-2	02/18/00	PCN-10	06/11/01
PCN-3	03/17/00	PCN-11	10/05/01
PCN-4	06/16/00	PCN-12	10/22/01
PCN-5	08/11/00	PCN-13	11/09/01
PCN-6	10/19/00	PCN-14	02/11/02
Sign Off	*	ALL/GEN J
ii	*	ALL/GEN J
iii	*	ALL/GEN J,11
iv	*	ALL/GEN J,11
v	*	2,4/GEN J,14
vi	*	2,4/GEN J,14
vii	*	2,4/GEN J,14
viii	*	2,4/GEN J,14
ix	*	2,4/GEN J,14
x	*	2,4/GEN J,14
xi	*	2,4/GEN J,14
xii	*	2,4/GEN J,14
xiiia	*	4/GEN J,9
xiiib	*	ALL/GEN J,9
xiii		4/GEN J
xiv		4/GEN J,2
xv		ALL/GEN J,2
xvi		ALL/GEN J
xvii		4/GEN J,2
xviii		ALL/GEN J,2
xix		ALL/GEN J
xx		ALL/GEN J
xxi		4/GEN J
xxii		4/GEN J

* – Omit from MS flight book

xxiii	ALL/GEN J,2
xxiv	4/GEN J,2
xxv	4/GEN J,2
xxvi	4/GEN J
MS A-i	* ALL/A/GEN J
MS A-ii	* ALL/A/GEN J
MS A1-1	ALL/A/GEN J
MS A1-2	ALL/A/GEN J
MS A2-1	ALL/A/GEN J,8
MS A2-2	ALL/A/GEN J,8
MS A3-1	ALL/A/GEN J
MS A3-2	4/A/GEN J
MS A3-3	ALL/A/GEN J,8
MS A3-4	2,4/A/GEN J,12
MS (A)A3-5	4/A/GEN J,9
MS (A)A3-6	⊗ OI-28/A/GEN J,10
MS (B)A3-5	4/A/GEN J,9
MS (B)A3-6	⊗ OI-29/A/GEN J,10
MS A4-1	deleted
MS A4-2	deleted
MS (A)A4-1	ALL/A/GEN J,14
MS (A)A4-2	2/A/GEN J,14
MS (B)A4-1	ALL/A/GEN J,14
MS (B)A4-2	4/A/GEN J,14
MS A4-3	2,4/A/GEN J,11
MS A4-4	ALL/A/GEN J,12
MS A4-5	ALL/A/GEN J
MS A4-6	ALL/A/GEN J
MS A4-7	ALL/A/GEN J
MS A4-8	ALL/A/GEN J
MS A5-1	ALL/A/GEN J
MS A5-2	ALL/A/GEN J
MS A5-3	ALL/A/GEN J
MS A5-4	4/A/GEN J,2
MS A5-5	ALL/A/GEN J,8
MS A5-6	ALL/A/GEN J,8

* - Omit from MS flight book
⊗ - Highlights reqd

MS A5-7		ALL/A/GEN J,8
MS A5-8		ALL/A/GEN J,8
MS A5-9		4/A/GEN J,2
MS A5-10		4/A/GEN J
MS A5-11		ALL/A/GEN J
MS A5-12		ALL/A/GEN J
MS A6-1		ALL/A/GEN J
MS A6-2	☒	2,4/A/GEN J,14
MS A6-3	☒	ALL/A/GEN J,4
MS A6-4	☒	4/A/GEN J,6
MS A7-1		ALL/A/GEN J
MS A7-2		ALL/A/GEN J
MS A7-3		ALL/A/GEN J,13
MS A7-4		ALL/A/GEN J
MS A8-1		ALL/A/GEN J
MS A8-2		ALL/A/GEN J,2
MS A8-3	⊗	4/A/GEN J,8
MS A8-4		ALL/A/GEN J,8
MS A9-1	*	ALL/A/GEN J
MS A9-2	*	ALL/A/GEN J
MS E-i		ALL/E/GEN J
MS E-ii		ALL/E/GEN J
MS E1-1		ALL/E/GEN J
MS E1-2		ALL/E/GEN J
MS E1-3		ALL/E/GEN J
MS E1-4		ALL/E/GEN J
MS E1-5		ALL/E/GEN J
MS E1-6		ALL/E/GEN J
MS E2-1		ALL/E/GEN J,8
MS E2-2		ALL/E/GEN J,8
MS E2-3		ALL/E/GEN J,4
MS E2-4		ALL/E/GEN J
MS E3-1		ALL/E/GEN J
MS E3-2		ALL/E/GEN J,9
MS E3-3		ALL/E/GEN J,12
MS E3-4		ALL/E/GEN J,12

- ☒ - Prelift-off information reqd
- ⊗ - Highlights reqd
- * - Omit from MS flight book

MS (A)E3-5	ALL/E/GEN J,9
MS (A)E3-6	OI-28/E/GEN J,9
MS (B)E3-5	ALL/E/GEN J,9
MS (B)E3-6	OI-29/E/GEN J,9
MS E3-7	2,4/E/GEN J,12
MS E3-8	ALL/E/GEN J
MS E4-1	deleted
MS E4-2	deleted
MS (A)E4-1	ALL/E/GEN J,14
MS (A)E4-2	2/E/GEN J,14
MS (B)E4-1	ALL/E/GEN J,14
MS (B)E4-2	4/E/GEN J,14
MS E4-3	4/E/GEN J,2
MS E4-4	ALL/E/GEN J,2
MS E4-5	ALL/E/GEN J,12
MS E4-6	ALL/E/GEN J,12
MS E4-7	ALL/E/GEN J
MS E4-8	ALL/E/GEN J
MS E5-1	ALL/E/GEN J
MS E5-2	ALL/E/GEN J,5
MS E5-3	ALL/E/GEN J,5
MS E5-4	ALL/E/GEN J,5
MS E5-5	ALL/E/GEN J
MS E5-6	4/E/GEN J,2
MS E5-7	4/E/GEN J,8
MS E5-8	ALL/E/GEN J,8
MS E5-9	ALL/E/GEN J,8
MS E5-10	ALL/E/GEN J,8
MS E5-11	ALL/E/GEN J,3
MS E5-12	4/E/GEN J,3
MS E5-13	4/E/GEN J
MS E5-14	4/E/GEN J
MS E5-15	ALL/E/GEN J
MS E5-16	ALL/E/GEN J
MS E6-1	ALL/E/GEN J
MS E6-2	<input checked="" type="checkbox"/> ALL/E/GEN J

- Prelift-off information reqd

MS E6-3		ALL/E/GEN J
MS E6-4		ALL/E/GEN J
MS E7-1		ALL/E/GEN J
MS E7-2		ALL/E/GEN J
MS E7-3		ALL/E/GEN J,13
MS E7-4		ALL/E/GEN J
MS E8-1		ALL/E/GEN J
MS E8-2		ALL/E/GEN J
MS E9-1	*	ALL/E/GEN J
MS E9-2	*	ALL/E/GEN J
CC 10-i	*	ALL/A,E/GEN J
CC 10-ii	*	ALL/A,E/GEN J
CC 10-1	*	ALL/A,E/GEN J
CC 10-2	*⊗	4/A/GEN J,3
CC 10-3	*	4/A/GEN J
CC 10-4	*	ALL/A/GEN J
CC 10-5	*	ALL/A/GEN J
CC 10-6	*	ALL/E/GEN J
CC 10-7	*	4/A/GEN J,8
CC 10-8	*	ALL/A/GEN J,8
CC 10-9	*	ALL/A,E/GEN J
CC 10-10	*	ALL/A,E/GEN J
FB A11-i	*	ALL/A/GEN J
FB A11-ii	*	ALL/A/GEN J
FB A11-1	*⊗	2,4/A/GEN J,14
FB A11-2	*⊗	ALL/A/GEN J,4
FB A11-3	*⊗	4/A/GEN J,6
FB A11-4	*	ALL/A/GEN J
FB A11-5	*	ALL/A/GEN J,13
FB A11-6	*	ALL/A/GEN J
FB E11-i	*	ALL/E/GEN J
FB E11-ii	*	ALL/E/GEN J
FB E11-1	*⊗	ALL/E/GEN J,8
FB E11-2	*	ALL/E/GEN J
FB E11-3	*	ALL/E/GEN J
FB E11-4	*	ALL/E/GEN J,13

- * - Omit from MS flight book
- ⊗ - Highlights reqd
- ⊗ - Prelift-off information reqd

FB E11-5	*	ALL/E/GEN J
FB E11-6	*	ALL/E/GEN J
FB A12-i	*	ALL/A/GEN J
FB A12-ii	*	ALL/A/GEN J
FB A12-1	*	ALL/A/GEN J
FB A12-2	*	ALL/A/GEN J
FB (A)A12-3	*	OI-28/A/GEN J,9
FB (A)A12-4	*	4/A/GEN J,9
FB (B)A12-3	*	OI-29/A/GEN J,9
FB (B)A12-4	*	4/A/GEN J,9
FB A12-5	*	ALL/A/GEN J,8
FB A12-6	*	2,4/A/GEN J,12
FB A12-7	*⊗	4/A/GEN J,10
FB A12-8	*	ALL/A/GEN J
FB A12-9	*	ALL/A/GEN J,8
FB A12-10	*	ALL/A/GEN J,8
FB A12-11	*	ALL/A/GEN J,8
FB A12-12	*	ALL/A/GEN J,8
FB A12-13	*	4/A/GEN J,2
FB A12-14	*	4/A/GEN J
FB A12-15	*	ALL/A/GEN J
FB A12-16	*	ALL/A/GEN J
FB E12-i	*	ALL/E/GEN J
FB E12-ii	*	ALL/E/GEN J
FB E12-1	*	ALL/E/GEN J
FB E12-2	*	ALL/E/GEN J
FB E12-3	*	ALL/E/GEN J
FB E12-4	*	ALL/E/GEN J
FB E12-5	*	ALL/E/GEN J,8
FB E12-6	*	ALL/E/GEN J,8
FB E12-7	*	ALL/E/GEN J,9
FB E12-8	*	ALL/E/GEN J,12
FB (A)E12-9	*	OI-28/E/GEN J,9
FB (A)E12-10	*	ALL/E/GEN J,9
FB (B)E12-9	*	OI-29/E/GEN J,9
FB (B)E12-10	*	ALL/E/GEN J,9

* - Omit from MS flight book

⊗ - Highlights reqd

FB E12-11	*	2,4/E/GEN J,12
FB E12-12	*	ALL/E/GEN J,5
FB E12-13	*	ALL/E/GEN J,5
FB E12-14	*	ALL/E/GEN J,5
FB E12-15	*	4/E/GEN J,8
FB E12-16	*	ALL/E/GEN J,8
FB E12-17	*	ALL/E/GEN J,8
FB E12-18	*	ALL/E/GEN J,8
FB E12-19	*	4/E/GEN J,3
FB E12-20	*	4/E/GEN J
FB E12-21	*	ALL/E/GEN J
FB E12-22	*	ALL/E/GEN J
FB A13-i	*	ALL/A/GEN J
FB A13-ii	*	ALL/A/GEN J
FB (A)A13-1	*	OI-28/A/GEN J,9
FB (A)A13-2	*	4/A/GEN J,9
FB (B)A13-1	*	OI-29/A/GEN J,9
FB (B)A13-2	*	4/A/GEN J,9
FB A13-3	*	ALL/A/GEN J,8
FB A13-4	*	2,4/A/GEN J,12
FB A13-5		deleted
FB A13-6		deleted
FB (A)A13-5	*⊗	2/A/GEN J,14
FB (A)A13-6	*	2/A/GEN J,14
FB (B)A13-5	*⊗	4/A/GEN J,14
FB (B)A13-6	*	4/A/GEN J,14
FB A13-7	*	2,4/A/GEN J,11
FB A13-8	*	ALL/A/GEN J,12
FB A13-9	*	4/A/GEN J
FB A13-10	*	4/A/GEN J,2
FB A13-11	*	ALL/A/GEN J
FB A13-12	*	ALL/A/GEN J
FB E13-i	*	ALL/E/GEN J
FB E13-ii	*	ALL/E/GEN J
FB E13-1	*	ALL/E/GEN J,8
FB E13-2	*	ALL/E/GEN J,8

* - Omit from MS flight book

⊗ - Highlights reqd

FB E13-3	*	ALL/E/GEN J,4
FB E13-4	*	ALL/E/GEN J,9
FB (A)E13-5	*	ALL/E/GEN J,12
FB (A)E13-6	*	OI-28/E/GEN J,12
FB (B)E13-5	*	ALL/E/GEN J,12
FB (B)E13-6	*	OI-29/E/GEN J,12
FB E13-7	*	2,4/E/GEN J,12
FB E13-8	*	2,4/E/GEN J,12
FB E13-9		deleted
FB E13-10		deleted
FB (A)E13-9	*	2/E/GEN J,14
FB (A)E13-10	*	2/E/GEN J,14
FB (B)E13-9	*	4/E/GEN J,14
FB (B)E13-10	*	4/E/GEN J,14
FB E13-11	*	ALL/E/GEN J,12
FB E13-12	*	ALL/E/GEN J,12
FB E13-13	*	ALL/E/GEN J
FB E13-14	*	4/E/GEN J
FB E13-15	*	4/E/GEN J,2
FB E13-16	*	ALL/E/GEN J

* – Omit from MS flight book

MULTIPHASE SYSTEMS CUE CARDS

<u>Title</u>	<u>Ref. Page</u>	<u>Card No.</u>
POWER (Front)	CC 10-1	AESP-5a/A,O,E/N
(Back)	CC 10-1	AESP-5b/A,O,E/E
MPS 1 (Front)	CC 10-2	AESP-11a/4/A/F
(Back)	CC 10-3	AESP-11b/4/A/B
MPS 2 (Front)	CC 10-4	AESP-14a/A/D
(Back)	CC 10-4	AESP-14b/A/C
OPS 1/6/TAL TRANSITION RESTRING (Front)	CC 10-5	AESP-10a/A/F
POST OPS 3/GRTL TRANSITION RESTRING (Back)	CC 10-6	AESP-10b/E/B
MPS He P (Pre MECO)/ MPS PNEU TK(REG) P (Front)	CC 10-7	AESP-12a/4/A/D
(Back)	CC 10-7	AESP-12b/4/A/D
ET SEP (Front)	CC 10-8	AESP-13a/A/D
(Back)	CC 10-8	AESP-13b/A/E
FIRE/SMOKE (ASCENT/ENTRY) (Front) .	CC 10-9	AESP-7a/A,O,E/D
(ORBIT) (Back)	See ORBIT POCKET C/L	
POWERED FLIGHT – PLT Overhead Flip Book ..	See FB A11-1 thru FB A11-6	
PLT Window Flip Book	See FB A12-2 thru FB A12-16	
CDR Window Flip Book ...	See FB A13-1 thru FB A13-12	
GLIDED FLIGHT – PLT Overhead Flip Book ..	See FB E11-1 thru FB E11-6	
PLT Window Flip Book	See FB E12-1 thru FB E12-22	
CDR Window Flip Book ...	See FB E13-1 thru FB E13-16	

This Page Intentionally Blank

<u>CONTENTS</u>	<u>PAGE</u>
MS POWERED FLIGHT	MS A-i
<u>APU/HYDRAULICS</u>	MS A1-1
APU SHUTDN	MS A1-2
SPD HI (✓CRT)	MS A1-2
OVERSPEED (>129%)	MS A1-2
UNDERSPEED	MS A1-2
OIL OVERTEMP	MS A1-2
HYD PRESS (LOW) (CIL)	MS A1-2
RSVR QTY (LOW)	MS A1-2
W/B QTY (LOW)	MS A1-2
 <u>COMM/GNC</u>	 MS A2-1
COMM LOST (MULTI PANELS)	MS A2-2
ICOM LOST	MS A2-2
FCS CH 1(2,3,4) (2nd FAIL)	MS A2-2
RHC L(R) (2nd FAIL)	MS A2-2
DISPLAY SW L(R)	MS A2-2
RM FAIL IMU,RGA,AA	MS A2-2
DLMA IMU	MS A2-2
 <u>DPS</u>	 MS A3-1
PASS GPC FAIL	MS A3-2
BFS GPC FAIL	MS A3-2
FF(FA) MDM OUTPUT	MS A3-2
PL MDM I/O ERROR	MS A3-2
PCM I/O ERROR	MS A3-2
SUMWORD ICC	MS A3-2
FA/FF MDM I/O ERROR	MS A3-3
PORT MODE	MS A3-3
BCE STRG X	MS A3-4
DUAL DPS DISPLAY COMMANDERS/ DK XMTR 1(2,3)	MS A3-4
I/O ERROR CRT/DPS DISPLAY ANOMALY	MS A3-4
FLT INST DISPLAY ANOMALY	MS A3-5
SUBSYS STATUS DISPLAY ANOMALY	MS A3-5
BFS INADVERTENT DISENGAGE/ UNSUCCESSFUL ENGAGE	MS A3-5
MULT DATA PATH LOSS (Non-Recov) (CIL)	MS A3-6
OPS 1/6/TAL TRANSITION RESTRING	MS A3-6
POST BFS ENGAGE	MS A3-6

<u>ECLS</u>	MS A4-1
CAB PRESS LEAK	MS A4-2
HIGH	MS A4-2
PPO2 ABNORMAL	MS A4-2
H2O LOOP PRESS HIGH	MS A4-2
LOW	MS A4-2
AV BAY FAN Δ P	MS A4-2
TEMP HIGH	MS A4-2
CABIN FAN FAIL	MS A4-2
IMU FAN FAIL	MS A4-2
FREON FLOW LOW	MS A4-3
LOSS OF 1 FREON LOOP	MS A4-3
2 FREON LOOPS – PWRDN	MS A4-3
– LOOPS FAILED	MS A4-3
EVAP OUT TEMP LOW	MS A4-4
FREON QTY LOW	MS A4-4
EVAP OUT TEMP HIGH	MS A4-5
FIRE/SMOKE	MS A4-6
<u>EPS</u>	MS A5-1
MN BUS UNDER V/FC V (CIL) (PLT)	MS A5-2
AC VOLT HIGH (PLT)	MS A5-2
LOW or OVERLOAD (PLT)	MS A5-3
3 Φ MOTORS STOPPED (PLT)	MS A5-3
BUS TIE	MS A5-4
MNA or AC1 Multi Φ (CDR)	MS A5-4
MNB or AC2 Multi Φ (CDR)	MS A5-4
MNC (CDR)	MS A5-4
AC3 Multi Φ (CDR)	MS A5-4
ANY AC2 SINGLE Φ (CDR)	MS A5-4
MNA or AC1 Multi Φ (PLT) (CIL)	MS A5-5
MNB or AC2 Multi Φ (PLT) (CIL)	MS A5-5
MNC or AC3 Multi Φ (PLT) (CIL)	MS A5-5
AC SINGLE Φ (PLT)	MS A5-5
SUBBUS [APC4(5,6) or ALC1(2,3)] (PLT)	MS A5-5
ESS BUS V LOW (PLT)	MS A5-6
LOSS (CIL)	MS A5-6
CNTL BUS LOSS (CDR)	MS A5-6
V LOW (PLT)	MS A5-7
LOSS (PLT)	MS A5-7
FC REAC VLV CLOSED (PLT)	MS A5-8
pH \downarrow 1(2,3) or FC DELTA V 1(2,3) (PLT)	MS A5-8
STACK T (PLT)	MS A5-8

FC EXIT T (PLT)	MS A5-8
COOLANT PUMP ΔP LOW (PLT) (CIL)	MS A5-9
COOL P (PLT)	MS A5-9
SHUTDOWN (1st) (PLT) (CIL)	MS A5-9
LOSS OF 1 FC PWRDN (PLT)	MS A5-9
2nd FC SHUTDN (PLT)	MS A5-10
LOSS OF 2nd FC PWRDN (CDR)	MS A5-10
O2(H2) CRYO P/T HIGH (PLT)	MS A5-11
CRYO O2(H2) LEAK (3 or more tanks aff) (PLT)	MS A5-11
<u>OMS</u>	MS A6-1
OMS TEMP DURING DUMP	MS A6-2
Pc LOW DURING DUMP	MS A6-2
ENG FAIL	MS A6-2
PRPLT FAIL	MS A6-2
OMS N2 TK P LOW (N/A DURING ASSIST/RTLS/TAL/ATO DUMP)	MS A6-2
OMS N2 REG P HIGH or LOW	MS A6-2
TK P (FU or OX) LOW	MS A6-3
He TK P LOW	MS A6-4
<u>RCS</u>	MS A7-1
RCS JET FAIL (LEAK)	MS A7-2
(ON)	MS A7-2
RM DLMA MANF	MS A7-2
RCS JET FAIL (OFF)	MS A7-2
TK P HIGH (FU or OX)	MS A7-2
XFEED: RCS to RCS (CIL)	MS A7-2
RCS SECURE	MS A7-3
AFT RCS LK	MS A7-3
FWD RCS LK	MS A7-4
<u>MPS</u>	MS A8-1
SSME FAIL/SHUTDN (CIL)	MS A8-2
MPS DATA (CIL)	MS A8-2
LH2 ULL	MS A8-2
DUMP INHIBIT	MS A8-2
'ET SEP MAN' (ET SEP)	MS A8-2
MPS CMD/HYD/ELEC (CIL)	MS A8-3
He P (Pre MECO)	MS A8-4
PNEU TK(REG) P	MS A8-4

SPACELAB – RESERVED

MS GLIDED FLIGHT	MS E-i
<u>APU/HYDRAULICS</u>	MS E1-1
APU SHUTDN	MS E1-2
SPD HI (✓CRT)	MS E1-2
OVERSPEED (>129%)	MS E1-2
UNDERSPEED	MS E1-2
OIL OVERTEMP	MS E1-2
PUMP LEAK P (✓MCC)	MS E1-2
THERM (T HI)	MS E1-2
COOLDOWN	MS E1-3
RESTART (CIL)	MS E1-3
HYD PRESS (LOW) (CIL)	MS E1-4
RSVR QTY (LOW)	MS E1-5
T	MS E1-5
W/B QTY (LOW)	MS E1-5
<u>COMM/GNC</u>	MS E2-1
COMM LOST (MULTI PANELS)	MS E2-2
ICOM LOST	MS E2-2
FCS CH 1(2,3,4) (2nd FAIL)	MS E2-2
RHC L(R) (2nd FAIL)	MS E2-2
G51 ROLL MODE SW	MS E2-2
DISPLAY SW L(R)	MS E2-2
RM FAIL IMU,RGA,AA	MS E2-2
DLMA IMU	MS E2-2
FAIL ADTA	MS E2-3
DLMA ADTA * (CIL)	MS E2-3
FAIL TAC	MS E2-3
DLMA TAC	MS E2-3
<u>DPS</u>	MS E3-1
PASS GPC FAIL	MS E3-2
BFS GPC FAIL	MS E3-2
FA/FF MDM I/O ERROR	MS E3-2
PORT MODE	MS E3-3
FF(FA) MDM OUTPUT	MS E3-4
PL MDM I/O ERROR	MS E3-4
PCM I/O ERROR	MS E3-4
BCE STRG X	MS E3-5
POST OPS 3/	
GRTLS TRANSITION RESTRING	MS E3-6
POST BFS ENGAGE	MS E3-6

DUAL DPS DISPLAY COMMANDERS/ DK XMTR 1(2,3)	MS E3-7
I/O ERROR CRT/DPS DISPLAY ANOMALY	MS E3-7
FLT INST DISPLAY ANOMALY	MS E3-7
SUBSYS STATUS DISPLAY ANOMALY	MS E3-7
BFS INADVERTENT DISENGAGE/ UNSUCCESSFUL ENGAGE	MS E3-7
MULT DATA PATH LOSS (Non-Recov) (CIL)	MS E3-8
<u>ECLS</u>	MS E4-1
CAB PRESS LEAK	MS E4-2
HIGH	MS E4-2
H2O LOOP PRESS LOW(HIGH)	MS E4-2
AV BAY FAN ΔP	MS E4-2
TEMP HIGH	MS E4-2
LOSS OF AV BAY COOLING PWRDN	MS E4-2
CABIN FAN FAIL	MS E4-2
IMU FAN FAIL	MS E4-2
FREON FLOW LOW	MS E4-3
LOSS OF 1 FREON LOOP	MS E4-3
2 FREON LOOPS – PWRDN	MS E4-3
– LOOPS FAILED	MS E4-4
EVAP OUT TEMP HIGH (Rads cold soaked)	MS E4-4
(Rads <u>not</u> cold soaked) ...	MS E4-4
LOW	MS E4-5
FREON QTY LOW	MS E4-5
FIRE/SMOKE	MS E4-6
<u>EPS</u>	MS E5-1
MN BUS UNDER V/FC V (PLT) (CIL)	MS E5-2
AC VOLT HIGH (PLT)	MS E5-2
LOW or OVERLOAD (PLT)	MS E5-3
3Φ MOTORS STOPPED (PLT)	MS E5-4
AC SINGLE Φ (PLT)	MS E5-4
ANY AC2 SINGLE Φ (CDR)	MS E5-4
BUS TIE	MS E5-5
ESS BUS V LOW (PLT)	MS E5-5
LOSS (CIL)	MS E5-5
MNA or <u>AC1 Multi Φ</u> (CDR)	MS E5-6
MNB or <u>AC2 Multi Φ</u> (CDR)	MS E5-6
MNC or <u>AC3 Multi Φ</u> (CDR)	MS E5-6
MNA or <u>AC1 Multi Φ</u> (PLT) (CIL)	MS E5-7

MNB or AC2 Multi Φ (PLT) (CIL)	MS E5-7
MNC or AC3 Multi Φ (PLT) (CIL)	MS E5-7
SUBBUS (PLT)	MS E5-7
CNTL BUS V LOW (PLT)	MS E5-8
LOSS (CDR)	MS E5-8
(PLT)	MS E5-9
FC REAC VLV CLOSED (PLT)	MS E5-10
pH \downarrow 1(2,3) or FC DELTA V 1(2,3) (PLT)	MS E5-10
STACK T (PLT)	MS E5-10
EXIT T (PLT)	MS E5-10
COOLANT PUMP Δ P LOW (PLT) (CIL)	MS E5-11
COOL P	MS E5-11
SHUTDOWN (1st) (CIL)	MS E5-12
LOSS OF 1 FC PWRDN (GRTLS/TAL) (PLT)	MS E5-12
(ENTRY)(PLT)	MS E5-12
EMER PWRDN (PLT)	MS E5-12
2nd FC SHUTDN (GRTLS/TAL) (PLT)	MS E5-13
(ENTRY) (PLT)	MS E5-13
LOSS OF 2nd FC PWRDN	
(GRTLS/TAL) (CDR)	MS E5-14
(GRTLS/TAL) (PLT)	MS E5-15
(ENTRY) (CDR)	MS E5-15
O2(H2) CRYO P/T HIGH	MS E5-16
CRYO O2(H2) LEAK (3 or more tanks aff)	MS E5-16
<u>OMS</u>	MS E6-1
OMS TEMP DURING DUMP	MS E6-2
Pc LOW DURING DUMP	MS E6-2
ENG FAIL	MS E6-2
PRPLT FAIL	MS E6-2
OMS SECURE	MS E6-3
XFEED	
XFEED: R TO L	MS E6-3
L TO R	MS E6-3
XFEED RETURN: OMS to OMS	MS E6-3
<u>RCS</u>	MS E7-1
RCS JET FAIL (LEAK)	MS E7-2
(ON)	MS E7-2
RM DLMA MANF	MS E7-2
RCS JET FAIL (OFF)	MS E7-2
AFT RCS RM LOSS	MS E7-2
LK (GRTLS/304/305)	MS E7-3
RCS TK P HIGH (FU or OX)	MS E7-4

XFEED: RCS to RCS (CIL)	MS E7-4
RCS SECURE	MS E7-4
<u>MPS</u>	MS E8-1
MPS He P/MPS C&W LIGHT	
PNEU REG	MS E8-2
 <u>SPACELAB</u> – RESERVED	
MULTIPHASE SYSTEMS CUE CARDS	CC 10-i
POWER	
EMER PWRDN	CC 10-1
FC SHUTDN (1st) (CIL)	CC 10-1
BUS TIE	CC 10-1
MPS 1	
SSME FAIL/SHUTDN (CIL)	CC 10-2
MPS DATA (CIL)	CC 10-2
LH2 ULL	CC 10-2
DUMP INHIBIT	CC 10-2
CMD/HYD/ELEC (CIL)	CC 10-2
MPS 2	CC 10-4
OPS 1/6/TAL TRANSITION RESTRING	CC 10-5
POST OPS 3/GRTLs TRANSITION RESTRING .	CC 10-6
MPS He P (Pre MECO)	CC 10-7
PNEU TK(REG) P	CC 10-7
ET SEP	
‘ET SEP MAN’	CC 10-8
FIRE/SMOKE (ASCENT/ENTRY)	CC 10-9
 PLT OVERHEAD FLIP BOOK –	
POWERED FLIGHT	FB A11-i
OMS TEMP DURING DUMP	FB A11-1
Pc LOW DURING DUMP	FB A11-1
ENG FAIL	FB A11-1
PRPLT FAIL	FB A11-1
OMS N2 TK P LOW (N/A DURING	
ASSIST/RTLs/TAL/ATO DUMP)	FB A11-1
OMS N2 REG P HIGH or LOW	FB A11-1
TK P (FU or OX) LOW	FB A11-2
He TK P LOW	FB A11-3
RCS JET FAIL (LEAK)	FB A11-4

RCS JET FAIL (ON)	FB A11-4
RM DLMA MANF	FB A11-4
RCS JET FAIL (OFF)	FB A11-4
TK P HIGH (FU or OX)	FB A11-4
XFEED: RCS to RCS (CIL)	FB A11-4
RCS SECURE	FB A11-5
AFT RCS LK	FB A11-5
FWD RCS LK	FB A11-6

**PLT OVERHEAD FLIP BOOK –
GLIDED FLIGHT FB E11-i**

OMS TEMP DURING DUMP	FB E11-1
Pc LOW DURING DUMP	FB E11-1
ENG FAIL	FB E11-1
PRPLT FAIL	FB E11-1
OMS SECURE	FB E11-2
XFEED:	
XFEED: R TO L	FB E11-2
L TO R	FB E11-2
XFEED RETURN: OMS to OMS	FB E11-2
RCS JET FAIL (LEAK)	FB E11-3
(ON)	FB E11-3
RM DLMA MANF	FB E11-3
RCS JET FAIL (OFF)	FB E11-3
TK P HIGH (FU or OX)	FB E11-3
XFEED: RCS to RCS (CIL)	FB E11-3
AFT RCS LK (GRTLS/304/305)	FB E11-4
RCS SECURE	FB E11-5
AFT RCS RM LOSS	FB E11-5

**PLT WINDOW FLIP BOOK –
POWERED FLIGHT FB A12-i**

APU SHUTDN	FB A12-2
SPD HI (✓CRT)	FB A12-2
OVERSPEED (>129%)	FB A12-2
UNDERSPEED	FB A12-2
OIL OVERTEMP	FB A12-2
HYD PRESS (LOW) (CIL)	FB A12-2
RSVR QTY (LOW)	FB A12-2
W/B QTY (LOW)	FB A12-2
COMM LOST (MULTI PANELS)	FB A12-3
ICOM LOST	FB A12-3

FCS CH 1(2,3,4) (2nd FAIL)	FB A12-3
RHC L(R) (2nd FAIL)	FB A12-3
DISPLAY SW L(R)	FB A12-3
RM FAIL IMU,RGA,AA	FB A12-3
RM DLMA IMU	FB A12-3
POST BFS ENGAGE	FB A12-3
PASS GPC FAIL	FB A12-4
BFS GPC FAIL	FB A12-4
FF(FA) MDM OUTPUT	FB A12-4
PL MDM I/O ERROR	FB A12-4
PCM I/O ERROR	FB A12-4
FA/FF MDM I/O ERROR	FB A12-5
PORT MODE	FB A12-5
BCE STRG X	FB A12-6
DUAL DPS DISPLAY COMMANDERS/ DK XMTR 1(2,3)	FB A12-6
I/O ERROR CRT/DPS DISPLAY ANOMALY	FB A12-6
FLT INST DISPLAY ANOMALY	FB A12-7
SUBSYS STATUS DISPLAY ANOMALY	FB A12-7
MULT DATA PATH LOSS (Non-Recov) (CIL)	FB A12-7
MN BUS UNDER V/FC V (CIL)	FB A12-8
AC VOLT HIGH	FB A12-8
LOW or OVERLOAD	FB A12-9
3Φ MOTORS STOPPED	FB A12-9
MNA or AC1 Multi Φ (CIL)	FB A12-10
MNB or AC2 Multi Φ (CIL)	FB A12-10
MNC or AC3 Multi Φ (CIL)	FB A12-10
AC SINGLE Φ	FB A12-10
SUBBUS [APC4(5,6) or ALC1(2,3)]	FB A12-10
ESS BUS V LOW (CIL)	FB A12-10
LOSS (CIL)	FB A12-10
CNTL BUS V LOW	FB A12-11
LOSS	FB A12-11
FC REAC VLV CLOSED	FB A12-12
pH ↓ 1(2,3) or FC DELTA V 1(2,3)	FB A12-12
STACK T	FB A12-12
EXIT T	FB A12-12
COOLANT PUMP ΔP LOW (CIL)	FB A12-13
COOL P	FB A12-13
LOSS OF 1 FC PWRDN	FB A12-13
2nd FC SHUTDN	FB A12-14
O2(H2) CRYO P/T HIGH	FB A12-15
CRYO O2(H2) LEAK (3 or more tanks aff)	FB A12-15

PLT WINDOW FLIP BOOK – GLIDED FLIGHT FB E12-i

APU SHUTDN	FB E12-1
SPD HI (✓CRT)	FB E12-1
OVERSPEED (>129%)	FB E12-1
UNDERSPEED	FB E12-1
OIL OVERTEMP	FB E12-1
PUMP LEAK P (✓MCC)	FB E12-1
THERM (T HI)	FB E12-1
COOLDOWN	FB E12-2
RESTART (CIL)	FB E12-2
HYD PRESS (LOW) (CIL)	FB E12-3
RSVR QTY (LOW)	FB E12-4
T	FB E12-4
W/B QTY (LOW)	FB E12-4
COMM LOST (MULTI PANELS)	FB E12-5
ICOM LOST	FB E12-5
FCS CH 1(2,3,4) (2nd FAIL)	FB E12-5
RHC L(R) (2nd FAIL)	FB E12-5
G51 ROLL MODE SW	FB E12-5
DISPLAY SW L(R)	FB E12-5
RM FAIL IMU,RGA,AA	FB E12-5
DLMA IMU	FB E12-5
FAIL ADTA	FB E12-6
DLMA ADTA * (CIL)	FB E12-6
FAIL TAC	FB E12-6
DLMA TAC	FB E12-6
MPS He P/MPS C&W LIGHT	
PNEU REG	FB E12-6
PASS GPC FAIL	FB E12-7
BFS GPC FAIL	FB E12-7
FA/FF MDM I/O ERROR	FB E12-7
PORT MODE	FB E12-8
FF(FA) MDM OUTPUT	FB E12-9
PL MDM I/O ERROR	FB E12-9
PCM I/O ERROR	FB E12-9
POST BFS ENGAGE	FB E12-9
BCE STRG X	FB E12-10
DUAL DPS DISPLAY COMMANDERS/	
DK XMTR 1(2,3)	FB E12-11
I/O ERROR CRT/DPS DISPLAY ANOMALY	FB E12-11
FLT INST DISPLAY ANOMALY	FB E12-11
SUBSYS STATUS DISPLAY ANOMALY	FB E12-11

MULT DATA PATH LOSS (Non-Recov)	FB E12-11
MN BUS UNDER V/FC V (CIL)	FB E12-12
AC VOLT HIGH	FB E12-12
LOW or OVERLOAD	FB E12-13
3Φ MOTORS STOPPED	FB E12-14
AC SINGLE Φ	FB E12-14
MNA or AC1 Multi Φ (CIL)	FB E12-15
MNB or AC2 Multi Φ (CIL)	FB E12-15
MNC or AC3 Multi Φ (CIL)	FB E12-15
SUBBUS	FB E12-15
ESS BUS V LOW (CIL)	FB E12-15
LOSS (CIL)	FB E12-16
CNTL BUS V LOW	FB E12-16
LOSS	FB E12-16
FC REAC VLV CLOSED	FB E12-18
pH ↓ 1(2,3) or FC DELTA V 1(2,3)	FB E12-18
STACK T	FB E12-18
EXIT T	FB E12-18
COOLANT PUMP ΔP LOW (CIL)	FB E12-19
COOL P	FB E12-19
LOSS OF 1 FC PWRDN (GRTLS/TAL)	FB E12-19
(ENTRY)	FB E12-19
2nd FC SHUTDN (GRTLS/TAL)	FB E12-20
(ENTRY)	FB E12-20
LOSS OF 2nd FC PWRDN (GRTLS/TAL)	FB E12-21
O2(H2) CRYO P/T HIGH	FB E12-22
CRYO O2(H2) LEAK (3 or more tanks aff)	FB E12-22

CDR WINDOW FLIP BOOK –

POWERED FLIGHT **FB A13-i**

COMM LOST (MULTI PANELS)	FB A13-1
ICOM LOST	FB A13-1
FCS CH 1(2,3,4) (2nd FAIL)	FB A13-1
RHC L(R) (2nd FAIL)	FB A13-1
DISPLAY SW L(R)	FB A13-1
RM FAIL IMU,RGA,AA	FB A13-1
DLMA IMU	FB A13-1
POST BFS ENGAGE	FB A13-1
PASS GPC FAIL	FB A13-2
BFS GPC FAIL	FB A13-2
FF(FA) MDM OUTPUT	FB A13-2
PL MDM I/O ERROR	FB A13-2

PL PCM I/O ERROR	FB A13-2
SUMWORD ICC	FB A13-2
FA/FF MDM I/O ERROR	FB A13-3
PORT MODE	FB A13-3
BCE STRG X	FB A13-4
DUAL DPS DISPLAY COMMANDERS/ DK XMTR 1(2,3)	FB A13-4
I/O ERROR CRT/DPS DISPLAY ANOMALY	FB A13-4
FLT INST DISPLAY ANOMALY	FB A13-5
SUBSYS STATUS DISPLAY ANOMALY	FB A13-5
BFS INADVERTENT DISENGAGE/ UNSUCCESSFUL ENGAGE	FB A13-5
MULT DATA PATH LOSS (Non-Recov) (CIL)	FB A13-5
CAB PRESS LEAK	FB A13-6
HIGH	FB A13-6
PPO2 ABNORMAL	FB A13-6
H2O LOOP PRESS HIGH	FB A13-6
LOW	FB A13-6
AV BAY FAN Δ P	FB A13-6
TEMP HIGH	FB A13-6
CABIN FAN FAIL	FB A13-6
IMU FAN FAIL	FB A13-6
FREON FLOW LOW	FB A13-7
LOSS OF 1 FREON LOOP	FB A13-7
2 FREON LOOPS - PWRDN	FB A13-7
- LOOPS FAILED	FB A13-7
EVAP OUT TEMP HIGH	FB A13-8
LOW	FB A13-8
FREON QTY LOW	FB A13-8
ESS BUS LOSS (CIL)	FB A13-9
LOSS OF 2nd FC PWRDN	FB A13-9
MNA or AC1 Multi Φ (CIL)	FB A13-10
MNB or AC2 Multi Φ (CIL)	FB A13-10
MNC	FB A13-10
AC3 Multi Φ	FB A13-10
ANY AC2 SINGLE Φ	FB A13-10
CNTL BUS LOSS	FB A13-10
FWD RCS LK	FB A13-11

CDR WINDOW FLIP BOOK – GLIDED FLIGHT ... FB E13-i

COMM LOST (MULTI PANELS)	FB E13-1
ICOM LOST	FB E13-1
FCS CH 1(2,3,4) (2nd FAIL)	FB E13-2
RHC L(R) (2nd FAIL)	FB E13-2
G51 ROLL MODE SW	FB E13-2
DISPLAY SW L(R)	FB E13-2
RM FAIL IMU,RGA,AA	FB E13-2
DLMA IMU	FB E13-2
FAIL ADTA	FB E13-2
DLMA ADTA * (CIL)	FB E13-2
FAIL TAC	FB E13-3
DLMA TAC	FB E13-3
PASS GPC FAIL	FB E13-4
BFS GPC FAIL	FB E13-4
FA/FF MDM I/O ERROR	FB E13-4
PORT MODE	FB E13-5
FF(FA) MDM OUTPUT	FB E13-6
PL MDM I/O ERROR	FB E13-6
PCM I/O ERROR	FB E13-6
POST BFS ENGAGE	FB E13-6
BCE STRG X	FB E13-7
DUAL DPS DISPLAY COMMANDERS/ DK XMTR 1(2,3)	FB E13-7
I/O ERROR CRT/DPS DISPLAY ANOMALY	FB E13-8
FLT INST DISPLAY ANOMALY	FB E13-8
SUBSYS STATUS DISPLAY ANOMALY	FB E13-8
BFS INADVERTENT DISENGAGE/ UNSUCCESSFUL ENGAGE	FB E13-8
MULT DATA PATH LOSS (Non-Recov) (CIL)	FB E13-8
CAB PRESS LEAK	FB E13-9
HIGH	FB E13-9
H2O LOOP PRESS LOW(HIGH)	FB E13-9
AV BAY FAN ΔP	FB E13-9
TEMP HIGH	FB E13-9
LOSS OF AV BAY COOLING PWRDN	FB E13-9
CABIN FAN FAIL	FB E13-9
IMU FAN FAIL	FB E13-9
FREON FLOW LOW	FB E13-10
LOSS OF 1 FREON LOOP	FB E13-10
2 FREON LOOPS – PWRDN	FB E13-10
– LOOPS FAILED	FB E13-11

EVAP OUT TEMP HIGH	
(Rads cold soaked)	FB E13-11
(Rads <u>not</u> cold soaked) . . .	FB E13-11
LOW	FB E13-12
FREON QTY LOW	FB E13-12
ESS BUS LOSS (CIL)	FB E13-13
LOSS OF 2nd FC PWRDN (ENTRY)	FB E13-13
(GRTLS/TAL)	FB E13-14
MNA or AC1 Multi Φ (CIL)	FB E13-15
MNB or AC2 Multi Φ (CIL)	FB E13-15
MNC or AC3 Multi Φ (CIL)	FB E13-15
ANY AC2 SINGLE Φ	FB E13-15
CNTL BUS LOSS	FB E13-16

MS POWERED FLIGHT

----- MS POWERED FLIGHT, SECTIONS 1 thru 9 -----

MS A-i

AESP/ALL/A/GEN J

----- MS POWERED FLIGHT, SECTIONS 1 thru 9 -----

This Page Intentionally Blank

APU/
HYD

APU/HYDRAULICS

MS A1-1

AESP/ALL/A/GEN J

APU/
HYD

APU SHUTDN

APU OPER – OFF
FUEL TK VLV – CL
√SHUTDN (HYD PRESS)
Report APU F7 lts
APU CNTLR PWR – OFF
AUTO SHUTDN (two) – INH
SPEED SEL (two) – HI ⇒

APU SPD HI (√CRT)

APU SPEED SEL – HI ⇒

APU OVERSPEED (>129%)

Go to APU SHUTDN

APU UNDERSPEED

If 'PRL SYS X ↓' or if APU has shut down:
Perform APU SHUTDN, then: ⇒G

APU OIL OVERTEMP

◇ √BLR PWR – ON
CNTLR/HTR – B ⇒

HYD PRESS (LOW) G51

If 'PRL SYS X ↓' and APU still operating:
1. APU AUTO SHUTDN (two) – INH
2. SPEED SEL (two) – HI ⇒

HYD RSVR QTY (LOW)

Post MECO:
Aff MPS/TVC ISOL VLV – CL (5 sec) ⇒

W/B QTY (LOW)

Aff BLR PWR – OFF ⇒



**COMM/
GNC**

COMM/GNC



MS A2-1

AESP/ALL/A/GEN J,8

COMM/
GNC

COMM LOST (MULTI PANELS)

1. AUD CTR – 2
2. No joy, S-BD PM CNTL – PNL,CMD
3. Config per COMM COVERAGE **BFS G51** :
TDRS – ITEM 46 EXEC (*)
STDN-HI – ITEM 47 EXEC (*)
SGLS – ITEM 49 EXEC (*)
4. No joy, sel best S-BD PM ANT, else GPC ⇒

ICOM LOST

1. AUD CNTL – sel ALT
2. No joy, AUD CTR – 2

FCS CH 1(2,3,4) (2nd FAIL) **G53**

If 2 FCS CH ↓ on any actuator:

- ◇ 1. Remaining FCS CH (two) – ORIDE

RHC L(R) (2nd FAIL)

Aff FLT CNTLR PWR – OFF

DISPLAY SW L(R)

L(R) Disp sws (eight) – green dot

RM FAIL IMU,RGA,AA **BFS G51**

Aff LRU – desel

RM DLMA IMU **G51** **BFS G51**

1. ✓MCC, bad IMU – desel (PASS & BFS) >>
- ◇ 2. Desel lower # IMU with '?' (PASS)



DPS

DPS

MS A3-1

AESP/ALL/A/GEN J



DPS

PASS GPC FAIL

1. Aff FCS CH – OFF
- If two GPC/FA/FCS CHs ↓:
2. Good FCS CHs – ORIDE
 3. ✓MPS CMD
 4. **G53** aff SURF FDBK – desel
 5. If FTS and accessible – STBY,HALT
 6. ✓BIG 'X', then assign IDPs as reqd
 7. ✓MULT DATA PATH LOSS
- Post MECO:
8. ASAP, GPC MODE – STBY,HALT ⇒

BFS GPC FAIL

1. Post SRB SEP: FES PRI A – ON
- If IDP hard assigned to BFS:
2. Deassign IDP 4 if assigned to PASS
 3. Reassign any hard assigned BFS IDP to PASS
- Post MECO:
4. GPC MODE – STBY,HALT
OUTPUT – TERM
 5. If no comm: sel best S–BD PM ANT ⇒

FF(FA) MDM OUTPUT **FAULT**

- (Take action only if annun by entire set)
- If single 'MDM OUTPUT':
1. Go to FA/FF MDM I/O ERROR >>
- If both FF & FA annun:
2. I/O RESET; If reqd, BFS I/O RESET
 3. If msgs repeat: Go to PASS GPC FAIL >>
 4. If reqd, aff FCS CH – ORIDE,AUTO

PL MDM I/O ERROR

1. BFS I/O RESET; If recovered >>
2. **G01** PL 1/2 – port mode, then BFS I/O RESET
If recovered >>
3. If PL2 down:
Post SRB SEP: FES PRI A – ON
If no comm: sel best S–BD PM ANT ⇒

PCM I/O ERROR

OI PCMMU PWR – 2

SUMWORD ICC

- If TAL:
- Go to OPS 1/6/TAL TRANSITION RESTRING (Cue Card) for aff GPC >>
- If AOA/Uphill: ⇒A

FA/FF MDM I/O ERROR
(Annunciated by entire set)

		1. I/O RESET
RECOV	FA	2. If reqd, aff FCS CH – ORIDE,AUTO
		3. BFS I/O RESET >>
NOT RECOV	FA	4. Aff FCS CH – OFF 5. If 2 GPC/FA/FCS CHs ↓: Good FCS CHs – ORIDE 6. G53 aff SURF FDBK – desel
		7. ✓MULT DATA PATH LOSS ◇8. Go to FA/FF MDM PORT MODE ⇒

FA/FF MDM PORT MODE

NOTE: If BFS, 'BCE STRG X PASS', @GPC; else @MDM.
For '@GPC' port mode results in alternate MDM bypass

			1. G01 aff STRG – port mode 2. BFS I/O RESET
@MDM	RECOV	FA	3. Aff FCS CH – AUTO 4. G53 aff SURF FDBK – resel >>
		FF	5. >>
	NOT RECOV	FA	6. BFS G51 aff SURF FDBK, RGA – desel
		FF	7. BFS G51 aff AA – desel
			8. ✓MULT DATA PATH LOSS ⇒
@GPC	FA RECOV (FF Give Up)		9. Aff FCS CH – AUTO 10. G51 aff IMU – desel 11. G53 aff SURF FDBK – resel 12. ✓MULT DATA PATH LOSS ⇒A
	FF RECOV (FA Give Up)		13. Aff FCS CH – OFF 14. If 2 GPC/FA/FCS CHs ↓: Good FCS CHs – ORIDE 15. G53 aff SURF FDBK – desel 16. ✓MULT DATA PATH LOSS ⇒A

BCE STRG X (no 'MDM OUTPUT' msg)

	IMU	1. G51 IMU – desel
		2. I/O RESET
RECOV	IMU	3. >>
		4. >>
NOT RECOV	NSP	5. And no comm: PNL,CMD 6. BFS G51 Config per COMM COVERAGE: TDRS – ITEM 46 EXEC (*) STDN–HI – ITEM 47 EXEC (*) SGLS – ITEM 49 EXEC (*) >>
		◇ 7. G01 aff STRG – port mode
		8. BFS I/O RESET
		9. If recov, go to RECOV steps >>
	B	10. BFS G51 aff AA – desel
	D	11. BFS G51 aff SURF FDBK,RGA – desel
	B/D	12. ✓MULT DATA PATH LOSS ⇒

DUAL DPS DISPLAY COMMANDERS/DK XMTR 1(2,3)

1. BFC CRT SEL – aff IDP

If reqd to clean up display:

2. Aff IDP/CRT PWR – OFF,ON

I/O ERROR CRT/DPS DISPLAY ANOMALY

If IDP 4(CRT 4): IDP/CRT 4 PWR – OFF >>

If NO big X/POLL FAIL:

1. MDU PWR – OFF,ON; if recovered >>

If MCC GO for power cycle:

2. IDP/CRT PWR – OFF,ON; if recovered >>

If big X/POLL FAIL:

3. IDP/CRT PWR – OFF,ON; if recovered >>

If PASS:

4. GPC/CRT – same GPC/aff IDP; if recovered >>

5. BFC CRT SEL – aff IDP: Go to step 11

If BFS via BFC CRT SEL sw:

6. BFC CRT SEL – unaff IDP; if both IDPs OK >>

7. – original position

8. In PASS: GPC/CRT 5/X EXEC for aff IDP: Go to step 11

If BFS via GPC/CRT key:

9. Deassign IDP 4 if assigned to PASS

10. Assign aff IDP to PASS; if recovered >>

11. If reqd: In PASS, deassign/assign IDPs to maintain PASS interface with three IDPs

FLT INST DISPLAY ANOMALY

1. DATA BUS Select alternate FC BUS(s); if recovered >>
2. PORT SELECT aff MDU; if recovered >>
3. MDU PWR – OFF,ON

SUBSYS STATUS DISPLAY ANOMALY

1. PORT SELECT aff MDU; if recovered >>
2. MDU PWR – OFF,ON; if recovered >>

BFS INADVERTENT DISENGAGE/UNSUCCESSFUL ENGAGE (Lightning Strike)

1. CDR and PLT RHC ENGAGE pb – depress
If no response:
 2. BFS OUTPUT – NORM,B/U
 3. CDR,PLT RHC ENGAGE pb – depress

MULT DATA PATH LOSS (Non-Recov)

NOTE

If LRU data path loss due to GPC problem and not MDM, BFS will pick up MDMs/LRU when engaged

FAILURE	TYPE	ACTIONS
GPC/FA any combo	D	✓BFS MM at each transition Expect 'SEP INH' (FDLN Fail) combos 2&3,2&4
	I/O	✓OMS MAN SHUTDOWN Post MECO: Before MECO + 25 sec: ** 1. MPS FDLN RLF ISOL (two) – OP 2. MPS PREVLVs (six) – OP RTLS/TAL: MPS LH2 FILL/DRAIN INBD, OUTBD – OP
GPC/FF 1&2	I/O or B	Use R BODY FLAP & TRIM ENA SWs
GPC/FF 3&4	I/O or B	Use L BODY FLAP & TRIM ENA SWs

OPS 1/6/TAL TRANSITION RESTRING

	1. Config MC1(3) NBAT as reqd 2. ✓G53 aff SURF FDBK – desel (*)
Post MECO	3. ASAP, aff GPC(s) – STBY,HALT
ASC/RTLS	4. OPS Mode Recall: OPS XXX PRO 5. BFS I/O RESET ⇒G
TAL	6. OPS 301 PRO 7. BFS, OPS 301 PRO ⇒G

POST BFS ENGAGE

CAUTION

Do not assign more than 3 IDPs at a time

If PASS GPCs running:

1. Aff GPC MODE – STBY/HALT
2. BFS I/O RESET
3. ✓FCS CHs, IMU config

If Pre MECO:

4. If SSME failed: MAIN ENGINE LIMIT SHUT DN – INH
5. G51 DES failed (commfaulted) RGA, AA, SURF ⇒G
6. GPC/CRT 04 EXEC, as reqd

OI-28

FLT INST DISPLAY ANOMALY

1. DATA BUS Select alternate FC BUS(s); if recovered >>
2. PORT SELECT aff MDU; if recovered >>
3. MDU PWR – OFF,ON

SUBSYS STATUS DISPLAY ANOMALY

1. PORT SELECT aff MDU; if recovered >>
2. MDU PWR – OFF,ON; if recovered >>

BFS INADVERTENT DISENGAGE/UNSUCCESSFUL ENGAGE (Lightning Strike)

1. CDR and PLT RHC ENGAGE pb – depress
If no response:
 2. BFS OUTPUT – NORM,B/U
 3. CDR,PLT RHC ENGAGE pb – depress

MULT DATA PATH LOSS (Non-Recov)

NOTE

If LRU data path loss due to GPC problem and not MDM, BFS will pick up MDMs/LRU when engaged

FAILURE	TYPE	ACTIONS
GPC/FA any combo	I/O	D ✓BFS MM at each transition Expect 'SEP INH' (FDLN Fail) combos 2&3,2&4
		✓OMS MAN SHUTDOWN Post MECO: Before MECO + 25 sec: •• 1. MPS FDLN RLF ISOL (two) – OP 2. MPS PREVLVs (six) – OP RTLs/TAL: MPS LH2 FILL/DRAIN INBD, OUTBD – OP
GPC/FF 1&2	I/O or B	Use R BODY FLAP & TRIM ENA SWs
GPC/FF 3&4	I/O or B	Use L BODY FLAP & TRIM ENA SWs

OPS 1/6/TAL TRANSITION RESTRING

	1. Config MC1(3) NBAT as reqd 2. ✓G53 aff SURF FDBK – desel (*)
Post MECO	3. ASAP, aff GPC(s) – STBY,HALT
ASC/RTLs	4. OPS Mode Recall: OPS XXX PRO 5. BFS I/O RESET ⇒G
TAL	6. OPS 301 PRO 7. BFS, OPS 301 PRO ⇒G

POST BFS ENGAGE

If PASS GPCs running:

1. Aff GPC MODE – STBY/HALT
2. BFS I/O RESET
3. ✓FCS CHs, IMU config

If Pre MECO:

4. If SSME failed: MAIN ENGINE LIMIT SHUT DN – INH
5. G51 DES failed (commfaulted) RGA, AA, SURF ⇒G

OI-29

MS (B)A3-6 AESP/OI-29/A/GEN J,10

ECLS

ECLS

MS (A)A4-1 AESP/ALL/A/GEN J,14

ECLS

CAB PRESS LEAK

1. CAB RELIEF A – CL (pause)
B – CL
2. ✓ Tabs/Visors – CL/LES O2 – ON
3. If RTLS/TAL: O2/N2 CNTLR VLV SYS 2 – OP
4. O2 TK1,TK2 HTRS A,B (four) – AUTO ⇒

CAB PRESS HIGH

1. If increasing: LES O2 – OFF, Visors – OP
If still incr:
 2. N2 SYS 1,2 REG INLET (two) – CL
 3. O2 SYS 1,2 SPLY (two) – CL ⇒A

PPO2 ABNORMAL ⇒A

H2O LOOP PRESS HIGH

- ◇ Deact pump ⇒

H2O LOOP PRESS LOW ⇒

AV BAY FAN ΔP

- ◇ 1. Switch fans
2. If no joy: Aff TACAN – OFF ⇒A

AV BAY TEMP HIGH

- ◇ 1. Aff AV BAY FANS (two) – ON
2. If not decr: Switch H2O Loops
3. If no joy: Aff TACAN – OFF ⇒A

CABIN FAN FAIL ⇒

IMU FAN FAIL ⇒

ECLS

ECLS

MS (B)A4-1 AESP/ALL/A/GEN J,14

ECLS

CAB PRESS LEAK

1. CAB RELIEF A – CL (pause)
B – CL
2. ✓ Tabs/Visors – CL/LES O2 – ON
3. If RTLS/TAL: O2/N2 CNTLR VLV SYS 2 – OP
4. O2 TK1,TK2 HTRS A,B (four) – AUTO ⇒

CAB PRESS HIGH

1. If increasing: LES O2 – OFF, Visors – OP
If still incr:
 2. N2 SYS 1,2 REG INLET (two) – CL
 3. O2 SYS 1,2 SPLY (two) – CL ⇒A

PPO2 ABNORMAL ⇒A

H2O LOOP PRESS HIGH

◇ Deact pump ⇒

H2O LOOP PRESS LOW ⇒

AV BAY FAN ΔP

◇ Deact fan ⇒

AV BAY TEMP HIGH ⇒

CABIN FAN FAIL ⇒

IMU FAN FAIL ⇒

FREON FLOW LOW

- ◇ 1. Switch pumps
If flow still low:
 2. Aff RAD BYP VLV MAN SEL – RAD FLOW
(hold 5 sec)
- If flow still low:
 3. Perform LOSS OF FREON LOOP(s), then ⇒A

LOSS OF 1 FREON LOOP

1. Bad LOOP FREON PUMP – OFF
- If FREON LOOP 1(2) lost:
 2. O2 SYS 1(2) SPLY (one) – CL
- In good loop:
 3. ✓FLOW PROP VLV LOOP 1(2) – ICH
4. Monitor EVAP OUT TEMP
- If TAL/AOA/RTLs:
 - If LOOP 2 lost:
 5. NH3 CNTLR B – OFF
A – PRI/GPC

LOSS OF 2 FREON LOOPS – PWRDN

1. When loops fail (flow <700), CDR execute LOOPS
FAILED
 2. MSTR MADS PWR – OFF
 3. Use one IDP/CRT with two MDUs (three max)
 4. All PL PWR (seven) – OFF
 5. O2,H2 TK HTRS (all) – OFF
 6. MCC CMD FC purge, then BFS GPC – STBY,HALT
PWR – OFF
OUTPUT – NORM
 7. If no comm: Sel best S–BD PM ANT
- Post MECO:
- If RTLs:
8. TACAN 1,2 – OFF
 9. RADAR ALT 1 – OFF ⇒G
- If TAL:
10. All TACAN/RA – OFF
 11. Use one FLT CNTLR PWR ⇒G

LOSS OF 2 FREON LOOPS – LOOPS FAILED

1. LES O2 – OFF, Visor – OP
 2. O2 SYS SPLY (two) – OP
- Panel L1: All switches off, except:
3. H2O PUMP LOOP 2 – ON
 4. Perform PWRDN if not already accomplished

EVAP OUT TEMP LOW

1. If low in only one loop (snsr failed) >>
 2. FREON PUMP LOOP 1,2 (two) – OFF
 3. H2O PUMP LOOP 1 (two) – ON,B
- If no PL H2O Loop present:
4. FLOW PROP VLV LOOP 1,2 (two) – PL HX (tb-PL)
- If PL H2O Loop present:
5. Activate PL H2O Loop
 6. O2 SYS 1,2 SPLY VLV (two) – CL
 7. FLASH EVAP CNTLR PRI A, PRI B, SEC (three) – OFF
 - ◇ 8. FREON PUMP LOOP 1,2 (two) – B
 - ◇ 9. NH3 CNTLR A,B (two) – SEC/ON
- If FREON LOOP 1(2) running:
10. O2 SYS 1(2) SPLY VLV – OP
- When EVAP OUT T > 55 for at least 2 min (NH3 depleted):
- If any FREON LOOP off:
11. FREON PUMP LOOP 1(2) – B
 12. O2 SYS 1(2) SPLY VLV – OP
 13. Wait 3 min
 14. FLASH EVAP CNTLR PRI B(SEC) – GPC

FREON QTY LOW

- ◇ 1. FREON ISOL MODE – MAN
2. (Aff) FREON ISOL LOOP 1(2) – ISOL
Hold for 5 sec ⇒A

EVAP OUT TEMP HIGH

If temp high in only one loop, snsr failed >>

1. FES PRI A – OFF
 B – ON (wait 30 sec)
 If T decr >>
2. FES PRI B – OFF
 SEC – ON (HI LOAD ena) (wait 30 sec)
 If T decr >>
3. HI LOAD EVAP – OFF (wait 30 sec)
 If T decr (HI LOAD EVAP only lost) ⇒A
4. RAD BYP VLV (four) – MAN,RAD FLOW
 (total FES lost) ⇒

FIRE/SMOKE

SM SYS SUMM 1

If **VISUAL SMOKE/FIRE**, or
two SMOKE DETN It on, or
two CONC > 2, or
one SMOKE DETN It on and
other CONC > 2:

1. Go to step 6

If single Av Bay SMOKE DETN A(B) It and assoc CONC > 2:

2. SMOKE DETN CKT TEST – B(A) (25 sec)

If SMOKE DETN B(A) test good (It on):

3. SMOKE DETN CKT TEST – OFF

4. SNSR – RESET >>

If SMOKE DETN B(A) test bad (no It):

5. Go to step 6

If none of above >>

6. ✓ Tabs/Visors – CL

LES O2 – ON

If **AV BAY FIRE**:

7. FIRE SUPPR – ARM

pb – DISCH (push until lit)

8. If Ascent: AV BAY FAN (two) – OFF

9. If FIRE in Bay:

1: TACAN 1, MLS 1 – OFF

2: TACAN 2, MLS 2,3 – OFF

3: TACAN 3 – OFF

If **CABIN FIRE**:

10. CAB FAN A,B (two) – OFF (max 20 min)

11. Locate source (see matrix, facing page)

12. Unpower source of smoke

If smoke persists or source cannot be unpowered:

WARNING
Discharge is propulsive

13. Discharge handheld FIRE EXTGHR

If Ascent:

14. Post MECO, go to POST-FIRE CABIN CLEANUP (ASC
PKT, ECLS) >>

If Entry and prior to TIG:

15. Go to ECLS FRP-3, CONTINGENCY CABIN O2
CONTROL, step 3 (MAL)

Cont next page

MS A4-6

AESP/ALL/A/GEN J

ALARM SEQUENCE	SOURCE AREA
<div style="text-align: center;"> <div style="border: 1px solid black; padding: 2px; display: inline-block;">L(R) FLT DK</div> or <div style="display: flex; align-items: center; gap: 10px;"> <div style="border: 1px solid black; padding: 2px; display: inline-block;">L(R) FLT DK</div> <div style="font-size: 12px;">→</div> <div style="border: 1px solid black; padding: 2px; display: inline-block;">CABIN</div> </div> </div>	PS(MS), L(R) CONSOLE
<div style="display: flex; align-items: center; gap: 20px;"> <div style="border: 1px solid black; padding: 2px; display: inline-block;">L FLT DK</div> <div style="font-size: 12px;">↔</div> <div style="border: 1px solid black; padding: 2px; display: inline-block;">R FLT DK</div> </div>	AFT FLT DK, MIDDECK
<div style="text-align: center;"> <div style="border: 1px solid black; padding: 2px; display: inline-block;">CABIN</div> or <div style="display: flex; flex-direction: column; align-items: center; gap: 10px;"> <div style="border: 1px solid black; padding: 2px; display: inline-block;">L FLT DK</div> <div style="font-size: 12px;">↕</div> <div style="border: 1px solid black; padding: 2px; display: inline-block;">R FLT DK</div> </div> </div> <div style="display: flex; align-items: center; margin-top: 10px;"> <div style="border: 1px solid black; padding: 2px; display: inline-block; margin-right: 10px;">CABIN</div> <div style="font-size: 12px;">↙ ↘</div> </div>	FWD FLT DK, WCS, LEB

This Page Intentionally Blank

MS A4-8

AESP/ALL/A/GEN J



EPS

EPS



MS A5-1

AESP/ALL/A/GEN J

MN BUS UNDER V/FC V

PLT

If MN V < 26.4, FC V < 26.6, FC A > 480 (2 of 3)

(SHORT OR DEGRADED FC):

1. MSTR MADS PWR – OFF
2. If aff BUS tied – UNTIE
3. PL PRI (three) – OFF
- If AC VOLTS < 95, or STACK T > 243 and incr:
 4. Aff ESS BUS SOURCE FC – OFF
FC/MN BUS – OFF
 - If FC VOLTS < 32 (FC SHORT)
 5. Aff FC REAC VLV – CL
 6. Go to FC SHUTDN (Do not stop FC until
COOL P < 15 & STACK T < 243) >>
 - If FC VOLTS ≥ 32 (BUS SHORT)
 7. Go to BUS LOSS ACTIONS >>
8. ⇒

If MN V < 26.4 and FC V > 32 and FC A < 20

(FC DISCONNECT):

9. MSTR MADS PWR – OFF
10. PL PRI (three) – OFF
11. FC/MN BUS – ON
- If FC3 aff:
 12. PL PRI FC3 – ON
MNC – ON
 13. If MNC V < 26.4: PL PRI (three) – OFF
- If 1st FC failure:
 14. Perform BUS TIE, then:
If MN BUS recovered:
 15. GNC I/O RESET
- Post MECO: If aff FC VOLTS > 32:
 16. Go to FC SHUTDN

EPS

AC VOLT HIGH

If AC V > 123 and F7 “AC VOLTAGE”:

1. Unaff AC BUS SNSRS (two) – OFF
- If AC V ≥ 130:
 2. Aff AC BUS SNSR – AUTO TRIP
 3. Perform aff BUS LOSS, then:
- If AC3 aff and V < 130:
 4. H2O PUMP LOOP 2 – OFF
5. ⇒ AC VOLTS (LOW or HIGH)

AC VOLT LOW or OVERLOAD

PLT

MN
SUB

1. AC BUS SNSR (three) – OFF
- If amps > 14 and V < 95:
 2. If single Φ amps > 14:
 3. cb AC CONTR – cl
INV/AC BUS – OFF
INV PWR – OFF
cb AC CONTR – op
 4. If other Φ amps > 14:
Go to step 5
 5. If multi Φ (Bus short):
 6. Aff cb AC CONTR (three) – cl
INV/AC BUS – OFF (tb-OFF)
INV PWR – OFF (tb-OFF)
cb AC CONTR (three) – op
 7. Go to aff BUS LOSS >>
8. \Rightarrow AC VOLTS (LOW or HIGH)

3 Φ MOTORS STOPPED

1. AC BUS SNSR (three) – OFF
2. Determine AC BUS
 - FC1 & FREON PUMP 2B: AC1
 - FC2 & FREON PUMP 1B: AC2
 - FC3 & CAB FAN A: AC3
3. Aff FC – STOP
- If AC3 aff:
 4. AV BAY 3 FAN B – OFF, A – ON
 5. CAB FAN A – OFF
- Isolate aff Φ B:
 6. Aff cb AC CONTR – cl
 7. INV/AC BUS – OFF
- If AC1(2,3) aff and AV BAY 3(2,3) FAN Δ P < 0.5:
 8. Aff INV/AC BUS – ON
 9. cb AC CONTR – op
 10. Repeat from step 6 to isolate aff Φ C, Φ A, then:
 11. Aff cb AC CONTR (three) – cl
 12. INV/AC BUS – OFF
 13. Go to BUS LOSS, AC MULTI Φ >>
- If AC1(2,3) aff and AV BAY 3(2,3) FAN Δ P \geq 0.5:
 14. Aff FC – START (10 sec or Δ P tb-gray)
 15. Perform aff BUS LOSS and if AC1(AC2) aff >>
 16. If AC3 aff:
Post MECO:
CAB FAN B – ON

MN
3Φ

BUS TIE (Do not tie Bus short)

If MN Volts > 20: Bus Tie

If MN Volts < 20 and Post SRB SEP:

1. Pre MECO: CDR: Perform AC Multi Φ
2. Aff AC BUS SNSR (3 if Pre MECO) – OFF
3. cb AC CONTR (three) – cl
4. INV/AC BUS – OFF (tb-OFF)
5. INV PWR – OFF (tb-OFF)
6. If MNC(B) dn, CAB FAN A(B) – OFF
7. Bus Tie
8. INV PWR – ON (tb-ON)
9. INV/AC BUS – ON (tb-ON)
10. cb AC CONTR (three) – op
11. Post MECO: AC BUS SNSR – AUTO TRIP
12. Post PWRDN: ✓CAB FAN A(B) – ON
13. GNC I/O RESET

MNA or AC1 Multi Φ

CDR

Post SRB SEP:

- ◇
1. FREON PUMP LOOP 2 – A
 2. TOP EVAP HTR DUCT – B
 3. HI LOAD DUCT HTR – B
 4. BFS G51 AA1 – desel ⇒

FAILED: UHF HI PWR XMIT

MNB or AC2 Multi Φ

Post SRB SEP:

- ◇
1. AV BAY 1 FAN A – ON, B – OFF
 2. FREON PUMP LOOP 1 – A
 3. BFS G51 AA2, RGA 2 – desel ⇒

FAILED: S-BD PM 1 (NO PNL, CMD)

MNC

Post SRB SEP:

1. FES CNTLR PRI A – OFF, B – ON
2. BFS G51 RGA 3 – desel ⇒

AC3 Multi Φ ⇒

ANY AC2 SINGLE Φ ⇒

MNA or AC1 Multi Φ

PLT

1. Do not isolate MPS He C
2. MSTR MADS PWR – OFF
3. AC BUS SNSR (three) – OFF
4. Perform FC SHUTDN (within 9 min), then:

Post MECO:

5. L OMS – sel SEC \Rightarrow

MNB or AC2 Multi Φ

1. Do not isolate MPS He L
 2. MSTR MADS PWR – OFF
 3. AC BUS SNSR (three) – OFF
 4. Perform FC SHUTDN (within 9 min), then: \Rightarrow
- FAILED: S–BD PM 1 (NO PNL, CMD)

**ESS
CNTL**

MNC or AC3 Multi Φ

1. Do not isolate MPS He R
2. S–BD PM CNTL – PNL, CMD
3. Config per COMM COVERAGE **BFS G51**:
TDRS – ITEM 46 EXEC (*)
STDN–HI – ITEM 47 EXEC (*)
SGLS – ITEM 49 EXEC (*)
4. MSTR MADS PWR – OFF
5. AC BUS SNSR (three) – OFF
6. Perform FC SHUTDN (within 9 min), then:

Post MECO:

7. R OMS – sel SEC \Rightarrow

AC SINGLE Φ \Rightarrow

SUBBUS [APC4(5,6) or ALC1(2,3)]

Do not isolate MPS He C(L, R) \Rightarrow

MN
SUB

ESS BUS V LOW

If verified by F9 voltmeter:

1. Perform FC SHUTDN (<9 min), then:
2. Go to aff ESS BUS LOSS

ESS BUS LOSS

ESS 1BC	1. L AUD CNTL – R (CDR can't talk) 2. Pri C/W & Matrix lost
ESS 2CA	1. AUD CTR – 2 2. R AUD CNTL – L (PLT can't talk)
ESS 3AB	1. Do not ENGAGE BFS 2. CSM lost ⇒

CNTL BUS LOSS

CDR

AB1	1. TOP EVAP HTR DUCT – B 2. HI LOAD DUCT HTR – B ⇒
AB2	1. TOP EVAP HTR DUCT – B 2. HI LOAD DUCT HTR – B ⇒
AB3	1. TOP EVAP HTR DUCT – B 2. HI LOAD DUCT HTR – B If BFS ENGAGE reqd: 3. Use PLT's RHC, then GPCs 1,2,4 – STBY,HALT 4. BFS I/O RESET 5. ⇒
BC1	1. BFS G51 RGA 2 – desel ⇒
BC2	⇒
BC3	⇒
CA1	1. No BFS ENGAGE Post SRB SEP: 2. FES PRI A – ON 3. BFS G51 RGA 3 – desel ⇒
CA2	⇒

CNTL BUS V LOW

PLT

1. ✓BUS LOSS ID
2. Perform aff CNTL BUS LOSS, then:
If pwr reqd (<3 sec) for crit function:
 3. Hold crit function sw
 4. For CNTL BUS AB(BC, CA) VOLTS LOW
CNTL BUS PWR MNA(MNB, MNC) – RESET
5. If FIRE/SMOKE at any time:
For CNTL BUS AB(BC,CA):
 - ◇ CNTL BUS PWR MNA(B,C),MNB(C,A)
(two) – RESET (hold) (pnl R1)
 - If CNTL BUS AB(BC,CA) VOLTS still > 0:
ASAP 6. cb CNTL BUS AB1/2/3(BC1/2/3,
CA1/2/3) – op (pnl R14:B)
7. ⇒A

CNTL BUS LOSS

FC

AB1	⇒
AB2	G23 RCS FWD MANF VLVS 1 OVRD – ITEM 40 EXEC (CL) ⇒G
AB3	1. G51 RCS RM MANF CL OVRD – ITEM 41 EXEC If BFS ENGAGE reqd: 2. Use PLT's RHC, then GPCs 1,2,4 – STBY,HALT 3. BFS I/O RESET If no S-BD COMM: 4. S-BD PM CNTL – PNL, CMD 5. BFS G51 Config per COMM COVERAGE: TDRS – ITEM 46 EXEC (*) STDN-HI – ITEM 47 EXEC (*) SGLS – ITEM 49 EXEC (*) 6. ⇒
BC1	FAILED: S-BD PM 1 (NO PNL, CMD) ⇒
BC2	1. S-BD PM CNTL – PNL, CMD 2. BFS G51 Config per COMM COVERAGE: TDRS – ITEM 46 EXEC (*) STDN-HI – ITEM 47 EXEC (*) SGLS – ITEM 49 EXEC (*) 3. G23 RCS FWD MANF VLVS 2 OVRD – ITEM 41 EXEC (CL) 4. PLT Displays – green dot ⇒
BC3	G51 RCS RM MANF CL OVRD – ITEM 41 EXEC ⇒

ESS
CNTL

CNTL BUS LOSS (Cont)

CA1	No BFS ENGAGE ⇒
CA2	G23 RCS FWD MANF VLVS 3 OVRD – ITEM 42 EXEC (CL) ⇒
CA3	⇒

FC REAC VLV CLOSED

PLT

1. FC REAC (three) – OP
 2. Perform BUS TIE, then:
If no joy on REAC open:
 3. ✓cb FC REAC VLV CL ENA (three) – op
(pnl C3)
 4. FC REAC (three) – OP
- If FC COOL P < 50:
5. Go to FC SHUTDN

FC pH ↓ 1(2,3) or FC DELTA V 1(2,3)

If pH ↓ and FC SS 1(2,3) ΔV > 150

or FC SS ΔV > 150 and incr:

1. Perform BUS TIE, then:
 2. Aff FC REAC VLV – CL
 3. MSTR MADS PWR – OFF
 4. Go to LOSS OF 1(2nd) FC PWRDN >>
- If pH ↓ only and Post SRB SEP:
5. Perform BUS TIE, then:
 6. ⇒A FC pH 1(2,3)

FC STACK T

1. MSTR MADS PWR – OFF
- If STACK T > 243 and incr:
2. If 2nd FC: Go to 2nd FC SHUTDN >>
 3. PL PRI (three) – OFF
- If aff FC amps < 190 or > 360:
4. Go to MN BUS U/V, step 4 >>
- ◇ 5. Perform BUS TIE, then:
6. ESS BUS SOURCE FC – OFF
 7. FC/MN BUS – OFF
- If aff FC VOLTS < 32 or STACK T not decr:
8. Aff FC REAC – CL
 9. FC – STOP after COOL P < 15 and
STACK T < 243
 10. Go to LOSS OF 1 FC PWRDN

FC EXIT T

1. MSTR MADS PWR – OFF
2. Perform BUS TIE, then: ⇒

MS A5-8

AESP/ALL/A/GEN J,8

FC COOLANT PUMP Δ P LOW

PLT

1. FC – START (10 sec or Δ P tb–gray)
- ◇ 2. MSTR MADS PWR – OFF
Perform LOSS OF 1 FC PWRDN, then:
If > 9 min since failure:
◇ If EXIT T > 164 & not decr
or RDY tb – bp
or FC PUMP cb(s) open (pnl L4:C):
3. Go to FC SHUTDN >>
4. If < 9 min since failure \Rightarrow

FC COOL P

1. Perform BUS TIE, then:
If COOL P < 75: \Rightarrow
If COOL P incr and not 100 (H),
or COOL PUMP Δ P tb – bp/intermittent,
or STACK/EXIT T unstable,
or SS Δ V \geq 150:
2. Aff FC REAC VLV – CL
3. MSTR MADS PWR – OFF
4. Go to LOSS OF 1(2nd) FC PWRDN

FC SHUTDOWN (1st) (A/E CL PMP \downarrow : <9 min)

1. Pre OMS 2 or Entry:
MSTR MADS PWR – OFF
2. If not tied: Perform BUS TIE, then:
If ORB (not D/O Prep), kW > 18:
MN BUS TIE (three) – ON
3. ESS BUS SOURCE FC – OFF
FC/MN BUS – OFF
FC – STOP (1 sec)
4. FC REAC VLV – CL
 \checkmark PWRDN

LOSS OF 1 FC PWRDN

1. PRI PL (three) – OFF
AFT PL (two) – OFF
2. IDP/CRT 4 PWR – OFF
One MDU – OFF \Rightarrow A

2FC
CRYO

2nd FC SHUTDN

PLT

(CL PMP Lost: <6 min)

1. Have CDR start LOSS OF 2nd FC PWRDN

If three MN BUSES powered:

2. MN BUS TIE (three) – OFF
(Do not perform BUS LOSS ACTIONS)
3. LES O2 – OFF, Visors – OP
4. Switch off all but one IDP/CRT with four MDUs
5. All PL PWR (seven) – OFF
6. O2, H2 TK HTRS (all) – OFF
7. After CDR pnl L1 config complete, continue:

If two MN BUSES powered:

8. Powered MN BUS TIES (two) – ON

If only one MN BUS powered:

9. MN BUS TIE (three) – OFF
If only MNA(B,C) powered: Secure APU 2(3,1)
BUS TIE good FC/BUS (MNA if RTLS or TAL)
I/O RESET

When reqd:

10. ESS BUS SOURCE FC – OFF
FC/MN BUS – OFF
FC – STOP (1 sec)
FC REAC VLV – CL

11. G51 INCNCT ENA (if reqd for OMS load)

12. All TAC/RA – OFF

Post MECO:

13. B/U LH2 VLV – OP
14. ⇒ LOSS OF 2nd FC PWRDN

FC

LOSS OF 2nd FC PWRDN

CDR

1. LES O2 – OFF, Visors – OP
2. L1: Select one FREON PUMP on good FC/MN BUS and place other pump to OFF
Switch OFF all HUM SEPS, IMU FANS, H2O PUMPS, AV BAY FANS, CAB FANS, FES HTRS

3. Switch off all but one IDP/CRT with four MDUs

After BUS TIE, if MNC unpowered:

4. FES CNTLR PRI A – OFF
B – ON
5. ⇒ LOSS OF 2nd FC PWRDN

O2(H2) CRYO P/T HIGH

PLT

CRYO O2(H2) TK HTR (two) – OFF

CRYO O2(H2) LEAK (3 or more tanks aff)

Use meter if CRT data OSL

1. MANF VLV 1,2 (two) – CL
 2. TK3 HTR A – AUTO
- If TK 1 and 2 P decr slowly (HTR logic fail): ⇒
3. Perform aff MN BUS TIE, then:
If O2 TK 1(2) aff:
 4. O2 SYS 1(2) SPLY vlv – CL
 5. If O2 TK 1(2) P now incr: (PCS leak) >>
 6. Aff TK HTR B – AUTO
- If no aff FC COOL P alarm: ⇒
7. Aff TK HTRS A,B (two) – OFF
 8. MSTR MADS PWR – OFF
 9. Perform LOSS OF 1 FC PWRDN, then: ⇒



This Page Intentionally Blank

**2FC
CRYO**

MS A5-12 AESP/ALL/A/GEN J

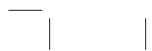

— | |

| | —

OMS

OMS

— | |

MS A6-1

AESP/ALL/A/GEN J

| | —

OMS TEMP DURING DUMP

1. **G51** INH INCNCT L R
If aff OMS FU IN P \geq :
2. Go to ENG FAIL >>
- If aff OMS FU IN P \leq :
3. Go to PRPLT FAIL >>
4. Otherwise snsr fail

Pc LOW DURING DUMP

1. ENG VLV < 70%: Go to ENG FAIL
2. ENG VLV > 70%: **G51** INH INCNCT
If aff OMS OX IN P > 227:
3. Go to ENG FAIL >>
If aff OMS OX IN P \leq 136:
4. Go to PRPLT FAIL >>
5. Otherwise snsr fail

ENG FAIL (During Dump)

1. Failed OMS ENG – OFF
- ◇ 2. If RTLS/TAL/ATO/**G51** DUMP:
G51 ENA INCNCT \Rightarrow G

PRPLT FAIL (During Dump)

1. ASSIST/ATO: Both OMS ENG (two) – OFF
Failed OMS XFEED (two) – CL
2. Other: Aff OMS ENG – OFF
Failed OMS XFEED (two) – CL
After 2:00 min, good OMS ENG – OFF \Rightarrow G

OMS N2 TK P LOW

(N/A DURING ASSIST/RTLS/TAL/ATO DUMP)

1. \checkmark N2 TK P decr (**OMS/MPS** and SPEC)
 2. OMS ENG – ARM
 3. If OMS N2 REG P decr: OMS ENG – OFF >>
- If OMS N2 REG P not decr & subs ASSIST/RTLS/TAL/ATO:
4. OMS ENG (two) – ARM/PRESS

OMS N2 REG P HIGH or LOW

OMS ENG – ARM

OMS

OMS TK P (FU or OX) LOW (✓ENG IN P)

Dumping ASSIST/ATO	ATO	1. ✓ Good OMS ENG – OFF
		2. [G51] ITEM 9 + [] EXEC
		3. [G51] ✓INCNCT = INH
		4. Aff OMS XFEED (two) – CL When aff OMS Pc < 80%: 5. Aff OMS ENG – OFF ⇒A
Dumping RTLSTAL/ [G51] DUMP	SERC	[BFS, GNC SYS SUMM 2] When aff AFT QTY < 20% or either OMS He P < 2000: 6. [G51] DUMP STOP 7. Aff OMS XFEED (two) – CL >>
	Not SERC	When aff AFT QTY < 20% or either OMS He P < 2000: 8. [G51] INH INCNCT 9. Aff OMS XFEED (two) – CL When aff OMS Pc < 80%: 10. Aff OMS ENG – OFF 11. After 2:00 min, good OMS ENG – OFF >>
Not Dumping		When FU IN P < 216 or OX IN P < 151: 12. [G51] INH INCNCT (N/A SERC) 13. Aff OMS ENG – OFF XFEED (two) – CL ⇒A
Subs ASSIST/ATO		14. Good OMS ENG – OFF
	FU IN P > 216 and OX IN P > 151	15. Aff OMS ENG – ARM/PRESS 16. Go to 'Dumping Assist/ATO'
Subs RTLSTAL		17. Good OMS ENG – ARM/PRESS
	FU IN P > 216 and OX IN P > 151	18. Aff OMS XFEED (two) – OP ENG – ARM/PRESS 19. [G51] ENA INCNCT 20. Go to 'Dumping RTLSTAL'
	Repress NO JOY after 2:00 min	21. Good OMS ENG – OFF >>

OMS He TK P LOW (✓SPEC and OMS/MPS)

Dumping RTLS/TAL/ G51 DUMP	SERC	When leaking He P < 640: 1. G51 DUMP STOP >>
	Not SERC	When leaking He P < 640: 2. G51 INH INCNCT When aff OMS Pc < 72%: 3. Aff OMS ENG – OFF After 2:00 min: 4. Good OMS ENG – OFF >>
Dumping ASSIST/ATO Not Dumping	◇	5. Good OMS ENG – OFF When MET > 2:30 min: 6. G51 ITEM 9 + EXEC
Leaking He P < 640		7. G51 ITEM 9 + <u>0</u> EXEC ⇒A
Sub RTLS/TAL	◇	8. Good OMS ENG – ARM/PRESS 9. G51 INH INCNCT 10. OMS XFEED (four) – OP 11. Aff OMS TK ISOL (two) – CL After 1:00 min: 12. OMS TK ISOL (four) – OP 13. OMS XFEED (four) – CL When aff OMS Pc < 72%: 14. Both OMS ENG (two) – OFF



RCS

RCS



MS A7-1

AESP/ALL/A/GEN J

RCS JET FAIL (LEAK)

If OX/FU Qty diverging:

1. Aff RCS MANF ISOL – CL

RCS JET FAIL (ON)

1. Aff RCS MANF ISOL – CL

If MANF P > 130 and stable (false alarm):

2. Aff RCS MANF ISOL – OP ⇒G

RM DLMA MANF

If aff MANF tb – OP or switch not thrown:

1. If FRCS: ✓MCC
2. If ARCS: G51 RCS RM MANF CL OVRD –
ITEM 41 EXEC
3. If aff MANF tb – bp: aff MANF – GPC

RCS JET FAIL (OFF)

If > 1 jet/pod/dir failed:

1. G23 resel jets
2. DES INH (*) (Reprioritize)

RCS TK P HIGH (FU or OX) (✓MANF P)

1. He PRESS (two) – CL
2. A – OP

If He P decr:

3. He PRESS A – CL
B – OP

XFEED: RCS to RCS

If AUTO XFEED:

1. L,R RCS TK ISOL (six) – GPC
XFEED (four) – GPC
2. OMS XFEED (four) – CL
3. MSTR RCS XFEED – FEED FROM L(R) >>

If MANUAL XFEED:

4. L,R OMS XFEED (four) – CL
5. RCS XFEED (four) – OP
6. Receiving RCS TK ISOL (three) – CL
He PRESS (two) – CL
7. MSTR RCS XFEED – FEED FROM L(R)

RCS

RCS SECURE

- RCS MANF ISOL (five) – CL
- XFEED (two) – CL
- TK ISOL (all) – CL
- He PRESS (two) – CL

AFT RCS LK

N/A During Dump/SE Roll Cntl
 (✓He P decr: CRT & meter)

1. If TK P ↑: Go to TK P HIGH >>

TK P ≥ 254 and not decr (He Leak)	2. MSTR XFEED – feed from good side 3. Aff RCS He PRESS (two) – CL 4. G51 AFT RCS – INH (ITEM 13) >>
TK P < 254 or decr (prop leak)	5. (N/A RTLS) ET SEP – MAN 6. (N/A RTLS) MPS PRPLT DUMP SEQ – STOP 7. Aff MANFs (five) – CL 8. Aff TK ISOLs (three) – CL
Single MANF leak	9. TK ISOLs (three) – OP (tb–OP),GPC 10. Good MANFs (four) – OP
QTY < 75%	11. MSTR XFEED – feed from good side
Two MANF P decr (TK leg leak)	12. Good leg TK ISOL(s) – OP (tb–OP), GPC 13. Good leg PRI MANFs (two) – OP 14. Leaking leg XFEED (one) – CL
QTY < 75%	15. MSTR XFEED – feed from good side
No MANF P decr (Prplt TK or MANF 5 leak)	16. L,R RCS XFEED (four) – OP 17. Aff RCS MANF 1,2,3,4 (four) – OP 18. Aff RCS He PRESS (two) – CL 19. MSTR XFEED – feed from good side
	20. ET SEP – AUTO 21. G51 AFT RCS – INH (ITEM 13) 22. Post ET SEP –Z transl: MPS PRPLT DUMP SEQ – GPC

FWD RCS LK

(√He P decr: CRT & meter)

(√TK P; if '↑': Go to TK P HIGH)

RTLS	1. Perform RCS SECURE, then: 2. Post PPD – reopen RCS Post ET SEP –Z transl: 3. Go to RCS SECURE >>
Pre ET SEP (N/A RTLS)	4. ET SEP – MAN 5. MPS PRPLT DUMP SEQ – STOP 6. Perform RCS SECURE, then:
Single MANF leak	7. Reopen RCS, except bad MANF 8. ET SEP – AUTO Post ET SEP –Z transl: 9. MPS PRPLT DUMP SEQ – GPC >>
TK leg leak (two MANF P Low)	10. Reopen RCS, except bad leg 11. ET SEP – AUTO Post ET SEP –Z transl: 12. MPS PRPLT DUMP SEQ – GPC >>
PRPLT TK P decr	
Post MECO	13. RATE DAMP with ARCS 14. Reopen FRCS
TK P > 200 & QTY > 0%	15. ET SEP – AUTO
TK P < 200 or QTY = 0%	16. Perform RCS SECURE, then: 17. DAP – INRTL, PITCH – PULSE 18. ET SEP pb – SEP 19. THC –Z (2 sec; –1.25°/sec) 20. THC –X and hold
At SEP (SEP init + approx 12 sec)	21. THC +Z (3 sec; +0.3°/sec) THC –Z (2 sec; –0.9°/sec) COAST (5 sec) THC +X (20 sec) After 10 sec of +X, then: PITCH – DISC RATE
	22. OPS 104 PRO, DAP – AUTO
Otherwise: (He TK or He leg)	Post MECO – reopen RCS 23. ET SEP – AUTO
Post ET SEP –Z transl	24. MPS PRPLT DUMP SEQ – GPC 25. Go to RCS SECURE

MPS

MPS

MS A8-1

AESP/ALL/A/GEN J

MPS

SSME FAIL/SHUTDN

AC BUS SNSR (three) – OFF

If 2 ENG remaining:

- ◇ MAIN ENGINE LIMIT
SHUT DN – ENA,AUTO

If 1 ENG remaining:

When MPS PRPLT = 2%:
MAN THROT Pc → 67%,
At CO: Shut dn MN ENG (pb)

MPS DATA

√MCC, accel, He dP/dT,

'MPS H2 OUT P',

'MPS O2 OUT T'

If SSME fail (MCC or 3 cues):

Aff MN ENG SHUTDN pb – push

If 3 ENG remaining:

- ◇ MAIN ENGINE LIMIT
SHUT DN – ENA,AUTO

If no comm: Assume MPS CMD

If multi (No MECO Confirm):

Post MECO:
MN ENG SHUTDN pb (three) –
push (simo)

MPS LH2 ULL

- ◇ If 2(3) Ps < 28.0 or > 34.0:
MPS LH2 ULL PRESS – OP

When all Ps > 34.0:

MPS LH2 ULL PRESS – AUTO

MPS DUMP INHIBIT

Post MECO:

Aff MPS ENG PWR (two) – OFF
LO2(H2) PRE VLV – CL

'ET SEP MAN' G51

ET SEP

Post MECO:

1. ET SEP AUTO – ITEM 38 (BFS 28)
2. If ET SEP pb reqd:
ET SEP SEP – ITEM 39 (BFS 29)

MPS CMD/HYD/ELEC

If 2 HYD SYS failed:

MAIN ENGINE LIMIT SHUT DN – INH

TRAJ Display – Cue SERC, ITEM 6
(EXEC if gimbaling eng fails)

If:	When:	Shut down:
2 Pcs stuck > 85% & 3-ENG RTLS	MECO -2:00	1 aff MN ENG: CMD: (AC/pb)** HYD: (pb) <u>ENG(HYD) SD</u> C(1) & R(3) C L(2) & C(1) L L(2) & R(3) R ELEC: (pb)
2 HYD SYS failed & Nom/ATO/TAL/ 2-ENG RTLS	Nom/ATO: SE PRESS TAL: SE TAL 2-ENG RTLS: 2 OUT RED	
He lk S/D reqd		Aff MN ENG (pb)
MPS CMD(s)**	Nom/ATO and: 3 ENG: V > 23K 2 ENG: V > 24.5K TAL: V > 22.5K RTLS: $\alpha = -1$	Aff MN ENG (AC/pb)** If 2 CMD: repeat
2 MPS HYD/ELEC & 3-ENG Nom/ATO/TAL		1 aff MN ENG: HYD: (pb) ELEC: (pb)
1 MPS HYD/ELEC & 3-ENG Nom/ATO	V > 23K	Aff MN ENG (pb)

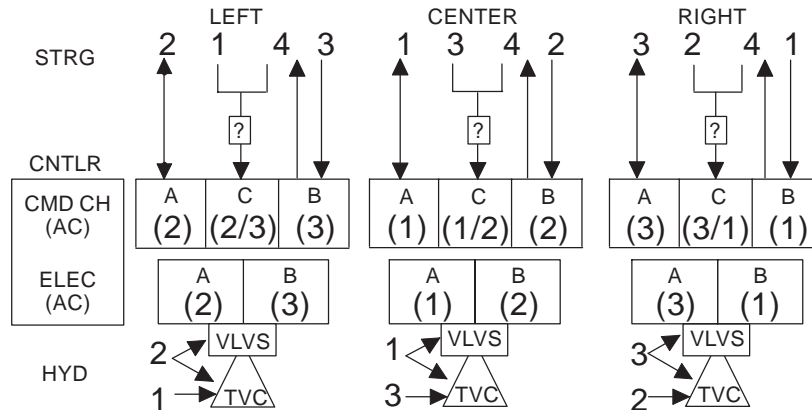

MPS He P (Pre MECO)

1. $\sqrt{dP/dT}$

If after MECO -60:

2. Shut dn MN ENG per MPS
CMD/HYD/ELEC >>

If He REG P \uparrow or \downarrow :

3. Aff He ISOL - CL

Otherwise:

4. Aff He ISOL A - CL

If no decr in dP/dT:

5. Aff He ISOL A - OP
B - CL

If no decr in dP/dT:

6. Aff He ISOL B - OP

If any ENG failed:

7. Failed ENG He I'CNCT -
OUT OP

If nonisolatable:

8. Shut dn MN ENG per
MPS CMD/HYD/ELEC

If/when TK P < 1150 or

REG P < 679:

9. Aff He I'CNCT - IN OP

If isolated:

10. Aff He I'CNCT - IN OP

If TK P < 2200 @ MECO -60:

11. Shut dn MN ENG per
MPS CMD/HYD/ELEC

Post ET Sep:

12. He I'CNCT(s) - GPC

MPS PNEU TK(REG) P

If after MECO -60:

At MECO -30:

1. L ENG He XOVR - OP >>

2. PNEU He ISOL - CL

If PNEU ACUM P decr:

At MECO -30:

3. PNEU He ISOL - OP,

Wait 5 sec, then:

4. L ENG He XOVR - OP >>

If PNEU TK P decr:

5. PNEU He ISOL - OP

— | |

| | —

RESERVED

— | |

MS A9-1

AESP/ALL/A/GEN J

| | —

This Page Intentionally Blank

MS A9-2

AESP/ALL/A/GEN J

GLIDED FLIGHT

MS GLIDED FLIGHT

----- MS GLIDED FLIGHT, SECTIONS 1 thru 9 -----

MS E-i

AESP/ALL/E/GEN J

GLIDED FLIGHT

----- MS GLIDED FLIGHT, SECTIONS 1 thru 9 -----

This Page Intentionally Blank

APU/
HYD

APU/HYDRAULICS

MS E1-1

AESP/ALL/E/GEN J

APU SHUTDN

1. APU OPER – OFF
 FUEL TK VLV – CL
 ✓SHUTDN (HYD PRESS)
 Report APU F7 lts
 APU CNTLR PWR – OFF

⇒ If one APU failed:

2. ✓APU AUTO SHUTDN (three) – ENA
3. MM304: ✓APU SPEED SEL (two) – NORM
4. MM602/305: APU SPEED SEL (two) – HI

If two APUs failed:

5. APU SPEED SEL (one) – HI
6. AUTO SHUTDN (one) – INH

APU SPD HI (✓CRT)

1. Aff APU SPEED SEL – HI

⇒ If two good APUs:

2. Perform APU SHUTDN, then:
3. Go to APU COOLDOWN

APU OVERSPEED (>129%)

Go to APU SHUTDN

APU UNDERSPEED

If 'PRL SYS X ↓' or if APU has shut down:

1. Perform APU SHUTDN, then:
2. Go to APU COOLDOWN

APU OIL OVERTEMP

1. BLR CNTLR/HTR – B(A)

⇒ If M > 1:

- If OIL IN T incr, and OUT T > 305:
2. Perform APU SHUTDN, then:
 3. Go to APU COOLDOWN

APU PUMP LEAK P (✓MCC)

Pre-TAEM if two good APUs:

1. Perform APU SHUTDN, then:
2. Go to APU COOLDOWN

APU THERM (T HI)

If APU GG/FU PMP HTR or APU TK/FU LINE HTR fail ON (↑):

1. Aff HTR – OFF

APU COOLDOWN

At M = 7:

1. HYD MN PUMP PRESS – LO
APU CNTLR PWR – ON
OPER – INJECTOR COOL
(start watch)

If APU not leaking:

2. APU FUEL TK VLV – OP

At Wheel Stop:

3. Go to APU SHUTDN

APU RESTART

1. HYD MN PUMP PRESS – LO
2. APU CNTLR PWR – ON
3. ✓AUTO SHUTDN – ENA

If COOLDOWN for > 3.5 min or INJ T < 400:

4. ✓APU FUEL TK VLV – OP
OPER – START/RUN
HYD MN PUMP PRESS – NORM >>

If not:

5. APU OPER – INJECTOR COOL (start watch)

If after 1.5 min, APU INJ T not decr:

6. Go to APU SHUTDN >>

At 3.5 min:

7. APU FUEL TK VLV – OP
OPER – START/RUN
HYD MN PUMP PRESS – NORM >>

If restart unsuccessful:

8. Go to APU SHUTDN

HYD PRESS (LOW) G51

⇒ PRL SYS	HYD PRESS	PROCEDURE
↓	P > 300	1. HYD MN PUMP PRESS – LO 2. Go to step 10
	P < 300	3. Go to APU SHUTDN >>
blank	meter <u>and</u> CRT P < 2600	If first HYD sys degraded: 4. HYD MN PUMP PRESS – LO 5. Go to step 10
		If two HYD sys degraded: 6. HYD MN PUMP PRESS (two) – NORM, then: 7. LO on system with lowest pressure 8. (Good) APU AUTO SHUTDN (one) – INH 9. Go to step 10

10. At TAEM:
APU SPEED SEL (two) – HI

HYD RSVR QTY (LOW)

1. Aff MPS/TVC ISOL VLV – CL (5 sec)

⇒ If still decr:

2. Aff HYD MN PUMP PRESS – LO

3. At TAEM: Good APU SPEED SEL (two) – HI

If second sys fail:

4. HYD MN PUMP PRESS (two) – NORM

5. (Good) APU AUTO SHUTDN (one) – INH

HYD RSVR T

1. BLR CNTLR/HTR – A(B)

If HYD RSVR T > 250:

2. HYD MN PUMP PRESS – LO

If HYD RSVR T > 268 and incr:

3. Perform APU SHUTDN, then:

4. Go to APU COOLDOWN

W/B QTY (LOW)

⇒ 1. ✓BLR PWR – ON

2. If QTY = zero or $M \leq 1$ >>

3. BLR CNTLR/HTR – A(B)

4. Note QTY

Wait 2 min, then:

5. ✓QTY

6. If QTY change < 3 >>

If QTY change ≥ 3 :

7. Cycle BLR PWR to maintain
200 < LUBE OIL IN T < 290 (C&W)

When $M \leq 1$:

8. BLR PWR – ON

This Page Intentionally Blank

MS E1-6

AESP/ALL/E/GEN J

— | |

| | —

**COMM/
GNC**

COMM/GNC

— | |

| | —

MS E2-1

AESP/ALL/E/GEN J,8

COMM LOST (MULTI PANELS)

1. AUD CTR – 2

No comm (✓UHF sites):

2. S–BD PM CNTL – PNL,CMD (pnl C3)

3. Config per COMM COVERAGE **G51**:

TDRS – ITEM 46 EXEC (*)

STDN–HI – ITEM 47 EXEC (*)

SGLS – ITEM 49 EXEC (*)

If * not next to selected config:

4. Config pnl A1 per Comm Coverage
(ASC/ENT PKT, **COMM**)

S–BD PM CNTL – PNL,CMD (pnl C3)

No comm:

5. Select best S–BD PM ANT

No comm:

6. S–BD PM ANT – GPC

ICOM LOST

1. AUD CNTL – sel ALT

No ICOM:

2. AUD CTR – 2

FCS CH 1(2,3,4) (2nd FAIL) **G53**

If 2 FCS CH ↓ on any actuator:

◇ 1. Remaining FCS CH (two) – ORIDE

RHC L(R) (2nd FAIL) **GNC SYS SUMM 1**

Aff FLT CNTLR PWR – OFF

G51 ROLL MODE SW **G51**

If ROLL MODE ≠ SW POS:

1. AUTO SEL – ITEM 42 EXEC

DISPLAY SW L(R)

L(R) Disp sws (eight) – green dot

RM FAIL IMU, RGA, AA **BFS G51**

Aff LRU – desel

RM DLMA IMU **G51** **BFS G51**

1. ✓MCC, bad IMU – desel (PASS & BFS) >>

◇ 2. Desel lower # IMU with '?' (PASS)

RM FAIL ADTA [G51]

- ◇ 1. ✓BFS [GNC SYS SUMM 1]
- 2. If '↓' for aff ADTA >>
- 3. If accessible, bad ADTA cb – op >>
- 4. BFS, ADTA to G&C – INH

RM DLMA ADTA * [G51]

M < 2.0		1. Fly Theta limits
ADTA data agrees		2. Desel, resel one ADTA 3. If no '?' >>
Bad probe		4. Stow bad probe >>
Bad ADTA	ADTA cb accessible	◇ 5. Bad ADTA cb – op >>
	ADTA cb not accessible	◇ 6. DES bad ADTA 7. ✓BFS [GNC SYS SUMM 1] 8. If '↓' for aff ADTA >> 9. BFS, ADTA to G&C – INH
Dilemma not resolved		10. ADTA to G&C – INH (PASS & BFS)

*If 3 ADTAs failed:
ADTA to G&C – INH (PASS)
Fly Theta limits

RM FAIL TAC [G50]

(RM LIMITS: 6 DEG, 0.5 NM)

- 1. If data good: desel, resel aff TACAN >>
- 2. If failure verified: desel failed TACAN in BFS

RM DLMA TAC [G50]

Do not desel or resel while in 'TEST'

- 1. If both data good: desel, resel one TACAN in DLMA >>
- 2. ✓TACAN MODE (three) – GPC
- 3. If 'RM FAIL TAC': desel failed TACAN in BFS >>
- 4. If continuous 'TEST': TACAN MODE (three) – T/R
If bad TACAN identified:
 - 5. Desel bad TACAN (PASS, ✓BFS)

This Page Intentionally Blank

MS E2-4

AESP/ALL/E/GEN J

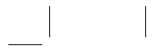

DPS

DPS

MS E3-1

AESP/ALL/E/GEN J



DPS

PASS GPC FAIL

1. GPC MODE – STBY,HALT
2. Aff FCS CH – OFF
3. If two GPC/FA/FCS CHs ↓: Good FCS CHs – ORIDE
4. **G53** aff SURF FDBK – desel
- ⇒ 5. If STRG 1(2): CDR(PLT) sws – green dot
6. ✓MULT DATA PATH LOSS

BFS GPC FAIL

- ⇒ 1. GPC MODE – STBY,HALT,pause
– STBY,RUN
2. If recovered: PRO to OPS 304
BFS **G50** ✓BFS R/W sel
✓GPC OUTPUT – B/U >>
3. If SM only: GPC MODE – STBY, then step 5
4. GPC MODE – HALT
- ◇ 5. OUTPUT – TERM
6. If no comm: Sel best S-BD PM ANT
7. MPS He ISOL B (three) – CL
PNEU He ISOL – CL
8. If AOA/GRTLS/TAL < 120K:
NH3 CNTLR B – SEC/ON

FA/FF MDM I/O ERROR

(Annunciated by entire set)

		1. I/O RESET
RECOV	FA	2. If reqd, aff FCS CH – ORIDE,AUTO
	FF 1,2,3	◇ If H > 200K or TACAN incorp: 3. G50 NAV DELTA zero 4. G51 IMU – resel
		5. BFS I/O RESET >>
NOT RECOV	FA	6. Aff FCS CH – OFF 7. If 2 GPC/FA/FCS CHs ↓: Good FCS CHs – ORIDE 8. G53 aff SURF FDBK – desel
		9. ✓MULT DATA PATH LOSS ⇒ ◇ 10. Go to FA/FF MDM PORT MODE

FA/FF MDM PORT MODE

NOTE: If BFS, 'BCE STRG X PASS', @GPC; else @MDM.
For '@GPC', port mode results in alternate MDM bypass

			<ol style="list-style-type: none"> 1. <input type="checkbox"/> G01 aff STRG – port mode 2. BFS I/O RESET
@MDM	RECOV	FA	<ol style="list-style-type: none"> 3. Aff FCS CH – AUTO 4. <input type="checkbox"/> G53 aff SURF FDBK – resel >>
		FF 1,2,3	<p>◇ If H > 200K or TACAN incorp:</p> <ol style="list-style-type: none"> 5. <input type="checkbox"/> G50 NAV DELTA zero 6. <input type="checkbox"/> G51 IMU – resel >>
	NOT RECOV		<p>⇒ If MCC GO for power cycle:</p> <ol style="list-style-type: none"> 7. Aff FA/FF MDM – OFF, ON 8. I/O RESET 9. If recov, go to @MDM RECOV >> 10. Aff MDM – OFF
		FA	<ol style="list-style-type: none"> 11. BFS <input type="checkbox"/> G51 aff SURF FDBK, RGA – desel 12. <input checked="" type="checkbox"/> GNC SYS SUMM 1
		FF	<ol style="list-style-type: none"> 13. BFS <input type="checkbox"/> G51 aff AA – desel 14. FF 1(2): CDR(PLT) – green dot
			15. <input checked="" type="checkbox"/> MULT DATA PATH LOSS >>
@GPC	FA RECOV (FF Give Up)		<ol style="list-style-type: none"> 16. Aff FCS CH – AUTO 17. <input type="checkbox"/> G53 aff SURF FDBK – resel 18. FF 1(2): CDR(PLT) – green dot 19. <input checked="" type="checkbox"/> MULT DATA PATH LOSS >>
		FF RECOV (FA Give Up)	<ol style="list-style-type: none"> 20. Aff FCS CH – OFF 21. If 2 GPC/FA/FCS CHs ↓: Good FCS CHs – ORIDE 22. <input type="checkbox"/> G53 aff SURF FDBK – desel
		FF 1,2,3	<p>◇ If H > 200K or TACAN incorp:</p> <ol style="list-style-type: none"> 23. <input type="checkbox"/> G50 NAV DELTA zero 24. <input type="checkbox"/> G51 IMU – resel

FF(FA) MDM OUTPUT FAULT

◇ (Take action only if annun by entire set)

If single 'MDM OUTPUT':

1. If 'FF MDM OUTPUT':
G51 aff IMU – desel
2. Go to FA/FF MDM I/O ERROR >>

If both FF & FA annun:

3. G51 aff IMU – desel
 4. I/O RESET; If reqd, BFS I/O RESET
 5. If msgs repeat: Go to PASS GPC FAIL >>
 6. If reqd, aff FCS CH – ORIDE,AUTO
- ◇ 7. If H > 200K or TACAN incorp:
G50 NAV DELTA zero
G51 IMU – resel

PL MDM I/O ERROR

1. BFS I/O RESET

If recovered >>

2. G01 PL 1/2 – port mode, then BFS I/O RESET
If recovered >>

3. Pre MM305: FES PRI B(A) – ON

4. If PL2 ↓ & no comm: Sel best S-BD PM ANT

- ⇒ 5. If PL2 ↓ & AOA/GRTLS/TAL < 120K:
NH3 CNTLR B – SEC/ON

PCM I/O ERROR

OI PCMMU PWR – 2(1)

BCE STRG X (no 'MDM OUTPUT' msg)

	IMU	1. G21 ✓IMU OPER, if STBY >>
		2. I/O RESET
RECOV	IMU	◇ If H > 200K or TACAN incorp: 3. G21 ✓att ANG, if delta > 1° >> 4. G50 NAV DELTA zero 5. G51 IMU – resel >>
		6. >>
NOT RECOV	NSP	7. And no comm: PNL, CMD 8. BFS G51 Config per COMM COVERAGE: TDRS – ITEM 46 EXEC (*) STDN-HI – ITEM 47 EXEC (*) SGLS – ITEM 49 EXEC (*) >>
		9. G01 aff STRG – port mode 10. BFS I/O RESET 11. If recov, go to RECOV steps >>
	A(B,C,D, IMU) ⇒	12. FF A(B, IMU) or FA C(D) MDM – OFF, ON 13. I/O RESET 14. If FA, aff FCS CH – ORIDE, AUTO 15. If recov, go to RECOV steps
	C(D)	16. If < 3Y, 2P jets/pod/dir: a. G23 aff jet DES INH (*) (Reprioritize) b. Aff MANF VLVs STAT OP – OVRD
	1A(2A)	17. CDR(PLT) sws – green dot
	B	18. BFS G51 aff AA – desel
	D	19. BFS G51 aff SURF FDBK, RGA – desel
		20. ✓MULT DATA PATH LOSS >>

OI-28

MS (A)E3-5 AESP/ALL/E/GEN J,9

POST OPS 3/GRTLs TRANSITION RESTRING

1. Aff GPC(s) – STBY,HALT
2. ✓G53 aff SURF FDBK – desel (*)
3. Config MC1(3) NBAT
4. OPS Mode Recall: OPS XXX PRO
5. BFS I/O RESET
- ⇒ 6. Config FCS CH(s) (See Table):
7. G53 config SURF FDBK (See Table):
- If STRG 1(2,3) recovered:
- ◇ If H > 200K or TACAN incorp:
 8. G50 NAV DELTA zero
 9. G51 IMU – resel

AVAILABLE GPCs	FCS CHs	FCS CH CONFIG			SURF FDBK	
		AUTO	ORIDE	OFF	SEL	DESEL
3	4	3		1	3	1*
	3	3		1	3	1*
	2		2	2	2	2
2	4		4		4	
	3		2	2	2	2
	2		2	2	2	2

*If CH 4 – OFF, DO NOT DESEL PASS SURF FDBK

POST BFS ENGAGE

CAUTION
Do not assign more than 3 IDPs at a time

- If PASS GPCs running:
1. Aff GPC MODE – STBY/HALT
 2. BFS I/O RESET
 3. ✓FCS CHs, IMU config
- ⇒ If Air Data not analyzed:
4. G50 INH AD to G&C
 5. M=5: Deploy, evaluate probes one at a time
 6. ✓AD to G&C by M = 1.5
- If failed ADTA(s) in PASS:
7. ADTA cb(s) – op or stow probe
 8. G51 DES failed (commfaulted) RGA, AA, SURF
 9. G50 DES failed TAC
 10. GPC/CRT 04 EXEC, as reqd
- At M ≤ 2.7:
11. CDR TRIM PANEL – OFF
RHC/PNL – ENA
- At H = 3K:
12. SPDBK – MAN (✓DEL PAD setting)
- At MAIN GEAR TD:
13. SPDBK – 100%

OI-28

BCE STRG X (no 'MDM OUTPUT' msg)

	IMU	1. G21 ✓IMU OPER, if STBY >>
		2. I/O RESET
RECOV	IMU	◇ If H > 200K or TACAN incorp: 3. G21 ✓att ANG, if delta > 1° >> 4. G50 NAV DELTA zero 5. G51 IMU – resel >>
		6. >>
NOT RECOV	NSP	7. And no comm: PNL, CMD 8. BFS G51 Config per COMM COVERAGE: TDRS – ITEM 46 EXEC (*) STDN-HI – ITEM 47 EXEC (*) SGLS – ITEM 49 EXEC (*) >>
		9. G01 aff STRG – port mode 10. BFS I/O RESET 11. If recov, go to RECOV steps >>
	A(B,C,D, IMU) ⇒	12. FF A(B, IMU) or FA C(D) MDM – OFF, ON 13. I/O RESET 14. If FA, aff FCS CH – ORIDE, AUTO 15. If recov, go to RECOV steps
	C(D)	16. If < 3Y, 2P jets/pod/dir: a. G23 aff jet DES INH (*) (Reprioritize) b. Aff MANF VLVs STAT OP – OVRD
	1A(2A)	17. CDR(PLT) sws – green dot
	B	18. BFS G51 aff AA – desel
	D	19. BFS G51 aff SURF FDBK, RGA – desel
		20. ✓MULT DATA PATH LOSS >>

OI-29

MS (B)E3-5 AESP/ALL/E/GEN J,9

POST OPS 3/GRTLS TRANSITION RESTRING

1. Aff GPC(s) – STBY, HALT
2. ✓ G53 aff SURF FDBK – desel (*)
3. Config MC1(3) NBAT
4. OPS Mode Recall: OPS XXX PRO
5. BFS I/O RESET
- ⇒ 6. Config FCS CH(s) (See Table):
7. G53 config SURF FDBK (See Table):
- If STRG 1(2,3) recovered:
 - ◇ If H > 200K or TACAN incorp:
 8. G50 NAV DELTA zero
 9. G51 IMU – resel

AVAILABLE GPCs	FCS CHs	FCS CH CONFIG			SURF FDBK	
		AUTO	ORIDE	OFF	SEL	DESEL
3	4	3		1	3	1*
	3	3		1	3	1*
	2		2	2	2	2
2	4		4		4	
	3		2	2	2	2
	2		2	2	2	2

*If CH 4 – OFF, DO NOT DESEL PASS SURF FDBK

POST BFS ENGAGE

- If PASS GPCs running:
1. Aff GPC MODE – STBY/HALT
 2. BFS I/O RESET
 3. ✓ FCS CHs, IMU config
- ⇒ If Air Data not analyzed:
4. G50 INH AD to G&C
 5. M=5: Deploy, evaluate probes one at a time
 6. ✓ AD to G&C by M = 1.5
- If failed ADTA(s) in PASS:
7. ADTA cb(s) – op or stow probe
 8. G51 DES failed (commfaulted) RGA, AA, SURF
 9. G50 DES failed TAC
- At M ≤ 2.7:
10. CDR TRIM PANEL – OFF
RHC/PNL – ENA
- At H = 3K:
11. SPDBK – MAN (✓ DEL PAD setting)
- At MAIN GEAR TD:
12. SPDBK – 100%

OI-29

MS (B)E3-6 AESP/OI-29/E/GEN J,9

DUAL DPS DISPLAY COMMANDERS/DK XMTR 1(2,3)

1. BFC CRT SEL – aff IDP
- If reqd to clean up display:
2. Aff IDP/CRT PWR – OFF,ON

I/O ERROR CRT/DPS DISPLAY ANOMALY

If IDP 4(CRT 4): IDP/CRT 4 PWR – OFF >>

If NO big X/POLL FAIL:

1. MDU PWR – OFF,ON; if recovered >>
If MCC GO for power cycle:
2. IDP/CRT PWR – OFF,ON; if recovered >>

If big X/POLL FAIL:

3. IDP/CRT PWR – OFF,ON; if recovered >>

If PASS:

4. GPC/CRT – same GPC/aff IDP; if recovered >>
5. BFC CRT SEL – aff IDP: Go to step 9

If BFS:

6. BFC CRT SEL – unaff IDP; if both IDPs OK >>
 7. – original position
 8. In PASS: GPC/CRT 5/X EXEC for aff IDP
9. If reqd: In PASS, deassign aff IDP, assign IDP 4 to PASS

FLT INST DISPLAY ANOMALY

1. DATA BUS Select alternate FC BUS(s); if recovered >>
2. PORT SELECT aff MDU; if recovered >>
3. MDU PWR – OFF,ON

SUBSYS STATUS DISPLAY ANOMALY

1. PORT SELECT aff MDU; if recovered >>
2. MDU PWR – OFF,ON; if recovered >>

BFS INADVERTENT DISENGAGE/UNSUCCESSFUL ENGAGE (Lightning Strike)

1. CDR and PLT RHC ENGAGE pb – depress
- If no response:
2. BFS OUTPUT – NORM,B/U
 3. CDR,PLT RHC ENGAGE pb – depress

MULT DATA PATH LOSS (Non-Recov)

NOTE

If LRU data path loss due to GPC problem and not MDM, BFS will pick up MDMs/LRU when engaged

FAILURE	TYPE	ACTIONS
GPC/FF 1&2	I/O or B	Use R BODY FLAP & TRIM ENA sws
GPC/FF 3&4	I/O or B	Use L BODY FLAP & TRIM ENA sws
GPC/FA any combo	I/O or D	No impact

ECLS

ECLS

MS (A)E4-1 AESP/ALL/E/GEN J,14

CAB PRESS LEAK

1. CAB RELIEF A – CL (pause)
B – CL
 2. ✓ Tabs/Visors – CL/LES O2 – ON
 3. If RTLS/TAL: O2/N2 CNTLR VLV SYS 2 – OP
 4. O2 TK1,TK2 HTRS A,B (four) – AUTO
 - ⇒ 5. TK3 HTRS A,B (two) – AUTO
- If possible:
6. Remove Inner A/L Hatch Caps (two)
 7. Equal vlv (two) – EMER
 8. If V > 15K: MLS (three) – OFF;
TACAN (three) – OFF
At V = 10K: TACAN 2,3 (two) – GPC
At M = 2.7:
If reqd: Use two MLS, GNC I/O RESET
- When CAB PRESS < 10 psia, if dP/dT EQ < 0.67:
9. ✓ O2/N2 CNTLR VLV SYS 2 – OP >>
- When CAB PRESS < 6.5 psia:
10. ✓ O2/N2 CNTLR VLV SYS 2 – OP
 11. CAB FAN (two) – ON

CAB PRESS HIGH

1. If increasing: LES O2 – OFF, Visors – OP
- If still incr:
2. N2 SYS 1,2 REG INLET (two) – CL
 3. O2 SYS 1,2 SPLY (two) – CL

H2O LOOP PRESS LOW(HIGH)

⇒ Switch Loops

AV BAY FAN ΔP

1. Switch fans
2. If no joy: Go to LOSS OF AV BAY COOLING PWRDN

AV BAY TEMP HIGH

1. Aff AV BAY FAN (two) – ON
2. If not decr: Switch H2O Loops
3. If no joy: Go to LOSS OF AV BAY COOLING PWRDN

LOSS OF AV BAY COOLING PWRDN

Bay 1: TACAN 1, MLS 1 – OFF
 Bay 2: 2, MLS 2,3 – OFF
 Bay 3: 3 – OFF

CABIN FAN FAIL

- ⇒ 1. Switch fans
- If both fans lost:
2. Minimize use of IDPs/MDUs/FLT CNTLR PWR

IMU FAN FAIL

⇒ Switch Fans

ECLS

ECLS

MS (B)E4-1 AESP/ALL/E/GEN J,14

CAB PRESS LEAK

1. CAB RELIEF A – CL (pause)
B – CL
 2. ✓ Tabs/Visors – CL/LES O2 – ON
 3. If RTLS/TAL: O2/N2 CNTLR VLV SYS 2 – OP
 4. O2 TK1,TK2 HTRS A,B (four) – AUTO
 - ⇒ 5. TK3 HTRS A,B (two) – AUTO
- If possible:
6. Remove Inner A/L Hatch Caps (two)
 7. Equal vlv (two) – EMER
 8. If V > 15K: MLS (three) – OFF;
TACAN (three) – OFF
At V = 10K: TACAN 2,3 (two) – GPC
At M = 2.7:
If reqd: Use two MLS, GNC I/O RESET
- When CAB PRESS < 10 psia, if dP/dT EQ < 0.67:
9. ✓ O2/N2 CNTLR VLV SYS 2 – OP >>
- When CAB PRESS < 6.5 psia:
10. ✓ O2/N2 CNTLR VLV SYS 2 – OP
 11. CAB FAN (two) – ON

CAB PRESS HIGH

1. If increasing: LES O2 – OFF, Visors – OP
- If still incr:
2. N2 SYS 1,2 REG INLET (two) – CL
 3. O2 SYS 1,2 SPLY (two) – CL

H2O LOOP PRESS LOW(HIGH)

⇒ Switch Loops

AV BAY FAN ΔP

- ⇒ 1. If AV Bay 1 aff: FAN A – ON; FAN B – OFF
If AV Bay 2 aff: FAN B – ON; FAN A – OFF
If AV Bay 3 aff: FAN A – ON; FAN B – OFF
2. If no joy: Go to LOSS OF AV BAY COOLING PWRDN

AV BAY TEMP HIGH

- ⇒ 1. Aff AV BAY FAN (two) – ON
2. If not decr: Switch H2O Loops
3. If no joy: Go to LOSS OF AV BAY COOLING PWRDN

LOSS OF AV BAY COOLING PWRDN

Bay 1: MLS 1 – OFF
Bay 2: MLS 2,3 – OFF
Bay 3: N/A

CABIN FAN FAIL

- ⇒ 1. Switch fans
- If both fans lost:
2. Minimize use of IDPs/MDUs/FLT CNTLR PWR

IMU FAN FAIL

- ⇒ Switch Fans

FREON FLOW LOW

1. Switch pumps

If flow still low:

2. Aff RAD BYP VLV MODE – AUTO
CNTLR LOOP – AUTO A(B)
(wait 90 sec)

If flow still low:

3. Go to LOSS OF FREON LOOP(s)

LOSS OF 1 FREON LOOP

1. Bad LOOP FREON PUMP – OFF

If FREON LOOP 1(2) lost:

2. O2 SYS 1(2) SPLY (one) – CL

In good loop:

3. ✓FLOW PROP VLV LOOP 1(2) – ICH

4. Monitor EVAP OUT TEMP

If TAL/AOA/RTLs: If LOOP 2 lost:

5. NH3 CNTLR B – OFF, A – PRI/GPC

LOSS OF 2 FREON LOOPS – PWRDN

1. When loops fail (flow <700), CDR execute LOOPS
FAILED

2. MSTR MADS PWR – OFF

3. Use one IDP/CRT with two MDUs (three max)

4. All PL PWR (seven) – OFF

5. O2,H2 TK HTRS (all) – OFF

6. MCC CMD FC purge, then BFS GPC – STBY,HALT
PWR – OFF
OUTPUT – NORM

7. If no comm: Sel best S–BD PM ANT

If RTLs: 8. TACAN 1,2 – OFF

9. RADAR ALT 1 – OFF

If TAL/AOA/ENTRY and V > 15K:

10. All TACAN/RA/MLS – OFF

11. Use one FLT CNTLR PWR

⇒ 12. DC UTIL PWR – OFF

◇ 13. FCS CH 4 – OFF

14. GPC 4 – STBY,HALT,PWR – OFF

15. FF4,FA4 – OFF

16. ANNUN BUS SEL ACA 2/3 – OFF

◇ When MPS dump complete:

17. MPS ENG PWR (six) – OFF

18. EIU (three) – OFF

19. MEC 1 – OFF, wait 2 sec, then:

20. MEC 2 – OFF

21. At V = 10K: ✓TACAN 3 – GPC

22. At M = 2.9: ✓RA2 – ON

23. If reqd: Use one MLS,
GNC I/O RESET

LOSS OF 2 FREON LOOPS – LOOPS FAILED

1. LES O2 – OFF, Visor – OP
 2. O2 SYS SPLY (two) – OP
- Panel L1: All switches off, except:
3. H2O PUMP LOOP 2 – ON
 4. Perform PWRDN if not already accomplished

EVAP OUT TEMP HIGH (Rads cold soaked)

If temp high in only one loop, snsr failed >>

1. If V < 12K:
RAD BYP VLV LOOP 1 – MAN, BYP
NH3 CNTLR B – PRI/GPC >>
2. FES PRI B(A) – OFF
A(B) – ON (wait 30 sec)
If T decr >>
3. FES PRI A(B) – OFF
SEC – ON (HI LOAD ena) (wait 30 sec)
If T decr:
TOP EVAP HTRS (three) – OFF >>
4. HI LOAD EVAP – OFF
DUCT HTR – OFF (wait 30 sec)
If T decr >>
5. TOP EVAP HTRS (three) – OFF
RAD BYP VLV (two) – AUTO
CNTLR LOOP (two) – AUTO B(A) (wait 90 sec)

EVAP OUT TEMP HIGH (Rads *not* cold soaked)

If temp high in only one loop, snsr failed >>

If V > 12K:

1. FES PRI A – OFF
B – ON (wait 30 sec)
If T decr >>
2. FES PRI B – OFF
SEC – ON (HI LOAD ena) (wait 30 sec)
If T decr >>
3. HI LOAD EVAP – OFF
If T decr >>
4. RAD BYP VLV (four) – MAN, RAD FLOW
- ⇒ 5. NH3 CNTLR B – SEC/ON (wait 60 sec)
6. If T decr >>
7. NH3 CNTLR B – OFF, A – SEC/ON

EVAP OUT TEMP LOW

1. If low in only one loop (snsr failed) >>
 2. FREON PUMP LOOP 1,2 (two) – OFF
 3. H2O PUMP LOOP 1 (two) – ON,B
- If no PL H2O Loop present:
4. FLOW PROP VLV LOOP 1,2 (two) – PL HX(tb-PL)
- If PL H2O Loop present:
5. Activate PL H2O Loop
 6. O2 SYS 1,2 SPLY VLV (two) – CL
 7. ✓RAD BYP VLV MODE (two) – MAN
 8. ✓MAN SEL (two) – BYP (tb-BYP ~3 sec)
 9. FLASH EVAP CNTLR PRI A, PRI B, SEC (three) – OFF
 - ◇ 10. FREON PUMP LOOP 1,2 (two) – B
 - ◇ 11. NH3 CNTLR A,B (two) – SEC/ON
- If FREON LOOP 1(2) running:
12. O2 SYS 1(2) SPLY VLV – OP
- When EVAP OUT T > 55 for at least 2 min (NH3 depleted):
- If any FREON LOOP off:
13. FREON PUMP LOOP 1(2) – B
 14. O2 SYS 1(2) SPLY VLV – OP
 15. Wait 3 min
- If V > 12K and FLASH EVAP CNTLR PRI A(B)
previously selected:
16. FLASH EVAP CNTLR PRI B(A) – GPC >>
- If V < 12K:
17. RAD BYP VLV MODE 1,2 (two) – AUTO
 18. CNTLR LOOP 1,2 (two) – OFF,
AUTO A(B)

FREON QTY LOW

- ◇ 1. FREON ISOL MODE – MAN
2. (Aff) FREON ISOL LOOP 1(2) – ISOL
Hold for 5 sec >>

FIRE/SMOKE

SM SYS SUMM 1

If **VISUAL SMOKE/FIRE**, or
two SMOKE DETN It on, or
two CONC > 2, or
one SMOKE DETN It on and
other CONC > 2:

1. Go to step 6

If single Av Bay SMOKE DETN A(B) It and assoc CONC > 2:

2. SMOKE DETN CKT TEST – B(A) (25 sec)

If SMOKE DETN B(A) test good (It on):

3. SMOKE DETN CKT TEST – OFF
4. SNSR – RESET >>

If SMOKE DETN B(A) test bad (no It):

5. Go to step 6

If none of above >>

6. ✓ Tabs/Visors – CL
LES O2 – ON

If **AV BAY FIRE**:

7. FIRE SUPPR – ARM
pb – DISCH (push until lit)
8. If Ascent: AV BAY FAN (two) – OFF
9. If FIRE in Bay:
 - 1: TACAN 1, MLS 1 – OFF
 - 2: TACAN 2, MLS 2,3 – OFF
 - 3: TACAN 3 – OFF

If **CABIN FIRE**:

10. CAB FAN A,B (two) – OFF (max 20 min)
11. Locate source (see matrix, facing page)
12. Unpower source of smoke

If smoke persists or source cannot be unpowered:

WARNING
Discharge is propulsive

13. Discharge handheld FIRE EXTGHR

If Ascent:

14. Post MECO, go to POST-FIRE CABIN CLEANUP (ASC
PKT, ECLS) >>

If Entry and prior to TIG:

15. Go to ECLS FRP-3, CONTINGENCY CABIN O2
CONTROL, step 3 (MAL)

Cont next page

MS E4-6 AESP/ALL/E/GEN J,12

ALARM SEQUENCE	SOURCE AREA
<div style="text-align: center;"> <div style="border: 1px solid black; padding: 2px; display: inline-block;">L(R) FLT DK</div> or <div style="display: inline-block; border: 1px solid black; padding: 2px;">L(R) FLT DK</div> → <div style="border: 1px solid black; padding: 2px; display: inline-block;">CABIN</div> </div>	PS(MS), L(R) CONSOLE
<div style="display: inline-block; border: 1px solid black; padding: 2px;">L FLT DK</div> ↔ <div style="border: 1px solid black; padding: 2px;">R FLT DK</div>	AFT FLT DK, MIDDECK
<div style="text-align: center;"> <div style="border: 1px solid black; padding: 2px; display: inline-block;">CABIN</div> or <div style="display: inline-block; border: 1px solid black; padding: 2px;">CABIN</div> </div> <div style="margin-left: 100px;"> <div style="border: 1px solid black; padding: 2px; display: inline-block;">L FLT DK</div> ↔ <div style="border: 1px solid black; padding: 2px; display: inline-block;">R FLT DK</div> </div>	FWD FLT DK, WCS, LEB

This Page Intentionally Blank

MS E4-8

AESP/ALL/E/GEN J

EPS

EPS

MS E5-1

AESP/ALL/E/GEN J

MN BUS UNDER V/FC V

PLT

⇒ If MN V < 26.4, FC V < 26.6, FC A > 480 (2 of 3)

(SHORT OR DEGRADED FC):

1. MSTR MADS PWR – OFF
 2. If aff BUS tied – UNTIE
 3. PL PRI (three) – OFF
 4. Aff ESS BUS SOURCE FC – OFF
FC/MN BUS – OFF
- If FC VOLTS < 32 (FC SHORT)
5. Aff FC REAC VLV – CL
 6. Go to FC SHUTDN (Do not stop FC until
COOL P < 15 & STACK T < 243) >>
- If FC VOLTS ≥ 32 (BUS SHORT)
7. Go to BUS LOSS ACTIONS >>

If MN V < 26.4 and FC V > 32 and FC A < 20

(FC DISCONNECT):

8. MSTR MADS PWR – OFF
 9. PL PRI (three) – OFF
 10. FC/MN BUS – ON
- If FC3 aff:
11. PL PRI FC3 – ON
MNC – ON
 12. If MNC V < 26.4: PL PRI (three) – OFF
- If 1st FC failure:
13. Perform BUS TIE, then:
If MN BUS recovered:
14. GNC I/O RESET
- If aff FC VOLTS > 32:
15. Go to FC SHUTDN

AC VOLT HIGH

If AC V > 123 and F9 V > 123:

- ⇒
1. Aff AC BUS SNSR – OFF
 2. cb AC CONTR – cl
INV/AC BUS – OFF
INV PWR – OFF
cb AC CONTR – op
 3. ✓H2O PUMP LOOP 2(1) – ON
 4. Go to aff BUS LOSS

EPS

AC VOLT LOW or OVERLOAD

1. Aff AC BUS SNSR – OFF
- ⇒ If amps > 14 or F9 V < 110:
- If single Φ amps > 14 or V > 10:
2. cb AC CONTR – cl
INV/AC BUS – OFF
INV PWR – OFF
cb AC CONTR – op
 3. If other Φ amps > 14:
Go to step 4
- If multi Φ (Bus short):
4. Aff cb AC CONTR (three) – cl
INV/AC BUS – OFF (tb-OFF)
INV PWR – OFF (tb-OFF)
cb AC CONTR (three) – op
5. Go to aff BUS LOSS

PLT |

3 Φ /AC
ESS

MN
AC

3Φ MOTORS STOPPED

PLT

1. Aff AC BUS SNSR – OFF
2. Determine AC BUS
 FC1 & FREON PUMP 2B: AC1
 FC2 & FREON PUMP 1B: AC2
 FC3 & CAB FAN A: AC3
3. Aff FC – STOP
 If AC3 aff:
 4. AV BAY 3 FAN B – OFF, A – ON
 5. CAB FAN A – OFF
 Isolate aff ΦB:
 6. Aff cb AC CONTR – cl
 7. INV/AC BUS – OFF
 If AC1(2,3) aff and AV BAY 3(2,3) FAN ΔP < 0.5:
 8. Aff INV/AC BUS – ON
 9. cb AC CONTR – op
 10. Repeat from step 6 to isolate aff ΦC, ΦA, then:
 11. Aff cb AC CONTR (three) – cl
 12. INV/AC BUS – OFF
 13. Go to BUS LOSS, AC MULTI Φ >>
 If AC1(2,3) aff and AV BAY 3(2,3) FAN ΔP ≥ 0.5:
 14. Aff FC – START (10 sec or ΔP tb-gray)
 15. Perform aff BUS LOSS and if AC1(AC2) aff >>
 16. If AC3 aff: CAB FAN B – ON

⇒ **AC SINGLE Φ**

AC1	ΦA	BLR CNTLR/HTR 1 – A When V = 12K: RAD CNTLR LOOP (two) – AUTO A
	ΦB	When V = 12K: RAD CNTLR LOOP (two) – AUTO A
	ΦC	BLR CNTLR/HTR 3 – B
AC2	ΦA	BLR CNTLR/HTR 1 – B
	ΦB	SIG CONDR FREON A – AC3
	ΦC	BLR CNTLR/HTR 2 – A
AC3	ΦA	BLR CNTLR/HTR 2 – B
	ΦB	SIG CONDR FREON B – AC2
	ΦC	BLR CNTLR/HTR 3 – A

ANY AC2 SINGLE Φ

CDR

⇒ FREON PUMP LOOP 1 – A

BUS TIE (Do not tie Bus short)

If MN Volts > 20: Bus Tie

If MN Volts < 20 and Post SRB SEP:

1. Pre MECO: CDR: Perform AC Multi Φ
2. Aff AC BUS SNSR (3 if Pre MECO) – OFF
3. cb AC CONTR (three) – cl
4. INV/AC BUS – OFF (tb–OFF)
5. INV PWR – OFF (tb–OFF)
6. If MNC(B) dn, CAB FAN A(B) – OFF
7. Bus Tie
8. INV PWR – ON (tb–ON)
9. INV/AC BUS – ON (tb–ON)
10. cb AC CONTR (three) – op
11. Post MECO: AC BUS SNSR – AUTO TRIP
12. Post PWRDN: \checkmark CAB FAN A(B) – ON
13. GNC I/O RESET

MN
SUB

ESS BUS V LOW

If verified by F9 voltmeter:

1. Perform FC SHUTDN (<9 min), then:
2. Go to aff ESS BUS LOSS

ESS BUS LOSS

ESS 1BC	<ol style="list-style-type: none"> 1. L AUD CNTL – R (CDR can't talk) 2. Pri C/W & Matrix lost
ESS 2CA	<ol style="list-style-type: none"> 1. AUD CTR – 2 2. R AUD CNTL – L (PLT can't talk)
ESS 3AB	<ol style="list-style-type: none"> 1. Do not ENGAGE BFS 2. CSM lost ⇒ 3. BFS GPC OUTPUT – TERM

3Φ/AC
ESS

MNA or AC1 Multi Φ

CDR

- ⇒
1. FREON PUMP LOOP 2 – A
 2. TOP EVAP HTR DUCT – B
 3. HI LOAD DUCT HTR – B
 4. AV BAY 2 FAN (two) – ON
 5. AV BAY 3 FAN A – ON, B – OFF
- If V > 12K:
When V = 12K:
6. RAD BYP vlv MODE 1,2
(two) – AUTO
 7. RAD CNTLR LOOP 1,2
(two) – AUTO A
8. ANNUN BUS SEL ACA 1 – MNB
 9. NWS – 2
 10. BFS G51 AA1 – desel
- FAILED: NH3 A PRI, NWS 1,
UHF HI PWR XMIT, L HUD

MNB or AC2 Multi Φ

- ⇒
1. AV BAY 1 FAN A – ON, B – OFF
 2. FREON PUMP LOOP 1 – A
 3. HUM SEP A – ON, B – OFF
 4. IMU FAN A – ON, B – OFF
 5. AV BAY 2 FAN B – ON, A – OFF
3 FAN (two) – ON
 6. ✓cb AC3 ΦA LG SNSR 1 – cl
 7. ANNUN BUS SEL ACA 2/3 – MNC
 8. BFS G51 AA2, RGA 2 – desel
- FAILED: NH3 B SEC, RA-2, NWS 2
PLT DRAG CHUTE ARM
S-BD PM 1 (NO PNL,CMD)

MNC or AC3 Multi Φ

- ⇒
1. FES CNTLR PRI A – OFF, B – ON
 2. CAB FAN B – ON, A – OFF
 3. AV BAY 1 FAN (two) – ON
 4. H2O PUMP LOOP 1 – ON, 2 – OFF
 5. ✓cb AC2 ΦA LG SNSR 2 – cl
 6. BFS G51 RGA 3 – desel
- FAILED: NH3 A SEC, B PRI
CDR DRAG CHUTE ARM

MNA or AC1 Multi Φ **PLT**

- 1. MSTR MADS PWR – OFF
- 2. Perform FC SHUTDN (within 9 min), then:
- ⇒ 3. BLR CNTLR/HTR 1 – A
3 – B

FAILED: TAC 1
MLS 1, RA 1, NWS 1, L HUD

MNB or AC2 Multi Φ

- 1. MSTR MADS PWR – OFF
- 2. Perform FC SHUTDN (within 9 min), then:
- ⇒ 3. BLR CNTLR/HTR 2 – A
1 – B
- 4. SIG CONDR FREON A – AC3

FAILED: TAC 2
MLS 2, RA 2, NWS 2
PLT DRAG CHUTE ARM
S–BD PM 1 (NO PNL,CMD)

MNC or AC3 Multi Φ

- 1. S–BD PM CNTL – PNL,CMD
- 2. Config per COMM COVERAGE **BFS G51**:
TDRS – ITEM 46 EXEC (*)
STDN–HI – ITEM 47 EXEC (*)
SGLS – ITEM 49 EXEC (*)
- 3. MSTR MADS PWR – OFF
- 4. Perform FC SHUTDN (within 9 min), then:
- ⇒ 5. BLR CNTLR/HTR 3 – A
2 – B
- 6. SIG CONDR FREON B – AC2

FAILED: TAC 3, MLS 3, R HUD
CDR DRAG CHUTE ARM

CNTL

SUBBUS

	SUBBUS APC or ALC	4 1	5 2	6 3
⇒ 1.	BLR CNTLR/HTR	1 – A 3 – B	2 – A 1 – B	3 – A 2 – B

CNTL BUS V LOW**PLT**

1. ✓BUS LOSS ID
2. Perform aff CNTL BUS LOSS, then:
If pwr reqd (<3 sec) for crit function:
 3. Hold crit function sw
 4. For CNTL BUS AB(BC,CA) VOLTS LOW
CNTL BUS PWR MNA(MNB,MNC) – RESET
5. If FIRE/SMOKE at any time:
For CNTL BUS AB(BC,CA):
 - ◇ CNTL BUS PWR MNA(B,C),MNB(C,A)
(two) – RESET (hold) (pnl R1)
 - If CNTL BUS AB(BC,CA) VOLTS still > 0:
ASAP
6. cb CNTL BUS AB1/2/3(BC1/2/3,
CA1/2/3) – op (pnl R14:B)

**MN
SUB****CNTL BUS LOSS****CDR**

AB1	⇒ 1. Use R TRIM & BDY FLP sws FAILED: NH3 A SEC, FES PRI B GPC
AB2	⇒ 1. CDR Display – green dot FAILED: NH3 B SEC, L HUD, FES PRI B ON, H2O LOOP 1, A ON
AB3	⇒ If BFS ENGAGE reqd: 1. Use PLT's RHC, then GPCs 1,2,4 – STBY,HALT 2. BFS I/O RESET
BC1	⇒ 1. Use R TRIM & BDY FLP sws 2. [BFS G51] RGA 2 – desel FAILED: R HUD, CDR DRAG CHUTE DPY/JETT
BC2	⇒ FAILED: NH3 B PRI, FES SEC GPC, H2O LOOP 1, B ON, CDR DRAG CHUTE DPY/JETT
BC3	⇒ FAILED: NH3 A PRI, FES SEC ON
CA1	⇒◇ 1. No BFS ENGAGE GPC 3,5 2. BFS GPC OUTPUT – TERM 3. [BFS G51] RGA 3 – desel FAILED: NH3 B SEC, FES PRI A GPC, H2O LOOP 2 GPC, PLT DRAG CHUTE DPY/JETT
CA2	⇒ FAILED: NH3 A SEC , FES PRI A ON, PLT DRAG CHUTE DPY/JETT

CNTL BUS LOSS

PLT

AB1	⇒ 1. Use R TRIM & BDY FLP sws 2. BLR CNTLR/HTR 1 – A
AB2	1. G23 RCS FWD MANF VLVS 1 OVRD – ITEM 40 EXEC (CL) 2. BLR CNTLR/HTR 1 – A ⇒ FAILED: L HUD
AB3	1. G51 RCS RM MANF CL OVRD – ITEM 41 EXEC If BFS ENGAGE reqd: 2. Use PLT's RHC, then GPCs 1,2,4 – STBY,HALT 3. BFS I/O RESET If no S-BD COMM: 4. S-BD PM CNTL – PNL,CMD 5. BFS G51 Config per COMM COVERAGE: TDRS – ITEM 46 EXEC (*) STDN-HI – ITEM 47 EXEC (*) SGLS – ITEM 49 EXEC (*) ⇒ 6. BLR CNTLR/HTR 1,3 (two) – B
BC1	⇒ 1. Use R TRIM & BDY FLP sws 2. BLR CNTLR/HTR 2 – A FAILED: R HUD, CDR DRAG CHUTE DPY/JETT S-BD PM 1 (NO PNL,CMD)
BC2	1. S-BD PM CNTL – PNL,CMD 2. BFS G51 Config per COMM COVERAGE: TDRS – ITEM 46 EXEC (*) STDN-HI – ITEM 47 EXEC (*) SGLS – ITEM 49 EXEC (*) 3. G23 RCS FWD MANF VLVS 2 OVRD – ITEM 41 EXEC (CL) 4. PLT Displays – green dot ⇒ 5. Use L TRIM & BDY FLP sws 6. BLR CNTLR/HTR 2 – A FAILED: CDR DRAG CHUTE DPY/JETT
BC3	1. G51 RCS RM MANF CL OVRD – ITEM 41 EXEC ⇒ 2. BLR CNTLR/HTR 1,2 (two) – B
CA1	⇒◇ 1. No BFS ENGAGE GPC 3,5 2. BFS GPC OUTPUT – TERM 3. BLR CNTLR/HTR 3 – A FAILED: PLT DRAG CHUTE DPY/JETT

I

FC

I

CNTL BUS LOSS (Cont)

CA2	1. G23 RCS FWD MANF VLVS 3 OVRD – ITEM 42 EXEC (CL) ⇒ 2. Use L TRIM & BDY FLP sws 3. BLR CNTLR/HTR 3 – A FAILED: PLT DRAG CHUTE DPY/JETT
CA3	⇒ 1. BLR CNTLR/HTR 2,3 (two) – B

FC REAC VLV CLOSED

PLT

1. FC REAC (three) – OP
2. Perform BUS TIE, then:
If no joy on REAC open:
 3. ✓cb FC REAC VLV CL ENA (three) – op (pnl C3)
 4. FC REAC (three) – OP

If FC COOL P < 50:

5. Go to FC SHUTDN

FC pH ↓ 1(2,3) or FC DELTA V 1(2,3)

If pH ↓ and FC SS 1(2,3) ΔV > 150

or FC SS ΔV > 150 and incr:

1. Perform BUS TIE, then:
2. Aff FC REAC VLV – CL
3. MSTR MADS PWR – OFF
4. Go to LOSS OF 1(2nd) FC PWRDN >>

If pH ↓ only:

5. Go to BUS TIE

FC STACK T

1. MSTR MADS PWR – OFF

If STACK T > 243 and incr:

2. If 2nd FC: Go to 2nd FC SHUTDN >>
3. PL PRI (three) – OFF

If aff FC amps < 170 or > 360:

4. Go to MN BUS U/V, step 4 >>
- ◇ 5. Perform BUS TIE, then:
6. ESS BUS SOURCE FC – OFF
7. FC/MN BUS – OFF

If aff FC VOLTS < 32 or STACK T not decr:

8. Aff FC REAC – CL
9. FC – STOP after COOL P < 15 and
STACK T < 243

10. Go to LOSS OF 1 FC PWRDN

FC EXIT T

1. MSTR MADS PWR – OFF

2. Perform BUS TIE, then:

⇒ If EXIT T > 164 and incr or < 131 and no comm:

3. Go to FC SHUTDN

CNTL

FC COOLANT PUMP Δ P LOW

1. FC – START (10 sec or Δ P tb–gray)
- ⇒ 2. \checkmark FC PUMP cb(s) – cl (pnl L4:C)
- ◇ If EXIT T > 164 & not decr or RDY tb – bp
 (30 sec after START):
 3. Go to FC SHUTDN >>
- If EXIT T norm, RDY tb – gray, & no comm:
 4. Monitor AC amps
 5. FC – STOP
- If AMPS decr 0.7–0.9 AMP/ Φ :
 6. FC – START (hold 30 sec if Δ P tb–bp)
 7. If AMPS incr 0.7–0.9 AMP/ Φ >>
 8. Go to FC SHUTDN

FC COOL P

1. Perform BUS TIE, then:
- ⇒ If COOL P > 75, incr, and not 100 (H),
 or COOL PUMP Δ P tb – bp/intermittent,
 or STACK/EXIT T unstable,
 or SS Δ V \geq 150:
 - If COOL P > 75:
 2. Aff FC REAC VLV – CL
 3. MSTR MADS PWR – OFF
 4. Go to LOSS OF 1(2nd) FC PWRDN >>
 - If COOL P < 50:
 5. Go to FC SHUTDN

FC / 2FC
EMER

FC SHUTDOWN (1st) (A/E CL PMP ↓: <9 min)

1. Pre OMS 2 or Entry:
MSTR MADS PWR – OFF
2. If not tied: Perform BUS TIE, then:
If ORB (not D/O Prep), kW > 18:
MN BUS TIE (three) – ON
3. ESS BUS SOURCE FC – OFF
FC/MN BUS – OFF
FC – STOP (1 sec)
4. FC REAC VLV – CL
✓PWRDN

LOSS OF 1 FC PWRDN (GRTLS/TAL) PLT

1. PRI PL (three) – OFF
AFT PL (two) – OFF
2. IDP/CRT 4 PWR – OFF
One MDU – OFF

LOSS OF 1 FC PWRDN (ENTRY)

1. If V < 15K >>
2. IDP/CRT 4,one MDU,FLT CNTLR PWR – OFF
3. TAC/RA/MLS – OFF
If middeck PL on:
4. cb MNB UTIL PWR – op (pnl O15:C)
- ◇ 5. PRI PL (three) – OFF
AFT PL (two) – OFF

FC

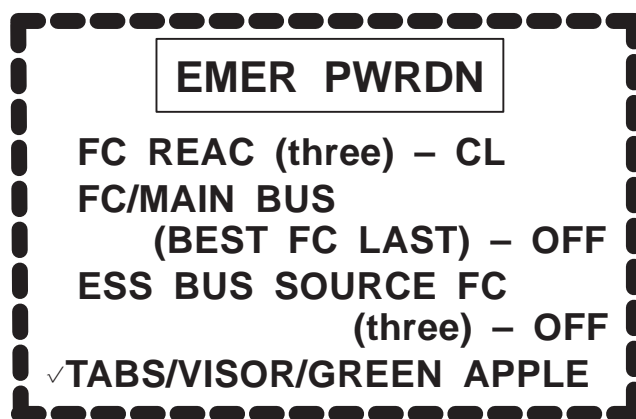

2nd FC SHUTDN (GRTLS/TAL)

PLT

(CL PMP Lost: <6 min)

1. Have CDR start LOSS OF 2nd FC PWRDN (GRTLS/TAL)

If three MN BUSES powered:

2. MN BUS TIE (three) – OFF
(Do not perform BUS LOSS ACTIONS)
3. LES O2 – OFF, Visors – OP
4. Switch off all but one IDP/CRT with four MDUs
5. All PL PWR (seven) – OFF
6. O2, H2 TK HTRS (all) – OFF
7. After CDR pnl L1 config complete, continue:

If two MN BUSES powered:

8. Powered MN BUS TIES (two) – ON

If only one MN BUS powered:

9. MN BUS TIE (three) – OFF
If only MNA(B,C) powered: Secure APU 2(3,1)
BUS TIE good FC/BUS (MNA)
I/O RESET

When reqd:

10. ESS BUS SOURCE FC – OFF
FC/MN BUS – OFF
FC – STOP (1 sec)
FC REAC VLV – CL
11. G51 ✓ INCNCT ENA (if reqd for OMS load)
12. Go to LOSS OF 2nd FC PWRDN (GRTLS/TAL)

2nd FC SHUTDN (ENTRY)

1. Have CDR go to LOSS OF 2nd FC PWRDN (ENTRY)
2. O2/H2 HTRS (twelve) – OFF (pnl R1)
PL PWR (seven) – OFF
3. ✓ MSTR MADS PWR – OFF

If aff FC/MN BUS is tied:

4. MN BUS TIE (two) – OFF
5. If only MNA(B,C) powered: Secure APU 2(3,1)
6. Perform BUS TIE (Good FC/BUS to another BUS), then:
7. ESS BUS SOURCE FC – OFF
FC/MN BUS – OFF
FC – STOP (1 sec)
FC REAC VLV – CL

2FC

**LOSS OF 2nd FC PWRDN
(GRTLS/TAL)**

CDR

1. ES O2 – OFF, Visors – OP
 2. L1: Select one FREON PUMP on good FC/MN BUS and place other pump to OFF
Switch OFF all HUM SEPS, IMU FANS, H2O PUMPS, AV BAY FANS, CAB FANS, FES HTRS
 3. Switch off all but one IDP/CRT with four MDUs
After BUS TIE, if MNC unpowered:
 4. FES CNTLR PRI A – OFF
B – ON
 - ⇒ 5. Assign all strings to GPC 1 OPS 30X(60X) PRO
 6. Unassigned GPCs MODE – STBY (tb–bp), HALT
– STBY (tb–RUN)
– HALT (tb–bp)
GPC PWR – OFF
 7. IMU (one) – OFF (choose previously failed IMU, if any)
 8. IMU FAN (one) – ON
 9. H2O PUMP (one) – ON
 10. AV BAY 1,2 FAN (two) – ON (✓Fan ON in each bay with a powered GPC)
- After MPS Pwrn:
- If MNA unpowered:
11. FREON PUMP LOOP 1 – B
2 – A
 12. TOP EVAP HTR DUCT – B
HI LOAD DUCT HTR – B
- If MNB(C) unpowered:
13. FREON PUMP LOOP 1,2 (two) – A(B)
 14. TOP EVAP HTR DUCT – A
HI LOAD DUCT HTR – A
- If TAL:
15. HUM SEP (one) – ON
 16. CAB FAN (one) – ON

**FC/2FC
EMER**

**LOSS OF 2nd FC PWRDN
(GRTLS/TAL)**

PLT

- ⇒ ◇ When MPS Dump complete:
1. MPS ENG PWR (six) – OFF
EIU (three) – OFF
 2. MEC 1 – OFF, wait 2 sec, then
2 – OFF

If MNA(MNB) unpowered:

3. O₂,H₂ TK1 HTRS B (two) – AUTO

If MNC unpowered:

4. O₂,H₂ TK2 HTRS B (two) – AUTO
5. Safe Payload, if reqd
6. Go to APU RESTART for secured APU

LOSS OF 2nd FC PWRDN (ENTRY)

CDR

1. MDM PL1 – OFF
2. FCS CH 4 – OFF
GPC MODE 4 – STBY,HALT
PWR 4 – OFF
MDM FF4,FA4 – OFF
3. HUM SEP (two) – OFF
4. FLASH EVAP FDLN HTR SPLY (two) – OFF
5. TOP EVAP HTR NOZ L,R (two) – OFF
DUCT – OFF
HI LOAD DUCT HTR – OFF
6. If V > 10K: ✓CAB FAN A(B) – ON
7. M = 2.9: CAB FAN (two) – OFF
AV BAY FAN (six) – OFF

CRYO

O2(H2) CRYO P/T HIGH**PLT**

CRYO O2(H2) TK HTR (two) – OFF

CRYO O2(H2) LEAK (3 or more tanks aff)

Use meter if CRT data OSL

1. MANF VLV 1,2 (two) – CL
2. TK3 HTR A – AUTO

⇒ If TK1 and 2 P decr slowly (HTR logic fail):

3. If QTY > 55%: TK3 HTR B – AUTO
4. MANF VLV 1,2 (two) – OP >>
5. Perform aff MN BUS TIE, then:

If O2 TK 1(2) aff:

6. O2 SYS 1(2) SPLY vlv – CL
7. If O2 TK 1(2) P now incr:
(PCS leak) >>
8. If O2 leak: Aff TK HTR B – AUTO

If aff TK P not incr:

9. If TK3 aff: ✓HTR A(&B if O2) – AUTO
10. Perform aff FC SHUTDN (post COOL P alarm if O2 leak), then:
If TK3 aff and P not decr within 2 min: (FC leak)
11. MANF VLV 1,2 (two) – OP (ASAP) >>
12. Aff TK HTRS A,B (two) – OFF

2FC

— | |

| | —

OMS

OMS

— | |

MS E6-1

AESP/ALL/E/GEN J

| | —

OMS TEMP DURING DUMP

1. **G51** INH INCNCT L R
If aff OMS FU IN P \geq :
2. Go to ENG FAIL >>
- If aff OMS FU IN P \leq :
3. Go to PRPLT FAIL >>
4. Otherwise snsr fail

Pc LOW DURING DUMP

1. ENG VLV < 70%: Go to ENG FAIL
2. ENG VLV > 70%: **G51** INH INCNCT
If aff OMS OX IN P > 227:
 3. Go to ENG FAIL >>If aff OMS OX IN P \leq 136:
 4. Go to PRPLT FAIL >>
5. Otherwise snsr fail

ENG FAIL (During Dump)

1. Failed OMS ENG – OFF
- ⇒ 2. ✓ **G51** INH INCNCT
3. Balance prop by XFEED

PRPLT FAIL (During Dump)

- ⇒ Both OMS ENG (two) – OFF

OMS

OMS SECURE

1. If leak, **G51** VENT DOORS – OP
2. Aff: OMS ENG – OFF
XFEED (two) – CL
TK ISOL (two) – CL
He PRESS (two) – CL

If leak isolated or FU TK leak and post D/O burn:

3. **G51** VENT DOORS – CL

OMS XFEED:

XFEED: R TO L

1. L,R OMS XFEED (four) – OP
2. L OMS TK ISOL (two) – CL
He PRESS/VAP ISOL (two) – CL

XFEED: L TO R

1. L,R OMS XFEED (four) – OP
2. R OMS TK ISOL (two) – CL
He PRESS/VAP ISOL (two) – CL

XFEED RETURN: OMS to OMS

1. L,R OMS TK ISOL (four) – OP
XFEED (four) – CL

This Page Intentionally Blank

MS E6-4

AESP/ALL/E/GEN J



RCS

RCS

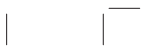

MS E7-1

AESP/ALL/E/GEN J

RCS JET FAIL (LEAK)

If OX/FU Qty diverging:

1. Aff RCS MANF ISOL – CL

RCS JET FAIL (ON)

1. Aff RCS MANF ISOL – CL

If MANF P > 130 and stable (false alarm):

2. Aff RCS MANF ISOL – OP
 3. ✓AFT RCS RM LOSS
- ⇒

RM DLMA MANF

If aff MANF tb – OP or switch not thrown:

1. If FRCS: ✓MCC
2. If ARCS: G51 RCS RM MANF CL OVRD –
ITEM 41 EXEC
3. If aff MANF tb – bp: aff MANF – GPC

RCS JET FAIL (OFF)

If > 1 jet/pod/dir failed:

1. G23 resel jets
2. DES INH (*) (Reprioritize)

AFT RCS RM LOSS

If loss of jet RM and > 3Y, 2P jets/pod/dir:

1. G23 aff jet DES INH (*) (Reprioritize)
2. If yaw jet: desel >>

If total RM loss (BCE) and < 3Y, 2P jets/pod/dir:

3. Aff jet DES INH (*) (Reprioritize)
4. Aff MANF VLVS STAT OP – OVRD

RCS

AFT RCS LK (GRTLS/304/305)

(√He P decr: CRT & meter)

1. If TK P ↑: Go to TK P HIGH >>

OX Leak	2. [G51] VENT DOOR CNTL – OPEN (ITEM 43)
RTLS/TAL	3. [G51] AFT RCS – INH (ITEM 13)
	4. Aff 3/4/5 MANFs – CL 5. Aff 3/4/5 TK ISOL(s) – CL
Single MANF leak	6. TK ISOL(s) – OP (tb–OP),GPC 7. Good PRI MANF (one) – OP
Two MANF P decr (TK leg leak)	8. Leaking leg XFEED (one) – CL
No MANF P decr	9. TK ISOL(s) – OP (tb–OP),GPC 10. PRI MANFs (two) – OP 11. Repeat steps 4–10 for 1/2 leg
Leak not found	12. Aff RCS He PRESS (two) – CL
He P decr (He TK leak) M > 3	13. [G51] VENT DOOR CNTL – CLOSE (ITEM 44)
	14. He PRESS (two) – OP 15. When He P < 456, MSTR XFEED – feed from good side >>
OX/FU TK P diverge (Prplt TK leak)	16. He PRESS (two) – OP 17. When QTY = 0, MSTR XFEED – feed from good side & Aff He PRESS (two) – CL >>
Leak not found	18. He PRESS (two) – OP
He P decr (He leg leak) M > 3	19. [G51] VENT DOOR CNTL – CLOSE (ITEM 44)
	20. Cycle He PRESS so 220 < TK P < 245 21. When He P < 456, MSTR XFEED – feed from good side >>
Leak not found	22. Assume MANF 5 leak
M > 3	23. [G51] VENT DOOR CNTL – CLOSE (ITEM 44)

RCS TK P HIGH (FU or OX) (✓MANF P)

1. He PRESS (two) – CL
2. A – OP

If He P decr:

3. He PRESS A – CL
B – OP

XFEED: RCS to RCS

If AUTO XFEED:

1. L,R RCS TK ISOL (six) – GPC
XFEED (four) – GPC
2. OMS XFEED (four) – CL
3. MSTR RCS XFEED – FEED FROM L(R) >>

If MANUAL XFEED:

4. L,R OMS XFEED (four) – CL
5. RCS XFEED (four) – OP
6. Receiving RCS TK ISOL (three) – CL
He PRESS (two) – CL
7. MSTR RCS XFEED – FEED FROM L(R)

RCS SECURE

1. If OX leak: G51 VENT DOORS – OP
2. RCS MANF ISOL (five) – CL
XFEED (two) – CL
TK ISOL (all) – CL
He PRESS (two) – CL

MPS

MPS

MS E8-1

AESP/ALL/E/GEN J

MPS

MPS He P/MPS C&W LIGHT
MPS PNEU REG
If M > 2.4: Aff MPS He ISOL – CL

MS E8-2

AESP/ALL/E/GEN J

— | |

| | —

RESERVED

— | |

MS E9-1

AESP/ALL/E/GEN J

| | —

This Page Intentionally Blank

MS E9-2

AESP/ALL/E/GEN J

MULTIPHASE SYSTEMS CUE CARDS

----- MULTIPHASE SYSTEMS CUE CARDS, SECTION 10 -----

This Page Intentionally Blank

FAB USE ONLY

CC 10-1

AESP/ALL/A,E/GEN J

(reduced copy)

TOP

EMER PWRDN

FC REAC (three) – CL

FC/MAIN BUS

(BEST FC LAST) – OFF

ESS BUS SOURCE FC

(three) – OFF

✓TABS/VISOR/GREEN APPLE

- FC SHUTDN (1st)** (A/E CL PMP ↓
<9 min)
1. Pre OMS 2 or Entry:
MSTR MADS PWR – OFF
 2. If not tied: Perform BUS TIE, then:
If ORB (not D/O Prep), kW > 18:
MN BUS TIE (three) – ON
 3. ESS BUS SOURCE FC – OFF
FC/MN BUS – OFF
FC – STOP (1 sec)
 4. FC REAC VLV – CL, ✓PWRDN

BUS TIE (Do not tie Bus short)

If MN Volts > 20: Bus Tie

If MN Volts < 20 and Post SRB SEP:

1. Pre MECO: CDR: Perform AC Multi Φ
2. Aff AC BUS SNSR (3 if Pre MECO) – OFF
3. cb AC CONTR (three) – cl
4. INV/AC BUS – OFF (tb-OFF)
5. INV PWR – OFF (tb-OFF)
6. If MNC(B) dn, CAB FAN A(B) – OFF
7. Bus Tie
8. INV PWR – ON (tb-ON)
9. INV/AC BUS – ON (tb-ON)
10. cb AC CONTR (three) – op
11. Post MECO: AC BUS SNSR – AUTO TRIP
12. Post PWRDN: ✓CAB FAN A(B) – ON
13. GNC I/O RESET

POWER

AESP-5a/A,O,E/N

TOP
BACK OF 'POWER'

HOOK
VELCRO

HOOK
VELCRO

HOOK
VELCRO

AESP-5b/A,O,E/E

TOP

SSME FAIL/SHUTDN	CMD/HYD/ELEC	MPS 1																					
AC BUS SNSR (three) – OFF If 2 ENG remaining: ♦ MAIN ENGINE LIMIT SHUT DN – ENA,AUTO If 1 ENG remaining: When MPS PRPLT = 2%: MAN THROT Pc → 67%, At CO: Shut dn MN ENG (pb)	If 2 HYD SYS failed: MAIN ENGINE LIMIT SHUT DN – INH [TRAJ] Display – Cue SERC, ITEM 6 (EXEC if gimbaling eng fails)																						
MPS DATA																							
✓ MCC, accel, He dP/dT, 'MPS H2 OUT P', 'MPS O2 OUT T' If SSME fail (MCC or 3 cues): Aff MN ENG SHUTDN pb – push																							
If 3 ENG remaining: ♦ MAIN ENGINE LIMIT SHUT DN – ENA,AUTO																							
If no comm: Assume MPS CMD If multi (No MECO Confirm): Post MECO: MN ENG SHUTDN pb (three) – push (simo)																							
MPS LH2 ULL																							
♦ If 2(3) Ps < 28.0 or > 34.0: MPS LH2 ULL PRESS – OP When all Ps > 34.0: MPS LH2 ULL PRESS – AUTO																							
MPS DUMP INHIBIT																							
Post MECO: Aff MPS ENG PWR (two) – OFF LO2(H2) PRE VLV – CL AESP-11a/4/A/F																							
	<table border="1"> <thead> <tr> <th data-bbox="756 709 781 730">If:</th> <th data-bbox="906 709 963 730">When:</th> <th data-bbox="1052 709 1149 730">Shut down:</th> </tr> </thead> <tbody> <tr> <td data-bbox="667 741 837 800">2 Pcs stuck > 85% & 3-ENG RTLS</td> <td data-bbox="854 741 1016 762">MECO –2:00</td> <td data-bbox="1036 730 1179 800">1 aff MN ENG: CMD: (AC/pb)· HYD: (pb)</td> </tr> <tr> <td data-bbox="667 831 837 900">2 HYD SYS failed & Nom/ATO/TAL/ 2-ENG RTLS</td> <td data-bbox="854 821 1016 900">Nom/ATO: SE PRESS TAL: SE TAL 2 ENG RTLS: 2 OUT RED</td> <td data-bbox="1052 810 1179 900">ENG(HYD) S/D C(1) & R(3) C L(2) & C(1) L L(2) & R(3) R ELEC: (pb)</td> </tr> <tr> <td data-bbox="667 921 789 942">He lk S/D reqd</td> <td></td> <td data-bbox="1036 921 1179 942">Aff MN ENG (pb)</td> </tr> <tr> <td data-bbox="667 974 789 995">MPS CMD(s)·</td> <td data-bbox="854 953 1016 1033">Nom/ATO and: 3 ENG: V > 23K 2 ENG: V > 24.5K TAL: V > 22.5K RTLS: α = -1</td> <td data-bbox="1036 953 1179 1010">Aff MN ENG (AC/pb)· If 2 CMD: repeat</td> </tr> <tr> <td data-bbox="667 1022 837 1064">2 MPS HYD/ELEC & 3-ENG Nom/ATO/TAL</td> <td></td> <td data-bbox="1036 1012 1179 1073">1 aff MN ENG: HYD: (pb) ELEC: (pb)</td> </tr> <tr> <td data-bbox="667 1075 837 1115">1 MPS HYD/ELEC & 3-ENG Nom/ATO</td> <td data-bbox="906 1085 979 1106">V > 23K</td> <td data-bbox="1036 1085 1179 1106">Aff MN ENG (pb)</td> </tr> </tbody> </table>	If:	When:	Shut down:	2 Pcs stuck > 85% & 3-ENG RTLS	MECO –2:00	1 aff MN ENG: CMD: (AC/pb)· HYD: (pb)	2 HYD SYS failed & Nom/ATO/TAL/ 2-ENG RTLS	Nom/ATO: SE PRESS TAL: SE TAL 2 ENG RTLS: 2 OUT RED	ENG(HYD) S/D C(1) & R(3) C L(2) & C(1) L L(2) & R(3) R ELEC: (pb)	He lk S/D reqd		Aff MN ENG (pb)	MPS CMD(s)·	Nom/ATO and: 3 ENG: V > 23K 2 ENG: V > 24.5K TAL: V > 22.5K RTLS: α = -1	Aff MN ENG (AC/pb)· If 2 CMD: repeat	2 MPS HYD/ELEC & 3-ENG Nom/ATO/TAL		1 aff MN ENG: HYD: (pb) ELEC: (pb)	1 MPS HYD/ELEC & 3-ENG Nom/ATO	V > 23K	Aff MN ENG (pb)	
If:	When:	Shut down:																					
2 Pcs stuck > 85% & 3-ENG RTLS	MECO –2:00	1 aff MN ENG: CMD: (AC/pb)· HYD: (pb)																					
2 HYD SYS failed & Nom/ATO/TAL/ 2-ENG RTLS	Nom/ATO: SE PRESS TAL: SE TAL 2 ENG RTLS: 2 OUT RED	ENG(HYD) S/D C(1) & R(3) C L(2) & C(1) L L(2) & R(3) R ELEC: (pb)																					
He lk S/D reqd		Aff MN ENG (pb)																					
MPS CMD(s)·	Nom/ATO and: 3 ENG: V > 23K 2 ENG: V > 24.5K TAL: V > 22.5K RTLS: α = -1	Aff MN ENG (AC/pb)· If 2 CMD: repeat																					
2 MPS HYD/ELEC & 3-ENG Nom/ATO/TAL		1 aff MN ENG: HYD: (pb) ELEC: (pb)																					
1 MPS HYD/ELEC & 3-ENG Nom/ATO	V > 23K	Aff MN ENG (pb)																					

(reduced copy)

FAB USE ONLY

CC 10-2

AESP/4/A/GEN J,3

TOP
BACK OF 'MPS 1'

HOOK
VELCRO

HOOK
VELCRO

HOOK
VELCRO

HOOK
VELCRO

HOOK
VELCRO

AESP-11b/4/A/B

(reduced copy)

FAB USE ONLY

CC 10-3

AESP/4/A/GEN J

TOP

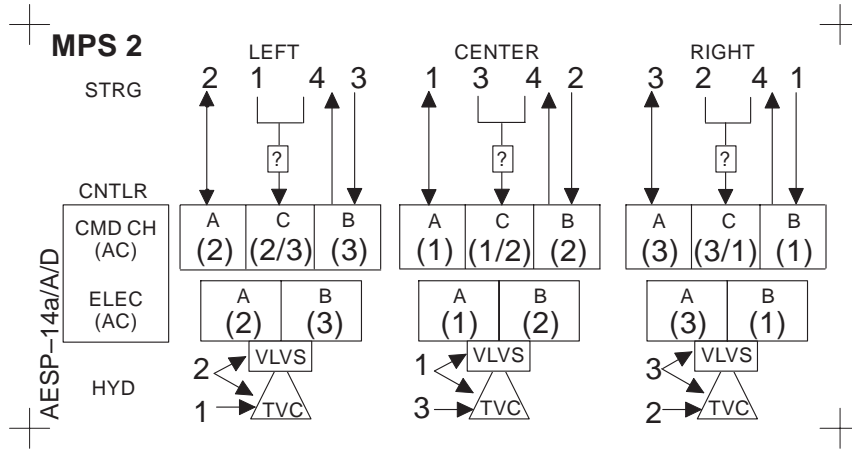

TOP
BACK OF 'MPS 2'

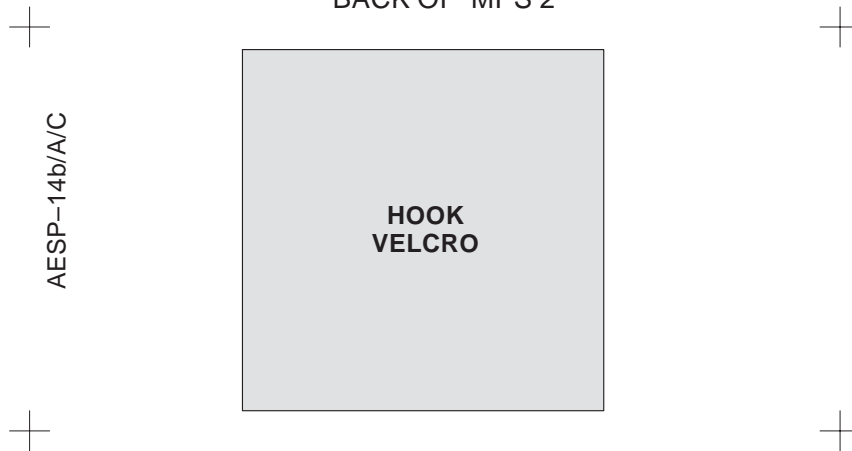

(reduced copy)

FAB USE ONLY

CC 10-4

AESP/ALL/A/GEN J

TOP

OPS 1/6/TAL TRANSITION RESTRING

	1. Config MC1(3) NBAT as reqd 2. <input checked="" type="checkbox"/> G53 aff SURF FDBK – desel (*)
Post MECO	3. ASAP, aff GPC(s) – STBY, HALT
ASC/ RTLS	4. OPS Mode Recall: OPS XXX PRO 5. BFS I/O RESET ⇒G
TAL	6. OPS 301 PRO 7. BFS, OPS 301 PRO ⇒G

**HOOK
VELCRO**

AESP-10a/A/F

FAB USE ONLY

CC 10-5

AESP/ALL/A/GEN J

TOP
BACK OF 'OPS 1/6/TAL TRANSITION RESTRING'

POST OPS 3/GRTLS TRANSITION RESTRING

1. Aff GPC(s) – STBY, HALT
 2. ✓ G53 Aff SURF FDBK – desel (*)
 3. Config MC1(3) NBAT
 4. OPS Mode Recall: OPS XXX PRO
 5. BFS I/O RESET
 - ⇒ 6. Config FCS CH(s) (See Table):
 7. G53 Config SURF FDBK (See Table):
- If STRG 1(2,3) recovered:
- ◇ If H > 200K or TACAN incorp:
 8. G50 NAV DELTA zero
 9. G51 IMU – resel

AESP-10b/E/B

**HOOK
VELCRO**

AVAILABLE		FCS CH CONFIG		SURF FDBK	
GPCs	FCS CHs	AUTO	ORIDE	SEL	DESEL
3	4	3	1	3	1*
	3	3	1	3	1*
	2	2	2	2	2
2	4	4		4	
	3	2	2	2	2
	2	2	2	2	2

*If CH 4 – OFF, DO NOT DESEL PASS SURF FDBK

TOP

TOP
BACK OF 'MPS He P'

MPS He P (Pre MECO)

1. ✓ dP/dT	AESP-12a/4/D
If after MECO -60: 2. Shut dn MN ENG per MPS CMD/HYD/ELEC >>	
If He REG P ↑ or ↓: 3. Aff He ISOL - CL	
Otherwise: 4. Aff He ISOL A - CL If no decr in dP/dT: 5. Aff He ISOL A - OP B - CL	
If no decr in dP/dT: 6. Aff He ISOL B - OP	
If any ENG failed: 7. Failed ENG He I'CNCT - OUT OP	
If nonisolatable: 8. Shut dn MN ENG per MPS CMD/HYD/ELEC If/when TK P < 1150 or REG P < 679: 9. Aff He I'CNCT - IN OP	
If isolated: 10. Aff He I'CNCT - IN OP If TK P < 2200 @ MECO -60: 11. Shut dn MN ENG per MPS CMD/HYD/ELEC	
Post ET SEP: 12. He I'CNCT(s) - GPC	

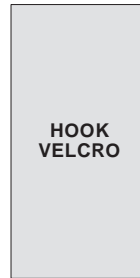

MPS PNEU TK(REG) P

If after MECO -60: At MECO -30: 1. L ENG He XOVR - OP >>
2. PNEU He ISOL - CL
If PNEU ACUM P decr: At MECO -30: 3. PNEU He ISOL - OP, Wait 5 sec, then: 4. L ENG He XOVR - OP >>
If PNEU TK P decr: 5. PNEU He ISOL - OP

FIRE HOLE UNDER CARD

AESP-12b/4/A/D

(reduced copy)

FAB USE ONLY

CC 10-7

AESP/4/A/GEN J,8

TOP

'ET SEP MAN' G51 ET SEP

Post Mecho:

1. ET SEP AUTO – ITEM 38 (BFS 28)
2. If ET SEP pb reqd:
ET SEP SEP – ITEM 39 (BFS 29)

AESP-13a/A/D

TOP
BACK OF 'ET SEP'

HOOK VELCRO

AESP-13b/A/E

FAB USE ONLY

CC 10-8

AESP/ALL/A/GEN J,8

TOP
MATE TOP-TO-BOTTOM;
FLIP VERTICALLY TO TURN

VELCRO
HOOK

AESP-7a(OPCL-7a)/A,O,E/D

FIRE/SMOKE (ASCENT/ENTRY)

SM SYS SUMM 1

If **VISUAL SMOKE/FIRE**, or
two SMOKE DETN It on, or
two CONC > 2, or
one SMOKE DETN It on and
other CONC > 2:

1. Go to step 6
- If single Av Bay SMOKE DETN A(B) It and
assoc CONC > 2:
2. SMOKE DETN CKT TEST - B(A)
(25 sec)
- If SMOKE DETN B(A) test good (It on):
3. SMOKE DETN CKT
TEST - OFF
 4. SMOKE DETN SNSR -
RESET >>
- If SMOKE DETN B(A) test bad (no It):
5. Go to step 6

If none of above >>
6. ✓ Tabs/Visors - CL
LES O2 - ON

If AV BAY FIRE:

7. FIRE SUPPR - ARM
pb - DISCH
(push until lit)
8. If Ascent:
AV BAY FAN (two) - OFF
9. If Fire in Bay:
1: TACAN 1, MLS 1 - OFF
2: TACAN 2, MLS 2,3 - OFF
3: TACAN 3 - OFF

If CABIN FIRE:

10. CAB FAN A,B (two) - OFF
(max 20 min)
11. Locate source
(see matrix, below)
12. Unpower source of smoke
If smoke persists or source cannot be
unpowered:

WARNING
Discharge is propulsive

13. Discharge handheld FIRE
EXTGHR

If Ascent:

14. Post MECO, go to POST-FIRE
CABIN CLEANUP (ASC PKT,
ECLS) >>

If Entry and prior to TIG:

15. Go to ECLS FRP-3,
CONTINGENCY CABIN O2
CONTROL, step 3 (MAL)

ALARM SEQUENCE	SOURCE AREA
L(R) FLT DK or L(R) FLT DK → CABIN	PS(MS), L(R) CONSOLE
L FLT DK ↔ R FLT DK	AFT FLT DK, MIDDECK
CABIN or CABIN ← L FLT DK ↑ R FLT DK	FWD FLT DK, WCS, LEB

VELCRO
HOOK

BOTTOM

FIRE/SMOKE (ORBIT)
(OPCL-7b), back
of FIRE/SMOKE
(ASCENT/ENTRY)
appears in the
ORBIT POCKET C/L



replace side tab
with clear tape
and Hook Velcro

(reduced copy)

FAB USE ONLY

CC 10-9

AESP/ALL/A,E/GEN J

This Page Intentionally Blank

FAB USE ONLY

CC 10-10

AESP/ALL/A,E/GEN J



POWERED
FLIGHT

**PLT OVERHEAD FLIP BOOK
POWERED FLIGHT**

PLT OVERHEAD
FLIP BOOK



PLT OVHD

FB A11-i

AESP/ALL/A/GEN J



FAB USE ONLY



POWERED
FLIGHT

This Page Intentionally Blank

PILOT OVERHEAD
FLIP BOOK



PLT OVHD

FB A11-ii

AESP/ALL/A/GEN J

FAB USE ONLY

TOP
FACING LEFT SIDE OF BACKBOARD

HOOK

OMS/
OMS
He
TK P
LOW

OMS TEMP DURING DUMP

1. G51 INH INCNCT L R
If aff OMS FU IN P \geq :
2. Go to ENG FAIL >>
If aff OMS FU IN P \leq :
3. Go to PRPLT FAIL >>
4. Otherwise snsr fail

Pc LOW DURING DUMP

1. ENG VLV < 70%: Go to ENG FAIL
2. ENG VLV > 70%: G51 INH INCNCT
If aff OMS OX IN P > 227:
 3. Go to ENG FAIL >>If aff OMS OX IN P \leq 136:
 4. Go to PRPLT FAIL >>
5. Otherwise snsr fail

ENG FAIL (During Dump)

1. Failed OMS ENG – OFF
- ◇ 2. If RTLS/TAL/ATO/ G51 DUMP:
 G51 ENA INCNCT \Rightarrow G

PRPLT FAIL (During Dump)

1. ASSIST/ATO: Both OMS ENG (two) – OFF
Failed OMS XFEED (two) – CL
2. Other: Aff OMS ENG – OFF
Failed OMS XFEED (two) – CL
After 2:00 min, good OMS ENG – OFF \Rightarrow G

OMS N2 TK P LOW

(N/A DURING ASSIST/RTLS/TAL/ATO DUMP)

1. \checkmark N2 TK P decr (OMS/MPS and SPEC)
 2. OMS ENG – ARM
 3. If OMS N2 REG P decr: OMS ENG – OFF >>
- If OMS N2 REG P not decr & subs ASSIST/RTLS/TAL/ATO:
4. OMS ENG (two) – ARM/PRESS

OMS N2 REG P HIGH or LOW

OMS ENG – ARM

PLT OVHD

FB A11-1

AESP/2,4/A/GEN J,14

FAB USE ONLY

TOP
BACK OF 'OMS TEMP DURING DUMP'

PILE

OMS
T, Pc/
FAIL/
N2

OMS TK P (FU or OX) LOW (✓ENG IN P)

Dumping ASSIST/ATO		1. ✓ Good OMS ENG – OFF 2. G51 ITEM 9 + EXEC 3. G51 ✓INCNCT = INH
	ATO	4. Aff OMS XFEED (two) – CL When aff OMS Pc < 80%: 5. Aff OMS ENG – OFF ⇒A
Dumping RTLS/TAL/ G51 DUMP		BFS, GNC SYS SUMM 2
	SERC	When aff AFT QTY < 20% or either OMS He P < 2000: 6. G51 DUMP STOP 7. Aff OMS XFEED (two) – CL >>
	Not SERC	When aff AFT QTY < 20% or either OMS He P < 2000: 8. G51 INH INCNCT 9. Aff OMS XFEED (two) – CL When aff OMS Pc < 80%: 10. Aff OMS ENG – OFF 11. After 2:00 min, good OMS ENG – OFF >>
Not Dumping		When FU IN P < 216 or OX IN P < 151: 12. G51 INH INCNCT (N/A SERC) 13. Aff OMS ENG – OFF XFEED (two) – CL ⇒A
Subs ASSIST/ATO		14. Good OMS ENG – OFF
	FU IN P > 216 and OX IN P > 151	15. Aff OMS ENG – ARM/PRESS 16. Go to 'Dumping Assist/ATO'
Subs RTLS/TAL		17. Good OMS ENG – ARM/PRESS
	FU IN P > 216 and OX IN P > 151	18. Aff OMS XFEED (two) – OP ENG – ARM/PRESS 19. G51 ENA INCNCT 20. Go to 'Dumping RTLS/TAL'
	Repress NO JOY after 2:00 min	21. Good OMS ENG – OFF >>

PLT OVHD

FB A11-2

AESP/ALL/A/GEN J,4

FAB USE ONLY

OMS He TK P LOW (✓SPEC and OMS/MPS)

HOOK

Dumping RTLS/TAL/ G51 DUMP	SERC	When leaking He P < 640: 1. G51 DUMP STOP >>
	Not SERC	When leaking He P < 640: 2. G51 INH INCNCT When aff OMS Pc < 72%: 3. Aff OMS ENG – OFF After 2:00 min: 4. Good OMS ENG – OFF >>
Dumping ASSIST/ATO Not Dumping	◇	5. Good OMS ENG – OFF When MET > 2:30 min: 6. G51 ITEM 9 + EXEC
Leaking He P < 640		7. G51 ITEM 9 + <u>0</u> EXEC ⇒A
Sub RTLS/TAL	◇	8. Good OMS ENG – ARM/PRESS 9. G51 INH INCNCT 10. OMS XFEED (four) – OP 11. Aff OMS TK ISOL (two) – CL After 1:00 min: 12. OMS TK ISOL (four) – OP 13. OMS XFEED (four) – CL When aff OMS Pc < 72%: 14. Both OMS ENG (two) – OFF

**RCS
JET/
AFT
RCS**

I

PILE

RCS JET FAIL (LEAK)

If OX/FU Qty diverging:

1. Aff RCS MANF ISOL – CL

RCS JET FAIL (ON)

1. Aff RCS MANF ISOL – CL

If MANF P > 130 and stable (false alarm):

2. Aff RCS MANF ISOL – OP ⇒G

OMS/
OMS
He
TK P
LOW

RM DLMA MANF

If aff MANF tb – OP or switch not thrown:

1. If FRCS: ✓MCC
2. If ARCS: **G51** RCS RM MANF CL OVRD –
ITEM 41 EXEC
3. If aff MANF tb – bp: aff MANF – GPC

RCS JET FAIL (OFF)

If > 1 jet/pod/dir failed:

1. **G23** resel jets
2. DES INH (*) (Reprioritize)

RCS TK P HIGH (FU or OX) (✓MANF P)

1. He PRESS (two) – CL
2. A – OP

If He P decr:

3. He PRESS A – CL
B – OP

XFEED: RCS to RCS

If AUTO XFEED:

1. L,R RCS TK ISOL (six) – GPC
XFEED (four) – GPC
2. OMS XFEED (four) – CL
3. MSTR RCS XFEED – FEED FROM L(R) >>

If MANUAL XFEED:

4. L,R OMS XFEED (four) – CL
5. RCS XFEED (four) – OP
6. Receiving RCS TK ISOL (three) – CL
He PRESS (two) – CL
7. MSTR RCS XFEED – FEED FROM L(R)

PLT OVHD

FB A11-4

AESP/ALL/A/GEN J

FAB USE ONLY

HOOK

RCS SECURE

- RCS MANF ISOL (five) – CL
- XFEED (two) – CL
- TK ISOL (all) – CL
- He PRESS (two) – CL

AFT RCS LK

N/A During Dump/SE Roll Cntl

(√He P decr: CRT & meter)

1. If TK P '↑': Go to TK P HIGH >>

TK P ≥ 254 and not decr (He Leak)	2. MSTR XFEED – feed from good side
	3. Aff RCS He PRESS (two) – CL
	4. G51 AFT RCS – INH (ITEM 13) >>
TK P < 254 or decr (prop leak)	5. (N/A RTLS) ET SEP – MAN
	6. (N/A RTLS) MPS PRPLT DUMP SEQ – STOP
	7. Aff MANFs (five) – CL
	8. Aff TK ISOLs (three) – CL
Single MANF leak	9. TK ISOLs (three) – OP (tb–OP), GPC
	10. Good MANFs (four) – OP
QTY < 75%	11. MSTR XFEED – feed from good side
Two MANF P decr (TK leg leak)	12. Good leg TK ISOL(s) – OP (tb–OP), GPC
	13. Good leg PRI MANFs (two) – OP
	14. Leaking leg XFEED (one) – CL
QTY < 75%	15. MSTR XFEED – feed from good side
No MANF P decr (Prplt TK or MANF 5 leak)	16. L,R RCS XFEED (four) – OP
	17. Aff RCS MANF 1,2,3,4 (four) – OP
	18. Aff RCS He PRESS (two) – CL
	19. MSTR XFEED – feed from good side
	20. ET SEP – AUTO
	21. G51 AFT RCS – INH (ITEM 13)
	22. Post ET SEP –Z transl: MPS PRPLT DUMP SEQ – GPC

FWD
RCS
LK

TOP
BACK OF 'RCS SECURE'

PILE

FWD RCS LK

(✓He P decr: CRT & meter)
(✓TK P; if '↑': Go to TK P HIGH)

**RCS
JET/
AFT
RCS**

RTLS	1. Perform RCS SECURE, then: 2. Post PPD – reopen RCS Post ET SEP –Z transl: 3. Go to RCS SECURE >>
Pre ET SEP (N/A RTLS)	4. ET SEP – MAN 5. MPS PRPLT DUMP SEQ – STOP 6. Perform RCS SECURE, then:
Single MANF leak	7. Reopen RCS, except bad MANF 8. ET SEP – AUTO Post ET SEP –Z transl: 9. MPS PRPLT DUMP SEQ – GPC >>
TK leg leak (two MANF P Low)	10. Reopen RCS, except bad leg 11. ET SEP – AUTO Post ET SEP –Z transl: 12. MPS PRPLT DUMP SEQ – GPC >>
PRPLT TK P decr	
Post MECO	13. RATE DAMP with ARCS 14. Reopen FRCS
TK P > 200 & QTY > 0%	15. ET SEP – AUTO
TK P < 200 or QTY = 0%	16. Perform RCS SECURE, then: 17. DAP – INRTL, PITCH – PULSE 18. ET SEP pb – SEP 19. THC –Z (2 sec; –1.25°/sec) 20. THC –X and hold
At SEP (SEP init + approx 12 sec)	21. THC +Z (3 sec; +0.3°/sec) THC –Z (2 sec; –0.9°/sec) COAST (5 sec) THC +X (20 sec) After 10 sec of +X, then: PITCH – DISC RATE
	22. OPS 104 PRO, DAP – AUTO
Otherwise: (He TK or He leg)	Post MECO – reopen RCS 23. ET SEP – AUTO
Post ET SEP –Z transl	24. MPS PRPLT DUMP SEQ – GPC 25. Go to RCS SECURE

PLT OVHD

FB A11–6

AESP/ALL/A/GEN J

FAB USE ONLY



GLIDED
FLIGHT

PLT OVERHEAD FLIP BOOK
GLIDED FLIGHT

PLT OVERHEAD
FLIP BOOK



PLT OVHD

FB E11-i

AESP/ALL/E/GEN J



FAB USE ONLY

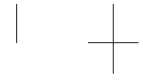

GLIDED
FLIGHT

This Page Intentionally Blank

PLT OVERHEAD
FLIP BOOK



PLT OVHD

FB E11-ii

AESP/ALL/E/GEN J

FAB USE ONLY

TOP
FACING LEFT SIDE OF BACKBOARD

HOOK

OMS
SEC
RCS
JET
XFD

OMS TEMP DURING DUMP

1. G51 INH INCNCT L R
If aff OMS FU IN P \geq :
2. Go to ENG FAIL >>
- If aff OMS FU IN P \leq :
3. Go to PRPLT FAIL >>
4. Otherwise snsr fail

Pc LOW DURING DUMP

1. ENG VLV < 70%: Go to ENG FAIL
2. ENG VLV > 70%: G51 INH INCNCT
If aff OMS OX IN P > 227:
 3. Go to ENG FAIL >>If aff OMS OX IN P \leq 136:
 4. Go to PRPLT FAIL >>
5. Otherwise snsr fail

ENG FAIL (During Dump)

1. Failed OMS ENG – OFF
- ⇒ 2. G51 INH INCNCT
3. Balance prop by XFEED

PRPLT FAIL (During Dump)

- ⇒ Both OMS ENG (two) – OFF

PLT OVHD

FB E11-1

AESP/ALL/E/GEN J,8

FAB USE ONLY

TOP
BACK OF 'OMS TEMP DURING DUMP'

PILE

OMS,
Pc/
FAIL

OMS SECURE

1. If leak, G51 VENT DOORS – OP
2. Aff: OMS ENG – OFF
XFEED (two) – CL
TK ISOL (two) – CL
He PRESS (two) – CL

If leak isolated or FU TK leak and post D/O burn:

3. G51 VENT DOORS – CL

OMS XFEED:

XFEED: R TO L

1. L,R OMS XFEED (four) – OP
2. L OMS TK ISOL (two) – CL
He PRESS/VAP ISOL (two) – CL

XFEED: L TO R

1. L,R OMS XFEED (four) – OP
2. R OMS TK ISOL (two) – CL
He PRESS/VAP ISOL (two) – CL

XFEED RETURN: OMS to OMS

1. L,R OMS TK ISOL (four) – OP
XFEED (four) – CL

PLT OVHD

FB E11-2

AESP/ALL/E/GEN J

FAB USE ONLY

HOOK

RCS JET FAIL (LEAK)

If OX/FU Qty diverging:

1. Aff RCS MANF ISOL – CL

RCS JET FAIL (ON)

1. Aff RCS MANF ISOL – CL

If MANF P > 130 and stable (false alarm):

2. Aff RCS MANF ISOL – OP
3. ✓AFT RCS RM LOSS

⇒

AFT
RCS/
LK/
RM**RM DLMA MANF**

If aff MANF tb – OP or switch not thrown:

1. If FRCS: ✓MCC
2. If ARCS: G51 RCS RM MANF CL OVRD –
ITEM 41 EXEC
3. If aff MANF tb – bp: aff MANF – GPC

RCS JET FAIL (OFF)

If > 1 jet/pod/dir failed:

1. G23 resel jets
2. DES INH (*) (Reprioritize)

RCS TK P HIGH (FU or OX) (✓MANF P)

1. He PRESS (two) – CL
2. A – OP

If He P decr:

3. He PRESS A – CL
B – OP

XFEED: RCS to RCS

If AUTO XFEED:

1. L,R RCS TK ISOL (six) – GPC
XFEED (four) – GPC
2. OMS XFEED (four) – CL
3. MSTR RCS XFEED – FEED FROM L(R) >>

If MANUAL XFEED:

4. L,R OMS XFEED (four) – CL
5. RCS XFEED (four) – OP
6. Receiving RCS TK ISOL (three) – CL
He PRESS (two) – CL
7. MSTR RCS XFEED – FEED FROM L(R)

PLT OVHD

FB E11–3

AESP/ALL/E/GEN J

FAB USE ONLY

TOP
BACK OF 'RCS JET FAIL (LEAK)'

PILE

AFT RCS LK (GRTLS/304/305)

(✓He P decr: CRT & meter)

1. If TK P ↑: Go to TK P HIGH >>

OMS
SEC
RCS
JET
XFD

OX Leak		2. G51 VENT DOOR CNTL – OPEN (ITEM 43)
RTLS/TAL		3. G51 AFT RCS – INH (ITEM 13)
		4. Aff 3/4/5 MANFs – CL 5. Aff 3/4/5 TK ISOL(s) – CL
Single MANF leak		6. TK ISOL(s) – OP (tb–OP),GPC 7. Good PRI MANF (one) – OP
Two MANF P decr (TK leg leak)		8. Leaking leg XFEED (one) – CL
No MANF P decr		9. TK ISOL(s) – OP (tb–OP),GPC 10. PRI MANFs (two) – OP 11. Repeat steps 4–10 for 1/2 leg
Leak not found		12. Aff RCS He PRESS (two) – CL
He P decr (He TK leak)	M > 3	13. G51 VENT DOOR CNTL – CLOSE (ITEM 44)
		14. He PRESS (two) – OP 15. When He P < 456, MSTR XFEED – feed from good side >>
OX/FU TK P diverge (Prplt TK leak)		16. He PRESS (two) – OP 17. When QTY = 0, MSTR XFEED – feed from good side & Aff He PRESS (two) – CL >>
Leak not found		18. He PRESS (two) – OP
He P decr (He leg leak)	M > 3	19. G51 VENT DOOR CNTL – CLOSE (ITEM 44)
		20. Cycle He PRESS so 220 < TK P < 245 21. When He P < 456, MSTR XFEED – feed from good side >>
Leak not found		22. Assume MANF 5 leak
M > 3		23. G51 VENT DOOR CNTL – CLOSE (ITEM 44)

PLT OVHD

FB E11–4

AESP/ALL/E/GEN J,13

FAB USE ONLY

FAB REMOVES TAB FROM THIS PAGE ONLY
TOP
MOUNT ON RIGHT SIDE OF BACKBOARD FACING 'AFT RCS LK'

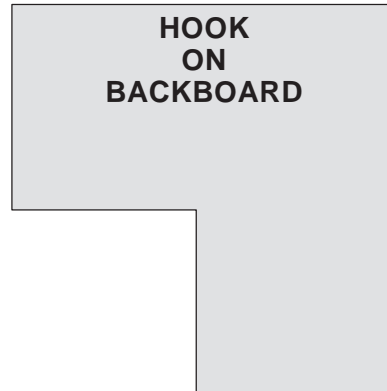

↓FAB CUT HERE↓

RCS SECURE

1. If OX leak: **G51** VENT DOORS – OP
2. RCS MANF ISOL (five) – CL
 - XFEED (two) – CL
 - TK ISOL (all) – CL
 - He PRESS (two) – CL

AFT RCS RM LOSS

If loss of jet RM and > 3Y, 2P jets/pod/dir:

1. **G23** aff jet DES INH (*) (Reprioritize)
2. If yaw jet: desel >>

If total RM loss (BCE) and < 3Y, 2P jets/pod/dir:

3. Aff jet DES INH (*) (Reprioritize)
4. Aff MANF VLVS STAT OP – OVRD

PLT OVHD

FB E11-5

AESP/ALL/E/GEN J

FAB USE ONLY



AFT
RCS/
LK/
RM

This Page Intentionally Blank



PLT OVHD

FB E11-6

AESP/ALL/E/GEN J



FAB USE ONLY



POWERED
FLIGHT

PLT WINDOW FLIP BOOK
POWERED FLIGHT

PLT WINDOW
FLIP BOOK



PLT WND

FB A12-i

AESP/ALL/A/GEN J



FAB USE ONLY

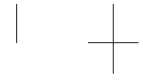

POWERED
FLIGHT



This Page Intentionally Blank

PLT WINDOW
FLIP BOOK



PLT WND

FB A12-ii

AESP/ALL/A/GEN J

FAB USE ONLY



**APU
HYD**

This Page Intentionally Blank



PLT WND

FB A12-1

AESP/ALL/A/GEN J



FAB USE ONLY

TOP
MOUNT ON LEFT SIDE OF BACKBOARD FACING 'COMM LOST'

PILE

APU SHUTDN

APU OPER – OFF
FUEL TK VLV – CL
✓SHUTDN (HYD PRESS)
Report APU F7 lts
APU CNTLR PWR – OFF
AUTO SHUTDN (two) – INH
SPEED SEL (two) – HI ⇒

APU SPD HI (✓CRT)

APU SPEED SEL – HI ⇒

APU OVERSPEED (>129%)

Go to APU SHUTDN

APU UNDERSPEED

If 'PRL SYS X ↓' or if APU has shut down:
Perform APU SHUTDN, then: ⇒G

APU OIL OVERTEMP

◇ ✓BLR PWR – ON
CNTLR/HTR – B ⇒

HYD PRESS (LOW) G51

If 'PRL SYS X ↓' and APU still operating:
1. APU AUTO SHUTDN (two) – INH
2. SPEED SEL (two) – HI ⇒

HYD RSVR QTY (LOW)

Post MECO:
Aff MPS/TVS ISOL VLV – CL (5 sec) ⇒

W/B QTY (LOW)

Aff BLR PWR – OFF ⇒

PLT WND

FB A12-2

AESP/ALL/A/GEN J

FAB USE ONLY

HOOK

COMM LOST (MULTI PANELS)

1. AUD CTR – 2
2. No joy, S-BD PM CNTL – PNL, CMD
3. Config per COMM COVERAGE **[BFS G51]**:
 - TDRS – ITEM 46 EXEC (*)
 - STDN-HI – ITEM 47 EXEC (*)
 - SGLS – ITEM 49 EXEC (*)
4. No joy, sel best S-BD PM ANT, else GPC ⇒

DPS
GPC
MDM**ICOM LOST**

1. AUD CNTL – sel ALT
2. No joy, AUD CTR – 2

FCS CH 1(2,3,4) (2nd FAIL) [G53]

If 2 FCS CH ↓ on any actuator:

- ◇ 1. Remaining FCS CH (two) – ORIDE

RHC L(R) (2nd FAIL)

Aff FLT CNTLR PWR – OFF

DISPLAY SW L(R)

L(R) Disp sws (eight) – green dot

RM FAIL IMU, RGA,AA [BFS G51]

Aff LRU – desel

RM DLMA IMU [G51] [BFS G51]

1. ✓MCC, bad IMU – desel (PASS & BFS) >>
- ◇ 2. Desel lower # IMU with '?' (PASS)

POST BFS ENGAGE**CAUTION**

Do not assign more than 3 IDPs at a time

If PASS GPCs running:

1. Aff GPC MODE – STBY/HALT
2. BFS I/O RESET
3. ✓FCS CHs, IMU config

If Pre MECO:

4. If SSME failed: MAIN ENGINE LIMIT
SHUT DN – INH
5. **[G51]** DES failed (commfaulted) RGA,AA,SURF ⇒G
6. GPC/CRT 04 EXEC, as reqd

01-28

PLT WND

FB (A)A12-3

AESP/4/A/GEN J,9

FAB USE ONLY

PILE

APU
HYD
COMM
GNC
DPS

PASS GPC FAIL

1. Aff FCS CH – OFF
- If two GPC/FA/FCS CHs ↓:
2. Good FCS CHs – ORIDE
 3. ✓MPS CMD
 4. **G53** aff SURF FDBK – desel
 5. If FTS and accessible – STBY,HALT
 6. ✓BIG 'X', then assign IDPs as reqd
 7. ✓MULT DATA PATH LOSS
- Post MECO:
8. ASAP, GPC MODE – STBY,HALT ⇒

BFS GPC FAIL

1. Post SRB SEP: FES PRI A – ON
- If IDP hard assigned to BFS:
2. Deassign IDP 4 if assigned to PASS
 3. Reassign any hard assigned BFS IDP to PASS
- Post MECO:
4. GPC MODE – STBY,HALT
- ◇ OUTPUT – TERM
5. If no comm: sel best S–BD PM ANT ⇒

FF(FA) MDM OUTPUT

FAULT

- ◇ (Take action only if annun by entire set)
- If single 'MDM OUTPUT':
1. Go to FA/FF MDM I/O ERROR >>
- If both FF & FA annun:
2. I/O RESET; If reqd, BFS I/O RESET
 3. If msgs repeat: Go to PASS GPC FAIL >>
 4. If reqd, aff FCS CH – ORIDE,AUTO

PL MDM I/O ERROR

1. BFS I/O RESET; If recovered >>
- ◇ 2. **G01** PL 1/2 – port mode, then BFS I/O RESET
- If recovered >>
3. If PL2 down:
Post SRB SEP: FES PRI A – ON
If no comm: sel best S–BD PM ANT ⇒

PCM I/O ERROR

OI PCMMU PWR – 2

01-28

PLT WND

FB (A)A12-4

AESP/4/A/GEN J,9

FAB USE ONLY

HOOK

COMM LOST (MULTI PANELS)

1. AUD CTR – 2
2. No joy, S–BD PM CNTL – PNL, CMD
3. Config per COMM COVERAGE **[BFS G51]**:
 - TDRS – ITEM 46 EXEC (*)
 - STDN–HI – ITEM 47 EXEC (*)
 - SGLS – ITEM 49 EXEC (*)
4. No joy, sel best S–BD PM ANT, else GPC ⇒

DPS
GPC
MDM**ICOM LOST**

1. AUD CNTL – sel ALT
2. No joy, AUD CTR – 2

FCS CH 1(2,3,4) (2nd FAIL) [G53]

If 2 FCS CH ↓ on any actuator:

- ◇ 1. Remaining FCS CH (two) – ORIDE

RHC L(R) (2nd FAIL)

Aff FLT CNTLR PWR – OFF

DISPLAY SW L(R)

L(R) Disp sws (eight) – green dot

RM FAIL IMU, RGA,AA [BFS G51]

Aff LRU – desel

RM DLMA IMU [G51] [BFS G51]

- 1. ✓MCC, bad IMU – desel (PASS & BFS) >>
- ◇ 2. Desel lower # IMU with '?' (PASS)

POST BFS ENGAGE

If PASS GPCs running:

1. Aff GPC MODE – STBY/HALT
2. BFS I/O RESET
3. ✓FCS CHs, IMU config

If Pre MECO:

4. If SSME failed: MAIN ENGINE LIMIT
SHUT DN – INH
5. **[G51]** DES failed (commfaulted) RGA,AA,SURF ⇒G
6. GPC/CRT 04 EXEC, as reqd

OI–29

PLT WND

FB (B)A12–3

AESP/4/A/GEN J,9

FAB USE ONLY

PILE

APU
HYD
COMM
GNC
DPS

PASS GPC FAIL

1. Aff FCS CH – OFF
- If two GPC/FA/FCS CHs ↓:
2. Good FCS CHs – ORIDE
 3. ✓MPS CMD
 4. **G53** aff SURF FDBK – desel
 5. If FTS and accessible – STBY,HALT
 6. ✓BIG 'X', then assign IDPs as reqd
 7. ✓MULT DATA PATH LOSS
- Post MECO:
8. ASAP, GPC MODE – STBY,HALT ⇒

BFS GPC FAIL

1. Post SRB SEP: FES PRI A – ON
- If IDP hard assigned to BFS:
2. Deassign IDP 4 if assigned to PASS
 3. Reassign any hard assigned BFS IDP to PASS
- Post MECO:
4. GPC MODE – STBY,HALT
- ◇ OUTPUT – TERM
5. If no comm: sel best S–BD PM ANT ⇒

FF(FA) MDM OUTPUT

FAULT

- ◇ (Take action only if annun by entire set)
- If single 'MDM OUTPUT':
1. Go to FA/FF MDM I/O ERROR >>
- If both FF & FA annun:
2. I/O RESET; If reqd, BFS I/O RESET
 3. If msgs repeat: Go to PASS GPC FAIL >>
 4. If reqd, aff FCS CH – ORIDE,AUTO

PL MDM I/O ERROR

1. BFS I/O RESET; If recovered >>
- ◇ 2. **G01** PL 1/2 – port mode, then BFS I/O RESET
- If recovered >>
3. If PL2 down:
Post SRB SEP: FES PRI A – ON
If no comm: sel best S–BD PM ANT ⇒

PCM I/O ERROR

OI PCMMU PWR – 2

01-29

PLT WND

FB (B)A12-4

AESP/4/A/GEN J,9

FAB USE ONLY

HOOK

FA/FF MDM I/O ERROR
(Annunciated by entire set)

		1. I/O RESET
RECOV	FA	2. If reqd, aff FCS CH – ORIDE,AUTO
		3. BFS I/O RESET >>
NOT RECOV	FA	4. Aff FCS CH – OFF
		5. If 2 GPC/FA/FCS CHs ↓: Good FCS CHs – ORIDE
		6. G53 aff SURF FDBK – desel
		7. ✓MULT DATA PATH LOSS
		◇ 8. Go to FA/FF MDM PORT MODE ⇒

**DPS
BCE
MDP**

FA/FF MDM PORT MODE

NOTE: If BFS, 'BCE STRG X PASS', @GPC; else @MDM.
For '@GPC', port mode results in alternate MDM bypass

			1. G01 aff STRG – port mode
			2. BFS I/O RESET
@MDM	RECOV	FA	3. Aff FCS CH – AUTO
		FF	4. G53 aff SURF FDBK – resel >>
	NOT RECOV	FA	5. >>
		FF	6. BFS G51 aff SURF FDBK, RGA – desel
			7. BFS G51 aff AA – desel
			8. ✓MULT DATA PATH LOSS ⇒
@GPC	FA RECOV (FF Give Up)		9. Aff FCS CH – AUTO
			10. G51 aff IMU – desel
			11. G53 aff SURF FDBK – resel
			12. ✓MULT DATA PATH LOSS ⇒A
	FF RECOV (FA Give Up)		13. Aff FCS CH – OFF
			14. If 2 GPC/FA/FCS CHs ↓: Good FCS CHs – ORIDE
			15. G53 aff SURF FDBK – desel
			16. ✓MULT DATA PATH LOSS ⇒A

PLT WND

FB A12-5

AESP/ALL/A/GEN J,8

FAB USE ONLY

PILE

BCE STRG X (no 'MDM OUTPUT' msg)

DPS
GPC
MDM

	IMU	1. G51 IMU – desel
		2. I/O RESET
RECOV	IMU	3. >>
		4. >>
NOT RECOV	NSP	5. And no comm: PNL,CMD 6. BFS G51 Config per COMM COVERAGE: TDRS – ITEM 46 EXEC (*) STDN-HI – ITEM 47 EXEC (*) SGLS – ITEM 49 EXEC (*) >>
		◇ 7. G01 aff STRG – port mode 8. BFS I/O RESET 9. If recov, go to RECOV steps >>
	B	10. BFS G51 aff AA – desel
	D	11. BFS G51 aff SURF FDBK,RGA – desel
	B/D	12. ✓MULT DATA PATH LOSS ⇒

DUAL DPS DISPLAY COMMANDERS/DK XMTR 1(2,3)

1. BFC CRT SEL – aff IDP

If reqd to clean up display:

2. Aff IDP/CRT PWR – OFF,ON

I/O ERROR CRT/DPS DISPLAY ANOMALY

If IDP 4(CRT 4): IDP/CRT 4 PWR – OFF >>

If NO big X/POLL FAIL:

1. MDU PWR – OFF,ON; if recovered >>

If MCC GO for power cycle:

2. IDP/CRT PWR – OFF,ON; if recovered >>

If big X/POLL FAIL:

3. IDP/CRT PWR – OFF,ON; if recovered >>

If PASS:

4. GPC/CRT – same GPC/aff IDP; if recovered >>

5. BFC CRT SEL – aff IDP: Go to step 11

If BFS via BFC CRT SEL sw:

6. BFC CRT SEL – unaff IDP; if both IDPs OK >>

7. – original position

8. In PASS: GPC/CRT 5/X EXEC for aff IDP: Go to step 11

If BFS via GPC/CRT key:

9. Deassign IDP 4 if assigned to PASS

10. Assign aff IDP to PASS; if recovered >>

11. If reqd: In PASS, deassign/assign IDPs to maintain PASS interface with three IDPs

PLT WND

FB A12-6

AESP/2,4/A/GEN J,12

FAB USE ONLY

HOOK

FLT INST DISPLAY ANOMALY

1. DATA BUS Select alternate FC BUS(s); if recovered >>
2. PORT SELECT aff MDU; if recovered >>
3. MDU PWR – OFF,ON

SUBSYS STATUS DISPLAY ANOMALY

1. PORT SELECT aff MDU; if recovered >>
2. MDU PWR – OFF,ON; if recovered >>

MULT DATA PATH LOSS (Non-Recov)

NOTE

If LRU data path loss due to GPC problem and not MDM, BFS will pick up MDMs/LRU when engaged

FAILURE	TYPE	ACTIONS
GPC/FA any combo	D	✓BFS MM at each transition Expect 'SEP INH' (FDLN Fail) combos 2&3,2&4
	I/O	✓OMS MAN SHUTDOWN Post MECO: Before MECO + 25 sec: •• 1. MPS FDLN RLF ISOL (two) – OP 2. MPS PREVLVs (six) – OP RTAL/TAL: MPS LH2 FILL/DRAIN INBD, OUTBD – OP
GPC/FF 1&2	I/O or B	Use R BODY FLAP & TRIM ENA SWs
GPC/FF 3&4	I/O or B	Use L BODY FLAP & TRIM ENA SWs

EPS
MN
AC

PLT WND

FB A12-7

AESP/4/A/GEN J,10

FAB USE ONLY

PILE

MN BUS UNDER V/FC V

If MN V < 26.4, FC V < 26.6, FC A > 480 (2 of 3)

(SHORT OR DEGRADED FC):

1. MSTR MADS PWR – OFF
 2. If aff BUS tied – UNTIE
 3. PL PRI (three) – OFF
- If AC VOLTS < 95, or STACK T > 243 and incr:
4. Aff ESS BUS SOURCE FC – OFF
FC/MN BUS – OFF
- If FC VOLTS < 32 (FC SHORT)
5. Aff FC REAC VLV – CL
 6. Go to FC SHUTDN (Do not stop FC until
COOL P < 15 & STACK T < 243) >>
- If FC VOLTS ≥ 32 (BUS SHORT)
7. Go to BUS LOSS ACTIONS >>

8. ⇒

If MN V < 26.4 and FC V > 32 and FC A < 20

(FC DISCONNECT):

9. MSTR MADS PWR – OFF
 10. PL PRI (three) – OFF
 11. FC/MN BUS – ON
- If FC3 aff:
12. PL PRI FC3 – ON
MNC – ON
 13. If MNC V < 26.4: PL PRI (three) – OFF
- If 1st FC failure:
14. Perform BUS TIE, then:
- If MN BUS recovered:
15. GNC I/O RESET
- Post MECO: If aff FC VOLTS > 32:
16. Go to FC SHUTDN

DPS
BCE
MDP

AC VOLT HIGH

If AC V > 123 and F7 "AC VOLTAGE":

1. Unaff AC BUS SNSRS (two) – OFF
- If AC V ≥ 130:
2. Aff AC BUS SNSR – AUTO TRIP
 3. Perform aff BUS LOSS, then:
- If AC3 aff and V < 130:
4. H2O PUMP LOOP 2 – OFF
 5. ⇒ AC VOLTS (LOW or HIGH)

PLT WND

FB A12-8

AESP/ALL/A/GEN J

FAB USE ONLY

HOOK

AC VOLT LOW or OVERLOAD

1. AC BUS SNSR (three) – OFF
- If amps > 14 and V < 95:
 2. If single Φ amps > 14:
 3. cb AC CONTR – cl
INV/AC BUS – OFF
INV PWR – OFF
cb AC CONTR – op
 4. If other Φ amps > 14:
Go to step 5
 5. If multi Φ (Bus short):
 6. Aff cb AC CONTR (three) – cl
INV/AC BUS – OFF (tb-OFF)
INV PWR – OFF (tb-OFF)
cb AC CONTR (three) – op
 7. Go to aff BUS LOSS >>
8. \Rightarrow AC VOLTS (LOW or HIGH)

3 Φ MOTORS STOPPED

1. AC BUS SNSR (three) – OFF
2. Determine AC BUS
FC1 & FREON PUMP 2B: AC1
FC2 & FREON PUMP 1B: AC2
FC3 & CAB FAN A: AC3
3. Aff FC – STOP
- If AC3 aff:
 4. AV BAY 3 FAN B – OFF, A – ON
 5. CAB FAN A – OFF
- Isolate aff Φ B:
 6. Aff cb AC CONTR – cl
 7. INV/AC BUS – OFF
- If AC1(2,3) aff and AV BAY 3(2,3) FAN Δ P < 0.5:
 8. Aff INV/AC BUS – ON
 9. cb AC CONTR – op
 10. Repeat from step 6 to isolate aff Φ C, Φ A, then:
 11. Aff cb AC CONTR (three) – cl
 12. INV/AC BUS – OFF
 13. Go to BUS LOSS, AC MULTI Φ >>
- If AC1(2,3) aff and AV BAY 3(2,3) FAN Δ P \geq 0.5:
 14. Aff FC – START (10 sec or Δ P tb-gray)
 15. Perform aff BUS LOSS and if AC1(AC2) aff >>
 16. If AC3 aff:
 - Post MECO:
CAB FAN B – ON

MN
ESS
CNTL

PLT WND

FB A12-9

AESP/ALL/A/GEN J,8

FAB USE ONLY

PILE

MNA or AC1 Multi Φ

1. Do not isolate MPS He C
2. MSTR MADS PWR – OFF
3. AC BUS SNSR (three) – OFF
4. Perform FC SHUTDN (within 9 min), then:

Post MECO:

5. L OMS – sel SEC ⇒

MNB or AC2 Multi Φ

1. Do not isolate MPS He L
2. MSTR MADS PWR – OFF
3. AC BUS SNSR (three) – OFF
4. Perform FC SHUTDN (within 9 min), then: ⇒

FAILED: S–BD PM 1 (NO PNL,CMD)

MNC or AC3 Multi Φ

1. Do not isolate MPS He R
2. S–BD PM CNTL – PNL,CMD
3. Config per COMM COVERAGE **BFS G51**:
 TDRS – ITEM 46 EXEC (*)
 STDN–HI – ITEM 47 EXEC (*)
 SGLS – ITEM 49 EXEC (*)
4. MSTR MADS PWR – OFF
5. AC BUS SNSR (three) – OFF
6. Perform FC SHUTDN (within 9 min), then:

Post MECO:

7. R OMS – sel SEC ⇒

AC SINGLE Φ ⇒

SUBBUS [APC4(5,6) or ALC1(2,3)]

Do not isolate MPS He C(L,R) ⇒

ESS BUS V LOW

If verified by F9 voltmeter:

1. Perform FC SHUTDN (<9 min), then:
2. Go to aff ESS BUS LOSS

ESS BUS LOSS

ESS 1BC	1. L AUD CNTL – R (CDR can't talk) 2. Pri C/W & Matrix lost
ESS 2CA	1. AUD CTR – 2 2. R AUD CNTL – L (PLT can't talk)
ESS 3AB	1. Do not ENGAGE BFS 2. CSM lost ⇒

PLT WND

FB A12–10

AESP/ALL/A/GEN J,8

**MN
AC
3Φ**

FAB USE ONLY

HOOK

CNTL BUS V LOW

1. ✓BUS LOSS ID
2. Perform aff CNTL BUS LOSS, then:
If pwr reqd (<3 sec) for crit function:
 3. Hold crit function sw
 4. For CNTL BUS AB(BC,CA) VOLTS LOW CNTL BUS PWR MNA(MNB,MNC) – RESET
5. If FIRE/SMOKE at any time:
For CNTL BUS AB(BC,CA):
 - ◇ CNTL BUS PWR MNA(B,C),MNB(C,A) (two) – RESET (hold) (pnl R1)
 - If CNTL BUS AB(BC,CA) VOLTS still > 0:
ASAP
6. cb CNTL BUS AB1/2/3(BC1/2/3, CA1/2/3) – op (pnl R14:B)
7. ⇒A

CNTL BUS LOSS

AB1	⇒
AB2	[G23] RCS FWD MANF VLVS 1 OVRD – ITEM 40 EXEC (CL) ⇒G
AB3	1. [G51] RCS RM MANF CL OVRD – ITEM 41 EXEC If BFS ENGAGE reqd: 2. Use PLT's RHC, then GPCs 1,2,4 – STBY,HALT 3. BFS I/O RESET If no S–BD COMM: 4. S–BD PM CNTL – PNL,CMD 5. [BFS G51] Config per COMM COVERAGE: TDRS – ITEM 46 EXEC (*) STDN–HI – ITEM 47 EXEC (*) SGLS – ITEM 49 EXEC (*) 6. ⇒
BC1	FAILED: S–BD PM 1 (NO PNL,CMD) ⇒
BC2	1. S–BD PM CNTL – PNL,CMD 2. [BFS G51] Config per COMM COVERAGE: TDRS – ITEM 46 EXEC (*) STDN–HI – ITEM 47 EXEC (*) SGLS – ITEM 49 EXEC (*) 3. [G23] RCS FWD MANF VLVS 2 OVRD – ITEM 41 EXEC (CL) 4. PLT Displays – green dot ⇒
BC3	[G51] RCS RM MANF CL OVRD – ITEM 41 EXEC ⇒

FC

PLT WND

FB A12–11

AESP/ALL/A/GEN J,8

FAB USE ONLY

PILE

CNTL BUS LOSS (Cont)

CA1	No BFS ENGAGE ⇒
CA2	G23 RCS FWD MANF VLVS 3 OVRD – ITEM 42 EXEC (CL) ⇒
CA3	⇒

FC REAC VLV CLOSED

1. FC REAC (three) – OP
2. Perform BUS TIE, then:
If no joy on REAC open:
 3. ✓cb FC REAC VLV CL ENA (three) – op (pnl C3)
 4. FC REAC (three) – OP
- If FC COOL P < 50:
 5. Go to FC SHUTDN

FC pH ↓ 1(2,3) or FC DELTA V 1(2,3)

- If pH ↓ and FC SS 1(2,3) ΔV > 150
or FC SS ΔV > 150 and incr:
1. Perform BUS TIE, then:
 2. Aff FC REAC VLV – CL
 3. MSTR MADS PWR – OFF
 4. Go to LOSS OF 1(2nd) FC PWRDN >>
- If pH ↓ only and Post SRB SEP:
5. Perform BUS TIE, then:
 6. ⇒A FC pH 1(2,3)

FC STACK T

1. MSTR MADS PWR – OFF
- If STACK T > 243 and incr:
2. If 2nd FC: Go to 2nd FC SHUTDN >>
 3. PL PRI (three) – OFF
- If aff FC amps < 190 or > 360:
4. Go to MN BUS U/V, step 4 >>
- ◇ 5. Perform BUS TIE, then:
6. ESS BUS SOURCE FC – OFF
 7. FC/MN BUS – OFF
- If aff FC VOLTS < 32 or STACK T not decr:
8. Aff FC REAC – CL
 9. FC – STOP after COOL P < 15 and
STACK T < 243
 10. Go to LOSS OF 1 FC PWRDN

FC

FC EXIT T

1. MSTR MADS PWR – OFF
2. Perform BUS TIE, then: ⇒

PLT WND

FB A12-12

AESP/ALL/A/GEN J,8

FAB USE ONLY

 HOOK
2FC
CRYO**FC COOLANT PUMP Δ P LOW**

- 1. FC – START (10 sec or Δ P tb–gray)
- ◇ 2. MSTR MADS PWR – OFF
Perform LOSS OF 1 FC PWRDN, then:
- ◇ If > 9 min since failure:
 - If EXIT T > 164 & not decr
 - or RDY tb – bp
 - or FC PUMP cb(s) open (pnl L4:C):
 - 3. Go to FC SHUTDN >>
- 4. If < 9 min since failure \Rightarrow

FC COOL P

- 1. Perform BUS TIE, then:
- If COOL P < 75: \Rightarrow
- If COOL P incr and not 100 (H),
- or COOL PUMP Δ P tb – bp/intermittent,
- or STACK/EXIT T unstable,
- or SS Δ V \geq 150:
- 2. Aff FC REAC VLV – CL
- 3. MSTR MADS PWR – OFF
- 4. Go to LOSS OF 1(2nd) FC PWRDN

LOSS OF 1 FC PWRDN

- 1. PRI PL (three) – OFF
AFT PL (two) – OFF
- 2. IDP/CRT 4 PWR – OFF
One MDU – OFF \Rightarrow A

PLT WND

FB A12–13

AESP/4/A/GEN J,2

FAB USE ONLY

TOP
BACK OF 'FC COOLANT PUMP ΔP LOW'

PILE

FC

2nd FC SHUTDOWN

(CL PMP Lost: <6 min)

1. Have CDR start LOSS OF 2nd FC PWRDN

If three MN BUSES powered:

2. MN BUS TIE (three) – OFF

(Do not perform BUS LOSS ACTIONS)

3. LES O2 – OFF, Visors – OP

4. Switch off all but one IDP/CRT with four MDUs

5. All PL PWR (seven) – OFF

6. O2, H2 TK HTRS (all) – OFF

7. After CDR pnl L1 config complete, continue:

If two MN BUSES powered:

8. Powered MN BUS TIES (two) – ON

If only one MN BUS powered:

9. MN BUS TIE (three) – OFF

If only MNA(B,C) powered: Secure APU 2(3,1)

BUS TIE good FC/BUS (MNA if RTLS or TAL)

I/O RESET

When reqd:

10. ESS BUS SOURCE FC – OFF

FC/MN BUS – OFF

FC – STOP (1 sec)

FC REAC VLV – CL

11. G51 INCNCT ENA (if reqd for OMS load)

12. All TAC/RA – OFF

Post MECO:

13. B/U LH2 VLV – OP

14. ⇒ LOSS OF 2nd FC PWRDN

PLT WND

FB A12-14

AESP/4/A/GEN J

FAB USE ONLY

HOOK

O2(H2) CRYO P/T HIGH

CRYO O2(H2) TK HTR (two) – OFF

CRYO O2(H2) LEAK (3 or more tanks aff)

Use meter if CRT data OSL

1. MANF VLV 1,2 (two) – CL

2. TK3 HTR A – AUTO

If TK 1 and 2 P decr slowly (HTR logic fail): ⇒

3. Perform aff MN BUS TIE, then:

If O2 TK 1(2) aff:

4. O2 SYS 1(2) SPLY vlv – CL

5. If O2 TK 1(2) P now incr: (PCS leak) >>

6. Aff TK HTR B – AUTO

If no aff FC COOL P alarm: ⇒

7. Aff TK HTRS A,B (two) – OFF

8. MSTR MADS PWR – OFF

9. Perform LOSS OF 1 FC PWRDN, then: ⇒

PLT WND

FB A12–15

AESP/ALL/A/GEN J

FAB USE ONLY

TOP
BACK OF 'O2(H2) CRYO P/T HIGH'

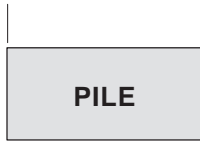

2FC
CRYO

This Page Intentionally Blank



PLT WND

FB A12-16

AESP/ALL/A/GEN J



FAB USE ONLY



GLIDED
FLIGHT

PLT WINDOW FLIP BOOK
GLIDED FLIGHT

PLT WINDOW
FLIP BOOK



PLT WND

FB E12-i

AESP/ALL/E/GEN J



FAB USE ONLY



GLIDED
FLIGHT



This Page Intentionally Blank

PLT WINDOW
FLIP BOOK



PLT WND

FB E12-ii

AESP/ALL/E/GEN J



FAB USE ONLY

TOP
FACING LEFT SIDE OF BACKBOARD

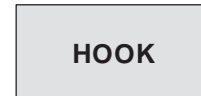

APU/
HYD

APU SHUTDOWN

1. APU OPER – OFF
FUEL TK VLV – CL
✓SHUTDOWN (HYD PRESS)
Report APU F7 lts
APU CNTLR PWR – OFF

⇒ If one APU failed:

2. ✓APU AUTO SHUTDOWN (three) – ENA
3. MM304: ✓APU SPEED SEL (two) – NORM
4. MM602/305: APU SPEED SEL (two) – HI

If two APUs failed:

5. APU SPEED SEL (one) – HI
6. AUTO SHUTDOWN (one) – INH

APU SPD HI (✓CRT)

1. Aff APU SPEED SEL – HI

⇒ If two good APUs:

2. Perform APU SHUTDOWN, then:
3. Go to APU COOLDOWN

APU OVERSPEED (>129%)

Go to APU SHUTDOWN

APU UNDERSPEED

If 'PRL SYS X ↓' or if APU has shut down:

1. Perform APU SHUTDOWN, then:
2. Go to APU COOLDOWN

APU OIL OVERTEMP

1. BLR CNTLR/HTR – B(A)

⇒ If M > 1:

- If OIL IN T incr, and OUT T > 305:
2. Perform APU SHUTDOWN, then:
3. Go to APU COOLDOWN

APU PUMP LEAK P (✓MCC)

Pre-TAEM if two good APUs:

1. Perform APU SHUTDOWN, then:
2. Go to APU COOLDOWN

APU THERM (T HI)

If APU GG/FU PMP HTR or APU TK/FU LINE HTR
fail ON (↑):

1. Aff HTR – OFF

PLT WND

FB E12-1

AESP/ALL/E/GEN J

FAB USE ONLY

PILE

APU

APU COOLDOWN

At M = 7:

1. HYD MN PUMP PRESS – LO
APU CNTLR PWR – ON
OPER – INJECTOR COOL
(start watch)

If APU not leaking:

2. APU FUEL TK VLV – OP

At Wheel Stop:

3. Go to APU SHUTDN

APU RESTART

1. HYD MN PUMP PRESS – LO
2. APU CNTLR PWR – ON
3. ✓AUTO SHUTDN – ENA

If COOLDOWN for > 3.5 min or INJ T < 400:

4. ✓APU FUEL TK VLV – OP
OPER – START/RUN
HYD MN PUMP PRESS – NORM >>

If not:

5. APU OPER – INJECTOR COOL (start watch)

If after 1.5 min, APU INJ T not decr:

6. Go to APU SHUTDN >>

At 3.5 min:

7. APU FUEL TK VLV – OP
OPER – START/RUN
HYD MN PUMP PRESS – NORM >>

If restart unsuccessful:

8. Go to APU SHUTDN

PLT WND

FB E12-2

AESP/ALL/E/GEN J

FAB USE ONLY

HOOK

HYD PRESS (LOW) G51

⇒ PRL SYS	HYD PRESS	PROCEDURE
↓	P > 300	1. HYD MN PUMP PRESS – LO 2. Go to step 10
	P < 300	3. Go to APU SHUTDN >>
blank	meter <u>and</u> CRT P < 2600	If first HYD sys degraded: 4. HYD MN PUMP PRESS – LO 5. Go to step 10
		If two HYD sys degraded: 6. HYD MN PUMP PRESS (two) – NORM, then: 7. LO on system with lowest pressure 8. (Good) APU AUTO SHUTDN (one) – INH 9. Go to step 10

**HYD/
COMM
GNC**

10. At TAEM:
APU SPEED SEL (two) – HI

PILE

APU/
HYD

HYD RSVR QTY (LOW)

1. Aff MPS/TVC ISOL VLV – CL (5 sec)
- ⇒ If still decr:
2. Aff HYD MN PUMP PRESS – LO
 3. At TAEM: Good APU SPEED SEL (two) – HI
- If second sys fail:
4. HYD MN PUMP PRESS (two) – NORM
 5. (Good) APU AUTO SHUTDN (one) – INH

HYD RSVR T

1. BLR CNTLR/HTR – A(B)
- If HYD RSVR T > 250:
2. HYD MN PUMP PRESS – LO
- If HYD RSVR T > 268 and incr:
3. Perform APU SHUTDN, then:
 4. Go to APU COOLDOWN

W/B QTY (LOW)

- ⇒
1. ✓BLR PWR – ON
 2. If QTY = zero or $M \leq 1$ >>
 3. BLR CNTLR/HTR – A(B)
 4. Note QTY
- Wait 2 min, then:
5. ✓QTY
 6. If QTY change < 3 >>
If QTY change ≥ 3 :
 7. Cycle BLR PWR to maintain
200 < LUBE OIL IN T < 290 (C&W)
- When $M \leq 1$:
8. BLR PWR – ON

PLT WND

FB E12-4

AESP/ALL/E/GEN J

FAB USE ONLY

HOOK

COMM LOST (MULTI PANELS)

1. AUD CTR – 2

No comm (✓UHF sites):

2. S–BD PM CNTL – PNL,CMD (pnl C3)

3. Config per COMM COVERAGE **BFS G51**:

TDRS – ITEM 46 EXEC (*)

STDN–HI – ITEM 47 EXEC (*)

SGLS – ITEM 49 EXEC (*)

If * not next to selected config:

4. Config pnl A1 per Comm Coverage

(ASC/ENT PKT, **COMM**)

S–BD PM CNTL – PNL,CMD (pnl C3)

No comm:

5. Select best S–BD PM ANT

No comm:

6. S–BD PM ANT – GPC

GNC
MPS
DPS**ICOM LOST**

1. AUD CNTL – sel ALT

No ICOM:

2. AUD CTR – 2

FCS CH 1(2,3,4) (2nd FAIL) **G53**

If 2 FCS CH ↓ on any actuator:

◇ 1. Remaining FCS CH (two) – ORIDE

RHC L(R) (2nd FAIL) **GNC SYS SUMM 1**

Aff FLT CNTLR PWR – OFF

G51 ROLL MODE SW **G51**

If ROLL MODE ≠ SW POS:

1. AUTO SEL – ITEM 42 EXEC

DISPLAY SW L(R)

L(R) Disp sws (eight) – green dot

RM FAIL IMU,RGA,AA **BFS G51**

Aff LRU – desel

RM DLMA IMU **G51 **BFS G51****

1. ✓MCC, bad IMU – desel (PASS & BFS) >>

◇ 2. Desel lower # IMU with '?' (PASS)

PLT WND

FB E12–5

AESP/ALL/E/GEN J,8

FAB USE ONLY

PILE

HYD/
COMM
GNC

RM FAIL ADTA G51

- ◇ 1. ✓BFS GNC SYS SUMM 1
- 2. If '↓' for aff ADTA >>
- 3. If accessible, bad ADTA cb – op >>
- 4. BFS, ADTA to G&C – INH

RM DLMA ADTA * G51

M < 2.0		1. Fly Theta limits
ADTA data agrees		2. Desel, resel one ADTA 3. If no '?' >>
Bad probe		4. Stow bad probe >>
Bad ADTA	ADTA cb accessible	◇ 5. Bad ADTA cb – op >>
	ADTA cb not accessible	◇ 6. DES bad ADTA 7. ✓BFS GNC SYS SUMM 1 8. If '↓' for aff ADTA >> 9. BFS, ADTA to G&C – INH
Dilemma not resolved		10. ADTA to G&C – INH (PASS & BFS)

*If 3 ADTAs failed:
ADTA to G&C – INH (PASS)
Fly Theta limits

RM FAIL TAC G50

(RM LIMITS: 6 DEG, 0.5 NM)

- 1. If data good: desel, resel aff TACAN >>
- 2. If failure verified: desel failed TACAN in BFS

RM DLMA TAC G50

Do not desel or resel while in 'TEST'

- 1. If both data good: desel, resel one TACAN in DLMA >>
- 2. ✓TACAN MODE (three) – GPC
- 3. If 'RM FAIL TAC': desel failed TACAN in BFS >>
- 4. If continuous 'TEST': TACAN MODE (three) – T/R
If bad TACAN identified:
- 5. Desel bad TACAN (PASS, ✓BFS)

MPS He P/MPS C&W LIGHT

MPS PNEU REG

If M > 2.4: Aff MPS He ISOL – CL

PLT WND

FB E12-6

AESP/ALL/E/GEN J,8

FAB USE ONLY

HOOK

PASS GPC FAIL

1. GPC MODE – STBY,HALT
2. Aff FCS CH – OFF
3. If two GPC/FA/FCS CHs ↓: Good FCS CHs – ORIDE
4. G53 aff SURF FDBK – desel
- ⇒ 5. If STRG 1(2): CDR(PLT) sws – green dot
6. ✓MULT DATA PATH LOSS

BFS GPC FAIL

- ⇒ 1. GPC MODE – STBY,HALT,pause
– STBY,RUN
2. If recovered: PRO to OPS 304
BFS G50 ✓BFS R/W sel >>
✓GPC OUTPUT – B/U >>
3. If SM only: GPC MODE – STBY, then step 5
4. GPC MODE – HALT
- ◇ 5. OUTPUT – TERM
6. If no comm: Sel best S-BD PM ANT
7. MPS He ISOL B (three) – CL
PNEU He ISOL – CL
8. If AOA/GRTLS/TAL < 120K:
NH3 CNTLR B – SEC/ON

FA/FF MDM I/O ERROR

(Annunciated by entire set)

**DPS
MDM
BFS**

		1. I/O RESET
RECOV	FA	2. If reqd, aff FCS CH – ORIDE,AUTO
	FF 1,2,3	◇ If H > 200K or TACAN incorp: 3. G50 NAV DELTA zero 4. G51 IMU – resel
		5. BFS I/O RESET >>
NOT RECOV	FA	6. Aff FCS CH – OFF 7. If 2 GPC/FA/FCS CHs ↓: Good FCS CHs – ORIDE 8. G53 aff SURF FDBK – desel
		9. ✓MULT DATA PATH LOSS ⇒ ◇ 10. Go to FA/FF MDM PORT MODE

PLT WND

FB E12-7

AESP/ALL/E/GEN J,9

FAB USE ONLY

PILE

FA/FF MDM PORT MODE

NOTE: If BFS, 'BCE STRG X PASS', @GPC; else @MDM.
For '@GPC', port mode results in alternate MDM bypass

GNC
MPS
DPS

			1. G01 aff STRG – port mode 2. BFS I/O RESET
@MDM	RECOV	FA	3. Aff FCS CH – AUTO 4. G53 aff SURF FDBK – resel >>
		FF 1,2,3	◇ If H > 200K or TACAN incorp: 5. G50 NAV DELTA zero 6. G51 IMU – resel >>
	NOT RECOV		⇒ If MCC GO for power cycle: 7. Aff FA/FF MDM – OFF, ON 8. I/O RESET 9. If recov, go to @MDM RECOV >> 10. Aff MDM – OFF
		FA	11. BFS G51 aff SURF FDBK, RGA – desel 12. ✓ GNC SYS SUMM 1
		FF	13. BFS G51 aff AA – desel 14. FF 1(2): CDR(PLT) – green dot 15. ✓ MULT DATA PATH LOSS >>
@GPC	FA RECOV (FF Give Up)		16. Aff FCS CH – AUTO 17. G53 aff SURF FDBK – resel 18. FF 1(2): CDR(PLT) – green dot 19. ✓ MULT DATA PATH LOSS >>
		FF RECOV (FA Give Up)	20. Aff FCS CH – OFF 21. If 2 GPC/FA/FCS CHs ↓: Good FCS CHs – ORIDE 22. G53 aff SURF FDBK – desel
		FF 1,2,3	◇ If H > 200K or TACAN incorp: 23. G50 NAV DELTA zero 24. G51 IMU – resel 25. ✓ MULT DATA PATH LOSS >>

PLT WND

FB E12-8

AESP/ALL/E/GEN J,12

FAB USE ONLY

HOOK

FF(FA) MDM OUTPUT **FAULT**

◇ (Take action only if annun by entire set)

If single 'MDM OUTPUT':

1. If 'FF MDM OUTPUT':
 G51 aff IMU – desel
2. Go to FA/FF MDM I/O ERROR >>

If both FF & FA annun:

3. **G51** aff IMU – desel
4. I/O RESET; if reqd, BFS I/O RESET
5. If msgs repeat: Go to PASS GPC FAIL >>
6. If reqd, aff FCS CH – ORIDE,AUTO
- ◇ 7. If $H > 200K$ or TACAN incorp:
 G50 NAV DELTA zero
 G51 IMU – resel

PL MDM I/O ERROR

1. BFS I/O RESET

If recovered >>

2. **G01** PL 1/2 – port mode, then BFS I/O RESET
 If recovered >>
3. Pre MM305: FES PRI B(A) – ON
4. If PL2 ↓ & no comm: Sel best S–BD PM ANT
- ⇒ 5. If PL2 ↓ & AOA/GRTL5/TAL < 120K:
 NH3 CNTLR B – SEC/ON

PCM I/O ERROR

OI PCMMU PWR – 2(1)

POST BFS ENGAGE**CAUTION**

Do not assign more than 3 IDPs at a time

If PASS GPCs running:

1. Aff GPC MODE – STBY/HALT
2. BFS I/O RESET
3. ✓ FCS CHs, IMU config

⇒ If Air Data not analyzed:

4. **G50** INH AD to G&C
5. M=5: Deploy, evaluate probes one at a time
6. ✓ AD to G&C by M = 1.5

If failed ADTA(s) in PASS:

7. ADTA cb(s) – op or stow probe
8. **G51** DES failed (commfaulted) RGA, AA, SURF
9. **G50** DES failed TAC
10. GPC/CRT 04 EXEC, as reqd

At $M \leq 2.7$: 11. CDR TRIM PANEL – OFF
RHC/PNL – ENAAt $H = 3K$: 12. SPDBK – MAN (✓ DEL PAD setting)

At MAIN GEAR TD: 13. SPDBK – 100%

PLT WND

FB (A)E12–9

AESP/4/E/GEN J,9

OI–28**BCE
CRT
MDP**

FAB USE ONLY

TOP
BACK OF 'FF(FA) MDM OUTPUT'

PILE

BCE STRG X (no 'MDM OUTPUT' msg)

	IMU	1. G21 ✓IMU OPER, if STBY >>
		2. I/O RESET
RECOV	IMU	◇ If H > 200K or TACAN incorp: 3. G21 ✓att ANG, if delta > 1° >> 4. G50 NAV DELTA zero 5. G51 IMU – resel >> 6. >>
NOT RECOV	NSP	7. And no comm: PNL,CMD 8. BFS G51 Config per COMM COVERAGE: TDRS – ITEM 46 EXEC (*) STDN-HI – ITEM 47 EXEC (*) SGLS – ITEM 49 EXEC (*) >>
		9. G01 aff STRG – port mode 10. BFS I/O RESET 11. If recov, go to RECOV steps >>
	A(B,C,D, IMU)	⇒ 12. FF A(B, IMU) or FA C(D) MDM – OFF, ON 13. I/O RESET 14. If FA, aff FCS CH – ORIDE,AUTO 15. If recov, go to RECOV steps
	C(D)	16. If < 3Y, 2P jets/pod/dir: a. G23 aff jet DES INH (*) (Reprioritize) b. Aff MANF VLVs STAT OP – OVRD
	1A(2A)	17. CDR(PLT) sws – green dot
	B	18. BFS G51 aff AA – desel
	D	19. BFS G51 aff SURF FDBK,RGA – desel
		20. ✓MULT DATA PATH LOSS >>

DPS
MDM
BFS

OI-28

PLT WND

FB (A)E12-10

AESP/ALL/E/GEN J,9

FAB USE ONLY

HOOK

FF(FA) MDM OUTPUT **FAULT**

◇ (Take action only if annun by entire set)

If single 'MDM OUTPUT':

1. If 'FF MDM OUTPUT':
 G51 aff IMU – desel
2. Go to FA/FF MDM I/O ERROR >>

If both FF & FA annun:

3. **G51** aff IMU – desel
4. I/O RESET; if reqd, BFS I/O RESET
5. If msgs repeat: Go to PASS GPC FAIL >>
6. If reqd, aff FCS CH – ORIDE,AUTO
- ◇ 7. If $H > 200K$ or TACAN incorp:
 G50 NAV DELTA zero
 G51 IMU – resel

PL MDM I/O ERROR

1. BFS I/O RESET

If recovered >>

2. **G01** PL 1/2 – port mode, then BFS I/O RESET
 If recovered >>
3. Pre MM305: FES PRI B(A) – ON
4. If PL2 ↓ & no comm: Sel best S-BD PM ANT
- ⇒ 5. If PL2 ↓ & AOA/GRTLs/TAL < 120K:
 NH3 CNTLR B – SEC/ON

PCM I/O ERROR

OI PCMMU PWR – 2(1)

POST BFS ENGAGE

If PASS GPCs running:

1. Aff GPC MODE – STBY/HALT
2. BFS I/O RESET
3. ✓FCS CHs, IMU config
- ⇒ If Air Data not analyzed:
4. **G50** INH AD to G&C
5. M=5: Deploy, evaluate probes one at a time
6. ✓AD to G&C by M = 1.5

If failed ADTA(s) in PASS:

7. ADTA cb(s) – op or stow probe
8. **G51** DES failed (commfaulted) RGA, AA, SURF
9. **G50** DES failed TAC

At $M \leq 2.7$:

10. CDR TRIM PANEL – OFF
 RHC/PNL – ENA

At $H = 3K$:

11. SPDBK – MAN (✓DEL PAD setting)

At MAIN GEAR TD:

12. SPDBK – 100%

BCE
CRT
MDP**01-29**

PLT WND

FB (B)E12-9

AESP/4/E/GEN J,9

FAB USE ONLY

TOP
BACK OF 'FF(FA) MDM OUTPUT'

FILE

BCE STRG X (no 'MDM OUTPUT' msg)

	IMU	1. G21 ✓IMU OPER, if STBY >> 2. I/O RESET
RECOV	IMU	◇ If H > 200K or TACAN incorp: 3. G21 ✓att ANG, if delta > 1° >> 4. G50 NAV DELTA zero 5. G51 IMU – resel >> 6. >>
NOT RECOV	NSP	7. And no comm: PNL,CMD 8. BFS G51 Config per COMM COVERAGE: TDRS – ITEM 46 EXEC (*) STDN-HI – ITEM 47 EXEC (*) SGLS – ITEM 49 EXEC (*) >>
		9. G01 aff STRG – port mode 10. BFS I/O RESET 11. If recov, go to RECOV steps >>
	A(B,C,D, IMU)	⇒ 12. FF A(B, IMU) or FA C(D) MDM – OFF, ON 13. I/O RESET 14. If FA, aff FCS CH – ORIDE,AUTO 15. If recov, go to RECOV steps
	C(D)	16. If < 3Y, 2P jets/pod/dir: a. G23 aff jet DES INH (*) (Reprioritize) b. Aff MANF VLVs STAT OP – OVRD
	1A(2A)	17. CDR(PLT) sws – green dot
	B	18. BFS G51 aff AA – desel
	D	19. BFS G51 aff SURF FDBK,RGA – desel
		20. ✓MULT DATA PATH LOSS >>

DPS
MDM
BFS

OI-29

PLT WND

FB (B)E12-10

AESP/ALL/E/GEN J,9

FAB USE ONLY

HOOK

**DUAL DPS DISPLAY COMMANDERS/
DK XMTR 1(2,3)**

1. BFC CRT SEL – aff IDP

If reqd to clean up display:

2. Aff IDP/CRT PWR – OFF,ON

I/O ERROR CRT/DPS DISPLAY ANOMALY

If IDP 4(CRT 4): IDP/CRT 4 PWR – OFF >>

If NO big X/POLL FAIL:

1. MDU PWR – OFF,ON; if recovered >>

If MCC GO for power cycle:

2. IDP/CRT PWR – OFF,ON; if recovered >>

If big X/POLL FAIL:

3. IDP/CRT PWR – OFF,ON; if recovered >>

If PASS:

4. GPC/CRT – same GPC/aff IDP; if recovered >>

5. BFC CRT SEL – aff IDP: Go to step 9

If BFS:

6. BFC CRT SEL – unaff IDP; if both IDPs OK >>

7. – original position

8. In PASS: GPC/CRT 5/X EXEC for aff IDP

9. If reqd: In PASS, deassign aff IDP, assign IDP 4 to PASS

FLT INST DISPLAY ANOMALY

1. DATA BUS Select alternate FC BUS(s); if recovered >>

2. PORT SELECT aff MDU; if recovered >>

3. MDU PWR – OFF,ON

SUBSYS STATUS DISPLAY ANOMALY

1. PORT SELECT aff MDU; if recovered >>

2. MDU PWR – OFF,ON; if recovered >>

MULT DATA PATH LOSS (Non-Recov)

NOTE

If LRU data path loss due to GPC problem and not MDM,
BFS will pick up MDMs/LRU when engaged

FAILURE	TYPE	ACTIONS
GPC/FF 1&2	I/O or B	Use R BODY FLAP & TRIM ENA sws
GPC/FF 3&4	I/O or B	Use L BODY FLAP & TRIM ENA sws
GPC/FA any combo	I/O or D	No impact

MN
AC

PLT WND

FB E12-11

AESP/2,4/E/GEN J,12

FAB USE ONLY

PILE

MN BUS UNDER V/FC V

⇒ If MN V < 26.4, FC V < 26.6, FC A > 480 (2 of 3)

(SHORT OR DEGRADED FC):

1. MSTR MADS PWR – OFF
2. If aff BUS tied – UNTIE
3. PL PRI (three) – OFF
4. Aff ESS BUS SOURCE FC – OFF
FC/MN BUS – OFF

If FC VOLTS < 32 (FC SHORT)

5. Aff FC REAC VLV – CL
6. Go to FC SHUTDN (Do not stop FC until
COOL P < 15 & STACK T < 243) >>

If FC VOLTS ≥ 32 (BUS SHORT)

7. Go to BUS LOSS ACTIONS >>

If MN V < 26.4 and FC V > 32 and FC A < 20

(FC DISCONNECT):

8. MSTR MADS PWR – OFF
9. PL PRI (three) – OFF
10. FC/MN BUS – ON

If FC3 aff:

11. PL PRI FC3 – ON
MNC – ON

12. If MNC V < 26.4: PL PRI (three) – OFF

If 1st FC failure:

13. Perform BUS TIE, then:

If MN BUS recovered:

14. GNC I/O RESET

If aff FC VOLTS > 32:

15. Go to FC SHUTDN

AC VOLT HIGH

If AC V > 123 and F9 V > 123:

- ⇒
1. Aff AC BUS SNSR – OFF
 2. cb AC CONTR – cl
INV/AC BUS – OFF
INV PWR – OFF
cb AC CONTR – op
 3. ✓H2O PUMP LOOP 2(1) – ON
 4. Go to aff BUS LOSS

BCE
CRT
MDP

PLT WND

FB E12-12

AESP/ALL/E/GEN J,5

FAB USE ONLY

HOOK

3 Φ
MN
AC
SUB**AC VOLT LOW or OVERLOAD**

1. Aff AC BUS SNSR – OFF
- ⇒ If amps > 14 or F9 V < 110:
- If single Φ amps > 14 or V > 10:
2. cb AC CONTR – cl
INV/AC BUS – OFF
INV PWR – OFF
cb AC CONTR – op
 3. If other Φ amps > 14:
Go to step 4
- If multi Φ (Bus short):
4. Aff cb AC CONTR (three) – cl
INV/AC BUS – OFF (tb-OFF)
INV PWR – OFF (tb-OFF)
cb AC CONTR (three) – op
 5. Go to aff BUS LOSS

PLT WND

FB E12-13

AESP/ALL/E/GEN J,5

FAB USE ONLY

PILE

**MN
AC**

3Φ MOTORS STOPPED

1. Aff AC BUS SNSR – OFF
2. Determine AC BUS
 FC1 & FREON PUMP 2B: AC1
 FC2 & FREON PUMP 1B: AC2
 FC3 & CAB FAN A: AC3
3. Aff FC – STOP
 If AC3 aff:
 4. AV BAY 3 FAN B – OFF, A – ON
 5. CAB FAN A – OFF
- Isolate aff ΦB:
 6. Aff cb AC CONTR – cl
 7. INV/AC BUS – OFF
- If AC1(2,3) aff and AV BAY 3(2,3) FAN ΔP < 0.5:
 8. Aff INV/AC BUS – ON
 9. cb AC CONTR – op
 10. Repeat from step 6 to isolate aff ΦC, ΦA, then:
 11. Aff cb AC CONTR (three) – cl
 12. INV/AC BUS – OFF
 13. Go to BUS LOSS, AC MULTI Φ >>
- If AC1(2,3) aff and AV BAY 3(2,3) FAN ΔP ≥ 0.5:
 14. Aff FC – START (10 sec or ΔP tb-gray)
 15. Perform aff BUS LOSS and if AC1(AC2) aff >>
 16. If AC3 aff: CAB FAN B – ON

⇒ **AC SINGLE Φ**

AC1	ΦA	BLR CNTLR/HTR 1 – A When V = 12K: RAD CNTLR LOOP (two) – AUTO A
	ΦB	When V = 12K: RAD CNTLR LOOP (two) – AUTO A
	ΦC	BLR CNTLR/HTR 3 – B
AC2	ΦA	BLR CNTLR/HTR 1 – B
	ΦB	SIG CONDR FREON A – AC3
	ΦC	BLR CNTLR/HTR 2 – A
AC3	ΦA	BLR CNTLR/HTR 2 – B
	ΦB	SIG CONDR FREON B – AC2
	ΦC	BLR CNTLR/HTR 3 – A

HOOK

MNA or AC1 Multi Φ

- 1. MSTR MADS PWR – OFF
- 2. Perform FC SHUTDN (within 9 min), then:
- ⇒ 3. BLR CNTLR/HTR 1 – A
3 – B

FAILED: TAC 1
MLS 1, RA 1, NWS 1, L HUD

ESS
CNTL

MNB or AC2 Multi Φ

- 1. MSTR MADS PWR – OFF
- 2. Perform FC SHUTDN (within 9 min), then:
- ⇒ 3. BLR CNTLR/HTR 2 – A
1 – B
- 4. SIG CONDR FREON A – AC3

FAILED: TAC 2
MLS 2, RA 2, NWS 2
PLT DRAG CHUTE ARM
S-BD PM 1 (NO PNL, CMD)

MNC or AC3 Multi Φ

- 1. S-BD PM CNTL – PNL, CMD
- 2. Config per COMM COVERAGE **BFS G51**:
TDRS – ITEM 46 EXEC (*)
STDN-HI – ITEM 47 EXEC (*)
SGLS – ITEM 49 EXEC (*)
- 3. MSTR MADS PWR – OFF
- ⇒ 4. Perform FC SHUTDN (within 9 min), then:
- 5. BLR CNTLR/HTR 3 – A
2 – B
- 6. SIG CONDR FREON B – AC2

FAILED: TAC 3, MLS 3, R HUD
CDR DRAG CHUTE ARM

SUBBUS

SUBBUS	APC or ALC	4	5	6
⇒ 1.	BLR CNTLR/HTR	1 – A 3 – B	2 – A 1 – B	3 – A 2 – B

ESS BUS V LOW

- If verified by F9 voltmeter:
- 1. Perform FC SHUTDN (<9 min), then:
 - 2. Go to aff ESS BUS LOSS

PLT WND

FB E12-15

AESP/4/E/GEN J,8

PILE

ESS BUS LOSS

ESS 1BC	1. L AUD CNTL – R (CDR can't talk) 2. Pri C/W & Matrix lost
ESS 2CA	1. AUD CTR – 2 2. R AUD CNTL – L (PLT can't talk)
ESS 3AB	1. Do not ENGAGE BFS 2. CSM lost ⇒ 3. BFS GPC OUTPUT – TERM

3Φ
MN
AC
SUB

CNTL BUS V LOW

1. ✓BUS LOSS ID
2. Perform aff CNTL BUS LOSS, then:
If pwr reqd (<3 sec) for crit function:
 3. Hold crit function sw
 4. For CNTL BUS AB(BC,CA) VOLTS LOW CNTL BUS PWR MNA(MNB,MNC) – RESET
5. If FIRE/SMOKE at any time:
For CNTL BUS AB(BC,CA):
 - ◇ CNTL BUS PWR MNA(B,C),MNB(C,A) (two) – RESET (hold) (pnl R1)
 - If CNTL BUS AB(BC,CA) VOLTS still > 0:
ASAP 6. cb CNTL BUS AB1/2/3(BC1/2/3, CA1/2/3) – op (pnl R14:B)

CNTL BUS LOSS

AB1	⇒ 1. Use R TRIM & BDY FLP sws 2. BLR CNTLR/HTR 1 – A
AB2	1. G23 RCS FWD MANF VLVS 1 OVRD – ITEM 40 EXEC (CL) 2. BLR CNTLR/HTR 1 – A ⇒ FAILED: L HUD
AB3	1. G51 RCS RM MANF CL OVRD – ITEM 41 EXEC If BFS ENGAGE reqd: 2. Use PLT's RHC, then GPCs 1,2,4 – STBY,HALT 3. BFS I/O RESET If no S-BD COMM: 4. S-BD PM CNTL – PNL, CMD 5. BFS G51 Config per COMM COVERAGE: TDRS – ITEM 46 EXEC (*) STDN-HI – ITEM 47 EXEC (*) SGLS – ITEM 49 EXEC (*) ⇒ 6. BLR CNTLR/HTR 1,3 (two) – B

PLT WND

FB E12-16

AESP/ALL/E/GEN J,8

FAB USE ONLY

HOOK

CNTL BUS LOSS (Cont)

BC1	⇒	1. Use R TRIM & BDY FLP sws 2. BLR CNTLR/HTR 2 – A FAILED: R HUD, CDR DRAG CHUTE DPY/JETT S–BD PM 1 (NO PNL,CMD)
BC2	⇒	1. S–BD PM CNTL – PNL,CMD 2. G51 Config per COMM COVERAGE: TDRS – ITEM 46 EXEC (*) STDN–HI – ITEM 47 EXEC (*) SGLS – ITEM 49 EXEC (*) 3. G23 RCS FWD MANF VLVS 2 OVRD – ITEM 41 EXEC (CL) 4. PLT Displays – green dot 5. Use L TRIM & BDY FLP sws 6. BLR CNTLR/HTR 2 – A FAILED: CDR DRAG CHUTE DPY/JETT
BC3	⇒	1. G51 RCS RM MANF CL OVRD – ITEM 41 EXEC 2. BLR CNTLR/HTR 1,2 (two) – B
CA1	⇒◇	1. No BFS ENGAGE GPC 3,5 2. BFS GPC OUTPUT – TERM 3. BLR CNTLR/HTR 3 – A FAILED: PLT DRAG CHUTE DPY/JETT
CA2	⇒	1. G23 RCS FWD MANF VLVS 3 OVRD – ITEM 42 EXEC (CL) 2. Use L TRIM & BDY FLP sws 3. BLR CNTLR/HTR 3 – A FAILED: PLT DRAG CHUTE DPY/JETT
CA3	⇒	1. BLR CNTLR/HTR 2,3 (two) – B

FC

PLT WND

FB E12–17

AESP/ALL/E/GEN J,8

FAB USE ONLY

PILE

FC REAC VLV CLOSED

1. FC REAC (three) – OP
2. Perform BUS TIE, then:
If no joy on REAC open:
 3. ✓cb FC REAC VLV CL ENA (three) – op (pnl C3)
 4. FC REAC (three) – OP
5. Go to FC SHUTDN
If FC COOL P < 50:

FC pH ↓ 1(2,3) or FC DELTA V 1(2,3)

If pH ↓ and FC SS 1(2,3) ΔV > 150
or FC SS ΔV > 150 and incr:

ESS
CNTL

1. Perform BUS TIE, then:
 2. Aff FC REAC VLV – CL
 3. MSTR MADS PWR – OFF
 4. Go to LOSS OF 1(2nd) FC PWRDN >>
- If pH ↓ only:
5. Go to BUS TIE

FC STACK T

1. MSTR MADS PWR – OFF
- If STACK T > 243 and incr:
2. If 2nd FC: Go to 2nd FC SHUTDN >>
 3. PL PRI (three) – OFF
- If aff FC amps < 170 or > 360:
4. Go to MN BUS U/V, step 4 >>
- ◇ 5. Perform BUS TIE, then:
6. ESS BUS SOURCE FC – OFF
 7. FC/MN BUS – OFF
- If aff FC VOLTS < 32 or STACK T not decr:
8. Aff FC REAC – CL
 9. FC – STOP after COOL P < 15 and STACK T < 243
10. Go to LOSS OF 1 FC PWRDN

FC EXIT T

1. MSTR MADS PWR – OFF
 2. Perform BUS TIE, then:
- ⇒ If EXIT T > 164 and incr or < 131 and no comm:
3. Go to FC SHUTDN

PLT WND

FB E12-18

AESP/ALL/E/GEN J,8

FAB USE ONLY

HOOK

FC COOLANT PUMP ΔP LOW

- ⇒ 1. FC – START (10 sec or ΔP tb–gray)
 2. ✓FC PUMP cb(s) – cl (pnl L4:C)
 ◇ If EXIT T > 164 & not decr or RDY tb – bp
 (30 sec after START):
 3. Go to FC SHUTDN >>
 If EXIT T norm, RDY tb – gray, & no comm:
 4. Monitor AC amps
 5. FC – STOP
 If AMPS decr 0.7–0.9 AMP/Φ:
 6. FC – START (hold 30 sec if ΔP tb–bp)
 7. If AMPS incr 0.7–0.9 AMP/Φ >>
 8. Go to FC SHUTDN

FC COOL P

- ⇒ 1. Perform BUS TIE, then:
 If COOL P > 75, incr, and not 100 (H),
or COOL PUMP ΔP tb – bp/intermittent,
or STACK/EXIT T unstable,
or SS ΔV ≥ 150:
 If COOL P > 75:
 2. Aff FC REAC VLV – CL
 3. MSTR MADS PWR – OFF
 4. Go to LOSS OF 1(2nd) FC PWRDN >>
 If COOL P < 50:
 5. Go to FC SHUTDN

2FC

LOSS OF 1 FC PWRDN (GRTL5/TAL)

1. PRI PL (three) – OFF
 AFT PL (two) – OFF
 2. IDP/CRT 4 PWR – OFF
 One MDU – OFF

LOSS OF 1 FC PWRDN (ENTRY)

1. If V < 15K >>
 2. IDP/CRT 4,one MDU,FLT CNTLR PWR – OFF
 3. TAC/RA/MLS – OFF
 If middeck PL on:
 4. cb MNB UTIL PWR – op (pnl O15:C)
 ◇ 5. PRI PL (three) – OFF
 AFT PL (two) – OFF

PLT WND

FB E12–19

AESP/4/E/GEN J,3

FAB USE ONLY

PILE

2nd FC SHUTDN (GRTLS/TAL)

(CL PMP Lost: <6 min)

1. Have CDR start LOSS OF 2nd FC PWRDN (GRTLS/TAL)
If 3 MN BUSES powered:

2. MN BUS TIE (three) – OFF
(Do not perform BUS LOSS ACTIONS)
3. LES O2 – OFF, Visors – OP
4. Switch off all but one IDP/CRT with four MDUs
5. All PL PWR (seven) – OFF
6. O2, H2 TK HTRS (all) – OFF
7. After CDR pnl L1 config complete, continue:

If two MN BUSES powered:

8. Powered MN BUS TIES (two) – ON

If only one MN BUS powered:

9. MN BUS TIE (three) – OFF
If only MNA(B,C) powered: Secure APU 2(3,1)
BUS TIE good FC/BUS (MNA)
I/O RESET

When reqd:

10. ESS BUS SOURCE FC – OFF
FC/MN BUS – OFF
FC – STOP (1 sec)
FC REAC VLV – CL
11. G51 ✓ INCNCT ENA (if reqd for OMS load)
12. Go to LOSS OF 2nd FC PWRDN (GRTLS/TAL)

FC 2nd FC SHUTDN (ENTRY)

1. Have CDR go to LOSS OF 2nd FC PWRDN (ENTRY)
 2. O2/H2 HTRS (twelve) – OFF (pnl R1)
PL PWR (seven) – OFF
 3. ✓ MSTR MADS PWR – OFF
- If aff FC/MN BUS is tied:
4. MN BUS TIE (two) – OFF
 5. If only MNA(B,C) powered: Secure APU 2(3,1)
 6. Perform BUS TIE (Good FC/BUS to another BUS),
then:
 7. ESS BUS SOURCE FC – OFF
FC/MN BUS – OFF
FC – STOP (1 sec)
FC REAC VLV – CL

PLT WND

FB E12-20

AESP/4/E/GEN J

FAB USE ONLY

HOOK**LOSS OF 2nd FC PWRDN
(GRTLS/TAL)**

⇒ ◇ When MPS Dump complete:

1. MPS ENG PWR (six) – OFF
EIU (three) – OFF
2. MEC 1 – OFF, wait 2 sec, then
2 – OFF

If MNA(MNB) unpowered:

3. O₂,H₂ TK1 HTRS B (two) – AUTO

If MNC unpowered:

4. O₂,H₂ TK2 HTRS B (two) – AUTO
5. Safe Payload, if reqd
6. Go to APU RESTART for secured APU

CRYO

PLT WND

FB E12-21

AESP/ALL/E/GEN J

FAB USE ONLY

TOP
BACK OF 'LOSS OF 2nd PWRDN (GRTLS/TAL)'
FACING RIGHT SIDE OF BACKBOARD

PILE

O2(H2) CRYO P/T HIGH

CRYO O2(H2) TK HTR (two) – OFF

CRYO O2(H2) LEAK (3 or more tanks aff)

Use meter if CRT data OSL

1. MANF VLV 1,2 (two) – CL
 2. TK3 HTR A – AUTO
- ⇒ If TK1 and 2 P decr slowly (HTR logic fail):
3. If QTY > 55%: TK3 HTR B – AUTO
 4. MANF VLV 1,2 (two) – OP >>
 5. Perform aff MN BUS TIE, then:
If O2 TK 1(2) aff:
 6. O2 SYS 1(2) SPLY vlv – CL
 7. If O2 TK 1(2) P now incr:
(PCS leak) >>
 8. If O2 leak: Aff TK HTR B – AUTO
If aff TK P not incr:
 9. If TK3 aff: ✓HTR A(&B if O2) – AUTO
 10. Perform aff FC SHUTDN (post COOL P alarm if O2 leak), then:
If TK3 aff and P not decr within 2 min: (FC leak)
 11. MANF VLV 1,2 (two) – OP (ASAP) >>
 12. Aff TK HTRS A,B (two) – OFF

2FC

PLT WND

FB E12-22

AESP/ALL/E/GEN J

FAB USE ONLY



POWERED
FLIGHT

CDR WINDOW FLIP BOOK
POWERED FLIGHT

CDR WINDOW
FLIP BOOK



CDR WND

FB A13-i

AESP/ALL/A/GEN J



FAB USE ONLY



POWERED
FLIGHT



This Page Intentionally Blank

CDR WINDOW
FLIP BOOK



CDR WND

FB A13-ii

AESP/ALL/A/GEN J

FAB USE ONLY

TOP
FACING LEFT SIDE OF BACKBOARD

HOOK

DPS
GPC
MDM

COMM LOST (MULTI PANELS)

1. AUD CTR – 2
2. No joy, S-BD PM CNTL – PNL, CMD
3. Config per COMM COVERAGE **[BFS G51]**:
 - TDRS – ITEM 46 EXEC (*)
 - STDN-HI – ITEM 47 EXEC (*)
 - SGLS – ITEM 49 EXEC (*)
4. No joy, sel best S-BD PM ANT, else GPC ⇒

ICOM LOST

1. AUD CNTL – sel ALT
2. No joy, AUD CTR – 2

FCS CH 1(2,3,4) (2nd FAIL) [G53]

If 2 FCS CH ↓ on any actuator:

- ◇ 1. Remaining FCS CH (two) – ORIDE

RHC L(R) (2nd FAIL)

Aff FLT CNTLR PWR – OFF

DISPLAY SW L(R)

L(R) Disp sws (eight) – green dot

RM FAIL IMU, RGA, AA [BFS G51]

Aff LRU – desel

RM DLMA IMU [G51] [BFS G51]

1. ✓MCC, bad IMU – desel (PASS & BFS) >>
- ◇ 2. Desel lower # IMU with '?' (PASS)

POST BFS ENGAGE

CAUTION

Do not assign more than 3 IDPs at a time

If PASS GPCs running:

1. Aff GPC MODE – STBY/HALT
2. BFS I/O RESET
3. ✓FCS CHs, IMU config

If Pre MECO:

4. If SSME failed: MAIN ENGINE LIMIT
SHUT DN – INH
5. **[G51]** DES failed (commfaulted) RGA, AA, SURF ⇒G
6. GPC/CRT 04 EXEC, as reqd

01-28

CDR WND

FB (A)A13-1

AESP/4/A/GEN J,9

FAB USE ONLY

PILE

COMM
GNC
DPS
BFS

PASS GPC FAIL

1. Aff FCS CH – OFF
- If two GPC/FA/FCS CHs ↓:
2. Good FCS CHs – ORIDE
 3. ✓MPS CMD
 4. **G53** aff SURF FDBK – desel
 5. If FTS and accessible – STBY,HALT
 6. ✓BIG 'X', then assign IDPs as reqd
 7. ✓MULT DATA PATH LOSS
- Post MECO:
8. ASAP, GPC MODE – STBY,HALT ⇒

BFS GPC FAIL

1. Post SRB SEP: FES PRI A – ON
- If IDP hard assigned to BFS:
2. Deassign IDP 4 if assigned to PASS
 3. Reassign any hard assigned BFS IDP to PASS
- Post MECO:
4. GPC MODE – STBY,HALT
- ◇ OUTPUT – TERM
5. If no comm: sel best S–BD PM ANT ⇒

FF(FA) MDM OUTPUT **FAULT**

- ◇ (Take action only if annun by entire set)
- If single 'MDM OUTPUT':
1. Go to FA/FF MDM I/O ERROR >>
- If both FF & FA annun:
2. I/O RESET; if reqd, BFS I/O RESET
 3. If msgs repeat: Go to PASS GPC FAIL >>
 4. If reqd, aff FCS CH – ORIDE,AUTO

PL MDM I/O ERROR

1. BFS I/O RESET; if recovered >>
- ◇ 2. **G01** PL 1/2 – port mode, then BFS I/O RESET
- If recovered >>
3. If PL2 down:
Post SRB SEP: FES PRI A – ON
If no comm: sel best S–BD PM ANT ⇒

PCM I/O ERROR

OI PCMMU PWR – 2

SUMWORD ICC

- If TAL:
- Go to OPS 1/6/TAL TRANSITION RESTRING (Cue Card) for aff GPC >>
- If AOA/Uphill: ⇒A

01-28

CDR WND

FB (A)A13-2

AESP/4/A/GEN J,9

FAB USE ONLY

HOOK

DPS
GPC
MDM

COMM LOST (MULTI PANELS)

1. AUD CTR – 2
2. No joy, S-BD PM CNTL – PNL, CMD
3. Config per COMM COVERAGE **G51**:
 - TDRS – ITEM 46 EXEC (*)
 - STDN-HI – ITEM 47 EXEC (*)
 - SGLS – ITEM 49 EXEC (*)
4. No joy, sel best S-BD PM ANT, else GPC ⇒

ICOM LOST

1. AUD CNTL – sel ALT
2. No joy, AUD CTR – 2

FCS CH 1(2,3,4) (2nd FAIL) **G53**

If 2 FCS CH ↓ on any actuator:

- ◇ 1. Remaining FCS CH (two) – ORIDE

RHC L(R) (2nd FAIL)

Aff FLT CNTLR PWR – OFF

DISPLAY SW L(R)

L(R) Disp sws (eight) – green dot

RM FAIL IMU, RGA, AA **G51**

Aff LRU – desel

RM DLMA IMU **G51** **G51**

1. ✓MCC, bad IMU – desel (PASS & BFS) >>
- ◇ 2. Desel lower # IMU with '?' (PASS)

POST BFS ENGAGE

If PASS GPCs running:

1. Aff GPC MODE – STBY/HALT
2. BFS I/O RESET
3. ✓FCS CHs, IMU config

If Pre MECO:

4. If SSME failed: MAIN ENGINE LIMIT
SHUT DN – INH
5. **G51** DES failed (commfaulted) RGA, AA, SURF ⇒G

OI-29

CDR WND

FB (B)A13-1

AESP/4/A/GEN J,9

FAB USE ONLY

PILE

COMM
GNC
DPS
BFS

PASS GPC FAIL

1. Aff FCS CH – OFF
- If two GPC/FA/FCS CHs ↓:
2. Good FCS CHs – ORIDE
 3. ✓MPS CMD
 4. **G53** aff SURF FDBK – desel
 5. If FTS and accessible – STBY,HALT
 6. ✓BIG 'X', then assign IDPs as reqd
 7. ✓MULT DATA PATH LOSS
- Post MECO:
8. ASAP, GPC MODE – STBY,HALT ⇒

BFS GPC FAIL

1. Post SRB SEP: FES PRI A – ON
- If IDP hard assigned to BFS:
2. Deassign IDP 4 if assigned to PASS
 3. Reassign any hard assigned BFS IDP to PASS
- Post MECO:
4. GPC MODE – STBY,HALT
- ◇ OUTPUT – TERM
5. If no comm: sel best S–BD PM ANT ⇒

FF(FA) MDM OUTPUT **FAULT**

- ◇ (Take action only if annun by entire set)
- If single 'MDM OUTPUT':
1. Go to FA/FF MDM I/O ERROR >>
- If both FF & FA annun:
2. I/O RESET; if reqd, BFS I/O RESET
 3. If msgs repeat: Go to PASS GPC FAIL >>
 4. If reqd, aff FCS CH – ORIDE,AUTO

PL MDM I/O ERROR

1. BFS I/O RESET; if recovered >>
- ◇ 2. **G01** PL 1/2 – port mode, then BFS I/O RESET
- If recovered >>
3. If PL2 down:
Post SRB SEP: FES PRI A – ON
If no comm: sel best S–BD PM ANT ⇒

PCM I/O ERROR

OI PCMMU PWR – 2

SUMWORD ICC

- If TAL:
- Go to OPS 1/6/TAL TRANSITION RESTRING (Cue Card) for aff GPC >>
- If AOA/Uphill: ⇒A

01-29

CDR WND

FB (B)A13-2

AESP/4/A/GEN J,9

FAB USE ONLY

HOOK

FA/FF MDM I/O ERROR
(Annunciated by entire set)

		1. I/O RESET
RECOV	FA	2. If reqd, aff FCS CH – ORIDE,AUTO
		3. BFS I/O RESET >>
NOT RECOV	FA	4. Aff FCS CH – OFF
		5. If 2 GPC/FA/FCS CHs ↓: Good FCS CHs – ORIDE
		6. G53 aff SURF FDBK – desel
		7. ✓MULT DATA PATH LOSS
		◇ 8. Go to FA/FF MDM PORT MODE ⇒

**BCE
MDP**

FA/FF MDM PORT MODE

NOTE: If BFS, 'BCE STRG X PASS', @GPC; else @MDM.
For '@GPC' port mode results in alternate MDM bypass

			1. G01 aff STRG – port mode
			2. BFS I/O RESET
@MDM	RECOV	FA	3. Aff FCS CH – AUTO
		FF	4. G53 aff SURF FDBK – resel >>
	NOT RECOV	FA	5. >>
		FF	6. BFS G51 aff SURF FDBK, RGA – desel
			7. BFS G51 aff AA – desel
			8. ✓MULT DATA PATH LOSS ⇒
@GPC	FA RECOV (FF Give Up)		9. Aff FCS CH – AUTO
			10. G51 aff IMU – desel
			11. G53 aff SURF FDBK – resel
			12. ✓MULT DATA PATH LOSS ⇒A
	FF RECOV (FA Give Up)		13. Aff FCS CH – OFF
			14. If 2 GPC/FA/FCS CHs ↓: Good FCS CHs – ORIDE
			15. G53 aff SURF FDBK – desel
			16. ✓MULT DATA PATH LOSS ⇒A

CDR WND

FB A13-3

AESP/ALL/A/GEN J,8

FAB USE ONLY

DPS
GPC
MDM

PILE		BCE STRG X (no 'MDM OUTPUT' msg)	
	IMU	1.	G51 IMU – desel
		2.	I/O RESET
RECOV	IMU	3.	>>
		4.	>>
NOT RECOV	NSP	5.	And no comm: PNL,CMD
		6.	BFS G51 Config per COMM COVERAGE: TDRS – ITEM 46 EXEC (*) STDN-HI – ITEM 47 EXEC (*) SGLS – ITEM 49 EXEC (*) >>
		◇ 7.	G01 aff STRG – port mode
		8.	BFS I/O RESET
		9.	If recov, go to RECOV steps >>
	B	10.	BFS G51 aff AA – desel
	D	11.	BFS G51 aff SURF FDBK,RGA – desel
	B/D	12.	✓MULT DATA PATH LOSS ⇒

DUAL DPS DISPLAY COMMANDERS/DK XMTR 1(2,3)

1. BFC CRT SEL – aff IDP

If reqd to clean up display:

2. Aff IDP/CRT PWR – OFF,ON

I/O ERROR CRT/DPS DISPLAY ANOMALY

If IDP 4(CRT 4): IDP/CRT 4 PWR – OFF >>

If NO big X/POLL FAIL:

1. MDU PWR – OFF,ON; if recovered >>

If MCC GO for power cycle:

2. IDP/CRT PWR – OFF,ON; if recovered >>

If big X/POLL FAIL:

3. IDP/CRT PWR – OFF,ON; if recovered >>

If PASS:

4. GPC/CRT – same GPC/aff IDP; if recovered >>

5. BFC CRT SEL – aff IDP: Go to step 11

If BFS via BFC CRT SEL sw:

6. BFC CRT SEL – unaff IDP; if both IDPs OK >>

7. – original position

8. In PASS: GPC/CRT 5/X EXEC for aff IDP: Go to step 11

If BFS via GPC/CRT key:

9. Deassign IDP 4 if assigned to PASS

10. Assign aff IDP to PASS; if recovered >>

11. If reqd: In PASS, deassign/assign IDPs to maintain PASS interface with three IDPs

CDR WND

FB A13-4

AESP/2,4/A/GEN J,12

FAB USE ONLY

HOOK

FLT INST DISPLAY ANOMALY

1. DATA BUS Select alternate FC BUS(s); if recovered >>
2. PORT SELECT aff MDU; if recovered >>
3. MDU PWR – OFF,ON

SUBSYS STATUS DISPLAY ANOMALY

1. PORT SELECT aff MDU; if recovered >>
2. MDU PWR – OFF,ON; if recovered >>

BFS INADVERTENT DISENGAGE/UNSUCCESSFUL ENGAGE (Lightning Strike)

1. CDR and PLT RHC ENGAGE pb – depress
If no response:
 2. BFS OUTPUT – NORM,B/U
 3. CDR,PLT RHC ENGAGE pb – depress

**CAB P
ECLS
FREON**

MULT DATA PATH LOSS (Non-Recov)

NOTE

If LRU data path loss due to GPC problem and not MDM,
BFS will pick up MDMs/LRU when engaged

FAILURE	TYPE	ACTIONS
GPC/FA any combo	I/O	D ✓BFS MM at each transition Expect 'SEP INH' (FDLN Fail) combos 2&3,2&4
		✓OMS MAN SHUTDOWN Post MECO: Before MECO + 25 sec: •• 1. MPS FDLN RLF ISOL (two) – OP 2. MPS PREVLVs (six) – OP RTLS/TAL: MPS LH2 FILL/DRAIN INBD, OUTBD – OP
GPC/FF 1&2	I/O or B	Use R BODY FLAP & TRIM ENA SWs
GPC/FF 3&4	I/O or B	Use L BODY FLAP & TRIM ENA SWs

PILE

CAB PRESS LEAK

1. CAB RELIEF A – CL (pause)
B – CL
2. ✓ Tabs/Visors – CL/LES O2 – ON
3. If RTLS/TAL: O2/N2 CNTLR VLV SYS 2 – OP
4. O2 TK1,TK2 HTRS A,B (four) – AUTO ⇒

CAB PRESS HIGH

1. If increasing: LES O2 – OFF, Visors – OP
If still incr:
 2. N2 SYS 1,2 REG INLET (two) – CL
 3. O2 SYS 1,2 SPLY (two) – CL ⇒A

**BCE
MDP**

PPO2 ABNORMAL⇒A

H2O LOOP PRESS HIGH

◇ Deact pump ⇒

H2O LOOP PRESS LOW ⇒

AV BAY FAN ΔP

- ◇ 1. Switch fans
2. If no joy: Aff TACAN – OFF ⇒A

AV BAY TEMP HIGH

- ◇ 1. Aff AV BAY FANS (two) – ON
2. If not decr: Switch H2O Loops
3. If no joy: Aff TACAN – OFF ⇒A

CABIN FAN FAIL ⇒

IMU FAN FAIL ⇒

CDR WND

FB (A)A13–6

AESP/2/A/GEN J,14

FAB USE ONLY

HOOK

FLT INST DISPLAY ANOMALY

1. DATA BUS Select alternate FC BUS(s); if recovered >>
2. PORT SELECT aff MDU; if recovered >>
3. MDU PWR – OFF,ON

SUBSYS STATUS DISPLAY ANOMALY

1. PORT SELECT aff MDU; if recovered >>
2. MDU PWR – OFF,ON; if recovered >>

BFS INADVERTENT DISENGAGE/UNSUCCESSFUL ENGAGE (Lightning Strike)

1. CDR and PLT RHC ENGAGE pb – depress
If no response:
 2. BFS OUTPUT – NORM,B/U
 3. CDR,PLT RHC ENGAGE pb – depress

**CAB P
ECLS
FREON**

MULT DATA PATH LOSS (Non-Recov)

NOTE

If LRU data path loss due to GPC problem and not MDM, BFS will pick up MDMs/LRU when engaged

FAILURE	TYPE	ACTIONS
GPC/FA any combo	I/O	D ✓BFS MM at each transition Expect 'SEP INH' (FDLN Fail) combos 2&3,2&4
		✓OMS MAN SHUTDOWN Post MECO: Before MECO + 25 sec: •• 1. MPS FDLN RLF ISOL (two) – OP 2. MPS PREVLVs (six) – OP RTLS/TAL: MPS LH2 FILL/DRAIN INBD, OUTBD – OP
GPC/FF 1&2	I/O or B	Use R BODY FLAP & TRIM ENA SWs
GPC/FF 3&4	I/O or B	Use L BODY FLAP & TRIM ENA SWs

PILE

CAB PRESS LEAK

1. CAB RELIEF A – CL (pause)
B – CL
2. ✓ Tabs/Visors – CL/LES O2 – ON
3. If RTLS/TAL: O2/N2 CNTLR VLV SYS 2 – OP
4. O2 TK1,TK2 HTRS A,B (four) – AUTO ⇒

CAB PRESS HIGH

1. If increasing: LES O2 – OFF, Visors – OP
If still incr:
 2. N2 SYS 1,2 REG INLET (two) – CL
 3. O2 SYS 1,2 SPLY (two) – CL ⇒A

**BCE
MDP**

PPO2 ABNORMAL⇒A

H2O LOOP PRESS HIGH

◇ Deact pump ⇒

H2O LOOP PRESS LOW ⇒

AV BAY FAN ΔP

◇ Deact fan ⇒

AV BAY TEMP HIGH ⇒

CABIN FAN FAIL ⇒

IMU FAN FAIL ⇒

CDR WND

FB (B)A13-6

AESP/4/A/GEN J,14

FAB USE ONLY

HOOK

FREON FLOW LOW

- ◇ 1. Switch pumps

If flow still low:

- 2. Aff RAD BYP VLV MAN SEL – RAD FLOW
(hold 5 sec)

If flow still low:

- 3. Perform LOSS OF FREON LOOP(s), then ⇒A

LOSS OF 1 FREON LOOP

- 1. Bad LOOP FREON PUMP – OFF

If FREON LOOP 1(2) lost:

- 2. O2 SYS 1(2) SPLY (one) – CL

In good loop:

- 3. ✓FLOW PROP VLV LOOP 1(2) – ICH

- 4. Monitor EVAP OUT TEMP

If TAL/AOA/RTLs:

If LOOP 2 lost:

- 5. NH3 CNTLR B – OFF
A – PRI/GPC

LOSS OF 2 FREON LOOPS – PWRDN

- 1. When loops fail (flow <700), CDR execute LOOPS
FAILED

- 2. MSTR MADS PWR – OFF
- 3. Use one IDP/CRT with two MDUs (three max)
- 4. All PL PWR (seven) – OFF
- 5. O2,H2 TK HTRS (all) – OFF
- 6. MCC CMD FC purge, then BFS GPC – STBY,HALT
PWR – OFF
OUTPUT – NORM

EVAP
ESS

- 7. If no comm: Sel best S-BD PM ANT

Post MECO:

If RTLs:

- 8. TACAN 1,2 – OFF
- 9. RADAR ALT 1 – OFF ⇒G

If TAL:

- 10. All TACAN/RA – OFF
- 11. Use one FLT CNTLR PWR ⇒G

LOSS OF 2 FREON LOOPS – LOOPS FAILED

- 1. LES O2 – OFF, Visor – OP
- 2. O2 SYS SPLY (two) – OP

Panel L1: All switches off, except:

- 3. H2O PUMP LOOP 2 – ON
- 4. Perform PWRDN if not already accomplished

CDR WND

FB A13-7

AESP/2,4/A/GEN J,11

FAB USE ONLY

PILE

EVAP OUT TEMP HIGH

If temp high in only one loop, snsr failed >>

1. FES PRI A – OFF
 B – ON (wait 30 sec)
 If T decr >>
2. FES PRI B – OFF
 SEC – ON (HI LOAD ena) (wait 30 sec)
 If T decr >>
3. HI LOAD EVAP – OFF (wait 30 sec)
 If T decr (HI LOAD EVAP only lost) ⇒A
4. RAD BYP VLV (four) – MAN,RAD FLOW
 (total FES lost) ⇒

EVAP OUT TEMP LOW

1. If low in only one loop (snsr failed) >>
 2. FREON PUMP LOOP 1,2 (two) – OFF
 3. H2O PUMP LOOP 1 (two) – ON,B
- If no PL H2O Loop present:
4. FLOW PROP VLV LOOP 1,2 (two) – PL HX(tb-PL)
- If PL H2O Loop present:
5. Activate PL H2O Loop
 6. O2 SYS 1,2 SPLY VLV (two) – CL
 7. FLASH EVAP CNTLR PRI A, PRI B, SEC (three) – OFF
 - ◇ 8. FREON PUMP LOOP 1,2 (two) – B
 - ◇ 9. NH3 CNTLR A,B (two) – SEC/ON
- If FREON LOOP 1(2) running:
10. O2 SYS 1(2) SPLY VLV – OP
- When EVAP OUT T > 55 for at least 2 min (NH3 depleted):
- If any FREON LOOP off:
11. FREON PUMP LOOP 1(2) – B
 12. O2 SYS 1(2) SPLY VLV – OP
 13. Wait 3 min
 14. FLASH EVAP CNTLR PRI B(SEC) – GPC

CAB P
ECLS
FREON

FREON QTY LOW

- ◇ 1. FREON ISOL MODE – MAN
2. (Aff) FREON ISOL LOOP 1(2) – ISOL
 Hold for 5 sec ⇒A

CDR WND

FB A13-8

AESP/ALL/A/GEN J,12

FAB USE ONLY

HOOK

ESS BUS LOSS

ESS 1BC	1. L AUD CNTL – R (CDR can't talk) 2. Pri C/W & Matrix lost
ESS 2CA	1. AUD CTR – 2 2. R AUD CNTL – L (PLT can't talk)
ESS 3AB	1. Do not ENGAGE BFS 2. CSM lost ⇒

LOSS OF 2nd FC PWRDN

1. LES O2 – OFF, Visors – OP
2. L1: Select one FREON PUMP on good FC/MN BUS and place other pump to OFF
Switch OFF all HUM SEPS, IMU FANS, H2O PUMPS, AV BAY FANS, CAB FANS, FES HTRS
3. Switch off all but one IDP/CRT with four MDUs
After BUS TIE, if MNC unpowered:
4. FES CNTLR PRI A – OFF
B – ON
5. ⇒ LOSS OF 2nd FC PWRDN

**MN
AC
CNTL**

FWD

CDR WND

FB A13-9

AESP/4/A/GEN J

FAB USE ONLY

TOP
BACK OF 'ESS BUS LOSS'

PILE

MNA or AC1 Multi Φ

Post SRB SEP:

- ◇ 1. FREON PUMP LOOP 2 – A
- 2. TOP EVAP HTR DUCT – B
- 3. HI LOAD DUCT HTR – B
- 4. **BFS G51** AA1 – desel ⇒

FAILED: UHF HI PWR XMIT

MNB or AC2 Multi Φ

Post SRB SEP:

- ◇ 1. AV BAY 1 FAN A – ON, B – OFF
- ◇ 2. FREON PUMP LOOP 1 – A
- 3. **BFS G51** AA2, RGA 2 – desel ⇒

FAILED: S-BD PM 1 (NO PNL, CMD)

MNC

Post SRB SEP:

- 1. FES CNTLR PRI A – OFF, B – ON
- 2. **BFS G51** RGA 3 – desel ⇒

AC3 Multi Φ ⇒

ANY AC2 SINGLE Φ ⇒

CNTL BUS LOSS

AB1	1. TOP EVAP HTR DUCT – B 2. HI LOAD DUCT HTR – B ⇒
AB2	1. TOP EVAP HTR DUCT – B 2. HI LOAD DUCT HTR – B ⇒
AB3	1. TOP EVAP HTR DUCT – B 2. HI LOAD DUCT HTR – B If BFS ENGAGE reqd: 3. Use PLT's RHC, then GPCs 1,2,4 – STBY, HALT 4. BFS I/O RESET 5. ⇒
BC1	1. BFS G51 RGA 2 – desel ⇒
BC2	⇒
BC3	⇒
CA1	1. No BFS ENGAGE Post SRB SEP: 2. FES PRI A – ON 3. BFS G51 RGA 3 – desel ⇒
CA2	⇒

EVAP
ESS

CDR WND

FB A13-10

AESP/4/A/GEN J,2

FAB USE ONLY

HOOK

FWD RCS LK

(✓He P decr: CRT & meter)

(✓TK P; if '↑': Go to TK P HIGH)

RTLS	1. Perform RCS SECURE, then: 2. Post PPD – reopen RCS Post ET SEP –Z transl: 3. Go to RCS SECURE >>
Pre ET SEP (N/A RTLS)	4. ET SEP – MAN 5. MPS PRPLT DUMP SEQ – STOP 6. Perform RCS SECURE, then:
Single MANF leak	7. Reopen RCS, except bad MANF 8. ET SEP – AUTO Post ET SEP –Z transl: 9. MPS PRPLT DUMP SEQ – GPC >>
TK leg leak (two MANF P Low)	10. Reopen RCS, except bad leg 11. ET SEP – AUTO Post ET SEP –Z transl: 12. MPS PRPLT DUMP SEQ – GPC >>
PRPLT TK P decr	
Post MECO	13. RATE DAMP with ARCS 14. Reopen FRCS
TK P > 200 & QTY > 0%	15. ET SEP – AUTO
TK P < 200 or QTY = 0%	16. Perform RCS SECURE, then: 17. DAP – INRTL, PITCH – PULSE 18. ET SEP pb – SEP 19. THC –Z (2 sec; –1.25°/sec) 20. THC –X and hold
At SEP (SEP init + approx 12 sec)	21. THC +Z (3 sec; +0.3°/sec) THC –Z (2 sec; –0.9°/sec) COAST (5 sec) THC +X (20 sec) After 10 sec of +X, then: PITCH – DISC RATE
	22. OPS 104 PRO, DAP – AUTO
Otherwise: (He TK or He leg)	Post MECO – reopen RCS 23. ET SEP – AUTO
Post ET SEP –Z transl	24. MPS PRPLT DUMP SEQ – GPC 25. Go to RCS SECURE

CDR WND

FB A13–11

AESP/ALL/A/GEN J

FAB USE ONLY

TOP
BACK OF 'FWD RCS LK'

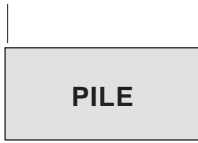

This Page Intentionally Blank

MN
AC
CNTL
FWD



CDR WND

FB A13-12

AESP/ALL/A/GEN J



FAB USE ONLY



GLIDED
FLIGHT

CDR WINDOW FLIP BOOK
GLIDED FLIGHT

CDR WINDOW
FLIP BOOK



CDR WND

FB E13-i

AESP/ALL/E/GEN J



FAB USE ONLY

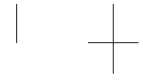

GLIDED
FLIGHT

This Page Intentionally Blank

CDR WINDOW
FLIP BOOK



CDR WND

FB E13-ii

AESP/ALL/E/GEN J

FAB USE ONLY

HOOK

GNC

COMM LOST (MULTI PANELS)

1. AUD CTR - 2

No comm (✓UHF sites):

2. S-BD PM CNTL - PNL, CMD (pnl C3)

3. Config per COMM COVERAGE BFS G51:

TDRS - ITEM 46 EXEC (*)

STDN-HI - ITEM 47 EXEC (*)

SGLS - ITEM 49 EXEC (*)

If * not next to selected config:

4. Config pnl A1 per Comm Coverage

(ASC/ENT PKT, COMM)

S-BD PM CNTL - PNL, CMD (pnl C3)

No comm:

5. Select best S-BD PM ANT

No comm:

6. S-BD PM ANT - GPC

ICOM LOST

1. AUD CNTL - sel ALT

No ICOM:

2. AUD CTR - 2

CDR WND

FB E13-1

AESP/ALL/E/GEN J,8

FAB USE ONLY

TOP
BACK OF 'COMM LOST (MULTI PANELS)'

PILE

- COMM FCS CH 1(2,3,4) (2nd FAIL)** G53
 If 2 FCS CH ↓ on any actuator:
 ◇ 1. Remaining FCS CH (two) – ORIDE
- RHC L(R) (2nd FAIL)** GNC SYS SUMM 1
 Aff FLT CNTLR PWR – OFF
- G51 ROLL MODE SW** G51
 If ROLL MODE ≠ SW POS:
 1. AUTO SEL – ITEM 42 EXEC
- DISPLAY SW L(R)**
 L(R) Disp sws (eight) – green dot
- RM FAIL IMU,RGA,AA** BFS G51
 Aff LRU – desel
- RM DLMA IMU** G51 BFS G51
 1. ✓MCC, bad IMU – desel (PASS & BFS) >>
 ◇ 2. Desel lower # IMU with '?' (PASS)
- RM FAIL ADTA** G51
 ◇ 1. ✓BFS GNC SYS SUMM 1
 2. If '↓' for aff ADTA >>
 3. If accessible, bad ADTA cb – op >>
 4. BFS, ADTA to G&C – INH

RM DLMA ADTA * G51

M < 2.0	1. Fly Theta limits
ADTA data agrees	2. Desel, resel one ADTA 3. If no '?' >>
Bad probe	4. Stow bad probe >>
Bad ADTA	ADTA cb accessible ◇5. Bad ADTA cb – op >>
	ADTA cb not accessible ◇6. DES bad ADTA 7. ✓BFS GNC SYS SUMM 1 8. If '↓' for aff ADTA >> 9. BFS, ADTA to G&C – INH
Dilemma not resolved	10. ADTA to G&C – INH (PASS & BFS)

*If 3 ADTAs failed:
 ADTA to G&C – INH (PASS)
 Fly Theta limits

CDR WND

FB E13-2

AESP/ALL/E/GEN J,8

FAB USE ONLY

HOOK

RM FAIL TAC [G50]

(RM LIMITS: 6 DEG, 0.5 NM)

1. If data good: desel, resel aff TACAN >>
2. If failure verified: desel failed TACAN in BFS

RM DLMA TAC [G50]

Do not desel or resel while in 'TEST'

1. If both data good: desel, resel one TACAN in DLMA >>
2. ✓TACAN MODE (three) – GPC
3. If 'RM FAIL TAC': desel failed TACAN in BFS >>
4. If continuous 'TEST': TACAN MODE (three) – T/R
If bad TACAN identified:
 5. Desel bad TACAN (PASS, ✓BFS)

DPS
GPC
MDM

CDR WND

FB E13-3

AESP/ALL/E/GEN J,4

FAB USE ONLY

PILE

- PASS GPC FAIL**
- GNC ⇒
1. GPC MODE – STBY, HALT
 2. Aff FCS CH – OFF
 3. If two GPC/FA/FCS CHs ↓: Good FCS CHs – ORIDE
 4. **G53** aff SURF FDBK – desel
 5. If STRG 1(2): CDR(PLT) sws – green dot
 6. ✓MULT DATA PATH LOSS

- BFS GPC FAIL**
- ⇒
1. GPC MODE – STBY, HALT, pause
– STBY, RUN
 2. If recovered: PRO to OPS 304
BFS **G50** ✓BFS R/W sel >>
✓GPC OUTPUT – B/U >>
 3. If SM only: GPC MODE – STBY, then step 5
 4. GPC MODE – HALT
 - ◇ 5. OUTPUT – TERM
 6. If no comm: Sel best S-BD PM ANT
 7. MPS He ISOL B (three) – CL
PNEU He ISOL – CL
 8. If AOA/GRTL/TAL < 120K:
NH3 CNTLR B – SEC/ON

FA/FF MDM I/O ERROR
(Annunciated by entire set)

		1. I/O RESET
RECOV	FA	2. If reqd, aff FCS CH – ORIDE, AUTO
	FF 1,2,3	◇ If H > 200K or TACAN incorp: 3. G50 NAV DELTA zero 4. G51 IMU – resel
		5. BFS I/O RESET >>
NOT RECOV	FA	6. Aff FCS CH – OFF 7. If 2 GPC/FA/FCS CHs ↓: Good FCS CHs – ORIDE 8. G53 aff SURF FDBK – desel
		9. ✓MULT DATA PATH LOSS ⇒ ◇ 10. Go to FA/FF MDM PORT MODE

CDR WND

FB E13-4

AESP/ALL/E/GEN J,9

FAB USE ONLY

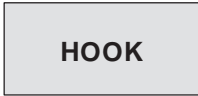

FA/FF MDM PORT MODE

NOTE: If BFS, 'BCE STRG X PASS', @GPC; else @MDM.
 For '@GPC', port mode results in alternate MDM bypass

			<ol style="list-style-type: none"> 1. <input type="checkbox"/> G01 aff STRG – port mode 2. <input type="checkbox"/> BFS I/O RESET
@MDM	RECOV	FA	<ol style="list-style-type: none"> 3. <input type="checkbox"/> Aff FCS CH – AUTO 4. <input type="checkbox"/> G53 aff SURF FDBK – resel >>
		FF 1,2,3	◇ If H > 200K or TACAN incorp: <ol style="list-style-type: none"> 5. <input type="checkbox"/> G50 NAV DELTA zero 6. <input type="checkbox"/> G51 IMU – resel >>
	NOT RECOV		⇒ If MCC GO for power cycle: <ol style="list-style-type: none"> 7. <input type="checkbox"/> Aff FA/FF MDM – OFF,ON 8. <input type="checkbox"/> I/O RESET 9. <input type="checkbox"/> If recov, go to @MDM RECOV >> 10. <input type="checkbox"/> Aff MDM – OFF
		FA	<ol style="list-style-type: none"> 11. <input type="checkbox"/> BFS G51 aff SURF FDBK, RGA – desel 12. <input checked="" type="checkbox"/> GNC SYS SUMM 1
		FF	<ol style="list-style-type: none"> 13. <input type="checkbox"/> BFS G51 aff AA – desel 14. <input type="checkbox"/> FF 1(2): CDR(PLT) – green dot
			15. <input checked="" type="checkbox"/> MULT DATA PATH LOSS >>
@GPC	FA RECOV (FF Give Up)		<ol style="list-style-type: none"> 16. <input type="checkbox"/> Aff FCS CH – AUTO 17. <input type="checkbox"/> G53 aff SURF FDBK – resel 18. <input type="checkbox"/> FF 1(2): CDR(PLT) – green dot 19. <input checked="" type="checkbox"/> MULT DATA PATH LOSS >>
			<ol style="list-style-type: none"> 20. <input type="checkbox"/> Aff FCS CH – OFF 21. <input type="checkbox"/> If 2 GPC/FA/FCS CHs ↓: Good FCS CHs – ORIDE 22. <input type="checkbox"/> G53 aff SURF FDBK – desel
		FF 1,2,3	◇ If H > 200K or TACAN incorp: <ol style="list-style-type: none"> 23. <input type="checkbox"/> G50 NAV DELTA zero 24. <input type="checkbox"/> G51 IMU – resel
			25. <input checked="" type="checkbox"/> MULT DATA PATH LOSS >>

DPS
BCE

OI-28

CDR WND FB (A)E13-5 AESP/ALL/E/GEN J,12

FAB USE ONLY

PILE

FF(FA) MDM OUTPUT **FAULT**

- ◇ (Take action only if annun by entire set)
- If single 'MDM OUTPUT':
 - 1. If 'FF MDM OUTPUT':
 - G51 aff IMU – desel
 - 2. Go to FA/FF MDM I/O ERROR >>
- If both FF & FA annun:
 - 3. G51 aff IMU – desel
 - 4. I/O RESET; if reqd, BFS I/O RESET
 - 5. If msgs repeat: Go to PASS GPC FAIL >>
 - 6. If reqd, aff FCS CH – ORIDE,AUTO
- ◇ 7. If H > 200K or TACAN incorp:
 - G50 NAV DELTA zero
 - G51 IMU – resel

DPS
GPC
MDM

PL MDM I/O ERROR

- 1. BFS I/O RESET
- If recovered >>
- 2. G01 PL 1/2 – port mode, then BFS I/O RESET
- If recovered >>
- 3. Pre MM305: FES PRI B(A) – ON
- 4. If PL2 ↓ & no comm: Sel best S–BD PM ANT
- ⇒ 5. If PL2 ↓ & AOA/GRTLS/TAL < 120K:
NH3 CNTLR B – SEC/ON

PCM I/O ERROR

OI PCMMU PWR – 2(1)

POST BFS ENGAGE

CAUTION

Do not assign more than 3 IDPs at a time

If PASS GPCs running:

- 1. Aff GPC MODE – STBY/HALT
- 2. BFS I/O RESET
- 3. ✓FCS CHs, IMU config
- ⇒ If Air Data not analyzed:
 - 4. G50 INH AD to G&C
 - 5. M=5: Deploy,evaluate probes one at a time
 - 6. ✓AD to G&C by M = 1.5

OI-28

If failed ADTA(s) in PASS:

- 7. ADTA cb(s) – op or stow probe
- 8. G51 DES failed (commfaulted) RGA,AA,SURF
- 9. G50 DES failed TAC
- 10. GPC/CRT 04 EXEC, as reqd
- At M ≤ 2.7: 11. CDR TRIM PANEL – OFF
RHC/PNL – ENA
- At H = 3K: 12. SPDBK – MAN (✓DEL PAD setting)
- At MAIN GEAR TD: 13. SPDBK – 100%

CDR WND

FB (A)E13–6

AESP/2,4/E/GEN J,12

HOOK

FA/FF MDM PORT MODE

NOTE: If BFS, 'BCE STRG X PASS', @GPC; else @MDM.
For '@GPC', port mode results in alternate MDM bypass

			<ol style="list-style-type: none"> 1. G01 aff STRG – port mode 2. BFS I/O RESET
@MDM	RECOV	FA	<ol style="list-style-type: none"> 3. Aff FCS CH – AUTO 4. G53 aff SURF FDBK – resel >>
		FF 1,2,3	<p>◇ If H > 200K or TACAN incorp:</p> <ol style="list-style-type: none"> 5. G50 NAV DELTA zero 6. G51 IMU – resel >>
	NOT RECOV		<p>⇒ If MCC GO for power cycle:</p> <ol style="list-style-type: none"> 7. Aff FA/FF MDM – OFF,ON 8. I/O RESET 9. If recov, go to @MDM RECOV >> 10. Aff MDM – OFF
		FA	<ol style="list-style-type: none"> 11. BFS G51 aff SURF FDBK, RGA – desel 12. GNC SYS SUMM 1
		FF	<ol style="list-style-type: none"> 13. BFS G51 aff AA – desel 14. FF 1(2): CDR(PLT) – green dot
			15. MULT DATA PATH LOSS >>
@GPC	FA RECOV (FF Give Up)		<ol style="list-style-type: none"> 16. Aff FCS CH – AUTO 17. G53 aff SURF FDBK – resel 18. FF 1(2): CDR(PLT) – green dot 19. MULT DATA PATH LOSS >>
	FF RECOV (FA Give Up)		<ol style="list-style-type: none"> 20. Aff FCS CH – OFF 21. If 2 GPC/FA/FCS CHs ↓: Good FCS CHs – ORIDE 22. G53 aff SURF FDBK – desel
		FF 1,2,3	<p>◇ If H > 200K or TACAN incorp:</p> <ol style="list-style-type: none"> 23. G50 NAV DELTA zero 24. G51 IMU – resel
			25. MULT DATA PATH LOSS >>

DPS
BCE

OI-29

CDR WND FB (B)E13-5 AESP/ALL/E/GEN J,12

FAB USE ONLY

PILE

FF(FA) MDM OUTPUT **FAULT**

- ◇ (Take action only if annun by entire set)
- If single 'MDM OUTPUT':
 1. If 'FF MDM OUTPUT':
 - G51 aff IMU – desel
 2. Go to FA/FF MDM I/O ERROR >>
- If both FF & FA annun:
 3. G51 aff IMU – desel
 4. I/O RESET; if reqd, BFS I/O RESET
 5. If msgs repeat: Go to PASS GPC FAIL >>
 6. If reqd, aff FCS CH – ORIDE,AUTO
- ◇ 7. If H > 200K or TACAN incorp:
 - G50 NAV DELTA zero
 - G51 IMU – resel

DPS
GPC
MDM

PL MDM I/O ERROR

1. BFS I/O RESET
- If recovered >>
2. G01 PL 1/2 – port mode, then BFS I/O RESET
- If recovered >>
3. Pre MM305: FES PRI B(A) – ON
 4. If PL2 ↓ & no comm: Sel best S–BD PM ANT
- ⇒ 5. If PL2 ↓ & AOA/GRTLs/TAL < 120K:
NH3 CNTLR B – SEC/ON

PCM I/O ERROR

OI PCMMU PWR – 2(1)

POST BFS ENGAGE

If PASS GPCs running:

1. Aff GPC MODE – STBY/HALT
 2. BFS I/O RESET
 3. ✓FCS CHs, IMU config
- ⇒ If Air Data not analyzed:
4. G50 INH AD to G&C
 5. M=5: Deploy, evaluate probes one at a time
 6. ✓AD to G&C by M = 1.5

If failed ADTA(s) in PASS:

7. ADTA cb(s) – op or stow probe
8. G51 DES failed (commfaulted) RGA, AA, SURF
9. G50 DES failed TAC

At M ≤ 2.7:

10. CDR TRIM PANEL – OFF
RHC/PNL – ENA

At H = 3K:

11. SPDBK – MAN (✓DEL PAD setting)

At MAIN GEAR TD:

12. SPDBK – 100%

01-29

CDR WND

FB (B)E13-6

AESP/2,4/E/GEN J,12

FAB USE ONLY

HOOK

BCE STRG X (no 'MDM OUTPUT' msg)

	IMU	1.	G21 ✓IMU OPER, if STBY >>
		2.	I/O RESET
RECOV	IMU	◇ If H > 200K or TACAN incorp:	
		3.	G21 ✓att ANG, if delta > 1° >>
		4.	G50 NAV DELTA zero
		5.	G51 IMU - resel >>
		6.	>>
NOT RECOV	NSP	7.	And no comm: PNL, CMD
		8.	BFS G51 Config per COMM COVERAGE: TDRS - ITEM 46 EXEC (*) STDN-HI - ITEM 47 EXEC (*) SGLS - ITEM 49 EXEC (*) >>
		9.	G01 aff STRG - port mode
		10.	BFS I/O RESET
		11.	If recov, go to RECOV steps >>
	A(B,C,D, IMU)	⇒	12. FF A(B,IMU) or FA C(D) MDM - OFF, ON
			13. I/O RESET
			14. If FA, aff FCS CH - ORIDE, AUTO
			15. If recov, go to RECOV steps
	C(D)		16. If < 3Y, 2P jets/pod/dir: a. G23 aff jet DES INH (*) (Reprioritize) b. Aff MANF VLVs STAT OP - OVRD
	1A(2A)		17. CDR(PLT) sws - green dot
	B		18. BFS G51 aff AA - desel
	D		19. BFS G51 aff SURF FDBK, RGA - desel
			20. ✓MULT DATA PATH LOSS >>

**DPS/
MDP
CAB P
ECLS**

**DUAL DPS DISPLAY COMMANDERS/
DK XMTR 1(2,3)**

1. BFC CRT SEL - aff IDP

If reqd to clean up display:

2. Aff IDP/CRT PWR - OFF, ON

CDR WND

FB E13-7

AESP/2,4/E/GEN J,12

FAB USE ONLY

PILE

I/O ERROR CRT/DPS DISPLAY ANOMALY

If IDP 4(CRT 4): IDP/CRT 4 PWR – OFF >>

If NO big X/POLL FAIL:

1. MDU PWR – OFF,ON; if recovered >>

If MCC GO for power cycle:

2. IDP/CRT PWR – OFF,ON; if recovered >>

If big X/POLL FAIL:

3. IDP/CRT PWR – OFF,ON; if recovered >>

If PASS:

4. GPC/CRT – same GPC/aff IDP; if recovered >>

5. BFC CRT SEL – aff IDP: Go to step 9

If BFS:

6. BFC CRT SEL – unaff IDP; if both IDPs OK >>

7. – original position

8. In PASS: GPC/CRT 5/X EXEC for aff IDP

9. If reqd: In PASS, deassign aff IDP, assign IDP 4 to PASS

FLT INST DISPLAY ANOMALY

1. DATA BUS Select alternate FC BUS(s); if recovered >>

2. PORT SELECT aff MDU; if recovered >>

3. MDU PWR – OFF,ON

SUBSYS STATUS DISPLAY ANOMALY

1. PORT SELECT aff MDU; if recovered >>

2. MDU PWR – OFF,ON; if recovered >>

BFS INADVERTENT DISENGAGE/UNSUCCESSFUL

ENGAGE (Lightning Strike)

1. CDR and PLT RHC ENGAGE pb – depress

If no response:

2. BFS OUTPUT – NORM,B/U

3. CDR,PLT RHC ENGAGE pb – depress

MULT DATA PATH LOSS (Non-Recov)

NOTE

If LRU data path loss due to GPC problem and not MDM,
BFS will pick up MDMs/LRU when engaged

FAILURE	TYPE	ACTIONS
GPC/FF 1&2	I/O or B	Use R BODY FLAP & TRIM ENA sws
GPC/FF 3&4	I/O or B	Use L BODY FLAP & TRIM ENA sws
GPC/FA any combo	I/O or D	No impact

CDR WND

FB E13-8

AESP/2,4/E/GEN J,12

DPS
BCE

FAB USE ONLY

HOOK

CAB PRESS LEAK

1. CAB RELIEF A – CL, pause
B – CL
 2. ✓ Tabs/Visors – CL/LES O2 – ON
 3. If RTLS/TAL: O2/N2 CNTLR VLV SYS 2 – OP
 4. O2 TK1, TK2 HTRS A, B (four) – AUTO
 - ⇒ 5. O2 TK3 HTRS A, B (two) – AUTO
- If possible:
6. Remove Inner A/L Hatch Caps (two)
 7. Equal vlv (two) – EMER
 8. If V > 15K: MLS (three) – OFF;
TACAN (three) – OFF
At V = 10K: TACAN 2,3 (two) – GPC
At M = 2.7:
If reqd: Use two MLS, GNC I/O RESET
- When CAB PRESS < 10 psia, if dP/dT EQ < 0.67:
9. ✓ O2/N2 CNTLR VLV SYS 2 – OP >>
- When CAB PRESS < 6.5 psia:
10. ✓ O2/N2 CNTLR VLV SYS 2 – OP
 11. CAB FAN (two) – ON

CAB PRESS HIGH

1. If increasing: LES O2 – OFF, Visors – OP
- If still incr:
2. N2 SYS 1,2 REG INLET (two) – CL
 3. O2 SYS 1,2 SPLY (two) – CL

H2O LOOP PRESS LOW(HIGH)

⇒ Switch Loops

AV BAY FAN ΔP

1. Switch fans
2. If no joy: Go to LOSS OF AV BAY COOLING PWRDN

AV BAY TEMP HIGH

1. Aff AV BAY FAN (two) – ON
2. If not decr: Switch H2O Loops
3. If no joy: Go to LOSS OF AV BAY COOLING PWRDN

LOSS OF AV BAY COOLING PWRDN

Bay 1: TACAN 1, MLS 1 – OFF
 Bay 2: 2, MLS 2,3 – OFF
 Bay 3: 3 – OFF

FREON
EVAP**CABIN FAN FAIL**

- ⇒ 1. Switch fans
- If both fans lost:
2. Minimize use of IDPs/MDUs/FLT CNTLR PWR

IMU FAN FAIL

⇒ Switch Fans

CDR WND

FB (A)E13–9

AESP/2/E/GEN J,14

TOP
BACK OF 'CAB PRESS LEAK'

PILE

FREON FLOW LOW

1. Switch pumps
If flow still low:
 2. Aff RAD BYP VLV MODE – AUTO
CNTLR LOOP – AUTO A(B)(wait 90 sec)

If flow still low:

3. Go to LOSS OF FREON LOOP(s)

LOSS OF 1 FREON LOOP

1. Bad LOOP FREON PUMP – OFF
If FREON LOOP 1(2) lost:
 2. O2 SYS 1(2) SPLY (one) – CL
- In good loop:
 3. ✓FLOW PROP VLV LOOP 1(2) – ICH
4. Monitor EVAP OUT TEMP
If TAL/AOA/RTL: If LOOP 2 lost:
 5. NH3 CNTLR B – OFF, A – PRI/GPC

LOSS OF 2 FREON LOOPS – PWRDN

1. When loops fail (flow <700), CDR execute LOOPS
FAILED
2. MSTR MADS PWR – OFF
3. Use one IDP/CRT with two MDUs (three max)
4. All PL PWR (seven) – OFF
5. O2,H2 TK HTRS (all) – OFF
6. MCC CMD FC purge, then BFS GPC – STBY,HALT
PWR – OFF
OUTPUT – NORM
7. If no comm: Sel best S–BD PM ANT
- If RTL:
 8. TACAN 1,2 – OFF
 9. RADAR ALT 1 – OFF
- If TAL/AOA/ENTRY and V > 15K:
 10. All TACAN/RA/MLS – OFF
 11. Use one FLT CNTLR PWR

⇒

12. DC UTIL PWR – OFF
- ◇ 13. FCS CH 4 – OFF
14. GPC 4 – STBY,HALT,PWR – OFF
15. FF4,FA4 – OFF
16. ANNUN BUS SEL ACA 2/3 – OFF
- ◇ When MPS dump complete:
 17. MPS ENG PWR (six) – OFF
 18. EIU (three) – OFF
 19. MEC 1 – OFF, wait 2 sec, then:
 20. MEC 2 – OFF
21. At V = 10K: ✓TACAN 3 – GPC
22. At M = 2.9: ✓RA2 – ON
23. If reqd: Use one MLS,
GNC I/O RESET

**DPS/
MDP**

**CAB P
ECLS**

CDR WND

FB (A)E13–10

AESP/2/E/GEN J,14

FAB USE ONLY

HOOK

CAB PRESS LEAK

1. CAB RELIEF A – CL, pause
B – CL
 2. ✓ Tabs/Visors – CL/LES O2 – ON
 3. If RTLS/TAL: O2/N2 CNTLR VLV SYS 2 – OP
 4. O2 TK1, TK2 HTRS A, B (four) – AUTO
 - ⇒ 5. O2 TK3 HTRS A, B (two) – AUTO
- If possible:
6. Remove Inner A/L Hatch Caps (two)
 7. Equal vlv (two) – EMER
 8. If V > 15K: MLS (three) – OFF;
TACAN (three) – OFF
At V = 10K: TACAN 2,3 (two) – GPC
At M = 2.7:
If reqd: Use two MLS, GNC I/O RESET
- When CAB PRESS < 10 psia, if dP/dT EQ < 0.67:
9. ✓ O2/N2 CNTLR VLV SYS 2 – OP >>
- When CAB PRESS < 6.5 psia:
10. ✓ O2/N2 CNTLR VLV SYS 2 – OP
 11. CAB FAN (two) – ON

CAB PRESS HIGH

1. If increasing: LES O2 – OFF, Visors – OP
- If still incr:
2. N2 SYS 1,2 REG INLET (two) – CL
 3. O2 SYS 1,2 SPLY (two) – CL

H2O LOOP PRESS LOW(HIGH)

⇒ Switch Loops

AV BAY FAN ΔP

- ⇒ 1. If AV Bay 1 aff: FAN A – ON; FAN B – OFF
If AV Bay 2 aff: FAN B – ON; FAN A – OFF
If AV Bay 3 aff: FAN A – ON; FAN B – OFF
2. If no joy: Go to LOSS OF AV BAY COOLING PWRDN

AV BAY TEMP HIGH

- ⇒ 1. Aff AV BAY FAN (two) – ON
2. If not decr: Switch H2O Loops
3. If no joy: Go to LOSS OF AV BAY COOLING PWRDN

LOSS OF AV BAY COOLING PWRDN

Bay 1: MLS 1 – OFF
 Bay 2: MLS 2,3 – OFF
 Bay 3: N/A

FREON
EVAP**CABIN FAN FAIL**

- ⇒ 1. Switch fans
- If both fans lost:
2. Minimize use of IDPs/MDUs/FLT CNTLR PWR

IMU FAN FAIL

⇒ Switch Fans

CDR WND

FB (B)E13–9

AESP/4/E/GEN J,14

FAB USE ONLY

TOP
BACK OF 'CAB PRESS LEAK'

PILE

FREON FLOW LOW

1. Switch pumps

If flow still low:

2. Aff RAD BYP VLV MODE – AUTO
CNTLR LOOP – AUTO A(B) (wait 90 sec)

If flow still low:

3. Go to LOSS OF FREON LOOP(s)

LOSS OF 1 FREON LOOP

1. Bad LOOP FREON PUMP – OFF

If FREON LOOP 1(2) lost:

2. O2 SYS 1(2) SPLY (one) – CL

In good loop:

3. ✓FLOW PROP VLV LOOP 1(2) – ICH

4. Monitor EVAP OUT TEMP

If TAL/AOA/RTLS: If LOOP 2 lost:

5. NH3 CNTLR B – OFF, A – PRI/GPC

LOSS OF 2 FREON LOOPS – PWRDN

1. When loops fail (flow <700), CDR execute LOOPS
FAILED

2. MSTR MADS PWR – OFF

3. Use one IDP/CRT with two MDUs (three max)

4. All PL PWR (seven) – OFF

5. O2,H2 TK HTRS (all) – OFF

6. MCC CMD FC purge, then BFS GPC – STBY,HALT
PWR – OFF
OUTPUT – NORM

7. If no comm: Sel best S-BD PM ANT

If RTLS: 8. TACAN 1,2 – OFF

9. RADAR ALT 1 – OFF

If TAL/AOA/ENTRY and V > 15K:

10. All TACAN/RA/MLS – OFF

11. Use one FLT CNTLR PWR

⇒ 12. DC UTIL PWR – OFF

◇ 13. FCS CH 4 – OFF

14. GPC 4 – STBY,HALT,PWR – OFF

15. FF4,FA4 – OFF

16. ANNUN BUS SEL ACA 2/3 – OFF

◇ When MPS dump complete:

17. MPS ENG PWR (six) – OFF

18. EIU (three) – OFF

19. MEC 1 – OFF, wait 2 sec, then:

20. MEC 2 – OFF

21. At V = 10K: ✓TACAN 3 – GPC

22. At M = 2.9: ✓RA2 – ON

23. If reqd: Use one MLS,
GNC I/O RESET

**DPS/
MDP**
**CAB P
ECLS**

CDR WND

FB (B)E13-10

AESP/4/E/GEN J,14

FAB USE ONLY

HOOK

LOSS OF 2 FREON LOOPS – LOOPS FAILED

1. LES O2 – OFF, Visor – OP
 2. O2 SYS SPLY (two) – OP
- Panel L1: All switches off, except:
3. H2O PUMP LOOP 2 – ON
 4. Perform PWRDN if not already accomplished

EVAP OUT TEMP HIGH (Rads cold soaked)

If temp high in only one loop, snsr failed >>

1. If V < 12K:
 - RAD BYP VLV LOOP 1 – MAN, BYP
 - NH3 CNTLR B – PRI/GPC >>
2. FES PRI B(A) – OFF
 - A(B) – ON (wait 30 sec)
 - If T decr >>
3. FES PRI A(B) – OFF
 - SEC – ON (HI LOAD ena) (wait 30 sec)
 - If T decr:
 - TOP EVAP HTRS (three) – OFF >>
4. HI LOAD EVAP – OFF
 - DUCT HTR – OFF (wait 30 sec)
 - If T decr >>
5. TOP EVAP HTRS (three) – OFF
 - RAD BYP VLV (two) – AUTO
 - CNTLR LOOP (two) – AUTO B(A) (wait 90 sec)

EVAP OUT TEMP HIGH (Rads *not* cold soaked)

If temp high in only one loop, snsr failed >>

If V > 12K:

1. FES PRI A – OFF
 - B – ON (wait 30 sec)
 - If T decr >>
2. FES PRI B – OFF
 - SEC – ON (HI LOAD ena) (wait 30 sec)
 - If T decr >>
3. HI LOAD EVAP – OFF
 - If T decr >>
4. RAD BYP VLV (four) – MAN, RAD FLOW
- ⇒ 5. NH3 CNTLR B – SEC/ON (wait 60 sec)
6. If T decr >>
7. NH3 CNTLR B – OFF, A – SEC/ON

EVAP
ESS

CDR WND

FB E13-11

AESP/ALL/E/GEN J,12

FAB USE ONLY

PILE

EVAP OUT TEMP LOW

1. If low in only one loop (snsr failed) >>
 2. FREON PUMP LOOP 1,2 (two) – OFF
 3. H2O PUMP LOOP 1 (two) – ON,B
- If no PL H2O Loop present:
4. FLOW PROP VLV LOOP 1,2 (two) – PL HX (tb-PL)
- If PL H2O Loop present:
5. Activate PL H2O Loop
 6. O2 SYS 1,2 SPLY VLV (two) – CL
 7. ✓RAD BYP VLV MODE (two) – MAN
 8. ✓MAN SEL (two) – BYP (tb-BYP ~3 sec)
 9. FLASH EVAP CNTLR PRI A, PRI B, SEC (three) – OFF
 - ◇ 10. FREON PUMP LOOP 1,2 (two) – B
 - ◇ 11. NH3 CNTLR A,B (two) – SEC/ON
- If FREON LOOP 1(2) running:
12. O2 SYS 1(2) SPLY VLV – OP
- When EVAP OUT T > 55 for at least 2 min (NH3 depleted):
- If any FREON LOOP off:
13. FREON PUMP LOOP 1(2) – B
 14. O2 SYS 1(2) SPLY VLV – OP
 15. Wait 3 min
- If V > 12K and FLASH EVAP CNTLR PRI A(B)
previously selected:
16. FLASH EVAP CNTLR PRI B(A) – GPC >>
- If V < 12K:
17. RAD BYP VLV MODE 1,2 (two) – AUTO
 18. CNTLR LOOP 1,2 (two) – OFF,
AUTO A(B)

FREON QTY LOW

- ◇ 1. FREON ISOL MODE – MAN
2. (Aff) FREON ISOL LOOP 1(2) – ISOL
Hold for 5 sec >>

**FREON
EVAP**

CDR WND

FB E13-12

AESP/ALL/E/GEN J,12

FAB USE ONLY

HOOK

FC
MN**ESS BUS LOSS**

ESS 1BC	1. L AUD CNTL – R (CDR can't talk) 2. Pri C/W & Matrix lost
ESS 2CA	1. AUD CTR – 2 2. R AUD CNTL – L (PLT can't talk)
ESS 3AB	1. Do not ENGAGE BFS 2. CSM lost ⇒ 3. BFS GPC OUTPUT – TERM

LOSS OF 2nd FC PWRDN (ENTRY)

1. MDM PL1 – OFF
2. FCS CH 4 – OFF
GPC MODE 4 – STBY, HALT
PWR 4 – OFF
MDM FF4, FA4 – OFF
3. HUM SEP (two) – OFF
4. FLASH EVAP FDLN HTR SPLY (two) – OFF
5. TOP EVAP HTR NOZ L,R (two) – OFF
DUCT – OFF
HI LOAD DUCT HTR – OFF
6. If V > 10K: ✓CAB FAN A(B) – ON
7. M = 2.9: CAB FAN (two) – OFF
AV BAY FAN (six) – OFF

CDR WND

FB E13-13

AESP/ALL/E/GEN J

FAB USE ONLY

TOP
BACK OF 'ESS BUS LOSS'

PILE

EVAP
ESS

LOSS OF 2nd FC PWRDN (GRTL5/TAL)

1. LES O2 – OFF, Visors – OP
 2. L1: Select one FREON PUMP on good FC/MN BUS and place other pump to OFF
Switch OFF all HUM SEPS, IMU FANS, H2O PUMPS, AV BAY FANS, CAB FANS, FES HTRS
 3. Switch off all but one IDP/CRT with four MDUs
After BUS TIE, if MNC unpowered:
 4. FES CNTLR PRI A – OFF
B – ON
 - ⇒ 5. Assign all strings to GPC 1 OPS 30X(60X) PRO
 6. Unassigned GPCs MODE – STBY (tb-bp), HALT
– STBY (tb-RUN)
– HALT (tb-bp)
GPC PWR – OFF
 7. IMU (one) – OFF (choose previously failed IMU, if any)
 8. IMU FAN (one) – ON
 9. H2O PUMP (one) – ON
 10. AV BAY 1,2 FAN (two) – ON (✓Fan ON in each bay with a powered GPC)
- After MPS Pwrnd:
- If MNA unpowered:
11. FREON PUMP LOOP 1 – B
2 – A
 12. TOP EVAP HTR DUCT – B
HI LOAD DUCT HTR – B
- If MNB(C) unpowered:
13. FREON PUMP LOOP 1,2 (two) – A(B)
 14. TOP EVAP HTR DUCT – A
HI LOAD DUCT HTR – A
- If TAL:
15. HUM SEP (one) – ON
 16. CAB FAN (one) – ON

CDR WND

FB E13-14

AESP/4/E/GEN J

FAB USE ONLY

HOOK

MNA or AC1 Multi Φ

- 1. FREON PUMP LOOP 2 - A
 - 2. TOP EVAP HTR DUCT - B
 - 3. HI LOAD DUCT HTR - B
 - ⇒ 4. AV BAY 2 FAN (two) - ON
 - 5. AV BAY 3 FAN A - ON, B - OFF
- If V > 12K:
When V = 12K:
- 6. RAD BYP vlv MODE 1,2
(two) - AUTO
 - 7. RAD CNTLR LOOP 1,2
(two) - AUTO A
 - 8. ANNUN BUS SEL ACA 1 - MNB
 - 9. NWS - 2
 - 10. BFS G51 AA1 - desel
- FAILED: NH3 A PRI, NWS 1
UHF HI PWR XMIT, L HUD

CNTL

MNB or AC2 Multi Φ

- 1. AV BAY 1 FAN A - ON, B - OFF
 - 2. FREON PUMP LOOP 1 - A
 - ⇒ 3. HUM SEP A - ON, B - OFF
 - 4. IMU FAN A - ON, B - OFF
 - 5. AV BAY 2 FAN B - ON, A - OFF
3 FAN (two) - ON
 - 6. ✓cb AC3 Φ A LG SNSR 1 - cl
 - 7. ANNUN BUS SEL ACA 2/3 - MNC
 - 8. BFS G51 AA2, RGA 2 - desel
- FAILED: NH3 B SEC, RA-2, NWS 2
PLT DRAG CHUTE ARM
S-BD PM 1 (NO PNL,CMD)

MNC or AC3 Multi Φ

- 1. FES CNTLR PRI A - OFF, B - ON
 - ⇒ 2. CAB FAN B - ON, A - OFF
 - 3. AV BAY 1 FAN (two) - ON
 - 4. H2O PUMP LOOP 1 - ON, 2 - OFF
 - 5. ✓cb AC2 Φ A LG SNSR 2 - cl
 - 6. BFS G51 RGA 3 - desel
- FAILED: NH3 A SEC, B PRI
CDR DRAG CHUTE ARM

ANY AC2 SINGLE Φ

- ⇒ FREON PUMP LOOP 1 - A

CDR WND

FB E13-15

AESP/4/E/GEN J,2

FAB USE ONLY

TOP
 BACK OF 'MNA or AC1 MULTI Φ'
 FACING RIGHT SIDE OF BACKBOARD

PILE

FC
MN

CNTL BUS LOSS

AB1	⇒	1. Use R TRIM & BDY FLP sws FAILED: NH3 A SEC, FES PRI B GPC
AB2	⇒	1. CDR Display – green dot FAILED: NH3 B SEC, L HUD, FES PRI B ON, H2O LOOP 1,A ON
AB3	⇒	If BFS ENGAGE reqd: 1. Use PLT's RHC, then GPCs 1,2,4 – STBY, HALT 2. BFS I/O RESET
BC1	⇒	1. Use R TRIM & BDY FLP sws 2. BFS G51 RGA 2 – desel FAILED: R HUD, CDR DRAG CHUTE DPY/JETT
BC2	⇒	FAILED: NH3 B PRI, FES SEC GPC, H2O LOOP 1,B ON, CDR DRAG CHUTE DPY/JETT
BC3	⇒	FAILED: NH3 A PRI, FES SEC ON
CA1	⇒◇	1. No BFS ENGAGE GPC 3,5 2. BFS GPC OUTPUT – TERM 3. BFS G51 RGA 3 – desel FAILED: NH3 B SEC, FES PRI A GPC, H2O LOOP 2 GPC, PLT DRAG CHUTE DPY/JETT
CA2	⇒	FAILED: NH3 A SEC, FES PRI A ON, PLT DRAG CHUTE DPY/JETT

CDR WND

FB E13-16

AESP/ALL/E/GEN J

FAB USE ONLY

Space Shuttle Program
FLIGHT DATA FILE

JSC-48001-II
GENERIC, REV J



**ASCENT/ENTRY
SYSTEMS PROC**

**OV
102,
104**

Flight Cover (trim bottom to expose tabs)