

# Ascent/Entry Systems Procedures

**Mission Operations Directorate  
Operations Division**

**Generic, Rev O  
June 1, 2007**

**NOTE**

For STS-118 and subsequent flights

AESP: MM101

APCL: MM104

OPCL: MM106

EPCL: MM301

AESP: MM304

National Aeronautics and  
Space Administration

Lyndon B. Johnson Space Center  
Houston, Texas

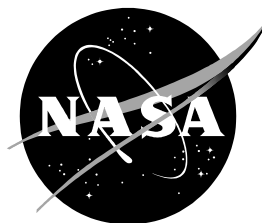

*United Space Alliance*

Verify this is the correct version for the pending operation (training, simulation or flight).  
Electronic copies of FDF books are available. URL: <http://mod.jsc.nasa.gov/do3/FDF/index.html>



ASC/ENT SYSTEMS PROCEDURES

GENERIC, Rev O (June 1, 2007)

## PCN-3 (Oct 9, 2007) Sheet 1 of 1

List of Implemented Change Requests (482s):

AESP-0713                      MULTI-1808

**NOTE**

For STS-120 and subsequent flights

Incorporate the following:

1. Replace v thru xii
2. Replace MS E3-1 & MS E3-2
3. Replace FB E11-5 & FB E11-6
4. Replace FB E12-9 & FB E12-10
5. Replace (OV103,104) FB E13-3 thru (OV105) FB E13-4 (4 pages)

Prepared by:

  
Publication Manager

Approved by:

  
Manager, Shuttle Procedures Management

Accepted by:

  
FDF Manager

Encl: 18 pages

**File this PCN immediately behind the front cover as a permanent record**



ASC/ENT SYSTEMS PROCEDURES	GENERIC, Rev O (June 1, 2007)
----------------------------	-------------------------------

PCN-2 (Oct 1, 2007) Sheet 1 of 1

List of Implemented Change Requests (482s):

AESP-0710               MULTI-1784  
                                  MULTI-1803  
                                  MULTI-1805

**NOTE**  
For STS-120 and subsequent flights

Incorporate the following:

- 1. Replace v thru xiv
- 2. Replace (OV103,104) MS A4-3 thru (OV105) MS A4-4 (6 pages)  
Delete TEMP MS A4-3 & TEMP MS A4-4  
Replace (OV105) MS A4-5 & (OV105) MS A4-6
- 3. Replace MS A8-1 & MS A8-2
- 4. Replace MS E3-1 & MS E3-2
- 5. Replace (OV103,104) MS E4-5 & (OV103,104) MS E4-6  
Replace (OV105) MS E4-5 & (OV105) E4-6  
Delete TEMP MS E4-5 & TEMP MS E4-6
- 6. Replace CC 10-1 & CC 10-2  
Replace (OV103,104) CC 10-9 thru (OV105) CC 10-10 (4 pages)
- 7. Replace FB E12-9 & FB E12-10
- 8. Replace (OV103,104) FB A13-9 thru (OV105) FB A13-10 (4 pages)  
Delete TEMP FB A13-9 & TEMP FB A13-10  
Replace (OV103,104) FB E13-3 thru (OV105) FB E13-4 (4 pages)  
Replace FB E13-13 & FB E13-14  
Delete TEMP FB E13-13 & TEMP FB E13-14

Prepared by: STEP 3  
                                  Publication Manager

Approved by: [Signature]  
                                  Manager, Shuttle Procedures Management

Accepted by: [Signature]  
                                  FDF Manager

Encl: 44 pages

File this PCN immediately behind the front cover as a permanent record



ASC/ENT SYSTEMS PROCEDURES

GENERIC, Rev O (June 1, 2007)

## PCN-1 (July 18, 2007) Sheet 1 of 1

List of Implemented Change Requests (482s):

AESP-0709

Incorporate the following:

1. Replace v thru xii (8 pages), xix thru xxii (4 pages)
2. Replace MS E7-3 & MS E7-4
3. Replace FB E11-3 thru FB E11-6

**NOTE**

For STS-118 and subsequent flights

Prepared by:

  
Publication Manager

Approved by:

  
Manager, Shuttle Procedures Management

Accepted by:

  
FDF Manager

Encl: 18 pages

**File this PCN immediately behind the front cover as a permanent record**





JSC-48001

MISSION OPERATIONS DIRECTORATE

**ASCENT/ENTRY SYSTEMS PROCEDURES**

GENERIC, REVISION 0

June 1, 2007

PREPARED BY:



Michele M. Crisp  
Publication Manager

APPROVED BY:

ACCEPTED BY:

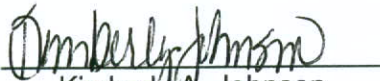

Kimberly A. Johnson  
Manager, Shuttle  
Procedures Management



Michael T. Hurt  
FDF Manager

This document is under the configuration control of the Crew Procedures Control Board (CPCB). All proposed changes must be submitted via FDF Workflow Crew Procedure Change Request (CR) to DO3/FDF Manager.

Additional distribution of this book, for official use only, may be requested in writing to DO3/PMO Administrator. The request must include justification and requester's name, organization, position, and phone number. Contractor requests are made through the NASA or DOD organization supported. Deletions, reduction in quantity, or change of address may be submitted to DO3/FDF Management Office, 281-244-1184.

AESP/ALL/GEN 0

Incorporates the following:		
482#:	AESP-0704	AESP-0706
		AESP-0707

AREAS OF TECHNICAL RESPONSIBILITY

Publication Manager	DO35/M. Crisp	281-483-5975
Alternate	DO35/T. Vaughan	281-483-4180
APU/HYD (MMACS)	DF5/K. McCluney	281-483-0867
COMM (INCO)	DF2/G. Horlacher	281-483-3878
DPS	DF3/B. Schwank	281-244-0004
ECLS (EECOM)	DF8/D. Fasbender	281-483-7857
EPS (EGIL)	DF7/M. Friant	281-483-0682
GNC	DF6/D. Gruber	281-483-0709
OMS/RCS (PROP)	DF63/J. Campa	281-244-1002
MPS (BOOSTER)	DF5/M. Patel	281-483-0083
PWRDN	DF7/M. Friant	281-483-0682

## NOTES

1. Sections 1 through 8 of this book are inserted in the front of the Mission Specialist copies of the Ascent and/or Entry Pocket Checklists.
2. Sections 10 thru 13 are the Multiphase Cue Cards, the Pilot's Overhead Flip Book, the Pilot's Window Flip Book, and the Commander's Window Flip Book which are printed in this book for documentation and control purposes only. They will be removed from Simulator and Flight copies.
3. The Mission Specialist book and all flip books will each be separated into two divisions, Powered Flight (A) and Glided Flight (E).
4. Icons will be used in the following manner:
  - '⇒' At the end of a procedure line indicates a choice to continue to either the Glided Flight division of the AESP and/or to the ASC PKT C/L as dictated by the prevailing flight phase.
  - '⇒G' At the end of a procedure line indicates one should continue to the Glided Flight division of the AESP.
  - '⇒A' At the end of a procedure line indicates one should continue to the ASC PKT C/L.
  - '⇒' Preceding a line indicates the starting point of the procedure if coming from a procedure with a continue (⇒) icon.
  - '◆' Indicates one should √MCC and if no comm continue with the procedure.



This Page Intentionally Blank



ASCENT/ENTRY SYSTEMS PROCEDURES

**LIST OF EFFECTIVE PAGES**

GENERIC	07/02/87
REV O	06/01/07
PCN-1	07/18/07
PCN-2	10/01/07
PCN-3	10/09/07

Sign Off.....	*	ALL/GEN O
ii.....	*	ALL/GEN O
iii.....	*	ALL/GEN O
iv.....	*	ALL/GEN O
v.....	*	ALL/GEN O,3
vi.....	*	ALL/GEN O,2
vii.....	*	ALL/GEN O,3
viii.....	*	ALL/GEN O,2
ix.....	*	ALL/GEN O,2
x.....	*	ALL/GEN O,3
xi.....	*	ALL/GEN O,3
xii.....	*	ALL/GEN O,3
xiii.....	*	ALL/GEN O,2
xiv.....	*	ALL/GEN O
xv.....		ALL/GEN O
xvi.....		ALL/GEN O
xvii.....		ALL/GEN O
xviii.....		ALL/GEN O
xix.....		ALL/GEN O
xx.....		ALL/GEN O,1
xxi.....		ALL/GEN O
xxii.....		ALL/GEN O,1
xxiii.....		ALL/GEN O
xxiv.....		ALL/GEN O
xxv.....		ALL/GEN O
xxvi.....		ALL/GEN O
xxvii.....		ALL/GEN O
xxviii.....		ALL/GEN O

\* – Omit from MS flight book

MS A-i.....	*	ALL/A/GEN O
MS A-ii.....	*	ALL/A/GEN O
MS A1-1.....		ALL/A/GEN O
MS A1-2.....		ALL/A/GEN O
MS A2-1.....		ALL/A/GEN O
MS A2-2.....		ALL/A/GEN O
MS A3-1.....		ALL/A/GEN O
MS A3-2.....		ALL/A/GEN O
MS A3-3.....		ALL/A/GEN O
MS A3-4.....		ALL/A/GEN O
MS A3-5.....		ALL/A/GEN O
MS A3-6.....	⊗	ALL/A/GEN O
MS A4-1.....		ALL/A/GEN O
MS A4-2.....		ALL/A/GEN O
(OV103,104) MS A4-3.....		3,4/A/GEN O
(OV103,104) MS A4-4.....		ALL/A/GEN O,2
(OV103,104) MS A4-5.....		ALL/A/GEN O
(OV103,104) MS A4-6.....		3,4/A/GEN O,2
(OV105) MS A4-3.....		5/A/GEN O
(OV105) MS A4-4.....		ALL/A/GEN O,2
TEMP MS A4-3.....		deleted
TEMP MS A4-4.....		deleted
(OV105) MS A4-5.....		ALL/A/GEN O
(OV105) MS A4-6.....		5/A/GEN O,2
MS A4-7.....		ALL/A/GEN O
MS A4-8.....		ALL/A/GEN O
MS A5-1.....		ALL/A/GEN O
MS A5-2.....		ALL/A/GEN O
MS A5-3.....		ALL/A/GEN O
MS A5-4.....		ALL/A/GEN O
MS A5-5.....		ALL/A/GEN O
MS A5-6.....		ALL/A/GEN O
MS A5-7.....		ALL/A/GEN O
MS A5-8.....		ALL/A/GEN O
MS A5-9.....		ALL/A/GEN O
MS A5-10.....		ALL/A/GEN O

\* – Omit from MS flight book

⊗ – Highlights reqd

(OV103,104) MS A5-11 .....		3,4/A/GEN O
(OV103,104) MS A5-12 .....		ALL/A/GEN O
(OV105) MS A5-11 .....		5/A/GEN O
(OV105) MS A5-12 .....		ALL/A/GEN O
MS A6-1 .....		ALL/A/GEN O
MS A6-2 .....	☒	ALL/A/GEN O
MS A6-3 .....	☒	ALL/A/GEN O
MS A6-4 .....	☒	ALL/A/GEN O
MS A7-1 .....		ALL/A/GEN O
MS A7-2 .....		ALL/A/GEN O
MS A7-3 .....		ALL/A/GEN O
MS A7-4 .....		ALL/A/GEN O
MS A8-1 .....		ALL/A/GEN O
MS A8-2 .....		ALL/A/GEN O,2
MS A8-3 .....	⊗	ALL/A/GEN O
MS A8-4 .....		ALL/A/GEN O
MS A9-1 .....	*	ALL/A/GEN O
MS A9-2 .....	*	ALL/A/GEN O
MS E-i .....		ALL/E/GEN O
MS E-ii .....		ALL/E/GEN O
MS E1-1 .....		ALL/E/GEN O
MS E1-2 .....		ALL/E/GEN O
MS E1-3 .....		ALL/E/GEN O
MS E1-4 .....		ALL/E/GEN O
MS E1-5 .....		ALL/E/GEN O
MS E1-6 .....		ALL/E/GEN O
MS E2-1 .....		ALL/E/GEN O
MS E2-2 .....		ALL/E/GEN O
(OV103,104) MS E2-3 .....		ALL/E/GEN O
(OV103,104) MS E2-4 .....		3,4/E/GEN O
(OV105) MS E2-3 .....		ALL/E/GEN O
(OV105) MS E2-4 .....		5/E/GEN O
MS E3-1 .....		ALL/E/GEN O
MS E3-2 .....		ALL/E/GEN O,3
MS E3-3 .....		ALL/E/GEN O
MS E3-4 .....		ALL/E/GEN O

- ☒ – Prelift-off information reqd
- ⊗ – Highlights reqd
- \* – Omit from MS flight book

MS E3-5.....	ALL/E/GEN O
MS E3-6.....	ALL/E/GEN O
MS E3-7.....	ALL/E/GEN O
MS E3-8.....	ALL/E/GEN O
MS E4-1.....	ALL/E/GEN O
MS E4-2.....	ALL/E/GEN O
(OV103,104) MS E4-3.....	3,4/E/GEN O
(OV103,104) MS E4-4.....	ALL/E/GEN O
(OV103,104) MS E4-5.....	ALL/E/GEN O,2
(OV103,104) MS E4-6.....	3,4/E/GEN O,2
(OV105) MS E4-3.....	5/E/GEN O
(OV105) MS E4-4.....	ALL/E/GEN O
(OV105) MS E4-5.....	ALL/E/GEN O,2
(OV105) MS E4-6.....	5/E/GEN O,2
TEMP MS E4-5.....	deleted
TEMP MS E4-6.....	deleted
MS E4-7.....	ALL/E/GEN O
MS E4-8.....	ALL/E/GEN O
MS E5-1.....	ALL/E/GEN O
MS E5-2.....	ALL/E/GEN O
MS E5-3.....	ALL/E/GEN O
MS E5-4.....	ALL/E/GEN O
MS E5-5.....	ALL/E/GEN O
MS E5-6.....	ALL/E/GEN O
MS E5-7.....	ALL/E/GEN O
MS E5-8.....	ALL/E/GEN O
MS E5-9.....	ALL/E/GEN O
MS E5-10.....	ALL/E/GEN O
MS E5-11.....	ALL/E/GEN O
MS E5-12.....	ALL/E/GEN O
(OV103,104) MS E5-13.....	3,4/E/GEN O
(OV103,104) MS E5-14.....	ALL/E/GEN O
(OV105) MS E5-13.....	5/E/GEN O
(OV105) MS E5-14.....	ALL/E/GEN O
MS E5-15.....	ALL/E/GEN O
MS E5-16.....	ALL/E/GEN O



MS E5-17.....		ALL/E/GEN O
MS E5-18.....		ALL/E/GEN O
MS E6-1.....		ALL/E/GEN O
MS E6-2.....	☒	ALL/E/GEN O
MS E6-3.....		ALL/E/GEN O
MS E6-4.....		ALL/E/GEN O
MS E7-1.....		ALL/E/GEN O
MS E7-2.....		ALL/E/GEN O
MS E7-3.....		ALL/E/GEN O,1
MS E7-4.....		ALL/E/GEN O,1
MS E7-5.....		ALL/E/GEN O
MS E7-6.....		ALL/E/GEN O
MS E8-1.....		ALL/E/GEN O
MS E8-2.....		ALL/E/GEN O
MS E9-1.....	*	ALL/E/GEN O
MS E9-2.....	*	ALL/E/GEN O
CC 10-i.....	*	ALL/A,E/GEN O
CC 10-ii.....	*	ALL/A,E/GEN O
CC 10-1.....	*	ALL/A,E/GEN O
CC 10-2.....	*⊗	ALL/A/GEN O,2
CC 10-3.....	*	ALL/A/GEN O
CC 10-4.....	*	ALL/A/GEN O
CC 10-5.....	*	ALL/A/GEN O
CC 10-6.....	*	ALL/E/GEN O
CC 10-7.....	*	ALL/A/GEN O
CC 10-8.....	*	ALL/A/GEN O
(OV103,104) CC 10-9.....	*	3,4/A,E/GEN O,2
(OV103,104) CC 10-10.....	*	ALL/A,E/GEN O
(OV105) CC 10-9.....	*	5/A,E/GEN O,2
(OV105) CC 10-10.....	*	ALL/A,E/GEN O
FB A11-i.....	*	ALL/A/GEN O
FB A11-ii.....	*	ALL/A/GEN O
FB A11-1.....	*☒	ALL/A/GEN O
FB A11-2.....	*☒	ALL/A/GEN O
FB A11-3.....	*☒	ALL/A/GEN O
FB A11-4.....	*	ALL/A/GEN O

- ☒ – Prelift-off information reqd
- \* – Omit from MS flight book
- ⊗ – Highlights reqd

FB A11-5 .....	*	ALL/A/GEN O
FB A11-6 .....	*	ALL/A/GEN O
FB E11-i.....	*	ALL/E/GEN O
FB E11-ii.....	*	ALL/E/GEN O
FB E11-1 .....	*☒	ALL/E/GEN O
FB E11-2 .....	*	ALL/E/GEN O
FB E11-3 .....	*	ALL/E/GEN O
FB E11-4 .....	*	ALL/E/GEN O,1
FB E11-5 .....	*	ALL/E/GEN O,1
FB E11-6 .....	*	ALL/E/GEN O,3
FB A12-i.....	*	ALL/A/GEN O
FB A12-ii.....	*	ALL/A/GEN O
FB A12-1 .....	*	ALL/A/GEN O
FB A12-2 .....	*	ALL/A/GEN O
FB A12-3 .....	*	ALL/A/GEN O
FB A12-4 .....	*	ALL/A/GEN O
FB A12-5 .....	*	ALL/A/GEN O
FB A12-6 .....	*	ALL/A/GEN O
FB A12-7 .....	*	ALL/A/GEN O
FB A12-8 .....	*	ALL/A/GEN O
FB A12-9 .....	*⊗	ALL/A/GEN O
FB A12-10 .....	*	ALL/A/GEN O
FB A12-11 .....	*	ALL/A/GEN O
FB A12-12 .....	*	ALL/A/GEN O
FB A12-13 .....	*	ALL/A/GEN O
FB A12-14 .....	*	ALL/A/GEN O
FB A12-15 .....	*	ALL/A/GEN O
FB A12-16 .....	*	ALL/A/GEN O
(OV103,104) FB A12-17 .....	*	3,4/A/GEN O
(OV103,104) FB A12-18.....	*	ALL/A/GEN O
(OV105) FB A12-17.....	*	5/A/GEN O
(OV105) FB A12-18.....	*	ALL/A/GEN O
FB E12-i.....	*	ALL/E/GEN O
FB E12-ii.....	*	ALL/E/GEN O
FB E12-1 .....	*	ALL/E/GEN O
FB E12-2 .....	*	ALL/E/GEN O

- \* – Omit from MS flight book
- ☒ – Prelift-off information reqd
- ⊗ – Highlights reqd

FB E12-3 .....	*	ALL/E/GEN O
FB E12-4 .....	*	ALL/E/GEN O
FB E12-5 .....	*	ALL/E/GEN O
FB E12-6 .....	*	ALL/E/GEN O
(OV103,104) FB E12-7 .....	*	3,4/E/GEN O
(OV103,104) FB E12-8 .....	*	3,4/E/GEN O
(OV105) FB E12-7 .....	*	5/E/GEN O
(OV105) FB E12-8 .....	*	5/E/GEN O
FB E12-9 .....	*	ALL/E/GEN O,3
FB E12-10 .....	*	ALL/E/GEN O
FB E12-11 .....	*	ALL/E/GEN O
FB E12-12 .....	*	ALL/E/GEN O
FB E12-13 .....	*	ALL/E/GEN O
FB E12-14 .....	*	ALL/E/GEN O
FB E12-15 .....	*	ALL/E/GEN O
FB E12-16 .....	*	ALL/E/GEN O
FB E12-17 .....	*	ALL/E/GEN O
FB E12-18 .....	*	ALL/E/GEN O
FB E12-19 .....	*	ALL/E/GEN O
FB E12-20 .....	*	ALL/E/GEN O
FB E12-21 .....	*	ALL/E/GEN O
FB E12-22 .....	*	ALL/E/GEN O
(OV103,104) FB E12-23 .....	*	ALL/E/GEN O
(OV103,104) FB E12-24 .....	*	3,4/E/GEN O
(OV105) FB E12-23 .....	*	ALL/E/GEN O
(OV105) FB E12-24 .....	*	5/E/GEN O
FB E12-25 .....	*	ALL/E/GEN O
FB E12-26 .....	*	ALL/E/GEN O
FB A13-i .....	*	ALL/A/GEN O
FB A13-ii .....	*	ALL/A/GEN O
FB A13-1 .....	*	ALL/A/GEN O
FB A13-2 .....	*	ALL/A/GEN O
FB A13-3 .....	*	ALL/A/GEN O
FB A13-4 .....	*	ALL/A/GEN O
FB A13-5 .....	*	ALL/A/GEN O
FB A13-6 .....	*	ALL/A/GEN O
FB A13-7 .....	*⊗	ALL/A/GEN O
FB A13-8 .....	*	ALL/A/GEN O

\* – Omit from flight book

⊗ – Highlights reqd

(OV103,104) FB A13-9.....	*	3,4/A/GEN O
(OV103,104) FB A13-10.....	*	ALL/A/GEN O,2
(OV105) FB A13-9.....	*	5/A/GEN O
(OV105) FB A13-10.....	*	ALL/A/GEN O,2
TEMP FB A13-9 .....	*	deleted
TEMP FB A13-10 .....	*	deleted
FB A13-11 .....	*	ALL/A/GEN O
FB A13-12 .....	*	ALL/A/GEN O
FB A13-13 .....	*	ALL/A/GEN O
FB A13-14 .....	*	ALL/A/GEN O
FB E13-i.....	*	ALL/E/GEN O
FB E13-ii.....	*	ALL/E/GEN O
FB E13-1 .....	*	ALL/E/GEN O
FB E13-2 .....	*	ALL/E/GEN O
(OV103,104) FB E13-3.....	*	3,4/E/GEN O
(OV103,104) FB E13-4.....	*	ALL/E/GEN O,3
(OV105) FB E13-3.....	*	5/E/GEN O
(OV105) FB E13-4.....	*	ALL/E/GEN O,3
FB E13-5 .....	*	ALL/E/GEN O
FB E13-6 .....	*	ALL/E/GEN O
FB E13-7 .....	*	ALL/E/GEN O
FB E13-8 .....	*	ALL/E/GEN O
FB E13-9 .....	*	ALL/E/GEN O
FB E13-10 .....	*	ALL/E/GEN O
(OV103,104) FB E13-11 .....	*	ALL/E/GEN O
(OV103,104) FB E13-12.....	*	3,4/E/GEN O
(OV105) FB E13-11 .....	*	ALL/E/GEN O
(OV105) FB E13-12.....	*	5/E/GEN O
FB E13-13 .....	*	ALL/E/GEN O
FB E13-14 .....	*	ALL/E/GEN O,2
TEMP FB E13-13 .....	*	deleted
TEMP FB E13-14 .....	*	deleted
FB E13-15 .....	*	ALL/E/GEN O
FB E13-16 .....	*	ALL/E/GEN O
FB E13-17 .....	*	ALL/E/GEN O
FB E13-18 .....	*	ALL/E/GEN O

\* – Omit from MS flight book

MULTIPHASE SYSTEMS CUE CARDS

<u>Title</u>	<u>Ref. Page</u>	<u>Card No.</u>
POWER (Front) .....	CC 10-1	AESP-5a/A,O,E/S
(Back).....	CC 10-1	AESP-5b/A,O,E/F
MPS 1 (Front).....	CC 10-2	AESP-11a/A/M
(Back) .....	CC 10-3	AESP-11b/A/E
MPS 2 (Front).....	CC 10-4	AESP-14a/A/E
(Back).....	CC 10-4	AESP-14b/A/D
OPS 1/6/TAL TRANSITION RESTRING (Front) .....	CC 10-5	AESP-10a/A/G
POST OPS 3/GRTL TRANSITION RESTRING (Back) .....	CC 10-6	AESP-10b/E/F
MPS He P (Pre MECO)/ MPS PNEU TK(REG) P (Front).....	CC 10-7	AESP-15a/A/B
(Back) .....	CC 10-7	AESP-15b/A/C
ET SEP (Front).....	CC 10-8	AESP-13a/A/F
(Back) .....	CC 10-8	AESP-13b/A/F
FIRE/SMOKE (ASCENT/ENTRY) (Front)...	CC 10-9	AESP-7a/A,O,E/H
(ORBIT) (Back).....	See ORBIT POCKET C/L	
POWERED FLIGHT – PLT Overhead Flip Book ...	See FB A11-1 thru FB A11-6	
PLT Window Flip Book .....	See FB A12-2 thru FB A12-18	
CDR Window Flip Book .....	See FB A13-1 thru FB A13-14	
GLIDED FLIGHT – PLT Overhead Flip Book ...	See FB E11-1 thru FB E11-6	
PLT Window Flip Book .....	See FB E12-1 thru FB E12-26	
CDR Window Flip Book .....	See FB E13-1 thru FB E13-18	



This Page Intentionally Blank



CONTENTS

PAGE

<b>MS POWERED FLIGHT .....</b>	<b>MS A-i</b>
<u>APU/HYDRAULICS</u> .....	MS A1-1
APU SHUTDN .....	MS A1-2
SPD HI .....	MS A1-2
OVERSPEED .....	MS A1-2
UNDERSPEED .....	MS A1-2
OIL OVERTEMP .....	MS A1-2
HYD PRESS (LOW) (CIL) .....	MS A1-2
RSVR QTY (LOW) .....	MS A1-2
W/B QTY (LOW).....	MS A1-2
<u>COMM/GNC</u> .....	MS A2-1
COMM LOST (mult pnls).....	MS A2-2
ICOM LOST.....	MS A2-2
FCS CH 1(2,3,4) (2nd FAIL).....	MS A2-2
RHC L(R) (2nd FAIL).....	MS A2-2
DISPLAY SW L(R) .....	MS A2-2
RM FAIL IMU,RGA,AA .....	MS A2-2
DLMA IMU .....	MS A2-2
<u>DPS</u> .....	MS A3-1
PASS GPC FAIL .....	MS A3-2
BFS GPC FAIL .....	MS A3-2
FF(FA) MDM OUTPUT.....	MS A3-2
PL MDM I/O ERROR.....	MS A3-2
PCM I/O ERROR.....	MS A3-2
SUMWORD ICC.....	MS A3-2
FA/FF MDM I/O ERROR .....	MS A3-3
PORT MODE .....	MS A3-3
BCE STRG X.....	MS A3-4
DUAL DPS DISPLAY COMMANDERS/ DK XMTR 1(2,3) .....	MS A3-4
PASS DISPLAY FAIL .....	MS A3-4
BFS DISPLAY FAIL.....	MS A3-5
FLT INST DISPLAY ANOMALY .....	MS A3-5
SUBSYS STATUS DISPLAY ANOMALY .....	MS A3-5
BFS INADVERTENT DISENGAGE/ UNSUCCESSFUL ENGAGE .....	MS A3-5
MULT DATA PATH LOSS (non-Recov) (CIL) .....	MS A3-6
OPS 1/6/TAL TRANSITION RESTRING .....	MS A3-6
POST BFS ENGAGE .....	MS A3-6

<u>ECLS</u> .....	MS A4-1
CAB PRESS LEAK.....	MS A4-2
HIGH.....	MS A4-2
PPO2 ABNORMAL.....	MS A4-2
H2O LOOP PRESS HIGH.....	MS A4-2
LOW.....	MS A4-2
AV BAY FAN ΔP.....	MS A4-2
TEMP HIGH .....	MS A4-2
CABIN FAN FAIL.....	MS A4-2
IMU FAN FAIL .....	MS A4-2
FREON FLOW LOW .....	MS A4-3
LOSS OF 1 FREON LOOP .....	MS A4-3
2 FREON LOOPS – PWRDN .....	MS A4-3
– LOOPS FAILED ....	MS A4-3
EVAP OUT T LOW.....	MS A4-4
FREON LEAK.....	MS A4-4
EVAP OUT TEMP HIGH .....	MS A4-5
FIRE/SMOKE .....	MS A4-6
<u>EPS</u> .....	MS A5-1
MN BUS UNDERVOLTS/FC VOLTS (PLT) (CIL) ...	MS A5-2
AC VOLT HIGH (PLT) .....	MS A5-2
LOW or OVERLOAD (PLT).....	MS A5-3
3Φ AC MOTORS STOPPED (PLT).....	MS A5-3
BUS TIE .....	MS A5-4
MNA (CDR) .....	MS A5-4
MNB (CDR) .....	MS A5-4
MNC (CDR).....	MS A5-4
ANY AC BUS LOSS (CDR).....	MS A5-4
SUBBUS [MNA O14] (CDR).....	MS A5-4
[APC6 or ALC3].....	MS A5-4
MNA or <span style="border: 1px solid black; padding: 0 2px;">AC1 Multi Φ</span> (PLT) (CIL) .....	MS A5-5
MNB or <span style="border: 1px solid black; padding: 0 2px;">AC2 Multi Φ</span> (PLT) (CIL) .....	MS A5-5
MNC or <span style="border: 1px solid black; padding: 0 2px;">AC3 Multi Φ</span> (PLT) (CIL) .....	MS A5-5
AC SINGLE Φ (PLT) .....	MS A5-5
SUBBUS [APC4(5,6) or ALC1(2,3)] (PLT) .....	MS A5-5
ESS BUS V LOW (PLT) .....	MS A5-6
LOSS (PLT) (CIL) .....	MS A5-6
CNTL BUS LOSS (CDR).....	MS A5-6
V LOW/CNTL BUS RPC (PLT).....	MS A5-7
LOSS (PLT) .....	MS A5-8
FC REAC VLV CLOSED (PLT).....	MS A5-9
pH ↓ 1(2,3) or FC DELTA V 1(2,3) (PLT) .....	MS A5-9
STACK T (PLT) .....	MS A5-9



FC EXIT T (PLT) .....	MS A5-9
COOLANT PUMP ΔP LOW (PLT) (CIL) .....	MS A5-10
COOL P (PLT) .....	MS A5-10
SHUTDN (1st) (PLT) (CIL) .....	MS A5-10
LOSS OF 1 FC PWRDN (PLT) .....	MS A5-10
2nd FC SHUTDN (PLT).....	MS A5-11
LOSS OF 2nd FC PWRDN (CDR) .....	MS A5-11
O2(H2) CRYO PRESS/TEMP HIGH (PLT) .....	MS A5-12
CRYO O2(H2) LEAK (three or more tanks aff) (PLT) .....	MS A5-12
<u>OMS</u> .....	MS A6-1
OMS He TK P LOW .....	MS A6-2
OMS N2 TK P LOW (N/A DURING ASSIST/RTLS/TAL/ATO DUMP).....	MS A6-2
OMS N2 REG P HIGH OR LOW.....	MS A6-2
TK P LOW (↓, OX or FU) NOT DUMPING ...	MS A6-3
TEMP DURING DUMP .....	MS A6-4
Pc LOW DURING DUMP .....	MS A6-4
ENG FAIL .....	MS A6-4
PRPLT FAIL .....	MS A6-4
OMS TK P LOW (↓, OX and FU) DURING DUMP ...	MS A6-4
HIGH (↑, OX and FU) DURING DUMP ..	MS A6-4
<u>RCS</u> .....	MS A7-1
RCS JET FAIL (LEAK) .....	MS A7-2
(ON) .....	MS A7-2
RM DLMA MANF.....	MS A7-2
RCS JET FAIL (OFF) .....	MS A7-2
TK P HIGH (FU or OX) .....	MS A7-2
XFEED: RCS to RCS (CIL) .....	MS A7-2
RCS SECURE .....	MS A7-3
AFT RCS LK.....	MS A7-3
FWD RCS LK .....	MS A7-4
<u>MPS</u> .....	MS A8-1
SSME FAIL/SHUTDN (CIL).....	MS A8-2
MPS DATA (CIL) .....	MS A8-2
LH2 ULL .....	MS A8-2
DUMP INHIBIT .....	MS A8-2
'ET SEP MAN' (ET SEP).....	MS A8-2
MPS CMD/HYD/ELEC (CIL) .....	MS A8-3
He P (Pre MECO).....	MS A8-4
PNEU TK(REG) P .....	MS A8-4

SECTION RESERVED

**MS GLIDED FLIGHT ..... MS E-i**

<u>APU/HYDRAULICS</u> .....	MS E1-1
APU SHUTDN.....	MS E1-2
SPD HI.....	MS E1-2
OVERSPEED.....	MS E1-2
UNDERSPEED.....	MS E1-2
OIL OVERTEMP.....	MS E1-2
PUMP LEAK P.....	MS E1-2
THERM (T HI).....	MS E1-2
COOLDOWN.....	MS E1-3
RESTART (CIL).....	MS E1-3
HYD PRESS (LOW) (CIL).....	MS E1-4
RSVR QTY (LOW).....	MS E1-5
T.....	MS E1-5
W/B QTY (LOW).....	MS E1-5

<u>COMM/GNC</u> .....	MS E2-1
COMM LOST (mult pnls).....	MS E2-2
ICOM LOST.....	MS E2-2
FCS CH 1(2,3,4) (2nd FAIL).....	MS E2-2
RHC L(R) (2nd FAIL).....	MS E2-2
G51 ROLL MODE SW.....	MS E2-2
DISPLAY SW L(R).....	MS E2-2
RM FAIL IMU,RGA,AA.....	MS E2-2
DLMA IMU.....	MS E2-2
FAIL ADTA.....	MS E2-3
DLMA ADTA (CIL).....	MS E2-3
FAIL TAC.....	MS E2-3
DLMA TAC.....	MS E2-3
SPD BRK.....	MS E2-3
G55 GPS FAIL 1(2,3).....	MS E2-4
RM DLMA GPS (OV105).....	MS E2-4
NO UPDATE GPS.....	MS E2-4

<u>DPS</u> .....	MS E3-1
PASS GPC FAIL.....	MS E3-2
BFS GPC FAIL.....	MS E3-2
FA/FF MDM I/O ERROR.....	MS E3-2
PORT MODE.....	MS E3-3
FF(FA) MDM OUTPUT.....	MS E3-4
PL MDM I/O ERROR.....	MS E3-4
PCM I/O ERROR.....	MS E3-4
BCE STRG X.....	MS E3-5
POST OPS 3/	
GRTLS TRANSITION RESTRING.....	MS E3-6
POST BFS ENGAGE.....	MS E3-6

DUAL DPS DISPLAY COMMANDERS/ DK XMTR 1(2,3).....	MS E3-7
PASS DISPLAY FAIL.....	MS E3-7
BFS DISPLAY FAIL.....	MS E3-7
FLT INST DISPLAY ANOMALY.....	MS E3-8
SUBSYS STATUS DISPLAY ANOMALY.....	MS E3-8
BFS INADVERTENT DISENGAGE/ UNSUCCESSFUL ENGAGE.....	MS E3-8
MULT DATA PATH LOSS (non-Recov) (CIL).....	MS E3-8
<u>ECLS</u> .....	MS E4-1
CAB PRESS LEAK.....	MS E4-2
HIGH.....	MS E4-2
H2O LOOP PRESS LOW(HIGH).....	MS E4-2
AV BAY FAN ΔP.....	MS E4-2
TEMP HIGH.....	MS E4-2
LOSS OF AV BAY COOLING PWRDN.....	MS E4-2
CABIN FAN FAIL.....	MS E4-2
IMU FAN FAIL.....	MS E4-2
FREON FLOW LOW.....	MS E4-3
LOSS OF 1 FREON LOOP.....	MS E4-3
2 FREON LOOPS – PWRDN.....	MS E4-3
– LOOPS FAILED....	MS E4-4
EVAP OUT TEMP HIGH.....	
(Rads cold soaked).....	MS E4-4
(Rads <i>not</i> cold soaked).....	MS E4-4
EVAP OUT T LOW.....	MS E4-5
FREON LEAK.....	MS E4-5
FIRE/SMOKE.....	MS E4-6
<u>EPS</u> .....	MS E5-1
MN BUS UNDERVOLTS/FC VOLTS (PLT) (CIL) ...	MS E5-2
AC VOLT HIGH (PLT).....	MS E5-2
LOW or OVERLOAD (PLT).....	MS E5-3
3Φ AC MOTORS STOPPED (PLT).....	MS E5-4
AC SINGLE Φ (PLT).....	MS E5-4
ANY AC2 SINGLE Φ (CDR).....	MS E5-4
BUS TIE.....	MS E5-5
ESS BUS V LOW (PLT).....	MS E5-5
LOSS (CIL).....	MS E5-5
MNA or <span style="border: 1px solid black; padding: 0 2px;">AC1 Multi Φ</span> (CDR).....	MS E5-6
MNB or <span style="border: 1px solid black; padding: 0 2px;">AC2 Multi Φ</span> (CDR).....	MS E5-6
MNC or <span style="border: 1px solid black; padding: 0 2px;">AC3 Multi Φ</span> (CDR).....	MS E5-6
SUBBUS [MNA O14] (CDR).....	MS E5-6
[APC4(5,6) or ALC1(2,3)].....	MS E5-6
MNA or <span style="border: 1px solid black; padding: 0 2px;">AC1 Multi Φ</span> (PLT) (CIL).....	MS E5-7

MNB or AC2 Multi $\Phi$ (PLT) (CIL) .....	MS E5-7
MNC or AC3 Multi $\Phi$ (PLT) (CIL) .....	MS E5-7
SUBBUS (PLT).....	MS E5-7
CNTL BUS V LOW/CNTL BUS RPC (PLT).....	MS E5-8
LOSS (CDR).....	MS E5-9
(PLT).....	MS E5-10
FC REAC VLV CLOSED (PLT) .....	MS E5-11
pH $\downarrow$ 1(2,3) or FC DELTA V 1(2,3) (PLT) .....	MS E5-11
STACK T (PLT) .....	MS E5-11
EXIT T (PLT) .....	MS E5-11
COOLANT PUMP $\Delta$ P LOW (PLT) (CIL).....	MS E5-12
COOL P (PLT).....	MS E5-12
SHUTDN (1st) (CIL) .....	MS E5-13
LOSS OF 1 FC PWRDN (GRTLS/TAL) (PLT) .....	MS E5-13
(ENTRY)(PLT).....	MS E5-13
EMER PWRDN (PLT) .....	MS E5-13
2nd FC SHUTDN (GRTLS/TAL) (PLT).....	MS E5-14
(ENTRY) (PLT) .....	MS E5-14
LOSS OF 2nd FC PWRDN	
(GRTLS/TAL) (CDR) .....	MS E5-15
(GRTLS/TAL) (PLT).....	MS E5-16
(ENTRY) (CDR).....	MS E5-16
O2(H2) CRYO P/T HIGH (PLT).....	MS E5-17
CRYO O2(H2) LEAK	
(three or more tanks aff) (PLT).....	MS E5-17
<u>OMS</u> .....	MS E6-1
OMS TEMP DURING DUMP .....	MS E6-2
Pc LOW DURING DUMP .....	MS E6-2
ENG FAIL .....	MS E6-2
PRPLT FAIL .....	MS E6-2
OMS SECURE .....	MS E6-3
OMS XFEED: R to L.....	MS E6-3
L to R.....	MS E6-3
XFEED RETURN: OMS to OMS.....	MS E6-3
<u>RCS</u> .....	MS E7-1
RCS JET FAIL (LEAK) .....	MS E7-2
(ON) .....	MS E7-2
RM DLMA MANF.....	MS E7-2
RCS JET FAIL (OFF) .....	MS E7-2
AFT RCS RM LOSS.....	MS E7-2
LOW QBAR AFT RCS LK (GRTLS/304/305).....	MS E7-3
AFT RCS LK (GRTLS/304/305) .....	MS E7-4
RCS TK P HIGH (FU or OX) .....	MS E7-5

XFEED: RCS to RCS (CIL) .....	MS E7-5
RCS SECURE .....	MS E7-5
<b>MPS</b> .....	MS E8-1
MPS He P/MPS C&W LIGHT	
PNEU REG .....	MS E8-2

SECTION RESERVED

**MULTIPHASE SYSTEMS CUE CARDS .....**      **CC 10-i**

POWER	
EMER PWRDN .....	CC 10-1
FC SHUTDN (1st) (CIL) .....	CC 10-1
BUS TIE .....	CC 10-1
MPS 1	
SSME FAIL/SHUTDN (CIL) .....	CC 10-2
MPS DATA (CIL) .....	CC 10-2
LH2 ULL .....	CC 10-2
DUMP INHIBIT .....	CC 10-2
CMD/HYD/ELEC (CIL) .....	CC 10-2
MPS 2 .....	CC 10-4
OPS 1/6/TAL TRANSITION RESTRING .....	CC 10-5
POST OPS 3/GRTLS TRANSITION RESTRING ..	CC 10-6
MPS He P (Pre MECO) .....	CC 10-7
PNEU TK(REG) P .....	CC 10-7
ET SEP	
'ET SEP MAN' .....	CC 10-8
FIRE/SMOKE (ASCENT/ENTRY) .....	CC 10-9

**PLT OVERHEAD FLIP BOOK -**

**POWERED FLIGHT .....**      **FB A11-i**

OMS He TK P LOW .....	FB A11-1
OMS N2 TK P LOW (N/A DURING	
ASSIST/RTLS/TAL/ATO DUMP) .....	FB A11-1
OMS N2 REG P HIGH or LOW .....	FB A11-1
TK P LOW (↓, OX or FU) NOT DUMPING ...	FB A11-2
TEMP DURING DUMP .....	FB A11-3
Pc LOW DURING DUMP .....	FB A11-3
ENG FAIL .....	FB A11-3
PRPLT FAIL .....	FB A11-3
OMS TK P LOW (↓, OX and FU) DURING DUMP ...	FB A11-3
HIGH (↑, OX and FU) DURING DUMP ..	FB A11-3

RCS JET FAIL (LEAK) .....	FB A11-4
(ON) .....	FB A11-4
RM DLMA MANF .....	FB A11-4
RCS JET FAIL (OFF) .....	FB A11-4
TK P HIGH (FU or OX) .....	FB A11-4
XFEED: RCS to RCS (CIL) .....	FB A11-4
RCS SECURE .....	FB A11-5
AFT RCS LK .....	FB A11-5
FWD RCS LK .....	FB A11-6

**PLT OVERHEAD FLIP BOOK -**

**GLIDED FLIGHT..... FB E11-i**

OMS TEMP DURING DUMP .....	FB E11-1
Pc LOW DURING DUMP .....	FB E11-1
ENG FAIL .....	FB E11-1
PRPLT FAIL .....	FB E11-1
OMS SECURE .....	FB E11-2
OMS XFEED: R to L .....	FB E11-2
L to R .....	FB E11-2
XFEED RETURN: OMS to OMS .....	FB E11-2
RCS JET FAIL (LEAK) .....	FB E11-3
(ON) .....	FB E11-3
RM DLMA MANF .....	FB E11-3
RCS JET FAIL (OFF) .....	FB E11-3
TK P HIGH (FU or OX) .....	FB E11-3
XFEED: RCS to RCS (CIL) .....	FB E11-3
LOW QBAR AFT RCS LK (GRTLS/304/305) .....	FB E11-4
AFT RCS LK (GRTLS/304/305) .....	FB E11-5
RCS SECURE .....	FB E11-6
AFT RCS RM LOSS .....	FB E11-6

**PLT WINDOW FLIP BOOK -**

**POWERED FLIGHT..... FB A12-i**

APU SHUTDN .....	FB A12-2
SPD HI .....	FB A12-2
OVERSPEED .....	FB A12-2
UNDERSPEED .....	FB A12-2
OIL OVERTEMP .....	FB A12-2
HYD PRESS (LOW) (CIL) .....	FB A12-2
RSVR QTY (LOW) .....	FB A12-2
W/B QTY (LOW) .....	FB A12-2
COMM LOST (mult pnls) .....	FB A12-3

ICOM LOST.....	FB A12-3
FCS CH 1(2,3,4) (2nd FAIL).....	FB A12-3
RHC L(R) (2nd FAIL).....	FB A12-3
DISPLAY SW L(R) .....	FB A12-3
RM FAIL IMU,RGA,AA .....	FB A12-3
DLMA IMU .....	FB A12-3
POST BFS ENGAGE .....	FB A12-3
PASS GPC FAIL .....	FB A12-4
BFS GPC FAIL .....	FB A12-4
FF(FA) MDM OUTPUT.....	FB A12-4
PL MDM I/O ERROR.....	FB A12-4
PCM I/O ERROR.....	FB A12-4
FA/FF MDM I/O ERROR .....	FB A12-5
PORT MODE .....	FB A12-5
BCE STRG X.....	FB A12-6
DUAL DPS DISPLAY COMMANDERS/ DK XMTR 1(2,3).....	FB A12-6
PASS DISPLAY FAIL .....	FB A12-6
BFS DISPLAY FAIL.....	FB A12-7
FLT INST DISPLAY ANOMALY .....	FB A12-9
SUBSYS STATUS DISPLAY ANOMALY .....	FB A12-9
MULT DATA PATH LOSS (non-Recov) (CIL) .....	FB A12-9
MN BUS UNDERVOLTS/FC VOLTS (CIL) .....	FB A12-10
AC VOLT HIGH .....	FB A12-10
LOW or OVERLOAD.....	FB A12-11
3Φ AC MOTORS STOPPED.....	FB A12-11
MNA or AC1 Multi Φ (CIL) .....	FB A12-12
MNB or AC2 Multi Φ (CIL) .....	FB A12-12
MNC or AC3 Multi Φ (CIL) .....	FB A12-12
AC SINGLE Φ .....	FB A12-12
SUBBUS [APC4(5,6) or ALC1(2,3)] .....	FB A12-12
ESS BUS V LOW (CIL) .....	FB A12-12
LOSS (CIL) .....	FB A12-12
CNTL BUS V LOW/CNTL BUS RPC.....	FB A12-13
LOSS .....	FB A12-14
FC REAC VLV CLOSED .....	FB A12-15
pH ↓ 1(2,3) or FC DELTA V 1(2,3).....	FB A12-15
STACK T .....	FB A12-15
EXIT T .....	FB A12-15
COOLANT PUMP ΔP LOW (CIL) .....	FB A12-16
COOL P .....	FB A12-16
LOSS OF 1 FC PWRDN .....	FB A12-16
2nd FC SHUTDN.....	FB A12-17
O2(H2) CRYO PRESS/TEMP HIGH .....	FB A12-18
CRYO O2(H2) LEAK (three or more tanks aff) .....	FB A12-18

**PLT WINDOW FLIP BOOK - GLIDED FLIGHT ..... FB E12-i**

APU SHUTDN.....	FB E12-1
SPD HI.....	FB E12-1
OVERSPEED.....	FB E12-1
UNDERSPEED.....	FB E12-1
OIL OVERTEMP.....	FB E12-1
PUMP LEAK P.....	FB E12-1
THERM (T HI).....	FB E12-1
COOLDOWN.....	FB E12-2
RESTART (CIL).....	FB E12-2
HYD PRESS (LOW) (CIL).....	FB E12-3
RSVR QTY (LOW).....	FB E12-4
T.....	FB E12-4
W/B QTY (LOW).....	FB E12-4
COMM LOST (mult pnls).....	FB E12-5
ICOM LOST.....	FB E12-5
FCS CH 1(2,3,4) (2nd FAIL).....	FB E12-5
RHC L(R) (2nd FAIL).....	FB E12-5
G51 ROLL MODE SW.....	FB E12-5
DISPLAY SW L(R).....	FB E12-5
RM FAIL IMU,RGA,AA.....	FB E12-5
DLMA IMU.....	FB E12-5
FAIL ADTA.....	FB E12-6
DLMA ADTA (CIL).....	FB E12-6
FAIL TAC.....	FB E12-6
DLMA TAC.....	FB E12-6
SPD BRK.....	FB E12-6
MPS He P/MPS C&W LIGHT.....	FB E12-7
PNEU REG.....	FB E12-7
G55 GPS FAIL 1(2,3).....	FB E12-7
RM DLMA GPS.....	FB E12-7
NO UPDATE GPS.....	FB E12-7
PASS GPC FAIL.....	FB E12-9
BFS GPC FAIL.....	FB E12-9
FA/FF MDM I/O ERROR.....	FB E12-9
PORT MODE.....	FB E12-10
FF(FA) MDM OUTPUT.....	FB E12-11
PL MDM I/O ERROR.....	FB E12-11
PCM I/O ERROR.....	FB E12-11
POST BFS ENGAGE.....	FB E12-11
BCE STRG X.....	FB E12-12
DUAL DPS DISPLAY COMMANDERS/ DK XMTR 1(2,3).....	FB E12-13
PASS DISPLAY FAIL.....	FB E12-13
BFS DISPLAY FAIL.....	FB E12-13
FLT INST DISPLAY ANOMALY.....	FB E12-14



SUBSYS STATUS DISPLAY ANOMALY .....	FB E12-14	
MULT DATA PATH LOSS (non-Recov) (CIL) .....	FB E12-14	
MN BUS UNDERVOLTS/FC VOLTS (CIL) .....	FB E12-16	
AC VOLT HIGH .....	FB E12-16	
LOW or OVERLOAD.....	FB E12-17	
3Φ AC MOTORS STOPPED.....	FB E12-18	
AC SINGLE Φ .....	FB E12-18	
MNA or <table border="1" style="display: inline-table; vertical-align: middle;"><tr><td>AC1 Multi Φ</td></tr></table> (CIL) .....	AC1 Multi Φ	FB E12-19
AC1 Multi Φ		
MNB or <table border="1" style="display: inline-table; vertical-align: middle;"><tr><td>AC2 Multi Φ</td></tr></table> (CIL) .....	AC2 Multi Φ	FB E12-19
AC2 Multi Φ		
MNC or <table border="1" style="display: inline-table; vertical-align: middle;"><tr><td>AC3 Multi Φ</td></tr></table> (CIL) .....	AC3 Multi Φ	FB E12-19
AC3 Multi Φ		
SUBBUS.....	FB E12-19	
ESS BUS V LOW (CIL) .....	FB E12-19	
LOSS (CIL) .....	FB E12-20	
CNTL BUS V LOW/CNTL BUS RPC.....	FB E12-20	
LOSS .....	FB E12-21	
FC REAC VLV CLOSED .....	FB E12-23	
pH ↓ 1(2,3) or FC DELTA V 1(2,3) .....	FB E12-23	
STACK T .....	FB E12-23	
EXIT T .....	FB E12-24	
COOLANT PUMP ΔP LOW (CIL) .....	FB E12-24	
COOL P .....	FB E12-24	
LOSS OF 1 FC PWRDN (GRTLS/TAL) .....	FB E12-24	
(ENTRY).....	FB E12-24	
2nd FC SHUTDN (GRTLS/TAL).....	FB E12-25	
(ENTRY) .....	FB E12-25	
LOSS OF 2nd FC PWRDN (GRTLS/TAL) .....	FB E12-26	
O2(H2) CRYO P/T HIGH.....	FB E12-26	
CRYO O2(H2) LEAK (three or more tanks aff) .....	FB E12-26	

**CDR WINDOW FLIP BOOK -**

**POWERED FLIGHT..... FB A13-i**

COMM LOST (mult pnls).....	FB A13-1
ICOM LOST.....	FB A13-1
FCS CH 1(2,3,4) (2nd FAIL).....	FB A13-1
RHC L(R) (2nd FAIL).....	FB A13-1
DISPLAY SW L(R) .....	FB A13-1
RM FAIL IMU,RGA,AA .....	FB A13-1
DLMA IMU .....	FB A13-1
POST BFS ENGAGE .....	FB A13-1
PASS GPC FAIL .....	FB A13-2
BFS GPC FAIL .....	FB A13-2
FF(FA) MDM OUTPUT.....	FB A13-2
PL MDM I/O ERROR.....	FB A13-2

PCM I/O ERROR.....	FB A13-2
SUMWORD ICC.....	FB A13-2
FA/FF MDM I/O ERROR.....	FB A13-3
PORT MODE.....	FB A13-3
BCE STRG X.....	FB A13-4
DUAL DPS DISPLAY COMMANDERS/ DK XMTR 1(2,3).....	FB A13-4
PASS DISPLAY FAIL.....	FB A13-4
BFS DISPLAY FAIL.....	FB A13-5
FLT INST DISPLAY ANOMALY.....	FB A13-7
SUBSYS STATUS DISPLAY ANOMALY.....	FB A13-7
BFS INADVERTENT DISENGAGE/ UNSUCCESSFUL ENGAGE.....	FB A13-7
MULT DATA PATH LOSS (non-Recov) (CIL).....	FB A13-7
CAB PRESS LEAK.....	FB A13-8
HIGH.....	FB A13-8
PPO2 ABNORMAL.....	FB A13-8
H2O LOOP PRESS HIGH.....	FB A13-8
LOW.....	FB A13-8
AV BAY FAN $\Delta$ P.....	FB A13-8
TEMP HIGH.....	FB A13-8
CABIN FAN FAIL.....	FB A13-8
IMU FAN FAIL.....	FB A13-8
FREON FLOW LOW.....	FB A13-9
LOSS OF 1 FREON LOOP.....	FB A13-9
2 FREON LOOPS – PWRDN.....	FB A13-9
– LOOPS FAILED....	FB A13-9
EVAP OUT TEMP HIGH.....	FB A13-10
T LOW.....	FB A13-10
FREON LEAK.....	FB A13-10
ESS BUS LOSS (CIL).....	FB A13-11
LOSS OF 2nd FC PWRDN.....	FB A13-11
MNA.....	FB A13-12
MNB.....	FB A13-12
MNC.....	FB A13-12
ANY AC BUS LOSS.....	FB A13-12
SUBBUS [MNA O14].....	FB A13-12
[APC6 or ALC3].....	FB A13-12
CNTL BUS LOSS.....	FB A13-12
FWD RCS LK.....	FB A13-13

**CDR WINDOW FLIP BOOK - GLIDED FLIGHT ..... FB E13-i**

COMM LOST (mult pnls).....	FB E13-1
ICOM LOST.....	FB E13-1
FCS CH 1(2,3,4) (2nd FAIL).....	FB E13-2
RHC L(R) (2nd FAIL).....	FB E13-2
G51 ROLL MODE SW.....	FB E13-2
DISPLAY SW L(R) .....	FB E13-2
RM FAIL IMU,RGA,AA .....	FB E13-2
DLMA IMU .....	FB E13-2
FAIL ADTA.....	FB E13-2
DLMA ADTA (CIL) .....	FB E13-2
FAIL TAC.....	FB E13-3
DLMA TAC.....	FB E13-3
SPD BRK.....	FB E13-3
G55 GPS FAIL 1(2,3).....	FB E13-3
RM DLMA GPS (OV105).....	FB E13-3
NO UPDATE GPS .....	FB E13-3
PASS GPC FAIL .....	FB E13-4
BFS GPC FAIL .....	FB E13-4
FA/FF MDM I/O ERROR .....	FB E13-4
PORT MODE .....	FB E13-5
FF(FA) MDM OUTPUT.....	FB E13-6
PL MDM I/O ERROR.....	FB E13-6
PCM I/O ERROR.....	FB E13-6
POST BFS ENGAGE .....	FB E13-6
BCE STRG X.....	FB E13-7
DUAL DPS DISPLAY COMMANDERS/ DK XMTR 1(2,3).....	FB E13-7
PASS DISPLAY FAIL .....	FB E13-8
BFS DISPLAY FAIL.....	FS E13-8
FLT INST DISPLAY ANOMALY .....	FB E13-9
SUBSYS STATUS DISPLAY ANOMALY .....	FB E13-9
BFS INADVERTENT DISENGAGE/ UNSUCCESSFUL ENGAGE.....	FB E13-9
MULT DATA PATH LOSS (non-Recov) (CIL).....	FB E13-9
CAB PRESS LEAK.....	FB E13-11
HIGH.....	FB E13-11
H2O LOOP PRESS LOW(HIGH) .....	FB E13-11
AV BAY FAN ΔP.....	FB E13-11
TEMP HIGH .....	FB E13-11
LOSS OF AV BAY COOLING PWRDN.....	FB E13-11
CABIN FAN FAIL.....	FB E13-11
IMU FAN FAIL .....	FB E13-11
FREON FLOW LOW .....	FB E13-12

LOSS OF 1 FREON LOOP .....	FB E13-12
2 FREON LOOPS – PWRDN .....	FB E13-12
– LOOPS FAILED.....	FB E13-13
EVAP OUT TEMP HIGH	
(Rads cold soaked).....	FB E13-13
(Rads <i>not</i> cold soaked).....	FB E13-13
EVAP OUT T LOW.....	FB E13-14
FREON LEAK.....	FB E13-14
ESS BUS LOSS (CIL) .....	FB E13-15
LOSS OF 2nd FC PWRDN (ENTRY).....	FB E13-15
(GRTLS/TAL) .....	FB E13-16
MNA or AC1 Multi $\Phi$ .....	FB E13-17
MNB or AC2 Multi $\Phi$ .....	FB E13-17
MNC or AC3 Multi $\Phi$ .....	FB E13-17
ANY AC2 SINGLE $\Phi$ .....	FB E13-17
CNTL BUS LOSS .....	FB E13-18
SUBBUS [MNA O14].....	FB E13-18
[APC4(5,6) or ALC1(2,3)] .....	FB E13-18



**MS POWERED FLIGHT**

----- MS POWERED FLIGHT, SECTIONS 1 thru 9 -----

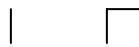

MS A-i

AESP/ALL/A/GEN O

----- MS POWERED FLIGHT, SECTIONS 1 thru 9 -----

This Page Intentionally Blank



APU/  
HYD

## APU/HYDRAULICS



MS A1-1

AESP/ALL/A/GEN O

APU/  
HYD

### APU SHUTDN

APU OPER – OFF  
FU TK VLV – CL  
√Shutdn (HYD PRESS < 200)  
Report APU F7 Its  
APU CNTLR PWR – OFF  
AUTO SHTDN (two) – INH  
SPEED SEL (two) – HI ⇒

### APU SPD HI

If SPEED % exceeds 111:  
APU SPEED SEL – HI ⇒

### APU OVERSPEED

If SPEED % exceeds 129:  
Go to APU SHUTDN

### APU UNDERSPEED [G51]

If 'PRL SYS X ↓' or if APU has shut dn:  
Perform APU SHUTDN, then: ⇒G

### APU OIL OVERTEMP

◆BLR CNTLR/HTR – B  
√N2 SPLY – ON ⇒

### HYD PRESS (LOW) [G51]

If 'PRL SYS X ↓' and APU still oper:  
1. APU AUTO SHTDN (two) – INH  
2. SPEED SEL (two) – HI ⇒

### HYD RSVR QTY (LOW)

Post MECO:  
(Aff) HYD MPS/TVC ISOL VLV SYS – CL  
(hold 5 sec, tb-CL) ⇒

### W/B QTY (LOW)

1. If W/B QTY = 0 >>  
2. BLR N2 SPLY – OFF  
3. CNTLR/HTR – OFF ⇒





**COMM/  
GNC**

**COMM/GNC**



MS A2-1

AESP/ALL/A/GEN O

COMM/  
GNC

### COMM LOST (mult pnls)

1. AUD CTR – 2
2. No joy, S-BD PM CNTL – PNL,CMD
3. Config per COMM COVER (ASC) **[BFS G51]**:  
TDRS – ITEM 46 EXEC (\*)  
STDN-HI – ITEM 47 EXEC (\*)  
SGLS – ITEM 49 EXEC (\*)
4. No joy, sel best S-BD PM ANT; else GPC ⇒

### ICOM LOST

1. AUD CNTL sel – sel alt
2. No joy, AUD CTR – 2

### FCS CH 1(2,3,4) (2nd FAIL) **[G53]**

If two FCS CH ↓ on any actuator:

- ◆ (Remaining) FCS CH (two) – ORIDE

### RHC L(R) (2nd FAIL)

(Aff) FLT CNTLR PWR – OFF

### DISPLAY SW L(R)

L(R) disp sws – green dot

### RM FAIL IMU,RGA,AA **[BFS G51]**

Aff LRU – desel

### RM DLMA IMU **[G51]** **[BFS G51]**

1. √MCC, bad IMU – desel (PASS & BFS) >>
- ◆ 2. Desel lower # IMU with '?' (PASS)



**DPS**

**DPS**



MS A3-1

AESP/ALL/A/GEN O

DPS

### PASS GPC FAIL

1. (Aff) FCS CH – OFF
- If two GPC/FA/FCS CHs ↓:
2. (Good) FCS CHs – ORIDE
  3. √MPS CMD
  4. **G53** aff SURF FDBK – desel
  5. If FTS, ASAP, GPC MODE – STBY,HALT
  6. √BIG 'X', then assign IDPs as reqd
  7. √MULT DATA PATH LOSS
- Post MECO:
8. ASAP, GPC MODE – STBY,HALT ⇒

### BFS GPC FAIL

1. Post SRB SEP: FLASH EVAP CNTLR PRI A – ON
- Post MECO:
2. GPC MODE – STBY,HALT  
OUTPUT – TERM
- ◆ 3. If no comm: sel best S-BD PM ANT ⇒

### FF(FA) MDM OUTPUT

**FAULT**

- ◆ (Take action only if annun by entire set)
- If single 'MDM OUTPUT':
1. Go to FA/FF MDM I/O ERROR >>
- If both FF and FA annun:
2. I/O RESET; if reqd, BFS I/O RESET
  3. If msgs repeat: Go to PASS GPC FAIL >>
  4. If reqd, (aff) FCS CH – ORIDE,AUTO

### PL MDM I/O ERROR

1. BFS I/O RESET; if recovered >>
- ◆ 2. **G01** PL1/2 – port mode, then BFS I/O RESET;  
if recovered >>
3. If PL2 down:  
Post SRB SEP: FLASH EVAP CNTLR PRI A – ON  
If no comm: sel best S-BD PM ANT ⇒

### PCM I/O ERROR

OI PCMMU PWR – 2

### SUMWORD ICC

- If TAL:
- | Go to OPS 1/6/TAL TRANSITION RESTRING (Cue Card)  
| for aff GPC >>
- If AOA/Uphill: ⇒A

**FA/FF MDM I/O ERROR**  
(Annunciated by entire set)

		1. I/O RESET
RECOV	FA	2. If reqd, (aff) FCS CH – ORIDE,AUTO
		3. BFS I/O RESET >>
NOT RECOV	FA	4. (Aff) FCS CH – OFF
		5. If two GPC/FA/FCS CHs ↓: (Good) FCS CHs – ORIDE
		6. <b>G53</b> aff SURF FDBK – desel
		7. √MULT DATA PATH LOSS
		◆ 8. Go to FA/FF MDM PORT MODE ⇒

**FA/FF MDM PORT MODE**

NOTE

If BFS, 'BCE STRG X PASS', @GPC; else @MDM.

For '@GPC' port mode results in alternate MDM bypass

			1. <b>G01</b> aff String – port mode
			2. BFS I/O RESET
@MDM	RECOV	FA	3. (Aff) FCS CH – AUTO
			4. <b>G53</b> aff SURF FDBK – resel >>
		FF	5. >>
	NOT RECOV	FA	6. <b>BFS G51</b> aff SURF FDBK, RGA – desel
		FF	7. <b>BFS G51</b> aff AA – desel
			8. √MULT DATA PATH LOSS ⇒
@GPC	FA RECOV (FF Give Up)		9. (Aff) FCS CH – AUTO
			10. <b>G51</b> aff IMU – desel
			11. <b>G53</b> aff SURF FDBK – resel
			12. √MULT DATA PATH LOSS ⇒A
	FF RECOV (FA Give Up)		13. (Aff) FCS CH – OFF
			14. If two GPC/FA/FCS CHs ↓: (Good) FCS CHs – ORIDE
			15. <b>G53</b> aff SURF FDBK – desel
			16. √MULT DATA PATH LOSS ⇒A

**BCE STRG X** (no 'MDM OUTPUT' msg)

	IMU	1.	G51 IMU – desel
		2.	I/O RESET
RECOV	IMU	3.	>>
		4.	>>
NOT RECOV	NSP	5.	And no comm: PNL,CMD
		6.	BFS G51 Config per <u>COMM COVER</u> (ASC): TDRS – ITEM 46 EXEC (*) STDN-HI – ITEM 47 EXEC (*) SGLS – ITEM 49 EXEC (*) >>
		♦ 7.	G01 aff String – port mode
		8.	BFS I/O RESET
		9.	If recov, go to RECOV steps >>
	B	10.	BFS G51 aff AA – desel
	D	11.	BFS G51 aff SURF FDBK,RGA – desel
	B/D	12.	If RTLS: G23 OVRD aff MANF(s) – OP
		13.	√MULT DATA PATH LOSS ⇒

**DUAL DPS DISPLAY COMMANDERS/DK XMTR 1(2,3)**

1. BFC CRT SEL – aff IDP  
If reqd to clean up display:
2. (Aff) IDP/CRT PWR – OFF,ON

**PASS DISPLAY FAIL**

1. MDU PWR – OFF,ON; if recovered >>
2. GPC/CRT – same GPC/aff IDP; if recovered >>
3. BFC CRT SEL – aff IDP; if both IDPs OK go to step 9
4. – orig posn
5. Report MDU symptoms  
If MCC GO for pwr cycle:
6. IDP/CRT PWR – OFF,ON; if recovered >>
7. Set other MDU on same IDP to DPS Mode; if recovered >>
8. Return other MDU to nominal config
9. Deassign aff IDP from PASS
10. GPC/CRT 04 EXEC
11. In PASS: GPC/CRT 44 EXEC

### **BFS DISPLAY FAIL**

1. If IDP4(CRT4): IDP/CRT4 PWR – OFF >>
  2. MDU PWR – OFF,ON; if recovered >>
  3. BFC CRT SEL – unaff IDP; if both IDPs OK >>
  4. – orig posn
  5. BFC CRT DISPLAY – OFF,ON; if recovered >>
  6. In PASS: GPC/CRT 5/X for aff IDP; if recovered >>
  7. Report MDU symptoms
- If MCC GO for pwr cycle:
8. IDP/CRT PWR – OFF,ON; if recovered >>
- If MDU blank or autonomous:
9. Set other MDU on same IDP to DPS Mode; if recovered >>
  10. Return other MDU to nominal config
11. BFC CRT SEL – unaff IDP
  12. Deassign aff IDP from PASS
  13. GPC/CRT 04 EXEC
  14. In PASS: GPC/CRT 44 EXEC

### **FLT INST DISPLAY ANOMALY**

1. DATA BUS sel alt FC BUS(s); if recovered >>
2. PORT SELECT aff MDU; if recovered >>
3. MDU PWR – OFF,ON

### **SUBSYS STATUS DISPLAY ANOMALY**

1. PORT SELECT aff MDU; if recovered >>
2. MDU PWR – OFF,ON; if recovered >>

### **BFS INADVERTENT DISENGAGE/UNSUCCESSFUL ENGAGE (Lightning Strike)**

1. CDR and PLT RHC BFS engage pb – push
- If no response:
2. BFS OUTPUT – NORM,B/U
  3. CDR,PLT RHC BFS engage pb – push

## MULT DATA PATH LOSS (non-Recov)

### NOTE

If LRU data path loss due to GPC prob and not MDM,  
BFS will pick up MDMs/LRU when engaged

FAILURE	TYPE	ACTIONS
GPC/FA any combo	I/O	D √BFS MM at each transition Expect 'SEP INH' (FDLN Fail) combos 2&3,2&4 √OMS MAN SHUTDOWN Post MECO: Before MECO + 25 sec: •• 1. MPS FDLN RLF ISOL (two) – OP 2. MPS PREVLVs (six) – OP RTLS/TAL: MPS FILL/DRAIN LH2 INBD, OUTBD – OP
GPC/FF 1&2	I/O or B	Use R BODY FLAP & TRIM ENA SWs
GPC/FF 3&4	I/O or B	Use L BODY FLAP & TRIM ENA SWs

## OPS 1/6/TAL TRANSITION RESTRING

	1. Config MC1(3) NBAT as reqd
	2. √G53 aff SURF FDBK – desel (*)
Post MECO	3. ASAP, (aff) GPC(s) – STBY,HALT
ASC/RTLS	4. OPS Mode Recall: OPS XXX PRO
	5. BFS I/O RESET ⇒G
TAL	6. OPS 301 PRO
	7. BFS, OPS 301 PRO ⇒G

## POST BFS ENGAGE

If PASS GPCs running:

1. (Aff) GPC MODE – STBY/HALT
2. BFS I/O RESET
3. √FCS CHs, IMU config

If Pre MECO:

4. If SSME failed: MN ENG LIMIT SHUTDN – INH
5. G51 DES failed(commfaulted) RGA,AA,SURF ⇒G





**ECLS**

**ECLS**



MS A4-1

AESP/ALL/A/GEN O

**CAB PRESS LEAK**

1. CAB RELIEF A – CL, pause,  
B – CL
2. Check tabs, visors – CL, LES O2 – ON
3. If RTLS/TAL: O2/N2 CNTLR VLV SYS 2 – OP
4. O2 TK1, TK2 HTRS A, B (four) – AUTO ⇒

**CAB PRESS HIGH**

1. If incr: LES O2 – OFF, visors – OP  
If still incr:
  2. N2 SYS 1, 2 REG INLET (two) – CL
  3. O2 SYS 1, 2 SPLY (two) – CL ⇒A

**PPO2 ABNORMAL ⇒A****H2O LOOP PRESS HIGH**

- ◆ Deact pump ⇒

**H2O LOOP PRESS LOW ⇒****AV BAY FAN ΔP**

- ◆ Deact fan ⇒

**AV BAY TEMP HIGH ⇒****CABIN FAN FAIL ⇒****IMU FAN FAIL ⇒**

### **FREON FLOW LOW**

- ◆ 1. Switch pumps
- If flow still low:
  - 2. (Aff) RAD BYP VLV MAN SEL – RAD FLOW  
(hold 5 sec)
- If flow still low:
  - 3. Perform LOSS OF FREON LOOP(s), then ⇒A

### **LOSS OF 1 FREON LOOP**

- 1. (Bad) FREON PUMP LOOP – OFF
- If FREON LOOP 1(2) lost:
  - 2. O2 SYS 1(2) SPLY (one) – CL
  - 3. √FLOW PROP VLV LOOP 2(1) – ICH
- 4. Monitor EVAP OUT TEMP
- If TAL/AOA/RTLS and LOOP 2 lost:
  - 5. NH3 CNTLR B – OFF  
A – PRI/GPC

### **LOSS OF 2 FREON LOOPS – PWRDN**

- 1. When loops fail (flow <700), CDR execute LOOPS  
FAILED
- 2. MSTR MADS PWR – OFF
- 3. Use one IDP/CRT with two MDUs (three max)
- 4. All PL pwr (seven) – OFF
- 5. O2,H2 TK HTRS (all) – OFF
- 6. MCC CMD FC purge, then BFS GPC – STBY,HALT  
PWR – OFF  
OUTPUT – NORM
- 7. If no comm: sel best S-BD PM ANT
- Post MECO:
  - If RTLS:
    - 8. TACAN (three) – OFF
    - 9. RDR ALTM 1 – OFF ⇒G
  - If TAL:
    - 10. All TACAN/RA – OFF
    - 11. Use one FLT CNTLR PWR ⇒G

### **LOSS OF 2 FREON LOOPS – LOOPS FAILED**

- 1. LES O2 – OFF, visor – OP
- 2. O2 SYS 1,2 SPLY (two) – OP
- Panel L1: All sws off, except:
  - 3. H2O PUMP LOOP 2 – ON
- 4. Perform PWRDN if not already accomplished

# **OV103,104**

(OV103,104) MS A4-3

AESP/3,4/A/GEN O

### EVAP OUT T LOW

1. If temp low in only one loop (snsr failed) >>
2. FREON PUMP LOOP 1,2 (two) – OFF
3. H2O PUMP LOOP 1 (two) – ON,B
4. FLOW PROP VLV LOOP 1,2 (two) – PL HX (tb-PL)
5. O2 SYS 1,2 SPLY (two) – CL (tb-CL)
6. √RAD BYP VLV MODE (two) – MAN
7. √MAN SEL (two) – BYP (tb-BYP ~3 sec)
8. FLASH EVAP CNTLR PRI A,B,SEC (three) – OFF
- ◆ 9. FREON PUMP LOOP 1,2 (two) – B  
NH3 CNTLR A,B (two) – SEC/ON

Wait 3 min, then if any Freon Loop off:

10. FREON PUMP LOOP 1,2 (two) – B

When EVAP OUT T > 55 for at least 2 min (NH3 depleted):

11. FLASH EVAP CNTLR PRI B – ON
12. O2 SYS 1,2 SPLY (two) – OP (tb-OP)
13. NH3 CNTLR A,B (two) – OFF

### FREON LEAK

- ◆ 1. FREON ISOL MODE – MAN
  2. (Aff) FREON ISOL LOOP 1(2) – ISOL  
Hold for 5 sec
- If (aff) FREON LOOP 1(2) ACCUM QTY decr:
3. When loop fails ('SM2 FREON FLOW 1(2)'), CDR  
execute LOSS OF 1 FREON LOOP for (aff) Freon  
Loop ⇒
- If (aff) FREON LOOP 1(2) ACCUM QTY not decr, ⇒A

# OV103,104

(OV103,104) MS A4-4

AESP/ALL/A/GEN O,2

## **EVAP OUT TEMP HIGH**

If temp high in only one loop (snsr failed) >>

1. FLASH EVAP CNTLR PRI A – OFF  
B – ON (wait 30 sec)  
If T decr >>
2. FLASH EVAP CNTLR PRI B – OFF  
SEC – ON (HI LOAD ena) (wait 30 sec)  
If T decr:
  3. TOP EVAP HTR DUCT sel – A/B >>
4. HI LOAD EVAP – OFF (wait 30 sec)  
If T decr (HI LOAD EVAP only lost):
  5. HI LOAD DUCT HTR sel – A/B ⇒A
6. RAD BYP VLV (four) – MAN, RAD FLOW (total FES lost) ⇒A

# **OV103,104**

(OV103,104) MS A4-5

AESP/ALL/A/GEN O

## FIRE/SMOKE

SM SYS SUMM 1

If **VISUAL SMOKE/FIRE**, or  
two SMOKE DETN lt on, or  
two CONC > 2, or  
one SMOKE DETN lt on and  
other CONC > 2:

1. Go to step 6

If single Av Bay SMOKE DETN A(B) lt and assoc CONC > 2:

2. SMOKE DETN CKT TEST – B(A) (25 sec)

If SMOKE DETN B(A) test good (lt on):

3. SMOKE DETN CKT TEST – OFF

4. SNSR – RESET >>

If SMOKE DETN B(A) test bad (no lt):

5. Go to step 6

If none of above >>

6. Check tabs, visors – CL  
LES O2 – ON

If **AV BAY FIRE**:

7. FIRE SUPPR – ARM

pb – DISCH (push until lit)

8. If Ascent: AV BAY FAN (two) – OFF

9. If FIRE in Bay:

1: TACAN 1, MLS 1 – OFF

2: TACAN 2, MLS 2,3 – OFF

3: TACAN 3 – OFF

If **CABIN FIRE**:

10. CAB FAN A,B (two) – OFF (max 20 min)

11. Locate source (see matrix, facing page)

12. Unpwr source of smoke

If smoke persists or source cannot be unpwr:

**WARNING**  
Discharge is propulsive

13. Discharge handheld FIRE EXTGHR

If Ascent:

14. Post MECO, go to POST-FIRE CABIN CLEANUP (ASC  
PKT, ECLS) >>

If Entry and prior to TIG:

15. Go to ECLS FRP-3, FIRE/HAZ SPILL O2 CONTROL, step  
3 (MAL)

Cont next page **OV103,104**

(OV103,104) MS A4-6

AESP/3,4/A/GEN O,2

### **FREON FLOW LOW**

- ◆ 1. Switch pumps
- If flow still low:
  - 2. (Aff) RAD BYP VLV MAN SEL – RAD FLOW  
(hold 5 sec)
- If flow still low:
  - 3. Perform LOSS OF FREON LOOP(s), then ⇒A

### **LOSS OF 1 FREON LOOP**

- 1. (Bad) FREON PUMP LOOP – OFF
- If FREON LOOP 1(2) lost:
  - 2. O2 SYS 1(2) SPLY (one) – CL
  - 3. √FLOW PROP VLV LOOP 2(1) – ICH
- 4. Monitor EVAP OUT TEMP
- If TAL/AOA/RTLS and LOOP 2 lost:
  - 5. NH3 CNTLR B – OFF  
A – PRI/GPC

### **LOSS OF 2 FREON LOOPS – PWRDN**

- 1. When loops fail (flow <700), CDR execute LOOPS  
FAILED
- 2. MSTR MADS PWR – OFF
- 3. Use one IDP/CRT with two MDUs (three max)
- 4. All PL pwr (seven) – OFF
- 5. O2,H2 TK HTRS (all) – OFF
- 6. MCC CMD FC purge, then BFS GPC – STBY,HALT  
PWR – OFF  
OUTPUT – NORM
- 7. If no comm: sel best S-BD PM ANT
- Post MECO:
  - 8. GPS 1,3 – OFF
  - If RTLS:
    - 9. RDR ALTM 1 – OFF ⇒G
  - If TAL:
    - 10. RA 1,2 – OFF
    - 11. Use one FLT CNTLR PWR ⇒G

### **LOSS OF 2 FREON LOOPS – LOOPS FAILED**

- 1. LES O2 – OFF, visor – OP
- 2. O2 SYS 1,2 SPLY (two) – OP
- Panel L1: All sws off, except:
  - 3. H2O PUMP LOOP 2 – ON
- 4. Perform PWRDN if not already accomplished

# **OV105**

(OV105) MS A4-3

AESP/5/A/GEN O

### EVAP OUT T LOW

1. If temp low in only one loop (snsr failed) >>
2. FREON PUMP LOOP 1,2 (two) – OFF
3. H2O PUMP LOOP 1 (two) – ON,B
4. FLOW PROP VLV LOOP 1,2 (two) – PL HX (tb-PL)
5. O2 SYS 1,2 SPLY (two) – CL (tb-CL)
6. √RAD BYP VLV MODE (two) – MAN
7. √MAN SEL (two) – BYP (tb-BYP ~3 sec)
8. FLASH EVAP CNTLR PRI A,B,SEC (three) – OFF
- ◆ 9. FREON PUMP LOOP 1,2 (two) – B  
NH3 CNTLR A,B (two) – SEC/ON

Wait 3 min, then if any Freon Loop off:

10. FREON PUMP LOOP 1,2 (two) – B

When EVAP OUT T > 55 for at least 2 min (NH3 depleted):

11. FLASH EVAP CNTLR PRI B – ON
12. O2 SYS 1,2 SPLY (two) – OP (tb-OP)
13. NH3 CNTLR A,B (two) – OFF

### FREON LEAK

- ◆ 1. FREON ISOL MODE – MAN
  2. (Aff) FREON ISOL LOOP 1(2) – ISOL  
Hold for 5 sec
- If (aff) FREON LOOP 1(2) ACCUM QTY decr:
3. When loop fails ('SM2 FREON FLOW 1(2)'), CDR  
execute LOSS OF 1 FREON LOOP for (aff) Freon  
Loop ⇒
- If (aff) FREON LOOP 1(2) ACCUM QTY not decr, ⇒A

# OV105

(OV105) MS A4-4

AESP/ALL/A/GEN O,2



## **EVAP OUT TEMP HIGH**

If temp high in only one loop (snsr failed) >>

1. FLASH EVAP CNTLR PRI A – OFF  
B – ON (wait 30 sec)  
If T decr >>
2. FLASH EVAP CNTLR PRI B – OFF  
SEC – ON (HI LOAD ena) (wait 30 sec)  
If T decr:
  3. TOP EVAP HTR DUCT sel – A/B >>
4. HI LOAD EVAP – OFF (wait 30 sec)  
If T decr (HI LOAD EVAP only lost):
  5. HI LOAD DUCT HTR sel – A/B ⇒A
6. RAD BYP VLV (four) – MAN, RAD FLOW (total FES lost) ⇒A

# **OV105**

(OV105) MS A4-5

AESP/ALL/A/GEN O

## FIRE/SMOKE

SM SYS SUMM 1

If **VISUAL SMOKE/FIRE**, or  
two SMOKE DETN lt on, or  
two CONC > 2, or  
one SMOKE DETN lt on and  
other CONC > 2:

1. Go to step 6

If single Av Bay SMOKE DETN A(B) lt and assoc CONC > 2:

2. SMOKE DETN CKT TEST – B(A) (25 sec)

If SMOKE DETN B(A) test good (lt on):

3. SMOKE DETN CKT TEST – OFF

4. SNSR – RESET >>

If SMOKE DETN B(A) test bad (no lt):

5. Go to step 6

If none of above >>

6. Check tabs, visors – CL  
LES O2 – ON

If **AV BAY FIRE**:

7. FIRE SUPPR – ARM

pb – DISCH (push until lit)

8. If Ascent: AV BAY FAN (two) – OFF

9. If FIRE in Bay:

1: GPS 1, MLS 1 – OFF

2: MLS 2,3 – OFF

3: GPS 3 – OFF

If **CABIN FIRE**:

10. CAB FAN A,B (two) – OFF (max 20 min)

11. Locate source (see matrix, facing page)

12. Unpwr source of smoke

If smoke persists or source cannot be unpwr:

### WARNING

Discharge is propulsive

13. Discharge handheld FIRE EXTGHR

If Ascent:

14. Post MECO, go to POST-FIRE CABIN CLEANUP (ASC  
PKT, ECLS) >>

If Entry and prior to TIG:

15. Go to ECLS FRP-3, FIRE/HAZ SPILL O2 CONTROL, step  
3 (MAL)

Cont next page

(OV105) MS A4-6

# OV105

AESP/5/A/GEN O,2

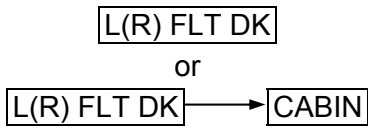
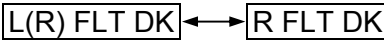
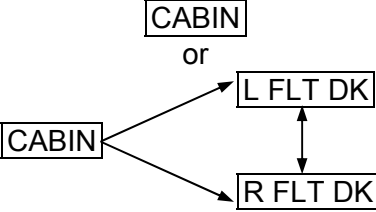
ALARM SEQUENCE	SOURCE AREA
 <p style="text-align: center;">L(R) FLT DK or L(R) FLT DK → CABIN</p>	PS(MS), L(R) CONSOLE
 <p style="text-align: center;">L(R) FLT DK ↔ R FLT DK</p>	AFT FLT DK, MIDDECK
 <p style="text-align: center;">CABIN or CABIN → L FLT DK CABIN → R FLT DK L FLT DK ↔ R FLT DK</p>	FWD FLT DK, WCS, LEB



This Page Intentionally Blank





**EPS**

**EPS**



MS A5-1

AESP/ALL/A/GEN O

**MN BUS UNDERVOLTS/FC VOLTS**

PLT

If MN V &lt; 26.4, FC V &lt; 26.6, FC A &gt; 480 (2 of 3)

(SHORT or degraded FC):

1. MSTR MADS PWR – OFF
2. If aff BUS tied – untie
3. PL PRI (three) – OFF

If AC VOLTS &lt; 95, or STACK T &gt; 243 and incr:

4. (Aff) ESS BUS SOURCE FC – OFF  
FC/MN BUS – OFF

If FC VOLTS &lt; 32 (FC SHORT)

5. (Aff) FC REAC VLV – CL
6. Perform BUS LOSS ACTION (do not perform FC SHUTDN)

Post MECO:

7. ⇒ FC SHUTDN (do not stop FC until COOL P < 15 and STACK T < 243) >>

If FC VOLTS ≥ 32 (BUS SHORT)

8. Go to BUS LOSS ACTION >>

9. ⇒

If MN V &lt; 26.4 and FC V &gt; 32 and FC A &lt; 20

(FC disconnect, check APUs):

10. AC BUS SNSR (three) – OFF
11. MSTR MADS PWR – OFF
12. PL PRI (three) – OFF
13. FC/MN BUS – ON

If FC3 aff:

14. PL PRI MNC – ON  
FC3 – ON
15. If MNC V < 26.4: PL PRI (three) – OFF

If MN BUS recovered (FC VOLTS &lt; 32):

16. GNC I/O RESET
17. ⇒ BUS TIE >>

If MN BUS not recovered (FC VOLTS &gt; 32):

18. Perform BUS LOSS ACTION (do not perform FC SHUTDN)

Post MECO:

19. ⇒ FC SHUTDN

**AC VOLT HIGH**

If AC V &gt; 123 and F7 “AC VOLTAGE”:

1. (Unaff) AC BUS SNSRS (two) – OFF

If AC V ≥ 130:

2. (Aff) AC BUS SNSR – AUTO TRIP

If AC V &lt; 130 and AC3 aff:

3. H2O PUMP LOOP 2 – OFF

If RTLS/TAL:

4. AC VOLTS HIGH ⇒G
5. ⇒ AC VOLTS (LOW or HIGH)

## AC VOLT LOW or OVERLOAD

PLT

MN  
SUB

1. AC BUS SNSR (three) – OFF

If amps > 14 and V < 95:

If single  $\Phi$  amps > 14:

2. cb AC CONTR – cl  
INV/AC BUS – OFF  
INV PWR – OFF  
cb AC CONTR – op

3. If other  $\Phi$  amps > 14:  
Go to step 6

If RTLS/TAL:

4. Go to aff BUS LOSS  $\Rightarrow$  G
5. Go to AC OVERLOAD  $\Rightarrow$  A

If multi  $\Phi$  (bus short):

6. (Aff) cb AC CONTR (three) – cl  
INV/AC BUS – OFF (tb-OFF)  
INV PWR – OFF (tb-OFF)  
cb AC CONTR (three) – op

7. Go to aff BUS LOSS >>

8.  $\Rightarrow$  AC VOLTS (LOW or HIGH)

### 3 $\Phi$ AC MOTORS STOPPED

1. AC BUS SNSR (three) – OFF

2. Determine AC BUS:

- FC1 and FREON PUMP 2B: AC1
- FC2 and FREON PUMP 1B: AC2
- FC3 and CAB FAN A: AC3

3. (Aff) FC – STOP

If AC3 aff:

4. AV BAY 3 FAN B – OFF, A – ON
5. CAB FAN A – OFF

Isolate aff  $\Phi$ B( $\Phi$ C, $\Phi$ A):

6. (Aff) cb AC CONTR – cl
7. INV/AC BUS – OFF

If AC1(2,3) aff and AV BAY 3(2,3) FAN  $\Delta$ P  $\geq$  0.5:

8. Go to step 16 (bad  $\Phi$  isolated)
9. (Aff) INV/AC BUS – ON
10. cb AC CONTR – op
11. Repeat from step 6 to isolate aff  $\Phi$ C( $\Phi$ A), then:

Drop aff AC bus (three  $\Phi$ s):

12. (Aff) cb AC CONTR (three) – cl
13. INV/AC BUS – OFF
14. INV PWR – OFF
15. Go to aff BUS LOSS >>

Bad  $\Phi$  isolated:

16. (Aff) FC – START (10 sec or  $\Delta$ P tb-gray)
17. Perform aff BUS LOSS and if AC1(AC2) aff >>
18. If AC3 aff:

Post MECO:

CAB FAN B – ON

MN  
3Φ

**BUS TIE** (do not tie bus short, check APUs)

If MN Volts > 20: Bus Tie >>

If MN Volts < 20 (do not BUS TIE Pre MECO for 1st FC):

1. (Aff) AC BUS SNSR – OFF
2. cb AC CONTR (three) – cl
3. INV/AC BUS – OFF (tb-OFF)
4. INV PWR – OFF (tb-OFF)
5. If MNC(B) dn, CAB FAN A(B) – OFF
6. Bus Tie
7. INV PWR – ON (tb-ON)
- ◆ 8. INV/AC BUS – ON (tb-ON)
9. cb AC CONTR (three) – op
10. GNC I/O RESET
11. Post MECO: (Aff) AC BUS SNSR – AUTO  
TRIP
12. Post PWRDN: √CAB FAN A(B) – ON

**MNA**

**CDR**

Post SRB SEP:

- ◆ 1. TOP EVAP HTR DUCT sel – B
  2. HI LOAD DUCT HTR sel – B
  3. BFS G51 AA1 – desel ⇒
  4. MS AUD CNTL – PS (MS can't talk)
- FAILED: UHF HI PWR XMIT

**MNB**

Post SRB SEP:

BFS G51 AA2, RGA 2 – desel ⇒  
FAILED: S-BD PM 1 (NO PNL,CMD)

**MNC**

Post SRB SEP:

1. FLASH EVAP CNTLR PRI A – OFF, B – GPC
2. BFS G51 RGA 3 – desel ⇒

**ANY AC BUS LOSS ⇒**

**SUBBUS [MNA O14] ⇒G**

**SUBBUS [APC6 or ALC3]**

1. FLASH EVAP CNTLR PRI A – OFF, B – GPC



**MNA or AC1 Multi  $\Phi$**

**PLT**

1. Do not isolate MPS He C
2. MSTR MADS PWR – OFF
3. AC BUS SNSR (three) – OFF
4. Perform FC SHUTDOWN (within 9 min), then:

Post MECO:

5. L OMS – sel SEC  $\Rightarrow$

**MNB or AC2 Multi  $\Phi$**

1. Do not isolate MPS He L
2. MSTR MADS PWR – OFF
3. AC BUS SNSR (three) – OFF
4. Perform FC SHUTDOWN (within 9 min), then:  $\Rightarrow$

FAILED: S-BD PM 1 (NO PNL,CMD)

**MNC or AC3 Multi  $\Phi$**

1. Do not isolate MPS He R
2. S-BD PM CNTL – PNL,CMD
3. Config per COMM COVER (ASC) **BFS G51**:  
TDRS – ITEM 46 EXEC (\*)  
STDN-HI – ITEM 47 EXEC (\*)  
SGLS – ITEM 49 EXEC (\*)
4. MSTR MADS PWR – OFF
5. AC BUS SNSR (three) – OFF
6. Perform FC SHUTDOWN (within 9 min), then:

Post MECO:

7. R OMS – sel SEC  $\Rightarrow$

**AC SINGLE  $\Phi$   $\Rightarrow$**

**SUBBUS [APC4(5,6) or ALC1(2,3)]**

Do not isolate MPS He C(L,R)  $\Rightarrow$

**ESS  
CNTL**

**ESS BUS V LOW****PLT**

If verified by F9 voltmeter:

1. Perform FC SHUTDN (<9 min), then:
2. Go to aff ESS BUS LOSS

MN  
SUB**ESS BUS LOSS**

<b>ESS 1BC</b>	<b>O13&amp;R14</b>	1. L AUD CNTL sel – R (CDR can't talk) 2. Pri C/W & F7 Matrix lost ⇒A 3. ⇒A
<b>ESS 2CA</b>	<b>O13&amp;R14</b>	1. AUD CTR – 2 2. R AUD CNTL sel – L (PLT can't talk) ⇒A 3. ⇒A
<b>ESS 3AB</b>	<b>O13</b>	1. GPC CAM Lights lost 2. Do not engage BFS ⇒

**CNTL BUS LOSS****CDR**

<b>AB1</b>	1. TOP EVAP HTR DUCT sel – B 2. HI LOAD DUCT HTR sel – B ⇒
<b>AB2</b>	1. TOP EVAP HTR DUCT sel – B 2. HI LOAD DUCT HTR sel – B ⇒
<b>AB3</b>	1. TOP EVAP HTR DUCT sel – B 2. HI LOAD DUCT HTR sel – B If BFS engage reqd: 3. Use PLT's RHC, then GPCs 1,2,4 - STBY,HALT 4. BFS I/O RESET 5. ⇒
<b>BC1</b>	<b>[BFS G51]</b> RGA 2 – desel ⇒
<b>BC2</b>	⇒
<b>BC3</b>	⇒
<b>CA1</b>	1. No BFS engage Post SRB SEP: 2. FLASH EVAP CNTLR PRI A – ON 3. <b>[BFS G51]</b> RGA 3 – desel ⇒
<b>CA2</b>	⇒

**CNTL BUS V LOW/CNTL BUS RPC**

**PLT**

**WARNING**  
 If VISIBLE FIRE/SMOKE AT ANY TIME, cb CNTL BUS AB1/2/3(BC1/2/3,CA1/2/3) – op (pnl R14:B)

1. Identify BUS (√BUS LOSS ID)  
 If bus critical (per MCC):
- ◆ 2. ⇒
- ◆ If one CNTL BUS RPC tripped (\*):  
 Aff CNTL BUS:

**AB1(2,3)**

	Tripped RPC (*)	Action (for RESET, hold w/sw reten device)
3.	<b>A</b>	R1 CNTL BUS PWR MNB – RESET R14:B cb CNTL BUS AB1/2/3 – op
4.	<b>B</b>	R1 CNTL BUS PWR MNA – RESET R14:B cb CNTL BUS AB1/2/3 – op

**BC1(2,3)**

	Tripped RPC (*)	Action (for RESET, hold w/sw reten device)
5.	<b>B</b>	R1 CNTL BUS PWR MNC – RESET R14:B cb CNTL BUS BC1/2/3 – op
6.	<b>C</b>	R1 CNTL BUS PWR MNB – RESET R14:B cb CNTL BUS BC1/2/3 – op

**CA1(2,3)**

	Tripped RPC (*)	Action (for RESET, hold w/sw reten device)
7.	<b>C</b>	R1 CNTL BUS PWR MNA – RESET R14:B cb CNTL BUS CA1/2/3 – op
8.	<b>A</b>	R1 CNTL BUS PWR MNC – RESET R14:B cb CNTL BUS CA1/2/3 – op

- ◆ If no CNTL BUS RPC tripped (no \*):

	aff CNTL BUS	Panel R1 action (RESET, hold w/sw reten device)
9.	<b>AB1(2,3)</b>	CNTL BUS PWR MNA,MNB (two) – RESET
10.	<b>BC1(2,3)</b>	CNTL BUS PWR MNB,MNC (two) – RESET
11.	<b>CA1(2,3)</b>	CNTL BUS PWR MNA,MNC (two) – RESET

**CNTL  
FC**

Cont next page

MS A5-7 AESP/ALL/A/GEN O

◆ 12. Perform aff CNTL BUS LOSS, then:

If pwr reqd (<3 sec) for crit function:

13. Hold crit function sw

For tripped RPC:

14. CNTL BUS PWR MNA(MNB,MNC) –  
RESET (1 sec), then dn

15. ⇒

ESS/  
CNTL

**CNTL BUS LOSS**

**PLT**

<b>AB1</b>	⇒
<b>AB2</b>	[G23] RCS FWD MANF VLVS 1 OVRD – ITEM 40 EXEC (CL) ⇒
<b>AB3</b>	1. [G51] RCS RM MANF CL OVRD – ITEM 41 EXEC If BFS engage reqd: 2. Use PLT's RHC, then GPCs 1,2,4 – STBY,HALT 3. BFS I/O RESET 4. ⇒
<b>BC1</b>	Failed: S-BD PM 1 (NO PNL,CMD) ⇒
<b>BC2</b>	1. S-BD PM CNTL – PNL,CMD 2. [BFS G51] Config per <u>COMM COVER</u> (ASC): TDRS – ITEM 46 EXEC (*) STDN-HI – ITEM 47 EXEC (*) SGLS – ITEM 49 EXEC (*) 3. [G23] RCS FWD MANF VLVS 2 OVRD – ITEM 41 EXEC (CL) 4. PLT disp sws – green dot ⇒
<b>BC3</b>	[G51] RCS RM MANF CL OVRD – ITEM 41 EXEC ⇒
<b>CA1</b>	No BFS engage ⇒
<b>CA2</b>	[G23] RCS FWD MANF VLVS 3 OVRD – ITEM 42 EXEC (CL)
<b>CA3</b>	⇒

### FC REAC VLV CLOSED

PLT

1. FC REAC VLV (three) – OP
2. Perform BUS TIE, then:  
If FC COOL P < 50:
3. Go to FC SHUTDN

### FC pH ↓ 1(2,3) or FC DELTA V 1(2,3)

If pH ↓ and FC SS 1(2,3) ΔV > 150

or FC SS ΔV > 150 and incr:

1. Perform BUS TIE, then:
  2. (Aff) FC REAC VLV – CL
  3. MSTR MADS PWR – OFF
  4. Go to LOSS OF 1(2nd) FC PWRDN >>
- If pH ↓ only and Post SRB SEP:
- ◆ 5. Perform BUS TIE, then:
  6. ⇒A FC pH 1(2,3)

### FC STACK T

1. MSTR MADS PWR – OFF

If STACK T > 243 and incr:

2. If 2nd FC: Go to 2nd FC SHUTDN >>
  3. PL PRI (three) – OFF
- If aff FC amps < 190 or > 360:
4. Go to MN BUS UNDERVOLTS/FC VOLTS, step 4 >>
- ◆ 5. Perform BUS TIE, then:
  6. ESS BUS SOURCE FC – OFF
  7. FC/MN BUS – OFF
- If aff FC VOLTS < 32 or STACK T not decr:
8. (Aff) FC REAC VLV – CL
  9. FC – STOP after COOL P < 15 and STACK T < 243
10. Go to LOSS OF 1 FC PWRDN

FC

### FC EXIT T

1. MSTR MADS PWR – OFF
  2. Perform LOSS OF 1 FC PWRDN
  3. Post SRB SEP:
- ◆ Perform BUS TIE, then: ⇒

### FC COOLANT PUMP ΔP LOW

1. FC – START (10 sec or ΔP tb-gray)
- ◆ 2. MSTR MADS PWR – OFF  
Perform LOSS OF 1 FC PWRDN, then:  
If > 9 min since failure:
  - ◆ If EXIT T > 164 and not decr or  
RDY tb – bp or  
FC PUMP cb(s) open (pnl L4:C):
    3. Go to FC SHUTDN >>
4. If < 9 min since failure ⇒

### PLT

### FC COOL P

1. Perform BUS TIE, then:  
If COOL P < 75: ⇒  
If COOL P incr and not 100 (H),  
or FC COOL PUMP = ΔP (intermittent),  
or STACK/EXIT T unstable:
  2. (Aff) FC REAC VLV – CL
  3. MSTR MADS PWR – OFF
  4. Go to LOSS OF 1(2nd) FC PWRDN

FC

### FC SHUTDN (1st) (<9 min)

1. MSTR MADS PWR – OFF
2. If not tied: Perform BUS TIE, then:  
If ORB (not deorb prep), kW > 18:  
MN BUS TIE (three) – ON
3. ESS BUS SOURCE FC – OFF  
FC/MN BUS – OFF  
FC – STOP (1 sec)
4. FC REAC VLV – CL
- ◆ Go to LOSS OF 1 FC PWRDN

### LOSS OF 1 FC PWRDN

1. PRI PL (three) – OFF  
AFT PL (two) – OFF
2. IDP/CRT4 PWR – OFF  
One MDU – OFF ⇒

## 2nd FC SHUTDN

PLT

(CL PMP Lost: <6 min)

1. Have CDR start LOSS OF 2nd FC PWRDN

If three MN buses pwr:

2. MN BUS TIE (three) – OFF  
(do not perform BUS LOSS ACTION)
3. LES O2 – OFF, visors – OP
4. Switch off all but one IDP/CRT with four MDUs
5. All PL pwr (seven) – OFF
6. O2,H2 TK HTRS (all) – OFF
7. After CDR pnl L1 config complete, continue:

If two MN buses pwr:

8. Pwr MN BUS TIES (two) – ON

If only one MN bus pwr:

9. MN BUS TIE (three) – OFF  
If only MNA(B,C) pwr: Secure APU 2(3,1)  
BUS TIE good FC/BUS (MNA if RTLS or TAL)  
I/O RESET

When reqd:

10. ESS BUS SOURCE FC – OFF  
FC/MN BUS – OFF  
FC – STOP (1 sec)  
FC REAC VLV – CL
11. G51 √ICNCT ENA (if reqd for OMS load)
12. All TACAN/RA – OFF

Post MECO:

13. MPS PRPLT DUMP B/U LH2 VLV – OP
14. ⇒ LOSS OF 2nd FC PWRDN

## LOSS OF 2nd FC PWRDN

CDR

CRYO

1. LES O2 – OFF, visors – OP
2. L1: Select one FREON PUMP on good FC/MN  
BUS and place other pump to OFF  
Switch OFF all HUM SEPS, IMU FANS, H2O  
PUMPS, AV BAY FANS, CAB FANS, FES  
HTRS
3. Switch off all but one IDP/CRT with four MDUs  
After BUS TIE, if MNC unpwr:
4. FLASH EVAP CNTLR PRI A – OFF  
B – ON
5. ⇒ LOSS OF 2nd FC PWRDN

# OV103,104

(OV103,104) MS A5-11 AESP/3,4/A/GEN O

**O2(H2) CRYO PRESS/TEMP HIGH**

**PLT**

O2(H2) TK HTR (two) – OFF ⇒A

**CRYO O2(H2) LEAK (three or more tanks aff)**

Use meter if CRT data OSL

1. O2(H2) MANF VLV TK1,TK2 (two) – CL
  2. O2(H2) TK3 HTRS A – AUTO
- If TK1 and TK2 P decr slowly (HTR logic fail): ⇒
3. Perform aff MN BUS TIE, then:  
If O2(H2) TK1(2) aff (open unaff manf):
  4. O2(H2) MANF VLV TK2(1) – OP
- If O2 TK1(2) aff:
5. O2 SYS 1(2) SPLY – CL
  6. If O2 TK1(2) P now incr (PCS leak): >>
7. (Aff) TK HTR B – AUTO
- If no aff FC COOL P alarm: ⇒
8. (Aff) TK HTRS A, B (two) – OFF
  9. MSTR MADS PWR – OFF
  10. Perform LOSS OF 1 FC PWRDN, then: ⇒

2FC

**OV103,104**

(OV103,104) MS A5-12 AESP/ALL/A/GEN O



## 2nd FC SHUTDN

PLT

(CL PMP Lost: <6 min)

1. Have CDR start LOSS OF 2nd FC PWRDN

If three MN buses pwr:

2. MN BUS TIE (three) – OFF  
(do not perform BUS LOSS ACTION)
3. LES O2 – OFF, visors – OP
4. Switch off all but one IDP/CRT with four MDUs
5. All PL pwr (seven) – OFF
6. O2,H2 TK HTRS (all) – OFF
7. After CDR pnl L1 config complete, continue:

If two MN buses pwr:

8. Pwr MN BUS TIES (two) – ON

If only one MN bus pwr:

9. MN BUS TIE (three) – OFF  
If only MNA(B,C) pwr: Secure APU 2(3,1)  
BUS TIE good FC/BUS (MNA if RTLS or TAL)  
I/O RESET

When reqd:

10. ESS BUS SOURCE FC – OFF  
FC/MN BUS – OFF  
FC – STOP (1 sec)  
FC REAC VLV – CL
11. G51 √ICNCT ENA (if reqd for OMS load)
12. All GPS/RA – OFF

Post MECO:

13. MPS PRPLT DUMP B/U LH2 VLV – OP
14. ⇒ LOSS OF 2nd FC PWRDN

## LOSS OF 2nd FC PWRDN

CDR

CRYO

1. LES O2 – OFF, visors – OP
2. L1: Select one FREON PUMP on good FC/MN  
BUS and place other pump to OFF  
Switch OFF all HUM SEPS, IMU FANS, H2O  
PUMPS, AV BAY FANS, CAB FANS, FES  
HTRS
3. Switch off all but one IDP/CRT with four MDUs  
After BUS TIE, if MNC unpwr:
4. FLASH EVAP CNTLR PRI A – OFF  
B – ON
5. ⇒ LOSS OF 2nd FC PWRDN

# OV105

(OV105) MS A5-11

AESP/5/A/GEN O

**O2(H2) CRYO PRESS/TEMP HIGH**

**PLT**

O2(H2) TK HTR (two) – OFF ⇒A

**CRYO O2(H2) LEAK (three or more tanks aff)**

Use meter if CRT data OSL

1. O2(H2) MANF VLV TK1,TK2 (two) – CL
  2. O2(H2) TK3 HTRS A – AUTO
- If TK1 and TK2 P decr slowly (HTR logic fail): ⇒
3. Perform aff MN BUS TIE, then:  
If O2(H2) TK1(2) aff (open unaff manf):
  4. O2(H2) MANF VLV TK2(1) – OP
- If O2 TK1(2) aff:
5. O2 SYS 1(2) SPLY – CL
  6. If O2 TK1(2) P now incr (PCS leak): >>
  7. (Aff) TK HTR B – AUTO
- If no aff FC COOL P alarm: ⇒
8. (Aff) TK HTRS A, B (two) – OFF
  9. MSTR MADS PWR – OFF
  10. Perform LOSS OF 1 FC PWRDN, then: ⇒

2FC

**OV105**

(OV105) MS A5-12 AESP/ALL/A/GEN O



**OMS**

**OMS**



MS A6-1

AESP/ALL/A/GEN O

**OMS He TK P LOW** ( $\sqrt{\text{SPEC}}$  and **[OMS/MPS]**)

Dumping RTLS/TAL/ <b>[G51]</b> DUMP	SERC	When leaking He P < 640: 1. <b>[G51]</b> DUMP STOP >>
	Not SERC	When leaking He P < 640: 2. <b>[G51]</b> INH ICNCT When aff OMS Pc < 72%: 3. (Aff) OMS ENG – OFF After 2:00 min: 4. (Good) OMS ENG – OFF >>
Dumping ASSIST/ATO Not Dumping	◆	5. (Good) OMS ENG – OFF When MET > 2:30 min: 6. <b>[G51]</b> ITEM 9 + <input type="text"/> EXEC
Leaking He P < 640		7. <b>[G51]</b> ITEM 9 + 0 EXEC ⇒A
Sub RTLS/TAL	◆	8. (Good) OMS ENG – ARM/PRESS 9. <b>[G51]</b> INH ICNCT 10. OMS XFEED (four) – OP 11. (Aff) OMS TK ISOL (two) – CL After 1:00 min: 12. OMS TK ISOL (four) – OP 13. OMS XFEED (four) – CL When aff OMS Pc < 72%: 14. (Both) OMS ENG (two) – OFF

**OMS N2 TK P LOW**  
**(N/A DURING ASSIST/RTLS/TAL/ATO DUMP)**

1.  $\sqrt{\text{N2 TK P}}$  decr (meter and CRT)
  2. OMS ENG – ARM
  3. If OMS N2 REG P decr: OMS ENG – OFF >>
- If OMS N2 REG P not decr and subs ASSIST/RTLS/TAL/ATO:
4. OMS ENG (two) – ARM/PRESS

**OMS N2 REG P HIGH or LOW**  
OMS ENG – ARM

**OMS**

**OMS TK P LOW (↓, OX or FU) NOT DUMPING (√ENG IN P)**

1. (Good) OMS ENG – OFF
2. Monitor OMS Inlet Pressures  
If OX IN P < 151 or FU IN P < 216:  
(Aff) OMS ENG – OFF  
XFEED (two) – CL

Dumping Assist/ATO Not Dumping	When MET > 2:30 min: 3. [G51] ITEM 9 + [ ] EXEC
OX IN P > 151 and FU IN P > 216	4. (Aff) OMS ENG – ARM/PRESS 5. If ATO: [G51] √ICNCT = INH 6. (Aff) OMS XFEED (two) – CL When aff Pc < 80% (depletion cutoff): 7. (Aff) OMS ENG – OFF [G51] ITEM 9 + 0 EXEC >> If depletion cutoff does not occur ⇒A
Repress NO JOY	8. [G51] ITEM 9 + 0 EXEC
Subs RTLS/TAL/[G51]	9. (Good) OMS ENG – ARM/PRESS
OX IN P > 151 and FU IN P > 216	10. (Aff) OMS XFEED (two) – OP ENG – ARM/PRESS 11. [G51] ENA ICNCT (N/A SERC)
AFT QTY < 20% or He P < 2000	12. If SERC: [G51] DUMP STOP If not SERC: [G51] INH ICNCT 13. (Aff) OMS XFEED (two) – CL When aff Pc < 80% (depletion cutoff): 14. (Aff) OMS ENG – OFF 15. After 2:00 min: (Good) OMS ENG – OFF >>
Repress NO JOY after 2:00 min	16. (Good) OMS ENG – OFF >>

### OMS TEMP DURING DUMP

1.  G51 INH ICNCT  
If aff OMS FU IN P  $\geq$ 

--	--

L R  
| 2. Go to ENG FAIL >>
- If aff OMS FU IN P  $\leq$ 

--	--

 :  
3. Go to PRPLT FAIL >>
4. Otherwise, snsr fail

### Pc LOW DURING DUMP

1. ENG VLV < 70%: Go to ENG FAIL >>
2. ENG VLV > 70%:  G51 INH ICNCT  
If aff OMS OX IN P > 227:  
| 3. Go to ENG FAIL >>  
If aff OMS OX IN P  $\leq$  136:  
4. Go to PRPLT FAIL >>
5. Otherwise, snsr fail

### ENG FAIL (During Dump)

1. (Failed) OMS ENG – OFF
- ◆ 2. If RTLS/TAL/ATO/ G51 DUMP:  
 G51 ENA ICNCT  $\Rightarrow$  G

### PRPLT FAIL (During Dump)

1. ASSIST/ATO: (Both) OMS ENG (two) – OFF  
(Failed) OMS XFEED (two) – CL
2. Other: (Aff) OMS ENG – OFF  
(Failed) OMS XFEED (two) – CL  
After 2:00 min, (good) OMS ENG – OFF  $\Rightarrow$  G

### OMS TK P LOW ( $\downarrow$ , OX and FU) DURING DUMP

( $\sqrt$ ENG IN P)

1. (Aff) OMS He PRESS/VAP ISOL (two) – OP  
If aff TK P not incr:  
2.  G51  $\sqrt$ ICNCT = INH  
3. OMS He PRESS/VAP ISOL (two) – CL  
At Pc < 72% or OMS TEMP: Go to PRPLT FAIL

### OMS TK P HIGH ( $\uparrow$ , OX and FU) DURING DUMP

( $\sqrt$ ENG IN P)

1.  G51  $\sqrt$ ICNCT = INH
2. (Aff) OMS He PRESS/VAP ISOL A – CL  
If aff TK P not decr:  
3. OMS He PRESS/VAP ISOL A – OP  
B – CL



**RCS**

**RCS**



MS A7-1

AESP/ALL/A/GEN O

### **RCS JET FAIL (LEAK)**

If OX/FU Qty diverging:  
(Aff) RCS MANF ISOL – CL

### **RCS JET FAIL (ON)**

1. (Aff) RCS MANF ISOL – CL
- If MANF P > 130 and stable (false alarm):
  2. (Aff) RCS MANF ISOL – OP ⇒G

### **RM DLMA MANF**

If (aff) MANF tb – OP or sw not thrown:

1. If FRCS: √MCC
2. If ARCS: [G51] RCS RM MANF CL OVRD –  
ITEM 41 EXEC
3. If (aff) MANF tb – bp: (aff) MANF – GPC

### **RCS JET FAIL (OFF)**

If > one jet/pod/dir failed:

1. [G23] resel jets
2. DES INH (\*) (reprioritize)

### **RCS TK P HIGH (FU or OX) (√MANF P)**

1. RCS He PRESS (two) – CL
2. A – OP

If He P decr:

3. RCS He PRESS A – CL  
B – OP

### **XFEED: RCS to RCS**

If AUTO XFEED:

1. L,R RCS TK ISOL (six) – GPC  
XFEED (four) – GPC
2. OMS XFEED (four) – CL
3. MSTR RCS XFEED – FEED FROM L(R) >>

If MANUAL XFEED:

4. L,R OMS XFEED (four) – CL
5. RCS XFEED (four) – OP
6. (Receiving) RCS TK ISOL (three) – CL  
He PRESS (two) – CL
7. MSTR RCS XFEED – FEED FROM L(R)

**RCS**



**RCS SECURE**

- RCS MANF ISOL (five) – CL
- XFEED (two) – CL
- TK ISOL (all) – CL
- He PRESS (two) – CL

**AFT RCS LK**

- N/A During Dump/SE Roll Cntl  
 (check He P decr: CRT and meter)
1. If TK P ‘↑’: Go to TK P HIGH >>

TK P ≥ 254 and not decr (He Leak)	2. MSTR XFEED – feed from good side 3. (Aff) RCS He PRESS (two) – CL 4. <b>G51</b> AFT RCS – INH (ITEM 13) >>
TK P < 254 or decr (prop leak)	5. (N/A RTLS) ET SEP – MAN 6. (N/A RTLS) MPS PRPLT DUMP SEQ – STOP 7. (Aff) MANFs (five) – CL 8. (Aff) TK ISOLs (three) – CL
Single MANF leak	9. TK ISOLs (three) – OP (tb-OP), GPC 10. (Good) MANFs (four) – OP
QTY < 75%	11. MSTR XFEED – feed from good side
Two MANF P decr (TK leg leak)	12. (Good leg) TK ISOL(s) – OP (tb-OP), GPC 13. (Good leg) Pri MANFs (two) – OP 14. (Leaking leg) XFEED (one) – CL
QTY < 75%	15. MSTR XFEED – feed from good side
No MANF P decr (PrplT TK or MANF 5 leak)	16. L,R RCS XFEED (four) – OP 17. (Aff) RCS MANF 1,2,3,4 (four) – OP 18. (Aff) RCS He PRESS (two) – CL 19. MSTR XFEED – feed from good side
	20. ET SEP – AUTO 21. <b>G51</b> AFT RCS – INH (ITEM 13) 22. Post ET SEP -Z transl: MPS PRPLT DUMP SEQ – GPC

### FWD RCS LK

(check He P decr: CRT and meter)

(check TK P; if '↑': Go to TK P HIGH >>)

RTLS	1. Perform RCS SECURE, then: 2. Post PPD – reopen RCS Post ET SEP -Z transl: 3. Go to RCS SECURE >>
Pre ET SEP (N/A RTLS)	4. ET SEP – MAN 5. MPS PRPLT DUMP SEQ – STOP 6. Perform RCS SECURE, then:
Single MANF leak	7. Reopen RCS, except bad MANF 8. ET SEP – AUTO Post ET SEP -Z transl: 9. MPS PRPLT DUMP SEQ – GPC >>
TK leg leak (two MANF P Low)	10. Reopen RCS, except bad leg 11. ET SEP – AUTO Post ET SEP -Z transl: 12. MPS PRPLT DUMP SEQ – GPC >>
PRPLT TK P decr	
Post MECO	13. RATE DAMP with ARCS 14. Reopen FRCS
TK P > 200 & QTY > 0%	15. ET SEP – AUTO
TK P < 200 or QTY = 0%	16. Perform RCS SECURE, then: 17. DAP – INRTL, PITCH – PULSE 18. ET SEP pb – SEP 19. THC -Z (UP) (2 sec; -1.25°/sec) 20. THC -X (OUT) and hold
At SEP (SEP init + approx 12 sec)	21. THC +Z (DOWN) (3 sec; +0.3°/sec) THC -Z (UP) (2 sec; -0.9°/sec) COAST (5 sec) THC +X (IN) (20 sec) After 10 sec of +X, then: PITCH – DISC RATE
	22. OPS 104 PRO, DAP – AUTO
Otherwise: (He TK or He leg)	Post MECO: 23. Reopen RCS 24. ET SEP – AUTO
Post ET SEP -Z transl	25. MPS PRPLT DUMP SEQ – GPC 26. Go to RCS SECURE



**MPS**

**MPS**



MS A8-1

AESP/ALL/A/GEN O

**MPS**

**SSME FAIL/SHUTDN**

AC BUS SNSR (three) – OFF

If two ENG remaining:

- ◆ MN ENG LIMIT SHUTDN – ENA,AUTO

**MPS DATA**

√MCC, accel, He dP/dT,

‘MPS H2 OUT P’,

‘MPS O2 OUT T’

If SSME fail (MCC or three cues):

(Aff) MN ENG SHUTDN pb – push

If three ENG remaining:

- ◆ MN ENG LIMIT SHUTDN – ENA,AUTO

If no comm: Assume MPS CMD

If mult (no MECO confirm):

Post MECO:

MN ENG SHUTDN pb (three) – push (simo)

**MPS LH2 ULL**

- ◆ If two or three Ps < 28.0 or > 34.0:

MPS LH2 ULL PRESS – OP

When all Ps > 33.0:

MPS LH2 ULL PRESS – AUTO

**MPS DUMP INHIBIT**

Post MECO:

(Aff) MPS ENG PWR (two) – OFF

LO2(H2) PREVLV – CL

**‘ET SEP MAN’** G51

**ET SEP**

Post MECO prior to MECO+1 min:

1. ET SEP AUTO – ITEM 38 (BFS 28)

2. If ET SEP pb reqd:

ET SEP SEP – ITEM 39 (BFS 29)

### MPS CMD/HYD/ELEC

If two HYD SYS failed:

MN ENG LIMIT SHUTDN – INH

**TRAJ** disp – Cue SERC, ITEM 6

(EXEC if gimbaling eng fails)

If:	When:	Shut down:								
2 Pcs stuck > 85% & 3-ENG RTLS	MECO -2:00	1 aff MN ENG: <b>CMD: (AC/pb)**</b> HYD: (pb)								
2 HYD SYS failed & Nom/ATO/TAL/ 2-ENG RTLS	Nom/ATO: SE PRESS TAL: SE TAL 2-ENG RTLS: 2 OUT RED	<table border="1"> <tr> <td>ENG(HYD)</td> <td>S/D</td> </tr> <tr> <td>C(1) &amp; R(3)</td> <td>C</td> </tr> <tr> <td>L(2) &amp; C(1)</td> <td>L</td> </tr> <tr> <td>L(2) &amp; R(3)</td> <td>R</td> </tr> </table> ELEC: (pb)	ENG(HYD)	S/D	C(1) & R(3)	C	L(2) & C(1)	L	L(2) & R(3)	R
ENG(HYD)	S/D									
C(1) & R(3)	C									
L(2) & C(1)	L									
L(2) & R(3)	R									
He lk S/D reqd		Aff MN ENG (pb)								
<b>MPS CMD(s)**</b>	Nom/ATO and: 3 ENG: V > 23K 2 ENG: V > 24.5K	Aff MN ENG <b>(AC/pb)**</b> If 2 CMD: repeat								
2 MPS HYD/ELEC & 3-ENG Nom/ATO/TAL	TAL: V > 22.5K RTLS: α = -1	1 aff MN ENG: HYD: (pb) ELEC: (pb)								
1 MPS HYD/ELEC & 3-ENG Nom/ATO	V > 23K	Aff MN ENG (pb)								

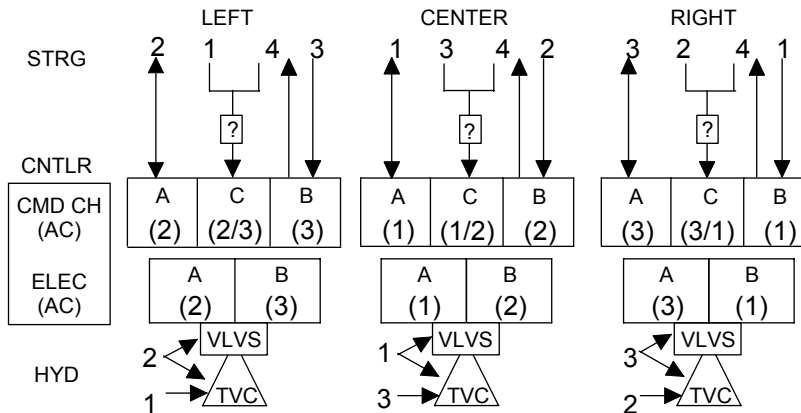

---

**MPS He P (Pre MECO)**

---

1. Check dP/dT

---

If after MECO -60:

2. Shut dn MN ENG per MPS  
CMD/HYD/ELEC >>
- 

If He REG P ↑ or ↓:

3. (Aff) He ISOL – CL

Otherwise:

4. (Aff) He ISOL A – CL

If no decr in dP/dT:

5. (Aff) He ISOL A – OP  
B – CL

If no decr in dP/dT:

6. (Aff) He ISOL B – OP
- 

If any ENG failed:

7. (Failed) ENG He I'CNCT –  
OUT OP
- 

If nonisolatable:

8. Shut dn MN ENG per  
MPS CMD/HYD/ELEC

If/when TK P < 1150 or

REG P < 679:

9. (Aff) He I'CNCT – IN OP
- 

If isolated:

10. (Aff) He I'CNCT – IN OP

If TK P < 2200 @ MECO -60:

11. Shut dn MN ENG per  
MPS CMD/HYD/ELEC
- 

Post ET SEP:

12. He I'CNCT(s) – GPC
- 

---

**MPS PNEU TK(REG) P**

---

If after MECO -60:

At MECO -30:

1. L ENG He XOVR – OP >>
- 

2. PNEU He ISOL – CL
- 

If PNEU ACUM P decr:

At MECO -30:

3. PNEU He ISOL – OP,

Wait 5 sec, then:

4. L ENG He XOVR – OP >>
- 

If PNEU TK P decr:

5. PNEU He ISOL – OP
-



**RESERVED**



MS A9-1

AESP/ALL/A/GEN O





This Page Intentionally Blank



MS A9-2

AESP/ALL/A/GEN O





# GLIDED FLIGHT

MS GLIDED FLIGHT

----- MS GLIDED FLIGHT, SECTIONS 1 thru 9 -----

MS E-i

AESP/ALL/E/GEN O

# GLIDED FLIGHT

----- MS GLIDED FLIGHT, SECTIONS 1 thru 9 -----

This Page Intentionally Blank



APU/  
HYD

## APU/HYDRAULICS



MS E1-1

AESP/ALL/E/GEN O

APU/  
HYD

### APU SHUTDN

1. APU OPER – OFF  
FU TK VLV – CL  
√Shutdn (HYD PRESS < 200)  
Report APU F7 lts  
APU CNTLR PWR – OFF

If one APU failed:

- ⇒
2. √APU AUTO SHTDN (three) – ENA
  3. MM304: √APU SPEED SEL (two) – NORM
  4. MM602/305: APU SPEED SEL (two) – HI

If two APUs failed:

5. APU SPEED SEL (one) – HI
6. AUTO SHTDN (one) – INH

### APU SPD HI

If SPEED % exceeds 111:

- ⇒
1. APU SPEED SEL – HI  
Pre-TAEM if two good APUs:
  2. Perform APU SHUTDN, then:
  3. Go to APU COOLDOWN

### APU OVERSPEED

If SPEED % exceeds 129:

Go to APU SHUTDN

### APU UNDERSPEED G51

If 'PRL SYS X ↓' or if APU has shut dn:

- ⇒
1. Perform APU SHUTDN, then:
  2. Go to APU COOLDOWN

### APU OIL OVERTEMP

1. BLR CNTLR/HTR – A(B)  
√N2 SPLY – ON

⇒ If M > 1:

If OIL IN T incr, and OUT T > 305:

2. Perform APU SHUTDN, then:
3. Go to APU COOLDOWN

### APU PUMP LEAK P

1. √MCC

Pre-TAEM if two good APUs:

2. Perform APU SHUTDN, then:
3. Go to APU COOLDOWN

### APU THERM (T HI)

If APU GG/FU PMP HTR or APU TK/FU LN HTR fail ON (↑):  
(Aff) HTR – OFF

## **APU COOLDOWN**

At M = 7:

1. HYD MN PUMP PRESS – LO  
APU CNTLR PWR – ON  
OPER – INJ COOL (start watch)

If APU not leaking:

2. APU FU TK VLV – OP

At Wheel Stop:

3. Go to APU SHUTDN

## **APU RESTART**

- ◆ 1. √APU AUTO SHTDN – ENA
  2. HYD MN PUMP PRESS – LO
  3. APU CNTLR PWR – ON
- If COOLDOWN for > 3.5 min or APU TEMP INJ < 380:
4. Go to step 7
  5. APU OPER – INJ COOL (start watch)
- If after 1.5 min, APU TEMP INJ not decr:
6. Go to APU SHUTDN >>
- At 3.5 min:
7. √APU FU TK VLV – OP  
OPER – START/RUN
- If restart unsuccessful:
8. Go to APU SHUTDN >>
  9. HYD MN PUMP PRESS – NORM

## HYD PRESS (LOW)

GNC 51 OVERRIDE  
BFS, SM SYS SUMM 2

- ⇒ 1. Compare 'PRL SYS X' status and aff HYD PRESS  
(HYD/APU meter and CRT):

PRL SYS	HYD PRESS	ACTION
'↓'	both meter and CRT P < 300	Go to APU SHUTDN >>
blank	either meter or CRT P > 2600	No action reqd >>
'?'	ACUM P > 2800	No action reqd >>

2. (Aff) HYD MN PUMP PRESS – LO

If two good APU/HYD remain:

3. √APU AUTO SHTDN (three) – ENA
4. MM304: √APU SPEED SEL (two) – NORM
5. MM305/602: APU SPEED SEL (two) – HI >>

If only one good APU/HYD remains:

6. APU AUTO SHTDN (one) – INH  
SPEED SEL (one) – HI

On MCC call:

7. (Degraded) HYD MN PUMP PRESS – NORM

### HYD RSVR QTY (LOW)

1. (Aff) √HYD MPS/TVC ISOL VLV SYS – CL  
(hold 5 sec, tb-CL)

⇒

√BK ISOL VLV – CL (hold 5 sec, tb-CL)

If HYD sys 1 leaking:

√LG EXT D ISO VLV – CL (hold 5 sec, tb-CL)

If qty still decr:

If two good Hyd sys:

2. (Aff) HYD MN PUMP PRESS – LO

If second sys fails:

3. At TAEM: (Leaking) HYD MN PUMP  
PRESS – NORM

4. At TAEM: (Good) APU SPEED SEL (two) – HI

If one good Hyd sys:

5. (Good) APU AUTO SHTDN – INH

6. (Good) APU SPEED SEL – HI

If prior to TAEM:

7. (Leaking) HYD MN PUMP PRESS – LO

8. At TAEM: (Leaking) HYD MN PUMP  
PRESS – NORM

### HYD RSVR T

1. BLR CNTLR/HTR – A(B)

If HYD RSVR T > 250:

2. HYD MN PUMP PRESS – LO

If HYD RSVR T > 268 and incr:

3. Perform APU SHUTDOWN, then:

4. Go to APU COOLDOWN

### W/B QTY (LOW)

1. BLR CNTLR/HTR – A(B)

⇒

2. If BLR CNTLR/HTR – OFF:

3. BLR CNTLR/HTR – B  
N2 SPLY – ON

4. If W/B QTY = 0 or  $M \leq 1$  >>

5. Monitor W/B QTY for 2 min, then:

6. If W/B QTY change > 3:

7. Cycle BLR CNTLR/HTR to maintain:  
 $200 < \text{LUBE OIL IN T} < 290$  (C&W)

When  $M \leq 1$ :

8. BLR CNTLR/HTR – A(B)



This Page Intentionally Blank







**COMM/  
GNC**

**COMM/GNC**



MS E2-1

AESP/ALL/E/GEN O

COMM/  
GNC

### COMM LOST (mult pnls)

1. AUD CTR – 2

No comm (check UHF sites):

2. S-BD PM CNTL – PNL,CMD (pnl C3)

3. Config per COMM COVER (ASC) BFS G51:

TDRS – ITEM 46 EXEC (\*)

STDN-HI – ITEM 47 EXEC (\*)

SGLS – ITEM 49 EXEC (\*)

If \* not next to selected config:

4. Config pnl A1 per Comm Coverage

(ASC/ENT PKT, COMM)

S-BD PM CNTL – PNL,CMD (pnl C3)

No comm:

5. Sel best S-BD PM ANT

No comm:

6. S-BD PM ANT – GPC

### ICOM LOST

1. AUD CNTL sel – sel alt

No ICOM:

2. AUD CTR – 2

### FCS CH 1(2,3,4) (2nd FAIL) G53

If two FCS CH ↓ on any actuator:

- ◆ (Remaining) FCS CH (two) – ORIDE

### RHC L(R) (2nd FAIL)

(Aff) FLT CNTLR PWR – OFF

GNC SYS SUMM 1

### G51 ROLL MODE SW G51

If ROLL MODE ≠ sw pos:

AUTO SEL – ITEM 42 EXEC

### DISPLAY SW L(R)

L(R) disp sws – green dot

### RM FAIL IMU,RGA,AA BFS G51

Aff LRU – desel

### RM DLMA IMU G51 BFS G51

- 1. √MCC, bad IMU – desel (PASS & BFS) >>
- ◆ 2. Desel lower # IMU with '?' (PASS)

**RM FAIL ADTA** [G51]

- ◆ 1. √BFS [GNC SYS SUMM 1]
- 2. If '↓' for aff ADTA >>
- 3. If accessible, (bad) ADTA cb – op >>
- 4. BFS, ADTA to G&C – INH

**RM DLMA ADTA \*** [G51]

M < 2.0		1. Fly Theta limits
ADTA data agrees		2. Desel, resel one ADTA 3. If no '?' >>
Bad probe		4. Stow bad probe >>
Bad ADTA	ADTA cb accessible	◆ 5. (Bad) ADTA cb – op >>
	ADTA cb not accessible	◆ 6. DES bad ADTA 7. √BFS [GNC SYS SUMM 1] 8. If '↓' for aff ADTA >> 9. BFS, ADTA to G&C – INH
Dilemma not resolved		10. ADTA to G&C – INH (PASS & BFS)

\*If three ADTAs failed:  
ADTA to G&C – INH (PASS)  
Fly Theta limits

**RM FAIL TAC** [G50]

(RM LIMITS: 6 DEG, 0.5 NM)

- 1. If data good: desel, resel aff TACAN >>
- 2. If failure verified: desel failed TACAN in BFS

**RM DLMA TAC** [G50]

Do not desel or resel while in 'TEST'

- 1. If both data good: desel, resel one TACAN in DLMA >>
- 2. √TACAN MODE (three) – GPC
- 3. If 'RM FAIL TAC': desel failed TACAN in BFS >>
- 4. If continuous 'TEST': TACAN MODE (three) – T/R  
If bad TACAN identified:
  - 5. Desel bad TACAN (PASS, √BFS)

**SPD BRK** [G51] [BFS G51]

M > 5.0	◆ WRAP MODE – INH
M ≤ 5.0	WRAP MODE – INH √MCC for energy mgmt procs

**OV103,104**

(OV103,104) MS E2-3

AESP/ALL/E/GEN O

**G55 GPS FAIL 2** [G50] [BFS G50]  
GPS to NAV INH – ITEM 43 EXEC (PASS, √BFS)

**NO UPDATE GPS** [G55]  
√MCC  
If ALT < 300kft and ALT > 180kft  
    No Update due to plasma, reevaluate at ALT < 180kft  
Else  
    INIT – ITEM 15 EXEC  
    NAV – ITEM 18 EXEC

**OV103,104**

(OV103,104) MS E2-4

AESP/3,4/E/GEN O

**RM FAIL ADTA** [G51]

- ◆ 1. √BFS [GNC SYS SUMM 1]
- 2. If '↓' for aff ADTA >>
- 3. If accessible, (bad) ADTA cb – op >>
- 4. BFS, ADTA to G&C – INH

**RM DLMA ADTA \*** [G51]

M < 2.0		1. Fly Theta limits
ADTA data agrees		2. Desel, resel one ADTA 3. If no '?' >>
Bad probe		4. Stow bad probe >>
Bad ADTA	ADTA cb accessible	◆ 5. (Bad) ADTA cb – op >>
	ADTA cb not accessible	◆ 6. DES bad ADTA 7. √BFS [GNC SYS SUMM 1] 8. If '↓' for aff ADTA >> 9. BFS, ADTA to G&C – INH
Dilemma not resolved		10. ADTA to G&C – INH (PASS & BFS)

\*If three ADTAs failed:  
ADTA to G&C – INH (PASS)  
Fly Theta limits

**RM FAIL TAC** [G50]

(RM LIMITS: 6 DEG, 0.5 NM)

- 1. If data good: desel, resel aff TACAN >>
- 2. If failure verified: desel failed TACAN in BFS

**RM DLMA TAC** [G50]

Do not desel or resel while in 'TEST'

- 1. If both data good: desel, resel one TACAN in DLMA >>
- 2. √TACAN MODE (three) – GPC
- 3. If 'RM FAIL TAC': desel failed TACAN in BFS >>
- 4. If continuous 'TEST': TACAN MODE (three) – T/R  
If bad TACAN identified:
  - 5. Desel bad TACAN (PASS, √BFS)

**SPD BRK** [G51] [BFS G51]

M > 5.0	◆ WRAP MODE – INH
M ≤ 5.0	WRAP MODE – INH √MCC for energy mgmt procs

**OV105**

(OV105) MS E2-3

AESP/ALL/E/GEN O

**G55 GPS FAIL 1(2,3) [G50] [BFS G50]**

Aff LRU – desel (PASS,  $\sqrt{\text{BFS}}$ )

**RM DLMA GPS [G50] [BFS G50]**

- ◆ 1.  $\sqrt{\text{MCC}}$ , bad GPS – desel (PASS,  $\sqrt{\text{BFS}}$ ) >>
- 2. If 300kft > ALT > 180kft  
DLMA due to plasma  
Reevaluate when ALT < 180kft  
Else
- 3. Desel GPS with highest  $P1\sigma$   
If  $P1\sigma$  values are equal, desel highest number LRU  
If DLMA not resolved
- 4. Desel GPS with next highest  $P1\sigma$

**NO UPDATE GPS [G55]**

- 1.  $\sqrt{\text{MCC}}$ , bad GPS – desel (PASS,  $\sqrt{\text{BFS}}$ ) >>
- 2. If RM DLMA GPS message, see RM DLMA GPS >>
- 3. If 300kft > ALT > 180 kft  
No Update due to plasma  
Reevaluate when ALT < 180kft  
Else
- 4. Initialize GPS with highest  $P1\sigma$   
INIT – ITEM 14(15,16) EXEC  
NAV – ITEM 17(18,19) EXEC  
May take up to 2 min for GPS to provide SV

**OV105**

(OV105) MS E2-4

AESP/5/E/GEN O



**DPS**

**DPS**



MS E3-1

AESP/ALL/E/GEN O

DPS

**PASS GPC FAIL**

1. (Aff) FCS CH – OFF
2. If two GPC/FA/FCS CHs ↓: (Good) FCS CHs – ORIDE
3. GPC MODE – STBY,HALT
4. **G53** aff SURF FDBK – desel
- ⇒ 5. If String 1(2): CDR(PLT) disp sws – green dot  
NWS – 2
6. √MULT DATA PATH LOSS

**BFS GPC FAIL**

1. GPC MODE – STBY,HALT
- ◆ 2. OUTPUT – TERM  
MODE – STBY
- ⇒ 3. If BFS cannot drive an IDP:  
GPC MODE – HALT, then go to step 8
4. If BFS currently in OPS 3 or 6:  
Go to step 7
5. If BFS currently in OPS 1:  
PRO to OPS 106  
BFS, OPS 000 PRO  
PRO to OPS 304
6. If BFS in desired MM (304):  
BFS **G50** √BFS R/W sel  
GPC MODE – RUN  
OUTPUT – B/U  
Advise MCC BFS in BACKUP >>
7. √GPC MODE – STBY (BFS is SM Only)
8. If no comm: sel best S-BD PM ANT
9. MPS He ISOL B (three) – CL  
PNEU He ISOL – CL
10. If AOA/GRTLs/TAL < 120K:  
NH3 CNTLR B – SEC/ON

**FA/FF MDM I/O ERROR**

(Annunciated by entire set)

		1. I/O RESET
RECOV	FA	2. If reqd, (aff) FCS CH – ORIDE,AUTO
	FF 1,2,3	◆ 3. <b>G51</b> IMU – resel
		4. BFS I/O RESET >>
NOT RECOV	FA	5. (Aff) FCS CH – OFF
		6. If two GPC/FA/FCS CHs ↓: (Good) FCS CHs – ORIDE
		7. <b>G53</b> aff SURF FDBK – desel
		8. √MULT DATA PATH LOSS
		⇒ ◆ 9. Go to FA/FF MDM PORT MODE



## FA/FF MDM PORT MODE

### NOTE

If BFS, 'BCE STRG X PASS', @GPC; else @MDM.

For '@GPC' port mode results in alternate MDM bypass

			1. <u>G01</u> aff String – port mode 2. BFS I/O RESET
@MDM	RECOV	FA	3. (Aff) FCS CH – AUTO 4. <u>G53</u> aff SURF FDBK – resel >>
		FF 1,2,3	◆ 5. <u>G51</u> IMU – resel >>
	NOT RECOV		⇒ If MCC GO for pwr cycle: 6. (Aff) FA/FF MDM – OFF, ON 7. I/O RESET 8. If recov, go to @MDM RECOV >> 9. (Aff) MDM – OFF
		FA	10. <u>BFS G51</u> aff SURF FDBK, RGA – desel
		FF	11. <u>BFS G51</u> aff AA – desel 12. FF 1(2): CDR(PLT) disp sws – green dot NWS – 2
			13. √MULT DATA PATH LOSS >>
@GPC	FA RECOV (FF Give Up)		14. (Aff) FCS CH – AUTO 15. <u>G53</u> aff SURF FDBK – resel 16. FF 1(2): CDR(PLT) disp sws – green dot NWS – 2 17. √MULT DATA PATH LOSS >>
		FF RECOV (FA Give Up)	18. (Aff) FCS CH – OFF 19. If two GPC/FA/FCS CHs ↓: (Good) FCS CHs – ORIDE 20. <u>G53</u> aff SURF FDBK – desel
		FF 1,2,3	◆ 21. <u>G51</u> IMU – resel
			22. √MULT DATA PATH LOSS >>

### FF(FA) MDM OUTPUT

FAULT

- ◆ (Take action only if annun by entire set)
- If single 'MDM OUTPUT':
  1. If 'FF MDM OUTPUT':
    - ◆ [G51] aff IMU – desel
  2. Go to FA/FF MDM I/O ERROR >>
- If both FF and FA annun:
  3. [G51] aff IMU – desel
  4. I/O RESET; if reqd, BFS I/O RESET
  5. If msgs repeat: Go to PASS GPC FAIL >>
  6. If reqd, (aff) FCS CH – ORIDE,AUTO
- ◆ 7. [G51] IMU – resel

### PL MDM I/O ERROR

1. BFS I/O RESET; if recovered >>
2. [G01] PL1/2 – port mode, then BFS I/O RESET;  
if recovered >>
3. If PL1 ↓ and pre MM305: FLASH EVAP CNTLR PRI  
B – ON
4. If PL2 ↓ and no comm: sel best S-BD PM ANT
5. If PL2 ↓ and AOA/GRTLS/TAL < 120K:  
⇒ NH3 CNTLR B – SEC/ON

### PCM I/O ERROR

OI PCMMU PWR – 2(1)

**BCE STRG X** (no 'MDM OUTPUT' msg)

	IMU	1. <b>G21</b> √IMU OPER, if STBY >>
		2. I/O RESET
RECOV	IMU	3. <b>G21</b> √att ANG, if delta > 1° >>
		◆ 4. <b>G51</b> IMU – resel >>
		5. >>
NOT RECOV	NSP	6. And no comm: PNL,CMD
		7. <b>BFS G51</b> Config per <u>COMM COVER</u> (ASC): TDRS – ITEM 46 EXEC (*) STDN-HI – ITEM 47 EXEC (*) SGLS – ITEM 49 EXEC (*) >>
		8. <b>G01</b> aff String – port mode
		9. <b>BFS</b> I/O RESET
		10. If recov, go to RECOV steps >>
A(B,C,D, IMU)	⇒	11. FF A(B,IMU) or FA C(D) MDM – OFF,ON
		12. I/O RESET
		13. If FA, (aff) FCS CH – ORIDE,AUTO
		14. If recov, go to RECOV steps
	C(D)	15. If < 3Y,2P jets/pod/dir: a. <b>G23</b> aff jet DES INH (*) (reprioritize) b. Aff MANF VLVS STAT OP – OVRD
	1A(2A)	16. CDR(PLT) disp sws – green dot
	B	17. <b>BFS G51</b> aff AA – desel
	D	18. <b>BFS G51</b> aff SURF FDBK,RGA – desel
		19. √MULT DATA PATH LOSS >>

### POST OPS 3/GRTL5 TRANSITION RESTRING

1. (Aff) GPC(s) – STBY,HALT
2. √G53 aff SURF FDBK – desel (\*)
3. Config MC1(3) NBAT
4. OPS Mode Recall: OPS XXX PRO
5. BFS I/O RESET

If OPS 3 and String 1(2,3) recovered:

- ⇒ ♦
6. G51 IMU – resel
  7. Config FCS CH(s) (see Table):
  8. G53 config SURF FDBK (see Table):

AVAILABLE		FCS CH CONFIG			SURF FDBK	
GPCs	FCS CHs	AUTO	ORIDE	OFF	SEL	DESEL
3	4	3		1	3	1*
	3	3		1	3	1*
	2		2	2	2	2
2	4		4		4	
	3		2	2	2	2
	2		2	2	2	2

\*If CH 4 – OFF, DO NOT DESEL PASS SURF FDBK

### POST BFS ENGAGE

If PASS GPCs running:

1. (Aff) GPC MODE – STBY/HALT
2. BFS I/O RESET
3. √FCS CHs, IMU config

⇒ If Air Data not analyzed:

4. G50 INH AD to G&C
5. M = 5: Deploy, evaluate probes one at a time
6. √AD to G&C by M = 1.5

If failed ADTA(s) in PASS:

7. cb(s) ADTA – op, or stow probe
8. G51 DES failed(commfaulted) RGA,AA,SURF
9. G50 DES failed TAC

At M ≤ 2.7:

10. CDR TRIM PNL – OFF  
RHC/PNL – ENA

At H = 3K:

11. SPDBK – MAN (check DEL PAD setting)

At MAIN GEAR TD:

12. SPDBK – 100%

### **DUAL DPS DISPLAY COMMANDERS/DK XMTR 1(2,3)**

1. BFC CRT SEL – aff IDP
- If reqd to clean up display:
2. (Aff) IDP/CRT PWR – OFF,ON

### **PASS DISPLAY FAIL**

1. MDU PWR – OFF,ON; if recovered >>
  2. GPC/CRT – same GPC/aff IDP; if recovered >>
  3. BFC CRT SEL – aff IDP; if both IDPs OK go to step 9
  4. – orig posn
  5. Report MDU symptoms
- If MCC GO for pwr cycle:
6. IDP/CRT PWR – OFF,ON; if recovered >>
- If MDU blank or autonomous:
7. Set other MDU on same IDP to DPS Mode; if recovered >>
  8. Return other MDU to nominal config
9. Deassign aff IDP from PASS
  10. GPC/CRT 04 EXEC
  11. In PASS: GPC/CRT 44 EXEC

### **BFS DISPLAY FAIL**

1. If IDP4(CRT4): IDP/CRT4 PWR – OFF >>
  2. MDU PWR – OFF,ON; if recovered >>
  3. BFC CRT SEL – unaff IDP; if both IDPs OK >>
  4. – orig posn
  5. BFC CRT DISPLAY – OFF,ON; if recovered >>
  6. In PASS: GPC/CRT 5/X for aff IDP; if recovered >>
  7. Report MDU symptoms
- If MCC GO for pwr cycle:
8. IDP/CRT PWR – OFF,ON; if recovered >>
- If MDU blank or autonomous:
9. Set other MDU on same IDP to DPS Mode; if recovered >>
  10. Return other MDU to nominal config
11. BFC CRT SEL – unaff IDP
  12. Deassign aff IDP from PASS
  13. GPC/CRT 04 EXEC
  14. In PASS: GPC/CRT 44 EXEC

**FLT INST DISPLAY ANOMALY**

1. DATA BUS sel alt FC BUS(s); if recovered >>
2. PORT SELECT aff MDU; if recovered >>
3. MDU PWR – OFF,ON

**SUBSYS STATUS DISPLAY ANOMALY**

1. PORT SELECT aff MDU; if recovered >>
2. MDU PWR – OFF,ON; if recovered >>

**BFS INADVERTENT DISENGAGE/UNSUCCESSFUL ENGAGE (Lightning Strike)**

1. CDR and PLT RHC BFS engage pb – push  
If no response:
2. BFS OUTPUT – NORM, B/U
3. CDR,PLT RHC BFS engage pb – push

**MULT DATA PATH LOSS (non-Recov)**

NOTE

If LRU data path loss due to GPC prob and not MDM, BFS will pick up MDMs/LRU when engaged

FAILURE	TYPE	ACTIONS
GPC/FF 1&2	I/O or B	Use R BODY FLAP & TRIM ENA sws
GPC/FF 3&4	I/O or B	Use L BODY FLAP & TRIM ENA sws
GPC/FA any combo	I/O or D	No impact



**ECLS**

**ECLS**



MS E4-1

AESP/ALL/E/GEN O

ECLS

### **CAB PRESS LEAK**

1. CAB RELIEF A – CL, pause,  
B – CL
  2. Check tabs, visors – CL, LES O2 – ON
  3. If RTLS/TAL: O2/N2 CNTLR VLV SYS 2 – OP
  4. O2 TK1, TK2 HTRS A, B (four) – AUTO
  - ⇒ 5. TK3 HTRS A, B (two) – AUTO
- If possible:
6. Remove INNER HATCH cap (two)
  7. Equal vlv (two) – EMER
- When CAB PRESS < 10 psia, if dP/dT EQ < 0.67:
8. √O2/N2 CNTLR VLV SYS 2 – OP >>
- When CAB PRESS < 6.5 psia:
9. √O2/N2 CNTLR VLV SYS 2 – OP
  10. CAB FAN (two) – ON

### **CAB PRESS HIGH**

1. If incr: LES O2 – OFF, visors – OP

If still incr:

2. N2 SYS 1, 2 REG INLET (two) – CL
3. O2 SYS 1, 2 SPLY (two) – CL

### **H2O LOOP PRESS LOW(HIGH)**

⇒ Switch Loops

### **AV BAY FAN ΔP**

- ⇒ 1. If Av Bay 1 aff: FAN A – ON; FAN B – OFF  
If Av Bay 2 aff: FAN B – ON; FAN A – OFF  
If Av Bay 3 aff: FAN A – ON; FAN B – OFF
2. If no joy: Go to LOSS OF AV BAY COOLING PWRDN

### **AV BAY TEMP HIGH**

- ⇒ 1. (Aff) AV BAY FAN (two) – ON
2. If not decr: Switch H2O Loops
3. If no joy: Go to LOSS OF AV BAY COOLING PWRDN

### **LOSS OF AV BAY COOLING PWRDN**

Bay 1: MLS 1 – OFF  
Bay 2: 2, 3 – OFF  
Bay 3: N/A

### **CABIN FAN FAIL**

- ⇒ 1. Switch fans
- If both fans lost:
2. Minimize use of IDPs/MDUs/FLT CNTLR PWR

### **IMU FAN FAIL**

⇒ Switch fans



## **FREON FLOW LOW**

1. Switch pumps
- If flow still low:
2. (Aff) RAD BYP VLV MODE – AUTO  
CNTLR LOOP – AUTO A(B) (wait 90 sec)
- If flow still low in both loops:
3. Go to LOSS OF FREON LOOP(s)

## **LOSS OF 1 FREON LOOP**

1. (Bad) FREON PUMP LOOP – OFF
- If FREON LOOP 1(2) lost:
2. O2 SYS 1(2) SPLY (one) – CL
  3. √FLOW PROP VLV LOOP 2(1) – ICH
4. Monitor EVAP OUT TEMP
- If TAL/AOA/RTLS and LOOP 2 lost:
5. NH3 CNTLR B – OFF, A – PRI/GPC

## **LOSS OF 2 FREON LOOPS – PWRDN**

1. When loops fail (flow <700), CDR execute LOOPS  
FAILED
  2. MSTR MADS PWR – OFF
  3. Use one IDP/CRT with two MDUs (three max)
  4. All PL pwr (seven) – OFF
  5. O2,H2 TK HTRS (all) – OFF
  6. MCC CMD FC purge, then BFS GPC – STBY,HALT  
PWR – OFF  
OUTPUT – NORM
  7. If no comm: sel best S-BD PM ANT
- If RTLS:
8. TACAN (three) – OFF
  9. RDR ALTM 1 – OFF
- If TAL/AOA/ENTRY and V > 15K:
10. All TACAN/RA/MLS – OFF
  11. Use one FLT CNTLR PWR
- ⇒
12. DC UTIL PWR – OFF
  - ◆ 13. FCS CH 4 – OFF
  14. GPC 4 – STBY,HALT,PWR – OFF
  15. FF4,FA4 – OFF
  16. ANNUN BUS SEL ACA 2/3 – OFF
  - ◆ When MPS dump complete:
    17. MPS ENG PWR (six) – OFF
    18. EIU (three) – OFF
    19. MEC 1 – OFF, wait 2 sec, then:
    20. MEC 2 – OFF
  - ◆ 21. G50 √GPS, INCORPORATE
  22. At M = 2.9: √RA 2 – ON
  23. If reqd: Use one MLS, GNC I/O RESET

# **OV103,104**

(OV103,104) MS E4-3

AESP/3,4/E/GEN O

### LOSS OF 2 FREON LOOPS – LOOPS FAILED

1. LES O2 – OFF, visor – OP
2. O2 SYS 1,2 SPLY (two) – OP  
Panel L1: All sws off, except:
  3. H2O PUMP LOOP 2 – ON
4. Perform PWRDN if not already accomplished

### EVAP OUT TEMP HIGH (Rads cold soaked)

If temp high in only one loop (snsr failed) >>

1. If V < 12K:  
RAD BYP VLV LOOP 1 – MAN,BYP  
NH3 CNTLR B – PRI/GPC >>
2. FLASH EVAP CNTLR PRI B(A) – OFF  
A(B) – ON (wait 30 sec)  
  
If T decr >>
3. FLASH EVAP CNTLR PRI A(B) – OFF  
SEC – ON (HI LOAD ena)  
(wait 30 sec)  
  
If T decr:  
TOP EVAP HTRS (three) – OFF >>
4. HI LOAD EVAP – OFF  
DUCT HTR sel – OFF (wait 30 sec)  
  
If T decr >>
5. TOP EVAP HTRS (three) – OFF  
RAD BYP VLV MODE (two) – AUTO  
CNTLR LOOP (two) – AUTO B(A) (wait 90 sec)

### EVAP OUT TEMP HIGH (Rads *not* cold soaked)

If temp high in only one loop (snsr failed) >>

If V > 12K:

1. FLASH EVAP CNTLR PRI A – OFF  
B – ON (wait 30 sec)  
  
If T decr >>
2. FLASH EVAP CNTLR PRI B – OFF  
SEC – ON (HI LOAD ena)  
(wait 30 sec)  
  
If T decr >>
3. HI LOAD EVAP – OFF  
If T decr >>
4. RAD BYP VLV (four) – MAN,RAD FLOW
- ⇒ 5. NH3 CNTLR B – SEC/ON (wait 60 sec)
6. If T decr >>
7. NH3 CNTLR B – OFF, A – SEC/ON

# OV103,104

(OV103,104) MS E4-4

AESP/ALL/E/GEN O

## EVAP OUT T LOW

1. If temp low in only one loop (snsr failed) >>
2. FREON PUMP LOOP 1,2 (two) – OFF
3. H2O PUMP LOOP 1 (two) – ON,B
4. FLOW PROP VLV LOOP 1,2 (two) – PL HX (tb-PL)
5. O2 SYS 1,2 SPLY (two) – CL (tb-CL)
6. √RAD BYP VLV MODE (two) – MAN
7. √MAN SEL (two) – BYP (tb-BYP ~3 sec)
8. FLASH EVAP CNTLR PRI A,B,SEC (three) – OFF
- ◆ 9. FREON PUMP LOOP 1,2 (two) – B  
NH3 CNTLR A,B (two) – SEC/ON

Wait 3 min, then if any Freon Loop off:

10. FREON PUMP LOOP 1,2 (two) – B

When EVAP OUT T > 55 for at least 2 min (NH3 depleted):

11. O2 SYS 1,2 SPLY (two) – OP (tb-OP)
12. NH3 CNTLR A,B (two) – OFF

If V > 12K and FLASH EVAP CNTLR PRI A(B)

previously selected:

13. FLASH EVAP CNTLR PRI B(A) – GPC >>

If V < 12K:

14. RAD BYP VLV MODE 1,2 (two) – AUTO
15. CNTLR LOOP 1,2 (two) – OFF  
AUTO A(B)

## FREON LEAK

- ◆ 1. FREON ISOL MODE – MAN
  2. (Aff) FREON ISOL LOOP 1(2) – ISOL  
Hold for 5 sec
- If (aff) FREON LOOP 1(2) ACCUM QTY decr:
- ◆ 3. (Aff) FREON ISOL LOOP 1(2) – RAD  
Hold for 5 sec
  4. When loop fails ('SM2 FREON FLOW 1(2)'), CDR  
execute LOSS OF 1 FREON LOOP for (aff) Freon  
Loop >>
- If (aff) FREON LOOP 1(2) ACCUM QTY not decr:  
When V<12K and rads cold soaked:  
In good loop:
5. √RAD BYP VLV MODE 2(1) – AUTO
  6. √RAD CNTLR LOOP 2(1) – AUTO B
  7. NH3 CNTLR B(A) – PRI/GPC

# OV103,104

(OV103,104) MS E4-5

AESP/ALL/E/GEN O,2

## FIRE/SMOKE

SM SYS SUMM 1

If **VISUAL SMOKE/FIRE**, or  
two SMOKE DETN lt on, or  
two CONC > 2, or  
one SMOKE DETN lt on and  
other CONC > 2:

1. Go to step 6

If single Av Bay SMOKE DETN A(B) lt and assoc CONC > 2:

2. SMOKE DETN CKT TEST – B(A) (25 sec)

If SMOKE DETN B(A) test good (lt on):

3. SMOKE DETN CKT TEST – OFF

4. SNSR – RESET >>

If SMOKE DETN B(A) test bad (no lt):

5. Go to step 6

If none of above >>

6. Check tabs, visors – CL  
LES O2 – ON

If **AV BAY FIRE**:

7. FIRE SUPPR – ARM

pb – DISCH (push until lit)

8. If Ascent: AV BAY FAN (two) – OFF

9. If FIRE in Bay:

1: TACAN 1, MLS 1 – OFF

2: TACAN 2, MLS 2,3 – OFF

3: TACAN 3 – OFF

If **CABIN FIRE**:

10. CAB FAN A,B (two) – OFF (max 20 min)

11. Locate source (see matrix, facing page)

12. Unpwr source of smoke

If smoke persists or source cannot be unpwr:

**WARNING**

Discharge is propulsive

13. Discharge handheld FIRE EXTGHR

If Ascent:

14. Post MECO, go to POST-FIRE CABIN CLEANUP (ASC  
PKT, ECLS) >>

If Entry and prior to TIG:

15. Go to ECLS FRP-3, FIRE/HAZ SPILL O2 CONTROL, step |  
3 (MAL)

Cont next page

**OV103,104**

(OV103,104) MS E4-6

AESP/3,4/E/GEN O,2

## **FREON FLOW LOW**

1. Switch pumps
- If flow still low:
2. (Aff) RAD BYP VLV MODE – AUTO  
CNTLR LOOP – AUTO A(B) (wait 90 sec)
- If flow still low in both loops:
3. Go to LOSS OF FREON LOOP(s)

## **LOSS OF 1 FREON LOOP**

1. (Bad) FREON PUMP LOOP – OFF
- If FREON LOOP 1(2) lost:
2. O2 SYS 1(2) SPLY (one) – CL
  3. √FLOW PROP VLV LOOP 2(1) – ICH
4. Monitor EVAP OUT TEMP
- If TAL/AOA/RTLS and LOOP 2 lost:
5. NH3 CNTLR B – OFF, A – PRI/GPC

## **LOSS OF 2 FREON LOOPS – PWRDN**

1. When loops fail (flow <700), CDR execute LOOPS  
FAILED
  2. MSTR MADS PWR – OFF
  3. Use one IDP/CRT with two MDUs (three max)
  4. All PL pwr (seven) – OFF
  5. O2,H2 TK HTRS (all) – OFF
  6. MCC CMD FC purge, then BFS GPC – STBY,HALT  
PWR – OFF  
OUTPUT – NORM
  7. If no comm: sel best S-BD PM ANT
  8. GPS 1,3 – OFF
- If RTLS:
9. RDR ALTM 1 – OFF
- If TAL/AOA/ENTRY and V > 15K:
10. All RA/MLS – OFF
  11. Use one FLT CNTLR PWR
- ⇒
12. DC UTIL PWR – OFF
  - ◆ 13. FCS CH 4 – OFF
  14. GPC 4 – STBY,HALT,PWR – OFF
  15. FF4,FA4 – OFF
  16. ANNUN BUS SEL ACA 2/3 – OFF
  - ◆ When MPS dump complete:
    17. MPS ENG PWR (six) – OFF
    18. EIU (three) – OFF
    19. MEC 1 – OFF, wait 2 sec, then:
    20. MEC 2 – OFF
  - ◆ 21. G50 √GPS, INCORPORATE
  22. At M = 2.9: √RA 2 – ON
  23. If reqd: Use one MLS, GNC I/O RESET

# **OV105**

(OV105) MS E4-3

AESP/5/E/GEN O

## LOSS OF 2 FREON LOOPS – LOOPS FAILED

1. LES O2 – OFF, visor – OP
2. O2 SYS 1,2 SPLY (two) – OP  
Panel L1: All sws off, except:
  3. H2O PUMP LOOP 2 – ON
4. Perform PWRDN if not already accomplished

## EVAP OUT TEMP HIGH (Rads cold soaked)

If temp high in only one loop (snsr failed) >>

1. If V < 12K:  
RAD BYP VLV LOOP 1 – MAN,BYP  
NH3 CNTLR B – PRI/GPC >>
2. FLASH EVAP CNTLR PRI B(A) – OFF  
A(B) – ON (wait 30 sec)  
  
If T decr >>
3. FLASH EVAP CNTLR PRI A(B) – OFF  
SEC – ON (HI LOAD ena)  
(wait 30 sec)  
  
If T decr:  
TOP EVAP HTRS (three) – OFF >>
4. HI LOAD EVAP – OFF  
DUCT HTR sel – OFF (wait 30 sec)  
  
If T decr >>
5. TOP EVAP HTRS (three) – OFF  
RAD BYP VLV MODE (two) – AUTO  
CNTLR LOOP (two) – AUTO B(A) (wait 90 sec)

## EVAP OUT TEMP HIGH (Rads *not* cold soaked)

If temp high in only one loop (snsr failed) >>

If V > 12K:

1. FLASH EVAP CNTLR PRI A – OFF  
B – ON (wait 30 sec)  
  
If T decr >>
2. FLASH EVAP CNTLR PRI B – OFF  
SEC – ON (HI LOAD ena)  
(wait 30 sec)  
  
If T decr >>
3. HI LOAD EVAP – OFF  
If T decr >>
4. RAD BYP VLV (four) – MAN,RAD FLOW
- ⇒ 5. NH3 CNTLR B – SEC/ON (wait 60 sec)
6. If T decr >>
7. NH3 CNTLR B – OFF, A – SEC/ON

# OV105

(OV105) MS E4-4

AESP/ALL/E/GEN O

## EVAP OUT T LOW

1. If temp low in only one loop (snsr failed) >>
2. FREON PUMP LOOP 1,2 (two) – OFF
3. H2O PUMP LOOP 1 (two) – ON,B
4. FLOW PROP VLV LOOP 1,2 (two) – PL HX (tb-PL)
5. O2 SYS 1,2 SPLY (two) – CL (tb-CL)
6. √RAD BYP VLV MODE (two) – MAN
7. √MAN SEL (two) – BYP (tb-BYP ~3 sec)
8. FLASH EVAP CNTLR PRI A,B,SEC (three) – OFF
- ◆ 9. FREON PUMP LOOP 1,2 (two) – B  
NH3 CNTLR A,B (two) – SEC/ON

Wait 3 min, then if any Freon Loop off:

10. FREON PUMP LOOP 1,2 (two) – B

When EVAP OUT T > 55 for at least 2 min (NH3 depleted):

11. O2 SYS 1,2 SPLY (two) – OP (tb-OP)
12. NH3 CNTLR A,B (two) – OFF

If V > 12K and FLASH EVAP CNTLR PRI A(B)

previously selected:

13. FLASH EVAP CNTLR PRI B(A) – GPC >>

If V < 12K:

14. RAD BYP VLV MODE 1,2 (two) – AUTO
15. CNTLR LOOP 1,2 (two) – OFF  
AUTO A(B)

## FREON LEAK

- ◆ 1. FREON ISOL MODE – MAN
  2. (Aff) FREON ISOL LOOP 1(2) – ISOL  
Hold for 5 sec
- If (aff) FREON LOOP 1(2) ACCUM QTY decr:
- ◆ 3. (Aff) FREON ISOL LOOP 1(2) – RAD  
Hold for 5 sec
  4. When loop fails ('SM2 FREON FLOW 1(2)'), CDR  
execute LOSS OF 1 FREON LOOP for (aff) Freon  
Loop >>
- If (aff) FREON LOOP 1(2) ACCUM QTY not decr:  
When V<12K and rads cold soaked:  
In good loop:
5. √RAD BYP VLV MODE 2(1) – AUTO
  6. √RAD CNTLR LOOP 2(1) – AUTO B
  7. NH3 CNTLR B(A) – PRI/GPC

# OV105

(OV105) MS E4-5

AESP/ALL/E/GEN O,2

## FIRE/SMOKE

SM SYS SUMM 1

If **VISUAL SMOKE/FIRE**, or  
two SMOKE DETN lt on, or  
two CONC > 2, or  
one SMOKE DETN lt on and  
other CONC > 2:

1. Go to step 6

If single Av Bay SMOKE DETN A(B) lt and assoc CONC > 2:

2. SMOKE DETN CKT TEST – B(A) (25 sec)

If SMOKE DETN B(A) test good (lt on):

3. SMOKE DETN CKT TEST – OFF

4. SNSR – RESET >>

If SMOKE DETN B(A) test bad (no lt):

5. Go to step 6

If none of above >>

6. Check tabs, visors – CL  
LES O2 – ON

If **AV BAY FIRE**:

7. FIRE SUPPR – ARM

pb – DISCH (push until lit)

8. If Ascent: AV BAY FAN (two) – OFF

9. If FIRE in Bay:

1: GPS 1, MLS 1 – OFF

2: MLS 2,3 – OFF

3: GPS 3 – OFF

If **CABIN FIRE**:

10. CAB FAN A,B (two) – OFF (max 20 min)

11. Locate source (see matrix, facing page)

12. Unpwr source of smoke

If smoke persists or source cannot be unpwr:

**WARNING**

Discharge is propulsive

13. Discharge handheld FIRE EXTGHR

If Ascent:

14. Post MECO, go to POST-FIRE CABIN CLEANUP (ASC  
PKT, ECLS) >>

If Entry and prior to TIG:

15. Go to ECLS FRP-3, FIRE/HAZ SPILL O2 CONTROL, step |  
3 (MAL)

Cont next page

(OV105) MS E4-6

# OV105

AESP/5/E/GEN O,2

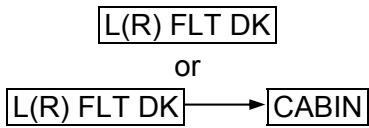
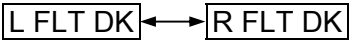
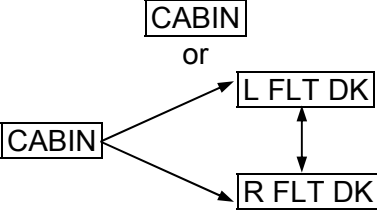

ALARM SEQUENCE	SOURCE AREA
 <p style="text-align: center;">L(R) FLT DK or L(R) FLT DK → CABIN</p>	PS(MS), L(R) CONSOLE
 <p style="text-align: center;">L FLT DK ↔ R FLT DK</p>	AFT FLT DK, MIDDECK
 <p style="text-align: center;">CABIN or CABIN → L FLT DK CABIN → R FLT DK L FLT DK ↔ R FLT DK</p>	FWD FLT DK, WCS, LEB



This Page Intentionally Blank





**EPS**

**EPS**



MS E5-1

AESP/ALL/E/GEN O

**MN BUS UNDERVOLTS/FC VOLTS PLT**

If MN V < 26.4, FC V < 26.6, FC A > 480 (2 of 3)

(SHORT or degraded FC):

- ⇒
1. MSTR MADS PWR – OFF
  2. If aff BUS tied – untie
  3. PL PRI (three) – OFF
  4. (Aff) ESS BUS SOURCE FC – OFF  
FC/MN BUS – OFF
- If FC VOLTS < 32 (FC SHORT)
5. (Aff) FC REAC VLV – CL
  6. Go to FC SHUTDN (do not stop FC until  
COOL P < 15 and STACK T < 243) >>
- If FC VOLTS ≥ 32 (BUS SHORT)
7. Go to BUS LOSS ACTION >>
- If MN V < 26.4 and FC V > 32 and FC A < 20  
(FC disconnect, check APUs):
8. MSTR MADS PWR – OFF
  9. PL PRI (three) – OFF
  10. FC/MN BUS – ON
- If FC3 aff:
11. PL PRI MNC – ON  
FC3 – ON
  12. If MNC V < 26.4: PL PRI (three) – OFF
- If 1st FC failure:
13. Perform BUS TIE, then:
- If MN BUS recovered:
14. GNC I/O RESET
- If aff FC VOLTS > 32:
15. Go to FC SHUTDN

**AC VOLT HIGH**

If AC V > 123 and F9 V > 123:

- ⇒
1. (Aff) AC BUS SNSR – OFF
  2. cb AC CONTR – cl  
INV/AC BUS – OFF  
INV PWR – OFF  
cb AC CONTR – op
  3. √H2O PUMP LOOP 2(1) – ON
  4. Go to aff BUS LOSS

EPS

**AC VOLT LOW or OVERLOAD**

PLT

3Φ/AC  
ESS

⇒

If amps > 14 or V < 110:

If single Φ amps > 14 or V > 10:

1.   cb AC CONTR – cl  
      INV/AC BUS – OFF  
      INV PWR – OFF  
      cb AC CONTR – op
2.   If other Φ amps > 14:  
      Go to step 3

If multi Φ (bus short):

3.   (Aff) cb AC CONTR (three) – cl  
      INV/AC BUS – OFF (tb-OFF)  
      INV PWR – OFF (tb-OFF)  
      cb AC CONTR (three) – op  
      AC BUS SNSR – OFF
4.   Go to aff BUS LOSS

MN  
AC

**3Φ AC MOTORS STOPPED**

PLT

1. (Aff) AC BUS SNSR – OFF
2. Determine AC BUS:
  - FC1 and FREON PUMP 2B: AC1
  - FC2 and FREON PUMP 1B: AC2
  - FC3 and CAB FAN A: AC3
3. (Aff) FC – STOP
- If AC3 aff:
  4. AV BAY 3 FAN B – OFF, A – ON
  5. CAB FAN A – OFF
- Isolate aff ΦB(ΦC,ΦA):
  6. (Aff) cb AC CONTR – cl
  7. INV/AC BUS – OFF
- If AC1(2,3) aff and AV BAY 3(2,3) FAN ΔP ≥ 0.5:
  8. Go to step 16 (bad Φ isolated)
  9. (Aff) INV/AC BUS – ON
  10. cb AC CONTR – op
  11. Repeat from step 6 to isolate aff ΦC(ΦA), then:
- Drop aff AC bus (three Φs):
  12. (Aff) cb AC CONTR (three) – cl
  13. INV/AC BUS – OFF
  14. INV PWR – OFF
  15. Go to aff BUS LOSS >>
- Bad Φ isolated:
  16. (Aff) FC – START (10 sec or ΔP tb-gray)
  17. Perform aff BUS LOSS and if AC1(AC2) aff >>
  18. If AC3 aff: CAB FAN B – ON

⇒ **AC SINGLE Φ**

<b>AC1</b>	<b>ΦA</b>	BLR CNTLR/HTR 1 – A When V = 12K: RAD CNTLR LOOP (two) – AUTO A
	<b>ΦB</b>	When V = 12K: RAD CNTLR LOOP (two) – AUTO A
	<b>ΦC</b>	BLR CNTLR/HTR 3 – B
<b>AC2</b>	<b>ΦA</b>	BLR CNTLR/HTR 1 – B
	<b>ΦB</b>	SIG CONDR FREON A – AC3
	<b>ΦC</b>	BLR CNTLR/HTR 2 – A
<b>AC3</b>	<b>ΦA</b>	BLR CNTLR/HTR 2 – B
	<b>ΦB</b>	SIG CONDR FREON B – AC2
	<b>ΦC</b>	BLR CNTLR/HTR 3 – A

**ANY AC2 SINGLE Φ**

CDR

⇒ FREON PUMP LOOP 1 – A

**BUS TIE** (do not tie bus short, check APUs)

If MN Volts > 20: Bus Tie >>

If MN Volts < 20 (do not BUS TIE Pre MECO for 1st FC):

1. (Aff) AC BUS SNSR – OFF
2. cb AC CONTR (three) – cl
3. INV/AC BUS – OFF (tb-OFF)
4. INV PWR – OFF (tb-OFF)
5. If MNC(B) dn, CAB FAN A(B) – OFF
6. Bus Tie
7. INV PWR – ON (tb-ON)
- ◆ 8. INV/AC BUS – ON (tb-ON)
9. cb AC CONTR (three) – op
10. GNC I/O RESET
11. Post MECO: (Aff) AC BUS SNSR – AUTO TRIP
12. Post PWRDN: √CAB FAN A(B) – ON

**MN  
SUB**

**ESS BUS V LOW**

**PLT**

If verified by F9 voltmeter:

1. Perform FC SHUTDN (<9 min), then:
2. Go to aff ESS BUS LOSS

**ESS BUS LOSS**

<b>ESS 1BC</b>	<b>O13&amp;R14</b>	<ol style="list-style-type: none"> <li>1. L AUD CNTL sel – R (CDR can't talk)</li> <li>2. Pri C/W &amp; F7 Matrix lost</li> </ol>
<b>ESS 2CA</b>	<b>O13&amp;R14</b>	<ol style="list-style-type: none"> <li>1. AUD CTR – 2</li> <li>2. R AUD CNTL sel – L (PLT can't talk)</li> </ol>
<b>ESS 3AB</b>	<b>O13</b>	<ol style="list-style-type: none"> <li>1. GPC CAM Lights lost</li> <li>2. Do not engage BFS</li> <li>⇒ 3. BFS GPC OUTPUT – TERM</li> </ol>

3Φ/AC  
ESS

**MNA or AC1 Multi Φ CDR**

- 1. FLASH EVAP CNTLR PRI B – OFF, A – GPC
  - 2. TOP EVAP HTR DUCT sel – B
  - 3. HI LOAD DUCT HTR sel – B
  - ⇒ 4. FREON PUMP LOOP 2 – A
  - 5. AV BAY 3 FAN A – ON, B – OFF
- If rads cold soaked:  
When  $V \leq 12K$ :
- 6. RAD BYP VLV MODE 1,2 (two) – AUTO
  - 7. RAD CNTLR LOOP 1,2 (two) – AUTO A
- 8. ANNUN BUS SEL ACA 1 – MNB
  - 9. NWS – 2
  - 10. [BFS G51] AA1 – desel
  - 11. MS AUD CNTL – PS (MS can't talk)
- FAILED: NH3 A PRI, NWS 1,  
UHF HI PWR XMIT, L HUD, AUTO B

**MNB or AC2 Multi Φ**

- ⇒ 1. AV BAY 1 FAN A – ON, B – OFF
  - 2. FREON PUMP LOOP 1 – A
  - 3. HUM SEP A – ON, B – OFF
  - 4. IMU FAN A – ON, B – OFF
  - 5. AV BAY 2 FAN B – ON, A – OFF
  - 6. √cb AC3 ΦA LG SNSR 1 – cl
  - 7. ANNUN BUS SEL ACA 2/3 – MNC
  - 8. [BFS G51] AA2, RGA 2 – desel
- FAILED: NH3 B SEC, RA 2, NWS 2  
PLT DRAG CHUTE ARM  
S-BD PM 1 (NO PNL,CMD)

**MNC or AC3 Multi Φ**

- ⇒ 1. FLASH EVAP CNTLR PRI A – OFF, B – GPC
  - 2. CAB FAN B – ON, A – OFF
  - 3. √AV BAY 3 FAN B – ON
  - 4. H2O PUMP LOOP 1 – ON, 2 – OFF
  - 5. √cb AC2 ΦA LG SNSR 2 – cl
  - 6. [BFS G51] RGA 3 – desel
- FAILED: NH3 A SEC, B PRI  
CDR DRAG CHUTE ARM

**SUBBUS [MNA O14]**

- 1. NWS – 2
- If rads cold soaked:  
When  $V \leq 12K$ :
- 2. RAD BYP VLV MODE 1,2 (two) – AUTO
  - 3. RAD CNTLR LOOP 1,2 (two) – AUTO A
- FAILED: AUTO B

**SUBBUS [APC4(5,6) or ALC1(2,3)]**

SUBBUS	APC or ALC	4 1	5 2	6 3
1.	FLASH EVAP CNTLR	PRI A – GPC		√PRI B – GPC



**MNA or AC1 Multi Φ** **PLT**

- 1. MSTR MADS PWR – OFF
- 2. Perform FC SHUTDN (within 9 min), then:
- ⇒ 3. BLR CNTLR/HTR 1 – A  
3 – B

FAILED: TAC 1  
MLS 1, RA 1, NWS 1, L HUD

**MNB or AC2 Multi Φ**

- 1. MSTR MADS PWR – OFF
- 2. Perform FC SHUTDN (within 9 min), then:
- ⇒ 3. BLR CNTLR/HTR 2 – A  
1 – B
- 4. SIG CONDR FREON A – AC3

FAILED: TAC 2  
MLS 2, RA 2, NWS 2  
PLT DRAG CHUTE ARM  
S-BD PM 1 (NO PNL,CMD)

**CNTL**

**MNC or AC3 Multi Φ**

- 1. S-BD PM CNTL – PNL,CMD
- 2. Config per COMM COVER (ASC) **[BFS G51]**:  
TDRS – ITEM 46 EXEC (\*)  
STDN-HI – ITEM 47 EXEC (\*)  
SGLS – ITEM 49 EXEC (\*)
- 3. MSTR MADS PWR – OFF
- ⇒ 4. Perform FC SHUTDN (within 9 min), then:
- 5. BLR CNTLR/HTR 3 – A  
2 – B
- 6. SIG CONDR FREON B – AC2

FAILED: TAC 3, MLS 3, R HUD  
CDR DRAG CHUTE ARM

**SUBBUS**

SUBBUS	APC or ALC	4 1	5 2	6 3
⇒ 1.	BLR CNTLR/HTR	1 – A 3 – B	2 – A 1 – B	3 – A 2 – B

**CNTL BUS V LOW/CNTL BUS RPC**

**PLT**

**WARNING**  
 If VISIBLE FIRE/SMOKE AT ANY TIME, cb CNTL BUS AB1/2/3(BC1/2/3,CA1/2/3) – op (pnl R14:B)

1. Identify BUS (√BUS LOSS ID)  
 ⇒ If bus critical (per MCC):

◆ 2. >>

- ◆ If one CNTL BUS RPC tripped (\*):  
 Aff CNTL BUS:

**MN  
SUB**

**AB1(2,3)**

	Tripped RPC (*)	Action (for RESET, hold w/sw reten device)
3.	<b>A</b>	R1 CNTL BUS PWR MNB – RESET R14:B cb CNTL BUS AB1/2/3 – op
4.	<b>B</b>	R1 CNTL BUS PWR MNA – RESET R14:B cb CNTL BUS AB1/2/3 – op

**BC1(2,3)**

	Tripped RPC (*)	Action (for RESET, hold w/sw reten device)
5.	<b>B</b>	R1 CNTL BUS PWR MNC – RESET R14:B cb CNTL BUS BC1/2/3 – op
6.	<b>C</b>	R1 CNTL BUS PWR MNB – RESET R14:B cb CNTL BUS BC1/2/3 – op

**CA1(2,3)**

	Tripped RPC (*)	Action (for RESET, hold w/sw reten device)
7.	<b>C</b>	R1 CNTL BUS PWR MNA – RESET R14:B cb CNTL BUS CA1/2/3 – op
8.	<b>A</b>	R1 CNTL BUS PWR MNC – RESET R14:B cb CNTL BUS CA1/2/3 – op

- ◆ If no CNTL BUS RPC tripped (no \*):

	aff CNTL BUS	Pnl R1 action (RESET, hold w/sw reten device)
9.	<b>AB1(2,3)</b>	CNTL BUS PWR MNA,MNB (two) – RESET
10.	<b>BC1(2,3)</b>	CNTL BUS PWR MNB,MNC (two) – RESET
11.	<b>CA1(2,3)</b>	CNTL BUS PWR MNA,MNC (two) – RESET

Cont next page

- ◆ 12. Perform aff CNTL BUS LOSS, then:

If pwr reqd (<3 sec) for crit function:

- 13. Hold crit function sw

For tripped RPC:

- 14. CNTL BUS PWR MNA(MNB,MNC) – RESET (1 sec), then dn

15. ⇒

**CNTL BUS LOSS**

**CDR**

<b>AB1</b>	⇒	1. Use R TRIM & BDY FLP sws FAILED: NH3 A SEC, FES PRI B GPC
<b>AB2</b>	⇒	1. CDR disp sws – green dot FAILED: NH3 B SEC, L HUD, FES PRI B ON, H2O LOOP 1,A ON
<b>AB3</b>	⇒	If BFS engage reqd: 1. Use PLT's RHC, then GPCs 1,2,4 – STBY,HALT  2. BFS I/O RESET
<b>BC1</b>	⇒	1. Use R TRIM & BDY FLP sws 2. <b>[BFS G51]</b> RGA 2 – desel FAILED: R HUD, CDR DRAG CHUTE DPY/JETT
<b>BC2</b>	⇒	If TAL/AOA/RTLs: 1. NH3 CNTLR B – OFF A – PRI/GPC FAILED: NH3 B PRI, FES SEC GPC, H2O LOOP 1, B ON, CDR DRAG CHUTE DPY/JETT
<b>BC3</b>	⇒	FAILED: NH3 A PRI, FES SEC ON
<b>CA1</b>	⇒	1. No BFS engage GPC 3,5 ◆ 2. BFS GPC OUTPUT – TERM 3. <b>[BFS G51]</b> RGA 3 – desel FAILED: NH3 B SEC, FES PRI A GPC, H2O LOOP 2 GPC, PLT DRAG CHUTE DPY/JETT
<b>CA2</b>	⇒	FAILED: NH3 A SEC, FES PRI A ON, PLT DRAG CHUTE DPY/JETT

**CNTL  
FC**

CNTL

CNTL BUS LOSS		PLT
<b>AB1</b>	⇒	1. Use R TRIM & BDY FLP sws 2. BLR CNTLR/HTR 1 – A
<b>AB2</b>	⇒	1. <b>G23</b> RCS FWD MANF VLVS 1 OVRD – ITEM 40 EXEC (CL) 2. BLR CNTLR/HTR 1 – A FAILED: L HUD
<b>AB3</b>	⇒	1. <b>G51</b> RCS RM MANF CL OVRD – ITEM 41 EXEC If BFS engage reqd: 2. Use PLT's RHC, then GPCs 1,2,4 – STBY, HALT 3. BFS I/O RESET 4. BLR CNTLR/HTR 1,3 (two) – B
<b>BC1</b>	⇒	1. Use R TRIM & BDY FLP sws 2. BLR CNTLR/HTR 2 – A FAILED: R HUD, CDR DRAG CHUTE DPY/JETT S-BD PM 1 (NO PNL, CMD)
<b>BC2</b>	⇒	1. S-BD PM CNTL – PNL, CMD 2. <b>BFS G51</b> Config per <u>COMM COVER</u> (ASC): TDRS – ITEM 46 EXEC (*) STDN-HI – ITEM 47 EXEC (*) SGLS – ITEM 49 EXEC (*) 3. <b>G23</b> RCS FWD MANF VLVS 2 OVRD – ITEM 41 EXEC (CL) 4. PLT disp sws – green dot 5. Use L TRIM & BDY FLP sws 6. BLR CNTLR/HTR 2 – A FAILED: CDR DRAG CHUTE DPY/JETT
<b>BC3</b>	⇒	1. <b>G51</b> RCS RM MANF CL OVRD – ITEM 41 EXEC 2. BLR CNTLR/HTR 1,2 (two) – B
<b>CA1</b>	⇒ ♦	1. No BFS engage GPC 3,5 2. BFS GPC OUTPUT – TERM 3. BLR CNTLR/HTR 3 – A FAILED: PLT DRAG CHUTE DPY/JETT
<b>CA2</b>	⇒	1. <b>G23</b> RCS FWD MANF VLVS 3 OVRD – ITEM 42 EXEC (CL) 2. Use L TRIM & BDY FLP sws 3. BLR CNTLR/HTR 3 – A FAILED: PLT DRAG CHUTE DPY/JETT
<b>CA3</b>	⇒	BLR CNTLR/HTR 2,3 (two) – B

Cont next page

MS E5-10 AESP/ALL/E/GEN O

### FC REAC VLV CLOSED

PLT

1. FC REAC VLV (three) – OP
2. Perform BUS TIE, then:  
If FC COOL P < 50:
3. Go to FC SHUTDN

### FC pH ↓ 1(2,3) or FC DELTA V 1(2,3)

If pH ↓ and FC SS 1(2,3) ΔV > 150

or FC SS ΔV > 150 and incr:

1. Perform BUS TIE, then:
2. (Aff) FC REAC VLV – CL
3. MSTR MADS PWR – OFF
4. Go to LOSS OF 1(2nd) FC PWRDN >>

If pH ↓ only:

- ◆ 5. Go to BUS TIE

### FC STACK T

1. MSTR MADS PWR – OFF

If STACK T > 243 and incr:

2. If 2nd FC: Go to 2nd FC SHUTDN >>
3. PL PRI (three) – OFF

If aff FC amps < 170 or > 360:

4. Go to MN BUS UNDERVOLTS/FC VOLTS, step 4 >>
  - ◆ 5. Perform BUS TIE, then:
  6. ESS BUS SOURCE FC – OFF
  7. FC/MN BUS – OFF
- If aff FC VOLTS < 32 or STACK T not decr:
8. (Aff) FC REAC VLV – CL
  9. FC – STOP after COOL P < 15 and STACK T < 243
  10. Go to LOSS OF 1 FC PWRDN

FC  
EMER

### FC EXIT T

1. MSTR MADS PWR – OFF
2. Perform BUS TIE, then:

- ⇒ If EXIT T > 164 and incr or < 131 and no comm:
3. Go to FC SHUTDN

### FC COOLANT PUMP $\Delta$ P LOW

PLT

1. FC – START (10 sec or  $\Delta$ P tb-gray)
- ⇒ ♦ If EXIT T > 164 and not decr or  
RDY tb – bp (30 sec after START) or  
FC PUMP cb(s) – op (pnl L4:C):
2. Go to FC SHUTDN >>
- If EXIT T norm, RDY tb – gray, and no comm:
3. Monitor AC amps
  4. FC – STOP
- If AMPS decr 0.7-0.9 AMP/ $\Phi$ :
5. FC – START (hold 30 sec if  $\Delta$ P tb-bp)
  6. If AMPS incr 0.7-0.9 AMP/ $\Phi$  >>
  7. Go to FC SHUTDN

### FC COOL P

1. Perform BUS TIE, then:  
If COOL P < 75: >>  
If COOL P incr and not 100 (H),  
or FC COOL PUMP =  $\Delta$ P (intermittent),  
or STACK/EXIT T unstable,
2. (Aff) FC REAC VLV – CL
  3. MSTR MADS PWR – OFF
  4. Go to LOSS OF 1(2nd) FC PWRDN

CNTL  
FC

**FC SHUTDN (1st) (<9 min)**

1. MSTR MADS PWR – OFF
  2. If not tied: Perform BUS TIE, then:  
If ORB (not deorb prep), kW > 18:  
MN BUS TIE (three) – ON
  3. ESS BUS SOURCE FC – OFF  
FC/MN BUS – OFF  
FC – STOP (1 sec)
  4. FC REAC VLV – CL
- ◆ Go to LOSS OF 1 FC PWRDN

**LOSS OF 1 FC PWRDN (GRTLS/TAL) PLT**

1. PRI PL (three) – OFF  
AFT PL (two) – OFF
  2. IDP/CRT4 PWR – OFF  
One MDU – OFF
- ⇒ If TAL:  
When V < 19K:  
3. MPS ENG PWR (six) – OFF

**LOSS OF 1 FC PWRDN (ENTRY)**

1. If V < 15K >>
  2. IDP/CRT4, one MDU, FLT CNTLR PWR – OFF
  3. TACAN/RA/MLS – OFF
- If middeck PL on:  
4. cb MNB UTIL PWR – op (pnl O15:C)
- ◆ 5. PRI PL (three) – OFF  
AFT PL (two) – OFF

<b>EMER PWRDN</b>
<b>FC REAC (three) – CL</b>
<b>FC/MN BUS</b>
<b>(BEST FC LAST) – OFF</b>
<b>ESS BUS SOURCE FC</b>
<b>(three) – OFF</b>
<b>√TABS/VISOR/GREEN APPLE</b>

FC

# OV103,104

(OV103,104) MS E5-13 AESP/3,4/E/GEN O

## 2nd FC SHUTDN (GRTLS/TAL)

PLT

(CL PMP Lost: < 6 min)

1. Have CDR start LOSS OF 2nd FC PWRDN (GRTLS/TAL)

If three MN buses pwr:

2. MN BUS TIE (three) – OFF  
(do not perform BUS LOSS ACTION)
3. LES O2 – OFF, visors – OP
4. Switch off all but one IDP/CRT with four MDUs
5. All PL pwr (seven) – OFF
6. O2,H2 TK HTRS (all) – OFF
7. After CDR pnl L1 config complete, continue:

If two MN buses pwr:

8. Pwr MN BUS TIES (two) – ON

If only one MN bus pwr:

9. MN BUS TIE (three) – OFF  
If only MNA(B,C) pwr: Secure APU 2(3,1)  
BUS TIE good FC/BUS (MNA)  
I/O RESET

When reqd:

10. ESS BUS SOURCE FC – OFF  
FC/MN BUS – OFF  
FC – STOP (1 sec)  
FC REAC VLV – CL
11. G51 √ICNCT ENA (if reqd for OMS load)
12. Go to LOSS OF 2nd FC PWRDN (GRTLS/TAL)

## 2nd FC SHUTDN (ENTRY)

1. Have CDR go to LOSS OF 2nd FC PWRDN (ENTRY)
2. O2/H2 HTRS (twelve) – OFF (pnl R1)  
PL pwr (seven) – OFF
3. √MSTR MADS PWR – OFF

If aff FC/MN BUS is tied:

4. MN BUS TIE (two) – OFF
5. If only MNA(B,C) pwr: Secure APU 2(3,1)
6. Perform BUS TIE (good FC/BUS to another BUS),  
then:
7. ESS BUS SOURCE FC – OFF  
FC/MN BUS – OFF  
FC – STOP (1 sec)  
FC REAC VLV – CL

FC  
EMER

# OV103,104

(OV103,104) MS E5-14 AESP/ALL/E/GEN O



**FC SHUTDN (1st) (<9 min)**

1. MSTR MADS PWR – OFF
  2. If not tied: Perform BUS TIE, then:  
If ORB (not deorb prep), kW > 18:  
    MN BUS TIE (three) – ON
  3. ESS BUS SOURCE FC – OFF  
    FC/MN BUS – OFF  
    FC – STOP (1 sec)
  4. FC REAC VLV – CL
- ◆ Go to LOSS OF 1 FC PWRDN

**LOSS OF 1 FC PWRDN (GRTLS/TAL)      PLT**

1. PRI PL (three) – OFF  
    AFT PL (two) – OFF
  2. IDP/CRT4 PWR – OFF  
    One MDU – OFF
- ⇒ If TAL:  
    When V < 19K:  
        3. MPS ENG PWR (six) – OFF

**LOSS OF 1 FC PWRDN (ENTRY)**

1. If V < 15K >>
  2. IDP/CRT4, one MDU, FLT CNTLR PWR – OFF
  3. RA/MLS – OFF
- If middeck PL on:
4. cb MNB UTIL PWR – op (pnl O15:C)
- ◆ 5. PRI PL (three) – OFF  
    AFT PL (two) – OFF

<b>EMER PWRDN</b>
<b>FC REAC (three) – CL</b>
<b>FC/MN BUS</b>
<b>(BEST FC LAST) – OFF</b>
<b>ESS BUS SOURCE FC</b>
<b>(three) – OFF</b>
<b>√TABS/VISOR/GREEN APPLE</b>

FC

**OV105**

(OV105) MS E5-13

AESP/5/E/GEN O

## 2nd FC SHUTDN (GRTLS/TAL)

PLT

(CL PMP Lost: < 6 min)

1. Have CDR start LOSS OF 2nd FC PWRDN (GRTLS/TAL)

If three MN buses pwr:

2. MN BUS TIE (three) – OFF  
(do not perform BUS LOSS ACTION)
3. LES O2 – OFF, visors – OP
4. Switch off all but one IDP/CRT with four MDUs
5. All PL pwr (seven) – OFF
6. O2,H2 TK HTRS (all) – OFF
7. After CDR pnl L1 config complete, continue:

If two MN buses pwr:

8. Pwr MN BUS TIES (two) – ON

If only one MN bus pwr:

9. MN BUS TIE (three) – OFF  
If only MNA(B,C) pwr: Secure APU 2(3,1)  
BUS TIE good FC/BUS (MNA)  
I/O RESET

When reqd:

10. ESS BUS SOURCE FC – OFF  
FC/MN BUS – OFF  
FC – STOP (1 sec)  
FC REAC VLV – CL
11. G51 √ICNCT ENA (if reqd for OMS load)
12. Go to LOSS OF 2nd FC PWRDN (GRTLS/TAL)

## 2nd FC SHUTDN (ENTRY)

1. Have CDR go to LOSS OF 2nd FC PWRDN (ENTRY)
2. O2/H2 HTRS (twelve) – OFF (pnl R1)  
PL pwr (seven) – OFF
3. √MSTR MADS PWR – OFF

If aff FC/MN BUS is tied:

4. MN BUS TIE (two) – OFF
5. If only MNA(B,C) pwr: Secure APU 2(3,1)
6. Perform BUS TIE (good FC/BUS to another BUS),  
then:
7. ESS BUS SOURCE FC – OFF  
FC/MN BUS – OFF  
FC – STOP (1 sec)  
FC REAC VLV – CL

FC  
EMER

# OV105

(OV105) MS E5-14 AESP/ALL/E/GEN O

**LOSS OF 2nd FC PWRDN  
(GRTLS/TAL)**

**CDR**

1. LES O2 – OFF, visors – OP
  2. L1: Select one FREON PUMP on good FC/  
MN BUS and place other pump to OFF  
Switch OFF all HUM SEPS, IMU FANS,  
H2O PUMPS, AV BAY FANS, CAB FANS,  
FES HTRS
  3. Switch off all but one IDP/CRT with four MDUs  
After BUS TIE, if MNC unpwrn:
    4. FLASH EVAP CNTLR PRI A – OFF  
B – ON
  - ⇒ 5. Assign all strings to GPC 1 OPS 30X(60X) PRO
  6. Unassigned GPCs MODE – STBY (tb-bp), HALT  
– STBY (tb-RUN)  
– HALT (tb-bp)  
GPC PWR – OFF
  7. IMU (one) – OFF (choose previously failed IMU,  
if any)
  8. IMU FAN (one) – ON
  9. H2O PUMP (one) – ON
  10. AV BAY 1,2 FAN (two) – ON (check fan ON in  
each bay with a pwrn GPC)
- After MPS Pwrn:
- If MNA unpwrn:
11. FREON PUMP LOOP 1 – B  
2 – A
  12. TOP EVAP HTR DUCT sel – B  
HI LOAD DUCT HTR sel – B
- If MNB(C) unpwrn:
13. FREON PUMP LOOP 1,2 (two) – A(B)
  14. TOP EVAP HTR DUCT sel – A  
HI LOAD DUCT HTR sel – A
- If TAL:
15. HUM SEP (one) – ON
  16. CAB FAN (one) – ON

**2FC  
CRYO**

**LOSS OF 2nd FC PWRDN  
(GRTLS/TAL)**

**PLT**

- ⇒ ♦ When MPS Dump complete:
1. MPS ENG PWR (six) – OFF  
EIU (three) – OFF
  2. MEC 1 – OFF, wait 2 sec, then  
2 – OFF
- If MNA(MNB) unpwrdd:
3. O2,H2 TK1 HTRS B (two) – AUTO
- If MNC unpwrdd:
4. O2,H2 TK2 HTRS B (two) – AUTO
5. Safe Payload, if reqd
  6. Go to APU RESTART for secured APU

**LOSS OF 2nd FC PWRDN (ENTRY)**

**CDR**

1. MDM PL1 – OFF
2. FCS CH 4 – OFF  
GPC MODE 4 – STBY,HALT  
PWR 4 – OFF  
MDM FF4,FA4 – OFF
3. HUM SEP (two) – OFF
4. FLASH EVAP FDLN HTR SPLY (two) – OFF
5. TOP EVAP HTR NOZ L,R (two) – OFF  
DUCT sel – OFF  
HI LOAD DUCT HTR sel – OFF
6. If V > 10K: √CAB FAN A(B) – ON
7. M = 2.9: CAB FAN (two) – OFF  
AV BAY FAN (six) – OFF

**2FC**

**O2(H2) CRYO P/T HIGH**  
O2(H2) TK HTRS (two) – OFF

**PLT**

**CRYO**

**CRYO O2(H2) LEAK (three or more tanks aff)**

Use meter if CRT data OSL

1. O2(H2) MANF VLV TK1,TK2 (two) – CL
2. O2(H2) TK3 HTRS A – AUTO

⇒ If TK1 and TK2 P decr slowly (HTR logic fail):

3. If QTY > 55%: TK3 HTRS B – AUTO
4. MANF VLV 1,2 (two) – OP >>
5. Perform aff MN BUS TIE, then:

If O2(H2) TK1(2) aff (open unaff manf):

6. O2(H2) TK2(1) – OP

If O2 TK1(2) aff:

7. O2 SYS 1(2) SPLY – CL
8. If O2 TK1(2) P now incr (PCS leak): >>
9. If O2 leak: (Aff) TK HTRS B – AUTO

If aff TK P not incr:

10. If TK3 aff: √HTRS A(&B if O2) – AUTO
11. Perform aff FC SHUTDN (post COOL P alarm if O2 leak), then:

If TK3 aff and P not decr within 2 min (FC leak):

12. MANF VLV 1,2 (two) – OP (ASAP) >>
13. (Aff) TK HTRS A,B (two) – OFF

2FC  
CRYO

This Page Intentionally Blank

MS E5-18 AESP/ALL/E/GEN O



**OMS**

**OMS**



MS E6-1

AESP/ALL/E/GEN O

**OMS TEMP DURING DUMP**

1.  G51 INH ICNCT
- If aff OMS FU IN P  $\geq$ 

--	--

 :
  - | 2. Go to ENG FAIL >>
- If aff OMS FU IN P  $\leq$ 

--	--

 :
  - 3. Go to PRPLT FAIL >>
4. Otherwise, snsr fail

**Pc LOW DURING DUMP**

1. ENG VLV < 70%: Go to ENG FAIL >>
2. ENG VLV > 70%:  G51 INH ICNCT
  - If aff OMS OX IN P > 227:
    - | 3. Go to ENG FAIL >>
  - If aff OMS OX IN P  $\leq$  136:
    - 4. Go to PRPLT FAIL >>
5. Otherwise, snsr fail

**ENG FAIL (DURING DUMP)**

1. (Failed) OMS ENG – OFF
- ⇒ 2.  G51 INH ICNCT
3. Balance prop by XFEED

**PRPLT FAIL (DURING DUMP)**

- ⇒ (Both) OMS ENG (two) – OFF

**OMS**



**OMS SECURE**

If leak and

M > 24 or M < 3.5:

1. **G51** VENT DOOR CNTL OPEN – ITEM 43 EXEC
2. (Aff) OMS ENG – OFF
  - XFEED (two) – CL
  - TK ISOL (two) – CL
  - He PRESS (two) – CL

If leak isolated or

FU TK leak or

M < 24 & M > 3.5:

3. **G51** VENT DOOR CNTL CLOSE – ITEM 44 EXEC

**OMS XFEED: R to L**

1. L,R OMS XFEED (four) – OP
2. L OMS TK ISOL (two) – CL
  - He PRESS/VAP ISOL (two) – CL

**OMS XFEED: L to R**

1. L,R OMS XFEED (four) – OP
2. R OMS TK ISOL (two) – CL
  - He PRESS/VAP ISOL (two) – CL

**OMS XFEED RETURN: OMS to OMS**

L,R OMS TK ISOL (four) – OP  
XFEED (four) – CL



This Page Intentionally Blank





**RCS**

**RCS**



MS E7-1

AESP/ALL/E/GEN O

### **RCS JET FAIL (LEAK)**

If OX/FU Qty diverging:  
(Aff) RCS MANF ISOL – CL

### **RCS JET FAIL (ON)**

1. (Aff) RCS MANF ISOL – CL
- If MANF P > 130 and stable (false alarm):
2. (Aff) RCS MANF ISOL – OP
  3. √AFT RCS RM LOSS
- ⇒

### **RM DLMA MANF**

If (aff) MANF tb – OP or sw not thrown:

1. If FRCS: √MCC
2. If ARCS: [G51] RCS RM MANF CL OVRD –  
ITEM 41 EXEC
3. If (aff) MANF tb – bp: (aff) MANF – GPC

### **RCS JET FAIL (OFF)**

If > one jet/pod/dir failed:

1. [G23] resel jets
2. DES INH (\*) (reprioritize)

### **AFT RCS RM LOSS**

If loss of jet RM and > 3Y,2P jets/pod/dir:

1. [G23] aff jet DES INH (\*) (reprioritize)
  2. If yaw jet: desel >>
- If total RM loss (BCE) and < 3Y,2P jets/pod/dir:
3. Aff jet DES INH (\*) (reprioritize)
  4. Aff MANF VLVS STAT OP – OVRD

RCS

### LOW QBAR AFT RCS LK (GRTL5/304/305)

( $\sqrt{\text{He P}}$  decr: CRT and meter)

( $\sqrt{q} < 20$ : CRT)

1. If TK P '↑': Go to TK P HIGH >>

OX Leak & M > 24	2. [G51] VENT DOOR CNTL OPEN – ITEM 43 EXEC
RTLS/TAL	3. [G51] AFT RCS – INH (ITEM 13)
	4. (Aff) 3/4/5 MANFs – CL
	5. (Aff) 3/4/5 TK ISOLs – CL
Single MANF leak	6. TK ISOL(s) – OP (tb-OP), GPC
	7. (Good) Pri MANF (one) – OP
Two MANF P decr (TK leg leak)	8. (Leaking leg) XFEED (one) – CL
No MANF P decr	9. TK ISOL(s) – OP (tb-OP), GPC
	10. Pri MANFs (two) – OP
	11. Repeat steps 4-10 for 1/2 leg
Leak not found	12. (Aff) RCS He PRESS (two) – CL
He P decr (He TK leak)	13. RCS He PRESS (two) – OP
	14. When He P < 456: MSTR XFEED – feed from good side
OX/FU TK P diverge (Prplt TK leak)	15. RCS He PRESS (two) – OP
	16. When QTY = 0: MSTR XFEED – feed from good side and (aff) RCS He PRESS (two) – CL
Leak not found	17. RCS He PRESS (two) – OP
He P decr (He leg leak)	18. RCS He PRESS (two) – CL
	19. Cycle He PRESS so 220 < TK P < 245
	20. When He P < 456: MSTR XFEED – feed from good side
Leak not found	21. Assume MANF 5 leak
3.5 < M < 24	22. [G51] VENT DOOR CNTL CLOSE – ITEM 44 EXEC

### AFT RCS LK (GRTLS/304/305)

(√He P decr: CRT and meter)

1. If TK P '↑': Go to TK P HIGH >>
2. If  $\bar{q} < 20$  or control problems:  
Go to LOW QBAR AFT RCS LK >>

	3. ENTRY MODE – NO Y JET (R/Y CSS; expect sluggish control)
RTLS/TAL	4. <b>G51</b> AFT RCS – INH (ITEM 13)
	5. (Aff) RCS MANF ISOL (five) – CL XFEED (two) – CL TK ISOL (all) – CL HE PRESS (two) – CL
(N/A RTLS)	6. <b>G51</b> ELEVON FIXED – ITEM 18 EXEC (*)
Single MANF leak	7. Return to normal config except bad MANF ENTRY MODE – AUTO >>
Two MANF P decr (TK leg leak)	8. Return to normal config except bad leg ENTRY MODE – AUTO >>
He P decr (He TK leak)	9. Return to normal config ENTRY MODE – AUTO 10. When He P < 456: MSTR XFEED – feed from good side >>
OX/FU TK P diverge (Prplt TK leak)	11. Return to normal config ENTRY MODE – AUTO 12. When QTY = 0: MSTR XFEED – feed from good side and (aff) RCS He PRESS (two) – CL >>
Leak not found	13. RCS He PRESS (two) – OP
He P decr (He leg leak)	14. Return to normal config ENTRY MODE – AUTO 15. RCS He PRESS (two) – CL 16. Cycle He PRESS so $220 < TK P < 245$ 17. When He P < 456: MSTR XFEED – feed from good side >>
Leak not found (Assume MANF 5 leak)	18. Return to normal config except MANF 5 ENTRY MODE – AUTO >>

**RCS TK P HIGH (FU or OX) ( $\sqrt{MANF P}$ )**

1. RCS He PRESS (two) – CL
2. A – OP

If He P decr:

3. RCS He PRESS A – CL  
B – OP

**XFEED: RCS to RCS**

If AUTO XFEED:

1. L,R RCS TK ISOL (six) – GPC  
XFEED (four) – GPC
2. OMS XFEED (four) – CL
3. MSTR RCS XFEED – FEED FROM L(R) >>

If MANUAL XFEED:

4. L,R OMS XFEED (four) – CL
5. RCS XFEED (four) – OP
6. (Receiving) RCS TK ISOL (three) – CL  
He PRESS (two) – CL
7. MSTR RCS XFEED – FEED FROM L(R)

**RCS SECURE**

If OX leak and

$M > 24$  or  $\bar{M} < 3.5$ :

1. [G51] VENT DOOR CNTL OPEN – ITEM 43 EXEC
2. RCS MANF ISOL (five) – CL  
XFEED (two) – CL  
TK ISOL (all) – CL  
He PRESS (two) – CL

If leak isolated or

$M < 24$  &  $\bar{M} > 3.5$ :

3. [G51] VENT DOOR CNTL CLOSE – ITEM 44 EXEC



This Page Intentionally Blank







**MPS**

**MPS**



MS E8-1

AESP/ALL/E/GEN O

**MPS**

**MPS He P/MPS C&W LIGHT  
PNEU REG**

If M > 2.4: (Aff) MPS He ISOL – CL



**RESERVED**

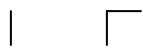

MS E9-1

AESP/ALL/E/GEN O



This Page Intentionally Blank



**MULTIPHASE SYSTEMS CUE CARDS**

----- MULTIPHASE SYSTEMS CUE CARDS, SECTION 10 -----

This Page Intentionally Blank

FAB USE ONLY

CC 10-1

AESP/ALL/A,E/GEN O

(reduced copy)

TOP

**EMER PWRDN**  
**FC REAC (three) – CL**  
**FC/MN BUS**  
**(BEST FC LAST) – OFF**  
**ESS BUS SOURCE FC**  
**(three) – OFF**  
**√TABS/VISOR/GREEN APPLE**

- FC SHUTDN (1st)** (<9 min)
1. MSTR MADS PWR – OFF
  2. If not tied: Perform BUS TIE, then:  
If ORB (not deorb prep), kW > 18:  
MN BUS TIE (three) – ON
  3. ESS BUS SOURCE FC – OFF  
FC/MN BUS – OFF  
FC – STOP (1 sec)
  4. FC REAC VLV – CL  
Go to LOSS OF 1 FC PWRDN

- BUS TIE** (do not tie bus short, check APUs)
- If MN Volts > 20: Bus Tie
- POWER**
- If MN Volts < 20 (do not BUS TIE Pre MECO for 1st FC):
1. (Aff) AC BUS SNSR – OFF
  2. cb AC CONTR (three) – cl
  3. INV/AC BUS – OFF (tb-OFF)
  4. INV PWR – OFF (tb-OFF)
  5. If MNC(B) dn, CAB FAN A(B) – OFF
  6. Bus Tie
  7. INV PWR – ON (tb-ON)
  8. INV/AC BUS – ON (tb-ON)
  9. cb AC CONTR (three) – op
  10. GNC I/O RESET
  11. Post MECO: (Aff) AC BUS SNSR – AUTO TRIP
  12. Post PWRDN: √CAB FAN A(B) – ON
- AESP-5a/A,O,E/S

TOP  
BACK OF 'POWER'

HOOK  
VELCRO

HOOK  
VELCRO

HOOK  
VELCRO

AESP-5b/A,O,E/F

TOP

**SSME FAIL/SHUTDN**

AC BUS SNSR (three) – OFF  
 If two ENG remaining:  
 ♦ MN ENG LIMIT SHUTDN – ENA,AUTO

**MPS DATA**

√MCC, accel, He dP/dT,  
 'MPS H2 OUT P',  
 'MPS O2 OUT T'  
 If SSME fail (MCC or three cues):  
 (Aff) MN ENG SHUTDN pb – push  
 If three ENG remaining:  
 ♦ MN ENG LIMIT SHUTDN – ENA,AUTO  
 If no comm:  
 Assume MPS CMD  
 If mult (no MECO confirm):  
 Post MECO:  
 MN ENG SHUTDN pb  
 (three) – push (simo)

**MPS LH2 ULL**

♦ If two or three Ps < 28.0 or > 34.0:  
 MPS LH2 ULL PRESS – OP  
 When all Ps > 33.0:  
 MPS LH2 ULL PRESS – AUTO

**MPS DUMP INHIBIT**

Post MECO:  
 (Aff) MPS ENG PWR (two) – OFF  
 LO2(H2) PREVLV – CL

**FIRE HOLE UNDER CARD**

**MPS CMD/HYD/ELEC**

If two HYD SYS failed:  
 MN ENG LIMIT SHUTDN – INH  
 [TRAJ] disp – Cue SERC, ITEM 6  
 (EXEC if gimbaling eng fails)

If:	When:	Shut down:
2 Pcs stuck > 85% & 3-ENG RTLS	MECO -2:00	1 aff MN ENG: CMD: (AC/pb)** HYD: (pb)
2 HYD SYS failed & Nom/ATO/TAL/ 2-ENG RTLS	Nom/ATO: SE PRESS TAL: SE TAL 2-ENG RTLS: 2 OUT RED	ENG(HYD)   S/D C(1) & R(3)   C L(2) & C(1)   L L(2) & R(3)   R ELEC: (pb)
He lk S/D reqd		Aff MN ENG (pb)
MPS CMD(s)**	Nom/ATO and: 3 ENG: V > 23K 2 ENG: V > 24.5K TAL: V > 22.5K RTLS: α = -1	Aff MN ENG (AC/pb)** If 2 CMD: repeat
2 MPS HYD/ELEC & 3-ENG Nom/ATO/TAL		1 aff MN ENG: HYD: (pb) ELEC: (pb)
1 MPS HYD/ELEC & 3-ENG Nom/ATO	V > 23K	Aff MN ENG (pb)

**MPS 1**

AESP-11a/A/M

(reduced copy)

FAB USE ONLY

CC 10-2

AESP/ALL/A/GEN O,2



TOP  
BACK OF 'MPS 1'

HOOK  
VELCRO

HOOK  
VELCRO

HOOK  
VELCRO

HOOK  
VELCRO

HOOK  
VELCRO

HOOK  
VELCRO

AESP-11b/A/E

(reduced copy)

FAB USE ONLY

CC 10-3

AESP/ALL/A/GEN O

TOP

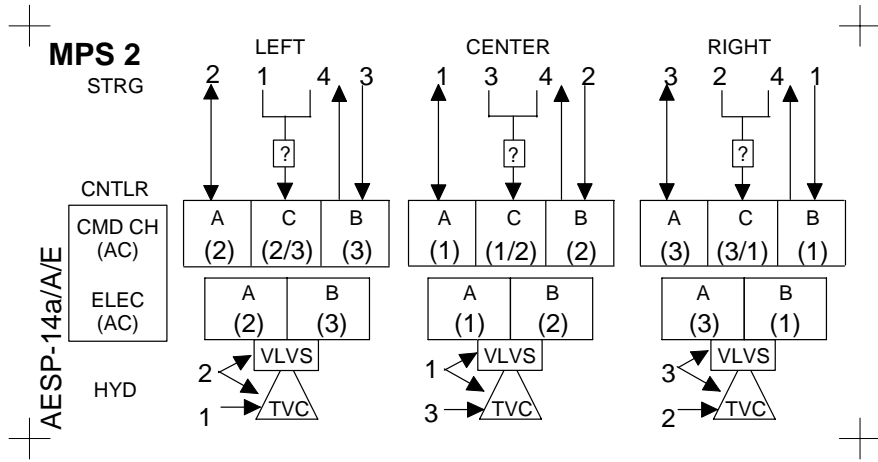

TOP  
BACK OF 'MPS 2'

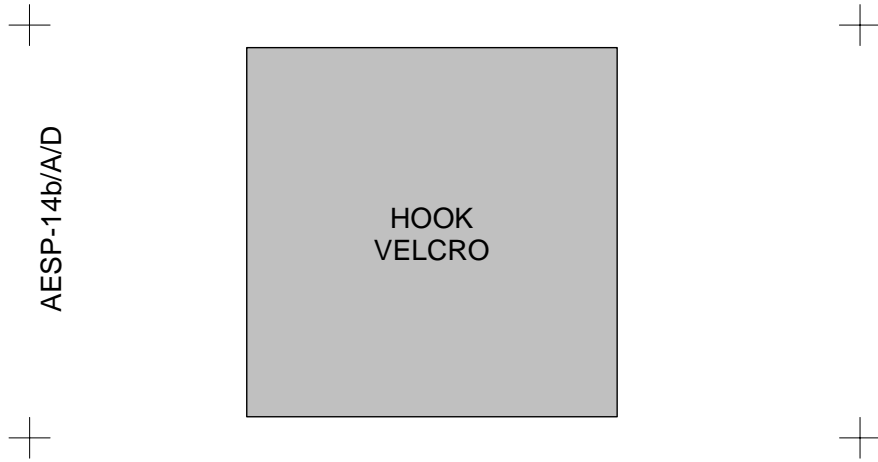

(reduced copy)

FAB USE ONLY

CC 10-4

AESP/ALL/A/GEN O

TOP

**OPS 1/6/TAL TRANSITION RESTRING**

	1. Config MC1(3) NBAT as reqd 2. $\sqrt{G53}$ aff SURF FDBK – desel (*)
Post MECO	3. ASAP, (aff) GPC(s) – STBY,HALT
ASC/ RTLS	4. OPS Mode Recall: OPS XXX PRO 5. BFS I/O RESET $\Rightarrow$ G
TAL	6. OPS 301 PRO 7. BFS, OPS 301 PRO $\Rightarrow$ G

HOOK  
VELCRO

AESP-10a/A/G

FAB USE ONLY

CC 10-5

AESP/ALL/A/GEN O

TOP  
BACK OF 'OPS 1/6/TAL TRANSITION RESTRING'

**POST OPS 3/GRTLS TRANSITION RESTRING**

1. (Aff) GPC(s) – STBY,HALT
  2. √[G53] aff SURF FDBK – desel (\*)
  3. Config MC1(3) NBAT
  4. OPS Mode Recall: OPS XXX PRO
  5. BFS I/O RESET
- If OPS 3 and String 1(2,3) recovered:
- ◆ 6. [G51] IMU – resel
  - ⇒ 7. Config FCS CH(s) (see Table):
  - 8. [G53] config SURF FDBK (see Table):

AESP-10b/E/F

HOOK  
VELCRO

AVAILABLE		FCS CH CONFIG			SURF FDBK	
GPCs	FCS CHs	AUTO	ORIDE	OFF	SEL	DESEL
3	4	3		1	3	1*
	3	3		1	3	1*
	2		2	2	2	2
2	4		4		4	
	3		2	2	2	2
	2		2	2	2	2

\*If CH 4 – OFF, DO NOT DESEL PASS SURF FDBK

TOP

TOP  
BACK OF 'MPS He P'

**MPS He P (Pre MECO)**

1. Check dP/dT
If after MECO -60: 2. Shut dn MN ENG per MPS CMD/HYD/ELEC >>
If He REG P ↑ or ↓: 3. (Aff) He ISOL – CL
Otherwise: 4. (Aff) He ISOL A – CL
If no decr in dP/dT: 5. (Aff) He ISOL A – OP B – CL
If no decr in dP/dT: 6. (Aff) He ISOL B – OP
If any ENG failed: 7. (Failed) ENG He I'CNCT – OUT OP
If nonisolatable: 8. Shut dn MN ENG per MPS CMD/HYD/ELEC If/when TK P < 1150 or REG P < 679: 9. (Aff) He I'CNCT – IN OP
If isolated: 10. (Aff) He I'CNCT – IN OP If TK P < 2200 @ MECO -60: 11. Shut dn MN ENG per MPS CMD/HYD/ELEC
Post ET SEP: 12. He I'CNCT(s) – GPC

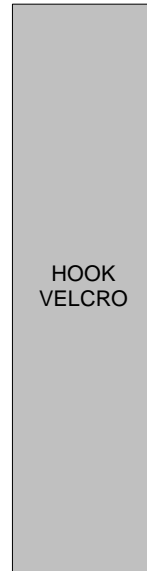

**MPS PNEU TK(REG) P**

If after MECO -60: At MECO -30: 1. L ENG He XOV R – OP >>
2. PNEU He ISOL – CL
If PNEU ACUM P decr: At MECO -30: 3. PNEU He ISOL – OP, Wait 5 sec, then: 4. L ENG He XOV R – OP >>
If PNEU TK P decr: 5. PNEU He ISOL – OP

AESP-15a/A/B

AESP-15b/A/C

Cont next page

FAB USE ONLY

CC 10-7

AESP/ALL/A/GEN O

TOP

**'ET SEP MAN' G51** **ET SEP**

Post MECO prior to MECO+1 min:

1. ET SEP AUTO – ITEM 38 (BFS 28)
2. If ET SEP pb reqd:  
ET SEP SEP – ITEM 39 (BFS 29)

AESP-13a/A/F

TOP  
BACK OF 'ET SEP'

HOOK  
VELCRO

AESP-13b/A/F

FAB USE ONLY

CC 10-8

AESP/ALL/A/GEN O

TOP  
MATE TOP-TO-BOTTOM;  
FLIP VERTICALLY TO TURN

HOOK VELCRO

AESP-7a(OPCL-7a)/A,O,E/H

**OV103,104**

**FIRE/SMOKE (ASCENT/ENTRY)**

**SM SYS SUMM 1**

If **VISUAL SMOKE/FIRE**, or  
two SMOKE DETN lt on, or  
two CONC > 2, or  
one SMOKE DETN lt on and  
other CONC > 2:

- Go to step 6

If single Av Bay SMOKE DETN A(B) lt and  
assoc CONC > 2:

- SMOKE DETN CKT TEST - B(A)  
(25 sec)

If SMOKE DETN B(A) test good (lt on):

- SMOKE DETN CKT TEST - OFF
- SMOKE DETN SNSR - RESET >>

If SMOKE DETN B(A) test bad (no lt):

- Go to step 6

If none of above >>

- Check tabs, visors - CL  
LES O2 - ON

**IF AV BAY FIRE:**

- FIRE SUPPR - ARM  
pb - DISCH  
(push until lit)
- If Ascent:  
AV BAY FAN (two) - OFF
- If Fire in Bay:
  - TACAN 1, MLS 1 - OFF
  - TACAN 2, MLS 2,3 - OFF
  - TACAN 3 - OFF

**IF CABIN FIRE:**

- CAB FAN A,B (two) - OFF  
(max 20 min)
- Locate source  
(see matrix, below)
- Unpwr source of smoke  
If smoke persists or source cannot be unpwr:

**WARNING**  
Discharge is propulsive

- Discharge handheld FIRE  
EXTGHR

**If Ascent:**

- Post MECO, go to POST-FIRE  
CABIN CLEANUP (ASC PKT,  
ECLS) >>

**If Entry and prior to TIG:**

- Go to ECLS FRP-3, FIRE/HAZ  
SPILL O2 CONTROL, step 3 (MAL)

FIRE/SMOKE (ORBIT)  
(OPCL-7b), back  
of FIRE/SMOKE  
(ASCENT/ENTRY)  
appears in the  
ORBIT POCKET C/L



replace side tab  
with clear tape  
and Hook Velcro

ALARM SEQUENCE	SOURCE AREA
L(R) FLT DK or L(R) FLT DK → CABIN	PS(MS), L(R) CONSOLE
L FLT DK ↔ R FLT DK	AFT FLT DK, MIDDECK
CABIN or CABIN → L FLT DK CABIN → R FLT DK	FWD FLT DK, WCS, LEB

HOOK VELCRO

BOTTOM

(reduced copy) **OV103,104**

FAB USE ONLY (OV103,104) CC 10-9

AESP/3,4/A,E/GEN O,2

This Page Intentionally Blank

FAB USE ONLY(OV103,104)CC 10-10

**OV103,104**

AESP/ALL/A,E/GEN O



TOP  
MATE TOP-TO-BOTTOM:  
FLIP VERTICALLY TO TURN

HOOK VELOCRO

AESP-7a(OPCL-7a)/A,O,E/H

**OV105**

**FIRE/SMOKE (ASCENT/ENTRY)**

**SM SYS SUMM 1**

If **VISUAL SMOKE/FIRE**, or  
two SMOKE DETN It on, or  
two CONC > 2, or  
one SMOKE DETN It on and  
other CONC > 2:  
1. Go to step 6  
If single Av Bay SMOKE DETN A(B) It and  
assoc CONC > 2:  
2. SMOKE DETN CKT TEST – B(A)  
(25 sec)  
If SMOKE DETN B(A) test good (It on):  
3. SMOKE DETN CKT TEST – OFF  
4. SMOKE DETN SNSR –  
RESET >>  
If SMOKE DETN B(A) test bad (no It):  
5. Go to step 6  
If none of above >>

6. Check tabs, visors – CL  
LES O2 – ON  
If **AV BAY FIRE**:  
7. FIRE SUPPR – ARM  
pb – DISCH  
(push until lit)  
8. If Ascent:  
AV BAY FAN (two) – OFF  
9. If Fire in Bay:  
1: GPS 1, MLS 1 – OFF  
2: MLS 2,3 – OFF  
3: GPS 3 – OFF

If **CABIN FIRE**:  
10. CAB FAN A,B (two) – OFF  
(max 20 min)  
11. Locate source  
(see matrix, below)  
12. Unpwr source of smoke  
If smoke persists or source cannot be  
unpwr:

**WARNING**  
Discharge is propulsive

13. Discharge handheld FIRE  
EXTGHR  
If Ascent:  
14. Post MECO, go to POST-FIRE  
CABIN CLEANUP (ASC PKT,  
ECLS) >>  
If Entry and prior to TIG:  
15. Go to ECLS FRP-3, FIRE/HAZ  
SPILL O2 CONTROL, step 3 (MAL)

FIRE/SMOKE (ORBIT)  
(OPCL-7b), back  
of FIRE/SMOKE  
(ASCENT/ENTRY)  
appears in the  
ORBIT POCKET C/L



replace side tab  
with clear tape  
and Hook Velcro

ALARM SEQUENCE	SOURCE AREA
<div style="border: 1px solid black; padding: 2px; display: inline-block;">L(R) FLT DK</div> or <div style="display: inline-block; border: 1px solid black; padding: 2px;">L(R) FLT DK</div> → <div style="border: 1px solid black; padding: 2px; display: inline-block;">CABIN</div>	PS(MS), L(R) CONSOLE
<div style="display: inline-block; border: 1px solid black; padding: 2px;">L FLT DK</div> ↔ <div style="border: 1px solid black; padding: 2px;">R FLT DK</div>	AFT FLT DK, MIDDECK
<div style="border: 1px solid black; padding: 2px; display: inline-block;">CABIN</div> or <div style="display: inline-block; border: 1px solid black; padding: 2px;">CABIN</div> → <div style="border: 1px solid black; padding: 2px; display: inline-block;">L FLT DK</div> ↕ <div style="border: 1px solid black; padding: 2px; display: inline-block;">R FLT DK</div>	FWD FLT DK, WCS, LEB

HOOK VELOCRO

BOTTOM

(reduced copy)

FAB USE ONLY (OV105) CC 10-9

**OV105**

AESP/5/A,E/GEN O,2

This Page Intentionally Blank

FAB USE ONLY (OV105) CC 10-10

**OV105**

AESP/ALL/A,E/GEN O

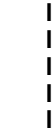
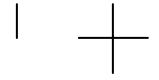
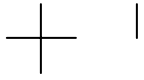

**POWERED  
FLIGHT**

**PLT OVERHEAD FLIP BOOK  
POWERED FLIGHT**

**PLT OVERHEAD  
FLIP BOOK**

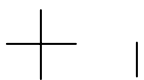

PLT OVHD

FB A11-i

AESP/ALL/A/GEN O

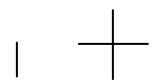

**FAB USE ONLY**

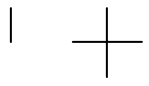
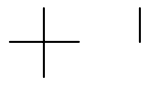

**POWERED  
FLIGHT**



This Page Intentionally Blank

**PLT OVERHEAD  
FLIP BOOK**

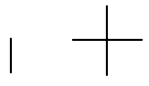
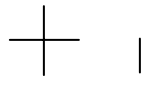

PLT OVHD

FB A11-ii

AESP/ALL/A/GEN O

FAB USE ONLY

TOP  
FACING LEFT SIDE OF BACKBOARD

HOOK

OMS  
(OX/  
FU)  
TK P  
LOW

**OMS He TK P LOW** ( $\sqrt$ SPEC and OMS/MPS)

Dumping RTLS/TAL/ G51 DUMP	SERC	When leaking He P < 640: 1. G51 DUMP STOP >>
	Not SERC	When leaking He P < 640: 2. G51 INH ICNCT When aff OMS Pc < 72%: 3. (Aff) OMS ENG – OFF After 2:00 min: 4. (Good) OMS ENG – OFF >>
Dumping ASSIST/ATO Not Dumping	◆	5. (Good) OMS ENG – OFF When MET > 2:30 min: 6. G51 ITEM 9 + [ ] EXEC
Leaking He P < 640		7. G51 ITEM 9 + 0 EXEC ⇒A
Sub RTLS/TAL	◆	8. (Good) OMS ENG – ARM/PRESS 9. G51 INH ICNCT 10. OMS XFEED (four) – OP 11. (Aff) OMS TK ISOL (two) – CL After 1:00 min: 12. OMS TK ISOL (four) – OP 13. OMS XFEED (four) – CL When aff OMS Pc < 72%: 14. (Both) OMS ENG (two) – OFF

**OMS N2 TK P LOW**  
**(N/A DURING ASSIST/RTLS/TAL/ATO DUMP)**

1.  $\sqrt$ N2 TK P decr (meter and CRT)
  2. OMS ENG – ARM
  3. If OMS N2 REG P decr: OMS ENG – OFF >>
- If OMS N2 REG P not decr and subs ASSIST/RTLS/TAL/ATO:
4. OMS ENG (two) – ARM/PRESS

**OMS N2 REG P HIGH or LOW**  
OMS ENG – ARM

PLT OVHD

FB A11-1

AESP/ALL/A/GEN O

FAB USE ONLY

TOP  
BACK OF 'OMS He TK P LOW'

OMS  
He/  
N2  
TK P  
LOW

PILE

**OMS TK P LOW (↓, OX or FU) NOT DUMPING (√ENG IN P)**

1. (Good) OMS ENG – OFF
2. Monitor OMS Inlet Pressures  
If OX IN P < 151 or FU IN P < 216:  
(Aff) OMS ENG – OFF  
XFEED (two) – CL

Dumping Assist/ATO Not Dumping	When MET > 2:30 min: 3. [G51] ITEM 9 + [ ] EXEC
OX IN P > 151 and FU IN P > 216	4. (Aff) OMS ENG – ARM/PRESS 5. If ATO: [G51] √ICNCT = INH 6. (Aff) OMS XFEED (two) – CL When aff Pc < 80% (depletion cutoff): 7. (Aff) OMS ENG – OFF [G51] ITEM 9 + 0 EXEC >> If depletion cutoff does not occur =>A
Repress NO JOY	8. [G51] ITEM 9 + 0 EXEC
Subs RTLS/TAL/[G51]	9. (Good) OMS ENG – ARM/PRESS
OX IN P > 151 and FU IN P > 216	10. (Aff) OMS XFEED (two) – OP ENG – ARM/PRESS 11. [G51] ENA ICNCT (N/A SERC)
AFT QTY < 20% or He P < 2000	12. If SERC: [G51] DUMP STOP If not SERC: [G51] INH ICNCT 13. (Aff) OMS XFEED (two) – CL When aff Pc < 80% (depletion cutoff): 14. (Aff) OMS ENG – OFF 15. After 2:00 min: (Good) OMS ENG – OFF >>
Repress NO JOY after 2:00 min	16. (Good) OMS ENG – OFF >>

PLT OVHD

FB A11-2

AESP/ALL/A/GEN O

FAB USE ONLY

HOOK

**OMS TEMP DURING DUMP**

1.  G51 INH ICNCT
- If aff OMS FU IN P  $\geq$ 

--	--

 L R:
2. Go to ENG FAIL >>
- If aff OMS FU IN P  $\leq$ 

--	--

:
3. Go to PRPLT FAIL >>
4. Otherwise, snsr fail

RCS  
JET/  
AFT  
RCS**Pc LOW DURING DUMP**

1. ENG VLV < 70%: Go to ENG FAIL >>
2. ENG VLV > 70%:  G51 INH ICNCT
- If aff OMS OX IN P > 227:
3. Go to ENG FAIL >>
- If aff OMS OX IN P  $\leq$  136:
4. Go to PRPLT FAIL >>
5. Otherwise, snsr fail

**ENG FAIL (During Dump)**

1. (Failed) OMS ENG – OFF
- ◆ 2. If RTLS/TAL/ATO/ G51 DUMP:  
 G51 ENA ICNCT  $\Rightarrow$  G

**PRPLT FAIL (During Dump)**

1. ASSIST/ATO: (Both) OMS ENG (two) – OFF  
(Failed) OMS XFEED (two) – CL
2. Other: (Aff) OMS ENG – OFF  
(Failed) OMS XFEED (two) – CL  
After 2:00 min, (good) OMS ENG – OFF  $\Rightarrow$  G

**OMS TK P LOW ( $\downarrow$ , OX and FU) DURING DUMP**( $\sqrt$ ENG IN P)

1. (Aff) OMS He PRESS/VAP ISOL (two) – OP
  - If aff TK P not incr:
  2.  G51  $\sqrt$ ICNCT = INH
  3. OMS He PRESS/VAP ISOL (two) – CL
- At Pc < 72% or OMS TEMP: Go to PRPLT FAIL

**OMS TK P HIGH ( $\uparrow$ , OX and FU) DURING DUMP**( $\sqrt$ ENG IN P)

1.  G51  $\sqrt$ ICNCT = INH
2. (Aff) OMS He PRESS/VAP ISOL A – CL
- If aff TK P not decr:
3. OMS He PRESS/VAP ISOL A – OP  
B – CL

PLT OVHD

FB A11-3

AESP/ALL/A/GEN O

FAB USE ONLY

PILE

**RCS JET FAIL (LEAK)**

If OX/FU Qty diverging:  
(Aff) RCS MANF ISOL – CL

OMS T,  
Pc/  
FAIL/  
OMS  
OX/FU

**RCS JET FAIL (ON)**

1. (Aff) RCS MANF ISOL – CL
- If MANF P > 130 and stable (false alarm):
2. (Aff) RCS MANF ISOL – OP ⇒G

**RM DLMA MANF**

If (aff) MANF tb – OP or sw not thrown:

1. If FRCS: √MCC
  2. If ARCS: [G51] RCS RM MANF CL OVRD –  
ITEM 41 EXEC
3. If (aff) MANF tb – bp: (aff) MANF – GPC

**RCS JET FAIL (OFF)**

If > one jet/pod/dir failed:

1. [G23] resel jets
2. DES INH (\*) (reprioritize)

**RCS TK P HIGH (FU or OX) (√MANF P)**

1. RCS He PRESS (two) – CL
2. A – OP

If He P decr:

3. RCS He PRESS A – CL  
B – OP

**XFEED: RCS to RCS**

If AUTO XFEED:

1. L,R RCS TK ISOL (six) – GPC  
XFEED (four) – GPC
2. OMS XFEED (four) – CL
3. MSTR RCS XFEED – FEED FROM L(R) >>

If MANUAL XFEED:

4. L,R OMS XFEED (four) – CL
5. RCS XFEED (four) – OP
6. (Receiving) RCS TK ISOL (three) – CL  
He PRESS (two) – CL
7. MSTR RCS XFEED – FEED FROM L(R)

PLT OVHD

FB A11-4

AESP/ALL/A/GEN O

FAB USE ONLY





**RCS SECURE**

- RCS MANF ISOL (five) – CL
- XFEED (two) – CL
- TK ISOL (all) – CL
- He PRESS (two) – CL

**AFT RCS LK**

N/A During Dump/SE Roll Cntl  
(check He P decr: CRT and meter)

1. If TK P '↑': Go to TK P HIGH >>

TK P ≥ 254 and not decr (He Leak)	2. MSTR XFEED – feed from good side 3. (Aff) RCS He PRESS (two) – CL 4. <b>G51</b> AFT RCS – INH (ITEM 13) >>
TK P < 254 or decr (prop leak)	5. (N/A RTLS) ET SEP – MAN 6. (N/A RTLS) MPS PRPLT DUMP SEQ – STOP 7. (Aff) MANFs (five) – CL 8. (Aff) TK ISOLs (three) – CL
Single MANF leak	9. TK ISOLs (three) – OP (tb-OP), GPC 10. (Good) MANFs (four) – OP
QTY < 75%	11. MSTR XFEED – feed from good side
Two MANF P decr (TK leg leak)	12. (Good leg) TK ISOL(s) – OP (tb-OP), GPC 13. (Good leg) Pri MANFs (two) – OP 14. (Leaking leg) XFEED (one) – CL
QTY < 75%	15. MSTR XFEED – feed from good side
No MANF P decr (Prplt TK or MANF 5 leak)	16. L,R RCS XFEED (four) – OP 17. (Aff) RCS MANF 1,2,3,4 (four) – OP 18. (Aff) RCS He PRESS (two) – CL 19. MSTR XFEED – feed from good side
	20. ET SEP – AUTO 21. <b>G51</b> AFT RCS – INH (ITEM 13) 22. Post ET SEP -Z transl: MPS PRPLT DUMP SEQ – GPC

**FWD  
RCS  
LK**

TOP  
BACK OF 'RCS SECURE'

PILE

**FWD RCS LK**

(check He P decr: CRT and meter)  
(check TK P; if '↑': Go to TK P HIGH >>)

RCS  
JET/  
AFT  
RCS

RTLS	1. Perform RCS SECURE, then: 2. Post PPD – reopen RCS Post ET SEP -Z transl: 3. Go to RCS SECURE >>
Pre ET SEP (N/A RTLS)	4. ET SEP – MAN 5. MPS PRPLT DUMP SEQ – STOP 6. Perform RCS SECURE, then:
Single MANF leak	7. Reopen RCS, except bad MANF 8. ET SEP – AUTO Post ET SEP -Z transl: 9. MPS PRPLT DUMP SEQ – GPC >>
TK leg leak (two MANF P Low)	10. Reopen RCS, except bad leg 11. ET SEP – AUTO Post ET SEP -Z transl: 12. MPS PRPLT DUMP SEQ – GPC >>
PRPLT TK P decr	
Post MECO	13. RATE DAMP with ARCS 14. Reopen FRCS
TK P > 200 & QTY > 0%	15. ET SEP – AUTO
TK P < 200 or QTY = 0%	16. Perform RCS SECURE, then: 17. DAP – INRTL, PITCH – PULSE 18. ET SEP pb – SEP 19. THC -Z (UP) (2 sec; -1.25°/sec) 20. THC -X (OUT) and hold
At SEP (SEP init + approx 12 sec)	21. THC +Z (DOWN) (3 sec; +0.3°/sec) THC -Z (UP) (2 sec; -0.9°/sec) COAST (5 sec) THC +X (IN) (20 sec) After 10 sec of +X, then: PITCH – DISC RATE
Otherwise: (He TK or He leg)	22. OPS 104 PRO, DAP – AUTO Post MECO: 23. Reopen RCS 24. ET SEP – AUTO
Post ET SEP -Z transl	25. MPS PRPLT DUMP SEQ – GPC 26. Go to RCS SECURE

PLT OVHD

FB A11-6

AESP/ALL/A/GEN O

FAB USE ONLY

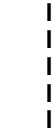
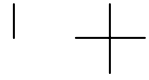
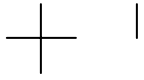

**GLIDED  
FLIGHT**

**PLT OVERHEAD FLIP BOOK  
GLIDED FLIGHT**

**PLT OVERHEAD  
FLIP BOOK**

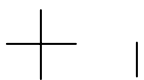

PLT OVHD

FB E11-i

AESP/ALL/E/GEN O

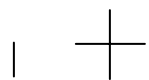

FAB USE ONLY

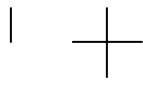
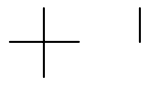

**GLIDED  
FLIGHT**



This Page Intentionally Blank

**PLT OVERHEAD  
FLIP BOOK**

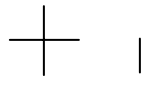

PLT OVHD

FB E11-ii

AESP/ALL/E/GEN O

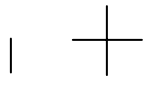

FAB USE ONLY

TOP  
FACING LEFT SIDE OF BACKBOARD



OMS  
SEC  
RCS  
JET  
XFD

**OMS TEMP DURING DUMP**

1.  G51 INH ICNCT
- If aff OMS FU IN P  $\geq$ 

--	--

L R :
2. Go to ENG FAIL >>
- If aff OMS FU IN P  $\leq$ 

--	--

 :
3. Go to PRPLT FAIL >>
4. Otherwise, snsr fail

**Pc LOW DURING DUMP**

1. ENG VLV < 70%: Go to ENG FAIL >>
2. ENG VLV > 70%:  G51 INH ICNCT
- If aff OMS OX IN P > 227:
  3. Go to ENG FAIL >>
- If aff OMS OX IN P  $\leq$  136:
  4. Go to PRPLT FAIL >>
5. Otherwise, snsr fail

**ENG FAIL (During Dump)**

1. (Failed) OMS ENG – OFF
- ⇒ 2.  G51 INH ICNCT
3. Balance prop by XFEED

**PRPLT FAIL (During Dump)**

- ⇒ (Both) OMS ENG (two) – OFF

PLT OVHD

FB E11-1

AESP/ALL/E/GEN O

FAB USE ONLY

TOP  
BACK OF 'OMS TEMP DURING DUMP'

OMS,  
Pc/  
FAIL

PILE

**OMS SECURE**

If leak and

M > 24 or M < 3.5:

1. [G51] VENT DOOR CNTL OPEN – ITEM 43 EXEC
2. (Aff) OMS ENG – OFF  
XFEED (two) – CL  
TK ISOL (two) – CL  
He PRESS (two) – CL

If leak isolated or

FU TK leak or

M < 24 & M > 3.5:

3. [G51] VENT DOOR CNTL CLOSE – ITEM 44 EXEC

**OMS XFEED: R to L**

1. L,R OMS XFEED (four) – OP
2. L OMS TK ISOL (two) – CL  
He PRESS/VAP ISOL (two) – CL

**OMS XFEED: L to R**

1. L,R OMS XFEED (four) – OP
2. R OMS TK ISOL (two) – CL  
He PRESS/VAP ISOL (two) – CL

**OMS XFEED RETURN: OMS to OMS**

L,R OMS TK ISOL (four) – OP  
XFEED (four) – CL

PLT OVHD

FB E11-2

AESP/ALL/E/GEN O

FAB USE ONLY

HOOK

**RCS JET FAIL (LEAK)**

If OX/FU Qty diverging:  
(Aff) RCS MANF ISOL – CL

**RCS JET FAIL (ON)**

1. (Aff) RCS MANF ISOL – CL
- If MANF P > 130 and stable (false alarm):
2. (Aff) RCS MANF ISOL – OP
  3. √AFT RCS RM LOSS

⇒

AFT  
RCS  
LK  
QBAR

**RM DLMA MANF**

If (aff) MANF tb – OP or sw not thrown:

1. If FRCS: √MCC
2. If ARCS: G51 RCS RM MANF CL OVRD –  
ITEM 41 EXEC
3. If (aff) MANF tb – bp: (aff) MANF – GPC

**RCS JET FAIL (OFF)**

If > one jet/pod/dir failed:

1. G23 resel jets
2. DES INH (\*) (reprioritize)

**RCS TK P HIGH (FU or OX) (√MANF P)**

1. RCS He PRESS (two) – CL
2. A – OP

If He P decr:

3. RCS He PRESS A – CL  
B – OP

**XFEED: RCS to RCS**

If AUTO XFEED:

1. L,R RCS TK ISOL (six) – GPC  
XFEED (four) – GPC
2. OMS XFEED (four) – CL
3. MSTR RCS XFEED – FEED FROM L(R) >>

If MANUAL XFEED:

4. L,R OMS XFEED (four) – CL
5. RCS XFEED (four) – OP
6. (Receiving) RCS TK ISOL (three) – CL  
He PRESS (two) – CL
7. MSTR RCS XFEED – FEED FROM L(R)

PLT OVHD

FB E11-3

AESP/ALL/E/GEN O

FAB USE ONLY

TOP  
BACK OF 'RCS JET FAIL (LEAK)'

PILE

**LOW QBAR AFT RCS LK (GRTLS/304/305)**

( $\sqrt{\text{He P}} > 20$ : CRT and meter)

( $\sqrt{\text{q}} < 20$ : CRT)

1. If TK P '↑': Go to TK P HIGH >>

OMS  
SEC  
RCS  
JET  
XFD

OX Leak & M > 24	2. [G51] VENT DOOR CNTL OPEN – ITEM 43 EXEC
RTLS/TAL	3. [G51] AFT RCS – INH (ITEM 13)
	4. (Aff) 3/4/5 MANFs – CL 5. (Aff) 3/4/5 TK ISOLs – CL
Single MANF leak	6. TK ISOL(s) – OP (tb-OP), GPC 7. (Good) Pri MANF (one) – OP
Two MANF P decr (TK leg leak)	8. (Leaking leg) XFEED (one) – CL
No MANF P decr	9. TK ISOL(s) – OP (tb-OP), GPC 10. Pri MANFs (two) – OP 11. Repeat steps 4-10 for 1/2 leg
Leak not found	12. (Aff) RCS He PRESS (two) – CL
He P decr (He TK leak)	13. RCS He PRESS (two) – OP 14. When He P < 456: MSTR XFEED – feed from good side
OX/FU TK P diverge (Prplf TK leak)	15. RCS He PRESS (two) – OP 16. When QTY = 0: MSTR XFEED – feed from good side and (aff) RCS He PRESS (two) – CL
Leak not found	17. RCS He PRESS (two) – OP
He P decr (He leg leak)	18. RCS He PRESS (two) – CL 19. Cycle He PRESS so $220 < \text{TK P} < 245$ 20. When He P < 456: MSTR XFEED – feed from good side
Leak not found	21. Assume MANF 5 leak
$3.5 < M < 24$	22. [G51] VENT DOOR CNTL CLOSE – ITEM 44 EXEC

PLT OVHD

FB E11-4

AESP/ALL/E/GEN O,1

FAB USE ONLY



HOOK

**AFT RCS LK (GRTLS/304/305)**

(√He P decr: CRT and meter)

1. If TK P '↑': Go to TK P HIGH >>
2. If  $\bar{q} < 20$  or control problems:  
Go to LOW QBAR AFT RCS LK >>

	3. ENTRY MODE – NO Y JET (R/Y CSS; expect sluggish control)
RTLS/TAL	4. <b>G51</b> AFT RCS – INH (ITEM 13)
	5. (Aff) RCS MANF ISOL (five) – CL XFEED (two) – CL TK ISOL (all) – CL HE PRESS (two) – CL
(N/A RTLS)	6. <b>G51</b> ELEVON FIXED – ITEM 18 EXEC (*)
Single MANF leak	7. Return to normal config except bad MANF ENTRY MODE – AUTO >>
Two MANF P decr (TK leg leak)	8. Return to normal config except bad leg ENTRY MODE – AUTO >>
He P decr (He TK leak)	9. Return to normal config ENTRY MODE – AUTO 10. When He P < 456: MSTR XFEED – feed from good side >>
OX/FU TK P diverge (Prplt TK leak)	11. Return to normal config ENTRY MODE – AUTO 12. When QTY = 0: MSTR XFEED – feed from good side <u>and</u> (aff) RCS He PRESS (two) – CL >>
Leak not found	13. RCS He PRESS (two) – OP
He P decr (He leg leak)	14. Return to normal config ENTRY MODE – AUTO 15. RCS He PRESS (two) – CL 16. Cycle He PRESS so $220 < TK P < 245$ 17. When He P < 456: MSTR XFEED – feed from good side >>
Leak not found (Assume MANF 5 leak)	18. Return to normal config except MANF 5 ENTRY MODE – AUTO >>

AFT  
RCS/  
LK  
RM

PLT OVHD

FB E11-5

AESP/ALL/E/GEN O,1

FAB USE ONLY

PILE

**RCS SECURE**

If OX leak and

M > 24 or M < 3.5:

1. [G51] VENT DOOR CNTL OPEN – ITEM 43 EXEC
2. RCS MANF ISOL (five) – CL
  - XFEED (two) – CL
  - TK ISOL (all) – CL
  - He PRESS (two) – CL

If leak isolated or

M < 24 & M > 3.5:

3. [G51] VENT DOOR CNTL CLOSE – ITEM 44 EXEC

QBAR  
AFT  
RCS/  
LK/  
RM

**AFT RCS RM LOSS**

If loss of jet RM and > 3Y,2P jets/pod/dir:

1. [G23] aff jet DES INH (\*) (reprioritize)
2. If yaw jet: desel >>

If total RM loss (BCE) and < 3Y,2P jets/pod/dir:

3. Aff jet DES INH (\*) (reprioritize)
4. Aff MANF VLVS STAT OP – OVRD

PLT OVHD

FB E11-6

AESP/ALL/E/GEN O,3

FAB USE ONLY

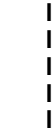
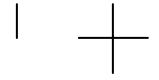
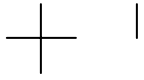

**POWERED  
FLIGHT**

**PLT WINDOW FLIP BOOK  
POWERED FLIGHT**

**PLT WINDOW  
FLIP BOOK**

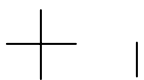

PLT WND

FB A12-i

AESP/ALL/A/GEN O

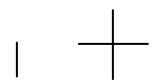

**FAB USE ONLY**

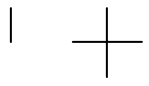
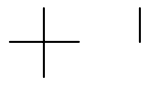

POWERED  
FLIGHT



This Page Intentionally Blank

PLT WINDOW  
FLIP BOOK

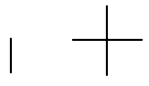
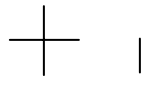

PLT WND

FB A12-ii

AESP/ALL/A/GEN O

FAB USE ONLY

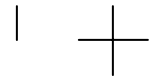
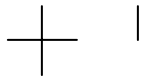

**APU  
HYD**

This Page Intentionally Blank

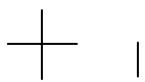

PLT WND

FB A12-1

AESP/ALL/A/GEN O

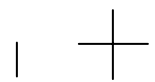

FAB USE ONLY

TOP  
MOUNT ON LEFT SIDE OF BACKBOARD FACING 'COMM LOST'

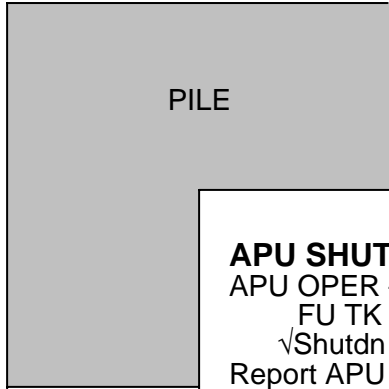

PILE

**APU SHUTDN**

APU OPER – OFF  
FU TK VLV – CL  
√Shutdn (HYD PRESS < 200)  
Report APU F7 lts  
APU CNTLR PWR – OFF  
AUTO SHTDN (two) – INH  
SPEED SEL (two) – HI ⇒

**APU SPD HI**

If SPEED % exceeds 111:  
APU SPEED SEL – HI ⇒

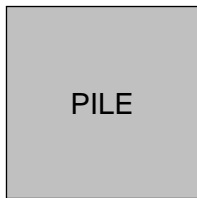

PILE

**APU OVERSPEED**

If SPEED % exceeds 129:  
Go to APU SHUTDN

**APU UNDERSPEED [G51]**

If 'PRL SYS X ↓' or if APU has shut dn:  
Perform APU SHUTDN, then: ⇒G

**APU OIL OVERTEMP**

◆BLR CNTLR/HTR – B  
√N2 SPLY – ON ⇒

**HYD PRESS (LOW) [G51]**

If 'PRL SYS X ↓' and APU still oper:  
1. APU AUTO SHTDN (two) – INH  
2. SPEED SEL (two) – HI ⇒

**HYD RSVR QTY (LOW)**

Post MECO:  
(Aff) HYD MPS/TVC ISOL VLV SYS – CL  
(hold 5 sec, tb-CL) ⇒

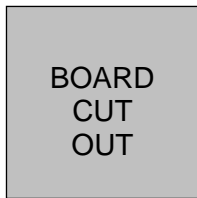

BOARD  
CUT  
OUT

**W/B QTY (LOW)**

1. If W/B QTY = 0 >>  
2. BLR N2 SPLY – OFF  
3. CNTLR/HTR – OFF ⇒

PLT WND FB A12-2 AESP/ALL/A/GEN O



FAB USE ONLY

HOOK

**COMM LOST (mult pnls)**

1. AUD CTR – 2
2. No joy, S-BD PM CNTL – PNL,CMD
3. Config per COMM COVER (ASC) BFS G51:
  - TDRS – ITEM 46 EXEC (\*)
  - STDN-HI – ITEM 47 EXEC (\*)
  - SGLS – ITEM 49 EXEC (\*)
4. No joy, sel best S-BD PM ANT; else GPC ⇒

DPS  
GPC  
MDM**ICOM LOST**

1. AUD CNTL sel – sel alt
2. No joy, AUD CTR – 2

**FCS CH 1(2,3,4) (2nd FAIL) G53**

If two FCS CH ↓ on any actuator:

- ◆ (Remaining) FCS CH (two) – ORIDE

**RHC L(R) (2nd FAIL)**

(Aff) FLT CNTLR PWR – OFF

**DISPLAY SW L(R)**

L(R) disp sws – green dot

**RM FAIL IMU,RGA,AA BFS G51**

Aff LRU – desel

**RM DLMA IMU G51 BFS G51**

1. √MCC, bad IMU – desel (PASS & BFS) >>
- ◆ 2. Desel lower # IMU with '?' (PASS)

**POST BFS ENGAGE**

If PASS GPCs running:

1. (Aff) GPC MODE – STBY/HALT
2. BFS I/O RESET
3. √FCS CHs, IMU config

If Pre MECO:

4. If SSME failed: MN ENG LIMIT SHUTDN – INH
5. G51 DES failed(commfaulted) RGA,AA,SURF ⇒G

PLT WND

FB A12-3

AESP/ALL/A/GEN O

FAB USE ONLY

TOP  
BACK OF 'COMM LOST (mult pnls)'

PILE

APU  
HYD  
COMM  
GNC  
DPS

**PASS GPC FAIL**

1. (Aff) FCS CH – OFF  
If two GPC/FA/FCS CHs ↓:
2. (Good) FCS CHs – ORIDE
3. √MPS CMD
4. **G53** aff SURF FDBK – desel
5. If FTS, ASAP, GPC MODE – STBY,HALT
6. √BIG 'X', then assign IDPs as reqd
7. √MULT DATA PATH LOSS  
Post MECO:
8. ASAP, GPC MODE – STBY,HALT ⇒

**BFS GPC FAIL**

1. Post SRB SEP: FLASH EVAP CNTLR PRI A – ON  
Post MECO:
2. GPC MODE – STBY,HALT  
OUTPUT – TERM
- ◆ If no comm: sel best S-BD PM ANT ⇒

**FF(FA) MDM OUTPUT**

**FAULT**

- ◆ (Take action only if annun by entire set)  
If single 'MDM OUTPUT':
  1. Go to FA/FF MDM I/O ERROR >>
- If both FF and FA annun:
  2. I/O RESET; if reqd, BFS I/O RESET
  3. If msgs repeat: Go to PASS GPC FAIL >>
  4. If reqd, (aff) FCS CH – ORIDE,AUTO

**PL MDM I/O ERROR**

1. BFS I/O RESET; if recovered >>
- ◆ **G01** PL1/2 – port mode, then BFS I/O RESET;  
if recovered >>
3. If PL2 down:  
Post SRB SEP: FLASH EVAP CNTLR PRI A – ON  
If no comm: sel best S-BD PM ANT ⇒

**PCM I/O ERROR**

OI PCMMU PWR – 2

PLT WND

FB A12-4

AESP/ALL/A/GEN O

FAB USE ONLY





**FA/FF MDM I/O ERROR**  
(Annunciated by entire set)

		1. I/O RESET
RECOV	FA	2. If reqd, (aff) FCS CH – ORIDE,AUTO
		3. BFS I/O RESET >>
NOT RECOV	FA	4. (Aff) FCS CH – OFF
		5. If two GPC/FA/FCS CHs ↓: (Good) FCS CHs – ORIDE
		6. <b>G53</b> aff SURF FDBK – desel
		7. √MULT DATA PATH LOSS
		◆ 8. Go to FA/FF MDM PORT MODE ⇒

**DPS  
BCE  
MDP**

**FA/FF MDM PORT MODE**

NOTE

If BFS, 'BCE STRG X PASS', @GPC; else @MDM.  
For '@GPC' port mode results in alternate MDM bypass

			1. <b>G01</b> aff String – port mode
			2. BFS I/O RESET
@MDM	RECOV	FA	3. (Aff) FCS CH – AUTO
		FF	4. <b>G53</b> aff SURF FDBK – resel >>
			5. >>
	NOT RECOV	FA	6. <b>BFS G51</b> aff SURF FDBK, RGA – desel
		FF	7. <b>BFS G51</b> aff AA – desel
			8. √MULT DATA PATH LOSS ⇒
@GPC	FA RECOV (FF Give Up)		9. (Aff) FCS CH – AUTO
			10. <b>G51</b> aff IMU – desel
			11. <b>G53</b> aff SURF FDBK – resel
			12. √MULT DATA PATH LOSS ⇒A
	FF RECOV (FA Give Up)		13. (Aff) FCS CH – OFF
			14. If two GPC/FA/FCS CHs ↓: (Good) FCS CHs – ORIDE
			15. <b>G53</b> aff SURF FDBK – desel
			16. √MULT DATA PATH LOSS ⇒A

PILE

**BCE STRG X** (no 'MDM OUTPUT' msg)

	IMU	1. [G51] IMU – desel
		2. I/O RESET
RECOV	IMU	3. >>
		4. >>
NOT RECOV	NSP	5. And no comm: PNL,CMD
		6. [BFS G51] Config per <u>COMM COVER</u> (ASC): TDRS – ITEM 46 EXEC (*) STDN-HI – ITEM 47 EXEC (*) SGLS – ITEM 49 EXEC (*) >>
		◆ 7. [G01] aff String – port mode
		8. BFS I/O RESET
		9. If recov, go to RECOV steps >>
	B	10. [BFS G51] aff AA – desel
	D	11. [BFS G51] aff SURF FDBK,RGA – desel
	B/D	12. If RTLS: [G23] OVRD aff MANF(s) – OP
		13. √MULT DATA PATH LOSS ⇒

DPS  
GPC  
MDM

**DUAL DPS DISPLAY COMMANDERS/DK XMTR 1(2,3)**

1. BFC CRT SEL – aff IDP
- If reqd to clean up display:
2. (Aff) IDP/CRT PWR – OFF,ON

**PASS DISPLAY FAIL**

1. MDU PWR – OFF,ON; if recovered >>
2. GPC/CRT – same GPC/aff IDP; if recovered >>
3. BFC CRT SEL – aff IDP; if both IDPs OK go to step 9
4. – orig posn
5. Report MDU symptoms
- If MCC GO for pwr cycle:
6. IDP/CRT PWR – OFF,ON; if recovered >>
- If MDU blank or autonomous:
7. Set other MDU on same IDP to DPS Mode; if recovered >>
8. Return other MDU to nominal config
9. Deassign aff IDP from PASS
10. GPC/CRT 04 EXEC
11. In PASS: GPC/CRT 44 EXEC

PLT WND

FB A12-6

AESP/ALL/A/GEN O

FAB USE ONLY

HOOK

**BFS DISPLAY FAIL**

1. If IDP4(CRT4): IDP/CRT4 PWR – OFF >>
  2. MDU PWR – OFF,ON; if recovered >>
  3. BFC CRT SEL – unaff IDP; if both IDPs OK >>
  4. – orig posn
  5. BFC CRT DISPLAY – OFF,ON; if recovered >>
  6. In PASS: GPC/CRT 5/X for aff IDP; if recovered >>
  7. Report MDU symptoms
- If MCC GO for pwr cycle:
8. IDP/CRT PWR – OFF,ON; if recovered >>
- If MDU blank or autonomous:
9. Set other MDU on same IDP to DPS Mode; if recovered >>
  10. Return other MDU to nominal config
11. BFC CRT SEL – unaff IDP
  12. Deassign aff IDP from PASS
  13. GPC/CRT 04 EXEC
  14. In PASS: GPC/CRT 44 EXEC

PLT WND

FB A12-7

AESP/ALL/A/GEN O

FAB USE ONLY

TOP  
BACK OF 'BFS DISPLAY FAIL'

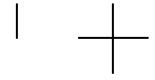
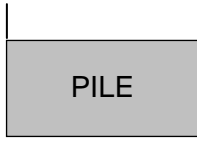

This Page Intentionally Blank



PLT WND

FB A12-8

AESP/ALL/A/GEN O

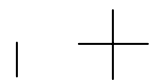

FAB USE ONLY



**FLT INST DISPLAY ANOMALY**

1. DATA BUS sel alt FC BUS(s); if recovered >>
2. PORT SELECT aff MDU; if recovered >>
3. MDU PWR – OFF,ON

**SUBSYS STATUS DISPLAY ANOMALY**

1. PORT SELECT aff MDU; if recovered >>
2. MDU PWR – OFF,ON; if recovered >>

**MULT DATA PATH LOSS (non-Recov)**

NOTE

If LRU data path loss due to GPC prob and not MDM,  
BFS will pick up MDMs/LRU when engaged

FAILURE	TYPE	ACTIONS
GPC/FA any combo	I/O	D √BFS MM at each transition Expect 'SEP INH' (FDLN Fail) combos 2&3,2&4
		√OMS MAN SHUTDOWN Post MECO: <b>Before MECO + 25 sec: ••</b> 1. MPS FDLN RLF ISOL (two) – OP 2. MPS PREVLVs (six) – OP RTLS/TAL: MPS FILL/DRAIN LH2 INBD, OUTBD – OP
GPC/FF 1&2	I/O or B	Use R BODY FLAP & TRIM ENA SWs
GPC/FF 3&4	I/O or B	Use L BODY FLAP & TRIM ENA SWs

**EPS  
MN  
AC**

PILE

**MN BUS UNDERVOLTS/FC VOLTS**

If MN V < 26.4, FC V < 26.6, FC A > 480 (2 of 3)

(SHORT or degraded FC):

1. MSTR MADS PWR – OFF
  2. If aff BUS tied – untie
  3. PL PRI (three) – OFF
- If AC VOLTS < 95, or STACK T > 243 and incr:
4. (Aff) ESS BUS SOURCE FC – OFF  
FC/MN BUS – OFF
- If FC VOLTS < 32 (FC SHORT)
5. (Aff) FC REAC VLV – CL
  6. Perform BUS LOSS ACTION (do not perform FC SHUTDN)
- Post MECO:
7. ⇒ FC SHUTDN (do not stop FC until COOL P < 15 and STACK T < 243) >>
- If FC VOLTS ≥ 32 (BUS SHORT)
8. Go to BUS LOSS ACTION >>

9. ⇒

If MN V < 26.4 and FC V > 32 and FC A < 20

(FC disconnect, check APUs):

10. AC BUS SNSR (three) – OFF
11. MSTR MADS PWR – OFF
12. PL PRI (three) – OFF
13. FC/MN BUS – ON

If FC3 aff:

14. PL PRI MNC – ON  
FC3 – ON
15. If MNC V < 26.4: PL PRI (three) – OFF

If MN BUS recovered (FC VOLTS < 32):

16. GNC I/O RESET
17. ⇒ BUS TIE >>

If MN BUS not recovered (FC VOLTS > 32):

18. Perform BUS LOSS ACTION (do not perform FC SHUTDN)

Post MECO:

19. ⇒ FC SHUTDN

**AC VOLT HIGH**

If AC V > 123 and F7 "AC VOLTAGE":

1. (Unaff) AC BUS SNSRS (two) – OFF
- If AC V ≥ 130:
2. (Aff) AC BUS SNSR – AUTO TRIP
- If AC V < 130 and AC3 aff:
3. H2O PUMP LOOP 2 – OFF
- If RTLS/TAL:
4. AC VOLTS HIGH ⇒G
  5. ⇒ AC VOLTS (LOW or HIGH)

DPS  
BCE  
MDP

PLT WND

FB A12-10

AESP/ALL/A/GEN O

FAB USE ONLY

HOOK

**AC VOLT LOW or OVERLOAD**

1. AC BUS SNSR (three) – OFF

If amps &gt; 14 and V &lt; 95:

If single  $\Phi$  amps > 14:2. cb AC CONTR – cl  
INV/AC BUS – OFF  
INV PWR – OFF  
cb AC CONTR – op3. If other  $\Phi$  amps > 14:  
Go to step 6

If RTLS/TAL:

4. Go to aff BUS LOSS  $\Rightarrow$  G5. Go to AC OVERLOAD  $\Rightarrow$  AIf multi  $\Phi$  (bus short):6. (Aff) cb AC CONTR (three) – cl  
INV/AC BUS – OFF (tb-OFF)  
INV PWR – OFF (tb-OFF)  
cb AC CONTR (three) – op

7. Go to aff BUS LOSS &gt;&gt;

8.  $\Rightarrow$  AC VOLTS (LOW or HIGH)**3 $\Phi$  AC MOTORS STOPPED**

1. AC BUS SNSR (three) – OFF

2. Determine AC BUS:

FC1 and FREON PUMP 2B: AC1

FC2 and FREON PUMP 1B: AC2

FC3 and CAB FAN A: AC3

3. (Aff) FC – STOP

If AC3 aff:

4. AV BAY 3 FAN B – OFF, A – ON

5. CAB FAN A – OFF

Isolate aff  $\Phi$ B( $\Phi$ C, $\Phi$ A):

6. (Aff) cb AC CONTR – cl

7. INV/AC BUS – OFF

If AC1(2,3) aff and AV BAY 3(2,3) FAN  $\Delta$ P  $\geq$  0.5:8. Go to step 16 (bad  $\Phi$  isolated)

9. (Aff) INV/AC BUS – ON

10. cb AC CONTR – op

11. Repeat from step 6 to isolate aff  $\Phi$ C( $\Phi$ A), then:Drop aff AC bus (three  $\Phi$ s):

12. (Aff) cb AC CONTR (three) – cl

13. INV/AC BUS – OFF

14. INV PWR – OFF

15. Go to aff BUS LOSS &gt;&gt;

Bad  $\Phi$  isolated:16. (Aff) FC – START (10 sec or  $\Delta$ P tb-gray)

17. Perform aff BUS LOSS and if AC1(AC2) aff &gt;&gt;

18. If AC3 aff:

Post MECO:

CAB FAN B – ON

MN  
ESS  
CNTL

PLT WND

FB A12-11

AESP/ALL/A/GEN O

FAB USE ONLY

TOP  
BACK OF 'AC VOLT LOW or OVERLOAD'

PILE

**MNA or AC1 Multi Φ**

1. Do not isolate MPS He C
2. MSTR MADS PWR – OFF
3. AC BUS SNSR (three) – OFF
4. Perform FC SHUTDN (within 9 min), then:

Post MECO:

5. L OMS – sel SEC ⇒

**MNB or AC2 Multi Φ**

1. Do not isolate MPS He L
2. MSTR MADS PWR – OFF
3. AC BUS SNSR (three) – OFF
4. Perform FC SHUTDN (within 9 min), then: ⇒

FAILED: S-BD PM 1 (NO PNL,CMD)

**MNC or AC3 Multi Φ**

1. Do not isolate MPS He R
2. S-BD PM CNTL – PNL,CMD
3. Config per COMM COVER (ASC) [BFS G51]:  
TDRS – ITEM 46 EXEC (\*)  
STDN-HI – ITEM 47 EXEC (\*)  
SGLS – ITEM 49 EXEC (\*)
4. MSTR MADS PWR – OFF
5. AC BUS SNSR (three) – OFF
6. Perform FC SHUTDN (within 9 min), then:

Post MECO:

7. R OMS – sel SEC ⇒

**AC SINGLE Φ ⇒**

**SUBBUS [APC4(5,6) or ALC1(2,3)]**

Do not isolate MPS He C(L,R) ⇒

**ESS BUS V LOW**

If verified by F9 voltmeter:

1. Perform FC SHUTDN (<9 min), then:
2. Go to aff ESS BUS LOSS

**ESS BUS LOSS**

<b>ESS 1BC</b>	<b>O13&amp;R14</b>	1. L AUD CNTL sel – R (CDR can't talk)
		2. Pri C/W & F7 Matrix lost ⇒A
		3. ⇒A
<b>ESS 2CA</b>	<b>O13&amp;R14</b>	1. AUD CTR – 2
		2. R AUD CNTL sel – L (PLT can't talk) ⇒A
		3. ⇒A
<b>ESS 3AB</b>	<b>O13</b>	1. GPC CAM Lights lost
		2. Do not engage BFS ⇒

PLT WND

FB A12-12

AESP/ALL/A/GEN O

MN  
AC  
3Φ

FAB USE ONLY





**CNTL BUS V LOW/CNTL BUS RPC**

WARNING  
 If VISIBLE FIRE/SMOKE AT ANY TIME, cb CNTL BUS AB1/2/3(BC1/2/3,CA1/2/3) – op (pnl R14:B)

1. Identify BUS (√BUS LOSS ID)  
 If bus critical (per MCC):

- ◆ 2. ⇒
- ◆ If one CNTL BUS RPC tripped (\*):

Aff CNTL BUS:

**AB1(2,3)**

	Tripped RPC (*)	Action (for RESET, hold w/sw reten device)
3.	<b>A</b>	R1 CNTL BUS PWR MNB – RESET R14:B cb CNTL BUS AB1/2/3 – op
4.	<b>B</b>	R1 CNTL BUS PWR MNA – RESET R14:B cb CNTL BUS AB1/2/3 – op

**BC1(2,3)**

	Tripped RPC (*)	Action (for RESET, hold w/sw reten device)
5.	<b>B</b>	R1 CNTL BUS PWR MNC – RESET R14:B cb CNTL BUS BC1/2/3 – op
6.	<b>C</b>	R1 CNTL BUS PWR MNB – RESET R14:B cb CNTL BUS BC1/2/3 – op

**CA1(2,3)**

	Tripped RPC (*)	Action (for RESET, hold w/sw reten device)
7.	<b>C</b>	R1 CNTL BUS PWR MNA – RESET R14:B cb CNTL BUS CA1/2/3 – op
8.	<b>A</b>	R1 CNTL BUS PWR MNC – RESET R14:B cb CNTL BUS CA1/2/3 – op

- ◆ If no CNTL BUS RPC tripped (no \*):

	aff CNTL BUS	Panel R1 action (RESET, hold w/sw reten device)
9.	<b>AB1(2,3)</b>	CNTL BUS PWR MNA,MNB (two) – RESET
10.	<b>BC1(2,3)</b>	CNTL BUS PWR MNB,MNC (two) – RESET
11.	<b>CA1(2,3)</b>	CNTL BUS PWR MNA,MNC (two) – RESET

**CNTL BUS LOSS**

Cont next page

PILE

- ◆ 12. Perform aff CNTL BUS LOSS, then:  
If pwr reqd (<3 sec) for crit function:
  - 13. Hold crit function sw
  - For tripped RPC:
    - 14. CNTL BUS PWR MNA(MNB,MNC) – RESET  
(1 sec), then dn
- 15. ⇒

**CNTL BUS LOSS**

<b>AB1</b>	⇒
<b>AB2</b>	[G23] RCS FWD MANF VLVS 1 OVRD – ITEM 40 EXEC (CL) ⇒
<b>AB3</b>	1. [G51] RCS RM MANF CL OVRD – ITEM 41 EXEC If BFS engage reqd: 2. Use PLT's RHC, then GPCs 1,2,4 – STBY,HALT 3. BFS I/O RESET 4. ⇒
<b>BC1</b>	Failed: S-BD PM 1 (NO PNL,CMD) ⇒
<b>BC2</b>	1. S-BD PM CNTL – PNL,CMD 2. [BFS G51] Config per <u>COMM COVER</u> (ASC): TDRS – ITEM 46 EXEC (*) STDN-HI – ITEM 47 EXEC (*) SGLS – ITEM 49 EXEC (*) 3. [G23] RCS FWD MANF VLVS 2 OVRD – ITEM 41 EXEC (CL) 4. PLT disp sws – green dot ⇒
<b>BC3</b>	[G51] RCS RM MANF CL OVRD – ITEM 41 EXEC ⇒
<b>CA1</b>	No BFS engage ⇒
<b>CA2</b>	[G23] RCS FWD MANF VLVS 3 OVRD – ITEM 42 EXEC (CL) ⇒
<b>CA3</b>	⇒

**CNTL  
LOW/  
RPC**

PLT WND

FB A12-14

AESP/ALL/A/GEN O

FAB USE ONLY

HOOK

FC

**FC REAC VLV CLOSED**

1. FC REAC VLV (three) – OP
2. Perform BUS TIE, then:  
If FC COOL P < 50:
3. Go to FC SHUTDN

**FC pH ↓ 1(2,3) or FC DELTA V 1(2,3)**

If pH ↓ and FC SS 1(2,3)  $\Delta V > 150$   
or FC SS  $\Delta V > 150$  and incr:

1. Perform BUS TIE, then:
  2. (Aff) FC REAC VLV – CL
  3. MSTR MADS PWR – OFF
  4. Go to LOSS OF 1(2nd) FC PWRDN >>
- If pH ↓ only and Post SRB SEP:
- ◆ 5. Perform BUS TIE, then:
  - 6. ⇒A FC pH 1(2,3)

**FC STACK T**

1. MSTR MADS PWR – OFF
- If STACK T > 243 and incr:
2. If 2nd FC: Go to 2nd FC SHUTDN >>
  3. PL PRI (three) – OFF
- If aff FC amps < 190 or > 360:
4. Go to MN BUS UNDERVOLTS/FC VOLTS,  
step 4 >>
- ◆ 5. Perform BUS TIE, then:
  - 6. ESS BUS SOURCE FC – OFF
  - 7. FC/MN BUS – OFF
- If aff FC VOLTS < 32 or STACK T not decr:
8. (Aff) FC REAC VLV – CL
  9. FC – STOP after COOL P < 15 and  
STACK T < 243
  10. Go to LOSS OF 1 FC PWRDN

**FC EXIT T**

1. MSTR MADS PWR – OFF
  2. Perform LOSS OF 1 FC PWRDN
  3. Post SRB SEP:
- ◆ Perform BUS TIE, then: ⇒

PLT WND

FB A12-15

AESP/ALL/A/GEN O

FAB USE ONLY

TOP  
BACK OF 'FC REAC VLV CLOSED'



FC

**FC COOLANT PUMP  $\Delta$ P LOW**

1. FC – START (10 sec or  $\Delta$ P tb-gray)
- ◆ 2. MSTR MADS PWR – OFF  
Perform LOSS OF 1 FC PWRDN, then:  
If > 9 min since failure:
  - ◆ If EXIT T > 164 and not decr or  
RDY tb – bp or  
FC PUMP cb(s) open (pnl L4:C):
    3. Go to FC SHUTDN >>
  4. If < 9 min since failure  $\Rightarrow$

**FC COOL P**

1. Perform BUS TIE, then:  
If COOL P < 75:  $\Rightarrow$   
If COOL P incr and not 100 (H),  
or FC COOL PUMP =  $\Delta$ P (intermittent),  
or STACK/EXIT T unstable:
  2. (Aff) FC REAC VLV – CL
  3. MSTR MADS PWR – OFF
  4. Go to LOSS OF 1(2nd) FC PWRDN

**LOSS OF 1 FC PWRDN**

1. PRI PL (three) – OFF  
AFT PL (two) – OFF
2. IDP/CRT4 PWR – OFF  
One MDU – OFF  $\Rightarrow$

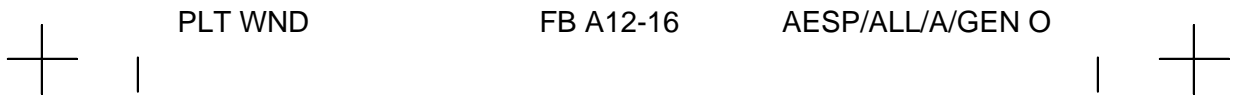

FAB USE ONLY

HOOK

**2nd FC SHUTDN**

(CL PMP Lost: &lt;6 min)

1. Have CDR start LOSS OF 2nd FC PWRDN

If three MN buses pwr:

2. MN BUS TIE (three) – OFF  
(do not perform BUS LOSS ACTION)
3. LES O2 – OFF, visors – OP
4. Switch off all but one IDP/CRT with four MDUs
5. All PL pwr (seven) – OFF
6. O2,H2 TK HTRS (all) – OFF
7. After CDR pnl L1 config complete, continue:

If two MN buses pwr:

8. Pwr MN BUS TIES (two) – ON

If only one MN bus pwr:

9. MN BUS TIE (three) – OFF  
If only MNA(B,C) pwr: Secure APU 2(3,1)  
BUS TIE good FC/BUS (MNA if RTLS or TAL)  
I/O RESET

When reqd:

10. ESS BUS SOURCE FC – OFF  
FC/MN BUS – OFF  
FC – STOP (1 sec)  
FC REAC VLV – CL
11. G51 √ICNCT ENA (if reqd for OMS load)
12. All TACAN/RA – OFF

Post MECO:

13. MPS PRPLT DUMP B/U LH2 VLV – OP
14. ⇒ LOSS OF 2nd FC PWRDN

CRYO

**OV103,104**

PLT WND (OV103,104) FB A12-17

AESP/3,4/A/GEN O

FAB USE ONLY

PILE

**O2(H2) CRYO PRESS/TEMP HIGH**

O2(H2) TK HTR (two) – OFF ⇒A

**CRYO O2(H2) LEAK (three or more tanks aff)**

Use meter if CRT data OSL

**2FC**

1. O2(H2) MANF VLV TK1,TK2 (two) – CL
  2. O2(H2) TK3 HTRS A – AUTO
- If TK1 and TK2 P decr slowly (HTR logic fail): ⇒
3. Perform aff MN BUS TIE, then:
- If O2(H2) TK1(2) aff (open unaff manf):
4. O2(H2) MANF VLV TK2(1) – OP
- If O2 TK1(2) aff:
5. O2 SYS 1(2) SPLY – CL
  6. If O2 TK1(2) P now incr (PCS leak): >>
7. (Aff) TK HTR B – AUTO
- If no aff FC COOL P alarm: ⇒
8. (Aff) TK HTRS A,B (two) – OFF
  9. MSTR MADS PWR – OFF
  10. Perform LOSS OF 1 FC PWRDN, then: ⇒

**OV103,104**

PLT WND (OV103,104) FB A12-18

AESP/ALL/A/GEN O

FAB USE ONLY

HOOK

**2nd FC SHUTDN**

(CL PMP Lost: &lt;6 min)

1. Have CDR start LOSS OF 2nd FC PWRDN

If three MN buses pwr:

2. MN BUS TIE (three) – OFF  
(do not perform BUS LOSS ACTION)
3. LES O2 – OFF, visors – OP
4. Switch off all but one IDP/CRT with four MDUs
5. All PL pwr (seven) – OFF
6. O2,H2 TK HTRS (all) – OFF
7. After CDR pnl L1 config complete, continue:

If two MN buses pwr:

8. Pwr MN BUS TIES (two) – ON

If only one MN bus pwr:

9. MN BUS TIE (three) – OFF  
If only MNA(B,C) pwr: Secure APU 2(3,1)  
BUS TIE good FC/BUS (MNA if RTLS or TAL)  
I/O RESET

When reqd:

10. ESS BUS SOURCE FC – OFF  
FC/MN BUS – OFF  
FC – STOP (1 sec)  
FC REAC VLV – CL
11. G51 √ICNCT ENA (if reqd for OMS load)
12. All GPS/RA – OFF

Post MECO:

13. MPS PRPLT DUMP B/U LH2 VLV – OP
14. ⇒ LOSS OF 2nd FC PWRDN

CRYO

**OV105**

PLT WND

(OV105) FB A12-17

AESP/5/A/GEN O

FAB USE ONLY

PILE

**O2(H2) CRYO PRESS/TEMP HIGH**

O2(H2) TK HTR (two) – OFF ⇒A

**CRYO O2(H2) LEAK (three or more tanks aff)**

Use meter if CRT data OSL

**2FC**

1. O2(H2) MANF VLV TK1,TK2 (two) – CL
  2. O2(H2) TK3 HTRS A – AUTO
- If TK1 and TK2 P decr slowly (HTR logic fail): ⇒
3. Perform aff MN BUS TIE, then:
- If O2(H2) TK1(2) aff (open unaff manf):
4. O2(H2) MANF VLV TK2(1) – OP
- If O2 TK1(2) aff:
5. O2 SYS 1(2) SPLY – CL
  6. If O2 TK1(2) P now incr (PCS leak): >>
7. (Aff) TK HTR B – AUTO
- If no aff FC COOL P alarm: ⇒
8. (Aff) TK HTRS A,B (two) – OFF
  9. MSTR MADS PWR – OFF
  10. Perform LOSS OF 1 FC PWRDN, then: ⇒

**OV105**

PLT WND

(OV105) FB A12-18

AESP/ALL/A/GEN O

FAB USE ONLY



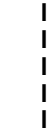
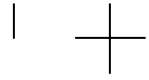
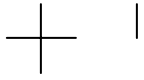

**GLIDED  
FLIGHT**

**PLT WINDOW FLIP BOOK**

**GLIDED FLIGHT**

**PLT WINDOW  
FLIP BOOK**

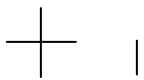

PLT WND

FB E12-i

AESP/ALL/E/GEN O

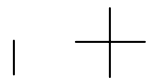

**FAB USE ONLY**

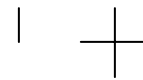
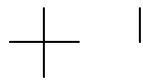

GLIDED  
FLIGHT



This Page Intentionally Blank

PLT WINDOW  
FLIP BOOK

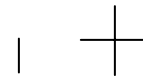
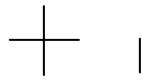

PLT WND

FB E12-ii

AESP/ALL/E/GEN O

FAB USE ONLY

TOP  
FACING LEFT SIDE OF BACKBOARD

HOOK

APU/  
HYD

**APU SHUTDN**

1. APU OPER – OFF  
FU TK VLV – CL  
√Shutdn (HYD PRESS < 200)  
Report APU F7 lts  
APU CNTLR PWR – OFF

If one APU failed:

- ⇒
2. √APU AUTO SHTDN (three) – ENA
  3. MM304: √APU SPEED SEL (two) – NORM
  4. MM602/305: APU SPEED SEL (two) – HI

If two APUs failed:

5. APU SPEED SEL (one) – HI
6. AUTO SHTDN (one) – INH

**APU SPD HI**

If SPEED % exceeds 111:

- ⇒
1. APU SPEED SEL – HI
- Pre-TAEM if two good APUs:
2. Perform APU SHUTDN, then:
  3. Go to APU COOLDOWN

**APU OVERSPEED**

If SPEED % exceeds 129:

Go to APU SHUTDN

**APU UNDERSPEED [G51]**

If 'PRL SYS X ↓' or if APU has shut dn:

- ⇒
1. Perform APU SHUTDN, then:
  2. Go to APU COOLDOWN

**APU OIL OVERTEMP**

1. BLR CNTLR/HTR – A(B)  
√N2 SPLY – ON

⇒ If M > 1:

- If OIL IN T incr, and OUT T > 305:
2. Perform APU SHUTDN, then:
  3. Go to APU COOLDOWN

**APU PUMP LEAK P**

1. √MCC

Pre-TAEM if two good APUs:

2. Perform APU SHUTDN, then:
3. Go to APU COOLDOWN

**APU THERM (T HI)**

If APU GG/FU PMP HTR or APU TK/FU LN HTR fail ON (↑):  
(Aff) HTR – OFF

PLT WND

FB E12-1

AESP/ALL/E/GEN O

FAB USE ONLY

TOP  
BACK OF 'APU SHUTDN'



**APU**

**APU COOLDOWN**

At M = 7:

1. HYD MN PUMP PRESS – LO  
APU CNTLR PWR – ON  
OPER – INJ COOL (start watch)

If APU not leaking:

2. APU FU TK VLV – OP

At Wheel Stop:

3. Go to APU SHUTDN

**APU RESTART**

- ◆ 1. √APU AUTO SHTDN – ENA
  2. HYD MN PUMP PRESS – LO
  3. APU CNTLR PWR – ON
- If COOLDOWN for > 3.5 min or APU TEMP INJ < 380:
4. Go to step 7
  5. APU OPER – INJ COOL (start watch)
- If after 1.5 min, APU TEMP INJ not decr:
6. Go to APU SHUTDN >>
- At 3.5 min:
7. √APU FU TK VLV – OP  
OPER – START/RUN
- If restart unsuccessful:
8. Go to APU SHUTDN >>
  9. HYD MN PUMP PRESS – NORM

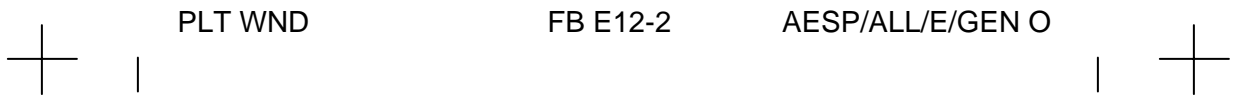

PLT WND

FB E12-2

AESP/ALL/E/GEN O

FAB USE ONLY

HOOK

**HYD PRESS (LOW)**

GNC 51 OVERRIDE
BFS, SM SYS SUMM 2

- ⇒ 1. Compare 'PRL SYS X' status and aff HYD PRESS  
(HYD/APU) meter and CRT):

PRL SYS	HYD PRESS	ACTION
↓	both meter and CRT P < 300	Go to APU SHUTDN >>
blank	either meter or CRT P > 2600	No action reqd >>
'?'	ACUM P > 2800	No action reqd >>

**HYD/  
COMM  
GNC**

## 2. (Aff) HYD MN PUMP PRESS – LO

If two good APU/HYD remain:

3. √APU AUTO SHTDN (three) – ENA
4. MM304: √APU SPEED SEL (two) – NORM
5. MM305/602: APU SPEED SEL (two) – HI >>

If only one good APU/HYD remains:

6. APU AUTO SHTDN (one) – INH  
SPEED SEL (one) – HI

On MCC call:

7. (Degraded) HYD MN PUMP PRESS – NORM

PLT WND

FB E12-3

AESP/ALL/E/GEN O

FAB USE ONLY

TOP  
BACK OF 'HYD PRESS (LOW)'

PILE

APU/  
HYD

**HYD RSVR QTY (LOW)**

1. (Aff)  $\sqrt{\text{HYD MPS/TVC ISOL VLV SYS}} - \text{CL}$   
(hold 5 sec, tb-CL)
- ⇒  $\sqrt{\text{BK ISOL VLV}} - \text{CL}$  (hold 5 sec, tb-CL)
- If HYD sys 1 leaking:  
 $\sqrt{\text{LG EXTD ISO VLV}} - \text{CL}$  (hold 5 sec, tb-CL)
- If qty still decr:
- If two good Hyd sys:
2. (Aff) HYD MN PUMP PRESS – LO
- If second sys fails:
3. At TAEM: (Leaking) HYD MN PUMP  
PRESS – NORM
4. At TAEM: (Good) APU SPEED SEL (two) – HI
- If one good Hyd sys:
5. (Good) APU AUTO SHTDN – INH
6. (Good) APU SPEED SEL – HI
- If prior to TAEM:
7. (Leaking) HYD MN PUMP PRESS – LO
8. At TAEM: (Leaking) HYD MN PUMP  
PRESS – NORM

**HYD RSVR T**

1. BLR CNTLR/HTR – A(B)
- If HYD RSVR T > 250:
2. HYD MN PUMP PRESS – LO
- If HYD RSVR T > 268 and incr:
3. Perform APU SHUTDOWN, then:
4. Go to APU COOLDOWN

**W/B QTY (LOW)**

- ⇒ 1. BLR CNTLR/HTR – A(B)
2. If BLR CNTLR/HTR – OFF:
3. BLR CNTLR/HTR – B  
N2 SPLY – ON
4. If W/B QTY = 0 or  $M \leq 1$  >>
5. Monitor W/B QTY for 2 min, then:
6. If W/B QTY change > 3:
7. Cycle BLR CNTLR/HTR to maintain:  
200 < LUBE OIL IN T < 290 (C&W)
- When  $M \leq 1$ :
8. BLR CNTLR/HTR – A(B)

PLT WND

FB E12-4

AESP/ALL/E/GEN O

FAB USE ONLY

HOOK

**COMM LOST (mult pnls)**

1. AUD CTR – 2

No comm (check UHF sites):

2. S-BD PM CNTL – PNL,CMD (pnl C3)

3. Config per COMM COVER (ASC) BFS G51:

TDRS – ITEM 46 EXEC (\*)

STDN-HI – ITEM 47 EXEC (\*)

SGLS – ITEM 49 EXEC (\*)

If \* not next to selected config:

4. Config pnl A1 per Comm Coverage

(ASC/ENT PKT, COMM)

S-BD PM CNTL – PNL,CMD (pnl C3)

No comm:

5. Sel best S-BD PM ANT

No comm:

6. S-BD PM ANT – GPC

GNC  
MPS  
DPS**ICOM LOST**

1. AUD CNTL sel – sel alt

No ICOM:

2. AUD CTR – 2

**FCS CH 1(2,3,4) (2nd FAIL) G53**

If two FCS CH ↓ on any actuator:

- ◆ (Remaining) FCS CH (two) – ORIDE

**RHC L(R) (2nd FAIL)**

(Aff) FLT CNTLR PWR – OFF

GNC SYS SUMM 1**G51 ROLL MODE SW G51**

If ROLL MODE ≠ sw pos:

AUTO SEL – ITEM 42 EXEC

**DISPLAY SW L(R)**

L(R) disp sws – green dot

**RM FAIL IMU,RGA,AA BFS G51**

Aff LRU – desel

**RM DLMA IMU G51 BFS G51**

- 1. √MCC, bad IMU – desel (PASS & BFS) >>
- ◆ 2. Desel lower # IMU with '?' (PASS)

PLT WND

FB E12-5

AESP/ALL/E/GEN O

FAB USE ONLY

PILE

- RM FAIL ADTA** [G51]
- ◆ 1. √BFS [GNC SYS SUMM 1]
  - 2. If '↓' for aff ADTA >>
  - 3. If accessible, (bad) ADTA cb – op >>
  - 4. BFS, ADTA to G&C – INH

**RM DLMA ADTA \*** [G51]

M < 2.0		1. Fly Theta limits
ADTA data agrees		2. Desel, resel one ADTA
		3. If no '?' >>
Bad probe		4. Stow bad probe >>
Bad ADTA	ADTA cb accessible	◆ 5. (Bad) ADTA cb – op >>
	ADTA cb not accessible	◆ 6. DES bad ADTA
		7. √BFS [GNC SYS SUMM 1]
		8. If '↓' for aff ADTA >>
		9. BFS, ADTA to G&C – INH
Dilemma not resolved		10. ADTA to G&C – INH (PASS & BFS)

HYD/  
COMM  
GNC

\*If three ADTAs failed:  
ADTA to G&C – INH (PASS)  
Fly Theta limits

**RM FAIL TAC** [G50]

(RM LIMITS: 6 DEG, 0.5 NM)

- 1. If data good: desel, resel aff TACAN >>
- 2. If failure verified: desel failed TACAN in BFS

**RM DLMA TAC** [G50]

Do not desel or resel while in 'TEST'

- 1. If both data good: desel, resel one TACAN in DLMA >>
- 2. √TACAN MODE (three) – GPC
- 3. If 'RM FAIL TAC': desel failed TACAN in BFS >>
- 4. If continuous 'TEST': TACAN MODE (three) – T/R  
If bad TACAN identified:
- 5. Desel bad TACAN (PASS, √BFS)

**SPD BRK** [G51] [BFS G51]

M > 5.0	◆ WRAP MODE – INH
M ≤ 5.0	WRAP MODE – INH √MCC for energy mgmt procs



TOP  
FRONT

HOOK

**MPS He P/MPS C&W LIGHT  
PNEU REG**

If M > 2.4: (Aff) MPS He ISOL – CL

**G55 GPS FAIL 2** G50 BFS G50  
GPS to NAV INH – ITEM 43 EXEC (PASS,  $\sqrt$ BFS)

**NO UPDATE GPS** G55  
 $\sqrt$ MCC  
If ALT < 300kft and ALT > 180kft  
    No Update due to plasma, reevaluate at ALT < 180kft  
Else  
    INIT – ITEM 15 EXEC  
    NAV – ITEM 18 EXEC

**OV103,104**

PLT WND (OV103,104) FB E12-7

AESP/3,4/E/GEN O

FAB USE ONLY

TOP  
BACK

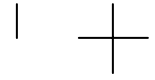
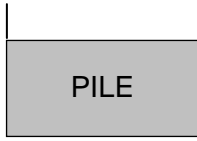

PILE

This Page Intentionally Blank



PLT WND (OV103,104) FB E12-8

**OV103,104**

AESP/3,4/E/GEN O

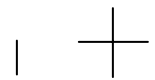

FAB USE ONLY

TOP  
FRONT

HOOK

**MPS He P/MPS C&W LIGHT  
PNEU REG**

If M > 2.4: (Aff) MPS He ISOL – CL

**G55 GPS FAIL 1(2,3)** G50 BFS G50  
Aff LRU – desel (PASS,  $\sqrt{\text{BFS}}$ )

**RM DLMA GPS** G50 BFS G50

- ◆ 1.  $\sqrt{\text{MCC}}$ , bad GPS – desel (PASS,  $\sqrt{\text{BFS}}$ ) >>
- 2. If 300kft > ALT > 180kft  
DLMA due to plasma  
Reevaluate when ALT < 180kft  
Else
- 3. Desel GPS with highest P1 $\sigma$   
If P1 $\sigma$  values are equal, desel highest number  
LRU  
If DLMA not resolved
- 4. Desel GPS with next highest P1 $\sigma$

**NO UPDATE GPS** G55

- 1.  $\sqrt{\text{MCC}}$ , bad GPS – desel (PASS,  $\sqrt{\text{BFS}}$ ) >>
- 2. If RM DLMA GPS message, see RM DLMA GPS >>
- 3. If 300kft > ALT > 180kft  
No Update due to plasma  
Reevaluate when ALT < 180kft  
Else
- 4. Initialize GPS with highest P1 $\sigma$   
INIT – ITEM 14(15,16) EXEC  
NAV – ITEM 17(18,19) EXEC  
May take up to 2 minutes for GPS to provide SV

**OV105**

PLT WND

(OV105) FB E12-7

AESP/5/E/GEN O

FAB USE ONLY

TOP  
BACK

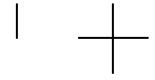
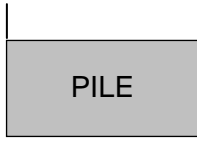

This Page Intentionally Blank



PLT WND

(OV105) FB E12-8

**OV105**  
AESP/5/E/GEN O

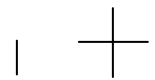

FAB USE ONLY

HOOK

**PASS GPC FAIL**

1. (Aff) FCS CH – OFF
2. If two GPC/FA/FCS CHs ↓: (Good) FCS CHs – ORIDE
3. GPC MODE – STBY,HALT
4. **G53** aff SURF FDBK – desel
- ⇒ 5. If String 1(2): CDR(PLT) disp sws – green dot  
NWS – 2
6. √MULT DATA PATH LOSS

**BFS GPC FAIL**

1. GPC MODE – STBY,HALT
- ◆ 2. OUTPUT – TERM  
⇒ MODE – STBY
3. If BFS cannot drive an IDP:  
GPC MODE – HALT, then go to step 8
4. If BFS currently in OPS 3 or 6:  
Go to step 7
5. If BFS currently in OPS 1:  
PRO to OPS 106  
BFS, OPS 000 PRO  
PRO to OPS 304
6. If BFS in desired MM (304):  
BFS **G50** √BFS R/W sel  
GPC MODE – RUN  
OUTPUT – B/U  
Advise MCC BFS in BACKUP >>
7. √GPC MODE – STBY (BFS is SM Only)
8. If no comm: sel best S-BD PM ANT
9. MPS He ISOL B (three) – CL  
PNEU He ISOL – CL
10. If AOA/GRTLs/TAL < 120K:  
NH3 CNTLR B – SEC/ON

DPS  
MDM  
BFS

**FA/FF MDM I/O ERROR**

(Annunciated by entire set)

		1. I/O RESET
RECOV	FA	2. If reqd, (aff) FCS CH – ORIDE,AUTO
	FF 1,2,3	◆ 3. <b>G51</b> IMU – resel
		4. BFS I/O RESET >>
NOT RECOV	FA	5. (Aff) FCS CH – OFF 6. If two GPC/FA/FCS CHs ↓: (Good) FCS CHs – ORIDE 7. <b>G53</b> aff SURF FDBK – desel
		⇒ ◆ 8. √MULT DATA PATH LOSS 9. Go to FA/FF MDM PORT MODE

PLT WND

FB E12-9

AESP/ALL/E/GEN O,3

FAB USE ONLY

PILE

**FA/FF MDM PORT MODE**

NOTE

If BFS, 'BCE STRG X PASS', @GPC; else @MDM.  
For '@GPC' port mode results in alternate MDM bypass

GNC  
MPS  
DPS

			1. <span style="border: 1px solid black;">G01</span> aff String – port mode 2. BFS I/O RESET
@MDM	RECOV	FA	3. (Aff) FCS CH – AUTO 4. <span style="border: 1px solid black;">G53</span> aff SURF FDBK – resel >>
		FF 1,2,3	◆ 5. <span style="border: 1px solid black;">G51</span> IMU – resel >>
	NOT RECOV		⇒ If MCC GO for pwr cycle: 6. (Aff) FA/FF MDM – OFF,ON 7. I/O RESET 8. If recov, go to @MDM RECOV >> 9. (Aff) MDM – OFF
		FA	10. <span style="border: 1px solid black;">BFS G51</span> aff SURF FDBK, RGA – desel
		FF	11. <span style="border: 1px solid black;">BFS G51</span> aff AA – desel 12. FF 1(2): CDR(PLT) disp sws – green dot NWS – 2
			13. √MULT DATA PATH LOSS >>
@GPC	FA RECOV (FF Give Up)		14. (Aff) FCS CH – AUTO 15. <span style="border: 1px solid black;">G53</span> aff SURF FDBK – resel 16. FF 1(2): CDR(PLT) disp sws – green dot NWS – 2 17. √MULT DATA PATH LOSS >>
			18. (Aff) FCS CH – OFF 19. If two GPC/FA/FCS CHs ↓: (Good) FCS CHs – ORIDE 20. <span style="border: 1px solid black;">G53</span> aff SURF FDBK – desel
	FF RECOV (FA Give Up)		◆ 21. <span style="border: 1px solid black;">G51</span> IMU – resel
		FF 1,2,3	22. √MULT DATA PATH LOSS >>

PLT WND

FB E12-10

AESP/ALL/E/GEN O

FAB USE ONLY

HOOK

FAULT

**FF(FA) MDM OUTPUT**

- ◆ (Take action only if annun by entire set)
- If single 'MDM OUTPUT':
  1. If 'FF MDM OUTPUT':
    - ☐G51 aff IMU – desel
  2. Go to FA/FF MDM I/O ERROR >>
- If both FF and FA annun:
  3. ☐G51 aff IMU – desel
  4. I/O RESET; if reqd, BFS I/O RESET
  5. If msgs repeat: Go to PASS GPC FAIL >>
  6. If reqd, (aff) FCS CH – ORIDE,AUTO
- ◆ 7. ☐G51 IMU – resel

**PL MDM I/O ERROR**

1. BFS I/O RESET; if recovered >>
2. ☐G01 PL1/2 – port mode, then BFS I/O RESET; if recovered >>
3. If PL1 ↓ and pre MM305: FLASH EVAP CNTLR PRI B – ON
4. If PL2 ↓ and no comm: sel best S-BD PM ANT
5. If PL2 ↓ and AOA/GRTLS/TAL < 120K:
  - ⇒ NH3 CNTLR B – SEC/ON

**PCM I/O ERROR**

OI PCMMU PWR – 2(1)

**POST BFS ENGAGE**

If PASS GPCs running:

1. (Aff) GPC MODE – STBY/HALT
  2. BFS I/O RESET
  3. √FCS CHs, IMU config
- ⇒ If Air Data not analyzed:
4. ☐G50 INH AD to G&C
  5. M = 5: Deploy, evaluate probes one at a time
  6. √AD to G&C by M = 1.5

If failed ADTA(s) in PASS:

7. cb(s) ADTA – op, or stow probe
8. ☐G51 DES failed(commfaulted) RGA,AA,SURF
9. ☐G50 DES failed TAC

At  $M \leq 2.7$ :

10. CDR TRIM PNL – OFF  
RHC/PNL – ENA

At H = 3K:

11. SPDBK – MAN (check DEL PAD setting)

At MAIN GEAR TD:

12. SPDBK – 100%

BCE  
CRT

PLT WND

FB E12-11

AESP/ALL/E/GEN O

FAB USE ONLY

TOP  
BACK OF 'FF(FA) MDM OUTPUT'

PILE

**BCE STRG X** (no 'MDM OUTPUT' msg)

	IMU	1. [G21] √IMU OPER, if STBY >>
		2. I/O RESET
RECOV	IMU	3. [G21] √att ANG, if delta > 1° >> ◆ 4. [G51] IMU – resel >>
		5. >>
NOT RECOV	NSP	6. And no comm: PNL,CMD 7. [BFS G51] Config per <u>COMM COVER</u> (ASC): TDRS – ITEM 46 EXEC (*) STDN-HI – ITEM 47 EXEC (*) SGLS – ITEM 49 EXEC (*) >>
		8. [G01] aff String – port mode 9. BFS I/O RESET 10. If recov, go to RECOV steps >>
A(B,C,D, IMU)	⇒	11. FF A(B,IMU) or FA C(D) MDM – OFF,ON 12. I/O RESET 13. If FA, (aff) FCS CH – ORIDE,AUTO 14. If recov, go to RECOV steps
	C(D)	15. If < 3Y,2P jets/pod/dir: a. [G23] aff jet DES INH (*) (reprioritize) b. Aff MANF VLVS STAT OP – OVRD
	1A(2A)	16. CDR(PLT) disp sws – green dot
	B	17. [BFS G51] aff AA – desel
	D	18. [BFS G51] aff SURF FDBK,RGA – desel
		19. √MULT DATA PATH LOSS >>

DPS  
MDM  
BFS

PLT WND

FB E12-12

AESP/ALL/E/GEN O

FAB USE ONLY



HOOK

**DUAL DPS DISPLAY COMMANDERS/DK XMTR 1(2,3)**

1. BFC CRT SEL – aff IDP
- If reqd to clean up display:
2. (Aff) IDP/CRT PWR – OFF,ON

**PASS DISPLAY FAIL**

1. MDU PWR – OFF,ON; if recovered >>
2. GPC/CRT – same GPC/aff IDP; if recovered >>
3. BFC CRT SEL – aff IDP; if both IDPs OK go to step 9
4. – orig posn
5. Report MDU symptoms
- If MCC GO for pwr cycle:
6. IDP/CRT PWR – OFF,ON; if recovered >>
- If MDU blank or autonomous:
7. Set other MDU on same IDP to DPS Mode; if recovered >>
8. Return other MDU to nominal config
9. Deassign aff IDP from PASS
10. GPC/CRT 04 EXEC
11. In PASS: GPC/CRT 44 EXEC

**BFS DISPLAY FAIL**

1. If IDP4(CRT4): IDP/CRT4 PWR – OFF >>
2. MDU PWR – OFF,ON; if recovered >>
3. BFC CRT SEL – unaff IDP; if both IDPs OK >>
4. – orig posn
5. BFC CRT DISPLAY – OFF,ON; if recovered >>
6. In PASS: GPC/CRT 5/X for aff IDP; if recovered >>
7. Report MDU symptoms
- If MCC GO for pwr cycle:
8. IDP/CRT PWR – OFF,ON; if recovered >>
- If MDU blank or autonomous:
9. Set other MDU on same IDP to DPS Mode; if recovered >>
10. Return other MDU to nominal config
11. BFC CRT SEL – unaff IDP
12. Deassign aff IDP from PASS
13. GPC/CRT 04 EXEC
14. In PASS: GPC/CRT 44 EXEC

MDP

PLT WND

FB E12-13

AESP/ALL/E/GEN O

FAB USE ONLY

PILE

**FLT INST DISPLAY ANOMALY**

1. DATA BUS sel alt FC BUS(s); if recovered >>
2. PORT SELECT aff MDU; if recovered >>
3. MDU PWR – OFF,ON

**SUBSYS STATUS DISPLAY ANOMALY**

1. PORT SELECT aff MDU; if recovered >>
2. MDU PWR – OFF,ON; if recovered >>

**MULT DATA PATH LOSS (non-Recov)**

NOTE

If LRU data path loss due to GPC prob and not MDM,  
BFS will pick up MDMs/LRU when engaged

FAILURE	TYPE	ACTIONS
GPC/FF 1&2	I/O or B	Use R BODY FLAP & TRIM ENA sws
GPC/FF 3&4	I/O or B	Use L BODY FLAP & TRIM ENA sws
GPC/FA any combo	I/O or D	No impact

**BCE  
CRT**

PLT WND

FB E12-14

AESP/ALL/E/GEN O

FAB USE ONLY

TOP

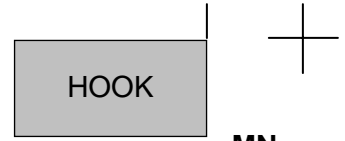
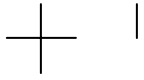

**MN  
AC**

This Page Intentionally Blank

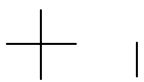

PLT WND

FB E12-15

AESP/ALL/E/GEN O

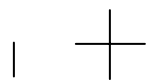

FAB USE ONLY

PILE

BCE  
CRT  
MDP

### MN BUS UNDERVOLTS/FC VOLTS

If MN V < 26.4, FC V < 26.6, FC A > 480 (2 of 3)

(SHORT or degraded FC):

- ⇒
1. MSTR MADS PWR – OFF
  2. If aff BUS tied – untie
  3. PL PRI (three) – OFF
  4. (Aff) ESS BUS SOURCE FC – OFF  
FC/MN BUS – OFF

If FC VOLTS < 32 (FC SHORT)

5. (Aff) FC REAC VLV – CL
6. Go to FC SHUTDN (do not stop FC until  
COOL P < 15 and STACK T < 243) >>

If FC VOLTS ≥ 32 (BUS SHORT)

7. Go to BUS LOSS ACTION >>

If MN V < 26.4 and FC V > 32 and FC A < 20

(FC disconnect, check APUs):

8. MSTR MADS PWR – OFF
9. PL PRI (three) – OFF
10. FC/MN BUS – ON

If FC3 aff:

11. PL PRI MNC – ON  
FC3 – ON
12. If MNC V < 26.4: PL PRI (three) – OFF

If 1st FC failure:

13. Perform BUS TIE, then:

If MN BUS recovered:

14. GNC I/O RESET

If aff FC VOLTS > 32:

15. Go to FC SHUTDN

### AC VOLT HIGH

If AC V > 123 and F9 V > 123:

- ⇒
1. (Aff) AC BUS SNSR – OFF
  2. cb AC CONTR – cl  
INV/AC BUS – OFF  
INV PWR – OFF  
cb AC CONTR – op
  3. √H2O PUMP LOOP 2(1) – ON
  4. Go to aff BUS LOSS

PLT WND

FB E12-16

AESP/ALL/E/GEN O

FAB USE ONLY

HOOK

**AC VOLT LOW or OVERLOAD**

- ⇒ If amps > 14 or V < 110:  
If single  $\Phi$  amps > 14 or V > 10:  
1. cb AC CONTR – cl  
INV/AC BUS – OFF  
INV PWR – OFF  
cb AC CONTR – op  
2. If other  $\Phi$  amps > 14:  
Go to step 3  
If multi  $\Phi$  (bus short):  
3. (Aff) cb AC CONTR (three) – cl  
INV/AC BUS – OFF (tb-OFF)  
INV PWR – OFF (tb-OFF)  
cb AC CONTR (three) – op  
AC BUS SNSR – OFF  
4. Go to aff BUS LOSS

**3 $\Phi$   
MN  
AC  
SUB**

PLT WND

FB E12-17

AESP/ALL/E/GEN O

FAB USE ONLY

TOP  
BACK OF 'AC VOLT LOW or OVERLOAD'

PILE

**MN  
AC**

**3Φ AC MOTORS STOPPED**

1. (Aff) AC BUS SNSR – OFF
2. Determine AC BUS:
  - FC1 and FREON PUMP 2B: AC1
  - FC2 and FREON PUMP 1B: AC2
  - FC3 and CAB FAN A: AC3
3. (Aff) FC – STOP  
If AC3 aff:
  4. AV BAY 3 FAN B – OFF, A – ON
  5. CAB FAN A – OFF
 Isolate aff ΦB(ΦC,ΦA):
  6. (Aff) cb AC CONTR – cl
  7. INV/AC BUS – OFF
 If AC1(2,3) aff and AV BAY 3(2,3) FAN ΔP ≥ 0.5:
  8. Go to step 16 (bad Φ isolated):
  9. (Aff) INV/AC BUS – ON
  10. cb AC CONTR – op
  11. Repeat from step 6 to isolate aff ΦC(ΦA), then:
 Drop aff AC bus (three Φs):
  12. (Aff) cb AC CONTR (three) – cl
  13. INV/AC BUS – OFF
  14. INV PWR – OFF
  15. Go to aff BUS LOSS >>
 Bad Φ isolated:
  16. (Aff) FC – START (10 sec or ΔP tb-gray)
  17. Perform aff BUS LOSS and if AC1(AC2) aff >>
  18. If AC3 aff: CAB FAN B – ON

⇒ **AC SINGLE Φ**

<b>AC1</b>	<b>ΦA</b>	BLR CNTLR/HTR 1 – A When V = 12K: RAD CNTLR LOOP (two) – AUTO A
	<b>ΦB</b>	When V = 12K: RAD CNTLR LOOP (two) – AUTO A
	<b>ΦC</b>	BLR CNTLR/HTR 3 – B
<b>AC2</b>	<b>ΦA</b>	BLR CNTLR/HTR 1 – B
	<b>ΦB</b>	SIG CONDR FREON A – AC3
	<b>ΦC</b>	BLR CNTLR/HTR 2 – A
<b>AC3</b>	<b>ΦA</b>	BLR CNTLR/HTR 2 – B
	<b>ΦB</b>	SIG CONDR FREON B – AC2
	<b>ΦC</b>	BLR CNTLR/HTR 3 – A

PLT WND

FB E12-18

AESP/ALL/E/GEN O

FAB USE ONLY



**MNA or AC1 Multi Φ**

- 1. MSTR MADS PWR – OFF
- 2. Perform FC SHUTDN (within 9 min), then:
- ⇒ 3. BLR CNTLR/HTR 1 – A  
3 – B

FAILED: TAC 1  
MLS 1, RA 1, NWS 1, L HUD

**MNB or AC2 Multi Φ**

- 1. MSTR MADS PWR – OFF
- 2. Perform FC SHUTDN (within 9 min), then:
- ⇒ 3. BLR CNTLR/HTR 2 – A  
1 – B
- 4. SIG CONDR FREON A – AC3

FAILED: TAC 2  
MLS 2, RA 2, NWS 2  
PLT DRAG CHUTE ARM  
S-BD PM 1 (NO PNL,CMD)

**ESS  
CNTL**

**MNC or AC3 Multi Φ**

- 1. S-BD PM CNTL – PNL,CMD
- 2. Config per COMM COVER (ASC) BFS G51:  
TDRS – ITEM 46 EXEC (\*)  
STDN-HI – ITEM 47 EXEC (\*)  
SGLS – ITEM 49 EXEC (\*)
- 3. MSTR MADS PWR – OFF
- ⇒ 4. Perform FC SHUTDN (within 9 min), then:
- 5. BLR CNTLR/HTR 3 – A  
2 – B
- 6. SIG CONDR FREON B – AC2

FAILED: TAC 3, MLS 3, R HUD  
CDR DRAG CHUTE ARM

**SUBBUS**

SUBBUS or ALC	4 1	5 2	6 3
⇒ 1. BLR CNTLR/HTR	1 – A 3 – B	2 – A 1 – B	3 – A 2 – B

**ESS BUS V LOW**

If verified by F9 voltmeter:

- 1. Perform FC SHUTDN (<9 min), then:
- 2. Go to aff ESS BUS LOSS

PILE

**ESS BUS LOSS**

<b>ESS 1BC</b>	<b>O13&amp;R14</b>	1. L AUD CNTL sel – R (CDR can't talk) 2. Pri C/W & F7 Matrix lost
<b>ESS 2CA</b>	<b>O13&amp;R14</b>	1. AUD CTR – 2 2. R AUD CNTL sel – L (PLT can't talk)
<b>ESS 3AB</b>	<b>O13</b>	1. GPC CAM Lights lost 2. Do not engage BFS ⇒ 3. BFS GPC OUTPUT – TERM

3Φ  
MN  
AC  
SUB

**CNTL BUS V LOW/CNTL BUS RPC**

WARNING  
If VISIBLE FIRE/SMOKE AT ANY TIME, cb CNTL  
BUS AB1/2/3(BC1/2/3,CA1/2/3) – op (pnl R14:B)

1. Identify BUS (√BUS LOSS ID)
- ⇒ If bus critical (per MCC):
- ◆ 2. >>
- ◆ If one CNTL BUS RPC tripped (\*):  
Aff CNTL BUS:

**AB1(2,3)**

	Tripped RPC (*)	Action (for RESET, hold w/sw reten device)
3.	<b>A</b>	R1 CNTL BUS PWR MNB – RESET R14:B cb CNTL BUS AB1/2/3 – op
4.	<b>B</b>	R1 CNTL BUS PWR MNA – RESET R14:B cb CNTL BUS AB1/2/3 – op

**BC1(2,3)**

	Tripped RPC (*)	Action (for RESET, hold w/sw reten device)
5.	<b>B</b>	R1 CNTL BUS PWR MNC – RESET R14:B cb CNTL BUS BC1/2/3 – op
6.	<b>C</b>	R1 CNTL BUS PWR MNB – RESET R14:B cb CNTL BUS BC1/2/3 – op

Cont next page

PLT WND

FB E12-20

AESP/ALL/E/GEN O

FAB USE ONLY





**CA1(2,3)**

	Tripped RPC (*)	Action (for RESET, hold w/sw reten device)
7.	<b>C</b>	R1 CNTL BUS PWR MNA – RESET R14:B cb CNTL BUS CA1/2/3 – op
8.	<b>A</b>	R1 CNTL BUS PWR MNC – RESET R14:B cb CNTL BUS CA1/2/3 – op

◆ If no CNTL BUS RPC tripped (no \*):

	aff CNTL BUS	Pnl R1 Action (RESET, hold w/sw reten device)
9.	<b>AB1(2,3)</b>	CNTL BUS PWR MNA,MNB (two) – RESET
10.	<b>BC1(2,3)</b>	CNTL BUS PWR MNB,MNC (two) – RESET
11.	<b>CA1(2,3)</b>	CNTL BUS PWR MNA,MNC (two) – RESET

◆ 12. Perform aff CNTL BUS LOSS, then:

If pwr reqd (<3 sec) for crit function:

13. Hold crit function sw

For tripped RPC:

14. CNTL BUS PWR MNA(MNB,MNC) – RESET  
(1 sec), then dn

15. ⇒

**CNTL BUS LOSS**

<b>AB1</b>	⇒	1. Use R TRIM & BDY FLP sws 2. BLR CNTLR/HTR 1 – A
<b>AB2</b>	⇒	1. <b>G23</b> RCS FWD MANF VLVS 1 OVRD – ITEM 40 EXEC (CL) 2. BLR CNTLR/HTR 1 – A FAILED: L HUD
<b>AB3</b>	⇒	1. <b>G51</b> RCS RM MANF CL OVRD – ITEM 41 EXEC If BFS engage reqd: 2. Use PLT's RHC, then GPCs 1,2,4 – STBY,HALT 3. BFS I/O RESET ⇒ 4. BLR CNTLR/HTR 1,3 (two) – B

**CNTL  
BUS  
LOSS**

Cont next page

PLT WND

FB E12-21

AESP/ALL/E/GEN O

FAB USE ONLY

TOP  
 BACK OF 'CNTL BUS V LOW/CNTL BUS RPC' (Cont)

PILE

**CNTL BUS LOSS (Cont)**

<b>BC1</b>	⇒	1. Use R TRIM & BDY FLP sws 2. BLR CNTLR/HTR 2 – A FAILED: R HUD CDR DRAG CHUTE DPY/JETT S-BD PM 1 (NO PNL,CMD)
<b>BC2</b>		1. S-BD PM CNTL – PNL,CMD 2. <b>G51</b> Config per <u>COMM COVER</u> (ASC): TDRS – ITEM 46 EXEC (*) STDN-HI – ITEM 47 EXEC (*) SGLS – ITEM 49 EXEC (*) 3. <b>G23</b> RCS FWD MANF VLVS 2 OVRD – ITEM 41 EXEC (CL) 4. PLT disp sws – green dot ⇒ 5. Use L TRIM & BDY FLP sws 6. BLR CNTLR/HTR 2 – A FAILED: CDR DRAG CHUTE DPY/JETT
<b>BC3</b>		1. <b>G51</b> RCS RM MANF CL OVRD – ITEM 41 EXEC ⇒ 2. BLR CNTLR/HTR 1,2 (two) – B
<b>CA1</b>	⇒ ♦	1. No BFS engage GPC 3,5 2. BFS GPC OUTPUT – TERM 3. BLR CNTLR/HTR 3 – A FAILED: PLT DRAG CHUTE DPY/JETT
<b>CA2</b>	⇒	1. <b>G23</b> RCS FWD MANF VLVS 3 OVRD – ITEM 42 EXEC (CL) 2. Use L TRIM & BDY FLP sws 3. BLR CNTLR/HTR 3 – A FAILED: PLT DRAG CHUTE DPY/JETT
<b>CA3</b>	⇒	1. BLR CNTLR/HTR 2,3 (two) – B

CNTL  
BUS  
LOSS

PLT WND

FB E12-22

AESP/ALL/E/GEN O

FAB USE ONLY

HOOK

**FC REAC VLV CLOSED**

1. FC REAC VLV (three) – OP
2. Perform BUS TIE, then:  
If FC COOL P < 50:
3. Go to FC SHUTDN

**FC pH ↓ 1(2,3) or FC DELTA V 1(2,3)**

If pH ↓ and FC SS 1(2,3) ΔV > 150  
or FC SS ΔV > 150 and incr:

1. Perform BUS TIE, then:
2. (Aff) FC REAC VLV – CL
3. MSTR MADS PWR – OFF
4. Go to LOSS OF 1(2nd) FC PWRDN >>

If pH ↓ only:

- ◆ 5. Go to BUS TIE

**FC STACK T**

1. MSTR MADS PWR – OFF

If STACK T > 243 and incr:

2. If 2nd FC: Go to 2nd FC SHUTDN >>
3. PL PRI (three) – OFF

If aff FC amps < 170 or > 360:

4. Go to MN BUS UNDERVOLTS/FC VOLTS,  
step 4 >>
  - ◆ 5. Perform BUS TIE, then:
  6. ESS BUS SOURCE FC – OFF
  7. FC/MN BUS – OFF
- If aff FC VOLTS < 32 or STACK T not decr:
8. (Aff) FC REAC VLV – CL
  9. FC – STOP after COOL P < 15 and  
STACK T < 243
  10. Go to LOSS OF 1 FC PWRDN

FC

**OV103,104**

PLT WND (OV103,104) FB E12-23

AESP/ALL/E/GEN O

FAB USE ONLY

TOP  
BACK OF 'FC REAC VLV CLOSED'

PILE

**FC EXIT T**

1. MSTR MADS PWR – OFF
2. Perform BUS TIE, then:

- ⇒ If EXIT T > 164 and incr or < 131 and no comm:  
3. Go to FC SHUTDN

**FC COOLANT PUMP ΔP LOW**

1. FC – START (10 sec or ΔP tb-gray)

- ⇒ ♦ If EXIT T > 164 and not decr or  
RDY tb – bp (30 sec after START) or  
FC PUMP cb(s) – op (pnl L4:C):

2. Go to FC SHUTDN >>

If EXIT T norm, RDY tb – gray, and no comm:

3. Monitor AC amps

4. FC – STOP

If AMPS decr 0.7-0.9 AMP/Φ:

5. FC – START (hold 30 sec if ΔP tb-bp)

6. If AMPS incr 0.7-0.9 AMP/Φ >>

7. Go to FC SHUTDN

**FC COOL P**

1. Perform BUS TIE, then:

- ⇒ If COOL P < 75: >>

If COOL P incr and not 100 (H),  
or FC COOL PUMP = ΔP (intermittent),  
or STACK/EXIT T unstable,

2. (Aff) FC REAC VLV – CL

3. MSTR MADS PWR – OFF

4. Go to LOSS OF 1(2nd) FC PWRDN

**LOSS OF 1 FC PWRDN (GRTLS/TAL)**

1. PRI PL (three) – OFF  
AFT PL (two) – OFF

2. IDP/CRT4 PWR – OFF  
One MDU – OFF

- ⇒ If TAL:

When V < 19K:

3. MPS ENG PWR (six) – OFF

**LOSS OF 1 FC PWRDN (ENTRY)**

1. If V < 15K >>

2. IDP/CRT4, one MDU, FLT CNTLR PWR – OFF

3. TACAN/RA/MLS – OFF

If middeck PL on:

4. cb MNB UTIL PWR – op (pnl O15:C)

- ♦ 5. PRI PL (three) – OFF  
AFT PL (two) – OFF

FC

**OV103,104**

PLT WND (OV103,104) FB E12-24

AESP/3,4/E/GEN O

FAB USE ONLY

HOOK

**FC REAC VLV CLOSED**

1. FC REAC VLV (three) – OP
2. Perform BUS TIE, then:  
If FC COOL P < 50:
3. Go to FC SHUTDN

**FC pH ↓ 1(2,3) or FC DELTA V 1(2,3)**

If pH ↓ and FC SS 1(2,3)  $\Delta V > 150$   
or FC SS  $\Delta V > 150$  and incr:

1. Perform BUS TIE, then:
  2. (Aff) FC REAC VLV – CL
  3. MSTR MADS PWR – OFF
  4. Go to LOSS OF 1(2nd) FC PWRDN >>
- If pH ↓ only:
- ◆ 5. Go to BUS TIE

**FC STACK T**

1. MSTR MADS PWR – OFF
- If STACK T > 243 and incr:
2. If 2nd FC: Go to 2nd FC SHUTDN >>
  3. PL PRI (three) – OFF
- If aff FC amps < 170 or > 360:
4. Go to MN BUS UNDERVOLTS/FC VOLTS,  
step 4 >>
- ◆ 5. Perform BUS TIE, then:
  - 6. ESS BUS SOURCE FC – OFF
  - 7. FC/MN BUS – OFF
- If aff FC VOLTS < 32 or STACK T not decr:
8. (Aff) FC REAC VLV – CL
  9. FC – STOP after COOL P < 15 and  
STACK T < 243
  10. Go to LOSS OF 1 FC PWRDN

FC

**OV105**

PLT WND

(OV105) FB E12-23

AESP/ALL/E/GEN O

FAB USE ONLY

TOP  
BACK OF 'FC REAC VLV CLOSED'

PILE

**FC EXIT T**

1. MSTR MADS PWR – OFF
2. Perform BUS TIE, then:

- ⇒ If EXIT T > 164 and incr or < 131 and no comm:  
3. Go to FC SHUTDN

**FC COOLANT PUMP ΔP LOW**

1. FC – START (10 sec or ΔP tb-gray)

- ⇒ ♦ If EXIT T > 164 and not decr or  
RDY tb – bp (30 sec after START) or  
FC PUMP cb(s) – op (pnl L4:C):

2. Go to FC SHUTDN >>

If EXIT T norm, RDY tb – gray, and no comm:

3. Monitor AC amps
4. FC – STOP

If AMPS decr 0.7-0.9 AMP/Φ:

5. FC – START (hold 30 sec if ΔP tb-bp)

6. If AMPS incr 0.7-0.9 AMP/Φ >>

7. Go to FC SHUTDN

**FC COOL P**

1. Perform BUS TIE, then:

- ⇒ If COOL P < 75: >>

If COOL P incr and not 100 (H),  
or FC COOL PUMP = ΔP (intermittent),  
or STACK/EXIT T unstable,

2. (Aff) FC REAC VLV – CL

3. MSTR MADS PWR – OFF

4. Go to LOSS OF 1(2nd) FC PWRDN >>

**LOSS OF 1 FC PWRDN (GRTLS/TAL)**

1. PRI PL (three) – OFF

AFT PL (two) – OFF

2. IDP/CRT4 PWR – OFF

One MDU – OFF

- ⇒ If TAL:

When V < 19K:

3. MPS ENG PWR (six) – OFF

**LOSS OF 1 FC PWRDN (ENTRY)**

1. If V < 15K >>

2. IDP/CRT4, one MDU, FLT CNTLR PWR – OFF

3. RA/MLS – OFF

If middeck PL on:

4. cb MNB UTIL PWR – op (pnl O15:C)

- ♦ 5. PRI PL (three) – OFF

AFT PL (two) – OFF

FC

**OV105**

PLT WND

(OV105) FB E12-24

AESP/5/E/GEN O

FAB USE ONLY

HOOK

**2nd FC SHUTDOWN (GRTLS/TAL)**

(CL PMP Lost: &lt; 6 min)

1. Have CDR start LOSS OF 2nd FC PWRDN (GRTLS/TAL)

If three MN buses pwr:

2. MN BUS TIE (three) – OFF  
(do not perform BUS LOSS ACTION)
3. LES O2 – OFF, visors – OP
4. Switch off all but one IDP/CRT with four MDUs
5. All PL pwr (seven) – OFF
6. O2,H2 TK HTRS (all) – OFF
7. After CDR pnl L1 config complete, continue:

If two MN buses pwr:

8. Pwr MN BUS TIES (two) – ON

If only one MN bus pwr:

9. MN BUS TIE (three) – OFF  
If only MNA(B,C) pwr: Secure APU 2(3,1)  
BUS TIE good FC/BUS (MNA)  
I/O RESET

When reqd:

10. ESS BUS SOURCE FC – OFF  
FC/MN BUS – OFF  
FC – STOP (1 sec)  
FC REAC VLV – CL
11. G51 √ICNCT ENA (if reqd for OMS load)
12. Go to LOSS OF 2nd FC PWRDN (GRTLS/TAL)

**2nd FC SHUTDOWN (ENTRY)**

1. Have CDR go to LOSS OF 2nd FC PWRDN (ENTRY)
  2. O2/H2 HTRS (twelve) – OFF (pnl R1)  
PL pwr (seven) – OFF
  3. √MSTR MADS PWR – OFF
- If aff FC/MN BUS is tied:
4. MN BUS TIE (two) – OFF
  5. If only MNA(B,C) pwr: Secure APU 2(3,1)
  6. Perform BUS TIE (good FC/BUS to another BUS), then:
  7. ESS BUS SOURCE FC – OFF  
FC/MN BUS – OFF  
FC – STOP (1 sec)  
FC REAC VLV – CL

**2FC/  
CRYO**

PLT WND

FB E12-25

AESP/ALL/E/GEN O

FAB USE ONLY

TOP  
BACK OF '2nd FC SHUTDOWN (GRTLS/TAL);  
FACING RIGHT SIDE OF BACKBOARD

PILE

### LOSS OF 2nd FC PWRDN (GRTLS/TAL)

- ⇒ ♦ When MPS Dump complete:
1. MPS ENG PWR (six) – OFF  
EIU (three) – OFF
  2. MEC 1 – OFF, wait 2 sec, then  
2 – OFF
- If MNA(MNB) unpwrdr:
3. O<sub>2</sub>,H<sub>2</sub> TK1 HTRS B (two) – AUTO
- If MNC unpwrdr:
4. O<sub>2</sub>,H<sub>2</sub> TK2 HTRS B (two) – AUTO
  5. Safe Payload, if reqd
  6. Go to APU RESTART for secured APU

### O<sub>2</sub>(H<sub>2</sub>) CRYO P/T HIGH

O<sub>2</sub>(H<sub>2</sub>) TK HTRS (two) – OFF

### CRYO O<sub>2</sub>(H<sub>2</sub>) LEAK (three or more tanks aff)

Use meter if CRT data OSL

1. O<sub>2</sub>(H<sub>2</sub>) MANF VLV TK1,TK2 (two) – CL
  2. O<sub>2</sub>(H<sub>2</sub>) TK3 HTRS A – AUTO
- ⇒ If TK1 and TK2 P decr slowly (HTR logic fail):
3. If QTY > 55%: TK3 HTRS B – AUTO
  4. MANF VLV 1,2 (two) – OP >>
  5. Perform aff MN BUS TIE, then:
- If O<sub>2</sub>(H<sub>2</sub>) TK1(2) aff (open unaff manf):
6. O<sub>2</sub>(H<sub>2</sub>) TK2(1) – OP
- If O<sub>2</sub> TK1(2) aff:
7. O<sub>2</sub> SYS 1(2) SPLY – CL
  8. If O<sub>2</sub> TK1(2) P now incr (PCS leak): >>
  9. If O<sub>2</sub> leak: (Aff) TK HTR B – AUTO
- If aff TK P not incr:
10. If TK3 aff: √HTRS A(&B if O<sub>2</sub>) – AUTO
  11. Perform aff FC SHUTDOWN (post COOL P alarm if O<sub>2</sub> leak), then:
- If TK3 aff and P not decr within 2 min (FC leak):
12. MANF VLV 1,2 (two) – OP (ASAP) >>
  13. (Aff) TK HTRS A,B (two) – OFF

2FC

PLT WND

FB E12-26

AESP/ALL/E/GEN O

FAB USE ONLY



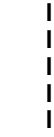
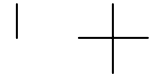
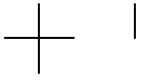

**POWERED  
FLIGHT**

**CDR WINDOW FLIP BOOK**

**POWERED FLIGHT**

**CDR WINDOW  
FLIP BOOK**

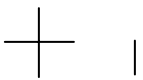

CDR WND

FB A13-i

AESP/ALL/A/GEN O

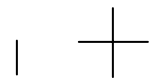

**FAB USE ONLY**

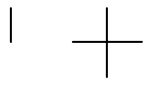
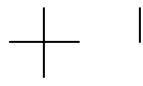

POWERED  
FLIGHT



This Page Intentionally Blank

CDR WINDOW  
FLIP BOOK

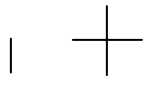
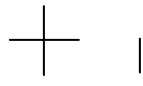

CDR WND

FB A13-ii

AESP/ALL/A/GEN O

FAB USE ONLY

TOP  
FACING LEFT SIDE OF BACKBOARD

HOOK

DPS  
GPC  
MDM

**COMM LOST (mult pnls)**

1. AUD CTR – 2
2. No joy, S-BD PM CNTL – PNL,CMD
3. Config per COMM COVER (ASC) BFS G51:  
TDRS – ITEM 46 EXEC (\*)  
STDN-HI – ITEM 47 EXEC (\*)  
SGLS – ITEM 49 EXEC (\*)
4. No joy, sel best S-BD PM ANT; else GPC ⇒

**ICOM LOST**

1. AUD CNTL sel – sel alt
2. No joy, AUD CTR – 2

---

**FCS CH 1(2,3,4) (2nd FAIL) G53**

If two FCS CH ↓ on any actuator:

- ◆ (Remaining) FCS CH (two) – ORIDE

**RHC L(R) (2nd FAIL)**

(Aff) FLT CNTLR PWR – OFF

**DISPLAY SW L(R)**

L(R) disp sws – green dot

**RM FAIL IMU,RGA,AA BFS G51**

Aff LRU – desel

**RM DLMA IMU G51 BFS G51**

1. √MCC, bad IMU – desel (PASS & BFS) >>
- ◆ 2. Desel lower # IMU with '?' (PASS)

---

**POST BFS ENGAGE**

If PASS GPCs running:

1. (Aff) GPC MODE – STBY/HALT
  2. BFS I/O RESET
  3. √FCS CHs, IMU config
- If Pre MECO:
4. If SSME failed: MN ENG LIMIT SHUTDN –INH
  5. G51 DES failed(commfaulted) RGA,AA,SURF ⇒G

CDR WND

FB A13-1

AESP/ALL/A/GEN O

FAB USE ONLY

COMM  
GNC  
DPS  
BFS

PILE

**PASS GPC FAIL**

1. (Aff) FCS CH – OFF  
If two GPC/FA/FCS CHs ↓:
    2. (Good) FCS CHs – ORIDE
    3. √MPS CMD
    4. [G53] aff SURF FDBK – desel
    5. If FTS, ASAP, GPC MODE – STBY,HALT
    6. √BIG 'X', then assign IDPs as reqd
    7. √MULT DATA PATH LOSS
- Post MECO:
8. ASAP, GPC MODE – STBY,HALT ⇒

**BFS GPC FAIL**

1. Post SRB SEP: FLASH EVAP CNTLR PRI A – ON
- Post MECO:
2. GPC MODE – STBY,HALT  
OUTPUT – TERM
- ◆ 3. If no comm: sel best S-BD PM ANT ⇒

**FF(FA) MDM OUTPUT**

**FAULT**

- ◆ (Take action only if annun by entire set)  
If single 'MDM OUTPUT':
  1. Go to FA/FF MDM I/O ERROR >>
- If both FF and FA annun:
  2. I/O RESET; if reqd, BFS I/O RESET
  3. If msgs repeat: Go to PASS GPC FAIL >>
  4. If reqd, (aff) FCS CH – ORIDE,AUTO

**PL MDM I/O ERROR**

1. BFS I/O RESET; if recovered >>
- ◆ 2. [G01] PL1/2 – port mode, then BFS I/O RESET;  
if recovered >>
3. If PL2 down:  
Post SRB SEP: FLASH EVAP CNTLR PRI A – ON  
If no comm: sel best S-BD PM ANT ⇒

**PCM I/O ERROR**

OI PCMMU PWR – 2

**SUMWORD ICC**

- If TAL:  
| Go to OPS 1/6/TAL TRANSITION RESTRING (Cue Card)  
| for aff GPC >>
- If AOA/Uphill: ⇒A

CDR WND

FB A13-2

AESP/ALL/A/GEN O

FAB USE ONLY



**FA/FF MDM I/O ERROR**  
(Annunciated by entire set)

		1. I/O RESET
RECOV	FA	2. If reqd, (aff) FCS CH – ORIDE,AUTO
		3. BFS I/O RESET >>
NOT RECOV	FA	4. (Aff) FCS CH – OFF
		5. If two GPC/FA/FCS CHs ↓: (Good) FCS CHs – ORIDE
		6. <b>G53</b> aff SURF FDBK – desel
		7. √MULT DATA PATH LOSS
		◆ 8. Go to FA/FF MDM PORT MODE ⇒

**BCE  
MDP**

**FA/FF MDM PORT MODE**

NOTE

If BFS, 'BCE STRG X PASS', @GPC; else @MDM.  
For '@GPC' port mode results in alternate MDM bypass

			1. <b>G01</b> aff String – port mode
			2. BFS I/O RESET
@MDM	RECOV	FA	3. (Aff) FCS CH – AUTO
		FF	4. <b>G53</b> aff SURF FDBK – resel >>
			5. >>
	NOT RECOV	FA	6. <b>BFS G51</b> aff SURF FDBK, RGA – desel
		FF	7. <b>BFS G51</b> aff AA – desel
			8. √MULT DATA PATH LOSS ⇒
@GPC	FA RECOV (FF Give Up)		9. (Aff) FCS CH – AUTO
			10. <b>G51</b> aff IMU – desel
			11. <b>G53</b> aff SURF FDBK – resel
			12. √MULT DATA PATH LOSS ⇒A
	FF RECOV (FA Give Up)		13. (Aff) FCS CH – OFF
			14. If two GPC/FA/FCS CHs ↓: (Good) FCS CHs – ORIDE
			15. <b>G53</b> aff SURF FDBK – desel
			16. √MULT DATA PATH LOSS ⇒A

PILE

DPS  
GPC  
MDM

**BCE STRG X** (no 'MDM OUTPUT' msg)

	IMU	1. <b>G51</b> IMU – desel
		2. I/O RESET
RECOV	IMU	3. >>
		4. >>
NOT RECOV	NSP	5. And no comm: PNL,CMD
		6. <b>BFS G51</b> Config per COMM COVER (ASC): TDRS – ITEM 46 EXEC (*) STDN-HI – ITEM 47 EXEC (*) SGLS – ITEM 49 EXEC (*) >>
		◆ 7. <b>G01</b> aff String – port mode
		8. BFS I/O RESET
		9. If recov, go to RECOV steps >>
	B	10. <b>BFS G51</b> aff AA – desel
	D	11. <b>BFS G51</b> aff SURF FDBK,RGA – desel
	B/D	12. If RTLS: <b>G23</b> OVRD aff MANF(s) – OP
		13. √MULT DATA PATH LOSS ⇒

**DUAL DPS DISPLAY COMMANDERS/DK XMTR 1(2,3)**

1. BFC CRT SEL – aff IDP  
If reqd to clean up display:
2. (Aff) IDP/CRT PWR – OFF,ON

**PASS DISPLAY FAIL**

1. MDU PWR – OFF,ON; if recovered >>
2. GPC/CRT – same GPC/aff IDP; if recovered >>
3. BFC CRT SEL – aff IDP; if both IDPs OK go to step 9
4. – orig posn
5. Report MDU symptoms
- If MCC GO for pwr cycle:
6. IDP/CRT PWR – OFF,ON; if recovered >>
- If MDU blank or autonomous:
7. Set other MDU on same IDP to DPS Mode; if recovered >>
8. Return other MDU to nominal config
9. Deassign aff IDP from PASS
10. GPC/CRT 04 EXEC
11. In PASS: GPC/CRT 44 EXEC

CDR WND

FB A13-4

AESP/ALL/A/GEN O

FAB USE ONLY

HOOK

**BFS DISPLAY FAIL**

1. If IDP4(CRT4): IDP/CRT4 PWR – OFF >>
  2. MDU PWR – OFF,ON; if recovered >>
  3. BFC CRT SEL – unaff IDP; if both IDPs OK >>
  4. – orig posn
  5. BFC CRT DISPLAY – OFF,ON; if recovered >>
  6. In PASS: GPC/CRT 5/X for aff IDP; if recovered >>
  7. Report MDU symptoms
- If MCC GO for pwr cycle:
8. IDP/CRT PWR – OFF,ON; if recovered >>
- If MDU blank or autonomous:
9. Set other MDU on same IDP to DPS Mode; if recovered >>
  10. Return other MDU to nominal config
11. BFC CRT SEL – unaff IDP
  12. Deassign aff IDP from PASS
  13. GPC/CRT 04 EXEC
  14. In PASS: GPC/CRT 44 EXEC

CDR WND

FB A13-5

AESP/ALL/A/GEN O

FAB USE ONLY

TOP  
BACK OF 'BFS DISPLAY FAIL'

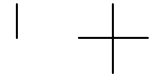
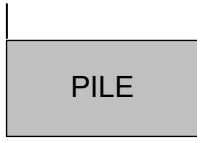

This Page Intentionally Blank



CDR WND

FB A13-6

AESP/ALL/A/GEN O

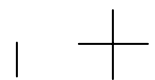

FAB USE ONLY





**FLT INST DISPLAY ANOMALY**

1. DATA BUS sel alt FC BUS(s); if recovered >>
2. PORT SELECT aff MDU; if recovered >>
3. MDU PWR – OFF,ON

**SUBSYS STATUS DISPLAY ANOMALY**

1. PORT SELECT aff MDU; if recovered >>
2. MDU PWR – OFF,ON; if recovered >>

**BFS INADVERTENT DISENGAGE/UNSUCCESSFUL ENGAGE (Lightning Strike)**

1. CDR and PLT RHC BFS engage pb – push  
If no response:
  2. BFS OUTPUT – NORM,B/U
  3. CDR,PLT RHC BFS engage pb – push

**CAB P  
ECLSS  
FREON**

**MULT DATA PATH LOSS (non-Recov)**

NOTE

If LRU data path loss due to GPC prob and not MDM,  
BFS will pick up MDMs/LRU when engaged

FAILURE	TYPE	ACTIONS
GPC/FA any combo	I/O	D √BFS MM at each transition Expect 'SEP INH' (FDLN Fail) combos 2&3,2&4
		√OMS MAN SHUTDOWN Post MECO: <b>Before MECO + 25 sec: ••</b> 1. MPS FDLN RLF ISOL (two) – OP 2. MPS PREVLVs (six) – OP RTLS/TAL: MPS FILL/DRAIN LH2 INBD, OUTBD – OP
GPC/FF 1&2	I/O or B	Use R BODY FLAP & TRIM ENA SWs
GPC/FF 3&4	I/O or B	Use L BODY FLAP & TRIM ENA SWs

CDR WND

FB A13-7

AESP/ALL/A/GEN O

FAB USE ONLY

TOP  
BACK OF 'FLT INST DISPLAY ANOMALY'

PILE

**CAB PRESS LEAK**

1. CAB RELIEF A – CL,pause,  
B – CL
2. Check tabs, visors – CL, LES O2 – ON
3. If RTLS/TAL: O2/N2 CNTLR VLV SYS 2 – OP
4. O2 TK1,TK2 HTRS A,B (four) – AUTO ⇒

**CAB PRESS HIGH**

1. If incr: LES O2 – OFF, visors – OP  
If still incr:
  2. N2 SYS 1,2 REG INLET (two) – CL
  3. O2 SYS 1,2 SPLY (two) – CL ⇒A

**BCE  
MDP**

**PPO2 ABNORMAL ⇒A**

**H2O LOOP PRESS HIGH**

◆ Deact pump ⇒

**H2O LOOP PRESS LOW ⇒**

**AV BAY FAN ΔP**

◆ Deact fan ⇒

**AV BAY TEMP HIGH ⇒**

**CABIN FAN FAIL ⇒**

**IMU FAN FAIL ⇒**

CDR WND

FB A13-8

AESP/ALL/A/GEN O

FAB USE ONLY

HOOK

**FREON FLOW LOW**

- ◆ 1. Switch pumps
- If flow still low:
  - 2. (Aff) RAD BYP VLV MAN SEL – RAD FLOW  
(hold 5 sec)
- If flow still low:
  - 3. Perform LOSS OF FREON LOOP(s), then ⇒A

**LOSS OF 1 FREON LOOP**

- 1. (Bad) FREON PUMP LOOP – OFF
- If FREON LOOP 1(2) lost:
  - 2. O2 SYS 1(2) SPLY (one) – CL
  - 3. √FLOW PROP VLV LOOP 2(1) – ICH
- 4. Monitor EVAP OUT TEMP
- If TAL/AOA/RTLs and LOOP 2 lost:
  - 5. NH3 CNTLR B – OFF  
A – PRI/GPC

**LOSS OF 2 FREON LOOPS – PWRDN**

- 1. When loops fail (flow <700), CDR execute LOOPS  
FAILED
  - 2. MSTR MADS PWR – OFF
  - 3. Use one IDP/CRT with two MDUs (three max)
  - 4. All PL pwr (seven) – OFF
  - 5. O2,H2 TK HTRS (all) – OFF
  - 6. MCC CMD FC purge, then BFS GPC – STBY,HALT  
PWR – OFF  
OUTPUT – NORM
  - 7. If no comm: sel best S-BD PM ANT
- Post MECO:
- If RTLs:
    - 8. TACAN (three) – OFF
    - 9. RDR ALTM 1 – OFF ⇒G
  - If TAL:
    - 10. All TACAN/RA – OFF
    - 11. Use one FLT CNTLR PWR ⇒G

EVAP  
ESS**LOSS OF 2 FREON LOOPS – LOOPS FAILED**

- 1. LES O2 – OFF, visor – OP
- 2. O2 SYS 1,2 SPLY (two) – OP
- Panel L1: All sws off, except:
  - 3. H2O PUMP LOOP 2 – ON
- 4. Perform PWRDN if not already accomplished

**OV103,104**

CDR WND (OV103,104) FB A13-9

AESP/3,4/A/GEN O

FAB USE ONLY

TOP  
BACK OF 'FREON FLOW LOW'

PILE

**EVAP OUT TEMP HIGH**

If temp high in only one loop (snsr failed) >>

1. FLASH EVAP CNTLR PRI A – OFF  
B – ON (wait 30 sec)  
If T decr >>
2. FLASH EVAP CNTLR PRI B – OFF  
SEC – ON (HI LOAD ena)  
(wait 30 sec)  
If T decr:
  3. TOP EVAP HTR DUCT sel – A/B >>
4. HI LOAD EVAP – OFF (wait 30 sec)  
If T decr (HI LOAD EVAP only lost):
  5. HI LOAD DUCT HTR sel – A/B ⇒A
6. RAD BYP VLV (four) – MAN,RAD FLOW  
(total FES lost) ⇒A

**EVAP OUT T LOW**

1. If temp low in only one loop (snsr failed) >>
  2. FREON PUMP LOOP 1,2 (two) – OFF
  3. H2O PUMP LOOP 1 (two) – ON,B
  4. FLOW PROP VLV LOOP 1,2 (two) – PL HX (tb-PL)
  5. O2 SYS 1,2 SPLY (two) – CL (tb-CL)
  6. √RAD BYP VLV MODE (two) – MAN
  7. √MAN SEL (two) – BYP (tb-BYP ~3 sec)
  8. FLASH EVAP CNTLR PRI A,B,SEC (three) – OFF
  - ◆ 9. FREON PUMP LOOP 1,2 (two) – B  
NH3 CNTLR A,B (two) – SEC/ON
- Wait 3 min, then if any Freon Loop off:
10. FREON PUMP LOOP 1,2 (two) – B
- When EVAP OUT T > 55 for at least 2 min (NH3 depleted):
11. FLASH EVAP CNTLR PRI B – ON
  12. O2 SYS 1,2 SPLY (two) – OP (tb-OP)
  13. NH3 CNTLR A,B (two) – OFF

**FREON LEAK**

- ◆ 1. FREON ISOL MODE – MAN
  2. (Aff) FREON ISOL LOOP 1(2) – ISOL  
Hold for 5 sec  
If (aff) FREON LOOP 1(2) ACCUM QTY decr:
    3. When loop fails ('SM2 FREON FLOW 1(2)'), CDR  
execute LOSS OF 1 FREON LOOP for (aff) Freon  
Loop ⇒
- If (aff) FREON LOOP 1(2) ACCUM QTY not decr, ⇒A

CAB P  
ECLSS  
FREON

**OV103,104**

CDR WND (OV103,104) FB A13-10 AESP/ALL/A/GEN O,2

FAB USE ONLY

HOOK

**FREON FLOW LOW**

- ◆ 1. Switch pumps
- If flow still low:
  - 2. (Aff) RAD BYP VLV MAN SEL – RAD FLOW  
(hold 5 sec)
- If flow still low:
  - 3. Perform LOSS OF FREON LOOP(s), then ⇒A

**LOSS OF 1 FREON LOOP**

- 1. (Bad) FREON PUMP LOOP – OFF
- If FREON LOOP 1(2) lost:
  - 2. O2 SYS 1(2) SPLY (one) – CL
  - 3. √FLOW PROP VLV LOOP 2(1) – ICH
- 4. Monitor EVAP OUT TEMP
- If TAL/AOA/RTLS and LOOP 2 lost:
  - 5. NH3 CNTLR B – OFF  
A – PRI/GPC

**LOSS OF 2 FREON LOOPS – PWRDN**

- 1. When loops fail (flow <700), CDR execute LOOPS  
FAILED
- 2. MSTR MADS PWR – OFF
- 3. Use one IDP/CRT with two MDUs (three max)
- 4. All PL pwr (seven) – OFF
- 5. O2,H2 TK HTRS (all) – OFF
- 6. MCC CMD FC purge, then BFS GPC – STBY,HALT  
PWR – OFF  
OUTPUT – NORM
- 7. If no comm: sel best S-BD PM ANT
- Post MECO:
  - 8. GPS 1,3 (two) – OFF
  - If RTLS:
    - 9. RDR ALTM 1 – OFF ⇒G
  - If TAL:
    - 10. RA 1,2 (two) – OFF
    - 11. Use one FLT CNTLR PWR ⇒G

EVAP  
ESS**LOSS OF 2 FREON LOOPS – LOOPS FAILED**

- 1. LES O2 – OFF, visor – OP
- 2. O2 SYS 1,2 SPLY (two) – OP
- Panel L1: All sws off, except:
  - 3. H2O PUMP LOOP 2 – ON
- 4. Perform PWRDN if not already accomplished

**OV105**

CDR WND

(OV105) FB A13-9

AESP/5/A/GEN O

FAB USE ONLY

TOP  
BACK OF 'FREON FLOW LOW'

PILE

**EVAP OUT TEMP HIGH**

If temp high in only one loop (snsr failed) >>

1. FLASH EVAP CNTLR PRI A – OFF  
B – ON (wait 30 sec)  
If T decr >>
2. FLASH EVAP CNTLR PRI B – OFF  
SEC – ON (HI LOAD ena)  
(wait 30 sec)  
If T decr:
  3. TOP EVAP HTR DUCT sel – A/B >>
4. HI LOAD EVAP – OFF (wait 30 sec)  
If T decr (HI LOAD EVAP only lost):
  5. HI LOAD DUCT HTR sel – A/B ⇒A
6. RAD BYP VLV (four) – MAN, RAD FLOW  
(total FES lost) ⇒A

**EVAP OUT T LOW**

1. If temp low in only one loop (snsr failed) >>
  2. FREON PUMP LOOP 1,2 (two) – OFF
  3. H2O PUMP LOOP 1 (two) – ON,B
  4. FLOW PROP VLV LOOP 1,2 (two) – PL HX (tb-PL)
  5. O2 SYS 1,2 SPLY (two) – CL (tb-CL)
  6. √RAD BYP VLV MODE (two) – MAN
  7. √MAN SEL (two) – BYP (tb-BYP ~3 sec)
  8. FLASH EVAP CNTLR PRI A,B,SEC (three) – OFF
  - ◆ 9. FREON PUMP LOOP 1,2 (two) – B  
NH3 CNTLR A,B (two) – SEC/ON
- Wait 3 min, then if any Freon Loop off:  
10. FREON PUMP LOOP 1,2 (two) – B
- When EVAP OUT T > 55 for at least 2 min (NH3 depleted):
11. FLASH EVAP CNTLR PRI B – ON
  12. O2 SYS 1,2 SPLY (two) – OP (tb-OP)
  13. NH3 CNTLR A,B (two) – OFF

**FREON LEAK**

- ◆ 1. FREON ISOL MODE – MAN
  2. (Aff) FREON ISOL LOOP 1(2) – ISOL  
Hold for 5 sec
- If (aff) FREON LOOP 1(2) ACCUM QTY decr:  
3. When loop fails ('SM2 FREON FLOW 1(2)'), CDR  
execute LOSS OF 1 FREON LOOP for (aff) Freon  
Loop
- If (aff) FREON LOOP 1(2) ACCUM QTY not decr, ⇒A

CAB P  
ECLSS  
FREON

**OV105**

CDR WND

(OV105) FB A13-10

AESP/ALL/A/GEN O,2

FAB USE ONLY

HOOK

**ESS BUS LOSS**

<b>ESS 1BC</b>	<b>O13&amp;R14</b>	1. L AUD CNTL sel – R (CDR can't talk) 2. Pri C/W & F7 Matrix lost ⇒A 3. ⇒A
<b>ESS 2CA</b>	<b>O13&amp;R14</b>	1. AUD CTR – 2 2. R AUD CNTL sel – L (PLT can't talk) ⇒A 3. ⇒A
<b>ESS 3AB</b>	<b>O13</b>	1. GPC CAM Lights lost 2. Do not engage BFS ⇒

**LOSS OF 2nd FC PWRDN**

1. LES O2 – OFF, visors – OP
2. L1: Select one FREON PUMP on good FC/MN BUS and place other pump to OFF  
Switch OFF all HUM SEPS, IMU FANS, H2O PUMPS, AV BAY FANS, CAB FANS, FES HTRS
3. Switch off all but one IDP/CRT with four MDUs  
After BUS TIE, if MNC unprwd:
4. FLASH EVAP CNTLR PRI A – OFF  
B – ON
5. ⇒ LOSS OF 2nd FC PWRDN

MN  
AC  
CNTL  
FWD

CDR WND

FB A13-11

AESP/ALL/A/GEN O

FAB USE ONLY

TOP  
BACK OF 'ESS BUS LOSS'

PILE

**MNA**

Post SRB SEP:

- ◆ 1. TOP EVAP HTR DUCT sel – B
- 2. HI LOAD DUCT HTR sel – B
- 3. **BFS G51** AA1 – desel ⇒
- 4. MS AUD CNTL – PS (MS can't talk)

FAILED: UHF HI PWR XMIT

**MNB**

Post SRB SEP:

**BFS G51** AA2, RGA 2 – desel ⇒

FAILED: S-BD PM 1 (NO PNL,CMD)

**MNC**

Post SRB SEP:

- 1. FLASH EVAP CNTLR PRI A – OFF, B – GPC
- 2. **BFS G51** RGA 3 – desel ⇒

**ANY AC BUS LOSS ⇒**

**SUBBUS [MNA O14] ⇒G**

**SUBBUS [APC6 or ALC3]**

- 1. FLASH EVAP CNTLR PRI A – OFF, B – GPC

**CNTL BUS LOSS**

<b>AB1</b>	1. TOP EVAP HTR DUCT sel – B 2. HI LOAD DUCT HTR sel – B ⇒
<b>AB2</b>	1. TOP EVAP HTR DUCT sel – B 2. HI LOAD DUCT HTR sel – B ⇒
<b>AB3</b>	1. TOP EVAP HTR DUCT sel – B 2. HI LOAD DUCT HTR sel – B If BFS engage reqd: 3. Use PLT's RHC, then GPCs 1,2,4 - STBY,HALT 4. BFS I/O RESET 5. ⇒
<b>BC1</b>	<b>BFS G51</b> RGA 2 – desel ⇒
<b>BC2</b>	⇒
<b>BC3</b>	⇒
<b>CA1</b>	1. No BFS engage Post SRB SEP: 2. FLASH EVAP CNTLR PRI A – ON 3. <b>BFS G51</b> RGA 3 – desel ⇒
<b>CA2</b>	⇒

EVAP  
ESS

CDR WND

FB A13-12

AESP/ALL/A/GEN O

FAB USE ONLY



HOOK

**FWD RCS LK**

(check He P decr: CRT and meter)

(check TK P; if '↑': Go to TK P HIGH &gt;&gt;)

RTLS	1. Perform RCS SECURE, then: 2. Post PPD – reopen RCS Post ET SEP -Z transl: 3. Go to RCS SECURE >>
Pre ET SEP (N/A RTLS)	4. ET SEP – MAN 5. MPS PRPLT DUMP SEQ – STOP 6. Perform RCS SECURE, then:
Single MANF leak	7. Reopen RCS, except bad MANF 8. ET SEP – AUTO Post ET SEP -Z transl: 9. MPS PRPLT DUMP SEQ – GPC >>
TK leg leak (two MANF P Low)	10. Reopen RCS, except bad leg 11. ET SEP – AUTO Post ET SEP -Z transl: 12. MPS PRPLT DUMP SEQ – GPC >>
PRPLT TK P decr	
Post MECO	13. RATE DAMP with ARCS 14. Reopen FRCS
TK P > 200 & QTY > 0%	15. ET SEP – AUTO
TK P < 200 or QTY = 0%	16. Perform RCS SECURE, then: 17. DAP – INRTL, PITCH – PULSE 18. ET SEP pb – SEP 19. THC -Z (UP) (2 sec; -1.25°/sec) 20. THC -X (OUT) and hold
At SEP (SEP init + approx 12 sec)	21. THC +Z (DOWN) (3 sec; +0.3°/sec) THC -Z (UP) (2 sec; -0.9°/sec) COAST (5 sec) THC +X (IN) (20 sec) After 10 sec of +X, then: PITCH – DISC RATE
Otherwise: (He TK or He leg)	22. OPS 104 PRO, DAP – AUTO Post MECO: 23. Reopen RCS 24. ET SEP – AUTO
Post ET SEP -Z transl	25. MPS PRPLT DUMP SEQ – GPC 26. Go to RCS SECURE

CDR WND

FB A13-13

AESP/ALL/A/GEN O

FAB USE ONLY

TOP  
BACK OF 'FWD RCS LK'

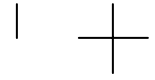
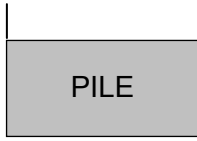

PILE

This Page Intentionally Blank

**MN**  
**AC**  
**CNTL**  

---

**FWD**



CDR WND

FB A13-14

AESP/ALL/A/GEN O

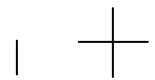

FAB USE ONLY

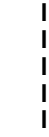
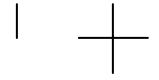
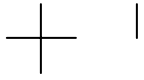

**GLIDED  
FLIGHT**

**CDR WINDOW FLIP BOOK**

**GLIDED FLIGHT**

**CDR WINDOW  
FLIP BOOK**



CDR WND

FB E13-i

AESP/ALL/E/GEN O

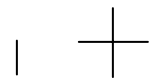
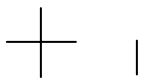

**FAB USE ONLY**

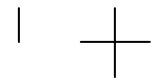
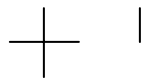

GLIDED  
FLIGHT



This Page Intentionally Blank

CDR WINDOW  
FLIP BOOK



CDR WND

FB E13-ii

AESP/ALL/E/GEN O

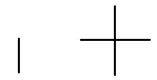
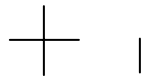

FAB USE ONLY

TOP

HOOK

GNC

**COMM LOST (mult pnls)**

1. AUD CTR – 2

No comm (check UHF sites):

2. S-BD PM CNTL – PNL,CMD (pnl C3)

3. Config per COMM COVER (ASC) BFS G51:

TDRS – ITEM 46 EXEC (\*)

STDN-HI – ITEM 47 EXEC (\*)

SGLS – ITEM 49 EXEC (\*)

If \* not next to selected config:

4. Config pnl A1 per Comm Coverage

(ASC/ENT PKT, COMM)

S-BD PM CNTL – PNL,CMD (pnl C3)

No comm:

5. Sel best S-BD PM ANT

No comm:

6. S-BD PM ANT – GPC

**ICOM LOST**

1. AUD CNTL sel – sel alt

No ICOM:

2. AUD CTR – 2

CDR WND

FB E13-1

AESP/ALL/E/GEN O

FAB USE ONLY

TOP  
BACK OF 'COMM LOST (mult pnls)'



**COMM**

**FCS CH 1(2,3,4) (2nd FAIL) [G53]**

If two FCS CH ↓ on any actuator:

- ◆ (Remaining) FCS CH (two) – ORIDE

**RHC L(R) (2nd FAIL)**

[GNC SYS SUMM 1]

(Aff) FLT CNTLR PWR – OFF

**G51 ROLL MODE SW [G51]**

If ROLL MODE ≠ sw pos:

AUTO SEL – ITEM 42 EXEC

**DISPLAY SW L(R)**

L(R) disp sws – green dot

**RM FAIL IMU, RGA, AA [BFS G51]**

Aff LRU – desel

**RM DLMA IMU [G51] [BFS G51]**

- 1. √MCC, bad IMU – desel (PASS & BFS) >>
- ◆ 2. Desel lower # IMU with '?' (PASS)

**RM FAIL ADTA [G51]**

- ◆ 1. √BFS [GNC SYS SUMM 1]
- 2. If '↓' for aff ADTA >>
- 3. If accessible, (bad) ADTA cb – op >>
- 4. BFS, ADTA to G&C – INH

**RM DLMA ADTA \* [G51]**

M < 2.0		1. Fly Theta limits
ADTA data agrees		2. Desel, resel one ADTA
		3. If no '?' >>
Bad probe		4. Stow bad probe >>
Bad ADTA	ADTA cb accessible	◆ 5. (Bad) ADTA cb – op >>
	ADTA cb not accessible	◆ 6. DES bad ADTA
		7. √BFS [GNC SYS SUMM 1]
		8. If '↓' for aff ADTA >>
		9. BFS, ADTA to G&C – INH
Dilemma not resolved		10. ADTA to G&C – INH (PASS & BFS)

\*If three ADTAs failed:  
ADTA to G&C – INH (PASS)  
Fly Theta limits

CDR WND

FB E13-2

AESP/ALL/E/GEN O

FAB USE ONLY

HOOK

**RM FAIL TAC** [G50]

(RM LIMITS: 6 DEG, 0.5 NM)

1. If data good: desel, resel aff TACAN >>
2. If failure verified: desel failed TACAN in BFS

**RM DLMA TAC** [G50]

Do not desel or resel while in 'TEST'

1. If both data good: desel, resel one TACAN in DLMA >>
2. √TACAN MODE (three) – GPC
3. If 'RM FAIL TAC': desel failed TACAN in BFS >>
4. If continuous 'TEST': TACAN MODE (three) – T/R  
If bad TACAN identified:
  5. Desel bad TACAN (PASS, √BFS)

DPS  
GPC  
MDM**SPD BRK** [G51] [BFS G51]

M>5.0	◆ WRAP MODE – INH
M≤5.0	WRAP MODE – INH √MCC for energy mgmt procs

**G55 GPS FAIL 2** [G50] [BFS G50]

GPS to NAV INH – ITEM 43 EXEC (PASS, √BFS)

**NO UPDATE GPS** [G55]

√MCC

If ALT &lt; 300kft and ALT &gt; 180kft

No Update due to plasma, reevaluate at ALT &lt; 180kft

Else

INIT – ITEM 15 EXEC

NAV – ITEM 18 EXEC

**OV103,104**

CDR WND (OV103,104) FB E13-3

AESP/3,4/E/GEN O

FAB USE ONLY

PILE

**PASS GPC FAIL**

1. (Aff) FCS CH – OFF
2. If two GPC/FA/FCS CHs ↓: (Good) FCS CHs – ORIDE
3. GPC MODE – STBY,HALT
4. [G53] aff SURF FDBK – desel
- ⇒ 5. If String 1(2): CDR(PLT) disp sws – green dot  
NWS – 2
6. √MULT DATA PATH LOSS

GNC

**BFS GPC FAIL**

1. GPC MODE – STBY,HALT
- ◆ 2. OUTPUT – TERM  
MODE – STBY
- ⇒ 3. If BFS cannot drive an IDP:  
GPC MODE – HALT, then go to step 8
4. If BFS currently in OPS 3 or 6:  
Go to step 7
5. If BFS currently in OPS 1:  
PRO to OPS 106  
BFS, OPS 000 PRO  
PRO to OPS 304
6. If BFS in desired MM (304):  
BFS [G50] √BFS R/W sel  
GPC MODE – RUN  
OUTPUT – B/U  
Advise MCC BFS in BACKUP >>
7. √GPC MODE – STBY (BFS is SM Only)
8. If no comm: sel best S-BD PM ANT
9. MPS He ISOL B (three) – CL  
PNEU He ISOL – CL
10. If AOA/GRTL/TAL < 120K:  
NH3 CNTLR B – SEC/ON

**FA/FF MDM I/O ERROR**

(Annunciated by entire set)

		1. I/O RESET
RECOV	FA	2. If reqd, (aff) FCS CH – ORIDE,AUTO
	FF 1,2,3	◆ 3. [G51] IMU – resel
		4. BFS I/O RESET >>
NOT RECOV	FA	5. (Aff) FCS CH – OFF
		6. If two GPC/FA/FCS CHs ↓: (Good) FCS CHs – ORIDE
		7. [G53] aff SURF FDBK – desel
		8. √MULT DATA PATH LOSS
		⇒ ◆ 9. Go to FA/FF MDM PORT MODE

**OV103,104**

CDR WND (OV103,104) FB E13-4 AESP/ALL/E/GEN O,3

FAB USE ONLY



HOOK

**RM FAIL TAC** [G50]

(RM LIMITS: 6 DEG, 0.5 NM)

1. If data good: desel, resel aff TACAN >>
2. If failure verified: desel failed TACAN in BFS

**RM DLMA TAC** [G50]

Do not desel or resel while in 'TEST'

1. If both data good: desel, resel one TACAN in DLMA >>
2. √TACAN MODE (three) – GPC
3. If 'RM FAIL TAC': desel failed TACAN in BFS >>
4. If continuous 'TEST': TACAN MODE (three) – T/R  
If bad TACAN identified:
  5. Desel bad TACAN (PASS, √BFS)

DPS  
GPC  
MDM**SPD BRK** [G51] [BFS G51]

M>5.0	◆ WRAP MODE – INH
M≤5.0	WRAP MODE – INH √MCC for energy mgmt procs

**G55 GPS FAIL 1(2,3)** [G50] [BFS G50]

Aff LRU – desel (PASS, √BFS)

**RM DLMA GPS** [G50] [BFS G50]

- ◆ 1. √MCC, bad GPS – desel (PASS, √BFS) >>
2. If 300kft > ALT > 180kft  
DLMA due to plasma  
Reevaluate when ALT < 180kft  
Else
  3. Desel GPS with highest P1σ  
If P1σ values are equal, desel highest number  
LRU  
If DLMA not resolved
    4. Desel GPS with next highest P1σ

**NO UPDATE GPS** [G55]

1. √MCC, bad GPS – desel (PASS, √BFS) >>
2. If RM DLMA GPS message, see RM DLMA GPS >>
3. If 300kft > ALT > 180kft  
No Update due to plasma  
Reevaluate when ALT < 180kft  
Else
  4. Initialize GPS with highest P1σ  
INIT – ITEM 14(15,16) EXEC  
NAV – ITEM 17(18,19) EXEC  
May take up to 2 minutes for GPS to provide SV

**OV105**

CDR WND

(OV105) FB E13-3

AESP/5/E/GEN O

FAB USE ONLY

PILE

GNC

**PASS GPC FAIL**

1. (Aff) FCS CH – OFF
2. If two GPC/FA/FCS CHs ↓: (Good) FCS CHs – ORIDE
3. GPC MODE – STBY,HALT
4. **G53** aff SURF FDBK – desel
- ⇒ 5. If String 1(2): CDR(PLT) disp sws – green dot  
NWS – 2
6. √MULT DATA PATH LOSS

**BFS GPC FAIL**

1. GPC MODE – STBY,HALT
- ◆ 2. OUTPUT – TERM  
MODE – STBY
- ⇒ 3. If BFS cannot drive an IDP:  
GPC MODE – HALT, then go to step 8
4. If BFS currently in OPS 3 or 6:  
Go to step 7
5. If BFS currently in OPS 1:  
PRO to OPS 106  
BFS, OPS 000 PRO  
PRO to OPS 304
6. If BFS in desired MM (304):  
BFS **G50** √BFS R/W sel  
GPC MODE – RUN  
OUTPUT – B/U  
Advise MCC BFS in BACKUP >>
7. √GPC MODE – STBY (BFS is SM Only)
8. If no comm: sel best S-BD PM ANT
9. MPS He ISOL B (three) – CL  
PNEU He ISOL – CL
10. If AOA/GRTLS/TAL < 120K:  
NH3 CNTLR B – SEC/ON

**FA/FF MDM I/O ERROR**

(Annunciated by entire set)

		1. I/O RESET
RECOV	FA	2. If reqd, (aff) FCS CH – ORIDE,AUTO
	FF 1,2,3	◆ 3. <b>G51</b> IMU – resel
		4. BFS I/O RESET >>
NOT RECOV	FA	5. (Aff) FCS CH – OFF
		6. If two GPC/FA/FCS CHs ↓: (Good) FCS CHs – ORIDE
		7. <b>G53</b> aff SURF FDBK – desel
		8. √MULT DATA PATH LOSS
		⇒ ◆ 9. Go to FA/FF MDM PORT MODE

**OV105**

CDR WND

(OV105) FB E13-4

AESP/ALL/E/GEN O,3

FAB USE ONLY



**FA/FF MDM PORT MODE**

NOTE

If BFS, 'BCE STRG X PASS', @GPC; else @MDM.  
 For '@GPC' port mode results in alternate MDM bypass

			1. <b>G01</b> aff String – port mode 2. BFS I/O RESET
@MDM	RECOV	FA	3. (Aff) FCS CH – AUTO 4. <b>G53</b> aff SURF FDBK – resel >>
		FF 1,2,3	◆ 5. <b>G51</b> IMU – resel >>
	NOT RECOV		⇒ If MCC GO for pwr cycle: 6. (Aff) FA/FF MDM – OFF, ON 7. I/O RESET 8. If recov, go to @MDM RECOV >> 9. (Aff) MDM – OFF
		FA	10. <b>BFS G51</b> aff SURF FDBK, RGA – desel
		FF	11. <b>BFS G51</b> aff AA – desel 12. FF 1(2): CDR(PLT) disp sws – green dot NWS – 2
			13. √MULT DATA PATH LOSS >>
@GPC	FA RECOV (FF Give Up)		14. (Aff) FCS CH – AUTO 15. <b>G53</b> aff SURF FDBK – resel 16. FF 1(2): CDR(PLT) disp sws – green dot NWS – 2 17. √MULT DATA PATH LOSS >>
	FF RECOV (FA Give Up)		18. (Aff) FCS CH – OFF 19. If two GPC/FA/FCS CHs ↓: (Good) FCS CHs – ORIDE 20. <b>G53</b> aff SURF FDBK – desel
		FF 1,2,3	◆ 21. <b>G51</b> IMU – resel
			22. √MULT DATA PATH LOSS >>

**DPS  
BCE**

PILE

FAULT

**FF(FA) MDM OUTPUT**

- ◆ (Take action only if annun by entire set)  
If single 'MDM OUTPUT':
  1. If 'FF MDM OUTPUT':
    - G51 aff IMU – desel
  2. Go to FA/FF MDM I/O ERROR >>
- If both FF and FA annun:
  3. G51 aff IMU – desel
  4. I/O RESET; if reqd, BFS I/O RESET
  5. If msgs repeat: Go to PASS GPC FAIL >>
  6. If reqd, (aff) FCS CH – ORIDE,AUTO
- ◆ 7. G51 IMU – resel

DPS  
GPC  
MDM

**PL MDM I/O ERROR**

1. BFS I/O RESET; if recovered >>
2. G01 PL1/2 – port mode, then BFS I/O RESET;  
if recovered >>
3. If PL1 ↓ and pre MM305: FLASH EVAP CNTLR  
PRI B – ON
4. If PL2 ↓ and no comm: sel best S-BD PM ANT
5. If PL2 ↓ and AOA/GRTL/TAL < 120K:  
⇒ NH3 CNTLR B – SEC/ON

**PCM I/O ERROR**

OI PCMMU PWR – 2(1)

**POST BFS ENGAGE**

If PASS GPCs running:

1. (Aff) GPC MODE – STBY/HALT
2. BFS I/O RESET
3. √FCS CHs, IMU config

⇒ If Air Data not analyzed:

4. G50 INH AD to G&C
5. M = 5: Deploy, evaluate probes one at a time
6. √AD to G&C by M = 1.5

If failed ADTA(s) in PASS:

7. cb(s) ADTA – op, or stow probe
8. G51 DES failed(commfaulted) RGA,AA,SURF
9. G50 DES failed TAC

At  $M \leq 2.7$ :

10. CDR TRIM PNL – OFF  
RHC/PNL – ENA

At H = 3K:

11. SPDBK – MAN (check DEL PAD setting)

At MAIN GEAR TD:

12. SPDBK – 100%

CDR WND

FB E13-6

AESP/ALL/E/GEN O

FAB USE ONLY



**BCE STRG X** (no 'MDM OUTPUT' msg)

	IMU	1. <b>G21</b> √IMU OPER, if STBY >>
		2. I/O RESET
RECOV	IMU	3. <b>G21</b> √att ANG, if delta > 1° >> ♦ 4. <b>G51</b> IMU – resel >>
		5. >>
NOT RECOV	NSP	6. And no comm: PNL,CMD 7. <b>BFS G51</b> Config per <u>COMM COVER</u> (ASC): TDRS – ITEM 46 EXEC (*) STDN-HI – ITEM 47 EXEC (*) SGLS – ITEM 49 EXEC (*) >>
		8. <b>G01</b> aff String – port mode 9. <b>BFS</b> I/O RESET 10. If recov, go to RECOV steps >>
A(B,C,D, IMU)	⇒	11. FF A(B,IMU) or FA C(D) MDM – OFF,ON 12. I/O RESET 13. If FA, (aff) FCS CH – ORIDE,AUTO 14. If recov, go to RECOV steps
	C(D)	15. If < 3Y,2P jets/pod/dir: a. <b>G23</b> aff jet DES INH (*) (reprioritize) b. Aff MANF VLVS STAT OP – OVRD
	1A(2A)	16. CDR(PLT) disp sws – green dot
	B	17. <b>BFS G51</b> aff AA – desel
	D	18. <b>BFS G51</b> aff SURF FDBK,RGA – desel
		19. √MULT DATA PATH LOSS >>

**DPS/  
MDP  
CAB P  
ECLS**

**DUAL DPS DISPLAY COMMANDERS/DK XMTR 1(2,3)**

1. BFC CRT SEL – aff IDP  
If reqd to clean up display:
2. (Aff) IDP/CRT PWR – OFF,ON

CDR WND

FB E13-7

AESP/ALL/E/GEN O

FAB USE ONLY

PILE

**PASS DISPLAY FAIL**

1. MDU PWR – OFF,ON; if recovered >>
  2. GPC/CRT – same GPC/aff IDP; if recovered >>
  3. BFC CRT SEL – aff IDP; if both IDPs OK go to step 9
  4. – orig posn
  5. Report MDU symptoms
- If MCC GO for pwr cycle:
6. IDP/CRT PWR – OFF,ON; if recovered >>
- If MDU blank or autonomous:
7. Set other MDU on same IDP to DPS Mode; if recovered >>
  8. Return other MDU to nominal config
  9. Deassign aff IDP from PASS
  10. GPC/CRT 04 EXEC
  11. In PASS: GPC/CRT 44 EXEC

**BFS DISPLAY FAIL**

1. If IDP4(CRT4): IDP/CRT4 PWR – OFF >>
  2. MDU PWR – OFF,ON; if recovered >>
  3. BFC CRT SEL – unaff IDP; if both IDPs OK >>
  4. – orig posn
  5. BFC CRT DISPLAY – OFF,ON; if recovered >>
  6. In PASS: GPC/CRT 5/X for aff IDP; if recovered >>
  7. Report MDU symptoms
- If MCC GO for pwr cycle:
8. IDP/CRT PWR – OFF,ON; if recovered >>
- If MDU blank or autonomous:
9. Set other MDU on same IDP to DPS Mode; if recovered >>
  10. Return other MDU to nominal config
  11. BFC CRT SEL – unaff IDP
  12. Deassign aff IDP from PASS
  13. GPC/CRT 04 EXEC
  14. In PASS: GPC/CRT 44 EXEC

DPS  
BCE

CDR WND

FB E13-8

AESP/ALL/E/GEN O

FAB USE ONLY

HOOK

**FLT INST DISPLAY ANOMALY**

1. DATA BUS sel alt FC BUS(s); if recovered >>
2. PORT SELECT aff MDU; if recovered >>
3. MDU PWR – OFF,ON

**SUBSYS STATUS DISPLAY ANOMALY**

1. PORT SELECT aff MDU; if recovered >>
2. MDU PWR – OFF,ON; if recovered >>

**BFS INADVERTENT DISENGAGE/UNSUCCESSFUL ENGAGE** (Lightning Strike)

1. CDR and PLT RHC BFS engage pb – push  
If no response:
  2. BFS OUTPUT – NORM, B/U
  3. CDR,PLT RHC BFS engage pb – push

**MULT DATA PATH LOSS (non-Recov)**NOTE

If LRU data path loss due to GPC prob and not MDM,  
BFS will pick up MDMs/LRU when engaged

FAILURE	TYPE	ACTIONS
GPC/FF 1&2	I/O or B	Use R BODY FLAP & TRIM ENA sws
GPC/FF 3&4	I/O or B	Use L BODY FLAP & TRIM ENA sws
GPC/FA any combo	I/O or D	No impact

CDR WND

FB E13-9

AESP/ALL/E/GEN O

FAB USE ONLY

TOP  
BACK OF 'FLT INST DISPLAY ANOMALY'

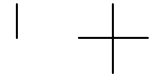
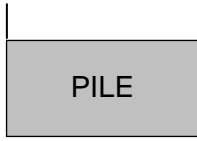

This Page Intentionally Blank



CDR WND

FB E13-10

AESP/ALL/E/GEN O

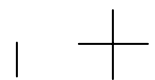

FAB USE ONLY



HOOK

**CAB PRESS LEAK**

1. CAB RELIEF A – CL,pause,  
B – CL
  2. Check tabs, visors – CL, LES O2 – ON
  3. If RTLS/TAL: O2/N2 CNTLR VLV SYS 2 – OP
  4. O2 TK1,TK2 HTRS A,B (four) – AUTO
  - ⇒ 5. TK3 HTRS A,B (two) – AUTO
- If possible:
6. Remove INNER HATCH cap (two)
  7. Equal vlv (two) – EMER
- When CAB PRESS < 10 psia, if dP/dT EQ < 0.67:
8. √O2/N2 CNTLR VLV SYS 2 – OP >>
- When CAB PRESS < 6.5 psia:
9. √O2/N2 CNTLR VLV SYS 2 – OP
  10. CAB FAN (two) – ON

**CAB PRESS HIGH**

1. If incr: LES O2 – OFF, visors – OP
- If still incr:
2. N2 SYS 1,2 REG INLET (two) – CL
  3. O2 SYS 1,2 SPLY (two) – CL

**H2O LOOP PRESS LOW(HIGH)**

⇒ Switch loops

**AV BAY FAN ΔP**

- ⇒ 1. If Av Bay 1 aff: FAN A – ON; FAN B – OFF  
If Av Bay 2 aff: FAN B – ON; FAN A – OFF  
If Av Bay 3 aff: FAN A – ON; FAN B – OFF
2. If no joy: Go to LOSS OF AV BAY COOLING PWRDN

**AV BAY TEMP HIGH**

- ⇒ 1. (Aff) AV BAY FAN (two) – ON
2. If not decr: Switch H2O Loops
3. If no joy: Go to LOSS OF AV BAY COOLING PWRDN

**LOSS OF AV BAY COOLING PWRDN**

Bay 1: MLS 1 – OFF  
 Bay 2: 2,3 – OFF  
 Bay 3: N/A

**CABIN FAN FAIL**

- ⇒ 1. Switch fans
- If both fans lost:
2. Minimize use of IDPs/MDUs/FLT CNTLR PWR

**IMU FAN FAIL**

- ⇒ Switch fans

FREON  
EVAP**OV103,104**

CDR WND (OV103,104) FB E13-11

AESP/ALL/E/GEN O

FAB USE ONLY

TOP  
BACK OF 'CAB PRESS LEAK'

PILE

**FREON FLOW LOW**

1. Switch pumps  
If flow still low:
    2. (Aff) RAD BYP VLV MODE – AUTO  
CNTLR LOOP – AUTO A(B) (wait 90 sec)
- If flow still low in both loops:
3. Go to LOSS OF FREON LOOP(s)

**LOSS OF 1 FREON LOOP**

1. (Bad) FREON PUMP LOOP – OFF  
If FREON LOOP 1(2) lost:
  2. O2 SYS 1(2) SPLY (one) – CL
  3. √FLOW PROP VLV LOOP 2(1) – ICH
4. Monitor EVAP OUT TEMP  
If TAL/AOA/RTLS and LOOP 2 lost:
  5. NH3 CNTLR B – OFF, A – PRI/GPC

**LOSS OF 2 FREON LOOPS – PWRDN**

1. When loops fail (flow <700), CDR execute LOOPS  
FAILED
  2. MSTR MADS PWR – OFF
  3. Use one IDP/CRT with two MDUs (three max)
  4. All PL pwr (seven) – OFF
  5. O2,H2 TK HTRS (all) – OFF
  6. MCC CMD FC purge, then BFS GPC – STBY,HALT  
PWR – OFF  
OUTPUT – NORM
  7. If no comm: sel best S-BD PM ANT  
If RTLS:
    8. TACAN (three) – OFF
    9. RDR ALTM 1 – OFF
- If TAL/AOA/ENTRY and V > 15K:
10. All TACAN/RA/MLS – OFF
  11. Use one FLT CNTLR PWR
- ⇒
12. DC UTIL PWR – OFF
  - ◆ 13. FCS CH 4 – OFF
  14. GPC 4 – STBY,HALT,PWR – OFF
  15. FF4,FA4 – OFF
  16. ANNUN BUS SEL ACA 2/3 – OFF
  - ◆ When MPS dump complete:
    17. MPS ENG PWR (six) – OFF
    18. EIU (three) – OFF
    19. MEC 1 – OFF, wait 2 sec, then:
    20. MEC 2 – OFF
  - ◆ 21. G50 √GPS, INCORPORATE
  22. At M = 2.9: √RA 2 – ON
  23. If reqd: Use one MLS, GNC I/O RESET

**DPS/  
MDP**  

---

**CAB P  
ECLS**

**OV103,104**

CDR WND (OV103,104) FB E13-12 AESP/3,4/E/GEN O

FAB USE ONLY

HOOK

**CAB PRESS LEAK**

1. CAB RELIEF A – CL,pause,  
B – CL
  2. Check tabs, visors – CL, LES O2 – ON
  3. If RTLS/TAL: O2/N2 CNTLR VLV SYS 2 – OP
  4. O2 TK1,TK2 HTRS A,B (four) – AUTO
  - ⇒ 5. TK3 HTRS A,B (two) – AUTO
- If possible:
6. Remove INNER HATCH cap (two)
  7. Equal vlv (two) – EMER
- When CAB PRESS < 10 psia, if dP/dT EQ < 0.67:
8. √O2/N2 CNTLR VLV SYS 2 – OP >>
- When CAB PRESS < 6.5 psia:
9. √O2/N2 CNTLR VLV SYS 2 – OP
  10. CAB FAN (two) – ON

**CAB PRESS HIGH**

1. If incr: LES O2 – OFF, visors – OP
- If still incr:
2. N2 SYS 1,2 REG INLET (two) – CL
  3. O2 SYS 1,2 SPLY (two) – CL

**H2O LOOP PRESS LOW(HIGH)**

⇒ Switch loops

**AV BAY FAN ΔP**

- ⇒ 1. If Av Bay 1 aff: FAN A – ON; FAN B – OFF  
If Av Bay 2 aff: FAN B – ON; FAN A – OFF  
If Av Bay 3 aff: FAN A – ON; FAN B – OFF
2. If no joy: Go to LOSS OF AV BAY COOLING PWRDN

**AV BAY TEMP HIGH**

- ⇒ 1. (Aff) AV BAY FAN (two) – ON
2. If not decr: Switch H2O Loops
3. If no joy: Go to LOSS OF AV BAY COOLING PWRDN

**LOSS OF AV BAY COOLING PWRDN**

Bay 1: MLS 1 – OFF  
 Bay 2: 2,3 – OFF  
 Bay 3: N/A

**CABIN FAN FAIL**

- ⇒ 1. Switch fans
- If both fans lost:
2. Minimize use of IDPs/MDUs/FLT CNTLR PWR

**IMU FAN FAIL**

- ⇒ Switch fans

FREON  
EVAP**OV105**

CDR WND

(OV105) FB E13-11

AESP/ALL/E/GEN O

TOP  
BACK OF 'CAB PRESS LEAK'

PILE

**FREON FLOW LOW**

1. Switch pumps  
If flow still low:
  2. (Aff) RAD BYP VLV MODE – AUTO  
CNTLR LOOP – AUTO A(B) (wait 90 sec)
- If flow still low in both loops:
  3. Go to LOSS OF FREON LOOP(s)

**LOSS OF 1 FREON LOOP**

1. (Bad) FREON PUMP LOOP – OFF  
If FREON LOOP 1(2) lost:
  2. O2 SYS 1(2) SPLY (one) – CL
  3. √FLOW PROP VLV LOOP 2(1) – ICH
4. Monitor EVAP OUT TEMP  
If TAL/AOA/RTLS and LOOP 2 lost:
  5. NH3 CNTLR B – OFF, A – PRI/GPC

**LOSS OF 2 FREON LOOPS – PWRDN**

1. When loops fail (flow <700), CDR execute LOOPS  
FAILED
2. MSTR MADS PWR – OFF
3. Use one IDP/CRT with two MDUs (three max)
4. All PL pwr (seven) – OFF
5. O2,H2 TK HTRS (all) – OFF
6. MCC CMD FC purge, then BFS GPC – STBY,HALT  
PWR – OFF  
OUTPUT – NORM
7. If no comm: sel best S-BD PM ANT
8. GPS 1,3 – OFF  
If RTLS:
  9. RDR ALTM 1 – OFF
- If TAL/AOA/ENTRY and V > 15K:
  10. All RA/MLS – OFF
  11. Use one FLT CNTLR PWR
- ⇒ 12. DC UTIL PWR – OFF
- ◆ 13. FCS CH 4 – OFF
14. GPC 4 – STBY,HALT,PWR – OFF
15. FF4,FA4 – OFF
16. ANNUN BUS SEL ACA 2/3 – OFF
- ◆ When MPS dump complete:
  17. MPS ENG PWR (six) – OFF
  18. EIU (three) – OFF
  19. MEC 1 – OFF, wait 2 sec, then:
  20. MEC 2 – OFF
- ◆ 21. G50 √GPS, INCORPORATE
22. At M = 2.9: √RA 2 – ON
23. If reqd: Use one MLS, GNC I/O RESET

**DPS/  
MDP  
CAB P  
ECLS**

**OV105**

CDR WND

(OV105) FB E13-12

AESP/5/E/GEN O

FAB USE ONLY

HOOK

**LOSS OF 2 FREON LOOPS – LOOPS FAILED**

1. LES O2 – OFF, visor – OP
  2. O2 SYS 1,2 SPLY (two) – OP
- Panel L1: All sws off, except:
3. H2O PUMP LOOP 2 – ON
  4. Perform PWRDN if not already accomplished

**EVAP OUT TEMP HIGH (Rads cold soaked)**

If temp high in only one loop (snsr failed) &gt;&gt;

1. If V < 12K:
  - RAD BYP VLV LOOP 1 – MAN,BYP
  - NH3 CNTLR B – PRI/GPC >>
2. FLASH EVAP CNTLR PRI B(A) – OFF
  - A(B) – ON (wait 30 sec)

If T decr >>
3. FLASH EVAP CNTLR PRI A(B) – OFF
  - SEC – ON (HI LOAD ena)
  - (wait 30 sec)

If T decr:

  - TOP EVAP HTRS (three) – OFF >>
4. HI LOAD EVAP – OFF
  - DUCT HTR sel – OFF (wait 30 sec)

If T decr >>
5. TOP EVAP HTRS (three) – OFF
  - RAD BYP VLV sel (two) – AUTO
  - CNTLR LOOP (two) – AUTO B(A) (wait 90 sec)

**EVAP OUT TEMP HIGH (Rads *not* cold soaked)**

If temp high in only one loop (snsr failed) &gt;&gt;

If V &gt; 12K:

1. FLASH EVAP CNTLR PRI A – OFF
  - B – ON (wait 30 sec)

If T decr >>
2. FLASH EVAP CNTLR PRI B – OFF
  - SEC – ON (HI LOAD ena)
  - (wait 30 sec)

If T decr >>
3. HI LOAD EVAP – OFF
  - If T decr >>
- ⇒ 4. RAD BYP VLV (four) – MAN,RAD FLOW
5. NH3 CNTLR B – SEC/ON (wait 60 sec)
6. If T decr >>
7. NH3 CNTLR B – OFF, A – SEC/ON

**EVAP**  
**ESS**

CDR WND

FB E13-13

AESP/ALL/E/GEN O

FAB USE ONLY

TOP  
BACK OF 'LOSS OF 2 FREON LOOPS – LOOPS FAILED'

PILE

**EVAP OUT T LOW**

1. If temp low in only one loop (snsr failed) >>
  2. FREON PUMP LOOP 1,2 (two) – OFF
  3. H2O PUMP LOOP 1 (two) – ON,B
  4. FLOW PROP VLV LOOP 1,2 (two) – PL HX (tb-PL)
  5. O2 SYS 1,2 SPLY (two) – CL (tb-CL)
  6. √RAD BYP VLV MODE (two) – MAN
  7. √MAN SEL (two) – BYP (tb-BYP ~3 sec)
  8. FLASH EVAP CNTLR PRI A,B,SEC (three) – OFF
  - ◆ 9. FREON PUMP LOOP 1,2 (two) – B  
NH3 CNTLR A,B (two) – SEC/ON
- Wait 3 min, then if any Freon Loop off:
10. FREON PUMP LOOP 1,2 (two) – B
- When EVAP OUT T > 55 for at least 2 min (NH3 depleted):
11. O2 SYS 1,2 SPLY (two) – OP (tb-OP)
  12. NH3 CNTLR A,B (two) – OFF
- If V > 12K and FLASH EVAP CNTLR PRI A(B)  
previously selected:
13. FLASH EVAP CNTLR PRI B(A) – GPC >>
- If V < 12K:
14. RAD BYP VLV MODE 1,2 (two) – AUTO
  15. CNTLR LOOP 1,2 (two) – OFF  
AUTO A(B)

**FREON LEAK**

- ◆ 1. FREON ISOL MODE – MAN
  2. (Aff) FREON ISOL LOOP 1(2) – ISOL  
Hold for 5 sec
- If (aff) FREON LOOP 1(2) ACCUM QTY decr:
- ◆ 3. (Aff) FREON ISOL LOOP 1(2) – RAD  
Hold for 5 sec
  4. When loop fails ('SM2 FREON FLOW 1(2)'), CDR  
execute LOSS OF 1 FREON LOOP for (aff) Freon  
Loop >>
- If (aff) FREON LOOP 1(2) ACCUM QTY not decr:  
When V<12K and rads cold soaked:  
In good loop:
5. √RAD BYP VLV MODE 2(1) – AUTO
  6. √RAD CNTLR LOOP 2(1) – AUTO B
  7. NH3 CNTLR B(A) – PRI/GPC

**FREON  
EVAP**

CDR WND

FB E13-14

AESPALL/E/GEN O,2

FAB USE ONLY

HOOK

FC  
MN**ESS BUS LOSS**

<b>ESS 1BC</b>	<b>O13&amp;R14</b>	1. L AUD CNTL sel – R (CDR can't talk) 2. Pri C/W & F7 Matrix lost
<b>ESS 2CA</b>	<b>O13&amp;R14</b>	1. AUD CTR – 2 2. R AUD CNTL sel – L (PLT can't talk)
<b>ESS 3AB</b>	<b>O13</b>	1. GPC CAM Lights lost 2. Do not engage BFS ⇒ 3. BFS GPC OUTPUT – TERM

**LOSS OF 2nd FC PWRDN (ENTRY)**

1. MDM PL1 – OFF
2. FCS CH 4 – OFF  
GPC MODE 4 – STBY,HALT  
PWR 4 – OFF  
MDM FF4,FA4 – OFF
3. HUM SEP (two) – OFF
4. FLASH EVAP FDLN HTR SPLY (two) – OFF
5. TOP EVAP HTR NOZ L,R (two) – OFF  
DUCT sel – OFF  
HI LOAD DUCT HTR sel – OFF
6. If V > 10K: √CAB FAN A(B) – ON
7. M = 2.9: CAB FAN (two) – OFF  
AV BAY FAN (six) – OFF

CDR WND

FB E13-15

AESP/ALL/E/GEN O

FAB USE ONLY

TOP  
BACK OF 'ESS BUS LOSS'



EVAP  
ESS



PILE

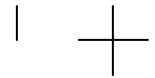

**LOSS OF 2nd FC PWRDN (GRTLS/TAL)**

1. LES O2 – OFF, visors – OP
  2. L1: Select one FREON PUMP on good FC/MN BUS and place other pump to OFF  
Switch OFF all HUM SEPS, IMU FANS, H2O PUMPS, AV BAY FANS, CAB FANS, FES HTRS
  3. Switch off all but one IDP/CRT with four MDUs  
After BUS TIE, if MNC unpwr:
    4. FLASH EVAP CNTLR PRI A – OFF  
B – ON
  - ⇒ 5. Assign all strings to GPC 1 OPS 30X(60X) PRO
  6. Unassigned GPCs MODE – STBY (tb-bp), HALT  
– STBY (tb-RUN)  
– HALT (tb-bp)  
GPC PWR – OFF
  7. IMU (one) – OFF (choose previously failed IMU, if any)
  8. IMU FAN (one) – ON
  9. H2O PUMP (one) – ON
  10. AV BAY 1,2 FAN (two) – ON (check fan ON in each bay with a pwr GPC)
- After MPS Pwrn:
- If MNA unpwr:
11. FREON PUMP LOOP 1 – B  
2 – A
  12. TOP EVAP HTR DUCT sel – B  
HI LOAD DUCT HTR sel – B
- If MNB(C) unpwr:
13. FREON PUMP LOOP 1,2 (two) – A(B)
  14. TOP EVAP HTR DUCT sel – A  
HI LOAD DUCT HTR sel – A
- If TAL:
15. HUM SEP (one) – ON
  16. CAB FAN (one) – ON



CDR WND

FB E13-16

AESP/ALL/E/GEN O

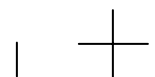

FAB USE ONLY



HOOK

**MNA or AC1 Multi  $\Phi$** 

1. FLASH EVAP CNTLR PRI B – OFF, A – GPC
  2. TOP EVAP HTR DUCT sel – B
  3. HI LOAD DUCT HTR sel – B
  - ⇒ 4. FREON PUMP LOOP 2 – A
  5. AV BAY 3 FAN A – ON, B – OFF
- If rads cold soaked:  
When  $V \leq 12K$ :
6. RAD BYP VLV MODE 1,2 (two) – AUTO
  7. RAD CNTLR LOOP 1,2 (two) – AUTO A
8. ANNUN BUS SEL ACA 1 – MNB
  9. NWS – 2
  10. **BFS G51** AA1 – desel
  11. MS AUD CNTL – PS (MS can't talk)
- FAILED: NH3 A PRI, NWS 1,  
UHF HI PWR XMIT, L HUD, AUTO B

CNTL

**MNB or AC2 Multi  $\Phi$** 

- ⇒ 1. AV BAY 1 FAN A – ON, B – OFF
  2. FREON PUMP LOOP 1 – A
  3. HUM SEP A – ON, B – OFF
  4. IMU FAN A – ON, B – OFF
  5. AV BAY 2 FAN B – ON, A – OFF
  6.  $\sqrt{cb}$  AC3  $\Phi$ A LG SNSR 1 – cl
  7. ANNUN BUS SEL ACA 2/3 – MNC
  8. **BFS G51** AA2, RGA 2 – desel
- FAILED: NH3 B SEC, RA 2, NWS 2  
PLT DRAG CHUTE ARM  
S-BD PM 1 (NO PNL,CMD)

**MNC or AC3 Multi  $\Phi$** 

- ⇒ 1. FLASH EVAP CNTLR PRI A – OFF, B – GPC
  2. CAB FAN B – ON, A – OFF
  3.  $\sqrt{AV}$  BAY 3 FAN B – ON
  4. H2O PUMP LOOP 1 – ON, 2 – OFF
  5.  $\sqrt{cb}$  AC2  $\Phi$ A LG SNSR 2 – cl
  6. **BFS G51** RGA 3 – desel
- FAILED: NH3 A SEC, B PRI  
CDR DRAG CHUTE ARM

**ANY AC2 SINGLE  $\Phi$** 

- ⇒ FREON PUMP LOOP 1 – A

CDR WND

FB E13-17

AESP/ALL/E/GEN O

FAB USE ONLY

TOP  
 BACK OF 'MNA or AC1 Multi  $\Phi$ '  
 FACING RIGHT SIDE OF BACKBOARD

PILE

FC  
MN

**CNTL BUS LOSS**

<b>AB1</b>	⇒	1. Use R TRIM & BDY FLP sws FAILED: NH3 A SEC, FES PRI B GPC
<b>AB2</b>	⇒	1. CDR disp sws – green dot FAILED: NH3 B SEC, L HUD, FES PRI B ON, H2O LOOP 1, A ON
<b>AB3</b>	⇒	If BFS engage reqd: 1. Use PLT's RHC, then GPCs 1,2,4 – STBY,HALT 2. BFS I/O RESET
<b>BC1</b>	⇒	1. Use R TRIM & BDY FLP sws 2. <b>[BFS G51]</b> RGA 2 – desel FAILED: R HUD CDR DRAG CHUTE DPY/JETT
<b>BC2</b>	⇒	If TAL/AOA/RTLS: 1. NH3 CNTLR B – OFF A – PRI/GPC FAILED: NH3 B PRI, FES SEC GPC, H2O LOOP 1, B ON, CDR DRAG CHUTE DPY/JETT
<b>BC3</b>	⇒	FAILED: NH3 A PRI, FES SEC ON
<b>CA1</b>	⇒ ♦	1. No BFS engage GPC 3,5 2. BFS GPC OUTPUT – TERM 3. <b>[BFS G51]</b> RGA 3 – desel FAILED: NH3 B SEC, FES PRI A GPC, H2O LOOP 2 GPC, PLT DRAG CHUTE DPY/JETT
<b>CA2</b>	⇒	FAILED: NH3 A SEC, FES PRI A ON, PLT DRAG CHUTE DPY/JETT

**SUBBUS [MNA O14]**

1. NWS – 2
- If rads cold soaked:  
 When  $V \leq 12K$ :
2. RAD BYP VLV MODE 1,2 (two) – AUTO
  3. RAD CNTLR LOOP 1,2 (two) – AUTO A
- FAILED: AUTO B

**SUBBUS [APC4(5,6) or ALC1(2,3)]**

SUBBUS	APC or ALC	4 1	5 2	6 3
1.	FLASH EVAP CNTLR	PRI A – GPC		√PRI B – GPC

CDR WND

FB E13-18

AESP/ALL/E/GEN O

FAB USE ONLY

Space Shuttle Program  
FLIGHT DATA FILE

JSC-48001  
GENERIC, REV O

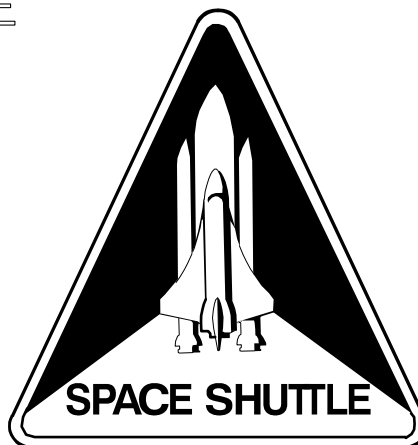

AESP:	MM101
APCL:	MM104
OPCL:	MM106
EPCL:	MM301
AESP:	MM304

<b>ASCENT/ENTRY SYSTEMS PRO</b>	<b>OV ALL</b>
-------------------------------------	-------------------

Flight Cover (trim bottom to expose tabs)