

Ascent/Entry Systems Procedures

**Mission Operations Directorate
Operations Division**

**Generic, Rev O
June 1, 2007**

NOTE

For STS-118 and subsequent flights

AESP: MM101

APCL: MM104

OPCL: MM106

EPCL: MM301

AESP: MM304

National Aeronautics and
Space Administration

Lyndon B. Johnson Space Center
Houston, Texas

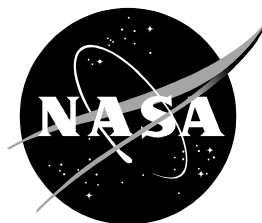

United Space Alliance

Verify this is the correct version for the pending operation (training, simulation or flight).
Electronic copies of FDF books are available. URL: <http://mod.jsc.nasa.gov/do3/FDF/index.html>

ASC/ENT SYSTEMS PROCEDURES

GENERIC, Rev O (June 1, 2007)

PCN-3 (Oct 9, 2007) Sheet 1 of 1

List of Implemented Change Requests (482s):

AESP-0713

MULTI-1808

NOTE

For STS-120 and subsequent flights

Incorporate the following:

1. Replace v thru xii
2. Replace MS E3-1 & MS E3-2
3. Replace FB E11-5 & FB E11-6
4. Replace FB E12-9 & FB E12-10
5. Replace (OV103,104) FB E13-3 thru (OV105) FB E13-4 (4 pages)

Prepared by:

Publication Manager

Approved by:

Manager, Shuttle Procedures Management

Accepted by:

FDF Manager

Encl: 18 pages

File this PCN immediately behind the front cover as a permanent record

ASC/ENT SYSTEMS PROCEDURES

GENERIC, Rev O (June 1, 2007)

PCN-1 (July 18, 2007) Sheet 1 of 1

List of Implemented Change Requests (482s):

AESP-0709

Incorporate the following:

1. Replace v thru xii (8 pages), xix thru xxii (4 pages)
2. Replace MS E7-3 & MS E7-4
3. Replace FB E11-3 thru FB E11-6

NOTE

For STS-118 and subsequent flights

Prepared by:

Publication Manager

Approved by:

Manager, Shuttle Procedures Management

Accepted by:

FDF Manager

Encl: 18 pages

File this PCN immediately behind the front cover as a permanent record

JSC-48001

MISSION OPERATIONS DIRECTORATE

ASCENT/ENTRY SYSTEMS PROCEDURES

GENERIC, REVISION 0

June 1, 2007

PREPARED BY:



Michele M. Crisp
Publication Manager

APPROVED BY:

ACCEPTED BY:

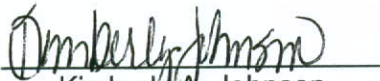

Kimberly A. Johnson
Manager, Shuttle
Procedures Management



Michael T. Hurt
FDF Manager

This document is under the configuration control of the Crew Procedures Control Board (CPCB). All proposed changes must be submitted via FDF Workflow Crew Procedure Change Request (CR) to DO3/FDF Manager.

Additional distribution of this book, for official use only, may be requested in writing to DO3/PMO Administrator. The request must include justification and requester's name, organization, position, and phone number. Contractor requests are made through the NASA or DOD organization supported. Deletions, reduction in quantity, or change of address may be submitted to DO3/FDF Management Office, 281-244-1184.

AESP/ALL/GEN 0

Incorporates the following:		
482#:	AESP-0704	AESP-0706
		AESP-0707

AREAS OF TECHNICAL RESPONSIBILITY

Publication Manager	DO35/M. Crisp	281-483-5975
Alternate	DO35/T. Vaughan	281-483-4180
APU/HYD (MMACS)	DF5/K. McCluney	281-483-0867
COMM (INCO)	DF2/G. Horlacher	281-483-3878
DPS	DF3/B. Schwank	281-244-0004
ECLS (EECOM)	DF8/D. Fasbender	281-483-7857
EPS (EGIL)	DF7/M. Friant	281-483-0682
GNC	DF6/D. Gruber	281-483-0709
OMS/RCS (PROP)	DF63/J. Campa	281-244-1002
MPS (BOOSTER)	DF5/M. Patel	281-483-0083
PWRDN	DF7/M. Friant	281-483-0682

NOTES

1. Sections 1 through 8 of this book are inserted in the front of the Mission Specialist copies of the Ascent and/or Entry Pocket Checklists.
2. Sections 10 thru 13 are the Multiphase Cue Cards, the Pilot's Overhead Flip Book, the Pilot's Window Flip Book, and the Commander's Window Flip Book which are printed in this book for documentation and control purposes only. They will be removed from Simulator and Flight copies.
3. The Mission Specialist book and all flip books will each be separated into two divisions, Powered Flight (A) and Glided Flight (E).
4. Icons will be used in the following manner:
 - '⇒' At the end of a procedure line indicates a choice to continue to either the Glided Flight division of the AESP and/or to the ASC PKT C/L as dictated by the prevailing flight phase.
 - '⇒G' At the end of a procedure line indicates one should continue to the Glided Flight division of the AESP.
 - '⇒A' At the end of a procedure line indicates one should continue to the ASC PKT C/L.
 - '⇒' Preceding a line indicates the starting point of the procedure if coming from a procedure with a continue (⇒) icon.
 - '◆' Indicates one should √MCC and if no comm continue with the procedure.



This Page Intentionally Blank



ASCENT/ENTRY SYSTEMS PROCEDURES

LIST OF EFFECTIVE PAGES

GENERIC	07/02/87
REV O	06/01/07
PCN-1	07/18/07
PCN-2	10/01/07
PCN-3	10/09/07
PCN-4	10/22/08

Sign Off.....	*	ALL/GEN O
ii.....	*	ALL/GEN O
iii.....	*	ALL/GEN O
iv.....	*	ALL/GEN O
v.....	*	ALL/GEN O,4
vi.....	*	ALL/GEN O,4
vii.....	*	ALL/GEN O,4
viii.....	*	ALL/GEN O,2
ix.....	*	ALL/GEN O,4
x.....	*	ALL/GEN O,4
xi.....	*	ALL/GEN O,4
xii.....	*	ALL/GEN O,4
xiii.....	*	ALL/GEN O,4
xiv.....	*	ALL/GEN O
xv.....		ALL/GEN O
xvi.....		ALL/GEN O
xvii.....		ALL/GEN O
xviii.....		ALL/GEN O
xix.....		ALL/GEN O
xx.....		ALL/GEN O,1
xxi.....		ALL/GEN O
xxii.....		ALL/GEN O,1
xxiii.....		ALL/GEN O
xxiv.....		ALL/GEN O
xxv.....		ALL/GEN O
xxvi.....		ALL/GEN O
xxvii.....		ALL/GEN O
xxviii.....		ALL/GEN O

* – Omit from MS flight book

MS A-i.....	*	ALL/A/GEN O
MS A-ii.....	*	ALL/A/GEN O
MS A1-1.....		ALL/A/GEN O
MS A1-2.....		ALL/A/GEN O
MS A2-1.....		ALL/A/GEN O
MS A2-2.....		ALL/A/GEN O
MS A3-1.....		ALL/A/GEN O
MS A3-2.....		ALL/A/GEN O
MS A3-3.....		ALL/A/GEN O,4
MS A3-4.....		ALL/A/GEN O
MS A3-5.....		ALL/A/GEN O
MS A3-6.....	⊗	ALL/A/GEN O
MS A4-1.....		ALL/A/GEN O
MS A4-2.....		ALL/A/GEN O
(OV103,104) MS A4-3.....		3,4/A/GEN O
(OV103,104) MS A4-4.....		ALL/A/GEN O,2
(OV103,104) MS A4-5.....		ALL/A/GEN O
(OV103,104) MS A4-6.....		3,4/A/GEN O,2
(OV105) MS A4-3.....		5/A/GEN O
(OV105) MS A4-4.....		ALL/A/GEN O,2
(OV105) MS A4-5.....		ALL/A/GEN O
(OV105) MS A4-6.....		5/A/GEN O,2
MS A4-7.....		ALL/A/GEN O
MS A4-8.....		ALL/A/GEN O
MS A5-1.....		ALL/A/GEN O
MS A5-2.....		ALL/A/GEN O
MS A5-3.....		ALL/A/GEN O
MS A5-4.....		ALL/A/GEN O
MS A5-5.....		ALL/A/GEN O
MS A5-6.....		ALL/A/GEN O
MS A5-7.....		ALL/A/GEN O
MS A5-8.....		ALL/A/GEN O
MS A5-9.....		ALL/A/GEN O
MS A5-10.....		ALL/A/GEN O

* – Omit from MS flight book

⊗ – Highlights reqd

(OV103,104) MS A5-11		3,4/A/GEN O
(OV103,104) MS A5-12		ALL/A/GEN O
(OV105) MS A5-11		5/A/GEN O
(OV105) MS A5-12		ALL/A/GEN O
MS A6-1		ALL/A/GEN O
MS A6-2	☒	ALL/A/GEN O
MS A6-3	☒	ALL/A/GEN O
MS A6-4	☒	ALL/A/GEN O
MS A7-1		ALL/A/GEN O
MS A7-2		ALL/A/GEN O
MS A7-3		ALL/A/GEN O
MS A7-4		ALL/A/GEN O
MS A8-1		ALL/A/GEN O
MS A8-2		ALL/A/GEN O,4
MS A8-3	⊗	ALL/A/GEN O,4
MS A8-4		ALL/A/GEN O
MS A9-1	*	ALL/A/GEN O
MS A9-2	*	ALL/A/GEN O
MS E-i		ALL/E/GEN O
MS E-ii		ALL/E/GEN O
MS E1-1		ALL/E/GEN O
MS E1-2		ALL/E/GEN O
MS E1-3		ALL/E/GEN O
MS E1-4		ALL/E/GEN O
MS E1-5		ALL/E/GEN O
MS E1-6		ALL/E/GEN O
MS E2-1		ALL/E/GEN O
MS E2-2		ALL/E/GEN O
(OV103,104) MS E2-3		ALL/E/GEN O
(OV103,104) MS E2-4		3,4/E/GEN O
(OV105) MS E2-3		ALL/E/GEN O
(OV105) MS E2-4		5/E/GEN O
MS E3-1		ALL/E/GEN O
MS E3-2		ALL/E/GEN O,4
MS E3-3		ALL/E/GEN O
MS E3-4		ALL/E/GEN O

- ☒ – Prelift-off information reqd
- ⊗ – Highlights reqd
- * – Omit from MS flight book

MS E3-5.....	ALL/E/GEN O
MS E3-6.....	ALL/E/GEN O
MS E3-7.....	ALL/E/GEN O
MS E3-8.....	ALL/E/GEN O
MS E4-1.....	ALL/E/GEN O
MS E4-2.....	ALL/E/GEN O
(OV103,104) MS E4-3.....	3,4/E/GEN O
(OV103,104) MS E4-4.....	ALL/E/GEN O
(OV103,104) MS E4-5.....	ALL/E/GEN O,2
(OV103,104) MS E4-6.....	3,4/E/GEN O,2
(OV105) MS E4-3.....	5/E/GEN O
(OV105) MS E4-4.....	ALL/E/GEN O
(OV105) MS E4-5.....	ALL/E/GEN O,2
(OV105) MS E4-6.....	5/E/GEN O,2
MS E4-7.....	ALL/E/GEN O
MS E4-8.....	ALL/E/GEN O
MS E5-1.....	ALL/E/GEN O
MS E5-2.....	ALL/E/GEN O
MS E5-3.....	ALL/E/GEN O
MS E5-4.....	ALL/E/GEN O
MS E5-5.....	ALL/E/GEN O
MS E5-6.....	ALL/E/GEN O
MS E5-7.....	ALL/E/GEN O
MS E5-8.....	ALL/E/GEN O
MS E5-9.....	ALL/E/GEN O
MS E5-10.....	ALL/E/GEN O
MS E5-11.....	ALL/E/GEN O
MS E5-12.....	ALL/E/GEN O
(OV103,104) MS E5-13.....	3,4/E/GEN O
(OV103,104) MS E5-14.....	ALL/E/GEN O
(OV105) MS E5-13.....	5/E/GEN O
(OV105) MS E5-14.....	ALL/E/GEN O
MS E5-15.....	ALL/E/GEN O
MS E5-16.....	ALL/E/GEN O

MS E5-17.....		ALL/E/GEN O
MS E5-18.....		ALL/E/GEN O
MS E6-1.....		ALL/E/GEN O
MS E6-2.....	☒	ALL/E/GEN O
MS E6-3.....		ALL/E/GEN O
MS E6-4.....		ALL/E/GEN O
MS E7-1.....		ALL/E/GEN O
MS E7-2.....		ALL/E/GEN O
MS E7-3.....		ALL/E/GEN O,1
MS E7-4.....		ALL/E/GEN O,1
MS E7-5.....		ALL/E/GEN O
MS E7-6.....		ALL/E/GEN O
MS E8-1.....		ALL/E/GEN O
MS E8-2.....		ALL/E/GEN O
MS E9-1.....	*	ALL/E/GEN O
MS E9-2.....	*	ALL/E/GEN O
CC 10-i.....	*	ALL/A,E/GEN O
CC 10-ii.....	*	ALL/A,E/GEN O
CC 10-1.....	*	ALL/A,E/GEN O
CC 10-2.....	*⊗	ALL/A/GEN O,4
CC 10-3.....	*	ALL/A/GEN O
CC 10-4.....	*	ALL/A/GEN O
CC 10-5.....	*	ALL/A/GEN O
CC 10-6.....	*	ALL/E/GEN O
CC 10-7.....	*	ALL/A/GEN O
CC 10-8.....	*	ALL/A/GEN O
(OV103,104) CC 10-9.....	*	3,4/A,E/GEN O,2
(OV103,104) CC 10-10.....	*	ALL/A,E/GEN O
(OV105) CC 10-9.....	*	5/A,E/GEN O,2
(OV105) CC 10-10.....	*	ALL/A,E/GEN O
FB A11-i.....	*	ALL/A/GEN O
FB A11-ii.....	*	ALL/A/GEN O
FB A11-1.....	*☒	ALL/A/GEN O
FB A11-2.....	*☒	ALL/A/GEN O
FB A11-3.....	*☒	ALL/A/GEN O
FB A11-4.....	*	ALL/A/GEN O

- ☒ – Prelift-off information reqd
- * – Omit from MS flight book
- ⊗ – Highlights reqd

FB A11-5	*	ALL/A/GEN O
FB A11-6	*	ALL/A/GEN O
FB E11-i.....	*	ALL/E/GEN O
FB E11-ii.....	*	ALL/E/GEN O
FB E11-1	*☒	ALL/E/GEN O
FB E11-2	*	ALL/E/GEN O
FB E11-3	*	ALL/E/GEN O
FB E11-4	*	ALL/E/GEN O,1
FB E11-5	*	ALL/E/GEN O,1
FB E11-6	*	ALL/E/GEN O,3
FB A12-i.....	*	ALL/A/GEN O
FB A12-ii.....	*	ALL/A/GEN O
FB A12-1	*	ALL/A/GEN O
FB A12-2	*	ALL/A/GEN O
FB A12-3	*	ALL/A/GEN O
FB A12-4	*	ALL/A/GEN O
FB A12-5	*	ALL/A/GEN O,4
FB A12-6	*	ALL/A/GEN O
FB A12-7	*	ALL/A/GEN O
FB A12-8	*	ALL/A/GEN O
FB A12-9	*⊗	ALL/A/GEN O
FB A12-10	*	ALL/A/GEN O
FB A12-11	*	ALL/A/GEN O
FB A12-12	*	ALL/A/GEN O
FB A12-13	*	ALL/A/GEN O
FB A12-14	*	ALL/A/GEN O
FB A12-15	*	ALL/A/GEN O
FB A12-16	*	ALL/A/GEN O
(OV103,104) FB A12-17	*	3,4/A/GEN O
(OV103,104) FB A12-18.....	*	ALL/A/GEN O
(OV105) FB A12-17.....	*	5/A/GEN O
(OV105) FB A12-18.....	*	ALL/A/GEN O
FB E12-i.....	*	ALL/E/GEN O
FB E12-ii.....	*	ALL/E/GEN O
FB E12-1	*	ALL/E/GEN O
FB E12-2	*	ALL/E/GEN O

- * – Omit from MS flight book
- ☒ – Prelift-off information reqd
- ⊗ – Highlights reqd

FB E12-3	*	ALL/E/GEN O
FB E12-4	*	ALL/E/GEN O
FB E12-5	*	ALL/E/GEN O
FB E12-6	*	ALL/E/GEN O
(OV103,104) FB E12-7	*	3,4/E/GEN O
(OV103,104) FB E12-8	*	3,4/E/GEN O
(OV105) FB E12-7	*	5/E/GEN O
(OV105) FB E12-8	*	5/E/GEN O
FB E12-9	*	ALL/E/GEN O,4
FB E12-10	*	ALL/E/GEN O
FB E12-11	*	ALL/E/GEN O
FB E12-12	*	ALL/E/GEN O
FB E12-13	*	ALL/E/GEN O
FB E12-14	*	ALL/E/GEN O
FB E12-15	*	ALL/E/GEN O
FB E12-16	*	ALL/E/GEN O
FB E12-17	*	ALL/E/GEN O
FB E12-18	*	ALL/E/GEN O
FB E12-19	*	ALL/E/GEN O
FB E12-20	*	ALL/E/GEN O
FB E12-21	*	ALL/E/GEN O
FB E12-22	*	ALL/E/GEN O
(OV103,104) FB E12-23	*	ALL/E/GEN O
(OV103,104) FB E12-24	*	3,4/E/GEN O
(OV105) FB E12-23	*	ALL/E/GEN O
(OV105) FB E12-24	*	5/E/GEN O
FB E12-25	*	ALL/E/GEN O
FB E12-26	*	ALL/E/GEN O
FB A13-i	*	ALL/A/GEN O
FB A13-ii	*	ALL/A/GEN O
FB A13-1	*	ALL/A/GEN O
FB A13-2	*	ALL/A/GEN O
FB A13-3	*	ALL/A/GEN O,4
FB A13-4	*	ALL/A/GEN O
FB A13-5	*	ALL/A/GEN O
FB A13-6	*	ALL/A/GEN O
FB A13-7	*⊗	ALL/A/GEN O
FB A13-8	*	ALL/A/GEN O

* – Omit from flight book

⊗ – Highlights reqd

(OV103,104) FB A13-9.....	*	3,4/A/GEN O
(OV103,104) FB A13-10.....	*	ALL/A/GEN O,2
(OV105) FB A13-9.....	*	5/A/GEN O
(OV105) FB A13-10.....	*	ALL/A/GEN O,2
FB A13-11	*	ALL/A/GEN O
FB A13-12	*	ALL/A/GEN O
FB A13-13	*	ALL/A/GEN O
FB A13-14	*	ALL/A/GEN O
FB E13-i.....	*	ALL/E/GEN O
FB E13-ii.....	*	ALL/E/GEN O
FB E13-1	*	ALL/E/GEN O
FB E13-2	*	ALL/E/GEN O
(OV103,104) FB E13-3.....	*	3,4/E/GEN O
(OV103,104) FB E13-4.....	*	ALL/E/GEN O,4
(OV105) FB E13-3.....	*	5/E/GEN O
(OV105) FB E13-4.....	*	ALL/E/GEN O,4
FB E13-5	*	ALL/E/GEN O
FB E13-6	*	ALL/E/GEN O
FB E13-7	*	ALL/E/GEN O
FB E13-8	*	ALL/E/GEN O
FB E13-9	*	ALL/E/GEN O
FB E13-10	*	ALL/E/GEN O
(OV103,104) FB E13-11	*	ALL/E/GEN O
(OV103,104) FB E13-12.....	*	3,4/E/GEN O
(OV105) FB E13-11	*	ALL/E/GEN O
(OV105) FB E13-12.....	*	5/E/GEN O
FB E13-13	*	ALL/E/GEN O
FB E13-14	*	ALL/E/GEN O,2
FB E13-15	*	ALL/E/GEN O
FB E13-16	*	ALL/E/GEN O
FB E13-17	*	ALL/E/GEN O
FB E13-18	*	ALL/E/GEN O

* – Omit from MS flight book

MULTIPHASE SYSTEMS CUE CARDS

<u>Title</u>	<u>Ref. Page</u>	<u>Card No.</u>
POWER (Front)	CC 10-1	AESP-5a/A,O,E/S
(Back).....	CC 10-1	AESP-5b/A,O,E/F
MPS 1 (Front)	CC 10-2	AESP-11a/A/N
(Back)	CC 10-3	AESP-11b/A/E
MPS 2 (Front)	CC 10-4	AESP-14a/A/E
(Back).....	CC 10-4	AESP-14b/A/D
OPS 1/6/TAL TRANSITION RESTRING (Front)	CC 10-5	AESP-10a/A/G
POST OPS 3/GRTL TRANSITION RESTRING (Back)	CC 10-6	AESP-10b/E/F
MPS He P (Pre MECO)/ MPS PNEU TK(REG) P (Front)	CC 10-7	AESP-15a/A/B
(Back)	CC 10-7	AESP-15b/A/C
ET SEP (Front).....	CC 10-8	AESP-13a/A/F
(Back)	CC 10-8	AESP-13b/A/F
FIRE/SMOKE (ASCENT/ENTRY) (Front)...	CC 10-9	AESP-7a/A,O,E/H
(ORBIT) (Back).....	See ORBIT POCKET C/L	
POWERED FLIGHT – PLT Overhead Flip Book ...	See FB A11-1 thru FB A11-6	
PLT Window Flip Book	See FB A12-2 thru FB A12-18	
CDR Window Flip Book	See FB A13-1 thru FB A13-14	
GLIDED FLIGHT – PLT Overhead Flip Book ...	See FB E11-1 thru FB E11-6	
PLT Window Flip Book	See FB E12-1 thru FB E12-26	
CDR Window Flip Book	See FB E13-1 thru FB E13-18	



This Page Intentionally Blank



CONTENTS

PAGE

MS POWERED FLIGHT	MS A-i
<u>APU/HYDRAULICS</u>	MS A1-1
APU SHUTDN	MS A1-2
SPD HI	MS A1-2
OVERSPEED	MS A1-2
UNDERSPEED	MS A1-2
OIL OVERTEMP	MS A1-2
HYD PRESS (LOW) (CIL)	MS A1-2
RSVR QTY (LOW)	MS A1-2
W/B QTY (LOW).....	MS A1-2
<u>COMM/GNC</u>	MS A2-1
COMM LOST (mult pnls).....	MS A2-2
ICOM LOST.....	MS A2-2
FCS CH 1(2,3,4) (2nd FAIL).....	MS A2-2
RHC L(R) (2nd FAIL).....	MS A2-2
DISPLAY SW L(R)	MS A2-2
RM FAIL IMU,RGA,AA	MS A2-2
DLMA IMU	MS A2-2
<u>DPS</u>	MS A3-1
PASS GPC FAIL	MS A3-2
BFS GPC FAIL	MS A3-2
FF(FA) MDM OUTPUT.....	MS A3-2
PL MDM I/O ERROR.....	MS A3-2
PCM I/O ERROR.....	MS A3-2
SUMWORD ICC.....	MS A3-2
FA/FF MDM I/O ERROR	MS A3-3
PORT MODE	MS A3-3
BCE STRG X.....	MS A3-4
DUAL DPS DISPLAY COMMANDERS/ DK XMTR 1(2,3)	MS A3-4
PASS DISPLAY FAIL	MS A3-4
BFS DISPLAY FAIL.....	MS A3-5
FLT INST DISPLAY ANOMALY	MS A3-5
SUBSYS STATUS DISPLAY ANOMALY	MS A3-5
BFS INADVERTENT DISENGAGE/ UNSUCCESSFUL ENGAGE	MS A3-5
MULT DATA PATH LOSS (non-Recov) (CIL)	MS A3-6
OPS 1/6/TAL TRANSITION RESTRING	MS A3-6
POST BFS ENGAGE	MS A3-6

<u>ECLS</u>	MS A4-1
CAB PRESS LEAK.....	MS A4-2
HIGH.....	MS A4-2
PPO2 ABNORMAL.....	MS A4-2
H2O LOOP PRESS HIGH.....	MS A4-2
LOW.....	MS A4-2
AV BAY FAN ΔP.....	MS A4-2
TEMP HIGH	MS A4-2
CABIN FAN FAIL.....	MS A4-2
IMU FAN FAIL	MS A4-2
FREON FLOW LOW	MS A4-3
LOSS OF 1 FREON LOOP	MS A4-3
2 FREON LOOPS – PWRDN	MS A4-3
– LOOPS FAILED	MS A4-3
EVAP OUT T LOW.....	MS A4-4
FREON LEAK.....	MS A4-4
EVAP OUT TEMP HIGH	MS A4-5
FIRE/SMOKE	MS A4-6
<u>EPS</u>	MS A5-1
MN BUS UNDERVOLTS/FC VOLTS (PLT) (CIL) ...	MS A5-2
AC VOLT HIGH (PLT)	MS A5-2
LOW or OVERLOAD (PLT).....	MS A5-3
3Φ AC MOTORS STOPPED (PLT).....	MS A5-3
BUS TIE	MS A5-4
MNA (CDR)	MS A5-4
MNB (CDR)	MS A5-4
MNC (CDR).....	MS A5-4
ANY AC BUS LOSS (CDR).....	MS A5-4
SUBBUS [MNA O14] (CDR).....	MS A5-4
[APC6 or ALC3].....	MS A5-4
MNA or AC1 Multi Φ (PLT) (CIL)	MS A5-5
MNB or AC2 Multi Φ (PLT) (CIL)	MS A5-5
MNC or AC3 Multi Φ (PLT) (CIL)	MS A5-5
AC SINGLE Φ (PLT)	MS A5-5
SUBBUS [APC4(5,6) or ALC1(2,3)] (PLT)	MS A5-5
ESS BUS V LOW (PLT)	MS A5-6
LOSS (PLT) (CIL)	MS A5-6
CNTL BUS LOSS (CDR).....	MS A5-6
V LOW/CNTL BUS RPC (PLT).....	MS A5-7
LOSS (PLT)	MS A5-8
FC REAC VLV CLOSED (PLT).....	MS A5-9
pH ↓ 1(2,3) or FC DELTA V 1(2,3) (PLT)	MS A5-9
STACK T (PLT)	MS A5-9

FC EXIT T (PLT)	MS A5-9
COOLANT PUMP ΔP LOW (PLT) (CIL)	MS A5-10
COOL P (PLT)	MS A5-10
SHUTDN (1st) (PLT) (CIL)	MS A5-10
LOSS OF 1 FC PWRDN (PLT)	MS A5-10
2nd FC SHUTDN (PLT).....	MS A5-11
LOSS OF 2nd FC PWRDN (CDR)	MS A5-11
O2(H2) CRYO PRESS/TEMP HIGH (PLT)	MS A5-12
CRYO O2(H2) LEAK (three or more tanks aff) (PLT)	MS A5-12
<u>OMS</u>	MS A6-1
OMS He TK P LOW	MS A6-2
OMS N2 TK P LOW (N/A DURING ASSIST/RTLS/TAL/ATO DUMP).....	MS A6-2
OMS N2 REG P HIGH OR LOW.....	MS A6-2
TK P LOW (↓, OX or FU) NOT DUMPING ...	MS A6-3
TEMP DURING DUMP	MS A6-4
Pc LOW DURING DUMP	MS A6-4
ENG FAIL	MS A6-4
PRPLT FAIL	MS A6-4
OMS TK P LOW (↓, OX and FU) DURING DUMP ...	MS A6-4
HIGH (↑, OX and FU) DURING DUMP ..	MS A6-4
<u>RCS</u>	MS A7-1
RCS JET FAIL (LEAK)	MS A7-2
(ON)	MS A7-2
RM DLMA MANF.....	MS A7-2
RCS JET FAIL (OFF)	MS A7-2
TK P HIGH (FU or OX)	MS A7-2
XFEED: RCS to RCS (CIL)	MS A7-2
RCS SECURE	MS A7-3
AFT RCS LK.....	MS A7-3
FWD RCS LK	MS A7-4
<u>MPS</u>	MS A8-1
SSME FAIL/SHUTDN (CIL).....	MS A8-2
MPS DATA (CIL)	MS A8-2
LH2 ULL	MS A8-2
DUMP INHIBIT	MS A8-2
'ET SEP MAN' (ET SEP).....	MS A8-2
MPS CMD/HYD/ELEC (CIL)	MS A8-3
He P (Pre MECO).....	MS A8-4
PNEU TK(REG) P	MS A8-4

SECTION RESERVED

MS GLIDED FLIGHT MS E-i

<u>APU/HYDRAULICS</u>	MS E1-1
APU SHUTDN.....	MS E1-2
SPD HI.....	MS E1-2
OVERSPEED.....	MS E1-2
UNDERSPEED.....	MS E1-2
OIL OVERTEMP.....	MS E1-2
PUMP LEAK P.....	MS E1-2
THERM (T HI).....	MS E1-2
COOLDOWN.....	MS E1-3
RESTART (CIL).....	MS E1-3
HYD PRESS (LOW) (CIL).....	MS E1-4
RSVR QTY (LOW).....	MS E1-5
T.....	MS E1-5
W/B QTY (LOW).....	MS E1-5

<u>COMM/GNC</u>	MS E2-1
COMM LOST (mult pnls).....	MS E2-2
ICOM LOST.....	MS E2-2
FCS CH 1(2,3,4) (2nd FAIL).....	MS E2-2
RHC L(R) (2nd FAIL).....	MS E2-2
G51 ROLL MODE SW.....	MS E2-2
DISPLAY SW L(R).....	MS E2-2
RM FAIL IMU,RGA,AA.....	MS E2-2
DLMA IMU.....	MS E2-2
FAIL ADTA.....	MS E2-3
DLMA ADTA (CIL).....	MS E2-3
FAIL TAC.....	MS E2-3
DLMA TAC.....	MS E2-3
SPD BRK.....	MS E2-3
G55 GPS FAIL 1(2,3).....	MS E2-4
RM DLMA GPS (OV105).....	MS E2-4
NO UPDATE GPS.....	MS E2-4

<u>DPS</u>	MS E3-1
PASS GPC FAIL.....	MS E3-2
BFS GPC FAIL.....	MS E3-2
FA/FF MDM I/O ERROR.....	MS E3-2
PORT MODE.....	MS E3-3
FF(FA) MDM OUTPUT.....	MS E3-4
PL MDM I/O ERROR.....	MS E3-4
PCM I/O ERROR.....	MS E3-4
BCE STRG X.....	MS E3-5
POST OPS 3/	
GRTLS TRANSITION RESTRING.....	MS E3-6
POST BFS ENGAGE.....	MS E3-6

DUAL DPS DISPLAY COMMANDERS/ DK XMTR 1(2,3)	MS E3-7
PASS DISPLAY FAIL	MS E3-7
BFS DISPLAY FAIL	MS E3-7
FLT INST DISPLAY ANOMALY	MS E3-8
SUBSYS STATUS DISPLAY ANOMALY	MS E3-8
BFS INADVERTENT DISENGAGE/ UNSUCCESSFUL ENGAGE	MS E3-8
MULT DATA PATH LOSS (non-Recov) (CIL)	MS E3-8
<u>ECLS</u>	MS E4-1
CAB PRESS LEAK	MS E4-2
HIGH	MS E4-2
H2O LOOP PRESS LOW(HIGH)	MS E4-2
AV BAY FAN Δ P	MS E4-2
TEMP HIGH	MS E4-2
LOSS OF AV BAY COOLING PWRDN	MS E4-2
CABIN FAN FAIL	MS E4-2
IMU FAN FAIL	MS E4-2
FREON FLOW LOW	MS E4-3
LOSS OF 1 FREON LOOP	MS E4-3
2 FREON LOOPS – PWRDN	MS E4-3
– LOOPS FAILED	MS E4-4
EVAP OUT TEMP HIGH	
(Rads cold soaked)	MS E4-4
(Rads <i>not</i> cold soaked)	MS E4-4
EVAP OUT T LOW	MS E4-5
FREON LEAK	MS E4-5
FIRE/SMOKE	MS E4-6
<u>EPS</u>	MS E5-1
MN BUS UNDERVOLTS/FC VOLTS (PLT) (CIL) ...	MS E5-2
AC VOLT HIGH (PLT)	MS E5-2
LOW or OVERLOAD (PLT)	MS E5-3
3 Φ AC MOTORS STOPPED (PLT)	MS E5-4
AC SINGLE Φ (PLT)	MS E5-4
ANY AC2 SINGLE Φ (CDR)	MS E5-4
BUS TIE	MS E5-5
ESS BUS V LOW (PLT)	MS E5-5
LOSS (CIL)	MS E5-5
MNA or AC1 Multi Φ (CDR)	MS E5-6
MNB or AC2 Multi Φ (CDR)	MS E5-6
MNC or AC3 Multi Φ (CDR)	MS E5-6
SUBBUS [MNA O14] (CDR)	MS E5-6
[APC4(5,6) or ALC1(2,3)]	MS E5-6
MNA or AC1 Multi Φ (PLT) (CIL)	MS E5-7

MNB or <u>AC2 Multi Φ</u> (PLT) (CIL)	MS E5-7
MNC or <u>AC3 Multi Φ</u> (PLT) (CIL)	MS E5-7
SUBBUS (PLT).....	MS E5-7
CNTL BUS V LOW/CNTL BUS RPC (PLT).....	MS E5-8
LOSS (CDR).....	MS E5-9
(PLT).....	MS E5-10
FC REAC VLV CLOSED (PLT)	MS E5-11
pH ↓ 1(2,3) or FC DELTA V 1(2,3) (PLT)	MS E5-11
STACK T (PLT)	MS E5-11
EXIT T (PLT)	MS E5-11
COOLANT PUMP ΔP LOW (PLT) (CIL).....	MS E5-12
COOL P (PLT).....	MS E5-12
SHUTDN (1st) (CIL)	MS E5-13
LOSS OF 1 FC PWRDN (GRTLS/TAL) (PLT)	MS E5-13
(ENTRY)(PLT).....	MS E5-13
EMER PWRDN (PLT)	MS E5-13
2nd FC SHUTDN (GRTLS/TAL) (PLT).....	MS E5-14
(ENTRY) (PLT)	MS E5-14
LOSS OF 2nd FC PWRDN	
(GRTLS/TAL) (CDR)	MS E5-15
(GRTLS/TAL) (PLT).....	MS E5-16
(ENTRY) (CDR).....	MS E5-16
O2(H2) CRYO P/T HIGH (PLT).....	MS E5-17
CRYO O2(H2) LEAK	
(three or more tanks aff) (PLT).....	MS E5-17
<u>OMS</u>	MS E6-1
OMS TEMP DURING DUMP	MS E6-2
Pc LOW DURING DUMP	MS E6-2
ENG FAIL	MS E6-2
PRPLT FAIL	MS E6-2
OMS SECURE	MS E6-3
OMS XFEED: R to L.....	MS E6-3
L to R.....	MS E6-3
XFEED RETURN: OMS to OMS.....	MS E6-3
<u>RCS</u>	MS E7-1
RCS JET FAIL (LEAK)	MS E7-2
(ON)	MS E7-2
RM DLMA MANF.....	MS E7-2
RCS JET FAIL (OFF)	MS E7-2
AFT RCS RM LOSS.....	MS E7-2
LOW QBAR AFT RCS LK (GRTLS/304/305).....	MS E7-3
AFT RCS LK (GRTLS/304/305)	MS E7-4
RCS TK P HIGH (FU or OX)	MS E7-5

XFEED: RCS to RCS (CIL)	MS E7-5
RCS SECURE	MS E7-5
MPS	MS E8-1
MPS He P/MPS C&W LIGHT	
PNEU REG	MS E8-2

SECTION RESERVED

MULTIPHASE SYSTEMS CUE CARDS **CC 10-i**

POWER	
EMER PWRDN	CC 10-1
FC SHUTDN (1st) (CIL)	CC 10-1
BUS TIE	CC 10-1
MPS 1	
SSME FAIL/SHUTDN (CIL)	CC 10-2
MPS DATA (CIL)	CC 10-2
LH2 ULL	CC 10-2
DUMP INHIBIT	CC 10-2
CMD/HYD/ELEC (CIL)	CC 10-2
MPS 2	CC 10-4
OPS 1/6/TAL TRANSITION RESTRING	CC 10-5
POST OPS 3/GRTLS TRANSITION RESTRING	CC 10-6
MPS He P (Pre MECO)	CC 10-7
PNEU TK(REG) P	CC 10-7
ET SEP	
'ET SEP MAN'	CC 10-8
FIRE/SMOKE (ASCENT/ENTRY)	CC 10-9

PLT OVERHEAD FLIP BOOK -

POWERED FLIGHT **FB A11-i**

OMS He TK P LOW	FB A11-1
OMS N2 TK P LOW (N/A DURING	
ASSIST/RTLS/TAL/ATO DUMP)	FB A11-1
OMS N2 REG P HIGH or LOW	FB A11-1
TK P LOW (↓, OX or FU) NOT DUMPING ...	FB A11-2
TEMP DURING DUMP	FB A11-3
Pc LOW DURING DUMP	FB A11-3
ENG FAIL	FB A11-3
PRPLT FAIL	FB A11-3
OMS TK P LOW (↓, OX and FU) DURING DUMP ...	FB A11-3
HIGH (↑, OX and FU) DURING DUMP ..	FB A11-3

RCS JET FAIL (LEAK)	FB A11-4
(ON)	FB A11-4
RM DLMA MANF	FB A11-4
RCS JET FAIL (OFF)	FB A11-4
TK P HIGH (FU or OX)	FB A11-4
XFEED: RCS to RCS (CIL)	FB A11-4
RCS SECURE	FB A11-5
AFT RCS LK	FB A11-5
FWD RCS LK	FB A11-6

PLT OVERHEAD FLIP BOOK -

GLIDED FLIGHT..... FB E11-i

OMS TEMP DURING DUMP	FB E11-1
Pc LOW DURING DUMP	FB E11-1
ENG FAIL	FB E11-1
PRPLT FAIL	FB E11-1
OMS SECURE	FB E11-2
OMS XFEED: R to L	FB E11-2
L to R	FB E11-2
XFEED RETURN: OMS to OMS	FB E11-2
RCS JET FAIL (LEAK)	FB E11-3
(ON)	FB E11-3
RM DLMA MANF	FB E11-3
RCS JET FAIL (OFF)	FB E11-3
TK P HIGH (FU or OX)	FB E11-3
XFEED: RCS to RCS (CIL)	FB E11-3
LOW QBAR AFT RCS LK (GRTLS/304/305)	FB E11-4
AFT RCS LK (GRTLS/304/305)	FB E11-5
RCS SECURE	FB E11-6
AFT RCS RM LOSS	FB E11-6

PLT WINDOW FLIP BOOK -

POWERED FLIGHT..... FB A12-i

APU SHUTDN	FB A12-2
SPD HI	FB A12-2
OVERSPEED	FB A12-2
UNDERSPEED	FB A12-2
OIL OVERTEMP	FB A12-2
HYD PRESS (LOW) (CIL)	FB A12-2
RSVR QTY (LOW)	FB A12-2
W/B QTY (LOW)	FB A12-2
COMM LOST (mult pnls)	FB A12-3

ICOM LOST.....	FB A12-3
FCS CH 1(2,3,4) (2nd FAIL).....	FB A12-3
RHC L(R) (2nd FAIL).....	FB A12-3
DISPLAY SW L(R)	FB A12-3
RM FAIL IMU,RGA,AA	FB A12-3
DLMA IMU	FB A12-3
POST BFS ENGAGE	FB A12-3
PASS GPC FAIL	FB A12-4
BFS GPC FAIL	FB A12-4
FF(FA) MDM OUTPUT.....	FB A12-4
PL MDM I/O ERROR.....	FB A12-4
PCM I/O ERROR.....	FB A12-4
FA/FF MDM I/O ERROR	FB A12-5
PORT MODE	FB A12-5
BCE STRG X.....	FB A12-6
DUAL DPS DISPLAY COMMANDERS/ DK XMTR 1(2,3).....	FB A12-6
PASS DISPLAY FAIL	FB A12-6
BFS DISPLAY FAIL.....	FB A12-7
FLT INST DISPLAY ANOMALY	FB A12-9
SUBSYS STATUS DISPLAY ANOMALY	FB A12-9
MULT DATA PATH LOSS (non-Recov) (CIL)	FB A12-9
MN BUS UNDERVOLTS/FC VOLTS (CIL)	FB A12-10
AC VOLT HIGH	FB A12-10
LOW or OVERLOAD.....	FB A12-11
3Φ AC MOTORS STOPPED.....	FB A12-11
MNA or AC1 Multi Φ (CIL)	FB A12-12
MNB or AC2 Multi Φ (CIL)	FB A12-12
MNC or AC3 Multi Φ (CIL)	FB A12-12
AC SINGLE Φ	FB A12-12
SUBBUS [APC4(5,6) or ALC1(2,3)]	FB A12-12
ESS BUS V LOW (CIL)	FB A12-12
LOSS (CIL)	FB A12-12
CNTL BUS V LOW/CNTL BUS RPC.....	FB A12-13
LOSS	FB A12-14
FC REAC VLV CLOSED	FB A12-15
pH ↓ 1(2,3) or FC DELTA V 1(2,3).....	FB A12-15
STACK T	FB A12-15
EXIT T	FB A12-15
COOLANT PUMP ΔP LOW (CIL)	FB A12-16
COOL P	FB A12-16
LOSS OF 1 FC PWRDN	FB A12-16
2nd FC SHUTDN.....	FB A12-17
O2(H2) CRYO PRESS/TEMP HIGH	FB A12-18
CRYO O2(H2) LEAK (three or more tanks aff)	FB A12-18

PLT WINDOW FLIP BOOK - GLIDED FLIGHT FB E12-i

APU SHUTDN.....	FB E12-1
SPD HI.....	FB E12-1
OVERSPEED.....	FB E12-1
UNDERSPEED.....	FB E12-1
OIL OVERTEMP.....	FB E12-1
PUMP LEAK P.....	FB E12-1
THERM (T HI).....	FB E12-1
COOLDOWN.....	FB E12-2
RESTART (CIL).....	FB E12-2
HYD PRESS (LOW) (CIL).....	FB E12-3
RSVR QTY (LOW).....	FB E12-4
T.....	FB E12-4
W/B QTY (LOW).....	FB E12-4
COMM LOST (mult pnls).....	FB E12-5
ICOM LOST.....	FB E12-5
FCS CH 1(2,3,4) (2nd FAIL).....	FB E12-5
RHC L(R) (2nd FAIL).....	FB E12-5
G51 ROLL MODE SW.....	FB E12-5
DISPLAY SW L(R).....	FB E12-5
RM FAIL IMU,RGA,AA.....	FB E12-5
DLMA IMU.....	FB E12-5
FAIL ADTA.....	FB E12-6
DLMA ADTA (CIL).....	FB E12-6
FAIL TAC.....	FB E12-6
DLMA TAC.....	FB E12-6
SPD BRK.....	FB E12-6
MPS He P/MPS C&W LIGHT.....	FB E12-7
PNEU REG.....	FB E12-7
G55 GPS FAIL 1(2,3).....	FB E12-7
RM DLMA GPS.....	FB E12-7
NO UPDATE GPS.....	FB E12-7
PASS GPC FAIL.....	FB E12-9
BFS GPC FAIL.....	FB E12-9
FA/FF MDM I/O ERROR.....	FB E12-9
PORT MODE.....	FB E12-10
FF(FA) MDM OUTPUT.....	FB E12-11
PL MDM I/O ERROR.....	FB E12-11
PCM I/O ERROR.....	FB E12-11
POST BFS ENGAGE.....	FB E12-11
BCE STRG X.....	FB E12-12
DUAL DPS DISPLAY COMMANDERS/ DK XMTR 1(2,3).....	FB E12-13
PASS DISPLAY FAIL.....	FB E12-13
BFS DISPLAY FAIL.....	FB E12-13
FLT INST DISPLAY ANOMALY.....	FB E12-14

SUBSYS STATUS DISPLAY ANOMALY	FB E12-14	
MULT DATA PATH LOSS (non-Recov) (CIL)	FB E12-14	
MN BUS UNDERVOLTS/FC VOLTS (CIL)	FB E12-16	
AC VOLT HIGH	FB E12-16	
LOW or OVERLOAD.....	FB E12-17	
3Φ AC MOTORS STOPPED.....	FB E12-18	
AC SINGLE Φ	FB E12-18	
MNA or <table border="1"><tr><td>AC1 Multi Φ</td></tr></table> (CIL)	AC1 Multi Φ	FB E12-19
AC1 Multi Φ		
MNB or <table border="1"><tr><td>AC2 Multi Φ</td></tr></table> (CIL)	AC2 Multi Φ	FB E12-19
AC2 Multi Φ		
MNC or <table border="1"><tr><td>AC3 Multi Φ</td></tr></table> (CIL)	AC3 Multi Φ	FB E12-19
AC3 Multi Φ		
SUBBUS.....	FB E12-19	
ESS BUS V LOW (CIL)	FB E12-19	
LOSS (CIL)	FB E12-20	
CNTL BUS V LOW/CNTL BUS RPC.....	FB E12-20	
LOSS	FB E12-21	
FC REAC VLV CLOSED	FB E12-23	
pH ↓ 1(2,3) or FC DELTA V 1(2,3)	FB E12-23	
STACK T	FB E12-23	
EXIT T	FB E12-24	
COOLANT PUMP ΔP LOW (CIL)	FB E12-24	
COOL P	FB E12-24	
LOSS OF 1 FC PWRDN (GRTLS/TAL)	FB E12-24	
(ENTRY).....	FB E12-24	
2nd FC SHUTDN (GRTLS/TAL).....	FB E12-25	
(ENTRY)	FB E12-25	
LOSS OF 2nd FC PWRDN (GRTLS/TAL)	FB E12-26	
O2(H2) CRYO P/T HIGH.....	FB E12-26	
CRYO O2(H2) LEAK (three or more tanks aff)	FB E12-26	

CDR WINDOW FLIP BOOK -

POWERED FLIGHT..... FB A13-i

COMM LOST (mult pnls).....	FB A13-1
ICOM LOST.....	FB A13-1
FCS CH 1(2,3,4) (2nd FAIL).....	FB A13-1
RHC L(R) (2nd FAIL).....	FB A13-1
DISPLAY SW L(R)	FB A13-1
RM FAIL IMU,RGA,AA	FB A13-1
DLMA IMU	FB A13-1
POST BFS ENGAGE	FB A13-1
PASS GPC FAIL	FB A13-2
BFS GPC FAIL	FB A13-2
FF(FA) MDM OUTPUT.....	FB A13-2
PL MDM I/O ERROR.....	FB A13-2

PCM I/O ERROR.....	FB A13-2
SUMWORD ICC.....	FB A13-2
FA/FF MDM I/O ERROR.....	FB A13-3
PORT MODE.....	FB A13-3
BCE STRG X.....	FB A13-4
DUAL DPS DISPLAY COMMANDERS/ DK XMTR 1(2,3).....	FB A13-4
PASS DISPLAY FAIL.....	FB A13-4
BFS DISPLAY FAIL.....	FB A13-5
FLT INST DISPLAY ANOMALY.....	FB A13-7
SUBSYS STATUS DISPLAY ANOMALY.....	FB A13-7
BFS INADVERTENT DISENGAGE/ UNSUCCESSFUL ENGAGE.....	FB A13-7
MULT DATA PATH LOSS (non-Recov) (CIL).....	FB A13-7
CAB PRESS LEAK.....	FB A13-8
HIGH.....	FB A13-8
PPO2 ABNORMAL.....	FB A13-8
H2O LOOP PRESS HIGH.....	FB A13-8
LOW.....	FB A13-8
AV BAY FAN Δ P.....	FB A13-8
TEMP HIGH.....	FB A13-8
CABIN FAN FAIL.....	FB A13-8
IMU FAN FAIL.....	FB A13-8
FREON FLOW LOW.....	FB A13-9
LOSS OF 1 FREON LOOP.....	FB A13-9
2 FREON LOOPS – PWRDN.....	FB A13-9
– LOOPS FAILED....	FB A13-9
EVAP OUT TEMP HIGH.....	FB A13-10
T LOW.....	FB A13-10
FREON LEAK.....	FB A13-10
ESS BUS LOSS (CIL).....	FB A13-11
LOSS OF 2nd FC PWRDN.....	FB A13-11
MNA.....	FB A13-12
MNB.....	FB A13-12
MNC.....	FB A13-12
ANY AC BUS LOSS.....	FB A13-12
SUBBUS [MNA O14].....	FB A13-12
[APC6 or ALC3].....	FB A13-12
CNTL BUS LOSS.....	FB A13-12
FWD RCS LK.....	FB A13-13

CDR WINDOW FLIP BOOK - GLIDED FLIGHT FB E13-i

COMM LOST (mult pnls).....	FB E13-1
ICOM LOST.....	FB E13-1
FCS CH 1(2,3,4) (2nd FAIL).....	FB E13-2
RHC L(R) (2nd FAIL).....	FB E13-2
G51 ROLL MODE SW.....	FB E13-2
DISPLAY SW L(R)	FB E13-2
RM FAIL IMU,RGA,AA	FB E13-2
DLMA IMU	FB E13-2
FAIL ADTA.....	FB E13-2
DLMA ADTA (CIL)	FB E13-2
FAIL TAC.....	FB E13-3
DLMA TAC.....	FB E13-3
SPD BRK.....	FB E13-3
G55 GPS FAIL 1(2,3).....	FB E13-3
RM DLMA GPS (OV105).....	FB E13-3
NO UPDATE GPS	FB E13-3
PASS GPC FAIL	FB E13-4
BFS GPC FAIL	FB E13-4
FA/FF MDM I/O ERROR	FB E13-4
PORT MODE	FB E13-5
FF(FA) MDM OUTPUT.....	FB E13-6
PL MDM I/O ERROR.....	FB E13-6
PCM I/O ERROR.....	FB E13-6
POST BFS ENGAGE	FB E13-6
BCE STRG X.....	FB E13-7
DUAL DPS DISPLAY COMMANDERS/ DK XMTR 1(2,3).....	FB E13-7
PASS DISPLAY FAIL	FB E13-8
BFS DISPLAY FAIL.....	FS E13-8
FLT INST DISPLAY ANOMALY	FB E13-9
SUBSYS STATUS DISPLAY ANOMALY	FB E13-9
BFS INADVERTENT DISENGAGE/ UNSUCCESSFUL ENGAGE.....	FB E13-9
MULT DATA PATH LOSS (non-Recov) (CIL).....	FB E13-9
CAB PRESS LEAK.....	FB E13-11
HIGH.....	FB E13-11
H2O LOOP PRESS LOW(HIGH)	FB E13-11
AV BAY FAN ΔP.....	FB E13-11
TEMP HIGH	FB E13-11
LOSS OF AV BAY COOLING PWRDN.....	FB E13-11
CABIN FAN FAIL.....	FB E13-11
IMU FAN FAIL	FB E13-11
FREON FLOW LOW	FB E13-12

LOSS OF 1 FREON LOOP	FB E13-12
2 FREON LOOPS – PWRDN	FB E13-12
– LOOPS FAILED....	FB E13-13
EVAP OUT TEMP HIGH	
(Rads cold soaked).....	FB E13-13
(Rads <i>not</i> cold soaked).....	FB E13-13
EVAP OUT T LOW.....	FB E13-14
FREON LEAK.....	FB E13-14
ESS BUS LOSS (CIL)	FB E13-15
LOSS OF 2nd FC PWRDN (ENTRY).....	FB E13-15
(GRTLS/TAL)	FB E13-16
MNA or AC1 Multi Φ	FB E13-17
MNB or AC2 Multi Φ	FB E13-17
MNC or AC3 Multi Φ	FB E13-17
ANY AC2 SINGLE Φ	FB E13-17
CNTL BUS LOSS	FB E13-18
SUBBUS [MNA O14].....	FB E13-18
[APC4(5,6) or ALC1(2,3)]	FB E13-18

MS POWERED FLIGHT

----- MS POWERED FLIGHT, SECTIONS 1 thru 9 -----

MS A-i

AESP/ALL/A/GEN O

----- MS POWERED FLIGHT, SECTIONS 1 thru 9 -----

This Page Intentionally Blank



APU/
HYD

APU/HYDRAULICS



MS A1-1

AESP/ALL/A/GEN O

APU/
HYD

APU SHUTDN

APU OPER – OFF
FU TK VLV – CL
√Shutdn (HYD PRESS < 200)
Report APU F7 Its
APU CNTLR PWR – OFF
AUTO SHTDN (two) – INH
SPEED SEL (two) – HI ⇒

APU SPD HI

If SPEED % exceeds 111:
APU SPEED SEL – HI ⇒

APU OVERSPEED

If SPEED % exceeds 129:
Go to APU SHUTDN

APU UNDERSPEED [G51]

If 'PRL SYS X ↓' or if APU has shut dn:
Perform APU SHUTDN, then: ⇒G

APU OIL OVERTEMP

◆BLR CNTLR/HTR – B
√N2 SPLY – ON ⇒

HYD PRESS (LOW) [G51]

If 'PRL SYS X ↓' and APU still oper:
1. APU AUTO SHTDN (two) – INH
2. SPEED SEL (two) – HI ⇒

HYD RSVR QTY (LOW)

Post MECO:
(Aff) HYD MPS/TVC ISOL VLV SYS – CL
(hold 5 sec, tb-CL) ⇒

W/B QTY (LOW)

1. If W/B QTY = 0 >>
2. BLR N2 SPLY – OFF
3. CNTLR/HTR – OFF ⇒



**COMM/
GNC**

COMM/GNC



MS A2-1

AESP/ALL/A/GEN O

COMM/
GNC

COMM LOST (mult pnls)

1. AUD CTR – 2
2. No joy, S-BD PM CNTL – PNL,CMD
3. Config per COMM COVER (ASC) **[BFS G51]**:
TDRS – ITEM 46 EXEC (*)
STDN-HI – ITEM 47 EXEC (*)
SGLS – ITEM 49 EXEC (*)
4. No joy, sel best S-BD PM ANT; else GPC ⇒

ICOM LOST

1. AUD CNTL sel – sel alt
2. No joy, AUD CTR – 2

FCS CH 1(2,3,4) (2nd FAIL) **[G53]**

If two FCS CH ↓ on any actuator:

- ◆ (Remaining) FCS CH (two) – ORIDE

RHC L(R) (2nd FAIL)

(Aff) FLT CNTLR PWR – OFF

DISPLAY SW L(R)

L(R) disp sws – green dot

RM FAIL IMU,RGA,AA **[BFS G51]**

Aff LRU – desel

RM DLMA IMU **[G51]** **[BFS G51]**

1. √MCC, bad IMU – desel (PASS & BFS) >>
- ◆ 2. Desel lower # IMU with '?' (PASS)



DPS

DPS



MS A3-1

AESP/ALL/A/GEN O

DPS

PASS GPC FAIL

1. (Aff) FCS CH – OFF
- If two GPC/FA/FCS CHs ↓:
2. (Good) FCS CHs – ORIDE
 3. √MPS CMD
 4. **G53** aff SURF FDBK – desel
 5. If FTS, ASAP, GPC MODE – STBY,HALT
 6. √BIG 'X', then assign IDPs as reqd
 7. √MULT DATA PATH LOSS
- Post MECO:
8. ASAP, GPC MODE – STBY,HALT ⇒

BFS GPC FAIL

1. Post SRB SEP: FLASH EVAP CNTLR PRI A – ON
- Post MECO:
2. GPC MODE – STBY,HALT
OUTPUT – TERM
- ◆ 3. If no comm: sel best S-BD PM ANT ⇒

FF(FA) MDM OUTPUT

FAULT

- ◆ (Take action only if annun by entire set)
- If single 'MDM OUTPUT':
1. Go to FA/FF MDM I/O ERROR >>
- If both FF and FA annun:
2. I/O RESET; if reqd, BFS I/O RESET
 3. If msgs repeat: Go to PASS GPC FAIL >>
 4. If reqd, (aff) FCS CH – ORIDE,AUTO

PL MDM I/O ERROR

1. BFS I/O RESET; if recovered >>
- ◆ 2. **G01** PL1/2 – port mode, then BFS I/O RESET;
if recovered >>
3. If PL2 down:
Post SRB SEP: FLASH EVAP CNTLR PRI A – ON
If no comm: sel best S-BD PM ANT ⇒

PCM I/O ERROR

OI PCMMU PWR – 2

SUMWORD ICC

- If TAL:
- | Go to OPS 1/6/TAL TRANSITION RESTRING (Cue Card)
| for aff GPC >>
- If AOA/Uphill: ⇒A

FA/FF MDM I/O ERROR
(Annunciated by entire set)

	FA	1. (Aff) FCS CH – OFF ◆ 2. I/O RESET
RECOV	FA	3. (Aff) FCS CH – AUTO 4. BFS I/O RESET >>
NOT RECOV	FA	5. If two GPC/FA/FCS CHs ↓: (Good) FCS CHs – ORIDE 6. G53 aff SURF FDBK – desel 7. √MULT DATA PATH LOSS ◆ 8. Go to FA/FF MDM PORT MODE ⇒

FA/FF MDM PORT MODE

NOTE

If BFS, 'BCE STRG X PASS', @GPC; else @MDM.
For '@GPC' port mode results in alternate MDM bypass

			1. G01 aff String – port mode 2. BFS I/O RESET
@MDM	RECOV	FA	3. (Aff) FCS CH – AUTO 4. G53 aff SURF FDBK – resel >>
		FF	5. >>
	NOT RECOV	FA	6. BFS G51 aff SURF FDBK, RGA – desel
		FF	7. BFS G51 aff AA – desel 8. √MULT DATA PATH LOSS ⇒
@GPC	FA RECOV (FF Give Up)		9. (Aff) FCS CH – AUTO 10. G51 aff IMU – desel 11. G53 aff SURF FDBK – resel 12. √MULT DATA PATH LOSS ⇒A
	FF RECOV (FA Give Up)		13. (Aff) FCS CH – OFF 14. If two GPC/FA/FCS CHs ↓: (Good) FCS CHs – ORIDE 15. G53 aff SURF FDBK – desel 16. √MULT DATA PATH LOSS ⇒A

BCE STRG X (no 'MDM OUTPUT' msg)

	IMU	1.	G51 IMU – desel
		2.	I/O RESET
RECOV	IMU	3.	>>
		4.	>>
NOT RECOV	NSP	5.	And no comm: PNL,CMD
		6.	BFS G51 Config per <u>COMM COVER</u> (ASC): TDRS – ITEM 46 EXEC (*) STDN-HI – ITEM 47 EXEC (*) SGLS – ITEM 49 EXEC (*) >>
		♦ 7.	G01 aff String – port mode
		8.	BFS I/O RESET
		9.	If recov, go to RECOV steps >>
	B	10.	BFS G51 aff AA – desel
	D	11.	BFS G51 aff SURF FDBK,RGA – desel
	B/D	12.	If RTLS: G23 OVRD aff MANF(s) – OP
		13.	√MULT DATA PATH LOSS ⇒

DUAL DPS DISPLAY COMMANDERS/DK XMTR 1(2,3)

1. BFC CRT SEL – aff IDP
If reqd to clean up display:
2. (Aff) IDP/CRT PWR – OFF,ON

PASS DISPLAY FAIL

1. MDU PWR – OFF,ON; if recovered >>
2. GPC/CRT – same GPC/aff IDP; if recovered >>
3. BFC CRT SEL – aff IDP; if both IDPs OK go to step 9
4. – orig posn
5. Report MDU symptoms
If MCC GO for pwr cycle:
6. IDP/CRT PWR – OFF,ON; if recovered >>
7. Set other MDU on same IDP to DPS Mode; if recovered >>
8. Return other MDU to nominal config
9. Deassign aff IDP from PASS
10. GPC/CRT 04 EXEC
11. In PASS: GPC/CRT 44 EXEC

BFS DISPLAY FAIL

1. If IDP4(CRT4): IDP/CRT4 PWR – OFF >>
 2. MDU PWR – OFF,ON; if recovered >>
 3. BFC CRT SEL – unaff IDP; if both IDPs OK >>
 4. – orig posn
 5. BFC CRT DISPLAY – OFF,ON; if recovered >>
 6. In PASS: GPC/CRT 5/X for aff IDP; if recovered >>
 7. Report MDU symptoms
- If MCC GO for pwr cycle:
8. IDP/CRT PWR – OFF,ON; if recovered >>
- If MDU blank or autonomous:
9. Set other MDU on same IDP to DPS Mode; if recovered >>
 10. Return other MDU to nominal config
 11. BFC CRT SEL – unaff IDP
 12. Deassign aff IDP from PASS
 13. GPC/CRT 04 EXEC
 14. In PASS: GPC/CRT 44 EXEC

FLT INST DISPLAY ANOMALY

1. DATA BUS sel alt FC BUS(s); if recovered >>
2. PORT SELECT aff MDU; if recovered >>
3. MDU PWR – OFF,ON

SUBSYS STATUS DISPLAY ANOMALY

1. PORT SELECT aff MDU; if recovered >>
2. MDU PWR – OFF,ON; if recovered >>

BFS INADVERTENT DISENGAGE/UNSUCCESSFUL ENGAGE (Lightning Strike)

1. CDR and PLT RHC BFS engage pb – push
- If no response:
2. BFS OUTPUT – NORM,B/U
 3. CDR,PLT RHC BFS engage pb – push

MULT DATA PATH LOSS (non-Recov)

NOTE

If LRU data path loss due to GPC prob and not MDM,
BFS will pick up MDMs/LRU when engaged

FAILURE	TYPE	ACTIONS
GPC/FA any combo	I/O	D √BFS MM at each transition Expect 'SEP INH' (FDLN Fail) combos 2&3,2&4 √OMS MAN SHUTDOWN Post MECO: Before MECO + 25 sec: •• 1. MPS FDLN RLF ISOL (two) – OP 2. MPS PREVLVs (six) – OP RTLS/TAL: MPS FILL/DRAIN LH2 INBD, OUTBD – OP
GPC/FF 1&2	I/O or B	Use R BODY FLAP & TRIM ENA SWs
GPC/FF 3&4	I/O or B	Use L BODY FLAP & TRIM ENA SWs

OPS 1/6/TAL TRANSITION RESTRING

	1. Config MC1(3) NBAT as reqd
	2. √G53 aff SURF FDBK – desel (*)
Post MECO	3. ASAP, (aff) GPC(s) – STBY,HALT
ASC/RTLS	4. OPS Mode Recall: OPS XXX PRO
	5. BFS I/O RESET ⇒G
TAL	6. OPS 301 PRO
	7. BFS, OPS 301 PRO ⇒G

POST BFS ENGAGE

If PASS GPCs running:

1. (Aff) GPC MODE – STBY/HALT
2. BFS I/O RESET
3. √FCS CHs, IMU config

If Pre MECO:

4. If SSME failed: MN ENG LIMIT SHUTDN – INH
5. G51 DES failed(commfaulted) RGA,AA,SURF ⇒G



ECLS

ECLS



MS A4-1

AESP/ALL/A/GEN O

ECLS

CAB PRESS LEAK

1. CAB RELIEF A – CL, pause,
B – CL
2. Check tabs, visors – CL, LES O2 – ON
3. If RTLS/TAL: O2/N2 CNTLR VLV SYS 2 – OP
4. O2 TK1, TK2 HTRS A, B (four) – AUTO ⇒

CAB PRESS HIGH

1. If incr: LES O2 – OFF, visors – OP
If still incr:
 2. N2 SYS 1, 2 REG INLET (two) – CL
 3. O2 SYS 1, 2 SPLY (two) – CL ⇒A

PPO2 ABNORMAL ⇒A

H2O LOOP PRESS HIGH

- ◆ Deact pump ⇒

H2O LOOP PRESS LOW ⇒

AV BAY FAN ΔP

- ◆ Deact fan ⇒

AV BAY TEMP HIGH ⇒

CABIN FAN FAIL ⇒

IMU FAN FAIL ⇒

FREON FLOW LOW

- ◆ 1. Switch pumps
- If flow still low:
 - 2. (Aff) RAD BYP VLV MAN SEL – RAD FLOW
(hold 5 sec)
- If flow still low:
 - 3. Perform LOSS OF FREON LOOP(s), then ⇒A

LOSS OF 1 FREON LOOP

- 1. (Bad) FREON PUMP LOOP – OFF
- If FREON LOOP 1(2) lost:
 - 2. O2 SYS 1(2) SPLY (one) – CL
 - 3. √FLOW PROP VLV LOOP 2(1) – ICH
- 4. Monitor EVAP OUT TEMP
- If TAL/AOA/RTLS and LOOP 2 lost:
 - 5. NH3 CNTLR B – OFF
A – PRI/GPC

LOSS OF 2 FREON LOOPS – PWRDN

- 1. When loops fail (flow <700), CDR execute LOOPS
FAILED
- 2. MSTR MADS PWR – OFF
- 3. Use one IDP/CRT with two MDUs (three max)
- 4. All PL pwr (seven) – OFF
- 5. O2,H2 TK HTRS (all) – OFF
- 6. MCC CMD FC purge, then BFS GPC – STBY,HALT
PWR – OFF
OUTPUT – NORM
- 7. If no comm: sel best S-BD PM ANT
- Post MECO:
 - If RTLS:
 - 8. TACAN (three) – OFF
 - 9. RDR ALTM 1 – OFF ⇒G
 - If TAL:
 - 10. All TACAN/RA – OFF
 - 11. Use one FLT CNTLR PWR ⇒G

LOSS OF 2 FREON LOOPS – LOOPS FAILED

- 1. LES O2 – OFF, visor – OP
- 2. O2 SYS 1,2 SPLY (two) – OP
- Panel L1: All sws off, except:
 - 3. H2O PUMP LOOP 2 – ON
- 4. Perform PWRDN if not already accomplished

OV103,104

(OV103,104) MS A4-3

AESP/3,4/A/GEN O

EVAP OUT T LOW

1. If temp low in only one loop (snsr failed) >>
2. FREON PUMP LOOP 1,2 (two) – OFF
3. H2O PUMP LOOP 1 (two) – ON,B
4. FLOW PROP VLV LOOP 1,2 (two) – PL HX (tb-PL)
5. O2 SYS 1,2 SPLY (two) – CL (tb-CL)
6. √RAD BYP VLV MODE (two) – MAN
7. √MAN SEL (two) – BYP (tb-BYP ~3 sec)
8. FLASH EVAP CNTLR PRI A,B,SEC (three) – OFF
- ◆ 9. FREON PUMP LOOP 1,2 (two) – B
NH3 CNTLR A,B (two) – SEC/ON

Wait 3 min, then if any Freon Loop off:

10. FREON PUMP LOOP 1,2 (two) – B

When EVAP OUT T > 55 for at least 2 min (NH3 depleted):

11. FLASH EVAP CNTLR PRI B – ON
12. O2 SYS 1,2 SPLY (two) – OP (tb-OP)
13. NH3 CNTLR A,B (two) – OFF

FREON LEAK

- ◆ 1. FREON ISOL MODE – MAN
 2. (Aff) FREON ISOL LOOP 1(2) – ISOL
Hold for 5 sec
- If (aff) FREON LOOP 1(2) ACCUM QTY decr:
3. When loop fails ('SM2 FREON FLOW 1(2)'), CDR
execute LOSS OF 1 FREON LOOP for (aff) Freon
Loop ⇒
- If (aff) FREON LOOP 1(2) ACCUM QTY not decr, ⇒A

OV103,104

(OV103,104) MS A4-4

AESP/ALL/A/GEN O,2

EVAP OUT TEMP HIGH

If temp high in only one loop (snsr failed) >>

1. FLASH EVAP CNTLR PRI A – OFF
B – ON (wait 30 sec)
If T decr >>
2. FLASH EVAP CNTLR PRI B – OFF
SEC – ON (HI LOAD ena) (wait 30 sec)
If T decr:
 3. TOP EVAP HTR DUCT sel – A/B >>
4. HI LOAD EVAP – OFF (wait 30 sec)
If T decr (HI LOAD EVAP only lost):
 5. HI LOAD DUCT HTR sel – A/B ⇒A
6. RAD BYP VLV (four) – MAN, RAD FLOW (total FES lost) ⇒A

OV103,104

(OV103,104) MS A4-5

AESP/ALL/A/GEN O

FIRE/SMOKE

SM SYS SUMM 1

If **VISUAL SMOKE/FIRE**, or
two SMOKE DETN lt on, or
two CONC > 2, or
one SMOKE DETN lt on and
other CONC > 2:

1. Go to step 6

If single Av Bay SMOKE DETN A(B) lt and assoc CONC > 2:

2. SMOKE DETN CKT TEST – B(A) (25 sec)

If SMOKE DETN B(A) test good (lt on):

3. SMOKE DETN CKT TEST – OFF

4. SNSR – RESET >>

If SMOKE DETN B(A) test bad (no lt):

5. Go to step 6

If none of above >>

6. Check tabs, visors – CL
LES O2 – ON

If **AV BAY FIRE**:

7. FIRE SUPPR – ARM

pb – DISCH (push until lit)

8. If Ascent: AV BAY FAN (two) – OFF

9. If FIRE in Bay:

1: TACAN 1, MLS 1 – OFF

2: TACAN 2, MLS 2,3 – OFF

3: TACAN 3 – OFF

If **CABIN FIRE**:

10. CAB FAN A,B (two) – OFF (max 20 min)

11. Locate source (see matrix, facing page)

12. Unpwr source of smoke

If smoke persists or source cannot be unpwr:

WARNING
Discharge is propulsive

13. Discharge handheld FIRE EXTGHR

If Ascent:

14. Post MECO, go to POST-FIRE CABIN CLEANUP (ASC
PKT, ECLS) >>

If Entry and prior to TIG:

15. Go to ECLS FRP-3, FIRE/HAZ SPILL O2 CONTROL, step
3 (MAL)

Cont next page **OV103,104**

(OV103,104) MS A4-6

AESP/3,4/A/GEN O,2

FREON FLOW LOW

- ◆ 1. Switch pumps
- If flow still low:
 - 2. (Aff) RAD BYP VLV MAN SEL – RAD FLOW
(hold 5 sec)
- If flow still low:
 - 3. Perform LOSS OF FREON LOOP(s), then ⇒A

LOSS OF 1 FREON LOOP

- 1. (Bad) FREON PUMP LOOP – OFF
- If FREON LOOP 1(2) lost:
 - 2. O2 SYS 1(2) SPLY (one) – CL
 - 3. √FLOW PROP VLV LOOP 2(1) – ICH
- 4. Monitor EVAP OUT TEMP
- If TAL/AOA/RTLS and LOOP 2 lost:
 - 5. NH3 CNTLR B – OFF
A – PRI/GPC

LOSS OF 2 FREON LOOPS – PWRDN

- 1. When loops fail (flow <700), CDR execute LOOPS
FAILED
- 2. MSTR MADS PWR – OFF
- 3. Use one IDP/CRT with two MDUs (three max)
- 4. All PL pwr (seven) – OFF
- 5. O2,H2 TK HTRS (all) – OFF
- 6. MCC CMD FC purge, then BFS GPC – STBY,HALT
PWR – OFF
OUTPUT – NORM
- 7. If no comm: sel best S-BD PM ANT
- Post MECO:
 - 8. GPS 1,3 – OFF
 - If RTLS:
 - 9. RDR ALTM 1 – OFF ⇒G
 - If TAL:
 - 10. RA 1,2 – OFF
 - 11. Use one FLT CNTLR PWR ⇒G

LOSS OF 2 FREON LOOPS – LOOPS FAILED

- 1. LES O2 – OFF, visor – OP
- 2. O2 SYS 1,2 SPLY (two) – OP
- Panel L1: All sws off, except:
 - 3. H2O PUMP LOOP 2 – ON
- 4. Perform PWRDN if not already accomplished

OV105

(OV105) MS A4-3

AESP/5/A/GEN O

EVAP OUT T LOW

1. If temp low in only one loop (snsr failed) >>
2. FREON PUMP LOOP 1,2 (two) – OFF
3. H2O PUMP LOOP 1 (two) – ON,B
4. FLOW PROP VLV LOOP 1,2 (two) – PL HX (tb-PL)
5. O2 SYS 1,2 SPLY (two) – CL (tb-CL)
6. √RAD BYP VLV MODE (two) – MAN
7. √MAN SEL (two) – BYP (tb-BYP ~3 sec)
8. FLASH EVAP CNTLR PRI A,B,SEC (three) – OFF
- ◆ 9. FREON PUMP LOOP 1,2 (two) – B
NH3 CNTLR A,B (two) – SEC/ON

Wait 3 min, then if any Freon Loop off:

10. FREON PUMP LOOP 1,2 (two) – B

When EVAP OUT T > 55 for at least 2 min (NH3 depleted):

11. FLASH EVAP CNTLR PRI B – ON
12. O2 SYS 1,2 SPLY (two) – OP (tb-OP)
13. NH3 CNTLR A,B (two) – OFF

FREON LEAK

- ◆ 1. FREON ISOL MODE – MAN
 2. (Aff) FREON ISOL LOOP 1(2) – ISOL
Hold for 5 sec
- If (aff) FREON LOOP 1(2) ACCUM QTY decr:
3. When loop fails ('SM2 FREON FLOW 1(2)'), CDR
execute LOSS OF 1 FREON LOOP for (aff) Freon
Loop ⇒
- If (aff) FREON LOOP 1(2) ACCUM QTY not decr, ⇒A

OV105

(OV105) MS A4-4

AESP/ALL/A/GEN O,2

EVAP OUT TEMP HIGH

If temp high in only one loop (snsr failed) >>

1. FLASH EVAP CNTLR PRI A – OFF
B – ON (wait 30 sec)
If T decr >>
2. FLASH EVAP CNTLR PRI B – OFF
SEC – ON (HI LOAD ena) (wait 30 sec)
If T decr:
 3. TOP EVAP HTR DUCT sel – A/B >>
4. HI LOAD EVAP – OFF (wait 30 sec)
If T decr (HI LOAD EVAP only lost):
 5. HI LOAD DUCT HTR sel – A/B ⇒A
6. RAD BYP VLV (four) – MAN, RAD FLOW (total FES lost) ⇒A

OV105

(OV105) MS A4-5

AESP/ALL/A/GEN O

FIRE/SMOKE

SM SYS SUMM 1

If **VISUAL SMOKE/FIRE**, or
two SMOKE DETN lt on, or
two CONC > 2, or
one SMOKE DETN lt on and
other CONC > 2:

1. Go to step 6

If single Av Bay SMOKE DETN A(B) lt and assoc CONC > 2:

2. SMOKE DETN CKT TEST – B(A) (25 sec)

If SMOKE DETN B(A) test good (lt on):

3. SMOKE DETN CKT TEST – OFF

4. SNSR – RESET >>

If SMOKE DETN B(A) test bad (no lt):

5. Go to step 6

If none of above >>

6. Check tabs, visors – CL
LES O2 – ON

If **AV BAY FIRE**:

7. FIRE SUPPR – ARM

pb – DISCH (push until lit)

8. If Ascent: AV BAY FAN (two) – OFF

9. If FIRE in Bay:

1: GPS 1, MLS 1 – OFF

2: MLS 2,3 – OFF

3: GPS 3 – OFF

If **CABIN FIRE**:

10. CAB FAN A,B (two) – OFF (max 20 min)

11. Locate source (see matrix, facing page)

12. Unpwr source of smoke

If smoke persists or source cannot be unpwr:

WARNING

Discharge is propulsive

13. Discharge handheld FIRE EXTGHR

If Ascent:

14. Post MECO, go to POST-FIRE CABIN CLEANUP (ASC
PKT, ECLS) >>

If Entry and prior to TIG:

15. Go to ECLS FRP-3, FIRE/HAZ SPILL O2 CONTROL, step
3 (MAL)

Cont next page

(OV105) MS A4-6

OV105

AESP/5/A/GEN O,2

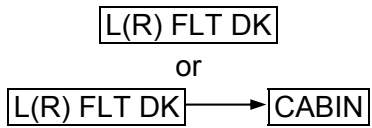
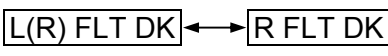
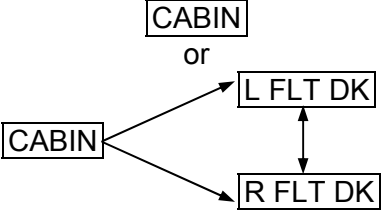
ALARM SEQUENCE	SOURCE AREA
 <p style="text-align: center;">L(R) FLT DK or L(R) FLT DK → CABIN</p>	PS(MS), L(R) CONSOLE
 <p style="text-align: center;">L(R) FLT DK ↔ R FLT DK</p>	AFT FLT DK, MIDDECK
 <p style="text-align: center;">CABIN or CABIN → L FLT DK CABIN → R FLT DK L FLT DK ↔ R FLT DK</p>	FWD FLT DK, WCS, LEB



This Page Intentionally Blank





EPS

EPS



MS A5-1

AESP/ALL/A/GEN O

MN BUS UNDERVOLTS/FC VOLTS

PLT

If MN V < 26.4, FC V < 26.6, FC A > 480 (2 of 3)

(SHORT or degraded FC):

1. MSTR MADS PWR – OFF
2. If aff BUS tied – untie
3. PL PRI (three) – OFF

If AC VOLTS < 95, or STACK T > 243 and incr:

4. (Aff) ESS BUS SOURCE FC – OFF
FC/MN BUS – OFF

If FC VOLTS < 32 (FC SHORT)

5. (Aff) FC REAC VLV – CL
6. Perform BUS LOSS ACTION (do not perform FC SHUTDN)

Post MECO:

7. ⇒ FC SHUTDN (do not stop FC until COOL P < 15 and STACK T < 243) >>

If FC VOLTS ≥ 32 (BUS SHORT)

8. Go to BUS LOSS ACTION >>

9. ⇒

If MN V < 26.4 and FC V > 32 and FC A < 20

(FC disconnect, check APUs):

10. AC BUS SNSR (three) – OFF
11. MSTR MADS PWR – OFF
12. PL PRI (three) – OFF
13. FC/MN BUS – ON

If FC3 aff:

14. PL PRI MNC – ON
FC3 – ON
15. If MNC V < 26.4: PL PRI (three) – OFF

If MN BUS recovered (FC VOLTS < 32):

16. GNC I/O RESET
17. ⇒ BUS TIE >>

If MN BUS not recovered (FC VOLTS > 32):

18. Perform BUS LOSS ACTION (do not perform FC SHUTDN)

Post MECO:

19. ⇒ FC SHUTDN

AC VOLT HIGH

If AC V > 123 and F7 “AC VOLTAGE”:

1. (Unaff) AC BUS SNSRS (two) – OFF

If AC V ≥ 130:

2. (Aff) AC BUS SNSR – AUTO TRIP

If AC V < 130 and AC3 aff:

3. H2O PUMP LOOP 2 – OFF

If RTLS/TAL:

4. AC VOLTS HIGH ⇒G
5. ⇒ AC VOLTS (LOW or HIGH)

AC VOLT LOW or OVERLOAD

PLT

MN
SUB

1. AC BUS SNSR (three) – OFF

If amps > 14 and V < 95:

If single Φ amps > 14:

2. cb AC CONTR – cl
INV/AC BUS – OFF
INV PWR – OFF
cb AC CONTR – op

3. If other Φ amps > 14:
Go to step 6

If RTLS/TAL:

4. Go to aff BUS LOSS \Rightarrow G
5. Go to AC OVERLOAD \Rightarrow A

If multi Φ (bus short):

6. (Aff) cb AC CONTR (three) – cl
INV/AC BUS – OFF (tb-OFF)
INV PWR – OFF (tb-OFF)
cb AC CONTR (three) – op

7. Go to aff BUS LOSS >>

8. \Rightarrow AC VOLTS (LOW or HIGH)

3 Φ AC MOTORS STOPPED

1. AC BUS SNSR (three) – OFF

2. Determine AC BUS:

FC1 and FREON PUMP 2B: AC1
FC2 and FREON PUMP 1B: AC2
FC3 and CAB FAN A: AC3

3. (Aff) FC – STOP

If AC3 aff:

4. AV BAY 3 FAN B – OFF, A – ON
5. CAB FAN A – OFF

Isolate aff Φ B(Φ C, Φ A):

6. (Aff) cb AC CONTR – cl
7. INV/AC BUS – OFF

If AC1(2,3) aff and AV BAY 3(2,3) FAN Δ P \geq 0.5:

8. Go to step 16 (bad Φ isolated)
9. (Aff) INV/AC BUS – ON
10. cb AC CONTR – op

11. Repeat from step 6 to isolate aff Φ C(Φ A), then:

Drop aff AC bus (three Φ s):

12. (Aff) cb AC CONTR (three) – cl
13. INV/AC BUS – OFF
14. INV PWR – OFF

15. Go to aff BUS LOSS >>

Bad Φ isolated:

16. (Aff) FC – START (10 sec or Δ P tb-gray)
17. Perform aff BUS LOSS and if AC1(AC2) aff >>
18. If AC3 aff:

Post MECO:
CAB FAN B – ON

MN
3Φ

BUS TIE (do not tie bus short, check APUs)

If MN Volts > 20: Bus Tie >>

If MN Volts < 20 (do not BUS TIE Pre MECO for 1st FC):

1. (Aff) AC BUS SNSR – OFF
2. cb AC CONTR (three) – cl
3. INV/AC BUS – OFF (tb-OFF)
4. INV PWR – OFF (tb-OFF)
5. If MNC(B) dn, CAB FAN A(B) – OFF
6. Bus Tie
7. INV PWR – ON (tb-ON)
- ◆ 8. INV/AC BUS – ON (tb-ON)
9. cb AC CONTR (three) – op
10. GNC I/O RESET
11. Post MECO: (Aff) AC BUS SNSR – AUTO TRIP
12. Post PWRDN: √CAB FAN A(B) – ON

MNA

CDR

Post SRB SEP:

- ◆ 1. TOP EVAP HTR DUCT sel – B
 2. HI LOAD DUCT HTR sel – B
 3. BFS G51 AA1 – desel ⇒
 4. MS AUD CNTL – PS (MS can't talk)
- FAILED: UHF HI PWR XMIT

MNB

Post SRB SEP:

BFS G51 AA2, RGA 2 – desel ⇒
FAILED: S-BD PM 1 (NO PNL,CMD)

MNC

Post SRB SEP:

1. FLASH EVAP CNTLR PRI A – OFF, B – GPC
2. BFS G51 RGA 3 – desel ⇒

ANY AC BUS LOSS ⇒

SUBBUS [MNA O14] ⇒G

SUBBUS [APC6 or ALC3]

1. FLASH EVAP CNTLR PRI A – OFF, B – GPC

MNA or AC1 Multi Φ

PLT

1. Do not isolate MPS He C
2. MSTR MADS PWR – OFF
3. AC BUS SNSR (three) – OFF
4. Perform FC SHUTDOWN (within 9 min), then:

Post MECO:

5. L OMS – sel SEC \Rightarrow

MNB or AC2 Multi Φ

1. Do not isolate MPS He L
2. MSTR MADS PWR – OFF
3. AC BUS SNSR (three) – OFF
4. Perform FC SHUTDOWN (within 9 min), then: \Rightarrow

FAILED: S-BD PM 1 (NO PNL,CMD)

MNC or AC3 Multi Φ

1. Do not isolate MPS He R
2. S-BD PM CNTL – PNL,CMD
3. Config per COMM COVER (ASC) [BFS G51]:
TDRS – ITEM 46 EXEC (*)
STDN-HI – ITEM 47 EXEC (*)
SGLS – ITEM 49 EXEC (*)
4. MSTR MADS PWR – OFF
5. AC BUS SNSR (three) – OFF
6. Perform FC SHUTDOWN (within 9 min), then:

Post MECO:

7. R OMS – sel SEC \Rightarrow

AC SINGLE Φ \Rightarrow

SUBBUS [APC4(5,6) or ALC1(2,3)]

Do not isolate MPS He C(L,R) \Rightarrow

**ESS
CNTL**

ESS BUS V LOW**PLT**

If verified by F9 voltmeter:

1. Perform FC SHUTDN (<9 min), then:
2. Go to aff ESS BUS LOSS

MN
SUB**ESS BUS LOSS**

ESS 1BC	O13&R14	1. L AUD CNTL sel – R (CDR can't talk) 2. Pri C/W & F7 Matrix lost ⇒A 3. ⇒A
ESS 2CA	O13&R14	1. AUD CTR – 2 2. R AUD CNTL sel – L (PLT can't talk) ⇒A 3. ⇒A
ESS 3AB	O13	1. GPC CAM Lights lost 2. Do not engage BFS ⇒

CNTL BUS LOSS**CDR**

AB1	1. TOP EVAP HTR DUCT sel – B 2. HI LOAD DUCT HTR sel – B ⇒
AB2	1. TOP EVAP HTR DUCT sel – B 2. HI LOAD DUCT HTR sel – B ⇒
AB3	1. TOP EVAP HTR DUCT sel – B 2. HI LOAD DUCT HTR sel – B If BFS engage reqd: 3. Use PLT's RHC, then GPCs 1,2,4 - STBY,HALT 4. BFS I/O RESET 5. ⇒
BC1	[BFS G51] RGA 2 – desel ⇒
BC2	⇒
BC3	⇒
CA1	1. No BFS engage Post SRB SEP: 2. FLASH EVAP CNTLR PRI A – ON 3. [BFS G51] RGA 3 – desel ⇒
CA2	⇒

CNTL BUS V LOW/CNTL BUS RPC

PLT

WARNING
 If VISIBLE FIRE/SMOKE AT ANY TIME, cb CNTL BUS AB1/2/3(BC1/2/3,CA1/2/3) – op (pnl R14:B)

1. Identify BUS (√BUS LOSS ID)
 If bus critical (per MCC):
- ◆ 2. ⇒
- ◆ If one CNTL BUS RPC tripped (*):
 Aff CNTL BUS:

AB1(2,3)

	Tripped RPC (*)	Action (for RESET, hold w/sw reten device)
3.	A	R1 CNTL BUS PWR MNB – RESET R14:B cb CNTL BUS AB1/2/3 – op
4.	B	R1 CNTL BUS PWR MNA – RESET R14:B cb CNTL BUS AB1/2/3 – op

BC1(2,3)

	Tripped RPC (*)	Action (for RESET, hold w/sw reten device)
5.	B	R1 CNTL BUS PWR MNC – RESET R14:B cb CNTL BUS BC1/2/3 – op
6.	C	R1 CNTL BUS PWR MNB – RESET R14:B cb CNTL BUS BC1/2/3 – op

CA1(2,3)

	Tripped RPC (*)	Action (for RESET, hold w/sw reten device)
7.	C	R1 CNTL BUS PWR MNA – RESET R14:B cb CNTL BUS CA1/2/3 – op
8.	A	R1 CNTL BUS PWR MNC – RESET R14:B cb CNTL BUS CA1/2/3 – op

- ◆ If no CNTL BUS RPC tripped (no *):

	aff CNTL BUS	Panel R1 action (RESET, hold w/sw reten device)
9.	AB1(2,3)	CNTL BUS PWR MNA,MNB (two) – RESET
10.	BC1(2,3)	CNTL BUS PWR MNB,MNC (two) – RESET
11.	CA1(2,3)	CNTL BUS PWR MNA,MNC (two) – RESET

**CNTL
FC**

Cont next page

MS A5-7 AESP/ALL/A/GEN O

◆ 12. Perform aff CNTL BUS LOSS, then:

If pwr reqd (<3 sec) for crit function:

13. Hold crit function sw

For tripped RPC:

14. CNTL BUS PWR MNA(MNB,MNC) –
RESET (1 sec), then dn

15. ⇒

ESS/
CNTL

CNTL BUS LOSS

PLT

AB1	⇒
AB2	[G23] RCS FWD MANF VLVS 1 OVRD – ITEM 40 EXEC (CL) ⇒
AB3	1. [G51] RCS RM MANF CL OVRD – ITEM 41 EXEC If BFS engage reqd: 2. Use PLT's RHC, then GPCs 1,2,4 – STBY,HALT 3. BFS I/O RESET 4. ⇒
BC1	Failed: S-BD PM 1 (NO PNL,CMD) ⇒
BC2	1. S-BD PM CNTL – PNL,CMD 2. [BFS G51] Config per <u>COMM COVER</u> (ASC): TDRS – ITEM 46 EXEC (*) STDN-HI – ITEM 47 EXEC (*) SGLS – ITEM 49 EXEC (*) 3. [G23] RCS FWD MANF VLVS 2 OVRD – ITEM 41 EXEC (CL) 4. PLT disp sws – green dot ⇒
BC3	[G51] RCS RM MANF CL OVRD – ITEM 41 EXEC ⇒
CA1	No BFS engage ⇒
CA2	[G23] RCS FWD MANF VLVS 3 OVRD – ITEM 42 EXEC (CL)
CA3	⇒

FC REAC VLV CLOSED

PLT

1. FC REAC VLV (three) – OP
2. Perform BUS TIE, then:
If FC COOL P < 50:
3. Go to FC SHUTDN

FC pH ↓ 1(2,3) or FC DELTA V 1(2,3)

If pH ↓ and FC SS 1(2,3) ΔV > 150

or FC SS ΔV > 150 and incr:

1. Perform BUS TIE, then:
 2. (Aff) FC REAC VLV – CL
 3. MSTR MADS PWR – OFF
 4. Go to LOSS OF 1(2nd) FC PWRDN >>
- If pH ↓ only and Post SRB SEP:
- ◆ 5. Perform BUS TIE, then:
 6. ⇒A FC pH 1(2,3)

FC STACK T

1. MSTR MADS PWR – OFF

If STACK T > 243 and incr:

2. If 2nd FC: Go to 2nd FC SHUTDN >>
 3. PL PRI (three) – OFF
- If aff FC amps < 190 or > 360:
4. Go to MN BUS UNDERVOLTS/FC VOLTS, step 4 >>
- ◆ 5. Perform BUS TIE, then:
 6. ESS BUS SOURCE FC – OFF
 7. FC/MN BUS – OFF
- If aff FC VOLTS < 32 or STACK T not decr:
8. (Aff) FC REAC VLV – CL
 9. FC – STOP after COOL P < 15 and STACK T < 243
10. Go to LOSS OF 1 FC PWRDN

FC

FC EXIT T

1. MSTR MADS PWR – OFF
 2. Perform LOSS OF 1 FC PWRDN
 3. Post SRB SEP:
- ◆ Perform BUS TIE, then: ⇒

FC COOLANT PUMP ΔP LOW

1. FC – START (10 sec or ΔP tb-gray)
- ◆ 2. MSTR MADS PWR – OFF
Perform LOSS OF 1 FC PWRDN, then:
If > 9 min since failure:
 - ◆ If EXIT T > 164 and not decr or
RDY tb – bp or
FC PUMP cb(s) open (pnl L4:C):
 3. Go to FC SHUTDN >>
4. If < 9 min since failure ⇒

PLT

FC COOL P

1. Perform BUS TIE, then:
If COOL P < 75: ⇒
If COOL P incr and not 100 (H),
or FC COOL PUMP = ΔP (intermittent),
or STACK/EXIT T unstable:
 2. (Aff) FC REAC VLV – CL
 3. MSTR MADS PWR – OFF
 4. Go to LOSS OF 1(2nd) FC PWRDN

FC

FC SHUTDN (1st) (<9 min)

1. MSTR MADS PWR – OFF
2. If not tied: Perform BUS TIE, then:
If ORB (not deorb prep), kW > 18:
MN BUS TIE (three) – ON
3. ESS BUS SOURCE FC – OFF
FC/MN BUS – OFF
FC – STOP (1 sec)
4. FC REAC VLV – CL
- ◆ Go to LOSS OF 1 FC PWRDN

LOSS OF 1 FC PWRDN

1. PRI PL (three) – OFF
AFT PL (two) – OFF
2. IDP/CRT4 PWR – OFF
One MDU – OFF ⇒

2nd FC SHUTDN

PLT

(CL PMP Lost: <6 min)

1. Have CDR start LOSS OF 2nd FC PWRDN

If three MN buses pwr:

2. MN BUS TIE (three) – OFF
(do not perform BUS LOSS ACTION)
3. LES O2 – OFF, visors – OP
4. Switch off all but one IDP/CRT with four MDUs
5. All PL pwr (seven) – OFF
6. O2,H2 TK HTRS (all) – OFF
7. After CDR pnl L1 config complete, continue:

If two MN buses pwr:

8. Pwr MN BUS TIES (two) – ON

If only one MN bus pwr:

9. MN BUS TIE (three) – OFF
If only MNA(B,C) pwr: Secure APU 2(3,1)
BUS TIE good FC/BUS (MNA if RTLS or TAL)
I/O RESET

When reqd:

10. ESS BUS SOURCE FC – OFF
FC/MN BUS – OFF
FC – STOP (1 sec)
FC REAC VLV – CL
11. G51 √ICNCT ENA (if reqd for OMS load)
12. All TACAN/RA – OFF

Post MECO:

13. MPS PRPLT DUMP B/U LH2 VLV – OP
14. ⇒ LOSS OF 2nd FC PWRDN

LOSS OF 2nd FC PWRDN

CDR

CRYO

1. LES O2 – OFF, visors – OP
2. L1: Select one FREON PUMP on good FC/MN
BUS and place other pump to OFF
Switch OFF all HUM SEPS, IMU FANS, H2O
PUMPS, AV BAY FANS, CAB FANS, FES
HTRS
3. Switch off all but one IDP/CRT with four MDUs
After BUS TIE, if MNC unpwr:
4. FLASH EVAP CNTLR PRI A – OFF
B – ON
5. ⇒ LOSS OF 2nd FC PWRDN

OV103,104

(OV103,104) MS A5-11 AESP/3,4/A/GEN O

O2(H2) CRYO PRESS/TEMP HIGH

PLT

O2(H2) TK HTR (two) – OFF ⇒A

CRYO O2(H2) LEAK (three or more tanks aff)

Use meter if CRT data OSL

1. O2(H2) MANF VLV TK1,TK2 (two) – CL
 2. O2(H2) TK3 HTRS A – AUTO
- If TK1 and TK2 P decr slowly (HTR logic fail): ⇒
3. Perform aff MN BUS TIE, then:
If O2(H2) TK1(2) aff (open unaff manf):
 4. O2(H2) MANF VLV TK2(1) – OP
- If O2 TK1(2) aff:
5. O2 SYS 1(2) SPLY – CL
 6. If O2 TK1(2) P now incr (PCS leak): >>
7. (Aff) TK HTR B – AUTO
- If no aff FC COOL P alarm: ⇒
8. (Aff) TK HTRS A, B (two) – OFF
 9. MSTR MADS PWR – OFF
 10. Perform LOSS OF 1 FC PWRDN, then: ⇒

2FC

OV103,104

(OV103,104) MS A5-12 AESP/ALL/A/GEN O

2nd FC SHUTDN

PLT

(CL PMP Lost: <6 min)

1. Have CDR start LOSS OF 2nd FC PWRDN

If three MN buses pwr:

2. MN BUS TIE (three) – OFF
(do not perform BUS LOSS ACTION)
3. LES O2 – OFF, visors – OP
4. Switch off all but one IDP/CRT with four MDUs
5. All PL pwr (seven) – OFF
6. O2,H2 TK HTRS (all) – OFF
7. After CDR pnl L1 config complete, continue:

If two MN buses pwr:

8. Pwr MN BUS TIES (two) – ON

If only one MN bus pwr:

9. MN BUS TIE (three) – OFF
If only MNA(B,C) pwr: Secure APU 2(3,1)
BUS TIE good FC/BUS (MNA if RTLS or TAL)
I/O RESET

When reqd:

10. ESS BUS SOURCE FC – OFF
FC/MN BUS – OFF
FC – STOP (1 sec)
FC REAC VLV – CL
11. G51 √ICNCT ENA (if reqd for OMS load)
12. All GPS/RA – OFF

Post MECO:

13. MPS PRPLT DUMP B/U LH2 VLV – OP
14. ⇒ LOSS OF 2nd FC PWRDN

LOSS OF 2nd FC PWRDN

CDR

CRYO

1. LES O2 – OFF, visors – OP
2. L1: Select one FREON PUMP on good FC/MN
BUS and place other pump to OFF
Switch OFF all HUM SEPS, IMU FANS, H2O
PUMPS, AV BAY FANS, CAB FANS, FES
HTRS
3. Switch off all but one IDP/CRT with four MDUs
After BUS TIE, if MNC unpwr:
4. FLASH EVAP CNTLR PRI A – OFF
B – ON
5. ⇒ LOSS OF 2nd FC PWRDN

OV105

(OV105) MS A5-11

AESP/5/A/GEN O

O2(H2) CRYO PRESS/TEMP HIGH

PLT

O2(H2) TK HTR (two) – OFF ⇒A

CRYO O2(H2) LEAK (three or more tanks aff)

Use meter if CRT data OSL

1. O2(H2) MANF VLV TK1,TK2 (two) – CL
 2. O2(H2) TK3 HTRS A – AUTO
- If TK1 and TK2 P decr slowly (HTR logic fail): ⇒
3. Perform aff MN BUS TIE, then:
If O2(H2) TK1(2) aff (open unaff manf):
 4. O2(H2) MANF VLV TK2(1) – OP
- If O2 TK1(2) aff:
5. O2 SYS 1(2) SPLY – CL
 6. If O2 TK1(2) P now incr (PCS leak): >>
 7. (Aff) TK HTR B – AUTO
- If no aff FC COOL P alarm: ⇒
8. (Aff) TK HTRS A, B (two) – OFF
 9. MSTR MADS PWR – OFF
 10. Perform LOSS OF 1 FC PWRDN, then: ⇒

2FC

OV105

(OV105) MS A5-12 AESP/ALL/A/GEN O



OMS

OMS



MS A6-1

AESP/ALL/A/GEN O

OMS He TK P LOW ($\sqrt{\text{SPEC}}$ and **OMS/MPS**)

Dumping RTLS/TAL/ G51 DUMP	SERC	When leaking He P < 640: 1. G51 DUMP STOP >>
	Not SERC	When leaking He P < 640: 2. G51 INH ICNCT When aff OMS Pc < 72%: 3. (Aff) OMS ENG – OFF After 2:00 min: 4. (Good) OMS ENG – OFF >>
Dumping ASSIST/ATO Not Dumping	◆	5. (Good) OMS ENG – OFF When MET > 2:30 min: 6. G51 ITEM 9 + 46 EXEC
Leaking He P < 640		7. G51 ITEM 9 + 0 EXEC ⇒A
Sub RTLS/TAL	◆	8. (Good) OMS ENG – ARM/PRESS 9. G51 INH ICNCT 10. OMS XFEED (four) – OP 11. (Aff) OMS TK ISOL (two) – CL After 1:00 min: 12. OMS TK ISOL (four) – OP 13. OMS XFEED (four) – CL When aff OMS Pc < 72%: 14. (Both) OMS ENG (two) – OFF

OMS N2 TK P LOW
(N/A DURING ASSIST/RTLS/TAL/ATO DUMP)

1. $\sqrt{\text{N2 TK P}}$ decr (meter and CRT)
 2. OMS ENG – ARM
 3. If OMS N2 REG P decr: OMS ENG – OFF >>
- If OMS N2 REG P not decr and subs ASSIST/RTLS/TAL/ATO:
4. OMS ENG (two) – ARM/PRESS

OMS N2 REG P HIGH or LOW
OMS ENG – ARM

OMS

P & I

MS A6-2

AESP/ALL/A/GEN O

OMS TK P LOW (↓, OX or FU) NOT DUMPING (√ENG IN P)

1. (Good) OMS ENG – OFF
2. Monitor OMS Inlet Pressures
If OX IN P < 151 or FU IN P < 216:
(Aff) OMS ENG – OFF
XFEED (two) – CL

Dumping Assist/ATO Not Dumping	When MET > 2:30 min: 3. [G51] ITEM 9 + [74] EXEC
OX IN P > 151 and FU IN P > 216	4. (Aff) OMS ENG – ARM/PRESS 5. If ATO: [G51] √ICNCT = INH 6. (Aff) OMS XFEED (two) – CL When aff Pc < 80% (depletion cutoff): 7. (Aff) OMS ENG – OFF [G51] ITEM 9 + 0 EXEC >> If depletion cutoff does not occur ⇒A
Repress NO JOY	8. [G51] ITEM 9 + 0 EXEC
Subs RTLS/TAL/[G51]	9. (Good) OMS ENG – ARM/PRESS
OX IN P > 151 and FU IN P > 216	10. (Aff) OMS XFEED (two) – OP ENG – ARM/PRESS 11. [G51] ENA ICNCT (N/A SERC)
AFT QTY < 20% or He P < 2000	12. If SERC: [G51] DUMP STOP If not SERC: [G51] INH ICNCT 13. (Aff) OMS XFEED (two) – CL When aff Pc < 80% (depletion cutoff): 14. (Aff) OMS ENG – OFF 15. After 2:00 min: (Good) OMS ENG – OFF >>
Repress NO JOY after 2:00 min	16. (Good) OMS ENG – OFF >>

P & I

OMS TEMP DURING DUMP

1. G51 INH ICNCT
If aff OMS FU IN P \geq 219 220
| 2. Go to ENG FAIL >>
- If aff OMS FU IN P \leq 201 208
3. Go to PRPLT FAIL >>
4. Otherwise, snsr fail

Pc LOW DURING DUMP

1. ENG VLV < 70%: Go to ENG FAIL >>
2. ENG VLV > 70%: G51 INH ICNCT
If aff OMS OX IN P > 227:
| 3. Go to ENG FAIL >>
If aff OMS OX IN P \leq 136:
4. Go to PRPLT FAIL >>
5. Otherwise, snsr fail

ENG FAIL (During Dump)

1. (Failed) OMS ENG – OFF
- ◆ 2. If RTLS/TAL/ATO/ G51 DUMP:
 G51 ENA ICNCT \Rightarrow G

PRPLT FAIL (During Dump)

1. ASSIST/ATO: (Both) OMS ENG (two) – OFF
(Failed) OMS XFEED (two) – CL
2. Other: (Aff) OMS ENG – OFF
(Failed) OMS XFEED (two) – CL
After 2:00 min, (good) OMS ENG – OFF \Rightarrow G

OMS TK P LOW (\downarrow , OX and FU) DURING DUMP

($\sqrt{\text{ENG IN P}}$)

1. (Aff) OMS He PRESS/VAP ISOL (two) – OP
If aff TK P not incr:
2. G51 $\sqrt{\text{ICNCT}} = \text{INH}$
3. OMS He PRESS/VAP ISOL (two) – CL
At Pc < 72% or OMS TEMP: Go to PRPLT FAIL

OMS TK P HIGH (\uparrow , OX and FU) DURING DUMP

($\sqrt{\text{ENG IN P}}$)

1. G51 $\sqrt{\text{ICNCT}} = \text{INH}$
2. (Aff) OMS He PRESS/VAP ISOL A – CL
If aff TK P not decr:
3. OMS He PRESS/VAP ISOL A – OP
B – CL

P & I



RCS

RCS



MS A7-1

AESP/ALL/A/GEN O

RCS JET FAIL (LEAK)

If OX/FU Qty diverging:
(Aff) RCS MANF ISOL – CL

RCS JET FAIL (ON)

1. (Aff) RCS MANF ISOL – CL
- If MANF P > 130 and stable (false alarm):
 2. (Aff) RCS MANF ISOL – OP ⇒G

RM DLMA MANF

If (aff) MANF tb – OP or sw not thrown:

1. If FRCS: √MCC
2. If ARCS: [G51] RCS RM MANF CL OVRD –
ITEM 41 EXEC
3. If (aff) MANF tb – bp: (aff) MANF – GPC

RCS JET FAIL (OFF)

If > one jet/pod/dir failed:

1. [G23] resel jets
2. DES INH (*) (reprioritize)

RCS TK P HIGH (FU or OX) (√MANF P)

1. RCS He PRESS (two) – CL
2. A – OP

If He P decr:

3. RCS He PRESS A – CL
B – OP

XFEED: RCS to RCS

If AUTO XFEED:

1. L,R RCS TK ISOL (six) – GPC
XFEED (four) – GPC
2. OMS XFEED (four) – CL
3. MSTR RCS XFEED – FEED FROM L(R) >>

If MANUAL XFEED:

4. L,R OMS XFEED (four) – CL
5. RCS XFEED (four) – OP
6. (Receiving) RCS TK ISOL (three) – CL
He PRESS (two) – CL
7. MSTR RCS XFEED – FEED FROM L(R)

RCS

FWD RCS LK

(check He P decr: CRT and meter)

(check TK P; if '↑': Go to TK P HIGH >>)

RTLS	1. Perform RCS SECURE, then: 2. Post PPD – reopen RCS Post ET SEP -Z transl: 3. Go to RCS SECURE >>
Pre ET SEP (N/A RTLS)	4. ET SEP – MAN 5. MPS PRPLT DUMP SEQ – STOP 6. Perform RCS SECURE, then:
Single MANF leak	7. Reopen RCS, except bad MANF 8. ET SEP – AUTO Post ET SEP -Z transl: 9. MPS PRPLT DUMP SEQ – GPC >>
TK leg leak (two MANF P Low)	10. Reopen RCS, except bad leg 11. ET SEP – AUTO Post ET SEP -Z transl: 12. MPS PRPLT DUMP SEQ – GPC >>
PRPLT TK P decr	
Post MECO	13. RATE DAMP with ARCS 14. Reopen FRCS
TK P > 200 & QTY > 0%	15. ET SEP – AUTO
TK P < 200 or QTY = 0%	16. Perform RCS SECURE, then: 17. DAP – INRTL, PITCH – PULSE 18. ET SEP pb – SEP 19. THC -Z (UP) (2 sec; -1.25°/sec) 20. THC -X (OUT) and hold
At SEP (SEP init + approx 12 sec)	21. THC +Z (DOWN) (3 sec; +0.3°/sec) THC -Z (UP) (2 sec; -0.9°/sec) COAST (5 sec) THC +X (IN) (20 sec) After 10 sec of +X, then: PITCH – DISC RATE
	22. OPS 104 PRO, DAP – AUTO
Otherwise: (He TK or He leg)	Post MECO: 23. Reopen RCS 24. ET SEP – AUTO
Post ET SEP -Z transl	25. MPS PRPLT DUMP SEQ – GPC 26. Go to RCS SECURE



MPS

MPS



MS A8-1

AESP/ALL/A/GEN O

MPS

SSME FAIL/SHUTDN

AC BUS SNSR (three) – OFF

If two ENG remaining:

- ◆ MN ENG LIMIT SHUTDN – ENA,AUTO

If one ENG remaining: (N/A for TAL or OPS 6)

When MPS PRPLT = 5%

MAN THROT

When MPS PRPLT = 2%

MIN THROT (Pc → 67%)

AUTO THROT

MPS DATA

√MCC, accel, He dP/dT,

‘MPS H2 OUT P’,

‘MPS O2 OUT T’

If SSME fail (MCC or three cues):

(Aff) MN ENG SHUTDN pb – push

If three ENG remaining:

- ◆ MN ENG LIMIT SHUTDN – ENA,AUTO

If no comm: Assume MPS CMD

If mult (no MECO confirm):

Post MECO:

MN ENG SHUTDN pb (three) – push (simo)

MPS LH2 ULL

- ◆ If two or three Ps < 28.0 or > 34.0:

MPS LH2 ULL PRESS – OP

When all Ps > 33.0:

MPS LH2 ULL PRESS – AUTO

MPS DUMP INHIBIT

Post MECO:

(Aff) MPS ENG PWR (two) – OFF

LO2(H2) PREVLV – CL

‘ET SEP MAN’ G51

ET SEP

Post MECO prior to MECO+1 min:

1. ET SEP AUTO – ITEM 38 (BFS 28)

2. If ET SEP pb reqd:

ET SEP SEP – ITEM 39 (BFS 29)

MPS CMD/HYD/ELEC

If two HYD SYS failed:

MN ENG LIMIT SHUTDN – INH

TRAJ disp – Cue SERC, ITEM 6

(EXEC if gimbaling eng fails)

If:	When:	Shut down:								
2 Pcs stuck > 85% & 3-ENG RTLS	MECO -2:00	1 aff MN ENG: CMD: (AC/pb)** HYD: (pb)								
2 HYD SYS failed & Nom/ATO/TAL/ 2-ENG RTLS	Nom/ATO: SE PRESS TAL: SE TAL 2-ENG RTLS: 2 OUT RED	<table border="1"> <tr> <td>ENG(HYD)</td> <td>S/D</td> </tr> <tr> <td>C(1) & R(3)</td> <td>C</td> </tr> <tr> <td>L(2) & C(1)</td> <td>L</td> </tr> <tr> <td>L(2) & R(3)</td> <td>R</td> </tr> </table> ELEC: (pb)	ENG(HYD)	S/D	C(1) & R(3)	C	L(2) & C(1)	L	L(2) & R(3)	R
ENG(HYD)	S/D									
C(1) & R(3)	C									
L(2) & C(1)	L									
L(2) & R(3)	R									
He lk S/D reqd		Aff MN ENG (pb)								
MPS CMD(s)**	Nom/ATO and: 3 ENG: V > 23K 2 ENG: V > 24.5K	Aff MN ENG (AC/pb)** If 2 CMD: repeat								
2 MPS HYD/ELEC & 3-ENG Nom/ATO/TAL	TAL: V > 22.5K RTLS: $\alpha = +2$	1 aff MN ENG: HYD: (pb) ELEC: (pb)								
1 MPS HYD/ELEC & 3-ENG Nom/ATO	V > 23K	Aff MN ENG (pb)								

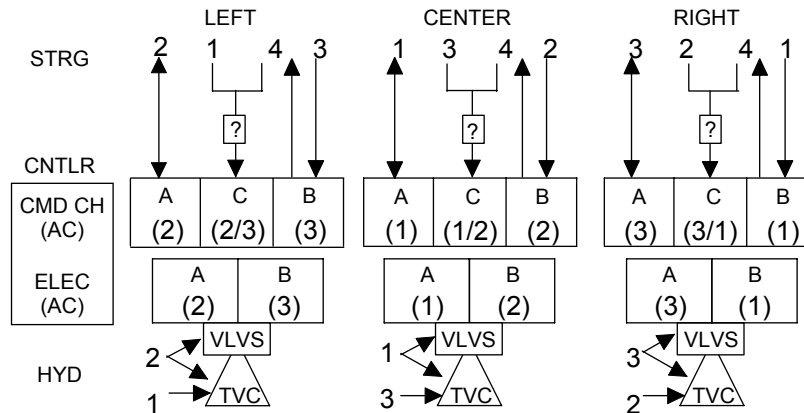

MPS He P (Pre MECO)

1. Check dP/dT

If after MECO -60:

2. Shut dn MN ENG per MPS
CMD/HYD/ELEC >>

If He REG P ↑ or ↓:

3. (Aff) He ISOL – CL

Otherwise:

4. (Aff) He ISOL A – CL

If no decr in dP/dT:

5. (Aff) He ISOL A – OP
B – CL

If no decr in dP/dT:

6. (Aff) He ISOL B – OP

If any ENG failed:

7. (Failed) ENG He I'CNCT –
OUT OP

If nonisolatable:

8. Shut dn MN ENG per
MPS CMD/HYD/ELEC

If/when TK P < 1150 or

REG P < 679:

9. (Aff) He I'CNCT – IN OP

If isolated:

10. (Aff) He I'CNCT – IN OP

If TK P < 2200 @ MECO -60:

11. Shut dn MN ENG per
MPS CMD/HYD/ELEC

Post ET SEP:

12. He I'CNCT(s) – GPC

MPS PNEU TK(REG) P

If after MECO -60:

At MECO -30:

1. L ENG He XOVR – OP >>

2. PNEU He ISOL – CL

If PNEU ACUM P decr:

At MECO -30:

3. PNEU He ISOL – OP,

Wait 5 sec, then:

4. L ENG He XOVR – OP >>

If PNEU TK P decr:

5. PNEU He ISOL – OP



RESERVED



MS A9-1

AESP/ALL/A/GEN O



This Page Intentionally Blank



MS A9-2

AESP/ALL/A/GEN O



GLIDED FLIGHT

MS GLIDED FLIGHT

----- MS GLIDED FLIGHT, SECTIONS 1 thru 9 -----

MS E-i

AESP/ALL/E/GEN O

GLIDED FLIGHT

----- MS GLIDED FLIGHT, SECTIONS 1 thru 9 -----

This Page Intentionally Blank



APU/
HYD

APU/HYDRAULICS



MS E1-1

AESP/ALL/E/GEN O

APU/
HYD

APU SHUTDN

1. APU OPER – OFF
FU TK VLV – CL
√Shutdn (HYD PRESS < 200)
Report APU F7 lts
APU CNTLR PWR – OFF

If one APU failed:

- ⇒
2. √APU AUTO SHTDN (three) – ENA
 3. MM304: √APU SPEED SEL (two) – NORM
 4. MM602/305: APU SPEED SEL (two) – HI

If two APUs failed:

5. APU SPEED SEL (one) – HI
6. AUTO SHTDN (one) – INH

APU SPD HI

If SPEED % exceeds 111:

- ⇒
1. APU SPEED SEL – HI
Pre-TAEM if two good APUs:
 2. Perform APU SHUTDN, then:
 3. Go to APU COOLDOWN

APU OVERSPEED

If SPEED % exceeds 129:

Go to APU SHUTDN

APU UNDERSPEED G51

If 'PRL SYS X ↓' or if APU has shut dn:

- ⇒
1. Perform APU SHUTDN, then:
 2. Go to APU COOLDOWN

APU OIL OVERTEMP

1. BLR CNTLR/HTR – A(B)
√N2 SPLY – ON

⇒ If M > 1:

If OIL IN T incr, and OUT T > 305:

2. Perform APU SHUTDN, then:
3. Go to APU COOLDOWN

APU PUMP LEAK P

1. √MCC

Pre-TAEM if two good APUs:

2. Perform APU SHUTDN, then:
3. Go to APU COOLDOWN

APU THERM (T HI)

If APU GG/FU PMP HTR or APU TK/FU LN HTR fail ON (↑):
(Aff) HTR – OFF

APU COOLDOWN

At M = 7:

1. HYD MN PUMP PRESS – LO
APU CNTLR PWR – ON
OPER – INJ COOL (start watch)

If APU not leaking:

2. APU FU TK VLV – OP

At Wheel Stop:

3. Go to APU SHUTDN

APU RESTART

- ◆ 1. √APU AUTO SHTDN – ENA
 2. HYD MN PUMP PRESS – LO
 3. APU CNTLR PWR – ON
- If COOLDOWN for > 3.5 min or APU TEMP INJ < 380:
4. Go to step 7
 5. APU OPER – INJ COOL (start watch)
- If after 1.5 min, APU TEMP INJ not decr:
6. Go to APU SHUTDN >>
- At 3.5 min:
7. √APU FU TK VLV – OP
OPER – START/RUN
- If restart unsuccessful:
8. Go to APU SHUTDN >>
 9. HYD MN PUMP PRESS – NORM

HYD PRESS (LOW)

GNC 51 OVERRIDE
BFS, SM SYS SUMM 2

- ⇒ 1. Compare 'PRL SYS X' status and aff HYD PRESS
(HYD/APU meter and CRT):

PRL SYS	HYD PRESS	ACTION
'↓'	both meter and CRT P < 300	Go to APU SHUTDN >>
blank	either meter or CRT P > 2600	No action reqd >>
'?'	ACUM P > 2800	No action reqd >>

2. (Aff) HYD MN PUMP PRESS – LO

If two good APU/HYD remain:

3. √APU AUTO SHTDN (three) – ENA
4. MM304: √APU SPEED SEL (two) – NORM
5. MM305/602: APU SPEED SEL (two) – HI >>

If only one good APU/HYD remains:

6. APU AUTO SHTDN (one) – INH
SPEED SEL (one) – HI

On MCC call:

7. (Degraded) HYD MN PUMP PRESS – NORM

HYD RSVR QTY (LOW)

1. (Aff) √HYD MPS/TVC ISOL VLV SYS – CL
(hold 5 sec, tb-CL)
- ⇒ √BK ISOL VLV – CL (hold 5 sec, tb-CL)
- If HYD sys 1 leaking:
√LG EXT D ISO VLV – CL (hold 5 sec, tb-CL)
- If qty still decr:
If two good Hyd sys:
2. (Aff) HYD MN PUMP PRESS – LO
If second sys fails:
3. At TAEM: (Leaking) HYD MN PUMP
PRESS – NORM
4. At TAEM: (Good) APU SPEED SEL (two) – HI
- If one good Hyd sys:
5. (Good) APU AUTO SHTDN – INH
6. (Good) APU SPEED SEL – HI
- If prior to TAEM:
7. (Leaking) HYD MN PUMP PRESS – LO
8. At TAEM: (Leaking) HYD MN PUMP
PRESS – NORM

HYD RSVR T

1. BLR CNTLR/HTR – A(B)
- If HYD RSVR T > 250:
2. HYD MN PUMP PRESS – LO
- If HYD RSVR T > 268 and incr:
3. Perform APU SHUTDOWN, then:
4. Go to APU COOLDOWN

W/B QTY (LOW)

1. BLR CNTLR/HTR – A(B)
- ⇒ 2. If BLR CNTLR/HTR – OFF:
3. BLR CNTLR/HTR – B
N2 SPLY – ON
4. If W/B QTY = 0 or $M \leq 1$ >>
 5. Monitor W/B QTY for 2 min, then:
 6. If W/B QTY change > 3:
7. Cycle BLR CNTLR/HTR to maintain:
200 < LUBE OIL IN T < 290 (C&W)
- When $M \leq 1$:
8. BLR CNTLR/HTR – A(B)



This Page Intentionally Blank





**COMM/
GNC**

COMM/GNC



MS E2-1

AESP/ALL/E/GEN O

COMM/
GNC

COMM LOST (mult pnls)

1. AUD CTR – 2

No comm (check UHF sites):

2. S-BD PM CNTL – PNL,CMD (pnl C3)

3. Config per COMM COVER (ASC) [BFS G51]:

TDRS – ITEM 46 EXEC (*)

STDN-HI – ITEM 47 EXEC (*)

SGLS – ITEM 49 EXEC (*)

If * not next to selected config:

4. Config pnl A1 per Comm Coverage

(ASC/ENT PKT, COMM)

S-BD PM CNTL – PNL,CMD (pnl C3)

No comm:

5. Sel best S-BD PM ANT

No comm:

6. S-BD PM ANT – GPC

ICOM LOST

1. AUD CNTL sel – sel alt

No ICOM:

2. AUD CTR – 2

FCS CH 1(2,3,4) (2nd FAIL) [G53]

If two FCS CH ↓ on any actuator:

- ◆ (Remaining) FCS CH (two) – ORIDE

RHC L(R) (2nd FAIL)

(Aff) FLT CNTLR PWR – OFF

[GNC SYS SUMM 1]

G51 ROLL MODE SW [G51]

If ROLL MODE ≠ sw pos:

AUTO SEL – ITEM 42 EXEC

DISPLAY SW L(R)

L(R) disp sws – green dot

RM FAIL IMU,RGA,AA [BFS G51]

Aff LRU – desel

RM DLMA IMU [G51] [BFS G51]

- 1. √MCC, bad IMU – desel (PASS & BFS) >>
- ◆ 2. Desel lower # IMU with '?' (PASS)

RM FAIL ADTA [G51]

- ◆ 1. √BFS [GNC SYS SUMM 1]
- 2. If '↓' for aff ADTA >>
- 3. If accessible, (bad) ADTA cb – op >>
- 4. BFS, ADTA to G&C – INH

RM DLMA ADTA * [G51]

M < 2.0		1. Fly Theta limits
ADTA data agrees		2. Desel, resel one ADTA 3. If no '?' >>
Bad probe		4. Stow bad probe >>
Bad ADTA	ADTA cb accessible	◆ 5. (Bad) ADTA cb – op >>
	ADTA cb not accessible	◆ 6. DES bad ADTA 7. √BFS [GNC SYS SUMM 1] 8. If '↓' for aff ADTA >> 9. BFS, ADTA to G&C – INH
Dilemma not resolved		10. ADTA to G&C – INH (PASS & BFS)

*If three ADTAs failed:
ADTA to G&C – INH (PASS)
Fly Theta limits

RM FAIL TAC [G50]

(RM LIMITS: 6 DEG, 0.5 NM)

- 1. If data good: desel, resel aff TACAN >>
- 2. If failure verified: desel failed TACAN in BFS

RM DLMA TAC [G50]

Do not desel or resel while in 'TEST'

- 1. If both data good: desel, resel one TACAN in DLMA >>
- 2. √TACAN MODE (three) – GPC
- 3. If 'RM FAIL TAC': desel failed TACAN in BFS >>
- 4. If continuous 'TEST': TACAN MODE (three) – T/R
If bad TACAN identified:
 - 5. Desel bad TACAN (PASS, √BFS)

SPD BRK [G51] [BFS G51]

M > 5.0	◆ WRAP MODE – INH
M ≤ 5.0	WRAP MODE – INH √MCC for energy mgmt procs

OV103,104

(OV103,104) MS E2-3

AESP/ALL/E/GEN O

G55 GPS FAIL 2 [G50] [BFS G50]
GPS to NAV INH – ITEM 43 EXEC (PASS, √BFS)

NO UPDATE GPS [G55]
√MCC
If ALT < 300kft and ALT > 180kft
 No Update due to plasma, reevaluate at ALT < 180kft
Else
 INIT – ITEM 15 EXEC
 NAV – ITEM 18 EXEC

OV103,104

(OV103,104) MS E2-4

AESP/3,4/E/GEN O

RM FAIL ADTA [G51]

- ◆ 1. √BFS [GNC SYS SUMM 1]
- 2. If '↓' for aff ADTA >>
- 3. If accessible, (bad) ADTA cb – op >>
- 4. BFS, ADTA to G&C – INH

RM DLMA ADTA * [G51]

M < 2.0		1. Fly Theta limits
ADTA data agrees		2. Desel, resel one ADTA 3. If no '?' >>
Bad probe		4. Stow bad probe >>
Bad ADTA	ADTA cb accessible	◆ 5. (Bad) ADTA cb – op >>
	ADTA cb not accessible	◆ 6. DES bad ADTA 7. √BFS [GNC SYS SUMM 1] 8. If '↓' for aff ADTA >> 9. BFS, ADTA to G&C – INH
Dilemma not resolved		10. ADTA to G&C – INH (PASS & BFS)

*If three ADTAs failed:
ADTA to G&C – INH (PASS)
Fly Theta limits

RM FAIL TAC [G50]

(RM LIMITS: 6 DEG, 0.5 NM)

- 1. If data good: desel, resel aff TACAN >>
- 2. If failure verified: desel failed TACAN in BFS

RM DLMA TAC [G50]

Do not desel or resel while in 'TEST'

- 1. If both data good: desel, resel one TACAN in DLMA >>
- 2. √TACAN MODE (three) – GPC
- 3. If 'RM FAIL TAC': desel failed TACAN in BFS >>
- 4. If continuous 'TEST': TACAN MODE (three) – T/R
If bad TACAN identified:
 - 5. Desel bad TACAN (PASS, √BFS)

SPD BRK [G51] [BFS G51]

M > 5.0	◆ WRAP MODE – INH
M ≤ 5.0	WRAP MODE – INH √MCC for energy mgmt procs

OV105

(OV105) MS E2-3

AESP/ALL/E/GEN O

G55 GPS FAIL 1(2,3) [G50] [BFS G50]

Aff LRU – desel (PASS, $\sqrt{\text{BFS}}$)

RM DLMA GPS [G50] [BFS G50]

- ◆ 1. $\sqrt{\text{MCC}}$, bad GPS – desel (PASS, $\sqrt{\text{BFS}}$) >>
- 2. If 300kft > ALT > 180kft
DLMA due to plasma
Reevaluate when ALT < 180kft
Else
- 3. Desel GPS with highest $P1\sigma$
If $P1\sigma$ values are equal, desel highest number LRU
If DLMA not resolved
- 4. Desel GPS with next highest $P1\sigma$

NO UPDATE GPS [G55]

- 1. $\sqrt{\text{MCC}}$, bad GPS – desel (PASS, $\sqrt{\text{BFS}}$) >>
- 2. If RM DLMA GPS message, see RM DLMA GPS >>
- 3. If 300kft > ALT > 180 kft
No Update due to plasma
Reevaluate when ALT < 180kft
Else
- 4. Initialize GPS with highest $P1\sigma$
INIT – ITEM 14(15,16) EXEC
NAV – ITEM 17(18,19) EXEC
May take up to 2 min for GPS to provide SV

OV105

(OV105) MS E2-4

AESP/5/E/GEN O



DPS

DPS



MS E3-1

AESP/ALL/E/GEN O

DPS

PASS GPC FAIL

1. (Aff) FCS CH – OFF
2. If two GPC/FA/FCS CHs ↓: (Good) FCS CHs – ORIDE
3. GPC MODE – STBY,HALT
4. [G53] aff SURF FDBK – desel
- ⇒ 5. If String 1(2): CDR(PLT) disp sws – green dot
NWS – 2
6. √MULT DATA PATH LOSS

BFS GPC FAIL

1. GPC MODE – STBY,HALT
- ◆ 2. OUTPUT – TERM
⇒ MODE – STBY
3. If BFS cannot drive an IDP:
GPC MODE – HALT, then go to step 8
4. If BFS currently in OPS 3 or 6:
Go to step 7
5. If BFS currently in OPS 1:
PRO to OPS 106
BFS, OPS 000 PRO
PRO to OPS 304
6. If BFS in desired MM (304):
BFS [G50] √BFS R/W sel
GPC MODE – RUN
OUTPUT – B/U
Advise MCC BFS in BACKUP >>
7. √GPC MODE – STBY (BFS is SM Only)
8. If no comm: sel best S-BD PM ANT
9. MPS He ISOL B (three) – CL
PNEU He ISOL – CL
10. If AOA/GRTLS/TAL < 120K:
NH3 CNTLR B – SEC/ON

FA/FF MDM I/O ERROR

(Annunciated by entire set)

	FA	1. (Aff) FCS CH – OFF
		◆ 2. I/O RESET
RECOV	FA	3. (Aff) FCS CH – AUTO
	FF 1,2,3	◆ 4. [G51] IMU – resel
		5. BFS I/O RESET >>
NOT RECOV	FA	6. If two GPC/FA/FCS CHs ↓: (Good) FCS CHs – ORIDE
		7. [G53] aff SURF FDBK – desel
		8. √MULT DATA PATH LOSS
		⇒ ◆ 9. Go to FA/FF MDM PORT MODE ⇒

FA/FF MDM PORT MODE

NOTE

If BFS, 'BCE STRG X PASS', @GPC; else @MDM.

For '@GPC' port mode results in alternate MDM bypass

			1. <u>G01</u> aff String – port mode 2. BFS I/O RESET
@MDM	RECOV	FA	3. (Aff) FCS CH – AUTO 4. <u>G53</u> aff SURF FDBK – resel >>
		FF 1,2,3	◆ 5. <u>G51</u> IMU – resel >>
	NOT RECOV		⇒ If MCC GO for pwr cycle: 6. (Aff) FA/FF MDM – OFF, ON 7. I/O RESET 8. If recov, go to @MDM RECOV >> 9. (Aff) MDM – OFF
		FA	10. <u>BFS G51</u> aff SURF FDBK, RGA – desel
		FF	11. <u>BFS G51</u> aff AA – desel 12. FF 1(2): CDR(PLT) disp sws – green dot NWS – 2
			13. √MULT DATA PATH LOSS >>
@GPC	FA RECOV (FF Give Up)		14. (Aff) FCS CH – AUTO 15. <u>G53</u> aff SURF FDBK – resel 16. FF 1(2): CDR(PLT) disp sws – green dot NWS – 2 17. √MULT DATA PATH LOSS >>
		FF RECOV (FA Give Up)	18. (Aff) FCS CH – OFF 19. If two GPC/FA/FCS CHs ↓: (Good) FCS CHs – ORIDE 20. <u>G53</u> aff SURF FDBK – desel
		FF 1,2,3	◆ 21. <u>G51</u> IMU – resel
			22. √MULT DATA PATH LOSS >>

FF(FA) MDM OUTPUT

FAULT

- ◆ (Take action only if annun by entire set)
- If single 'MDM OUTPUT':
 1. If 'FF MDM OUTPUT':
 - ◆ [G51] aff IMU – desel
 2. Go to FA/FF MDM I/O ERROR >>
- If both FF and FA annun:
 3. [G51] aff IMU – desel
 4. I/O RESET; if reqd, BFS I/O RESET
 5. If msgs repeat: Go to PASS GPC FAIL >>
 6. If reqd, (aff) FCS CH – ORIDE,AUTO
- ◆ 7. [G51] IMU – resel

PL MDM I/O ERROR

1. BFS I/O RESET; if recovered >>
2. [G01] PL1/2 – port mode, then BFS I/O RESET;
if recovered >>
3. If PL1 ↓ and pre MM305: FLASH EVAP CNTLR PRI
B – ON
4. If PL2 ↓ and no comm: sel best S-BD PM ANT
5. If PL2 ↓ and AOA/GRTLS/TAL < 120K:
⇒ NH3 CNTLR B – SEC/ON

PCM I/O ERROR

OI PCMMU PWR – 2(1)

BCE STRG X (no 'MDM OUTPUT' msg)

	IMU	1. G21 √IMU OPER, if STBY >>
		2. I/O RESET
RECOV	IMU	3. G21 √att ANG, if delta > 1° >>
		◆ 4. G51 IMU – resel >>
		5. >>
NOT RECOV	NSP	6. And no comm: PNL,CMD
		7. BFS G51 Config per <u>COMM COVER</u> (ASC): TDRS – ITEM 46 EXEC (*) STDN-HI – ITEM 47 EXEC (*) SGLS – ITEM 49 EXEC (*) >>
		8. G01 aff String – port mode
		9. BFS I/O RESET
		10. If recov, go to RECOV steps >>
A(B,C,D, IMU)	⇒	11. FF A(B,IMU) or FA C(D) MDM – OFF,ON
		12. I/O RESET
		13. If FA, (aff) FCS CH – ORIDE,AUTO
		14. If recov, go to RECOV steps
	C(D)	15. If < 3Y,2P jets/pod/dir: a. G23 aff jet DES INH (*) (reprioritize) b. Aff MANF VLVS STAT OP – OVRD
	1A(2A)	16. CDR(PLT) disp sws – green dot
	B	17. BFS G51 aff AA – desel
	D	18. BFS G51 aff SURF FDBK,RGA – desel
		19. √MULT DATA PATH LOSS >>

POST OPS 3/GRTL5 TRANSITION RESTRING

1. (Aff) GPC(s) – STBY,HALT
2. √G53 aff SURF FDBK – desel (*)
3. Config MC1(3) NBAT
4. OPS Mode Recall: OPS XXX PRO
5. BFS I/O RESET

If OPS 3 and String 1(2,3) recovered:

- ⇒ ♦
6. G51 IMU – resel
 7. Config FCS CH(s) (see Table):
 8. G53 config SURF FDBK (see Table):

AVAILABLE		FCS CH CONFIG			SURF FDBK	
GPCs	FCS CHs	AUTO	ORIDE	OFF	SEL	DESEL
3	4	3		1	3	1*
	3	3		1	3	1*
	2		2	2	2	2
2	4		4		4	
	3		2	2	2	2
	2		2	2	2	2

*If CH 4 – OFF, DO NOT DESEL PASS SURF FDBK

POST BFS ENGAGE

If PASS GPCs running:

1. (Aff) GPC MODE – STBY/HALT
2. BFS I/O RESET
3. √FCS CHs, IMU config

⇒ If Air Data not analyzed:

4. G50 INH AD to G&C
5. M = 5: Deploy, evaluate probes one at a time
6. √AD to G&C by M = 1.5

If failed ADTA(s) in PASS:

7. cb(s) ADTA – op, or stow probe
8. G51 DES failed(commfaulted) RGA,AA,SURF
9. G50 DES failed TAC

At M ≤ 2.7:

10. CDR TRIM PNL – OFF
RHC/PNL – ENA

At H = 3K:

11. SPDBK – MAN (check DEL PAD setting)

At MAIN GEAR TD:

12. SPDBK – 100%

DUAL DPS DISPLAY COMMANDERS/DK XMTR 1(2,3)

1. BFC CRT SEL – aff IDP
- If reqd to clean up display:
2. (Aff) IDP/CRT PWR – OFF,ON

PASS DISPLAY FAIL

1. MDU PWR – OFF,ON; if recovered >>
 2. GPC/CRT – same GPC/aff IDP; if recovered >>
 3. BFC CRT SEL – aff IDP; if both IDPs OK go to step 9
 4. – orig posn
 5. Report MDU symptoms
- If MCC GO for pwr cycle:
6. IDP/CRT PWR – OFF,ON; if recovered >>
- If MDU blank or autonomous:
7. Set other MDU on same IDP to DPS Mode; if recovered >>
 8. Return other MDU to nominal config
9. Deassign aff IDP from PASS
 10. GPC/CRT 04 EXEC
 11. In PASS: GPC/CRT 44 EXEC

BFS DISPLAY FAIL

1. If IDP4(CRT4): IDP/CRT4 PWR – OFF >>
 2. MDU PWR – OFF,ON; if recovered >>
 3. BFC CRT SEL – unaff IDP; if both IDPs OK >>
 4. – orig posn
 5. BFC CRT DISPLAY – OFF,ON; if recovered >>
 6. In PASS: GPC/CRT 5/X for aff IDP; if recovered >>
 7. Report MDU symptoms
- If MCC GO for pwr cycle:
8. IDP/CRT PWR – OFF,ON; if recovered >>
- If MDU blank or autonomous:
9. Set other MDU on same IDP to DPS Mode; if recovered >>
 10. Return other MDU to nominal config
11. BFC CRT SEL – unaff IDP
 12. Deassign aff IDP from PASS
 13. GPC/CRT 04 EXEC
 14. In PASS: GPC/CRT 44 EXEC

FLT INST DISPLAY ANOMALY

1. DATA BUS sel alt FC BUS(s); if recovered >>
2. PORT SELECT aff MDU; if recovered >>
3. MDU PWR – OFF,ON

SUBSYS STATUS DISPLAY ANOMALY

1. PORT SELECT aff MDU; if recovered >>
2. MDU PWR – OFF,ON; if recovered >>

BFS INADVERTENT DISENGAGE/UNSUCCESSFUL ENGAGE (Lightning Strike)

1. CDR and PLT RHC BFS engage pb – push
If no response:
2. BFS OUTPUT – NORM, B/U
3. CDR,PLT RHC BFS engage pb – push

MULT DATA PATH LOSS (non-Recov)

NOTE

If LRU data path loss due to GPC prob and not MDM,
BFS will pick up MDMs/LRU when engaged

FAILURE	TYPE	ACTIONS
GPC/FF 1&2	I/O or B	Use R BODY FLAP & TRIM ENA sws
GPC/FF 3&4	I/O or B	Use L BODY FLAP & TRIM ENA sws
GPC/FA any combo	I/O or D	No impact



ECLS

ECLS



MS E4-1

AESP/ALL/E/GEN O

ECLS

CAB PRESS LEAK

1. CAB RELIEF A – CL, pause,
B – CL
 2. Check tabs, visors – CL, LES O2 – ON
 3. If RTLS/TAL: O2/N2 CNTLR VLV SYS 2 – OP
 4. O2 TK1, TK2 HTRS A, B (four) – AUTO
 - ⇒ 5. TK3 HTRS A, B (two) – AUTO
- If possible:
6. Remove INNER HATCH cap (two)
 7. Equal vlv (two) – EMER
- When CAB PRESS < 10 psia, if dP/dT EQ < 0.67:
8. √O2/N2 CNTLR VLV SYS 2 – OP >>
- When CAB PRESS < 6.5 psia:
9. √O2/N2 CNTLR VLV SYS 2 – OP
 10. CAB FAN (two) – ON

CAB PRESS HIGH

1. If incr: LES O2 – OFF, visors – OP

If still incr:

2. N2 SYS 1, 2 REG INLET (two) – CL
3. O2 SYS 1, 2 SPLY (two) – CL

H2O LOOP PRESS LOW(HIGH)

⇒ Switch Loops

AV BAY FAN ΔP

- ⇒ 1. If Av Bay 1 aff: FAN A – ON; FAN B – OFF
If Av Bay 2 aff: FAN B – ON; FAN A – OFF
If Av Bay 3 aff: FAN A – ON; FAN B – OFF
2. If no joy: Go to LOSS OF AV BAY COOLING PWRDN

AV BAY TEMP HIGH

- ⇒ 1. (Aff) AV BAY FAN (two) – ON
2. If not decr: Switch H2O Loops
3. If no joy: Go to LOSS OF AV BAY COOLING PWRDN

LOSS OF AV BAY COOLING PWRDN

Bay 1: MLS 1 – OFF
Bay 2: 2, 3 – OFF
Bay 3: N/A

CABIN FAN FAIL

- ⇒ 1. Switch fans
- If both fans lost:
2. Minimize use of IDPs/MDUs/FLT CNTLR PWR

IMU FAN FAIL

⇒ Switch fans

FREON FLOW LOW

1. Switch pumps
- If flow still low:
2. (Aff) RAD BYP VLV MODE – AUTO
CNTLR LOOP – AUTO A(B) (wait 90 sec)
- If flow still low in both loops:
3. Go to LOSS OF FREON LOOP(s)

LOSS OF 1 FREON LOOP

1. (Bad) FREON PUMP LOOP – OFF
- If FREON LOOP 1(2) lost:
2. O2 SYS 1(2) SPLY (one) – CL
 3. √FLOW PROP VLV LOOP 2(1) – ICH
4. Monitor EVAP OUT TEMP
- If TAL/AOA/RTLS and LOOP 2 lost:
5. NH3 CNTLR B – OFF, A – PRI/GPC

LOSS OF 2 FREON LOOPS – PWRDN

1. When loops fail (flow <700), CDR execute LOOPS
FAILED
 2. MSTR MADS PWR – OFF
 3. Use one IDP/CRT with two MDUs (three max)
 4. All PL pwr (seven) – OFF
 5. O2,H2 TK HTRS (all) – OFF
 6. MCC CMD FC purge, then BFS GPC – STBY,HALT
PWR – OFF
OUTPUT – NORM
 7. If no comm: sel best S-BD PM ANT
- If RTLS:
8. TACAN (three) – OFF
 9. RDR ALTM 1 – OFF
- If TAL/AOA/ENTRY and V > 15K:
10. All TACAN/RA/MLS – OFF
 11. Use one FLT CNTLR PWR
- ⇒
12. DC UTIL PWR – OFF
 - ◆ 13. FCS CH 4 – OFF
 14. GPC 4 – STBY,HALT,PWR – OFF
 15. FF4,FA4 – OFF
 16. ANNUN BUS SEL ACA 2/3 – OFF
 - ◆ When MPS dump complete:
 17. MPS ENG PWR (six) – OFF
 18. EIU (three) – OFF
 19. MEC 1 – OFF, wait 2 sec, then:
 20. MEC 2 – OFF
 - ◆ 21. G50 √GPS, INCORPORATE
 22. At M = 2.9: √RA 2 – ON
 23. If reqd: Use one MLS, GNC I/O RESET

OV103,104

(OV103,104) MS E4-3

AESP/3,4/E/GEN O

LOSS OF 2 FREON LOOPS – LOOPS FAILED

1. LES O2 – OFF, visor – OP
2. O2 SYS 1,2 SPLY (two) – OP
Panel L1: All sws off, except:
 3. H2O PUMP LOOP 2 – ON
4. Perform PWRDN if not already accomplished

EVAP OUT TEMP HIGH (Rads cold soaked)

If temp high in only one loop (snsr failed) >>

1. If V < 12K:
RAD BYP VLV LOOP 1 – MAN,BYP
NH3 CNTLR B – PRI/GPC >>
2. FLASH EVAP CNTLR PRI B(A) – OFF
A(B) – ON (wait 30 sec)

If T decr >>
3. FLASH EVAP CNTLR PRI A(B) – OFF
SEC – ON (HI LOAD ena)
(wait 30 sec)

If T decr:
TOP EVAP HTRS (three) – OFF >>
4. HI LOAD EVAP – OFF
DUCT HTR sel – OFF (wait 30 sec)

If T decr >>
5. TOP EVAP HTRS (three) – OFF
RAD BYP VLV MODE (two) – AUTO
CNTLR LOOP (two) – AUTO B(A) (wait 90 sec)

EVAP OUT TEMP HIGH (Rads *not* cold soaked)

If temp high in only one loop (snsr failed) >>

If V > 12K:

1. FLASH EVAP CNTLR PRI A – OFF
B – ON (wait 30 sec)

If T decr >>
2. FLASH EVAP CNTLR PRI B – OFF
SEC – ON (HI LOAD ena)
(wait 30 sec)

If T decr >>
3. HI LOAD EVAP – OFF
If T decr >>
4. RAD BYP VLV (four) – MAN,RAD FLOW
- ⇒ 5. NH3 CNTLR B – SEC/ON (wait 60 sec)
6. If T decr >>
7. NH3 CNTLR B – OFF, A – SEC/ON

OV103,104

(OV103,104) MS E4-4

AESP/ALL/E/GEN O

EVAP OUT T LOW

1. If temp low in only one loop (snsr failed) >>
2. FREON PUMP LOOP 1,2 (two) – OFF
3. H2O PUMP LOOP 1 (two) – ON,B
4. FLOW PROP VLV LOOP 1,2 (two) – PL HX (tb-PL)
5. O2 SYS 1,2 SPLY (two) – CL (tb-CL)
6. √RAD BYP VLV MODE (two) – MAN
7. √MAN SEL (two) – BYP (tb-BYP ~3 sec)
8. FLASH EVAP CNTLR PRI A,B,SEC (three) – OFF
- ◆ 9. FREON PUMP LOOP 1,2 (two) – B
NH3 CNTLR A,B (two) – SEC/ON

Wait 3 min, then if any Freon Loop off:

10. FREON PUMP LOOP 1,2 (two) – B

When EVAP OUT T > 55 for at least 2 min (NH3 depleted):

11. O2 SYS 1,2 SPLY (two) – OP (tb-OP)
12. NH3 CNTLR A,B (two) – OFF

If V > 12K and FLASH EVAP CNTLR PRI A(B)

previously selected:

13. FLASH EVAP CNTLR PRI B(A) – GPC >>

If V < 12K:

14. RAD BYP VLV MODE 1,2 (two) – AUTO
15. CNTLR LOOP 1,2 (two) – OFF
AUTO A(B)

FREON LEAK

- ◆ 1. FREON ISOL MODE – MAN
 2. (Aff) FREON ISOL LOOP 1(2) – ISOL
Hold for 5 sec
- If (aff) FREON LOOP 1(2) ACCUM QTY decr:
- ◆ 3. (Aff) FREON ISOL LOOP 1(2) – RAD
Hold for 5 sec
 4. When loop fails ('SM2 FREON FLOW 1(2)'), CDR
execute LOSS OF 1 FREON LOOP for (aff) Freon
Loop >>
- If (aff) FREON LOOP 1(2) ACCUM QTY not decr:
When V<12K and rads cold soaked:
In good loop:
5. √RAD BYP VLV MODE 2(1) – AUTO
 6. √RAD CNTLR LOOP 2(1) – AUTO B
 7. NH3 CNTLR B(A) – PRI/GPC

OV103,104

(OV103,104) MS E4-5

AESP/ALL/E/GEN O,2

FIRE/SMOKE

SM SYS SUMM 1

If **VISUAL SMOKE/FIRE**, or
two SMOKE DETN lt on, or
two CONC > 2, or
one SMOKE DETN lt on and
other CONC > 2:

1. Go to step 6

If single Av Bay SMOKE DETN A(B) lt and assoc CONC > 2:

2. SMOKE DETN CKT TEST – B(A) (25 sec)

If SMOKE DETN B(A) test good (lt on):

3. SMOKE DETN CKT TEST – OFF

4. SNSR – RESET >>

If SMOKE DETN B(A) test bad (no lt):

5. Go to step 6

If none of above >>

6. Check tabs, visors – CL
LES O2 – ON

If **AV BAY FIRE**:

7. FIRE SUPPR – ARM

pb – DISCH (push until lit)

8. If Ascent: AV BAY FAN (two) – OFF

9. If FIRE in Bay:

1: TACAN 1, MLS 1 – OFF

2: TACAN 2, MLS 2,3 – OFF

3: TACAN 3 – OFF

If **CABIN FIRE**:

10. CAB FAN A,B (two) – OFF (max 20 min)

11. Locate source (see matrix, facing page)

12. Unpwr source of smoke

If smoke persists or source cannot be unpwr:

WARNING
Discharge is propulsive

13. Discharge handheld FIRE EXTGHR

If Ascent:

14. Post MECO, go to POST-FIRE CABIN CLEANUP (ASC
PKT, ECLS) >>

If Entry and prior to TIG:

15. Go to ECLS FRP-3, FIRE/HAZ SPILL O2 CONTROL, step |
3 (MAL)

Cont next page

OV103,104

(OV103,104) MS E4-6

AESP/3,4/E/GEN O,2

FREON FLOW LOW

1. Switch pumps

If flow still low:

2. (Aff) RAD BYP VLV MODE – AUTO
CNTLR LOOP – AUTO A(B) (wait 90 sec)

If flow still low in both loops:

3. Go to LOSS OF FREON LOOP(s)

LOSS OF 1 FREON LOOP

1. (Bad) FREON PUMP LOOP – OFF

If FREON LOOP 1(2) lost:

2. O2 SYS 1(2) SPLY (one) – CL
3. √FLOW PROP VLV LOOP 2(1) – ICH

4. Monitor EVAP OUT TEMP

If TAL/AOA/RTLS and LOOP 2 lost:

5. NH3 CNTLR B – OFF, A – PRI/GPC

LOSS OF 2 FREON LOOPS – PWRDN

1. When loops fail (flow <700), CDR execute LOOPS
FAILED

2. MSTR MADS PWR – OFF

3. Use one IDP/CRT with two MDUs (three max)

4. All PL pwr (seven) – OFF

5. O2,H2 TK HTRS (all) – OFF

6. MCC CMD FC purge, then BFS GPC – STBY,HALT
PWR – OFF
OUTPUT – NORM

7. If no comm: sel best S-BD PM ANT

8. GPS 1,3 – OFF

If RTLS:

9. RDR ALTM 1 – OFF

If TAL/AOA/ENTRY and V > 15K:

10. All RA/MLS – OFF
11. Use one FLT CNTLR PWR

⇒ 12. DC UTIL PWR – OFF

◆ 13. FCS CH 4 – OFF

14. GPC 4 – STBY,HALT,PWR – OFF

15. FF4,FA4 – OFF

16. ANNUN BUS SEL ACA 2/3 – OFF

◆ When MPS dump complete:

17. MPS ENG PWR (six) – OFF

18. EIU (three) – OFF

19. MEC 1 – OFF, wait 2 sec, then:

20. MEC 2 – OFF

◆ 21. G50 √GPS, INCORPORATE

22. At M = 2.9: √RA 2 – ON

23. If reqd: Use one MLS, GNC I/O RESET

OV105

(OV105) MS E4-3

AESP/5/E/GEN O

LOSS OF 2 FREON LOOPS – LOOPS FAILED

1. LES O2 – OFF, visor – OP
2. O2 SYS 1,2 SPLY (two) – OP
Panel L1: All sws off, except:
 3. H2O PUMP LOOP 2 – ON
4. Perform PWRDN if not already accomplished

EVAP OUT TEMP HIGH (Rads cold soaked)

If temp high in only one loop (snsr failed) >>

1. If V < 12K:
RAD BYP VLV LOOP 1 – MAN,BYP
NH3 CNTLR B – PRI/GPC >>
2. FLASH EVAP CNTLR PRI B(A) – OFF
A(B) – ON (wait 30 sec)

If T decr >>
3. FLASH EVAP CNTLR PRI A(B) – OFF
SEC – ON (HI LOAD ena)
(wait 30 sec)

If T decr:
TOP EVAP HTRS (three) – OFF >>
4. HI LOAD EVAP – OFF
DUCT HTR sel – OFF (wait 30 sec)

If T decr >>
5. TOP EVAP HTRS (three) – OFF
RAD BYP VLV MODE (two) – AUTO
CNTLR LOOP (two) – AUTO B(A) (wait 90 sec)

EVAP OUT TEMP HIGH (Rads *not* cold soaked)

If temp high in only one loop (snsr failed) >>

If V > 12K:

1. FLASH EVAP CNTLR PRI A – OFF
B – ON (wait 30 sec)

If T decr >>
2. FLASH EVAP CNTLR PRI B – OFF
SEC – ON (HI LOAD ena)
(wait 30 sec)

If T decr >>
3. HI LOAD EVAP – OFF
If T decr >>
4. RAD BYP VLV (four) – MAN,RAD FLOW
- ⇒ 5. NH3 CNTLR B – SEC/ON (wait 60 sec)
6. If T decr >>
7. NH3 CNTLR B – OFF, A – SEC/ON

OV105

(OV105) MS E4-4

AESP/ALL/E/GEN O

EVAP OUT T LOW

1. If temp low in only one loop (snsr failed) >>
2. FREON PUMP LOOP 1,2 (two) – OFF
3. H2O PUMP LOOP 1 (two) – ON,B
4. FLOW PROP VLV LOOP 1,2 (two) – PL HX (tb-PL)
5. O2 SYS 1,2 SPLY (two) – CL (tb-CL)
6. √RAD BYP VLV MODE (two) – MAN
7. √MAN SEL (two) – BYP (tb-BYP ~3 sec)
8. FLASH EVAP CNTLR PRI A,B,SEC (three) – OFF
- ◆ 9. FREON PUMP LOOP 1,2 (two) – B
NH3 CNTLR A,B (two) – SEC/ON

Wait 3 min, then if any Freon Loop off:

10. FREON PUMP LOOP 1,2 (two) – B

When EVAP OUT T > 55 for at least 2 min (NH3 depleted):

11. O2 SYS 1,2 SPLY (two) – OP (tb-OP)
12. NH3 CNTLR A,B (two) – OFF

If V > 12K and FLASH EVAP CNTLR PRI A(B)

previously selected:

13. FLASH EVAP CNTLR PRI B(A) – GPC >>

If V < 12K:

14. RAD BYP VLV MODE 1,2 (two) – AUTO
15. CNTLR LOOP 1,2 (two) – OFF
AUTO A(B)

FREON LEAK

- ◆ 1. FREON ISOL MODE – MAN
 2. (Aff) FREON ISOL LOOP 1(2) – ISOL
Hold for 5 sec
- If (aff) FREON LOOP 1(2) ACCUM QTY decr:
- ◆ 3. (Aff) FREON ISOL LOOP 1(2) – RAD
Hold for 5 sec
 4. When loop fails ('SM2 FREON FLOW 1(2)'), CDR
execute LOSS OF 1 FREON LOOP for (aff) Freon
Loop >>
- If (aff) FREON LOOP 1(2) ACCUM QTY not decr:
When V<12K and rads cold soaked:
In good loop:
5. √RAD BYP VLV MODE 2(1) – AUTO
 6. √RAD CNTLR LOOP 2(1) – AUTO B
 7. NH3 CNTLR B(A) – PRI/GPC

OV105

(OV105) MS E4-5

AESP/ALL/E/GEN O,2

FIRE/SMOKE

SM SYS SUMM 1

If **VISUAL SMOKE/FIRE**, or
two SMOKE DETN lt on, or
two CONC > 2, or
one SMOKE DETN lt on and
other CONC > 2:

1. Go to step 6

If single Av Bay SMOKE DETN A(B) lt and assoc CONC > 2:

2. SMOKE DETN CKT TEST – B(A) (25 sec)

If SMOKE DETN B(A) test good (lt on):

3. SMOKE DETN CKT TEST – OFF

4. SNSR – RESET >>

If SMOKE DETN B(A) test bad (no lt):

5. Go to step 6

If none of above >>

6. Check tabs, visors – CL
LES O2 – ON

If **AV BAY FIRE**:

7. FIRE SUPPR – ARM

pb – DISCH (push until lit)

8. If Ascent: AV BAY FAN (two) – OFF

9. If FIRE in Bay:

1: GPS 1, MLS 1 – OFF

2: MLS 2,3 – OFF

3: GPS 3 – OFF

If **CABIN FIRE**:

10. CAB FAN A,B (two) – OFF (max 20 min)

11. Locate source (see matrix, facing page)

12. Unpwr source of smoke

If smoke persists or source cannot be unpwr:

WARNING

Discharge is propulsive

13. Discharge handheld FIRE EXTGHR

If Ascent:

14. Post MECO, go to POST-FIRE CABIN CLEANUP (ASC
PKT, ECLS) >>

If Entry and prior to TIG:

15. Go to ECLS FRP-3, FIRE/HAZ SPILL O2 CONTROL, step |
3 (MAL)

Cont next page

(OV105) MS E4-6

OV105

AESP/5/E/GEN O,2

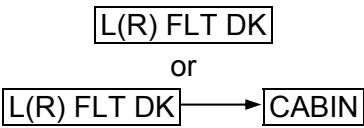
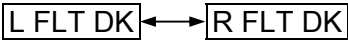
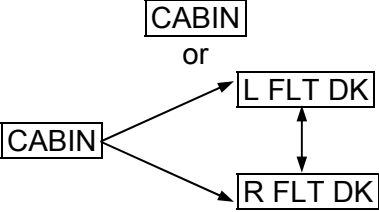
ALARM SEQUENCE	SOURCE AREA
 <p style="text-align: center;">L(R) FLT DK or L(R) FLT DK → CABIN</p>	PS(MS), L(R) CONSOLE
 <p style="text-align: center;">L FLT DK ↔ R FLT DK</p>	AFT FLT DK, MIDDECK
 <p style="text-align: center;">CABIN or CABIN → L FLT DK CABIN → R FLT DK L FLT DK ↔ R FLT DK</p>	FWD FLT DK, WCS, LEB

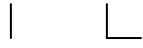

This Page Intentionally Blank

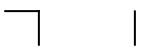



EPS

EPS



MS E5-1

AESP/ALL/E/GEN O

MN BUS UNDERVOLTS/FC VOLTS PLT

If MN V < 26.4, FC V < 26.6, FC A > 480 (2 of 3)

(SHORT or degraded FC):

- ⇒
1. MSTR MADS PWR – OFF
 2. If aff BUS tied – untie
 3. PL PRI (three) – OFF
 4. (Aff) ESS BUS SOURCE FC – OFF
FC/MN BUS – OFF
- If FC VOLTS < 32 (FC SHORT)
5. (Aff) FC REAC VLV – CL
 6. Go to FC SHUTDN (do not stop FC until
COOL P < 15 and STACK T < 243) >>
- If FC VOLTS ≥ 32 (BUS SHORT)
7. Go to BUS LOSS ACTION >>
- If MN V < 26.4 and FC V > 32 and FC A < 20
(FC disconnect, check APUs):
8. MSTR MADS PWR – OFF
 9. PL PRI (three) – OFF
 10. FC/MN BUS – ON
- If FC3 aff:
11. PL PRI MNC – ON
FC3 – ON
 12. If MNC V < 26.4: PL PRI (three) – OFF
- If 1st FC failure:
13. Perform BUS TIE, then:
If MN BUS recovered:
14. GNC I/O RESET
- If aff FC VOLTS > 32:
15. Go to FC SHUTDN

AC VOLT HIGH

If AC V > 123 and F9 V > 123:

- ⇒
1. (Aff) AC BUS SNSR – OFF
 2. cb AC CONTR – cl
INV/AC BUS – OFF
INV PWR – OFF
cb AC CONTR – op
 3. √H2O PUMP LOOP 2(1) – ON
 4. Go to aff BUS LOSS

EPS

AC VOLT LOW or OVERLOAD

PLT

3Φ/AC
ESS

⇒

If amps > 14 or V < 110:

If single Φ amps > 14 or V > 10:

1. cb AC CONTR – cl
 INV/AC BUS – OFF
 INV PWR – OFF
 cb AC CONTR – op
2. If other Φ amps > 14:
 Go to step 3

If multi Φ (bus short):

3. (Aff) cb AC CONTR (three) – cl
 INV/AC BUS – OFF (tb-OFF)
 INV PWR – OFF (tb-OFF)
 cb AC CONTR (three) – op
 AC BUS SNSR – OFF
4. Go to aff BUS LOSS

MN
AC

PLT

3Φ AC MOTORS STOPPED

1. (Aff) AC BUS SNSR – OFF
 2. Determine AC BUS:
 - FC1 and FREON PUMP 2B: AC1
 - FC2 and FREON PUMP 1B: AC2
 - FC3 and CAB FAN A: AC3
 3. (Aff) FC – STOP
- If AC3 aff:
4. AV BAY 3 FAN B – OFF, A – ON
 5. CAB FAN A – OFF
- Isolate aff ΦB(ΦC,ΦA):
6. (Aff) cb AC CONTR – cl
 7. INV/AC BUS – OFF
- If AC1(2,3) aff and AV BAY 3(2,3) FAN ΔP ≥ 0.5:
8. Go to step 16 (bad Φ isolated)
 9. (Aff) INV/AC BUS – ON
 10. cb AC CONTR – op
 11. Repeat from step 6 to isolate aff ΦC(ΦA), then:
- Drop aff AC bus (three Φs):
12. (Aff) cb AC CONTR (three) – cl
 13. INV/AC BUS – OFF
 14. INV PWR – OFF
 15. Go to aff BUS LOSS >>
- Bad Φ isolated:
16. (Aff) FC – START (10 sec or ΔP tb-gray)
 17. Perform aff BUS LOSS and if AC1(AC2) aff >>
 18. If AC3 aff: CAB FAN B – ON

⇒ AC SINGLE Φ

AC1	ΦA	BLR CNTLR/HTR 1 – A When V = 12K: RAD CNTLR LOOP (two) – AUTO A
	ΦB	When V = 12K: RAD CNTLR LOOP (two) – AUTO A
	ΦC	BLR CNTLR/HTR 3 – B
AC2	ΦA	BLR CNTLR/HTR 1 – B
	ΦB	SIG CONDR FREON A – AC3
	ΦC	BLR CNTLR/HTR 2 – A
AC3	ΦA	BLR CNTLR/HTR 2 – B
	ΦB	SIG CONDR FREON B – AC2
	ΦC	BLR CNTLR/HTR 3 – A

⇒ ANY AC2 SINGLE Φ

CDR

⇒ FREON PUMP LOOP 1 – A

BUS TIE (do not tie bus short, check APUs)

If MN Volts > 20: Bus Tie >>

If MN Volts < 20 (do not BUS TIE Pre MECO for 1st FC):

1. (Aff) AC BUS SNSR – OFF
2. cb AC CONTR (three) – cl
3. INV/AC BUS – OFF (tb-OFF)
4. INV PWR – OFF (tb-OFF)
5. If MNC(B) dn, CAB FAN A(B) – OFF
6. Bus Tie
7. INV PWR – ON (tb-ON)
- ◆ 8. INV/AC BUS – ON (tb-ON)
9. cb AC CONTR (three) – op
10. GNC I/O RESET
11. Post MECO: (Aff) AC BUS SNSR – AUTO TRIP
12. Post PWRDN: √CAB FAN A(B) – ON

**MN
SUB**

ESS BUS V LOW

PLT

If verified by F9 voltmeter:

1. Perform FC SHUTDN (<9 min), then:
2. Go to aff ESS BUS LOSS

ESS BUS LOSS

ESS 1BC	O13&R14	<ol style="list-style-type: none"> 1. L AUD CNTL sel – R (CDR can't talk) 2. Pri C/W & F7 Matrix lost
ESS 2CA	O13&R14	<ol style="list-style-type: none"> 1. AUD CTR – 2 2. R AUD CNTL sel – L (PLT can't talk)
ESS 3AB	O13	<ol style="list-style-type: none"> 1. GPC CAM Lights lost ⇒ 2. Do not engage BFS 3. BFS GPC OUTPUT – TERM

3Φ/AC
ESS

MNA or AC1 Multi Φ CDR

- 1. FLASH EVAP CNTLR PRI B – OFF, A – GPC
 - 2. TOP EVAP HTR DUCT sel – B
 - 3. HI LOAD DUCT HTR sel – B
 - ⇒ 4. FREON PUMP LOOP 2 – A
 - 5. AV BAY 3 FAN A – ON, B – OFF
- If rads cold soaked:
When $V \leq 12K$:
- 6. RAD BYP VLV MODE 1,2 (two) – AUTO
 - 7. RAD CNTLR LOOP 1,2 (two) – AUTO A
- 8. ANNUN BUS SEL ACA 1 – MNB
 - 9. NWS – 2
 - 10. [BFS G51] AA1 – desel
 - 11. MS AUD CNTL – PS (MS can't talk)
- FAILED: NH3 A PRI, NWS 1,
UHF HI PWR XMIT, L HUD, AUTO B

MNB or AC2 Multi Φ

- ⇒ 1. AV BAY 1 FAN A – ON, B – OFF
 - 2. FREON PUMP LOOP 1 – A
 - 3. HUM SEP A – ON, B – OFF
 - 4. IMU FAN A – ON, B – OFF
 - 5. AV BAY 2 FAN B – ON, A – OFF
 - 6. √cb AC3 ΦA LG SNSR 1 – cl
 - 7. ANNUN BUS SEL ACA 2/3 – MNC
 - 8. [BFS G51] AA2, RGA 2 – desel
- FAILED: NH3 B SEC, RA 2, NWS 2
PLT DRAG CHUTE ARM
S-BD PM 1 (NO PNL,CMD)

MNC or AC3 Multi Φ

- ⇒ 1. FLASH EVAP CNTLR PRI A – OFF, B – GPC
 - 2. CAB FAN B – ON, A – OFF
 - 3. √AV BAY 3 FAN B – ON
 - 4. H2O PUMP LOOP 1 – ON, 2 – OFF
 - 5. √cb AC2 ΦA LG SNSR 2 – cl
 - 6. [BFS G51] RGA 3 – desel
- FAILED: NH3 A SEC, B PRI
CDR DRAG CHUTE ARM

SUBBUS [MNA O14]

- 1. NWS – 2
- If rads cold soaked:
When $V \leq 12K$:
- 2. RAD BYP VLV MODE 1,2 (two) – AUTO
 - 3. RAD CNTLR LOOP 1,2 (two) – AUTO A
- FAILED: AUTO B

SUBBUS [APC4(5,6) or ALC1(2,3)]

SUBBUS	APC or ALC	4 1	5 2	6 3
1.	FLASH EVAP CNTLR	PRI A – GPC		√PRI B – GPC

CNTL BUS V LOW/CNTL BUS RPC

PLT

WARNING
 If VISIBLE FIRE/SMOKE AT ANY TIME, cb CNTL BUS AB1/2/3(BC1/2/3,CA1/2/3) – op (pnl R14:B)

1. Identify BUS (√BUS LOSS ID)
 ⇒ If bus critical (per MCC):

◆ 2. >>

- ◆ If one CNTL BUS RPC tripped (*):

Aff CNTL BUS:

AB1(2,3)

	Tripped RPC (*)	Action (for RESET, hold w/sw reten device)
3.	A	R1 CNTL BUS PWR MNB – RESET R14:B cb CNTL BUS AB1/2/3 – op
4.	B	R1 CNTL BUS PWR MNA – RESET R14:B cb CNTL BUS AB1/2/3 – op

BC1(2,3)

	Tripped RPC (*)	Action (for RESET, hold w/sw reten device)
5.	B	R1 CNTL BUS PWR MNC – RESET R14:B cb CNTL BUS BC1/2/3 – op
6.	C	R1 CNTL BUS PWR MNB – RESET R14:B cb CNTL BUS BC1/2/3 – op

CA1(2,3)

	Tripped RPC (*)	Action (for RESET, hold w/sw reten device)
7.	C	R1 CNTL BUS PWR MNA – RESET R14:B cb CNTL BUS CA1/2/3 – op
8.	A	R1 CNTL BUS PWR MNC – RESET R14:B cb CNTL BUS CA1/2/3 – op

- ◆ If no CNTL BUS RPC tripped (no *):

	aff CNTL BUS	Pnl R1 action (RESET, hold w/sw reten device)
9.	AB1(2,3)	CNTL BUS PWR MNA,MNB (two) – RESET
10.	BC1(2,3)	CNTL BUS PWR MNB,MNC (two) – RESET
11.	CA1(2,3)	CNTL BUS PWR MNA,MNC (two) – RESET

**MN
SUB**

Cont next page

- ◆ 12. Perform aff CNTL BUS LOSS, then:

If pwr reqd (<3 sec) for crit function:

- 13. Hold crit function sw

For tripped RPC:

- 14. CNTL BUS PWR MNA(MNB,MNC) – RESET (1 sec), then dn

15. ⇒

CNTL BUS LOSS

CDR

AB1	⇒	1. Use R TRIM & BDY FLP sws FAILED: NH3 A SEC, FES PRI B GPC
AB2	⇒	1. CDR disp sws – green dot FAILED: NH3 B SEC, L HUD, FES PRI B ON, H2O LOOP 1,A ON
AB3	⇒	If BFS engage reqd: 1. Use PLT's RHC, then GPCs 1,2,4 – STBY,HALT 2. BFS I/O RESET
BC1	⇒	1. Use R TRIM & BDY FLP sws 2. [BFS G51] RGA 2 – desel FAILED: R HUD, CDR DRAG CHUTE DPY/JETT
BC2	⇒	If TAL/AOA/RTLs: 1. NH3 CNTLR B – OFF A – PRI/GPC FAILED: NH3 B PRI, FES SEC GPC, H2O LOOP 1, B ON, CDR DRAG CHUTE DPY/JETT
BC3	⇒	FAILED: NH3 A PRI, FES SEC ON
CA1	⇒	1. No BFS engage GPC 3,5 ◆ 2. BFS GPC OUTPUT – TERM 3. [BFS G51] RGA 3 – desel FAILED: NH3 B SEC, FES PRI A GPC, H2O LOOP 2 GPC, PLT DRAG CHUTE DPY/JETT
CA2	⇒	FAILED: NH3 A SEC, FES PRI A ON, PLT DRAG CHUTE DPY/JETT

**CNTL
FC**

CNTL

CNTL BUS LOSS		PLT
AB1	⇒	1. Use R TRIM & BDY FLP sws 2. BLR CNTLR/HTR 1 – A
AB2	⇒	1. G23 RCS FWD MANF VLVS 1 OVRD – ITEM 40 EXEC (CL) 2. BLR CNTLR/HTR 1 – A FAILED: L HUD
AB3	⇒	1. G51 RCS RM MANF CL OVRD – ITEM 41 EXEC If BFS engage reqd: 2. Use PLT's RHC, then GPCs 1,2,4 – STBY, HALT 3. BFS I/O RESET 4. BLR CNTLR/HTR 1,3 (two) – B
BC1	⇒	1. Use R TRIM & BDY FLP sws 2. BLR CNTLR/HTR 2 – A FAILED: R HUD, CDR DRAG CHUTE DPY/JETT S-BD PM 1 (NO PNL, CMD)
BC2	⇒	1. S-BD PM CNTL – PNL, CMD 2. BFS G51 Config per <u>COMM COVER</u> (ASC): TDRS – ITEM 46 EXEC (*) STDN-HI – ITEM 47 EXEC (*) SGLS – ITEM 49 EXEC (*) 3. G23 RCS FWD MANF VLVS 2 OVRD – ITEM 41 EXEC (CL) 4. PLT disp sws – green dot 5. Use L TRIM & BDY FLP sws 6. BLR CNTLR/HTR 2 – A FAILED: CDR DRAG CHUTE DPY/JETT
BC3	⇒	1. G51 RCS RM MANF CL OVRD – ITEM 41 EXEC 2. BLR CNTLR/HTR 1,2 (two) – B
CA1	⇒ ♦	1. No BFS engage GPC 3,5 2. BFS GPC OUTPUT – TERM 3. BLR CNTLR/HTR 3 – A FAILED: PLT DRAG CHUTE DPY/JETT
CA2	⇒	1. G23 RCS FWD MANF VLVS 3 OVRD – ITEM 42 EXEC (CL) 2. Use L TRIM & BDY FLP sws 3. BLR CNTLR/HTR 3 – A FAILED: PLT DRAG CHUTE DPY/JETT
CA3	⇒	BLR CNTLR/HTR 2,3 (two) – B

Cont next page

MS E5-10 AESP/ALL/E/GEN O

FC REAC VLV CLOSED

PLT

1. FC REAC VLV (three) – OP
2. Perform BUS TIE, then:
If FC COOL P < 50:
3. Go to FC SHUTDN

FC pH ↓ 1(2,3) or FC DELTA V 1(2,3)

If pH ↓ and FC SS 1(2,3) ΔV > 150

or FC SS ΔV > 150 and incr:

1. Perform BUS TIE, then:
2. (Aff) FC REAC VLV – CL
3. MSTR MADS PWR – OFF
4. Go to LOSS OF 1(2nd) FC PWRDN >>

If pH ↓ only:

- ◆ 5. Go to BUS TIE

FC STACK T

1. MSTR MADS PWR – OFF

If STACK T > 243 and incr:

2. If 2nd FC: Go to 2nd FC SHUTDN >>
3. PL PRI (three) – OFF

If aff FC amps < 170 or > 360:

4. Go to MN BUS UNDERVOLTS/FC VOLTS, step 4 >>
 - ◆ 5. Perform BUS TIE, then:
 6. ESS BUS SOURCE FC – OFF
 7. FC/MN BUS – OFF
- If aff FC VOLTS < 32 or STACK T not decr:
8. (Aff) FC REAC VLV – CL
 9. FC – STOP after COOL P < 15 and STACK T < 243
 10. Go to LOSS OF 1 FC PWRDN

FC
EMER

FC EXIT T

1. MSTR MADS PWR – OFF
2. Perform BUS TIE, then:

- ⇒ If EXIT T > 164 and incr or < 131 and no comm:
3. Go to FC SHUTDN

FC COOLANT PUMP Δ P LOW

PLT

1. FC – START (10 sec or Δ P tb-gray)
- ⇒ ♦ If EXIT T > 164 and not decr or
RDY tb – bp (30 sec after START) or
FC PUMP cb(s) – op (pnl L4:C):
2. Go to FC SHUTDN >>
- If EXIT T norm, RDY tb – gray, and no comm:
3. Monitor AC amps
 4. FC – STOP
- If AMPS decr 0.7-0.9 AMP/ Φ :
5. FC – START (hold 30 sec if Δ P tb-bp)
 6. If AMPS incr 0.7-0.9 AMP/ Φ >>
 7. Go to FC SHUTDN

FC COOL P

1. Perform BUS TIE, then:
If COOL P < 75: >>
If COOL P incr and not 100 (H),
or FC COOL PUMP = Δ P (intermittent),
or STACK/EXIT T unstable,
2. (Aff) FC REAC VLV – CL
 3. MSTR MADS PWR – OFF
 4. Go to LOSS OF 1(2nd) FC PWRDN

CNTL
FC

FC SHUTDN (1st) (<9 min)

1. MSTR MADS PWR – OFF
 2. If not tied: Perform BUS TIE, then:
If ORB (not deorb prep), kW > 18:
MN BUS TIE (three) – ON
 3. ESS BUS SOURCE FC – OFF
FC/MN BUS – OFF
FC – STOP (1 sec)
 4. FC REAC VLV – CL
- ◆ Go to LOSS OF 1 FC PWRDN

LOSS OF 1 FC PWRDN (GRTLS/TAL) PLT

1. PRI PL (three) – OFF
AFT PL (two) – OFF
 2. IDP/CRT4 PWR – OFF
One MDU – OFF
- ⇒ If TAL:
When V < 19K:
3. MPS ENG PWR (six) – OFF

LOSS OF 1 FC PWRDN (ENTRY)

1. If V < 15K >>
 2. IDP/CRT4, one MDU,FLT CNTLR PWR – OFF
 3. TACAN/RA/MLS – OFF
- If middeck PL on:
4. cb MNB UTIL PWR – op (pnl O15:C)
- ◆ 5. PRI PL (three) – OFF
AFT PL (two) – OFF

EMER PWRDN
FC REAC (three) – CL
FC/MN BUS
(BEST FC LAST) – OFF
ESS BUS SOURCE FC
(three) – OFF
√TABS/VISOR/GREEN APPLE

FC

OV103,104

(OV103,104) MS E5-13 AESP/3,4/E/GEN O

2nd FC SHUTDN (GRTLS/TAL)

PLT

(CL PMP Lost: < 6 min)

1. Have CDR start LOSS OF 2nd FC PWRDN (GRTLS/TAL)

If three MN buses pwr:

2. MN BUS TIE (three) – OFF
(do not perform BUS LOSS ACTION)
3. LES O2 – OFF, visors – OP
4. Switch off all but one IDP/CRT with four MDUs
5. All PL pwr (seven) – OFF
6. O2,H2 TK HTRS (all) – OFF
7. After CDR pnl L1 config complete, continue:

If two MN buses pwr:

8. Pwr MN BUS TIES (two) – ON

If only one MN bus pwr:

9. MN BUS TIE (three) – OFF
If only MNA(B,C) pwr: Secure APU 2(3,1)
BUS TIE good FC/BUS (MNA)
I/O RESET

When reqd:

10. ESS BUS SOURCE FC – OFF
FC/MN BUS – OFF
FC – STOP (1 sec)
FC REAC VLV – CL
11. G51 √ICNCT ENA (if reqd for OMS load)
12. Go to LOSS OF 2nd FC PWRDN (GRTLS/TAL)

2nd FC SHUTDN (ENTRY)

1. Have CDR go to LOSS OF 2nd FC PWRDN (ENTRY)
2. O2/H2 HTRS (twelve) – OFF (pnl R1)
PL pwr (seven) – OFF
3. √MSTR MADS PWR – OFF

If aff FC/MN BUS is tied:

4. MN BUS TIE (two) – OFF
5. If only MNA(B,C) pwr: Secure APU 2(3,1)
6. Perform BUS TIE (good FC/BUS to another BUS),
then:
7. ESS BUS SOURCE FC – OFF
FC/MN BUS – OFF
FC – STOP (1 sec)
FC REAC VLV – CL

FC
EMER

OV103,104

(OV103,104) MS E5-14 AESP/ALL/E/GEN O

FC SHUTDN (1st) (<9 min)

1. MSTR MADS PWR – OFF
 2. If not tied: Perform BUS TIE, then:
If ORB (not deorb prep), kW > 18:
 MN BUS TIE (three) – ON
 3. ESS BUS SOURCE FC – OFF
 FC/MN BUS – OFF
 FC – STOP (1 sec)
 4. FC REAC VLV – CL
- ◆ Go to LOSS OF 1 FC PWRDN

LOSS OF 1 FC PWRDN (GRTLS/TAL) PLT

1. PRI PL (three) – OFF
 AFT PL (two) – OFF
 2. IDP/CRT4 PWR – OFF
 One MDU – OFF
- ⇒ If TAL:
 When V < 19K:
 3. MPS ENG PWR (six) – OFF

LOSS OF 1 FC PWRDN (ENTRY)

1. If V < 15K >>
 2. IDP/CRT4, one MDU, FLT CNTLR PWR – OFF
 3. RA/MLS – OFF
- If middeck PL on:
4. cb MNB UTIL PWR – op (pnl O15:C)
- ◆ 5. PRI PL (three) – OFF
 AFT PL (two) – OFF

EMER PWRDN
FC REAC (three) – CL
FC/MN BUS
(BEST FC LAST) – OFF
ESS BUS SOURCE FC
(three) – OFF
√TABS/VISOR/GREEN APPLE

FC

OV105

(OV105) MS E5-13

AESP/5/E/GEN O

2nd FC SHUTDN (GRTLS/TAL)

PLT

(CL PMP Lost: < 6 min)

1. Have CDR start LOSS OF 2nd FC PWRDN (GRTLS/TAL)

If three MN buses pwr:

2. MN BUS TIE (three) – OFF
(do not perform BUS LOSS ACTION)
3. LES O2 – OFF, visors – OP
4. Switch off all but one IDP/CRT with four MDUs
5. All PL pwr (seven) – OFF
6. O2,H2 TK HTRS (all) – OFF
7. After CDR pnl L1 config complete, continue:

If two MN buses pwr:

8. Pwr MN BUS TIES (two) – ON

If only one MN bus pwr:

9. MN BUS TIE (three) – OFF
If only MNA(B,C) pwr: Secure APU 2(3,1)
BUS TIE good FC/BUS (MNA)
I/O RESET

When reqd:

10. ESS BUS SOURCE FC – OFF
FC/MN BUS – OFF
FC – STOP (1 sec)
FC REAC VLV – CL
11. G51 √ICNCT ENA (if reqd for OMS load)
12. Go to LOSS OF 2nd FC PWRDN (GRTLS/TAL)

2nd FC SHUTDN (ENTRY)

1. Have CDR go to LOSS OF 2nd FC PWRDN (ENTRY)
2. O2/H2 HTRS (twelve) – OFF (pnl R1)
PL pwr (seven) – OFF
3. √MSTR MADS PWR – OFF

If aff FC/MN BUS is tied:

4. MN BUS TIE (two) – OFF
5. If only MNA(B,C) pwr: Secure APU 2(3,1)
6. Perform BUS TIE (good FC/BUS to another BUS),
then:
7. ESS BUS SOURCE FC – OFF
FC/MN BUS – OFF
FC – STOP (1 sec)
FC REAC VLV – CL

FC
EMER

OV105

(OV105) MS E5-14 AESP/ALL/E/GEN O

**LOSS OF 2nd FC PWRDN
(GRTLS/TAL)**

CDR

1. LES O2 – OFF, visors – OP
 2. L1: Select one FREON PUMP on good FC/
MN BUS and place other pump to OFF
Switch OFF all HUM SEPS, IMU FANS,
H2O PUMPS, AV BAY FANS, CAB FANS,
FES HTRS
 3. Switch off all but one IDP/CRT with four MDUs
After BUS TIE, if MNC unpwrn:
 4. FLASH EVAP CNTLR PRI A – OFF
B – ON
 - ⇒ 5. Assign all strings to GPC 1 OPS 30X(60X) PRO
 6. Unassigned GPCs MODE – STBY (tb-bp), HALT
– STBY (tb-RUN)
– HALT (tb-bp)
GPC PWR – OFF
 7. IMU (one) – OFF (choose previously failed IMU,
if any)
 8. IMU FAN (one) – ON
 9. H2O PUMP (one) – ON
 10. AV BAY 1,2 FAN (two) – ON (check fan ON in
each bay with a pwrn GPC)
- After MPS Pwrn:
- If MNA unpwrn:
11. FREON PUMP LOOP 1 – B
2 – A
 12. TOP EVAP HTR DUCT sel – B
HI LOAD DUCT HTR sel – B
- If MNB(C) unpwrn:
13. FREON PUMP LOOP 1,2 (two) – A(B)
 14. TOP EVAP HTR DUCT sel – A
HI LOAD DUCT HTR sel – A
- If TAL:
15. HUM SEP (one) – ON
 16. CAB FAN (one) – ON

**2FC
CRYO**

**LOSS OF 2nd FC PWRDN
(GRTLS/TAL)**

PLT

- ⇒ ♦ When MPS Dump complete:
1. MPS ENG PWR (six) – OFF
EIU (three) – OFF
 2. MEC 1 – OFF, wait 2 sec, then
2 – OFF
- If MNA(MNB) unpwrdd:
3. O2,H2 TK1 HTRS B (two) – AUTO
- If MNC unpwrdd:
4. O2,H2 TK2 HTRS B (two) – AUTO
5. Safe Payload, if reqd
 6. Go to APU RESTART for secured APU

LOSS OF 2nd FC PWRDN (ENTRY)

CDR

1. MDM PL1 – OFF
2. FCS CH 4 – OFF
GPC MODE 4 – STBY,HALT
PWR 4 – OFF
MDM FF4,FA4 – OFF
3. HUM SEP (two) – OFF
4. FLASH EVAP FDLN HTR SPLY (two) – OFF
5. TOP EVAP HTR NOZ L,R (two) – OFF
DUCT sel – OFF
HI LOAD DUCT HTR sel – OFF
6. If V > 10K: √CAB FAN A(B) – ON
7. M = 2.9: CAB FAN (two) – OFF
AV BAY FAN (six) – OFF

2FC

O2(H2) CRYO P/T HIGH
O2(H2) TK HTRS (two) – OFF

PLT

CRYO

CRYO O2(H2) LEAK (three or more tanks aff)

Use meter if CRT data OSL

1. O2(H2) MANF VLV TK1,TK2 (two) – CL
2. O2(H2) TK3 HTRS A – AUTO

⇒ If TK1 and TK2 P decr slowly (HTR logic fail):

3. If QTY > 55%: TK3 HTRS B – AUTO
4. MANF VLV 1,2 (two) – OP >>
5. Perform aff MN BUS TIE, then:

If O2(H2) TK1(2) aff (open unaff manf):

6. O2(H2) TK2(1) – OP

If O2 TK1(2) aff:

7. O2 SYS 1(2) SPLY – CL
8. If O2 TK1(2) P now incr (PCS leak): >>
9. If O2 leak: (Aff) TK HTRS B – AUTO

If aff TK P not incr:

10. If TK3 aff: √HTRS A(&B if O2) – AUTO
11. Perform aff FC SHUTDN (post COOL P alarm if O2 leak), then:

If TK3 aff and P not decr within 2 min (FC leak):

12. MANF VLV 1,2 (two) – OP (ASAP) >>
13. (Aff) TK HTRS A,B (two) – OFF

2FC
CRYO

This Page Intentionally Blank

MS E5-18 AESP/ALL/E/GEN O



OMS

OMS



MS E6-1

AESP/ALL/E/GEN O

OMS TEMP DURING DUMP

1. G51 INH ICNCT L R
If aff OMS FU IN P \geq 219 220
- | 2. Go to ENG FAIL >>
If aff OMS FU IN P \leq 201 208
3. Go to PRPLT FAIL >>
4. Otherwise, snsr fail

Pc LOW DURING DUMP

1. ENG VLV < 70%: Go to ENG FAIL >>
2. ENG VLV > 70%: G51 INH ICNCT
If aff OMS OX IN P > 227:
| 3. Go to ENG FAIL >>
If aff OMS OX IN P \leq 136:
4. Go to PRPLT FAIL >>
5. Otherwise, snsr fail

ENG FAIL (DURING DUMP)

1. (Failed) OMS ENG – OFF
- ⇒ 2. G51 INH ICNCT
3. Balance prop by XFEED

PRPLT FAIL (DURING DUMP)

- ⇒ (Both) OMS ENG (two) – OFF

OMS

P & I

MS E6-2

AESP/ALL/E/GEN O

OMS SECURE

If leak and

M > 24 or M < 3.5:

1. **G51** VENT DOOR CNTL OPEN – ITEM 43 EXEC
2. (Aff) OMS ENG – OFF
 - XFEED (two) – CL
 - TK ISOL (two) – CL
 - He PRESS (two) – CL

If leak isolated or

FU TK leak or

M < 24 & M > 3.5:

3. **G51** VENT DOOR CNTL CLOSE – ITEM 44 EXEC

OMS XFEED: R to L

1. L,R OMS XFEED (four) – OP
2. L OMS TK ISOL (two) – CL
 - He PRESS/VAP ISOL (two) – CL

OMS XFEED: L to R

1. L,R OMS XFEED (four) – OP
2. R OMS TK ISOL (two) – CL
 - He PRESS/VAP ISOL (two) – CL

OMS XFEED RETURN: OMS to OMS

L,R OMS TK ISOL (four) – OP
XFEED (four) – CL

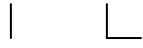

This Page Intentionally Blank





RCS

RCS



MS E7-1

AESP/ALL/E/GEN O

RCS JET FAIL (LEAK)

If OX/FU Qty diverging:
(Aff) RCS MANF ISOL – CL

RCS JET FAIL (ON)

1. (Aff) RCS MANF ISOL – CL
- If MANF P > 130 and stable (false alarm):
2. (Aff) RCS MANF ISOL – OP
 3. √AFT RCS RM LOSS
- ⇒

RM DLMA MANF

If (aff) MANF tb – OP or sw not thrown:

1. If FRCS: √MCC
2. If ARCS: [G51] RCS RM MANF CL OVRD –
ITEM 41 EXEC
3. If (aff) MANF tb – bp: (aff) MANF – GPC

RCS JET FAIL (OFF)

If > one jet/pod/dir failed:

1. [G23] resel jets
2. DES INH (*) (reprioritize)

AFT RCS RM LOSS

If loss of jet RM and > 3Y,2P jets/pod/dir:

1. [G23] aff jet DES INH (*) (reprioritize)
 2. If yaw jet: desel >>
- If total RM loss (BCE) and < 3Y,2P jets/pod/dir:
3. Aff jet DES INH (*) (reprioritize)
 4. Aff MANF VLVS STAT OP – OVRD

RCS

LOW QBAR AFT RCS LK (GRTL5/304/305)

($\sqrt{\text{He P}}$ decr: CRT and meter)

($\sqrt{q} < 20$: CRT)

1. If TK P '↑': Go to TK P HIGH >>

OX Leak & M > 24	2. [G51] VENT DOOR CNTL OPEN – ITEM 43 EXEC
RTL5/TAL	3. [G51] AFT RCS – INH (ITEM 13)
	4. (Aff) 3/4/5 MANFs – CL 5. (Aff) 3/4/5 TK ISOLs – CL
Single MANF leak	6. TK ISOL(s) – OP (tb-OP), GPC 7. (Good) Pri MANF (one) – OP
Two MANF P decr (TK leg leak)	8. (Leaking leg) XFEED (one) – CL
No MANF P decr	9. TK ISOL(s) – OP (tb-OP), GPC 10. Pri MANFs (two) – OP 11. Repeat steps 4-10 for 1/2 leg
Leak not found	12. (Aff) RCS He PRESS (two) – CL
He P decr (He TK leak)	13. RCS He PRESS (two) – OP 14. When He P < 456: MSTR XFEED – feed from good side
OX/FU TK P diverge (Prplt TK leak)	15. RCS He PRESS (two) – OP 16. When QTY = 0: MSTR XFEED – feed from good side and (aff) RCS He PRESS (two) – CL
Leak not found	17. RCS He PRESS (two) – OP
He P decr (He leg leak)	18. RCS He PRESS (two) – CL 19. Cycle He PRESS so 220 < TK P < 245 20. When He P < 456: MSTR XFEED – feed from good side
Leak not found	21. Assume MANF 5 leak
3.5 < M < 24	22. [G51] VENT DOOR CNTL CLOSE – ITEM 44 EXEC

AFT RCS LK (GRTLS/304/305)

(√He P decr: CRT and meter)

1. If TK P '↑': Go to TK P HIGH >>
2. If $\bar{q} < 20$ or control problems:
Go to LOW QBAR AFT RCS LK >>

	3. ENTRY MODE – NO Y JET (R/Y CSS; expect sluggish control)
RTLS/TAL	4. G51 AFT RCS – INH (ITEM 13)
	5. (Aff) RCS MANF ISOL (five) – CL XFEED (two) – CL TK ISOL (all) – CL HE PRESS (two) – CL
(N/A RTLS)	6. G51 ELEVON FIXED – ITEM 18 EXEC (*)
Single MANF leak	7. Return to normal config except bad MANF ENTRY MODE – AUTO >>
Two MANF P decr (TK leg leak)	8. Return to normal config except bad leg ENTRY MODE – AUTO >>
He P decr (He TK leak)	9. Return to normal config ENTRY MODE – AUTO 10. When He P < 456: MSTR XFEED – feed from good side >>
OX/FU TK P diverge (Prplt TK leak)	11. Return to normal config ENTRY MODE – AUTO 12. When QTY = 0: MSTR XFEED – feed from good side and (aff) RCS He PRESS (two) – CL >>
Leak not found	13. RCS He PRESS (two) – OP
He P decr (He leg leak)	14. Return to normal config ENTRY MODE – AUTO 15. RCS He PRESS (two) – CL 16. Cycle He PRESS so $220 < TK P < 245$ 17. When He P < 456: MSTR XFEED – feed from good side >>
Leak not found (Assume MANF 5 leak)	18. Return to normal config except MANF 5 ENTRY MODE – AUTO >>

RCS TK P HIGH (FU or OX) ($\sqrt{MANF P}$)

1. RCS He PRESS (two) – CL
2. A – OP

If He P decr:

3. RCS He PRESS A – CL
B – OP

XFEED: RCS to RCS

If AUTO XFEED:

1. L,R RCS TK ISOL (six) – GPC
XFEED (four) – GPC
2. OMS XFEED (four) – CL
3. MSTR RCS XFEED – FEED FROM L(R) >>

If MANUAL XFEED:

4. L,R OMS XFEED (four) – CL
5. RCS XFEED (four) – OP
6. (Receiving) RCS TK ISOL (three) – CL
He PRESS (two) – CL
7. MSTR RCS XFEED – FEED FROM L(R)

RCS SECURE

If OX leak and

$M > 24$ or $\bar{M} < 3.5$:

1. [G51] VENT DOOR CNTL OPEN – ITEM 43 EXEC
2. RCS MANF ISOL (five) – CL
XFEED (two) – CL
TK ISOL (all) – CL
He PRESS (two) – CL

If leak isolated or

$M < 24$ & $\bar{M} > 3.5$:

3. [G51] VENT DOOR CNTL CLOSE – ITEM 44 EXEC



This Page Intentionally Blank





MPS

MPS



MS E8-1

AESP/ALL/E/GEN O

MPS

**MPS He P/MPS C&W LIGHT
PNEU REG**

If M > 2.4: (Aff) MPS He ISOL – CL

MS E8-2

AESP/ALL/E/GEN O

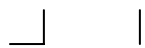

RESERVED



MS E9-1

AESP/ALL/E/GEN O



This Page Intentionally Blank



MULTIPHASE SYSTEMS CUE CARDS

----- MULTIPHASE SYSTEMS CUE CARDS, SECTION 10 -----

----- MULTIPHASE SYSTEMS CUE CARDS, SECTION 10 -----

This Page Intentionally Blank

FAB USE ONLY

CC 10-1

AESP/ALL/A,E/GEN O

(reduced copy)

TOP

EMER PWRDN
FC REAC (three) – CL
FC/MN BUS
(BEST FC LAST) – OFF
ESS BUS SOURCE FC
(three) – OFF
√TABS/VISOR/GREEN APPLE

- FC SHUTDN (1st)** (<9 min)
1. MSTR MADS PWR – OFF
 2. If not tied: Perform BUS TIE, then:
If ORB (not deorb prep), kW > 18:
MN BUS TIE (three) – ON
 3. ESS BUS SOURCE FC – OFF
FC/MN BUS – OFF
FC – STOP (1 sec)
 4. FC REAC VLV – CL
Go to LOSS OF 1 FC PWRDN

- BUS TIE** (do not tie bus short, check APUs)
- If MN Volts > 20: Bus Tie
- POWER**
- If MN Volts < 20 (do not BUS TIE Pre MECO for 1st FC):
1. (Aff) AC BUS SNSR – OFF
 2. cb AC CONTR (three) – cl
 3. INV/AC BUS – OFF (tb-OFF)
 4. INV PWR – OFF (tb-OFF)
 5. If MNC(B) dn, CAB FAN A(B) – OFF
 6. Bus Tie
 7. INV PWR – ON (tb-ON)
 8. INV/AC BUS – ON (tb-ON)
 9. cb AC CONTR (three) – op
 10. GNC I/O RESET
 11. Post MECO: (Aff) AC BUS SNSR – AUTO TRIP
 12. Post PWRDN: √CAB FAN A(B) – ON
- AESP-5a/A,O,E/S

TOP
BACK OF 'POWER'

HOOK
VELCRO

HOOK
VELCRO

HOOK
VELCRO

AESP-5b/A,O,E/F

TOP

SSME FAIL/SHUTDN

AC BUS SNSR (three) – OFF
 If two ENG remaining:
 ◆ MN ENG LIMIT SHUTDN – ENA,AUTO
 If one ENG remaining: (N/A for TAL or OPS 6)
 When MPS PRPLT = 5%
 MAN THROT
 When MPS PRPLT = 2%
 MIN THROT (Pc → 67%)
 AUTO THROT

MPS DATA

√MCC, accel, He dP/dT,
 'MPS H2 OUT P',
 'MPS O2 OUT T'
 If SSME fail (MCC or three cues):
 (Aff) MN ENG SHUTDN pb – push
 If three ENG remaining:
 ◆ MN ENG LIMIT SHUTDN – ENA,AUTO
 If no comm:
 Assume MPS CMD
 If mult (no MECO confirm):
 Post MECO:
 MN ENG SHUTDN pb
 (three) – push (simo)

MPS LH2 ULL

◆ If two or three Ps < 28.0 or > 34.0:
 MPS LH2 ULL PRESS – OP
 When all Ps > 33.0:
 MPS LH2 ULL PRESS – AUTO

MPS DUMP INHIBIT

Post MECO:
 (Aff) MPS ENG PWR (two) – OFF
 LO2(H2) PREVLV – CL

FIRE HOLE UNDER CARD

AESP-11a/A/N

MPS CMD/HYD/ELEC

If two HYD SYS failed:
 MN ENG LIMIT SHUTDN – INH
 [TRAJ] disp – Cue SERC, ITEM 6
 (EXEC if gimbaling eng fails)

MPS 1

If:	When:	Shut down:
2 Pcs stuck > 85% & 3-ENG RTLS	MECO -2:00	1 aff MN ENG: CMD: (AC/pb)** HYD: (pb)
2 HYD SYS failed & Nom/ATO/TAL/ 2-ENG RTLS	Nom/ATO: SE PRESS TAL: SE TAL 2-ENG RTLS: 2 OUT RED	ENG(HYD) S/D C(1) & R(3) C L(2) & C(1) L L(2) & R(3) R ELEC: (pb)
He lk S/D reqd		Aff MN ENG (pb)
MPS CMD(s)**	Nom/ATO and: 3 ENG: V > 23K 2 ENG: V > 24.5K	Aff MN ENG (AC/pb)** If 2 CMD: repeat
2 MPS HYD/ELEC & 3-ENG Nom/ATO/TAL	TAL: V > 22.5K RTLS: α = +2	1 aff MN ENG: HYD: (pb) ELEC: (pb)
1 MPS HYD/ELEC & 3-ENG Nom/ATO	V > 23K	Aff MN ENG (pb)

(reduced copy)

FAB USE ONLY

CC 10-2

AESP/ALL/A/GEN O,4

TOP
BACK OF 'MPS 1'

HOOK
VELCRO

HOOK
VELCRO

HOOK
VELCRO

HOOK
VELCRO

HOOK
VELCRO

HOOK
VELCRO

AESP-11b/A/E

(reduced copy)

FAB USE ONLY

CC 10-3

AESP/ALL/A/GEN O

TOP

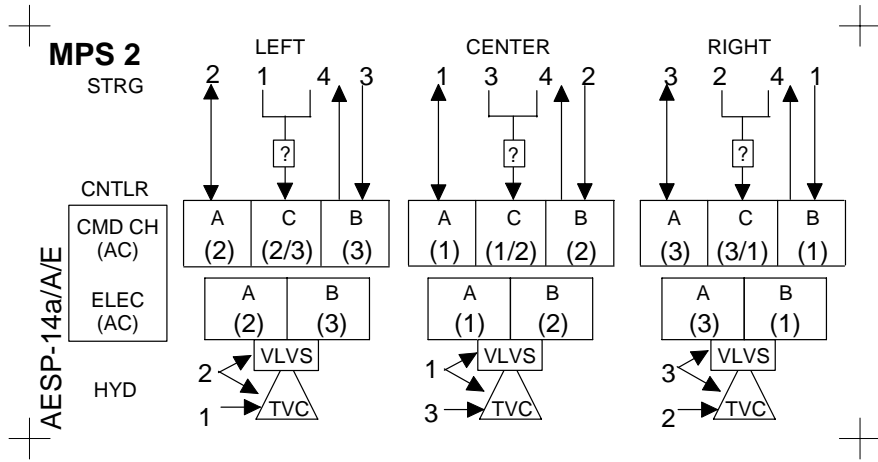

TOP
BACK OF 'MPS 2'

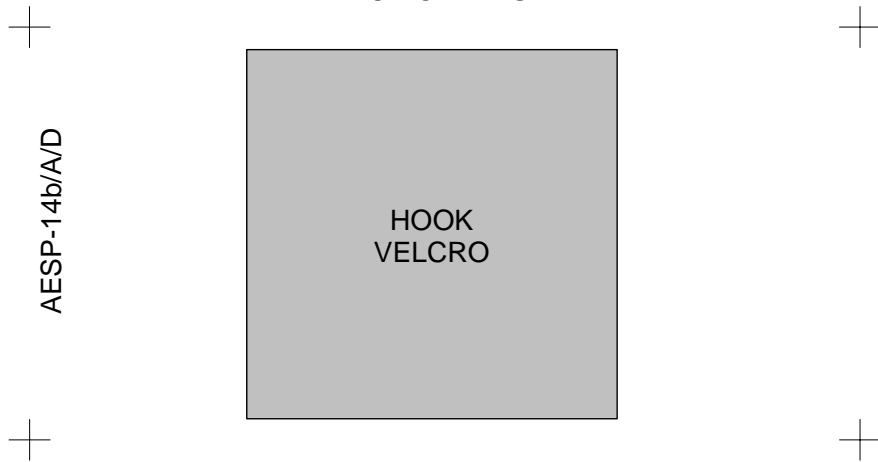

(reduced copy)

FAB USE ONLY

CC 10-4

AESP/ALL/A/GEN O

TOP

OPS 1/6/TAL TRANSITION RESTRING

	1. Config MC1(3) NBAT as reqd 2. $\sqrt{G53}$ aff SURF FDBK – desel (*)
Post MECO	3. ASAP, (aff) GPC(s) – STBY,HALT
ASC/ RTL	4. OPS Mode Recall: OPS XXX PRO 5. BFS I/O RESET \Rightarrow G
TAL	6. OPS 301 PRO 7. BFS, OPS 301 PRO \Rightarrow G

HOOK
VELCRO

AESP-10a/A/G

FAB USE ONLY

CC 10-5

AESP/ALL/A/GEN O

TOP
BACK OF 'OPS 1/6/TAL TRANSITION RESTRING'

POST OPS 3/GRTLs TRANSITION RESTRING

1. (Aff) GPC(s) – STBY,HALT
 2. √[G53] aff SURF FDBK – desel (*)
 3. Config MC1(3) NBAT
 4. OPS Mode Recall: OPS XXX PRO
 5. BFS I/O RESET
- If OPS 3 and String 1(2,3) recovered:
- ◆ 6. [G51] IMU – resel
 - ⇒ 7. Config FCS CH(s) (see Table):
 - 8. [G53] config SURF FDBK (see Table):

AESP-10b/E/F

HOOK
VELCRO

AVAILABLE		FCS CH CONFIG			SURF FDBK	
GPCs	FCS CHs	AUTO	ORIDE	OFF	SEL	DESEL
3	4	3		1	3	1*
	3	3		1	3	1*
	2		2	2	2	2
2	4		4		4	
	3		2	2	2	2
	2		2	2	2	2

*If CH 4 – OFF, DO NOT DESEL PASS SURF FDBK

TOP

TOP
BACK OF 'MPS He P'

MPS He P (Pre MECO)

1. Check dP/dT
If after MECO -60: 2. Shut dn MN ENG per MPS CMD/HYD/ELEC >>
If He REG P ↑ or ↓: 3. (Aff) He ISOL – CL
Otherwise: 4. (Aff) He ISOL A – CL
If no decr in dP/dT: 5. (Aff) He ISOL A – OP B – CL
If no decr in dP/dT: 6. (Aff) He ISOL B – OP
If any ENG failed: 7. (Failed) ENG He I'CNCT – OUT OP
If nonisolatable: 8. Shut dn MN ENG per MPS CMD/HYD/ELEC If/when TK P < 1150 or REG P < 679: 9. (Aff) He I'CNCT – IN OP
If isolated: 10. (Aff) He I'CNCT – IN OP If TK P < 2200 @ MECO -60: 11. Shut dn MN ENG per MPS CMD/HYD/ELEC
Post ET SEP: 12. He I'CNCT(s) – GPC

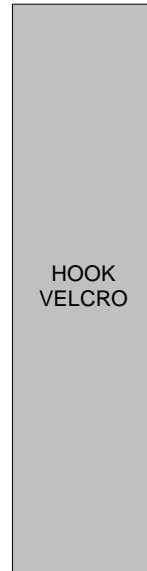

MPS PNEU TK(REG) P

If after MECO -60: At MECO -30: 1. L ENG He XOVR – OP >>
2. PNEU He ISOL – CL
If PNEU ACUM P decr: At MECO -30: 3. PNEU He ISOL – OP, Wait 5 sec, then: 4. L ENG He XOVR – OP >>
If PNEU TK P decr: 5. PNEU He ISOL – OP

AESP-15a/A/B

AESP-15b/A/C

Cont next page

FAB USE ONLY

CC 10-7

AESP/ALL/A/GEN O

TOP

'ET SEP MAN' G51 **ET SEP**

Post MECO prior to MECO+1 min:

1. ET SEP AUTO – ITEM 38 (BFS 28)
2. If ET SEP pb reqd:
ET SEP SEP – ITEM 39 (BFS 29)

AESP-13a/A/F

TOP
BACK OF 'ET SEP'

HOOK
VELCRO

AESP-13b/A/F

FAB USE ONLY

CC 10-8

AESP/ALL/A/GEN O

TOP
MATE TOP-TO-BOTTOM;
FLIP VERTICALLY TO TURN

HOOK VELCRO

AESP-7a(OPCL-7a)/A,O,E/H

OV103,104

FIRE/SMOKE (ASCENT/ENTRY)

SM SYS SUMM 1

If **VISUAL SMOKE/FIRE**, or
two SMOKE DETN lt on, or
two CONC > 2, or
one SMOKE DETN lt on and
other CONC > 2:
1. Go to step 6
If single Av Bay SMOKE DETN A(B) lt and
assoc CONC > 2:
2. SMOKE DETN CKT TEST - B(A)
(25 sec)
If SMOKE DETN B(A) test good (lt on):
3. SMOKE DETN CKT TEST - OFF
4. SMOKE DETN SNSR - RESET >>
If SMOKE DETN B(A) test bad (no lt):
5. Go to step 6
If none of above >>

6. Check tabs, visors - CL
LES O2 - ON
If **AV BAY FIRE**:
7. FIRE SUPPR - ARM
pb - DISCH
(push until lit)
8. If Ascent:
AV BAY FAN (two) - OFF
9. If Fire in Bay:
1: TACAN 1, MLS 1 - OFF
2: TACAN 2, MLS 2,3 - OFF
3: TACAN 3 - OFF

If **CABIN FIRE**:
10. CAB FAN A,B (two) - OFF
(max 20 min)
11. Locate source
(see matrix, below)
12. Unpwr source of smoke
If smoke persists or source cannot be
unpwr:

WARNING
Discharge is propulsive

13. Discharge handheld FIRE
EXTGHR
If Ascent:
14. Post MECO, go to POST-FIRE
CABIN CLEANUP (ASC PKT,
ECLS) >>
If Entry and prior to TIG:
15. Go to ECLS FRP-3, FIRE/HAZ
SPILL O2 CONTROL, step 3 (MAL)

FIRE/SMOKE (ORBIT)
(OPCL-7b), back
of FIRE/SMOKE
(ASCENT/ENTRY)
appears in the
ORBIT POCKET C/L



replace side tab
with clear tape
and Hook Velcro

ALARM SEQUENCE	SOURCE AREA
L(R) FLT DK or L(R) FLT DK → CABIN	PS(MS), L(R) CONSOLE
L FLT DK ↔ R FLT DK	AFT FLT DK, MIDDECK
CABIN or CABIN → L FLT DK ↓ R FLT DK	FWD FLT DK, WCS, LEB

HOOK VELCRO

BOTTOM

(reduced copy) **OV103,104**

FAB USE ONLY (OV103,104) CC 10-9

AESP/3,4/A,E/GEN O,2

This Page Intentionally Blank

FAB USE ONLY(OV103,104)CC 10-10

OV103,104

AESP/ALL/A,E/GEN O

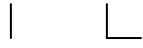

This Page Intentionally Blank



FAB USE ONLY (OV105) CC 10-10

OV105
AESP/ALL/A,E/GEN O



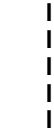
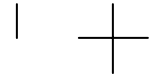
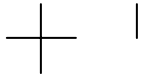

**POWERED
FLIGHT**

**PLT OVERHEAD FLIP BOOK
POWERED FLIGHT**

**PLT OVERHEAD
FLIP BOOK**

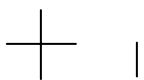

PLT OVHD

FB A11-i

AESP/ALL/A/GEN O

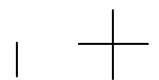

FAB USE ONLY

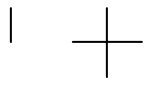
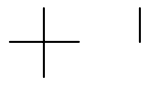

**POWERED
FLIGHT**



This Page Intentionally Blank

**PLT OVERHEAD
FLIP BOOK**

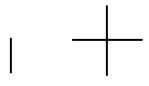
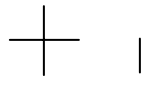

PLT OVHD

FB A11-ii

AESP/ALL/A/GEN O

FAB USE ONLY

TOP
FACING LEFT SIDE OF BACKBOARD

HOOK

OMS
(OX/
FU)
TK P
LOW

OMS He TK P LOW (\sqrt SPEC and OMS/MPS)

Dumping RTLS/TAL/ G51 DUMP	SERC	When leaking He P < 640: 1. G51 DUMP STOP >>
	Not SERC	When leaking He P < 640: 2. G51 INH ICNCT When aff OMS Pc < 72%: 3. (Aff) OMS ENG – OFF After 2:00 min: 4. (Good) OMS ENG – OFF >>
Dumping ASSIST/ATO Not Dumping	◆	5. (Good) OMS ENG – OFF When MET > 2:30 min: 6. G51 ITEM 9 + 46 EXEC
Leaking He P < 640		7. G51 ITEM 9 + 0 EXEC ⇒A
Sub RTLS/TAL	◆	8. (Good) OMS ENG – ARM/PRESS 9. G51 INH ICNCT 10. OMS XFEED (four) – OP 11. (Aff) OMS TK ISOL (two) – CL After 1:00 min: 12. OMS TK ISOL (four) – OP 13. OMS XFEED (four) – CL When aff OMS Pc < 72%: 14. (Both) OMS ENG (two) – OFF

OMS N2 TK P LOW
(N/A DURING ASSIST/RTLS/TAL/ATO DUMP)

1. \sqrt N2 TK P decr (meter and CRT)
 2. OMS ENG – ARM
 3. If OMS N2 REG P decr: OMS ENG – OFF >>
- If OMS N2 REG P not decr and subs ASSIST/RTLS/TAL/ATO:
4. OMS ENG (two) – ARM/PRESS

OMS N2 REG P HIGH or LOW
OMS ENG – ARM

P & I

PLT OVHD

FB A11-1

AESP/ALL/A/GEN O

FAB USE ONLY

TOP
BACK OF 'OMS He TK P LOW'

OMS
He/
N2
TK P
LOW

PILE

OMS TK P LOW (↓, OX or FU) NOT DUMPING (√ENG IN P)

1. (Good) OMS ENG – OFF
2. Monitor OMS Inlet Pressures
If OX IN P < 151 or FU IN P < 216:
(Aff) OMS ENG – OFF
XFEED (two) – CL

Dumping Assist/ATO Not Dumping	When MET > 2:30 min: 3. [G51] ITEM 9 + [74] EXEC
OX IN P > 151 and FU IN P > 216	4. (Aff) OMS ENG – ARM/PRESS 5. If ATO: [G51] √ICNCT = INH 6. (Aff) OMS XFEED (two) – CL When aff Pc < 80% (depletion cutoff): 7. (Aff) OMS ENG – OFF [G51] ITEM 9 + 0 EXEC >> If depletion cutoff does not occur =>A
Repress NO JOY	8. [G51] ITEM 9 + 0 EXEC
Subs RTLS/TAL/[G51]	9. (Good) OMS ENG – ARM/PRESS
OX IN P > 151 and FU IN P > 216	10. (Aff) OMS XFEED (two) – OP ENG – ARM/PRESS 11. [G51] ENA ICNCT (N/A SERC)
AFT QTY < 20% or He P < 2000	12. If SERC: [G51] DUMP STOP If not SERC: [G51] INH ICNCT 13. (Aff) OMS XFEED (two) – CL When aff Pc < 80% (depletion cutoff): 14. (Aff) OMS ENG – OFF 15. After 2:00 min: (Good) OMS ENG – OFF >>
Repress NO JOY after 2:00 min	16. (Good) OMS ENG – OFF >>

P & I

PLT OVHD

FB A11-2

AESP/ALL/A/GEN O

FAB USE ONLY

PILE

RCS JET FAIL (LEAK)

If OX/FU Qty diverging:
(Aff) RCS MANF ISOL – CL

OMS T,
Pc/
FAIL/
OMS
OX/FU

RCS JET FAIL (ON)

1. (Aff) RCS MANF ISOL – CL
- If MANF P > 130 and stable (false alarm):
2. (Aff) RCS MANF ISOL – OP ⇒G

RM DLMA MANF

If (aff) MANF tb – OP or sw not thrown:

1. If FRCS: √MCC
2. If ARCS: [G51] RCS RM MANF CL OVRD –
ITEM 41 EXEC
3. If (aff) MANF tb – bp: (aff) MANF – GPC

RCS JET FAIL (OFF)

If > one jet/pod/dir failed:

1. [G23] resel jets
2. DES INH (*) (reprioritize)

RCS TK P HIGH (FU or OX) (√MANF P)

1. RCS He PRESS (two) – CL
2. A – OP

If He P decr:

3. RCS He PRESS A – CL
B – OP

XFEED: RCS to RCS

If AUTO XFEED:

1. L,R RCS TK ISOL (six) – GPC
XFEED (four) – GPC
2. OMS XFEED (four) – CL
3. MSTR RCS XFEED – FEED FROM L(R) >>

If MANUAL XFEED:

4. L,R OMS XFEED (four) – CL
5. RCS XFEED (four) – OP
6. (Receiving) RCS TK ISOL (three) – CL
He PRESS (two) – CL
7. MSTR RCS XFEED – FEED FROM L(R)

PLT OVHD

FB A11-4

AESP/ALL/A/GEN O

FAB USE ONLY



RCS SECURE

- RCS MANF ISOL (five) – CL
- XFEED (two) – CL
- TK ISOL (all) – CL
- He PRESS (two) – CL

AFT RCS LK

- N/A During Dump/SE Roll Cntl
 (check He P decr: CRT and meter)
1. If TK P '↑': Go to TK P HIGH >>

TK P ≥ 254 and not decr (He Leak)	2. MSTR XFEED – feed from good side 3. (Aff) RCS He PRESS (two) – CL 4. G51 AFT RCS – INH (ITEM 13) >>
TK P < 254 or decr (prop leak)	5. (N/A RTLS) ET SEP – MAN 6. (N/A RTLS) MPS PRPLT DUMP SEQ – STOP 7. (Aff) MANFs (five) – CL 8. (Aff) TK ISOLs (three) – CL
Single MANF leak	9. TK ISOLs (three) – OP (tb-OP), GPC 10. (Good) MANFs (four) – OP
QTY < 75%	11. MSTR XFEED – feed from good side
Two MANF P decr (TK leg leak)	12. (Good leg) TK ISOL(s) – OP (tb-OP), GPC 13. (Good leg) Pri MANFs (two) – OP 14. (Leaking leg) XFEED (one) – CL
QTY < 75%	15. MSTR XFEED – feed from good side
No MANF P decr (Prplt TK or MANF 5 leak)	16. L,R RCS XFEED (four) – OP 17. (Aff) RCS MANF 1,2,3,4 (four) – OP 18. (Aff) RCS He PRESS (two) – CL 19. MSTR XFEED – feed from good side
	20. ET SEP – AUTO 21. G51 AFT RCS – INH (ITEM 13) 22. Post ET SEP -Z transl: MPS PRPLT DUMP SEQ – GPC

**FWD
RCS
LK**

TOP
BACK OF 'RCS SECURE'

PILE

FWD RCS LK

(check He P decr: CRT and meter)
(check TK P; if '↑': Go to TK P HIGH >>)

**RCS
JET/
AFT
RCS**

RTLS	1. Perform RCS SECURE, then: 2. Post PPD – reopen RCS Post ET SEP -Z transl: 3. Go to RCS SECURE >>
Pre ET SEP (N/A RTLS)	4. ET SEP – MAN 5. MPS PRPLT DUMP SEQ – STOP 6. Perform RCS SECURE, then:
Single MANF leak	7. Reopen RCS, except bad MANF 8. ET SEP – AUTO Post ET SEP -Z transl: 9. MPS PRPLT DUMP SEQ – GPC >>
TK leg leak (two MANF P Low)	10. Reopen RCS, except bad leg 11. ET SEP – AUTO Post ET SEP -Z transl: 12. MPS PRPLT DUMP SEQ – GPC >>
PRPLT TK P decr	
Post MECO	13. RATE DAMP with ARCS 14. Reopen FRCS
TK P > 200 & QTY > 0%	15. ET SEP – AUTO
TK P < 200 or QTY = 0%	16. Perform RCS SECURE, then: 17. DAP – INRTL, PITCH – PULSE 18. ET SEP pb – SEP 19. THC -Z (UP) (2 sec; -1.25°/sec) 20. THC -X (OUT) and hold
At SEP (SEP init + approx 12 sec)	21. THC +Z (DOWN) (3 sec; +0.3°/sec) THC -Z (UP) (2 sec; -0.9°/sec) COAST (5 sec) THC +X (IN) (20 sec) After 10 sec of +X, then: PITCH – DISC RATE
Otherwise: (He TK or He leg)	22. OPS 104 PRO, DAP – AUTO Post MECO: 23. Reopen RCS 24. ET SEP – AUTO
Post ET SEP -Z transl	25. MPS PRPLT DUMP SEQ – GPC 26. Go to RCS SECURE

PLT OVHD

FB A11-6

AESP/ALL/A/GEN O

FAB USE ONLY

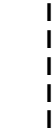
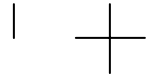
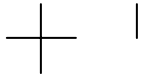

**GLIDED
FLIGHT**

PLT OVERHEAD FLIP BOOK

GLIDED FLIGHT

**PLT OVERHEAD
FLIP BOOK**

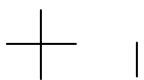

PLT OVHD

FB E11-i

AESP/ALL/E/GEN O

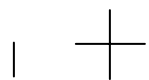

FAB USE ONLY

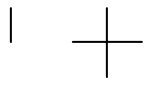
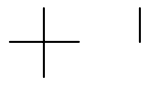

**GLIDED
FLIGHT**



This Page Intentionally Blank

**PLT OVERHEAD
FLIP BOOK**

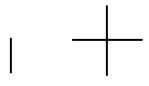
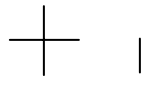

PLT OVHD

FB E11-ii

AESP/ALL/E/GEN O

FAB USE ONLY

TOP
BACK OF 'OMS TEMP DURING DUMP'

OMS,
Pc/
FAIL

PILE

OMS SECURE

If leak and

M > 24 or M < 3.5:

1. [G51] VENT DOOR CNTL OPEN – ITEM 43 EXEC
2. (Aff) OMS ENG – OFF
XFEED (two) – CL
TK ISOL (two) – CL
He PRESS (two) – CL

If leak isolated or

FU TK leak or

M < 24 & M > 3.5:

3. [G51] VENT DOOR CNTL CLOSE – ITEM 44 EXEC

OMS XFEED: R to L

1. L,R OMS XFEED (four) – OP
2. L OMS TK ISOL (two) – CL
He PRESS/VAP ISOL (two) – CL

OMS XFEED: L to R

1. L,R OMS XFEED (four) – OP
2. R OMS TK ISOL (two) – CL
He PRESS/VAP ISOL (two) – CL

OMS XFEED RETURN: OMS to OMS

L,R OMS TK ISOL (four) – OP
XFEED (four) – CL

PLT OVHD

FB E11-2

AESP/ALL/E/GEN O

FAB USE ONLY

HOOK

RCS JET FAIL (LEAK)

If OX/FU Qty diverging:
(Aff) RCS MANF ISOL – CL

RCS JET FAIL (ON)

1. (Aff) RCS MANF ISOL – CL
- If MANF P > 130 and stable (false alarm):
2. (Aff) RCS MANF ISOL – OP
 3. √AFT RCS RM LOSS

⇒

AFT
RCS
LK
QBAR

RM DLMA MANF

If (aff) MANF tb – OP or sw not thrown:

1. If FRCS: √MCC
2. If ARCS: G51 RCS RM MANF CL OVRD –
ITEM 41 EXEC
3. If (aff) MANF tb – bp: (aff) MANF – GPC

RCS JET FAIL (OFF)

If > one jet/pod/dir failed:

1. G23 resel jets
2. DES INH (*) (reprioritize)

RCS TK P HIGH (FU or OX) (√MANF P)

1. RCS He PRESS (two) – CL
2. A – OP

If He P decr:

3. RCS He PRESS A – CL
B – OP

XFEED: RCS to RCS

If AUTO XFEED:

1. L,R RCS TK ISOL (six) – GPC
XFEED (four) – GPC
2. OMS XFEED (four) – CL
3. MSTR RCS XFEED – FEED FROM L(R) >>

If MANUAL XFEED:

4. L,R OMS XFEED (four) – CL
5. RCS XFEED (four) – OP
6. (Receiving) RCS TK ISOL (three) – CL
He PRESS (two) – CL
7. MSTR RCS XFEED – FEED FROM L(R)

PLT OVHD

FB E11-3

AESP/ALL/E/GEN O

FAB USE ONLY

TOP
BACK OF 'RCS JET FAIL (LEAK)'

PILE

LOW QBAR AFT RCS LK (GRTLS/304/305)

($\sqrt{\text{He P}} > 20$: CRT and meter)

($\sqrt{\text{q}} < 20$: CRT)

1. If TK P '↑': Go to TK P HIGH >>

OMS
SEC
RCS
JET
XFD

OX Leak & M > 24	2. [G51] VENT DOOR CNTL OPEN – ITEM 43 EXEC
RTLS/TAL	3. [G51] AFT RCS – INH (ITEM 13)
	4. (Aff) 3/4/5 MANFs – CL 5. (Aff) 3/4/5 TK ISOLs – CL
Single MANF leak	6. TK ISOL(s) – OP (tb-OP), GPC 7. (Good) Pri MANF (one) – OP
Two MANF P decr (TK leg leak)	8. (Leaking leg) XFEED (one) – CL
No MANF P decr	9. TK ISOL(s) – OP (tb-OP), GPC 10. Pri MANFs (two) – OP 11. Repeat steps 4-10 for 1/2 leg
Leak not found	12. (Aff) RCS He PRESS (two) – CL
He P decr (He TK leak)	13. RCS He PRESS (two) – OP 14. When He P < 456: MSTR XFEED – feed from good side
OX/FU TK P diverge (Prplf TK leak)	15. RCS He PRESS (two) – OP 16. When QTY = 0: MSTR XFEED – feed from good side and (aff) RCS He PRESS (two) – CL
Leak not found	17. RCS He PRESS (two) – OP
He P decr (He leg leak)	18. RCS He PRESS (two) – CL 19. Cycle He PRESS so $220 < \text{TK P} < 245$ 20. When He P < 456: MSTR XFEED – feed from good side
Leak not found	21. Assume MANF 5 leak
$3.5 < M < 24$	22. [G51] VENT DOOR CNTL CLOSE – ITEM 44 EXEC

PLT OVHD

FB E11-4

AESP/ALL/E/GEN O,1

FAB USE ONLY



AFT RCS LK (GRTLS/304/305)

(√He P decr: CRT and meter)

1. If TK P '↑': Go to TK P HIGH >>
2. If $\bar{q} < 20$ or control problems:
Go to LOW QBAR AFT RCS LK >>

	3. ENTRY MODE – NO Y JET (R/Y CSS; expect sluggish control)
RTLS/TAL	4. G51 AFT RCS – INH (ITEM 13)
	5. (Aff) RCS MANF ISOL (five) – CL XFEED (two) – CL TK ISOL (all) – CL HE PRESS (two) – CL
(N/A RTLS)	6. G51 ELEVON FIXED – ITEM 18 EXEC (*)
Single MANF leak	7. Return to normal config except bad MANF ENTRY MODE – AUTO >>
Two MANF P decr (TK leg leak)	8. Return to normal config except bad leg ENTRY MODE – AUTO >>
He P decr (He TK leak)	9. Return to normal config ENTRY MODE – AUTO 10. When He P < 456: MSTR XFEED – feed from good side >>
OX/FU TK P diverge (Prplt TK leak)	11. Return to normal config ENTRY MODE – AUTO 12. When QTY = 0: MSTR XFEED – feed from good side <u>and</u> (aff) RCS He PRESS (two) – CL >>
Leak not found	13. RCS He PRESS (two) – OP
He P decr (He leg leak)	14. Return to normal config ENTRY MODE – AUTO 15. RCS He PRESS (two) – CL 16. Cycle He PRESS so 220 < TK P < 245 17. When He P < 456: MSTR XFEED – feed from good side >>
Leak not found (Assume MANF 5 leak)	18. Return to normal config except MANF 5 ENTRY MODE – AUTO >>

**AFT
RCS/
LK
RM**

PILE

RCS SECURE

If OX leak and

M > 24 or M < 3.5:

1. [G51] VENT DOOR CNTL OPEN – ITEM 43 EXEC
2. RCS MANF ISOL (five) – CL
 - XFEED (two) – CL
 - TK ISOL (all) – CL
 - He PRESS (two) – CL

If leak isolated or

M < 24 & M > 3.5:

3. [G51] VENT DOOR CNTL CLOSE – ITEM 44 EXEC

QBAR
AFT
RCS/
LK/
RM

AFT RCS RM LOSS

If loss of jet RM and > 3Y,2P jets/pod/dir:

1. [G23] aff jet DES INH (*) (reprioritize)
2. If yaw jet: desel >>

If total RM loss (BCE) and < 3Y,2P jets/pod/dir:

3. Aff jet DES INH (*) (reprioritize)
4. Aff MANF VLVS STAT OP – OVRD

PLT OVHD

FB E11-6

AESP/ALL/E/GEN O,3

FAB USE ONLY

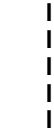
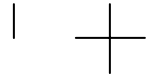
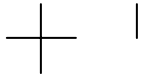

**POWERED
FLIGHT**

**PLT WINDOW FLIP BOOK
POWERED FLIGHT**

**PLT WINDOW
FLIP BOOK**

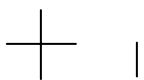

PLT WND

FB A12-i

AESP/ALL/A/GEN O

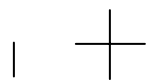

FAB USE ONLY

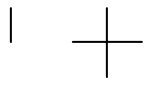
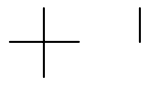

POWERED
FLIGHT



This Page Intentionally Blank

PLT WINDOW
FLIP BOOK

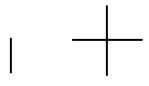
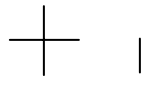

PLT WND

FB A12-ii

AESP/ALL/A/GEN O

FAB USE ONLY

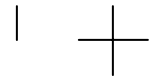
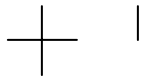

**APU
HYD**

This Page Intentionally Blank

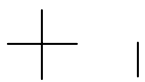

PLT WND

FB A12-1

AESP/ALL/A/GEN O

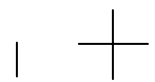

FAB USE ONLY

TOP
MOUNT ON LEFT SIDE OF BACKBOARD FACING 'COMM LOST'

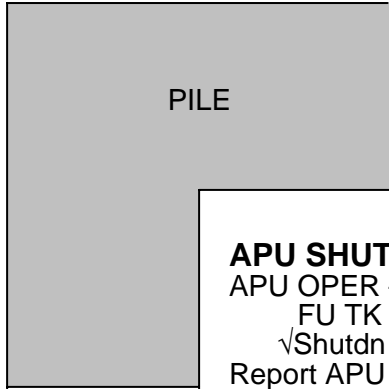

PILE

APU SHUTDN

APU OPER – OFF
FU TK VLV – CL
√Shutdn (HYD PRESS < 200)
Report APU F7 lts
APU CNTLR PWR – OFF
AUTO SHTDN (two) – INH
SPEED SEL (two) – HI ⇒

APU SPD HI

If SPEED % exceeds 111:
APU SPEED SEL – HI ⇒

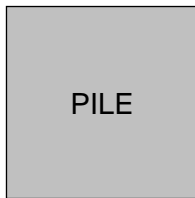

PILE

APU OVERSPEED

If SPEED % exceeds 129:
Go to APU SHUTDN

APU UNDERSPEED [G51]

If 'PRL SYS X ↓' or if APU has shut dn:
Perform APU SHUTDN, then: ⇒G

APU OIL OVERTEMP

◆BLR CNTLR/HTR – B
√N2 SPLY – ON ⇒

HYD PRESS (LOW) [G51]

If 'PRL SYS X ↓' and APU still oper:
1. APU AUTO SHTDN (two) – INH
2. SPEED SEL (two) – HI ⇒

HYD RSVR QTY (LOW)

Post MECO:
(Aff) HYD MPS/TVC ISOL VLV SYS – CL
(hold 5 sec, tb-CL) ⇒

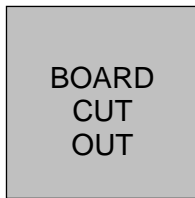

BOARD
CUT
OUT

W/B QTY (LOW)

1. If W/B QTY = 0 >>
2. BLR N2 SPLY – OFF
3. CNTLR/HTR – OFF ⇒

PLT WND FB A12-2 AESP/ALL/A/GEN O



FAB USE ONLY

HOOK

COMM LOST (mult pnls)

1. AUD CTR – 2
2. No joy, S-BD PM CNTL – PNL,CMD
3. Config per COMM COVER (ASC) [BFS G51]:
 - TDRS – ITEM 46 EXEC (*)
 - STDN-HI – ITEM 47 EXEC (*)
 - SGLS – ITEM 49 EXEC (*)
4. No joy, sel best S-BD PM ANT; else GPC ⇒

DPS
GPC
MDM**ICOM LOST**

1. AUD CNTL sel – sel alt
2. No joy, AUD CTR – 2

FCS CH 1(2,3,4) (2nd FAIL) [G53]

If two FCS CH ↓ on any actuator:

- ◆ (Remaining) FCS CH (two) – ORIDE

RHC L(R) (2nd FAIL)

(Aff) FLT CNTLR PWR – OFF

DISPLAY SW L(R)

L(R) disp sws – green dot

RM FAIL IMU,RGA,AA [BFS G51]

Aff LRU – desel

RM DLMA IMU [G51] [BFS G51]

1. √MCC, bad IMU – desel (PASS & BFS) >>
- ◆ 2. Desel lower # IMU with '?' (PASS)

POST BFS ENGAGE

If PASS GPCs running:

1. (Aff) GPC MODE – STBY/HALT
2. BFS I/O RESET
3. √FCS CHs, IMU config

If Pre MECO:

4. If SSME failed: MN ENG LIMIT SHUTDN – INH
5. [G51] DES failed(commfaulted) RGA,AA,SURF ⇒G

PLT WND

FB A12-3

AESP/ALL/A/GEN O

FAB USE ONLY

TOP
BACK OF 'COMM LOST (mult pnls)'

PILE

APU
HYD
COMM
GNC
DPS

PASS GPC FAIL

1. (Aff) FCS CH – OFF
If two GPC/FA/FCS CHs ↓:
2. (Good) FCS CHs – ORIDE
3. √MPS CMD
4. **G53** aff SURF FDBK – desel
5. If FTS, ASAP, GPC MODE – STBY,HALT
6. √BIG 'X', then assign IDPs as reqd
7. √MULT DATA PATH LOSS
Post MECO:
8. ASAP, GPC MODE – STBY,HALT ⇒

BFS GPC FAIL

1. Post SRB SEP: FLASH EVAP CNTLR PRI A – ON
Post MECO:
2. GPC MODE – STBY,HALT
OUTPUT – TERM
- ◆ If no comm: sel best S-BD PM ANT ⇒

FF(FA) MDM OUTPUT

FAULT

- ◆ (Take action only if annun by entire set)
If single 'MDM OUTPUT':
 1. Go to FA/FF MDM I/O ERROR >>
- If both FF and FA annun:
 2. I/O RESET; if reqd, BFS I/O RESET
 3. If msgs repeat: Go to PASS GPC FAIL >>
 4. If reqd, (aff) FCS CH – ORIDE,AUTO

PL MDM I/O ERROR

1. BFS I/O RESET; if recovered >>
- ◆ **G01** PL1/2 – port mode, then BFS I/O RESET;
if recovered >>
3. If PL2 down:
Post SRB SEP: FLASH EVAP CNTLR PRI A – ON
If no comm: sel best S-BD PM ANT ⇒

PCM I/O ERROR

OI PCMMU PWR – 2

PLT WND

FB A12-4

AESP/ALL/A/GEN O

FAB USE ONLY



FA/FF MDM I/O ERROR
(Annunciated by entire set)

	FA	1. (Aff) FCS CH – OFF
		◆ 2. I/O RESET
RECOV	FA	3. (Aff) FCS CH – AUTO
		4. BFS I/O RESET >>
NOT RECOV	FA	5. If two GPC/FA/FCS CHs ↓: (Good) FCS CHs – ORIDE
		6. G53 aff SURF FDBK – desel
		7. √MULT DATA PATH LOSS
		◆ 8. Go to FA/FF MDM PORT MODE ⇒

DPS
BCE
MDP

FA/FF MDM PORT MODE

NOTE

If BFS, 'BCE STRG X PASS', @GPC; else @MDM.
For '@GPC' port mode results in alternate MDM bypass

			1. G01 aff String – port mode
			2. BFS I/O RESET
@MDM	RECOV	FA	3. (Aff) FCS CH – AUTO
			4. G53 aff SURF FDBK – resel >>
		FF	5. >>
	NOT RECOV	FA	6. BFS G51 aff SURF FDBK, RGA – desel
		FF	7. BFS G51 aff AA – desel
			8. √MULT DATA PATH LOSS ⇒
@GPC	FA RECOV (FF Give Up)		9. (Aff) FCS CH – AUTO
			10. G51 aff IMU – desel
			11. G53 aff SURF FDBK – resel
			12. √MULT DATA PATH LOSS ⇒A
	FF RECOV (FA Give Up)		13. (Aff) FCS CH – OFF
			14. If two GPC/FA/FCS CHs ↓: (Good) FCS CHs – ORIDE
			15. G53 aff SURF FDBK – desel
			16. √MULT DATA PATH LOSS ⇒A

PILE

BCE STRG X (no 'MDM OUTPUT' msg)

	IMU	1. [G51] IMU – desel
		2. I/O RESET
RECOV	IMU	3. >>
		4. >>
NOT RECOV	NSP	5. And no comm: PNL,CMD
		6. [BFS G51] Config per COMM COVER (ASC): TDRS – ITEM 46 EXEC (*) STDN-HI – ITEM 47 EXEC (*) SGLS – ITEM 49 EXEC (*) >>
		♦ 7. [G01] aff String – port mode
		8. BFS I/O RESET
		9. If recov, go to RECOV steps >>
	B	10. [BFS G51] aff AA – desel
	D	11. [BFS G51] aff SURF FDBK,RGA – desel
	B/D	12. If RTLS: [G23] OVRD aff MANF(s) – OP
		13. √MULT DATA PATH LOSS ⇒

DPS
GPC
MDM

DUAL DPS DISPLAY COMMANDERS/DK XMTR 1(2,3)

1. BFC CRT SEL – aff IDP
If reqd to clean up display:
2. (Aff) IDP/CRT PWR – OFF,ON

PASS DISPLAY FAIL

1. MDU PWR – OFF,ON; if recovered >>
2. GPC/CRT – same GPC/aff IDP; if recovered >>
3. BFC CRT SEL – aff IDP; if both IDPs OK go to step 9
4. – orig posn
5. Report MDU symptoms
- If MCC GO for pwr cycle:
 6. IDP/CRT PWR – OFF,ON; if recovered >>
- If MDU blank or autonomous:
 7. Set other MDU on same IDP to DPS Mode; if recovered >>
 8. Return other MDU to nominal config
9. Deassign aff IDP from PASS
10. GPC/CRT 04 EXEC
11. In PASS: GPC/CRT 44 EXEC

PLT WND

FB A12-6

AESP/ALL/A/GEN O

FAB USE ONLY

HOOK

BFS DISPLAY FAIL

1. If IDP4(CRT4): IDP/CRT4 PWR – OFF >>
 2. MDU PWR – OFF,ON; if recovered >>
 3. BFC CRT SEL – unaff IDP; if both IDPs OK >>
 4. – orig posn
 5. BFC CRT DISPLAY – OFF,ON; if recovered >>
 6. In PASS: GPC/CRT 5/X for aff IDP; if recovered >>
 7. Report MDU symptoms
- If MCC GO for pwr cycle:
8. IDP/CRT PWR – OFF,ON; if recovered >>
- If MDU blank or autonomous:
9. Set other MDU on same IDP to DPS Mode; if recovered >>
 10. Return other MDU to nominal config
11. BFC CRT SEL – unaff IDP
 12. Deassign aff IDP from PASS
 13. GPC/CRT 04 EXEC
 14. In PASS: GPC/CRT 44 EXEC

PLT WND

FB A12-7

AESP/ALL/A/GEN O

FAB USE ONLY

TOP
BACK OF 'BFS DISPLAY FAIL'

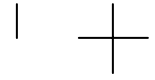
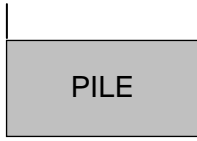

This Page Intentionally Blank



PLT WND

FB A12-8

AESP/ALL/A/GEN O

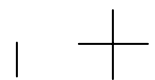

FAB USE ONLY



FLT INST DISPLAY ANOMALY

1. DATA BUS sel alt FC BUS(s); if recovered >>
2. PORT SELECT aff MDU; if recovered >>
3. MDU PWR – OFF,ON

SUBSYS STATUS DISPLAY ANOMALY

1. PORT SELECT aff MDU; if recovered >>
2. MDU PWR – OFF,ON; if recovered >>

MULT DATA PATH LOSS (non-Recov)

NOTE

If LRU data path loss due to GPC prob and not MDM,
BFS will pick up MDMs/LRU when engaged

FAILURE	TYPE	ACTIONS
GPC/FA any combo	I/O	D √BFS MM at each transition Expect 'SEP INH' (FDLN Fail) combos 2&3,2&4
		√OMS MAN SHUTDOWN Post MECO: Before MECO + 25 sec: •• 1. MPS FDLN RLF ISOL (two) – OP 2. MPS PREVLVs (six) – OP RTLS/TAL: MPS FILL/DRAIN LH2 INBD, OUTBD – OP
GPC/FF 1&2	I/O or B	Use R BODY FLAP & TRIM ENA SWs
GPC/FF 3&4	I/O or B	Use L BODY FLAP & TRIM ENA SWs

**EPS
MN
AC**

PILE

MN BUS UNDERVOLTS/FC VOLTS

If MN V < 26.4, FC V < 26.6, FC A > 480 (2 of 3)

(SHORT or degraded FC):

1. MSTR MADS PWR – OFF
 2. If aff BUS tied – untie
 3. PL PRI (three) – OFF
- If AC VOLTS < 95, or STACK T > 243 and incr:
4. (Aff) ESS BUS SOURCE FC – OFF
FC/MN BUS – OFF
- If FC VOLTS < 32 (FC SHORT)
5. (Aff) FC REAC VLV – CL
 6. Perform BUS LOSS ACTION (do not perform FC SHUTDN)
- Post MECO:
7. ⇒ FC SHUTDN (do not stop FC until COOL P < 15 and STACK T < 243) >>
- If FC VOLTS ≥ 32 (BUS SHORT)
8. Go to BUS LOSS ACTION >>

9. ⇒

If MN V < 26.4 and FC V > 32 and FC A < 20

(FC disconnect, check APUs):

10. AC BUS SNSR (three) – OFF
11. MSTR MADS PWR – OFF
12. PL PRI (three) – OFF
13. FC/MN BUS – ON

If FC3 aff:

14. PL PRI MNC – ON
FC3 – ON
15. If MNC V < 26.4: PL PRI (three) – OFF

If MN BUS recovered (FC VOLTS < 32):

16. GNC I/O RESET
17. ⇒ BUS TIE >>

If MN BUS not recovered (FC VOLTS > 32):

18. Perform BUS LOSS ACTION (do not perform FC SHUTDN)

Post MECO:

19. ⇒ FC SHUTDN

AC VOLT HIGH

If AC V > 123 and F7 "AC VOLTAGE":

1. (Unaff) AC BUS SNSRS (two) – OFF
- If AC V ≥ 130:
2. (Aff) AC BUS SNSR – AUTO TRIP
- If AC V < 130 and AC3 aff:
3. H2O PUMP LOOP 2 – OFF
- If RTLS/TAL:
4. AC VOLTS HIGH ⇒G
 5. ⇒ AC VOLTS (LOW or HIGH)

DPS
BCE
MDP

PLT WND

FB A12-10

AESP/ALL/A/GEN O

FAB USE ONLY

HOOK

AC VOLT LOW or OVERLOAD

1. AC BUS SNSR (three) – OFF

If amps > 14 and V < 95:

If single Φ amps > 14:

2. cb AC CONTR – cl
INV/AC BUS – OFF
INV PWR – OFF
cb AC CONTR – op

3. If other Φ amps > 14:
Go to step 6

If RTLS/TAL:

4. Go to aff BUS LOSS \Rightarrow G
5. Go to AC OVERLOAD \Rightarrow A

If multi Φ (bus short):

6. (Aff) cb AC CONTR (three) – cl
INV/AC BUS – OFF (tb-OFF)
INV PWR – OFF (tb-OFF)
cb AC CONTR (three) – op

7. Go to aff BUS LOSS >>

8. \Rightarrow AC VOLTS (LOW or HIGH)**3 Φ AC MOTORS STOPPED**

1. AC BUS SNSR (three) – OFF

2. Determine AC BUS:

- FC1 and FREON PUMP 2B: AC1
FC2 and FREON PUMP 1B: AC2
FC3 and CAB FAN A: AC3

3. (Aff) FC – STOP

If AC3 aff:

4. AV BAY 3 FAN B – OFF, A – ON
5. CAB FAN A – OFF

Isolate aff Φ B(Φ C, Φ A):

6. (Aff) cb AC CONTR – cl
7. INV/AC BUS – OFF

If AC1(2,3) aff and AV BAY 3(2,3) FAN Δ P \geq 0.5:8. Go to step 16 (bad Φ isolated)

9. (Aff) INV/AC BUS – ON

10. cb AC CONTR – op

11. Repeat from step 6 to isolate aff Φ C(Φ A), then:Drop aff AC bus (three Φ s):

12. (Aff) cb AC CONTR (three) – cl

13. INV/AC BUS – OFF

14. INV PWR – OFF

15. Go to aff BUS LOSS >>

Bad Φ isolated:16. (Aff) FC – START (10 sec or Δ P tb-gray)

17. Perform aff BUS LOSS and if AC1(AC2) aff >>

18. If AC3 aff:

Post MECO:

CAB FAN B – ON

MN
ESS
CNTL

PLT WND

FB A12-11

AESP/ALL/A/GEN O

FAB USE ONLY

TOP
BACK OF 'AC VOLT LOW or OVERLOAD'

PILE

MNA or AC1 Multi Φ

1. Do not isolate MPS He C
2. MSTR MADS PWR – OFF
3. AC BUS SNSR (three) – OFF
4. Perform FC SHUTDN (within 9 min), then:

Post MECO:

5. L OMS – sel SEC ⇒

MNB or AC2 Multi Φ

1. Do not isolate MPS He L
2. MSTR MADS PWR – OFF
3. AC BUS SNSR (three) – OFF
4. Perform FC SHUTDN (within 9 min), then: ⇒

FAILED: S-BD PM 1 (NO PNL,CMD)

MNC or AC3 Multi Φ

1. Do not isolate MPS He R
2. S-BD PM CNTL – PNL,CMD
3. Config per COMM COVER (ASC) [BFS G51]:
TDRS – ITEM 46 EXEC (*)
STDN-HI – ITEM 47 EXEC (*)
SGLS – ITEM 49 EXEC (*)
4. MSTR MADS PWR – OFF
5. AC BUS SNSR (three) – OFF
6. Perform FC SHUTDN (within 9 min), then:

Post MECO:

7. R OMS – sel SEC ⇒

AC SINGLE Φ ⇒

SUBBUS [APC4(5,6) or ALC1(2,3)]

Do not isolate MPS He C(L,R) ⇒

ESS BUS V LOW

If verified by F9 voltmeter:

1. Perform FC SHUTDN (<9 min), then:
2. Go to aff ESS BUS LOSS

ESS BUS LOSS

ESS 1BC	O13&R14	1. L AUD CNTL sel – R (CDR can't talk)
		2. Pri C/W & F7 Matrix lost ⇒A
		3. ⇒A
ESS 2CA	O13&R14	1. AUD CTR – 2
		2. R AUD CNTL sel – L (PLT can't talk) ⇒A
		3. ⇒A
ESS 3AB	O13	1. GPC CAM Lights lost
		2. Do not engage BFS ⇒

PLT WND

FB A12-12

AESP/ALL/A/GEN O

MN
AC
3Φ

FAB USE ONLY



CNTL BUS V LOW/CNTL BUS RPC

WARNING
 If VISIBLE FIRE/SMOKE AT ANY TIME, cb CNTL BUS AB1/2/3(BC1/2/3,CA1/2/3) – op (pnl R14:B)

1. Identify BUS (√BUS LOSS ID)
 If bus critical (per MCC):

- ◆ 2. ⇒
- ◆ If one CNTL BUS RPC tripped (*):

Aff CNTL BUS:

AB1(2,3)

	Tripped RPC (*)	Action (for RESET, hold w/sw reten device)
3.	A	R1 CNTL BUS PWR MNB – RESET R14:B cb CNTL BUS AB1/2/3 – op
4.	B	R1 CNTL BUS PWR MNA – RESET R14:B cb CNTL BUS AB1/2/3 – op

BC1(2,3)

	Tripped RPC (*)	Action (for RESET, hold w/sw reten device)
5.	B	R1 CNTL BUS PWR MNC – RESET R14:B cb CNTL BUS BC1/2/3 – op
6.	C	R1 CNTL BUS PWR MNB – RESET R14:B cb CNTL BUS BC1/2/3 – op

CA1(2,3)

	Tripped RPC (*)	Action (for RESET, hold w/sw reten device)
7.	C	R1 CNTL BUS PWR MNA – RESET R14:B cb CNTL BUS CA1/2/3 – op
8.	A	R1 CNTL BUS PWR MNC – RESET R14:B cb CNTL BUS CA1/2/3 – op

- ◆ If no CNTL BUS RPC tripped (no *):

	aff CNTL BUS	Panel R1 action (RESET, hold w/sw reten device)
9.	AB1(2,3)	CNTL BUS PWR MNA,MNB (two) – RESET
10.	BC1(2,3)	CNTL BUS PWR MNB,MNC (two) – RESET
11.	CA1(2,3)	CNTL BUS PWR MNA,MNC (two) – RESET

**CNTL
BUS
LOSS**

Cont next page

PILE

- ◆ 12. Perform aff CNTL BUS LOSS, then:
If pwr reqd (<3 sec) for crit function:
 - 13. Hold crit function sw
 - For tripped RPC:
 - 14. CNTL BUS PWR MNA(MNB,MNC) – RESET
(1 sec), then dn
- 15. ⇒

CNTL BUS LOSS

AB1	⇒
AB2	[G23] RCS FWD MANF VLVS 1 OVRD – ITEM 40 EXEC (CL) ⇒
AB3	1. [G51] RCS RM MANF CL OVRD – ITEM 41 EXEC If BFS engage reqd: 2. Use PLT's RHC, then GPCs 1,2,4 – STBY,HALT 3. BFS I/O RESET 4. ⇒
BC1	Failed: S-BD PM 1 (NO PNL,CMD) ⇒
BC2	1. S-BD PM CNTL – PNL,CMD 2. [BFS G51] Config per <u>COMM COVER</u> (ASC): TDRS – ITEM 46 EXEC (*) STDN-HI – ITEM 47 EXEC (*) SGLS – ITEM 49 EXEC (*) 3. [G23] RCS FWD MANF VLVS 2 OVRD – ITEM 41 EXEC (CL) 4. PLT disp sws – green dot ⇒
BC3	[G51] RCS RM MANF CL OVRD – ITEM 41 EXEC ⇒
CA1	No BFS engage ⇒
CA2	[G23] RCS FWD MANF VLVS 3 OVRD – ITEM 42 EXEC (CL) ⇒
CA3	⇒

**CNTL
LOW/
RPC**

PLT WND

FB A12-14

AESP/ALL/A/GEN O

FAB USE ONLY

HOOK

FC

FC REAC VLV CLOSED

1. FC REAC VLV (three) – OP
2. Perform BUS TIE, then:
If FC COOL P < 50:
3. Go to FC SHUTDN

FC pH ↓ 1(2,3) or FC DELTA V 1(2,3)

If pH ↓ and FC SS 1(2,3) $\Delta V > 150$
or FC SS $\Delta V > 150$ and incr:

1. Perform BUS TIE, then:
 2. (Aff) FC REAC VLV – CL
 3. MSTR MADS PWR – OFF
 4. Go to LOSS OF 1(2nd) FC PWRDN >>
- If pH ↓ only and Post SRB SEP:
- ◆ 5. Perform BUS TIE, then:
 - 6. ⇒A FC pH 1(2,3)

FC STACK T

1. MSTR MADS PWR – OFF
- If STACK T > 243 and incr:
2. If 2nd FC: Go to 2nd FC SHUTDN >>
 3. PL PRI (three) – OFF
- If aff FC amps < 190 or > 360:
4. Go to MN BUS UNDERVOLTS/FC VOLTS,
step 4 >>
- ◆ 5. Perform BUS TIE, then:
 - 6. ESS BUS SOURCE FC – OFF
 - 7. FC/MN BUS – OFF
- If aff FC VOLTS < 32 or STACK T not decr:
8. (Aff) FC REAC VLV – CL
 9. FC – STOP after COOL P < 15 and
STACK T < 243
 10. Go to LOSS OF 1 FC PWRDN

FC EXIT T

1. MSTR MADS PWR – OFF
 2. Perform LOSS OF 1 FC PWRDN
 3. Post SRB SEP:
- ◆ Perform BUS TIE, then: ⇒

PLT WND

FB A12-15

AESP/ALL/A/GEN O

FAB USE ONLY

TOP
BACK OF 'FC REAC VLV CLOSED'

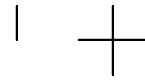

FC

FC COOLANT PUMP Δ P LOW

1. FC – START (10 sec or Δ P tb-gray)
- ◆ 2. MSTR MADS PWR – OFF
Perform LOSS OF 1 FC PWRDN, then:
If > 9 min since failure:
 - ◆ If EXIT T > 164 and not decr or
RDY tb – bp or
FC PUMP cb(s) open (pnl L4:C):
 3. Go to FC SHUTDN >>
 4. If < 9 min since failure \Rightarrow

FC COOL P

1. Perform BUS TIE, then:
If COOL P < 75: \Rightarrow
If COOL P incr and not 100 (H),
or FC COOL PUMP = Δ P (intermittent),
or STACK/EXIT T unstable:
 2. (Aff) FC REAC VLV – CL
 3. MSTR MADS PWR – OFF
 4. Go to LOSS OF 1(2nd) FC PWRDN

LOSS OF 1 FC PWRDN

1. PRI PL (three) – OFF
AFT PL (two) – OFF
2. IDP/CRT4 PWR – OFF
One MDU – OFF \Rightarrow



PLT WND

FB A12-16

AESP/ALL/A/GEN O

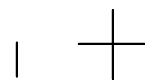

FAB USE ONLY

HOOK

2nd FC SHUTDN

(CL PMP Lost: <6 min)

1. Have CDR start LOSS OF 2nd FC PWRDN

If three MN buses pwr:

2. MN BUS TIE (three) – OFF
(do not perform BUS LOSS ACTION)
3. LES O2 – OFF, visors – OP
4. Switch off all but one IDP/CRT with four MDUs
5. All PL pwr (seven) – OFF
6. O2,H2 TK HTRS (all) – OFF
7. After CDR pnl L1 config complete, continue:

If two MN buses pwr:

8. Pwr MN BUS TIES (two) – ON

If only one MN bus pwr:

9. MN BUS TIE (three) – OFF
If only MNA(B,C) pwr: Secure APU 2(3,1)
BUS TIE good FC/BUS (MNA if RTLS or TAL)
I/O RESET

When reqd:

10. ESS BUS SOURCE FC – OFF
FC/MN BUS – OFF
FC – STOP (1 sec)
FC REAC VLV – CL
11. G51 √ICNCT ENA (if reqd for OMS load)
12. All TACAN/RA – OFF

Post MECO:

13. MPS PRPLT DUMP B/U LH2 VLV – OP
14. ⇒ LOSS OF 2nd FC PWRDN

CRYO

OV103,104

PLT WND (OV103,104) FB A12-17

AESP/3,4/A/GEN O

FAB USE ONLY

PILE

O2(H2) CRYO PRESS/TEMP HIGH

O2(H2) TK HTR (two) – OFF ⇒A

CRYO O2(H2) LEAK (three or more tanks aff)

Use meter if CRT data OSL

2FC

1. O2(H2) MANF VLV TK1,TK2 (two) – CL
 2. O2(H2) TK3 HTRS A – AUTO
- If TK1 and TK2 P decr slowly (HTR logic fail): ⇒
3. Perform aff MN BUS TIE, then:
- If O2(H2) TK1(2) aff (open unaff manf):
4. O2(H2) MANF VLV TK2(1) – OP
- If O2 TK1(2) aff:
5. O2 SYS 1(2) SPLY – CL
 6. If O2 TK1(2) P now incr (PCS leak): >>
7. (Aff) TK HTR B – AUTO
- If no aff FC COOL P alarm: ⇒
8. (Aff) TK HTRS A,B (two) – OFF
 9. MSTR MADS PWR – OFF
 10. Perform LOSS OF 1 FC PWRDN, then: ⇒

OV103,104

PLT WND (OV103,104) FB A12-18

AESP/ALL/A/GEN O

FAB USE ONLY

HOOK

2nd FC SHUTDN

(CL PMP Lost: <6 min)

1. Have CDR start LOSS OF 2nd FC PWRDN

If three MN buses pwr:

2. MN BUS TIE (three) – OFF
(do not perform BUS LOSS ACTION)
3. LES O2 – OFF, visors – OP
4. Switch off all but one IDP/CRT with four MDUs
5. All PL pwr (seven) – OFF
6. O2,H2 TK HTRS (all) – OFF
7. After CDR pnl L1 config complete, continue:

If two MN buses pwr:

8. Pwr MN BUS TIES (two) – ON

If only one MN bus pwr:

9. MN BUS TIE (three) – OFF
If only MNA(B,C) pwr: Secure APU 2(3,1)
BUS TIE good FC/BUS (MNA if RTLS or TAL)
I/O RESET

When reqd:

10. ESS BUS SOURCE FC – OFF
FC/MN BUS – OFF
FC – STOP (1 sec)
FC REAC VLV – CL
11. G51 √ICNCT ENA (if reqd for OMS load)
12. All GPS/RA – OFF

Post MECO:

13. MPS PRPLT DUMP B/U LH2 VLV – OP
14. ⇒ LOSS OF 2nd FC PWRDN

CRYO

OV105

PLT WND

(OV105) FB A12-17

AESP/5/A/GEN O

FAB USE ONLY

PILE

O2(H2) CRYO PRESS/TEMP HIGH

O2(H2) TK HTR (two) – OFF ⇒A

CRYO O2(H2) LEAK (three or more tanks aff)

Use meter if CRT data OSL

2FC

1. O2(H2) MANF VLV TK1,TK2 (two) – CL
 2. O2(H2) TK3 HTRS A – AUTO
- If TK1 and TK2 P decr slowly (HTR logic fail): ⇒
3. Perform aff MN BUS TIE, then:
- If O2(H2) TK1(2) aff (open unaff manf):
4. O2(H2) MANF VLV TK2(1) – OP
- If O2 TK1(2) aff:
5. O2 SYS 1(2) SPLY – CL
 6. If O2 TK1(2) P now incr (PCS leak): >>
7. (Aff) TK HTR B – AUTO
- If no aff FC COOL P alarm: ⇒
8. (Aff) TK HTRS A,B (two) – OFF
 9. MSTR MADS PWR – OFF
 10. Perform LOSS OF 1 FC PWRDN, then: ⇒

OV105

PLT WND

(OV105) FB A12-18

AESP/ALL/A/GEN O

FAB USE ONLY

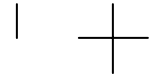
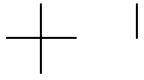

GLIDED
FLIGHT

PLT WINDOW FLIP BOOK
GLIDED FLIGHT

PLT WINDOW
FLIP BOOK

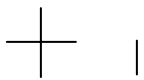

PLT WND

FB E12-i

AESP/ALL/E/GEN O

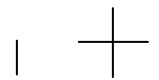

FAB USE ONLY

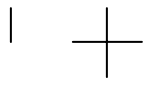
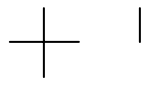

GLIDED
FLIGHT



This Page Intentionally Blank

PLT WINDOW
FLIP BOOK

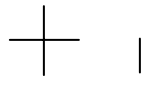

PLT WND

FB E12-ii

AESP/ALL/E/GEN O

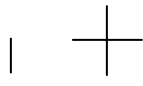

FAB USE ONLY

TOP
FACING LEFT SIDE OF BACKBOARD

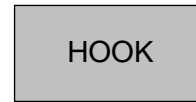

APU/
HYD

APU SHUTDN

1. APU OPER – OFF
FU TK VLV – CL
√Shutdn (HYD PRESS < 200)
Report APU F7 lts
APU CNTLR PWR – OFF

If one APU failed:

- ⇒
2. √APU AUTO SHTDN (three) – ENA
 3. MM304: √APU SPEED SEL (two) – NORM
 4. MM602/305: APU SPEED SEL (two) – HI

If two APUs failed:

5. APU SPEED SEL (one) – HI
6. AUTO SHTDN (one) – INH

APU SPD HI

If SPEED % exceeds 111:

- ⇒
1. APU SPEED SEL – HI
- Pre-TAEM if two good APUs:
2. Perform APU SHUTDN, then:
 3. Go to APU COOLDOWN

APU OVERSPEED

If SPEED % exceeds 129:

Go to APU SHUTDN

APU UNDERSPEED [G51]

If 'PRL SYS X ↓' or if APU has shut dn:

- ⇒
1. Perform APU SHUTDN, then:
 2. Go to APU COOLDOWN

APU OIL OVERTEMP

1. BLR CNTLR/HTR – A(B)
√N2 SPLY – ON

⇒ If M > 1:

If OIL IN T incr, and OUT T > 305:

2. Perform APU SHUTDN, then:
3. Go to APU COOLDOWN

APU PUMP LEAK P

1. √MCC

Pre-TAEM if two good APUs:

2. Perform APU SHUTDN, then:
3. Go to APU COOLDOWN

APU THERM (T HI)

If APU GG/FU PMP HTR or APU TK/FU LN HTR fail ON (↑):
(Aff) HTR – OFF

PLT WND

FB E12-1

AESP/ALL/E/GEN O

FAB USE ONLY

TOP
BACK OF 'APU SHUTDN'



APU

APU COOLDOWN

At M = 7:

1. HYD MN PUMP PRESS – LO
APU CNTLR PWR – ON
OPER – INJ COOL (start watch)

If APU not leaking:

2. APU FU TK VLV – OP

At Wheel Stop:

3. Go to APU SHUTDN

APU RESTART

- ◆ 1. √APU AUTO SHTDN – ENA
 2. HYD MN PUMP PRESS – LO
 3. APU CNTLR PWR – ON
- If COOLDOWN for > 3.5 min or APU TEMP INJ < 380:
4. Go to step 7
 5. APU OPER – INJ COOL (start watch)
- If after 1.5 min, APU TEMP INJ not decr:
6. Go to APU SHUTDN >>
- At 3.5 min:
7. √APU FU TK VLV – OP
OPER – START/RUN
- If restart unsuccessful:
8. Go to APU SHUTDN >>
 9. HYD MN PUMP PRESS – NORM

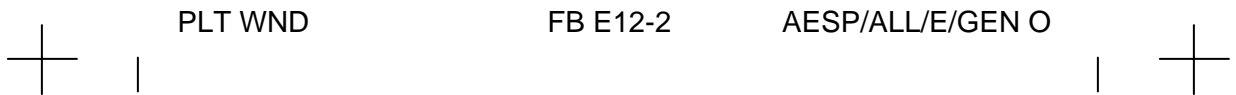

PLT WND

FB E12-2

AESP/ALL/E/GEN O

FAB USE ONLY



HYD PRESS (LOW)

GNC 51 OVERRIDE
BFS, SM SYS SUMM 2

- ⇒ 1. Compare 'PRL SYS X' status and aff HYD PRESS (HYD/APU) meter and CRT):

**HYD/
 COMM
 GNC**

PRL SYS	HYD PRESS	ACTION
'↓'	both meter and CRT P < 300	Go to APU SHUTDN >>
blank	either meter or CRT P > 2600	No action reqd >>
'?'	ACUM P > 2800	No action reqd >>

2. (Aff) HYD MN PUMP PRESS – LO

If two good APU/HYD remain:

- 3. √APU AUTO SHTDN (three) – ENA
- 4. MM304: √APU SPEED SEL (two) – NORM
- 5. MM305/602: APU SPEED SEL (two) – HI >>

If only one good APU/HYD remains:

- 6. APU AUTO SHTDN (one) – INH
 SPEED SEL (one) – HI

On MCC call:

- 7. (Degraded) HYD MN PUMP PRESS – NORM

TOP
BACK OF 'HYD PRESS (LOW)'

PILE

APU/
HYD

HYD RSVR QTY (LOW)

1. (Aff) \sqrt HYD MPS/TVC ISOL VLV SYS – CL
(hold 5 sec, tb-CL)
- ⇒ \sqrt BK ISOL VLV – CL (hold 5 sec, tb-CL)
- If HYD sys 1 leaking:
 \sqrt LG EXTD ISO VLV – CL (hold 5 sec, tb-CL)
- If qty still decr:
- If two good Hyd sys:
2. (Aff) HYD MN PUMP PRESS – LO
- If second sys fails:
3. At TAEM: (Leaking) HYD MN PUMP
PRESS – NORM
4. At TAEM: (Good) APU SPEED SEL (two) – HI
- If one good Hyd sys:
5. (Good) APU AUTO SHTDN – INH
6. (Good) APU SPEED SEL – HI
- If prior to TAEM:
7. (Leaking) HYD MN PUMP PRESS – LO
8. At TAEM: (Leaking) HYD MN PUMP
PRESS – NORM

HYD RSVR T

1. BLR CNTLR/HTR – A(B)
- If HYD RSVR T > 250:
2. HYD MN PUMP PRESS – LO
- If HYD RSVR T > 268 and incr:
3. Perform APU SHUTDN, then:
4. Go to APU COOLDOWN

W/B QTY (LOW)

- ⇒ 1. BLR CNTLR/HTR – A(B)
2. If BLR CNTLR/HTR – OFF:
3. BLR CNTLR/HTR – B
N2 SPLY – ON
4. If W/B QTY = 0 or $M \leq 1$ >>
5. Monitor W/B QTY for 2 min, then:
6. If W/B QTY change > 3:
7. Cycle BLR CNTLR/HTR to maintain:
200 < LUBE OIL IN T < 290 (C&W)
- When $M \leq 1$:
8. BLR CNTLR/HTR – A(B)

PLT WND

FB E12-4

AESP/ALL/E/GEN O

FAB USE ONLY

HOOK

COMM LOST (mult pnls)

1. AUD CTR – 2

No comm (check UHF sites):

2. S-BD PM CNTL – PNL,CMD (pnl C3)

3. Config per COMM COVER (ASC) BFS G51:

TDRS – ITEM 46 EXEC (*)

STDN-HI – ITEM 47 EXEC (*)

SGLS – ITEM 49 EXEC (*)

If * not next to selected config:

4. Config pnl A1 per Comm Coverage

(ASC/ENT PKT, COMM)

S-BD PM CNTL – PNL,CMD (pnl C3)

No comm:

5. Sel best S-BD PM ANT

No comm:

6. S-BD PM ANT – GPC

**GNC
MPS
DPS****ICOM LOST**

1. AUD CNTL sel – sel alt

No ICOM:

2. AUD CTR – 2

FCS CH 1(2,3,4) (2nd FAIL) G53

If two FCS CH ↓ on any actuator:

- ◆ (Remaining) FCS CH (two) – ORIDE

RHC L(R) (2nd FAIL)

(Aff) FLT CNTLR PWR – OFF

GNC SYS SUMM 1**G51 ROLL MODE SW G51**

If ROLL MODE ≠ sw pos:

AUTO SEL – ITEM 42 EXEC

DISPLAY SW L(R)

L(R) disp sws – green dot

RM FAIL IMU,RGA,AA BFS G51

Aff LRU – desel

RM DLMA IMU G51 BFS G51

- 1. √MCC, bad IMU – desel (PASS & BFS) >>
- ◆ 2. Desel lower # IMU with '?' (PASS)

PLT WND

FB E12-5

AESP/ALL/E/GEN O

FAB USE ONLY

PILE

- RM FAIL ADTA** [G51]
- ◆ 1. √BFS [GNC SYS SUMM 1]
 - 2. If '↓' for aff ADTA >>
 - 3. If accessible, (bad) ADTA cb – op >>
 - 4. BFS, ADTA to G&C – INH

RM DLMA ADTA * [G51]

M < 2.0		1. Fly Theta limits
ADTA data agrees		2. Desel, resel one ADTA
		3. If no '?' >>
Bad probe		4. Stow bad probe >>
Bad ADTA	ADTA cb accessible	◆ 5. (Bad) ADTA cb – op >>
	ADTA cb not accessible	◆ 6. DES bad ADTA
		7. √BFS [GNC SYS SUMM 1]
		8. If '↓' for aff ADTA >>
		9. BFS, ADTA to G&C – INH
Dilemma not resolved		10. ADTA to G&C – INH (PASS & BFS)

HYD/
COMM
GNC

*If three ADTAs failed:
ADTA to G&C – INH (PASS)
Fly Theta limits

RM FAIL TAC [G50]

(RM LIMITS: 6 DEG, 0.5 NM)

- 1. If data good: desel, resel aff TACAN >>
- 2. If failure verified: desel failed TACAN in BFS

RM DLMA TAC [G50]

Do not desel or resel while in 'TEST'

- 1. If both data good: desel, resel one TACAN in DLMA >>
- 2. √TACAN MODE (three) – GPC
- 3. If 'RM FAIL TAC': desel failed TACAN in BFS >>
- 4. If continuous 'TEST': TACAN MODE (three) – T/R
If bad TACAN identified:
 - 5. Desel bad TACAN (PASS, √BFS)

SPD BRK [G51] [BFS G51]

M > 5.0	◆ WRAP MODE – INH
M ≤ 5.0	WRAP MODE – INH √MCC for energy mgmt procs

TOP
FRONT

HOOK

**MPS He P/MPS C&W LIGHT
PNEU REG**

If M > 2.4: (Aff) MPS He ISOL – CL

G55 GPS FAIL 2 G50 BFS G50
GPS to NAV INH – ITEM 43 EXEC (PASS, \sqrt BFS)

NO UPDATE GPS G55
 \sqrt MCC
If ALT < 300kft and ALT > 180kft
 No Update due to plasma, reevaluate at ALT < 180kft
Else
 INIT – ITEM 15 EXEC
 NAV – ITEM 18 EXEC

OV103,104

PLT WND (OV103,104) FB E12-7

AESP/3,4/E/GEN O

FAB USE ONLY

TOP
BACK

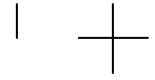
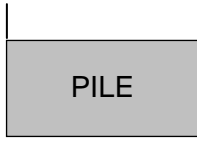

This Page Intentionally Blank



PLT WND (OV103,104) FB E12-8

OV103,104

AESP/3,4/E/GEN O

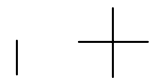

FAB USE ONLY

TOP
FRONT

HOOK

**MPS He P/MPS C&W LIGHT
PNEU REG**

If M > 2.4: (Aff) MPS He ISOL – CL

G55 GPS FAIL 1(2,3) G50 BFS G50
Aff LRU – desel (PASS, $\sqrt{\text{BFS}}$)

RM DLMA GPS G50 BFS G50

- ◆ 1. $\sqrt{\text{MCC}}$, bad GPS – desel (PASS, $\sqrt{\text{BFS}}$) >>
- 2. If 300kft > ALT > 180kft
DLMA due to plasma
Reevaluate when ALT < 180kft
Else
- 3. Desel GPS with highest P1 σ
If P1 σ values are equal, desel highest number
LRU
If DLMA not resolved
- 4. Desel GPS with next highest P1 σ

NO UPDATE GPS G55

- 1. $\sqrt{\text{MCC}}$, bad GPS – desel (PASS, $\sqrt{\text{BFS}}$) >>
- 2. If RM DLMA GPS message, see RM DLMA GPS >>
- 3. If 300kft > ALT > 180kft
No Update due to plasma
Reevaluate when ALT < 180kft
Else
- 4. Initialize GPS with highest P1 σ
INIT – ITEM 14(15,16) EXEC
NAV – ITEM 17(18,19) EXEC
May take up to 2 minutes for GPS to provide SV

OV105

PLT WND

(OV105) FB E12-7

AESP/5/E/GEN O

FAB USE ONLY

TOP
BACK

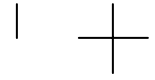
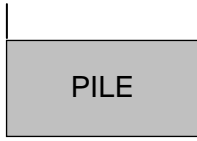

PILE

This Page Intentionally Blank



PLT WND

(OV105) FB E12-8

OV105
AESP/5/E/GEN O

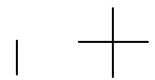

FAB USE ONLY



PASS GPC FAIL

1. (Aff) FCS CH – OFF
2. If two GPC/FA/FCS CHs ↓: (Good) FCS CHs – ORIDE
3. GPC MODE – STBY,HALT
4. [G53] aff SURF FDBK – desel
- ⇒ 5. If String 1(2): CDR(PLT) disp sws – green dot
NWS – 2
6. √MULT DATA PATH LOSS

BFS GPC FAIL

1. GPC MODE – STBY,HALT
- ◆ 2. OUTPUT – TERM
⇒ MODE – STBY
3. If BFS cannot drive an IDP:
GPC MODE – HALT, then go to step 8
4. If BFS currently in OPS 3 or 6:
Go to step 7
5. If BFS currently in OPS 1:
PRO to OPS 106
BFS, OPS 000 PRO
PRO to OPS 304
6. If BFS in desired MM (304):
BFS [G50] √BFS R/W sel
GPC MODE – RUN
OUTPUT – B/U
Advise MCC BFS in BACKUP >>
7. √GPC MODE – STBY (BFS is SM Only)
8. If no comm: sel best S-BD PM ANT
9. MPS He ISOL B (three) – CL
PNEU He ISOL – CL
10. If AOA/GRTLs/TAL < 120K:
NH3 CNTLR B – SEC/ON

DPS
MDM
BFS

FA/FF MDM I/O ERROR

(Annunciated by entire set)

	FA	1. (Aff) FCS CH – OFF
		◆ 2. I/O RESET
RECOV	FA	3. (Aff) FCS CH – AUTO
	FF 1,2,3	◆ 4. [G51] IMU – resel
		5. BFS I/O RESET >>
NOT RECOV	FA	6. If two GPC/FA/FCS CHs ↓: (Good) FCS CHs – ORIDE
		7. [G53] aff SURF FDBK – desel
		8. √MULT DATA PATH LOSS
		⇒ ◆ 9. Go to FA/FF MDM PORT MODE ⇒

PLT WND

FB E12-9

AESP/ALL/E/GEN O,4

FAB USE ONLY

PILE

FA/FF MDM PORT MODE

NOTE

If BFS, 'BCE STRG X PASS', @GPC; else @MDM.
For '@GPC' port mode results in alternate MDM bypass

GNC
MPS
DPS

			1. G01 aff String – port mode 2. BFS I/O RESET
@MDM	RECOV	FA	3. (Aff) FCS CH – AUTO 4. G53 aff SURF FDBK – resel >>
		FF 1,2,3	◆ 5. G51 IMU – resel >>
	NOT RECOV		⇒ If MCC GO for pwr cycle: 6. (Aff) FA/FF MDM – OFF,ON 7. I/O RESET 8. If recov, go to @MDM RECOV >> 9. (Aff) MDM – OFF
		FA	10. BFS G51 aff SURF FDBK, RGA – desel
		FF	11. BFS G51 aff AA – desel 12. FF 1(2): CDR(PLT) disp sws – green dot NWS – 2
			13. √MULT DATA PATH LOSS >>
@GPC	FA RECOV (FF Give Up)		14. (Aff) FCS CH – AUTO 15. G53 aff SURF FDBK – resel 16. FF 1(2): CDR(PLT) disp sws – green dot NWS – 2 17. √MULT DATA PATH LOSS >>
	FF RECOV (FA Give Up)		18. (Aff) FCS CH – OFF 19. If two GPC/FA/FCS CHs ↓: (Good) FCS CHs – ORIDE 20. G53 aff SURF FDBK – desel
		FF 1,2,3	◆ 21. G51 IMU – resel
			22. √MULT DATA PATH LOSS >>

PLT WND

FB E12-10

AESP/ALL/E/GEN O

FAB USE ONLY

HOOK

FAULT

FF(FA) MDM OUTPUT

- ◆ (Take action only if annun by entire set)
- If single 'MDM OUTPUT':
 1. If 'FF MDM OUTPUT':
 - ◆ **G51** aff IMU – desel
 2. Go to FA/FF MDM I/O ERROR >>
- If both FF and FA annun:
 3. **G51** aff IMU – desel
 4. I/O RESET; if reqd, BFS I/O RESET
 5. If msgs repeat: Go to PASS GPC FAIL >>
 6. If reqd, (aff) FCS CH – ORIDE,AUTO
 - ◆ 7. **G51** IMU – resel

PL MDM I/O ERROR

- 1. BFS I/O RESET; if recovered >>
- 2. **G01** PL1/2 – port mode, then BFS I/O RESET; if recovered >>
- 3. If PL1 ↓ and pre MM305: FLASH EVAP CNTLR PRI B – ON
- 4. If PL2 ↓ and no comm: sel best S-BD PM ANT
- ⇒ 5. If PL2 ↓ and AOA/GRTLS/TAL < 120K: NH3 CNTLR B – SEC/ON

PCM I/O ERROR

OI PCMMU PWR – 2(1)

POST BFS ENGAGE

If PASS GPCs running:

- 1. (Aff) GPC MODE – STBY/HALT
- 2. BFS I/O RESET
- 3. √FCS CHs, IMU config
- ⇒ If Air Data not analyzed:
 4. **G50** INH AD to G&C
 5. M = 5: Deploy, evaluate probes one at a time
 6. √AD to G&C by M = 1.5

If failed ADTA(s) in PASS:

- 7. cb(s) ADTA – op, or stow probe
- 8. **G51** DES failed(commfaulted) RGA,AA,SURF
- 9. **G50** DES failed TAC

At $M \leq 2.7$:

- 10. CDR TRIM PNL – OFF
RHC/PNL – ENA

At H = 3K:

- 11. SPDBK – MAN (check DEL PAD setting)

At MAIN GEAR TD:

- 12. SPDBK – 100%

BCE
CRT

PLT WND

FB E12-11

AESP/ALL/E/GEN O

FAB USE ONLY

TOP
BACK OF 'FF(FA) MDM OUTPUT'

PILE

BCE STRG X (no 'MDM OUTPUT' msg)

	IMU	1. [G21] √IMU OPER, if STBY >>
		2. I/O RESET
RECOV	IMU	3. [G21] √att ANG, if delta > 1° >> ◆ 4. [G51] IMU – resel >>
		5. >>
NOT RECOV	NSP	6. And no comm: PNL,CMD 7. [BFS G51] Config per <u>COMM COVER</u> (ASC): TDRS – ITEM 46 EXEC (*) STDN-HI – ITEM 47 EXEC (*) SGLS – ITEM 49 EXEC (*) >>
		8. [G01] aff String – port mode 9. BFS I/O RESET 10. If recov, go to RECOV steps >>
A(B,C,D, IMU)	⇒	11. FF A(B,IMU) or FA C(D) MDM – OFF,ON 12. I/O RESET 13. If FA, (aff) FCS CH – ORIDE,AUTO 14. If recov, go to RECOV steps
	C(D)	15. If < 3Y,2P jets/pod/dir: a. [G23] aff jet DES INH (*) (reprioritize) b. Aff MANF VLVS STAT OP – OVRD
	1A(2A)	16. CDR(PLT) disp sws – green dot
	B	17. [BFS G51] aff AA – desel
	D	18. [BFS G51] aff SURF FDBK,RGA – desel
		19. √MULT DATA PATH LOSS >>

DPS
MDM
BFS

PLT WND

FB E12-12

AESP/ALL/E/GEN O

FAB USE ONLY

HOOK

DUAL DPS DISPLAY COMMANDERS/DK XMTR 1(2,3)

1. BFC CRT SEL – aff IDP
- If reqd to clean up display:
2. (Aff) IDP/CRT PWR – OFF,ON

PASS DISPLAY FAIL

1. MDU PWR – OFF,ON; if recovered >>
 2. GPC/CRT – same GPC/aff IDP; if recovered >>
 3. BFC CRT SEL – aff IDP; if both IDPs OK go to step 9
 4. – orig posn
 5. Report MDU symptoms
- If MCC GO for pwr cycle:
6. IDP/CRT PWR – OFF,ON; if recovered >>
- If MDU blank or autonomous:
7. Set other MDU on same IDP to DPS Mode; if recovered >>
 8. Return other MDU to nominal config
 9. Deassign aff IDP from PASS
 10. GPC/CRT 04 EXEC
 11. In PASS: GPC/CRT 44 EXEC

BFS DISPLAY FAIL

1. If IDP4(CRT4): IDP/CRT4 PWR – OFF >>
 2. MDU PWR – OFF,ON; if recovered >>
 3. BFC CRT SEL – unaff IDP; if both IDPs OK >>
 4. – orig posn
 5. BFC CRT DISPLAY – OFF,ON; if recovered >>
 6. In PASS: GPC/CRT 5/X for aff IDP; if recovered >>
 7. Report MDU symptoms
- If MCC GO for pwr cycle:
8. IDP/CRT PWR – OFF,ON; if recovered >>
- If MDU blank or autonomous:
9. Set other MDU on same IDP to DPS Mode; if recovered >>
 10. Return other MDU to nominal config
 11. BFC CRT SEL – unaff IDP
 12. Deassign aff IDP from PASS
 13. GPC/CRT 04 EXEC
 14. In PASS: GPC/CRT 44 EXEC

MDP

PLT WND

FB E12-13

AESP/ALL/E/GEN O

FAB USE ONLY

PILE

FLT INST DISPLAY ANOMALY

1. DATA BUS sel alt FC BUS(s); if recovered >>
2. PORT SELECT aff MDU; if recovered >>
3. MDU PWR – OFF,ON

SUBSYS STATUS DISPLAY ANOMALY

1. PORT SELECT aff MDU; if recovered >>
2. MDU PWR – OFF,ON; if recovered >>

MULT DATA PATH LOSS (non-Recov)

NOTE

If LRU data path loss due to GPC prob and not MDM,
BFS will pick up MDMs/LRU when engaged

FAILURE	TYPE	ACTIONS
GPC/FF 1&2	I/O or B	Use R BODY FLAP & TRIM ENA sws
GPC/FF 3&4	I/O or B	Use L BODY FLAP & TRIM ENA sws
GPC/FA any combo	I/O or D	No impact

**BCE
CRT**

PLT WND

FB E12-14

AESP/ALL/E/GEN O

FAB USE ONLY

TOP

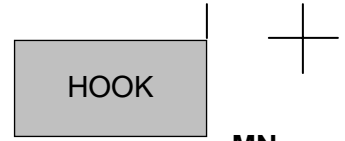
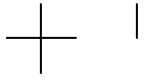

**MN
AC**

This Page Intentionally Blank

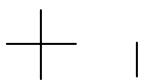

PLT WND

FB E12-15

AESP/ALL/E/GEN O

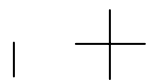

FAB USE ONLY

PILE

BCE
CRT
MDP

MN BUS UNDERVOLTS/FC VOLTS

If MN V < 26.4, FC V < 26.6, FC A > 480 (2 of 3)

(SHORT or degraded FC):

- ⇒
1. MSTR MADS PWR – OFF
 2. If aff BUS tied – untie
 3. PL PRI (three) – OFF
 4. (Aff) ESS BUS SOURCE FC – OFF
FC/MN BUS – OFF

If FC VOLTS < 32 (FC SHORT)

5. (Aff) FC REAC VLV – CL
6. Go to FC SHUTDN (do not stop FC until
COOL P < 15 and STACK T < 243) >>

If FC VOLTS ≥ 32 (BUS SHORT)

7. Go to BUS LOSS ACTION >>

If MN V < 26.4 and FC V > 32 and FC A < 20

(FC disconnect, check APUs):

8. MSTR MADS PWR – OFF
9. PL PRI (three) – OFF
10. FC/MN BUS – ON

If FC3 aff:

11. PL PRI MNC – ON
FC3 – ON
12. If MNC V < 26.4: PL PRI (three) – OFF

If 1st FC failure:

13. Perform BUS TIE, then:

If MN BUS recovered:

14. GNC I/O RESET

If aff FC VOLTS > 32:

15. Go to FC SHUTDN

AC VOLT HIGH

If AC V > 123 and F9 V > 123:

- ⇒
1. (Aff) AC BUS SNSR – OFF
 2. cb AC CONTR – cl
INV/AC BUS – OFF
INV PWR – OFF
cb AC CONTR – op
 3. √H2O PUMP LOOP 2(1) – ON
 4. Go to aff BUS LOSS

PLT WND

FB E12-16

AESP/ALL/E/GEN O

FAB USE ONLY



AC VOLT LOW or OVERLOAD

- ⇒ If amps > 14 or V < 110:
- If single Φ amps > 14 or V > 10:
 1. cb AC CONTR – cl
 INV/AC BUS – OFF
 INV PWR – OFF
 cb AC CONTR – op
 2. If other Φ amps > 14:
 Go to step 3
 - If multi Φ (bus short):
 3. (Aff) cb AC CONTR (three) – cl
 INV/AC BUS – OFF (tb-OFF)
 INV PWR – OFF (tb-OFF)
 cb AC CONTR (three) – op
 AC BUS SNSR – OFF
 4. Go to aff BUS LOSS

**3 Φ
MN
AC
SUB**

PLT WND

FB E12-17

AESP/ALL/E/GEN O

FAB USE ONLY

TOP
BACK OF 'AC VOLT LOW or OVERLOAD'

PILE

**MN
AC**

3Φ AC MOTORS STOPPED

1. (Aff) AC BUS SNSR – OFF
2. Determine AC BUS:
 - FC1 and FREON PUMP 2B: AC1
 - FC2 and FREON PUMP 1B: AC2
 - FC3 and CAB FAN A: AC3
3. (Aff) FC – STOP
If AC3 aff:
 4. AV BAY 3 FAN B – OFF, A – ON
 5. CAB FAN A – OFF
 Isolate aff ΦB(ΦC,ΦA):
 6. (Aff) cb AC CONTR – cl
 7. INV/AC BUS – OFF
 If AC1(2,3) aff and AV BAY 3(2,3) FAN ΔP ≥ 0.5:
 8. Go to step 16 (bad Φ isolated):
 9. (Aff) INV/AC BUS – ON
 10. cb AC CONTR – op
 11. Repeat from step 6 to isolate aff ΦC(ΦA), then:
 Drop aff AC bus (three Φs):
 12. (Aff) cb AC CONTR (three) – cl
 13. INV/AC BUS – OFF
 14. INV PWR – OFF
 15. Go to aff BUS LOSS >>
 Bad Φ isolated:
 16. (Aff) FC – START (10 sec or ΔP tb-gray)
 17. Perform aff BUS LOSS and if AC1(AC2) aff >>
 18. If AC3 aff: CAB FAN B – ON

⇒ **AC SINGLE Φ**

AC1	ΦA	BLR CNTLR/HTR 1 – A When V = 12K: RAD CNTLR LOOP (two) – AUTO A
	ΦB	When V = 12K: RAD CNTLR LOOP (two) – AUTO A
	ΦC	BLR CNTLR/HTR 3 – B
AC2	ΦA	BLR CNTLR/HTR 1 – B
	ΦB	SIG CONDR FREON A – AC3
	ΦC	BLR CNTLR/HTR 2 – A
AC3	ΦA	BLR CNTLR/HTR 2 – B
	ΦB	SIG CONDR FREON B – AC2
	ΦC	BLR CNTLR/HTR 3 – A

PLT WND

FB E12-18

AESP/ALL/E/GEN O

FAB USE ONLY



MNA or AC1 Multi Φ

- 1. MSTR MADS PWR – OFF
- 2. Perform FC SHUTDN (within 9 min), then:
- ⇒ 3. BLR CNTLR/HTR 1 – A
3 – B

FAILED: TAC 1
MLS 1, RA 1, NWS 1, L HUD

MNB or AC2 Multi Φ

- 1. MSTR MADS PWR – OFF
- 2. Perform FC SHUTDN (within 9 min), then:
- ⇒ 3. BLR CNTLR/HTR 2 – A
1 – B
- 4. SIG CONDR FREON A – AC3

FAILED: TAC 2
MLS 2, RA 2, NWS 2
PLT DRAG CHUTE ARM
S-BD PM 1 (NO PNL,CMD)

**ESS
CNTL**

MNC or AC3 Multi Φ

- 1. S-BD PM CNTL – PNL,CMD
- 2. Config per COMM COVER (ASC) BFS G51:
TDRS – ITEM 46 EXEC (*)
STDN-HI – ITEM 47 EXEC (*)
SGLS – ITEM 49 EXEC (*)
- 3. MSTR MADS PWR – OFF
- ⇒ 4. Perform FC SHUTDN (within 9 min), then:
- 5. BLR CNTLR/HTR 3 – A
2 – B
- 6. SIG CONDR FREON B – AC2

FAILED: TAC 3, MLS 3, R HUD
CDR DRAG CHUTE ARM

SUBBUS

SUBBUS or ALC	4 1	5 2	6 3
⇒ 1. BLR CNTLR/HTR	1 – A 3 – B	2 – A 1 – B	3 – A 2 – B

ESS BUS V LOW

If verified by F9 voltmeter:

- 1. Perform FC SHUTDN (<9 min), then:
- 2. Go to aff ESS BUS LOSS

PILE

ESS BUS LOSS

ESS 1BC	O13&R14	1. L AUD CNTL sel – R (CDR can't talk) 2. Pri C/W & F7 Matrix lost
ESS 2CA	O13&R14	1. AUD CTR – 2 2. R AUD CNTL sel – L (PLT can't talk)
ESS 3AB	O13	1. GPC CAM Lights lost 2. Do not engage BFS ⇒ 3. BFS GPC OUTPUT – TERM

3Φ
MN
AC
SUB

CNTL BUS V LOW/CNTL BUS RPC

WARNING
If VISIBLE FIRE/SMOKE AT ANY TIME, cb CNTL
BUS AB1/2/3(BC1/2/3,CA1/2/3) – op (pnl R14:B)

1. Identify BUS (√BUS LOSS ID)
- ⇒ If bus critical (per MCC):
- ◆ 2. >>
- ◆ If one CNTL BUS RPC tripped (*):

Aff CNTL BUS:

AB1(2,3)

	Tripped RPC (*)	Action (for RESET, hold w/sw reten device)
3.	A	R1 CNTL BUS PWR MNB – RESET R14:B cb CNTL BUS AB1/2/3 – op
4.	B	R1 CNTL BUS PWR MNA – RESET R14:B cb CNTL BUS AB1/2/3 – op

BC1(2,3)

	Tripped RPC (*)	Action (for RESET, hold w/sw reten device)
5.	B	R1 CNTL BUS PWR MNC – RESET R14:B cb CNTL BUS BC1/2/3 – op
6.	C	R1 CNTL BUS PWR MNB – RESET R14:B cb CNTL BUS BC1/2/3 – op

Cont next page

PLT WND

FB E12-20

AESP/ALL/E/GEN O

FAB USE ONLY



CA1(2,3)

Tripped RPC (*)	Action (for RESET, hold w/sw reten device)
7. C	R1 CNTL BUS PWR MNA – RESET R14:B cb CNTL BUS CA1/2/3 – op
8. A	R1 CNTL BUS PWR MNC – RESET R14:B cb CNTL BUS CA1/2/3 – op

◆ If no CNTL BUS RPC tripped (no *):

aff CNTL BUS	Pnl R1 Action (RESET, hold w/sw reten device)
9. AB1(2,3)	CNTL BUS PWR MNA,MNB (two) – RESET
10. BC1(2,3)	CNTL BUS PWR MNB,MNC (two) – RESET
11. CA1(2,3)	CNTL BUS PWR MNA,MNC (two) – RESET

◆ 12. Perform aff CNTL BUS LOSS, then:

If pwr reqd (<3 sec) for crit function:

13. Hold crit function sw

For tripped RPC:

14. CNTL BUS PWR MNA(MNB,MNC) – RESET
(1 sec), then dn

15. ⇒

CNTL BUS LOSS

AB1	⇒ 1. Use R TRIM & BDY FLP sws 2. BLR CNTLR/HTR 1 – A
AB2	1. G23 RCS FWD MANF VLVS 1 OVRD – ITEM 40 EXEC (CL) ⇒ 2. BLR CNTLR/HTR 1 – A FAILED: L HUD
AB3	1. G51 RCS RM MANF CL OVRD – ITEM 41 EXEC If BFS engage reqd: 2. Use PLT's RHC, then GPCs 1,2,4 – STBY,HALT 3. BFS I/O RESET ⇒ 4. BLR CNTLR/HTR 1,3 (two) – B

**CNTL
BUS
LOSS**

Cont next page

PLT WND

FB E12-21

AESP/ALL/E/GEN O

FAB USE ONLY

TOP
BACK OF 'CNTL BUS V LOW/CNTL BUS RPC' (Cont)

PILE

CNTL BUS LOSS (Cont)

BC1	⇒	1. Use R TRIM & BDY FLP sws 2. BLR CNTLR/HTR 2 – A FAILED: R HUD CDR DRAG CHUTE DPY/JETT S-BD PM 1 (NO PNL,CMD)
BC2	⇒	1. S-BD PM CNTL – PNL,CMD 2. G51 Config per <u>COMM COVER</u> (ASC): TDRS – ITEM 46 EXEC (*) STDN-HI – ITEM 47 EXEC (*) SGLS – ITEM 49 EXEC (*) 3. G23 RCS FWD MANF VLVS 2 OVRD – ITEM 41 EXEC (CL) 4. PLT disp sws – green dot 5. Use L TRIM & BDY FLP sws 6. BLR CNTLR/HTR 2 – A FAILED: CDR DRAG CHUTE DPY/JETT
BC3	⇒	1. G51 RCS RM MANF CL OVRD – ITEM 41 EXEC 2. BLR CNTLR/HTR 1,2 (two) – B
CA1	⇒ ♦	1. No BFS engage GPC 3,5 2. BFS GPC OUTPUT – TERM 3. BLR CNTLR/HTR 3 – A FAILED: PLT DRAG CHUTE DPY/JETT
CA2	⇒	1. G23 RCS FWD MANF VLVS 3 OVRD – ITEM 42 EXEC (CL) 2. Use L TRIM & BDY FLP sws 3. BLR CNTLR/HTR 3 – A FAILED: PLT DRAG CHUTE DPY/JETT
CA3	⇒	1. BLR CNTLR/HTR 2,3 (two) – B

CNTL
BUS
LOSS

PLT WND

FB E12-22

AESP/ALL/E/GEN O

FAB USE ONLY

HOOK

FC REAC VLV CLOSED

1. FC REAC VLV (three) – OP
2. Perform BUS TIE, then:
If FC COOL P < 50:
3. Go to FC SHUTDN

FC pH ↓ 1(2,3) or FC DELTA V 1(2,3)

If pH ↓ and FC SS 1(2,3) ΔV > 150
or FC SS ΔV > 150 and incr:

1. Perform BUS TIE, then:
 2. (Aff) FC REAC VLV – CL
 3. MSTR MADS PWR – OFF
 4. Go to LOSS OF 1(2nd) FC PWRDN >>
- If pH ↓ only:
- ◆ 5. Go to BUS TIE

FC STACK T

1. MSTR MADS PWR – OFF
- If STACK T > 243 and incr:
2. If 2nd FC: Go to 2nd FC SHUTDN >>
 3. PL PRI (three) – OFF
- If aff FC amps < 170 or > 360:
4. Go to MN BUS UNDERVOLTS/FC VOLTS,
step 4 >>
- ◆ 5. Perform BUS TIE, then:
 - 6. ESS BUS SOURCE FC – OFF
 - 7. FC/MN BUS – OFF
- If aff FC VOLTS < 32 or STACK T not decr:
8. (Aff) FC REAC VLV – CL
 9. FC – STOP after COOL P < 15 and
STACK T < 243
 10. Go to LOSS OF 1 FC PWRDN

FC

OV103,104

PLT WND (OV103,104) FB E12-23

AESP/ALL/E/GEN O

FAB USE ONLY

TOP
BACK OF 'FC REAC VLV CLOSED'

PILE

FC EXIT T

1. MSTR MADS PWR – OFF
2. Perform BUS TIE, then:

- ⇒ If EXIT T > 164 and incr or < 131 and no comm:
3. Go to FC SHUTDN

FC COOLANT PUMP ΔP LOW

1. FC – START (10 sec or ΔP tb-gray)

- ⇒ ♦ If EXIT T > 164 and not decr or
RDY tb – bp (30 sec after START) or
FC PUMP cb(s) – op (pnl L4:C):

2. Go to FC SHUTDN >>

If EXIT T norm, RDY tb – gray, and no comm:

3. Monitor AC amps
4. FC – STOP

If AMPS decr 0.7-0.9 AMP/Φ:

5. FC – START (hold 30 sec if ΔP tb-bp)

6. If AMPS incr 0.7-0.9 AMP/Φ >>

7. Go to FC SHUTDN

FC COOL P

1. Perform BUS TIE, then:

- ⇒ If COOL P < 75: >>

If COOL P incr and not 100 (H),
or FC COOL PUMP = ΔP (intermittent),
or STACK/EXIT T unstable,

2. (Aff) FC REAC VLV – CL

3. MSTR MADS PWR – OFF

4. Go to LOSS OF 1(2nd) FC PWRDN

LOSS OF 1 FC PWRDN (GRTLS/TAL)

1. PRI PL (three) – OFF

AFT PL (two) – OFF

2. IDP/CRT4 PWR – OFF

One MDU – OFF

- ⇒ If TAL:

When V < 19K:

3. MPS ENG PWR (six) – OFF

LOSS OF 1 FC PWRDN (ENTRY)

1. If V < 15K >>

2. IDP/CRT4, one MDU, FLT CNTLR PWR – OFF

3. TACAN/RA/MLS – OFF

If middeck PL on:

4. cb MNB UTIL PWR – op (pnl O15:C)

- ♦ 5. PRI PL (three) – OFF

AFT PL (two) – OFF

FC

OV103,104

PLT WND (OV103,104) FB E12-24

AESP/3,4/E/GEN O

FAB USE ONLY

HOOK

FC REAC VLV CLOSED

1. FC REAC VLV (three) – OP
2. Perform BUS TIE, then:
If FC COOL P < 50:
3. Go to FC SHUTDN

FC pH ↓ 1(2,3) or FC DELTA V 1(2,3)

If pH ↓ and FC SS 1(2,3) $\Delta V > 150$
or FC SS $\Delta V > 150$ and incr:

1. Perform BUS TIE, then:
2. (Aff) FC REAC VLV – CL
3. MSTR MADS PWR – OFF
4. Go to LOSS OF 1(2nd) FC PWRDN >>

If pH ↓ only:

- ◆ 5. Go to BUS TIE

FC STACK T

1. MSTR MADS PWR – OFF

If STACK T > 243 and incr:

2. If 2nd FC: Go to 2nd FC SHUTDN >>
3. PL PRI (three) – OFF

If aff FC amps < 170 or > 360:

4. Go to MN BUS UNDERVOLTS/FC VOLTS,
step 4 >>
 - ◆ 5. Perform BUS TIE, then:
 6. ESS BUS SOURCE FC – OFF
 7. FC/MN BUS – OFF
- If aff FC VOLTS < 32 or STACK T not decr:
8. (Aff) FC REAC VLV – CL
 9. FC – STOP after COOL P < 15 and
STACK T < 243
 10. Go to LOSS OF 1 FC PWRDN

FC

OV105

PLT WND

(OV105) FB E12-23

AESP/ALL/E/GEN O

FAB USE ONLY

TOP
BACK OF 'FC REAC VLV CLOSED'

PILE

FC EXIT T

1. MSTR MADS PWR – OFF
2. Perform BUS TIE, then:

⇒ If EXIT T > 164 and incr or < 131 and no comm:
3. Go to FC SHUTDN

FC COOLANT PUMP ΔP LOW

1. FC – START (10 sec or ΔP tb-gray)

⇒ ♦ If EXIT T > 164 and not decr or
RDY tb – bp (30 sec after START) or
FC PUMP cb(s) – op (pnl L4:C):

2. Go to FC SHUTDN >>

If EXIT T norm, RDY tb – gray, and no comm:

3. Monitor AC amps
 4. FC – STOP
- If AMPS decr 0.7-0.9 AMP/Φ:
5. FC – START (hold 30 sec if ΔP tb-bp)
 6. If AMPS incr 0.7-0.9 AMP/Φ >>
 7. Go to FC SHUTDN

FC COOL P

1. Perform BUS TIE, then:

⇒ If COOL P < 75: >>

If COOL P incr and not 100 (H),
or FC COOL PUMP = ΔP (intermittent),
or STACK/EXIT T unstable,

2. (Aff) FC REAC VLV – CL
3. MSTR MADS PWR – OFF
4. Go to LOSS OF 1(2nd) FC PWRDN >>

LOSS OF 1 FC PWRDN (GRTLS/TAL)

1. PRI PL (three) – OFF
AFT PL (two) – OFF
2. IDP/CRT4 PWR – OFF
One MDU – OFF

⇒ If TAL:

When V < 19K:

3. MPS ENG PWR (six) – OFF

LOSS OF 1 FC PWRDN (ENTRY)

1. If V < 15K >>
2. IDP/CRT4, one MDU, FLT CNTLR PWR – OFF
3. RA/MLS – OFF

If middeck PL on:

4. cb MNB UTIL PWR – op (pnl O15:C)
- ♦ 5. PRI PL (three) – OFF
AFT PL (two) – OFF

FC

OV105

PLT WND

(OV105) FB E12-24

AESP/5/E/GEN O

FAB USE ONLY

HOOK

2nd FC SHUTDOWN (GRTLS/TAL)

(CL PMP Lost: < 6 min)

1. Have CDR start LOSS OF 2nd FC PWRDN (GRTLS/TAL)

If three MN buses pwr:

2. MN BUS TIE (three) – OFF
(do not perform BUS LOSS ACTION)
3. LES O2 – OFF, visors – OP
4. Switch off all but one IDP/CRT with four MDUs
5. All PL pwr (seven) – OFF
6. O2,H2 TK HTRS (all) – OFF
7. After CDR pnl L1 config complete, continue:

If two MN buses pwr:

8. Pwr MN BUS TIES (two) – ON

If only one MN bus pwr:

9. MN BUS TIE (three) – OFF
If only MNA(B,C) pwr: Secure APU 2(3,1)
BUS TIE good FC/BUS (MNA)
I/O RESET

When reqd:

10. ESS BUS SOURCE FC – OFF
FC/MN BUS – OFF
FC – STOP (1 sec)
FC REAC VLV – CL
11. G51 √ICNCT ENA (if reqd for OMS load)
12. Go to LOSS OF 2nd FC PWRDN (GRTLS/TAL)

2nd FC SHUTDOWN (ENTRY)

1. Have CDR go to LOSS OF 2nd FC PWRDN (ENTRY)
 2. O2/H2 HTRS (twelve) – OFF (pnl R1)
PL pwr (seven) – OFF
 3. √MSTR MADS PWR – OFF
- If aff FC/MN BUS is tied:
4. MN BUS TIE (two) – OFF
 5. If only MNA(B,C) pwr: Secure APU 2(3,1)
 6. Perform BUS TIE (good FC/BUS to another BUS), then:
 7. ESS BUS SOURCE FC – OFF
FC/MN BUS – OFF
FC – STOP (1 sec)
FC REAC VLV – CL

**2FC/
CRYO**

PLT WND

FB E12-25

AESP/ALL/E/GEN O

FAB USE ONLY

TOP
BACK OF '2nd FC SHUTDOWN (GRTLS/TAL);
FACING RIGHT SIDE OF BACKBOARD

PILE

LOSS OF 2nd FC PWRDN (GRTLS/TAL)

- ⇒ ♦ When MPS Dump complete:
1. MPS ENG PWR (six) – OFF
EIU (three) – OFF
 2. MEC 1 – OFF, wait 2 sec, then
2 – OFF
- If MNA(MNB) unprwd:
3. O₂,H₂ TK1 HTRS B (two) – AUTO
- If MNC unprwd:
4. O₂,H₂ TK2 HTRS B (two) – AUTO
 5. Safe Payload, if reqd
 6. Go to APU RESTART for secured APU

O₂(H₂) CRYO P/T HIGH

O₂(H₂) TK HTRS (two) – OFF

CRYO O₂(H₂) LEAK (three or more tanks aff)

Use meter if CRT data OSL

1. O₂(H₂) MANF VLV TK1,TK2 (two) – CL
 2. O₂(H₂) TK3 HTRS A – AUTO
- ⇒ If TK1 and TK2 P decr slowly (HTR logic fail):
3. If QTY > 55%: TK3 HTRS B – AUTO
 4. MANF VLV 1,2 (two) – OP >>
 5. Perform aff MN BUS TIE, then:
- If O₂(H₂) TK1(2) aff (open unaff manf):
6. O₂(H₂) TK2(1) – OP
- If O₂ TK1(2) aff:
7. O₂ SYS 1(2) SPLY – CL
 8. If O₂ TK1(2) P now incr (PCS leak): >>
 9. If O₂ leak: (Aff) TK HTR B – AUTO
- If aff TK P not incr:
10. If TK3 aff: √HTRS A(&B if O₂) – AUTO
 11. Perform aff FC SHUTDOWN (post COOL P alarm if O₂ leak), then:
- If TK3 aff and P not decr within 2 min (FC leak):
12. MANF VLV 1,2 (two) – OP (ASAP) >>
 13. (Aff) TK HTRS A,B (two) – OFF

2FC

PLT WND

FB E12-26

AESP/ALL/E/GEN O

FAB USE ONLY

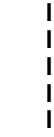
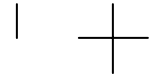
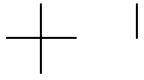

**POWERED
FLIGHT**

CDR WINDOW FLIP BOOK

POWERED FLIGHT

**CDR WINDOW
FLIP BOOK**

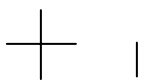

CDR WND

FB A13-i

AESP/ALL/A/GEN O

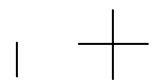

FAB USE ONLY

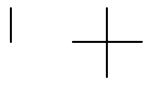
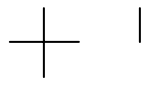

POWERED
FLIGHT



This Page Intentionally Blank

CDR WINDOW
FLIP BOOK

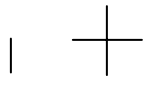
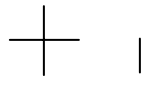

CDR WND

FB A13-ii

AESP/ALL/A/GEN O

FAB USE ONLY

TOP
FACING LEFT SIDE OF BACKBOARD

HOOK

DPS
GPC
MDM

COMM LOST (mult pnls)

1. AUD CTR – 2
2. No joy, S-BD PM CNTL – PNL,CMD
3. Config per COMM COVER (ASC) BFS G51:
TDRS – ITEM 46 EXEC (*)
STDN-HI – ITEM 47 EXEC (*)
SGLS – ITEM 49 EXEC (*)
4. No joy, sel best S-BD PM ANT; else GPC ⇒

ICOM LOST

1. AUD CNTL sel – sel alt
2. No joy, AUD CTR – 2

FCS CH 1(2,3,4) (2nd FAIL) G53

If two FCS CH ↓ on any actuator:

- ◆ (Remaining) FCS CH (two) – ORIDE

RHC L(R) (2nd FAIL)

(Aff) FLT CNTLR PWR – OFF

DISPLAY SW L(R)

L(R) disp sws – green dot

RM FAIL IMU,RGA,AA BFS G51

Aff LRU – desel

RM DLMA IMU G51 BFS G51

1. √MCC, bad IMU – desel (PASS & BFS) >>
- ◆ 2. Desel lower # IMU with '?' (PASS)

POST BFS ENGAGE

If PASS GPCs running:

1. (Aff) GPC MODE – STBY/HALT
 2. BFS I/O RESET
 3. √FCS CHs, IMU config
- If Pre MECO:
4. If SSME failed: MN ENG LIMIT SHUTDN –INH
 5. G51 DES failed(commfaulted) RGA,AA,SURF ⇒G

CDR WND

FB A13-1

AESP/ALL/A/GEN O

FAB USE ONLY

COMM
GNC
DPS
BFS

PILE

PASS GPC FAIL

1. (Aff) FCS CH – OFF
- If two GPC/FA/FCS CHs ↓:
2. (Good) FCS CHs – ORIDE
 3. √MPS CMD
 4. [G53] aff SURF FDBK – desel
 5. If FTS, ASAP, GPC MODE – STBY,HALT
 6. √BIG 'X', then assign IDPs as reqd
 7. √MULT DATA PATH LOSS
- Post MECO:
8. ASAP, GPC MODE – STBY,HALT ⇒

BFS GPC FAIL

1. Post SRB SEP: FLASH EVAP CNTLR PRI A – ON
- Post MECO:
2. GPC MODE – STBY,HALT
OUTPUT – TERM
- ◆ 3. If no comm: sel best S-BD PM ANT ⇒

FF(FA) MDM OUTPUT

FAULT

- ◆ (Take action only if annun by entire set)
- If single 'MDM OUTPUT':
1. Go to FA/FF MDM I/O ERROR >>
- If both FF and FA annun:
2. I/O RESET; if reqd, BFS I/O RESET
 3. If msgs repeat: Go to PASS GPC FAIL >>
 4. If reqd, (aff) FCS CH – ORIDE,AUTO

PL MDM I/O ERROR

1. BFS I/O RESET; if recovered >>
- ◆ 2. [G01] PL1/2 – port mode, then BFS I/O RESET;
if recovered >>
3. If PL2 down:
Post SRB SEP: FLASH EVAP CNTLR PRI A – ON
If no comm: sel best S-BD PM ANT ⇒

PCM I/O ERROR

OI PCMMU PWR – 2

SUMWORD ICC

- If TAL:
1. Go to OPS 1/6/TAL TRANSITION RESTRING (Cue Card)
for aff GPC >>
- If AOA/Uphill: ⇒A

CDR WND

FB A13-2

AESP/ALL/A/GEN O

FAB USE ONLY



FA/FF MDM I/O ERROR
(Annunciated by entire set)

	FA	1. (Aff) FCS CH – OFF
		◆ 2. I/O RESET
RECOV	FA	3. (Aff) FCS CH – AUTO
		4. BFS I/O RESET >>
NOT RECOV	FA	5. If two GPC/FA/FCS CHs ↓: (Good) FCS CHs – ORIDE
		6. G53 aff SURF FDBK – desel
		7. √MULT DATA PATH LOSS
		◆ 8. Go to FA/FF MDM PORT MODE ⇒

**BCE
MDP**

FA/FF MDM PORT MODE

NOTE

If BFS, 'BCE STRG X PASS', @GPC; else @MDM.
For '@GPC' port mode results in alternate MDM bypass

			1. G01 aff String – port mode
			2. BFS I/O RESET
@MDM	RECOV	FA	3. (Aff) FCS CH – AUTO
			4. G53 aff SURF FDBK – resel >>
		FF	5. >>
	NOT RECOV	FA	6. BFS G51 aff SURF FDBK, RGA – desel
		FF	7. BFS G51 aff AA – desel
			8. √MULT DATA PATH LOSS ⇒
@GPC	FA RECOV (FF Give Up)		9. (Aff) FCS CH – AUTO
			10. G51 aff IMU – desel
			11. G53 aff SURF FDBK – resel
			12. √MULT DATA PATH LOSS ⇒A
	FF RECOV (FA Give Up)		13. (Aff) FCS CH – OFF
			14. If two GPC/FA/FCS CHs ↓: (Good) FCS CHs – ORIDE
			15. G53 aff SURF FDBK – desel
			16. √MULT DATA PATH LOSS ⇒A

PILE

DPS
GPC
MDM

BCE STRG X (no 'MDM OUTPUT' msg)

	IMU	1. G51 IMU – desel
		2. I/O RESET
RECOV	IMU	3. >>
		4. >>
NOT RECOV	NSP	5. And no comm: PNL,CMD
		6. BFS G51 Config per COMM COVER (ASC): TDRS – ITEM 46 EXEC (*) STDN-HI – ITEM 47 EXEC (*) SGLS – ITEM 49 EXEC (*) >>
		◆ 7. G01 aff String – port mode
		8. BFS I/O RESET
		9. If recov, go to RECOV steps >>
	B	10. BFS G51 aff AA – desel
	D	11. BFS G51 aff SURF FDBK,RGA – desel
	B/D	12. If RTLS: G23 OVRD aff MANF(s) – OP
		13. √MULT DATA PATH LOSS ⇒

DUAL DPS DISPLAY COMMANDERS/DK XMTR 1(2,3)

1. BFC CRT SEL – aff IDP
If reqd to clean up display:
2. (Aff) IDP/CRT PWR – OFF,ON

PASS DISPLAY FAIL

1. MDU PWR – OFF,ON; if recovered >>
2. GPC/CRT – same GPC/aff IDP; if recovered >>
3. BFC CRT SEL – aff IDP; if both IDPs OK go to step 9
4. – orig posn
5. Report MDU symptoms
- If MCC GO for pwr cycle:
6. IDP/CRT PWR – OFF,ON; if recovered >>
- If MDU blank or autonomous:
7. Set other MDU on same IDP to DPS Mode; if recovered >>
8. Return other MDU to nominal config
9. Deassign aff IDP from PASS
10. GPC/CRT 04 EXEC
11. In PASS: GPC/CRT 44 EXEC

CDR WND

FB A13-4

AESP/ALL/A/GEN O

FAB USE ONLY

HOOK

BFS DISPLAY FAIL

1. If IDP4(CRT4): IDP/CRT4 PWR – OFF >>
 2. MDU PWR – OFF,ON; if recovered >>
 3. BFC CRT SEL – unaff IDP; if both IDPs OK >>
 4. – orig posn
 5. BFC CRT DISPLAY – OFF,ON; if recovered >>
 6. In PASS: GPC/CRT 5/X for aff IDP; if recovered >>
 7. Report MDU symptoms
- If MCC GO for pwr cycle:
8. IDP/CRT PWR – OFF,ON; if recovered >>
- If MDU blank or autonomous:
9. Set other MDU on same IDP to DPS Mode; if recovered >>
 10. Return other MDU to nominal config
11. BFC CRT SEL – unaff IDP
 12. Deassign aff IDP from PASS
 13. GPC/CRT 04 EXEC
 14. In PASS: GPC/CRT 44 EXEC

CDR WND

FB A13-5

AESP/ALL/A/GEN O

FAB USE ONLY

TOP
BACK OF 'BFS DISPLAY FAIL'

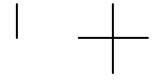
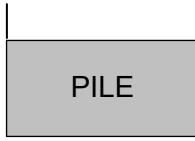

This Page Intentionally Blank



CDR WND

FB A13-6

AESP/ALL/A/GEN O

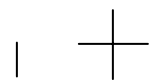

FAB USE ONLY



FLT INST DISPLAY ANOMALY

1. DATA BUS sel alt FC BUS(s); if recovered >>
2. PORT SELECT aff MDU; if recovered >>
3. MDU PWR – OFF,ON

SUBSYS STATUS DISPLAY ANOMALY

1. PORT SELECT aff MDU; if recovered >>
2. MDU PWR – OFF,ON; if recovered >>

BFS INADVERTENT DISENGAGE/UNSUCCESSFUL ENGAGE (Lightning Strike)

1. CDR and PLT RHC BFS engage pb – push
If no response:
 2. BFS OUTPUT – NORM,B/U
 3. CDR,PLT RHC BFS engage pb – push

**CAB P
ECLSS
FREON**

MULT DATA PATH LOSS (non-Recov)

NOTE

If LRU data path loss due to GPC prob and not MDM,
BFS will pick up MDMs/LRU when engaged

FAILURE	TYPE	ACTIONS
GPC/FA any combo	I/O	D √BFS MM at each transition Expect 'SEP INH' (FDLN Fail) combos 2&3,2&4
		√OMS MAN SHUTDOWN Post MECO: Before MECO + 25 sec: •• 1. MPS FDLN RLF ISOL (two) – OP 2. MPS PREVLVs (six) – OP RTLS/TAL: MPS FILL/DRAIN LH2 INBD, OUTBD – OP
GPC/FF 1&2	I/O or B	Use R BODY FLAP & TRIM ENA SWs
GPC/FF 3&4	I/O or B	Use L BODY FLAP & TRIM ENA SWs

TOP
BACK OF 'FLT INST DISPLAY ANOMALY'

PILE

CAB PRESS LEAK

1. CAB RELIEF A – CL,pause,
B – CL
2. Check tabs, visors – CL, LES O2 – ON
3. If RTLS/TAL: O2/N2 CNTLR VLV SYS 2 – OP
4. O2 TK1,TK2 HTRS A,B (four) – AUTO ⇒

CAB PRESS HIGH

1. If incr: LES O2 – OFF, visors – OP
If still incr:
 2. N2 SYS 1,2 REG INLET (two) – CL
 3. O2 SYS 1,2 SPLY (two) – CL ⇒A

**BCE
MDP**

PPO2 ABNORMAL ⇒A

H2O LOOP PRESS HIGH

◆ Deact pump ⇒

H2O LOOP PRESS LOW ⇒

AV BAY FAN ΔP

◆ Deact fan ⇒

AV BAY TEMP HIGH ⇒

CABIN FAN FAIL ⇒

IMU FAN FAIL ⇒

CDR WND

FB A13-8

AESP/ALL/A/GEN O

FAB USE ONLY

HOOK

FREON FLOW LOW

- ◆ 1. Switch pumps
- If flow still low:
 - 2. (Aff) RAD BYP VLV MAN SEL – RAD FLOW
(hold 5 sec)
- If flow still low:
 - 3. Perform LOSS OF FREON LOOP(s), then ⇒A

LOSS OF 1 FREON LOOP

- 1. (Bad) FREON PUMP LOOP – OFF
- If FREON LOOP 1(2) lost:
 - 2. O2 SYS 1(2) SPLY (one) – CL
 - 3. √FLOW PROP VLV LOOP 2(1) – ICH
- 4. Monitor EVAP OUT TEMP
- If TAL/AOA/RTLs and LOOP 2 lost:
 - 5. NH3 CNTLR B – OFF
A – PRI/GPC

LOSS OF 2 FREON LOOPS – PWRDN

- 1. When loops fail (flow <700), CDR execute LOOPS
FAILED
- 2. MSTR MADS PWR – OFF
- 3. Use one IDP/CRT with two MDUs (three max)
- 4. All PL pwr (seven) – OFF
- 5. O2,H2 TK HTRS (all) – OFF
- 6. MCC CMD FC purge, then BFS GPC – STBY,HALT
PWR – OFF
OUTPUT – NORM
- 7. If no comm: sel best S-BD PM ANT
- Post MECO:
 - If RTLs:
 - 8. TACAN (three) – OFF
 - 9. RDR ALTM 1 – OFF ⇒G
 - If TAL:
 - 10. All TACAN/RA – OFF
 - 11. Use one FLT CNTLR PWR ⇒G

EVAP
ESS**LOSS OF 2 FREON LOOPS – LOOPS FAILED**

- 1. LES O2 – OFF, visor – OP
- 2. O2 SYS 1,2 SPLY (two) – OP
- Panel L1: All sws off, except:
 - 3. H2O PUMP LOOP 2 – ON
- 4. Perform PWRDN if not already accomplished

OV103,104

CDR WND (OV103,104) FB A13-9

AESP/3,4/A/GEN O

FAB USE ONLY

TOP
BACK OF 'FREON FLOW LOW'

PILE

EVAP OUT TEMP HIGH

If temp high in only one loop (snsr failed) >>

1. FLASH EVAP CNTLR PRI A – OFF
B – ON (wait 30 sec)
If T decr >>
2. FLASH EVAP CNTLR PRI B – OFF
SEC – ON (HI LOAD ena)
(wait 30 sec)
If T decr:
 3. TOP EVAP HTR DUCT sel – A/B >>
4. HI LOAD EVAP – OFF (wait 30 sec)
If T decr (HI LOAD EVAP only lost):
 5. HI LOAD DUCT HTR sel – A/B ⇒A
6. RAD BYP VLV (four) – MAN, RAD FLOW
(total FES lost) ⇒A

EVAP OUT T LOW

1. If temp low in only one loop (snsr failed) >>
 2. FREON PUMP LOOP 1,2 (two) – OFF
 3. H2O PUMP LOOP 1 (two) – ON,B
 4. FLOW PROP VLV LOOP 1,2 (two) – PL HX (tb-PL)
 5. O2 SYS 1,2 SPLY (two) – CL (tb-CL)
 6. √RAD BYP VLV MODE (two) – MAN
 7. √MAN SEL (two) – BYP (tb-BYP ~3 sec)
 8. FLASH EVAP CNTLR PRI A,B,SEC (three) – OFF
 - ◆ 9. FREON PUMP LOOP 1,2 (two) – B
NH3 CNTLR A,B (two) – SEC/ON
- Wait 3 min, then if any Freon Loop off:
10. FREON PUMP LOOP 1,2 (two) – B
- When EVAP OUT T > 55 for at least 2 min (NH3 depleted):
11. FLASH EVAP CNTLR PRI B – ON
 12. O2 SYS 1,2 SPLY (two) – OP (tb-OP)
 13. NH3 CNTLR A,B (two) – OFF

FREON LEAK

- ◆ 1. FREON ISOL MODE – MAN
 2. (Aff) FREON ISOL LOOP 1(2) – ISOL
Hold for 5 sec
- If (aff) FREON LOOP 1(2) ACCUM QTY decr:
3. When loop fails ('SM2 FREON FLOW 1(2)'), CDR
execute LOSS OF 1 FREON LOOP for (aff) Freon
Loop ⇒
- If (aff) FREON LOOP 1(2) ACCUM QTY not decr, ⇒A

CAB P
ECLSS
FREON

OV103,104

CDR WND (OV103,104) FB A13-10 AESP/ALL/A/GEN O,2

FAB USE ONLY

HOOK

FREON FLOW LOW

- ◆ 1. Switch pumps
- If flow still low:
 - 2. (Aff) RAD BYP VLV MAN SEL – RAD FLOW
(hold 5 sec)
- If flow still low:
 - 3. Perform LOSS OF FREON LOOP(s), then ⇒A

LOSS OF 1 FREON LOOP

- 1. (Bad) FREON PUMP LOOP – OFF
- If FREON LOOP 1(2) lost:
 - 2. O2 SYS 1(2) SPLY (one) – CL
 - 3. √FLOW PROP VLV LOOP 2(1) – ICH
- 4. Monitor EVAP OUT TEMP
- If TAL/AOA/RTLS and LOOP 2 lost:
 - 5. NH3 CNTLR B – OFF
A – PRI/GPC

LOSS OF 2 FREON LOOPS – PWRDN

- 1. When loops fail (flow <700), CDR execute LOOPS
FAILED
- 2. MSTR MADS PWR – OFF
- 3. Use one IDP/CRT with two MDUs (three max)
- 4. All PL pwr (seven) – OFF
- 5. O2,H2 TK HTRS (all) – OFF
- 6. MCC CMD FC purge, then BFS GPC – STBY,HALT
PWR – OFF
OUTPUT – NORM
- 7. If no comm: sel best S-BD PM ANT
- Post MECO:
 - 8. GPS 1,3 (two) – OFF
 - If RTLS:
 - 9. RDR ALTM 1 – OFF ⇒G
 - If TAL:
 - 10. RA 1,2 (two) – OFF
 - 11. Use one FLT CNTLR PWR ⇒G

EVAP
ESS**LOSS OF 2 FREON LOOPS – LOOPS FAILED**

- 1. LES O2 – OFF, visor – OP
- 2. O2 SYS 1,2 SPLY (two) – OP
- Panel L1: All sws off, except:
 - 3. H2O PUMP LOOP 2 – ON
- 4. Perform PWRDN if not already accomplished

OV105

CDR WND

(OV105) FB A13-9

AESP/5/A/GEN O

FAB USE ONLY

TOP
BACK OF 'FREON FLOW LOW'

PILE

EVAP OUT TEMP HIGH

If temp high in only one loop (snsr failed) >>

1. FLASH EVAP CNTLR PRI A – OFF
B – ON (wait 30 sec)
If T decr >>
2. FLASH EVAP CNTLR PRI B – OFF
SEC – ON (HI LOAD ena)
(wait 30 sec)
If T decr:
3. TOP EVAP HTR DUCT sel – A/B >>
4. HI LOAD EVAP – OFF (wait 30 sec)
If T decr (HI LOAD EVAP only lost):
5. HI LOAD DUCT HTR sel – A/B ⇒A
6. RAD BYP VLV (four) – MAN, RAD FLOW
(total FES lost) ⇒A

EVAP OUT T LOW

1. If temp low in only one loop (snsr failed) >>
 2. FREON PUMP LOOP 1,2 (two) – OFF
 3. H2O PUMP LOOP 1 (two) – ON,B
 4. FLOW PROP VLV LOOP 1,2 (two) – PL HX (tb-PL)
 5. O2 SYS 1,2 SPLY (two) – CL (tb-CL)
 6. √RAD BYP VLV MODE (two) – MAN
 7. √MAN SEL (two) – BYP (tb-BYP ~3 sec)
 8. FLASH EVAP CNTLR PRI A,B,SEC (three) – OFF
 - ◆ 9. FREON PUMP LOOP 1,2 (two) – B
NH3 CNTLR A,B (two) – SEC/ON
- Wait 3 min, then if any Freon Loop off:
10. FREON PUMP LOOP 1,2 (two) – B
- When EVAP OUT T > 55 for at least 2 min (NH3 depleted):
11. FLASH EVAP CNTLR PRI B – ON
 12. O2 SYS 1,2 SPLY (two) – OP (tb-OP)
 13. NH3 CNTLR A,B (two) – OFF

FREON LEAK

- ◆ 1. FREON ISOL MODE – MAN
 2. (Aff) FREON ISOL LOOP 1(2) – ISOL
Hold for 5 sec
- If (aff) FREON LOOP 1(2) ACCUM QTY decr:
3. When loop fails ('SM2 FREON FLOW 1(2)'), CDR
execute LOSS OF 1 FREON LOOP for (aff) Freon
Loop
- If (aff) FREON LOOP 1(2) ACCUM QTY not decr, ⇒A

CAB P
ECLSS
FREON

OV105

CDR WND

(OV105) FB A13-10

AESP/ALL/A/GEN O,2

FAB USE ONLY

HOOK

ESS BUS LOSS

ESS 1BC	O13&R14	1. L AUD CNTL sel – R (CDR can't talk) 2. Pri C/W & F7 Matrix lost ⇒A 3. ⇒A
ESS 2CA	O13&R14	1. AUD CTR – 2 2. R AUD CNTL sel – L (PLT can't talk) ⇒A 3. ⇒A
ESS 3AB	O13	1. GPC CAM Lights lost 2. Do not engage BFS ⇒

LOSS OF 2nd FC PWRDN

1. LES O2 – OFF, visors – OP
2. L1: Select one FREON PUMP on good FC/MN BUS and place other pump to OFF
Switch OFF all HUM SEPS, IMU FANS, H2O PUMPS, AV BAY FANS, CAB FANS, FES HTRS
3. Switch off all but one IDP/CRT with four MDUs
After BUS TIE, if MNC unpwrn:
4. FLASH EVAP CNTLR PRI A – OFF
B – ON
5. ⇒ LOSS OF 2nd FC PWRDN

**MN
AC
CNTL
FWD**

CDR WND

FB A13-11

AESP/ALL/A/GEN O

FAB USE ONLY

TOP
BACK OF 'ESS BUS LOSS'

PILE

MNA

Post SRB SEP:

- ◆ 1. TOP EVAP HTR DUCT sel – B
- 2. HI LOAD DUCT HTR sel – B
- 3. BFS G51 AA1 – desel ⇒
- 4. MS AUD CNTL – PS (MS can't talk)

FAILED: UHF HI PWR XMIT

MNB

Post SRB SEP:

BFS G51 AA2, RGA 2 – desel ⇒

FAILED: S-BD PM 1 (NO PNL,CMD)

MNC

Post SRB SEP:

- 1. FLASH EVAP CNTLR PRI A – OFF, B – GPC
- 2. BFS G51 RGA 3 – desel ⇒

ANY AC BUS LOSS ⇒

SUBBUS [MNA O14] ⇒G

SUBBUS [APC6 or ALC3]

- 1. FLASH EVAP CNTLR PRI A – OFF, B – GPC

CNTL BUS LOSS

AB1	1. TOP EVAP HTR DUCT sel – B 2. HI LOAD DUCT HTR sel – B ⇒
AB2	1. TOP EVAP HTR DUCT sel – B 2. HI LOAD DUCT HTR sel – B ⇒
AB3	1. TOP EVAP HTR DUCT sel – B 2. HI LOAD DUCT HTR sel – B If BFS engage reqd: 3. Use PLT's RHC, then GPCs 1,2,4 - STBY,HALT 4. BFS I/O RESET 5. ⇒
BC1	BFS G51 RGA 2 – desel ⇒
BC2	⇒
BC3	⇒
CA1	1. No BFS engage Post SRB SEP: 2. FLASH EVAP CNTLR PRI A – ON 3. BFS G51 RGA 3 – desel ⇒
CA2	⇒

EVAP
ESS

CDR WND

FB A13-12

AESP/ALL/A/GEN O

FAB USE ONLY

HOOK

FWD RCS LK

(check He P decr: CRT and meter)
 (check TK P; if '↑': Go to TK P HIGH >>)

RTLS	1. Perform RCS SECURE, then: 2. Post PPD – reopen RCS Post ET SEP -Z transl: 3. Go to RCS SECURE >>
Pre ET SEP (N/A RTLS)	4. ET SEP – MAN 5. MPS PRPLT DUMP SEQ – STOP 6. Perform RCS SECURE, then:
Single MANF leak	7. Reopen RCS, except bad MANF 8. ET SEP – AUTO Post ET SEP -Z transl: 9. MPS PRPLT DUMP SEQ – GPC >>
TK leg leak (two MANF P Low)	10. Reopen RCS, except bad leg 11. ET SEP – AUTO Post ET SEP -Z transl: 12. MPS PRPLT DUMP SEQ – GPC >>
PRPLT TK P decr	
Post MECO	13. RATE DAMP with ARCS 14. Reopen FRCS
TK P > 200 & QTY > 0%	15. ET SEP – AUTO
TK P < 200 or QTY = 0%	16. Perform RCS SECURE, then: 17. DAP – INRTL, PITCH – PULSE 18. ET SEP pb – SEP 19. THC -Z (UP) (2 sec; -1.25°/sec) 20. THC -X (OUT) and hold
At SEP (SEP init + approx 12 sec)	21. THC +Z (DOWN) (3 sec; +0.3°/sec) THC -Z (UP) (2 sec; -0.9°/sec) COAST (5 sec) THC +X (IN) (20 sec) After 10 sec of +X, then: PITCH – DISC RATE
Otherwise: (He TK or He leg)	22. OPS 104 PRO, DAP – AUTO Post MECO: 23. Reopen RCS 24. ET SEP – AUTO
Post ET SEP -Z transl	25. MPS PRPLT DUMP SEQ – GPC 26. Go to RCS SECURE

CDR WND

FB A13-13

AESP/ALL/A/GEN O

FAB USE ONLY

TOP
BACK OF 'FWD RCS LK'

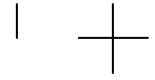
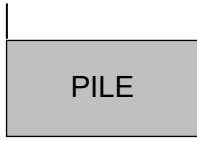

PILE

This Page Intentionally Blank

MN
AC
CNTL

FWD



CDR WND

FB A13-14

AESP/ALL/A/GEN O

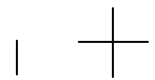

FAB USE ONLY

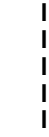
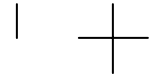
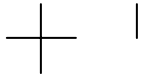

**GLIDED
FLIGHT**

CDR WINDOW FLIP BOOK

GLIDED FLIGHT

**CDR WINDOW
FLIP BOOK**



CDR WND

FB E13-i

AESP/ALL/E/GEN O

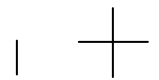
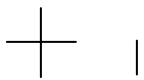

FAB USE ONLY

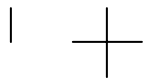
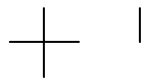

GLIDED
FLIGHT



This Page Intentionally Blank

CDR WINDOW
FLIP BOOK



CDR WND

FB E13-ii

AESP/ALL/E/GEN O

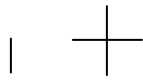
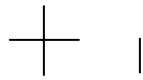

FAB USE ONLY

TOP

HOOK

GNC

COMM LOST (mult pnls)

1. AUD CTR – 2

No comm (check UHF sites):

2. S-BD PM CNTL – PNL,CMD (pnl C3)

3. Config per COMM COVER (ASC) BFS G51:

TDRS – ITEM 46 EXEC (*)

STDN-HI – ITEM 47 EXEC (*)

SGLS – ITEM 49 EXEC (*)

If * not next to selected config:

4. Config pnl A1 per Comm Coverage

(ASC/ENT PKT, COMM)

S-BD PM CNTL – PNL,CMD (pnl C3)

No comm:

5. Sel best S-BD PM ANT

No comm:

6. S-BD PM ANT – GPC

ICOM LOST

1. AUD CNTL sel – sel alt

No ICOM:

2. AUD CTR – 2

CDR WND

FB E13-1

AESP/ALL/E/GEN O

FAB USE ONLY

TOP
BACK OF 'COMM LOST (mult pnls)'



COMM

FCS CH 1(2,3,4) (2nd FAIL) [G53]

If two FCS CH ↓ on any actuator:

- ◆ (Remaining) FCS CH (two) – ORIDE

RHC L(R) (2nd FAIL)

[GNC SYS SUMM 1]

(Aff) FLT CNTLR PWR – OFF

G51 ROLL MODE SW [G51]

If ROLL MODE ≠ sw pos:

AUTO SEL – ITEM 42 EXEC

DISPLAY SW L(R)

L(R) disp sws – green dot

RM FAIL IMU, RGA, AA [BFS G51]

Aff LRU – desel

RM DLMA IMU [G51] [BFS G51]

- 1. √MCC, bad IMU – desel (PASS & BFS) >>
- ◆ 2. Desel lower # IMU with '?' (PASS)

RM FAIL ADTA [G51]

- ◆ 1. √BFS [GNC SYS SUMM 1]
- 2. If '↓' for aff ADTA >>
- 3. If accessible, (bad) ADTA cb – op >>
- 4. BFS, ADTA to G&C – INH

RM DLMA ADTA * [G51]

M < 2.0		1. Fly Theta limits
ADTA data agrees		2. Desel, resel one ADTA 3. If no '?' >>
Bad probe		4. Stow bad probe >>
Bad ADTA	ADTA cb accessible	◆ 5. (Bad) ADTA cb – op >>
	ADTA cb not accessible	◆ 6. DES bad ADTA 7. √BFS [GNC SYS SUMM 1] 8. If '↓' for aff ADTA >> 9. BFS, ADTA to G&C – INH
Dilemma not resolved		10. ADTA to G&C – INH (PASS & BFS)

*If three ADTAs failed:
ADTA to G&C – INH (PASS)
Fly Theta limits

CDR WND

FB E13-2

AESP/ALL/E/GEN O

FAB USE ONLY

HOOK

RM FAIL TAC [G50]

(RM LIMITS: 6 DEG, 0.5 NM)

1. If data good: desel, resel aff TACAN >>
2. If failure verified: desel failed TACAN in BFS

RM DLMA TAC [G50]

Do not desel or resel while in 'TEST'

1. If both data good: desel, resel one TACAN in DLMA >>
2. √TACAN MODE (three) – GPC
3. If 'RM FAIL TAC': desel failed TACAN in BFS >>
4. If continuous 'TEST': TACAN MODE (three) – T/R
If bad TACAN identified:
 5. Desel bad TACAN (PASS, √BFS)

DPS
GPC
MDM**SPD BRK** [G51] [BFS G51]

M>5.0	◆ WRAP MODE – INH
M≤5.0	WRAP MODE – INH √MCC for energy mgmt procs

G55 GPS FAIL 2 [G50] [BFS G50]

GPS to NAV INH – ITEM 43 EXEC (PASS, √BFS)

NO UPDATE GPS [G55]

√MCC

If ALT < 300kft and ALT > 180kft

No Update due to plasma, reevaluate at ALT < 180kft

Else

INIT – ITEM 15 EXEC

NAV – ITEM 18 EXEC

OV103,104

CDR WND (OV103,104) FB E13-3

AESP/3,4/E/GEN O

FAB USE ONLY

PILE

GNC

PASS GPC FAIL

1. (Aff) FCS CH – OFF
2. If two GPC/FA/FCS CHs ↓: (Good) FCS CHs – ORIDE
3. GPC MODE – STBY,HALT
4. [G53] aff SURF FDBK – desel
- ⇒ 5. If String 1(2): CDR(PLT) disp sws – green dot
NWS – 2
6. √MULT DATA PATH LOSS

BFS GPC FAIL

1. GPC MODE – STBY,HALT
- ◆ 2. OUTPUT – TERM
⇒ MODE – STBY
3. If BFS cannot drive an IDP:
GPC MODE – HALT, then go to step 8
4. If BFS currently in OPS 3 or 6:
Go to step 7
5. If BFS currently in OPS 1:
PRO to OPS 106
BFS, OPS 000 PRO
PRO to OPS 304
6. If BFS in desired MM (304):
BFS [G50] √BFS R/W sel
GPC MODE – RUN
OUTPUT – B/U
Advise MCC BFS in BACKUP >>
7. √GPC MODE – STBY (BFS is SM Only)
8. If no comm: sel best S-BD PM ANT
9. MPS He ISOL B (three) – CL
PNEU He ISOL – CL
10. If AOA/GRTLS/TAL < 120K:
NH3 CNTLR B – SEC/ON

FA/FF MDM I/O ERROR

(Annunciated by entire set)

	FA	1. (Aff) FCS CH – OFF
		◆ 2. I/O RESET
RECOV	FA	3. (Aff) FCS CH – AUTO
	FF 1,2,3	◆ 4. [G51] IMU – resel
		5. BFS I/O RESET >>
NOT RECOV	FA	6. If two GPC/FA/FCS CHs ↓: (Good) FCS CHs – ORIDE
		7. [G53] aff SURF FDBK – desel
		8. √MULT DATA PATH LOSS
		⇒ ◆ 9. Go to FA/FF MDM PORT MODE ⇒

OV103,104

CDR WND (OV103,104) FB E13-4 AESP/ALL/E/GEN O,4

FAB USE ONLY

HOOK

RM FAIL TAC [G50]

(RM LIMITS: 6 DEG, 0.5 NM)

1. If data good: desel, resel aff TACAN >>
2. If failure verified: desel failed TACAN in BFS

RM DLMA TAC [G50]

Do not desel or resel while in 'TEST'

1. If both data good: desel, resel one TACAN in DLMA >>
2. \sqrt TACAN MODE (three) – GPC
3. If 'RM FAIL TAC': desel failed TACAN in BFS >>
4. If continuous 'TEST': TACAN MODE (three) – T/R
If bad TACAN identified:
 5. Desel bad TACAN (PASS, \sqrt BFS)

DPS
GPC
MDM**SPD BRK** [G51] [BFS G51]

M>5.0	◆ WRAP MODE – INH
M≤5.0	WRAP MODE – INH \sqrt MCC for energy mgmt procs

G55 GPS FAIL 1(2,3) [G50] [BFS G50]Aff LRU – desel (PASS, \sqrt BFS)**RM DLMA GPS** [G50] [BFS G50]

- ◆ 1. \sqrt MCC, bad GPS – desel (PASS, \sqrt BFS) >>
2. If 300kft > ALT > 180kft
DLMA due to plasma
Reevaluate when ALT < 180kft
Else
 3. Desel GPS with highest P1 σ
If P1 σ values are equal, desel highest number LRU
If DLMA not resolved
 4. Desel GPS with next highest P1 σ

NO UPDATE GPS [G55]

1. \sqrt MCC, bad GPS – desel (PASS, \sqrt BFS) >>
2. If RM DLMA GPS message, see RM DLMA GPS >>
3. If 300kft > ALT > 180kft
No Update due to plasma
Reevaluate when ALT < 180kft
Else
 4. Initialize GPS with highest P1 σ
INIT – ITEM 14(15,16) EXEC
NAV – ITEM 17(18,19) EXEC
May take up to 2 minutes for GPS to provide SV

OV105

CDR WND

(OV105) FB E13-3

AESP/5/E/GEN O

FAB USE ONLY

PILE

GNC

PASS GPC FAIL

1. (Aff) FCS CH – OFF
2. If two GPC/FA/FCS CHs ↓: (Good) FCS CHs – ORIDE
3. GPC MODE – STBY,HALT
4. [G53] aff SURF FDBK – desel
- ⇒ 5. If String 1(2): CDR(PLT) disp sws – green dot
NWS – 2
6. √MULT DATA PATH LOSS

BFS GPC FAIL

1. GPC MODE – STBY,HALT
- ◆ 2. OUTPUT – TERM
- ⇒ 3. MODE – STBY
3. If BFS cannot drive an IDP:
GPC MODE – HALT, then go to step 8
4. If BFS currently in OPS 3 or 6:
Go to step 7
5. If BFS currently in OPS 1:
PRO to OPS 106
BFS, OPS 000 PRO
PRO to OPS 304
6. If BFS in desired MM (304):
BFS [G50] √BFS R/W sel
GPC MODE – RUN
OUTPUT – B/U
Advise MCC BFS in BACKUP >>
7. √GPC MODE – STBY (BFS is SM Only)
8. If no comm: sel best S-BD PM ANT
9. MPS He ISOL B (three) – CL
PNEU He ISOL – CL
10. If AOA/GRTLS/TAL < 120K:
NH3 CNTLR B – SEC/ON

FA/FF MDM I/O ERROR

(Annunciated by entire set)

	FA	1. (Aff) FCS CH – OFF
		◆ 2. I/O RESET
RECOV	FA	3. (Aff) FCS CH – AUTO
	FF 1,2,3	◆ 4. [G51] IMU – resel
		5. BFS I/O RESET >>
NOT RECOV	FA	6. If two GPC/FA/FCS CHs ↓: (Good) FCS CHs – ORIDE
		7. [G53] aff SURF FDBK – desel
		8. √MULT DATA PATH LOSS
		⇒ ◆ 9. Go to FA/FF MDM PORT MODE ⇒

OV105

CDR WND

(OV105) FB E13-4

AESP/ALL/E/GEN O,4

FAB USE ONLY



FA/FF MDM PORT MODE

NOTE

If BFS, 'BCE STRG X PASS', @GPC; else @MDM.
 For '@GPC' port mode results in alternate MDM bypass

			1. G01 aff String – port mode 2. BFS I/O RESET
@MDM	RECOV	FA	3. (Aff) FCS CH – AUTO 4. G53 aff SURF FDBK – resel >>
		FF 1,2,3	◆ 5. G51 IMU – resel >>
	NOT RECOV		⇒ If MCC GO for pwr cycle: 6. (Aff) FA/FF MDM – OFF,ON 7. I/O RESET 8. If recov, go to @MDM RECOV >> 9. (Aff) MDM – OFF
		FA	10. BFS G51 aff SURF FDBK, RGA – desel
		FF	11. BFS G51 aff AA – desel 12. FF 1(2): CDR(PLT) disp sws – green dot NWS – 2
			13. √MULT DATA PATH LOSS >>
@GPC	FA RECOV (FF Give Up)		14. (Aff) FCS CH – AUTO 15. G53 aff SURF FDBK – resel 16. FF 1(2): CDR(PLT) disp sws – green dot NWS – 2
			17. √MULT DATA PATH LOSS >>
	FF RECOV (FA Give Up)		18. (Aff) FCS CH – OFF 19. If two GPC/FA/FCS CHs ↓: (Good) FCS CHs – ORIDE 20. G53 aff SURF FDBK – desel
		FF 1,2,3	◆ 21. G51 IMU – resel
			22. √MULT DATA PATH LOSS >>

**DPS
BCE**

PILE

FAULT

FF(FA) MDM OUTPUT

- ◆ (Take action only if annun by entire set)
If single 'MDM OUTPUT':
 1. If 'FF MDM OUTPUT':
 - ◆ **G51** aff IMU – desel
 2. Go to FA/FF MDM I/O ERROR >>
- If both FF and FA annun:
 3. **G51** aff IMU – desel
 4. I/O RESET; if reqd, BFS I/O RESET
 5. If msgs repeat: Go to PASS GPC FAIL >>
 6. If reqd, (aff) FCS CH – ORIDE,AUTO
- ◆ **G51** IMU – resel

DPS
GPC
MDM

PL MDM I/O ERROR

1. BFS I/O RESET; if recovered >>
2. **G01** PL1/2 – port mode, then BFS I/O RESET;
if recovered >>
3. If PL1 ↓ and pre MM305: FLASH EVAP CNTLR
PRI B – ON
4. If PL2 ↓ and no comm: sel best S-BD PM ANT
5. If PL2 ↓ and AOA/GRTL/TAL < 120K:
⇒ NH3 CNTLR B – SEC/ON

PCM I/O ERROR

OI PCMMU PWR – 2(1)

POST BFS ENGAGE

If PASS GPCs running:

1. (Aff) GPC MODE – STBY/HALT
2. BFS I/O RESET
3. √FCS CHs, IMU config

⇒ If Air Data not analyzed:

4. **G50** INH AD to G&C
5. M = 5: Deploy, evaluate probes one at a time
6. √AD to G&C by M = 1.5

If failed ADTA(s) in PASS:

7. cb(s) ADTA – op, or stow probe
8. **G51** DES failed(commfaulted) RGA,AA,SURF
9. **G50** DES failed TAC

At $M \leq 2.7$:

10. CDR TRIM PNL – OFF
RHC/PNL – ENA

At H = 3K:

11. SPDBK – MAN (check DEL PAD setting)

At MAIN GEAR TD:

12. SPDBK – 100%

CDR WND

FB E13-6

AESP/ALL/E/GEN O

FAB USE ONLY



BCE STRG X (no 'MDM OUTPUT' msg)

	IMU	1. G21 √IMU OPER, if STBY >>
		2. I/O RESET
RECOV	IMU	3. G21 √att ANG, if delta > 1° >> ♦ 4. G51 IMU – resel >>
		5. >>
NOT RECOV	NSP	6. And no comm: PNL,CMD 7. BFS G51 Config per <u>COMM COVER</u> (ASC): TDRS – ITEM 46 EXEC (*) STDN-HI – ITEM 47 EXEC (*) SGLS – ITEM 49 EXEC (*) >>
		8. G01 aff String – port mode 9. BFS I/O RESET 10. If recov, go to RECOV steps >>
A(B,C,D, IMU)	⇒	11. FF A(B,IMU) or FA C(D) MDM – OFF,ON 12. I/O RESET 13. If FA, (aff) FCS CH – ORIDE,AUTO 14. If recov, go to RECOV steps
	C(D)	15. If < 3Y,2P jets/pod/dir: a. G23 aff jet DES INH (*) (reprioritize) b. Aff MANF VLVS STAT OP – OVRD
	1A(2A)	16. CDR(PLT) disp sws – green dot
	B	17. BFS G51 aff AA – desel
	D	18. BFS G51 aff SURF FDBK,RGA – desel
		19. √MULT DATA PATH LOSS >>

**DPS/
MDP
CAB P
ECLS**

DUAL DPS DISPLAY COMMANDERS/DK XMTR 1(2,3)

1. BFC CRT SEL – aff IDP
If reqd to clean up display:
2. (Aff) IDP/CRT PWR – OFF,ON

CDR WND

FB E13-7

AESP/ALL/E/GEN O

FAB USE ONLY

PILE

PASS DISPLAY FAIL

1. MDU PWR – OFF,ON; if recovered >>
 2. GPC/CRT – same GPC/aff IDP; if recovered >>
 3. BFC CRT SEL – aff IDP; if both IDPs OK go to step 9
 4. – orig posn
 5. Report MDU symptoms
- If MCC GO for pwr cycle:
6. IDP/CRT PWR – OFF,ON; if recovered >>
- If MDU blank or autonomous:
7. Set other MDU on same IDP to DPS Mode; if recovered >>
 8. Return other MDU to nominal config
 9. Deassign aff IDP from PASS
 10. GPC/CRT 04 EXEC
 11. In PASS: GPC/CRT 44 EXEC

BFS DISPLAY FAIL

1. If IDP4(CRT4): IDP/CRT4 PWR – OFF >>
 2. MDU PWR – OFF,ON; if recovered >>
 3. BFC CRT SEL – unaff IDP; if both IDPs OK >>
 4. – orig posn
 5. BFC CRT DISPLAY – OFF,ON; if recovered >>
 6. In PASS: GPC/CRT 5/X for aff IDP; if recovered >>
 7. Report MDU symptoms
- If MCC GO for pwr cycle:
8. IDP/CRT PWR – OFF,ON; if recovered >>
- If MDU blank or autonomous:
9. Set other MDU on same IDP to DPS Mode; if recovered >>
 10. Return other MDU to nominal config
 11. BFC CRT SEL – unaff IDP
 12. Deassign aff IDP from PASS
 13. GPC/CRT 04 EXEC
 14. In PASS: GPC/CRT 44 EXEC

DPS
BCE

CDR WND

FB E13-8

AESP/ALL/E/GEN O

FAB USE ONLY

HOOK

FLT INST DISPLAY ANOMALY

1. DATA BUS sel alt FC BUS(s); if recovered >>
2. PORT SELECT aff MDU; if recovered >>
3. MDU PWR – OFF,ON

SUBSYS STATUS DISPLAY ANOMALY

1. PORT SELECT aff MDU; if recovered >>
2. MDU PWR – OFF,ON; if recovered >>

BFS INADVERTENT DISENGAGE/UNSUCCESSFUL ENGAGE (Lightning Strike)

1. CDR and PLT RHC BFS engage pb – push
If no response:
 2. BFS OUTPUT – NORM, B/U
 3. CDR,PLT RHC BFS engage pb – push

MULT DATA PATH LOSS (non-Recov)NOTE

If LRU data path loss due to GPC prob and not MDM,
BFS will pick up MDMs/LRU when engaged

FAILURE	TYPE	ACTIONS
GPC/FF 1&2	I/O or B	Use R BODY FLAP & TRIM ENA sws
GPC/FF 3&4	I/O or B	Use L BODY FLAP & TRIM ENA sws
GPC/FA any combo	I/O or D	No impact

CDR WND

FB E13-9

AESP/ALL/E/GEN O

FAB USE ONLY

TOP
BACK OF 'FLT INST DISPLAY ANOMALY'

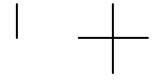
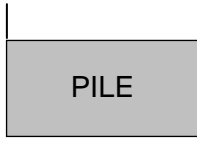

This Page Intentionally Blank



CDR WND

FB E13-10

AESP/ALL/E/GEN O

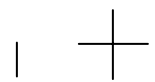

FAB USE ONLY

HOOK

CAB PRESS LEAK

1. CAB RELIEF A – CL,pause,
B – CL
 2. Check tabs, visors – CL, LES O2 – ON
 3. If RTLS/TAL: O2/N2 CNTLR VLV SYS 2 – OP
 4. O2 TK1,TK2 HTRS A,B (four) – AUTO
 - ⇒ 5. TK3 HTRS A,B (two) – AUTO
- If possible:
6. Remove INNER HATCH cap (two)
 7. Equal vlv (two) – EMER
- When CAB PRESS < 10 psia, if dP/dT EQ < 0.67:
8. √O2/N2 CNTLR VLV SYS 2 – OP >>
- When CAB PRESS < 6.5 psia:
9. √O2/N2 CNTLR VLV SYS 2 – OP
 10. CAB FAN (two) – ON

CAB PRESS HIGH

1. If incr: LES O2 – OFF, visors – OP
- If still incr:
2. N2 SYS 1,2 REG INLET (two) – CL
 3. O2 SYS 1,2 SPLY (two) – CL

H2O LOOP PRESS LOW(HIGH)

⇒ Switch loops

AV BAY FAN ΔP

- ⇒ 1. If Av Bay 1 aff: FAN A – ON; FAN B – OFF
If Av Bay 2 aff: FAN B – ON; FAN A – OFF
If Av Bay 3 aff: FAN A – ON; FAN B – OFF
2. If no joy: Go to LOSS OF AV BAY COOLING PWRDN

AV BAY TEMP HIGH

- ⇒ 1. (Aff) AV BAY FAN (two) – ON
2. If not decr: Switch H2O Loops
3. If no joy: Go to LOSS OF AV BAY COOLING PWRDN

LOSS OF AV BAY COOLING PWRDN

Bay 1: MLS 1 – OFF
 Bay 2: 2,3 – OFF
 Bay 3: N/A

CABIN FAN FAIL

- ⇒ 1. Switch fans
- If both fans lost:
2. Minimize use of IDPs/MDUs/FLT CNTLR PWR

IMU FAN FAIL

⇒ Switch fans

FREON
EVAP**OV103,104**

CDR WND (OV103,104) FB E13-11

AESP/ALL/E/GEN O

FAB USE ONLY

TOP
BACK OF 'CAB PRESS LEAK'

PILE

FREON FLOW LOW

1. Switch pumps
If flow still low:
 2. (Aff) RAD BYP VLV MODE – AUTO
CNTLR LOOP – AUTO A(B) (wait 90 sec)
- If flow still low in both loops:
 3. Go to LOSS OF FREON LOOP(s)

LOSS OF 1 FREON LOOP

1. (Bad) FREON PUMP LOOP – OFF
If FREON LOOP 1(2) lost:
 2. O2 SYS 1(2) SPLY (one) – CL
 3. √FLOW PROP VLV LOOP 2(1) – ICH
4. Monitor EVAP OUT TEMP
If TAL/AOA/RTLS and LOOP 2 lost:
 5. NH3 CNTLR B – OFF, A – PRI/GPC

LOSS OF 2 FREON LOOPS – PWRDN

1. When loops fail (flow <700), CDR execute LOOPS
FAILED
2. MSTR MADS PWR – OFF
3. Use one IDP/CRT with two MDUs (three max)
4. All PL pwr (seven) – OFF
5. O2,H2 TK HTRS (all) – OFF
6. MCC CMD FC purge, then BFS GPC – STBY,HALT
PWR – OFF
OUTPUT – NORM
7. If no comm: sel best S-BD PM ANT
If RTLS:
 8. TACAN (three) – OFF
 9. RDR ALTM 1 – OFF
- If TAL/AOA/ENTRY and V > 15K:
 10. All TACAN/RA/MLS – OFF
 11. Use one FLT CNTLR PWR
- ⇒ 12. DC UTIL PWR – OFF
- ◆ 13. FCS CH 4 – OFF
14. GPC 4 – STBY,HALT,PWR – OFF
15. FF4,FA4 – OFF
16. ANNUN BUS SEL ACA 2/3 – OFF
- ◆ When MPS dump complete:
 17. MPS ENG PWR (six) – OFF
 18. EIU (three) – OFF
 19. MEC 1 – OFF, wait 2 sec, then:
 20. MEC 2 – OFF
- ◆ 21. G50 √GPS, INCORPORATE
22. At M = 2.9: √RA 2 – ON
23. If reqd: Use one MLS, GNC I/O RESET

**DPS/
MDP
CAB P
ECLS**

OV103,104

CDR WND (OV103,104) FB E13-12 AESP/3,4/E/GEN O

FAB USE ONLY

HOOK

CAB PRESS LEAK

1. CAB RELIEF A – CL,pause,
B – CL
 2. Check tabs, visors – CL, LES O2 – ON
 3. If RTLS/TAL: O2/N2 CNTLR VLV SYS 2 – OP
 4. O2 TK1,TK2 HTRS A,B (four) – AUTO
 - ⇒ 5. TK3 HTRS A,B (two) – AUTO
- If possible:
6. Remove INNER HATCH cap (two)
 7. Equal vlv (two) – EMER
- When CAB PRESS < 10 psia, if dP/dT EQ < 0.67:
8. √O2/N2 CNTLR VLV SYS 2 – OP >>
- When CAB PRESS < 6.5 psia:
9. √O2/N2 CNTLR VLV SYS 2 – OP
 10. CAB FAN (two) – ON

CAB PRESS HIGH

1. If incr: LES O2 – OFF, visors – OP
- If still incr:
2. N2 SYS 1,2 REG INLET (two) – CL
 3. O2 SYS 1,2 SPLY (two) – CL

H2O LOOP PRESS LOW(HIGH)

⇒ Switch loops

AV BAY FAN ΔP

- ⇒ 1. If Av Bay 1 aff: FAN A – ON; FAN B – OFF
If Av Bay 2 aff: FAN B – ON; FAN A – OFF
If Av Bay 3 aff: FAN A – ON; FAN B – OFF
2. If no joy: Go to LOSS OF AV BAY COOLING PWRDN

AV BAY TEMP HIGH

- ⇒ 1. (Aff) AV BAY FAN (two) – ON
2. If not decr: Switch H2O Loops
3. If no joy: Go to LOSS OF AV BAY COOLING PWRDN

LOSS OF AV BAY COOLING PWRDN

Bay 1: MLS 1 – OFF
 Bay 2: 2,3 – OFF
 Bay 3: N/A

CABIN FAN FAIL

- ⇒ 1. Switch fans
- If both fans lost:
2. Minimize use of IDPs/MDUs/FLT CNTLR PWR

IMU FAN FAIL

⇒ Switch fans

FREON
EVAP**OV105**

CDR WND

(OV105) FB E13-11

AESP/ALL/E/GEN O

TOP
BACK OF 'CAB PRESS LEAK'

PILE

FREON FLOW LOW

1. Switch pumps
If flow still low:
 2. (Aff) RAD BYP VLV MODE – AUTO
CNTLR LOOP – AUTO A(B) (wait 90 sec)
- If flow still low in both loops:
3. Go to LOSS OF FREON LOOP(s)

LOSS OF 1 FREON LOOP

1. (Bad) FREON PUMP LOOP – OFF
If FREON LOOP 1(2) lost:
 2. O2 SYS 1(2) SPLY (one) – CL
 3. √FLOW PROP VLV LOOP 2(1) – ICH
4. Monitor EVAP OUT TEMP
If TAL/AOA/RTLS and LOOP 2 lost:
 5. NH3 CNTLR B – OFF, A – PRI/GPC

LOSS OF 2 FREON LOOPS – PWRDN

1. When loops fail (flow <700), CDR execute LOOPS
FAILED
2. MSTR MADS PWR – OFF
3. Use one IDP/CRT with two MDUs (three max)
4. All PL pwr (seven) – OFF
5. O2,H2 TK HTRS (all) – OFF
6. MCC CMD FC purge, then BFS GPC – STBY,HALT
PWR – OFF
OUTPUT – NORM
7. If no comm: sel best S-BD PM ANT
8. GPS 1,3 – OFF
If RTLS:
 9. RDR ALTM 1 – OFF
- If TAL/AOA/ENTRY and V > 15K:
 10. All RA/MLS – OFF
 11. Use one FLT CNTLR PWR
- ⇒ 12. DC UTIL PWR – OFF
- ◆ 13. FCS CH 4 – OFF
14. GPC 4 – STBY,HALT,PWR – OFF
15. FF4,FA4 – OFF
16. ANNUN BUS SEL ACA 2/3 – OFF
- ◆ When MPS dump complete:
 17. MPS ENG PWR (six) – OFF
 18. EIU (three) – OFF
 19. MEC 1 – OFF, wait 2 sec, then:
 20. MEC 2 – OFF
- ◆ 21. G50 √GPS, INCORPORATE
22. At M = 2.9: √RA 2 – ON
23. If reqd: Use one MLS, GNC I/O RESET

**DPS/
MDP
CAB P
ECLS**

OV105

CDR WND

(OV105) FB E13-12

AESP/5/E/GEN O

FAB USE ONLY

HOOK

LOSS OF 2 FREON LOOPS – LOOPS FAILED

1. LES O2 – OFF, visor – OP
 2. O2 SYS 1,2 SPLY (two) – OP
- Panel L1: All sws off, except:
3. H2O PUMP LOOP 2 – ON
 4. Perform PWRDN if not already accomplished

EVAP OUT TEMP HIGH (Rads cold soaked)

If temp high in only one loop (snsr failed) >>

1. If V < 12K:
 - RAD BYP VLV LOOP 1 – MAN,BYP
 - NH3 CNTLR B – PRI/GPC >>
2. FLASH EVAP CNTLR PRI B(A) – OFF
 - A(B) – ON (wait 30 sec)

If T decr >>
3. FLASH EVAP CNTLR PRI A(B) – OFF
 - SEC – ON (HI LOAD ena)
 - (wait 30 sec)

If T decr:
4. TOP EVAP HTRS (three) – OFF >>
4. HI LOAD EVAP – OFF
 - DUCT HTR sel – OFF (wait 30 sec)

If T decr >>
5. TOP EVAP HTRS (three) – OFF
- RAD BYP VLV sel (two) – AUTO
- CNTLR LOOP (two) – AUTO B(A) (wait 90 sec)

EVAP OUT TEMP HIGH (Rads *not* cold soaked)

If temp high in only one loop (snsr failed) >>

If V > 12K:

1. FLASH EVAP CNTLR PRI A – OFF
 - B – ON (wait 30 sec)

If T decr >>
2. FLASH EVAP CNTLR PRI B – OFF
 - SEC – ON (HI LOAD ena)
 - (wait 30 sec)

If T decr >>
3. HI LOAD EVAP – OFF
- If T decr >>
- ⇒ 4. RAD BYP VLV (four) – MAN,RAD FLOW
5. NH3 CNTLR B – SEC/ON (wait 60 sec)
6. If T decr >>
7. NH3 CNTLR B – OFF, A – SEC/ON

EVAP
ESS

CDR WND

FB E13-13

AESP/ALL/E/GEN O

FAB USE ONLY

TOP
BACK OF 'LOSS OF 2 FREON LOOPS – LOOPS FAILED'

PILE

EVAP OUT T LOW

1. If temp low in only one loop (snsr failed) >>
 2. FREON PUMP LOOP 1,2 (two) – OFF
 3. H2O PUMP LOOP 1 (two) – ON,B
 4. FLOW PROP VLV LOOP 1,2 (two) – PL HX (tb-PL)
 5. O2 SYS 1,2 SPLY (two) – CL (tb-CL)
 6. √RAD BYP VLV MODE (two) – MAN
 7. √MAN SEL (two) – BYP (tb-BYP ~3 sec)
 8. FLASH EVAP CNTLR PRI A,B,SEC (three) – OFF
 - ◆ 9. FREON PUMP LOOP 1,2 (two) – B
NH3 CNTLR A,B (two) – SEC/ON
- Wait 3 min, then if any Freon Loop off:
10. FREON PUMP LOOP 1,2 (two) – B
- When EVAP OUT T > 55 for at least 2 min (NH3 depleted):
11. O2 SYS 1,2 SPLY (two) – OP (tb-OP)
 12. NH3 CNTLR A,B (two) – OFF
- If V > 12K and FLASH EVAP CNTLR PRI A(B)
previously selected:
13. FLASH EVAP CNTLR PRI B(A) – GPC >>
- If V < 12K:
14. RAD BYP VLV MODE 1,2 (two) – AUTO
 15. CNTLR LOOP 1,2 (two) – OFF
AUTO A(B)

FREON LEAK

- ◆ 1. FREON ISOL MODE – MAN
 2. (Aff) FREON ISOL LOOP 1(2) – ISOL
Hold for 5 sec
- If (aff) FREON LOOP 1(2) ACCUM QTY decr:
- ◆ 3. (Aff) FREON ISOL LOOP 1(2) – RAD
Hold for 5 sec
 4. When loop fails ('SM2 FREON FLOW 1(2)'), CDR
execute LOSS OF 1 FREON LOOP for (aff) Freon
Loop >>
- If (aff) FREON LOOP 1(2) ACCUM QTY not decr:
When V<12K and rads cold soaked:
In good loop:
5. √RAD BYP VLV MODE 2(1) – AUTO
 6. √RAD CNTLR LOOP 2(1) – AUTO B
 7. NH3 CNTLR B(A) – PRI/GPC

**FREON
EVAP**

CDR WND

FB E13-14

AESPALL/E/GEN O,2

FAB USE ONLY



FC
MN

ESS BUS LOSS

ESS 1BC	O13&R14	<ol style="list-style-type: none"> 1. L AUD CNTL sel – R (CDR can't talk) 2. Pri C/W & F7 Matrix lost
ESS 2CA	O13&R14	<ol style="list-style-type: none"> 1. AUD CTR – 2 2. R AUD CNTL sel – L (PLT can't talk)
ESS 3AB	O13	<ol style="list-style-type: none"> 1. GPC CAM Lights lost 2. Do not engage BFS ⇒ 3. BFS GPC OUTPUT – TERM

LOSS OF 2nd FC PWRDN (ENTRY)

1. MDM PL1 – OFF
2. FCS CH 4 – OFF
GPC MODE 4 – STBY,HALT
PWR 4 – OFF
MDM FF4,FA4 – OFF
3. HUM SEP (two) – OFF
4. FLASH EVAP FDLN HTR SPLY (two) – OFF
5. TOP EVAP HTR NOZ L,R (two) – OFF
DUCT sel – OFF
HI LOAD DUCT HTR sel – OFF
6. If V > 10K: √CAB FAN A(B) – ON
7. M = 2.9: CAB FAN (two) – OFF
AV BAY FAN (six) – OFF

CDR WND

FB E13-15

AESP/ALL/E/GEN O

FAB USE ONLY

TOP
BACK OF 'ESS BUS LOSS'

PILE

EVAP
ESS

LOSS OF 2nd FC PWRDN (GRTLS/TAL)

1. LES O2 – OFF, visors – OP
 2. L1: Select one FREON PUMP on good FC/MN BUS and place other pump to OFF
Switch OFF all HUM SEPS, IMU FANS, H2O PUMPS, AV BAY FANS, CAB FANS, FES HTRS
 3. Switch off all but one IDP/CRT with four MDUs
After BUS TIE, if MNC unpwr:
 4. FLASH EVAP CNTLR PRI A – OFF
B – ON
 - ⇒ 5. Assign all strings to GPC 1 OPS 30X(60X) PRO
 6. Unassigned GPCs MODE – STBY (tb-bp), HALT
– STBY (tb-RUN)
– HALT (tb-bp)
GPC PWR – OFF
 7. IMU (one) – OFF (choose previously failed IMU, if any)
 8. IMU FAN (one) – ON
 9. H2O PUMP (one) – ON
 10. AV BAY 1,2 FAN (two) – ON (check fan ON in each bay with a pwr GPC)
- After MPS Pwrn:
- If MNA unpwr:
11. FREON PUMP LOOP 1 – B
2 – A
 12. TOP EVAP HTR DUCT sel – B
HI LOAD DUCT HTR sel – B
- If MNB(C) unpwr:
13. FREON PUMP LOOP 1,2 (two) – A(B)
 14. TOP EVAP HTR DUCT sel – A
HI LOAD DUCT HTR sel – A
- If TAL:
15. HUM SEP (one) – ON
 16. CAB FAN (one) – ON

CDR WND

FB E13-16

AESP/ALL/E/GEN O

FAB USE ONLY

HOOK

MNA or AC1 Multi Φ

1. FLASH EVAP CNTLR PRI B – OFF, A – GPC
 2. TOP EVAP HTR DUCT sel – B
 3. HI LOAD DUCT HTR sel – B
 - ⇒ 4. FREON PUMP LOOP 2 – A
 5. AV BAY 3 FAN A – ON, B – OFF
- If rads cold soaked:
When $V \leq 12K$:
6. RAD BYP VLV MODE 1,2 (two) – AUTO
 7. RAD CNTLR LOOP 1,2 (two) – AUTO A
8. ANNUN BUS SEL ACA 1 – MNB
 9. NWS – 2
 10. **BFS G51** AA1 – desel
 11. MS AUD CNTL – PS (MS can't talk)
- FAILED: NH3 A PRI, NWS 1,
UHF HI PWR XMIT, L HUD, AUTO B

CNTL

MNB or AC2 Multi Φ

- ⇒ 1. AV BAY 1 FAN A – ON, B – OFF
 2. FREON PUMP LOOP 1 – A
 3. HUM SEP A – ON, B – OFF
 4. IMU FAN A – ON, B – OFF
 5. AV BAY 2 FAN B – ON, A – OFF
 6. \sqrt{cb} AC3 Φ A LG SNSR 1 – cl
 7. ANNUN BUS SEL ACA 2/3 – MNC
 8. **BFS G51** AA2, RGA 2 – desel
- FAILED: NH3 B SEC, RA 2, NWS 2
PLT DRAG CHUTE ARM
S-BD PM 1 (NO PNL,CMD)

MNC or AC3 Multi Φ

- ⇒ 1. FLASH EVAP CNTLR PRI A – OFF, B – GPC
 2. CAB FAN B – ON, A – OFF
 3. \sqrt{AV} BAY 3 FAN B – ON
 4. H2O PUMP LOOP 1 – ON, 2 – OFF
 5. \sqrt{cb} AC2 Φ A LG SNSR 2 – cl
 6. **BFS G51** RGA 3 – desel
- FAILED: NH3 A SEC, B PRI
CDR DRAG CHUTE ARM

ANY AC2 SINGLE Φ

- ⇒ FREON PUMP LOOP 1 – A

CDR WND

FB E13-17

AESP/ALL/E/GEN O

FAB USE ONLY

TOP
 BACK OF 'MNA or AC1 Multi Φ '
 FACING RIGHT SIDE OF BACKBOARD

PILE

FC
MN

CNTL BUS LOSS

AB1	⇒	1. Use R TRIM & BDY FLP sws FAILED: NH3 A SEC, FES PRI B GPC
AB2	⇒	1. CDR disp sws – green dot FAILED: NH3 B SEC, L HUD, FES PRI B ON, H2O LOOP 1, A ON
AB3	⇒	If BFS engage reqd: 1. Use PLT's RHC, then GPCs 1,2,4 – STBY,HALT 2. BFS I/O RESET
BC1	⇒	1. Use R TRIM & BDY FLP sws 2. [BFS G51] RGA 2 – desel FAILED: R HUD CDR DRAG CHUTE DPY/JETT
BC2	⇒	If TAL/AOA/RTLS: 1. NH3 CNTLR B – OFF A – PRI/GPC FAILED: NH3 B PRI, FES SEC GPC, H2O LOOP 1, B ON, CDR DRAG CHUTE DPY/JETT
BC3	⇒	FAILED: NH3 A PRI, FES SEC ON
CA1	⇒ ♦	1. No BFS engage GPC 3,5 2. BFS GPC OUTPUT – TERM 3. [BFS G51] RGA 3 – desel FAILED: NH3 B SEC, FES PRI A GPC, H2O LOOP 2 GPC, PLT DRAG CHUTE DPY/JETT
CA2	⇒	FAILED: NH3 A SEC, FES PRI A ON, PLT DRAG CHUTE DPY/JETT

SUBBUS [MNA O14]

1. NWS – 2
- If rads cold soaked:
 When $V \leq 12K$:
2. RAD BYP VLV MODE 1,2 (two) – AUTO
 3. RAD CNTLR LOOP 1,2 (two) – AUTO A
- FAILED: AUTO B

SUBBUS [APC4(5,6) or ALC1(2,3)]

SUBBUS	APC or ALC	4 1	5 2	6 3
1.	FLASH EVAP CNTLR	PRI A – GPC		√PRI B – GPC

CDR WND

FB E13-18

AESP/ALL/E/GEN O

FAB USE ONLY

Space Shuttle Program
FLIGHT DATA FILE

JSC-48001
GENERIC, REV O

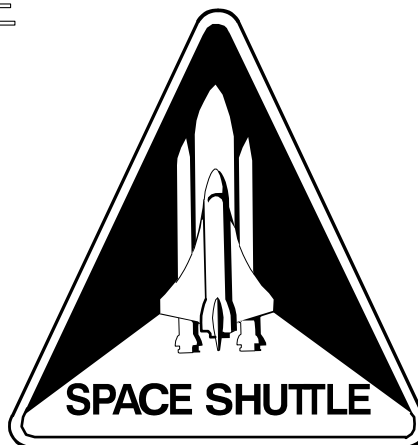

AESP:	MM101
APCL:	MM104
OPCL:	MM106
EPCL:	MM301
AESP:	MM304

**ASCENT/ENTRY
SYSTEMS PRO**

**OV
ALL**

Flight Cover (trim bottom to expose tabs)