

09 NOV 09

Sheet 1 of 1

## List of Implemented CR(s):

Assy_OpsU1421	Assy_OpsU1435	Assy_OpsU1440
Assy_OpsU1422	Assy_OpsU1436	Assy_OpsU1441
Assy_OpsU1433	Assy_OpsU1438A	

Uplinked Messages (or Approved Flight Notes) replaced by this PCN, remove from Book:

None

## Incorporates the following:

1. Replace cover
2. Replace iii thru xii
3. Replace 3 thru 52; after 52, add 52a thru 52f  
Replace 53 thru 84; after 84, add 84a thru 84f  
After 138, add 138a and 138b  
Replace 183 and 184, 309 thru 312  
Replace 335 thru 346, 349 and 350  
Replace 355 thru 360

## APPROVED BY:



Courtney A. Graham  
Book Manager

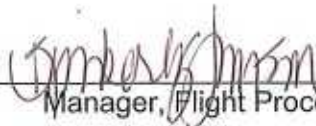

Manager, Flight Procedures

EEL



SODF Coordinator

## ACCEPTED BY:



Michael T. Hurt  
SODF Manager



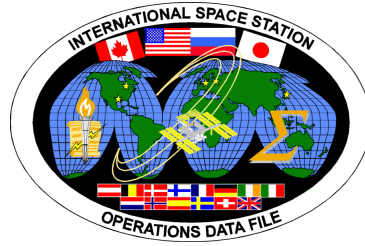

# International Space Station Assembly Operations Book

## ISS-ULF3

Mission Operations Directorate  
Operations Division

09 NOV 09

*These procedures are available  
electronically on the SODF Homepage  
at <http://mod.jsc.nasa.gov/do3>*

National Aeronautics and  
Space Administration

Lyndon B. Johnson Space Center  
Houston, Texas



*United Space Alliance*



**INTERNATIONAL SPACE STATION  
ASSEMBLY OPERATIONS  
ISS-ULF3**

**LIST OF EFFECTIVE PAGES**

29 OCT 09  
09 NOV 09

Sign Off .....	* 29 OCT 09	30.....	09 NOV 09
ii.....	* 29 OCT 09	31.....	09 NOV 09
iii.....	* 09 NOV 09	32.....	09 NOV 09
iv.....	* 09 NOV 09	33.....	09 NOV 09
v.....	* 09 NOV 09	34.....	09 NOV 09
vi.....	* 09 NOV 09	35.....	09 NOV 09
vii.....	* 09 NOV 09	36.....	09 NOV 09
viii.....	* 09 NOV 09	37.....	09 NOV 09
ix.....	09 NOV 09	38.....	09 NOV 09
x.....	09 NOV 09	39.....	09 NOV 09
xi.....	09 NOV 09	40.....	09 NOV 09
xii.....	09 NOV 09	41.....	09 NOV 09
1.....	28 OCT 09	42.....	09 NOV 09
2.....	28 OCT 09	43.....	09 NOV 09
3.....	09 NOV 09	44.....	09 NOV 09
4.....	09 NOV 09	45.....	09 NOV 09
5.....	09 NOV 09	46.....	09 NOV 09
6.....	09 NOV 09	47.....	09 NOV 09
7.....	09 NOV 09	48.....	09 NOV 09
8.....	09 NOV 09	49.....	09 NOV 09
9.....	09 NOV 09	50.....	09 NOV 09
10.....	09 NOV 09	51.....	09 NOV 09
11.....	09 NOV 09	52.....	09 NOV 09
12.....	09 NOV 09	52a.....	09 NOV 09
13.....	09 NOV 09	52b.....	09 NOV 09
14.....	09 NOV 09	52c.....	09 NOV 09
15.....	09 NOV 09	52d.....	09 NOV 09
16.....	09 NOV 09	52e.....	09 NOV 09
17.....	09 NOV 09	52f.....	TPIB
18.....	09 NOV 09	53.....	09 NOV 09
19.....	09 NOV 09	54.....	09 NOV 09
20.....	09 NOV 09	55.....	09 NOV 09
21.....	09 NOV 09	56.....	09 NOV 09
22.....	09 NOV 09	57.....	09 NOV 09
23.....	09 NOV 09	58.....	09 NOV 09
24.....	09 NOV 09	59.....	09 NOV 09
25.....	09 NOV 09	60.....	09 NOV 09
26.....	09 NOV 09	61.....	09 NOV 09
27.....	09 NOV 09	62.....	09 NOV 09
28.....	09 NOV 09	63.....	09 NOV 09
29.....	09 NOV 09	64.....	09 NOV 09

\* - Omit from flight book

65.....	09 NOV 09	109.....	28 OCT 09
66.....	09 NOV 09	110.....	28 OCT 09
67.....	09 NOV 09	111.....	28 OCT 09
68.....	09 NOV 09	112.....	28 OCT 09
69.....	09 NOV 09	113.....	14 OCT 09
70.....	09 NOV 09	114.....	14 OCT 09
71.....	09 NOV 09	115.....	14 OCT 09
72.....	09 NOV 09	116.....	14 OCT 09
73.....	09 NOV 09	117.....	28 OCT 09
74.....	09 NOV 09	118.....	28 OCT 09
75.....	09 NOV 09	119.....	21 OCT 09
76.....	09 NOV 09	120.....	21 OCT 09
77.....	09 NOV 09	121.....	21 OCT 09
78.....	09 NOV 09	122.....	21 OCT 09
79.....	09 NOV 09	123.....	21 OCT 09
80.....	09 NOV 09	124.....	21 OCT 09
81.....	09 NOV 09	125.....	28 OCT 09
82.....	09 NOV 09	126.....	28 OCT 09
83.....	09 NOV 09	127.....	02 JUL 09
84.....	09 NOV 09	128.....	02 JUL 09
84a.....	09 NOV 09	129.....	02 JUL 09
84b.....	09 NOV 09	130.....	02 JUL 09
84c.....	09 NOV 09	131.....	02 JUL 09
84d.....	09 NOV 09	132.....	02 JUL 09
84e.....	09 NOV 09	133.....	12 AUG 09
84f.....	09 NOV 09	134.....	12 AUG 09
85.....	19 OCT 09	135.....	12 AUG 09
86.....	19 OCT 09	136.....	12 AUG 09
87.....	19 OCT 09	137.....	12 AUG 09
88.....	19 OCT 09	138.....	12 AUG 09
89.....	19 OCT 09	138a.....	02 NOV 09
90.....	19 OCT 09	138b.....	TPIB
91.....	19 OCT 09	139.....	23 OCT 09
92.....	19 OCT 09	140.....	23 OCT 09
93.....	19 OCT 09	141.....	23 OCT 09
94.....	19 OCT 09	142.....	23 OCT 09
95.....	19 OCT 09	143.....	23 OCT 09
96.....	19 OCT 09	144.....	23 OCT 09
97.....	28 OCT 09	145.....	15 OCT 09
98.....	28 OCT 09	146.....	15 OCT 09
99.....	28 OCT 09	147.....	15 OCT 09
100.....	28 OCT 09	148.....	15 OCT 09
101.....	28 OCT 09	149.....	15 OCT 09
102.....	28 OCT 09	150.....	15 OCT 09
103.....	28 OCT 09	151.....	15 OCT 09
104.....	28 OCT 09	152.....	15 OCT 09
105.....	28 OCT 09	153.....	15 OCT 09
106.....	28 OCT 09	154.....	TPIB
107.....	28 OCT 09	155.....	15 OCT 09
108.....	28 OCT 09	156.....	15 OCT 09

\* - Omit from flight book

157.....	15 OCT 09	207.....	26 OCT 09
158.....	TPIB	208.....	26 OCT 09
159.....	21 AUG 09	209.....	26 OCT 09
160.....	21 AUG 09	210.....	26 OCT 09
161.....	21 AUG 09	211.....	26 OCT 09
162.....	21 AUG 09	212.....	26 OCT 09
163.....	21 AUG 09	213.....	26 OCT 09
164.....	21 AUG 09	214.....	26 OCT 09
165.....	21 AUG 09	215.....	26 OCT 09
166.....	21 AUG 09	216.....	26 OCT 09
167.....	21 AUG 09	217.....	26 OCT 09
168.....	21 AUG 09	218.....	26 OCT 09
169.....	21 AUG 09	219.....	26 OCT 09
170.....	21 AUG 09	220.....	26 OCT 09
171.....	31 JUL 09	221.....	26 OCT 09
172.....	TPIB	222.....	26 OCT 09
173.....	22 OCT 09	223.....	26 OCT 09
174.....	22 OCT 09	224.....	TPIB
175.....	22 OCT 09	225.....	19 MAY 09
176.....	TPIB	226.....	19 MAY 09
177.....	26 OCT 09	227.....	19 MAY 09
178.....	26 OCT 09	228.....	19 MAY 09
179.....	26 OCT 09	229.....	19 MAY 09
180.....	TPIB	230.....	19 MAY 09
181.....	15 OCT 09	231.....	19 MAY 09
182.....	TPIB	232.....	19 MAY 09
183.....	06 NOV 09	233.....	19 MAY 09
184.....	06 NOV 09	234.....	TPIB
185.....	13 OCT 09	235.....	26 OCT 09
186.....	13 OCT 09	236.....	26 OCT 09
187.....	19 MAY 09	237.....	26 OCT 09
188.....	19 MAY 09	238.....	TPIB
189.....	08 OCT 09	239.....	26 OCT 09
190.....	08 OCT 09	240.....	26 OCT 09
191.....	08 OCT 09	241.....	26 OCT 09
192.....	08 OCT 09	242.....	26 OCT 09
193.....	08 OCT 09	243.....	26 OCT 09
194.....	08 OCT 09	244.....	26 OCT 09
195.....	08 OCT 09	245.....	13 OCT 09
196.....	08 OCT 09	246.....	13 OCT 09
197.....	08 OCT 09	247.....	13 OCT 09
198.....	08 OCT 09	248.....	13 OCT 09
199.....	08 OCT 09	249.....	13 OCT 09
200.....	TPIB	250.....	13 OCT 09
201.....	08 OCT 09	251.....	13 OCT 09
202.....	08 OCT 09	252.....	13 OCT 09
203.....	08 OCT 09	253.....	13 OCT 09
204.....	08 OCT 09	254.....	13 OCT 09
205.....	08 OCT 09	255.....	13 OCT 09
206.....	08 OCT 09	256.....	13 OCT 09

\* - Omit from flight book

257.....	13 OCT 09	307.....	28 OCT 09
258.....	13 OCT 09	308.....	28 OCT 09
259.....	13 OCT 09	309.....	09 NOV 09
260.....	13 OCT 09	310.....	TPIB
261.....	13 OCT 09	311.....	09 NOV 09
262.....	13 OCT 09	312.....	TPIB
263.....	13 OCT 09	313.....	28 OCT 09
264.....	13 OCT 09	314.....	28 OCT 09
265.....	13 OCT 09	315.....	20 MAY 09
266.....	TPIB	316.....	TPIB
267.....	13 OCT 09	317.....	29 JUL 09
268.....	13 OCT 09	318.....	29 JUL 09
269.....	13 OCT 09	319.....	29 JUL 09
270.....	13 OCT 09	320.....	TPIB
271.....	13 OCT 09	321.....	08 OCT 09
272.....	13 OCT 09	322.....	TPIB
273.....	13 OCT 09	323.....	18 AUG 09
274.....	13 OCT 09	324.....	18 AUG 09
275.....	15 OCT 09	325.....	18 AUG 09
276.....	15 OCT 09	326.....	TPIB
277.....	19 MAY 09	327.....	15 OCT 09
278.....	19 MAY 09	328.....	15 OCT 09
279.....	19 MAY 09	329.....	15 OCT 09
280.....	TPIB	330.....	TPIB
281.....	19 MAY 09	331.....	08 JUL 09
282.....	19 MAY 09	332.....	TPIB
283.....	19 MAY 09	333.....	08 JUL 09
284.....	19 MAY 09	334.....	TPIB
285.....	19 MAY 09	335.....	02 NOV 09
286.....	TPIB	336.....	TPIB
287.....	19 MAY 09	337.....	02 NOV 09
288.....	19 MAY 09	338.....	TPIB
289.....	19 MAY 09	339.....	02 NOV 09
290.....	TPIB	340.....	02 NOV 09
291.....	19 MAY 09	341.....	02 NOV 09
292.....	19 MAY 09	342.....	02 NOV 09
293.....	15 OCT 09	343.....	02 NOV 09
294.....	15 OCT 09	344.....	02 NOV 09
295.....	19 MAY 09	345.....	02 NOV 09
296.....	TPIB	346.....	TPIB
297.....	15 OCT 09	347.....	07 OCT 09
298.....	15 OCT 09	348.....	07 OCT 09
299.....	15 OCT 09	349.....	06 NOV 09
300.....	15 OCT 09	350.....	06 NOV 09
301.....	15 OCT 09	351.....	09 OCT 09
302.....	15 OCT 09	352.....	09 OCT 09
303.....	11 AUG 09	353.....	28 OCT 09
304.....	11 AUG 09	354.....	28 OCT 09
305.....	11 AUG 09	355.....	05 NOV 09
306.....	11 AUG 09	356.....	TPIB

\* - Omit from flight book



357 .....	02 NOV 09
358 .....	TPIB
359 .....	02 NOV 09
360 .....	TPIB
361 .....	28 OCT 09
362 .....	28 OCT 09
363 .....	14 AUG 09
364 .....	14 AUG 09
365 .....	14 AUG 09
366 .....	TPIB
367 .....	10 JUL 09
368 .....	10 JUL 09
369 .....	09 JUL 09
370 .....	09 JUL 09
371 .....	09 JUL 09
372 .....	TPIB
373 .....	28 OCT 09
374 .....	28 OCT 09
375 .....	07 OCT 09
376 .....	07 OCT 09
377 .....	31 JUL 09
378 .....	31 JUL 09
379 .....	31 JUL 09
380 .....	31 JUL 09
381 .....	31 JUL 09
382 .....	31 JUL 09

\* - Omit from flight book

**INTERNATIONAL SPACE STATION  
ASSEMBLY OPERATIONS  
ISS-ULF3**

CUE CARD LIST OF EFFECTIVE PAGES
-------------------------------------

29 OCT 09  
09 NOV 09

<u>Title</u>	<u>Page</u>	<u>Card Number</u>	<u>Date</u>	<u>Fab Notes</u>
CGBA AND ABRs STATUS CHECK				
(Front) .....	375	ASSY OPS-1a/ULF3/B	07 OCT 09	
(Back) .....	376	ASSY OPS-1b/ULF3/B	07 OCT 09	
GLACIER STATUS CHECK				
(Front) .....	377	ASSY OPS-2a/ULF3/A	31 JUL 09	
(Back) .....	378	ASSY OPS-2b/ULF3/A	31 JUL 09	
SPINAL ELONGATION STANDING HEIGHT LOG				
(Front) .....	379	ASSY OPS-3a/17A - ALL/A	31 JUL 09	
(Back) .....	380	ASSY OPS-3b/17A - ALL/A	31 JUL 09	
(Front - Bottom) .....	381	ASSY OPS-3aa/17A - ALL/A	31 JUL 09	
(Back - Bottom) .....	382	ASSY OPS-3bb/17A - ALL/A	31 JUL 09	

## CONTENTS

<b>ACTIVATION AND CHECKOUT .....</b>	<b>1</b>
1.100 Node 1 Prep for Node 3 - Midbay Hardware Installation .....	3
1.102 Node 1 Prep for Node 3 - Alcove Hardware Installations .....	53
1.103 Node 1 Prep for Node 3 - Video/Audio Bus A Connection .....	85
1.104 ULF-3 Airlock Battery Charger Module (BCM) R&R .....	97
1.105 New Hi Pressure O2 Tank Leak Check.....	113
<b>TRANSFER.....</b>	<b>117</b>
2.100 ULF-3 Descent Sample Transfer from MELFI to Glacier.....	119
<b>PAYLOADS .....</b>	<b>125</b>
NLP - NOMINAL	
NLP Activation.....	127
NLP Termination .....	133
CGBA Adjust Set Temp.....	138a
ABRS - NOMINAL	
ABRS Ascent Filter Changeout.....	139
ABRS Transfer Mddk to ISS.....	145
ABRS - CONTINGENCY	
ABRS Safing .....	155
SPINAL ELONGATION	
Spinal Elongation Operator Procedure.....	159
Spinal Elongation Log .....	171
GLACIER - NOMINAL	
Glacier Unpack and Power Up .....	173
Glacier Set Point .....	177
Glacier Record Quick Diagnostic Data (Nominal) .....	181
GLACIER - CONTINGENCY	
Glacier Reboot .....	183
Glacier Shutdown .....	185
Glacier Max Power Reconfigure.....	187
Glacier Transfer Middeck to ISS .....	189
Glacier Transfer ISS to Middeck .....	201

## GLACIER - MALFUNCTION

Glacier Error Message .....	207
Glacier Fail to Hold Set Point .....	225
Glacier Fail to Repower .....	235
Glacier LCD Blank .....	239
Glacier Manual Reconfigure .....	245
Glacier Power Cycle .....	267
Glacier Record Cryogenic Diagnostic Data .....	269
Glacier Record Quick Diagnostic Data .....	271
Glacier Record Resources Diagnostic Data .....	273
Glacier Record System Diagnostic Data .....	275

## GLACIER - TABLES

Table 1 Glacier Error Message Log .....	277
Table 2 Glacier Reset Log File .....	281
Table 3 Glacier Diagnostic Log File .....	287

## CGBA - CONTINGENCY

CGBA Set GMT .....	291
--------------------	-----

## CGBA - MALFUNCTION

CGBA Incorrect (No) Display .....	293
CGBA Incorrect Temp .....	295

## MDS

MDS Transfer to Shuttle .....	297
MDS Status Check .....	303

## **CONTINGENCY EVA PL CONFIGURATION .....** 307

Pre-EVA PL Configuration .....	309
Post EVA PL Configuration .....	311

## **MALFUNCTION .....** 313

### COMM

Comm Malfunction Points .....	315
OIU Fail to Command .....	317
OIU Temp High Malfunction .....	321
S212 OIU AD 1 NOLK/Loss of ISS or SSOR Telemetry .....	323
S62 PDI DECOM Fail .....	327

### APCU MALFUNCTION

APCU Activation .....	331
APCU Deactivation .....	333

APCU Amps (Up Arrow).....	335
APCU Temp (Down Arrow/Up Arrow) .....	337
APCU Trip .....	339
APCU Volts (Up Arrow/Down Arrow) .....	343
 <b>PAYLOAD DPS RECONFIG</b>	
PL/DPS Reconfiguration .....	347
 <b>CRITICAL EQUIPMENT LOSS</b>	
Orbiter Electrical Bus Loss Matrix .....	349
Orbiter MDM Loss Impacts.....	351
<b>DEORBIT PREP</b> .....	353
Payload Deactivation.....	355
Payload Reactivation.....	357
Payload Entry Switch List/Verification .....	359
<b>REFERENCE</b> .....	361
Standard Switch Panel 1 .....	363
Standard Switch Panel 2 .....	367
SPEC 200 APCU Status .....	369
<b>CUE CARD</b> .....	373
CGBA and ABRS Status Check .....	375
Glacier Status Check.....	377
Spinal Elongation Standing Height Log.....	379

This Page Intentionally Blank

## 1.100 NODE 1 PREP FOR NODE 3 – MIDBAY HARDWARE INSTALLATION

(ASSY OPS/ULF3/FIN 2)

Page 1 of 55 pages

### OBJECTIVE:

Install equipment in Node 1 Midbay area to support installation on Node 3 on Node 1 Port. New equipment includes cables, hoses, ducting, IMV Valve, and a new Closeout Panel.

### LOCATION:

Node 1

### DURATION:

6 hours, 30 minutes (Two Crew - Mod Kit Install)

1 hour 10 minutes (One Crew - Access)

### CREW:

Two

### PARTS:

Node 1 Avionics and Fluids Modification Kit [Refer to Table 1]

Node 1 IMV Modification Kit [Refer to Table 1]

### MATERIALS:

Velcro Ties

Dry Wipes

Nitrile Gloves

Clean Room Gloves

Kapton Tape

Dust Mask

#### ALSP Kit:

Povidone Iodine Pads

### TOOLS:

Flashlight

CSA-O2

Vacuum Cleaner

Digital Camera

#### Gamah Seal Maintenance Kit:

Fluid Fitting Torque Device

1.00" Drive Gear

0.625" Reaction Gear

#### ISS IVA Toolbox:

Drawer 2:

Driver Handle, 1/4" Drive

Ratchet, 1/4" Drive

Ratchet, 3/8" Drive

3/8" Socket, 1/4" Drive

5/32" Hex Head, 1/4" Drive

4" Ext, 1/4" Drive

6" Ext, 1/4" Drive

10" Ext, 1/4" Drive

1/4" Deep Socket, 1/4" Drive

1/2" Deep Socket, 1/4" Drive

(40-200 in-lbs) Trq Wrench, 3/8" Drive

## **1.100 NODE 1 PREP FOR NODE 3 – MIDBAY HARDWARE INSTALLATION**

(ASSY OPS/ULF3/FIN 2)

Page 2 of 55 pages

(10-50 in-lbs) Trq Wrench, 1/4" Drive

(5-35 in-lbs) Trq Driver, 1/4" Drive

1/4" to 3/8" Adapter

7/16" Deep Socket, 1/4" Drive

Drawer 3:

4" Common Tip Screwdriver

#6 Long Torq Driver, 3/8" Drive

6" Long, 3/8" Hex Head, 3/8" Drive

### REFERENCED PROCEDURE(S):

1.401 SMOKE DETECTOR ACTIVATION

1.402 SMOKE DETECTOR DEACTIVATION

1.504 IMV FAN ACTIVATION/DEACTIVATION POST CCS

2.506 IMV VALVE RECONFIGURATION

A.2.1 FLUID FITTING TORQUE DEVICE (FFTD) ASSEMBLY AND USAGE

A.2.3 MATING GAMAH FITTING USING THE FFTD

A.2.13 GAMAH SEAL R&R



# 1.100 NODE 1 PREP FOR NODE 3 – MIDBAY HARDWARE INSTALLATION

(ASSY OPS/ULF3/FIN 2)

Page 3 of 55 pages

Table 1. Node 1 Mod Kit Midbay Hardware

#	Part Name	Part Number	Serial Number	Barcode Number	Qty
1	RMO (Handle)	683-99532-1	000001	00115701H	1
2	NOD1P3-01 Closeout Panel	683-99519-1	000001	00106759H	1
3	NOD1P3-02 Closeout Panel	683-99519-2	000001	00115727H	1
4	NOD1P3-01 Closeout Panel	683-99519-6	000001	00109152H	1
5	NOD1 IMV Valve Power Cable (W9436)	683-99436-1	000001	00106730H	1
6	NOD1 IMV Valve Data Cable (W9437)	683-99437-1	000001	00106731H	1
7	NOD1O2 IMV Duct	683-99516-1	000001	00106749H	1
8	Band Clamp 4"	NAS1922-0400-3	N/A	N/A	6
9	IMV Duct Clamp	NAS1922-0525-3	N/A	N/A	1
10	IMV Duct Sleeve 4" Diameter (for contingency IMV use)	BACD40R16A30	N/A	N/A	1
11	NOD1P2 IMV Duct	683-99516-2	000001	00106750H	1
12	NOD1 IMV Diffuser Cover	683-99518-2	1001 1002	N/A	2
13	IMV Diffuser Gasket	683-15116-2	2001 2002 2003	N/A	3
14	NOD1 Waste Water Hose	683-99511-3	00001	00106739H	1
15	NOD1 Potable Water Hose	683-99511-4	00001	00106740H	1
16	NOD1 Video/Audio Bus A Cable (W9423)	683-99423-1	00001	00106719H	1
17	NOD1 ISL Ethernet Cable (W9426)	683-99426-1	00001	00106722H	1
18	NOD1 1553 CH A Cable (W9421)	683-99421-1	00001	00106717H	1
19	NOD1 1553 Termination Plug (W9427)	683-99427-1	00001	00106746H	1
20	NOD1 Wireless Audio Cable (W9425)	683-99425-1	00001	00106721H	1
21	NOD1 Wireless Audio Loopback Plug (W9428)	683-99428-1	00001	00106748H	1
22	EVA Tape (1 roll)	P-213	N/A	N/A	AR
23	Braycote (1 tube)	601-EF	N/A	N/A	AR
24	Cable Tie (100)	T50R2HAL	N/A	N/A	AR
25	Releaseable Wire Tie (60)	REZ200	N/A	N/A	AR

AR = As Required

**1.100 NODE 1 PREP FOR NODE 3 – MIDBAY HARDWARE INSTALLATION**  
(ASSY OPS/ULF3/FIN 2) Page 4 of 55 pages

1. ACCESS

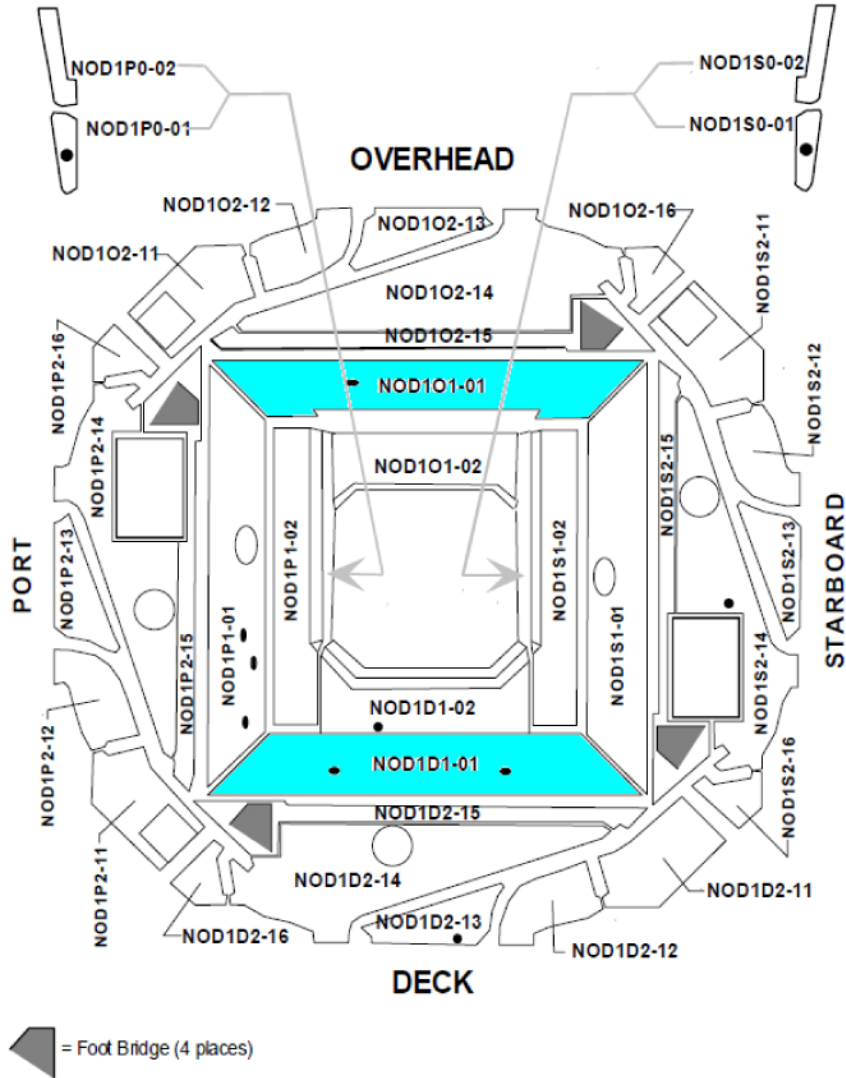

Figure 1.- Alcove Closeout Panel Removal.

**1.100 NODE 1 PREP FOR NODE 3 – MIDBAY HARDWARE INSTALLATION**  
 (ASSY OPS/ULF3/FIN 2) Page 5 of 55 pages

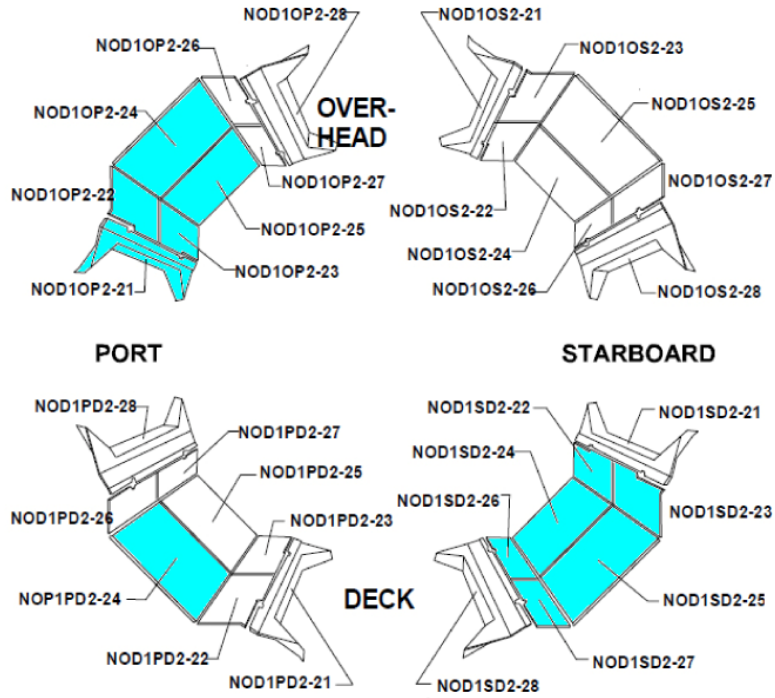

Figure 2.- Radial Closeout Panel Removal.

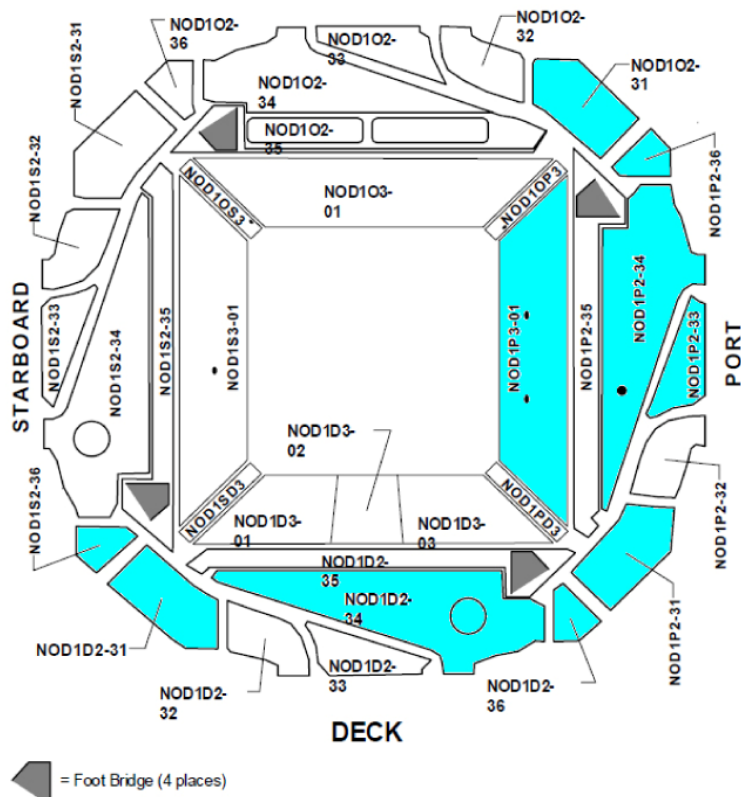

Figure 3.- Midbay Closeout Panel Removal.



Figure 4.- Closeout Seam Supports.

- 1.1 Remove the Closeout Panels listed in Table 2 (Ratchet, 1/4" Drive; 5/32" Hex Head, 1/4" Drive). Refer to Figures 1, 2, 3, and 4.

Table 2. Closeout Panels to be Removed

Closeout Panel	Fasteners	Notes
NOD1O1-01	8	
NOD1D1-01	8	
NOD1OP2-21	15	
NOD1OP2-22	3	Remove panels as a group
NOD1OP2-23	3	
NOD1OP2-24	6	
NOD1OP2-25	8	
NOD1PD2-24	6	
NOD1SD2-22	3	Remove panels as a group
NOD1SD2-23	3	
NOD1SD2-24	8	
NOD1SD2-25	6	
NOD1SD2-26	3	Remove panels as a group
NOD1SD2-27	3	
NOD1O2-31	6	Remove panels as a group
NOD1P2-36	5	
NOD1P2-33	5	
NOD1P2-34	24	
NOD1P3-01	6	
NOD1D2-36	5	Remove panels as a group
NOD1P2-31	6	
NOD1D2-34	24	
NOD1S2-36	5	Remove panels as a group
NOD1D2-31	6	

# 1.100 NODE 1 PREP FOR NODE 3 – MIDBAY HARDWARE INSTALLATION

(ASSY OPS/ULF3/FIN 2)

Page 7 of 55 pages

\*\*\*\*\*

- \* If required for removal of Closeout Panels
- \* | Remove L-shaped Closeout Seam Supports (two), fasteners
- \* | (four each) (Ratchet, 1/4" Drive; 1/8" Hex Head, 1/4" Drive).
- \* | Remove T-shaped Closeout Seam Support, fasteners (eight)
- \* | (Ratchet, 1/4" Drive; 1/8" Hex Head, 1/4" Drive).

\*\*\*\*\*

<b>WARNING</b>
CSA-O2 readings are required to insure O2 % is not above flammability levels or N2 pockets do not exist that can cause crew asphyxiation.

1.2 Perform CSA-O2 sampling in open cabin, then record: \_\_\_\_\_.

1.3 Comparison to MCA Sampling

US LAB: ECLSS: AR Rack: MCA

Lab MCA

'(ORU 2) Mass Spectrometer Assembly'

Record O2 %: \_\_\_\_\_

√Difference between CSA-O2 and MCA O2 percentages is less than or equal to 1.1 %

1.4 Perform CSA-O2 sampling in areas where Closeout Panel was removed for 1 minute.

If O2 % is between 16.5 and 23.3 %, proceed.

1.5 √NOD1P4 Rack rotation path unobstructed

NOD1P4

1.6 Disengage K-BAR Thumb Latches (two) from Standoff.  
Slowly rotate Rack down to a controlled stop.  
Temporarily restrain as required.

**2. INSTALLING NODE 1 PORT-AFT IMV VALVE**

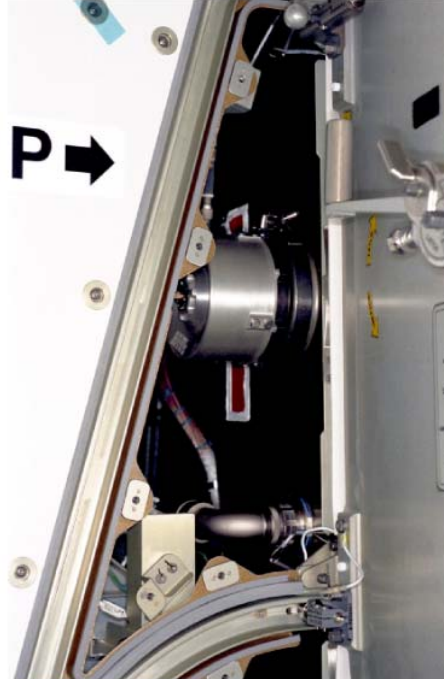

Figure 5.- Node 1 Port Aft NPRV.

- NOD1P2-Aft 2.1 Loosen, remove V-Band Clamp and stow on Bulkhead flange.  
Remove NPRV (Ratchet, 1/4" Drive; 4" Ext, 1/4" Drive; 7/16" Deep Socket,  
1/4" Drive or 1/2" Deep Socket, 1/4" Drive).  
Temporarily stow NPRV.  
Refer to Figure 5.
- 2.2 Inspect Node 1 Port-Aft IMV flange for FOD or damage (Flashlight).  
If required, wipe sealing surface with Dry Wipe.

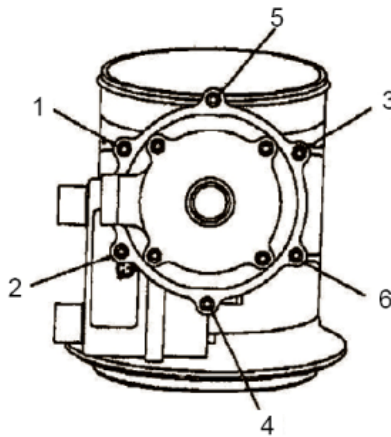

Figure 6.- IMV Valve RMO Flex Shaft Interface Noncaptive Fasteners.

## 1.100 NODE 1 PREP FOR NODE 3 – MIDBAY HARDWARE INSTALLATION

(ASSY OPS/ULF3/FIN 2)

Page 9 of 55 pages

### NOTE

IMV Valve RMO Flex Shaft Interface will be temporarily loosened to allow realignment for proper orientation of RMO Flex Shaft interface. These fasteners will be tightened and torqued after the RMO Handle is properly adjusted.

- 2.3 Loosen (do not remove) IMV Valve RMO Flex Shaft Interface noncaptive fasteners (six) (Ratchet, 1/4" Drive; 5/32" Hex Head, 1/4" Drive). Refer to Figure 6.

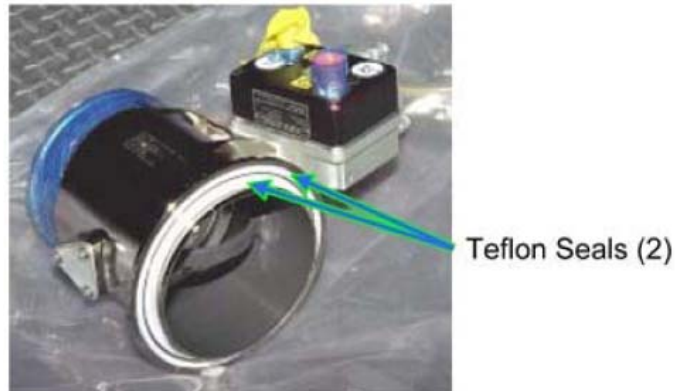

Figure 7.- Typical View IMV Teflon Seals.

- 2.4 ✓ Teflon Seal (two) on mating surface of IMV Valve flange clean, free of debris. Clean, if required, by wiping around circumference of seal (Dry Wipes). Refer to Figure 7.



Figure 8.- Example of Closed IMV Valve.

- 2.5 Visually verify IMV Valve is in Closed position. Refer to Figure 8.
- 2.6 Don Nitrile Glove.
- 2.7 Apply small amount of Braycote to fingertip. Work Braycote between fingertips until a very thin film is achieved with no visible pieces of Braycote present.

## 1.100 NODE 1 PREP FOR NODE 3 – MIDBAY HARDWARE INSTALLATION

(ASSY OPS/ULF3/FIN 2)

Page 10 of 55 pages

2.8 Use lubricated fingertip to apply thin film of Braycote to seal crowns.

If Glove begins to stick to seal surface  
Repeat step 2.7 for relubrication of Glove.

2.9 Verify no visible white Braycote clumps on seals; clumping can prevent proper seal performance.

2.10 Doff Nitrile Glove.

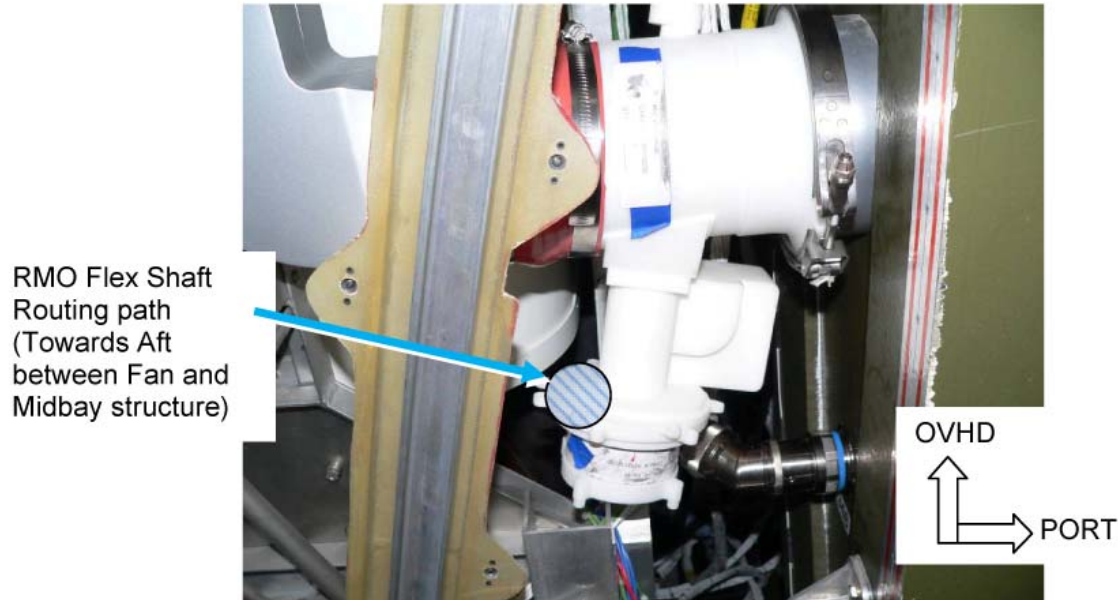

Figure 9.- IMV Valve Installed on Node 1 Port Bulkhead (Mockup in B9).

2.11 Align IMV Valve on Node 1 Port-Aft Bulkhead with mechanism housing and electronics assembly oriented slightly forward (12 degrees) of nadir. Minimize rubbing Teflon seals on Bulkhead. Refer to Figure 9.

2.12 RMO Flex Shaft will be routed between Node 1 Cabin Fan and Midbay structure. Rotate RMO Flex Shaft Interface to align with RMO Flex Shaft routing path: slightly starboard (11 degrees) of aft. Refer to Figure 9.

2.13 Install V-Band Clamp, tighten enough to keep IMV Valve in place but loose enough to allow IMV Valve rotation, if required, during RMO Flex Shaft connection (Ratchet, 1/4" Drive; 4" Ext, 1/4" Drive; 7/16" Deep Socket, 1/4" Drive or 1/2" Deep Socket, 1/4" Drive).



**3. INSTALLING IMV VALVE REMOTE MANUAL OVERRIDE (RMO)**

NOTE  
New NOD1P3-01 Panel must be assembled prior to installation. Once assembled, upper and lower segments will not need to be separated for subsequent access to Node 1 Port Midbay.

- 3.1 Align new NOD1P3-01 upper and middle Closeout Panels.
- 3.2 Tighten, torque NOD1P3-01 fasteners (six) joining upper and lower panels to 27 in-lbs [Ratchet, 1/4" Drive; 5/32" Hex Head, 1/4" Drive; (10-50 in-lbs) Trq Wrench, 1/4" Drive].

NOD1P3 3.3 Install new NOD1P3-01 Closeout Panel, fasteners (four) (Ratchet, 1/4" Drive; 5/32" Hex Head, 1/4" Drive).

- 3.4 Remove tethered cap from RMO Flex Shaft.

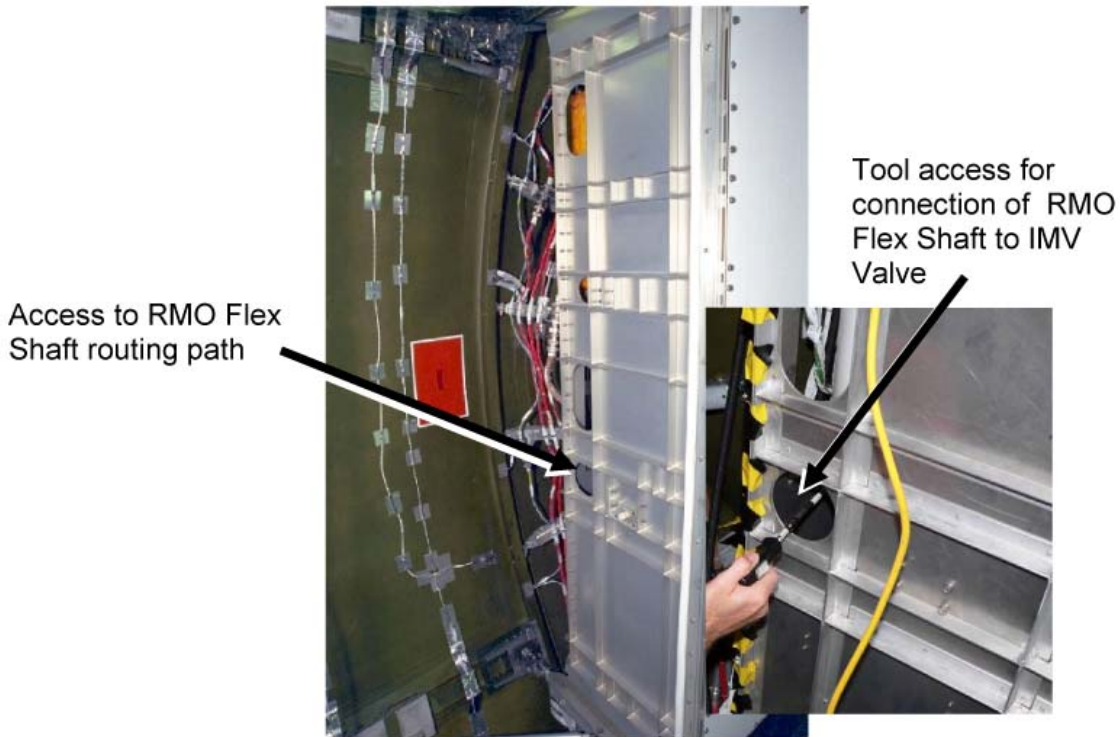

Figure 10.- Access Holes on Aft Side of Port Midbay.

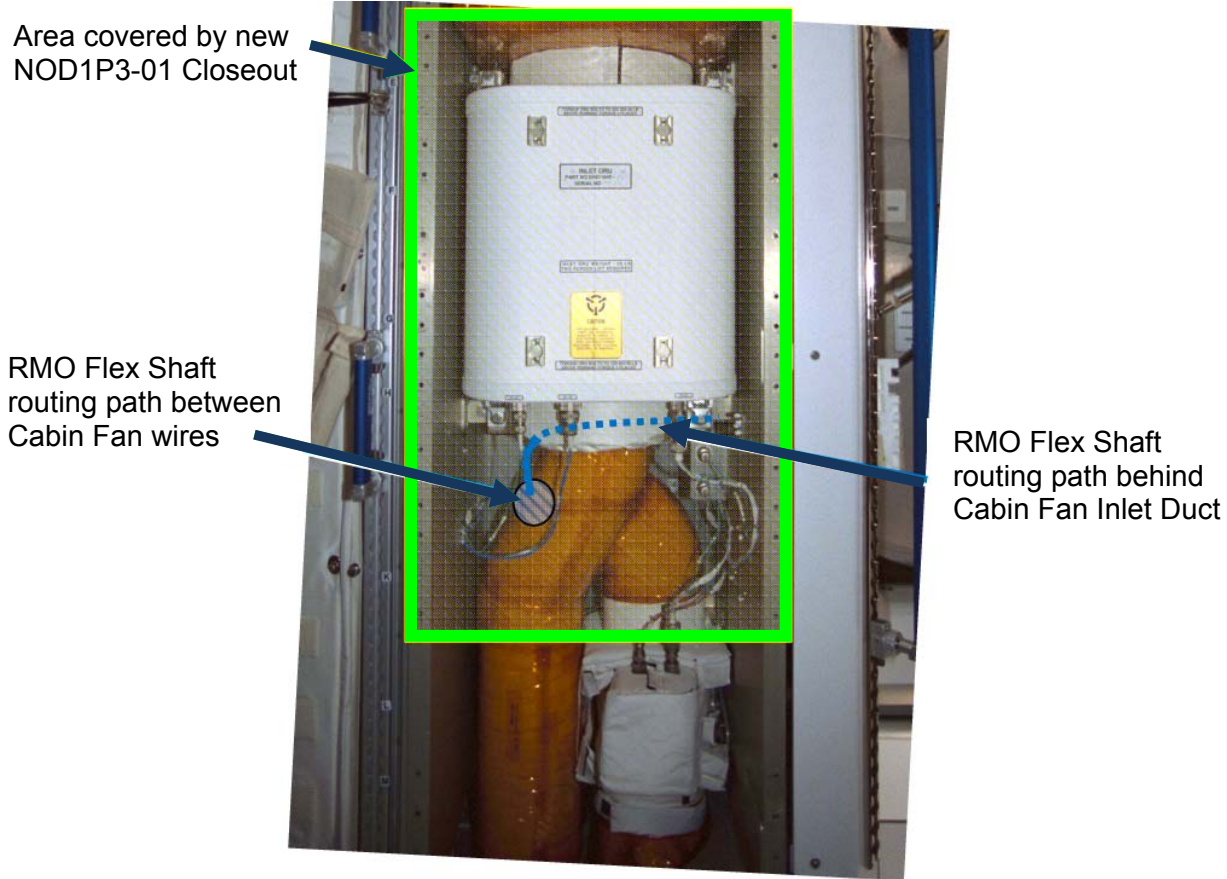

Figure 11.- Node 1 Port Midbay.

**CAUTION**

RMO Flex Shaft cable has a minimum bend radius of 8 inches. To prevent hardware damage, do not subject Flex Shaft to a bend radius of less than 8 inches.

- 3.5 Position RMO Handle below new NOD1P3-01 Closeout Panel. Feed free end of RMO Flex Shaft between Node 1 Cabin Fan Wire Harnesses (W0307 and W0137). Using a second crewmember accessing midbay volume from aft and port sides, continue feeding RMO Flex Shaft around Node 1 Cabin Fan towards IMV Valve. Maintain RMO Flex Shaft bend radius > 8 inches. Refer to Figures 10 and 11.
- 3.6 Align RMO Handle with cutout in new NOD1P3-01. Snug RMO Handle attachment fasteners (four) (Ratchet, 1/4" Drive; 5/32" Hex Head, 1/4" Drive). Refer to Figures 10 and 11.

## 1.100 NODE 1 PREP FOR NODE 3 – MIDBAY HARDWARE INSTALLATION

(ASSY OPS/ULF3/FIN 2)

Page 13 of 55 pages



Figure 12.- RMO Handle.

- 3.7 Deploy RMO Handle and align indicator with “C” in “CLOSED.”  
Refer to Green Line on Figure 12.
- 3.8 While maintaining RMO Flex Shaft bend radius > 8 inches, attempt alignment of the RMO Flex Shaft with IMV Valve RMO Flex Shaft Interface.

If alignment is not possible while maintaining proper bend radius

Rotate IMV RMO Flex Shaft Interface  $\curvearrowright$  or  $\curvearrowleft$  relative to valve body as required.

Loosen IMV Valve V-Band Clamp, rotate IMV Valve on Bulkhead flange for proper alignment (Ratchet, 1/4" Drive; 4" Ext, 1/4" Drive; 7/16" Deep Socket, 1/4" Drive or 1/2" Deep Socket, 1/4" Drive).

Minimize scrubbing of IMV Valve Teflon seals.

Tighten IMV Valve V-Band Clamp (Ratchet, 1/4" Drive; 4" Ext, 1/4" Drive; 7/16" Deep Socket, 1/4" Drive or 1/2" Deep Socket, 1/4" Drive).

- 3.9 Attach RMO Flex Shaft, fasteners (two) to IMV Valve.  
Tighten, torque to 39 in-lbs [Ratchet, 1/4" Drive; 10" Ext, 1/4" Drive; 6" Ext, 1/4" Drive; 4" Ext, 1/4" Drive; 5/32" Hex Head, 1/4" Drive; (10-50 in-lbs) Trq Wrench, 1/4" Drive].  
Refer to Figure 10.

### NOTE

Some IMV Valve RMO Flex Shaft Interface fasteners will not be accessible due to adjacent hardware. A minimum of two opposing fasteners should be tightened.

- 3.10 Snug all accessible IMV Valve RMO Flex Shaft Interface fasteners (Ratchet, 1/4" Drive; 5/32" Hex Head, 1/4" Drive).
- 3.11 Create alignment mark on IMV Valve and Node 1 Port Bulkhead to ensure IMV Valve could be reinstalled on Bulkhead in same position (Sharpie).

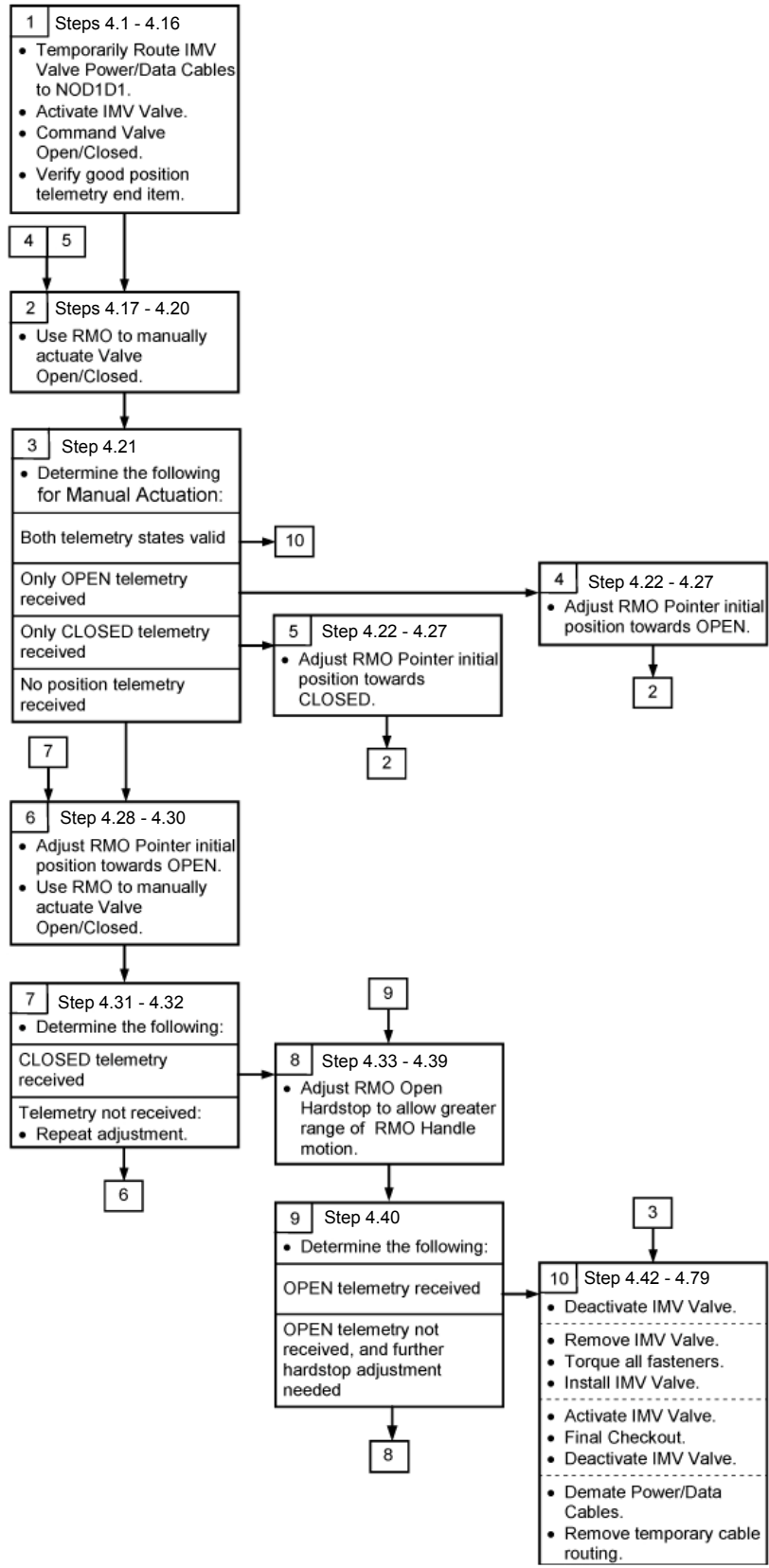

Figure 13.- RMO Checkout Overview.

**4. RMO CHECKOUT AND ADJUSTMENT**

NOTE

1. Figure 13 provides a graphical overview of the RMO Checkout and Adjustment activities performed in step 4.
2. The goal of step 4 is to adjust interface between the RMO and IMV Valve to enable manual actuation of the IMV Valve so that the physical position of the valve is fully open or fully closed. Until this step is completed, the RMO cannot be relied upon to fully close the IMV Valve or verify the valve position (via RMO Pointer).
3. The PCS Telemetry of valve position should be considered “truth”:  
 Open: IMV Valve is fully open  
 In Transit: IMV Valve is between fully open and fully closed (this indication does not require that the valve be in motion)  
 Closed: IMV Valve is fully closed
4. If adjustments result in mismatch between RMO pointer and PCS telemetry, new RMO positions will be marked on the Closeout Panel.
5. If multiple attempts to adjust the RMO are unsuccessful at matching both open and closed telemetry states, the minimal required configuration is adjustment so that the valve can be manually closed (as indicated on the PCS telemetry). It is less critical to have a manual open actuation be completely successful.

4.1 ✓ **MCC-H** to verify following safing complete:  
 RPCM N13BB RPC 16 Open and Close Command Inhibited

NOD1P3 4.2 Protective Cap ←|→ P1 of NOD1 IMV Valve Power Cable (W9436)  
 Protective Cap (or Kapton Tape) ←|→ J1 of Node 1 Port-Aft IMV Valve  
  
 Stow Protective Caps in Ziplock Bag labeled “NOD 1 Mod Kit Caps and Plugs.”

4.3 NOD1 IMV Valve Power Cable (W9436) P1 →|← J1 of Node 1 Port-Aft IMV Valve  
  
 Temporarily stow Wire Harness.

4.4 Protective Cap ←|→ P2 of NOD1 IMV Valve Data Cable (W9437)  
 Protective Cap (or Kapton Tape) ←|→ J2 of Node 1 Port-Aft IMV Valve  
  
 Stow Protective Caps in Ziplock Bag labeled “NOD 1 Mod Kit Caps and Plugs.”

# 1.100 NODE 1 PREP FOR NODE 3 – MIDBAY HARDWARE INSTALLATION

(ASSY OPS/ULF3/FIN 2)

Page 16 of 55 pages

- 4.5 NOD1 IMV Valve Data Cable (W9437) P2 →|← J2 of Node 1 Port-Aft IMV Valve

Temporarily stow Wire Harness.

- 4.6 Route NOD1 IMV Valve Power Cable (W9436) and NOD1 IMV Valve Data Cable (W9437) from port midbay to nadir alcove.  
This routing is temporary for the purpose of the IMV Valve checkout.

- NOD1D1 4.7 Protective Cap ←|→ J426 of NOD1 IMV Valve Power Cable (W9436)  
Protective Cap (or Kapton Tape) ←|→ P426 of W0136

Stow Protective Caps in Ziplock Bag labeled “NOD 1 Mod Kit Caps and Plugs.”

- 4.8 NOD1 IMV Valve Power Cable (W9436) J426 →|← P426 of W0136

- 4.9 Protective Cap ←|→ J427 of NOD1 IMV Valve Data Cable (W9437)  
Protective Cap (or Kapton Tape) ←|→ P427 of W0308

Stow Protective Caps in Ziplock Bag labeled “NOD 1 Mod Kit Caps and Plugs.”

- 4.10 NOD1 IMV Valve Data Cable (W9437) J427 →|← P427 of W0308

Table 3. IMV Valve RMO Initial Condition

Action	RMO Pointer Position	IMV Valve Telemetry
Commanded Open		
Commanded Close		
Manually Open		
Manually Close		

**NOTE**

IMV Valve telemetry indicates the true hardware state of the IMV Valve. RMO pointer position is only valid after RMO adjustments are made. If pointer does not match telemetry after RMO adjustments, its final location will be marked by Sharpie.

- 4.11 Activating Node 1 Port Aft IMV Valve  
Node 1: ECLSS: IMV Port Aft Valve  
Node 1 IMV Port Aft Vlv

sel RPCM N13BB RPC 16

RPCM N13BB RPC 16

**cmd** Close Cmd – Enable (Verify – Ena)  
**cmd** RPC Position – Close (Verify – Cl)

Node 1 IMV Port Aft Vlv

'State'  
'Enable'

**cmd** Arm

√Arm Status – Armed

**cmd** Enable

√State – Enabled

4.12 Opening Node 1 Port Aft IMV Valve

Node 1 IMV Port Aft Vlv

'Position'  
'Open'

**cmd** Arm

√Arm Status – Armed

**cmd** Open

√Position – In Transit

Wait 25 Seconds.

√Position – Open

Record PCS telemetry for Commanded Open in Table 3.

4.13 Verify RMO Pointer contacts OPEN position range.

Record RMO Pointer Position data in Table 3.

4.14 Closing Node 1 Port Aft Valve

**MCC-H**

Node 1: ECLSS: IMV Port Aft Valve

Node 1 IMV Port Aft Vlv

'Close'

**cmd** Arm

√Arm Status – Armed

**cmd** Close

√Position – In Transit

Wait 25 seconds.

## 1.100 NODE 1 PREP FOR NODE 3 – MIDBAY HARDWARE INSTALLATION

(ASSY OPS/ULF3/FIN 2)

Page 18 of 55 pages

√Position – Closed

Record PCS telemetry for Command Close in Table 3.

- 4.15 Verify RMO Pointer contacts “CLOSED” position range.

Record RMO Pointer Position data in Table 3.

- 4.16 Verify commanded positions and PCS telemetry match in Table 3.

If valve commanding did not produce expected valve telemetry

| position  
| Notify **MCC-H**.

### NOTE

Expect suppressed ‘**IMV Deck Fwd Valve Failure-Node 1**’ Caution when valve is manually opened. Caution should clear when valve returns to Close (commanded) position. The Caution text is incorrect, as it refers to the IMV Valve’s old location in Node 1.

- 4.17 Deploy RMO Handle, rotate ↻ to hard stop until pointer contacts RMO “OPEN” position.

Allow handle to return to neutral position.

Note position of pointer at neutral position.

Record whether pointer contacts “OPEN” position range in Table 3.

- 4.18 Node 1 IMV Port Aft Vlv

Verify Position – Open

Record PCS telemetry for “Manually Open” in Table 3.

- 4.19 Deploy RMO Handle, rotate ↻ to hard stop until pointer contacts RMO “CLOSED” position.

Allow handle to return to neutral position.

Note position of pointer at neutral position.

Record whether pointer contacts “CLOSED” position range in Table 3.

- 4.20 Node 1 IMV Port Aft Vlv

Verify Position – Closed

Record PCS telemetry for “Manually Close” in Table 3.



## 1.100 NODE 1 PREP FOR NODE 3 – MIDBAY HARDWARE INSTALLATION

(ASSY OPS/ULF3/FIN 2)

Page 19 of 55 pages

### 4.21 Assessing RMO Functionality

For manual IMV Valve open and close attempts

If telemetry matches for both manual inputs  
Go to step 4.42.

If telemetry matches “OPEN” manual input only  
Go to step 4.22 to rotate IMV Valve RMO Flex Shaft Interface  
towards “OPEN” (↺) to hard stop.

If telemetry matches “CLOSED” manual input only  
Go to step 4.22 to rotate IMV Valve RMO Flex Shaft Interface  
towards “CLOSED” (↻) to hard stop.

If telemetry does not match for either manual input  
Go to step 4.28.

### 4.22 Closing and Deactivating Node 1 Port Aft Valve

Node 1: ECLSS: IMV Port Aft Valve

Node 1 IMV Port Aft Vlv

‘Close’

**cmd** Arm

√Arm Status – Armed

**cmd** Close

√Position – In Transit

Wait 25 seconds.

√Position – Closed

‘State’

‘Inhibit’

**cmd** Arm

√Arm Status – Armed

**cmd** Inhibit

√State – Inhibited

sel RPCM N13BB RPC 16

RPCM N13BB RPC 16

**cmd** RPC Position – Open (Verify – Op)

**cmd** Close Cmd – Inhibit (Verify – Inh)

## 1.100 NODE 1 PREP FOR NODE 3 – MIDBAY HARDWARE INSTALLATION

(ASSY OPS/ULF3/FIN 2)

Page 20 of 55 pages

- 4.23 Loosen, but do not remove IMV Valve RMO Flex Shaft Interface noncaptive fasteners (six) (Ratchet, 1/4" Drive; 5/32" Hex Head, 1/4" Drive). Refer to Figure 6.
- 4.24 While observing RMO pointer position, rotate IMV Valve RMO Flex Shaft Interface to achieve approximately 1/4" travel of RMO Pointer in direction described in step 4.21.
- 4.25 Snug all accessible IMV Valve RMO Flex Shaft Interface fasteners (Ratchet, 1/4" Drive; 5/32" Hex Head, 1/4" Drive).

### 4.26 Activating Node 1 Port Aft IMV Valve

Node 1: ECLSS: IMV Port Aft Valve

Node 1 IMV Port Aft Vlv

sel RPCM N13BB RPC 16

RPCM N13BB RPC 16

**cmd** Close Cmd – Enable (Verify – Ena)

**cmd** RPC Position – Close (Verify – Cl)

Node 1 IMV Port Aft Vlv

'State'

'Enable'

**cmd** Arm

√Arm Status – Armed

**cmd** Enable

√State – Enabled

- 4.27 Go to step 4.17 to repeat manual IMV Valve position; additional adjustments may be required.

#### NOTE

If neither manual input achieves proper telemetry indication, IMV Valve Flex Shaft Interface will be configured to achieve proper "CLOSED" telemetry after manual close input. Once IMV Valve Flex Shaft Interface is configured for proper functionality in Close direction, the RMO Handle hardstop will be adjusted to allow additional travel in Open direction (↷) to hard stop.

- 4.28 To adjust initial RMO pointer position towards "OPEN" direction (↷) to hard stop, perform steps 4.22 to 4.26.

## 1.100 NODE 1 PREP FOR NODE 3 – MIDBAY HARDWARE INSTALLATION

(ASSY OPS/ULF3/FIN 2)

Page 21 of 55 pages

- 4.29 Deploy RMO Handle, rotate ↻ to hard stop until pointer contacts RMO “OPEN” position.  
Allow handle to return to neutral position.
- 4.30 Rotate RMO Handle ↻ to hard stop until pointer contacts RMO “CLOSED” position.  
Allow handle to return to neutral position.
- 4.31 Node 1 IMV Port Aft Vlv  
  
Verify Position – Closed
- 4.32 If telemetry position does not indicate “CLOSED”, repeat steps 4.28 to 4.31.

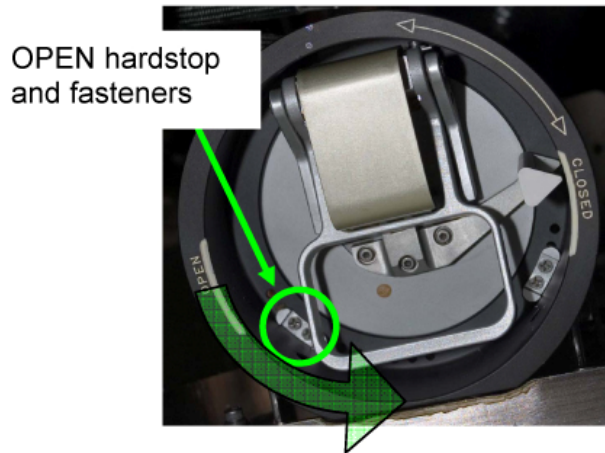

Figure 14.- Front side of RMO Handle.

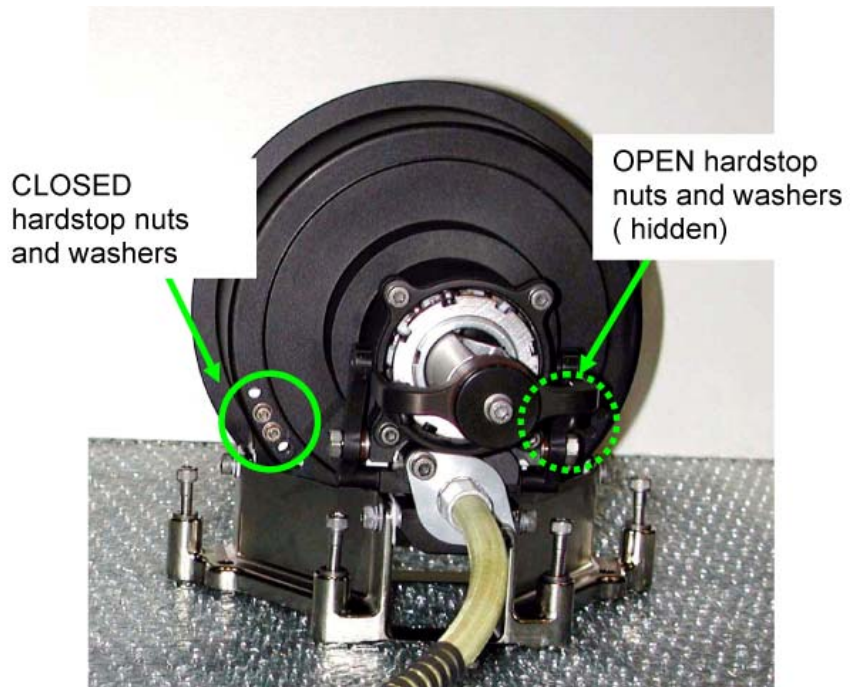

Figure 15.- Rear of RMO Handle.

## 1.100 NODE 1 PREP FOR NODE 3 – MIDBAY HARDWARE INSTALLATION

(ASSY OPS/ULF3/FIN 2)

Page 23 of 55 pages

### NOTE

Hardstop fasteners consist of a noncaptive fastener, nut, and washer.

- 4.33 Note initial position of RMO "OPEN" hardstop.
- 4.34 Supporting noncaptive hardware on rear of RMO, remove noncaptive fasteners, washers, nuts (two each) (#6 Long Torq Driver, 3/8" Drive; 1/4" to 3/8" Adapter; Ratchet, 1/4" Drive).  
Refer to Figure 14 and 15.
- 4.35 Install RMO Open hardstop, noncaptive fasteners, washers, nuts (two each) one position further in "OPEN" direction (↻) to hard stop as compared to initial position (#6 Long Torq Driver, 3/8" Drive; 1/4" to 3/8" Adapter; Ratchet, 1/4" Drive).  
Refer to Figures 14 and 15.
- 4.36 Deploy RMO Handle, rotate ↻ to hard stop until pointer contacts RMO "OPEN" position.  
Allow handle to return to neutral position.

PCS

- 4.37 Node 1 IMV Port Aft Vlv

Verify Position – Open

- 4.38 Deploy RMO Handle, rotate ↻ to hard stop until pointer contacts RMO "CLOSED" position.  
Allow handle to return to neutral position.

- 4.39 Node 1 IMV Port Aft Vlv

Verify Position – Closed

- 4.40 If telemetry does not match manual inputs, repeat steps 4.33 to 4.39.
- 4.41 Torque RMO Open hardstop fasteners to 20 in-lbs (two) [#6 Long Torq Driver, 3/8" Drive; 1/4" to 3/8" Adapter; (10-50 in-lbs) Trq Wrench, 1/4" Drive].
- 4.42 Mark final position of IMV Valve RMO Flex Shaft Interface (Sharpie).
- 4.43 If all six IMV Valve RMO Flex Shaft Interface fasteners can be accessed while valve is installed, go to step 4.51.

MCC-H

- 4.44 [Closing and Deactivating Node 1 Port Aft Valve](#)

Node 1: ECLSS: IMV Port Aft Valve

Node 1 IMV Port Aft Vlv

'Close'

**cmd** Arm

## 1.100 NODE 1 PREP FOR NODE 3 – MIDBAY HARDWARE INSTALLATION

(ASSY OPS/ULF3/FIN 2)

Page 24 of 55 pages

√Arm Status – Armed

**cmd** Close

√Position – In Transit

Wait 25 seconds.

√Position – Closed

### 4.45 Deactivating Node 1 Port Aft Valve

'State'

'Inhibit'

**cmd** Arm

√Arm Status – Armed

**cmd** Inhibit

√State – Inhibited

sel RPCM N13BB RPC 16

RPCM N13BB RPC 16
-------------------

**cmd** RPC Position – Open (Verify – Op)

**cmd** Close Cmd – Inhibit (Verify – Inh)

4.46 NOD1 IMV Valve Power Cable (W9436) P1 ←|→ J1 of Node 1 Port-Aft IMV Valve

4.47 NOD1 IMV Valve Data Cable (W9437) P2 ←|→ J2 of Node 1 Port-Aft IMV Valve

4.48 Note position of RMO pointer, this position must be maintained for reinstallation of RMO Flex Shaft.

4.49 Release RMO Flex Shaft from IMV Valve, fasteners (two) (Ratchet, 1/4" Drive; 10" Ext, 1/4" Drive; 6" Ext, 1/4" Drive; 4" Ext, 1/4" Drive; 5/32" Hex Head, 1/4" Drive).

4.50 Remove IMV Valve, V-Band Clamp (Ratchet, 1/4" Drive; 4" Ext, 1/4" Drive; 7/16" Deep Socket, 1/4" Drive or 1/2" Deep Socket, 1/4" Drive).

4.51 Verify alignment mark made in step 4.42 is still properly aligned. Snug IMV Valve RMO Flex Shaft Interface noncaptive fasteners (six) in an X-pattern per Figure 6 (Ratchet, 1/4" Drive; 5/32" Hex Head, 1/4" Drive). Torque noncaptive fasteners to 23 in-lbs in an X-pattern [(10-50 in-lbs) Trq Wrench, 1/4" Drive; 5/32" Hex Head, 1/4" Drive].

## 1.100 NODE 1 PREP FOR NODE 3 – MIDBAY HARDWARE INSTALLATION

(ASSY OPS/ULF3/FIN 2)

Page 25 of 55 pages

Refer to Figure 6.

- 4.52 If IMV Valve not removed from Bulkhead, go to step 4.58.
- 4.53 Install IMV Valve, V-Band Clamp onto Bulkhead, aligning marks made in step 3.11 (Ratchet, 1/4" Drive; 4" Ext, 1/4" Drive; 7/16" Deep Socket, 1/4" Drive or 1/2" Deep Socket, 1/4" Drive).
- 4.54 Attach RMO Flex Shaft, fasteners (two) to IMV Valve (Ratchet, 1/4" Drive; 10" Ext, 1/4" Drive; 6" Ext, 1/4" Drive; 4" Ext, 1/4" Drive; 5/32" Hex Head, 1/4" Drive).
- 4.55 NOD1 IMV Valve Power Cable (W9436) P1 →|← J1 of Node 1 Port-Aft IMV Valve
- 4.56 NOD1 IMV Valve Data Cable (W9437) P2 →|← J2 of Node 1 Port-Aft IMV Valve
- 4.57 Activating Node 1 Port Aft IMV Valve  
Node 1: ECLSS: IMV Port Aft Valve
- sel RPCM N13BB RPC 16
- 
- cmd** Close Cmd – Enable (Verify – Ena)  
**cmd** RPC Position – Close (Verify – Cl)
- 
- 'State'  
'Enable'
- cmd** Arm
- √Arm Status – Armed
- cmd** Enable
- √State – Enable
- 4.58 If 1/2" Nut on V-Band Clamp, torque to 135 in-lbs [Ratchet, 1/4" Drive; 1/2" Deep Socket, 1/4" Drive; (40-200 in-lbs) Trq Wrench, 1/4" Drive].  
If 7/16" Nut on V-Band Clamp, torque to 35 in-lbs [Ratchet, 1/4" Drive; 7/16" Deep Socket; (10-50 in-lbs) Trq Wrench, 1/4" Drive].
- 4.59 Tighten, torque RMO Flex Shaft fasteners (two) to 39 in-lbs [Ratchet, 1/4" Drive; 10" Ext, 1/4" Drive; 6" Ext, 1/4" Drive; 4" Ext, 1/4" Drive; 5/32" Hex Head, 1/4" Drive; (10-50 in-lbs) Trq Wrench, 1/4" Drive].

## 1.100 NODE 1 PREP FOR NODE 3 – MIDBAY HARDWARE INSTALLATION

(ASSY OPS/ULF3/FIN 2)

Page 26 of 55 pages

### NOTE

Steps 4.60 to 4.71 perform a final checkout of the IMV Valve and RMO.

#### 4.60 Opening Node 1 Port Aft IMV Valve

Node 1 IMV Port Aft Vlv

'Position'

'Open'

**cmd** Arm

√Arm Status – Armed

**cmd** Open

√Position – In Transit

Wait 25 Seconds.

√Position – Open

4.61 Verify RMO Handle commanded to “OPEN” position range.  
If RMO Handle does not point to open range, create temporary “OPEN” label (Gray Tape, Sharpie).

4.62 Photo document RMO showing pointer position (Digital Camera).

#### 4.63 Closing Node 1 Port Aft IMV Valve

Node 1: ECLSS: IMV Port Aft Valve

Node 1 IMV Port Aft Vlv

'Close'

**cmd** Arm

√Arm Status – Armed

**cmd** Close

√Position – In Transit

Wait 25 seconds.

√Position – Closed

4.64 Verify RMO Handle commanded to “CLOSED” position range.  
If RMO Handle does not point to closed range, create temporary “CLOSED” label (Gray Tape, Sharpie).

4.65 Photo document RMO showing pointer position (Digital Camera).



## 1.100 NODE 1 PREP FOR NODE 3 – MIDBAY HARDWARE INSTALLATION

(ASSY OPS/ULF3/FIN 2)

Page 27 of 55 pages

### NOTE

Expect suppressed 'IMV Deck Fwd Valve Failure- Node 1' Caution when valve is opened. Caution should clear when valve returned to Close (commanded) position. The Caution text is incorrect, as it refers to the IMV Valve's old location in Node 1.

4.66 Deploy RMO Handle, rotate ↻ to hard stop until pointer contacts RMO "OPEN" position.  
Allow handle to return to neutral position.

4.67 Note position of pointer at neutral position.  
Determine whether pointer contacts "OPEN" position range.

Node 1 IMV Port Aft Vlv

Verify Position – Open

4.68 Photo document RMO showing pointer position (Digital Camera).

4.69 Deploy RMO Handle, rotate ↻ to hard stop until pointer contacts RMO "CLOSED" position.  
Allow handle to return to neutral position.

4.70 Note position of pointer at neutral position.  
Determine whether pointer contacts "CLOSED" position range.

Node 1 IMV Port Aft Vlv

Verify Position – Closed

4.71 Photo document RMO showing pointer position (Digital Camera).

4.72 **On MCC-H GO**  
Node 1: ECLSS: IMV Port Aft Valve

Node 1 IMV Port Aft Vlv

'State'

'Inhibit'

**cmd** Arm

√Arm Status – Armed

**cmd** Inhibit

√State – Inhibited

sel RPCM N13BB RPC 16

RPCM N13BB RPC 16

**cmd** RPC Position – Open (Verify – Op)

**cmd** Close Cmd – Inhibit (Verify – Inh)

## 1.100 NODE 1 PREP FOR NODE 3 – MIDBAY HARDWARE INSTALLATION

(ASSY OPS/ULF3/FIN 2)

Page 28 of 55 pages

NOD1D1 4.73 NOD1 IMV Valve Power Cable (W9436) J426 ←|→ P426 of W0136

4.74 Protective Cap →|← J426 of NOD1 IMV Valve Power Cable (W9436)  
Protective Cap (or Kapton Tape) →|← P426 of W0136

Retrieve Protective Caps from Ziplock Bag labeled “NOD 1 Mod Kit Caps and Plugs.”

4.75 NOD1 IMV Valve Data Cable (W9437) J427 ←|→ P427 of W0308

4.76 Protective Cap →|← J427 of NOD1 IMV Valve Data Cable (W9437)  
Protective Cap (or Kapton Tape) →|← P427 of W0308

Retrieve Protective Caps from Ziplock Bag labeled “NOD 1 Mod Kit Caps and Plugs.”

4.77 Coil and temporarily stow NOD1 IMV Valve Data Cable (W9437) and NOD1 IMV Valve Power Cable (W9436) behind Port Midbay.  
The cable will be permanently routed in a subsequent step.

4.78 Install NOD1D1-01 Closeout Panel, fasteners (eight) (Ratchet, 1/4" Drive; 5/32" Hex Head, 1/4" Drive).

4.79 Install new NOD1P3-02 Closeout Panel, fasteners (four) (Ratchet, 1/4" Drive; 5/32" Hex Head, 1/4" Drive).

### 5. RECONFIGURING IMV FLOW

#### NOTE

To stop airflow through NOD1O2 IMV duct to be replaced, while maintaining minimal level of IMV into Node 1, several IMV reconfiguration steps are required.

PMA1 5.1 Open PMA1 IMV Duct Grill (Velcro cover).

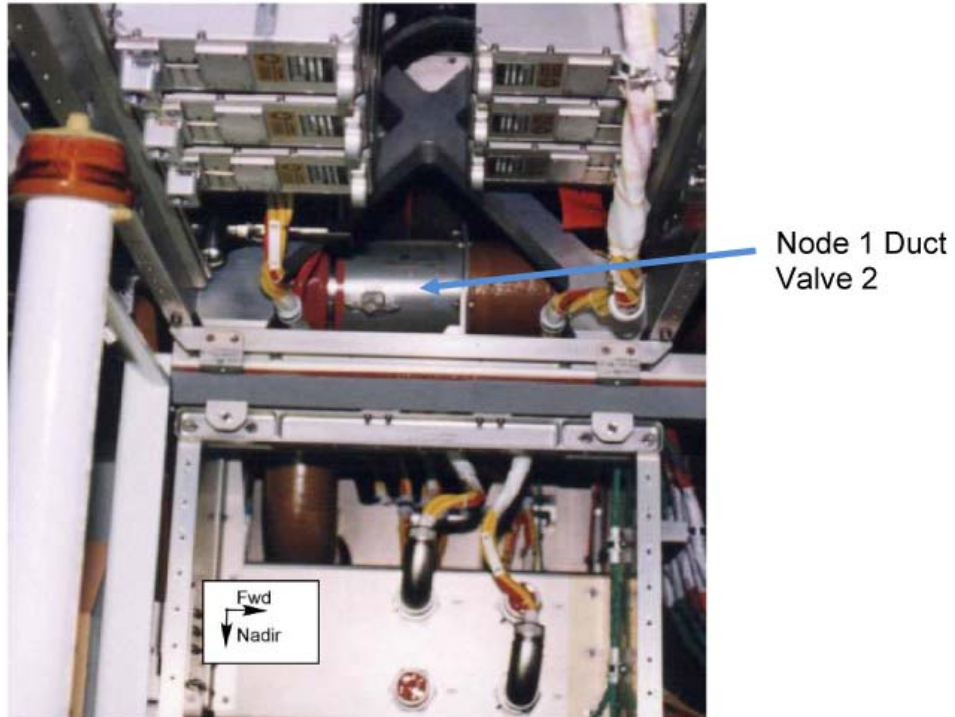

Figure 16.- Node 1 Duct Valve 2 (located at NOD1OP1).

NOD1O1-01 5.2 Node 1 IMV Duct Valve 2 → Open

**MCC-H** 5.3 To turn off Node 1 Aft Port IMV Fan, perform [1.504 IMV FAN ACTIVATION/DEACTIVATION POST CCS](#), step 3.1 (SODF: ECLSS: ACTIVATION AND CHECKOUT: THC), then:

5.4 To close Node 1 Aft Port IMV Valve, perform [2.506 IMV VALVE RECONFIGURATION](#), step 3 (SODF: ECLSS: NOMINAL: THC), then:

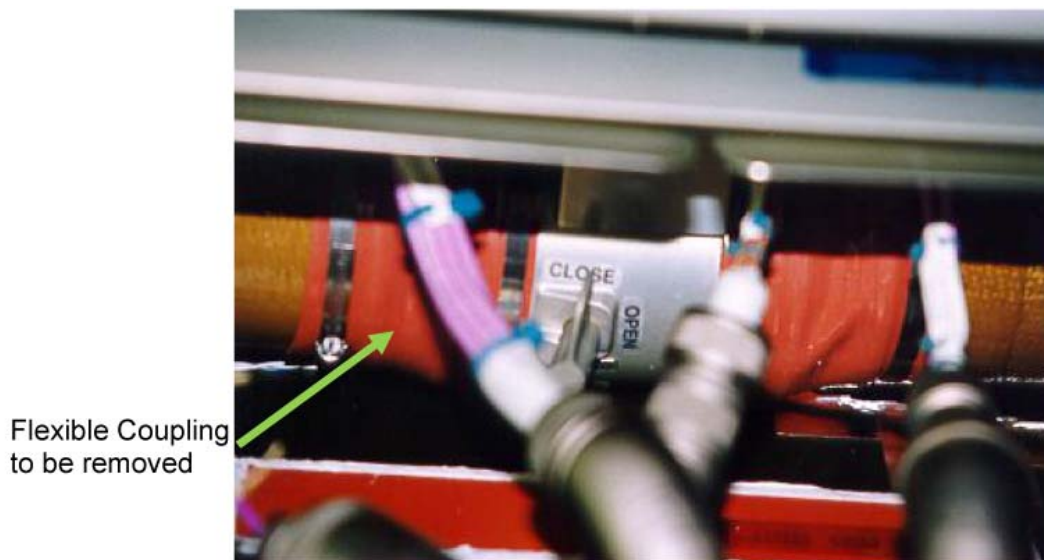

Figure 17.- Node 1 Duct Valve 4 (Located at NOD1OP2).

5.5 **On MCC-H GO**  
NOD1OP2 Node 1 IMV Duct Valve 4 → CLOSE

6. [REPLACING NOD1OP2 IMV DUCT](#)

**NOTE**

Removal of IMV duct will likely release FOD and dust into cabin. Use appropriate PPE and prepare Vacuum Cleaner to capture loose dust. To ensure loose dust will not annunciate a false fire in Node 1, **MCC-H** will inhibit all Node 1 cabin smoke detection for the duration of this activity.

**WARNING**

Node 1 Smoke Detection will be inhibited during steps 6 and 7. Crew is prime for smoke detection in Node 1 until it is enabled post activity.

- MCC-H**
- 6.1 To inhibit Node 1 Smoke Detection, perform [1.402 SMOKE DETECTOR DEACTIVATION](#), step 1 for Node 1 SD1 and Node 1 SD2 (SODF: ECLSS: ACTIVATION AND CHECKOUT: FDS), then:
  - 6.2 Configure Vacuum Cleaner in Node 1.  
Use Vacuum Cleaner as required.

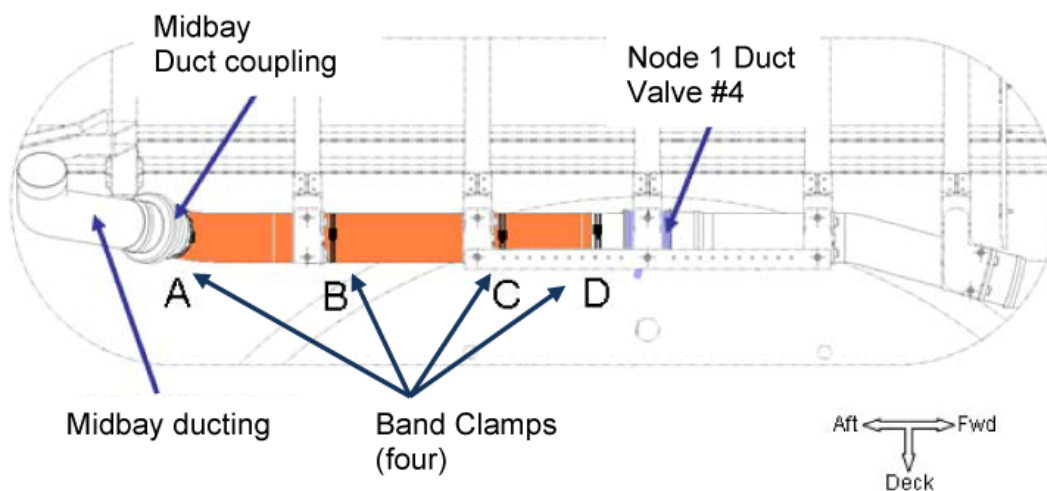

Figure 18.- Original NOD102 IMV Duct.

NOD1OP2 6.3 **On MCC-H GO**  
Loosen band clamps (four) holding original NOD102 IMV Ducting (Driver Handle, 1/4" Drive; 1/4" Deep Socket, 1/4" Drive; 4" Common Tip Screwdriver).

## 1.100 NODE 1 PREP FOR NODE 3 – MIDBAY HARDWARE INSTALLATION

(ASSY OPS/ULF3/FIN 2)

Page 31 of 55 pages

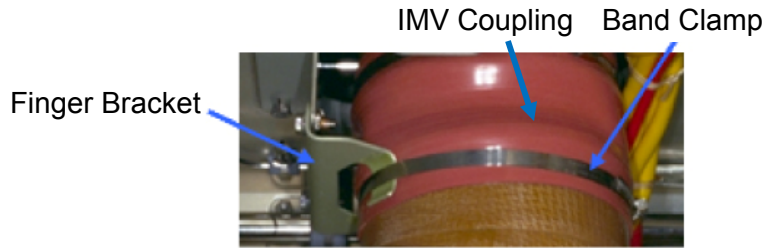

Figure 19.- IMV Duct Finger Bracket.

- 6.4 Move loosened Band Clamps away from IMV couplings and finger brackets.
- 6.5 Don Goggles, Dust Mask.
- 6.6 Position crewmembers at NOD1P2 and NOD1P4.
- 6.7 Remove original NOD1O2 IMV duct by rotating down and away from midbay ducting.  
Once free of midbay ducting, slide original NOD1O2 IMV duct towards aft to release from Node 1 IMV Duct Valve 4 coupling.  
Remove duct segment through NOD1P4 Rack bay area.
- 6.8 If original NOD1O2 IMV Duct is full of dust and FOD, cover both ends of duct (Ziplock Bags, Gray Tape).
- 6.9 Remove 4" Band Clamps (four) from original NOD1O2 IMV Duct.  
Stow Band Clamps in Ziplock Bag labeled "Spare IMV Parts."  
Stow original NOD1O2 IMV duct.
- 6.10 Remove Flexible Coupling, 4" Band Clamp from Node 1 IMV Duct Valve 4 (Driver Handle, 1/4" Drive; 1/4" Deep Socket, 1/4" Drive; 4" Common Tip Screwdriver).  
Stow Flexible Coupling, Band Clamp in Ziplock Bag labeled "Spare IMV Parts."  
Refer to Figure 17.
- 6.11 Loosely install new 4" Band Clamps (four) onto new NOD1O2 IMV Duct.  
Three Band Clamps should be installed on long segment of duct, one Band Clamp should be installed on short curved segment of duct.

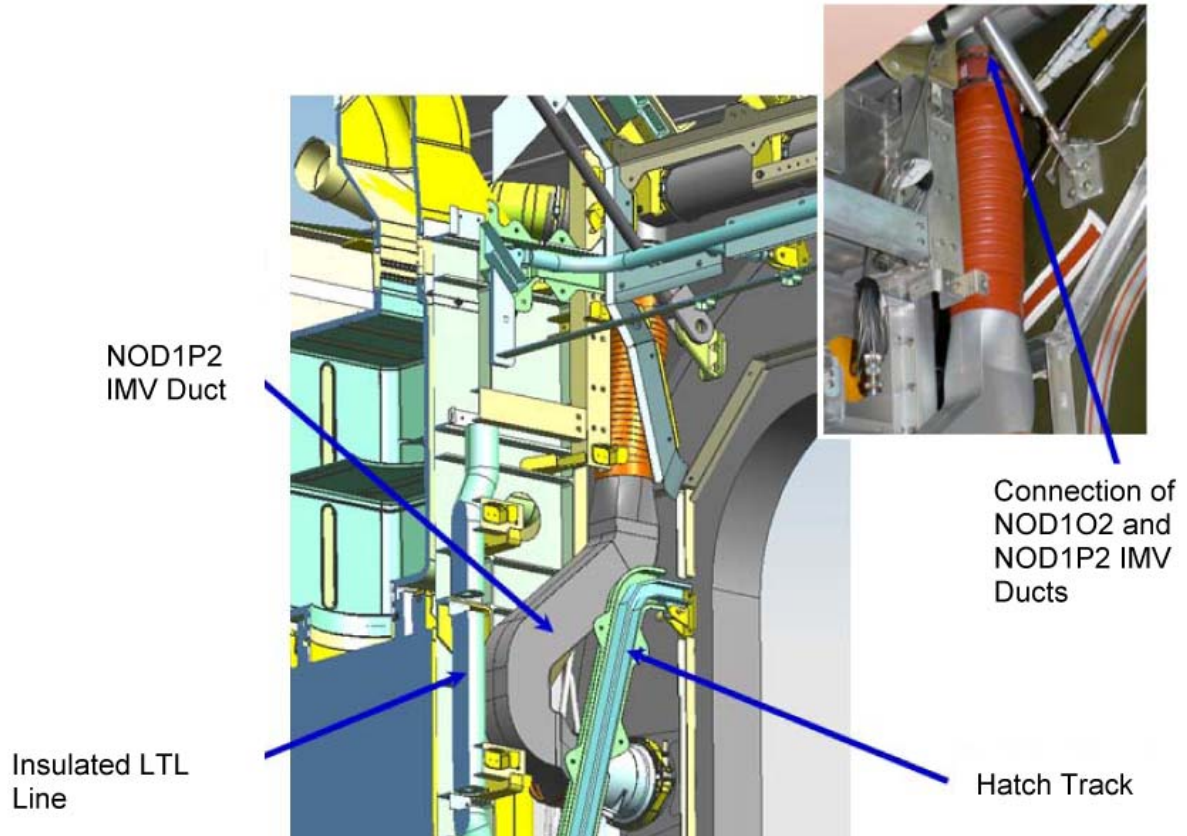

Figure 20.- New IMV Ducting Installed Behind Node 1 Port Midbay.

- 6.12 Performing opposite motion of step 6.6, install new NOD1O2 IMV Duct. When mating Flexible Coupling to Node 1 IMV Duct Valve 4, ensure minimum 1.25" overlap is present.  
Mate new NOD1O2 IMV Duct to midbay duct with a rotational motion, ensuring minimum 1.25" coupling overlap is present.  
Verify "T" outlet oriented Nadir.
- 6.13 Position 4" Band Clamps over Flexible Couplings and Finger Brackets. Snug Band Clamps (Driver Handle, 1/4" Drive; 1/4" Deep Socket, 1/4" Drive; 4" Common Tip Screwdriver).
- 6.14 Remove temporary covering from Port-Aft IMV Valve. Inspect IMV Valve for FOD or damage.
- 6.15 Loosely install new 4" Band Clamp onto Flexible end of new NOD1P2 IMV Duct.  
Loosely install IMV Duct Clamp (5" diameter) onto rigid end of new NOD1P2 IMV Duct.
- 6.16 Avoiding contact with Insulated LTL Line, install new NOD1P2 IMV Duct by guiding flexible segment behind secondary structure towards NOD1O2 IMV Duct "T" outlet.  
Rigid ducting will fit behind Hatch Track.

## 1.100 NODE 1 PREP FOR NODE 3 – MIDBAY HARDWARE INSTALLATION

(ASSY OPS/ULF3/FIN 2)

Page 33 of 55 pages

- 6.17 Overlap flexible couplings (two) between NOD1P2 IMV Duct and IMV Valve (NOD1O2 IMV Duct) by 1.25".  
Snug Band Clamps (two) (Driver Handle, 1/4" Drive; 1/4" Deep Socket, 1/4" Drive; 4" Common Tip Screwdriver).
- 6.18 Tighten, torque Band Clamps (six) to 16 in-lbs [1/4" Deep Socket, 1/4" Drive; (5-35 in-lbs) Trq Driver, 1/4" Drive].
- 6.19 Doff Goggles, Dust Mask.
- 6.20 Photo document newly installed hardware (Digital Camera).
- 6.21 Install following Closeout Panels (Ratchet, 1/4" Drive; 5/32" Hex Head, 1/4" Drive).  
NOD1P2-34 (twenty-four fasteners)  
NOD1P2-33 (five fasteners)

### 7. INSTALLING NOD1P4 IMV DIFFUSER COVERS

- NOD1OP3/  
NOD1OP4
- 7.1 Remove, discard temporary diffuser covers from NOD1OP3 and NOD1OP4 diffusers.
  - 7.2 Remove Diffuser Grilles (two), fasteners (six each) from NOD1OP3 and NOD1OP4 (Ratchet, 1/4" Drive; 3/8" Socket, 1/4" Drive).  
Stow Diffuser Grilles.
  - 7.3 Install Diffuser Covers (two), IMV Diffuser Gaskets (two), fasteners (six each) at NOD1OP3 and NOD1OP4 (Ratchet, 1/4" Drive; 3/8" Socket, 1/4" Drive).  
Torque fasteners (six each) to 22 in-lbs [Ratchet, 1/4" Drive; 3/8" Socket, 1/4" Drive; (10-50 in-lbs) Trq Wrench, 1/4" Drive].
  - 7.4 Photo document newly installed hardware.

### 8. ENABLING NODE 1 IMV FLOW

- NOD1OP2
- 8.1 Node 1 IMV Duct Valve 4 → OPEN  
Refer to Figure 17.
  - 8.2 ISS ↓ **MCC-H**: "Node 1 Midbay IMV Reconfiguration complete. Ready for Node 1 IMV and Smoke Detector activation."
- MCC-H**
- 8.3 To enable Node 1 Smoke Detection, perform [1.401 SMOKE DETECTOR ACTIVATION](#), steps 2 and 3 for Node 1 SD1 and Node 1 SD2 (SODF: ECLSS: ACTIVATION AND CHECKOUT: FDS), then:
  - 8.4 To open Node 1 Aft Port IMV Valve, perform [2.506 IMV VALVE RECONFIGURATION](#), step 2 (SODF: ECLSS: NOMINAL: THC), then:
  - 8.5 To turn on Node 1 Aft Port IMV Fan, perform [1.504 IMV FAN ACTIVATION/DEACTIVATION POST CCS](#), step 2.2 (SODF: ECLSS: ACTIVATION AND CHECKOUT: THC), then:

**1.100 NODE 1 PREP FOR NODE 3 – MIDBAY HARDWARE INSTALLATION**  
(ASSY OPS/ULF3/FIN 2) Page 34 of 55 pages

NOD1OP1 8.6 **On MCC-H GO**  
Node 1 IMV Duct Valve 2 → Close  
Refer to Figure 16.

PMA1 8.7 Cover PMA1 IMV Duct Grill (Velcro cover).

8.8 Install NOD1O1-01 Closeout Panel, fasteners (eight) (Ratchet, 1/4" Drive;  
5/32" Hex Head, 1/4" Drive).

**9. FLUID HOSE ROUTING AND CONNECTION**

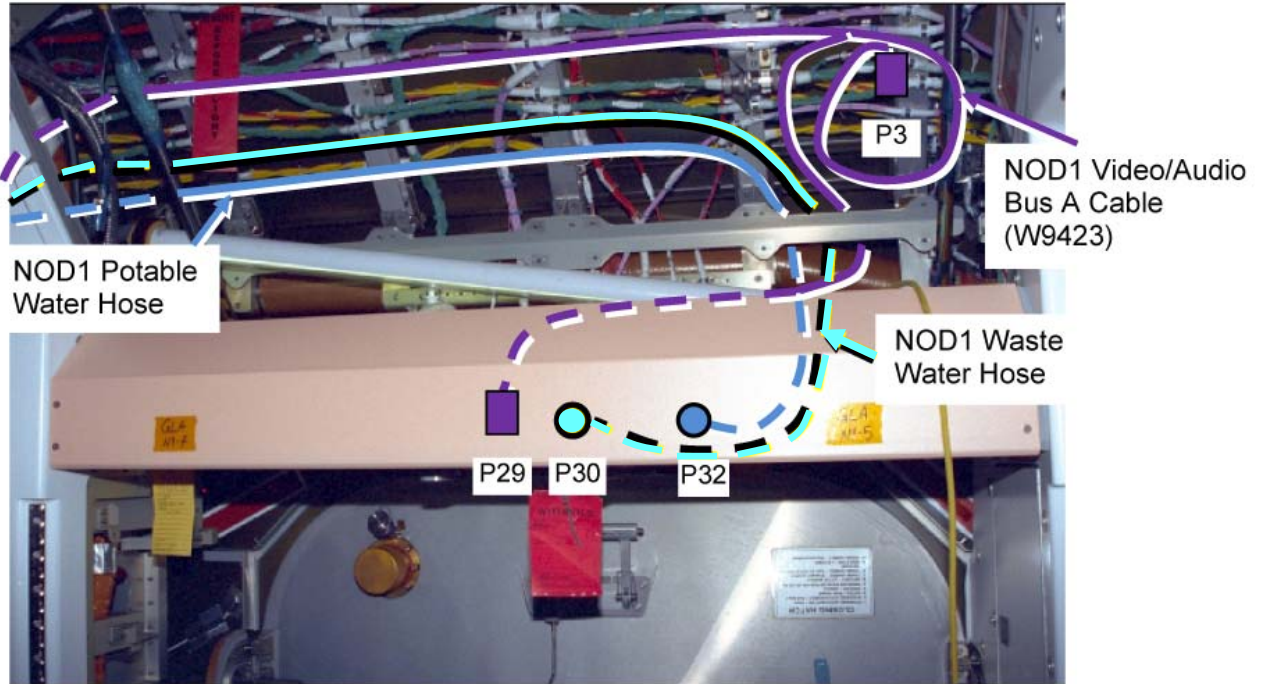

Figure 21.- Routing of Fluid Hoses in NOD1OP2 Area.



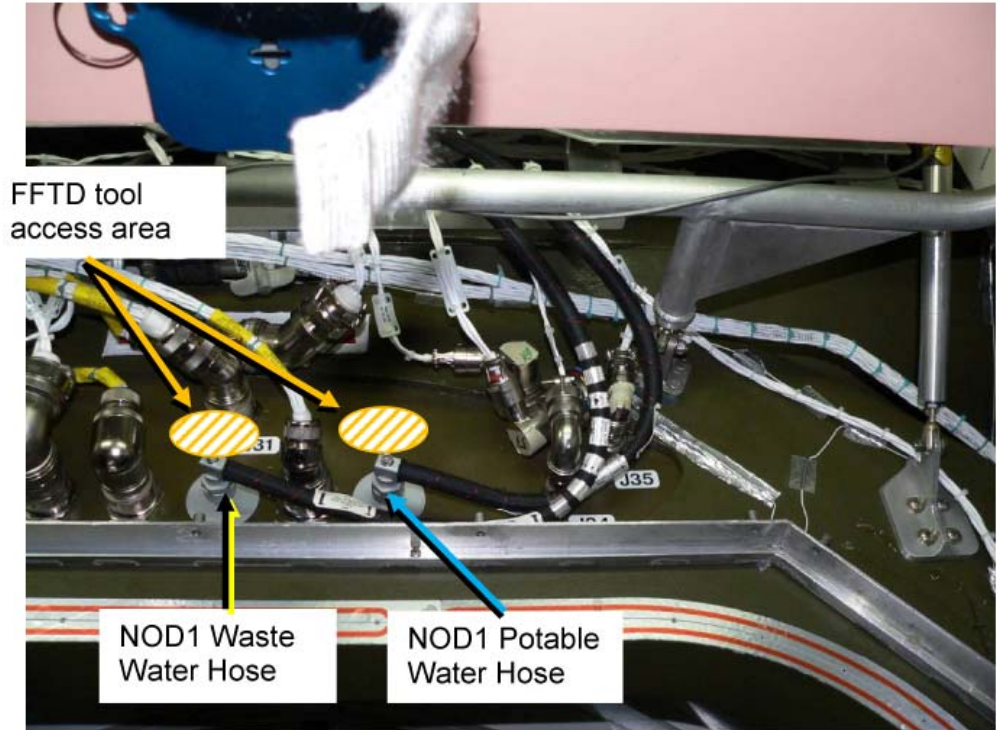

Figure 22.- Routing of Fluid Hoses.

- 9.1 Locate NOD1 Waste Water Hose and NOD1 Potable Water Hose. Stage hoses in NOD1P4 Rack bay.

NOTE  
 Proper routing of fluid hoses will ensure sufficient access to worksite for FFTD torquing of fluid fittings.

- NOD1P4 9.2 Route 90-degree Gamah connector of NOD1 Waste Water Hose from NOD1P4 to NOD1OP2 Bulkhead connector J30 - Waste Water. Refer to Figures 21 and 22 for recommended routing.
- NOD1OP2 9.3 Route 90-degree Gamah connector of NOD1 Potable Water Hose from NOD1P4 to NOD1OP2 Bulkhead connector J33 - Fuel Cell H2O. Refer to Figures 21 and 22 for recommended routing.
- 9.4 Verify hose routing will not interfere with installation of Closeout Panels.
- 9.5 Verify no sharp edges along hose routing path.

If sharp edge located

Relocate hose or cover sharp edge with multiple layers of EVA Tape and wrap hose with EVA Tape to prevent abrasion.

# 1.100 NODE 1 PREP FOR NODE 3 – MIDBAY HARDWARE INSTALLATION

(ASSY OPS/ULF3/FIN 2)

Page 36 of 55 pages

- 9.6 Verify sufficient access to actuate J27, J29, J31 and J32 in subsequent steps.

NOTE

Gamah fitting and FFTD reference information can be found in:  
[A.2.1 FLUID FITTING TORQUE DEVICE \(FTTD\) ASSEMBLY AND USAGE](#) (SODF: IFM: REFERENCE: APPENDIX A: ISS IVA TOOLS)  
[A.2.3 MATING GAMAH FITTING USING THE FFTD](#) (SODF: IFM: REFERENCE: APPENDIX A: ISS IVA TOOLS)  
[A.2.13 GAMAH SEAL R&R](#) (SODF: IFM: REFERENCE: APPENDIX A: ISS IVA TOOLS) (Gamah Seal R&R is not expected for this activity)

- 9.7 Gamah Cap ←|→ J30 (Waste Water) on Bulkhead (by hand)  
Gamah Plug ←|→ TO: NOD1 Port Bulkhead J30 on NOD1 Waste Water Hose (by hand)

Stow Gamah Caps in Ziplock Bag labeled “NOD 1 Mod Kit Caps and Plugs.”

- 9.8 NOD1 Waste Water Hose TO: NOD1 Port Bulkhead J30 →|← J30 (Waste Water) on Bulkhead  
Hand Tighten.

**WARNING**

Skin contact with the fluid-contacting surfaces of the potable water system (i.e., “Fuel Cell Water”) QDs or gamah fittings can potentially lead to contamination of water supply and crew illness.

\*\*\*\*\*

- \* If skin contact is made with fluid-contacting surface of potable water system
- \* Clean surfaces with Povidone Iodine Pads from the ALSP Kit.
- \* Notify **MCC-H**.

\*\*\*\*\*

- 9.9 Don Clean Room Gloves.
- 9.10 Gamah Cap ←|→ J33 (Fuel Cell H2O) on Bulkhead (by hand)  
Gamah Plug ←|→ TO: NOD1 Port Bulkhead J33 on NOD1 Potable Water Hose (by hand)
- Stow Gamah Caps in Ziplock Bag labeled “NOD 1 Mod Kit Caps and Plugs.”
- 9.11 NOD1 Potable Water Hose TO: NOD1 Port Bulkhead J33 →|← J33 (Fuel Cell H2O) on Bulkhead  
Hand Tighten.
- 9.12 Doff Clean Room Gloves.

## 1.100 NODE 1 PREP FOR NODE 3 – MIDBAY HARDWARE INSTALLATION

(ASSY OPS/ULF3/FIN 2)

Page 37 of 55 pages

- 9.13 Set torque wrench per FFTD Calibration Card for Output Torque of 345 in-lbs [FFTD; (40-200 in-lbs) Trq Wrench, 3/8" Drive; 1.00" Drive Gear, 0.625" Reaction Gear].  
Torque J30, J33 gamah connections.  
Refer to Table 2 of FFTD Calibration Card on FFTD Kit Lid.
- 9.14 Restrain hoses in NOD1OP2 and NOD1OP3 area to secondary structure per crew preference (minimum every 3 feet).  
Routing from NOD1OP3 to NOD1PD3 will occur in a subsequent step.

### 10. CONNECTION SAFING FOR W0201 P31

#### 10.1 INH BC Comm Fail

CDH: Primary C&C: Recovery Retry: CCS MDM

CCS Recovery Retry

**cmd** BC Comm Fail – Inhibit **Execute** ( $\sqrt{\text{Inh}}$ )

#### 10.2 CDH: C&C Primary: CB Int 2: Bus Status

CB INT 2 Bus Status

'Channel Selected'

**cmd** Select Ch B **Execute** ( $\sqrt{\text{B}}$ )

'Auto Channel Switch Status'

**cmd** Inhibit **Execute** ( $\sqrt{\text{Inh}}$ )

#### 10.3 CNT: CUP

CUP1

$\sqrt{\text{Bus}}$  I/O (two) – Inhibit

#### 10.4 Verify Robotics system is ready to support Robotics 1553 bus disruption during cable connections on the following buses:

BCU LB 2

HC LB 2

**11. AVIONICS WIRE HARNESS ROUTING AND CONNECTION**

**NOTE**

1. During Wire Harness routing in subsequent steps, precautions must be taken to prevent Electromagnetic Interference (EMI) issues. Incompatible Wire Harnesses must be separated by 2 inches when routed parallel for more than 1 foot, Wire Harnesses must be separated by 3 inches when routed parallel for more than 3 feet. There are no constraints for the routing of the NOD1 Waste Water Hose or NOD1 Potable Water Hose.

2. While routing Wire Harnesses in this procedure, the following routing is recommended:

- a) NOD1 1553 CH A Cable (W9421)  
NOD1 Video/Audio Bus A Cable (W9423)  
NOD1 Wireless Audio Cable (W9425)  
NOD1 ISL Ethernet Cable (W9426)

These Wire Harnesses are compatible with each other and existing Node 1 1553 cabling. These Wire Harnesses will be bundled together and routed with existing 1553 lines.

- b) NOD1 IMV Valve Power Cable (W9436)  
This Wire Harness is not compatible with others being installed in this procedure. This Wire Harness should be routed with existing Node 1 power Wire Harnesses.
- c) NOD1 IMV Valve Data Cable (W9437)  
This Wire Harness is not compatible with others being installed in this procedure. This Wire Harness should be routed with existing Node 1 instrumentation Wire Harnesses.
- d) Crossing of incompatible Wire Harnesses is acceptable as long as the Wire Harnesses are not within 2 inches of each other for more than 1 foot.

11.1 For all cable routing, maintain Bend Radius greater than six times diameter of Harness.

Prior to connector mating, inspect both connectors for FOD, damage.

11.2 Locate following Wire Harnesses:

- NOD1 1553 CH A Cable (W9421)
- NOD1 Video/Audio Bus A Cable (W9423)
- NOD1 Wireless Audio Cable (W9425)
- NOD1 ISL Ethernet Cable (W9426)

Stage Wire Harnesses in NOD1P4 Rack bay.

## 1.100 NODE 1 PREP FOR NODE 3 – MIDBAY HARDWARE INSTALLATION

(ASSY OPS/ULF3/FIN 2)

Page 39 of 55 pages

### CAUTION

When routing and connecting NOD1 Video/Audio Bus A Cable (W9423), use caution to avoid damage to fiber optic lines. Do not subject Harness to bend radius less than six times cable diameter, compression or high tension forces.

- NOD1P4 11.3 Locate P3 and P29 of NOD1 Video/Audio Bus A Cable (W9423). Route P3 and P29 from NOD1P4 to NOD1OP2 as shown in Figure 21.
- NOD1OP2 11.4 Coil and stow P3 leg of NOD1 Video/Audio Bus A Cable (W9423) at location shown in Figure 21.  
Restrain coiled Harness loosely with Velcro Straps.
- 11.5 Route P29 leg of NOD1 Video/Audio Bus A Cable (W9423) to J29 of Bulkhead.  
Verify routing will not interfere with Closeout Panel installation.
- 11.6 W0401 P29 ←|→ J29 of Bulkhead
- 11.7 Transfer Protective Cap from NOD1 Video/Audio Bus A Cable (W9423) P29 to W0401 P29.
- 11.8 Restrain W0401 P29 away from worksite (Cable Tie).
- 11.9 NOD1 Video/Audio Bus A Cable (W9423) P29 →|← J29 of Bulkhead

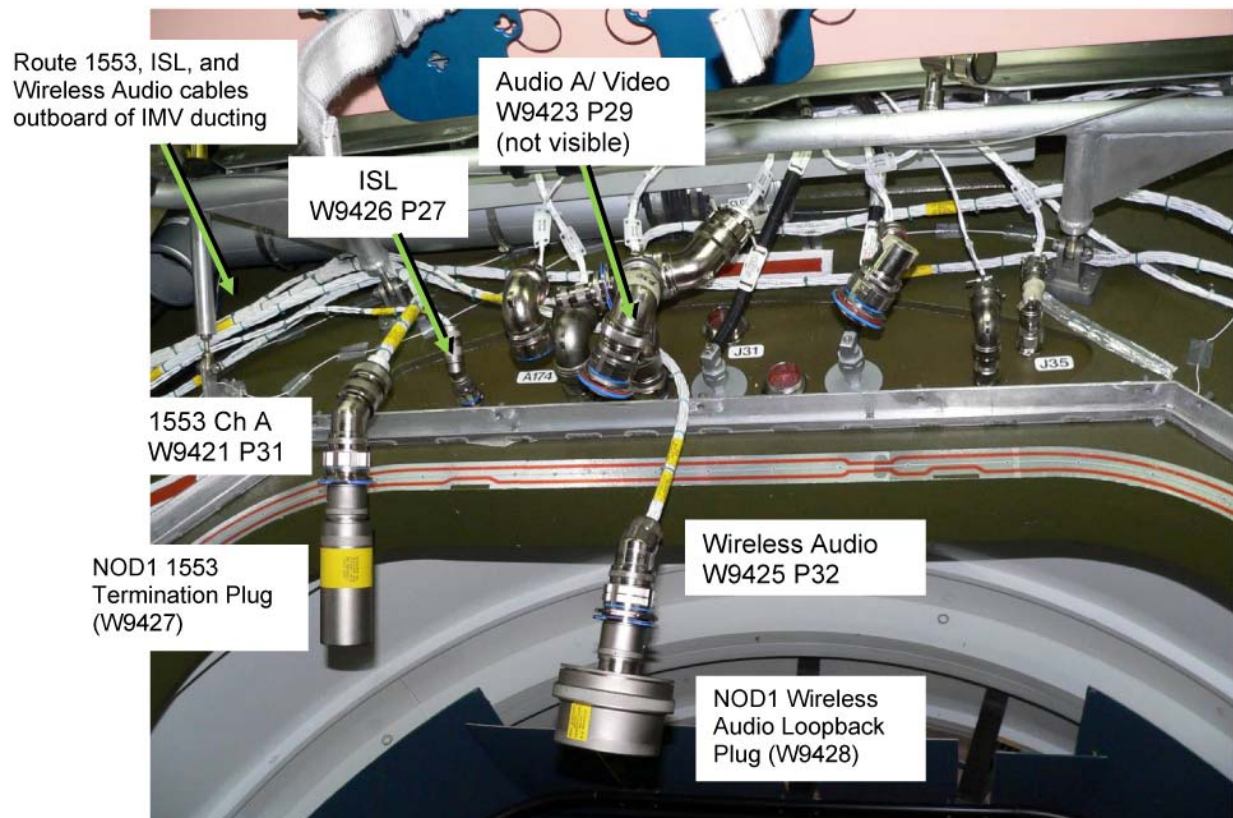

Figure 23.- Node 1 Port Overhead Bulkhead (B9 Photo).

## 1.100 NODE 1 PREP FOR NODE 3 – MIDBAY HARDWARE INSTALLATION

(ASSY OPS/ULF3/FIN 2)

Page 40 of 55 pages

- NOD1P4 11.10 Locate P27 of NOD1 ISL Ethernet Cable (W9426).  
Route P27 from NOD1P4 to NOD1OP2 near J27 of Bulkhead as shown in Figure 23.
- NOD1OP2 11.11 Protective Cap ←|→ J27 of Bulkhead  
Protective Cap ←|→ P27 of NOD1 ISL Ethernet Cable (W9426)  
  
Stow Protective Caps in Ziplock Bag labeled “NOD 1 Mod Kit Caps and Plugs.”
- 11.12 NOD1 ISL Ethernet Cable (W9426) P27 →|← J27 of Bulkhead
- 11.13 ✓**MCC-H** verify safing complete per step 10
- NOD1P4 11.14 Locate P31 and J31 of NOD1 1553 CH A Cable (W9421).  
Route P31 and J31 from NOD1P4 to NOD1OP2 near J31 of Bulkhead as shown in Figure 23.
- 11.15 Locate NOD1 1553 Termination Plug (W9427).
- NOD1OP2 11.16 Protective Cap ←|→ NOD1 1553 Termination Plug (W9427)  
Protective Cap ←|→ P31 of NOD1 1553 CH A Cable (W9421)  
  
Stow Protective Cap in Ziplock Bag labeled “NOD 1 Mod Kit Caps and Plugs.”
- NOTE

NOD1 1553 CH A Cable (W9421) P31 will be connected to the Node 1 Port Bulkhead during vestibule outfitting of Flight 20A. To prevent 1553 transaction errors until that connection is made, NOD1 1553 Termination Plug (W9427) must be connected.
- 11.17 NOD1 1553 CH A Cable (W9421) P31 →|← NOD1 1553 Termination Plug (W9427)
- 11.18 W0201 P31 ←|→ J31 of Bulkhead
- 11.19 Transfer Protective Cap from J31 of NOD1 1553 CH A Cable (W9421) to J31 of Bulkhead.
- 11.20 W0201 P31 →|← J31 of NOD1 1553 CH A Cable (W9421)
- 11.21 Stow terminated P31 of NOD1 1553 CH A Cable (W9421) near J31 of Bulkhead.
- NOD1P4 11.22 Locate P32 of NOD1 Wireless Audio Cable (W9425).  
Route P32 from NOD1P4 to NOD1OP2 near J32 of Bulkhead as shown in Figure 23.
- NOD1OP2 11.23 W0410 P32 ←|→ J32 of Bulkhead

09 NOV 09

## 1.100 NODE 1 PREP FOR NODE 3 – MIDBAY HARDWARE INSTALLATION

(ASSY OPS/ULF3/FIN 2)

Page 41 of 55 pages

- 11.24 Transfer Protective Cap from NOD1 Wireless Audio Cable (W9425) P32 to W0410 P32.
- 11.25 Restrain W0410 P32 away from worksite (Cable Tie).
- 11.26 Locate NOD1 Wireless Audio Loopback Plug (W9428).
- 11.27 Transfer Protective Cap from NOD1 Wireless Audio Loopback Plug (W9428) to J32 of Bulkhead.
- 11.28 NOD1 Wireless Audio Cable (W9425) P32 →|← NOD1 Wireless Audio Loopback Plug (W9428)  
  
Stow terminated NOD1 Wireless Audio Cable (W9425) P32 near J32 of Bulkhead.
- 11.29 Restrain all Wire Harnesses per crew preference, with a minimum spacing of 3 feet (Cable Ties).  
Do not tighten Zip Ties on NOD1 Video/Audio Bus A Cable (W9423), as this may damage the fiber optic lines.
- 11.30 Photo document all connections and cable routing.
- 11.31 Install following Closeout Panels (Ratchet, 1/4" Drive; 5/32" Hex Head, 1/4" Drive):
  - NOD1OP2-25 (eight fasteners)
  - NOD1OP2-24 (six fasteners)
  - NOD1OP2-22, -23 (three fasteners each) (install panels as a group)
  - NOD1OP2-21 (fifteen fasteners)
  - NOD1O2-31 (six fasteners), NOD1P2-36 (five fasteners) (install panels as a group)
- 11.32 If complete for the day
  - Coil Wire Harnesses and fluid hoses behind Node 1 Port Midbay.
  - √NOD1P4 Rack rotation path unobstructed
  - K-BAR Thumb Latches (two) → up position
  - Slowly rotate Rack up.
  - Engage K-BAR Thumb Latches (two) into Standoff Capture Mechanism.

12. NORMALIZING 1553 SAFING

12.1 CDH: C&C Primary: CB Int 2: Bus Status

CB INT 2 Bus Status

'Channel Selected'

**cmd** Select Ch A **Execute** (√A)

'Auto Channel Switch Status'

**cmd** Enable **Execute** (√Ena)

12.2 Enabling BC Comm Fail

CDH: Primary C&C: Recovery Retry: CCS MDM

CCS Recovery Retry

**cmd** BC Comm Fail – Enable **Execute** (√Ena)

13. PORT MIDBAY WIRE HARNESS ROUTING

\*\*\*\*\*

- \* If insufficient space is available in Standoff between Node 1 Port and
- \* Nadir Midbays to allow temporary placement of Wire Harnesses
- \* and fluid hoses during subsequent routing steps
- \* Partially rotate NOD1P4 up.
- \*
- \* Perform steps 15.1 to 15.5 to partially rotate NOD1D4 down.
- \*
- \* Avoid obstruction of Node 1 - PMA1 translation path.
- \*
- \* Pass end of Wire Harness between crewmembers.
- \* Temporarily stow coiled Harness behind Node 1 Deck Midbay.
- \*
- \* Perform steps 17.1 to 17.7 to rotate NOD1D4 up.

\*\*\*\*\*



**1.100 NODE 1 PREP FOR NODE 3 – MIDBAY HARDWARE INSTALLATION**  
 (ASSY OPS/ULF3/FIN 2) Page 43 of 55 pages

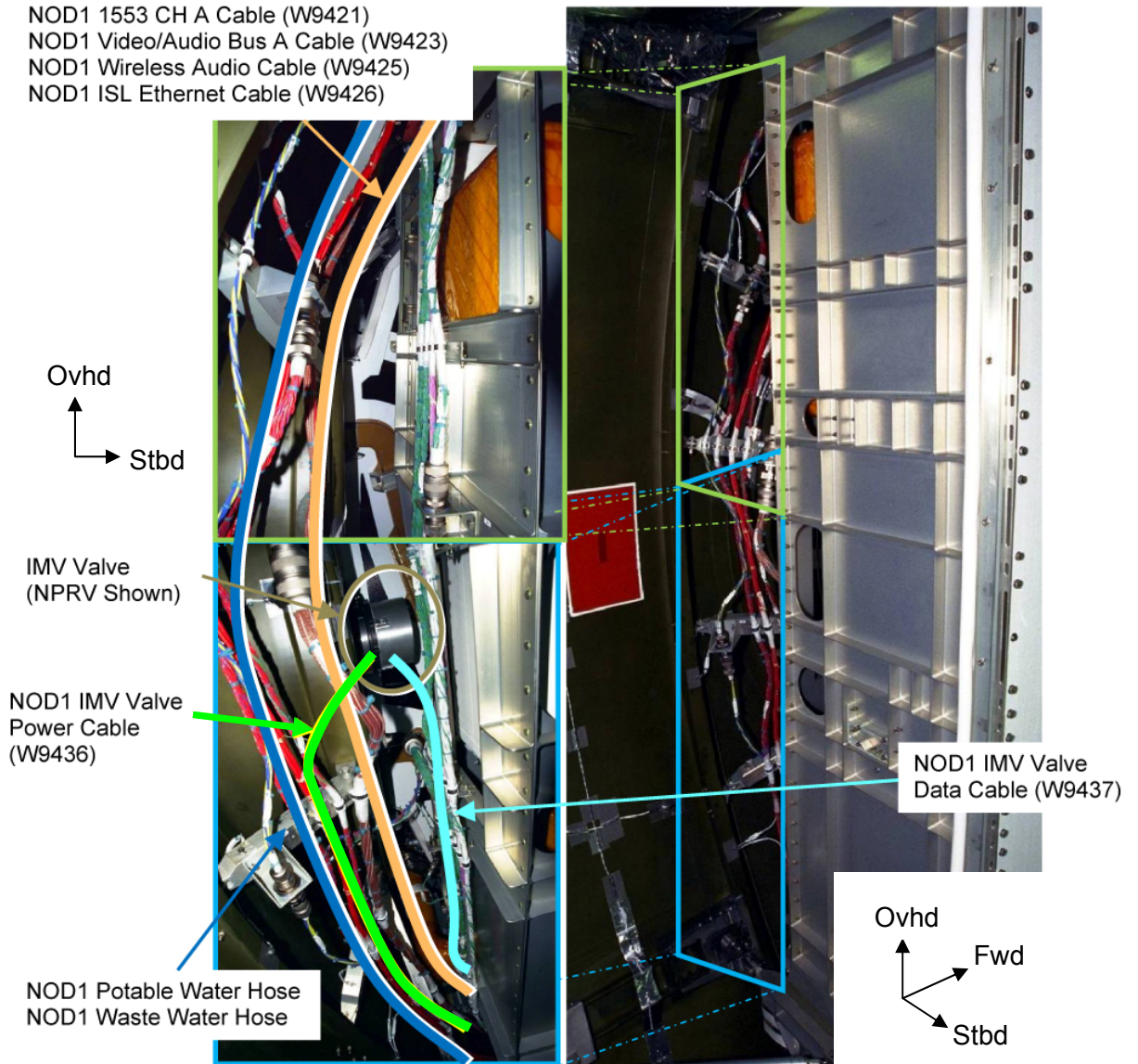

Figure 24.- Node 1 Port Midbay.

- NOD1P4 13.1 ✓ NOD1P4 Rack rotated down
- 13.2 Route fluid hoses (two) from top to bottom of Node 1 Port Midbay; these hoses have no EMI routing constraints. Recommend routing per Figure 24, near red cables. Restrain to secondary structure, as required (Cable Ties).
- 13.3 Verify no sharp edges along hose routing path.
- If sharp edge located  
 | Relocate hose or cover sharp edge with multiple layers of EVA Tape and wrap hose with EVA Tape to prevent abrasion.

## 1.100 NODE 1 PREP FOR NODE 3 – MIDBAY HARDWARE INSTALLATION

(ASSY OPS/ULF3/FIN 2)

Page 44 of 55 pages

- 13.4 Coil, temporarily restrain remaining fluid hose in Standoff between Port and Deck Midbays (Velcro Ties).
- 13.5 Bundle the following cables to aid routing in Node 1 Port Midbay:
  - NOD1 1553 CH A Cable (W9421)
  - NOD1 Video/Audio Bus A Cable (W9423)
  - NOD1 Wireless Audio Cable (W9425)
  - NOD1 ISL Ethernet Cable (W9426)
- 13.6 Route bundle as shown in Figure 24, following existing W0205 Harness from top to bottom of Node 1 Port Midbay.  
Keep bundle away from red-insulated wires to prevent EMI concerns.  
Restrain loosely to secondary structure as required (Cable Ties).
- 13.7 Coil, temporarily restrain remaining length of wire bundle in Standoff between Port and Deck Midbays (Velcro Ties).
- 13.8 Route NOD1 IMV Valve Power Cable (W9436) from newly installed IMV Valve to bottom of Node 1 Port Midbay as shown in Figure 24.  
Follow W0115 (red cables) to prevent EMI concerns.  
Restrain loosely to secondary structure as required (Cable Ties).
- 13.9 Coil, temporarily restrain remaining length of Wire Harness in Standoff between Port and Deck Midbays (Velcro Ties).
- 13.10 Route NOD1 IMV Valve Data Cable (W9437) from newly installed IMV Valve to bottom of Node 1 Port Midbay as shown in Figure 24.  
Follow W0303 (green cables) on Port face of Midbay structure to prevent EMI concerns.  
Restrain loosely to secondary structure, as required (Cable Ties).
- 13.11 Photo document cable routing (Digital Camera).
- 13.12 ✓NOD1P4 Rack rotation path unobstructed
  - K-BAR Thumb Latches (two) → up position
  - Slowly rotate Rack up.
  - Engage K-BAR Thumb Latches (two) into Standoff Capture Mechanism.
14. CONNECTION SAFING FOR W0205 P106
  - 14.1 INH BC Comm Fail
    - CDH: Primary C&C: Recovery Retry: CCS MDM
    - CCS Recovery Retry
    - cmd BC Comm Fail – Inhibit Execute** (✓Inh)

# 1.100 NODE 1 PREP FOR NODE 3 – MIDBAY HARDWARE INSTALLATION

(ASSY OPS/ULF3/FIN 2)

Page 45 of 55 pages

## 14.2 [Inhibiting Auto Transition to Diagnostics in PMCU MDM](#)

CDH: Primary PMCU: MDM FDIR

**cmd** Auto Transition Diag – Inhibit **Execute** (√Inh)

## 14.3 [Inhibiting Comm Safing Response in INT MDM](#)

CDH: Primary INT: MDM FDIR

**cmd** Comm Safing Response – Inhibit **Execute** (√Inh)

Table 4. Buses in W0205 P106 Connector

Bus Name [YY]	Controlling MDM
LB ORB HAB 1	Prime GNC
LB ORB HAB 2	Prime GNC
LB EPS HAB 23	Prime PMCU
LB EPS HAB 14	Prime PMCU
LB SYS HAB 1	Prime INT
LB SYS HAB 2	Prime INT
LB SEPS HAB 23	Prime INT
LB SEPS HAB 14	Prime INT
CB CT BIA 23	Prime C&C
CB CT 4	Prime C&C
CB INT 2	Prime C&C
LB CheCS HAB	Prime PL

14.4 Use Table 4 to switch channels to B and inhibit channel switching.

sel [YY] where [YY] = Bus Name from Table 4

'Channel Selected'

**cmd** Select Ch B **Execute** (√B)

'Auto Channel Switch Status'

**cmd** Inhibit **Execute** (√Inh)

Repeat

14.5 Verify Robotics system is ready to support Robotics 1553 bus disruption during cable connections on MSS PDGF LB.

15. DECK MIDBAY ROUTING

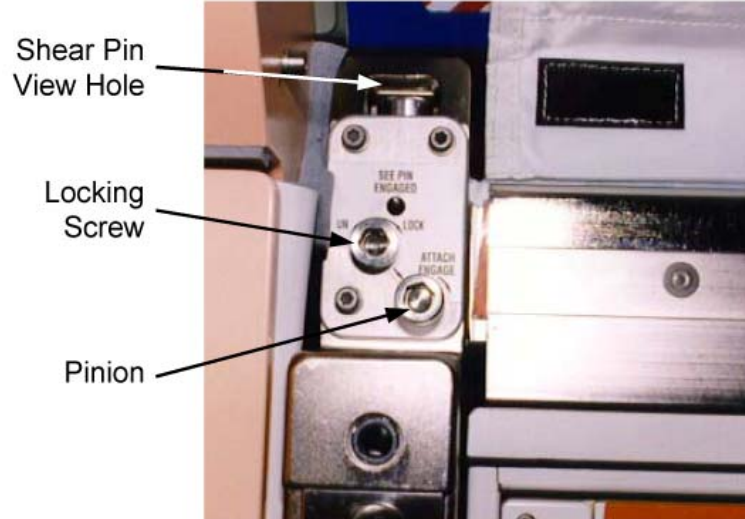

Figure 25.- Upper Attach Mechanism (Left Side).

- NOD1D4 15.1 Loosen left locking screw 10 to 12 turns, or until threads completely disengage (Ratchet, 3/8" Drive; 6" Long, 3/8" Hex Head, 3/8" Drive). Refer to Figure 25.

**NOTE**

Left, right pinions have reverse gearing:  
To disengage left pinion, turn ↺.  
To disengage right pinion, turn ↻.

- 15.2 Disengage left pinion one full turn until hard stop (Ratchet, 3/8" Drive; 6" Long, 3/8" Hex Head, 3/8" Drive).
- 15.3 Repeat steps 15.1, 15.2 for right Upper Attach Mechanism.
- 15.4 ✓NOD1D4 Rack rotation path unobstructed
- 15.5 Slowly rotate Rack Down to a controlled stop.  
Temporarily restrain as required.
- 15.6 Retrieve Wire Harnesses and hoses from Standoff between Node 1 Port and Deck Midbays.

# 1.100 NODE 1 PREP FOR NODE 3 – MIDBAY HARDWARE INSTALLATION

(ASSY OPS/ULF3/FIN 2)

Page 47 of 55 pages

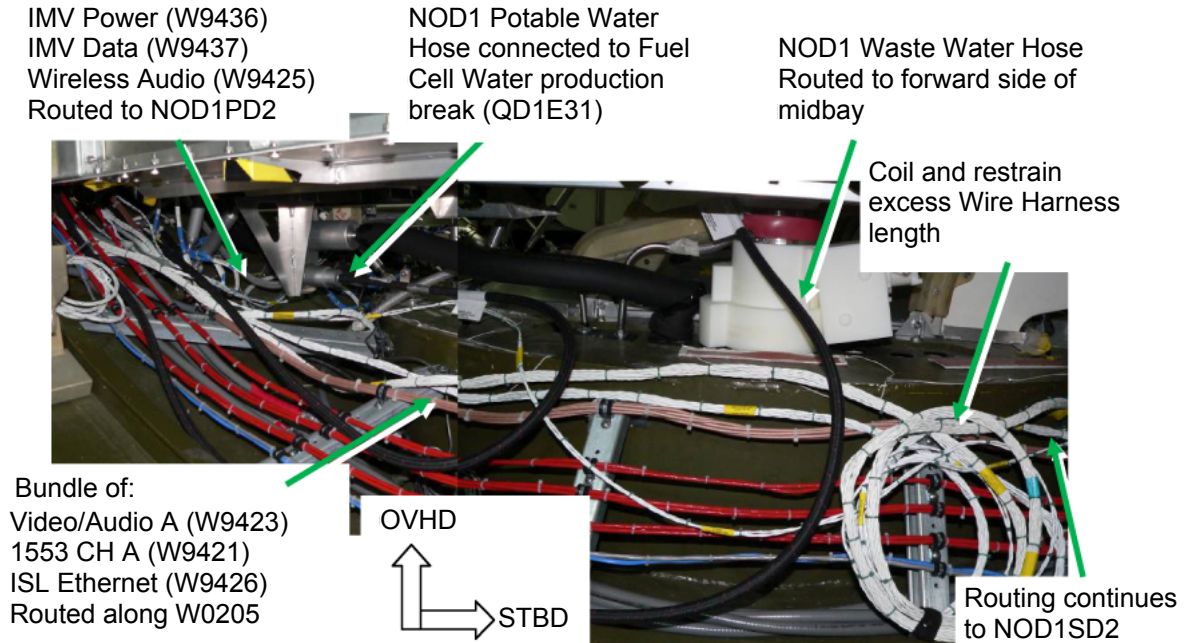

Figure 26.- Routing of Cables/Hoses in Nadir Midbay (View Looking Forward, B9 Mockup).

- 15.7 Locate and route NOD1 Potable Water Hose to Fuel Cell Water Hose production break.  
Refer to Figure 26.

WARNING
Skin contact of the wetted surfaces of the potable water system (i.e., “Fuel Cell Water”) QDs or gamah fittings can potentially lead to contamination of water supply and crew illness.

\*\*\*\*\*  
 \* If skin contact is made with fluid-contacting surface of potable water  
 \* | system  
 \* | Clean surfaces with Povidone Iodine Pads from the ALSP Kit.  
 \* | Notify **MCC-H**.  
 \*\*\*\*\*

- 15.8 Fuel Cell Water Hose ←|→ QD1E31 (Node 1 Production Break)
- 15.9 Transfer Protective Cap from NOD1 Potable Water Hose to Fuel Cell Water Hose.  
Restrain Fuel Cell Water Hose (Zip Ties).
- 15.10 NOD1 Potable Water Hose →|← QD1E31 (Node 1 Production Break)
- 15.11 Route any excess length of NOD1 Potable Water Hose along secondary structure toward center of module.  
Restrain hose to secondary structure (Cable Ties).

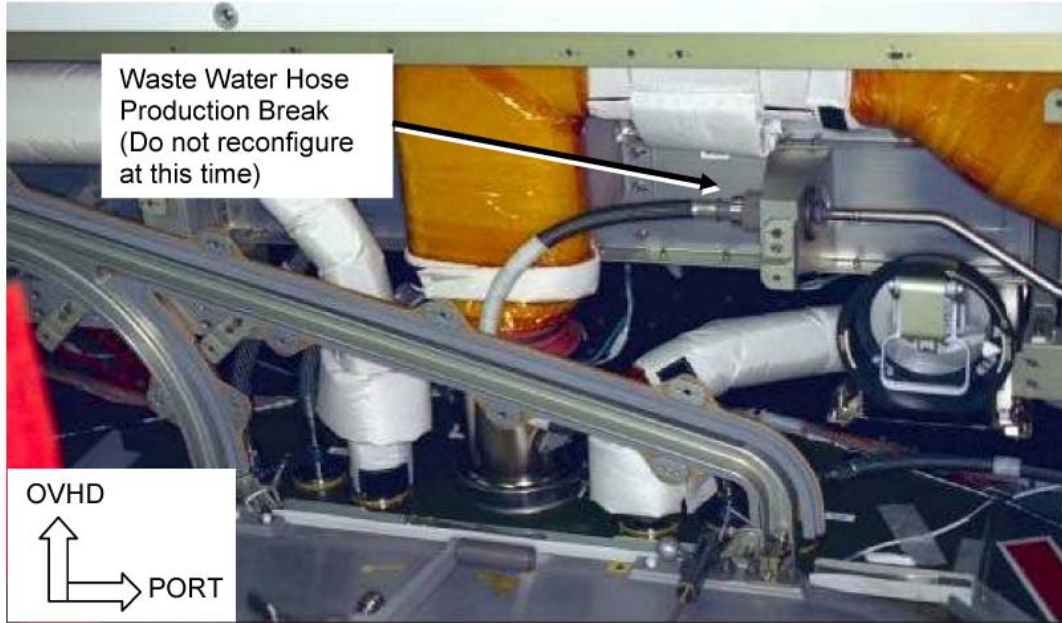

Figure 27.- Node 1 Nadir Midbay, Forward Side.

- 15.12 Locate and route NOD1 Waste Water Hose to center of Nadir Midbay. Keeping hose to the port side of the Node 1 Nadir-aft IMV Valve, pass QD to second crewmember in Node 1 Deck Radial bay. Restrain NOD1 Waste Water Hose to currently installed hose at production break (QD1E30) (Velcro Tie). Do not reconfigure Waste Water QDs at this time. Refer to Figure 27.

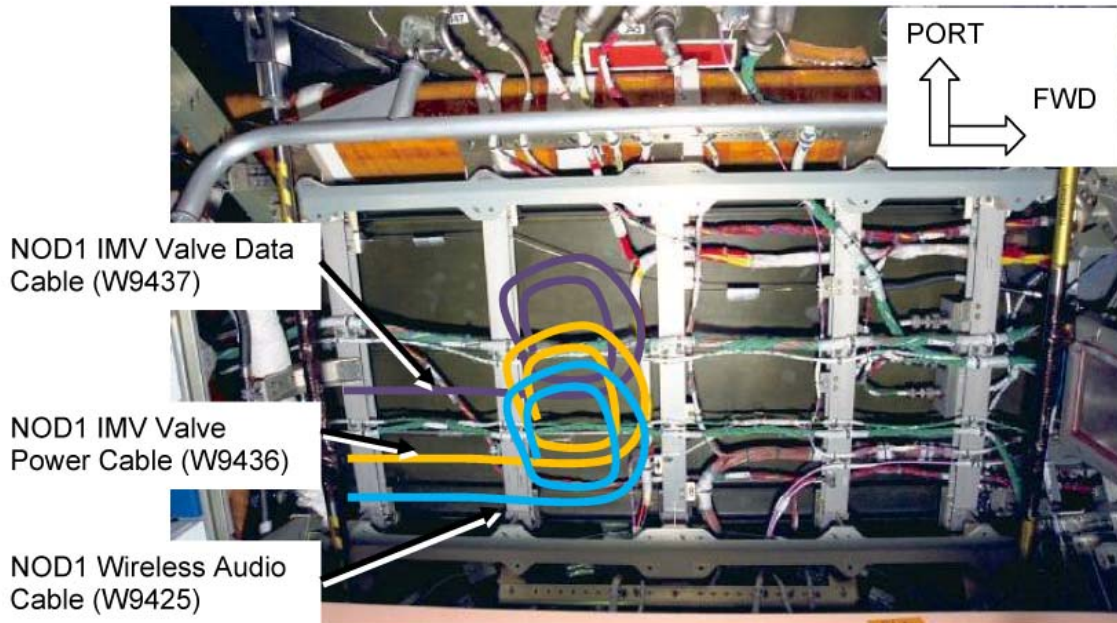

Figure 28.- NOD1PD2 Area.

**1.100 NODE 1 PREP FOR NODE 3 – MIDBAY HARDWARE INSTALLATION**  
(ASSY OPS/ULF3/FIN 2) Page 49 of 55 pages

- 15.13 Locate and route the following three Harnesses from Deck Midbay to NOD1PD2 area:  
NOD1 Wireless Audio Cable (W9425)  
NOD1 IMV Valve Data Cable (W9437)  
NOD1 IMV Valve Power Cable (W9436)  
Maintain 3 inch spacing between all adjacent parallel Wire Harnesses while routing forward through midbay.
- 15.14 Coil and restrain Wire Harnesses in NOD1PD2 area for later routing and connection.  
During this temporary stowage, no EMI constraints exist, so cables may be positioned adjacent to any other Wire Harnesses.

Route all three cables from Deck Midbay into NOD1SD2 area outboard of secondary structure.  
Route along W0205

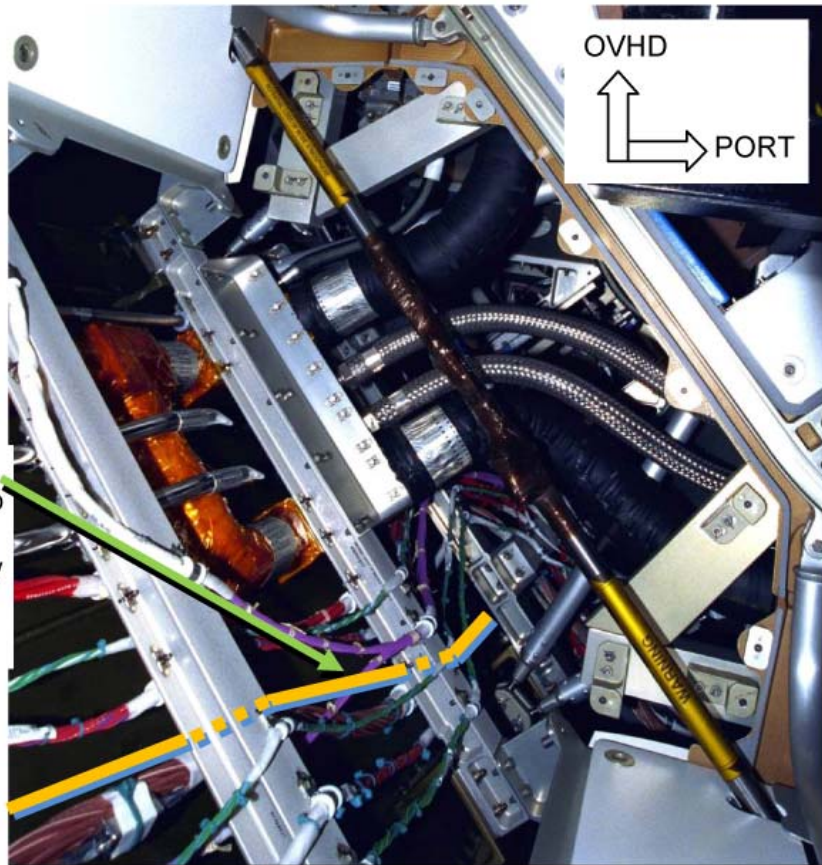

Figure 29.- NOD1SD2 Area, Looking Aft.

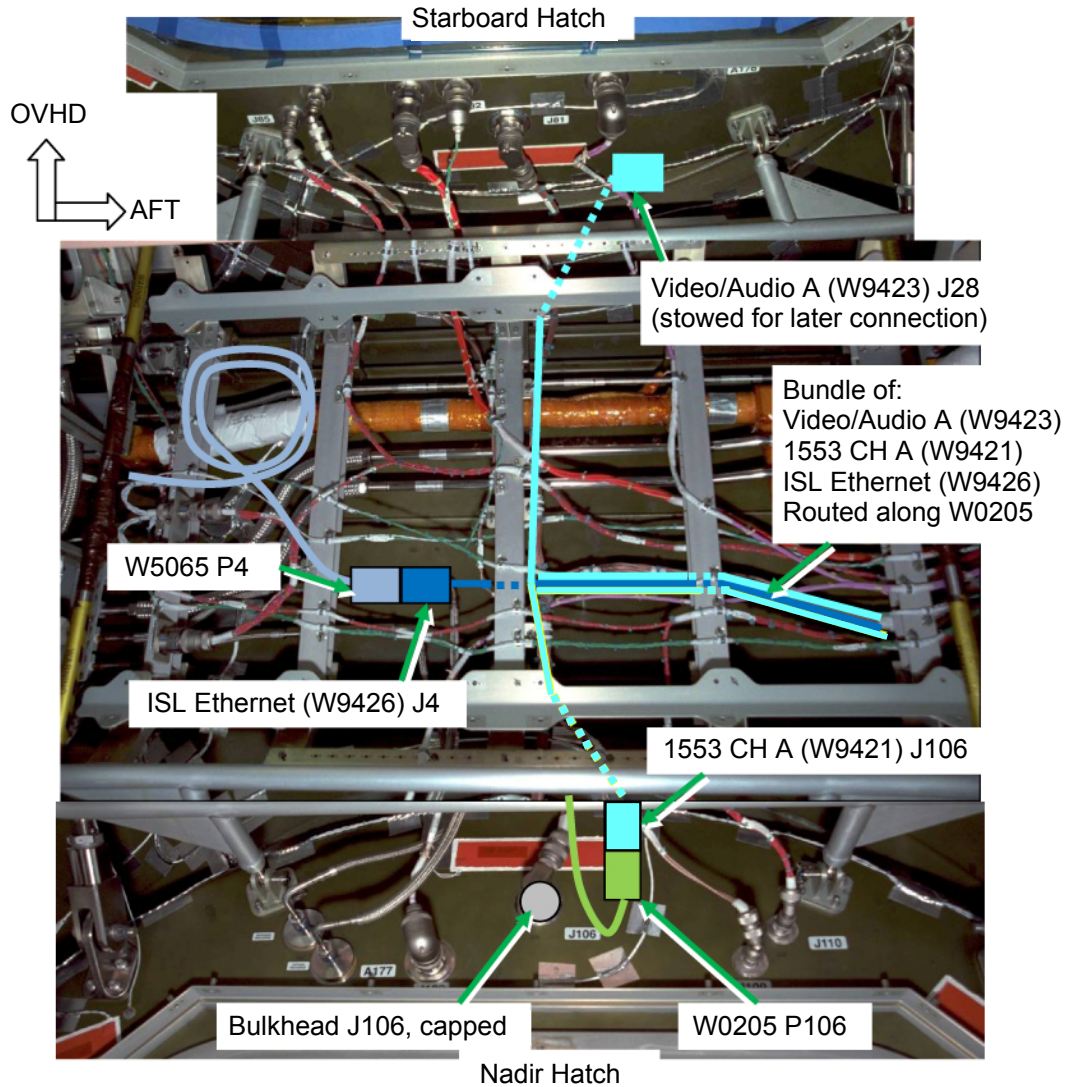

Figure 30.- Routing Cables in NOD1SD2 Area.

**NOTE**

NOD1 ISL Ethernet Cable (W9426), NOD1 1553 CH A Cable (W9421), and NOD1 Video/Audio A Cable (W9423) will initially be routed separately to allow management of excess Wire Harness length.

- 15.15 Locate and route J4 of NOD1 ISL Ethernet Cable (W9426) from Port to Starboard of Node 1 Nadir Midbay.  
Do not restrain Wire Harness at this time.
- 15.16 Route approximately 2 feet of NOD1 ISL Ethernet Cable (W9426) into NOD1SD2 area, staying outboard of secondary structure to avoid EMI concerns.  
Route along W0205 Wire Harness.  
Leave any excess cable in Nadir Midbay area.



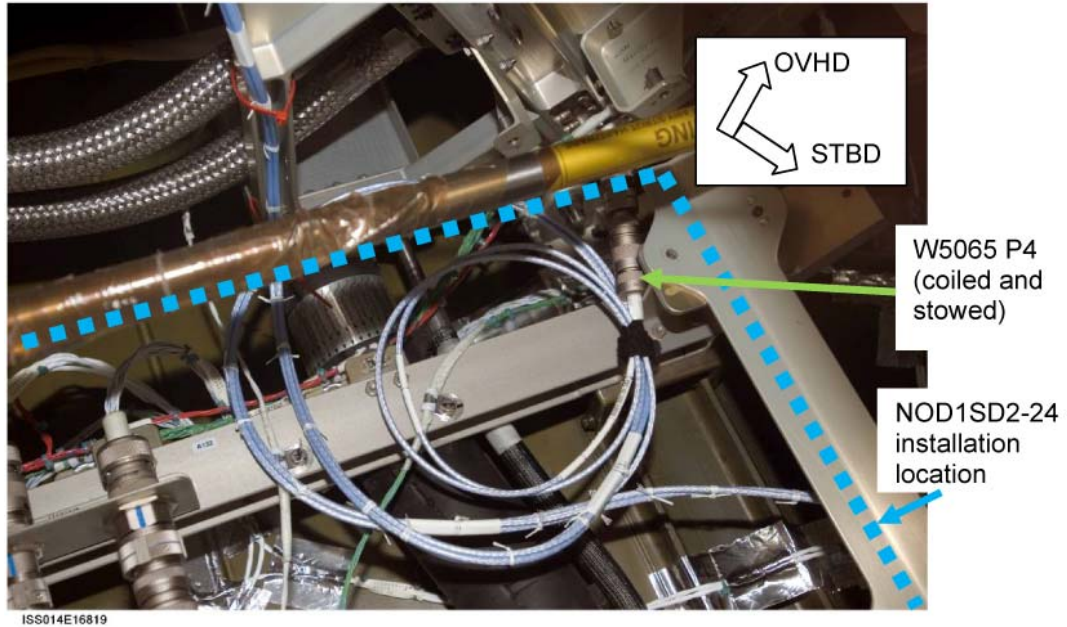

Figure 31.- W5065 Stowed in NOD1SD2 Area.

- 15.17 Locate P4 of W5065 Node 1 ISL Ethernet Cable, which was coiled and stowed during Expedition 14.  
 Refer to Figure 31.

NOTE  
 No system safing is required for ethernet connections.

- 15.18 Protective Cap ←|→ J4 of NOD1 ISL Ethernet Cable (W9426)  
 Protective Cap ←|→ P4 of W5065

Stow Protective Caps in Ziplock Bag labeled “NOD 1 Mod Kit Caps and Plugs.”

- 15.19 W5065 P4 →|← J4 of NOD1 ISL Ethernet Cable (W9426)

- 15.20 Pull any excess wire length back into Node 1 Nadir Midbay.

- 15.21 Restrain NOD1 ISL Ethernet Cable (W9426) on same routing path as W0205 in NOD1SD2 area as shown in Figure 30.

Nadir  
 Midbay

- 15.22 Route NOD1 ISL Ethernet Cable (W9426) along W0205, gathering excess wire length near center of Midbay. Coil excess wire length, maintaining minimum bend radius of six times the harness diameter. Coiled Wire Harness may cross any other Wire Harness without EMI risk. Restrain Wire Harness to secondary structure (Cable Ties). Refer to Figure 26.

## 1.100 NODE 1 PREP FOR NODE 3 – MIDBAY HARDWARE INSTALLATION

(ASSY OPS/ULF3/FIN 2)

Page 52 of 55 pages

- 15.23 Locate and route J106 of NOD1 1553 CH A Cable (W9421) from Port to Starboard of Node 1 Nadir Midbay.  
Do not restrain Wire Harness at this time.
- NOD1SD2 15.24 Route approximately 4 feet of NOD1 1553 CH A Cable (W9421) into NOD1SD2 area, staying outboard of secondary structure to avoid EMI concerns.  
Route along W0205 Wire Harness.  
Leave any excess cable in Nadir Midbay area.
- 15.25 ✓ **MCC-H** to verify 1553 bus safing complete per step 14
- 15.26 W0205 P106 ←|→ J106 of Nadir Bulkhead
- 15.27 Transfer Protective Cap from J106 of NOD1 1553 CH A Cable (W9421) to J106 of Nadir Bulkhead.
- 15.28 W0205 P106 →|← J106 of NOD1 1553 CH A Cable (W9421)
- 15.29 Pull any excess wire length into Node 1 Nadir Midbay.
- 15.30 Restrain NOD1 1553 CH A Cable (W9421) on same routing path as W0205 in NOD1SD2 area as shown in Figure 30.
- Nadir Midbay 15.31 Route NOD1 1553 CH A Cable (W9421) along W0205, gathering excess wire length near center of Midbay.  
Coil excess wire length, maintaining minimum bend radius of six times the Harness diameter; coiled Wire Harness may cross any other Wire Harness without EMI risk.  
Restrain Wire Harness to secondary structure (Cable Ties).  
Refer to Figure 26.
- 15.32 Locate and route P78 of NOD1 Video/Audio Bus A Cable (W9423) from Port to Starboard of Node 1 Nadir Midbay.  
Do not restrain Wire Harness at this time.
- NOD1SD2 15.33 Route approximately 4 feet of NOD1 Video/Audio Bus A Cable (W9423) into NOD1SD2 area, staying outboard of secondary structure to avoid EMI concerns.  
Route along W0205 Wire Harness.  
Leave any excess cable in Nadir Midbay area.
- 15.34 Stow P78 of NOD1 Video/Audio Bus A Cable (W9423) near J78 of starboard Bulkhead.  
Do not make connections at this time. In a subsequent procedure, P78 of NOD1 Video/Audio Bus A Cable will be connected to the starboard Bulkhead.
- 15.35 Pull any excess wire length into Node 1 Nadir Midbay.

## 1.100 NODE 1 PREP FOR NODE 3 – MIDBAY HARDWARE INSTALLATION

(ASSY OPS/ULF3/FIN 2)

Page 53 of 55 pages

- 15.36 Loosely restrain NOD1 Video/Audio Bus A Cable (W9423) on same routing path as W0205 in NOD1SD2 area as shown in Figure 31.
- Nadir  
Midbay
- 15.37 Route NOD1 Video/Audio Bus A Cable (W9423) along W0205, gathering excess wire length near center of Midbay. Coil excess wire length, maintaining minimum bend radius of six times the Harness diameter; coiled Wire Harness may cross any other Wire Harness without EMI risk. Restrain Wire Harness to secondary structure (Cable Ties). Refer to Figure 26.
- 15.38 Photo document all routings and connections.

### 16. NORMALIZING 1553 BUSES

- 16.1 Use Table 4 to swap channels to A and enable channel switching.

```
sel [YY] where [YY] = Bus Name from Table 4
  [YY] Bus Status
  'Channel Selected'

  cmd Select Ch A Execute (√A)

  'Auto Channel Switch Status'

  cmd Enable Execute (√Ena)
Repeat
```

#### 16.2 Enabling BC Comm Fail

CDH: Primary C&C: Recovery Retry: CCS MDM

CCS Recovery Retry

**cmd BC Comm Fail – Enable Execute** (√Ena)

#### 16.3 Enabling Auto Transition to Diagnostics in PMCU MDM

CDH: Primary PMCU: MDM FDIR

Primary PMCU MDM FDIR

**cmd Auto Transition Diag – Enable Execute** (√Ena)

#### 16.4 Enabling Comm Safing Response in INT MDM

CDH: Primary INT: MDM FDIR

Primary INT MDM FDIR

**cmd Comm Safing Response – Enable Execute** (√Ena)

## 1.100 NODE 1 PREP FOR NODE 3 – MIDBAY HARDWARE INSTALLATION

(ASSY OPS/ULF3/FIN 2)

Page 54 of 55 pages

### 17. CLOSEOUT

NOD1D4 17.1 ✓NOD1D4 Rack rotation path unobstructed

17.2 ✓Knee Brace Spherical Bearings (two) are straight

17.3 Slowly rotate Rack up to a controlled stop.  
Place Knee Brace Spherical Bearings into rack Upper Attach Mechanism Shear Pin view holes (two).

17.4 Verify left Upper Attach Mechanism Locking Screw is fully unlocked.

#### CAUTION

Do not force Upper Attach Mechanism Pinions. Mechanism should easily engage Knee Brace Spherical Bearings. Forcing the Mechanism could result in stripping the gear teeth or driving the mechanism assembly apart.

#### NOTE

1. To engage left pinion, turn ↺.
2. To engage right pinion, turn ↻.

17.5 Engage left Upper Attach Mechanism pinion into Knee Brace Spherical Bearings until Shear Pin is visible at top of mechanism (Ratchet, 3/8" Drive; 6" Long, 3/8" Hex Head, 3/8" Drive).

17.6 Tighten left upper attach mechanism locking screw (Ratchet, 3/8" Drive; 6" Long, 3/8" Hex Head, 3/8" Drive).

17.7 Repeat steps 17.4 to 17.6 for right Upper Attach Mechanism.

#### NOTE

All Closeout Panels except NOD1PD2-24 may be reinstalled at this time.

17.8 Install Closeout Panels (Ratchet, 1/4" Drive; 5/32" Hex Head, 1/4" Drive) listed below:

- NOD1SD2-22, -23 (three fasteners each, install as a group)
- NOD1SD2-24 (eight fasteners)
- NOD1SD2-25 (six fasteners)
- NOD1SD2-26, -27 (three fasteners each, install as a group)
- NOD1D2-36 (five fasteners), NOD1P2-31 (six fasteners)  
(install as a group)
- NOD1D2-34 (twenty-four fasteners)
- NOD1S2-36 (five fasteners), NOD1D2-31 (six fasteners)  
(install as a group)

17.9 Restow items listed in Table 5 per stowage note.

**1.100 NODE 1 PREP FOR NODE 3 – MIDBAY HARDWARE INSTALLATION**

(ASSY OPS/ULF3/FIN 2)

Page 55 of 55 pages

Table 5. Node 1 Mod Kit Midbay Hardware To Be Restowed

#	Part Name	Part Number	Qty	Stowage Info	Disposition
1	Flexible coupling from NOD1OP2	1F89144-1	1	Place items one to two together in Ziplock Bag. Label Ziplock Bag "Spare IMV parts." Report any Qty deltas.	Kept as spare IMV parts
2	Band Clamp 4" (five used, one new)	NAS1922-0400-3	6		
3	Negative Pressure Relief Valve (NPRV)	683-16322-3	1	Stow items three to six per Stowage Note.	Position for Return
4	NOD1P3-01 Closeout Panel	1F66319-1	1		
5	NOD1O2 IMV Duct	1F89179-1	1		
6	IMV Diffuser Grilles	683-15110-4	2		
7	Protective Cap	NATC-PPC-N-25-0	1	Place items seven to fourteen together in Ziplock Bag. Label Ziplock Bag "NOD1 Mod Kit Caps and Plugs."	Kept for future IFM usage
8	Protective Cap	NATC-RPC-N-25-0	1		
9	Gamah Caps	683-19347-841	2		
10	Gamah Plugs	683-16347-818	2		
11	Protective Cap	NATC-RPC-N-13-0	1		
12	Protective Cap	NATC-PPC-N-13-0	1		
13	Protective Cap	NATC-RPC-N-11-0	3		
14	Protective Cap	NATC-PPC-N-11-0	3		

This Page Intentionally Blank

## 1.102 NODE 1 PREP FOR NODE 3 – ALCOVE HARDWARE INSTALLATIONS

(ASSY OPS/ULF3/FIN 2)

Page 1 of 38 pages

### OBJECTIVE:

To perform installation of a portion of the Node 1 Modification Kit into the Node 1 Alcove area. The Mod Kit installs hardware into Node 1 to redirect Wire Harnesses, fluids, Intra Module Ventilation (IMV), and other utilities to allow Node 3 to be physically installed onto the Radial Port CBM instead of the Radial Nadir CBM. Installs hardware into the physical portion of the Node "Alcove" area, which is in the forward portion of Node 1.

### LOCATION:

Node 1 Alcove, Node 1 Port Deck Radial area

### DURATION:

6 hours (two crewmembers)

### CREW:

Two

### PARTS:

Node 1 Avionics and Fluids Modification Kit (Refer to Table 1.)

Node 1 IMV Modification Kit (Refer to Table 1.)

### MATERIALS:

Kapton Tape

Aluminum Tape

Ziplock Bags

Sharpie

Clean Room Gloves

Braycote (from Mod Kit Midbay Hardware Bag)

Releasable Wire Tie (from Mod Kit Midbay Hardware Bag)

### TOOLS:

Flashlight (crew preference)

Digital Camera

CSA-O2

MRK Fan (if required for added ventilation)

#### Fluid Fitting Torque Device and Gamah Seal Maintenance Kit:

Fluid Fitting Torque Device S/N 001

0.875" Drive Gear S/N 001

0.625" Reaction Gear S/N 001

Brass Picks (if required)

#### ISS IVA Toolbox:

##### Drawer 1:

1/4" Combination Wrench (if preferred to 1/4" Deep Socket)

5/16" Combination Wrench

5/16" Crowfoot Wrench, 1/4" Drive

##### Drawer 2:

Driver Handle, 1/4" Drive

Ratchet, 1/4" Drive

1/8" Hex Head

Ratchet, 3/8" Drive

1/4" to 3/8" Adapter

6" Ext, 1/4" Drive

## 1.102 NODE 1 PREP FOR NODE 3 – ALCOVE HARDWARE INSTALLATIONS

(ASSY OPS/ULF3/FIN 2)

Page 2 of 38 pages

10" Ext, 1/4" Drive  
5/32" Hex Head, 1/4" Drive  
Driver Handle, 1/4" Drive  
1/4" Deep Socket, 1/4" Drive  
5/16" Socket, 1/4" Drive  
7/16" Deep Socket, 1/4" Drive  
3/8" Socket, 1/4" Drive  
(10-50 in-lbs) Trq Wrench, 1/4" Drive  
(40-200 in-lbs) Trq Wrench, 1/4" Drive

Drawer 3:

#10 Long Torq Driver, 3/8" Drive

### REFERENCED PROCEDURE(S):

1.504 IMV FAN ACTIVATION/DEACTIVATION POST CCS

2.506 IMV VALVE RECONFIGURATION

A.2.1 FLUID FITTING TORQUE DEVICE (FFTD) ASSEMBLY AND USAGE

A.2.3 MATING GAMAH FITTING USING THE FFTD

A.2.13 GAMAH SEAL R&R



# 1.102 NODE 1 PREP FOR NODE 3 – ALCOVE HARDWARE INSTALLATIONS

(ASSY OPS/ULF3/FIN 2)

Page 3 of 38 pages

Table 1. Node 1 Mod Kit Alcove Hardware

#	Part Name	Part Number	Serial Number	Barcode Number	Qty
1	NOD1D1 to NOD1P1 IMV Duct	683-99516-3	000001	00106751H	1
2	IMV Duct Cap	BOE2221-0015	N/A	N/A	2
3	IMV Hose Clamp (5.25")	NAS1922-0525-3	N/A	N/A	6
4	IMV Duct Sleeve 5" Diameter Short (for contingency IMV use)	BACD40R20A30	N/A	N/A	2
5	IMV Duct Sleeve 5" Diameter Long (for contingency IMV use)	BACD40R20A42	N/A	N/A	3
6	NOD1 IMV Diffuser Cover	683-99518-1	001001	00106752H	1
7	Bolt, #10-32 (for Diffuser Cover)	NAS1580C3T4	N/A	N/A	9
8	Washer (for Diffuser Cover)	NAS1587-3	N/A	N/A	9
9	Lock Nut, #10-32 (for Diffuser Cover)	MS21043-3	N/A	N/A	10
10	Node 1 IMV Valve RMO Cover	683-60444-1	N/A	N/A	1
11	Protective Cap	NATC-RPC-N-11-0	N/A	N/A	3
12	Protective Cap	NATC-PPC-N-11-0	N/A	N/A	3
13	Protective Cap	NATC-RPC-N-13-0	N/A	N/A	1
14	Protective Cap	NATC-PPC-N-13-0	N/A	N/A	1
15	NOD1 MTL Supply Hose	683-99511-6	000001	00106742H	1
16	NOD1 MTL Return Hose	683-99511-7	000001	00106743H	1
17	MTL Supply label	683-56471-15	N/A	N/A	2
18	MTL Return label	683-56471-10	N/A	N/A	2
19	To NOD3 label (left arrow)	683-99512-1	N/A	N/A	1
20	To NOD3 label (right arrow)	683-99512-2	N/A	N/A	1
21	To PMA3 label (down arrow)	683-99512-3	N/A	N/A	2
22	NOD1 Oxygen Hose	683-99511-1	000001	00106737H	1
23	NOD1 Nitrogen Hose	683-99511-2	000001	00106738H	1
24	NOD1 1553 CH B Cable (W9422)	683-99422-1	000001	00106718H	1
25	NOD1 1553 Termination Plug (W9427)	683-99427-1	000002	00106747H	1
26	NOD1 Audio Bus B Cable (W9424)	683-99424-1	000001	00106720H	1
27	EVA Tape (one roll)	P-213	N/A	N/A	AR
28	Cable Tie (one hundred)	T50R2HAL	N/A	N/A	AR

AR = As Required

# 1.102 NODE 1 PREP FOR NODE 3 – ALCOVE HARDWARE INSTALLATIONS

(ASSY OPS/ULF3/FIN 2) Page 4 of 38 pages

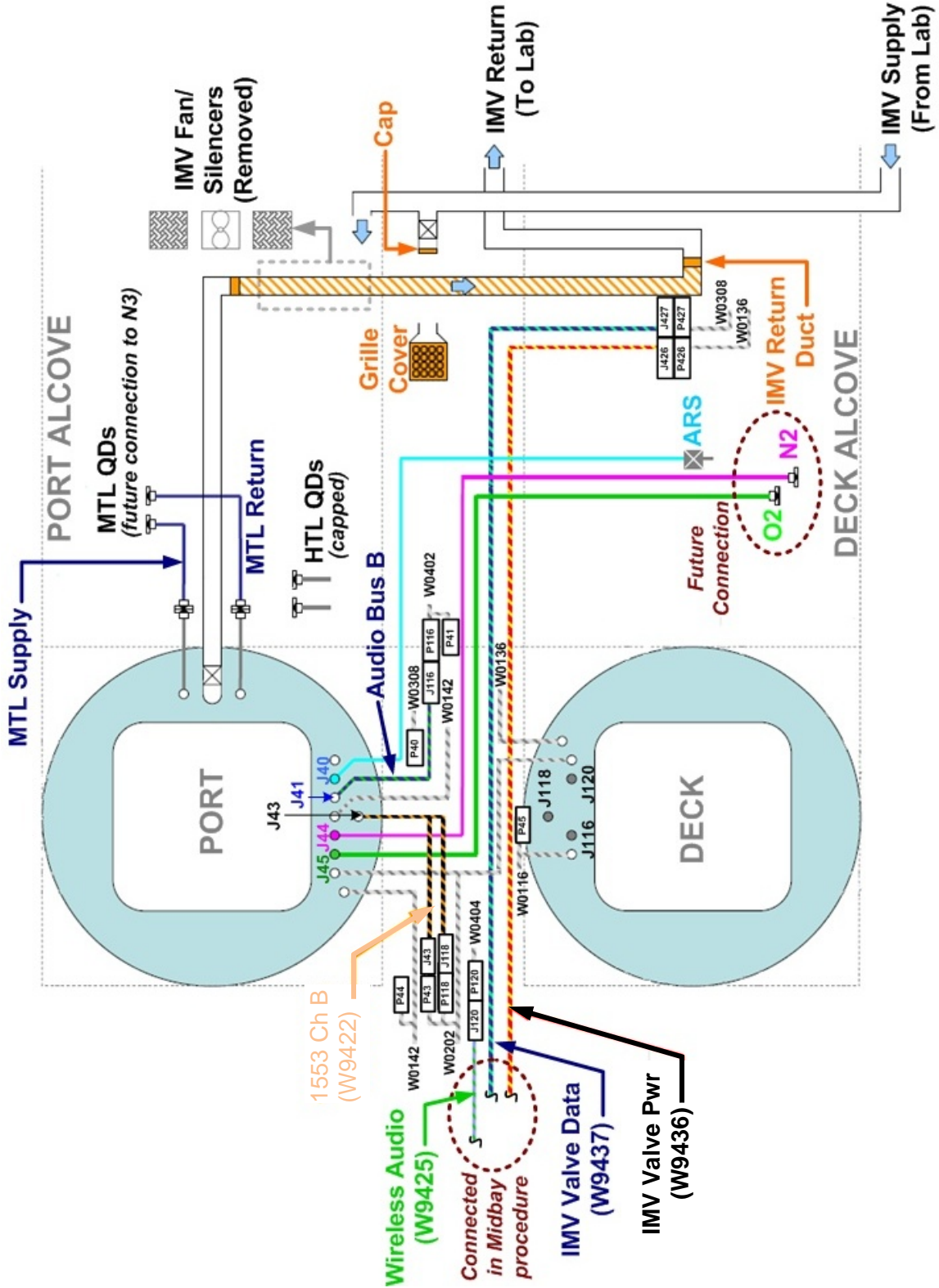

Figure 1.- Node 1 Alcove Hardware Installation Overview.

## 1.102 NODE 1 PREP FOR NODE 3 – ALCOVE HARDWARE INSTALLATIONS

(ASSY OPS/ULF3/FIN 2)

Page 5 of 38 pages

### 1. [SAFING AND RECONFIGURING IMV](#)

#### NOTE

To stop airflow through Node 1 Port/Deck Alcove while IMV Fan is being removed and new IMV ducting is being installed, several IMV reconfiguration steps are required.

- ISS 1.1 ✓ **MCC-H** to confirm the following safing actions have been completed:  
Verify Node 1 Port Fwd IMV Fan is deactivated.  
Verify RPCM N13B C RPC 16 (N1 Port Fwd IMV Fan) is Open and Close command Inhibited.
- PMA1 1.2 Open PMA1 IMV Duct Grill (Velcro cover).
- MCC-H** 1.3 To turn off LAB Aft Port IMV Fan, perform [1.504 IMV FAN ACTIVATION/DEACTIVATION POST CCS](#), step 3.1 (SODF: ECLSS: ACTIVATION AND CHECKOUT: THC), then:
- 1.4 To turn off Node 1 Aft Port IMV Fan, perform [1.504 IMV FAN ACTIVATION/DEACTIVATION POST CCS](#), step 3.1 (SODF: ECLSS: ACTIVATION AND CHECKOUT: THC), then:
- 1.5 To close Node 1 Aft Port IMV Valve, perform [2.506 IMV VALVE RECONFIGURATION](#), step 3 (SODF: ECLSS: NOMINAL: THC), then:

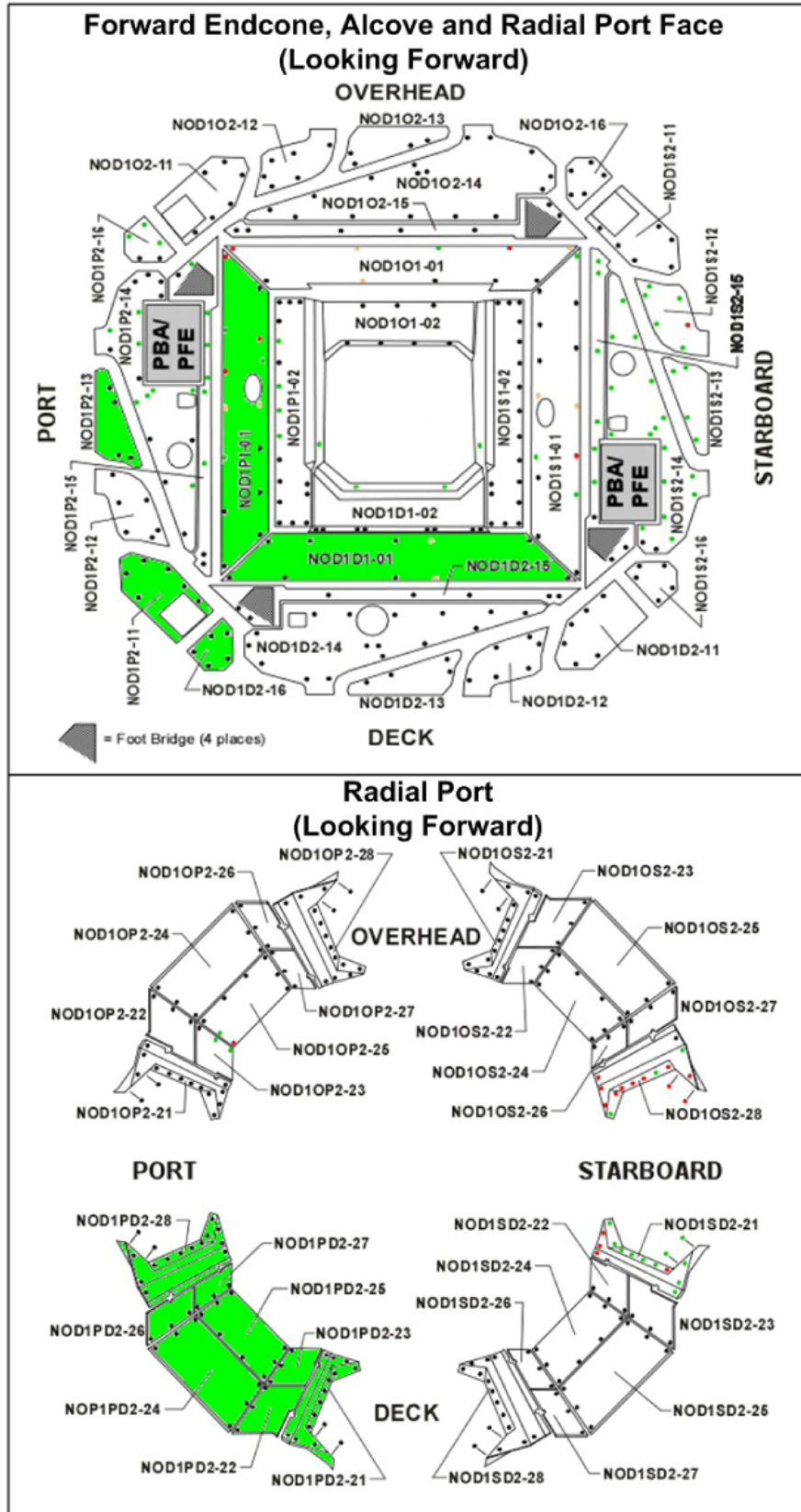

Figure 2.- Node 1 Closeout Panels to be Removed.

# 1.102 NODE 1 PREP FOR NODE 3 – ALCOVE HARDWARE INSTALLATIONS

(ASSY OPS/ULF3/FIN 2)

Page 7 of 38 pages

## 2. REMOVING CLOSEOUT PANELS AND CHECKING VENTILATION

- NOD1 2.1 Relocate any items from front of affected Closeout Panels.  
Refer to Figure 2.

### WARNING

CSA-O2 sampling is required to insure O2% is not above flammability levels or N2 pockets do not exist that can cause crew asphyxiation.

- 2.2 Perform CSA-O2 sampling in open cabin and record: \_\_\_\_\_.

- PCS 2.3 Comparison to MCA sampling  
US LAB: ECLSS: AR Rack: MCA  
LAB MCA  
'(ORU2) Mass Spectrometer Assembly'

Record O2 %: \_\_\_\_\_

√Difference between CSA-O2 and MCA O2 percentage is less than or equal to 1.1

### NOTE

1. Closeout Panels NOD1P2-11 and NOD1D2-16 are joined together with a seam support so panels should be removed together as a single unit.
2. Closeout Panels NOD1PD2-22(NOD1PD2-23) and NOD1PD2-26(NOD1PD2-27) are joined together with a T-shaped seam support and have L-shaped seam supports on either end. Both sets of panels should be able to be removed together as a single unit without removing any seam supports.

- NOD1 2.4 Remove NOD1P2-11(NOD1D2-16) Closeout Panels, fasteners (eleven) (5/32" Hex Head, 1/4" Drive; Driver Handle, 1/4" Drive).  
Temporarily stow.  
Refer to Figure 2.

- 2.5 Remove the following Closeout Panels (5/32" Hex Head, 1/4" Drive; Driver Handle, 1/4" Drive):  
NOD1PD2-22 and NOD1PD2-23 (together – three fasteners each)  
NOD1PD2-26 and NOD1PD2-27 (together – three fasteners each)

Temporarily stow.  
Refer to Figure 2.

# 1.102 NODE 1 PREP FOR NODE 3 – ALCOVE HARDWARE INSTALLATIONS

(ASSY OPS/ULF3/FIN 2)

Page 8 of 38 pages

\*\*\*\*\*  
\* If required for removal of NOD1PD2-22, NOD1PD2-23,  
\* NOD1PD2-26, or NOD1PD2-27  
\* Remove T-shaped Closeout Seam Support, fasteners (eight)  
\* (Ratchet, 1/4" Drive; 1/8" Hex Head).  
\* Remove L-shaped Closeout Seam Supports (two), fasteners  
\* (four each) (Ratchet, 1/4" Drive; 1/8" Hex Head).  
\*\*\*\*\*

2.6 Remove following Closeout Panels (5/32" Hex Head, 1/4" Drive;  
Driver Handle, 1/4" Drive):

- NOD1PD2-24 (eight fasteners)
- NOD1PD2-25 (eight fasteners)
- NOD1PD2-28 (fifteen fasteners)
- NOD1PD2-21 (fifteen fasteners)
- NOD1P2-13 (three fasteners)
- NOD1D1-01 (eight fasteners)
- NOD1P1-01 (twelve fasteners)

Temporarily stow.  
Refer to Figure 2.

2.7 Perform CSA-O2 sampling in each area where a Closeout Panel was  
removed for 1 minute.

If O2 % is between 16.5 to 23.3 %, proceed.

If O2 % is not between 16.5 to 23.3 %

√**MCC-H**

## 3. REMOVING NODE 1 PORT FORWARD IMV FAN AND SILENCERS

### NOTE

1. The Node 1 Port Forward IMV Fan and Silencers are being removed and replaced with new ducting. The IMV Fan will be kept onboard as a spare.
2. The duct couplings (P/N 1F89029-1) directly above and below the IMV Fan are wrapped with two layers of acoustic covering. The outer layer, consisting of two to three revolutions of acoustic insulation tape, covers the inner layer, consisting of two to three revolutions of acoustic isolator tape. It may be necessary to cut the insulation layer(s) in order to remove the duct couplings from the IMV Fan.

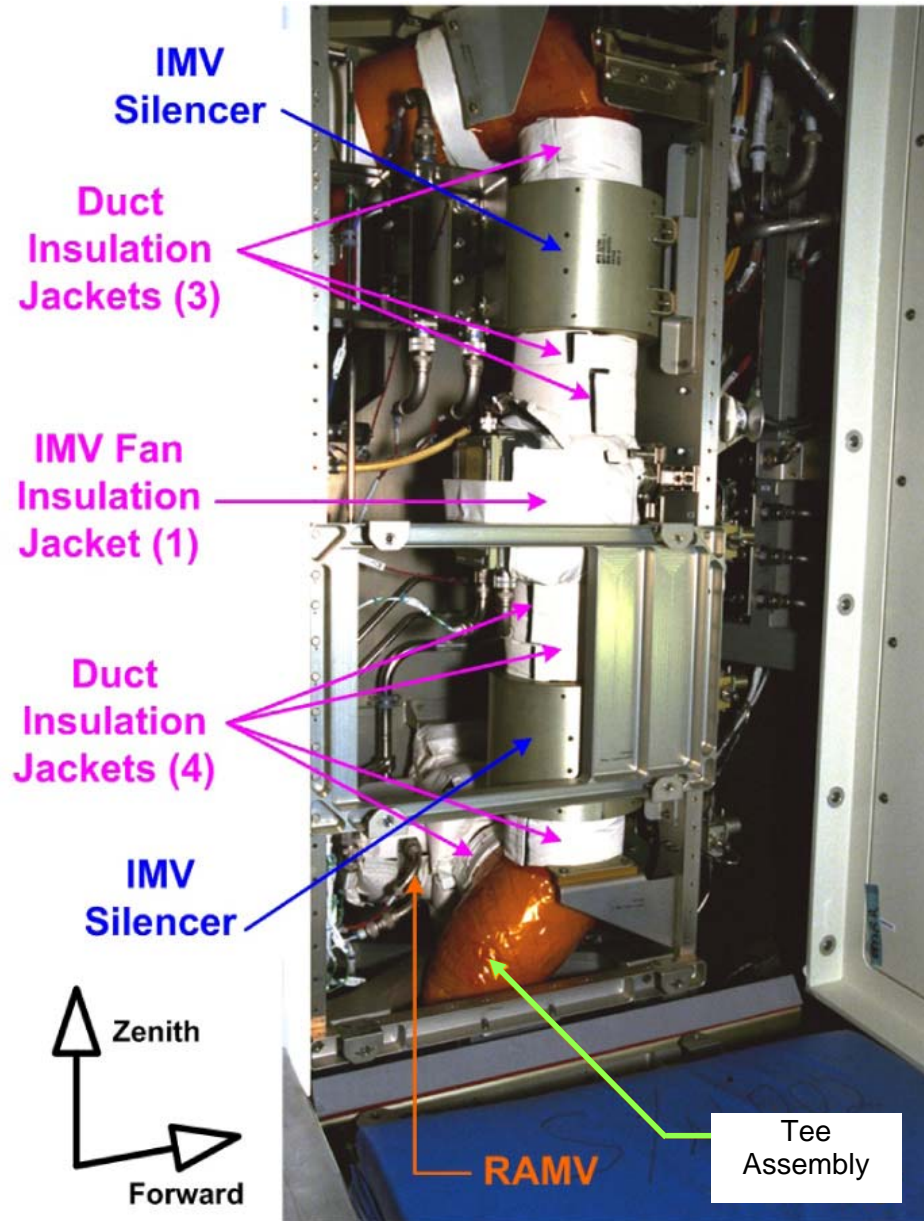

Figure 3.- Node 1 Port Forward IMV Insulation Jacket Locations.

LAB1P1

- 3.1 Remove Insulation Jackets (eight total) (held in place with Velcro) in the following locations:
  - above top IMV Silencer (one),
  - above IMV Fan (two),
  - below IMV Fan (two),
  - around IMV Fan (one),
  - below bottom IMV Silencer (one),
  - between Tee Assembly and the RAMV (one).

Temporarily stow insulation.  
Refer to Figure 3.

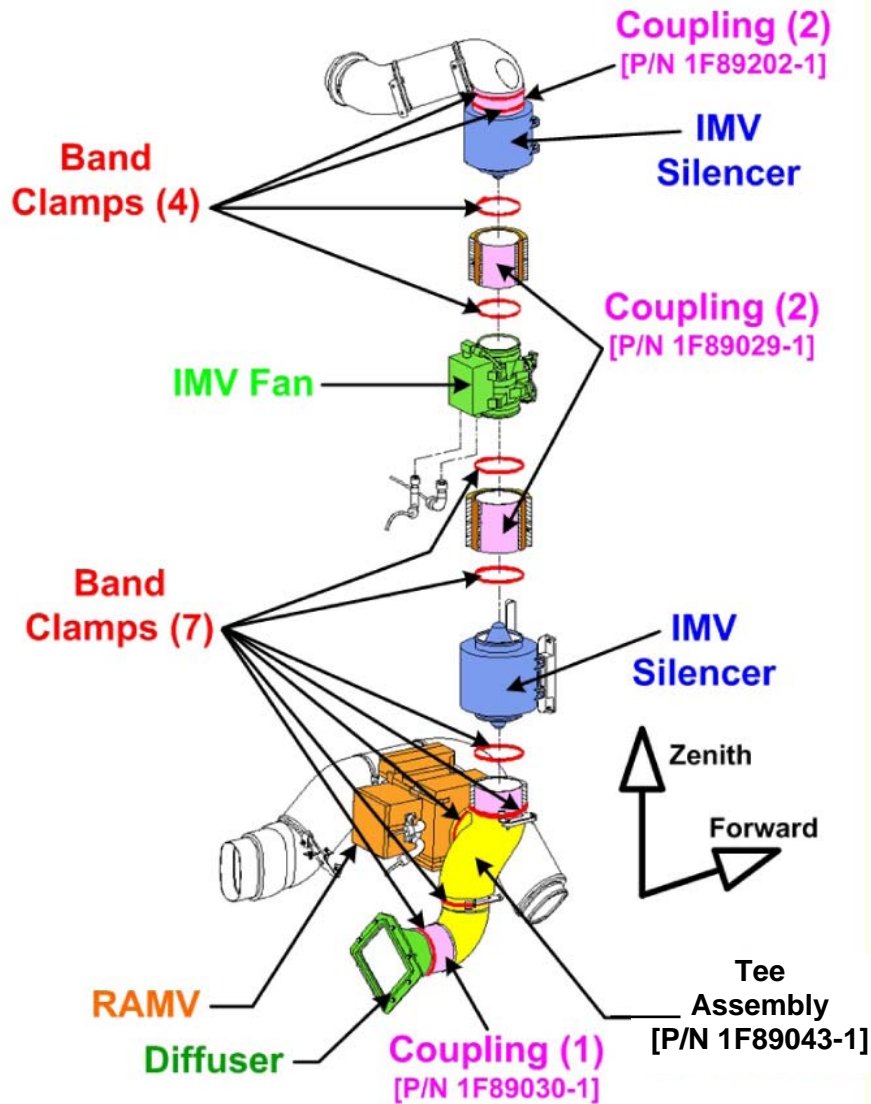

Figure 4.- Node 1 Port Forward IMV ducting Band Clamp Locations.

- 3.2 Loosen and remove Band Clamps (eleven total) (1/4" Deep Socket, 1/4" Drive; 6" Ext, 1/4" Drive; Ratchet, 1/4" Drive) in the following locations:
- above upper IMV Silencer (two),
  - between upper IMV Silencer and IMV Fan (two),
  - between lower IMV Silencer and IMV Fan (two),
  - below lower IMV Silencer (two),
  - in middle of Tee Assembly (one),
  - connecting Tee Assembly (with Coupling) to the RAMV (one),
  - connecting Tee Assembly Coupling to diffuser (one).

Temporarily stow clamps [5.25" (seven) and 5.75" (four)]. Refer to Figure 4.



## 1.102 NODE 1 PREP FOR NODE 3 – ALCOVE HARDWARE INSTALLATIONS

(ASSY OPS/ULF3/FIN 2)

Page 11 of 38 pages

- 3.3 Free Coupling above upper IMV Silencer and remove from Silencer and duct.  
Temporarily stow.  
Refer to Figure 4.
- 3.4 Loosen upper IMV Silencer fasteners (four) and remove Silencer (5/16" Socket, 1/4" Drive; 10" Ext, 1/4" Drive; Ratchet, 1/4" Drive).  
Temporarily stow.  
Refer to Figure 4.
- 3.5 Free duct Coupling from top of IMV Fan and remove, cutting acoustic insulation wrapping(s), if required.  
Temporarily stow.
- 3.6 W0308 P412 ←|→ IMV Fan J1  
W0308 P412 →|← Protective Cap (P/N NATC-PPC-N-11-0)  
IMV Fan J1 →|← Protective Cap (P/N NATC-RPC-N-11-0)  
W0136 P413 ←|→ IMV Fan J2  
W0136 P413 →|← Protective Cap (P/N NATC-PPC-N-13-0)  
IMV Fan J2 →|← Protective Cap (P/N NATC-RPC-N-13-0)
- 3.7 Loosen IMV Fan fasteners (four) and remove IMV Fan (7/16" Deep Socket, 1/4" Drive; 10" Ext, 1/4" Drive; Ratchet, 1/4" Drive).  
Temporarily stow.
- 3.8 Free Coupling from bottom of IMV Fan or from lower IMV Silencer.  
Temporarily stow.
- 3.9 Loosen lower IMV Silencer fasteners (four) and remove Silencer (5/16" Socket, 1/4" Drive; 10" Ext, 1/4" Drive; Ratchet, 1/4" Drive).  
Temporarily stow.  
Refer to Figure 4.
- 3.10 Free Coupling from top of Tee Assembly and remove from finger brackets holding it to structure.  
Temporarily stow.  
Refer to Figure 4.
- 3.11 Free Tee Assembly from RAMV leaving Coupling attached to Tee.  
Free Tee Assembly Coupling from Diffuser, which should allow entire Tee Assembly to be removed.  
If possible, loosen Band Clamps attaching Couplings to Tee Assembly.  
Temporarily stow.  
Refer to Figure 4.

## 1.102 NODE 1 PREP FOR NODE 3 – ALCOVE HARDWARE INSTALLATIONS

(ASSY OPS/ULF3/FIN 2)

Page 12 of 38 pages

- 3.12 Install Duct Cap (P/N BOE221-0016) onto RAMV duct opening where Tee Assembly was removed.  
Install Band Clamp over Duct Cap, ensuring there is at least ~1/8" overlap from end of cap, and tighten (snug) (1/4" Deep Socket, 1/4" Drive; 6" Ext, 1/4" Drive; Ratchet, 1/4" Drive).
- 3.13 Loosen and remove noncaptive bolts and washers (eight) connecting Diffuser to square mounting plate (3/8" Socket, Ratchet, 1/4" Drive).  
Remove Diffuser from mounting plate, reinstall bolts and washers (eight) onto loose Diffuser and tighten (hand-tight).  
Temporarily stow Diffuser.

### 4. ROUTING MTL JUMPERS IN PORT ALCOVE

#### NOTE

1. Two Moderate Temperature Loop (MTL) hoses with Quick Disconnects (QD) on both ends will be routed in Port Alcove prior to installation of new IMV ducting for better access.
2. Only one end of MTL hoses will be connected in this procedure to QD ports in Port Alcove, which in turn connect to hoses that go to Node 1 Port bulkhead. Free end of MTL hoses will not be connected until after Node 3 is mated to Node 1 Port, lines in Node 1 and Node 3 have been filled with ITCS fluid, and reconfigurations have been made to allow transition of Node 1/Airlock MTL cooling from LAB to Node 3.
3. The new MTL hoses launched dry and the hoses that they are connecting to in Node 1 are dry since they were originally designated for High Temperature Loop (HTL) function that was never utilized (not filled with ITCS fluid).
4. New labels for MTL Supply and Return functions will be installed over existing High Temp labels on Node 1 Port bulkhead. Due to Node 3 becoming the ITCS MTL source, what was previously labeled as Supply becomes Return and vice versa.
5. New MTL labels are not wide enough to completely cover old labels so Aluminum Tape is used to cover old labels and then new labels are applied onto the tape.

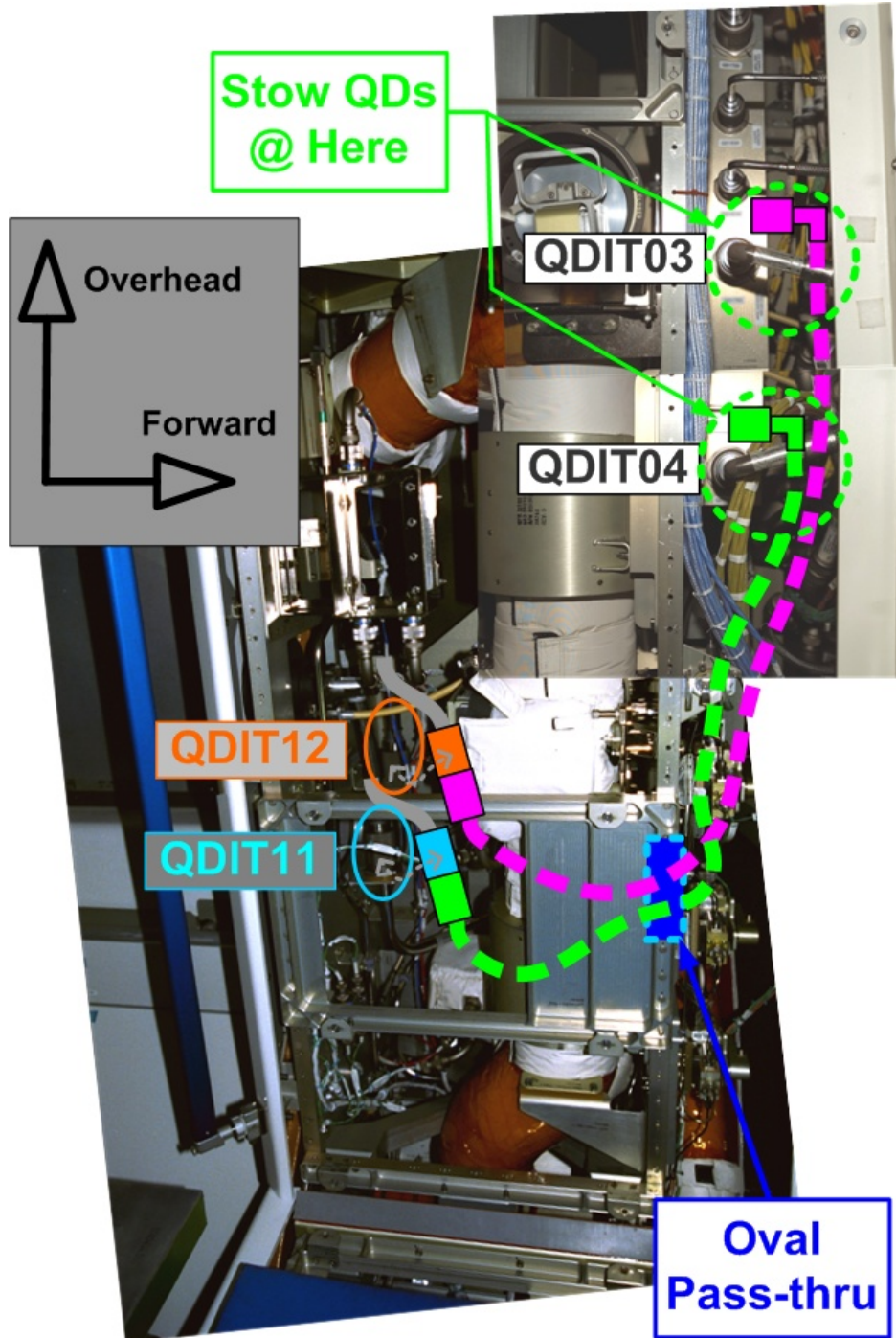

Figure 5.- NOD1 MTL Supply and Return Hose Routing in N1 Port Alcove.

- NOD1P1 4.1 Locate the oval shaped pass-thru on the forward face of the Port Alcove box structure.  
Route NOD1 MTL Supply Hose (straight end) from area forward of box structure through pass-thru and into Port Alcove.  
Refer to Figure 5.

- 4.2 QDIT12 Female Quick Disconnect ←|→ QDIT12 Male Fitting  
Protective Cap ←|→ NOD1 MTL Supply Hose (straight end)  
NOD1 MTL Supply Hose (straight end) →|← QDIT12 Female QD  
Protective Cap →|← QDIT12 Male Fitting  
Refer to Figure 5.
- 4.3 Route NOD1 MTL Return Hose (straight end) from area forward of box  
structure through pass-thru and into Port Alcove.  
Refer to Figure 5.
- 4.4 QDIT11 Female Quick Disconnect ←|→ QDIT11 Male Fitting  
Protective Cap ←|→ NOD1 MTL Return Hose (straight end)  
NOD1 MTL Return Hose (straight end) →|← QDIT11 Female QD  
Protective Cap →|← QDIT11 Male Fitting  
Refer to Figure 5.
- 4.5 Place the NOD1 MTL Supply Hose (90 degree end) near QDIT03.  
Place the NOD1 MTL Return Hose (90 degree end) near QDIT04.  
Restrain hoses and connectors with Cable Ties or Releasable Wire Ties.  
Refer to Figure 5.

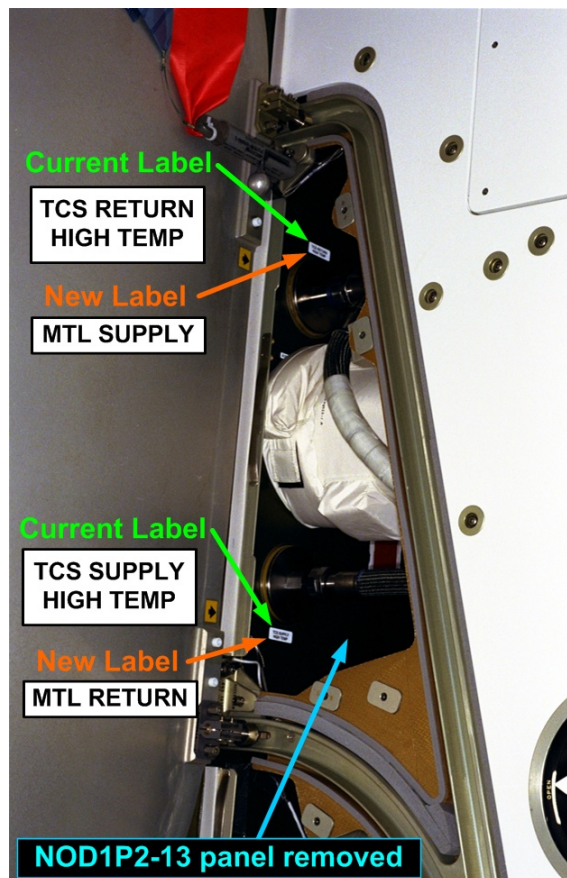

Figure 6.- NOD1 MTL Supply and Return Label Replacement Locations.

## 1.102 NODE 1 PREP FOR NODE 3 – ALCOVE HARDWARE INSTALLATIONS

(ASSY OPS/ULF3/FIN 2)

Page 15 of 38 pages

- 4.6 Cover existing High Temp labels (Aluminum Tape).  
Install new MTL Supply or MTL Return labels.  
Refer to Figure 6.

### 5. INSTALLING REPLACEMENT IMV DUCT

#### NOTE

1. A tape-reinforced Ziplock Bag is expected to be in place covering the IMV port in the deck Alcove where one end of the new duct is being installed. The cap originally intended to serve this function is launching on ULF-3 and will not arrive in time since the IMV Valve and ducting is expected to be removed prior to ULF-3 (prior to PMA 3 Relocate).
2. When installing duct couplers, try to have at least ~1.25" of coupler surface installed onto duct.
3. Reuse of Band Clamps removed from IMV Fan and Silencers is allowed as long as clamps are undamaged, but new clamps (including extras) were flown and are preferred for installing new duct.
4. Installing Band Clamps around IMV duct support brackets is not required since these are for support during launch.
5. Two Duct Insulation Jackets removed from IMV Fan (Silencers) are reused and placed around both couplers on the new duct.

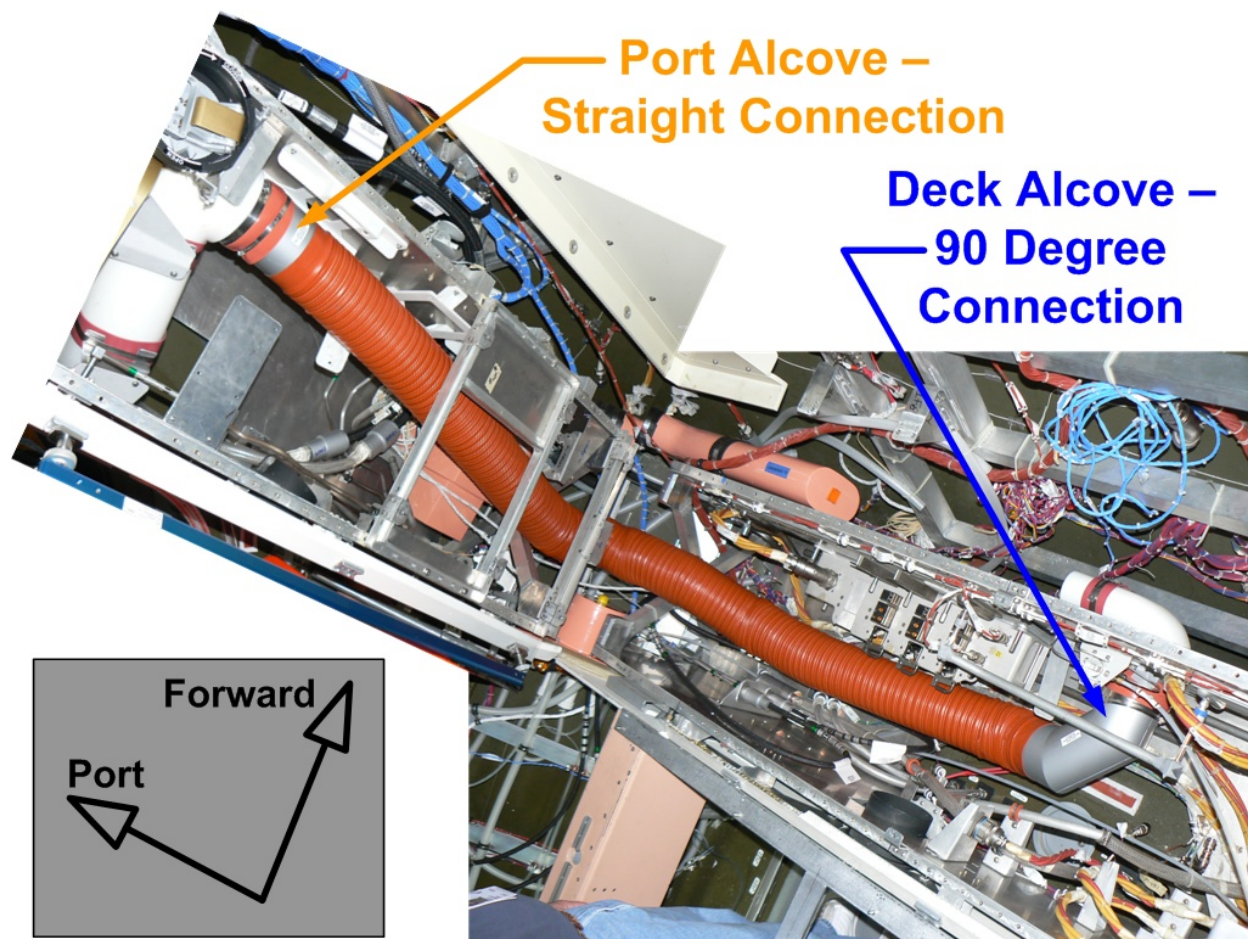

Figure 7.- NOD1D1 to NOD1P1 IMV Duct Routing and Installation.

- NOD1D1
- 5.1 Loosen and remove Band Clamp (one) holding tape-reinforced bag over Deck Alcove IMV Return duct (1/4" Deep Socket, 1/4" Drive; 6" Ext, 1/4" Drive; Ratchet, 1/4" Drive).  
Temporarily stow Band Clamp and trash Ziplock Bag.  
Refer to Figure 7.
  - 5.2 Slide IMV Hose Clamp (5.25") onto 90 degree end of NOD1D1 to NOD1P1 IMV Duct.  
Install duct (90 degree end) onto Deck Alcove IMV Return duct by using attached coupler.  
Install Hose Clamp onto coupler, ensuring there is at least ~1/8" overlap from end of coupler and tighten (snug) (1/4" Deep Socket, 1/4" Drive; 6" Ext, 1/4" Drive; Ratchet, 1/4" Drive).  
Refer to Figure 7.
- NOD1P1
- 5.3 Route remaining end of duct into Port Alcove through the x-shaped crossmembers.
  - 5.4 Slide IMV Hose Clamp (5.25") onto end of duct.  
Install duct onto Port Alcove IMV Return duct by using attached coupler.

## 1.102 NODE 1 PREP FOR NODE 3 – ALCOVE HARDWARE INSTALLATIONS

(ASSY OPS/ULF3/FIN 2)

Page 17 of 38 pages

Install Hose Clamp onto coupler, ensuring there is at least ~1/8" overlap from end of coupler and tighten (snug) (1/4" Deep Socket, 1/4" Drive; 6" Ext, 1/4" Drive; Ratchet, 1/4" Drive).  
Refer to Figure 7.

- 5.5 Install duct Insulation Jacket (one) around duct coupler in Port Alcove (attached by Velcro).  
Repeat for duct coupler in Deck Alcove.

### MCC-H

- 5.6 To open Node 1 Aft Port IMV Valve, perform [2.506 IMV VALVE RECONFIGURATION](#), step 2 (SODF: ECLSS: NOMINAL: THC), then:
- 5.7 To turn on LAB Aft Port IMV Fan, perform [1.504 IMV FAN ACTIVATION/DEACTIVATION POST CCS](#), step 2.2 (SODF: ECLSS: ACTIVATION AND CHECKOUT: THC), then:
- 5.8 To turn on Node 1 Aft Port IMV Fan, perform [1.504 IMV FAN ACTIVATION/DEACTIVATION POST CCS](#), step 2.2 (SODF: ECLSS: ACTIVATION AND CHECKOUT: THC), then:

### PMA1

- 5.9 Cover PMA1 IMV Duct Grill (Velcro cover).

## 1.102 NODE 1 PREP FOR NODE 3 – ALCOVE HARDWARE INSTALLATIONS

(ASSY OPS/ULF3/FIN 2)

Page 18 of 38 pages

### 6. ROUTING AND CONNECTING AIR SAMPLE, OXYGEN, AND NITROGEN HOSES

#### CAUTION

Failure to prevent contact of metal braided ARS and O2/N2 hoses with power cables by proper routing or not using protective Glass Tape may cause hardware damage as hoses rub/chafe against power cables.

#### NOTE

1. The Air Resource Sample (ARS) bulkhead feedthru connector contains a hose that was pre-integrated with the new feedthru. After feedthru was installed, hose was coiled and stowed in Node 1 Port/Deck radial area behind Closeout Panels. The steps below route hose to the Deck Alcove and connect to the ARS Valve.
2. The metal braided ARS, Oxygen (O2), and Nitrogen (N2) hoses should be kept at least 2 inches from any power cables, where possible. Power cables typically have red or yellow wire insulation.
3. O2 and N2 hoses have Gamah Fittings on one end that will be connected to bulkhead feedthrus that were installed previously. The other end of each hose has a Quick Disconnect that will be routed to the Deck Alcove but will not be connected until after Node 3 is installed. All of the Node 1 and Node 3 O2/N2 lines must be purged prior to connection into the O2/N2 system.
4. The N2 hose is connected before the O2 hose at Node 1 bulkhead in order to provide adequate access for the Fluid Fitting Torque Device (FFTD).
5. Torque input values for Gamah fittings in this step are written for the Prime FFTD (Serial Number 001).
6. Gamah fitting and FFTD reference information can be found in the following procedures:  
[A.2.1 FLUID FITTING TORQUE DEVICE \(FFTD\) ASSEMBLY AND USAGE](#)  
[A.2.3 MATING GAMAH FITTING USING THE FFTD](#)  
[A.2.13 GAMAH SEAL R&R](#) (SODF: IFM: REFERENCE: APPENDIX A: ISS IVA TOOLS)
7. Hose routings depicted in the figures below have been chosen to provide the best potential for adequate clearance around power lines.



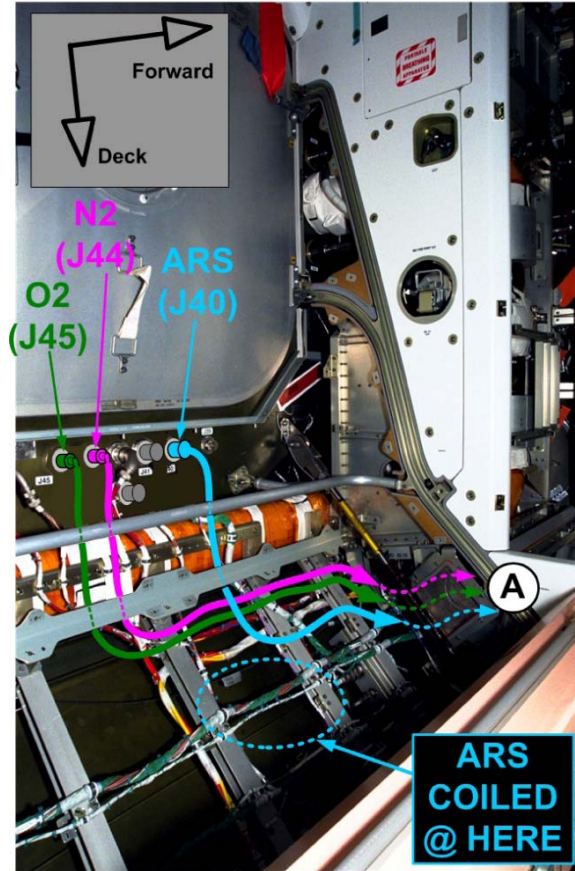

Figure 8.- ARS and O2/N2 Hose Routing in Port Deck Radial Area.

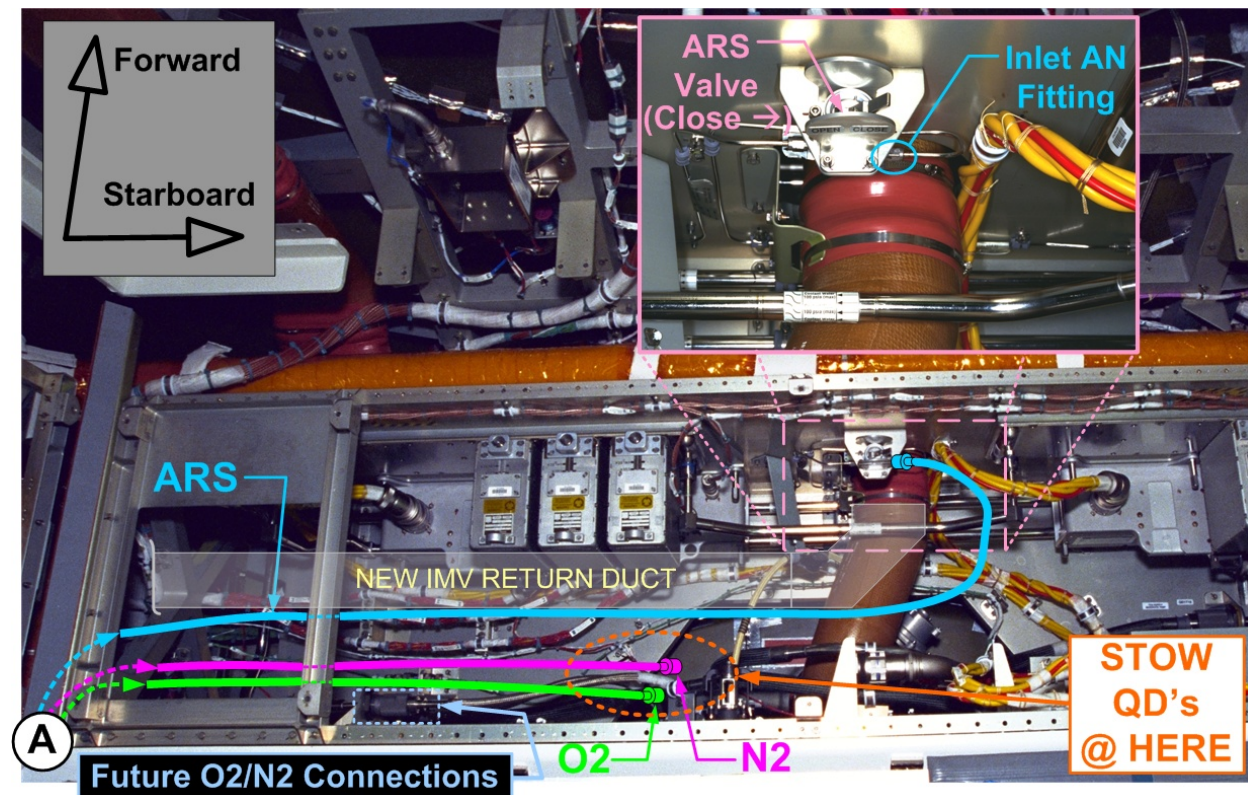

Figure 9.- ARS and O2/N2 Hose Routing in Deck Alcove Area.

6.1 ARS HOSE ROUTING AND CONNECTION

NOD1PD2

- 6.1.1 Uncoil pre-positioned NOD1 Air Sample Hose (ARS) and route free end toward Deck Alcove area. Route hose just under the square-shaped diffuser bracket and into area between Port and Deck Alcoves. Refer to Figure 8.

- 6.1.2 Restrain hose, as necessary, with Cable Ties and wrap metal braided hose with Glass Tape anywhere it crosses or contacts other cables and hoses.

NOD1D1

- 6.1.3 Route NOD1 Air Sample Hose (ARS) into Deck Alcove through zenith opening in the X-shaped structural member. Route NOD1 Air Sample Hose (ARS) hose parallel to new IMV duct installed in a previous step. Refer to Figure 9.

- 6.1.4 Node 1 Nadir Alcove ARS Valve is in “CLOSE” position (Switch rotated toward Starboard)  
 Refer to Figure 9.

- 6.1.5 Existing ARS hose ←|→ Node 1 Nadir Alcove ARS Valve Inlet by loosening AN fitting (5/16" Combination Wrench)  
 Refer to Figure 9.

## 1.102 NODE 1 PREP FOR NODE 3 – ALCOVE HARDWARE INSTALLATIONS

(ASSY OPS/ULF3/FIN 2)

Page 21 of 38 pages

- 6.1.6 ARS Protective Plug ←|→ NOD1 Air Sample Hose (ARS)  
ARS Protective Plug →|← Existing ARS hose (hand-tight)
- 6.1.7 NOD1 Air Sample Hose (ARS) →|← Node 1 Nadir Alcove ARS Valve Inlet  
Torque Inlet AN fitting to 70 in-lbs [5/16" Crowfoot Wrench, 1/4" Drive; (40-200 in-lbs) Trq Wrench, 1/4" Drive].

### 6.2 NITROGEN HOSE CONNECTION AND ROUTING

- 6.2.1 To set up Prime FFTD (S/N 001) utilizing 0.625" Reaction Gear and 0.875" Drive Gear (FFTD and Gamah Seal Maintenance Kit), perform [A.2.1 FLUID FITTING TORQUE DEVICE \(FFTD\) ASSEMBLY AND USAGE](#), all (SODF: IFM: REFERENCE: APPENDIX A), then:
  - 6.2.2 During Nitrogen and Oxygen hose connections steps
    - Inspect both sides of each gamah fitting for damage, debris before mating.
    - Report damage, debris to **MCC-H**.
    - Inspect male threads for absence of Braycote before mating.

# 1.102 NODE 1 PREP FOR NODE 3 – ALCOVE HARDWARE INSTALLATIONS

(ASSY OPS/ULF3/FIN 2)

Page 22 of 38 pages

Table 2. O2, N2 Hose Information

Jumper Name	NOD1 Blkhd	Hose End	Part Number	Input Torque	Output Torque	FFTD Gear Size (in)	
				(in-lbs)	(in-lbs)	Drive	Reaction
NOD1 Nitrogen Hose	J44	P44	683-99511-2	38	185	0.875	0.625
NOD1 Oxygen Hose	J45	P45	683-99511-1	38	185	0.875	0.625

NOD1PD2

6.2.3 Route NOD1 Nitrogen Hose P44 end (90 degree end) below Closeout Panel support bracket and above ducting or clamp bracket.

Refer to Figure 8.

6.2.4 Don Clean Room Gloves.

6.2.5 3/8" Gamah Cap ←|→ J44 Nitrogen Feedthru (Node 1 Port Bulkhead)

3/8" Gamah Plug ←|→ NOD1 Nitrogen Hose P44

Stow cap and plug in Ziplock Bag.

Refer to Figure 8 and Table 2.

If required, apply one drop of Braycote to exposed threads on bulkhead fitting; spread around threads by gloved hand.

6.2.6 NOD1 Nitrogen Hose P44 →|← J44 Nitrogen Feedthru Hand tighten Gamah fitting

Refer to Figure 8 and Table 2.

6.2.7 Tighten, torque P44/J44 Nitrogen to 38 in-lbs (Input Torque) [Fluid Fitting Torque Device; 0.875" Drive Gear, 0.625" Reaction Gear; 1/4" to 3/8" Adapter, (10-50 in-lbs) Trq Wrench, 1/4" Drive].

Refer to Table 2.

6.2.8 Route NOD1 Oxygen Hose P45 end (90 degree end) below Closeout Panel support bracket and above ducting or clamp bracket.

Refer to Figure 8 and Table 2.

## 1.102 NODE 1 PREP FOR NODE 3 – ALCOVE HARDWARE INSTALLATIONS

(ASSY OPS/ULF3/FIN 2)

Page 23 of 38 pages

### 6.3 OXYGEN HOSE CONNECTION AND O2/N2 HOSE ROUTING

#### **WARNING**

Failure to maintain clean environment during oxygen hose connection could result in a future fire hazard.

To prevent fire hazard during the Oxygen hose connection:  
Minimize the time connectors and caps or plugs are open or cover using Teflon Bags or Disposable Gloves.

If Clean Room Gloves become contaminated or damaged  
Replace immediately with new Clean Room Gloves.

If contaminants are found

Notify **MCC-H**.

Photo document (Digital Camera).

Remove using Brass Picks and retain for return to ground.

If contaminants cannot be completely removed

Reapply caps or plugs and hold for detailed **MCC-H** analysis.

6.3.1 3/8" Gamah Cap ←|→ J45 Oxygen Feedthru (Node 1 Port Bulkhead)

3/8" Gamah Plug ←|→ NOD1 Oxygen Hose P45

Stow cap and plug in Ziplock Bag.

Refer to Figure 8 and Table 2.

If required, apply one drop of Braycote to exposed threads on bulkhead fitting; spread around threads by gloved hand.

6.3.2 NOD1 Oxygen Hose P45 →|← J45 Oxygen Feedthru

Hand tighten Gamah fitting.

Refer to Figure 8 and Table 2.

6.3.3 Tighten, Torque P45/J45 Oxygen to 38 in-lbs (Input Torque)

[Fluid Fitting Torque Device; 0.875" Drive Gear, 0.625" Reaction Gear; 1/4" to 3/8" Adapter, (10-50 in-lbs) Trq Wrench, 1/4" Drive].

Refer to Table 2.

6.3.4 Doff Clean Room Gloves.

6.3.5 Route NOD1 Oxygen Hose and NOD1 Nitrogen Hose free ends toward Deck Alcove area.

Route hoses just under the square-shaped diffuser bracket and into area between Port and Deck Alcoves.

Refer to Figure 8 and Table 2.

## 1.102 NODE 1 PREP FOR NODE 3 – ALCOVE HARDWARE INSTALLATIONS

(ASSY OPS/ULF3/FIN 2)

Page 24 of 38 pages

6.3.6 Restrain hoses, as necessary, with Cable Ties and wrap metal braided hoses with Glass Tape anywhere hoses cross or contact other cables and hoses to prevent damage from rubbing or chafing.

NOD1D1

6.3.7 Route O2 and N2 hoses into Deck Alcove through aft opening in X-shaped structural member.

Route both hoses on aft side of alcove box and position Quick Disconnects (QD) with enough slack to allow future connection to O2/N2 ports on aft port end of alcove box.

Restrain hoses and QDs with Releasable Cable Ties, as necessary.

Refer to Figure 9.

### 7. ROUTING AND CONNECTING IMV POWER AND DATA CABLES

#### NOTE

1. The NOD1 IMV Valve Power Cable (W9436) and NOD1 IMV Valve Data Cable (W9437) were connected to the IMV Valve in the Midbay Hardware Installation procedure. The other ends of the cables are left stowed in the Node 1 Port Deck Radial area and the steps below route cables to the old IMV location in the Deck Alcove to make the final connections.
2. The IMV Power Cable (W9436) should be routed with at least 2 inch clearance from other cables when it is running parallel with other cables or metal braided hoses. The recommended routing in Port Deck area is in between the green cables running aft to forward.
3. The IMV Data Cable (W9437) can be routed near other cables of similar type (green cables). The recommended routing in Port Deck area is just above upper green cable.

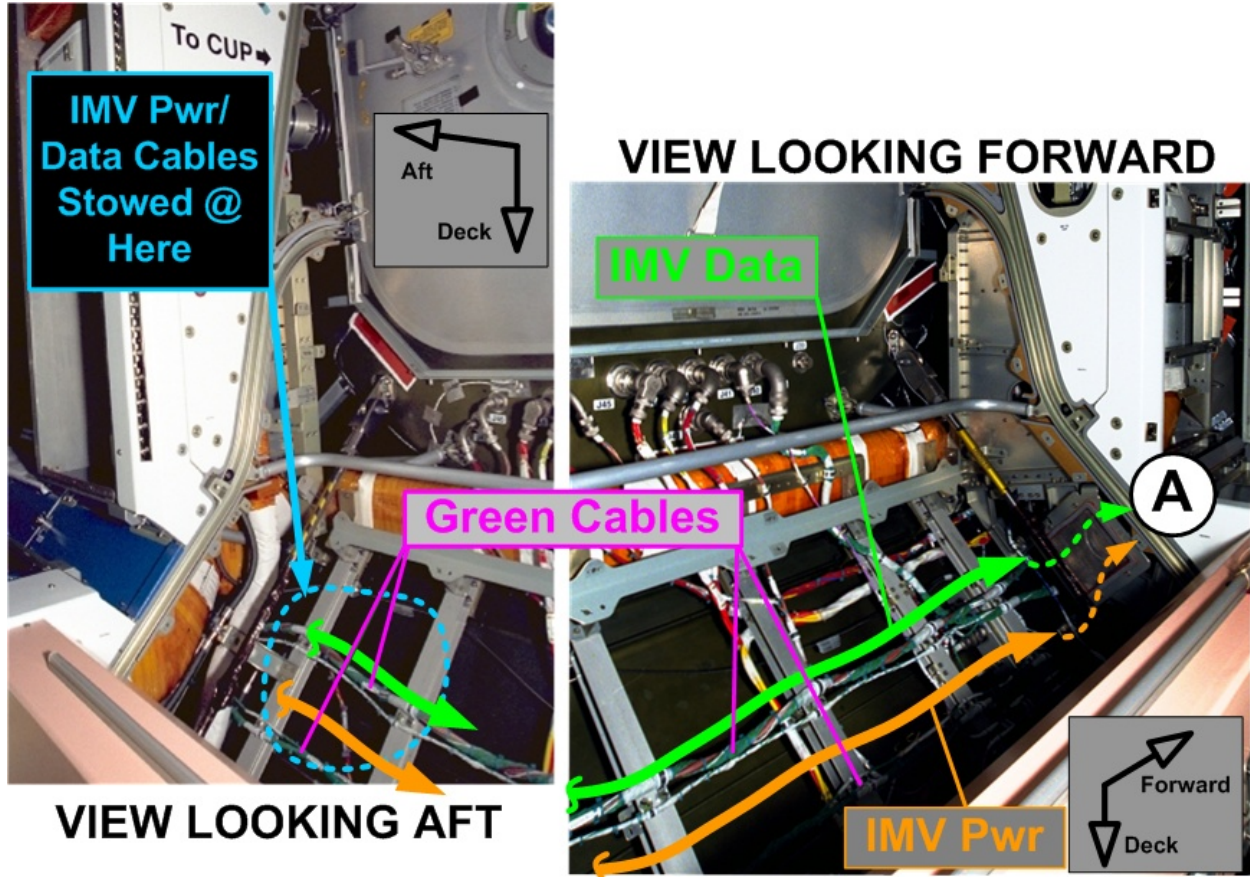

Figure 10.- IMV Valve Power and Data Routing in Port Deck Area.

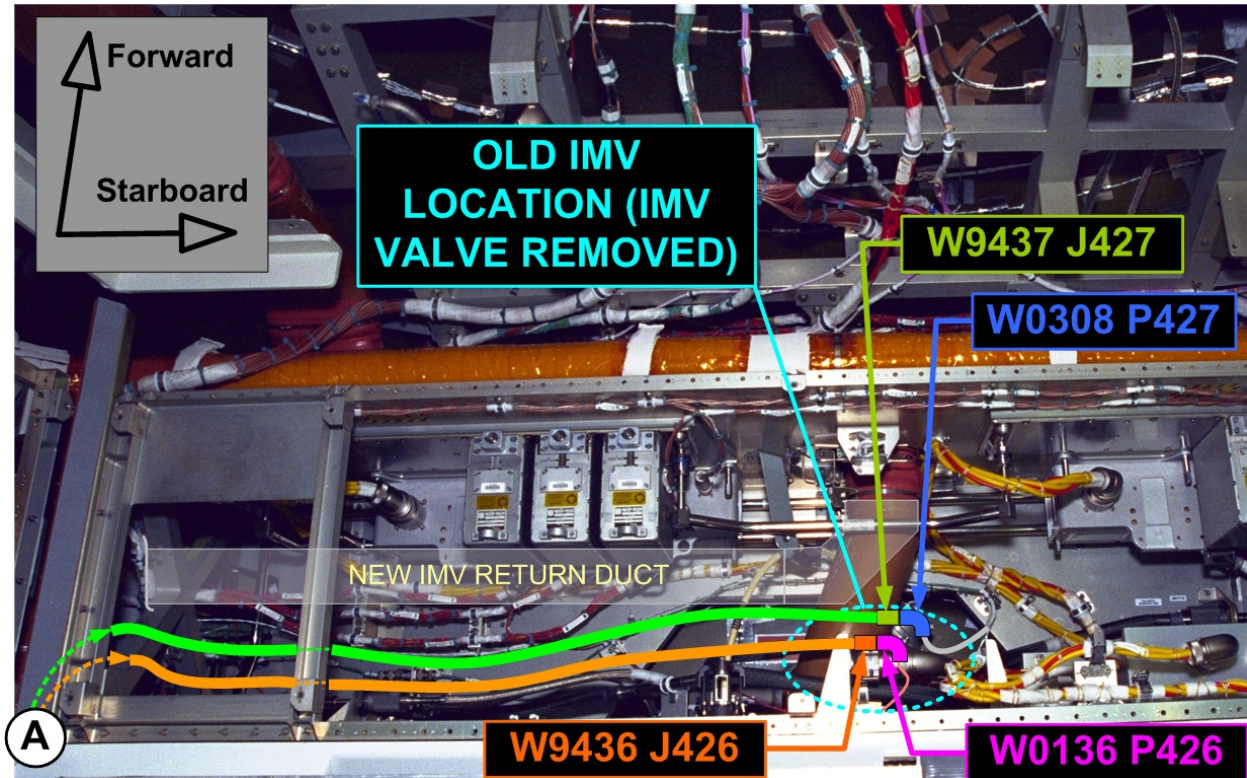

Figure 11.- IMV Valve Power and Data Routing in Port Deck Area.

- |         |  |
|---------|--|
| NOD1PD2 | <p>7.1 Uncoil pre-positioned IMV Valve Power/Data Cables and route forward toward Deck Alcove area.<br/>Route cables under the square-shaped diffuser bracket and into area between Port and Deck Alcoves.<br/>Refer to Figure 10.</p>   |
| NOD1D1  | <p>7.2 Route cables into Deck Alcove through zenith opening in the X-shaped structural member.<br/>Route cables toward area where IMV Valve was removed.<br/>Refer to Figure 11.</p> <p>7.3 Protective Cap ← → W0136 P426<br/>Protective Cap ← → NOD1 IMV Valve Power Cable (W9436) J426<br/>W0136 P426 → ← NOD1 IMV Valve Power Cable (W9436) J426<br/>Temporarily stow caps.<br/>Refer to Figure 11.</p> <p>7.4 Protective Cap ← → W0308 P427<br/>Protective Cap ← → NOD1 IMV Valve Data Cable (W9437) J427<br/>W0308 P427 → ← NOD1 IMV Valve Data Cable (W9436) J427<br/>Temporarily stow caps.<br/>Refer to Figure 11.</p> |



## 1.102 NODE 1 PREP FOR NODE 3 – ALCOVE HARDWARE INSTALLATIONS

(ASSY OPS/ULF3/FIN 2)

Page 27 of 38 pages

- 7.5 Restrain cables with Cable Ties, as necessary, trying to keep at least a 2 inch separation around IMV Power Cable from other metal braided hoses and any of the green colored Wire Harnesses or the IMV Data Cable.

### 8. CONNECTING WIRELESS AUDIO CABLE (UHF)

#### NOTE

1. The NOD1 Wireless Audio Cable (W9425) was routed and a Loopback Plug was installed on one end of the cable in the Midbay Hardware Installation procedure. The other end of the cable is left stowed in the Node 1 Port Deck Radial area and the steps below make the final connections.
2. No safining is required for this cable connection and there are no known impacts to Wireless Audio (UHF) communication during the connection.

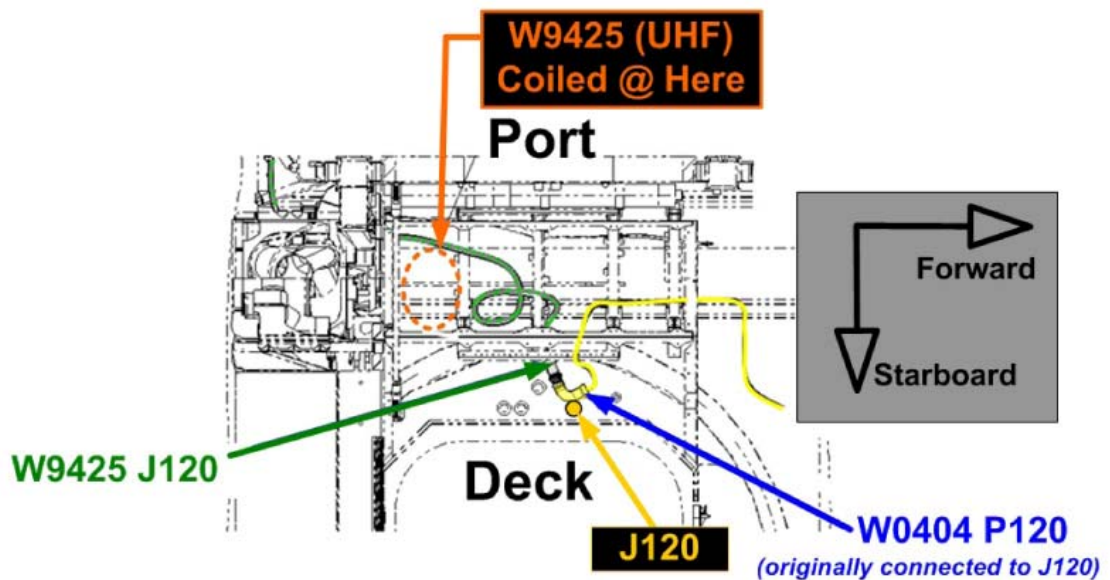

Figure 12.- Wireless Audio Cable Connection in Port(Deck) Area.

- 8.1 Locate stowed coil of NOD1 Wireless Audio Cable (W9425) in Port Deck Radial area.  
Uncoil cable and route underneath Closeout Panel support brackets routing cable toward deck Hatch area.  
Route free end to proximity of J120 bulkhead connection.  
Refer to Figure 12.
- 8.2 W0404 P120 ←|→ J120 (Deck Bulkhead)  
Protective Cap ←|→ NOD1 Wireless Audio Cable (W9425) J120  
Protective Cap →|← J120 (Deck Bulkhead)  
W0404 P120 →|← NOD1 Wireless Audio Cable (W9425) J120  
Refer to Figure 12.

9. [INSTALLING 1553 CHANNEL B HARNESS](#)

**NOTE**

1. Prior to installation of 1553 Channel B Wire Harness, all buses contained in harness are verified to be on channel (A) and controlling MDM FDIR response is reconfigured.

2. Tables 3 and 4 contain the 1553 buses contained in NOD1 1553 CH B CABLE (W9422).

Table 3. CDH 1553 Buses in NOD1 1553 CH B CABLE (W9422)

Bus Name [XX]	Controlling MDM
LB ORB HAB 1	Prime GNC
LB ORB HAB 2	Prime GNC
LB EPS HAB 23	Prime PMCU
LB EPS HAB 14	Prime PMCU
LB SYS HAB 1	Prime INT
LB SYS HAB 2	Prime INT
LB SEPS HAB 23	Prime INT
LB SEPS HAB 14	Prime INT
CB CT BIA 23	Prime C&C
CB CT 4	Prime C&C
CB INT 2	Prime C&C
LB CheCS HAB	Prime PL

Table 4. Robotics 1553 Buses in NOD1 1553 CH B CABLE (W9422)

Bus Name [YY]	Controlling Device
MSS PDGF LB	Prime CEU
HC LB 2	Cupola CEU
MSS BUD LB	Prime BCU
BCU LB 2	Cupola BCU

**MCC-H**

9.1 [INH BC Comm Fail](#)

CDH: Primary C&C: Recovery Retry: CCS MDM  
CCS Recovery Retry

**cmd BC Comm Fail – Inhibit Execute** (√Inh)

9.2 [Inhibiting Auto Transition to Diagnostics in PMCU MDM](#)

CDH: Primary PMCU: MDM FDIR  
Primary PMCU MDM FDIR

**cmd Auto Transition Diag – Inhibit Execute** (√Inh)

# 1.102 NODE 1 PREP FOR NODE 3 – ALCOVE HARDWARE INSTALLATIONS

(ASSY OPS/ULF3/FIN 2)

Page 29 of 38 pages

## 9.3 [Inhibiting Comm Safing Response in INT MDM](#)

CDH: Primary INT: MDM FDIR

**Primary INT MDM FDIR**

**cmd** Comm Safing Response – Inhibit **Execute** (√Inh)

## 9.4 [Inhibiting Channel Switching and Verifying CDH Buses on Channel A](#)

Use Table 3 to verify channels are on A and inhibit channel switching.

sel [XX] where [XX] = Bus Name from Table 3

**[XX] Bus Status**

Verify Channel Selected – A

'Auto Channel Switch Status'

**cmd** Inhibit **Execute** (√Inh)

Repeat

## 9.5 Verify Robotics system is ready to support Robotics 1553 bus disruption during cable connections.

Use Table 4 to verify or place Robotics channels on A.

ISS

## 9.6 √MCC-H to confirm all 1553 bus reconfigurations are ready to support connection of 1553 B Wire Harness

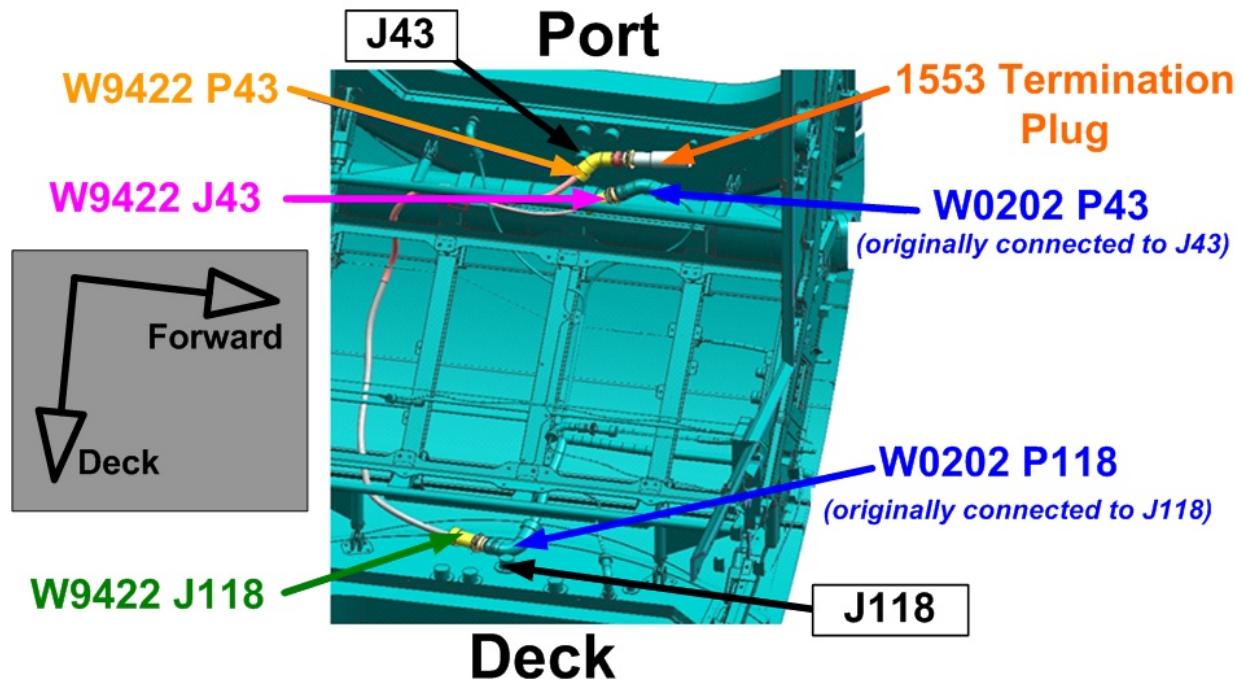

Figure 13.- 1553 Channel B Routing and Connections in Port/Deck Area.

# 1.102 NODE 1 PREP FOR NODE 3 – ALCOVE HARDWARE INSTALLATIONS

(ASSY OPS/ULF3/FIN 2)

Page 30 of 38 pages

NOD1PD2

- 9.7 After **MCC-H** GO  
Protective Cap ←|→ NOD1 1553 Termination Plug (W9427)  
Protective Cap ←|→ NOD1 1553 CH B Cable (W9422) P43  
NOD1 1553 Termination Plug (W9427) →|← NOD1 1553 CH B Cable (W9422) P43  
Temporarily stow Protective Caps (two).  
Refer to Figure 13.
- 9.8 W0202 P43 ←|→ J43 (Port Bulkhead)  
Protective Cap ←|→ NOD1 1553 CH B Cable (W9422) J43  
Protective Cap →|← J43 (Port Bulkhead)  
NOD1 1553 CH B Cable (W9422) J43 →|← W0202 P43  
Refer to Figure 13.
- 9.9 Route free end (J118 end) of NOD1 1553 CH B Cable (W9422) around ducting/connector clamp bracket (below the connectors) and underneath Closeout Panel support brackets routing cable toward deck Hatch area.  
Route free end to proximity of J118 bulkhead connection.  
Refer to Figure 13.
- 9.10 W0202 P118 ←|→ J118 (Deck Bulkhead)  
Protective Cap ←|→ NOD1 1553 CH B Cable (W9422) J118  
Protective Cap →|← J118 (Deck Bulkhead)  
W0202 P118 →|← NOD1 1553 CH B Cable (W9422) J118  
Refer to Figure 13.
- 9.11 Restrain cable, as necessary, with Cable Ties and stow cable end with 1553 Termination Plug in proximity to J43 (Port Bulkhead) connector.
- 9.12 Give **MCC-H** GO to reconfigure 1553 buses to nominal configuration.

**MCC-H**

- 9.13 [Reenabling Channel Switching](#)  
Use Table 3 to reenable channel switching.

sel [XX] where [XX] = Bus Name from Table 3

[XX] Bus Status  
'Auto Channel Switch Status'

**cmd** Enable **Execute** (√Ena)

Repeat

- 9.14 [Enabling BC Comm Fail](#)  
CDH: Primary C&C: Recovery Retry: CCS MDM  
 CCS Recovery Retry
- cmd** BC Comm Fail – Enable **Execute** (√Ena)

9.15 [Enabling Auto Transition to Diagnostics in PMCU MDM](#)  
 CDH: Primary PMCU: MDM FDIR  
Primary PMCU MDM FDIR

**cmd** Auto Transition Diag – Enable **Execute** (√Ena)

9.16 [Enabling Comm Safing Response in INT MDM](#)  
 CDH: Primary INT: MDM FDIR  
Primary INT MDM FDIR

**cmd** Comm Safing Response – Enable **Execute** (√Ena)

10. [ROUTING AND CONNECTING AUDIO BUS B HARNESS](#)

NOTE

1. Prior to installation of NOD1 Audio Bus B Cable (W9424), the Audio Bus Controller (ABC) in the LAB attached to channel B (ABC 2) will be deactivated and unpowered. This will result in a loss of redundancy for communication equipment.
2. Deactivating ABC 2 will cause some downstream ORUs to declare a PBIT Fault associated with the loss of Fiber Optic B channel. Downstream ORUs are completely functional with only Fiber Optic A (ABC1) being active.
3. After the new Audio Bus B Cable is connected, the ABC will be reactivated. After reactivation, the fiber optic I/O is cycled in order to clear transient PBIT faults on ORUs. A short loss of communication with the affected ORU is expected during this process.

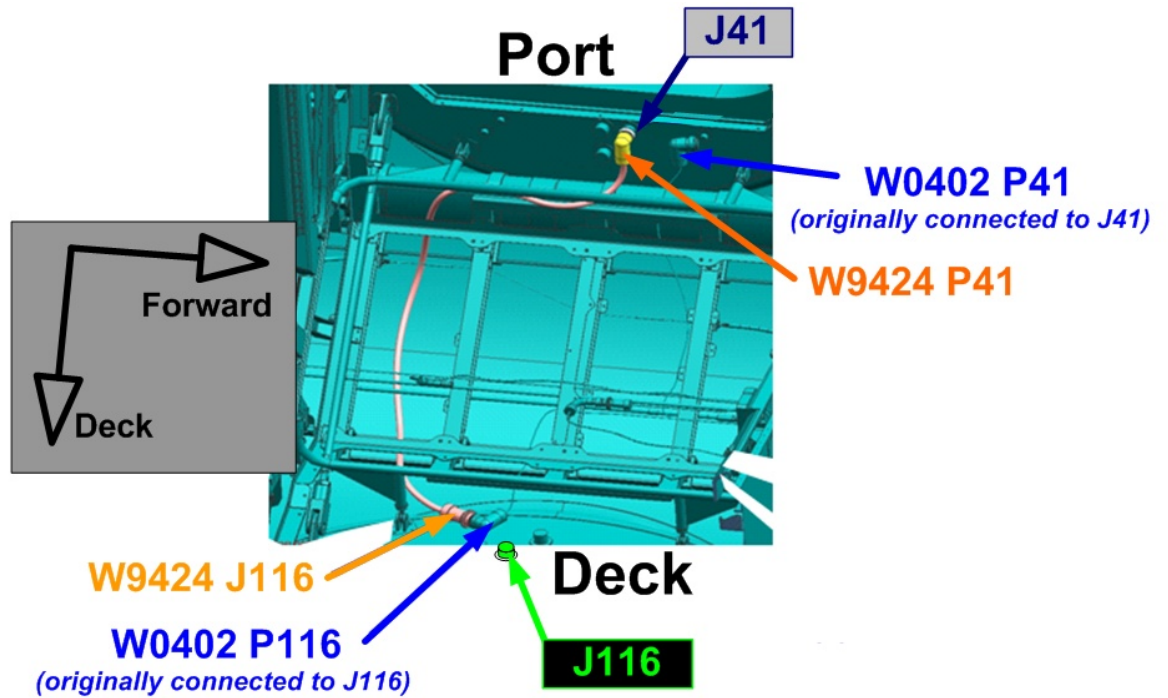

Figure 14.- Audio Bus B Cable Routing and Connections in Port(Deck) Area.

## 1.102 NODE 1 PREP FOR NODE 3 – ALCOVE HARDWARE INSTALLATIONS

(ASSY OPS/ULF3/FIN 2)

Page 32 of 38 pages

- MCC-H** 10.1 [Powering Down LAB ABC 2](#)  
C&T  
CNT Group Overview
- sel ABC2
- ABC2  
'IAC[X]' where [X] = Active and Powered IAC 1(2)
- cmd** Inhibit (Verify Bus I/O – Inhibit)
- sel RPCM LAD52B A RPC 07
- RPCM LAD52B A RPC 07
- cmd** RPC Position – Open (Verify – Op)  
**cmd** Close Cmd – Inhibit (Verify – Inh)
- ISS 10.2 ✓ **MCC-H** to confirm all Audio Bus B safing is in place to support connection of Audio Bus B Wire Harness
- NOD1PD2 10.3 After **MCC-H** GO  
W0402 P41 ←|→ J41 (Port Bulkhead)  
Protective Cap ←|→ NOD1 Audio Bus B Cable (W9424) P41  
Protective Cap →|← W0402 P41  
NOD1 Audio Bus B Cable (W9424) P41 →|← J41 (Port Bulkhead)  
Refer to Figure 14.
- 10.4 Route free end (J116 end) of NOD1 Audio Bus B Cable (W9424) around ducting/connector clamp bracket (below the connectors) and underneath Closeout Panel support brackets routing cable toward deck Hatch area.  
Route free end to proximity of J116 bulkhead connection.  
Refer to Figure 14.
- 10.5 W0402 P116 ←|→ J116 (Deck Bulkhead)  
Protective Cap ←|→ NOD1 Audio Bus B Cable (W9424) J116  
Protective Cap →|← J116 (Deck Bulkhead)  
W0402 P116 →|← NOD1 Audio Bus B Cable (W9424) J116  
Refer to Figure 14.
- 10.6 Restrain cable, as necessary, with Cable Ties and stow W0402 P41 cable end out of the way in the Port bulkhead.
- 10.7 Give **MCC-H** GO to reactivate LAB ABC 2.
- MCC-H** 10.8 [Powering Up LAB ABC 2](#)  
C&T: ABC2  
ABC 2

## 1.102 NODE 1 PREP FOR NODE 3 – ALCOVE HARDWARE INSTALLATIONS

(ASSY OPS/ULF3/FIN 2)

Page 33 of 38 pages

sel RPCM LAD52B A RPC 07

RPCM LAD52B A RPC 07

**cmd** Close Cmd – Enable (Verify – Ena)

**cmd** RPC Position – Close (Verify – Cl)

ABC 2

'IAC [X]' where [X] = Active and Powered IAC 1(2)

**cmd** Enable (Verify Bus I/O – Enable)

### 10.9 Clearing Audio PBIT Faults

At the appropriate time, go to [2.310 AUDIO DETAILED TROUBLESHOOTING](#), step 3 (SODF: GND AVIONICS: MALFUNCTION).

## 11. PHOTO DOCUMENTING INSTALLED HARDWARE

11.1 Prior to reinstallation of Closeout Panels, photo document all of the installed and reconfigured hardware (Digital Camera).

## 12. INSTALLING IMV GRILLE AND RMO COVERS ONTO CLOSEOUT PANELS

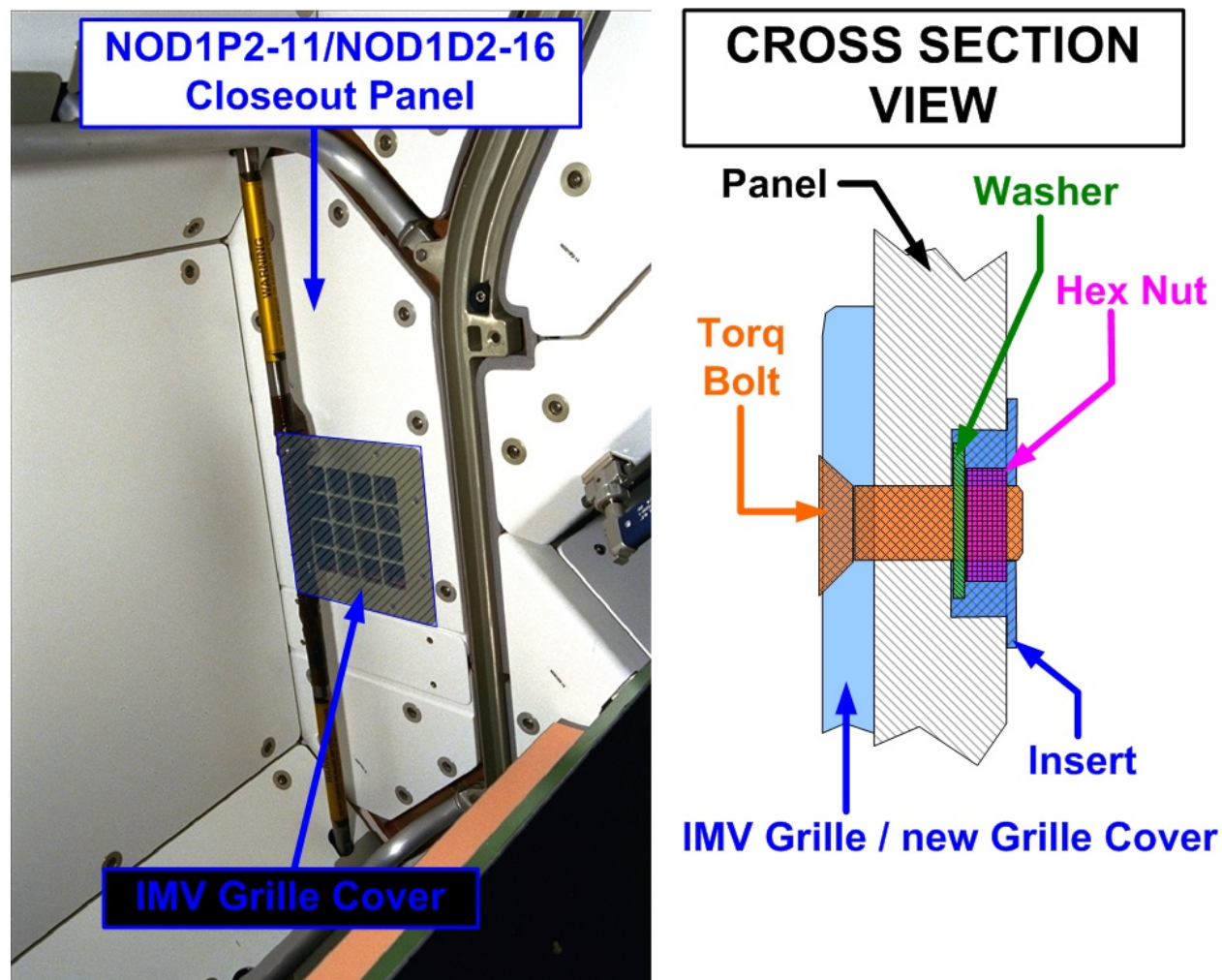

Figure 15.- Port Deck IMV Grille Cover Installation Details.

12.1 Loosen and remove noncaptive bolts, washers, and nuts (eight) holding square grille onto NOD1P2-11 Closeout Panel (#10 Long Torq Driver, 3/8" Drive; Ratchet, 3/8" Drive; 1/4" Deep Socket, 1/4" Drive; Ratchet, 1/4" Drive).  
Temporarily stow any bolts, washers, and nuts (will be reused).

12.2 Remove Grille from NOD1P2-11 Closeout Panel.  
Temporarily stow.

**NOTE**

1. The 1/4" Ratchet and 1/4" Deep Socket is called out to help remove/install nuts on inside of Closeout Panel since it is handy (used in previous steps). If a 1/4" Combination Wrench fits better or is preferred, it can be substituted.
2. During removal of Grille, using the 1/4" socket/wrench to remove nuts while using Torq Driver to prevent bolt turning can reduce potential of stripping the Torq bolt heads.



# 1.102 NODE 1 PREP FOR NODE 3 – ALCOVE HARDWARE INSTALLATIONS

(ASSY OPS/ULF3/FIN 2)

Page 35 of 38 pages

12.3 Install NOD1 IMV Diffuser Cover in place of removed grille (on cabin side of Closeout Panel) and use bolts, washers, and nuts (eight) removed from grille.

Tighten (snug) fasteners (eight) (#10 Long Torq Driver, 3/8" Drive; Ratchet, 3/8" Drive; 1/4" Deep Socket, 1/4" Drive; Ratchet, 1/4" Drive).

\*\*\*\*\*

- \* If any of the Torq bolts are damaged or if any of the bolts, nuts, or
- \* washers are lost
- \* A full complement, including extras of each flown with the new
- \* Diffuser Cover, can be used to replace any damaged or
- \* missing parts.

\*\*\*\*\*

12.4 Torque NOD1 IMV Diffuser Cover fasteners (eight) to 23 in-lbs [#10 Long Torq Driver, 3/8" Drive; 1/4" Deep Socket, 1/4" Drive; Ratchet; (10-50 in-lbs) Trq Wrench, 1/4" Drive; 1/4" to 3/8" Adapter (if required)].

NOD1PD2

12.5 Reinstall NOD1P2-11(NOD1D2-16) Closeout Panels, and tighten (snug) fasteners (eleven) (5/32" Hex Head, 1/4" Drive; Driver Handle, 1/4" Drive).

Refer to Figure 2.

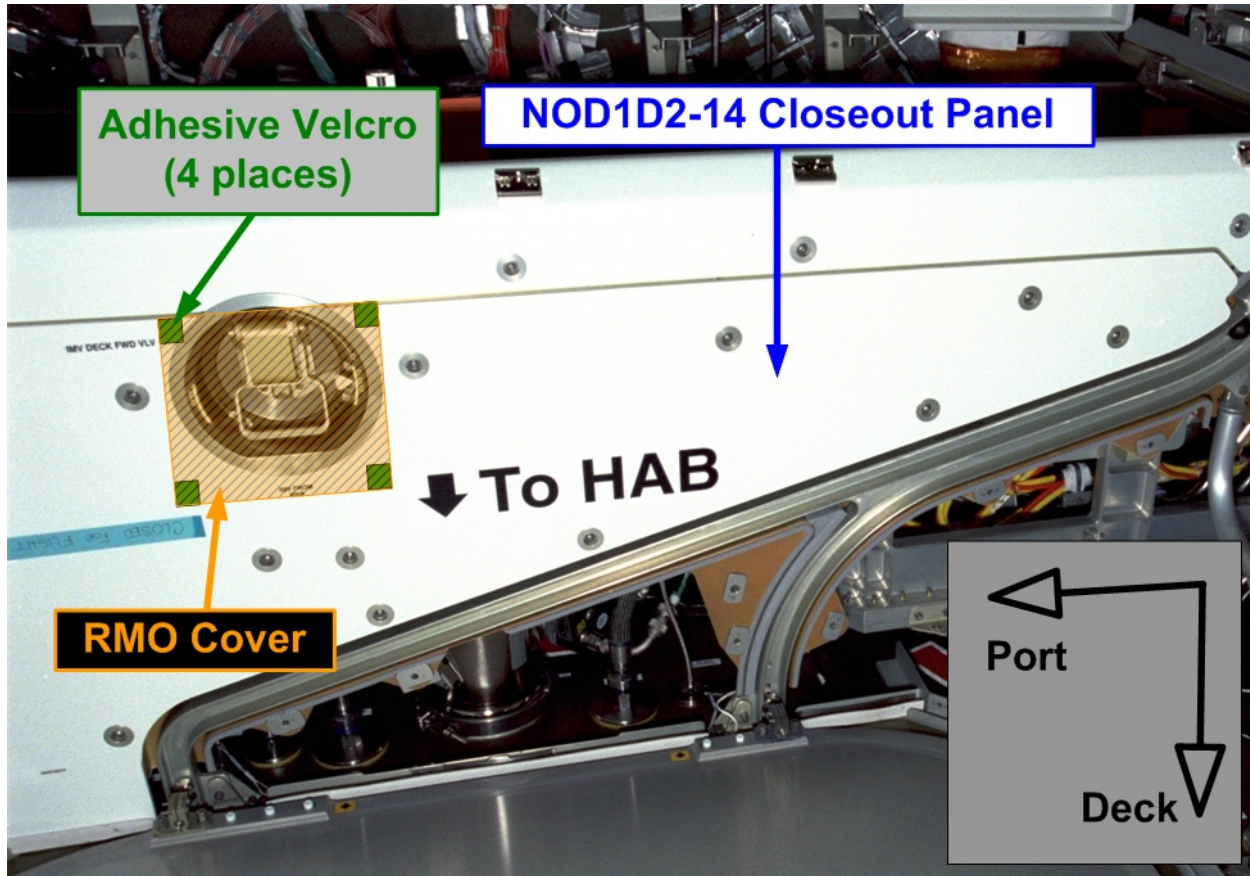

Figure 16.- Deck Forward Node 1 IMV Valve RMO Cover Installation Details.

- NOD1D2            12.6 Install Node 1 IMV Valve RMO Cover over location of removed IMV RMO on NOD1D2-14 Closeout Panel (attached by adhesive-backed Velcro).  
 Refer to Figure 16.
13.    REINSTALLING REMAINING CLOSEOUT PANELS
- 13.1 Reinstall all remaining Closeout Panels from this procedure, and tighten (snug) fasteners (eleven) (5/32" Hex Head, 1/4" Drive; Driver Handle, 1/4" Drive).  
 Refer to Figure 2.
- 13.2 Reinstall any remaining Closeout Panels and tighten (snug) fasteners (eleven) (5/32" Hex Head, 1/4" Drive; Driver Handle, 1/4" Drive).  
 Refer to Figures 1, 2, and 3 in [NODE 1 PREP FOR NODE 3 – ALCOVE HARDWARE INSTALLATIONS](#) (SODF: ASSY OPS: ULF3).

14. [INSTALLING NEW NODE 3 LABELS](#)

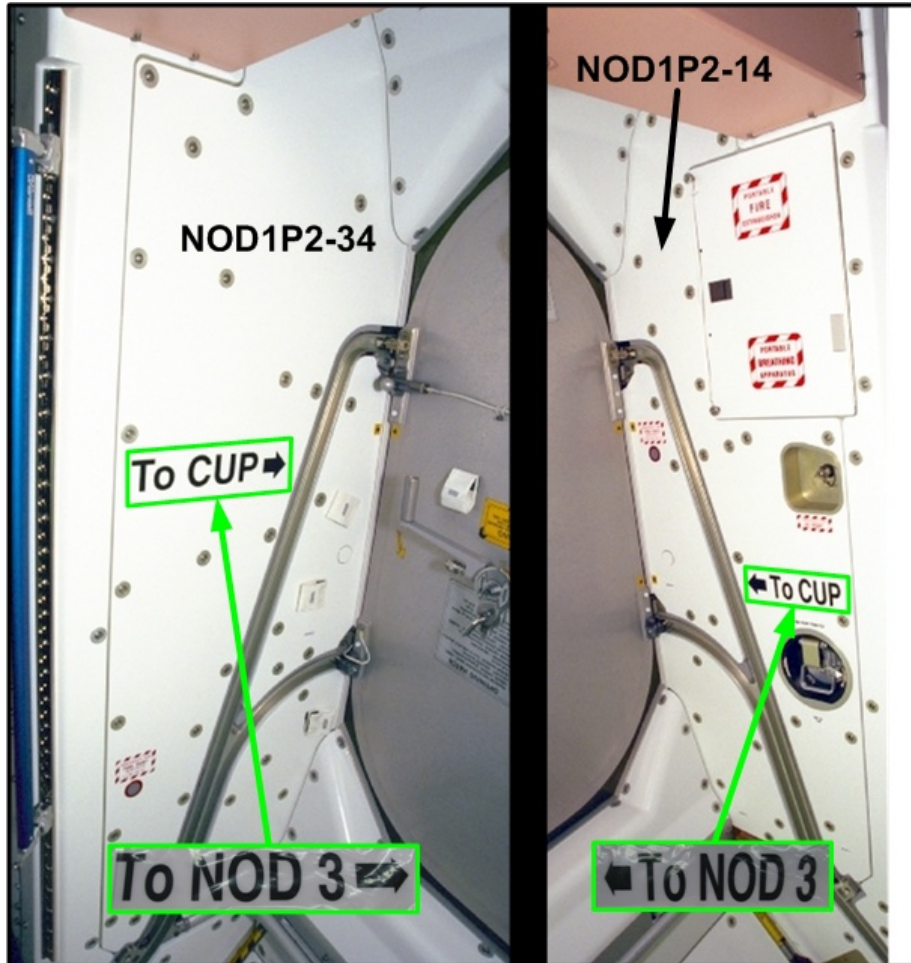

Figure 17.- New Node 3 Direction Labels Installation Details.

- 14.1 Install new Node 3 label (arrow toward Hatch) over existing Cupola label on NOD1P2-34 Closeout Panel.  
Install new Node 3 label (arrow toward Hatch) over existing Cupola label on NOD1P2-14 Closeout Panel.  
Refer to Figure 17.

15. [CLEANUP](#)

- 15.1 Notify **MCC-H** of task completion.
- 15.2 Record IMV Fan Serial Number: \_\_\_\_\_
- 15.3 Stow tools, materials.
- 15.4 Stow removed and extra Mod Kit hardware per Table 5.  
Refer to official Stowage Note for final recommended stowage locations of Bags or CTBs.

**1.102 NODE 1 PREP FOR NODE 3 – ALCOVE HARDWARE INSTALLATIONS**

(ASSY OPS/ULF3/FIN 2)

Page 38 of 38 pages

Table 5. Node 1 Mod Kit Alcove Hardware Stowage Matrix

#	Part Name	Part Number	Qty	Stowage Info	Disposition
1	IMV Fan	SV809111-6	1	Place items one to three together in Ziplock Bag. Label Ziplock Bag "Spare IMV Fan."	Kept onboard as spare
2	IMV Fan Insulation Jacket	1F98924-1	1		
3	IMV Hose Clamp (5.75")	NAS1922-0575-3	2		
4	IMV Hose Clamp (5.75")	NAS1922-0575-3	2	Place items four to eight together in Ziplock Bag. Label Ziplock Bag "Spare IMV parts." Report any Qty deltas.	Kept as spare IMV parts
5	IMV Hose Clamp (5.25")	NAS1922-0525-3	12		
6	IMV Duct Cap	BOE2221-0016	1		
7	IMV Duct Sleeve 5" Diameter Long	BACD40R20A42	3		
8	IMV Duct Sleeve 5" Diameter Short	BACD40R20A30	2		
9	IMV Silencer	683-15023-1	2	Place items nine to sixteen in an empty CTB. Report CTB S/N. _____	Position for Return
10	IMV Coupling (including acoustic insulation)	1F89029-1	2		
11	IMV Coupling	1F89030-1	1		
12	IMV Coupling	1F89202-1	3		
13	Diffuser	1F70847-1	1		
14	Intermodule Return Grille	683-15196-1	1		
15	Tee Assembly	1F89043-1	1		
16	IMV Duct Insulation Jacket	1F89204-1	5		
17	Protective Cap (from W9422)	NATC-PPC-N-25-0	1	Place items seventeen to twenty-two together in Ziplock Bag. Label Ziplock Bag "NOD1 Mod Kit Caps and Plugs."	Kept for future IFM usage
18	Protective Cap (from W9427)	NATC-RPC-N-25-0	1		
19	Protective Cap (from W9436, W9437, and two extra from Kit)	NATC-RPC-N-11-0	4		
20	Threaded Fluid Fitting (from N2 hose)	683-16347-822	1		
21	3/8" Gamah Plug (from O2 hose)	683-16347-825	1		
22	Feedthrough Cap (from O2 and N2 feedthru)	683-16347-845	2		
23	To PMA 3 Label (down arrow)	683-99512-3	2	Stow for future use	Keep for final location of PMA 3
24	EVA Tape	P-213	any	Stow in Tape Pantry	Keep any unused and stow with existing onboard inventory
25	Cable Tie	T50R2HAL	any	Stow in Tie Pantry	
26	Torq Bolt, #10-32 (Diffuser Cover)	NAS1580C3T4	9	Place items 26 to 28 together in Ziplock Bag. Label Ziplock Bag "Spare Diffuser Cover Hardware."	Position for Return or Trash
27	Washer (Diffuser Cover)	NAS1587-3	9		
28	Nut, #10-32 (Diffuser Cover)	MS21043-3	10		

OBJECTIVE:

Commercial Generic Bioprocessing Apparatus (CGBA). This procedure will direct the crew on the proper steps for adjusting the set temperature.

NOTE  
 If MENU selection is not made within 30 seconds, computer will time out and return to status display.

MF71E

1. On keypad  
 pb MENU → Press  
  
 pb 4 → Press  
  
 pb ENTER → Press
2. Verify display indicates  
  
 Enter new Set Temp  
  
 Temp: nn.n
3. Enter new Set Temp (nn.n)  
 pb ENTER → Press
4. Verify display indicates  
  
 New Set Temp  
  
 nn.n deg C  
  
 1 = Save Temp  
 9 = Reenter Temp

```

*****
*
* If displayed Set Temp is incorrect
* |   pb 9 → Press
* |   pb ENTER → Press
* |   Repeat steps 3 and 4.
*
*****
  
```

5. pb 1 → Press  
  
 pb ENTER → Press

This Page Intentionally Blank

OBJECTIVE:

The following steps will perform a reboot of Glacier Systems.

Glacier

1. ✓ Display 'HOME'  
\*\*\*\*\*  
\*  
\* If 'HOME' not shown:  
\* |  
\* | pb Right (EXIT) → Press until 'HOME' appears  
\* |  
\*\*\*\*\*
2. Log from Glacier front panel:  
GPS: \_\_\_\_\_:\_\_\_\_\_:\_\_\_\_\_  
CURR TEMP: \_\_\_\_\_.\_\_\_\_ °C
3. pb Left (MENU) → Press (one time), following appears:  
  
'MAIN MENU'  
'QUICK STATUS 1/5'
4. pb Left (NEXT) → Press (four times), following appears:  
  
'MAIN MENU'  
'SHUTDOWN 5/5'
5. pb Center (SELECT) → Press (one time), following appears:  
  
'SHUTDOWN'  
'SHUTDOWN 1/2'
6. pb Left (NEXT) → Press (one time), following appears:  
'SHUTDOWN'  
'REBOOT 2/2'
7. pb Center (SELECT) → Press (one time), following appears:  
'Confirm Shutdown'  
'REBOOT'
8. pb Left (APPLY) → Press (one time), following appears:  
'Glacier'  
'System'  
'Shutting Down'  
'Please wait...'
9. Verify Display—  
'Glacier'  
'System'  
'Rebooting'  
'Please wait...'

NOTE

System initialization may take up to 3 minutes. Initialization is complete once Line 1 of front panel display reads 'HOME'.

10. ✓Display 'HOME'

```
*****
*
*
* If 'HOME' not shown:
* |
* | ✓MCC-H
*
*****
*
* If Display - ***Error Pending***
* |
* | Perform GLACIER ERROR MESSAGE (SODF: ASSY OPS:
* | PAYLOADS), then:
*
*****
```

11. Notify MCC-H of recorded data in step 2.



**PRE-EVA PL CONFIGURATION**  
(ASSY OPS/ULF3/FIN 1) Page 1 of 1 pages

N/A

This Page Intentionally Blank

**POST EVA PL CONFIGURATION**  
(ASSY OPS/ULF3/FIN 1) Page 1 of 1 pages

N/A

This Page Intentionally Blank

# APCU

## APCU AMPS ↑ (ASSY OPS/ULF3/FIN 2)

**SM ALERT**

S200 APCU 1(2) AMPS HIGH

**APCU TEMP ↓↑**, block 3 (SODF: ASSY OPS: MALFUNCTION: APCU MALFUNCTION)

**APCU VOLTS ↑↓**, block 3 (SODF: ASSY OPS: MALFUNCTION: APCU MALFUNCTION)

If any APCU CONV AMPS ≥ 8.5

**Nominal Config:**  
R1  
PRI PL MNC – ON (tb-ON)  
PL CAB – MNA(MNB)  
PL AUX – ON (L12/SSP 1)  
cb SW PWR 1 – cl

**Nominal APCU Activated Config:**  
L12 (SSP 1)

APCU 1,2 CONV (two) – ON (tb-gray)

APCU 1,2 OUTPUT RLY (two) – CL (tb-gray)

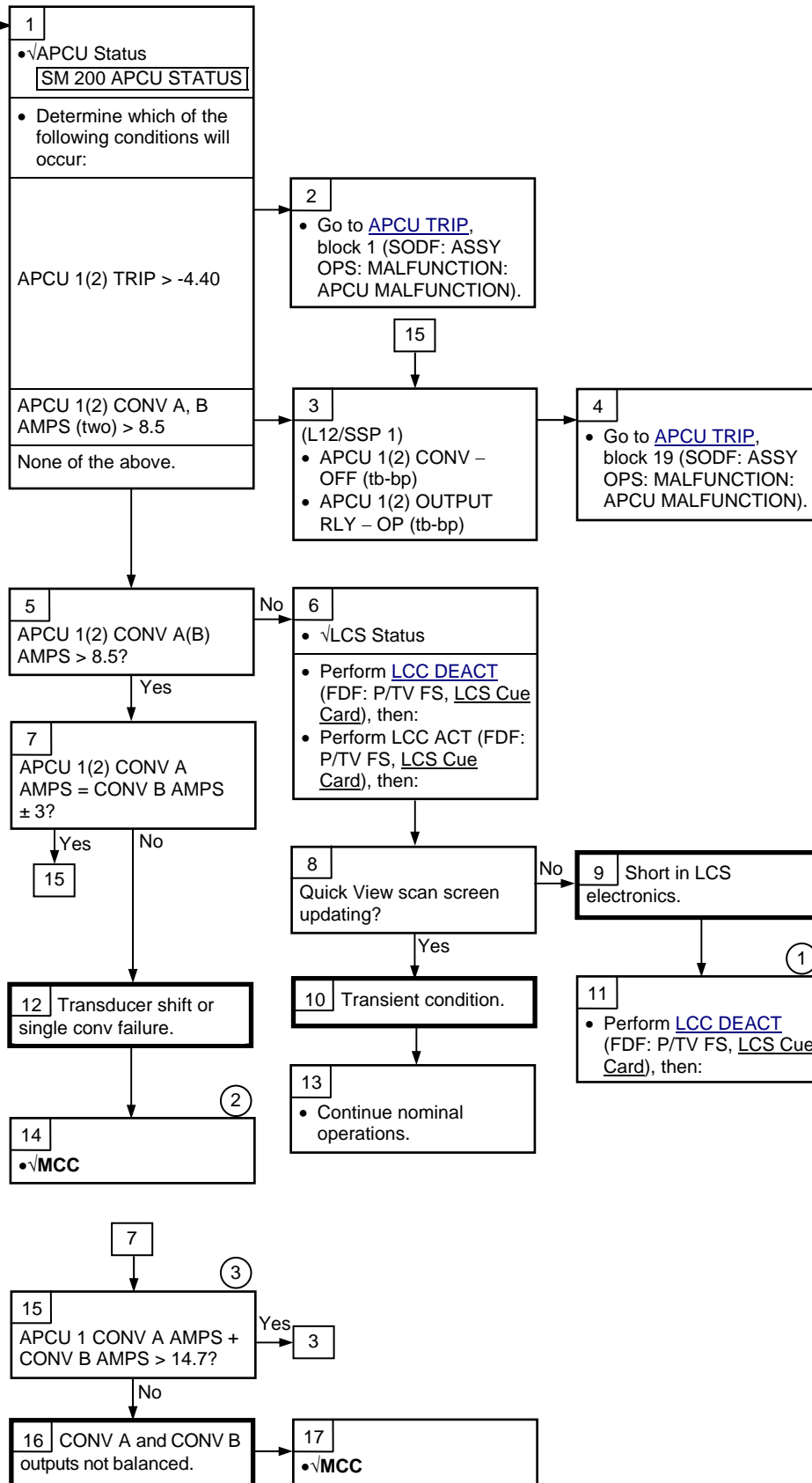

① APCU 2 provides power to LCS when OBSS is on the RMS.

② MCC will determine between a transducer shift and a real single converter failure.

③ Total output for each APCU must be maintained less than 14.7 amps and each CONV output must be maintained less than 8.5 amps.

This Page Intentionally Blank

# APCU

## APCU TEMP ↓↑ (ASSY OPS/ULF3/FIN 1) Page 1 of 1 page

SM ALERT

S200 APCU 1(2)  
TEMP HIGH

If: APCU 1(2)  
CONV TEMP A(B)  
≤ 20 or ≥ 130

**Nominal Config:**  
(R1)  
PRI PL MNC – ON  
(tb-ON)  
PL CAB  
– MNA(MNB)  
PL AUX – ON  
L12 (SSP 1)  
cb SW PWR 1 – cl

**Nominal APCU  
Activated Config:**  
L12 (SSP 1)

APCU 1,2  
CONV(two)  
– ON (tb-gray)

APCU 1,2 OUTPUT  
RLY (two) – CL  
(tb-gray)

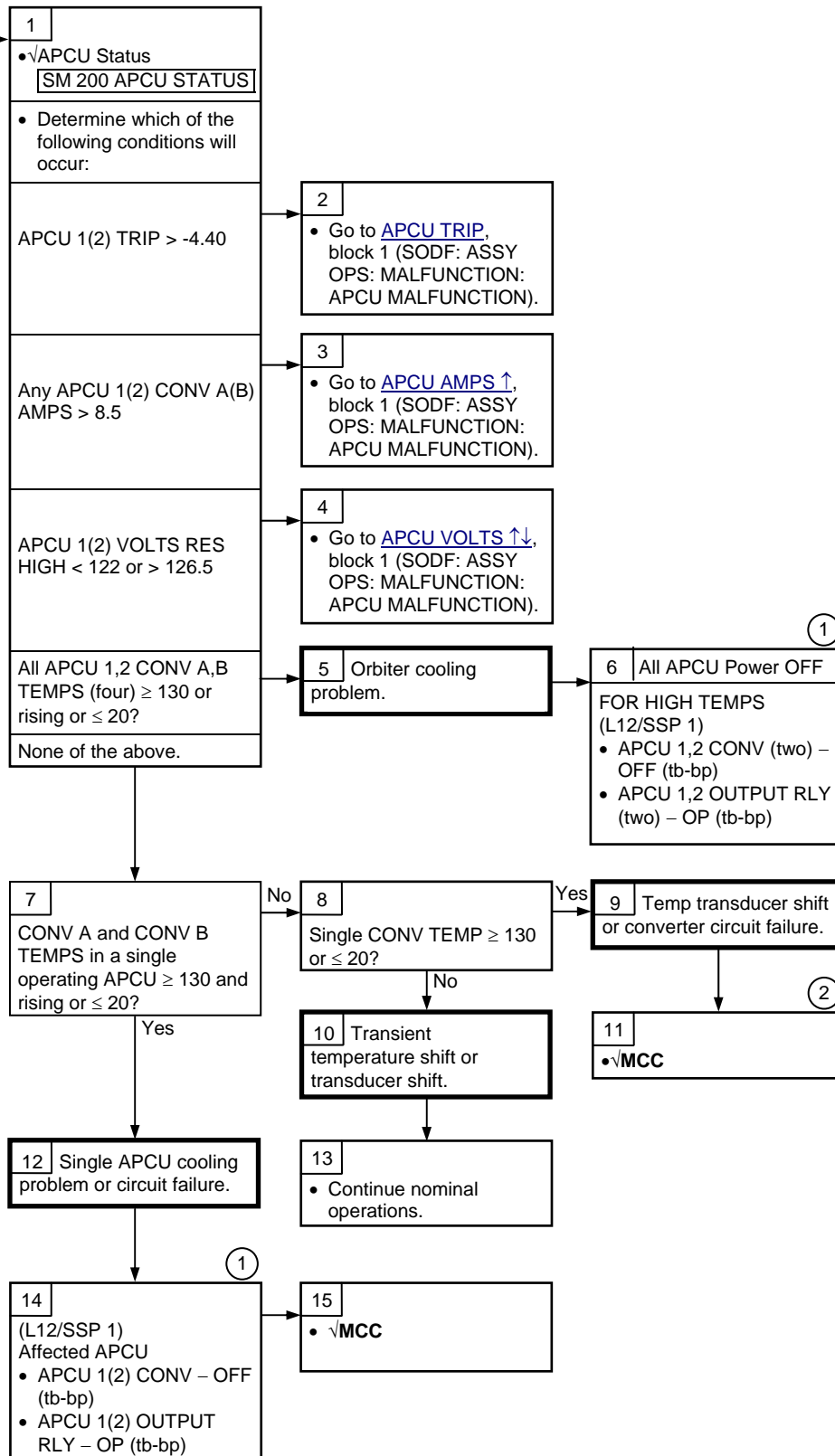

① Loss of APCU 2 results in loss of orbiter 120 V power to LCS/IDC.

② MCC will determine between a transducer shift and a real circuitry failure.

This Page Intentionally Blank



# APCU

# APCU TRIP

(ASSY OPS/ULF3/FIN 2) Page 1 of 4 pages

SM  
ALERT

- S200 APCU 1(2)  
TRIP
- APCU TEMP ↓↑,  
block 2 (SODF:  
ASSY OPS:  
MALFUNCTION:  
APCU  
MALFUNCTION)
- APCU VOLTS  
↑↓, block 2  
(SODF: ASSY  
OPS:  
MALFUNCTION:  
APCU  
MALFUNCTION)
- APCU AMPS ↑,  
block 2 (SODF:  
ASSY OPS:  
MALFUNCTION:  
APCU  
MALFUNCTION)

If APCU TRIP  
> -4.4  
√APCU TRIP  
STATUS TABLE

**Nominal Config:**  
R1  
PRI PL MNC – ON  
(tb-ON)  
PL CAB – MNA(MNB)  
PL AUX – ON  
L12 (SSP 1)  
cb SW PWR 1 – cl

**Nominal APCU  
Activated Config:**  
L12 (SSP 1)

APCU 1,2 CONV  
(two) – ON (tb-gray)

APCU 1,2 OUTPUT  
RLY (two) – CL  
(tb-gray)

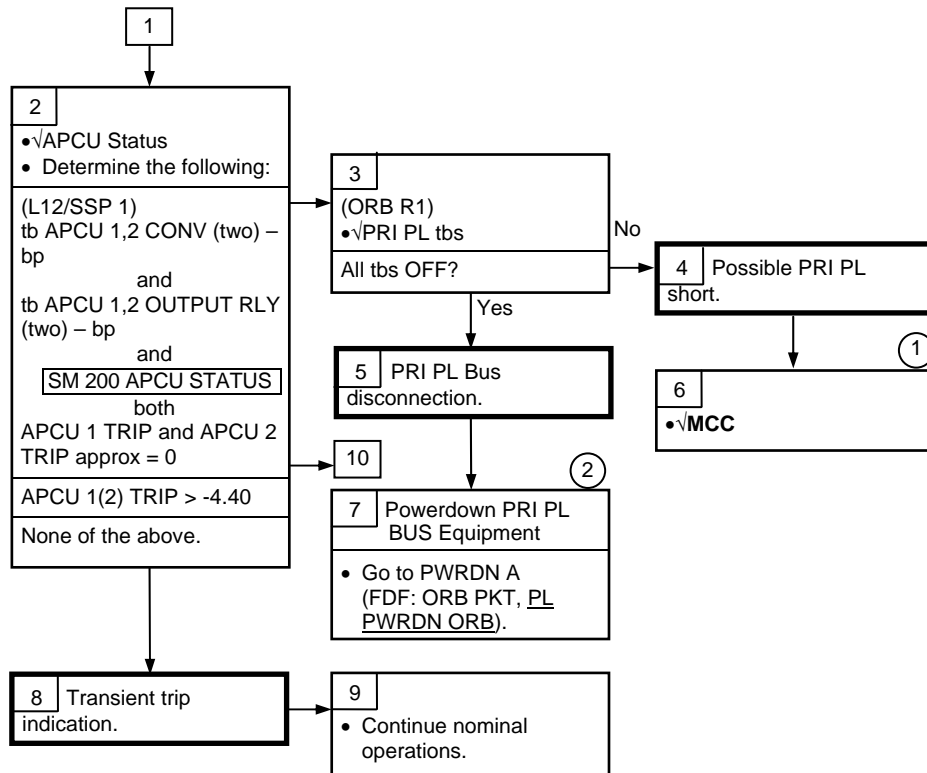
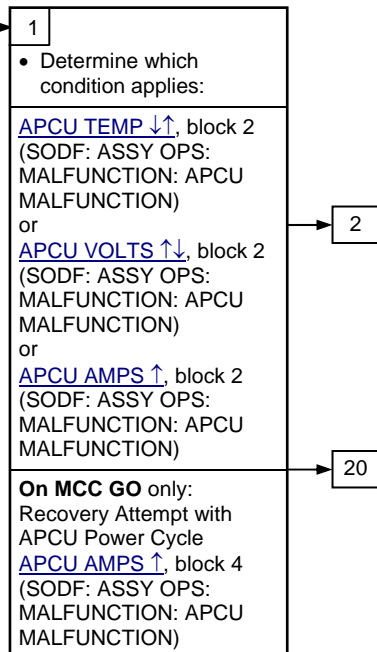

①  
**MCC** will determine cause of interruption of power or signal to the APCUs.

②  
**MCC** will coordinate recovery of the PRI PL bus and equipment.

# APCU

## APCU TRIP (ASSY OPS/ULF3/FIN 2) Page 2 of 4 pages

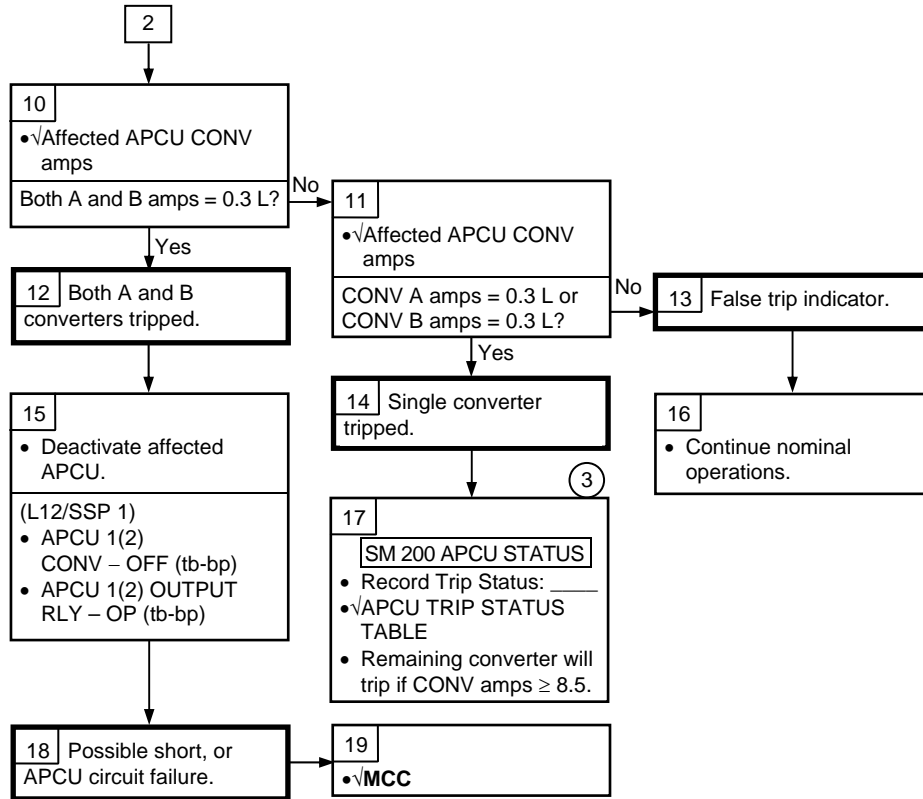

③  
LCS/IDC receives  
power through  
APCU 2.

④  
Loss of APCU 2  
results in loss of  
120 V power to  
LGS/IDC.

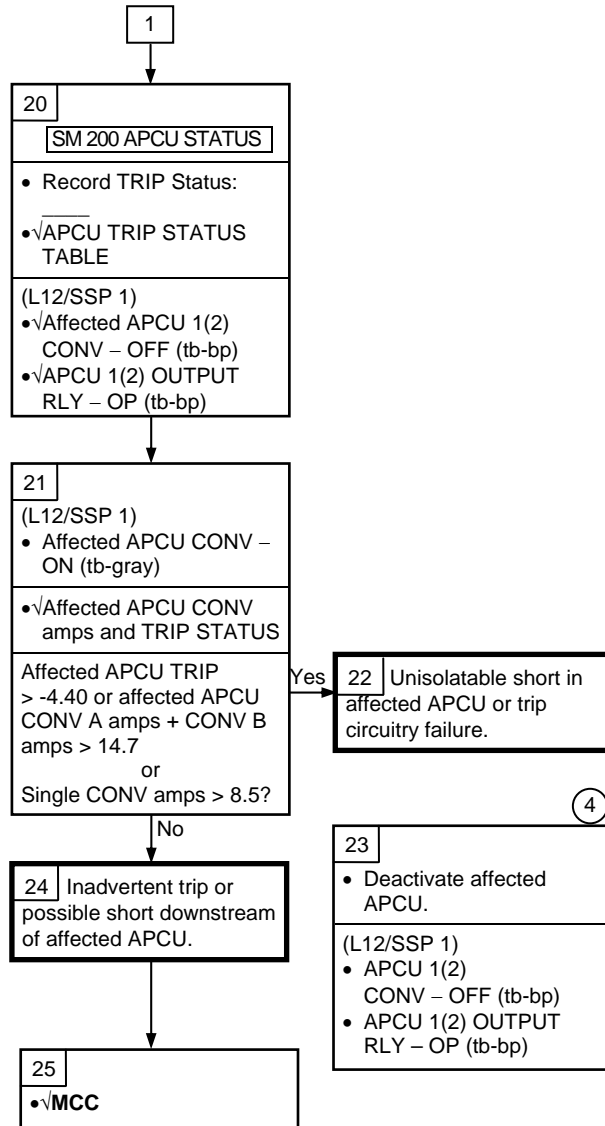

Table 1. APCU TRIP Status

TRIP (STATUS VOLTAGE)	TRIP CAUSE(S)			
	OV	OUV	OC	IUV
+4.88	X	X	X	X
+4.23	X	X	X	
+3.59	X	X		X
+2.95	X	X		
+2.27	X		X	X
+1.62	X		X	
+0.98	X			X
+0.34	X			
-0.30		X	X	X
-0.95		X	X	
-1.59		X		X
-2.23		X		
-2.91			X	X
-3.56			X	
-4.20				X
-4.86 (no trip)				

**NOTE**  
 OV: Output Overvoltage  
 OUV: Output Undervoltage  
 OC: Output Overcurrent  
 IUV: Input Undervoltage  
 Tolerance for all reported voltages is  $\pm 0.20$  V

# APCU

# APCU VOLTS $\uparrow\downarrow$

(ASSY OPS/ULF3/FIN 1) Page 1 of 3 pages

SM  
ALERT

S200 APCU 1(2)  
VOLT LMT

APCU TEMP  $\downarrow\uparrow$ ,  
block 4 (SODF:  
ASSY OPS:  
MALFUNCTION:  
APCU  
MALFUNCTION)

If: APCU VOLTS  
RES HIGH  $\geq$   
126.5 or  $\leq$  122

### Nominal Config:

R1  
PRI PL MNC – ON  
(tb-ON)  
PL CAB –  
MNA(MNB)  
PL AUX – ON  
L12 (SSP 1)  
cb SW PWR 1 – cl

### Nominal APCU

Activated Config:  
L12 (SSP 1)

APCU 1,2 CONV  
(two) – ON (tb-gray)

APCU 1,2 OUTPUT  
RLY (two) – CL  
(tb-gray)

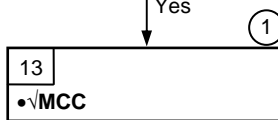
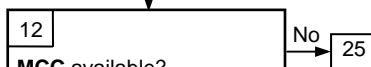
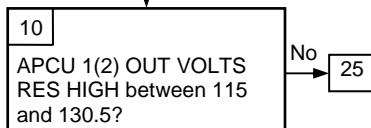
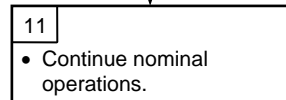
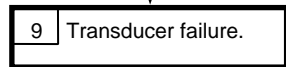
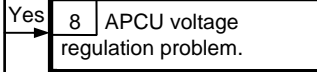
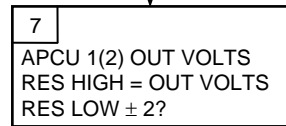
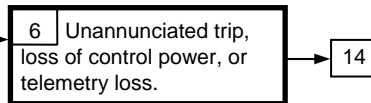
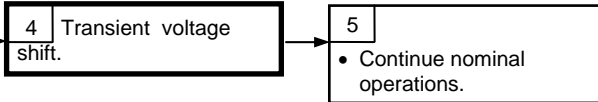
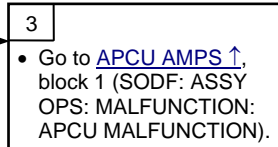
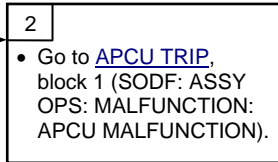
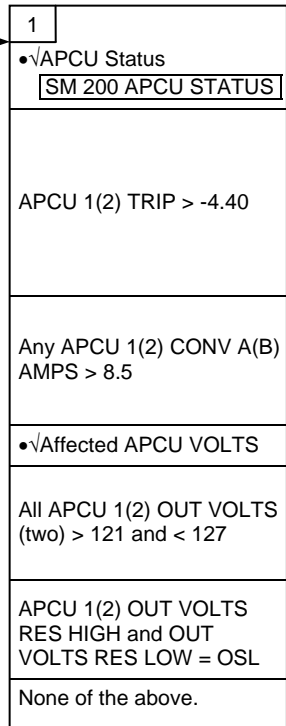

①  
SPEC voltage for  
APCU is 122 to  
126.5 volts. If  
APCU volts are  
outside this range  
but stable and  
usable,  
consideration will be  
given to continuing  
APCU operation.

**APCU**

**APCU VOLTS** ↑↓  
(ASSY OPS/ULF3/FIN 1) Page 2 of 3 pages

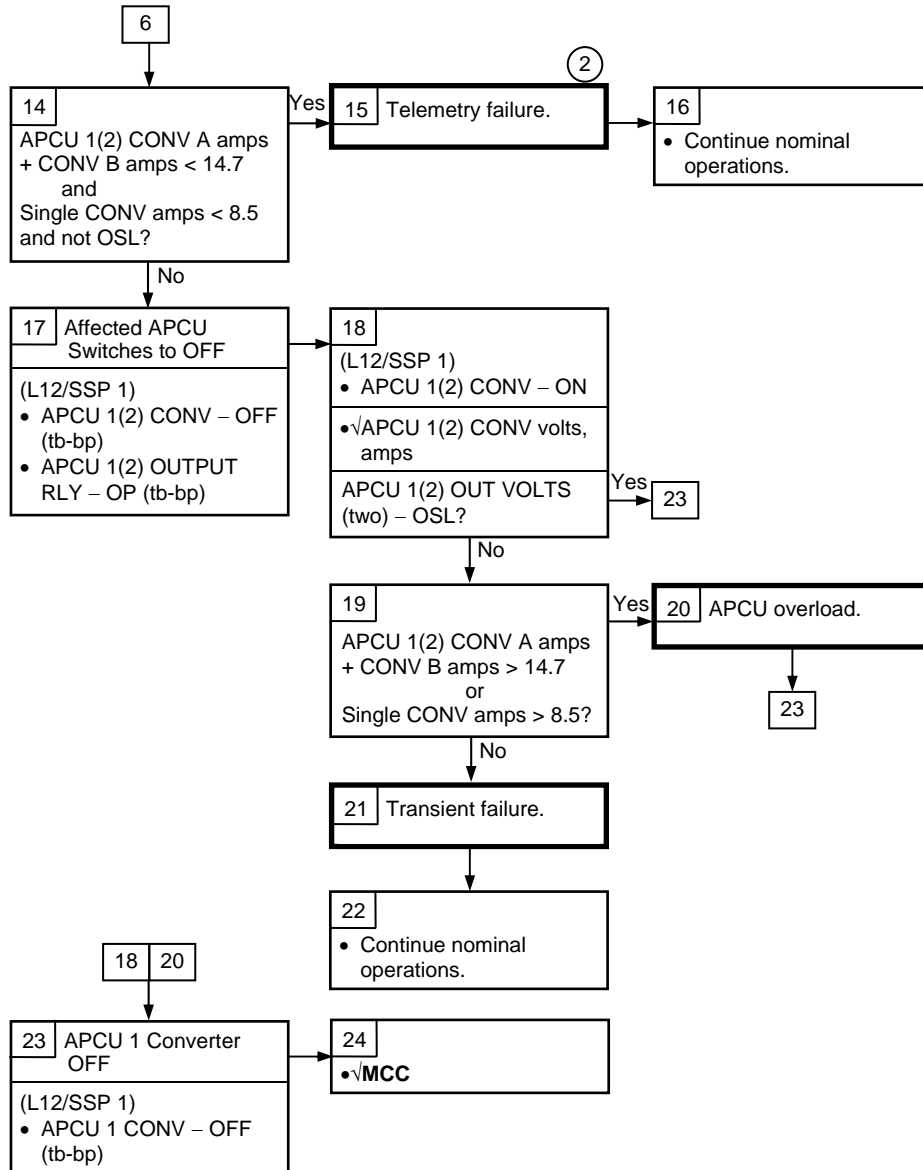

②  
There is a single point failure that will cause both the HIGH and LOW RES VOLTS to read low (broken wire).

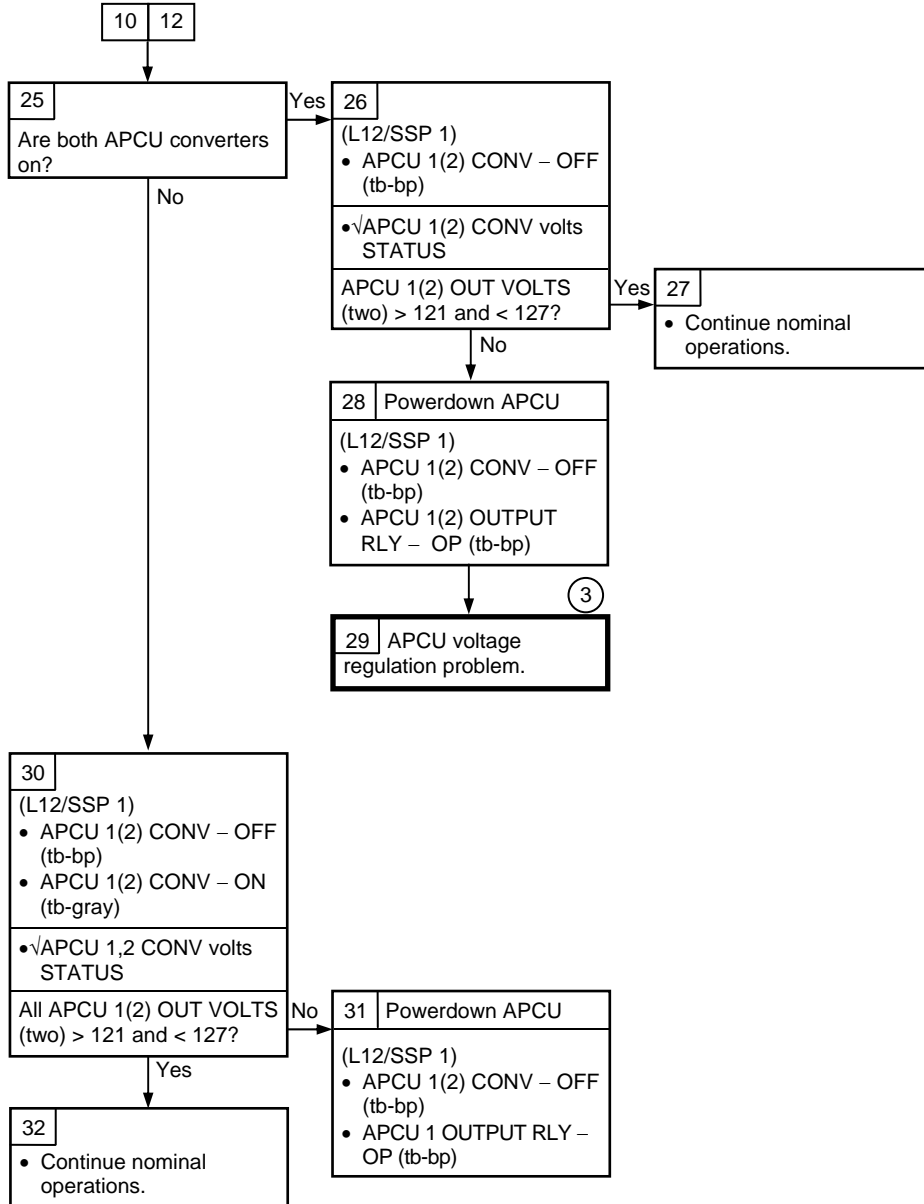

③  
 Loss of APCU 2 results in loss of 120 V orbiter power to LCS/IDC.

This Page Intentionally Blank



**ORBITER ELECTRICAL BUS LOSS MATRIX**

(ASSY OPS/ULF3/FIN 1) Page 1 of 2 pages

ORBITER EPS BUSES	ESS 1BC		ESS 2CA		ESS 3AB	CNT AB2	MNA DA1					MNB DA2					FC3		MNC DA3			CNT CA1																							
	PNL O13, R14	ESS 1BC FD	ESS 2CA FD	PNL O13, R14	PNL O13		PNL O14	MPC1		MPC2			FPC2	APC5	PNL O15	MAR2	MAR1	(R)	(R)	P	PNL O16		APC 6	MO63P																					
								AUX PLA	P	(R)	AUX PLB	AC2	APC2	PRI PL				AFT PLC																											
								PL1	PL2	PL3	ΦA	AFT PLB																																	
ORBITER EQUIPMENT																																													
APCU1											XC											R	R	P																					
APCU2 (LCS)																							R	R	P																				
OIU1														X																															
OIU2																																													
TCS																																													
Video Processing Unit (VPU)																											X																		
Primary C/L Camera																																													
Secondary C/L Camera																																													
PDIP 1 (Ku-Band relay, PCS-to-OIU interface)																																													
PDIP 2 (TCS/SSV)																																													
Payload Timing Buffer																																													
Orbiter PCS																																													
MIDDECK PAYLOADS																																													
Glacier																																													
MDS																																													
CGBA																																													
ABRS																																													

(1) Redundant LCS pwr is available from APCU1 through the interconnect cable (the power still must go through APCU2's output relay).  
X - Total Loss of Operational Power  
XR - Loss of Redundant Power  
XC - Total Loss of Control Power  
XRC - Loss of Redundant Control Power  
XRM - Loss of Redundant tb Monitor Power  
P - Primary Power Source  
(R) - Redundant Power Source (requires crew action to use)

**ORBITER ELECTRICAL BUS LOSS MATRIX**

(ASSY OPS/ULF3/FIN 1) Page 2 of 2 pages

ORBITER EPS BUSES	ESS 1BC		ESS 2CA		ESS 3AB	CNT AB2	MNA DA1						MNB DA2						FC3	MNC DA3			CNT CA1															
	PNL O13, R14	ESS 1BC FD	ESS 2CA FD	PNL O13, R14	PNL O13		PNL O14 & A8	PNL O14	MPC1			MPC2			FPC2	APC5	PNL O15	O15 & A8	MAR2	MAR1	(R)	(R)	P	PNL O16	APC 6	AFT PLC	MO63P											
									AUX PLA	P	(R)	AUX PLB	AC2	APC2	ΦA	AFT PLB					PRI PL	APC 3																
ISS EQUIPMENT																																						
ELC1 (hts)																												R	R	P								
ELC2 (hts)																												R	R	P								
PMA 2 Hooks - Group 1, 2 - Sys A	XRC								X																													
PMA 2 Hooks - Group 1, 2 - Sys B					XRC										X																			XRC				
SASA																																			X			
OBSS																																						
LCS (+124 VDC via APCU 2) (2)																												R	R	P								
LDRI, ITVC, PTU (on SRMS)										X																												
LDRI, ITVC, PTU, LCS HTRS (In MPMs)																																						
RSC																																						
RSC Illuminator										X																												
DTV MUX & VTR											X																											
PAYLOAD BUS CONTROL																																						
Cabin P/L Bus - MNA Cntl Pwr (nominal source)																																						
Cabin P/L Bus - MNB Cntl Pwr (backup source)																																						
Aux P/L Bus B - MNB Cntl Pwr																																						
Aux P/L Bus A - MNA Cntl Pwr																																						
PL AFT - MNB Cntl Pwr																																						
PL AFT - MNC Cntl Pwr																																						
P/L PRI - MNC DA3 Cntl Pwr (nominal source)																																						
P/L PRI - MNB DA2 Cntl Pwr (backup source)																																						
P/L PRI - FC3 Cntl Pwr (backup source)																																						

(1) Redundant LCS pwr is available from APCU1 through the interconnect cable (the power still must go through APCU2's output relay).  
X - Total Loss of Operational Power  
XR - Loss of Redundant Power  
XC - Total Loss of Control Power  
XRC - Loss of Redundant Control Power  
XRM - Loss of Redundant Monitor Power  
P - Primary Power Source  
(R) - Redundant Power Source (requires crew action to use)

## PAYLOAD DEACTIVATION

(ASSY OPS/ULF3/FIN 1)

Page 1 of 1 pages

- |                 |    |   |
|-----------------|----|---|
| L12U<br>(SSP 1) | 1. | cb SW PWR 1 – op<br>cb PDIP 1 PWR 2/KuBAND RLY – op<br>cb X1/X2 SW PDIP1 PWR 1 – op |
| L12L<br>(SSP 2) | 2. | cb PDIP 2 PWR 2 – op<br>cb PDIP 2 PWR 1 – op  |
| L12 (PDIP 1)    |    | Ku BAND RATE – OFF  |
| R1              | 3. | PL CAB – OFF  |

This Page Intentionally Blank

## **PAYLOAD REACTIVATION**

(ASSY OPS/ULF3/FIN 1)

Page 1 of 1 pages

- R1            1.    PL CAB – MNA
  
- L12L        2.    cb PDIP 2 PWR 2 - cl  
(SSP 2)

This Page Intentionally Blank

# PAYLOAD ENTRY SWITCH LIST/VERIFICATION

(ASSY OPS/ULF3/FIN 1)

Page 1 of 1 page

## PAYLOAD PWR CONFIG

- |          |           |  |
|----------|-----------|--|
| TIG-1:55 | R1        | 1. √PL CAB – OFF<br>√PL PRI MNC – ctr (tb-OFF)<br>√PL PRI MNB – ctr (tb-OFF)<br>√PL PRI FC3 – ctr (tb-OFF)<br>√PL AUX – ON<br>√PL AFT MNB – OFF<br>√PL AFT MNC – OFF |
| L12U     | (SSP1)    | 2. √cb SW PWR 1 – op<br>√cb PDIP 1 PWR 2/KuBAND RLY – op<br>√TCS PWR – OFF (tb-bp)<br>√cb X1/X2 SW PDIP 1 PWR 1 – op<br>√OIU PWR – OFF (tb-bp)                       |
| L12L     | (SSP2)    | 3. √cb PDIP 2 PWR 2 – op<br>√C/L CAM PWR – OFF<br>√cb PDIP 2 PWR 1 – op  |
| L12      | (PDIP1)   | 4. √Ku BAND RATE – OFF<br>√DC POWER 1 – OFF<br>√DC POWER 2 – OFF   |
| L11      | (PDIP2)   | 5. √SW – OIU<br>√DC POWER 1 – OFF<br>√DC POWER 2 – OFF   |
| MA16F/G  | (GLACIER) | 6. √cb POWER – cl (lt on)  |
| ML86B:E  |           | √BATTERY – ON (lt on)<br>√cb MNB MAR 1 – cl  |
| MF28E/G  |           | 7. √cb POWER cb – cl<br>√MDS POWER lt – on<br>√PRIMARY POWER lt – on   |
| (MDS)    |           |  |
| ML85E    |           | √DC 10 AMP MNB S4 – ON<br>√cb DC 10 AMP MNB CB4 – cl   |
| MF71E    | (CGBA)    | 8. √cb MAIN POWER – cl (lt on)   |
| MO63P    |           | √10A J4 – ON<br>√cb CB4/J4 – cl  |

This Page Intentionally Blank