

29 JAN 10

Sheet 1 of 1

List of Implemented CR(s):

Assy_OpsU1497	Assy_OpsU1499	Assy_OpsU1501
Assy_OpsU1498	Assy_OpsU1500	Assy_OpsU1502

Uplinked Messages (or Approved Flight Notes) replaced by this PCN, remove from Book:

None

Incorporates the following:

1. Replace cover
2. Replace iii thru xvi
3. After 188, add 188a thru 188d
Replace 261 thru 266, 321 thru 362; after 362, add 362a thru 362d
Replace 393 thru 410, 433 thru 448, 491 thru 496

APPROVED BY:

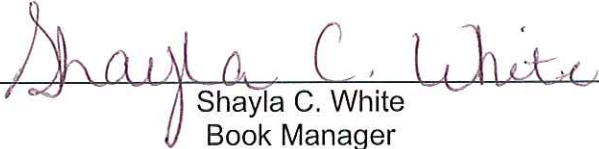

 Shayla C. White
 Book Manager



 Manager, Flight Procedures



 SODF Coordinator

ACCEPTED BY:



 Michael T. Hurt
 SODF Manager

File this PCN immediately behind the front cover as a permanent record



International Space Station Assembly Operations Book

ISS-20A

Mission Operations Directorate
Operations Division

29 JAN 10

*These procedures are available
electronically on the SODF Homepage
at <http://mod.jsc.nasa.gov/do3>*

National Aeronautics and
Space Administration

Lyndon B. Johnson Space Center
Houston, Texas



**INTERNATIONAL SPACE STATION
ASSEMBLY OPERATIONS
ISS-20A**

LIST OF EFFECTIVE PAGES

22 JAN 10

29 JAN 10

Sign Off	* 22 JAN 10	26.....	08 JAN 10
ii.....	* 22 JAN 10	27.....	08 JAN 10
iii.....	* 29 JAN 10	28.....	08 JAN 10
iv.....	* 29 JAN 10	29.....	08 JAN 10
v.....	* 29 JAN 10	30.....	08 JAN 10
vi.....	* 29 JAN 10	31.....	08 JAN 10
vii.....	* 29 JAN 10	32.....	08 JAN 10
viii.....	* 29 JAN 10	33.....	08 JAN 10
ix.....	* 29 JAN 10	34.....	08 JAN 10
x.....	* 29 JAN 10	35.....	08 JAN 10
xi.....	* 29 JAN 10	36.....	08 JAN 10
xii.....	* 29 JAN 10	37.....	08 JAN 10
xiii.....	29 JAN 10	38.....	TPIB
xiv.....	29 JAN 10	39.....	15 JAN 10
xv.....	29 JAN 10	40.....	15 JAN 10
xvi.....	29 JAN 10	41.....	15 JAN 10
1.....	22 JAN 10	42.....	15 JAN 10
2.....	22 JAN 10	43.....	15 JAN 10
3.....	08 JAN 10	44.....	15 JAN 10
4.....	08 JAN 10	45.....	15 JAN 10
5.....	08 JAN 10	46.....	15 JAN 10
6.....	08 JAN 10	47.....	15 JAN 10
7.....	08 JAN 10	48.....	15 JAN 10
8.....	08 JAN 10	49.....	15 JAN 10
9.....	08 JAN 10	50.....	15 JAN 10
10.....	08 JAN 10	51.....	19 JAN 10
11.....	08 JAN 10	52.....	19 JAN 10
12.....	08 JAN 10	53.....	19 JAN 10
13.....	08 JAN 10	54.....	19 JAN 10
14.....	08 JAN 10	55.....	19 JAN 10
15.....	08 JAN 10	56.....	19 JAN 10
16.....	08 JAN 10	57.....	19 JAN 10
17.....	08 JAN 10	58.....	19 JAN 10
18.....	08 JAN 10	59.....	19 JAN 10
19.....	08 JAN 10	60.....	19 JAN 10
20.....	08 JAN 10	61.....	19 JAN 10
21.....	08 JAN 10	62.....	19 JAN 10
22.....	08 JAN 10	63.....	19 JAN 10
23.....	08 JAN 10	64.....	19 JAN 10
24.....	08 JAN 10	65.....	19 JAN 10
25.....	08 JAN 10	66.....	19 JAN 10

* - Omit from flight book

67.....	19 JAN 10	117.....	19 JAN 10
68.....	19 JAN 10	118.....	TPIB
69.....	19 JAN 10	119.....	15 JAN 10
70.....	19 JAN 10	120.....	15 JAN 10
71.....	19 JAN 10	121.....	15 JAN 10
72.....	19 JAN 10	122.....	15 JAN 10
73.....	19 JAN 10	123.....	15 JAN 10
74.....	19 JAN 10	124.....	15 JAN 10
75.....	19 JAN 10	125.....	15 JAN 10
76.....	19 JAN 10	126.....	TPIB
77.....	19 JAN 10	127.....	08 JAN 10
78.....	19 JAN 10	128.....	08 JAN 10
79.....	19 JAN 10	129.....	08 JAN 10
80.....	19 JAN 10	130.....	08 JAN 10
81.....	19 JAN 10	131.....	08 JAN 10
82.....	19 JAN 10	132.....	08 JAN 10
83.....	19 JAN 10	133.....	08 JAN 10
84.....	19 JAN 10	134.....	08 JAN 10
85.....	19 JAN 10	135.....	08 JAN 10
86.....	19 JAN 10	136.....	08 JAN 10
87.....	19 JAN 10	137.....	08 JAN 10
88.....	19 JAN 10	138.....	TPIB
89.....	19 JAN 10	139.....	15 JAN 10
90.....	19 JAN 10	140.....	15 JAN 10
91.....	19 JAN 10	141.....	15 JAN 10
92.....	19 JAN 10	142.....	15 JAN 10
93.....	19 JAN 10	143.....	15 JAN 10
94.....	19 JAN 10	144.....	15 JAN 10
95.....	19 JAN 10	145.....	15 JAN 10
96.....	19 JAN 10	146.....	TPIB
97.....	19 JAN 10	147.....	18 SEP 09
98.....	19 JAN 10	148.....	18 SEP 09
99.....	19 JAN 10	149.....	20 JAN 10
100.....	19 JAN 10	150.....	20 JAN 10
101.....	19 JAN 10	151.....	20 JAN 10
102.....	19 JAN 10	152.....	20 JAN 10
103.....	19 JAN 10	153.....	20 JAN 10
104.....	19 JAN 10	154.....	20 JAN 10
105.....	19 JAN 10	155.....	20 JAN 10
106.....	19 JAN 10	156.....	20 JAN 10
107.....	19 JAN 10	157.....	20 JAN 10
108.....	19 JAN 10	158.....	20 JAN 10
109.....	19 JAN 10	159.....	20 JAN 10
110.....	19 JAN 10	160.....	20 JAN 10
111.....	19 JAN 10	161.....	20 JAN 10
112.....	19 JAN 10	162.....	20 JAN 10
113.....	19 JAN 10	163.....	20 JAN 10
114.....	19 JAN 10	164.....	20 JAN 10
115.....	19 JAN 10	165.....	20 JAN 10
116.....	19 JAN 10	166.....	20 JAN 10

* - Omit from flight book

167.....	20 JAN 10	213.....	15 JAN 10
168.....	20 JAN 10	214.....	15 JAN 10
169.....	20 JAN 10	215.....	15 JAN 10
170.....	TPIB	216.....	15 JAN 10
171.....	21 SEP 09	217.....	15 JAN 10
172.....	21 SEP 09	218.....	15 JAN 10
173.....	21 SEP 09	219.....	15 JAN 10
174.....	21 SEP 09	220.....	15 JAN 10
175.....	08 JAN 10	221.....	15 JAN 10
176.....	08 JAN 10	222.....	15 JAN 10
177.....	08 JAN 10	223.....	15 JAN 10
178.....	08 JAN 10	224.....	15 JAN 10
179.....	08 JAN 10	225.....	15 JAN 10
180.....	TPIB	226.....	15 JAN 10
181.....	07 JAN 10	227.....	15 JAN 10
182.....	07 JAN 10	228.....	15 JAN 10
183.....	07 JAN 10	229.....	15 JAN 10
184.....	07 JAN 10	230.....	15 JAN 10
185.....	07 JAN 10	231.....	15 JAN 10
186.....	07 JAN 10	232.....	15 JAN 10
187.....	07 JAN 10	233.....	15 JAN 10
188.....	TPIB	234.....	TPIB
188a.....	28 JAN 10	235.....	18 SEP 09
188b.....	28 JAN 10	236.....	18 SEP 09
188c.....	28 JAN 10	237.....	18 SEP 09
188d.....	28 JAN 10	238.....	18 SEP 09
189.....	08 JAN 10	239.....	23 SEP 09
190.....	08 JAN 10	240.....	23 SEP 09
191.....	08 JAN 10	241.....	23 SEP 09
192.....	08 JAN 10	242.....	23 SEP 09
193.....	08 JAN 10	243.....	23 SEP 09
194.....	08 JAN 10	244.....	TPIB
195.....	08 JAN 10	245.....	08 JAN 10
196.....	TPIB	246.....	08 JAN 10
197.....	22 SEP 09	247.....	08 JAN 10
198.....	22 SEP 09	248.....	08 JAN 10
199.....	22 SEP 09	249.....	08 JAN 10
200.....	22 SEP 09	250.....	08 JAN 10
201.....	22 SEP 09	251.....	08 JAN 10
202.....	22 SEP 09	252.....	08 JAN 10
203.....	22 SEP 09	253.....	08 JAN 10
204.....	22 SEP 09	254.....	08 JAN 10
205.....	22 SEP 09	255.....	08 JAN 10
206.....	22 SEP 09	256.....	TPIB
207.....	15 JAN 10	257.....	07 OCT 09
208.....	15 JAN 10	258.....	07 OCT 09
209.....	15 JAN 10	259.....	07 OCT 09
210.....	15 JAN 10	260.....	TPIB
211.....	15 JAN 10	261.....	25 JAN 10
212.....	15 JAN 10	262.....	25 JAN 10

* - Omit from flight book

263.....	25 JAN 10	313.....	08 JAN 10
264.....	25 JAN 10	314.....	08 JAN 10
265.....	25 JAN 10	315.....	08 JAN 10
266.....	25 JAN 10	316.....	08 JAN 10
267.....	19 JAN 10	317.....	08 JAN 10
268.....	19 JAN 10	318.....	08 JAN 10
269.....	19 JAN 10	319.....	08 JAN 10
270.....	19 JAN 10	320.....	TPIB
271.....	19 JAN 10	321.....	29 JAN 10
272.....	19 JAN 10	322.....	29 JAN 10
273.....	19 JAN 10	323.....	29 JAN 10
274.....	19 JAN 10	324.....	29 JAN 10
275.....	19 JAN 10	325.....	29 JAN 10
276.....	19 JAN 10	326.....	29 JAN 10
277.....	19 JAN 10	327.....	29 JAN 10
278.....	19 JAN 10	328.....	29 JAN 10
279.....	19 JAN 10	329.....	29 JAN 10
280.....	TPIB	330.....	29 JAN 10
281.....	07 OCT 09	331.....	29 JAN 10
282.....	07 OCT 09	332.....	29 JAN 10
283.....	07 OCT 09	333.....	29 JAN 10
284.....	07 OCT 09	334.....	29 JAN 10
285.....	07 OCT 09	335.....	29 JAN 10
286.....	07 OCT 09	336.....	29 JAN 10
287.....	10 DEC 09	337.....	29 JAN 10
288.....	10 DEC 09	338.....	29 JAN 10
289.....	10 DEC 09	339.....	29 JAN 10
290.....	10 DEC 09	340.....	29 JAN 10
291.....	10 DEC 09	341.....	29 JAN 10
292.....	10 DEC 09	342.....	29 JAN 10
293.....	10 DEC 09	343.....	29 JAN 10
294.....	10 DEC 09	344.....	29 JAN 10
295.....	10 DEC 09	345.....	29 JAN 10
296.....	10 DEC 09	346.....	29 JAN 10
297.....	23 SEP 09	347.....	29 JAN 10
298.....	23 SEP 09	348.....	29 JAN 10
299.....	23 SEP 09	349.....	29 JAN 10
300.....	23 SEP 09	350.....	29 JAN 10
301.....	23 SEP 09	351.....	29 JAN 10
302.....	23 SEP 09	352.....	29 JAN 10
303.....	23 SEP 09	353.....	29 JAN 10
304.....	23 SEP 09	354.....	29 JAN 10
305.....	23 SEP 09	355.....	29 JAN 10
306.....	TPIB	356.....	29 JAN 10
307.....	08 JAN 10	357.....	29 JAN 10
308.....	08 JAN 10	358.....	29 JAN 10
309.....	08 JAN 10	359.....	29 JAN 10
310.....	08 JAN 10	360.....	29 JAN 10
311.....	08 JAN 10	361.....	29 JAN 10
312.....	08 JAN 10	362.....	29 JAN 10

* - Omit from flight book

362a.....	29 JAN 10	409.....	26 JAN 10
362b.....	29 JAN 10	410.....	26 JAN 10
362c.....	29 JAN 10	411.....	08 JAN 10
362d.....	29 JAN 10	412.....	08 JAN 10
363.....	21 JAN 10	413.....	08 JAN 10
364.....	21 JAN 10	414.....	TPIB
365.....	21 JAN 10	415.....	19 JAN 10
366.....	21 JAN 10	416.....	19 JAN 10
367.....	23 SEP 09	417.....	19 JAN 10
368.....	23 SEP 09	418.....	19 JAN 10
369.....	23 SEP 09	419.....	19 JAN 10
370.....	23 SEP 09	420.....	19 JAN 10
371.....	23 SEP 09	421.....	19 JAN 10
372.....	23 SEP 09	422.....	19 JAN 10
373.....	23 SEP 09	423.....	19 JAN 10
374.....	TPIB	424.....	19 JAN 10
375.....	19 JAN 10	425.....	19 JAN 10
376.....	19 JAN 10	426.....	TPIB
377.....	19 JAN 10	427.....	13 JAN 10
378.....	19 JAN 10	428.....	13 JAN 10
379.....	19 JAN 10	429.....	13 JAN 10
380.....	19 JAN 10	430.....	13 JAN 10
381.....	19 JAN 10	431.....	13 JAN 10
382.....	19 JAN 10	432.....	13 JAN 10
383.....	19 JAN 10	433.....	25 JAN 10
384.....	19 JAN 10	434.....	25 JAN 10
385.....	19 JAN 10	435.....	25 JAN 10
386.....	19 JAN 10	436.....	25 JAN 10
387.....	19 JAN 10	437.....	25 JAN 10
388.....	19 JAN 10	438.....	25 JAN 10
389.....	19 JAN 10	439.....	25 JAN 10
390.....	19 JAN 10	440.....	25 JAN 10
391.....	19 JAN 10	441.....	25 JAN 10
392.....	TPIB	442.....	25 JAN 10
393.....	26 JAN 10	443.....	25 JAN 10
394.....	26 JAN 10	444.....	25 JAN 10
395.....	26 JAN 10	445.....	25 JAN 10
396.....	26 JAN 10	446.....	25 JAN 10
397.....	26 JAN 10	447.....	25 JAN 10
398.....	26 JAN 10	448.....	25 JAN 10
399.....	26 JAN 10	449.....	21 JAN 10
400.....	26 JAN 10	450.....	21 JAN 10
401.....	26 JAN 10	451.....	21 JAN 10
402.....	26 JAN 10	452.....	21 JAN 10
403.....	26 JAN 10	453.....	21 JAN 10
404.....	26 JAN 10	454.....	21 JAN 10
405.....	26 JAN 10	455.....	21 JAN 10
406.....	26 JAN 10	456.....	21 JAN 10
407.....	26 JAN 10	457.....	21 JAN 10
408.....	26 JAN 10	458.....	21 JAN 10

* - Omit from flight book

459.....	21 JAN 10	509.....	20 JAN 10
460.....	21 JAN 10	510.....	20 JAN 10
461.....	21 JAN 10	511.....	20 JAN 10
462.....	21 JAN 10	512.....	20 JAN 10
463.....	21 JAN 10	513.....	20 JAN 10
464.....	21 JAN 10	514.....	20 JAN 10
465.....	21 JAN 10	515.....	15 JAN 10
466.....	21 JAN 10	516.....	15 JAN 10
467.....	21 JAN 10	517.....	15 JAN 10
468.....	21 JAN 10	518.....	15 JAN 10
469.....	21 JAN 10	519.....	15 JAN 10
470.....	21 JAN 10	520.....	15 JAN 10
471.....	21 JAN 10	521.....	15 JAN 10
472.....	21 JAN 10	522.....	15 JAN 10
473.....	21 JAN 10	523.....	15 JAN 10
474.....	21 JAN 10	524.....	15 JAN 10
475.....	21 JAN 10	525.....	15 JAN 10
476.....	21 JAN 10	526.....	15 JAN 10
477.....	21 JAN 10	527.....	20 JAN 10
478.....	21 JAN 10	528.....	20 JAN 10
479.....	21 JAN 10	529.....	20 JAN 10
480.....	21 JAN 10	530.....	20 JAN 10
481.....	21 JAN 10	531.....	20 JAN 10
482.....	21 JAN 10	532.....	TPIB
483.....	21 JAN 10	533.....	20 JAN 10
484.....	21 JAN 10	534.....	20 JAN 10
485.....	21 JAN 10	535.....	20 JAN 10
486.....	21 JAN 10	536.....	20 JAN 10
487.....	21 JAN 10	537.....	15 JAN 10
488.....	21 JAN 10	538.....	15 JAN 10
489.....	21 JAN 10	539.....	15 JAN 10
490.....	21 JAN 10	540.....	15 JAN 10
491.....	25 JAN 10	541.....	15 JAN 10
492.....	25 JAN 10	542.....	15 JAN 10
493.....	25 JAN 10	543.....	15 JAN 10
494.....	25 JAN 10	544.....	15 JAN 10
495.....	25 JAN 10	545.....	15 JAN 10
496.....	25 JAN 10	546.....	15 JAN 10
497.....	20 JAN 10	547.....	15 JAN 10
498.....	20 JAN 10	548.....	15 JAN 10
499.....	20 JAN 10	549.....	15 JAN 10
500.....	20 JAN 10	550.....	TPIB
501.....	20 JAN 10	551.....	11 JAN 10
502.....	20 JAN 10	552.....	11 JAN 10
503.....	20 JAN 10	553.....	11 JAN 10
504.....	20 JAN 10	554.....	11 JAN 10
505.....	20 JAN 10	555.....	11 JAN 10
506.....	20 JAN 10	556.....	11 JAN 10
507.....	20 JAN 10	557.....	11 JAN 10
508.....	20 JAN 10	558.....	11 JAN 10

* - Omit from flight book

559.....	11 JAN 10	609.....	14 DEC 09
560.....	11 JAN 10	610.....	14 DEC 09
561.....	11 JAN 10	611.....	14 DEC 09
562.....	TPIB	612.....	14 DEC 09
563.....	15 JAN 10	613.....	14 DEC 09
564.....	15 JAN 10	614.....	14 DEC 09
565.....	15 JAN 10	615.....	13 JAN 10
566.....	15 JAN 10	616.....	13 JAN 10
567.....	15 JAN 10	617.....	13 JAN 10
568.....	15 JAN 10	618.....	13 JAN 10
569.....	15 JAN 10	619.....	13 JAN 10
570.....	15 JAN 10	620.....	13 JAN 10
571.....	15 JAN 10	621.....	13 JAN 10
572.....	TPIB	622.....	13 JAN 10
573.....	04 JAN 10	623.....	13 JAN 10
574.....	04 JAN 10	624.....	TPIB
575.....	04 JAN 10	625.....	22 JAN 10
576.....	TPIB	626.....	22 JAN 10
577.....	15 JAN 10	627.....	18 SEP 09
578.....	15 JAN 10	628.....	TPIB
579.....	15 JAN 10	629.....	12 JAN 10
580.....	15 JAN 10	630.....	12 JAN 10
581.....	15 JAN 10	631.....	12 JAN 10
582.....	15 JAN 10	632.....	12 JAN 10
583.....	15 JAN 10	633.....	12 JAN 10
584.....	TPIB	634.....	12 JAN 10
585.....	15 JAN 10	635.....	12 JAN 10
586.....	15 JAN 10	636.....	TPIB
587.....	15 JAN 10	637.....	10 DEC 09
588.....	15 JAN 10	638.....	10 DEC 09
589.....	15 JAN 10	639.....	10 DEC 09
590.....	TPIB	640.....	10 DEC 09
591.....	15 JAN 10	641.....	10 DEC 09
592.....	15 JAN 10	642.....	10 DEC 09
593.....	15 JAN 10	643.....	10 DEC 09
594.....	15 JAN 10	644.....	TPIB
595.....	15 JAN 10	645.....	22 JAN 10
596.....	15 JAN 10	646.....	22 JAN 10
597.....	15 JAN 10	647.....	18 DEC 09
598.....	15 JAN 10	648.....	18 DEC 09
599.....	15 JAN 10	649.....	18 DEC 09
600.....	15 JAN 10	650.....	18 DEC 09
601.....	15 JAN 10	651.....	18 DEC 09
602.....	TPIB	652.....	18 DEC 09
603.....	14 DEC 09	653.....	18 DEC 09
604.....	14 DEC 09	654.....	18 DEC 09
605.....	14 DEC 09	655.....	11 DEC 09
606.....	14 DEC 09	656.....	11 DEC 09
607.....	14 DEC 09	657.....	14 JAN 10
608.....	TPIB	658.....	14 JAN 10

* - Omit from flight book

659.....	14 JAN 10	709.....	06 OCT 09
660.....	TPIB	710.....	06 OCT 09
661.....	13 JAN 10	711.....	06 OCT 09
662.....	13 JAN 10	712.....	06 OCT 09
663.....	13 JAN 10	713.....	06 OCT 09
664.....	TPIB	714.....	06 OCT 09
665.....	11 JAN 10	715.....	06 OCT 09
666.....	11 JAN 10	716.....	06 OCT 09
667.....	11 JAN 10	717.....	06 OCT 09
668.....	11 JAN 10	718.....	06 OCT 09
669.....	11 JAN 10	719.....	06 OCT 09
670.....	11 JAN 10	720.....	06 OCT 09
671.....	11 JAN 10	721.....	06 OCT 09
672.....	11 JAN 10	722.....	06 OCT 09
673.....	11 JAN 10	723.....	06 OCT 09
674.....	11 JAN 10	724.....	06 OCT 09
675.....	11 JAN 10	725.....	06 OCT 09
676.....	11 JAN 10	726.....	06 OCT 09
677.....	11 JAN 10	727.....	06 OCT 09
678.....	11 JAN 10	728.....	06 OCT 09
679.....	07 OCT 09	729.....	06 OCT 09
680.....	TPIB	730.....	06 OCT 09
681.....	15 DEC 09	731.....	06 OCT 09
682.....	15 DEC 09	732.....	06 OCT 09
683.....	15 DEC 09	733.....	06 OCT 09
684.....	15 DEC 09	734.....	06 OCT 09
685.....	11 JAN 10	735.....	06 OCT 09
686.....	11 JAN 10	736.....	06 OCT 09
687.....	11 JAN 10	737.....	06 OCT 09
688.....	11 JAN 10	738.....	TPIB
689.....	12 JAN 10	739.....	06 OCT 09
690.....	12 JAN 10	740.....	06 OCT 09
691.....	12 JAN 10	741.....	06 OCT 09
692.....	12 JAN 10	742.....	06 OCT 09
693.....	12 JAN 10	743.....	06 OCT 09
694.....	TPIB	744.....	06 OCT 09
695.....	19 JAN 10	745.....	06 OCT 09
696.....	19 JAN 10	746.....	06 OCT 09
697.....	30 DEC 09	747.....	06 OCT 09
698.....	30 DEC 09	748.....	06 OCT 09
699.....	30 DEC 09	749.....	06 OCT 09
700.....	30 DEC 09	750.....	06 OCT 09
701.....	30 DEC 09	751.....	06 OCT 09
702.....	30 DEC 09	752.....	06 OCT 09
703.....	30 DEC 09	753.....	06 OCT 09
704.....	TPIB	754.....	06 OCT 09
705.....	18 DEC 09	755.....	06 OCT 09
706.....	TPIB	756.....	TPIB
707.....	14 JAN 10	757.....	06 OCT 09
708.....	14 JAN 10	758.....	06 OCT 09

* - Omit from flight book

759.....	06 OCT 09	809.....	07 OCT 09
760.....	06 OCT 09	810.....	07 OCT 09
761.....	06 OCT 09	811.....	07 OCT 09
762.....	06 OCT 09	812.....	TPIB
763.....	06 OCT 09	813.....	09 DEC 09
764.....	06 OCT 09	814.....	09 DEC 09
765.....	06 OCT 09	815.....	07 OCT 09
766.....	TPIB	816.....	07 OCT 09
767.....	06 OCT 09	817.....	07 OCT 09
768.....	06 OCT 09	818.....	TPIB
769.....	06 OCT 09	819.....	09 DEC 09
770.....	TPIB	820.....	09 DEC 09
771.....	09 DEC 09	821.....	09 DEC 09
772.....	09 DEC 09	822.....	TPIB
773.....	09 DEC 09	823.....	09 DEC 09
774.....	09 DEC 09	824.....	09 DEC 09
775.....	09 DEC 09	825.....	13 JAN 10
776.....	09 DEC 09	826.....	13 JAN 10
777.....	06 OCT 09	827.....	24 SEP 09
778.....	06 OCT 09	828.....	24 SEP 09
779.....	06 OCT 09	829.....	22 JAN 10
780.....	06 OCT 09	830.....	22 JAN 10
781.....	06 OCT 09	831.....	07 OCT 09
782.....	06 OCT 09	832.....	TPIB
783.....	06 OCT 09	833.....	07 OCT 09
784.....	06 OCT 09	834.....	TPIB
785.....	06 OCT 09	835.....	13 JAN 10
786.....	06 OCT 09	836.....	TPIB
787.....	06 OCT 09	837.....	22 JAN 10
788.....	TPIB	838.....	22 JAN 10
789.....	06 OCT 09	839.....	24 SEP 09
790.....	06 OCT 09	840.....	24 SEP 09
791.....	06 OCT 09	841.....	24 SEP 09
792.....	06 OCT 09	842.....	24 SEP 09
793.....	06 OCT 09	843.....	22 JAN 10
794.....	TPIB	844.....	22 JAN 10
795.....	06 OCT 09	845.....	30 SEP 09
796.....	06 OCT 09	846.....	30 SEP 09
797.....	06 OCT 09		
798.....	TPIB		
799.....	22 JAN 10		
800.....	22 JAN 10		
801.....	07 OCT 09		
802.....	TPIB		
803.....	07 OCT 09		
804.....	TPIB		
805.....	22 JAN 10		
806.....	22 JAN 10		
807.....	28 SEP 09		
808.....	TPIB		

* - Omit from flight book

**INTERNATIONAL SPACE STATION
ASSEMBLY OPERATIONS
ISS-20A**

CUE CARD LIST OF EFFECTIVE PAGES

22 JAN 10

29 JAN 10

<u>Title</u>	<u>Page</u>	<u>Card Number</u>	<u>Date</u>	<u>Fab Notes</u>
SPINAL ELONGATION STANDING				
HEIGHT LOG				
(Front)	681	ASSY OPS-3a/20A/B	15 DEC 09	
(Back)	682	ASSY OPS-3b/20A/B	15 DEC 09	
(Front - Bottom)	683	ASSY OPS-3aa/20A/B	15 DEC 09	
(Back - Bottom).....	684	ASSY OPS-3bb/20A/B	15 DEC 09	
GLACIER STATUS CHECK				
(Front)	845	ASSY OPS-1a/20A/A	30 SEP 09	
(Back)	846	ASSY OPS-1b/20A/A	30 SEP 09	

CONTENTS

ACTIVATION AND CHECKOUT	1
NODE 3	
1.100 Node 3 Initial Activation	3
1.101 Node 3 Initial Activation for Channel 1/4 or Channel 2/3 Act Only	39
1.102 Node 3 Activation Flowchart.....	49
INGRESS	
1.104 Vestibule Outfitting NOD1 to NOD3	51
1.105 Node 3 Nitrogen System Purge and Leak Check.....	119
1.106 Node 3 Temporary Ventilation Install and Remove for Initial Ingress.....	127
1.107 Node 3 Oxygen System Purge and Leak Check.....	139
1.108 Node 3 Positive Pressure Relief Valve (PPRV) Cap Install.....	147
1.109 Node 1 and Node 3 Potable Water and Urine Bus Purge with Vacuum Backfill of Potable Water Bus	149
1.110 Node 3 Negative Pressure Relief Valve (NPRV) Inspection	171
1.111 Node 3 Overhead IMV Cap Installation.....	175
1.112 Portable Fire Extinguisher and Portable Breathing Apparatus Installation	181
1.113 N3 Urine Jumper Fill.....	188a
1.114 Node 3 Port-Aft IMV Cap Installation	189
1.115 Node 3 PCA VRIV/VRCV/NIV/OIV Checkout.....	197
1.117 Node 1/Node 3 Vestibule Pressurization and Leak Check.....	199
OUTFITTING	
1.118 Node 3 Stbd Deck NPRV Removal and IMV Valve Installation	207
1.119 Node 3 Stbd Ovhd NPRV Removal and IMV Valve Installation	221
1.120 Node 3 PPRV Sample Port Cap Removal	235
1.122 Node 3 PPRV Removal and MPEV Installation	239
1.124 Node 3 Vacuum Access Port Cap Seal R&R	245
1.126 Node 3 ELPS Enable Power Sensing	257
1.127 Cupola Crew Restraint Installation	261
1.128 Node 3 ITCS Sampling Adapter Installation - MTL (NOD3O6)	267
1.130 Node 3 ITCS Sampling Adapter Installation - LTL (NOD3D6).....	273
1.132 Node 3 CCAA Anti-Vibration Module (AVM) Launch Bracket Removal	281
1.134 Node 3 LTL Pump Package Assembly (PPA) Launch Bracket Removal	287
1.136 Node 3 MTL Pump Package Assembly (PPA) Launch Bracket Removal	297
1.138 Node 3 Launch Restraint Bolt Removal	307
1.140 Cupola and Node 3/Node 1 ITCS Fill Using FSS.....	321

RACKS

1.142 Prepare Node 3 for Rack Installation on 20A	363
1.144 Node 3 Avionics Racks Outfitting	367
1.146 WHC Rack Transfer - LAB1P2 to NOD3F4.....	375
1.150 WRS-1 & WRS-2 Rack Transfer Lab to NOD3	393
1.151 WHC Deactivation and Rack Power Down	411
1.152 ARS Rack Transfer JPM1F3 to NOD3A4.....	415
1.153 WHC Activation	427
1.154 OGS Rack Transfer Lab to Node 3	433

CUPOLA

1.156 Vestibule Outfitting N3 - Cupola	449
1.158 Cupola Utility Outlet Panel Installation	491
1.160 Cupola RWS Relocation.....	497
1.162 Cupola Audio Terminal Unit (ATU) Installation.....	515
1.164 Cupola Side Window Scratch Pane Assembly R&R	527
1.166 Cupola Top Window Scratch Pane Assembly R&R	533
1.168 Cupola Corner Panel Installation.....	537
1.172 Cupola Depressurization (Node 3 Port)	551
1.174 Cupola Pressurization and Leak Check	563
1.176 Cupola Window Shutter Test.....	573
1.178 20A CBCS Installation/Removal - Cupola Install.....	577
1.180 20A CBCS Installation/Removal - PMA3 Install	585
1.182 Cupola Depressurization (Node 3 Port) with Node 3 PCA	591
1.184 Vacuum Access Jumper Setup Fit Check (Node 3 Port to Airlock)	603
1.186 RWS Video Monitor ORU Bumper Installation	609
1.188 Cupola Fine Leak Check on Node 3 Deck	615

TCS	625
------------------	-----

NOMINAL

2.100 ETCS Loop A(B) Lab/Node 3 Bypass Valve Close	627
--	-----

CORRECTIVE

4.100 Node 3 IATCS Startup with N3-1 MDM Failed	629
4.102 Node 3 IATCS Startup with N3-2 MDM Failed	637

PAYLOADS	645
-----------------------	-----

MYCO

MYCO Body Sample Collection	647
MYCO Kit	655

NLP

NLP Activation.....	657
NLP Termination	661

SPINAL ELONGATION

Spinal Elongation Operator Procedure.....	665
Spinal Elongation Log	679
Spinal Elongation Standing Height Log.....	681

TRANSFER

Ascent Sample Transfer from Glacier to MELFI.....	685
Descent Sample Transfer from MELFI to Glacier	689
20A CGBA Swap - Unpowered	695
20A CGBA Swap-ISS.....	697
20A CGBA Swap-STs.....	701

GLACIER - NOMINAL

Glacier Record Quick Diagnostic Data (Nominal)	705
Glacier Configuration for Descent	707

GLACIER - CONTINGENCY

Glacier Power Up	709
Glacier Reboot	711
Glacier Shutdown	713
Glacier Power Cycle.....	715
Glacier Manual Reconfigure	717

GLACIER - MALFUNCTION

Glacier Error Message	739
Glacier Fail to Hold Set Point	757
Glacier Fail to Repower.....	767
Glacier LCD Blank.....	771
Glacier Record Cryogenic Diagnostic Data.....	777
Glacier Record Quick Diagnostic Data.....	779
Glacier Record Resources Diagnostic Data.....	781
Glacier Record System Diagnostic Data	783

GLACIER - TABLES

Table 1 Glacier Error Message Log	785
Table 2 Glacier Reset Log File	789
Table 3 Glacier Diagnostic Log File	795

CONTINGENCY EVA PL CONFIG..... 799

Pre-EVA PL Configuration.....	801
Post-EVA PL Configuration	803

MALFUNCTION	805
COMM	
COMM Malfunction Points.....	807
OIU Fail to Command.....	809
OIU Temp High	813
S212 OIU AD 1 NOLK/Loss of ISS or SSOR Telemetry	815
S62 PDI DECOM Fail.....	819
PL/DPS RECONFIG	
PL/DPS Reconfiguration	823
CRITICAL EQUIPMENT	
Orbiter Electrical Bus Loss Matrix	825
Orbiter MDM Loss Impacts.....	827
DEORBIT PREP	829
Payload Deactivation.....	831
Payload Reactivation.....	833
Payload Entry Switch List/Verification	835
REFERENCE	837
Standard Switch Panel 1 Layout	839
Standard Switch Panel 2 Layout	841
PAYLOAD CUE CARDS	843
Glacier Status Check.....	845

1.113 N3 URINE JUMPER FILL

(ASSY OPS/20A/FIN)

Page 1 of 4 pages

OBJECTIVE:

Fills Node 3 Pre-Treated Urine Line by connecting spare Urine Filter Hose and full EDB-Y to Pre-Treated Urine Line, which is at vacuum. This procedure should be executed within 4 hours, 24 minutes of the Pre-Treated Urine Line being evacuated.

LOCATION:

NOD3F4

DURATION:

20 minutes

CREW:

One

PARTS:

Urine Filter Hose P/N 10523.6728.00.020

EDB-Y P/N 11Φ615.8711-180A15-1

MATERIALS:

Regen ECLSS Tox-2 PPE Kit P/N SEG42103702-302:

Safety Goggles

Silver Shield Gloves

Dust Mask

1. PREPARING FLUID HOSES

WARNING

When mating or demating connections that contain pre-treated urine (Toxic level 2) or during urine transfer operations, silver shield gloves, dust mask, and goggles shall be worn to mitigate any exposure to a release of fluid.

NOTE

Have a Mess-Up Mitt ready for possible release of fluid when mating or demating any connections.

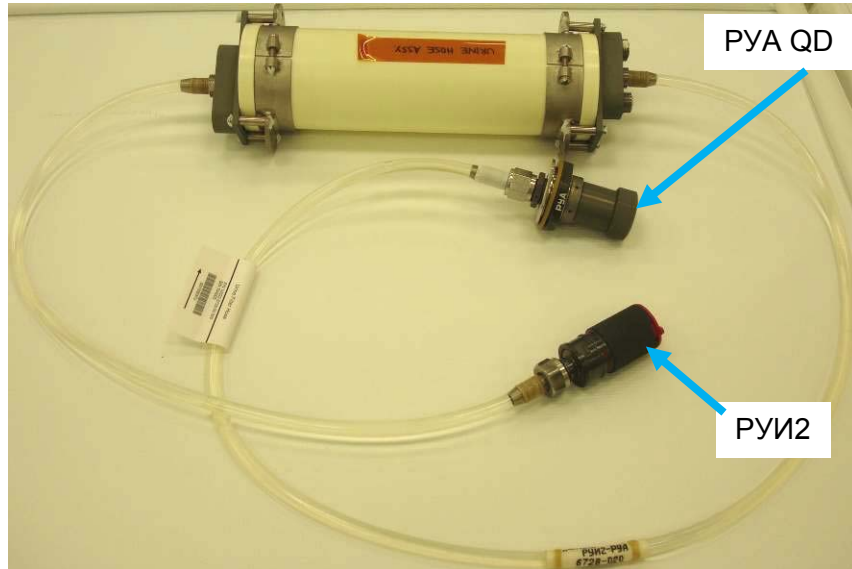

Figure 1.- Urine Filter Hose.

- 1.1 Don Silver Shield Gloves, Safety Goggles, Dust Mask.
- 1.2 Remove WHC Urine Filter Hose S/N 704003 from Ziplock Bags. Retrieve full ЕДВ-У per stowage notes.

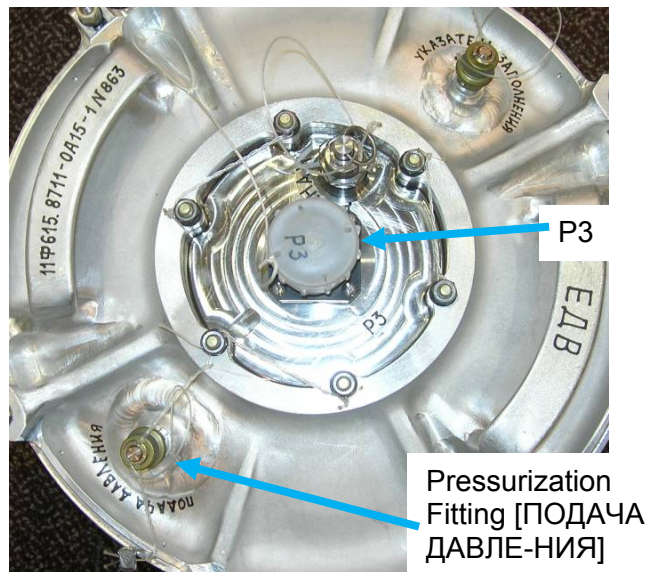
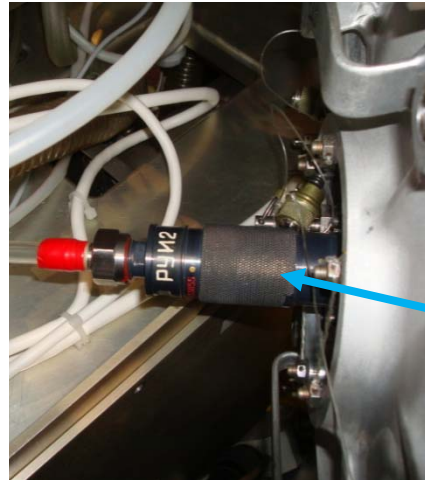

Figure 2.- ЕДВ-У Connections.

- 1.3 Tethered cap \leftrightarrow P3 of full ЕДВ-У
Tethered cap \leftrightarrow ПОДАЧА ДАВЛЕ-НИЯ of full ЕДВ-У
Cap \leftrightarrow РУИ2 of Urine Filter Hose
Temporarily stow cap.
Refer to Figures 1 and 2.



PYI2 Mated to P3
of EDB-Y

Figure 3.- Connection of Urine Filter Hose to EDB-Y.

1.4 Urine Filter Hose PYI2 →|← P3 of full EDB-Y
Refer to Figure 2.

2. FILLING NODE 3 PRE-TREATED URINE LINE

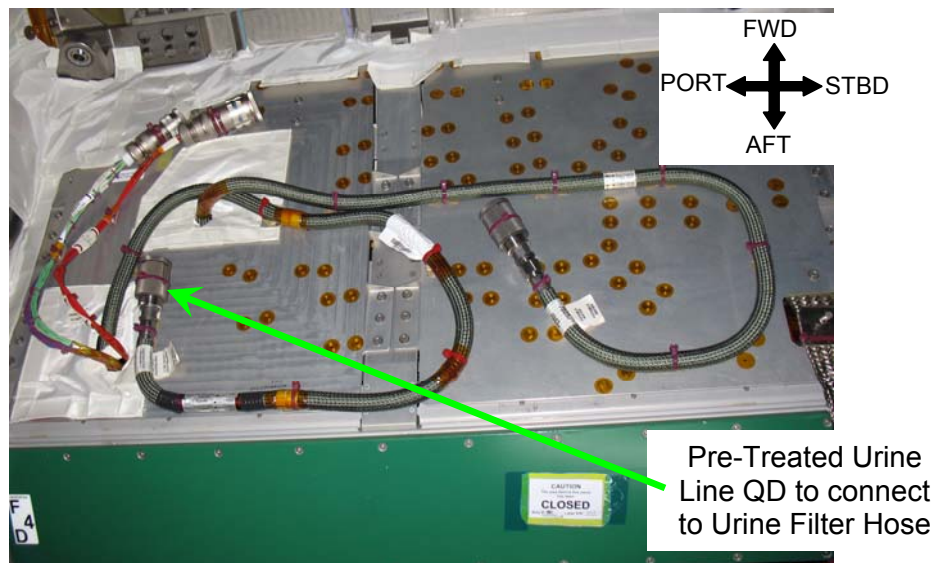

Figure 4.- WHC NOD3F4 Umbilical Launch Configuration.

NOD3F4

- 2.1 Locate Pre-Treated Urine Line in NOD3F4.
Remove Wire Ties as necessary for access (Wire Cutters).
- 2.2 Plug ←|→ QD Pre-Treated Urine Line
Cap ←|→ PYA QD of Urine Filter Hose
Temporarily stow cap and plug.
Refer to Figures 1 and 4.

1.113 N3 URINE JUMPER FILL

(ASSY OPS/20A/FIN)

Page 4 of 4 pages

NOTE

Preserved urine will transfer from the ЕДВ-У to the Pre-Treated Urine Line as soon as the РУА QD is connected. After 1 minute, fluid transfer should be complete.

- 2.3 Urine Filter Hose РУА QD →|← QD Pre-Treated Urine Line Monitor for leakage.

Visually verify fluid flow from ЕДВ-У through Urine Filter Hose to Node 3 Pre-Treated Urine Line.

- 2.4 Once fluid flow has stopped or after 1 minute of fluid transfer:
Urine Filter Hose РУА QD ←|→ QD Pre-Treated Urine Line
Plug →|← Pre-Treated Urine Line
Cap →|← РУА QD Urine Filter Hose

3. CLOSEOUT

- 3.1 Urine Filter Hose РУИ2 ←|→ P3 of ЕДВ-У
Cap →|← РУА QD of Urine Filter Hose
Refer to Figures 1 and 3.

ЕДВ-У

- 3.2 Tethered cap →|← P3 of ЕДВ-У
Tethered cap →|← ПОДАЧА ДАВЛЕ-НИЯ of ЕДВ-У
Refer to Figure 2.

- 3.3 Bag Urine Filter Hose (Ziplock Bag).

- 3.4 Doff Silver Shield Gloves, Safety Goggles, Dust Mask.

- 3.5 Stow items per stowage note.
Notify **MCC-H** of task completion.

1.127 CUPOLA CREW RESTRAINT INSTALLATION
(ASSY OPS/20A/FIN 1)

Page 1 of 6 pages

OBJECTIVE

Install the Cupola Crew Restraint.

LOCATION

Cupola

DURATION

20 Minutes

CREW:

One

PARTS:

Cupola Crew Restraint P/N 1700CU001-403 S/N 001
CCR Upper Restraint P/N 1710CU001-403 S/N 001
Platform Joint P/N 1723CU001-403 S/N 001
Lower Knee Post P/N 1724CU001-403 S/N 001
Upper Knee Post P/N 1722CU001-403 S/N 001

TOOLS

Digital Camera

1.127 CUPOLA CREW RESTRAINT INSTALLATION
(ASSY OPS/20A/FIN 1)

Page 2 of 6 pages

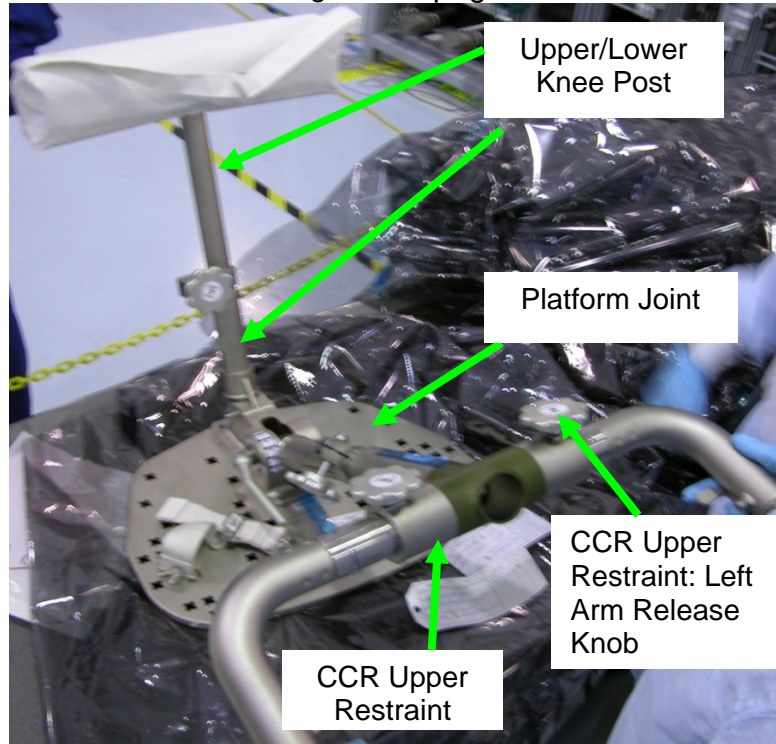

Figure 1. Cupola Crew Restraint Fully Assembled.

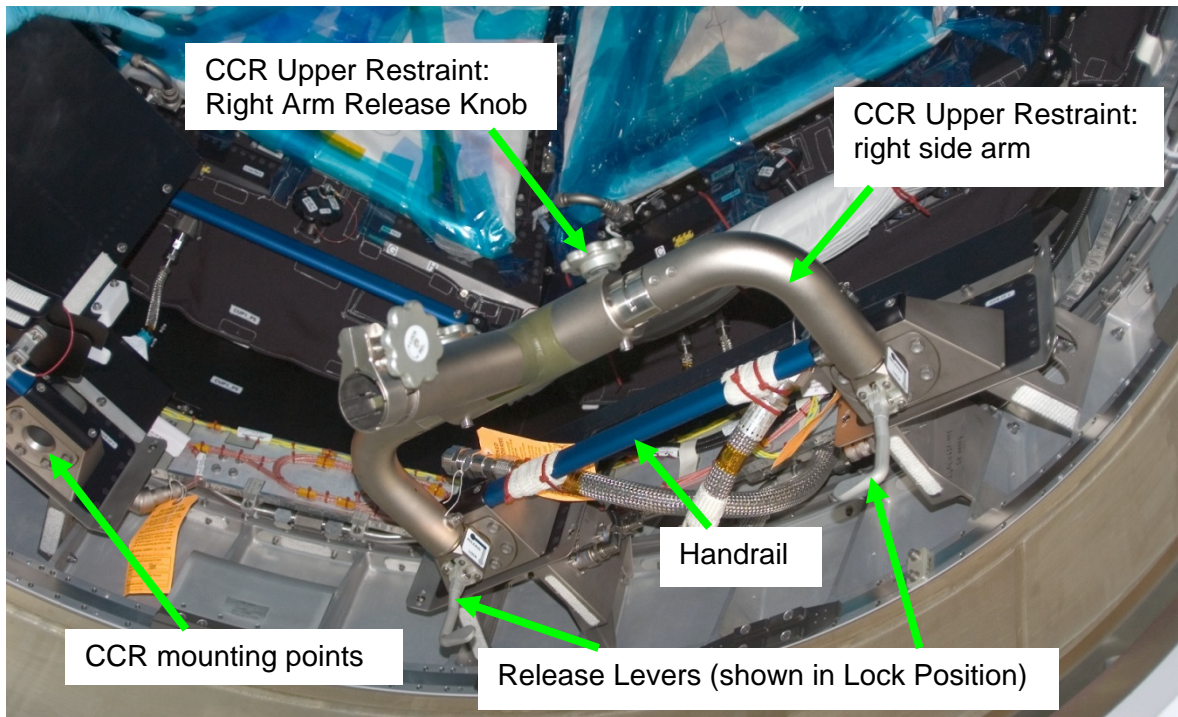

Figure 2. Mounting Location Directly in Front of Cupola Handrails
(Shown Installed at Window 4 Position).

1.127 CUPOLA CREW RESTRAINT INSTALLATION (ASSY OPS/20A/FIN 1)

Page 3 of 6 pages

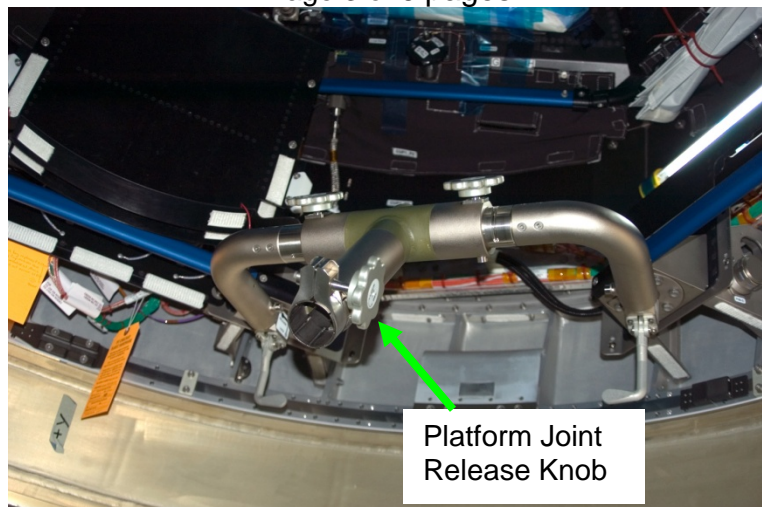

Figure 3. Mounting Location Between Cupola Handrails (Only CCR Upper Restraint Installed).



Figure 4. Upper Restraint: Right Arm Extended.

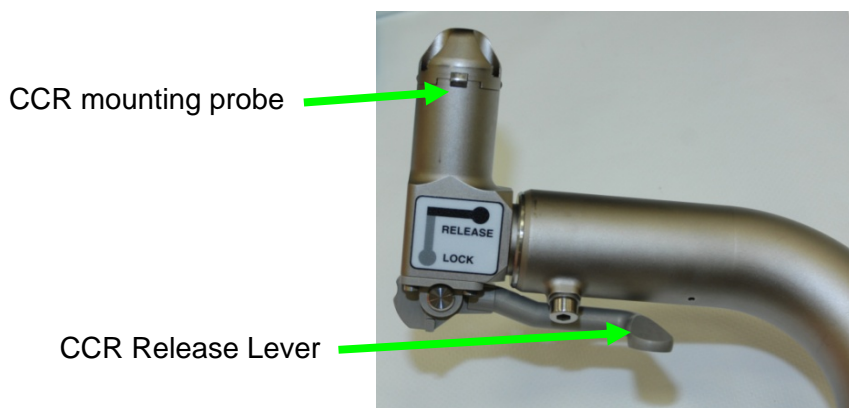

Figure 5. CCR Mounting Probe and Release Lever.

1.127 CUPOLA CREW RESTRAINT INSTALLATION

(ASSY OPS/20A/FIN 1)

Page 4 of 6 pages

NOTE

1. There are eight possible mounting positions for the Cupola Crew Restraint (CCR): directly in front of a Cupola Handrail (see Figure 2) or between a set of Handrails (see Figure 3).
2. Mounting between the handrails requires the right side arm of the CCR to slide out at the shoulder joint because the mounting points on Cupola are further apart.
3. Position of Cupola Crew Restraint is intended to be in front of RWS, but is up to crew discretion.
4. The reference for left and right is as you position your feet on the CCR.

1. INSTALLING CCR UPPER RESTRAINT IN CUPOLA

1.1 Adjusting Left Arm Length on CCR Upper Restraint

Loosen release knob on CCR Upper Restraint Left Arm by turning in REL. direction.

Slide out the Left Arm to hard stop.

Rotate Left Arm ~90 degrees, referring to Figure 2.

Tighten release knob by turning in LOCK direction.

Refer to Figures 1 and 2.

1.2 Adjusting Right Arm Length on CCR Upper Restraint

Loosen release knob on CCR Upper Restraint Right Arm by turning in REL. direction.

Rotate Right Arm ~90 degrees to match Left Arm.

Hold CCR Upper Restraint up to desired installation location to determine required width of Right Arm.

Insert the two Mounting Probes on the CCR Upper Restraint into

Cupola mounting locations, adjusting Right Arm width as required.

Once proper width is obtained, tighten release knob by turning in LOCK direction.

Refer to Figures 1 to 5.

1.3 Move CCR Release Levers (two) to Lock position to secure CCR Upper Restraint to Cupola Structure.

Refer to Figure 5.

1.127 CUPOLA CREW RESTRAINT INSTALLATION (ASSY OPS/20A/FIN 1)

Page 5 of 6 pages

Platform Joint Shaft
Slot (1 of 4)

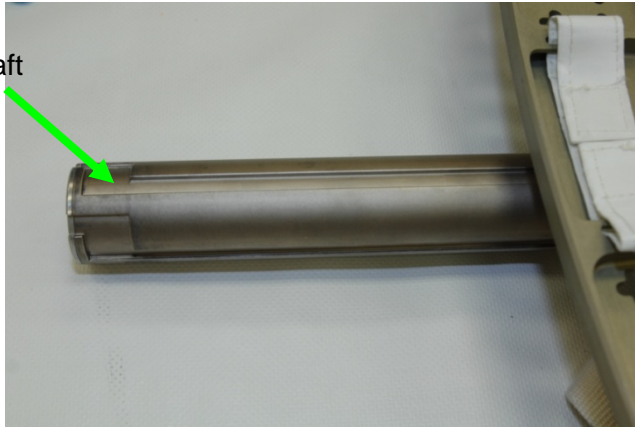

Figure 6. Platform Joint Shaft.

NOTE

There are four different mounting positions of the Platform Joint because of the four slots on the Platform Joint Shaft.

2. INSTALLING PLATFORM JOINT INTO UPPER RESTRAINT

- 2.1 Loosen Platform Joint Release Knob on CCR Upper Restraint by turning in REL. direction.
Refer to Figure 3.
- 2.2 Align the slots of the Platform Joint with the tab inside the end of the CCR Upper Restraint in desired orientation.
Refer to Figure 6.
- 2.3 Insert the Platform Joint Shaft approx. 1" into CCR Upper Restraint, then rotate 45 degrees and continue sliding shaft into Upper Restraint to desired length.
- 2.4 Tighten Platform Joint Release Knob by turning in LOCK direction.

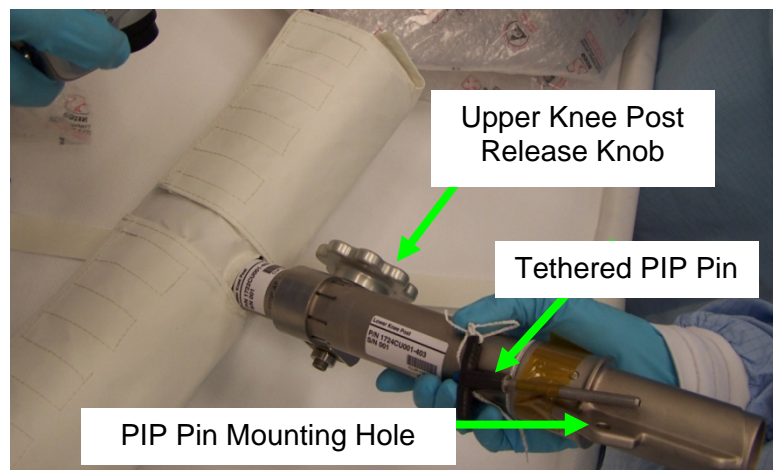

Figure 7. Upper and Lower Knee Post.

1.127 CUPOLA CREW RESTRAINT INSTALLATION (ASSY OPS/20A/FIN 1)

Page 6 of 6 pages

3. INSTALLING LOWER/UPPER KNEE POST

- 3.1 Insert the end of the Lower Knee Post into the Platform Joint and secure with tethered PIP pin.
Refer to Figure 7.
- 3.2 Loosen Upper Knee Post Release Knob by turning in REL. direction, and adjust Upper Knee Post as desired.
Tighten Upper Knee Post Release Knob by turning in LOCK direction.
- 3.3 Photo document completed installation of Cupola Crew Restraint, showing attachment points as well as overview.

CCR Upper Restraint:
Left side arm



Figure 8. Cupola Crew Restraint – Installed.

4. FINAL CONFIGURATION

Refer to Figure 8.

1.140 CUPOLA AND NODE 3/NODE 1 ITCS FILL USING FSS

(ASSY OPS/20A/FIN 1) Page 1 of 45 pages

OBJECTIVE:

Setup the Fluid System Servicer (FSS). Purge Cupola ITCS lines to vacuum and then fill with ITCS coolant using the FSS. Reconfigure Cupola ITCS QDs so that Cupola is cooled by the Node 3 ITCS. Close the MTL Cupola MFCV. Purge the dry Node 3/Node 1 ITCS lines and then fill with ITCS coolant. Reconfigure Node 3 ITCS QDs to connect Node 3 to the Node 1 ITCS. Reconfigure Node 1 ITCS QDs so that Node 3 provides cooling to Node 1 and Airlock instead of the LAB ITCS. After FSS operations are complete, drain and purge the FSS and FSS jumpers.

LOCATION:

Node 3: Cupola ITCS Reconfiguration QDs at NOD3D6 (Starboard Endcone)

Node 3: Node 3 ITCS Reconfiguration QDs at NOD3D3 (Deck Midbay)

Node 1: Node 1 Mod Kit ITCS Jumper installed at NOD1P1 (Port Alcove)

DURATION:

Cupola FSS Fill

30 minutes for FSS Setup (steps 1 to 8)

75 minutes for Cupola Purge and Fill (steps 9 to 15)

30 minutes for Cupola ITCS QD Reconfiguration (steps 16 to 17)

10 minutes for MTL Cupola MFCV Manipulation (step 18)

5 minutes for FSS safing (step 19)

Node 3/1 FSS Fill

30 minutes for FSS preparation for Node 3/Node 1 ITCS Fill (steps 20 to 24)

60 minutes for Node 3/Node 1 ITCS Fill (steps 25 to 33)

25 minutes for Node 3 ITCS QD Reconfiguration (steps 34 to 36)

25 minutes for Node 1 ITCS QD Reconfiguration (steps 37 to 38)

10 minutes to for FSS safing (step 39)

FSS Cleanup

90 minutes for FSS Cleanup (steps 40 to 46)

PARTS:

Ziplock Bag labeled "1.140 CUPOLA AND NODE 3/NODE 1 ITCS FILL USING FSS"

TCS MTL SUPPLY FROM NODE 3 Label (two)

TCS MTL RETURN TO NODE 3 Label (two)

MATERIALS:

Ziplock Bag, small (one)

Kapton Tape

Gray Tape

Aluminum Tape

Sharpie

1.140 CUPOLA AND NODE 3/NODE 1 ITCS FILL USING FSS

(ASSY OPS/20A/FIN 1) Page 2 of 45 pages

TOOLS:

Digital Camera

CSA-O2 (two) P/N SED46115801-305

PWR labeled "ITCS Water" P/N SEG46117689-301 S/N 1035

PWR labeled "ITCS Water" P/N SEG46117689-301 S/N 1034

PWR labeled "ITCS Water" P/N SEG46117689-301 S/N 1002

PS-120 Cable P/N SEG33114649-301

PEEK, 120 VDC 12 AMP 20" Extension Cable P/N SEG33112596-303

Restraint Mobility Aids (RMAs):

41.5" Hand Rail Assembly (two) P/N G11F5200-1

Adjustable Length Tether (one) P/N G11F5140-1

Fluid System Servicer (FSS):

Fluids Control Pump Assembly (FCPA) P/N 683-17117-1

Vacuum Access Jumpers:

VAJ-83-1 35 ft P/N 683-17111-2

FSS Jumpers:

5 ft FSS Jumpers

FSS-79-1 P/N 683-17111-9

FSS-79-2 P/N 683-17111-10

4 ft FSS Jumpers

FSS PWR Adapter P/N SEG46118440-301

3 ft FSS Jumpers

FSS-70-2 P/N 683-17111-20

FSS-64-2 Jumper P/N 683-17111-22

1.5 ft FSS Jumpers

FSS-68-1 Jumper P/N 683-17111-13

FSS-69-1 Jumper P/N 683-17111-15

FSS-77-2 P/N 683-17111-18

FSS-402-1 P/N 684-015090-0001 (new on 20A)

ISS IVA Toolbox:

Drawer 2:

Ratchet, 3/8" Drive

4" Ext, 3/8" Drive

5/32" Hex Head, 3/8" Drive

1/4" Hex Head Driver, 3/8" Drive (may be required in step 2.1)

Drawer 4:

Wire Cutters

REFERENCED PROCEDURE(S):

None

1.140 CUPOLA AND NODE 3/NODE 1 ITCS FILL USING FSS

(ASSY OPS/20A/FIN 1) Page 3 of 45 pages

1. PREPARING FSS WORKSITE

NOTE

Remove and replace protective caps, plugs from jumpers, electrical connectors as required throughout procedure.

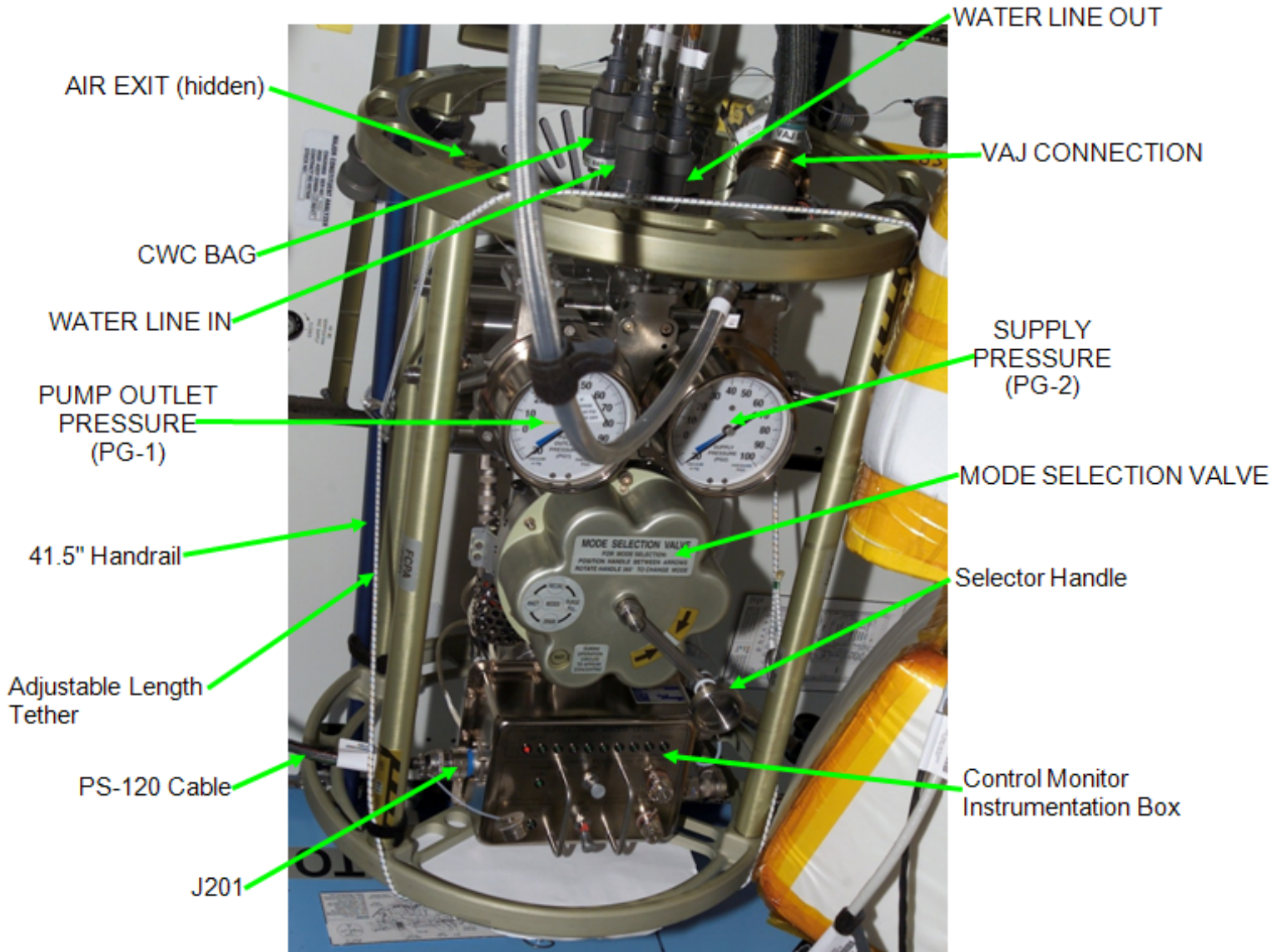

Figure 1.- Fluid Control Pump Assembly (FCPA).

- | | | |
|--------|-----|--|
| NOD3 | 1.1 | Install 41.5" Handrails (two) on seat tracks, in parallel, 6 to 8 inches apart, per crew preference.
Refer to Figure 1. |
| LAB106 | 1.2 | Remove FSS Beta Cloth Closeout covering top portion of LAB106 Rack, fold.
Temporarily stow. |

1.140 CUPOLA AND NODE 3/NODE 1 ITCS FILL USING FSS

(ASSY OPS/20A/FIN 1) Page 4 of 45 pages

2. SETTING UP FCPA

2.1 Unfasten triangular restraint bracket fasteners (six) securing FCPA by hand (if required, Ratchet, 3/8" Drive; 1/4" Hex Head, 3/8" Drive).

2.2 Remove FCPA.
Temporarily reinstall triangular restraint bracket.

2.3 Remove any FSS jumpers coiled in end of FCPA.
Temporarily stow jumpers.

NOD3 2.4 Place FCPA on pre-installed set of 41.5" Handrails (two), secure with Adjustable Length Tether (one).



Figure 2.- AIR EXIT and VAJ CONNECTION on FCPA.

2.5 Gamah Cap \leftarrow \rightarrow AIR EXIT on FCPA
Refer to Figures 1, 2.

2.6 Verifying FSS Power and Valve Positions

- √sw FSS MAIN POWER - OFF
- √MODE SELECTION VALVE - INACT
- √MV1 - BYPASS
- √MV2 - CLOSE
- √MV3 - DF1/SUPPLY

1.140 CUPOLA AND NODE 3/NODE 1 ITCS FILL USING FSS

(ASSY OPS/20A/FIN 1) Page 5 of 45 pages

3. CONFIGURING POWER

NOD3 UOP2 3.1 POWER OUT – RESET (illuminated)
(NOD3A6)

Verify FAULT/TEST – not illuminated

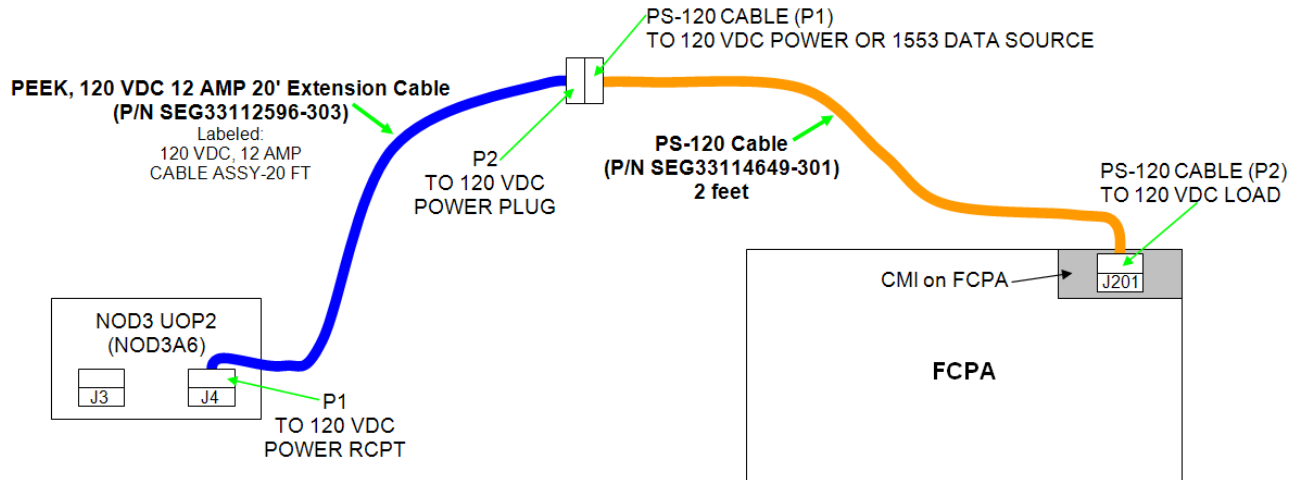

Figure 3.- FSS Power Configuration.

3.2 Configuring Power Cables Per Figure 3

PS-120 CABLE (P2) TO 120 VDC LOAD on PS-120 Cable →|← J201 on FCPA

P2 TO 120 VDC POWER PLUG on PEEK, 120 VDC 12 AMP 20' Extension Cable →|← PS-120 CABLE (P1) TO 120 VDC POWER OR 1553 DATA SOURCE on PS-120 Cable

P1 TO 120 VDC POWER RCPT on PEEK, 120 VDC 12 AMP 20' Extension Cable →|← J4 on NOD3 UOP2

Refer to Figure 3.

3.3 POWER OUT – (green ENABLE)

Verify FAULT/TEST – (green OK)

3.4 sw FSS MAIN POWER → ON

Verify POWER ON LED is illuminated.

3.5 sw PUMP TEST → ON for less than 3 seconds.

TEST ON LED will illuminate, pump noise should be heard.

1.140 CUPOLA AND NODE 3/NODE 1 ITCS FILL USING FSS

(ASSY OPS/20A/FIN 1) Page 6 of 45 pages

4. CONNECTING TO VACUUM SOURCE

- PCS 4.1 Verifying Vent and Relief Isolation Valve (VRIV), Vent and Relief Control Valve (VRCV) Closed
Node 3: ECLSS: PCA

'Pressure Control Assembly'

sel VRCV (Icon)

Verify Position – Closed

Node 3: ECLSS: PCA

'Pressure Control Assembly'

sel VRIV (Icon)

Verify Position – Closed
- NOD3F0 4.2 Remove Closeout Panel NOD3F0-03, fasteners (thirteen) (Ratchet, 3/8" Drive; 5/32" Hex Head, 3/8" Drive).
- 4.3 Remove Closeout Panel NOD3F0-02, fasteners (four) (Ratchet, 3/8" Drive; 5/32" Hex Head, 3/8" Drive).
- 4.4 Gamah Cap ←|→ PCA Vacuum Access Port
Temporarily stow Gamah Cap.
- 4.5 Verify VAJ seals free from damage, debris on both ends of VAJ-83-1 35 ft.
- 4.6 VAJ-83-1 35 ft (bent end) →|← PCA Vacuum Access Port, hand tighten.
- FCPA 4.7 Gamah Cap ←|→ VAJ CONNECTION on FCPA
VAJ-83-1 35 ft (straight end) →|← VAJ CONNECTION on FCPA, hand tighten.
Restrain VAJ-83-1 35 ft per crew preference.
Refer to Figures 1 and 2.
- MCC-H 4.8 Suppressing Node 3 PPR Failure Caution
C&W Summ

'Event Code Tools'

1.140 CUPOLA AND NODE 3/NODE 1 ITCS FILL USING FSS

(ASSY OPS/20A/FIN 1) Page 7 of 45 pages

sel Suppress

Suppress Annunciation of an Event

input Event Code – 1 7 0 5 3 ('Positive P Relief Failure - Node 3')

cmd Arm
cmd Execute

NOTE

The following Caution message will be received after PPR is inhibited: '**Positive P Relief Failure - Node 3**'

No action required. This message will return to normal once PPR is re-enabled.

PCS

4.9 Disabling Positive Pressure Relief

Node 3: ECLSS: PCA: PCA Commands

Node 3 PCA Commands

'PCA'

Verify State – Monitor

'Positive Pressure Relief'

'Inhibit'

cmd Arm (Verify Status – Armed)

cmd Inhibit (Verify Positive Pressure Relief Status – Inhibited)

4.10 Opening Vacuum Relief Isolation Valve (VRIV)

Node 3: ECLSS: PCA

Node 3 ACS

'Pressure Control Assembly'

sel VRIV (Icon)

Node 3 PCA VRIV

'Open'

cmd Arm (Verify Status – Armed)

cmd Open (Verify Position – Open)

5. CONFIGURING FOR DRAIN OF FSS JUMPERS

NOTE

Refer to Figure 4 for step 5.

1.140 CUPOLA AND NODE 3/NODE 1 ITCS FILL USING FSS

(ASSY OPS/20A/FIN 1) Page 8 of 45 pages

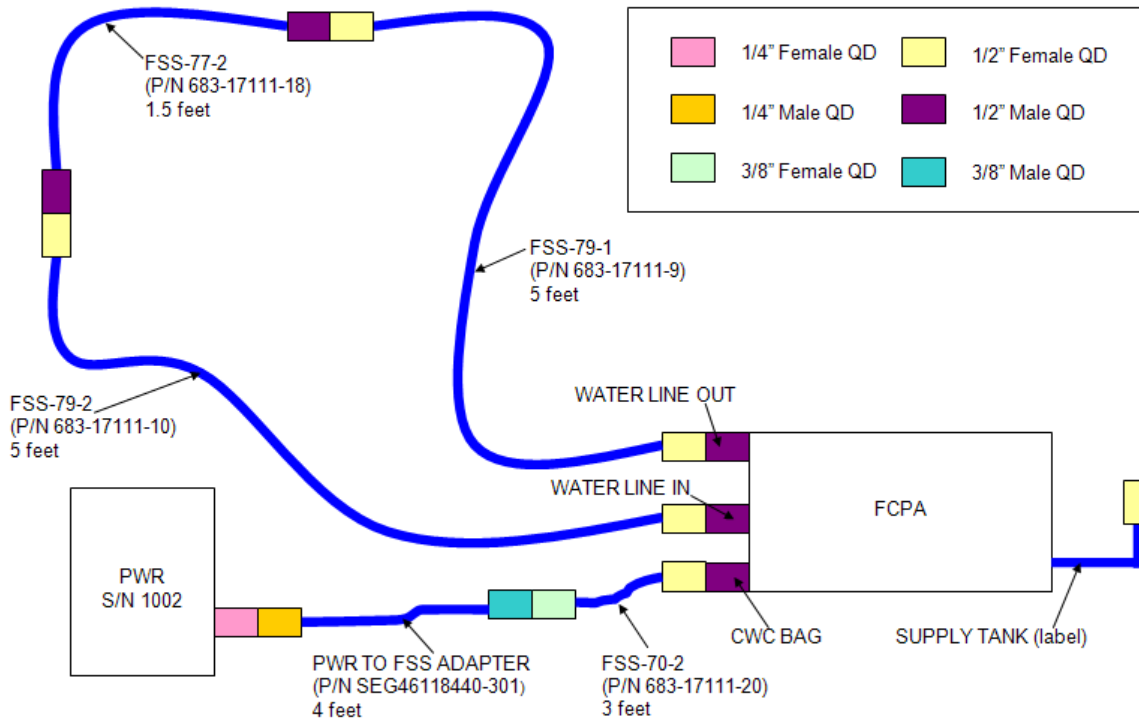

Figure 4.- FSS and Jumper Drain and Purge Setup.

- 5.1 FSS-79-1 →|← WATER LINE OUT on FCPA
 FSS-79-1 →|← FSS-77-2
 FSS-79-2 →|← FSS-77-2
 FSS-79-2 →|← WATER LINE IN on FCPA
- 5.2 FSS-70-2 →|← CWC BAG on FCPA
 PWR TO FSS ADAPTER →|← FSS-70-2
 PWR TO FSS ADAPTER →|← PWR S/N 1002

6. DRAINING FSS AND FSS JUMPERS

CAUTION

1. While in DRAIN, FILL, RECIRC mode (FSS Pump is on), PG1 (Pump Outlet Pressure) must be monitored to ensure FSS and ITCS lines do not become over pressurized.
2. PWR **S/N 1002** must be monitored to avoid overfilling during DRAIN operations. If PWR **S/N 1002** appears to approach the full point, MODE SELECTION VALVE should be rotated to INACT.

- 6.1 MV2 → OPEN
- 6.2 MODE SELECTION VALVE ↻ DRAIN (FCPA pump will turn ON)
- 6.3 Drain until PG-1 is in yellow range for 1 minute.

1.140 CUPOLA AND NODE 3/NODE 1 ITCS FILL USING FSS

(ASSY OPS/20A/FIN 1) Page 9 of 45 pages

* If PWR **S/N 1002** appears to be approaching full
* | MODE SELECTION VALVE ↻ INACT
* |
* | √**MCC-H** for further instructions
* |
* If PG1 pressure > 40 psig
* | sw FSS MAIN POWER → OFF
* |
* | √**MCC-H** for further instructions

6.4 MV2 → CLOSE
Drain for an additional 2 minutes.

7. PURGING FSS AND FSS JUMPERS

7.1 MODE SELECTION VALVE ↻ PURGE/FILL
(FCPA pump will turn OFF)

7.2 MV2 → OPEN

7.3 Purge until PG-1 is in blue arc for 30 seconds.
This action should take less than 10 minutes.

Record PG1 pressure: _____ in Hg

Record PG2 pressure: _____ in Hg

* If blue arc is not reached for 30 seconds within 10 minutes
* | MODE SELECTION VALVE ↻ INACT, then:
* |
* | MODE SELECTION VALVE ↻ DRAIN
* |
* | Drain until PG-1 is in yellow range for 30 seconds.
* |
* | If PWR S/N 1002 appears to be approaching full
* | | MODE SELECTION VALVE ↻ INACT
* | |
* | | √**MCC-H** for further instructions
* | |
* | MV2 → CLOSE
* |
* | Drain an additional 2 minutes.
* |
* | If PWR S/N 1002 appears to be approaching full
* | | MODE SELECTION VALVE ↻ INACT
* | |
* | | √**MCC-H** for further instructions
* | |
* | MODE SELECTION VALVE ↻ INACT
* |
* | Restart procedure from step 7.1.
* | Notify **MCC-H**.

1.140 CUPOLA AND NODE 3/NODE 1 ITCS FILL USING FSS

(ASSY OPS/20A/FIN 1) Page 10 of 45 pages

7.4 MV2 → CLOSE

7.5 MODE SELECTION VALVE ↻ INACT

8. DISCONNECTING FSS JUMPERS

8.1 Disconnecting FSS-77-2

FSS-77-2 ←|→ FSS-79-1

FSS-77-2 ←|→ FSS-79-2

8.2 If required, remove "WET" label from FSS-77-2.
Stow FSS-77-2.

8.3 Disconnecting PWR

FSS-70-2 ←|→ CWC BAG QD on FCPA

FSS-70-2 ←|→ PWR TO FSS ADAPTER

PWR TO FSS ADAPTER ←|→ PWR S/N 1002

9. REMOVING NODE 3 DECK MIDBAY CLOSEOUT PANELS

NOTE

Refer to Figure 5 for step 9.



Figure 5.- Node 3 Deck Midbay Closeout Panels (looking Starboard).

NOD3D2 9.1 Remove Closeout Panel NOD3D2-32, fasteners (four) (Ratchet, 3/8" Drive; 5/32" Hex Head, 3/8" Drive).

9.2 Remove Closeout Panel NOD3D2-33, fasteners (three) (Ratchet, 3/8" Drive; 5/32" Hex Head, 3/8" Drive).

1.140 CUPOLA AND NODE 3/NODE 1 ITCS FILL USING FSS

(ASSY OPS/20A/FIN 1) Page 11 of 45 pages

- 9.3 Remove Closeout Panel NOD3D2-34, fasteners (seventeen) (Ratchet, 3/8" Drive; 5/32" Hex Head, 3/8" Drive).
- 9.4 Record CSA-O2 sampling in open cabin: _____ % (first CSA-O2).
Record CSA-O2 sampling in open cabin: _____ % (second CSA-O2).

Verify CSA-O2 sampling from both units are within 1.1 % of each other.
- 9.5 Perform CSA-O2 sampling in area where Closeout Panel was removed for 1 minute.
Verify O2 % within nominal range specified on CSA-O2 decal.

10. DEMATING CUPOLA HTL QDS FOR FSS FILL

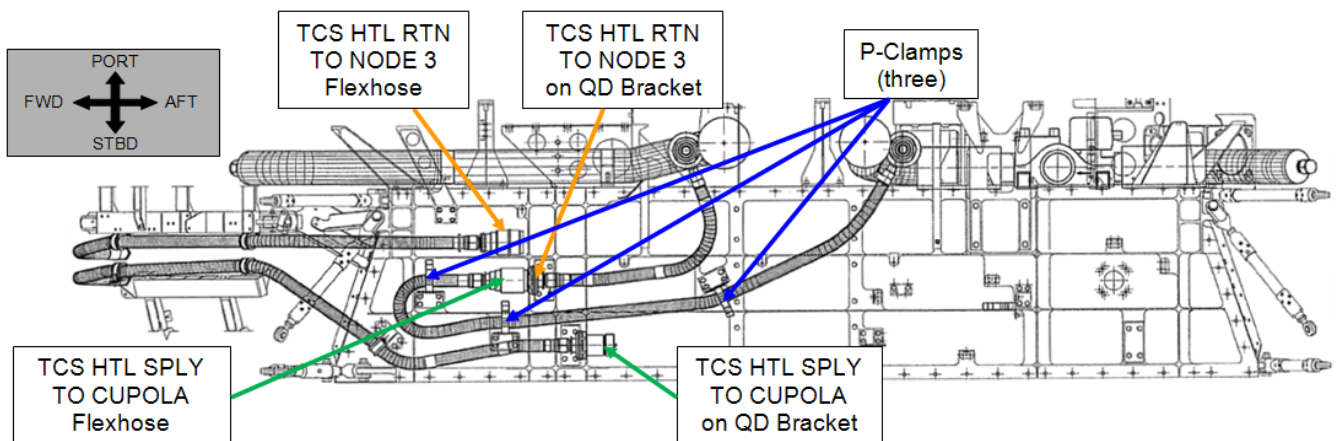

Figure 6.- Launch Configuration of Cupola HTL QDs (looking Overhead on Deck side of Deck Midbay).



Figure 7.- Cupola HTL QDs in Node 3 Deck Midbay (looking Starboard).

1.140 CUPOLA AND NODE 3/NODE 1 ITCS FILL USING FSS

(ASSY OPS/20A/FIN 1) Page 12 of 45 pages

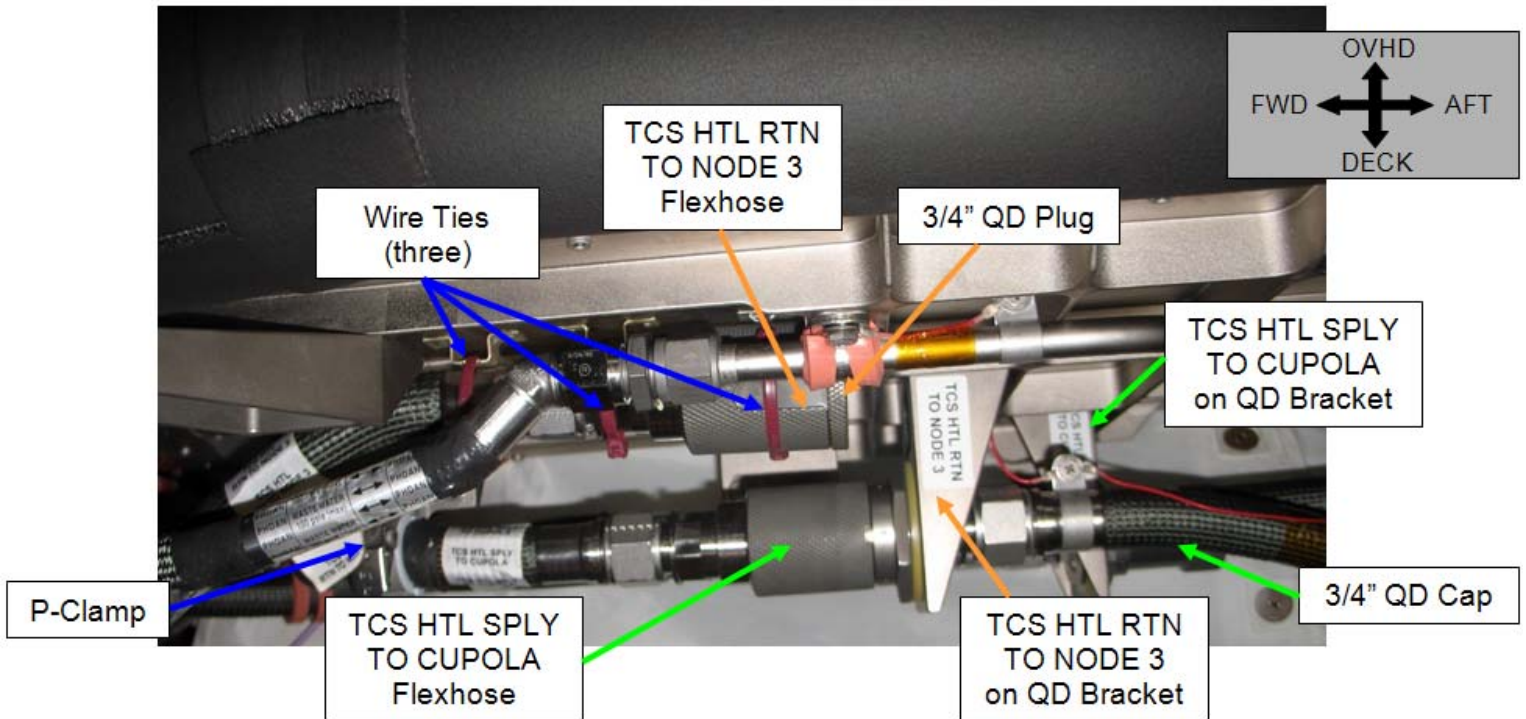

Figure 8.- Cupola HTL QDs (looking Starboard).

NOD3D3 10.1 Disengage P-Clamps (three) securing TCS HTL SPLY TO CUPOLA Flexhose to structure.
Refer to Figures 6, 7, and 8.

10.2 TCS HTL SPLY TO CUPOLA Flexhose \leftrightarrow TCS HTL RTN TO NODE 3 on QD Bracket
Refer to Figures 6, 7, and 8.

11. CONFIGURING FSS JUMPERS FOR CUPOLA FILL

NOTE

1. Refer to Figures 6, 7, 8, and 9 for step 11.
2. PWR S/N 1035 and associated jumpers shown in Figure 9 will not be connected until step 13.

1.140 CUPOLA AND NODE 3/NODE 1 ITCS FILL USING FSS

(ASSY OPS/20A/FIN 1) Page 13 of 45 pages

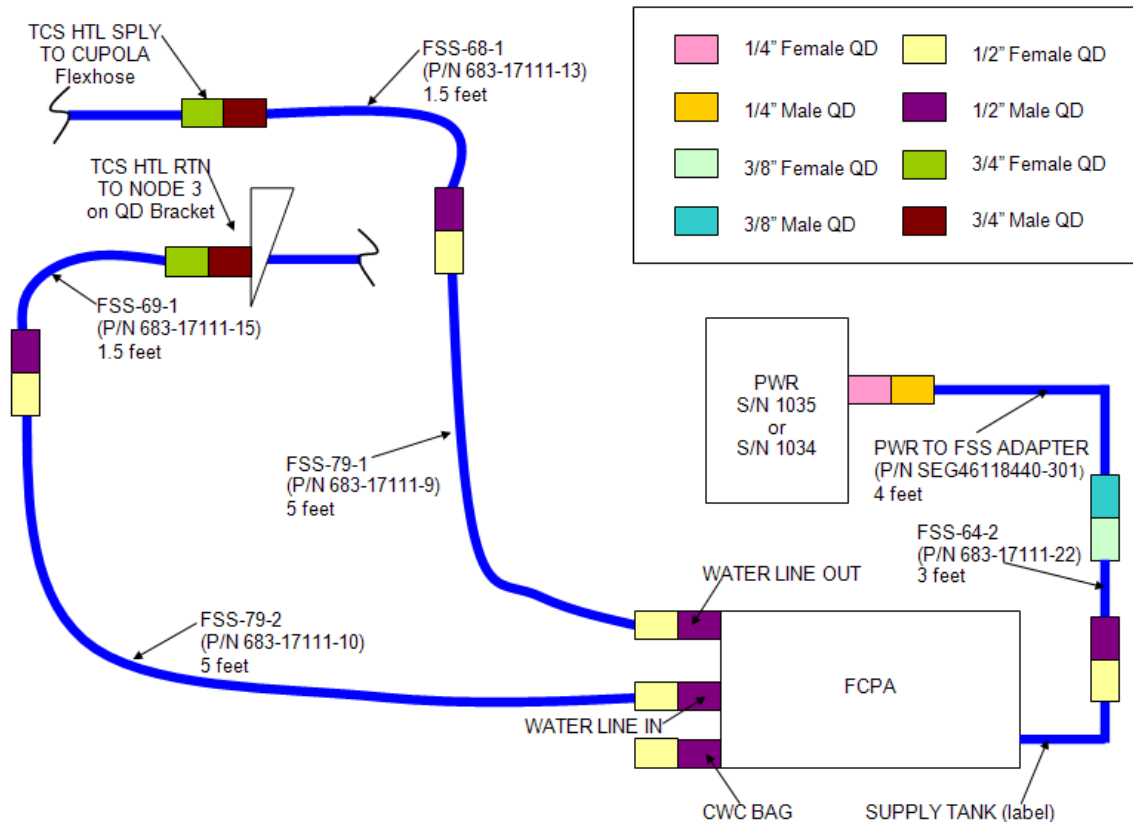

Figure 9.- FSS and Jumper Configuration for Cupola Fill.

- FCPA 11.1 √FSS-79-1 →|← WATER LINE OUT on FCPA
√FSS-79-2 →|← WATER LINE IN on FCPA
- NOD3D3 11.2 FSS-68-1 →|← FSS-79-1
FSS-68-1 →|← TCS HTL SPLY TO CUPOLA Flexhose
- 11.3 FSS-69-1 →|← FSS-79-2
FSS-69-1 →|← TCS HTL RTN TO NODE 3 on QD Bracket

12. PURGING CUPOLA

- FCPA 12.1 MODE SELECTION VALVE ↻ PURGE/FILL
- 12.2 MV2 → OPEN
- 12.3 Purge until PG-1 is in blue arc for 30 seconds.
This action should take less than 10 minutes.

Record PG1 pressure: _____ in Hg
Record PG2 pressure: _____ in Hg

1.140 CUPOLA AND NODE 3/NODE 1 ITCS FILL USING FSS

(ASSY OPS/20A/FIN 1) Page 14 of 45 pages

```
*****
* If blue arc is not reached for 30 seconds within 10 minutes
* | MODE SELECTION VALVE ↻ INACT, then:
* |
* | MODE SELECTION VALVE ↻ DRAIN
* |
* | Drain until PG-1 is in yellow range for 30 seconds.
* |
* | MV2 → CLOSE
* |
* | Drain an additional 2 minutes.
* |
* | MODE SELECTION VALVE ↻ INACT
* |
* | Restart procedure from step 12.1.
* | Notify MCC-H.
*****
```

12.4 MV2 → CLOSE

12.5 MODE SELECTION VALVE ↻ INACT

13. CONNECTING PAYLOAD WATER RESERVOIR (PWR)

13.1 FSS-64-2 →|← SUPPLY TANK on FCPA
FSS-64-2 →|← PWR TO FSS ADAPTER

13.2 PWR TO FSS ADAPTER →|← PWR S/N 1035
Refer to Figure 9.

14. FILLING AND RECIRCULATING CUPOLA

CAUTION

While in DRAIN, FILL, RECIRC mode (FSS Pump is on), PG1 (Pump Outlet Pressure) must be monitored to ensure FSS and ITCS lines do not become over pressurized.

14.1 MODE SELECTION VALVE ↻ PURGE/FILL

14.2 MV2 → OPEN

14.3 MV1 → FILL (FCPA pump will turn ON)

```
*****
* If PG1 pressure > 40 psig
* | sw FSS MAIN POWER → OFF
* |
* | √MCC-H for further instructions
*****
```

1.140 CUPOLA AND NODE 3/NODE 1 ITCS FILL USING FSS

(ASSY OPS/20A/FIN 1) Page 15 of 45 pages

```
*****
* If PWR S/N 1035 appears empty
* | MV1 → BYPASS (FCPA pump will turn OFF)
* |
* | MODE SELECTION VALVE ↶ to INACT
* |
* | Notify MCC-H.
* |
* | PWR TO FSS ADAPTER ←|→ PWR S/N 1035
* | PWR TO FSS ADAPTER →|← PWR S/N 1034
* |
* | MODE SELECTION VALVE ↶ PURGE/FILL
* |
* | MV1 → FILL (FCPA pump will turn ON)
*****
```

Wait 15 minutes.

Record PG1 pressure: _____ psig
Record PG2 pressure: _____ psig

14.4 MV1 → BYPASS (FCPA pump will turn OFF)

14.5 MODE SELECTION VALVE ↶ RECIRC (FCPA pump will turn ON)

```
*****
* If PG1 pressure > 40 psig
* | sw FSS MAIN POWER → OFF
* |
* | √MCC-H for further instructions
*****
```

Recirculate for 5 minutes.

Record PG1 pressure: _____ psig
Record PG2 pressure: _____ psig

14.6 MODE SELECTION VALVE ↶ INACT (FCPA pump will turn OFF)

14.7 MV2 → CLOSE

14.8 Notify **MCC-H** of coolant quantity remaining in PWR S/N 1035, 1034.

15. DISCONNECTING FSS FROM CUPOLA HTL QDS

NOD3D3

15.1 FSS-68-1 ←|→ TCS HTL SPLY TO CUPOLA Flexhose
3/4" QD Cap →|← FSS-68-1

15.2 FSS-69-1 ←|→ TCS HTL RTN TO NODE 3 on QD Bracket
3/4" QD Plug →|← FSS-69-1

1.140 CUPOLA AND NODE 3/NODE 1 ITCS FILL USING FSS

(ASSY OPS/20A/FIN 1) Page 16 of 45 pages

16. RECONFIGURING CUPOLA HTL QDS

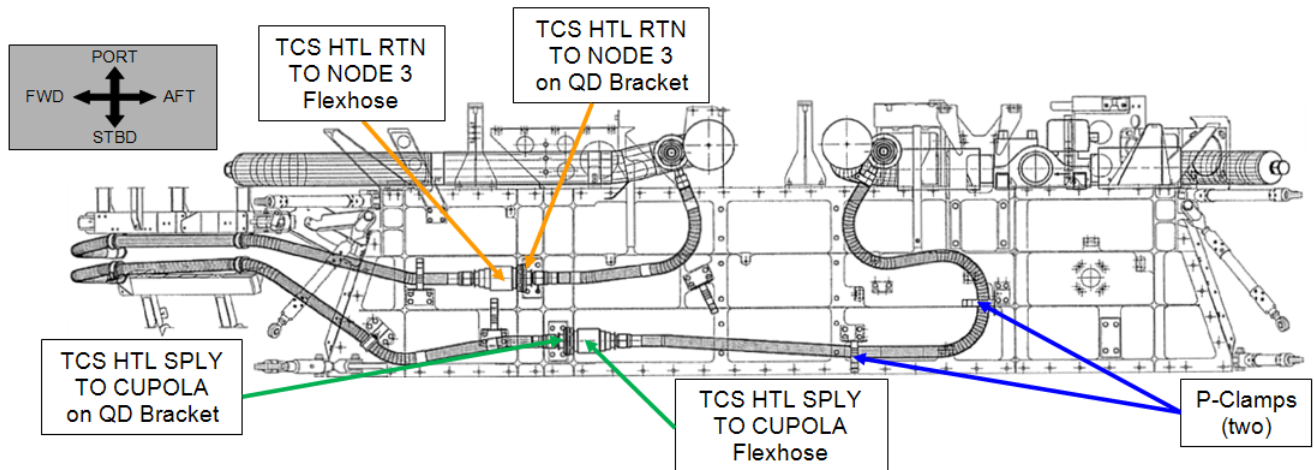

Figure 10.- On-Orbit Configuraiton of Cupola HTL QDs
(looking Overhead on Deck side of Deck Midbay).

- 16.1 3/4" QD Cap \leftarrow | \rightarrow TCS HTL SPLY TO CUPOLA on QD Bracket
TCS HTL SPLY TO CUPOLA Flexhose \rightarrow | \leftarrow TCS HTL SPLY TO CUPOLA on QD Bracket
Refer to Figures 6, 7, 8, 10.
- 16.2 Route TCS HTL SPLY TO CUPOLA Flexhose in on-orbit configuration.
Engage P-Clamps (two).
Refer to Figure 10.
- 16.3 Cut Wire Ties (three) securing TCS HTL RTN TO NODE 3 Flexhose to structure (Wire Cutters).
Refer to Figure 8.
- 16.4 3/4" QD Plug \leftarrow | \rightarrow TCS HTL RTN TO NODE 3 Flexhose
TCS HTL RTN TO NODE 3 Flexhose \rightarrow | \leftarrow TCS HTL RTN TO NODE 3 on QD Bracket
Refer to Figures 8 and 10.
- 16.5 Temporarily stow 3/4" QD Cap (from step 16.1) for later installation on FSS-402-1 (new on 20A).
Stow 3/4" QD Plug (from step 16.4).

17. INSTALLING NODE 3 DECK MIDBAY CLOSEOUT PANELS

NOTE
Refer to Figure 5 for step 17.

- NOD3D2 17.1 Install Closeout Panel NOD3D2-32, fasteners (four) (Ratchet, 3/8" Drive; 5/32" Hex Head, 3/8" Drive).

1.140 CUPOLA AND NODE 3/NODE 1 ITCS FILL USING FSS

(ASSY OPS/20A/FIN 1) Page 17 of 45 pages

- 17.2 Install Closeout Panel NOD3D2-33, fasteners (three) (Ratchet, 3/8" Drive; 5/32" Hex Head, 3/8" Drive).
- 17.3 Install Closeout Panel NOD3D2-34, fasteners (seventeen) (Ratchet, 3/8" Drive; 5/32" Hex Head, 3/8" Drive).

18. CLOSING CUPOLA MTL MFCV

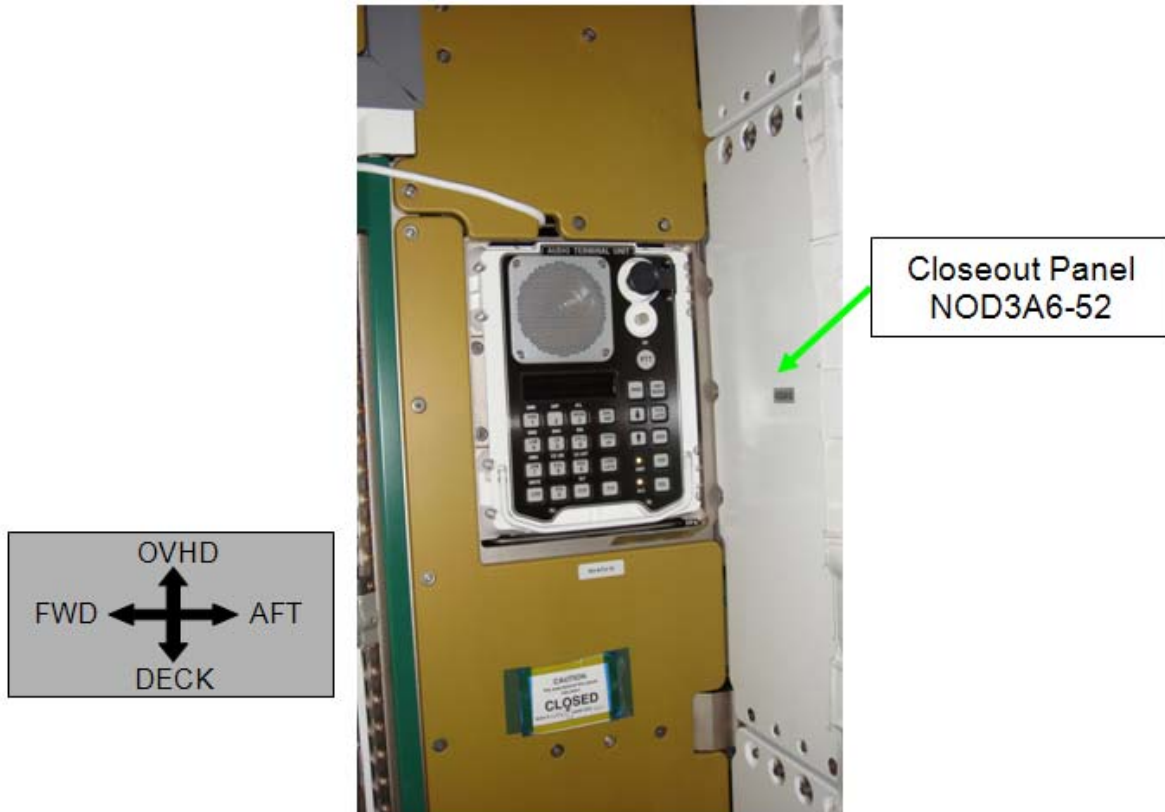

Figure 11.- Aft Portion of Node 3 Starboard Endcone (looking Starboard).

- NOD3A6
- 18.1 Remove Closeout Panel NOD3A6-52, fasteners (four) (Ratchet, 3/8" Drive; 5/32" Hex Head, 3/8" Drive). Refer to Figure 11.

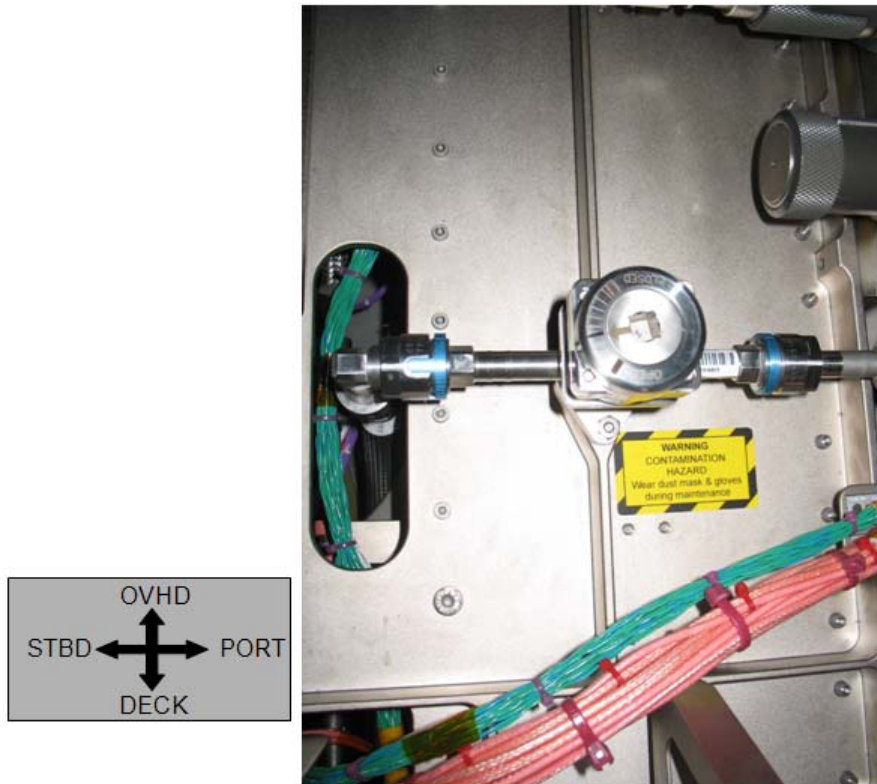

Figure 12.- N3-HTL/MTL-CUP/N1-MFCV (looking Aft).

CAUTION

When rotating the Manual Flow Control Valve (MFCV), rotate no faster than one tick mark every 15 seconds. If the MFCV is moved too quickly, ITCS FDIR software will automatically reduce the speed to the LTL and MTL pumps. Reduction in the pump speed protects the System Flow Control Assembly (SFCA) delta pressure sensor from damage.

18.2 Rotate N3-HTL/MTL-CUP/N1-MFCV ↻ Closed by incrementing one tick mark every 15 seconds (Ratchet, 3/8" Drive; 4" Ext, 3/8" Drive).

Refer to Figure 12.

18.3 Install Closeout Panel NOD3A6-52, fasteners (four) (Ratchet, 3/8" Drive; 5/32" Hex Head, 3/8" Drive).

19. SAFING FSS (IF REQUIRED)

19.1 sw FSS MAIN POWER → OFF

19.2 Verifying FSS Power and Valve Positions

- √MODE SELECTION VALVE - INACT
- √MV1 - BYPASS
- √MV2 - CLOSE
- √MV3 - DF1/SUPPLY

1.140 CUPOLA AND NODE 3/NODE 1 ITCS FILL USING FSS

(ASSY OPS/20A/FIN 1) Page 19 of 45 pages

19.3 Gamah Cap →|← AIR EXIT on FCPA, hand tighten
Refer to Figures 1 and 2.

PCS

19.4 Closing VRIV
Node 3: ECLSS: PCA
Node 3 ACS
'Pressure Control Assembly'

sel VRIV (Icon)

Node 3 PCA VRIV
'Close'

cmd Close (Verify Position – Closed)

19.5 Enabling Positive Pressure Relief (PPR)
Node 3: ECLSS: PCA: PCA Commands
Node 3 PCA Commands
'Positive Press Relief'
'Enable'

cmd Enable (Verify Positive Pressure Relief State – Enabled)

MCC-H

19.6 Enabling Node 3 PPR Failure Caution
C&W Summ
Caution & Warning Summary
'Event Code Tools'

sel Enable

Enable an Event

input Event Code – 1 7 0 5 3 ('Positive P Relief Failure - Node 3')

cmd Execute

19.7 ISS ↓ **MCC-H**, "FSS safing complete."

20. RECONFIGURING FOR FSS OPS (IF REQUIRED)

FCPA

20.1 Verifying FSS Power and Valve Positions

√sw FSS MAIN POWER	- OFF
√MODE SELECTION VALVE	- INACT
√MV1	- BYPASS
√MV2	- CLOSE
√MV3	- DF1/SUPPLY

20.2 Gamah Cap ←|→ AIR EXIT on FCPA
Refer to Figures 1 and 2.

1.140 CUPOLA AND NODE 3/NODE 1 ITCS FILL USING FSS

(ASSY OPS/20A/FIN 1) Page 20 of 45 pages

MCC-H

20.3 Suppressing Node 3 PPR Failure Caution C&W Summ

Caution & Warning Summary

'Event Code Tools'

sel Suppress

Suppress Annunciation of an Event

input Event Code – 1 7 0 5 3 ('**Positive P Relief Failure - Node 3**')

cmd Arm

cmd Execute

NOTE

The following Caution message will be received after PPR is inhibited: '**Positive P Relief Failure - Node 3**'

No action required. This message will return to normal once PPR is re-enabled.

PCS

20.4 Disabling Positive Pressure Relief Node 3: ECLSS: PCA: PCA Commands

Node 3 PCA Commands

'PCA'

Verify State – Monitor

'Positive Pressure Relief'

'Inhibit'

cmd Arm (Verify Status – Armed)

cmd Inhibit (Verify Positive Pressure Relief Status – Inhibited)

20.5 Opening Vacuum Relief Isolation Valve (VRIV)

Node 3: ECLSS: PCA

Node 3 ACS

'Pressure Control Assembly'

sel VRIV (Icon)

Node 3 PCA VRIV

'Open'

cmd Arm (Verify Status – Armed)

cmd Open (Verify Position – Open)

20.6 sw FSS MAIN POWER → ON

1.140 CUPOLA AND NODE 3/NODE 1 ITCS FILL USING FSS

(ASSY OPS/20A/FIN 1) Page 21 of 45 pages

21. CONFIGURING PWR FOR DRAINING FSS AND FSS JUMPERS

NOTE
Refer to Figure 13 for step 21.

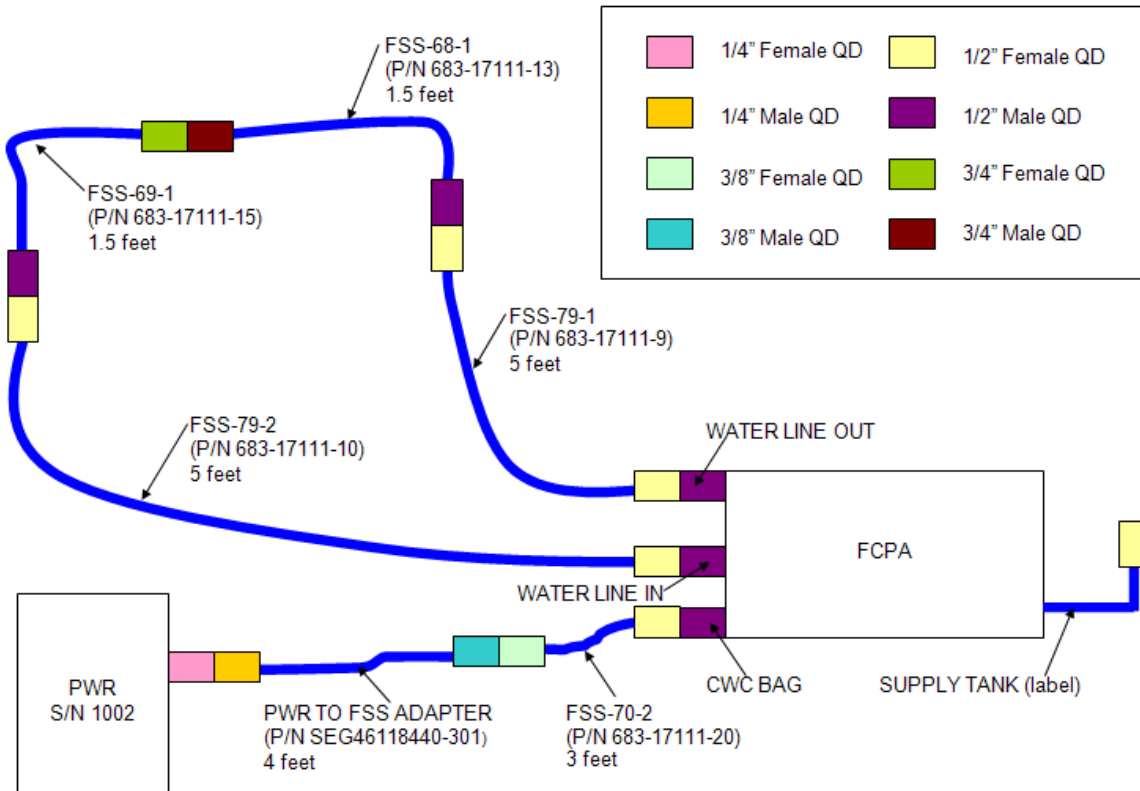

Figure 13.- FSS and FSS Jumper Drain and Purge Configuration.

- FCPA
- 21.1 FSS-68-1 →|← FSS-69-1
 - 21.2 FSS-64-2 ←|→ SUPPLY TANK on FCPA
FSS-64-2 ←|→ PWR TO FSS ADAPTER
PWR S/N 1034 ←|→ PWR TO FSS ADAPTER
 - 21.3 FSS-70-2 →|← CWC BAG on FCPA
PWR TO FSS ADAPTER →|← FSS-70-2
PWR TO FSS ADAPTER →|← PWR S/N 1002
 - 21.4 √FSS jumpers configured per Figure 13

1.140 CUPOLA AND NODE 3/NODE 1 ITCS FILL USING FSS

(ASSY OPS/20A/FIN 1) Page 22 of 45 pages

22. DRAINING FSS AND FSS JUMPERS

CAUTION
1. While in DRAIN, FILL, RECIRC mode (FSS Pump is on), PG1 (Pump Outlet Pressure) must be monitored to ensure FSS and ITCS lines do not become over pressurized.
2. PWR S/N 1002 must be monitored to avoid overfilling during DRAIN operations. If PWR S/N 1002 appears to approach the full point, MODE SELECTION VALVE should be rotated to INACT.

22.1 MV2 → OPEN

22.2 MODE SELECTION VALVE ↻ DRAIN (FCPA pump will turn ON)

22.3 Drain until PG-1 is in yellow range for 1 minute.

```
*****
* If PWR S/N 1002 appears to be approaching full
* | MODE SELECTION VALVE ↻ INACT
* |
* | √MCC-H for further instructions
* |
* If PG1 pressure > 40 psig
* | sw FSS MAIN POWER → OFF
* |
* | √MCC-H for further instructions
*****
```

22.4 MV2 → CLOSE

Drain for an additional 2 minutes.

23. PURGING FSS AND FSS JUMPERS

23.1 MODE SELECTION VALVE ↻ PURGE/FILL
(FCPA pump will turn OFF)

23.2 MV2 → OPEN

23.3 Purge until PG-1 is in blue arc for 30 seconds.
This action should take less than 10 minutes.

Record PG1 pressure: _____ in Hg

Record PG2 pressure: _____ in Hg

1.140 CUPOLA AND NODE 3/NODE 1 ITCS FILL USING FSS

(ASSY OPS/20A/FIN 1) Page 23 of 45 pages

```
*****
* If blue arc is not reached for 30 seconds within 10 minutes
* | MODE SELECTION VALVE ↻ INACT, then:
* |
* | MODE SELECTION VALVE ↻ DRAIN
* |
* | Drain until PG-1 is in yellow range for 30 seconds.
* |
* | If PWR S/N 1002 appears to be approaching full
* | | MODE SELECTION VALVE ↻ INACT
* | |
* | | √MCC-H for further instructions
* |
* | MV2 → CLOSE
* |
* | Drain an additional 2 minutes.
* |
* | If PWR S/N 1002 appears to be approaching full
* | | MODE SELECTION VALVE ↻ INACT
* | |
* | | √MCC-H for further instructions
* |
* | MODE SELECTION VALVE ↻ INACT
* |
* | Restart procedure from step 23.1.
* | Notify MCC-H.
*****
```

23.4 MV2 → CLOSE

23.5 MODE SELECTION VALVE ↻ INACT

24. DISCONNECTING FSS JUMPERS

24.1 Disconnecting PWR

FSS-70-2 ←|→ CWC BAG QD on FCPA

FSS-70-2 ←|→ PWR TO FSS ADAPTER

PWR TO FSS ADAPTER ←|→ PWR S/N 1002

25. REMOVING NODE 1 PORT ALCOVE CLOSEOUT PANEL

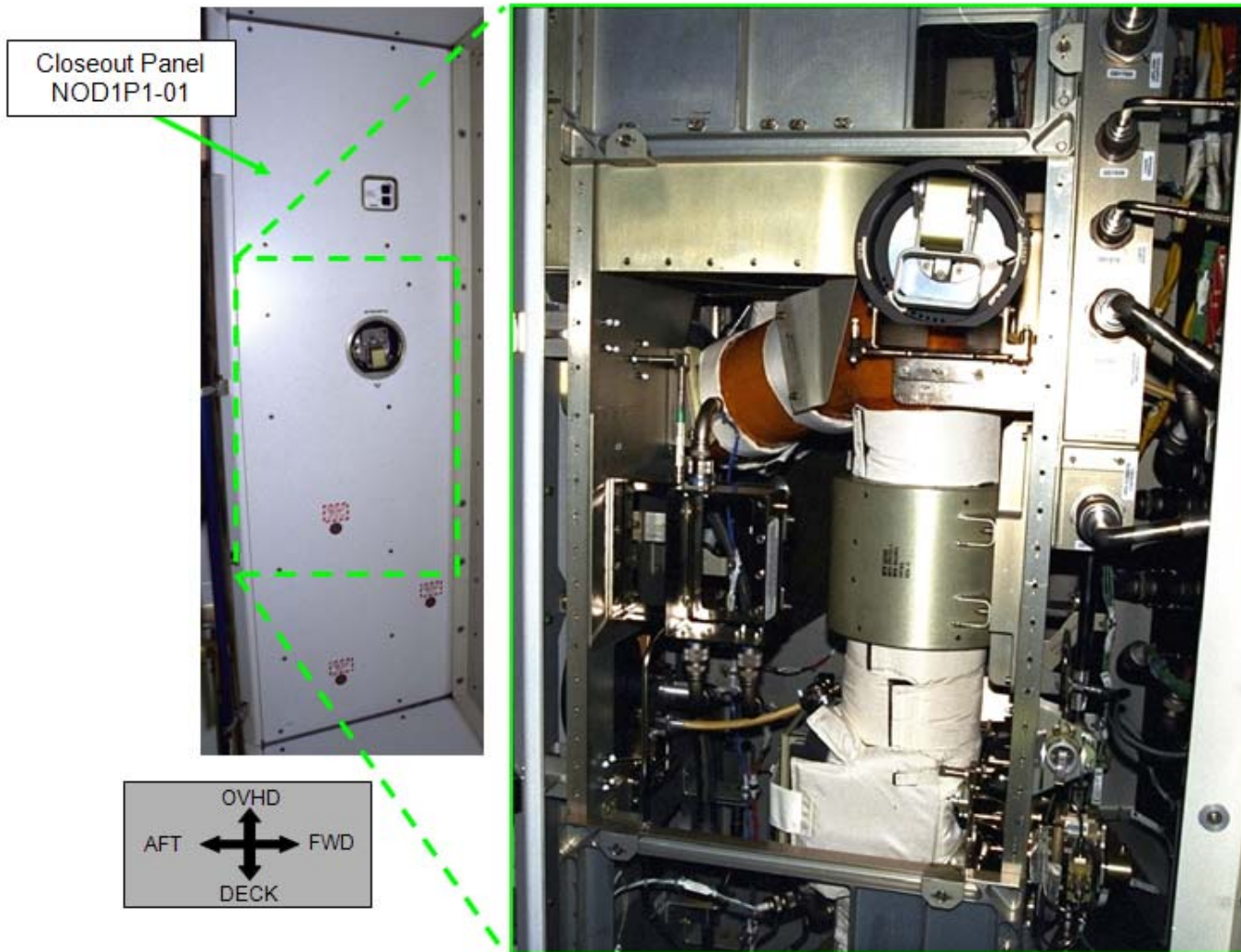

Figure 14.- Node 1 Port Alcove.

- NOD1P1
- 25.1 Remove Closeout Panel NOD1P1-01, fasteners (twelve) (Ratchet, 3/8" Drive; 5/32" Hex Head, 3/8" Drive). Refer to Figure 14.
 - 25.2 Record CSA-O2 sampling in open cabin: _____ % (first CSA-O2).
Record CSA-O2 sampling in open cabin: _____ % (second CSA-O2).

Verify CSA-O2 sampling from both units are within 1.1 % of each other.
 - 25.3 Perform CSA-O2 sampling in area where Closeout Panel was removed for 1 minute.
Verify O2 % within nominal range specified on CSA-O2 decal.

1.140 CUPOLA AND NODE 3/NODE 1 ITCS FILL USING FSS

(ASSY OPS/20A/FIN 1) Page 25 of 45 pages

26. CONFIGURING NODE 1 JUMPERS FOR NODE 3/NODE 1 FILL

NOTE

1. Refer to Figures 14 and 15 for step 26.
2. FSS-402-1 is a new adapter flying on 20A.

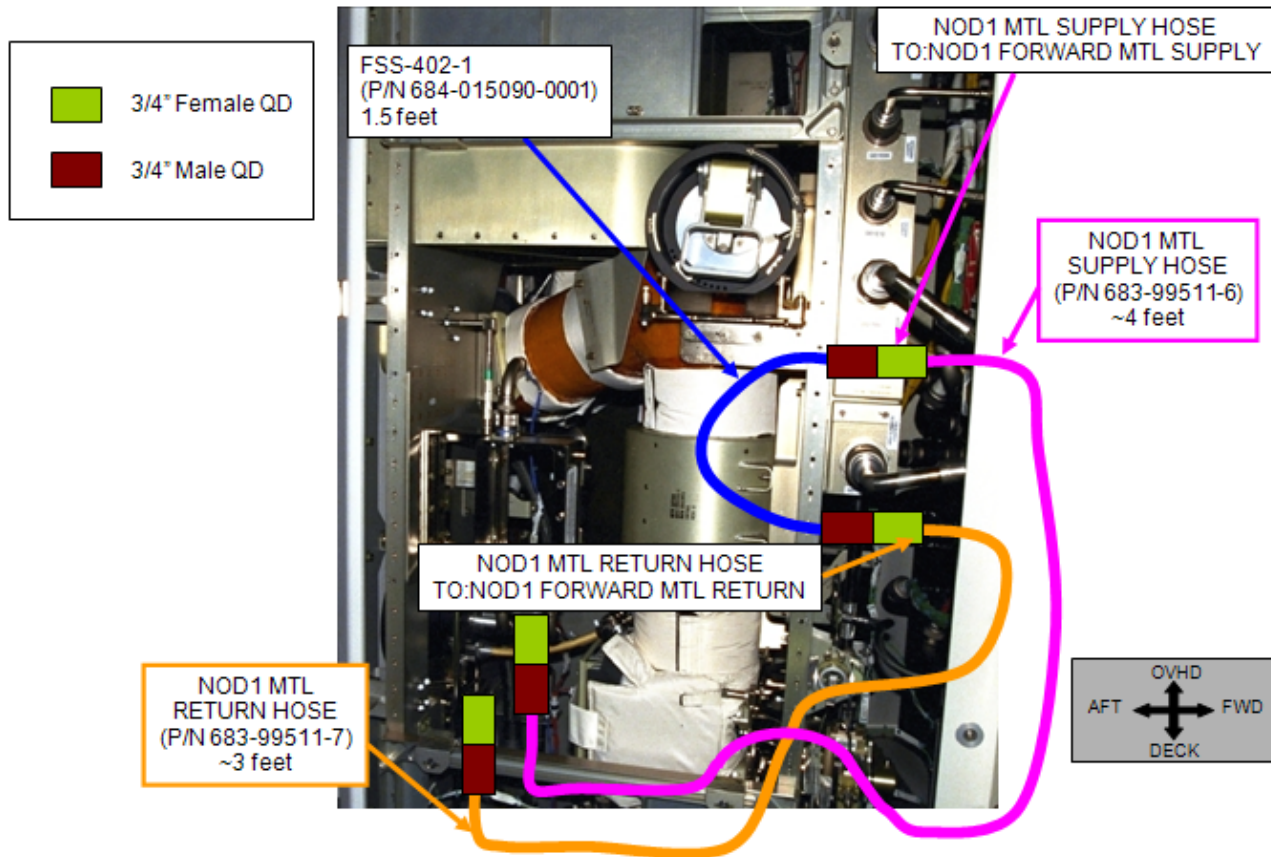

Figure 15.- Node 1 Mod Kit MTL Jumper Configuration in Node 1 Port Alcove (looking Port).

- NOD1P1
- 26.1 3/4" QD Plug $\leftarrow\rightarrow$ TO: NOD1 FORWARD MTL RETURN on NOD1 MTL RETURN HOSE
FSS-402-1 $\rightarrow\leftarrow$ TO: NOD1 FORWARD MTL RETURN on NOD1 MTL RETURN HOSE
 - 26.2 3/4" QD Plug $\leftarrow\rightarrow$ TO: NOD1 FORWARD MTL SUPPLY on NOD1 MTL SUPPLY HOSE
FSS-402-1 $\rightarrow\leftarrow$ TO: NOD1 FORWARD MTL SUPPLY on NOD1 MTL SUPPLY HOSE
 - 26.3 Temporarily stow 3/4" QD Plugs (two).

1.140 CUPOLA AND NODE 3/NODE 1 ITCS FILL USING FSS

(ASSY OPS/20A/FIN 1) Page 26 of 45 pages

27. REMOVING NODE 3 STARBOARD ENDCONE CLOSEOUT PANELS



Figure 16.- Node 3 Starboard Endcone Deck Closeout Panels (looking Starboard).

- NOD3D6 27.1 Remove NOD3D6-52 Closeout Panel, fasteners (two) (Ratchet, 3/8" Drive; 5/32" Hex Head, 3/8" Drive). Refer to Figure 16.

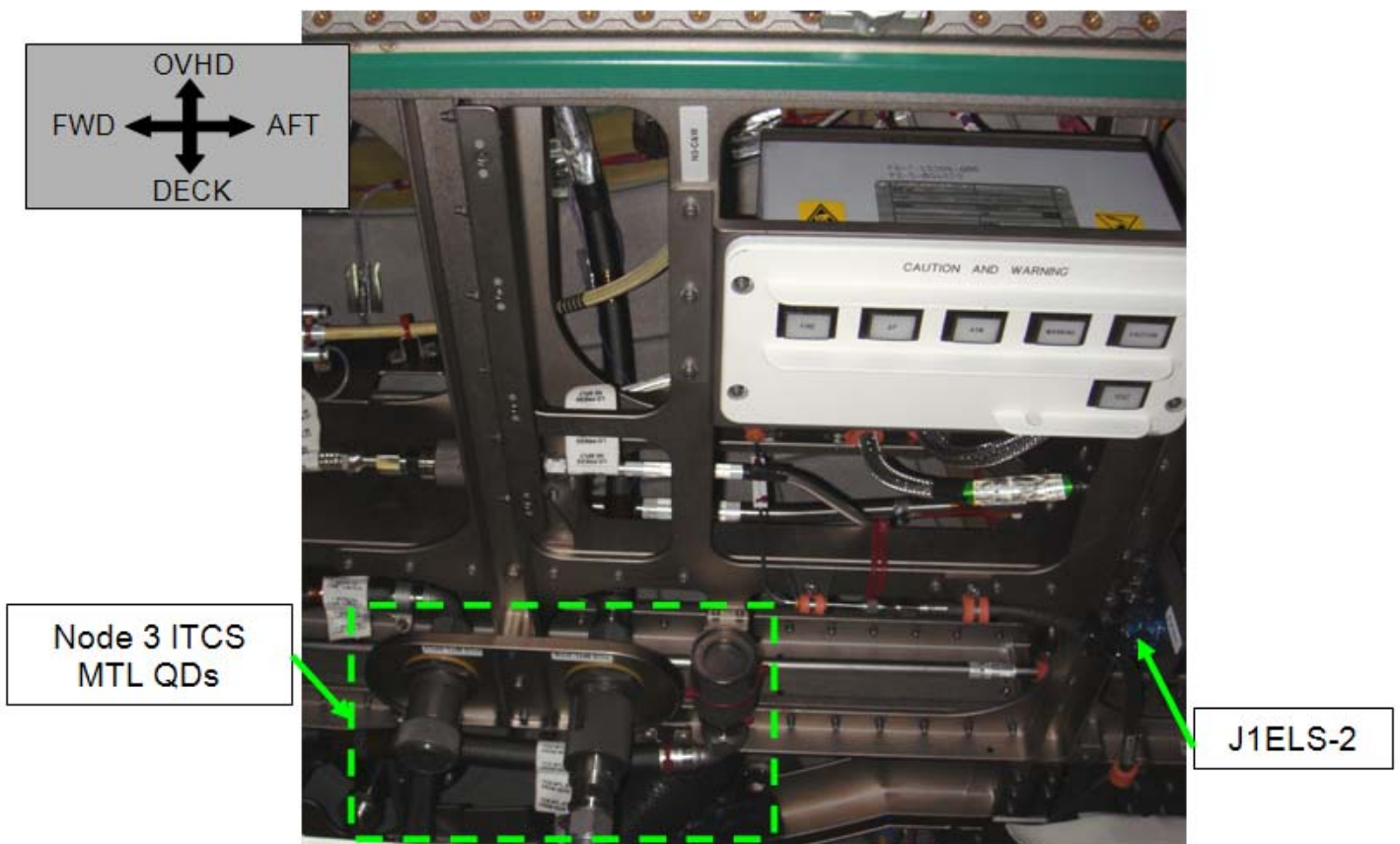

Figure 17.- Node 3 Deck Starboard Endcone (looking Deck Starboard).

- 27.2 EELS Power Cable \leftarrow \rightarrow J1ELS-2
Refer to Figure 17.

1.140 CUPOLA AND NODE 3/NODE 1 ITCS FILL USING FSS

(ASSY OPS/20A/FIN 1) Page 27 of 45 pages

- 27.3 Remove NOD3D6-51 Closeout Panel, fasteners (ten) (Ratchet, 3/8" Drive; 5/32" Hex Head, 3/8" Drive). Refer to Figure 16.
- 27.4 Record CSA-O2 sampling in open cabin: _____ % (first CSA-O2).
Record CSA-O2 sampling in open cabin: _____ % (second CSA-O2).

Verify CSA-O2 sampling from both units are within 1.1 % of each other.

- 27.5 Perform CSA-O2 sampling in area where Closeout Panel was removed for 1 minute.
Verify O2 % within nominal range specified on CSA-O2 decal.

28. CONNECTING FSS TO NODE 3 ITCS MTL QDS

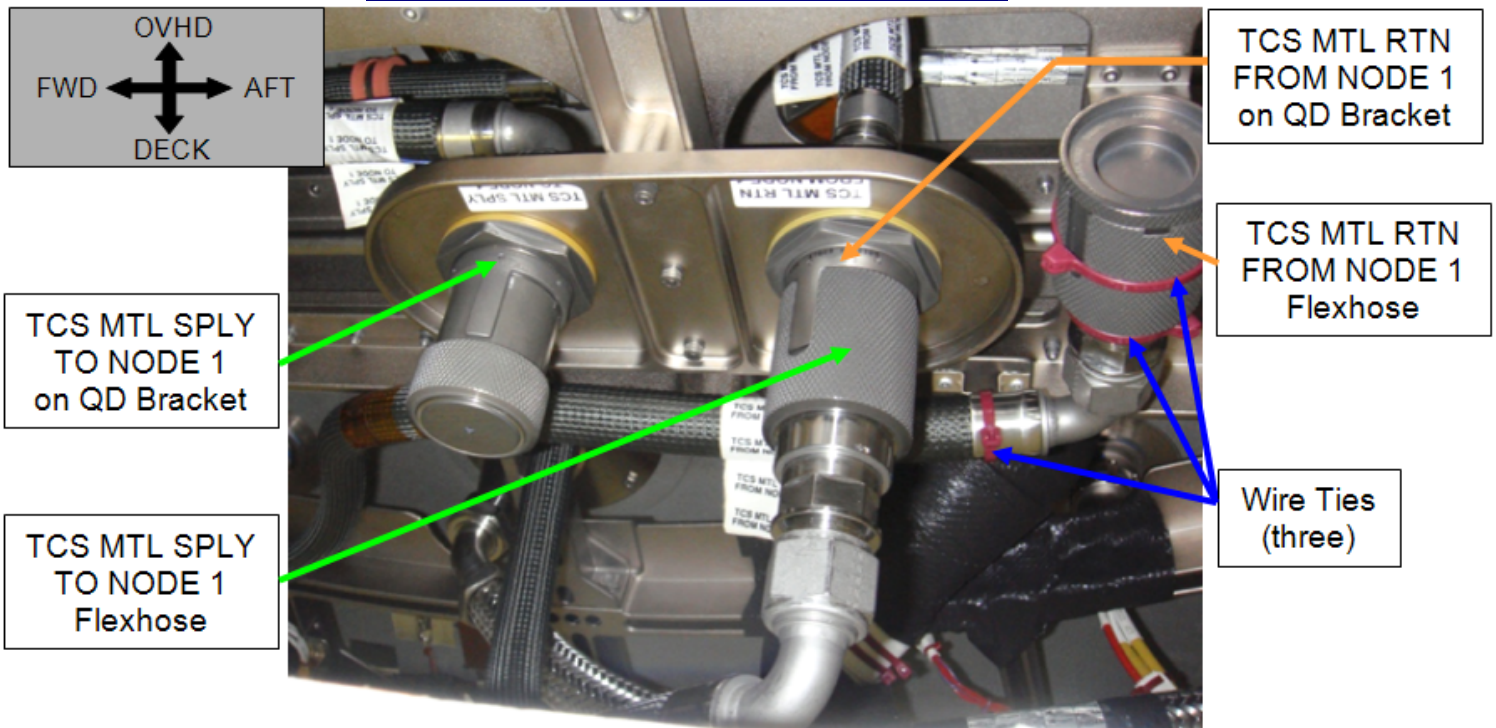

Figure 18.- Node 3 ITCS MTL QDs (looking Deck Starboard).

- 28.1 TCS MTL SPLY TO NODE 1 Flexhose ←|→ TCS MTL RTN FROM NODE 1 on QD Bracket
Refer to Figures 17 and 18.

NOTE

1. Refer to Figures 17, 18, and 19 for step 28.
2. PWR S/N 1034 and associated jumpers shown in Figure 19 will not be connected until step 30.

1.140 CUPOLA AND NODE 3/NODE 1 ITCS FILL USING FSS

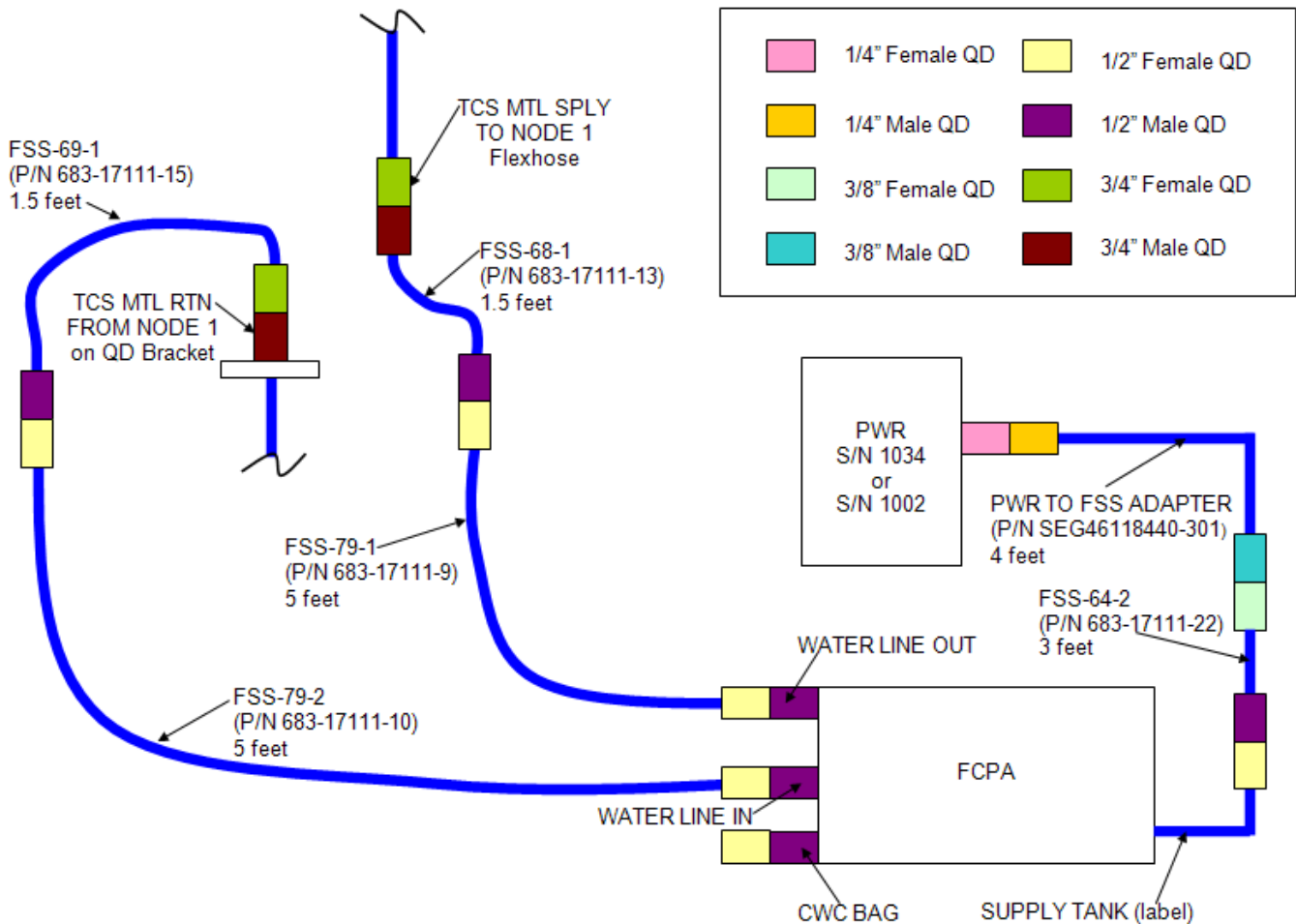

Figure 19.- FSS and Jumper Configuration for Node 3-Node 1 ITCS Fill.

28.2 Disconnecting FSS Jumpers

FSS-68-1 ←|→ FSS-69-1

28.3 √FSS-79-1 →|← WATER LINE OUT

√FSS-79-1 →|← FSS-68-1

28.4 √FSS-79-2 →|← WATER LINE IN

√FSS-79-2 →|← FSS-69-1

28.5 FSS-68-1 →|← TCS MTL SPLY TO NODE 1 Flexhose

FSS-69-1 →|← TCS MTL RTN FROM NODE 1 on QD Bracket

29. PURGING NODE 3/NODE 1 ITCS MTL LINES

FCPA

29.1 MODE SELECTION VALVE ↻ PURGE/FILL

29.2 MV2 → OPEN

29.3 Purge until PG-1 is in blue arc for 30 seconds.
This action should take less than 15 minutes.

1.140 CUPOLA AND NODE 3/NODE 1 ITCS FILL USING FSS

(ASSY OPS/20A/FIN 1) Page 29 of 45 pages

Record PG1 pressure: _____ in Hg

Record PG2 pressure: _____ in Hg

* If blue arc is not reached for 30 seconds within 15 minutes
* MODE SELECTION VALVE ↶ INACT, then:
*
* MODE SELECTION VALVE ↶ DRAIN
*
* Drain until PG-1 is in yellow range for 30 seconds.
*
* MV2 → CLOSE
*
* Drain an additional 2 minutes.
*
* MODE SELECTION VALVE ↶ INACT
*
* Restart procedure from step 29.1.
* Notify **MCC-H**.

29.4 MV2 → CLOSE

29.5 MODE SELECTION VALVE ↶ INACT

30. CONNECTING PAYLOAD WATER RESERVOIR (PWR)

30.1 FSS-64-2 →|← SUPPLY TANK on FCPA
FSS-64-2 →|← PWR TO FSS ADAPTER

30.2 PWR TO FSS ADAPTER →|← PWR S/N 1034
Refer to Figure 19.

31. FILLING AND RECIRCULATING NODE 3/NODE 1 ITCS MTL LINES

CAUTION

While in DRAIN, FILL, RECIRC mode (FSS Pump is on), PG1 (Pump Outlet Pressure) must be monitored to ensure FSS and ITCS lines do not become over pressurized.

31.1 MODE SELECTION VALVE ↶ PURGE/FILL

31.2 MV2 → OPEN

1.140 CUPOLA AND NODE 3/NODE 1 ITCS FILL USING FSS

(ASSY OPS/20A/FIN 1) Page 30 of 45 pages

31.3 MV1 → FILL (FCPA pump will turn ON)

```
*****
* If PG1 pressure > 40 psig
* | sw FSS MAIN POWER → OFF
* |
* | √MCC-H for further instructions
*****

*****
* If PWR S/N 1034 appears empty
* | MV1 → BYPASS (FCPA pump will turn OFF)
* |
* | MODE SELECTION VALVE ↶ to INACT
* |
* | Notify MCC-H.
* |
* | PWR TO FSS ADAPTER ←|→ PWR S/N 1034
* | PWR TO FSS ADAPTER →|← PWR S/N 1002
* |
* | MODE SELECTION VALVE ↶ PURGE/FILL
* |
* | MV1 → FILL (FCPA pump will turn ON)
*****
```

Wait 10 minutes.

Record PG1 pressure: _____ psig
Record PG2 pressure: _____ psig

31.4 MV1 → BYPASS (FCPA pump will turn OFF)

31.5 MODE SELECTION VALVE ↶ RECIRC (FCPA pump will turn ON)

```
*****
* If PG1 pressure > 40 psig
* | sw FSS MAIN POWER → OFF
* |
* | √MCC-H for further instructions
*****
```

Recirculate for 5 minutes.

Record PG1 pressure: _____ psig
Record PG2 pressure: _____ psig

31.6 MODE SELECTION VALVE ↶ INACT (FCPA pump will turn OFF)

31.7 MV2 → CLOSE

31.8 Notify MCC-H of quantity of coolant remaining in PWR S/N 1034, 1002.

1.140 CUPOLA AND NODE 3/NODE 1 ITCS FILL USING FSS

(ASSY OPS/20A/FIN 1) Page 31 of 45 pages

32. DISCONNECTING FSS FROM NODE 3 ITCS MTL QDS

- 32.1 FSS-68-1 →|← TCS MTL SPLY TO NODE 1 Flexhose
FSS-69-1 →|← TCS MTL RTN FROM NODE 1 on QD Bracket

33. DISCONNECTING FSS-402-1 FROM NODE 1 MOD KIT TCS JUMPERS

- NOD1P1 33.1 FSS-402-1 ←|→ TO: NOD1 FORWARD MTL RETURN on NOD1 MTL RETURN HOSE
3/4" QD Plug (from step 26.3) →|← TO: NOD1 FORWARD MTL RETURN on NOD1 MTL RETURN HOSE

- 33.2 FSS-402-1 ←|→ TO: NOD1 FORWARD MTL SUPPLY on NOD1 MTL SUPPLY HOSE
3/4" QD Plug (from step 26.3) →|← TO: NOD1 FORWARD MTL SUPPLY on NOD1 MTL SUPPLY HOSE

- 33.3 3/4" QD Cap (from step 16.5) →|← FSS-402-1

34. RECONFIGURING NODE 3 ITCS MTL QDS

- NOD3D6 34.1 √ **MCC-H** to verify Node 3 MTL Stbd RFCA closed

34.2 **On MCC-H GO**

- 3/4" QD Cap ←|→ TCS MTL SPLY TO NODE 1 on QD Bracket
TCS MTL SPLY TO CUPOLA Flexhose →|← TCS MTL SPLY TO CUPOLA on QD Bracket
Refer to Figures 17 and 18.

- 34.3 Cut Wire Ties (three) securing TCS MTL RTN FROM NODE 1 Flexhose to structure (Wire Cutters).
Refer to Figure 18.

- 34.4 3/4" QD Plug ←|→ TCS MTL RTN FROM NODE 1 Flexhose
TCS MTL RTN FROM NODE 1 Flexhose →|← TCS MTL RTN FROM NODE 1 on QD Bracket
Refer to Figures 17 and 18.

- 34.5 3/4" QD Cap (from step 34.2) →|← FSS-402-1
Stow 3/4" QD Plug (from step 34.4).

- 34.6 ISS ↓ **MCC-H**, "Node 3 ITCS QD reconfiguration complete."

35. INSTALLING NODE 3 STARBOARD ENDCONE CLOSEOUT PANELS

- NOD3D6 35.1 Install NOD3D6-51 Closeout Panel, fasteners (ten) (Ratchet, 3/8" Drive; 5/32" Hex Head, 3/8" Drive).
Refer to Figure 16.

- 35.2 EELS Power Cable →|← J1ELS-2
Refer to Figure 17.

1.140 CUPOLA AND NODE 3/NODE 1 ITCS FILL USING FSS

(ASSY OPS/20A/FIN 1) Page 32 of 45 pages

35.3 Install NOD3D6-52 Closeout Panel, fasteners (two) (Ratchet, 3/8" Drive; 5/32" Hex Head, 3/8" Drive).
Refer to Figure 16.

36. RELABELING QD1T11 AND QD1T12 IN NODE 1 PORT ALCOVE

NOTE

During ULF-3, NOD1 MTL RETURN HOSE was mated to QD1T11 and NOD1 MTL SUPPLY HOSE was mated to QD1T12. Neither hose is installed in Figure 20.

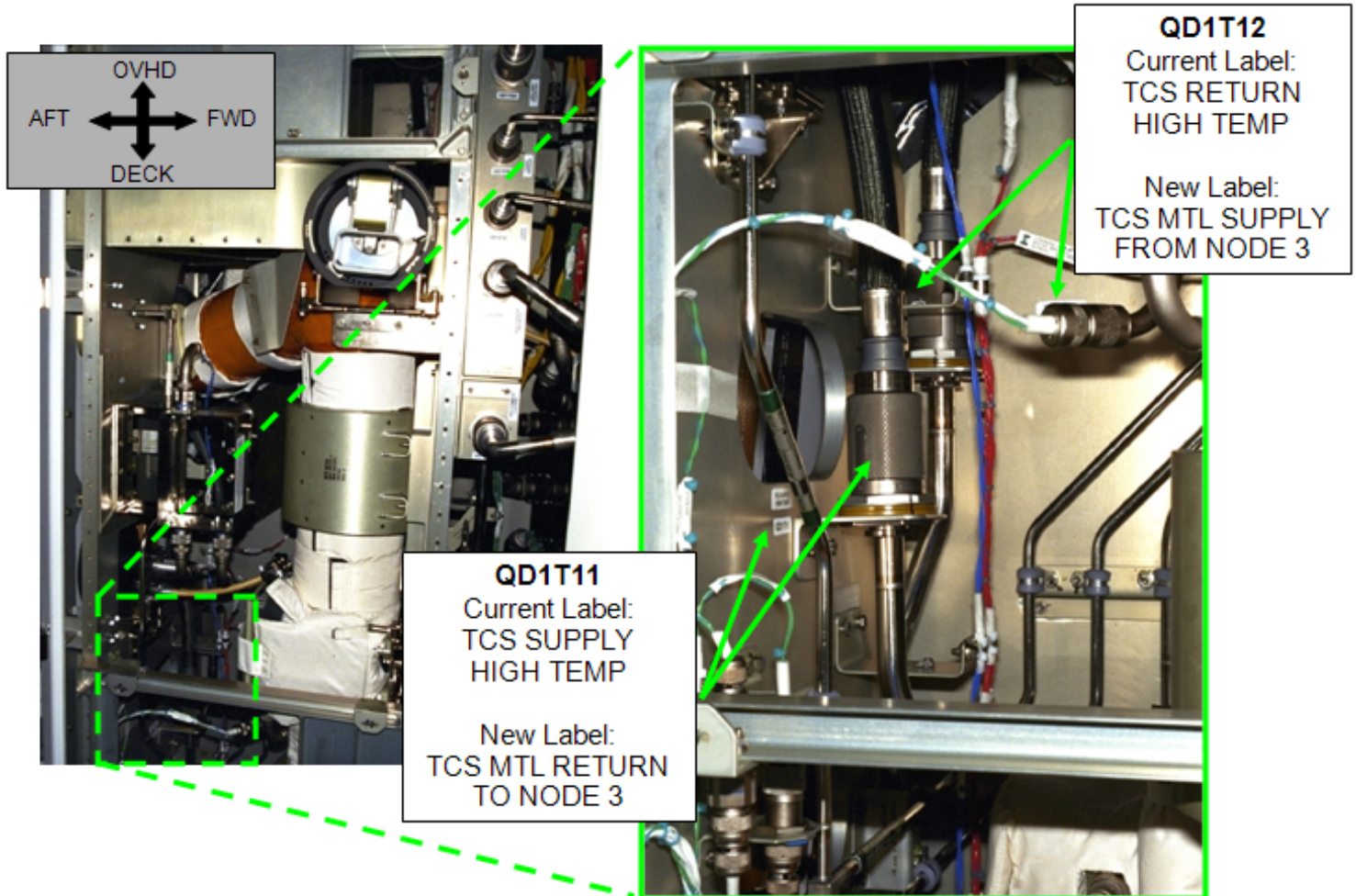

Figure 20.- QD1T11 and QD1T12 in Node 1 Port Alcove.

NOTE

New labels were flown with 20A Vestibule Outfitting hardware. If MTL Supply and MTL Return labels are not found, new labels can be fabricated using the Label Maker.

1.140 CUPOLA AND NODE 3/NODE 1 ITCS FILL USING FSS

(ASSY OPS/20A/FIN 1) Page 33 of 45 pages

NOD1P1 36.1 Cover current TCS labels (Aluminum Tape).
Install new TCS MTL SUPPLY FROM NODE 3 (one), TCS MTL
RETURN TO NODE 3 (one) labels.
Refer to Figure 20.

36.2 Photo document newly installed labels (Digital Camera).

37. RECONFIGURING NODE 1/AIRLOCK FROM LAB TO NODE 3

NOTE

Cooling will be lost to the hardware in the Node 1 and Airlock when Node 1 MTL Rack Flow Control Assembly (RFCA) closed in step 37.2. Cooling is restored after the completion of step 37.7.

37.1 ISS ↓ **MCC-H**, "Ready to close Node 1 MTL RFCA."

CAUTION

Both Flexhoses must be demated from QD1T03 and QD1T04 prior to mating NOD1 MTL SUPPLY HOSE and NOD1 MTL RETURN HOSE to prevent cross-strapping Node 3 and LAB.

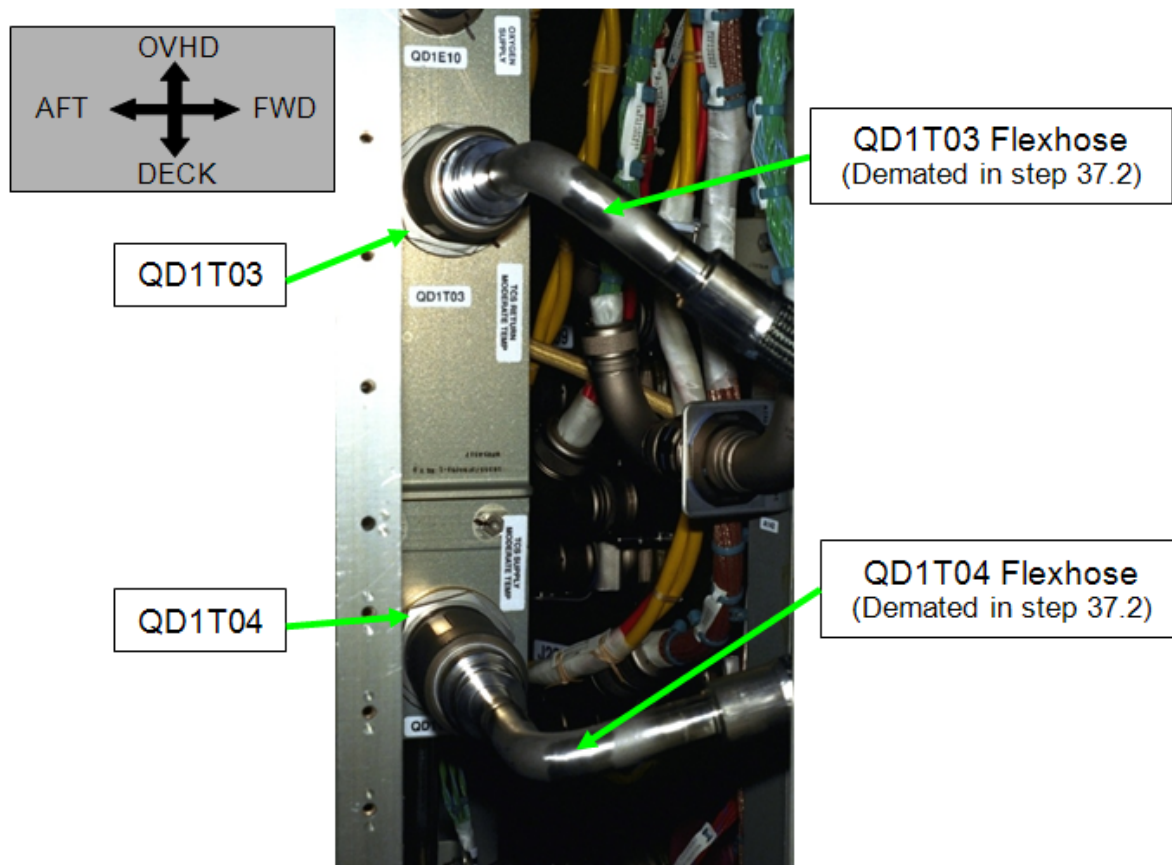

Figure 21.- Node 1 Port Alcove ITCS QD Panel.

1.140 CUPOLA AND NODE 3/NODE 1 ITCS FILL USING FSS

(ASSY OPS/20A/FIN 1) Page 34 of 45 pages

NOD1P1 37.2 Demating QD Flexhoses from ITCS QD Panel

On MCC-H GO,

QD1T03 Flexhose ←|→ QD1T03

QD1T04 Flexhose ←|→ QD1T04

Refer to Figure 21.

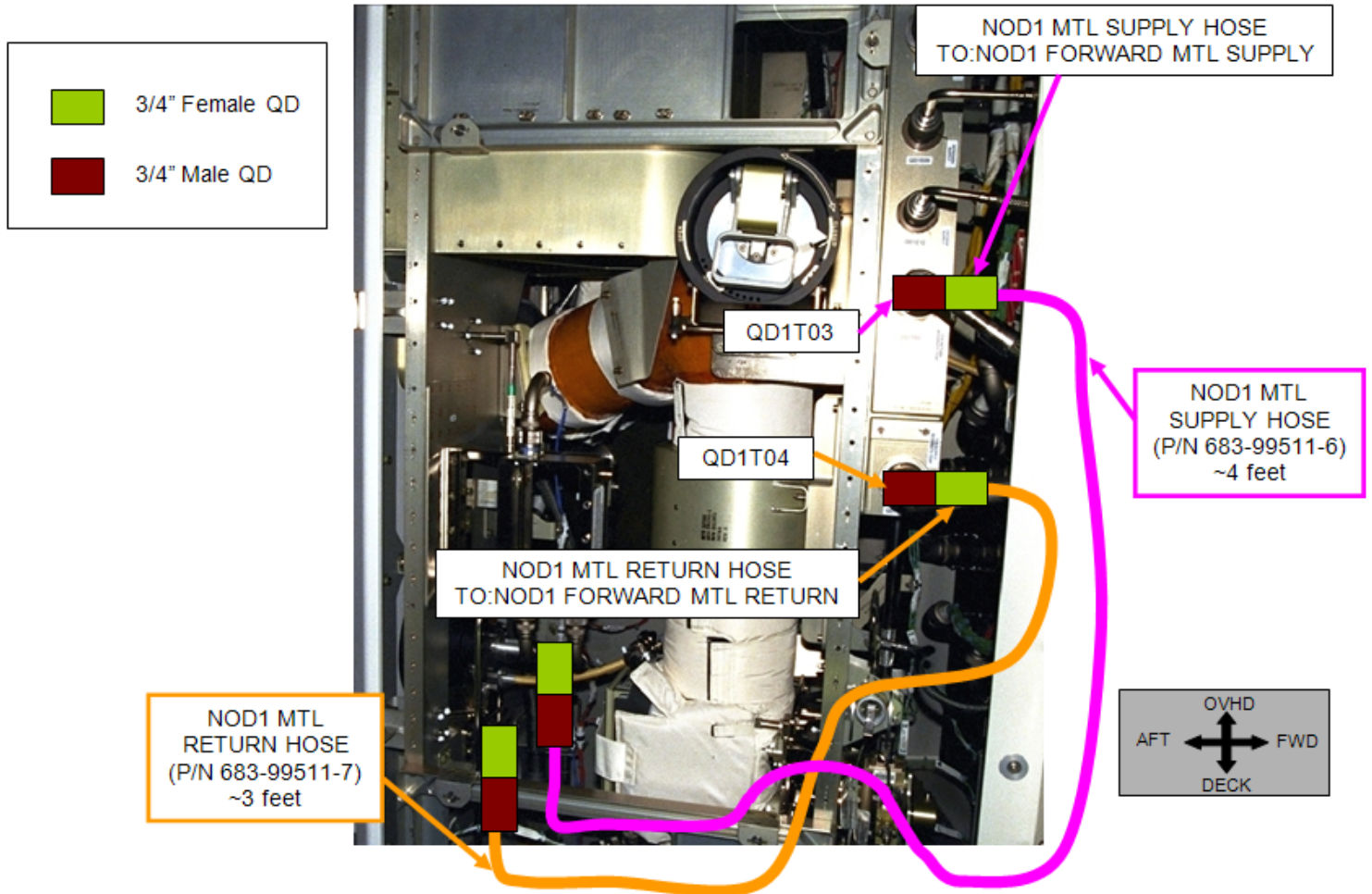

Figure 22.- Node 1 MTL Hose Final Configuration.

37.3 Removing 1/2" QD Plugs from Node 1 MTL Hoses

3/4" QD Plug ←|→ TO: NOD1 FORWARD MTL RETURN on NOD1

MTL RETURN HOSE →|← QD1T04

3/4" QD Plug ←|→ TO: NOD1 FORWARD MTL SUPPLY on NOD1
MTL SUPPLY HOSE

Refer to Figure 22.

37.4 Installing 1/2" QD Plugs on Demated QD Flexhoses

3/4" QD Plug →|← QD1T03 Flexhose

3/4" QD Plug →|← QD1T04 Flexhose

1.140 CUPOLA AND NODE 3/NODE 1 ITCS FILL USING FSS

(ASSY OPS/20A/FIN 1) Page 35 of 45 pages

- 37.5 Mating Node 1 MTL Supply Hose to ITCS QD Panel
TO: NOD1 FORWARD MTL SUPPLY on NOD1 MTL SUPPLY HOSE
→|← QD1T03
Refer to Figure 22.
- 37.6 Mating Node 1 MTL Return Hose to ITCS QD Panel
TO: NOD1 FORWARD MTL RETURN on NOD1 MTL RETURN HOSE
→|← QD1T04
Refer to Figure 22.
- 37.7 ISS ↓ **MCC-H**: “Node 1 ITCS QD reconfiguration complete. Ready to open Node 1 MTL RFCA and initiate Node 3 ITCS flow.”
- 37.8 Secure disconnected QD Flexhoses (two) to structure.

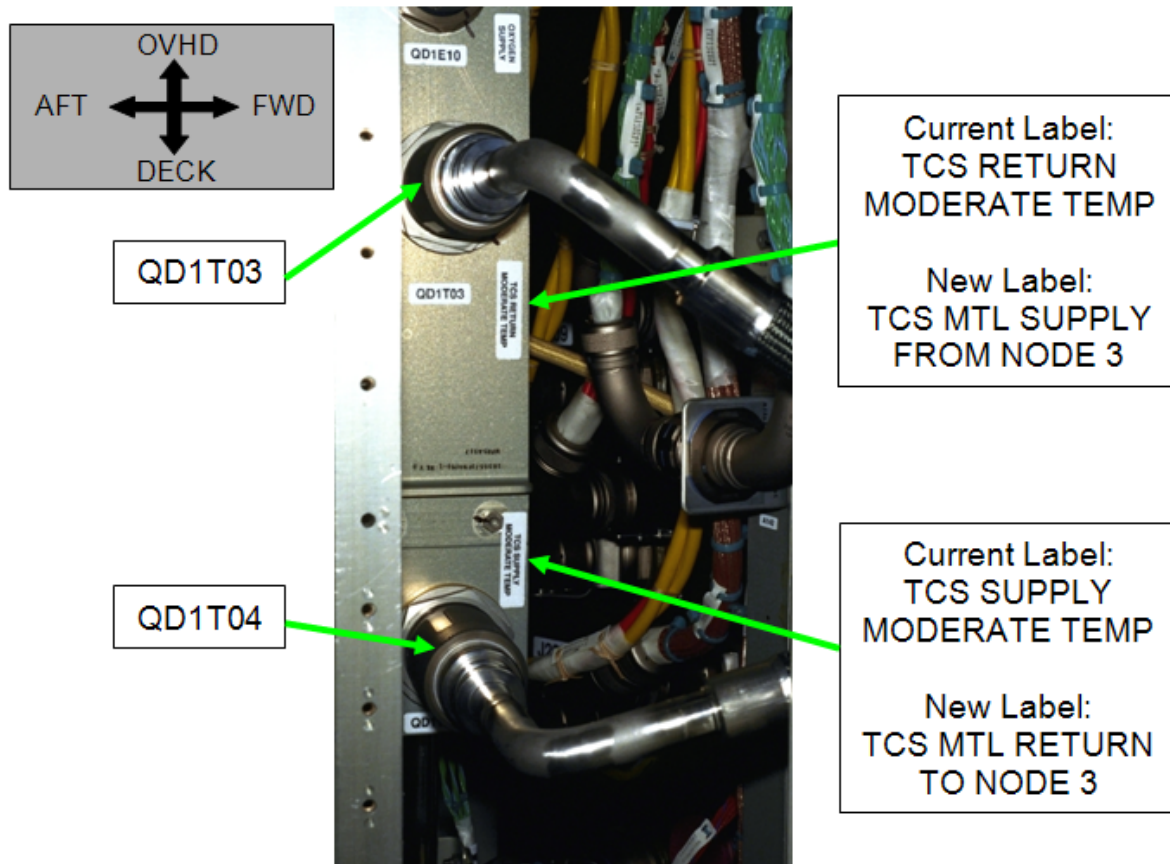

Figure 23.- Node 1 ITCS MTL QDs in Node 1 Port Alcove.

NOTE

New labels were flown with 20A Vestibule Outfitting hardware. If MTL Supply and MTL Return labels are not found, new labels can be fabricated using the Label Maker.

1.140 CUPOLA AND NODE 3/NODE 1 ITCS FILL USING FSS

(ASSY OPS/20A/FIN 1) Page 36 of 45 pages

37.9 Cover current TCS labels (Aluminum Tape).
Install new TCS MTL SUPPLY FROM NODE 3 (one) and TCS MTL
RETURN TO NODE 3 (one) labels.
Refer to Figure 23.

37.10 Photo document newly installed labels (Digital Camera).

38. INSTALLING NODE 1 PORT ALCOVE CLOSEOUT PANEL

38.1 Install Closeout Panel NOD1P1-01, fasteners (twelve) (Ratchet, 3/8"
Drive; 5/32" Hex Head, 3/8" Drive).
Refer to Figure 14.

39. SAFING FSS (IF REQUIRED)

39.1 sw FSS MAIN POWER → OFF

39.2 Verifying FSS Power and Valve Positions:

√MODE SELECTION VALVE	- INACT
√MV1	- BYPASS
√MV2	- CLOSE
√MV3	- DF1/SUPPLY

39.3 Gamah Cap →|← AIR EXIT on FCPA, hand tighten.
Refer to Figures 1 and 2.

PCS

39.4 Closing VRIV

Node 3: ECLSS: PCA

Node 3 ACS

'Pressure Control Assembly'

sel VRIV (Icon)

Node 3 PCA VRIV

'Close'

cmd Close (Verify Position – Closed)

39.5 Enabling Positive Pressure Relief (PPR)

Node 3: ECLSS: PCA: PCA Commands

Node 3 PCA Commands

'Positive Press Relief'

'Enable'

cmd Enable (Verify Positive Pressure Relief State – Enabled)

1.140 CUPOLA AND NODE 3/NODE 1 ITCS FILL USING FSS

(ASSY OPS/20A/FIN 1) Page 37 of 45 pages

- MCC-H** 39.6 Enabling Node 3 PPR Failure Caution
C&W Summ
Caution & Warning Summary
'Event Code Tools'

sel Enable

Enable an Event

input Event Code – 1 7 0 5 3 ('Positive P Relief Failure - Node 3')

cmd Execute
- NOD3F0** 39.7 Disconnecting from Node 3 Vacuum Access Port:
VAJ-83-1 35 ft ←|→ PCA Vacuum Access Port
Verify Gamah Cap seal free from FOD, damage.
Gamah Cap →|← VAJ-83-1 35 ft
- 39.8 Verify PCA Vacuum Access Port Gamah Cap seal free from FOD,
damage.
Gamah Cap →|← PCA Vacuum Access Port
- 39.9 Install Closeout Panel NOD3F0-03, fasteners (thirteen) (Ratchet, 3/8"
Drive; 5/32" Hex Head, 3/8" Drive).
- 39.10 Install Closeout Panel NOD3F0-02, fasteners (four) (Ratchet,
3/8" Drive; 5/32" Hex Head, 3/8" Drive).
- 39.11 ISS ↓ **MCC-H**, "FSS safing complete."
- FCPA** 40. RECONFIGURING FOR FSS OPS (IF REQUIRED)
40.1 Verifying FSS Power and Valve Positions:
√sw FSS MAIN POWER – OFF
√MODE SELECTION VALVE – INACT
√MV1 – BYPASS
√MV2 – CLOSE
√MV3 – DF1/SUPPLY
- 40.2 Gamah Cap ←|→ AIR EXIT on FCPA
Refer to Figures 1 and 2.

1.140 CUPOLA AND NODE 3/NODE 1 ITCS FILL USING FSS

(ASSY OPS/20A/FIN 1) Page 38 of 45 pages

- PCS 40.3 Verifying Vent and Relief Isolation Valve (VRIV), Vent and Relief Control Valve (VRCV) Closed
Node 3: ECLSS: PCA
 Node 3 ACS
'Pressure Control Assembly'
- sel VRCV (Icon)
- Node 3 PCA VRCV
- Verify Position – Closed
- Node 3: ECLSS: PCA
 Node 3 ACS
'Pressure Control Assembly'
- sel VRIV (Icon)
- Node 3 PCA VRIV
- Verify Position – Closed
- NOD3F0 40.4 Remove Closeout Panel NOD3F0-03, fasteners (thirteen) (Ratchet, 3/8" Drive; 5/32" Hex Head, 3/8" Drive).
- 40.5 Remove Closeout Panel NOD3F0-02, fasteners (four) (Ratchet, 3/8" Drive; 5/32" Hex Head, 3/8" Drive).
- 40.6 Gamah Cap ←|→ PCA Vacuum Access Port
Temporarily stow Gamah Cap.
- 40.7 Verify VAJ seal free from damage, debris on bent end of VAJ-83-1 35 ft.
- 40.8 VAJ-83-1 35 ft (bent end) →|← PCA Vacuum Access Port, hand tighten
Restrain VAJ-83-1 35 ft per crew preference.

1.140 CUPOLA AND NODE 3/NODE 1 ITCS FILL USING FSS

(ASSY OPS/20A/FIN 1) Page 39 of 45 pages

MCC-H 40.9 Suppressing Node 3 PPR Failure Caution C&W Summ

Caution & Warning Summary

'Event Code Tools'

sel Suppress

Suppress Annunciation of an Event

input Event Code – 1 7 0 5 3 ('Positive P Relief Failure - Node 3')

cmd Arm

cmd Execute

NOTE

The following Caution message will be received after PPR is inhibited: '**Positive P Relief Failure - Node 3**'

No action required. This message will return to normal once PPR is re-enabled.

PCS 40.10 Disabling Positive Pressure Relief Node 3: ECLSS: PCA: PCA Commands

Node 3 PCA Commands

'PCA'

Verify State – Monitor

'Positive Pressure Relief'

'Inhibit'

cmd Arm (Verify Status – Armed)

cmd Inhibit (Verify Positive Pressure Relief Status – Inhibited)

40.11 Opening Vacuum Relief Isolation Valve (VRIV)

Node 3: ECLSS: PCA

Node 3 ACS

'Pressure Control Assembly'

sel VRIV (Icon)

Node 3 PCA VRIV

'Open'

cmd Arm (Verify Status – Armed)

cmd Open (Verify Position – Open)

40.12 sw FSS MAIN POWER → ON

1.140 CUPOLA AND NODE 3/NODE 1 ITCS FILL USING FSS

(ASSY OPS/20A/FIN 1) Page 40 of 45 pages

41. CONFIGURING PWR FOR DRAINING FSS AND FSS JUMPERS

NOTE
Refer to Figure 24 for step 41.

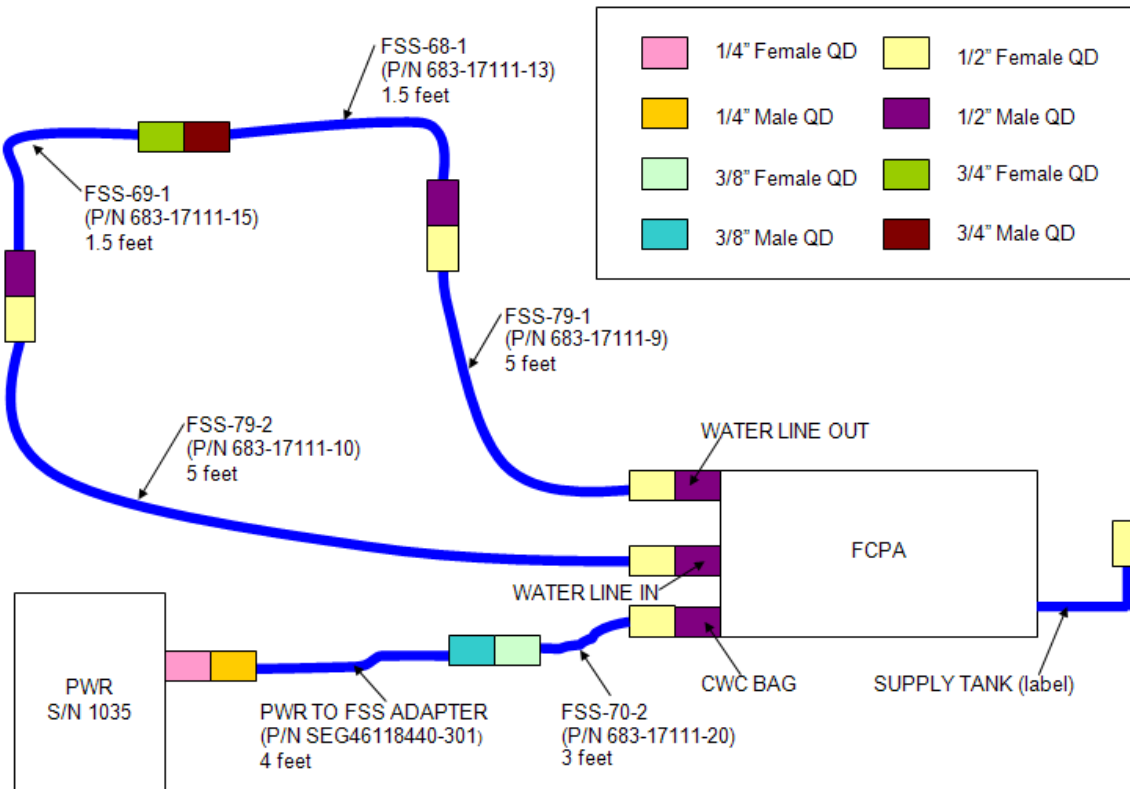

Figure 24.- FSS and FSS Jumper Drain and Purge Setup.

- FCPA
- 41.1 FSS-64-2 ←|→ SUPPLY TANK on FCPA
FSS-64-2 ←|→ PWR TO FSS ADAPTER
PWR S/N 1034 or 1002 ←|→ PWR TO FSS ADAPTER
 - 41.2 If required, label FSS-64-2, "WET" (Gray Tape, Sharpie).
 - 41.3 FSS-70-2 →|← CWC BAG on FCPA
PWR TO FSS ADAPTER →|← FSS-70-2
PWR TO FSS ADAPTER →|← PWR S/N 1035
 - 41.4 FSS-68-1 →|← FSS-69-1
√FSS-68-1 →|← FSS-79-1
√FSS-69-1 →|← FSS-79-2
√FSS-79-1 →|← WATER LINE OUT
√FSS-79-2 →|← WATER LINE IN

1.140 CUPOLA AND NODE 3/NODE 1 ITCS FILL USING FSS

(ASSY OPS/20A/FIN 1) Page 41 of 45 pages

42. DRAINING FSS AND FSS JUMPERS

CAUTION
1. While in DRAIN, FILL, RECIRC mode (FSS Pump is on), PG1 (Pump Outlet Pressure) must be monitored to ensure FSS and ITCS lines do not become over pressurized.
2. PWR S/N 1035 must be monitored to avoid overfilling during DRAIN operations. If PWR S/N 1035 appears to approach the full point, MODE SELECTION VALVE should be rotated to INACT.

42.1 MV2 → OPEN

42.2 MODE SELECTION VALVE ↻ DRAIN (FCPA pump will turn ON)

42.3 Drain until PG-1 is in yellow range for 1 minute.

```
*****
* If PWR S/N 1035 appears to be approaching full
* | MODE SELECTION VALVE ↻ INACT
* |
* | √MCC-H for further instructions
* |
* If PG1 pressure > 40 psig
* | sw FSS MAIN POWER → OFF
* |
* | √MCC-H for further instructions
*****
```

42.4 MV2 → CLOSE

Drain for an additional 2 minutes.

43. PURGING FSS AND FSS JUMPERS FOR STOWAGE

43.1 MODE SELECTION VALVE ↻ PURGE/FILL
(FCPA pump will turn OFF)

43.2 MV2 → OPEN

1.140 CUPOLA AND NODE 3/NODE 1 ITCS FILL USING FSS

(ASSY OPS/20A/FIN 1) Page 42 of 45 pages

- 43.3 Purge until PG-1 is in blue arc for 30 seconds.
This action should take less than 20 minutes.

Record PG1 pressure: _____ in Hg

Record PG2 pressure: _____ in Hg

* If blue arc is not reached for 30 seconds within 20 minutes
* MODE SELECTION VALVE ↻ INACT, then:

*

* MODE SELECTION VALVE ↻ DRAIN

*

* Drain until PG-1 is in yellow range for 30 seconds.

*

* If PWR S/N 1035 appears to be approaching full

* | MODE SELECTION VALVE ↻ INACT

*

* | √MCC-H for further instructions

*

* MV2 → CLOSE

*

* Drain an additional 2 minutes.

*

* If PWR S/N 1035 appears to be approaching full

* | MODE SELECTION VALVE ↻ INACT

*

* | √MCC-H for further instructions

*

* MODE SELECTION VALVE ↻ INACT

*

* Restart procedure from step 43.1.

* Notify MCC-H.

43.4 MV2 → CLOSE

43.5 MODE SELECTION VALVE ↻ INACT

43.6 Gamah Cap →|← AIR EXIT on FCPA, hand tighten

43.7 sw FSS MAIN POWER → OFF

44. DEMATING POWER CABLES

NOD3
UOP2
(NOD3A6)

44.1  POWER OUT – RESET (illuminated)

√FAULT/TEST – not illuminated

1.140 CUPOLA AND NODE 3/NODE 1 ITCS FILL USING FSS

(ASSY OPS/20A/FIN 1) Page 43 of 45 pages

44.2 Disconnecting Power Cables

PS-120 CABLE (P2) TO 120 VDC LOAD on PS-120 Cable ←|→ J201
on FCPA

P2 TO 120 VDC POWER PLUG on PEEK, 120 VDC 12 AMP 20'

Extension Cable ←|→ PS-120 CABLE (P1) TO 120 VDC POWER
OR 1553 DATA SOURCE on PS-120 Cable

P1 TO 120 VDC POWER RCPT on PEEK, 120 VDC 12 AMP 20'

Extension Cable ←|→ NOD3 UOP2 J4

NOD3
UOP2
(NOD3A6)

44.3 POWER OUT – (green ENABLE)

FAULT/TEST – (green OK)

45. DISCONNECTING FROM VACUUM SOURCE

PCS

45.1 Closing VRIV

Node 3: ECLSS: PCA

'Pressure Control Assembly'

sel VRIV (Icon)

'Close'

cmd Close (Verify Position – Closed)

45.2 Enabling Positive Pressure Relief (PPR)

Node 3: ECLSS: PCA: PCA Commands

'Positive Press Relief'

'Enable'

cmd Enable (Verify Positive Pressure Relief State – Enabled)

MCC-H

45.3 Enabling Node 3 PPR Failure Caution

C&W Summ

'Event Code Tools'

sel Enable

input Event Code – 1 7 0 5 3 ('Positive P Relief Failure - Node 3')

cmd Execute

1.140 CUPOLA AND NODE 3/NODE 1 ITCS FILL USING FSS

(ASSY OPS/20A/FIN 1) Page 44 of 45 pages

- FCPA 45.4 VAJ-83-1 35 ft (straight end) ←|→ VAJ CONNECTION on FCPA
- NOD3F0 45.5 Disconnecting from Node 3 Vacuum Access Port
VAJ-83-1 35 ft ←|→ PCA Vacuum Access Port
Verify Gamah Cap seal free from FOD, damage.
Gamah Cap →|← VAJ-83-1 35 ft
- 45.6 Verify PCA Vacuum Access Port Gamah Cap seal free from FOD, damage.
Gamah Cap →|← PCA Vacuum Access Port
- 45.7 Gamah Cap →|← VAJ-83-1 35 ft (both ends)
Hand tighten.
- 45.8 Install Closeout Panel NOD3F0-03, fasteners (thirteen) (Ratchet, 3/8" Drive; 5/32" Hex Head, 3/8" Drive).
- 45.9 Install Closeout Panel NOD3F0-02, fasteners (four) (Ratchet, 3/8" Drive; 5/32" Hex Head, 3/8" Drive).
- FCPA 46. DISCONNECTING AND STOWING FSS AND JUMPERS
- 46.1 Disconnecting All FSS Jumpers
FSS-79-1 ←|→ WATER LINE OUT
FSS-79-1 ←|→ FSS-68-1
FSS-69-1 ←|→ FSS-68-1
FSS-69-1 ←|→ FSS-79-2
FSS-79-2 ←|→ WATER LINE IN
- 46.2 If required, remove "WET" labels from FSS-79-1, FSS-79-2.
- 46.3 Disconnecting PWR
FSS-70-2 ←|→ CWC BAG QD on FCPA
FSS-70-2 ←|→ PWR TO FSS ADAPTER
PWR TO FSS ADAPTER ←|→ PWR S/N 1035
- Place Ziplock Bag over 1/4" QD on PWR TO FSS ADAPTER, secure with Kapton Tape.
- 46.4 If required, label FSS-70-2, "WET" (Gray Tape, Sharpie).
- 46.5 Notify **MCC-H** of the status of PWR S/N 1035, S/N 1034, S/N 1002.
- 46.6 Untether FCPA from Handrails.
- LAB106 46.7 Remove triangular restraint bracket.
Slide FCPA into LAB106 Rack.
Install triangular restraint bracket, and hand-tighten one bolt.
- 46.8 Reinstall Beta Cloth Closeout FSS stowage area (Velcro).

1.140 CUPOLA AND NODE 3/NODE 1 ITCS FILL USING FSS

(ASSY OPS/20A/FIN 1) Page 45 of 45 pages

- 46.9 Stow all FSS jumpers, VAJ-83-1 35 ft, and 3/4" QD Plugs (two).
- 46.10 Remove Handrails and Adjustable Length Tether, then stow.
- 46.11 Check for FOD around work area within 1 m radius.
- 46.12 Notify **MCC-H** of task completion and all recorded values.

This Page Intentionally Blank

1.150 WRS-1 & WRS-2 RACK TRANSFER LAB TO NOD3

(ASSY OPS/20A/FIN 2) Page 1 of 18 pages

OBJECTIVE:

Transfer WRS-1 and WRS-2 (Water Recovery System) Racks from LAB1D4 and LAB1P4 to NOD3D5 and NOD3D4. This transfer activity demates all Rack umbilicals, releases K-BARs and Pivot Mechanisms, transfers each rack from the LAB and then structurally attaches each Rack in Node 3. Rack umbilicals are mated in a separate procedure.

LOCATION:

Start: LAB1D4 (LAB1P4)

Finish: NOD3D5 (NOD3D4)

DURATION:

3 hours, 25 minutes

40 minutes – Rack transfer prep

1 hour, 25 minutes – umbilical demate

80 minutes – Rack transfers

CREW:

Two (second crewmember required for transfer only)

PARTS:

Ziplock Bag labeled "WRS1 O₂ Caps/Plugs"

Ziplock Bag labeled "WRS1 Potable Water Caps/Plugs"

Ziplock Bag labeled "WRS2 Waste Water Caps/Plugs"

Ziplock Bag labeled "WRS Process Water Caps/Plugs"

Ziplock Bag labeled "WRS TCS Caps/Plugs"

Ziplock Bag labeled "WRS Pwr/Data Caps"

QD Plug (four) P/N 683-16348-813

MATERIALS:

Ziplock Bag

Gray Tape

Kapton Tape

Dry Wipes

Clean Room Gloves

Empty 3.0 CTB

AMP Pallet 3 (A3) P/N SEG52101140-301 (if required)

Povidone Iodine Pads (P/N 68548)

Regen ECLSS Tox-2 PPE Kit (P/N SEG42103702-302):

Surgical Mask

Safety Goggles

Silver Shield Gloves

1.150 WRS-1 & WRS-2 RACK TRANSFER LAB TO NOD3

(ASSY OPS/20A/FIN 2) Page 2 of 18 pages

TOOLS:

Digital Camera

ISS IVA Toolbox:

Drawer 2:

- Ratchet, 3/8" Drive
- 9/16" Socket, 3/8" Drive
- (40-200 in-lbs) Trq Wrench, 3/8" Drive
- Ratchet, 1/4" Drive
- 5/16" Socket, 1/4" Drive

Drawer 3:

- 6" Long, 3/8" Hex Head, 3/8" Drive

Drawer 4:

- Wire Cutters
- Adjustable Joint Pliers, Straight Jaw

Drawer 5:

- Static Wrist Tether

NOTE

All directional references (up, down, left, right) are with respect to front face of Rack, as you face Rack, with feet oriented towards the pivot point.

1. RACK TRANSFER PREPARATION

1.1 ✓All unnecessary equipment protruding into Rack translation path has been removed, stowed (LAB, Node 1, Node 3)

NOD3D5

1.2 ✓ARIS Pivot Fitting Bottom Left (inside) (P/N 683-61711-31) installed on lower Standoff
✓K-BAR Capture Mechanisms (two) installed on upper Standoff link



Figure 1.- NOD3D5, WRS-1 Umbilicals in Launch Restraints.

1.150 WRS-1 & WRS-2 RACK TRANSFER LAB TO NOD3

(ASSY OPS/20A/FIN 2) Page 3 of 18 pages

NOTE

Utilities restrained on Node 3 Standoff need to be released to prevent interference with Rack during installation.

- 1.3 Release Umbilicals from Launch Restraints by cutting Zip Ties (two per umbilical) (Wire Cutters).
Release Ground Strap by cutting Zip Ties (two).
Refer to Figure 1.



Figure 2.- NOD3D4, WRS-2 Umbilicals in Launch Restraints.

- NOD3D4 1.4 Repeat steps 1.2 and 1.3 for second Rack bay.
Refer to Figure 2.
- LAB1P4 1.5 Restrain PWD Galley Supply Hose to LAB1P3 Rack, out of LAB1P4
rotation path.
- 1.6 Perform [1.291 WRS ACCESS](#), steps 2, 5 to 7 (SODF: S&M
NOMINAL: RACK), then:

1.150 WRS-1 & WRS-2 RACK TRANSFER LAB TO NOD3

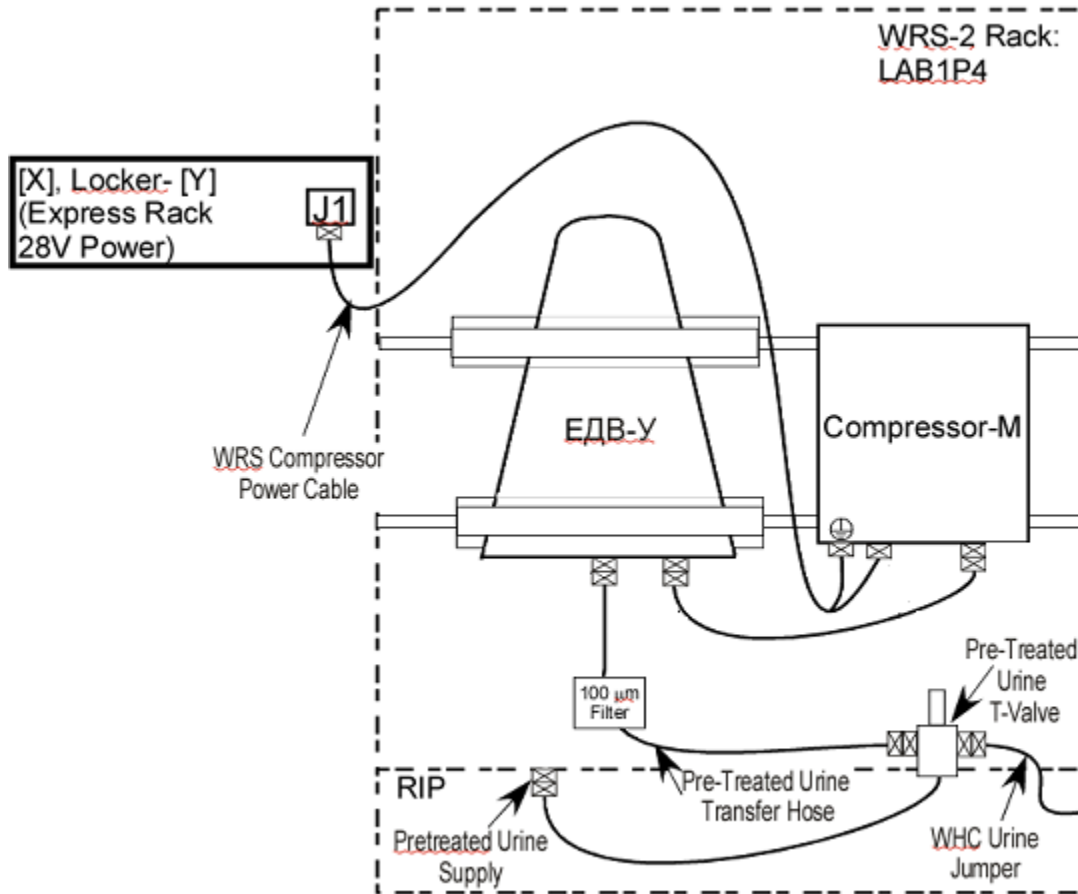

Figure 3.- EDV and Compressor setup on WRS-2.

1.7 Removing EDV and Compressor-M

Refer to Figure 3.

1.7.1 Don Static Wrist Tether.

LAB104

1.7.2 √sw LOCKER-4 POWER – OFF
√LOCKER-4 POWER Lt – Off

NOD3P4

1.7.3 Compressor-M Power Cable-P1 ←|→ LOCKER 4 POWER-J1
Cap →|← LOCKER 4 POWER-J1
Cap (or Kapton Tape) →|← WRS Compressor Power Cable P1

1.7.4 Doff Static Wrist Tether

WARNING

The UPA WSTA creates a positive pressure on the PRE-TREATED URINE SUPPLY QD. Removal of the Pre-treated Urine T-Valve from this QD without extra steps can result in the QD failing open and Tox-2 Fluid being released into the ISS cabin.

1.150 WRS-1 & WRS-2 RACK TRANSFER LAB TO NOD3

(ASSY OPS/20A/FIN 2) Page 5 of 18 pages

- 1.7.5 ✓ **MCC-H** to verify UPA WSTA in required configuration for disconnecting Pre-treated Urine T-Valve from WRS Rack 2 PRETREATED URINE SUPPLY
- 1.7.6 ✓ Pre-treated Urine T-valve → OFF (pull plunger, ~2.5 turns to OFF, verify black window, drop plunger)
- ЕДВ-У 1.7.7 Compressor-M Air Hose ←|→ ПОДАЧА ДАВЛЕНИЯ
- 1.7.8 Cap (tethered) → | ← Compressor-M Air Hose
Cap (tethered) → | ← ПОДАЧА ДАВЛЕНИЯ
- 1.7.9 Don Silver Shield Gloves, Surgical Mask, Safety Goggles.
- 1.7.10 WHC Urine Jumper ←|→ PRE-TREATED URINE T-VALVE
Install plug from Ziplock Bag taped to WHC Urine Jumper.
Cover T-valve male QD (Ziplock Bag; Gray Tape).
- 1.7.11 Feed WHC Urine Jumper back towards LAB1P3, and stow in LAB1P3 UIP area.
- 1.7.12 Pre-treated Urine T-Valve hose ←|→ PRETREATED URINE SUPPLY on WRS2
Pre-treated Urine T-Valve hose →|← PRE-TREATED URINE T-VALVE QD labeled WHC
Tox-2 specific Cap (in Ziplock labeled “Cap for Pre-treated Urine Supply RIP QD only” taped to UIP) →|← PRETREATED URINE SUPPLY on WRS2.
- 1.7.13 Doff Silver Shield Gloves, Surgical Mask, Safety Goggles.
- 1.7.14 Secure hoses to EDV Seat Track Brackets (Gray Tape).
- 1.7.15 Remove EDV Seat Track Brackets (two), seat track thumbscrews (four).
- 1.7.16 Temporarily stow assembly in Node 3 for installation after Rack transfers.
- LAB1S4 1.8 If installed, remove ARIS Microgravity Rack Barrier from Mounting Posts, latches (two).
Unscrew, remove Mounting Posts (two) from Standoff closest to WRS-1.
Temporarily stow.

1.150 WRS-1 & WRS-2 RACK TRANSFER LAB TO NOD3

(ASSY OPS/20A/FIN 2) Page 6 of 18 pages

WARNING

1. Rack Power Jumpers must be the first jumpers demated from each Rack.
2. Prior to demating power jumpers, the Rack Power Switch status must be verified via PCS or ground telemetry. This cannot be accomplished if data cables have been demated.

2. SAFING

LAB1D4 2.1 √sw WRS-1 RACK POWER → OFF

MCC-H/
PCS 2.2 US Lab: EPS: Rack Power: Rack Power 3

Rack Power 3
'Rack LAB1D4'

Verify Switch Position – OFF

- √Switch availability – YES
- √Monitoring Status – ENABLED

LAB1P4 2.3 √sw WRS-2 RACK POWER → OFF

MCC-H/
PCS 2.4 US Lab: EPS: Rack Power: Rack Power 3

Rack Power 3
'Rack LAB1P4'

Verify Switch Position – OFF

- √Switch availability – YES
- √Monitoring Status – ENABLED

2.5 √**MCC-H** that the following has been performed
RPCM LA2A3B A RPC 1 is open and close cmd inhibited.
Either DDCU LA2A or DDCU LA3B Converter has been powered off.
Oxygen System safed for QD disconnection.

2.6 Remove WRS Closeout Assembly, seat track thumbscrews (two).
Temporarily stow.

1.150 WRS-1 & WRS-2 RACK TRANSFER LAB TO NOD3

(ASSY OPS/20A/FIN 2) Page 7 of 18 pages

3. DEMATING ELECTRICAL CABLES

Refer to Figure 4.

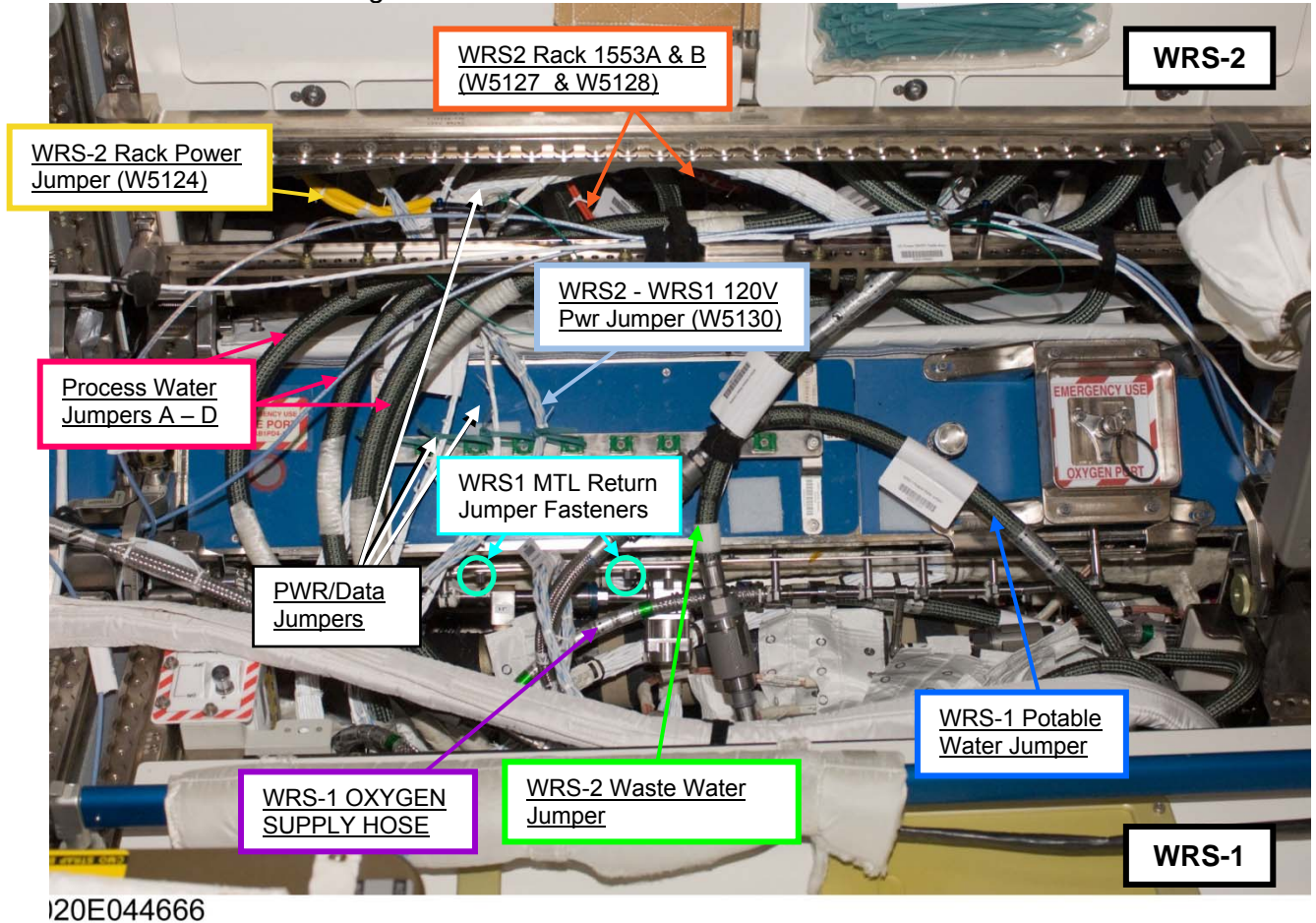

Figure 4.- WRS-1 and WRS-2 Jumpers.

3.1 Don Static Wrist Tether.
Secure to unpainted, unannodized metal surface.

LAB1PD4 3.2 For steps 3.3 to 3.13, install caps from Ziplock Bag labeled "WRS Pwr/Data Caps."
If cap not available, cover connector with Kapton Tape.

3.3 Demating WRS-2 Rack Power Jumper (W5124)
W5124-P1 ←|→ J1 on LAB1P4 ISPR Panel
W5124-P2 ←|→ J2 on Rack UIP
Release from WRS Jumper Support Bracket (Wire Cutters).
Stow in CTB.

1.150 WRS-1 & WRS-2 RACK TRANSFER LAB TO NOD3

(ASSY OPS/20A/FIN 2) Page 8 of 18 pages

- 3.4 Demating WRS2 - WRS1 120V Pwr Jumper (W5130)
W5130-P2 ←|→ J2 on LAB1D4 Rack UIP
W5130-P6 ←|→ J6 on LAB1P4 Rack UIP
Release from WRS Jumper Support Bracket (Wire Cutters).
Stow in CTB.

- 3.5 Demating WRS1 J6 - WRS2 J7 Pwr/Data Jumper (W5131)
W5131-P6 ←|→ J6 on LAB1D4 Rack UIP
W5131-P7 ←|→ J7 on LAB1P4 Rack UIP
Release from WRS Jumper Support Bracket (Wire Cutters).
Stow in CTB.

- 3.6 Demating WRS1 J7 - WRS2 J8 Pwr/Data Jumper (W5132)
W5132-P7 ←|→ J7 on LAB1D4 Rack UIP
W5132-P8 ←|→ J8 on LAB1P4 Rack UIP
Release from WRS Jumper Support Bracket (Wire Cutters).
Stow in CTB.

- 3.7 Demating WRS-1 J8 - WRS-2 J9 Data Jumper (W5133)
W5133-P8 ←|→ J8 on LAB1D4 Rack UIP
W5133-P9 ←|→ J9 on LAB1P4 Rack UIP
Release from WRS Jumper Support Bracket (Wire Cutters).
Stow in CTB.

- 3.8 Demating WRS-2 Rack 1553A Jumper (W5127)
W5127-P3 ←|→ J3 on LAB1P4 ISPR Panel
W5127-P4 ←|→ J4 on Rack UIP
Stow in CTB.

- 3.9 Demating WRS-2 Rack 1553B Jumper (W5128)
W5128-P4 ←|→ J4 on LAB1P4 ISPR Panel
W5128-P5 ←|→ J5 on Rack UIP
Stow in CTB.

- 3.10 Demating WRS-2 Rack Data Jumper (W5129)
W5129-P43 ←|→ J43 on LAB1P4 ISPR Panel
W5129-P3 ←|→ J3 on Rack UIP
Stow in CTB.

NOTE

RPS Switch Position will show "On" on PCS display when
Rack Data Jumper is demated.

- 3.11 Demating WRS-1 Rack Data Cable (W5120)
W5120-P3 ←|→ J3 on Rack UIP
Stow in CTB.

W5120-P1 ←|→ Manual RFCA temperature sensor connector on
WRS-1 MTL Return Jumper
Secure in Standoff.

1.150 WRS-1 & WRS-2 RACK TRANSFER LAB TO NOD3

(ASSY OPS/20A/FIN 2) Page 9 of 18 pages

- 3.12 Demating WRS-1 Rack 1553A Jumper (W5125)
W5125-J8 ←|→P8-W3305 (1553A Standoff umbilical)
Secure in standoff
W5125-P4 ←|→ J4 on Rack UIP
Stow in CTB.
- 3.13 Demating WRS-1 Rack 1553B Jumper (W5126)
W5126-J8 ←|→ P8-W3306 (1553B Standoff umbilical)
Secure in standoff
W5126-P5 ←|→ J5 on Rack UIP
Stow in CTB.
- 3.14 Doff Static Wrist Tether.

4. DEMATING FLUID LINES

4.1 Demating Process Water Jumpers

Cap and Plug both halves of QDs using Ziplock Bag labeled "WRS Process Water Caps/Plugs."



WRS Process Water A Jumper ←|→ "Process Water Line A" on both WRS Rack UIPs

WRS Process Water B Jumper ←|→ "Process Water Line B" on both WRS Rack UIPs

For WRS-1

| WRS Process Water C Jumper ←|→ "Process Water Line C" on WRS-1 Rack UIP

For WRS-2

| WRS Process Water C Jumper ←|→ check valve on "Process Water Line C" on WRS-2 Rack UIP

WRS Process Water D Jumper ←|→ "Process Water Line D" on both WRS Rack UIPs

Release from Velcro Straps.

Stow in CTB.

4.2 Demating WRS-2 Waste Water Jumper



Cap and Plug both halves of QDs using Ziplock Bag labeled "WRS2 Waste Water Caps/Plugs."

If QD cap(plug) not available

Cover QD with Ziplock Bag and secure with Gray Tape.

WRS-2 WASTE WATER JUMPER TO: X3 WASTE WATER BUS

←|→ LAB1D4 Waste Water Standoff umbilical

WRS-2 WASTE WATER JUMPER TO: WRS-2 WASTE WATER

←|→ WASTE WATER on Rack UIP

Release from Velcro Straps.

Stow in CTB.

1.150 WRS-1 & WRS-2 RACK TRANSFER LAB TO NOD3

(ASSY OPS/20A/FIN 2) Page 10 of 18 pages

4.3 For steps 4.4 to 4.7

Install caps and plugs from Ziplock Bag labeled "WRS TCS Caps/Plugs."

If QD cap(plug) not available

Cover QD with Ziplock Bag and secure with Gray Tape.

4.4 Demating WRS-1 MTL Return Jumper

MRFCA TO: MTL RETURN LAB1D4 JUMPER ←|→ MOD

TEMPERATURE COOLANT WATER RETURN in Standoff

MRFCA TO: WRS-1 MTL RETURN ←|→ TCS RETURN on Rack
UIP



Remove WRS-1 MTL Return Jumper mounting bracket, fasteners (two) from deck side of LAB1PD4 standoff (Ratchet, 1/4" Drive; 5/16" Socket, 1/4" Drive).

Refer to Figure 4.

Stow in CTB.

4.5 Demating WRS-1 MTL Supply Jumper

WRS-1 MTL SUPPLY JUMPER TO: X3 MTL SUPPLY ←|→ MOD
TEMPERATURE COOLANT WATER SUPPLY in Standoff

WRS-1 MTL SUPPLY JUMPER TO: WRS-1 TCS SUPPLY ←|→
TCS SUPPLY on Rack UIP

Stow in CTB.

4.6 Demating WRS-2 MTL Return Jumper

WRS-2 MTL RETURN JUMPER TO: LAB1P4 TCS MOD RETURN
←|→ TCS MOD RETURN on LAB1P4 ISPR Panel

WRS-2 MTL RETURN JUMPER TO: WRS-2 TCS RETURN ←|→
TCS RETURN on Rack UIP

Stow in CTB.

4.7 Demating WRS-2 MTL Supply Jumper

WRS-2 MTL SUPPLY JUMPER TO: LAB1P4 TCS MOD

SUPPLY ←|→ TCS MOD SUPPLY on LAB1P4 ISPR Panel

WRS-2 MTL SUPPLY JUMPER TO: WRS-2 TCS SUPPLY ←|→
TCS SUPPLY on Rack UIP

Stow in CTB.

WARNING

Contamination of Oxygen System may result in fire hazard.

1.150 WRS-1 & WRS-2 RACK TRANSFER LAB TO NOD3

(ASSY OPS/20A/FIN 2) Page 11 of 18 pages

4.8 Oxygen Safety Steps

To prevent fire hazard during this procedure

Minimize the time connectors and caps(plugs) are open or cover using Teflon Bags or Clean Room Gloves.

If Clean Room Gloves become contaminated or damaged, replace immediately with new Clean Room Gloves.

If contaminants are found

Photo document (Digital Camera).

Remove using the Brass Picks.

Retain for return to Houston.

If contaminants cannot be completely removed

Temporarily cap connectors.

Notify **MCC-H**.

4.9 Don Clean Room Gloves.

4.10 For step 4.11

Install cap and plug from Teflon Bag labeled "WRS1 O₂ Caps/Plugs."

4.11 Demating WRS-1 Oxygen Supply Hose

 WRS-1 OXYGEN SUPPLY HOSE ← | → OXYGEN SUPPLY on Rack
UIP

Secure in Standoff (Velcro Straps).

WARNING

Contact with the wetted surfaces of the potable water system QDs may lead to contamination and crew illness.

1.150 WRS-1 & WRS-2 RACK TRANSFER LAB TO NOD3

(ASSY OPS/20A/FIN 2) Page 12 of 18 pages

- 4.12 For step 4.13
| Install caps and plugs from Ziplock Bag labeled "WRS1 Potable Water Caps/Plugs."

- 4.13 Demating WRS-1 Potable Water Jumper
WRS-1 POTABLE WATER JUMPER TO: X3 FUEL CELL WATER BUS ←|→ FUEL CELL WATER in Standoff
WRS-1 POTABLE WATER JUMPER TO: WRS-1 POTABLE WATER RETURN ←|→ POTABLE WATER RETURN on Rack UIP
Release from Velcro Straps.
Stow in CTB.

If contact made with wetted surface of QD
Clean surface (Povidone Iodine Pads).

- 4.14 Doff Clean Room Gloves.

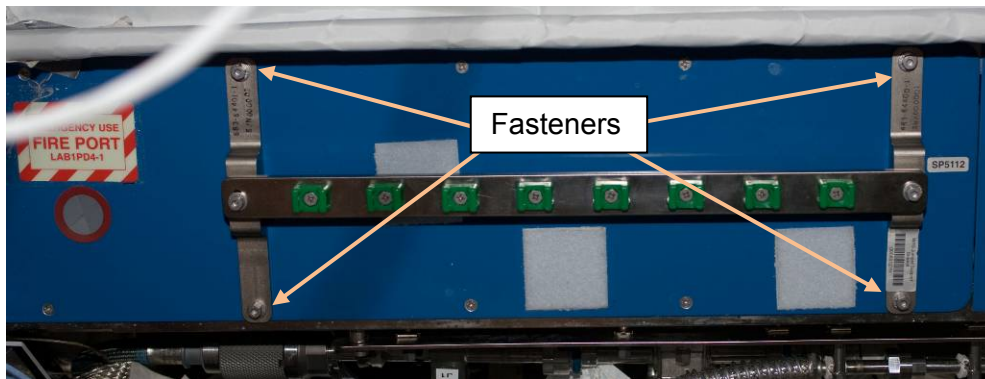

Figure 5.- WRS Jumper Support Bracket, Installed on LAB1PD4 Standoff.

- 4.15 Remove WRS Jumper Support Bracket, fasteners (four) (Ratchet, 1/4" Drive; 5/16" Socket, 1/4" Drive).
Temporarily stow.
Refer to Figure 5.

5. PIVOT MECHANISM KNOB DISENGAGEMENT

Refer to Figures 6 and 7.

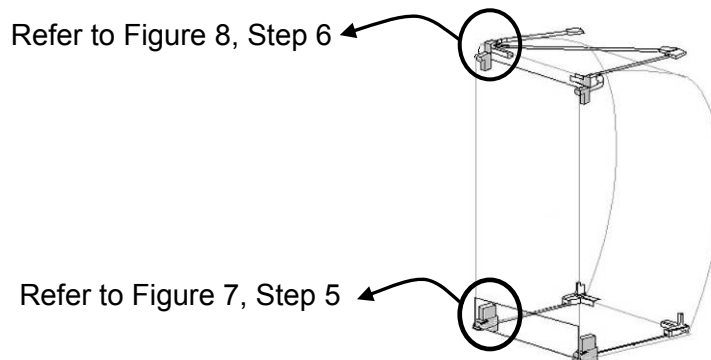

Figure 6.- Location of Rack Restraint Hardware.

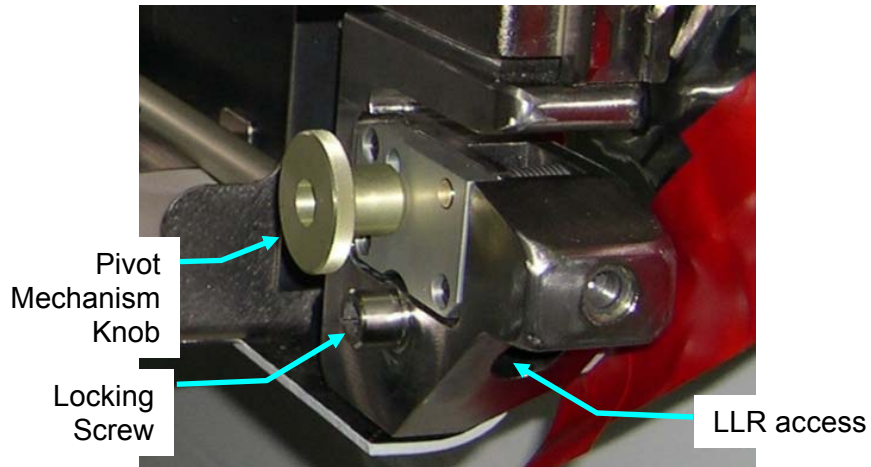

Figure 7.- WRS-2 Pivot Mechanism and Lower Launch Restraint (LLR), Right Side.

- LAB1P4 (LAB1D4) 5.1 Loosen Pivot Mechanism Knob one turn.
Snug in down position so Rack is free to lift off Pivot Fitting.
- 5.2 Repeat disengagement for opposite side.

6. K-BAR DISENGAGEMENT

Refer to Figures 6 and 8.

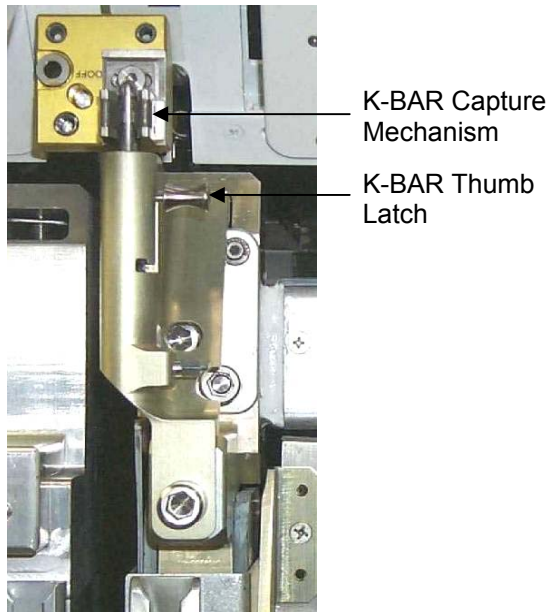

Figure 8.- K-BAR Shown Installed, Left Side.

- 6.1 Disengage Rack K-BAR Thumb Latch from Standoff.
- 6.2 Repeat disengagement for opposite side.

6.3 Slowly rotate Rack down to a controlled stop.

7. REMOVING GROUND STRAP

Refer to Figures 9 and 10.

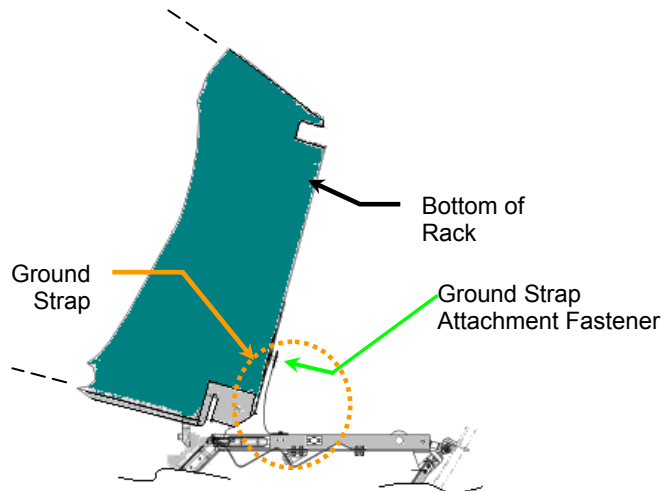

Figure 9.- Side View of Rotated Rack, Showing Rack Ground Strap Location.

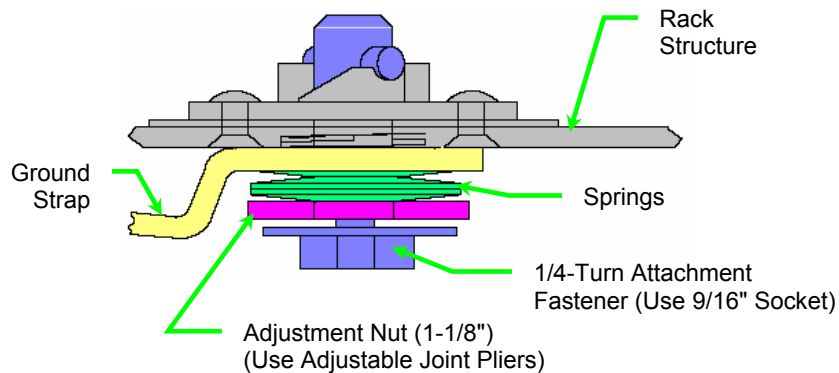

Figure 10.- Rack Ground Strap Cross Section.

- 7.1 Fully retract Adjustment Nut ↻ towards head of Attachment Fastener (Adjustable Joint Pliers, Straight Jaw).
- 7.2 Ground Strap ←|→ Rack, 1/4-Turn Attachment Fastener (Ratchet, 3/8" Drive; 9/16" Socket, 3/8" Drive)
- 7.3 Stow Ground Strap on Standoff location.

1.150 WRS-1 & WRS-2 RACK TRANSFER LAB TO NOD3

(ASSY OPS/20A/FIN 2) Page 15 of 18 pages

8. TRANSFERRING RACK TO NODE 3

8.1 Lift Rack off of Pivot Fittings.

NOTE

Due to the location of the Rack Power Switch, outside pivot fittings must be used on the right side to avoid interference.

The right side outer pivot fittings will transfer with the Racks.

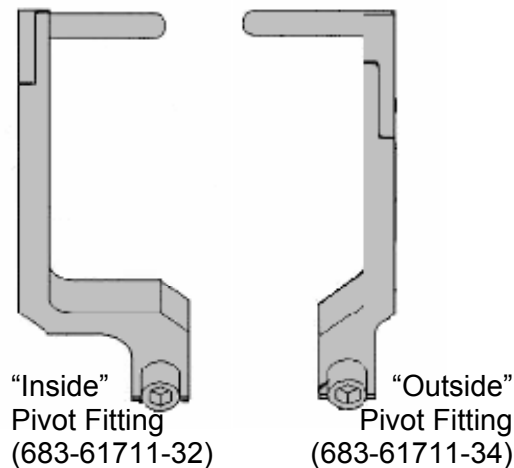

Figure 11.- ARIS Pivot Fitting Bottom Right, Outside vs. Inside.

8.2 Remove ARIS Pivot Fitting Bottom Right (outside) (P/N 683-61711-34) from lower Standoff (Ratchet, 3/8" Drive; 6" Long, 3/8" Hex Head, 3/8" Drive). Refer to Figure 11.

8.3 Loosen Mechanism Knobs so they are free to move. Refer to Figure 7.

8.4 Transfer WRS-1(WRS-2) Rack and Pivot Fitting to NOD3D5(NOD3D4).

NOD3D5(4) 8.5 Install, torque ARIS Pivot Fitting Bottom Right (outside), fastener (one) to 150 in-lbs [Ratchet, 3/8" Drive; 6" Long, 3/8" Hex Head, 3/8" Drive; (40-200 in-lbs) Trq Wrench, 3/8" Drive].

8.6 Align Rack onto Standoff until Rack Pivot Latches engage standoff Pivot Pin Brackets. Keep rack rotated down.

8.7 Tighten both Pivot Mechanism Knobs in latched, up position.

1.150 WRS-1 & WRS-2 RACK TRANSFER LAB TO NOD3

(ASSY OPS/20A/FIN 2) Page 16 of 18 pages

9. INSTALLING GROUND STRAP

- 9.1 Inspect Ground Strap contact surfaces for debris, clean if required (Dry Wipes).
- 9.2 Fully retract Adjustment Nut ↺ (towards head of Attachment Fastener), by hand.
Refer to Figure 10.
- 9.3 Ground Strap →|← Rack, 1/4-Turn Attachment Fastener (Ratchet, 3/8" Drive; 9/16" Socket).
Refer to Figures 9 and 10.
- 9.4 Snug Adjustment Nut ↻, until firm against Springs.
- 9.5 Tighten Adjustment Nut an additional 1/2 to 3/4 turn ↻ (Adjustable Joint Pliers, Straight Jaw).
- 9.6 Photo document installed Ground Strap (Digital Camera).

10. FINAL INSTALLATION

- 10.1 √Rack rotation path is unobstructed
- 10.2 K-BAR Thumb Latches (two) → up position
Refer to Figure 8.

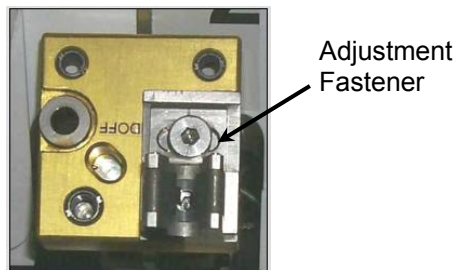

Figure 12.- K-BAR Capture Mechanism, Located on Upper Standoff.

- 10.3 Slowly rotate Rack up to a controlled stop.
Engage Rack K-BAR Thumb Latches (two) in K-BAR Capture Mechanism located on Columbus Standoff.

- * If K-BAR does not align with Capture Mechanism:
- * | Loosen Adjustment Fastener (Ratchet, 3/8" Drive; 5/32" Hex
- * | Head).
- * | Slide capture clip left or right, as required, to engage K-BAR.
- * | Once K-BAR engaged, re-tighten Adjustment Fastener
- * | (Ratchet, 3/8" Drive; 5/32" Hex Head, 3/8" Drive).
- * | Refer to Figure 12.

- 10.4 Repeat steps 5 to 10.3 for other Rack.

1.150 WRS-1 & WRS-2 RACK TRANSFER LAB TO NOD3

(ASSY OPS/20A/FIN 2) Page 17 of 18 pages

11. CLOSEOUT OR POST TRANSFER

11.1 Install EDV Seat Track Brackets (two) on aft end of WRS-2, seat track thumbscrews (four).

11.2 Photo document newly installed hardware (Digital Camera).

LAB1S4 11.3 If removed, Reinstall ARIS Microgravity Rack Barrier Mounting Posts (two) on LAB Standoff.
Reinstall ARIS Microgravity Rack Barrier onto Mounting Posts, latches (two).

11.4 Label CTB "WRS and OGS Lab Mod Kit Jumpers."
Stow remaining parts, tools, materials.
Notify **MCC-H** transfer activity for WRS-1 and WRS-2 is complete, CTB S/N.

Table 1. Jumpers Restow Table (in CTB)

OpNom	P/N
WRS-1 Jumpers	
WRS-1 MTL Return Jumper	683-63495-1
WRS-1 MTL Supply Jumper	683-63461-10
WRS-1 Potable Water Jumper	683-63461-11
WRS1 Rack 1553A Jumper	683-95125-1
WRS1 Rack 1553B Jumper	683-95126-1
WRS-2 Jumpers	
WRS-2 MTL Supply Jumper	683-63461-12
WRS-2 MTL Return Jumper	683-63461-13
WRS2 Rack Data Jumper	683-95129-1
WRS2 Rack 1553A Jumper	683-95127-1
WRS2 Rack 1553B Jumper	683-95128-1
Temporary OGS/WRS2 Rack Power Jumper	683-95124-1
WRS-2 Waste Water Jumper	683-63461-14
Rack to Rack Jumpers	
WRS1 J6 - WRS2 J7 Pwr/Data Jumper	683-95131-1
WRS1 J7 - WRS2 J8 Pwr/Data Jumper	683-95132-1
WRS1 J8 - WRS2 J9 Data Jumper	683-95133-1
WRS2 - WRS1 120V Pwr Jumper	683-95130-1
WRS Process Water A Jumper	683-63461-15
WRS Process Water B Jumper	683-63461-16
WRS Process Water C Jumper	683-63461-17
WRS Process Water D Jumper	683-63461-18

1.150 WRS-1 & WRS-2 RACK TRANSFER LAB TO NOD3

(ASSY OPS/20A/FIN 2) Page 18 of 18 pages

Table 2. Closeout Bracket Restow

OpNom	P/N
WRS Closeout Assembly	
WRS Jumper Support Bracket	683-64400-1
WRS Closeout Assembly - Seat Track Bracket	683-64400-3

1.154 OGS RACK TRANSFER LAB TO NODE 3

(ASSY OPS/20A/FIN 2) Page 1 of 16 pages

OBJECTIVE:

Transfer Oxygen Generation System (OGS) Rack from LAB1P1 to NOD3A5. This transfer activity demates all Rack umbilicals, releases K-BARs and Pivot Mechanisms, transfers the Rack from the LAB and then structurally attaches the Rack to the Node 3 module. Rack umbilicals will be subsequently remated using a separate procedure.

LOCATION:

Stowed: LAB1P1

Installed: NOD3A5

DURATION:

1 hour, 45 minutes

45 minutes - Demate Jumpers

30 minutes - Transfer

30 minutes - Install in Node 3, Closeout

CREW:

Two (second crewmember required for transfer only)

PARTS:

3.0 CTB labeled "WRS and OGS Lab Mod Kit Jumpers"

Ziplock Bag labeled "OGS Jumper Electrical Plugs"

Ziplock Bag labeled "OGS Jumper Fluid Plugs"

Ziplock Bag labeled "WHC/OGS Potable Water QD Caps"

Ziplock Bags (As required to replace Caps/Plugs)

Gray Tape

MATERIALS:

Dry Wipes

AMP Pallet 3, A3 (SEG52101140-301) (if required)

Povidone Iodine Pads (P/N 08486A7)

TOOLS:

Digital Camera

ISS IVA Toolbox:

Drawer 2:

Ratchet, 3/8" Drive

9/16" Socket, 3/8" Drive

5/32" Hex Head, 3/8" Drive

Ratchet, 1/4" Drive

6" Ext, 1/4" Drive

5/16" Socket, 1/4" Drive

(5-35 in-lbs) Trq Driver, 1/4" Drive

(40-200 in-lbs) Trq Wrench, 3/8" Drive

Drawer 3:

6" long, 3/8" Hex Head, 3/8" Drive

Drawer 4:

Wire Cutters

Adjustable Joint Pliers, Straight Jaw

Drawer 5:

Static Wrist Tether

25 JAN 10

1.154 OGS RACK TRANSFER LAB TO NODE 3

(ASSY OPS/20A/FIN 2) Page 2 of 16 pages

NOTE

All directional references (up, down, left, right) are with respect to front face of OGS, as you face Rack, with feet oriented towards the pivot point.

1. SAFING

LAB1P1 1.1 √sw RACK POWER – OFF

PCS 1.2 US Lab: EPS Rack Power: Rack Power 1
Rack Power 1
'Rack LAB1P1'

Verify Switch Position – Off
Verify Switch Avail – Yes
Verify Monitoring Status – Ena

1.3 √MCC-H to verify Rack power safing in place:
Either DDCU LA1A or DDCU LA4A converter Off, and
RPCM LA1A4A A RPC 2 Open, Close Cmd Inhibited, and
RPCM LA2B C RPC 3 Open, Close Cmd Inhibited.

1.4 √MCC-H to verify system is safed and H2 Vent Valve closed

2. RACK TRANSLATION PREPARATION

NOTE

Umbilicals restrained on Node 3 Standoff need to be released to prevent interference with Rack during installation.



Figure 1.- NOD3A5 Umbilicals in Launch Restraint.

1.154 OGS RACK TRANSFER LAB TO NODE 3

(ASSY OPS/20A/FIN 2) Page 3 of 16 pages

- NOD3A5 2.1 Release Umbilicals from Launch Restraints by cutting Zip Ties (two per umbilical; Wire Cutters).
Release Ground Strap by cutting Zip Ties (two).
Refer to Figure 1.
- LAB1P1 2.2 ✓All unnecessary equipment protruding into rack translation path has been removed, stowed (US LAB, Node 1, Node 3)
- 2.3 If installed, remove ARIS Microgravity Rack Barrier from Mounting Posts, latches (two).
Unscrew, remove Mounting Posts (two) from Standoff closest to OGS.
Temporarily stow.
- 2.4 Remove any hardware or Handrails from the face of the Rack.
- If Water Delivery System is still connected on OGS
| Proceed to step 3.
- If Water Delivery System not connected on OGS, go to step 4.

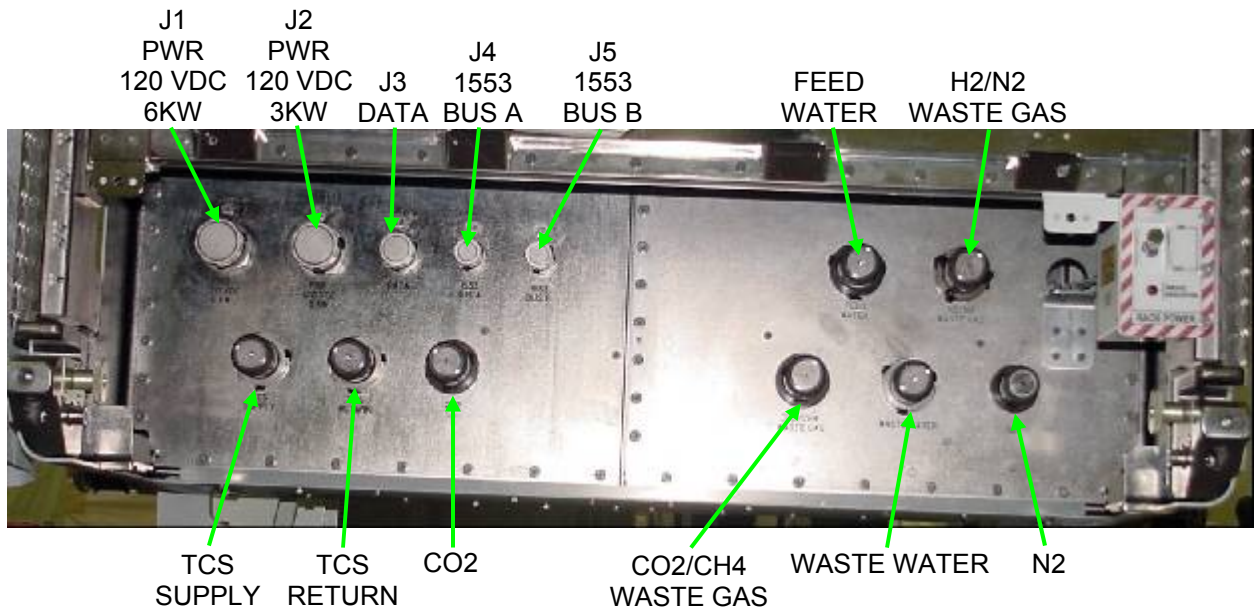

Figure 2.- OGS Rack Utility Interface Panel.

1.154 OGS RACK TRANSFER LAB TO NODE 3

(ASSY OPS/20A/FIN 2) Page 4 of 16 pages

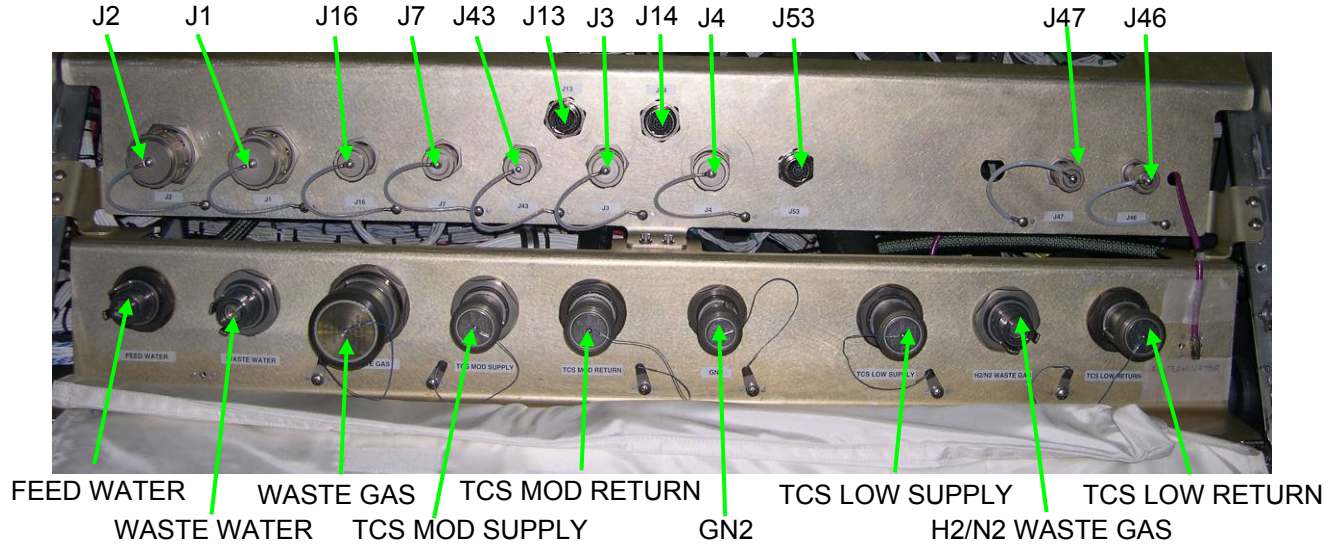

Figure 3.- LAB1P1 Modified Z-Panel.

NOTE

The Feed Water Hose in the Standoff did not fit through the Z-Panel cutout, it was routed around the Z-Panel instead.

1.154 OGS RACK TRANSFER LAB TO NODE 3

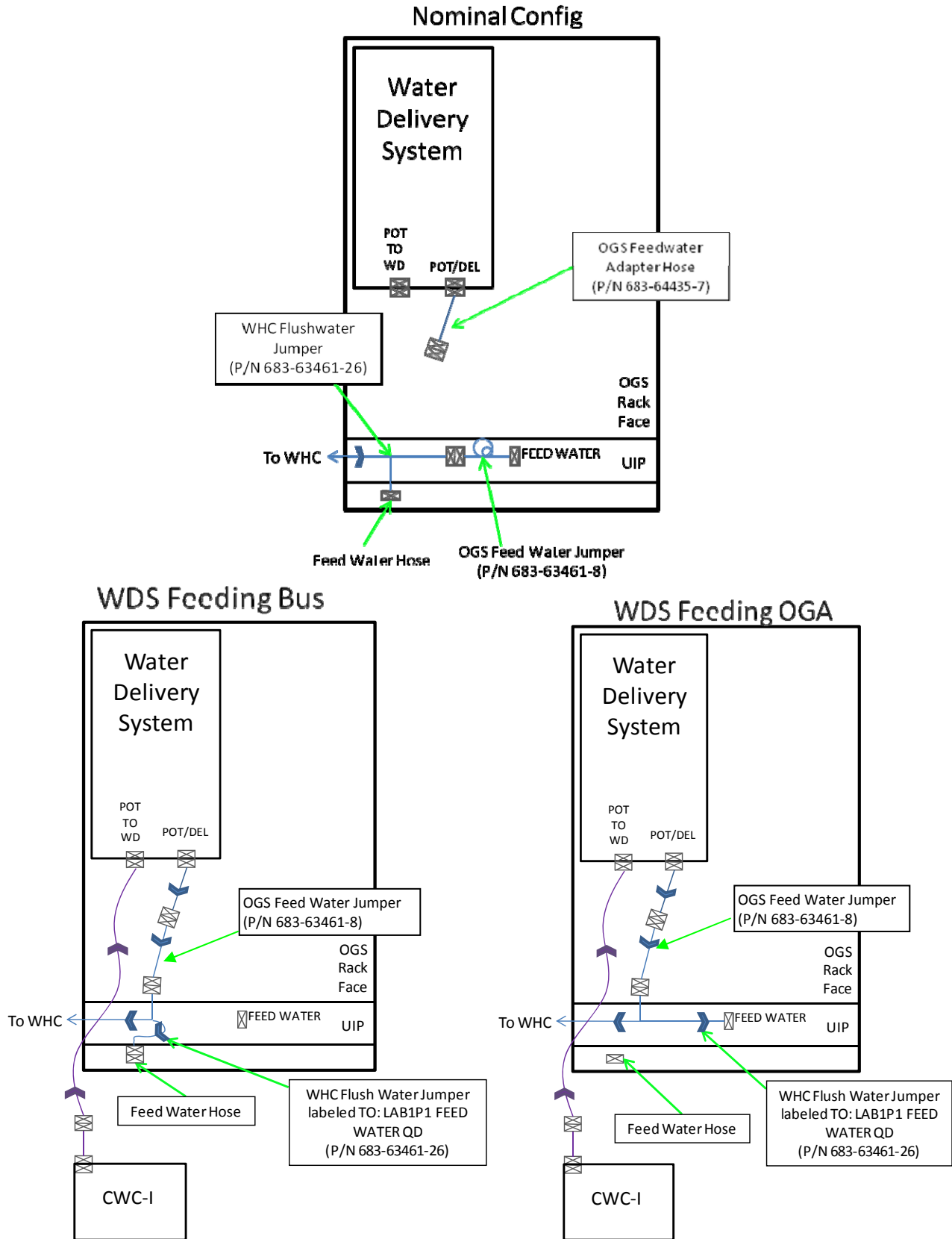

Figure 4.- Possible Potable Water System Connections.

1.154 OGS RACK TRANSFER LAB TO NODE 3

(ASSY OPS/20A/FIN 2) Page 6 of 16 pages

3. DEMATING POTABLE WATER UMBILICALS

Refer to Figures 2 to 4.

3.1 At any point in this procedure, if QD caps or plugs are not available, cover QD with Ziplock Bag and secure with Gray Tape.

LAB1P1 3.2 Remove UIP Closeout from Rack, 1/4 Turn fasteners (two).

WARNING

Contact with the wetted surfaces of the potable water system QDs can lead to contamination and crew illness.

3.3 If contact made with wetted surface of Potable Water QD, clean surface (Povidone Iodine Pads).

3.4 Retrieve Potable Water Plug from PWD:
1/2" QD Plug ←|→ 1/2" QD Cap, tethered to PWD Inlet

3.5 If Nominal Configuration (WPA feeding Potable Water Bus)

3.5.1 WHC Flush Water Jumper TO: OGS FEED WATER
JUMPER ←|→ OGS Feed Water Jumper TO: OGS FEED WATER

1/2" QD Cap, tethered →|← WHC Flush Water Jumper TO:
OGS FEED WATER JUMPER

1/2" QD Plug (From Ziplock Bag labeled "WHC/OGS
Potable Water QD Caps") →|← OGS Feed Water Jumper
TO: OGS FEED WATER

3.5.2 WHC Flush Water Jumper TO: LAB1P1 FEED WATER
QD ←|→ FEED WATER HOSE (routed past Z-Panel from
Standoff)

1/2" QD Plug (From PWD) →|← WHC Flush Water Jumper
labeled TO: LAB1P1 FEED WATER QD

1/2" QD Cap (tethered to Z-Panel) →|← FEED WATER
HOSE

3.5.3 OGS Feed Water Jumper TO: LAB1P1 FEED WATER/OGS
FEED WATER ADAPTER HOSE ←|→ FEED WATER
on OGS Rack

3.5.4 OGS Feed Water Jumper TO: LAB1P1 FEED WATER/OGS
FEED WATER ADAPTER HOSE →|← OGS Feed Water
Adapter Hose TO: OGS FEED WATER JUMPER

1.154 OGS RACK TRANSFER LAB TO NODE 3

(ASSY OPS/20A/FIN 2) Page 7 of 16 pages

- 3.6 If Water Delivery System configured to feed Potable Water Bus
 - 3.6.1 WHC Flush Water Jumper TO: OGS FEED WATER
JUMPER ←|→ OGS Feed Water Jumper TO: OGS FEED WATER

1/2" QD Cap, tethered →|← WHC Flush Water Jumper TO: OGS FEED WATER JUMPER

1/2" QD Plug (From Ziplock Bag labeled "WHC/OGS Potable Water QD Caps") →|← OGS Feed Water Jumper TO: OGS FEED WATER
 - 3.6.2 WHC Flush Water Jumper TO: LAB1P1 FEED WATER
QD ←|→ FEED WATER HOSE (routed past Z-Panel from Standoff)

1/2" QD Plug (From PWD) →|← WHC Flush Water Jumper labeled TO: LAB1P1 FEED WATER QD

1/2" QD Cap (tethered to Z-Panel) →|← FEED WATER HOSE
- 3.7 If Water Delivery System configured to feed OGA
 - 3.7.1 WHC Flush Water Jumper TO: OGS FEED WATER
JUMPER ←|→ OGS Feed Water Jumper TO: OGS FEED WATER

1/2" QD Cap, tethered →|← WHC Flush Water Jumper TO: OGS FEED WATER JUMPER

1/2" QD Plug (From Ziplock Bag labeled "WHC/OGS Potable Water QD Caps") →|← OGS Feed Water Jumper TO: OGS FEED WATER
 - 3.7.2 WHC Flush Water Jumper labeled TO: LAB1P1 FEED WATER QD ←|→ FEED WATER on OGS Rack

1/2" QD Cap (tethered to Z-Panel) →|← FEED WATER HOSE

1/2" QD Plug (From PWD) →|← WHC Flush Water Jumper labeled TO: LAB1P1 FEED WATER QD
- 3.8 Stow WHC Flush Water Jumper in 3.0 CTB labeled "WRS and OGS Lab Mod Kit Jumpers."
- 3.9 Remove Water Delivery System from LAB1P1, knobs (four) by hand. Temporarily stow Water Delivery System.

1.154 OGS RACK TRANSFER LAB TO NODE 3

(ASSY OPS/20A/FIN 2) Page 8 of 16 pages

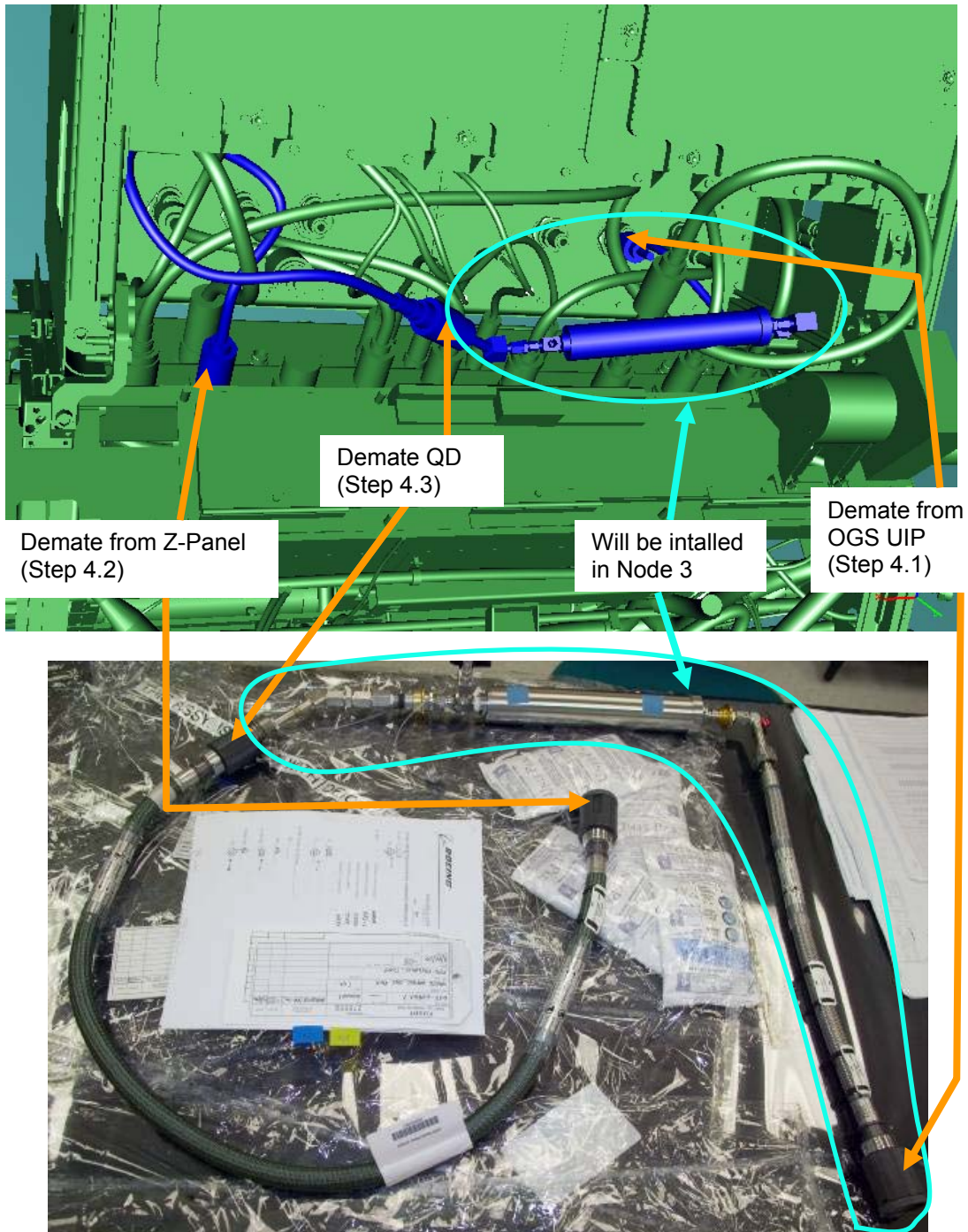

Figure 5.- OGS Waste Water Jumper (P/N 683-63461-7) - Check Valve Not Shown.

4. DEMATING WASTE WATER UMBILICAL

Refer to Figure 5.

4.1 OGS Waste Water Jumper labeled TO: OGS Waste Water ←|→
WASTE WATER on Rack UIP

1.154 OGS RACK TRANSFER LAB TO NODE 3

(ASSY OPS/20A/FIN 2) Page 9 of 16 pages

4.2 OGS Waste Water Jumper labeled TO: OGS Waste Water ←|→
WASTE WATER on Z-Panel

4.3 Green flex hose ←|→ metal line

Install plugs from Ziplock Bag “OGS Jumper Fluid Plugs” or tethered to the Z-Panel.

4.4 Stow green flex hose in 3.0 CTB labeled “WRS and OGS Lab Mod Kit Jumpers.”

4.5 Temporarily stow remaining portion of OGS Waste Water Jumper (Check Valve, ACTEX filter, and metal-braided hose) for later installation in Node 3.

5. DEMATING REMAINING FLUID UMBILICALS

Refer to Figures 2 and 3.

WARNING

OGS Rack Data Jumper must be removed last to ensure proper operation of Rack Power Switch. Failure to comply could result in electrical shock hazard.

Table 1. OGS Fluid Jumpers

OGS Rack Jumper	P/N	Z-Panel Connector	Rack Connector
OGS MTL Supply Jumper	683-63461-4	TCS MOD SUPPLY	TCS SUPPLY
OGS MTL Return Jumper	683-63461-5	TCS MOD RETURN	TCS RETURN
OGS Nitrogen Jumper	683-63461-6	GN2	N2
OGS H2/N2 Vent Jumper	683-63461-9	H2/N2 WASTE GAS	H2/N2 WASTE GAS

5.1 Remove fluid jumpers, demating both ends.
Refer to Table 1.

5.2 Install caps and plugs from Ziplock Bag “OGS Jumper Fluid Plugs” or tethered to the Z-Panel.

5.3 Stow Jumpers in 3.0 CTB labeled “WRS and OGS Lab Mod Kit Jumpers.”

6. DEMATING ELECTRICAL UMBILICALS PART 1

Refer to Figures 2 and 3.

1.154 OGS RACK TRANSFER LAB TO NODE 3

Table 2. OGS Electrical Jumpers

OGS Rack Jumper	P/N	Z-Panel Connector	Rack Connector
OGS Rack Pri Pwr Jumper	683-95134-1	J1	J1 PWR 120 VDC 6KW
OGS Rack Sec Pwr Jumper	683-95135-1	J2	J2 PWR 120 VDC 3KW
OGS Rack 1553A Y-Jumper	683-95112-1	J3	J4 1553 BUS A
OGS Rack 1553B Y-Jumper	683-95113-1	J4	J5 1553 BUS B

- 6.1 Don Static Wrist Tether.
Secure to unpainted, unannodized metal surface.
- 6.2 Demate electrical jumpers, demating both ends.
Do not demate OGS Rack Data Jumper at this time.
Refer to Table 2.
- 6.3 Install electrical caps from Ziplock Bag labeled "OGS Jumper Electrical Plugs."
- 6.4 Stow Jumpers in 3.0 CTB labeled "WRS and OGS Lab Mod Kit Jumpers."

7. DEMATING ELECTRICAL UMBILICALS PART 2

Refer to Figures 2 and 3.

NOTE
RPS Switch Position will show "On" on PCS display when Rack Data Jumper is demated.

Table 3. OGS Electrical Jumper

OGS Rack Jumper	P/N	Z-Panel Connector	Rack Connector
OGS Rack Data Jumper	683-95136-1	J43	J3
		J53	

- 7.1 Demate OGS Rack Data Jumper, demating both ends.
Refer to Table 3.
- 7.2 Install electrical caps from Ziplock Bag labeled "OGS Jumper Electrical Plugs."
- 7.3 Doff Static Wrist Tether.

1.154 OGS RACK TRANSFER LAB TO NODE 3

(ASSY OPS/20A/FIN 2) Page 11 of 16 pages

- 7.4 Stow OGS Rack Data Jumper in 3.0 CTB labeled "WRS and OGS Lab Mod Kit Jumpers."
Temporarily stow CTB.

8. SAFING AND REMOVING SMOKE DETECTOR

MCC-H/
PCS

8.1 Deactivating and Safing Smoke Detector

LAB Fire Display
'Smoke Detectors'

sel PD1

LAB1 PD1Smoke Detector
'Monitoring'

cmd Inh

√Status – Inhibited

sel RPCM_LA1B_H_RPC_03

RPCM_LA1B_H_RPC_03

cmd RPC Position – Open (Verify – Op)

cmd Close Cmd – Inhibit (Verify – Inh)

LAB1PD1

8.2 Removing Smoke Detector

8.2.1 P1-W3360 ←|→ J1

8.2.2 Remove Fasteners (four) securing Smoke Detector Bracket to Standoff (Ratchet, 1/4" Drive; 6" Ext, 1/4" Drive; 5/16" Socket, 1/4" Drive).

8.2.3 Cover connector plug, jack (small Ziplock Bag, Gray Tape).

8.2.4 Temporarily stow.

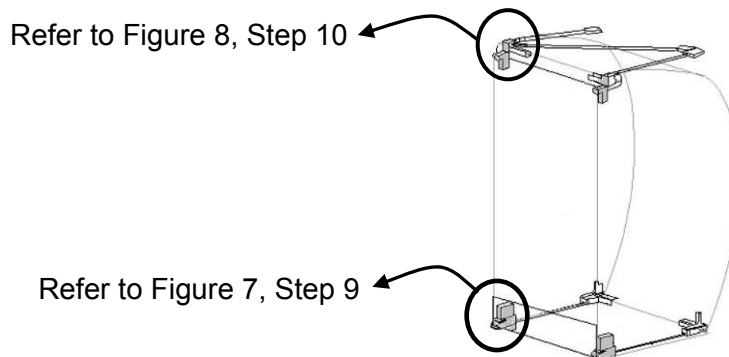

Figure 6.- Location of Rack Restraint Hardware.

1.154 OGS RACK TRANSFER LAB TO NODE 3

(ASSY OPS/20A/FIN 2)

Page 12 of 16 pages

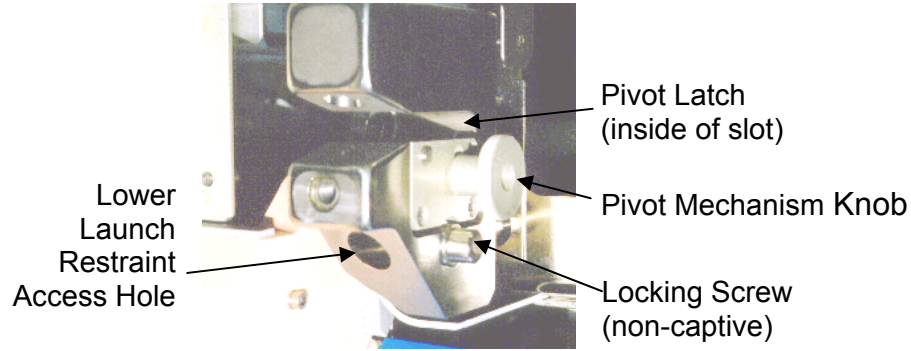

Figure 7.- Lower Launch Restraint, Left Side

9. PIVOT MECHANISM KNOB DISENGAGEMENT

Refer to Figures 6 and 7.

- 9.1 Loosen Pivot Mechanism Knob one turn.
Snug in down position so Rack is free to lift off Pivot Fitting.
- 9.2 Repeat disengagement for opposite side.

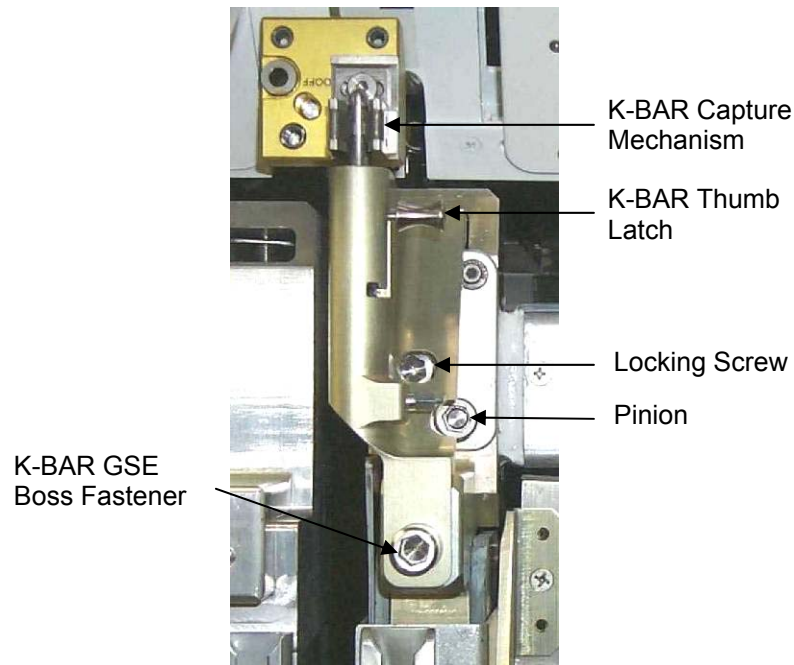

Figure 8.- K-BAR Shown Installed, Left Side.

10. K-BAR DISENGAGEMENT

Refer to Figures 6 and 8.

- 10.1 Disengage Rack K-BAR Thumb Latches (two) from Standoff.
- 10.2 Rotate Rack down to a controlled stop.

1.154 OGS RACK TRANSFER LAB TO NODE 3

(ASSY OPS/20A/FIN 2) Page 13 of 16 pages

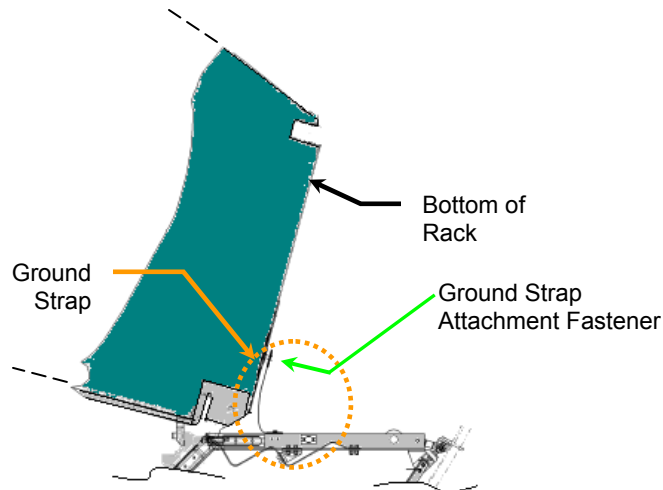

Figure 9.- Side View of Rotated Rack, Showing Rack Ground Strap Location.

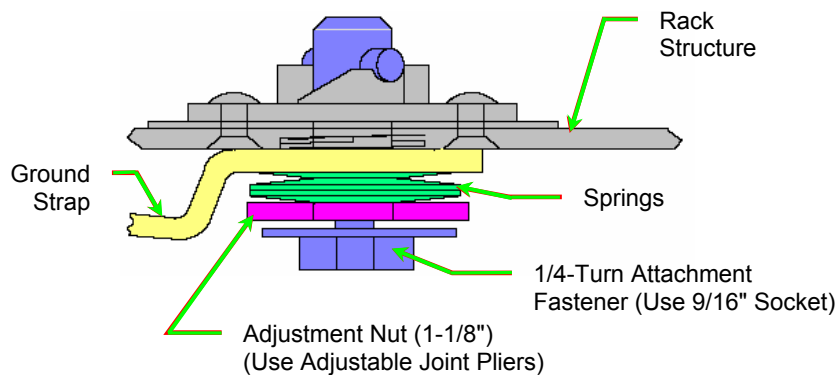

Figure 10.- Rack Ground Strap Cross Section.

11. REMOVING GROUND STRAP

Refer to Figures 9 and 10.

11.1 Fully retract Adjustment Nut ↻ towards head of Attachment Fastener (Adjustable Joint Pliers, Straight Jaw).

11.2 Ground Strap ←|→ Rack, 1/4-Turn Attachment Fastener (Ratchet, 3/8" Drive; 9/16" Socket, 3/8" Drive).

11.3 Stow Ground Strap into Standoff location.

12. TRANSFERRING OGS TO NODE 3

12.1 Lift Rack off of Pivot Fittings.

12.2 Loosen Mechanism Knobs one turn so they are free to move. Refer to Figure 7.

1.154 OGS RACK TRANSFER LAB TO NODE 3

(ASSY OPS/20A/FIN 2) Page 14 of 16 pages

- 12.3 Remove ARIS - Pivot Fitting Bottom Right (outside)
(P/N 683-61711-34) from lower standoff (Ratchet, 3/8" Drive; 6" Long, 3/8" Hex Head, 3/8" Drive)
- 12.4 Transfer OGS Rack and Pivot Fitting to NOD3A5.
- 12.5 Install, torque ARIS - Pivot Fitting Bottom Right (outside), fastener (one) to 150 in-lbs [Ratchet, 3/8" Drive; 6" Long, 3/8" Hex Head; (40-200 in-lbs) Trq Wrench, 3/8" Drive].
- NOD3A5 12.6 With Node 3 Umbilicals routed toward the front of the rack, align Rack onto Standoff until Rack Pivot Latches engage standoff Pivot Fittings.
Keep Rack rotated down.
- 12.7 Tighten both Pivot Mechanism Knobs in latched, up position.
13. INSTALLING GROUND STRAP
 - 13.1 Inspect Ground Strap contact surfaces for debris, clean if required (Dry Wipes).
 - 13.2 Fully retract Adjustment Nut ↶ (towards head of Attachment Fastener), by hand.
Refer to Figure 9.
 - 13.3 Ground Strap →|← Rack, 1/4-Turn Attachment Fastener (Ratchet, 3/8" Drive; 9/16" Socket, 3/8" Drive).
Refer to Figures 9 and 10.
 - 13.4 Snug Adjustment Nut ↷, until firm against Springs.
 - 13.5 Tighten Adjustment Nut an additional 1/2 to 3/4 turn ↷ (Adjustable Joint Pliers, Straight Jaw).
 - 13.6 Photo document installed Ground Strap (Digital Camera).
14. FINAL INSTALLATION
 - 14.1 √Rack rotation path is unobstructed
 - 14.2 K-BAR Thumb Latches (two) → up position
Refer to Figure 8.

1.154 OGS RACK TRANSFER LAB TO NODE 3

(ASSY OPS/20A/FIN 2) Page 15 of 16 pages

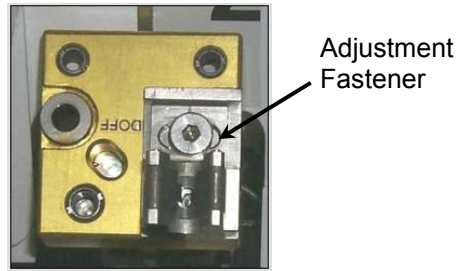

Figure 11.- K-BAR Capture Mechanism.

- 14.3 Slowly rotate Rack up to a controlled stop.
Engage Rack K-BAR Thumb Latches (two) in K-BAR Capture Mechanism located on upper Standoff.

- * If K-BAR does not align with Capture Mechanism:
- * | Loosen Adjustment Fastener (Ratchet, 3/8" Drive; 5/32" Hex
- * | Head, 3/8" Drive).
- * | Slide capture clip left or right, as required to engage K-BAR.
- * | Once K-BAR engaged, re-tighten Adjustment Fastener
- * | (Ratchet, 3/8" Drive; 5/32" Hex Head, 3/8" Drive).
- * |
- * Refer to Figure 11.

15. REINSTALLING SMOKE DETECTOR

- LAB1PD1 15.1 Remove Ziplock Bag, Gray Tape, from connectors.

15.2 P1-W3360 →|← J1

15.3 Install Smoke Detector Bracket on standoff, fasteners (four)
(Ratchet, 1/4" Drive; 6" Ext, 1/4" Drive; 5/16" Socket, 1/4" Drive).

15.4 Tighten, torque Fasteners (four) to 22 in-lbs [Ratchet, 1/4" Drive;
6" Ext, 1/4" Drive; 5/16" Socket, 1/4" Drive; (5-35 in-lbs) Trq
Driver, 1/4" Drive].

16. CLOSEOUT OR POST TRANSFER

16.1 Notify **MCC-H** smoke detector installed, transfer activity complete.
Stow tools, materials, parts.

16.2 Photo document OGS in Node 3 and LAB1P1 Z-Panel (Digital
Camera).

1.154 OGS RACK TRANSFER LAB TO NODE 3

(ASSY OPS/20A/FIN 2) Page 16 of 16 pages

Table 4. Restow Table

OpNom	P/N
WHC Flush Water Jumper	683-63461-26
OGS Rack Data Jumper	683-95136-1
OGS Rack Pri Pwr Jumper	683-95134-1
OGS Rack Sec Pwr Jumper	683-95135-1
OGS Rack 1553A Y-Jumper	683-95112-1
OGS Rack 1553B Y-Jumper	683-95113-1
OGS MTL Supply Jumper	683-63461-4
OGS MTL Return Jumper	683-63461-5
OGS Nitrogen Jumper	683-63461-6
OGS H2/N2 Vent Jumper	683-63461-9
OGS Waste Water Jumper (Green Flex Hose)	683-63461-7
OGS Waste Water Jumper (ACTEX Hose)	

1.158 CUPOLA UTILITY OUTLET PANEL INSTALLATION

(ASSY OPS/20A/FIN 1)

Page 1 of 6 pages

OBJECTIVE:

Install UOPs and associated hardware in the Cupola.

LOCATION:

Installed: CUP1P1, CUP1S1

Stowed: √Inventory Management System (IMS)

DURATION:

60 minutes

CREW:

One

PARTS:

UOP 1 (located at CUP1P1) P/N 683-27710-5 S/N 1029

UOP 2 (located at CUP1S1) P/N 683-27710-5 S/N 1030

UOP Support Bracket (located at CUP1P1) P/N 1240CU751-401 B/C CUP0023E

UOP Support Bracket (located at CUP1S1) P/N 1240CU751-401 B/C CUP0024E

MATERIALS:

Dry Wipes

Gray Tape

Sharpie

TOOLS:

Digital Camera

ISS IVA Toolbox:

Drawer 2:

1/8" Hex Head, 1/4" Drive

3/16" Hex Head, 1/4" Drive

Driver Handle, 1/4" Drive

Ratchet, 1/4" Drive

(10-50 in-lbs) Trq Wrench, 1/4" Drive

(40-200 in-lbs) Trq Wrench, 1/4" Drive

Drawer 4:

Wire Cutters

Drawer 5:

Static Wrist Tether

1.158 CUPOLA UTILITY OUTLET PANEL INSTALLATION

(ASSY OPS/20A/FIN 1)

Page 2 of 6 pages

REFERENCED PROCEDURE(S):

1.110 GENERIC UOP ACTIVATION AND CHECKOUT

1. SAFING

Table 1. UOP Locations and Power Sources

Utility Outlet Panel [X]	Location [Q]	Power Source [Y]	Parallel DDCU Set	Data Sources	UOP Support Bracket B/C [T]
CUP UOP 1 (S/N 1029)	CUP1P1	RPCM N32A2B C2 RPC 17	N32A & N32B	System 1553	CUP0023E
CUP UOP 2 (S/N 1030)	CUP1S1	RPCM N32A2B D2 RPC 17	N32A & N32B	System 1553	CUP0024E

√**MCC-H** that the following is true:

[Y] is open and close command inhibited

Either DDCU N32A or DDCU N32B converter is powered off

2. UOP PANEL ASSEMBLY INSTALLATION

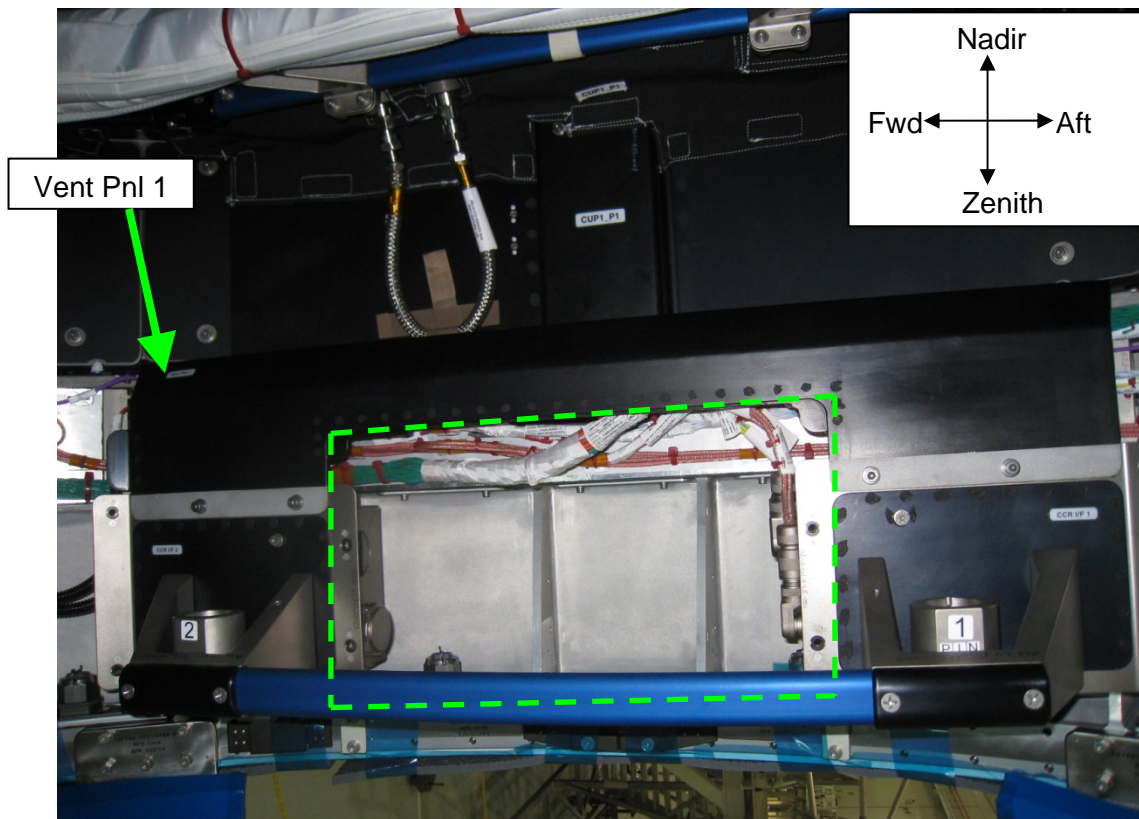

Figure 1.- UOP 1 Installation Area (Ground Photo Looking ISS Port).

1.158 CUPOLA UTILITY OUTLET PANEL INSTALLATION

(ASSY OPS/20A/FIN 1)



Figure 2.- UOP Support Bracket (Photos Taken at Bench Review).

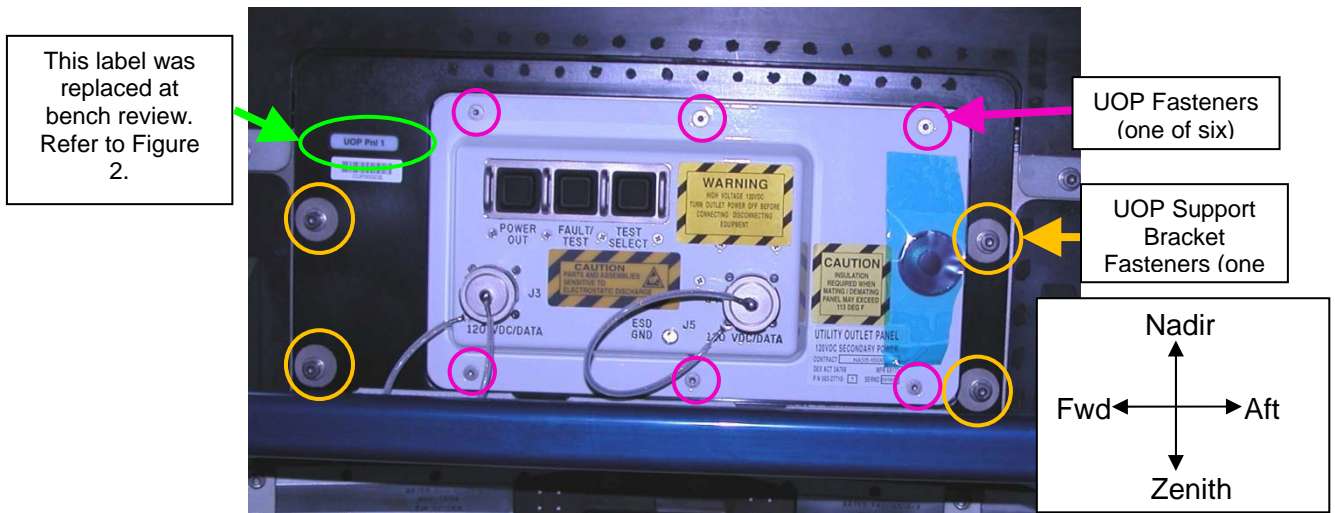

Figure 3.- UOP 1 Installed in UOP Support Bracket.

NOTE

The Cupola UOP Support Brackets have IMV deflector plates to distribute airflow entering from Node 3 throughout Cupola. Refer to Figure 2.

- Install UOP Support Bracket (B/C [T]) at [Q] by maneuvering behind handrail, fasteners (four).
- Tighten, torque UOP Support Bracket fasteners (four) to 115 in-lbs [Ratchet, 1/4" Drive; 3/16" Hex Head, 1/4" Drive; (40-200 in-lbs) Trq Wrench, 1/4" Drive].
- Refer to Figures 2 and 3.

1.158 CUPOLA UTILITY OUTLET PANEL INSTALLATION

(ASSY OPS/20A/FIN 1)

Page 4 of 6 pages

3. UOP INSTALLATION

Table 2. UOP Connectors and Wire Harnesses

Utility Outlet Panel [X]	Input Power Wire Harness to UOP J1 [V]	Input Data Wire Harness to UOP J2 [U]	Power Wire Harness Dummy Connector Label [S]	Data Wire Harness Dummy Connector Label [R]
CUP UOP 1	UOP1_P1 CP2107F	UOP1_P2 CP2108F	Park UOP1 P1	Park UOP1 P2
CUP UOP 2	UOP2_P1 CP2107F	UOP2_P2 CP2108F	Park UOP2 P1	Park UOP2 P2

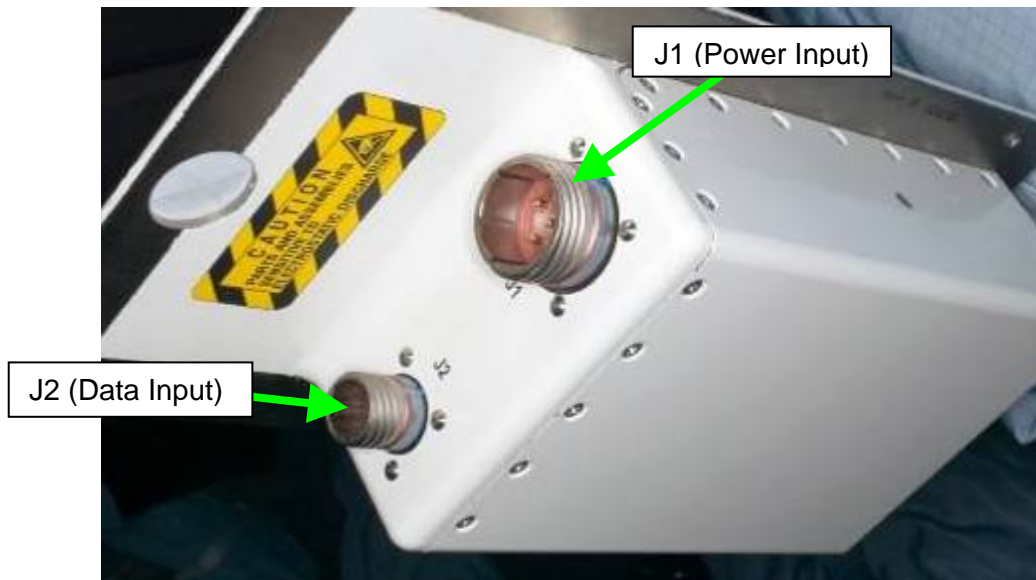

Figure 4.- Utility Outlet Panel Input Connectors (rear view of UOP).

1.158 CUPOLA UTILITY OUTLET PANEL INSTALLATION

(ASSY OPS/20A/FIN 1)

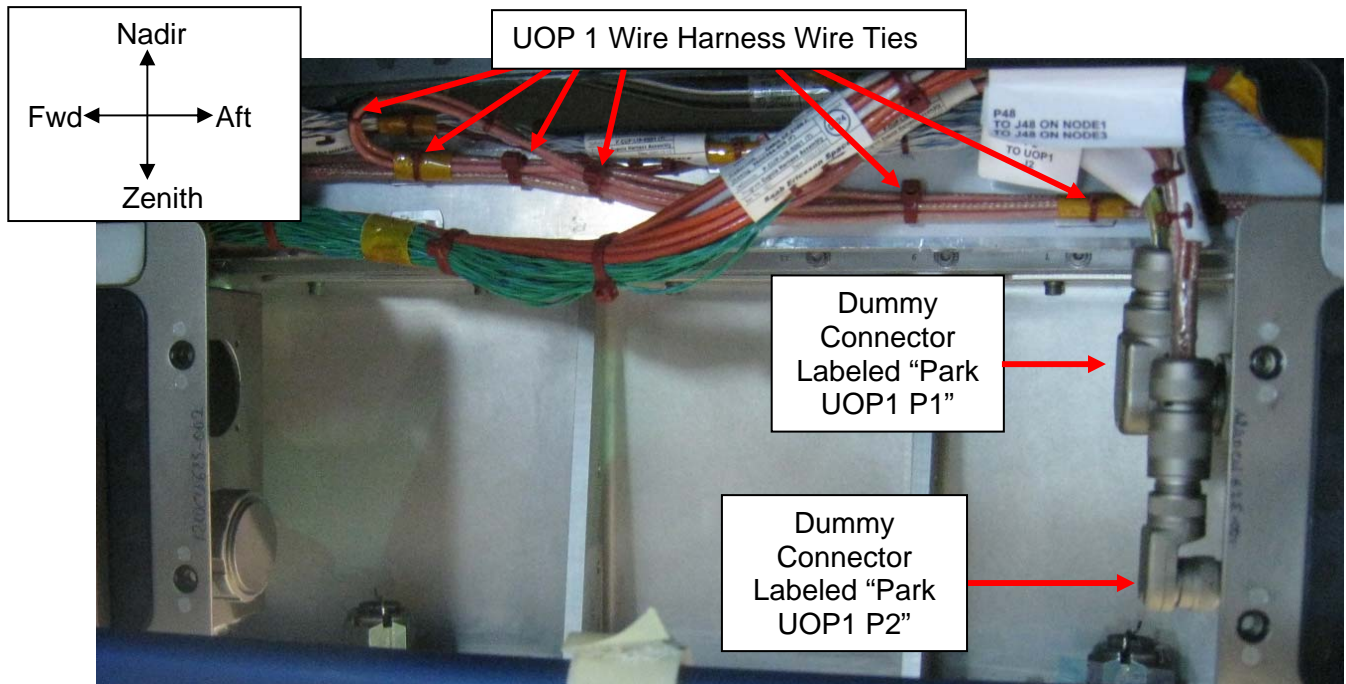

Figure 5.- CUP UOP 1 Installation Site.

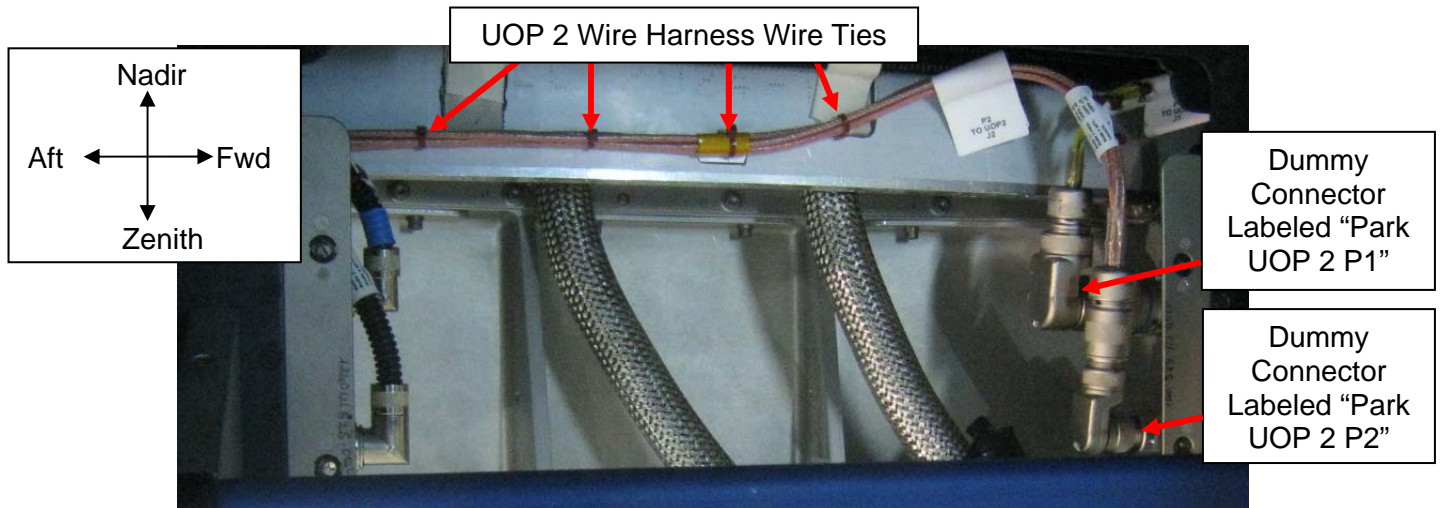

Figure 6.- CUP UOP 2 Installation Site.

- 3.1 Record P/N of [X]: _____
Record S/N of [X]: _____

WARNING

Care should be taken to only cut wire ties. If wire harnesses nicked or cut, could result in shock hazard.

- 3.2 As required, to provide adequate line length, cut wire ties securing UOP cables (Wire Cutters).

1.158 CUPOLA UTILITY OUTLET PANEL INSTALLATION

(ASSY OPS/20A/FIN 1)

Page 6 of 6 pages

Refer to Figures 5 and 6.

- 3.3 Don Static Wrist Tether.
Secure to unpainted, unanodized metal surface.
- 3.4 Demate Power Wire Harness [V] ←|→ Dummy Connector [S]
Demate Data Wire Harness [U] ←|→ Dummy Connector [R]
Refer to Table 2 and Figures 3, 4, and 5.
- 3.5 Route Power Wire Harness [V], Data Wire Harness [U] through opening in UOP Panel Assembly.
Remove protective caps on UOP, stow on Dummy Connector [S], Dummy Connector [R].
- 3.6 Input Power Wire Harness [V] →|← J1 on [X]
Input Data Wire Harness [U] →|← J2 on [X]
Refer to Table 2 and Figures 4, 5, and 6.
- 3.7 Install [X], assuring wire harnesses not pinched underneath UOP Support Bracket, fasteners (six).
Tighten, torque UOP Support Bracket to 30 in-lbs [Driver Handle, 1/4" Drive; 1/8" Hex Head, 1/4" Drive; (10-40 in-lbs) Trq Wrench, 1/4" Drive].
- 3.8 Doff static wrist tether.
- 3.9 Photo document final configuration (digital camera).
- 3.10 Repeat steps 1 to 3.9 for remaining Cupola UOP.
4. CHECKOUT
Perform 1.110 GENERIC UOP ACTIVATION AND CHECKOUT, all (SODF: EPS: ACTIVATION AND CHECKOUT: PRIMARY POWER SYSTEM), then:
5. POST MAINTENANCE
 - 5.1 Stow tools.
 - 5.2 Notify **MCC-H** of task completion, P/Ns, S/Ns of installed UOPs.