

Contingency Deorbit Prep

**Mission Operations Directorate
Operations Division**

**Generic, Rev H
March 29, 2001**

NOTE

For STS-100 and subsequent flights

REPRINT

Generic, Rev H, reprinted September 26, 2001.
Includes all updates thru PCN-3,
dated August 20, 2001

National Aeronautics and
Space Administration

Lyndon B. Johnson Space Center
Houston, Texas



United Space Alliance

Verify this is the correct version for the pending operation (training, simulation or flight).
Electronic copies of FDF books are available. URL: <http://fltproc.jsc.nasa.gov/dfd>

CONTINGENCY DEORBIT PREP

GENERIC, Rev H (March 29, 2001)

PCN-7 (Feb 11, 2002) Sheet 1 of 1

List of Implemented Change Requests (482s):

C D/O-490 MULTI-1589
MULTI-1591**NOTE**
For STS-109 and subsequent flights

Incorporate the following:

1. Replace iii thru xiv
2. Replace (MEDS) A2-19 and (MEDS) A2-20, (NOM) B2-19 and (NOM) B2-20
3. Replace (OV102) A3-3 thru (OV102) A3-10, (OV102) A3-13 and (OV102) A3-14, (OV102) A3-17 and (OV102) A3-18, (OV102) A3-25 and (OV102) A3-26, (OV103) B3-3 and (OV103) B3-4, (OV103) B3-23 and (OV103) B3-24, (OV104) C3-3 thru (OV104) C3-6, (OV104) C3-17 and (OV104) C3-18, (OV105) D3-3 and (OV105) D3-4
4. Replace (MEDS) A4-15 and (MEDS) A4-16, (NOM) B4-15 and (NOM) B4-16
5. Replace (MEDS) A5-29 and (MEDS) A5-30, (NOM) B5-29 and (NOM) B5-30
6. Replace (OV102) A6-5 thru (OV102) A6-10, (OV102) A6-13 and (OV102) A6-14, (OV102) A6-17 and (OV102) A6-18, (OV102) A6-25 and (OV102) A6-26, (OV104) C6-5 and (OV104) C6-6, (OV104) C6-17 and (OV104) C6-18
7. Replace (MEDS) A7-17 and (MEDS) A7-18, (NOM) B7-17 and (NOM) B7-18

Prepared by: _____
Book Manager**Approved by:** _____
Manager, Shuttle Procedures Management (USA)**Accepted by:** _____
FDF Subsystem Manager (NASA)

Encl: 70 pages

File this PCN immediately behind the front cover as a permanent record

MISSION OPERATIONS DIRECTORATE

CONTINGENCY DEORBIT PREP

GENERIC, REVISION H
March 29, 2001

PREPARED BY:

Mike Feierstein
Book Manager

APPROVED BY:

Deborah J. Jackson
Manager, Shuttle Procedures Management (USA)

John W. Bearley
FDF Subsystems Manager (NASA)

This document is under the configuration control of the Crew Procedures Control Board (CPCB). All proposed changes must be submitted on JSC Form 482 to DO3/FDF Manager.

Additional distribution of this book for official use must be requested in writing to DO3/FDF Manager. The request must include justification and requester's name, organization, position, and phone number. Contractor requests are made through the NASA or DOD organization supported. Deletions, reduction in quantity, or change of address may be submitted to DO3/FDF Management Office, 281-244-1184.

Incorporates the following:			
482#:	C D/O-428B	C D/O-453	MULTI-1544
	C D/O-445	C D/O-455	
	C D/O-446	C D/O-458	
	C D/O-447	C D/O-459	

AREAS OF TECHNICAL RESPONSIBILITY

Book Manager	DO3/M. Feierstein	281-483-1861
Alt Book Manager	DO3/D. Jackson	281-244-0286

CONTINGENCY DEORBIT PREP

LIST OF EFFECTIVE PAGES

GENERIC	04/29/88	PCN-4	10/24/01
REV H	03/29/01	PCN-5	11/01/01
PCN-1	05/14/01	PCN-6	01/03/02
PCN-2	06/20/01	PCN-7	02/11/02
PCN-3	08/20/01		

Sign Off	*	ALL/GEN H
ii	*	ALL/GEN H
iii	*	ALL/GEN H,7
iv	*	ALL/GEN H,7
v	*	ALL/GEN H,7
vi	*	ALL/GEN H,7
vii	*	ALL/GEN H,7
viii	*	ALL/GEN H,7
ix	*	ALL/GEN H,7
x	*	ALL/GEN H,7
xi	*	ALL/GEN H,7
xii	*	ALL/GEN H,7
xiii	*	ALL/GEN H,7
xiv	*	ALL/GEN H,7
xv	*	ALL/GEN H,6
xvi	*	ALL/GEN H,2
1-1		ALL/GEN H
1-2		ALL/GEN H
1-3		ALL/GEN H
1-4		ALL/GEN H
1-5		ALL/GEN H
1-6		ALL/GEN H
(MEDS) A1-7	<input checked="" type="checkbox"/>	MEDS/GEN H,1
(MEDS) A1-8		ALL/GEN H
(NOM) B1-7	<input checked="" type="checkbox"/>	NOM/GEN H,1
(NOM) B1-8		ALL/GEN H
1-9		ALL/GEN H,1
1-10		ALL/GEN H
1-11	<input checked="" type="checkbox"/>	ALL/GEN H,1
1-12		ALL/GEN H
1-13		ALL/GEN H,1
1-14		ALL/GEN H
2-1		ALL/GEN H
2-2		ALL/GEN H
2-3		ALL/GEN H
2-4		ALL/GEN H
(MEDS) A2-5		MEDS/GEN H
(MEDS) A2-6		MEDS/GEN H
(MEDS) A2-7		MEDS/GEN H
(MEDS) A2-8		MEDS/GEN H
(MEDS) A2-9		ALL/GEN H
(MEDS) A2-10		ALL/GEN H
(MEDS) A2-11		ALL/GEN H
(MEDS) A2-12		ALL/GEN H,3

* - Omit from flight book
 - Prelift-off information required

(MEDS) A2-13		MEDS/GEN H
(MEDS) A2-14	<input checked="" type="checkbox"/>	MEDS/GEN H,3
(MEDS) A2-15		MEDS/GEN H
(MEDS) A2-16		MEDS/GEN H,3
(MEDS) A2-17		ALL/GEN H
(MEDS) A2-18		ALL/GEN H
(MEDS) A2-19	<input checked="" type="checkbox"/>	ALL/GEN H,7
(MEDS) A2-20		ALL/GEN H
(MEDS) A2-21		ALL/GEN H,1
(MEDS) A2-22		ALL/GEN H
(NOM) B2-5		NOM/GEN H
(NOM) B2-6		NOM/GEN H
(NOM) B2-7		NOM/GEN H
(NOM) B2-8		NOM/GEN H
(NOM) B2-9		ALL/GEN H
(NOM) B2-10		ALL/GEN H
(NOM) B2-11		ALL/GEN H
(NOM) B2-12		ALL/GEN H,3
(NOM) B2-13		NOM/GEN H
(NOM) B2-14	<input checked="" type="checkbox"/>	NOM/GEN H,3
(NOM) B2-15		NOM/GEN H
(NOM) B2-16		NOM/GEN H,3
(NOM) B2-17		ALL/GEN H
(NOM) B2-18		ALL/GEN H
(NOM) B2-19	<input checked="" type="checkbox"/>	ALL/GEN H,7
(NOM) B2-20		ALL/GEN H
(NOM) B2-21		ALL/GEN H,1
(NOM) B2-22		ALL/GEN H
3-1		ALL/GEN H,1
3-2		ALL/GEN H,1
(OV102) A3-3		2/GEN H,6
(OV102) A3-4		ALL/GEN H,7
(OV102) A3-5		2/GEN H,3
(OV102) A3-6		ALL/GEN H,7
(OV102) A3-7		2/GEN H,7
(OV102) A3-8		2/GEN H
(OV102) A3-9		2/GEN H,7
(OV102) A3-10		2/GEN H,7
(OV102) A3-11		2/GEN H
(OV102) A3-12		ALL/GEN H
(OV102) A3-13		ALL/GEN H,7
(OV102) A3-14		ALL/GEN H
(OV102) A3-15		ALL/GEN H
(OV102) A3-16		2/GEN H
(OV102) A3-17		ALL/GEN H,7
(OV102) A3-18		2/GEN H,7
(OV102) A3-19		ALL/GEN H,1
(OV102) A3-20		2/GEN H,1
(OV102) A3-21		ALL/GEN H
(OV102) A3-22		2/GEN H,6
(OV102) A3-23		2/GEN H
(OV102) A3-24		2/GEN H
(OV102) A3-25		2/GEN H,7
(OV102) A3-26		2/GEN H,7
(OV102) A3-27		ALL/GEN H

– Prelift-off information required

(OV102) A3-28	ALL/GEN H
(OV102) A3-29	ALL/GEN H
(OV102) A3-30	ALL/GEN H
(OV103) B3-3	3/GEN H
(OV103) B3-4	ALL/GEN H,7
(OV103) B3-5	3/GEN H,5
(OV103) B3-6	ALL/GEN H
(OV103) B3-7	3/GEN H
(OV103) B3-8	3/GEN H
(OV103) B3-9	3/GEN H
(OV103) B3-10	3/GEN H
(OV103) B3-11	3/GEN H
(OV103) B3-12	ALL/GEN H
(OV103) B3-13	ALL/GEN H
(OV103) B3-14	ALL/GEN H
(OV103) B3-15	ALL/GEN H
(OV103) B3-16	3/GEN H
(OV103) B3-17	ALL/GEN H
(OV103) B3-18	3/GEN H,4
(OV103) B3-19	ALL/GEN H,1
(OV103) B3-20	3/GEN H,1
(OV103) B3-21	ALL/GEN H,1
(OV103) B3-22	3/GEN H,1
(OV103) B3-23	3/GEN H,1
(OV103) B3-24	3/GEN H,7
(OV103) B3-25	3/GEN H,1
(OV103) B3-26	3/GEN H,1
(OV103) B3-27	3/GEN H,2
(OV103) B3-28	3/GEN H,1
(OV103) B3-29	ALL/GEN H,1
(OV103) B3-30	ALL/GEN H,1
(OV103) B3-31	ALL/GEN H,1
(OV103) B3-32	ALL/GEN H,1
(OV104) C3-3	4/GEN H
(OV104) C3-4	ALL/GEN H,7
(OV104) C3-5	4/GEN H,3
(OV104) C3-6	4/GEN H,7
(OV104) C3-7	4/GEN H
(OV104) C3-8	4/GEN H
(OV104) C3-9	4/GEN H
(OV104) C3-10	4/GEN H
(OV104) C3-11	4/GEN H
(OV104) C3-12	ALL/GEN H
(OV104) C3-13	ALL/GEN H
(OV104) C3-14	ALL/GEN H
(OV104) C3-15	ALL/GEN H
(OV104) C3-16	4/GEN H
(OV104) C3-17	ALL/GEN H,7
(OV104) C3-18	4/GEN H,7
(OV104) C3-19	ALL/GEN H,1
(OV104) C3-20	4/GEN H,1
(OV104) C3-21	ALL/GEN H,1
(OV104) C3-22	4/GEN H,1
(OV104) C3-23	4/GEN H,1
(OV104) C3-24	4/GEN H,1

(OV104) C3-25	4/GEN H,1
(OV104) C3-26	4/GEN H,1
(OV104) C3-27	4/GEN H,2
(OV104) C3-28	4/GEN H,1
(OV104) C3-29	ALL/GEN H,1
(OV104) C3-30	ALL/GEN H,1
(OV104) C3-31	ALL/GEN H,1
(OV104) C3-32	ALL/GEN H,1
(OV105) D3-3	5/GEN H
(OV105) D3-4	ALL/GEN H,7
(OV105) D3-5	5/GEN H,3
(OV105) D3-6	ALL/GEN H
(OV105) D3-7	5/GEN H
(OV105) D3-8	5/GEN H
(OV105) D3-9	5/GEN H
(OV105) D3-10	5/GEN H
(OV105) D3-11	5/GEN H
(OV105) D3-12	ALL/GEN H
(OV105) D3-13	ALL/GEN H
(OV105) D3-14	ALL/GEN H
(OV105) D3-15	ALL/GEN H
(OV105) D3-16	5/GEN H
(OV105) D3-17	ALL/GEN H
(OV105) D3-18	5/GEN H,4
(OV105) D3-19	ALL/GEN H,1
(OV105) D3-20	5/GEN H,1
(OV105) D3-21	ALL/GEN H,1
(OV105) D3-22	5/GEN H,1
(OV105) D3-23	5/GEN H,1
(OV105) D3-24	5/GEN H,6
(OV105) D3-25	5/GEN H,1
(OV105) D3-26	5/GEN H,1
(OV105) D3-27	5/GEN H,2
(OV105) D3-28	5/GEN H,1
(OV105) D3-29	ALL/GEN H,1
(OV105) D3-30	ALL/GEN H,1
(OV105) D3-31	ALL/GEN H,1
(OV105) D3-32	ALL/GEN H,1
4-1	ALL/GEN H
4-2	ALL/GEN H
(MEDS) A4-3	ALL/GEN H
(MEDS) A4-4	MEDS/GEN H
(MEDS) A4-5	MEDS/GEN H
(MEDS) A4-6	ALL/GEN H,3
(MEDS) A4-7	MEDS/GEN H
(MEDS) A4-8	ALL/GEN H,1
(MEDS) A4-9	ALL/GEN H
(MEDS) A4-10	MEDS/GEN H
(MEDS) A4-11	MEDS/GEN H
(MEDS) A4-12	ALL/GEN H
(MEDS) A4-13	ALL/GEN H
(MEDS) A4-14	ALL/GEN H
(MEDS) A4-15	ALL/GEN H,1
(MEDS) A4-16	ALL/GEN H,7
(MEDS) A4-17	ALL/GEN H

(MEDS) A4-18	ALL/GEN H
(NOM) B4-3	NOM/GEN H
(NOM) B4-4	NOM/GEN H
(NOM) B4-5	NOM/GEN H
(NOM) B4-6	ALL/GEN H,3
(NOM) B4-7	NOM/GEN H
(NOM) B4-8	ALL/GEN H,1
(NOM) B4-9	ALL/GEN H
(NOM) B4-10	NOM/GEN H
(NOM) B4-11	NOM/GEN H
(NOM) B4-12	ALL/GEN H
(NOM) B4-13	NOM/GEN H
(NOM) B4-14	ALL/GEN H
(NOM) B4-15	ALL/GEN H,1
(NOM) B4-16	ALL/GEN H,7
(NOM) B4-17	ALL/GEN H
(NOM) B4-18	ALL/GEN H
5-1	ALL/GEN H
5-2	ALL/GEN H
(MEDS) A5-3	ALL/GEN H
(MEDS) A5-4	MEDS/GEN H,1
(MEDS) A5-5	MEDS/GEN H
(MEDS) A5-6	MEDS/GEN H
(MEDS) A5-7	ALL/GEN H
(MEDS) A5-8	ALL/GEN H
(MEDS) A5-9	MEDS/GEN H
(MEDS) A5-10	MEDS/GEN H,3
(MEDS) A5-11	ALL/GEN H,1
(MEDS) A5-12	ALL/GEN H,3
(MEDS) A5-13	MEDS/GEN H,4
(MEDS) A5-14	ALL/GEN H,3
(MEDS) A5-15	ALL/GEN H
(MEDS) A5-16	ALL/GEN H,3
(MEDS) A5-17	ALL/GEN H
(MEDS) A5-18	ALL/GEN H,3
(MEDS) A5-19	ALL/GEN H,1
(MEDS) A5-20	MEDS/GEN H
(MEDS) A5-21	ALL/GEN H,3
(MEDS) A5-22	MEDS/GEN H
(MEDS) A5-23	MEDS/GEN H
(MEDS) A5-24	MEDS/GEN H
(MEDS) A5-25	MEDS/GEN H
(MEDS) A5-26	ALL/GEN H
(MEDS) A5-27	ALL/GEN H,1
(MEDS) A5-28	MEDS/GEN H
(MEDS) A5-29	ALL/GEN H,7
(MEDS) A5-30	ALL/GEN H
(MEDS) A5-31	ALL/GEN H,1
(MEDS) A5-32	ALL/GEN H
(NOM) B5-3	ALL/GEN H
(NOM) B5-4	NOM/GEN H,1
(NOM) B5-5	NOM/GEN H
(NOM) B5-6	NOM/GEN H
(NOM) B5-7	ALL/GEN H
(NOM) B5-8	ALL/GEN H

(NOM) B5-9	NOM/GEN H
(NOM) B5-10	NOM/GEN H,3
(NOM) B5-11	ALL/GEN H,1
(NOM) B5-12	ALL/GEN H,3
(NOM) B5-13	NOM/GEN H,4
(NOM) B5-14	ALL/GEN H,3
(NOM) B5-15	ALL/GEN H
(NOM) B5-16	ALL/GEN H,3
(NOM) B5-17	ALL/GEN H
(NOM) B5-18	ALL/GEN H,3
(NOM) B5-19	NOM/GEN H,1
(NOM) B5-20	NOM/GEN H
(NOM) B5-21	ALL/GEN H,3
(NOM) B5-22	ALL/GEN H
(NOM) B5-23	NOM/GEN H
(NOM) B5-24	NOM/GEN H
(NOM) B5-25	NOM/GEN H
(NOM) B5-26	ALL/GEN H
(NOM) B5-27	ALL/GEN H,1
(NOM) B5-28	NOM/GEN H
(NOM) B5-29	ALL/GEN H,7
(NOM) B5-30	ALL/GEN H
(NOM) B5-31	ALL/GEN H,1
(NOM) B5-32	ALL/GEN H
6-1	ALL/GEN H,1
6-2	ALL/GEN H,1
(OV102) A6-3	2/GEN H,6
(OV102) A6-4	ALL/GEN H
(OV102) A6-5	2/GEN H,3
(OV102) A6-6	2/GEN H,7
(OV102) A6-7	2/GEN H,7
(OV102) A6-8	2/GEN H
(OV102) A6-9	2/GEN H,7
(OV102) A6-10	2/GEN H,7
(OV102) A6-11	2/GEN H,6
(OV102) A6-12	ALL/GEN H
(OV102) A6-13	2/GEN H,7
(OV102) A6-14	ALL/GEN H
(OV102) A6-15	ALL/GEN H
(OV102) A6-16	2/GEN H
(OV102) A6-17	ALL/GEN H
(OV102) A6-18	2/GEN H,7
(OV102) A6-19	ALL/GEN H,4
(OV102) A6-20	2/GEN H,4
(OV102) A6-21	ALL/GEN H
(OV102) A6-22	2/GEN H,6
(OV102) A6-23	2/GEN H
(OV102) A6-24	2/GEN H
(OV102) A6-25	2/GEN H,7
(OV102) A6-26	ALL/GEN H,7
(OV102) A6-27	ALL/GEN H
(OV102) A6-28	ALL/GEN H
(OV102) A6-29	ALL/GEN H
(OV102) A6-30	ALL/GEN H
(OV103) B6-3	3/GEN H

(OV103) B6-4	ALL/GEN H
(OV103) B6-5	3/GEN H,5
(OV103) B6-6	ALL/GEN H
(OV103) B6-7	3/GEN H
(OV103) B6-8	3/GEN H
(OV103) B6-9	3/GEN H
(OV103) B6-10	3/GEN H
(OV103) B6-11	3/GEN H
(OV103) B6-12	ALL/GEN H
(OV103) B6-13	ALL/GEN H
(OV103) B6-14	ALL/GEN H
(OV103) B6-15	ALL/GEN H
(OV103) B6-16	3/GEN H
(OV103) B6-17	ALL/GEN H
(OV103) B6-18	3/GEN H,4
(OV103) B6-19	ALL/GEN H,4
(OV103) B6-20	3/GEN H,4
(OV103) B6-21	3/GEN H,1
(OV103) B6-22	3/GEN H,1
(OV103) B6-23	ALL/GEN H,1
(OV103) B6-24	3/GEN H,1
(OV103) B6-25	3/GEN H,1
(OV103) B6-26	3/GEN H,1
(OV103) B6-27	3/GEN H,2
(OV103) B6-28	3/GEN H,1
(OV103) B6-29	ALL/GEN H,1
(OV103) B6-30	ALL/GEN H,1
(OV103) B6-31	ALL/GEN H,1
(OV103) B6-32	ALL/GEN H,1
(OV104) C6-3	4/GEN H
(OV104) C6-4	ALL/GEN H
(OV104) C6-5	4/GEN H,3
(OV104) C6-6	4/GEN H,7
(OV104) C6-7	4/GEN H
(OV104) C6-8	4/GEN H
(OV104) C6-9	4/GEN H
(OV104) C6-10	4/GEN H
(OV104) C6-11	4/GEN H
(OV104) C6-12	ALL/GEN H
(OV104) C6-13	MEDS/GEN H
(OV104) C6-14	ALL/GEN H
(OV104) C6-15	ALL/GEN H
(OV104) C6-16	4/GEN H
(OV104) C6-17	MEDS/GEN H
(OV104) C6-18	MEDS/GEN H,7
(OV104) C6-19	ALL/GEN H,4
(OV104) C6-20	4/GEN H,1
(OV104) C6-21	4/GEN H,1
(OV104) C6-22	4/GEN H,1
(OV104) C6-23	ALL/GEN H,1
(OV104) C6-24	4/GEN H,1
(OV104) C6-25	4/GEN H,1
(OV104) C6-26	4/GEN H,1
(OV104) C6-27	4/GEN H,2
(OV104) C6-28	4/GEN H,1

(OV104) C6-29	ALL/GEN H,1
(OV104) C6-30	ALL/GEN H,1
(OV104) C6-31	ALL/GEN H,1
(OV104) C6-32	ALL/GEN H,1
(OV105) D6-3	5/GEN H
(OV105) D6-4	ALL/GEN H
(OV105) D6-5	5/GEN H,3
(OV105) D6-6	ALL/GEN H
(OV105) D6-7	5/GEN H
(OV105) D6-8	5/GEN H
(OV105) D6-9	5/GEN H
(OV105) D6-10	5/GEN H
(OV105) D6-11	5/GEN H
(OV105) D6-12	ALL/GEN H
(OV105) D6-13	ALL/GEN H
(OV105) D6-14	ALL/GEN H
(OV105) D6-15	ALL/GEN H
(OV105) D6-16	5/GEN H
(OV105) D6-17	ALL/GEN H
(OV105) D6-18	5/GEN H,4
(OV105) D6-19	ALL/GEN H,5
(OV105) D6-20	5/GEN H,5
(OV105) D6-21	5/GEN H,1
(OV105) D6-22	5/GEN H,1
(OV105) D6-23	ALL/GEN H,1
(OV105) D6-24	5/GEN H,1
(OV105) D6-25	5/GEN H,1
(OV105) D6-26	5/GEN H,1
(OV105) D6-27	5/GEN H,2
(OV105) D6-28	5/GEN H,1
(OV105) D6-29	ALL/GEN H,1
(OV105) D6-30	ALL/GEN H,1
(OV105) D6-31	ALL/GEN H,1
(OV105) D6-32	ALL/GEN H,1
7-1	ALL/GEN H
7-2	ALL/GEN H
(MEDS) A7-3	MEDS/GEN H
(MEDS) A7-4	MEDS/GEN H
(MEDS) A7-5	ALL/GEN H
(MEDS) A7-6	MEDS/GEN H
(MEDS) A7-7	MEDS/GEN H
(MEDS) A7-8	ALL/GEN H
(MEDS) A7-9	ALL/GEN H,3
(MEDS) A7-10	ALL/GEN H
(MEDS) A7-11	ALL/GEN H,5
(MEDS) A7-12	ALL/GEN H
(MEDS) A7-13	MEDS/GEN H,1
(MEDS) A7-14	MEDS/GEN H,3
(MEDS) A7-15	ALL/GEN H
(MEDS) A7-16	ALL/GEN H
(MEDS) A7-17	ALL/GEN H,7
(MEDS) A7-18	<input checked="" type="checkbox"/> MEDS/GEN H
(MEDS) A7-19	ALL/GEN H,1
(MEDS) A7-20	ALL/GEN H
(MEDS) A7-21	MEDS/GEN H

– Prelift-off information required

(MEDS) A7-22	ALL/GEN H
(NOM) B7-3	NOM/GEN H
(NOM) B7-4	NOM/GEN H
(NOM) B7-5	ALL/GEN H
(NOM) B7-6	NOM/GEN H
(NOM) B7-7	NOM/GEN H
(NOM) B7-8	ALL/GEN H
(NOM) B7-9	ALL/GEN H,3
(NOM) B7-10	ALL/GEN H
(NOM) B7-11	ALL/GEN H,5
(NOM) B7-12	ALL/GEN H
(NOM) B7-13	NOM/GEN H,1
(NOM) B7-14	NOM/GEN H,3
(NOM) B7-15	ALL/GEN H
(NOM) B7-16	ALL/GEN H
(NOM) B7-17	ALL/GEN H,7
(NOM) B7-18	<input checked="" type="checkbox"/> NOM/GEN H
(NOM) B7-19	ALL/GEN H,1
(NOM) B7-20	ALL/GEN H
(NOM) B7-21	NOM/GEN H
(NOM) B7-22	ALL/GEN H
8-1	ALL/GEN H
8-2	ALL/GEN H
(MEDS) A8-3	ALL/GEN H
(MEDS) A8-4	ALL/GEN H
(MEDS) A8-5	MEDS/GEN H
(MEDS) A8-6	MEDS/GEN H,3
(MEDS) A8-7	ALL/GEN H
(MEDS) A8-8	ALL/GEN H
(MEDS) A8-9	ALL/GEN H
(MEDS) A8-10	MEDS/GEN H,4
(MEDS) A8-11	MEDS/GEN H,3
(MEDS) A8-12	MEDS/GEN H
(MEDS) A8-13	ALL/GEN H,3
(MEDS) A8-14	MEDS/GEN H
(MEDS) A8-15	MEDS/GEN H
(MEDS) A8-16	ALL/GEN H
(MEDS) A8-17	MEDS/GEN H
(MEDS) A8-18	ALL/GEN H
(NOM) B8-3	ALL/GEN H
(NOM) B8-4	ALL/GEN H
(NOM) B8-5	NOM/GEN H
(NOM) B8-6	NOM/GEN H,3
(NOM) B8-7	ALL/GEN H
(NOM) B8-8	ALL/GEN H
(NOM) B8-9	ALL/GEN H
(NOM) B8-10	NOM/GEN H,4
(NOM) B8-11	NOM/GEN H,3
(NOM) B8-12	NOM/GEN H
(NOM) B8-13	ALL/GEN H,3
(NOM) B8-14	NOM/GEN H
(NOM) B8-15	NOM/GEN H
(NOM) B8-16	ALL/GEN H
(NOM) B8-17	NOM/GEN H
(NOM) B8-18	ALL/GEN H

– Prelift-off information required

9-1	ALL/GEN H
9-2	ALL/GEN H
(MEDS) A9-3	ALL/GEN H
(MEDS) A9-4	ALL/GEN H
(MEDS) A9-5	ALL/GEN H
(MEDS) A9-6	ALL/GEN H
(MEDS) A9-7	MEDS/GEN H
(MEDS) A9-8	ALL/GEN H,1
(MEDS) A9-9	MEDS/GEN H
(MEDS) A9-10	ALL/GEN H
(A)A9-11	98,104,110/GEN H,4
(A)A9-12	MEDS/GEN H,4
(B)A9-11	107,109/GEN H,4
(B)A9-12	MEDS/GEN H,4
(MEDS) A9-13	MEDS/GEN H
(MEDS) A9-14	ALL/GEN H
(MEDS) A9-15	MEDS/GEN H
(MEDS) A9-16	ALL/GEN H
(MEDS) A9-17	MEDS/GEN H,5
(MEDS) A9-18	ALL/GEN H
(NOM) B9-3	ALL/GEN H
(NOM) B9-4	ALL/GEN H
(NOM) B9-5	ALL/GEN H
(NOM) B9-6	ALL/GEN H
(NOM) B9-7	NOM/GEN H
(NOM) B9-8	ALL/GEN H,2
(NOM) B9-9	NOM/GEN H
(NOM) B9-10	ALL/GEN H
(A)B9-11	102,105/GEN H,4
(A)B9-12	NOM/GEN H,4
(B)B9-11	100,108/GEN H,4
(B)B9-12	NOM/GEN H,4
(NOM) B9-13	NOM/GEN H
(NOM) B9-14	ALL/GEN H
(NOM) B9-15	NOM/GEN H
(NOM) B9-16	ALL/GEN H
(NOM) B9-17	NOM/GEN H,5
(NOM) B9-18	ALL/GEN H
10-1	ALL/GEN H
10-2	ALL/GEN H
(MEDS) A10-3	ALL/GEN H
(MEDS) A10-4	ALL/GEN H
(MEDS) A10-5	MEDS/GEN H
(MEDS) A10-6	ALL/GEN H
(MEDS) A10-7	ALL/GEN H
(MEDS) A10-8	ALL/GEN H
(MEDS) A10-9	ALL/GEN H,1
(MEDS) A10-10	ALL/GEN H,1
(MEDS) A10-11	MEDS/GEN H
(MEDS) A10-12	ALL/GEN H,4
(MEDS) A10-13	ALL/GEN H
(MEDS) A10-14	MEDS/GEN H,4
(MEDS) A10-15	MEDS/GEN H
(MEDS) A10-16	MEDS/GEN H
(MEDS) A10-17	MEDS/GEN H

(MEDS) A10-18	ALL/GEN H
(MEDS) A10-19	MEDS/GEN H
(MEDS) A10-20	MEDS/GEN H
(MEDS) A10-21	ALL/GEN H
(MEDS) A10-22	ALL/GEN H
(NOM) B10-3	ALL/GEN H
(NOM) B10-4	ALL/GEN H
(NOM) B10-5	NOM/GEN H
(NOM) B10-6	ALL/GEN H
(NOM) B10-7	ALL/GEN H
(NOM) B10-8	ALL/GEN H
(NOM) B10-9	ALL/GEN H,1
(NOM) B10-10	ALL/GEN H,2
(NOM) B10-11	NOM/GEN H
(NOM) B10-12	ALL/GEN H,4
(NOM) B10-13	ALL/GEN H
(NOM) B10-14	NOM/GEN H,4
(NOM) B10-15	NOM/GEN H
(NOM) B10-16	NOM/GEN H
(NOM) B10-17	NOM/GEN H
(NOM) B10-18	ALL/GEN H
(NOM) B10-19	NOM/GEN H
(NOM) B10-20	NOM/GEN H
(NOM) B10-21	ALL/GEN H
(NOM) B10-22	ALL/GEN H
11-1	ALL/GEN H
11-2	ALL/GEN H
(MEDS) A11-3	ALL/GEN H
(MEDS) A11-4	ALL/GEN H
(MEDS) A11-5	ALL/GEN H
(MEDS) A11-6	MEDS/GEN H
(MEDS) A11-7	ALL/GEN H
(MEDS) A11-8	ALL/GEN H
(MEDS) A11-9	ALL/GEN H,1
(MEDS) A11-10	ALL/GEN H
(MEDS) A11-11	MEDS/GEN H
(MEDS) A11-12	ALL/GEN H
(MEDS) A11-13	ALL/GEN H
(MEDS) A11-14	ALL/GEN H
(MEDS) A11-15	ALL/GEN H
(MEDS) A11-16	ALL/GEN H
(MEDS) A11-17	MEDS/GEN H
(MEDS) A11-18	MEDS/GEN H
(MEDS) A11-19	MEDS/GEN H
(MEDS) A11-20	ALL/GEN H
(NOM) B11-3	ALL/GEN H
(NOM) B11-4	ALL/GEN H
(NOM) B11-5	ALL/GEN H
(NOM) B11-6	NOM/GEN H
(NOM) B11-7	ALL/GEN H
(NOM) B11-8	ALL/GEN H
(NOM) B11-9	ALL/GEN H,2
(NOM) B11-10	ALL/GEN H
(NOM) B11-11	NOM/GEN H
(NOM) B11-12	ALL/GEN H

(NOM) B11-13	ALL/GEN H
(NOM) B11-14	ALL/GEN H
(NOM) B11-15	ALL/GEN H
(NOM) B11-16	ALL/GEN H
(NOM) B11-17	NOM/GEN H
(NOM) B11-18	NOM/GEN H
(NOM) B11-19	NOM/GEN H
(NOM) B11-20	ALL/GEN H
12-1	ALL/GEN H
12-2	ALL/GEN H
12-3	ALL/GEN H
12-4	ALL/GEN H
12-5	ALL/GEN H
12-6	ALL/GEN H
12-7	ALL/GEN H
12-8	ALL/GEN H
(MEDS) A12-9	MEDS/GEN H
(MEDS) A12-10	ALL/GEN H
(NOM) B12-9	NOM/GEN H
(NOM) B12-10	ALL/GEN H
13-1	ALL/GEN H
13-2	ALL/GEN H
14-1	ALL/GEN H,6
14-2	ALL/GEN H,6

CONTENTS

	PAGE
LAUNCH DAY DEORBIT PREP (ORBIT 2)	1-1
LAUNCH DAY DEORBIT PREP (ORBIT 3)	2-1
ENTRY SWITCH LIST/VERIFICATION	3-1
LOSS OF 2 FC LAUNCH DAY DEORBIT PREP (ORBIT 2 OR ORBIT 3)	4-1
LOSS OF 2 FUEL CELLS ENTRY MANEUVERS, $M = 2.0 \sqrt{\text{THETA}}$ LIMITS (CIL)	4-13
LOSS OF 2 FUEL CELLS DEORBIT PREP	5-1
LOSS OF 2 FUEL CELLS ENTRY MANEUVERS, $M = 2.0 \sqrt{\text{THETA}}$ LIMITS (CIL)	5-25
LOSS OF 2 FC SWITCH VERIFICATION LIST	6-1
LOSS OF FES DEORBIT PREP	7-1
LOSS OF 2 H ₂ O LOOPS	8-1
LOSS OF 2 H ₂ O LOOPS DEORBIT PREP/ENTRY	9-1
LOSS OF 2 H ₂ O LOOPS ENTRY MANEUVERS, $M = 2.0 \sqrt{\text{THETA}}$ LIMITS (CIL)	9-17
EMERGENCY DEORBIT PREP/ENTRY	10-1
STOW KU-BD ANTENNA (CIL)	10-7
IF NO AIR DATA AND $M < 1.5$, FLY THETA LIMITS (CIL)	10-22
LOSS OF 2 FREON LOOPS DEORBIT PREP/ENTRY	11-1
LOSS OF 2 FREON LOOPS ENTRY MANEUVERS, $M = 2.0 \sqrt{\text{THETA}}$ LIMITS (CIL)	11-19
QUICK RESPONSE JETTISON	12-1
POST-JETTISON CLEANUP, MCA PWR AC2 3 Φ MID 2, MCA PWR AC3 3 Φ MID 4 (CIL)	12-7
BAILOUT	13-1
MS PAGES	14-1

This Page Intentionally Blank

LAUNCH DAY DEORBIT PREP (ORBIT 2)

This Page Intentionally Blank

LAUNCH DAY DEORBIT PREP (ORBIT 2)

ASSUMPTIONS/INITIAL CONDITIONS

These procedures may be entered directly from ASC

There is no requirement for completion of any Nominal Post Insertion procedures

MSs only will egress seats

Procedures should be started at approximately MET 01:00

PROBLEM DESCRIPTION/RATIONALE

Failure in any system that requires deorbit as soon as possible after last AOA opportunity

LAUNCH DAY DEORBIT PREP (ORBIT 2) SUMMARY TIMELINE

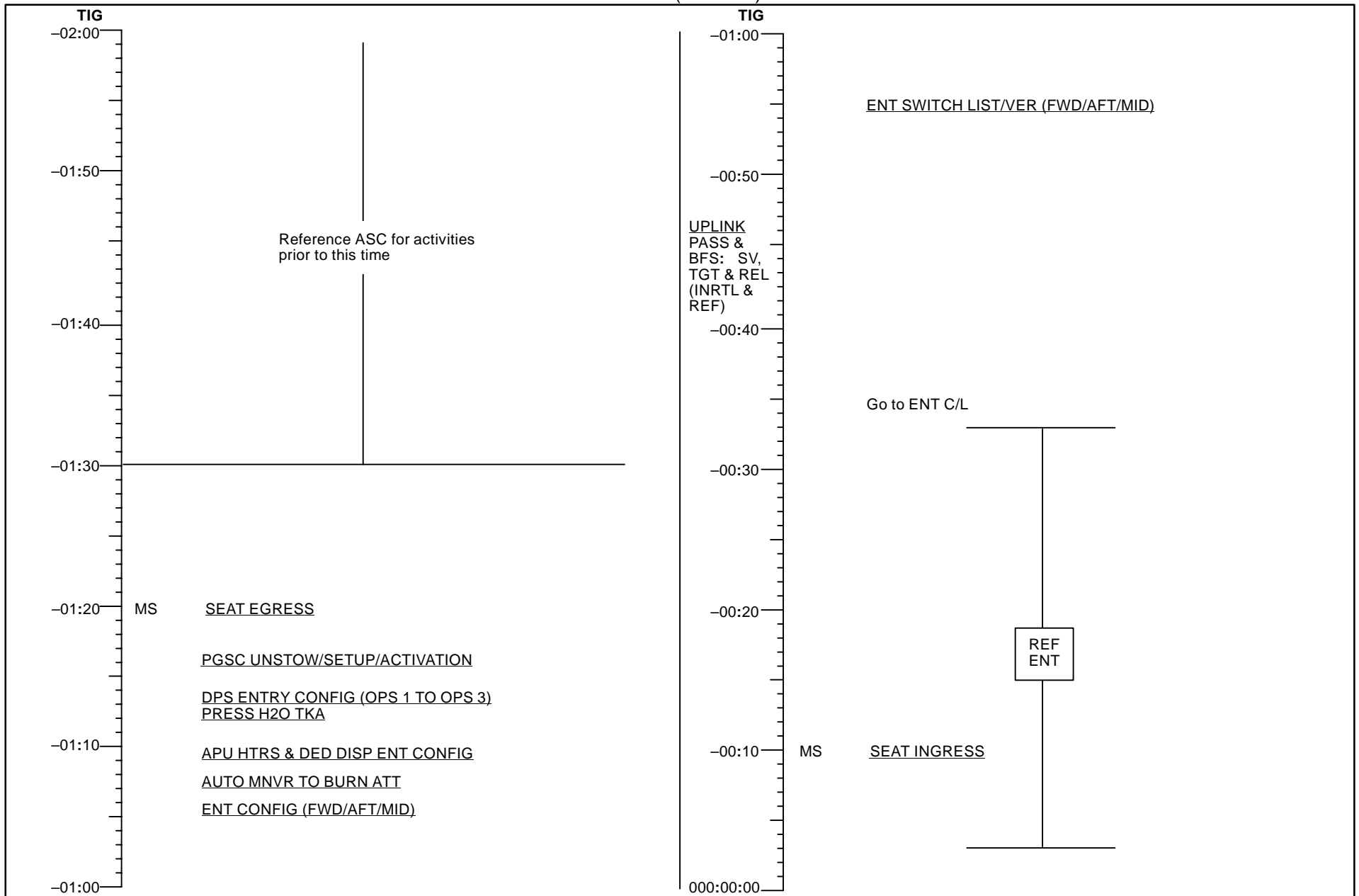

DPS ENTRY CONFIG 1

C,P 1. TRANSITION TO GNC OPS 3
 C2 Set event timer to count down to TIG

O14,O15, ✓ RGA,ACCEL,ASA,IMU (all) – ON
 O16

C3 CONFIG – ITEM 1 +3 EXEC
 Modify MC 3 per table
 BFC CRT DISP – OFF
 GNC, OPS 301 PRO

1: GNC DEORB MNVR COAST

CRT3 BFC CRT DISP – ON
 BFS, GNC OPS 000 PRO
 BFS, GNC OPS 301 PRO

2. LAND SITE UPDATE

1: GNC 50 HORIZ SIT

SEL SITE (See LAND SITE DATA)

3. LOAD IN TGTs

1: GNC DEORB MNVR COAST

* If MCC cannot provide DEORB TGT, use PGSC *

✓ PASS and BFS TGT per DEORBIT MNVR PAD (ENT, MNVR PADS) or
 PGSC

LOAD – ITEM 22 EXEC
 TIMER – ITEM 23 EXEC

✓ PASS and BFS solution per DEORBIT
 MNVR PAD (ENT, MNVR PADS):
 BURN ATT
 HA
 HP
 ΔVTOT
 TGO

4. VERIFY MC 9 TABLE (GNC 9) FOR POST LANDING

2: GNC 0 GPC MEMORY

✓ CONFIG – ITEM 1 +9 EXEC
 Modify MC 9 per table
 CONFIG – ITEM 1 +3 EXEC

CONFIG	3
GPC	12340
STR 1	1
2	2
3	3
4	4
PL 1/2	1
CRT 1	1
2	2
3	3
4	0
L 1	0
2	0
MM 1	1
2	2

CONFIG	9
GPC	12340
STR 1	1
2	2
3	3
4	4
PL 1/2	1
CRT 1	1
2	2
3	3
4	0
L 1	1
2	2
MM 1	1
2	2

This Page Intentionally Blank

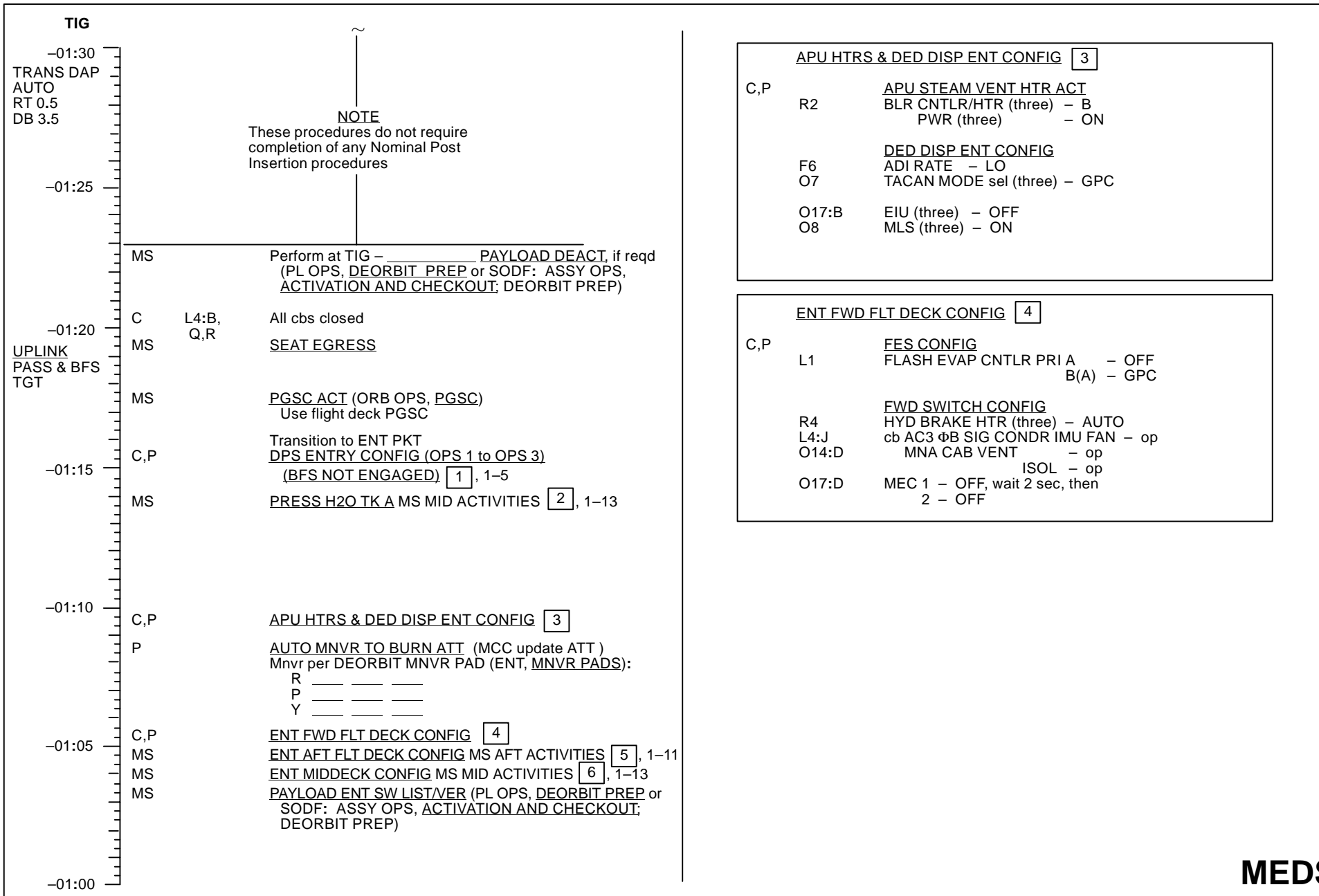

This Page Intentionally Blank

(MEDS) A1-8

MEDS
C D/O/ALL/GEN H

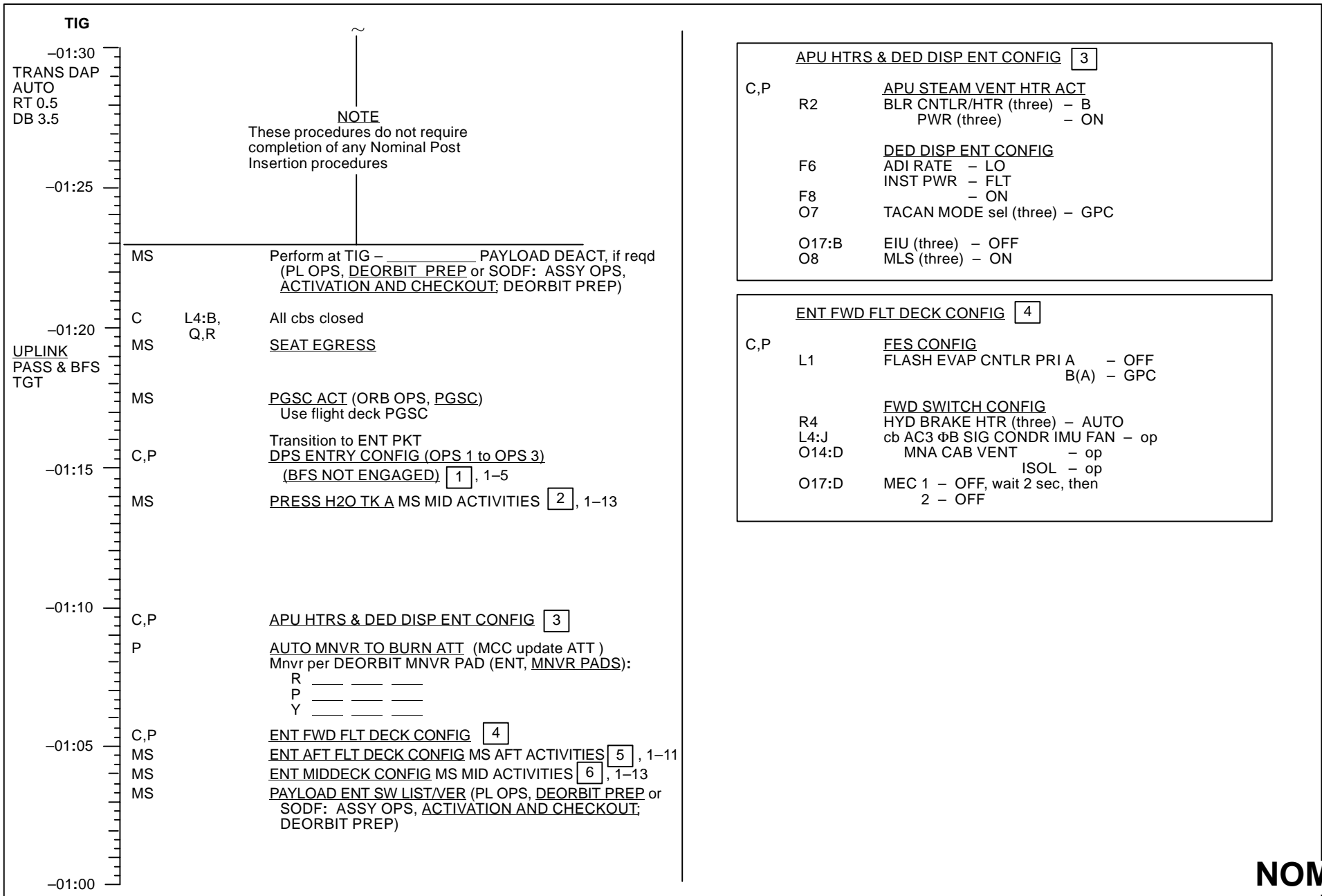

This Page Intentionally Blank

(NOM) B1-8

NOM
C D/O/ALL/GEN H

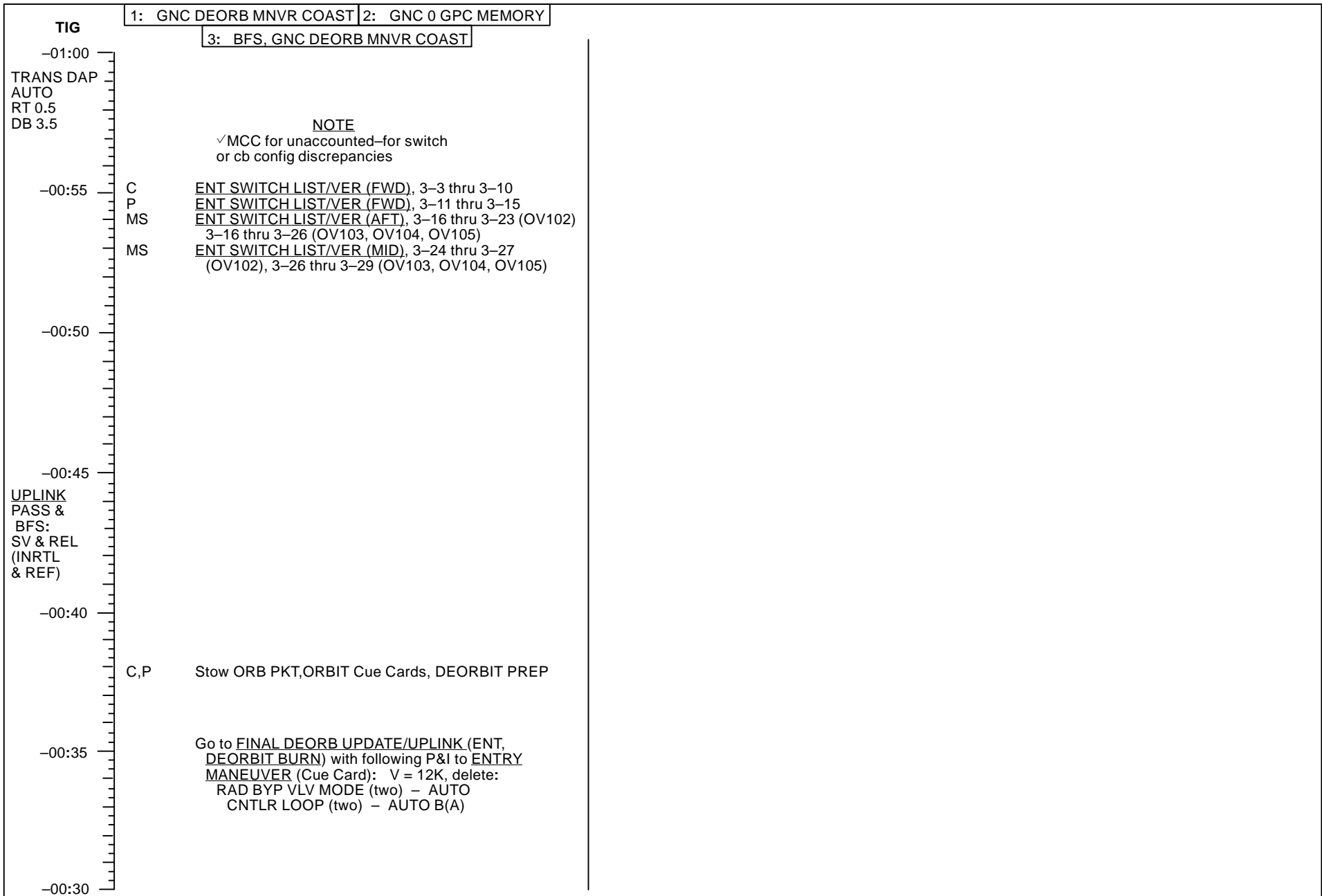

This Page Intentionally Blank

MS LAUNCH DAY DEORBIT PREP AFT DECK CONFIGURATION (ORBIT 2)

NOTE

Wait for GO from CDR or PLT before starting any activity on this page

TIME (TIG-)	MS AFT ACTIONS
—	<u>PAYLOAD DEACT</u> , if reqd (PL OPS, <u>DEORBIT PREP</u> or SODF: ASSY OPS, <u>ACTIVATION AND CHECKOUT</u> ; DEORBIT PREP)
01:19	<u>SEAT EGRESS</u>
01:18	<u>PGSC ACT</u> (ORB OPS, <u>PGSC</u>) Use flight deck PGSC
01:05	<u>ENT AFT FLT DECK CONFIG</u> 5
00:54	<u>ENT SWITCH LIST/VER (AFT)</u> , 3-16 thru 3-23 (OV102) 3-16 thru 3-24 (OV103, OV104, OV105)

ENT AFT FLT DECK CONFIG 5

A1L ENTRY COMM CONFIG
 S-BD PM MODE - STDN LO
 NSP CODING RCV - OFF
 ✓XMIT - OFF

A12 HTR CONFIG
 HYD HTR (eight) - OFF

ML86B:A ✓cb MNC SPLY H2O XOVR VLV - cl
 R11L SPLY H2O XOVR VLV - OP (tb-OP)
 ✓AFT deck lts as reqd

RESET C/W

R13U		
PARAMETER NAME	C/W CH	UPPER LIMIT
FREON LOOP EVAP OUT T1	107	1.90V/64.8 degF
T2	117	1.90V/64.8 degF

**Back of LAUNCH DAY DEORBIT PREP AFT DECK CONFIGURATION
(ORBIT 2)**

MS LAUNCH DAY DEORBIT PREP MIDDECK ACTIVITIES (ORBIT 2)

NOTE

Wait for GO from CDR or PLT before starting any activity on this page

TIME (TIG-)	MS MIDDECK ACTIONS
01:18	<u>SEAT EGRESS</u>
01:15	<u>PRESS H2O TKA</u> [2]
01:04	<u>ENT MIDDECK CONFIG</u> [6]
00:53	<u>ENT SWITCH LIST/VER (MID)</u> , 3-24 thru 3-27 (OV102) 3-26 thru 3-29 (OV103, OV104, OV105)

<u>ENT MIDDECK CONFIG</u> [6]	
MS	<u>MIDDECK PCS</u>
MO69M	LEH O2 7,8 vlv (two) – as reqd
MO32M	6 vlv – as reqd
MO13Q	✓ MIDDECK FLOODS as reqd
ML85E	<u>ENTRY COMM CONFIG</u>
	AC S1 – OFF

<u>PRESS H2O TKA</u> [2]
ML26C SPLY H2O GN2 TK VENT vlv – PRESS TKA SPLY vlv – OP
<u>NOTE</u>
Disregard possible 'S66 WASTE H2O PRE' fault msg

**Back of MS LAUNCH DAY DEORBIT PREP MIDDECK ACTIVITIES
(ORBIT 2)**

LAUNCH DAY DEORBIT PREP (ORBIT 3)

2-1

C D/O/ALL/GEN H

LAUNCH DAY
ORBIT 3

This Page Intentionally Blank

LAUNCH DAY DEORBIT PREP (ORBIT 3)

ASSUMPTIONS/INITIAL CONDITIONS

Launch Day Deorbit Prep (Orbit 3) may be entered directly from ascent config (ASC) or orbit config (POST INSERT)

Appropriate PKT or MAL should be accomplished prior to using these procedures

PROBLEM DESCRIPTION/RATIONALE

Any failure that results in a fail-safe condition will be cause for Launch Day Deorbit. Examples include those listed in POST INSERT, plus PLBD problems

NOTE

1. This procedure can be used for an OPS 1 failure or an OPS 2 failure that has occurred prior to GO FOR ORBIT OPS at MET 01:36. After GO FOR ORBIT OPS, these procedures no longer apply
2. If in OPS 1 or in OPS 2 prior to completion of activities preceding MNVR TO PLBD OPENING ATTITUDE, begin procedure at TIG-2:30. This will cover necessary Post Insertion procedures not yet accomplished
3. If in OPS 2 after INITIATION OF MNVR TO PLBD OPENING ATTITUDE; begin procedure at TIG-2:00
4. If entering this procedure due to Av Bay Fire and in OPS 1, incorporate AV BAY FIRE CONTINGENCY DELTAS (OPS 1 to OPS 3),
2-5
5. If entering this procedure due to Av Bay Fire and in OPS 2, incorporate AV BAY FIRE CONTINGENCY DELTAS (OPS 2 to OPS 3),
2-7

This Page Intentionally Blank

AV BAY FIRE CONTINGENCY DELTAS (OPS 1 to OPS 3)

Assumes AV BAY FIRE (ASC PKT, PWRDN) complete

NOTE

Single-fault tolerance used for most cabin air-cooled equipment. Additional LRUs may be activated if reqd and if CABIN PRESS stable \geq 8 psia. Minimize use of IDPs, MDUs, FLT CNTLR PWR, DDU's. Use one PGSC

1. TIG-2:30
If AV BAY 1 or 2 FIRE:
| FCS CH (four) – ORIDE
If AV BAY 3 FIRE:
✓ FCS CH 1,2,3 (three) – AUTO
4 – OFF
2. Skip DPS CONFIG 2 and perform following:
DPS CONFIG FOR AV BAY FIRE (OPS 1 to OPS 3)
Set event timer to count down to TIG
✓ RGA, ASA, IMU (all) – ON
ACCEL (at least three of four) – ON
Power up three of four ADTAs

C2
O14,
O15,
O16

TRANSITION GPCs TO GNC OPS 3

1: GNC GPC MEMORY

CONFIG – ITEM 1 +3 EXEC
Modify MC 3 per table
GNC, OPS 301 PRO

3: GNC DEORB MNVR COAST

TRANSITION BFS GPC TO GNC OPS 3

If AV BAY 1 or 3 FIRE:
GPC MODE 5 – STBY (tb-RUN)
– RUN (tb-RUN)
BFC CRT DISP – ON
✓ SEL – 3+1

3: BFS, GNC BFS MEMORY

✓ GPC OUTPUT 5 – B/U (tb-bp)
✓ TFL ENA – ITEM 29 (*)
BFS, GNC OPS 301 PRO

3: BFS GNC DEORB MNVR COAST

If AV BAY 2 FIRE:

Reassign BFS into GPC 3 via MAL DPS SSR-7 (do not activate MMU2), then take GPC OUTPUT 3 – B/U (tb-bp)
GPC MODE 3 – RUN (tb-RUN)

O6
C3

O6
CRT3

		LOSS OF		
		BAY 1	BAY 2	BAY 3
CONFIG	GPC	3	3	3
		02300	10040	12040
STR	1	3	1	1
	2	2	4	2
	3	3	1	4
	4	2	4	4
PL	1/2	2	1	1
CRT	1	2	1	1
	2	3	4	2
	3	2	1	4
	4	0	0	0
L	1	0	0	0
	2	0	0	0
MM	1	2	1	1
	2	3	4	2

LAND SITE UPDATE

1: GNC 50 HORIZ SIT

SEL SITE (See LAND SITE DATA)

LOAD IN TGTS

1: GNC DEORB MNVR COAST

* If MCC cannot provide DEORB TGT, use PGSC *

- ✓ PASS and BFS TGT per DEORBIT MNVR PAD (ENT, MNVR PADS) or PGSC
- LOAD – ITEM 22 EXEC
- TIMER – ITEM 23 EXEC
- ✓ PASS and BFS solution per DEORBIT MNVR PAD (ENT, MNVR PADS):
BURN ATT
HA
HP
ΔVTOT
TGO

R2

3. Replace APU STEAM VENT HTR ACT 6 with following:
BLR CNTLR/HTR (three) – B
If AV BAY 1(2,3) fire:
BLR CNTLR/HTR 1(2,3) – A
BLR PWR (three) – ON

NOTE

Htr reqd to be on prior to APU act

4. Deltas to ENT FWD FLT DECK CONFIG 10
Do not power up MLS

O14:E,
O15:E,
O16:E

cb MNA, B, C DDU L, R (four) – cl

L1

If AV BAY 1 fire:
FLASH EVAP CNTLR PRI A – GPC

ML31C

5. Deltas to ENT MIDDECK CONFIG 12
✓ VAC VENT ISOL VLV CNTL – OP (tb-OP)
✓ NOZ HTR – ON
6. ENT SWITCH LIST/VERIF
Do not activate pwrdn items

Cont next page

AV BAY FIRE CONTINGENCY DELTAS (OPS 1 to OPS 3) (Cont)

7. AV BAY FIRE P&I DELTAS TO ENTRY

Deltas to ENT, DEORBIT BURN

At TIG-4:

If AV BAY 1(2) FIRE:

GNC DEORB MNVR EXEC

L(R) OMS GMBL - SEC (*)

Use two IDP/CRTs with four MDUs

O14:E,O15:E, ✓cb MNA,B,C DDU L,R (four) - cl

O16:E

F6,F8

FLT CNTLR PWR (two) - ON

Deltas to ENT, POST BURN:

Use one IDP/CRT with two MDUs

F6,F8

FLT CNTLR PWR (two) - OFF

O14:E,

cb MNA,B DDU L (two) - op

O15:E

Delete ANTISKID,NWS callouts

(ENTRY SW CHECK)

If AV BAY 2 FIRE:

O16:F

RJDF 2B F4/F5 LOGIC - ON

F4 DRIVER - ON

O8

FWD RCS MANF ISOL 4 - OP (tb-OP)

Deltas to ENTRY MANEUVERS (Cue Card):

At EI:

Use only two IDP/CRTs with four MDUs

O14:E,

cb MNA,B DDU L (two) - cl

O15:E

F6

FLT CNTLR PWR - ON

O14:E,O15:E,

✓cb ADTA (three) - cl

O16:E

At V = 15K:

Activate all unaffected TACANs,RAs,MLSs

GNC I/O RESET

L2

At M = 0.9:

ANTISKID - ON

NWS - 1

Use two IDP/CRTs with five MDUs

MEDS

(MEDS) A2-6

C D/O/MEDS/GEN H

AV BAY FIRE CONTINGENCY DELTAS (OPS 2 to OPS 3)

Assumes AV BAY FIRE (ORB PKT, PWRDN) complete

NOTE

Single-fault tolerance used for most cabin air-cooled equipment. Additional LRUs may be activated if reqd and if CABIN PRESS stable \geq 8 psia. Minimize use of IDPs, MDUs, FLT CNTLR PWR, DDU's. Use one PGSC

1. TIG -2:30(2:00)
 If AV BAY 1 or 2 FIRE:
 | FCS CH (four) – ORIDE
 If AV BAY 3 FIRE:
 ✓ FCS CH 1,2,3 (three) – AUTO
 4 – OFF

2. Replace APU STEAM VENT HTR ACT 6 with following:
 BLR CNTLR/HTR (three) – B
 If AV BAY 1(2,3) fire:
 | BLR CNTLR/HTR 1(2,3) – A
 BLR PWR (three) – ON

NOTE

Htr reqd to be on prior to APU act

3. Skip OPS 2 TO 3 TRANSITION 9 and perform following:
OPS CONFIG FOR AV BAY FIRE (OPS 2 to OPS 3)
 (Omit if BFS engaged or if already configured with G3 set)

* If IMU or RHC dilemma, do not proceed with *
 * OPS 3 transition *

- ✓ Att mnvr complete
- ✓ RGA, ASA, IMU (all) – ON
- ACCEL (at least three of four) – ON

Power up at least three of four ADTAs

VERIFY IDP CONFIG

- GPC/CRT 0/4 EXEC
- ✓ IDP/CRT4 PWR – OFF
- GPC/CRT X/3 EXEC

LOAD ENTRY TFL/RECONFIG UPLK

Perform LOAD PDI DECOM FORMAT and LOAD PCMMU FORMAT (ORB OPS FS, COMM/INST) for entry config

TRANSITION GPCs TO GNC OPS 3

1: GNC 0 GPC MEMORY		LOSS OF		
		BAY 1	BAY 2	BAY 3
CONFIG – ITEM 1 +3 EXEC Modify MC 3 per table →		3	3	3
GNC, OPS 301 PRO		02000	10000	12000
1: GNC DEORB MNVR COAST				
STR	1	2	1	1
	2	2	1	2
	3	2	1	1
	4	2	1	2
PL	1/2	0	0	0
CRT	1	2	1	1
	2	2	1	2
	3	2	1	2
	4	0	0	0
L	1	0	0	0
	2	0	0	0
MM	1	2	1	1
	2	2	1	2

Cont next page

O14,
O15,
O16

CRT
R11L
CRT

MEDS

C D/O/MEDS/GEN H

AV BAY FIRE CONTINGENCY DELTAS (OPS 2 to OPS 3) (Cont)

TRANSITION BFS GPC TO GNC OPS 3

If AV BAY 1 or 3 FIRE:
 O6 GPC MODE 5 – STBY (tb–RUN)
 C3 BFC CRT DISP – ON
 ✓SEL – 3+1
 3: BFS, GNC BFS MEMORY

O6 GPC OUTPUT 5 – B/U (tb–bp)
 CRT3 ✓TFL ENA – ITEM 29 (*)
 BFS, GNC OPS 301 PRO
 3: BFS GNC DEORB MNVR COAST

If AV BAY 2 FIRE:
 GPC OUTPUT 3 – B/U (tb–bp)

TRANSITION REMAINING PASS GPCs TO GNC OPS 3

SM, OPS 000 PRO (release payload buses)

O6 **SM GPC MEMORY**
 (SM) GPC OUTPUT – NORM (tb–gray)

O6 If AV BAY 1 or 3 FIRE:
 GPC MODE 5 – RUN
 (tb–RUN)

C3 CONFIG – ITEM 1 +3 EXEC
 Modify MC 3 per table →
 BFC CRT DISP – OFF
 GNC, OPS 301 PRO

CRT3 **1: GNC DEORB MNVR COAST**
 BFC CRT DISP – ON
 BFS, GNC, OPS 000 PRO
 BFS, GNC, OPS 301 PRO

LAND SITE UPDATE
1: GNC 50 HORIZ SIT

SEL SITE (See LAND SITE DATA)

LOAD IN TGTs
1: GNC DEORB MNVR COAST

CONFIG GPC	LOSS OF		
	BAY 1	BAY 2	BAY 3
	3	3	3
	02300	10040	12040
STR 1	3	1	1
2	2	4	2
3	3	1	4
4	2	4	4
PL 1/2	2	1	1
CRT 1	2	1	1
2	3	4	2
3	2	1	4
4	0	0	0
L 1	0	0	0
2	0	0	0
MM 1	2	1	1
2	3	4	2

* If MCC cannot provide DEORB TGT, use PGSC *

- ✓ PASS and BFS TGT per DEORBIT MNVR PAD (ENT, MNVR PADS) or PGSC
- LOAD – ITEM 22 EXEC
- TIMER – ITEM 23 EXEC
- ✓ PASS and BFS solution per DEORBIT MNVR PAD (ENT, MNVR PADS):
- BURN ATT
- HA
- HP
- ΔVTOT
- TGO

4. Deltas to ENT FWD FLT DECK CONFIG **10**
 Do not power up MLS
 O14:E, cb MNA,B,C DDU L,R (four) – cl
 O15:E,O16:E

L1 If AV BAY 1 fire:
 FLASH EVAP CNTLR PRI A – GPC

5. Deltas to ENT MIDDECK CONFIG **12**
 ML31C ✓VAC VENT ISOL VLV CNTL – OP (tb–OP)
 ✓NOZ HTR – ON

6. ENT SWITCH LIST/VERIF
 Do not activate pwrdrn items

7. AV BAY FIRE P&I DELTAS TO ENTRY

Deltas to ENT, DEORBIT BURN:

At TIG–4:

If AV BAY 1(2) FIRE:

GNC DEORB MNVR EXEC

O14:E,O15:E, L(R) OMS GMBL – SEC (*)
 O16:E Use two IDP/CRTs with four MDUs for deorbit burn
 F6,F8 ✓cb MNA,B,C DDU L,R (four) – cl

FLT CNTLR PWR (two) – ON

Deltas to ENT, POST BURN:

O14:E, Use one IDP/CRT with two MDUs
 O15:E, FLT CNTLR PWR (two) – OFF
 O16:E cb MNA,B DDU L,R (four) – op
 Delete ANTISKID,NWS callouts
 (ENTRY SW CHECK)

If AV BAY 2 FIRE:

O16:F RJDF 2B F4/F5 LOGIC – ON
 F4 DRIVER – ON
 O8 FWD RCS MANF ISOL 4 – OP (tb–OP)

Deltas to ENTRY MANEUVERS (Cue Card):

At EI:

O14:E, Use two IDP/CRTs with four MDUs
 O15:E,O16:E cb MNA,B DDU L,R (four) – cl
 F6 FLT CNTLR PWR – ON
 O14:E,O15:E, ✓cb MNA,B,C ADTA (three) – cl
 O16:E

At V = 15K:

Activate all unaffected TACANs,RAs,MLSS
 GNC I/O RESET

At M = 0.9:

L2 ANTISKID – ON
 NWS – 1
 Use two IDP/CRTs with five MDUs

MEDS

LAUNCH DAY DEORBIT PREP (ORBIT 3) SUMMARY TIMELINE

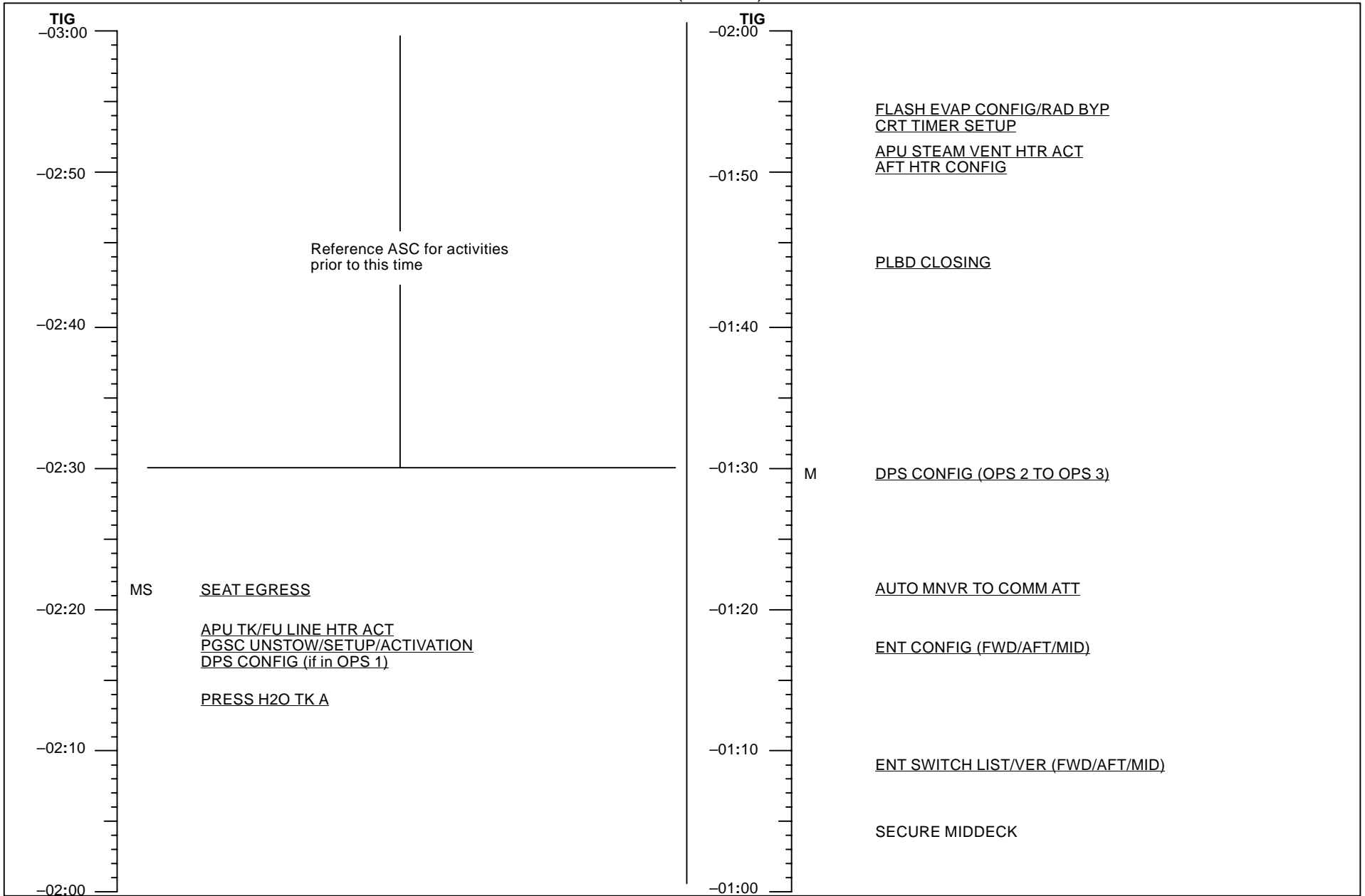

LAUNCH DAY DEORBIT PREP (ORBIT 3) SUMMARY TIMELINE

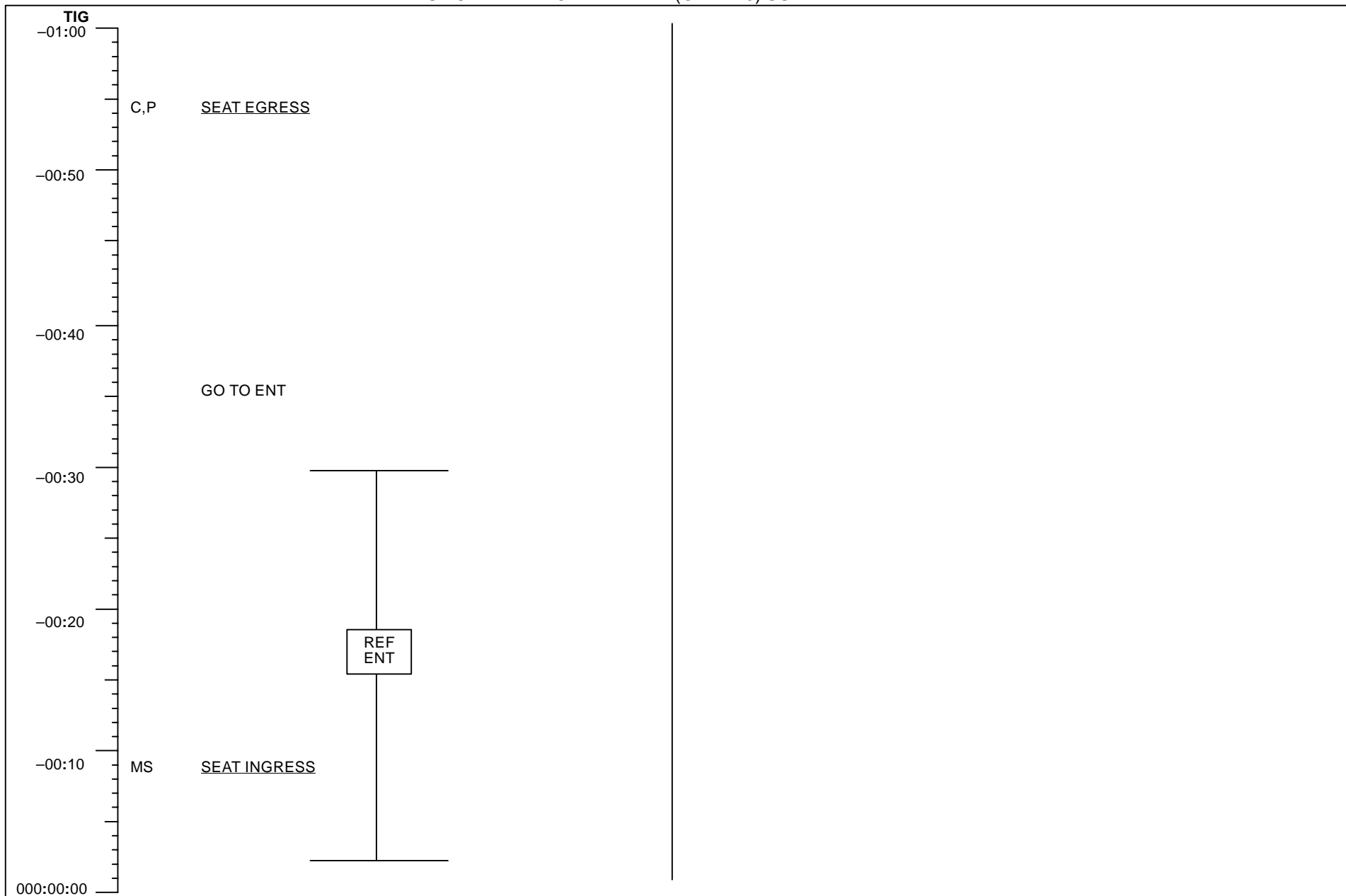

(MEDS) A2-10

C D/O/ALL/GEN H

DPS CONFIG 2

C,P

1. TRANSITION TO GNC OPS 3
 Set event timer to count down to TIG
 O14,O15, ✓ RGA,ACCEL,ASA,IMU (all) – ON
 O16

C3
 CONFIG – ITEM 1 +3 EXEC
 Modify MC 3 per table →
 BFC CRT DISP – OFF
 GNC, OPS 301 PRO

1: GNC DEORB MNVR COAST

CRT3
 BFC CRT DISP – ON
 BFS, GNC, OPS 000 PRO
 BFS, GNC, OPS 301 PRO

2. LAND SITE UPDATE

1: GNC 50 HORIZ SIT

SEL SITE (See LAND SITE DATA)

3. LOAD IN TGTs

1: GNC DEORB MNVR COAST

* If MCC cannot provide DEORB TGT, use PGSC *

- ✓ PASS and BFS TGT per DEORBIT MNVR PAD
 (ENT, MNVR PADS) or PGSC
 LOAD – ITEM 22 EXEC
 TIMER – ITEM 23 EXEC
- ✓ PASS and BFS solution per DEORBIT MNVR PAD
 (ENT, MNVR PADS):
 BURN ATT
 HA
 HP
 ΔVTOT
 TGO

4. VERIFY MC 9 TABLE (GNC 9) FOR POST LANDING

2: GNC 0 GPC MEMORY

- ✓ CONFIG – ITEM 1 +9 EXEC
 Modify MC 9 per table →
- CONFIG – ITEM 1 +3 EXEC

CONFIG	GPC	3	12340
STR	1	1	
	2	2	
	3	3	
	4	4	
PL	1/2	1	
CRT	1	1	
	2	2	
	3	3	
	4	0	
L	1	0	
	2	0	
MM	1	1	
	2	2	

CONFIG	GPC	9	12340
STR	1	1	
	2	2	
	3	3	
	4	4	
PL	1/2	1	
CRT	1	1	
	2	2	
	3	3	
	4	0	
L	1	0	
	2	0	
MM	1	1	
	2	2	

		<u>NOTE</u>
<p>TIG -02:30 TRANS DAP AUTO RT 0.5 DB 3.5</p>		<p>These procedures do not require completion of any Nominal Post Insertion procedures</p>
<p>-02:25</p>		
<p>C</p>	<p>L4:B, Q,R</p>	<p>All cbs closed</p>
<p>UPLINK PASS & BFS TGT</p>	<p>MS</p>	<p><u>SEAT EGRESS</u></p>
<p>-02:20</p>	<p>MS</p>	<p>PGSC ACT (ORB OPS, <u>PGSC</u>) Use flight deck PGSC</p>
<p>-02:15</p>	<p>C,P</p>	<p><u>DPS CONFIG</u> (if in OPS 1 to OPS 3) (BFS not engaged) 2, 2-11</p>
<p>-02:10</p>	<p>MS</p>	<p><u>PRESS H2O TK A MS MID ACTIVITIES</u> 3, 2-21</p>
<p>-02:05</p>	<p>MS</p>	<p>UNSTOW/DON WIRELESS HEADSETS (if reqd)</p>
<p>-02:00</p>		

RAD BYP (if rads not bypassed) 4

C L1 RAD BYP VLV MODE (two) – MAN
MAN SEL (two) – BYP (after ~3 sec, tb-BYP)
CNTLR LOOP (two) – OFF

O1 ✓FREON EVAP OUT TEMP ind -39 ± 1 degF (after ~2.5 min)

TIMER SETUP (Omit if BFS or OPS 3) 5

GNC 2 TIME

C COUNT TO – ITEM 17 +__ +__ +__ EXEC

APU STEAM VENT HTR ACT 6

P R2 BLR CNTLR/HTR (three) – B
PWR (three) – ON

NOTE
Htr reqd to be on prior to APU act

<p>TIG</p> <p>-02:00</p> <p>If OPS 2: A1(B1) AUTO PRI RT 0.2 DB 5.0</p> <p>-01:55</p> <p>If OPS 3: TRANS DAP AUTO RT 0.5 DB 3.5</p> <p>-01:50</p> <p>-01:45</p> <p>-01:40</p> <p>-01:35</p> <p>UPLINK PASS & BFS TGT</p> <p>-01:30</p>	<p>MS Perform at TIG – _____ PAYLOAD DEACT, if reqd (PL OPS, <u>DEORBIT PREP</u> or SODF: ASSY OPS, <u>ACTIVATION AND CHECKOUT</u>; DEORBIT PREP)</p> <p>C <u>RAD BYP</u> [4], 2-13</p> <p>P <u>TIMER SETUP</u> (Omit if BFS or OPS 3) [5], 2-13</p> <p>P <u>APU STEAM VENT HTR ACT</u> [6], 2-13</p> <p>MS <u>AFT HTR CONFIG MS AFT ACTIVITIES</u> [7], 2-19</p> <p>P <u>PLBD CLOSING (AUTO SEQ)</u> (if reqd) [8]</p>
---	---

PLBD CLOSING (AUTO SEQ) (if reqd) [8]

CAUTION

If SM GPC fails during this operation:
PL BAY DR SYS 1,2 (two) – DSBL
Perform PASS SM GPC FAIL (ORB PKT, DPS)

R13L

When closing and latching PLBD:
Verify no obstructions (Ku ANT,RMS,RAD, etc)

NOTE

Ref DETAILED PLBD CLOSING PROCEDURES
(DEORB PREP, NOMINAL DEORBIT PREP) (if reqd)

R11L ✓IDP/CRT4 PWR – ON
CRT4 SM, OPS X02 PRO
[4: SM PL BAY DOORS] or [BFS, SM 63 PL BAY DOORS]

R13L ✓PL BAY DR – STOP
CRT4 ✓PBD SW – STOP
✓MAN SEL (ten) – (no *)
✓PBD SW BYPASS – (no *)
AC POWER ON – ITEM 1 EXEC (*)
AUTO MODE SEL – ITEM 3 EXEC (*)
R13L PL BAY DR SYS 1,2 (two) – ENA
CRT4 ✓OP/CL STATUS (ten) – OP
R13L PL BAY DR – CL

- * If PORT(STBD) DOOR not 'CL' within 6 sec of *
- * 'RDY' then: *
- * PL BAY DR – STOP *
- * ✓PLBD BULKHEAD LATCH GO/NO-GO *
- * DIAGRAM (DEORBIT PREP, *
- * NOMINAL DEORBIT PREP) *
- * If NO-GO: Go to CONTINGENCY PLBD *
- * CLOSURE, MECH SSR-2 (MAL, MECH) *
- * If GO: PL BAY DR – CL *

When STBD DOOR is as close as possible to PORT DOOR
before contacting it:
PL BAY DR – STOP

✓ For C/L overlap, ref PLBD BULKHEAD LATCH GO/NO-GO
DIAGRAM (DEORBIT PREP, NOMINAL DEORBIT PREP)

- * If NO-GO, perform SIMULTANEOUS *
- * PLBD CL, MECH SSR-3 (MAL, MECH) *

PL BAY DR – CL

When closed and latched:
PL BAY DR – STOP
SYS 1,2 (two) – DSBL

CRT4 ✓OP/CL STATUS (ten) – CL
AC POWER OFF – ITEM 2 EXEC (*)
GPC/CRT 0/4 EXEC

R11L IDP/CRT4 PWR – OFF
AFD 1 PWR – OFF

MEDS

OPS 2 TO 3 TRANSITION 9

(Omit if BFS engaged or if already configured with G3 set)

- * If IMU or RHC dilemma, do not proceed *
- * with OPS 3 transition *

O14,O15, O16
 ✓Att mnvr complete
 ✓RGA,ACCEL,ASA,IMU (all) – ON

C2
 R11L
 1. **VERIFY MEDS CONFIG**
 ✓IDP/CRT PWR (three) – ON
 ✓IDP/CRT4 PWR – OFF

Verify all forward MDUs – ON and selected to primary port

O6
 2. **VERIFY GPC CONFIG**
 ✓GPC MODE 3 – HALT (tb-bp)
 ✓PWR 3,5 – ON
 ✓OUTPUT 1,2 – NORM (tb-gray)
 ✓3,5 – NORM (tb-bp)
 ✓4 – TERM (tb-bp)
 ✓MODE 1,2,4 – RUN (tb-RUN)
 3 – STBY (tb-RUN)
 5 – STBY (tb-RUN)

3. **SM CHECKPOINT/UL CNTL ENA**

- 1: SM 60 SM TABLE MAINT
- 2: SM 1 DPS UTILITY

CRT2
 CRT1
 MMU ASSIGN 2 SM – ITEM 4 EXEC
 CKPT INITIATE – ITEM 18 EXEC
 ✓Update of CKPT TIME and STATUS GOOD indicated
 CRT2
 CRT1
 MMU ASSIGN 1 SM – ITEM 3 EXEC
 CKPT INITIATE – ITEM 18 EXEC
 ✓Update of CKPT TIME and STATUS GOOD indicated
 CRT2
 CKPT RETRV ENA – ITEM 12 EXEC (*)
 UL CNTL ENA – ITEM 36 EXEC

4. **LOAD ENTRY TFL/RECONFIG UPLK**
 Perform LOAD PDI DECOM FORMAT
 and LOAD PCMMU FORMAT
 for entry config (ORB OPS FS,
 COMM/INST)

CONFIG GPC	3	12000
STR 1	1	1
2	2	2
3	1	1
4	2	2
PL 1/2	0	0
CRT 1	1	1
2	2	2
3	2	2
4	0	0
L 1	0	0
2	0	0
MM 1	1	1
2	2	2

5. **TRANSITION GPC 1&2 TO GNC OPS 3**

- 1: GNC 0 GPC MEMORY
- CONFIG – ITEM 1 +3 EXEC
 Modify MC 3 per table
 GNC, OPS 301 PRO
- 3: GNC DEORB MNVR COAST

C3
 6. **TRANSITION BFS GPC TO GNC OPS 3**
 BFC CRT DISP – ON
 ✓SEL – 3+1

- 3: BFS, GNC BFS MEMORY

O6
 CRT3
 GPC OUTPUT 5 – B/U (tb-bp)
 ✓TFL ENA – ITEM 29 (*)
 BFS, GNC, OPS 301 PRO

- 3: BFS, GNC DEORB MNVR COAST

7. **TRANSITION GPC 1,2,3,4 TO GNC OPS 3**
 SM, OPS 000 PRO (releases payload buses)

- SM GPC MEMORY

O6
 GPC OUTPUT 4 – NORM (tb-gray)
 MODE 3,5 (two) – RUN (tb-RUN)

✓CONFIG – ITEM 1 +3 EXEC

CONFIG GPC	3	12340
STR 1	1	1
2	2	2
3	3	3
4	4	4
PL 1/2	1	1
CRT 1	1	1
2	2	2
3	3	3
4	0	0
L 1	0	0
2	0	0
MM 1	1	1
2	2	2

Modify MC 3 per table
 BFC CRT DISP – OFF
 GNC, OPS 301 PRO

- 1: GNC DEORB MNVR COAST

C3
 CRT3
 BFC CRT DISP – ON
 BFS, GNC, OPS 000 PRO
 BFS, GNC, OPS 301 PRO

8. **LAND SITE UPDATE**

- 1: GNC 50 HORIZ SIT

SEL SITE (See LAND SITE DATA)

9. **LOAD IN TGTs**

- 1: GNC DEORB MNVR COAST

* If MCC cannot provide DEORB TGT, use PGSC *

✓PASS and BFS TGT per DEORBIT MNVR
 PAD (ENT, MNVR PADS) or PGSC
 LOAD – ITEM 22 EXEC
 TIMER – ITEM 23 EXEC

✓PASS and BFS solution per DEORBIT
 MNVR PAD (ENT, MNVR PADS):
 BURN ATT
 HA
 HP
 ΔVTOT
 TGO

CONFIG GPC	9	12340
STR 1	1	1
2	2	2
3	3	3
4	4	4
PL 1/2	1	1
CRT 1	1	1
2	2	2
3	3	3
4	0	0
L 1	1	1
2	2	2
MM 1	1	1
2	2	2

10. **VERIFY MC 9 TABLE (GNC 9) FOR POST LANDING**

- 2: GNC 0 GPC MEMORY

✓CONFIG – ITEM 1 +9 EXEC
 Modify MC 9 per table
 CONFIG – ITEM 1 +3 EXEC

	1: SM TABLE MAINT	2: SM ANTENNA
	3: BFS, GNC DEORB MNVR COAST	
TIG		
-01:30	C,P	<u>OPS 2 TO 3 TRANSITION</u> [9], 2-15 (Omit if BFS engaged or if already configured with G3 set)
If OPS 2: A1(B1) AUTO PRI RT 0.2 DB 5.0		
-01:25		
If OPS 3: TRANS DAP AUTO RT 0.5 DB 3.5		
-01:20	P	<u>AUTO MNVR TO COMM ATT</u> Mnvr per MCC: R ___ ___ ___ P ___ ___ ___ Y ___ ___ ___
-01:15	C,P MS MS MS	<u>ENT FWD FLT DECK CONFIG</u> [10] <u>ENT AFT FLT DECK CONFIG, MS AFT ACTIVITIES</u> [11], 2-19 <u>ENT MIDDECK CONFIG, MS MID ACTIVITIES</u> [12], 2-21 <u>PAYLOAD ENT SW LIST/VER</u> (PL OPS, <u>DEORBIT PREP</u> or SODF: ASSY OPS, <u>ACTIVATION AND CHECKOUT</u> , DEORBIT PREP)
-01:10	A12	<u>NOTE</u> Deltas to ENT SW LIST/VER APU HTR LUBE OIL LINE (three) - A AUTO <u>NOTE</u> ✓ MCC for unaccounted-for switch or cb config discrepancies
-01:05	C P MS MS	<u>ENT SWITCH LIST/VER (FWD)</u> , 3-3 thru 3-10 <u>ENT SWITCH LIST/VER (FWD)</u> , 3-11 thru 3-15 <u>ENT SWITCH LIST/VER (AFT)</u> , 3-16 thru 3-23 (OV102), 3-16 thru 3-26 (OV104) <u>ENT SWITCH LIST/VER (MID)</u> , 3-24 thru 3-27 (OV102), 3-27 thru 3-30 (OV104)
-01:00		

ENT FWD FLT DECK CONFIG [10]

C L1 FLASH EVAP CONFIG
FLASH EVAP CNTLR PRI A - OFF
B(A) - GPC

C,P O5,O9 ENTRY COMM
L,R AUD A/G 2 (two) - T/R

O8 ✓ MLS CH/TACAN CH
MLS CH tw (three) - See LANDSITE DATA
MLS (three) - ON

O17:A SSME HYD REPRESS PREP
ATVC (four) - ON

F6 CONTROL FOR ENTRY
ADI RATE - LO
O14:E cb MNA DDU AFT - op
O16:E MNC DDU AFT - op

R4 HYD HTR/SIG CONDR CONFIG
HYD BRAKE HTR (three) - AUTO
L4:J cb AC3 ΦA SIG CONDR HUM SEP - op
ΦB SIG CONDR IMU FAN - op

MEDS

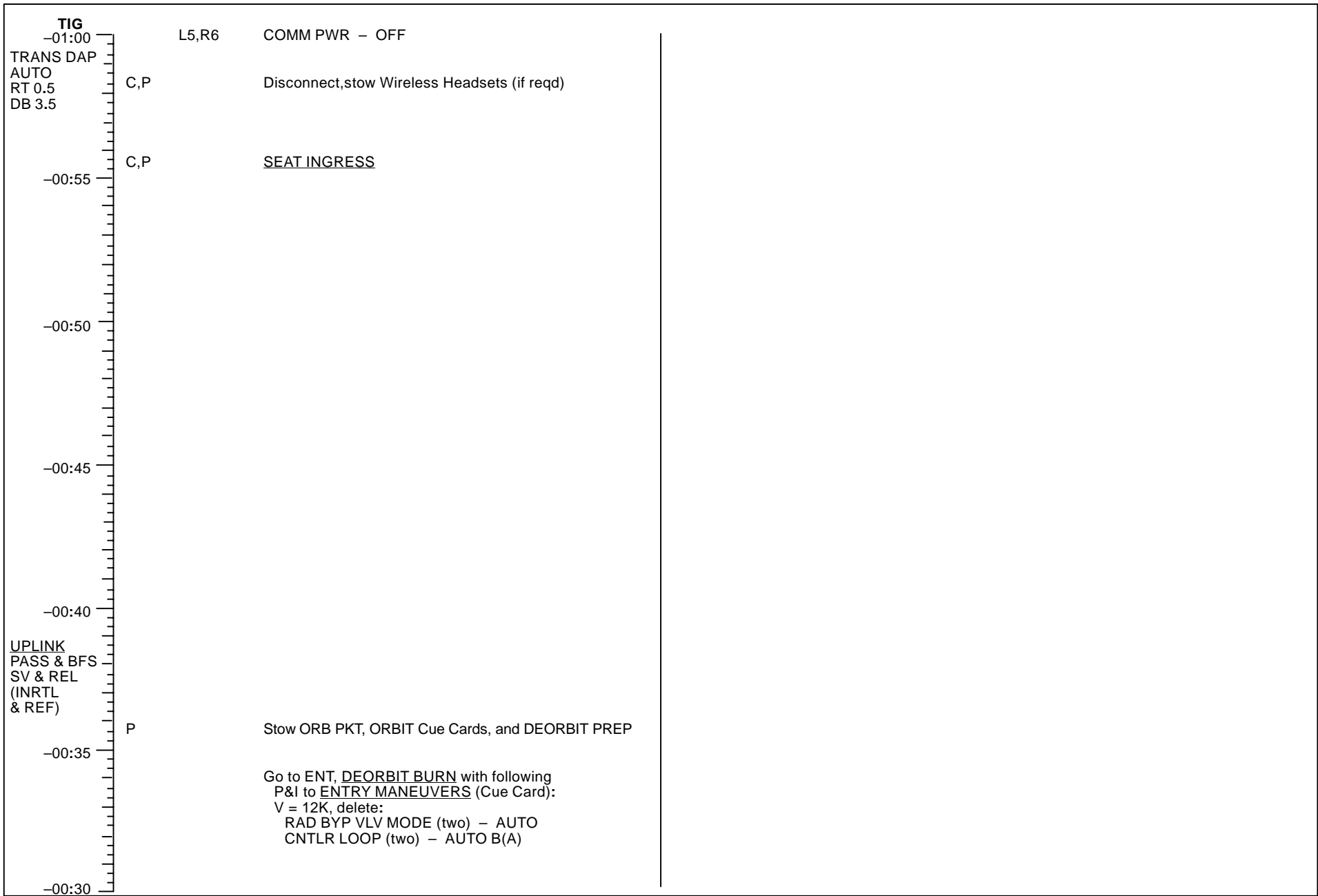

This Page Intentionally Blank

MS LAUNCH DAY DEORBIT PREP AFT DECK ACTIVITIES (ORBIT 3)

NOTE

Wait for GO from CDR or PLT before starting any activity on this page

TIME (TIG-)	MS AFT ACTIONS
—	PAYLOAD DEACT, if reqd (PL OPS, <u>DEORBIT PREP</u> or SODF: ASSY OPS, <u>ACTIVATION AND CHECKOUT</u> ; DEORBIT PREP)
02:22	SEAT EGRESS
02:20	PGSC ACT (ORB OPS, <u>PGSC</u>) Use flight deck PGSC
02:11	UNSTOW/DON WIRELESS HEADSETS (if reqd)
01:50	<u>AFT HTR CONFIG</u> 7
01:14	<u>ENT AFT FLT DECK CONFIG</u> 11
01:04	<u>ENT SWITCH LIST/VER (AFT)</u> , 3-16 thru 3-23 (OV102), 3-16 thru 3-26 (OV104)

<u>AFT HTR CONFIG</u> 7	
A12	HYD HTR (eight) - OFF
A14	RCS/OMS HTR FWD RCS - OFF L POD (two) - A OFF,B OFF R POD (two) - A OFF,B OFF OMS CRSFD LINES (two) - B AUTO,A AUTO ✓FWD,AFT RCS JET (ten) - AUTO
R11U	✓FC PURGE VLVS (three) - GPC ✓HTR - GPC ✓H2O LINE HTR - A AUTO
<u>NOTE</u> MCC command FC PURGE HTR off, if reqd	

<u>ENT AFT FLT DECK CONFIG</u> 11		
<u>ENTRY COMM CONFIG</u>		
A1L	S-BD PM MODE - STDN LO NSP CODING (two) - OFF	
A1R	AUD CTR VOICE RCD SEL CH 1 sel - ICOM A 2 sel - ICOM B	
A13	OS AUD SPKR PWR - OFF PWR - OFF (OV102)	
A15	PS COMM CCU PWR - as reqd	
R14:C	cb MNB KU ANT HTR - op UHF EVA (two) - op	
R10	MS AUD A/G 2 - T/R A/A - T/R	
L9	PS AUD PWR - AUD/TONE A/G 1 - T/R A/A - T/R ICOM (two) - T/R	
<u>H2O STORAGE SYS CONFIG</u>		
ML86B:A	✓cb MNC SPLY H2O XOVR VLV - cl	
R11L	SPLY H2O XOVR VLV - OP (tb-OP)	
<u>RESET C/W</u>		
<u>R13U</u>		
	C/W CH	UPPER LIMIT
FREON LOOP EVAP OUT T1	107	1.90V/64.8 degF
T2	117	1.90V/64.8 degF
A16	✓Secure	
R10	✓MS LTG FLOOD as reqd	
<u>FOOT LOOP CONFIG</u> Tape Foot Loops in egress routes		

**Back of MS LAUNCH DAY DEORBIT PREP AFT DECK ACTIVITIES
(ORBIT 3)**

MS LAUNCH DAY DEORBIT PREP MIDDECK ACTIVITIES (ORBIT 3)

NOTE

Wait for GO from CDR or PLT before starting any activity on this page

TIME (TIG-)	MS MIDDECK ACTIONS
02:22	<u>SEAT EGRESS</u>
02:14	<u>PRESS H2O TKA</u> 3
02:11	UNSTOW/DON WIRELESS HEADSETS (if reqd)
01:14	<u>ENT MIDDECK CONFIG</u> 12
01:04	<u>ENT SWITCH LIST/VER</u> (MID), 3-24 thru 3-27 (OV102), 3-26 thru 3-29 (OV104)

<u>PRESS H2O TKA</u> 3	
ML26C	SPLY H2O GN2 TK VENT vlv - PRESS TKA SPLY vlv - OP
<u>NOTE</u> Disregard possible 'S66 WASTE H2O PRES' fault msg	

<u>ENT MIDDECK CONFIG</u> 12	
	<u>CO2 RMVL SYS DEACT</u> (if flown)
ML31C	VAC VENT ISOL VLV CNTL - CL (tb-CL) NOZ HTR - OFF
MO51F	CNTRLR 1(2) MODE - STBY (hold 3 sec) Wait 6 sec
	✓ CNTRLR 1(2) OPER It - OFF
	MNA(MNC) - OFF
	AC1(AC3) - OFF (hold 3 sec)
	cb AC1(AC3) (three) - op
	COM INSTR - OFF
<u>ENTRY COMM CONFIG</u>	
MO42F	MIDDECK SPKR AUD A/G 2 - T/R
	Stow: Comm Equip Wireless Headsets
	✓ LOCKERS secure
MO13Q	✓ MIDDECK FLOODS as reqd
ML85E	AC S1 - OFF
<u>MIDDECK PCS</u>	
MO69M	LEH O2 7,8 vlv (two) - as reqd
MO32M	LEH O2 6 vlv - as reqd
<u>EGRESS ROUTE CONFIG</u>	
	Tape Foot Loops in egress routes

**Back of MS LAUNCH DAY DEORBIT PREP MIDDECK ACTIVITIES
(ORBIT 3)**

AV BAY FIRE CONTINGENCY DELTAS (OPS 1 to OPS 3)

Assumes AV BAY FIRE (ASC PKT, PWRDN) complete

NOTE

Single-fault tolerance used for most cabin air-cooled equipment. Additional LRUs may be activated if reqd and if CABIN PRESS stable ≥ 8 psia. Minimize use of CRTs, FLT CNTLR PWR, DDU's, INST PWR. Use one PGSC

1. TIG-2:30
If AV BAY 1 or 2 FIRE:
| FCS CH (four) – ORIDE
If AV BAY 3 FIRE:
✓ FCS CH 1,2,3 (three) – AUTO
4 – OFF
2. Skip DPS CONFIG 2 and perform following:
DPS CONFIG FOR AV BAY FIRE (OPS 1 to OPS 3)
Set event timer to count down to TIG
✓ RGA, ASA, IMU (all) – ON
ACCEL (at least three of four) – ON
Power up three of four ADTAs

C2
O14,
O15,
O16

TRANSITION GPCs TO GNC OPS 3

1: GNC GPC MEMORY

CONFIG – ITEM 1 +3 EXEC
Modify MC 3 per table
GNC, OPS 301 PRO

3: GNC DEORB MNVR COAST

TRANSITION BFS GPC TO GNC OPS 3

If AV BAY 1 or 3 FIRE:
GPC MODE 5 – STBY (tb-RUN)
– RUN (tb-RUN)
BFC CRT DISP – ON
✓ SEL – 3+1

3: BFS, GNC BFS MEMORY

✓ GPC OUTPUT 5 – B/U (tb-bp)
✓ TFL ENA – ITEM 29 (*)
BFS, GNC OPS 301 PRO

3: BFS GNC DEORB MNVR COAST

If AV BAY 2 FIRE:

Reassign BFS into GPC 3 via MAL DPS SSR-7 (Do not activate MMU2), then take GPC OUTPUT 3 – B/U (tb-bp)
GPC MODE 3 – RUN (tb-RUN)

O6
C3

O6
CRT3

		LOSS OF		
		BAY 1	BAY 2	BAY 3
CONFIG	GPC	3	3	3
		02300	10040	12040
STR	1	3	1	1
	2	2	4	2
	3	3	1	4
	4	2	4	4
PL	1/2	2	1	1
CRT	1	2	1	1
	2	3	4	2
	3	2	1	4
	4	0	0	0
L	1	0	0	0
	2	0	0	0
MM	1	2	1	1
	2	3	4	2

LAND SITE UPDATE

1: GNC 50 HORIZ SIT

SEL SITE (See LAND SITE DATA)

LOAD IN TGTS

1: GNC DEORB MNVR COAST

* If MCC cannot provide DEORB TGT, use PGSC *

- ✓ PASS and BFS TGT per DEORBIT MNVR PAD (ENT, MNVR PADS) or PGSC
- LOAD – ITEM 22 EXEC
- TIMER – ITEM 23 EXEC
- ✓ PASS and BFS solution per DEORBIT MNVR PAD (ENT, MNVR PADS):
BURN ATT
HA
HP
ΔVTOT
TGO

R2

3. Replace APU STEAM VENT HTR ACT 6 with following:
BLR CNTLR/HTR (three) – B
If AV BAY 1(2,3) fire:
BLR CNTLR/HTR 1(2,3) – A
BLR PWR (three) – ON

NOTE

Htr reqd to be on prior to APU act

O14:E,
O15:E,
O16:E

L1

4. Deltas to ENT FWD FLT DECK CONFIG 10
Do not power up MLS
Use one INST PWR
cb MNA, B, C DDU L, R (four) – cl
- If AV BAY 1 fire:
FLASH EVAP CNTLR PRI A – GPC
5. Deltas to ENT MIDDECK CONFIG 22
✓ VAC VENT ISOL VLV CNTL – OP (tb-OP)
✓ NOZ HTR – ON
6. ENT SWITCH LIST/VERIF
Do not activate pwrdn items

ML31C

Cont next page

NOM

(NOM) B2-5

C D/O/NOM/GEN H

AV BAY FIRE CONTINGENCY DELTAS (OPS 1 to OPS 3) (Cont)

7. AV BAY FIRE P&I DELTAS TO ENTRY

Deltas to ENT, DEORBIT BURN

At TIG-4:

If AV BAY 1(2) FIRE:

GNC DEORB MNVR EXEC

L(R) OMS GMBL - SEC (*)

Use two CRTs for deorbit burn

O14:E,O15:E, ✓cb MNA,B,C DDU L,R (four) - cl

O16:E

F7,F8

FLT CNTLR PWR (two) - ON

Deltas to ENT, POST BURN:

Use one CRT

F7,F8

FLT CNTLR PWR (two) - OFF

O14:E,

cb MNA,B DDU L, (two) - op

O15:E

Delete ANTISKID,NWS callouts

(ENTRY SW CHECK)

If AV BAY 2 FIRE:

O16:F

RJDF 2B F4/F5 LOGIC - ON

F4 DRIVER - ON

O8

FWD RCS MANF ISOL 4 - OP (tb-OP)

Deltas to ENTRY MANEUVERS (Cue Card):

At EI:

Use only two CRTs

O14:E,

cb MNA,B DDU L (two) - cl

O15:E

FLT CNTLR PWR - ON

F7

INST PWR - FLT

F6

O14:E,O15:E,

✓cb ADTA (three) - cl

O16:E

At V = 15K:

Activate all unaffected TACANs,RAs,MLSs

GNC I/O RESET

At M = 0.9:

L2

ANTISKID - ON

NWS - 1

F6

INST PWR - ON

NOM

(NOM) B2-6

C D/O/NOM/GEN H

AV BAY FIRE CONTINGENCY DELTAS (OPS 2 to OPS 3)

Assumes AV BAY FIRE (ORB PKT, PWRDN) complete

NOTE

Single-fault tolerance used for most cabin air-cooled equipment. Additional LRUs may be activated if reqd and if CABIN PRESS stable \geq 8 psia. Minimize use of CRTs, FLT CNTLR PWR, DDU's, INST PWR. Use one PGSC

1. TIG -2:30(2:00)
If AV BAY 1 or 2 FIRE:
| FCS CH (four) - ORIDE
If AV BAY 3 FIRE:
√ FCS CH 1,2,3 (three) - AUTO
4 - OFF

2. Replace APU STEAM VENT HTR ACT 6 with following:
BLR CNTLR/HTR (three) - B
If AV BAY 1(2,3) fire:
| BLR CNTLR/HTR 1(2,3) - A
BLR PWR (three) - ON

NOTE

Htr reqd to be on prior to APU act

3. Skip OPS 2 TO 3 TRANSITION 9 and perform following:
OPS 2 TO 3 TRANSITION FOR AV BAY FIRE
(Omit if BFS engaged or if already configured with G3 set)

* If IMU or RHC dilemma, do not proceed with *
* OPS 3 transition *

- √ Att mnvr complete
- √ RGA, ASA, IMU (all) - ON
- ACCEL (at least three of four) - ON

Power up at least three of four ADTAs

VERIFY CRT CONFIG

- GPC/CRT 4 EXEC
- √ CRT O/4 PWR - OFF
- GPC/CRT X/3 EXEC

LOAD ENTRY TFL/RECONFIG UPLK

Perform LOAD PDI DECOM FORMAT and LOAD PCMMU FORMAT (ORB OPS FS, COMM/INST) for entry config

TRANSITION GPCs TO GNC OPS 3

		LOSS OF			
		BAY 1	BAY 2	BAY 3	
1: GNC 0 GPC MEMORY					
CONFIG - ITEM 1 +3 EXEC Modify MC 3 per table →		3	3	3	
GNC, OPS 301 PRO		02000	10000	12000	
1: GNC DEORB MNVR COAST					
STR	1	2	1	1	
	2	2	1	2	
	3	2	1	1	
	4	2	1	2	
PL	1/2	0	0	0	
	CRT	1	2	1	1
		2	2	1	2
		3	2	1	2
4		0	0	0	
L	1	0	0	0	
	2	0	0	0	
MM	1	2	1	1	
	2	2	1	2	

Cont next page

O14,
O15,
O16

CRT
R11L
CRT

NOM

(NOM) B2-7

C D/O/NOM/GEN H

AV BAY FIRE CONTINGENCY DELTAS (OPS 2 to OPS 3) (Cont)

TRANSITION BFS GPC TO GNC OPS 3

If AV BAY 1 or 3 FIRE:

O6
C3
GPC MODE 5 – STBY (tb–RUN)
BFC CRT DISP – ON
✓SEL – 3+1

3: BFS, GNC BFS MEMORY

O6
CRT3
GPC OUTPUT 5 – B/U (tb–bp)
✓TFL ENA – ITEM 29 (*)
BFS, GNC OPS 301 PRO

3: BFS GNC DEORB MNVR COAST

If AV BAY 2 FIRE:

GPC OUTPUT 3 – B/U (tb–bp)

TRANSITION REMAINING PASS GPCs TO GNC OPS 3

SM, OPS 000 PRO (release payload buses)

SM GPC MEMORY

O6
(SM) GPC OUTPUT – NORM (tb–gray)

If AV BAY 1 or 3 FIRE:

O6
GPC MODE 5 – RUN
(tb–RUN)

CONFIG – ITEM 1 +3 EXEC

Modify MC 3 per table →

BFC CRT DISP – OFF

GNC, OPS 301 PRO

1: GNC DEORB MNVR COAST

BFC CRT DISP – ON

BFS, GNC, OPS 000 PRO

BFS, GNC, OPS 301 PRO

LAND SITE UPDATE

1: GNC 50 HORIZ SIT

SEL SITE (See LAND SITE DATA)

LOAD IN TGTs

1: GNC DEORB MNVR COAST

* If MCC cannot provide DEORB TGT, use PGSC *

✓PASS and BFS TGT per DEORBIT MNVR PAD

(ENT, MNVR PADS) or PGSC

LOAD – ITEM 22 EXEC

TIMER – ITEM 23 EXEC

✓PASS and BFS solution per DEORBIT MNVR PAD

(ENT, MNVR PADS):

BURN ATT

HA

HP

ΔVTOT

TGO

CONFIG GPC	LOSS OF		
	BAY 1	BAY 2	BAY 3
	3 02300	3 10040	3 12040
STR 1	3	1	1
2	2	4	2
3	3	1	4
4	2	4	4
PL 1/2	2	1	1
CRT 1	2	1	1
2	3	4	2
3	2	1	4
4	0	0	0
L 1	0	0	0
2	0	0	0
MM 1	2	1	1
2	3	4	2

4. Deltas to ENT FWD FLT DECK CONFIG 10

Do not power up MLS

Use one INST PWR

cb MNA,B,C DDU L,R (four) – cl

O14:E,
O15:E,O16:E

If AV BAY 1 fire:

FLASH EVAP CNTLR PRI A – GPC

L1

5. Deltas to ENT MIDDECK CONFIG 12

ML31C ✓VAC VENT ISOL VLV CNTL – OP (tb–OP)
✓NOZ HTR – ON

6. ENT SWITCH LIST/VERIF

Do not activate pwrdrn items

7. AV BAY FIRE P&I DELTAS TO ENTRY

Deltas to ENT, DEORBIT BURN:

At TIG–4:

If AV BAY 1(2) FIRE:

GNC DEORB MNVR EXEC

L(R) OMS GMBL – SEC (*)

Use two CRTs for deorbit burn

✓cb MNA,B,C DDU L,R (four) – cl

O14:E,O15:E,
O16:E
F6,F8

FLT CNTLR PWR (two) – ON

Deltas to ENT, POST BURN:

Use one CRT

FLT CNTLR PWR (two) – OFF

cb MNA,B DDU L (two) – op

Delete ANTISKID,NWS callouts

(ENTRY SW CHECK)

F6,F8
O14:E,
O15:E

If AV BAY 2 FIRE:

RJDF 2B F4/F5 LOGIC – ON

F4 DRIVER – ON

FWD RCS MANF ISOL 4 – OP (tb–OP)

O16:F

O8

Deltas to ENTRY MANEUVERS (Cue Card):

At EI:

Use only two CRTs

cb MNA,B DDU L (two) – cl

O14:E,
O15:E

FLT CNTLR PWR – ON

INST PWR – FLT

✓cb MNA,B,C ADTA (three) – cl

F7
F6
O14:E,O15:E,
O16:E

At V = 15K:

Activate all unaffected TACANs,RAs,MLSS

GNC I/O RESET

At M = 0.9:

ANTISKID – ON

NWS – 1

INST PWR – ON

L2

F8

NOM

(NOM) B2–8

C D/O/NOM/GEN H

LAUNCH DAY DEORBIT PREP (ORBIT 3) SUMMARY TIMELINE

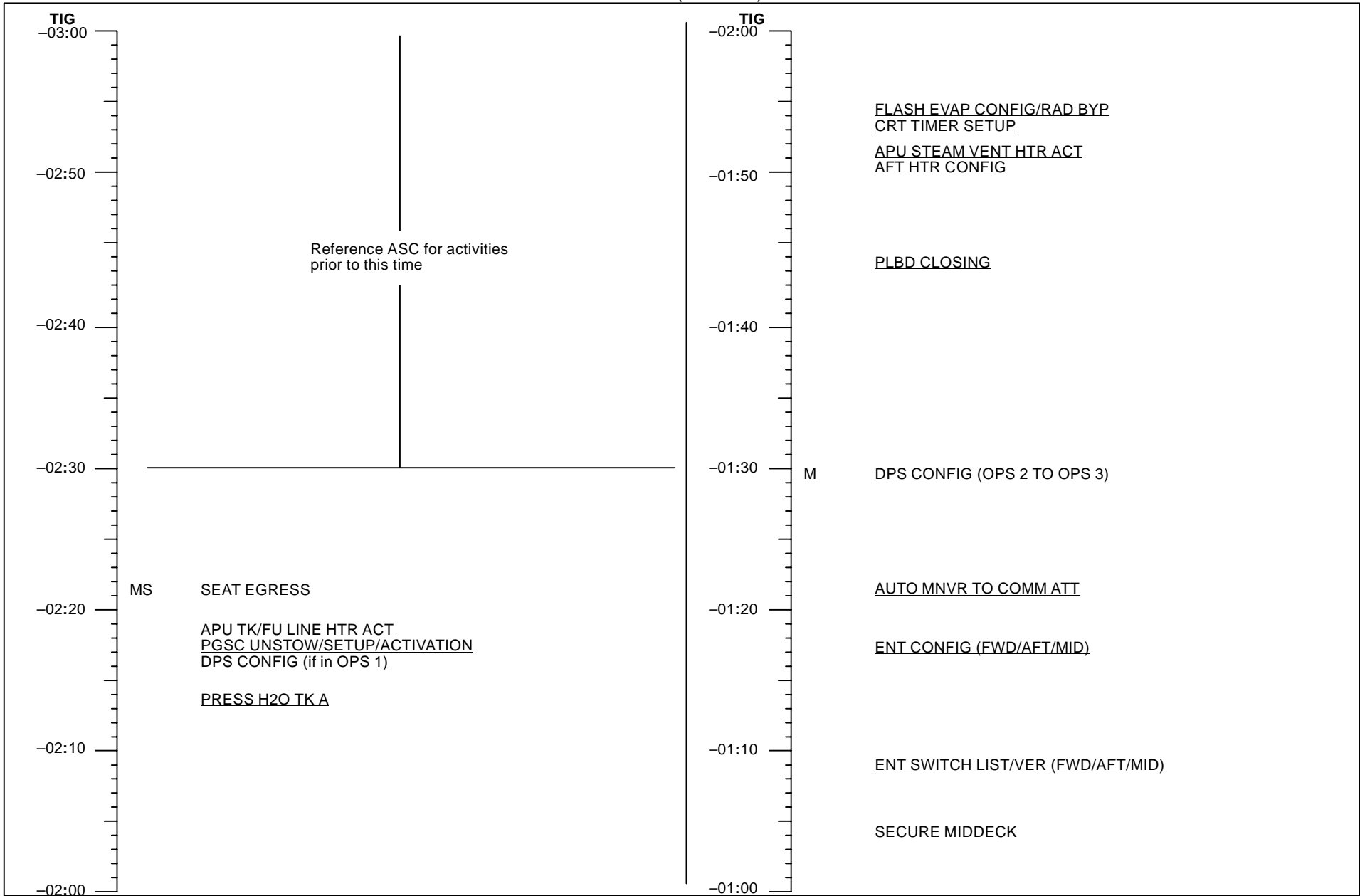

LAUNCH DAY DEORBIT PREP (ORBIT 3) SUMMARY TIMELINE

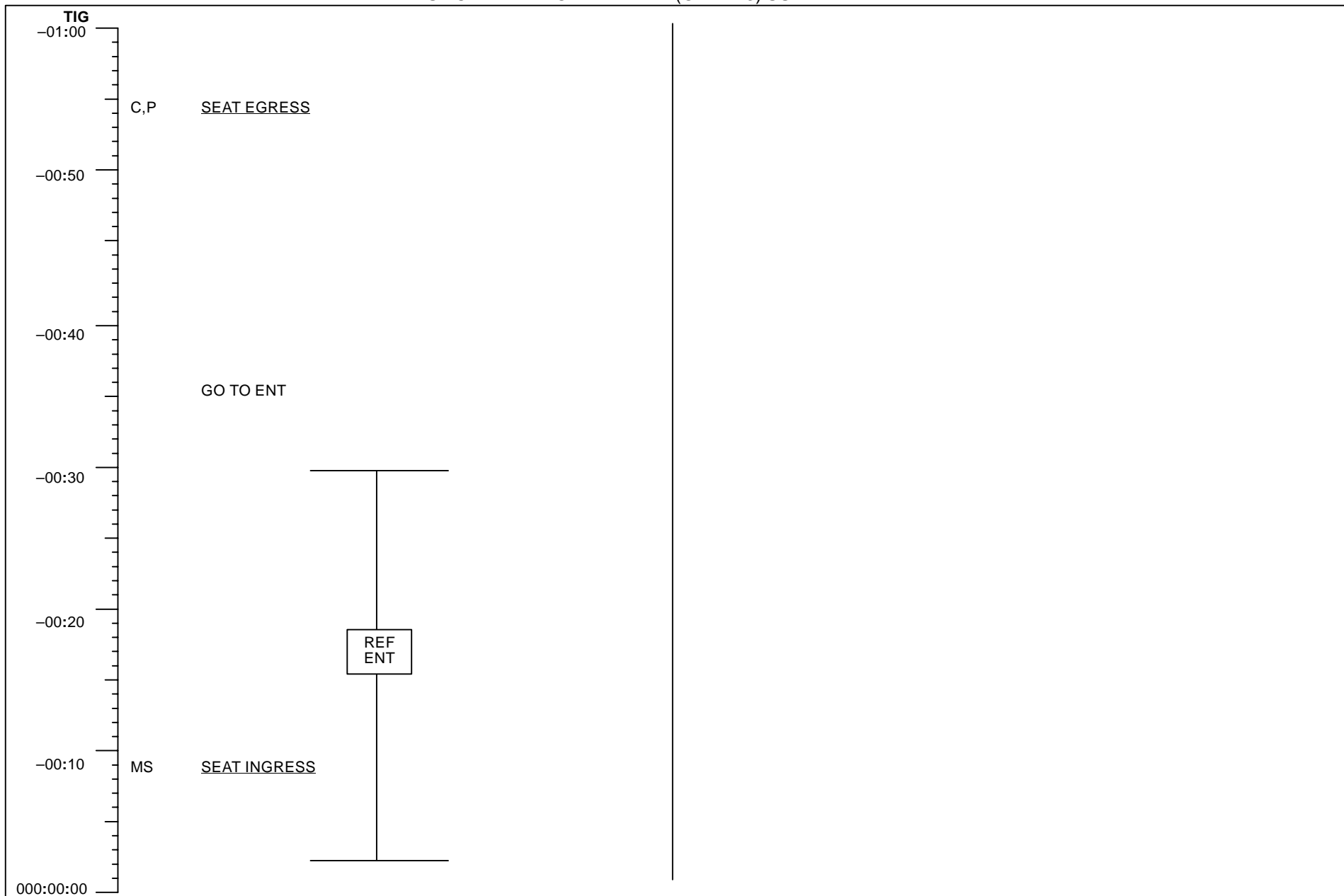

(NOM) B2-10

C D/O/ALL/GEN H

DPS CONFIG 2

C,P

1. TRANSITION TO GNC OPS 3
 Set event timer to count down to TIG
 O14,O15, ✓ RGA,ACCEL,ASA,IMU (all) – ON
 O16

C3
 CONFIG – ITEM 1 +3 EXEC
 Modify MC 3 per table →
 BFC CRT DISP – OFF
 GNC, OPS 301 PRO

1: GNC DEORB MNVR COAST

CRT3
 BFC CRT DISP – ON
 BFS, GNC, OPS 000 PRO
 BFS, GNC, OPS 301 PRO

2. LAND SITE UPDATE

1: GNC 50 HORIZ SIT

SEL SITE (See LAND SITE DATA)

3. LOAD IN TGTs

1: GNC DEORB MNVR COAST

* If MCC cannot provide DEORB TGT, use PGSC *

- ✓ PASS and BFS TGT per DEORBIT MNVR PAD
 (ENT, MNVR PADS) or PGSC

LOAD – ITEM 22 EXEC
 TIMER – ITEM 23 EXEC

- ✓ PASS and BFS solution per DEORBIT MNVR PAD
 (ENT, MNVR PADS):

BURN ATT
 HA
 HP
 ΔVTOT
 TGO

4. VERIFY MC 9 TABLE (GNC 9) FOR POST LANDING

2: GNC 0 GPC MEMORY

- ✓ CONFIG – ITEM 1 +9 EXEC
 Modify MC 9 per table →
 CONFIG – ITEM 1 +3 EXEC

CONFIG	GPC	3	12340
STR	1	1	
	2	2	
	3	3	
	4	4	
PL	1/2	1	
CRT	1	1	
	2	2	
	3	3	
	4	0	
L	1	0	
	2	0	
MM	1	1	
	2	2	

CONFIG	GPC	9	12340
STR	1	1	
	2	2	
	3	3	
	4	4	
PL	1/2	1	
CRT	1	1	
	2	2	
	3	3	
	4	0	
L	1	0	
	2	0	
MM	1	1	
	2	2	

TIG		NOTE
-02:30	TRANS DAP AUTO RT 0.5 DB 3.5	These procedures do not require completion of any Nominal Post Insertion procedures
-02:25		
	C L4:B, Q,R	All cbs closed
	MS	<u>SEAT EGRESS</u>
-02:20	UPLINK PASS & BFS TGT MS	PGSC ACT (ORB OPS, <u>PGSC</u>) Use flight deck PGSC
	C,P	<u>DPS CONFIG</u> (if in OPS 1 to OPS 3) (BFS not engaged) 2 , 2-11
-02:15		
	MS	<u>PRESS H2O TK A MS MID ACTIVITIES</u> 3 , 2-21
	MS	UNSTOW/DON WIRELESS HEADSETS (if reqd)
-02:10		
-02:05		
-02:00		

RAD BYP (if rads not bypassed) 4

- C L1 RAD BYP VLV MODE (two) – MAN
MAN SEL (two) – BYP (after ~3 sec, tb-BYP)
CNTLR LOOP (two) – OFF
- O1 ✓FREON EVAP OUT TEMP ind -39 ± 1 degF (after ~2.5 min)

CRT TIMER SETUP (Omit if BFS or OPS 3) 5

GNC 2 TIME

- C COUNT TO – ITEM 17 +__ +__ +__ EXEC

APU STEAM VENT HTR ACT 6

- P R2 BLR CNTLR/HTR (three) – B
PWR (three) – ON

NOTE
Htr reqd to be on prior to APU act

<p>TIG</p> <p>-02:00</p> <p>If OPS 2: A1(B1) AUTO PRI RT 0.2 DB 5.0</p> <p>-01:55</p> <p>If OPS 3: TRANS DAP AUTO RT 0.5 DB 3.5</p> <p>-01:50</p> <p>-01:45</p> <p>-01:40</p> <p>-01:35</p> <p>UPLINK PASS & BFS TGT</p> <p>-01:30</p>	<p>MS Perform at TIG – _____ PAYLOAD DEACT, if reqd (PL OPS, <u>DEORBIT PREP</u> or SODF: ASSY OPS, <u>ACTIVATION AND CHECKOUT</u>; DEORBIT PREP)</p> <p>C <u>RAD BYP</u> [4], 2-13</p> <p>P <u>TIMER SETUP</u> (Omit if BFS or OPS 3) [5], 2-13</p> <p>P <u>APU STEAM VENT HTR ACT</u> [6], 2-13</p> <p>MS <u>AFT HTR CONFIG MS AFT ACTIVITIES</u> [7], 2-19</p> <p>P <u>PLBD CLOSING (AUTO SEQ)</u> (if reqd) [8]</p>
---	---

PLBD CLOSING (AUTO SEQ) (if reqd) [8]

CAUTION

If SM GPC fails during this operation:
PL BAY DR SYS 1,2 (two) – DSBL
Perform PASS SM GPC FAIL (ORB PKT, DPS)

R13L When closing and latching PLBD:
Verify no obstructions (Ku ANT,RMS,RAD, etc)

NOTE

Ref DETAILED PLBD CLOSING PROCEDURES
(DEORB PREP, NOMINAL DEORBIT PREP) (if reqd)

R11L ✓ CRT4 PWR – ON
CRT4 SM, OPS X02 PRO
 [4: SM PL BAY DOORS] or [BFS, SM 63 PL BAY DOORS]

R13L ✓ PL BAY DR – STOP
CRT4 ✓ PBD SW – STOP
 ✓ MAN SEL (ten) – (no *)
 ✓ PBD SW BYPASS – (no *)
 AC POWER ON – ITEM 1 EXEC (*)
 AUTO MODE SEL – ITEM 3 EXEC (*)
 PL BAY DR SYS 1,2 (two) – ENA

R13L ✓ OP/CL STATUS (ten) – OP
CRT4 PL BAY DR – CL
R13L * If PORT(STBD) DOOR not 'CL' within 6 sec of *
 * 'RDY' then: *
 * PL BAY DR – STOP *
 * ✓ PLBD BULKHEAD LATCH GO/NO-GO *
 * DIAGRAM (DEORBIT PREP, *
 * NOMINAL DEORBIT PREP) *
 * If NO-GO: Go to CONTINGENCY PLBD *
 * CLOSURE, MECH SSR-2 (MAL, MECH) *
 * If GO: PL BAY DR – CL *

When STBD DOOR is as close as possible to PORT DOOR
before contacting it:
PL BAY DR – STOP
✓ For C/L overlap, ref PLBD BULKHEAD LATCH GO/NO-GO
DIAGRAM (DEORBIT PREP, NOMINAL DEORBIT PREP)
* If NO-GO, perform SIMULTANEOUS *
* PLBD CL, MECH SSR-3 (MAL, MECH) *

PL BAY DR – CL

When closed and latched:
PL BAY DR – STOP
SYS 1,2 (two) – DSBL

CRT4 ✓ OP/CL STATUS (ten) – CL
 AC POWER OFF – ITEM 2 EXEC (*)
 GPC/CRT 0/4 EXEC

R11L CRT4 PWR – OFF
 AFD 1 PWR

OPS 2 TO 3 TRANSITION 9

(Omit if BFS engaged or if already configured with G3 set)

- * If IMU or RHC dilemma, do not proceed *
- * with OPS 3 transition *

✓Att mnvr complete
 O14,O15, ✓RGA,ACCEL,ASA,IMU (all) – ON
 O16

1. VERIFY CRT CONFIG

C2 ✓CRT PWR (three) – ON
 R11L ✓CRT4 PWR – OFF

2. VERIFY GPC CONFIG

O6 ✓GPC MODE 3 – HALT (tb-bp)
 ✓PWR 3,5 – ON
 ✓OUTPUT 1,2 – NORM (tb-gray)
 ✓3,5 – NORM (tb-bp)
 ✓4 – TERM (tb-bp)
 ✓MODE 1,2,4 – RUN (tb-RUN)
 3 – STBY (tb-RUN)
 5 – STBY (tb-RUN)

3. SM CHECKPOINT/UL CNTL ENA

- 1: SM 60 SM TABLE MAINT
- 2: SM 1 DPS UTILITY

CRT2 MMU ASSIGN 2 SM – ITEM 4 EXEC
 CRT1 CKPT INITIATE – ITEM 18 EXEC
 ✓Update of CKPT TIME and STATUS GOOD indicated
 CRT2 MMU ASSIGN 1 SM – ITEM 3 EXEC
 CRT1 CKPT INITIATE – ITEM 18 EXEC
 ✓Update of CKPT TIME and STATUS GOOD indicated
 CRT2 CKPT RETRV ENA – ITEM 12 EXEC (*)
 UL CNTL ENA – ITEM 36 EXEC

4. LOAD ENTRY TFL/RECONFIG UPLK

Perform LOAD PDI DECOM FORMAT
 and LOAD PCMMU FORMAT
 for entry config (ORB OPS FS,
 COMM/INST)

CONFIG GPC	3	12000
STR 1	1	1
2	2	
3	1	
4	2	
PL 1/2	0	
CRT 1	1	
2	2	
3	2	
4	0	
L 1	0	
2	0	
MM 1	1	
2	2	

5. TRANSITION GPC 1&2 TO GNC OPS 3

- 1: GNC 0 GPC MEMORY

CONFIG – ITEM 1 +3 EXEC
 Modify MC 3 per table
 GNC, OPS 301 PRO

- 3: GNC DEORB MNVR COAST

C3 6. **TRANSITION BFS GPC TO GNC OPS 3**
 BFC CRT DISP – ON
 ✓SEL – 3+1

- 3: BFS, GNC BFS MEMORY

O6 GPC OUTPUT 5 – B/U (tb-bp)
 CRT3 ✓TFL ENA – ITEM 29 (*)
 BFS, GNC, OPS 301 PRO

- 3: BFS, GNC DEORB MNVR COAST

7. **TRANSITION GPC 1,2,3,4 TO GNC OPS 3**
 SM, OPS 000 PRO (releases payload buses)

- SM GPC MEMORY

O6 GPC OUTPUT 4 – NORM (tb-gray)
 MODE 3,5 (two) – RUN (tb-RUN)

- ✓CONFIG – ITEM 1 +3 EXEC

Modify MC 3 per table
 BFC CRT DISP – OFF
 GNC, OPS 301 PRO

- 1: GNC DEORB MNVR COAST

C3 BFC CRT DISP – ON
 CRT3 BFS, GNC, OPS 000 PRO
 BFS, GNC, OPS 301 PRO

8. **LAND SITE UPDATE**

- 1: GNC 50 HORIZ SIT

SEL SITE (See LAND SITE DATA)

9. **LOAD IN TGTs**

- 1: GNC DEORB MNVR COAST

* If MCC cannot provide DEORB TGT, use PGSC *

- ✓PASS and BFS TGT per DEORBIT MNVR PAD (ENT, MNVR PADS) or PGSC

LOAD – ITEM 22 EXEC
 TIMER – ITEM 23 EXEC
 ✓PASS and BFS solution per DEORBIT MNVR PAD (ENT, MNVR PADS):
 BURN ATT
 HA
 HP
 ΔVTOT
 TGO

10. **VERIFY MC 9 TABLE (GNC 9) FOR POST LANDING**

- 2: GNC 0 GPC MEMORY

- ✓CONFIG – ITEM 1 +9 EXEC

Modify MC 9 per table
 CONFIG – ITEM 1 +3 EXEC

CONFIG GPC	3	12340
STR 1	1	
2	2	
3	3	
4	4	
PL 1/2	1	
CRT 1	1	
2	2	
3	3	
4	0	
L 1	0	
2	0	
MM 1	1	
2	2	

CONFIG GPC	9	12340
STR 1	1	
2	2	
3	3	
4	4	
PL 1/2	1	
CRT 1	1	
2	2	
3	3	
4	0	
L 1	1	
2	2	
MM 1	1	
2	2	

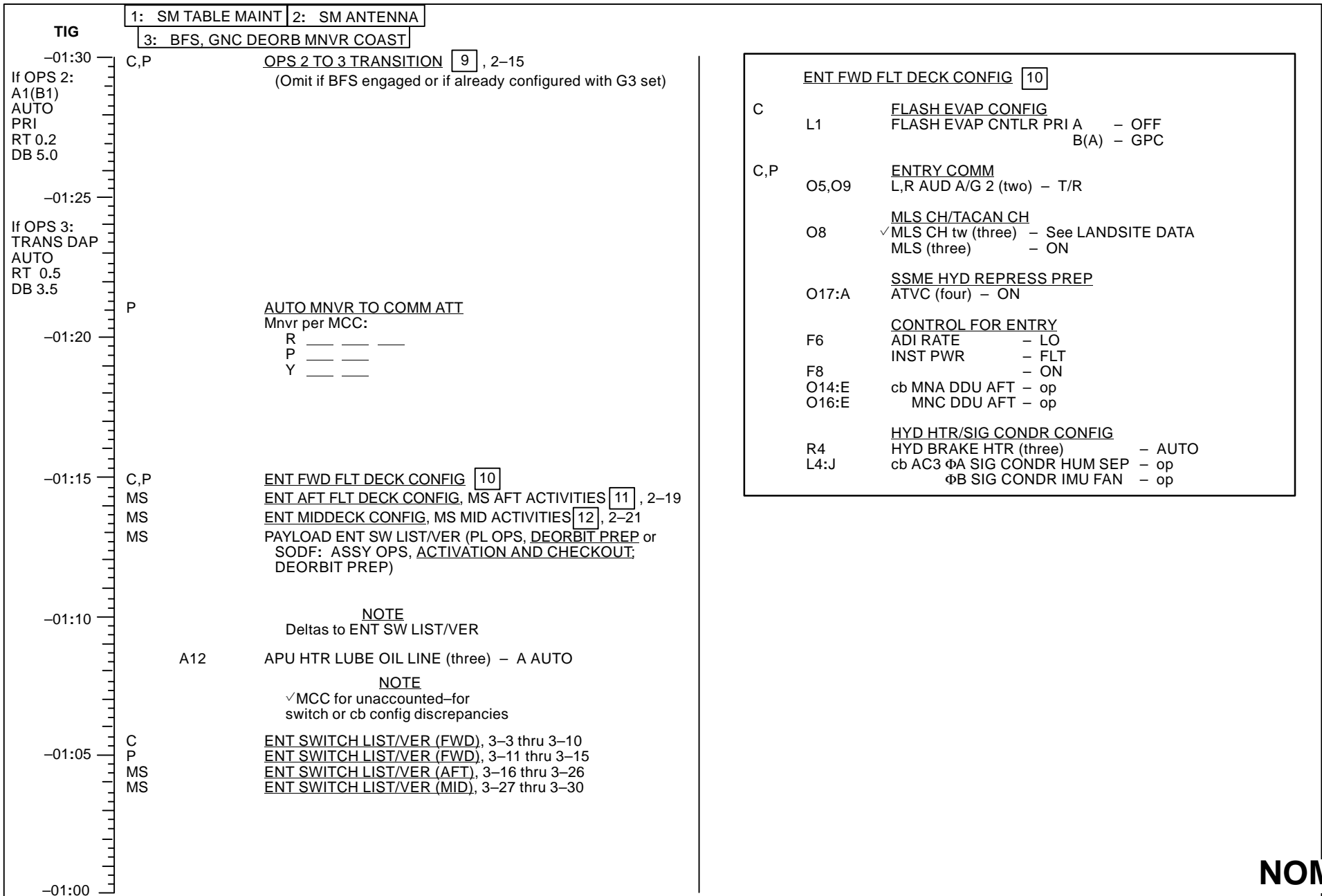

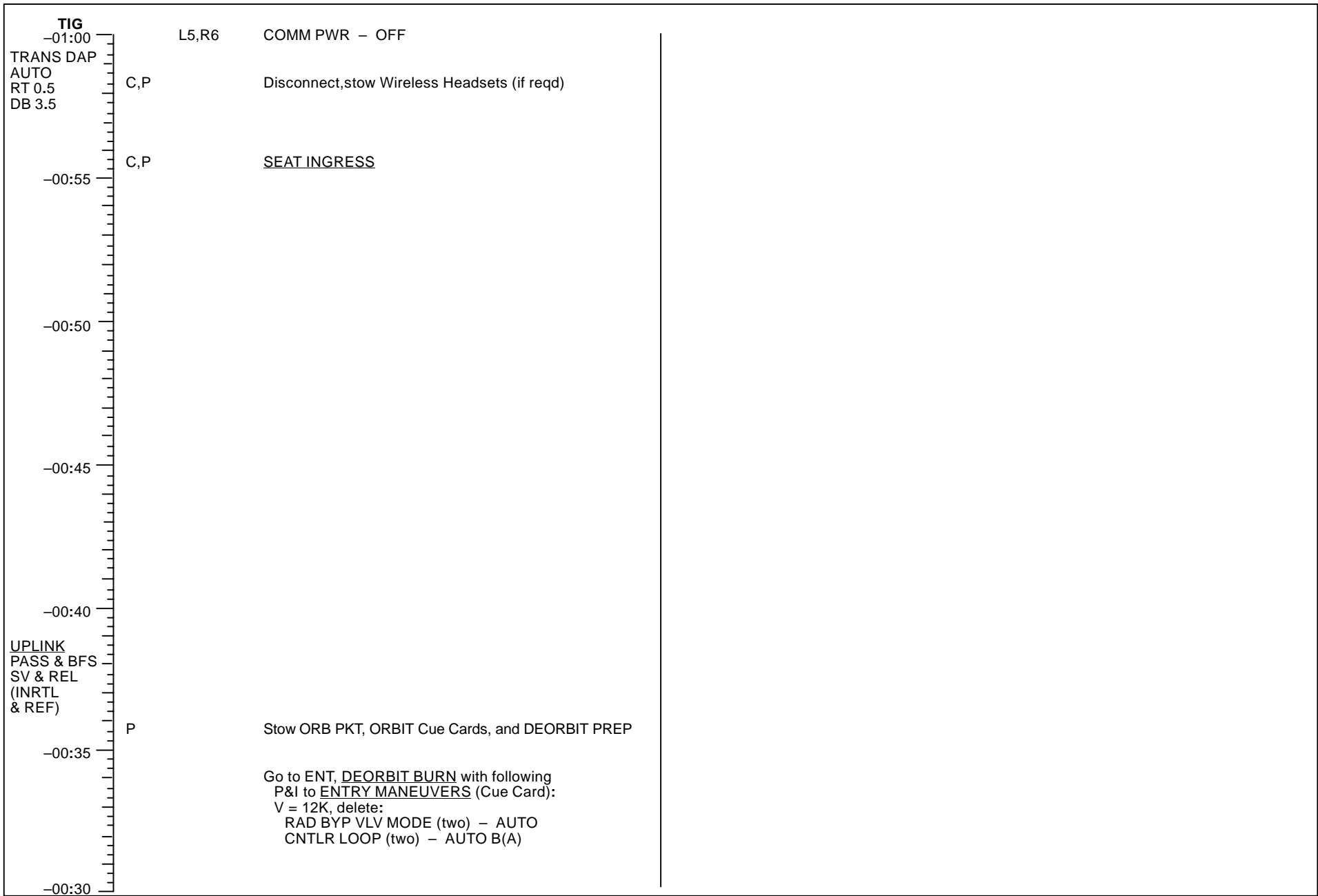

This Page Intentionally Blank

MS LAUNCH DAY DEORBIT PREP AFT DECK ACTIVITIES (ORBIT 3)

NOTE

Wait for GO from CDR or PLT before starting any activity on this page

TIME (TIG-)	MS AFT ACTIONS
—	PAYLOAD DEACT, if reqd (PL OPS, <u>DEORBIT PREP</u> or SODF: ASSY OPS, <u>ACTIVATION AND CHECKOUT</u> ; DEORBIT PREP)
02:22	SEAT EGRESS
02:20	PGSC ACT (ORB OPS, <u>PGSC</u>) Use flight deck PGSC
02:11	UNSTOW/DON WIRELESS HEADSETS (if reqd)
01:50	<u>AFT HTR CONFIG</u> 7
01:14	<u>ENT AFT FLT DECK CONFIG</u> 11
01:04	<u>ENT SWITCH LIST/VER (AFT)</u> , 3-16 thru 3-26

<u>AFT HTR CONFIG</u> 7	
A12	HYD HTR (eight) – OFF
A14	RCS/OMS HTR FWD RCS – OFF L POD (two) – A OFF, B OFF R POD (two) – A OFF, B OFF OMS CRSFD LINES (two) – B AUTO, A AUTO ✓FWD, AFT RCS JET (ten) – AUTO
R11U	✓FC PURGE VLVS (three) – GPC ✓HTR – GPC ✓H2O LINE HTR – A AUTO
<u>NOTE</u> MCC command FC PURGE HTR off, if reqd	

<u>ENT AFT FLT DECK CONFIG</u> 11		
<u>ENTRY COMM CONFIG</u>		
A1L	S-BD PM MODE – STDN LO NSP CODING (two) – OFF	
A1R	AUD CTR VOICE RCD SEL CH 1 sel – ICOM A 2 sel – ICOM B	
A13	OS AUD SPKR PWR – OFF PWR – OFF (OV102)	
A15	PS COMM CCU PWR – as reqd	
R14:C	cb MNB KU ANT HTR – op UHF EVA (two) – op	
R10	MS AUD A/G 2 – T/R A/A – T/R	
L9	PS AUD PWR – AUD/TONE A/G 1 – T/R A/A – T/R ICOM (two) – T/R	
<u>H2O STORAGE SYS CONFIG</u>		
ML86B:A	✓cb MNC SPLY H2O XOVR VLV – cl	
R11L	SPLY H2O XOVR VLV – OP (tb-OP)	
<u>RESET C/W</u>		
<u>R13U</u>		
PARAMETER NAME	C/W CH	UPPER LIMIT
FREON LOOP EVAP OUT T1	107	1.90V/64.8 degF
T2	117	1.90V/64.8 degF
A16	✓Secure	
R10	✓MS LTG FLOOD as reqd	
<u>FOOT LOOP CONFIG</u>		
Tape Foot Loops in egress routes		

**Back of MS LAUNCH DAY DEORBIT PREP AFT DECK ACTIVITIES
(ORBIT 3)**

(NOM) B2-20

C D/O/ALL/GEN H

MS LAUNCH DAY DEORBIT PREP MIDDECK ACTIVITIES (ORBIT 3)

NOTE

Wait for GO from CDR or PLT before starting any activity on this page

TIME (TIG-)	MS MIDDECK ACTIONS
02:22	<u>SEAT EGRESS</u>
02:14	<u>PRESS H2O TKA</u> 3
02:11	UNSTOW/DON WIRELESS HEADSETS (if reqd)
01:14	<u>ENT MIDDECK CONFIG</u> 12
01:04	<u>ENT SWITCH LIST/VER</u> (MID), 3-27 thru 3-30 (OV102), 3-29 thru 3-32 (OV103, OV104, OV105)

<u>PRESS H2O TKA</u> 3	
ML26C	SPLY H2O GN2 TK VENT vlv - PRESS TKA SPLY vlv - OP
<u>NOTE</u> Disregard possible 'S66 WASTE H2O PRES' fault msg	

<u>ENT MIDDECK CONFIG</u> 12	
	<u>CO2 RMVL SYS DEACT</u> (if flown)
ML31C	VAC VENT ISOL VLV CNTL - CL (tb-CL) NOZ HTR - OFF
MO51F	CNTRLR 1(2) MODE - STBY (hold 3 sec) Wait 6 sec
	✓ CNTRLR 1(2) OPER It - OFF
	MNA(MNC) - OFF
	AC1(AC3) - OFF (hold 3 sec)
	cb AC1(AC3) (three) - op
	COM INSTR - OFF
<u>ENTRY COMM CONFIG</u>	
MO42F	MIDDECK SPKR AUD A/G 2 - T/R
	Stow: Comm Equip Wireless Headsets
	✓ LOCKERS secure
MO13Q	✓ MIDDECK FLOODS as reqd
ML85E	AC S1 - OFF
<u>MIDDECK PCS</u>	
MO69M	LEH O2 7,8 vlv (two) - as reqd
MO32M	LEH O2 6 vlv - as reqd
<u>EGRESS ROUTE CONFIG</u>	
	Tape Foot Loops in egress routes

**Back of MS LAUNCH DAY DEORBIT PREP MIDDECK ACTIVITIES
(ORBIT 3)**

(NOM) B2-22

C D/O/ALL/GEN H

ENTRY SWITCH LIST/VERIFICATION

LEFT SEAT

L5	3-3
L4	3-3
L1	3-4
F3	3-4
L,R HUD	3-4
L2	3-5
F1	3-5
F2	3-6
F6	3-6
F7	3-6
C2	3-7
C3	3-7
O1	3-8
O2	3-8
L side OVHD flood	3-8
O5	3-8
O6	3-9
O7	3-9
O13	3-10
O14	3-10
O15	3-10

RIGHT SEAT

O16	3-11
O17	3-11
O8	3-12
O9	3-12
R side OVHD flood	3-12
O3	3-13
F4	3-13
F8	3-13
F9	3-13

RIGHT SEAT (Cont)

R1	3-14
R2	3-15
R4	3-15
R6	3-15

AFT

O19	3-16
C6	3-16
C5	3-16
C7	3-16
R10	3-17
R11U,L	3-17
R13U,L	3-18
R14	3-18
A1U,L,R	3-19
A4	3-20
A3	3-20
A6U	3-20
A7U	3-20
A8U,L	3-21
A11	3-22
A12	3-22

<u>LEGEND</u>	
- left	
- right	
- up	R - as reqd
- center	- cb close
- down	- cb open
indicates switch/display not checked during ENTRY SWITCH LIST/VERIFICATION	

<u>CIRCUIT BREAKER SNAPPING COLOR CODES</u>	
<u>COLOR</u>	<u>CONFIGURATION</u>
Red	Open at all times
Green	Open on orbit only
Yellow	Open ascent, close per procedure
Orange	Open orbit through entry
Blank (no ring)	Always closed or as reqd

**ENT SW
LIST/VER**

AFT (Cont)

A2,A13 3-22 (OV102)
 A13 3-24 (OV103,104,105)
 A14 3-23 (OV102)
 A14 3-24 (OV103,104,105)
 A15 3-23 (OV102)
 A15 3-24 (OV103,104,105)
 L9 3-23 (OV102)
 L9 3-24 (OV103,104,105)

MIDDECK FWD

MO42F 3-24 (OV102)
 MO42F 3-26 (OV103,104,105)
 MO58F 3-24 (OV102)
 MO58F 3-26 (OV103,104,105)
 MO32M 3-24 (OV102)
 MO32M 3-26 (OV103,104,105)
 MO39M 3-24 (OV102)
 MO39M 3-26 (OV103,104,105)
 MO69M 3-24 (OV102)
 MO69M 3-26 (OV103,104,105)
 MO29J 3-24 (OV102)
 MO29J 3-26 (OV103,104,105)
 MO52J 3-24 (OV102)
 MO52J 3-26 (OV103,104,105)
 MO30F 3-24 (OV102)
 MO30F 3-26 (OV103,104,105)
 MO62M 3-24 (OV102)
 MO62M 3-26 (OV103,104,105)
 MO63P 3-26 (OV104)
 MO51F 3-25 (OV102)
 ML86B 3-25 (OV102)
 ML86B 3-27 (OV103,104,105)

MIDDECK FWD (Cont)

MD44F 3-26 (OV102)
 MD44F 3-28 (OV103,104,105)
 MD24K 3-26 (OV102)
 MD24K 3-28 (OV103,104,105)

MIDDECK AFT

MA73C 3-25 (OV102)
 MA73C 3-27 (OV103,104,105)
 MO13Q 3-26 (OV102)
 MO13Q 3-28 (OV103,104,105)
 ML18F 3-26 (OV102)
 ML18F 3-28 (OV103,104,105)
 ML26C 3-26 (OV102)
 ML26C 3-28 (OV103,104,105)
 ML31C 3-26 (OV102)
 ML31C 3-28 (OV103,104,105)
 MO10W 3-27 (OV102)
 MO10W 3-29 (OV103,104,105)
 WCS 3-27 (OV102)
 WCS 3-29 (OV103,104,105)
 EDO WCS 3-27 (OV102)
 EDO WCS 3-29 (OV103,104,105)

AIRLOCK

AW18A 3-28 (OV102)
 AW18D 3-30 (OV103,104,105)
 AW18D 3-28 (OV102)
 AW18D 3-30 (OV103,104,105)
 AW18H 3-28 (OV102)
 AW18H 3-30 (OV103,104,105)
 AW82A 3-28 (OV102)
 AW82A 3-30 (OV103,104,105)
 AW82B 3-28 (OV102)
 AW82B 3-30 (OV103,104,105)
 AW82D 3-28 (OV102)
 AW82D 3-30 (OV103,104,105)
 AW82H 3-28 (OV102)
 AW82H 3-30 (OV103,104,105)
 INNER HATCH 3-29 (OV102)
 INNER HATCH .. 3-31 (OV103,104,105)

OV102

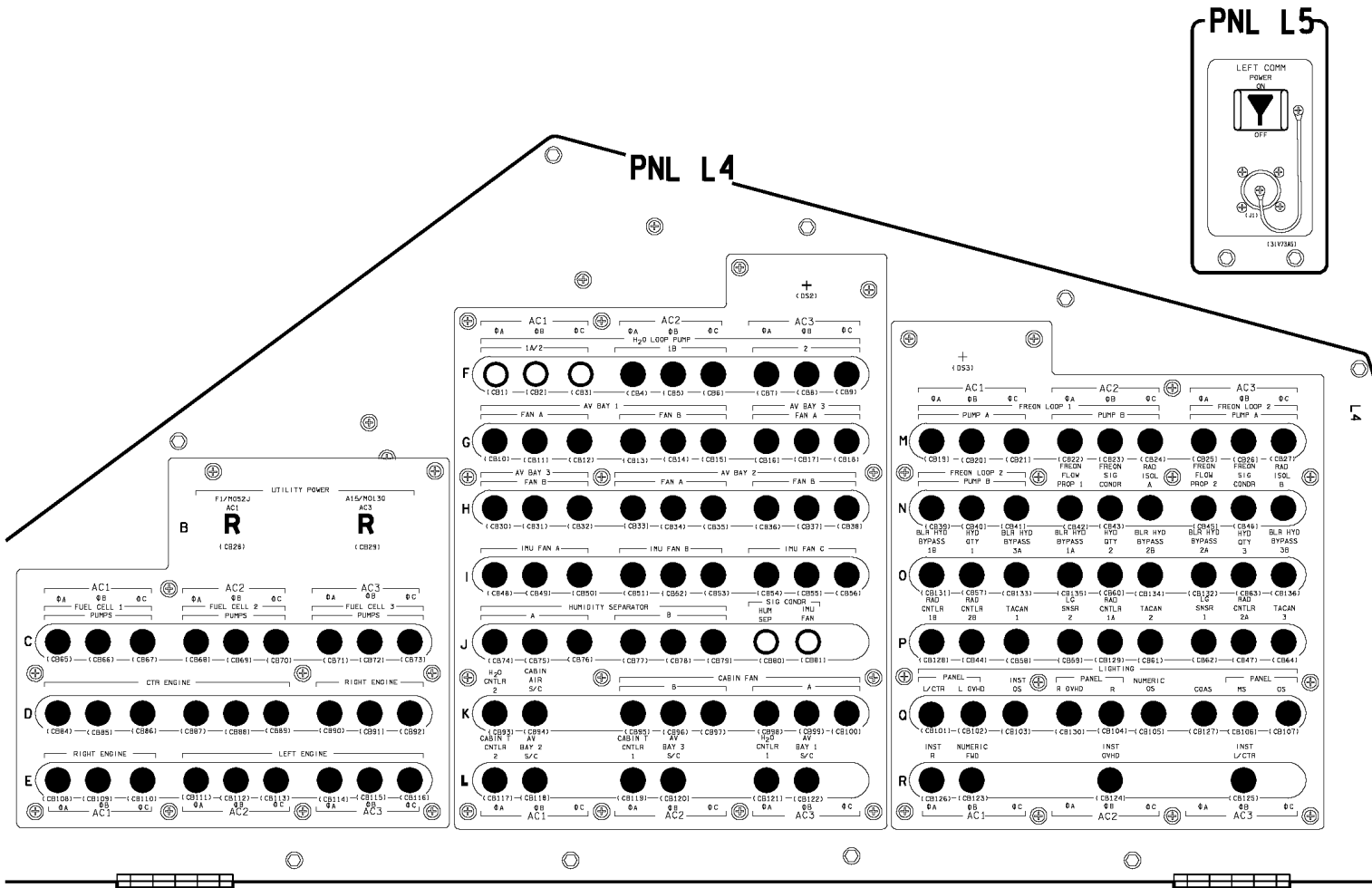

OV102

OV102

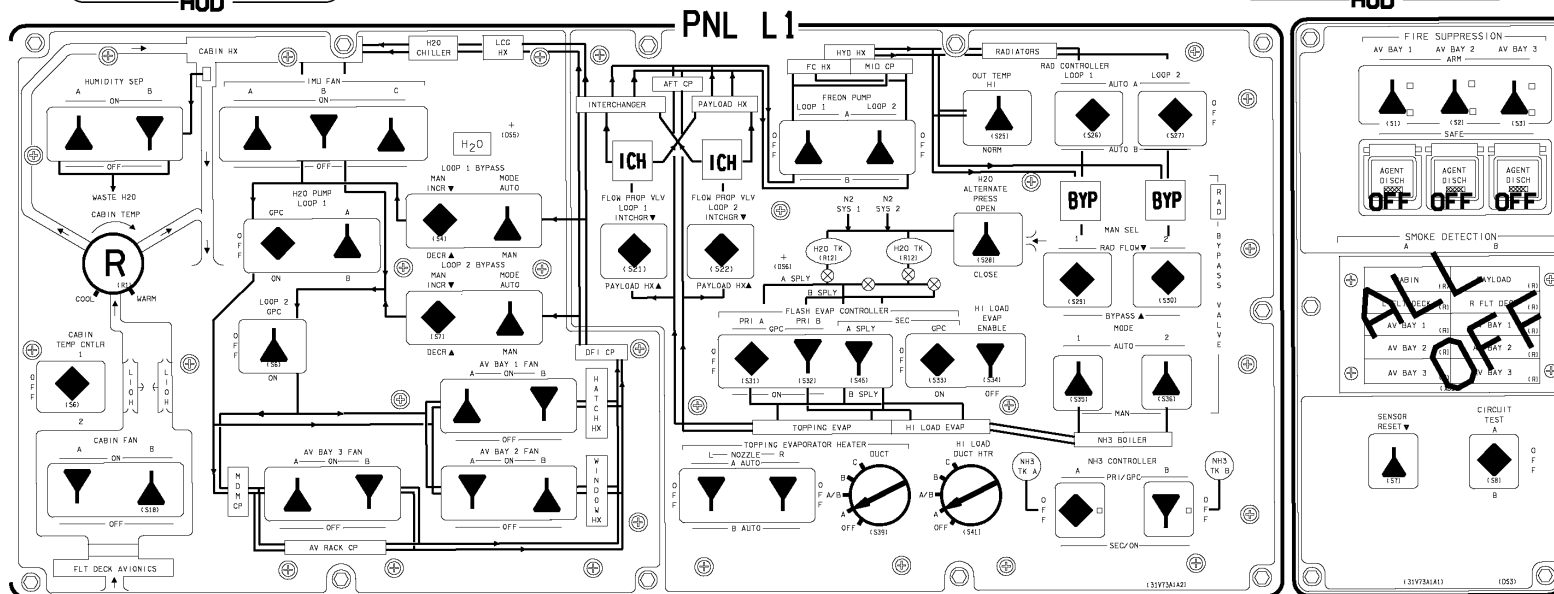
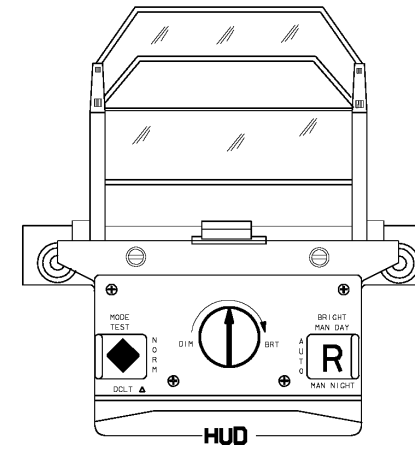
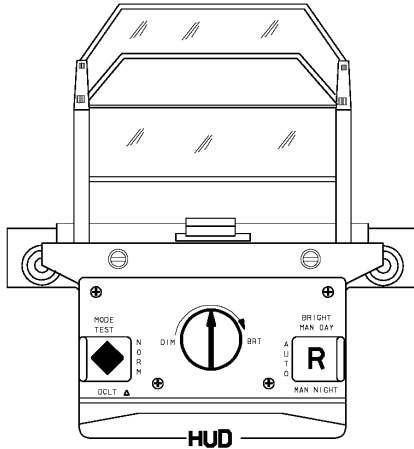
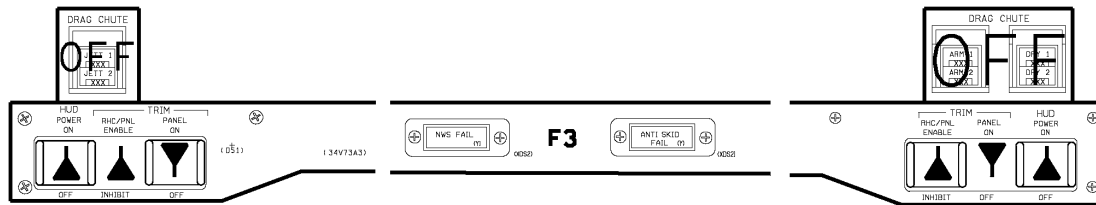

48007A304_109. PNL 1

OV102/DATE 02/01/02

(OV102) A3-4

C D/O/ALL/GEN H,7

OV102

OV102

PNL L2

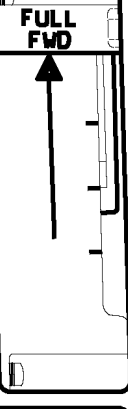
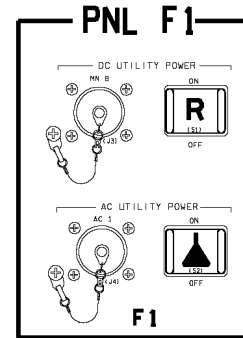
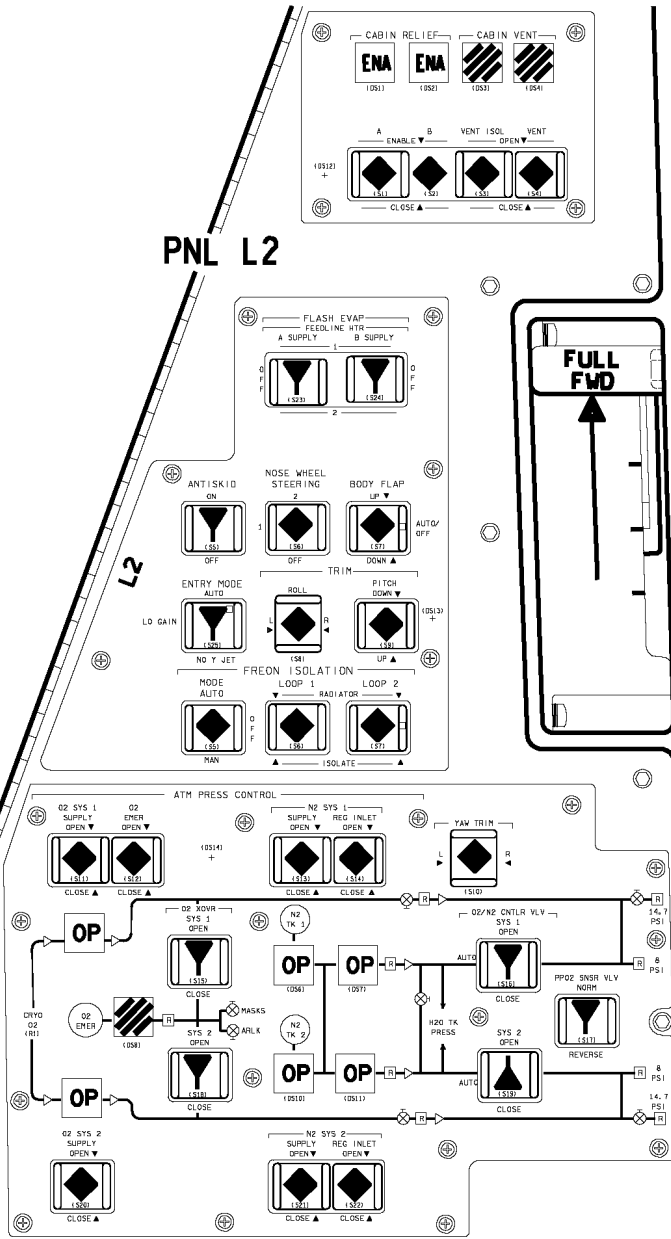

OV102

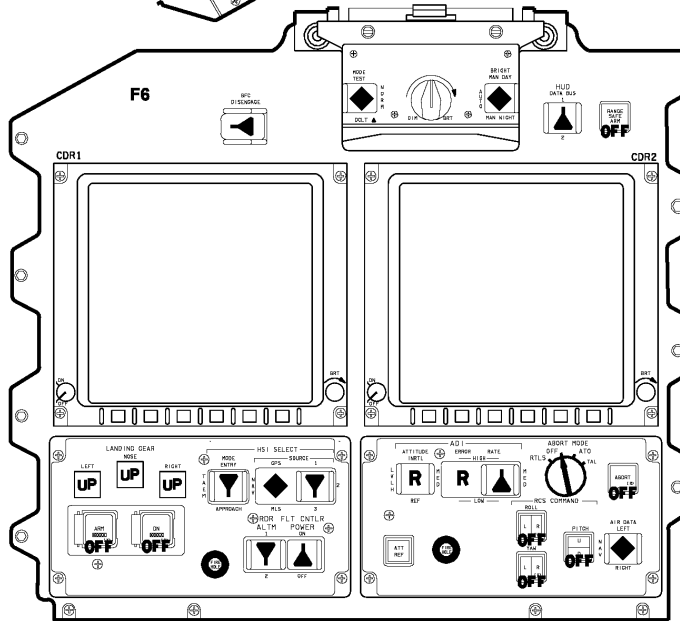
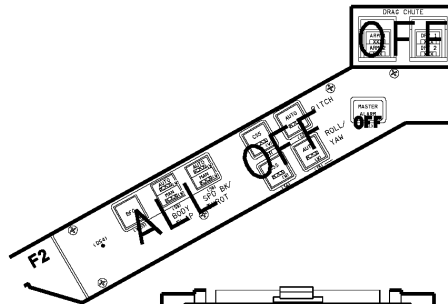
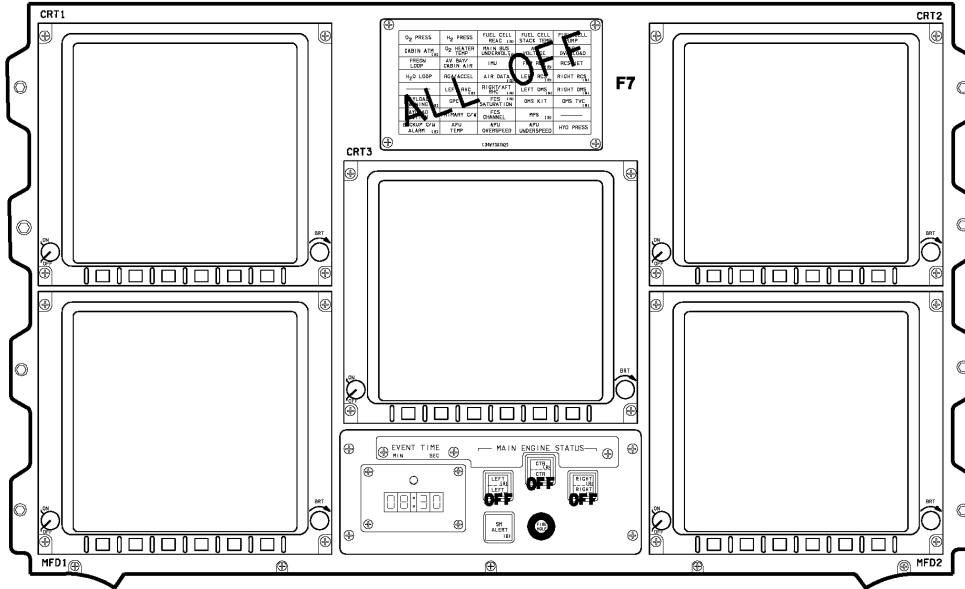

REDS REV/DATE 02/01/02

48007A306-109, PNL 1

OV102

(OV102) A3-6

C D/O/ALL/GEN H,7

PNL C2/C3

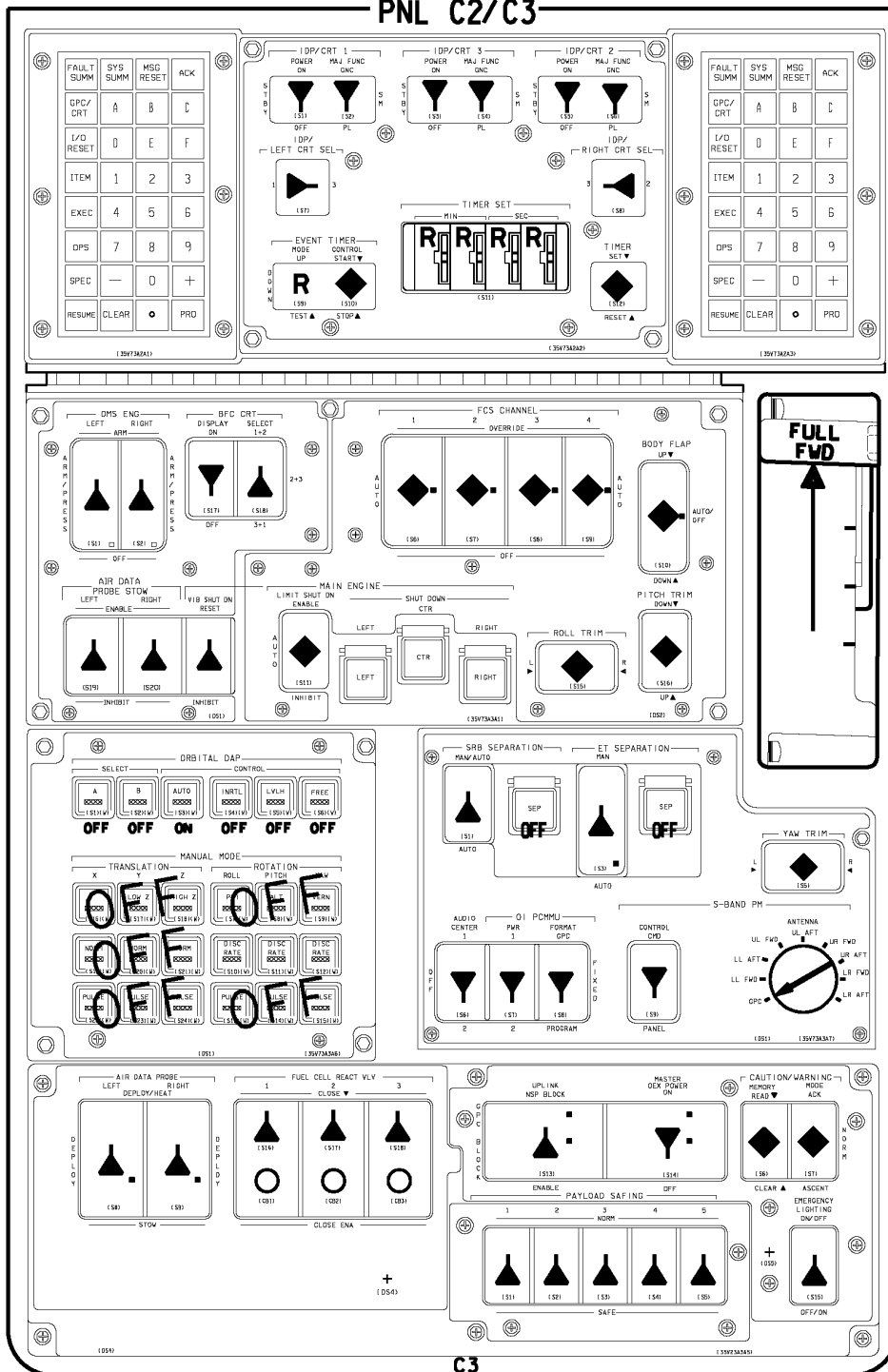

OV102

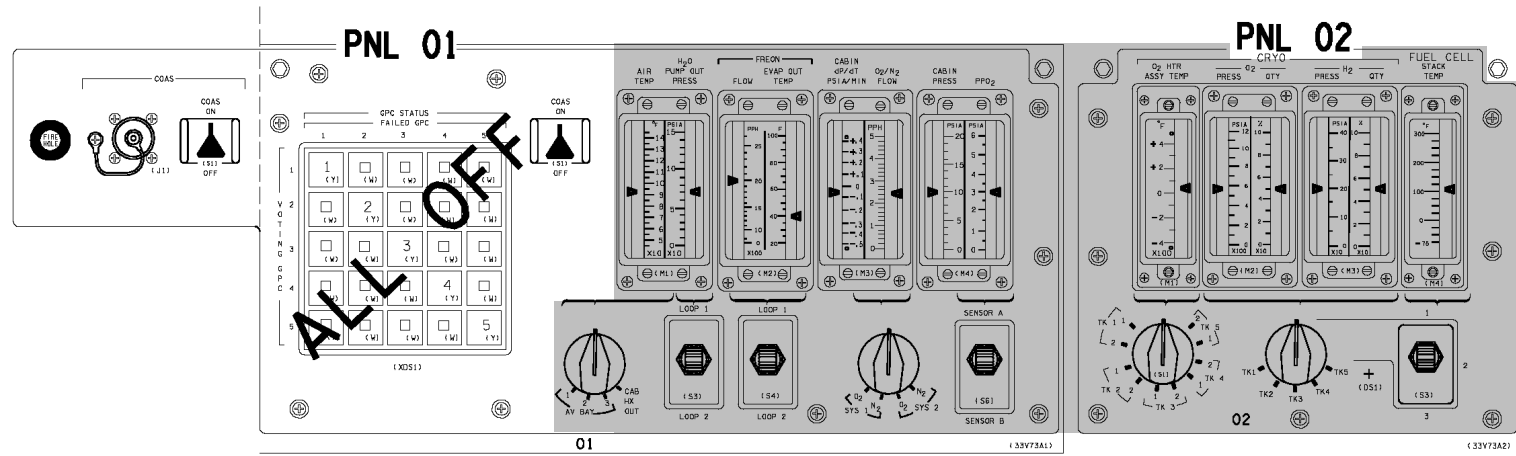

L side OVHD flood - R (MID)

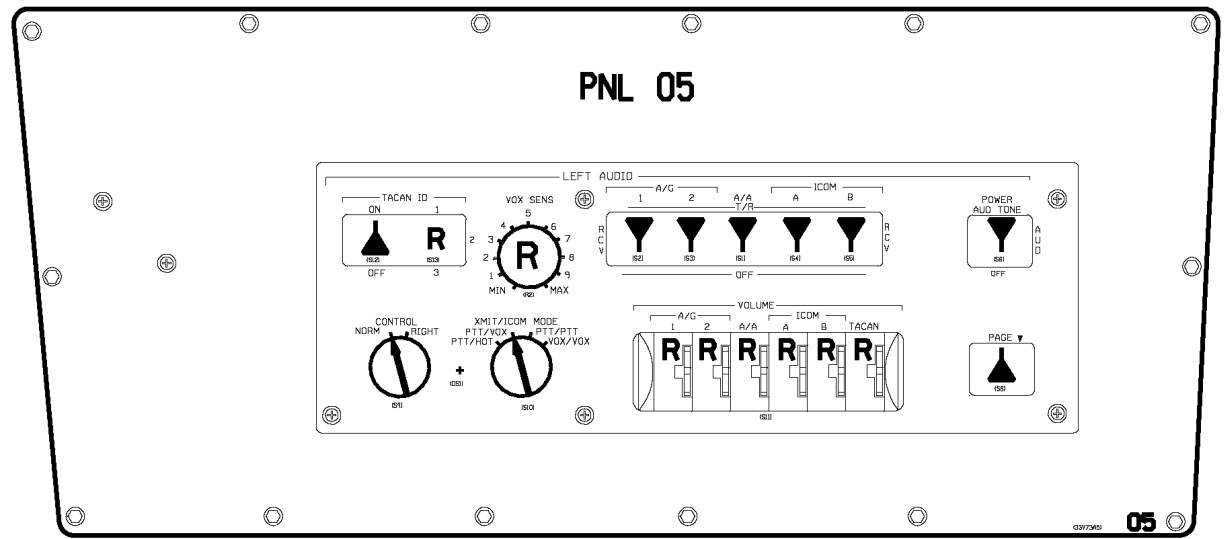

OV102

PNL 06

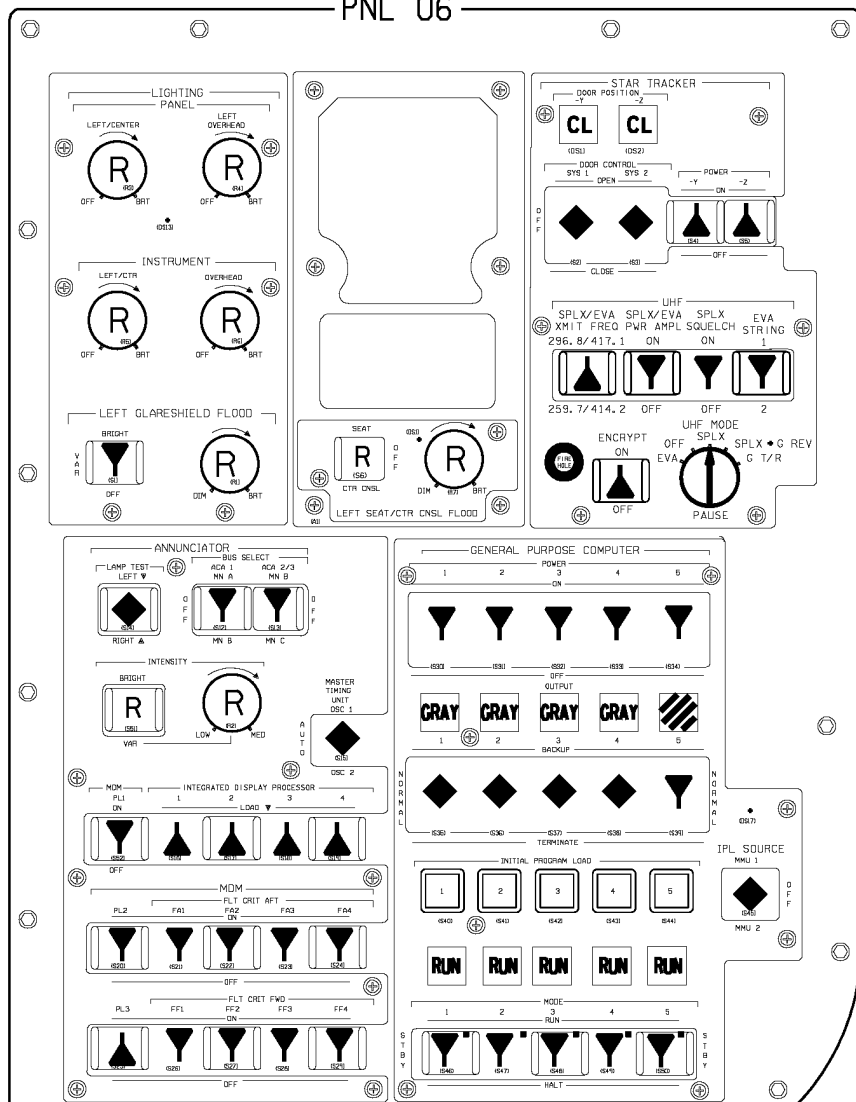

PNL 07

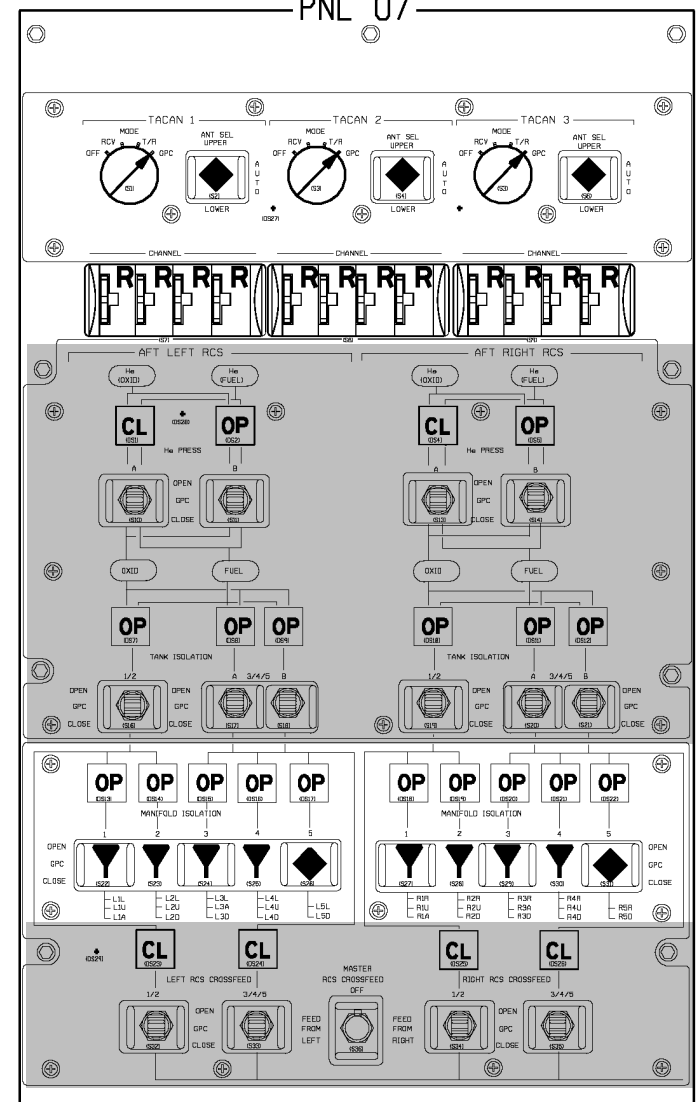

48007A309_109. PNL 1

(OV102) A3-9

OV102

OV102/DATE 02/01/02
C D/O/2/GEN H,7

OV102

PNL 013

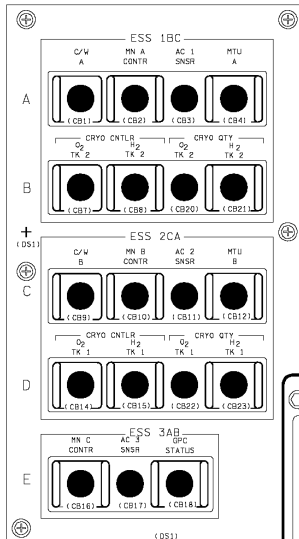

PNL 014

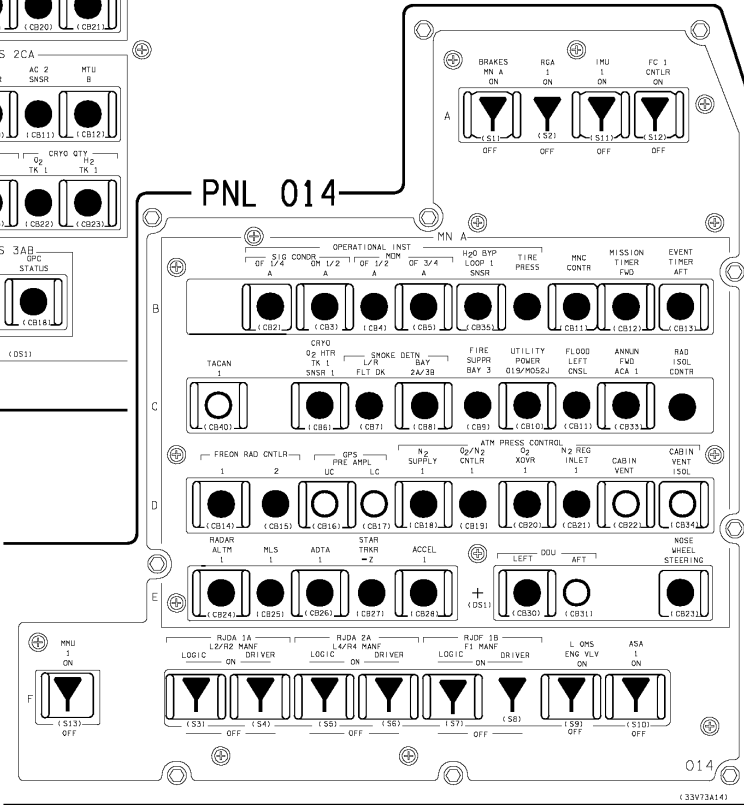

PNL 015

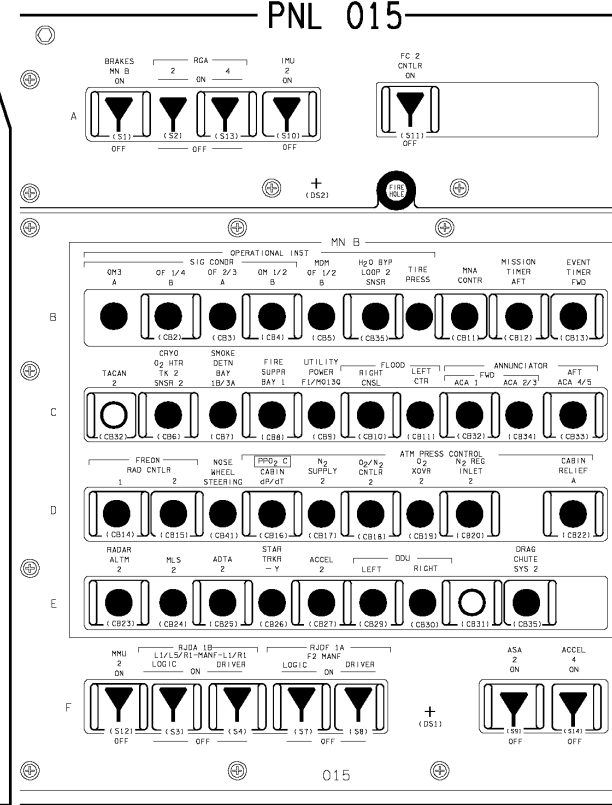

OV102

OV102

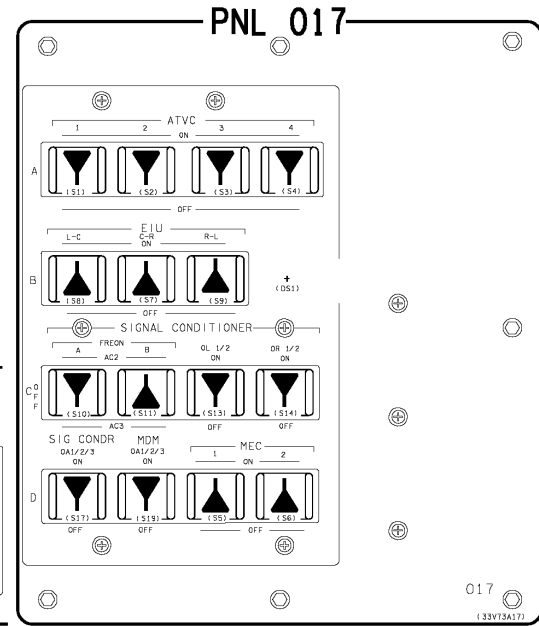
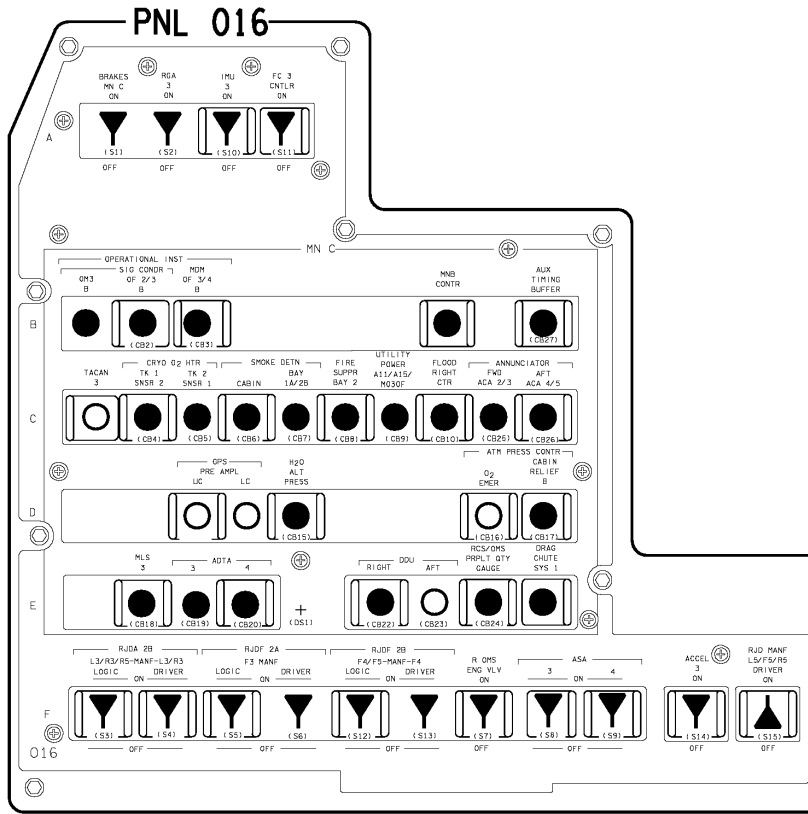

PNL 08

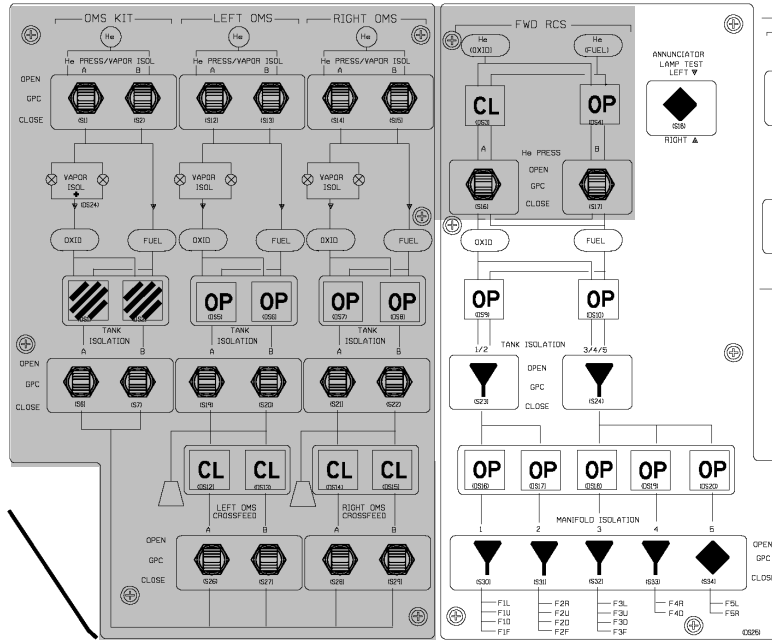
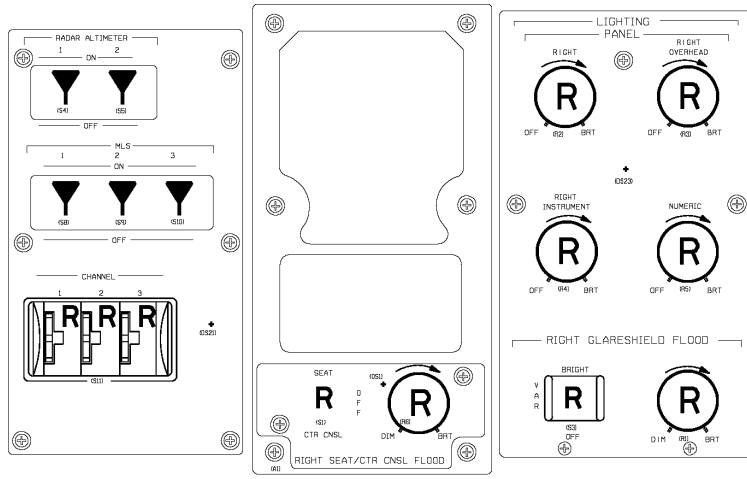

PNL 09

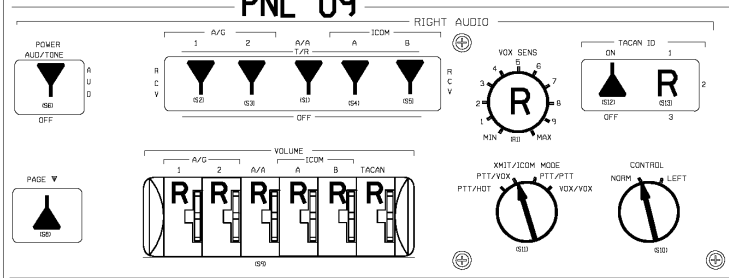

R side OVHD flood - R (MID)

OV102

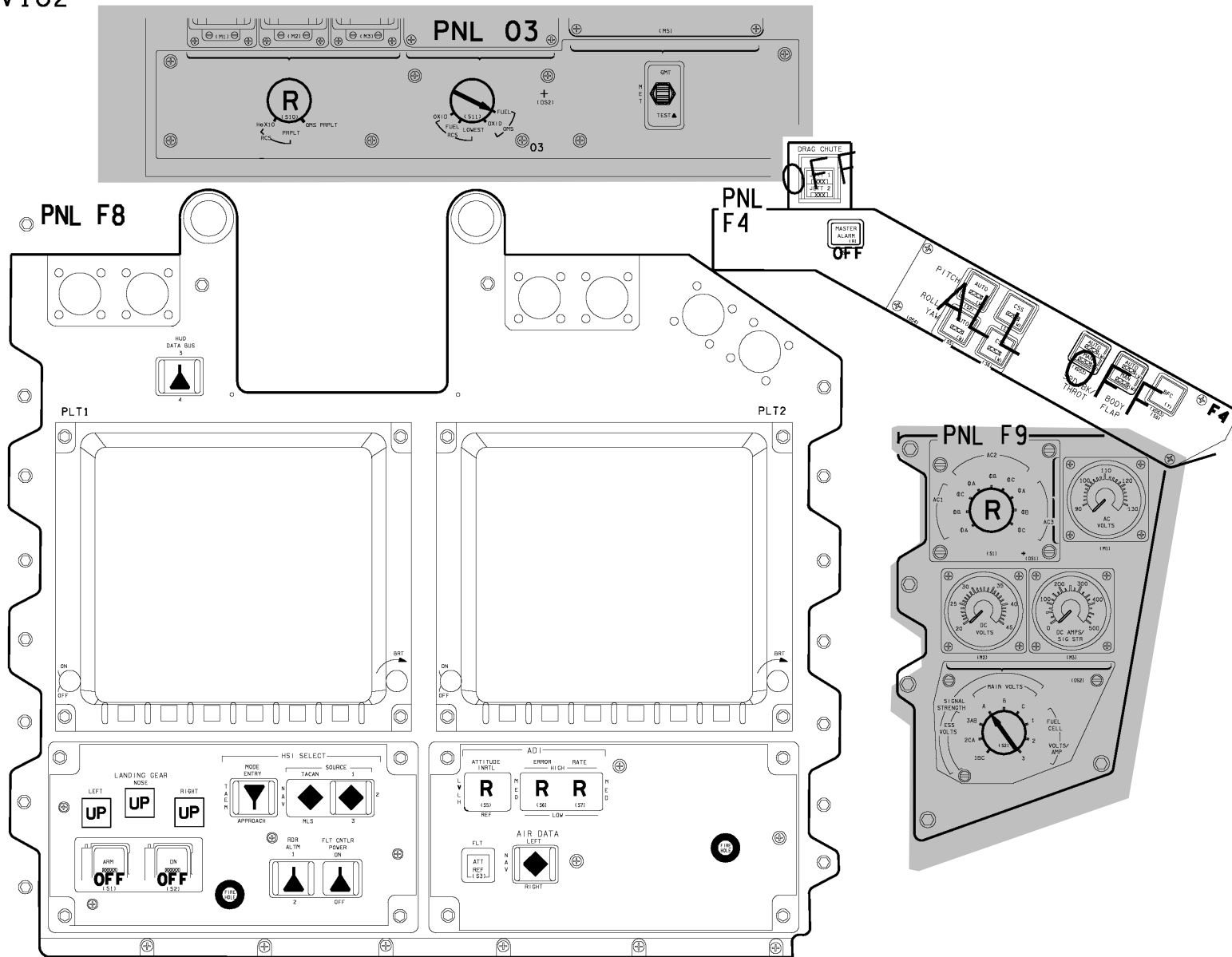

OV102

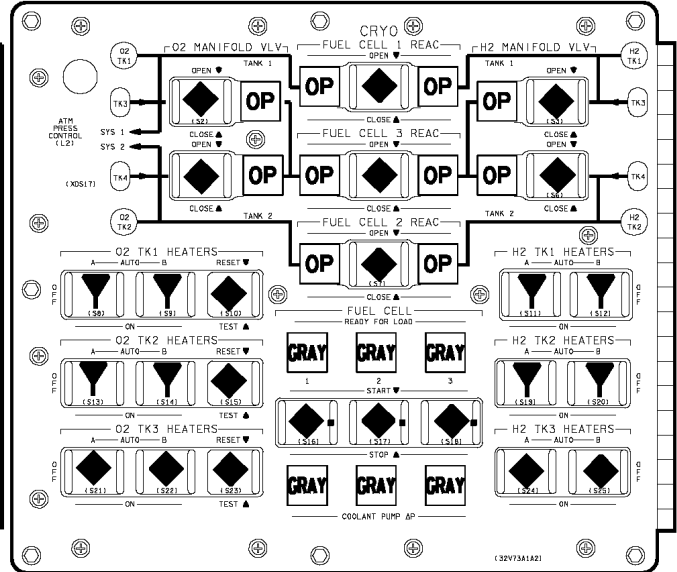
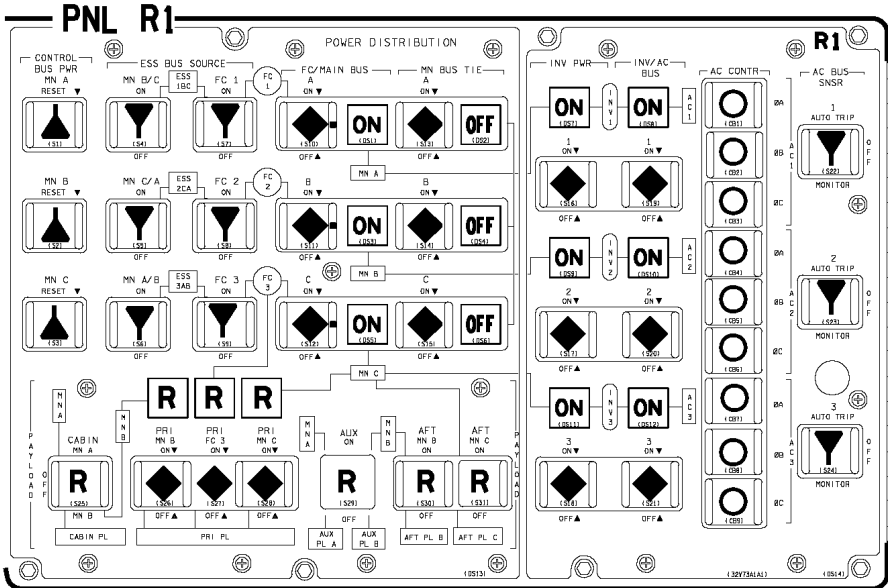

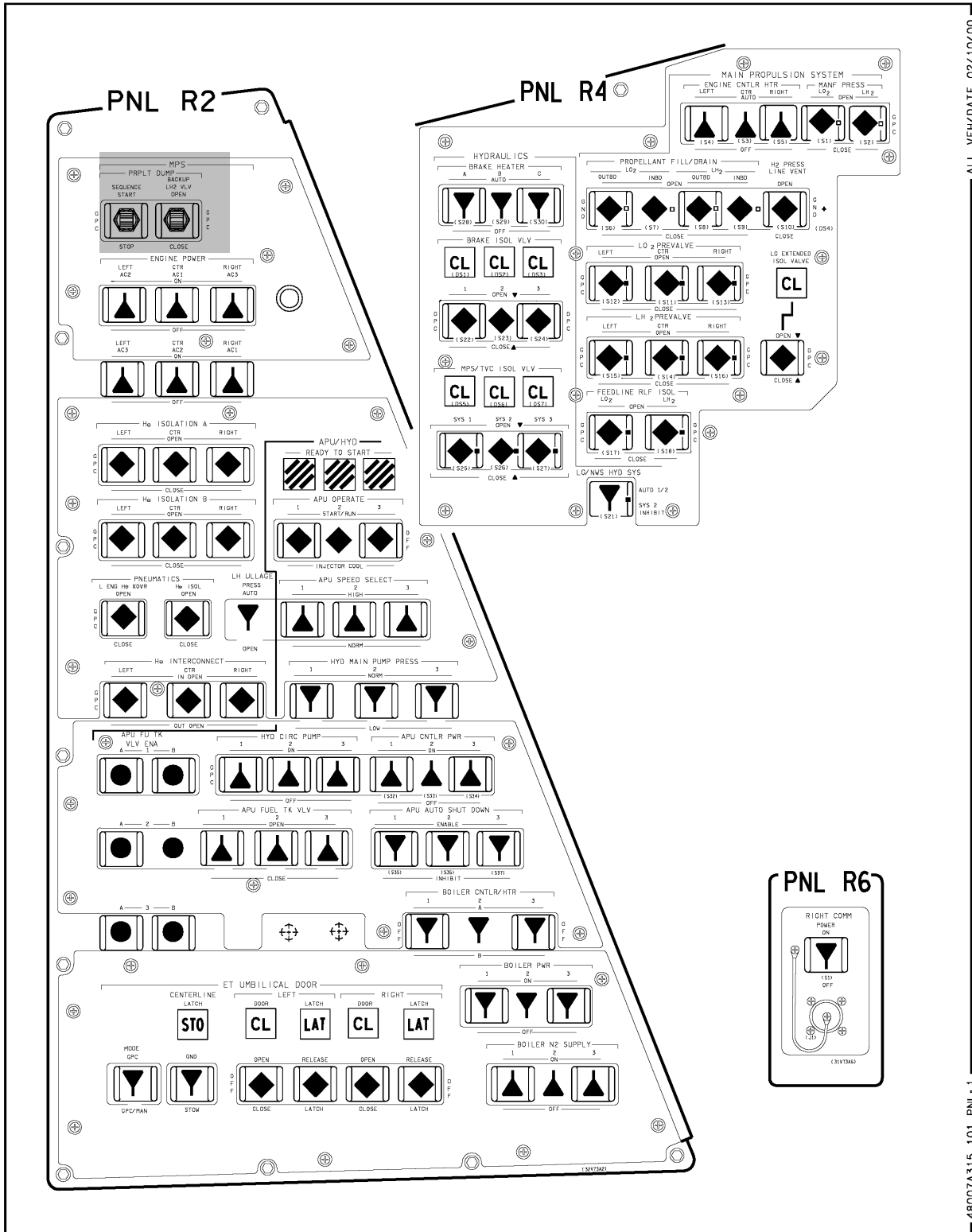

ALL VEH/DATE 02/10/00

48007A315_101_PNL R 1

OV102

(OV102) A3-15

C D/O/ALL/GEN H

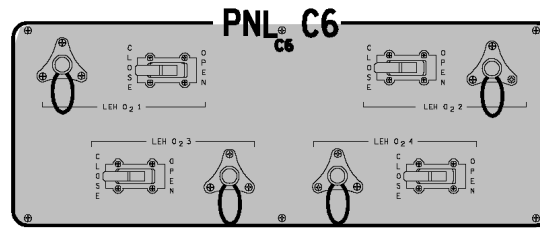
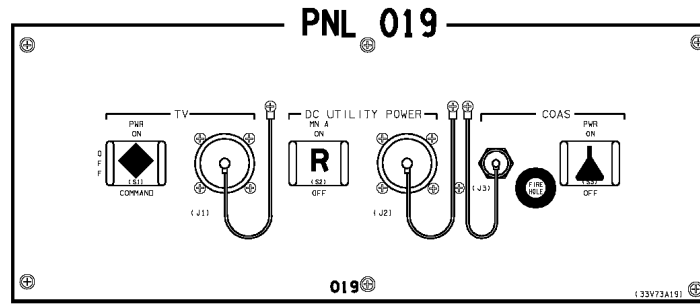

PNL C5

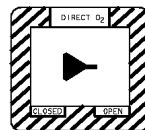

PNL C7

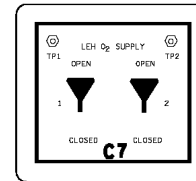

OV102

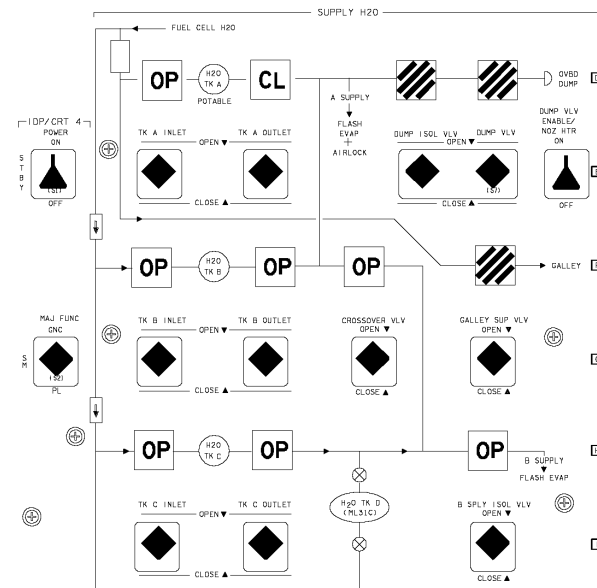
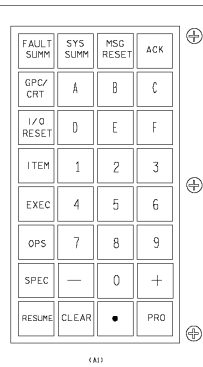
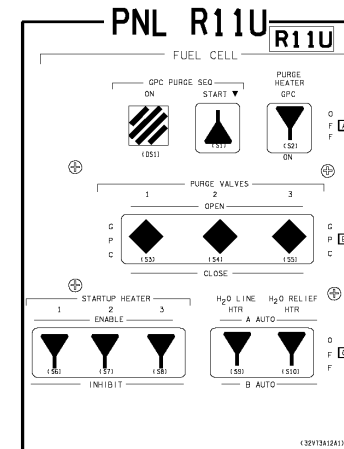
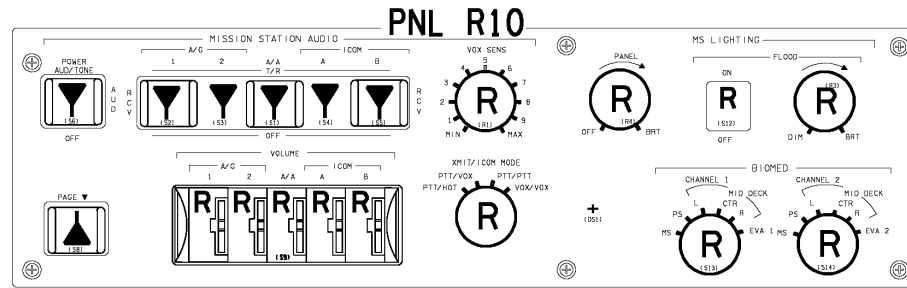

OV102

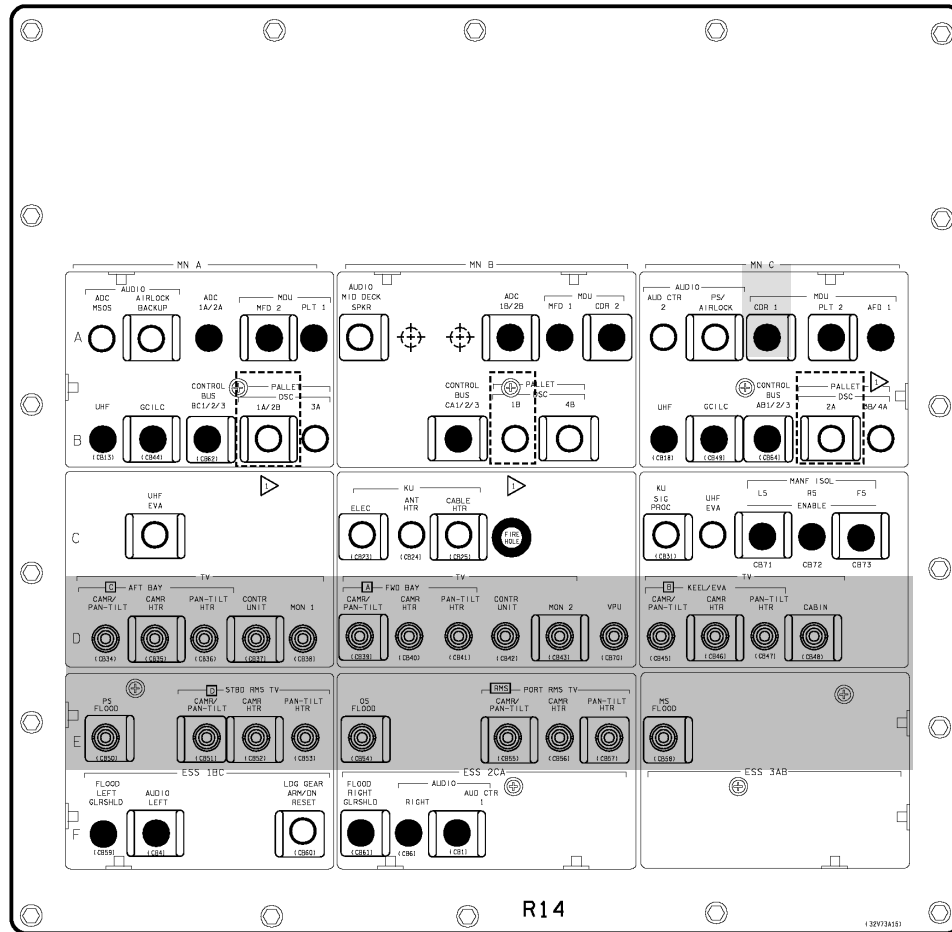
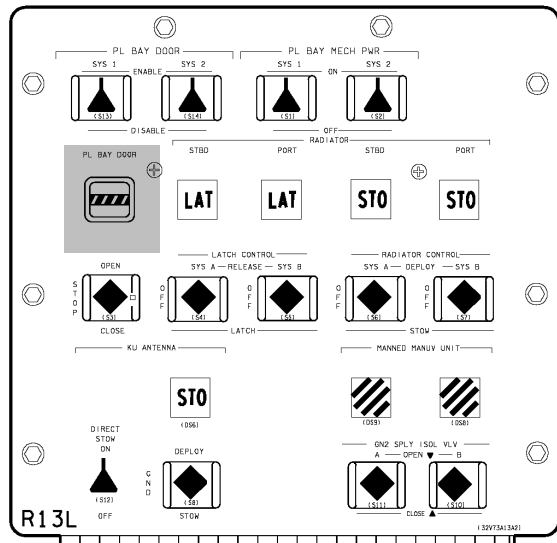
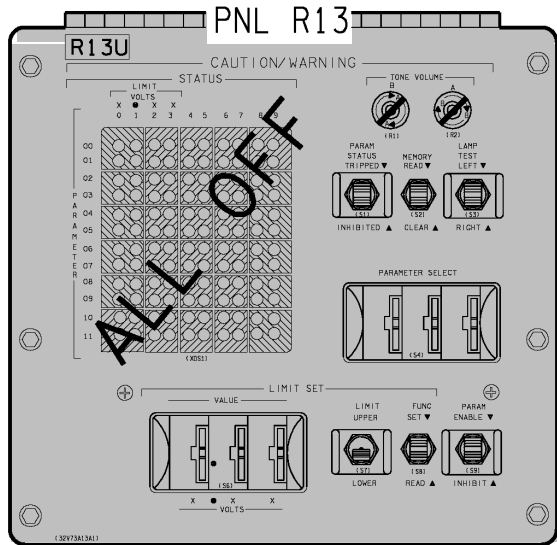

NOTES: ► CLOSED IF EDO

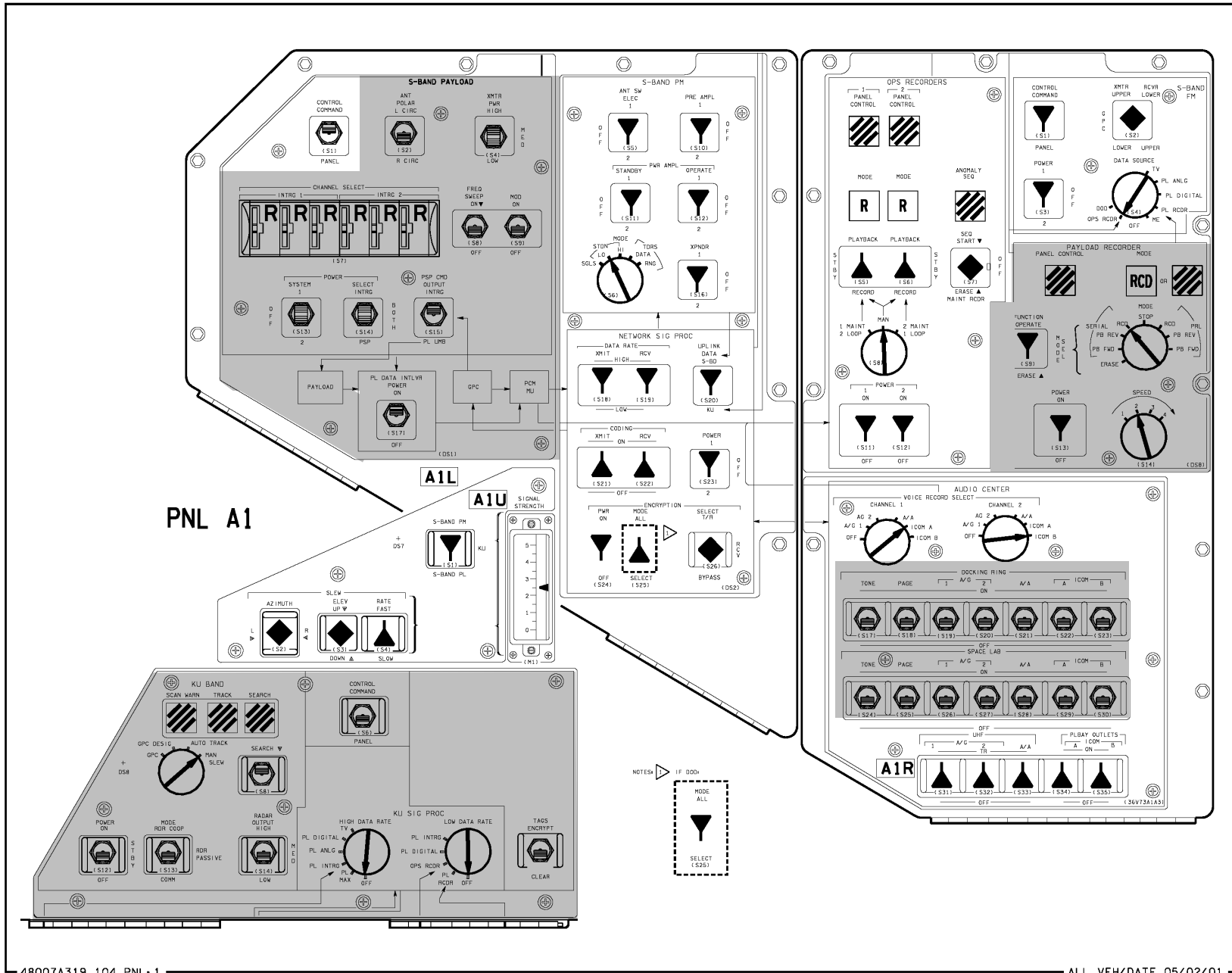

PNL A1

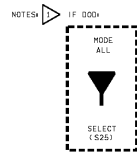

OV102

PNL A4

MISSION TIME
DAY HR MIN SEC

365:23:59:55

(M1)

EVENT TIME
MIN SEC

59:59

(M2)

MISSION TIMER GMT
TEST

PNL A3

CONTRAST R

BRIGHTNESS R

SOURCE PANEL DN-LINK DIRECT

MODE NORM

PULSE-X UNDER

DATA SYNC

OFF EXT

X-HAIR-POWER ON

OFF FAULT OFF

MON 1

CONTRAST R

BRIGHTNESS R

SOURCE PANEL DN-LINK DIRECT

MODE NORM

PULSE-X UNDER

DATA SYNC

OFF EXT

X-HAIR-POWER ON

OFF FAULT OFF

MON 2

PNL A6U

ORBIT STATION LIGHTING
FLOOD ON

ORBITAL DAP CONTROL
SELECT A B AUTO INRTL LVLH FREE

MANUAL MODE
OFF OFF ON OFF OFF OFF

TRANSLATION X Z ROTATION PITCH YAW

INSTRUMENT NUMERIC

ANNUNCIATOR LAMP TEST LEFT BRIGHT

INTENSITY

PAYLOAD RETENTION LATCHES
READY TO LATCH

EVENT TIMER
MIN SET SEC

PAYLOAD SELECT
MONITOR MONITOR

PNL A7U

PASTER OFF

CAMERA POWER
OFF OFF OFF OFF OFF

FWD KEEL/EVA AFT STBD PORT PANEL

BAY BMS DOWNLINK SYNC

ENABLE NORMAL

VIDEOD INPUT

VIDEOD OUTPUT

CAMERA COMMAND
PAN/TILT RESET FOCUS FAN VTR

IRIS OPEN TILT UP PAN

LOW RATE NEAR OUT CLOSE DOWN

WIRELESS VIDEO POWER

HEATER ON

ELBOW OFF

ALL OFF

ALL OFF

ALL OFF

ALL OFF

ALL OFF

ALL OFF

PNL A7L

SILTS
ACIP HTR ON
GEX EQUIP ON
HEATER ON
CAMERA AC30A
POWER ENABLE

MADS
CONTROL AUTO CALIBR
MAN CALIBR

136V73A6A1

48007A320_104, PNL, 1

(OV102) A3-20

OV102/DATE 05/02/01

C D/O/2/GEN H,1

OV102

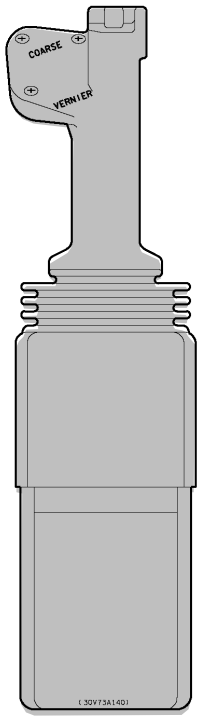
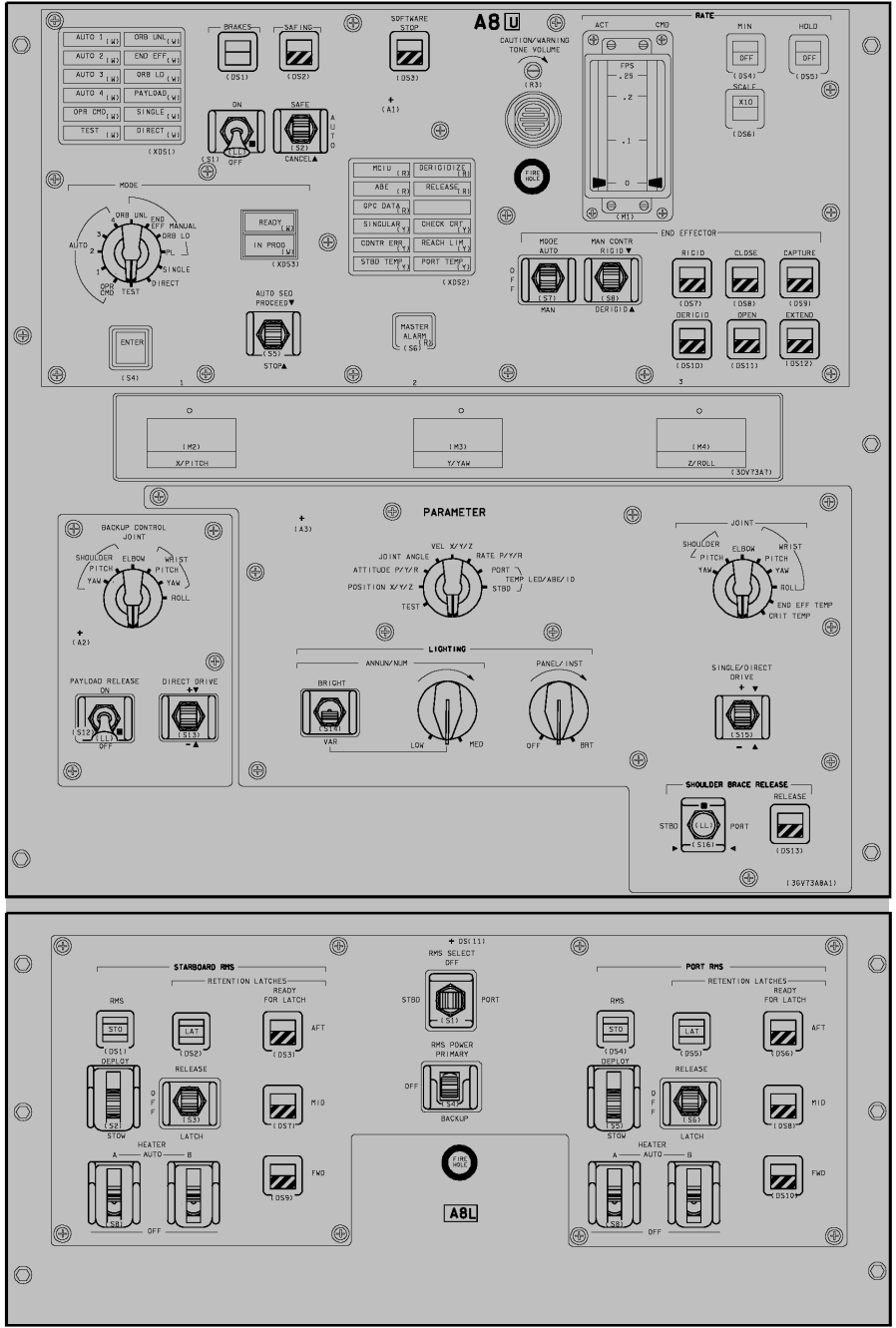

48007A321_101_PNL1 1 ALL VEH/DATE 02/10/00

OV102

(OV102) A3-21

C D/O/ALL/GEN H

OV102

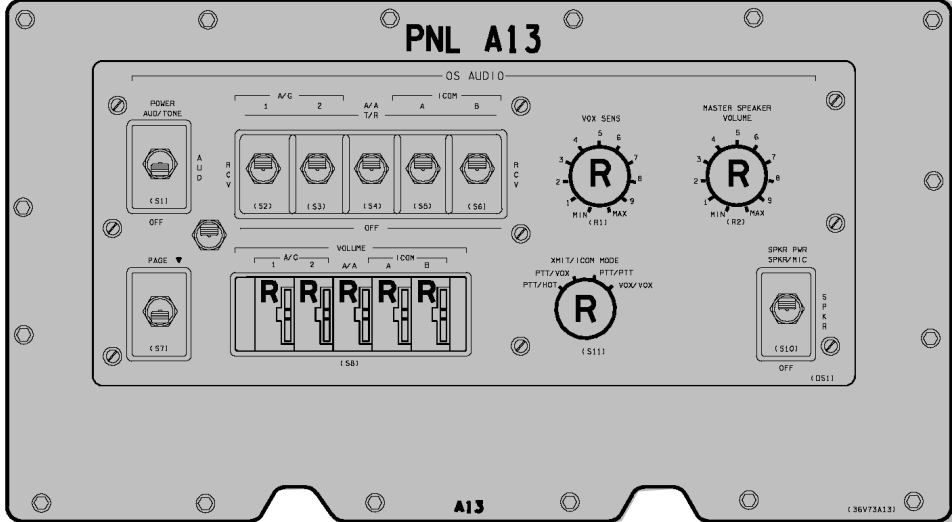
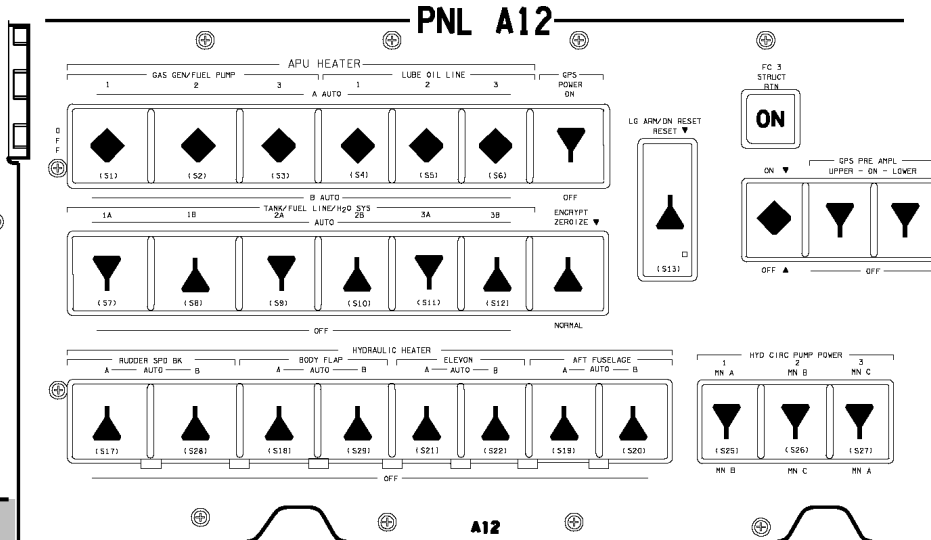
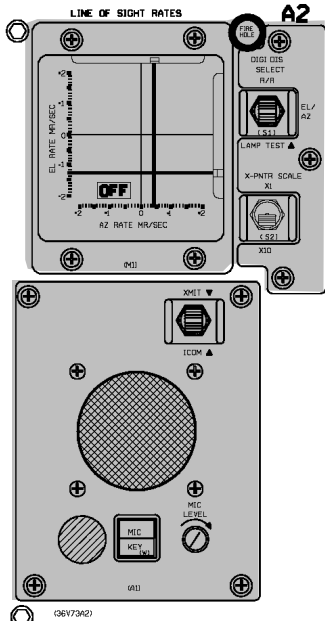

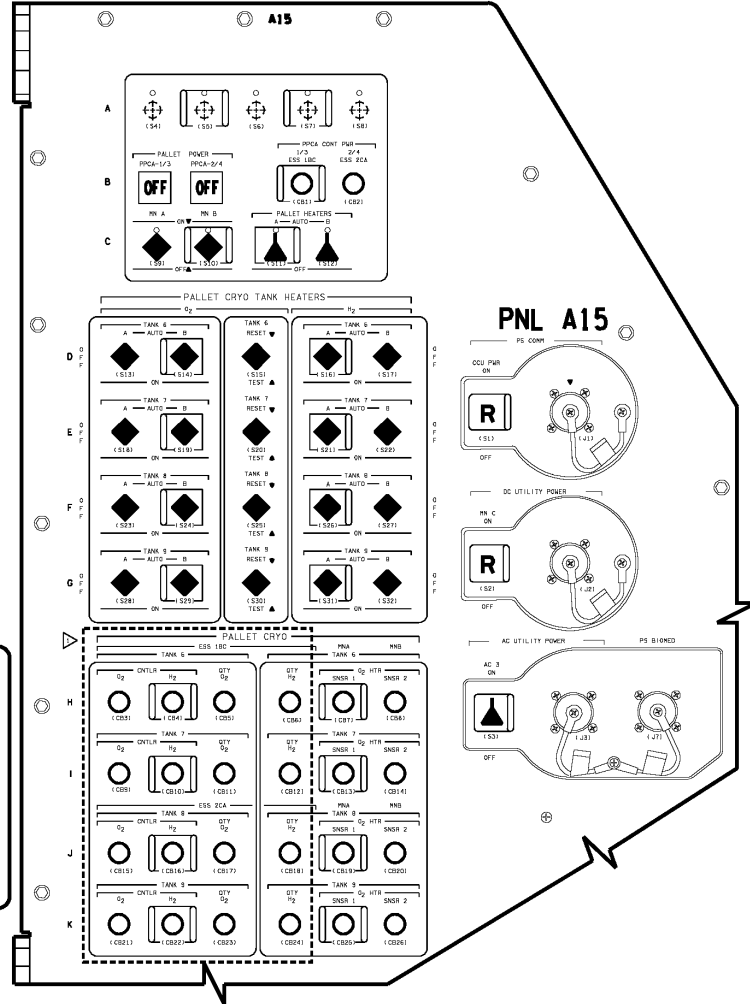
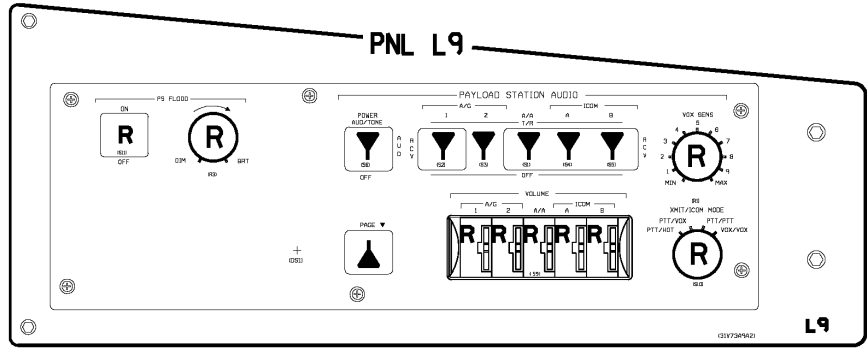
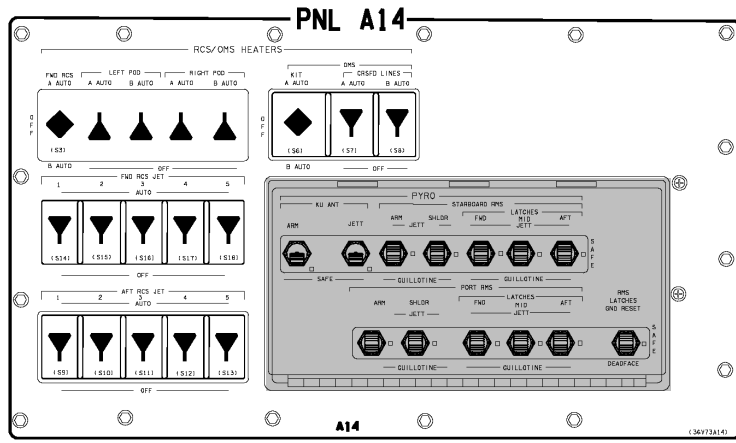

NOTES: ▷ CLOSED IF EDO

OV102

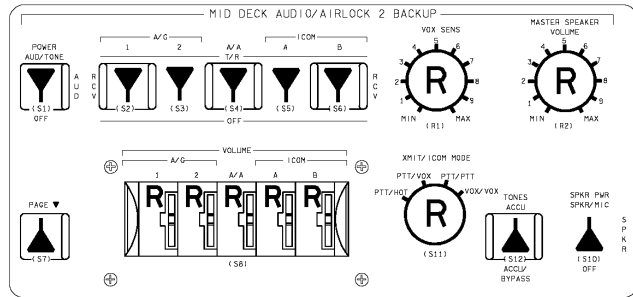

PNL M042F

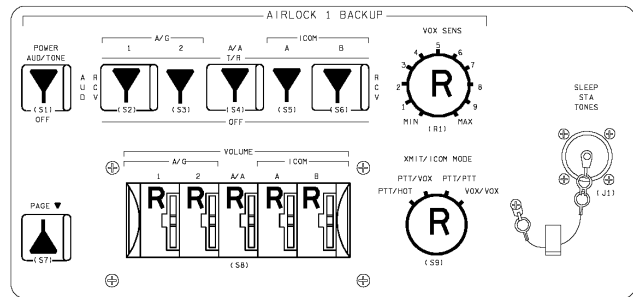
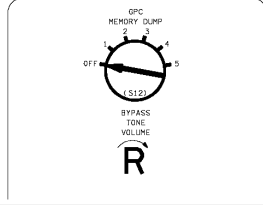

PNL M058F

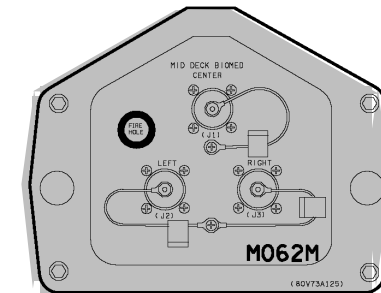
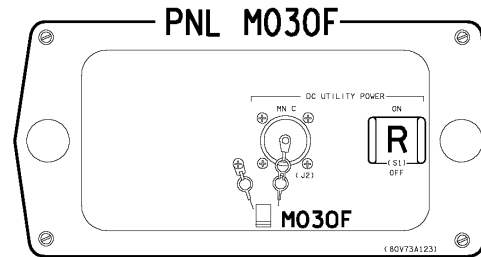
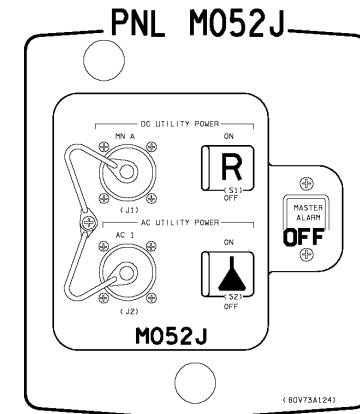
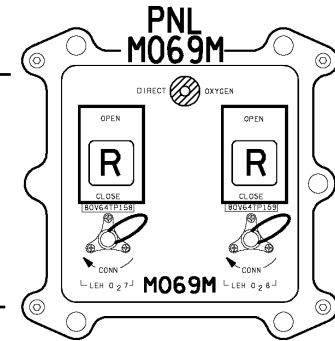
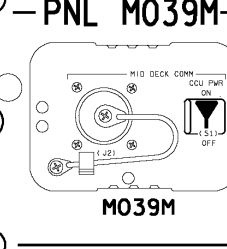
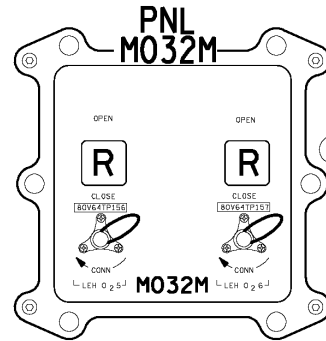
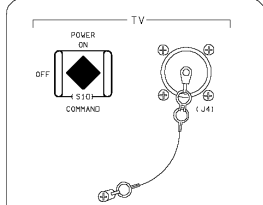

OV102

PNL MA73C

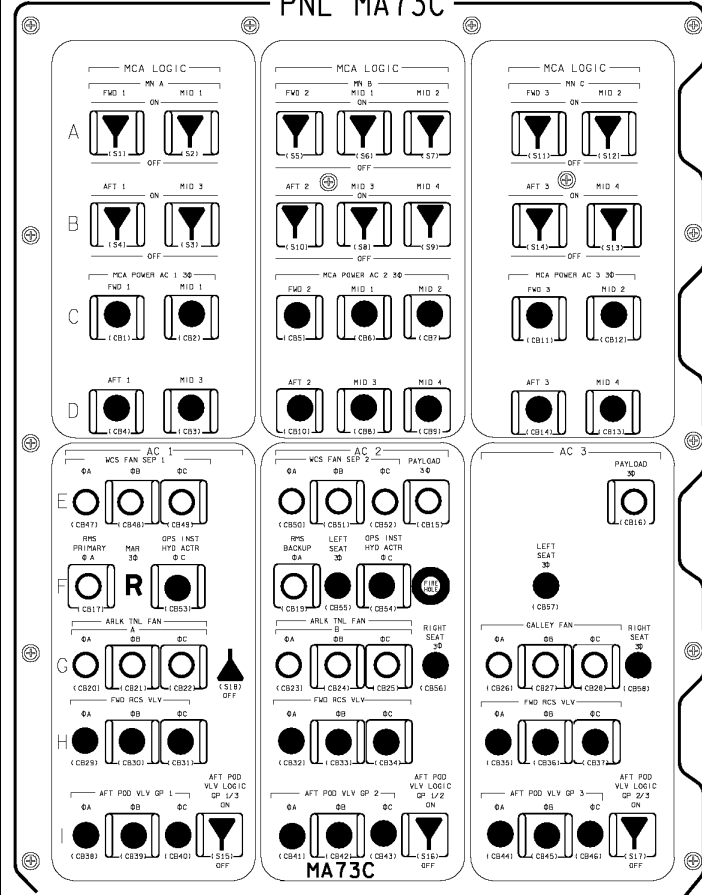

PNL ML86B

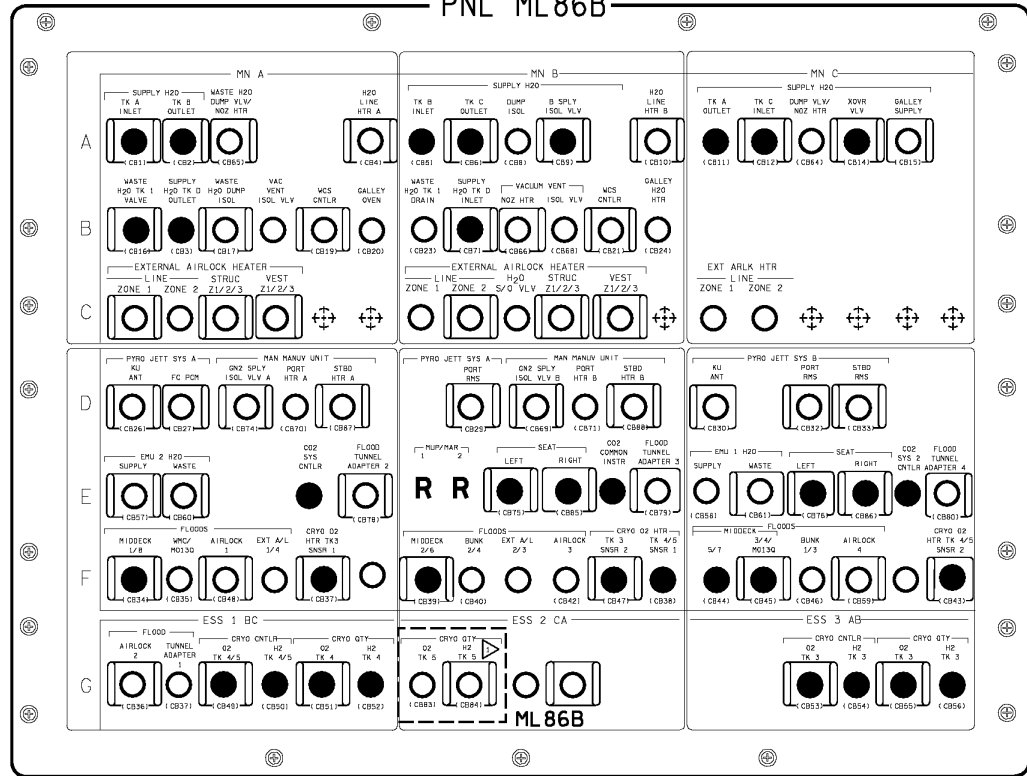

▷ CLOSED IF TK 5 FLOWN

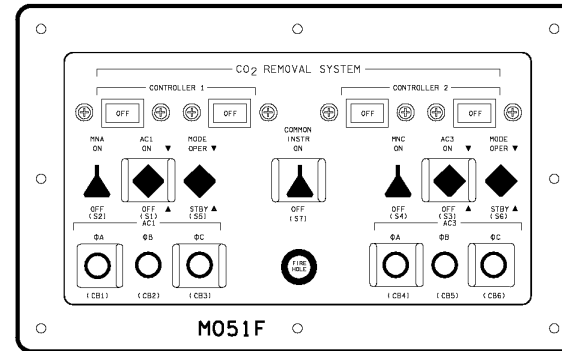

OV102

OV102

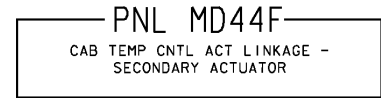
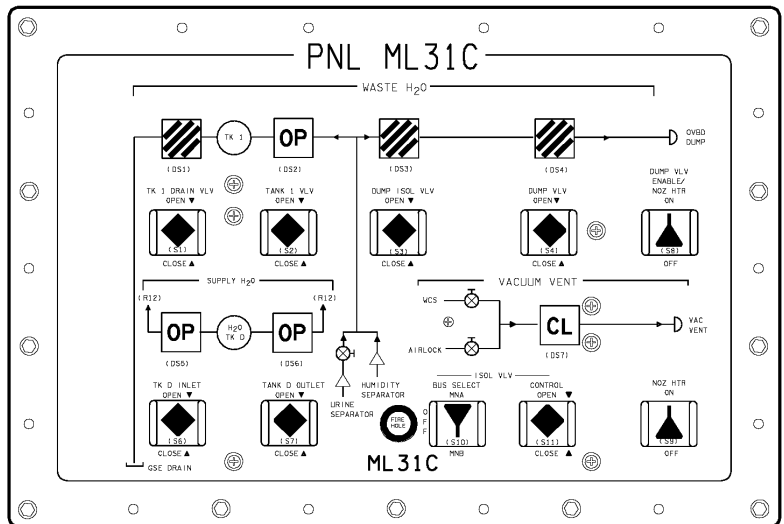
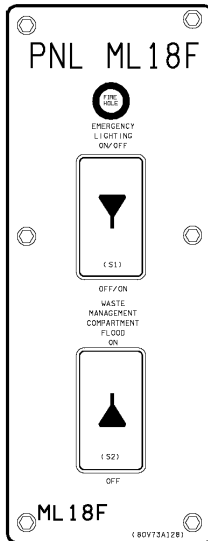
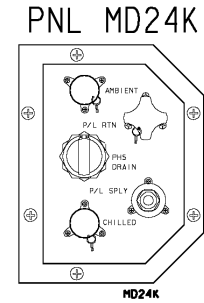
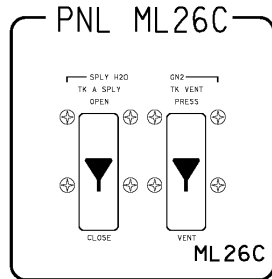
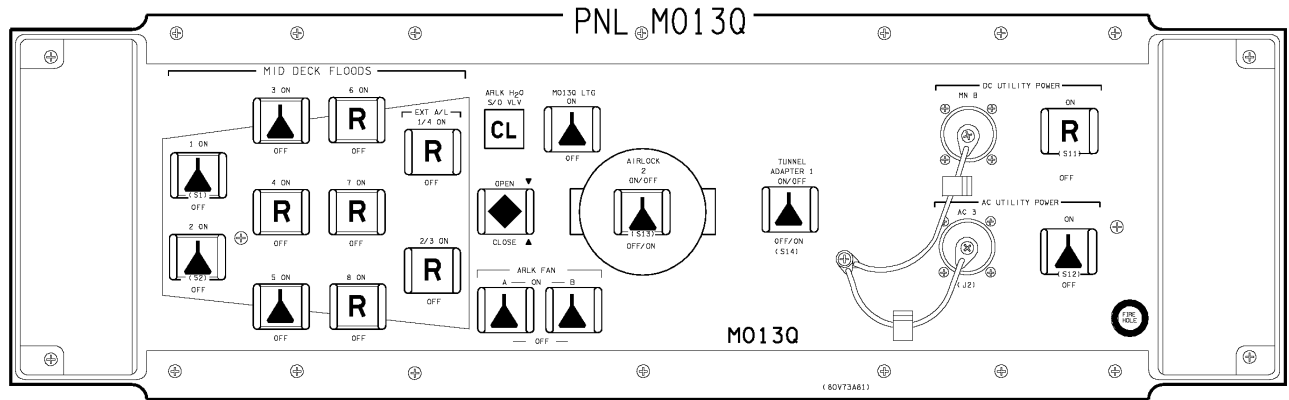

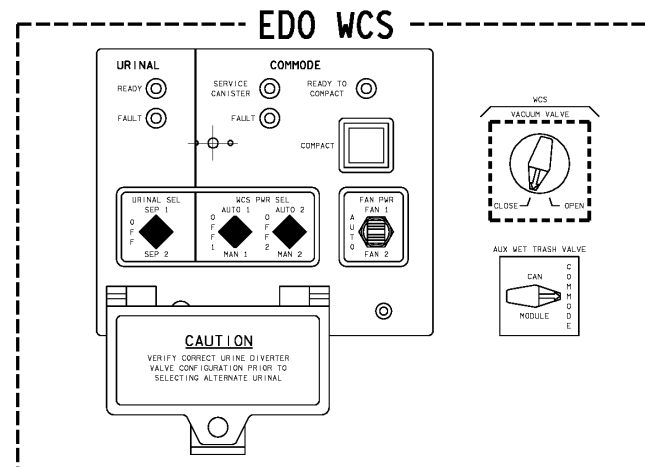
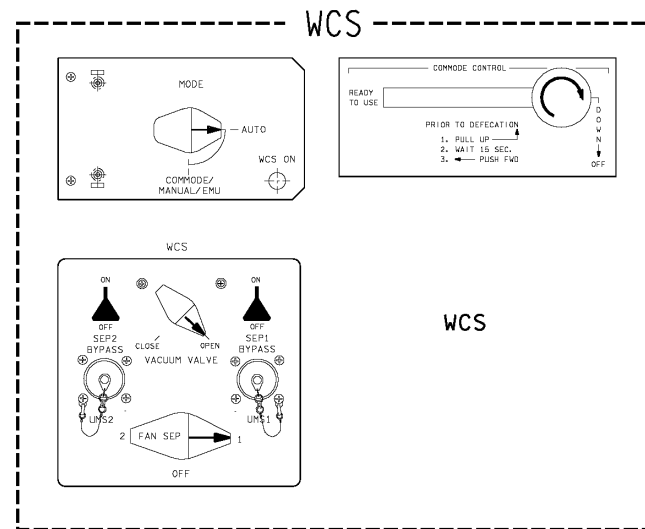
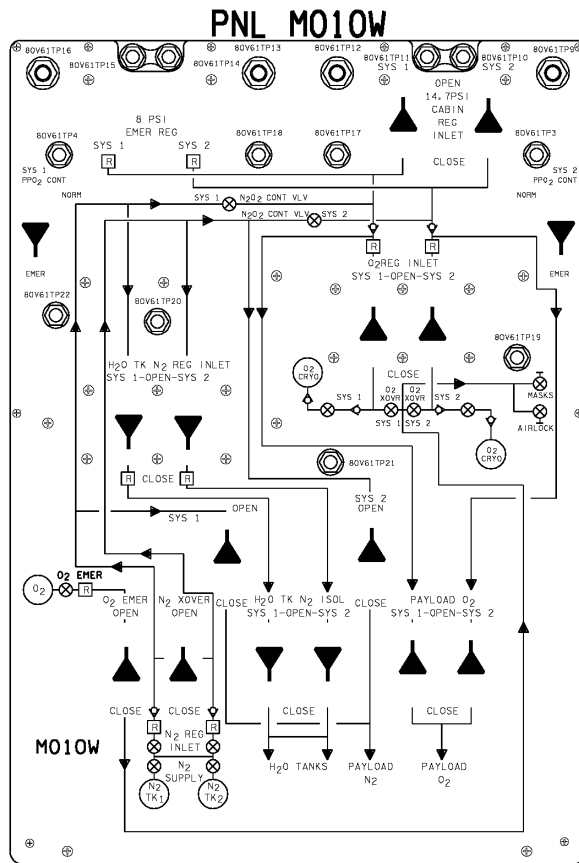

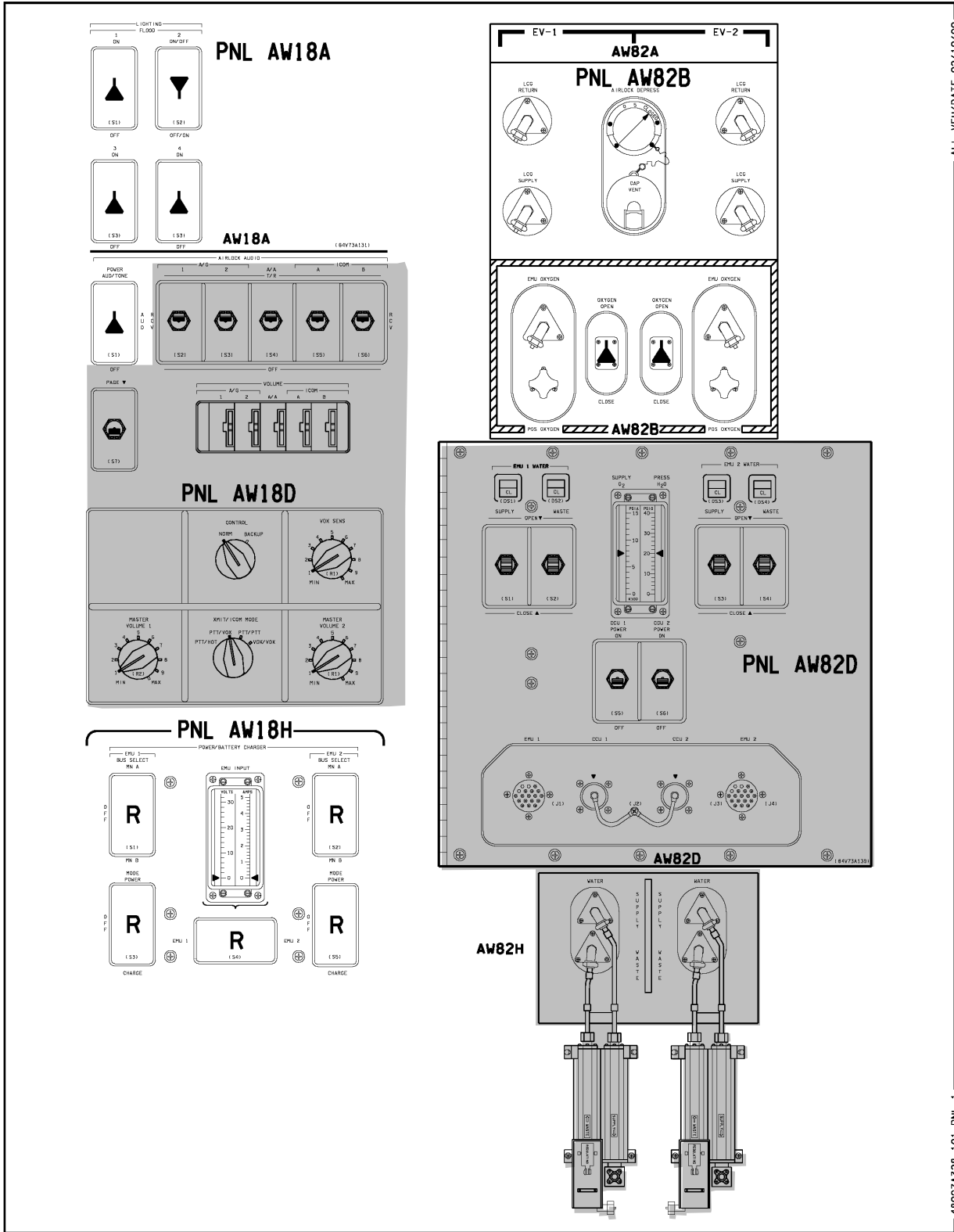

48007A328_101_PNL_1 ALL VEH/DATE 02/10/00

OV102

(OV102) A3-28

C D/O/ALL/GEN H

Inner Hatch

Actuator Handle – LATCHED

Lock Lever – LOCKED

Equalization vlv (two) – NORM, capped

This Page Intentionally Blank

OV103

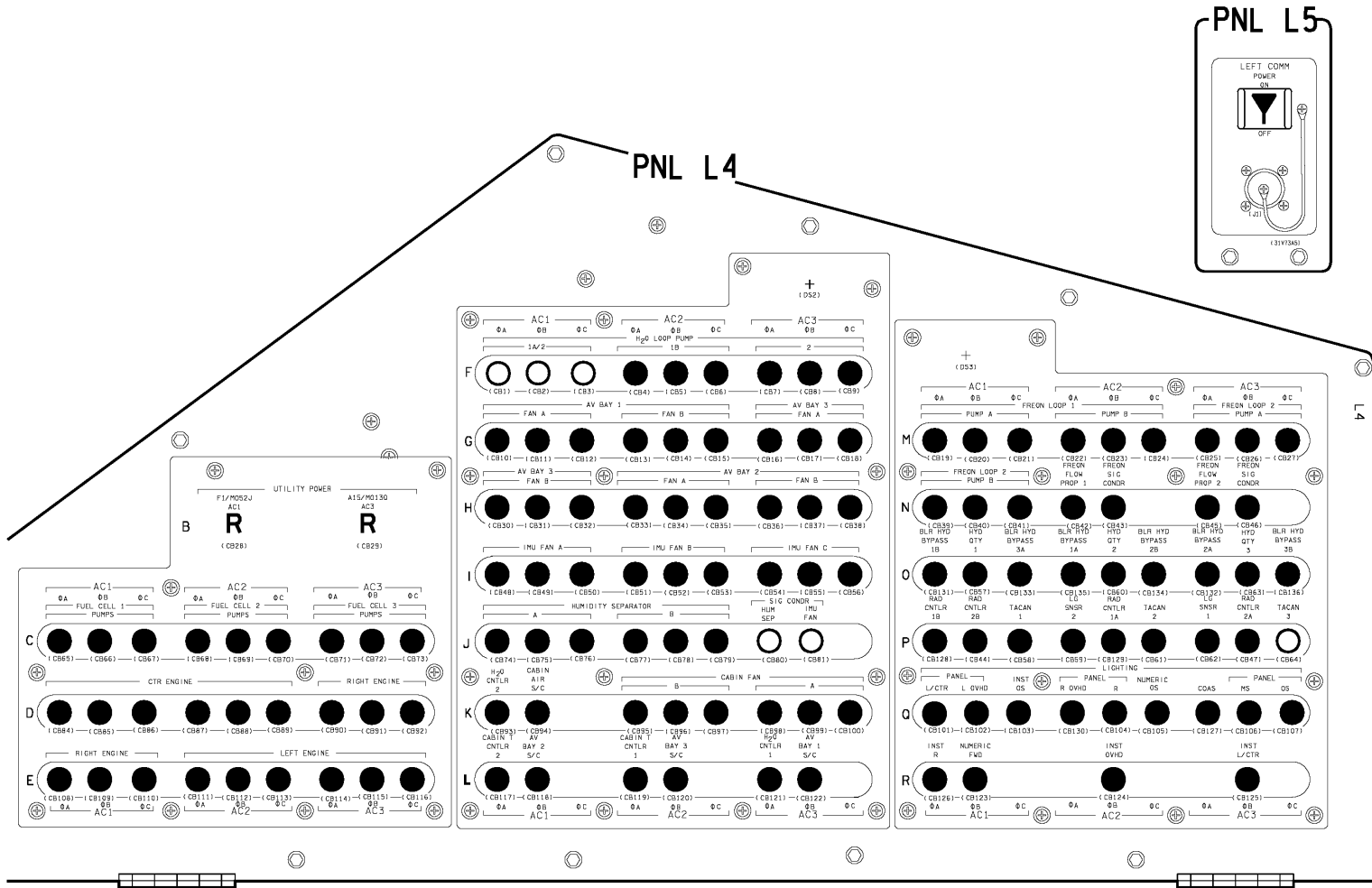

OV103

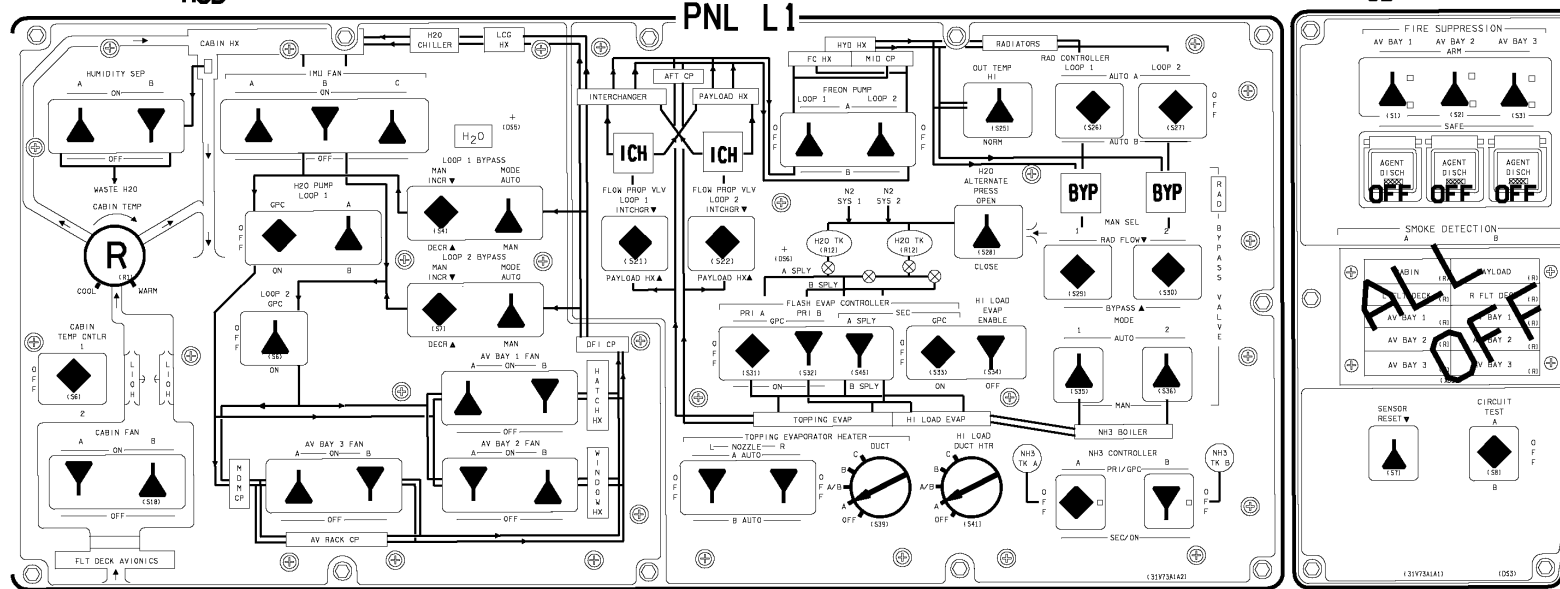
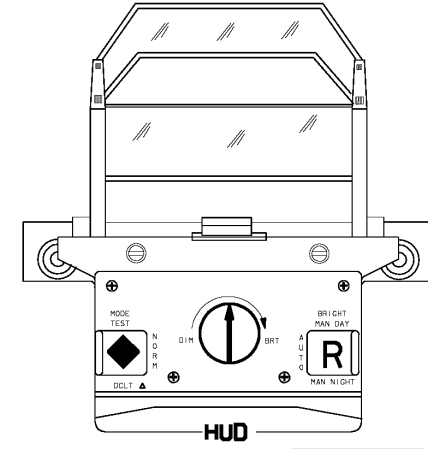
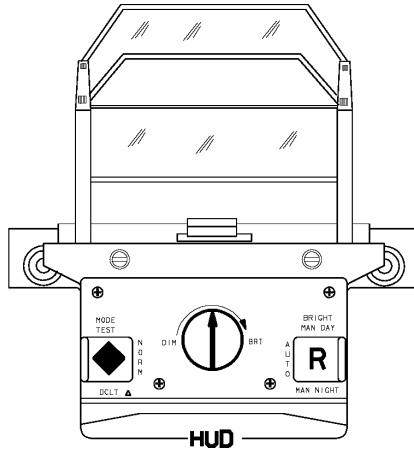
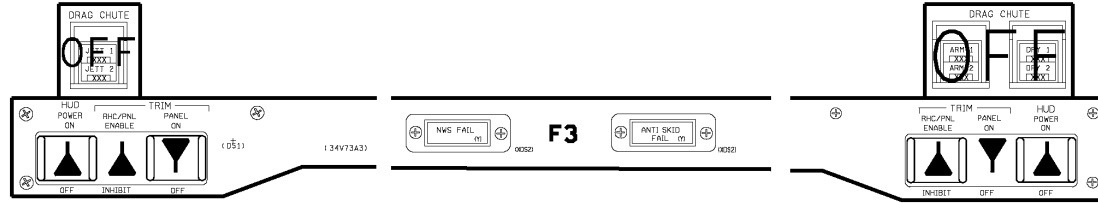

48007B304_109, PNL 1

OV103/DATE 02/01/02

(OV103) B3-4

C D/O/ALL/GEN H,7

OV103

OV103

PNL L2

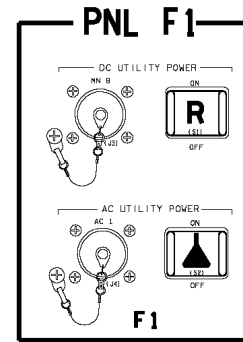
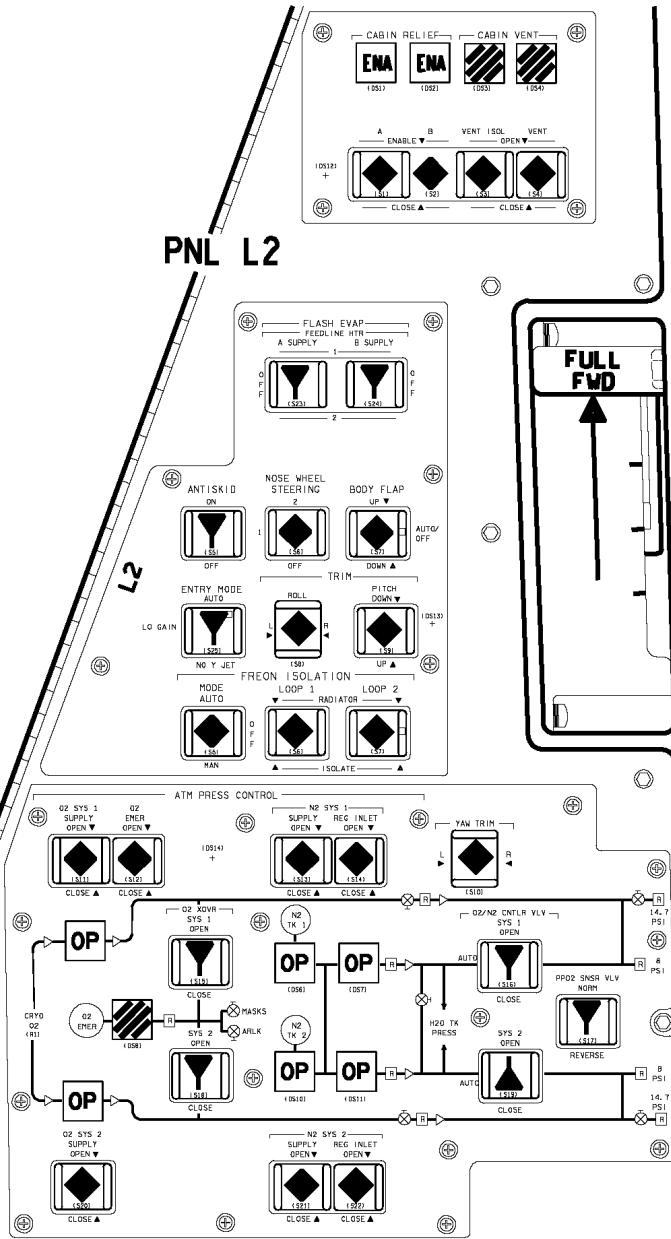

FULL FWD

OV103

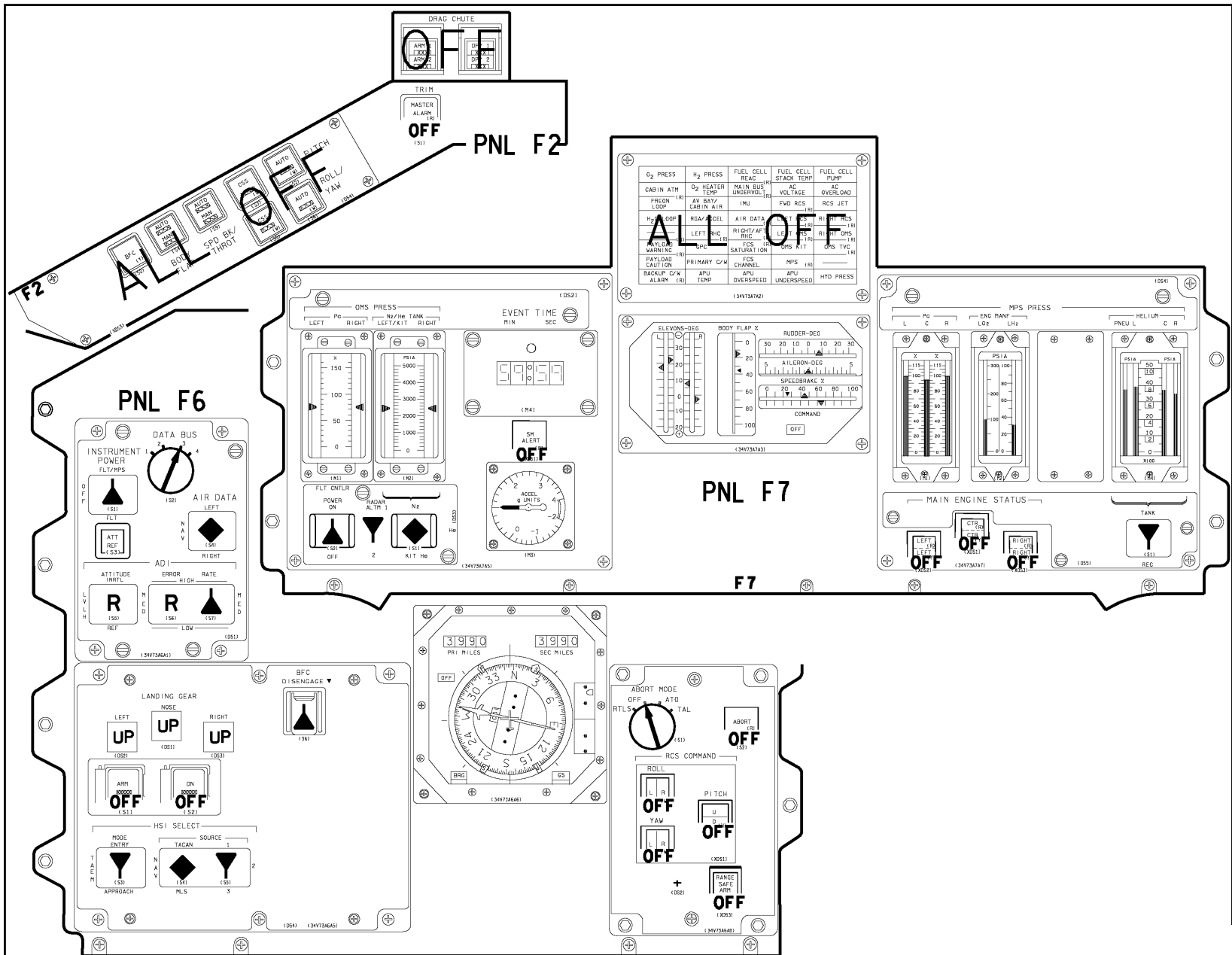

48007B306_101. PNL 1

(OV103) B3-6

ALL VEH/DATE 02/10/00

C D/O/ALL/GEN H

OV103

PNL C2/C3

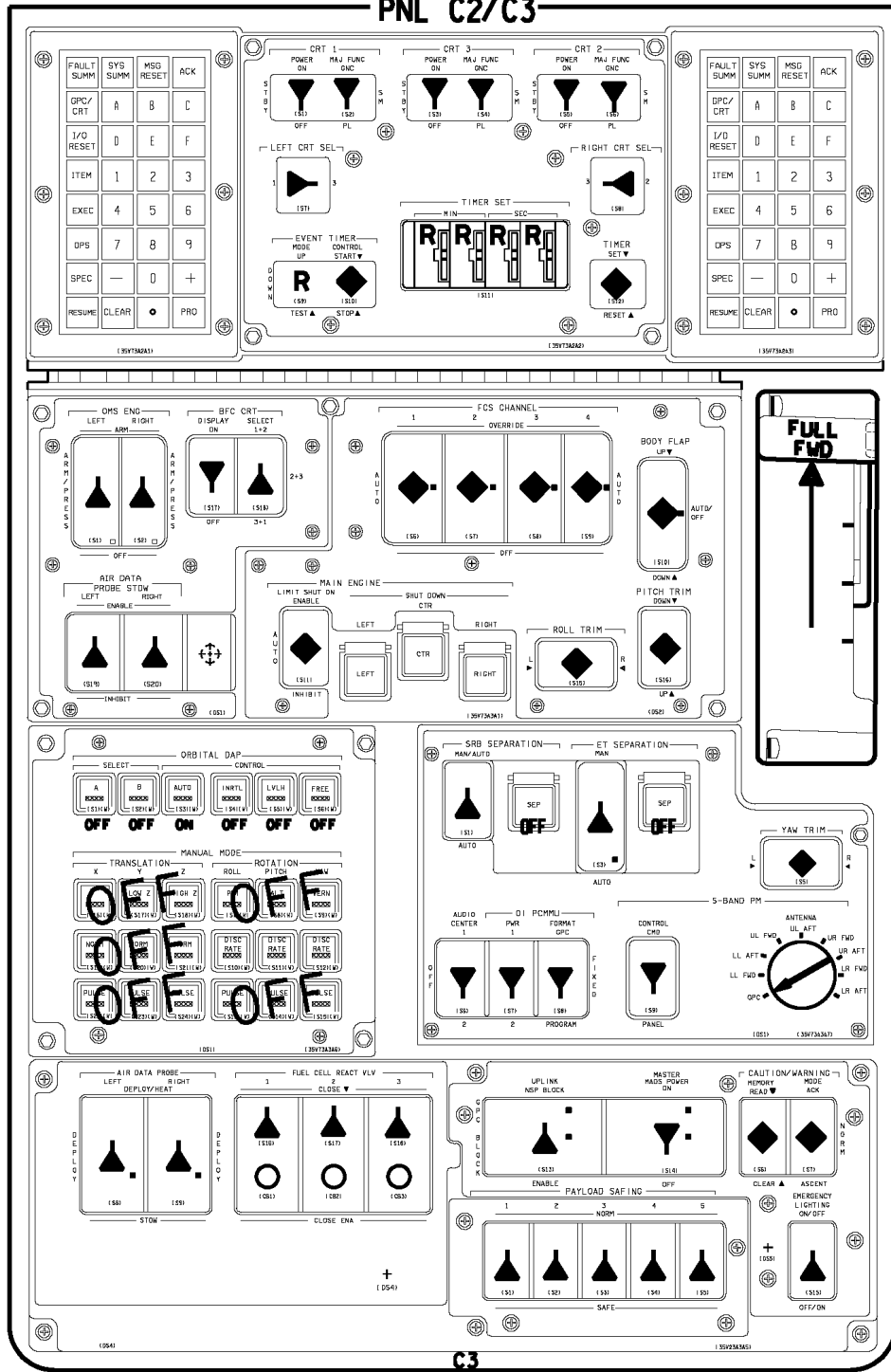

OV103/DATE 02/08/01
48007B307_1.DOC, PNL 1, 2

OV103

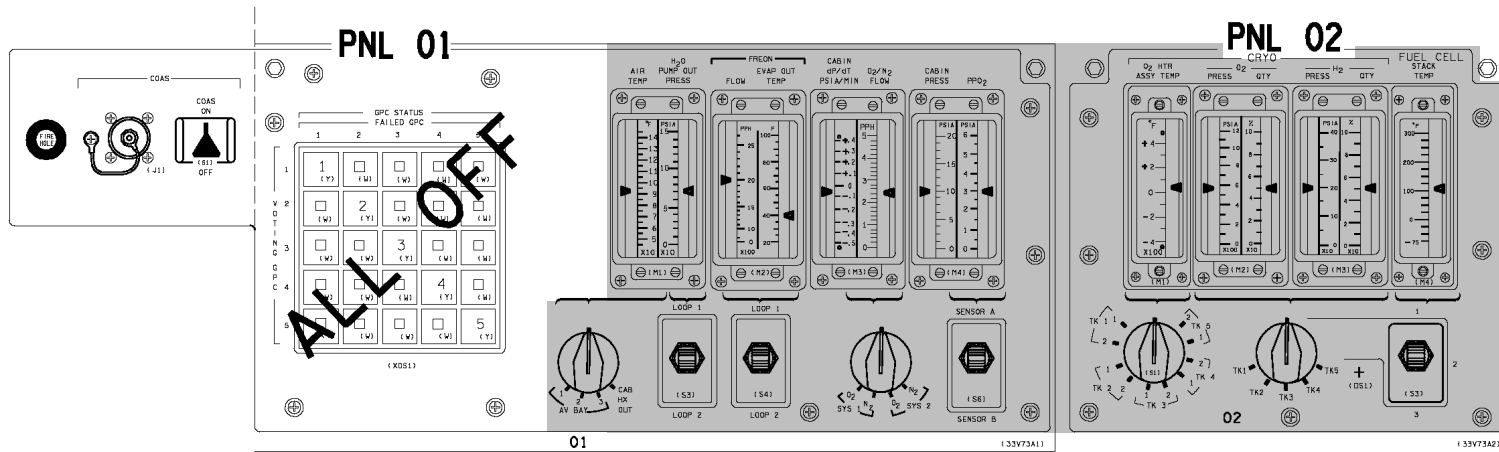

L side OVHD flood - R (MID)

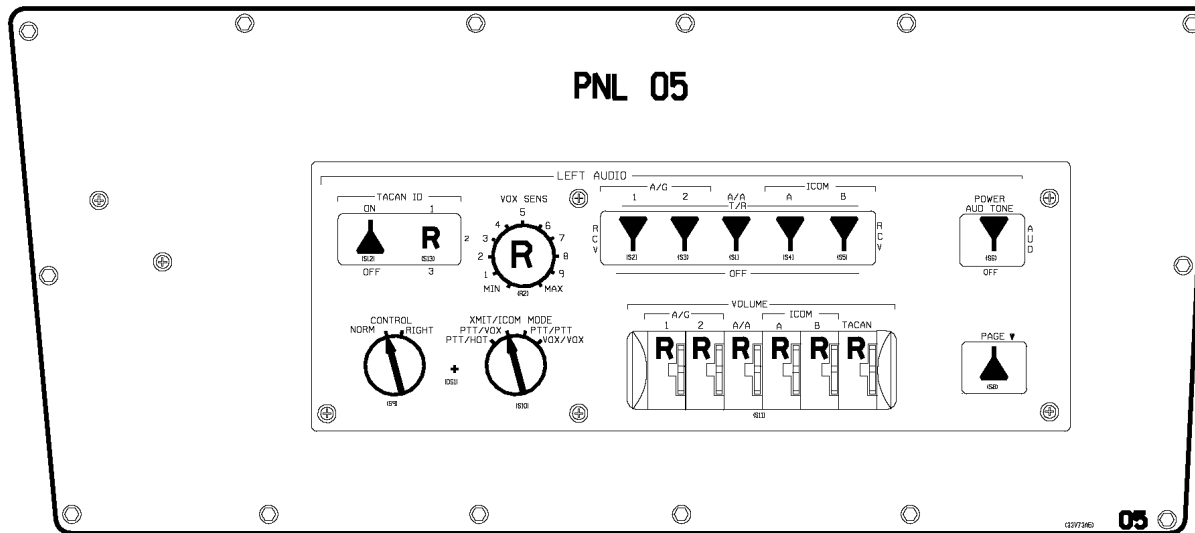

OV103

PNL 06

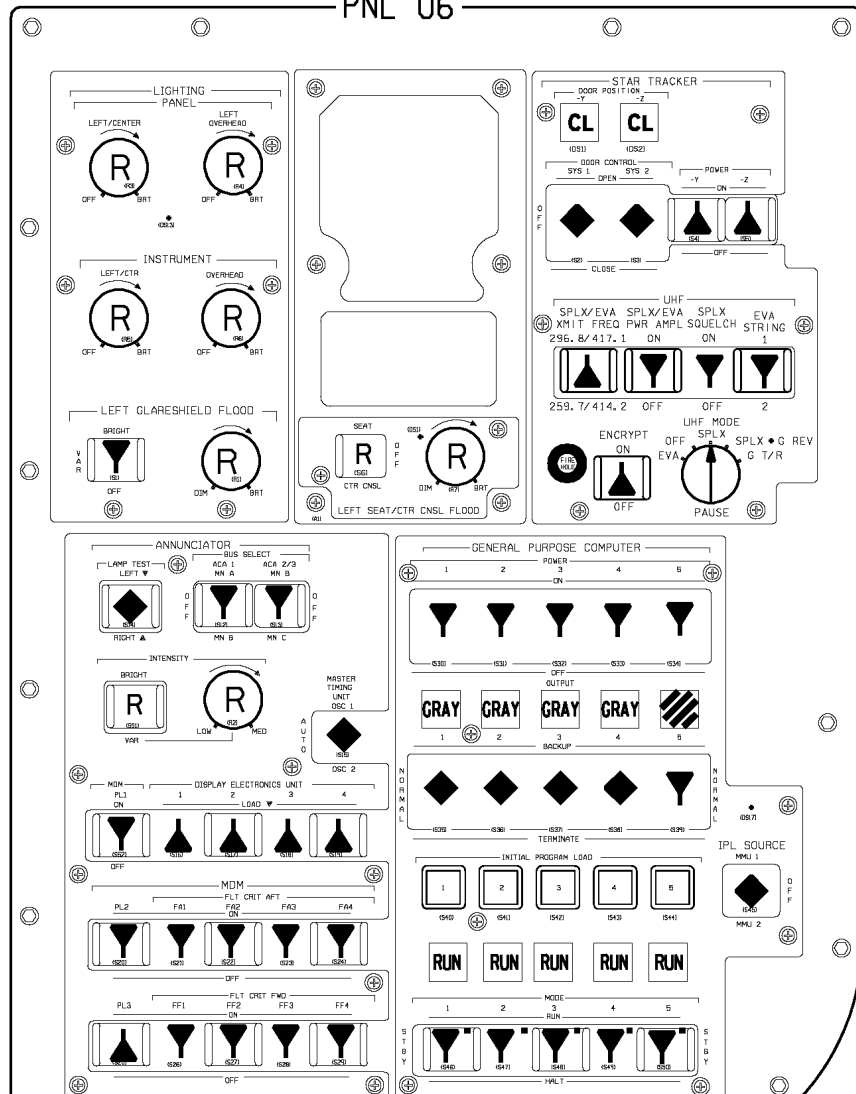

PNL 07

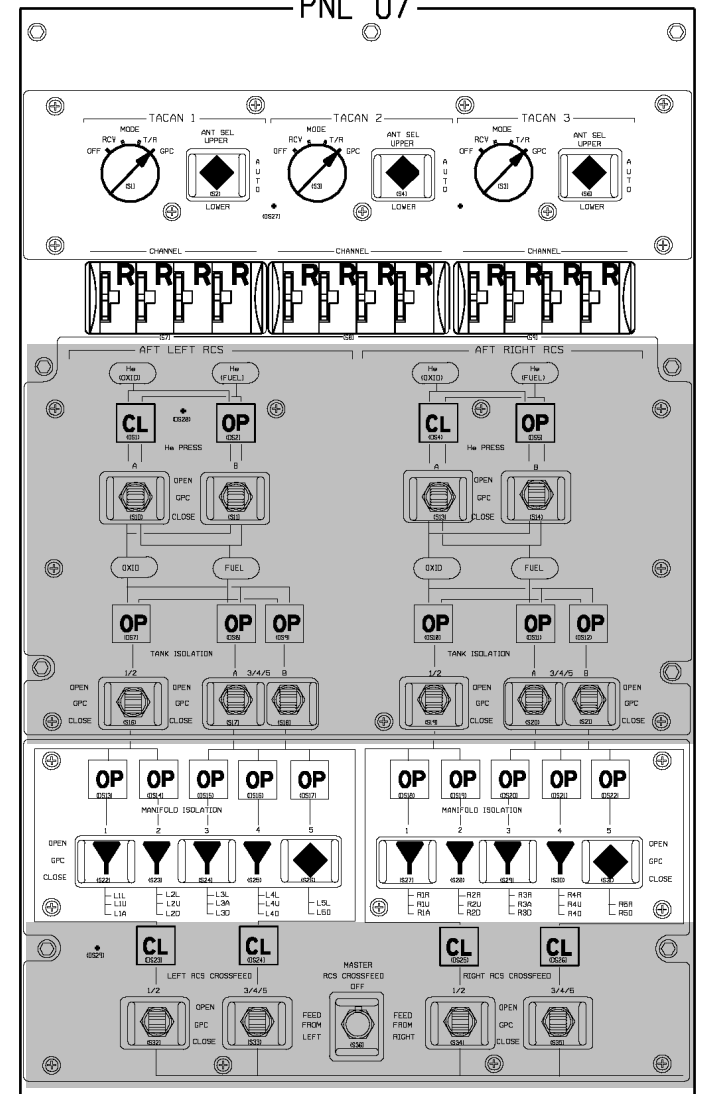

OV103

OV103

PNL 013

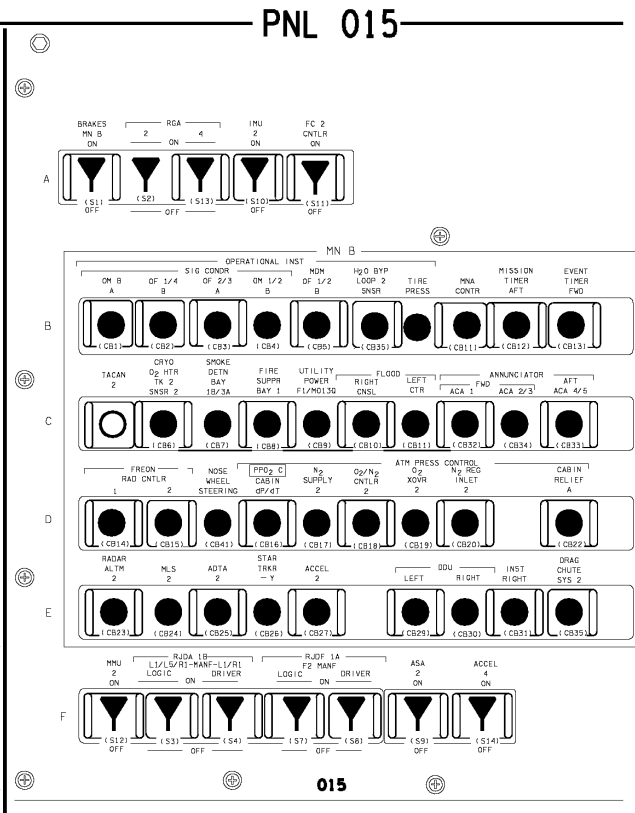
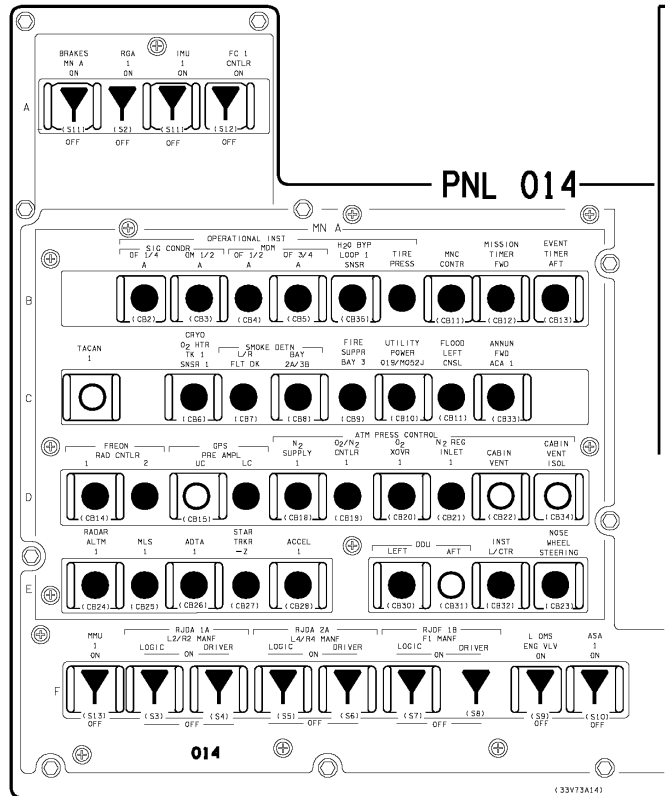
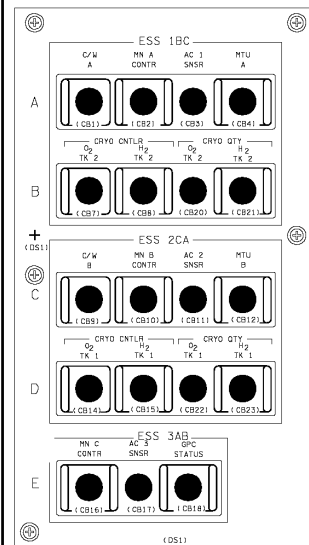

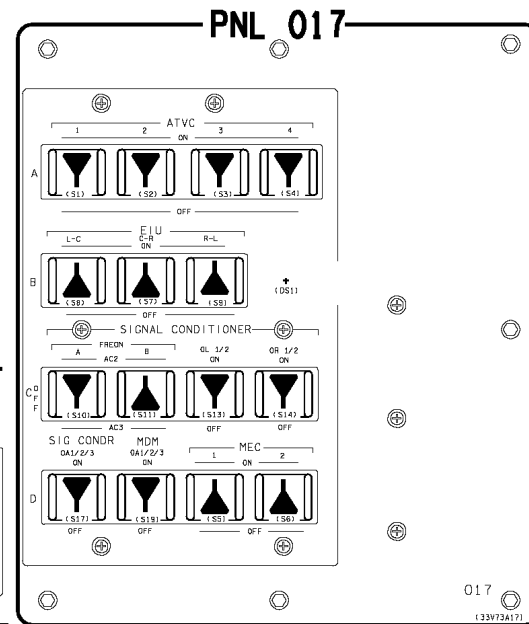
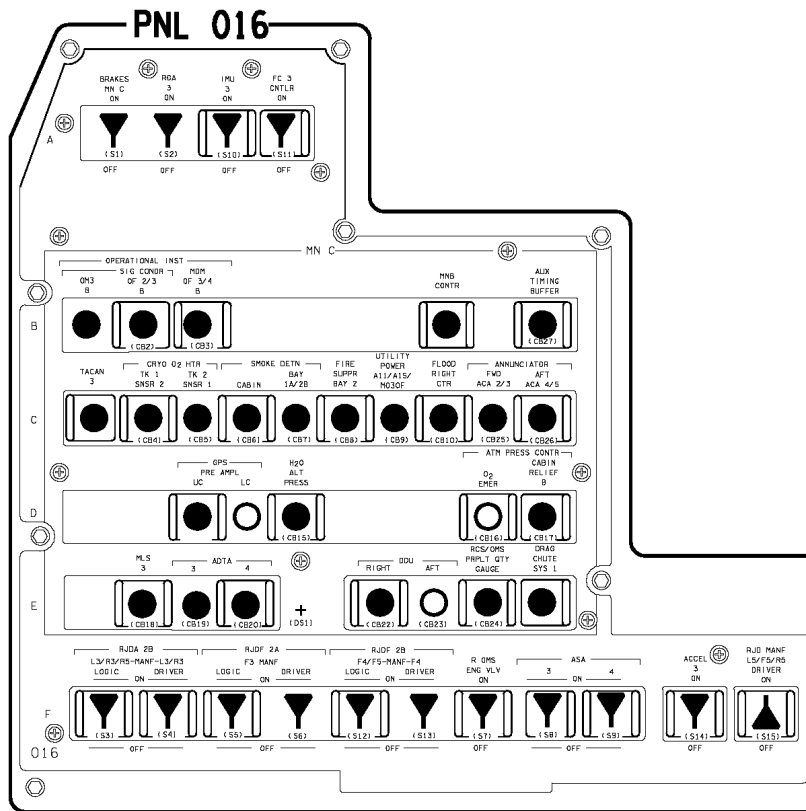

PNL 08

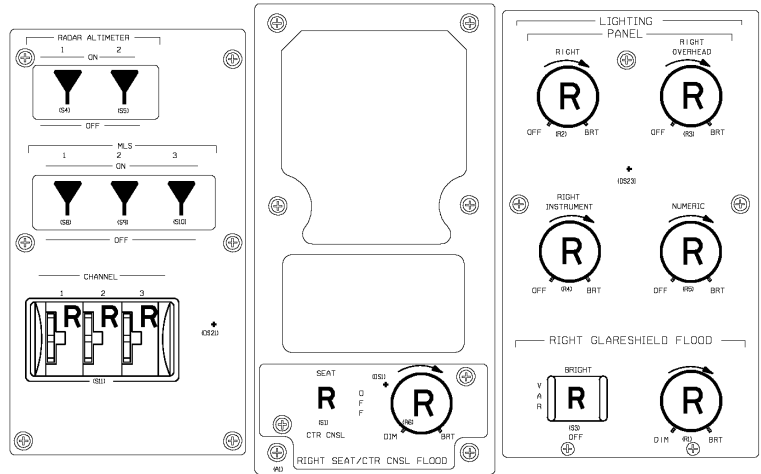

PNL 09

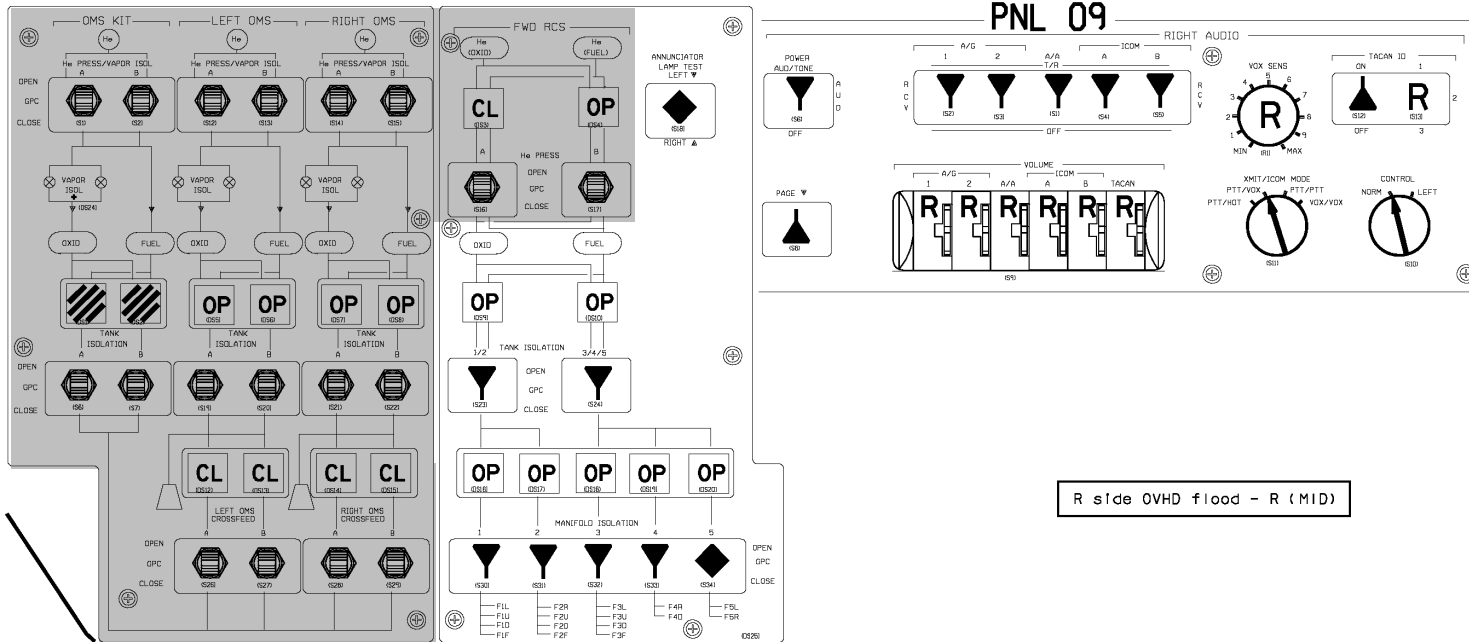

R side OVHD flood - R (MID)

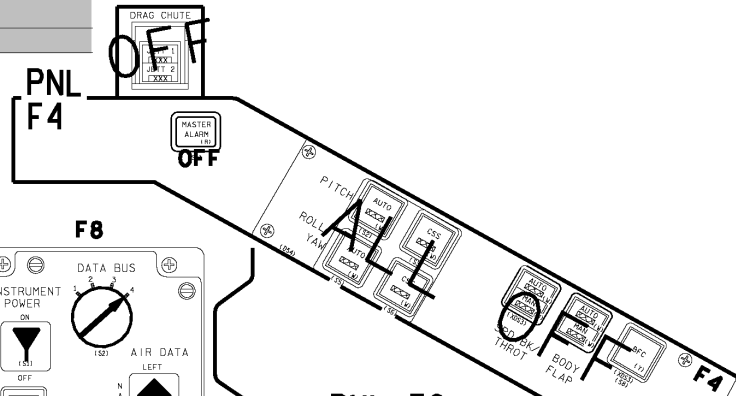
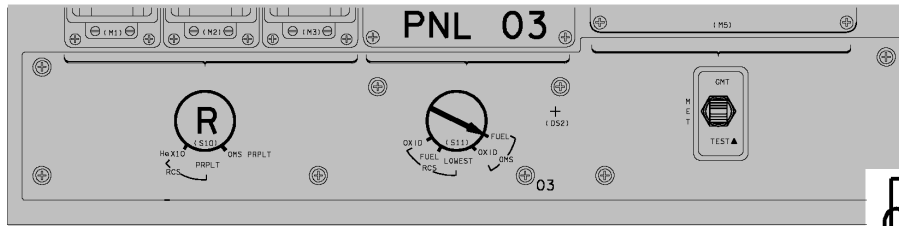

PNL F8

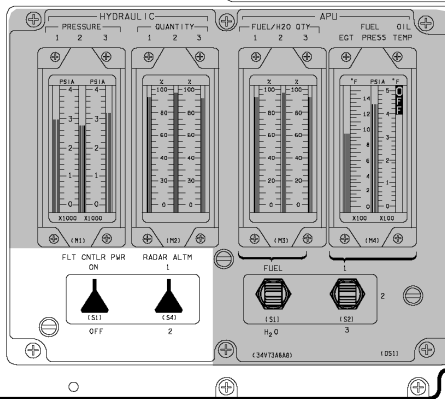
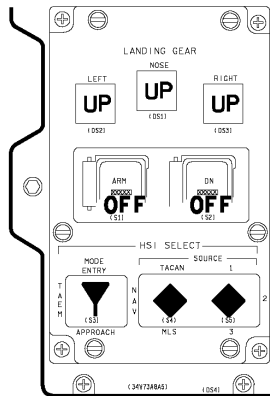
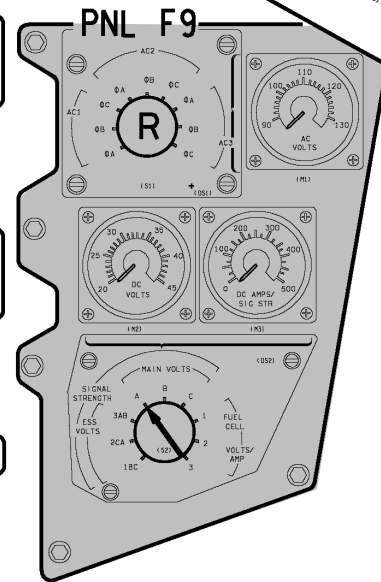
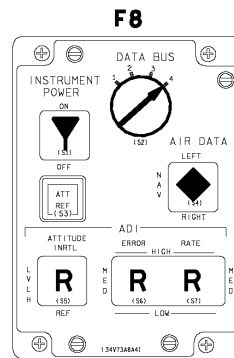

OV103

PNL R1

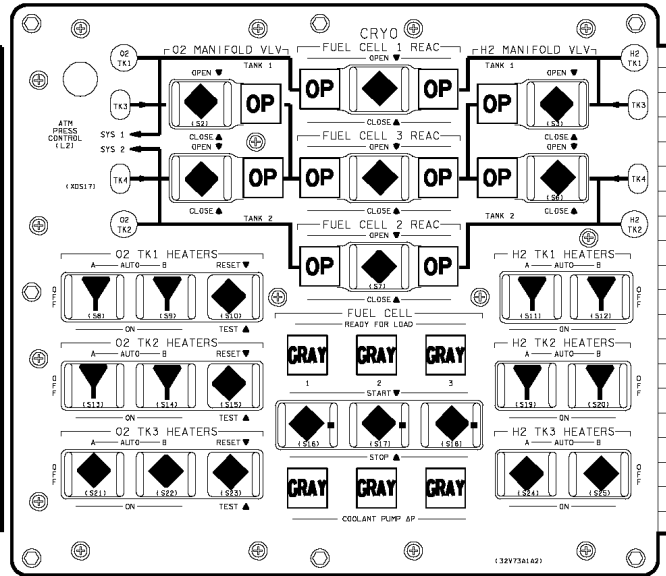
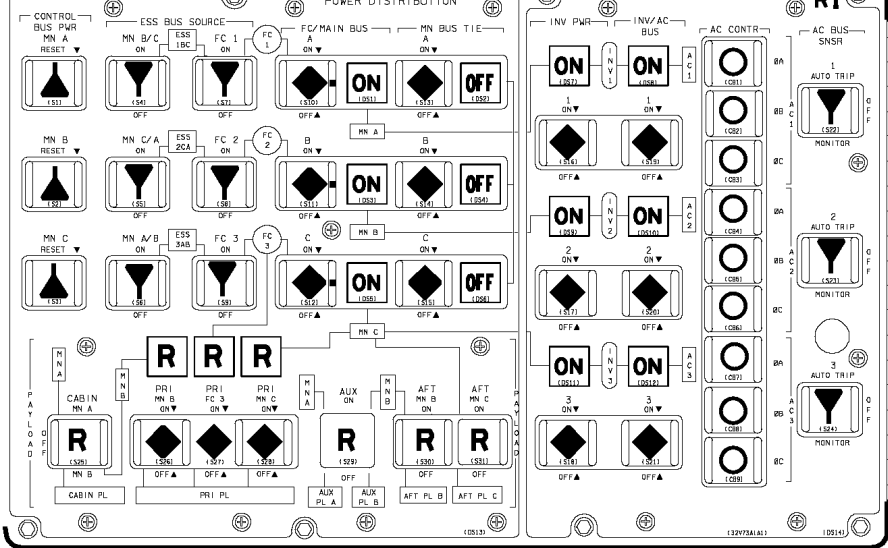

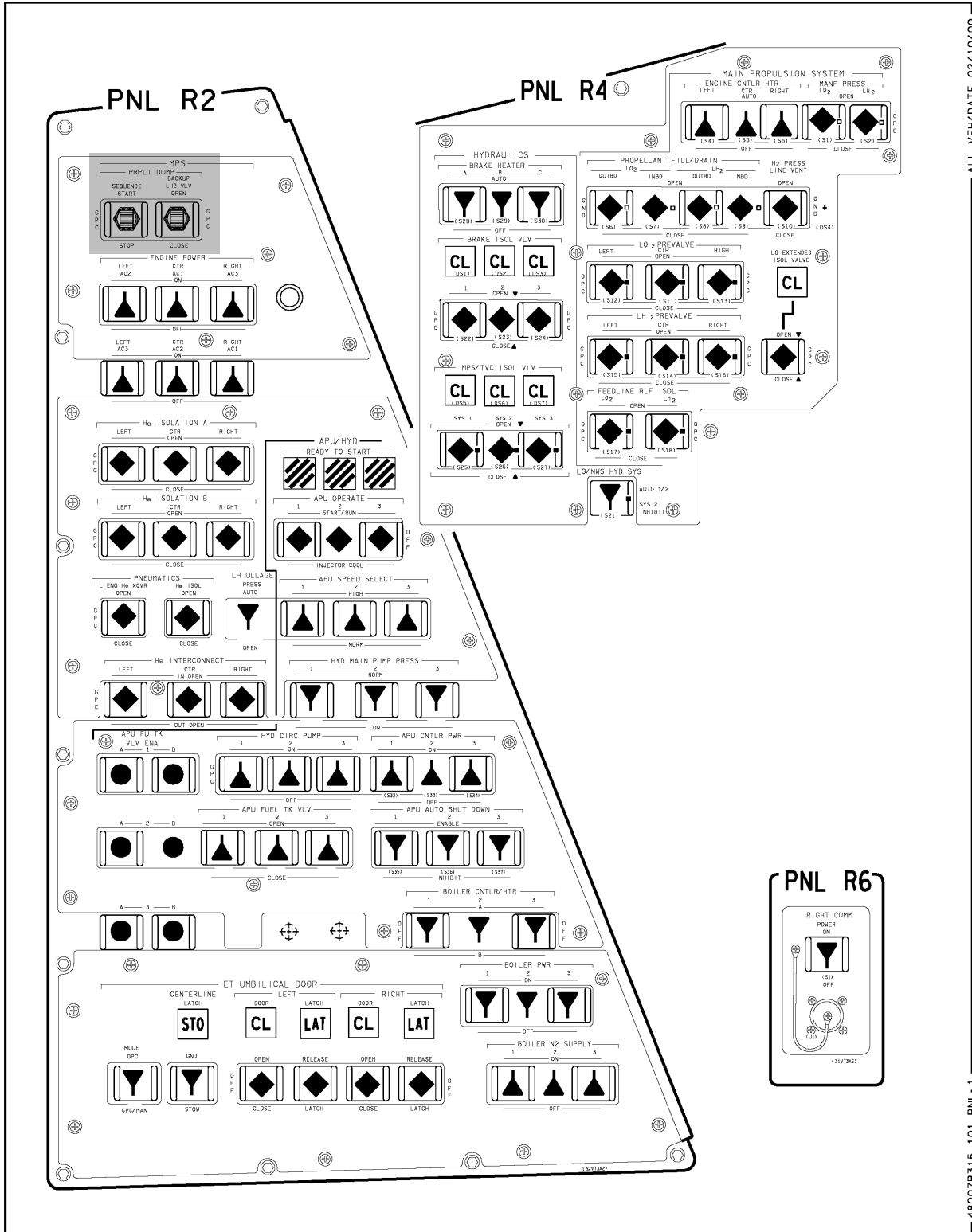

ALL VEH/DATE 02/10/00

48007B315_101. PNL 1

OV103

(OV103) B3-15

C D/O/ALL/GEN H

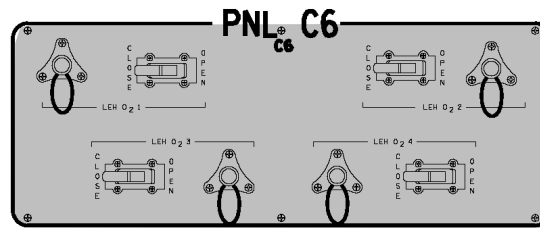
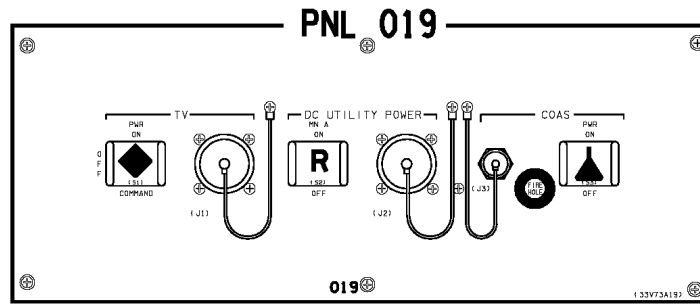

PNL C5

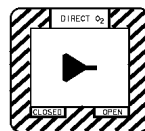

PNL C7

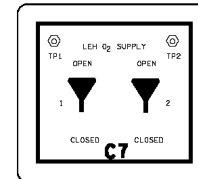

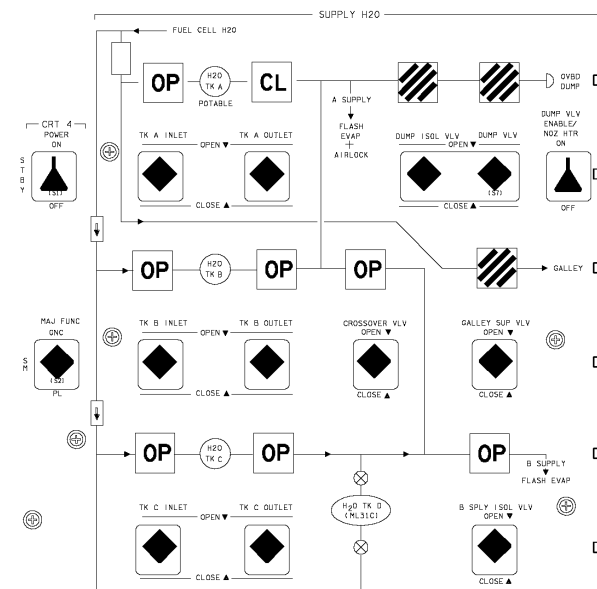
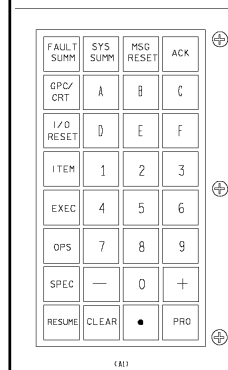
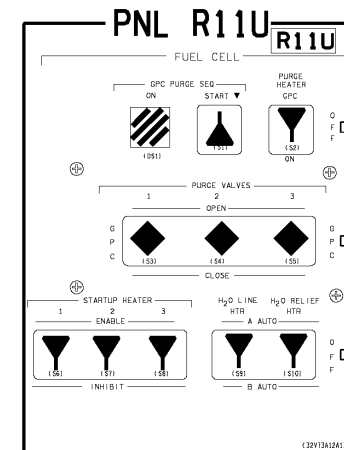
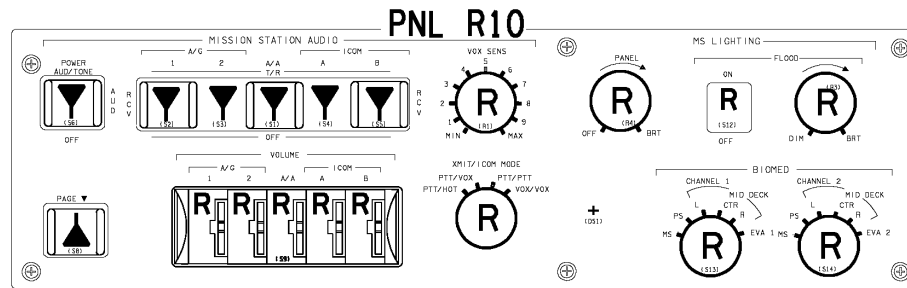

OV103

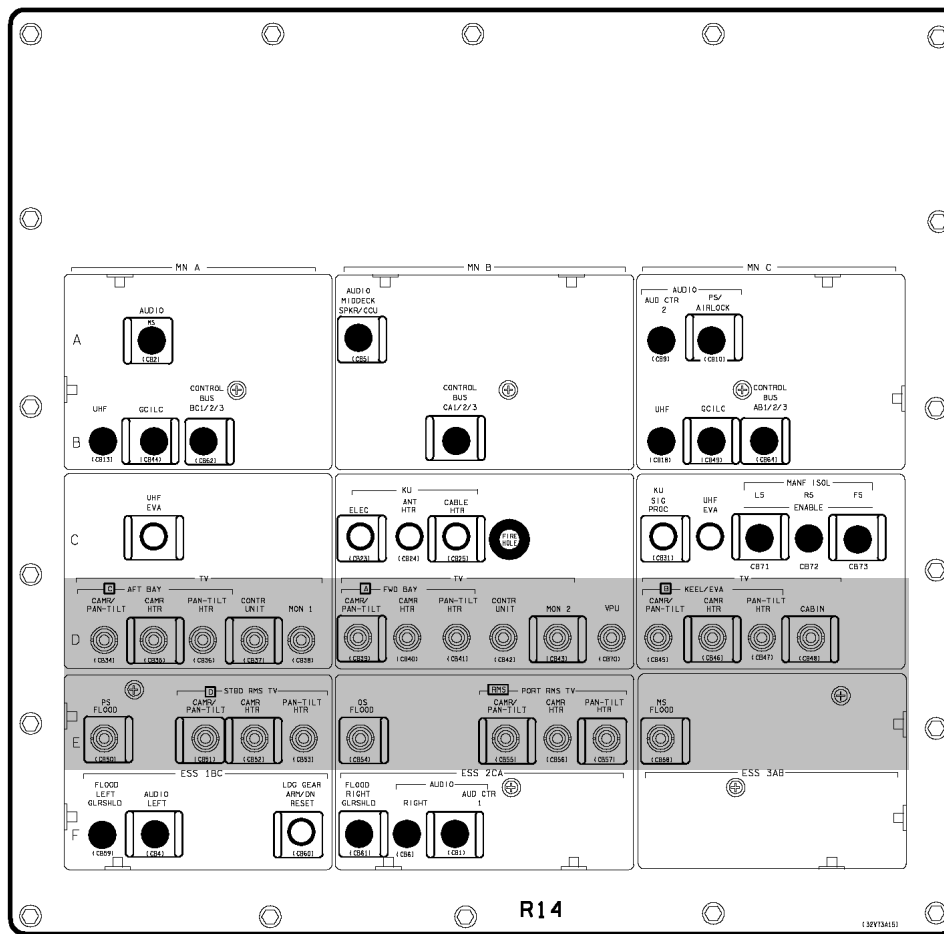
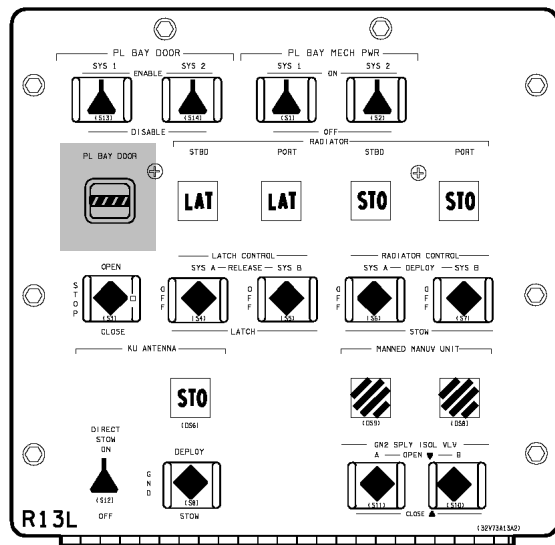
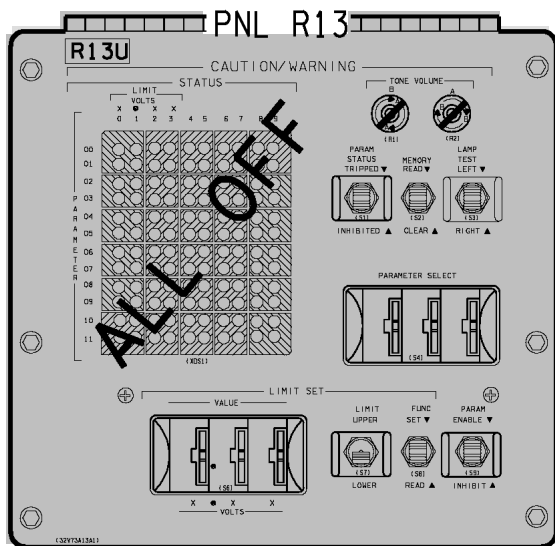

OV103

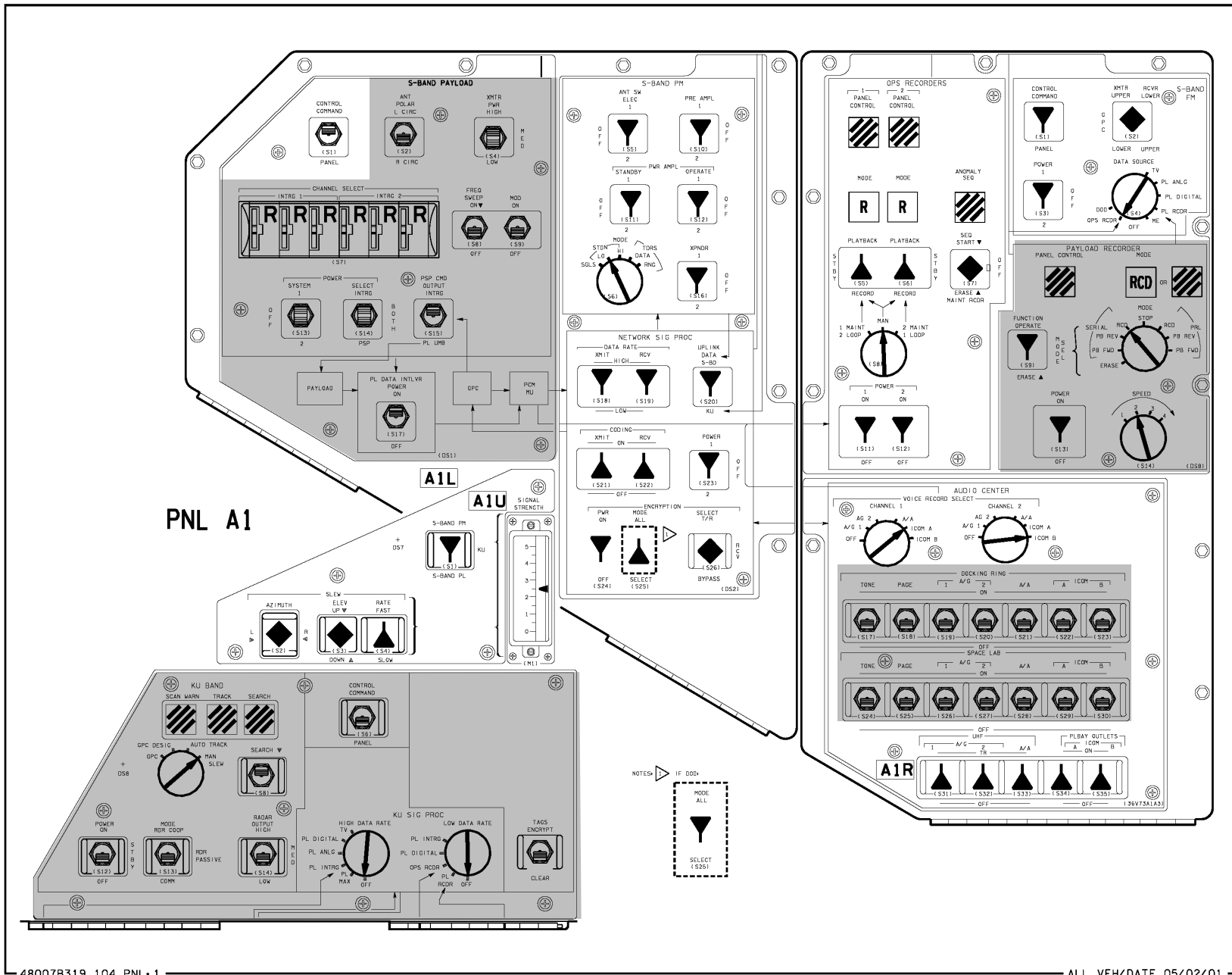

PNL A1

A1L

A1U

A1R

OV103

OV103

PNL A4

MISSION TIME
DAY HR MIN SEC

365:23:59:55

EVENT TIME
MIN SEC

59:59

MISSION TIMER GMT
R
TEST

PNL A3

CONTRAST R

BRIGHTNESS R

SOURCE PANEL DN-LINK DIRECT SCAN

MODE NORM

PULSE-X UNDER

DATA ON SYNC INT

OFF EXT

X-HAIR-POWER ON

OFF FAULT OFF

MON 1

CONTRAST R

BRIGHTNESS R

SOURCE PANEL DN-LINK DIRECT SCAN

MODE NORM

PULSE-X UNDER

DATA ON SYNC INT

OFF EXT

X-HAIR-POWER ON

OFF FAULT OFF

MON 2

PNL A6U

A6U

ORBITAL STATION LIGHTING
FLOOD ON PANEL ON

ORBITAL OAP CONTROL
SELECT CONTROL

A B AUTO NRTL LVLH FREE

OFF OFF ON OFF OFF OFF

MANUAL MODE

TRANSLATION X ROTATION PITCH YAW

OFF OFF OFF OFF OFF OFF

INSTRUMENT NUMERIC

OFF ON BRT OFF ON BRT

ANNUNCIATOR INTENSITY

BUS SELECT LAMP TEST LEFT BRIGHT

OFF ON BRT OFF ON BRT

PAYLOAD RETENTION LATCHES
READY TO LATCH

1 2 3 4 5

LAT LAT LAT LAT LAT

1 2 3 4 5

RELEASE LATCH

EVENT TIMER
MIN SET SEC

R R R R R

MODE UP CONTROL STARTY TIMER SET

R STOP RESET

PNL A7U

PASTER ALARM OFF

CAMERA POWER
OFF OFF OFF OFF OFF

FWD KEEL/EVA AFT STBD PORT PANEL TV POWER

BAY B C D RMS DOWNLINK TV CONTROL UNIT

ON ON ON ON ON ON

ENABLE NORMAL

OFFA OFFA INHIBIT REVERSE

VIDEO INPUT

MON DOW C

OFF OFF OFF OFF OFF OFF

VIDEO OUTPUT

MON DOW C

OFF OFF OFF OFF OFF OFF

CAMERA COMMAND
PAN/TILT RESET FOCUS FAIR ZOOM INW IRIS OPEN TILT UPW PAN LEFT

HIGH RATE LOW RATE NEAR ALC OUT CLOSE DOWN

ALL OFF ALL OFF ALL OFF ALL OFF

136V346A11

48007B327_104, PNL 2

(OV103) B3-20

OV103/DATE 05/02/01

C D/O/3/GEN H,1

OV103

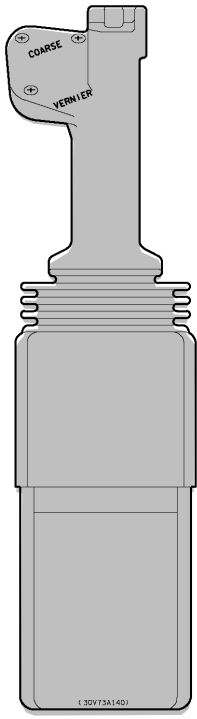
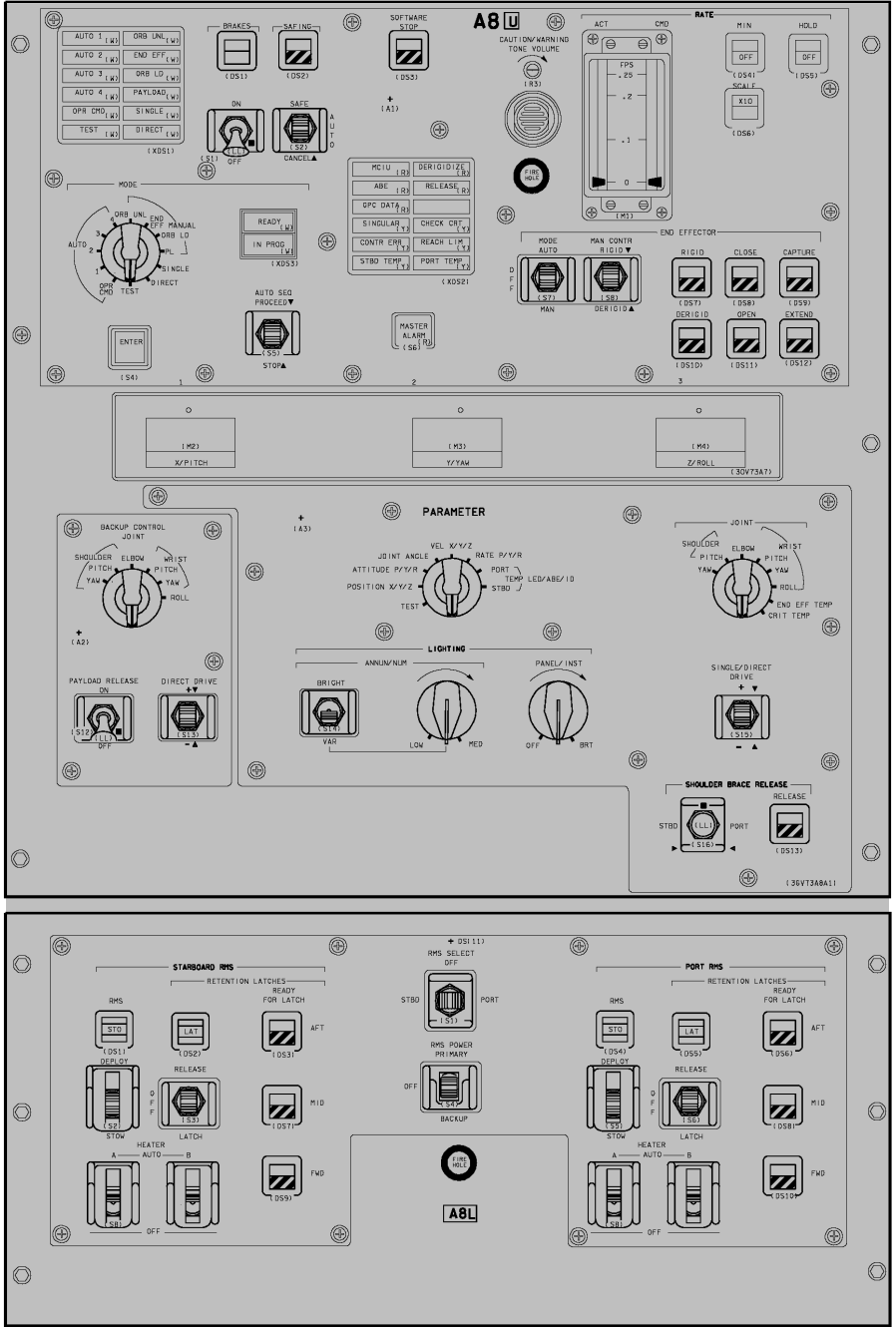

ALL VEH/DATE 02/14/00
48007C3220_101_PNL1_1

OV103 |

(OV103) B3-21

C D/O/ALL/GEN H,1

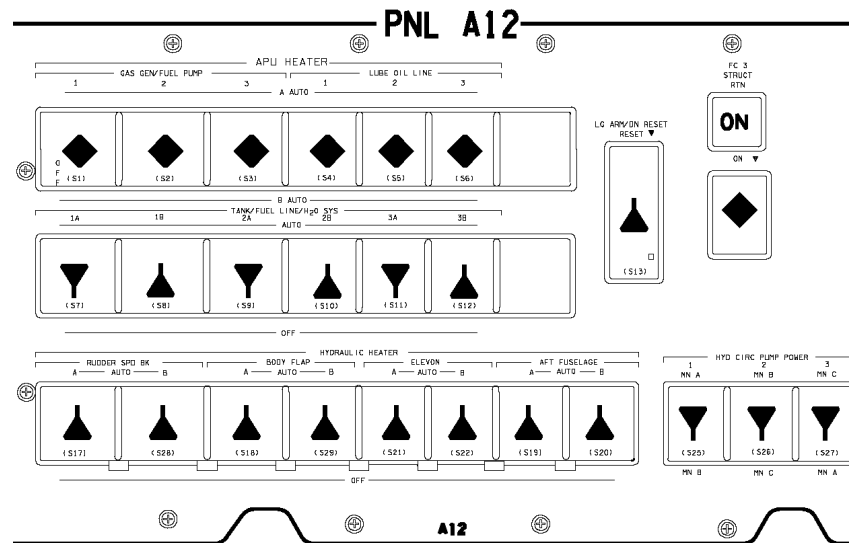
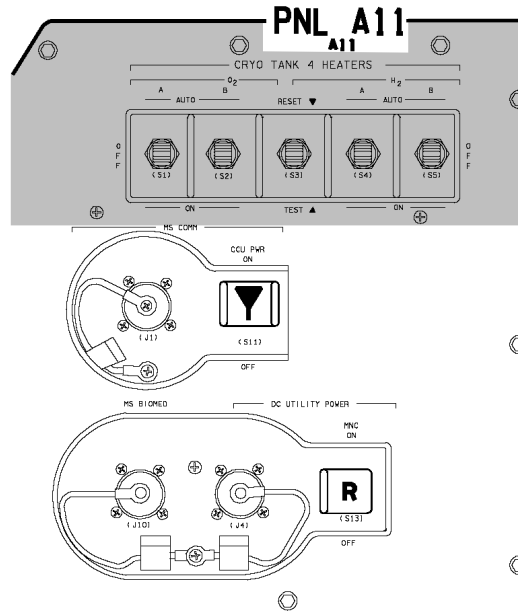

A6L

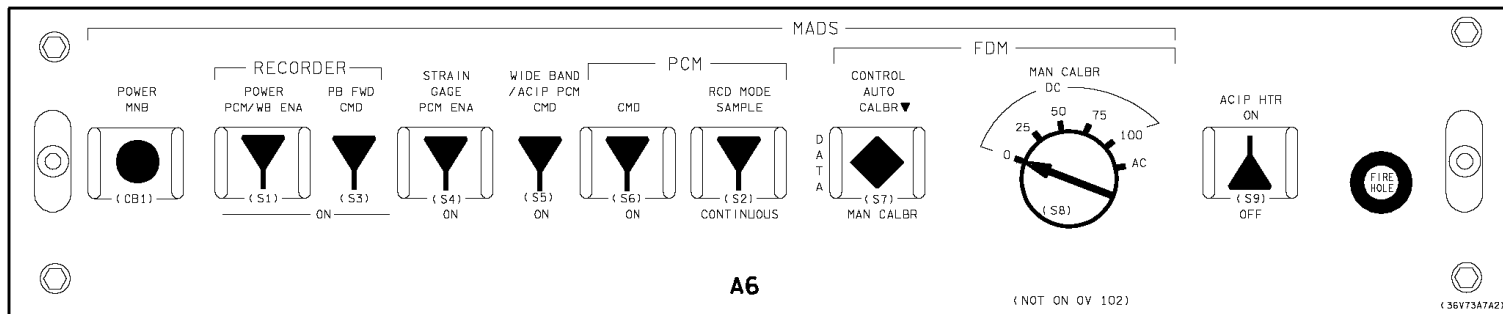
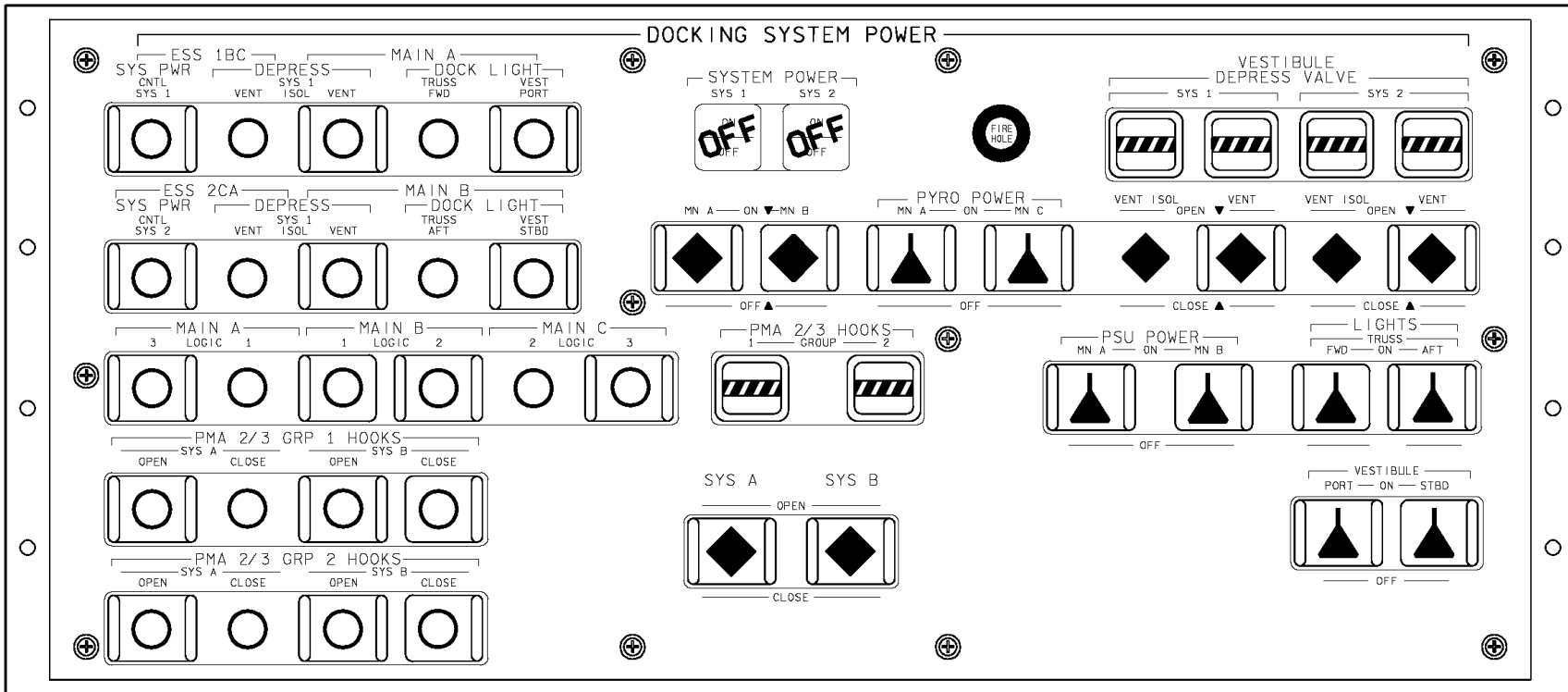

OV103

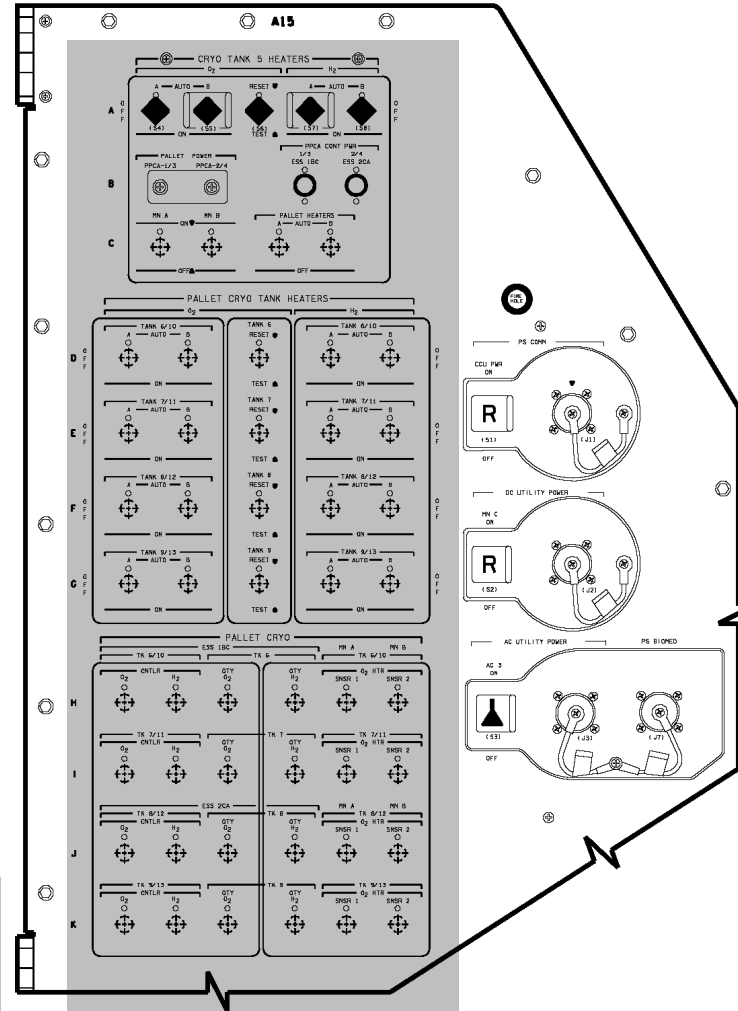
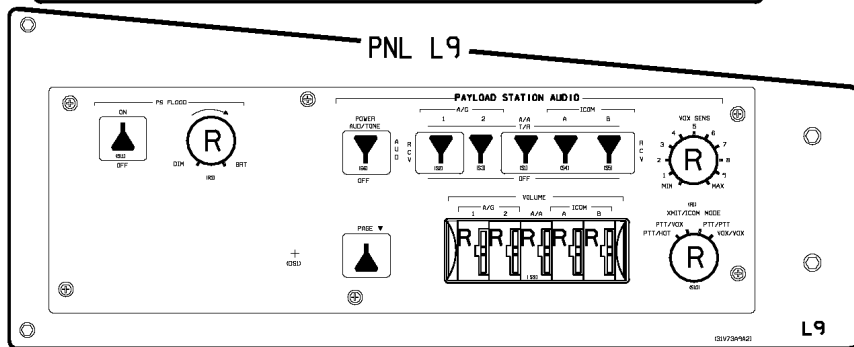
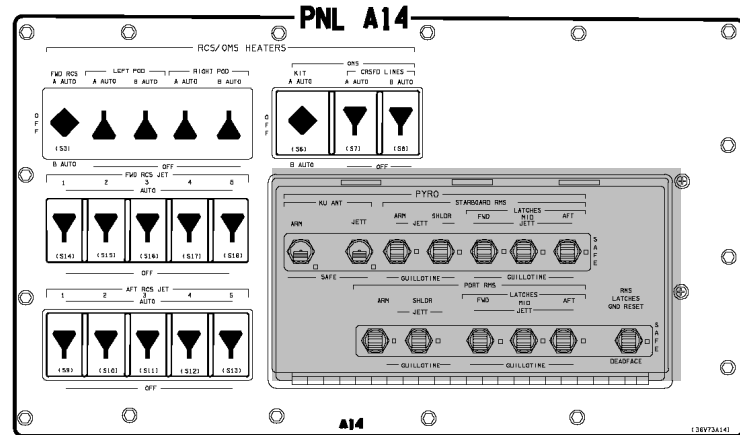
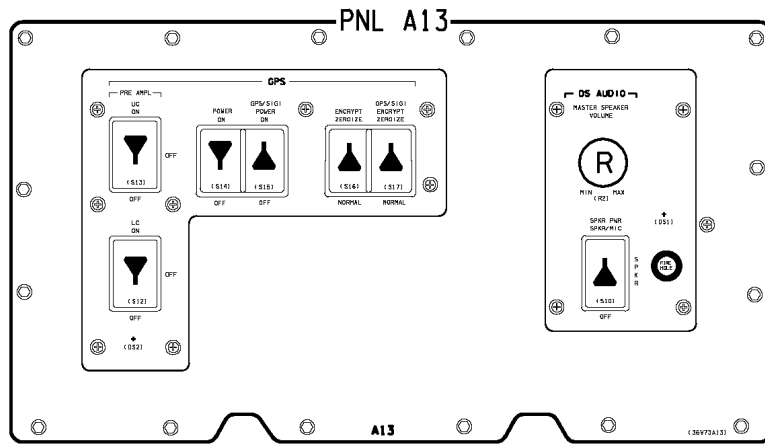

480078324_109, PNL 1

(OV103) B3-24

OV103/DATE 12/10/01

OV103
C D/O/3/GEN H,7

OV103

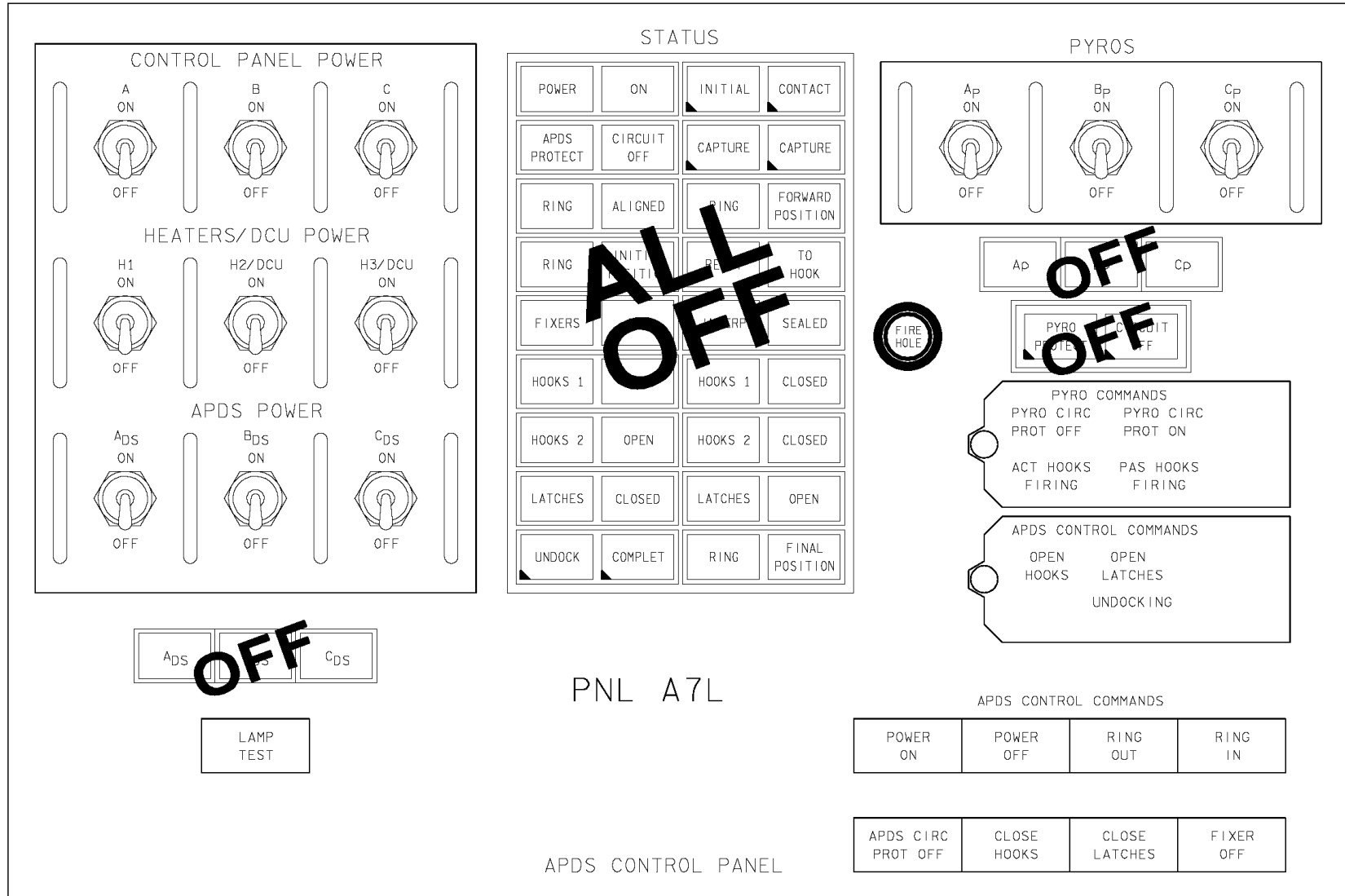

OV103

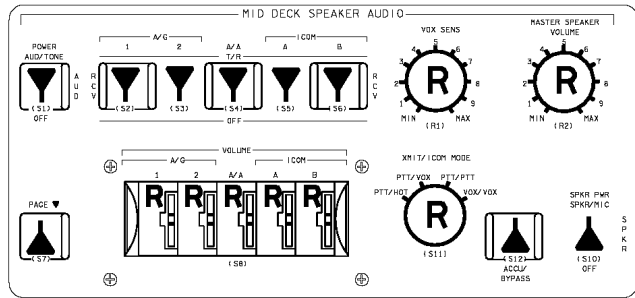

PNL M042F

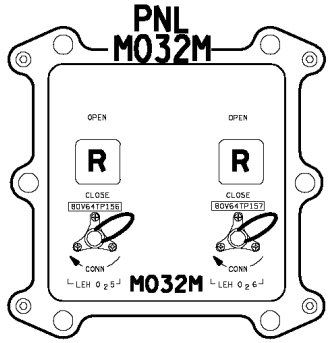
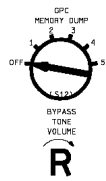

PNL M032M

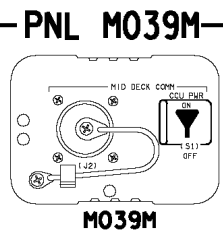

PNL M039M

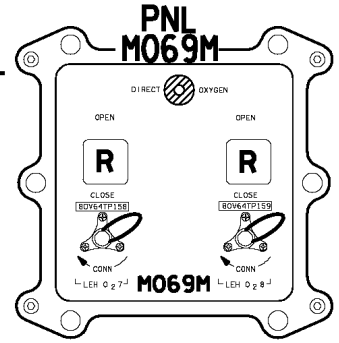

PNL M069M



PNL M029J

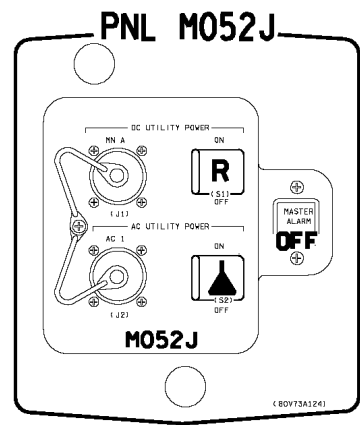

PNL M052J

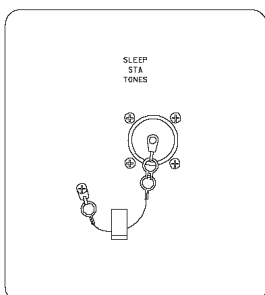

PNL M058F

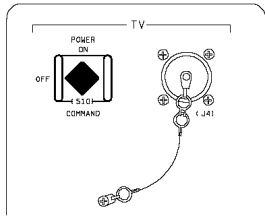

PNL M030F

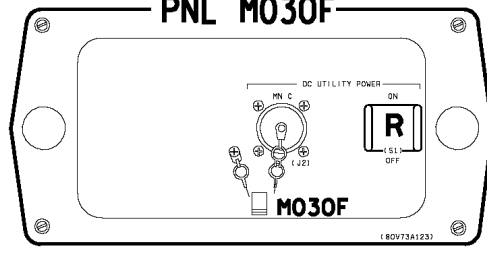

M030F

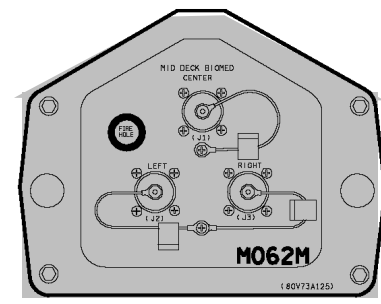

M062M

PNL MA73C

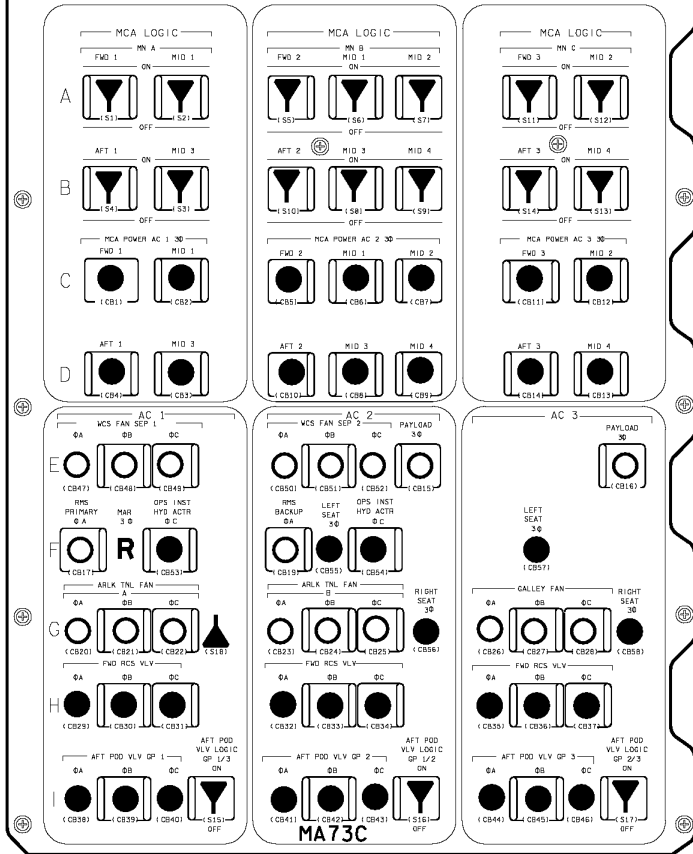

MA73C

PNL ML86B

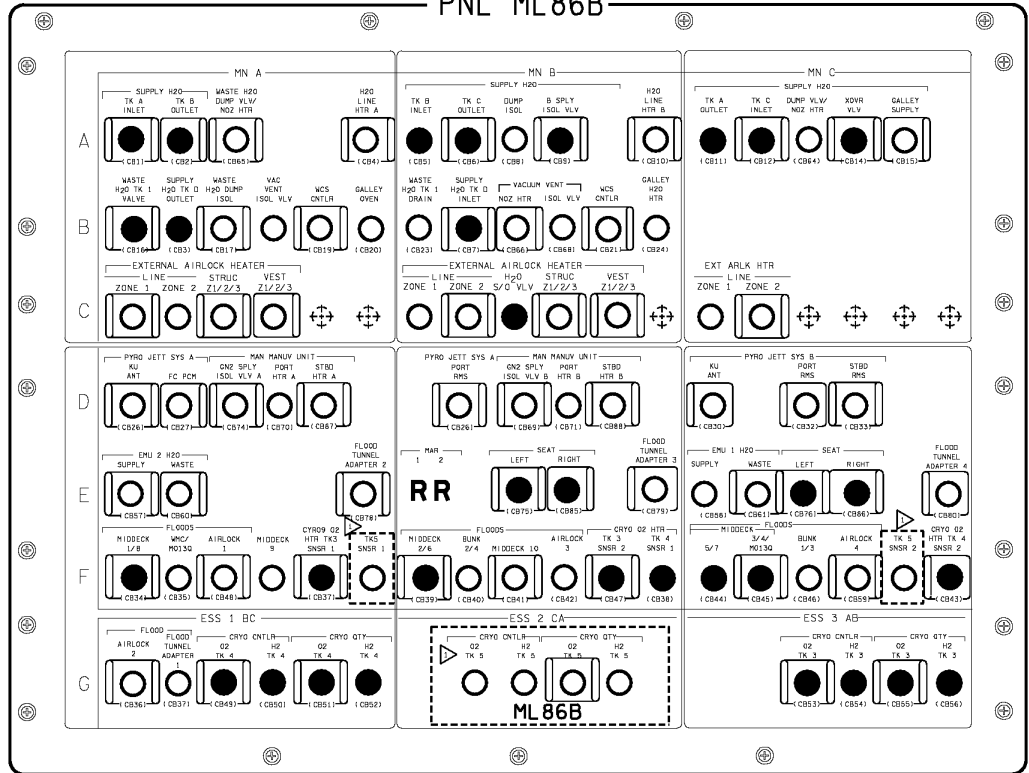

ML86B

NOTES: ▷ CLOSED IF TK5 FLOWN

OV103

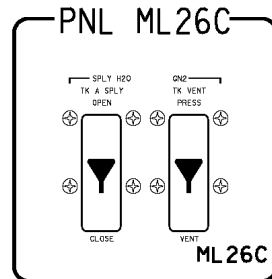
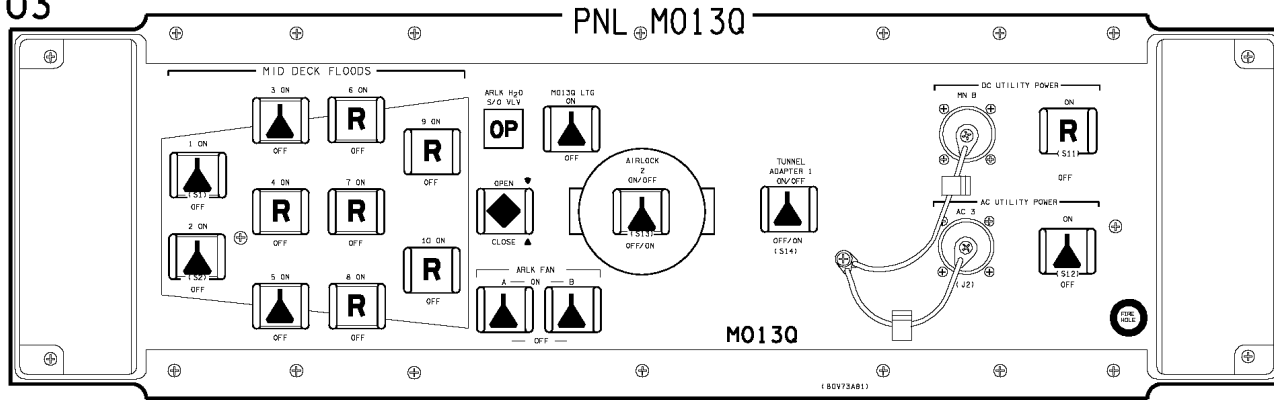

PNL MD24K

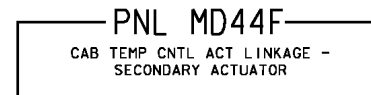
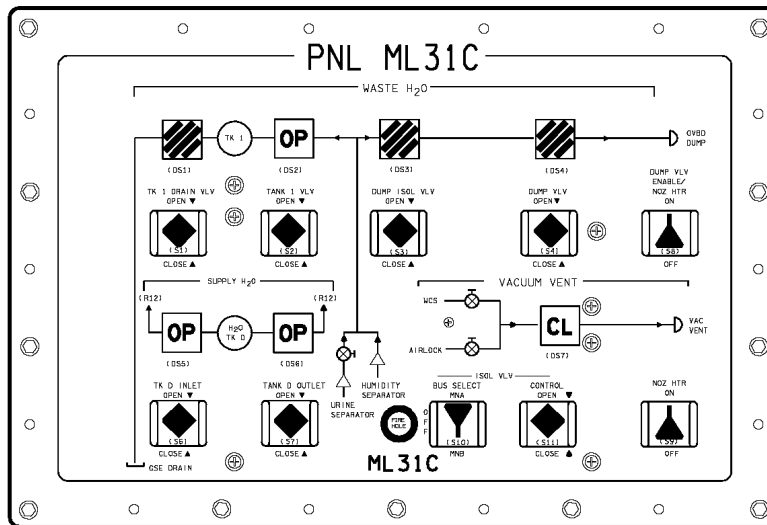
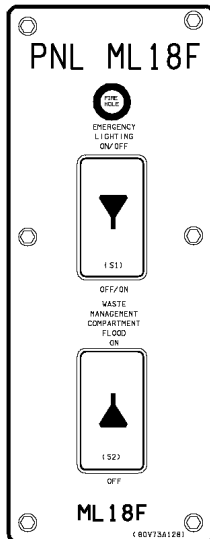
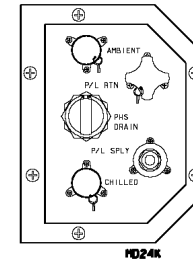

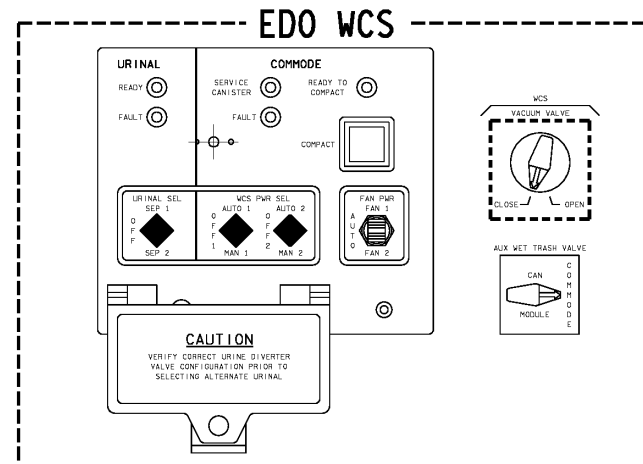
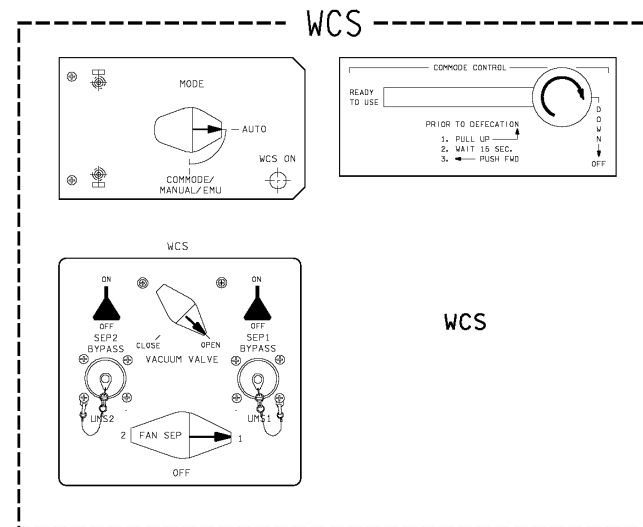
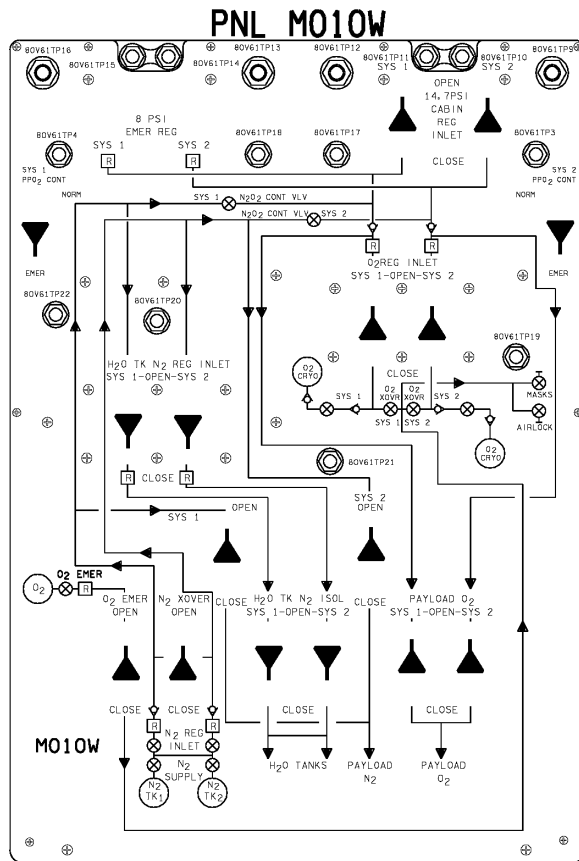

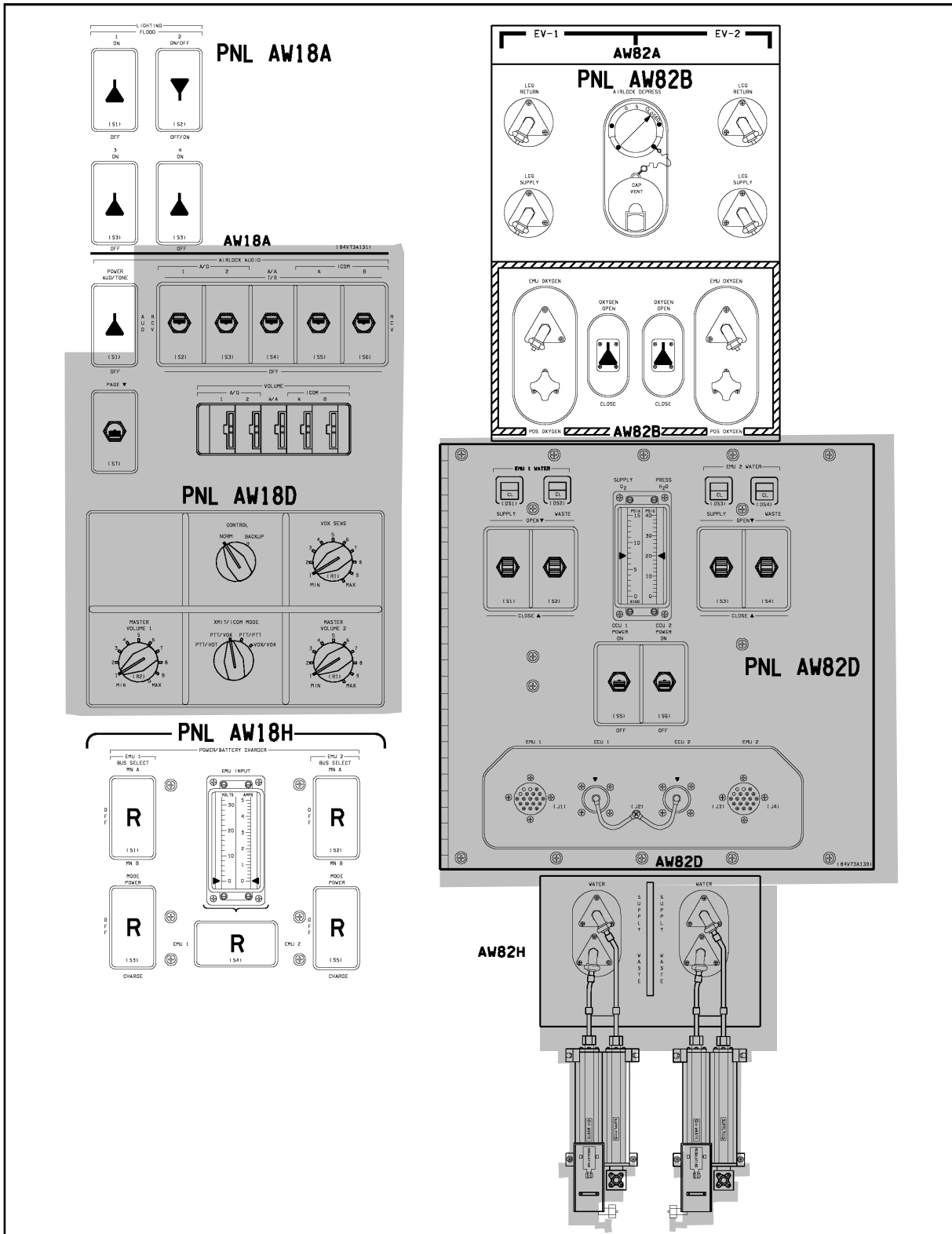

ALL VEH/DATE 02/11/00

4800TB331_101_PNL1

OV103

(OV103) B3-30

C D/O/ALL/GEN H,1

Inner Hatch

Actuator Handle – LATCHED

Lock Lever – LOCKED

Equalization vlv (two) – NORM, capped

This Page Intentionally Blank

OV104

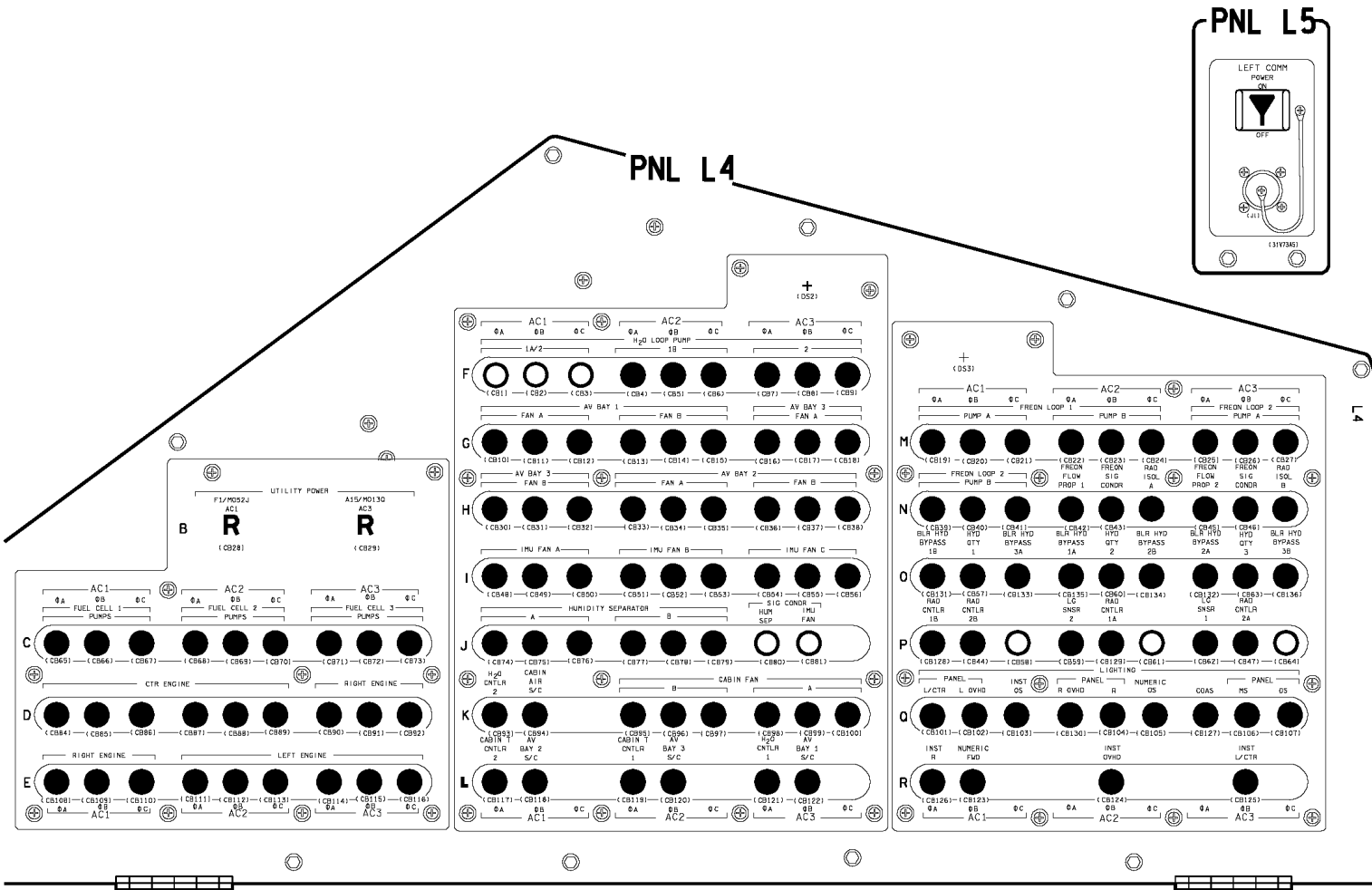

OV104

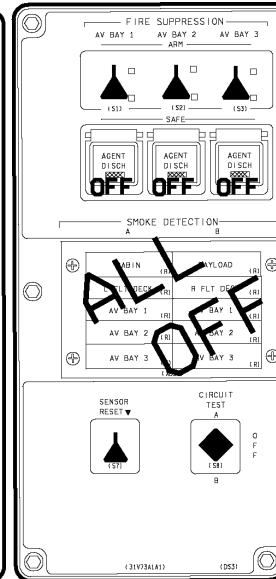
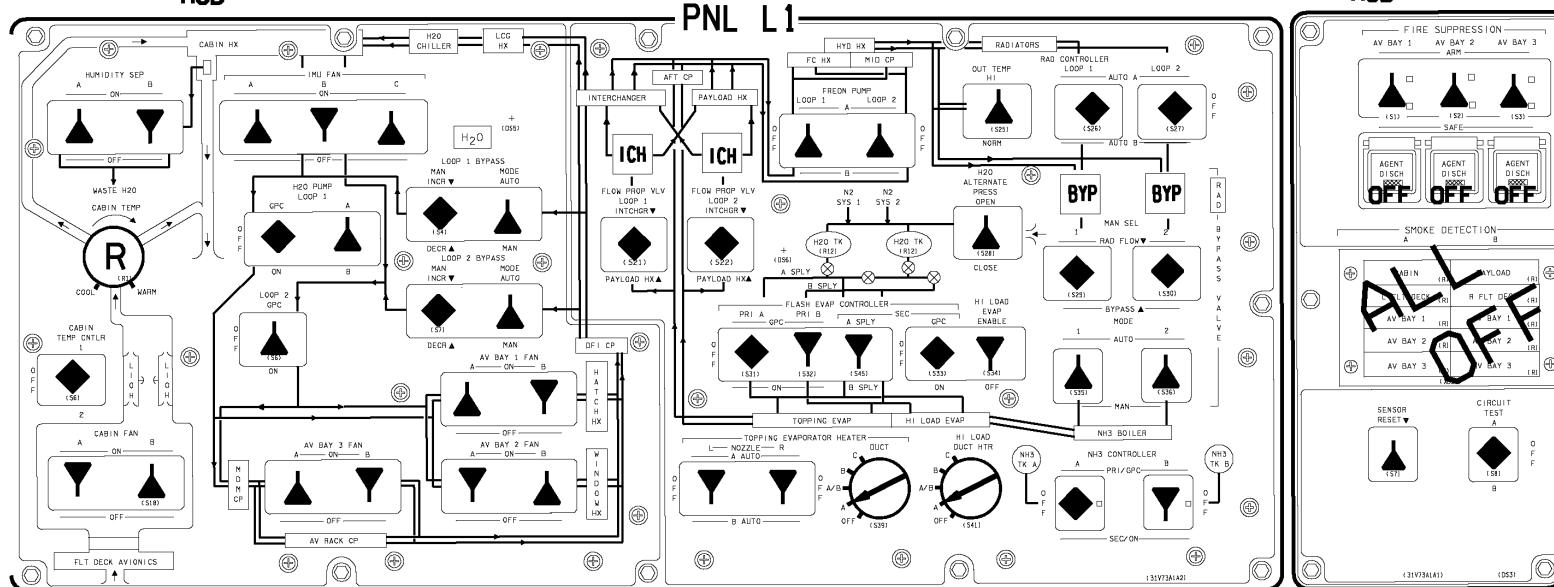
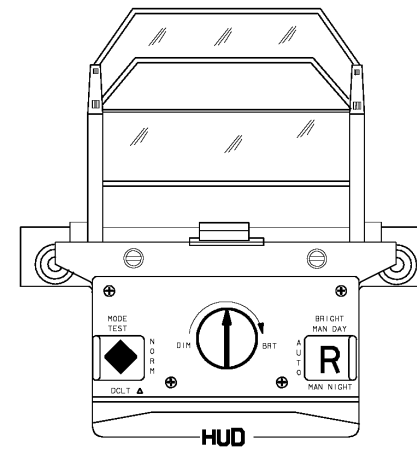
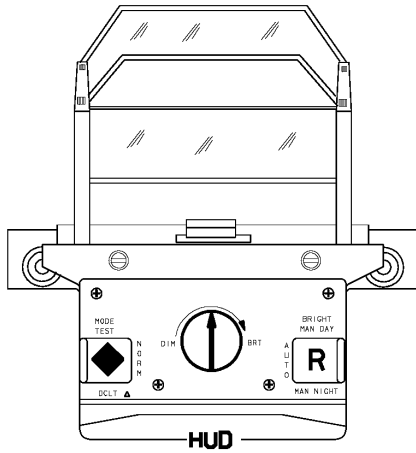
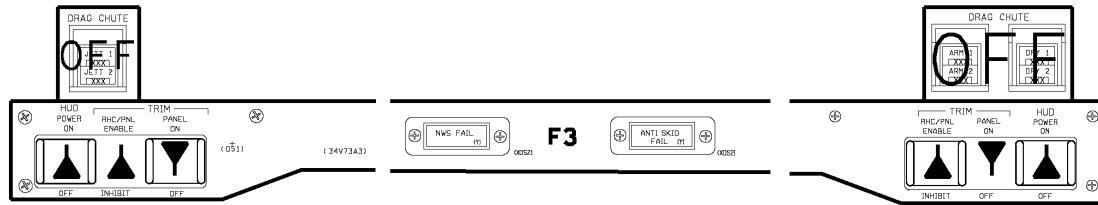

48007C304_109. PNL 1

OV104/DATE 02/01/02

(OV104) C3-4

C D/O/ALL/GEN H,7

OV104

OV104

PNL L2

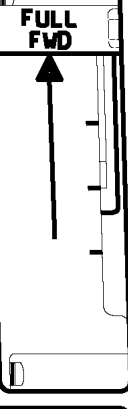
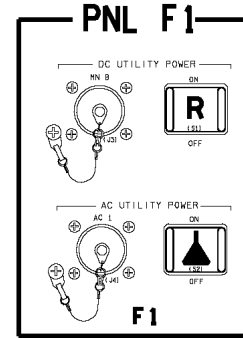
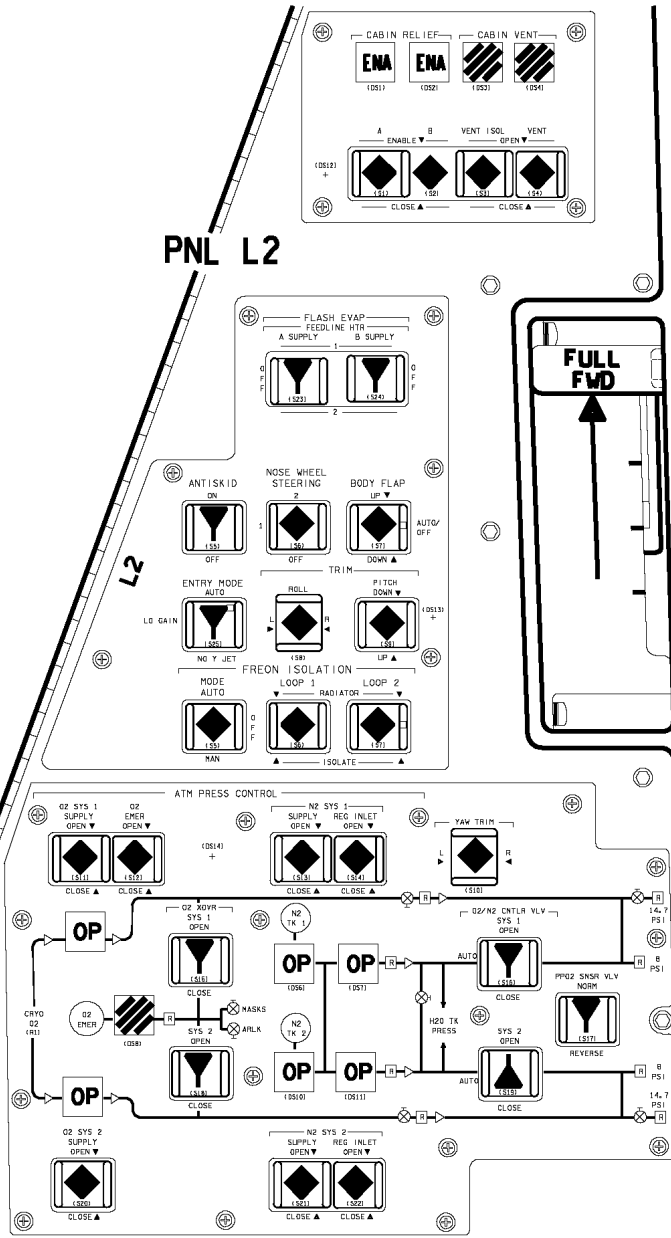

OV104

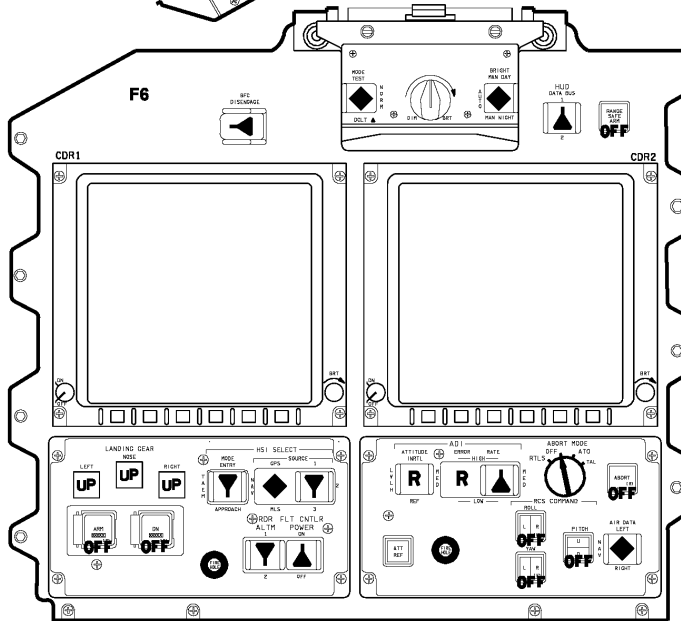
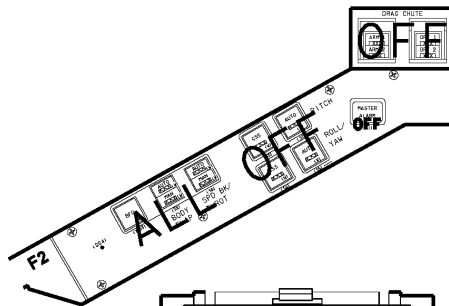
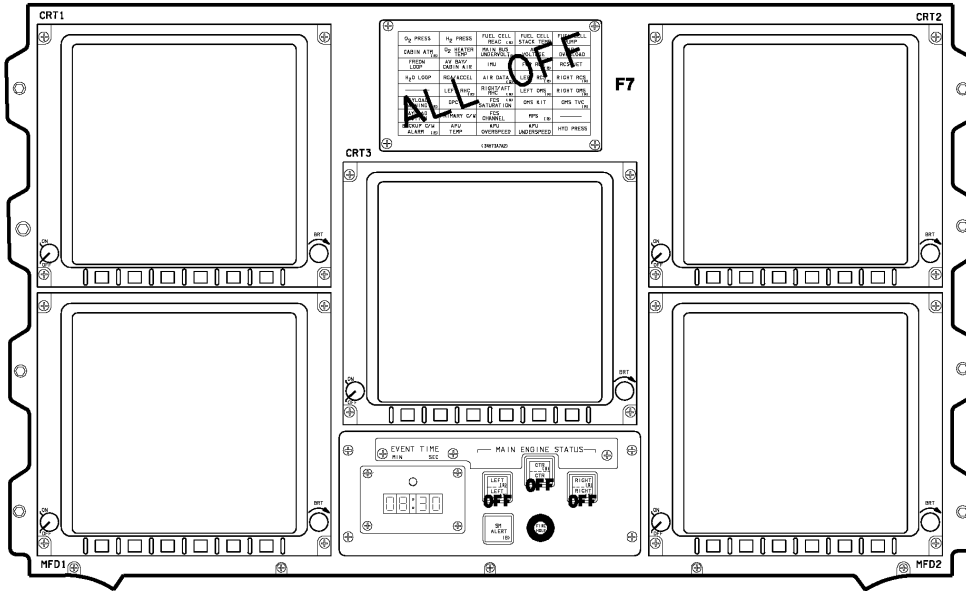

REDS REV/DATE 02/01/02

48007C306-109, PNL1, 1

OV104

(OV104) C3-6

C D/O/4/GEN H,7

PNL C2/C3

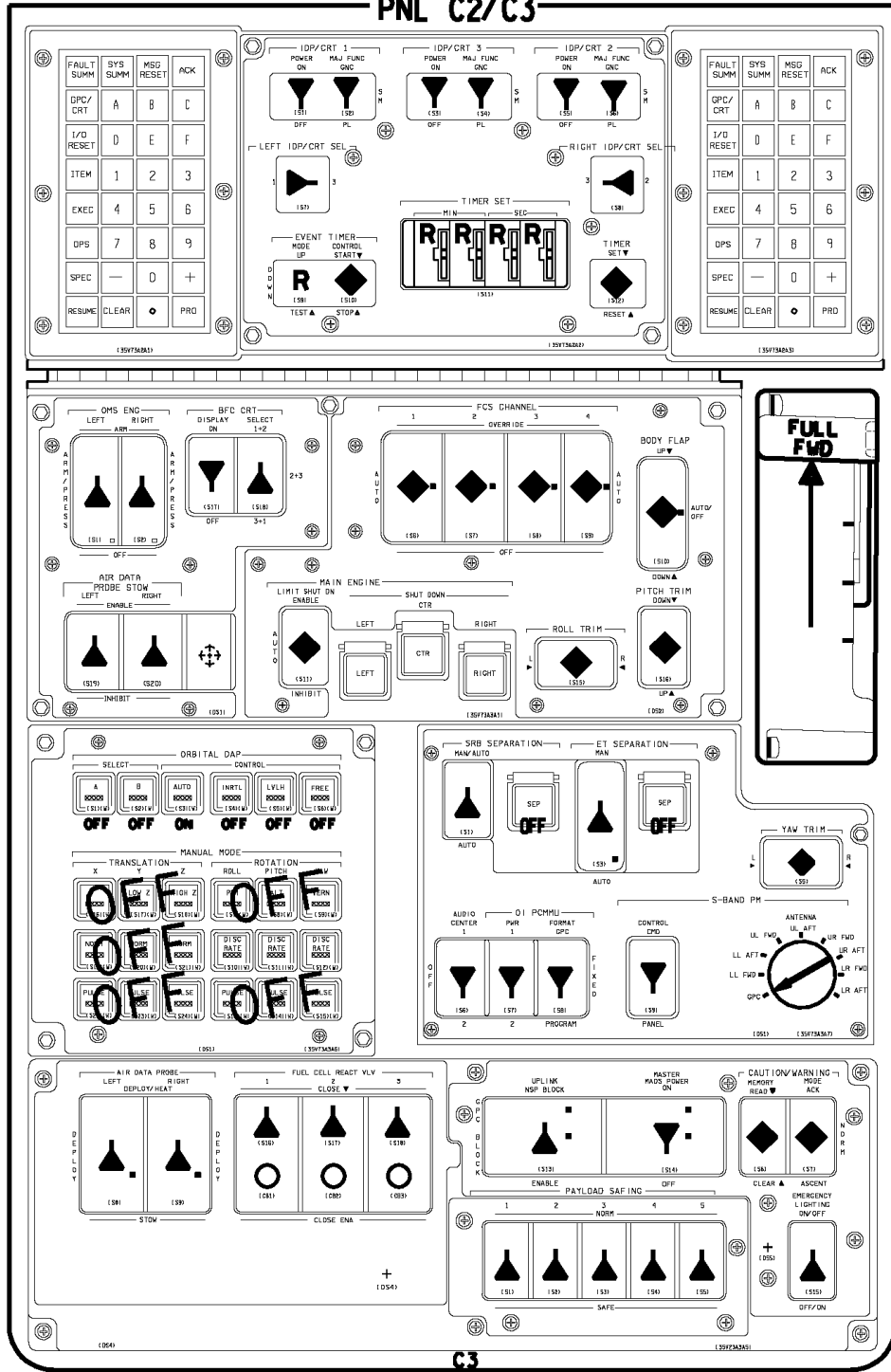

C3

OV104

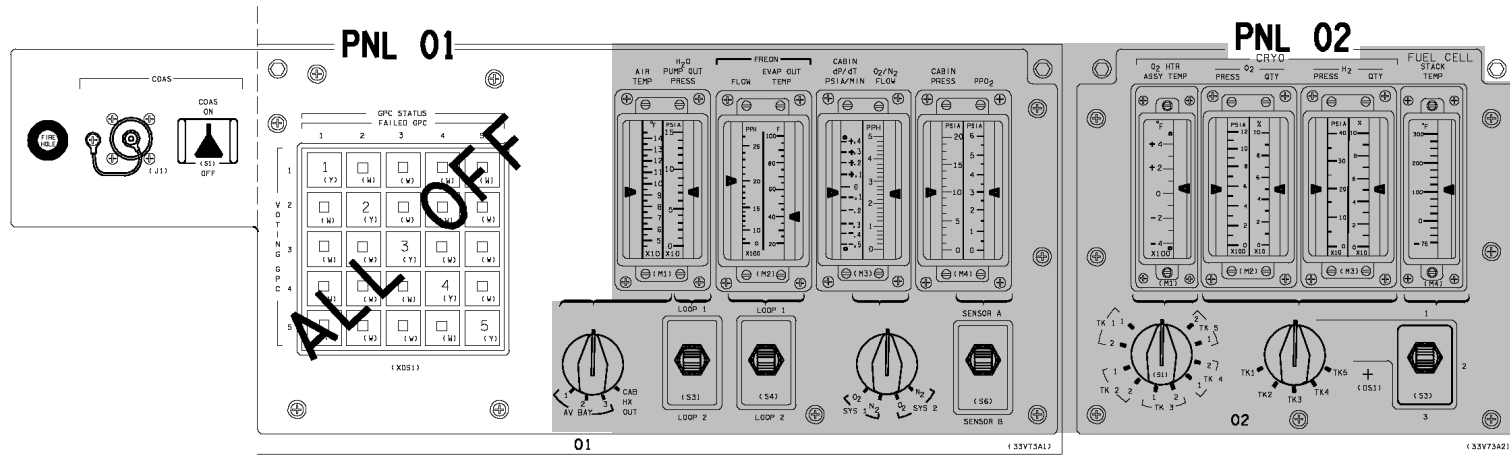

L side OVHD flood - R (MID)

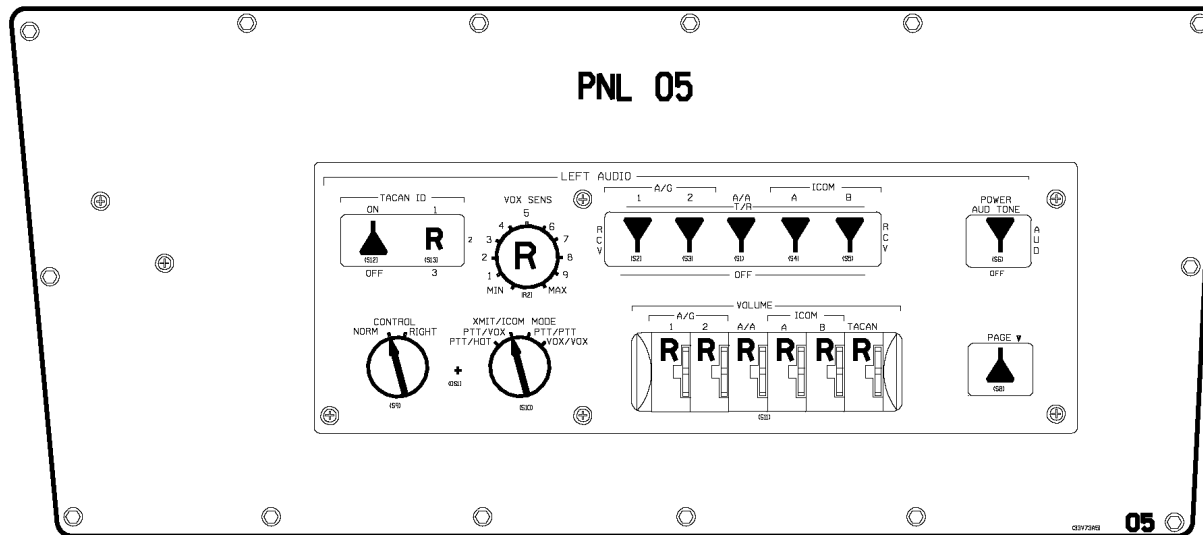

OV104

PNL 06

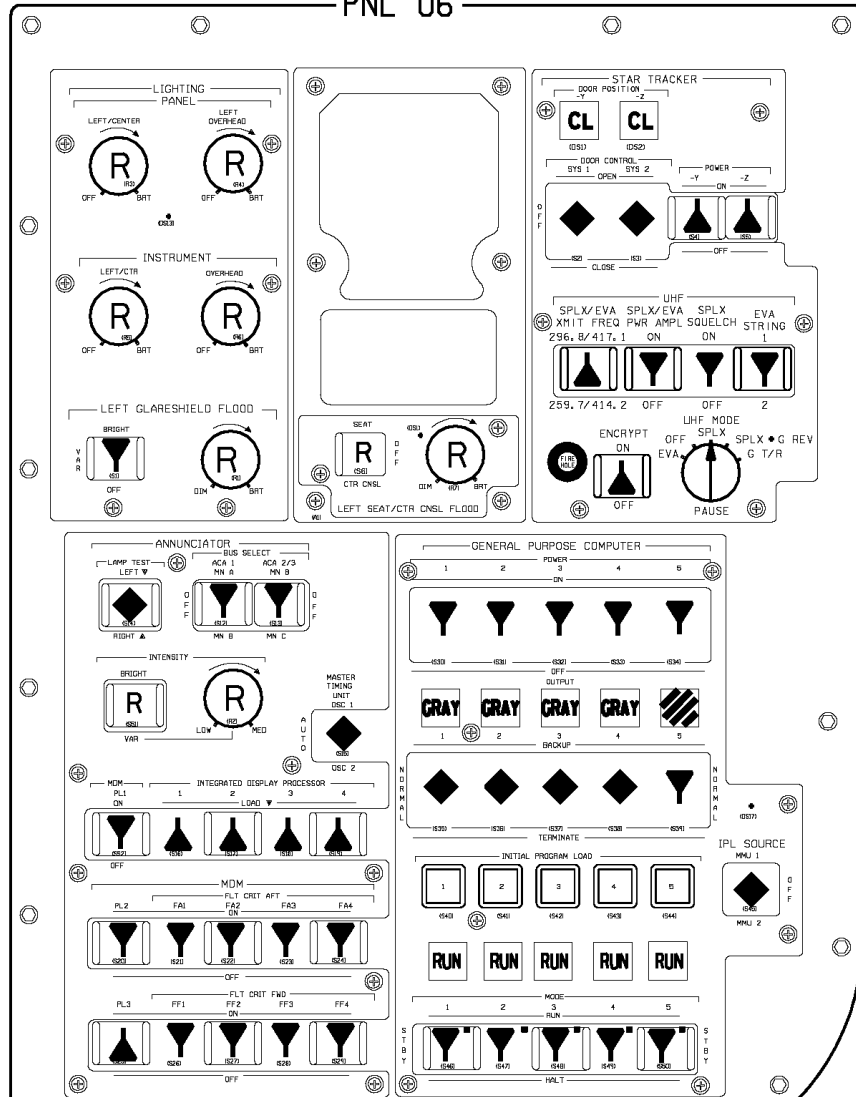

PNL 07

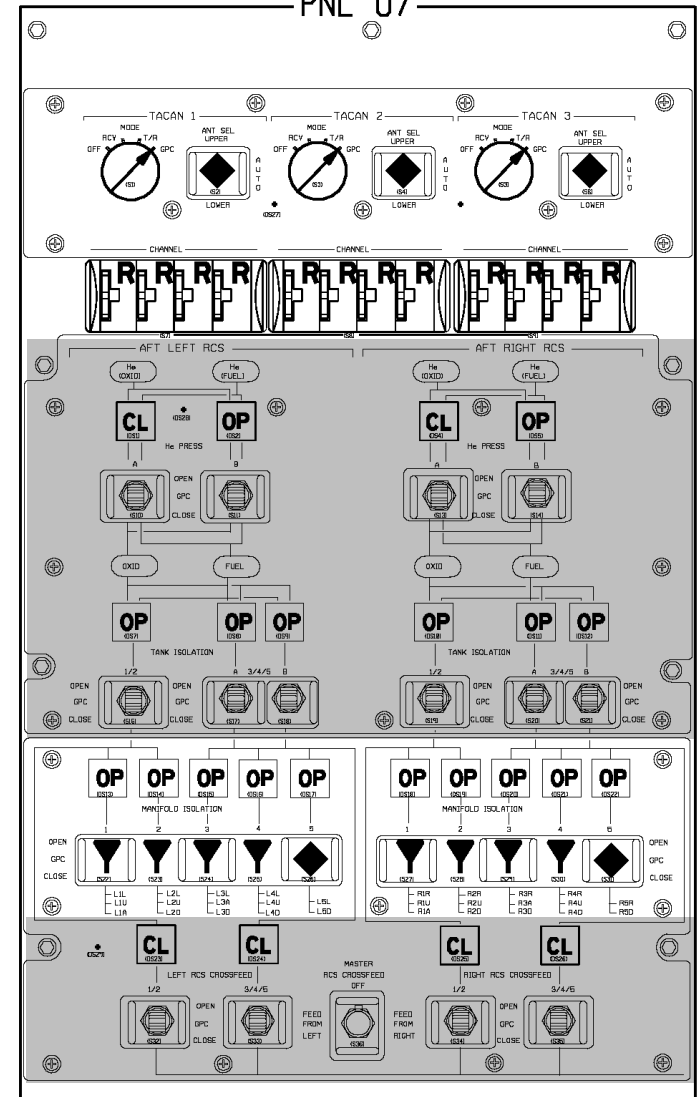

OV104

OV104

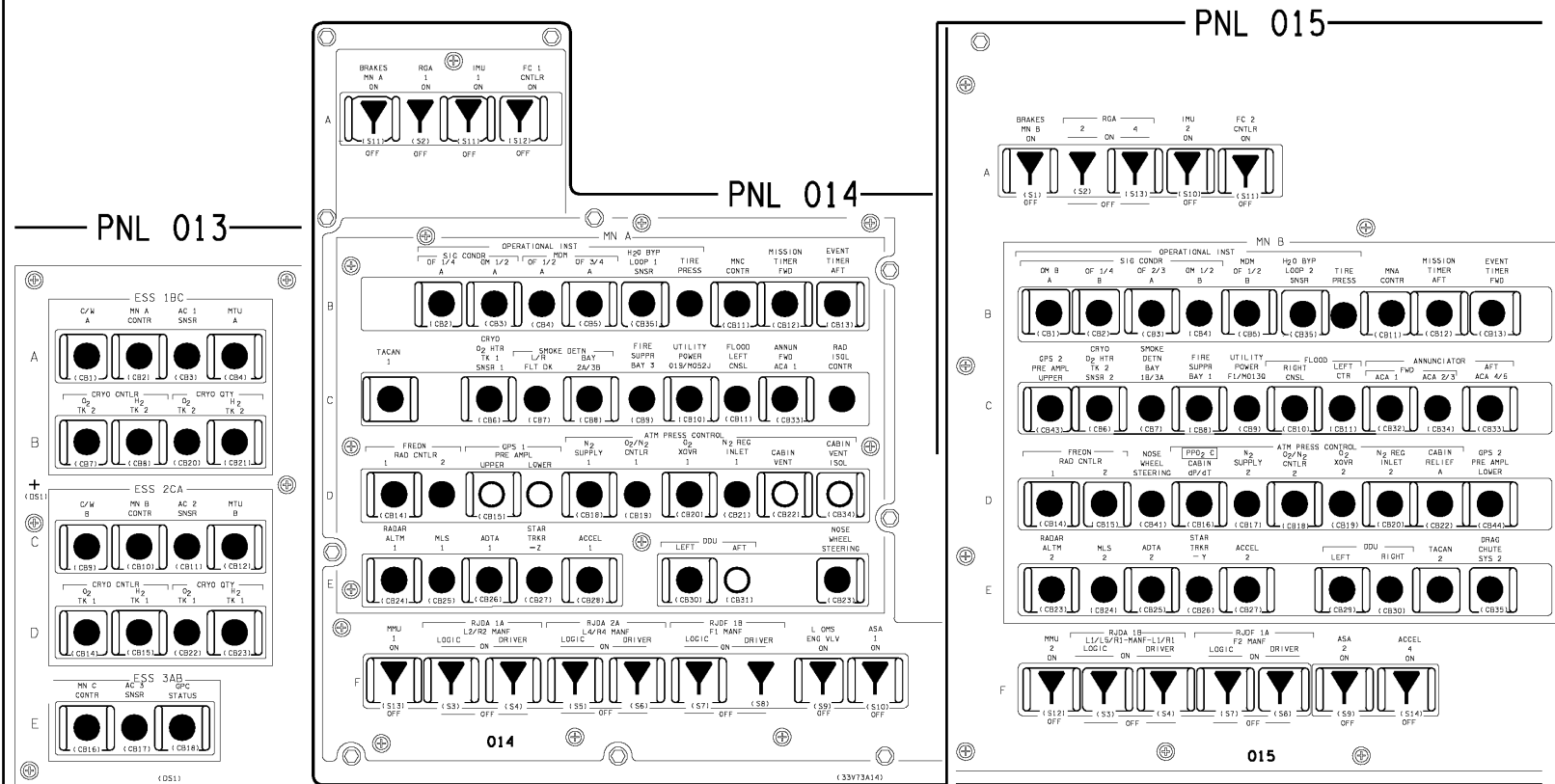

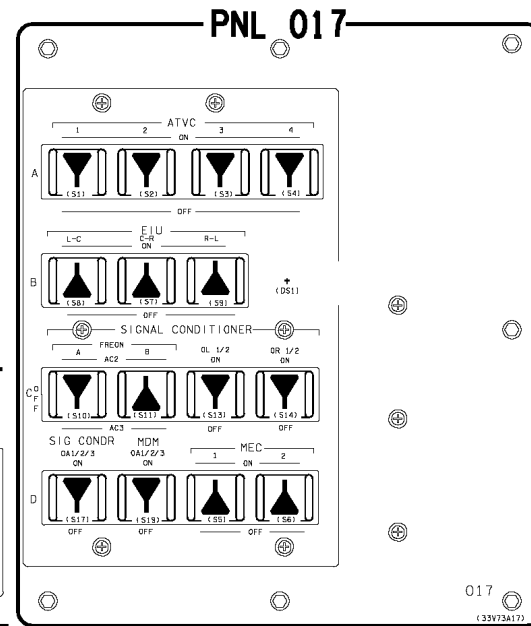
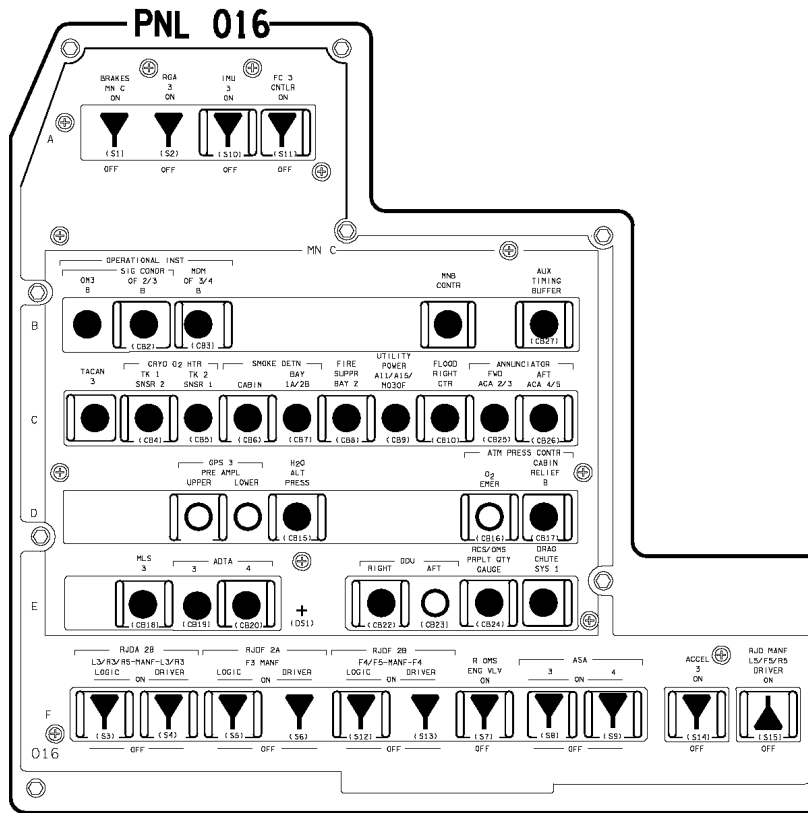

PNL 08

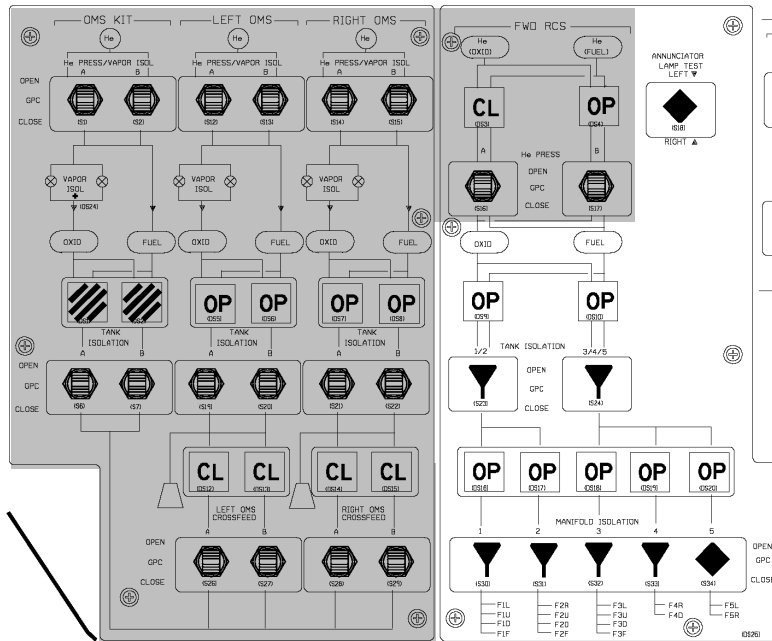
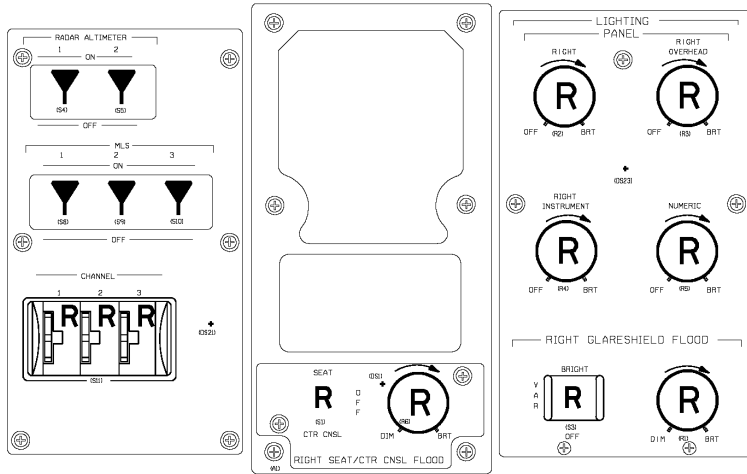

PNL 09

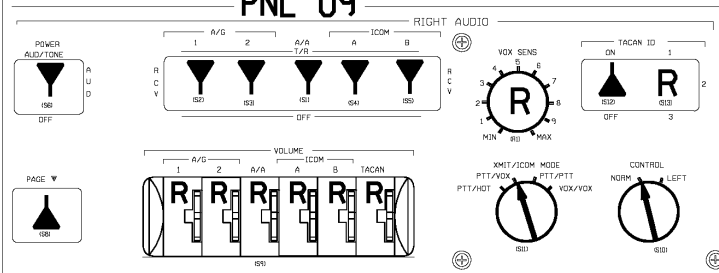

R side OVHD flood - R (MID)

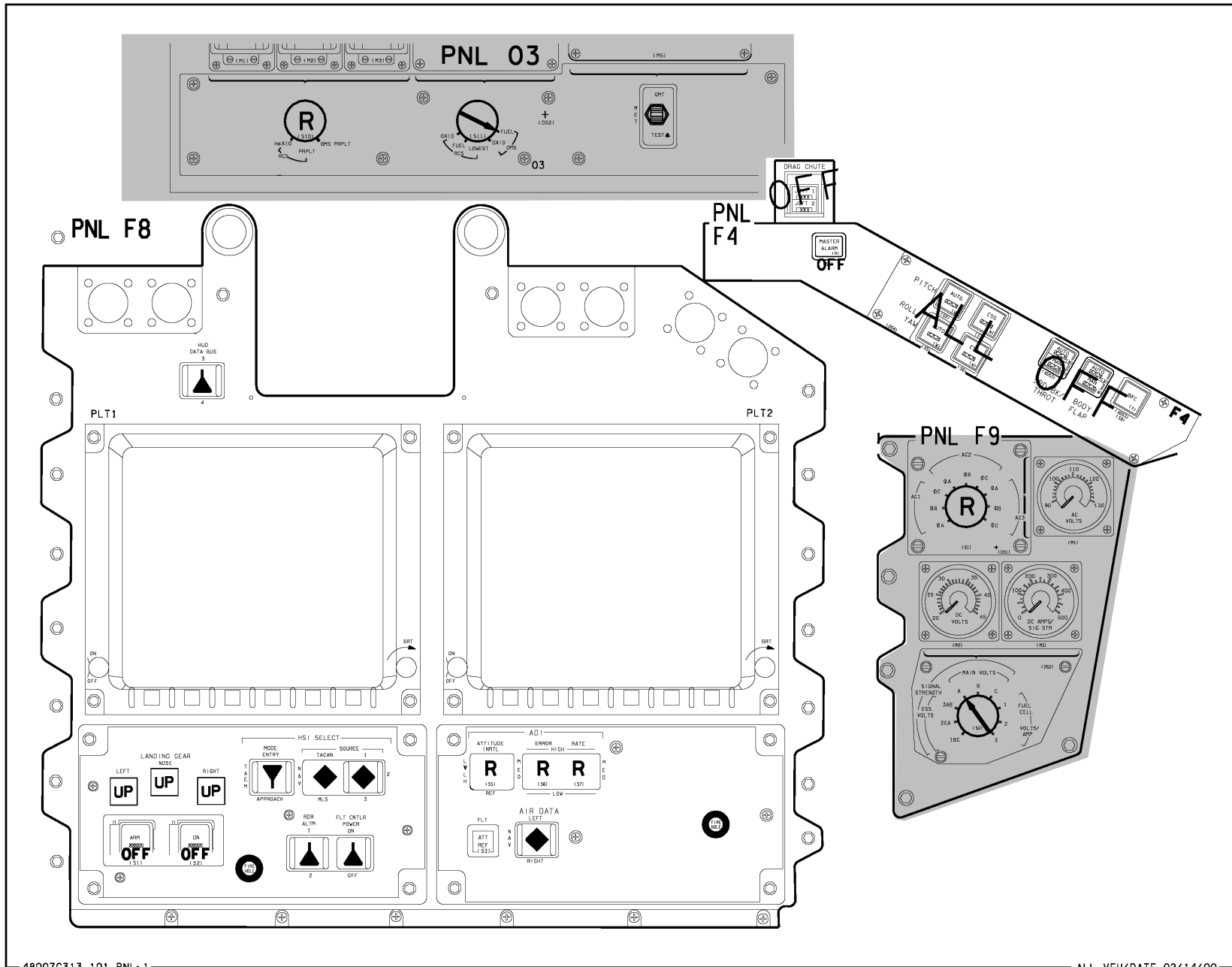

PNL R1

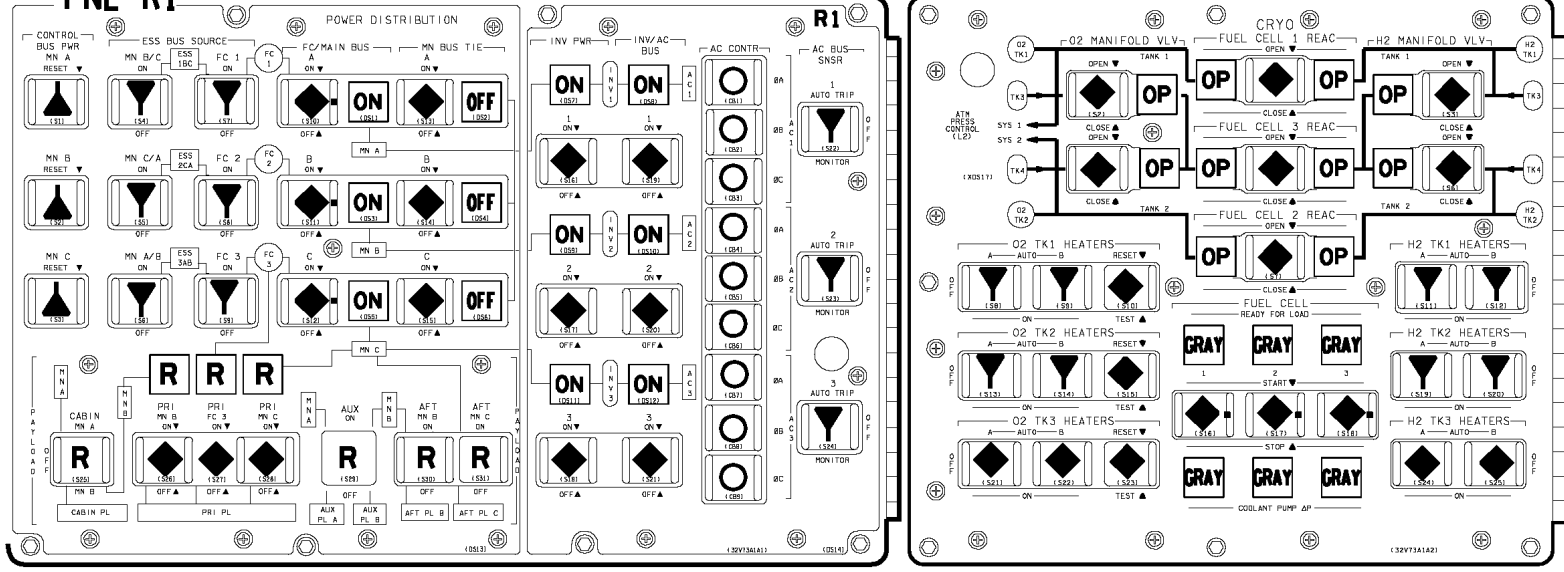

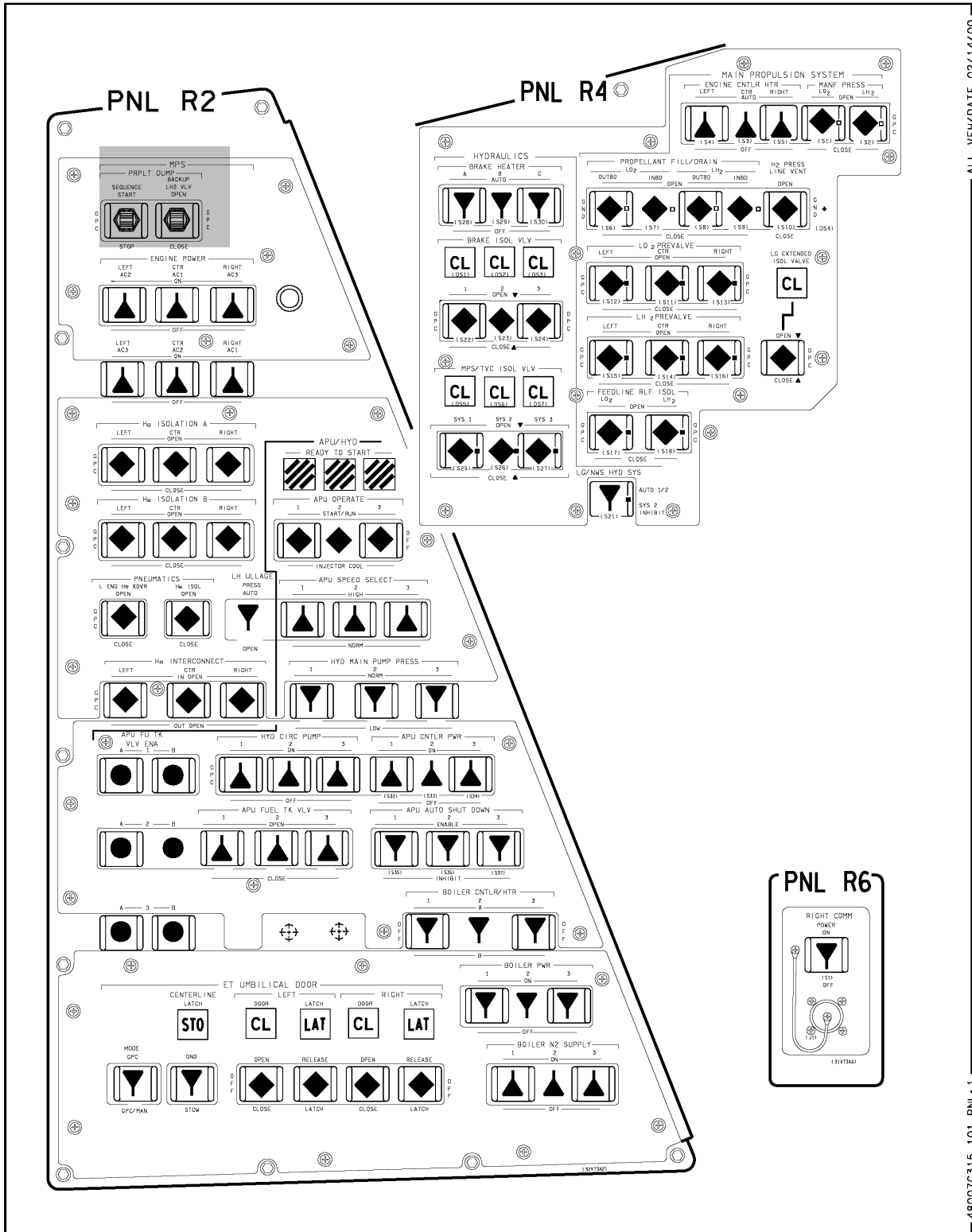

ALL VEH/DATE 02/14/00

48007C315_101_PNL1_1

OV104

(OV104) C3-15

C D/O/ALL/GEN H

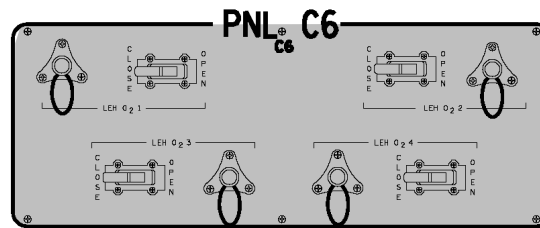
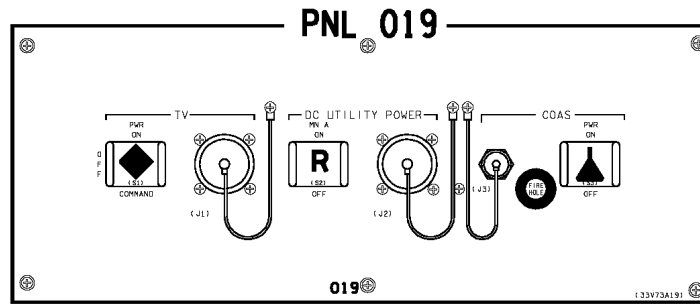

PNL C5

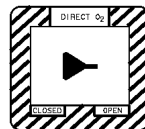

PNL C7

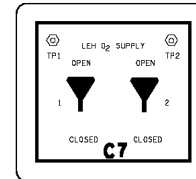

OV104

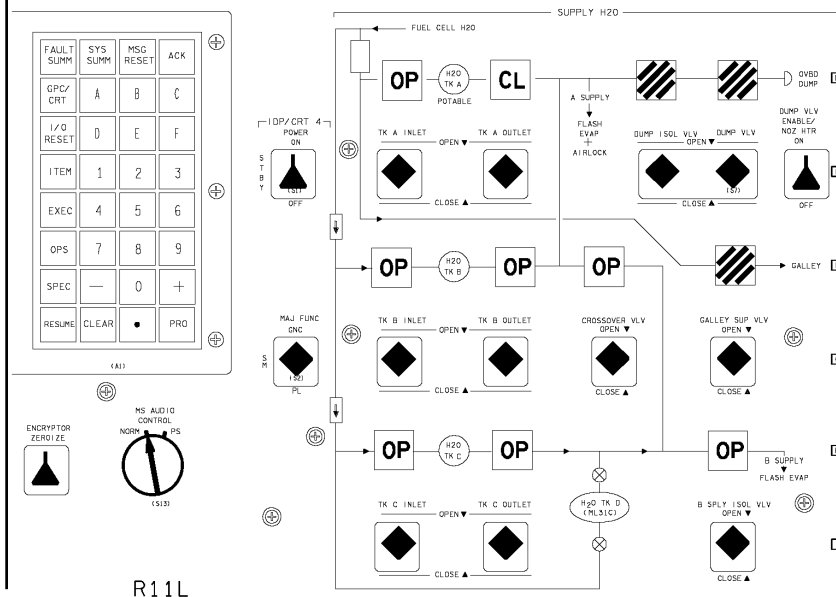
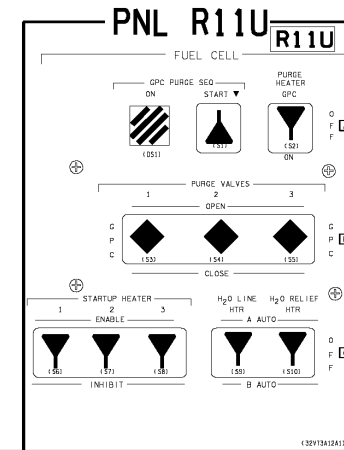
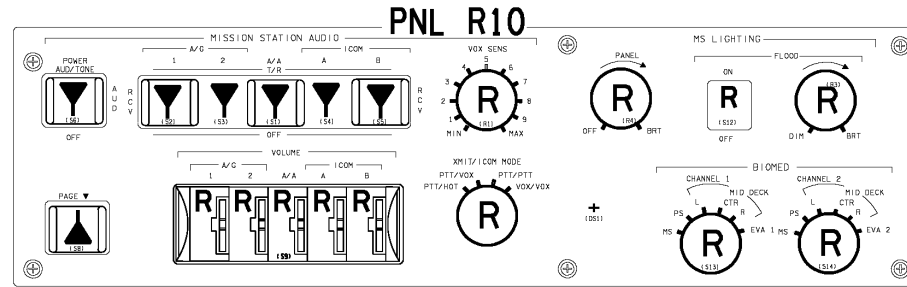

R11L

OV104

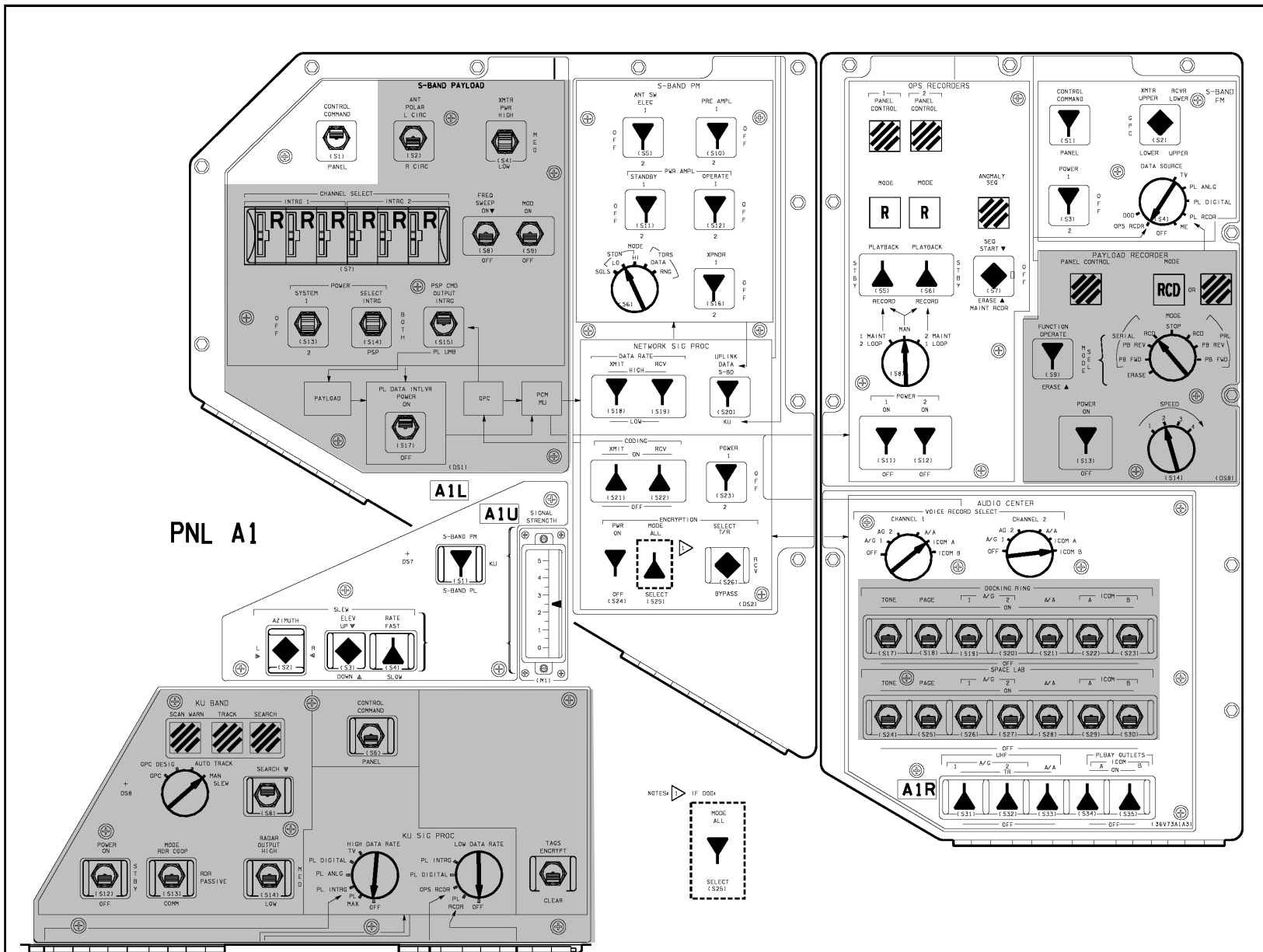

PNL A1

OV104

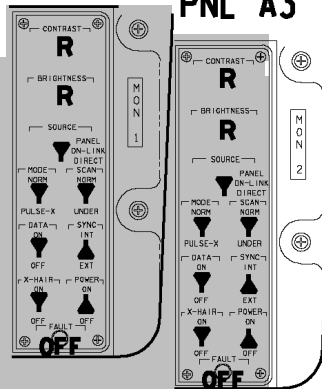
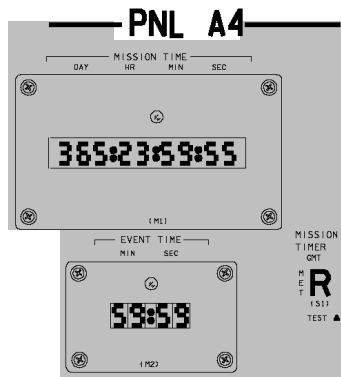

PNL A6U

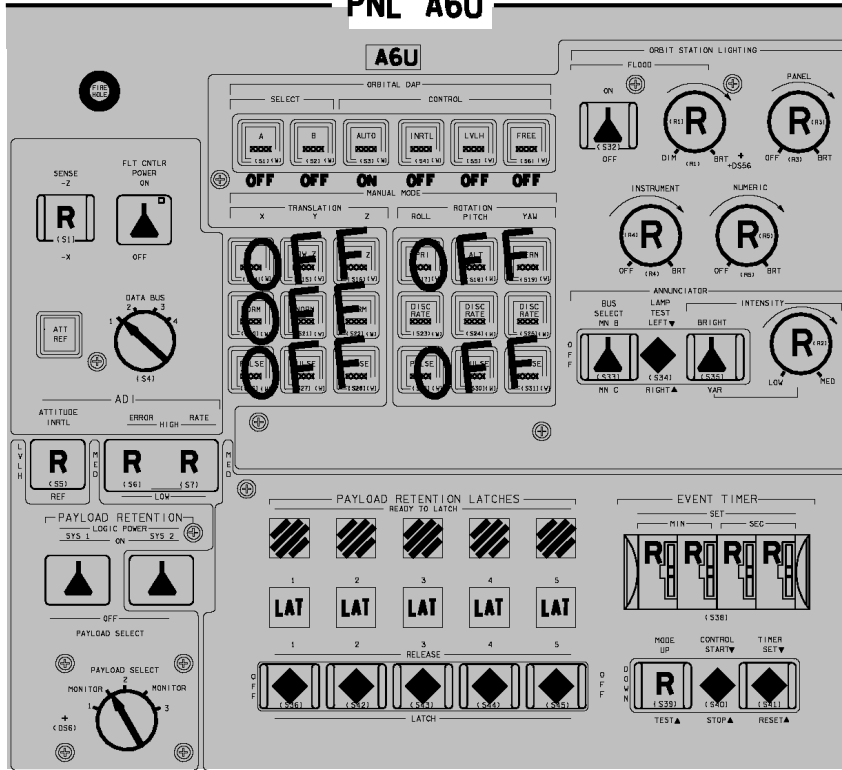

PNL A7U

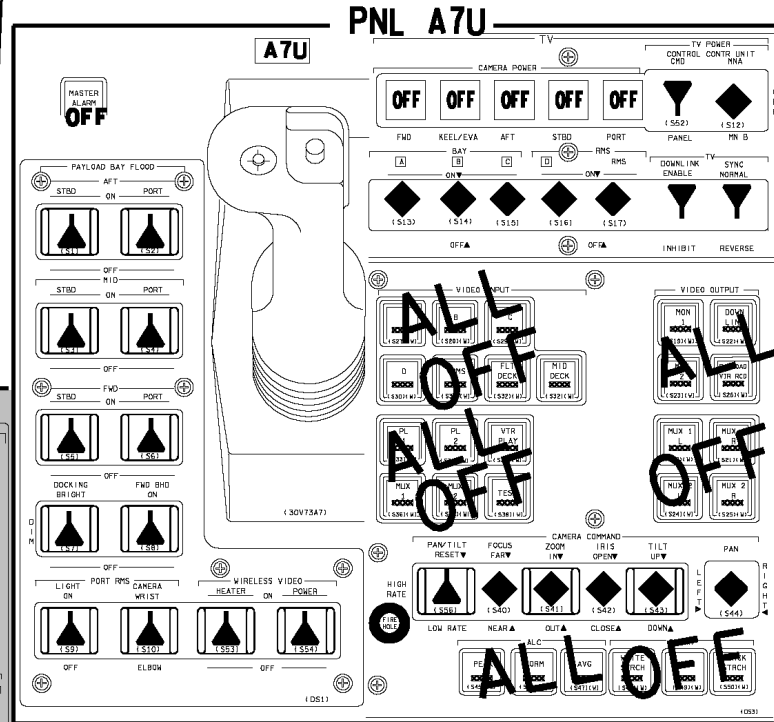

136V73A6A1

48007C327_104. PNL 1

(OV104) C3-20

OV104/DATE 04/11/01

C D/O/4/GEN H,1

OV104 I

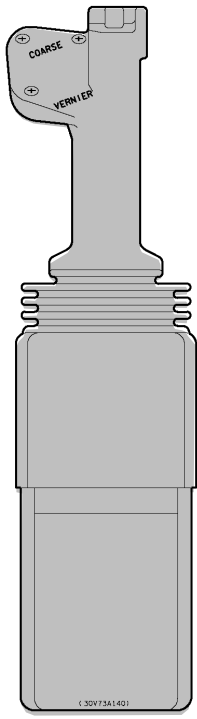
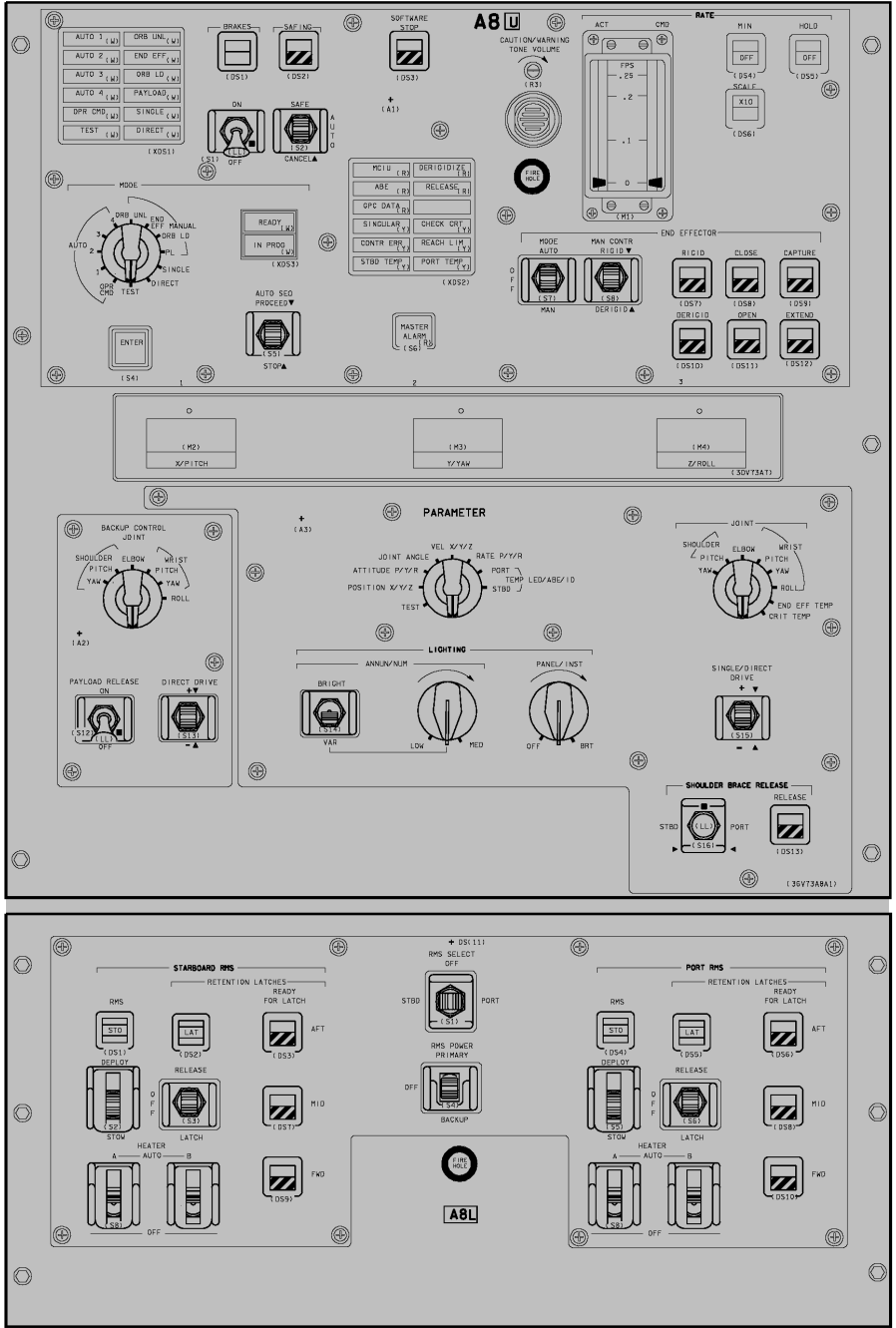

48007C3220_101_PNL 1 ALL VEH/DATE 02/14/00

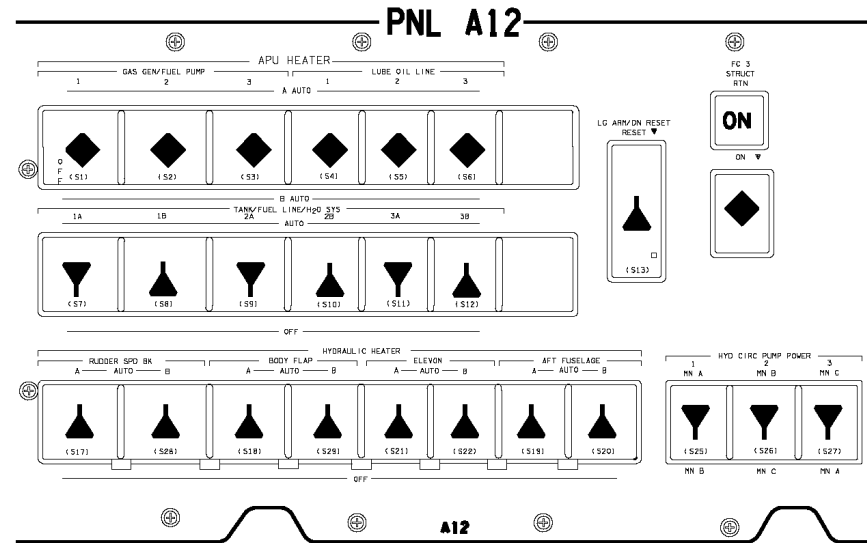
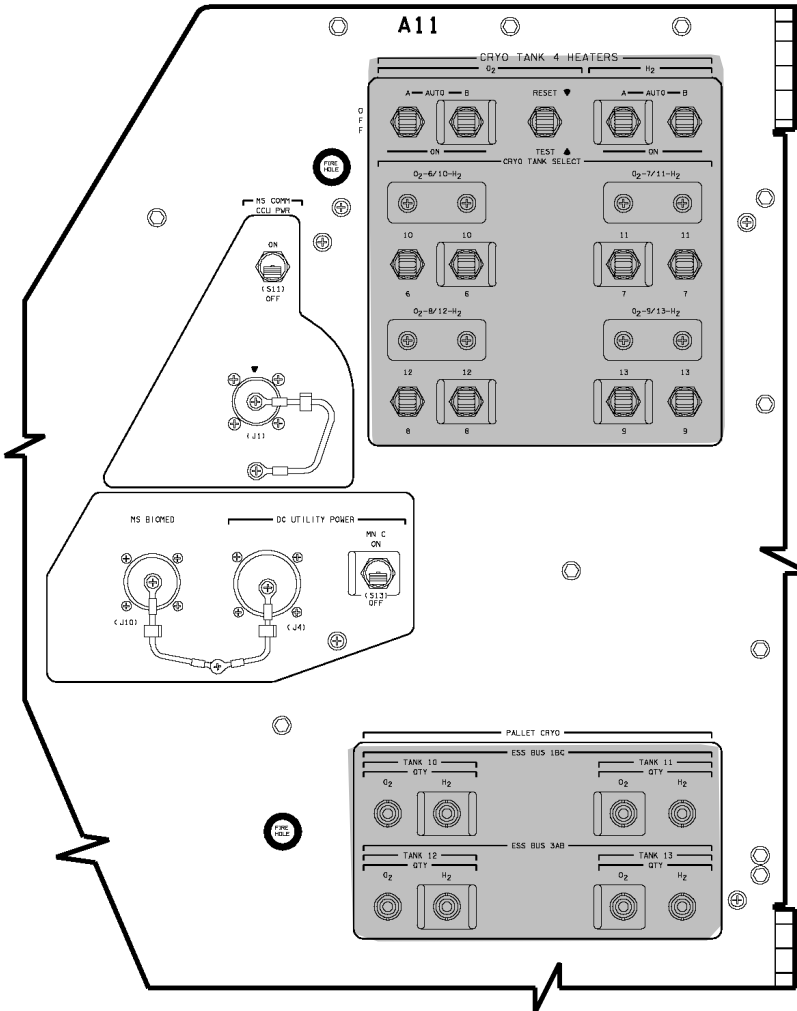

A6L

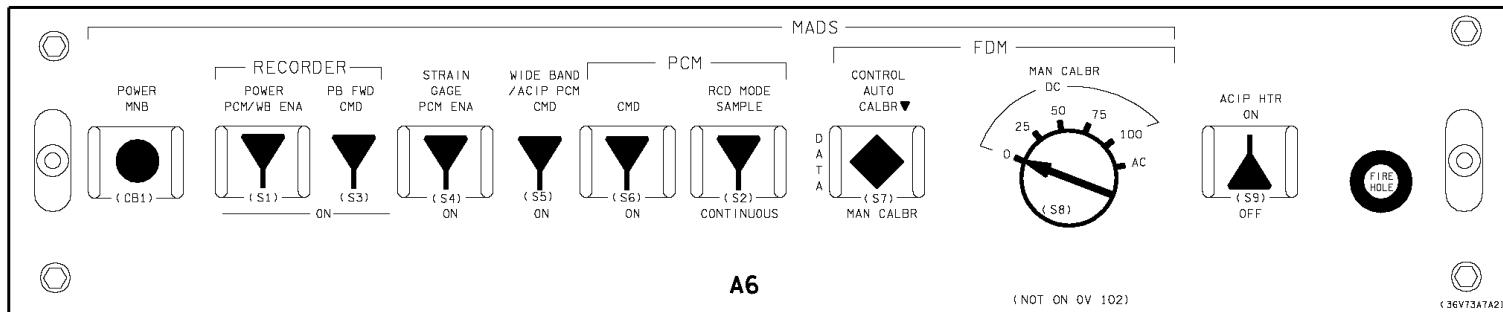
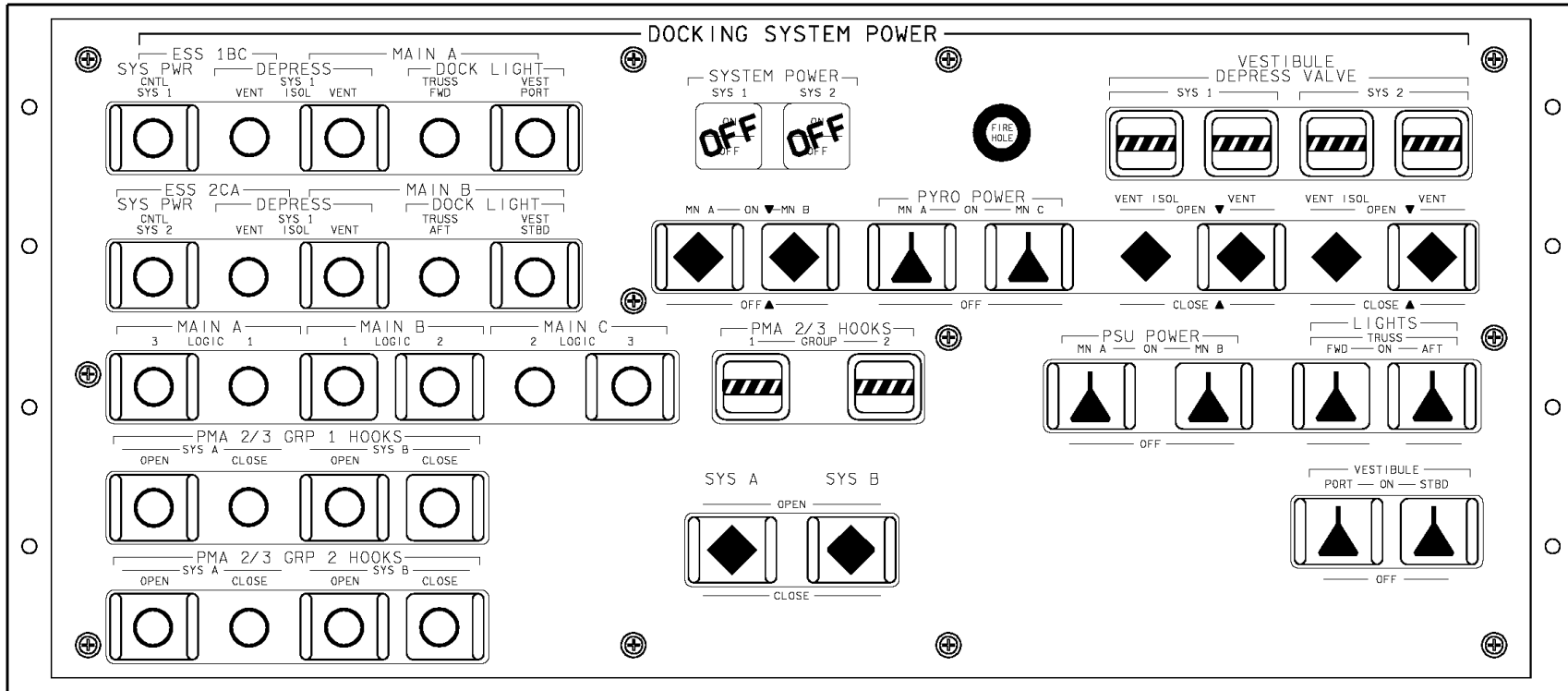

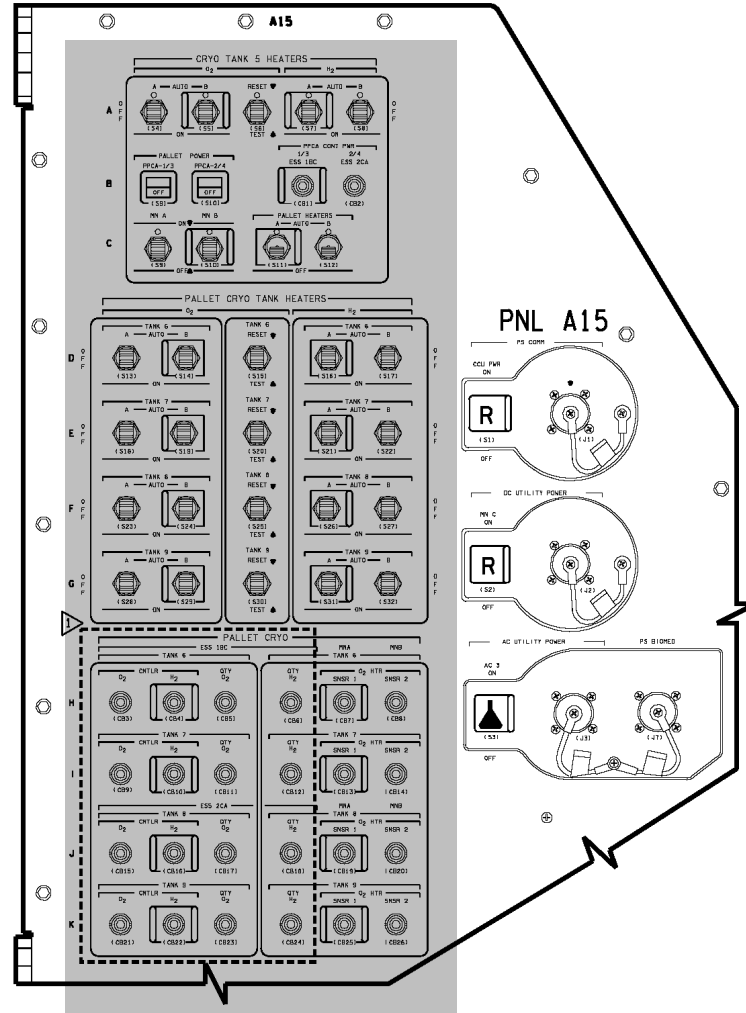
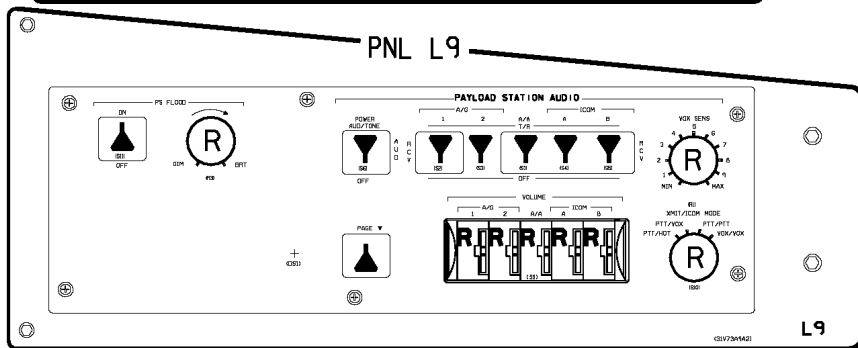
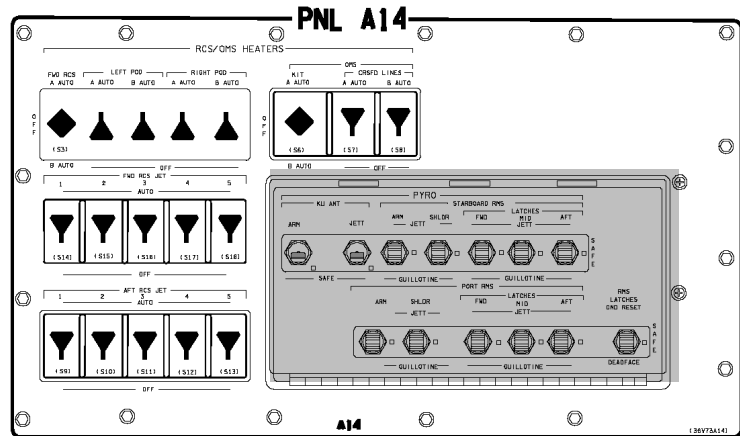

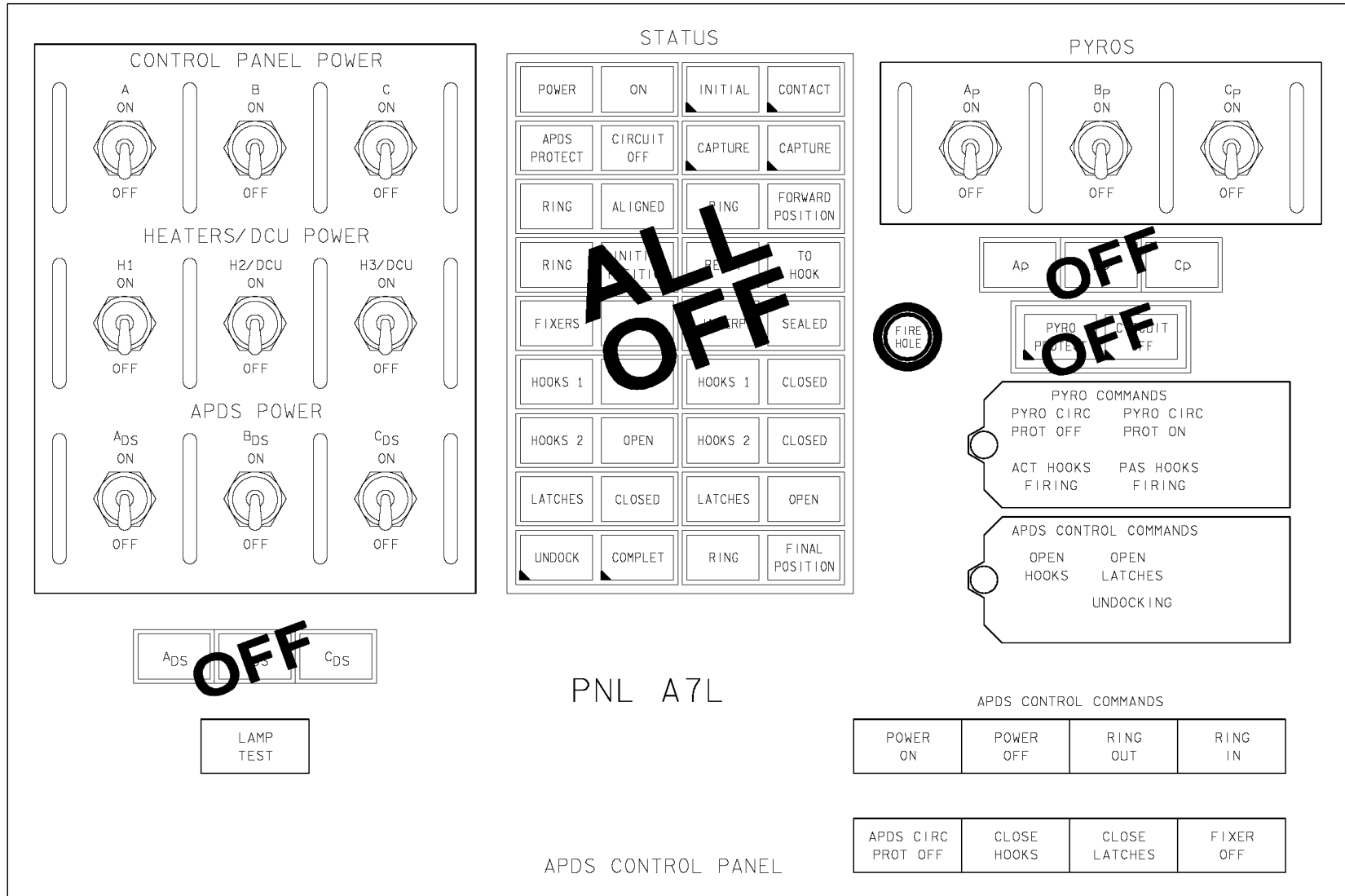

OV104

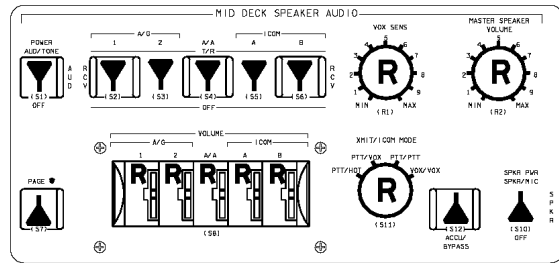

PNL M042F

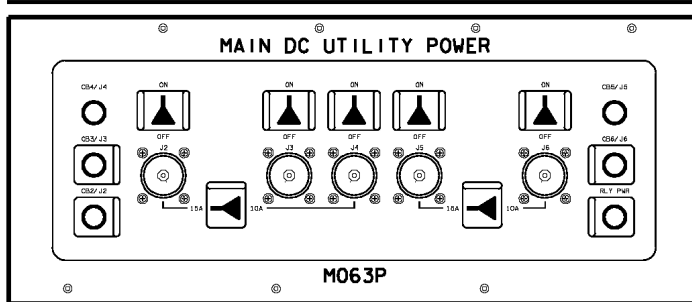
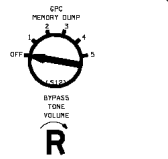

M063P

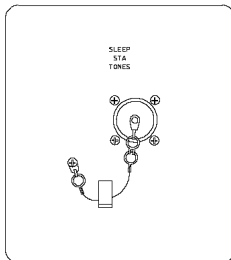

PNL M058F

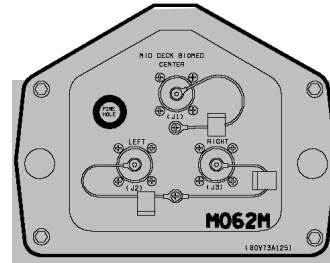
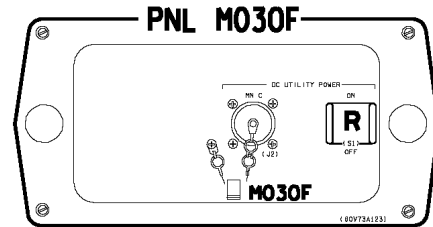
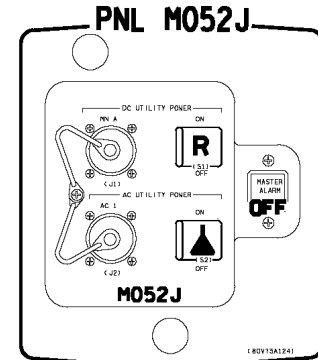
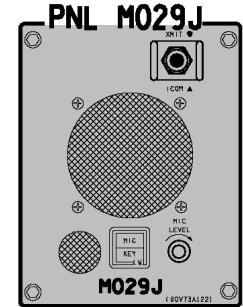
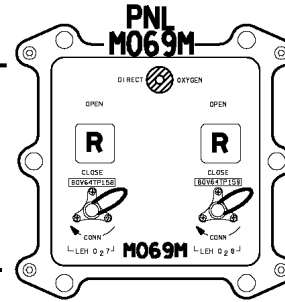
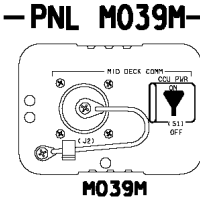
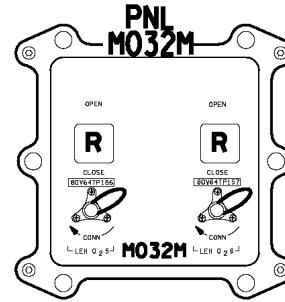
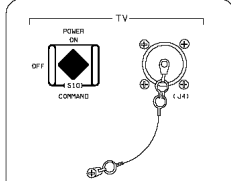

OV104

PNL MA73C

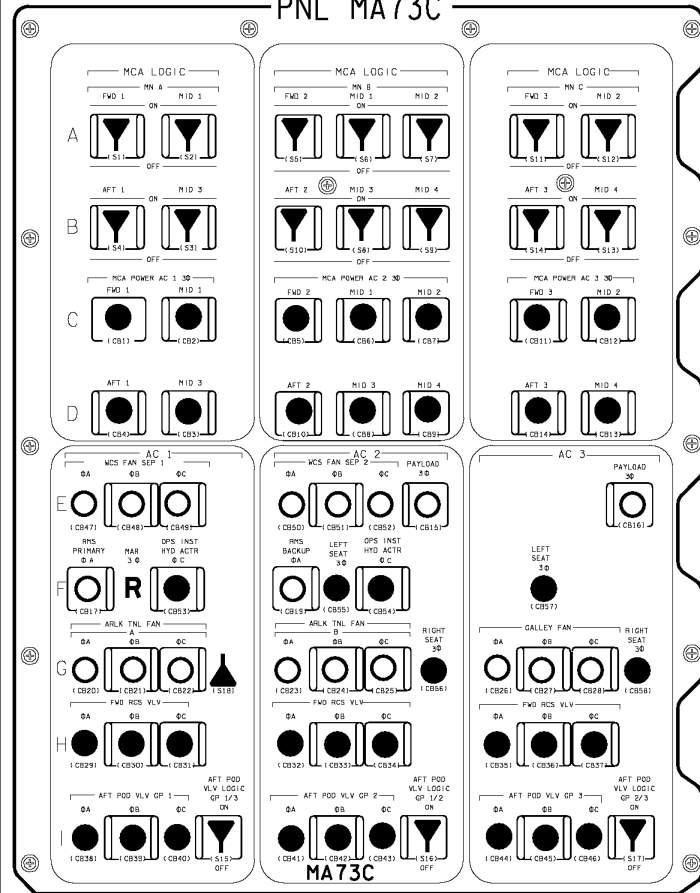

PNL ML86B

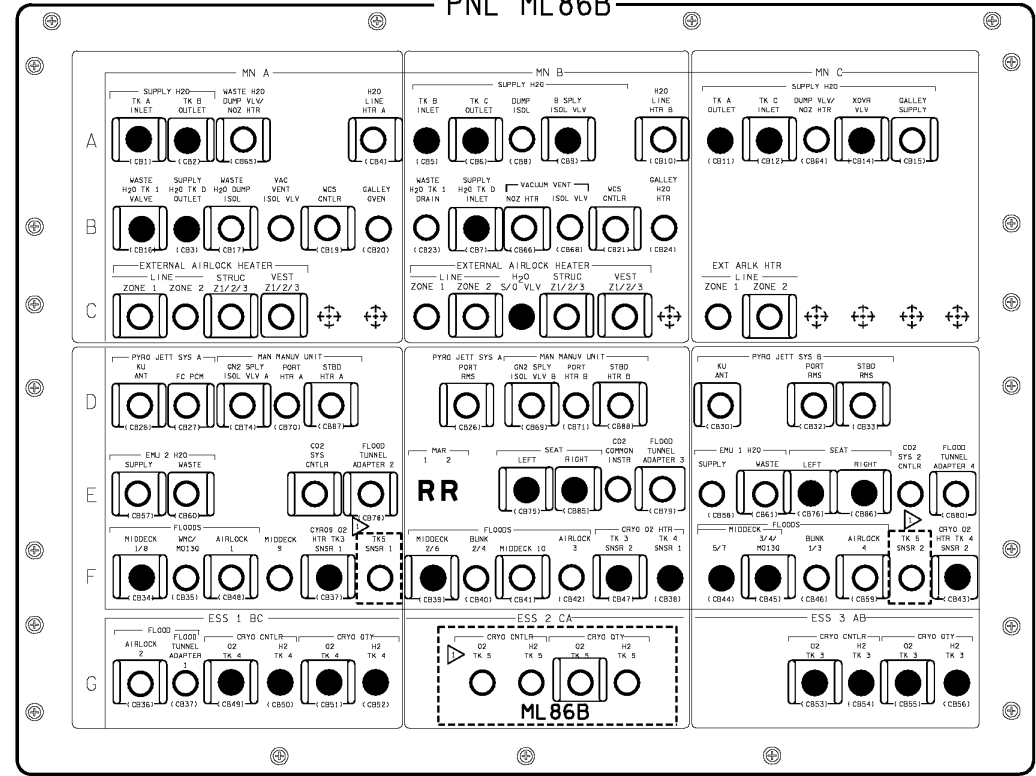

NOTES: ▷ CLOSED IF TK5 FLOWN

OV104

OV104

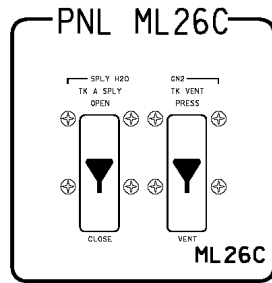
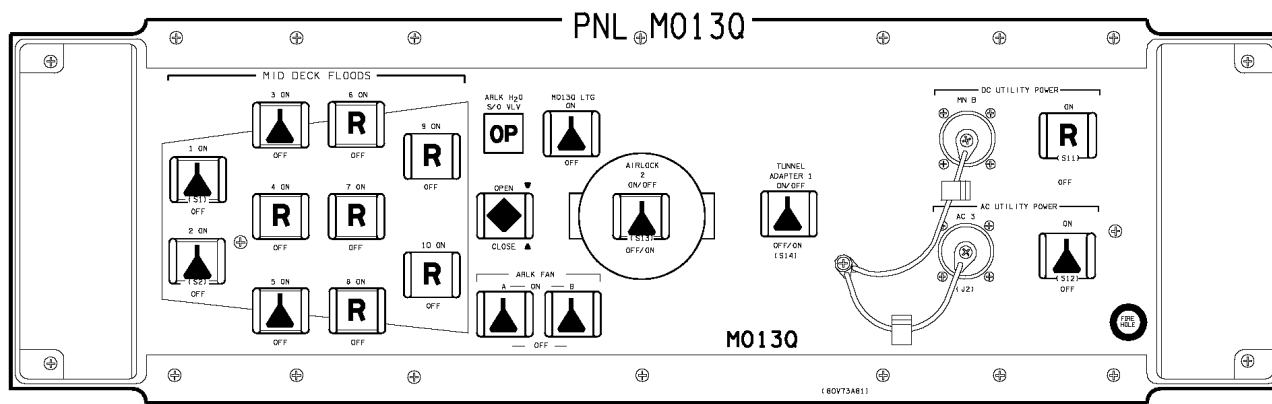

PNL MD24K

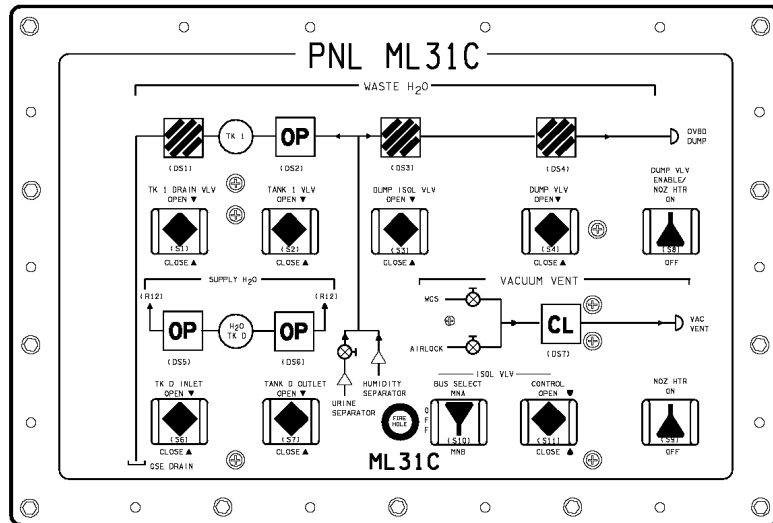
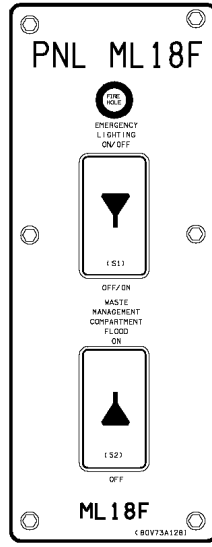
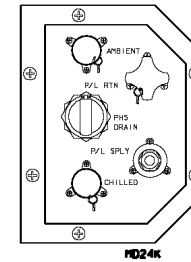

PNL MD44F
CAB TEMP CNTL ACT LINKAGE - SECONDARY ACTUATOR

OV104

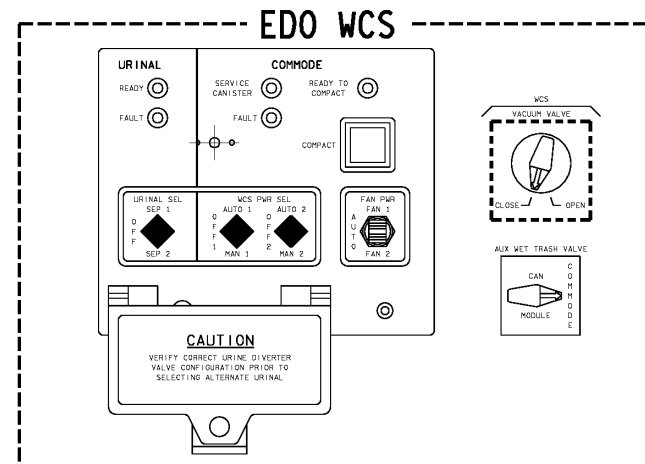
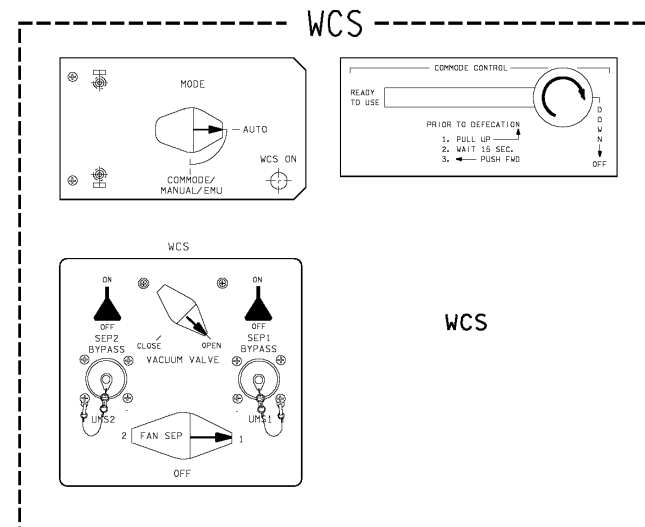
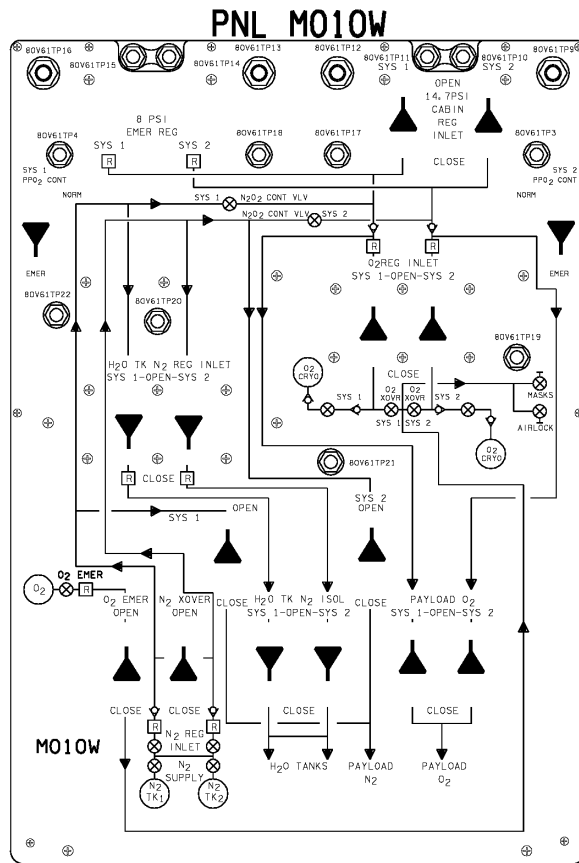

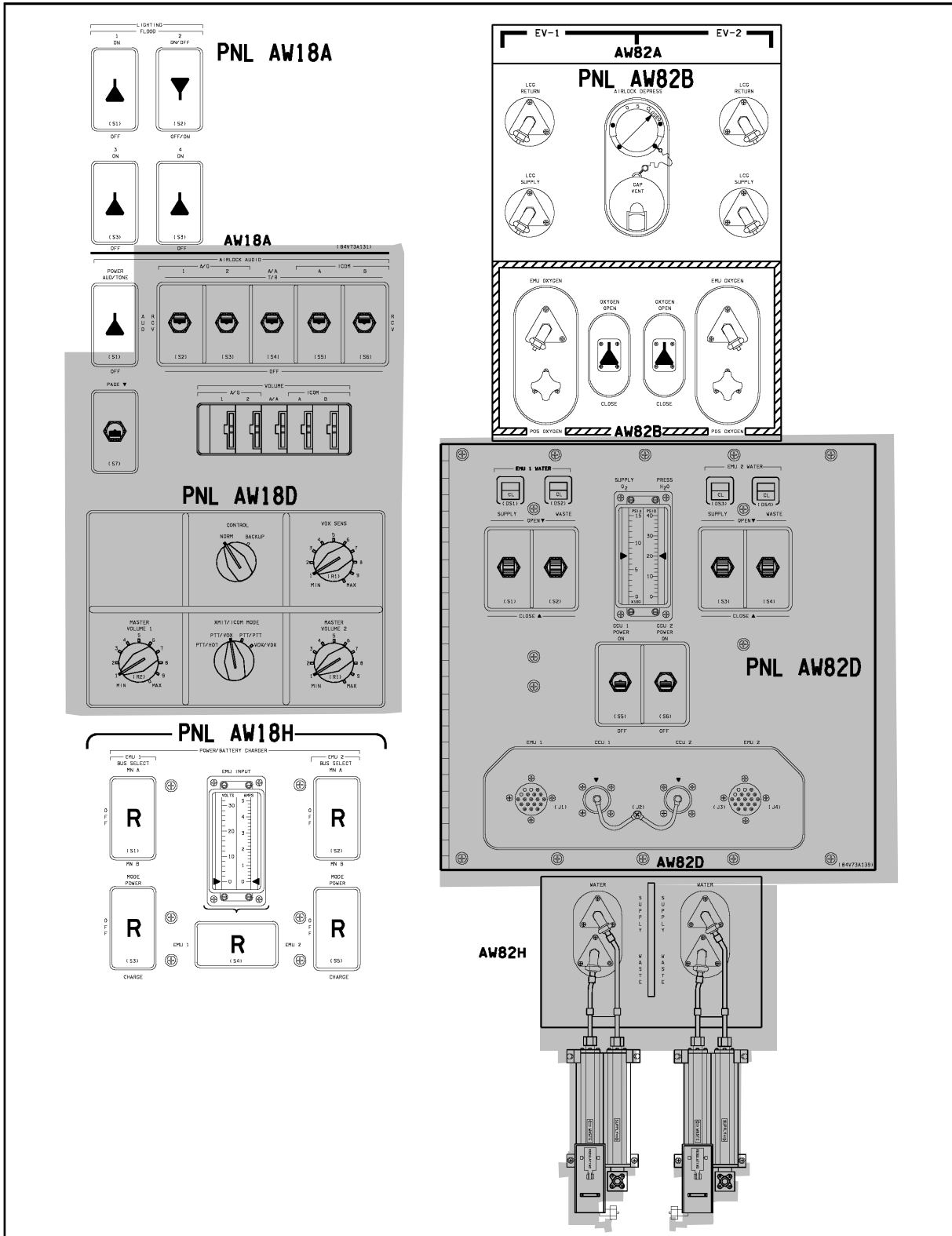

ALL VEH/DATE 02/14/00

48007C331_101 - PNLs 1

OV104

(OV104) C3-30

C D/O/ALL/GEN H,1

Inner Hatch

Actuator Handle – LATCHED

Lock Lever – LOCKED

Equalization vlv (two) – NORM, capped

This Page Intentionally Blank

OV105

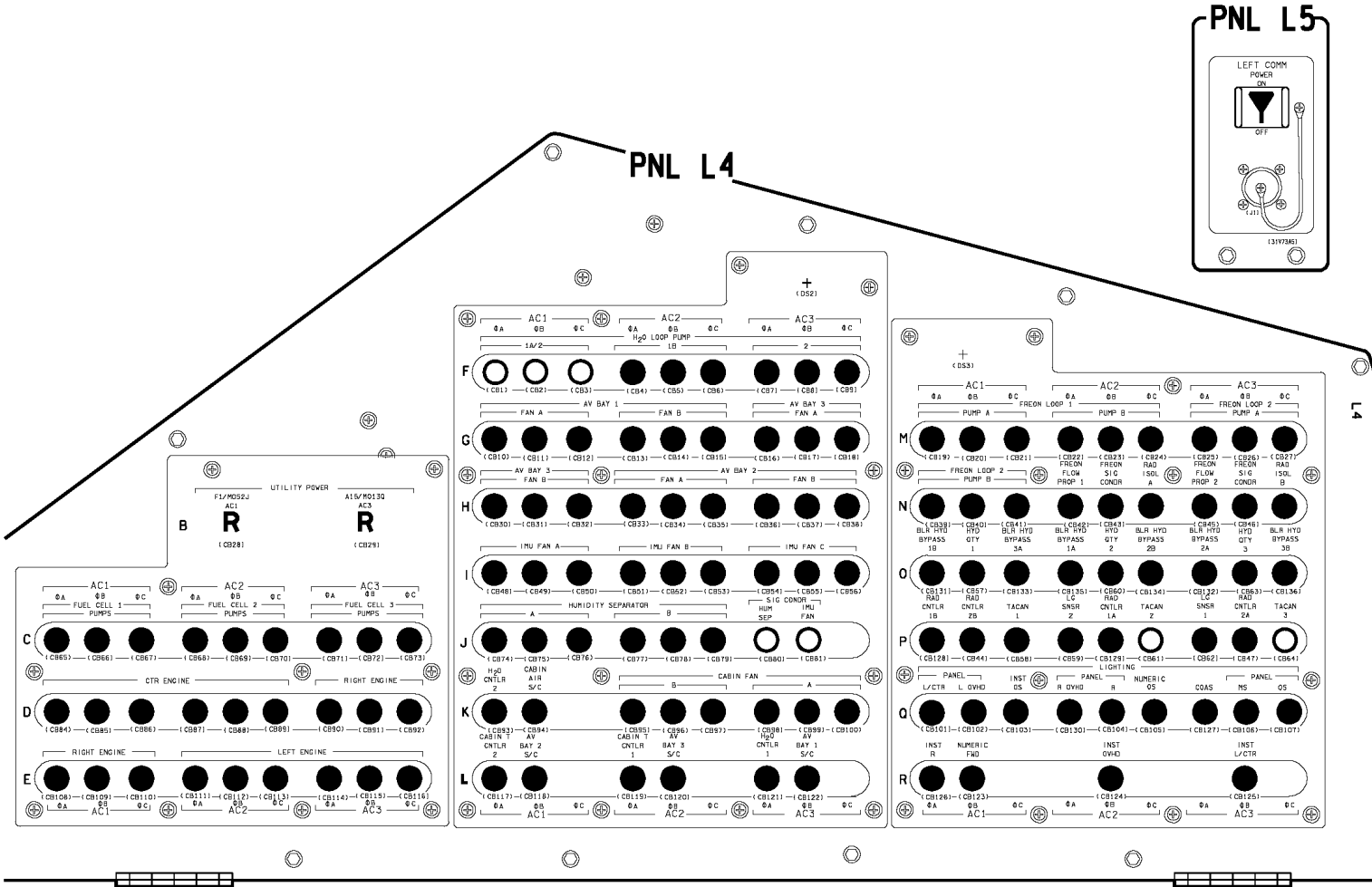

OV105

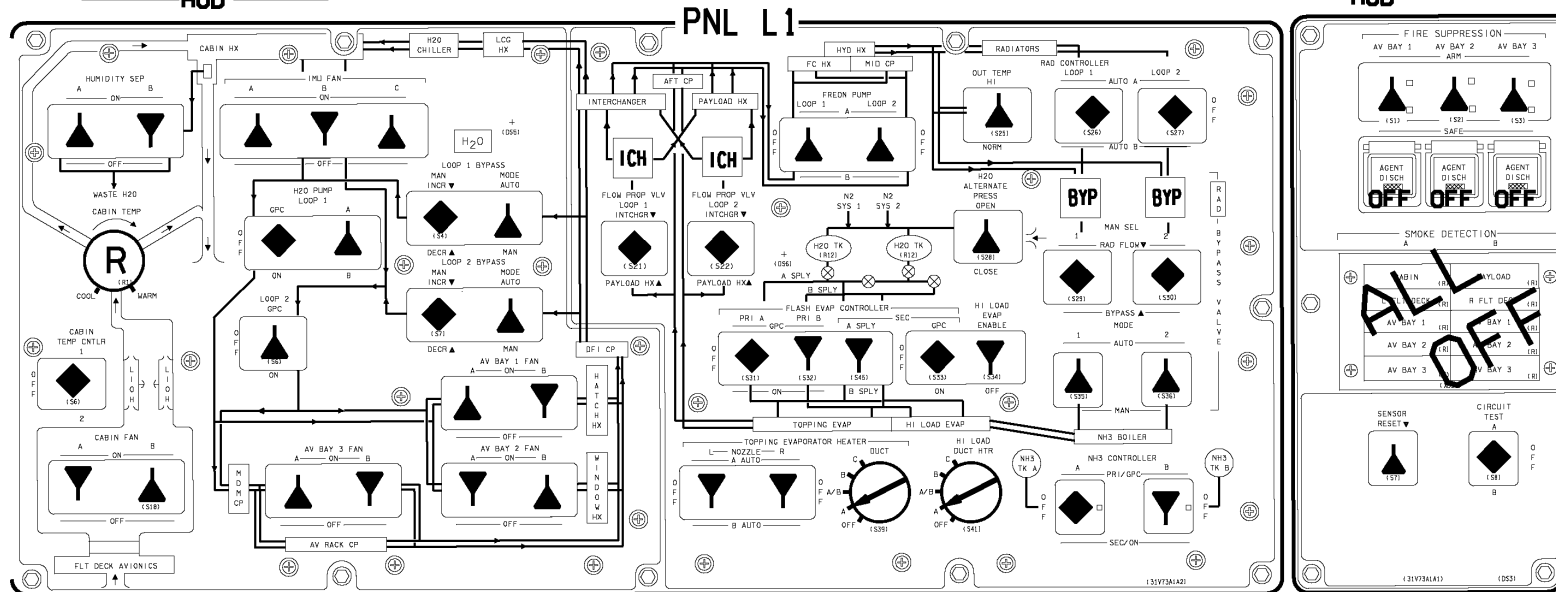
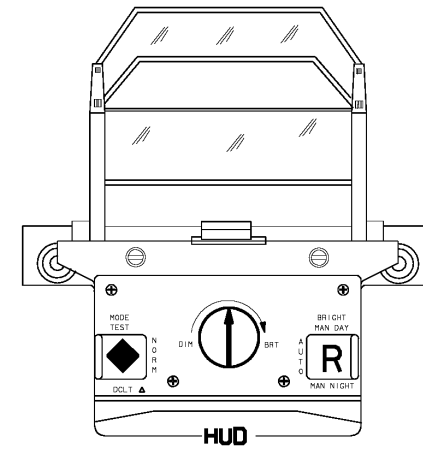
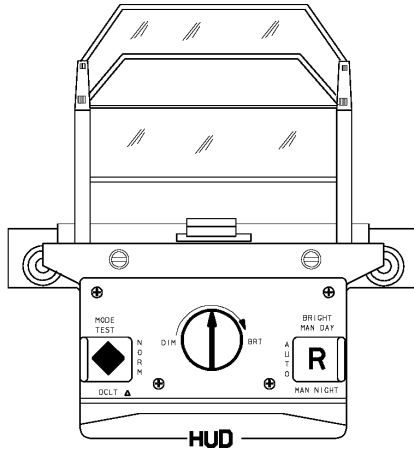
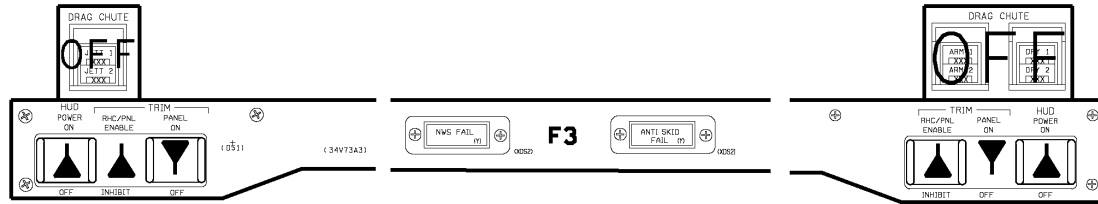

48007D304_109. PNL 1

OV105/DATE 02/01/02

(OV105) D3-4

C D/O/ALL/GEN H,7

OV105

OV105

PNL L2

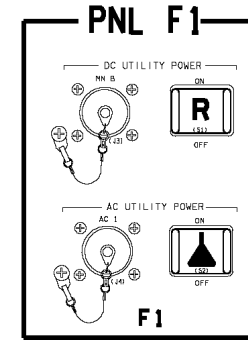
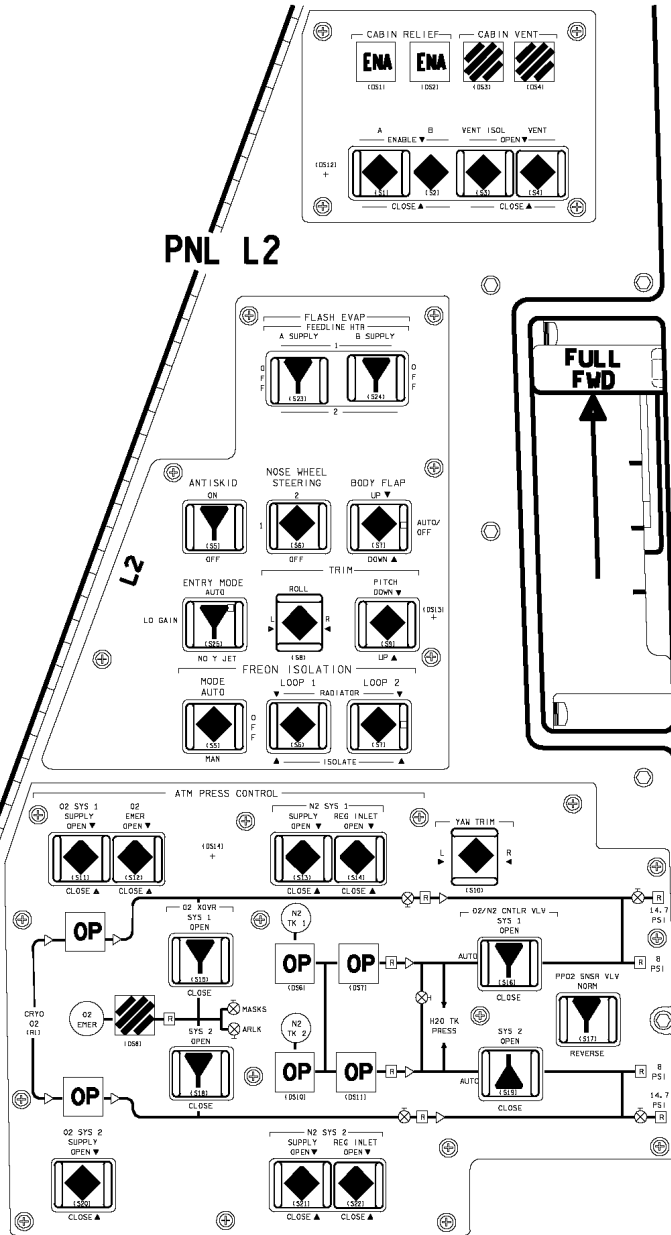

FULL FWD

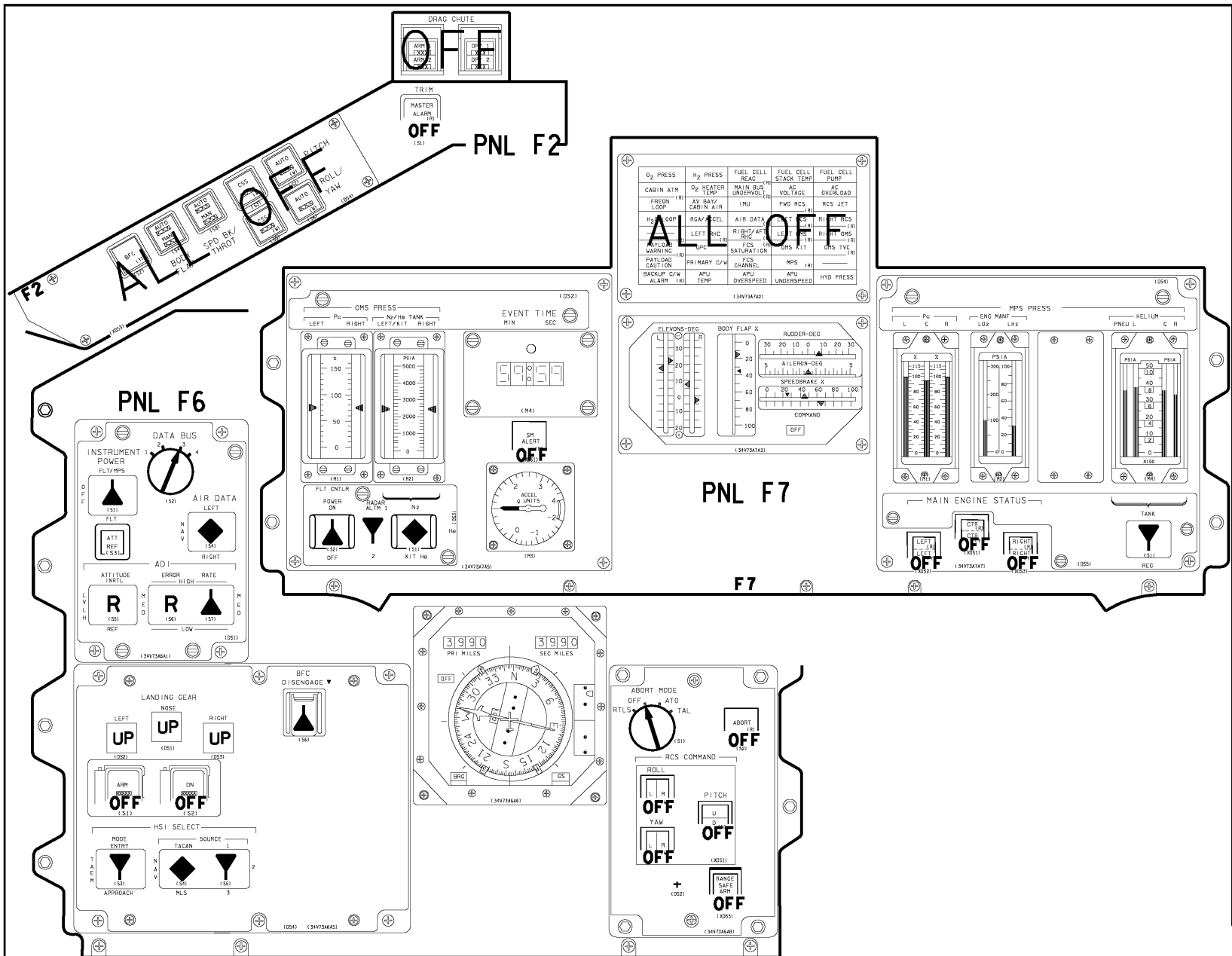

48007D306_101. PNL # 1

(OV105) D3-6

ALL VEH/DATE 02/15/00

C D/O/ALL/GEN H

OV105

PNL C2/C3

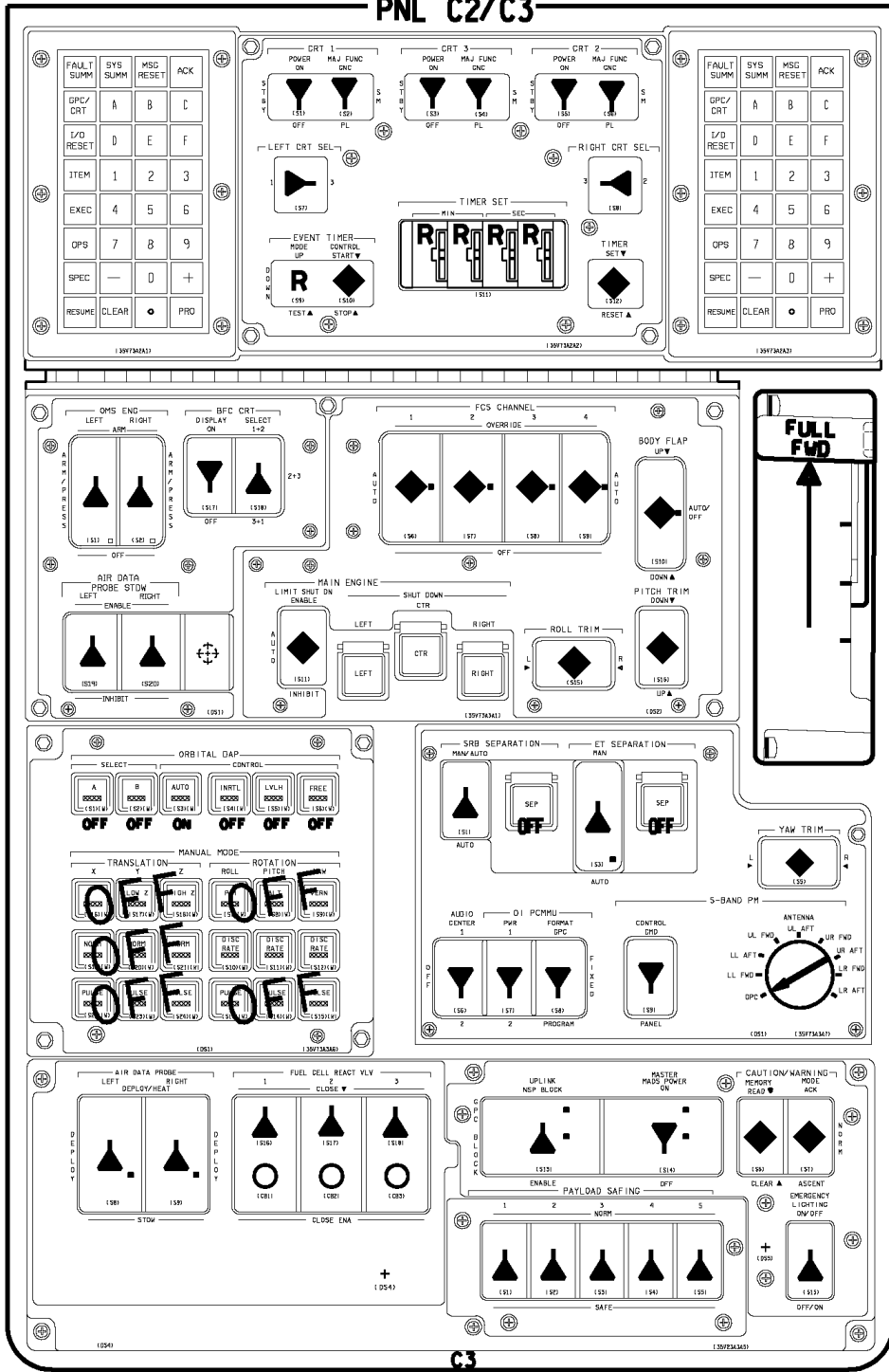

OV105

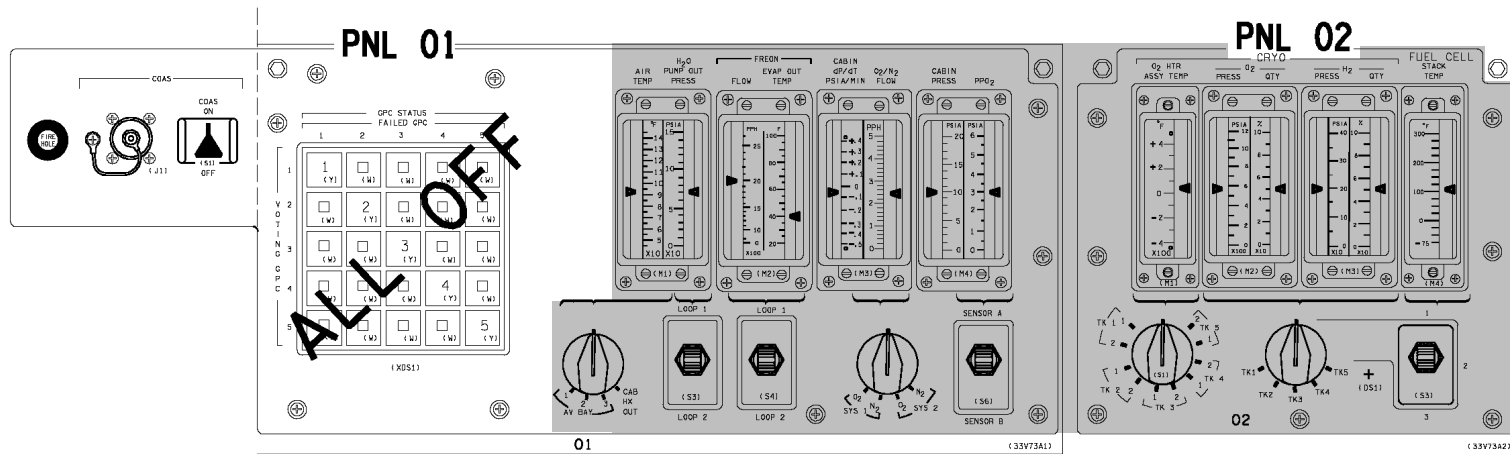

L side OVHD flood - R (MID)

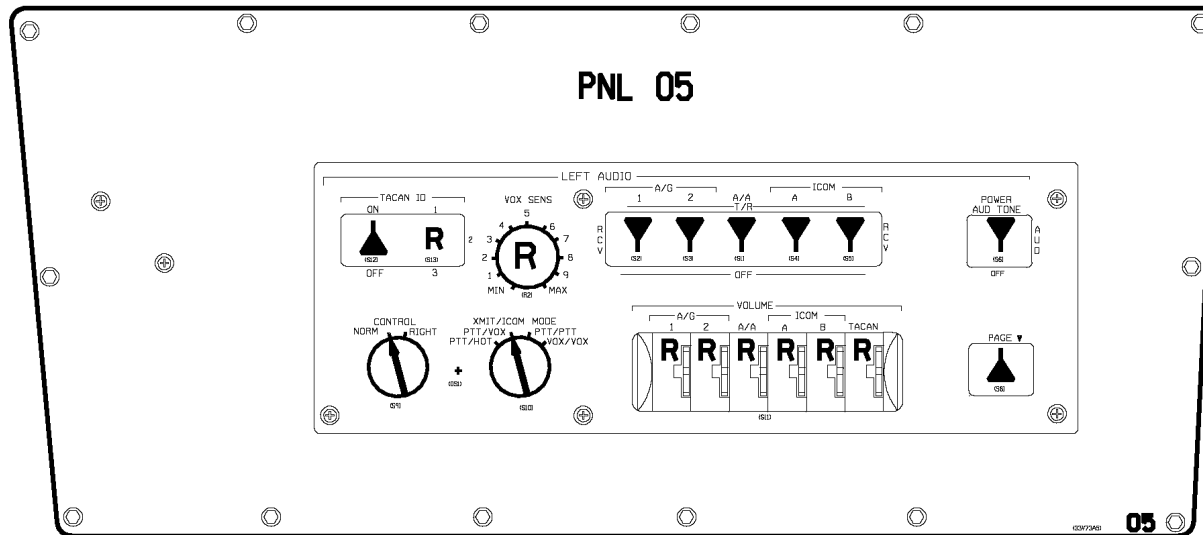

OV105

PNL 06

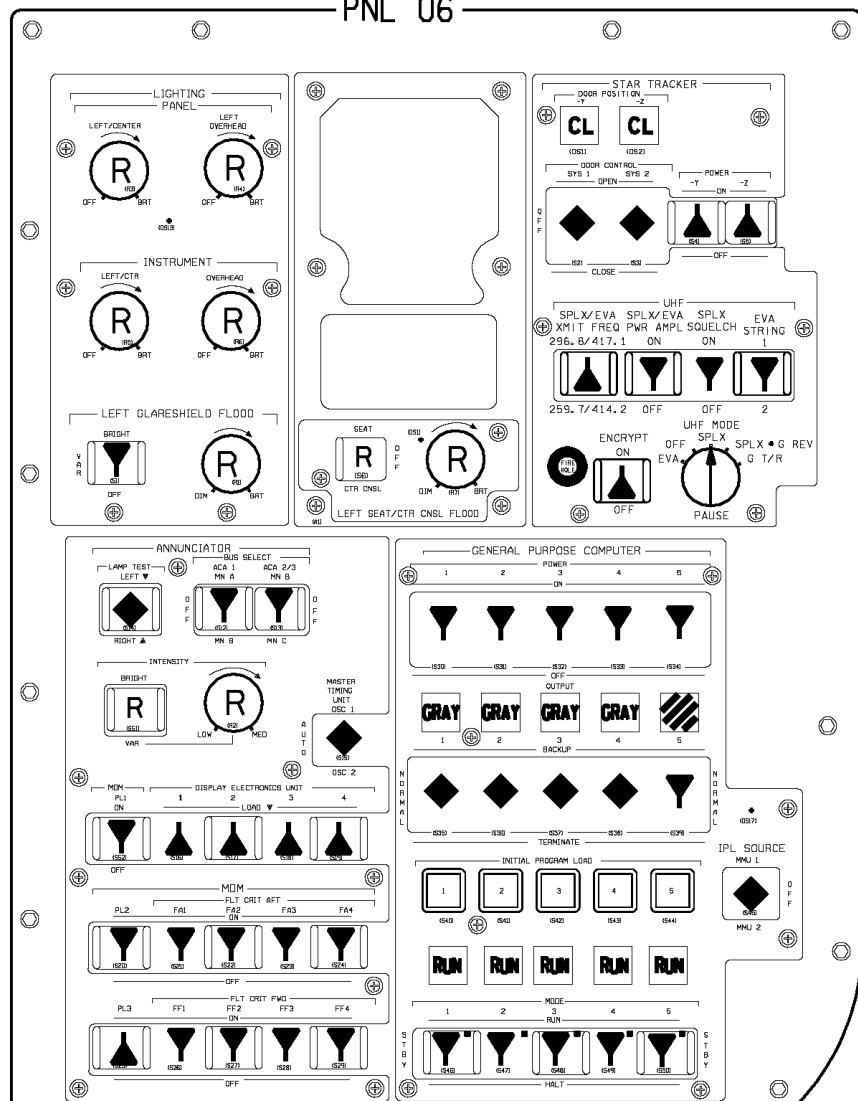

PNL 07

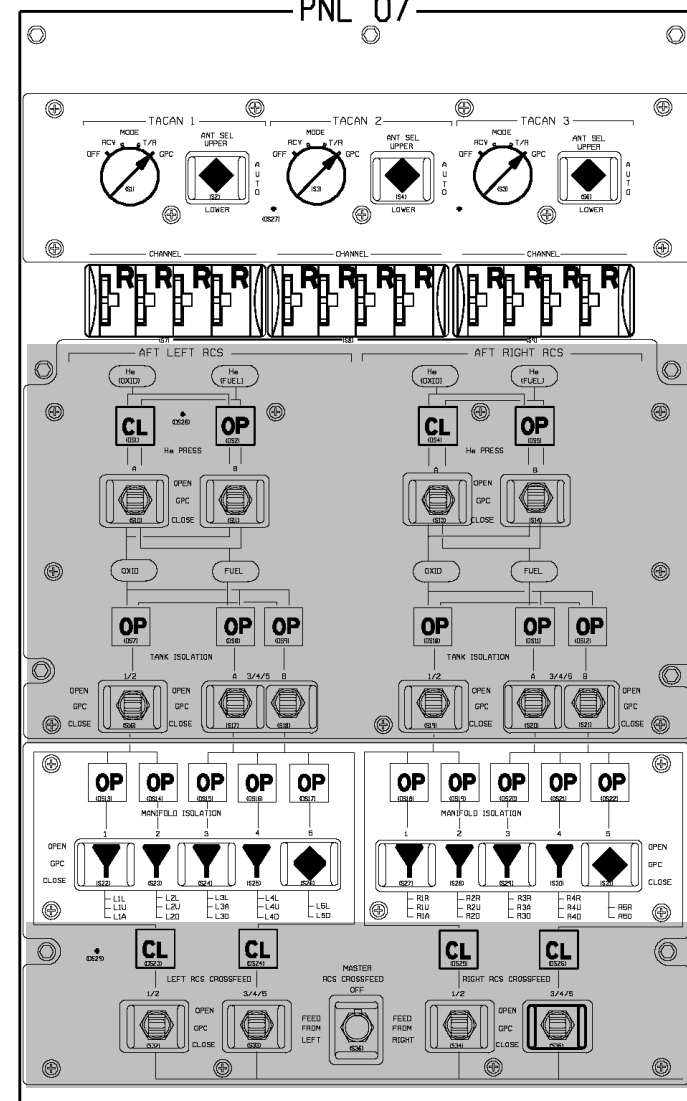

OV105

OV105

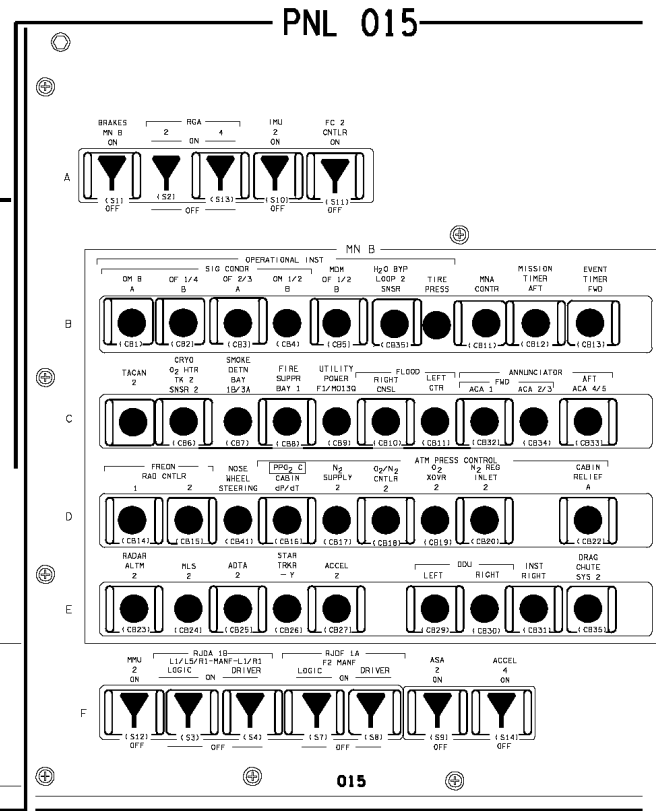
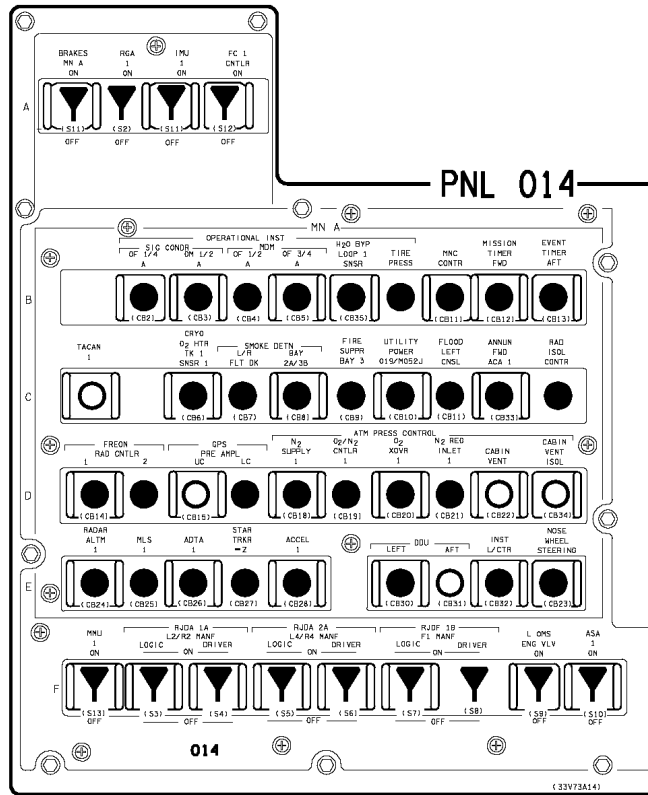
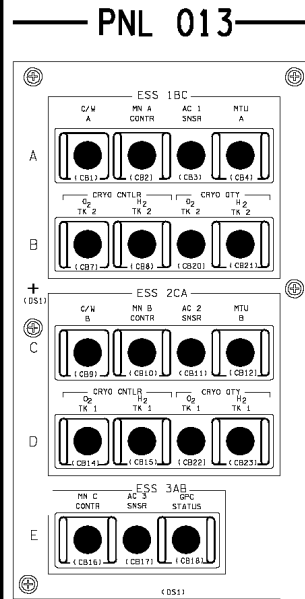

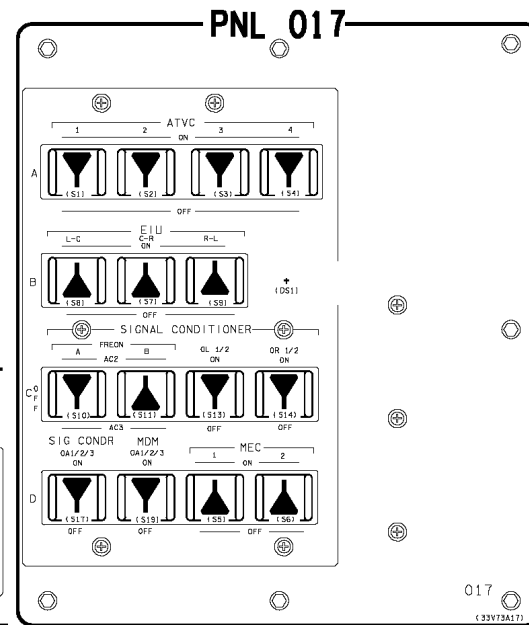
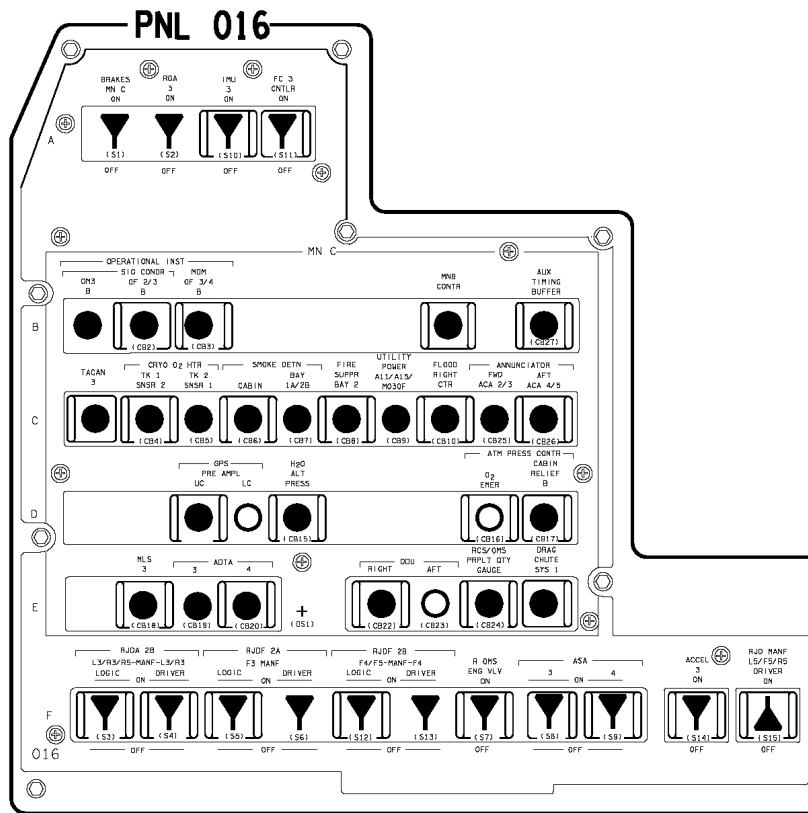

PNL 08

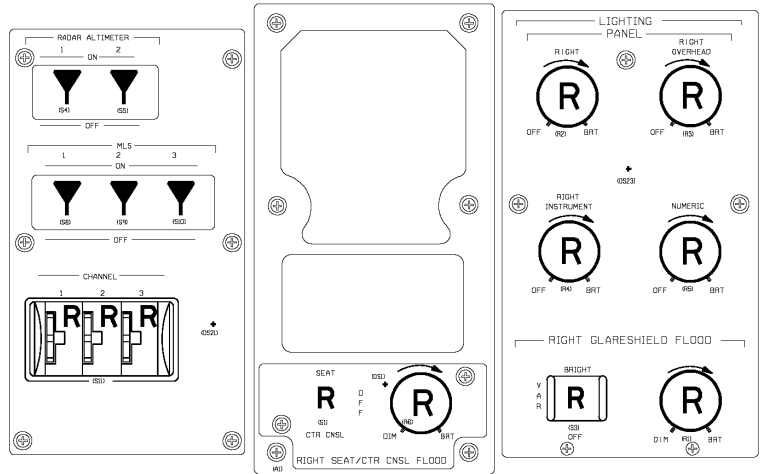

PNL 09

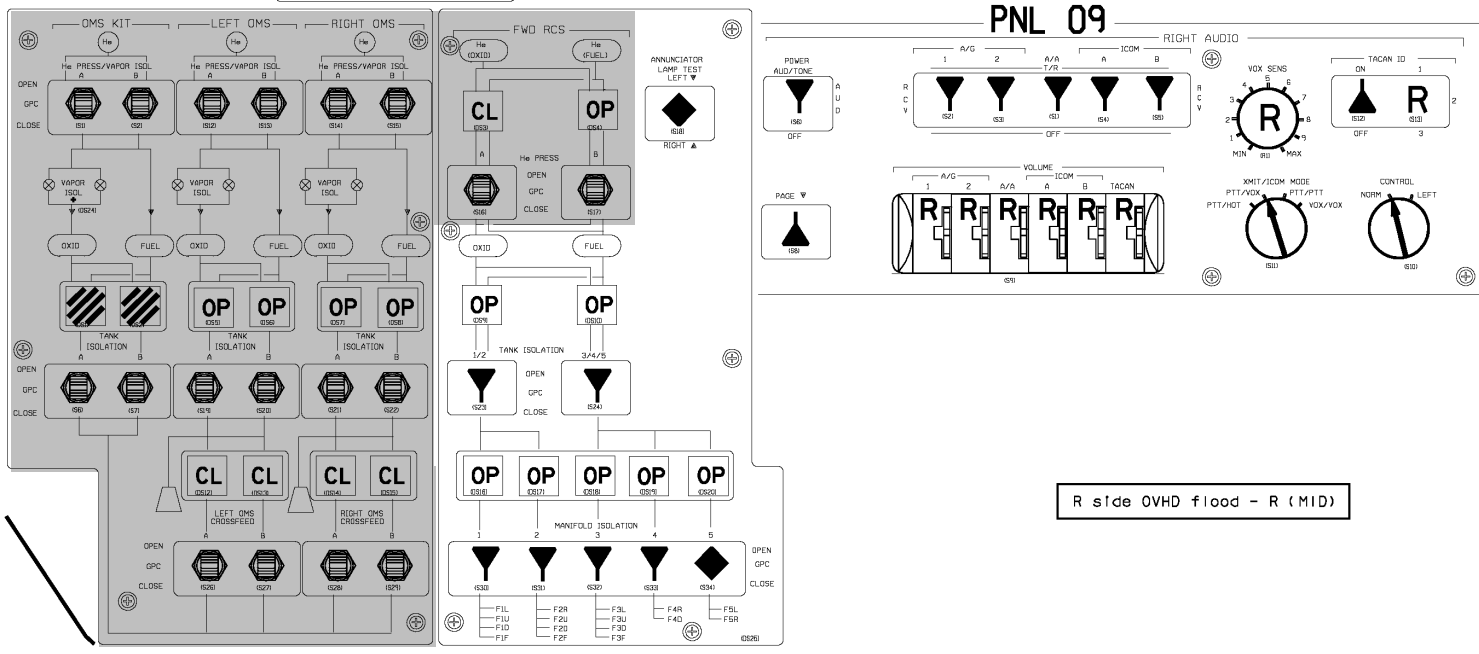

R side OVHD flood - R (MID)

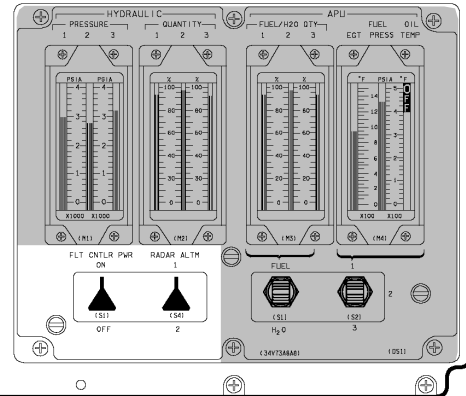
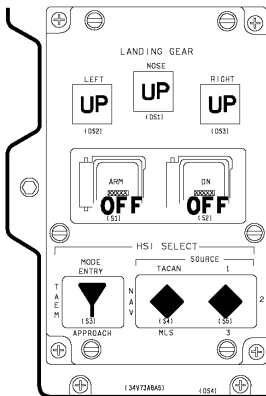
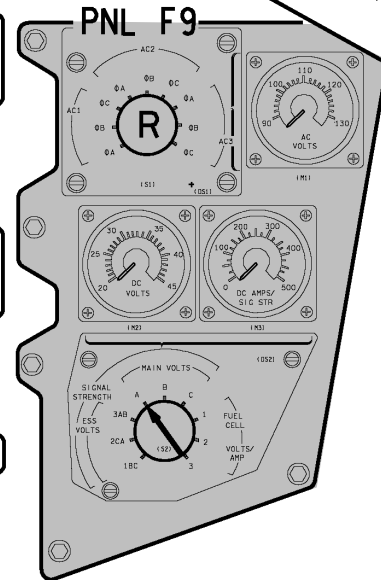
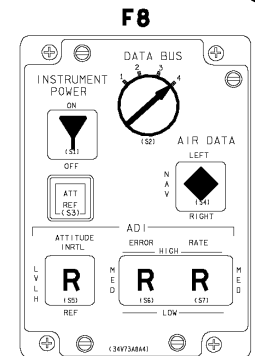
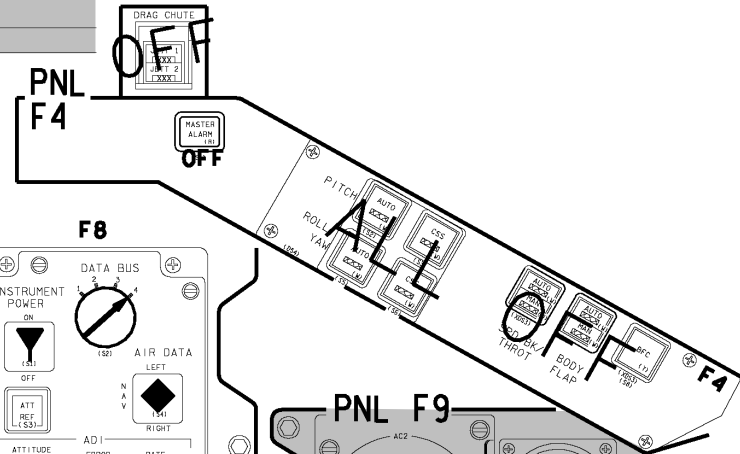
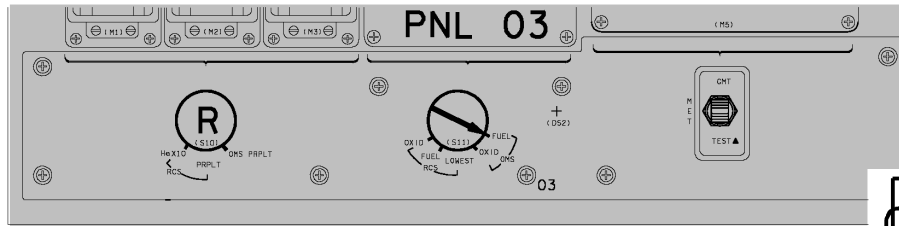

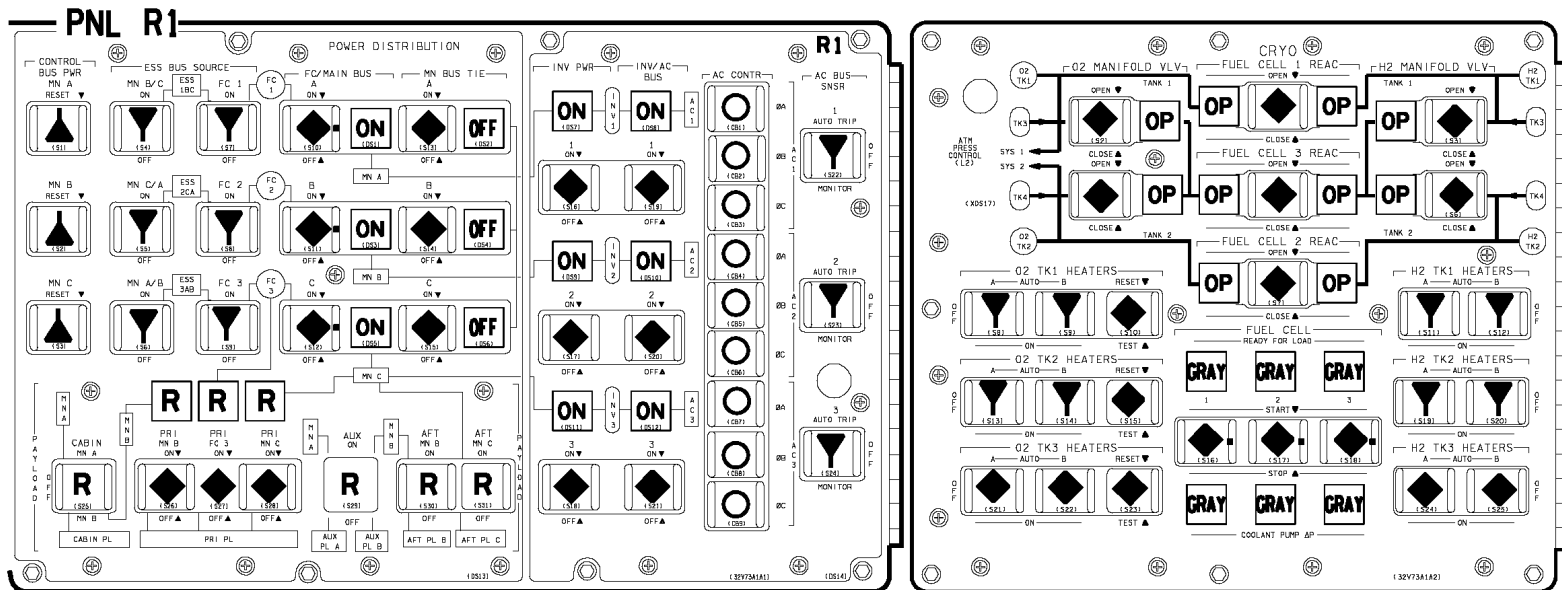

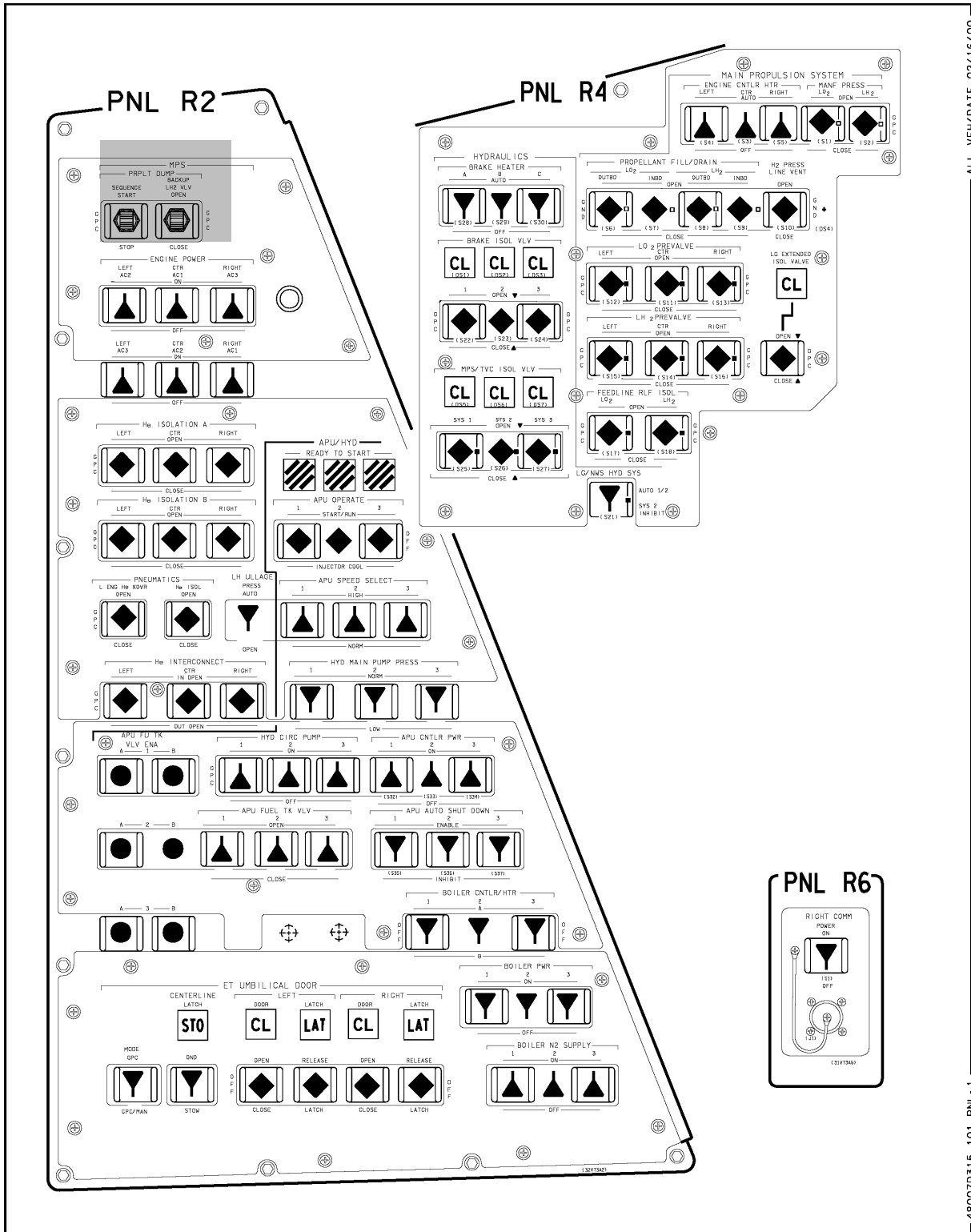

ALL VIEW/DATE 02/16/00

48007D315_101_PNL: 1

OV105

(OV105) D3-15

C D/O/ALL/GEN H

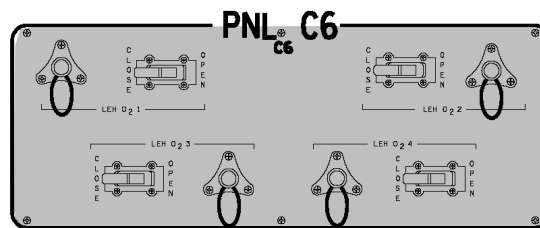
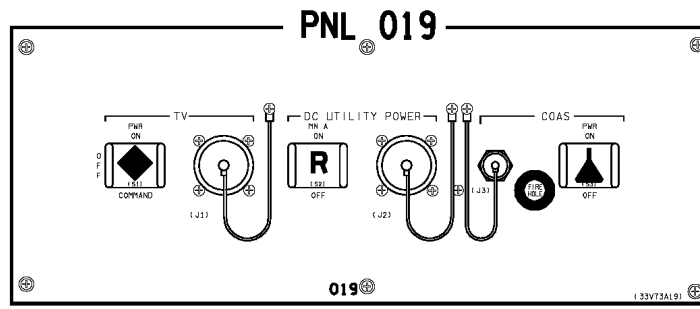

PNL C5



PNL C7

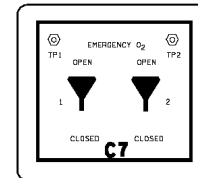

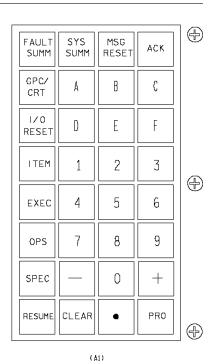
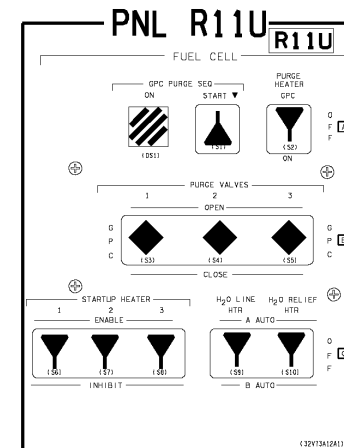
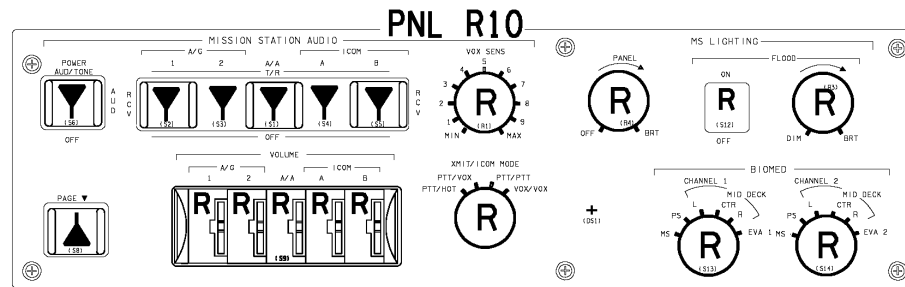

R11L

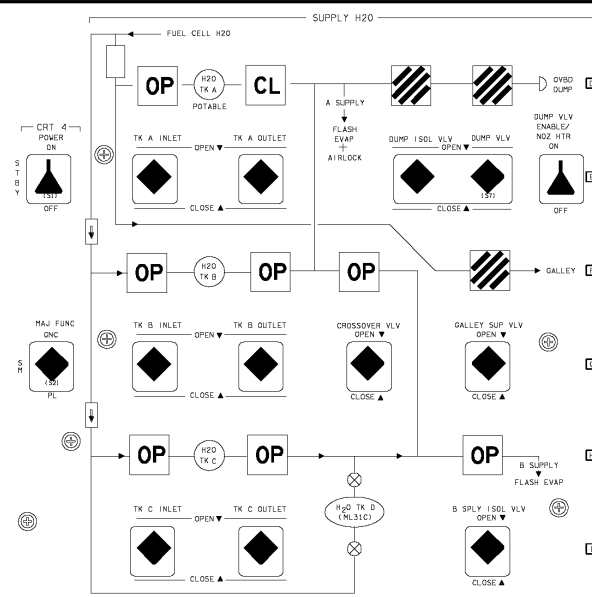

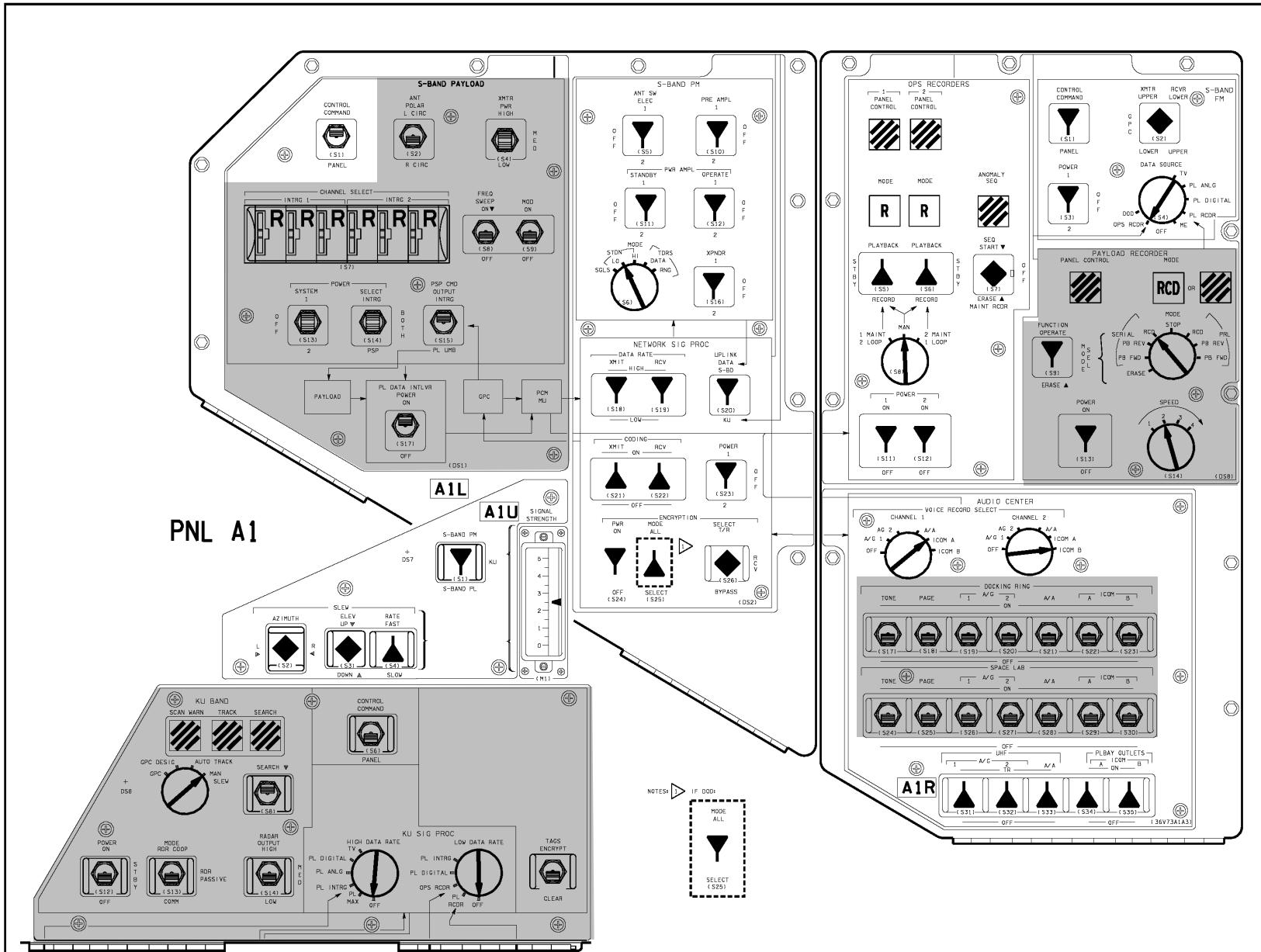

PNL A1

OV105

OV105

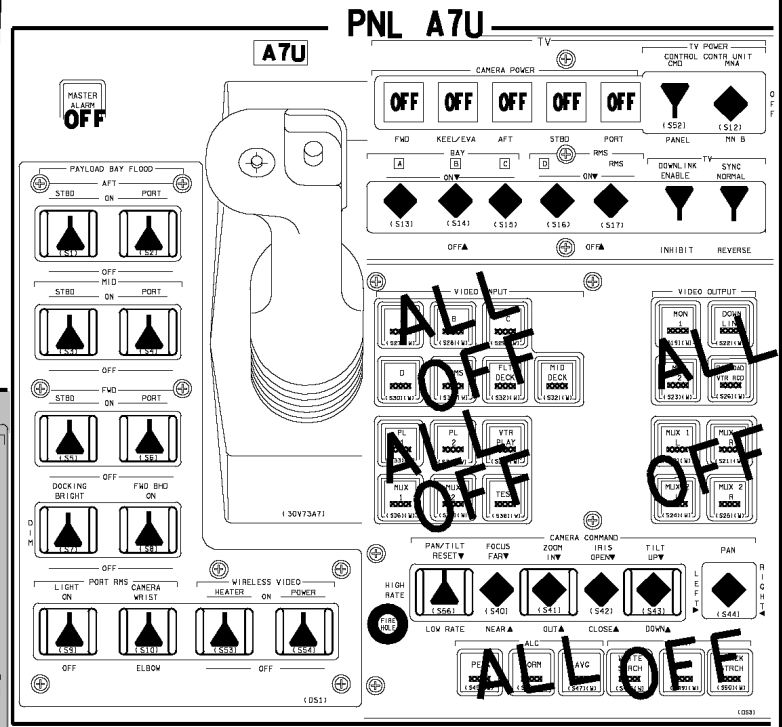
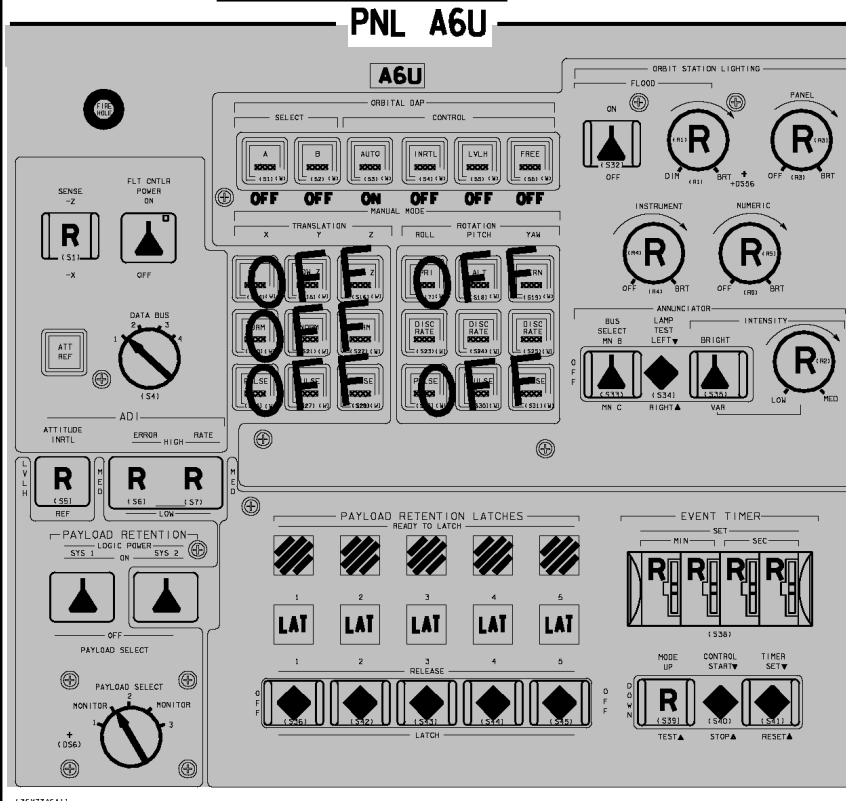
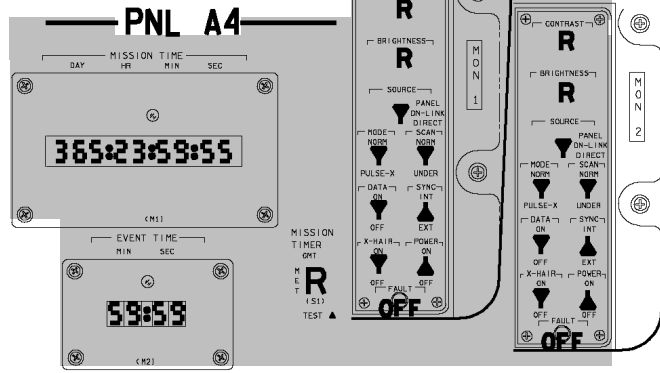

48007D327_104. PNL 1

(OV105) D3-20

OV105/DATE 04/11/01

OV105 | C D/O/5/GEN H,1

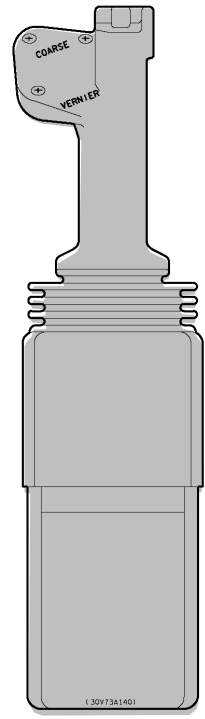
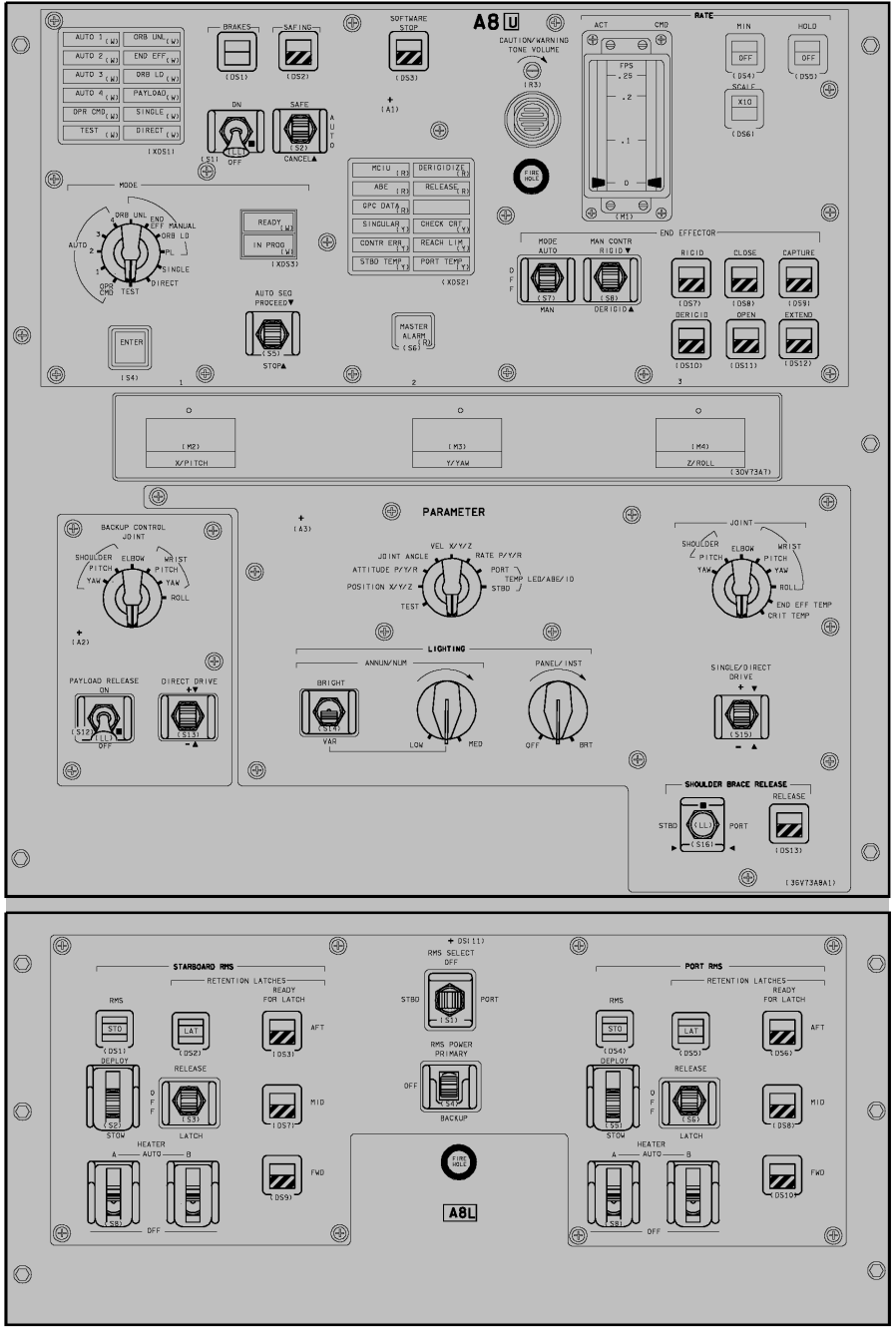

4800703220_101_PNL 1 ALL VEH/DATE 02/17/00

OV105

PNL A11

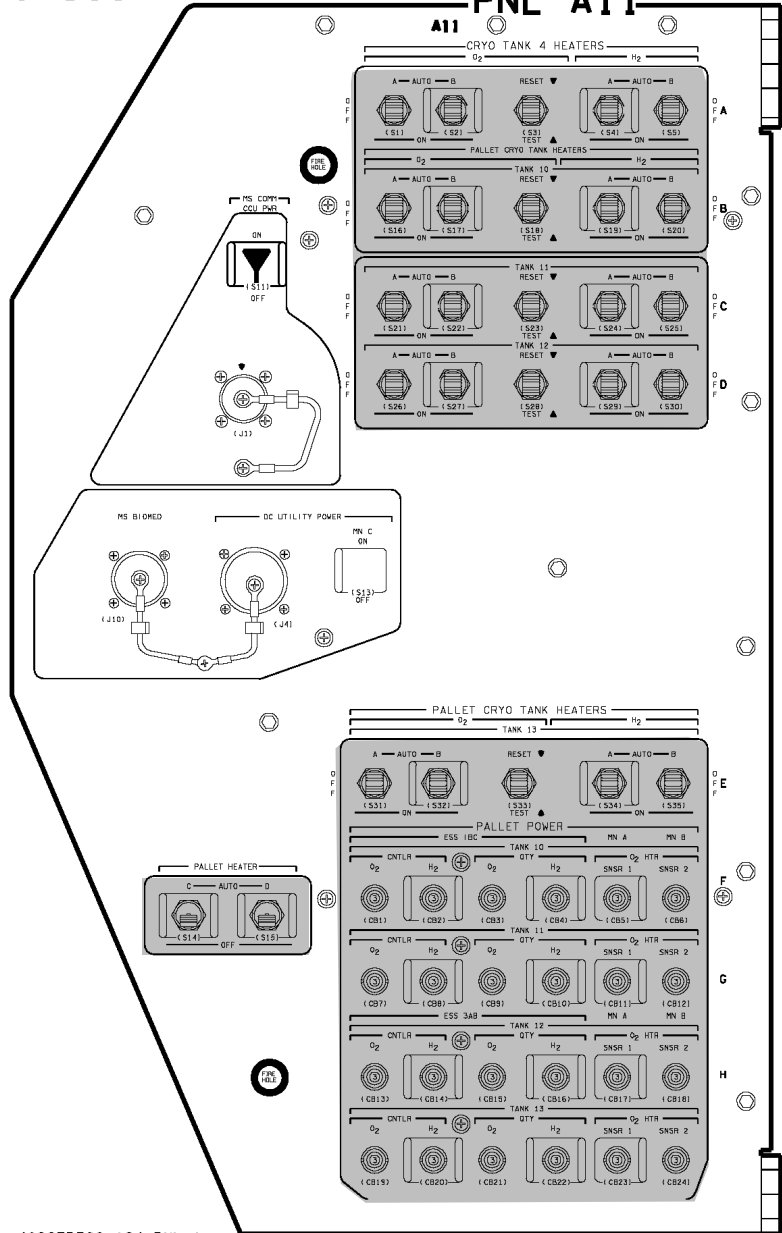

PNL A12

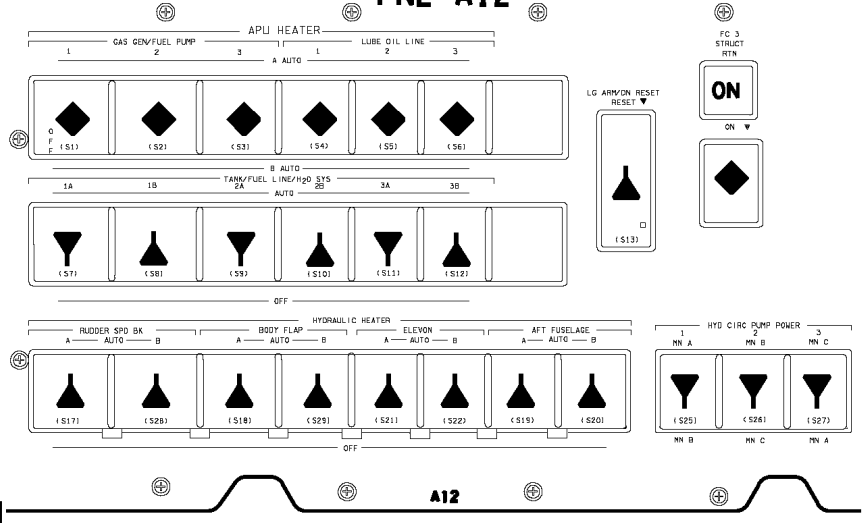

48007D329_104. PNL 1

OV105/DATE 04/11/01

(OV105) D3-22

OV105 | C D/O/5/GEN H,1

A6L

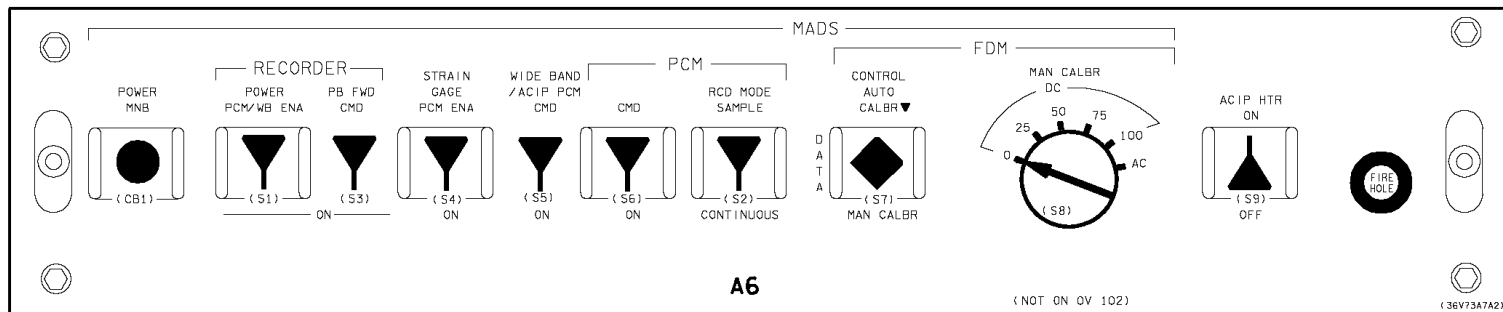
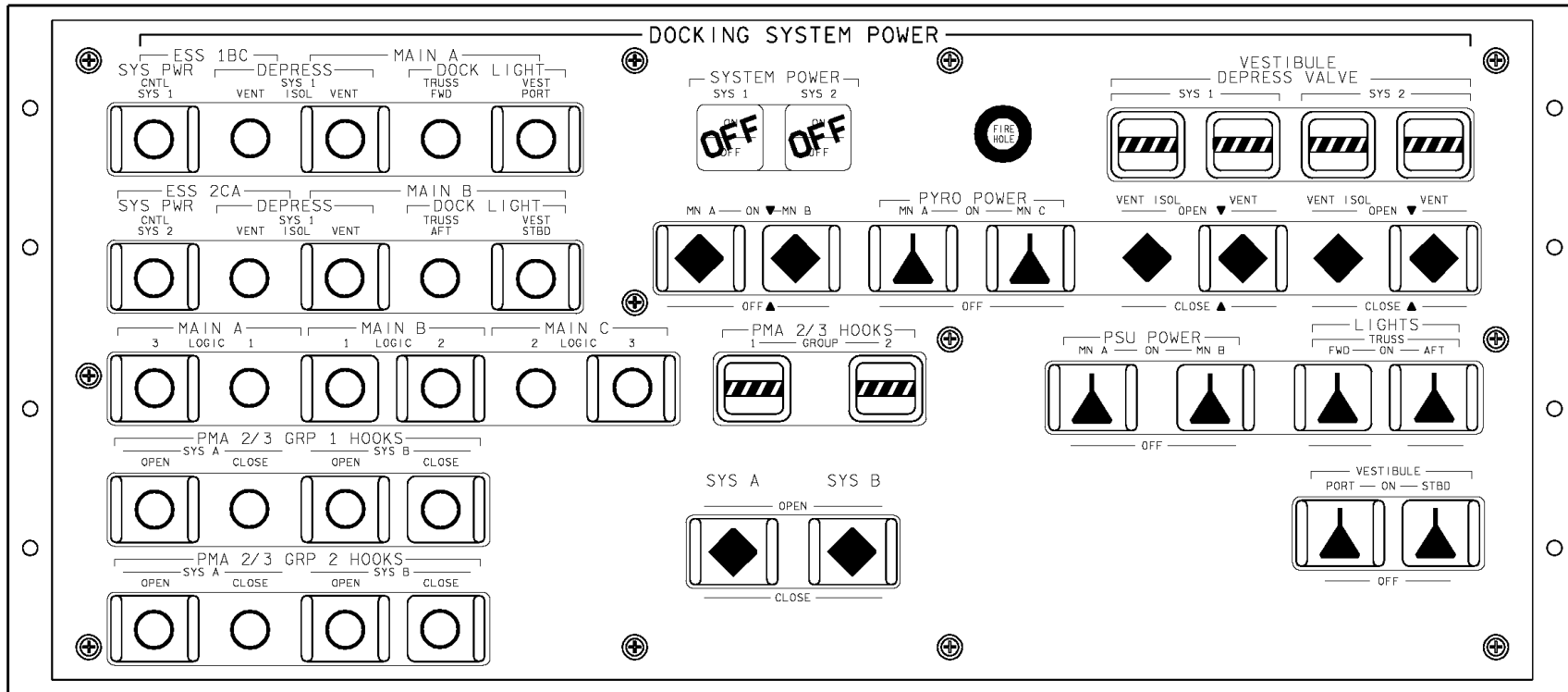

OV105

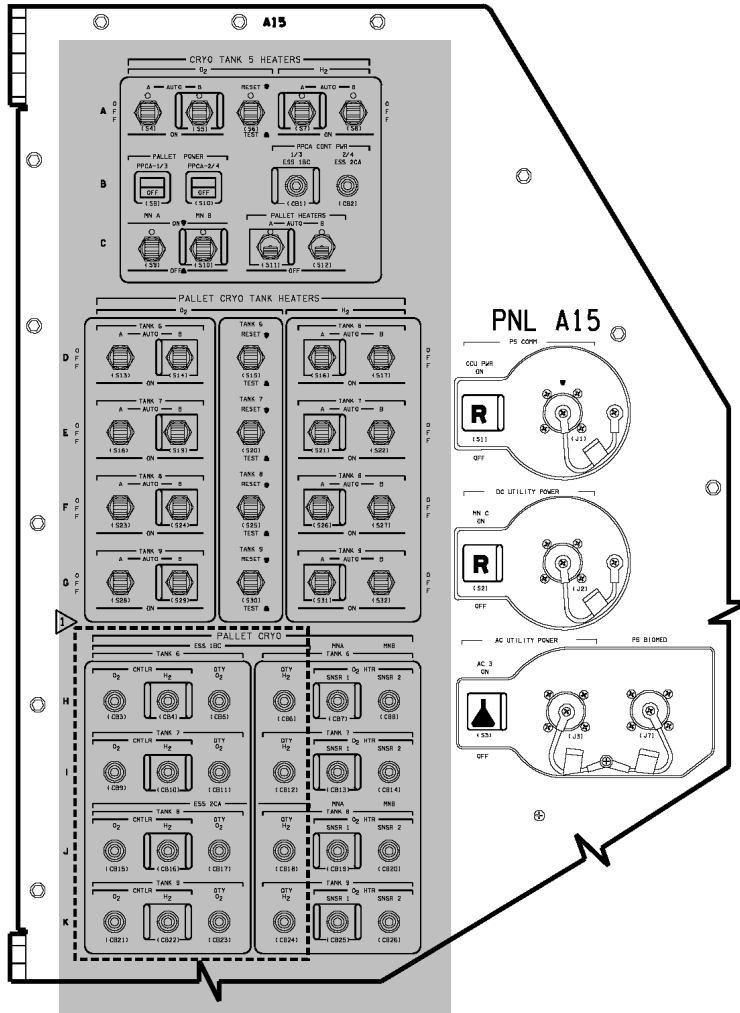
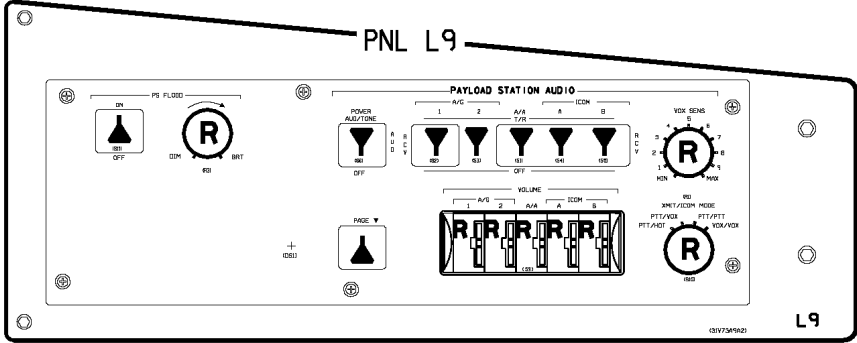
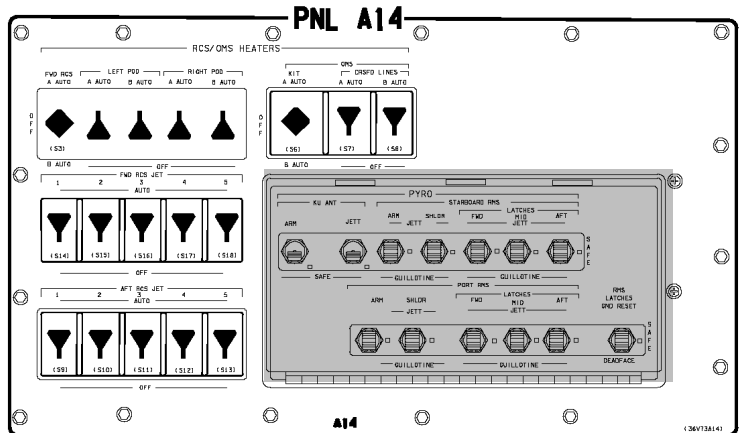
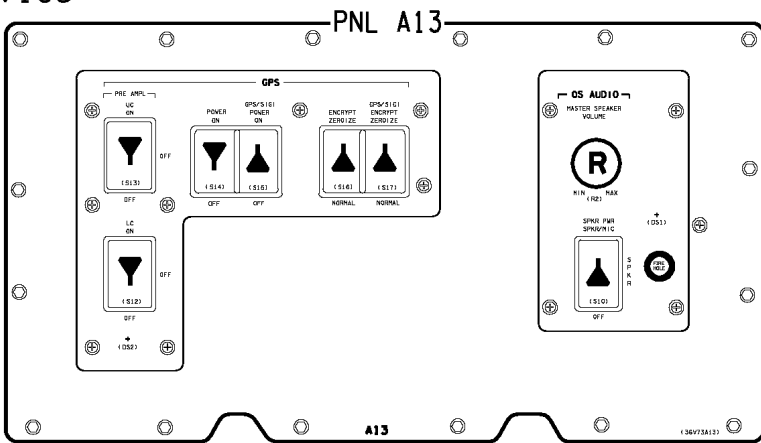

OV105

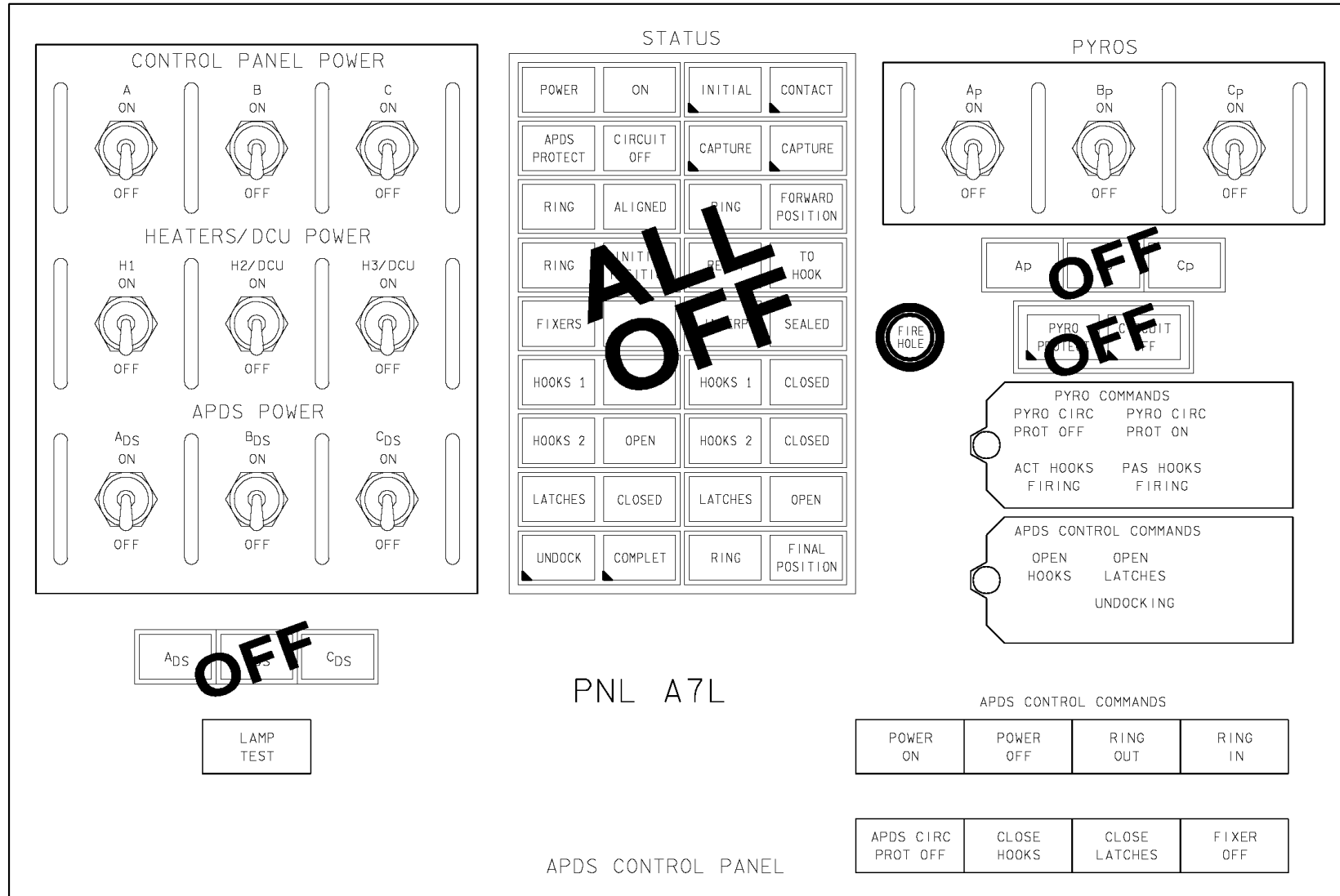

OV105

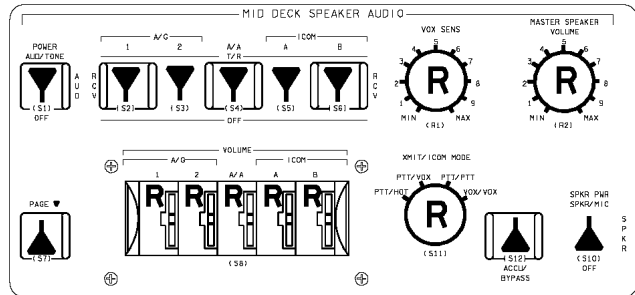

PNL M042F

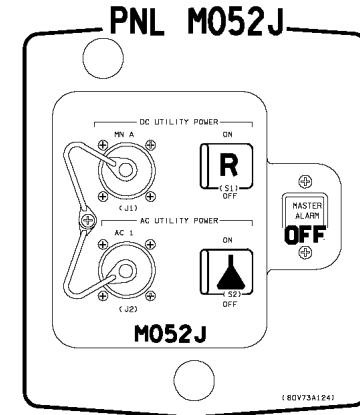
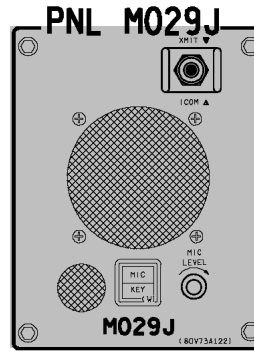
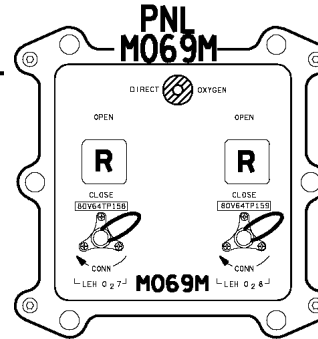
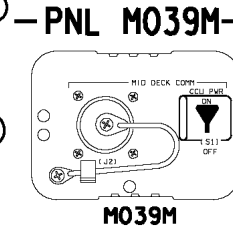
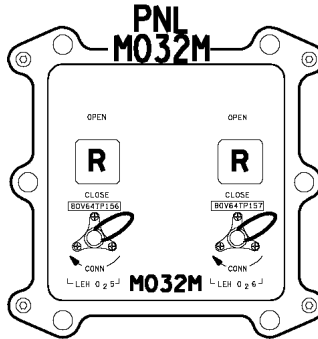
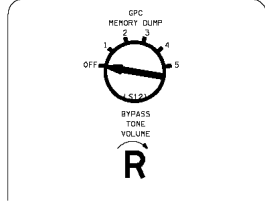

PNL M058F

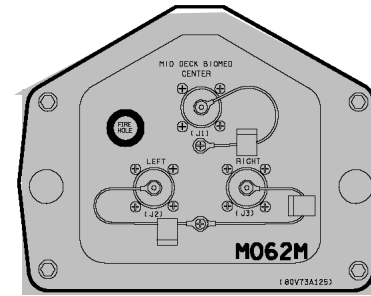
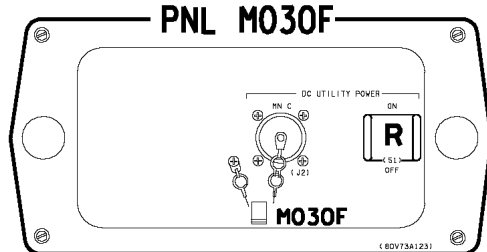
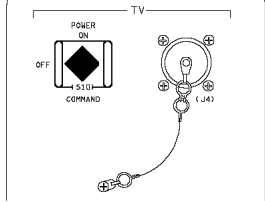
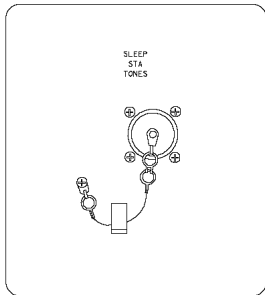

OV105

PNL MA73C

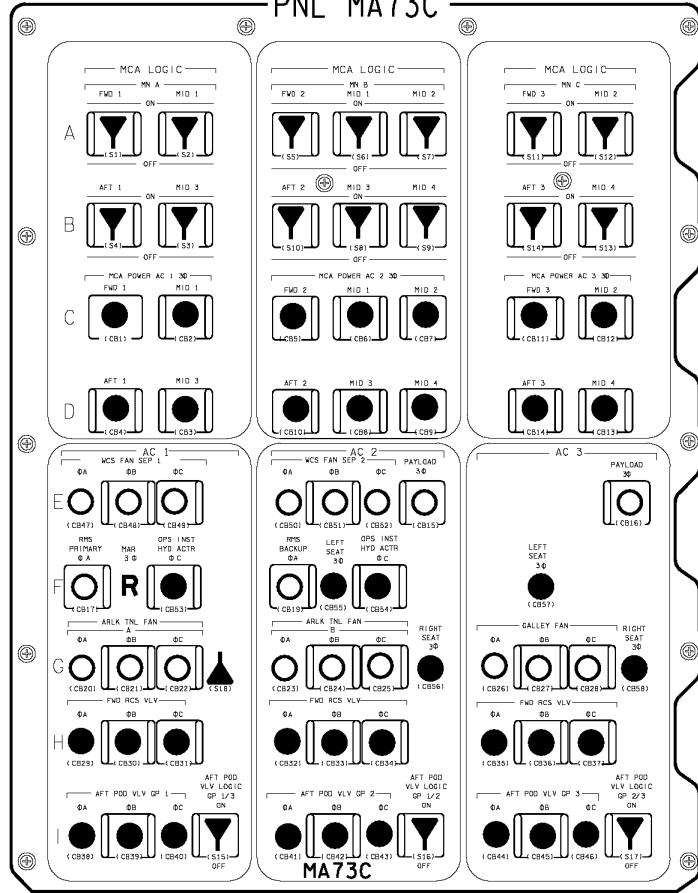

PNL ML86B

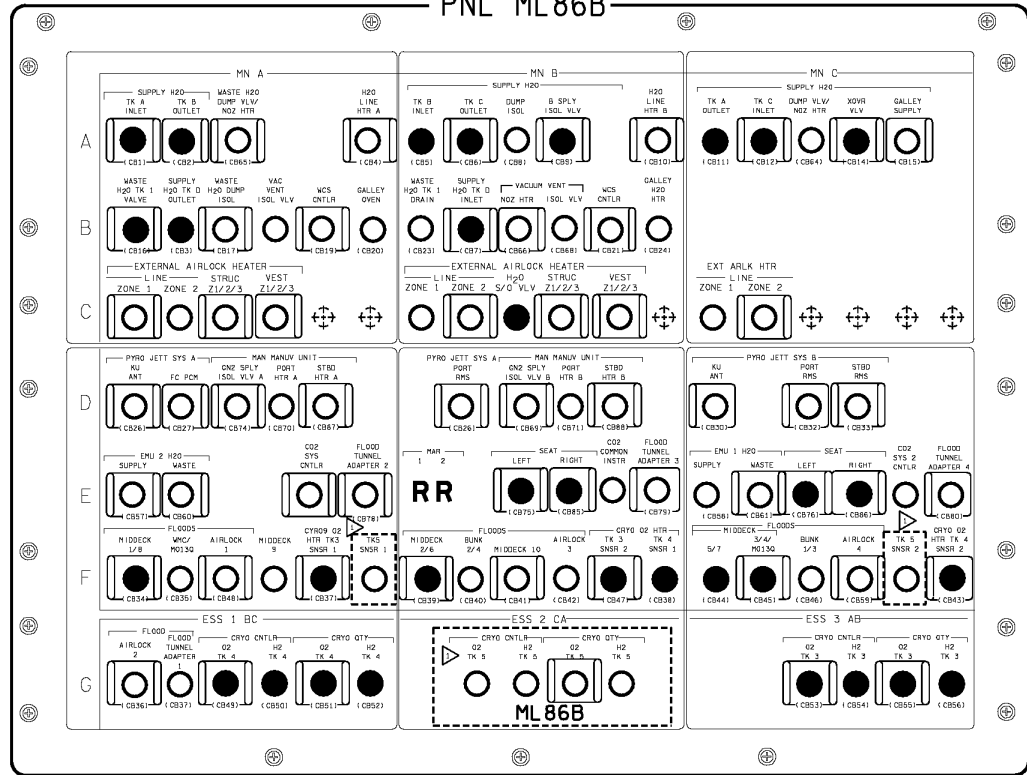

NOTES: ▷ CLOSED IF TK5 FLOWN

OV105

OV105

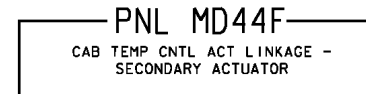
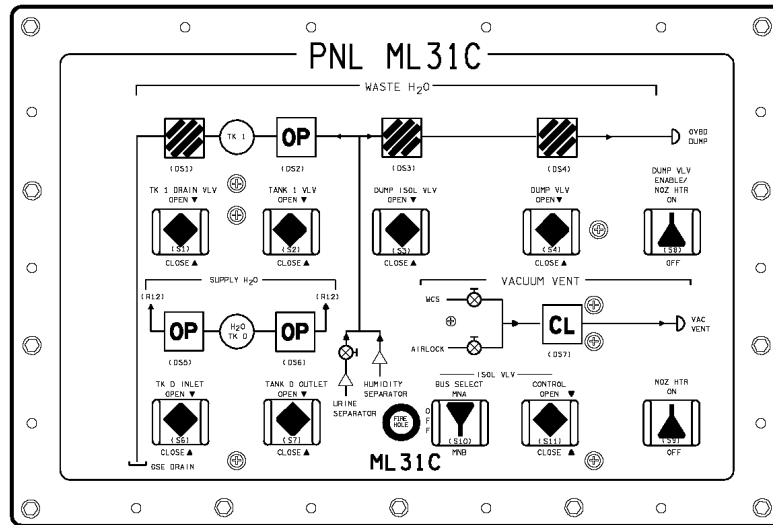
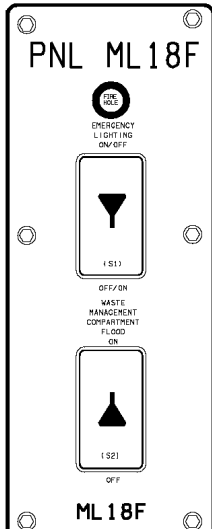
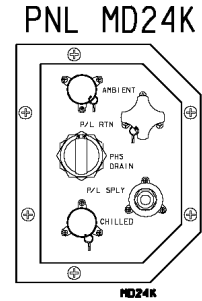
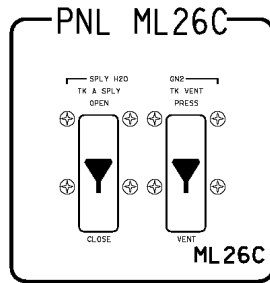
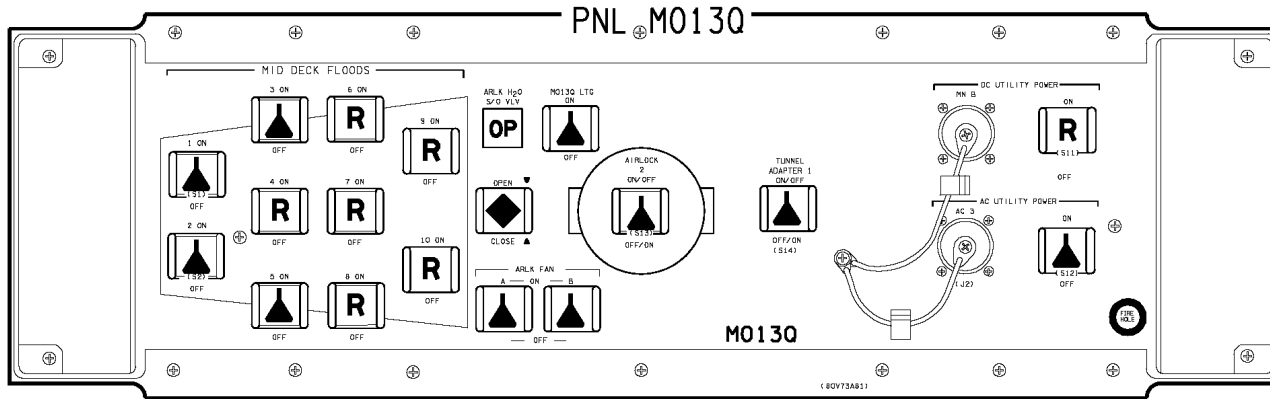

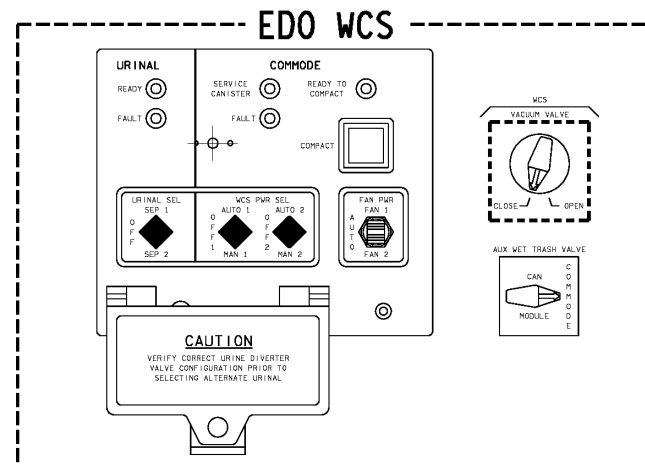
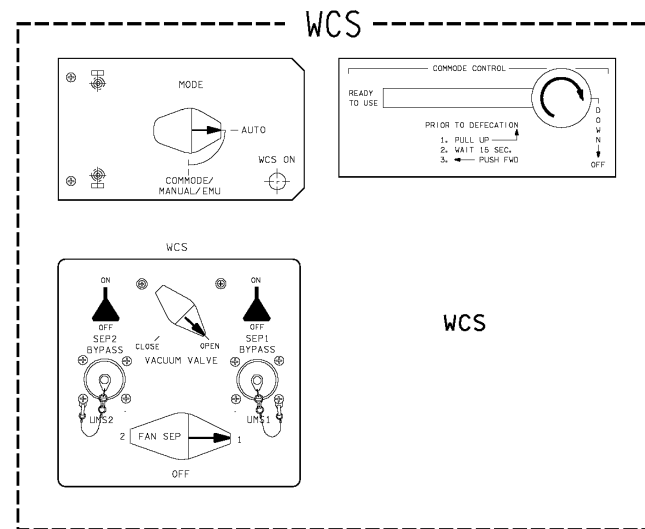
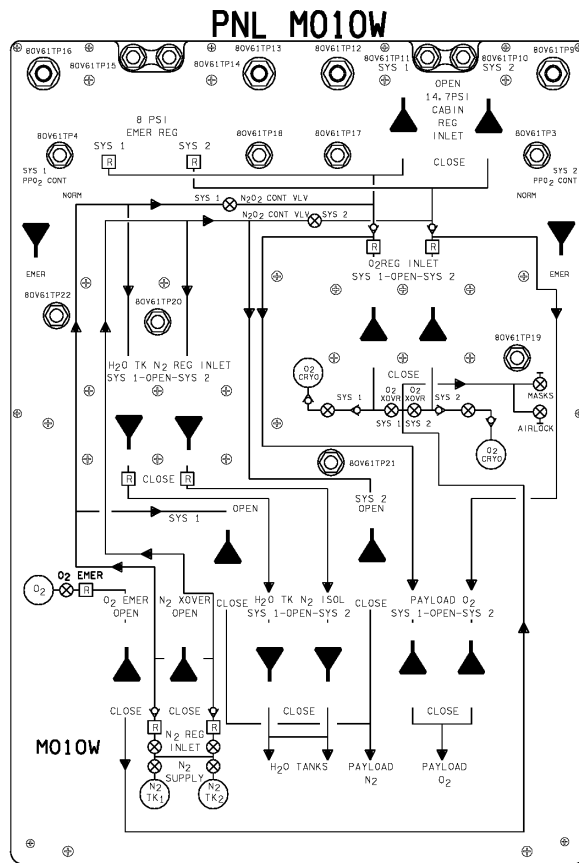

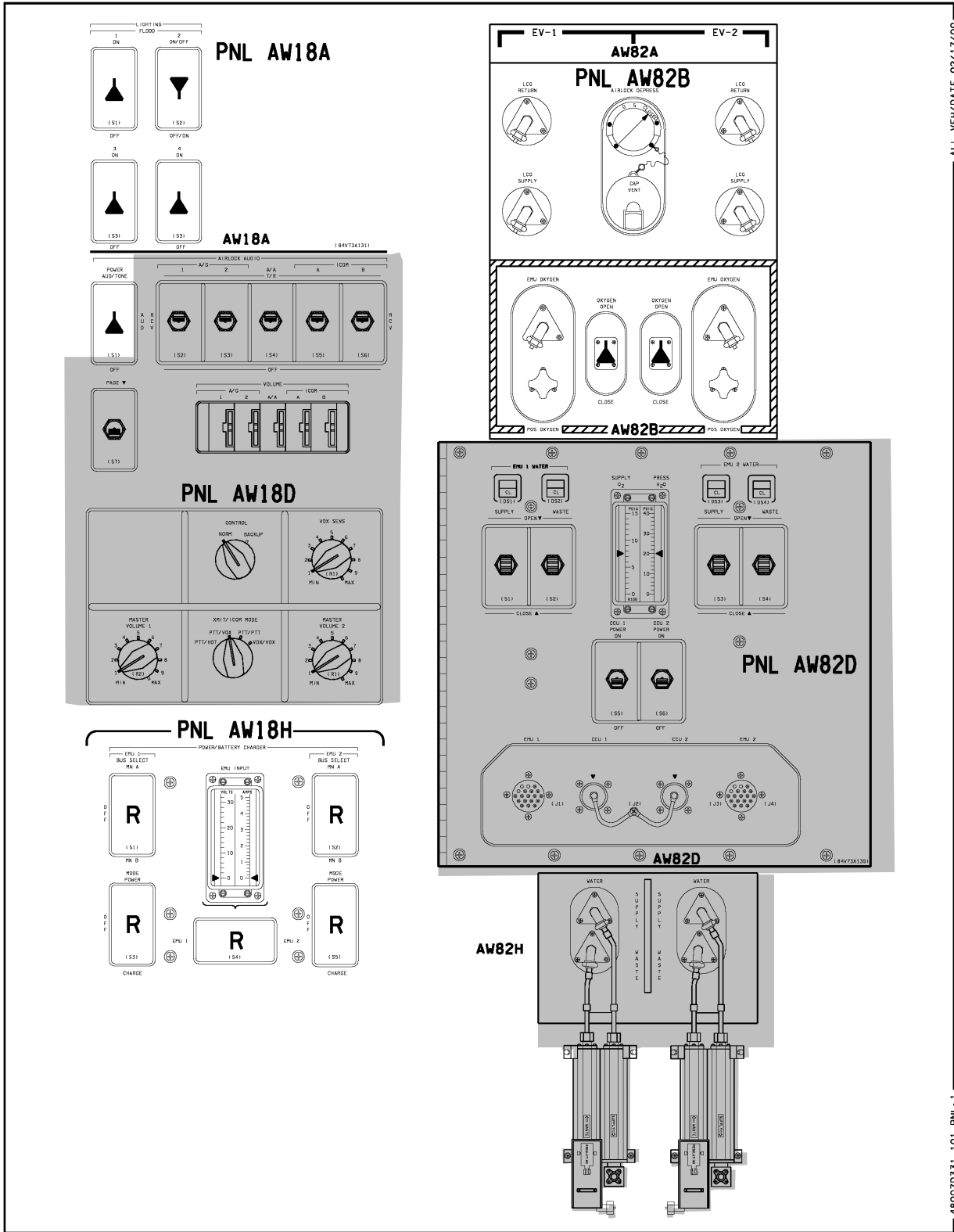

48007D331_101_PNL 1 1 ALL VEH/DATE 02/17/00

OV105

(OV105) D3-30

C D/O/ALL/GEN H,1

Inner Hatch

Actuator Handle – LATCHED

Lock Lever – LOCKED

Equalization vlv (two) – NORM, capped

This Page Intentionally Blank

**LOSS OF 2 FC LAUNCH DAY DEORBIT PREP
(ORBIT 2 OR ORBIT 3)**

**LOSS OF 2 FC
ORB 2 OR 3**

This Page Intentionally Blank

LOSS OF 2 FC LAUNCH DAY DEORBIT PREP (ORBIT 2 or ORBIT 3)

ASSUMPTIONS/INITIAL CONDITIONS

LOSS OF 2 FC LAUNCH DAY DEORBIT assumes LOSS OF 2nd FC (ASC PKT, PWRDN) has been accomplished

Electrical load will be 10–12 kW with transients to 14 kW during Deorbit Prep and Entry

This procedure assumes RAD ACT, PLBD OPENING, and subsequent Post Insertion activities have not been accomplished

PROBLEM DESCRIPTION/RATIONALE

Orbiter electrical load carried by one fuel cell; therefore, it is a critical component. LRUs may experience undervoltage with accompanying alarms

LOSS OF 2 FC LAUNCH DAY DEORBIT PREP

NOTE

1. Use one IDP/CRT with two MDUs whenever possible
2. Maintain minimum lighting
3. A second pass GPC (GPC 4) will be activated at ~TIG-20
4. Vent doors will be open throughout entry (except L,R vent doors 1&2)
5. MS procedures are located on MS PULLOUT PAGES, 4-13 thru 4-16. Extra copies are located in back of PLT's book

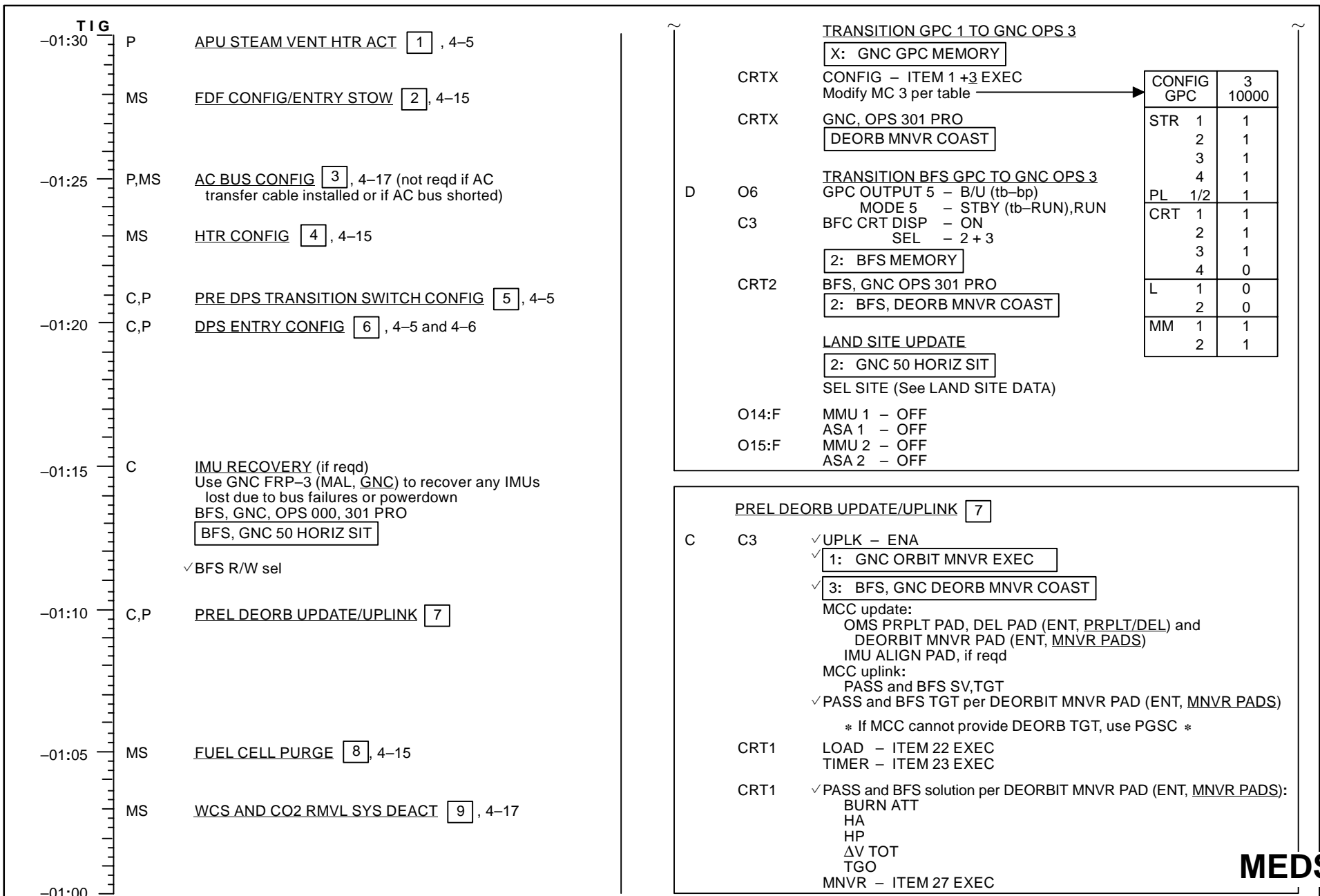

MEDS

PRE INGRESS CONFIG 12

P	R2	<u>MPS/H2 PURGE PREP</u> MPS He ISOL (six) - CL PNEU He ISOL - CL L ENG He XOVR - CL
	R4	MANF PRESS (two) - CL
C,P	O16:E	<u>ENABLE QTY GAUGE</u> cb RCS/OMS PRPLT QTY GAUGE - cl
	F8	<u>RA CONFIG</u> RDR ALTM - 1
	O8	<u>MLS CH/TACAN CH/DATA BUS</u> MLS CH tw (three) - See LAND SITE DATA
	O7	TACAN CH tw (three) - See LAND SITE DATA
C	L4:P	<u>ENABLE PROXIMITY PACKAGE</u> ✓cb AC2 ΦA LG SNSR 2 - cl ✓AC3 ΦA LG SNSR 1 - cl
C	L4:J	<u>cb CONFIG</u> cb AC3 ΦA SIG CONDR HUM SEP - op ΦB SIG CONDR IMU FAN - op

TIG		
-01:00	MS	<u>COMM CONFIG</u> [10], 4-16
	MS	<u>VENT DOOR OPS DISABLE</u> [11], 4-17
	C,P	<u>PRE INGRESS CONFIG</u> [12]
-00:55		
	C6	LEH O2 vlv (four) – OP
	C,P	<u>SEAT INGRESS</u> Adjust seat (one seat, direction at a time) Exercise brake pedals
-00:50		
	C,P	Perform <u>P&I CHANGES TO ENT</u> , 4-9, 4-10
-00:45	A	Go to ENT, <u>DEORBIT BURN</u>
-00:40		
-00:35		
-00:30		

LOSS OF 2 FUEL CELLS

P&I Changes to ENTRY

GENERAL

1. AV BAY FANS will be cycled as needed to keep pwr level low
2. GPCs 2,3 remain pwrn throughout ENTRY

SPECIFIC

TIG-46

Delete: **OMS TVC GMBL CHECK**

HORIZ SIT CONFIG (GNC 51, BFS GNC 51)

Delete: ✓SSME REPOS – ITEM 19 (ENA)

Add: “SSME REPOS – ITEM 19 EXEC (INH)”

TIG-25

L1

Delete: **VENT DOOR CLOSE**

Insert: “HUM SEP (two) – OFF

FES HEATER DEACT

TOP EVAP HTR NOZ L,R (two) – OFF

DUCT – OFF

HI LOAD DUCT HTR – OFF

L2

FLASH EVAP FDLN HTR B SPLY – OFF

ASA ACT

ASA (four) – ON”

O14:F,
O15:F,
O16:F

CONFIG GPC	3 10040
STR 1	1
2	4
3	1
4	4
PL 1/2	1
CRT 1	1
2	4
3	1
4	0
L 1	0
2	0
MM 1	1
2	4

DEORB
UPDATE/
UPLINK

Insert before GNC OPS 302 PRO:

“GPC 4 ACT

(1) GPC MODE 4 – STBY/RUN

(2) BFC CRT DISP – OFF

(3) For OPS 3 TRANS use

(4) GNC, OPS 301 PRO →

(5) BFC CRT DISP – ON; BFS I/O RESET

(6) FCS CH (four) – ORIDE

(7) G50 ✓LAND SITE/RWY per DEL PAD”

O6
C3

C3

TIG-20

Delete: **RCS/OMS HTR** steps
(MEDS) A4-9

MEDS

C D/O/ALL/GEN H

LOSS OF 2 FUEL CELLS

P&I Changes to ENTRY (Cont)

TIG-2		Use 2 DDU/FLT CNTLR PWR
	L1	Add: “AV BAY FAN CYCLE AV BAY FAN (six) – OFF”
DURING BURN		If FRCS COMPLETION reqd during burn, perform EI-18 FORWARD RCS RECOVERY steps below prior to fast flip
POST BURN		Add before PGSC STOW: “FLT CNTLR PWR (two) – OFF ✓DAP: AUTO cb MNA,B,C DDU L,R (four) – op
	O14:E, O15:E, O16:E	
	L1	Insert after OMS/RCS POST BURN RECONFIG: “AV BAY FAN 1B,2A,3A [3B vice 3A if FC 1 OK] – ON (3 sec between each start)”
EI-20		SECONDARY ACTUATOR CHECK
	C3	Add: “9. FCS CH (four) – ORIDE”
EI-18		If FORWARD RCS DUMP reqd for off-nominal CG, etc, insert FORWARD RCS RECOVERY before dump: “FORWARD RCS RECOVERY RJDF LOGIC,DRIVER (eight) – ON
	O14:F, O15:F, O16:F	
		GNC 23 RCS “ITEM 1 EXEC (FRCS page) OVRD FRCS MANF 1,2,3,4 STAT – OP”
		Insert after dump completion: GNC 23 RCS “ITEM 1 EXEC (FRCS page) OVRD FRCS MANF 1,2,3,4 STAT – CL RJDF LOGIC,DRIVER (eight) – OFF”
	O14:F, O15:F, O16:F	

MEDS

ENTRY SW
CHECK

Delete: ✓ANTISKID,NWS steps
Delete: ✓RADAR ALTM,MLS,TACAN steps

EI-13

Delete: **SSME HYD REPRESS**

ENTRY
MNVRS

Replace nominal ENTRY MANEUVERS (Cue Card)
with LOSS OF 2 FUEL CELLS ENTRY MANEUVERS, 4-13

This Page Intentionally Blank

LOSS OF 2 FUEL CELLS ENTRY MANEUVERS

FLIGHT CONDITIONS	MANEUVER
EI-5	BRAKES (three) – ON cb ADTA 1,2,3 – cl GNC I/O RESET ✓ cb MNA,B,C DDU L,R (four) – cl (L) FLT CNTLR PWR – ON Use two IDP/CRTs with four MDUs ✓ LVLH ATT GNC, OPS 304 PRO ✓ OPS 304, wait 1 min * If PREBANK: R/Y – CSS * * Roll at 1°/sec to <input type="text"/> <input type="text"/> <input type="text"/> * * Maintain PREBANK ± 5° *
‘Guidance Box’ @ q ~8 or D ~3	CLOSED LOOP GUIDANCE ___:___:___ * If PREBANK: P,R/Y – AUTO * Begin AIL trim monitoring
D = 11	✓ DRAG H (FORCE if editing)
V = 19K	✓ MPS/TVC ISOL VLV – CL
V = 15K	If FC 1 OK: TACAN 1,2 MODE – GPC If FC 2 or FC 3 OK: TACAN 2,3 MODE – GPC ✓ TACAN ANT SEL (two) – AUTO * If ELS,UHF MODE – G T/R *
V = 12K	RAD BYP VLV MODE (two) – AUTO CNTLR LOOP (two) – AUTO B(A)
V = 10K	✓ SPD BRK to 81%
V = 7K	✓ TACAN status
V = 5K	L AIR DATA PROBE – DPY (Wait 30 sec) R AIR DATA PROBE – DPY (Heat only one probe if reqd) Begin AIL and RUD trim monitoring
ΔAz = 10.5°	FIRST ROLL REVERSAL <input type="text"/> <input type="text"/> <input type="text"/> <input type="text"/> <input type="text"/>

FLIGHT CONDITIONS	MANEUVER
M = 2.9	CAB FAN (two) – OFF AV BAY FAN 2A – OFF 3A(3B) – OFF After ADTA incorporated, TACAN MODE (two) – OFF Use one HUD, one MLS, one RA GNC I/O RESET
M = 2.7	✓ APUs
	* If M < 2.5, P CSS for ADTA to G&C incorp *
M = 2.0	Ensure ADTA to G&C; else, ✓ Theta limits
M = 0.95	* For bailout procedures, go to BAILOUT *
M = 0.9	P,R/Y – CSS as reqd ✓ SPDBK CMD vs POS MAX Nz <input type="text"/> <input type="text"/> <input type="text"/> ANTISKID – ON (R) FLT CNTLR PWR – ON Use two IDP/CRTs with six MDUs NWS – 1 Lock Inertia Reels
M = 0.7	✓ LG EXTEND ISOL VLV – OP
h = 15K	✓ MLS
h = 10k	✓ A/L,TABS/LES VISORS – CL (KSC)
MAIN GEAR TD	✓ SPD BRK – 100%
DEROT INIT	DRAG CHUTE pb (two) – ARM, DPY (simo)
NOSE GEAR TD	SRB SEP – MAN/AUTO and depress pb ✓ Auto Load Relief ✓ HYD BRAKE ISOL VLV (three) – OP
	<p style="text-align: center;"> 0.25-0.3G 8-10 FPS² MAX < 0.2G NO BRAKING BEFORE MIDFIELD < 6 FPS² </p> <p style="text-align: center;"> NWTD ≤ 140 KGS LKBED 5K' REMAINING 40 KGS STOP 140 KGS CONCRETE < 140 KGS > 140 KGS </p>
V = 60 KGS	DRAG CHUTE JETT pb – JETT
STOP	✓ All landing/navaids off CAB FAN B – ON (Wait 3 sec, then continue) AV BAY FAN 2A,3A [3B vice 3A if FC1 OK] – ON (3 sec between each start) Go to ENT, POST LDG

MEDS

This Page Intentionally Blank

**LOSS OF 2 FC LAUNCH DAY DEORBIT PREP
Back of MS AFT FLIGHT DECK ACTIVITIES**

MS PULLOUT PAGE

COMM CONFIG 10		
A1L	S-BD PM MODE	- STDN LO
	NSP DATA RATE XMIT,RCV (two)	- HI
	CODING XMIT,RCV (two)	- OFF
A13	OS AUD SPKR PWR	- OFF
A15	PS COMM CCU PWR	- OFF
R14:C	✓cb MNB KU ELEC	- op
	✓ANT HTR	- op
	✓CABLE HTR	- op
	✓MNC KU SIG PROC	- op
	✓cb UHF EVA (two)	- op
O5,O9	L,R AUD A/G 2	- T/R
	ICOM B	- T/R
	VOX SENS sel	- as reqd
	VOL tw (six)	- as reqd
	XMIT/ICOM MODE sel	- PTT/VOX
MO42F	MIDDECK SPKR AUD PWR	- AUD/TONE
ML85E	AC S1 - OFF	
R10,L9	MS,PS AUD PWR	- AUD/TONE
	A/G 1	- T/R
	2	- T/R
	A/A	- T/R
	ICOM A,B	- T/R
	VOX SENS sel	- as reqd
	VOL tw (six)	- as reqd
	XMIT/ICOM MODE sel	- as reqd

LOSS OF 2 FC LAUNCH DAY DEORBIT PREP MS MIDDECK ACTIVITIES

MS PULLOUT PAGE

NOTE

Wait for GO from CDR or PLT before starting any activity on this page

TIME (TIG-)	MS ACTIONS (MID)
1:25	<u>AC BUS CONFIG</u> 3 (Not reqd if AC transfer cable installed or if AC bus shorted)
1:03	<u>WCS AND CO2 RMVL SYS DEACT</u>
:59	<u>VENT DOOR OPS DISABLE</u>

<u>AC BUS CONFIG</u> 3 (Not reqd if AC transfer cable installed or if AC bus shorted)	
C	L4:D,E,Q 1. ✓ All cbs (twenty-seven) – op
MS	2. If FC 1 OK: Perform AC3 (3Φ) BUS LOSS ACTIONS (ORB PKT, <u>EPS</u>). Do only steps in ORB PKT, do not proceed to MAL AC3 is affected bus in step 3 If FC 2 or FC 3 OK: Perform AC1 (3Φ) BUS LOSS ACTIONS (ORB PKT, <u>EPS</u>). Do only steps in ORB PKT, do not proceed to MAL AC1 is affected bus in step 3
P	R1 3. Affected BUS: cb AC CONTR (three) – cl AC BUS SNSR – OFF INV/AC BUS – OFF (tb-OFF) INV PWR – OFF (tb-OFF) cb AC CONTR (three) – op 4. Connect AC1 to AC3: Perform AC POWER TRANSFER CABLE INSTALLATION (IFM, PROCEDURES A THRU F)

<u>WCS AND CO2 RMVL SYS DEACT</u> 9	
EDO WCS	If EDO WCS: URINAL SEL – OFF WCS PWR SEL – OFF1,OFF2 FAN PWR – AUTO Lock odor lid/seat COMP LOCK DOWN PINS (three) – tighten
WCS	VAC VLV – CL ✓MODE – AUTO FAN SEP SEL sw – OFF Unstow hose from cradle, attach hose to WCS housing via Velcro straps Remove, stow: WCS Trash Can Mirror Privacy Curtain Foot restraints – up, locked Close, latch door
(EDO WCS)	
ML31C	VAC VENT ISOL VLV BUS SEL – MNB CNTL – CL (tb-CL) NOZ HTR – OFF
MO51F	If CO2 RMVL SYS flown: CNTLR 1(2) MODE – STBY (hold 3 sec)

<u>VENT DOOR OPS DISABLE</u> 11	
MA73C:A	MCA LOGIC MID (four) – OFF ✓FWD (three) – ON
:B	MCA LOGIC MID (four) – OFF AFT (three) – OFF
:C	If MNB and AC2 powered: cb MCA PWR AC1, AC3 3Φ FWD 1,3 – op
✓ Minimum middeck lighting	

This Page Intentionally Blank

LOSS OF 2 FC LAUNCH DAY DEORBIT PREP (ORBIT 2 or ORBIT 3)

ASSUMPTIONS/INITIAL CONDITIONS

LOSS OF 2 FC LAUNCH DAY DEORBIT assumes LOSS OF 2nd FC (ASC PKT, PWRDN) has been accomplished

Electrical load will be 10–12 kW with transients to 14 kW during Deorbit Prep and Entry

This procedure assumes RAD ACT, PLBD OPENING, and subsequent Post Insertion activities have not been accomplished

PROBLEM DESCRIPTION/RATIONALE

Orbiter electrical load carried by one fuel cell; therefore, it is a critical component. LRUs may experience undervoltage with accompanying alarms

LOSS OF 2 FC LAUNCH DAY DEORBIT PREP

NOTE

1. Use one CRT, one inst pwr, one DDU whenever possible
2. Maintain minimum lighting
3. A second pass GPC (GPC 4) will be activated at ~TIG-20
4. Vent doors will be open throughout entry (except L,R vent doors 1&2)
5. MS procedures are located on MS PULLOUT PAGES, 4-13 thru 4-15. Extra copies are located in back of PLT's book

APU STEAM VENT HTR ACT 1

P R2 If FC 1 OK:
 ✓BLR CNTLR/HTR 1 - A
 2 - B
 ✓3 - A
 If FC 2 or FC 3 OK:
 ✓BLR CNTLR/HTR 1 - A
 ✓2 - A
 3 - B
 BLR PWR (three) - ON

AC BUS CONFIG 3

C L4:D,E,Q 1. ✓All cbs (twenty-seven) - op
 MS 2. If FC 1 OK:
 Perform AC3 (3Φ) BUS LOSS ACTIONS (ORB PKT, EPS).
 Do only steps in ORB PKT, do not proceed to MAL
 AC3 is affected bus in step 3
 If FC 2 or FC 3 OK:
 Perform AC1 (3Φ) BUS LOSS ACTIONS (ORB PKT, EPS).
 Do only steps in ORB PKT, do not proceed to MAL
 AC1 is affected bus in step 3
 P R1 3. Affected BUS: cb AC CONTR (three) - cl
 AC BUS SNSR - OFF
 INV/AC BUS - OFF (tb-OFF)
 INV PWR - OFF (tb-OFF)
 cb AC CONTR (three) - op
 4. Connect AC1 to AC3:
 Perform AC POWER TRANSFER CABLE INSTALLATION
 (IFM, PROCEDURES A THRU F)

PRE DPS TRANSITION SWITCH CONFIG 5

C,P O14:A ✓RGA 1 - ON
 E ✓cb MNA ACCEL 1 - cl
 F ✓ASA 1 - ON
 O15:A ✓RGA 2 - ON
 E ✓cb MNB ACCEL 2 - cl
 F ✓ASA 2 - ON
 O16:A ✓RGA 3 - ON
 F ✓ACCEL 3 - ON

DPS ENTRY CONFIG 6

C,P L1 ✓AV BAY 2 FAN A(B) - ON
 O14:F ✓MMU 1 - ON
 O15:F ✓2 - ON
 C3 ✓FCS CH (four) - AUTO

LOAD ENTRY TFL
 Perform LOAD PDI DECOM FORMAT and LOAD PCMMU
 FORMAT (ORB OPS FS, COMM/INST) for entry config

SM CHECKPOINT/UL CNTL ENA
X: SM 60 SM TABLE MAINT
Y: SM 1 DPS UTILITY

 CRTX MMU ASSIGN 2 SM - ITEM 4 EXEC
 CKPT INITIATE - ITEM 18 EXEC
 ✓Update of CKPT TIME and STATUS GOOD indicated

 CRTX MMU ASSIGN 1 SM - ITEM 3 EXEC
 CKPT INITIATE - ITEM 18 EXEC

 ✓Update of CKPT TIME and STATUS GOOD indicated

 CRTX CKPT RETRV ENA - ITEM 12 EXEC (*)
 UL CNTL ENA - ITEM 36 EXEC

DEACT GPC 4
 MAJ FUNC - GNC

 NOTE
 All MAJ FUNC should be GNC
 prior to powering down SM GPC

 O6 GPC MODE 4 - STBY,HALT
 - STBY (tb-RUN)
 - HALT (tb-bp)
 OUTPUT 4 - NORM

 CRT1 GPC/CRT 04 EXEC
 13 EXEC

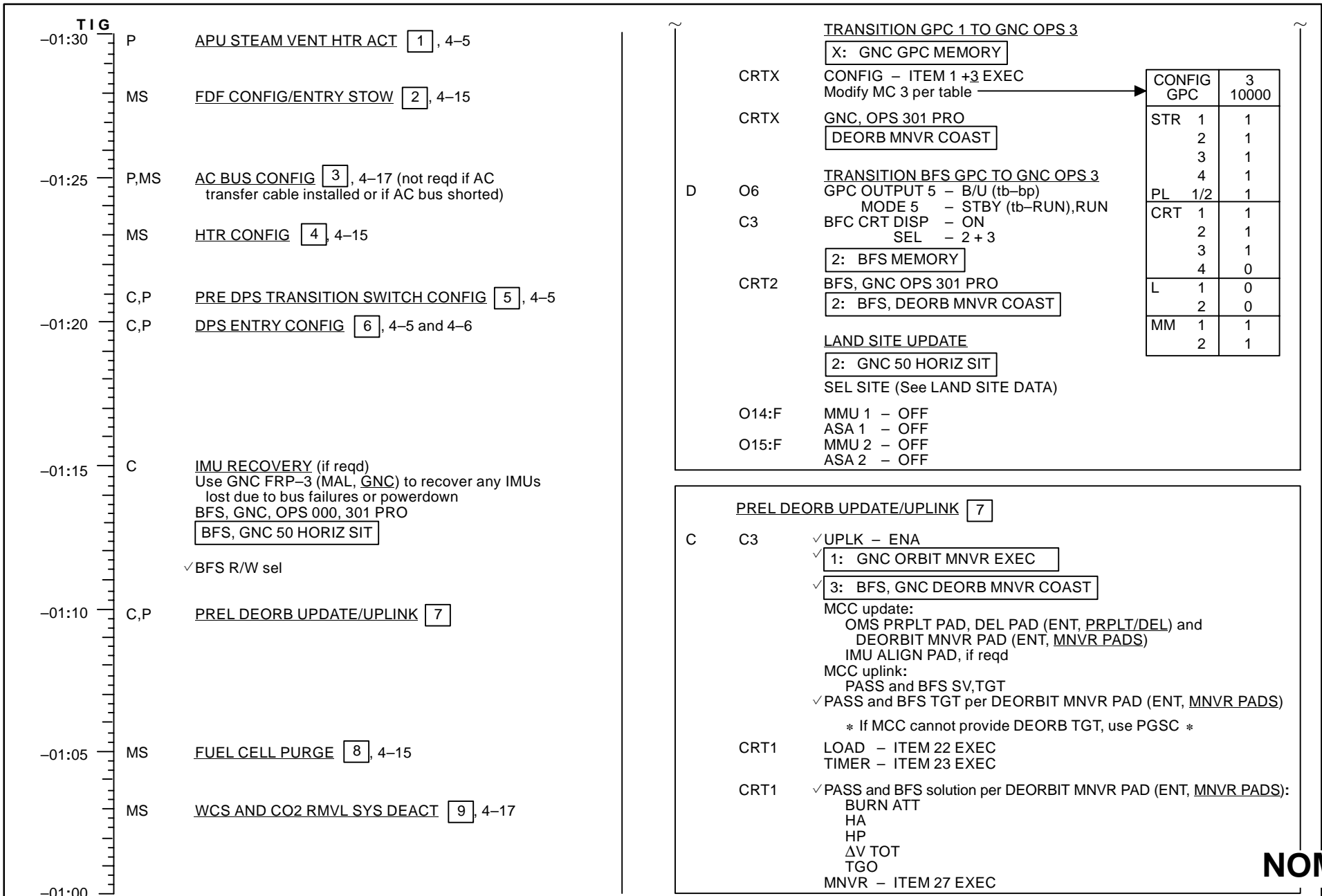

NOM

PRE INGRESS CONFIG 12

P	R2	<u>MPS/H2 PURGE PREP</u> MPS He ISOL (six) - CL PNEU He ISOL - CL L ENG He XOVR - CL
	R4	MANF PRESS (two) - CL
C,P	O16:E	<u>ENABLE QTY GAUGE</u> cb RCS/OMS PRPLT QTY GAUGE - cl
	F8	<u>RA CONFIG</u> RDR ALTM - 1
	O8	<u>MLS CH/TACAN CH/DATA BUS</u> MLS CH tw (three) - See LAND SITE DATA
	O7	TACAN CH tw (three) - See LAND SITE DATA
	F6	✓DATA BUS sel - 3
	F8	✓ - 4
C	L4:P	<u>ENABLE PROXIMITY PACKAGE</u> ✓cb AC2 ΦA LG SNSR 2 - cl ✓AC3 ΦA LG SNSR 1 - cl
C	L4:J	<u>cb CONFIG</u> cb AC3 ΦA SIG CONDR HUM SEP - op ΦB SIG CONDR IMU FAN - op

TIG		
-01:00	MS	<u>COMM CONFIG</u> [10], 4-16
	MS	<u>VENT DOOR OPS DISABLE</u> [11], 4-17
	C,P	<u>PRE INGRESS CONFIG</u> [12]
-00:55		
	C6	LEH O2 vlv (four) – OP
	C,P	<u>SEAT INGRESS</u> Adjust seat (one seat, direction at a time) Exercise brake pedals
-00:50		
	C,P	Perform <u>P&I CHANGES TO ENT</u> , 4-9, 4-10
-00:45	A	Go to ENT, <u>DEORBIT BURN</u>
-00:40		
-00:35		
-00:30		

LOSS OF 2 FUEL CELLS

P&I Changes to ENTRY

GENERAL

1. AV BAY FANS will be cycled as needed to keep pwr level low
2. GPCs 2,3 remain pwrdn throughout ENTRY

SPECIFIC

TIG-46

Delete: **OMS TVC GMBL CHECK**

HORIZ SIT CONFIG (GNC 51, BFS GNC 51)

Delete: ✓SSME REPOS – ITEM 19 (ENA)

Add: “SSME REPOS – ITEM 19 EXEC (INH)”

TIG-25

L1

Delete: **VENT DOOR CLOSE**

Insert: “HUM SEP (two) – OFF

FES HEATER DEACT

TOP EVAP HTR NOZ L,R (two) – OFF

DUCT – OFF

HI LOAD DUCT HTR – OFF

FLASH EVAP FDLN HTR B SPLY – OFF

L2

ASA ACT

ASA (four) – ON”

O14:F,
O15:F,
O16:F

DEORB
UPDATE/
UPLINK

O6
C3

Insert before GNC OPS 302 PRO:

“GPC 4 ACT

(1) GPC MODE 4 – STBY/RUN

(2) BFC CRT DISP – OFF

(3) For OPS 3 TRANS use

(4) GNC, OPS 301 PRO →

(5) BFC CRT DISP – ON; BFS I/O RESET

(6) FCS CH (four) – ORIDE

(7) G50 ✓LAND SITE/RWY per DEL PAD”

C3

CONFIG GPC	3 10040
STR 1	1
2	4
3	1
4	4
PL 1/2	1
CRT 1	1
2	4
3	1
4	0
L 1	0
2	0
MM 1	1
2	4

TIG-20

Delete: **RCS/OMS HTR** steps
(NOM) B4-9

NOM

C D/O/ALL/GEN H

LOSS OF 2 FUEL CELLS

P&I Changes to ENTRY (Cont)

TIG-2		Use 2 DDU/FLT CNTLR PWR
	L1	Add: “AV BAY FAN CYCLE AV BAY FAN (six) – OFF”
DURING BURN		If FRCS COMPLETION reqd during burn, perform EI-18 FORWARD RCS RECOVERY steps below prior to fast flip
POST BURN		Add before PGSC STOW: “FLT CNTLR PWR (two) – OFF ✓DAP: AUTO Use one DDU”
	L1	Insert after OMS/RCS POST BURN RECONFIG: “AV BAY FAN 1B,2A,3A [3B vice 3A if FC 1 OK] – ON (3 sec between each start)”
EI-20	C3	SECONDARY ACTUATOR CHECK Add: “9. FCS CH (four) – ORIDE”
EI-18		If FORWARD RCS DUMP reqd for off-nominal CG, etc, insert FORWARD RCS RECOVERY before dump: “FORWARD RCS RECOVERY RJDF LOGIC,DRIVER (eight) – ON
O14:F, O15:F, O16:F		GNC 23 RCS “ITEM 1 EXEC (FRCS page) OVRD FRCS MANF 1,2,3,4 STAT – OP”
		Insert after dump completion: GNC 23 RCS “ITEM 1 EXEC (FRCS page) OVRD FRCS MANF 1,2,3,4 STAT – CL RJDF LOGIC,DRIVER (eight) – OFF”
O14:F, O15:F, O16:F		

NOM

ENTRY SW
CHECK

Delete: ✓ANTISKID,NWS steps
Delete: ✓RADAR ALTM,MLS,TACAN steps

EI-13

Delete: **SSME HYD REPRESS**

ENTRY
MNVRS

Replace nominal ENTRY MANEUVERS (Cue Card)
with LOSS OF 2 FUEL CELLS ENTRY MANEUVERS, 4-13

(NOM) B4-11

NOM

C D/O/NOM/GEN H

This Page Intentionally Blank

(NOM) B4-12

NOM
C D/O/ALL/GEN H

LOSS OF 2 FUEL CELLS ENTRY MANEUVERS

FLIGHT CONDITIONS	MANEUVER
EI-5	BRAKES (three) – ON cb ADTA 1,2,3 – cl GNC I/O RESET ✓ cb MNA,B,C DDU L,R (four) – cl (L) FLT CNTLR PWR – ON (L) INST PWR – FLT ✓ LVLH ATT GNC, OPS 304 PRO ✓ OPS 304, wait 1 min * If PREBANK: R/Y – CSS * * Roll at 1°/sec to <input type="text"/> <input type="text"/> <input type="text"/> * * Maintain PREBANK ± 5° *
'Guidance Box' @ q~8 or D~3	CLOSED LOOP GUIDANCE ___:___:___ * If PREBANK: P,R/Y – AUTO * Begin AIL trim monitoring
D = 11	✓ DRAG H (FORCE if editing)
V = 19K	✓ MPS/TVC ISOL VLV – CL
V = 15K	If FC 1 OK: TACAN 1,2 MODE – GPC If FC 2 or FC 3 OK: TACAN 2,3 MODE – GPC ✓ TACAN ANT SEL (two) – AUTO * If ELS,UHF MODE – G T/R *
V = 12K	RAD BYP VLV MODE (two) – AUTO CNTLR LOOP (two) – AUTO B(A)
V = 10K	✓ SPD BRK to 81%
V = 7K	✓ TACAN status
V = 5K	L AIR DATA PROBE – DPY (Wait 30 sec) R AIR DATA PROBE – DPY (Heat only one probe if reqd) Begin AIL and RUD trim monitoring
ΔAz = 10.5°	FIRST ROLL REVERSAL <input type="text"/> <input type="text"/> <input type="text"/> <input type="text"/>

FLIGHT CONDITIONS	MANEUVER
M = 2.9	CAB FAN (two) – OFF AV BAY FAN 2A – OFF 3A(3B) – OFF After ADTA incorporated, TACAN MODE (two) – OFF Use one HUD, one MLS, one RA GNC I/O RESET
M = 2.7	✓ APUs * If M < 2.5, P CSS for ADTA to G&C incorp *
M = 2.0	Ensure ADTA to G&C; else, ✓ Theta limits
M = 0.95	* For bailout procedures, go to <u>BAILOUT</u> *
M = 0.9	P,R/Y – CSS as reqd ✓ SPDBK CMD vs POS MAX Nz <input type="text"/> <input type="text"/> <input type="text"/> ANTISKID – ON (R) FLT CNTLR PWR – ON (R) INST PWR – ON NWS – 1 Lock Inertia Reels
M = 0.7	✓ LG EXTEND ISOL VLV – OP
h = 15K	✓ MLS
h = 10k	✓ A/L,TABS/LES VISORS – CL (KSC)
MAIN GEAR TD	✓ SPD BRK – 100%
DEROT INIT	DRAG CHUTE pb (two) – ARM, DPY (simo)
NOSE GEAR TD	SRB SEP – MAN/AUTO and depress pb ✓ Auto Load Relief ✓ HYD BRAKE ISOL VLV (three) – OP
V = 60 KGS	DRAG CHUTE JETT pb – JETT
STOP	✓ All landing/nav aids off CAB FAN B – ON (Wait 3 sec, then continue) AV BAY FAN 2A,3A [3B vice 3A if FC1 OK] – ON (3 sec between each start) Go to ENT, <u>POST LDG</u>

NOM

This Page Intentionally Blank

(NOM) B4-14

NOM
C D/O/ALL/GEN H

LOSS OF 2 FC LAUNCH DAY DEORBIT PREP MS AFT FLIGHT DECK ACTIVITIES

MS PULLOUT PAGE

NOTE

Wait for GO from CDR or PLT before starting any activity on this page

TIME (TIG-)	MS ACTIONS (AFT)
1:28	<u>FDF CONFIG/ENTRY STOW</u> [2]
1:23	<u>HTR CONFIG</u> [4]
1:05	<u>FUEL CELL PURGE</u> [8]
1:00	<u>COMM CONFIG</u> [10], 4-16

FDF CONFIG/ENTRY STOW [2]

FDF CONFIG
 Unstow,install:
 ENTRY and DEORBIT BURN Cue Cards
 ENT
 ENT PKT
 ✓AVAILABLE for ENTRY:
 LDG SITE CHARTS
 Handheld Radio
 STAR CHART
 ORB OPS
 CONT DEORB
 ORB PKT
 REF DATA
 MAL
 Stow all other FDF articles

ENTRY STOW
 Stow: Flt Deck Camrs,Accessories
 VTR Cassettes (one in VTR)

EGRESS ROUTE CONFIG
 Tape Foot Loops in egress routes

HTR CONFIG [4]

R11U FC PURGE HTR - ON

NOTE
 Htr must be on 15 min prior to purge

A12 ✓APU HTR TK/FU LINE/H2O/SYS 1A,2A,3A - AUTO
✓1B,2B,3B - OFF

A14 ✓HYD HTR (eight) - OFF
 ✓RCS/OMS HTR FWD RCS - OFF
L POD (two) - A OFF,B OFF
R POD (two) - A OFF,B OFF
OMS CRSFD LINES (two) - A OFF
- B OFF
 ✓FWD,AFT RCS JET 5 (two) - OFF

FUEL CELL PURGE [8]

WARNING
 Do not purge if FC AMPS > 430

R11U ✓FC PURGE HTR ON > 15 min

FC PURGE VLV X - OP for 2 min, then
- GPC
HTR - GPC
 ✓VLV - GPC

**LOSS OF 2 FC LAUNCH DAY DEORBIT PREP
Back of MS AFT FLIGHT DECK ACTIVITIES**

MS PULLOUT PAGE

COMM CONFIG 10		
A1L	S-BD PM MODE	- STDN LO
	NSP DATA RATE XMIT,RCV (two)	- HI
	CODING XMIT,RCV (two)	- OFF
A13	OS AUD SPKR PWR	- OFF
A15	PS COMM CCU PWR	- OFF
R14:C	✓cb MNB KU ELEC	- op
	✓ANT HTR	- op
	✓CABLE HTR	- op
	✓MNC KU SIG PROC	- op
	✓cb UHF EVA (two)	- op
O5,O9	L,R AUD A/G 2	- T/R
	ICOM B	- T/R
	VOX SENS sel	- as reqd
	VOL tw (six)	- as reqd
	XMIT/ICOM MODE sel	- PTT/VOX
MO42F	MIDDECK SPKR AUD PWR	- AUD/TONE
ML85E	AC S1 - OFF	
R10,L9	MS,PS AUD PWR	- AUD/TONE
	A/G 1	- T/R
	2	- T/R
	A/A	- T/R
	ICOM A,B	- T/R
	VOX SENS sel	- as reqd
	VOL tw (six)	- as reqd
	XMIT/ICOM MODE sel	- as reqd

LOSS OF 2 FC LAUNCH DAY DEORBIT PREP MS MIDDECK ACTIVITIES

MS PULLOUT PAGE

NOTE

Wait for GO from CDR or PLT before starting any activity on this page

TIME (TIG-)	MS ACTIONS (MID)
1:25	<u>AC BUS CONFIG</u> 3 (Not reqd if AC transfer cable installed or if AC bus shorted)
1:03	<u>WCS AND CO2 RMVL SYS DEACT</u>
:59	<u>VENT DOOR OPS DISABLE</u>

<u>AC BUS CONFIG</u> 3 (Not reqd if AC transfer cable installed or if AC bus shorted)	
C	L4:D,E,Q 1. ✓ All cbs (twenty-seven) – op
MS	2. If FC 1 OK: Perform AC3 (3Φ) BUS LOSS ACTIONS (ORB PKT, <u>EPS</u>). Do only steps in ORB PKT, do not proceed to MAL AC3 is affected bus in step 3 If FC 2 or FC 3 OK: Perform AC1 (3Φ) BUS LOSS ACTIONS (ORB PKT, <u>EPS</u>). Do only steps in ORB PKT, do not proceed to MAL AC1 is affected bus in step 3
P	R1 3. Affected BUS: cb AC CONTR (three) – cl AC BUS SNSR – OFF INV/AC BUS – OFF (tb-OFF) INV PWR – OFF (tb-OFF) cb AC CONTR (three) – op 4. Connect AC1 to AC3: Perform AC POWER TRANSFER CABLE INSTALLATION (IFM, PROCEDURES A THRU F)

<u>WCS AND CO2 RMVL SYS DEACT</u> 9	
EDO WCS	If EDO WCS: URINAL SEL – OFF WCS PWR SEL – OFF1,OFF2 FAN PWR – AUTO Lock odor lid/seat COMP LOCK DOWN PINS (three) – tighten
WCS	VAC VLV – CL ✓ MODE – AUTO FAN SEP SEL sw – OFF Unstow hose from cradle, attach hose to WCS housing via Velcro straps Remove, stow: WCS Trash Can Mirror Privacy Curtain Foot restraints – up, locked Close, latch door
(EDO WCS)	
ML31C	VAC VENT ISOL VLV BUS SEL – MNB CNTL – CL (tb-CL) NOZ HTR – OFF
MO51F	If CO2 RMVL SYS flown: CNTLR 1(2) MODE – STBY (hold 3 sec)

<u>VENT DOOR OPS DISABLE</u> 11	
MA73C:A	MCA LOGIC MID (four) – OFF ✓ FWD (three) – ON
:B	MCA LOGIC MID (four) – OFF AFT (three) – OFF
:C	If MNB and AC2 powered: cb MCA PWR AC1, AC3 3Φ FWD 1,3 – op
✓ Minimum middeck lighting	

This Page Intentionally Blank

LOSS OF 2 FUEL CELLS DEORBIT PREP

This Page Intentionally Blank

LOSS OF 2 FUEL CELLS DEORBIT PREP

ASSUMPTIONS/INITIAL CONDITIONS

LOSS OF 2 FUEL CELLS DEORBIT PREP assumes one of following pwrdns has been accomplished:

LOSS OF 2nd FC ON-ORBIT (TIG < 4:00) (ORB PKT, PWRDN)

LOSS OF 2nd FC ON-ORBIT (TIG > 4:00) (ORB PKT, PWRDN)

Electrical load will be 10–12 kW with transients to 14 kW during Deorbit Prep and Entry

IF TIME TO TIG < 4:00

Refer to ACTIVITY PRIORITY TABLE, 5–8

Use EXPEDITED D/O column to determine LOSS OF 2 FC DEORBIT PREP procedures that must be performed (mandatory) and those that should be performed if time permits (optional)

If any portions of Nominal Deorbit Prep have been accomplished, reconfigure systems per LOSS OF 2 FC DEORBIT PREP as reqd

IF TIME TO TIG > 4:00

Perform all LOSS OF 2 FC DEORBIT PREP procedures

PROBLEM DESCRIPTION/RATIONALE

Orbiter electrical load carried by one fuel cell; therefore, it is a critical component. LRUs may experience undervoltage with accompanying alarms

LOSS OF 2 FUEL CELLS DEORBIT PREP

NOTE

1. Use only one IDP/CRT with two MDUs whenever possible
2. Omit all maneuvers prior to TIG-03:36 if GG from powerdown
3. Maintain minimum lighting
4. A second pass GPC (GPC 4) will be activated at ~TIG-20
5. Vent doors will be open throughout entry (except L,R vent doors 1&2)
6. MS procedures are located on MS PULLOUT PAGES, 5-27 thru 5-32. Extra copies are located in back of PLT's book

LOSS OF 2 FUEL CELLS OVERVIEW OF CONFIGURATION MANAGEMENT

	OPS 1 ASC PKT					OPS 2 ON-ORBIT WAIT					OPS 2 DEORBIT PREP					OPS 3 DEORBIT PREP										
DPS																										
GPC	1	2	3	4	5	1	2	3	4	5	1	2	3	4	5	1	2	3	4	5						
OPS	G1	-	-	-	BFS	G2	--	--	SM	--	G2	--	--	SM	--	G3	--	--	--	BFS						
POWER OUTPUT MODE	ON	OFF	ON	ON	ON	ON	OFF	OFF	ON	OFF	ON	OFF	ON	ON	OFF	ON	OFF	OFF	ON	ON						
	N	N	N	N	B	N	N	N	T	N	N	N	N	T	N	N	N	N	N	B						
	R	H	H	H	R	R	H	H	R	H	R	H	H	R	H	R	H	H	H	R						
CONFIG GPC	1	2	3	4	0	2	1	0	0	0	4	0	0	0	4	0	2	4	(5)	0	0	3	1	0	0	0
STR	1	1				1	1				0	0				1	1				1	1				
	2	1				1	1				0	0				1	1				1	1				
	3	1				1	1				0	0				1	1				1	1				
	4	1				0	1				4	4				0	1				1	1				
PL 1/2	1	1				1	1				4	4				1	1				1	1				
CRT	1	1				1	1				1	1				4	4				1	1				
	2	1				0	0				0	0				0	0				0	1				
	3	0				1	1				1	1				4	4				0	0				
	4	1				0	0				0	0				4	4				0	0				
L	1	2				0	0				0	0				0	0				0	0				
	2	1				1 (OFF)	1 (OFF)				4	4				1 (ON)	1 (ON)				1 (OFF)	1 (OFF)				
MM	1	1				1 (OFF)	1 (OFF)				4	4				1 (OFF)	1 (OFF)				1 (OFF)	1 (OFF)				
	2																									
MDM						FF3; PL2 – ON					ALL ON except FF4					ALL ON except FF4										
D & C	DDU MDU IDP	L,R Two Forward ALL	AFT -----▶ L-----▶					Minimize use -----▶					Minimize use -----▶													
E C L S	AV BAY FAN CABIN FAN IMU FAN WATER LP FREON LP RADIATOR FES	1,2,3 A B 2 1 Stow ON	1,3 -----▶ 1,2,3 -----▶					A -----▶					B -----▶													
			A -----▶					1 -----▶					1-OFF, 2-ON -----▶													
			1-A, 2-A -----▶					Stow -----▶					ON -----▶													
			OFF -----▶																							
F C S E / N A V A R I D S	FCS CH ASA AA RGA ADTA IMU MLS RA TACAN	AUTO ON ON ON ON 2,3 OFF OFF OFF	AUTO -----▶					OFF -----▶					OFF -----▶													
			OFF -----▶					OFF -----▶					1,2,3 -----▶													
			OFF -----▶					OFF -----▶					1,2,3 -----▶													
			OFF -----▶					OFF -----▶					1,2,3 -----▶													
			3 -----▶					OFF -----▶					1,2,3 -----▶													
			OFF -----▶					OFF -----▶																		
			OFF -----▶					OFF -----▶																		
R J D	RJDA ^(B) RJDF ^(B) VERNIER	ALL ON ALL ON OFF	OFF -----▶ 1A,1B,2B-----▶					OFF -----▶					ALL OFF -----▶													
			OFF -----▶					OFF -----▶					ALL OFF -----▶													
			OFF -----▶					OFF -----▶					ALL OFF -----▶													

^(A) Water loops cycled as reqd (950 lb/hr)

^(B) Primary RJDs will be OFF during sleep periods

NOTE: Maintain minimum lighting

LOSS OF 2 FUEL CELLS OVERVIEW OF CONFIGURATION MANAGEMENT (CONT)

		SEAT INGRESS					TIG-20					EI-5	V = 15K
DPS													
GPC OPS		1	2	3	4	5	1	2	3	4	5		
		G3	-	-	--	BFS	G3	--	--	G3	BFS		
POWER OUTPUT MODE		ON	OFF	OFF	ON	ON	ON	OFF	OFF	ON	ON		
		N	N	N	N	B	N	N	N	N	B		
		R	H	H	H	R	R	H	H	R	R		
CONFIG GPC		3 1 0 0 0 0					3 1 0 0 4 0						
STR		1	1				1	4					
		2	1				4						
		3	1				1						
		4	1				4						
PL 1/2		1	1				1						
CRT		1	1				1						
		2	1				1						
		3	1				4						
		4	0				0						
L		1	0				0						
		2	0				0						
MM		1	1 (ON)				1 (ON)						
		2	1 (ON)				4 (ON)						
MDM		ALL ON except FF4					ALL ON except FF4						
D & C	DDU	L,R-----					-----						
	MDU	Minimize use					-----						
	IDP	Minimize use					-----						
E C L S	AV BAY FAN	1,2,3-----					-----					1,2-----	
	CABIN FAN	A-----					-----						
	IMU FAN	B-----					-----						
	WATER LP	1-OFF,2-ON					-----						
	FREON LP	1-A,2-A					-----						
	RADIATOR	Stow					-----						
	FES	ON					-----						
F C S E N S O R S / N A V A T O R S	FCS CH	AUTO-----					ORIDE-----						
	ASA	OFF-----					ON-----						
	AA	1,2,3-----					-----						
	RGA	1,2,3-----					-----						
	ADTA	OFF-----					ON-----						
	IMU	1,2,3-----					-----						
	MLS	OFF-----					-----						
	RA	OFF-----					-----						
	TACAN	OFF-----					-----					1, 2 or 2,3	
			-----					-----					
R J D	RJDA	1A,1B,2B					-----						
	RJDF	ALL OFF					-----						
	VERNIER	ALL OFF					-----						

(MEDS) A5-6

MEDS

C D/O/MEDS/GEN H

LOSS OF 2 FUEL CELLS DEORBIT PREP

MCC

TIG

	CDR	PLT	MS(AFT)	MS(MID)
-04:00	FES HTR ACT	CRT TIMER SETUP	FDF CONFIG/ENT STOW	ENTRY STOWAGE
	MDM CONFIG			
	AC BUS CONFIG	AC BUS CONFIG	AC BUS CONFIG	AC BUS CONFIG
	FES RESTART	SEL AFT RCS JETS		
	PRESS CNTL ENT CONFIG	MNVR TO TAIL SUN		PRESS CNTL ENT CONFIG SEAT INSTALLATION
			SEAT INSTALLATION	MCA CONFIG
			KU-BD ANT STOW	
-03:00	RAD BYPASS			
			PLBD CLOSING	
	PRE DPS TRANS SW CONFIG	PRE DPS TRANS SW CONFIG		
	DPS ENTRY CONFIG	DPS ENTRY CONFIG		
	PREL D/O UPDATE/UPLINK HORIZ SIT CONFIG	PREL D/O UPDATE/UPLINK	EDO PALLET DEACT	
	IMU RECOVERY			FLUID LOADING PREP
-02:00	ACT STR TRK MNVR IMU ALIGN ATT	APU STEAM VENT HTR	HTR CONFIG	GALLEY/H2O DISP DEACT
	IMU ALIGNMENT			
			FC PURGE	WCS DEACT
	MNVR TO BURN ATT DEACT STR TRK		C/W, COMM CONFIG	VENT DOOR DISABLE
	LOSS OF 2 FC SW VERIF LIST	LOSS OF 2 FC SW VERIF LIST	LOSS OF 2 FC SW VERIF LIST	LOSS OF 2 FC SW VERIF LIST
	CLOTHING CONFIG	CLOTHING CONFIG		
-01:00	FLUID LOADING PRE INGRESS SEAT INGRESS STOW ORB PKT	FLUID LOADING PRE INGRESS SEAT INGRESS STOW ORB PKT	WIRELESS STOW FLUID LOADING CLOTHING CONFIG STOW ORB PKT	FLUID LOADING CLOTHING CONFIG

**LOSS OF 2 FUEL CELLS DEORBIT PREP
ACTIVITY PRIORITY TABLE**

TIG	ACTIVITY	PAGE	EXPEDITED D/O	
			Mandatory	Optional
4:00	TIMER SETUP	5-9	1	--
3:59	ENTRY STOWAGE	5-29	--	2
3:58	FES HTR ACT	5-9	--	--
3:57	FDG CONFIG/ENT STOW	5-25	4	--
3:54	RCS/OMS HTR ACT	5-10	--	--
3:45	MDM CONFIG	5-9	--	--
3:42	AC BUS CONFIG	5-10	6	--
3:36	SELECT AFT RCS	5-10	--	--
3:32	AIRLOCK SW VERIF	5-10	--	T/L
3:30	FES RESTART	5-11	--	--
3:29	MNVR TO TAIL SUN	5-12	T/L	--
3:25	PCS ENT CONFIG	5-11	9	--
3:24	SEAT INSTALLATION	5-12	T/L	--
3:14	MCA CONFIG	5-30	10	--
3:10	KU-BD ANT STOW	5-12	T/L	--
3:00	RAD BYP	5-14	11	--
2:59	PLBD CLOSING	5-26	12	--
2:49	CRYO QTY CONFIG	5-13	--	13
2:48	PRE DPS TRANS SW CONFIG	5-13	14	--
2:45	DPS ENTRY CONFIG	5-13	15	--
2:37	EDO PALLET DEACT	5-14	--	16
2:35	PREL D/O UPDT/UPLK	5-14	17	--
2:32	HORIZ SIT CONFIG	5-14	--	T/L

TIG	ACTIVITY	PAGE	EXPEDITED D/O	
			Mandatory	Optional
2:24	IMU RECOVERY	5-16	--	--
2:20	FLUID LOADING PREP	5-30	--	18
2:10	GALLEY DEACT	5-30	--	19
2:09	HTR CONFIG	5-27	20	--
2:08	APU STEAM VENT HTR ACT	5-15	21	--
2:07	S-TRKR ACT	5-16	T/L	--
2:04	MNVR TO IMU ATT	5-16	T/L	--
2:00	IMU ALIGNMENT	5-17	22	--
1:44	WCS DEACT	5-30	23	--
1:40	FUEL CELL PURGE	5-27	24	--
1:39	MNVR TO BURN ATT	5-18	T/L	--
1:34	S-TRKR DEACT	5-18	25	--
1:29	C/W, COMM CONFIG	5-27	26	--
1:27	VENT DOOR OPS DISABLE	5-30	27	--
1:25	SWITCH VERIF	5-19	--	T/L
1:15	CLOTHING CONFIG (C,P)	5-19	--	28
1:06	WIRELESS STOW	5-27	29	--
1:05	BEGIN FLUID LOADING	5-19	--	T/L
1:01	CLOTHING CONFIG (MS,PS)	5-28	--	30
1:00	PRE INGRESS CONFIG	5-20	31	--
:52	SEAT INGRESS	5-21	T/L	--
:45	GO TO ENT WITH P&Is	5-21	T/L	--

T/L procedure located in timeline vice procedure block

NOTE

1. This table assumes LOSS OF 2nd FC ON-ORBIT (TIG < 4 hr) (ORB PKT, PWRDN) has been performed
2. Procedure blocks listed in mandatory column are only ones that must be performed if failure occurs on orbit with TIG < 4:00 away
3. At least 1.5 hr is reqd to perform all mandatory activities
4. Those in optional column should be performed if time permits
5. If procedure has a dash in both mandatory and optional columns, it is not reqd for expedited case
6. Some procedures may be deleted if any nominal DEORBIT PREP actions have been accomplished

(MEDS) A5-8

C D/O/ALL/GEN H

TIMER SETUP 1

P

1: GNC 2 TIME

SET CRT TIMER TO COUNT DOWN TO TIG
(perform for GNC and SM)

ENTRY DAY (HR:MIN:SEC - MET)

ITEM 17 +

		+			+		
--	--	---	--	--	---	--	--

24 HOUR LATE DELAYED DEORBIT

ITEM 17 +

		+			+		
--	--	---	--	--	---	--	--

1: GNC UNIV PTG

FES HTR ACTIVATION 3

C

L1 TOP EVAP HTR NOZ (two) - B AUTO
DUCT - B

L2 FLASH EVAP FDLN HTR (two) - 2

R11L SPLY H2O TKA OUTLET - CL (tb-CL)
 TKB OUTLET - OP (tb-OP)
 B SPLY ISOL VLV - OP (tb-OP)

MDM CONFIG 5

C

O6 MDM PL 1,2 (two) - ON
 FF 1,2,3 (three) - ON
 FA 1,2,3,4 (four) - ON

CRTX GNC I/O RESET
SM I/O RESET

TIG	
-04:00	P <u>TIMER SETUP</u> 1
GRAVITY GRADIENT	MS <u>ENTRY STOWAGE</u> 2 , 5-31
	C <u>FES HTR ACTIVATION</u> 3
	MS <u>FDI CONFIG/ENTRY STOW</u> 4 , 5-27
-03:55	P A14 ✓RCS/OMS HTR AFT RCS JET 1,2,3,4 (four) – AUTO
-03:50	
-03:45	C <u>MDM CONFIG</u> 5 , 5-9
	A <u>AC BUS CONFIG</u> 6 , 5-27 and 5-28 (Not reqd if AC transfer cable installed or if AC bus shorted)
-03:40	
-03:35	P <u>SELECT AFT RCS JETS</u> 7 (if GG from pwrn)
-03:30	MS <u>LOSS OF 2 FC SW VERIF LIST</u> , 6-28, 6-29 (OV102) (Airlock and Airlock Hatch only) 6-30, 6-31 (OV104)

	<u>AC BUS CONFIG</u> 6 (Not reqd if AC transfer cable installed or if AC bus shorted)
ALL L4:D,E,Q	1. ✓ All cbs (twenty-seven) – op
	2. If FC 1 OK: Perform AC3 (3Φ) BUS LOSS ACTIONS (ORB PKT, <u>EPS</u>). Do only steps in ORB PKT, do not proceed to MAL Mark up pictorials in section 6 to match bus loss actions AC3 is affected bus in step 3
	If FC 2 or FC 3 OK: Perform AC1 (3Φ) BUS LOSS ACTIONS (ORB PKT, <u>EPS</u>). Do only steps in ORB PKT, do not proceed to MAL Mark up pictorials in section 6 to match bus loss actions AC1 is affected bus in step 3
R1	3. Affected BUS: cb AC CONTR (three) – cl AC BUS SNSR – OFF INV/AC BUS – OFF (tb-OFF) INV PWR – OFF (tb-OFF) cb AC CONTR (three) – op
	4. Connect AC1 to AC3: Perform AC POWER TRANSFER CABLE INSTALLATION (IFM, PROCEDURES A THRU F)

	<u>SELECT AFT RCS JETS</u> 7 (if GG from pwrn)
P O6	✓ MDM FA 1,2,3,4 (four) – ON GNC 20 DAP CONFIG
O14:F	Select TAIL P,Y OPTION
O15:F	✓ RJDA 1A L2/R2 LOGIC, DRIVER – ON ✓ 1B L1/L5/R1 LOGIC – ON ✓ L1/R1 DRIVER – ON
O16:F	✓ 2B L3/R3/R5 LOGIC – ON ✓ L3/R3 DRIVER – ON
	X: GNC 23 RCS
O7	ITEM 1 EXEC (FRCS page) OVRD FRCS MANF 1,2,3,4 STAT – CL ITEM 2 EXEC (LRCS page) OVRD LRCS MANF 4 STAT – CL ITEM 3 EXEC (RRCS page) OVRD RRCS MANF 4 STAT – CL

FES RESTART 8

C L1 RAD CNTLR OUT TEMP – HI
 O1 When FREON EVAP OUT TEMP ind
 > 50 degF:
 L1 FLASH EVAP CNTLR PRI B(A) – ON
 HI LOAD DUCT HTR sel – B
 ML86B:A ✓ cb MNC SPLY H2O XOVR VLV – cl
 R11L SPLY H2O XOVR VLV – OP (tb-OP)

PRESS CNTL SYS ENTRY CONFIG 9

MS MO10W 14.7 CAB REG INLET SYS 1,2 vlv (two) – CL
 H2O TK N2 REG INLET SYS 1,2 vlv (two) – OP
 O2 REG INLET SYS 1,2 vlv (two) – CL

 MO69M LEH O2 8 vlv – CL
 Remove, stow O2 Bleed Orifice
 LEH O2 7,8 vlv – OP (if reqd)
 MO32M 5,6 vlv – OP (if reqd)

 C L2 ✓ O2 SYS 1,2 SPLY (two) – OP (tb-OP)
 ✓ XOVR SYS 1,2 (two) – OP
 ✓ N2 SYS 1,2 SPLY (two) – OP (tb-OP)
 ✓ REG INLET (two) – OP (tb-OP)
 O2/N2 CNTLR VLV SYS 1 – OP
 2 – CL

T I G

-03:30
TAIL-SUN

C FES RESTART [8], 5-11
MNVR TO TAIL SUN
CRTX TG +4
BV +5
P 184
Y 0
Initiate TRK

-03:25

C,MS PRESS CNTL SYS ENTRY CONFIG [9], 5-32
MS SEAT INSTALLATION

-03:20

-03:15

MS MCA CONFIG [10], 5-32

CAUTION
Use only PL BAY MECH PWR SYS 2 during
KU-BD STOW. This will reduce voltage
demand on FC by using single-motor stowage

-03:10

MS KU-BD ANT STOW (ORB OPS, COMM/INST) (if deployed)

-03:05

-03:00

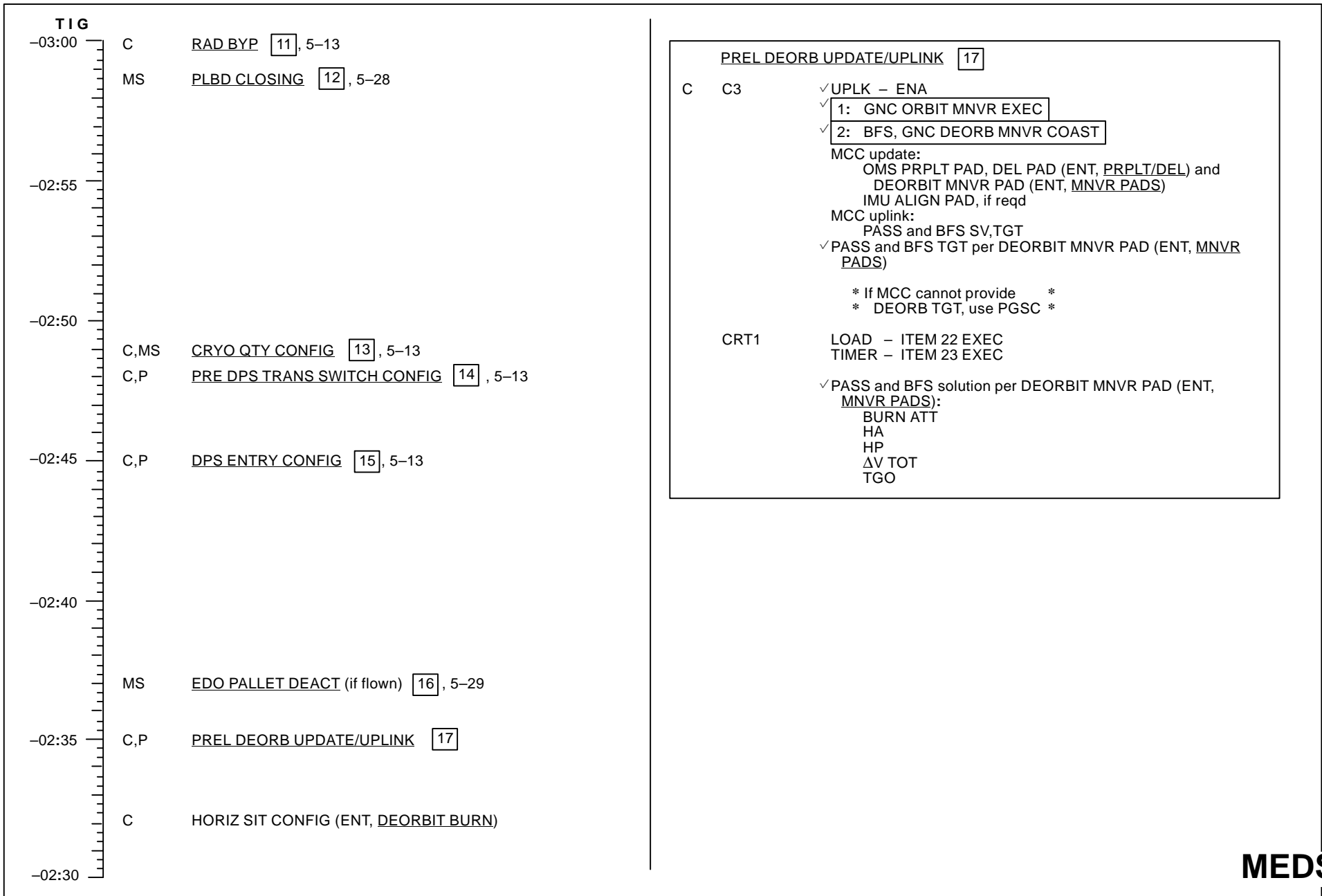

MEDS

APU STEAM VENT HTR ACT 21

P R2 | If FC 1 OK:
 | BLR CNTLR/HTR 1 – A
 | 2 – B
 | 3 – A

 | If FC 2 or FC 3 OK:
 | BLR CNTLR/HTR 1 – A
 | 2 – A
 | 3 – B

BLR PWR (three) – ON

NOTE

Htr reqd to be on 2 hr prior to APU act

TIG

-02:30
-02:25
-02:20
-02:15
-02:10
-02:05
-02:00

C
MS
MS
P
C
O6
CRT1
C

IMU RECOVERY (if reqd)
Use GNC FRP-3 (MAL, GNC) to recover any IMUs lost
due to bus failures or powerdown
BFS, GNC, OPS 000, 301 PRO

BFS, GNC 50 HORIZ SIT

✓ BFS R/W sel
FLUID LOADING PREP 18, 5-32

GALLEY DEACT 19, 5-32

HTR CONFIG 20, 5-29

APU STEAM VENT HTR ACT 21, 5-15

ACT STAR TRKR (omit if BFS)

- ✓ S TRK PWR -Z - ON
- ✓ S TRK PWR -Y - ON
- GNC I/O RESET
- ✓ STAR TRKR doors open

MNVR TO IMU ATT (omit if BFS) use pad on this page
DAP: AUTO

IMU STAR ALIGN PAD

NOTE

For pad data, ✓MCC or ref STAR PAIRS (ORB OPS, PTG)

STAR ID: -Y _____, _____ (TIG - ____ : ____ TO - ____ : ____)

-Z _____, _____ (TIG - ____ : ____ TO - ____ : ____)

ANG DIF: _____

ALIGNMENT ATTITUDE
(Dual or Single S TRK)

2nd ALIGNMENT ATTITUDE
(Single S TRK)

R _____
P _____
Y _____

-Z: _____
R _____
P _____
Y _____

-Y: _____
R _____
P _____
Y _____

IMU STAR ALIGN LOG

REQD ID: -Y _____, -Z _____ ANG ERR ____ . ____

ANG	1	2	3
ΔX ()	_____ . _____	() _____ . _____	() _____ . _____
ΔY ()	_____ . _____	() _____ . _____	() _____ . _____
ΔZ ()	_____ . _____	() _____ . _____	() _____ . _____

EXECUTE TIME ____ : ____ : ____ (TIG MINUS)

IMU VERIFICATION PAD

NOTE

For pad data, ✓MCC or ref STAR PAIRS (ORB OPS, PTG)

STAR ID: -Y _____, _____ (TIG - ____ : ____ TO - ____ : ____)

-Z _____, _____ (TIG - ____ : ____ TO - ____ : ____)

ANG DIF: _____

ALIGNMENT ATTITUDE
(Dual or Single S TRK)

2nd ALIGNMENT ATTITUDE
(Single S TRK)

R _____
P _____
Y _____

-Z: _____
R _____
P _____
Y _____

-Y: _____
R _____
P _____
Y _____

IMU VERIFICATION LOG

REQD ID: -Y _____, -Z _____ ANG ERR ____ . ____

ANG	1	2	3
ΔX ()	_____ . _____	() _____ . _____	() _____ . _____
ΔY ()	_____ . _____	() _____ . _____	() _____ . _____
ΔZ ()	_____ . _____	() _____ . _____	() _____ . _____

EXECUTE TIME ____ : ____ : ____ (TIG MINUS)

IMU ALIGNMENT 22

NOTE

Procedure applies for one or two S TRK aligns.
For one S TRK, a second att mnvr reqd between
data takes. See pad on 5-16 for att & stars

- C
1. 1: GNC 22 S TRK/COAS CNTL
- C3
- BFC CRT DISP – OFF
- 3: GNC 21 IMU ALIGN
- CRT1
2. ✓REQD ID – ITEM 11,12 – 0
 - ✓STATUS (two) – NO BITE
 - ✓SHUTTER (two) – OP
 - * If SHUTTER – CL: *
 - * ✓Att, MET – correct *
 - * Visually verify no bright object in FOV *
 - * After data collected and before changing *
 - * attitude, return shutter to AUTO *
 - * To open shutter: *
 - * MAN OP – ITEM 15(16) EXEC (*) *
 - * To return shutter to AUTO: *
 - * MAN OP – ITEM 15(16) EXEC (no *) *
- CRT3
- IMU 1,2,3:
- ✓STAT – blank
 - ✓OPER – ITEM 4,5,6 (*)
3. ✓IMU ALIGN ATT (pad)
- CRT1
4. S TABLE CLR – ITEM 20 EXEC
 5. Enable Star Tracker:
 - ✓S TRK – ITEM 3,4 EXEC (*)
 6. Verify S TABLE:
 - TRK ID 1,2 = STAR ID (pad)
 - ANG ERR ≤ 0.08
 - Wait approx 1 min for new IMU Δ ANGS
 - * If after 3 min no data (or bad data) in S Table: *
 - * ✓S TRK – ITEM 3,4 (*) *
 - * ✓ATT/STARS/TIME *
 - * ✓S TRK: TRK ID = STAR ID (pad) *
 - * Do S TRK Self Test *
 - * If neither tracker fails: *
 - * Mnvr to verification att – repeat steps 3,4,5,6 *
 - * If one tracker fails: *
 - * ✓TERM/IDLE for failed tracker – ITEM 9(10)(*) *
 - * proceed with one S TRK ALIGN *
 - * If both trackers fail, inform MCC *

For one S TRK align:

- S TRK for good tracker – ITEM 3(4) EXEC (*)
- S TABLE CLR – ITEM 20 EXEC, reacquire star with good tracker
- TERM/IDLE for good tracker during maneuvers – ITEM 9(10) EXEC (*)
- Mnvr to second att (single S TRK): Do not clear S Table
- Repeat steps 3,5,6 with second Star ID

- CRT1
- CRT3
7. ✓S TABLE SEL – ITEM 17,18 (*)
 - ALIGN IMU 1,2,3 – ITEM 10,11,12, EXEC (*)
 - ✓STAR ALIGN – ITEM 13 (*)
 - ✓IMU 1,2,3 – ANG ΔX,ΔY,ΔZ < 0.80
 - * If ANG ΔX,ΔY,ΔZ > 0.80 for two IMUs, do not *
 - * torque: *
 - * Mnvr to verification att, repeat steps 3 thru *
 - * 7 once *
 - * If still > 0.80, report to MCC *
 8. Record ANG ΔX,ΔY,ΔZ, ANG ERR, EXECUTE TIME (use log on 5-16)
 - EXEC – ITEM 16 EXEC (*)
- Alignment complete when:
- EXEC – ITEM 16 (no *)
- IMU ALIGN VERIFICATION
9. Mnvr per IMU VERIFICATION PAD, 5-16
DAP: AUTO
 10. Perform steps 3,4,5,6 using appropriate stars (pad)
 11. ✓IMU 1,2,3 ANG ΔX,ΔY,ΔZ < 0.1
 - * If ANG ΔX,ΔY,ΔZ > 0.1, perform steps 8 thru 11, *
 - * report to MCC *

NOTE

For alternate stars, ✓MCC or ref STAR PAIRS (ORB OPS, PTG)

12. Report IMU ALIGN results
- C3
13. BFC CRT DISP – ON
 - 3: BFS, GNC DORB MNVR COAST
 - 1: GNC DEORB MNVR COAST

TIG

-02:00 C IMU ALIGNMENT [22], 5-17 (omit if BFS)

-01:55

-01:50

-01:45 MS WCS DEACTIVATION [23], 5-32

-01:40 MS FUEL CELL PURGE [24], 5-29
 C MNVR TO BURN ATT
 MNVR per DEORBIT MNVR PAD (ENT, MNVR PADS):
 R _____
 P _____
 Y _____

-01:35 DAP: AUTO
 C DEACT STAR TRACKERS & CLOSE DOORS [25]

-01:30

DEACT STAR TRACKERS & CLOSE DOORS [25]

C O6 S TRK PWR (two) - OFF
 O14:E cb MNA S TRK -Z - op
 O15:E cb MNB S TRK -Y - op
 O6 S TRK DR CNTL SYS (two) - CL (start timer)
 √ POS tb (two) - bp
 When both tb - CL (-8-24 sec)
 or either tb - bp > 24 sec:
 S TRK DR CNTL SYS 1,2 (two) - OFF
 * If tb - bp > 8 sec, notify MCC *

TIG

-01:30 MS C/W, COMM CONFIG [26], 5-29

MS VENT DOOR OPS DISABLE [27], 5-32

-01:25 A LOSS OF 2 FC SW VERIF LIST, 6-3 thru 6-27 (OV102),
6-3 thru 6-29 (OV103, OV104, OV105)

-01:20

-01:15 C,P CLOTHING CONFIG [28]

-01:10

MS WIRELESS STOW [29], 5-29

-01:05 A Begin Fluid Loading per individual prescription
Fluid Loading should be completed by E1

-01:00 MS, PS CLOTHING CONFIG [30], 5-30, 5-32

CLOTHING CONFIG [28]

C,P Unstow, don:
LES
Harness
Boots

PRE INGRESS CONFIG 31

P R2 MPS/H2 PURGE PREP
MPS He ISOL (six) - CL
PNEU He ISOL - CL
L ENG He XOVR - CL
R4 MANF PRESS (two) - CL

C,P O16:E ENABLE QTY GAUGE
cb MNC RCS/OMS PRPLT QTY GAUGE - cl

F8 RA CONFIG
RDR ALTM - 1

O8 MLS CH/TACAN CH/DATA BUS
O7 MLS CH tw (three) - See LAND SITE DATA
TACAN CH tw (three) - See LAND SITE DATA

C L4:P ENABLE PROXIMITY PACKAGE
√cb AC2 ΦA LG SNSR 2 - cl
√AC3 ΦA LG SNSR 1 - cl

C L4:J cb CONFIG
cb AC3 ΦA SIG CONDR HUM SEP - op
ΦB SIG CONDR IMU FAN - op

HUD SETUP
Remove, stow HUD covers (two)
Ensure cloth cover does not obscure light sensor

MEDS

TIG

-01:00
-00:55
-00:50
-00:45
-00:40
-00:35
-00:30

C,P

PRE INGRESS CONFIG 31, 5-20

C,P

C6

LEH O2 vlv (four) - OP
SEAT INGRESS
Adjust seat (one seat, direction at a time)
Exercise brake pedals
LES PRESS INTEGRITY CHECK

C,P

Perform P&I CHANGES TO ENT, 5-22 and 5-23

A

Stow ORB PKT Orbit (Cue Cards)
Go to ENT, DEORBIT BURN

MEDS

LOSS OF 2 FUEL CELLS

P&I Changes to ENTRY

GENERAL

1. AV BAY FANS cycled as needed to keep power level low
2. GPCs 2,3 remain pwr d n throughout ENTRY

SPECIFIC

TIG-46

R4

Delete: **OMS TVC GMBL CHECK**

Under **APU PRE-START** delete:

✓HYD BRAKE ISOL VLV (three) tb – CL

✓LG EXTEND ISOL VLV tb – CL

and associated starred procedures

HORIZ SIT CONFIG (GNC 51, BFS GNC 51)

Delete: ✓SSME REPOS – ITEM 19 (ENA)

Add: “SSME REPOS – ITEM 19 EXEC (INH)”

TIG-25

L1

Delete: **VENT DOOR CLOSE**

Insert: “HUM SEP (two) – OFF

FES HEATER DEACT

TOP EVAP HTR NOZ L,R (two) – OFF

DUCT – OFF

HI LOAD DUCT HTR – OFF

FLASH EVAP FDLN HTR B SPLY – OFF

L2

ASA ACT

ASA (four) – ON”

O14:F,
O15:F,
O16:F

DEORB
UPDATE/
UPLINK

O6

Insert before GNC OPS 302 PRO:

“**GPC 4 ACT**

(1) GPC MODE 4 – STBY/RUN

(2) BFC CRT DISP – OFF

(3) For OPS 3 TRANS use

(4) GNC, OPS 301 PRO

(5) BFC CRT DISP – ON; BFS I/O RESET

(6) FCS CH (four) – ORIDE

(7) G50 ✓LAND SITE/RWY per DEL PAD”

C3

C3

CONFIG	3
GPC	10040
STR 1	1
2	4
3	1
4	4
PL 1/2	1
CRT 1	1
2	4
3	1
4	0
L 1	0
2	0
MM 1	1
2	4

(MEDS) A5-22

MEDS

C D/O/MEDS/GEN H

LOSS OF 2 FUEL CELLS
P&I Changes to ENTRY (Cont)

TIG-20		Delete: RCS/OMS HTR steps
TIG-5	R4	Insert after SINGLE APU START: "✓HYD BRAKE ISOL VLV (three) – GPC (tb-CL) ✓LG EXTEND ISOL VLV – GPC (tb-CL) <div style="border: 1px solid black; display: inline-block; padding: 2px;">GNC DEORB MNVR EXEC</div> R OMS GMBL – SEC (*)"
TIG-2	L1	Use 2 DDU/FLT CNTLR PWR Add: " AV BAY FAN CYCLE AV BAY FAN (six) – OFF"
DURING BURN		If FRCS COMPLETION required during burn, perform EI-18 FORWARD RCS RECOVERY steps below prior to fast flip
POST BURN		Add: "FLT CNTLR PWR (two) – OFF ✓DAP: AUTO cb MNA,B,C, DDU L,R (four) – op Insert after OMS/RCS POST BURN RECONFIG: "AV BAY FAN 1B,2A,3A [3B vice 3A if FC 1 OK] – ON (3 sec between each start)"
EI-20	C3	SECONDARY ACTUATOR CHECK Add: "9. FCS CH (four) – ORIDE"
EI-18	O14:F, O15:F, O16:F O6	If FORWARD RCS DUMP reqd for off-nominal CG, etc, insert FORWARD RCS RECOVERY before the dump: "FORWARD RCS RECOVERY RJDF LOGIC,DRIVER (eight) – ON MDM FF4 – ON GNC I/O RESET <div style="border: 1px solid black; display: inline-block; padding: 2px;">GNC 23 RCS</div> ITEM 1 EXEC (FRCS page) OVRD FRCS MANF 1,2,3,4 STAT – OP"

MEDS

O14:F,
O15:F,
O16:F

Insert after dump completion:
"RJDF LOGIC,DRIVER (eight) – OFF

GNC 23 RCS

ITEM 1 EXEC (FRCS page)
OVRD FRCS MANF 1,2,3,4 STAT – cl
MDM FF4 – OFF”

O6

ENTRY SW
CHECK

Delete: ✓ANTISKID,NWS steps
Delete: ✓RADAR ALTM,MLS,TACAN steps

EI-13

Delete: **SSME HYD REPRESS**

ENTRY
MNVRS

Replace nominal ENTRY MANEUVERS (Cue Card) with
LOSS OF 2 FUEL CELLS ENTRY MANEUVERS, A5-25

LOSS OF 2 FUEL CELLS ENTRY MANEUVERS

FLIGHT CONDITIONS	MANEUVER
EI-5	MDM FF4 - ON BRAKES (three) - ON cb ADTA 1,2,3 - cl GNC I/O RESET cb MNA,B,C DDU L,R (four) - cl (L) FLT CNTLR PWR - ON Use two IDP/CRTs with four MDUs ✓LVLH ATT GNC, OPS 304 PRO ✓OPS 304, wait 1 min MDM FF4 - OFF * If PREBANK: R/Y - CSS * * Roll at 1°/sec to <input type="text"/> <input type="text"/> * * Maintain PREBANK ± 5° *
'Guidance Box' @ q ~8 or D ~3	CLOSED LOOP GUIDANCE ___:___:___ * If PREBANK: P,R/Y - AUTO * Begin AIL trim monitoring
D = 11	✓DRAG H (FORCE if editing)
V = 19K	✓MPS/TVC ISOL VLV - CL
V = 15K	If FC 1 OK: TACAN 1,2 MODE - GPC If FC 2 or FC 3 OK: TACAN 2,3 MODE - GPC ✓TACAN ANT SEL (two) - AUTO * If ELS,UHF MODE - G T/R *
V = 12K	RAD BYP VLV MODE (two) - AUTO CNTLR LOOP (two) - AUTO B(A)
V = 10K	✓SPD BRK to 81%
V = 7K	✓TACAN status
V = 5K	L AIR DATA PROBE - DPY (Wait 30 sec) R AIR DATA PROBE - DPY (Heat only one probe if reqd) Begin AIL and RUD trim monitoring
ΔAz = 10.5°	FIRST ROLL REVERSAL <input type="text"/> <input type="text"/> <input type="text"/> <input type="text"/>

FLIGHT CONDITIONS	MANEUVER
M = 4	MDM FF4 - ON GNC I/O RESET
M = 2.9	CAB FAN (two) - OFF AV BAY FAN 2A - OFF 3A(3B) - OFF After ADTA incorporated, TACAN MODE (two) - OFF Use one HUD, one MLS, one RA GNC I/O RESET
M = 2.7	✓APUs TRIM PANEL (two) - OFF RHC/PNL (two) - ENA
* If M < 2.5, P CSS for ADTA to G&C incorp *	
M = 2.0	Ensure ADTA to G&C; else, ✓Theta limits
M = 0.95	* For bailout procedures, go to BAILOUT *
M = 0.9	P,R/Y - CSS as reqd ✓SPDBK CMD vs POS MAX Nz <input type="text"/> <input type="text"/> <input type="text"/> ANTISKID - ON (R) FLT CNTLR PWR - ON Use two IDP/CRTs with six MDUs NWS - 1 Lock Inertia Reels
M = 0.7	✓LG EXTEND ISOL VLV - OP
h = 15K	✓MLS
h = 10k	✓A/L, TAB/LES VISORS - CL (KSC)
MAIN GEAR TD	✓SPD BRK - 100%
DEROT INIT	DRAG CHUTE pb (two) - ARM,DPY (simo)
NOSE GEAR TD	SRB SEP - MAN/AUTO and depress pb ✓Auto Load Relief ✓HYD BRAKE ISOL VLV (three) - OP
V = 60 KGS	DRAG CHUTE JETT pb - JETT
STOP	✓All landing/navaids off CAB FAN B - ON (Wait 3 sec, then continue) AV BAY FAN 2A,3A [3B vice 3A if FC1 OK] - ON (3 sec between each start) Go to ENT C/L, POST LDG

MEDS

This Page Intentionally Blank

LOSS OF 2 FC MS AFT FLIGHT DECK ACTIVITIES MS PULLOUT PAGE

NOTE

Wait for GO from CDR or PLT before starting any activity on this page

TIME (TIG--)	MS ACTIONS (AFT)
3:57	<u>FDF CONFIG/ENTRY STOW</u> [4]
3:42	<u>AC BUS CONFIG</u> [6] (Not reqd if AC transfer cable installed or if AC bus shorted)
3:24	<u>SEAT INSTALLATION</u>
	<p style="text-align: center;">CAUTION</p> <p>Use only PL BAY MECH PWR SYS 2 during KU-BD STOW. This will reduce voltage demand on FC by using single-motor stowage</p>
3:10	<u>KU-BD ANT STOW</u> (ORB OPS, <u>COMM/INST</u>) (if deployed)
2:59	<u>PLBD CLOSING</u> [12], 5-28
2:37	<u>EDO PALLET DEACT</u> (if flown) [16], 5-29
2:09	<u>HTR CONFIG</u> [20], 5-29
1:40	<u>FUEL CELL PURGE</u> [24], 5-29
1:29	<u>C/W, COMM CONFIG</u> [26], 5-29
1:25	<u>LOSS OF 2 FC SW VERIF LIST</u>
1:06	<u>WIRELESS STOW</u> [29], 5-29
1:05	Begin Fluid Loading per individual prescription Fluid Loading should be completed by EI
1:01	<u>CLOTHING CONFIG</u> [30], 5-30

<u>FDF CONFIG/ENTRY STOW</u> [4]
<u>FDF CONFIG</u> Unstow,install: Entry,Deorbit Burn Cue Cards ENT ENT PKT
✓ Available for ENTRY: LDG SITE CHARTS Handheld Radio STAR CHART ORB OPS CONT DEORB ORB PKT REF DATA MAL Stow all other FDF articles
<u>ENTRY STOW</u> Stow: Flt Deck Camrs,Accessories Stow VTR Cassettes (one in VTR) Quick Don Masks
<u>FOOT LOOP CONFIG</u> Tape Foot Loops in egress routes

<u>AC BUS CONFIG</u> [6]
A L4:D,E,Q 1. ✓ All cbs (twenty-seven) – op
2. If FC 1 OK: Perform AC3 (3Φ) BUS LOSS ACTIONS (ORB PKT, <u>EPS</u>). Do only steps in ORB PKT, do not proceed to MAL Mark up pictorials in section 6 to match bus loss actions AC3 is affected bus in step 3
If FC 2 or FC 3 OK: Perform AC1 (3Φ) BUS LOSS ACTIONS (ORB PKT, <u>EPS</u>). Do only steps in ORB PKT, do not proceed to MAL Mark up pictorials in section 6 to match bus loss actions AC1 is affected bus in step 3
R1 3. Affected BUS: cb AC CONTR (three) – cl AC BUS SNSR – OFF INV/AC BUS – OFF (tb-OFF) INV PWR – OFF (tb-OFF) cb AC CONTR (three) – op
4. Connect AC1 to AC3: Go to AC POWER TRANSFER CABLE INSTALLATION (IFM, <u>PROCEDURES A THRU F</u>)

MEDS

LOSS OF 2 FC Back of MS AFT FLIGHT DECK ACTIVITIES

MS PULLOUT PAGE

PLBD CLOSING 12

GPC/CRT 4 EXEC
Use IDP/CRT 4

STOW RADIATORS (if reqd)

CAUTION

Use only PL BAY MECH PWR SYS 2 during RAD STOW.
This will reduce voltage demand on FC by using
single-motor stowage

Perform RAD STOW/DEPLOY, step 1 (ORB OPS, ECLS)

CONFIG RMS (if RMS onboard)

- ✓ Elbow Camr in aligned position
 - Pan 90° from X-axis
 - Tilt per decal

- A8L
- ✓ PORT RMS HTR A,B (two) – OFF
 - ✓ RMS PWR – OFF

CLOSE PLBD

R13L

CAUTION

If SM GPC fails during this operation:
PL BAY DR SYS 1,2 (two) – DSBL
Perform PASS SM GPC FAIL (ORB PKT, DPS)

When closing and latching PLBD:

- Verify no obstructions (Ku ANT,RMS,RAD,etc)
- Use only one PL BAY DR SYS switch during ALL PLBD procedures

If no motion determined visually or 'OP/CL' not
blank within 10 sec after cmd:

or

If door motion stops and not 'RDY' or 'CL':

or

If any other problem occurs:

PL BAY DR – STOP

SYS 1 – ENA

2 – DSBL

Continue in manual mode

NOTE

Ref DETAILED PLBD CLOSING PROCEDURES
(DEORBIT PREP, NOMINAL DEORBIT PREP) (if reqd)

CRT 4 SM, OPS X02 PRO

4: SM PL BAY DOORS

- R13L
CRT4
- ✓ PL BAY DR – STOP
 - ✓ PBD SW – STOP
 - ✓ MAN SEL (ten) – (no *)
 - ✓ PBD SW BYPASS – (no *)
 - AC POWER ON – ITEM 1 EXEC (*)
 - AUTO MODE SEL – ITEM 3 EXEC (*)
- R13L
PL BAY DR SYS 2 – ENA
- ✓1 – DSBL
- CRT4 ✓OP/CL STATUS (ten) – OP

NOTE

All drive times will be single-motor

R13L PL BAY DR – CL

- * If PORT(STBD) DOOR not 'CL' within 6 sec of *
- * 'RDY' then: *
- * PL BAY DR – STOP *
- * ✓PLBD BULKHEAD LATCH GO/NO-GO DIAGRAM *
- (DEORBIT PREP, NOMINAL DEORBIT PREP) *
- * If NO-GO: Go to CONTINGENCY PLBD CLOSURE, *
- MECH SSR-2 (MAL, MECH) *
- * If GO: PL BAY DR – CL *

When STBD DOOR as close as possible to PORT DOOR

before contacting it:

PL BAY DR – STOP

- ✓ For C/L overlap ref PLBD BULKHEAD LATCH GO/NO-GO
DIAGRAM (DEORBIT PREP, NOMINAL DEORBIT PREP)

- * If NO-GO, perform SIMULTANEOUS PLBD CL, MECH *
- * SSR-3 (MAL, MECH) *

PL BAY DR – CL

- R13L
When closed and latched:
PL BAY DR – STOP
PL BAY DR SYS 2 – DSBL
- ✓1 – DSBL
- CRT4 ✓OP/CL STATUS (ten) – CL
AC POWER OFF – ITEM 2 EXEC (*)
GPC/CRT 04 EXEC
IDP/CRT4 PWR – OFF
AFD 1 PWR – OFF
- R11L
✓70mm Camr (two), Spotmeter stowed
- A7U
✓PL BAY FLOOD (all) – OFF

MEDS

LOSS OF 2 FC MS AFT FLIGHT DECK ACTIVITIES (Cont)

MS PULLOUT PAGE

<u>EDO PALLET DEACT (if flown)</u> 26	
MS	A15:C PALLET HTRS A,B (two) – OFF A15:D–G O2,H2 TK6,7,8,9 HTRS A,B (sixteen) – OFF A15:C PWR PPCA–1 (PPCA–1/3 if OV105) MNA – OFF (tb–OFF) PALLET PWR PPCA–2 (PPCA–2/4 if OV105) MNB – OFF (tb–OFF)
A15:B	cb PPCA CONT PWR 1 (1/3 if OV105) ESS 1BC – op 2 (2/4 if OV105) ESS 2CA – op
A15:H–K	All cbs (twenty–four) – op (Cntlrs,Qty,O2 Htr Snrs)
R14:B	cb MNA,MNB,MNC PALLET DSC (three) – op

<u>HTR CONFIG</u> 20	
R11U	FC PURGE HTR – ON
<u>NOTE</u> Htr must be on 15 min prior to purge	
A12	✓APU HTR TK/FU LINE/H2O/SYS 1B,2B,3B – AUTO 1A,2A,3A – OFF
A14	✓HYD HTR (eight) – OFF RCS/OMS HTR FWD RCS – OFF L POD (two) – A OFF,B OFF R POD (two) – A OFF,B OFF OMS CRSFD LINES (two) – A OFF – B OFF FWD,AFT RCS JET 5 (two) – OFF

<u>FUEL CELL PURGE</u> 24	
<u>WARNING</u> Do not purge if FC AMPS > 430	
R11U	✓FC PURGE HTR ON > 15 min VLVS X – OP for 2 min, then – GPC HTR – GPC ✓VLV – GPC

<u>C/W, COMM CONFIG</u> 26			
<u>C/W RESET</u>			
R13U			
PARAMETER NAME	C/W CH	ENA/ INH	
HYD P	1	99	ENA
	2	109	ENA
	3	119	ENA
<u>COMM CONFIG</u>			
O6	✓UHF SPLX/EVA PWR AMPL	– ON	
A1L	S–BD PM MODE	– STDN LO	
	NSP DATA RATE XMIT,RCV (two)	– HI	
	CODING XMIT,RCV (two)	– OFF	
A13	OS AUD SPKR PWR	– OFF	
A15	PS COMM CCU PWR	– OFF	
R14:C	cb KU ELEC	– op	
	ANT HTR	– op	
	CABLE HTR	– op	
	SIG PROC	– op	
	cb UHF EVA (two)	– op	
O5,O9	L,R AUD A/G 2	– T/R	
	ICOM B	– T/R	
	VOX SENS	– as reqd	
	VOL tw (six)	– as reqd	
	XMIT/ICOM MODE	– PTT/VOX	
MO42F	MIDDECK SPKR AUD PWR	– AUD/TONE	
ML85E	AC S1 – OFF		
R10,L9	MS,PS AUD PWR	– AUD/TONE	
	A/G 1	– T/R	
	2	– T/R	
	A/A	– T/R	
	ICOM A,B	– T/R	
	VOX SENS	– as reqd	
	VOL tw (six)	– as reqd	
	XMIT/ICOM MODE	– as reqd	

<u>WIRELESS STOW</u> 29	
Disconnect, stow Wireless Headsets (if reqd)	
✓Minimum aft deck lighting	

LOSS OF 2 FC
Back of MS AFT FLIGHT DECK ACTIVITIES (Cont)

MS PULLOUT PAGE

CLOTHING CONFIG 30

MS,PS

Unstow,don:
LES
Harness
Boots

LOSS OF 2 FC MS MIDDECK ACTIVITIES

MS PULLOUT PAGE

NOTE

Wait for GO from CDR or PLT before starting any activity on this page

TIME (TIG-)	MS ACTIONS (MID)
3:59	<u>ENTRY STOWAGE</u> [2]
3:42	<u>AC BUS CONFIG</u> [6], 5-32 (Not reqd if AC transfer cable installed or if AC bus shorted)
3:32	<u>SW VERIF</u> (Airlock and Airlock Hatch only)
3:25	<u>PRESS CNTL SYS ENTRY CONFIG</u> [9], 5-32
3:24	<u>SEAT INSTALLATION</u>
3:14	<u>MCA CONFIG</u> [10], 5-32
2:49	<u>CRYO QTY CONFIG</u> [13], 5-32
2:20	<u>FLUID LOADING PREP</u> [18], 5-32
2:10	<u>GALLEY DEACT</u> [19], 5-32
1:44	<u>WCS DEACTIVATION</u> [23], 5-32
1:27	<u>VENT DOOR OPS DISABLE</u> [27], 5-32
1:25	<u>LOSS OF 2 FC SW VERIF LIST</u>
1:05	Begin Fluid Loading per individual prescription Fluid Loading should be completed by EI
1:01	<u>CLOTHING CONFIG</u> [30], 5-30

	<u>ENTRY STOWAGE</u> [2]
	<u>PERSONAL HYGIENE SYS STOWAGE</u> Stow: Personal Hygiene Kits Hose
	<u>WCS CONFIG</u> Foot restraints – up,locked Privacy Curtain – stow
	<u>AIRLOCK CLOSEOUT</u> Tether soft goods to EVA tether point or A/L Stowage Bag. Gray Tape to floor
MO13Q	✓ARLK FAN A(B) – OFF (OV103/OV104/OV105) if flown Stow all ducts as appropriate
	<u>ESCAPE POLE SETUP</u> Reinstall Stbd Pip Pin Reinstall large Port Pin: Retract and hold Locking Pin (Ring) Reinstall large Pin Release Locking Pin (Ring) Slide forward Safing Latch
	✓ Pole Straps secure
	<u>FDF STOWAGE</u> Stow FLIGHT PLAN
	<u>CABIN CONFIG</u> Stow: Backup PGSC Middeck Camrs, Accessories FWD/AFT Shades, Filters, Quick Don Masks Stow Exercise Equipment ✓ Retention net in ASC/ENT config
	<u>EGRESS ROUTE CONFIG</u> Tape Foot Loops in egress routes

LOSS of 2 FC Back of MS MIDDECK ACTIVITIES

MS PULLOUT PAGE

AC BUS CONFIG 6 (Not reqd if AC transfer cable installed or if AC bus shorted)

A L4:D,E,Q 1. ✓ All cbs (twenty-seven) – op

2. If FC 1 OK:
Perform AC3 (3Φ) BUS LOSS ACTIONS (ORB PKT, EPS).
Do only steps in ORB PKT, do not proceed to MAL
Mark up pictorials in section 6 to match bus loss actions
AC3 is affected bus in step 3

If FC 2 or FC 3 OK:
Perform AC1 (3Φ) BUS LOSS ACTIONS (ORB PKT, EPS).
Do only steps in ORB PKT, do not proceed to MAL
Mark up pictorials in section 6 to match bus loss actions
AC1 is affected bus in step 3

R1 3. Affected BUS: cb AC CONTR (three) – cl
AC BUS SNSR – OFF
INV/AC BUS – OFF (tb-OFF)
INV PWR – OFF (tb-OFF)
cb AC CONTR (three) – op

4. Connect AC1 to AC3:
Go to AC POWER TRANSFER CABLE INSTALLATION
(IFM, PROCEDURES A THRU F)

PRESS CNTL SYS ENTRY CONFIG 9

MS MO10W 14.7 CAB REG INLET SYS 1,2 vlv (two) – CL
H2O TK N2 REG INLET SYS 1,2 vlv (two) – OP
O2 REG INLET SYS 1,2 vlv (two) – CL

MO69M LEH O2 8 vlv – CL
Remove, stow O2 Bleed Orifice
LEH O2 7,8 vlv (two) – OP (if reqd)

MO32M 5,6 vlv (two) – OP (if reqd)

C L2 ✓ O2 SYS 1,2 SPLY (two) – OP (tb-OP)
✓ XOVR SYS 1,2 (two) – OP
✓ N2 SYS 1,2 SPLY (two) – OP (tb-OP)
✓ REG INLET (two) – OP (tb-OP)
O2/N2 CNTLR VLV SYS 1 – OP
2 – CL

MCA CONFIG 10

MA73C MCA LOGIC FWD (three) – ON
MID (eight) – ON

CLOTHING CONFIG 30

MS, PS Unstow, don:
LES
Harness
Boots

CRYO QTY CONFIG 13

C O13:B cb ESS 1BC CRYO QTY O2,H2 TK2 (two) – op
O13:D 2CA CRYO QTY O2,H2 TK1 (two) – op

MS ML86B:G cb ESS 1BC CRYO QTY O2,H2 TK4 (two) – op
✓ 2CA CRYO QTY O2,H2 TK5 (two) – op
3AB CRYO QTY O2,H2 TK3 (two) – op

FLUID LOADING PREP 18

Unstow, fill 4 drink containers (per crewmember) with
8 oz of water each; temp stow near seat
Unstow 8 salt tablets (per crewmember); temp stow
in Flight Suit pocket

GALLEY DEACT 19

GALLEY ✓ OVEN/RHS – OFF
✓ H2O HTRS (two) – OFF
✓ OVEN FAN – OFF
✓ REHYD STA lever – cl (push in)
✓ OVEN DOOR LATCH – latched

MA73C:G cb AC3 GALLEY FAN (three) – op
ML86B:A cb MNC SPLY H2O GALLEY SPLY – op
:B MNA GALLEY OVEN – op
MNB GALLEY H2O HTR – op

WCS DEACTIVATION 23

EDO If EDO WCS:
WCS URINAL SEL – OFF
WCS PWR SEL – OFF1, OFF2
FAN PWR – AUTO
Lock odor lid/seat
COMP LOCK DOWN PINS (three) – tighten

WCS VAC VLV – CL
✓ MODE – AUTO
FAN SEP SEL sw – OFF
Unstow hose from cradle, attach hose to WCS
housing via Velcro straps

(EDO WCS) Remove, stow: WCS Trash Can
Mirror
Privacy Curtain
Foot restraints – up, locked
Close, latch door

VENT DOOR OPS DISABLE 27

MA73C:A MCA LOGIC MID (four) – OFF
✓ FWD (three) – ON
:B MID (four) – OFF
AFT (three) – OFF

MA73C:C If MNB and AC2 powered:
cb MCA PWR AC1, AC3 3Φ FWD 1,3 (two) – op
✓ Minimum middeck lighting

LOSS OF 2 FUEL CELLS DEORBIT PREP

ASSUMPTIONS/INITIAL CONDITIONS

LOSS OF 2 FUEL CELLS DEORBIT PREP assumes one of following pwrdns has been accomplished:

LOSS OF 2nd FC ON-ORBIT (TIG < 4:00) (ORB PKT, PWRDN)

LOSS OF 2nd FC ON-ORBIT (TIG > 4:00) (ORB PKT, PWRDN)

Electrical load will be 10–12 kW with transients to 14 kW during Deorbit Prep and Entry

IF TIME TO TIG < 4:00

Refer to ACTIVITY PRIORITY TABLE, 5–8

Use EXPEDITED D/O column to determine LOSS OF 2 FC DEORBIT PREP procedures that must be performed (mandatory) and those that should be performed if time permits (optional)

If any portions of Nominal Deorbit Prep have been accomplished, reconfigure systems per LOSS OF 2 FC DEORBIT PREP as reqd

IF TIME TO TIG > 4:00

Perform all LOSS OF 2 FC DEORBIT PREP procedures

PROBLEM DESCRIPTION/RATIONALE

Orbiter electrical load carried by one fuel cell; therefore, it is a critical component. LRUs may experience undervoltage with accompanying alarms

LOSS OF 2 FUEL CELLS DEORBIT PREP

NOTE

1. Use only one CRT, one inst pwr, and one DDU whenever possible
2. Omit all maneuvers prior to TIG-03:36 if GG from powerdown
3. Maintain minimum lighting
4. A second pass GPC (GPC 4) will be activated at ~TIG-20
5. Vent doors will be open throughout entry (except L,R vent doors 1&2)
6. MS procedures are located on MS PULLOUT PAGES, 5-27 thru 5-32. Extra copies are located in back of PLT's book

LOSS OF 2 FUEL CELLS OVERVIEW OF CONFIGURATION MANAGEMENT

	OPS 1 ASC PKT					OPS 2 ON-ORBIT WAIT					OPS 2 DEORBIT PREP					OPS 3 DEORBIT PREP										
DPS																										
GPC	1	2	3	4	5	1	2	3	4	5	1	2	3	4	5	1	2	3	4	5						
OPS	G1	-	-	-	BFS	G2	--	--	SM	--	G2	--	--	SM	--	G3	--	--	--	BFS						
POWER OUTPUT MODE	ON	OFF	ON	ON	ON	ON	OFF	OFF	ON	OFF	ON	OFF	ON	ON	OFF	ON	OFF	OFF	ON	ON						
	N	N	N	N	B	N	N	N	T	N	N	N	N	T	N	N	N	N	N	B						
	R	H	H	H	R	R	H	H	R	H	R	H	H	R	H	R	H	H	H	R						
CONFIG GPC	1	2	3	4	0	2	1	0	0	0	4	0	0	0	4	0	2	4	(5)	0	0	3	1	0	0	0
STR	1	1				1	1				0	0				1	1				1	1				
	2	1				1	1				0	0				1	1				1	1				
	3	1				1	1				0	0				1	1				1	1				
	4	1				0	0				4	4				0	0				1	1				
PL 1/2	1	1				1	1				4	4				1	1				1	1				
CRT	1	1				1	1				1	1				4	4				1	1				
	2	1				0	0				0	0				0	0				1	1				
	3	0				1	1				1	1				4	4				0	0				
	4	1				0	0				0	0				4	4				0	0				
L	1	2				0	0				0	0				0	0				0	0				
	2	1				1 (OFF)	1 (OFF)				4	4				1 (ON)	1 (ON)				1 (OFF)	1 (OFF)				
	1	1				1 (OFF)	1 (OFF)				4	4				1 (OFF)	1 (OFF)				1 (OFF)	1 (OFF)				
	2																									
MDM						FF3; PL2 – ON					ALL ON except FF4					ALL ON except FF4										
D & C	ADI/DDU CRT/DEU INSTR	L,R 1 L,R	AFT -----▶ 4 -----▶ AFT -----▶			L-----▶ 3-----▶ L-----▶			1,3-----▶																	
E C L S	AV BAY FAN CABIN FAN IMU FAN WATER LP FREON LP RADIATOR FES	1,2,3 A B 2 1 Stow ON	1,3 -----▶ A -----▶ B -----▶ ① -----▶ 1-A, 2-A -----▶ Stow -----▶ OFF -----▶			1,2,3 -----▶ 1,2,3 -----▶ 1-OFF, 2-ON -----▶ ON -----▶																				
F C S E / N A V A R S I D S	FCS CH ASA AA RGA ADTA IMU MLS RA TACAN	AUTO ON ON ON ON 2,3 OFF OFF OFF	AUTO -----▶ OFF -----▶ OFF -----▶ OFF -----▶ OFF -----▶ 3 -----▶ OFF -----▶ OFF -----▶ OFF -----▶			1,2,3 -----▶ 1,2,3 -----▶ 1,2,3 -----▶																				
R J D	RJDA ② RJDF ② VERNIER	ALL ON ALL ON OFF	OFF -----▶ OFF -----▶ OFF -----▶			1A,1B,2B-----▶			ALL OFF -----▶ ALL OFF -----▶																	

① Water loops cycled as reqd (950 lb/hr)

② Primary RJDs will be OFF during sleep periods

NOTE: Maintain minimum lighting

LOSS OF 2 FUEL CELLS OVERVIEW OF CONFIGURATION MANAGEMENT (CONT)

	SEAT INGRESS					TIG-20					EI-5	V = 15K
DPS												
GPC OPS	1	2	3	4	5	1	2	3	4	5		
	G3	-	-	--	BFS	G3	--	--	G3	BFS		
POWER OUTPUT MODE	ON	OFF	OFF	ON	ON	ON	OFF	OFF	ON	ON		
	N	N	N	N	B	N	N	N	N	B		
	R	H	H	H	R	R	H	H	R	R		
CONFIG GPC	3 1 0 0 0 0					3 1 0 0 4 0						
STR	1	1				1						
	2	1				4						
	3	1				1						
	4	1				4						
PL	1/2	1				1						
CRT	1	1				1						
	2	1				1						
	3	1				4						
	4	0				0						
L	1	0				0						
	2	0				0						
MM	1	1 (ON)				1 (ON)						
	2	1 (ON)				4 (ON)						
MDM	ALL ON except FF4					ALL ON except FF4						
D & C	ADI/DDU CRT/DEU INSTR	L,R----- 1,3----- L-----				----- ----- -----					L,R-----	-----
E C L S	AV BAY FAN CABIN FAN IMU FAN WATER LP FREON LP RADIATOR FES	1,2,3----- A----- B----- 1-OFF,2-ON 1-A,2-A----- Stow----- ON-----				----- ----- ----- ----- ----- -----					1,2-----	-----
F C S E N S O R S / N A V A T O R S	FCS CH ASA AA RGA ADTA IMU MLS RA TACAN	AUTO----- OFF----- 1,2,3----- 1,2,3----- OFF----- 1,2,3----- OFF----- OFF----- OFF-----				ORIDE----- ON----- ----- ----- ON----- ----- ----- ----- -----					-----	-----
R J D	RJDA RJDF VERNIER	1A,1B,2B----- ALL OFF----- ALL OFF-----				----- ----- -----					-----	-----

(NOM) B5-6

NOM
C D/O/NOM/GEN H

LOSS OF 2 FUEL CELLS DEORBIT PREP

MCC

TIG

	CDR	PLT	MS(AFT)	MS(MID)
-04:00	FES HTR ACT	CRT TIMER SETUP	FDF CONFIG/ENT STOW	ENTRY STOWAGE
	MDM CONFIG			
	AC BUS CONFIG	AC BUS CONFIG	AC BUS CONFIG	AC BUS CONFIG
	FES RESTART	SEL AFT RCS JETS		
	PRESS CNTL ENT CONFIG	MNVR TO TAIL SUN	SEAT INSTALLATION KU-BD ANT STOW	PRESS CNTL ENT CONFIG SEAT INSTALLATION
				MCA CONFIG
-03:00	RAD BYPASS			
	PRE DPS TRANS SW CONFIG	PRE DPS TRANS SW CONFIG	PLBD CLOSING	
	DPS ENTRY CONFIG	DPS ENTRY CONFIG		
	PREL D/O UPDATE/UPLINK HORIZ SIT CONFIG	PREL D/O UPDATE/UPLINK	EDO PALLET DEACT	
	IMU RECOVERY			FLUID LOADING PREP
-02:00	ACT STR TRK MNVR IMU ALIGN ATT	APU STEAM VENT HTR	HTR CONFIG	GALLEY/H2O DISP DEACT
	IMU ALIGNMENT			
	MNVR TO BURN ATT DEACT STR TRK		FC PURGE	WCS DEACT
			C/W, COMM CONFIG	VENT DOOR DISABLE
	LOSS OF 2 FC SW VERIF LIST	LOSS OF 2 FC SW VERIF LIST	LOSS OF 2 FC SW VERIF LIST	LOSS OF 2 FC SW VERIF LIST
	CLOTHING CONFIG	CLOTHING CONFIG		
-01:00	FLUID LOADING PRE INGRESS SEAT INGRESS STOW ORB PKT	FLUID LOADING PRE INGRESS SEAT INGRESS STOW ORB PKT	WIRELESS STOW FLUID LOADING CLOTHING CONFIG STOW ORB PKT	FLUID LOADING CLOTHING CONFIG

**LOSS OF 2 FUEL CELLS DEORBIT PREP
ACTIVITY PRIORITY TABLE**

TIG	ACTIVITY	PAGE	EXPEDITED D/O	
			Mandatory	Optional
4:00	TIMER SETUP	5-9	1	--
3:59	ENTRY STOWAGE	5-29	--	2
3:58	FES HTR ACT	5-9	--	--
3:57	FDf CONFIG/ENT STOW	5-25	4	--
3:54	RCS/OMS HTR ACT	5-10	--	--
3:45	MDM CONFIG	5-9	--	--
3:42	AC BUS CONFIG	5-10	6	--
3:36	SELECT AFT RCS	5-10	--	--
3:32	AIRLOCK SW VERIF	5-10	--	T/L
3:30	FES RESTART	5-11	--	--
3:29	MNVR TO TAIL SUN	5-12	T/L	--
3:25	PCS ENT CONFIG	5-11	9	--
3:24	SEAT INSTALLATION	5-12	T/L	--
3:14	MCA CONFIG	5-30	10	--
3:10	KU-BD ANT STOW	5-12	T/L	--
3:00	RAD BYP	5-14	11	--
2:59	PLBD CLOSING	5-26	12	--
2:49	CRYO QTY CONFIG	5-13	--	13
2:48	PRE DPS TRANS SW CONFIG	5-13	14	--
2:45	DPS ENTRY CONFIG	5-13	15	--
2:37	EDO PALLET DEACT	5-14	--	16
2:35	PREL D/O UPDT/UPLK	5-14	17	--
2:32	HORIZ SIT CONFIG	5-14	--	T/L

TIG	ACTIVITY	PAGE	EXPEDITED D/O	
			Mandatory	Optional
2:24	IMU RECOVERY	5-16	--	--
2:20	FLUID LOADING PREP	5-30	--	18
2:10	GALLEY DEACT	5-30	--	19
2:09	HTR CONFIG	5-27	20	--
2:08	APU STEAM VENT HTR ACT	5-15	21	--
2:07	S-TRKR ACT	5-16	T/L	--
2:04	MNVR TO IMU ATT	5-16	T/L	--
2:00	IMU ALIGNMENT	5-17	22	--
1:44	WCS DEACT	5-30	23	--
1:40	FUEL CELL PURGE	5-27	24	--
1:39	MNVR TO BURN ATT	5-18	T/L	--
1:34	S-TRKR DEACT	5-18	25	--
1:29	C/W, COMM CONFIG	5-27	26	--
1:27	VENT DOOR OPS DISABLE	5-30	27	--
1:25	SWITCH VERIF	5-19	--	T/L
1:15	CLOTHING CONFIG (C,P)	5-19	--	28
1:06	WIRELESS STOW	5-27	29	--
1:05	BEGIN FLUID LOADING	5-19	--	T/L
1:01	CLOTHING CONFIG (MS,PS)	5-28	--	30
1:00	PRE INGRESS CONFIG	5-20	31	--
:52	SEAT INGRESS	5-21	T/L	--
:45	GO TO ENT WITH P&Is	5-21	T/L	--

T/L procedure located in timeline vice procedure block

NOTE

1. This table assumes LOSS OF 2nd FC ON-ORBIT (TIG < 4 hr) (ORB PKT, PWRDN) has been performed
2. Procedure blocks listed in mandatory column are only ones that must be performed if failure occurs on orbit with TIG < 4:00 away
3. At least 1.5 hr is reqd to perform all mandatory activities
4. Those in optional column should be performed if time permits
5. If procedure has a dash in both mandatory and optional columns, it is not reqd for expedited case
6. Some procedures may be deleted if any nominal DEORBIT PREP actions have been accomplished

(NOM) B5-8

C D/O/ALL/GEN H

CRT TIMER SETUP 1

P

1: GNC 2 TIME

SET CRT TIMER TO COUNT DOWN TO TIG
(perform for GNC and SM)

ENTRY DAY (HR:MIN:SEC - MET)

ITEM 17 +

		+			+		
--	--	---	--	--	---	--	--

24 HOUR LATE DELAYED DEORBIT

ITEM 17 +

		+			+		
--	--	---	--	--	---	--	--

1: GNC UNIV PTG

FES HTR ACTIVATION 3

C

L1 TOP EVAP HTR NOZ (two) - B AUTO
DUCT - B

L2 FLASH EVAP FDLN HTR (two) - 2

R11L SPLY H2O TKA OUTLET - CL (tb-CL)
 TKB OUTLET - OP (tb-OP)
 B SPLY ISOL VLV - OP (tb-OP)

MDM CONFIG 5

C

O6 MDM PL 1,2 (two) - ON
 FF 1,2,3 (three) - ON
 FA 1,2,3,4 (four) - ON

CRTX GNC I/O RESET
SM I/O RESET

TIG	
-04:00	P CRT TIMER SETUP 1 , 5-9
GRAVITY GRADIENT	MS ENTRY STOWAGE 2 , 5-31
	C FES HTR ACTIVATION 3 , 5-9
	MS FDF CONFIG/ENTRY STOW 4 , 5-27
-03:55	P A14 ✓RCS/OMS HTR AFT RCS JET 1,2,3,4 (four) - AUTO
-03:50	
-03:45	C MDM CONFIG 5 , 5-9
	A AC BUS CONFIG 6 , 5-27 and 5-28 (Not reqd if AC transfer cable installed or if AC bus shorted)
-03:40	
-03:35	P SELECT AFT RCS JETS 7 (if GG from pwrn)
-03:30	MS LOSS OF 2 FC SW VERIF LIST, 6-30, 6-31 (Airlock and Airlock Hatch only)

AC BUS CONFIG 6 (Not reqd if AC transfer cable installed or if AC bus shorted)

ALL L4:D,E,Q 1. ✓ All cbs (twenty-seven) - op

2. If FC 1 OK:
 Perform AC3 (3Φ) BUS LOSS ACTIONS (ORB PKT, EPS).
 Do only steps in ORB PKT, do not proceed to MAL
 Mark up pictorials in section 6 to match bus loss actions
 AC3 is affected bus in step 3

If FC 2 or FC 3 OK:
 Perform AC1 (3Φ) BUS LOSS ACTIONS (ORB PKT, EPS).
 Do only steps in ORB PKT, do not proceed to MAL
 Mark up pictorials in section 6 to match bus loss actions
 AC1 is affected bus in step 3

R1 3. Affected BUS: cb AC CONTR (three) - cl
 AC BUS SNSR - OFF
 INV/AC BUS - OFF (tb-OFF)
 INV PWR - OFF (tb-OFF)
 cb AC CONTR (three) - op

4. Connect AC1 to AC3:
 Perform AC POWER TRANSFER CABLE INSTALLATION (IFM, PROCEDURES A THRU F)

SELECT AFT RCS JETS 7 (if GG from pwrn)

P O6 ✓ MDM FA 1,2,3,4 (four) - ON
GNC 20 DAP CONFIG
 Select TAIL P,Y OPTION

O14:F ✓ RJDA 1A L2/R2 LOGIC, DRIVER - ON
 O15:F ✓ 1B L1/L5/R1 LOGIC - ON
 ✓ L1/R1 DRIVER - ON

O16:F ✓ 2B L3/R3/R5 LOGIC - ON
 ✓ L3/R3 DRIVER - ON

X: GNC 23 RCS

O7 ITEM 1 EXEC (FRCS page)
 OVRD FRCS MANF 1,2,3,4 STAT - CL
 ITEM 2 EXEC (LRCS page)
 OVRD LRCS MANF 4 STAT - CL
 ITEM 3 EXEC (RRCS page)
 OVRD RRCS MANF 4 STAT - CL

FES RESTART 8

C L1 RAD CNTLR OUT TEMP – HI
 O1 When FREON EVAP OUT TEMP ind
 > 50 degF:
 L1 FLASH EVAP CNTLR PRI B(A) – ON
 HI LOAD DUCT HTR sel – B
 ML86B:A ✓ cb MNC SPLY H2O XOVR VLV – cl
 R11L SPLY H2O XOVR VLV – OP (tb-OP)

PRESS CNTL SYS ENTRY CONFIG 9

MS MO10W 14.7 CAB REG INLET SYS 1,2 vlv (two) – CL
 H2O TK N2 REG INLET SYS 1,2 vlv (two) – OP
 O2 REG INLET SYS 1,2 vlv (two) – CL

 MO69M LEH O2 8 vlv – CL
 Remove, stow O2 Bleed Orifice
 LEH O2 7,8 vlv – OP (if reqd)
 MO32M 5,6 vlv – OP (if reqd)

 C L2 ✓ O2 SYS 1,2 SPLY (two) – OP (tb-OP)
 ✓ XOVR SYS 1,2 (two) – OP
 ✓ N2 SYS 1,2 SPLY (two) – OP (tb-OP)
 ✓ REG INLET (two) – OP (tb-OP)
 O2/N2 CNTLR VLV SYS 1 – OP
 2 – CL

TIG

-03:30
TAIL-SUN

C FES RESTART [8], 5-11
MNVR TO TAIL SUN
CRTX TG +4
BV +5
P 184
Y 0
Initiate TRK

-03:25

C,MS PRESS CNTL SYS ENTRY CONFIG [9], 5-32
MS SEAT INSTALLATION

-03:20

-03:15

MS MCA CONFIG [10], 5-32

CAUTION
Use only PL BAY MECH PWR SYS 2 during
KU-BD STOW. This will reduce voltage
demand on FC by using single-motor stowage

-03:10

MS KU-BD ANT STOW (ORB OPS, COMM/INST) (if deployed)

-03:05

-03:00

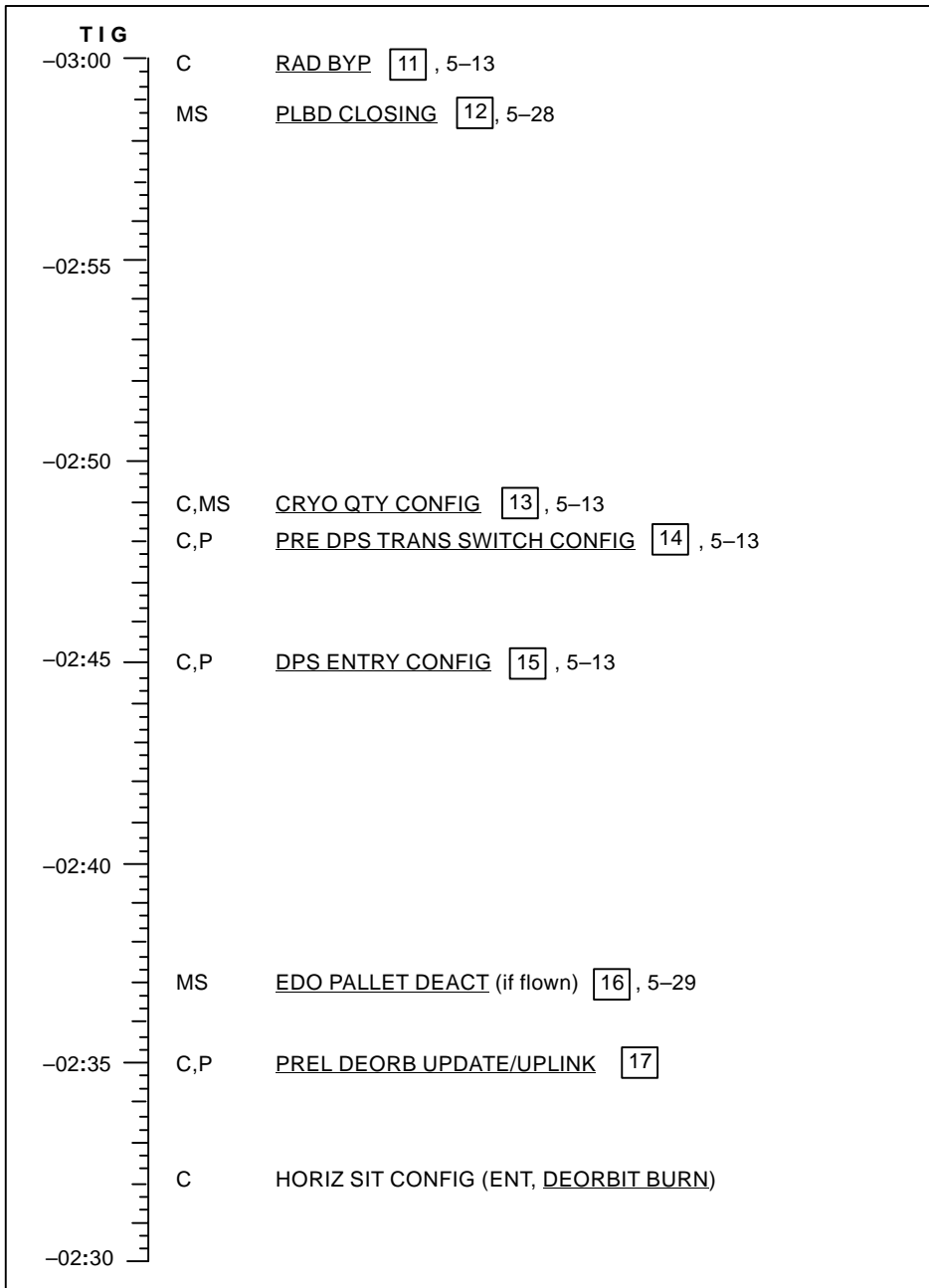

PREL DEORB UPDATE/UPLINK [17]

C C3

- ✓ UPLK - ENA
- ✓ 1: GNC ORBIT MNVR EXEC
- ✓ 2: BFS, GNC DEORB MNVR COAST

MCC update:
 OMS PRPLT PAD, DEL PAD (ENT, PRPLT/DEL) and
 DEORBIT MNVR PAD (ENT, MNVR PADS)
 IMU ALIGN PAD, if reqd

MCC uplink:
 PASS and BFS SV,TGT

✓ PASS and BFS TGT per DEORBIT MNVR PAD (ENT, MNVR PADS)

* If MCC cannot provide *

* DEORB TGT, use PGSC *

CRT1

LOAD - ITEM 22 EXEC
 TIMER - ITEM 23 EXEC

✓ PASS and BFS solution per DEORBIT MNVR PAD (ENT, MNVR PADS):
 BURN ATT
 HA
 HP
 ΔV TOT
 TGO

APU STEAM VENT HTR ACT 21

P R2

If FC 1 OK:
BLR CNTLR/HTR 1 - A
2 - B
3 - A

If FC 2 or FC 3 OK:
BLR CNTLR/HTR 1 - A
2 - A
3 - B

BLR PWR (three) - ON

NOTE

Htr reqd to be on 2 hr prior to APU act

TIG

-02:30
-02:25
-02:20
-02:15
-02:10
-02:05
-02:00

C

IMU RECOVERY (if reqd)
Use GNC FRP-3 (MAL, GNC) to recover any IMUs lost
due to bus failures or powerdown
BFS, GNC, OPS 000, 301 PRO
BFS, GNC 50 HORIZ SIT

✓ BFS R/W sel
FLUID LOADING PREP **18**, 5-32

MS

-02:15

MS

GALLEY DEACT **19**, 5-32

MS

HTR CONFIG **20**, 5-29

P

APU STEAM VENT HTR ACT **21**, 5-15

C

O6

ACT STAR TRKR (omit if BFS)
✓ S TRK PWR -Z - ON
✓ S TRK PWR -Y - ON
GNC I/O RESET
✓ STAR TRKR doors open

CRT1

C

MNVR TO IMU ATT (omit if BFS) use pad on this page
DAP: AUTO

IMU STAR ALIGN PAD

NOTE

For pad data, ✓MCC or ref STAR PAIRS (ORB OPS, PTG)

STAR ID: -Y _____, _____ (TIG - ____ : ____ TO - ____ : ____)

-Z _____, _____ (TIG - ____ : ____ TO - ____ : ____)

ANG DIF: _____

ALIGNMENT ATTITUDE
(Dual or Single S TRK)

2nd ALIGNMENT ATTITUDE
(Single S TRK)

R _____

-Z: _____ -Y: _____

R _____

R _____

P _____

P _____

P _____

Y _____

Y _____

Y _____

IMU STAR ALIGN LOG

REQD ID: -Y _____, -Z _____ ANG ERR ____ . ____

ANG 1 2 3

ΔX () _____ . _____ () _____ . _____ () _____ . _____

ΔY () _____ . _____ () _____ . _____ () _____ . _____

ΔZ () _____ . _____ () _____ . _____ () _____ . _____

EXECUTE TIME ____ : ____ : ____ (TIG MINUS)

IMU VERIFICATION PAD

NOTE

For pad data, ✓MCC or ref STAR PAIRS (ORB OPS, PTG)

STAR ID: -Y _____, _____ (TIG - ____ : ____ TO - ____ : ____)

-Z _____, _____ (TIG - ____ : ____ TO - ____ : ____)

ANG DIF: _____

ALIGNMENT ATTITUDE
(Dual or Single S TRK)

2nd ALIGNMENT ATTITUDE
(Single S TRK)

R _____

-Z: _____ -Y: _____

R _____

R _____

P _____

P _____

P _____

Y _____

Y _____

Y _____

IMU VERIFICATION LOG

REQD ID: -Y _____, -Z _____ ANG ERR ____ . ____

ANG 1 2 3

ΔX () _____ . _____ () _____ . _____ () _____ . _____

ΔY () _____ . _____ () _____ . _____ () _____ . _____

ΔZ () _____ . _____ () _____ . _____ () _____ . _____

EXECUTE TIME ____ : ____ : ____ (TIG MINUS)

IMU ALIGNMENT 22

NOTE

Procedure applies for one or two S TRK aligns.
For one S TRK, a second att mnvr reqd between
data takes. See pad on 5-16 for att & stars

- C
1. 1: GNC 22 S TRK/COAS CNTL
- C3
- BFC CRT DISP – OFF
- 3: GNC 21 IMU ALIGN
- CRT1
2. ✓REQD ID – ITEM 11,12 – 0
 - ✓STATUS (two) – NO BITE
 - ✓SHUTTER (two) – OP
 - * If SHUTTER – CL: *
 - * ✓Att, MET – correct *
 - * Visually verify no bright object in FOV *
 - * After data collected and before changing *
 - * attitude, return shutter to AUTO *
 - * To open shutter: *
 - * MAN OP – ITEM 15(16) EXEC (*) *
 - * To return shutter to AUTO: *
 - * MAN OP – ITEM 15(16) EXEC (no *) *
- CRT3
- IMU 1,2,3:
- ✓STAT – blank
 - ✓OPER – ITEM 4,5,6 (*)
3. ✓IMU ALIGN ATT (pad)
- CRT1
4. S TABLE CLR – ITEM 20 EXEC
 5. Enable Star Tracker:
 - ✓S TRK – ITEM 3,4 EXEC (*)
 6. Verify S TABLE:
 - TRK ID 1,2 = STAR ID (pad)
 - ANG ERR ≤ 0.08
 - Wait approx 1 min for new IMU Δ ANG
 - * If after 3 min no data (or bad data) in S Table: *
 - * ✓S TRK – ITEM 3,4 (*) *
 - * ✓ATT/STARS/TIME *
 - * ✓S TRK: TRK ID = STAR ID (pad) *
 - * Do S TRK Self Test *
 - * If neither tracker fails: *
 - * Mnvr to verification att – repeat steps 3,4,5,6 *
 - * If one tracker fails: *
 - * ✓TERM/IDLE for failed tracker – ITEM 9(10)(*) *
 - * proceed with one S TRK ALIGN *
 - * If both trackers fail, inform MCC *

For one S TRK align:

- S TRK for good tracker – ITEM 3(4) EXEC (*)
- S TABLE CLR – ITEM 20 EXEC, reacquire star with good tracker
- TERM/IDLE for good tracker during maneuvers – ITEM 9(10) EXEC (*)
- Mnvr to second att (single S TRK): Do not clear S Table
- Repeat steps 3,5,6 with second Star ID

- CRT1
- CRT3
7. ✓S TABLE SEL – ITEM 17,18 (*)
 - ALIGN IMU 1,2,3 – ITEM 10,11,12, EXEC (*)
 - ✓STAR ALIGN – ITEM 13 (*)
 - ✓IMU 1,2,3 – ANG ΔX,ΔY,ΔZ < 0.80
 - * If ANG ΔX,ΔY,ΔZ > 0.80 for two IMUs, do not *
 - * torque: *
 - * Mnvr to verification att, repeat steps 3 thru *
 - * 7 once *
 - * If still > 0.80, report to MCC *
 8. Record ANG ΔX,ΔY,ΔZ, ANG ERR, EXECUTE TIME (use log on 5-16)
 - EXEC – ITEM 16 EXEC (*)
 - Alignment complete when: EXEC – ITEM 16 (no *)
- IMU ALIGN VERIFICATION
9. Mnvr per IMU VERIFICATION PAD, 5-16
DAP: AUTO
 10. Perform steps 3,4,5,6 using appropriate stars (pad)
 11. ✓IMU 1,2,3 ANG ΔX,ΔY,ΔZ < 0.1
 - * If ANG ΔX,ΔY,ΔZ > 0.1, perform steps 8 thru 11, *
 - * report to MCC *

NOTE

For alternate stars, ✓MCC or ref STAR PAIRS (ORB OPS, PTG)

12. Report IMU ALIGN results
- C3
13. BFC CRT DISP – ON
 - 3: BFS, GNC DORB MNVR COAST
 - 1: GNC DEORB MNVR COAST

TIG

-02:00
-01:55
-01:50
-01:45
-01:40
-01:35
-01:30

C IMU ALIGNMENT [22], 5-17 (omit if BFS)

MS WCS DEACTIVATION [23], 5-32

MS FUEL CELL PURGE [24], 5-29

C MNVR TO BURN ATT
 MNVR per DEORBIT MNVR PAD (ENT, MNVR PADS):
 R _____
 P _____
 Y _____

DAP: AUTO

C DEACT STAR TRACKERS & CLOSE DOORS [25]

DEACT STAR TRACKERS & CLOSE DOORS [25]

C O6 S TRK PWR (two) - OFF
 O14:E cb MNA S TRK -Z - op
 O15:E cb MNB S TRK -Y - op
 O6 S TRK DR CNTL SYS (two) - CL (start timer)
 √ POS tb (two) - bp
 When both tb - CL (-8-24 sec)
 or either tb - bp > 24 sec:
 S TRK DR CNTL SYS 1,2 (two) - OFF

* If tb - bp > 8 sec, notify MCC *

TIG

-01:30 MS C/W, COMM CONFIG [26], 5-29

MS VENT DOOR OPS DISABLE [27], 5-32

-01:25 A LOSS OF 2 FC SW VERIF LIST, 6-3 thru 6-27 (OV102),
6-3 thru 6-29 (OV103, OV104, OV105)

-01:20

-01:15 C,P CLOTHING CONFIG [28]

-01:10

MS WIRELESS STOW [29], 5-29

-01:05 A Begin Fluid Loading per individual prescription
Fluid Loading should be completed by E1

-01:00 MS, PS CLOTHING CONFIG [30], 5-30, 5-32

CLOTHING CONFIG [28]

C,P Unstow, don:
LES
Harness
Boots

PRE INGRESS CONFIG 31

P R2 MPS/H2 PURGE PREP
MPS He ISOL (six) - CL
PNEU He ISOL - CL
L ENG He XOVR - CL
R4 MANF PRESS (two) - CL

C,P O16:E ENABLE QTY GAUGE
cb MNC RCS/OMS PRPLT QTY GAUGE - cl

F8 RA CONFIG
RDR ALTM - 1

O8 MLS CH/TACAN CH/DATA BUS
O7 MLS CH tw (three) - See LAND SITE DATA
TACAN CH tw (three) - See LAND SITE DATA

F6 ✓ DATA BUS sel - 3
F8 ✓ - 4

C L4:P ENABLE PROXIMITY PACKAGE
✓ cb AC2 ΦA LG SNSR 2 - cl
✓ AC3 ΦA LG SNSR 1 - cl

C L4:J cb CONFIG
cb AC3 ΦA SIG CONDR HUM SEP - op
ΦB SIG CONDR IMU FAN - op

HUD SETUP
Remove, stow HUD covers (two)
Ensure cloth cover does not obscure light sensor

TIG

-01:00
-00:55
-00:50
-00:45
-00:40
-00:35
-00:30

C,P

PRE INGRESS CONFIG 31, 5-20

C,P

C6

LEH O2 vlv (four) - OP
SEAT INGRESS
Adjust seat (one seat, direction at a time)
Exercise brake pedals
LES PRESS INTEGRITY CHECK

C,P

Perform P&I CHANGES TO ENT, 5-22 and 5-23

A

Stow ORB PKT Orbit Cue Cards
Go to ENT, DEORBIT BURN

LOSS OF 2 FUEL CELLS

P&I Changes to ENTRY

GENERAL

1. AV BAY FANS cycled as needed to keep power level low
2. GPCs 2,3 remain pwr d n throughout ENTRY

SPECIFIC

TIG-46

R4

Delete: **OMS TVC GMBL CHECK**

Under **APU PRE-START** delete:

✓HYD BRAKE ISOL VLV (three) tb – CL

✓LG EXTEND ISOL VLV tb – CL

and associated starred procedures

HORIZ SIT CONFIG (GNC 51, BFS GNC 51)

Delete: ✓SSME REPOS – ITEM 19 (ENA)

Add: “SSME REPOS – ITEM 19 EXEC (INH)”

TIG-25

L1

Delete: **VENT DOOR CLOSE**

Insert: “HUM SEP (two) – OFF

FES HEATER DEACT

TOP EVAP HTR NOZ L,R (two) – OFF

DUCT – OFF

HI LOAD DUCT HTR – OFF

FLASH EVAP FDLN HTR B SPLY – OFF

L2

ASA ACT

ASA (four) – ON”

O14:F,
O15:F,
O16:F

DEORB
UPDATE/
UPLINK

O6

C3

Insert before GNC OPS 302 PRO:

“**GPC 4 ACT**

(1) GPC MODE 4 – STBY/RUN

(2) BFC CRT DISP – OFF

(3) For OPS 3 TRANS use →

(4) GNC, OPS 301 PRO

(5) BFC CRT DISP – ON; BFS I/O RESET

(6) FCS CH (four) – ORIDE

(7) G50 ✓LAND SITE/RWY per DEL PAD”

C3

CONFIG	3
GPC	10040
STR 1	1
2	4
3	1
4	4
PL 1/2	1
CRT 1	1
2	4
3	1
4	0
L 1	0
2	0
MM 1	1
2	4

(NOM) B5-22

C D/O/ALL/GEN H

LOSS OF 2 FUEL CELLS
P&I Changes to ENTRY (Cont)

TIG-20		Delete: RCS/OMS HTR steps
TIG-5	R4	Insert after SINGLE APU START: "✓HYD BRAKE ISOL VLV (three) – GPC (tb-CL) ✓LG EXTEND ISOL VLV – GPC (tb-CL) <div style="border: 1px solid black; display: inline-block; padding: 2px;">GNC DEORB MNVR EXEC</div> R OMS GMBL – SEC (*)"
TIG-2	L1	Use 2 DDU/FLT CNTLR PWR Add: " AV BAY FAN CYCLE AV BAY FAN (six) – OFF"
DURING BURN POST BURN		If FRCS COMPLETION required during burn, perform EI-18 FORWARD RCS RECOVERY steps below prior to fast flip Add: "FLT CNTLR PWR (two) – OFF ✓DAP: AUTO Use one DDU"
	L1	Insert after OMS/RCS POST BURN RECONFIG: "AV BAY FAN 1B,2A,3A [3B vice 3A if FC 1 OK] – ON (3 sec between each start)"
EI-20	C3	SECONDARY ACTUATOR CHECK Add: "9. FCS CH (four) – ORIDE"
EI-18		If FORWARD RCS DUMP reqd for off-nominal CG, etc, insert FORWARD RCS RECOVERY before the dump: "FORWARD RCS RECOVERY RJDF LOGIC,DRIVER (eight) – ON
	O14:F, O15:F, O16:F O6	MDM FF4 – ON GNC I/O RESET <div style="border: 1px solid black; display: inline-block; padding: 2px;">GNC 23 RCS</div> ITEM 1 EXEC (FRCS page) OVRD FRCS MANF 1,2,3,4 STAT – OP"

NOM

O14:F,
O15:F,
O16:F

Insert after dump completion:
"RJDF LOGIC,DRIVER (eight) – OFF

GNC 23 RCS

ITEM 1 EXEC (FRCS page)
OVRD FRCS MANF 1,2,3,4 STAT – cl
MDM FF4 – OFF”

O6

ENTRY SW
CHECK

Delete: ✓ANTISKID,NWS steps
Delete: ✓RADAR ALTM,MLS,TACAN steps

EI-13

Delete: **SSME HYD REPRESS**

ENTRY
MNVRS

Replace nominal ENTRY MANEUVERS (Cue Card) with
LOSS OF 2 FUEL CELLS ENTRY MANEUVERS, B5-25

LOSS OF 2 FUEL CELLS ENTRY MANEUVERS

FLIGHT CONDITIONS	MANEUVER
EI-5	MDM FF4 - ON BRAKES (three) - ON cb ADTA 1,2,3 - cl GNC I/O RESET ✓cb MNA,B,C DDU L,R (four) - cl (L) FLT CNTLR PWR - ON (L) INST PWR - FLT ✓LVLH ATT GNC, OPS 304 PRO ✓OPS 304, wait 1 min MDM FF4 - OFF * If PREBANK: R/Y - CSS * * Roll at 1°/sec to <input type="text"/> <input type="text"/> * * Maintain PREBANK ± 5° *
'Guidance Box' @ q-8 or D-3	CLOSED LOOP GUIDANCE ___:___:___ * If PREBANK: P,R/Y - AUTO * Begin AIL trim monitoring
D = 11	✓DRAG H (FORCE if editing)
V = 19K	✓MPS/TVC ISOL VLV - CL
V = 15K	If FC 1 OK: TACAN 1,2 MODE - GPC If FC 2 or FC 3 OK: TACAN 2,3 MODE - GPC ✓TACAN ANT SEL (two) - AUTO * If ELS,UHF MODE - G T/R *
V = 12K	RAD BYP VLV MODE (two) - AUTO CNTLR LOOP (two) - AUTO B(A)
V = 10K	✓SPD BRK to 81%
V = 7K	✓TACAN status
V = 5K	L AIR DATA PROBE - DPY (Wait 30 sec) R AIR DATA PROBE - DPY (Heat only one probe if reqd) Begin AIL and RUD trim monitoring
ΔAz = 10.5°	FIRST ROLL REVERSAL <input type="text"/> <input type="text"/> <input type="text"/> <input type="text"/>

FLIGHT CONDITIONS	MANEUVER
M = 4	MDM FF4 - ON GNC I/O RESET
M = 2.9	CAB FAN (two) - OFF AV BAY FAN 2A - OFF 3A(3B) - OFF After ADTA incorporated, TACAN MODE (two) - OFF Use one HUD, one MLS, one RA GNC I/O RESET
M = 2.7	✓APUs TRIM PANEL (two) - OFF RHC/PNL (two) - ENA
* If M < 2.5, P CSS for ADTA to G&C incorp *	
M = 2.0	Ensure ADTA to G&C; else, ✓Theta limits
M = 0.95	* For bailout procedures, go to BAILOUT *
M = 0.9	P,R/Y - CSS as reqd ✓SPDBK CMD vs POS MAX Nz <input type="text"/> <input type="text"/> ANTISKID - ON (R) FLT CNTLR PWR - ON (R) INST PWR - ON NWS - 1 Lock Inertia Reels
M = 0.7	✓LG EXTEND ISOL VLV - OP
h = 15K	✓MLS
h = 10k	✓A/L, TAB/LES VISORS - CL (KSC)
MAIN GEAR TD	✓SPD BRK - 100%
DEROT INIT	DRAG CHUTE pb (two) - ARM,DPY (simo)
NOSE GEAR TD	SRB SEP - MAN/AUTO and depress pb ✓Auto Load Relief ✓HYD BRAKE ISOL VLV (three) - OP
V = 60 KGS	DRAG CHUTE JETT pb - JETT
STOP	✓All landing/navaids off CAB FAN B - ON (Wait 3 sec, then continue) AV BAY FAN 2A,3A [3B vice 3A if FC1 OK] - ON (3 sec between each start) Go to ENT C/L, POST LDG

NOM

This Page Intentionally Blank

(NOM) B5-26

NOM
C D/O/ALL/GEN H

LOSS OF 2 FC MS AFT FLIGHT DECK ACTIVITIES

MS PULLOUT PAGE

NOTE

Wait for GO from CDR or PLT before starting any activity on this page

TIME (TIG--)	MS ACTIONS (AFT)
3:57	<u>FDF CONFIG/ENTRY STOW</u> [4]
3:42	<u>AC BUS CONFIG</u> [6] (Not reqd if AC transfer cable installed or if AC bus shorted)
3:24	<u>SEAT INSTALLATION</u>
	<p>CAUTION Use only PL BAY MECH PWR SYS 2 during KU-BD STOW. This will reduce voltage demand on FC by using single-motor stowage</p>
3:10	<u>KU-BD ANT STOW</u> (ORB OPS, <u>COMM/INST</u>) (if deployed)
2:59	<u>PLBD CLOSING</u> [12], 5-28
2:37	<u>EDO PALLET DEACT</u> (if flown) [16], 5-29
2:09	<u>HTR CONFIG</u> [20], 5-29
1:40	<u>FUEL CELL PURGE</u> [24], 5-29
1:29	<u>C/W, COMM CONFIG</u> [26], 5-29
1:25	<u>LOSS OF 2 FC SW VERIF LIST</u>
1:06	<u>WIRELESS STOW</u> [29], 5-29
1:05	Begin Fluid Loading per individual prescription Fluid Loading should be completed by EI
1:01	<u>CLOTHING CONFIG</u> [30], 5-30

<u>FDF CONFIG/ENTRY STOW</u> [4]
<u>FDF CONFIG</u> Unstow,install: Entry,Deorbit Burn Cue Cards ENT ENT PKT
✓ Available for ENTRY: LDG SITE CHARTS Handheld Radio STAR CHART ORB OPS CONT DEORB ORB PKT REF DATA MAL Stow all other FDF articles
<u>ENTRY STOW</u> Stow: Flt Deck Camrs,Accessories Stow VTR Cassettes (one in VTR) Quick Don Masks
<u>FOOT LOOP CONFIG</u> Tape foot loops in egress routes

<u>AC BUS CONFIG</u> [6]
A L4:D,E,Q 1. ✓ All cbs (twenty-seven) – op
2. If FC 1 OK: Perform AC3 (3Φ) BUS LOSS ACTIONS (ORB PKT, <u>EPS</u>). Do only steps in ORB PKT, do not proceed to MAL Mark up pictorials in section 6 to match bus loss actions AC3 is affected bus in step 3
If FC 2 or FC 3 OK: Perform AC1 (3Φ) BUS LOSS ACTIONS (ORB PKT, <u>EPS</u>). Do only steps in ORB PKT, do not proceed to MAL Mark up pictorials in section 6 to match bus loss actions AC1 is affected bus in step 3
R1 3. Affected BUS: cb AC CONTR (three) – cl AC BUS SNSR – OFF INV/AC BUS – OFF (tb-OFF) INV PWR – OFF (tb-OFF) cb AC CONTR (three) – op
4. Connect AC1 to AC3: Go to AC POWER TRANSFER CABLE INSTALLATION (IFM, <u>PROCEDURES A THRU F</u>)

NOM

LOSS OF 2 FC Back of MS AFT FLIGHT DECK ACTIVITIES

MS PULLOUT PAGE

PLBD CLOSING 12

GPC/CRT 44 EXEC
Use CRT 4

STOW RADIATORS (if reqd)

CAUTION

Use only PL BAY MECH PWR SYS 2 during RAD STOW.
This will reduce voltage demand on FC by using single-motor stowage

Perform RAD STOW/DEPLOY, step 1 (ORB OPS, ECLS)

CONFIG RMS (if RMS onboard)

- ✓ Elbow Camr in aligned position
 - Pan 90° from X-axis
 - Tilt per decal

A8L ✓ PORT RMS HTR A,B (two) – OFF
✓ RMS PWR – OFF

CLOSE PLBD

R13L

CAUTION

If SM GPC fails during this operation:
PL BAY DR SYS 1,2 (two) – DSBL
Perform PASS SM GPC FAIL (ORB PKT, DPS)

When closing and latching PLBD:

- Verify no obstructions (Ku ANT,RMS,RAD,etc)
- Use only one PL BAY DR SYS switch during ALL PLBD procedures

If no motion determined visually or 'OP/CL' not blank within 10 sec after cmd:

or
If door motion stops and not 'RDY' or 'CL':
or

If any other problem occurs:
PL BAY DR – STOP
 SYS 1 – ENA
 2 – DSBL
Continue in manual mode

NOTE

Ref DETAILED PLBD CLOSING PROCEDURES
(DEORBIT PREP, NOMINAL DEORBIT PREP) (if reqd)

CRT 4 SM, OPS X02 PRO
4: SM PL BAY DOORS

R13L ✓ PL BAY DR – STOP
CRT4 ✓ PBD SW – STOP
 ✓ MAN SEL (ten) – (no *)
 ✓ PBD SW BYPASS – (no *)
 AC POWER ON – ITEM 1 EXEC (*)
 AUTO MODE SEL – ITEM 3 EXEC (*)

R13L PL BAY DR SYS 2 – ENA
 ✓ 1 – DSBL
CRT4 ✓ OP/CL STATUS (ten) – OP

NOTE

All drive times will be single-motor

R13L PL BAY DR – CL

- * If PORT(STBD) DOOR not 'CL' within 6 sec of *
* 'RDY' then: *
* PL BAY DR – STOP *
* ✓ PLBD BULKHEAD LATCH GO/NO-GO DIAGRAM *
* (DEORBIT PREP, NOMINAL DEORBIT PREP) *
* If NO-GO: Go to CONTINGENCY PLBD CLOSURE, *
* MECH SSR-2 (MAL, MECH) *
* If GO: PL BAY DR – CL *

When STBD DOOR as close as possible to PORT DOOR before contacting it:

PL BAY DR – STOP
✓ For C/L overlap ref PLBD BULKHEAD LATCH GO/NO-GO DIAGRAM (DEORBIT PREP, NOMINAL DEORBIT PREP)

- * If NO-GO, perform SIMULTANEOUS PLBD CL, MECH *
* SSR-3 (MAL, MECH) *

PL BAY DR – CL

When closed and latched:

R13L PL BAY DR – STOP
 PL BAY DR SYS 2 – DSBL
 ✓ 1 – DSBL
CRT4 ✓ OP/CL STATUS (ten) – CL
 AC POWER OFF – ITEM 2 EXEC (*)
 GPC/CRT 04 EXEC
R11L CRT4 PWR – OFF
A7U ✓ 70mm Camr (two), Spotmeter stowed
 ✓ PL BAY FLOOD (all) – OFF

NOM

LOSS OF 2 FC MS AFT FLIGHT DECK ACTIVITIES (Cont)

MS PULLOUT PAGE

EDO PALLET DEACT (if flown) 16

MS	A15:C	PALLET HTRS A,B (two) – OFF
	A15:D–G	O2,H2 TK6,7,8,9 HTRS A,B (sixteen) – OFF
	A15:C	PWR PPCA–1 (PPCA–1/3 if OV105)
		MNA – OFF (tb–OFF)
		PALLET PWR PPCA–2 (PPCA–2/4 if OV105)
		MNB – OFF (tb–OFF)
	A15:B	cb PPCA CONT PWR 1 (1/3 if OV105) ESS 1BC – op
		2 (2/4 if OV105) ESS 2CA – op
	A15:H–K	All cbs (twenty–four) – op (Cntlrs,Qty,O2 Htr Snrs)
	R14:B	cb MNA,MNB,MNC PALLET DSC (three) – op

HTR CONFIG 20

R11U	FC PURGE HTR – ON
	NOTE
	Htr must be on 15 min prior to purge
A12	✓APU HTR TK/FU LINE/H2O/SYS 1B,2B,3B – AUTO
	✓1A,2A,3A – OFF
A14	✓HYD HTR (eight) – OFF
	RCS/OMS HTR FWD RCS – OFF
	L POD (two) – A OFF,B OFF
	R POD (two) – A OFF,B OFF
	OMS CRSFD LINES (two) – A OFF
	– B OFF
	FWD,AFT RCS JET 5 (two) – OFF

FUEL CELL PURGE 24

WARNING
Do not purge if FC AMPS > 430

R11U	✓FC PURGE HTR ON > 15 min
	VLVS X – OP for 2 min, then
	– GPC
	HTR – GPC
	✓VLV – GPC

C/W, COMM CONFIG 26

C/W RESET

R13U			
PARAMETER NAME	C/W CH	ENA/INH	
HYD P	1	99	ENA
	2	109	ENA
	3	119	ENA

COMM CONFIG

O6	✓UHF SPLX/EVA PWR AMPL	– ON
A1L	S–BD PM MODE	– STDN LO
	NSP DATA RATE XMIT,RCV (two)	– HI
	CODING XMIT,RCV (two)	– OFF
A13	OS AUD SPKR PWR	– OFF
A15	PS COMM CCU PWR	– OFF
R14:C	cb KU ELEC	– op
	ANT HTR	– op
	CABLE HTR	– op
	SIG PROC	– op
	cb UHF EVA (two)	– op
O5,O9	L,R AUD A/G 2	– T/R
	ICOM B	– T/R
	VOX SENS	– as reqd
	VOL tw (six)	– as reqd
	XMIT/ICOM MODE	– PTT/VOX
MO42F	MIDDECK SPKR AUD PWR	– AUD/TONE
ML85E	AC S1 – OFF	
R10,L9	MS,PS AUD PWR	– AUD/TONE
	A/G 1	– T/R
	2	– T/R
	A/A	– T/R
	ICOM A,B	– T/R
	VOX SENS	– as reqd
	VOL tw (six)	– as reqd
	XMIT/ICOM MODE	– as reqd

WIRELESS STOW 29

Disconnect, stow Wireless Headsets (if reqd)

✓Minimum aft deck lighting

LOSS OF 2 FC
Back of MS AFT FLIGHT DECK ACTIVITIES (Cont)

MS PULLOUT PAGE

CLOTHING CONFIG 30

MS,PS

Unstow,don:
LES
Harness
Boots

LOSS OF 2 FC MS MIDDECK ACTIVITIES

MS PULLOUT PAGE

NOTE

Wait for GO from CDR or PLT before starting any activity on this page

TIME (TIG-)	MS ACTIONS (MID)
3:59	<u>ENTRY STOWAGE</u> [2]
3:42	<u>AC BUS CONFIG</u> [6], 5-32 (Not reqd if AC transfer cable installed or if AC bus shorted)
3:32	<u>SW VERIF</u> (Airlock and Airlock Hatch only)
3:25	<u>PRESS CNTL SYS ENTRY CONFIG</u> [9], 5-32
3:24	<u>SEAT INSTALLATION</u>
3:14	<u>MCA CONFIG</u> [10], 5-32
2:49	<u>CRYO QTY CONFIG</u> [13], 5-32
2:20	<u>FLUID LOADING PREP</u> [18], 5-32
2:10	<u>GALLEY DEACT</u> [19], 5-32
1:44	<u>WCS DEACTIVATION</u> [23], 5-32
1:27	<u>VENT DOOR OPS DISABLE</u> [27], 5-32
1:25	<u>LOSS OF 2 FC SW VERIF LIST</u>
1:05	Begin Fluid Loading per individual prescription Fluid Loading should be completed by EI
1:01	<u>CLOTHING CONFIG</u> [30], 5-30

	<u>ENTRY STOWAGE</u> [2]
	<u>PERSONAL HYGIENE SYS STOWAGE</u> Stow: Personal Hygiene Kits Hose
	<u>WCS CONFIG</u> Foot restraints – up,locked Privacy Curtain – stow
	<u>AIRLOCK CLOSEOUT</u> Tether soft goods to EVA tether point or A/L Stowage Bag. Gray Tape to floor
MO13Q	✓ARLK FAN A(B) – OFF (OV103/OV104/OV105) if flown Stow all ducts as appropriate
	<u>ESCAPE POLE SETUP</u> Reinstall Stbd Pip Pin Reinstall large Port Pin: Retract and hold Locking Pin (Ring) Reinstall large Pin Release Locking Pin (Ring) Slide forward Safing Latch
	✓ Pole Straps secure
	<u>FDL STOWAGE</u> Stow FLIGHT PLAN
	<u>CABIN CONFIG</u> Stow: Backup PGSC Middeck Camrs,Accessories FWD/AFT Shades,Filters,Quick Don Masks Stow Exercise Equipment ✓ Retention net in ASC/ENT config
	<u>EGRESS ROUTE CONFIG</u> Tape Foot Loops in egress routes

LOSS of 2 FC Back of MS MIDDECK ACTIVITIES

MS PULLOUT PAGE

AC BUS CONFIG 6 (Not reqd if AC transfer cable installed or if AC bus shorted)	
A	L4:D,E,Q 1. ✓ All cbs (twenty-seven) – op
	2. If FC 1 OK: Perform AC3 (3Φ) BUS LOSS ACTIONS (ORB PKT, EPS). Do only steps in ORB PKT, do not proceed to MAL Mark up pictorials in section 6 to match bus loss actions AC3 is affected bus in step 3
	If FC 2 or FC 3 OK: Perform AC1 (3Φ) BUS LOSS ACTIONS (ORB PKT, EPS). Do only steps in ORB PKT, do not proceed to MAL Mark up pictorials in section 6 to match bus loss actions AC1 is affected bus in step 3
R1	3. Affected BUS: cb AC CONTR (three) – cl AC BUS SNSR – OFF INV/AC BUS – OFF (tb-OFF) INV PWR – OFF (tb-OFF) cb AC CONTR (three) – op
	4. Connect AC1 to AC3: Go to AC POWER TRANSFER CABLE INSTALLATION (IFM, PROCEDURES A THRU F)

PRESS CNTL SYS ENTRY CONFIG 9	
MS	MO10W 14.7 CAB REG INLET SYS 1,2 vlv (two) – CL H2O TK N2 REG INLET SYS 1,2 vlv (two) – OP O2 REG INLET SYS 1,2 vlv (two) – CL
	MO69M LEH O2 8 vlv – CL Remove, stow O2 Bleed Orifice LEH O2 7,8 vlv (two) – OP (if reqd)
	MO32M 5,6 vlv (two) – OP (if reqd)
C	L2 ✓ O2 SYS 1,2 SPLY (two) – OP (tb-OP) ✓ XOVR SYS 1,2 (two) – OP ✓ N2 SYS 1,2 SPLY (two) – OP (tb-OP) ✓ REG INLET (two) – OP (tb-OP) O2/N2 CNTLR VLV SYS 1 – OP 2 – CL

MCA CONFIG 10	
MA73C	MCA LOGIC FWD (three) – ON MID (eight) – ON

CLOTHING CONFIG 30	
MS,PS	Unstow, don: LES Harness Boots

CRYO QTY CONFIG 13	
C	O13:B cb ESS 1BC CRYO QTY O2,H2 TK2 (two) – op O13:D 2CA CRYO QTY O2,H2 TK1 (two) – op
MS	ML86B:G cb ESS 1BC CRYO QTY O2,H2 TK4 (two) – op ✓ 2CA CRYO QTY O2,H2 TK5 (two) – op 3AB CRYO QTY O2,H2 TK3 (two) – op

FLUID LOADING PREP 18	
Unstow, fill 4 drink containers (per crewmember) with 8 oz of water each; temp stow near seat Unstow 8 salt tablets (per crewmember); temp stow in Flight Suit pocket	

GALLEY DEACT 19	
GALLEY	✓ OVEN/RHS – OFF ✓ H2O HTRS (two) – OFF ✓ OVEN FAN – OFF ✓ REHYD STA lever – cl (push in) ✓ OVEN DOOR LATCH – latched
MA73C:G	cb AC3 GALLEY FAN (three) – op
ML86B:A	cb MNC SPLY H2O GALLEY SPLY – op
:B	MNA GALLEY OVEN – op MNB GALLEY H2O HTR – op

WCS DEACTIVATION 23	
EDO	If EDO WCS: URINAL SEL – OFF WCS PWR SEL – OFF1, OFF2 FAN PWR – AUTO Lock odor lid/seat COMP LOCK DOWN PINS (three) – tighten
WCS	VAC VLV – CL ✓ MODE – AUTO FAN SEP SEL sw – OFF Unstow hose from cradle, attach hose to WCS housing via Velcro straps
(EDO WCS)	Remove, stow: WCS Trash Can Mirror Privacy Curtain Foot restraints – up, locked Close, latch door

VENT DOOR OPS DISABLE 27	
MA73C:A	MCA LOGIC MID (four) – OFF ✓ FWD (three) – ON
:B	MID (four) – OFF AFT (three) – OFF
MA73C:C	If MNB and AC2 powered: cb MCA PWR AC1, AC3 3Φ FWD 1,3 (two) – op ✓ Minimum middeck lighting

LOSS OF TWO FUEL CELLS SWITCH VERIFICATION LIST

LEFT SEAT

L5	6-3
L4	6-3
L,R HUD	6-4
L1	6-4
F3	6-4
L2	6-5
F1	6-5
F2	6-6
F6	6-6
F7	6-6
C2	6-7
C3	6-7
O1	6-8
O2	6-8
L side OVHD flood	6-8
O5	6-8
O6	6-9
O7	6-9
O13	6-10
O14	6-10
O15	6-10

RIGHT SEAT









O16	6-11
O17	6-11
O8	6-12
O9	6-12
R side OVHD flood	6-12
O3	6-13
F4	6-13
F8	6-13
F9	6-13

RIGHT SEAT (Cont)

R1	6-14
R2	6-15
R4	6-15
R6	6-15

AFT

O19	6-16
C6	6-16
C5	6-16
C7	6-16
R10	6-17
R11U,L	6-17
R13U,L	6-18
R14	6-18
A1U,L,R	6-19
A4	6-20
A3	6-20
A6U	6-20
A7U	6-20
A7L(MADS)	6-20 (OV102)
A6L	6-21 (OV103,104,105)
A7L	6-22
A8U,L	6-21 (OV102)
A8U,L	6-23 (OV103,104,105)
A2	6-22 (OV102)
A11	6-22 (OV102)
A11	6-24 (OV103,104,105)
A12	6-22 (OV102)
A12	6-24 (OV103,104,105)
A13	6-22 (OV102)
A13	6-25 (OV103,104,105)

<u>LEGEND</u>	
	- left
	- right
	- up
	- center
	- down
	- cb close
	- cb open
	indicates switch/display not checked during ENTRY SWITCH LIST/VERIFICATION

<u>CIRCUIT BREAKER SNAPPING COLOR CODES</u>	
<u>COLOR</u>	<u>CONFIGURATION</u>
Red	Open at all times
Green	Open on orbit only
Yellow	Open ascent, close per procedure
Orange	Open orbit through entry
Blank (no ring)	Always closed or as reqd

AFT (Cont)

A14 6-23 (OV102)
A14 6-25 (OV103,104,105)
L9 6-23 (OV102)
L9 6-25 (OV103,104,105)
A15 6-23 (OV102)
A15 6-25 (OV103,104,105)

MIDDECK FWD

MO42F 6-24 (OV102)
MO42F 6-26 (OV103,104,105)
MO58F 6-24 (OV102)
MO58F 6-26 (OV103,104,105)
MO32M 6-24 (OV102)
MO32M 6-26 (OV103,104,105)
MO39M 6-24 (OV102)
MO39M 6-26 (OV103,104,105)
MO69M 6-24 (OV102)
MO69M 6-26 (OV103,104,105)
MO29J 6-24 (OV102)
MO29J 6-26 (OV103,104,105)
MO52J 6-24 (OV102)
MO52J 6-26 (OV103,104,105)
MO30F 6-24 (OV102)
MO30F 6-26 (OV103,104,105)
MO62M 6-24 (OV102)
MO62M 6-26 (OV103,104,105)
MO63P 6-26 (OV104)
MO51F 6-25 (OV102)
ML86B 6-25 (OV102)
ML86B 6-27 (OV103,104,105)
MD24K 6-26 (OV102)
MD24K 6-28 (OV103,104,105)
MD44F 6-26 (OV102)
MD44F 6-28 (OV103,104,105)

MIDDECK AFT

MA73C 6-25 (OV102)
MA73C 6-27 (OV103,104,105)
MO13Q 6-26 (OV102)
MO13Q 6-28 (OV103,104,105)
ML26C 6-26 (OV102)
ML26C 6-28 (OV103,104,105)
ML18F 6-26 (OV102)
ML18F 6-28 (OV103,104,105)
ML31C 6-26 (OV102)
ML31C 6-28 (OV103,104,105)
MO10W 6-27 (OV102)
MO10W 6-29 (OV103,104,105)
WCS 6-27 (OV102)
WCS 6-29 (OV103,104,105)
EDO WCS 6-27 (OV102)
EDO WCS 6-29 (OV103,104,105)

AIRLOCK

AW18A 6-28 (OV102)
AW18A 6-30 (OV103,104,105)
AW18D 6-28 (OV102)
AW18D 6-30 (OV103,104,105)
AW18H 6-28 (OV102)
AW18H 6-30 (OV103,104,105)
AW82A 6-28 (OV102)
AW82A 6-30 (OV103,104,105)
AW82B 6-28 (OV102)
AW82B 6-30 (OV103,104,105)
AW82D 6-28 (OV102)
AW82D 6-30 (OV103,104,105)
AW82H 6-28 (OV102)
AW82H 6-30 (OV103,104,105)
INNER HATCH 6-29 (OV102)
INNER HATCH .. 6-31 (OV103,104,105)

OV102

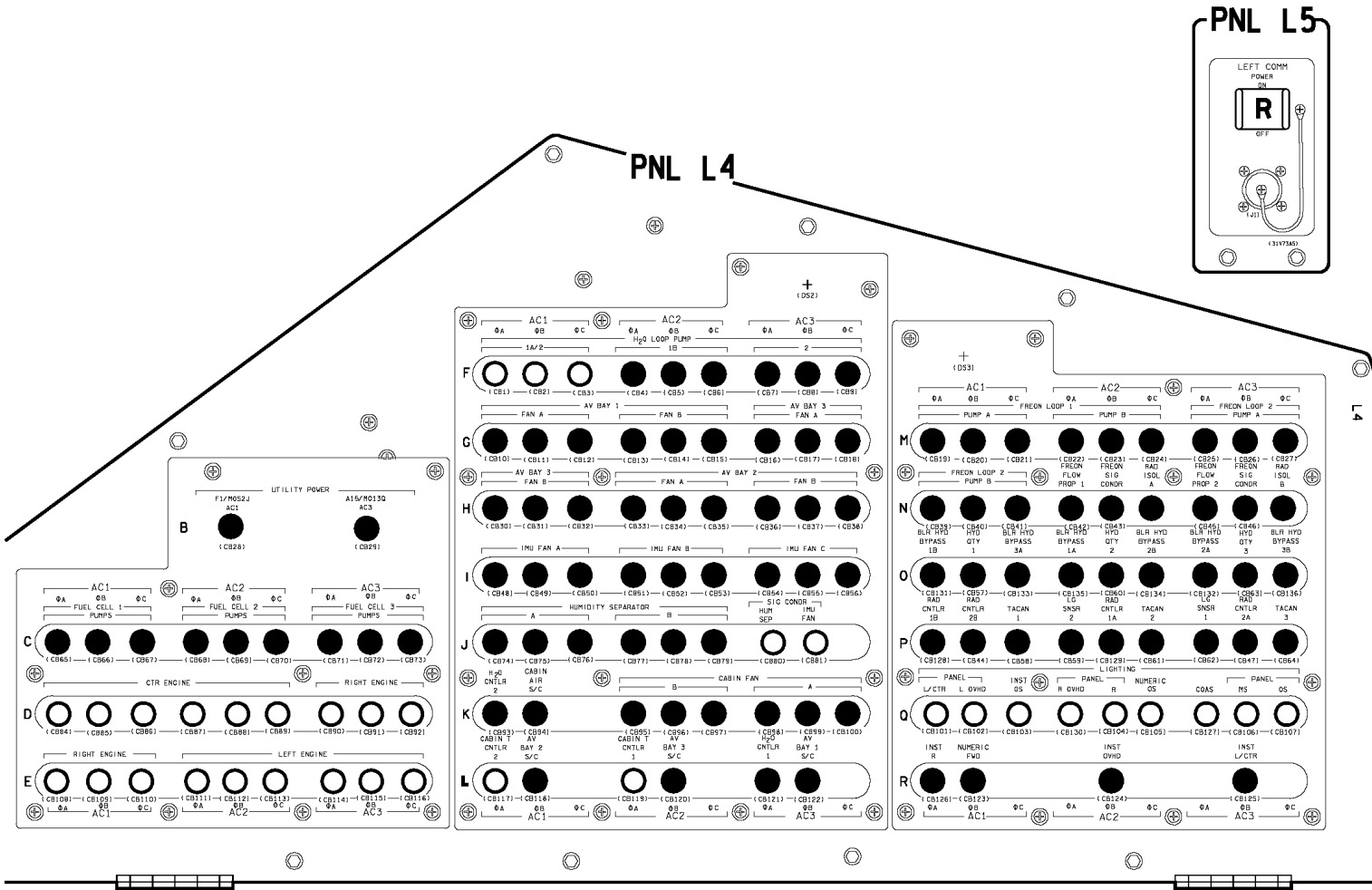

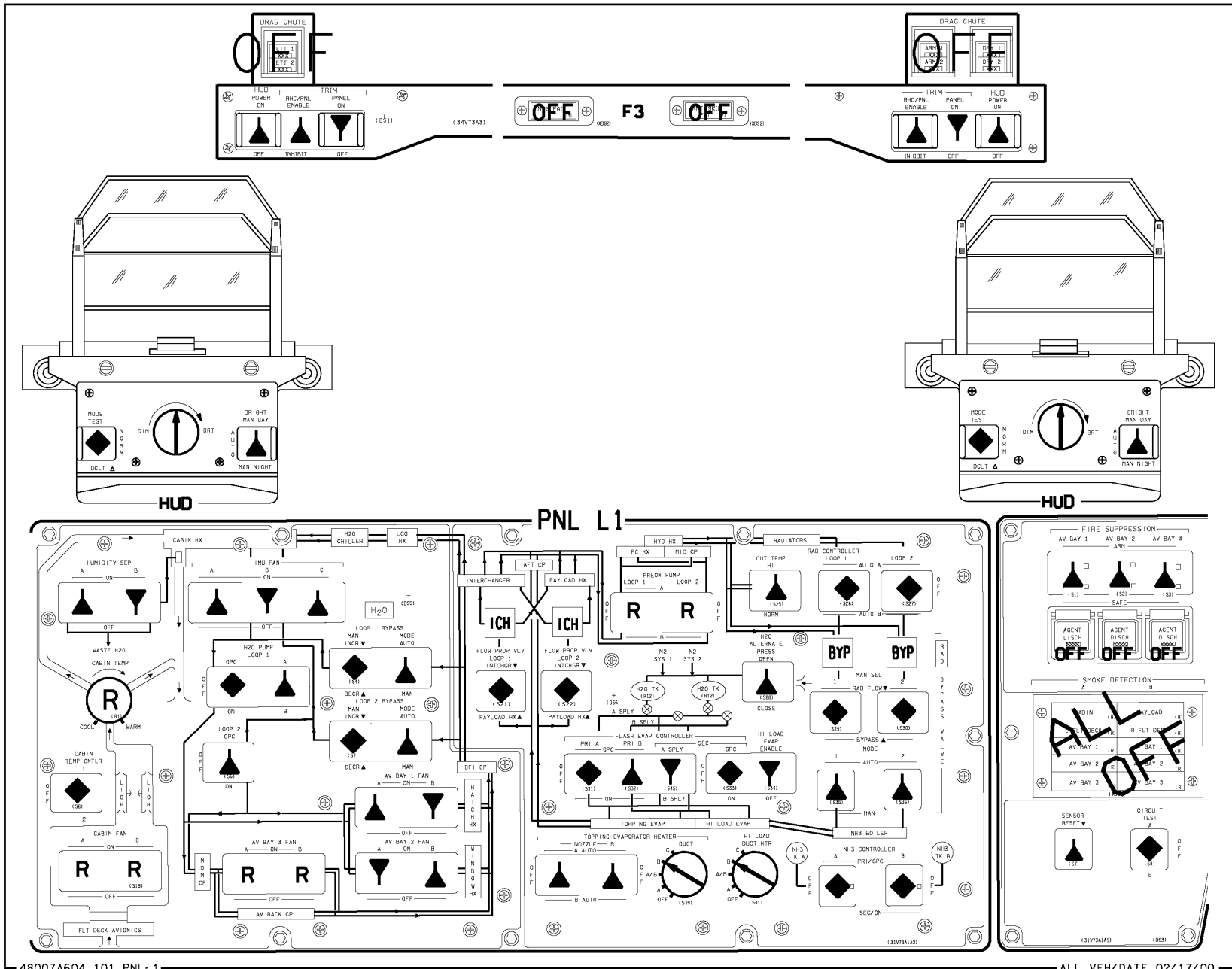

48007A604_101. PNL L1

(OV102) A6-4

ALL VEH/DATE 02/17/00

C D/O/ALL/GEN H

OV102

OV102

PNL L2

L2

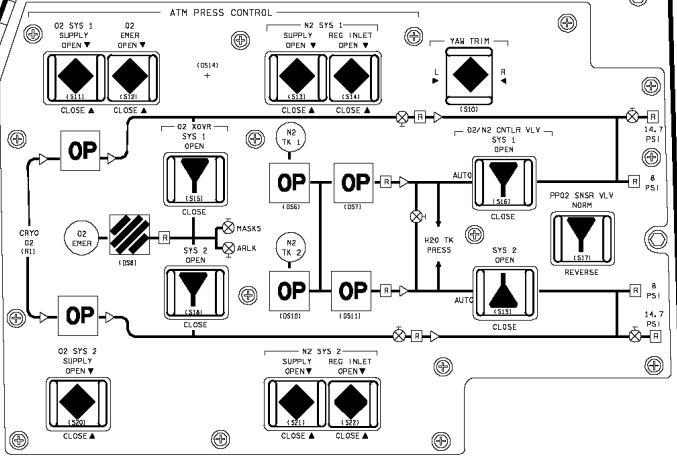
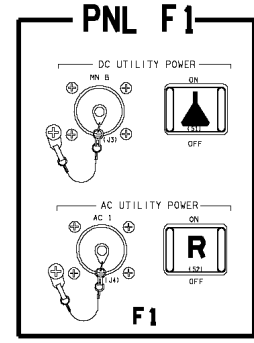
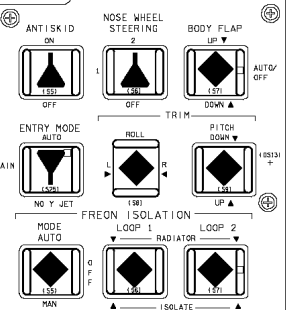
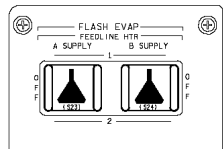
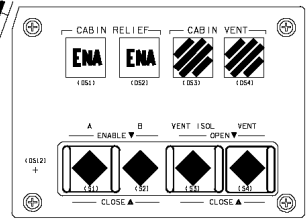

OV102

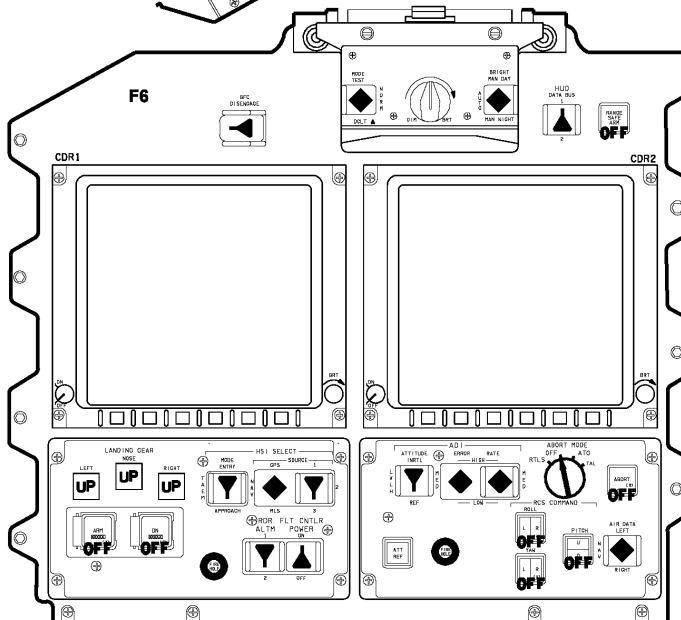
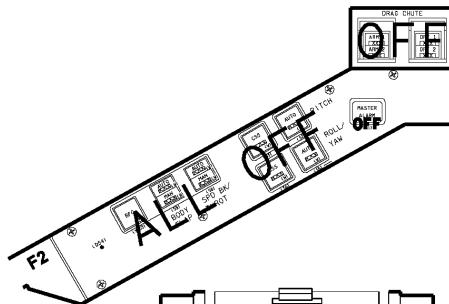
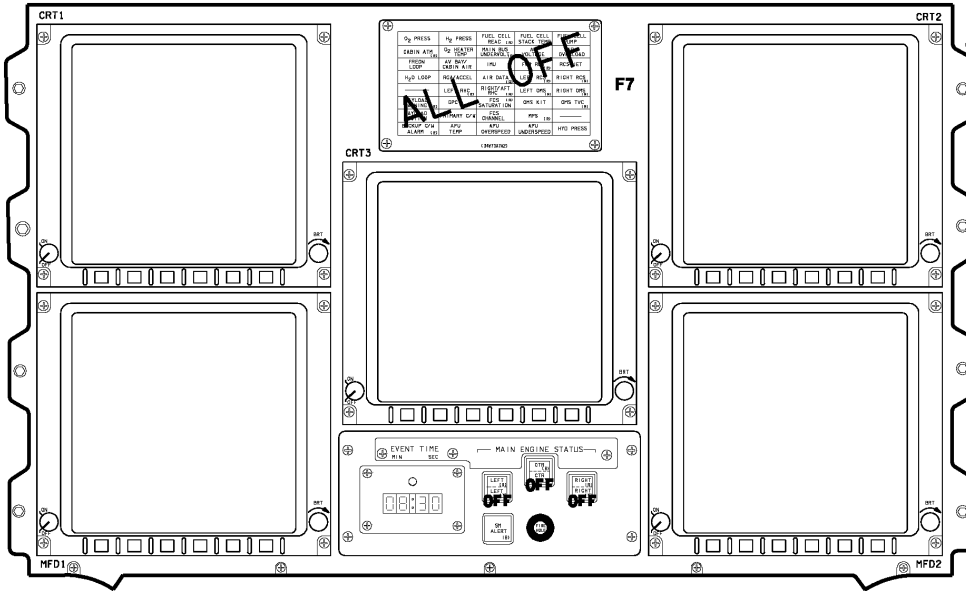

REDS REV/DATE 02/01/02

48007C606-109, PNL1, 1

OV102

(OV102) A6-6

C D/O/2/GEN H,7

PNL C2/C3

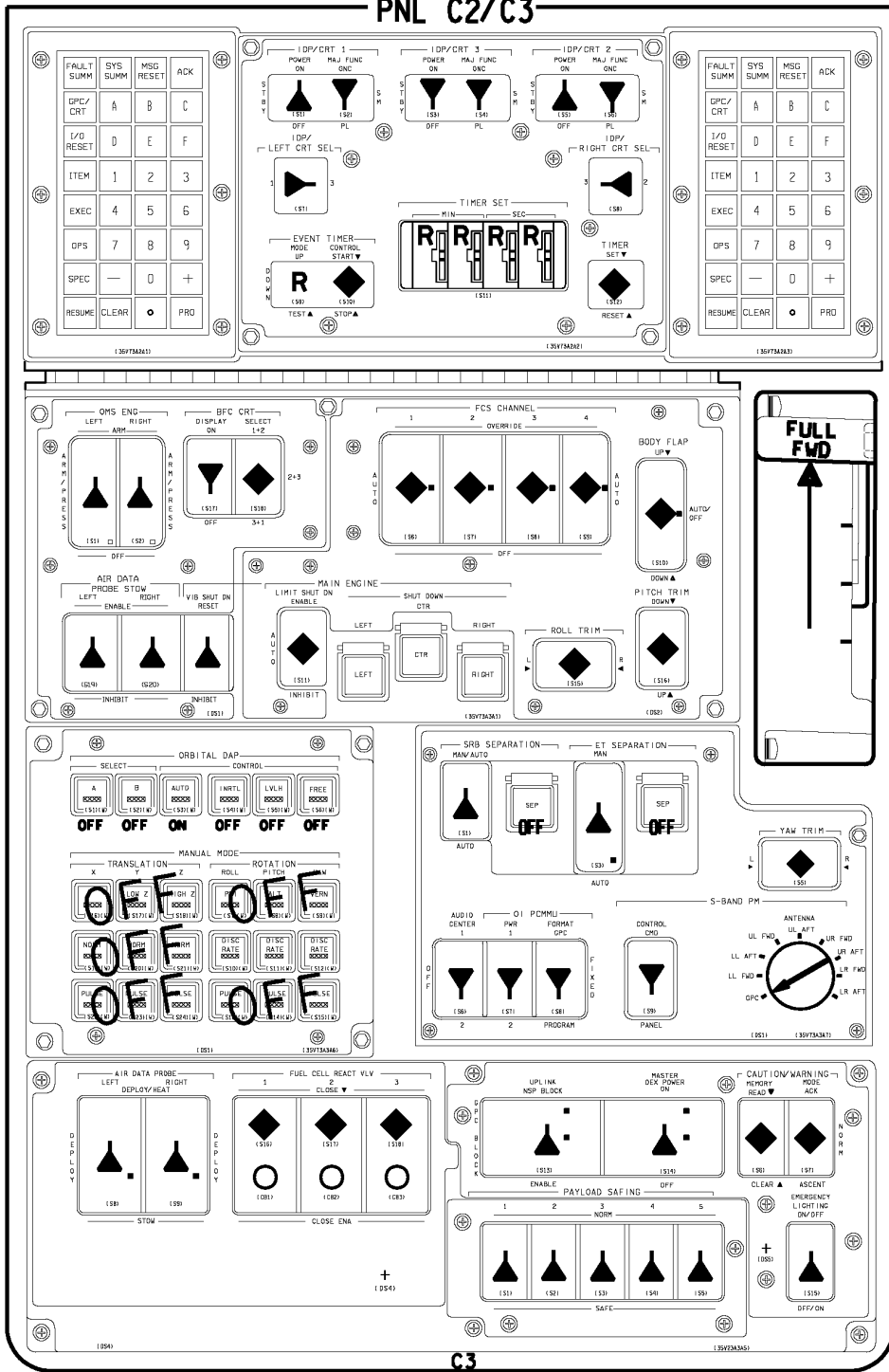

C3

OV102

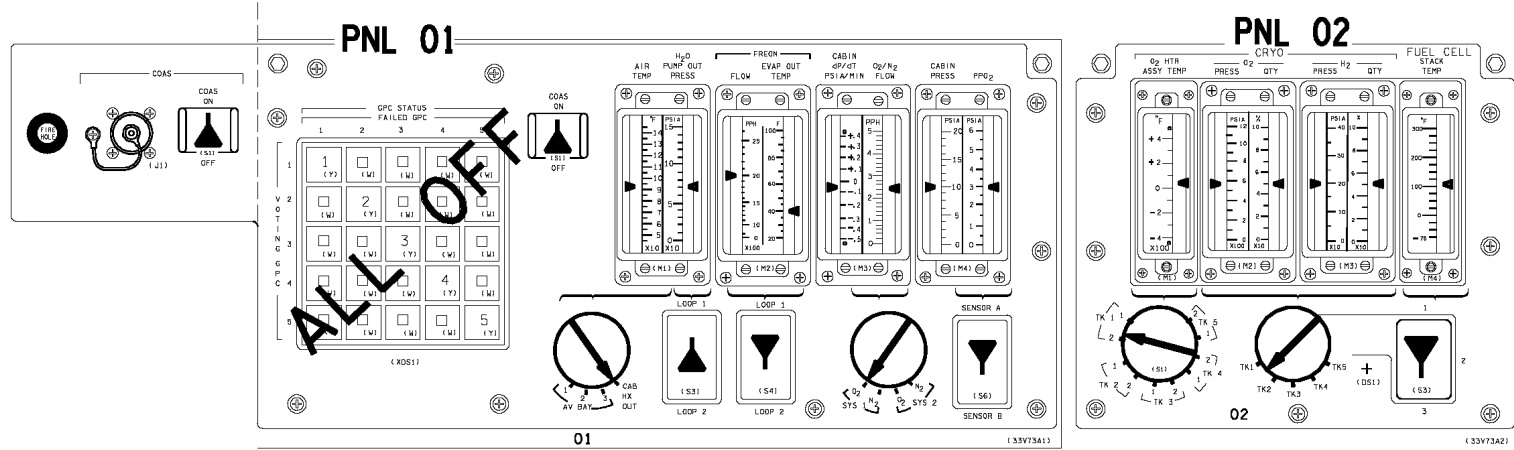

L side OVHD flood - R (MID)

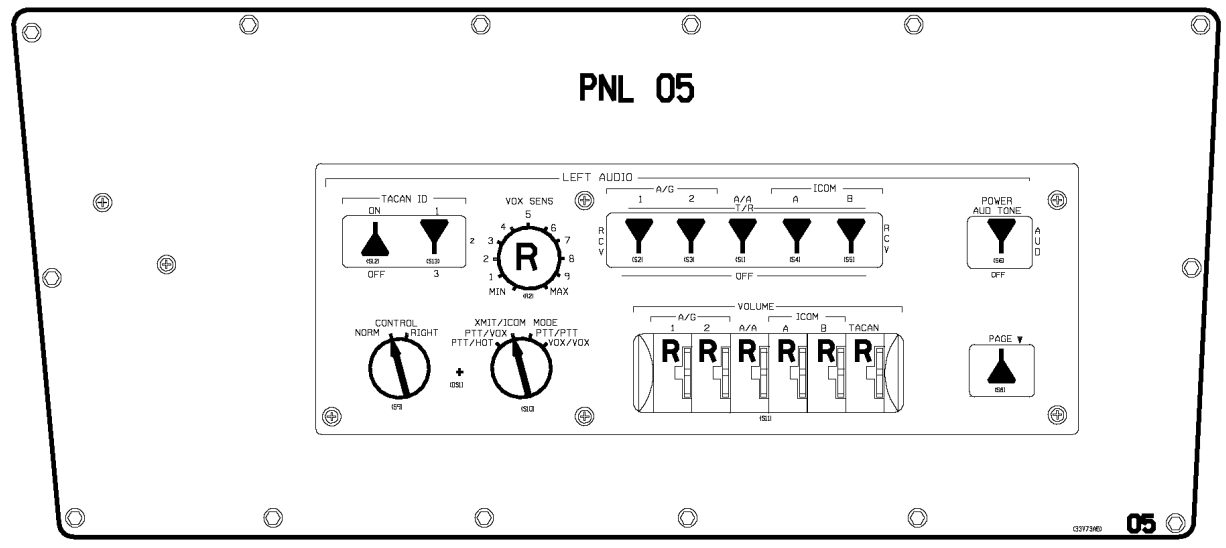

OV102

PNL 06

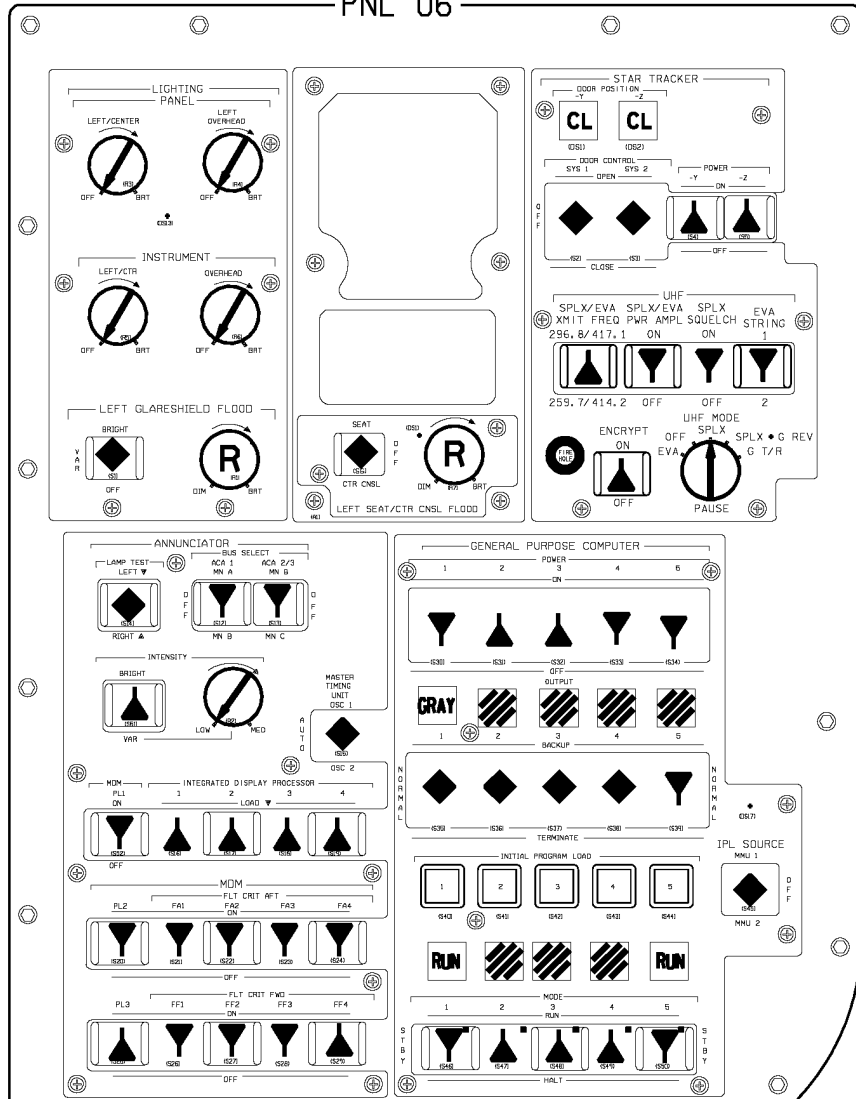

PNL 07

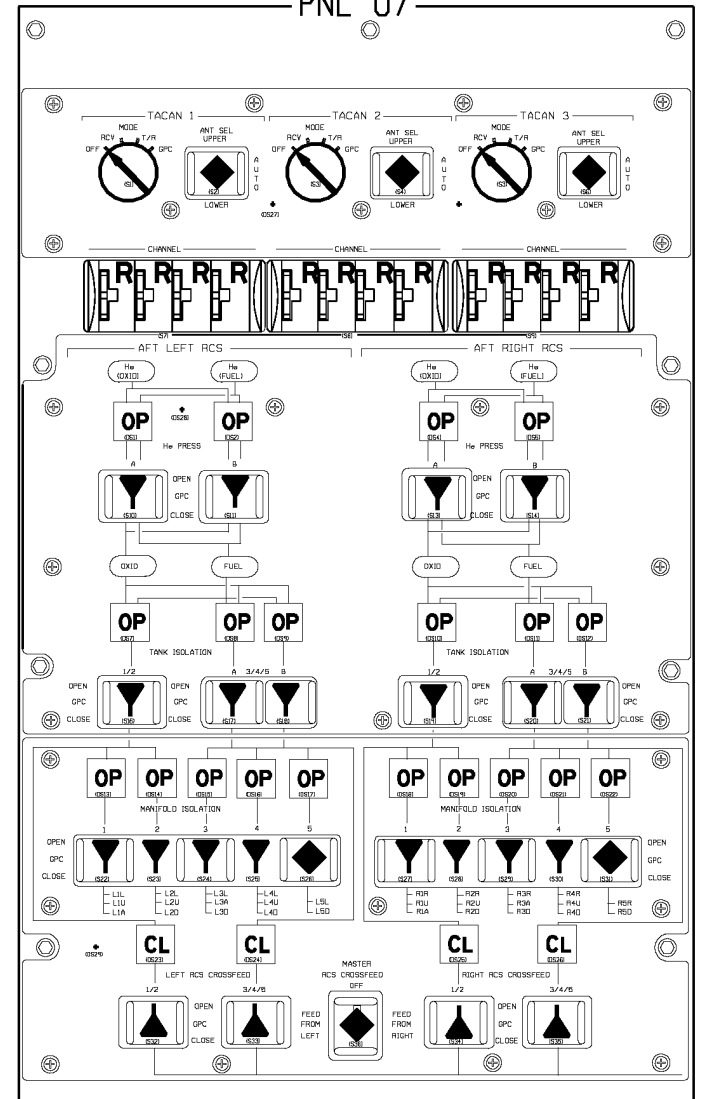

PNL 013

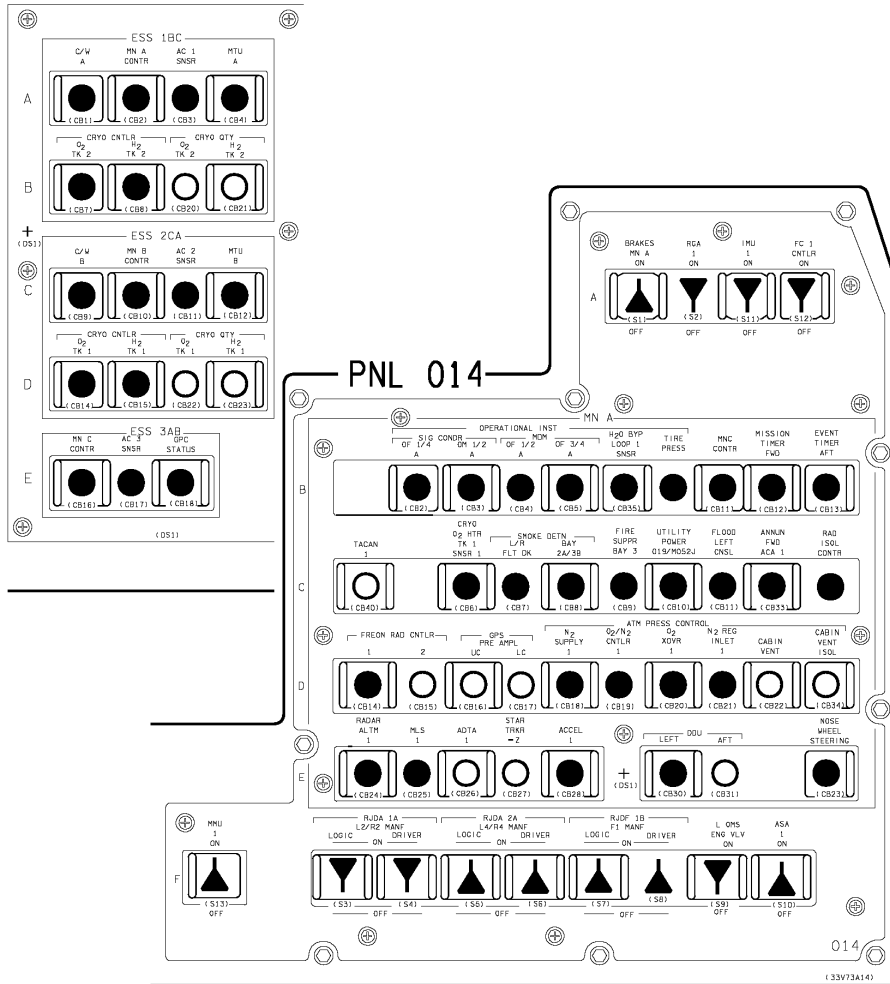

PNL 015

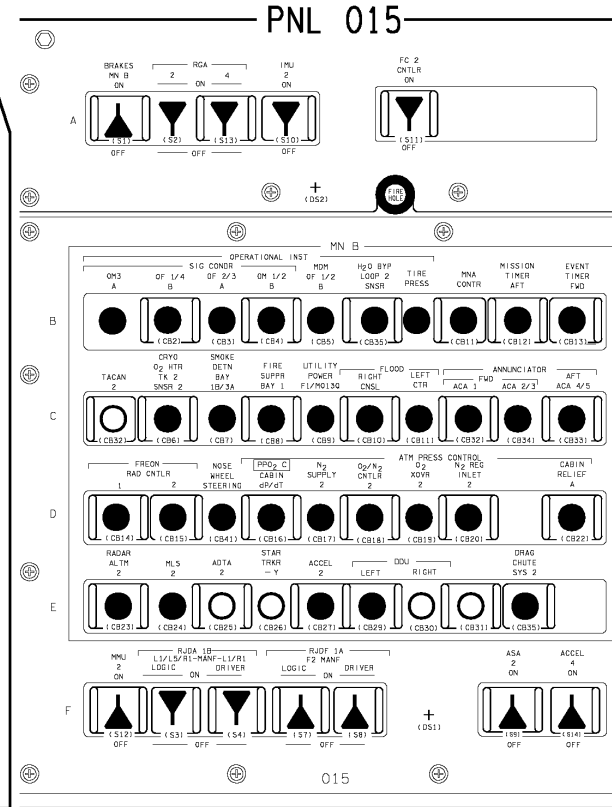

OV102

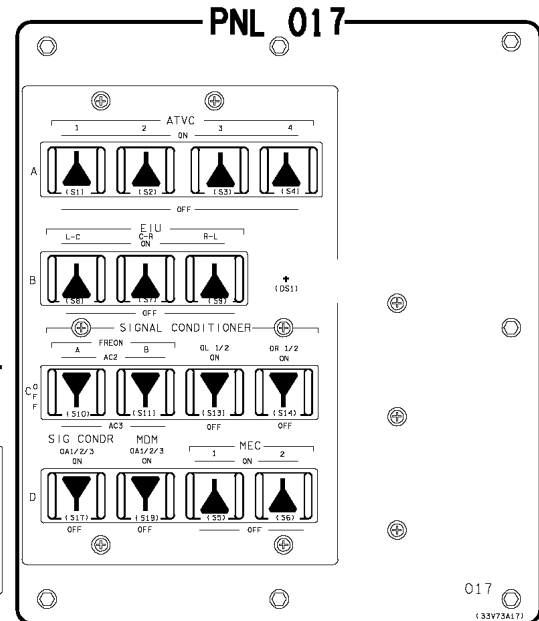
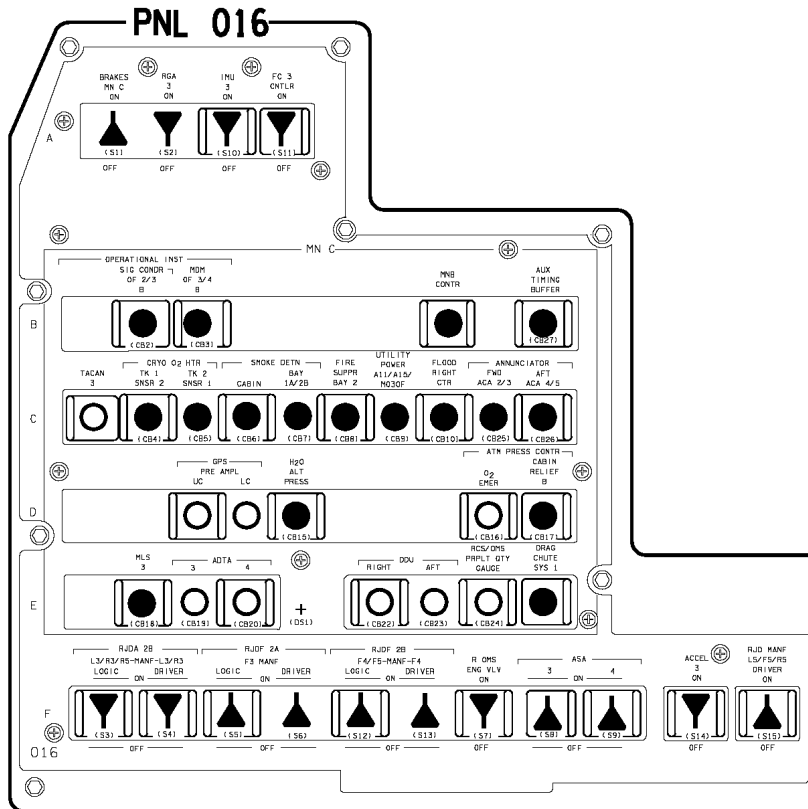

PNL 08

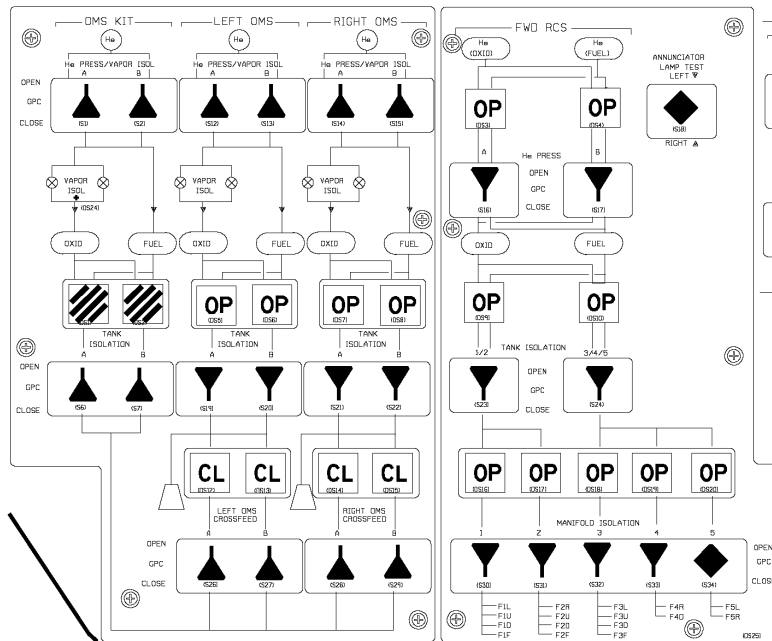
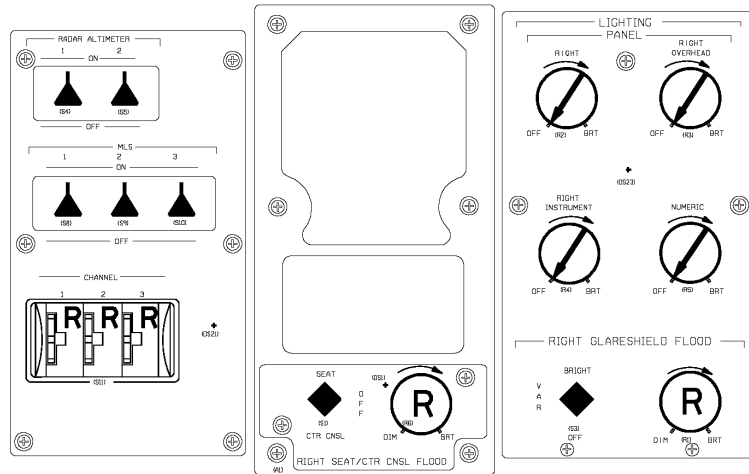

PNL 09

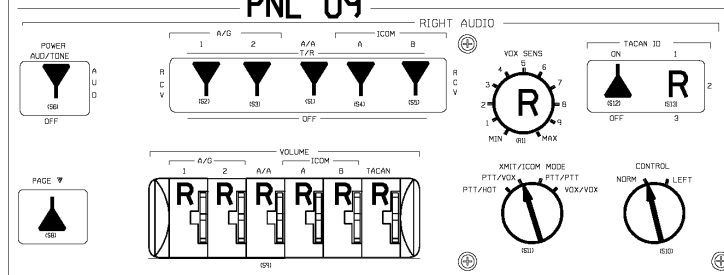

R side OVHD flood - R (MID)

OV102

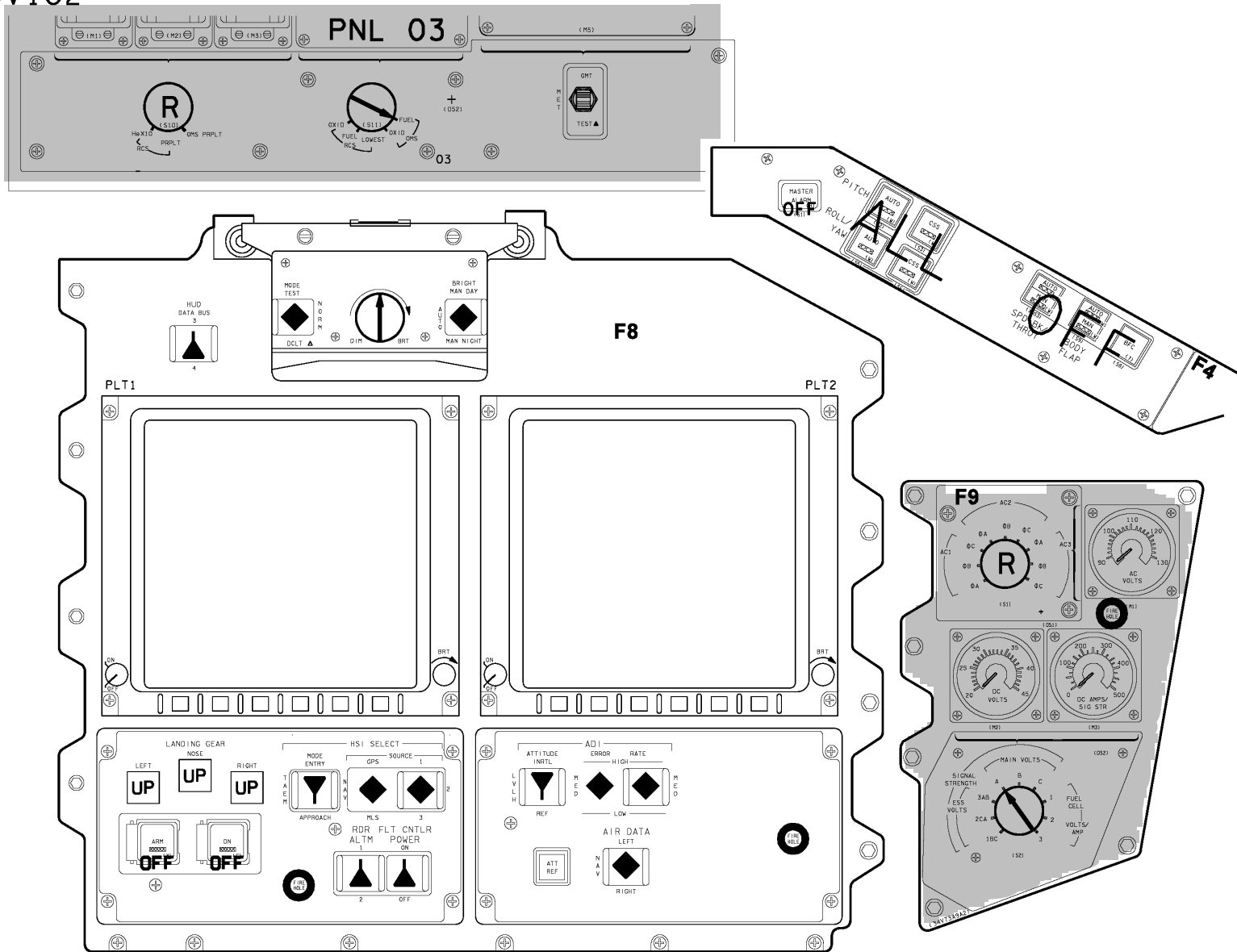

PNL R1

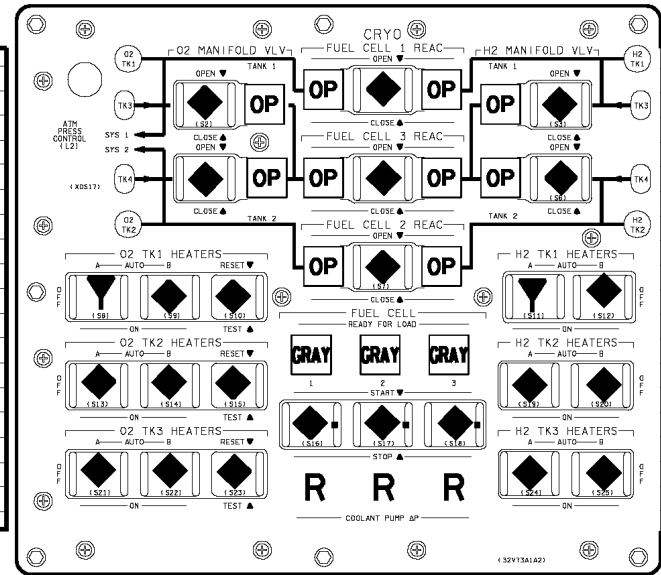
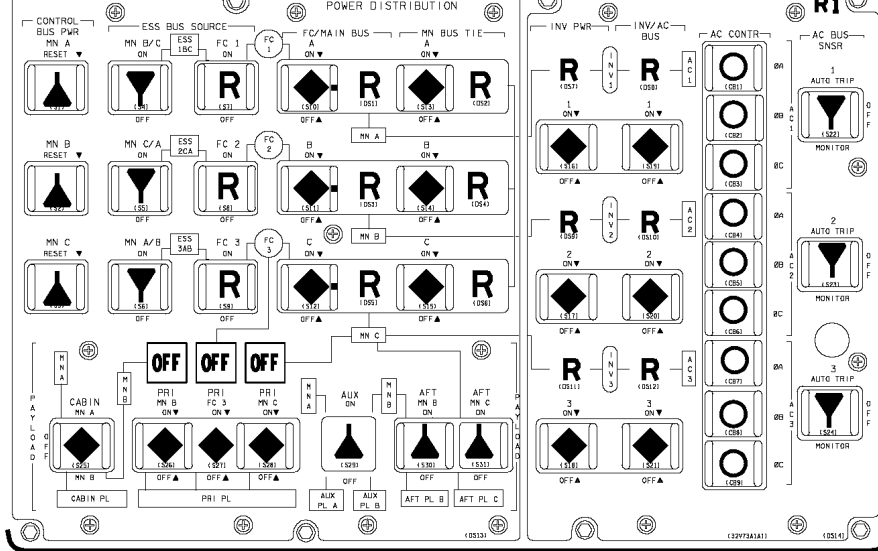

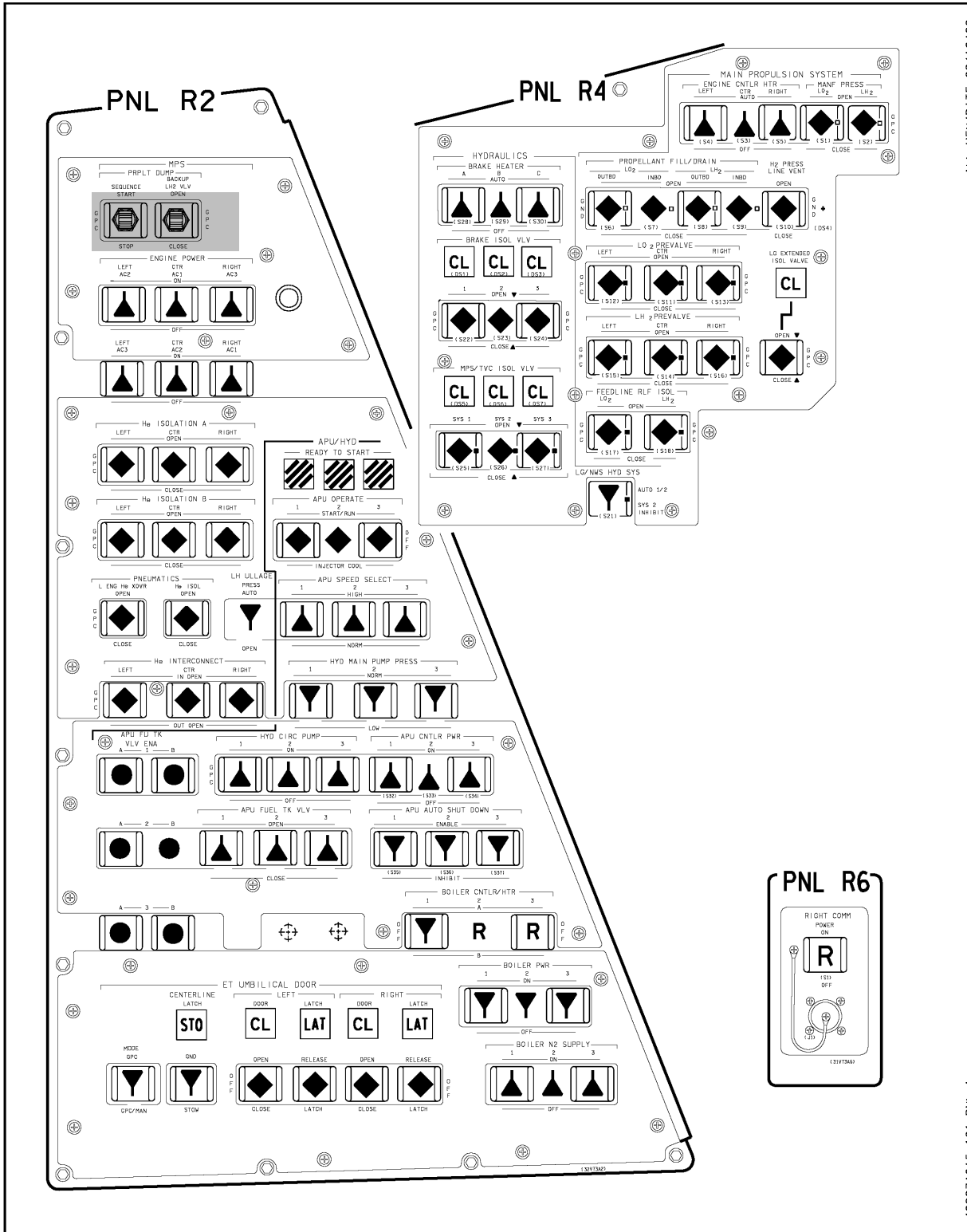

ALL VEH/DATE 02/18/00

4800746.15_101. PNL # 1

OV102

(OV102) A6-15

C D/O/ALL/GEN H

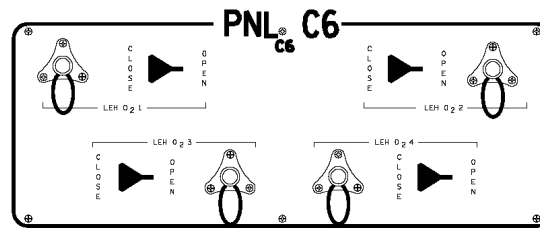
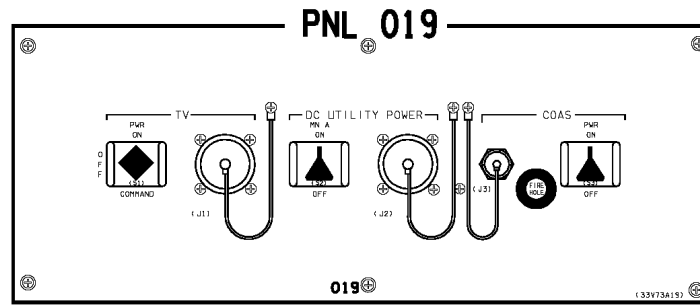

PNL C5

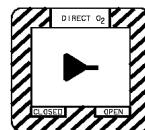

PNL C7

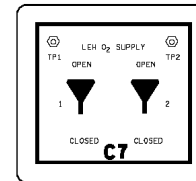

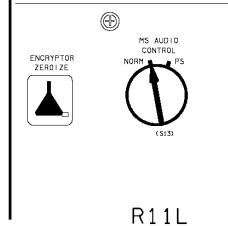
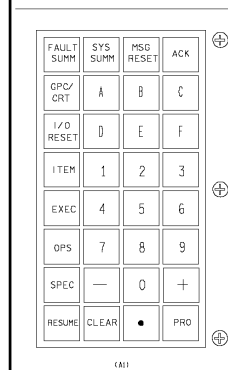
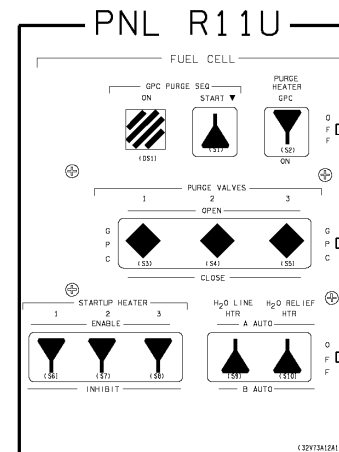
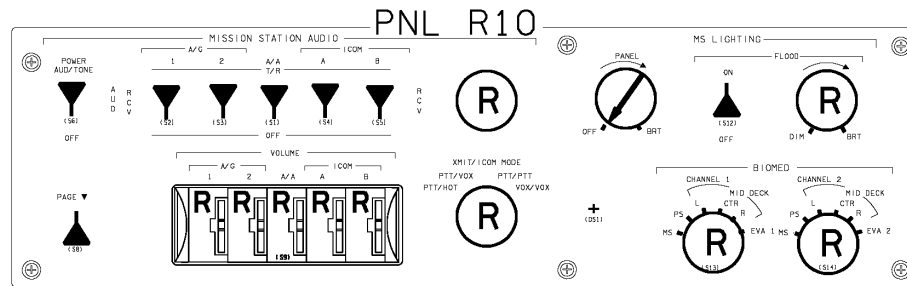

R11L

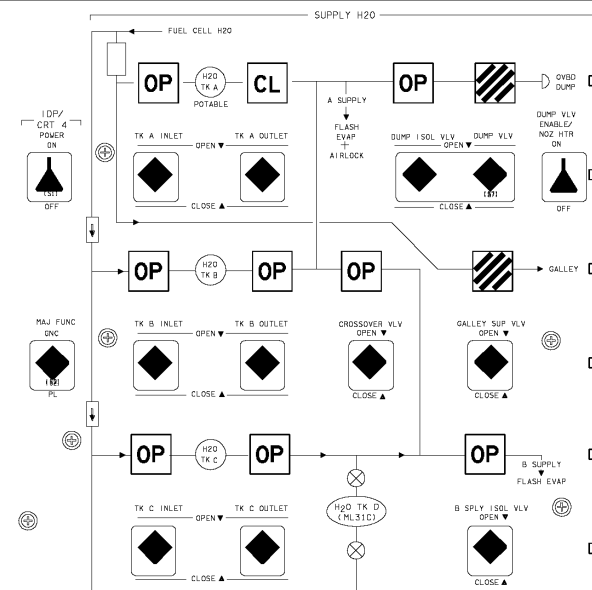

OV102

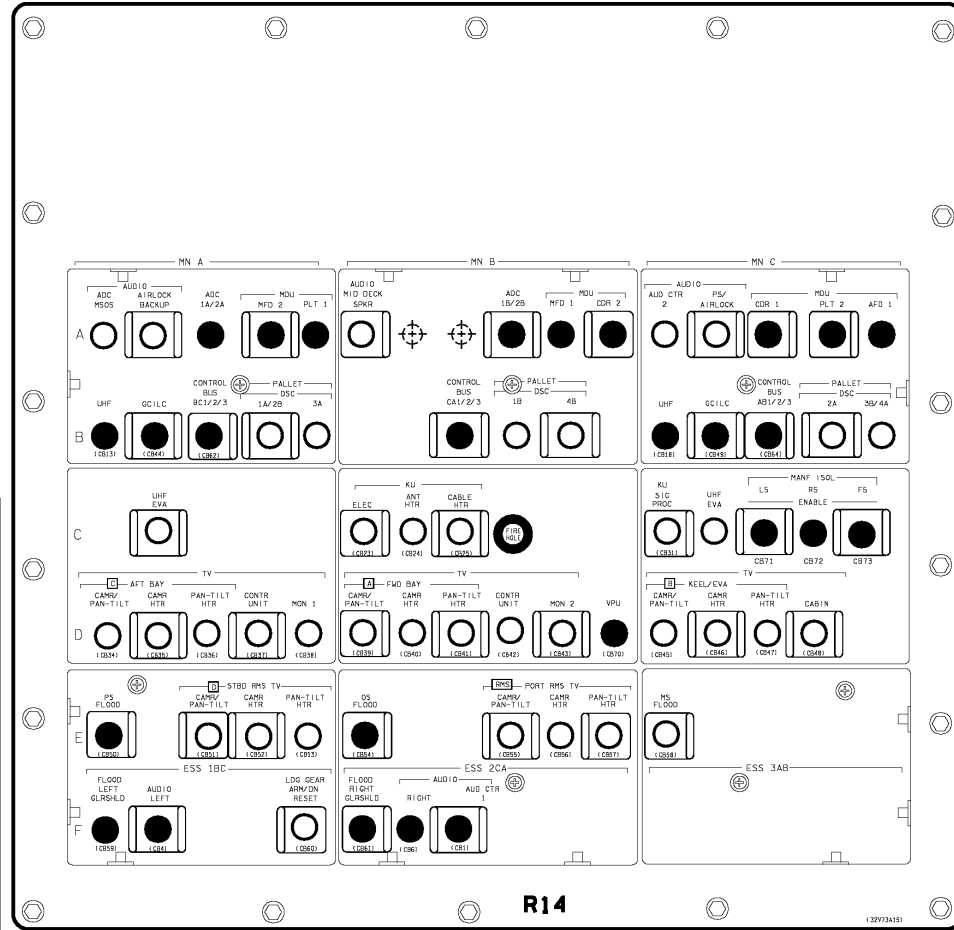
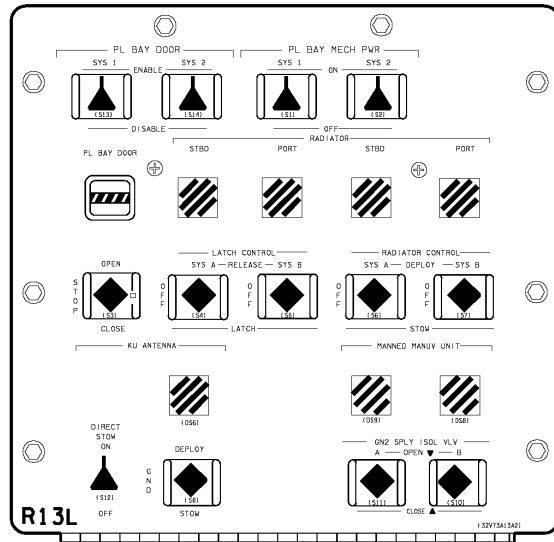
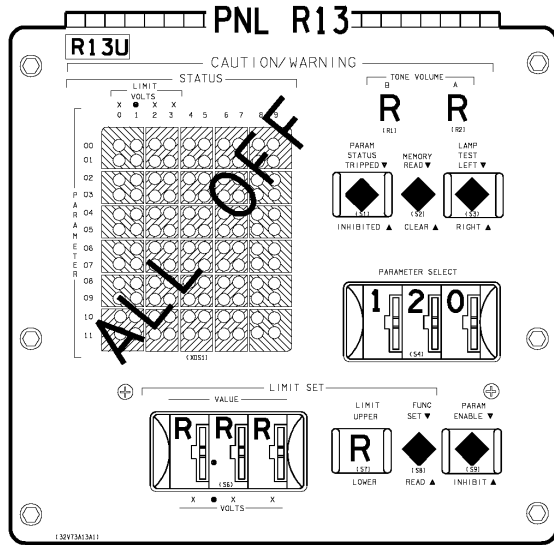

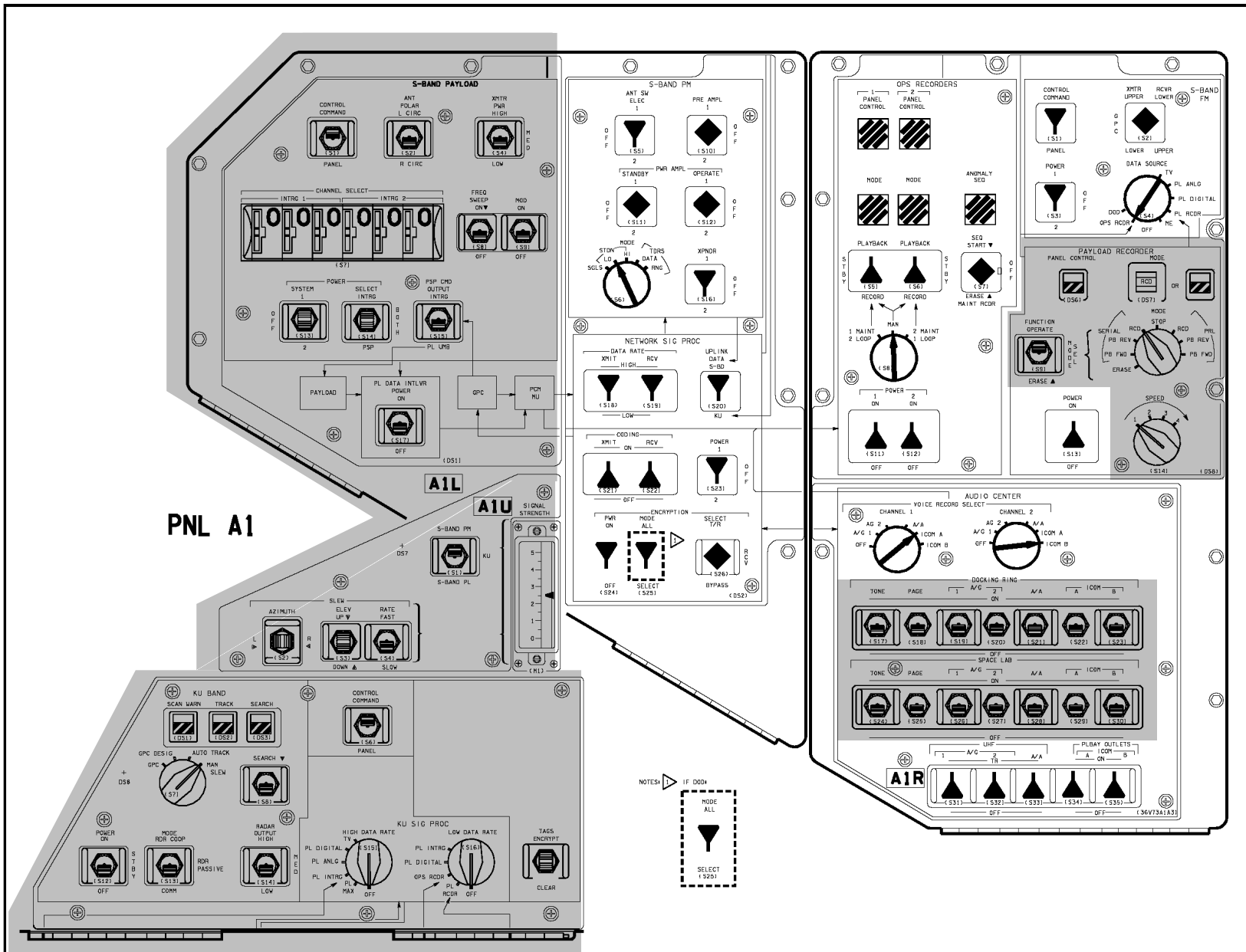

PNL A1

OV102

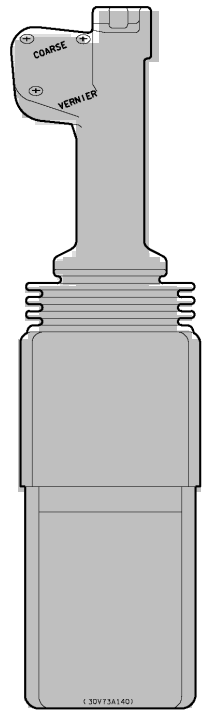
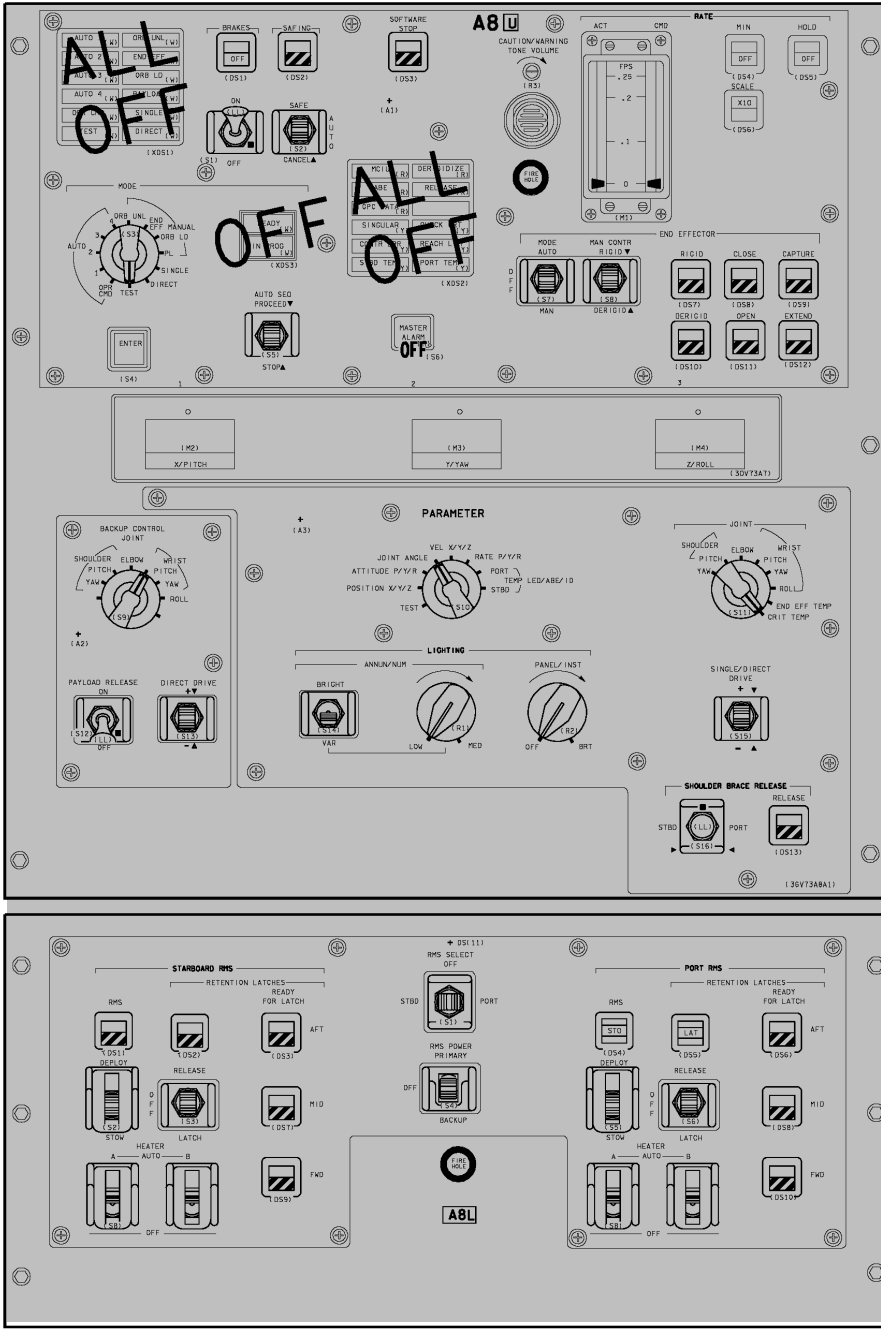

48007A621_101_PNL 1 ALL VEH/DATE 02/18/00

OV102

(OV102) A6-21

C D/O/ALL/GEN H

OV102

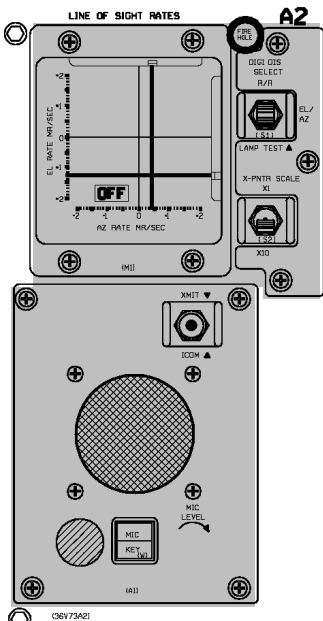

PNL A11

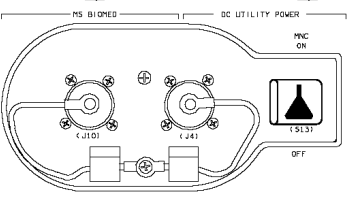
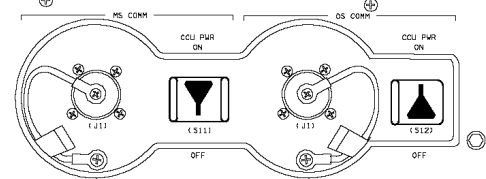
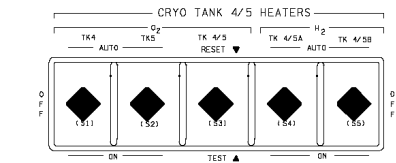

PNL A12

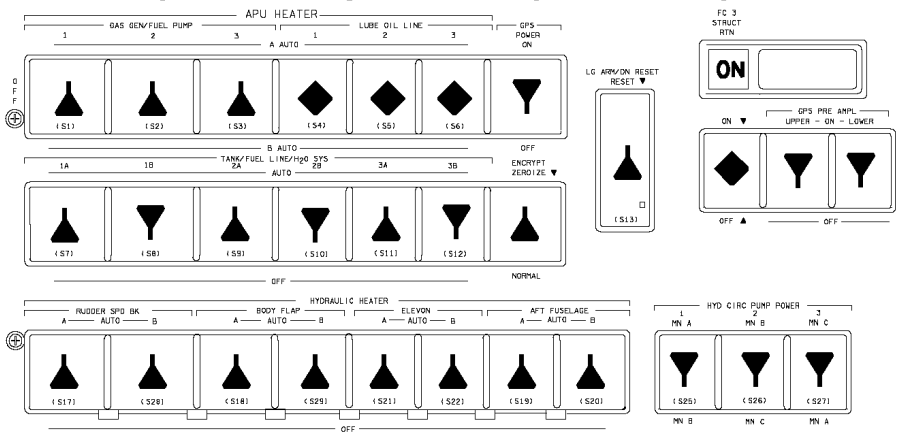

A12

PNL A13

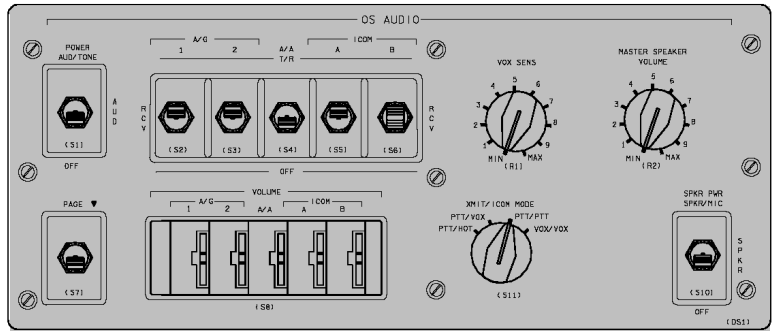

A13

OV102

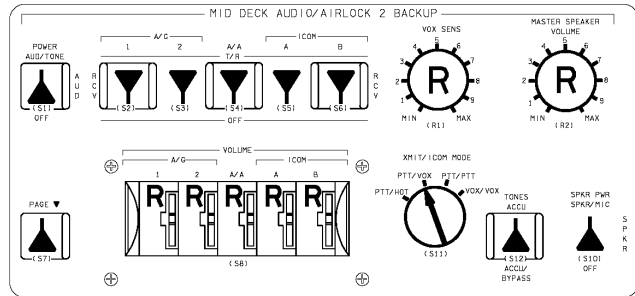

PNL M042F

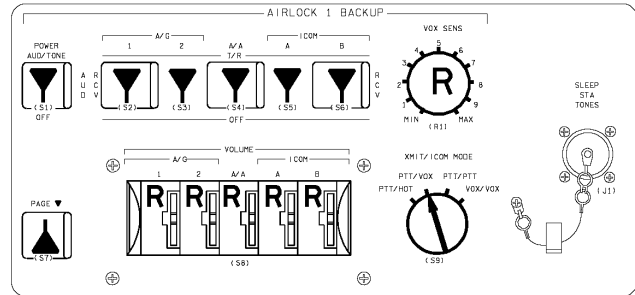
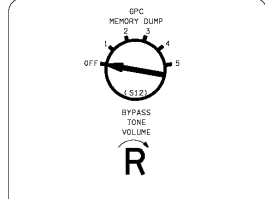

PNL M058F

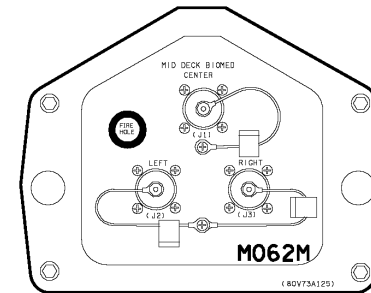
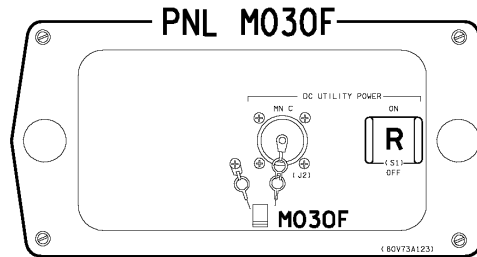
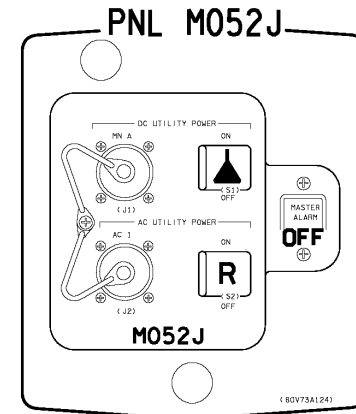
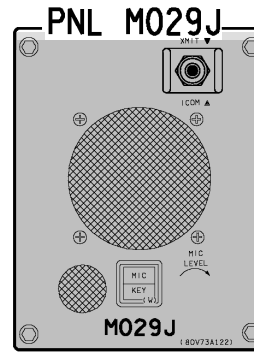
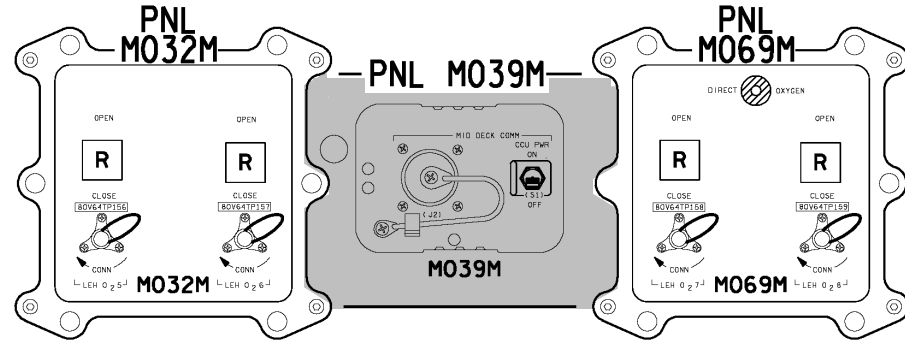
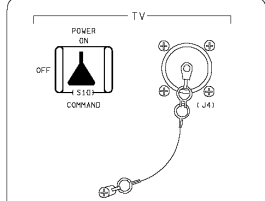

OV102

PNL MA73C

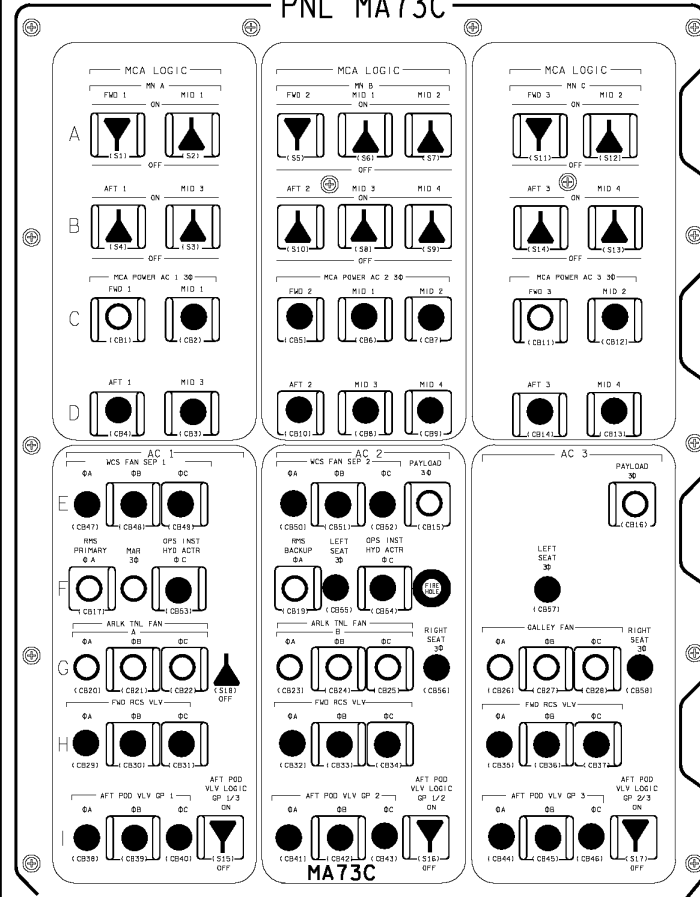

PNL ML86B

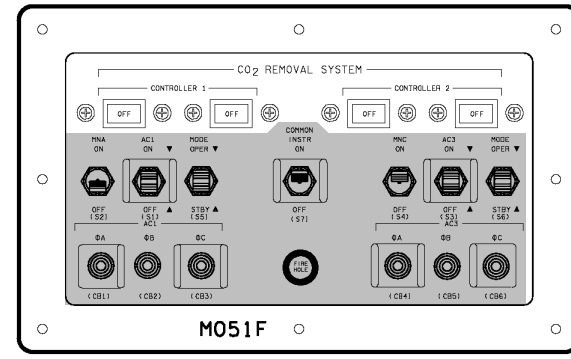
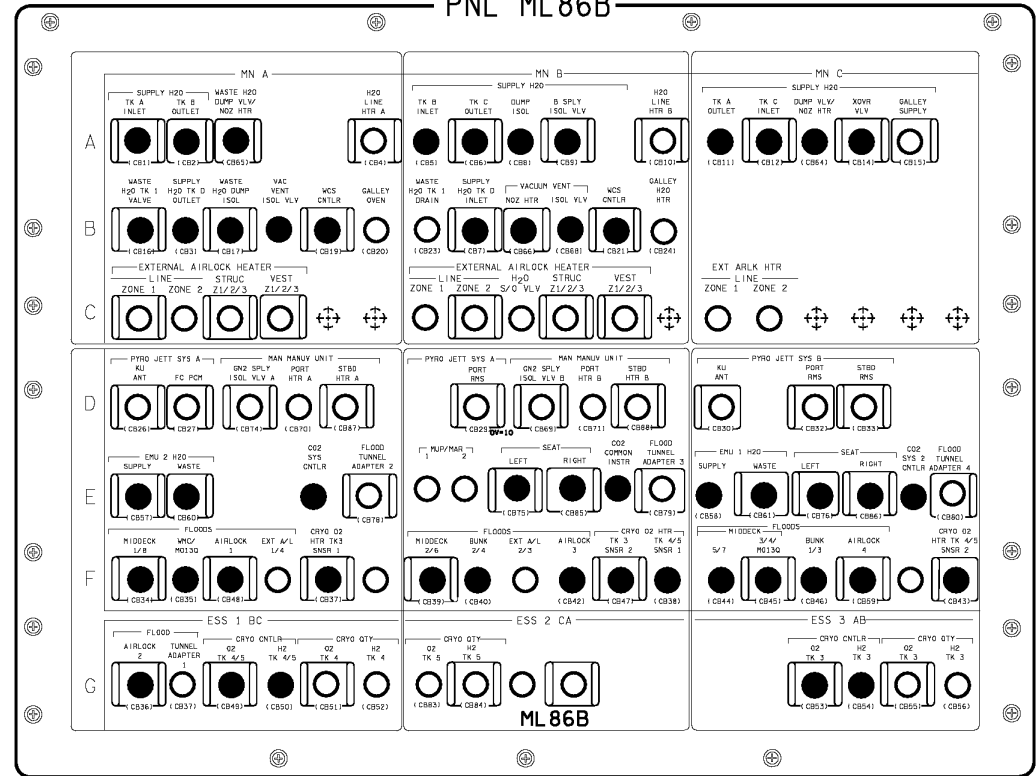

OV102

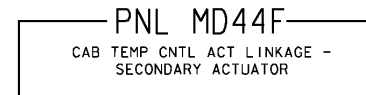
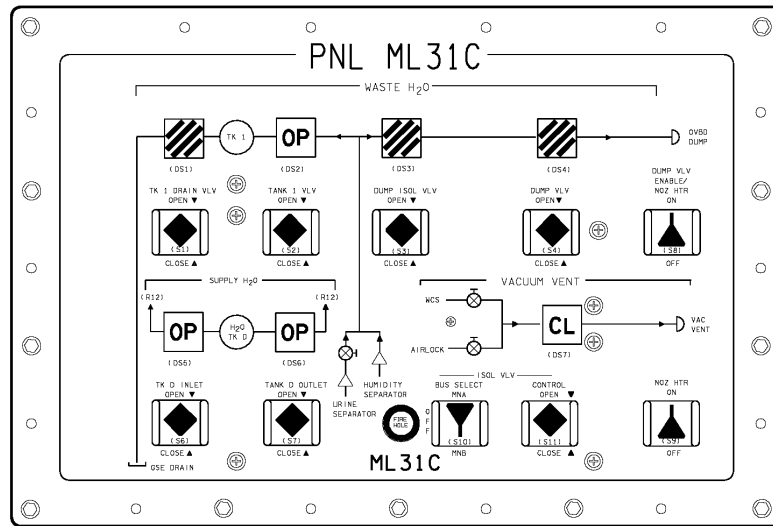
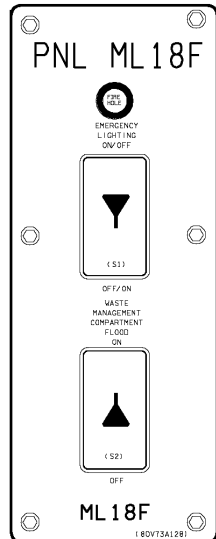
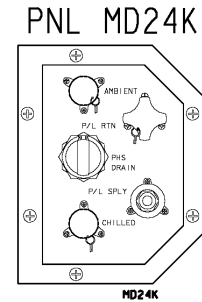
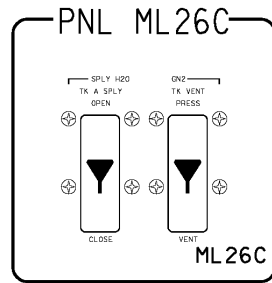
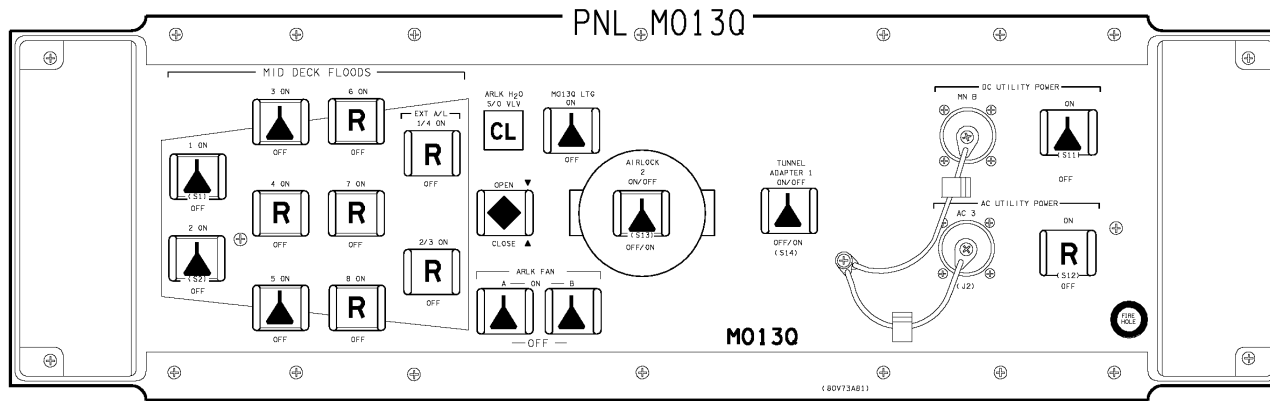

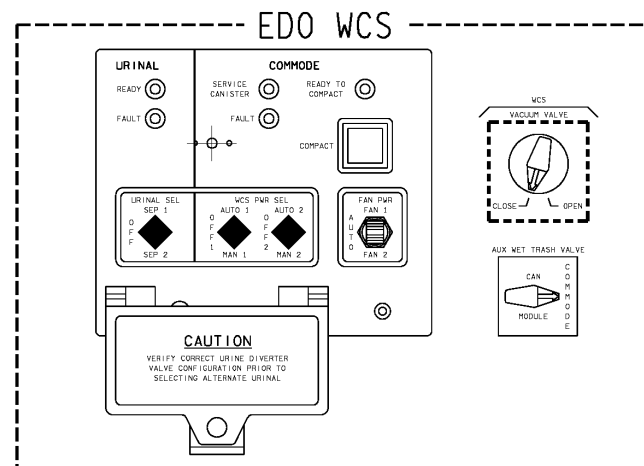
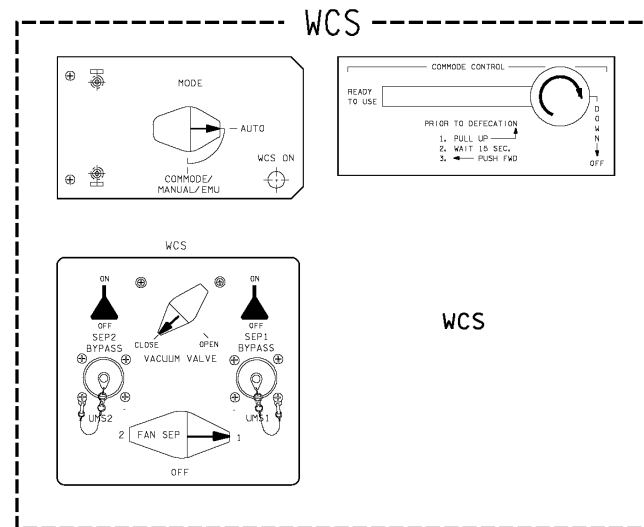
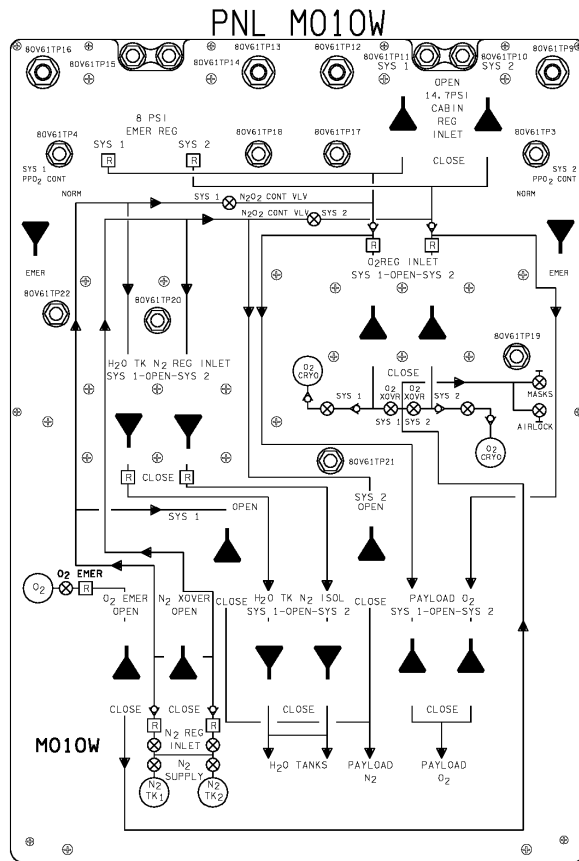

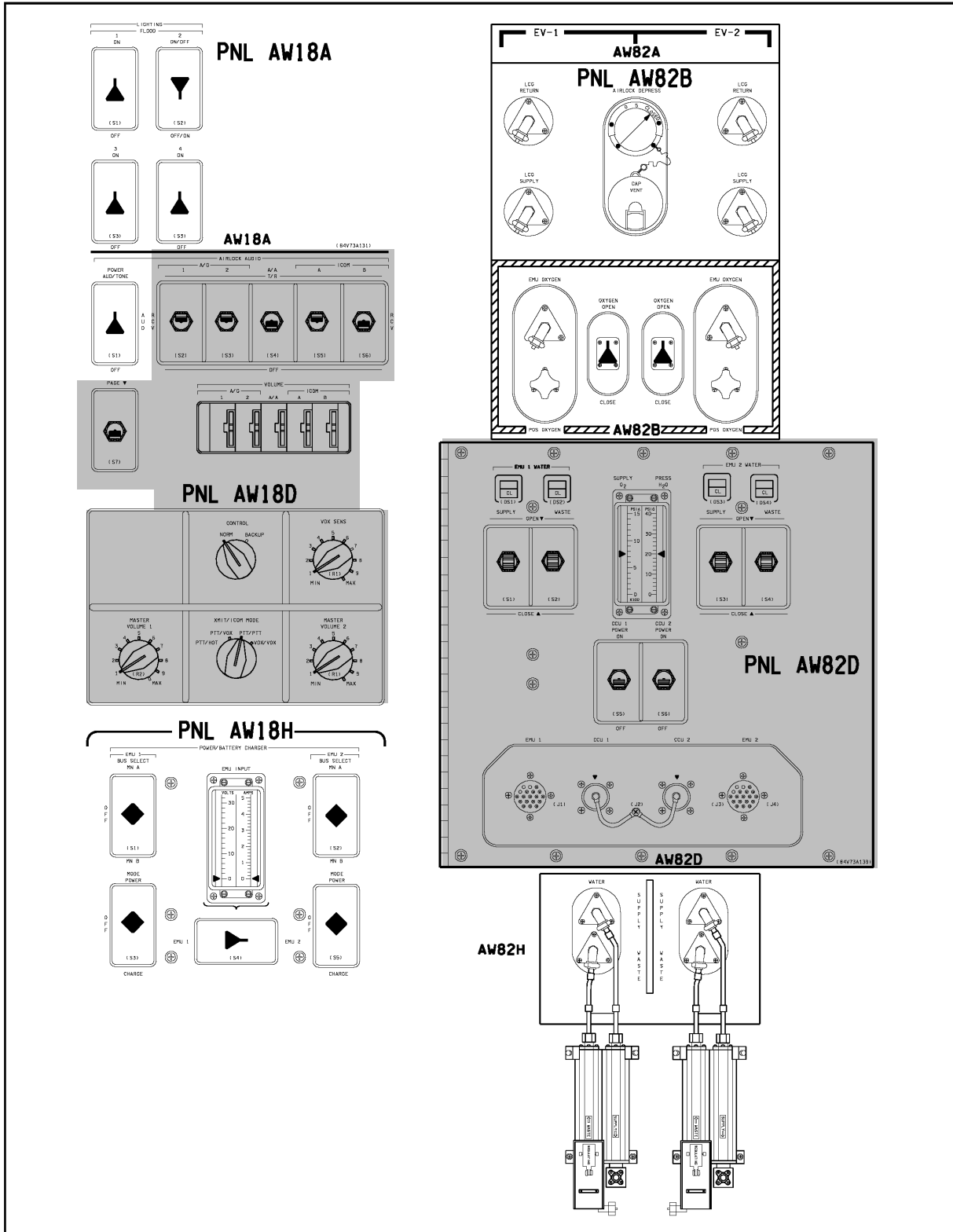

ALL VEH/DATE 02/21/00

48007A628_101, PNL 1

OV102

(OV102) A6-28

C D/O/ALL/GEN H

Inner Hatch

Actuator Handle – LATCHED

Lock Lever – LOCKED

Equalization vlv (two) – NORM, capped

This Page Intentionally Blank

OV103

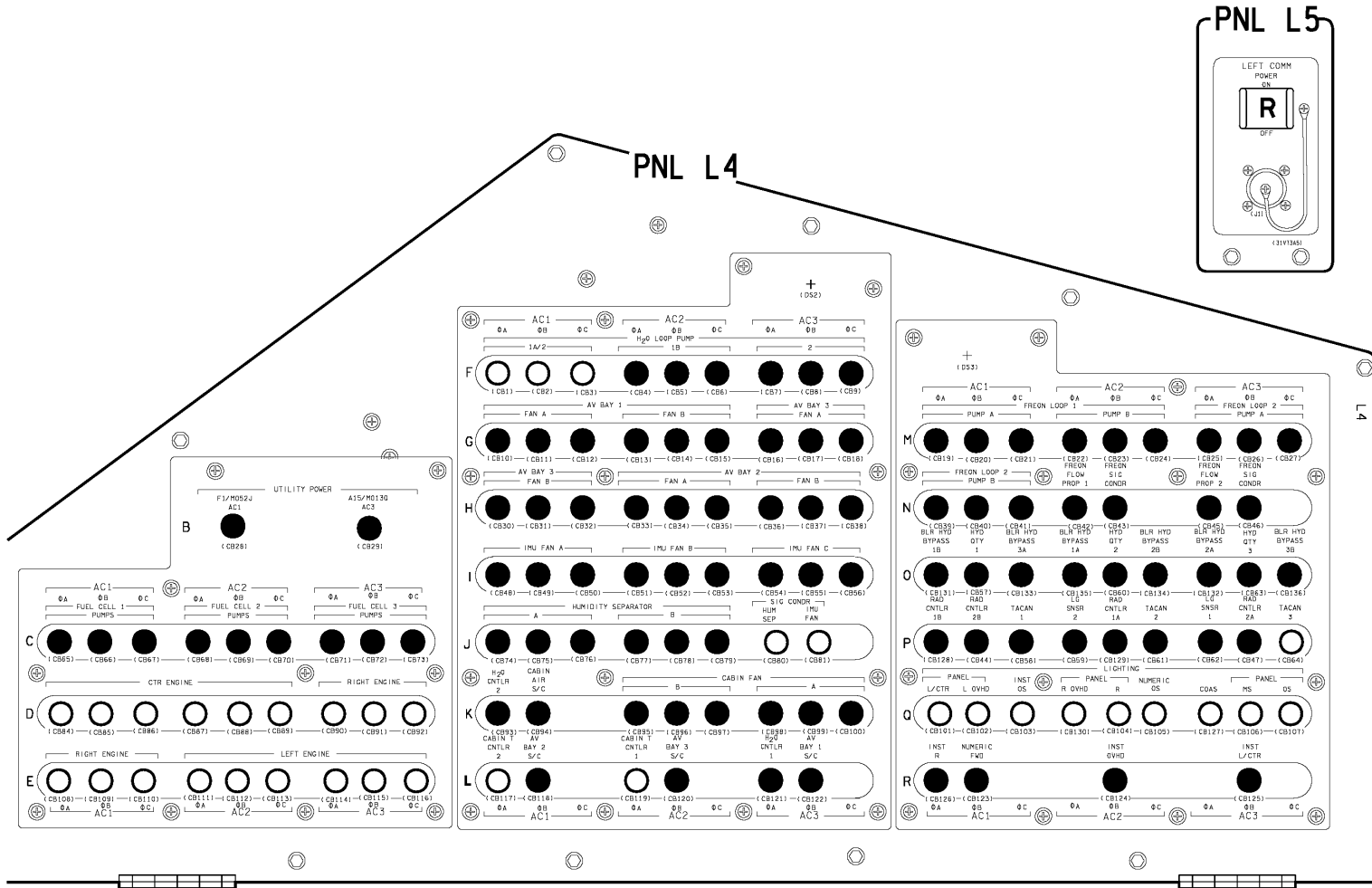

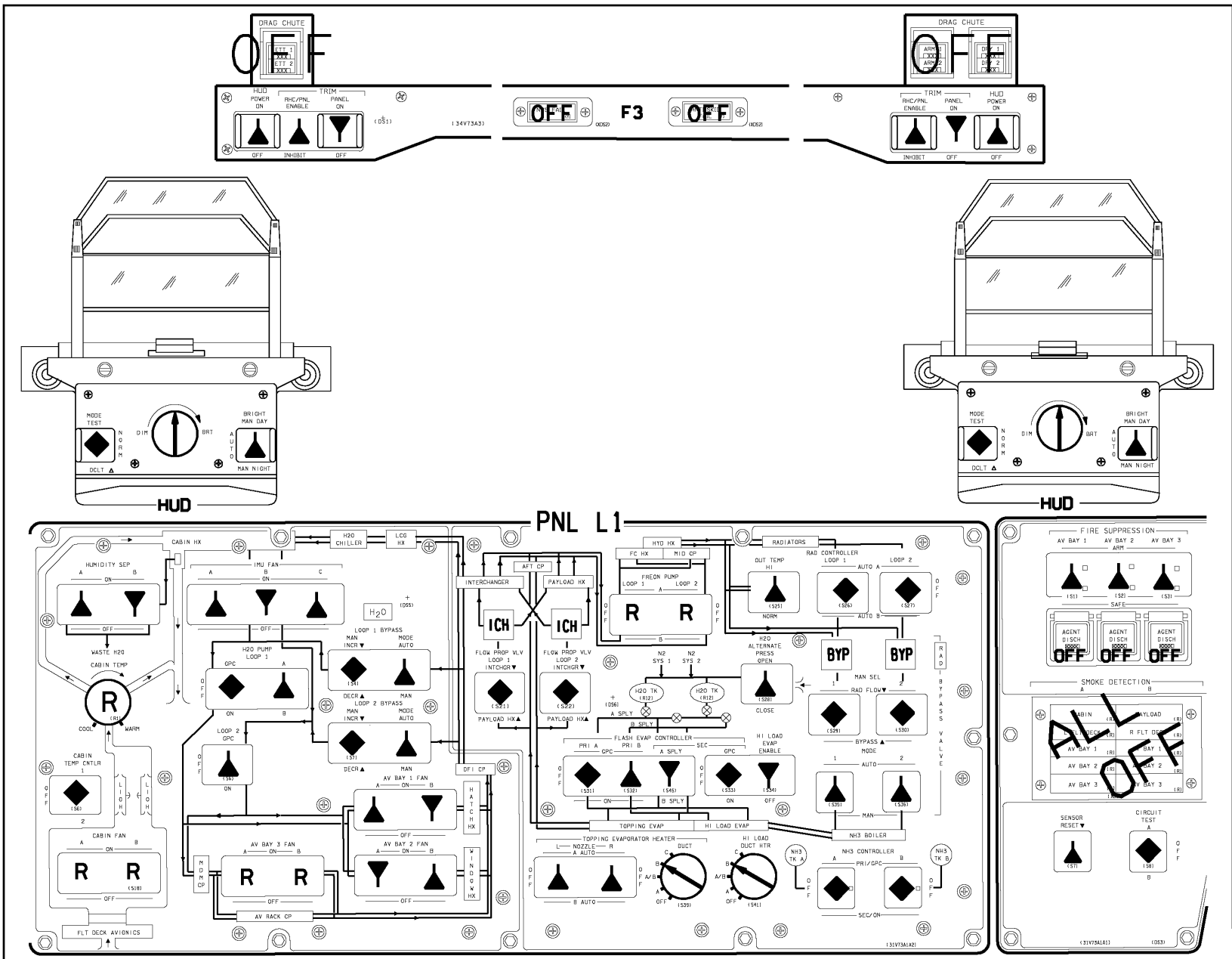

48007B604_101. PNL 1

ALL VEH/DATE 02/22/00

(OV103) B6-4

C D/O/ALL/GEN H

OV103

OV103

PNL L2

PNL F1

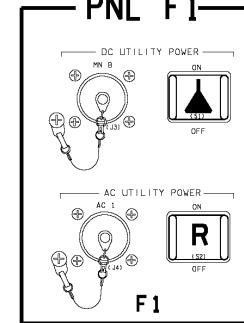
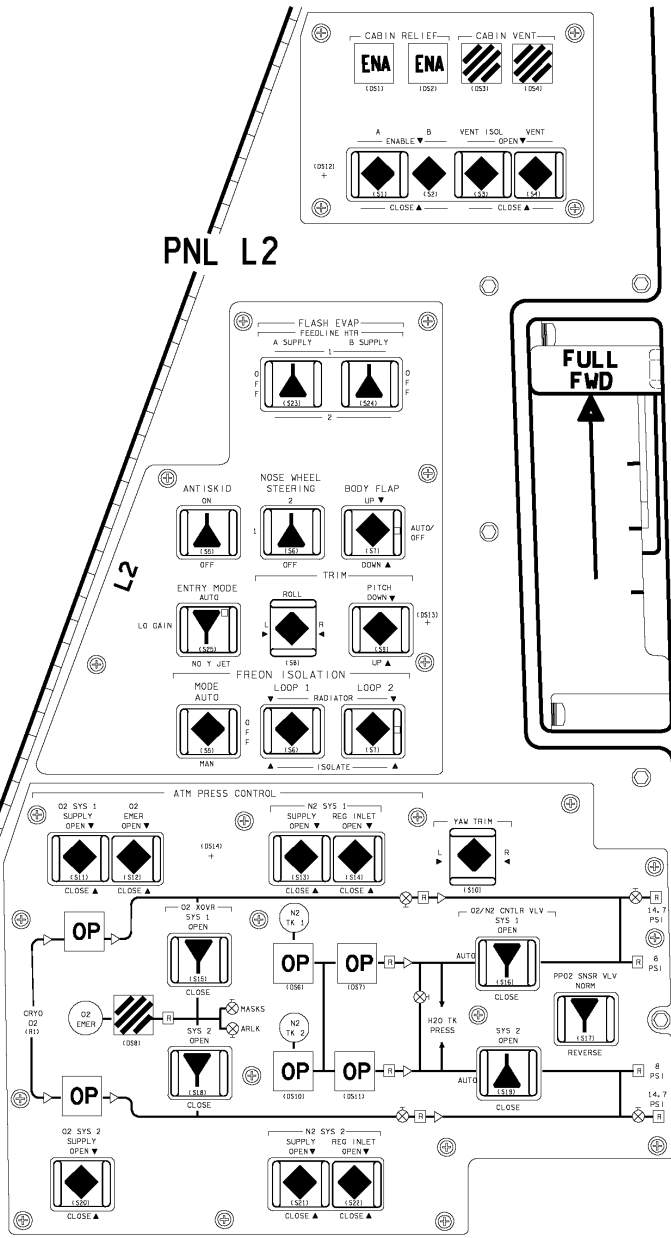

FULL FWD

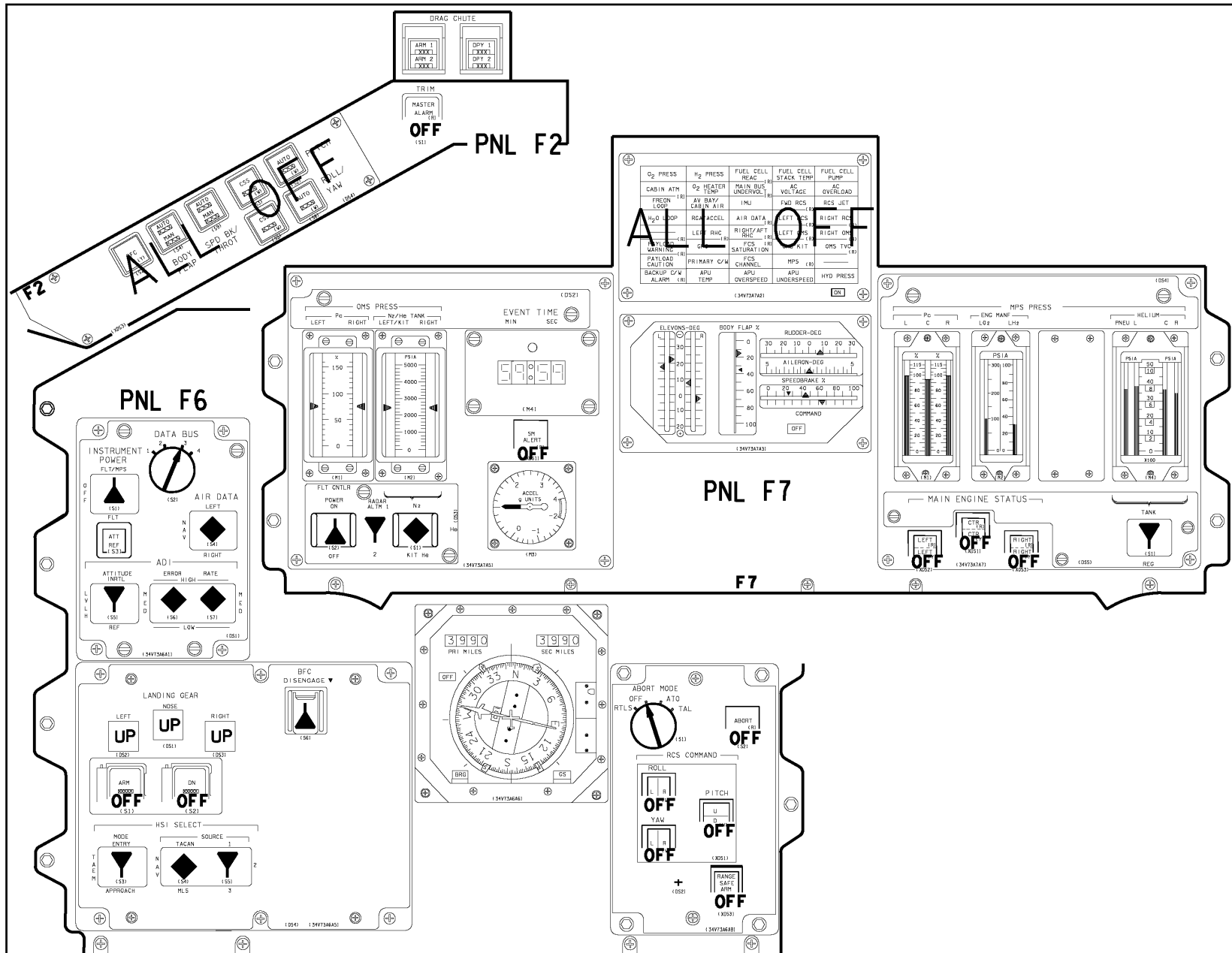

48007B606_101, PNL, 1

(OV103) B6-6

ALL VEH/DATE 02/22/00

C D/O/ALL/GEN H

OV103

PNL C2/C3

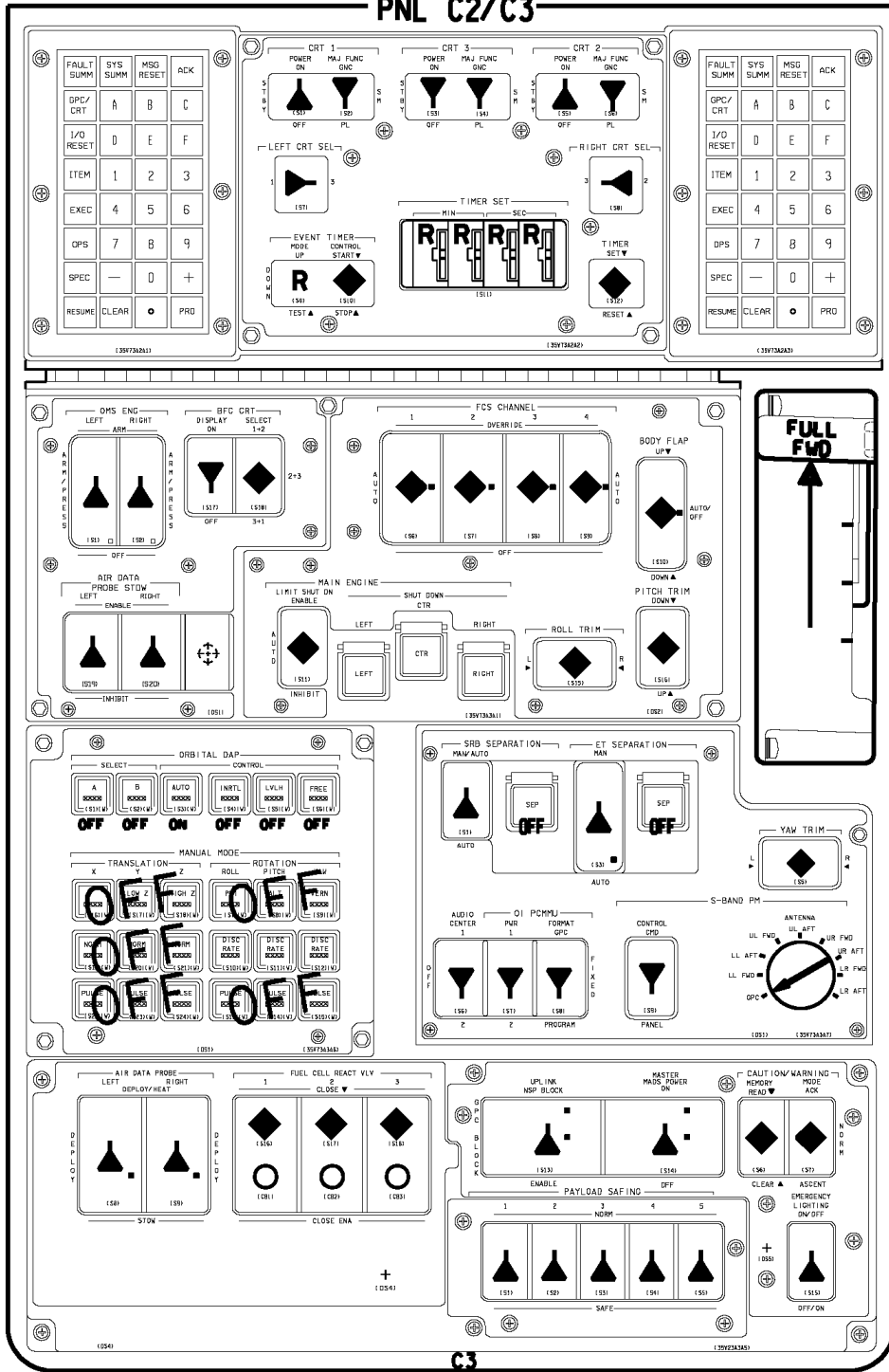

C3

OV103

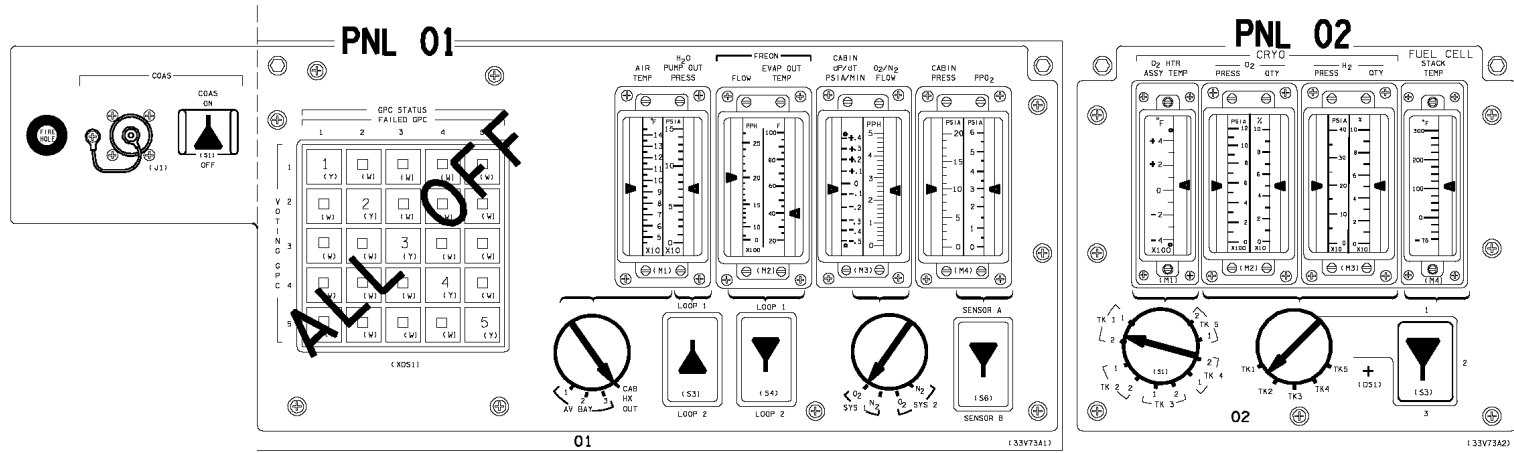

L side OVHD flood - R (MID)

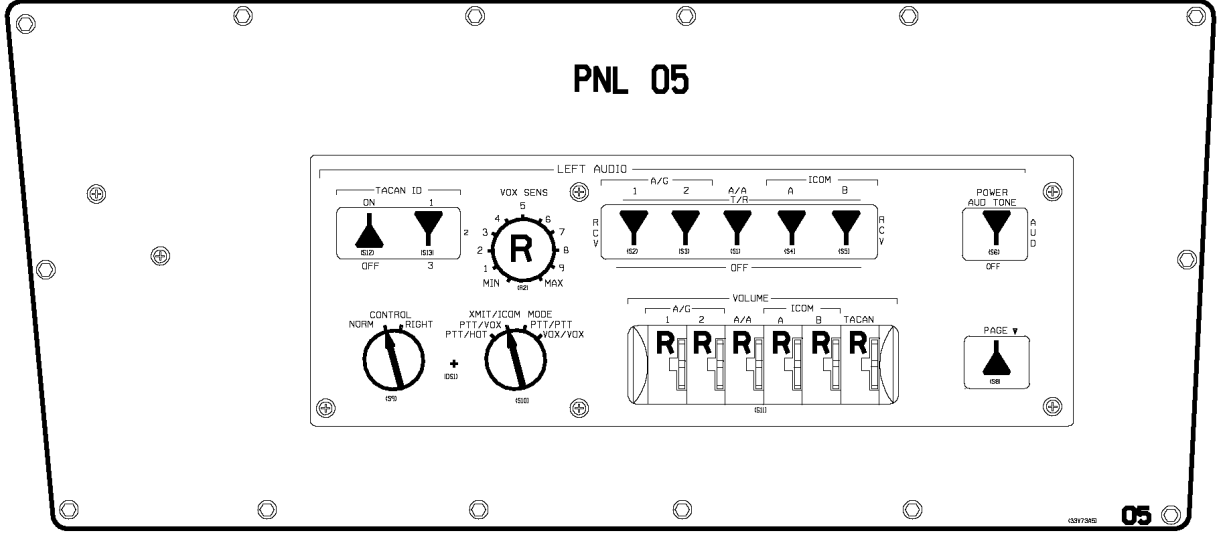

OV103

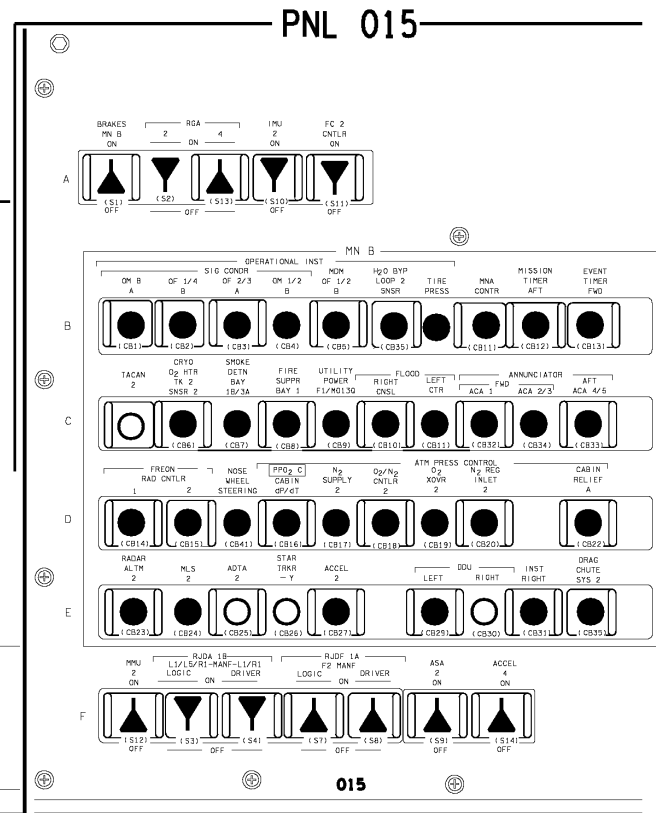
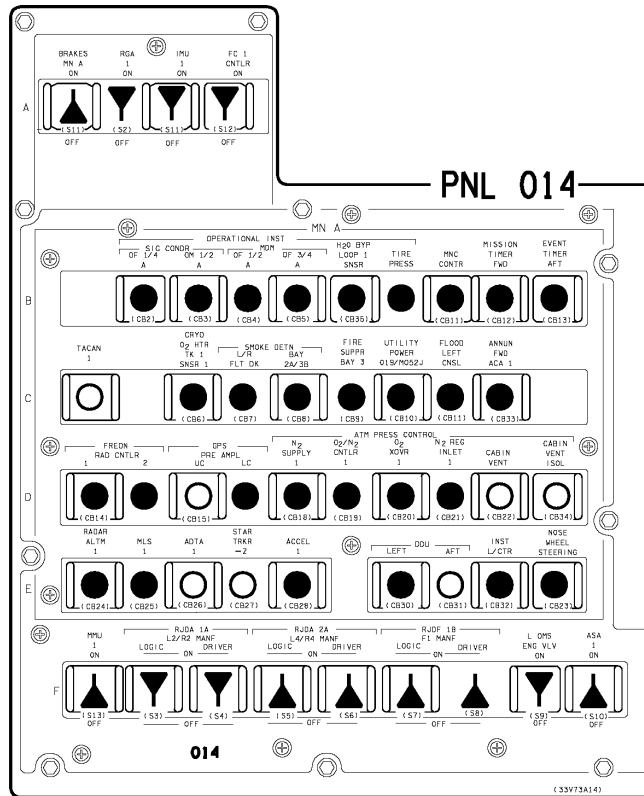
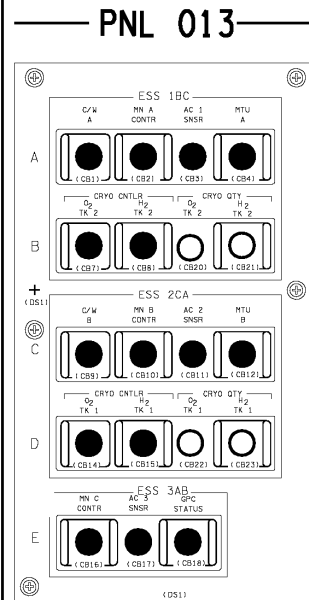

OV103

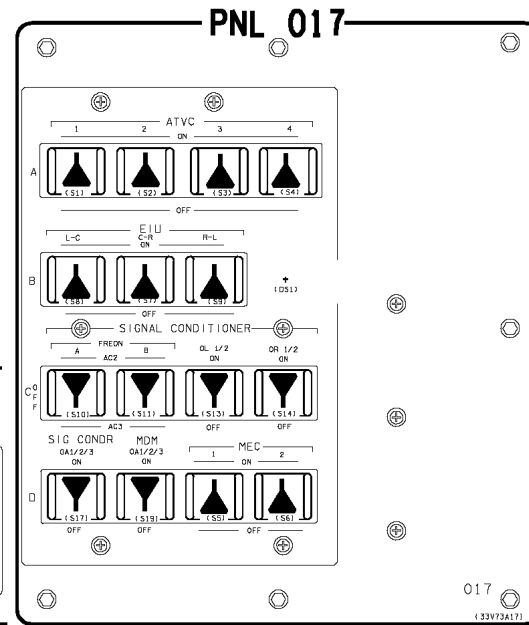
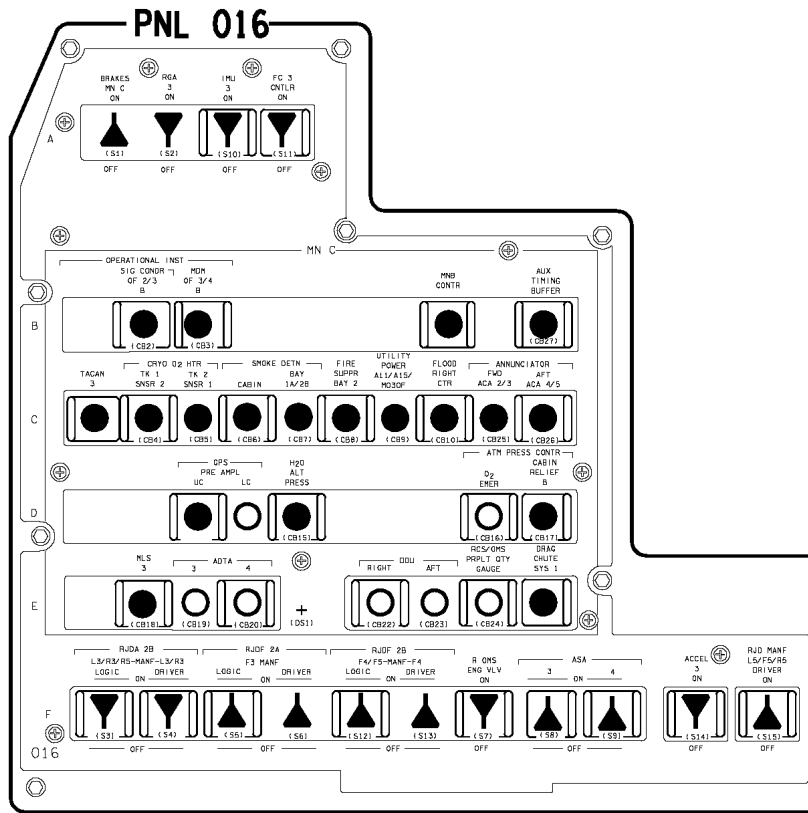

PNL 08

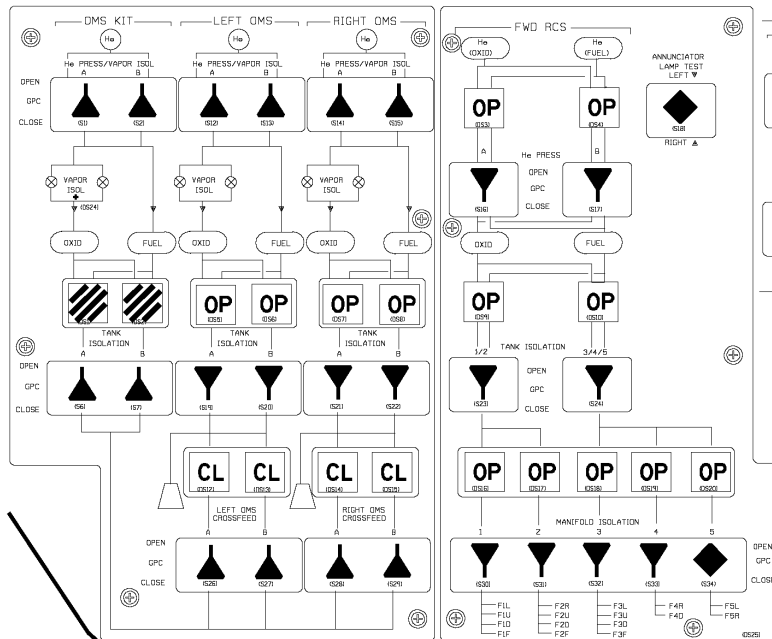
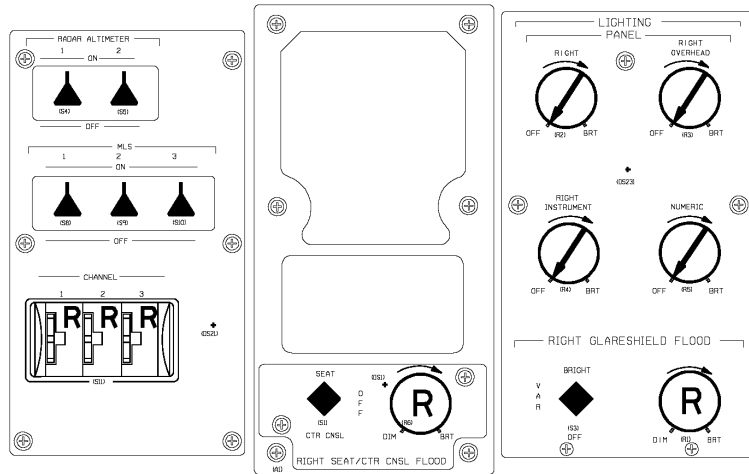

PNL 09

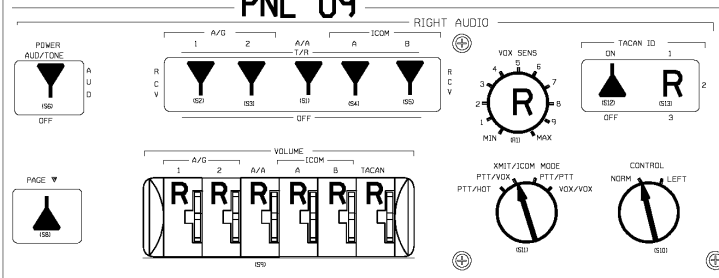

R side OVHD flood - R (MID)

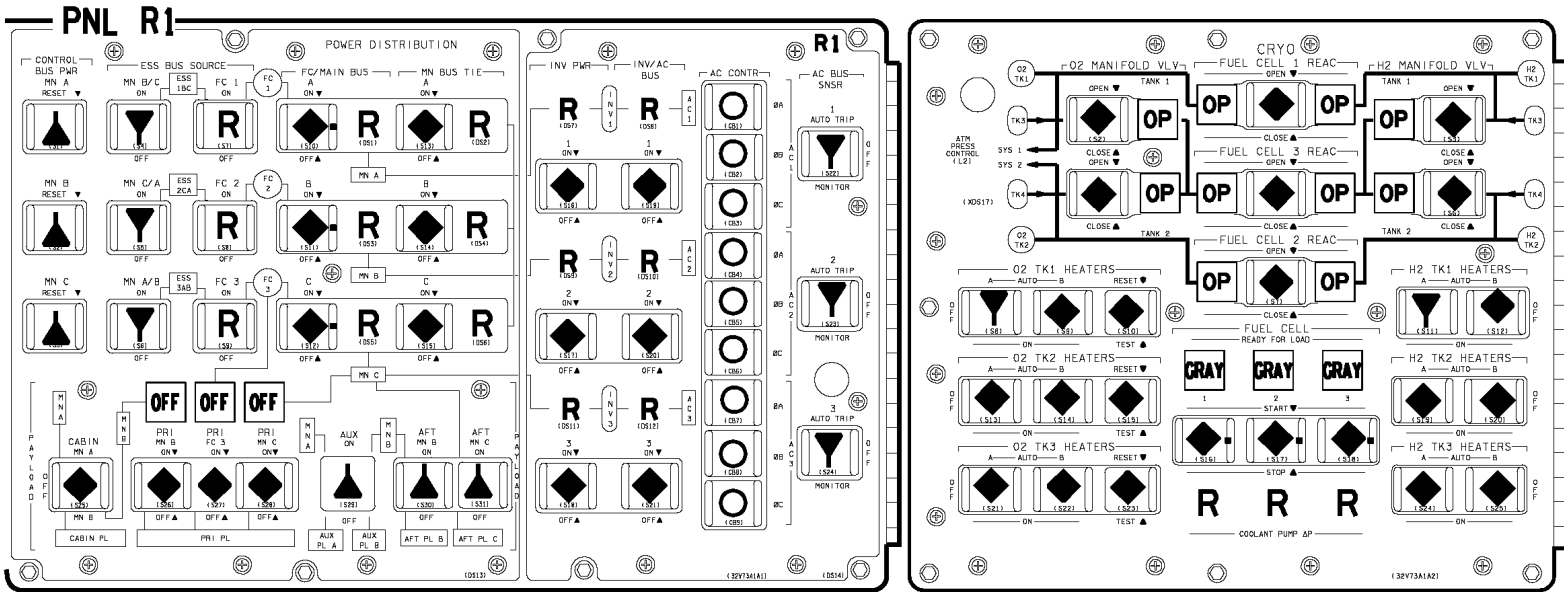

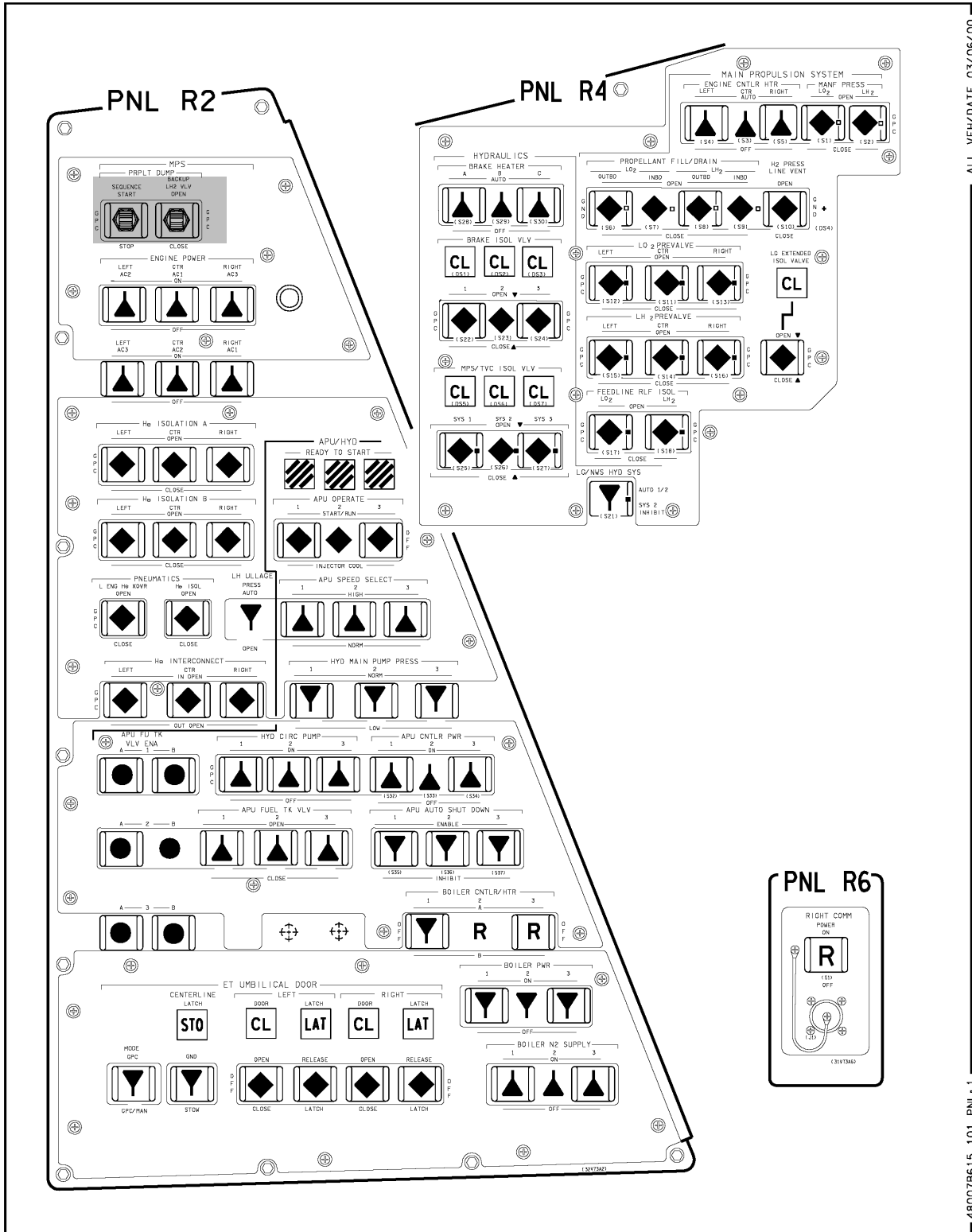

ALL VEH/DATE 03/06/00

480078615_101_PNL R 1

OV103

(OV103) B6-15

C D/O/ALL/GEN H

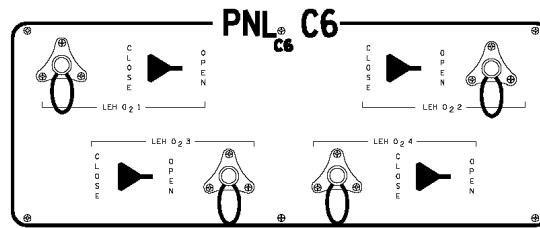
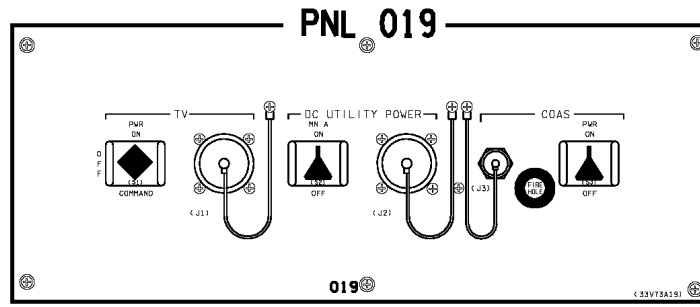

PNL C5



PNL C7

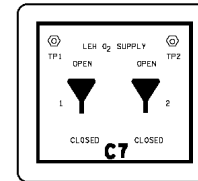

OV103

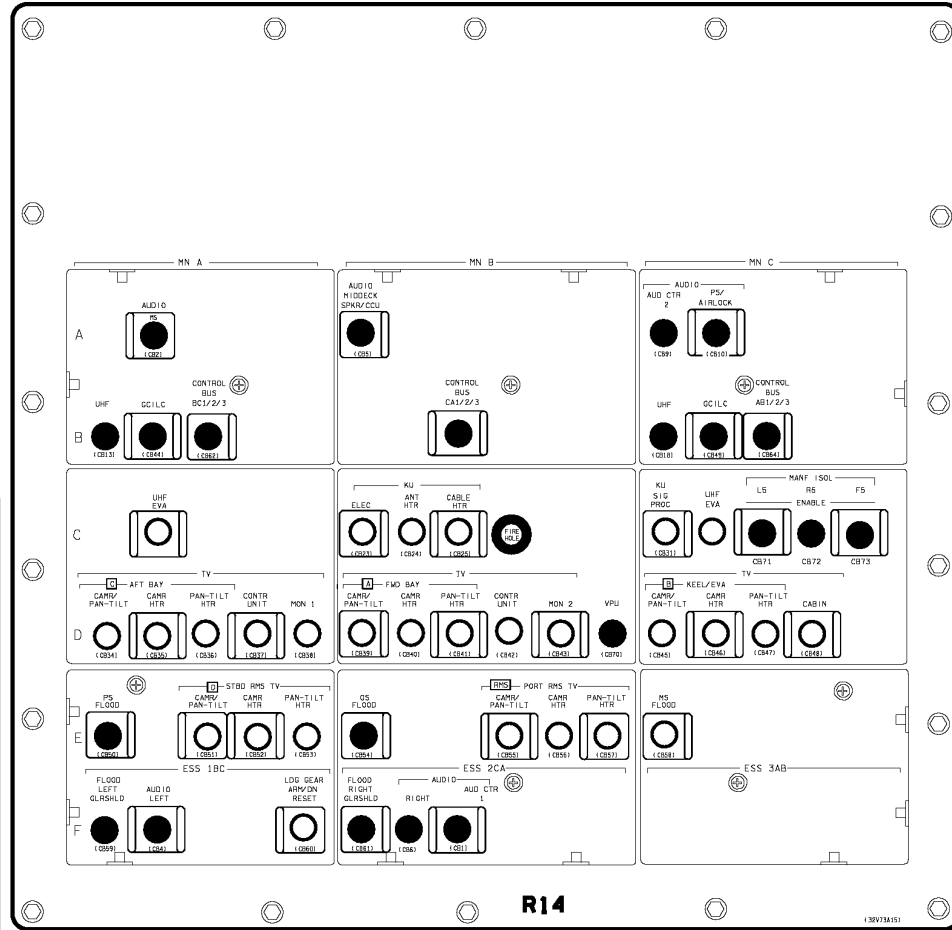
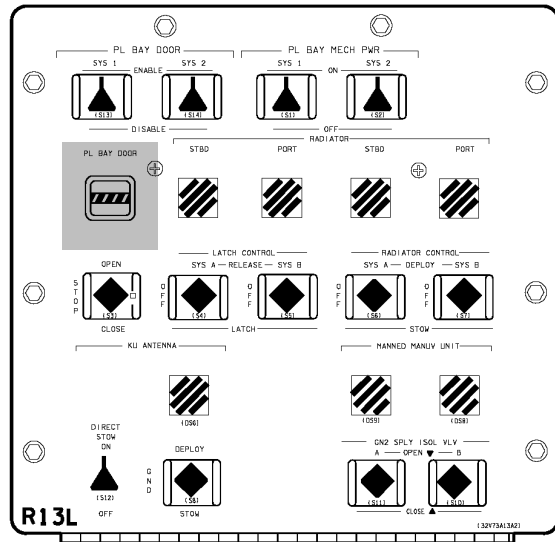
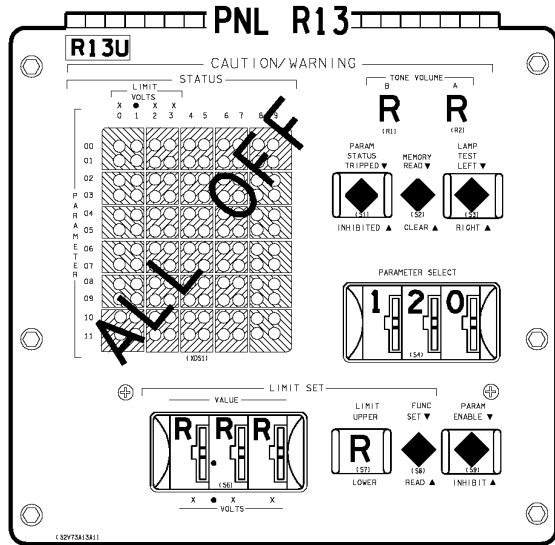

OV103

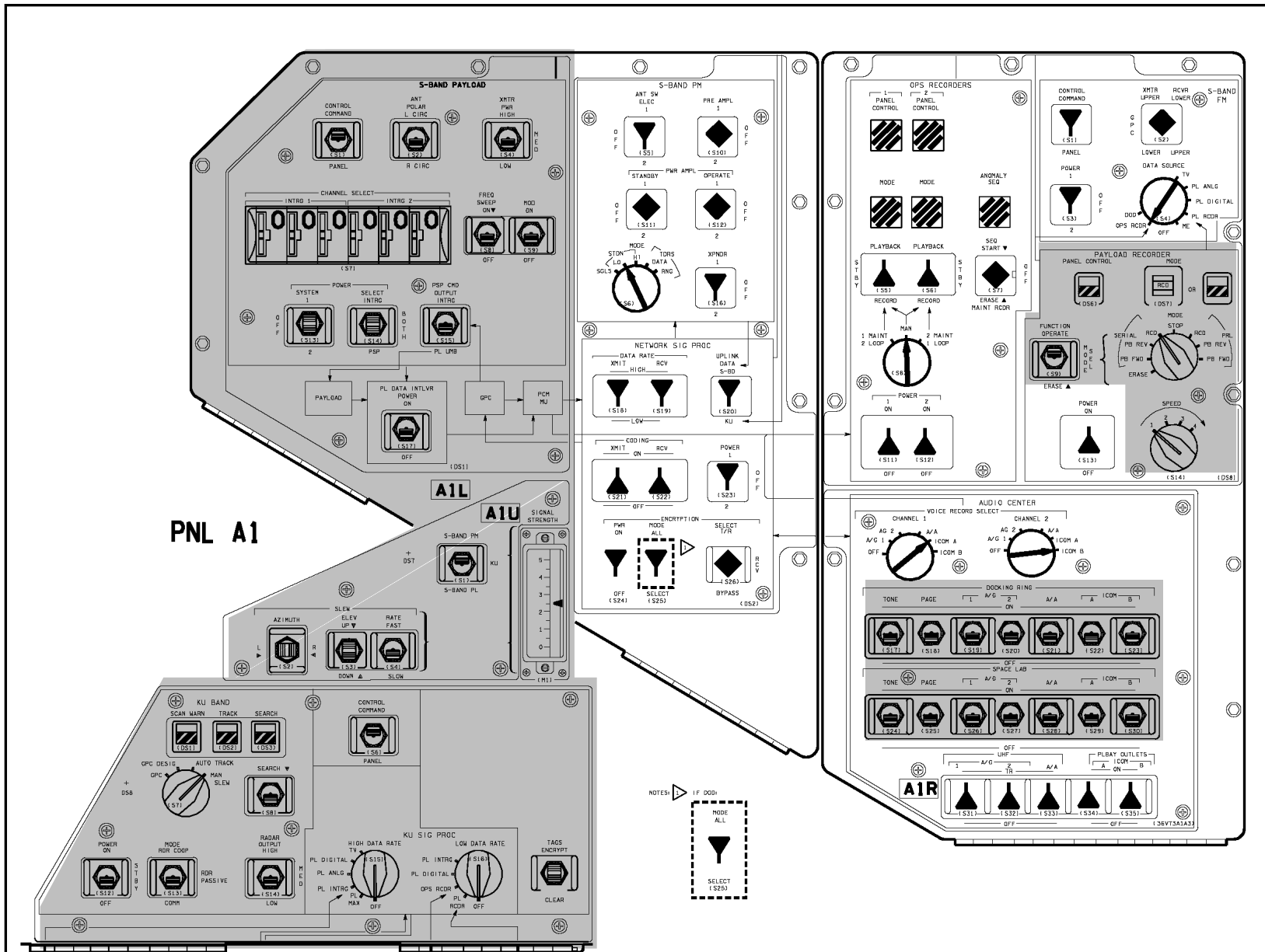

PNL A1

OV103

OV103

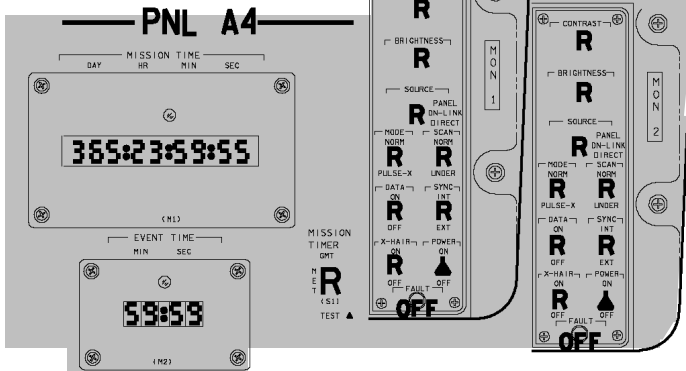

PNL A6U

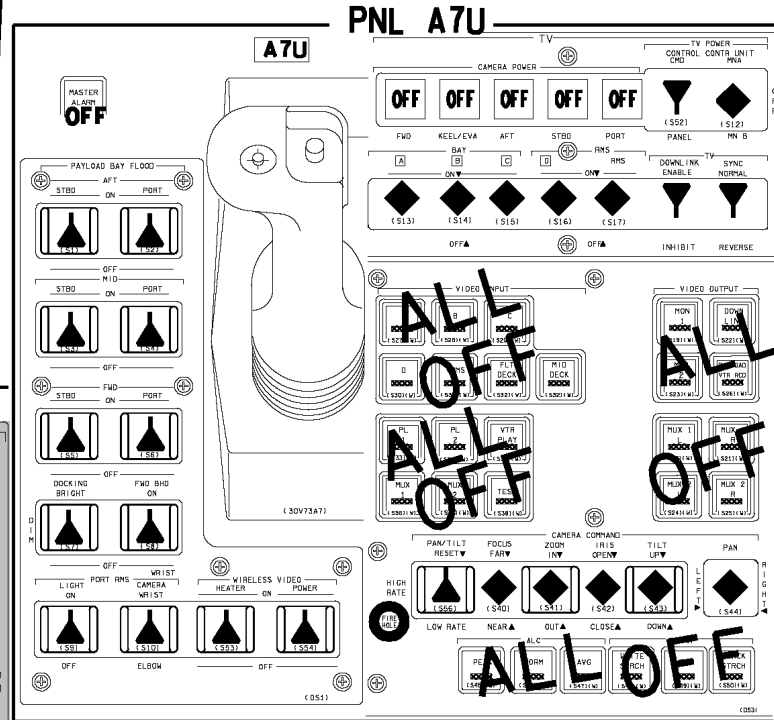
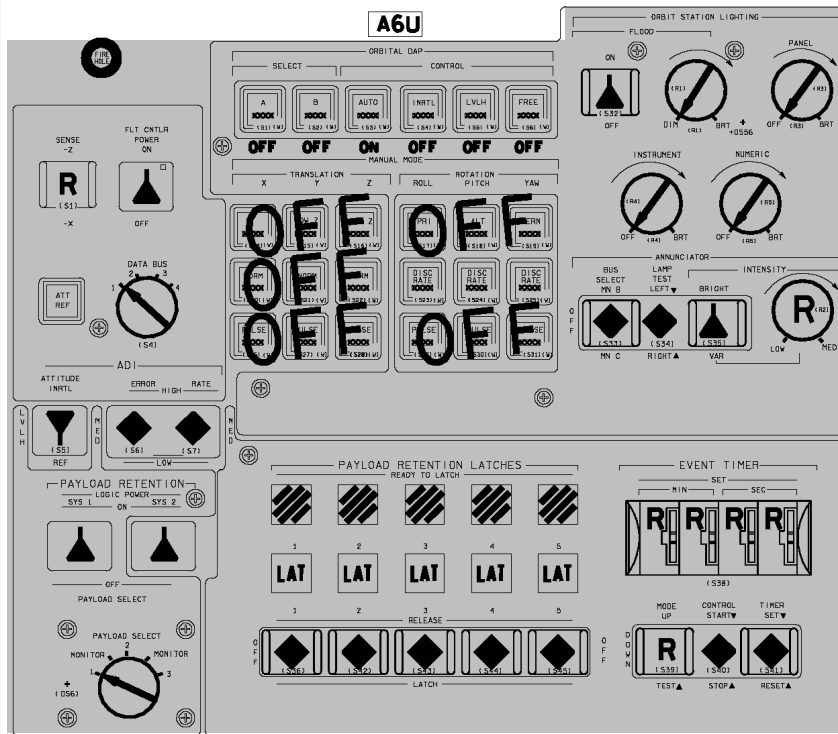

136V7346A1

48007B620_108. PNL 1

OV103

(OV103) B6-20

OV103/DATE 09/19/01

C D/O/3/GEN H,4

A6L

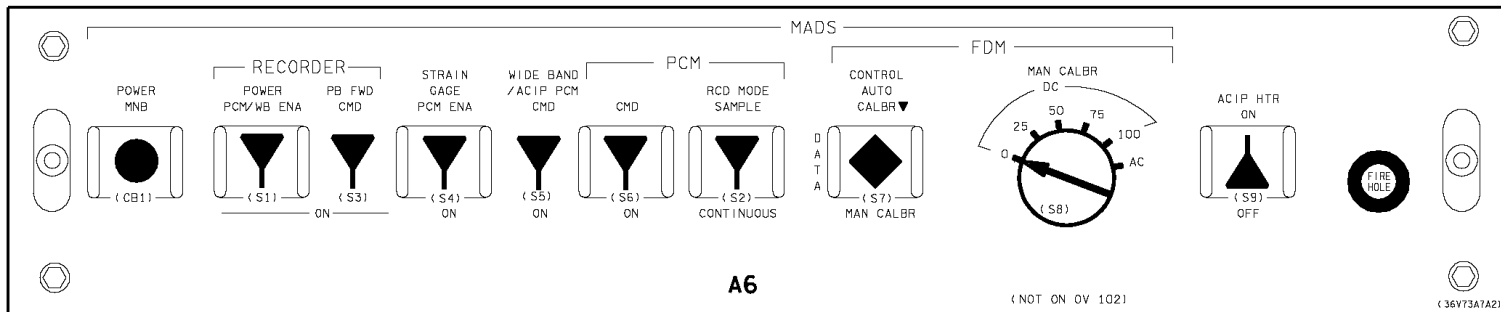
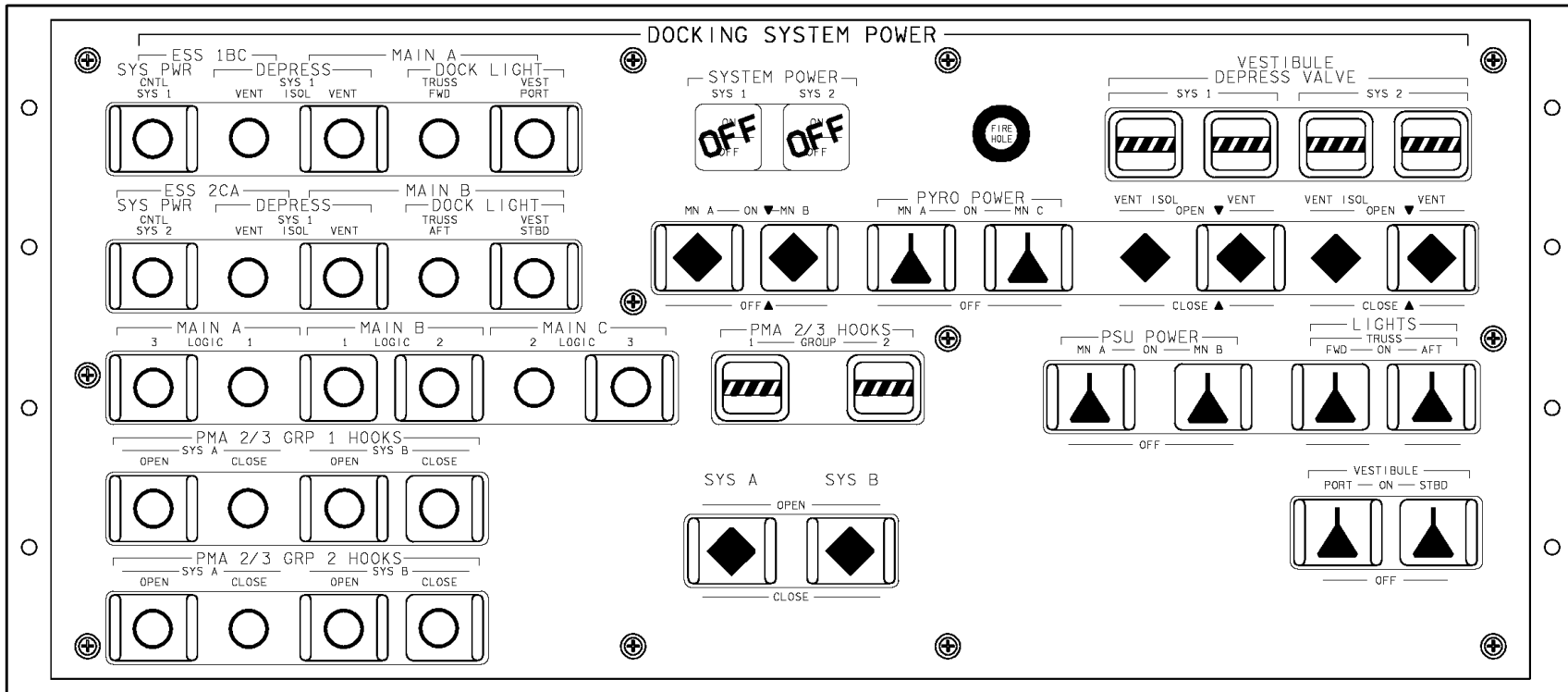

OV103

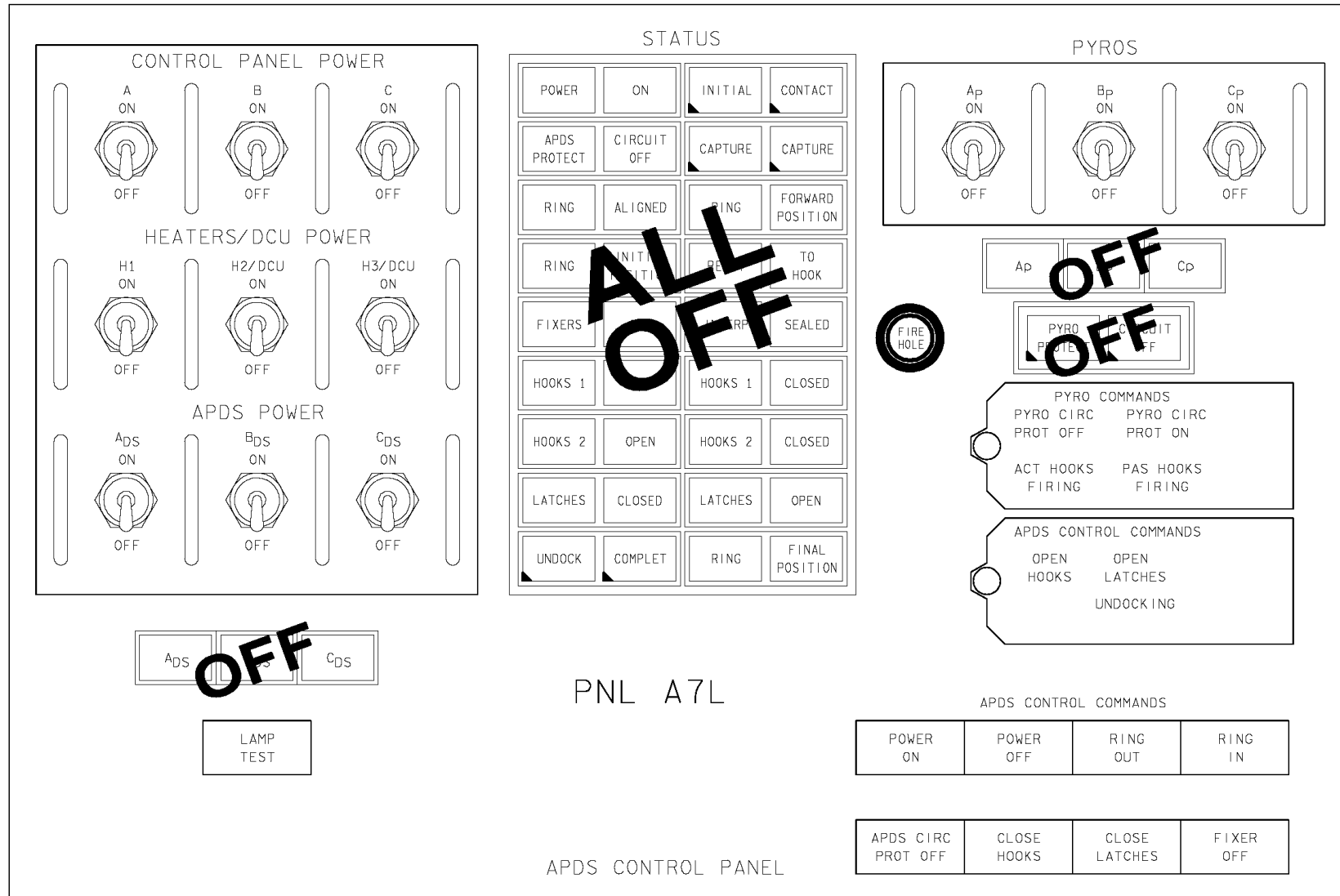

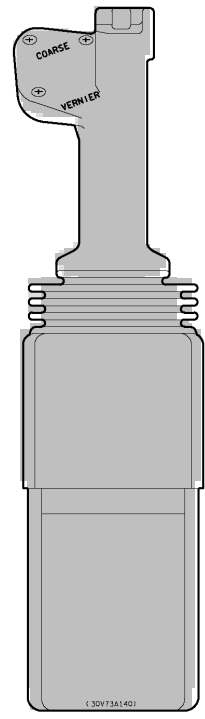
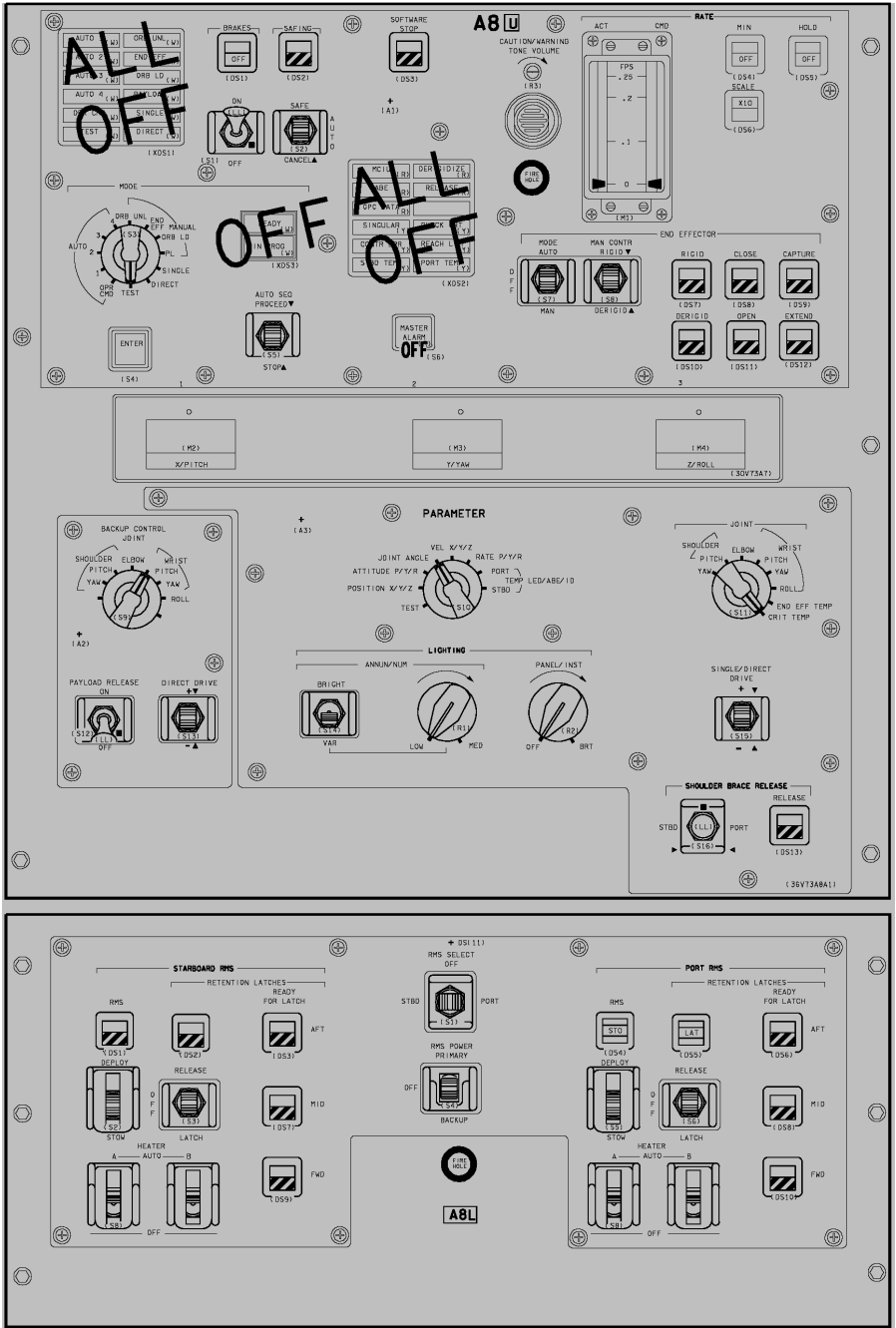

48007B623_101_PNL_1 1 ALL VEH/DATE 03/06/00

OV103

(OV103) B6-23

C D/O/ALL/GEN H,1

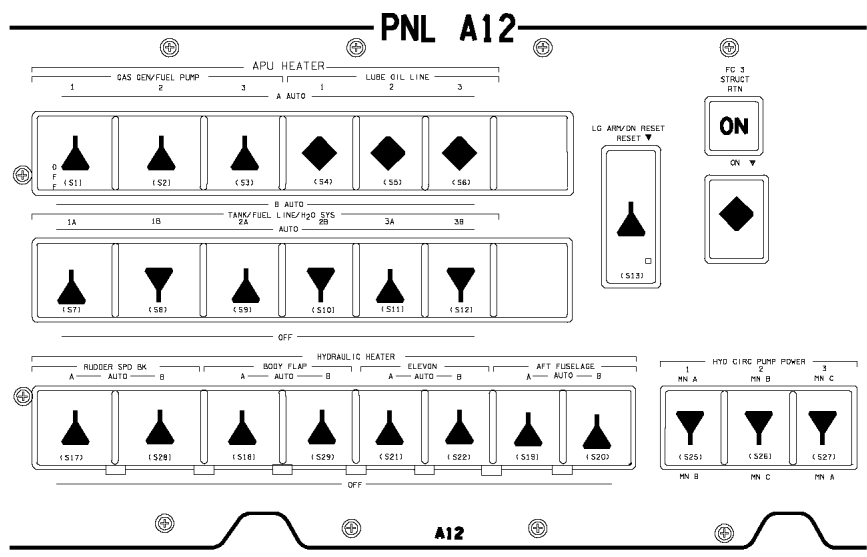
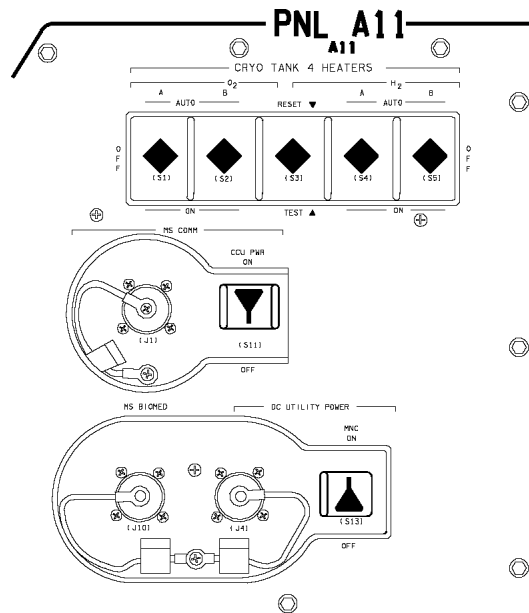

OV103

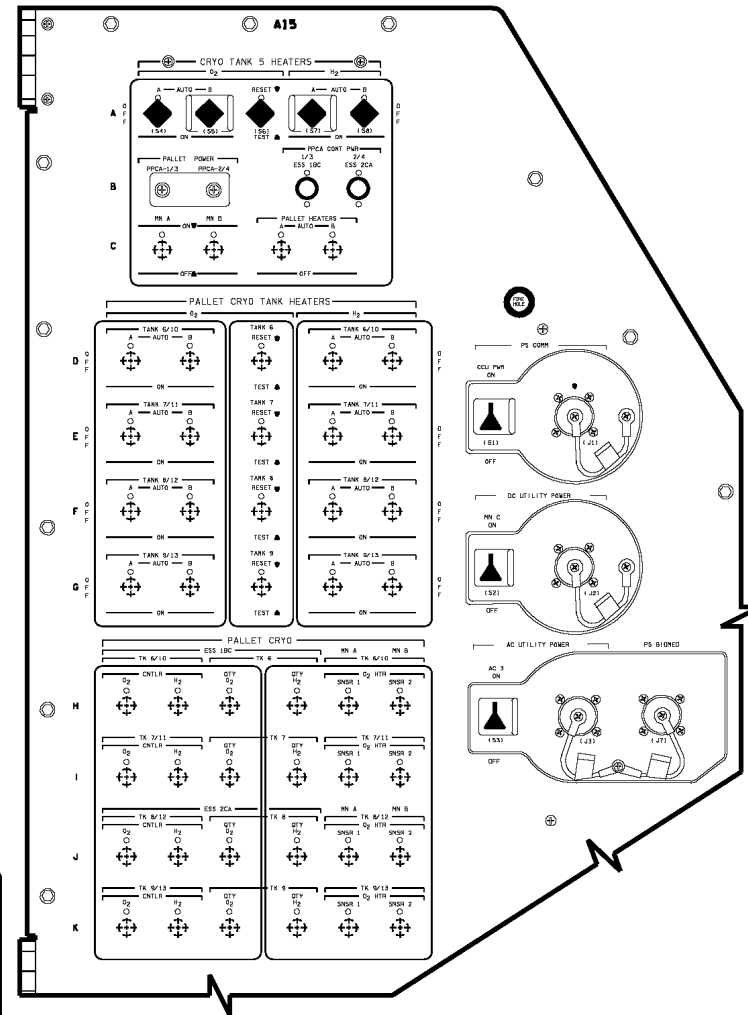
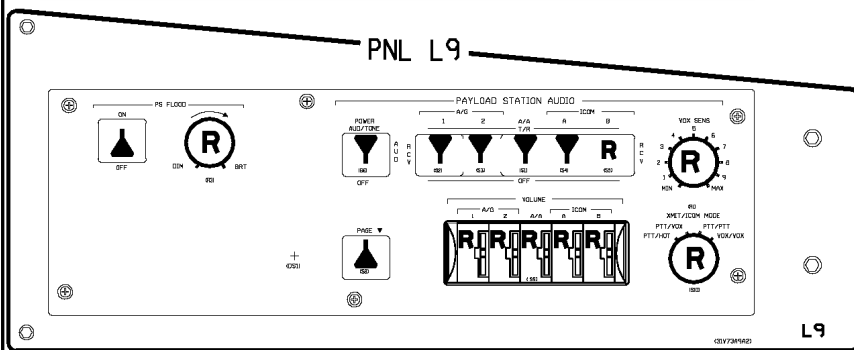
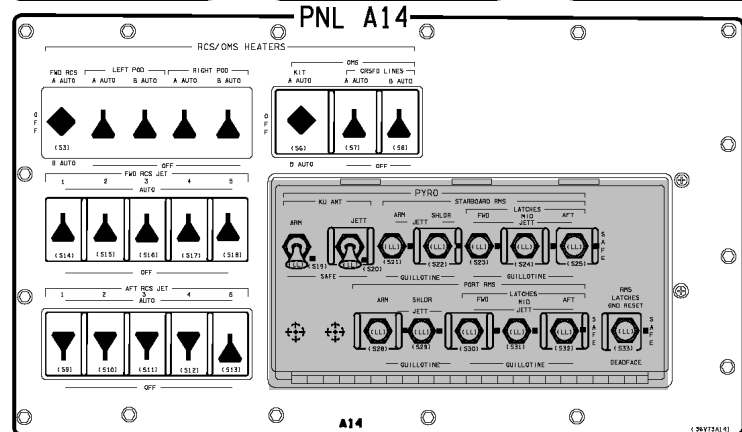
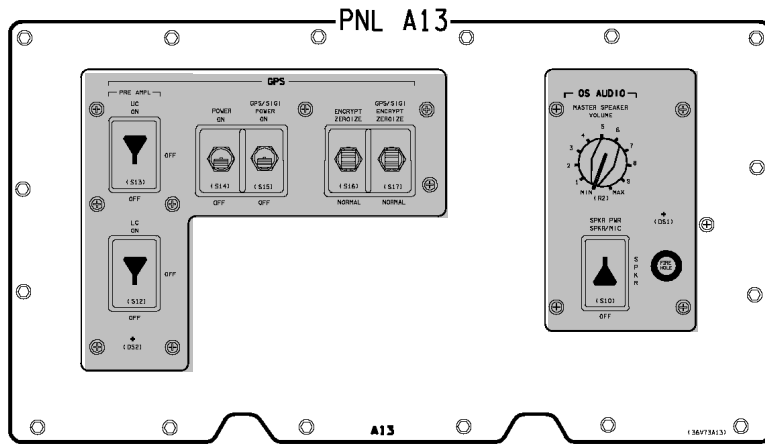

OV103

48007B629_100, PNL 1, 1

(OV103) B6-25

OV103/DATE 02/09/01

C D/O/3/GEN H,1

OV103

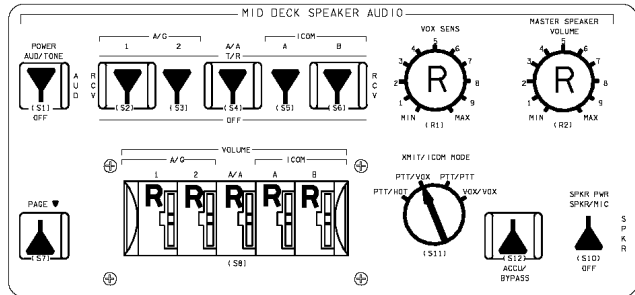

PNL M042F

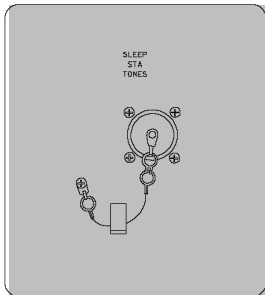
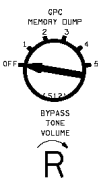

PNL M058F

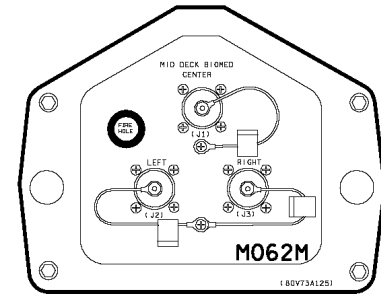
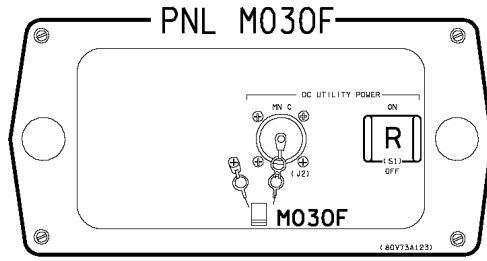
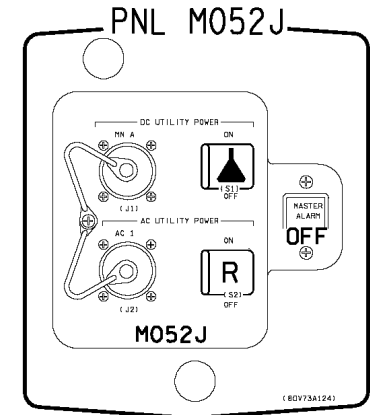
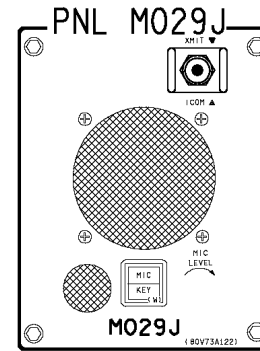
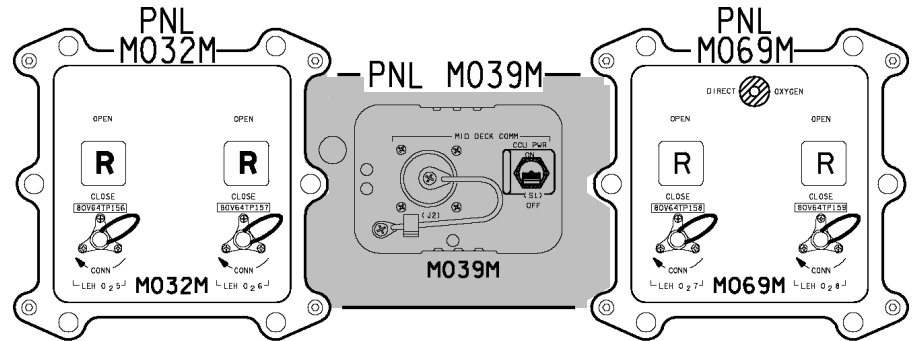

PNL MA73C

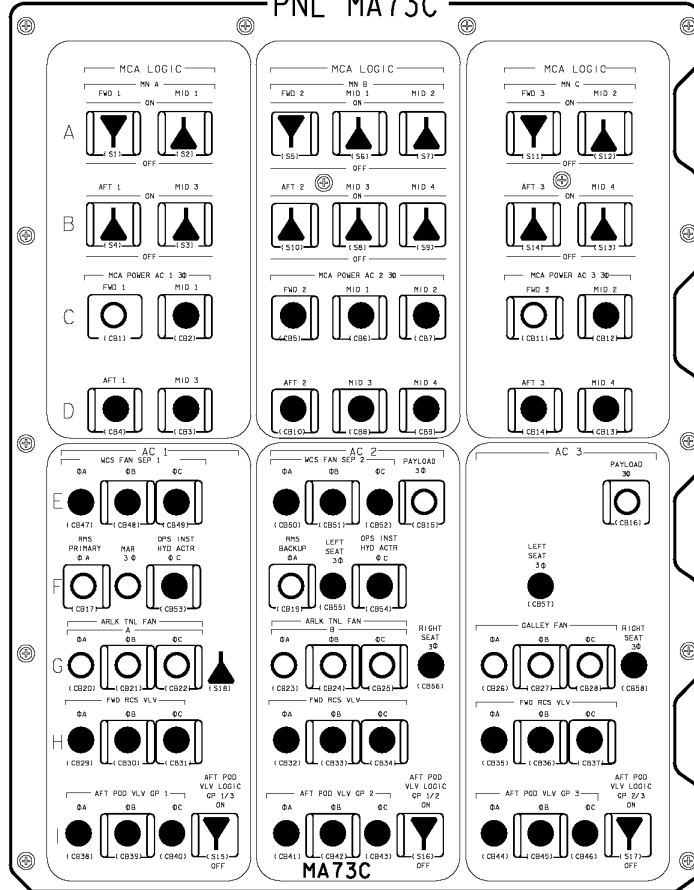

PNL ML86B

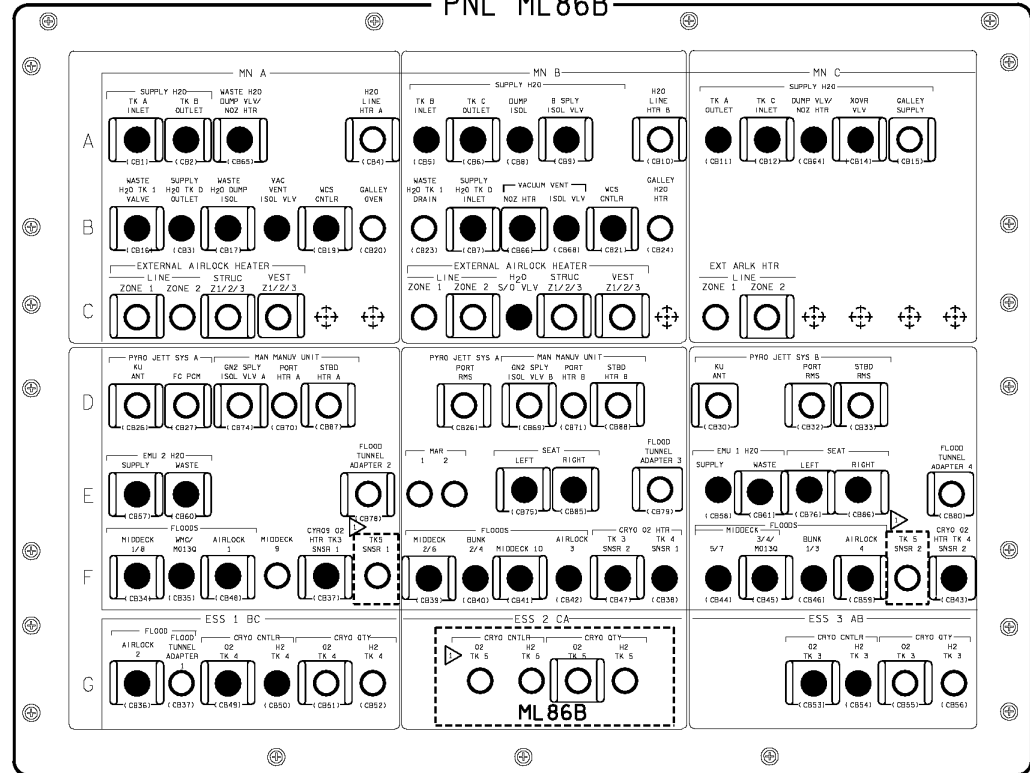

NOTES ▶ CLOSED IF TK5 FLOWN

OV103

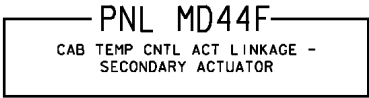
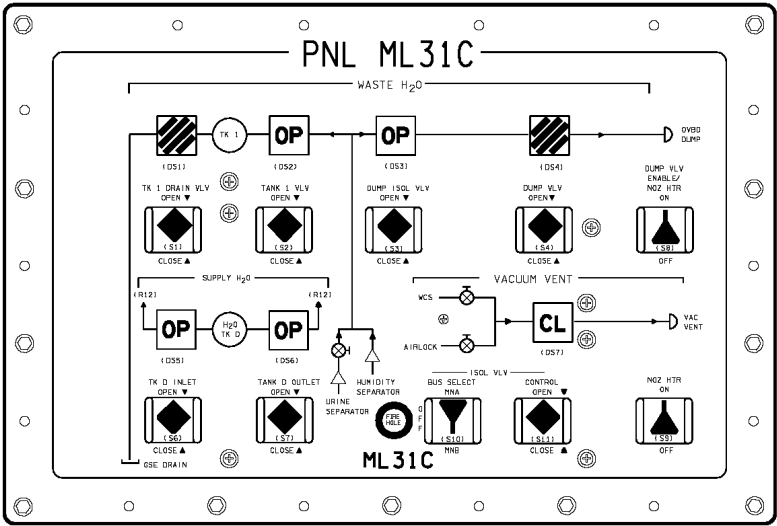
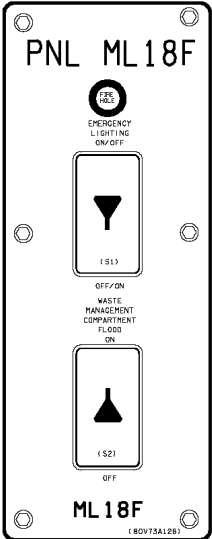
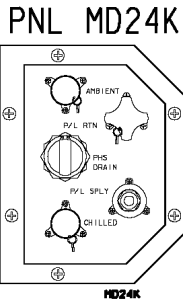
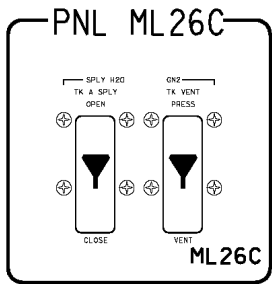
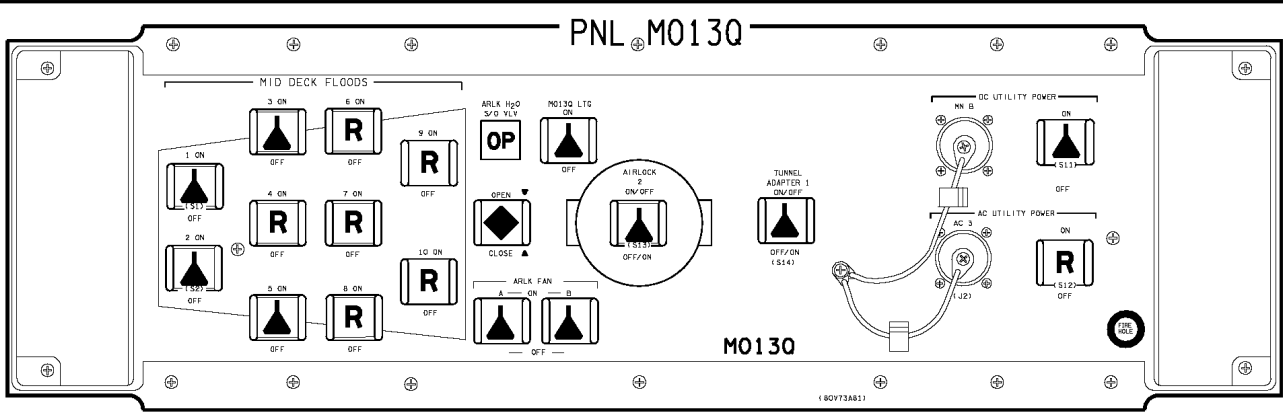

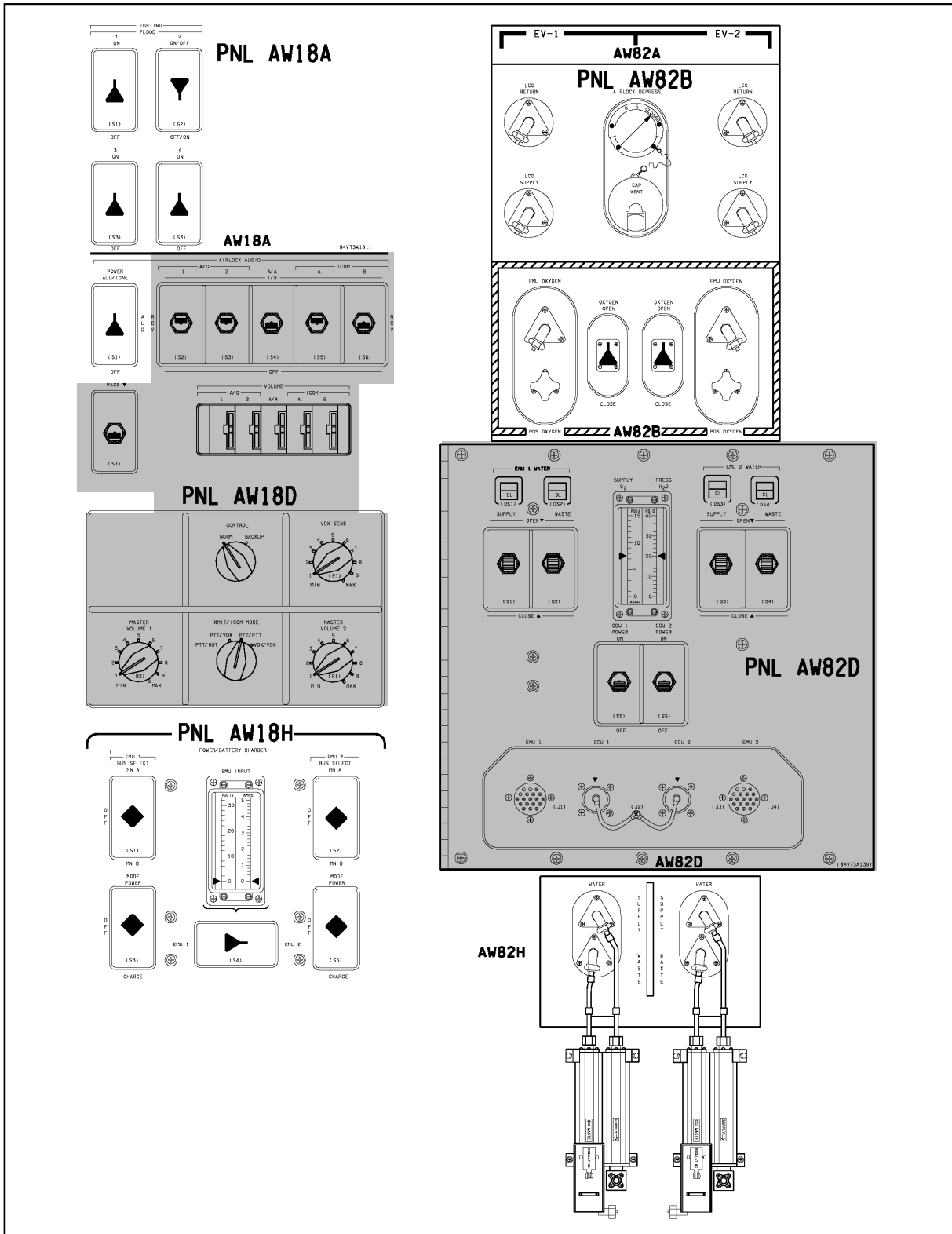

ALL VEH/DATE 03/06/00
4800/B630L101, PNL1 1

OV103

(OV103) B6-30

C D/O/ALL/GEN H,1

Inner Hatch

Actuator Handle – LATCHED

Lock Lever – LOCKED

Equalization vlv (two) – NORM, capped

This Page Intentionally Blank

(OV103) B6-32

OV103
C D/O/ALL/GEN H,1

OV104

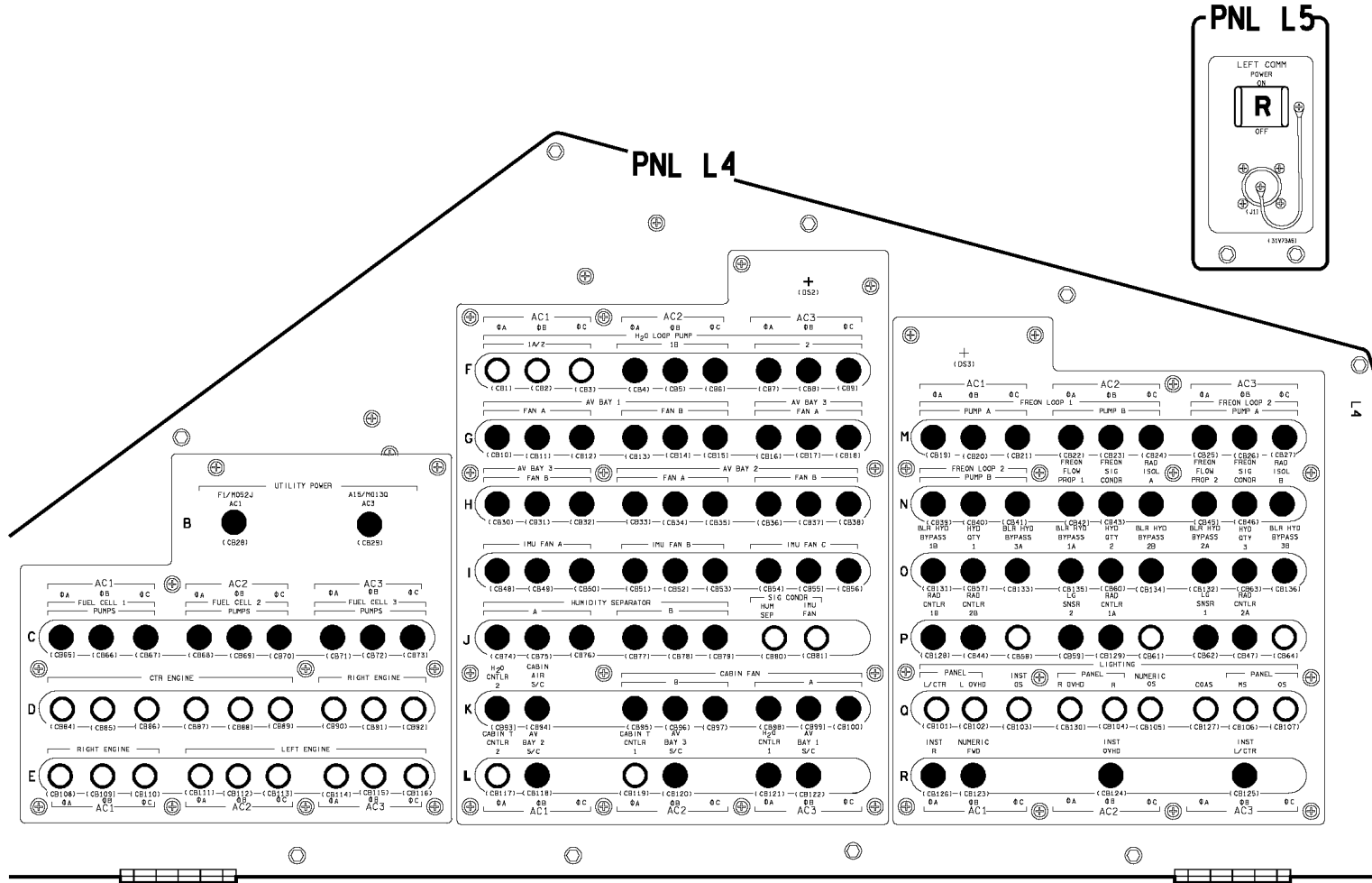

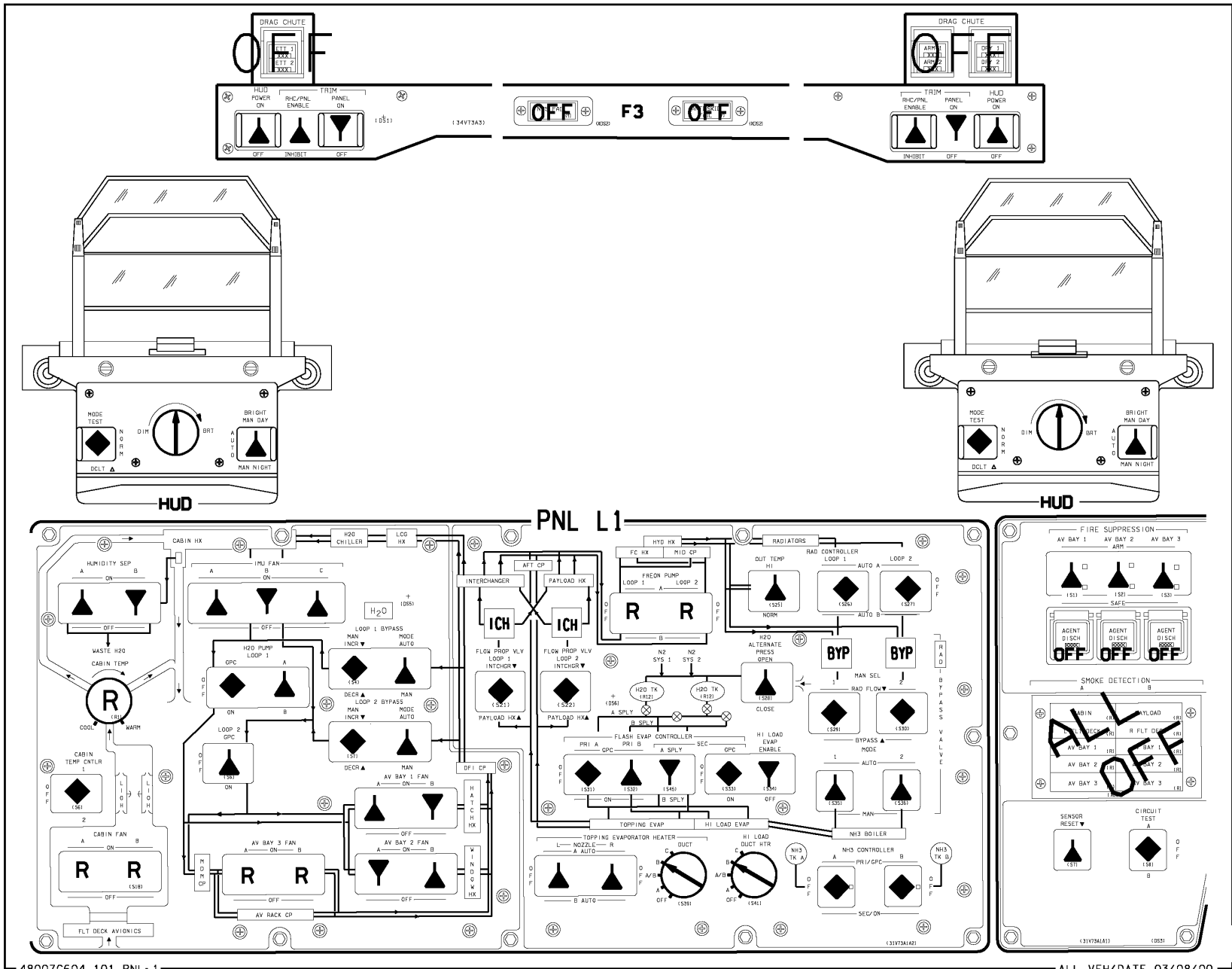

48007C604_101. PNL 1

(OV104) C6-4

ALL VEH/DATE 03/08/00

C D/O/ALL/GEN H

OV104

OV104

PNL L2

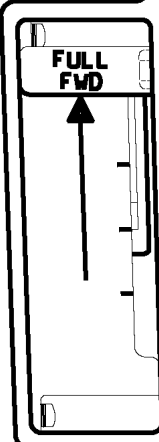
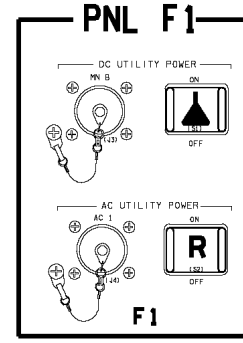
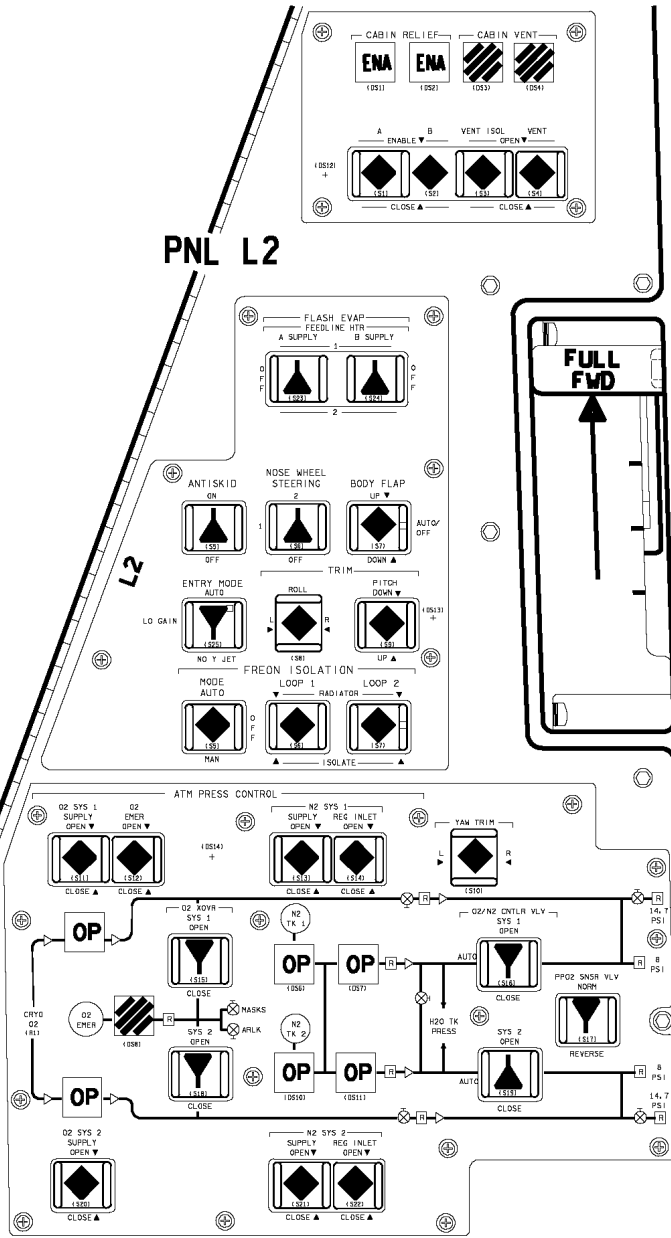

PNL C2/C3

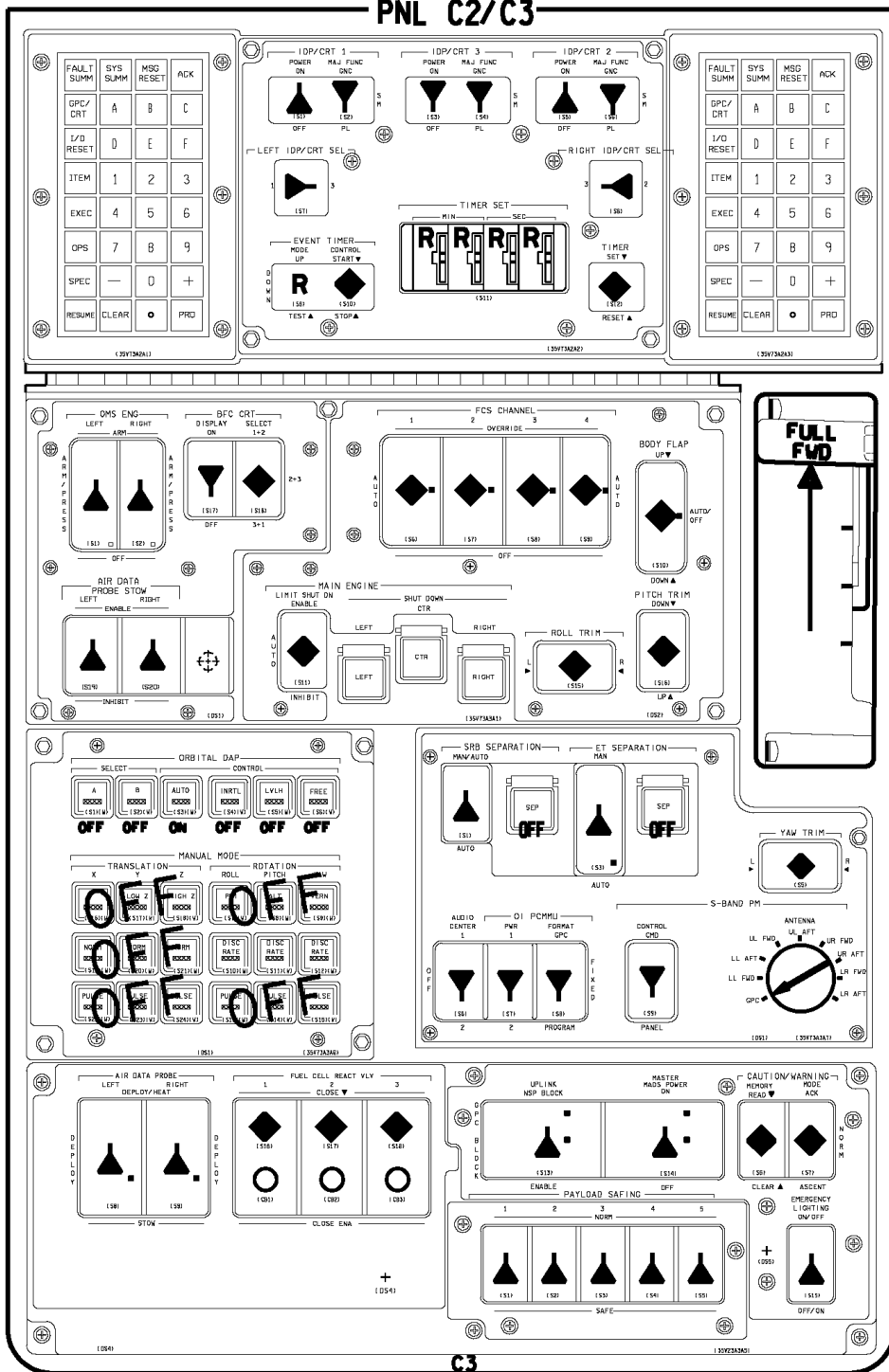

C3

OV104

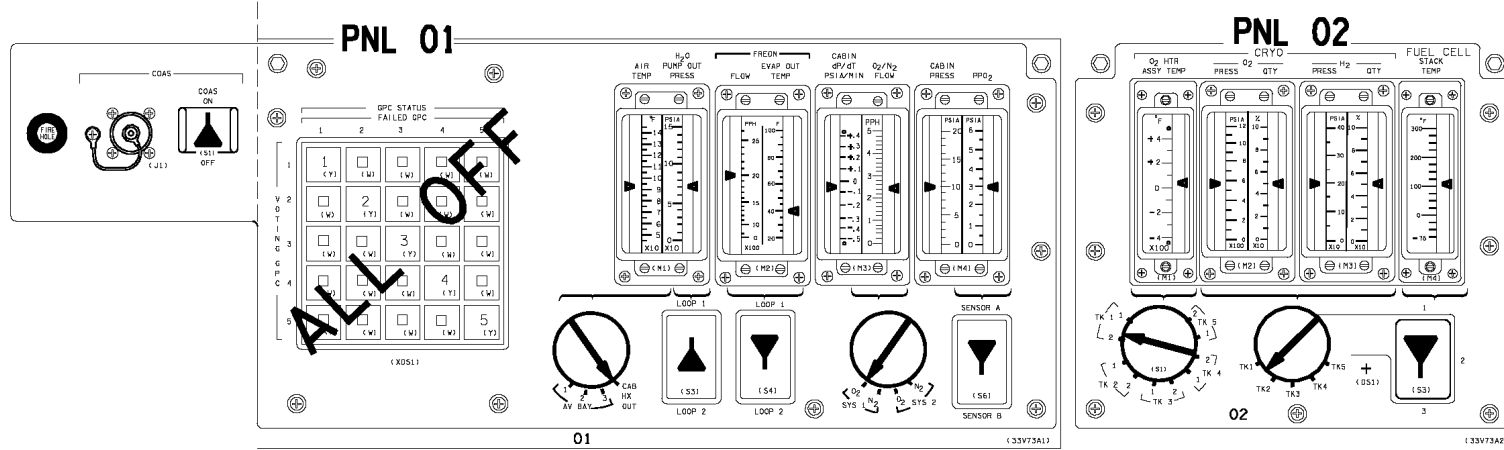

L side OVHD flood - R (MID)

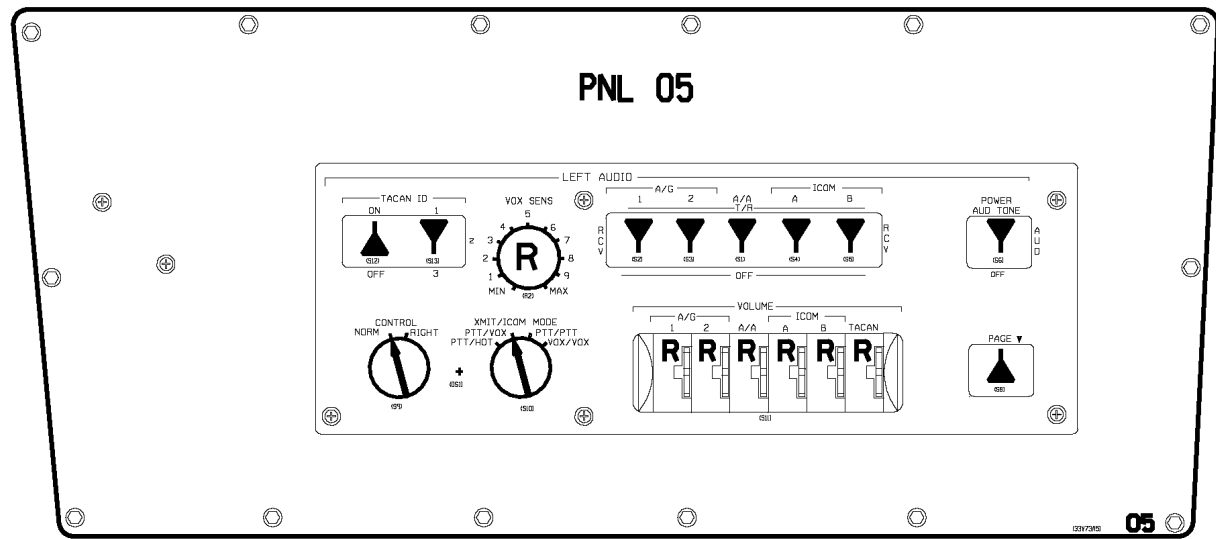

OV104

PNL 06

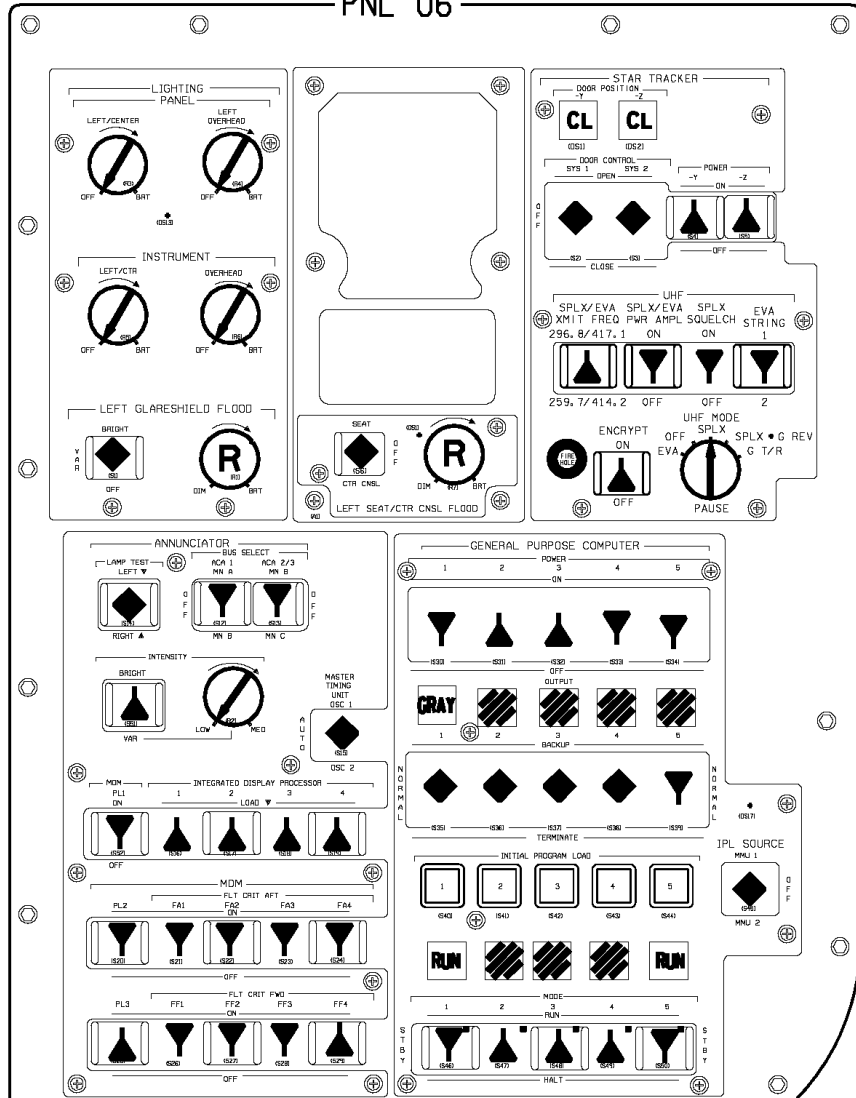

PNL 07

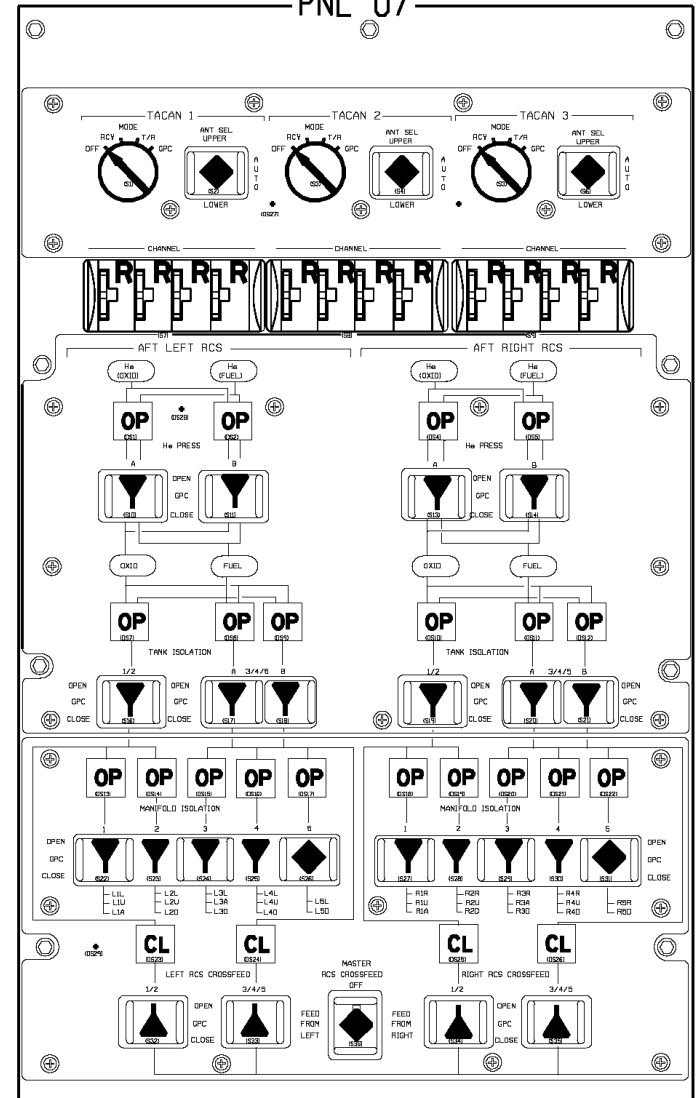

OV104

PNL 013

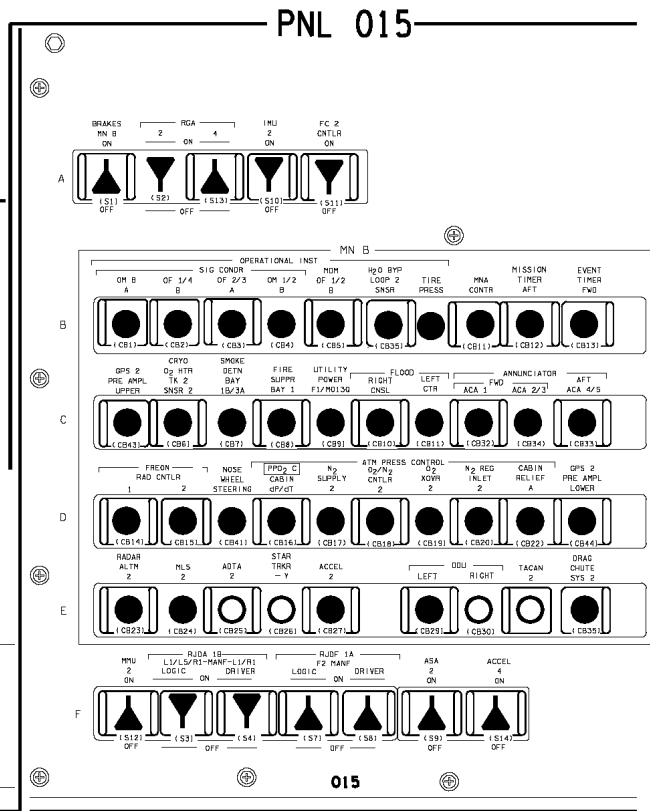
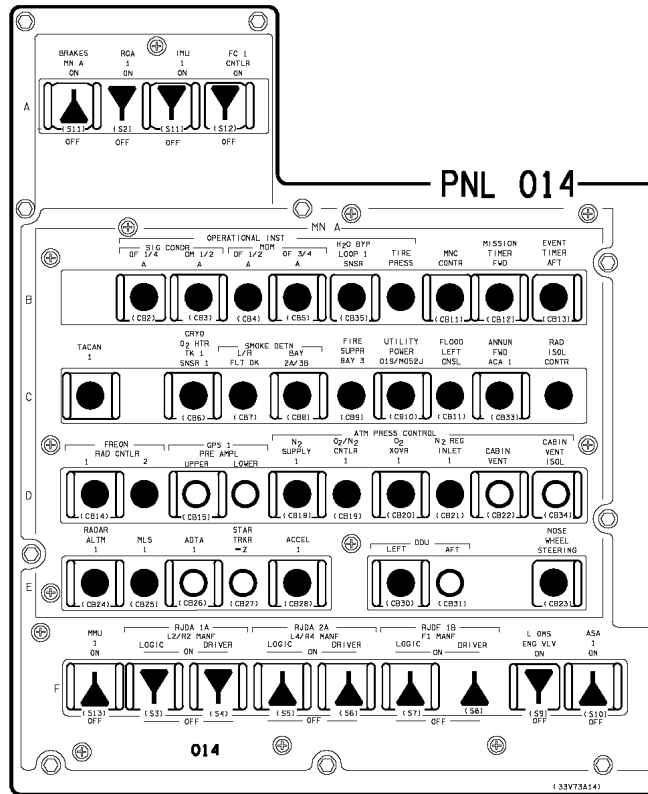
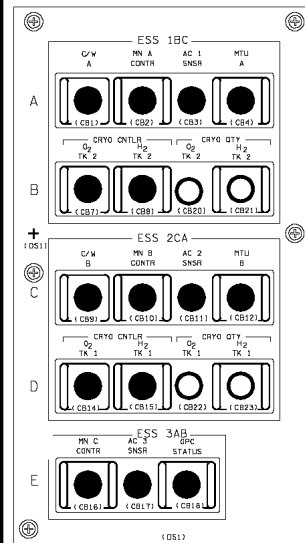

OV104

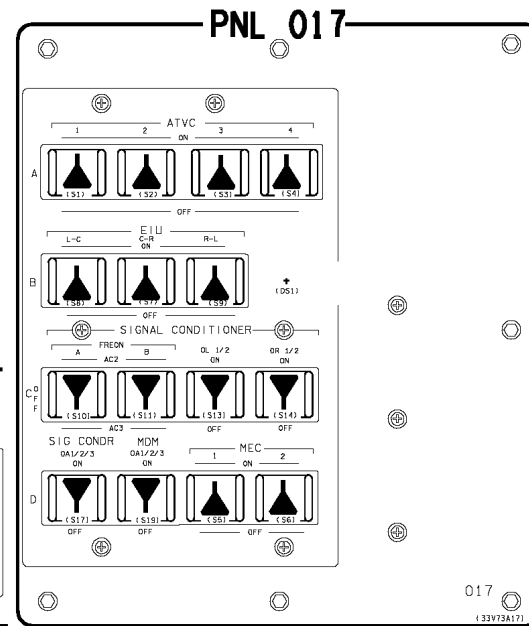
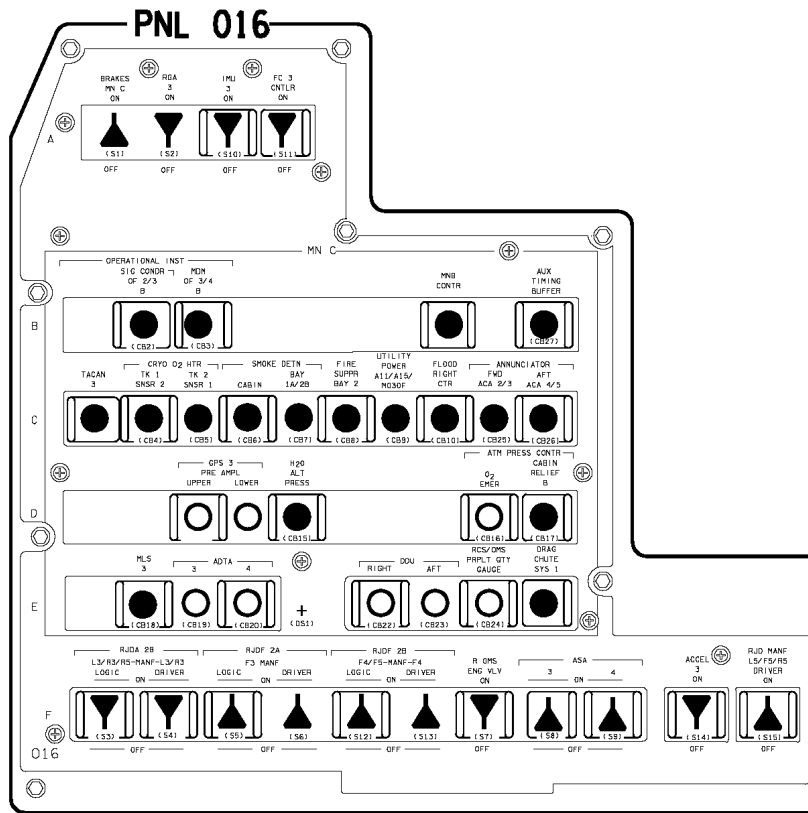

PNL 08

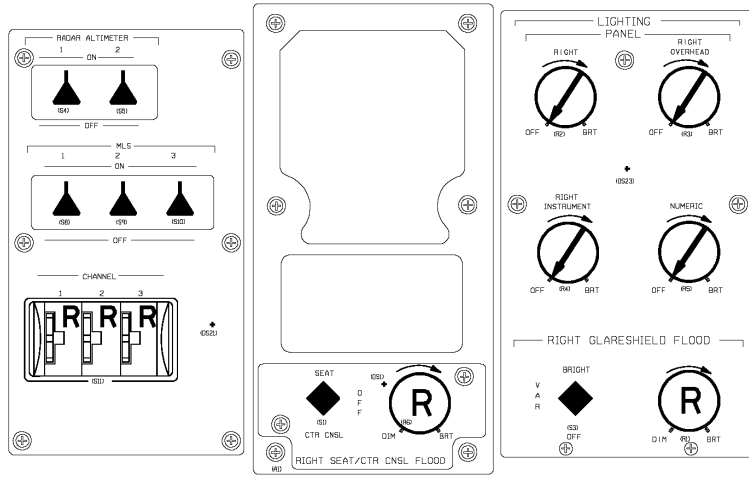

PNL 09

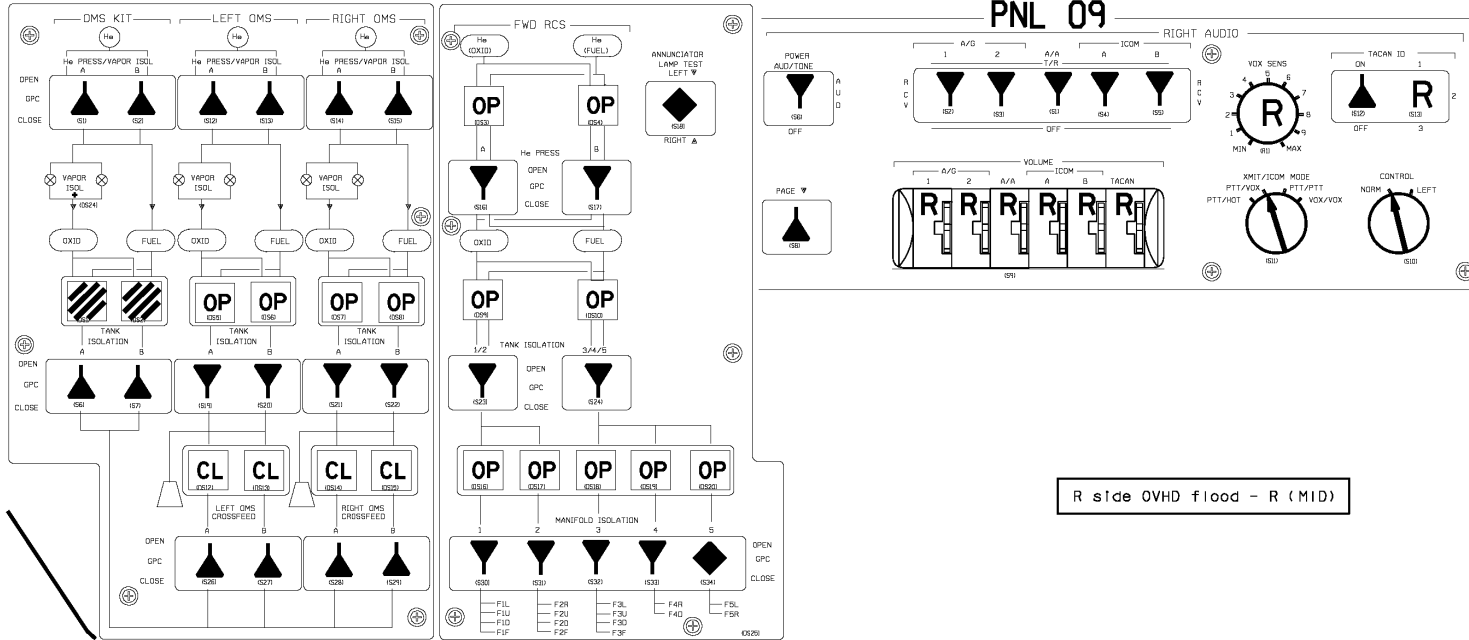

R side OVHD flood - R (MID)

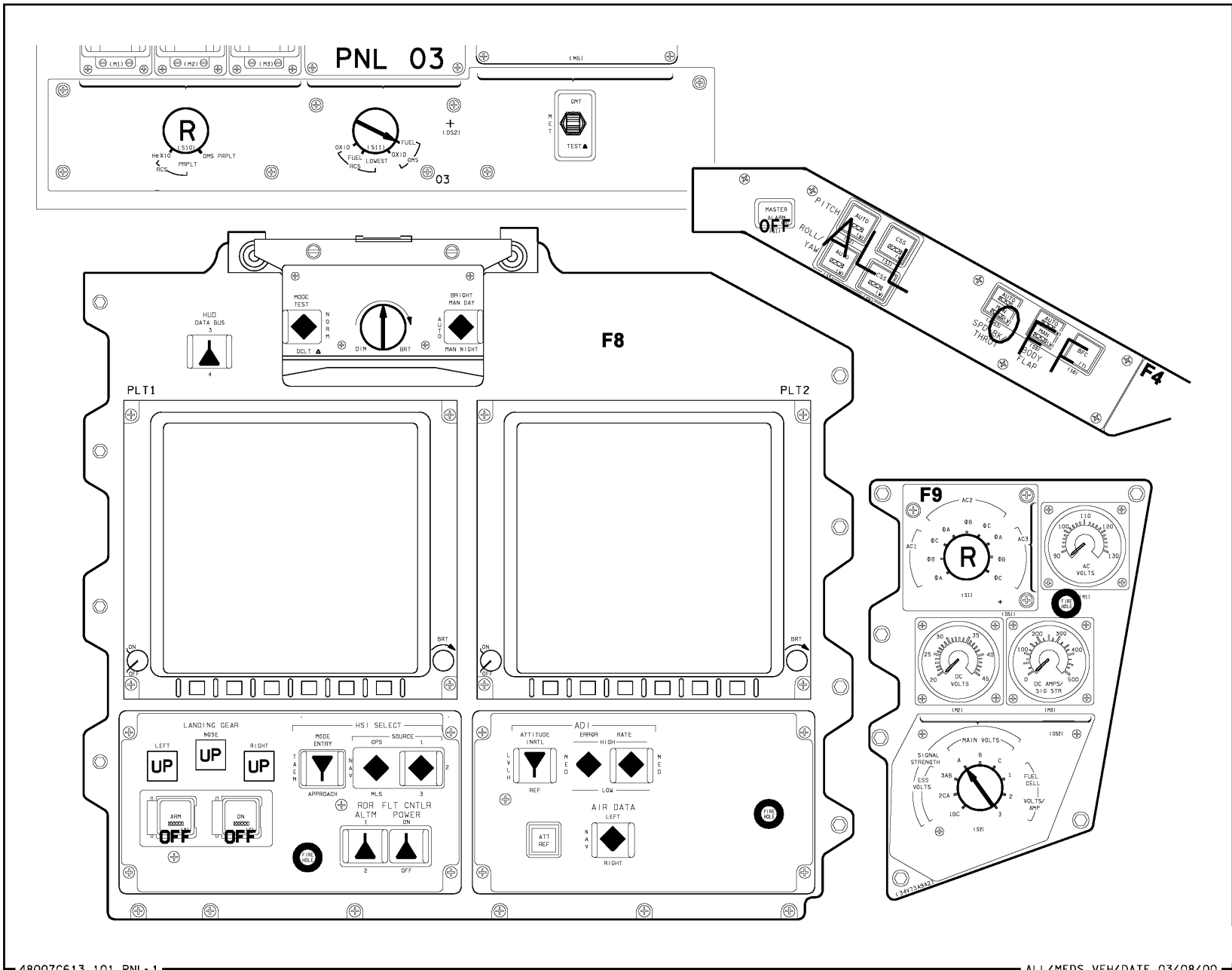

PNL R1

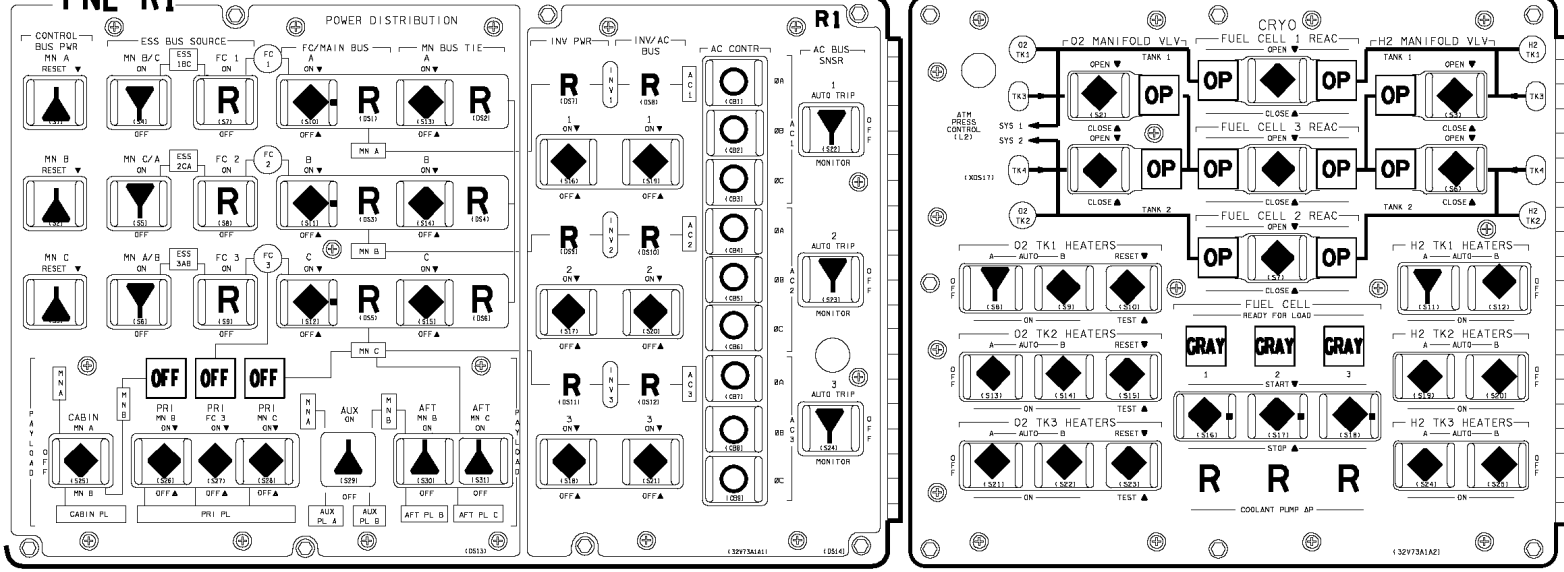

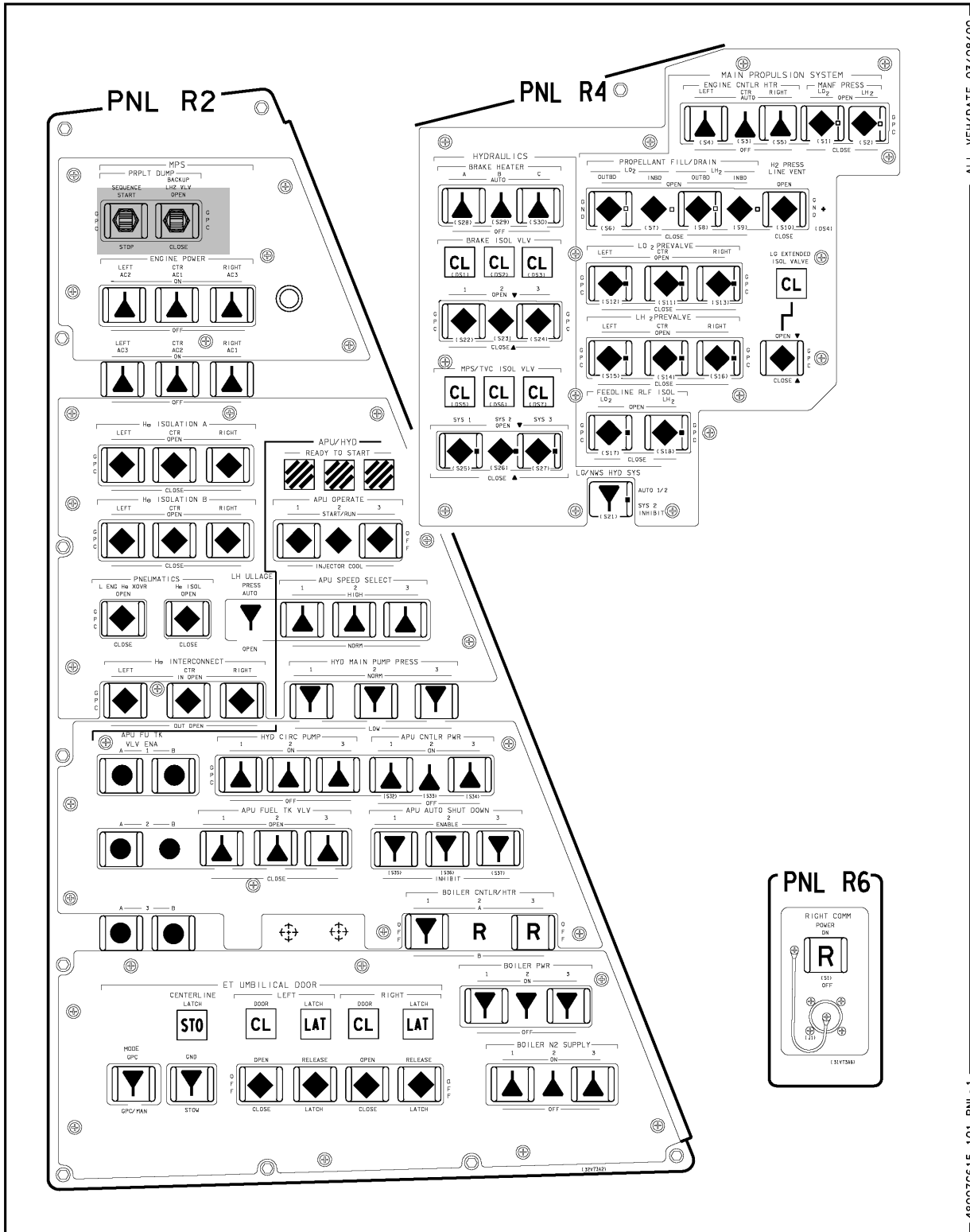

ALL VEH/DATE 03/08/00

480076615_101_PNL R1

OV104

(OV104) C6-15

C D/O/ALL/GEN H

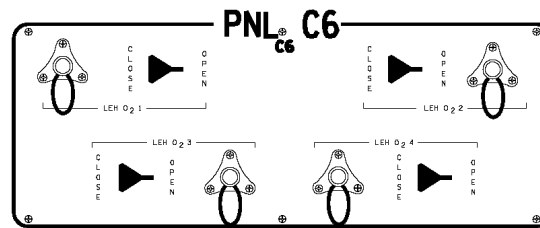
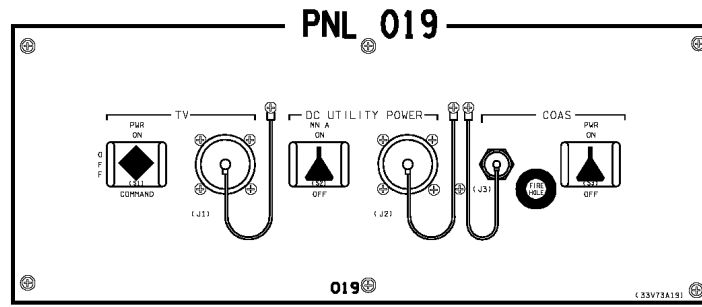

PNL C5



PNL C7

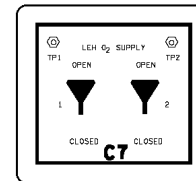

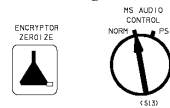
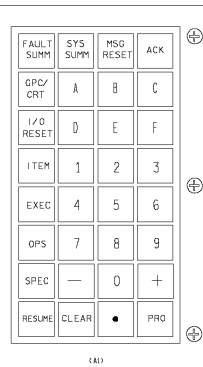
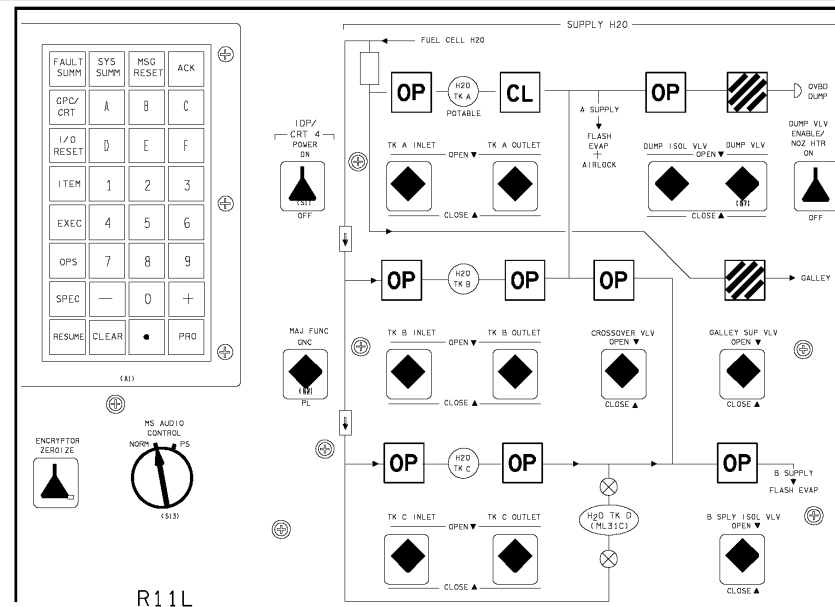
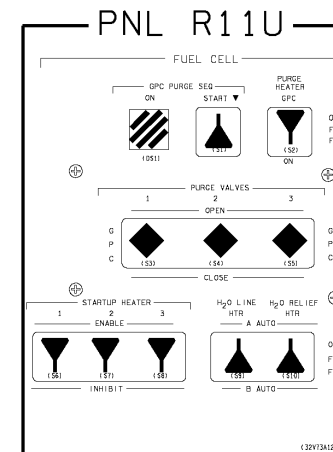
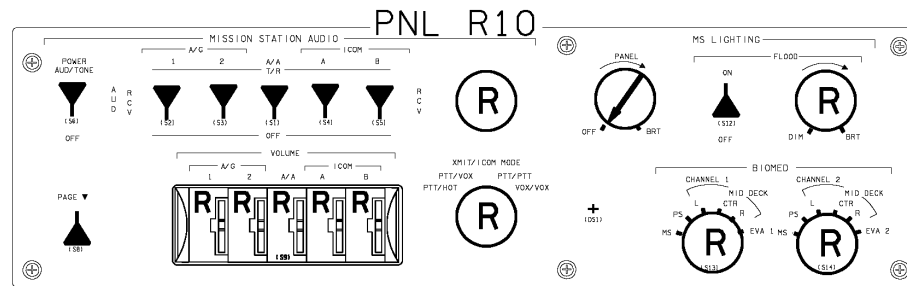

OV104

OV104

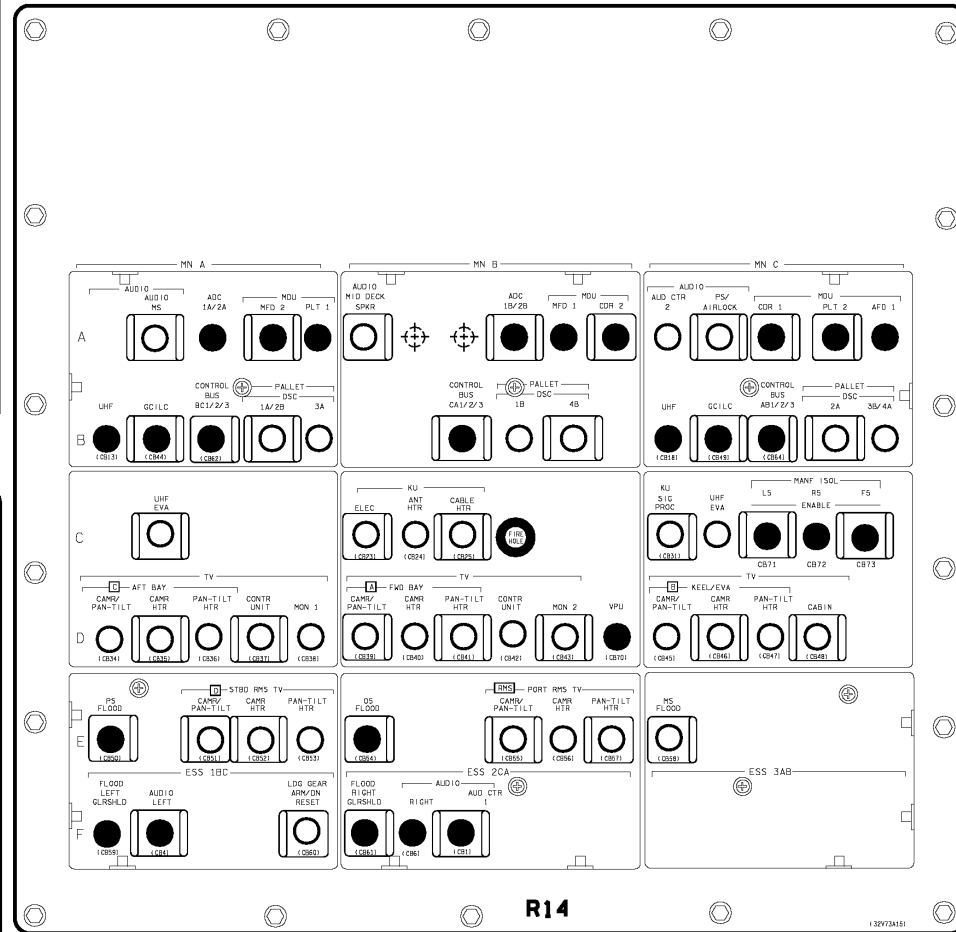
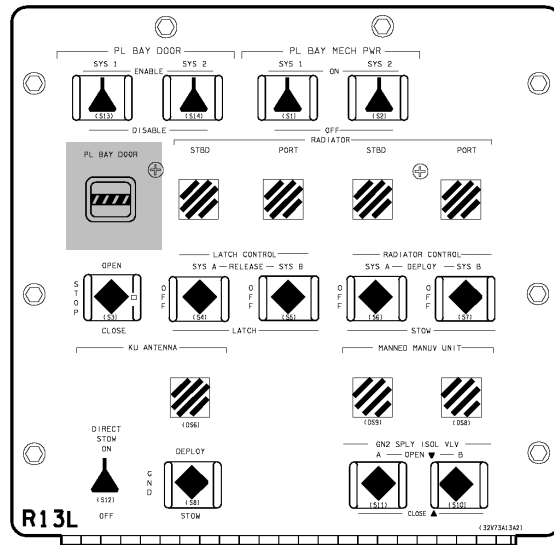
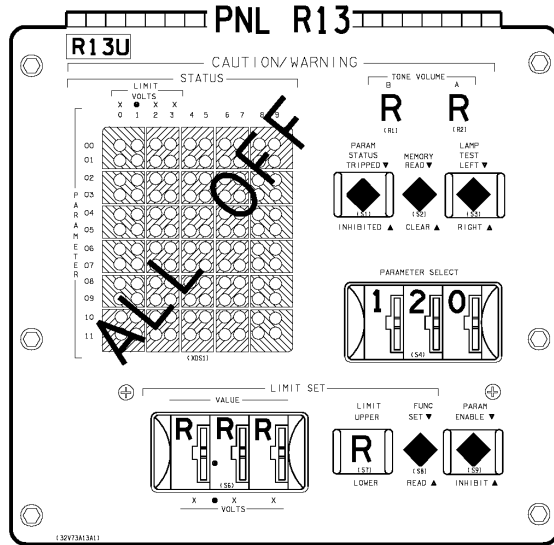

OV104

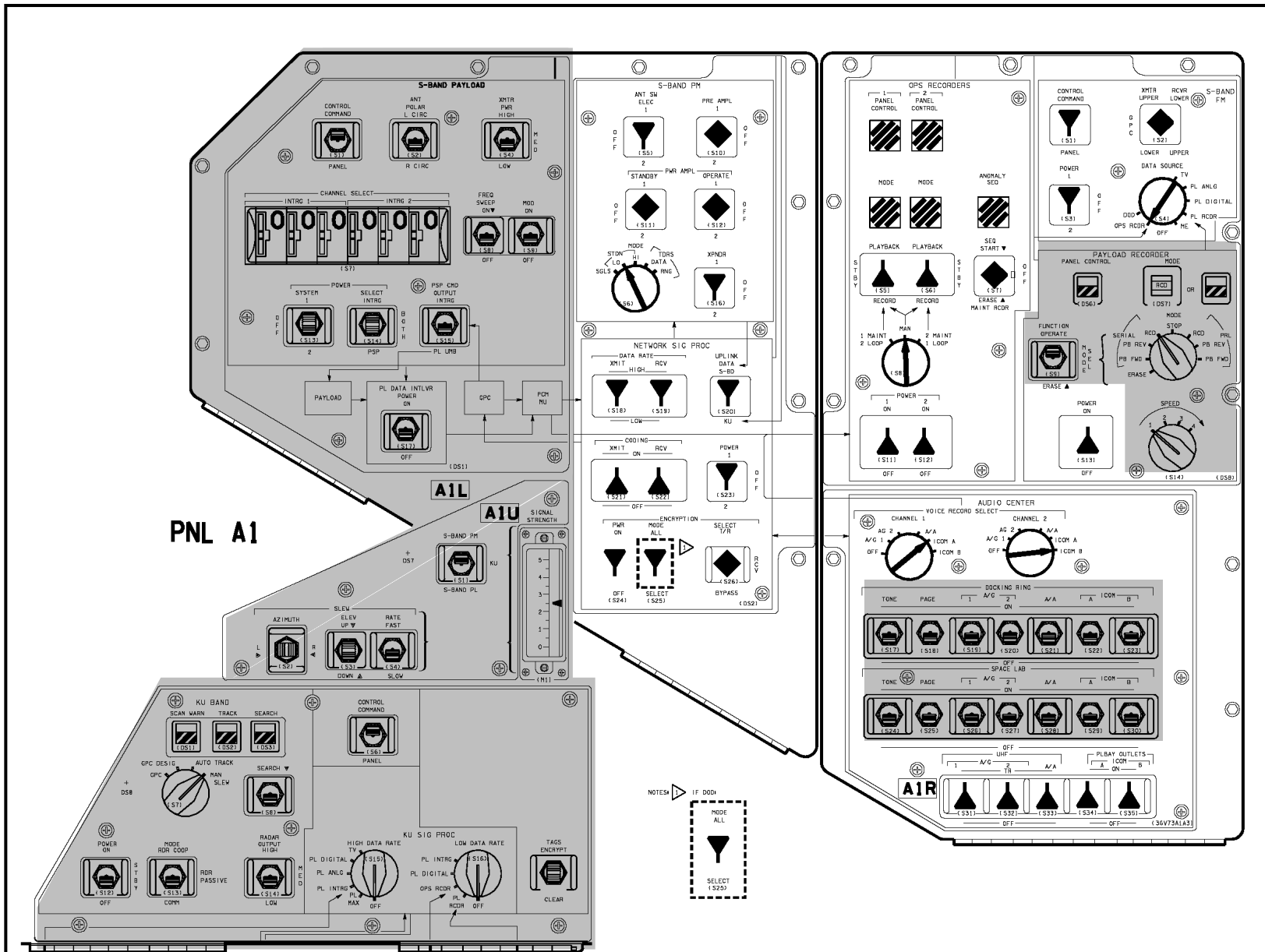

A6L

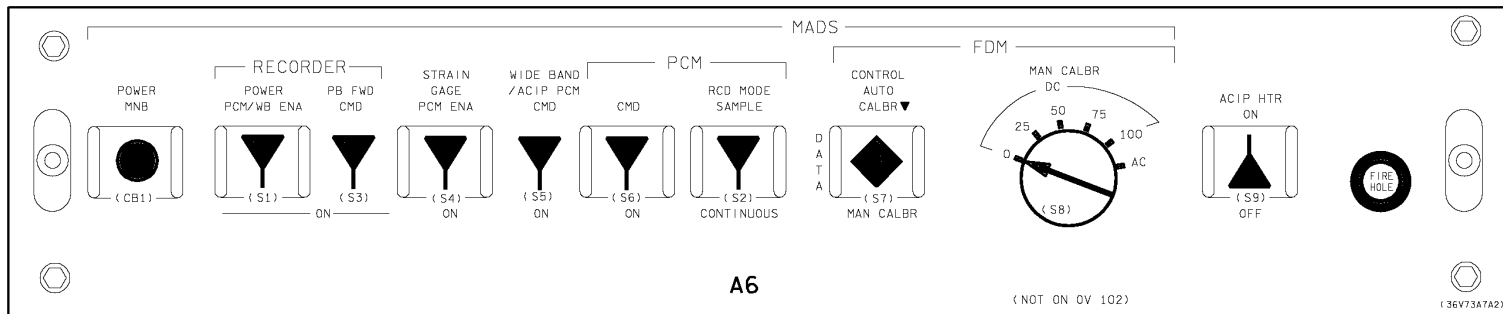
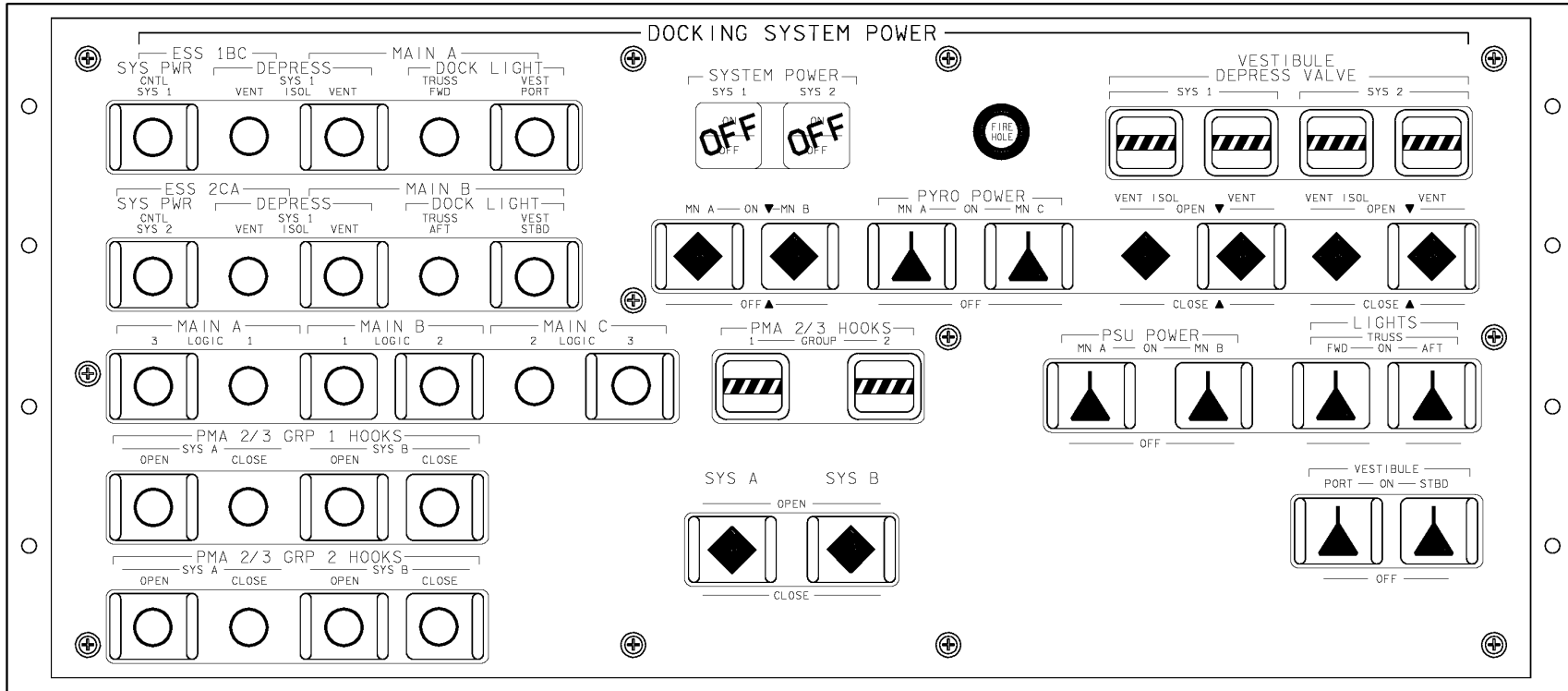

OV104

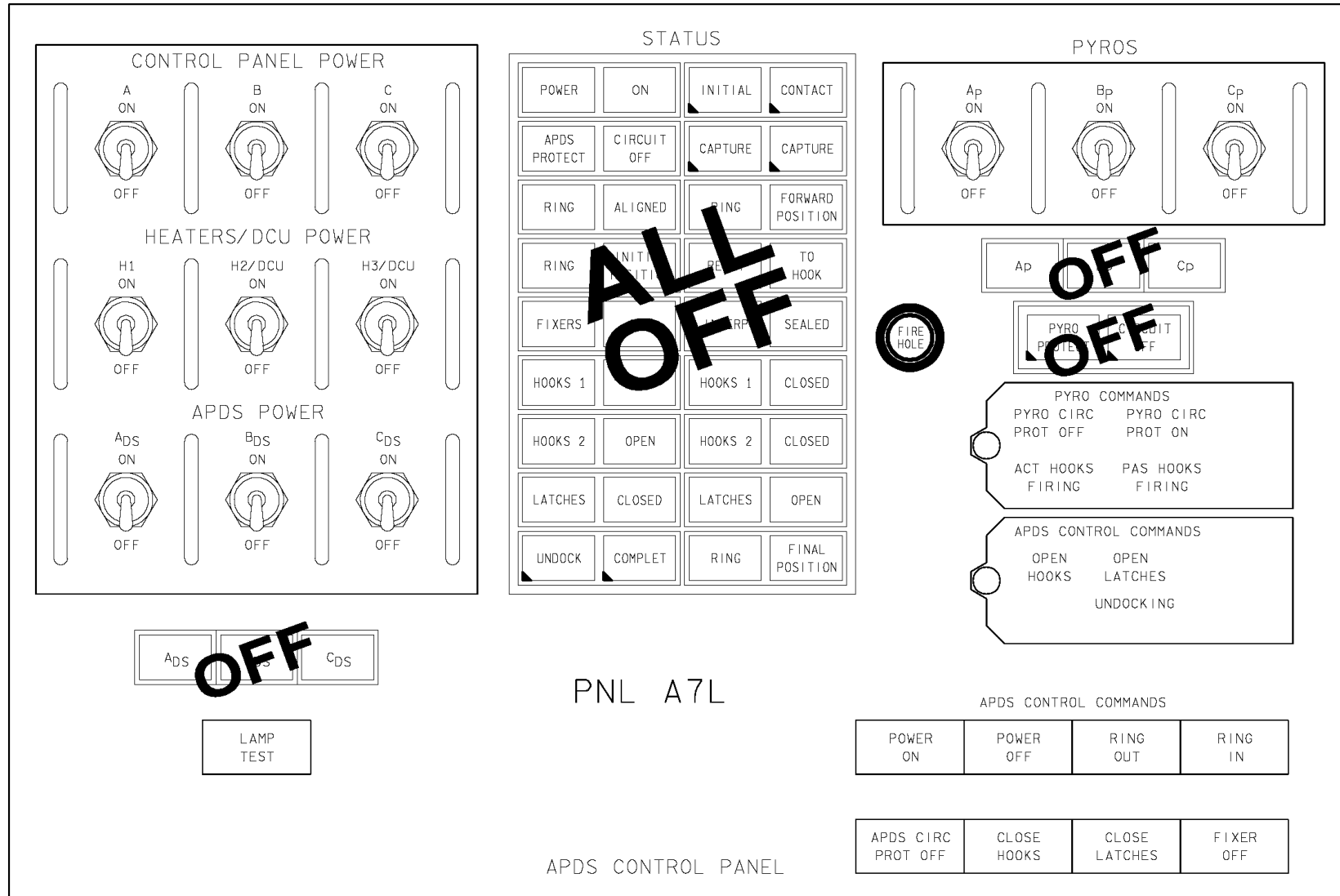

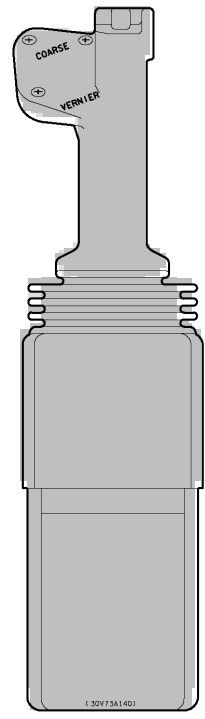
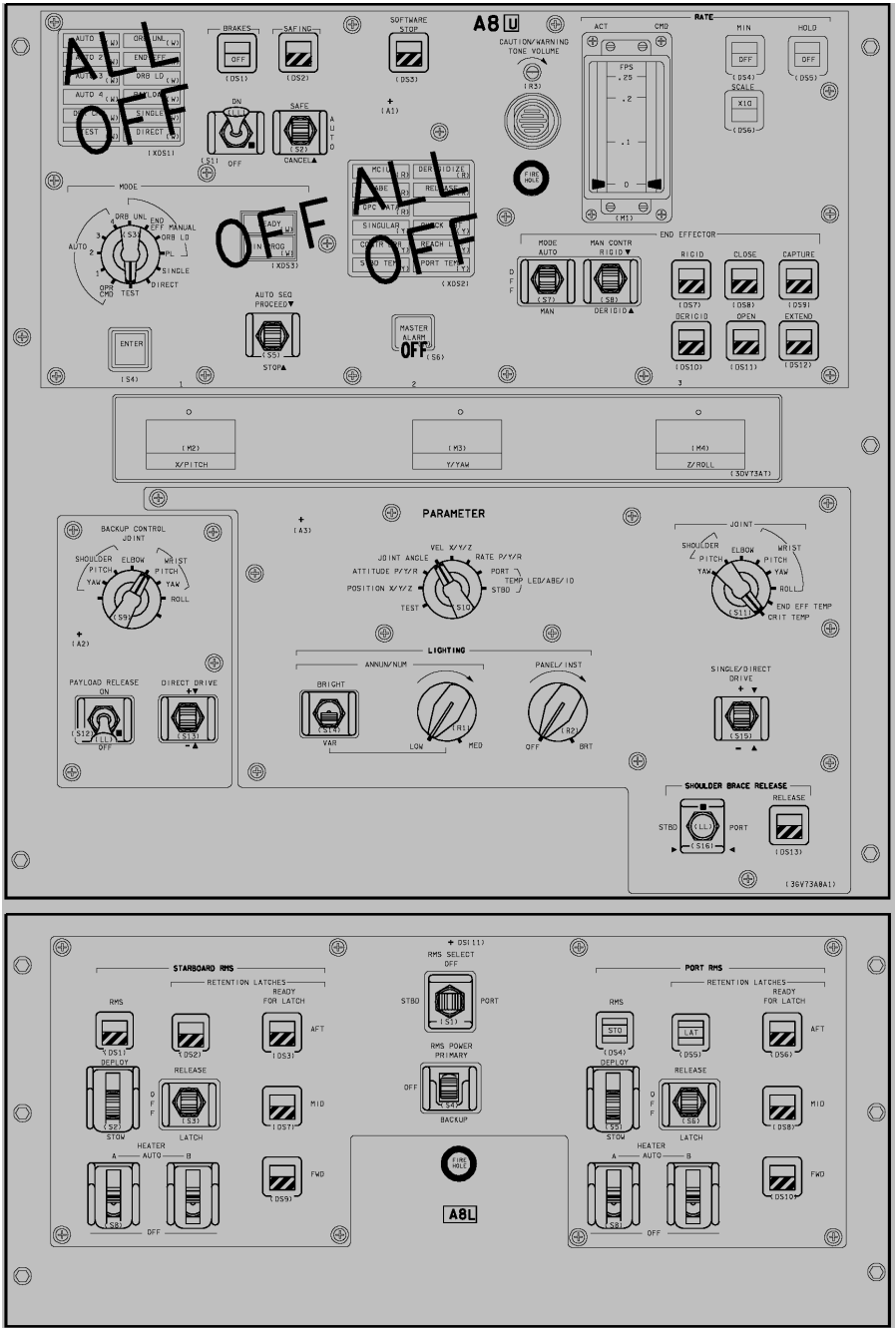

— 480076623_101_PNL_1 — ALL VEH/DATE 03/08/00

OV104

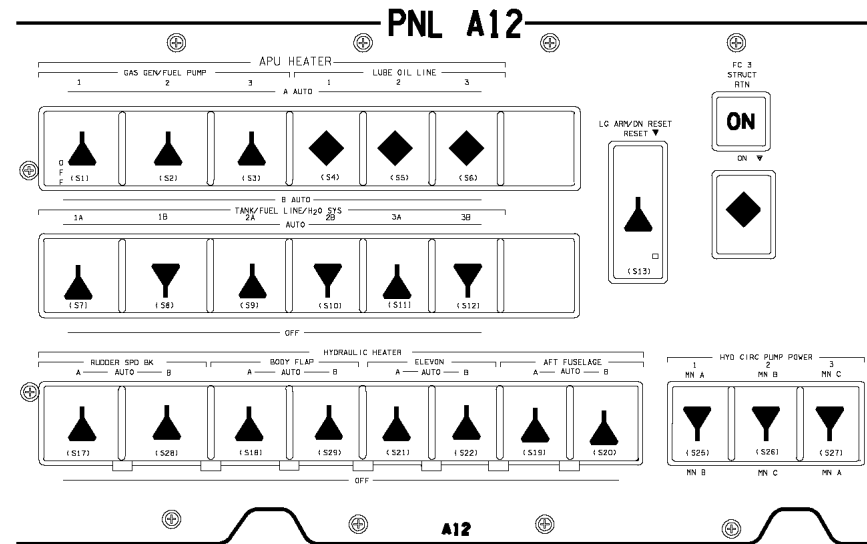
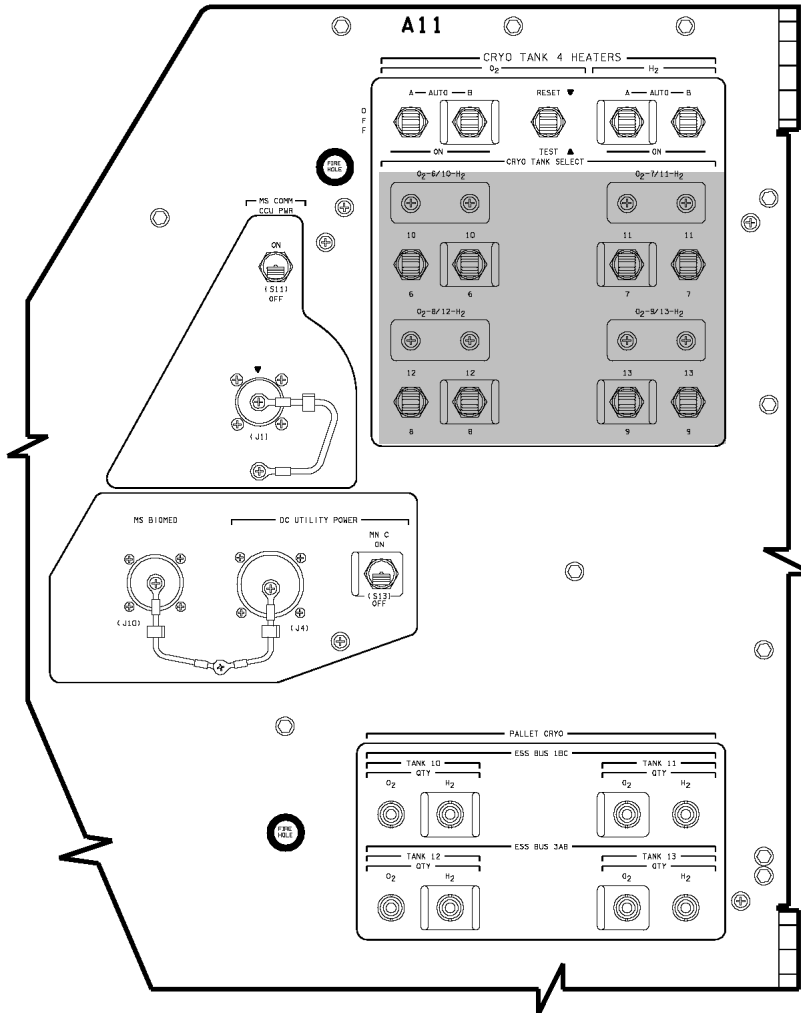

OV104

OV104

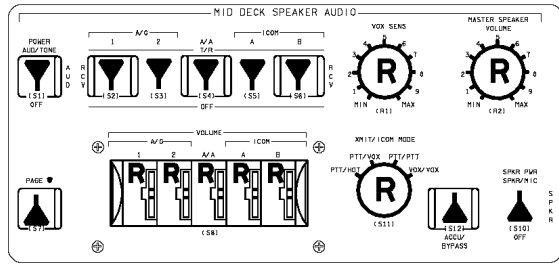

PNL M042F

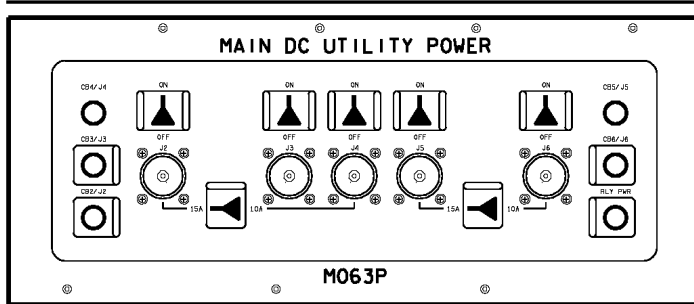
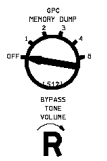

M063P

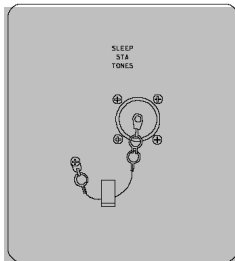

PNL M058F

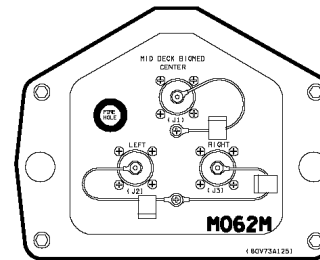
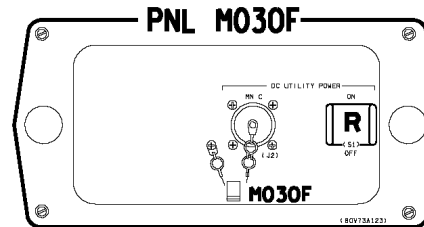
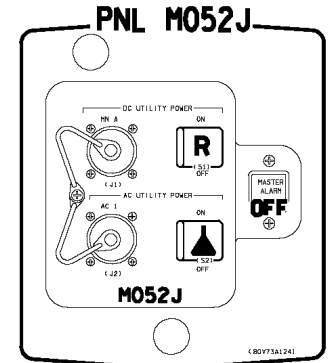
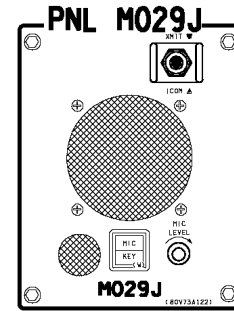
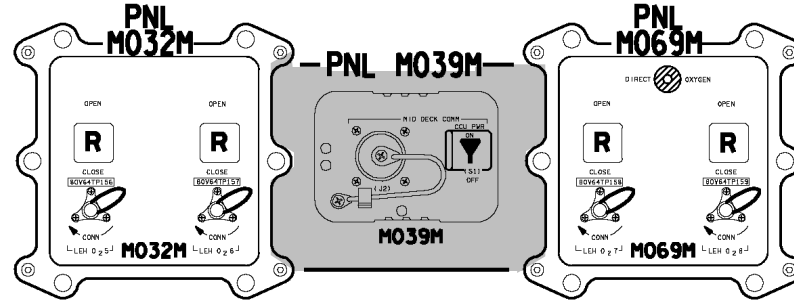
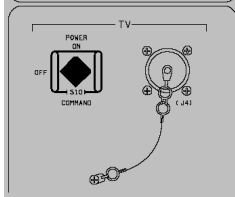

PNL MA73C

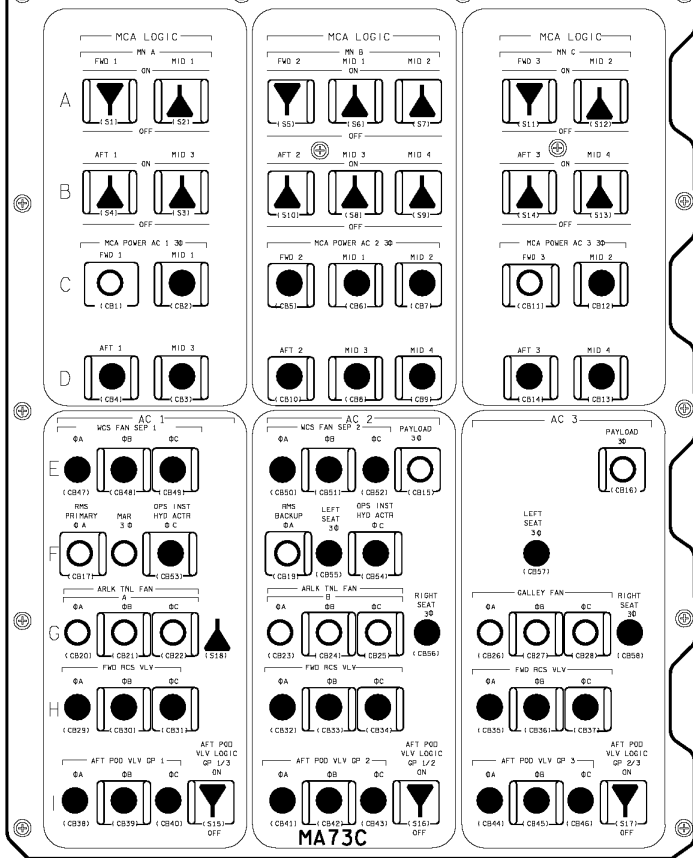

MA73C

PNL ML86B

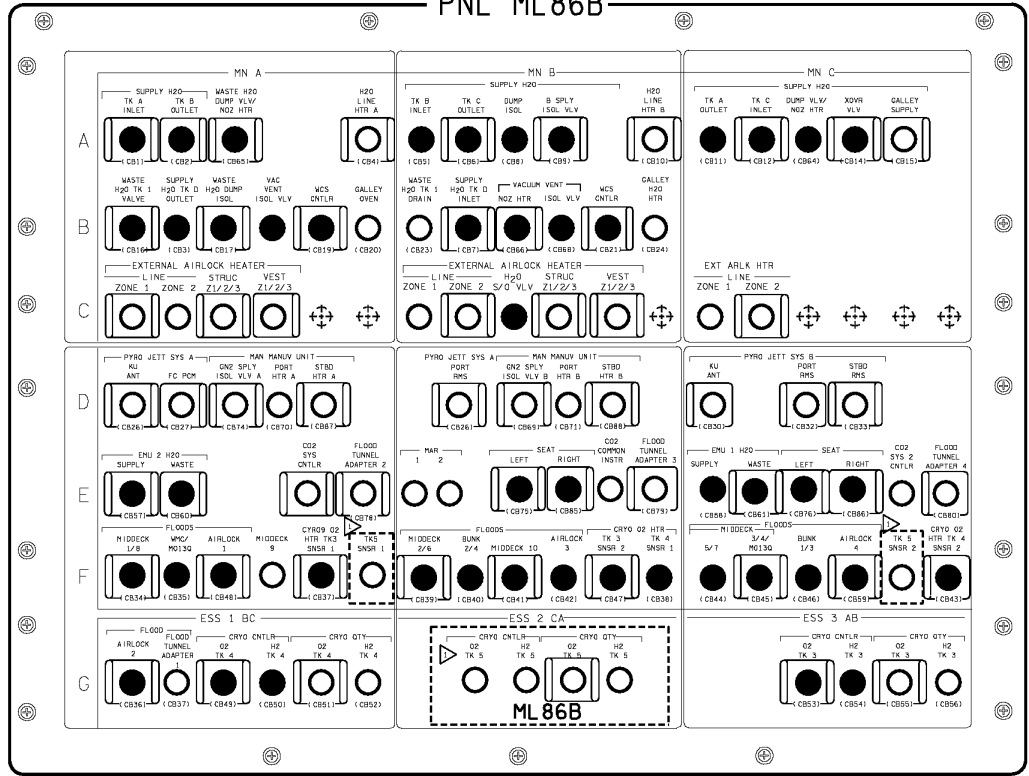

ML86B

NOTES: CLOSED IF TK5 FLOWN

OV104

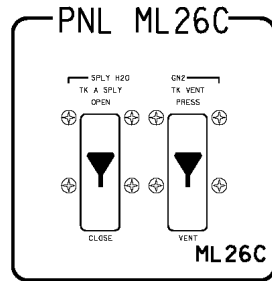
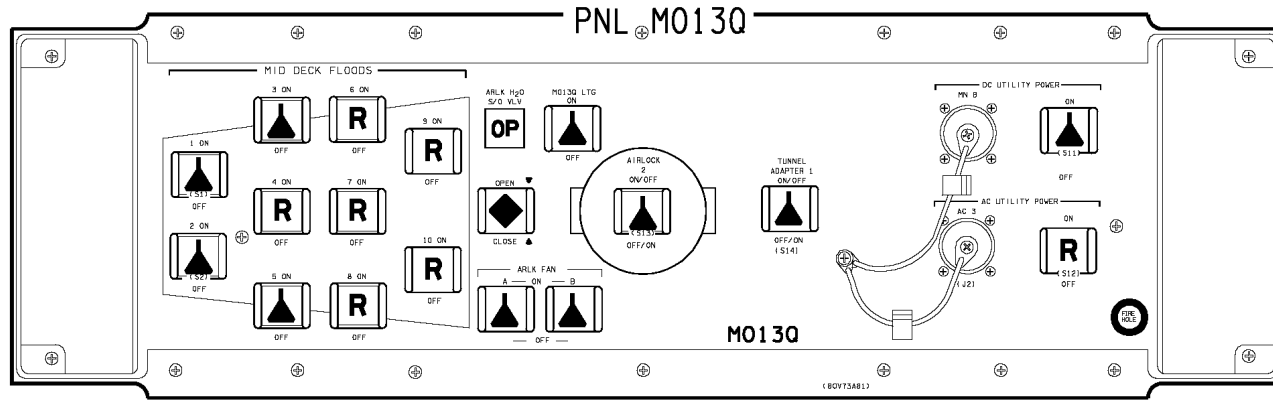

PNL MD24K

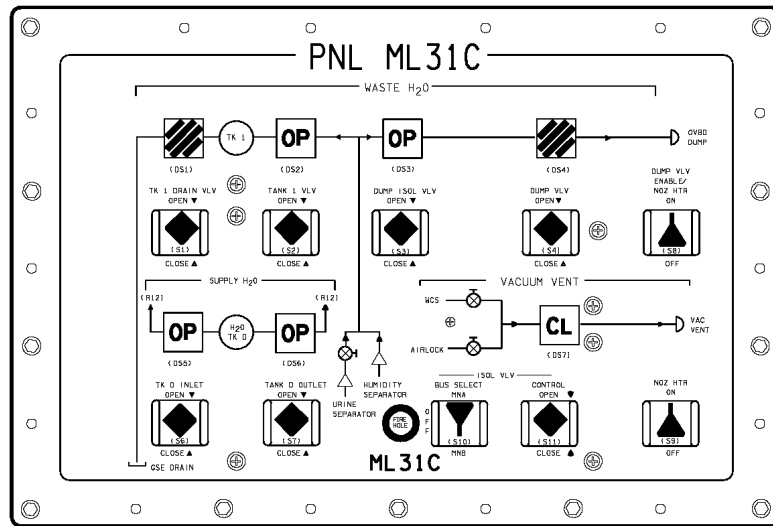
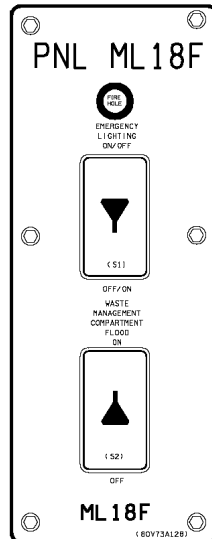
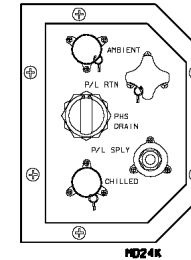

PNL MD44F
CAB TEMP CNTL ACT LINKAGE - SECONDARY ACTUATOR

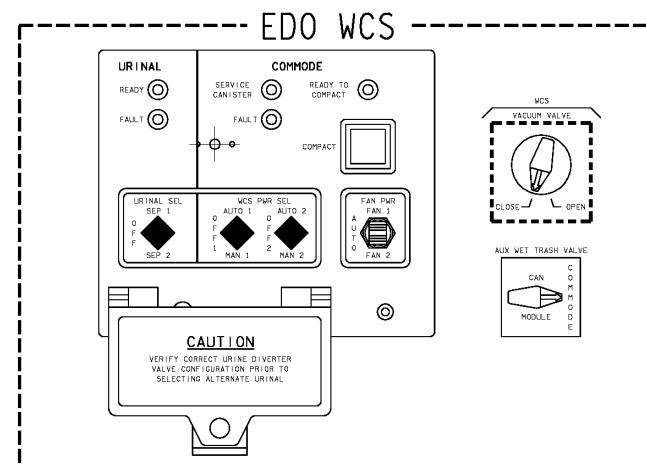
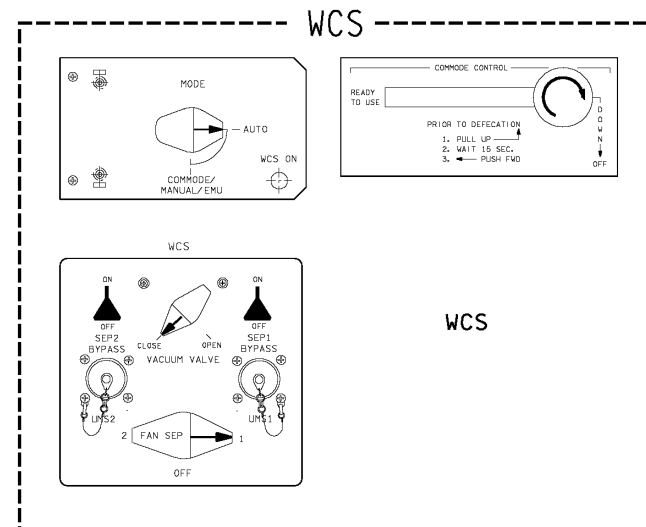
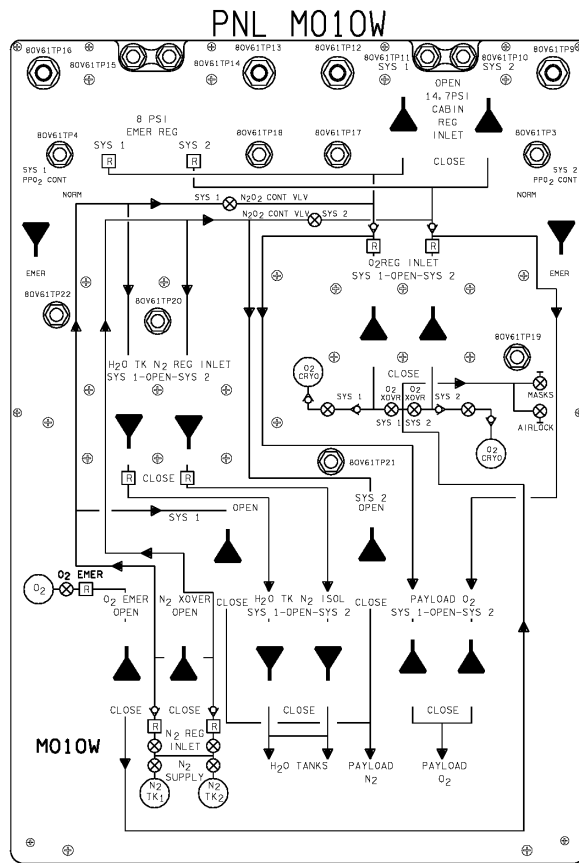

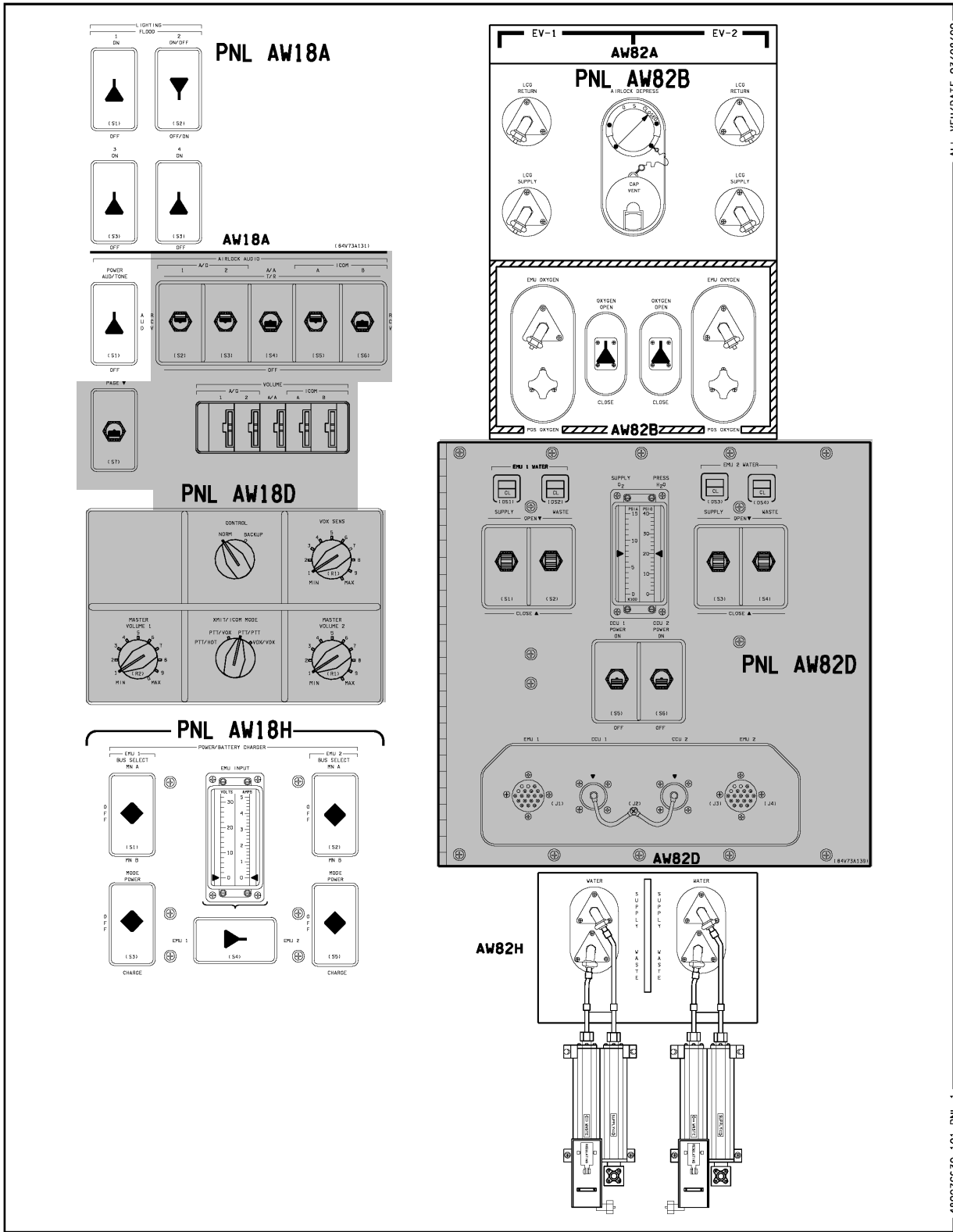

48007C630_1.01 - PNL 1 1 ALL VEH/DATE 03/08/00

Inner Hatch

Actuator Handle – LATCHED

Lock Lever – LOCKED

Equalization vlv (two) – NORM, capped

This Page Intentionally Blank

OV105

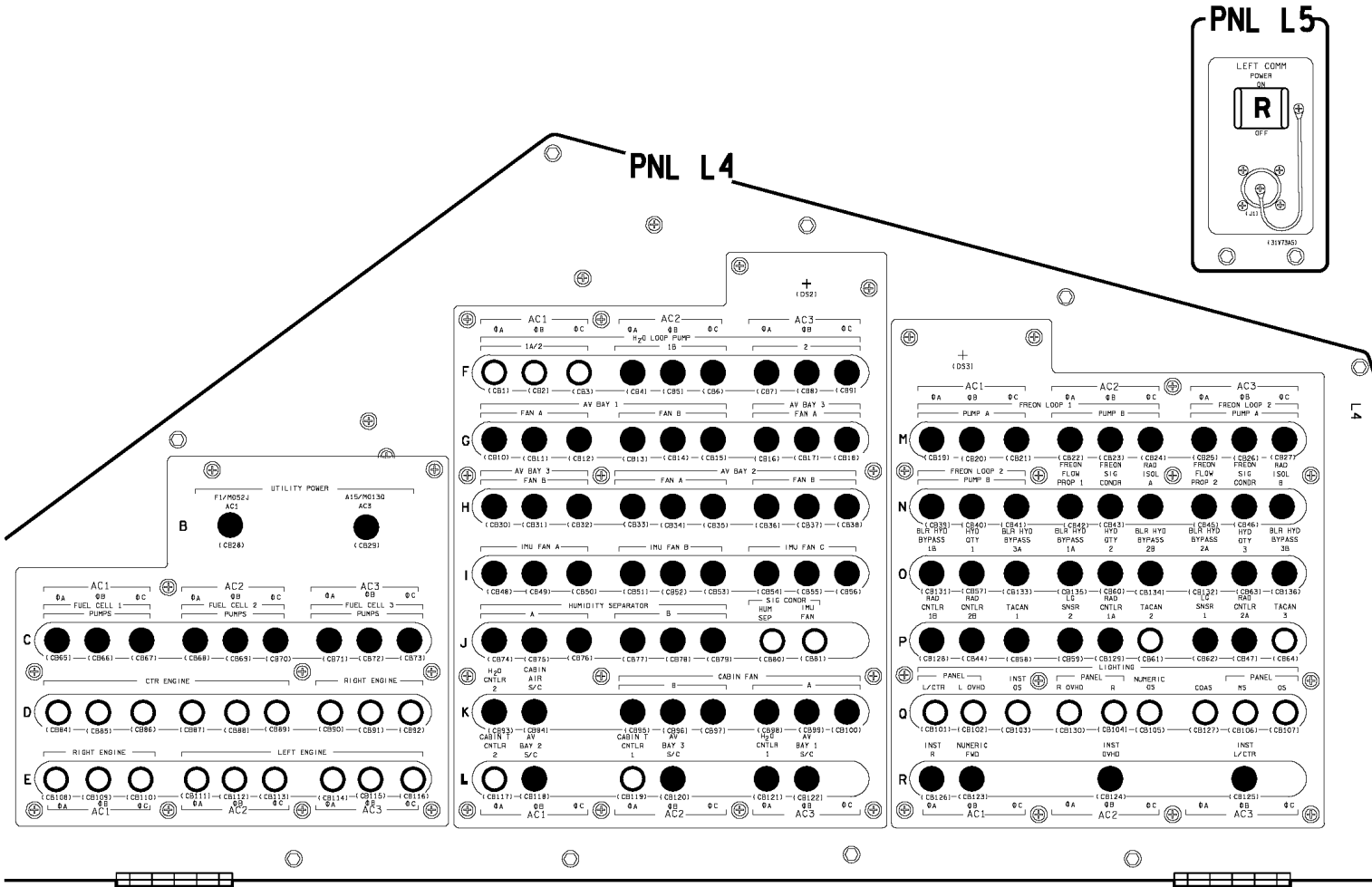

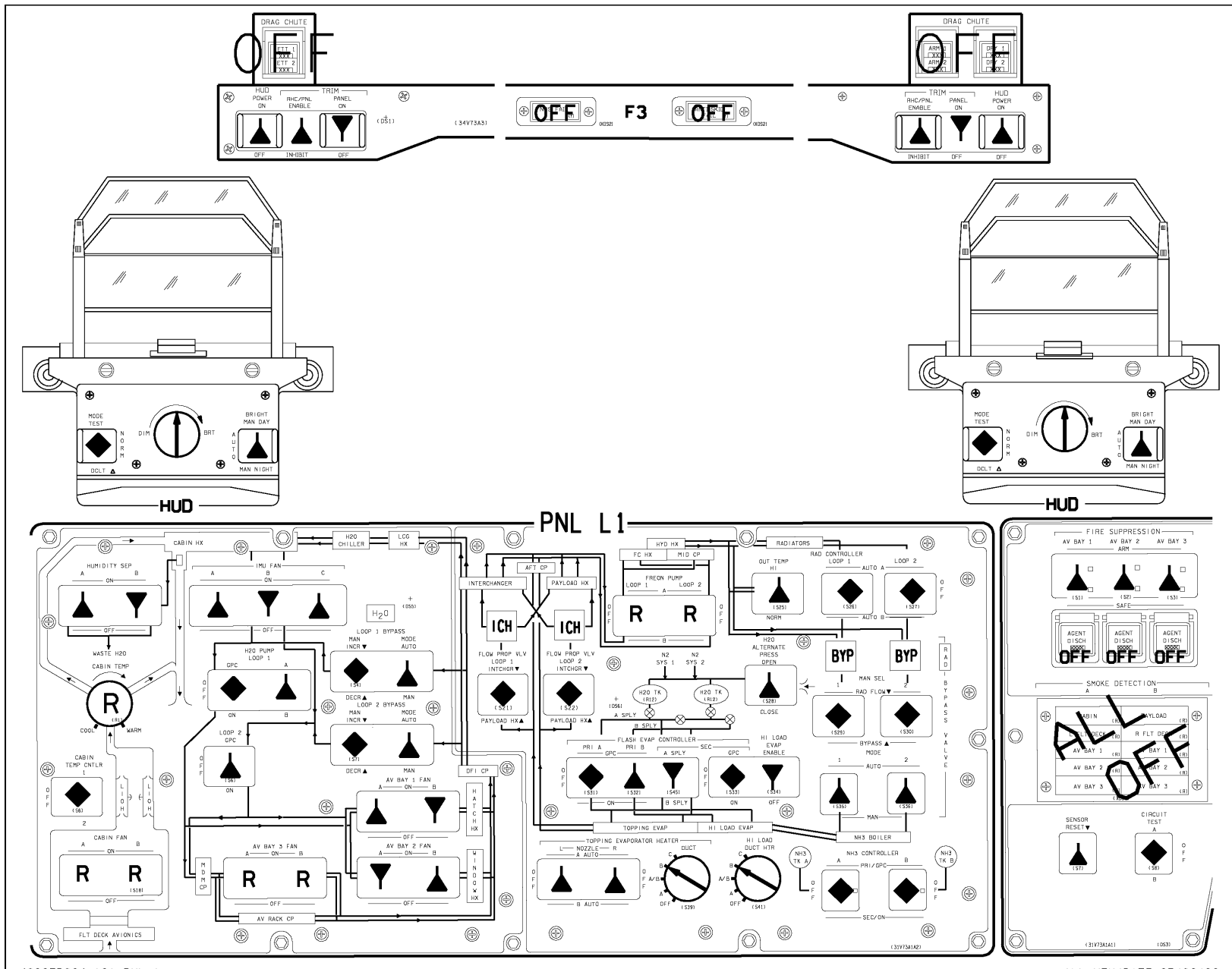

48007D604_101. PNL 1

ALL VEH/DATE 03/20/00

(OV105) D6-4

C D/O/ALL/GEN H

OV105

PNL L2

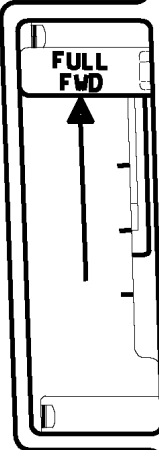
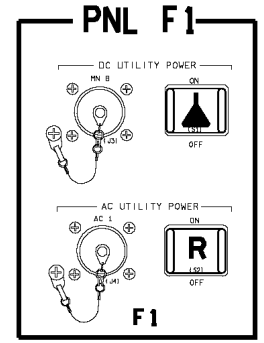
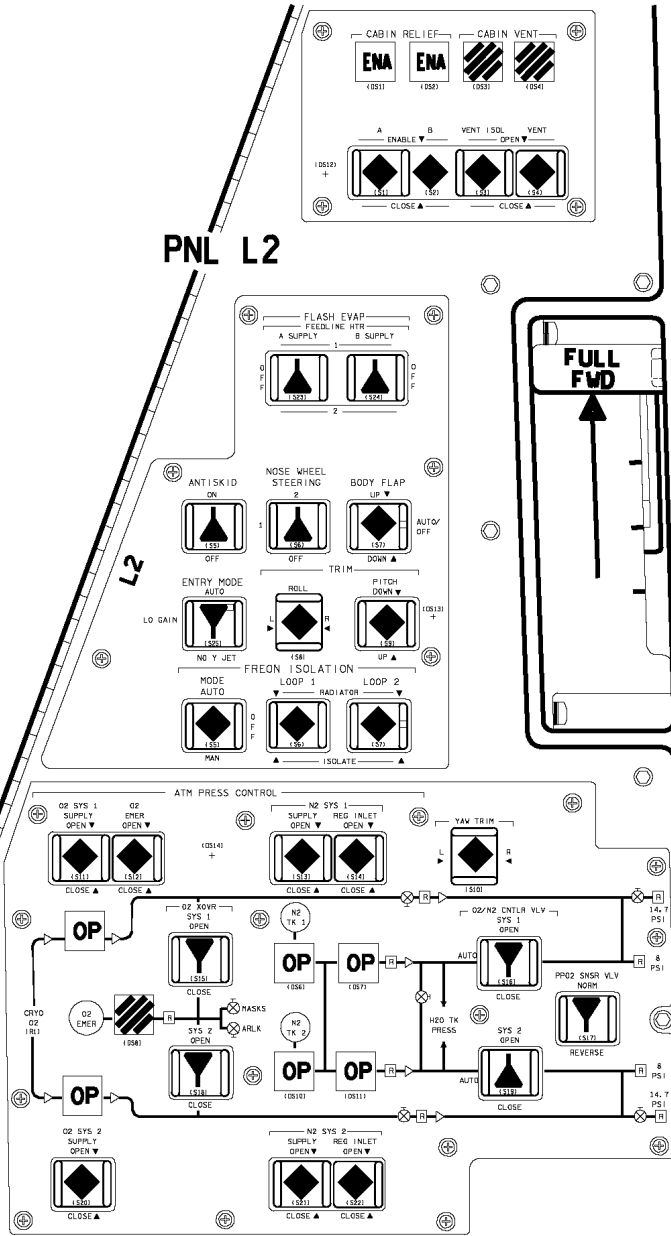

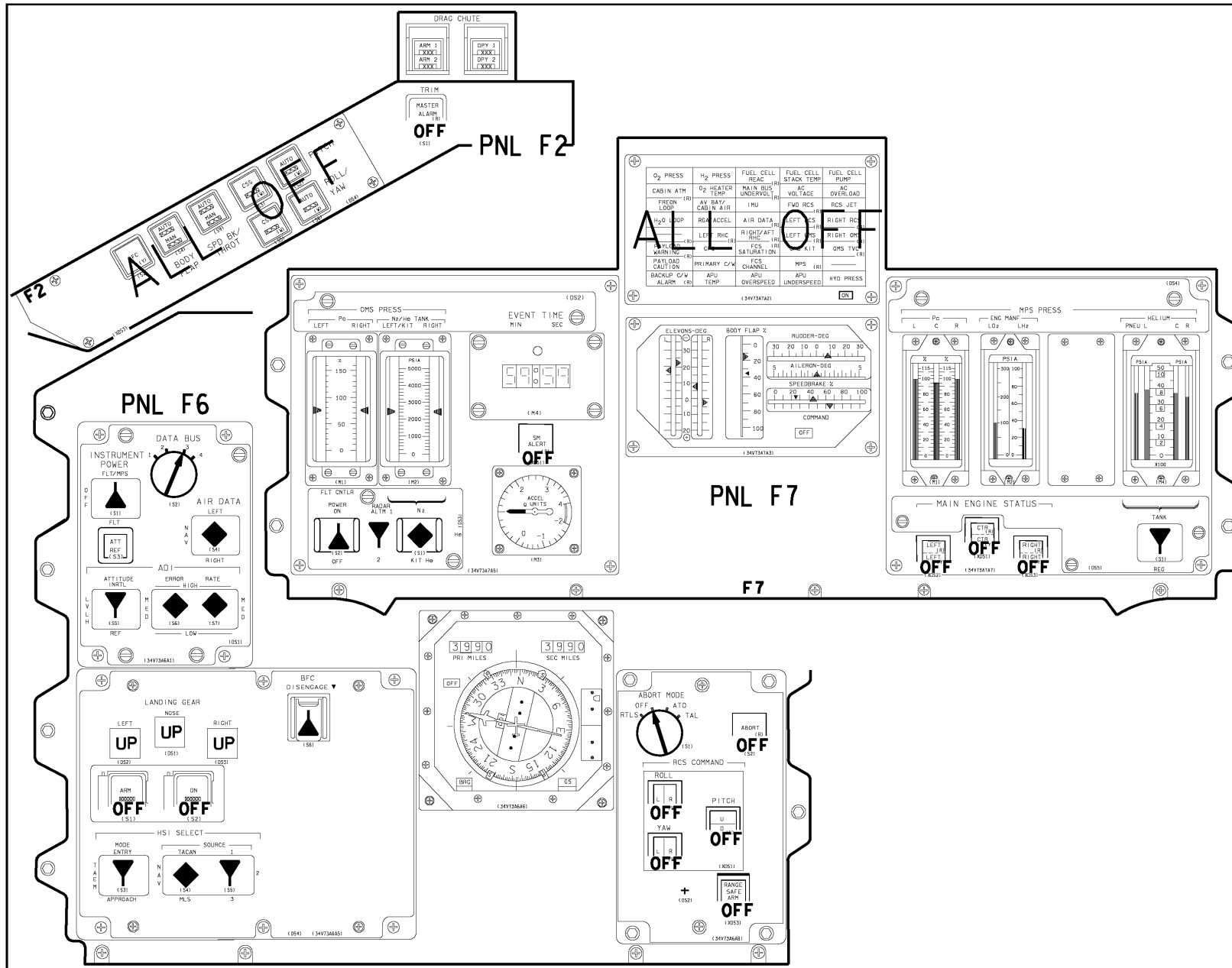

PNL C2/C3

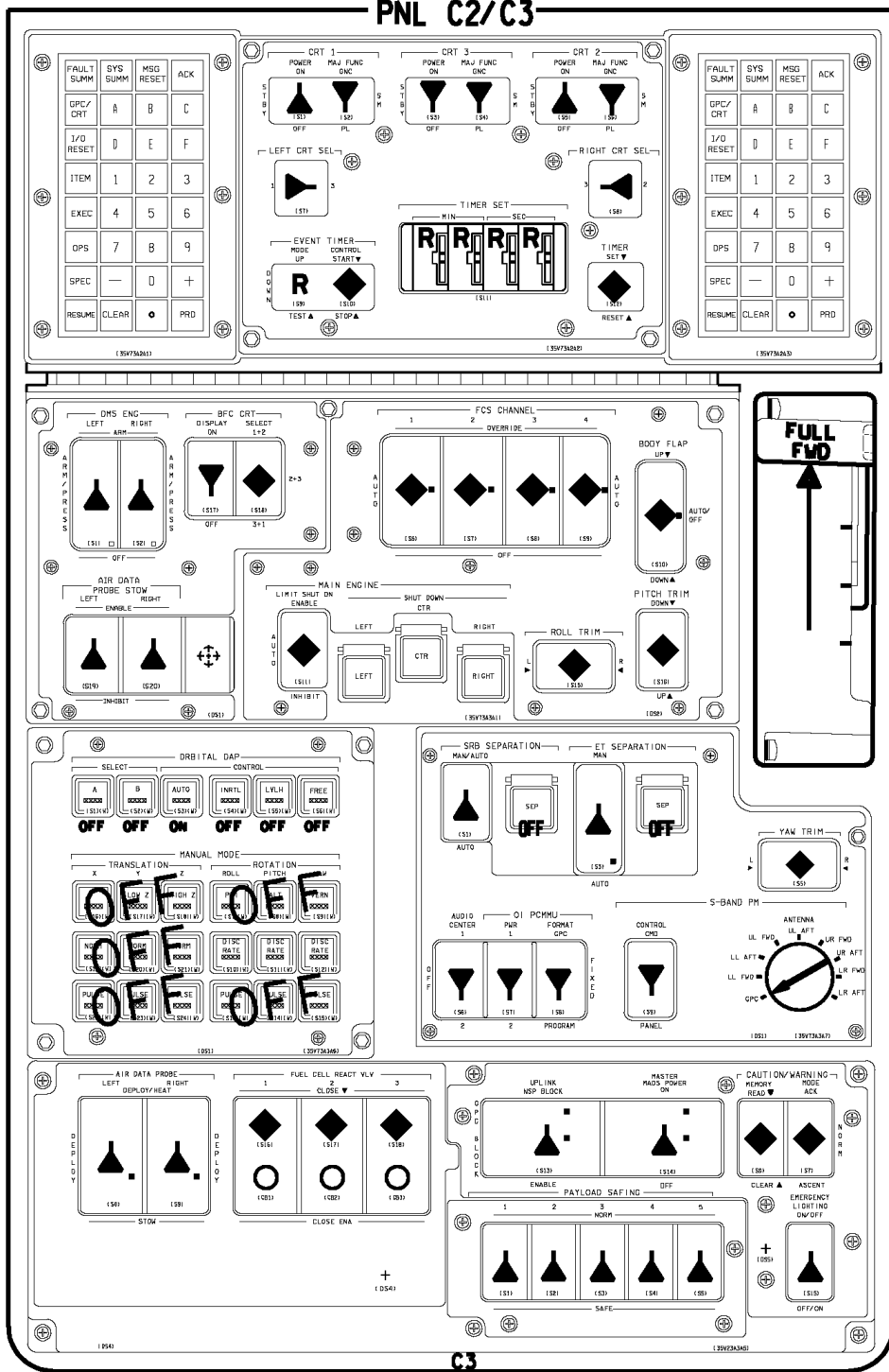

OV105

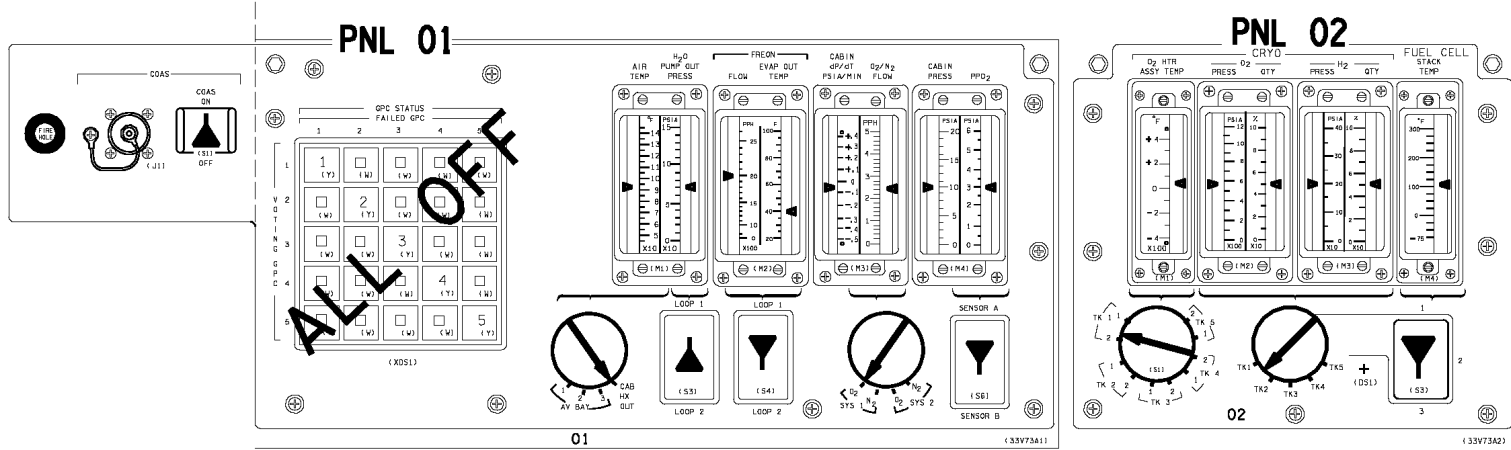

L side OVHD flood - R (MID)

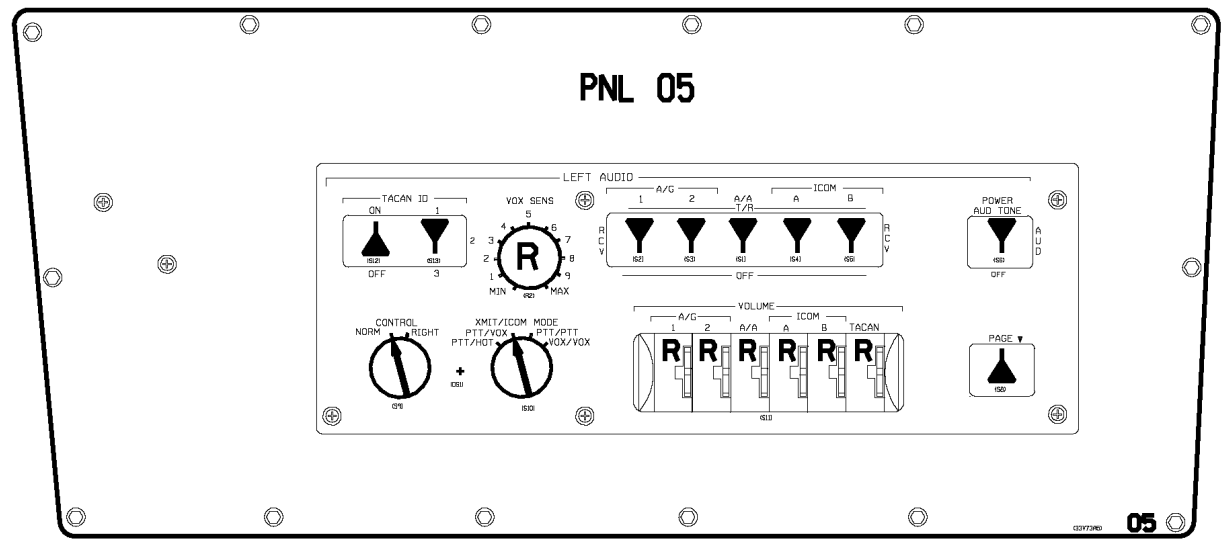

OV105

PNL 06

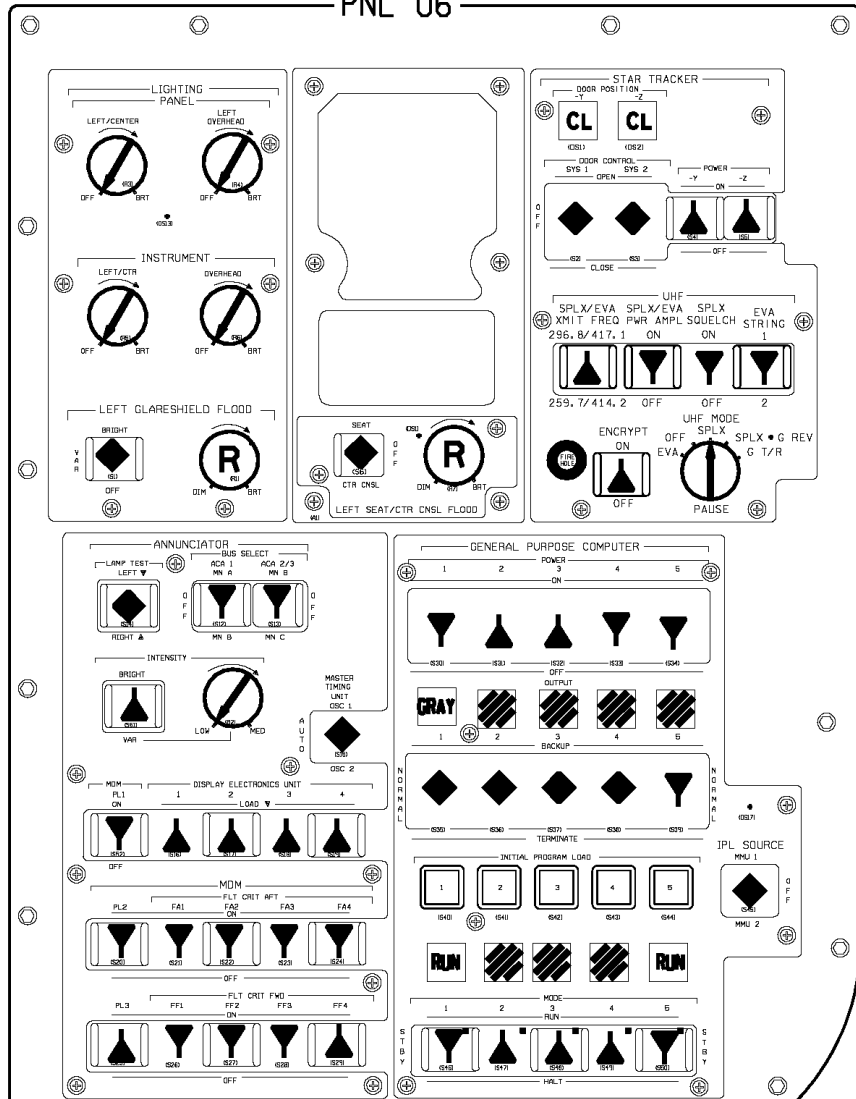

PNL 07

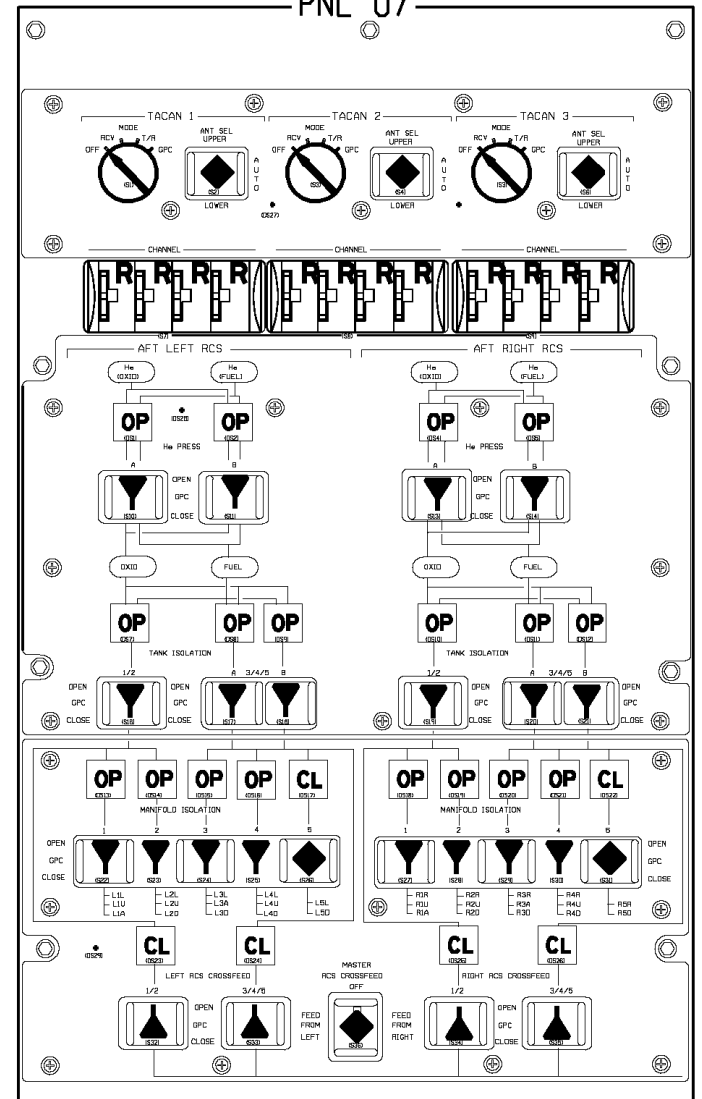

OV105

OV105

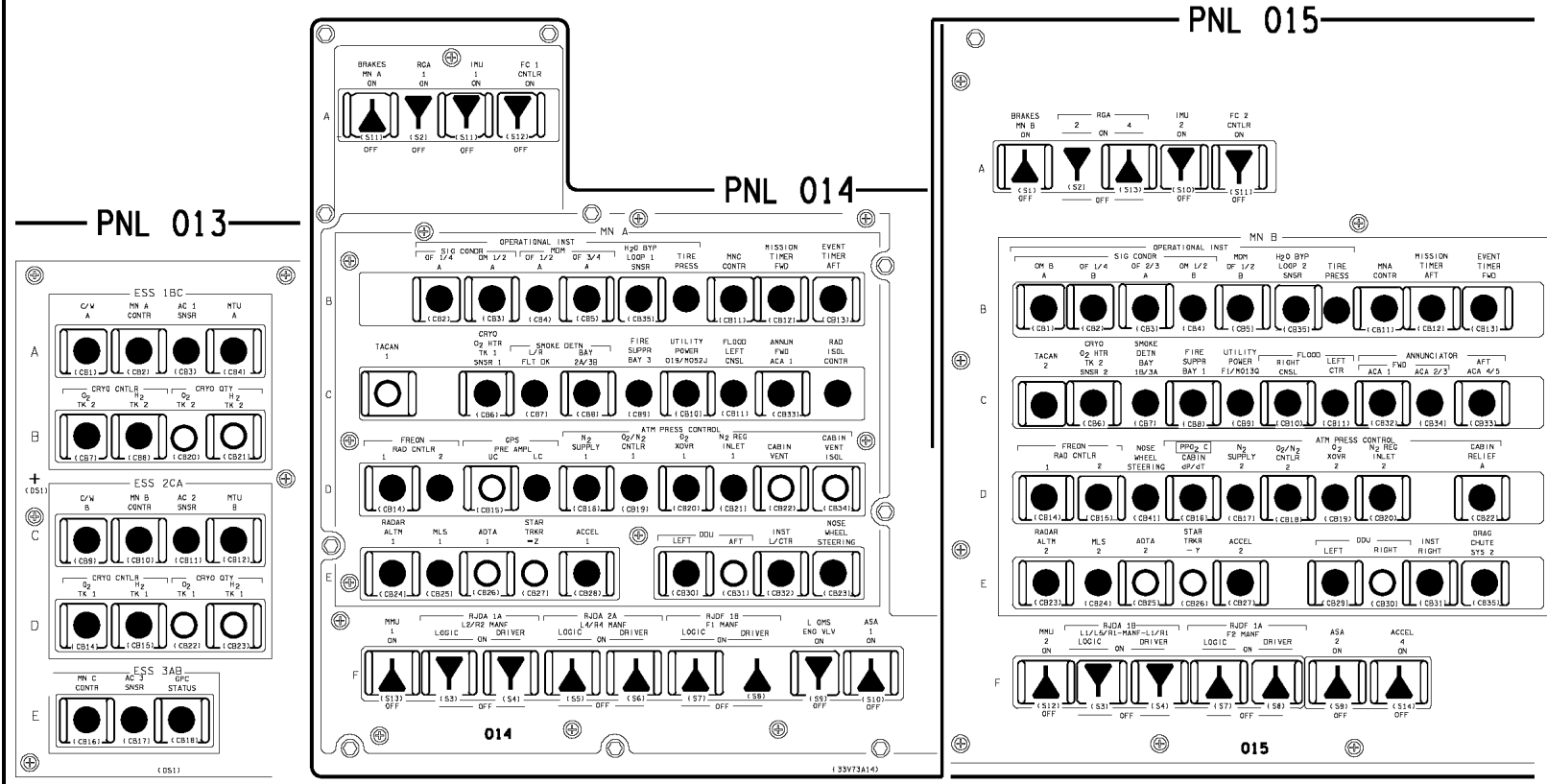

48007D610_100. PNL 1

OV105/DATE 02/09/01

(OV105) D6-10

OV105
C D/O/5/GEN H

OV105

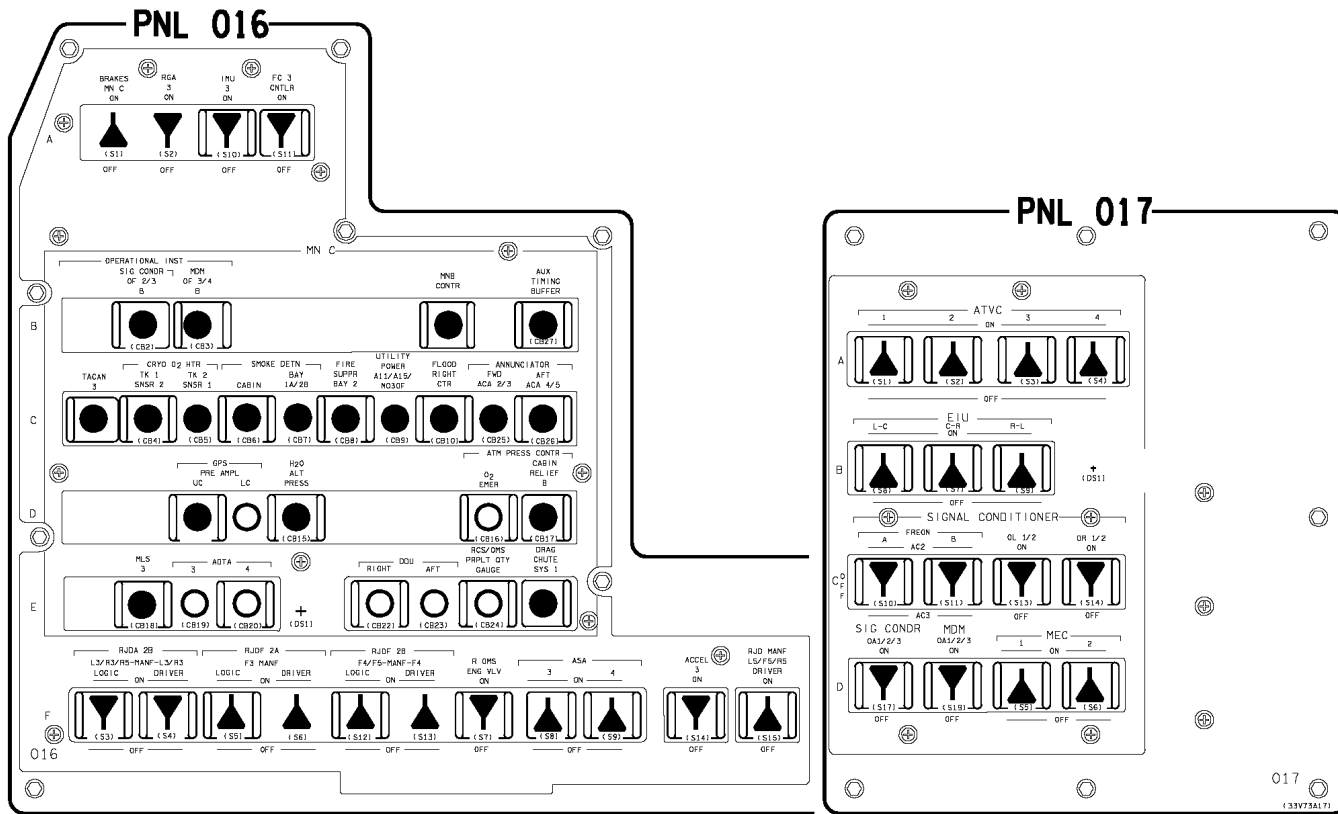

PNL 08

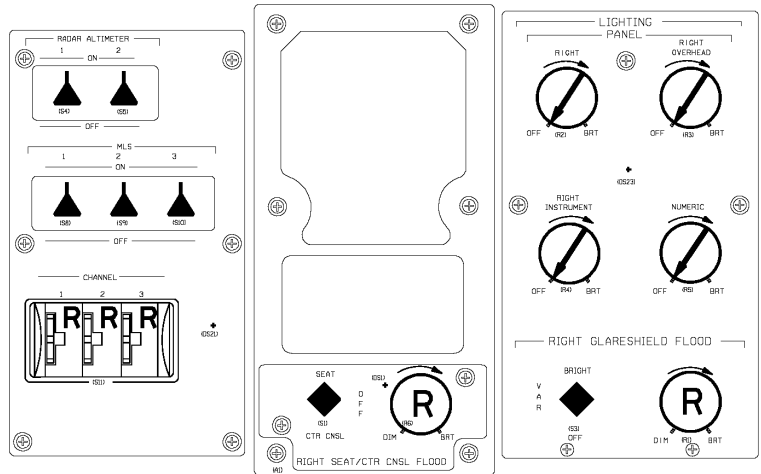

PNL 09

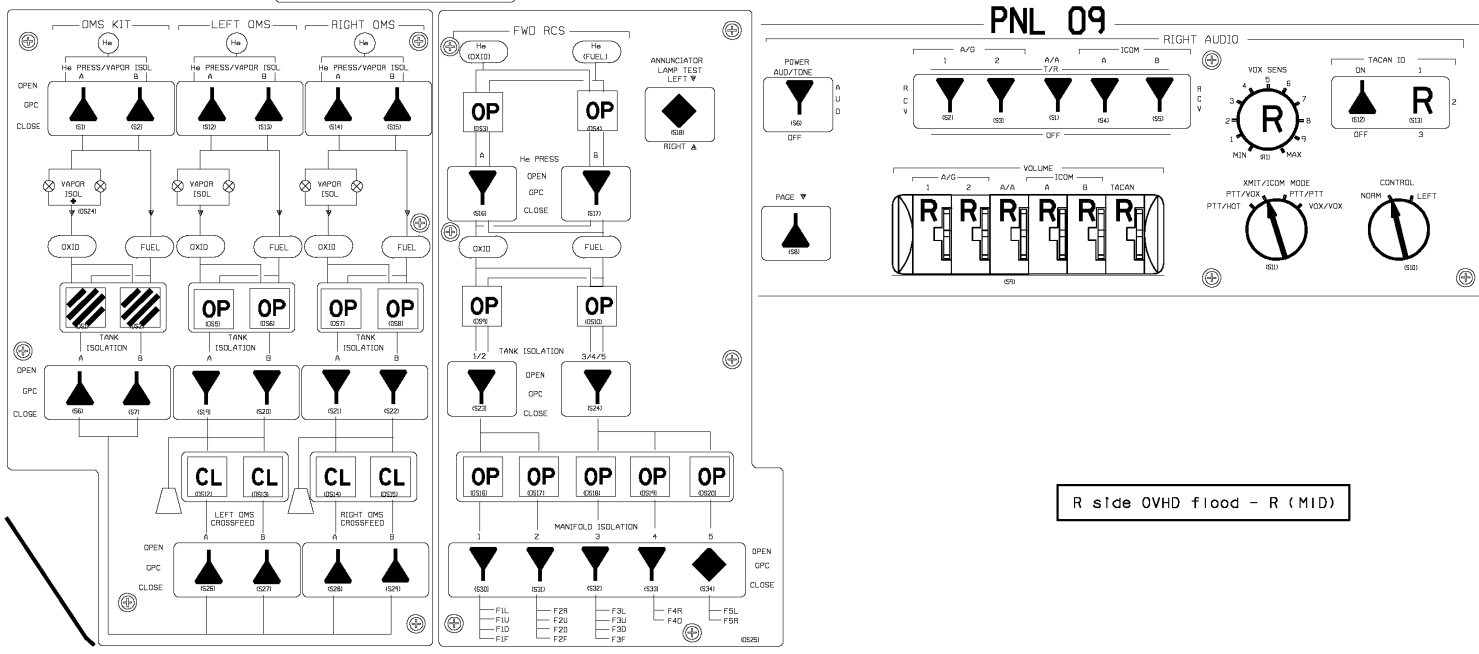

R side OVHD flood - R (MID)

OV105

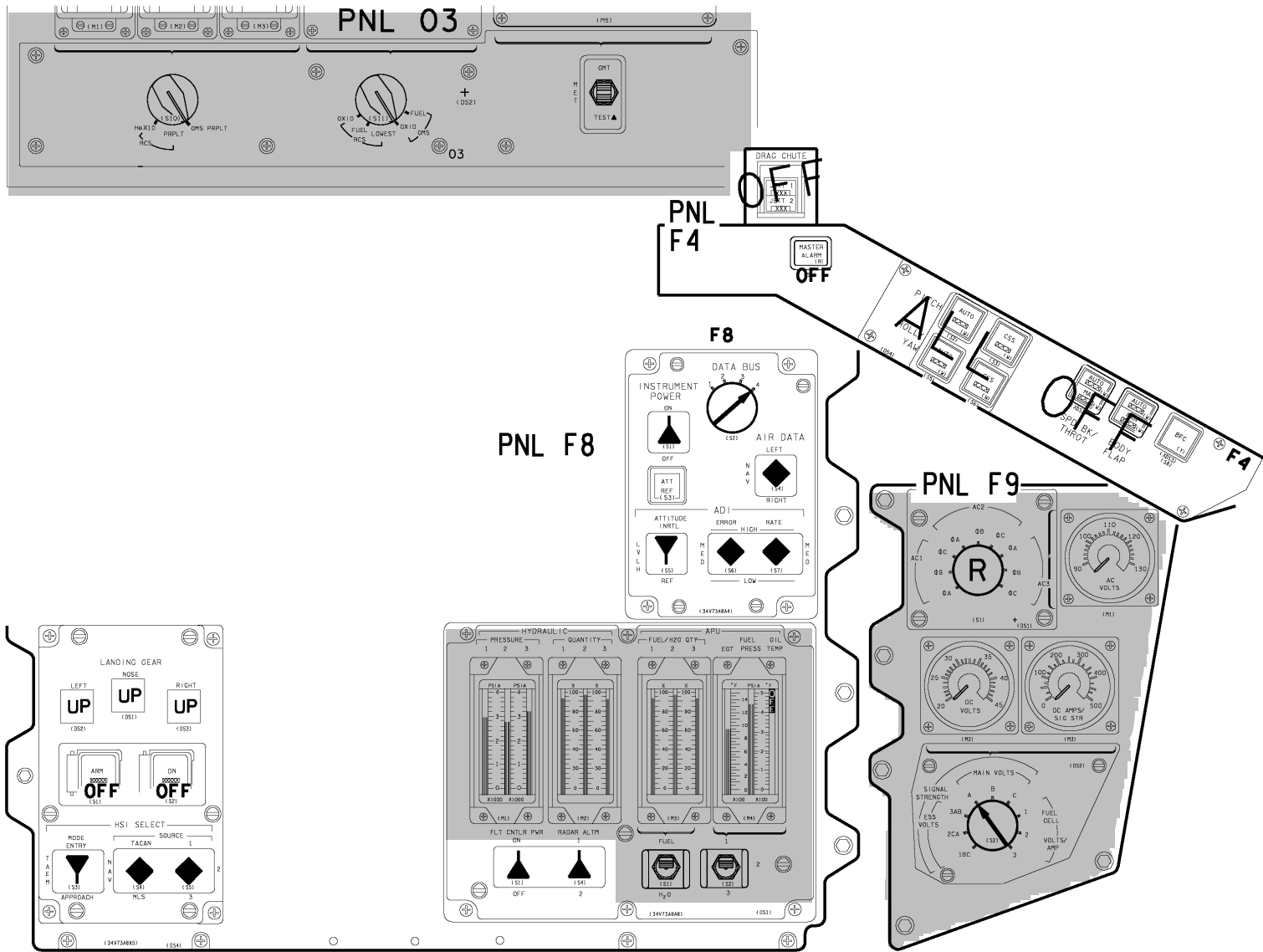

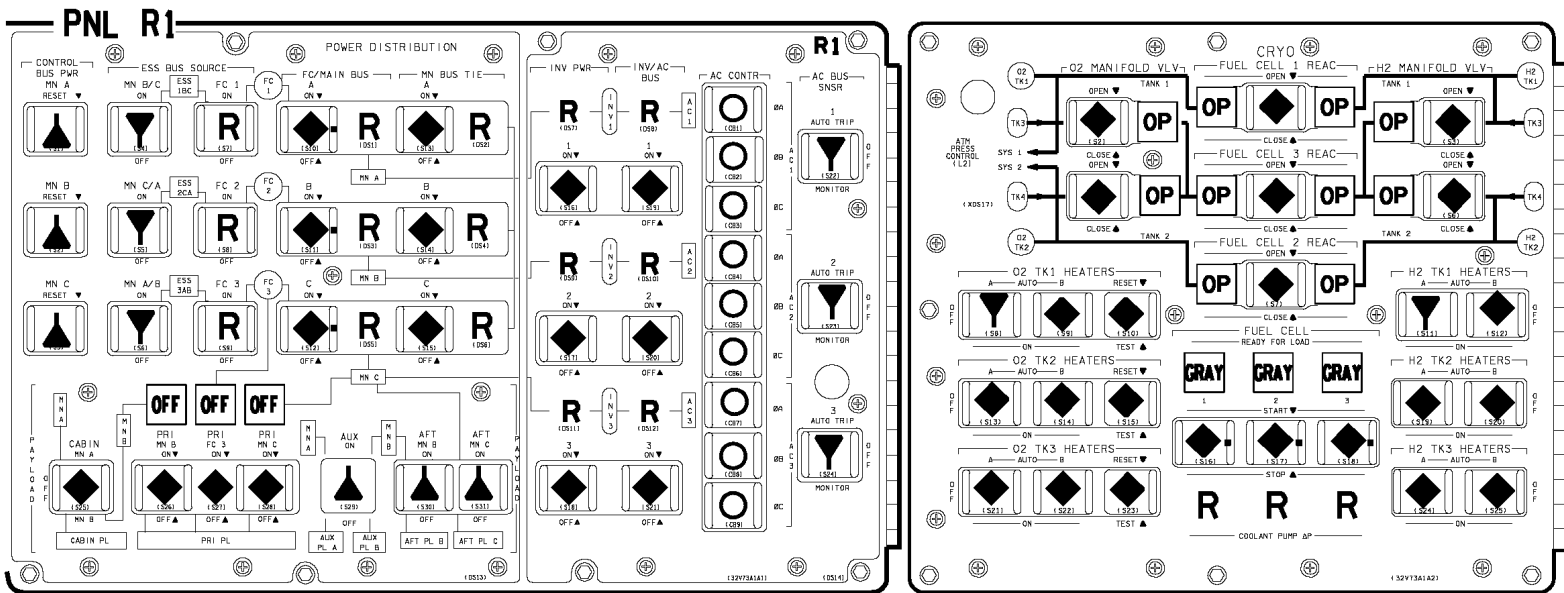

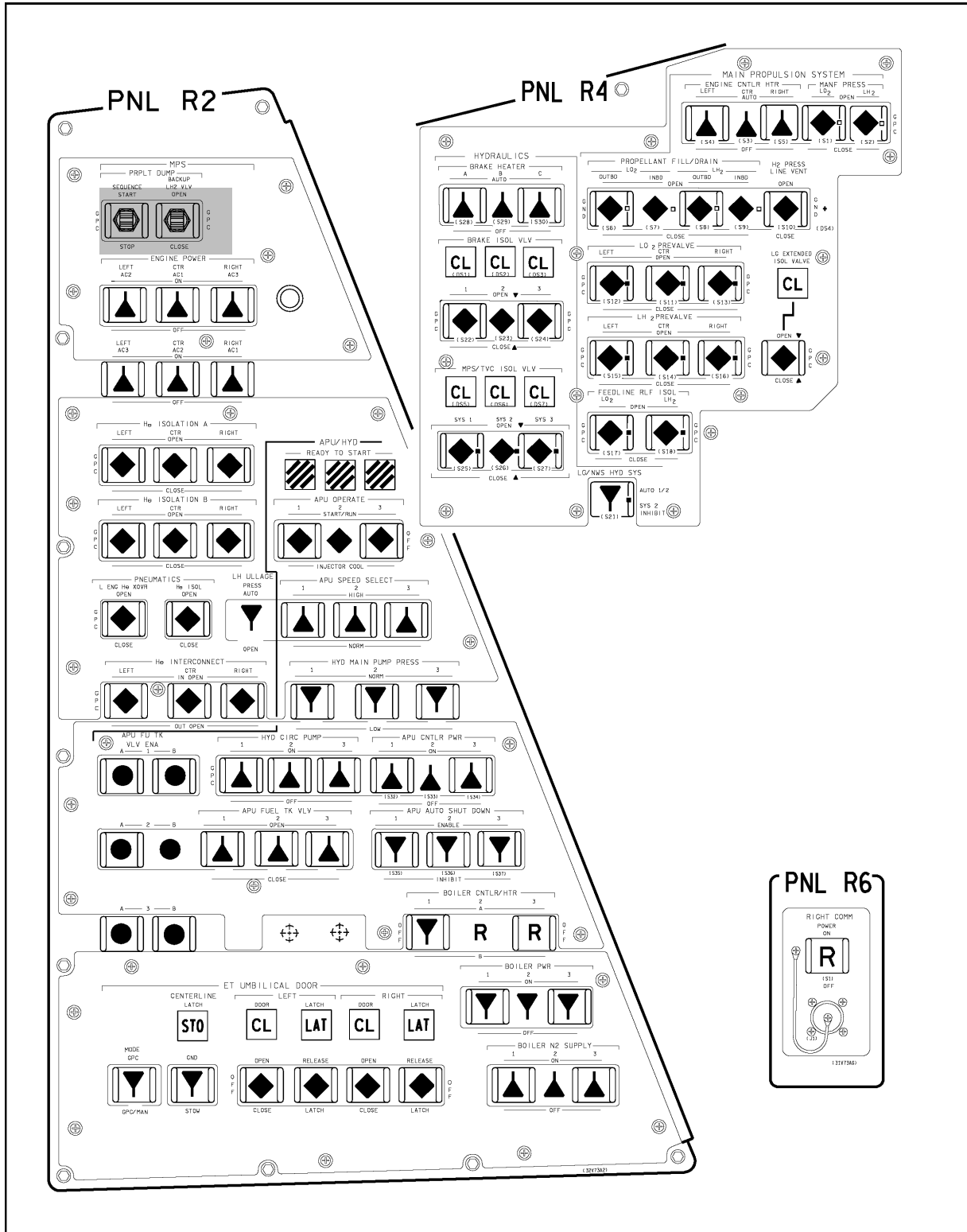

ALL VEH/DATE 03/21/00

480070615_101_PNL1

OV105

(OV105) D6-15

C D/O/ALL/GEN H

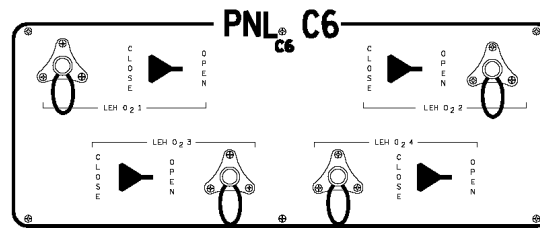
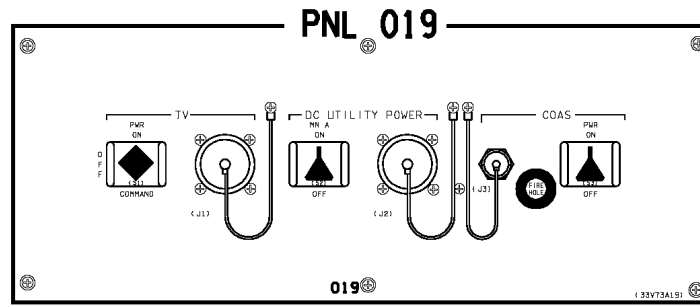

PNL C5

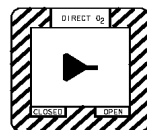

PNL C7

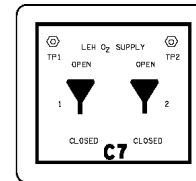

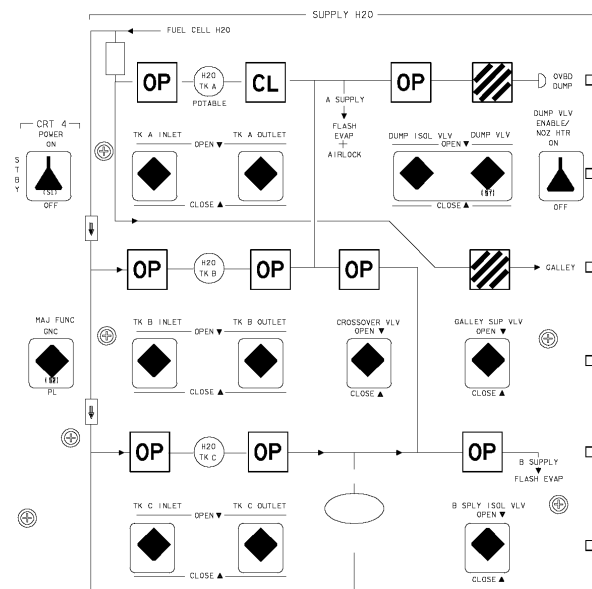
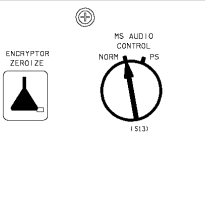
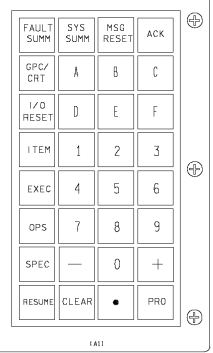
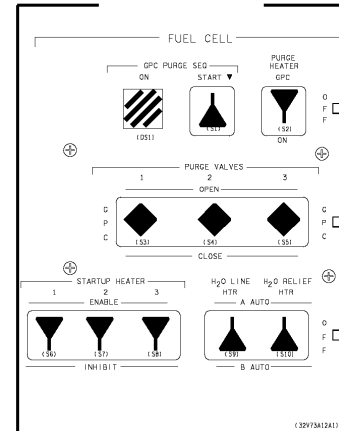
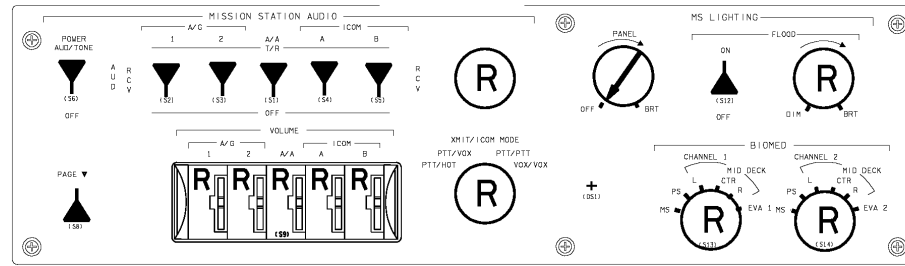

OV105

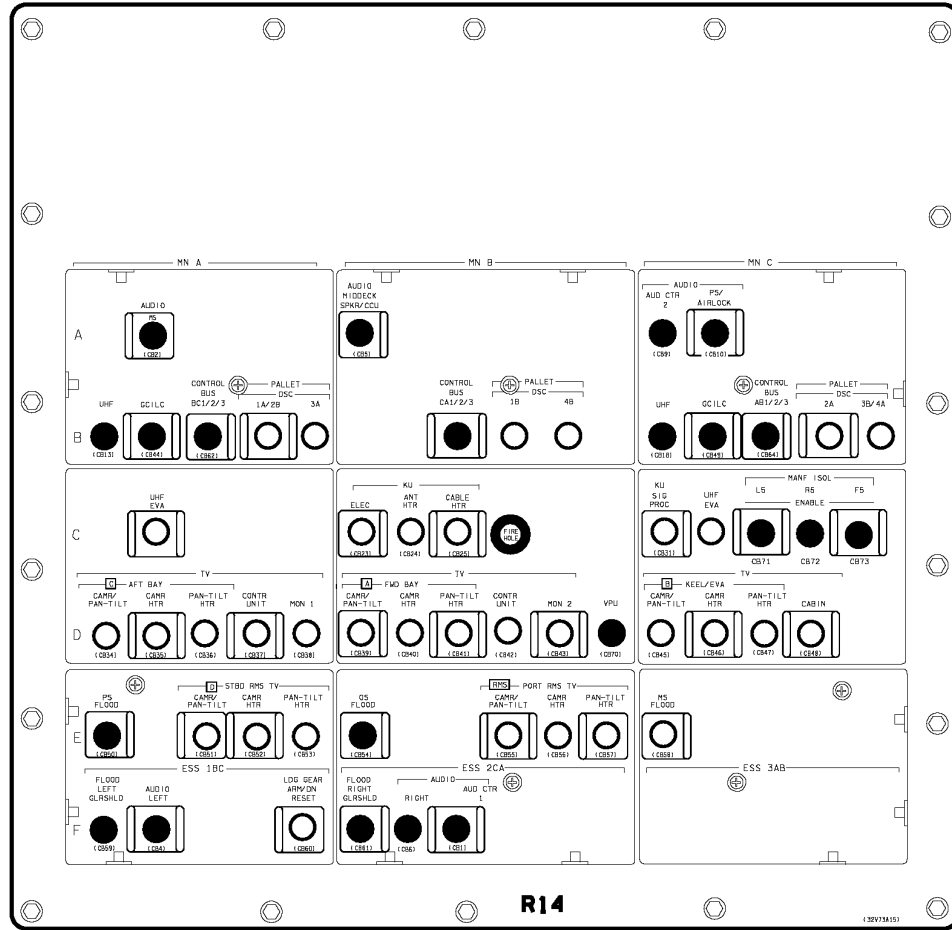
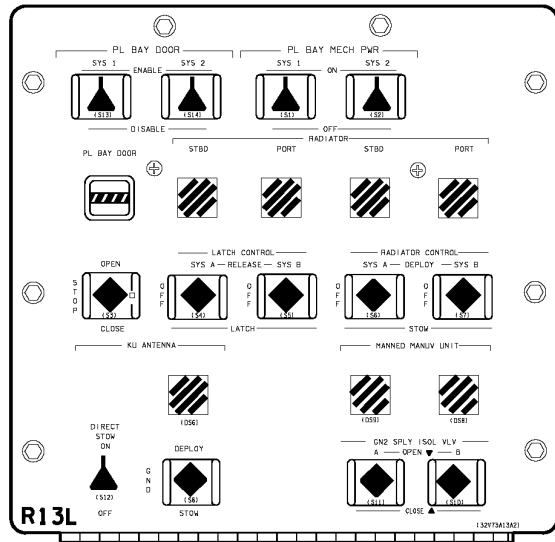
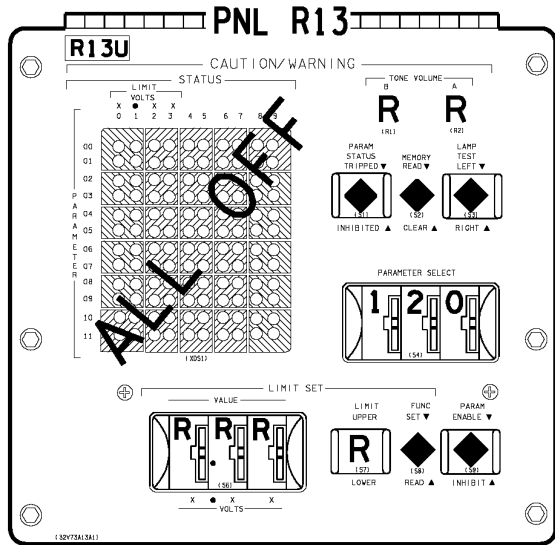

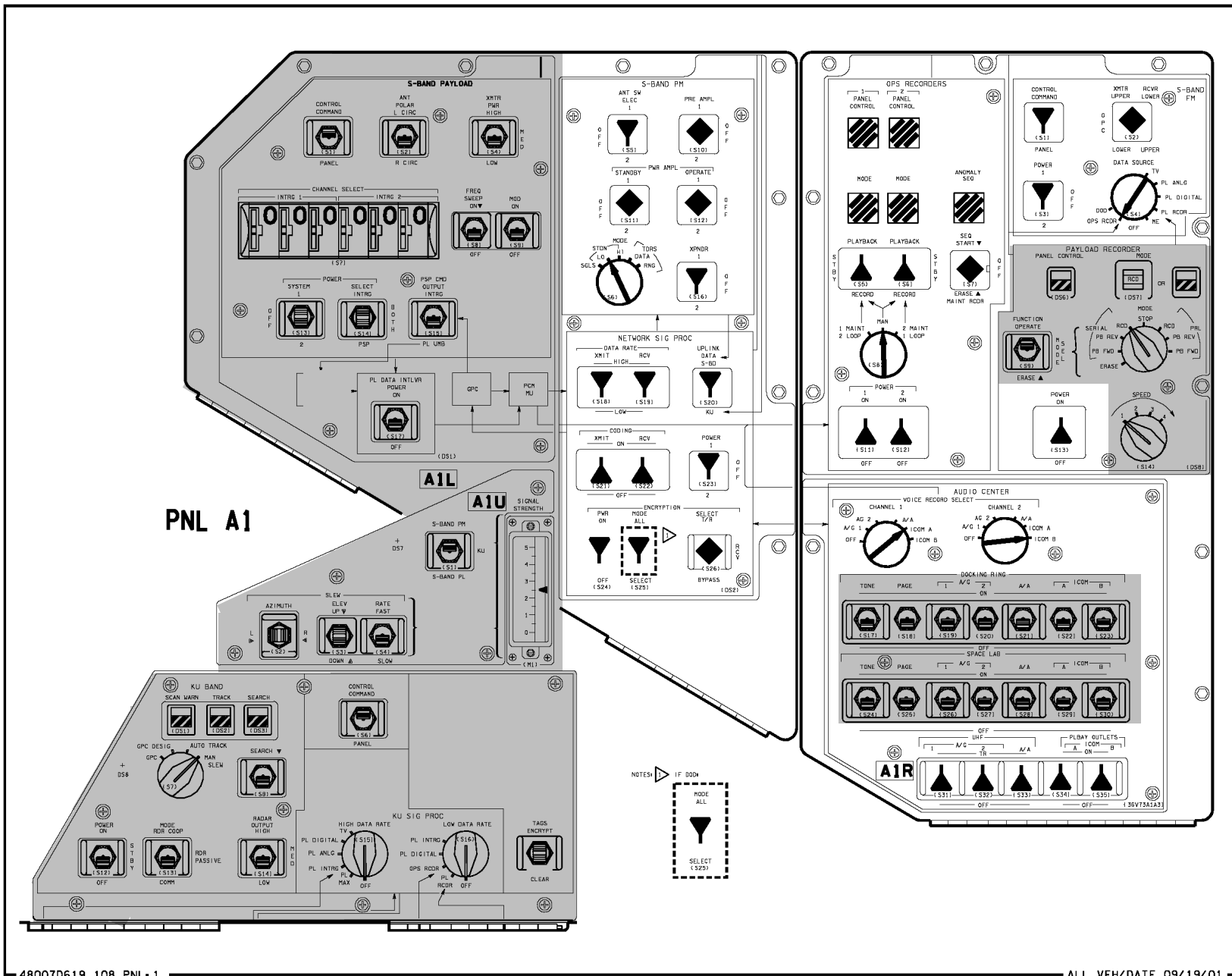

OV105

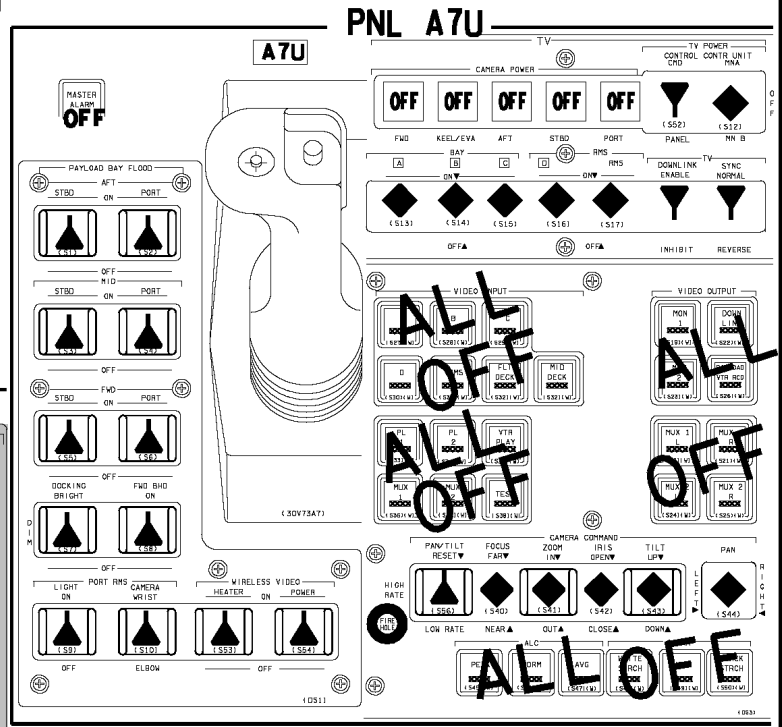
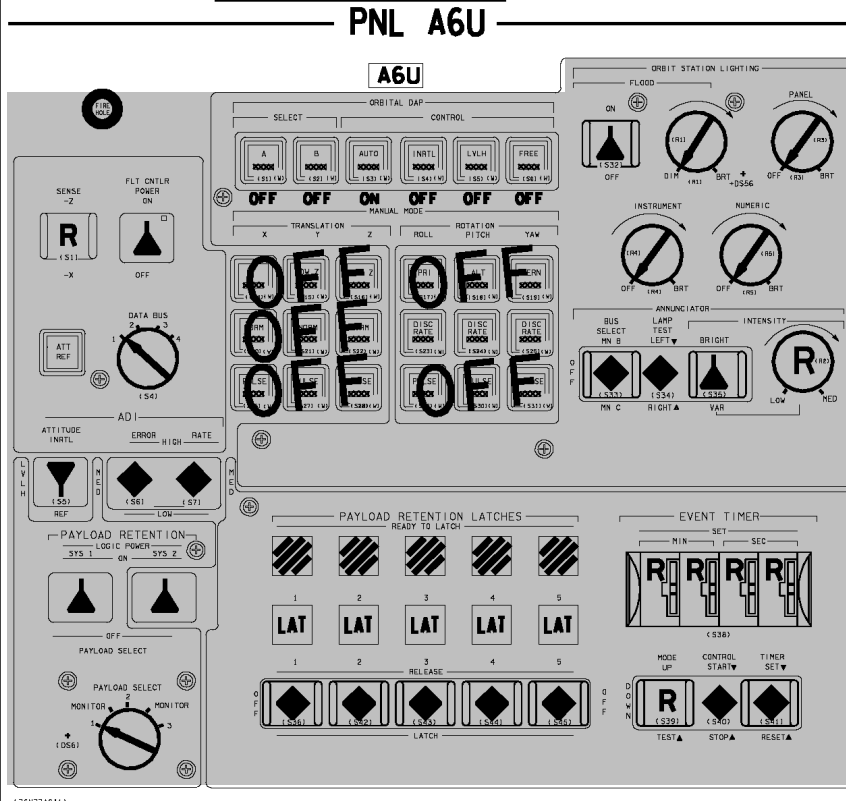
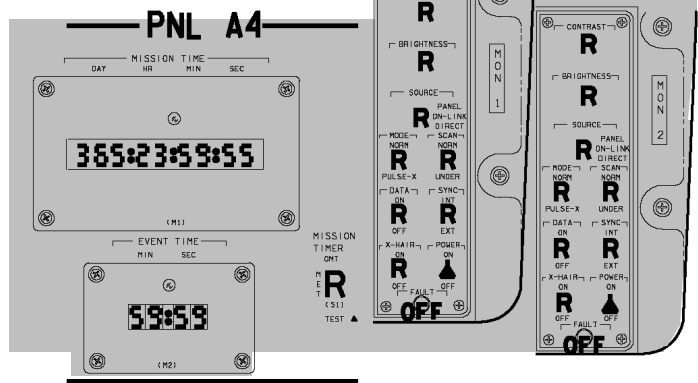

48007D624_104, PNL 1 1

(OV105) D6-20

OV105/DATE 04/11/01

OV105 | C D/O/5/GEN H,5

A6L

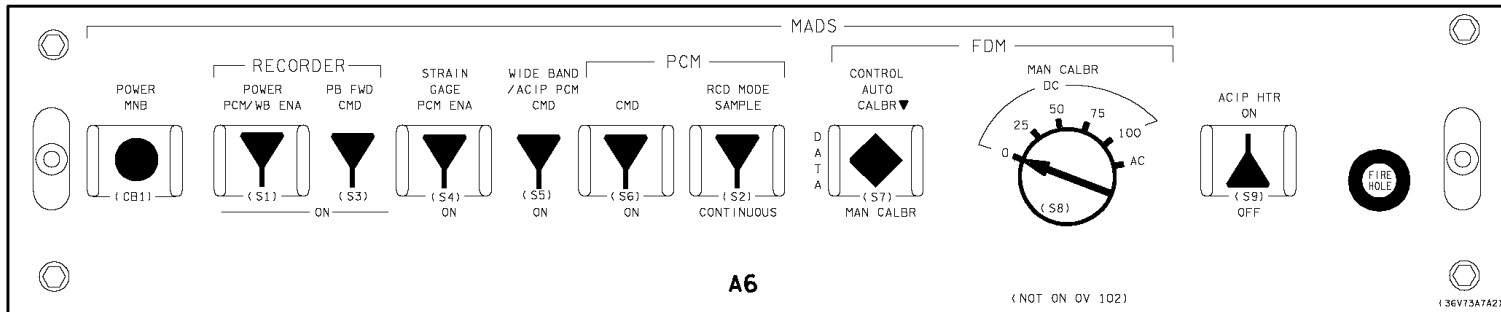
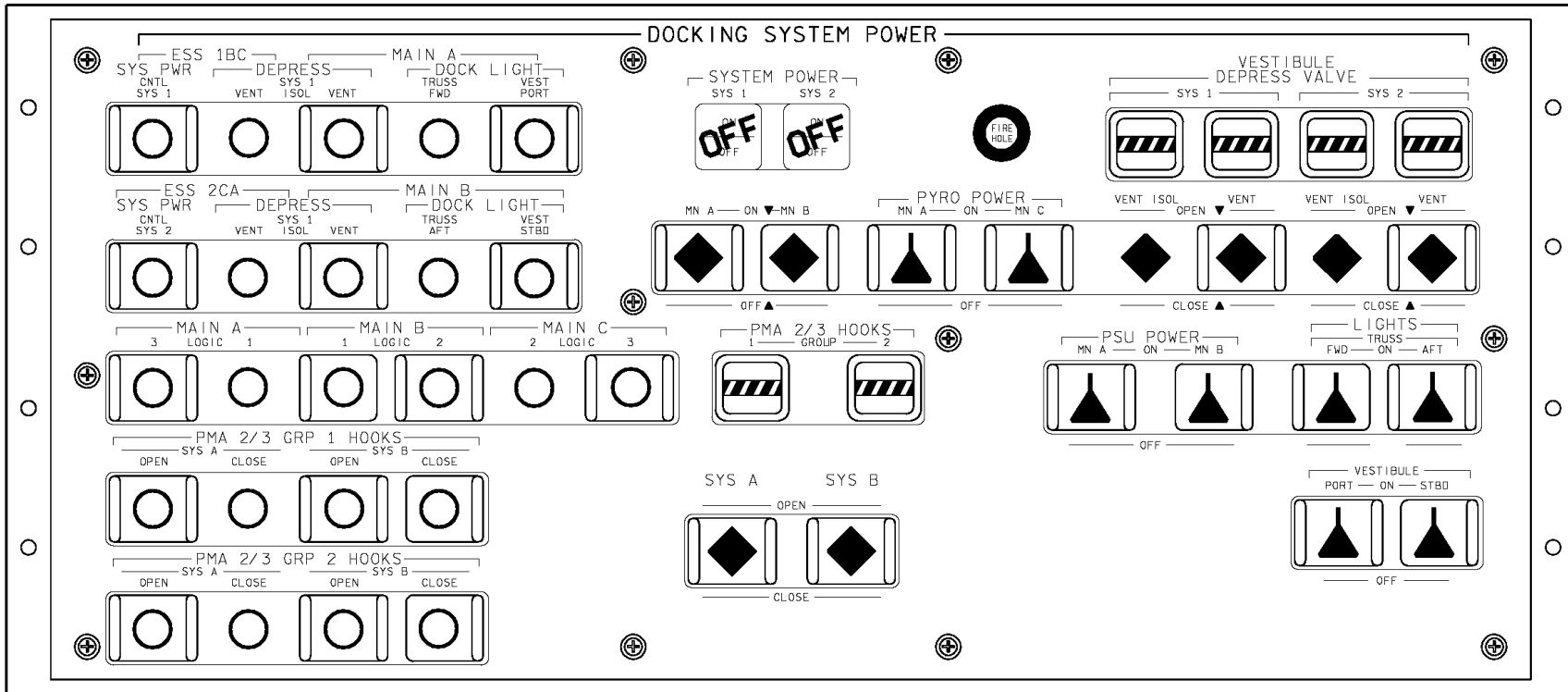

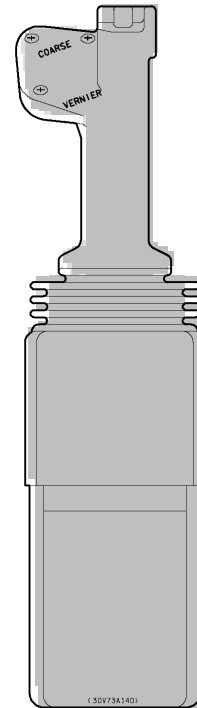
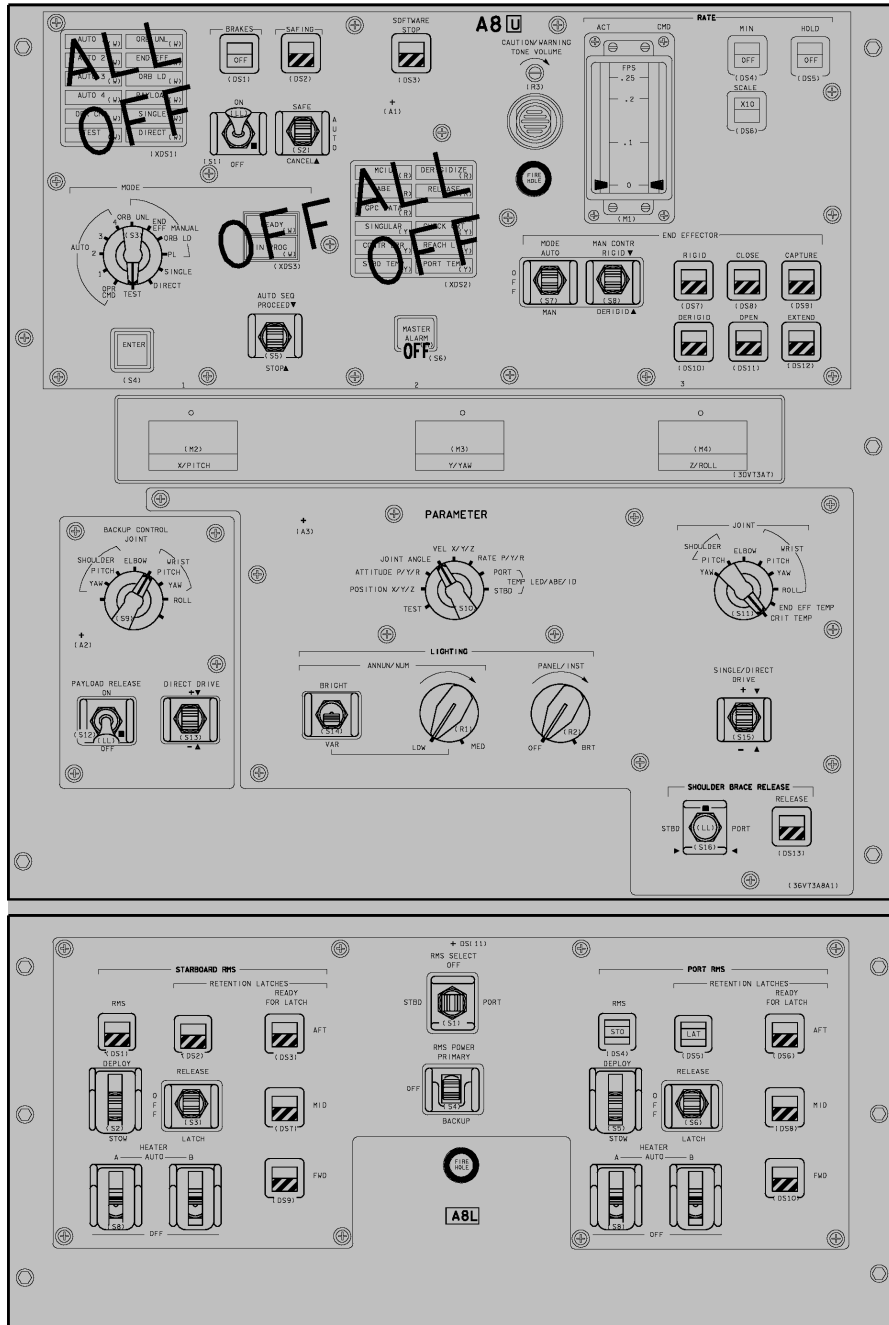

480070623_101_PNL 1 ALL VEH/DATE 03/21/00

OV105

PNL A11

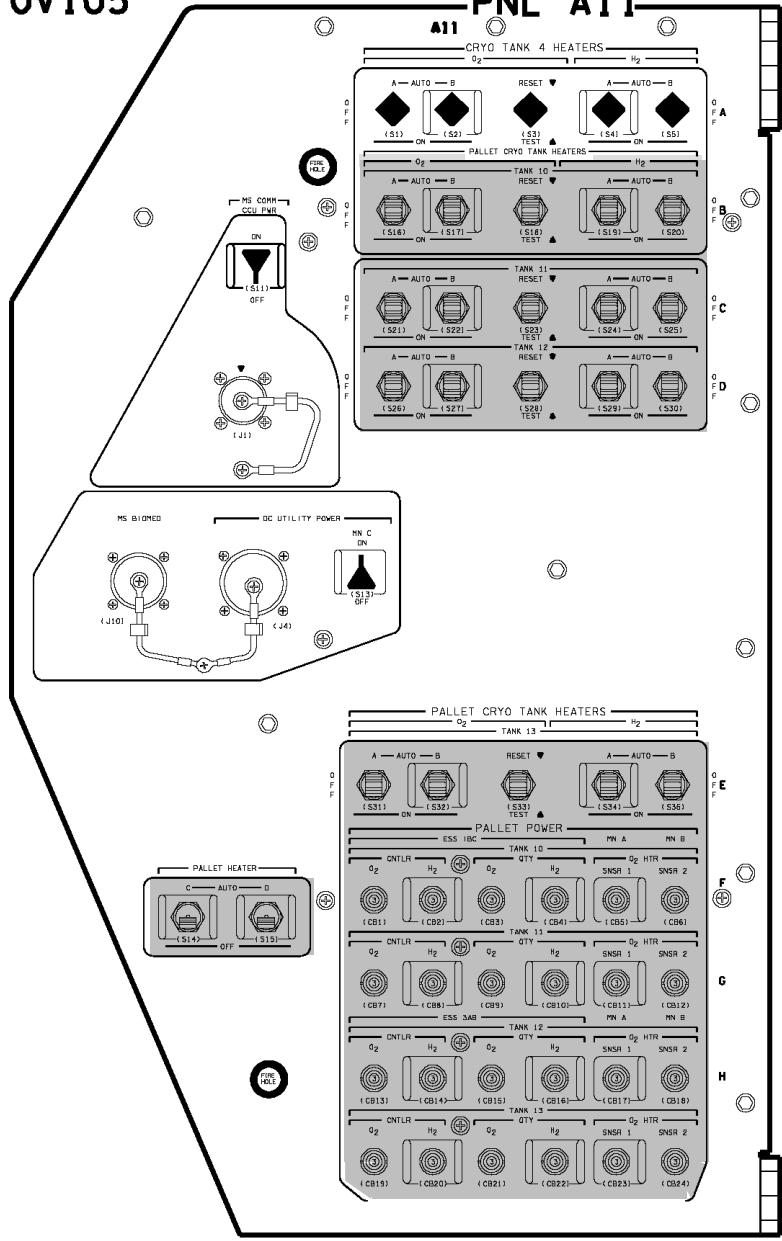

PNL A12

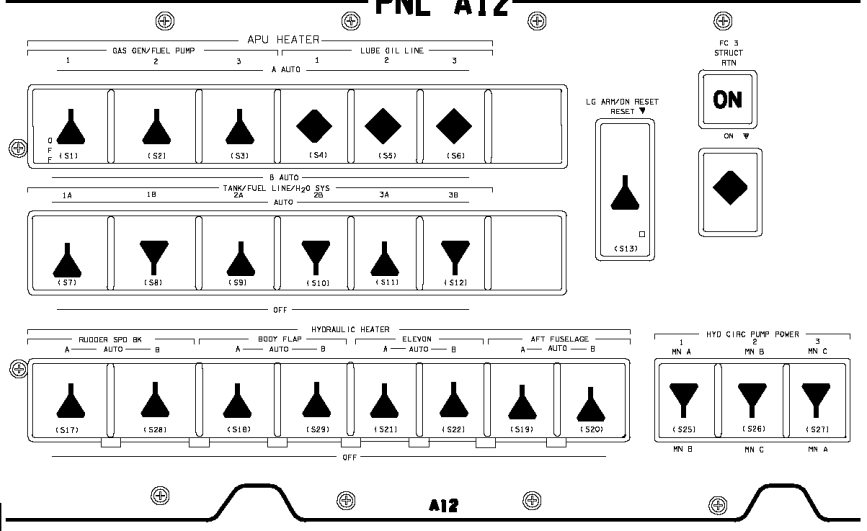

OV105

48007D628_100. PNL, 1

(OV105) D6-24

OV105/DATE 02/09/01

C D/O/5/GEN H,1

OV105

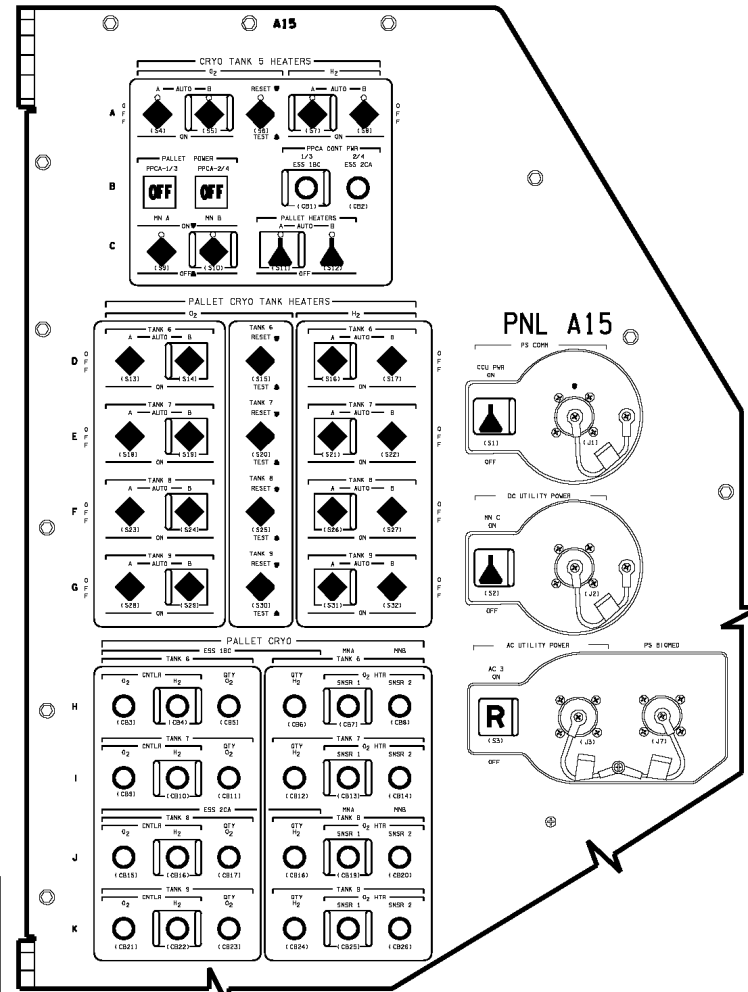
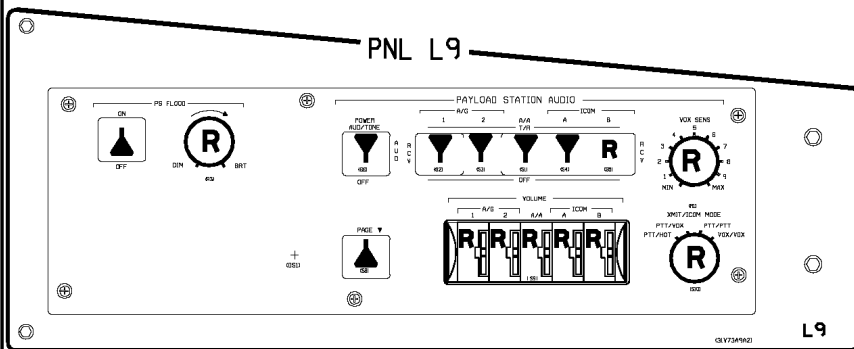
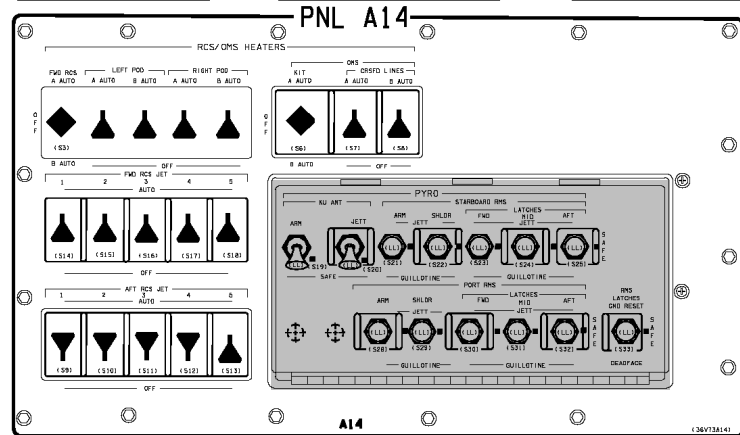
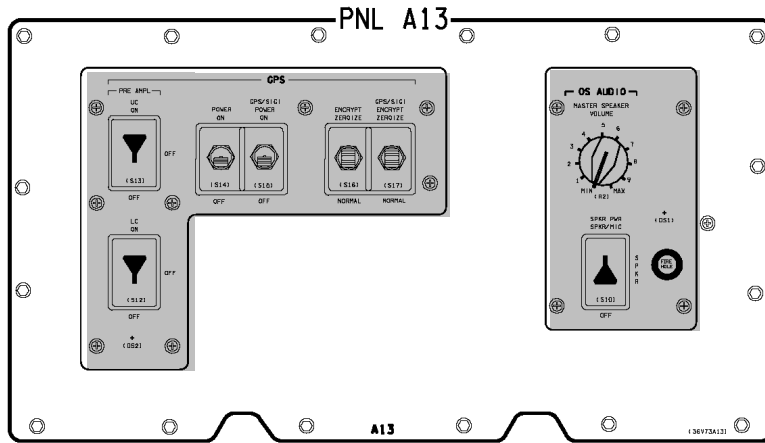

480070629_100, PNL, 2

(OV105) D6-25

OV105/DATE 03/08/01

C D/O/5/GEN H,1

OV105

OV105

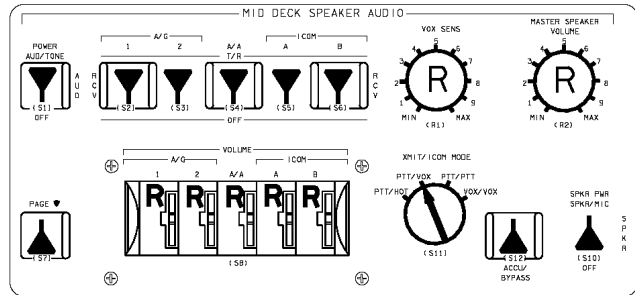

PNL M042F

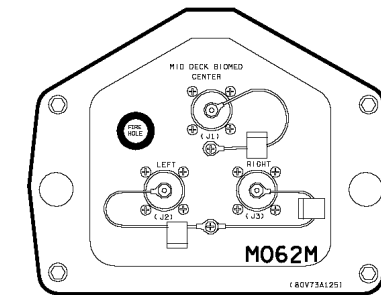
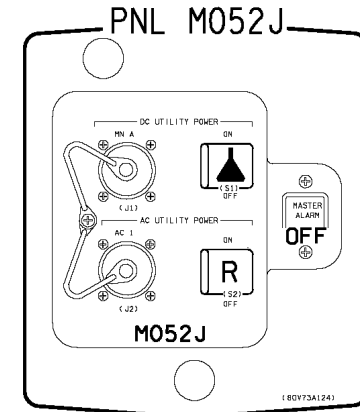
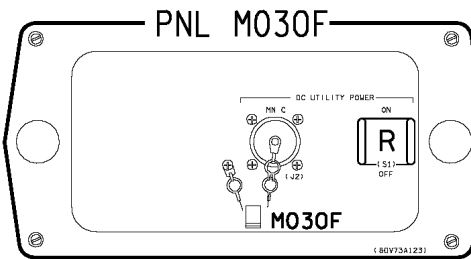
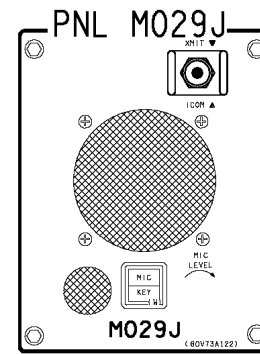
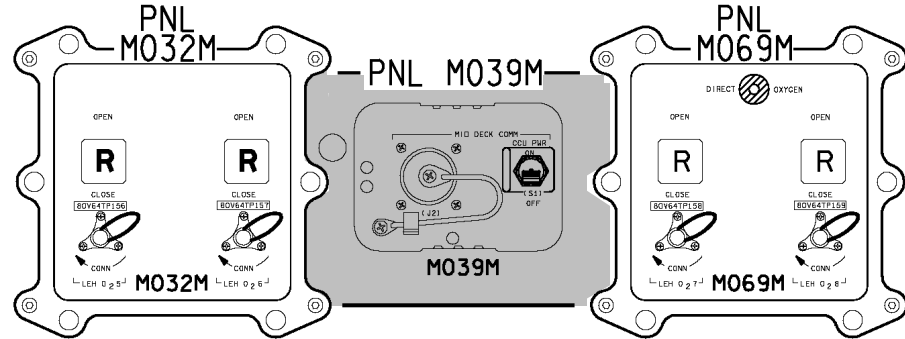
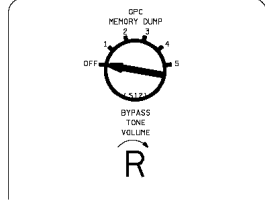

PNL M058F

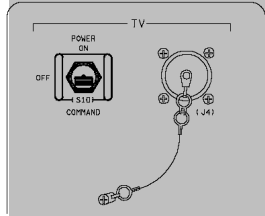
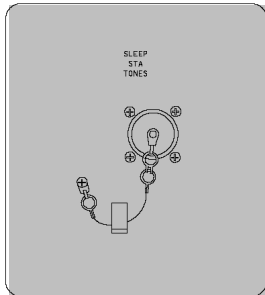

OV105

PNL MA73C

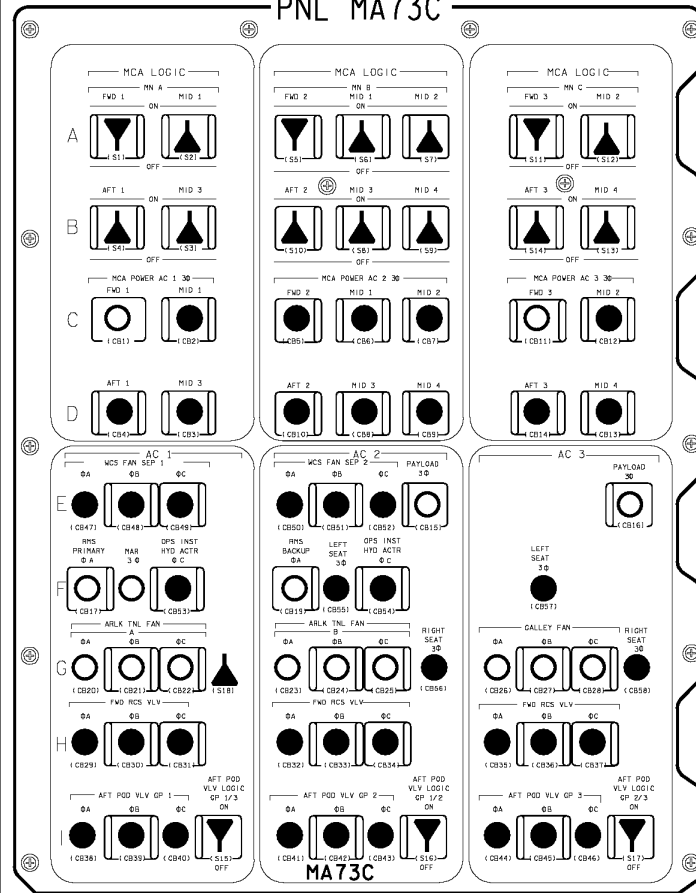

PNL ML86B

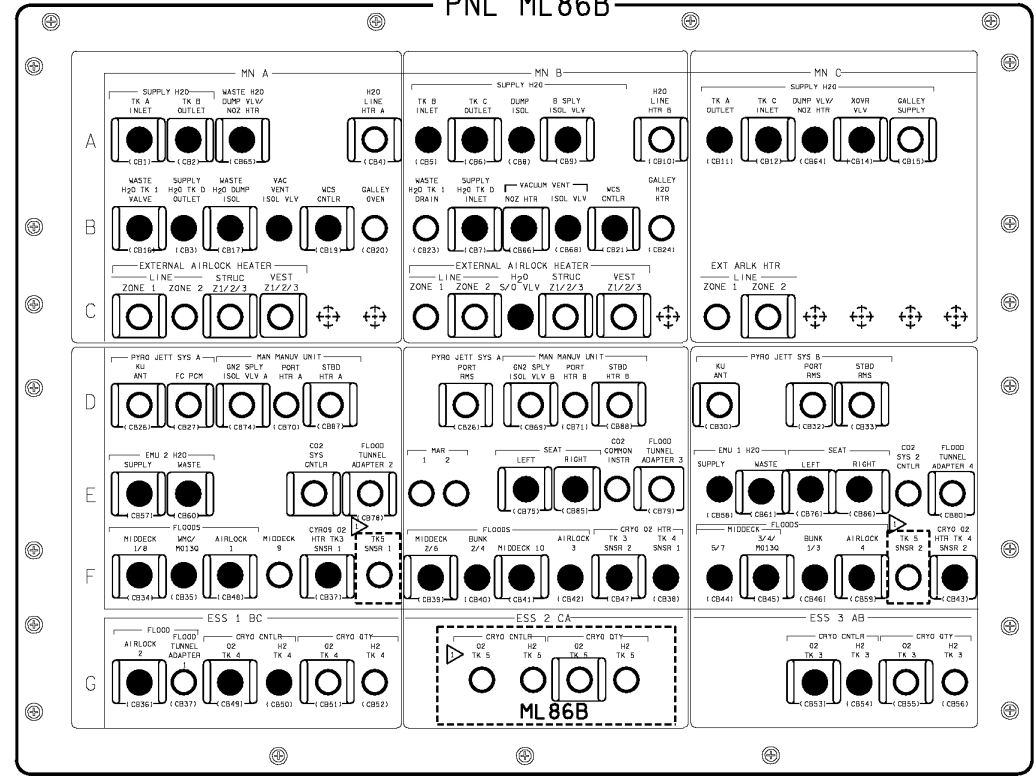

NOTES: CLOSED IF TK5 FLOWN

OV105

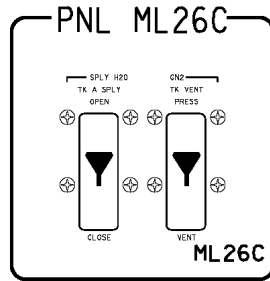
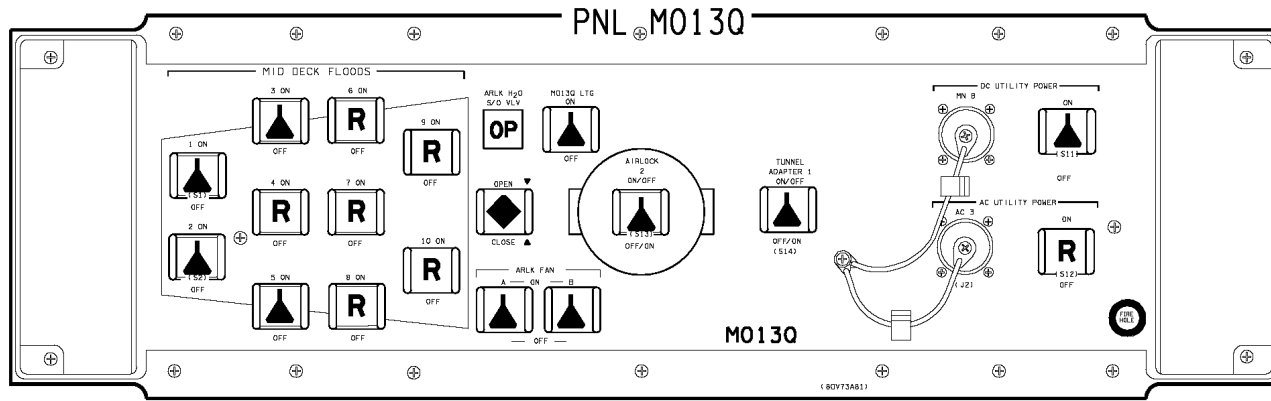

PNL MD24K

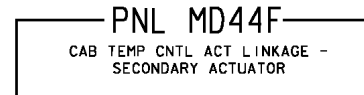
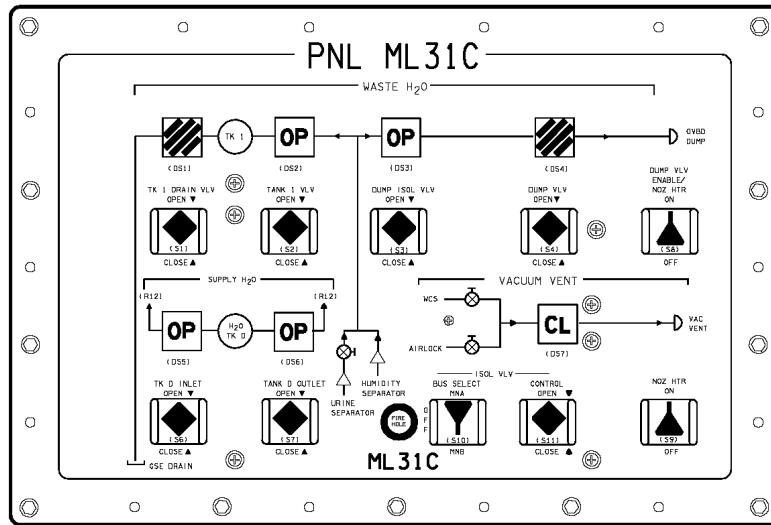
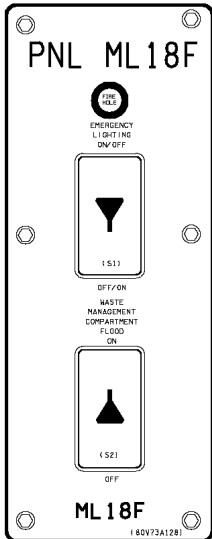
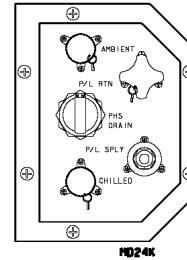

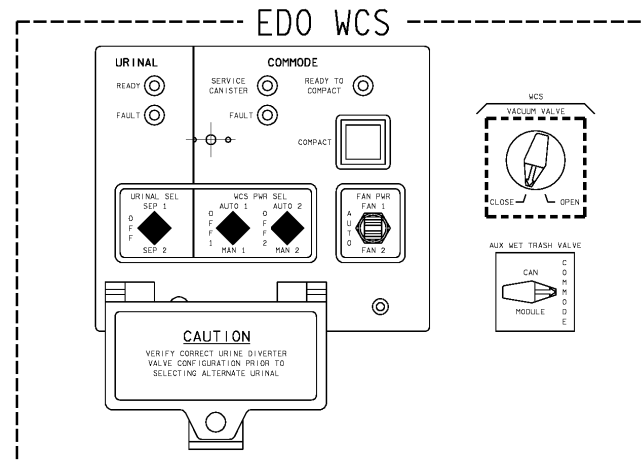
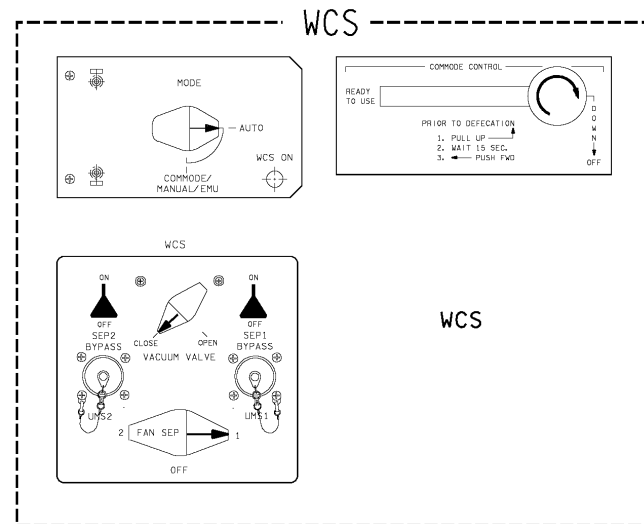
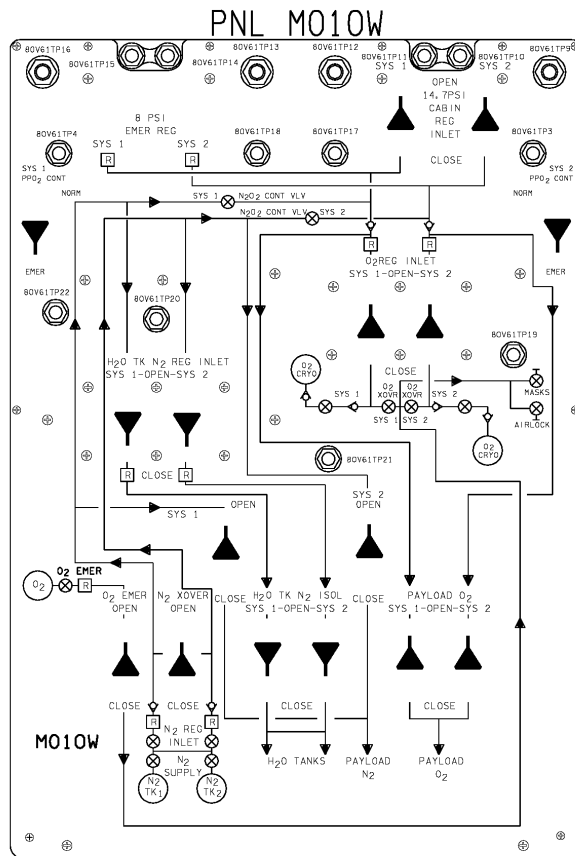

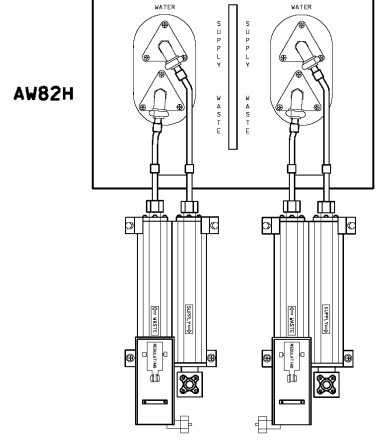
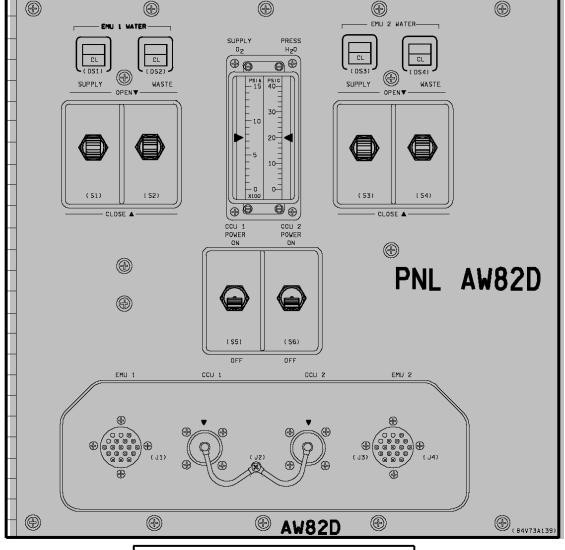
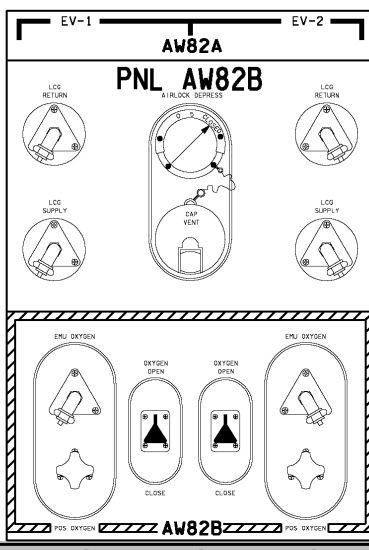
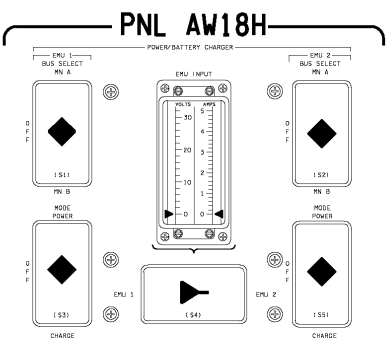
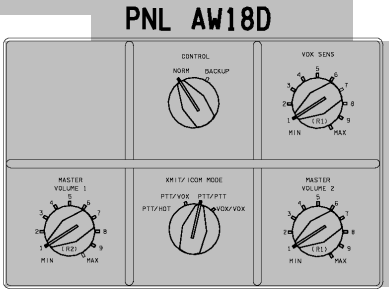
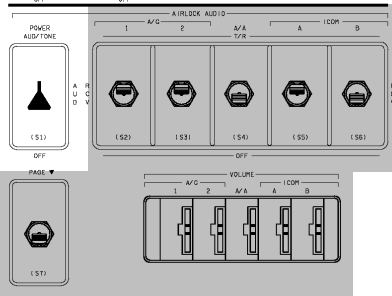
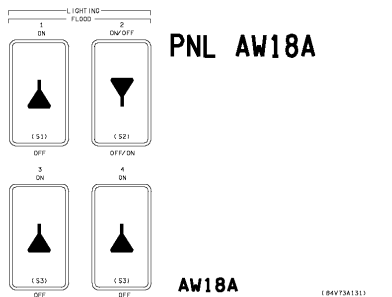

4800D630L101, PNL4 1 ALL VEH/DATE 03/21/00

Inner Hatch

Actuator Handle – LATCHED

Lock Lever – LOCKED

Equalization vlv (two) – NORM, capped

This Page Intentionally Blank

LOSS OF FES DEORBIT PREP

This Page Intentionally Blank

LOSS OF FES DEORBIT PREP

ASSUMPTIONS/INITIAL CONDITIONS

This procedure assumes EVAP OUT T HIGH (ORB PKT, ECLS) and LOSS OF FES (ORB PKT, PWRDN) have been performed

If failure occurs after Deorbit Prep entered, compare timeline, beginning at TIG-4 hr, with activities previously accomplished for misconfigurations

PROBLEM DESCRIPTION/RATIONALE

Immediate deorbit not mandatory if both Freon Loops operating and radiator flow has been established

Heat removal capability of radiators allows for normal on-orbit power levels without thermal problems. However, for Deorbit Prep, to allow some coldsoak of the radiators and vehicle, power levels must be limited

NOTE

A near normal deorbit prep and entry performed except that:

1. Nav and landing aids powered when needed during entry
2. Limited use of IDPs, MDUs, Flt Cntrlr Pwr, PGSC, lighting
3. GPC entry configuration and OPS 3 transition delayed to TIG-45 min to delay full GPC powerup
4. MS continues deorbit prep activities until TIG. CDR/PLT go to ENT at TIG-30
5. Door closure delayed to TIG-10 min
6. Radiator coldsoak attitude (tail sun) maintained until TIG-15 min except for IMU align attitude
7. Ammonia boiler activated at EI
8. HYD circ pump operated for additional cooling

LOSS OF FES DEORBIT PREP OVERVIEW OF CONFIGURATION MANAGEMENT

	OPS 1 ASC C/L					OPS 2 ON-ORBIT					OPS 2 DEORBIT PREP TIG -03:28					OPS 3 DEORBIT PREP TIG -0:45					TIG					EI-5	V = 15K
DPS																											
GPC	1	2	3	4	5	1	2	3	4	5	1	2	3	4	5	1	2	3	4	5	1	2	3	4	5		
OPS	G1	G1	G1	G1	BFS	G2	G2	G2	SM	BFS	G2	G2	G2	SM	BFS	G3	G3	G3	G3	BFS	G3	G3	G3	G3	BFS		
POWER	ON	ON	ON	ON	ON	ON	ON	ON	ON	ON	ON	ON	ON	ON	ON	ON	ON	ON	ON	ON	ON	ON	ON	ON	ON		
OUTPUT	N	N	N	N	B	N	N	N	T	N	N	N	N	T	N	N	N	N	N	B	N	N	N	N	B		
MODE	R	R	R	R	R	R	R	H	R	H	R	R	H	R	S	R	R	R	R	R	R	R	R	R	R		
CONFIG	1					2					2					3					3						
GPC	1	2	3	4	0	1	2	0	0	0	1	2	0	0	0	1	2	3	4	0	1	2	3	4	0		
STR	1	1				1				0	1				0	1				0	1				0		
	2	2				2				0	2				0	2				0	2				0		
	3	3				1				0	1				0	3				0	3				0		
	4	4				2				0	2				0	4				0	4				0		
PL	1/2	1				0				4	0				4	1				0	1				0		
CRT	1	1				1				4	1				4	1				0	1				0		
	2	2				2				4	2				4	2				0	2				0		
	3	3				0				0	0				0	3				0	3				0		
	4	0				2				4	2				4	0				0	0				0		
L	1	1				0				4	0				4	0				0	0				0		
	2	2				0				0	0				0	0				0	0				0		
MM	1	1				1				4	1				4	1				0	1				0		
	2	2				2				4	2				4	2				0	2				0		
MDM	ALL ON					ALL ON					ALL ON					ALL ON											
D & C	DDU MDU IDP	L,R All Forward ALL				L,A Minimize use					Minimize use					Minimize use											
E C L S	AV BAY FAN CABIN FAN IMU FAN WATER LP FREON LP RADIATOR	1-B,2-A,3-B A B 1-OFF, 2-ON 1-B,2-B STOWED				1-GPC,2-ON					1-OFF, 2-ON					STOW						1,2 ON					
F C S / N A S O R S A I D S	FCS ASA AA RGA ADTA IMU RA TACAN UHF MLS	AUTO ALL ON ALL ON ALL ON ALL ON ALL ON ALL ON ALL GPC ON ALL OFF				OFF					ALL ON					ALL ON						ON GPC ON					
R J D	RJDA RJDF VERNIER	ALL ON ALL ON OFF				ON					OFF					OFF											

MEDS

LOSS OF FES DEORBIT PREP

MCC	CDR	PLT	MS(AFT)	MS(MID)
TIG				
-04:00	SUPPLY H2O DUMP	CRT TIMER SETUP	SUPPLY H2O DUMP	
				FLUID LOADING PREP
	DPS CONFIG FOR D/O			
-03:00	AUTO MNVR TO IMU ATT	KU-BD ANT STOW		
	IMU ALIGNMENT			ENT STOWAGE
	PRE D/O UPDATE/UPLINK	HYD THERM COND		
	MNVR TAIL TO SUN	APU STEAM VENT HTR	SEAT INSTALLATION	SEAT INSTALLATION
-02:00	DEACT STAR TRKRS, CLOSE DOORS	DEACT STAR TRKRS, CLOSE DOORS		
	ENT FWD FLT DECK CONFIG	ENT FWD FLT DECK CONFIG	ENT AFT FLT DECK CONFIG	ENT MIDDECK CONFIG
			RESET C/W	
	P&I TO ENTRY C/L	P&I TO ENTRY C/L		
	CLOTHING CONFIG	CLOTHING CONFIG	N2 QTY COMP	
-01:00	BEGIN FLUID LOADING	BEGIN FLUID LOADING	BEGIN FLUID LOADING	BEGIN FLUID LOADING
	SEAT INGRESS HUD SETUP ADJUST SEAT	SEAT INGRESS HUD SETUP ADJUST SEAT	WIRELESS STOW	WCS DEACT
GO FOR OPS 3 TRANSITION	DED DISPLAY ENT CONFIG DPS ENTRY CONFIG	RCS ENTRY CONFIG DED DISP ENT CONFIG DPS ENTRY CONFIG	STOW RADIATORS CONFIG FOR PLBD CLOSURE EMERG. PLBD CLOSURE POST CLOSING CONFIG CLOTHING CONFIG SEAT INGRESS	CLOTHING CONFIG SEAT INGRESS
	STOW ORB PKT ENT, <u>DEORBIT BURN</u>	STOW ORB PKT ENT, <u>DEORBIT BURN</u>		
00:00	DEORBIT BURN			

MEDS

TIG

-04:00

A1(B1)
AUTO
VERN
RT 0.2
DB 1.0

P TIMER SETUP 1
L1 ✓ DAP: A1/AUTO/VERN
 ✓ DAP B set to B1

-03:55

C,MS SUPPLY WATER DUMP (ORB OPS, ECLS)
 If no MCC, dump TK B to 50%

-03:50

MS FLUID LOADING PREP MS MID ACTIVITIES 2, 7-19

-03:45

-03:40

-03:35

-03:30

TIMER SETUP 1

1: GNC 2 TIME

SET CRT TIMER TO COUNT DOWN TO TIG (perform for GNC and SM)

ENTRY DAY (HR:MIN:SEC - MET)

ITEM 17 +

		+			+		
--	--	---	--	--	---	--	--

24 HOUR LATE DELAYED DEORBIT

ITEM 17 +

		+			+		
--	--	---	--	--	---	--	--

1: GNC UNIV PTG

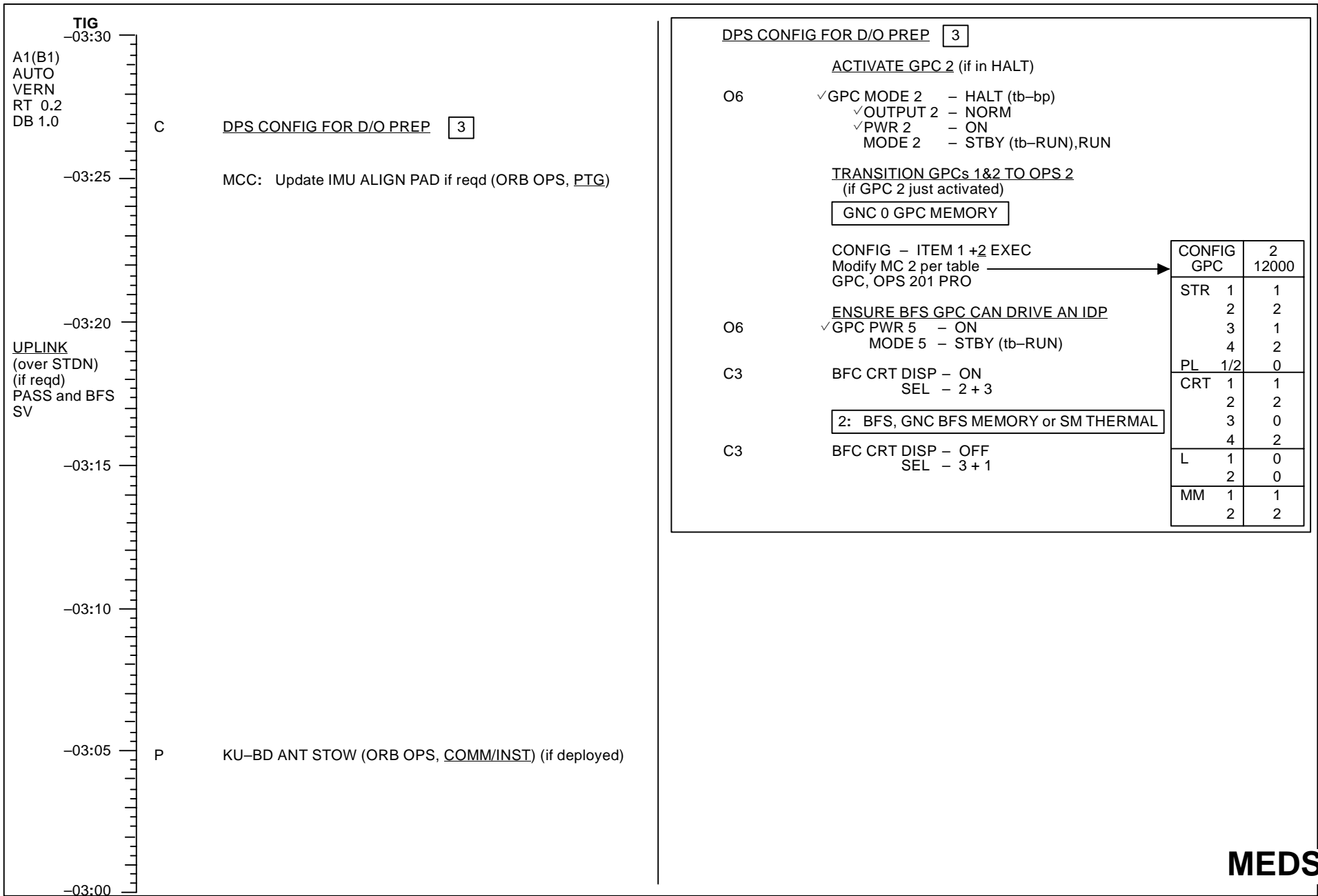

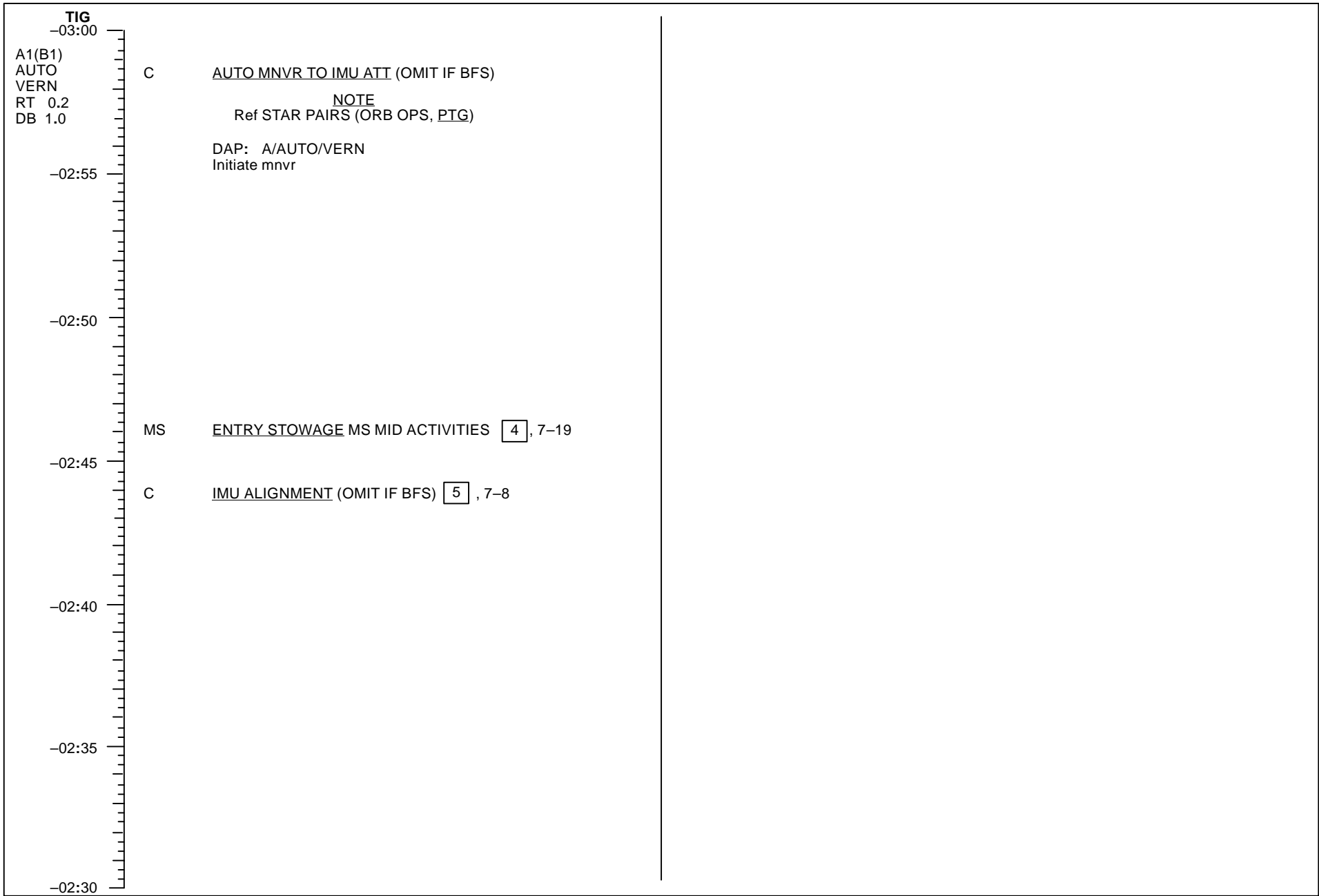

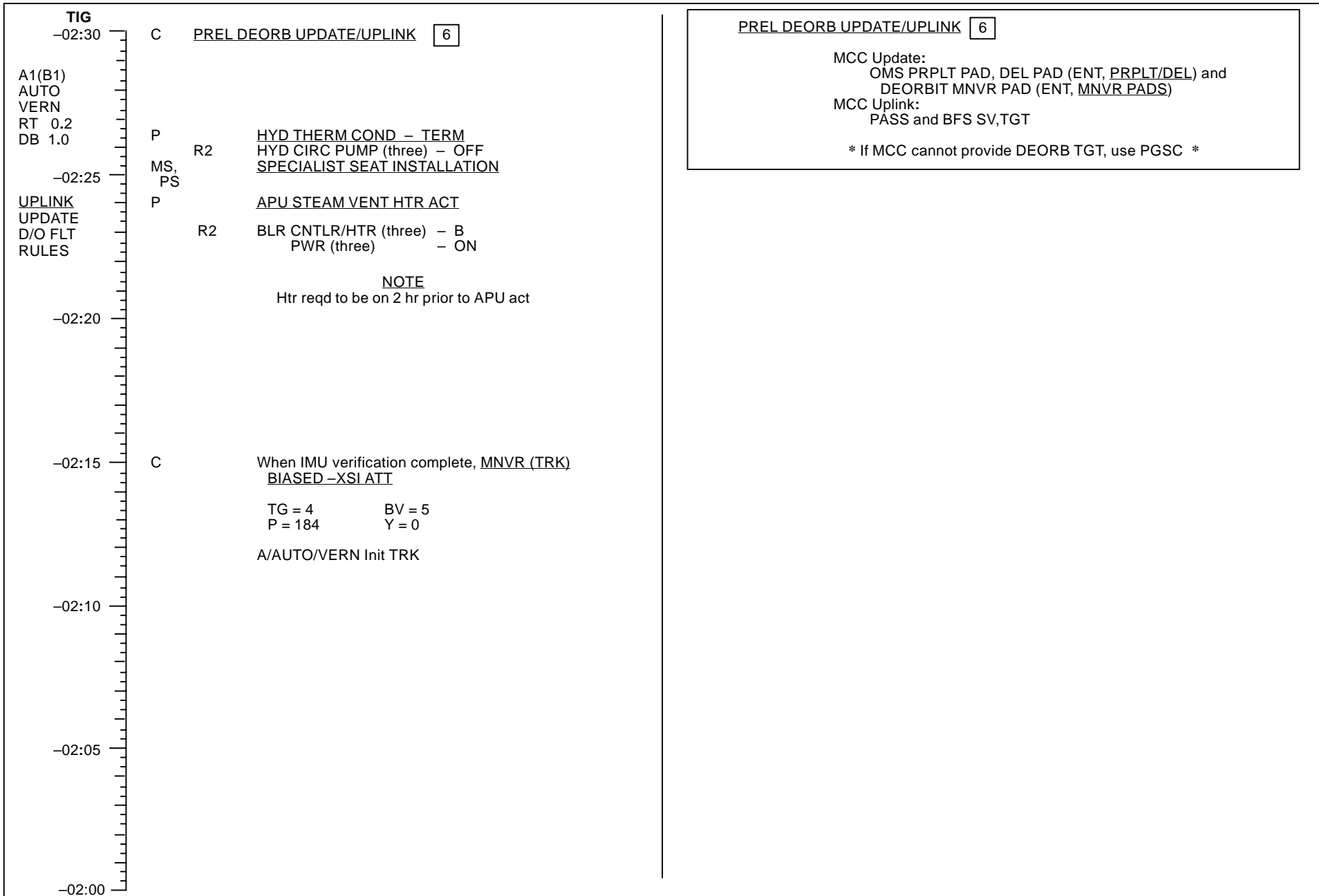

0	TIG		
-02:00	C,P	<u>DEACT STAR TRKRS & CLOSE DOORS</u> [7]	
A1(B1)			
AUTO			
VERN			
RT 0.2			
DB 1.0			
-01:55	C,P	<u>ENT FWD FLT DECK CONFIG</u> [8]	
	MS	<u>ENT AFT FLT DECK CONFIG</u>	
		MS AFT ACTIVITIES [9], 7-17	
	MS	<u>ENT MIDDECK CONFIG</u> MS MID ACTIVITIES [10], 7-20	
-01:50			
<u>UPLINK</u>			
<u>TMBU</u>			
-01:45			
-01:40			
	MS	<u>C/W RESET MS AFT ACTIVITIES</u> [11], 7-17	
-01:35			
-01:30			

DEACT STAR TRKRS & CLOSE DOORS [7]

O6 S TRK PWR (two) - OFF
O14:E, cb S TRK -Z,-Y (two) - op
O15:E
O6 S TRK DR CNTL SYS 1,2 (two) - CL (start timer)
✓ POS tb (two) - bp
When both tb - cl (-8-24 sec)
or either tb - bp > 24 sec:
S TRK DR CNTL SYS 1,2 (two) - OFF

* If tb - bp > 8 sec, ✓MCC *

ENT FWD FLT DECK CONFIG [8]

R4 HYD HTR CONFIG
HYD BRAKE HTR (three) - AUTO

L2 PCS/ARS CONFIG
✓ O2 SYS 1,2 SPLY (two) - OP (tb-OP)
✓ XOVR SYS 1,2 (two) - OP
✓ N2 SYS 1,2 SPLY (two) - OP (tb-OP)
✓ REG INLET (two) - OP (tb-OP)
O2/N2 CNTLR vlv SYS 1 - OP
2 - CL
C7 ✓ LEH O2 SPLY vlv (two) - OP

L4:J cb AC3 ΦA SIG CONDR HUM SEP - op
ΦB SIG CONDR IMU FAN - op

L2 RAD CONFIG
FREON ISOL MODE - OFF

O8 MLS CH/TACAN CH
✓ MLS CH tw (three) - see LAND SITE DATA
O7 ✓ TACAN MODE (three) - OFF
✓ ANT SEL (three) - AUTO

O5, ENT COMM
L,R AUD A/G 2 - T/R
O9 ICOM B - T/R
XMIT/ICOM MODE - PTT/VOX
O6 ✓ UHF SPLX/EVA PWR AMPL - ON

A1(B1)
AUTO
VERN
RT 0.2
DB 1.0

TIG
-01:30
-01:25
-01:20
-01:15
-01:10
-01:05
-01:00

MS EDO PALLET DEACT (if flown)
 MS AFT ACTIVITIES 12, 7-17

C,P Make P&I changes to ENTRY C/L using LOSS OF
 FES DEORBIT PREP ENTRY DELTAS, 7-21

C,P CLOTHING CONFIG 13

MS N2 QTY COMPUTE
 SM 66 ENVIRONMENT
 Add N2 QTY 1&2, then annotate value on CAB
 PRESS LEAK NOMOGRAPH (ENT PKT, ECLS)

ALL Begin Fluid Loading per individual prescription
 Fluid Loading should be completed by EI

CLOTHING CONFIG 13

Unstow, don:
LES
Harness
Boots

HUD SETUP 14

Remove, stow HUD Covers (two)
Ensure Cloth Cover does not obscure light sensor

RCS ENTRY CONFIGURATION 17

O14:F, ✓ R/JDA DRIVER (four) – ON
O15:F, ✓ LOGIC (four) – ON
O16:F
C3 DAP: A/AUTO/PRI
GNC 20 DAP CONFIG
Select TAIL P,Y OPTION
O14:F, R/JDF DRIVER (four) – OFF
O15:F, LOGIC (four) – OFF
O16:F
O8 FWD RCS MANF ISOL 1,2,3,4 (four) – CL (tb-CL)
5 – CL (mom), (tb-CL)
O16:F RJD MANF L5/F5/R5 DRIVER – OFF
A14 RCS/OMS HTR FWD RCS JET (five) – OFF
AFT RCS JET 5 – OFF

DED DISP ENT CONFIG 18

O14, RGA (four) – ON
O15, cb MNA,B ACCEL 1, 2 (two) – cl
O16 MNA,C DDU AFT (two) – op
ASA (four) – ON
ACCEL 4,3 (two) – ON
O7 TACAN ANT SEL (three) – AUTO
O8 MLS CH tw (three) – See LAND SITE DATA
F3 TRIM PNL (two) – ON

DPS ENTRY CONFIG 19

* If IMU or RHC dilemma, do not proceed with OPS 3 transition *

O14,O15, ✓ RGA,ACCEL,ASA,IMU (all) – ON
O16
O6 ✓ **VERIFY GPC CONFIG**
✓ GPC MODE 3 – HALT (tb-bp)
✓ PWR 3 – ON
✓ OUTPUT 1,2 (two) – NORM (tb-gray)
✓ 3,5 (two) – NORM (tb-bp)
✓ 4 – TERM (tb-bp)
✓ MODE 1,2,4 (three) – RUN (tb-RUN)
3 – STBY (tb-RUN)
✓ 5 – STBY (tb-RUN)

LOAD ENTRY TFL/RECONFIG UPLK
Perform LOAD PCMMU FORMAT and LOAD PDI DECOM
FORMAT (ORB OPS FS, COMM/INST) for entry config

O15:B cb EVENT TIMER FWD – cl

C2 Set event timer to count down to TIG

TRANSITION GPC 1&2 to GNC OPS 3
cb MNA,B,C ADTA (four) – cl

O14:E,
O15:E,
O16:E

GNC 0 GPC MEMORY

CONFIG – ITEM 1 +3 EXEC
Modify MC 3 per table →

GNC, OPS 301 PRO
3: GNC DEORB MNVR COAST

O14:E,O15:E, cb MNA,B,C ADTA (four) – op
O16:E

CONFIG	3
GPC	12000
STR 1	1
2	2
3	1
4	2
PL 1/2	0
CRT 1	1
2	2
3	2
4	0
L 1	0
2	0
MM 1	1
2	2

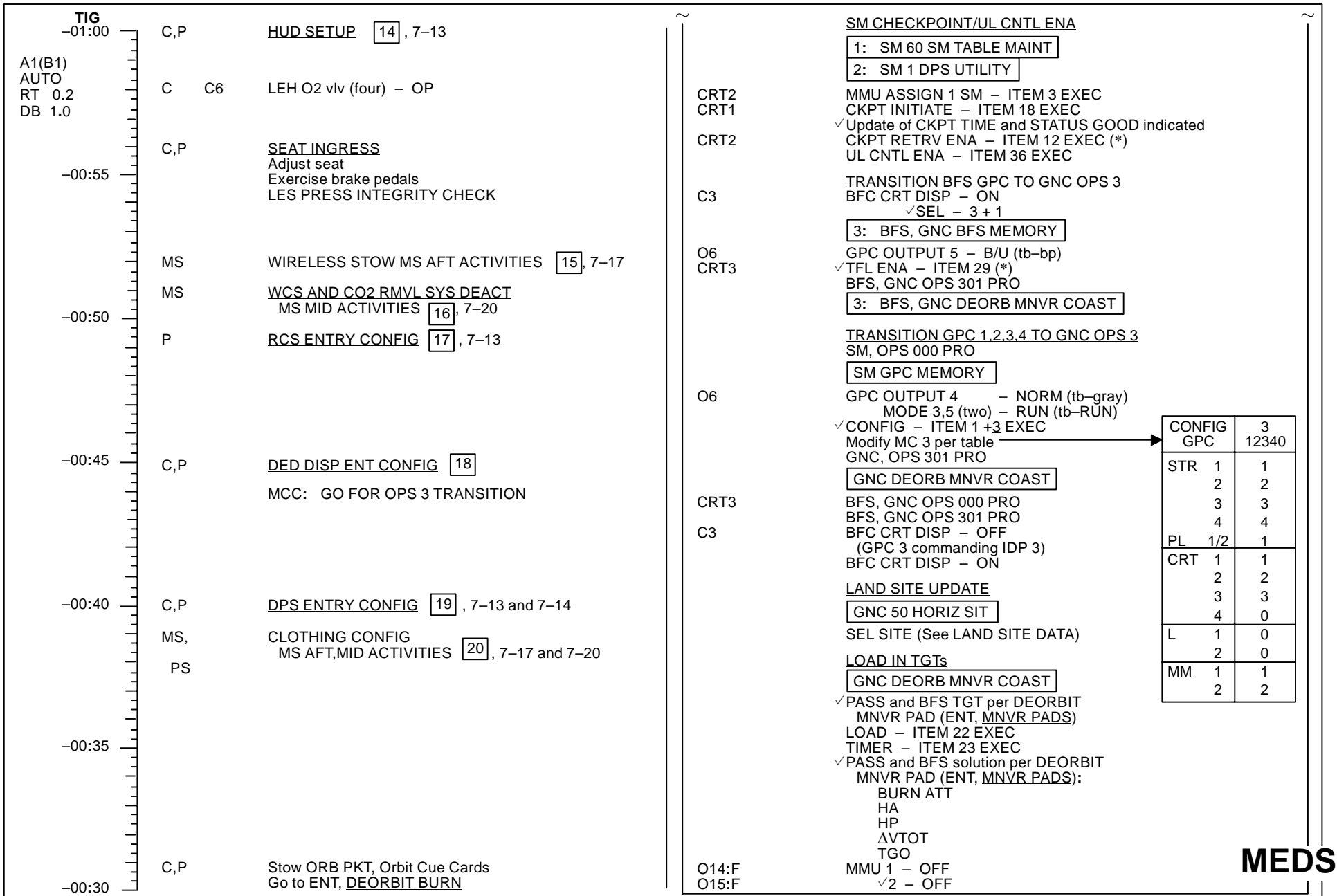

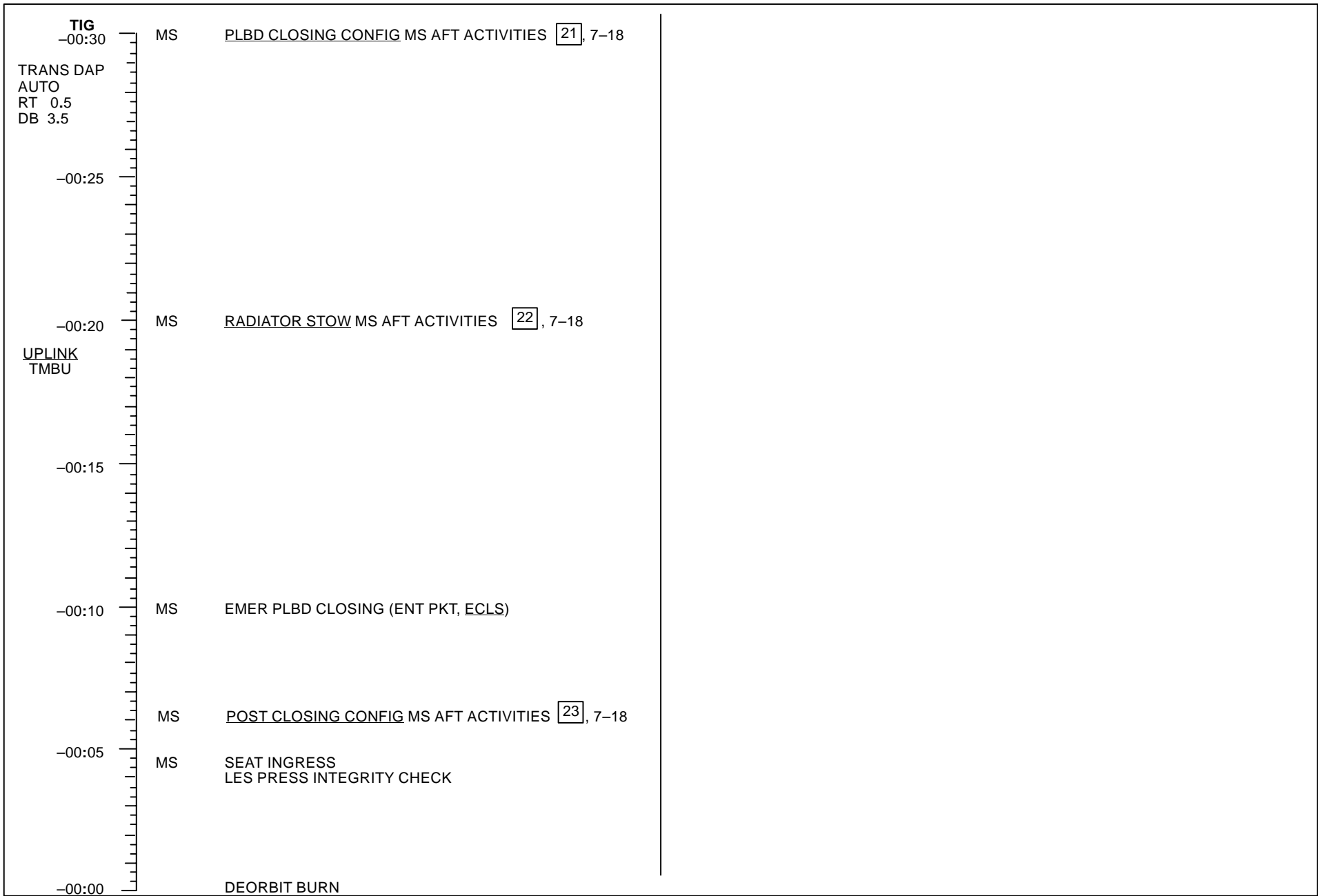

This Page Intentionally Blank

MS AFT FLIGHT DECK ACTIVITIES

NOTE

Wait for GO from CDR or PLT before starting any activity on this page

TIME (TIG-)	MS AFT ACTIONS
2:25	<u>SPECIALIST SEAT INSTALLATION</u>
1:55	<u>ENT AFT FLT DECK CONFIG</u> [9]
1:38	<u>C/W RESET</u> [11]
1:30	<u>EDO PALLET DEACT</u> (if flown) [12]
1:10	<u>N2 QTY COMPUTE</u> , 7-12
1:05	Begin Fluid Loading per individual prescription. Fluid Loading should be completed by E1
0:52	<u>WIRELESS STOW</u> [15]
0:39	<u>CLOTHING CONFIG</u> [20]
0:30	<u>PLBD CLOSING CONFIG</u> [21], 7-18
0:20	<u>RADIATOR STOW</u> [22], 7-18
0:10	EMER PLBD CLOSING (ENT PKT, ECLS)
0:06	<u>POST CLOSING CONFIG</u> [23], 7-18
0:05	<u>SEAT INGRESS</u>

C/W RESET (Contact CDR for additional parameters) [11]

R13U			
PARAMETER NAME	C/W CH	ENA/ INH	
HYD	P1	99	ENA
	2	109	ENA
	3	119	ENA

EDO PALLET DEACT (if flown) [12]

MS	A15:C	PALLET HTRS A,B (two) - OFF
	A15:D-G	O2,H2 TK6,7,8,9 HTRS A,B (sixteen) - OFF
	A15:C	PWR PPCA-1 (PPCA-1/3 if OV105) MNA - OFF (tb-OFF)
		PPCA-2 (PPCA-2/4 if OV105) MNB - OFF (tb-OFF)
	A15:B	cb PPCA CONT PWR 1 (1/3 if OV105) ESS 1BC - op
		2 (2/4 if OV105) ESS 2CA - op
	A15:H-K	All cbs (twenty-four) - op (Cntlrs,Qty,O2 Htr Snrsr)
	R14:B	cb MNA,MNB,MNC PALLET DSC (three) - op

WIRELESS STOW [15]

Disconnect, stow Wireless Headsets (if reqd)
✓ Aft deck lts as reqd (minimize use)

CLOTHING CONFIG [20]

Unstow, don:
LES
Harness
Boots

ENT AFT FLT DECK CONFIG [9]

	<u>ENTRY COMM</u>			
A1L	S-BD PM MODE	-	STDN LO	
	NSP CODING XMIT,RCV (two)	-	OFF	
A1R	AUD CTR VOICE RCD SEL CH 1	sel -	ICOM A	
		2 sel -	ICOM B	
A13	OS AUD SPKR PWR	-	OFF	
	PWR	-	OFF (OV102)	
R14:C	cb MNB KU ELEC	-	op	
	ANT HTR	-	op	
	✓ CABLE HTR	-	op	
	MNC KU SIG PROC	-	op	
	cb UHF EVA (two)	-	op	
R10,L9	MS,PS AUD PWR	-	AUD/TONE	
	A/G (two)	-	T/R	
	✓ A/A	-	T/R	
	ICOM (two)	-	T/R	

MEDS

(PROCEDURES CONTINUED ON BACK)

MS MIDDECK ACTIVITIES

NOTE

Wait for GO from CDR or PLT before starting any activity on this page

TIME (TIG-)	MS MIDDECK ACTIONS
3:50	<u>FLUID LOADING PREP</u> [2]
2:46	<u>ENTRY STOWAGE</u> [4]
2:25	<u>SPECIALIST SEAT INSTALLATION</u>
1:55	<u>ENT MIDDECK CONFIG</u> [10], 7-20
1:05	Begin Fluid Loading per individual prescription. Fluid Loading should be completed by EI
0:51	<u>WCS AND CO2 RMVL SYS DEACT</u> [16], 7-20
0:39	<u>CLOTHING CONFIG</u> [20], 7-20
0:05	<u>SEAT INGRESS</u>

<u>FLUID LOADING PREP</u> [2]
Unstow, fill 4 drink containers (per crewmember) with 8 oz of water each; temp stow near seat
Unstow 8 salt tablets (per crewmember); temp stow tablets in Flight Suit pocket

<u>ENTRY STOWAGE</u> [4]
<u>PERSONAL HYGIENE SYS STOWAGE</u> Stow: Personal Hygiene Kits Hose
<u>AIRLOCK CLOSEOUT</u> Tether soft goods to EVA tether point or A/L Stowage Bag. Gray Tape to floor
MO13Q ✓ ARLK FAN A(B) – OFF (OV103/OV104/OV105) if flown Stow all ducts as appropriate Airlock ENT SW VERIF, 3-28 and 3-29 (OV102), 3-30 and 3-31 (OV103, OV104, OV105)

ESCAPE POLE SETUP

Reinstall Stbd Pip Pin
Reinstall large Port Pin:
Retract and hold Locking Pin (Ring)
Reinstall large Pin
Release Locking Pin (Ring)
Slide forward Safing Latch

✓ Pole Straps secure

DFD STOWAGE

Stow FLIGHT PLAN

CABIN CONFIG

Stow: Backup PGSC
Middeck Camrs, Accessories
FWD/AFT Shades, Filters
Quick Don Masks

Stow Exercise Equipment

✓ Retention net in ASC/ENT config

EGRESS ROUTE CONFIG

Tape Foot Loops in egress routes

GALLEY

GALLEY DEACT

✓ OVEN/RHS – OFF
H2O HTRS (two) – OFF
✓ OVEN FAN – OFF
✓ REHYD STA lever – cl (push in)
✓ OVEN DOOR LATCH – latched
cb AC3 GALLEY FAN (three) – op
MNC SPLY H2O GALLEY SPLY – op
MNA GALLEY OVEN – op
MNB GALLEY H2O HTR – op

MA73C:G
ML86B:A
:B

(Cont next page)

Back of MS MIDDECK ACTIVITIES

ENT MIDDECK CONFIG 10

ENTRY COMM
MO42F MIDDECK SPKR AUD PWR - AUD/TONE
A/G (two) - T/R
✓A/A - T/R
ICOM (two) - T/R

ML85E AC S1 - OFF

MIDDECK PCS
MO10W 14.7 CAB REG INLET vlv (two) - CL
H2O TK N2 REG INLET vlv (two) - OP
O2 REG INLET vlv (two) - CL
MO69M LEH O2 vlv (two) - as reqd
MO32M 6 vlv - as reqd

RMS PNL LIGHTS (If RMS onboard)
MA73C:F cb AC1 RMS PRI ΦA - op
AC2 RMS B/U ΦA - op

WCS AND CO2 RMVL SYS DEACT 16

EDO WCS If EDO WCS:
URINAL SEL - OFF
WCS PWR SEL - OFF1,OFF2
FAN PWR - AUTO
Lock odor lid/seat
COMP LOCK DOWN PINS (three) - tighten

WCS VAC VLV - CL
✓MODE - AUTO
FAN SEP SEL sw - OFF
Unstow hose from cradle, attach hose to WCS housing via Velcro straps

(EDO WCS) Remove, stow: WCS Trash Can
Mirror
Privacy Curtain
Foot restraints - up, locked
Close, latch door

ML31C VAC VENT ISOL VLV BUS SEL - MNB
CNTL - CL (tb-CL)
NOZ HTR - OFF

✓Middeck lts as reqd (minimize use)

MO69M LEH O2 8 vlv - CL
Remove, stow O2 Bleed Orifice
LEH O2 8 vlv - as reqd

MO51F If CO2 RMVL SYS flown:
CNTLR 1(2) MODE - STBY (hold 3 sec)
Remove current cans and install two fresh LiOH Cans

CLOTHING CONFIG 20

Unstow, don:
LES
Harness
Boots

**LOSS OF FES DEORBIT PREP
ENTRY DELTAS PULLOUT PAGE**

DELTAS TO ENT, DEORBIT BURN

1. At TIG-30 min, enter ENT, DEORBIT BURN
(do all)
2. At TIG-15 min, use two IDP/CRTs with four MDUs as reqd for burn
Minimize use when possible
3. At TIG-15, do not perform pnl A14 OMS/RCS heater configurations
4. At TIG-5, use MDUs as reqd for APU start, two FLT CNTLR PWR/DDUs as reqd for burn
Minimize use

C3
O17
O17

8. Prior to SSME HYD REPRESS:

- ✓FCS CH (four) – AUTO
- ATVC (four) – ON
- When SSME REPRESS complete:
- ATVC (four) – OFF
- ✓EIU (three) – OFF
- ✓MEC 1,2 (two) – OFF
- GNC 51 , BFS GNC 51 SSME
- REPOS – ITEM 19 EXEC (INH)

DELTAS TO ENT, POST BURN

1. Use one FLT CNTLR PWR, one IDP/CRT with three MDUs only as reqd
2. Set event timer counting to EI
3. At EI-21:
HYD CIRC PUMP (one of two on non-operating hyd sys) – ON
4. At EI-18: If FRCS DUMP reqd:
RJDF LOGIC, DRIVER (eight) – ON
FWD RCS MANF ISOL 1,2,3,4 (four) – OP (tb-OP)
5. After dump completion:
RJDF LOGIC, DRIVER (eight) – OFF
6. In ENTRY SW CHECK, do not activate ANTISKID, NWS, NAV AIDS
7. At EI-13:
Operating HYD CIRC PUMP – OFF
Start second APU (one only)
HYD CIRC PUMP (remaining non-operating hyd sys) – ON

R2

O14,O15,O16:F
O8

O14,O15,O16:F

R2

R2

DELTAS TO ENTRY MANEUVERS CUE CARD

1. At EI-5:
HYD CIRC PMP – OFF
Start remaining APU
BRAKES MNA,B,C (three) – ON
cb ADTA 1,2,3,4 (four) – cl
GNC I/O RESET
2. At EI: NH3 CNTLR B – SEC/ON
Use two IDP/CRTs with six MDUs
cb MNA,B,C DDU L,R (four) – cl
FLT CNTLR PWR (two) – ON
3. At V = 15K: TACAN MODE (three) – GPC
4. At V = 12K: DELETE reference to radiator flow
5. At V = 6K: NH3 CNTLR B – OFF
A – PRI/GPC
6. At M = 2.9:
MLS (three) – ON
GNC I/O RESET
RADAR ALTM (two) – ON
HUD PWR (two) – ON
NWS – 1
ANTISKID – ON
7. Post Wheel-Stop, go to EXPEDITED PWRDN

MEDS

This Page Intentionally Blank

(MEDS) A7-22

MEDS
C D/O/ALL/GEN H

LOSS OF FES DEORBIT PREP

ASSUMPTIONS/INITIAL CONDITIONS

This procedure assumes EVAP OUT T HIGH (ORB PKT, ECLS) and LOSS OF FES (ORB PKT, PWRDN) have been performed

If failure occurs after Deorbit Prep entered, compare timeline, beginning at TIG-4 hr, with activities previously accomplished for misconfigurations

PROBLEM DESCRIPTION/RATIONALE

Immediate deorbit not mandatory if both Freon Loops operating and radiator flow has been established

Heat removal capability of radiators allows for normal on-orbit power levels without thermal problems. However, for Deorbit Prep, to allow some coldsoak of the radiators and vehicle, power levels must be limited

NOTE

A near normal deorbit prep and entry performed except that:

1. Nav and landing aids powered when needed during entry
2. Limited use of CRTs, Flt Cntlr Pwr, Inst Pwr, PGSC, lighting
3. GPC entry configuration and OPS 3 transition delayed to TIG-45 min to delay full GPC powerup
4. MS continues deorbit prep activities until TIG. CDR/PLT go to ENT at TIG-30
5. Door closure delayed to TIG-10 min
6. Radiator coldsoak attitude (tail sun) maintained until TIG-15 min except for IMU align attitude
7. Ammonia boiler activated at EI
8. HYD circ pump operated for additional cooling

(NOM) B7-3

NOM

C D/O/NOM/GEN H

LOSS OF FES DEORBIT PREP OVERVIEW OF CONFIGURATION MANAGEMENT

	OPS 1 ASC C/L					OPS 2 ON-ORBIT					OPS 2 DEORBIT PREP TIG -03:28					OPS 3 DEORBIT PREP TIG -0:45					TIG					EI-5	V = 15K					
DPS																																
GPC	1	2	3	4	5	1	2	3	4	5	1	2	3	4	5	1	2	3	4	5	1	2	3	4	5							
OPS	G1	G1	G1	G1	BFS	G2	G2	G2	SM	BFS	G2	G2	G2	SM	BFS	G3	G3	G3	G3	BFS	G3	G3	G3	G3	BFS							
POWER	ON	ON	ON	ON	ON	ON	ON	ON	ON	ON	ON	ON	ON	ON	ON	ON	ON	ON	ON	ON	ON	ON	ON	ON	ON							
OUTPUT	N	N	N	N	B	N	N	N	T	N	N	N	N	T	N	N	N	N	N	B	N	N	N	N	B							
MODE	R	R	R	R	R	R	R	H	R	H	R	R	H	R	S	R	R	R	R	R	R	R	R	R	R							
CONFIG	1					2					2					3					3											
GPC	1	2	3	4	0	1	2	0	0	0	1	2	0	0	0	1	2	3	4	0	1	2	3	4	0	1	2	3	4	0		
STR	1	1				1				0	1				0	1				0	1				0	1				0		
	2	2				2				0	2				0	2				0	2				0	2				0		
	3	3				1				0	1				0	3				0	3				0	3				0		
	4	4				2				0	2				0	4				0	4				0	4				0		
PL	1/2	1				0				4	0				4	1				0	1				0	1				0		
CRT	1	1				1				4	1				4	1				0	1				0	1				0		
	2	2				2				4	2				4	2				0	2				0	2				0		
	3	3				0				0	0				0	3				0	3				0	3				0		
	4	0				2				4	2				4	0				0	0				0	0				0		
L	1	1				0				4	0				4	0				0	0				0	0				0		
	2	2				0				0	0				0	0				0	0				0	0				0		
MM	1	1				1				4	1				4	1				0	1				0	1				0		
	2	2				2				4	2				4	2				0	2				0	2				0		
MDM	ALL ON					ALL ON					ALL ON					ALL ON					ALL ON											
D & C	ADI/DDU		L,R			L,A					Minimize use					Minimize use					Minimize use											
	CRT/DEU		1,2,3			1,2,4-ON					Minimize use					Minimize use					Minimize use											
	INSTR		L,R			NONE																										
ECLS	AV BAY FAN		1-B,2-A,3-B																													
	CABIN FAN		A																													
	IMU FAN		B																													
	WATER LP		1-OFF, 2-ON			1-GPC,2-ON					1-OFF, 2-ON																					
	FREON LP		1-B,2-B																													
	RADIATOR		STOWED			DEPLOY										STOW																
FCS / NAVSORS	FCS		AUTO																													
	ASA		ALL ON			OFF					ALL ON																					
	AA		ALL ON			OFF					ALL ON																					
	RGA		ALL ON			OFF					ALL ON																					
	ADTA		ALL ON			OFF					ALL ON																					
	IMU		ALL ON																		ALL ON											
	RA		ALL ON			OFF																										
	TACAN		ALL GPC			OFF																										
	UHF		ON																													
	MLS		ALL OFF																													
RJD	RJDA		ALL ON																													
	RJDF		ALL ON								OFF																					
	VERNIER		OFF			ON					OFF																					

NOM

LOSS OF FES DEORBIT PREP

MCC	CDR	PLT	MS(AFT)	MS(MID)
TIG				
-04:00	SUPPLY H2O DUMP	CRT TIMER SETUP	SUPPLY H2O DUMP	
				FLUID LOADING PREP
	DPS CONFIG FOR D/O			
-03:00	AUTO MNVR TO IMU ATT	KU-BD ANT STOW		
	IMU ALIGNMENT			ENT STOWAGE
	PRE D/O UPDATE/UPLINK	HYD THERM COND		
	MNVR TAIL TO SUN	APU STEAM VENT HTR	SEAT INSTALLATION	SEAT INSTALLATION
-02:00	DEACT STAR TRKRS, CLOSE DOORS	DEACT STAR TRKRS, CLOSE DOORS		
	ENT FWD FLT DECK CONFIG	ENT FWD FLT DECK CONFIG	ENT AFT FLT DECK CONFIG	ENT MIDDECK CONFIG
			RESET C/W	
	P&I TO ENTRY C/L	P&I TO ENTRY C/L		
	CLOTHING CONFIG	CLOTHING CONFIG	N2 QTY COMP	
-01:00	BEGIN FLUID LOADING	BEGIN FLUID LOADING	BEGIN FLUID LOADING	BEGIN FLUID LOADING
	SEAT INGRESS HUD SETUP ADJUST SEAT	SEAT INGRESS HUD SETUP ADJUST SEAT	WIRELESS STOW	WCS DEACT
GO FOR OPS 3 TRANSITION	DED DISPLAY ENT CONFIG DPS ENTRY CONFIG	RCS ENTRY CONFIG DED DISP ENT CONFIG DPS ENTRY CONFIG	STOW RADIATORS CONFIG FOR PLBD CLOSURE EMERG. PLBD CLOSURE POST CLOSING CONFIG CLOTHING CONFIG SEAT INGRESS	CLOTHING CONFIG SEAT INGRESS
	STOW ORB PKT ENT, <u>DEORBIT BURN</u>	STOW ORB PKT ENT, <u>DEORBIT BURN</u>		
00:00	DEORBIT BURN			

NOM

TIG

-04:00

A1(B1)
AUTO
VERN
RT 0.2
DB 1.0

P TIMER SETUP [1]
L1 ✓DAP: A1/AUTO/VERN
 ✓DAP B set to B1

-03:55

C,MS SUPPLY WATER DUMP (ORB OPS, ECLS)
 If no MCC, dump TK B to 50%

-03:50

MS FLUID LOADING PREP MS MID ACTIVITIES [2], 7-19

-03:45

-03:40

-03:35

-03:30

TIMER SETUP [1]

[1: GNC 2 TIME]

SET CRT TIMER TO COUNT DOWN TO TIG (perform for GNC and SM)

ENTRY DAY (HR:MIN:SEC - MET)

ITEM 17 + [][] + [][] + [][]

24 HOUR LATE DELAYED DEORBIT

ITEM 17 + [][] + [][] + [][]

[1: GNC UNIV PTG]

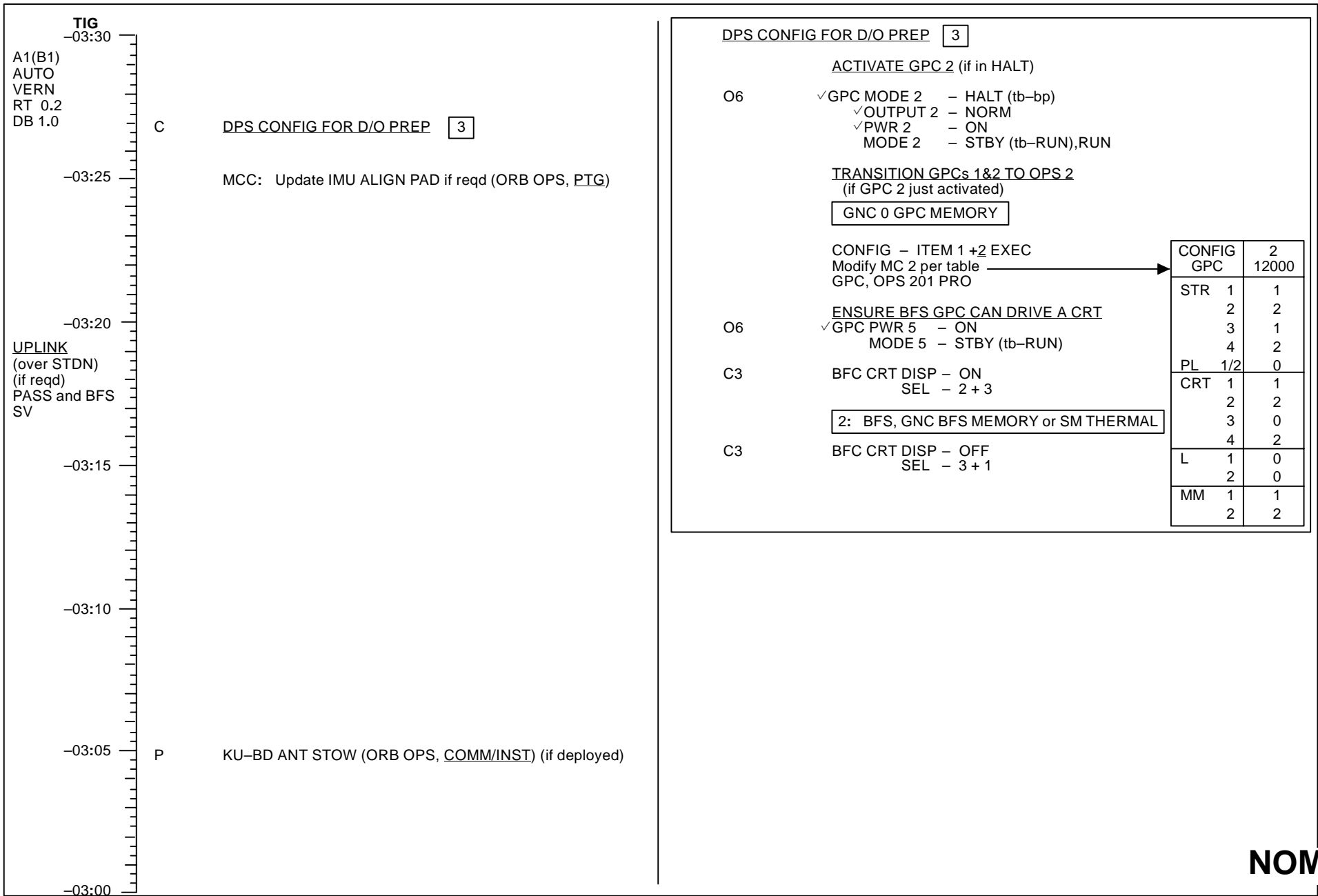

IMU ALIGNMENT 5

NOTE

Procedure applies for one or two S TRK aligns. For one S TRK, a second att mnvr reqd between data takes. Ref STAR PAIRS (ORB OPS, PTG)

- C
 1. X: GNC 22 S TRK/COAS CNTL
Y: GNC 21 IMU ALIGN

- CRTX 2. ✓REQD ID – ITEM 11,12 – 0
 ✓STATUS (two) – NO BITE
 ✓SHUTTER (two) – OP
 * If SHUTTER – CL: *
 * ✓Att,MET – correct *
 * Visually verify no bright object in FOV *
 * After data collected and before changing *
 * attitude, return shutter to AUTO *
 * To open shutter: *
 * MAN OP – ITEM 15(16) EXEC (*) *
 * To return shutter to AUTO: *
 * MAN OP – ITEM 15(16) EXEC (no *) *

- CRTY ✓IMU 1,2,3:
 ✓STAT – blank
 ✓OPER – ITEM 4,5,6 (*)

- CRTX 3. ✓IMU ALIGN ATT (pad)
 4. S TABLE CLR – ITEM 20 EXEC
 5. Enable Star Tracker:
 S TRK – ITEM 3,4 EXEC (*)
 6. Verify S TABLE:
 TRK ID 1,2 = STAR ID (pad)
 ANG ERR ≤ 0.08

Wait approx 1 min for new IMU Δ ANGS

- * If after 3 min no data (or bad data) in S TABLE: *
- * ✓S TRK – ITEM 3,4 (*) *
- * ✓ATT/STARS/TIME *
- * ✓S TRK: TRK ID = STAR ID (pad) *
- * Do S TRK self-test *
- * If neither tracker fails: *
- * Mnvr to verification att – repeat *
- * steps 3,4,5,6 *
- * If one tracker fails: *
- * ✓TERM/IDLE for failed tracker – *
- * ITEM 9(10) (*) *
- * Proceed with one S TRK ALIGN *
- * If both trackers fail, ✓MCC *

For one S TRK align:

S TRK for good tracker – ITEM 3(4) EXEC (*)
 S TABLE CLR – ITEM 20 EXEC, reacquire star with good tracker
 TERM/IDLE for good tracker during maneuvers – ITEM 9(10) EXEC (*)
 Mnvr to second att (single S TRK): Do not clear S Table
 Repeat steps 3,5,6 with second Star ID

- CRTX 7. ✓S TABLE SEL – ITEM 17,18 (*)
 CRTY ALIGN IMU 1,2,3 – ITEM 10,11,12 EXEC (*)
 ✓STAR ALIGN – ITEM 13 (*)
 ✓IMU 1,2,3 – ANG ΔX,ΔY,ΔZ < 0.80

- * If ANG ΔX,ΔY,ΔZ > 0.80 for two IMUs, do not torque: *
- * Mnvr to verification att & repeat steps 3 thru 7 once *
- * If still > 0.80, report to MCC *

8. Record ANG ΔX,ΔY,ΔZ,ANG ERR,EXECUTE TIME (use log this page)
 ITEM 16 – EXEC (*)
 Alignment complete when:
 ITEM 16 – EXEC (no *)

IMU ALIGN VERIFICATION

9. Mnvr to IMU VERIFICATION STAR ALIGN ATT (pad):
 ✓DAP: B/AUTO/PRI

10. Perform steps 3,4,5,6 using appropriate stars (pad)

11. ✓IMU 1,2,3 ANG ΔX,ΔY,ΔZ < 0.1

- * If ANG ΔX,ΔY,ΔZ ≥ 0.1, perform steps 8 thru 11; report to MCC *

NOTE

For alternate stars, ✓MCC or ref STAR PAIRS (ORB OPS, PTG)

12. Report IMU ALIGN results

IMU STAR ALIGN LOG			
REQD ID:	-Y _____, -Z _____	ANG ERR	____. ____
ANG	1 2 3		
ΔX()	_____ . _____ () _____ . _____ () _____ . _____		
ΔY()	_____ . _____ () _____ . _____ () _____ . _____		
ΔZ()	_____ . _____ () _____ . _____ () _____ . _____		
EXECUTE TIME ____ : ____ : ____ (TIG MINUS)			

IMU STAR ALIGN LOG			
REQD ID:	-Y _____, -Z _____	ANG ERR	____. ____
ANG	1 2 3		
ΔX()	_____ . _____ () _____ . _____ () _____ . _____		
ΔY()	_____ . _____ () _____ . _____ () _____ . _____		
ΔZ()	_____ . _____ () _____ . _____ () _____ . _____		
EXECUTE TIME ____ : ____ : ____ (TIG MINUS)			

NOM

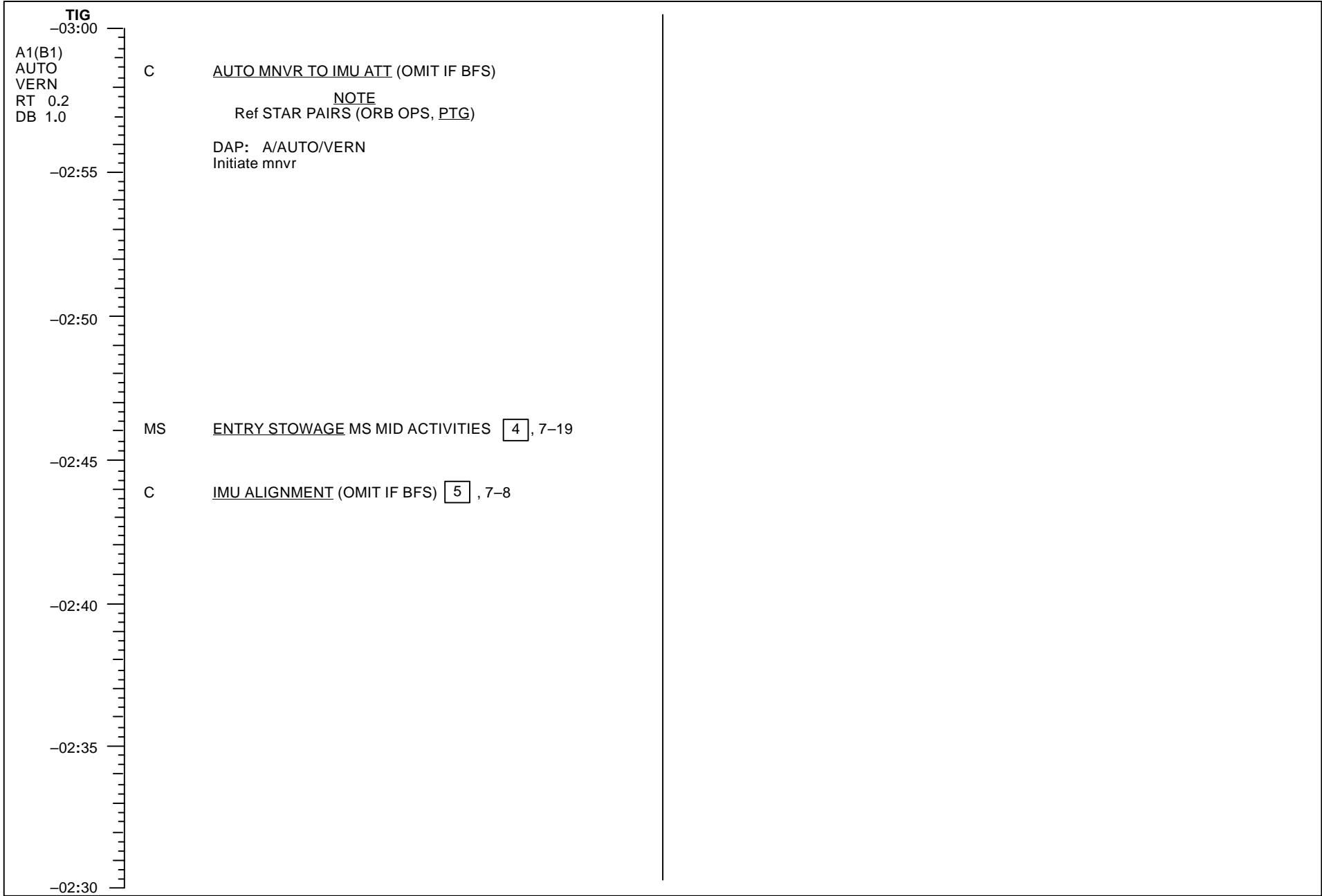

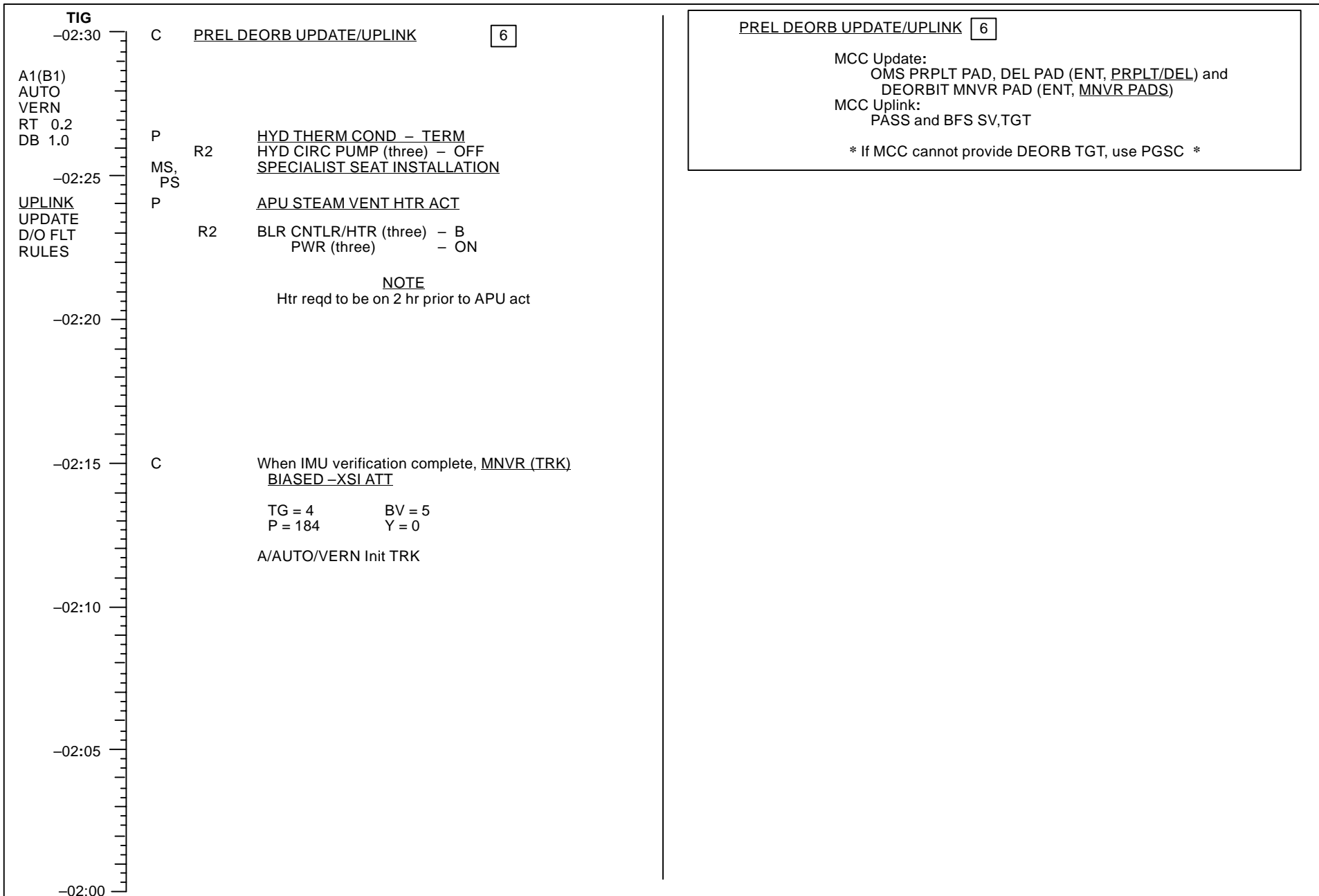

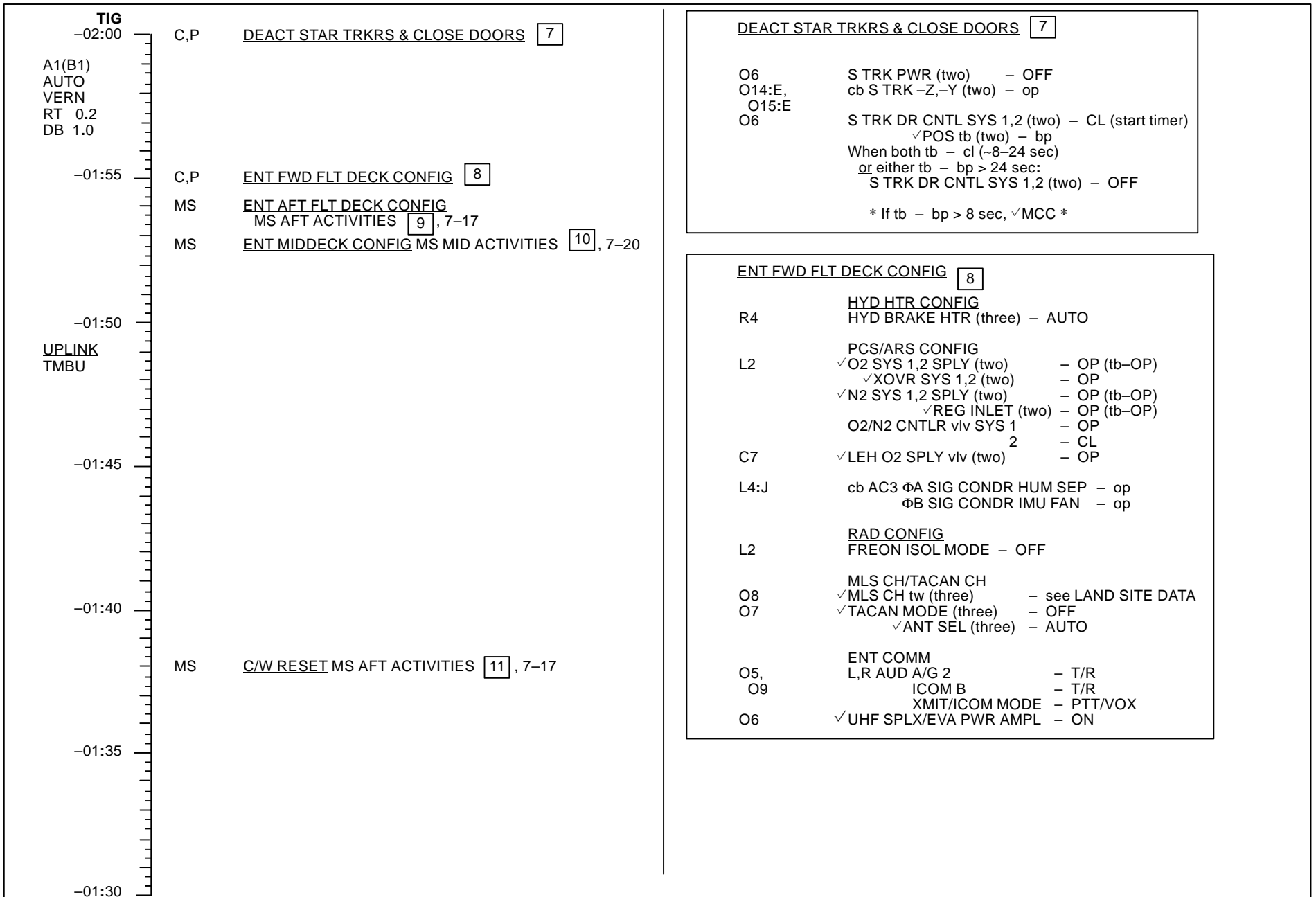

A1(B1)
AUTO
VERN
RT 0.2
DB 1.0

TIG
-01:30
-01:25
-01:20
-01:15
-01:10
-01:05
-01:00

MS EDO PALLET DEACT (if flown)
 MS AFT ACTIVITIES 12, 7-17

C,P Make P&I changes to ENTRY C/L using LOSS OF
 FES DEORBIT PREP ENTRY DELTAS, 7-21

C,P CLOTHING CONFIG 13

MS N2 QTY COMPUTE
 SM 66 ENVIRONMENT
 Add N2 QTY 1&2, then annotate value on CAB
 PRESS LEAK NOMOGRAPH (ENT PKT, ECLS)

ALL Begin Fluid Loading per individual prescription
 Fluid Loading should be completed by EI

CLOTHING CONFIG 13
Unstow, don:
LES
Harness
Boots

HUD SETUP 14

Remove, stow HUD Covers (two)
Ensure Cloth Cover does not obscure light sensor

RCS ENTRY CONFIGURATION 17

O14:F, ✓ RJA DRIVER (four) – ON
O15:F, ✓ LOGIC (four) – ON
O16:F
C3 DAP: A/AUTO/PRI
GNC 20 DAP CONFIG
Select TAIL P,Y OPTION
O14:F, RJDF DRIVER (four) – OFF
O15:F, LOGIC (four) – OFF
O16:F
O8 FWD RCS MANF ISOL 1,2,3,4 (four) – CL (tb-CL)
5 – CL (mom), (tb-CL)
O16:F RJD MANF L5/F5/R5 DRIVER – OFF
A14 RCS/OMS HTR FWD RCS JET (five) – OFF
AFT RCS JET 5 – OFF

DED DISP ENT CONFIG 18

O14, RGA (four) – ON
O15, cb MNA,B ACCEL 1, 2 (two) – cl
O16 MNA,C DDU AFT (two) – op
ASA (four) – ON
ACCEL 4,3 (two) – ON
O7 TACAN ANT SEL (three) – AUTO
O8 MLS CH tw (three) – See LAND SITE DATA
F3 TRIM PNL (two) – ON
F6/F8 HSI: ✓ Off flag – not visible
ADI: ✓ Error needles and rate pointers visible

DPS ENTRY CONFIG 19

* If IMU or RHC dilemma, do not proceed with OPS 3 transition *

O14,O15, ✓ RGA,ACCEL,ASA,IMU (all) – ON
O16
O6 ✓ **VERIFY GPC CONFIG**
GPC MODE 3 – HALT (tb-bp)
✓ PWR 3 – ON
✓ OUTPUT 1,2 (two) – NORM (tb-gray)
✓ 3,5 (two) – NORM (tb-bp)
✓ 4 – TERM (tb-bp)
✓ MODE 1,2,4 (three) – RUN (tb-RUN)
3 – STBY (tb-RUN)
✓ 5 – STBY (tb-RUN)

LOAD ENTRY TFL/RECONFIG UPLK
Perform LOAD PCMMU FORMAT and LOAD PDI DECOM
FORMAT (ORB OPS FS, COMM/INST) for entry config

O15:B cb EVENT TIMER FWD – cl

C2 Set event timer to count down to TIG

TRANSITION GPC 1&2 to GNC OPS 3

O14:E, cb MNA,B,C ADTA (four) – cl
O15:E,
O16:E

GNC 0 GPC MEMORY

CONFIG – ITEM 1 +3 EXEC
Modify MC 3 per table →

GNC, OPS 301 PRO
3: GNC DEORB MNVR COAST

O14:E,O15:E, cb MNA,B,C ADTA (four) – op
O16:E

CONFIG	3
GPC	12000
STR 1	1
2	2
3	1
4	2
PL 1/2	0
CRT 1	1
2	2
3	2
4	0
L 1	0
2	0
MM 1	1
2	2

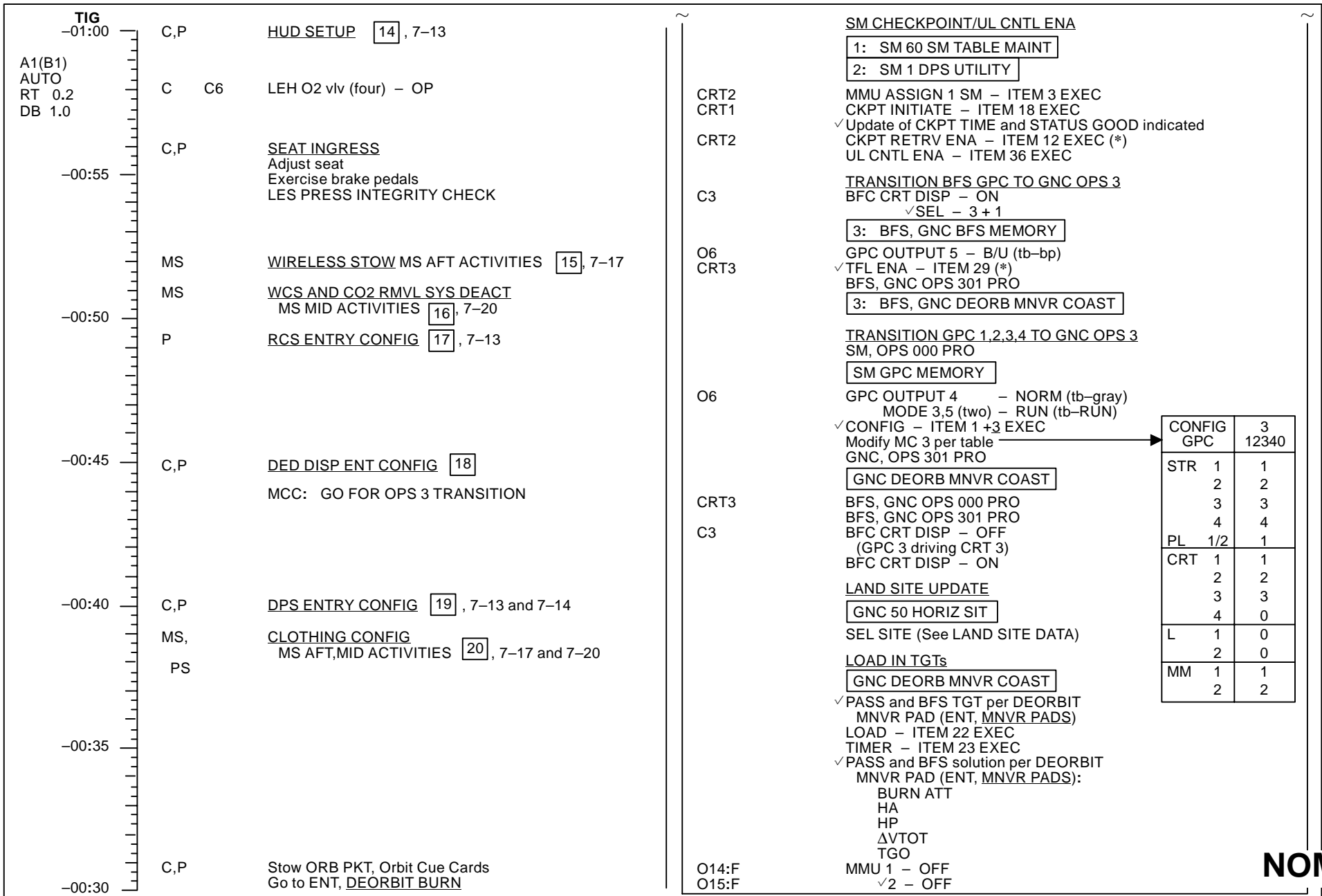

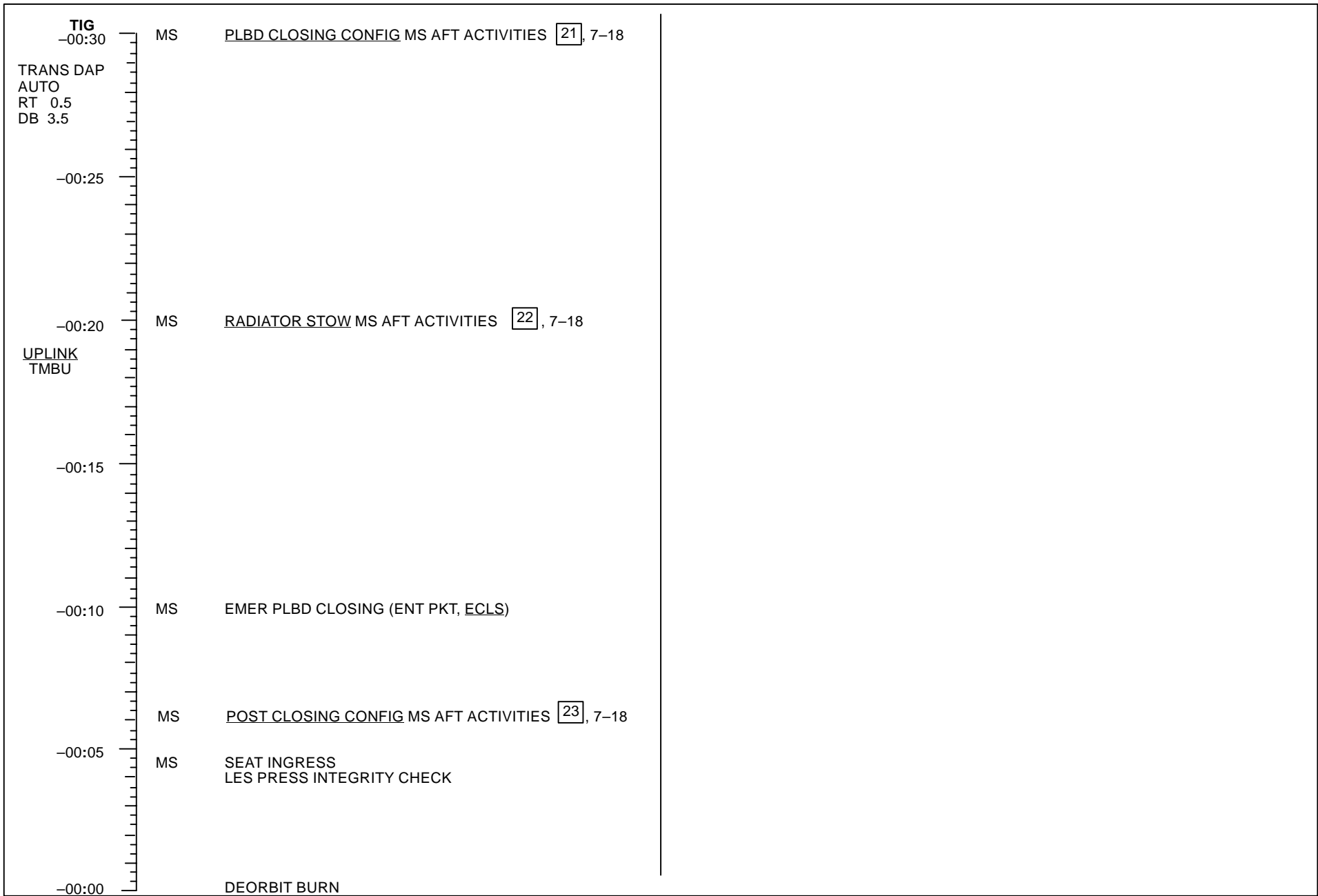

This Page Intentionally Blank

(NOM) B7-16

C D/O/ALL/GEN H

MS AFT FLIGHT DECK ACTIVITIES

NOTE

Wait for GO from CDR or PLT before starting any activity on this page

TIME (TIG-)	MS AFT ACTIONS
2:25	SPECIALIST SEAT INSTALLATION
1:55	ENT AFT FLT DECK CONFIG 9
1:38	C/W RESET 11
1:30	EDO PALLET DEACT (if flown) 12
1:10	N2 QTY COMPUTE , 7-12
1:05	Begin Fluid Loading per individual prescription. Fluid Loading should be completed by E1
0:52	WIRELESS STOW 15
0:39	CLOTHING CONFIG 20
0:30	PLBD CLOSING CONFIG 21 , 7-18
0:20	RADIATOR STOW 22 , 7-18
0:10	EMER PLBD CLOSING (ENT PKT, ECLS)
0:06	POST CLOSING CONFIG 23 , 7-18
0:05	SEAT INGRESS

C/W RESET (Contact CDR for additional parameters) 11

R13U			
PARAMETER NAME	C/W CH	99	ENA/INH
HYD	P1	99	ENA
	2	109	ENA
	3	119	ENA

EDO PALLET DEACT (if flown) 12

MS	A15:C	PALLET HTRS A,B (two) - OFF
	A15:D-G	O2,H2 TK6,7,8,9 HTRS A,B (sixteen) - OFF
	A15:C	PWR PPCA-1 (PPCA-1/3 if OV105) MNA - OFF (tb-OFF)
		PPCA-2 (PPCA-2/4 if OV105) MNB - OFF (tb-OFF)
	A15:B	cb PPCA CONT PWR 1 (1/3 if OV105) ESS 1BC - op
		2 (2/4 if OV105) ESS 2CA - op
	A15:H-K	All cbs (twenty-four) - op (Cntlrs,Qty,O2 Htr Snrsr)
	R14:B	cb MNA,MNB,MNC PALLET DSC (three) - op

WIRELESS STOW 15

Disconnect, stow Wireless Headsets (if reqd)
✓ Aft deck lts as reqd (minimize use)

CLOTHING CONFIG 20

Unstow, don:
LES
Harness
Boots

ENT AFT FLT DECK CONFIG 9

	ENTRY COMM	
A1L	S-BD PM MODE	- STDN LO
	NSP CODING XMIT,RCV (two)	- OFF
A1R	AUD CTR VOICE RCD SEL CH 1 sel	- ICOM A
	2 sel	- ICOM B
A13	OS AUD SPKR PWR	- OFF
	PWR	- OFF (OV102)
R14:C	cb MNB KU ELEC	- op
	ANT HTR	- op
	✓ CABLE HTR	- op
	MNC KU SIG PROC	- op
	cb UHF EVA (two)	- op
R10,L9	MS,PS AUD PWR	- AUD/TONE
	A/G (two)	- T/R
	✓ A/A	- T/R
	ICOM (two)	- T/R

NOM

(PROCEDURES CONTINUED ON BACK)

Back of MS AFT FLIGHT DECK ACTIVITIES

PLBD CLOSING CONFIG 21

- CONFIG RMS (if RMS onboard)
- ✓ Elbow Camr in aligned position
 - Pan 90° from X-axis
 - Tilt per decal

A8L PORT RMS HTR (two) – OFF
RMS PWR – OFF

R11L SET UP LIGHTS (minimize use)
CRT4 PWR – ON
A6U ✓ ANNUN BUS SEL – MNC

NOTE

Minimum operating time for PLB floodlight
is 25 min (~3 min to full bright)

A7U	PL BAY FLOOD AFT STBD	-	<input type="checkbox"/>
	PORT	-	<input type="checkbox"/>
	MID STBD	-	<input type="checkbox"/>
	PORT	-	<input type="checkbox"/>
	FWD STBD	-	<input type="checkbox"/>
	PORT	-	<input type="checkbox"/>
	BHD	-	<input type="checkbox"/>

Record MET ___/___:___

- * If PLB floodlight not ON to full bright within 5 min: *
- * (Aff) PL BAY FLOOD – OFF *

TV/VTR ACT

Activate TV/VTR per Cue Card (only if reqd)

RADIATOR STOW 22

R13L ✓ RAD LAT CNTL SYS A,B (two) – OFF (tb-REL)
✓ CNTL SYS A,B (two) – OFF (tb-DPY)

PL BAY MECH PWR SYS 1,2 (two) – ON
RAD CNTL SYS A,B (two) – STO (simo)
(✓ tb-bp ~50 sec, STO)
– OFF

RAD LAT CNTL SYS A,B (two) – LAT (simo)
(tb-bp ~30 sec, LAT)
– OFF

PL BAY MECH PWR SYS 1,2 (two) – OFF

POST CLOSING CONFIG 23

NOTE

Lights must be OFF minimum of 10 min
UNBLOCKED, 16 min BLOCKED prior
to reuse

A7U After floodlights ON > 25 min:
PL BAY FLOOD (all) – OFF

Stow Flt Deck Camrs, Accessories

C2 CRT3 PWR – ON (only as reqd)
CRT2 GPC/CRT 2/3 EXEC (only as reqd)

DEACT TV/VTR per Cue Card if reqd

FOOT LOOP CONFIG

Tape Foot Loops in egress routes

NOM

MS MIDDECK ACTIVITIES

NOTE

Wait for GO from CDR or PLT before starting any activity on this page

TIME (TIG-)	MS MIDDECK ACTIONS
3:50	<u>FLUID LOADING PREP</u> [2]
2:46	<u>ENTRY STOWAGE</u> [4]
2:25	<u>SPECIALIST SEAT INSTALLATION</u>
1:55	<u>ENT MIDDECK CONFIG</u> [10], 7-20
1:05	Begin Fluid Loading per individual prescription. Fluid Loading should be completed by EI
0:51	<u>WCS AND CO2 RMVL SYS DEACT</u> [16], 7-20
0:39	<u>CLOTHING CONFIG</u> [20], 7-20
0:05	<u>SEAT INGRESS</u>

FLUID LOADING PREP [2]

Unstow, fill 4 drink containers (per crewmember) with 8 oz of water each; temp stow near seat

Unstow 8 salt tablets (per crewmember); temp stow tablets in Flight Suit pocket

ENTRY STOWAGE [4]

PERSONAL HYGIENE SYS STOWAGE
Stow: Personal Hygiene Kits
Hose

AIRLOCK CLOSEOUT
Tether soft goods to EVA tether point or A/L Stowage Bag.
Gray Tape to floor

MO13Q ✓ ARLK FAN A(B) – OFF (OV103/OV104/OV105) if flown
Stow all ducts as appropriate
Airlock ENT SW VERIF, 3-28 and 3-29 (OV102), 3-30 and 3-31 (OV103, OV104, OV105)

ESCAPE POLE SETUP

Reinstall Stbd Pip Pin
Reinstall large Port Pin:
Retract and hold Locking Pin (Ring)
Reinstall large Pin
Release Locking Pin (Ring)
Slide forward Safing Latch

✓ Pole Straps secure

DFD STOWAGE

Stow FLIGHT PLAN

CABIN CONFIG

Stow: Backup PGSC
Middeck Camrs, Accessories
FWD/AFT Shades, Filters
Quick Don Masks

Stow Exercise Equipment

✓ Retention net in ASC/ENT config

EGRESS ROUTE CONFIG

Tape Foot Loops in egress routes

GALLEY

GALLEY DEACT

✓ OVEN/RHS – OFF
H2O HTRS (two) – OFF
✓ OVEN FAN – OFF
✓ REHYD STA lever – cl (push in)
✓ OVEN DOOR LATCH – latched
cb AC3 GALLEY FAN (three) – op
MNC SPLY H2O GALLEY SPLY – op
MNA GALLEY OVEN – op
MNB GALLEY H2O HTR – op

MA73C:G
ML86B:A
:B

(Cont next page)

LOSS OF FES DEORBIT PREP ENTRY DELTAS PULLOUT PAGE

DELTAS TO ENT, DEORBIT BURN

1. At TIG-30 min, enter ENT, DEORBIT BURN
(do all)
2. At TIG-15 min, use two CRTs as reqd for burn
Minimize use when possible
3. At TIG-15, do not perform pnl A14 OMS/RCS
heater configurations
4. At TIG-5, use R INST PWR as reqd for APU
start, two FLT CNTLR PWR/DDUs as reqd
for burn
Minimize use

C3
O17
O17

8. Prior to SSME HYD REPRESS:

- ✓ FCS CH (four) – AUTO
- ATVC (four) – ON
- When SSME REPRESS complete:
- ATVC (four) – OFF
- ✓ EIU (three) – OFF
- ✓ MEC 1,2 (two) – OFF
- GNC 51 , BFS GNC 51 SSME
- REPOS – ITEM 19 EXEC (INH)

DELTAS TO ENT, POST BURN

1. Use one CRT, one FLT CNTLR PWR, one INST
PWR only as reqd
2. Set event timer counting to EI
3. At EI-21:
HYD CIRC PUMP (one of two on
non-operating hyd sys) – ON
4. At EI-18: If FRCS DUMP reqd:
RJDF LOGIC, DRIVER (eight) – ON
FWD RCS MANF ISOL 1,2,3,4
(four) – OP (tb-OP)
5. After dump completion:
RJDF LOGIC, DRIVER (eight) – OFF
6. In ENTRY SW CHECK, do not activate
ANTISKID, NWS, NAV AIDS
7. At EI-13:
Operating HYD CIRC PUMP – OFF
Start second APU (one only)
HYD CIRC PUMP (remaining non-operating
hyd sys) – ON

R2

O14,O15,O16:F
O8

O14,O15,O16:F

R2

R2

DELTAS TO ENTRY MANEUVERS CUE CARD

1. At EI-5:
HYD CIRC PMP – OFF
Start remaining APU
BRAKES MNA,B,C (three) – ON
cb ADTA 1,2,3,4 (four) – cl
GNC I/O RESET
2. At EI: NH3 CNTLR B – SEC/ON
INST PWR (two) – FLT/ON
FLT CNTLR PWR (two) – ON
3. At V = 15K: TACAN MODE (three) – GPC
4. At V = 12K: DELETE reference to radiator flow
5. At V = 6K: NH3 CNTLR B – OFF
A – PRI/GPC
6. At M = 2.9:
MLS (three) – ON
GNC I/O RESET
RADAR ALTM (two) – ON
HUD PWR (two) – ON
NWS – 1
ANTISKID – ON
7. Post Wheel-Stop, go to EXPEDITED PWRDN

NOM

This Page Intentionally Blank

(NOM) B7-22

NOM
C D/O/ALL/GEN H

LOSS OF 2 H2O LOOPS

Part 1: ON-ORBIT WAIT

Part 2: ON-ORBIT WAIT BACKOUT

**LOSS OF 2 H₂O
LOOPS**

This Page Intentionally Blank

LOSS OF 2 H2O LOOPS

PART 1: ON-ORBIT WAIT

ASSUMPTIONS/INITIAL CONDITIONS

LOSS OF 2 H2O LOOPS assumes one of following pwrdns accomplished:

LOSS OF 2 H2O LOOPS (ORB PKT, PWRDN)

LOSS OF 2 H2O LOOPS (POST OMS-2) (ASC PKT, PWRDN)

IMU 2 and MDM FF2 have been activated

Comm is being cycled per ORB PKT pwrdrn comm pages

PROBLEM DESCRIPTION/RATIONALE

Use of H2O loop or air-cooled equipment is minimized or delayed because heat transfer from crew module is lost

Cabin atmosphere purges are done to aid in reducing cabin humidity and temp. This cycle should be started 1 hr 15 min after failure.

Attitude control is reqd during purge because venting is propulsive

Av Bay 1 equipment is used as much as possible to keep Av Bays 2 and 3 cool for entry

LOSS OF 2 H2O LOOPS (Cont)

PART 1: ON-ORBIT WAIT (Cont)

NOTE

1. MS procedures for PART 1: ON-ORBIT WAIT are located on MS PULLOUT PAGES, 8-7. Extra copies are located in back of PLT's book
2. Maintain minimum lighting
3. Use wristwatches for time reference until GMT/MET UPDATE (COARSE) in PART 2: ON-ORBIT WAIT BACKOUT
4. Alternate between GPC 4 and GPC 1 for each Cabin De/Repress cycle. Minimize time that GPCs are on
5. Each GPC will be powered up for 2 sec each cycle to allow error detection and correction logic to scrub memory of any accumulated errors
6. With MDM FF1/off, panel C3 DAP controls are functional even though lights are not on
7. Perform De/Repress during night pass, if possible. De/Repress should occur within 75 min of failure. Subsequent De/Represses at TIG-1:15 and TIG--:20
8. Monitor crew health by applying temp strip (MED Kit) to forehead and trunk of CDR and PLT. Record body temp every 15 min
9. Use Quick Don Mask as needed to provide relief during periods of high cabin temperature and humidity. Do not use Quick Don Mask during cabin repress. Don LES, activate O2, and close visor if cabin temp > 95 degF and no evaporative cooling is sensed

RJD CONFIG CHECK 1

O6 ✓MDM FA1,2,3,4 (four) – ON
O14:F, ✓RJDA LOGIC,DRIVER (eight) – ON
O15:F, ✓RJDF LOGIC,DRIVER (eight) – OFF
O16:F ✓RJD MANF L5/F5/R5 DRIVER – OFF

GNC GPC ACTIVATION 2

Alternate between GPCs 4 and 1
Record MET: 1) ____/____:____:____
 2) ____/____:____:____

C2 IDP/CRT2 PWR – ON
 MAJ FUNC – GNC
L1 AV BAY 1 FAN A(B) – ON
O6 ✓GPC MODE 4(1) – HALT (tb–bp)
 ✓OUTPUT 4(1) – NORM (tb–bp)
 PWR 4(1) – ON
 MODE 4(1) – STBY (tb–RUN), RUN

RESTRING TO GNC GPC 3

GNC 0 GPC MEMORY

CONFIG – ITEM 1 +2 EXEC
Assign all strings to GPC 4(1)
GNC, OPS 201 PRO

	ALL	Begin Fluid Loading (one 8 oz container every 15 min, with a salt tablet every other container) and continue through entry
	C,P	Start all <u>CABIN DE/REPRESS</u> cycles approx 20 min before sunrise, if possible
ELAPSED TIME		<u>CABIN DE/REPRESS</u>
00:00	C,P	<u>RJD CONFIG CHECK</u> [1], 8-5
	C	<u>PCS SETUP</u> [A] (20 MINUTE DE/REPRESS), 8-17
	C, MS	<u>CABIN DEPRESS SETUP</u> [B] (20 MINUTE DE/REPRESS), 8-17
	C,P	<u>GNC GPC ACTIVATION</u> [2], 8-5
00:05	C,P	<u>RESTRING TO GNC GPC</u> [3], 8-3
	C,P	<u>TAIL SUN ATT MNVR</u> [4]
	MS	<u>CABIN DEPRESS</u> [C] (20 MINUTE DE/REPRESS), 8-17
00:10		
00:15	C, MS	<u>CABIN REPRESS</u> [D] (20 MINUTE DE/REPRESS), 8-17
	C,P	<u>ESTABLISH FREE DRIFT</u> [5]
	C,P	<u>GNC GPC POWERDOWN</u> [6]
00:20		
	MS	If MCC requests data on cab temp and humidity, or Av Bay temp, perform <u>CABIN ENVIRONMENT MONITOR</u> [7], 8-7
	ALL	At TIG-1:30, go to PART 2: ON-ORBIT WAIT BACKOUT, 8-9

TAIL SUN ATT MNVR [4]

WARNING
Do not turn off FF MDM associated with IMU in operate

CRT GNC UNIV PTG

- ✓ TGT ID, ITEM 8 +4
- BODY VECT - ITEM 14 +5 EXEC
- Load Tail Sun Att P = 225, Y = 0, OM = (blank)
- DAP: A/AUTO/PRI
- TRK - ITEM 19 EXEC (CUR - *)
- ✓ ERR TOT - ITEM 23 (*)
- ✓ Att mnvr complete

ADJ

ESTABLISH FREE DRIFT [5]

C3 ✓ CABIN DEPRESS [C] complete

DAP: B/AUTO/PRI

Wait 30 sec

DAP: FREE

NOTE

Deviations from TAIL SUN att are expected during free drift period. No action reqd

GNC GPC POWERDOWN [6]

CRT GNC, OPS 000 PRO

O6 GPC MODE 4(1) - STBY (tb-bp)
- HALT (tb-bp)
- STBY (tb-RUN)
- HALT (tb-bp)

PWR 4(1) - OFF

C2 IDP/CRT 2 PWR - OFF

L1 AV BAY 1 FAN A(B) - OFF

Record MET: 1) ___ / ___ : ___ : ___

2) ___ / ___ : ___ : ___

O6 GPC PWR 1(4) - ON, wait 2 sec, OFF

2 - ON, wait 2 sec, OFF

3 - ON, wait 2 sec, OFF

5 - ON, wait 2 sec, OFF

MEDS

LOSS OF 2 H2O LOOPS

PART 1: ON-ORBIT WAIT MS ACTIVITIES

MS PULLOUT PAGE

NOTE

Wait for GO from CDR or PLT before starting any activity on this page

CABIN ENVIRONMENT MONITOR 7

Perform at GSTDN (SGLS) on MCC call

NOTE

Cab or Av Bay fan must be on for good cab air temp and humidity, or Av Bay temp readings as reqd

If MCC requests data on cab environ:
L1 ✓ CAB FAN A(B) – ON
O15:B cb MNB OI MDM OF 1/2 B – cl
L4:K ✓ AC1 ΦB CAB AIR S/C – cl
 :L ✓ AC2 ΦA CAB T CNTLR 1 – cl

If MCC requests data on Av Bay 1:
L1 ✓ AV BAY 1 FAN B(A) – ON
O15:B cb MNB OI MDM OF 1/2 B – cl
 SIG CONDR OF 2/3 A – cl
L4:L ✓ AC3 ΦB AV BAY 1 S/C – cl

If MCC requests data on Av Bay 2:
L1 ✓ AV BAY 2 FAN A(B) – ON
O14:B cb MNA OI MDM OF 3/4 A – cl
O15:B MNB OI SIG CONDR OF 2/3 A – cl
L4:L ✓ AC1 ΦB AV BAY 2 S/C – cl

If MCC requests data on Av Bay 3:
L1 ✓ AV BAY 3 FAN B(A) – ON
O15:B cb MNB OI MDM OF 1/2 B – cl
 SIG CONDR OF 1/4 B – cl
L4:L ✓ AC2 ΦB AV BAY 3 S/C – cl

Perform LOSS OF 2 H2O LOOPS COMM POWERUP,
steps 1,4,5,6 (ORB PKT, PWRDN)

C3 OI PCMMU PWR – 1

After comm/data complete:
Go to LOSS OF 2 H2O LOOPS COMM PWRDN
(ORB PKT, PWRDN) and pwrnd equipment
used in above steps

This Page Intentionally Blank

LOSS OF 2 H2O LOOPS

PART 2: ON ORBIT WAIT BACKOUT PROCEDURE NOTES

ASSUMPTIONS/INITIAL CONDITIONS

LOSS OF 2 H2O LOOPS (ORB PKT, PWRDN) has been accomplished

Orbiter in On–Orbit Wait config – IMU 2 and MDM FF2 activated

Cabin de/repress cycle has been performed during Part 1

Comm being cycled per ORB PKT pwrtn comm pages

CONUS TIG available in ≥ 1.5 hr

PROBLEM DESCRIPTION/RATIONALE

IMU reference maintained and heat load minimized during Part 1 by allowing IMU to run uncompensated (GPC off)

During Part 2: ON–ORBIT WAIT BACKOUT, minimum equipment configured to accomplish PLBD closing, IMU alignment, and GMT/MET update. Final powerup to single–fault tolerant entry config initiated at TIG–0:30 min in LOSS OF 2 H2O LOOPS DEORBIT PREP/ENTRY (Sec 9)

NOTE

1. MS procedures located on MS PULLOUT PAGE, 8–15. Extra copies located in back of PLT's book
2. Continue Fluid Loading (8 oz water every 15 min, with a salt tablet every other container)

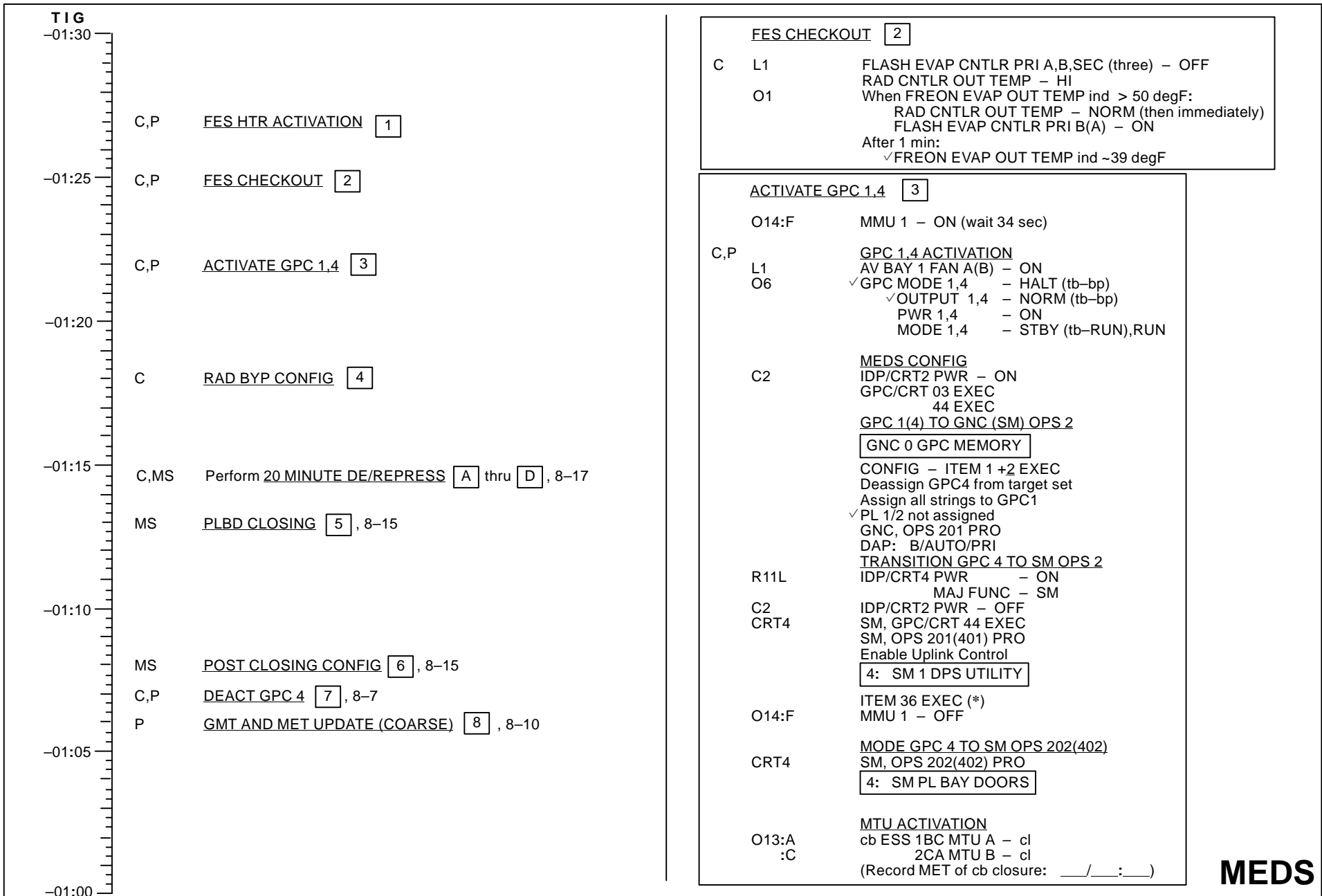

MEDS

IMU STAR ALIGN PAD

NOTE
For pad data, ref STAR PAIRS (ORB OPS, PTG)

STAR ID: -Y __, _____ (TIG- ____ : ____ TO- ____ : ____)
 -Z __, _____ (TIG- ____ : ____ TO- ____ : ____)

ANG DIF: _____

<p>ALIGNMENT ATTITUDE (Dual or Single S TRK)</p> <p>R _____ P _____ Y _____</p>	<p>2nd ALIGNMENT ATTITUDE (Single S TRK)</p> <p>-Z: _____ -Y: _____</p> <p>R _____ R _____ P _____ P _____ Y _____ Y _____</p>
---	--

MNVR TO IMU ALIGN ATT 9

R11L IDP/CRT4 PWR - ON
MAJ FUNC - GNC

C 4: GNC UNIV PTG

CRT
C3(A6)
L1

Load ALIGN ATT from MCC
or STAR PAIRS (ORB OPS, PTG)
ITEM 18 EXEC
DAP: A/AUTO/PRI
HI LOAD EVAP - ENA
FLASH EVAP CNTLR PRI B(A) - ON
SEC - OFF

✓ Att mnvr complete
DAP: B/AUTO/PRI

IMU ALIGN 10

C O6 MDM FF1 - ON
✓FF3 - ON

4: GNC 22 S TRK/COAS CNTL

GNC I/O RESET

1. S TABLE CLR - ITEM 20 EXEC
S TRK - ITEM 3,4 EXEC (*)
2. ✓S TABLE: TRK ID 1,2 - STAR ID (PAD)
✓ANG ERR 1: ≤ 0.08
✓SEL ITEM 17,18 (*)
4: GNC 21 IMU ALIGN
✓STAR ALIGN - ITEM 13 EXEC (*)
✓ANG 2 ΔX,ΔY,ΔZ ≤ 2°
3. ALIGN IMU 2 - ITEM 11 EXEC (*)
EXEC - ITEM 16 EXEC (*)
✓EXEC - ITEM 16 (no *)

WARNING
Do not turn off FF MDM
associated with IMU just aligned

O6 MDM FF1,3 - OFF

TIG
-01:00

P STATE VECTOR/TIME UPLINK
 (If not previously accomplished)
 MDM FF3 – ON
 GNC I/O RESET

-00:55 Perform COMM POWERUP (ORB PKT, PWRDN) on LOSS OF 2 H2O
 LOOPS MS PAGE to allow state vector uplink and update of GMT AND
 MET UPDATE (FINE) [11], 8-14 delta. Use GSTDN with data if available or
 TDRS with data if GSTDN coverage not available

C MNVR TO IMU ALIGN ATT [9], 8-12

-00:50

C IMU ALIGN [10], 8-12

-00:45

P GMT AND MET UPDATE (FINE) [11], 8-14

-00:40

C TRANSITION CONFIG [12], 8-14

-00:35

MS GALLEY DEACT [13], 8-15

-00:30

A Go to LOSS OF 2 H2O LOOPS DEORBIT PREP/ENTRY

MEDS

GMT AND MET UPDATE (FINE) 11

NOTE

This procedure is for updating onboard GMT and MET to degree of accuracy reqd for ENTRY. Use deltas provided by MCC. OPS 0 reqd for GMT UPDATE > 15 msec

R11L 1. IDP/CRT4 PWR – ON
P GNC, OPS 000 PRO

NOTE

Make no kybd entries during TIME SYNC and UPDATE actions. UPDATE causes reinitialization and TIME SPEC will have to be recalled

2. 2: GNC 2 TIME
TIME SYNC – ITEM 38 EXEC (takes up to 2 min)

3. GMT UPDATE
Use GMT Δ provided by MCC for ITEM 24 (DAY/HR:MIN:SEC)

ITEM 24 [±] / : : .

UPDATE – ITEM 32 EXEC (takes up to 2 min)

If LOS:

4. NOTE
Record GMT when RESET occurs: ___/___:___:___

MET RESET – ITEM 33 EXEC

5. Calculate MET Δ for ITEM 28 as follows:
MET Δ = GMT recorded in step 4 – GMT at liftoff

6. Go to step 7

7. If AOS:
MCC will provide MET Δ for ITEM 28 after GMT UPDATE complete

MET UPDATE

✓ITEM 2 (*)

ITEM 28 [±] / : : .

UPDATE – ITEM 32 EXEC (takes up to 2 min)

When UPDATE complete:
GNC, OPS 201 PRO

2: GNC 2 TIME

SET CRT TIMER TO COUNT DOWN TO TIG

(HR:MIN:SEC – MET)

R11L COUNT TO – ITEM 17 + + +

R11L IDP/CRT4 PWR – OFF

TRANSITION CONFIG 12

C O13:E cb ESS 3AB GPC STAT – cl
O14:C MNA SMOKE DETN L/R FLT DK – cl

MEDS

C D/O/MEDS/GEN H

LOSS OF 2 H2O LOOPS MS ACTIVITIES

Part 2: ON-ORBIT WAIT BACKOUT MS ACTIVITIES

MS PULLOUT PAGE

NOTE

Wait for GO from CDR or PLT before starting any activity on this page

TIME (TIG-)	MS ACTIONS
	<p>NOTE Prepare LES for donning. Don LES if cabin temp > 95 degF and no evaporative cooling sensed. Inflate anti-G suit as needed for circulatory support</p>
1:13	PLBD CLOSING 5
1:08	POST CLOSING CONFIG 6
0:42	STOW COAS
0:35	GALLEY DEACT 13

POST CLOSING CONFIG 6	
CRT4 R13L	AC POWER OFF – ITEM 2 EXEC PL BAY DR SYS 1,2 (two) – DSBL
	✓70mm Camr (2), Spotmeter stowed
A7U	✓PL BAY FLOOD (all) – OFF
MA73C:A :B	MCA LOGIC MID (four) – OFF MCA LOGIC MID (four) – OFF
O6	MDM PL1 – OFF If no data transmission in progress: MDM PL2 – OFF Go to EDO PALLET DEACT (if flown) (ORB OPS, EPS)

PLBD CLOSING 5	
MA73C:A :B	MCA LOGIC MID (four) – ON MCA LOGIC MID (four) – ON
O6 CRT	CLOSE PLBD MDM PL1,2 (two) – ON SM I/O RESET SM, OPS 202 PRO SM PL BAY DOORS
R13L CRT	<p>✓No obstruction (Ku ANT, RMS, RAD, etc) PL BAY DR SYS 1,2 (two) – ENA AC PWR ON – ITEM 1 EXEC AUTO MODE SEL – ITEM 3 EXEC PBD SW BYP – ITEM 14 EXEC CLOSE – ITEM 17 EXEC</p> <p>* If 'S63 PBD SEQ FAIL' msg during door closure and AFT LATCHES for that door not 'CL': * ✓DOOR SCALLOP on or below target line before continuing in MANUAL mode; otherwise, perform CONTINGENCY * PLBD CLOSURE, MECH SSR-2 (MAL, MECH) *</p> <p>After PLBD closed: PBD STOP – ITEM 16 EXEC</p>

GALLEY DEACT 13	
	NOTE Ensure sufficient containers and salt tablets prepared to continue Fluid Loading thru entry
MA73C:G ML86B:B	cb AC3 GALLEY FAN (three) – op cb MNA GALLEY OVEN – op MNB GALLEY H2O HTR – op REHYD STA lever – cl (push in) OVEN DOOR LATCH – latched

This Page Intentionally Blank

20 MINUTE
DE/REPRESS

MS PULLOUT PAGE
20 MINUTE DE/REPRESS

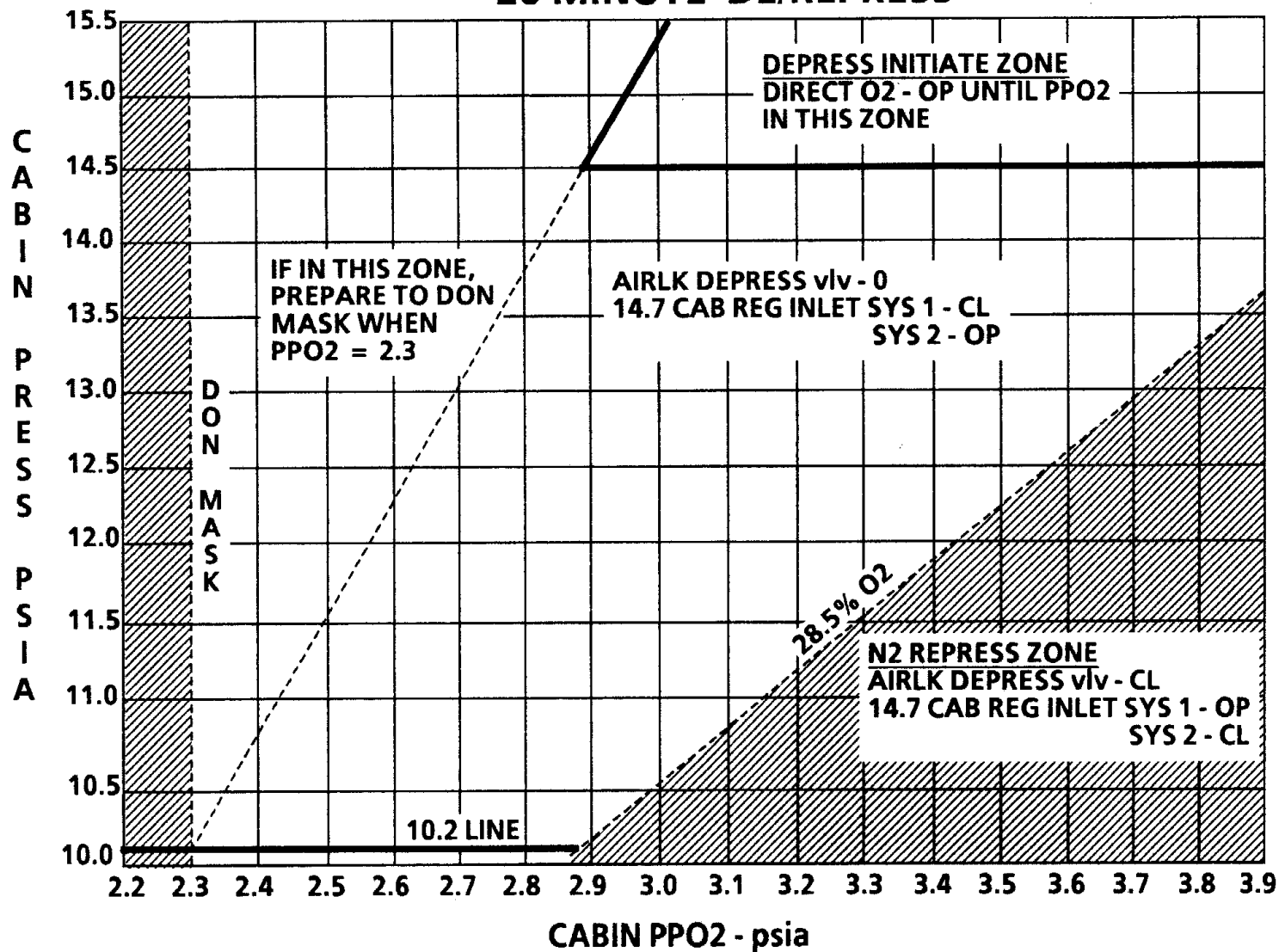

MEDS

LOSS OF 2 H2O LOOPS

PART 1: ON-ORBIT WAIT

ASSUMPTIONS/INITIAL CONDITIONS

LOSS OF 2 H2O LOOPS assumes one of following pwrdns accomplished:

LOSS OF 2 H2O LOOPS (ORB PKT, PWRDN)

LOSS OF 2 H2O LOOPS (POST OMS-2) (ASC PKT, PWRDN)

IMU 2 and MDM FF2 have been activated

Comm is being cycled per ORB PKT pwrdn comm pages

PROBLEM DESCRIPTION/RATIONALE

Use of H2O loop or air-cooled equipment is minimized or delayed because heat transfer from crew module is lost

Cabin atmosphere purges are done to aid in reducing cabin humidity and temp. This cycle should be started 1 hr 15 min after failure.

Attitude control is reqd during purge because venting is propulsive

Av Bay 1 equipment is used as much as possible to keep Av Bays 2 and 3 cool for entry

LOSS OF 2 H2O LOOPS (Cont)

PART 1: ON-ORBIT WAIT (Cont)

NOTE

1. MS procedures for PART 1: ON-ORBIT WAIT are located on MS PULLOUT PAGES, 8-7. Extra copies are located in back of PLT's book
2. Maintain minimum lighting
3. Use wristwatches for time reference until GMT/MET UPDATE (COARSE) in PART 2: ON-ORBIT WAIT BACKOUT
4. Alternate between GPC 4 and GPC 1 for each Cabin De/Repress cycle. Minimize time that GPCs are on
5. Each GPC will be powered up for 2 sec each cycle to allow error detection and correction logic to scrub memory of any accumulated errors
6. With MDM FF1/off, panel C3 DAP controls are functional even though lights are not on
7. Perform De/Repress during night pass, if possible. De/Repress should occur within 75 min of failure. Subsequent De/Represses at TIG-1:15 and TIG--:20
8. Monitor crew health by applying temp strip (MED Kit) to forehead and trunk of CDR and PLT. Record body temp every 15 min
9. Use Quick Don Mask as needed to provide relief during periods of high cabin temperature and humidity. Do not use Quick Don Mask during cabin repress. Don LES, activate O2, and close visor if cabin temp > 95 degF and no evaporative cooling is sensed

RJD CONFIG CHECK 1

O6 ✓MDM FA1,2,3,4 (four) – ON
O14:F, ✓RJDA LOGIC,DRIVER (eight) – ON
O15:F, ✓RJDF LOGIC,DRIVER (eight) – OFF
O16:F ✓RJD MANF L5/F5/R5 DRIVER – OFF

GNC GPC ACTIVATION 2

Alternate between GPCs 4 and 1
Record MET: 1) ____/____:____:____
 2) ____/____:____:____

C2 CRT2 PWR – ON
 MAJ FUNC – GNC
L1 AV BAY 1 FAN A(B) – ON
O6 ✓GPC MODE 4(1) – HALT (tb–bp)
 ✓OUTPUT 4(1) – NORM (tb–bp)
 PWR 4(1) – ON
 MODE 4(1) – STBY (tb–RUN), RUN

RESTRING TO GNC GPC 3

GNC 0 GPC MEMORY

CONFIG – ITEM 1 +2 EXEC
Assign all strings to GPC 4(1)
GNC, OPS 201 PRO

	ALL	Begin Fluid Loading (one 8 oz container every 15 min, with a salt tablet every other container) and continue through entry
	C,P	Start all <u>CABIN DE/REPRESS</u> cycles approx 20 min before sunrise, if possible
ELAPSED TIME		<u>CABIN DE/REPRESS</u>
00:00	C,P	<u>RJD CONFIG CHECK</u> [1], 8-5
	C	<u>PCS SETUP</u> [A] (20 MINUTE DE/REPRESS), 8-17
	C, MS	<u>CABIN DEPRESS SETUP</u> [B] (20 MINUTE DE/REPRESS), 8-17
	C,P	<u>GNC GPC ACTIVATION</u> [2], 8-5
00:05	C,P	<u>RESTRING TO GNC GPC</u> [3], 8-5
	C,P	<u>TAIL SUN ATT MNVR</u> [4]
	MS	<u>CABIN DEPRESS</u> [C] (20 MINUTE DE/REPRESS), 8-17
00:10		
00:15	C, MS	<u>CABIN REPRESS</u> [D] (20 MINUTE DE/REPRESS), 8-17
	C,P	<u>ESTABLISH FREE DRIFT</u> [5]
	C,P	<u>GNC GPC POWERDOWN</u> [6]
00:20		
	MS	If MCC requests data on cab temp and humidity, or Av Bay temp, perform <u>CABIN ENVIRONMENT MONITOR</u> [7], 8-7
	ALL	At TIG-1:30, go to PART 2: ON-ORBIT WAIT BACKOUT, 8-9

TAIL SUN ATT MNVR [4]

WARNING
Do not turn off FF MDM associated with IMU in operate

CRT GNC UNIV PTG

- ✓TGT ID, ITEM 8 +4
- BODY VECT - ITEM 14 +5 EXEC
- Load Tail Sun Att P = 225, Y = 0, OM = (blank)
- DAP: A/AUTO/PRI
- TRK - ITEM 19 EXEC (CUR - *)
- ✓ERR TOT - ITEM 23 (*)
- ✓Att mnvr complete

C3

F8

ESTABLISH FREE DRIFT [5]

- ✓CABIN DEPRESS [C] complete
- DAP: B/AUTO/PRI
- Wait 30 sec
- DAP: FREE
- cb MNB DDU R - op

O15:E

NOTE
Deviations from TAIL SUN att are expected during free drift period. No action reqd

GNC GPC POWERDOWN [6]

CRT GNC, OPS 000 PRO

O6 GPC MODE 4(1) - STBY (tb-bp)
- HALT (tb-bp)
- STBY (tb-RUN)
- HALT (tb-bp)

PWR 4(1) - OFF

C2 CRT 2 PWR - OFF

L1 AV BAY 1 FAN A(B) - OFF

Record MET: 1) ___ / ___ : ___ : ___
2) ___ / ___ : ___ : ___

O6 GPC PWR 1(4) - ON,wait 2 sec,OFF
2 - ON,wait 2 sec,OFF
3 - ON,wait 2 sec,OFF
5 - ON,wait 2 sec,OFF

NOM

LOSS OF 2 H2O LOOPS

PART 1: ON-ORBIT WAIT MS ACTIVITIES

MS PULLOUT PAGE

NOTE

Wait for GO from CDR or PLT before starting any activity on this page

CABIN ENVIRONMENT MONITOR 7

Perform at GSTDN (SGLS) on MCC call

NOTE

Cab or Av Bay fan must be on for good cab air temp and humidity, or Av Bay temp readings as reqd

If MCC requests data on cab environ:
L1 ✓ CAB FAN A(B) – ON
O15:B cb MNB OI MDM OF 1/2 B – cl
L4:K ✓ AC1 ΦB CAB AIR S/C – cl
:L ✓ AC2 ΦA CAB T CNTLR 1 – cl

If MCC requests data on Av Bay 1:
L1 ✓ AV BAY 1 FAN B(A) – ON
O15:B cb MNB OI MDM OF 1/2 B – cl
 SIG CONDR OF 2/3 A – cl
L4:L ✓ AC3 ΦB AV BAY 1 S/C – cl

If MCC requests data on Av Bay 2:
L1 ✓ AV BAY 2 FAN A(B) – ON
O14:B cb MNA OI MDM OF 3/4 A – cl
O15:B MNB OI SIG CONDR OF 2/3 A – cl
L4:L ✓ AC1 ΦB AV BAY 2 S/C – cl

If MCC requests data on Av Bay 3:
L1 ✓ AV BAY 3 FAN B(A) – ON
O15:B cb MNB OI MDM OF 1/2 B – cl
 SIG CONDR OF 1/4 B – cl
L4:L ✓ AC2 ΦB AV BAY 3 S/C – cl

Perform LOSS OF 2 H2O LOOPS COMM POWERUP,
steps 1,4,5,6 (ORB PKT, PWRDN)

C3 OI PCMMU PWR – 1

After comm/data complete:
Go to LOSS OF 2 H2O LOOPS COMM PWRDN
(ORB PKT, PWRDN) and pwrnd equipment
used in above steps

(NOM) B8-7

C D/O/ALL/GEN H

This Page Intentionally Blank

(NOM) B8-8

C D/O/ALL/GEN H

LOSS OF 2 H2O LOOPS

PART 2: ON ORBIT WAIT BACKOUT PROCEDURE NOTES

ASSUMPTIONS/INITIAL CONDITIONS

LOSS OF 2 H2O LOOPS (ORB PKT, PWRDN) has been accomplished

Orbiter in On–Orbit Wait config – IMU 2 and MDM FF2 activated

Cabin de/repress cycle has been performed during Part 1

Comm being cycled per ORB PKT pwrtn comm pages

CONUS TIG available in ≥ 1.5 hr

PROBLEM DESCRIPTION/RATIONALE

IMU reference maintained and heat load minimized during Part 1 by allowing IMU to run uncompensated (GPC off)

During Part 2: ON–ORBIT WAIT BACKOUT, minimum equipment configured to accomplish PLBD closing, IMU alignment, and GMT/MET update. Final powerup to single–fault tolerant entry config initiated at TIG–0:30 min in LOSS OF 2 H2O LOOPS DEORBIT PREP/ENTRY (section 9)

NOTE

1. MS procedures located on MS PULLOUT PAGE, 8–15. Extra copies located in back of PLT's book
2. Continue Fluid Loading (8 oz water every 15 min, with a salt tablet every other container)

FES HTR ACTIVATION 1

- C L1 ✓ TOP EVAP HTR NOZ L,R (two) – B AUTO
 ✓ DUCT sel – B
 HI LOAD DUCT HTR sel – B
 L2 ✓ FLASH EVAP FDLN HTR A,B SPLY (two) – 2
 R11L SPLY H2O B SPLY ISOL VLV – OP (tb-OP)

RAD BYP CONFIG 4

- C L1 FLASH EVAP CONFIG
 FLASH EVAP CNTLR SEC – ON
 PRI B(A) – OFF
- RAD BYP
 RAD BYP VLV MODE (two) – MAN
 RAD BYP VLV MAN SEL (two) – BYP
 (after ~3 sec, tb-BYP)
 RAD CNTLR LOOP 1,2 (two) – OFF
 L2 FREON ISOL MODE – OFF
 O1 ✓ FREON EVAP OUT TEMP ind ~62 ± 2 degF
 (after ~2.5 min)

DEACT GPC 4 7

- ✓ PLBD – closed
 GPC/CRT – 14 EXEC
 O6 GPC MODE 4 – STBY (tb-bp),HALT
 PWR 4 – OFF
 R11L CRT4 PWR – OFF

GMT AND MET UPDATE (COARSE) 8

NOTE

This procedure provides for crew autonomous update of onboard GMT and MET. OPS 0 reqd for GMT UPDATE > 15 msec

- ✓ PLBDs – closed
 ✓ Depress complete
 CRT2 PWR – ON
 GNC, OPS 000 PRO

2: GNC GPC MEMORY

NOTE

Make no kybd entries during TIME SYNC and UPDATE actions. UPDATE causes reinitialization and TIME SPEC will have to be recalled

1. 2: GNC 2 TIME
 TIME SYNC – ITEM 38 EXEC (takes up to 2 min)

2. **GMT UPDATE**
 Calculate GMT Δ for ITEM 24 as follows:
 GMT Δ = wristwatch GMT – orbiter GMT (DAY/HR:MIN:SEC)

ITEM 24 [±] / : : .

UPDATE – ITEM 32 EXEC (takes up to 2 min)

3. **NOTE**
 Record GMT when MET RESET occurs: ___/___:___:___
 Reset MET to 0 on an even GMT min

MET RESET – ITEM 33 EXEC

4. **MET UPDATE**
 GMT at liftoff = / : : .

Calculate MET Δ for ITEM 28 as follows:
 MET Δ = GMT recorded in step 3 – GMT at liftoff
 ✓ ITEM 2 (*)

ITEM 28 [±] / : : .

UPDATE – ITEM 32 EXEC (takes up to 2 min)

GNC, OPS 201 PRO

- C2 CRT2 PWR – OFF

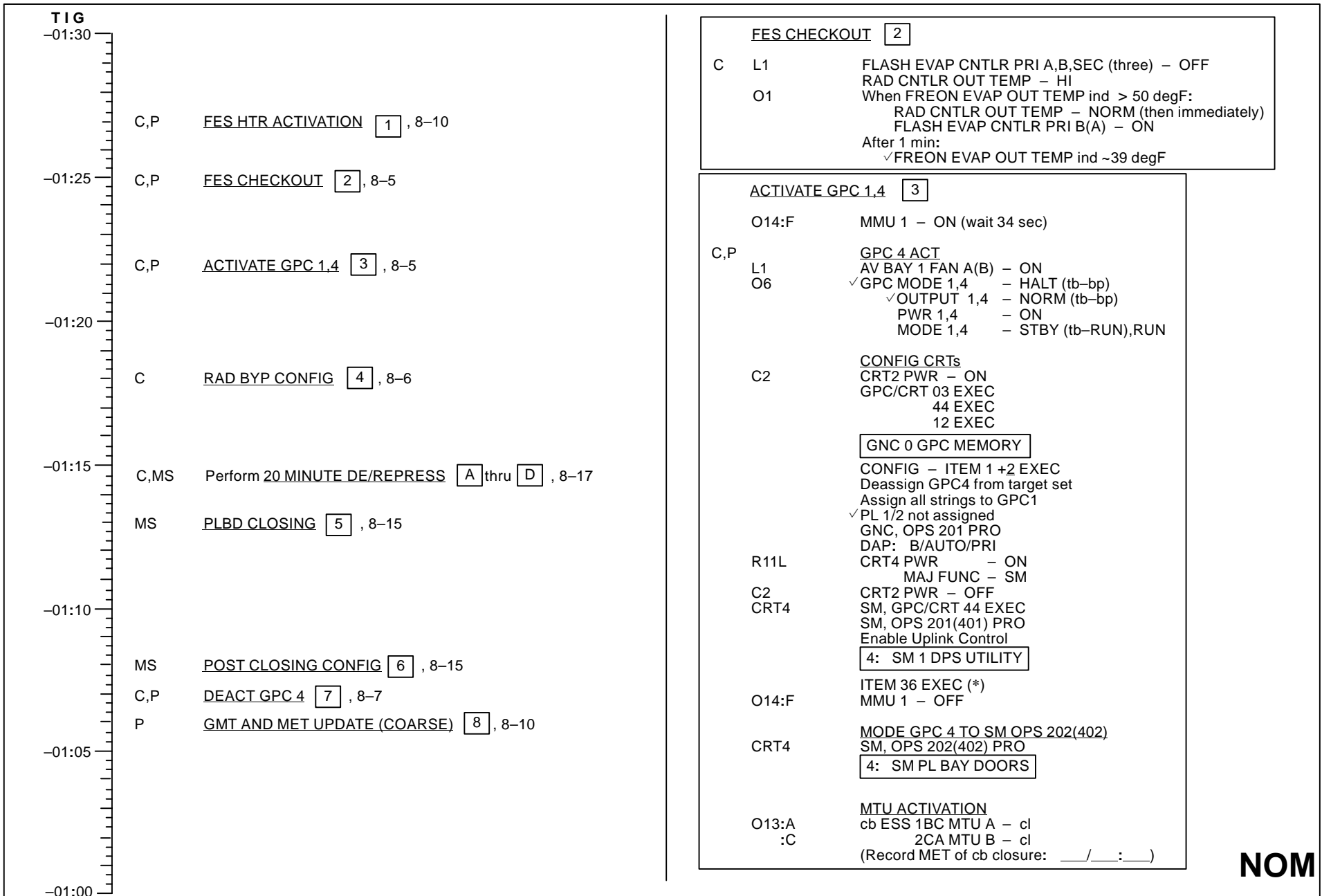

NOM

IMU STAR ALIGN PAD

NOTE
For pad data, ref STAR PAIRS (ORB OPS, PTG)

STAR ID: -Y __, _____ (TIG- ____ : ____ TO- ____ : ____)
 -Z __, _____ (TIG- ____ : ____ TO- ____ : ____)

ANG DIF: _____

<p>ALIGNMENT ATTITUDE (Dual or Single S TRK)</p> <p>R _____ P _____ Y _____</p>	<p>2nd ALIGNMENT ATTITUDE (Single S TRK)</p> <p>-Z: _____ -Y: _____</p> <p>R _____ R _____ P _____ P _____ Y _____ Y _____</p>
---	--

MNVR TO IMU ALIGN ATT 9

R11L CRT4 PWR - ON
MAJ FUNC - GNC

C 4: GNC UNIV PTG

CRT C3(A6) L1

Load ALIGN ATT from MCC
or STAR PAIRS (ORB OPS, PTG)
ITEM 18 EXEC
DAP: A/AUTO/PRI
HI LOAD EVAP - ENA
FLASH EVAP CNTLR PRI B(A) - ON
SEC - OFF

✓ Att mnvr complete
DAP: B/AUTO/PRI

IMU ALIGN 10

C O6 MDM FF1 - ON
✓FF3 - ON

4: GNC 22 S TRK/COAS CNTL

GNC I/O RESET

1. S TABLE CLR - ITEM 20 EXEC
S TRK - ITEM 3,4 EXEC (*)
2. ✓S TABLE: TRK ID 1,2 - STAR ID (PAD)
✓ANG ERR 1: ≤ 0.08
✓SEL ITEM 17,18 (*)
4: GNC 21 IMU ALIGN
✓STAR ALIGN - ITEM 13 EXEC (*)
✓ANG 2 ΔX,ΔY,ΔZ ≤ 2°
3. ALIGN IMU 2 - ITEM 11 EXEC (*)
EXEC - ITEM 16 EXEC (*)
✓EXEC - ITEM 16 (no *)

WARNING
Do not turn off FF MDM
associated with IMU just aligned

O6 MDM FF1,3 - OFF

NOM I

TIG
-01:00

P STATE VECTOR/TIME UPLINK
 (If not previously accomplished)
 MDM FF3 – ON
 GNC I/O RESET

-00:55 Perform COMM POWERUP (ORB PKT, PWRDN) on LOSS OF 2 H2O
 LOOPS MS PAGE to allow state vector uplink and update of GMT AND
 MET UPDATE (FINE) [11], 8–14 delta. Use GSTDN with data if available or
 TDRS with data if GSTDN coverage not available

C MNVR TO IMU ALIGN ATT [9], 8–12

-00:50

C IMU ALIGN [10], 8–12

-00:45

P GMT AND MET UPDATE (FINE) [11], 8–14

-00:40

C TRANSITION CONFIG [12], 8–14

-00:35

MS GALLEY DEACT [13], 8–15

-00:30

A Go to LOSS OF 2 H2O LOOPS DEORBIT PREP/ENTRY

NOM

GMT AND MET UPDATE (FINE) 11

NOTE

This procedure is for updating onboard GMT and MET to degree of accuracy reqd for ENTRY. Use deltas provided by MCC. OPS 0 reqd for GMT UPDATE >15 msec

P 1. GNC, OPS 000 PRO

NOTE

Make no kybd entries during TIME SYNC and UPDATE actions. UPDATE causes reinitialization and TIME SPEC will have to be recalled

2. 2: GNC 2 TIME

TIME SYNC – ITEM 38 EXEC (takes up to 2 min)

3. GMT UPDATE

Use GMT Δ provided by MCC for ITEM 24 (DAY/HR:MIN:SEC)

ITEM 24 [±] / : : .

UPDATE – ITEM 32 EXEC (takes up to 2 min)

If LOS:

4.

NOTE

Record GMT when RESET occurs: ___/___:___:___

MET RESET – ITEM 33 EXEC

5. Calculate MET Δ for ITEM 28 as follows:

MET Δ = GMT recorded in step 4 – GMT at liftoff

6. Go to step 7

7. If AOS:

MCC will provide MET Δ for ITEM 28 after GMT UPDATE complete

MET UPDATE

✓ITEM 2 (*)

ITEM 28 [±] / : : .

UPDATE – ITEM 32 EXEC (takes up to 2 min)

When UPDATE complete:

GNC, OPS 201 PRO

2: GNC 2 TIME

SET CRT TIMER TO COUNT DOWN TO TIG

(HR:MIN:SEC – MET)

COUNT TO – ITEM 17 + + +

TRANSITION CONFIG 12

C O13:E cb ESS 3AB GPC STAT – cl
O14:C MNA SMOKE DETN L/R FLT DK – cl

LOSS OF 2 H2O LOOPS MS ACTIVITIES

Part 2: ON-ORBIT WAIT BACKOUT MS ACTIVITIES

MS PULLOUT PAGE

NOTE

Wait for GO from CDR or PLT before starting any activity on this page

TIME (TIG-)	MS ACTIONS
	<p>NOTE Prepare LES for donning. Don LES if cabin temp > 95 degF and no evaporative cooling sensed. Inflate anti-G suit as needed for circulatory support</p>
1:13	PLBD CLOSING 5
1:08	POST CLOSING CONFIG 6
0:42	STOW COAS
0:35	GALLEY DEACT 13

POST CLOSING CONFIG 6	
CRT4	AC POWER OFF – ITEM 2 EXEC
R13L	PL BAY DR SYS 1,2 (two) – DSBL
R11L	CRT4 PWR – OFF ✓70mm Camr (2), Spotmeter stowed
A7U	✓PL BAY FLOOD (all) – OFF
MA73C:A	MCA LOGIC MID (four) – OFF
:B	MCA LOGIC MID (four) – OFF
O6	MDM PL1 – OFF If no data transmission in progress: MDM PL2 – OFF Go to EDO PALLET DEACT (if flown) (ORB OPS, EPS)

PLBD CLOSING 5	
MA73C:A	MCA LOGIC MID (four) – ON
:B	MCA LOGIC MID (four) – ON
O6	CLOSE PLBD
CRT	MDM PL1,2 (two) – ON SM I/O RESET SM, OPS 202 PRO SM PL BAY DOORS
R13L	✓No obstruction (Ku ANT, RMS, RAD, etc) PL BAY DR SYS 1,2 (two) – ENA
CRT	AC PWR ON – ITEM 1 EXEC AUTO MODE SEL – ITEM 3 EXEC PBD SW BYP – ITEM 14 EXEC CLOSE – ITEM 17 EXEC
	<ul style="list-style-type: none"> * If 'S63 PBD SEQ FAIL' msg during door closure and AFT LATCHES for that door not 'CL': * ✓DOOR SCALLOP on or below target line before continuing in MANUAL mode; otherwise, perform CONTINGENCY * PLBD CLOSURE, MECH SSR-2 (MAL, MECH) *
	<p>After PLBD closed: PBD STOP – ITEM 16 EXEC</p>

GALLEY DEACT 13	
	NOTE Ensure sufficient containers and salt tablets prepared to continue Fluid Loading thru entry
MA73C:G	cb AC3 GALLEY FAN (three) – op
ML86B:B	cb MNA GALLEY OVEN – op MNB GALLEY H2O HTR – op REHYD STA lever – cl (push in) OVEN DOOR LATCH – latched

(NOM) B8-15

NOM

C D/O/NOM/GEN H

This Page Intentionally Blank

(NOM) B8-16

NOM
C D/O/ALL/GEN H

20 MINUTE
DE/REPRESS

MS PULLOUT PAGE
20 MINUTE DE/REPRESS

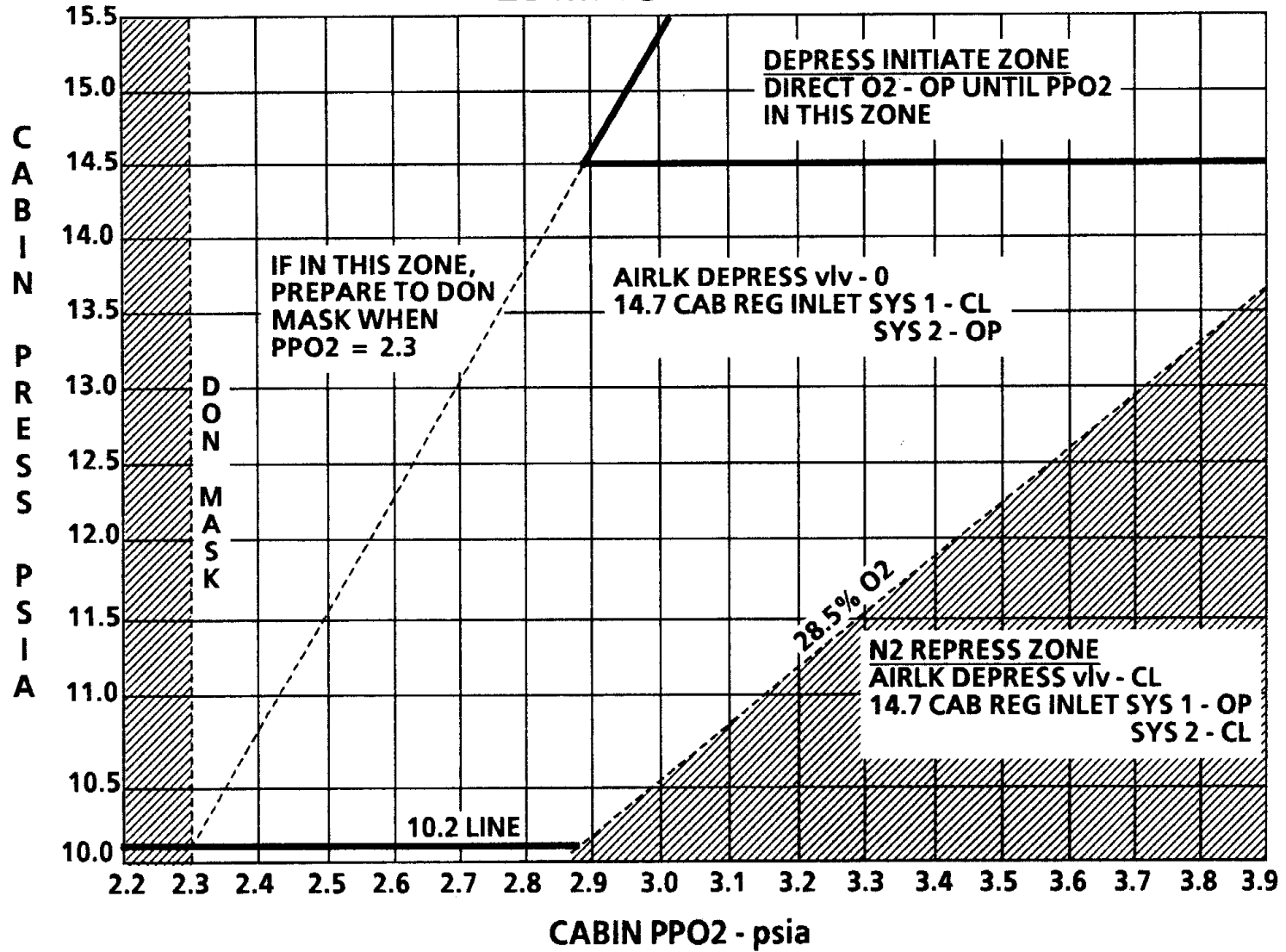

NOM

LOSS OF 2 H2O LOOPS DEORBIT PREP/ENTRY

**LOSS OF 2 H₂O
LOOPS D/O PREP**

This Page Intentionally Blank

LOSS OF 2 H2O LOOPS DEORBIT PREP/ENTRY

ASSUMPTIONS/INITIAL CONDITIONS

LOSS OF 2 H2O LOOPS DEORBIT PREP/ENTRY is a **STAND-ALONE procedure** that assumes one of the following has been accomplished:

LOSS OF 2 H2O LOOPS (ORB PKT, PWRDN)

LOSS OF 2 H2O LOOPS (POST OMS-2) (ASC PKT, PWRDN)

LOSS OF 2 H2O LOOPS (ORB PKT, PWRDN) and LOSS OF 2 H2O LOOPS Parts 1 and 2 (Section 8)

This procedure assumes 30 min remaining until deorbit burn

PROBLEM DESCRIPTION RATIONALE

With no H2O loop flow, heat not removed from water and air-cooled equipment. ORB PKT pwrdn maintained until TIG-30 min to minimize thermal load as long as possible

NOTE

1. LOSS OF 2 H2O LOOPS DEORBIT PREP/ENTRY configures vehicle for entry as quickly as possible and repowers critical equipment as late as possible to single-fault tolerant level
2. MS procedures located on MS PULLOUT PAGE, 9-5. Extra copies located in back of PLT's book
3. CDR and PLT procedures begin on 9-7
4. Use COMM pages from ORB PKT pwrdn to cycle COMM if necessary
5. This procedure utilizes modified version of DEORBIT BURN MONITOR and ENTRY MANEUVERS Cue Cards located at end of section

This Page Intentionally Blank

LOSS OF 2 H2O LOOPS DEORBIT PREP/ENTRY

MS PULLOUT PAGE

NOTE: Wait for GO from CDR before accomplishing any action on this page

TIG-20 MCA CONFIG

MA73C MCA LOGIC (fourteen) – ON

CABIN DE/REPRESS

TIG-20 Perform 20 MINUTE DE/REPRESS, 8-17

TIG-10 AFT PANEL CONFIG FOR ENTRY COMM

NOTE

This procedure configures aft panel for landing site comm coverage at V = 12K. If comm cycled post TIG-10 (using ORB PKT pwrn comm pages), this AFT PANEL CONFIG FOR ENTRY COMM must be reestablished

L9,R10	PS,MS AUD PWR	– AUD
R14:B	cb GCILC (two)	– cl
C3	S-BD PM CNTL	– CMD
A1L	ANT SW ELEC	– 2
	MODE	– STDN LO
	XPNDR	– 2
	NSP PWR	– 2
	DATA RATE XMIT	– HI
	RCV	– HI
	✓UPLK DATA	– S-BD
	✓CODING XMIT	– OFF
	✓RCV	– OFF

(Cont in right column)

TIG-7 AIRLOCK CLOSEOUT (assumes Cabin Depress complete)

Close INNER HATCH
Actuator Handle – LAT
Lock Lever – Lock
Equal vlv – NORM

TIG-5 LEH VLV CONFIG

MO69M LEH O2 8 vlv – CL
Remove, stow O2 Bleed Orifice
LEH O2 7,8 vlv (two) – OP (if reqd)
MO32M 5,6 vlv (two) – OP (if reqd)

CLOTHING CONFIG

C6 Don: LES, Harness, Boots
LEH O2 vlv (two) – OP

EI-10 Stow flight deck PGSC

This Page Intentionally Blank

LOSS OF 2 H2O LOOPS DEORBIT PREP/ENTRY

CDR

PLT

O6 MDM FF1,3 (two) – ON
 ✓FF2 – ON
 I/O RESET
F6 HUD DATA BUS – 1

CABIN DE/REPRESS

TIG-20 Perform 20 MINUTE DE/REPRESS, 8-17

VERIFY DAP/SELECT PRIs

✓DAP: A1/AUTO/PRI
 B set to B1

MCA CONFIG (no earlier than TIG-20)

Give MS GO for MCA LOGIC config

DEORBIT TARGET

Use PGSC to compute targets (record on 9-8)

APU STEAM VENT HTR ACT

R2 BLR PWR (three) – ON

SWITCH CONFIG FOR OPS 3

O14,O15,
 O16:A RGA 1,2,3 (three) – ON
O14,O15:E cb ACCEL 1,2 (two) – cl
O14,O15,
 O16:F ASA (four) – ON
 O16:F ACCEL 3 – ON
Verify MCA LOGIC config complete, then:
O8 FWD RCS MANF ISOL 1,2,3,4 (four) – CL
 (tb-CL)

IMU ACTIVATION (if IMUs 1,3 off)

NOTE

IMU ACT can be performed in OPS 2 or 3

ACTIVATE IMU 1,3

O14:A IMU 1 – ON
O16:A 3 – ON

GNC 21 IMU ALIGN

CRT IMU 1,3: OPER, ITEM 4,6 EXEC (*)
 (wait 90 sec for *)
 I/O RESET

IMU to IMU ALIGNMENT

✓IMU 1,3: STAT – blank
IMU/IMU – ITEM 14 +2 (ref IMU) EXEC
ALIGN IMU 1,3 – ITEM 10,12 EXEC (*)
 2 – ITEM 11 EXEC (no *)
EXEC – ITEM 16 EXEC (*)

(Cont next page)

MEDS

(MEDS) A9-7

C D/O/MEDS/GEN H

LOSS OF 2 H2O LOOPS DEORBIT PREP/ENTRY

CDR

PLT

STAR TRKR DEACT

O6 S TRK PWR (two) – OFF
 O14:E,
 O15:E cb S TRK –Z,–Y (two) – op
 O6 S TRK DR CNTL SYS 1,2 (two) – CL (start timer)
 ✓POS tb (two) – bp
 When both tb – CL (~8–24 sec)
 or either tb – bp > 24 sec,
 S TRK DR CNTL SYS 1,2 (two) – OFF

DPS ENTRY CONFIG (assumes GPC 1 active)

NOTE

Do not perform DPS ENTRY CONFIG
 if IMU Align in progress

O15:F MMU 2 – ON, wait 34 sec
 O6 ✓GPC MODE 2,3,4,5 (four) – HALT (tb–bp)
 ✓OUTPUT 2,3,4 (three) – NORM (tb–bp)
 5 – B/U (tb–bp)
 PWR 3,5 (two) – ON
 MODE 3,5 (two) – STBY (tb–RUN)
 – RUN

CRT GNC 0 GPC MEMORY
 CONFIG – ITEM 1 +3 EXEC
 Modify MC3 per table →
 GNC, OPS 301 PRO
DEORB MNVR COAST

CONFIG GPC	3 10000
STR 1	1
2	1
3	1
4	1
PL 1/2	1
CRT 1	1
2	1
3	1
4	0
L 1	0
2	0
MM 1	1
2	1

(Cont next page)

(MEDS) A9–8

RESELECT IMU 1,3

✓ALIGNMENT COMPLETE – ITEM 16 (no *)
 IMU 1,3: DES – ITEM 7,9 EXEC (no *)

Do not proceed until all DPS ENTRY CONFIG
 steps complete

CLOSE VENT DOORS

O6 MDM FF4 – ON
 GNC I/O RESET
GNC 51 OVERRIDE
 CRT VENT DOOR CNTL CLOSE – ITEM 44 EXEC
 (*), wait 1 min, then
 O6 MDM FF4 – OFF

LANDING SITE UPDATE

1: GNC 50 HORIZ SIT
 SEL SITE, RWY (PASS/BFS)

DRAG ALT ATM SELECTION

SEL ATM: incl ≤ 50° ✓ITEM 22 (*)
 incl > 50° SEL ITEM NR (table)

Hemi	Jan	Feb	Mar	Apr	May	Jun	Jul	Aug	Sep	Oct	Nov	Dec
N Desc	23	23	23	23	22	24	24	24	22	23	23	23
S Asc	24	24	22	23	23	23	23	23	23	23	22	24
N Asc	22											
S Desc												

CHECK CG

UPDATE PRPLT ITEM 18 as reqd

(Cont next page)

MEDS

C D/O/ALL/GEN H,1

LOSS OF 2 H2O LOOPS DEORBIT PREP/ENTRY

CDR

PLT

GNC 0 GPC MEMORY

CONFIG – ITEM 1 +3 EXEC
 Modify MC 3 per table →

CONFIG		3
GPC		10300
STR	1	3
	2	3
	3	3
	4	3
PL	1/2	3
CRT	1	3
	2	3
	3	3
	4	0
L	1	0
	2	0
MM	1	3
	2	3

GNC 0 GPC MEMORY

DOWNLIST GPC – ITEM 44
 +3 EXEC

O6 GPC MODE 1 – STBY (tb–bp)
 – HALT
 PWR 1 – OFF

GPC/CRT 0/4 EXEC
 For any fwd IDP pwrd off:
 GPC/CRT 3/X EXEC

O15:F L1 MMU 2 – OFF
 AV BAY 1 FAN (two) – OFF
 2 FAN A(B) – ON
 (wait 3 sec, then)
 3 FAN B(A) – ON

**AFT PANEL CONFIG FOR ENTRY COMM
 (no earlier than TIG–10 min)**

Give MS GO to config AFT panel

Cabin Repress (no earlier than TIG–10)
 Give MS GO for CABIN REPRESS **D**
 (20 MINUTE DE/REPRESS), 8–17 and
 AIRLOCK CLOSEOUT, 9–5
 Do not pwr off Cabin Fan A after Repress
 complete

OMS BURN PREP

O7 ✓AFT L,R RCS He PRESS (four) – OP (tb–OP)
 ✓TK ISOL (six) – GPC (tb–OP)
 ✓XFEED (four) – GPC (tb–CL)
 ✓MSTR RCS XFEED – OFF

O8 ✓L,R OMS He PRESS/VAP ISOL (four) – CL
 ✓TK ISOL (four) – OP
 – (tb–OP)
 ✓XFEED (four) – CL (tb–CL)
 ✓FWD RCS He PRESS (two) – OP (tb–OP)
 Use two IDP/CRTs with four MDUs for deorbit
 burn

LOSS OF 2 H2O LOOPS DEORBIT PREP/ENTRY

LOAD TGTs AND MNVR

CRT Enter TGT data from MCC or PGSC

—————▶ DEORBIT PAD

LOAD – ITEM 22 EXEC
 TIMER – ITEM 23 EXEC

O14:E,
 O15:E,
 O16:E cb MNA,B,C DDU L,R (four) – cl

Mnvr to burn att

Select right sec gimbals
 (because FF4 – OFF)
 RIGHT – ITEM 31 EXEC

CLOTHING CONFIG

Don: LES,Harness,Boots

C6 LEH O2 vlv (two) – OP

TIG-2 Go to Deorbit Burn Cue Cards

NOTE

If FRCS COMPLETION reqd during burn, perform FRCS RECOVERY prior to fast flip.

Use LOSS of 2 H2O LOOPS DEORBIT BURN MONITOR

RECORD DEORBIT OPPORTUNITIES		
SITE	APPROX TIG	XRNG
_____ / _____	: _____ : _____	_____
_____ / _____	: _____ : _____	_____
_____ / _____	: _____ : _____	_____
_____ / _____	: _____ : _____	_____

COMPUTE WEIGHT
 Use PGSC CG MANAGER program (record below)

COMPUTE TARGET

WT	_____
TIG	____ / ____ : ____ : ____
C1	_____
C2	(-).6000
HT	65.832
θT	_____ . _____
ΔVTOT	_____ . _____
REI	_____

FRCS RECOVERY (if reqd for FRCS COMPLETION)	
O14,O15, O16:F	RJDF LOGIC,DRIVER (eight) – ON
O6	MDM FF4 – ON GNC I/O RESET
O8	FWD RCS MANF ISOL 1,2,3,4 (four) – OP (tb-OP)

MEDS

LOSS OF 2 H2O LOOPS

DEORBIT BURN MONITOR

OMS TEMP* FU IN P \geq <table border="1" style="display: inline-table; vertical-align: middle;"><tr><td style="padding: 2px;">224</td><td style="padding: 2px;">217</td></tr><tr><td style="padding: 2px;">209</td><td style="padding: 2px;">201</td></tr></table> \leq or No FU IN P	224	217	209	201	OMS ENG FAIL ----- OMS PRPLT FAIL -----
224	217				
209	201				
OMS PC* & OMS ↓ (BFS: ✓accel) ENG VLV 1 or 2 < 70 or OX IN P > 227 OX IN P \leq 227 or No OX IN P	OMS ENG FAIL ----- OMS PRPLT FAIL -----				
OMS OX/FU TK P (✓ENG IN P) OX/FU LOW ----- OX & FU HIGH	He PRESS/VAP ISOL (two) – OP If aff TK P not incr: He PRESS/VAP ISOL (two) – CL At PC < 72 or OMS TEMP: OMS PRPLT FAIL ----- He PRESS/VAP ISOL (two) – CL Cycle He A(B) to maintain TK P 234–284				
OMS GMBL PRI fail SEC fail	L(R) OMS GMBL – SEC (twice) ----- If high RCS usage: OMS ENG FAIL -----				
GPC 3	BFS Engage -----				
I/O ERROR FA 1 ----- 2 FAs lost	L OMS GMBL – SEC ----- I/O RESET (if recov: BFS I/O RESET) If high RCS usage: OMS ENG FAIL ----- ✓MAN SHUTDN -----				
BCE STRG D 1 ----- 3	I/O RESET (if recov: >>) ----- If high RCS usage: L OMS GMBL – SEC (twice) ----- If high RCS usage: R OMS ENG FAIL -----				
RM DLMA IMU or 2 MN BUSES	CUR HP > <table border="1" style="display: inline-table; vertical-align: middle;"><tr><td style="width: 20px; height: 20px;"></td><td style="width: 20px; height: 20px;"></td></tr></table> (safe HP) IMU dilemma				
I/O ERROR PCM	After C/O: ✓Timer <table border="1" style="display: inline-table; vertical-align: middle;"><tr><td style="padding: 2px;">G21</td></tr></table> If any IMU ACC > 0.03: aff IMU – desel I'cnct OMS to RCS (✓RCS Burn time) THC +X to TGT HP ----- OI PCMMU PWR – 1 -----	G21			
G21					

*If XFD, BLDN, or sensor fail, monitor ENG IN P for off-nominal performance

MEDS
98,104,110

LOSS OF 2 H2O LOOPS DEORBIT PREP/ENTRY

	CDR	POST BURN ACTIVITIES	PLT
	O14:E, cb MNA,B DDU L (two) – op O15:E F6 FLT CNTLR PWR – OFF		O15:E, cb MNB,C DDU R (two) – op O16:E F8 FLT CNTLR PWR – OFF
	C3 ✓DAP: AUTO		C3 ✓DAP: AUTO
	MNVR TO EI-5 ATT		OMS/RCS POST BURN RECONFIG
	CRT1 GNC, OPS 303 PRO		O7 ✓AFT L,R RCS He PRESS (four) – OP (tb-OP) ✓TK ISOL (six) – GPC (tb-OP) ✓XFEED (four) – GPC (tb-CL)
TIME TO EI (MIN)	LVLH PITCH (DEG)		O8 ✓L,R OMS He PRESS/VAP ISOL (four) – CL ✓TK ISOL (four) – OP (tb-OP) ✓XFEED (four) – CL (tb-CL)
26	315		
25	319		
24	323		
	327		
	331		
	335		
20	339		
	343		
	347		
	351		
	355		
15	359		
	3		
	7		
	11		
	15		
10	19		
	23		
	27		
	31		
	35		
5	39		
		NOTE	
		Use LVLH table unless INRTL EI-5 attitude (ITEMS 24,25,26) supplied by MCC. Use DDU and FLT CNTLR PWR as reqd for manual mnvr	
			APU PRESTART
			R2 BLR N2 SPLY (three) – ON ✓PWR (three) – ON ✓CNTLR/HTR (three) – A(B) ✓APU AUTO SHUTDN (three) – ENA CNTLR PWR (three) – ON HYD MN PUMP PRESS (three) – LO ✓APU SPEED SEL (three) – NORM ✓OPER (three) – OFF ✓FUEL TK VLV (three) – CL ✓HYD CIRC PUMP (three) – OFF ✓cb APU FU TK VLV ENA (six) – cl
		<u>When mnvr complete</u>	
	L4:P cb LG SNSR (two) – cl		
	O14:A BRAKES MNA – ON		
	O15:A BRAKES MNB – ON		
	O16:A BRAKES MNC – ON		

(A)A9-12

MEDS
98,104,110

C D/O/MEDS/GEN H,4

LOSS OF 2 H2O LOOPS

DEORBIT BURN MONITOR

OMS TEMP* FU IN P \geq <table border="1" style="display: inline-table; vertical-align: middle;"><tr><td style="padding: 2px;">225</td><td style="padding: 2px;">221</td></tr><tr><td style="padding: 2px;">211</td><td style="padding: 2px;">200</td></tr></table> \leq or No FU IN P	225	221	211	200	OMS ENG FAIL ----- OMS PRPLT FAIL -----
225	221				
211	200				
OMS PC* & OMS ↓ (BFS: ✓accel) ENG VLV 1 or 2 < 70 or OX IN P > 227 OX IN P \leq 227 or No OX IN P	OMS ENG FAIL ----- OMS PRPLT FAIL -----				
OMS OX/FU TK P (✓ENG IN P) OX/FU LOW ----- OX & FU HIGH	He PRESS/VAP ISOL (two) – OP If aff TK P not incr: He PRESS/VAP ISOL (two) – CL At PC < 72 or OMS TEMP: OMS PRPLT FAIL ----- He PRESS/VAP ISOL (two) – CL Cycle He A(B) to maintain TK P 234–284				
OMS GMBL PRI fail SEC fail	L(R) OMS GMBL – SEC (twice) If high RCS usage: OMS ENG FAIL -----				
GPC3	BFS Engage				
I/O ERROR FA 1 ----- 2 FAs lost	L OMS GMBL – SEC I/O RESET (if recov: BFS I/O RESET) If high RCS usage: OMS ENG FAIL ----- ✓MAN SHUTDN				
BCE STRG D 1 ----- 3	I/O RESET (if recov: >>) If high RCS usage: L OMS GMBL – SEC (twice) ----- If high RCS usage: R OMS ENG FAIL				
RM DLMA IMU or 2 MN BUSES CUR HP > <table border="1" style="display: inline-table; vertical-align: middle;"><tr><td style="width: 20px; height: 20px;"></td><td style="width: 20px; height: 20px;"></td></tr></table> (safe HP) IMU dilemma			STOP BURN: OMS ENG(s) – OFF >> ----- After C/O: ✓Timer G21 If any IMU ACC > 0.03: aff IMU – desel I'cnct OMS to RCS (✓RCS Burn time) THC +X to TGT HP		
I/O ERROR PCM	OI PCMMU PWR – 1				

*If XFD, BLDN, or sensor fail, monitor ENG IN P for off-nominal performance

MEDS
107,109

LOSS OF 2 H2O LOOPS DEORBIT PREP/ENTRY

CDR	POST BURN ACTIVITIES	PLT
<p>FORWARD RCS DUMP (if reqd) (Use for off-nominal Xcg entry using lowest of OX or FU qty)</p> <p>Perform FRCS dump if reqd to maintain Xcg in box If FRCS dump not reqd, go to 9-12</p> <p>If FRCS dump reqd, perform FOUR JET DUMP FRCS REACTIVATION:</p> <p>MA73C:A ✓MCA LOGIC FWD (three) – ON O14:B cb OI SIG CONDR OF 1/4 A – cl :F RJDF 1B F1 DRIVER – ON LOGIC – ON</p> <p>O15:B cb OI SIG CONDR OF 2/3 A – cl :F RJDF 1A F2 DRIVER – ON LOGIC – ON</p> <p>O16:F RJDF 2A F3,2B F4 DRIVER (two) – ON F4/F5 LOGIC (two) – ON</p> <p>O6 ✓MDM FF1,2,3 (three) – ON FF4 – ON GNC I/O RESET</p> <p>O8 FWD RCS MANF ISOL 1,2,3,4 (four) – OP (tb-OP)</p> <p style="margin-left: 20px;">GNC 23 RCS</p> <p>CRT JET RESET – ITEM 45 EXEC Reselect deselected FRCS jets JET RESET – ITEM 45 EXEC</p>	<p>APU START</p> <p>C3 OI PCMMU PWR – 1 BFS I/O RESET</p> <p>R2 APU FUEL TK VLV (three) – OP ✓APU/HYD RDY tb (three) – gray</p> <p style="text-align: center;">* If tb – bp, attempt normal start *</p> <p style="text-align: center;">APU OPER (three) – START/RUN</p> <p>MDU ✓HYD PRESS ind (three) – LO green</p> <p>R2 APU/HYD RDY tb (three) – bp HYD MN PUMP PRESS (three) – NORM</p> <p>MDU ✓HYD PRESS ind (three) – HI green</p> <p>R2 * If OIL OUT P < 25 and OIL OUT * * TEMP not increasing after APU start * * or no start, perform <u>APU SHUTDN</u> * * (Cue Card) *</p> <p>R4 ✓HYD BRAKE ISOL VLV (three) – GPC (tb-CL) ✓LG EXTEND ISOL VLV – GPC (tb-CL)</p> <p>C3 OI PCMMU PWR – OFF</p>	

(B)A9-12

LOSS OF 2 H2O LOOPS DEORBIT PREP/ENTRY

CDR	POST BURN ACTIVITIES	PLT
<p>FORWARD RCS DUMP (if reqd) (Use for off-nominal Xcg entry using lowest of OX or FU qty)</p> <p>Perform FRCS dump if reqd to maintain Xcg in box If FRCS dump not reqd, go to 9-12</p> <p>If FRCS dump reqd, perform FOUR JET DUMP FRCS REACTIVATION:</p> <p>MA73C:A ✓MCA LOGIC FWD (three) – ON O14:B cb OI SIG CONDR OF 1/4 A – cl :F RJDF 1B F1 DRIVER – ON LOGIC – ON</p> <p>O15:B cb OI SIG CONDR OF 2/3 A – cl :F RJDF 1A F2 DRIVER – ON LOGIC – ON</p> <p>O16:F RJDF 2A F3,2B F4 DRIVER (two) – ON F4/F5 LOGIC (two) – ON</p> <p>O6 ✓MDM FF1,2,3 (three) – ON FF4 – ON</p> <p>O8 GNC I/O RESET FWD RCS MANF ISOL 1,2,3,4 (four) – OP (tb-OP)</p> <div style="border: 1px solid black; padding: 2px; display: inline-block; margin: 5px 0;">GNC 23 RCS</div> <p>CRT JET RESET – ITEM 45 EXEC Reselect deselected FRCS jets JET RESET – ITEM 45 EXEC</p>	<p>APU START</p> <p>C3 OI PCMMU PWR – 1 BFS I/O RESET</p> <p>R2 APU FUEL TK VLV (three) – OP ✓APU/HYD RDY tb (three) – gray</p> <p style="text-align: center;">* If tb – bp, attempt normal start *</p> <p style="text-align: center;">APU OPER (three) – START/RUN</p> <p>MDU ✓HYD PRESS ind (three) – LO green </p> <p>R2 APU/HYD RDY tb (three) – bp HYD MN PUMP PRESS (three) – NORM</p> <p>MDU ✓HYD PRESS ind (three) – HI green </p> <p>R2 * If OIL OUT P < 25 and OIL OUT * * TEMP not increasing after APU start * * or no start, perform <u>APU SHUTDN</u> * * (Cue Card) *</p> <p>R4 ✓HYD BRAKE ISOL VLV (three) – GPC (tb-CL) ✓LG EXTEND ISOL VLV – GPC (tb-CL)</p> <p>C3 OI PCMMU PWR – OFF</p>	

LOSS OF 2 H2O LOOPS DEORBIT PREP/ENTRY

FORWARD RCS DUMP (Cont)

Determine FWD RCS 'DUMP TO %' (calculator, cg wheel, or DEL PAD)

NOTE

During dump, disregard FWD RCS qty

GNC DEORB MNVR EXEC

CRT

FWD RCS ARM – ITEM 36 EXEC
DUMP – ITEM 37 EXEC (Start watch)

When dump time achieved:
FWD RCS OFF – ITEM 38 EXEC

O8

When dump complete:
FWD RCS MANF ISOL
1,2,3,4 (four) – CL (tb-CL)

O6

MDM FF4 – OFF
O14:B cb OI SIG CONDR OF 1/4 A – op
O14:F RJDF 1B F1 DRIVER, LOGIC – OFF
O15:B cb MNB OI SIG CONDR OF 2/3 A – op
O15:F RJDF 1A F2 LOGIC, DRIVER – OFF
O16:F 2A F3, 2B F4 DRIVER (two) – OFF
F4/F5 LOGIC (two) – OFF

FOUR JET DUMP

FWD RCS PRPLT TO BE DUMPED (%)

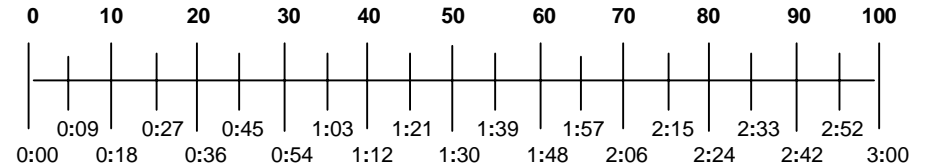

TIME FROM DUMP INITIATION (M:S)

TWO JET DUMP

FWD RCS PRPLT TO BE DUMPED (%)

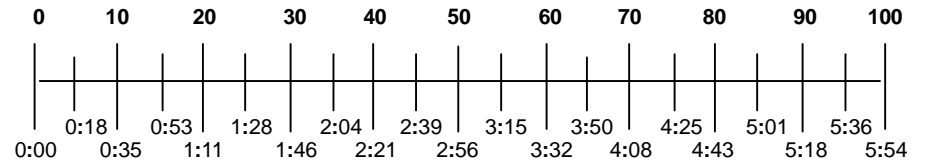

TIME FROM DUMP INITIATION (M:S)

MEDS

LOSS OF 2 H2O LOOPS DEORBIT PREP/ENTRY

1: GNC 53 ENTRY CONTROLS	2: BFS, GNC SYS SUMM 2
3: GNC DEORB MNVR COAST	

SECONDARY ACTUATOR CHECK (if not previously performed and time permits)

NOTE

If a port does not bypass during check, bypass aff port after check:

SEC ACT BYPASS – ITEM 8 +X X
EXEC

If aff port still does not bypass:

SEC ACT RESET – ITEM 9 +X X
EXEC

- R2 1. ✓HYD MN PUMP PRESS (three) – NORM

- CRT3 SURF DRIVE ON – ITEM 39 EXEC (*), wait at least 5 sec
- MDU ✓SPI: Stop drive test when elevon posns within +12° to -27°:
 SURF DRIVE OFF – ITEM 40 EXEC (*)

- CRT1 2. ✓POS STIM ENA – ITEM 7 (no *)

- C3 3. ✓FCS CH (four) – AUTO

- CRT1 4. SEC ACT CK, CH 1 – ITEM 1 EXEC (*)
 CK START – ITEM 5 EXEC

- 5. ✓All CH 1 ports bypass (↓)
 STOP – ITEM 6 EXEC (*)

- C3 6. FCS CH 1 – ORIDE
- CRT1 ✓All CH 1 ports reset (no ↓)
- C3 FCS CH 1 – AUTO

7. Repeat steps 5 thru 7 for CH 2,3,4

EQUIPMENT STOWAGE AND SEAT INGRESS

If not already accomplished:

- Stow equip
- Seat ingress
- Adjust seat, exercise brake pedals

SPACELAB FINAL DEACT (if flown)

- P R1 PL PRI MNC,FC3,MNB (three) – OFF (tb-OFF)
- PL AUX – OFF
- CAB – OFF
- AFT MNB,MNC (two) – OFF

ENTRY SWITCH CHECK

- C L1 NH3 CNTLR B – PRI/GPC
- L2 ✓CAB RELIEF (two) – ENA (tb-ENA)
- ✓ENTRY MODE – AUTO

- C,P C3 ✓SBTC – full fwd
- ✓SRB SEP – AUTO
- ✓ET SEP – AUTO

- F6/F8 ✓AIR DATA – NAV
- ✓ADI ERR – MED
- RATE – MED
- ✓HSI SEL MODE – ENTRY
- ✓SOURCE (two) – NAV,1
- ✓ – NAV,2

- C,P F3 ✓L,R TRIM RHC/PNL (two) – INH
- ✓PNL (two) – ON

MEDS

LOSS OF 2 H2O LOOPS DEORBIT PREP/ENTRY

CDR

PLT

HORIZ SIT CONFIG

ALTM – ITEM 9

--	--	--	--	--

	<u>PASS ITEM</u>		<u>BFS ITEM</u>
PTI	INH	✓1	
LAND SITE (DEL PAD)		✓41	✓41
RWY (DEL PAD)		✓3	✓3
		✓4	✓4
TACAN (DEL PAD)		✓5	✓5
RA	blank	✓46	
TAEM TGT			
G&N	OVHD	✓6	blank
HSI	blank		blank
XEP	NEP	✓7	NEP ✓7
AIM (DEL PAD)	NOM	✓8	NOM ✓8
	(or CLSE)		(or CLSE)
SPD BK	NOM	✓39	
TAC	INH	✓20	INH ✓20
GPS	INH	✓43	INH ✓43
DRAG H	AUT	✓22	AUT ✓22
ADTA H	INH	✓26	INH ✓26
ADTA TO G&C	INH	✓29	AUT ✓28
DES any failed TACANs		✓	✓
TAC	DELTA	✓35	
AIF_G	INH	✓48	

Stow:

Deorbit Burn Cue Cards (C6)

DEORBIT BURN MONITOR (Cue Card) (C6)

**Go to LOSS OF 2 H2O LOOPS ENTRY MANEUVERS
EI-5, 9-16**

1: GNC DEORB MNVR COAST | 2: GNC 50 HORIZ SIT

3: GNC 51 OVERRIDE

- ✓ELEVON AUTO – ITEM 17 (*)
- SSME REPOS – ITEM 19 EXEC (INH)
- ✓WRAP MODE – ITEM 45 (ENA)
- If PLB holding > 10K lb:
- FILTER ALT – ITEM 21 EXEC (*)

3: BFS, GNC 51 OVERRIDE

- ✓ELEVON AUTO – ITEM 17 (*)
- ✓SSME REPOS – ITEM 19 (INH)
- ✓WRAP MODE – ITEM 45 (ENA)
- If PLB holding > 10K lb:
- ✓FILTER ALT – ITEM 21 EXEC (*)

- * DES any failed/comm faulted *
- * IMU, RGA, AA, or SURF feedback *

G SUIT INFLATION

All Load – 1.5

**Go to LOSS OF 2 H2O LOOPS ENTRY
MANEUVERS EI-5, 9-16**

MEDS

(MEDS) A9-16

C D/O/ALL/GEN H

LOSS OF 2 H2O LOOPS ENTRY MANEUVERS

FLIGHT CONDITIONS	MANEUVER
EI-5	cb ADTA 1,2,3 (three) - cl cb MNA,B DDU L (two) - cl (L) FLT CNTLR PWR - ON Use one IDP/CRT with 2 MDUs MDM FF4 - ON GNC I/O RESET ✓LVLH ATT GNC, OPS 304 PRO * If PREBANK: R/Y - CSS * * Roll at 1°/sec to <input type="text"/> <input type="text"/> <input type="text"/> * * Maintain PREBANK ±5° *
'Guidance Box' @ q~8 or D~3	CLOSED LOOP GUIDANCE ___:___:___ * If PREBANK: P,R/Y - AUTO * Begin AIL trim monitoring
D = 11	✓DRAG H (FORCE if editing)
V = 19K	✓MPS/TVC ISOL VLV - CL
V = 15K	TACAN 2,3 MODE (two) - GPC
V = 12K	<u>ACTIVATE ENTRY COMM</u> L,R AUD PWR - AUD AUD CTR - 1 UHF SPLX/EVA PWR AMPL - ON UHF MODE - SPLX S-BD PM CNTL - PNL,CMD OI PCMMU PWR - 1 ✓FORMAT - FXD MDM PL2 - ON GNC, BFS I/O RESET
V = 10K	✓SPD BRK to 81%
V = 7K	✓TACAN status
V = 5K	ADTA PROBES - DEPLOY (✓HEAT) Begin AIL and RUD trim monitoring
ΔAZ = 10.5°	FIRST ROLL REVERSAL <input type="text"/> <input type="text"/> <input type="text"/> <input type="text"/> <input type="text"/>

FLIGHT CONDITIONS	MANEUVER
M = 2.9	CAB FAN A(B) - OFF Power one HUD, one MLS, one RA for landing GNC I/O RESET
M = 2.7	✓APUs
	* If M < 2.5, P CSS FOR ADTA TO G&C incorp *
M = 2.0	Ensure ADTA to G&C; else, ✓Theta limits
M = 0.95	* For bailout procedures, go to <u>BALLOUT</u> *
M = 0.9	P,R/Y - CSS as reqd ✓SPDBK CMD vs POS Use two IDP/CRTs with four MDUs cb MNB,C DDU R (two) - cl (R) FLT CNTLR PWR - ON NWS - 1 ANTISKID - ON Lock Inertia Reels MAX Nz <input type="text"/> <input type="text"/>
M = 0.7	✓LG EXTEND ISOL VLV - OP
h = 15K	✓MLS (if activated)
h = 10k	✓A/L,TABS/LES VISORS - CL (KSC)
MAIN GEAR TD	✓SPD BRK - 100%
DEROT INIT	DRAG CHUTE pb (two) - ARM,DPY (simo)
NOSE GEAR TD	SRB SEP - MAN/AUTO and depress pb ✓Auto Load Relief ✓HYD BRAKE ISOL VLV (three) - OP
<p style="text-align: center;"> 0.25-0.3G 8-10 FPS² NO BRAKING BEFORE MIDFIELD MAX < 0.2G < 6 FPS² NWTD ≤ 140 KGS LKBED 140 KGS CONCRETE 5K' REMAINING < 140 KGS > 140 KGS 40 KGS STOP </p>	
V = 60 KGS	DRAG CHUTE JETT pb - JETT
STOP	DIRECT O2 vlv - CL Go to EMER PWRDN (Cue Card)

MEDS

This Page Intentionally Blank

LOSS OF 2 H2O LOOPS DEORBIT PREP/ENTRY

ASSUMPTIONS/INITIAL CONDITIONS

LOSS OF 2 H2O LOOPS DEORBIT PREP/ENTRY is a **STAND-ALONE procedure** that assumes one of the following has been accomplished:

- LOSS OF 2 H2O LOOPS (ORB PKT, PWRDN)
- LOSS OF 2 H2O LOOPS (POST OMS-2) (ASC PKT, PWRDN)
- LOSS OF 2 H2O LOOPS (ORB PKT, PWRDN) and LOSS OF 2 H2O LOOPS Parts 1 and 2 (Section 8)

This procedure assumes 30 min remaining until deorbit burn

PROBLEM DESCRIPTION RATIONALE

With no H2O loop flow, heat not removed from water and air-cooled equipment. ORB PKT pwrdn maintained until TIG-30 min to minimize thermal load as long as possible

NOTE

1. LOSS OF 2 H2O LOOPS DEORBIT PREP/ENTRY configures vehicle for entry as quickly as possible and repowers critical equipment as late as possible to single-fault tolerant level
2. MS procedures located on MS PULLOUT PAGE, 9-5. Extra copies located in back of PLT's book
3. CDR and PLT procedures begin on 9-7
4. Use COMM pages from ORB PKT pwrdn to cycle COMM if necessary
5. This procedure utilizes modified version of DEORBIT BURN MONITOR and ENTRY MANEUVERS Cue Cards located at end of section

This Page Intentionally Blank

(NOM) B9-4

C D/O/ALL/GEN H

LOSS OF 2 H2O LOOPS DEORBIT PREP/ENTRY

MS PULLOUT PAGE

NOTE: Wait for GO from CDR before accomplishing any action on this page

TIG-20 MCA CONFIG

MA73C MCA LOGIC (fourteen) – ON

CABIN DE/REPRESS

TIG-20 Perform 20 MINUTE DE/REPRESS, 8-17

TIG-10 AFT PANEL CONFIG FOR ENTRY COMM

NOTE

This procedure configures aft panel for landing site comm coverage at V = 12K. If comm cycled post TIG-10 (using ORB PKT pwrn comm pages), this AFT PANEL CONFIG FOR ENTRY COMM must be reestablished

L9,R10	PS,MS AUD PWR	– AUD
R14:B	cb GCILC (two)	– cl
C3	S-BD PM CNTL	– CMD
A1L	ANT SW ELEC	– 2
	MODE	– STDN LO
	XPNDR	– 2
	NSP PWR	– 2
	DATA RATE XMIT	– HI
	RCV	– HI
	✓UPLK DATA	– S-BD
	✓CODING XMIT	– OFF
	✓RCV	– OFF

(Cont in right column)

TIG-7 AIRLOCK CLOSEOUT (assumes Cabin Depress complete)

Close INNER HATCH
Actuator Handle – LAT
Lock Lever – Lock
Equal vlv – NORM

TIG-5 LEH VLV CONFIG

MO69M LEH O2 8 vlv – CL
Remove, stow O2 Bleed Orifice
LEH O2 7,8 vlv (two) – OP (if reqd)
MO32M 5,6 vlv (two) – OP (if reqd)

CLOTHING CONFIG

C6 Don: LES, Harness, Boots
LEH O2 vlv (two) – OP

EI-10 Stow flight deck PGSC

This Page Intentionally Blank

(NOM) B9-6

C D/O/ALL/GEN H

LOSS OF 2 H2O LOOPS DEORBIT PREP/ENTRY

CDR

PLT

STAR TRKR DEACT

O6 S TRK PWR (two) – OFF
 O14:E,
 O15:E cb S TRK –Z,–Y (two) – op
 O6 S TRK DR CNTL SYS 1,2 (two) – CL (start timer)
 ✓POS tb (two) – bp
 When both tb – CL (~8–24 sec)
 or either tb – bp > 24 sec,
 S TRK DR CNTL SYS 1,2 (two) – OFF

DPS ENTRY CONFIG (assumes GPC 1 active)

NOTE

Do not perform DPS ENTRY CONFIG
 if IMU Align in progress

O15:F MMU 2 – ON, wait 34 sec
 O6 ✓GPC MODE 2,3,4,5 (four) – HALT (tb–bp)
 ✓OUTPUT 2,3,4 (three) – NORM (tb–bp)
 5 – B/U (tb–bp)
 PWR 3,5 (two) – ON
 MODE 3,5 (two) – STBY (tb–RUN)
 – RUN

CRT GNC 0 GPC MEMORY
 CONFIG – ITEM 1 +3 EXEC
 Modify MC3 per table →
 GNC, OPS 301 PRO
DEORB MNVR COAST

CONFIG GPC	3 10000
STR 1	1
2	1
3	1
4	1
PL 1/2	1
CRT 1	1
2	1
3	1
4	0
L 1	0
2	0
MM 1	1
2	1

(Cont next page)

(NOM) B9–8

RESELECT IMU 1,3

✓ALIGNMENT COMPLETE – ITEM 16 (no *)
 IMU 1,3: DES – ITEM 7,9 EXEC (no *)

Do not proceed until all DPS ENTRY CONFIG
 steps complete

CLOSE VENT DOORS

O6 MDM FF4 – ON
 GNC I/O RESET
GNC 51 OVERRIDE
 CRT VENT DOOR CNTL CLOSE – ITEM 44 EXEC
 (*), wait 1 min, then
 O6 MDM FF4 – OFF

LANDING SITE UPDATE

1: GNC 50 HORIZ SIT
 SEL SITE, RWY (PASS/BFS)

DRAG ALT ATM SELECTION

SEL ATM: incl ≤ 50° ✓ITEM 22 (*)
 incl > 50° SEL ITEM NR (table)

Hemi	Jan	Feb	Mar	Apr	May	Jun	Jul	Aug	Sep	Oct	Nov	Dec
N Desc	23	23	23	23	22	24	24	24	22	23	23	23
S Asc	24	24	22	23	23	23	23	23	23	23	22	24
N Asc	22											
S Desc												

CHECK CG

UPDATE PRPLT ITEM 18 as reqd

(Cont next page)

NOM

C D/O/ALL/GEN H,2

LOSS OF 2 H2O LOOPS DEORBIT PREP/ENTRY

LOAD TGTs AND MNVR

CRT Enter TGT data from MCC or PGSC

—————▶ DEORBIT PAD

LOAD – ITEM 22 EXEC
 TIMER – ITEM 23 EXEC

O14:E,
 O15:E,
 O16:E cb MNA,B,C DDU L,R (four) – cl

Mnvr to burn att

Select right sec gimbals
 (because FF4 – OFF)
 RIGHT – ITEM 31 EXEC

CLOTHING CONFIG

Don: LES,Harness,Boots

C6 LEH O2 vlv (two) – OP

TIG-2 Go to Deorbit Burn Cue Cards

NOTE

If FRCS COMPLETION reqd during burn, perform FRCS RECOVERY prior to fast flip.

Use LOSS of 2 H2O LOOPS DEORBIT BURN MONITOR

RECORD DEORBIT OPPORTUNITIES		
SITE	APPROX TIG	XRNG
_____ / _____	: _____ : _____	_____
_____ / _____	: _____ : _____	_____
_____ / _____	: _____ : _____	_____
_____ / _____	: _____ : _____	_____

COMPUTE WEIGHT
 Use PGSC CG MANAGER program (record below)

COMPUTE TARGET

WT	_____
TIG	____/____ : ____ : ____
C1	_____
C2	(-).6000
HT	65.832
θT	_____ . _____
ΔVTOT	_____ . _____
REI	_____

FRCS RECOVERY (if reqd for FRCS COMPLETION)	
O14,O15, O16:F	RJDF LOGIC,DRIVER (eight) – ON
O6	MDM FF4 – ON GNC I/O RESET
O8	FWD RCS MANF ISOL 1,2,3,4 (four) – OP (tb-OP)

NOM

LOSS OF 2 H2O LOOPS

DEORBIT BURN MONITOR

OMS TEMP* FU IN P \geq <table border="1" style="display: inline-table; vertical-align: middle;"> <tr> <td style="padding: 2px;">L</td> <td style="padding: 2px;">R</td> </tr> <tr> <td style="padding: 2px;">219</td> <td style="padding: 2px;">220</td> </tr> <tr> <td style="padding: 2px;">201</td> <td style="padding: 2px;">204</td> </tr> </table> or No FU IN P	L	R	219	220	201	204	OMS ENG FAIL ----- OMS PRPLT FAIL
L	R						
219	220						
201	204						
OMS PC* & OMS ↓ (BFS: ✓accel) ENG VLV 1 or 2 < 70 or OX IN P > 227 ----- OX IN P ≤ 227 or No OX IN P	OMS ENG FAIL ----- OMS PRPLT FAIL						
OMS OX/FU TK P (✓ENG IN P) OX/FU LOW ----- OX & FU HIGH	He PRESS/VAP ISOL (two) – OP If aff TK P not incr: He PRESS/VAP ISOL (two) – CL At PC < 72 or OMS TEMP: OMS PRPLT FAIL ----- He PRESS/VAP ISOL (two) – CL Cycle He A(B) to maintain TK P 234–284						
OMS GMBL PRI fail SEC fail	L(R) OMS GMBL – SEC (twice) If high RCS usage: OMS ENG FAIL						
GPC3	BFS Engage						
I/O ERROR FA 1 ----- 2 FAs lost	L OMS GMBL – SEC I/O RESET (if recov: BFS I/O RESET) If high RCS usage: OMS ENG FAIL ✓MAN SHUTDN						
BCE STRG D 1 ----- 3	I/O RESET (if recov: >>) If high RCS usage: L OMS GMBL – SEC (twice) If high RCS usage: R OMS ENG FAIL						
RM DLMA IMU or 2 MN BUSES IMU dilemma	CUR HP > <table border="1" style="display: inline-table; vertical-align: middle;"> <tr> <td style="width: 20px; height: 20px;"></td> <td style="width: 20px; height: 20px;"></td> </tr> </table> (safe HP) STOP BURN: OMS ENG(s) – OFF >> ----- After C/O: ✓Timer G21 If any IMU ACC > 0.03: aff IMU – desel I'cncnt OMS to RCS (✓RCS Burn time) THC +X to TGT HP						
I/O ERROR PCM	OI PCMMU PWR – 1						

*If XFD, BLDN, or sensor fail, monitor ENG IN P for off-nominal performance

NOM
102,105

LOSS OF 2 H2O LOOPS DEORBIT PREP/ENTRY

	CDR	POST BURN ACTIVITIES	PLT
	O14:E, O15:E F7	cb MNA,B DDU L (two) – op,cl as reqd to achieve/maintain EI-5 attitude FLT CNTLR PWR – OFF	O15:E, O16:E F8 FLT CNTLR PWR – OFF
	C3	✓DAP: AUTO	C3 ✓DAP: AUTO
	MNVR TO EI-5 ATT		OMS/RCS POST BURN RECONFIG
	CRT1	GNC, OPS 303 PRO	O7 ✓AFT L,R RCS He PRESS (four) – OP (tb-OP) ✓TK ISOL (six) – GPC (tb-OP) ✓XFEED (four) – GPC (tb-CL)
			O8 ✓L,R OMS He PRESS/VAP ISOL (four) – CL ✓TK ISOL (four) – OP (tb-OP) ✓XFEED (four) – CL (tb-CL)
			APU PRESTART
			R2 BLR N2 SPLY (three) – ON ✓PWR (three) – ON ✓CNTLR/HTR (three) – A(B) ✓APU AUTO SHUTDN (three) – ENA CNTLR PWR (three) – ON HYD MN PUMP PRESS (three) – LO ✓APU SPEED SEL (three) – NORM ✓OPER (three) – OFF ✓FUEL TK VLV (three) – CL ✓HYD CIRC PUMP (three) – OFF ✓cb APU FU TK VLV ENA (six) – cl
TIME TO EI (MIN)	LVLH PITCH (DEG)	<p style="text-align: center;"><u>NOTE</u></p> <p>Use LVLH table unless INRTL EI-5 attitude (ITEMS 24,25,26) supplied by MCC</p> <p style="text-align: center;"><u>When mnvr complete</u></p> <p>L4:P cb LG SNSR (two) – cl O14:A BRAKES MNA – ON O15:A BRAKES MNB – ON O16:A BRAKES MNC – ON</p>	
26 25 24 — — — 20 — — — — 15 — — — — 10 — — — — — 5	315 319 323 327 331 335 339 343 347 351 355 359 3 7 11 15 19 23 27 31 35 39		

(A)B9-12

NOM
102,105
C D/O/NOM/GEN H,4

LOSS OF 2 H2O LOOPS

DEORBIT BURN MONITOR

OMS TEMP* FU IN P \geq <table border="1" style="display: inline-table; vertical-align: middle;"> <tr> <td style="padding: 2px;">227</td> <td style="padding: 2px;">230</td> </tr> <tr> <td style="padding: 2px;">209</td> <td style="padding: 2px;">212</td> </tr> </table> or No FU IN P	227	230	209	212	Oms Eng Fail ----- Oms PRPLT Fail -----
227	230				
209	212				
OMS PC* & OMS ↓ (BFS: ✓accel) ENG VLV 1 or 2 < 70 or OX IN P > 227 OX IN P ≤ 227 or No OX IN P	Oms Eng Fail ----- Oms PRPLT Fail -----				
OMS OX/FU TK P (✓ENG IN P) OX/FU LOW OX & FU HIGH	He PRESS/VAP ISOL (two) – OP If aff TK P not incr: He PRESS/VAP ISOL (two) – CL At PC < 72 or OMS TEMP: Oms PRPLT Fail ----- He PRESS/VAP ISOL (two) – CL Cycle He A(B) to maintain TK P 234–284				
OMS GMBL PRI fail SEC fail	L(R) Oms GMBL – SEC (twice) If high RCS usage: Oms Eng Fail -----				
GPC3	BFS Engage -----				
I/O ERROR FA 1 2 FAs lost	L Oms GMBL – SEC I/O RESET (if recov: BFS I/O RESET) If high RCS usage: Oms Eng Fail ✓MAN SHUTDN -----				
BCE STRG D 1 3	I/O RESET (if recov: >>) If high RCS usage: L Oms GMBL – SEC (twice) If high RCS usage: R Oms Eng Fail -----				
RM DLMA IMU or 2 MN BUSES CUR HP > <table border="1" style="display: inline-table; vertical-align: middle;"> <tr> <td style="width: 20px; height: 20px;"></td> <td style="width: 20px; height: 20px;"></td> </tr> </table> (safe HP) IMU dilemma			STOP BURN: Oms Eng(s) – OFF >> ----- After C/O: ✓Timer G21 If any IMU ACC > 0.03: aff IMU – desel I'cncnt Oms to RCS (✓RCS Burn time) THC +X to TGT HP -----		
I/O ERROR PCM	OI PCMMU PWR – 1 -----				

*If XFD, BLDN, or sensor fail, monitor ENG IN P for off-nominal performance

NOM
100,108

LOSS OF 2 H2O LOOPS DEORBIT PREP/ENTRY

	CDR	POST BURN ACTIVITIES	PLT
	O14:E, O15:E F7	cb MNA,B DDU L (two) – op,cl as reqd to achieve/maintain EI-5 attitude FLT CNTLR PWR – OFF	O15:E, O16:E F8 FLT CNTLR PWR – OFF
	C3	✓DAP: AUTO	C3 ✓DAP: AUTO
	MNVR TO EI-5 ATT		OMS/RCS POST BURN RECONFIG
	CRT1	GNC, OPS 303 PRO	O7 ✓AFT L,R RCS He PRESS (four) – OP (tb-OP) ✓TK ISOL (six) – GPC (tb-OP) ✓XFEED (four) – GPC (tb-CL)
			O8 ✓L,R OMS He PRESS/VAP ISOL (four) – CL ✓TK ISOL (four) – OP (tb-OP) ✓XFEED (four) – CL (tb-CL)
			APU PRESTART
			R2 BLR N2 SPLY (three) – ON ✓PWR (three) – ON ✓CNTLR/HTR (three) – A(B) ✓APU AUTO SHUTDN (three) – ENA CNTLR PWR (three) – ON HYD MN PUMP PRESS (three) – LO ✓APU SPEED SEL (three) – NORM ✓OPER (three) – OFF ✓FUEL TK VLV (three) – CL ✓HYD CIRC PUMP (three) – OFF ✓cb APU FU TK VLV ENA (six) – cl
TIME TO EI (MIN)	LVLH PITCH (DEG)	<p style="text-align: center;"><u>NOTE</u></p> <p>Use LVLH table unless INRTL EI-5 attitude (ITEMS 24,25,26) supplied by MCC</p> <p style="text-align: center;"><u>When mnvr complete</u></p> <p>L4:P cb LG SNSR (two) – cl O14:A BRAKES MNA – ON O15:A BRAKES MNB – ON O16:A BRAKES MNC – ON</p>	
26 25 24 — — — 20 — — — — 15 — — — — 10 — — — — — 5	315 319 323 327 331 335 339 343 347 351 355 359 3 7 11 15 19 23 27 31 35 39		

(B)B9-12

**NOM
100,108**

C D/O/NOM/GEN H,4

LOSS OF 2 H2O LOOPS DEORBIT PREP/ENTRY

CDR	POST BURN ACTIVITIES	PLT
<p>FORWARD RCS DUMP (if reqd) (Use for off-nominal Xcg entry using lowest of OX or FU qty)</p> <p>If FRCS dump not reqd, go to 9-15</p> <p>FRCS REACTIVATION:</p> <p>MA73C:A ✓MCA LOGIC FWD (three) – ON O14:B cb OI SIG CONDR OF 1/4 A – cl :F RJDF 1B F1 DRIVER – ON LOGIC – ON</p> <p>O15:B cb OI SIG CONDR OF 2/3 A – cl :F RJDF 1A F2 DRIVER – ON LOGIC – ON</p> <p>O16:F RJDF 2A F3,2B F4 DRIVER (two) – ON F4/F5 LOGIC (two) – ON</p> <p>O6 ✓MDM FF1,2,3 (three) – ON FF4 – ON GNC I/O RESET</p> <p>O8 FWD RCS MANF ISOL 1,2,3,4 (four) – OP (tb-OP)</p> <div style="border: 1px solid black; padding: 2px; display: inline-block; margin: 5px 0;">GNC 23 RCS</div> <p>CRT JET RESET – ITEM 45 EXEC Reselect deselected FRCS jets JET RESET – ITEM 45 EXEC</p>	<p>APU START</p> <p>C3 OI PCMMU PWR – 1 BFS I/O RESET</p> <p>R2 APU FUEL TK VLV (three) – OP ✓APU/HYD RDY tb (three) – gray</p> <p style="text-align: center;">* If tb – bp, attempt normal start *</p> <p style="text-align: center;">APU OPER (three) – START/RUN</p> <p>F8 ✓HYD PRESS ind (three) – LO green</p> <p>R2 APU/HYD RDY tb (three) – bp HYD MN PUMP PRESS (three) – NORM</p> <p>F8 ✓HYD PRESS ind (three) – HI green</p> <p>R2 * If OIL OUT P < 25 and OIL OUT * * TEMP not increasing after APU start * * or no start, perform <u>APU SHUTDN</u> * * (Cue Card) *</p> <p>R4 ✓HYD BRAKE ISOL VLV (three) – GPC (tb-CL) ✓LG EXTEND ISOL VLV – GPC (tb-CL)</p> <p>C3 OI PCMMU PWR – OFF</p>	

LOSS OF 2 H2O LOOPS DEORBIT PREP/ENTRY

FORWARD RCS DUMP (Cont)

Determine FWD RCS 'DUMP TO %' (DEL PAD)

NOTE

During dump, disregard FWD RCS qty

GNC DEORB MNVR EXEC

CRT

FWD RCS ARM – ITEM 36 EXEC
 DUMP – ITEM 37 EXEC (Start watch)

When dump time achieved:
 FWD RCS OFF – ITEM 38 EXEC

O8

When dump complete:
 FWD RCS MANF ISOL
 1,2,3,4 (four) – CL (tb-CL)

O6

MDM FF4 – OFF
 O14:B cb OI SIG CONDR OF 1/4 A – op
 O14:F RJDF 1B F1 DRIVER, LOGIC – OFF
 O15:B cb MNB OI SIG CONDR OF 2/3 A – op
 O15:F RJDF 1A F2 LOGIC, DRIVER – OFF
 O16:F 2A F3, 2B F4 DRIVER (two) – OFF
 F4/F5 LOGIC (two) – OFF

FOUR JET DUMP

FWD RCS PRPLT TO BE DUMPED (%)

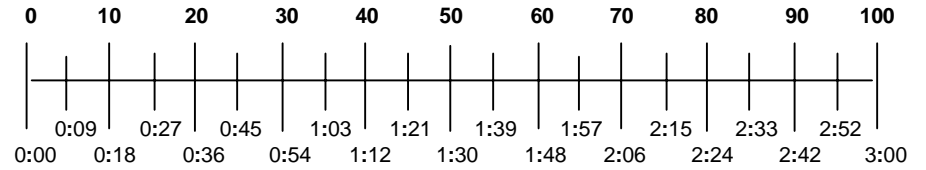

TIME FROM DUMP INITIATION (M:S)

TWO JET DUMP

FWD RCS PRPLT TO BE DUMPED (%)

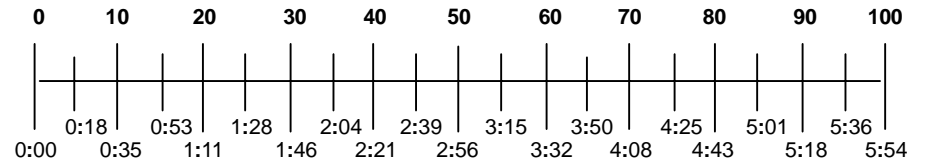

TIME FROM DUMP INITIATION (M:S)

NOM

LOSS OF 2 H2O LOOPS DEORBIT PREP/ENTRY

1: GNC 53 ENTRY CONTROLS	2: BFS, GNC SYS SUMM 2
3: GNC DEORB MNVR COAST	

SECONDARY ACTUATOR CHECK (if not previously performed and time permits)

NOTE

If a port does not bypass during check, bypass aff port after check:

SEC ACT BYPASS – ITEM 8 +X X
EXEC

If aff port still does not bypass:

SEC ACT RESET – ITEM 9 +X X
EXEC

- R2 1. ✓HYD MN PUMP PRESS (three) – NORM

- F6
CRT3 2. INST PWR – FLT
 SURF DRIVE ON – ITEM 39 EXEC (*), wait at
 least 5 sec
- F7 ✓SPI: Stop drive test when elevon posns within
 +12° to -27°:
 SURF DRIVE OFF – ITEM 40 EXEC
 (*)

- CRT1 3. ✓POS STIM ENA – ITEM 7 (no *)

- C3 4. ✓FCS CH (four) – AUTO

- CRT1 5. SEC ACT CK, CH 1 – ITEM 1 EXEC (*)
 CK START – ITEM 5 EXEC

- 6. ✓All CH 1 ports bypass (↓)
 STOP – ITEM 6 EXEC (*)

- C3 7. FCS CH 1 – ORIDE
- CRT1 ✓All CH 1 ports reset (no ↓)
- C3 FCS CH 1 – AUTO

- 8. Repeat steps 5 thru 7 for CH 2,3,4

EQUIPMENT STOWAGE AND SEAT INGRESS

If not already accomplished:

- Stow equip
- Seat ingress
- Adjust seat, exercise brake pedals

SPACELAB FINAL DEACT (if flown)

- P R1 PL PRI MNC,FC3,MNB (three) – OFF (tb-OFF)
- PL AUX – OFF
- CAB – OFF
- AFT MNB,MNC (two) – OFF

ENTRY SWITCH CHECK

- C L1 NH3 CNTLR B – PRI/GPC
- L2 ✓CAB RELIEF (two) – ENA (tb-ENA)
- ✓ENTRY MODE – AUTO

- C,P C3 ✓SBTC – full fwd
- ✓SRB SEP – AUTO
- ✓ET SEP – AUTO

- F6/F8 ✓AIR DATA – NAV
- ✓ADI ERR – MED
- RATE – MED
- ✓HSI SEL MODE – ENTRY
- ✓SOURCE (two) – NAV,1
- ✓ – NAV,2

- C,P F3 ✓L,R TRIM RHC/PNL (two) – INH
- ✓PNL (two) – ON

NOM

LOSS OF 2 H2O LOOPS DEORBIT PREP/ENTRY

CDR

PLT

HORIZ SIT CONFIG

ALTM – ITEM 9

--	--	--	--

	<u>PASS ITEM</u>	<u>BFS ITEM</u>
PTI	INH ✓1	
LAND SITE (DEL PAD)	✓41	✓41
RWY (DEL PAD)	✓3	✓3
	✓4	✓4
TACAN (DEL PAD)	✓5	✓5
RA	blank ✓46	
TAEM TGT		
G&N	OVHD ✓6	blank
HSI	blank	blank
XEP	NEP ✓7	NEP ✓7
AIM (DEL PAD)	NOM ✓8 (or CLSE)	NOM ✓8 (or CLSE)
SPD BK	NOM ✓39	
TAC	INH ✓20	INH ✓20
GPS	INH ✓43	INH ✓43
DRAG H	AUT ✓22	AUT ✓22
ADTA H	INH ✓26	INH ✓26
ADTA TO G&C	INH ✓29	AUT ✓28
DES any failed TACANs	✓	✓
TAC	DELTA ✓35	
AIF_G	INH ✓48	

Stow:

Deorbit Burn Cue Cards (C6)

DEORBIT BURN MONITOR (Cue Card) (C6)

**Go to LOSS OF 2 H2O LOOPS ENTRY MANEUVERS
EI-5, 9-17**

1: GNC DEORB MNVR COAST | 2: GNC 50 HORIZ SIT

3: GNC 51 OVERRIDE

- ✓ELEVON AUTO – ITEM 17 (*)
- SSME REPOS – ITEM 19 EXEC (INH)
- ✓WRAP MODE – ITEM 45 (ENA)
- If PLB holding > 10K lb:
- FILTER ALT – ITEM 21 EXEC (*)

3: BFS, GNC 51 OVERRIDE

- ✓ELEVON AUTO – ITEM 17 (*)
- ✓SSME REPOS – ITEM 19 (INH)
- ✓WRAP MODE – ITEM 45 (ENA)
- If PLB holding > 10K lb:
- ✓FILTER ALT – ITEM 21 EXEC (*)

- * DES any failed/comm faulted *
- * IMU, RGA, AA, or SURF feedback *

G SUIT INFLATION

All Load – 1.5

**Go to LOSS OF 2 H2O LOOPS ENTRY
MANEUVERS EI-5, 9-17**

NOM

(NOM) B9-16

C D/O/ALL/GEN H

LOSS OF 2 H2O LOOPS ENTRY MANEUVERS

FLIGHT CONDITIONS	MANEUVER
EI-5	cb ADTA 1,2,3 (three) - cl cb MNA,B DDU L (two) - cl (L) FLT CNTLR PWR - ON (L) INST PWR - FLT MDM FF4 - ON GNC I/O RESET ✓LVLH ATT GNC, OPS 304 PRO * If PREBANK: R/Y - CSS * * Roll at 1°/sec to <input type="text"/> <input type="text"/> <input type="text"/> * * Maintain PREBANK ±5° *
'Guidance Box' @ q ~8 or D ~3	CLOSED LOOP GUIDANCE ___:___:___ * If PREBANK: P,R/Y - AUTO * Begin AIL trim monitoring
D = 11	✓DRAG H (FORCE if editing)
V = 19K	✓MPS/TVC ISOL VLV - CL
V = 15K	TACAN 2,3 MODE (two) - GPC
V = 12K	<u>ACTIVATE ENTRY COMM</u> L,R AUD PWR - AUD AUD CTR - 1 UHF SPLX/EVA PWR AMPL - ON UHF MODE - SPLX S-BD PM CNTL - PNL,CMD OI PCMMU PWR - 1 ✓FORMAT - FXD MDM PL2 - ON GNC, BFS I/O RESET
V = 10K	✓SPD BRK to 81%
V = 7K	✓TACAN status
V = 5K	ADTA PROBES - DEPLOY (✓HEAT) Begin AIL and RUD trim monitoring
ΔAZ = 10.5°	FIRST ROLL REVERSAL <input type="text"/> <input type="text"/> <input type="text"/> <input type="text"/> <input type="text"/>

FLIGHT CONDITIONS	MANEUVER
M = 2.9	CAB FAN A(B) - OFF Power one HUD, one MLS, one RA for landing GNC I/O RESET
M = 2.7	✓APUs * If M < 2.5, P CSS FOR ADTA TO G&C incorp *
M = 2.0	Ensure ADTA to G&C; else, ✓Theta limits
M = 0.95	* For bailout procedures, go to <u>BAILOUT</u> *
M = 0.9	P,R/Y - CSS as reqd ✓SPDBK CMD vs POS (R) INST PWR - ON cb MNB,C DDU R (two) - cl (R) FLT CNTLR PWR - ON NWS - 1 ANTISKID - ON Lock Inertia Reels MAX Nz <input type="text"/> <input type="text"/>
M = 0.7	✓LG EXTEND ISOL VLV - OP
h = 15K	✓MLS (if activated)
h = 10k	✓A/L,TABS/LES VISORS - CL (KSC)
MAIN GEAR TD	✓SPD BRK - 100%
DEROT INIT	DRAG CHUTE pb (two) - ARM,DPY (simo)
NOSE GEAR TD	SRB SEP - MAN/AUTO and depress pb ✓Auto Load Relief ✓HYD BRAKE ISOL VLV (three) - OP
V = 60 KGS	DRAG CHUTE JETT pb - JETT
STOP	DIRECT O2 vlv - CL Go to <u>EMER PWRDN</u> (Cue Card)

NOM

This Page Intentionally Blank

(NOM) B9-18

NOM
C D/O/ALL/GEN H

EMERGENCY DEORBIT PREP/ENTRY

10-1

C D/O/ALL/GEN H

EMERGENCY

This Page Intentionally Blank

EMERGENCY DEORBIT PREP/ENTRY
(20 min < time to TIG < 2 hr 40 min)

ASSUMPTIONS/INITIAL CONDITIONS

Emergency Deorbit Prep/Entry may be used for any failure case requiring deorbit in less than 2 hr 40 min. For loss of cabin pressure, perform the pwrn on 10–5 if not already completed

This procedure assumes at least 20 min and at most 2 hr 40 min remain until deorbit burn

PROBLEM DESCRIPTION/RATIONALE

Maximum time to TIG (Tmax) is based on cabin pressure, leak rate, and total N2 quantity, and is determined from CAB PRESS LEAK NOMOGRAPH (ORB PKT, ECLS). Tmax can be exceeded, but cabin pressure will drop below 8 psi

Actual time to TIG based on landing site availability

NOTE

1. Procedure designed for worst–case scenario, 20 min until TIG. Any activity not absolutely necessary omitted, and any activity not reqd prior to burn delayed until after burn
2. AFT DECK and MIDDECK MS procedures located on MS PULLOUT PAGES, 10–7 and 10–9, respectively. Extra copies located in back of PLT's book
3. CDR and PLT procedures begin on 10–10
4. Nominal DEORBIT BURN MONITOR Cue Card used
5. If landing site available, this procedure exited on 10–19 and nominal ENTRY MANEUVERS Cue Card with P&Is used
6. If landing site not available, bailout procedures beginning on 10–20 are used
7. This procedure baselines single–fault tolerant configuration on most air–cooled equipment. If cabin pressure stabilizes at 8 psi or greater, additional equipment activated as desired
8. If time available, review NOMINAL DEORBIT PREP (DEORBIT PREP) for any additional activities that may be desired

EMERGENCY DEORBIT PREP/ENTRY MATRIX

The following matrix is for general information purposes only. First and second columns list all Nominal Deorbit Prep activities and times when performed, respectively. The third column indicates whether or not activities are performed in Emergency Deorbit Prep and, if so, when performed relative to the deorbit burn

ACTIVITY	NOM 4.0 HR D/O PREP	EMERGENCY D/O PREP
FLUID LOADING PREP	FLIGHT PLAN	-✓
TIMER SETUP	-03:59	-----
CONFIGURE DAP	-03:58	-✓
COLD SOAK INITIATE	-03:56	-----
ENT STOWAGE	-03:52	-----
KU-BD ANTENNA STOW	-03:48	-✓
RAD STOW	-03:45	-✓
N2 QTY COMPUTE	-03:42	-----
SPECIALIST SEAT INSTALLATION	-03:35	+✓
DPS CONFIG FOR D/O PREP	-03:27	-----
APU/HYD CONFIG	-03:25	-✓
DED DISP ENT CONFIG	-03:15	+✓
AUTO MNVR TO IMU ATT	-02:58	-----
SELECT NORM JETS	-02:56	-✓
RAD BYPASS/FES C/O	-02:55	-✓
PL DEACT	-02:54	-✓
CONFIG FOR PLBD CLOSING	-02:45	-✓
IMU ALIGNMENT	-02:44	-----
CLOSE PLBD	-02:40	-✓
POST CLOSING CONFIG	-02:25	-----
AUTO MNVR TO COMM ATT	-02:24	-----

ACTIVITY	NOM 4.0 HR D/O PREP	EMERGENCY D/O PREP
SPACELAB FINAL DEACT	-02:19	-----
DPS ENTRY CONFIG	-02:17	-✓
DEACT STAR TRKRS & CLOSE DOORS	-01:58	-✓
ENT SWITCH CONFIG	-01:55	-✓
ENT SWITCH LIST/VER	-01:50	-✓
DEORB PAD UPDATE	-01:42	-----
RESET C/W	-01:40	-----
ENTRY REVIEW	-01:39	-----
(C,P) CLOTHING CONFIG	-01:25	+✓
(MS) CLOTHING CONFIG	-01:10	+✓
IMU/IMU ALIGN	-01:06	-----
FLUID LOADING	-01:04	-✓
(C,P) SEAT INGRESS	-00:59	+✓
HUD SETUP	-00:57	-----
ADJUST SEAT	-00:55	+✓
C6 LEH O2 vlv - OP	-00:53	+✓
LES PRESS INTEGRITY CHECK	-00:52	+✓
CO2 REMOVAL SYS DEACT	-00:50	-----
WIRELESS STOW	-00:50	-----
WCS DEACT, BLEED ORF REMOVAL	-00:49	-----

-✓ Indicates accomplished sometime before TIG

+✓ Indicates accomplished sometime between TIG and EI

**EMERGENCY DEORBIT PREP/ENTRY
LOSS OF CABIN PRESSURE**

LOSS OF CAB PRESS PWRDN

- Perform following powerdown for loss of cabin pressure:
- C3 MSTR MADS PWR – OFF
Use minimum lighting
Use one IDP/CRT with one MDU (IDP 4 preferable)
Use one PGSC as reqd
 - O7 ✓TACAN MODE sel (three) – OFF
 - O8 ✓MLS (three) – OFF
 - ✓RADAR ALTM (two) – OFF
 - L1 HUM SEP (two) – OFF
H2O LOOP 2(1) BYP MODE – MAN
MAN – DECR (30 sec)
- If FES not ena:
If EVAP OUT T 41 to 47 degF:
RAD CNTLR OUT TEMP – HI
When EVAP OUT T > 50 degF:
FLASH EVAP CNTLR PRI A(B) – ON, then immediately
RAD CNTLR OUT TEMP – NORM
If EVAP OUT T < 41 or > 47 degF:
FLASH EVAP CNTLR PRI A(B) – ON
Go to MS PWRDN (ORB PKT, LOSS OF CAB PRESS PWRDN) if time permits

This Page Intentionally Blank

(MEDS) A10-6

MEDS
C D/O/ALL/GEN H

**EMERGENCY DEORBIT PREP/ENTRY
MIDDECK STATION MS**

Fluid Loading Prep (if time available)
Remove suits, loose equipment from airlock
Close Airlock Hatch

ENTRY SWITCH LIST/VERIFICATION (MIDDECK)

If time available, 3–24 thru 3–27 (OV102), 3–26 thru 3–29 (OV104) with following deltas:

ML31C ✓VAC VENT ISOL VLV CNTL – CL (tb–CL)
MO13Q ✓ARLK FAN A(B) – OFF
 (OV103/OV104/OV105) if flown

If not already accomplished:
Tape Foot Loops in egress routes
Foot restraints – up, locked

WCS

ESCAPE POLE SETUP

Reinstall Stbd Pip Pin
Reinstall large Port Pin:
Retract and hold Locking Pin (Ring)
Reinstall large Pin
Release Locking Pin (Ring)
Slide forward Safing Latch

✓Pole Straps secure

MO69M LEH O2 8 vlv – CL
Remove, stow O2 Bleed Orifice
LEH O2 7,8 vlv (two) – OP (if reqd)
MO32M 5,6 vlv (two) – OP (if reqd)
Stow: Exercise Equipment
Loose middeck equipment

(Cont in right column)

After deorbit targeting complete: Stow backup
PGSC
Remove, stow side hatch UV Filter, Locking
Device, Pyro Box Safing Pin
Unstow, install MS Seats
Don LES, Harness, Boots
Begin Fluid Loading (if time available)
Ingress seat
LES PRESS INTEGRITY CHECK

EMERGENCY DEORBIT PREP/ENTRY

CDR

PLT

CONFIG GPCs

	1	2	3	4	5
PWR	ON	ON	ON	ON	ON
OUTPUT	NORM	NORM	NORM	NORM	B/U
MODE	RUN	RUN	RUN	RUN	RUN

SM, OPS 000 PRO

SM 0 GPC MEMORY

VERIFY MC 3 PER TABLE

CONFIG GPC	3
	12340
STR 1	1
2	2
3	3
4	4
PL 1/2	1
CRT 1	1
2	2
3	3
4	0
L 1	0
2	0
MM 1	1
2	2

TRANSITION TO OPS 3

GNC, OPS 301 PRO
 BFS, GNC OPS 301 PRO
 GNC, OPS 302 PRO

Use three IDP/CRTs with five MDUs (six for burn)

CRT3

Do not proceed until all DPS ENTRY CONFIG steps complete

LANDING SITE UPDATE

1: GNC 50 HORIZ SIT
 SEL SITE, RWY (PASS/BFS)

DRAG ALT ATM SELECTION

GNC 51 OVERRIDE
 SEL ATM: incl ≤ 50° ✓ ITEM 22 (*)
 incl > 50° SEL ITEM NR (table)

Hemi	Jan	Feb	Mar	Apr	May	Jun	Jul	Aug	Sep	Oct	Nov	Dec
N Desc	23	23	23	23	22	24	24	24	22	23	23	23
S Asc	24	24	22	23	23	23	23	23	23	23	22	24
N Asc	22											
S Desc												

CHECK CG

GNC DEORB MNVR EXEC
 UPDATE PRPLT ITEM 18 as reqd

MEDS

EMERGENCY DEORBIT PREP/ENTRY

CDR

PLT

CLOTHING CONFIG (if time permits)

Don: LES
Harness
Boots

C6 LEH O2 vlv (four) – OP

LES PRESS INTEGRITY CHECK

TIG-2 **Go to DEORBIT BURN Cue Cards**

OMS BURN PREP

O7 AFT L,R RCS
He PRESS (four) – OP (tb-OP)
TK ISOL (six) – GPC (tb-OP)
XFEED (four) – GPC (tb-CL)
✓MSTR RCS XFEED – OFF

O8 L,R OMS
✓He PRESS/VAP ISOL (four) – CL
✓TK ISOL (four) – OP (tb-OP)
✓XFEED (four) – CL (tb-CL)
FWD RCS He PRESS (two) – OP (tb-OP)

CLOTHING CONFIG (if time permits)

Don: LES
Harness
Boots

C6 LEH O2 vlv (four) – OP

LES PRESS INTEGRITY CHECK

TIG-2 **Go to DEORBIT BURN Cue Cards**

(MEDS) A10-13

MEDS

C D/O/ALL/GEN H

EMERGENCY DEORBIT PREP/ENTRY

	CDR	POST BURN ACTIVITIES	PLT
	O14:E, cb MNA,B DDU L (two) – op O15:E F7 FLT CNTLR PWR – OFF		O15:E, cb MNB,C DDU R (two) – op O16:E F8 FLT CNTLR PWR – OFF
	C3 ✓DAP: AUTO		C3 ✓DAP: AUTO
	MNVR TO EI-5 ATT		OMS/RCS POST BURN RECONFIG
	CRT1 GNC, OPS 303 PRO		O7 AFT L,R RCS ✓He PRESS (four) – OP (tb-OP) ✓TK ISOL (six) – GPC (tb-OP) ✓XFEED (four) – GPC (tb-CL)
TIME TO EI (MIN)	LVLH PITCH (DEG)		O8 L,R OMS He PRESS/VAP ISOL (four) – CL ✓TK ISOL (four) – OP (tb-OP) ✓XFEED (four) – CL (tb-CL)
26	315		
25	319		
24	323		
	327		
	331		
	335		
20	339		
	343		
	347		
	351		
	355		
15	359		
	3		
	7		
	11		
	15		
10	19		
	23		
	27		
	31		
	35		
5	39		
		<u>NOTE</u> Use LVLH table unless INRTL EI-5 attitude (ITEMS 24,25,26) supplied by MCC. Use DDU and FLT CNTLR PWR as reqd for manual mnvr	
		<u>When mnvr complete</u> O14:A BRAKES MNA – ON O15:A BRAKES MNB – ON O16:A BRAKES MNC – ON	
			APU PRESTART
			R2 BLR N2 SPLY (three) – ON ✓PWR (three) – ON ✓CNTLR/HTR (three) – A(B) ✓APU AUTO SHUTDN (three) – ENA CNTLR PWR (three) – ON HYD MN PUMP PRESS (three) – LO ✓APU SPEED SEL (three) – NORM ✓OPER (three) – OFF ✓FUEL TK VLV (three) – CL ✓HYD CIRC PUMP (three) – OFF ✓cb APU FU TK VLV ENA (six) – cl

EMERGENCY DEORBIT PREP/ENTRY

CDR

PLT

FORWARD RCS DUMP

(Use for off-nominal Xcg entry using lowest of OX or FU qty)
Determine FWD RCS 'DUMP TO %' (DEL PAD)

FOUR JET DUMP:

FWD RCS PRPLT TO BE DUMPED (%)

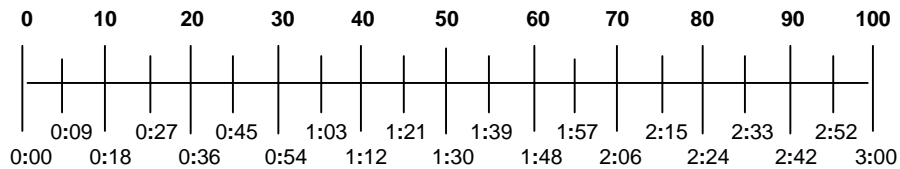

TIME FROM DUMP INITIATION (M:S)

TWO JET DUMP:

FWD RCS PRPLT TO BE DUMPED (%)

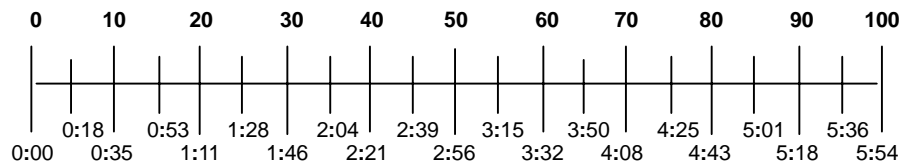

TIME FROM DUMP INITIATION (M:S)

APU START

R2 APU FUEL TK VLV (three) – OP
✓APU/HYD RDY tb (three) – gray

* If tb – bp, attempt normal start *

APU OPER (three) – START/RUN

MDU ✓HYD PRESS 1,2,3 ind (three) – LO green

R2 APU/HYD RDY tb (three) – bp
HYD MN PUMP PRESS (three) – NORM

MDU ✓HYD PRESS ind (three) – HI green

R2 * If OIL OUT P < 25 and OIL OUT *
* TEMP not increasing after APU *
* start, or no start perform APU *
* SHUTDN (Cue Card) *

R4 ✓HYD BRAKE ISOL VLV (three) – GPC (tb-CL)
✓LG EXTEND ISOL VLV – GPC (tb-CL)

EMERGENCY DEORBIT PREP/ENTRY

EQUIPMENT DONNING AND SEAT INGRESS

If not already accomplished:

Stow equip

Don: LES

Harness

Boots

- C6 LEH O2 1,2,3,4 vlv (four) – OP
Begin Fluid Loading (if time available)
Seat ingress
Install Entry Cue Cards
Adjust seat, exercise brake pedals

ENTRY SWITCH CHECK

- C L1 NH3 CNTLR B – PRI/GPC
L2 ✓CAB RELIEF A,B (two) – ENA (tb–ENA)
ANTISKID – ON
NWS – 1
✓ENTRY MODE – AUTO
C,P C3 ✓SBTC – full fwd
✓SRB SEP – AUTO
✓ET SEP – AUTO
F6/F8 ✓AIR DATA – NAV
✓ADI ERR – MED
RATE – MED
✓HSI SEL MODE – ENTRY
✓SOURCE (two) – NAV,1
– NAV,2
C,P F3 ✓L,R TRIM RHC/PNL (two) – INH
✓PNL (two) – ON
C F6 ✓RADAR ALTM – 1
P F8 ✓RDR ALTM – 2

MEDS

(MEDS) A10–17

C D/O/MEDS/GEN H

EMERGENCY DEORBIT PREP/ENTRY

CDR

PLT

HORIZ SIT CONFIG

ALTM - ITEM 9 +

		.		
--	--	---	--	--

	<u>PASS ITEM</u>	<u>BFS ITEM</u>
PTI	INH ✓1	
LAND SITE (DEL PAD)	✓41	✓41
RWY (DEL PAD)	✓3	✓3
	✓4	✓4
TACAN (DEL PAD)	✓5	✓5
RA	blank ✓46	
TAEM TGT		
G&N	OVHD ✓6	blank
HSI	blank	blank
XEP	NEP ✓7	NEP ✓7
AIM (DEL PAD)	NOM ✓8	NOM ✓8
	(or CLSE)	(or CLSE)
SPD BK	NOM ✓39	
TAC	INH ✓20	INH ✓20
GPS	INH ✓43	INH ✓43
DRAG H	AUT ✓22	AUT ✓22
ADTA H	INH ✓26	INH ✓26
ADTA TO G&C	INH ✓29	AUT ✓28
DES any failed TACANs	✓	✓
TAC	DELTA ✓35	
AIF_G	INH ✓48	

1: GNC DEORB MNVR COAST | 2: GNC 50 HORIZ SIT

3: GNC 51 OVERRIDE

- ✓ELEVON AUTO - ITEM 17 (*)
- SSME REPOS - ITEM 19 EXEC (INH)
- ✓WRAP MODE - ITEM 45 (ENA)
- If PLB holding > 10K lb:
- FILTER ALT - ITEM 21 EXEC (*)

3: BFS, GNC 51 OVERRIDE

- ✓ELEVON AUTO - ITEM 17 (*)
- ✓SSME REPOS - ITEM 19 (INH)
- ✓WRAP MODE - ITEM 45 (ENA)
- If PLB holding > 10K lb:
- ✓FILTER ALT - ITEM 21 EXEC (*)

- * DES any failed/comm faulted IMU, *
- * RGA, AA, or SURF feedback *

EMERGENCY DEORBIT PREP/ENTRY

Stow:

Deorbit Burn Cue Cards (C6)

DEORBIT BURN MONITOR (Cue Card) (C6)

✓Entry Cue Cards installed

If Landing Site available:

Go to ENTRY MANEUVERS (Cue Card) at

EI-5 with following P&I:

NOTE

If cabin pressure stabilizes at 8 psi or greater, activate additional air-cooled equipment as desired

EI-5	cb ADTA 1,2,3 (three) – cl GNC I/O RESET cb MNA,B DDU L (two) – cl (L) FLT CNTLR PWR – ON
V = 15K	TACAN MODE 1,2 (two) – GPC
V = 12K	Do not perform RAD Activation
M = 2.9	Use one HUD, one MLS, one RA
M = 0.9	cb MNB,C DDU R (two) – cl (R) FLT CNTLR – ON

EMERGENCY DEORBIT PREP/ENTRY

If Landing Site not available, perform following
bailout procedures:

EI-5

- cb ADTA (four) – cl
- MNA,B DDU L (two) – cl
- GNC I/O RESET
- (L) FLT CNTLR PWR – ON
- ✓ADI ATT – LVLH
- MNVR to R 001, P 039, Y 358
- GNC, OPS 304 PRO
- ✓ENTRY ATT (R 000, P 040, Y 000)
- SPDBK/THROT pb – AUTO
- ✓PITCH pb – AUTO (PASS)
- ✓ROLL/YAW pb – AUTO (PASS)
- (CSS if PREBANK)

C CRT1

C ADI
F2

EI

h = 400K
(00:00)

$\bar{q} = .5$

PITCH pb – CSS
ROLL/YAW pb – CSS

MEDS

(MEDS) A10-20

C D/O/MEDS/GEN H

EMERGENCY DEORBIT PREP/ENTRY

$\dot{H} = -200$ and increasing (D = 5-6)

Start 3°/sec roll to ENTRY ALPHA (Cue Card)
ref bank angle while maintaining alpha = 40°

Approaching ref bank angle, bank as necessary
to center phugoid damper with BIAS = 0

- * Always null alpha errors from ENTRY *
- * TRAJ display or ENTRY ALPHA Cue *
- * Card before nulling bank errors *
- * *
- * When roll reversal reqd or if phugoid *
- * damper becomes overly sensitive, use *
- * alpha and \dot{H} from cue card as primary *
- * fly-to indications *
- * *
- * During roll reversal, if phugoid damper *
- * commands an \dot{H} significantly different *
- * from cue card, establish approximate *
- * cue card \dot{H} with an \dot{H} of ± 3 to 5 ft/sec² *
- * and wait for phugoid damper to stabilize *
- * before following phugoid damper *

D = 11

✓DRAG H UPDATE ACTIVE

- * If editing occurs: *
- * 2: GNC 50 HORIZ SIT *
- * DRAG H FOR - ITEM 24 EXEC *

V = 15K

M = 6.0

TACAN MODE 1,2 (two) - GPC

Wings level, follow α sched

M = 5.0

2: GNC 51 OVERRIDE
AIR DATA PROBES (two) - DEPLOY(✓HEAT)

EMERGENCY DEORBIT PREP/ENTRY

P

✓AIR DATA R,L then NAV

3: GNC 50 HORIZ SIT

RATIO < 1	RATIO > 1	
	ADTA ERRATIC	ADTA STEADY
AUTO	AUTO	FORCE

When ADTA-H AUTO/FORCE:
ADTA to G&C – AUTO

- * If no Air Data and M < 1.5: *
- * Fly Theta limits *
- * If PRI DME > 80 nm, Theta limits *
- * unavailable: *
- * Maintain Theta below limits as *
- * determined by SB posn and roll angle *
- * Supersonic *
- * Theta < -7° for SB = 65% & F = 0° *
- * Subsonic *
- * Theta < -1° for SB = 0% & Φ = 0° *
- * Theta < -12° for SB = 100% & Φ = 0° *

M = 2.5
M = 0.95

FLY α = 12°
Go to BAILOUT

EMERGENCY DEORBIT PREP/ENTRY **(20 min < time to TIG < 2 hr 40 min)**

ASSUMPTIONS/INITIAL CONDITIONS

Emergency Deorbit Prep/Entry may be used for any failure case requiring deorbit in less than 2 hr 40 min. For loss of cabin pressure, perform the pwrn on 10–5 if not already completed

This procedure assumes at least 20 min and at most 2 hr 40 min remain until deorbit burn

PROBLEM DESCRIPTION/RATIONALE

Maximum time to TIG (Tmax) is based on cabin pressure, leak rate, and total N2 quantity, and is determined from CAB PRESS LEAK NOMOGRAPH (ORB PKT, ECLS). Tmax can be exceeded, but cabin pressure will drop below 8 psi

Actual time to TIG based on landing site availability

NOTE

1. Procedure designed for worst–case scenario, 20 min until TIG. Any activity not absolutely necessary omitted, and any activity not reqd prior to burn delayed until after burn
2. AFT DECK and MIDDECK MS procedures located on MS PULLOUT PAGES, 10–7 and 10–9, respectively. Extra copies located in back of PLT's book
3. CDR and PLT procedures begin on 10–10
4. Nominal DEORBIT BURN MONITOR Cue Card used
5. If landing site available, this procedure exited on 10–19 and nominal ENTRY MANEUVERS Cue Card with P&Is used
6. If landing site not available, bailout procedures beginning on 10–20 are used
7. This procedure baselines single–fault tolerant configuration on most air–cooled equipment. If cabin pressure stabilizes at 8 psi or greater, additional equipment activated as desired
8. If time available, review NOMINAL DEORBIT PREP (DEORBIT PREP) for any additional activities that may be desired

EMERGENCY DEORBIT PREP/ENTRY MATRIX

The following matrix is for general information purposes only. First and second columns list all Nominal Deorbit Prep activities and times when performed, respectively. The third column indicates whether or not activities are performed in Emergency Deorbit Prep and, if so, when performed relative to the deorbit burn

ACTIVITY	NOM 4.0 HR D/O PREP	EMERGENCY D/O PREP
FLUID LOADING PREP	FLIGHT PLAN	-✓
TIMER SETUP	-03:59	-----
CONFIGURE DAP	-03:58	-✓
COLD SOAK INITIATE	-03:56	-----
ENT STOWAGE	-03:52	-----
KU-BD ANTENNA STOW	-03:48	-✓
RAD STOW	-03:45	-✓
N2 QTY COMPUTE	-03:42	-----
SPECIALIST SEAT INSTALLATION	-03:35	+✓
DPS CONFIG FOR D/O PREP	-03:27	-----
APU/HYD CONFIG	-03:25	-✓
DED DISP ENT CONFIG	-03:15	+✓
AUTO MNVR TO IMU ATT	-02:58	-----
SELECT NORM JETS	-02:56	-✓
RAD BYPASS/FES C/O	-02:55	-✓
PL DEACT	-02:54	-✓
CONFIG FOR PLBD CLOSING	-02:45	-✓
IMU ALIGNMENT	-02:44	-----
CLOSE PLBD	-02:40	-✓
POST CLOSING CONFIG	-02:25	-----
AUTO MNVR TO COMM ATT	-02:24	-----

ACTIVITY	NOM 4.0 HR D/O PREP	EMERGENCY D/O PREP
SPACELAB FINAL DEACT	-02:19	-----
DPS ENTRY CONFIG	-02:17	-✓
DEACT STAR TRKRS & CLOSE DOORS	-01:58	-✓
ENT SWITCH CONFIG	-01:55	-✓
ENT SWITCH LIST/VER	-01:50	-✓
DEORB PAD UPDATE	-01:42	-----
RESET C/W	-01:40	-----
ENTRY REVIEW	-01:39	-----
(C,P) CLOTHING CONFIG	-01:25	+✓
(MS) CLOTHING CONFIG	-01:10	+✓
IMU/IMU ALIGN	-01:06	-----
FLUID LOADING	-01:04	-✓
(C,P) SEAT INGRESS	-00:59	+✓
HUD SETUP	-00:57	-----
ADJUST SEAT	-00:55	+✓
C6 LEH O2 vlv - OP	-00:53	+✓
LES PRESS INTEGRITY CHECK	-00:52	+✓
CO2 REMOVAL SYS DEACT	-00:50	-----
WIRELESS STOW	-00:50	-----
WCS DEACT, BLEED ORF REMOVAL	-00:49	-----

-✓ Indicates accomplished sometime before TIG

+✓ Indicates accomplished sometime between TIG and EI

**EMERGENCY DEORBIT PREP/ENTRY
LOSS OF CABIN PRESSURE**

LOSS OF CAB PRESS PWRDN

- Perform following powerdown for loss of cabin pressure:
- C3 MSTR MADS PWR – OFF
Use minimum lighting
Use one CRT (CRT4 preferable)
Use one PGSC as reqd
 - O7 ✓TACAN MODE sel (three) – OFF
 - O8 ✓MLS (three) – OFF
 - ✓RADAR ALTM (two) – OFF
 - L1 HUM SEP (two) – OFF
H2O LOOP 2(1) BYP MODE – MAN
MAN – DECR (30 sec)
- If FES not ena:
If EVAP OUT T 41 to 47 degF:
RAD CNTLR OUT TEMP – HI
When EVAP OUT T > 50 degF:
FLASH EVAP CNTLR PRI A(B) –
ON, then immediately
RAD CNTLR OUT TEMP – NORM
If EVAP OUT T < 41 or > 47 degF:
FLASH EVAP CNTLR PRI A(B) – ON
Go to MS PWRDN (ORB PKT, LOSS OF CAB PRESS PWRDN) if time permits

(NOM) B10-5

NOM

C D/O/NOM/GEN H

This Page Intentionally Blank

(NOM) B10-6

NOM
C D/O/ALL/GEN H

**EMERGENCY DEORBIT PREP/ENTRY
MIDDECK STATION MS**

Fluid Loading Prep (if time available)
Remove suits, loose equipment from airlock
Close Airlock Hatch

ENTRY SWITCH LIST/VERIFICATION (MIDDECK)

If time available, 3-26 thru 3-29 with following
deltas:

ML31C ✓VAC VENT ISOL VLV CNTL – CL (tb-CL)
MO13Q ✓ARLK FAN A(B) – OFF
 (OV103/OV104/OV105) if flown

If not already accomplished:
Tape Foot Loops in egress routes
Foot restraints – up, locked

WCS

ESCAPE POLE SETUP

Reinstall Stbd Pip Pin
Reinstall large Port Pin:
Retract and hold Locking Pin (Ring)
Reinstall large Pin
Release Locking Pin (Ring)
Slide forward Safing Latch

✓Pole Straps secure

MO69M LEH O2 8 vlv – CL
 Remove, stow O2 Bleed Orifice
MO32M LEH O2 7,8 vlv (two) – OP (if reqd)
 5,6 vlv (two) – OP (if reqd)
Stow: Exercise Equipment
 Loose middeck equipment

(Cont in right column)

After deorbit targeting complete: Stow backup
PGSC
Remove, stow side hatch UV Filter, Locking
Device, Pyro Box Safing Pin
Unstow, install MS Seats
Don LES, Harness, Boots
Begin Fluid Loading (if time available)
Ingress seat
LES PRESS INTEGRITY CHECK

EMERGENCY DEORBIT PREP/ENTRY

CDR

PLT

CONFIG GPCs

	1	2	3	4	5
PWR	ON	ON	ON	ON	ON
OUTPUT	NORM	NORM	NORM	NORM	B/U
MODE	RUN	RUN	RUN	RUN	RUN

SM, OPS 000 PRO

SM 0 GPC MEMORY

VERIFY MC 3 PER TABLE

CONFIG GPC	3
	12340
STR 1	1
2	2
3	3
4	4
PL 1/2	1
CRT 1	1
2	2
3	3
4	0
L 1	0
2	0
MM 1	1
2	2

TRANSITION TO OPS 3

GNC, OPS 301 PRO
 BFS, GNC OPS 301 PRO
 GNC, OPS 302 PRO

CRT3

Do not proceed until all DPS ENTRY CONFIG steps complete

LANDING SITE UPDATE

1: GNC 50 HORIZ SIT
 SEL SITE, RWY (PASS/BFS)

DRAG ALT ATM SELECTION

GNC 51 OVERRIDE
 SEL ATM: incl ≤ 50° ✓ ITEM 22 (*)
 incl > 50° ITEM NR (table)

Hemi	Jan	Feb	Mar	Apr	May	Jun	Jul	Aug	Sep	Oct	Nov	Dec
N Desc	23	23	23	23	22	24	24	24	22	23	23	23
S Asc	24	24	22	23	23	23	23	23	23	23	22	24
N Asc	22											
S Desc												

CHECK CG

GNC DEORB MNVR EXEC
 UPDATE PRPLT ITEM 18 as reqd

NOM

EMERGENCY DEORBIT PREP/ENTRY

CDR

PLT

CLOTHING CONFIG (if time permits)

Don: LES
Harness
Boots

C6 LEH O2 vlv (four) – OP

LES PRESS INTEGRITY CHECK

TIG-2 **Go to DEORBIT BURN Cue Cards**

OMS BURN PREP

O7 AFT L,R RCS
He PRESS (four) – OP (tb-OP)
TK ISOL (six) – GPC (tb-OP)
XFEED (four) – GPC (tb-CL)
✓MSTR RCS XFEED – OFF

O8 L,R OMS
✓He PRESS/VAP ISOL (four) – CL
✓TK ISOL (four) – OP (tb-OP)
✓XFEED (four) – CL (tb-CL)
FWD RCS He PRESS (two) – OP (tb-OP)

CLOTHING CONFIG (if time permits)

Don: LES
Harness
Boots

C6 LEH O2 vlv (four) – OP

LES PRESS INTEGRITY CHECK

TIG-2 **Go to DEORBIT BURN Cue Cards**

(NOM) B10-13

NOM

C D/O/ALL/GEN H

EMERGENCY DEORBIT PREP/ENTRY

	CDR	POST BURN ACTIVITIES	PLT
O14:E, O15:E F7	cb MNA,B DDU L (two) – op,cl as reqd to achieve/maintain EI-5 attitude FLT CNTLR PWR – OFF		O15:E, O16:E F8 FLT CNTLR PWR – OFF
C3	✓DAP: AUTO		C3 ✓DAP: AUTO
MNVR TO EI-5 ATT			OMS/RCS POST BURN RECONFIG
CRT1	GNC, OPS 303 PRO		O7 AFT L,R RCS ✓He PRESS (four) – OP (tb-OP) ✓TK ISOL (six) – GPC (tb-OP) ✓XFEED (four) – GPC (tb-CL)
TIME TO EI (MIN)	LVLH PITCH (DEG)		O8 L,R OMS He PRESS/VAP ISOL (four) – CL ✓TK ISOL (four) – OP (tb-OP) ✓XFEED (four) – CL (tb-CL)
26	315	NOTE Use LVLH table unless INRTL EI-5 attitude (ITEMS 24,25,26) supplied by MCC	
25	319		
24	323		
	327		
	331		
	335		
20	339		
	343		
	347		
	351		
	355		
15	359		
	3		
	7		
	11		
	15		
10	19		
	23		
	27		
	31		
	35		
5	39		
		<u>When mnvr complete</u> O14:A BRAKES MNA – ON O15:A BRAKES MNB – ON O16:A BRAKES MNC – ON	
			R2 BLR N2 SPLY (three) – ON ✓PWR (three) – ON ✓CNTLR/HTR (three) – A(B) ✓APU AUTO SHUTDN (three) – ENA CNTLR PWR (three) – ON HYD MN PUMP PRESS (three) – LO ✓APU SPEED SEL (three) – NORM ✓OPER (three) – OFF ✓FUEL TK VLV (three) – CL ✓HYD CIRC PUMP (three) – OFF ✓cb APU FU TK VLV ENA (six) – cl
			APU PRESTART

NOM

EMERGENCY DEORBIT PREP/ENTRY

CDR

PLT

FORWARD RCS DUMP

(Use for off-nominal Xcg entry using lowest of OX or FU qty)
Determine FWD RCS 'DUMP TO %' (DEL PAD)

FOUR JET DUMP:

FWD RCS PRPLT TO BE DUMPED (%)

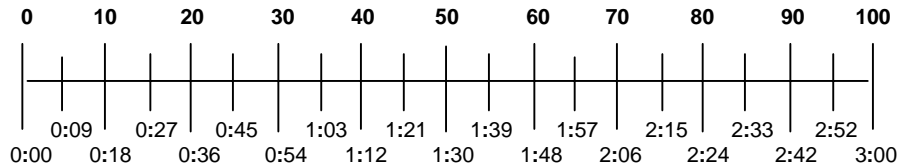

TIME FROM DUMP INITIATION (M:S)

TWO JET DUMP:

FWD RCS PRPLT TO BE DUMPED (%)

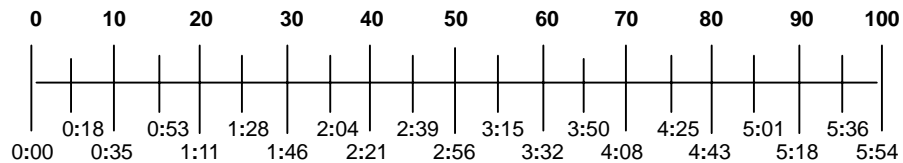

TIME FROM DUMP INITIATION (M:S)

APU START

- R2 APU FUEL TK VLV (three) – OP
- ✓APU/HYD RDY tb (three) – gray
- * If tb – bp, attempt normal start *
- APU OPER (three) – START/RUN
- F8 ✓HYD PRESS 1,2,3 ind (three) – LO green
- R2 APU/HYD RDY tb (three) – bp
- HYD MN PUMP PRESS (three) – NORM
- F8 ✓HYD PRESS ind (three) – HI green
- R2 * If OIL OUT P < 25 and OIL OUT *
- * TEMP not increasing after APU *
- * start, or no start, perform APU *
- * SHUTDN (Cue Card) *
- R4 ✓HYD BRAKE ISOL VLV (three) – GPC (tb-CL)
- ✓LG EXTEND ISOL VLV – GPC (tb-CL)

(NOM) B10-15

NOM

C D/O/NOM/GEN H

EMERGENCY DEORBIT PREP/ENTRY

EQUIPMENT DONNING AND SEAT INGRESS

If not already accomplished:

Stow equip

Don: LES

Harness

Boots

- C6 LEH O2 1,2,3,4 vlv (four) – OP
Begin Fluid Loading (if time available)
Seat ingress
Install Entry Cue Cards
Adjust seat, exercise brake pedals

ENTRY SWITCH CHECK

- C L1 NH3 CNTLR B – PRI/GPC
L2 ✓CAB RELIEF A,B (two) – ENA (tb–ENA)
ANTISKID – ON
NWS – 1
✓ENTRY MODE – AUTO
C,P C3 ✓SBTC – full fwd
✓SRB SEP – AUTO
✓ET SEP – AUTO
F6/F8 ✓AIR DATA – NAV
✓ADI ERR – MED
RATE – MED
✓HSI SEL MODE – ENTRY
✓SOURCE (two) – NAV,1
– NAV,2
C,P F3 ✓L,R TRIM RHC/PNL (two) – INH
✓PNL (two) – ON
C F7 ✓RADAR ALTM – 1
P F8 ✓RDR ALTM – 2

NOM

(NOM) B10–17

C D/O/NOM/GEN H

EMERGENCY DEORBIT PREP/ENTRY

CDR

PLT

HORIZ SIT CONFIG

ALTM - ITEM 9 +

		.		
--	--	---	--	--

	<u>PASS ITEM</u>	<u>BFS ITEM</u>
PTI	INH ✓1	
LAND SITE (DEL PAD)	✓41	✓41
RWY (DEL PAD)	✓3	✓3
	✓4	✓4
TACAN (DEL PAD)	✓5	✓5
RA	blank ✓46	
TAEM TGT		
G&N	OVHD ✓6	blank
HSI	blank	blank
XEP	NEP ✓7	NEP ✓7
AIM (DEL PAD)	NOM ✓8	NOM ✓8
	(or CLSE)	(or CLSE)
SPD BK	NOM ✓39	
TAC	INH ✓20	INH ✓20
GPS	INH ✓43	INH ✓43
DRAG H	AUT ✓22	AUT ✓22
ADTA H	INH ✓26	INH ✓26
ADTA TO G&C	INH ✓29	AUT ✓28
DES any failed TACANs	✓	✓
TAC	DELTA ✓35	
AIF_G	INH ✓48	

1: GNC DEORB MNVR COAST | 2: GNC 50 HORIZ SIT

3: GNC 51 OVERRIDE

- ✓ELEVON AUTO - ITEM 17 (*)
- SSME REPOS - ITEM 19 EXEC (INH)
- ✓WRAP MODE - ITEM 45 (ENA)
- If PLB holding > 10K lb:
- FILTER ALT - ITEM 21 EXEC (*)

3: BFS, GNC 51 OVERRIDE

- ✓ELEVON AUTO - ITEM 17 (*)
- ✓SSME REPOS - ITEM 19 (INH)
- ✓WRAP MODE - ITEM 45 (ENA)
- If PLB holding > 10K lb:
- ✓FILTER ALT - ITEM 21 EXEC (*)

- * DES any failed/comm faulted IMU, *
- * RGA, AA, or SURF feedback *

(NOM) B10-18

NOM

C D/O/ALL/GEN H

EMERGENCY DEORBIT PREP/ENTRY

Stow:

Deorbit Burn Cue Cards (C6)

DEORBIT BURN MONITOR (Cue Card) (C6)

✓Entry Cue Cards installed

If Landing Site available:

Go to ENTRY MANEUVERS (Cue Card) at

EI-5 with following P&I:

NOTE

If cabin pressure stabilizes at 8 psi or greater, activate additional air-cooled equipment as desired

EI-5	cb ADTA 1,2,3 (three) – cl GNC I/O RESET cb MNA,B DDU L (two) – cl (L) FLT CNTLR PWR – ON (L) INST PWR – FLT
V = 15K	TACAN MODE 1,2 (two) – GPC
V = 12K	Do not perform RAD Activation
M = 2.9	Use one HUD, one MLS, one RA
M = 0.9	cb MNB,C DDU R (two) – cl (R) FLT CNTLR – ON (R) INST PWR – ON

NOM

(NOM) B10-19

C D/O/NOM/GEN H

EMERGENCY DEORBIT PREP/ENTRY

If Landing Site not available, perform following
bailout procedures:

EI-5

- cb ADTA (four) – cl
- MNA,B DDU L (two) – cl
- GNC I/O RESET
- (L) FLT CNTLR PWR – ON
- (L) INST PWR – ON
- ✓ADI ATT – LVLH
- MNVR to R 001, P 039, Y 358
- GNC, OPS 304 PRO
- ✓ENTRY ATT (R 000, P 040, Y 000)
- SPDBK/THROT pb – AUTO
- ✓PITCH pb – AUTO (PASS)
- ✓ROLL/YAW pb – AUTO (PASS)
- (CSS if PREBANK)

C CRT1

C ADI
F2

EI

h = 400K
(00:00)

$\bar{q} = .5$

PITCH pb – CSS
ROLL/YAW pb – CSS

NOM

(NOM) B10-20

C D/O/NOM/GEN H

EMERGENCY DEORBIT PREP/ENTRY

$\dot{H} = -200$ and increasing (D = 5-6)

Start 3°/sec roll to ENTRY ALPHA (Cue Card)
ref bank angle while maintaining alpha = 40°

Approaching ref bank angle, bank as necessary
to center phugoid damper with BIAS = 0

- * Always null alpha errors from ENTRY *
- * TRAJ display or ENTRY ALPHA Cue *
- * Card before nulling bank errors *
- * *
- * When roll reversal reqd or if phugoid *
- * damper becomes overly sensitive, use *
- * alpha and \dot{H} from cue card as primary *
- * fly-to indications *
- * *
- * During roll reversal, if phugoid damper *
- * commands an \dot{H} significantly different *
- * from cue card, establish approximate *
- * cue card \dot{H} with an \dot{H} of ± 3 to 5 ft/sec² *
- * and wait for phugoid damper to stabilize *
- * before following phugoid damper *

D = 11

✓DRAG H UPDATE ACTIVE

- * If editing occurs: *
- * 2: GNC 50 HORIZ SIT *
- * DRAG H FOR - ITEM 24 EXEC *

V = 15K

M = 6.0

TACAN MODE 1,2 (two) - GPC

Wings level, follow α sched

M = 5.0

2: GNC 51 OVERRIDE
AIR DATA PROBES (two) - DEPLOY(✓HEAT)

EMERGENCY DEORBIT PREP/ENTRY

P

✓AIR DATA R,L then NAV

3: GNC 50 HORIZ SIT

RATIO < 1	RATIO > 1	
	ADTA ERRATIC	ADTA STEADY
AUTO	AUTO	FORCE

When ADTA-H AUTO/FORCE:
ADTA to G&C – AUTO

- * If no Air Data and M < 1.5: *
- * Fly Theta limits *
- * If PRI DME > 80 nm, Theta limits *
- * unavailable: *
- * Maintain Theta below limits as *
- * determined by SB posn and roll angle *
- * Supersonic *
- * Theta < -7° for SB = 65% & F = 0° *
- * Subsonic *
- * Theta < -1° for SB = 0% & Φ = 0° *
- * Theta < -12° for SB = 100% & Φ = 0° *

M = 2.5
M = 0.95

FLY α = 12°
Go to BAILOUT

LOSS OF 2 FREON LOOPS DEORBIT PREP/ENTRY

This Page Intentionally Blank

LOSS OF 2 FREON LOOPS DEORBIT PREP/ENTRY

ASSUMPTIONS/INITIAL CONDITIONS

Loss of Two Freon Loops Deorbit Prep/Entry is a **STAND-ALONE procedure** that assumes FREON FLOW LOW and LOSS OF 2 FREON LOOPS (ORB PKT, PWRDN) or LOSS OF 2 FREON LOOPS (ENTRY) (ENT PKT, PWRDN) accomplished

This failure requires immediate deorbit to first available landing site while powered down to very low level

If Deorbit TIG to ELS within 40 min, all FCs will be on with continuous purge; otherwise, two FCs will be shut down and additional equipment powered off for wait period

PROBLEM DESCRIPTION/RATIONALE

Source of orbiter cooling is Freon coolant loops. With no Freon flow, heat not removed from Freon and, hence, from water and air-cooled equipment as well

Orbiter Freon Loops are designed to remove heat from fuel cell coolant (FC-40), maintaining FCs at ~200 degF. When the Freon no longer cools FC-40, fuel cell stack temperature rises and electrolyte concentration drops. Byproduct H₂O not condensed/removed and accumulates in cells, causing fuel cells to flood. Flooding predicted to occur when electrolyte concentration drops below 25% and will result in loss of power to orbiter. Additionally, fuel cell stack can fail allowing mixing and/or escape of reactants if stack temperature becomes excessively high (~250 degF)

If pwrdsn accomplished to 8 kW total load immediately following failure of second Freon loop, analysis indicates that with continuous purge, orbiter life extended to 120 min

LOSS OF 2 FREON LOOPS DEORBIT PREP/ENTRY

NOTE

1. MS procedures are located on MS PULLOUT PAGE, 11–5. Extra copies are located in the back of PLT's book
2. Use COMM pages from ORB PKT pwrn to cycle COMM if necessary
3. Maintain minimum lighting
4. Only two APUs used for entry. APUs will be started at EI–5
5. Vent doors open throughout entry (Except L,R VENT DOORS 1&2)
6. This procedure utilizes modified DEORBIT BURN MONITOR and ENTRY MANEUVERS Cue Cards located in this section
7. Don Quick Don Mask as needed for additional respiratory cooling. If cabin temp > 95 degF and no evaporative cooling sensed, don LES, activate O2, and close visor
8. If two FCs stopped (ON–ORBIT WAIT), perform ON–ORBIT WAIT BACKOUT on 11–6 and 11–7; otherwise, go directly to ENTRY CONFIG on 11–8

LOSS OF 2 FREON LOOPS DEORBIT PREP (Cont)

ON-ORBIT WAIT BACKOUT

CDR

PLT

~TIG-20 **POWERUP**

O6 ✓MDM FF2,3 (two) – ON
 ✓FF1,4 (two) – OFF (CDR GREEN DOT)
 FA2,3 (two) – ON
 ✓FA1,4 (two) – OFF
CRTX GNC I/O RESET
L4:P cb AC2 ΦA LG SNSR 2 – cl
 AC3 ΦA LG SNSR 1 – cl

By ~TIG-15, go to 11-8

By ~TIG-15, go to 11-8

(MEDS) A11-7

C D/O/ALL/GEN H

LOSS OF 2 FREON LOOPS DEORBIT PREP (Cont)

ENTRY CONFIG

CDR

PLT

3. ASSIGN GPC 3 TO MC3 REDUNDANT SET
GNC 0 GPC MEMORY
 CRT CONFIG – ITEM 1 +3 EXEC
 Modify MC3 per table →
 GNC, OPS 301 PRO
GNC 0 GPC MEMORY
 DOWNLIST GPC – ITEM 44
 +3 EXEC
- | | | | |
|--------|-----|---|-------|
| CONFIG | GPC | 3 | 10300 |
| STR | 1 | 3 | |
| | 2 | 3 | |
| | 3 | 3 | |
| | 4 | 3 | |
| PL | 1/2 | 3 | |
| CRT | 1 | 3 | |
| | 2 | 3 | |
| | 3 | 3 | |
| | 4 | 0 | |
| L | 1 | 0 | |
| | 2 | 0 | |
| MM | 1 | 3 | |
| | 2 | 3 | |
4. DEACT GPC 1, MMU 1, ASAs
 O6 GPC MODE 1 – STBY,HALT
 PWR 1 – OFF
- O14:F MMU 1 – OFF
 O15:F ASA 2 – OFF
 O16:F 3 – OFF
- L1 5. SWITCH AV BAY FANS
 AV BAY 1 FAN A – OFF
 3 FAN B – ON
- O6 6. ACTIVATE FA4 FOR BURN
 MDM FA4 – ON
 GNC I/O RESET

Do not proceed until all DPS ENTRY CONFIG steps complete

ATMOSPHERE SELECT

GNC 51 OVERRIDE

CRT SELECT ATM: incl ≤ 50° ✓ITEM 22 (*)
 incl > 50° SEL ITEM NR

Hemi	Jan	Feb	Mar	Apr	May	Jun	Jul	Aug	Sep	Oct	Nov	Dec
N Desc	23	23	23	23	22	24	24	24	22	23	23	23
S Asc	24	24	22	23	23	23	23	23	23	23	22	24
N Asc	22											
S Desc	22											

LAND SITE UPDATE

✓LAND SITE UPDATE

GNC 50 HORIZ SIT

CRT SEL SITE (See LAND SITE DATA)

O7 ✓TACAN 3 CH tw – as reqd
 (See LAND SITE DATA)

CG CHECK

DEORB MNVR COAST

CRT UPDATE PRPLT, ITEM 18, as reqd

LOSS OF 2 FREON LOOPS DEORBIT PREP

ENTRY CONFIG

LOAD TGTs AND MNVR

CRT Enter TGT DATA from MCC or PGSC →
 LOAD – ITEM 22 EXEC
 TIMER – ITEM 23 EXEC
 DAP: AUTO
 Mnvr to Burn Att

Select SEC GIMBALS (because FF1,FF4 – OFF)
 LEFT – ITEM 30 EXEC
 RIGHT – ITEM 31 EXEC
 GNC, OPS 302 PRO

MEDS CONFIG FOR ENTRY

C2 IDP/CRT3 PWR – ON
 ✓All other IDP/CRTs – OFF

Use two MDUs
 O13:A cb ESS 1BC MTU A – op
 O15:E MNB DDU R – cl
 O16:E MNC DDU R – cl

CLOTHING CONFIG

C6 Don: LES, Harness, Boots
 LEH O2 vlv (two) – OP

~TIG-3 **Go to DEORBIT BURN (Cue Cards)**

NOTE
 Use LOSS OF 2 FREON LOOPS
 D/O BURN MONITOR CARD

PGSC DEORBIT PAD

RECORD DEORBIT OPPORTUNITIES		
SITE	APPROX TIG	XRNG
_____ / _____	: _____ : _____	_____
_____ / _____	: _____ : _____	_____
_____ / _____	: _____ : _____	_____
_____ / _____	: _____ : _____	_____

COMPUTE WEIGHT
 Use PGSC CG MANAGER program (record below)

COMPUTE TARGET

WT	_____
TIG	_____ / _____ : _____ : _____
C1	_____
C2	(-).6000
HT	65.832
θT	_____ . _____
ΔVTOT	_____ . _____
REI	_____

LOAD TARGET IN OPS 3

MEDS

DEORBIT BURN MONITOR

(LOSS OF 2 FREON LOOPS)

OMS PC & OMS ↓	OMS PRPLT FAIL
OMS OX/FU TK P (✓ OMS/MPS) OX/FU LOW	He PRESS/VAP ISOL (two) – OP If aff TK P not incr: He PRESS/VAP ISOL (two) – CL At PC < 72: OMS PRPLT FAIL
OX & FU HIGH	He PRESS/VAP ISOL (two) – CL Cycle He A(B) to maintain TK P 234–284
OMS GMBL	If high RCS usage: OMS ENG FAIL
I/O ERROR FA	I/O RESET (if recov: >>) If high RCS usage: OMS ENG FAIL ✓MAN SHUTDN
BCE STRG D	I/O RESET (if recov: >>) ✓If high RCS usage: OMS ENG FAIL

LOSS OF 2 FREON LOOPS

ENTRY

CDR

PLT

MNVR TO EI-5 ATT

O6 MDM FA4 – OFF
 CRT GNC, OPS 303 PRO
 O14:E, cb DDU L (two) – cl, as reqd to achieve/
 O15:E maintain EI-5 attitude

TIME TO EI (MIN)	LVLH PITCH (DEG)
26	315
25	319
24	323
	327
	331
	335
20	339
	343
	347
	351
	355
15	359
	3
	7
	11
	15
10	19
	23
	27
	31
	35
5	39

NOTE
 Use LVLH table unless **INRTL**
 EI-5 attitude (ITEMS 24,25,26)
 supplied by MCC

F8 FLT CNTLR PWR – OFF
 O15:E, cb DDU R – op
 O16:E

OMS/RCS POST BURN RECONFIG

O7 ✓AFT L,R RCS He PRESS (four) – OP (tb-OP)
 ✓TK ISOL (six) – GPC (tb-OP)
 ✓XFEED (four) – GPC (tb-CL)

O8 L,R OMS
 ✓He PRESS/VAP ISOL (four) – CL
 ✓TK ISOL (four) – OP (tb-OP)
 ✓XFEED (four) – CL (tb-CL)

OMS GIMBAL PWRDN (PASS only)

CRT Verify gimbal positions:

	<u>L</u>	<u>R</u>
P	+5.9	+5.9
Y	+6.4	-6.4

GMBL OFF – ITEM 32 EXEC
 – ITEM 33 EXEC

LOSS OF 2 FREON LOOPS (Cont)

ENTRY

CDR

PLT

Perform FRCS dump if reqd to maintain Xcg in box

If no FRCS dump reqd, go to 11-16

HORIZ SIT CONFIG

ALTM - ITEM 9 +

		.		
--	--	---	--	--

	PASS ITEM
PTI	INH ✓1
LAND SITE (DEL PAD)	✓41
RWY (DEL PAD)	✓3
	✓4
TACAN (DEL PAD)	✓5
RA	blank ✓46
TAEM TGT	
G&N	OVHD ✓6
HSI	blank
XEP	NEP ✓7
AIM (DEL PAD)	NOM ✓8
	(or CLSE)
SPD BK	NOM ✓39
TAC	INH ✓20
GPS	INH ✓43
DRAG H	AUT ✓22
ADTA H	INH ✓26
ADTA TO G&C	INH ✓29
DES any failed TACANs	✓
TAC	DELTA ✓35
AIF_G	INH ✓48

FWD RCS RECOVERY

- O14:B ✓cb OI SIG CONDR OF 1/4 A - cl
:F RJDF 1B F1 DRIVER - ON
LOGIC - ON
- O15:B ✓cb OI SIG CONDR OF 2/3 A - cl
:F RJDF 1A F2 DRIVER - ON
LOGIC - ON
- O16:F 2A F3,2B F4 DRIVER (two) - ON
F4/F5 LOGIC (two) - ON
- O6 MDM FF1,4 - ON
GNC I/O RESET
- O8 Reopen FWD RCS
GNC 23 RCS
- CRTX JET RESET - ITEM 45 EXEC
Reselect deselected FRCS jets
JET RESET - ITEM 45 EXEC

FORWARD RCS DUMP (Use for off-nominal Xcg entry using lowest of OX or FU qty)

Determine FWD RCS 'DUMP TO %'
(calculator, cg wheel, or DEL PAD)

FOUR JET DUMP:

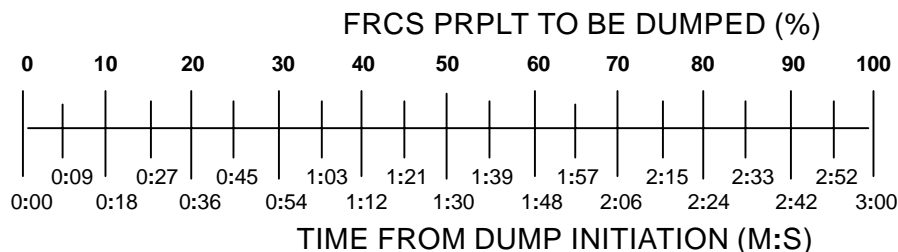

LOSS OF 2 FREON LOOPS (Cont)

ENTRY

CDR

PLT

1: GNC DEORB MNVR COAST 2: GNC 50 HORIZ SIT
3: GNC 51 OVERRIDE

- ✓ELEVON AUTO – ITEM 17 (*)
- SSME REPOS – ITEM 19 EXEC (INH)
- ✓WRAP MODE – ITEM 45 (ENA)
- If PLB holding >10K lb:
FILTER ALT – ITEM 21 EXEC (*)

TWO JET DUMP:

FRCS PRPLT TO BE DUMPED (%)

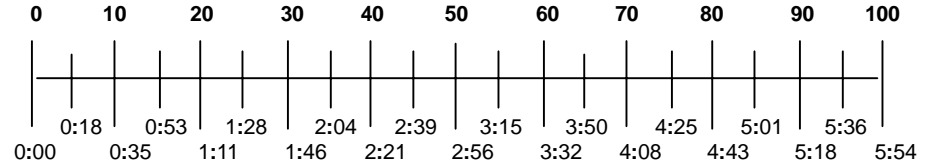

TIME FROM DUMP INITIATION (M:S)

NOTE

During dump, disregard FRCS qty

GNC DEORB MNVR EXEC

- FWD RCS ARM – ITEM 36 EXEC
- DUMP – ITEM 37 EXEC
(start watch)

When dump time achieved:
OFF – ITEM 38 EXEC

When dump complete:
O8 FWD RCS MANF ISOL 1,2,3,4 (four) – CL
(tb-CL)

- O6 MDM FF1,4 (two) – OFF
- O14:F, RJDF LOGIC,DRIVER (eight) – OFF
- O15:F,
- O16:F

LOSS OF 2 FREON LOOPS (Cont)

ENTRY

	CDR		PLT
	Stow: <u>DEORBIT BURN</u> and <u>DEORBIT BURN MONITOR</u> Cue Cards		FC PERFORMANCE CHECK
~EI-10	Give MS GO to stow flight deck PGSC ✓ENTRY Cue Cards installed		Two FCs reqd for ENTRY/LANDING Monitor FC performance through landing: If any single FC STACK TEMP ≥ 250 degF: Affected ESS BUS SOURCE FC1(2,3) – OFF Affected FC/MN BUS A(B,C) – OFF When FC STACK TEMP within 5 degF of either remaining FC, reconnect FC to buses (MN first, then ESS) If all three FC STACK TEMPs ≥ 250 degF: No action
	SEAT INGRESS		
	Adjust seat (one seat and direction at a time) Exercise brake pedals		
	G-SUIT INFLATION		
	All Load – 1.5		
EI-5	Go to LOSS OF 2 FREON LOOPS ENTRY MANEUVERS, 11-19	EI-5	APU PRESTART
			R2 BLR N2 SPLY 1,3 (two) – ON ✓PWR 1,3 (two) – ON ✓CNTLR/HTR 1,3 (two) – A(B) APU AUTO SHTDN 1,3 (two) – ENA CNTLR PWR 1,3 (two) – ON HYD MN PUMP PRESS 1,3 (two) – LO ✓APU SPEED SEL 1,3 (two) – NORM ✓OPER 1,3 (two) – OFF ✓FUEL TK VLV 1,3 (two) – CL ✓HYD CIRC PUMP 1,3 (two) – OFF ✓cb APU FU TK VLV ENA 1 A,1 B – cl 3 A,3 B – cl
			C3 FCS CH 1,4 (two) – OFF 2,3 (two) – ORIDE ASA (four) – ON
			O14:F, O15:F, O16:F

(MEDS) A11-16

C D/O/ALL/GEN H

LOSS OF 2 FREON LOOPS (Cont)

ENTRY

CDR

PLT

APU START

- R2 APU FUEL TK VLV 1,3 (two) – OP
- ✓APU/HYD RDY tb 1,3 (two) – gray
- APU OPER 1,3 (two) – START/RUN
- MDU ✓HYD PRESS ind 1,3 (two) – LO green

- R2 APU/HYD RDY 1,3 tb (two) – bp

- * If APU 1(3) does not start: *
- * BLR CNTLR/HTR 2 – A(B) *
- * N2 SPLY 2 – ON *
- * PWR 2 – ON *
- * ✓APU AUTO SHUTDN 2 – ENA *
- * CNTLR PWR 2 – ON *
- * HYD MN PUMP PRESS 2 – LO *
- * ✓APU SPEED SEL 2 – NORM *
- * ✓OPER 2 – OFF *
- * ✓FUEL TK VLV 2 – cl *
- * ✓HYD CIRC PUMP 2 – OFF *
- * ✓cb APU FU TK VLV ENA 2A,2B – cl *
- * APU FUEL TK VLV 2 – OP *
- * OPER 2 – START/RUN *
- * ✓HYD PRESS ind 2 – LO green *
- * If less than two APUs running: *
- * APU AUTO SHUTDN (one) – INH *
- * If any APU does not start: *
- * BLR CNTLR/HTR – OFF *
- * APU OPER – OFF *
- * FUEL TK VLV – CL *
- * CNTLR PWR – OFF *
- * HYD MN PUMP PRESS – NORM *

MEDS

(MEDS) A11-17

C D/O/MEDS/GEN H

LOSS OF 2 FREON LOOPS (Cont)

ENTRY

CDR

PLT

APU START

HYD MN PUMP PRESS 1,3 – NORM

MDU ✓HYD PRESS 1,3 ind (two) – HI green
INST PWR – OFF

R4 ✓HYD BRAKE ISOL VLV 1,3 (two) –
GPC (tb-CL)
✓LG EXTEND ISOL VLV – GPC (tb-CL)

(MEDS) A11-18

MEDS

C D/O/MEDS/GEN H

LOSS OF 2 FREON LOOPS ENTRY MANEUVERS

FLIGHT CONDITIONS	MANEUVER
EI-5	MDM FF 1,4 - ON CAB FAN B - ON cb MNA,B DDU L (two) - cl cb ADTA 2,3 - cl ACCEL 2 - CL ACCEL 3 - ON GNC I/O RESET ✓LVLH ATT GNC, OPS 304 PRO ✓OPS 304, wait 1 min MDM FF 1,4 - OFF * If PREBANK: R/Y - CSS * * Roll at 1°/sec to <input type="text"/> <input type="text"/> <input type="text"/> <input type="text"/> * * Maintain PREBANK ± 5° *
'Guidance Box' @ q̇ ~8 or D -3	CLOSED LOOP GUIDANCE ____:__:____ * If PREBANK: P,R/Y - AUTO * Begin AIL trim monitoring
D = 11	✓DRAG H (FORCE if editing)
V = 19K	✓MPS/TVC ISOL VLV - CL
V = 12K	BRAKES MNB,MNC - ON UHF MODE - SPLX (G T/R if ELS) AUD CTR - 1 ✓OI PCMMU FORMAT - FXD L,R AUD PWR - AUD PS,MS AUD PWR - AUD (if reqd) If command or data reqd: OI PCMMU PWR - 2 MDM PL2 - ON S-BD PM CNTL - PNL, then CMD GNC I/O RESET ANT SW - Select best ANT On MCC call: MDM PL2 - OFF OI PCMMU PWR - OFF
V = 10K	✓SPD BRK to 81% TACAN 3 - GPC
V = 7K	✓TACAN status
V = 5K	ADTA PROBES - DEPLOY (✓HEAT, only one side if reqd) Begin AIL and RUD trim monitoring
ΔAZ = 10.5°	FIRST ROLL REVERSAL <input type="text"/> <input type="text"/> <input type="text"/> <input type="text"/> <input type="text"/>

FLIGHT CONDITIONS	MANEUVER
M = 4	MDM FF4 - ON MDM FF1 - ON (if NWS reqd) GNC I/O RESET
M = 2.9	RADAR ALTM 2 - ON CAB FAN (two) - OFF Use no landing aids (HUD,MLS) unless reqd to land vehicle safely (L HUD DATA BUS - 2 reqd)
M = 2.7	✓APUs APU SPEED SEL (two) - HI
	* If M < 2.5, P CSS for ADTA to G&C incorp *
M = 2.0	Ensure ADTA to G&C; else, ✓Theta limits
M = 0.95	* For bailout procedures, go to BAILOUT *
M = 0.9	(L) FLT CNTLR PWR - ON P,R/Y - CSS as reqd ✓SPDBK CMD vs POS ANTISKID - ON If NWS reqd: cb MNB,C DDU R (two) - cl (R) FLT CNTLR PWR - ON NWS - 1 Lock Inertia Reels Use one IDP/CRT with three MDUs MAX Nz <input type="text"/> <input type="text"/> <input type="text"/>
M = 0.7	LG EXTEND ISOL VLV - OP HYD BRAKE ISOL VLV 1,3 - OP
h = 15K	✓MLS (if on)
h = 10k	✓A/L, TABS/LES VISORS - CL (KSC)
MAIN GEAR TD	✓SPD BRK - 100%
DEROT INIT	DRAG CHUTE pb (two) - ARM,DPY (simo)
NOSE GEAR TD	SRB SEP - MAN/AUTO and depress pb ✓Auto Load Relief
	<p>NWTD ≤ 140 KGS LKBED 5K' REMAINING 40 KGS STOP 140 KGS CONCRETE < 140 KGS > 140 KGS</p>
V = 60 KGS	DRAG CHUTE JETT pb - JETT
STOP	Go to EMER PWRDN (Cue Card)

(MEDS) A11-19

MEDS
C D/O/MEDS/GEN H

This Page Intentionally Blank

(MEDS) A11-20

MEDS
C D/O/ALL/GEN H

LOSS OF 2 FREON LOOPS DEORBIT PREP/ENTRY

ASSUMPTIONS/INITIAL CONDITIONS

Loss of Two Freon Loops Deorbit Prep/Entry is a **STAND-ALONE procedure** that assumes FREON FLOW LOW and LOSS OF 2 FREON LOOPS (ORB PKT, PWRDN) or LOSS OF 2 FREON LOOPS (ENTRY) (ENT PKT, PWRDN) accomplished

This failure requires immediate deorbit to first available landing site while powered down to very low level

If Deorbit TIG to ELS within 40 min, all FCs will be on with continuous purge; otherwise, two FCs will be shut down and additional equipment powered off for wait period

PROBLEM DESCRIPTION/RATIONALE

Source of orbiter cooling is Freon coolant loops. With no Freon flow, heat not removed from Freon and, hence, from water and air-cooled equipment as well

Orbiter Freon Loops are designed to remove heat from fuel cell coolant (FC-40), maintaining FCs at ~200 degF. When the Freon no longer cools FC-40, fuel cell stack temperature rises and electrolyte concentration drops. Byproduct H₂O not condensed/removed and accumulates in cells, causing fuel cells to flood. Flooding predicted to occur when electrolyte concentration drops below 25% and will result in loss of power to orbiter. Additionally, fuel cell stack can fail allowing mixing and/or escape of reactants if stack temperature becomes excessively high (~250 degF)

If pwrdn accomplished to 8 kW total load immediately following failure of second Freon loop, analysis indicates that with continuous purge, orbiter life extended to 120 min

LOSS OF 2 FREON LOOPS DEORBIT PREP/ENTRY

NOTE

1. MS procedures are located on MS PULLOUT PAGE, 11–5. Extra copies are located in the back of PLT's book
2. Use COMM pages from ORB PKT pwrn to cycle COMM if necessary
3. Maintain minimum lighting
4. Only two APUs used for entry. APUs will be started at EI–5
5. Vent doors open throughout entry (Except L,R VENT DOORS 1&2)
6. This procedure utilizes modified DEORBIT BURN MONITOR and ENTRY MANEUVERS Cue Cards located in this section
7. Don Quick Don Mask as needed for additional respiratory cooling. If cabin temp > 95 degF and no evaporative cooling sensed, don LES, activate O2, and close visor
8. If two FCs stopped (ON–ORBIT WAIT), perform ON–ORBIT WAIT BACKOUT on 11–6 and 11–7; otherwise, go directly to ENTRY CONFIG on 11–8

LOSS OF 2 FREON LOOPS DEORBIT PREP

MS PULLOUT PAGE

NOTE: Wait for GO from CDR before accomplishing any action on this page

Prepare LES for donning

~TIG-15 MCA CONFIG

MA73C:A MCA LOGIC FWD (three) – ON
:C cb MCA PWR AC1 3Φ FWD 1 – op
AC3 3Φ FWD 3 – op

~TIG-10 AFT PANEL CONFIG FOR ENTRY COMM

NOTE

This procedure configures aft panel for landing site comm coverage at V = 12K. If comm cycled post TIG-10 (using ORB PKT pwrn comm pages), this AFT PANEL CONFIG FOR ENTRY COMM must be reestablished

R14:B cb GCILC (two) – cl
C3 S-BD PM CNTL – CMD
A1L ANT SW ELEC – 2
 MODE – STDN LO
 XPNDR – 2
NSP PWR – 2
 DATA RATE XMI – HI
 RCV – HI
 ✓UPLK DATA – S-BD
 ✓CODING XMIT – OFF
 ✓RCV – OFF

(cont next column)

TIG-5 LEH VLV CONFIG

MO69M LEH O2 8 vlv – CL
 Stow O2 Bleed Orifice
MO32M LEH O2 7,8 vlv (two) – OP (if reqd)
 5,6 vlv (two) – OP (if reqd)

~EI-10 Stow flight deck PGSC

CLOTHING CONFIG

Don: LES
 Harness
 Boots
C6 LEH O2 vlv (two) – OP

(NOM) B11-5

NOM

C D/O/ALL/GEN H

LOSS OF 2 FREON LOOPS DEORBIT PREP

ON-ORBIT WAIT BACKOUT

NOTE: If two FCs stopped (ON-ORBIT WAIT), execute ON-ORBIT WAIT BACKOUT, 11-6 and 11-7; otherwise go to ENTRY CONFIG, 11-8

CDR

PLT

~TIG-25 SWITCH TO COOL IMU

1. Activate IMU 2
 C2 CRTX PWR – ON
X: GNC 21 IMU ALIGN
 CRTX ✓IMU 2 – deselected (ITEM 8)
 O15:A IMU 2 – ON

2. Activate MDM FF2 (✓MNB-ON)
 O6 MDM FF2 – ON
 CRTX GNC I/O RESET
 IMU 2 OPER – ITEM 5 EXEC (*)
 (wait 90 sec)
 CRTX GNC I/O RESET

3. Align IMU 2 to IMU 3
 CRTX IMU/IMU – ITEM 14 +3 EXEC
 ALIGN IMU 2 – ITEM 11 EXEC (*)
 EXEC – ITEM 16 EXEC (*)

4. Reselect IMU 2, Deselect IMU 3
X: GNC 21 IMU ALIGN
 CRTX DES – ITEM 8 EXEC (no *)
 DES – ITEM 9 EXEC (*)
 O16:A IMU 3 – OFF

NOTE
 Leave MDM FF2 and FF3 on

~TIG-30 ACTIVATE FUEL CELL 2 THEN 3

1. ✓cb OI SIG CONDR OF 1/4 A – cl
 O14:B
 O15:B ✓2/3 A – cl
 R11U FC STARTUP HTR (three) – INH
 R1 MN BUS TIE A – ON (tb-ON)
 B – ON (tb-ON)

2. cb AC CONTR AC2(3) (three) – cl
 INV PWR 2(3) – ON (tb-ON)
 INV/AC PWR BUS – ON (tb-ON)
 AC BUS SENSOR 2(3) – AUTO
 cb AC CONTR AC 2(3) (three) – op
 FC2(3) – START
 FC2(3) COOL PUMP ΔP tb – gray (~4 sec)
 FC/MN BUS B(C) – ON (tb-ON)
 ESS BUS SOURCE FC2(3) – ON

3. ASAP after FC start, begin continuous purge
 R11U ✓FC PURGE HTR – ON
 FC PURGE VLVS 2(3) – OP

4. MN BUS TIE C – ON (tb-ON)
 Repeat steps 2 & 3 for FC 3

CAUTION

O2 Two FCs reqd for Entry/Landing
 R1 Monitor FC performance through landing:
 If any single FC STACK TEMP ≥ 250 degF:
 Aff ESS BUS SOURCE FC1(2,3) – OFF
 FC/MN BUS A(B,C) – OFF
 When FC STACK TEMP within 5 degF of
 either remaining FC, reconnect FC to
 buses (MN first, then ESS)
 If all three FC STACK TEMPS ≥ 250 degF: **NOM**
 No action

(NOM) B11-6

C D/O/NOM/GEN H

LOSS OF 2 FREON LOOPS DEORBIT PREP (Cont)

ON-ORBIT WAIT BACKOUT

CDR

PLT

~TIG-20 **POWERUP**

- O6 ✓MDM FF2,3 (two) – ON
- ✓FF1,4 (two) – OFF (CDR GREEN DOT)
- FA2,3 (two) – ON
- ✓FA1,4 (two) – OFF
- CRTX GNC I/O RESET
- L4:P cb AC2 ΦA LG SNSR 2 – cl
- AC3 ΦA LG SNSR 1 – cl

By ~TIG-15, go to 11-8

By ~TIG-15, go to 11-8

(NOM) B11-7

C D/O/ALL/GEN H

LOSS OF 2 FREON LOOPS DEORBIT PREP

ENTRY CONFIG

CDR

PLT

~TIG-15 **MCA CONFIG**

Give MS GO to config MCAs

SW CONFIG FOR OPS 3 (assumes MNA, MNB on)

- O6 ✓MDM FF2,3 – ON
 - ✓FF1,4 – OFF (CDR GREEN DOT)
 - ✓FA2,3 – ON
 - ✓FA1,4 – OFF

- F7 ✓RADAR ALTM – 2

- O14:B ✓cb MNA OI SIG CONDR OF 1/4 A – cl
 - OM 1/2 A – cl
 - ✓MDM OF 1/2 A – op
 - ✓3/4 A – op

- O15:A RGA 2 – ON
- :B ✓cb MNB OI SIG CONDR OF 2/3 A – cl
- O16:A RGA 3 – ON
- O17:D SIG CONDR OA 1/2/3 – ON
 - ✓MDM OA 1/2/3 – OFF

~TIG-15 **DEORBIT TARGET**

Use PGSC to compute targets (record in pad on 11-11)

APU STEAM VENT HTR ACTIVATION

- R2 ✓BLR CNTLR/HTR 1,3 (two) – A(B)
 - PWR 1,3 (two) – ON

SW CONFIG FOR OPS 3

- F8 ✓RDR ALTM – 2

- O14:F RJDA 1A L2/R2 LOGIC – ON
 - DRIVER – ON
- O15:F ASA 2 – ON
- O16:F RJDA 2B L3/R3/R5 LOGIC – ON
 - L3/R3 DRIVER – ON
 - ✓RJD MANF L5/F5/R5 DRIVER – OFF
- ASA 3 – ON
- O7 AFT L,R RCS MANF ISOL 4 (two) – CL
 - (tb-CL)

- O8 Verify MCA LOGIC config complete, then:
 - FWD RCS MANF ISOL 1,2,3,4 (four) – CL
 - (tb-CL)

LOSS OF 2 FREON LOOPS DEORBIT PREP (Cont)

ENTRY CONFIG

CDR

PLT

3. ASSIGN GPC 3 TO MC3 REDUNDANT SET

CRT	GNC 0 GPC MEMORY		CONFIG GPC	3 10300
	CONFIG – ITEM 1 +3 EXEC Modify MC3 per table →		STR 1	3
	GNC, OPS 301 PRO		2	3
	GNC 0 GPC MEMORY		3	3
	DOWNLIST GPC – ITEM 44 +3 EXEC		4	3
			PL 1/2	3
			CRT 1	3
			2	3
			3	3
			4	0
			L 1	0
			2	0
O14:F	MMU 1 – OFF		MM 1	3
O15:F	ASA 2 – OFF		2	3
O16:F	3 – OFF			

4. DEACT GPC 1, MMU 1, ASAs

O6 GPC MODE 1 – STBY,HALT
PWR 1 – OFF

O14:F MMU 1 – OFF
O15:F ASA 2 – OFF
O16:F 3 – OFF

5. SWITCH AV BAY FANS

L1 AV BAY 1 FAN A – OFF
3 FAN B – ON

6. ACTIVATE FA4 FOR BURN

O6 MDM FA4 – ON
GNC I/O RESET

Do not proceed until all DPS ENTRY CONFIG steps complete

ATMOSPHERE SELECT

GNC 51 OVERRIDE

CRT SELECT ATM: incl ≤ 50° ✓ITEM 22 (*)
incl > 50° SEL ITEM NR

Hemi	Jan	Feb	Mar	Apr	May	Jun	Jul	Aug	Sep	Oct	Nov	Dec
N Desc	23	23	23	23	22	24	24	24	22	23	23	23
S Asc	24	24	22	23	23	23	23	23	23	23	22	24
N Asc	22											
S Desc												

LAND SITE UPDATE

✓LAND SITE UPDATE

GNC 50 HORIZ SIT

CRT SEL SITE (See LAND SITE DATA)
O7 ✓TACAN 3 CH tw – as reqd
(See LAND SITE DATA)

CG CHECK

DEORB MNVR COAST

CRT UPDATE PRPLT, ITEM 18, as reqd

LOSS OF 2 FREON LOOPS DEORBIT PREP

ENTRY CONFIG

LOAD TGTs AND MNVR

CRT Enter TGT DATA from MCC or PGSC →
 LOAD – ITEM 22 EXEC
 TIMER – ITEM 23 EXEC
 DAP: AUTO
 Mnvr to Burn Att

Select SEC GIMBALS (because FF1,FF4 – OFF)
 LEFT – ITEM 30 EXEC
 RIGHT – ITEM 31 EXEC
 GNC, OPS 302 PRO

CRT CONFIG FOR ENTRY

C2 CRT3 PWR – ON
 ✓All other CRTs – OFF

O13:A cb ESS 1BC MTU A – op
 O15:E MNB DDU R – cl
 O16:E MNC DDU R – cl

CLOTHING CONFIG

C6 Don: LES, Harness, Boots
 LEH O2 vlv (two) – OP

PGSC DEORBIT PAD

RECORD DEORBIT OPPORTUNITIES		
SITE	APPROX TIG	XRNG
_____ / _____	: _____ : _____	_____
_____ / _____	: _____ : _____	_____
_____ / _____	: _____ : _____	_____
_____ / _____	: _____ : _____	_____

COMPUTE WEIGHT
 Use PGSC CG MANAGER program (record below)

COMPUTE TARGET

WT _____

TIG _____ / _____ : _____ : _____

C1 _____

C2 (-).6000

HT 65.832

θT _____ . _____

ΔVTOT _____ . _____

REI _____

LOAD TARGET IN OPS 3

~TIG-3 **Go to DEORBIT BURN (Cue Cards)**

NOTE
 Use LOSS OF 2 FREON LOOPS
 D/O BURN MONITOR CARD

NOM

DEORBIT BURN MONITOR

(LOSS OF 2 FREON LOOPS)

OMS PC & OMS ↓	OMS PRPLT FAIL
OMS OX/FU TK P (monitor meter) OX/FU LOW	He PRESS/VAP ISOL (two) – OP If aff TK P not incr: He PRESS/VAP ISOL (two) – CL At PC < 72: OMS PRPLT FAIL
OX & FU HIGH	He PRESS/VAP ISOL (two) – CL Cycle He A(B) to maintain TK P 234–284
OMS GMBL	If high RCS usage: OMS ENG FAIL
I/O ERROR FA	I/O RESET (if recov: >>) If high RCS usage: OMS ENG FAIL ✓MAN SHUTDN
BCE STRG D	I/O RESET (if recov: >>) ✓If high RCS usage: OMS ENG FAIL

LOSS OF 2 FREON LOOPS

ENTRY

CDR

PLT

MNVR TO EI-5 ATT

O6 MDM FA4 – OFF
 CRT GNC, OPS 303 PRO
 O14:E, cb DDU L (two) – cl, as reqd to achieve/
 O15:E maintain EI-5 attitude

TIME TO EI (MIN)	LVLH PITCH (DEG)
26	315
25	319
24	323
	327
	331
	335
20	339
	343
	347
	351
	355
15	359
	3
	7
	11
	15
10	19
	23
	27
	31
	35
5	39

NOTE
 Use LVLH table unless **INRTL**
 EI-5 attitude (ITEMS 24,25,26)
 supplied by MCC

F8 FLT CNTLR PWR – OFF
 O15:E, cb DDU R – op
 O16:E

OMS/RCS POST BURN RECONFIG

O7 ✓AFT L,R RCS He PRESS (four) – OP (tb-OP)
 ✓TK ISOL (six) – GPC (tb-OP)
 ✓XFEED (four) – GPC (tb-CL)

O8 L,R OMS
 ✓He PRESS/VAP ISOL (four) – CL
 ✓TK ISOL (four) – OP (tb-OP)
 ✓XFEED (four) – CL (tb-CL)

OMS GIMBAL PWRDN (PASS only)

CRT Verify gimbal positions:

	<u>L</u>	<u>R</u>
P	+5.9	+5.9
Y	+6.4	-6.4

GMBL OFF – ITEM 32 EXEC
 – ITEM 33 EXEC

LOSS OF 2 FREON LOOPS (Cont)

ENTRY

CDR

PLT

Perform FRCS dump if reqd to maintain Xcg in box

If no FRCS dump reqd, go to 11-16

HORIZ SIT CONFIG

ALTM - ITEM 9 +

		.		
--	--	---	--	--

	PASS ITEM
PTI	INH ✓1
LAND SITE (DEL PAD)	✓41
RWY (DEL PAD)	✓3
	✓4
TACAN (DEL PAD)	✓5
RA	blank ✓46
TAEM TGT	
G&N	OVHD ✓6
HSI	blank
XEP	NEP ✓7
AIM (DEL PAD)	NOM ✓8
	(or CLSE)
SPD BK	NOM ✓39
TAC	INH ✓20
GPS	INH ✓43
DRAG H	AUT ✓22
ADTA H	INH ✓26
ADTA TO G&C	INH ✓29
DES any failed TACANs	✓
TAC	DELTA ✓35
AIF_G	INH ✓48

FWD RCS RECOVERY

- O14:B ✓cb OI SIG CONDR OF 1/4 A - cl
- :F RJDF 1B F1 DRIVER - ON
- LOGIC - ON
- O15:B ✓cb OI SIG CONDR OF 2/3 A - cl
- :F RJDF 1A F2 DRIVER - ON
- LOGIC - ON
- O16:F 2A F3,2B F4 DRIVER (two) - ON
- F4/F5 LOGIC (two) - ON
- O6 MDM FF1,4 - ON
- GNC I/O RESET
- O8 Reopen FWD RCS
- GNC 23 RCS
- CRTX JET RESET - ITEM 45 EXEC
- Reselect deselected FRCS jets
- JET RESET - ITEM 45 EXEC

FORWARD RCS DUMP (Use for off-nominal Xcg entry using lowest of OX or FU qty)

Determine FWD RCS 'DUMP TO %'
(calculator, cg wheel, or DEL PAD)

FOUR JET DUMP:

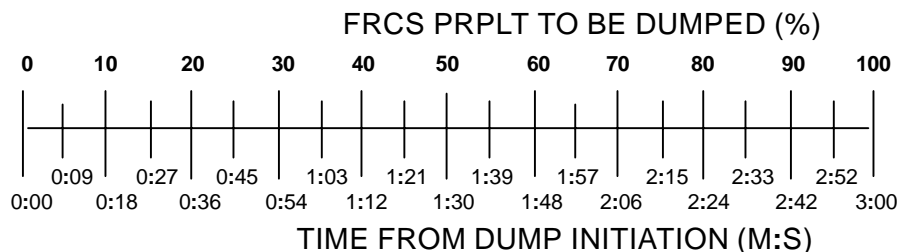

(NOM) B11-14

C D/O/ALL/GEN H

LOSS OF 2 FREON LOOPS (Cont)

ENTRY

CDR

PLT

1: GNC DEORB MNVR COAST 2: GNC 50 HORIZ SIT
3: GNC 51 OVERRIDE

- ✓ELEVON AUTO – ITEM 17 (*)
- SSME REPOS – ITEM 19 EXEC (INH)
- ✓WRAP MODE – ITEM 45 (ENA)
- If PLB holding >10K lb:
FILTER ALT – ITEM 21 EXEC (*)

TWO JET DUMP:

FRCS PRPLT TO BE DUMPED (%)

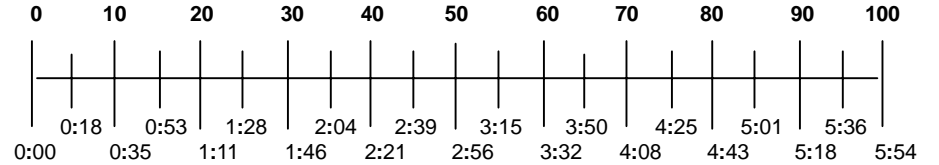

TIME FROM DUMP INITIATION (M:S)

NOTE

During dump, disregard FRCS qty

GNC DEORB MNVR EXEC

- FWD RCS ARM – ITEM 36 EXEC
- DUMP – ITEM 37 EXEC
(start watch)

When dump time achieved:
OFF – ITEM 38 EXEC

When dump complete:
O8 FWD RCS MANF ISOL 1,2,3,4 (four) – CL
(tb-CL)

- O6 MDM FF1,4 (two) – OFF
- O14:F, RJDF LOGIC, DRIVER (eight) – OFF
- O15:F,
- O16:F

LOSS OF 2 FREON LOOPS (Cont)

ENTRY

	CDR		PLT
	Stow: <u>DEORBIT BURN</u> and <u>DEORBIT BURN MONITOR</u> Cue Cards		FC PERFORMANCE CHECK
~EI-10	Give MS GO to stow flight deck PGSC		Two FCs reqd for ENTRY/LANDING Monitor FC performance through landing:
	✓ENTRY Cue Cards installed		If any single FC STACK TEMP ≥ 250 degF:
	SEAT INGRESS		O2 R1 Affected ESS BUS SOURCE FC1(2,3) – OFF
	Adjust seat (one seat and direction at a time)		O2 Affected FC/MN BUS A(B,C) – OFF
	Exercise brake pedals		When FC STACK TEMP within 5 degF of either remaining FC, reconnect FC to buses (MN first, then ESS)
	G-SUIT INFLATION		If all three FC STACK TEMPs ≥ 250 degF: No action
	All Load – 1.5	EI-5	APU PRESTART
EI-5	Go to LOSS OF 2 FREON LOOPS ENTRY MANEUVERS, 11-19		R2 BLR N2 SPLY 1,3 (two) – ON ✓PWR 1,3 (two) – ON ✓CNTLR/HTR 1,3 (two) – A(B) APU AUTO SHTDN 1,3 (two) – ENA CNTLR PWR 1,3 (two) – ON HYD MN PUMP PRESS 1,3 (two) – LO ✓APU SPEED SEL 1,3 (two) – NORM ✓OPER 1,3 (two) – OFF ✓FUEL TK VLV 1,3 (two) – CL ✓HYD CIRC PUMP 1,3 (two) – OFF ✓cb APU FU TK VLV ENA 1 A,1 B – cl 3 A,3 B – cl
			C3 FCS CH 1,4 (two) – OFF 2,3 (two) – ORIDE
			O14:F, ASA (four) – ON O15:F, O16:F
	(NOM) B11-16		C D/O/ALL/GEN H

LOSS OF 2 FREON LOOPS (Cont)

ENTRY

CDR

PLT

APU START

- R2 APU FUEL TK VLV 1,3 (two) – OP
- ✓APU/HYD RDY tb 1,3 (two) – gray
- APU OPER 1,3 (two) – START/RUN
- F8 INST PWR – ON
- ✓HYD PRESS ind 1,3 (two) – LO green

- R2 APU/HYD RDY 1,3 tb (two) – bp

- * If APU 1(3) does not start: *
- * BLR CNTLR/HTR 2 – A(B) *
- * N2 SPLY 2 – ON *
- * PWR 2 – ON *
- * ✓APU AUTO SHUTDN 2 – ENA *
- * CNTLR PWR 2 – ON *
- * HYD MN PUMP PRESS 2 – LO *
- * ✓APU SPEED SEL 2 – NORM *
- * ✓OPER 2 – OFF *
- * ✓FUEL TK VLV 2 – cl *
- * ✓HYD CIRC PUMP 2 – OFF *
- * ✓cb APU FU TK VLV ENA 2A,2B – cl *
- * APU FUEL TK VLV 2 – OP *
- * OPER 2 – START/RUN *
- * ✓HYD PRESS ind 2 – LO green *
- * If less than two APUs running: *
- * APU AUTO SHUTDN (one) – INH *
- * If any APU does not start: *
- * BLR CNTLR/HTR – OFF *
- * APU OPER – OFF *
- * FUEL TK VLV – CL *
- * CNTLR PWR – OFF *
- * HYD MN PUMP PRESS – NORM *

(NOM) B11-17

NOM

C D/O/NOM/GEN H

LOSS OF 2 FREON LOOPS (Cont)

ENTRY

CDR

PLT

APU START

HYD MN PUMP PRESS 1,3 – NORM

F8 ✓HYD PRESS 1,3 ind (two) – HI green
INST PWR – OFF

R4 ✓HYD BRAKE ISOL VLV 1,3 (two) –
GPC (tb-CL)
✓LG EXTEND ISOL VLV – GPC (tb-CL)

(NOM) B11-18

NOM
C D/O/NOM/GEN H

LOSS OF 2 FREON LOOPS ENTRY MANEUVERS

FLIGHT CONDITIONS	MANEUVER
EI-5	MDM FF 1,4 - ON CAB FAN B - ON (L) INST PWR - FLT cb MNA,B DDU L (two) - cl cb ADTA 2,3 - cl ACCEL 2 - CL ACCEL 3 - ON GNC I/O RESET ✓LVLH ATT GNC, OPS 304 PRO ✓OPS 304, wait 1 min MDM FF 1,4 - OFF * If PREBANK: R/Y - CSS * * Roll at 1°/sec to <input type="text"/> <input type="text"/> <input type="text"/> * * Maintain PREBANK ± 5° *
'Guidance Box' @ q̄ -8 or D -3	CLOSED LOOP GUIDANCE ___:___:___ * If PREBANK: P,R/Y - AUTO * Begin AIL trim monitoring
D = 11	✓DRAG H (FORCE if editing)
V = 19K	✓MPS/TVC ISOL VLV - CL
V = 12K	BRAKES MNB,MNC - ON UHF MODE - SPLX (G T/R if ELS) AUD CTR - 1 ✓OI PCMMU FORMAT - FXD L,R AUD PWR - AUD PS,MS AUD PWR - AUD (if reqd) If command or data reqd: OI PCMMU PWR - 2 MDM PL2 - ON S-BD PM CNTL - PNL, then CMD GNC I/O RESET ANT SW - Select best ANT On MCC call: MDM PL2 - OFF OI PCMMU PWR - OFF
V = 10K	✓SPD BRK to 81% TACAN 3 - GPC
V = 7K	✓TACAN status
V = 5K	ADTA PROBES - DEPLOY (✓HEAT, only one side if reqd) Begin AIL and RUD trim monitoring
ΔAZ = 10.5°	FIRST ROLL REVERSAL <input type="text"/> <input type="text"/> <input type="text"/> <input type="text"/>

FLIGHT CONDITIONS	MANEUVER
M = 4	MDM FF4 - ON MDM FF1 - ON (if NWS reqd) GNC I/O RESET
M = 2.9	RADAR ALTM 2 - ON CAB FAN (two) - OFF Use no landing aids (HUD,MLS) unless reqd to land vehicle safely
M = 2.7	R INST PWR - ON ✓APUs APU SPEED SEL (two) - HI (R) INST PWR - OFF * If M < 2.5, P CSS for ADTA to G&C incorp *
M = 2.0	Ensure ADTA to G&C; else, ✓Theta limits
M = 0.95	* For bailout procedures, go to BAILOUT *
M = 0.9	(L) FLT CNTLR PWR - ON P,R/Y - CSS as reqd ✓SPDBK CMD vs POS ANTISKID - ON If NWS reqd: cb MNB,C DDU R (two) - cl (R) FLT CNTLR PWR - ON NWS - 1 Lock Inertia Reels MAX Nz <input type="text"/> <input type="text"/> <input type="text"/>
M = 0.7	LG EXTEND ISOL VLV - OP HYD BRAKE ISOL VLV 1,3 - OP
h = 15K	✓MLS (if on)
h = 10k	✓A/L, TABS/LES VISORS - CL (KSC)
MAIN GEAR TD	✓SPD BRK - 100%
DEROT INIT	DRAG CHUTE pb (two) - ARM,DPY (simo)
NOSE GEAR TD	SRB SEP - MAN/AUTO and depress pb ✓Auto Load Relief
V = 60 KGS	DRAG CHUTE JETT pb - JETT
STOP	Go to EMER PWRDN (Cue Card)

NOM

This Page Intentionally Blank

(NOM) B11-20

NOM
C D/O/ALL/GEN H

QUICK RESPONSE JETTISON

12-1

C D/O/ALL/GEN H

**QUICK RESPONSE
JETTISON**

QUICK RESPONSE JETTISON

ASSUMPTIONS/INITIAL CONDITIONS

Failed KU-BD and/or RMS (possibly with PL attached) must be jettisoned ASAP

At least one G2 GPC up and running

Full RCS and AFT DDU/FLT CNTLR PWR available for use

Hardware jettison and initial sep mnvr may be done in any attitude

PROBLEM DESCRIPTION/RATIONALE

Integrated, rapidly executable procedure to accomplish time-constrained jettison and sep from failed KU-BD and/or RMS

Designed to be used as reqd during time critical pwrdn and/or deorbit scenario

NOTE

1. Deorbit burn is done in place of third sep mnvr if deorbit TIG < 28 min from initial sep mnvr done in an arbitrary attitude, or if deorbit TIG < 45 min from initial sep mnvr done in $-ZLV \pm 10^\circ$
2. If initial sep mnvr done in $-ZLV \pm 10^\circ$ attitude, out-of-plane sep mnvr not reqd
3. Initial sep mnvr rate must be between 0.7 and 0.9 fps
4. This procedure divided into CDR actions in left column and MS actions in right column

QUICK RESPONSE JETTISON (Cont)

CDR

MS

<p>R14:C</p> <p>A1U</p> <p>A14</p> <p>MA73C:A :B</p> <p>ML86B:D</p> <p>R14:C</p> <p>R14:E A1U</p> <p>A14</p>	<p style="text-align: center;">} If only KU ANT jettison reqd</p> <p>cb MNB KU ELEC – op ANT HTR – op ✓CABLE HTR – op MNC KU SIG PROC – op</p> <p>✓KU PWR – OFF CNTL – PNL</p> <p>✓KU ANT ARM – SAFE ✓JETT – SAFE</p> <p>MCA LOGIC MNC MID 2 – OFF MNB MID 4 – OFF</p> <p>cb MNA PYRO JETT SYS A KU ANT – cl MNC PYRO JETT SYS B KU ANT – cl</p> <p style="text-align: center;">Go to step 2, 12–6</p> <p style="text-align: center;">} If KU ANT and RMS/payload jettison reqd:</p> <p>cb MNB KU ELEC – op ANT HTR – op ✓CABLE HTR – op MNC KU SIG PROC – op</p> <p>cb MNB PORT RMS TV (three) – op</p> <p>✓KU PWR – OFF CNTL – PNL</p> <p>✓KU ANT ARM – SAFE ✓JETT – SAFE</p> <p>✓PYRO PORT RMS (five) – SAFE ✓RMS LAT – SAFE</p>
--	--

QUICK RESPONSE JETTISON (Cont)

CDR

MS

MA73C:A :B	MCA LOGIC MNC MID 2 – OFF MNB MID 4 – OFF
ML86B:D	cb MNA PYRO JETT SYS A KU ANT – cl MNC PYRO JETT SYS B KU ANT – cl MNB PYRO JETT SYS A PORT RMS – cl MNC PYRO JETT SYS B PORT RMS – cl
A7	TV CAMR PWR RMS – OFF (tb-OFF) ✓RMS SPOT PORT – OFF
A8U	RMS MODE – best available Mnvr RMS/payload clear of upfiring jets and orbiter structure BRAKES – ON (tb-ON)
A8L	PORT RMS HTR A,B (two) – OFF RMS SEL – OFF PWR – OFF ✓PL pwr thru SPEE connector off (PAYLOAD PWRDN)
A14	PYRO PORT RMS ARM – GUILLOTINE Wait 1 sec, then PYRO PORT RMS SHLDR – GUILLOTINE – SAFE ARM – SAFE

QUICK RESPONSE JETTISON (Cont)

CDR

MS

2. INITIAL SEP MNVR

2. KU/RMS/PAYLOAD JETTISON

WARNING
Initial sep mnvr must be 0.8 ± 0.1 fps

A6U

FLT CNTLR PWR – ON
✓DAP TRANS: PULSE/PULSE/PULSE, no LO Z
DAP: A/FREE/PRI

A14

If payload jettison/deploy,
complete jettison/deploy procedure
PL SAFING (ORB PKT)

If KU ANT jettison:
PYRO KU ANT ARM – ARM
Wait 1 sec, then
PYRO KU ANT JETT – JETT

If RMS/payload jettison:
PYRO PORT RMS ARM – JETT
Wait 1 sec, then
PYRO PORT RMS SHLDR – JETT

DAP: LVLH

NOTE MET ___/___:___:___

THC – +Z 8 PULSES (-X sense – dn)
(-Z sense – out)

DAP: INRTL

QUICK RESPONSE JETTISON (Cont)

CDR

MS

3. OUT-OF-PLANE SEP MNVR

If initial sep (step 2) was done in $-ZLV \pm 10^\circ$,
go to step 4, 12-8

CRT

GNC, OPS 202 PRO

GNC ORB MNVR EXEC

RCS SEL - ITEM 4 EXEC (*)

Set TIG to initial sep mnvr from
step 2 +4:00 min

TGT PEG 7 ΔV_x - ITEM 19 +0 EXEC

ΔV_y - ITEM 20 +4 EXEC

ΔV_z - ITEM 21 +0 EXEC

LOAD - ITEM 22 EXEC

TIMER - ITEM 23 EXEC

If VGO Z < 0:

TGT PEG 7 ΔV_y - ITEM 20 -4 EXEC

LOAD - ITEM 22 EXEC

TIMER - ITEM 23 EXEC

✓VGO Z > 0

Do not mnvr to Burn Att

A6U

✓DAP: A/INRTL/PRI

DAP TRANS: as reqd

At TIG, THC - Trim VGO < 0.2 fps

3. POST-JETTISON CLEANUP

A14 PYRO KU ANT JETT - SAFE
ARM - SAFE
PORT RMS SHLDR - SAFE
ARM - SAFE

MA73C:A ✓MCA LOGIC MNA MID 1 - ON
✓MNB MID 2 - ON
✓MNC MID 2 - ON
:B ✓MNB MID 4 - ON
✓MNC MID 4 - ON

IF RMS JETTISONED, STOW MPM

WARNING
Payload bay door cannot be
closed until MPMs stowed

MA73C:C cb MCA PWR AC2 3Φ MID 2 - cl
AC3 3Φ MID 4 - cl
:D
R13L PL BAY MECH PWR SYS 1,2 (two) - ON
A8 PORT RMS - STO (tb-STO) (68 sec max)
- OFF

R13L PL BAY MECH PWR SYS 1,2 (two) - OFF

ML86B:D cb MNA PYRO JETT SYS A KU ANT - op
MNC PYRO JETT SYS B KU ANT - op
MNB PYRO JETT SYS A PORT RMS - op
MNC PYRO JETT SYS B PORT RMS - op

Perform post jettison/deploy cleanup steps,
if reqd (ORB PKT, PL SAFING)

QUICK RESPONSE JETTISON (Cont)

CDR

MS

4. FINAL (POSIGRADE) SEP MNVR

If Deorbit TIG < 28 min from initial sep done in an arbitrary attitude, go to step 5

If Deorbit TIG < 45 min from initial sep done in $-ZLV \pm 10^\circ$, go to step 5

CRT

GNC ORB MNVR EXEC

RCS SEL – ITEM 4 (*)

Set TIG to TIG from previous
sep mnvr +4:00 min

TGT PEG 7 ΔV_x – ITEM 19 +3 EXEC

ΔV_y – ITEM 20 +0 EXEC

ΔV_z – ITEM 21 -2 EXEC

LOAD – ITEM 22 EXEC

TIMER – ITEM 23 EXEC

Do not mnvr to Burn Att

A6U

✓DAP: A/INRTL/PRI

✓DAP TRANS: as reqd

At TIG, THC – Trim VGO < 0.2 fps

If VGO Z is neg, Z,X,Y seq; otherwise, X,Y,Z

QUICK RESPONSE JETTISON (Cont)

CDR

MS

5. POST-SEP CLEANUP

CAUTION

If Deorbit TIG < 9 min after initial sep,
> 500 ft clearance not guaranteed

A6U
CRT

FLT CNTLR PWR – OFF
GNC, OPS 201 PRO

O7,O8

Perform RCS SECURE (FWD,AFT) (ORB PKT,
RCS) if reqd

MA73C:A
O6

MCA LOGIC FWD (three) – as reqd
MDM FF,FA (eight) – as reqd

O14:F,
O15:F,
O16:F

✓ Primary RJDs DRIVER,LOGIC (sixteen) – as reqd

O14:E,
O16:E

cb DDU AFT (two) – op

(MEDS) A12-9

MEDS

C D/O/MEDS/GEN H

This Page Intentionally Blank

(MEDS) A12-10

MEDS
C D/O/ALL/GEN H

QUICK RESPONSE JETTISON (Cont)

CDR

MS

6. POST-SEP CLEANUP

CAUTION

If Deorbit TIG < 9 min after initial sep,
> 500 ft clearance not guaranteed

A6U
CRT

FLT CNTLR PWR – OFF
GNC, OPS 201 PRO

O7,O8

Perform RCS SECURE (FWD,AFT) (ORB PKT,
RCS) if reqd

MA73C:A
O6

MCA LOGIC FWD (three) – as reqd
MDM FF,FA (eight) – as reqd

O14:F,
O15:F,
O16:F

✓Primary RJDs DRIVER,LOGIC (sixteen) – as reqd

O14:E,
O16:E

✓cb DDU AFT (two) – op

(NOM) B12-9

NOM

C D/O/NOM/GEN H

This Page Intentionally Blank

(NOM) B12-10

NOM
C D/O/ALL/GEN H

BAILOUT

13-1

C D/O/ALL/GEN H

BAILOUT

BAILOUT

BAILOUT MODE 8

REPORT POSITION

MACH < 0.95, OPS 305/603

SB – AUTO; BF – AUTO

FLY 185–195 KEAS, $\Phi = 0^\circ$

ABORT MODE – ATO

ABORT PBI – PUSH

P,R/Y – AUTO

FLT CNTLR PWR (two) – OFF

~50K FT

TABS – RELEASE

VISOR – CLOSE / LOCK

LES O2 – ON

GREEN APPLE – PULL

~40K FT

MS3 – VENT CABIN

CDR,PLT SEATS – LOWER

KNEEBOARDS – REMOVE

COOLING – DISCONNECT

RESTRAINT – RELEASE

D-RING – UNCOVER

~30K FT

MS3 – JETTISON HATCH

COMM – DISCONNECT

(G-SUIT CLIP – PULL)

LES O2 – DISCONNECT

EGRESS SEAT

POLE – DEPLOY

D-RING – HOOKUP

BAILOUT

MS PAGES

14-1

C D/O/ALL/GEN H,6

MS PAGES

This Page Intentionally Blank

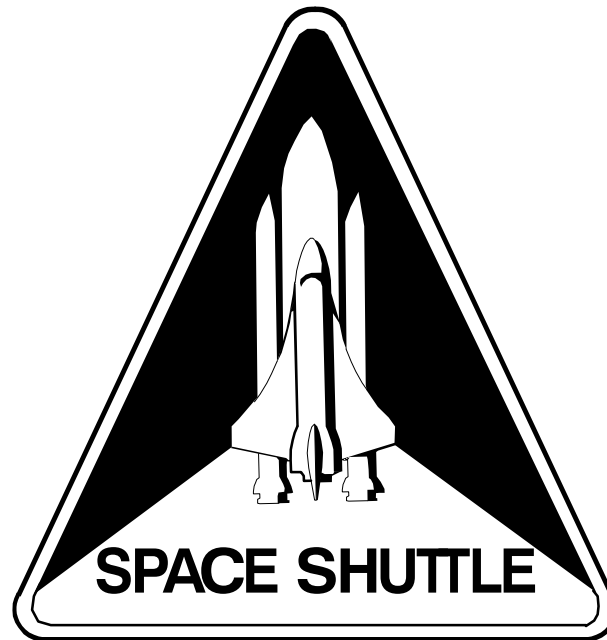

**CONTINGENCY
DEORBIT**

**STS
ALL**