

# Contingency Deorbit Prep

**Mission Operations Directorate  
Operations Division**

**Generic, Rev M  
May 14, 2009**

**NOTE**

For STS-127 and subsequent flights

National Aeronautics and  
Space Administration

**Lyndon B. Johnson Space Center**  
Houston, Texas



**Verify this is the correct version for the pending operation (training, simulation or flight).**  
Electronic copies of FDF books are available. URL: <http://mod.jsc.nasa.gov/do3/FDF/index.html>





<b>CONTINGENCY DEORBIT PREP</b>	<b>GENERIC, Rev M (May 14, 2009)</b>
---------------------------------	--------------------------------------

**PCN-3 (Oct 23, 2009) Sheet 1 of 1**

List of Implemented Change Requests (482s):

C D/O-657

Incorporate the following:

- 1. Replace iii thru viii
- 2. Replace 9-11 and 9-12

<p align="center"><b>NOTE</b> For STS-129 and subsequent flights</p>
--

Prepared by:   
Publication Manager

Approved by:   
Manager, Flight Procedures

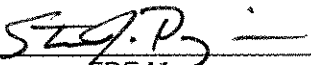
Accepted by:   
FDF Manager

Encl: 8 pages

<b>File this PCN immediately behind the front cover as a permanent record</b>
---



<b>CONTINGENCY DEORBIT PREP</b>	<b>GENERIC, Rev M (May 14, 2009)</b>
---------------------------------	--------------------------------------

**PCN-2 (Sept 29, 2009) Sheet 1 of 1**

List of Implemented Change Requests (482s):

C D/O-654

Incorporate the following:

1. Replace iii thru viii
2. After 9-10, add 9-11 and 9-12  
Delete A9-11 thru H9-12 (12 pages)

<p align="center"><b>NOTE</b> For STS-129 and subsequent flights</p>
--

**Prepared by:** *Christa Valer*  
Publication Manager

**Approved by:** *Timberly Johnson*  
Manager, Flight Procedures

**Accepted by:** *Michael T. Lee*  
FDF Manager

Encl: 8 pages

<b>File this PCN immediately behind the front cover as a permanent record</b>
---



CONTINGENCY DEORBIT PREP

GENERIC, Rev M (May 14, 2009)

## PCN-1 (Aug 24, 2009) Sheet 1 of 1

List of Implemented Change Requests (482s):

C D/O-653

Incorporate the following:

1. Replace iii thru vi
2. Replace 10-9 and 10-10

**NOTE**

For STS-129 and subsequent flights

Prepared by:

  
\_\_\_\_\_  
Publication Manager

Approved by:

  
\_\_\_\_\_  
Manager, Flight Procedures

Accepted by:

  
\_\_\_\_\_  
FDF Manager

Encl: 6 pages

**File this PCN immediately behind the front cover as a permanent record**



MISSION OPERATIONS DIRECTORATE

**CONTINGENCY DEORBIT PREP**

GENERIC, REVISION M

May 14, 2009

PREPARED BY:



---

Anita Valle  
Publication Manager

APPROVED BY:

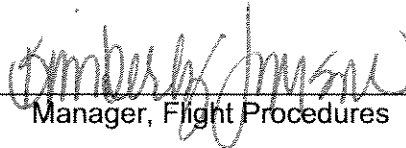

---

Manager, Flight Procedures



---

Michael T. Hurt  
FDF Manager

This document is under the configuration control of the Crew Procedures Control Board (CPCB). All proposed changes must be submitted via Change Request Workflow (CRW) to DO3/FDF Manager.

Additional distribution of this book, for official use only, may be requested in writing to DO3/PMO Administrator. The request must include justification and requester's name, organization, position, and phone number. Contractor requests are made through the NASA or DOD organization supported. Deletions, reduction in quantity, or change of address may be submitted to DO3/FDF Management Office, 281-244-1184.

Incorporates the following:	
482#:	C D/O-00650 C D/O-00651 C D/O-00652

AREAS OF TECHNICAL RESPONSIBILITY

Publication Manager	DO3/A. Valle	281-244-6401
Alternate Publication Manager	DO3/A. Blaylock	281-244-1184
BOOSTER	DS65/E. Turcotte	281-483-5730
COMM/INCO	DS23/D. Branham R. Gardner	281-483-1187 281-483-5902
DPS	DS24/J. McDonald	281-483-0793
ECS	DS44/D. Fasbender	281-483-7857
MMACS	DS42/J. Dake A. Foxworth	281-483-6538 281-483-0616
GPO	DM/J. Jones	281-483-1170
PROP DATA	DS63/T. Campa	281-244-1002



CONTINGENCY DEORBIT PREP

**LIST OF EFFECTIVE PAGES**

GENERIC	04/29/88	PCN-2	09/29/09
REV M	05/14/09	PCN-3	10/23/09
PCN-1	08/24/09		

Sign Off .....	*	ALL/GEN M	2-23 .....	Δ	ALL/GEN M
ii.....	*	ALL/GEN M	2-24 .....	Δ	ALL/GEN M
iii.....	*	ALL/GEN M,3	2-25 .....	Δ	ALL/GEN M
iv.....	*	ALL/GEN M	2-26 .....	Δ	ALL/GEN M
v .....	*	ALL/GEN M	3-1 .....		ALL/GEN M
vi.....	*	ALL/GEN M,3	3-2 .....		ALL/GEN M
vii.....	*	ALL/GEN M,3	(OV103) A3-3 .....		3/GEN M
viii.....	*	ALL/GEN M	(OV103) A3-4 .....		ALL/GEN M
ix.....		ALL/GEN M	(OV103) A3-5 .....		3/GEN M
x .....		ALL/GEN M	(OV103) A3-6 .....		ALL/GEN M
1-1 .....		ALL/GEN M	(OV103) A3-7 .....		3/GEN M
1-2.....		ALL/GEN M	(OV103) A3-8 .....		3/GEN M
1-3.....		ALL/GEN M	(OV103) A3-9 .....		3/GEN M
1-4.....		ALL/GEN M	(OV103) A3-10 .....		ALL/GEN M
1-5.....		ALL/GEN M	(OV103) A3-11 .....		ALL/GEN M
1-6.....		ALL/GEN M	(OV103) A3-12 .....		ALL/GEN M
1-7.....		ALL/GEN M	(OV103) A3-13 .....		ALL/GEN M
1-8.....		ALL/GEN M	(OV103) A3-14 .....		ALL/GEN M
1-9.....		ALL/GEN M	(OV103) A3-15 .....		3/GEN M
1-10.....		ALL/GEN M	(OV103) A3-16 .....		3/GEN M
1-11.....	Δ	ALL/GEN M	(OV103) A3-17 .....		3/GEN M
1-12.....	Δ	ALL/GEN M	(OV103) A3-18 .....		3,5/GEN M
1-13.....	Δ	ALL/GEN M	(OV103) A3-19 .....		3/GEN M
1-14.....	Δ	ALL/GEN M	(OV103) A3-20 .....		ALL/GEN M
2-1 .....		ALL/GEN M	(OV103) A3-21 .....		3/GEN M
2-2.....		ALL/GEN M	(OV103) A3-22 .....		3/GEN M
2-3.....		ALL/GEN M	(OV103) A3-23 .....		ALL/GEN M
2-4.....		ALL/GEN M	(OV103) A3-24 .....		3/GEN M
2-5.....		ALL/GEN M	(OV103) A3-25 .....		3/GEN M
2-6.....		ALL/GEN M	(OV103) A3-26 .....		3/GEN M
2-7.....		ALL/GEN M	(OV103) A3-27 .....		3/GEN M
2-8.....		ALL/GEN M	(OV103) A3-28 .....		3/GEN M
2-9.....		ALL/GEN M	(OV103) A3-29 .....		3/GEN M
2-10.....		ALL/GEN M	(OV103) A3-30 .....		ALL/GEN M
2-11.....		ALL/GEN M	(OV103) A3-31 .....		ALL/GEN M
2-12.....		ALL/GEN M	(OV103) A3-32 .....		ALL/GEN M
2-13.....		ALL/GEN M	(OV104) B3-3 .....		4/GEN M
2-14.....		ALL/GEN M	(OV104) B3-4 .....		ALL/GEN M
2-15.....		ALL/GEN M	(OV104) B3-5 .....		4/GEN M
2-16.....		ALL/GEN M	(OV104) B3-6 .....		ALL/GEN M
2-17.....		ALL/GEN M	(OV104) B3-7 .....		4/GEN M
2-18.....		ALL/GEN M	(OV104) B3-8 .....		4/GEN M
2-19.....		ALL/GEN M	(OV104) B3-9 .....		4/GEN M
2-20.....		ALL/GEN M	(OV104) B3-10 .....		ALL/GEN M
2-21.....		ALL/GEN M	(OV104) B3-11 .....		ALL/GEN M
2-22.....		ALL/GEN M	(OV104) B3-12 .....		ALL/GEN M

\* – Omit from flight book

Δ – MS pullout page. Add to MS PAGES in PLT copy only

(OV104) B3-13.....	ALL/GEN M	4-7 .....	ALL/GEN M
(OV104) B3-14.....	ALL/GEN M	4-8 .....	ALL/GEN M
(OV104) B3-15.....	4/GEN M	4-9 .....	ALL/GEN M
(OV104) B3-16.....	4/GEN M	4-10 .....	ALL/GEN M
(OV104) B3-17.....	4/GEN M	A4-11 .....	3,4/GEN M
(OV104) B3-18.....	4/GEN M	A4-12 .....	3,4/GEN M
(OV104) B3-19.....	4/GEN M	A4-13 .....	3,4/GEN M
(OV104) B3-20.....	ALL/GEN M	A4-14 .....	ALL/GEN M
(OV104) B3-21.....	4/GEN M	B4-11 .....	5/GEN M
(OV104) B3-22.....	4/GEN M	B4-12 .....	5/GEN M
(OV104) B3-23.....	ALL/GEN M	B4-13 .....	5/GEN M
(OV104) B3-24.....	4/GEN M	B4-14 .....	ALL/GEN M
(OV104) B3-25.....	4/GEN M	4-15 .....	Δ ALL/GEN M
(OV104) B3-26.....	4/GEN M	4-16 .....	Δ ALL/GEN M
(OV104) B3-27.....	4/GEN M	4-17 .....	Δ ALL/GEN M
(OV104) B3-28.....	4/GEN M	4-18 .....	Δ ALL/GEN M
(OV104) B3-29.....	4/GEN M	5-1 .....	ALL/GEN M
(OV104) B3-30.....	ALL/GEN M	5-2 .....	ALL/GEN M
(OV104) B3-31.....	ALL/GEN M	5-3 .....	ALL/GEN M
(OV104) B3-32.....	ALL/GEN M	5-4 .....	ALL/GEN M
(OV105) C3-3.....	5/GEN M	A5-5.....	3,4/GEN M
(OV105) C3-4.....	ALL/GEN M	A5-6.....	3,4/GEN M
(OV105) C3-5.....	5/GEN M	B5-5.....	5/GEN M
(OV105) C3-6.....	ALL/GEN M	B5-6.....	5/GEN M
(OV105) C3-7.....	5/GEN M	5-7 .....	ALL/GEN M
(OV105) C3-8.....	5/GEN M	5-8 .....	ALL/GEN M
(OV105) C3-9.....	5/GEN M	5-9 .....	ALL/GEN M
(OV105) C3-10.....	ALL/GEN M	5-10 .....	ALL/GEN M
(OV105) C3-11.....	ALL/GEN M	5-11 .....	ALL/GEN M
(OV105) C3-12.....	ALL/GEN M	5-12 .....	ALL/GEN M
(OV105) C3-13.....	ALL/GEN M	5-13 .....	ALL/GEN M
(OV105) C3-14.....	ALL/GEN M	5-14 .....	ALL/GEN M
(OV105) C3-15.....	5/GEN M	5-15 .....	ALL/GEN M
(OV105) C3-16.....	5/GEN M	5-16 .....	ALL/GEN M
(OV105) C3-17.....	5/GEN M	5-17 .....	ALL/GEN M
(OV105) C3-18.....	3,5/GEN M	5-18 .....	ALL/GEN M
(OV105) C3-19.....	5/GEN M	5-19 .....	ALL/GEN M
(OV105) C3-20.....	ALL/GEN M	5-20 .....	ALL/GEN M
(OV105) C3-21.....	5/GEN M	5-21 .....	ALL/GEN M
(OV105) C3-22.....	5/GEN M	5-22 .....	ALL/GEN M
(OV105) C3-23.....	ALL/GEN M	A5-23.....	ALL/GEN M
(OV105) C3-24.....	5/GEN M	A5-24.....	3,4/GEN M
(OV105) C3-25.....	5/GEN M	A5-25.....	3,4/GEN M
(OV105) C3-26.....	5/GEN M	A5-26.....	3,4/GEN M
(OV105) C3-27.....	5/GEN M	B5-23.....	ALL/GEN M
(OV105) C3-28.....	5/GEN M	B5-24.....	5/GEN M
(OV105) C3-29.....	5/GEN M	B5-25.....	5/GEN M
(OV105) C3-30.....	ALL/GEN M	B5-26.....	5/GEN M
(OV105) C3-31.....	ALL/GEN M	5-27 .....	Δ ALL/GEN M
(OV105) C3-32.....	ALL/GEN M	5-28 .....	Δ ALL/GEN M
4-1 .....	ALL/GEN M	5-29 .....	Δ ALL/GEN M
4-2 .....	ALL/GEN M	5-30 .....	Δ ALL/GEN M
4-3 .....	ALL/GEN M	5-31 .....	Δ ALL/GEN M
4-4 .....	ALL/GEN M	5-32 .....	Δ ALL/GEN M
4-5 .....	ALL/GEN M	5-33 .....	Δ ALL/GEN M
4-6 .....	ALL/GEN M	5-34 .....	Δ ALL/GEN M

Δ – MS pullout page. Add to MS PAGES in PLT copy only

5-35.....	△	ALL/GEN M	(OV104) B6-25 .....	4/GEN M
5-36.....	△	ALL/GEN M	(OV104) B6-26 .....	4/GEN M
6-1.....		ALL/GEN M	(OV104) B6-27 .....	4/GEN M
6-2.....		ALL/GEN M	(OV104) B6-28 .....	4/GEN M
(OV103) A6-3.....		3/GEN M	(OV104) B6-29 .....	4/GEN M
(OV103) A6-4.....		ALL/GEN M	(OV104) B6-30 .....	ALL/GEN M
(OV103) A6-5.....		3/GEN M	(OV104) B6-31 .....	ALL/GEN M
(OV103) A6-6.....		ALL/GEN M	(OV104) B6-32 .....	ALL/GEN M
(OV103) A6-7.....		3/GEN M	(OV105) C6-3 .....	5/GEN M
(OV103) A6-8.....		3/GEN M	(OV105) C6-4 .....	ALL/GEN M
(OV103) A6-9.....		3/GEN M	(OV105) C6-5 .....	5/GEN M
(OV103) A6-10.....		ALL/GEN M	(OV105) C6-6 .....	ALL/GEN M
(OV103) A6-11.....		3/GEN M	(OV105) C6-7 .....	5/GEN M
(OV103) A6-12.....		ALL/GEN M	(OV105) C6-8 .....	5/GEN M
(OV103) A6-13.....		ALL/GEN M	(OV105) C6-9 .....	5/GEN M
(OV103) A6-14.....		ALL/GEN M	(OV105) C6-10 .....	ALL/GEN M
(OV103) A6-15.....		3/GEN M	(OV105) C6-11 .....	5/GEN M
(OV103) A6-16.....		3/GEN M	(OV105) C6-12 .....	ALL/GEN M
(OV103) A6-17.....		3/GEN M	(OV105) C6-13 .....	ALL/GEN M
(OV103) A6-18.....		ALL/GEN M	(OV105) C6-14 .....	ALL/GEN M
(OV103) A6-19.....		3/GEN M	(OV105) C6-15 .....	5/GEN M
(OV103) A6-20.....		ALL/GEN M	(OV105) C6-16 .....	5/GEN M
(OV103) A6-21.....		3/GEN M	(OV105) C6-17 .....	5/GEN M
(OV103) A6-22.....		3/GEN M	(OV105) C6-18 .....	ALL/GEN M
(OV103) A6-23.....		3/GEN M	(OV105) C6-19 .....	5/GEN M
(OV103) A6-24.....		ALL/GEN M	(OV105) C6-20 .....	ALL/GEN M
(OV103) A6-25.....		3/GEN M	(OV105) C6-21 .....	5/GEN M
(OV103) A6-26.....		3/GEN M	(OV105) C6-22 .....	5/GEN M
(OV103) A6-27.....		3/GEN M	(OV105) C6-23 .....	5/GEN M
(OV103) A6-28.....		3/GEN M	(OV105) C6-24 .....	ALL/GEN M
(OV103) A6-29.....		3/GEN M	(OV105) C6-25 .....	5/GEN M
(OV103) A6-30.....		ALL/GEN M	(OV105) C6-26 .....	5/GEN M
(OV103) A6-31.....		ALL/GEN M	(OV105) C6-27 .....	5/GEN M
(OV103) A6-32.....		ALL/GEN M	(OV105) C6-28 .....	5/GEN M
(OV104) B6-3.....		4/GEN M	(OV105) C6-29 .....	5/GEN M
(OV104) B6-4.....		ALL/GEN M	(OV105) C6-30 .....	ALL/GEN M
(OV104) B6-5.....		4/GEN M	(OV105) C6-31 .....	ALL/GEN M
(OV104) B6-6.....		ALL/GEN M	(OV105) C6-32 .....	ALL/GEN M
(OV104) B6-7.....		4/GEN M	7-1 .....	ALL/GEN M
(OV104) B6-8.....		4/GEN M	7-2 .....	ALL/GEN M
(OV104) B6-9.....		4/GEN M	A7-3 .....	ALL/GEN M
(OV104) B6-10.....		ALL/GEN M	A7-4 .....	3,4/GEN M
(OV104) B6-11.....		4/GEN M	B7-3 .....	ALL/GEN M
(OV104) B6-12.....		ALL/GEN M	B7-4 .....	5/GEN M
(OV104) B6-13.....		ALL/GEN M	7-5 .....	ALL/GEN M
(OV104) B6-14.....		ALL/GEN M	7-6 .....	ALL/GEN M
(OV104) B6-15.....		4/GEN M	7-7 .....	ALL/GEN M
(OV104) B6-16.....		4/GEN M	7-8 .....	ALL/GEN M
(OV104) B6-17.....		4/GEN M	7-9 .....	ALL/GEN M
(OV104) B6-18.....		ALL/GEN M	7-10 .....	ALL/GEN M
(OV104) B6-19.....		4/GEN M	A7-11 .....	3,4/GEN M
(OV104) B6-20.....		ALL/GEN M	A7-12 .....	ALL/GEN M
(OV104) B6-21.....		4/GEN M	B7-11 .....	5/GEN M
(OV104) B6-22.....		4/GEN M	B7-12 .....	ALL/GEN M
(OV104) B6-23.....		4/GEN M	7-13 .....	ALL/GEN M
(OV104) B6-24.....		ALL/GEN M	7-14 .....	ALL/GEN M

7-15.....	ALL/GEN M	10-7.....	△ ALL/GEN M
7-16.....	ALL/GEN M	10-8.....	△ ALL/GEN M
7-17.....	△ ALL/GEN M	10-9.....	△ ALL/GEN M,1
7-18.....	☒△ ALL/GEN M	10-10.....	△ ALL/GEN M
7-19.....	△ ALL/GEN M	10-11.....	ALL/GEN M
7-20.....	△ ALL/GEN M	10-12.....	ALL/GEN M
7-21.....	△ ALL/GEN M	10-13.....	ALL/GEN M
7-22.....	△ ALL/GEN M	10-14.....	ALL/GEN M
8-1.....	ALL/GEN M	10-15.....	ALL/GEN M
8-2.....	ALL/GEN M	10-16.....	ALL/GEN M
8-3.....	ALL/GEN M	10-17.....	ALL/GEN M
8-4.....	ALL/GEN M	10-18.....	ALL/GEN M
8-5.....	ALL/GEN M	A10-19.....	3,4/GEN M
8-6.....	ALL/GEN M	A10-20.....	3,4/GEN M
8-7.....	△ ALL/GEN M	B10-19.....	5/GEN M
8-8.....	△ ALL/GEN M	B10-20.....	5/GEN M
8-9.....	△ ALL/GEN M	10-21.....	ALL/GEN M
8-10.....	△ ALL/GEN M	10-22.....	ALL/GEN M
8-11.....	ALL/GEN M	10-23.....	ALL/GEN M
8-12.....	ALL/GEN M	10-24.....	ALL/GEN M
8-13.....	ALL/GEN M	11-1.....	ALL/GEN M
8-14.....	ALL/GEN M	11-2.....	ALL/GEN M
8-15.....	△ ALL/GEN M	11-3.....	△ ALL/GEN M
8-16.....	△ ALL/GEN M	11-4.....	△ ALL/GEN M
8-17.....	△ ALL/GEN M	A11-5.....	△ 3,4/GEN M
8-18.....	△ ALL/GEN M	A11-6.....	△ ALL/GEN M
9-1.....	ALL/GEN M	B11-5.....	△ 5/GEN M
9-2.....	ALL/GEN M	B11-6.....	△ ALL/GEN M
9-3.....	ALL/GEN M	11-7.....	ALL/GEN M
9-4.....	ALL/GEN M	11-8.....	ALL/GEN M
9-5.....	△ ALL/GEN M	11-9.....	ALL/GEN M
9-6.....	△ ALL/GEN M	11-10.....	ALL/GEN M
9-7.....	ALL/GEN M	11-11.....	ALL/GEN M
9-8.....	ALL/GEN M	11-12.....	ALL/GEN M
9-9.....	ALL/GEN M	A11-13.....	ALL/GEN M
9-10.....	ALL/GEN M	A11-14.....	3,4/GEN M
9-11.....	☒ ALL/GEN M,3	B11-13.....	ALL/GEN M
9-12.....	ALL/GEN M,2	B11-14.....	5/GEN M
A9-13.....	ALL/GEN M	11-15.....	ALL/GEN M
A9-14.....	3,4/GEN M	11-16.....	ALL/GEN M
A9-15.....	ALL/GEN M	11-17.....	ALL/GEN M
A9-16.....	3,4/GEN M	11-18.....	ALL/GEN M
A9-17.....	3,4/GEN M	A11-19.....	3,4/GEN M
A9-18.....	ALL/GEN M	A11-20.....	ALL/GEN M
B9-13.....	ALL/GEN M	B11-19.....	5/GEN M
B9-14.....	5/GEN M	B11-20.....	ALL/GEN M
B9-15.....	ALL/GEN M	12-1.....	ALL/GEN M
B9-16.....	5/GEN M	12-2.....	ALL/GEN M
B9-17.....	5/GEN M	12-3.....	△ ALL/GEN M
B9-18.....	ALL/GEN M	12-4.....	△ ALL/GEN M
10-1.....	ALL/GEN M	12-5.....	△ ALL/GEN M
10-2.....	ALL/GEN M	12-6.....	△ ALL/GEN M
10-3.....	ALL/GEN M	12-7.....	△ ALL/GEN M
10-4.....	ALL/GEN M	12-8.....	△ ALL/GEN M
10-5.....	ALL/GEN M	12-9.....	△ ALL/GEN M
10-6.....	ALL/GEN M	12-10.....	△ ALL/GEN M

△ – MS pullout page. Add to MS PAGES in PLT copy only

☒ – Prelift-off information reqd

13-1 .....	ALL/GEN M
13-2 .....	ALL/GEN M
14-1 .....†	ALL/GEN M
14-2 .....†	ALL/GEN M
Entry C/L pg .....‡	
Entry C/L pg .....‡	

† – Flown in PLT copy only  
‡ – Landing Site Data Chart from Entry C/L in Flight books only

This Page Intentionally Blank

CONTENTS

	<u>PAGE</u>
LAUNCH DAY DEORBIT PREP (ORBIT 2) .....	1-1
LAUNCH DAY DEORBIT PREP (ORBIT 3) .....	2-1
ENTRY SWITCH LIST/VERIFICATION.....	3-1
LOSS OF 2 FC LAUNCH DAY DEORBIT PREP (ORBIT 2 OR ORBIT 3).....	4-1
LOSS OF 2 FUEL CELLS ENTRY MANEUVERS (M = 2.0 $\sqrt{\text{THETA}}$ LIMITS) (CIL) .....	4-13
LOSS OF 2 FUEL CELLS DEORBIT PREP .....	5-1
LOSS OF 2 FUEL CELLS ENTRY MANEUVERS (M = 2.0 $\sqrt{\text{THETA}}$ LIMITS) (CIL) .....	5-26
LOSS OF 2 FC SWITCH VERIFICATION LIST .....	6-1
LOSS OF FES DEORBIT PREP .....	7-1
LOSS OF 2 H2O LOOPS .....	8-1
PART 1: ON-ORBIT WAIT .....	8-3
PART 2: ON-ORBIT BACKOUT .....	8-9
20-MINUTE DE/REPRESS.....	8-17
LOSS OF 2 H2O LOOPS DEORBIT PREP/ENTRY .....	9-1
LOSS OF 2 H2O LOOPS ENTRY MANEUVERS (M = 2.0 $\sqrt{\text{THETA}}$ LIMITS) (CIL).....	9-17
EMERGENCY DEORBIT PREP/ENTRY.....	10-1
STOW KU-BD ANTENNA (CIL).....	10-7
(IF NO AIR DATA AND M < 1.5, FLY THETA LIMITS) (CIL).....	10-24
LOSS OF 2 FREON LOOPS DEORBIT PREP/ENTRY .....	11-1
LOSS OF 2 FREON LOOPS ENTRY MANEUVERS (M = 2.0 $\sqrt{\text{THETA}}$ LIMITS) (CIL).....	11-19
QUICK-RESPONSE JETTISON.....	12-1
POST-JETTISON CLEANUP (CIL).....	12-7
(MCA PWR AC2 3 $\Phi$ MID 2, MCA PWR AC3 3 $\Phi$ MID 4) (CIL) .....	12-7
BAILOUT .....	13-1
MS PAGES.....	14-1

This Page Intentionally Blank



# LAUNCH DAY DEORBIT PREP (ORBIT 2)

This Page Intentionally Blank

## LAUNCH DAY DEORBIT PREP (ORBIT 2)

### ASSUMPTIONS/INITIAL CONDITIONS

These procedures may be entered directly from ASC

There is no requirement for completion of any Nominal Post Insertion procedures

MSs only will egress seats

Procedures should be started at approximately MET 01:00

### PROBLEM DESCRIPTION/RATIONALE

Failure in any system that requires deorbit as soon as possible after last AOA opportunity

# LAUNCH DAY DEORBIT PREP (ORBIT 2) SUMMARY TIMELINE

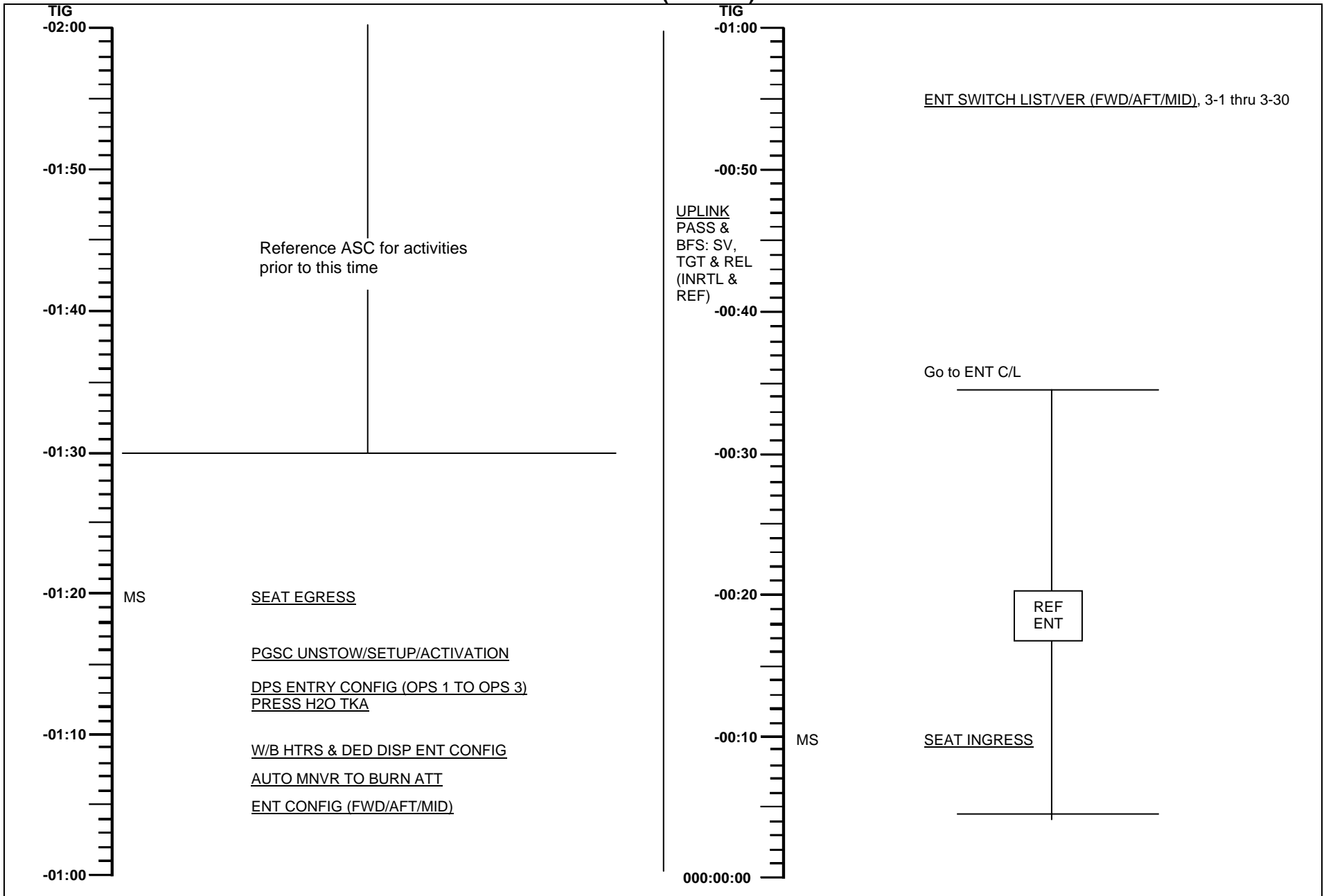

DPS ENTRY CONFIG 1

C,P

C2 1. TRANSITION TO GNC OPS 3  
Set event timer to count down to TIG

O14,O15,  
O16 √RGA,ACCEL,ASA,IMU (all) – ON

CONFIG – ITEM 1 +3 EXEC  
Modify MC 3 per table →

C3 BFC CRT DISP – OFF  
GNC, OPS 301 PRO

1: GNC DEORB MNVR COAST

CRT3 BFC CRT DISP – ON  
BFS, GNC OPS 000 PRO  
301 PRO

CONFIG	3	
GPC	12340	
STR	1	1
	2	2
	3	3
	4	4
PL	1/2	1
CRT	1	1
	2	2
	3	3
	4	0
L	1	0
	2	0
MM	1	1
	2	2

2. LAND SITE UPDATE

1: GNC 50 HORIZ SIT

SEL SITE (See LAND SITE DATA)

3. LOAD IN TGTs

1: GNC DEORB MNVR COAST

\* If MCC cannot provide DEORB TGT, use Deorbit Manager on PGSC \*

√PASS and BFS TGT per DEORBIT MNVR PAD (ENT, MNVR PADS) or PGSC

LOAD – ITEM 22 EXEC

TIMER – ITEM 23 EXEC

√PASS and BFS solution per DEORBIT MNVR PAD (ENT, MNVR PADS):

BURN ATT

HA

HP

ΔVTOT

TGO

CONFIG	9	
GPC	12340	
STR	1	1
	2	2
	3	3
	4	4
PL	1/2	1
CRT	1	1
	2	2
	3	3
	4	0
L	1	1
	2	2
MM	1	1
	2	2

4. VERIFY MC 9 TABLE (GNC 9) FOR POST LANDING

2: GNC 0 GPC MEMORY

√CONFIG – ITEM 1 +9 EXEC

Modify MC 9 per table →

CONFIG – ITEM 1 +3 EXEC

This Page Intentionally Blank

<b>TIG</b>		
<b>-01:30</b>	TRANS DAP AUTO RT 0.5 DB 3.5	
		<b>NOTE</b> These procedures do not require completion of any nominal Post Insertion procedures
<b>-01:25</b>		
	MS	If reqd, PAYLOAD DEACT (PL OPS, <u>DEORBIT PREP</u> ) or PAYLOAD DEACTIVATION (SODF: ASSY OPS: DEORBIT PREP)
<b>-01:20</b>	C	L4:D,E All cbs open L4:B, All cbs closed Q,R
	MS	<u>SEAT EGRESS</u>
<b>UPLINK</b>	MS	<u>PGSC ACT (ORB OPS, PGSC)</u> Use flight deck PGSC
<b>PASS &amp; BFS</b>		Transition to ENT PKT
<b>TGT</b>	C,P	<u>DPS ENTRY CONFIG (OPS 1 to OPS 3)</u> (BFS NOT <u>ENGAGED</u> ) <u>1</u> , 1-5
<b>-01:15</b>	MS	<u>PRESS H2O TK A MS MID ACTIVITIES</u> <u>2</u> , 1-13
	C,P	GPS INCORPORATION (EPCL, <u>GNC</u> ) (Omit if voice or cmd available)
<b>-01:10</b>	C,P	<u>APU HTRS &amp; DED DISP ENT CONFIG</u> <u>3</u>
	P	<u>AUTO MNVR TO BURN ATT</u> (MCC update ATT) Mnvr per DEORBIT MNVR PAD (ENT, <u>MNVR PADS</u> ): R _____ P _____ Y _____
<b>-01:05</b>	C,P	<u>ENT FWD FLT DECK CONFIG</u> <u>4</u>
	MS	<u>ENT AFT FLT DECK CONFIG MS AFT ACTIVITIES</u> <u>5</u> , 1-11
	MS	<u>ENT MIDDECK CONFIG MS MID ACTIVITIES</u> <u>6</u> , 1-13
	MS	<u>PAYLOAD ENT SW LIST/VER (PL OPS, DEORBIT PREP)</u> or PAYLOAD DEACTIVATION (SODF: ASSY OPS: DEORBIT PREP)
<b>-01:00</b>		

<u>W/B HTRS &amp; DED DISP ENT CONFIG</u> <u>3</u>	
C,P	<u>W/B STEAM VENT HTR ACT</u> BLR CNTLR/HTR (three) – B PWR (three) – ON
F6	<u>DED DISP ENT CONFIG</u> ADI RATE – LO
O7	If OV103,4:   TACAN MODE sel (three) – GPC If OV105: √GPS PWR (three) – ON GPS PWRUP (ORB OPS, <u>GNC</u> )
O17:B	EIU (three) – OFF
O8	MLS (three) – ON

<u>ENT FWD FLT DECK CONFIG</u> <u>4</u>	
C,P	<u>FES CONFIG</u> FLASH EVAP CNTLR PRI A – OFF B(A) – GPC
R4	<u>FWD SWITCH CONFIG</u> HYD BK HTR (three) – AUTO
L4:J	cb AC3 ΦB SIG CONDR IMU FAN – op
O14:D	MNA CAB VENT – op ISOL – op
O17:D	MEC 1 – OFF, wait 2 sec, then 2 – OFF

This Page Intentionally Blank



TIG

1: GNC DEORB MNVR COAST | 2: GNC 0 GPC MEMORY

3: BFS, GNC DEORB MNVR COAST

-01:00  
TRANS DAP  
AUTO  
RT 0.5  
DB 3.5

NOTE

√MCC for unaccounted-for sw or  
cb config discrepancies

-00:55  
C  
P  
MS  
MS

ENT SWITCH LIST/VER (FWD), 3-3 thru 3-9  
ENT SWITCH LIST/VER (FWD), 3-10 thru 3-13  
ENT SWITCH LIST/VER (AFT), 3-15 thru 3-26  
ENT SWITCH LIST/VER (MID), 3-27 thru 3-30

-00:50

-00:45

UPLINK  
PASS &  
BFS:  
SV & REL  
(INRTL &  
REF)

-00:40

C,P

Stow ORB PKT,ORBIT Cue Cards, DEORBIT PREP

-00:35

Go to FINAL DEORB UPDATE/UPLINK (ENT, DEORBIT BURN)  
with following P&I to ENTRY MANEUVER (Cue Card): V = 12K,  
delete: RAD BYP VLV MODE (two) – AUTO CNTLR LOOP  
(two) – AUTO B(A)

-00:30

This Page Intentionally Blank

## MS LAUNCH DAY DEORBIT PREP AFT DECK CONFIGURATION (ORBIT 2)

### MS PULLOUT PAGE

#### NOTE

Wait for GO from CDR or PLT before starting any activity on this page

TIME (TIG-)	MS AFT ACTIONS
01:23	If reqd, PAYLOAD DEACT (PL OPS, <u>DEORBIT PREP</u> ) or PAYLOAD DEACTIVATION (SODF: ASSY OPS: DEORBIT PREP)
01:19	<u>SEAT EGRESS</u>
01:18	<u>PGSC ACT</u> (ORB OPS, <u>PGSC</u> ) Use flight deck PGSC
01:05	<u>ENT AFT FLT DECK CONFIG</u> <span style="border: 1px solid black; padding: 0 2px;">5</span>
00:54	<u>ENT SWITCH LIST/VER (AFT)</u> , 3-16 thru 3-26

<u>ENT AFT FLT DECK CONFIG</u> <span style="border: 1px solid black; padding: 0 2px;">5</span>		
A1L	<u>ENTRY COMM CONFIG</u> S-BD PM MODE – STDN LO NSP CODING RCV – OFF √XMIT – OFF	
A12	<u>HTR CONFIG</u> HYD HTR (eight) – OFF	
ML86B:A R11L	<u>AFT SW CONFIG</u> √cb MNC SPLY H2O XOVR VLV – cl SPLY H2O XOVR VLV – OP (tb-OP) √AFT deck lts as reqd	
	<u>RESET C/W</u>	
	R13U	
	PARAMETER NAME	C/W CH
	FREON LOOP EVAP OUT T1	107
	T2	117
		UPPER LIMIT
		1.90V/64.8 degF
		1.90V/64.8 degF

**Back of LAUNCH DAY DEORBIT PREP AFT DECK CONFIGURATION  
(ORBIT 2)**

**MS PULLOUT PAGE**

**MS LAUNCH DAY DEORBIT PREP MIDDECK CONFIGURATION  
(ORBIT 2)**

**MS PULLOUT PAGE**

NOTE

Wait for GO from CDR or PLT before starting any activity on this page

TIME (TIG-)	MS MIDDECK ACTIONS
01:18	<u>SEAT EGRESS</u>
01:15	<u>PRESS H2O TK A</u> [ 2 ]
01:04	<u>ENT MIDDECK CONFIG</u> [ 6 ]
00:53	<u>ENT SWITCH LIST/VER (MID)</u> , 3-27 thru 3-32

<u>ENT MIDDECK CONFIG</u> [ 6 ]	
MS	<u>MIDDECK PCS</u>
MO69M	LEH O2 7,8 vlv (two) – as reqd
MO32M	6 vlv– as reqd
MO13Q	√MIDDECK FLOODS as reqd
	<u>ENTRY COMM CONFIG</u>
ML85E	AC S1 – OFF

<u>PRESS H2O TK A</u> [ 2 ]	
ML26C	SPLY H2O GN2 TK VENT vlv – PRESS TKA SPLY vlv – OP
	<u>NOTE</u> Disregard possible 'S66 WASTE H2O PRE' fault msg

**Back of MS LAUNCH DAY DEORBIT PREP MIDDECK ACTIVITIES  
(ORBIT 2)  
MS PULLOUT PAGE**

# LAUNCH DAY DEORBIT PREP (ORBIT 3)

This Page Intentionally Blank



## LAUNCH DAY DEORBIT PREP (ORBIT 3)

### ASSUMPTIONS/INITIAL CONDITIONS

Launch Day Deorbit Prep (Orbit 3) may be entered directly from ascent config (ASC) or orbit config (POST INSERT)

Appropriate PKT or MAL should be accomplished prior to using these procedures

### PROBLEM DESCRIPTION/RATIONALE

Any failure that results in a fail-safe condition will be cause for Launch Day Deorbit. Examples include those listed in POST INSERT, plus PLBD problems

### NOTE

1. This procedure can be used for an OPS 1 failure or an OPS 2 failure that has occurred prior to GO FOR ORBIT OPS at MET 01:36. After GO FOR ORBIT OPS, these procedures no longer apply
2. If in OPS 1 or in OPS 2 prior to completion of activities preceding MNVR TO PLBD OPENING ATTITUDE, begin procedure at TIG-2:30. This will cover necessary Post Insertion procedures not yet accomplished
3. If in OPS 2 after INITIATION OF MNVR TO PLBD OPENING ATTITUDE; begin procedure at TIG-2:00
4. If entering this procedure due to Av Bay Fire and in OPS 1, incorporate AV BAY FIRE CONTINGENCY DELTAS (OPS 1 to OPS 3), 2-5
5. If entering this procedure due to Av Bay Fire and in OPS 2, incorporate AV BAY FIRE CONTINGENCY DELTAS (OPS 2 to OPS 3), 2-7

This Page Intentionally Blank

# AV BAY FIRE CONTINGENCY DELTAS (OPS 1 TO OPS 3)

Assumes AV BAY FIRE (ASC PKT, PWRDN) complete

NOTE

Single-fault tolerance used for most cabin air-cooled equipment. Additional LRUs may be activated if reqd and if CABIN PRESS stable  $\geq$  8 psia. Minimize use of IDPs,MDUs,FLT CNTLR PWR, DDU's. Use one PGSC

WARNING

If associated AV BAY AC BUS, FF MDM, or FMCA is unrecoverable,  $\sqrt$ MCC for vent door config. Certain failure combinations will cause multiple vent doors to remain open during entry

LAND SITE UPDATE

**1: GNC 50 HORIZ SIT**  
SEL SITE (See LAND SITE DATA)  
LOAD IN TGTs

**1: GNC DEORB MNVR COAST**

- \* If MCC cannot provide DEORB TGT, use Deorbit \*
- \* Manager on PGSC \*

$\sqrt$ PASS and BFS TGT per DEORBIT MNVR PAD (ENT, MNVR PADS) or PGSC  
LOAD – ITEM 22 EXEC  
TIMER – ITEM 23 EXEC  
 $\sqrt$ PASS and BFS solution per DEORBIT MNVR PAD (ENT, MNVR PADS):  
BURN ATT  
HA  
HP  
 $\Delta$ VTOT  
TGO

1. TIG-2:30  
If AV BAY 1 or 2 FIRE:  
| FCS CH (four) – ORIDE  
If AV BAY 3 FIRE:  
 $\sqrt$ FCS CH 1,2,3 (three) – AUTO  
4 – OFF
2. Skip DPS CONFIG 2 and perform following:  
DPS CONFIG FOR AV BAY FIRE (OPS 1 to OPS 3)  
Set event timer to count down to TIG  
 $\sqrt$ RGA,ASA,IMU (all) – ON  
ACCEL, ADTA (all unaffected) – ON

C2  
O14,  
O15,  
O16

3. Replace W/B STEAM VENT HTR ACT 6 with following:  
BLR CNTLR/HTR (three) – B  
If AV BAY 1(2,3) fire:  
BLR CNTLR/HTR 1(2,3) – A  
BLR PWR (three) – ON

R2

TRANSITION GPCs TO GNC OPS 3

**1: GNC GPC MEMORY**

CONFIG – ITEM 1 +3 EXEC

Modify MC 3 per table

GNC, OPS 301 PRO

**3: GNC DEORB MNVR COAST**

TRANSITION BFS GPC TO GNC OPS 3

If AV BAY 1 or 3 FIRE:

GPC MODE 5 – STBY (tb-RUN)

– RUN (tb-RUN)

BFC CRT DISP – ON

$\sqrt$ SEL – 3+1

**3: BFS, GNC BFS MEMORY**

$\sqrt$ GPC OUTPUT 5 – B/U (tb-bp)

$\sqrt$ TFL ENA – ITEM 29 (\*)

BFS, GNC OPS 301 PRO

**3: BFS GNC DEORB MNVR COAST**

If AV BAY 2 FIRE:

Reassign BFS into GPC 3 via MAL DPS SSR-7 (do not activate

MMU2), then take GPC OUTPUT 3 – B/U (tb-bp)

GPC MODE 3 – RUN (tb-RUN)

CONFIG GPC	LOSS OF		
	BAY 1	BAY 2	BAY 3
3	3	3	3
02300	10040	12040	
STR 1	3	1	1
2	2	4	2
3	3	1	4
4	2	4	4
PL 1/2	2	1	1
CRT 1	2	1	1
2	3	4	2
3	2	1	4
4	0	0	0
L 1	0	0	0
2	0	0	0
MM 1	2	1	1
2	3	4	2

O6

C3

O6

CRT3

O6  
CRT

O6

O14:E,  
O15:E,  
O16:E

L1

- NOTE
- Htr reqd to be on prior to APU act
4. Deltas to PLBD CLOSING (AUTO SEQ) (if reqd) **8**  
If AV BAY 2 FIRE:  
Perform the following prior to step 1:  
MDM PL2 – ON  
SM (BFS) I/O RESET  
Add the following after step 14:  
MDM PL2 – OFF
  5. Deltas to ENT FWD FLT DECK CONFIG 10  
Do not power up MLS  
  
cb MNA,B,C DDU L,R (four) – cl
- If AV BAY 1 fire:  
FLASH EVAP CNTLR PRI A – GPC

Cont next page

## AV BAY FIRE CONTINGENCY DELTAS (OPS 1 to OPS 3) (Cont)

6. Deltas to ENT MIDDECK CONFIG 12
- ML31C           √VAC VENT ISOL VLV CNTL – OP (tb-OP)  
                   √NOZ HTR           – ON
7. ENT SWITCH LIST/VERIF  
 Do not activate pwrdrn items
8. AV BAY FIRE P&I DELTAS TO ENTRY  
 Deltas to ENT, DEORBIT BURN  
 At TIG-4:  
   If AV BAY 1(2) FIRE:  
     GNC DEORB MNVR EXEC  
     L(R) OMS GMBL – SEC (\*)  
     Use two IDP/CRTs with four MDUs  
     √cb MNA,B,C DDU L,R (four) – cl
- O14:E,O15:E,  
 O16:E  
 F6,F8           FLT CNTLR PWR (two) – ON
- Deltas to ENT, POST BURN:  
 Use one IDP/CRT with two MDUs  
 FLT CNTLR PWR (two) – OFF  
 cb MNA,B DDU L (two) – op  
 If AV BAY 1(2) FIRE:  
   **ENTRY SW CHECK**  
   Delete: √NWS – 1  
   Add: NWS – 2 (OFF)
- O16:F  
 F6,F8  
 O14:E,O15:E
- If AV BAY 2 FIRE:  
 RJDF 2B F4/F5 LOGIC   – ON  
                   F4 DRIVER       – ON  
 O8               FWD RCS MANF ISOL 4 – OP (tb-OP)
- Deltas to ENTRY MANEUVERS (Cue Card):  
 At EI:  
   Use only two IDP/CRTs with four MDUs  
   cb MNA,B DDU L (two) – cl  
   FLT CNTLR PWR – ON  
 O14:E,O15:E  
 F6               √cb ADTA (all unaffected) – cl  
 O14:E,O15:E,  
 O16:E
- At V = 15K:  
 Activate all unaffected TACANs (OV103,4), RAs, MLSs  
 GNC I/O RESET
- At M < 1.0  
 Use two IDP/CRTs with five MDUs

# AV BAY FIRE CONTINGENCY DELTAS (OPS 2 TO OPS 3)

Assumes AV BAY FIRE (ORB PKT, PWRDN) complete

**NOTE**

Single-fault tolerance used for most cabin air-cooled equipment. Additional LRUs may be activated if reqd and if CABIN PRESS stable ≥ 8 psia. Minimize use of IDPs,MDUs,FLT CNTLR PWR,DDUs. Use one PGSC

CRT  
R11L  
CRT

VERIFY IDP CONFIG

GPC/CRT 0/4 EXEC  
√IDP/CRT4 PWR – OFF  
GPC/CRT X/3 EXEC

**WARNING**

If associated AV BAY AC BUS, FF MDM, or FMCA is unrecoverable, √MCC for vent door config. Certain failure combinations will cause multiple vent doors to remain open during entry

LOAD ENTRY TFL/RECONFIG UPLK

Perform LOAD PDI DECOM FORMAT and LOAD PCMMU FORMAT (ORB OPS FS, COMM/INST) for entry config

TRANSITION GPCs TO GNC OPS 3

1: GNC 0 GPC MEMORY

CONFIG – ITEM 1 +3 EXEC  
Modify MC 3 per table →

GNC, OPS 301 PRO

1: GNC DEORB MNVR COAST

		LOSS OF		
		BAY 1	BAY 2	BAY 3
CONFIG	3	3	3	
GPC	02000	10000	12000	
STR	1	2	1	1
	2	2	1	2
	3	2	1	1
	4	2	1	2
PL	1/2	0	0	0
CRT	1	2	1	1
	2	2	1	2
	3	2	1	2
	4	0	0	0
L	1	0	0	0
	2	0	0	0
MM	1	2	1	1
	2	2	1	2

1. TIG -2:30(2:00)  
If AV BAY 1 or 2 FIRE:  
| FCS CH (four) – ORIDE  
If AV BAY 3 FIRE:  
√FCS CH 1,2,3 (three) – AUTO  
4 – OFF
2. Replace W/B STEAM VENT HTR ACT [6] with following:  
BLR CNTLR/HTR (three) – B  
If AV BAY 1(2,3) fire:  
| BLR CNTLR/HTR 1(2,3) – A  
BLR PWR (three) – ON  
  

NOTE

Htr reqd to be on prior to APU act
3. Deltas to PLBD CLOSING (AUTO SEQ) (if reqd) [8]  
If AV BAY 2 FIRE:  
Perform the following prior to step 1:  
MDM PL2 – ON  
SM (BFS) I/O RESET  
Add the following after step 14:  
MDM PL2 – OFF
4. Skip OPS 2 TO 3 TRANSITION [9] and perform following:  
OPS CONFIG FOR AV BAY FIRE (OPS 2 to OPS 3)  
(Omit if BFS engaged or if already configured with G3 set)  
  
\* If IMU or RHC dilemma, do not proceed with \*  
\* OPS 3 transition \*

P R2

O6  
CRT

O6

O14,  
O15,  
O16

Cont next page

## AV BAY FIRE CONTINGENCY DELTAS (OPS 2 TO OPS 3) (Cont)

### TRANSITION BFS GPC TO GNC OPS 3

O6  
C3  
If AV BAY 1 or 3 FIRE:  
GPC MODE 5 – STBY (tb-RUN)  
BFC CRT DISP – ON  
√SEL – 3+1  
**3: BFS, GNC BFS MEMORY**

O6  
CRT3  
GPC OUTPUT 5 – B/U (tb-bp)  
√TFL ENA – ITEM 29 (\*)  
BFS, GNC OPS 301 PRO  
**3: BFS GNC DEORB MNVR COAST**

If AV BAY 2 FIRE:  
GPC OUTPUT 3 – B/U (tb-bp)

### TRANSITION REMAINING PASS GPCs TO GNC OPS 3

SM, OPS 000 PRO (release payload buses)

**X: SM GPC MEMORY**

O6  
(SM) GPC OUTPUT – NORM (tb-gray)

O6  
If AV BAY 1 or 3 FIRE:  
GPC MODE 5 – RUN (tb-RUN)  
If AV BAY 2 FIRE:  
GPC MODE 3 – RUN (tb-RUN)

**1: GNC 0 GPC MEMORY**

CONFIG – ITEM 1 +3 EXEC

Modify MC 3 per table →

BFC CRT DISP – OFF

GNC, OPS 301 PRO

**1: GNC DEORB MNVR COAST**

BFC CRT DISP – ON

BFS, GNC, OPS 000 PRO  
301 PRO

#### LAND SITE UPDATE

**1: GNC 50 HORIZ SIT**

SEL SITE (See LAND SITE DATA)

#### LOAD IN TGTs

**1: GNC DEORB MNVR COAST**

\* If MCC cannot provide DEORB TGT, use Deorbit \*

\* Manager on PGSC \*

√PASS and BFS TGT per DEORB TGT (ENT, MNVR PADS) or PGSC

LOAD – ITEM 22 EXEC

TIMER – ITEM 23 EXEC

√PASS and BFS solution per DEORB TGT (ENT, MNVR PADS):

BURN ATT

HA

HP

ΔVTOT

TGO

	CONFIG GPC	LOSS OF		
		BAY 1	BAY 2	BAY 3
		3	3	3
		02300	10040	12040
STR	1	3	1	1
	2	2	4	2
	3	3	1	4
	4	2	4	4
PL	1/2	2	1	1
CRT	1	2	1	1
	2	3	4	2
	3	2	1	4
	4	0	0	0
L	1	0	0	0
	2	0	0	0
MM	1	2	1	1
	2	3	4	2

5. Deltas to ENT FWD FLT DECK CONFIG **10**

Do not power up MLS  
cb MNA,B,C DDU L,R (four) – cl

O14:E,  
O15:E,O16:E

If AV BAY 1 fire:  
FLASH EVAP CNTLR PRI A – GPC

L1

6. Deltas to ENT MIDDECK CONFIG **12**

√VAC VENT ISOL VLV CNTL – OP (tb-OP)  
√NOZ HTR – ON

ML31C

7. ENT SWITCH LIST/VERIF  
Do not activate pwrn items

8. AV BAY FIRE P&I DELTAS TO ENTRY

Deltas to ENT, DEORBIT BURN:

At TIG-4:

If AV BAY 1(2) FIRE:

**GNC DEORB MNVR EXEC**

L(R) OMS GMBL – SEC (\*)

Use two IDP/CRTs with four MDUs for deorbit burn

√cb MNA,B,C DDU L,R (four) – cl

O14:E,O15:E,  
O16:E

FLT CNTLR PWR (two) – ON

F6,F8

Deltas to ENT, POST BURN:

Use one IDP/CRT with two MDUs

FLT CNTLR PWR (two) – OFF

cb MNA,B DDU L,R (four) – op

If AV BAY 1(2) FIRE:

**ENTRY SW CHECK**

Delete: √NWS – 1

Add: NWS – 2 (OFF)

F6,F8  
O14:E,  
O15:E,  
O16:E

If AV BAY 2 FIRE:

RJDF 2B F4/F5 LOGIC – ON

F4 DRIVER – ON

FWD RCS MANF ISOL 4 – OP (tb-OP)

O16:F

O8

Deltas to ENTRY MANEUVERS (Cue Card):

At EI:

Use two IDP/CRTs with four MDUs

cb MNA,B DDU L,R (four) – cl

O14:E,  
O15:E,O16:E

FLT CNTLR PWR – ON

√cb ADTA (all unaffected) – cl

F6

O14:E,O15:E,  
O16:E

At V = 15K:

Activate all unaffected TACANs (OV103,4), RAs, MLSS

GNC I/O RESET

At M < 1.0:

Use two IDP/CRTs with five MDUs

# LAUNCH DAY DEORBIT PREP (ORBIT 3) SUMMARY TIMELINE

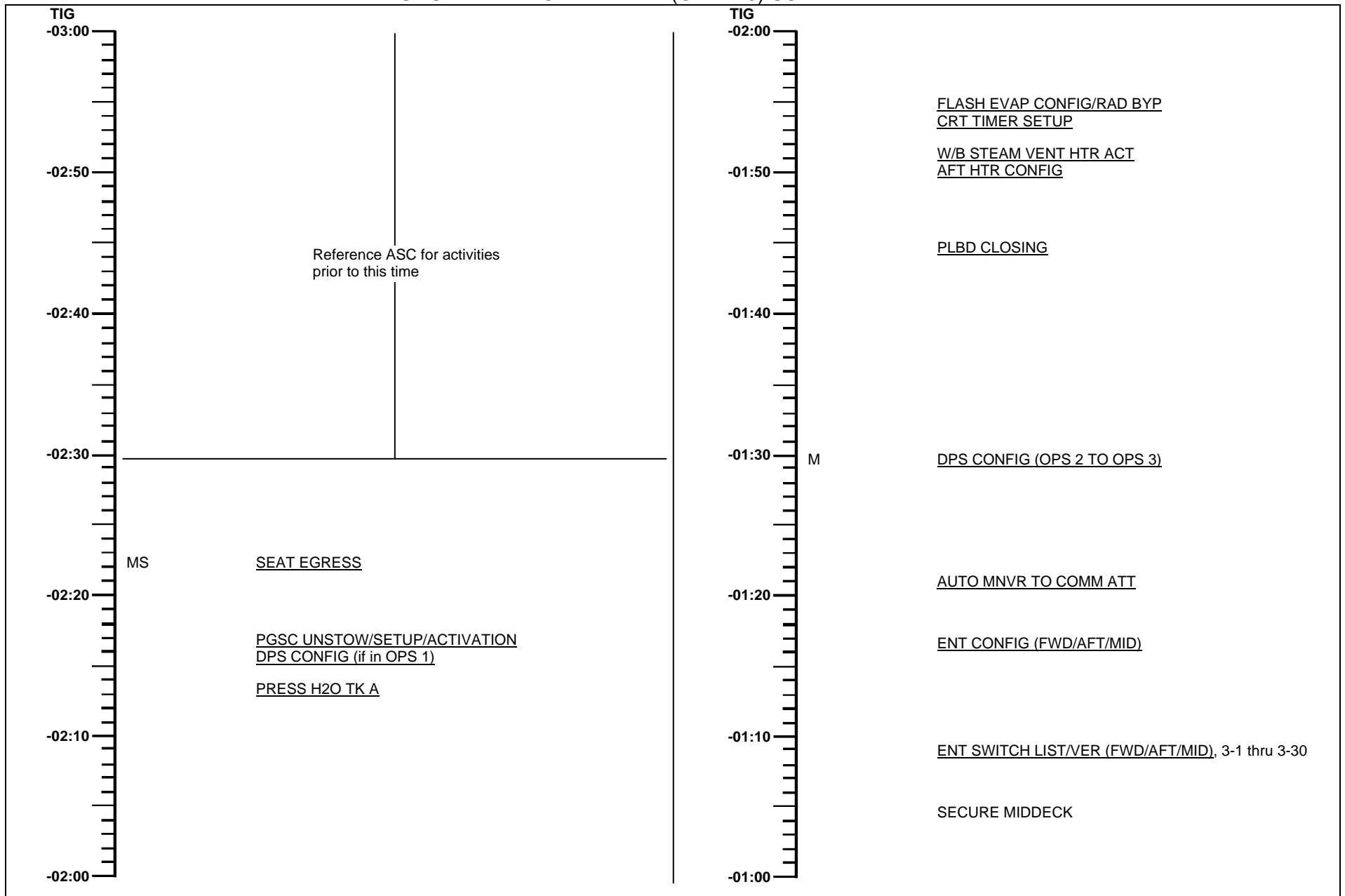

# LAUNCH DAY DEORBIT PREP (ORBIT 3) SUMMARY TIMELINE

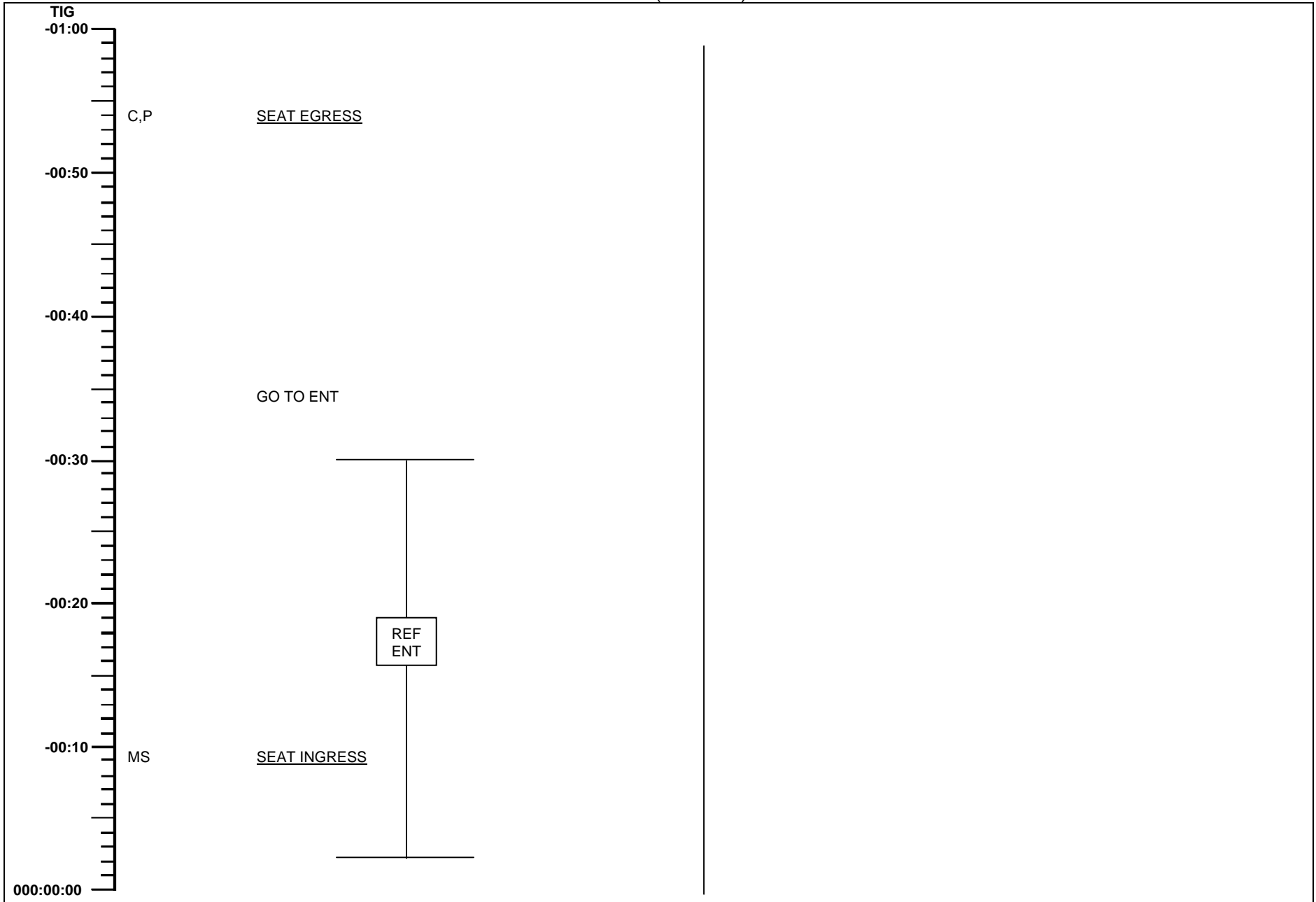



DPS CONFIG 2

C,P

C2  
O14,O15,  
O16

- TRANSITION TO GNC OPS 3  
Set event timer to count down to TIG  
√RGA,ACCEL,ASA,IMU (all) – ON

CONFIG – ITEM 1 +3 EXEC  
Modify MC 3 per table

C3

BFC CRT DISP – OFF  
GNC, OPS 301 PRO

1: GNC DEORB MNVR COAST

CRT3

BFC CRT DISP – ON  
BFS, GNC, OPS 000 PRO  
301 PRO

- LAND SITE UPDATE

1: GNC 50 HORIZ SIT

SEL SITE (See LAND SITE DATA)

- LOAD IN TGTs

1: GNC DEORB MNVR COAST

\* If MCC cannot provide DEORB TGT, use Deorbit Manager on PGSC \*

√PASS and BFS TGT per DEORBIT MNVR PAD  
(ENT, MNVR PADS) or PGSC  
LOAD – ITEM 22 EXEC  
TIMER – ITEM 23 EXEC

√PASS and BFS solution per DEORBIT MNVR PAD  
(ENT, MNVR PADS):  
BURN ATT  
HA  
HP  
ΔVTOT  
TGO

- VERIFY MC 9 TABLE (GNC 9) FOR POST LANDING

2: GNC 0 GPC MEMORY

√CONFIG – ITEM 1 +9 EXEC  
Modify MC 9 per table  
CONFIG – ITEM 1 +3 EXEC

CONFIG	3
GPC	12340
STR	1
	2
	3
	4
PL	1/2
	1
CRT	1
	2
	3
	4
L	1
	0
	2
MM	1
	1
	2
	2

CONFIG	9
GPC	12340
STR	1
	2
	3
	4
PL	1/2
	1
CRT	1
	2
	3
	4
L	1
	0
	2
MM	1
	1
	2
	2

<b>TIG</b>		
-02:30	TRANS DAP AUTO RT 0.5 DB 3.5	
		<u>NOTE</u> These procedures do not require completion of any Nominal Post Insertion procedures  If AV BAY FIRE, check deltas to FCS configuration, 2-5 or 2-7
-02:25		
	C	L4:D,E All cbs open L4:B, All cbs closed Q,R
	<u>UPLINK</u> PASS & BFS TGT	
-02:20	MS	<u>SEAT EGRESS</u>
	MS	PGSC ACT (ORB OPS, <u>PGSC</u> ) Use flight deck PGSC
	C,P	<u>DPS CONFIG</u> (if in OPS 1 to OPS 3) (BFS not engaged) <u>2</u> , 2-11. If AV BAY FIRE, check deltas, 2-5
-02:15		
	MS	<u>PRESS H2O TK A MS MID ACTIVITIES</u> <u>3</u> , 2-25
	MS	UNSTOW/DON WIRELESS HEADSETS (if reqd)
-02:10		
-02:05		
-02:00		

RAD BYP (if rads not bypassed) 4

C	L1	RAD BYP VLV MODE (two) – MAN
		MAN SEL (two) – BYP (after ~3 sec, tb-BYP)
		CNTRLR LOOP (two) – OFF
	O1	√FREON EVAP OUT TEMP ind ~39 ± degF (after ~2.5 min)

TIMER SETUP (omit if BFS or OPS 3) 5

GNC 2 TIME

C COUNT TO – ITEM 17 + \_\_ + \_\_ + \_\_ EXEC

W/B STEAM VENT HTR ACT 6 (If AV BAY FIRE, check deltas, 2-5 or 2-7)

P	R2	BLR CNTRLR/HTR (three) – B
		PWR (three) – ON

NOTE  
Htr reqd to be on prior to APU act

TIG		
-02:00	MS	If reqd, PAYLOAD DEACT (PL OPS, <u>DEORBIT PREP</u> ) or PAYLOAD DEACTIVATION (SODF: ASSY OPS: DEORBIT PREP)
If OPS 2: A1(B1) AUTO PRI RT 0.2 DB 5.0	MS	A15 If SSPTS (OV103,105 only): PTU/MAIN BUS A,B (two) – OFF (tb-OFF) cb CNTL PWR PTU 1,2 (two) – op OPCU 1,2 V-ADJ (two) – OFF
-01:55	C	<u>RAD BYP</u> <u>4</u> , 2-13
If OPS 3: TRANS DAP AUTO RT 0.5 DB 3.5	P	<u>TIMER SETUP</u> (Omit if BFS or OPS 3) <u>5</u> , 2-13
-01:50	P	<u>W/B STEAM VENT HTR ACT</u> <u>6</u> , 2-13
MS		<u>AFT HTR CONFIG MS AFT ACTIVITIES</u> <u>7</u> , 2-23
-01:45	P	<u>AUTO PLBD CLOSING</u> (if reqd) <u>8</u> , 2-15 If AV BAY 2 FIRE, check deltas, 2-5 or 2-7
-01:40		
-01:35		
<u>UPLINK</u> PASS & BFS TGT		
-01:30		

AUTO PLBD CLOSING 8

CAUTION

Verify no obstructions before closing and latching PLBD (Ku ANT, RMS, RAD, etc)

Use MANUAL mode for subsequent BFS PLBD ops if BFS AUTO sequence has been interrupted by reversing latch/door drive direction, or if MANUAL mode has already been used during mission

- R13L
  - \* If no motion determined visually or 'OP/CL' not blank \*
  - \* within 10 sec after cmd: \*
  - \* PL BAY DR – STOP \*
  - \* Perform MAL, MECH, 9.1a \*
  - \* If Latch not 'CL' in single-motor time: \*
  - \* PL BAY DR – STOP \*
  - \* Perform MAL, MECH, 9.1e \*
  - \* If door motion stops and not 'RDY' or 'CL': \*
  - \* PL BAY DR – STOP \*
  - \* Perform MAL, MECH, 9.1g \*
  - \* If SM GPC fails during this operation: \*
  - \* PL BAY DR SYS (two) – DSBL \*
  - \* DR – STOP \*
  - \* Perform PASS SM GPC FAIL (ORB PKT, DPS) \*
  
- R11L
  - 1. √IDP/CRT4 PWR – ON
- CRT4
  - 2. SM, OPS 202 PRO or BFS SM 63 PL BAY DOORS
  - 4: SM PL BAY DOORS
  
- R13L
  - √PL BAY DR – STOP
- CRT4
  - √PBD SW – STOP
  - √MAN SEL (ten) – (no \*)
  - √PBD SW BYPASS – (no \*)
  
- 3. AC POWER ON – ITEM 1 EXEC (\*)
  - 4. AUTO MODE SEL – ITEM 3 EXEC (\*)
- R13L
  - 5. PL BAY DR SYS (two) – ENA
- CRT4
  - √OP/CL STATUS (ten) – OP

- \* If PORT DOOR not 'CL' within 6 sec of 'RDY': \*
- \* PL BAY DR – STOP \*
- \* Go to PORT BKHD LATCH TROUBLESHOOTING 8A, \*
- \* 2-17 \*

- R13L
  - 6. PL BAY DR – CL
- CRT4
  - √PORT DOOR – blank, RDY, CL (~63 sec)
  - √FWD, AFT LATCHES – blank, CL (~30 sec)
  - √STBD DOOR – blank
  
- 7. When STBD DOOR as close as possible to PORT DOOR before contact, perform PLBD fit check:
- R13L
  - PL BAY DR – STOP
  - Determine C/L Latch clearance on C/L LATCH EXTENDED GUIDE ROLLER TRAJECTORY NO-GO DIAGRAM, 2-16
  
- \* If NO-GO for PLBD CLOSE: \*
  - \* If no waveoff capability: Perform MAL, MECH SSR-3 \*
  - \* (SIMULTANEOUS PLBD CL) \*
  - \* If waveoff OK: √MCC \*
- 8. PL BAY DR – CL
  
- \* If STBD DOOR not 'CL' within 6 sec of 'RDY': \*
  - \* PL BAY DR – STOP \*
  - \* Go to STBD BKHD LATCH TROUBLESHOOTING 8B, \*
  - \* 2-17 \*
- CRT4
  - √STBD DOOR – CL (~63 sec)
  - √FWD, AFT LATCHES (two) – blank, CL (~30 sec)
  - √CENTER LATCHES 1-4, 13-16 (two) – blank, CL (~20 sec)
  - √5-8, 9-12 (two) – blank, CL (~20 sec)
  
- R13L
  - 9. PL BAY DR – STOP
- CRT4
  - 10. SYS (two) – DSBL
  - √OP/CL STATUS (ten) – CL
  
- 11. AC POWER OFF – ITEM 2 EXEC (\*)
  - 12. GPC/CRT 04 EXEC
- R11L
  - 13. IDP/CRT4 PWR – OFF
- 14. AFD 1 PWR – OFF
- A7U
  - 15. √PL BAY FLOOD (eight) – OFF

**AUTO PLBD CLOSING**

**PORT AFT BULKHEAD LATCH GO/NO-GO DIAGRAM**

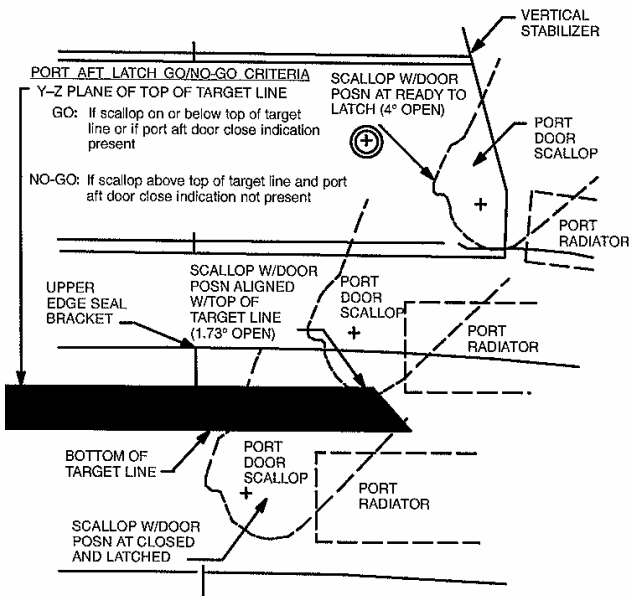

FUNCTION	PLBD CONTROL								PLBD DISPLAY PL MDM								
	Ref: MA73C:C&D for MCA (cb)																
	MTR 1				MTR 2				C	C	O	O	C	R	R	R	O
	AC/MCA	CNTL	MDM	SYS	AC/MCA	CNTL	MDM	SYS	A	B	A	B	A	B	C		
LATCH																	
5-8	1/MID3	AB3/AB2	PL1	2	3/MID2	CA3/CA1	PL2	1	1	2	1	2					
9-12	1/MID1	AB3/AB1	PL1	1	3/MID4	CA3/CA2	PL2	2	1	2	1	2					
1-4	1/MID3	AB3/AB2	PL1	2	3/MID2	CA3/CA1	PL2	1	1	2	1	2					
13-16	3/MID4	CA3/CA2	PL2	2	2/MID2	BC3/BC1	PL1	1	2	1	2	1					
S FWD	1/MID1	AB3/AB1	PL1	1	2/MID4	BC3/BC2	PL2	2	1	2	1	2					
S AFT	3/MID4	CA3/CA2	PL2	2	2/MID2	BC3/BC1	PL1	1	2	1	2	1					
S DOOR	1/MID1	AB3/AB1	PL1	1	2/MID4	BC3/BC2	PL2	2					1	1	2	2	1
													2	1	2	2	2
P FWD	1/MID1	AB3/AB1	PL1	1	2/MID4	BC3/BC2	PL2	2	1	2	1	2					
P AFT	1/MID3	AB3/AB2	PL1	2	3/MID2	CA3/CA1	PL2	1	1	2	1	2					
P DOOR	3/MID4	CA3/CA2	PL2	2	2/MID2	BC3/BC1	PL1	1					2	1	1	2	2
													1	1	1	2	1

**C/L LATCH EXTENDED GUIDE ROLLER TRAJECTORY NO-GO DIAGRAM**

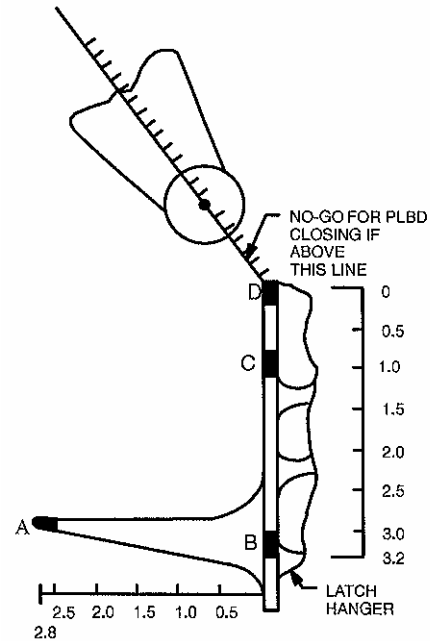

**PORT BKHD LATCH TROUBLESHOOTING [8A]**

- CRT4 1. √PORT DOOR FWD, AFT MICRO-SW STATs  
 If PORT DOOR AFT 'C' = '0':  
 : 2. √PORT AFT BULKHEAD LATCH GO/NO DIAGRAM, 2-16  
 : If NO-GO:  
 L Go to MAL, MECH, SSR-2 (CONTINGENCY PLBD CLOSURE)
- If PORT DOOR FWD 'C' = '0':  
 :  
 : NOTE  
 : Use PLB camera A to view port fwd bkhd latch  
 : hook/roller #3 as seen in figures 2-1 and 2-2, 2-18
- R13L 3. PL BAY DR SYS 1 – DSBL  
 During the following step, monitor latch hook #3 while driving to  
 ensure hook motion and proper roller engagement
- \* If latch hook #3 stops moving while commanded, or \*  
 \* it appears that the hook is going to miss or jam \*  
 \* into its roller: \*  
 \* PL BAY DR – STOP \*  
 \* Go to MAL, MECH, SSR-2 (CONTINGENCY \*  
 \* PLBD CLOSURE) \*
4. PL BAY DR – CL
5. When proper roller engagement verified for latch #3:  
 PL BAY DR – STOP  
 L SYS 1 – ENA
6. Go to step 5 of AUTO PLBD CLOSING [8], 2-15 ignoring the starred  
 block

**STBD BKHD LATCH TROUBLESHOOTING [8B]**

- CRT4 1. √STBD DOOR FWD, AFT MICRO-SW STATs  
 If STBD DOOR AFT (FWD) 'C' = '0':  
 :  
 : NOTE  
 : Use PLB camera C(D) to view stbd aft (fwd) bkhd latch  
 : hook/roller #3 as seen in figures 2-1 and 2-2, 2-18
- R13L 2. PL BAY DR SYS 1(2) – DSBL
- During the following step, monitor latch hook #3 while driving to  
 ensure hook motion and proper roller engagement
- \* If at any point latch hook #3 stops moving while \*  
 \* commanded, or it appears that the hook is going \*  
 \* to miss or jam into its roller: \*  
 \* PL BAY DR – STOP \*  
 \* Go to MAL, MECH, SSR-2 (CONTINGENCY \*  
 \* PLBD CLOSURE) \*
3. PL BAY DR – CL
4. When proper roller engagement verified for latch #3:  
 PL BAY DR – STOP  
 L SYS 1(2) – ENA
5. Go to step 8 of AUTO PLBD CLOSING [8], 2-15 ignoring the starred  
 block

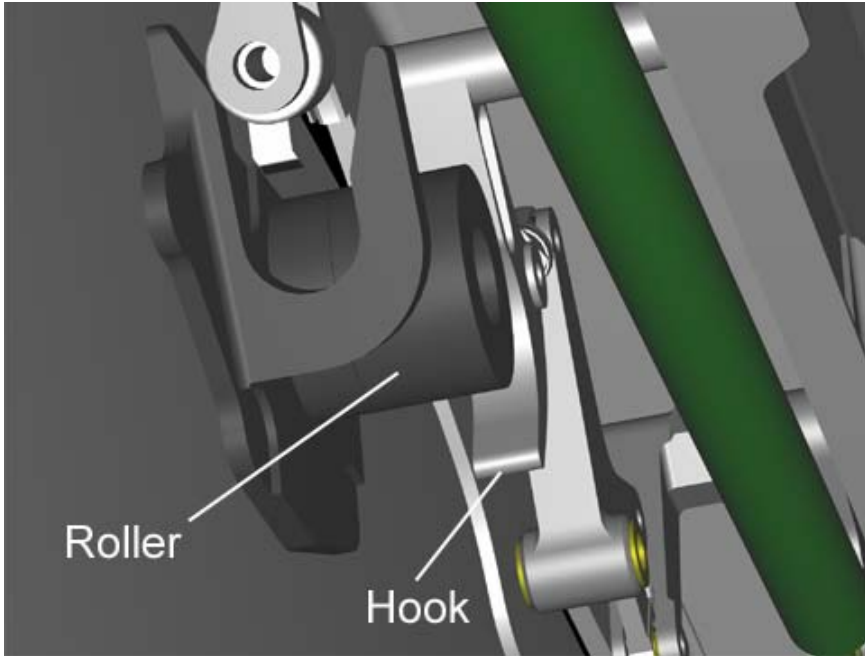

Figure 2-1.- Latch hook/roller #3 typical view from PLB camera

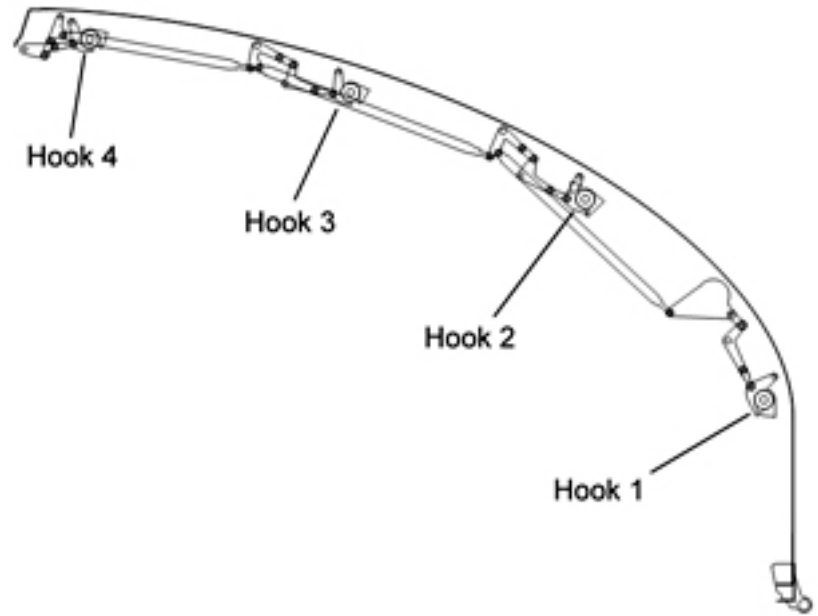

Figure 2-2.- Typical latch hook/roller numbering



**OPS 2 TO 3 TRANSITION 9**

(Omit if BFS engaged or if already configured with G3 set)

\* If IMU or RHC dilemma, do not proceed \*  
 \* with OPS 3 transition \*

O14,O15,  
O16

- √Att mnvr complete
- √RGA,ACCEL,ASA,IMU (all) – ON

C2  
R11L

1. VERIFY MEDS CONFIG  
 √IDP/CRT PWR (three) – ON  
 √IDP/CRT4 PWR – OFF

Verify all forward MDUs – ON and selected to primary port

O6

2. VERIFY GPC CONFIG  
 √GPC MODE 3 – HALT (tb-bp)  
     √PWR 3,5 – ON  
     √OUTPUT 1,2 – NORM (tb-gray)  
         √3,5 – NORM (tb-bp)  
         √4 – TERM (tb-bp)  
 √MODE 1,2,4 – RUN (tb-RUN)  
     3 – STBY (tb-RUN)  
     5 – STBY (tb-RUN)

3. SM CHECKPOINT/UL CNTL ENA

- 1: SM 60 SM TABLE MAINT
- 2: SM 1 DPS UTILITY

CRT2  
CRT1

- MMU ASSIGN 2 SM – ITEM 4 EXEC
- CKPT INITIATE – ITEM 18 EXEC

CRT2  
CRT1

- √Update of CKPT TIME and STATUS GOOD indicated
- MMU ASSIGN 1 SM – ITEM 3 EXEC
- CKPT INITIATE – ITEM 18 EXEC

CRT2

- √Update of CKPT TIME and STATUS GOOD indicated
- CKPT RETRV ENA – ITEM 12 EXEC (\*)
- UL CNTL ENA – ITEM 36 EXEC

4. LOAD ENTRY TFL/RECONFIG UPLK

Perform LOAD PDI DECOM FORMAT  
and LOAD PCMMU FORMAT  
for entry config (ORB OPS FS,  
COMM/INST)

CONFIG GPC	3	12000
STR 1	1	1
2	2	
3	1	
4	2	
PL 1/2	0	
CRT 1	1	1
2	2	
3	2	
4	0	
L 1	0	
2	0	
MM 1	1	1
2	2	

5. TRANSITION GPC 1&2 TO GNC OPS 3

- 1: GNC 0 GPC MEMORY
- CONFIG – ITEM 1 +3 EXEC
- Modify MC 3 per table →
- GNC, OPS 301 PRO
- 3: GNC DEORB MNVR COAST

C3

6. TRANSITION BFS GPC TO GNC OPS 3

BFC CRT DISP – ON  
 √SEL – 3+1

O6  
CRT3

- 3: BFS, GNC BFS MEMORY
- GPC OUTPUT 5 – B/U (tb-bp)
- √TFL ENA – ITEM 29 (\*)
- BFS, GNC, OPS 301 PRO
- 3: BFS, GNC DEORB MNVR COAST

O6

7. TRANSITION GPC 1,2,3,4 TO GNC OPS 3  
 SM, OPS 000 PRO (releases payload buses)

X: SM GPC MEMORY  
 GPC OUTPUT 4 – NORM (tb-gray)  
 MODE 3,5 (two) – RUN (tb-RUN)

C3

- 1: GNC 0 GPC MEMORY
- √CONFIG – ITEM 1 +3 EXEC
- Modify MC 3 per table →
- BFC CRT DISP – OFF
- GNC, OPS 301 PRO
- 1: GNC DEORB MNVR COAST
- BFC CRT DISP – ON
- BFS, GNC, OPS 000 PRO
- 301 PRO

CONFIG GPC	3	12340
STR 1	1	1
2	2	
3	3	
4	4	
PL 1/2	1	
CRT 1	1	1
2	2	
3	3	
4	0	
L 1	0	
2	0	
MM 1	1	1
2	2	

C3  
CRT3

8. LAND SITE UPDATE

1: GNC 50 HORIZ SIT  
 SEL SITE (See LAND SITE DATA)

9. LOAD IN TGTs

1: GNC DEORB MNVR COAST

\* If MCC cannot provide DEORB TGT, use Deorbit \*  
 \* Manager on PGSC \*

√PASS and BFS TGT per DEORBIT MNVR PAD (ENT,  
 MNVR PADS) or PGSC

LOAD – ITEM 22 EXEC  
 TIMER – ITEM 23 EXEC

√PASS and BFS solution per DEORBIT  
 MNVR PAD (ENT, MNVR PADS):  
 BURN ATT  
 HA  
 HP  
 ΔVTOT  
 TGO

CONFIG GPC	9	12340
STR 1	1	1
2	2	
3	3	
4	4	
PL 1/2	1	
CRT 1	1	1
2	2	
3	3	
4	0	
L 1	1	1
2	2	
MM 1	1	1
2	2	

10. VERIFY MC 9 TABLE (GNC 9) FOR  
 POST LANDING

- 2: GNC 0 GPC MEMORY
- √CONFIG – ITEM 1 +9 EXEC
- Modify MC 9 per table →
- CONFIG – ITEM 1 +3 EXEC

TIG		1: SM TABLE MAINT	2: SM ANTENNA
-01:30	C,P	3: BFS, GNC DEORB MNVR COAST	
If OPS 2: A1(B1) AUTO PRI RT 0.2 DB 5.0		<u>OPS 2 TO 3 TRANSITION</u> <u>9</u> , 2-19 (Omit if BFS engaged or if already configured with G3 set) (If AV BAY FIRE, check deltas, 2-7)	
-01:25	C,P	GPS INCORPORATION (EPCL, <u>GNC</u> ) Omit if voice or cmd available	
If OPS 3: TRANS DAP AUTO RT 0.5 DB 3.5			
-01:20	P	<u>AUTO MNVR TO COMM ATT</u> Mnvr per MCC: R _____ P _____ Y _____	
-01:15	C,P MS MS MS	<u>ENT FWD FLT DECK CONFIG</u> <u>10</u> <u>ENT AFT FLT DECK CONFIG, MS AFT ACTIVITIES</u> <u>11</u> , 2-23 <u>ENT MIDDECK CONFIG, MS MID ACTIVITIES</u> <u>12</u> , 2-25 <u>PAYLOAD ENT SW LIST/VER</u> (PL OPS, <u>DEORBIT PREP</u> or SODF: ASSY OPS: DEORBIT PREP)	
-01:10		<p style="text-align: center;"><u>NOTE</u> If AV BAY FIRE, check deltas, 2-5 or 2-8 Deltas to ENT SW LIST/VER</p> <p>A12 APU HTR LUBE OIL LINE (three) – A AUTO</p> <p style="text-align: center;"><u>NOTE</u> √MCC for unaccounted-for sw or cb config discrepancies</p>	
-01:05	C P MS MS	<u>ENT SWITCH LIST/VER (FWD)</u> , 3-3 thru 3-9 <u>ENT SWITCH LIST/VER (FWD)</u> , 3-10 thru 3-13 <u>ENT SWITCH LIST/VER (AFT)</u> , 3-15 thru 3-26 <u>ENT SWITCH LIST/VER (MID)</u> , 3-27 thru 3-30	
-01:00			

<u>ENT FWD FLT DECK CONFIG</u> <u>10</u> (If AV BAY FIRE, check deltas, 2-5 or 2-8)	
C	FLASH EVAP CONFIG FLASH EVAP CNTLR PRI A – OFF B(A) – GPC
C,P	<u>ENTRY COMM</u> L,R AUD A/G 2 (two) – T/R
O8	<u>MLS CH</u> √MLS CH tw (three) – See LANDSITE DATA MLS (three) – ON
O17:A	<u>SSME HYD REPRESS PREP</u> ATVC (four) – ON
F6 O14:E O16:E	<u>CONTROL FOR ENTRY</u> ADI RATE – LO cb MNA DDU AFT – op MNC DDU AFT – op
R4 L4:J	<u>HYD HTR/SIG CONDR CONFIG</u> HYD BK HTR (three) – AUTO cb AC3 ΦA SIG CONDR HUM SEP – op ΦB SIG CONDR IMU FAN – op

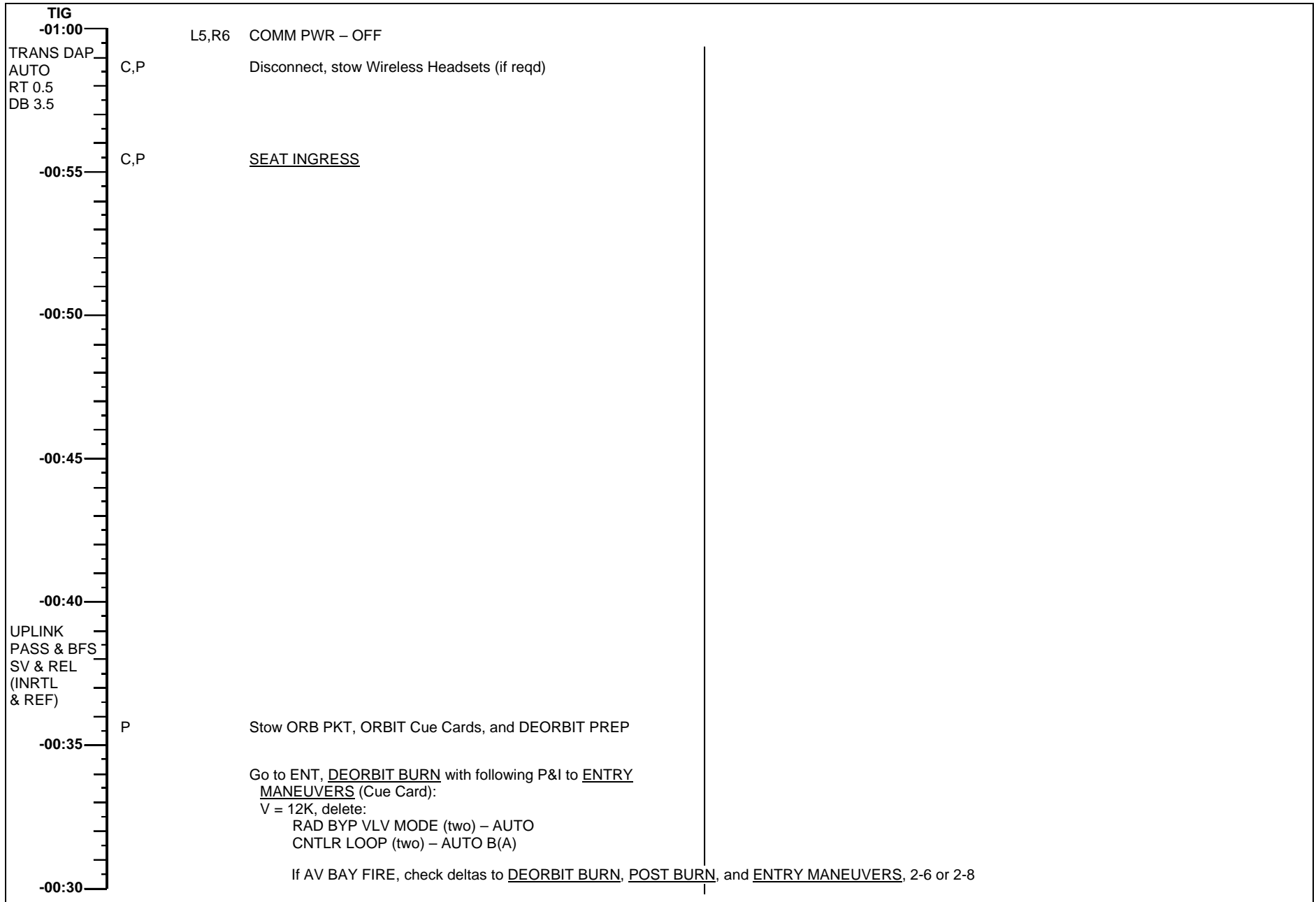

This Page Intentionally Blank

## MS LAUNCH DAY DEORBIT PREP AFT DECK ACTIVITIES (ORBIT 3)

### MS PULLOUT PAGE

#### NOTE

Wait for GO from CDR or PLT before starting any activity on this page

TIME (TIG-)	MS AFT ACTIONS
02:22	SEAT EGRESS
02:20	PGSC ACT (ORB OPS, <u>PGSC</u> ) Use flight deck PGSC
02:11	UNSTOW/DON WIRELESS HEADSETS (if reqd)
02:00	If reqd, PAYLOAD DEACT (PL OPS, <u>DEORBIT PREP</u> ) or PAYLOAD DEACTIVATION (SODF: ASSY OPS: DEORBIT PREP)
01:50	<u>AFT HTR CONFIG</u> <span style="border: 1px solid black; padding: 0 2px;">7</span>
01:14	<u>ENT AFT FLT DECK CONFIG</u> <span style="border: 1px solid black; padding: 0 2px;">11</span>
01:04	<u>ENT SWITCH LIST/VER (AFT)</u> , 3-15 thru 3-26

<u>AFT HTR CONFIG</u> <span style="border: 1px solid black; padding: 0 2px;">7</span>	
A12	HYD HTR (eight) – OFF
A14	RCS/OMS HTR FWD RCS – OFF L POD (two) – A OFF, B OFF R POD (two) – A OFF, B OFF OMS CRSFD LINES (two) – B AUTO, A AUTO √FWD, AFT RCS JET (ten) – AUTO
R11U	√FC PURGE VLVS (three) – GPC √HTR – GPC √H2O LINE HTR – A AUTO
<b>NOTE</b> MCC command FC PURGE HTR off, if reqd	

<u>ENT AFT FLT DECK CONFIG</u> <span style="border: 1px solid black; padding: 0 2px;">11</span>		
A1L	<u>ENTRY COMM CONFIG</u> S-BD PM MODE – STDN LO NSP CODING (two) – OFF	
A1R	AUD CTR VOICE RCD SEL CH 1 sel – ICOM A 2 sel – ICOM B	
A13	OS AUD SPKR PWR – OFF	
A15	PS COMM CCU PWR – as reqd	
R14:C	cb MNB KU ANT HTR – op UHF EVA (two) – op	
R10	MS AUD A/G 2 – T/R A/A – T/R	
L9	PS AUD PWR – AUD/TONE A/G 1 – T/R A/A – T/R ICOM (two) – T/R	
ML86B:A R11L	<u>H2O STORAGE SYS CONFIG</u> √cb MNC SPLY H2O XOVR VLV – cl SPLY H2O XOVR VLV – OP (tb-OP)	
<u>RESET C/W</u>		
R13U		
PARAMETER NAME	C/W CH	UPPER LIMIT
FREON LOOP EVAP OUT T1	107	1.90V/64.8 degF
T2	117	1.90V/64.8 degF
A16	√Secure	
R10	√MS LTG FLOOD as reqd	
<u>FOOT LOOP CONFIG</u> Tape Foot Loops in egress routes		

**Back of MS LAUNCH DAY DEORBIT PREP AFT DECK ACTIVITIES  
(ORBIT 3)  
MS PULLOUT PAGE**

**MS LAUNCH DAY DEORBIT PREP MIDDECK ACTIVITIES  
(ORBIT 3) MS PULLOUT PAGE**

**MS PULLOUT PAGE**

NOTE

Wait for GO from CDR or PLT before starting any activity on this page

TIME (TIG-)	MS MIDDECK ACTIONS
02:22	<u>SEAT EGRESS</u>
02:14	<u>PRESS H2O TK A</u> [ 3 ]
02:11	UNSTOW/DON WIRELESS HEADSETS (if reqd)
01:14	<u>ENT MIDDECK CONFIG</u> [ 12 ]
01:04	<u>ENT SWITCH LIST/VER</u> (MID), 3-27 thru 3-30

<u>PRESS H2O TK A</u> [ 3 ]	
ML26C	SPLY H2O GN2 TK VENT vlv – PRESS TKA SPLY vlv – OP
<u>NOTE</u> Disregard possible 'S66 WASTE H2O PRES' fault msg	

<u>ENT MIDDECK CONFIG</u> [ 12 ] (If AV BAY FIRE, check deltas, 2-5 or 2-8)	
ML31C	VAC VENT ISOL VLV CNTL – CL (tb-CL) NOZ HTR – OFF
MO42F	<u>ENTRY COMM CONFIG</u> MIDDECK SPKR AUD A/G 2 – T/R  Stow: Comm Equip Wireless Headsets
MO13Q	√LOCKERS secure √MIDDECK FLOODS as reqd
ML85E	AC S1 – OFF
MO69M MO32M	<u>MIDDECK PCS</u> LEH O2 7,8 vlv (two) – as reqd LEH O2 6 vlv – as reqd
<u>EGRESS ROUTE CONFIG</u> Tape Foot Loops in egress routes	

**Back of MS LAUNCH DAY DEORBIT PREP MIDDECK ACTIVITIES  
(ORBIT 3)  
MS PULLOUT PAGE**



## ENTRY SWITCH LIST/VERIFICATION

### LEFT SEAT

L5.....	3-3
L4.....	3-3
L1.....	3-4
F3.....	3-4
L,R HUD.....	3-4
L2.....	3-5
F1.....	3-5
F2.....	3-6
F6.....	3-6
F7.....	3-6
C2.....	3-7
C3.....	3-7
O1.....	3-8
O2.....	3-8
L side OVHD flood...	3-8
O5.....	3-8
O6.....	3-9
O7.....	3-9

### RIGHT SEAT

O8.....	3-10
O9.....	3-10
R side OVHD flood ..	3-10
O3.....	3-11
F4.....	3-11
F8.....	3-11
F9.....	3-11







### RIGHT SEAT (Cont)

R1.....	3-12
R2.....	3-13
R4.....	3-13
R6.....	3-13

### AFT

O13.....	3-15
O14.....	3-15
O15.....	3-15
O16.....	3-16
O17.....	3-16
O19.....	3-17
C6.....	3-17
C5.....	3-17
C7.....	3-17
R10.....	3-18
R11U.....	3-18
R11L.....	3-18
R13U,L.....	3-19
R14.....	3-19
A1U,L,R.....	3-20
A4.....	3-21
A3.....	3-21
A6U.....	3-21
A7U.....	3-21
A7L.....	3-22
A8U,L.....	3-23
A11.....	3-24
A12.....	3-24
A13.....	3-24
A6L.....	3-25
A6.....	3-25
A14.....	3-26
A15.....	3-26
L9.....	3-26

### LEGEND

	- left		
	- right		
	- up	R - as reqd	
	- center		- cb close
	- down		- cb open

 indicates switch/display not checked during ENT SWITCH LIST/VERIFICATION

### CIRCUIT BREAKER SNAPPING COLOR CODES

<u>COLOR</u>	<u>CONFIGURATION</u>
Red	Open at all times
Green	Open on orbit only
Yellow	Open ascent, close per procedure
Orange	Open orbit through entry
Blank (no ring)	Always closed or as reqd

**ENT SW  
LIST/VER**

**MIDDECK FWD**

MO42F.....	3-27
MO58F.....	3-27
MO32M.....	3-27
MO39M.....	3-27
MO69M.....	3-27
MO29J.....	3-27
MO52J.....	3-27
MO30F.....	3-27
MO62M.....	3-27
MO63P.....	3-27 (OV104)
ML86B.....	3-28

**MIDDECK FWD (Cont)**

MD44F.....	3-29
MD24K.....	3-29

**MIDDECK AFT**

MA73C.....	3-28
MO13Q.....	3-29
ML18F.....	3-29
ML26C.....	3-29
ML31C.....	3-29
MO10W.....	3-30
WCS.....	3-30

**AIRLOCK**

AW18A.....	3-31
AW18D.....	3-31
AW18H.....	3-31
AW82A.....	3-31
AW82B.....	3-31
AW82D.....	3-31
AW82H.....	3-31
INNER HATCH.....	3-32

OV103

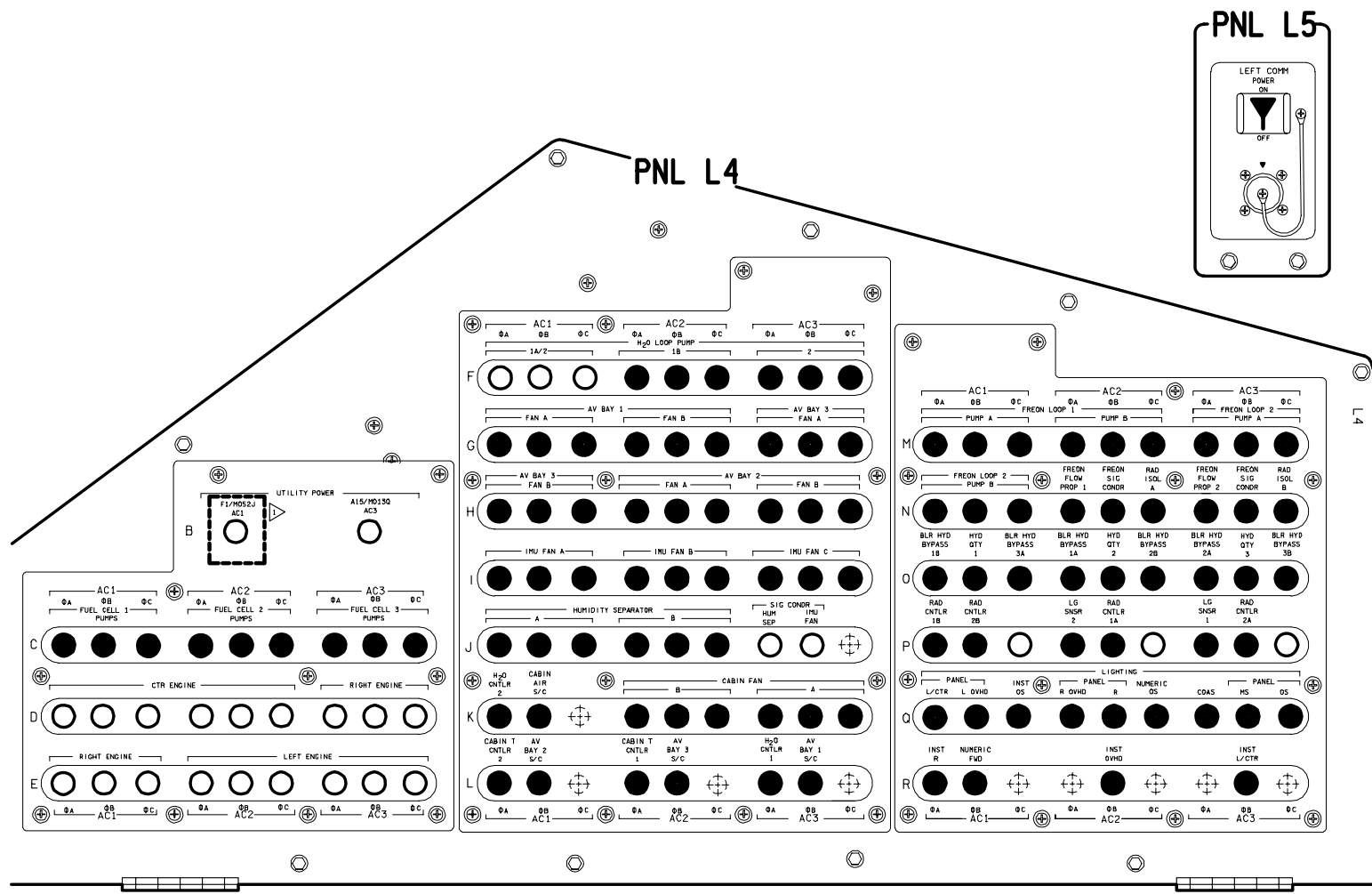

NOTE: ▷ CB CAN REMAIN CLOSED FOR AC PGSC USAGE.  
 OPEN WHEN PGSC UNPOWERED/STOWED

OV103

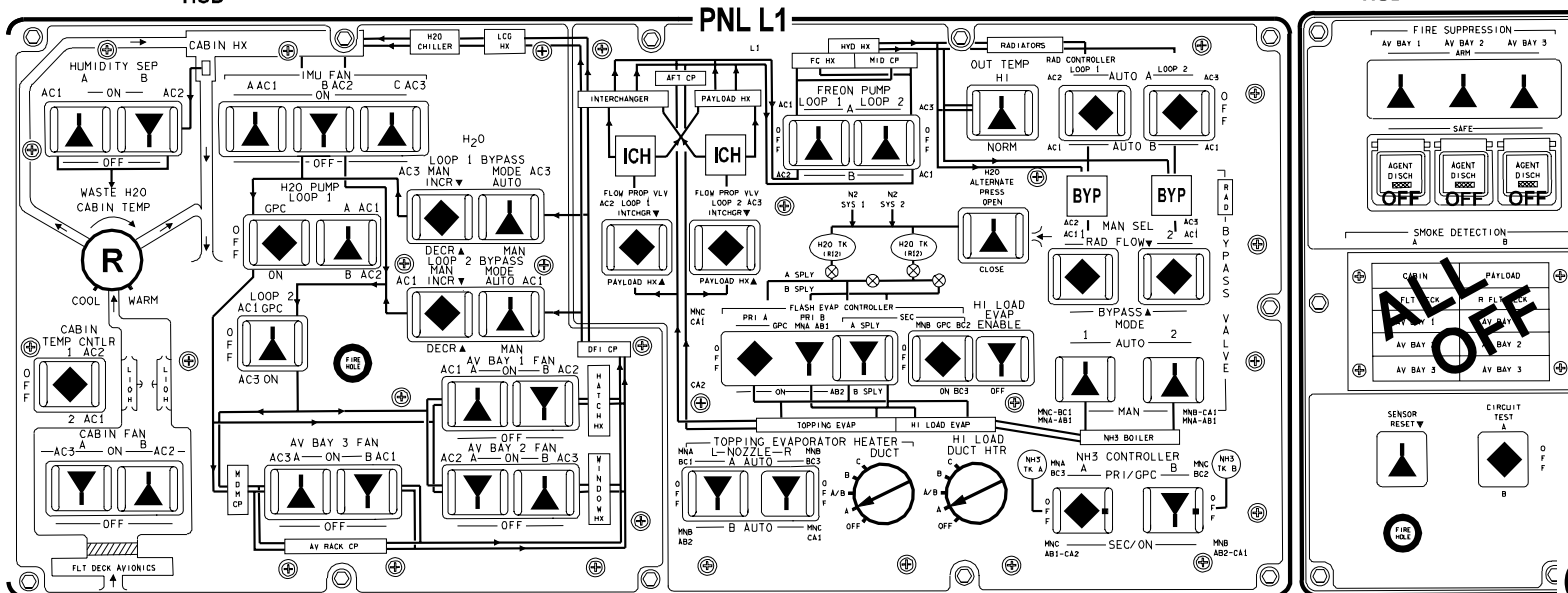
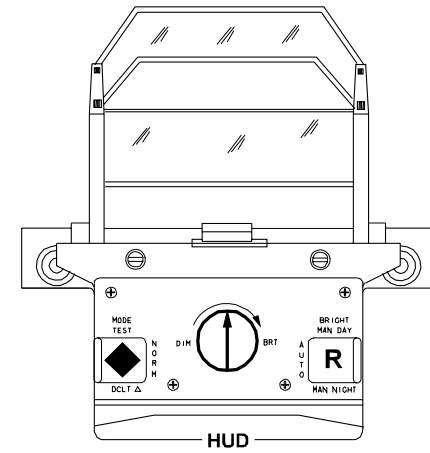
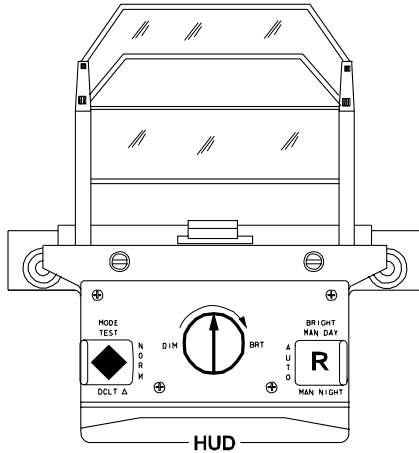
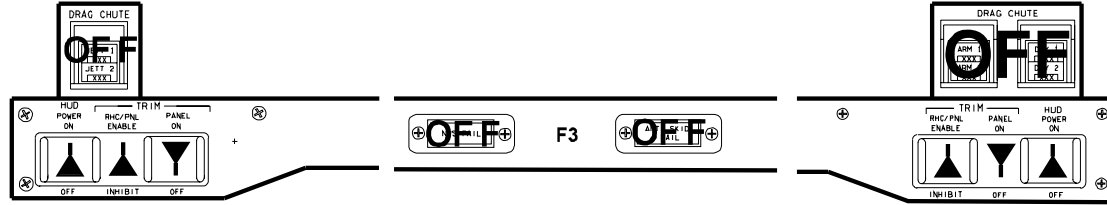

48007E304\_121, PNL: 2

OV103/DATE 09/30/05

OV103

(OV103) A3-4

C D/O/ALL/GEN M

OV103

PNL L2

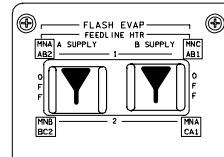
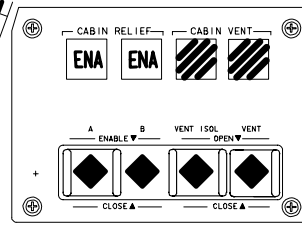

L2

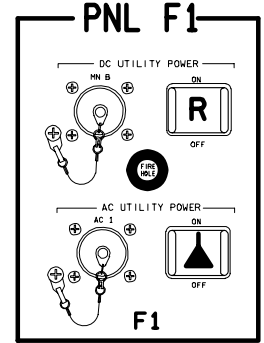
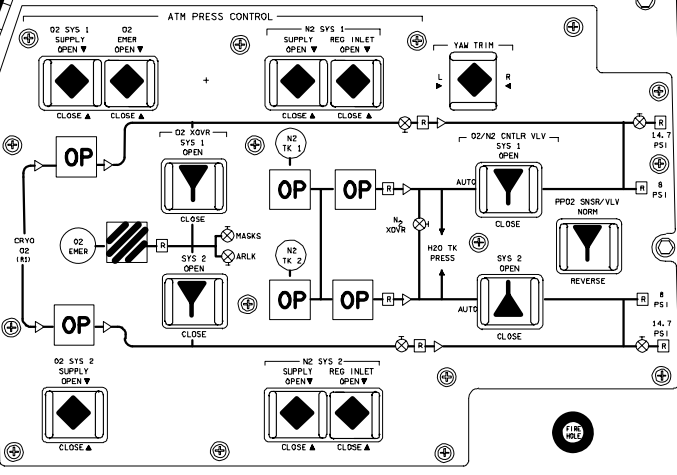
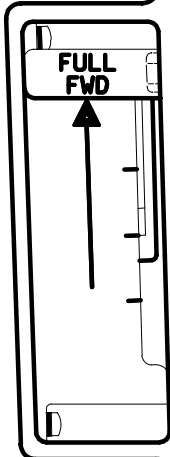
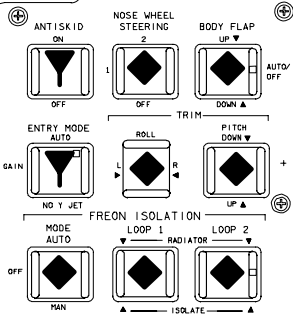

OV103

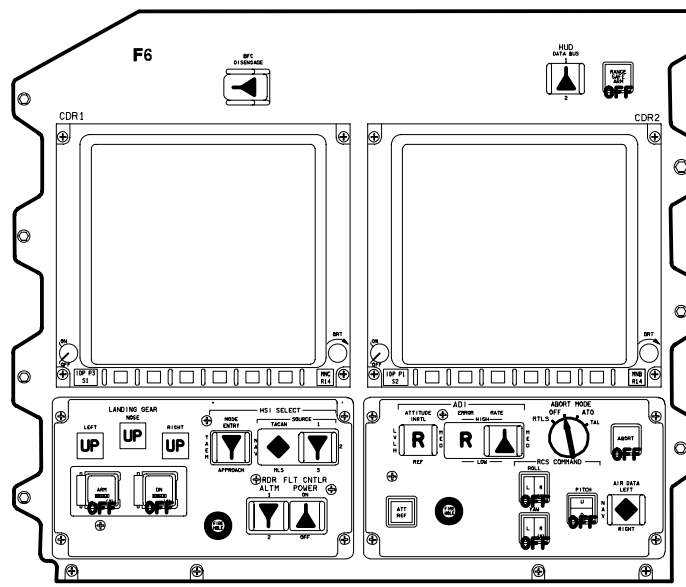
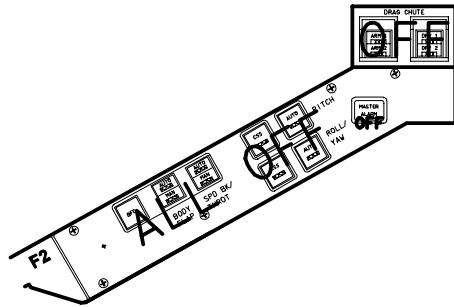
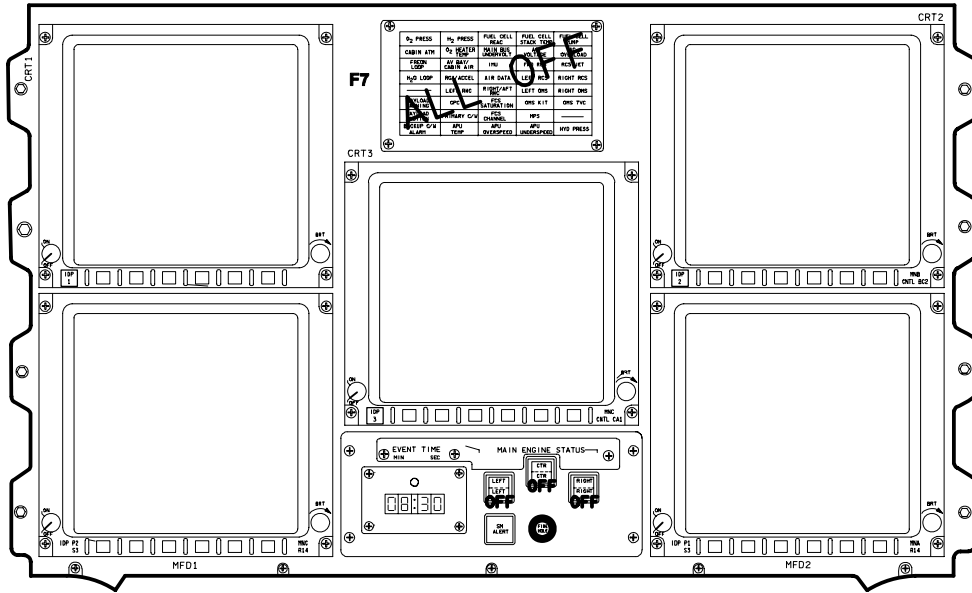

OV103/DATE 06/22/05 4800TES06\_114\_PNL\_4

(OV103) A3-6

OV103  
C D/O/ALL/GEN M

PNL C2/C3

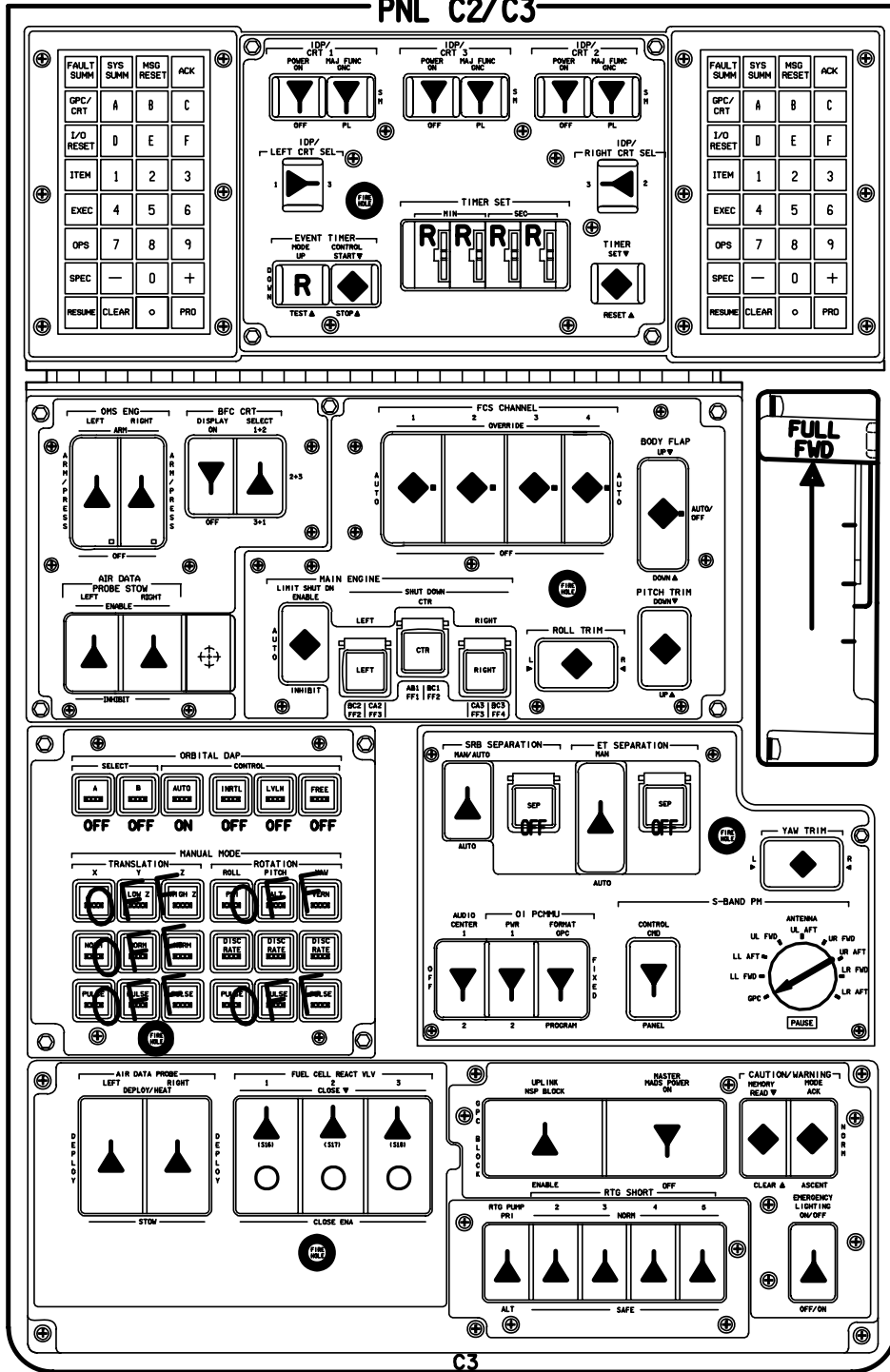

OV103

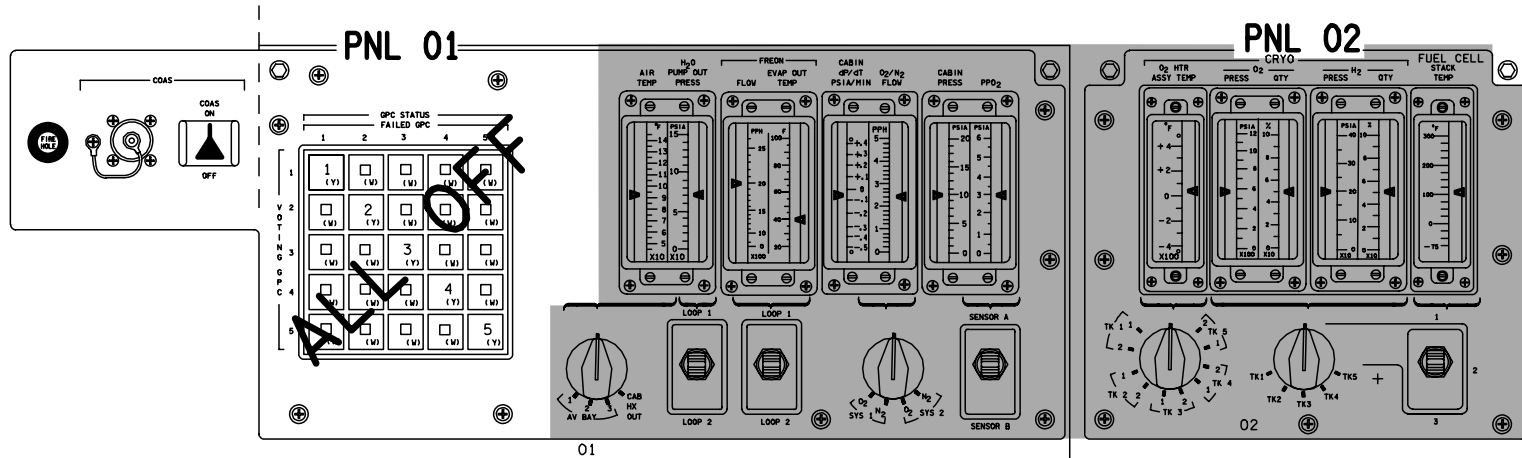

L side OVHD flood - R (MID)

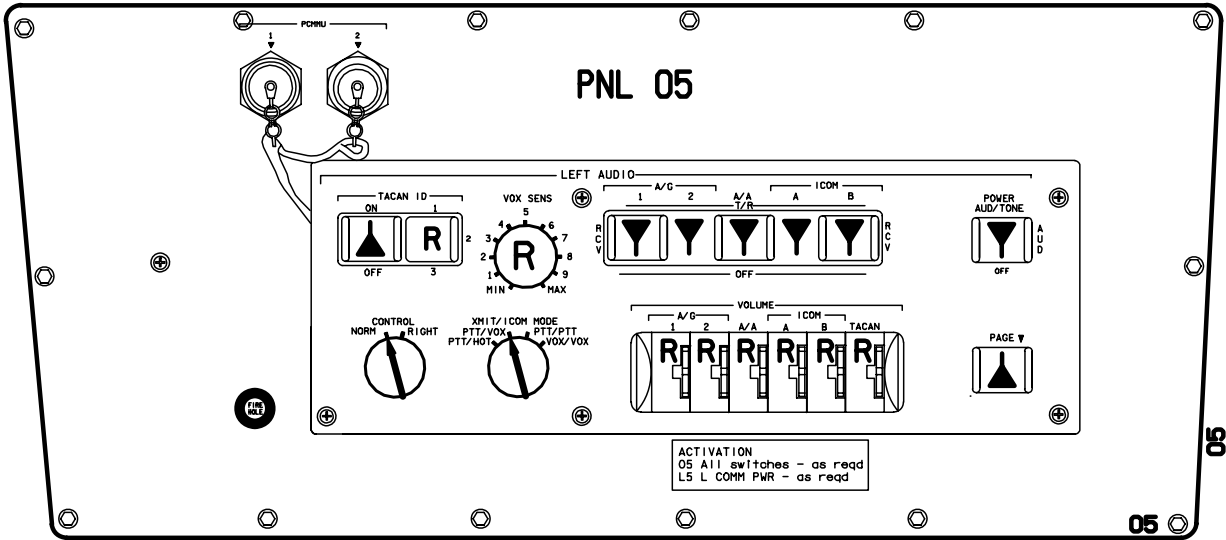



OV103

PNL 06

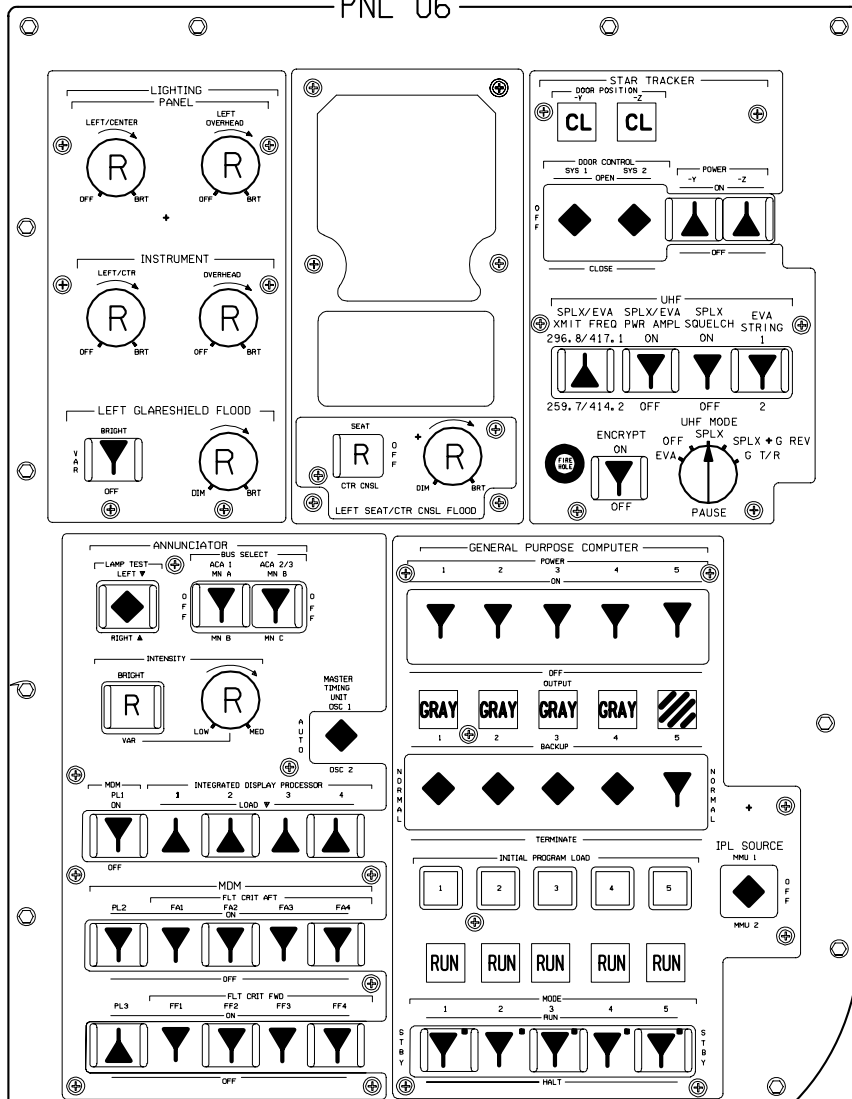

PNL 07

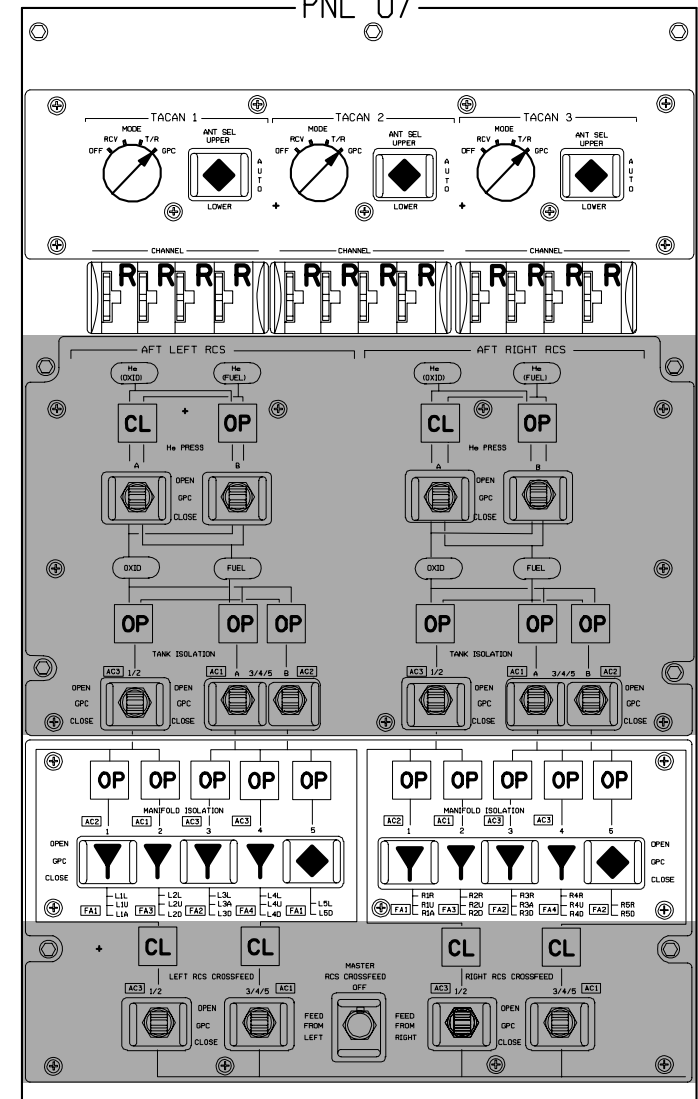

OV103

PNL 08

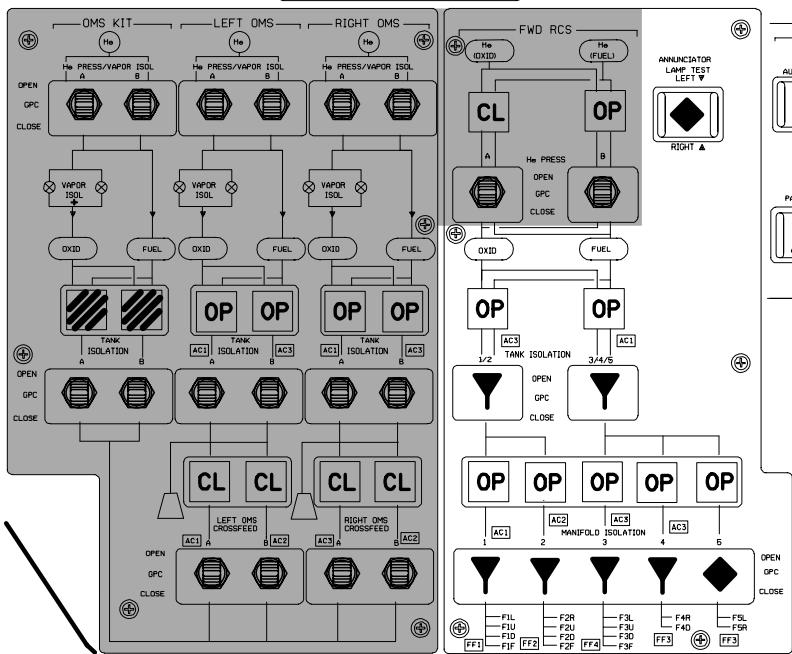
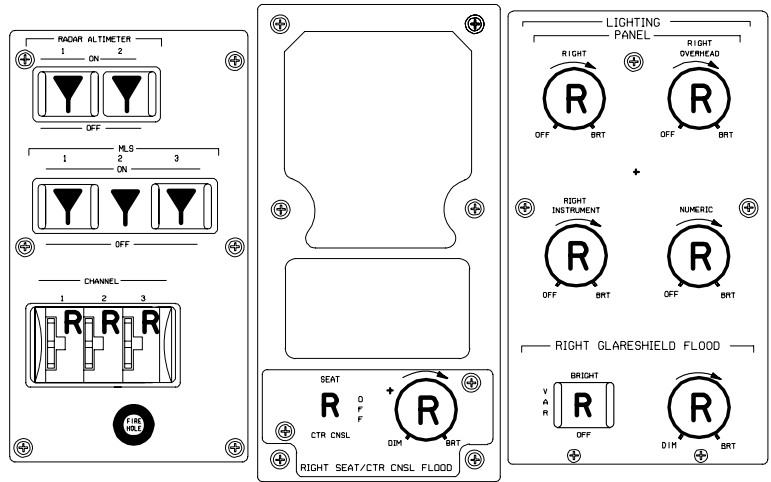

PNL 09

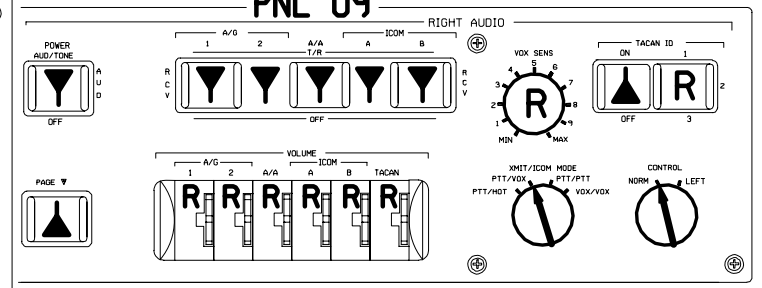

ACTIVATION  
 09 R AUD PWR - AUD/TONE  
 All other sws - as reqd  
 R6 R COMM PWR - as reqd

R side OVHD flood - R (MID)

OV103

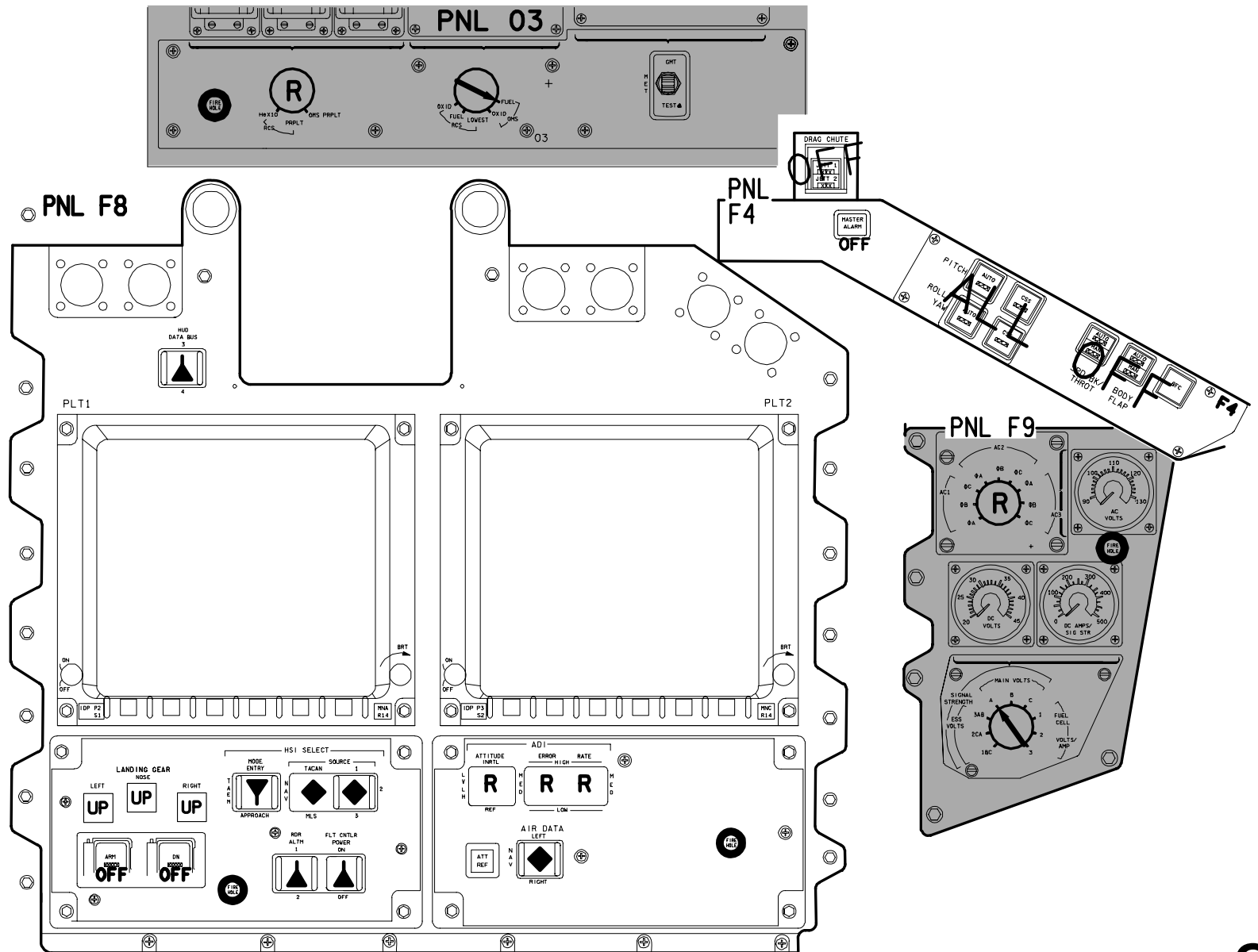

OV103

OV103

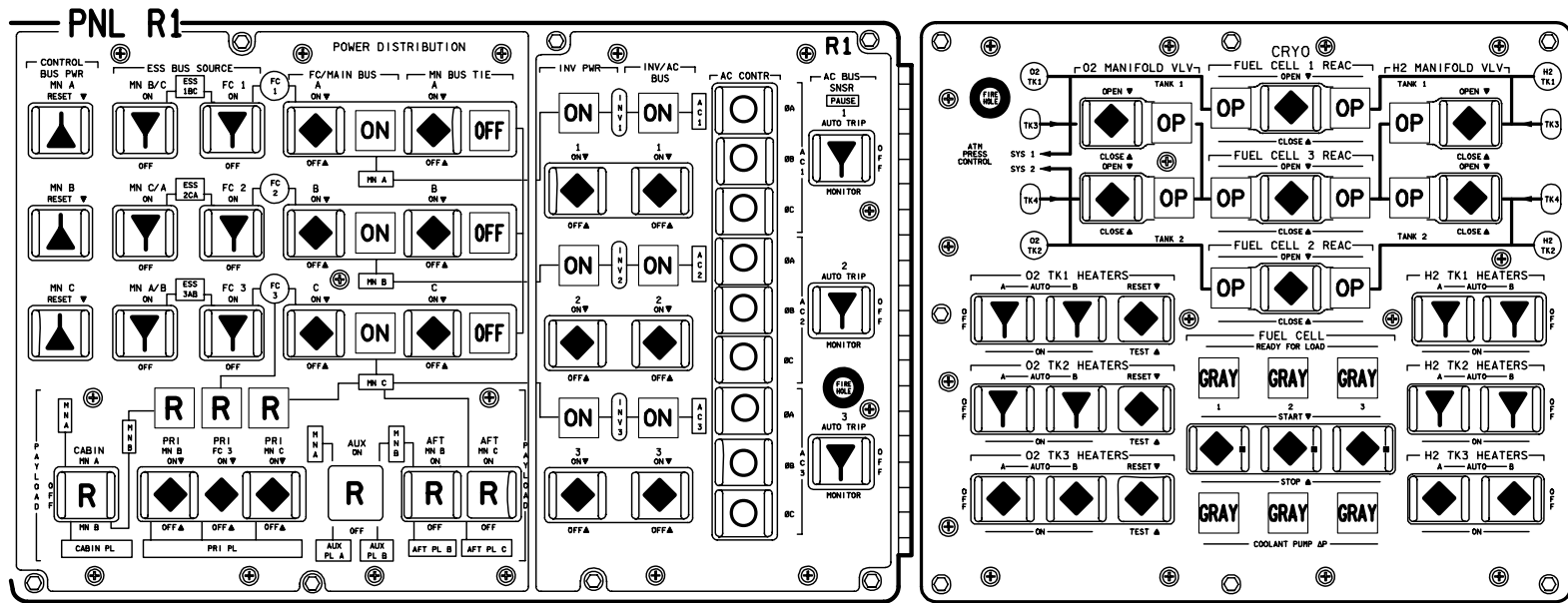

OV103

OV103

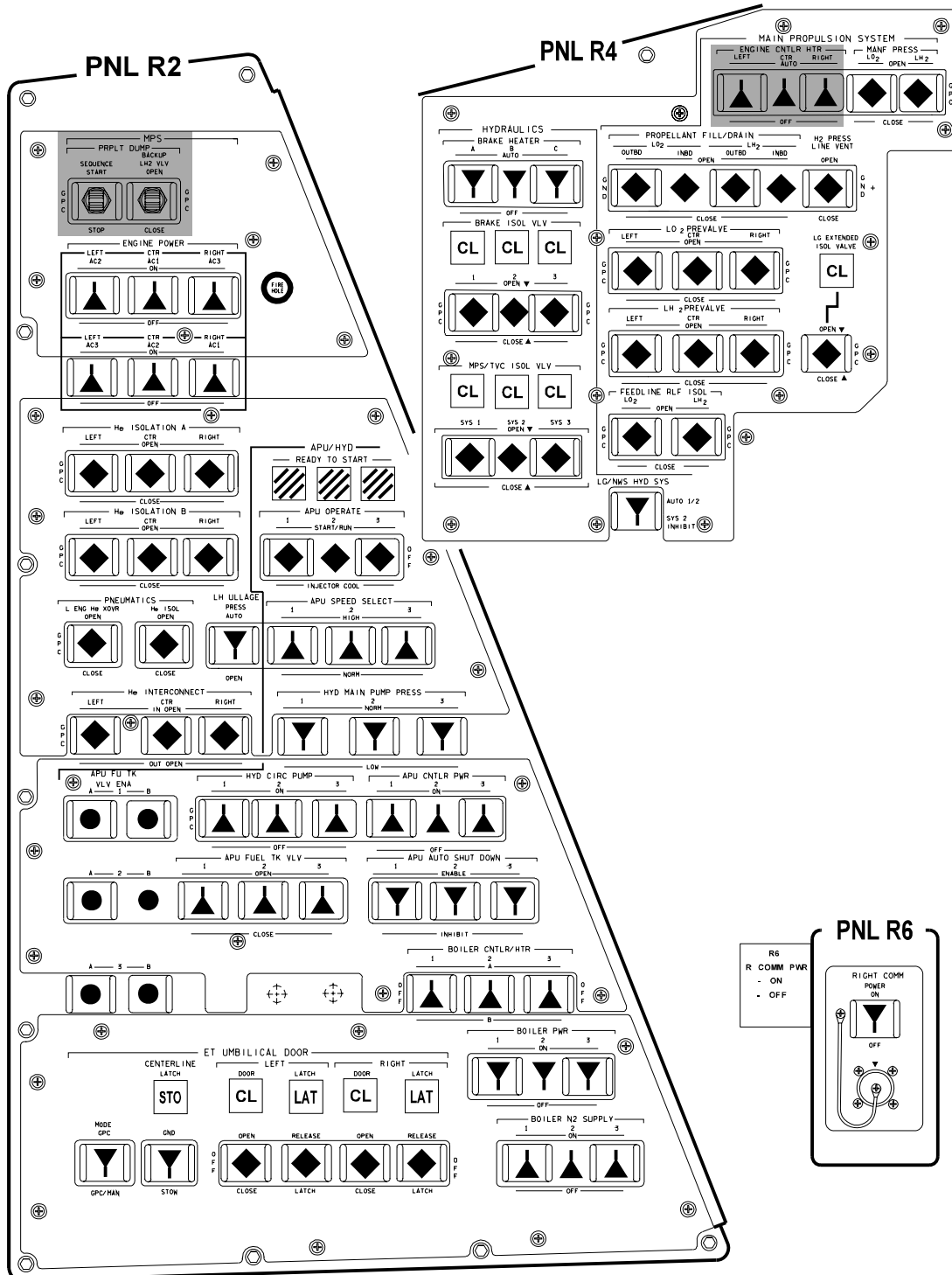

ALL VEH/DATE 07/28/06 48007E313\_115\_PNL 2

This Page Intentionally Blank

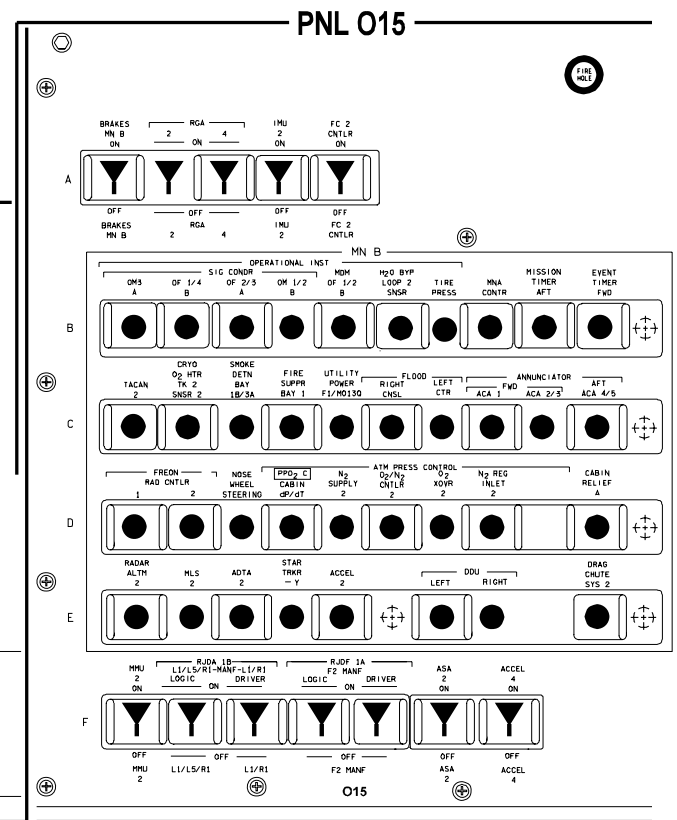
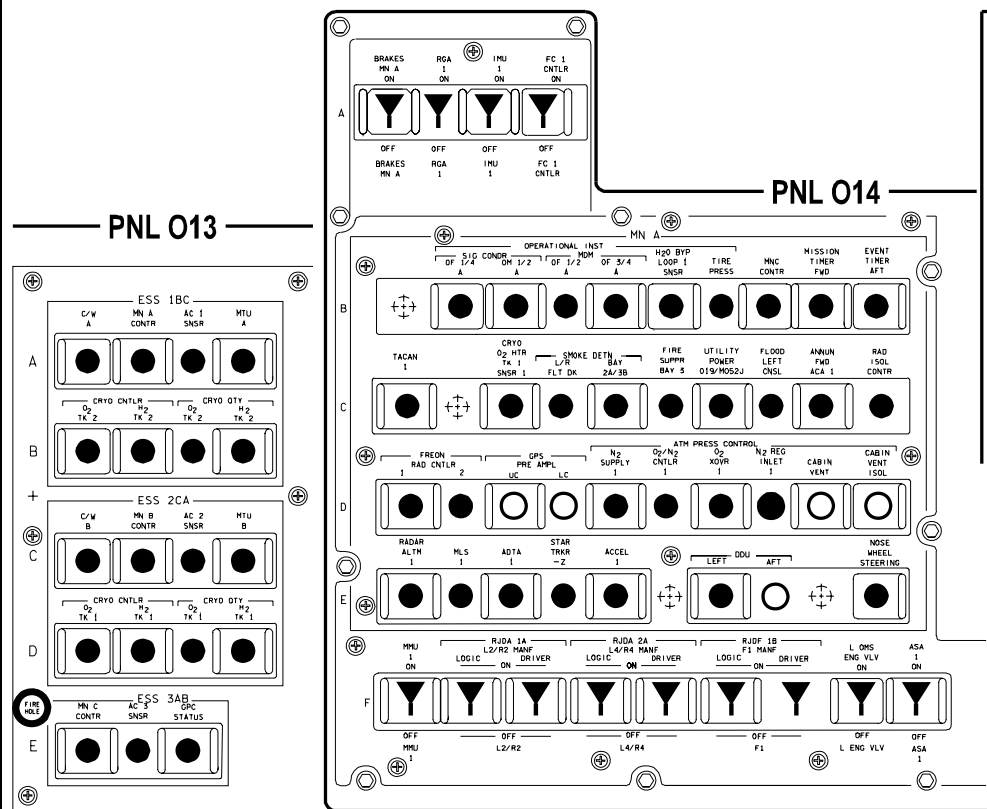

OV103

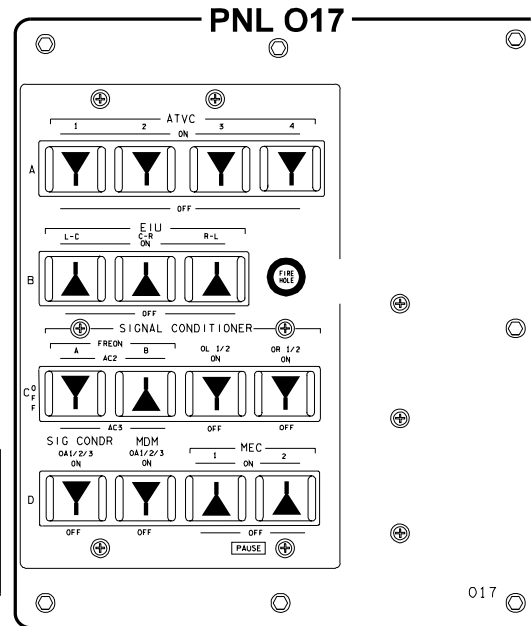
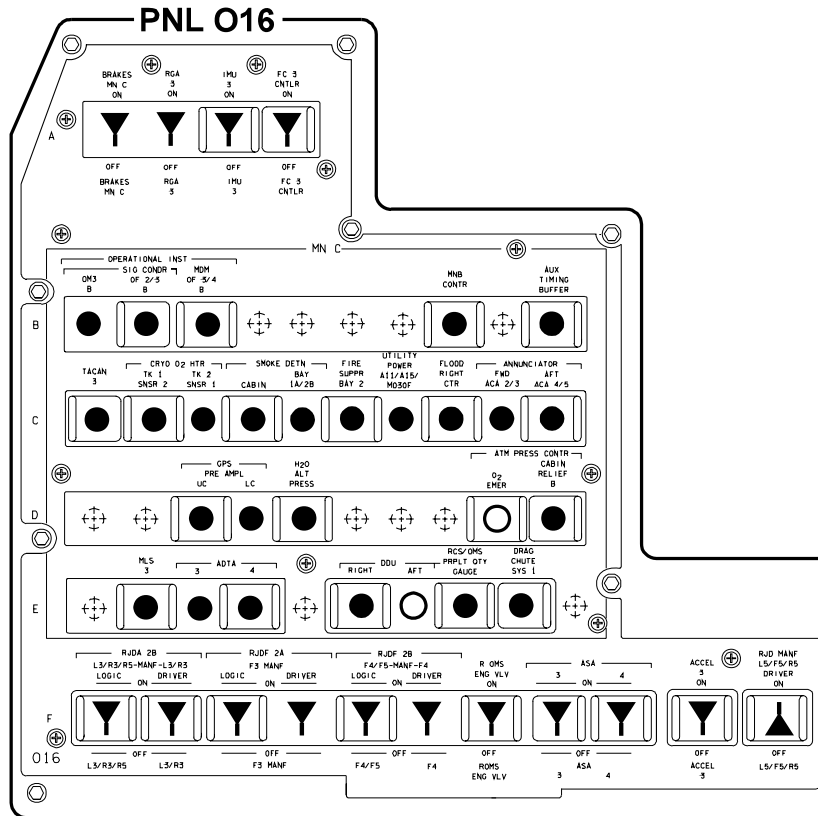



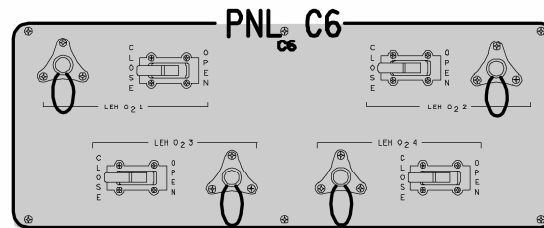
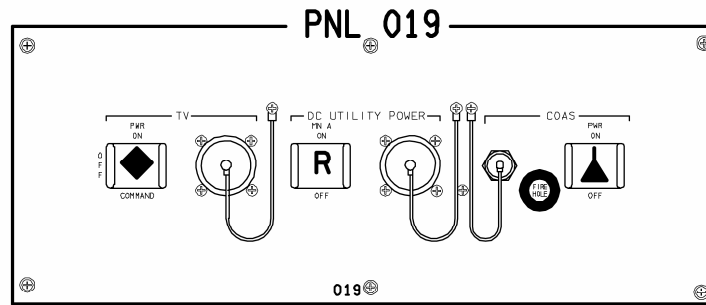

PNL C5

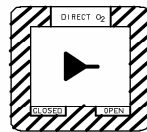

PNL C7

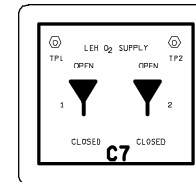

OV103

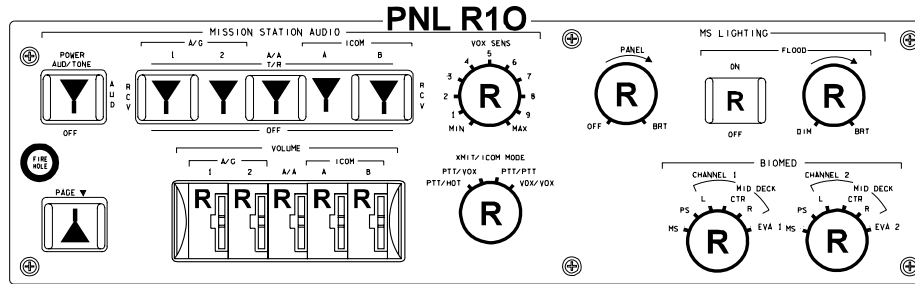

ACTIVATION  
 R10 MS AUD PWR - AUD/TONE  
 All other sws - as reqd  
 R12 MS AUD CNTL - NORM  
 A11 MS COMM CCU PWR - ON

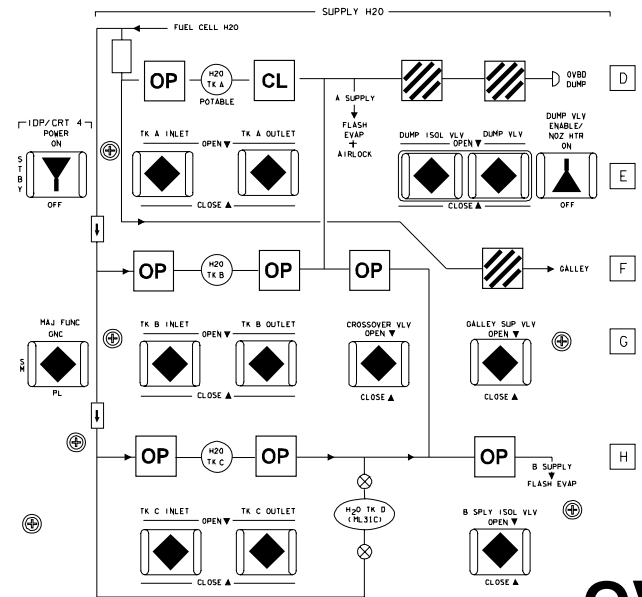
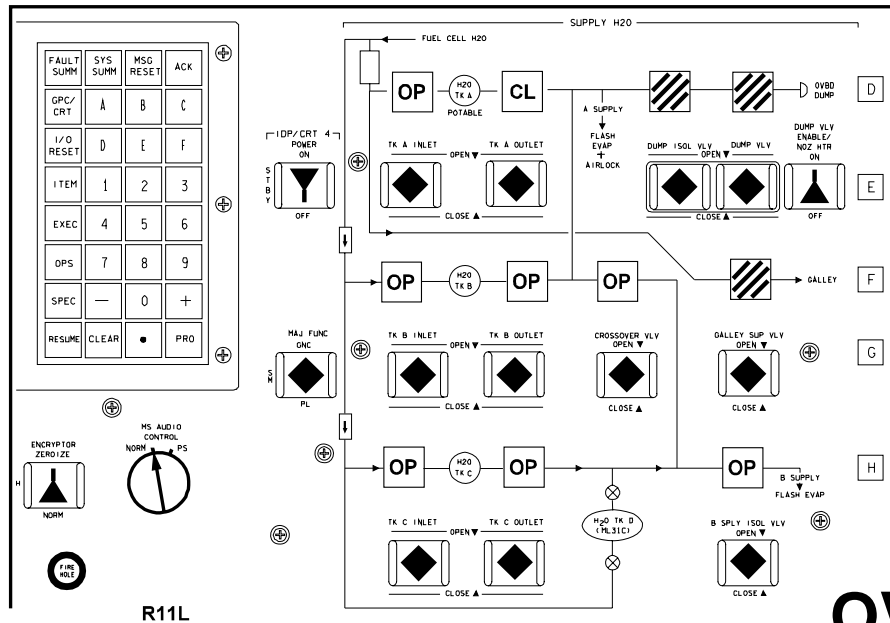
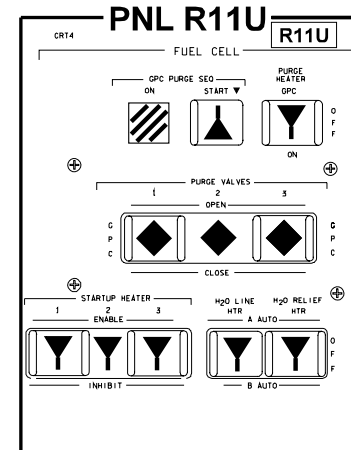

OV103

OV103

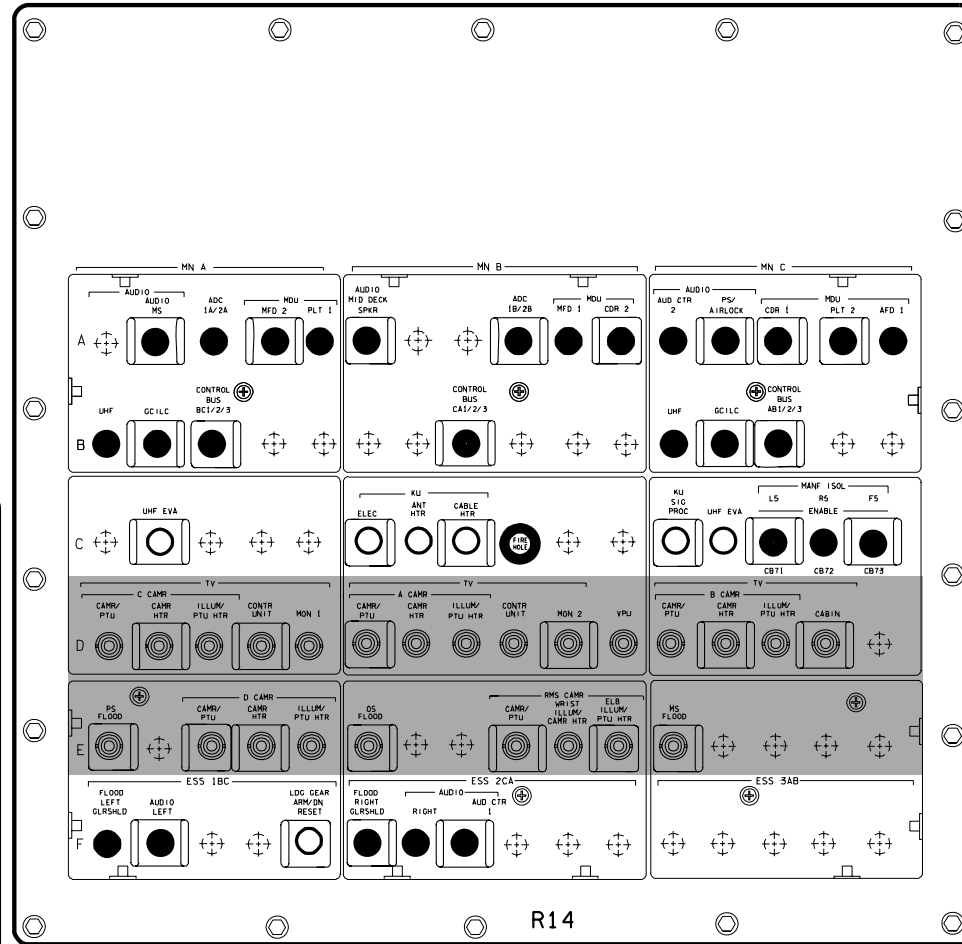
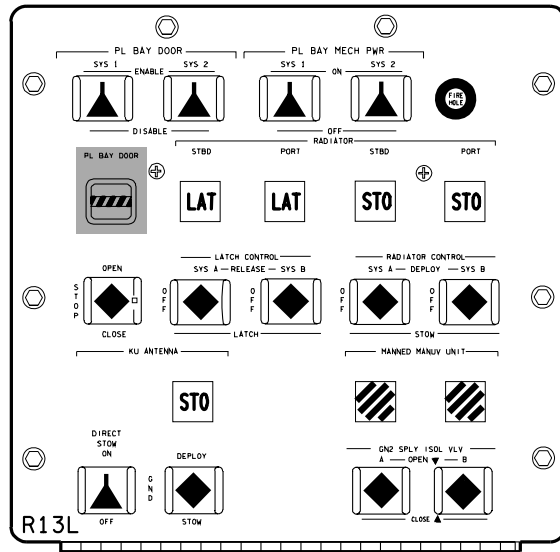
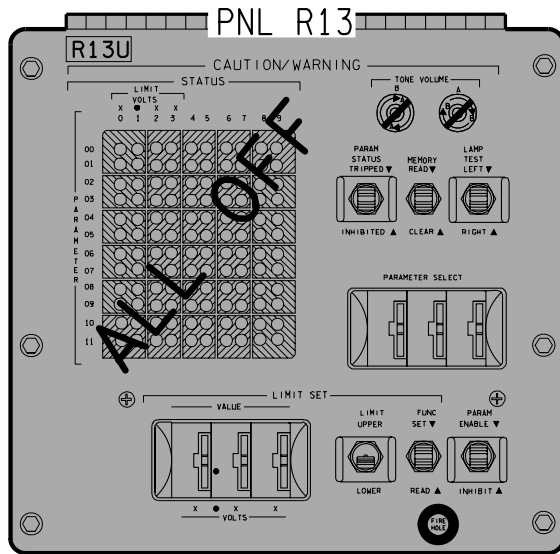

OV103

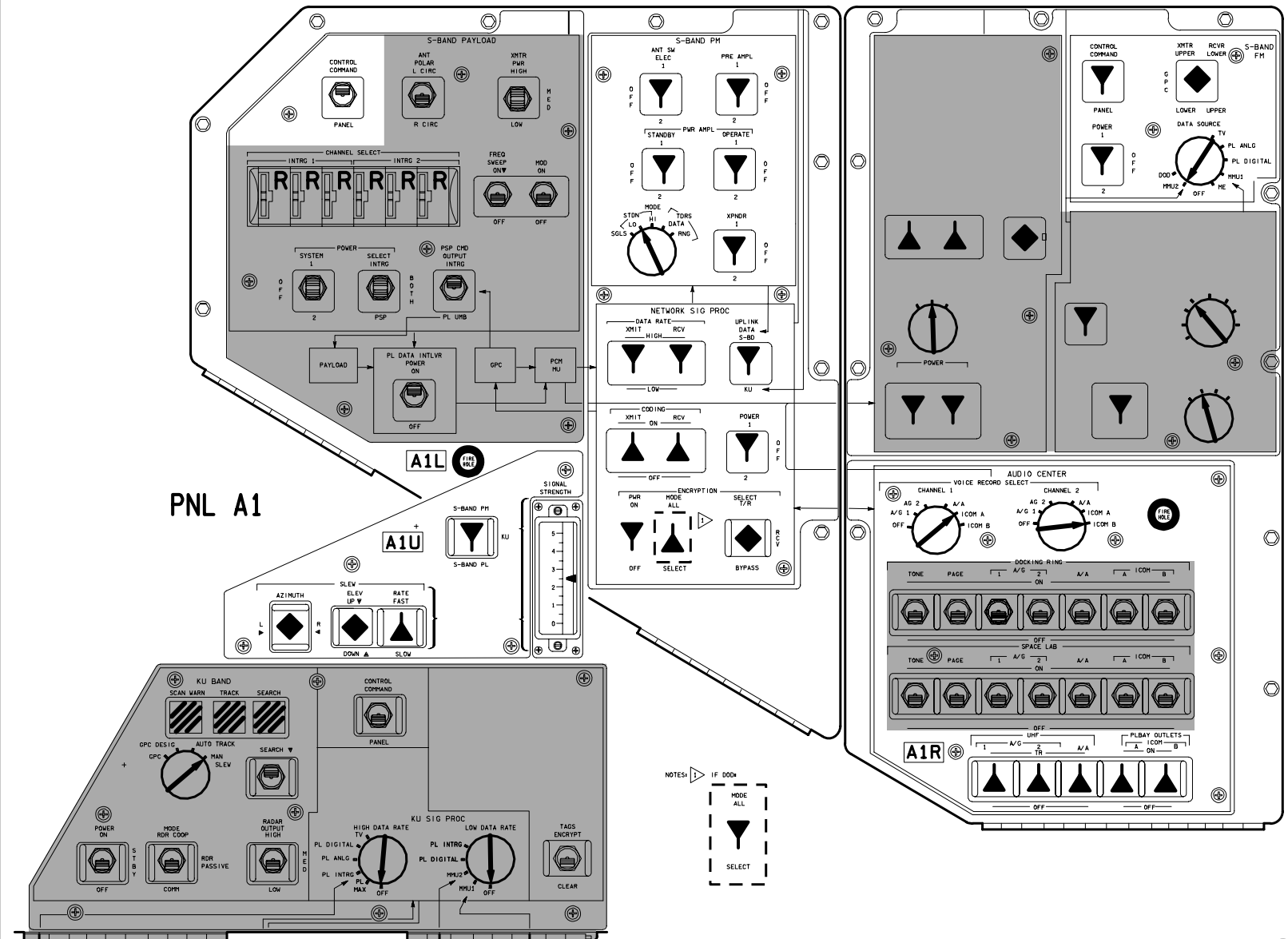

PNL A1

A1L

A1U

A1R

OV103

**PNL A4**

MISSION TIME

DAY: 365:23:59:55

EVENT TIME

MIN: 59:59

**PNL A3**

CONTRAST BRIGHTNESS

MON 1

CONTRAST BRIGHTNESS

MON 2

FAULT OFF

TEST A

**PNL A6U**

ORBITAL CAP CONTROL

AUTO INRTL LVLH FREE

MANUAL MODE

TRANSLATION Z ROLL ROTATION PITCH YAW

FLIGHT INSTRUMENT NUMERIC

ANNUNCIATOR

INSTRUMENT NUMERIC

PAYLOAD RETENTION LATCHES

READY TO LATCH

LAT LAT LAT LAT LAT

RELEASE LATCH

EVENT TIMER

MIN SET SEC

MODE UP CONTROL START TIMER SET

TESTA STOPA RESETA

**ALL OFF**

**PNL A7U**

MASTER ALARM OFF

PAYLOAD BAY FLOOD

STBD ON PORT

DOCKING BRIGHT

WIRELESS VIDEO HEATER

CAMERA POWER

CONTROL CONTR UNIT

VIDEO INPUT

VIDEO OUTPUT

CAUTION CLOSE CENTERLINE TRUSS CAMERA PRIOR TO POWERDOWN

CAMERA COMMAND

PAN TILT FOCUS ZOOM IRIS TILT PAN

WIRELESS VIDEO HEATER

**ALL OFF**

OV103

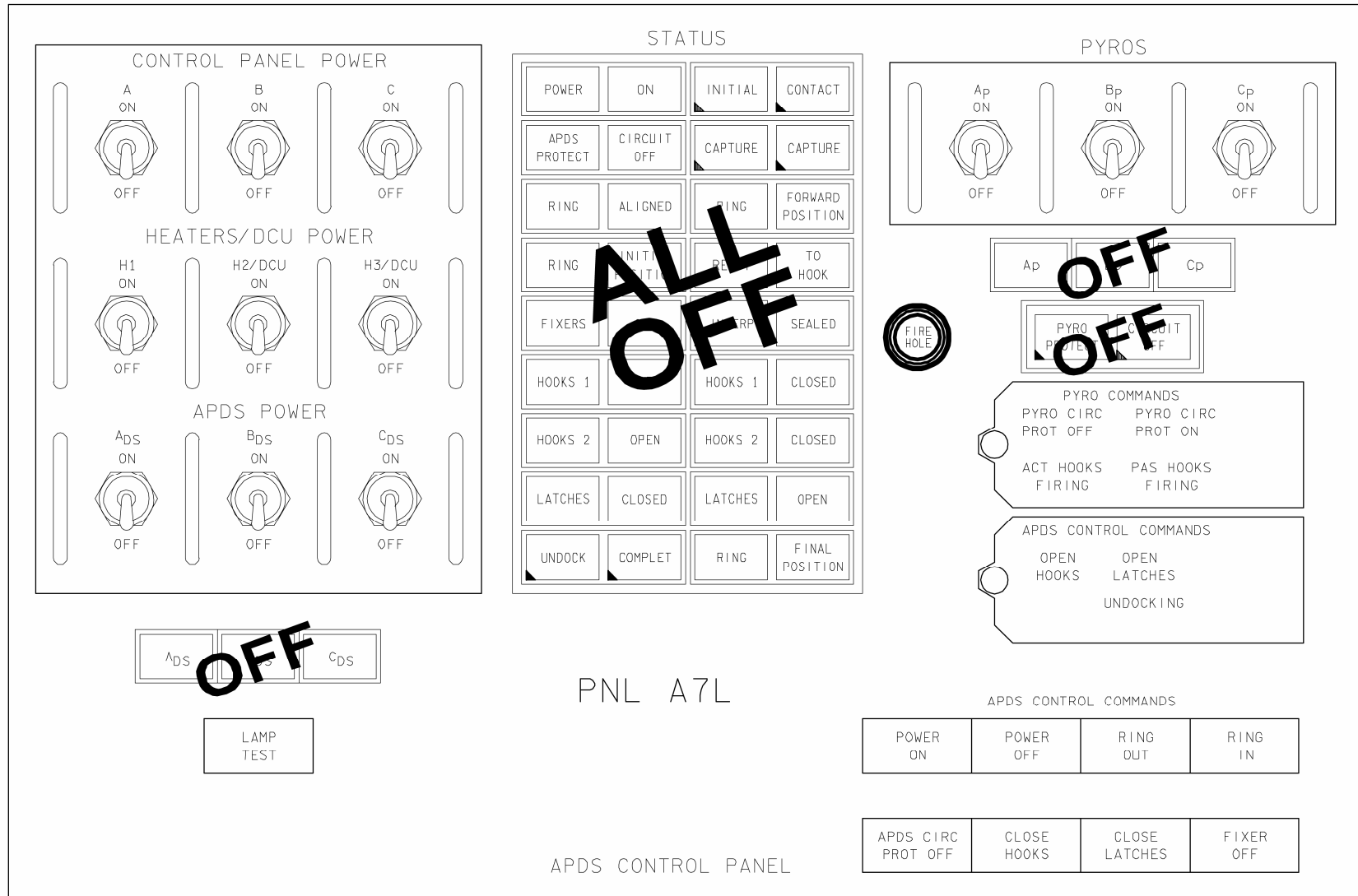

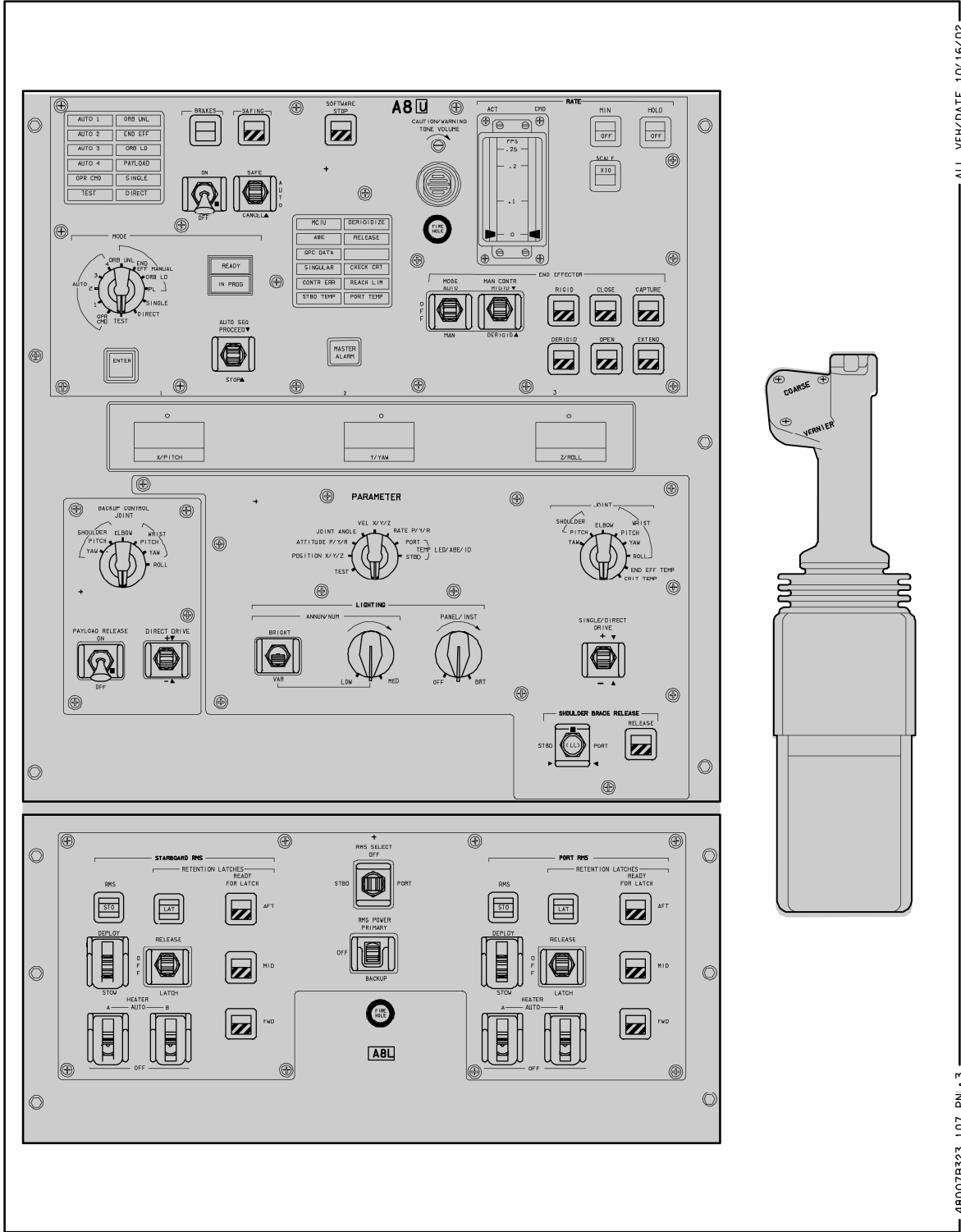

ALL VEH/DATE 10/16/02

48007B523\_1107\_PN1\_3

OV103

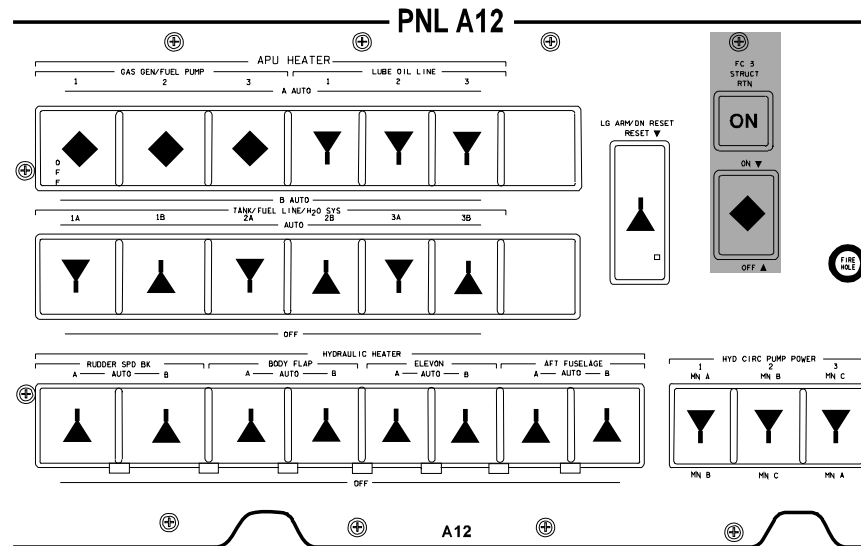
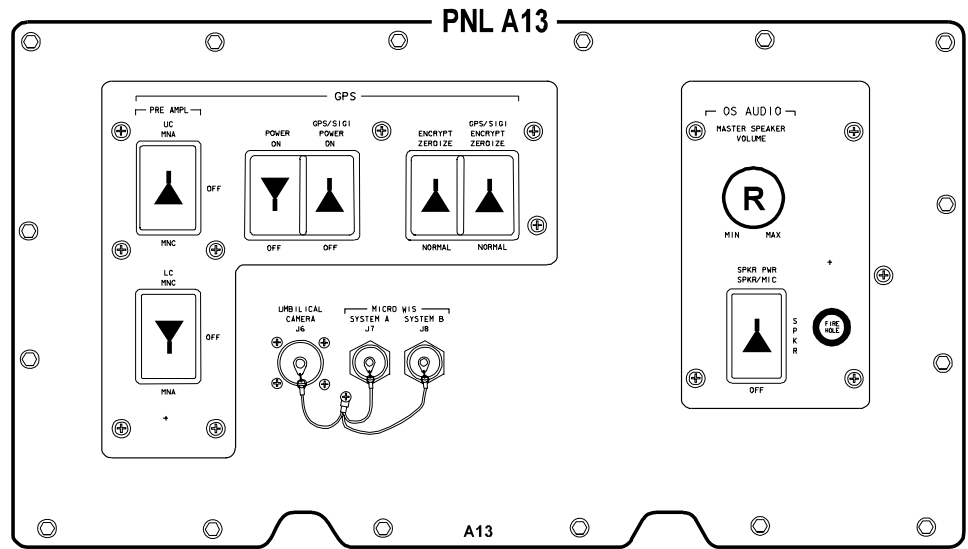
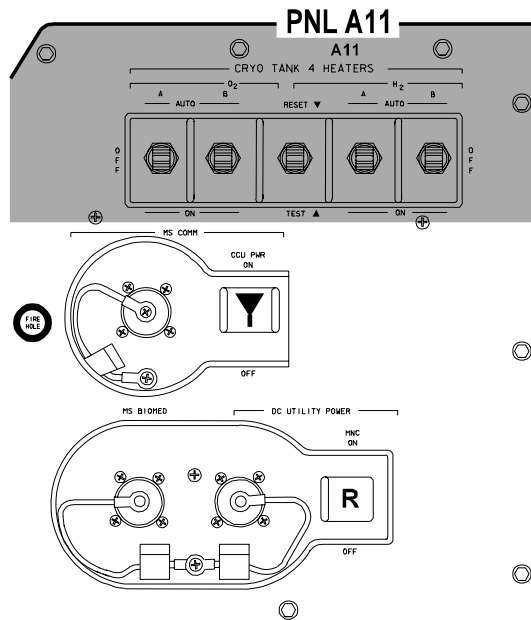

OV103



OV103

### A6L

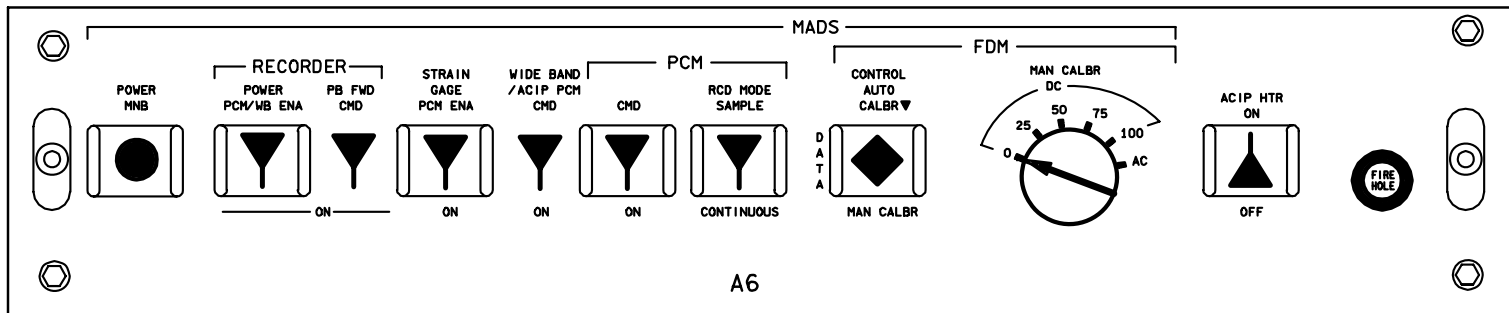
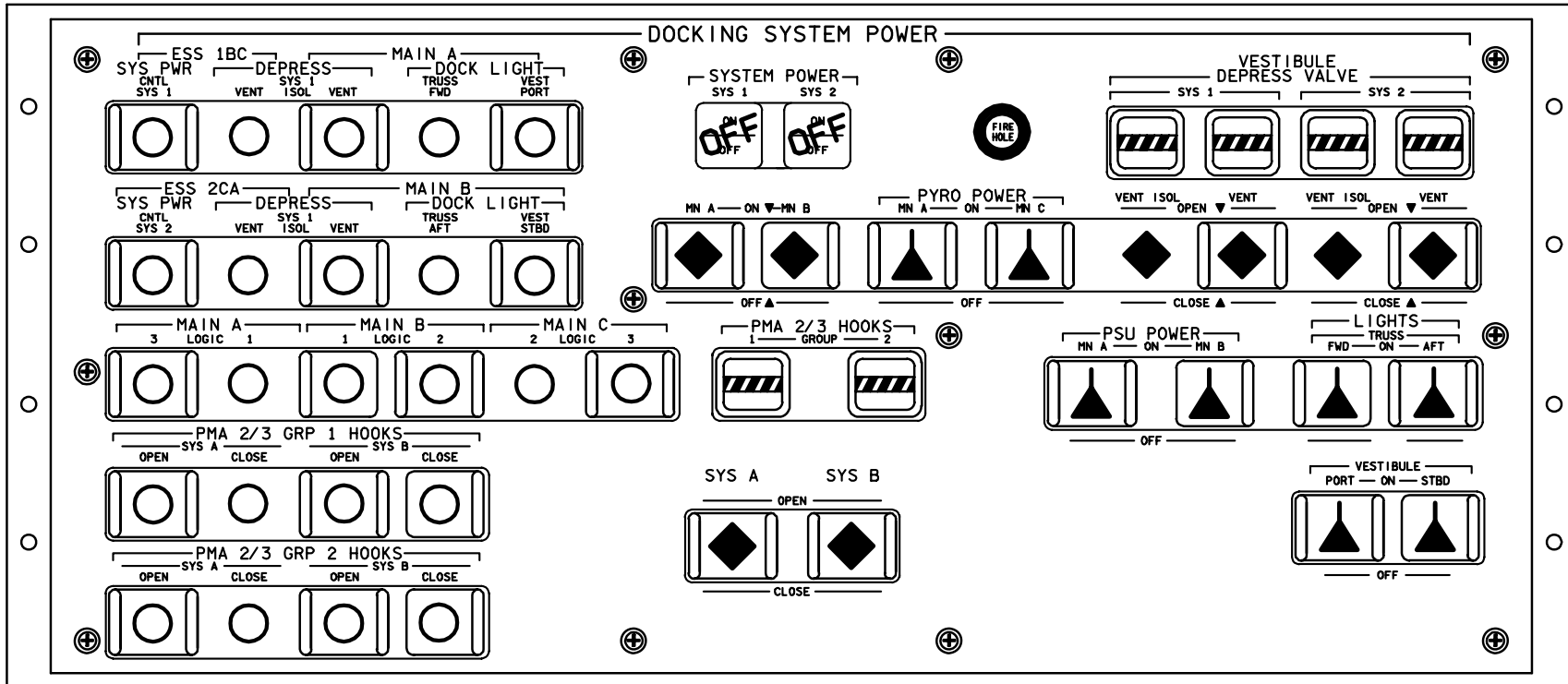

### A6

# OV103

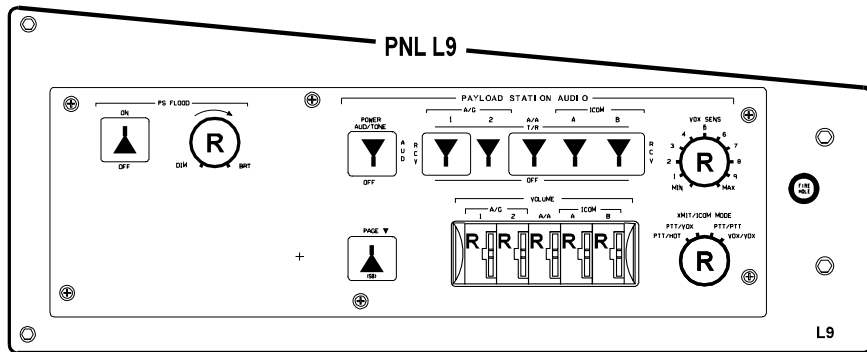
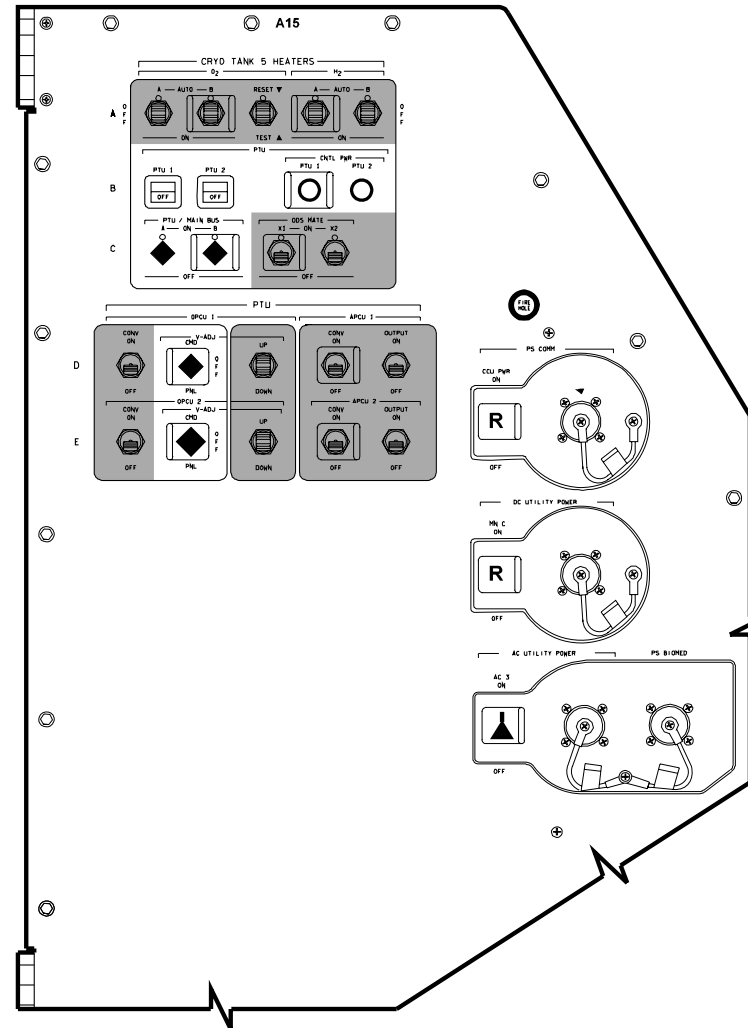
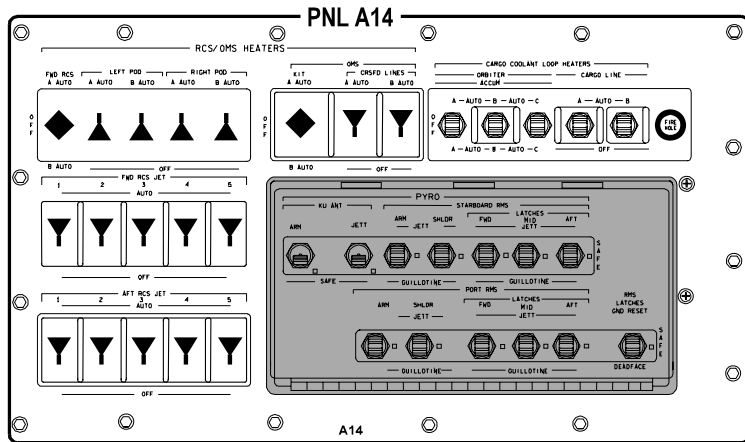

ACTIVATION  
L9 All switches - as read  
A15 PS COMM CCU PWR-ON

# OV103

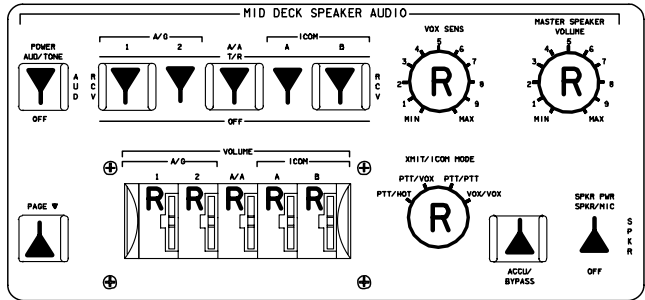

PNL M042F

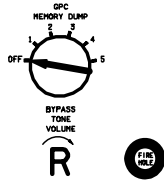

PNL M058F

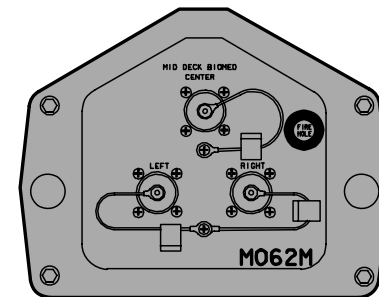
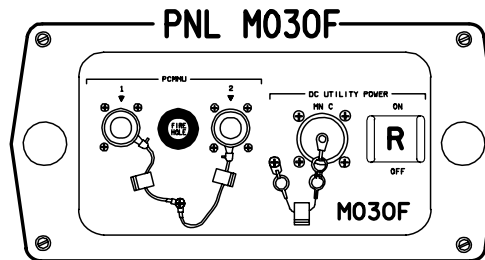
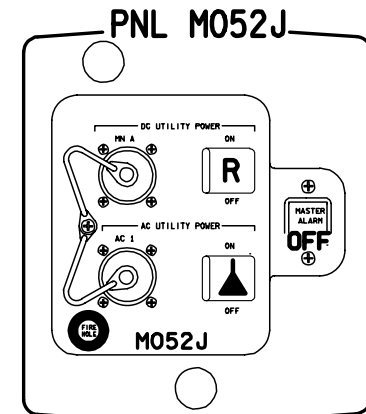
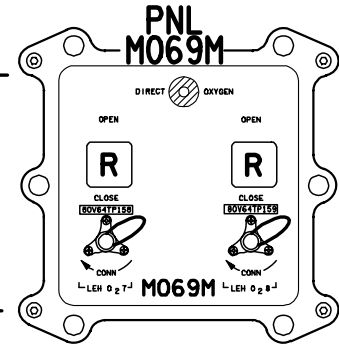
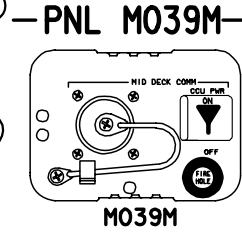
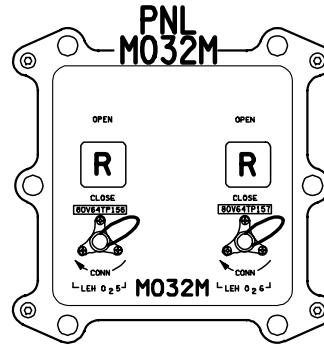
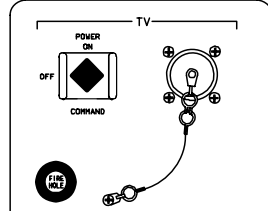
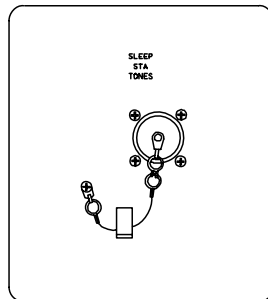

OV103

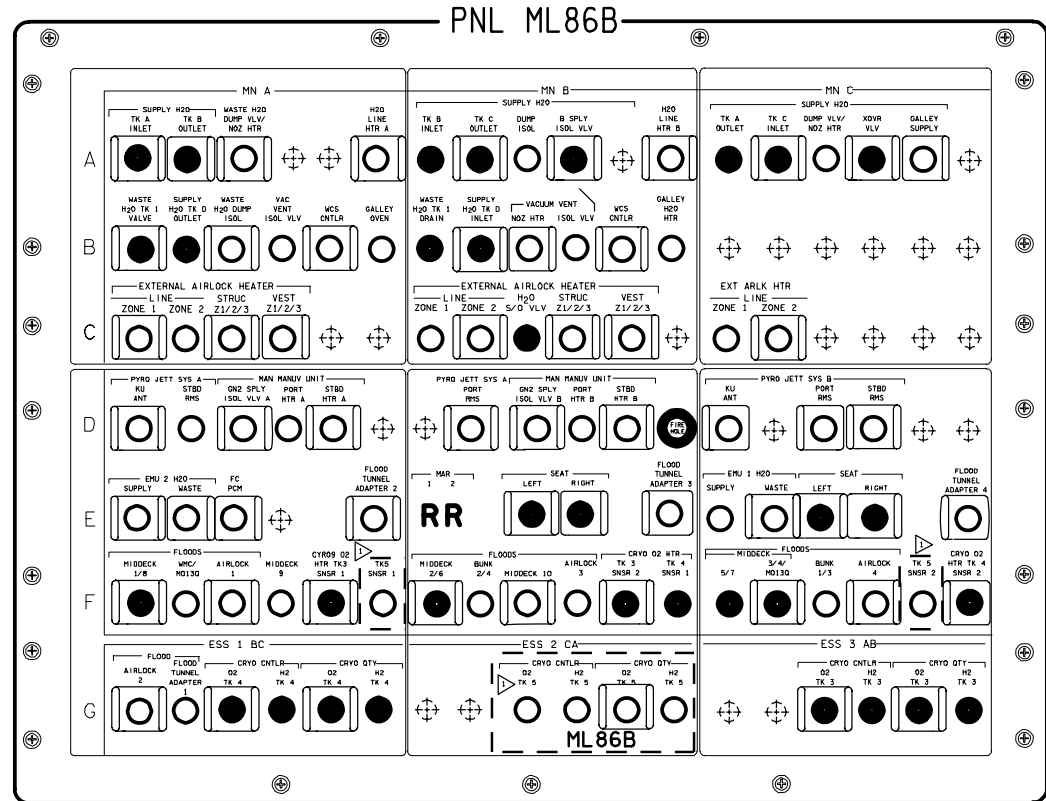
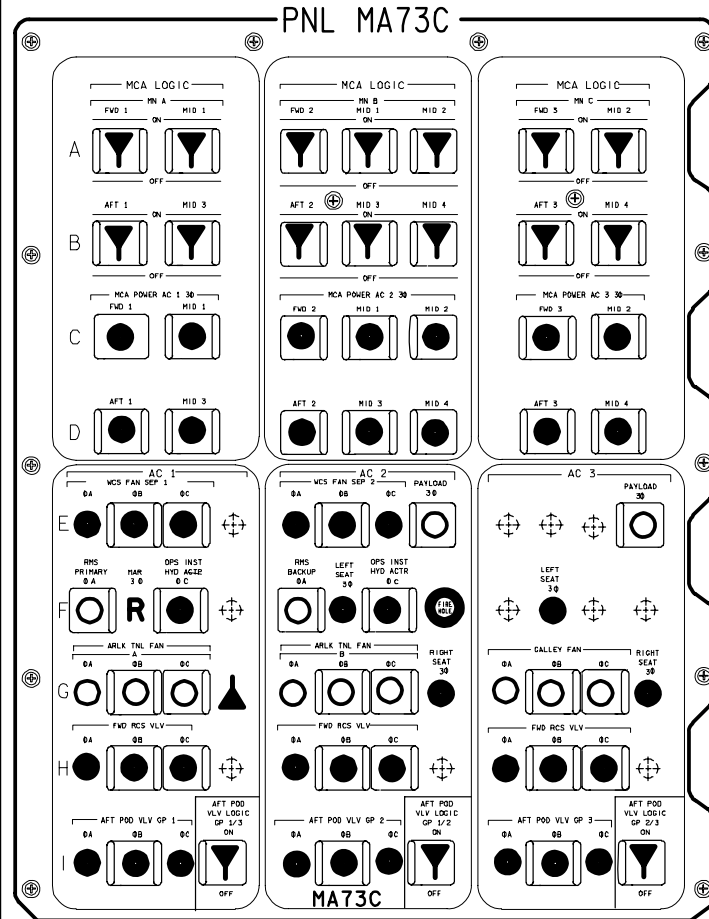

NOTES: ▷ CLOSED IF TK5 FLOWN

OV103

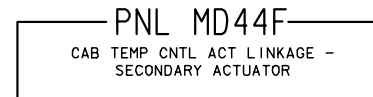
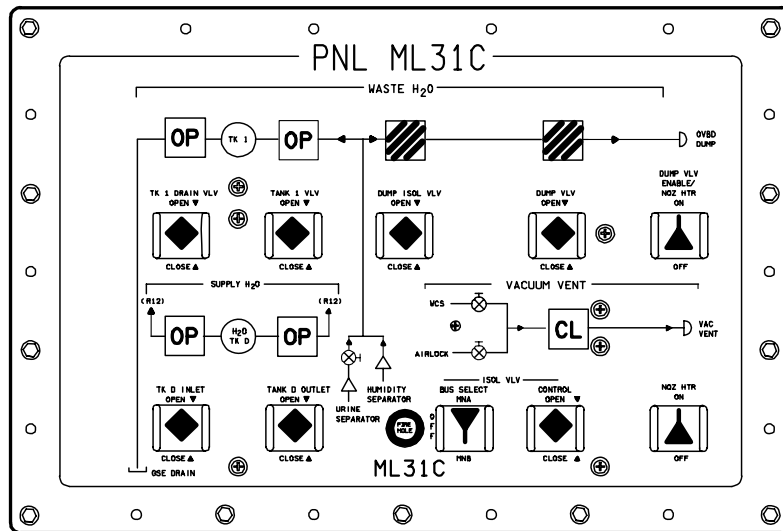
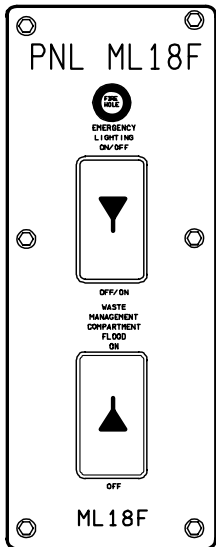
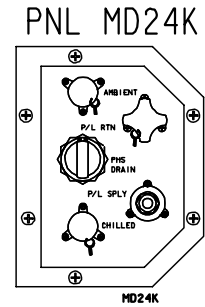
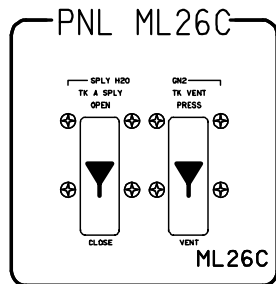
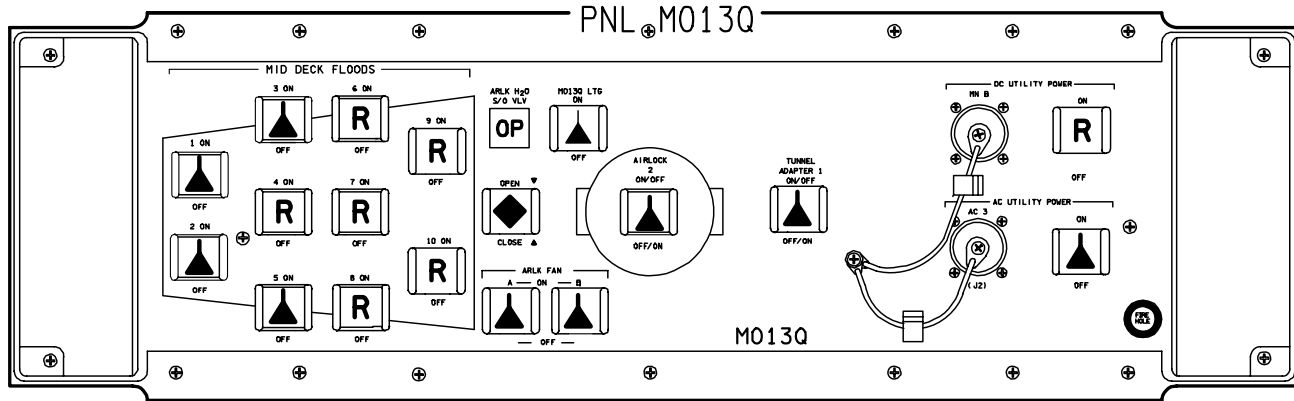

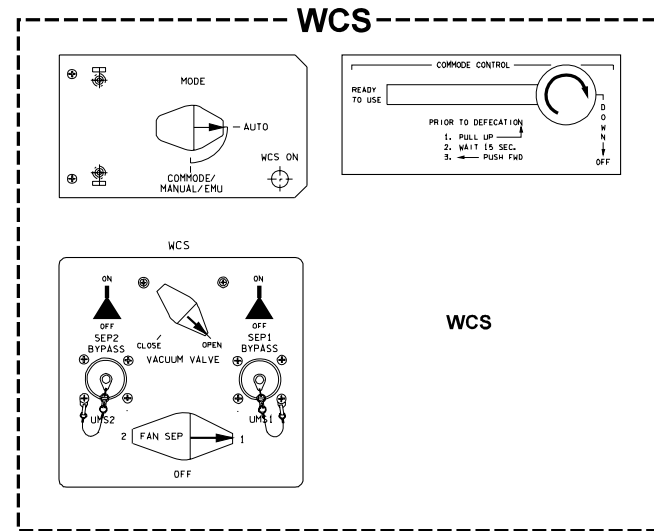
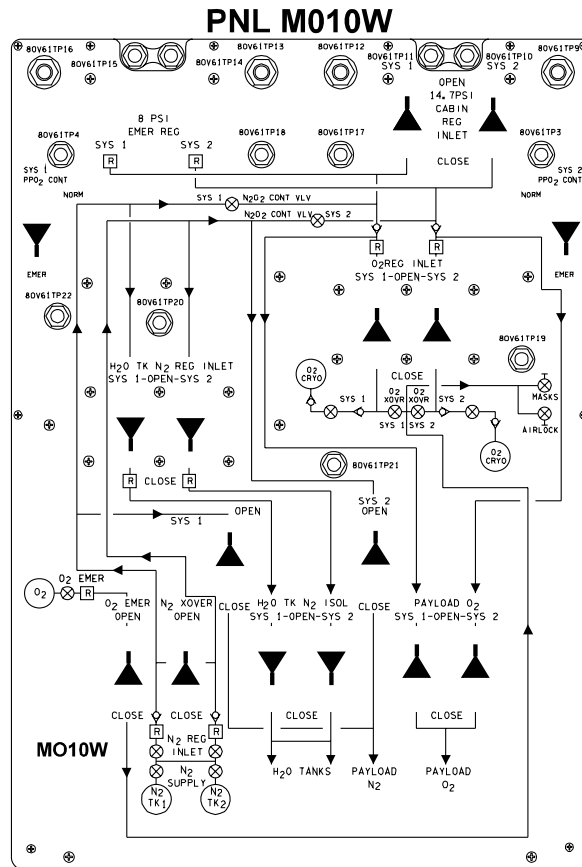

OV103

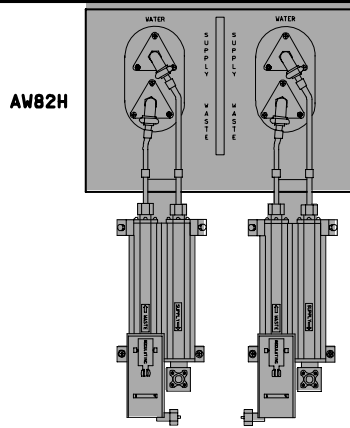
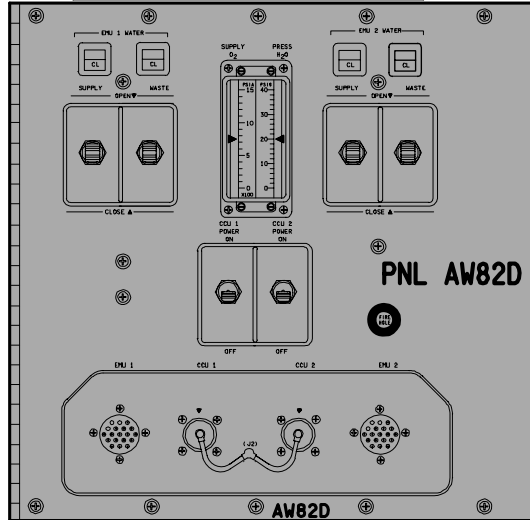
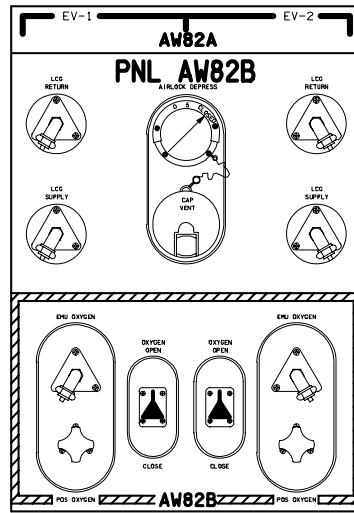
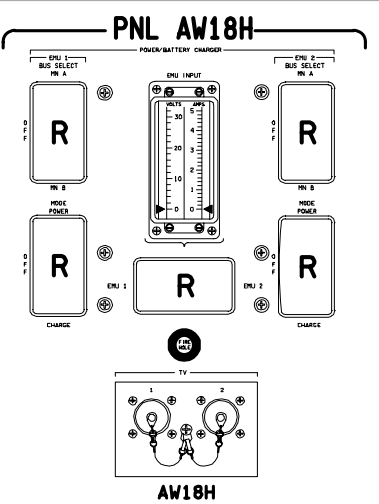
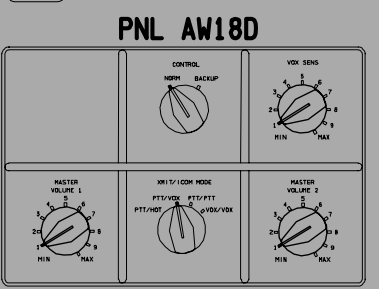
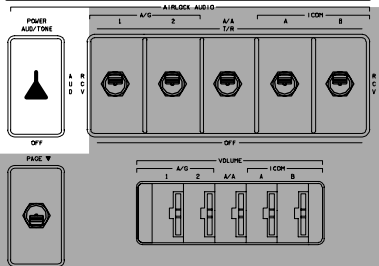
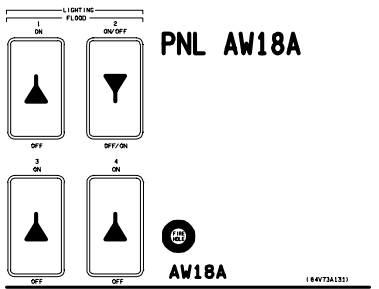

ALL VEH/DATE 04/26/05 4800E331-114; PNL 1

### **Inner Hatch**

Actuator Handle – LATCHED

Lock Lever – LOCKED

Equalization vlv (two) – NORM, capped



OV104

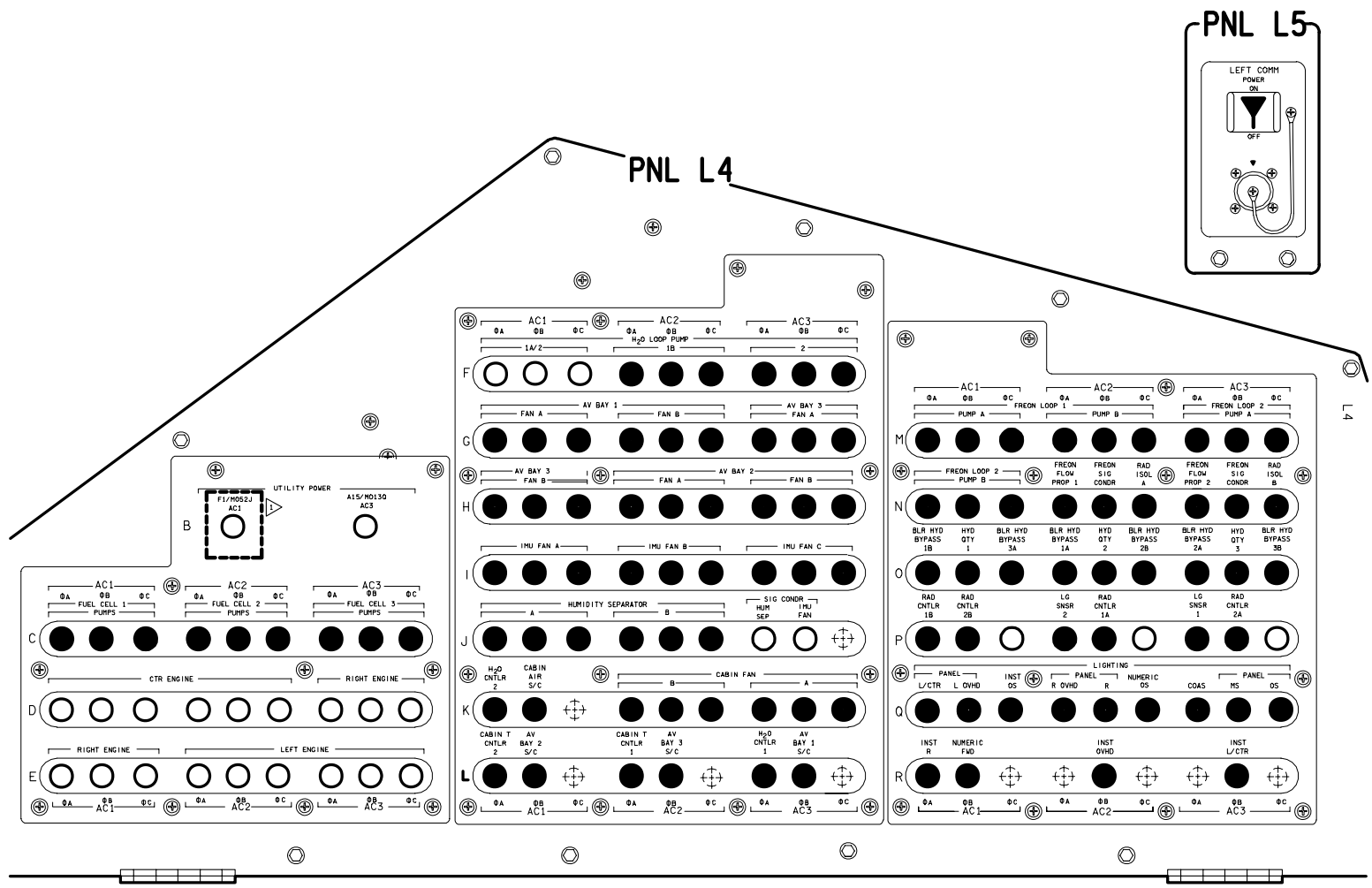

NOTE: ▸ CB CAN REMAIN CLOSED FOR AC PGSC USAGE.  
 OPEN WHEN PGSC UNPOWERED/STOWED

OV104

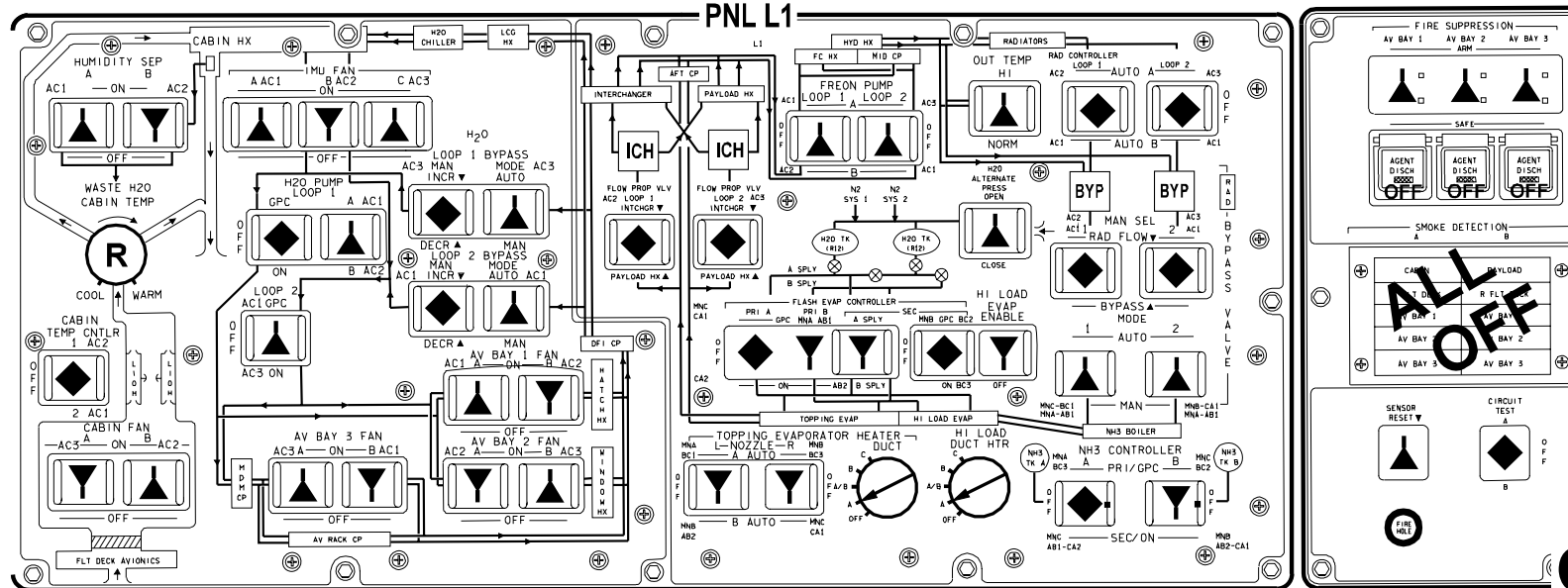
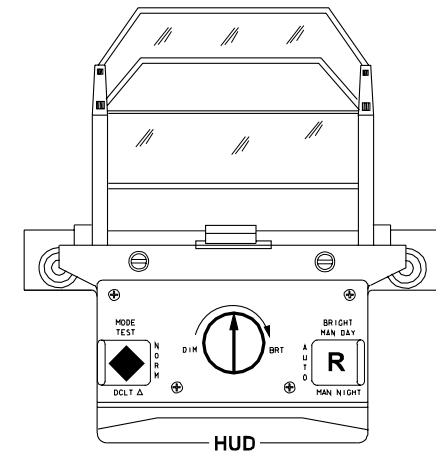
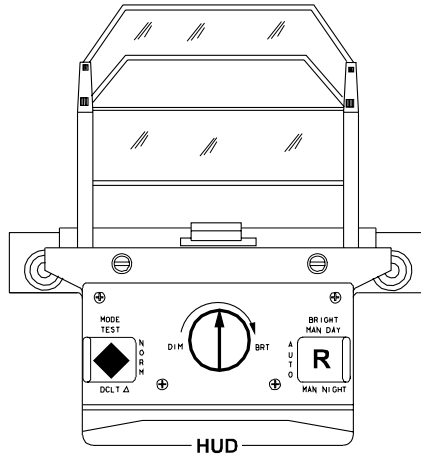
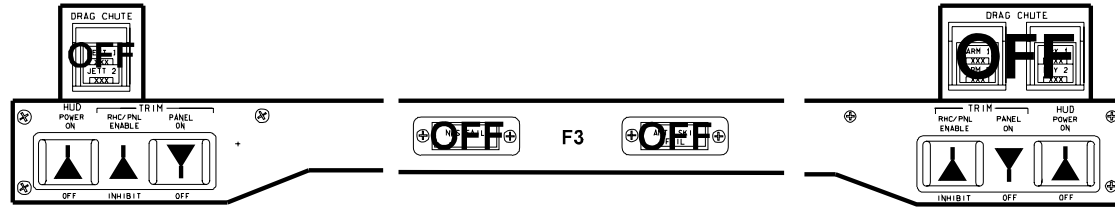

OV104

OV104

PNL L2

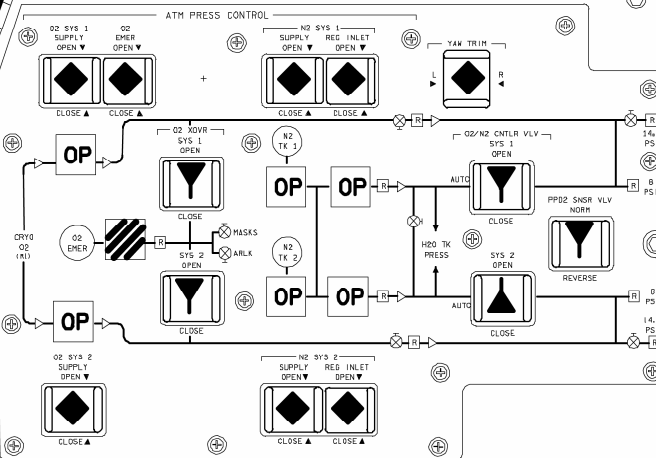
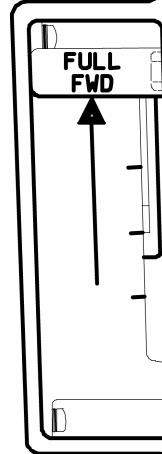
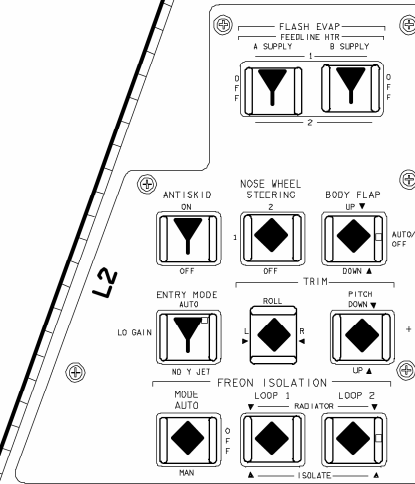
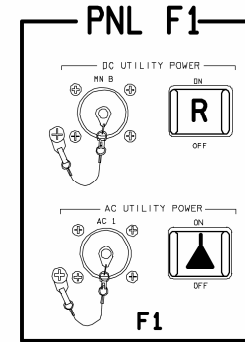
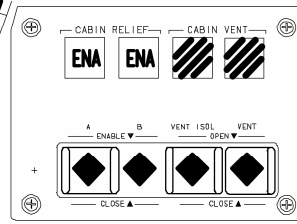

OV104

OV104

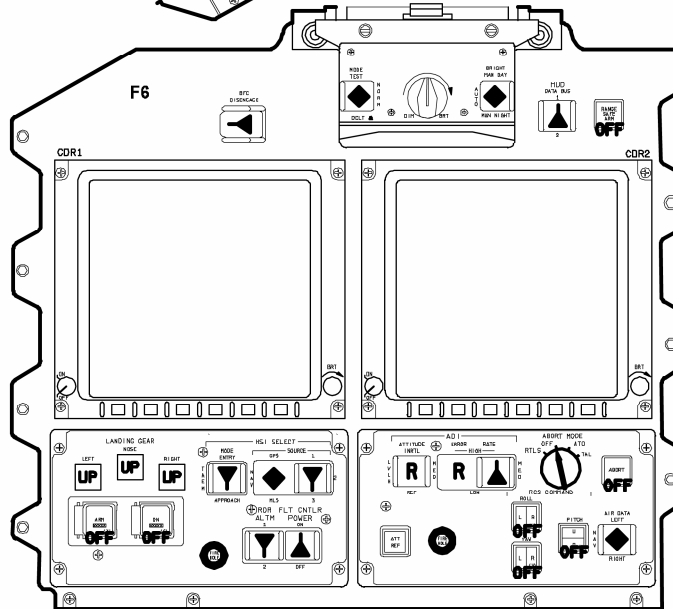
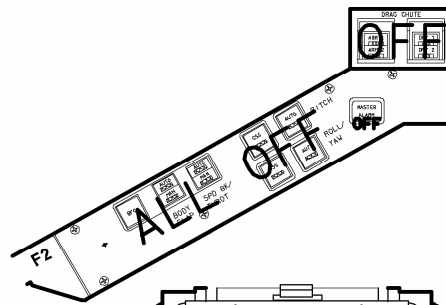
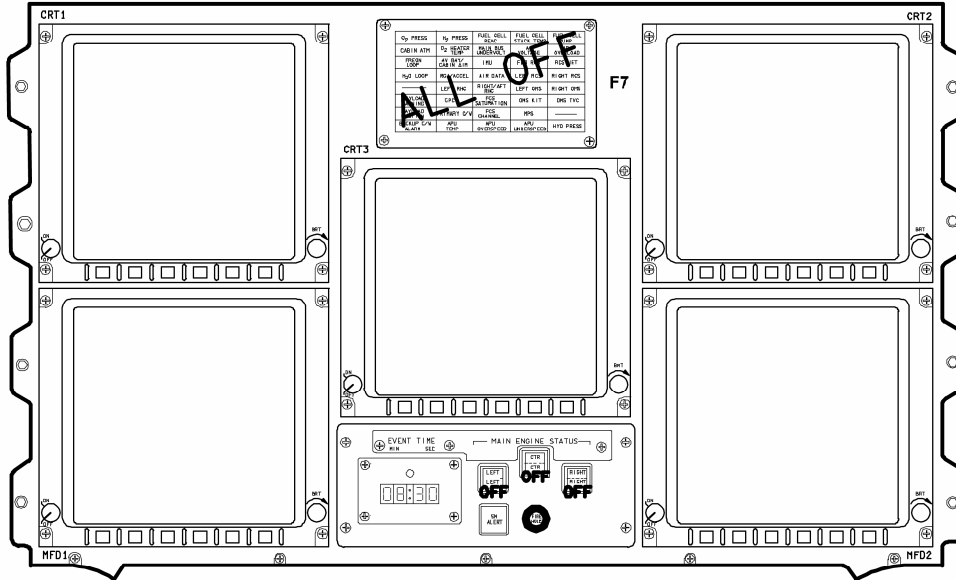

48007C306\_10T\_PNL1 1 MEDS VIEW DATE 10/02/02

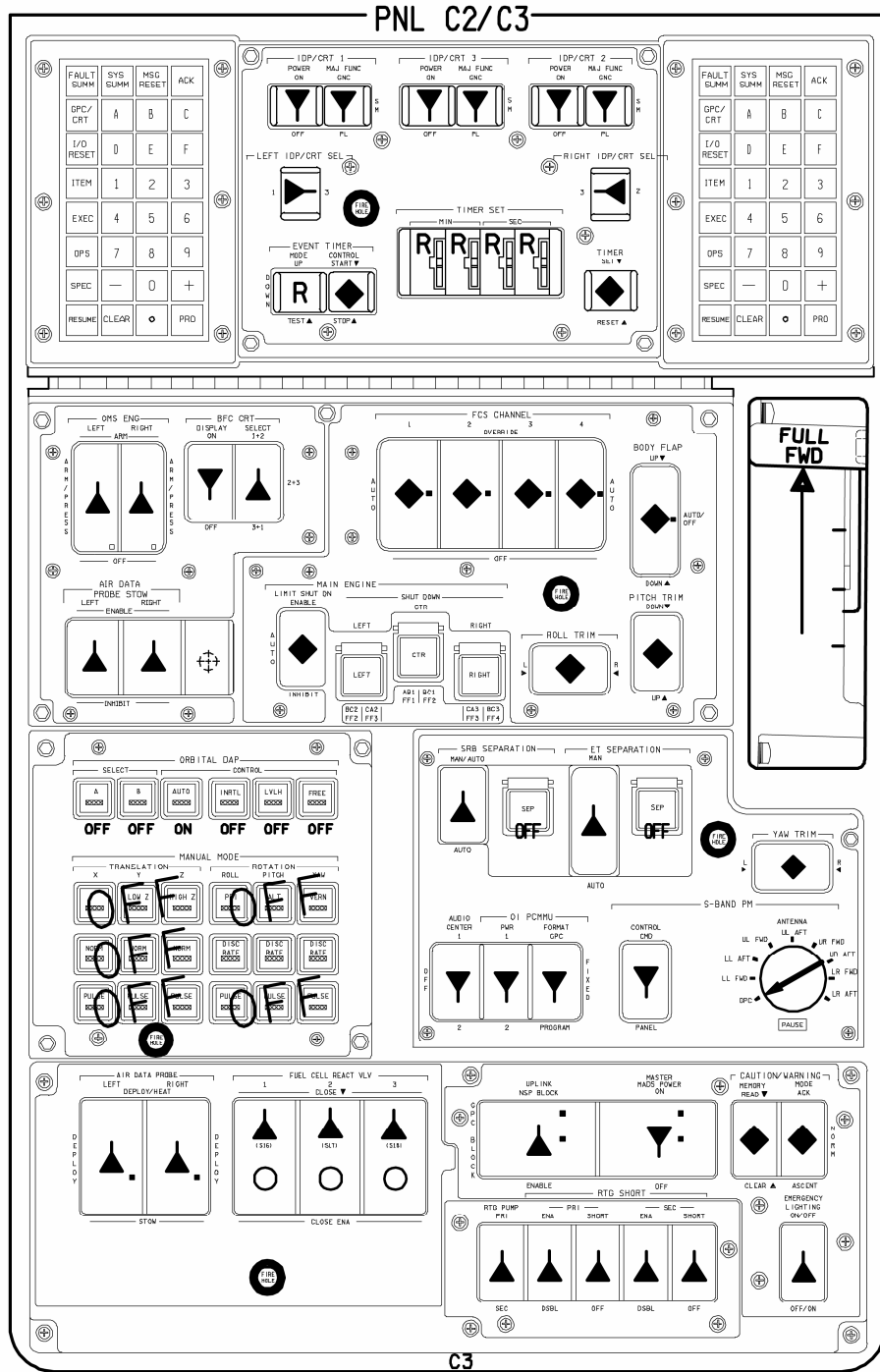

OV104

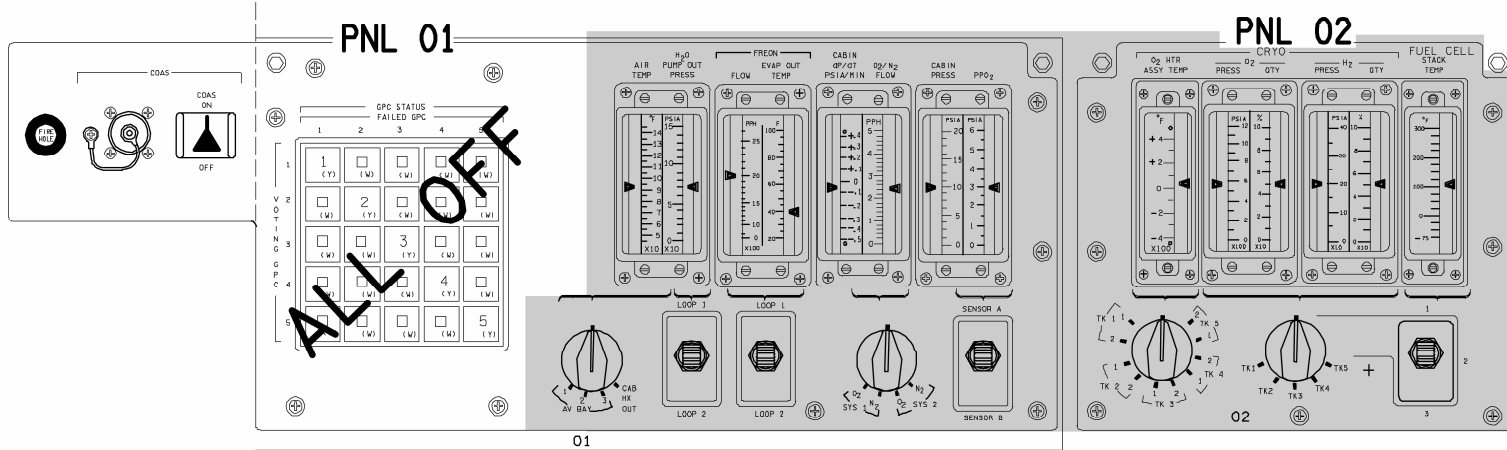

L side OVHD flood - R (MID)

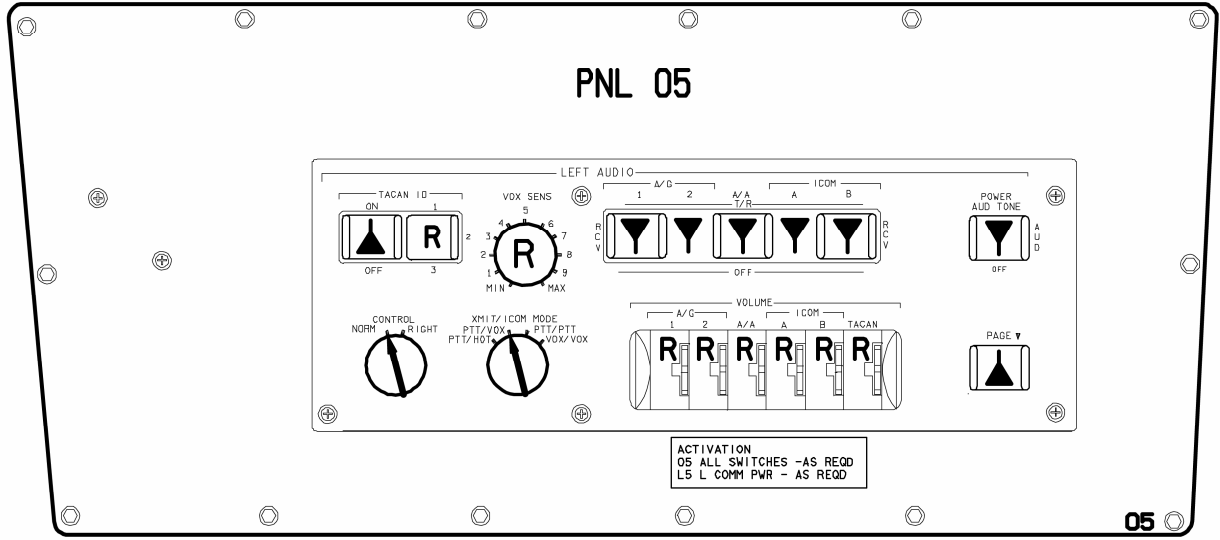

ACTIVATION  
05 ALL SWITCHES -AS REQD  
L5 L COMM PWR - AS REQD

# OV104

## PNL 06

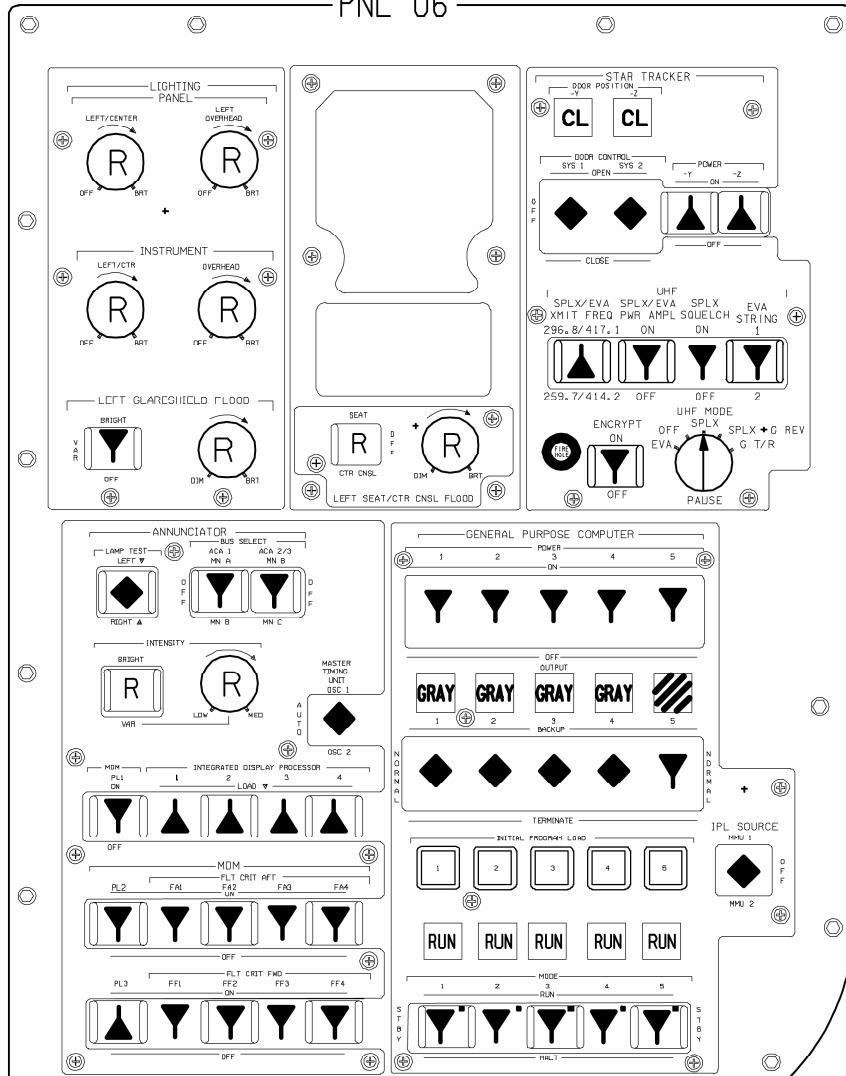

## PNL 07

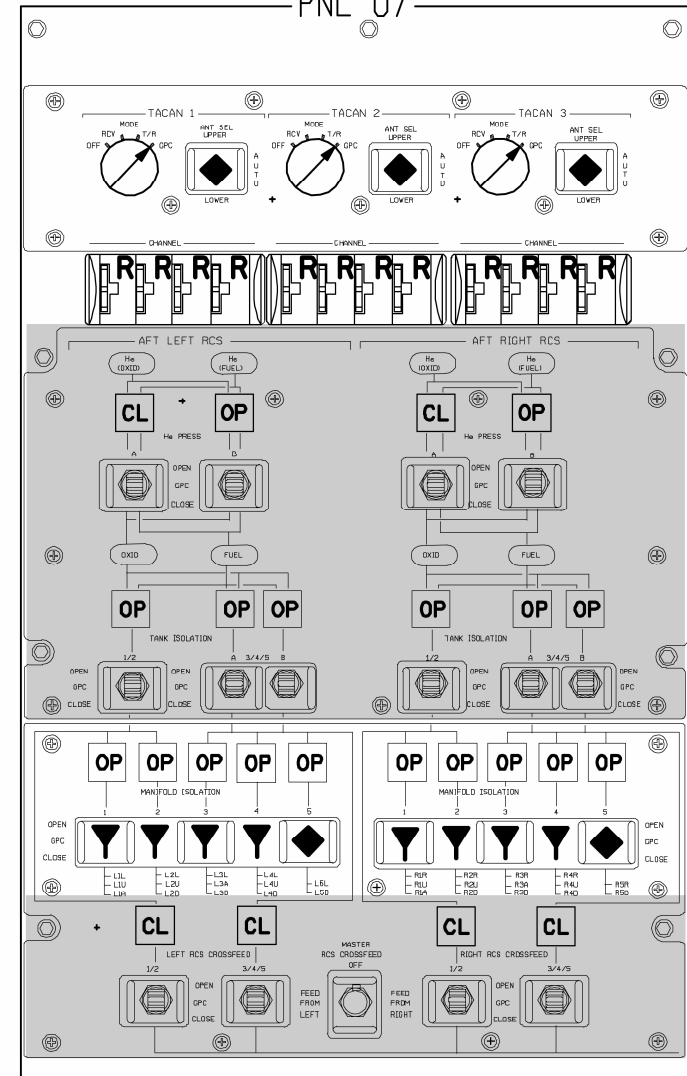

PNL 08

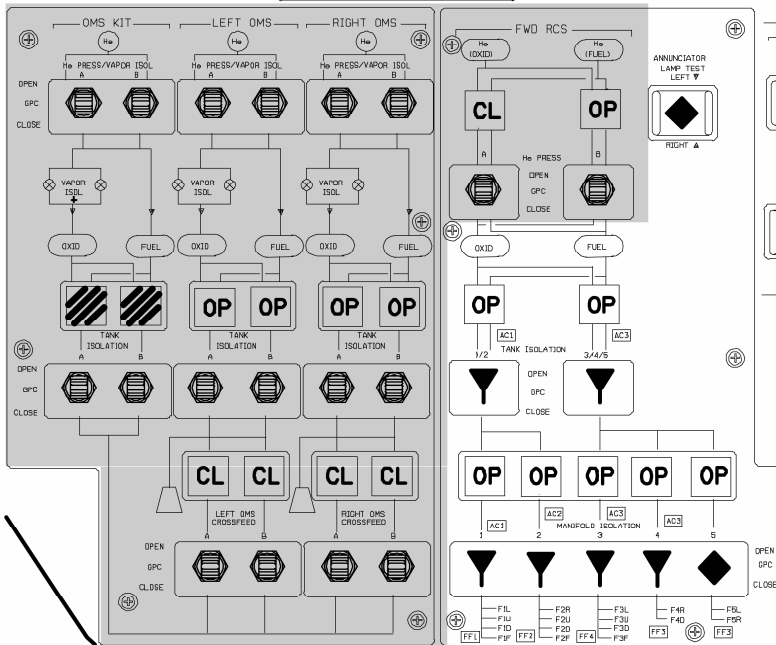
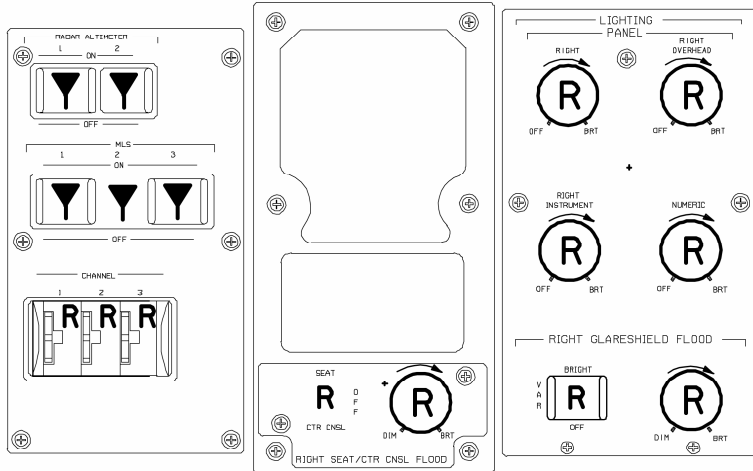

PNL 09

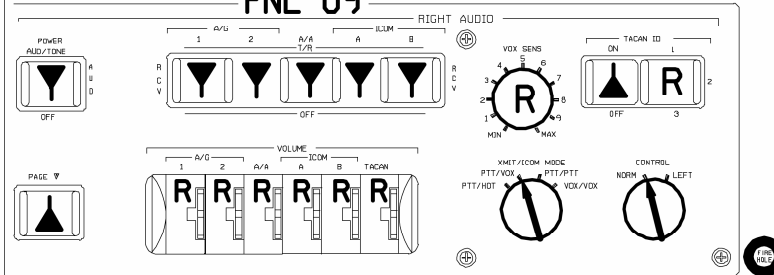

ACTIVATION  
 09 R AUD PWR - AUD/TONE  
 ALL OTHER SWS- AS REQD  
 R6 R COMM PWR - AS REQD

R side OVHD flood - R (MID)



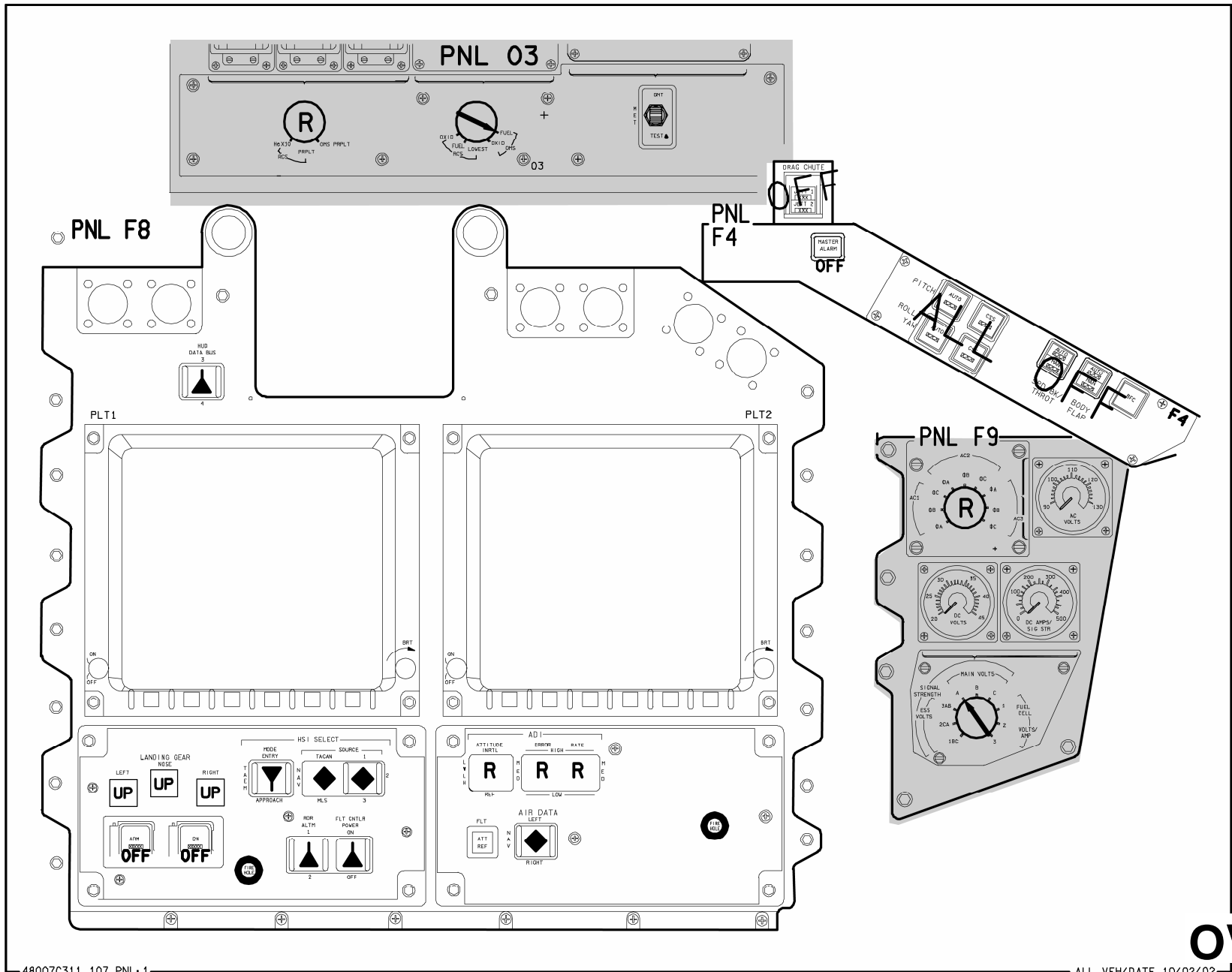

48007C311\_107, PNL 1

ALL VEH/DATE 10/02/02

**OV104**

(OV104) B3-11

C D/O/ALL/GEN M

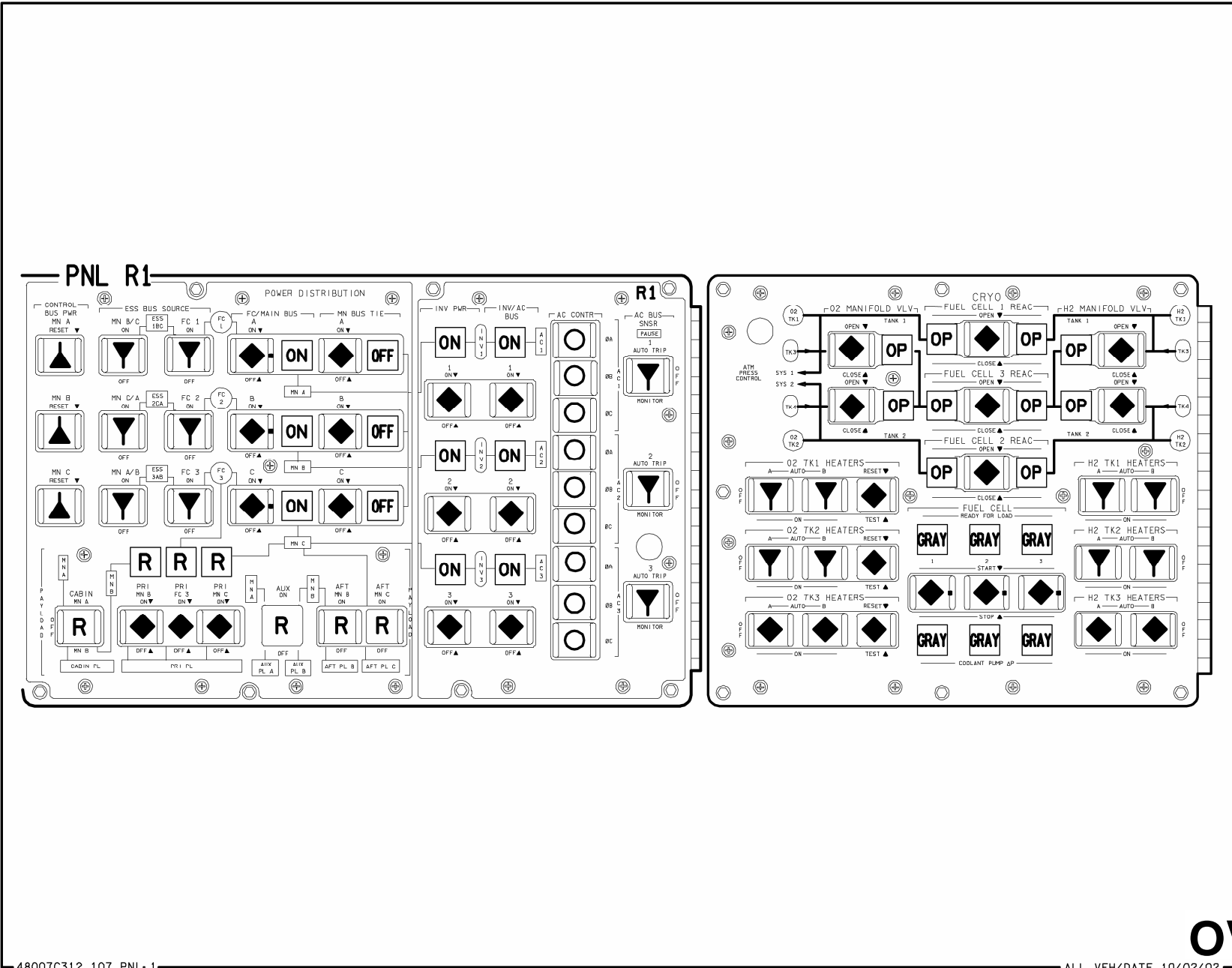

48007C312\_107.PNL, 1

ALL VEH/DATE 10/02/02

**OV104**

(OV104) B3-12

C D/O/ALL/GEN M

OV104

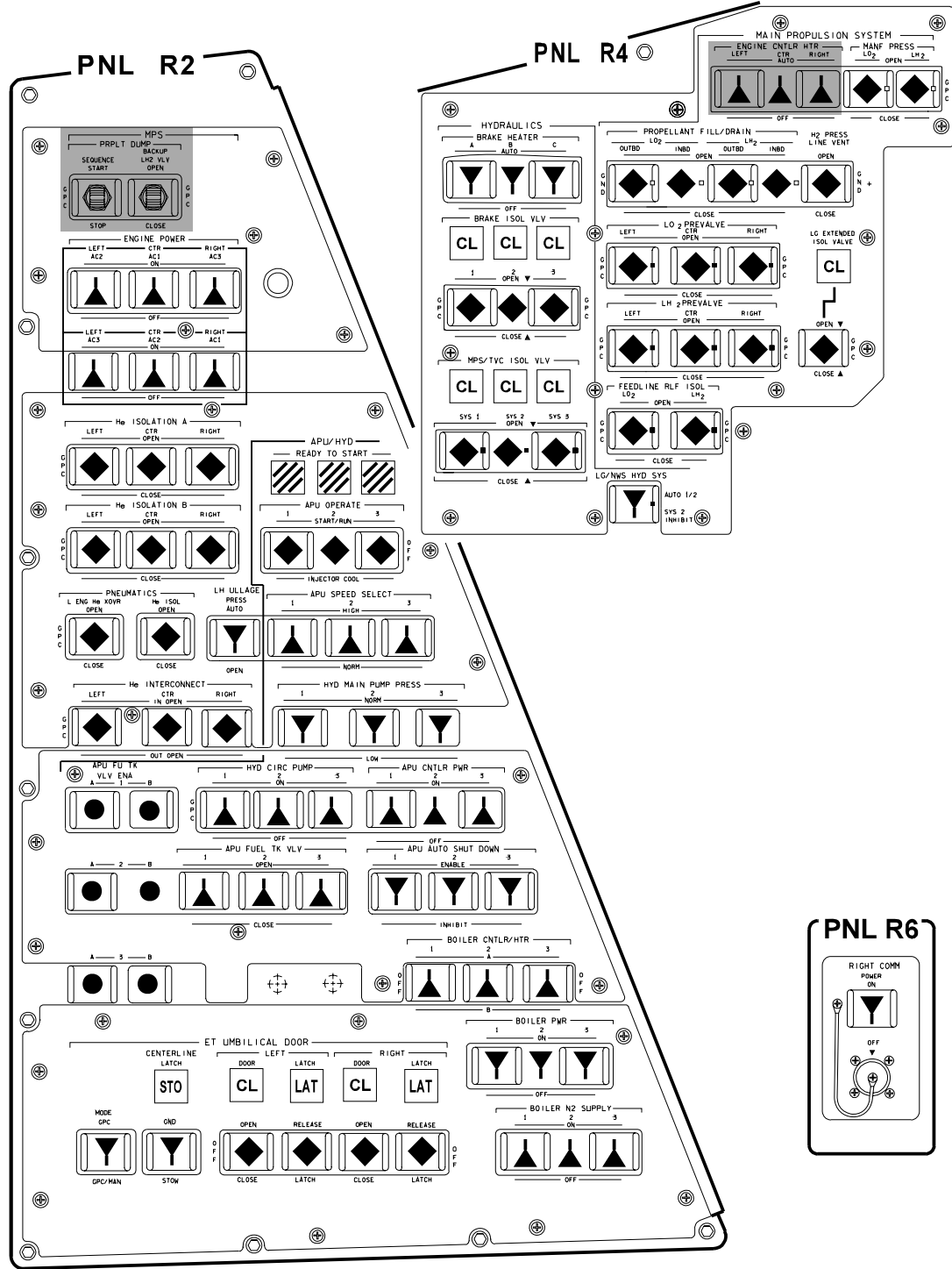

48007313\_115\_PNL R 2 ALL VEH/DATE 07/26/06

This Page Intentionally Blank

OV104

PNL 013

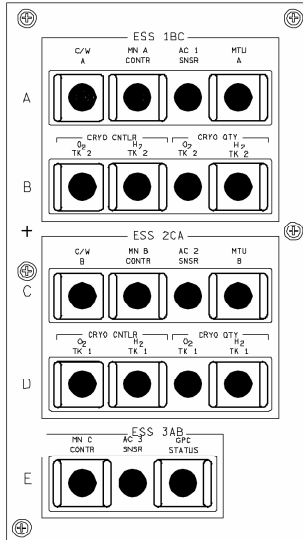

PNL 014

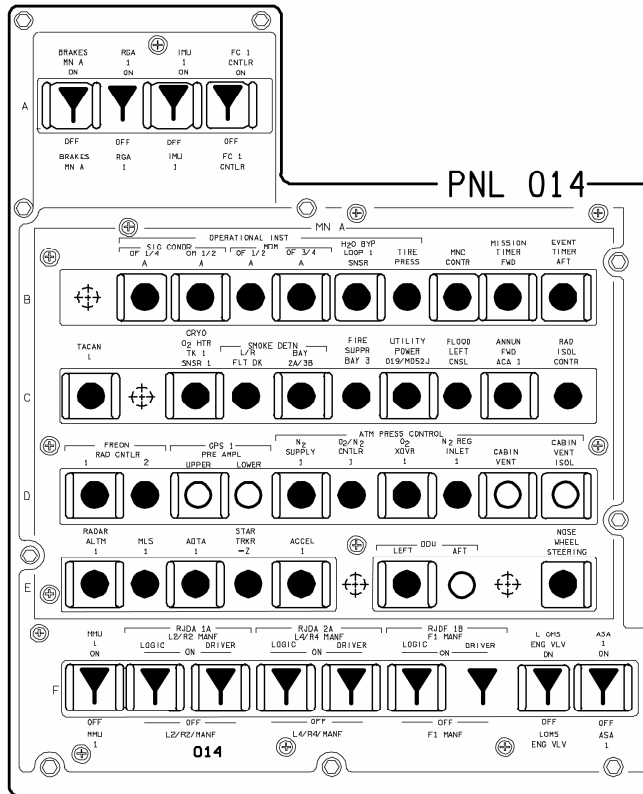

PNL 015

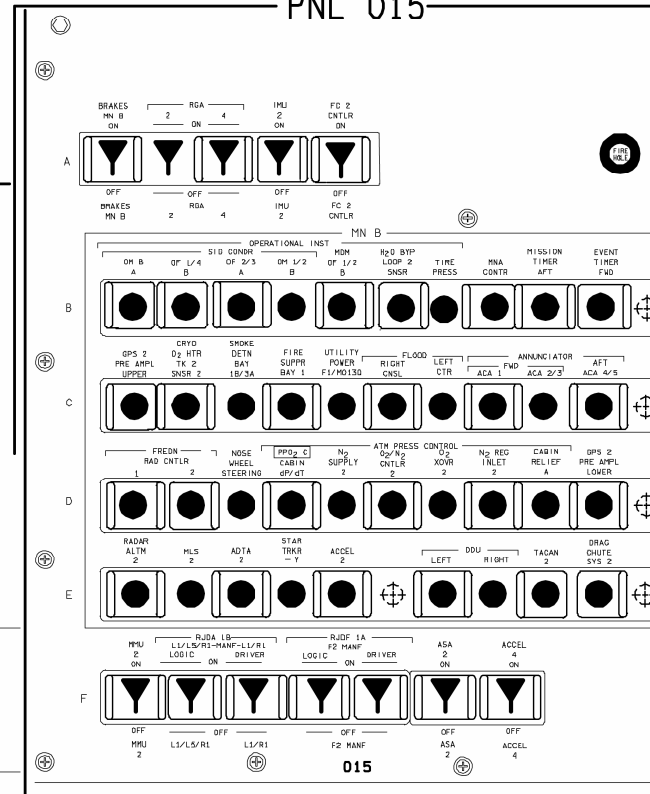

OV104

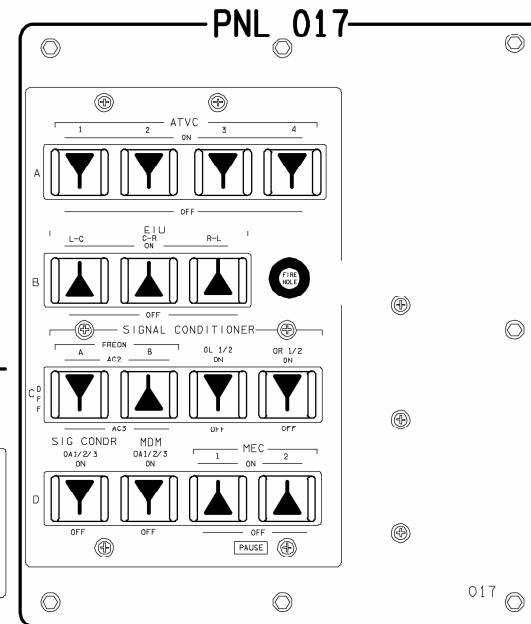
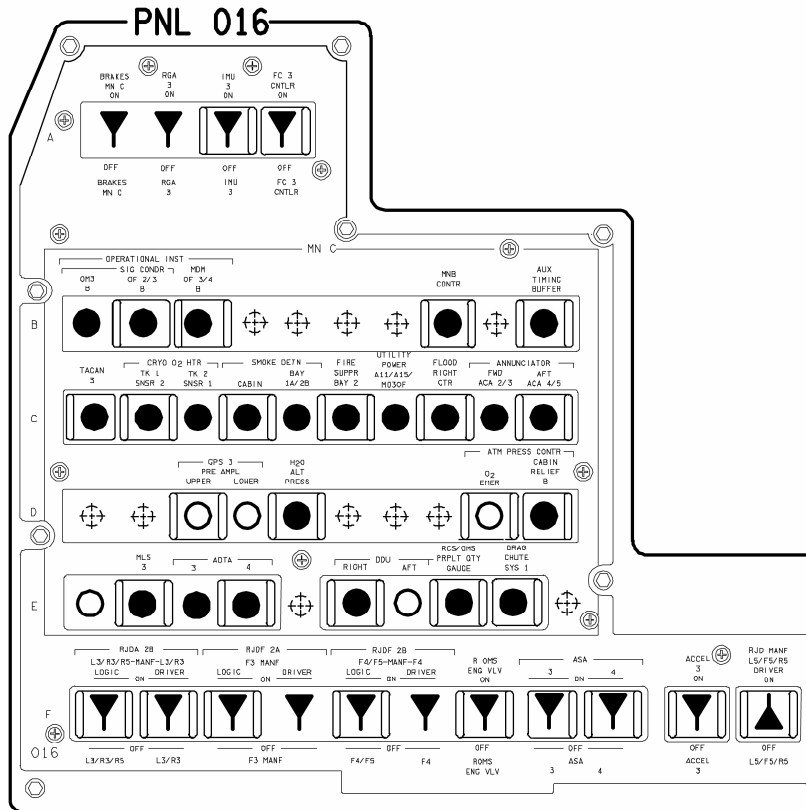

OV104

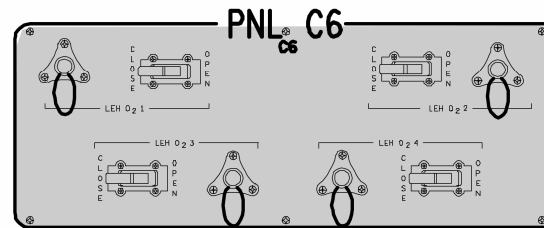
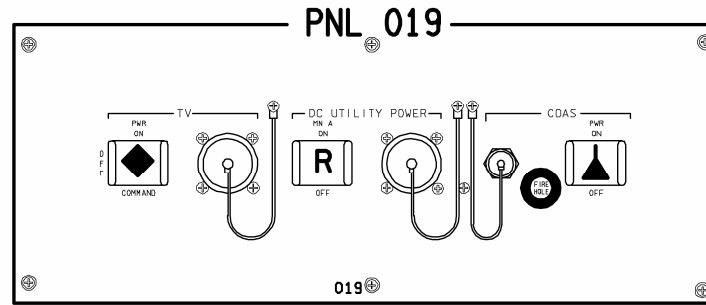

**PNL C5**

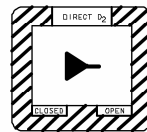

**PNL C7**

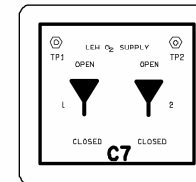

OV104

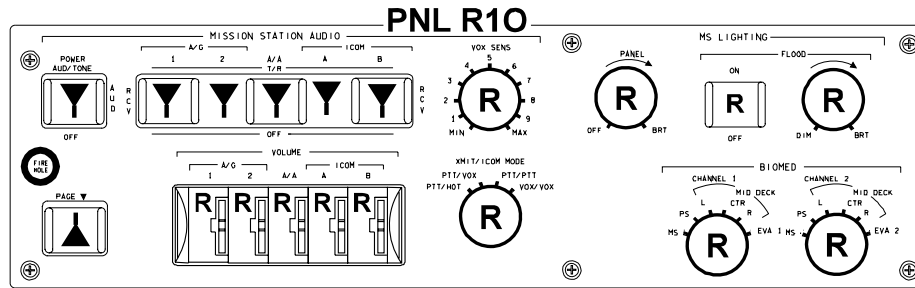

ACTIVATION  
 R10 MS AUD PWR - AUD/TONE  
 ALL OTHER SWS - AS RECD  
 R12 MS AUD CNTRL - NORM  
 A11 MS COMM CCU PWR - ON

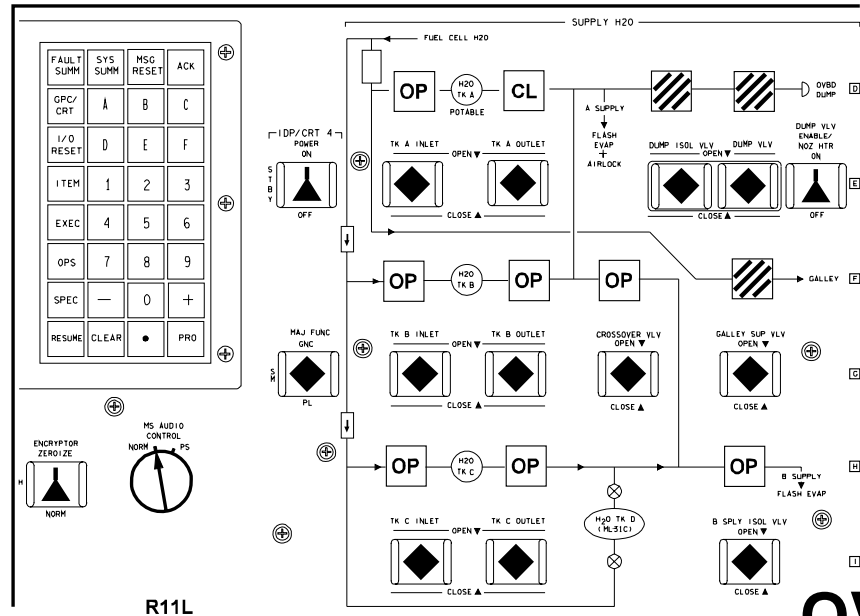
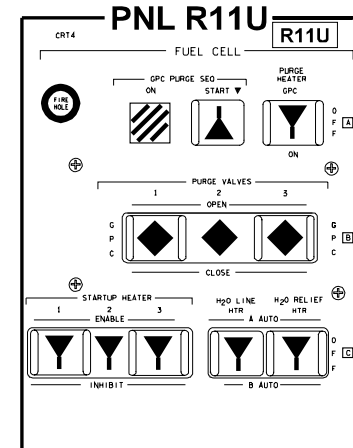

OV104



OV104

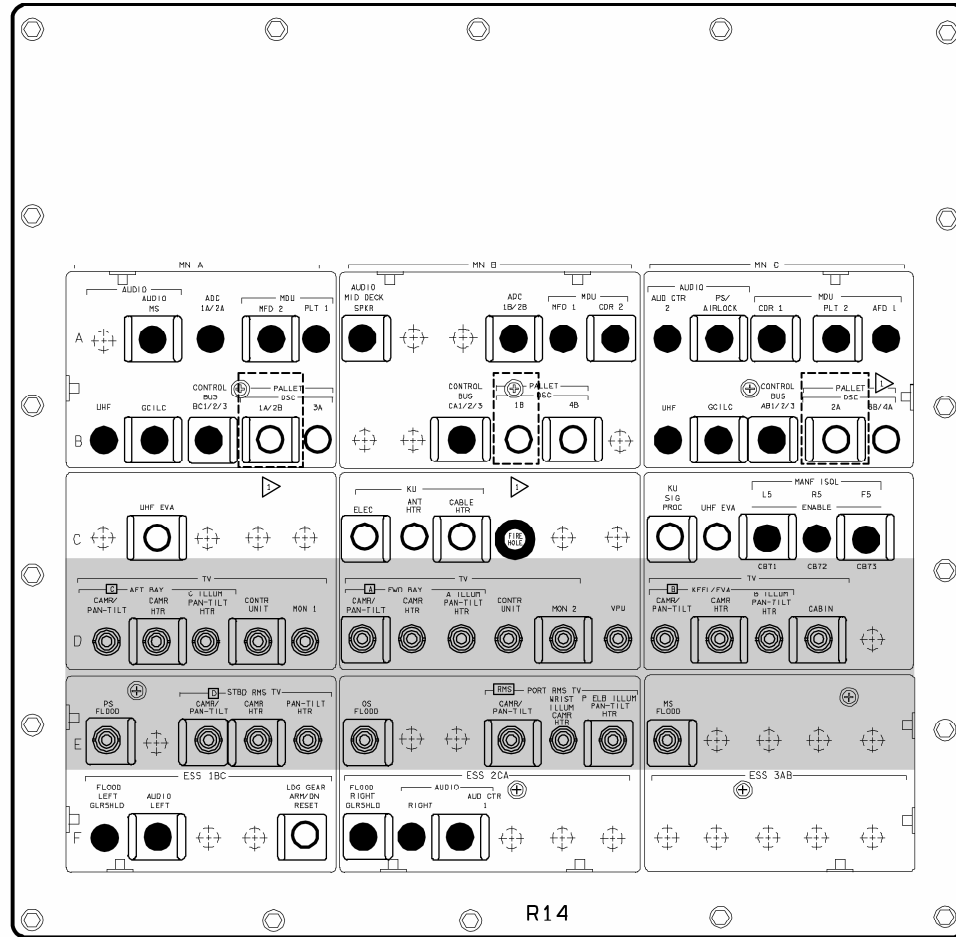
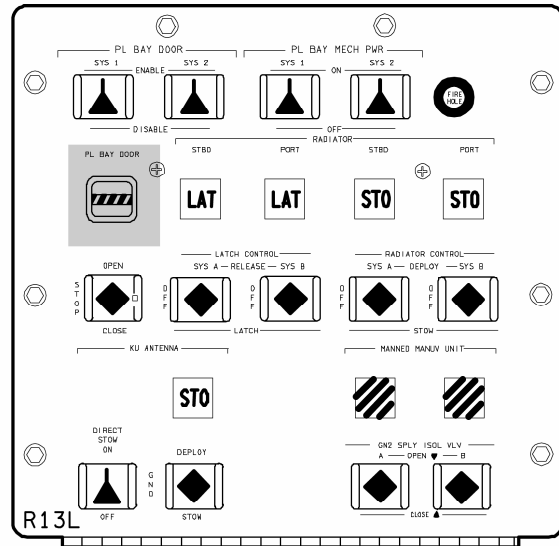
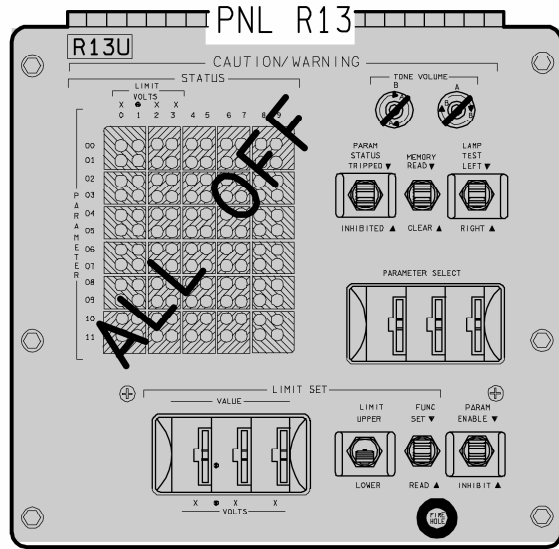

NOTES: > CLOSED IF EDO

OV104

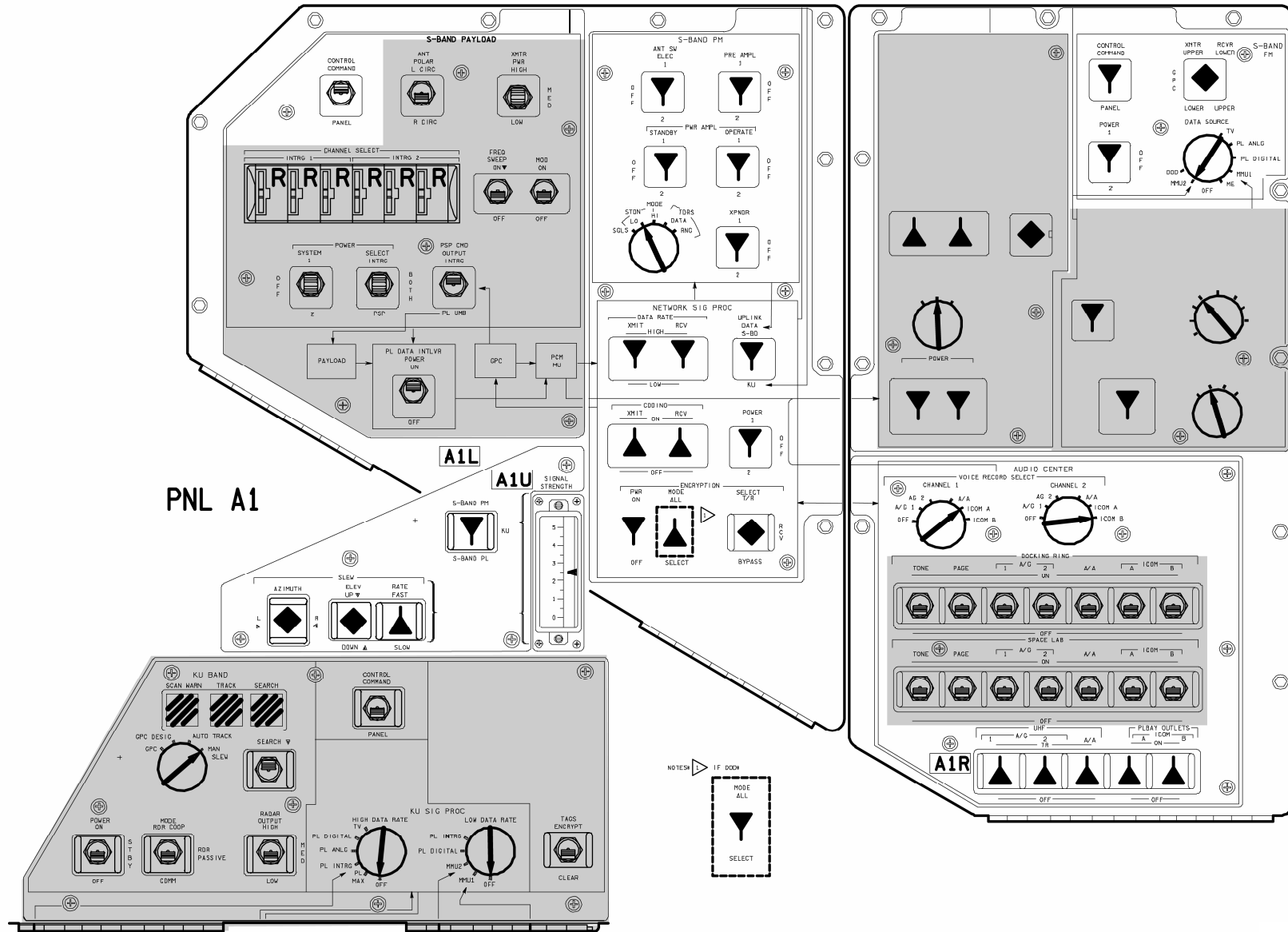

OV104

**PNL A4**

MISSION TIME  
DAY HR MIN SEC

365:23:59:55

EVENT TIME  
MIN SEC

59:59

MISSION TIMER GMT

TEST

**PNL A3**

CONTRAST

BRIGHTNESS

SOURCE

PANEL DN-LINK DIRECT

MODE

PULSE-X

DATA

OFF

X-HAIR

OFF

FAULT

TEST

MON 1

MON 2

**PNL A7U**

WIRELESS ALARM OFF

CAMERA POWER

OFF OFF OFF OFF OFF

TV POWER CONTROL CONTR UNIT

OFF OFF

LA B C D EHS PANEL IN B

FWD KEEL/EVA AFT STBD RMS PORT DOWN LINK TV SYNC

ON ON ON ON ON ON ON ON ON ON ON ON

OFF OFF INHIBIT REVERSE

VIDEO INPUT

VIDEO OUTPUT

CAUTION CLOSE CENTER LINE TRUSS CAMERA PRIOR TO POWERDOWN

PAN/TILT RESET FOCUS FAIRY CAMERA COMMAND ZOOM IRI S OPEN TILT UP

LOW RATE NEAR OUT CLOSE DOWN

ALL OFF ALL OFF ALL OFF ALL OFF

**PNL A6U**

A6U

ORBIT STATION LIGHTING

FLOOD ON

PANEL DIM BRT

SELECT ORBITAL GAP CONTROL

A R AUTO NRFL LVLK FREE

OFF OFF ON OFF OFF OFF

MANUAL MODE

X TRANSLATION 2 ROLL ROTATION PITCH YAW

OFF OFF OFF OFF OFF OFF

INSTRUMENT NUMERIC

OFF BRT OFF BRT

ANNUNCIATOR

BUS SELECT LAMP TEST BRIGHT INTENSITY

MIN B LEFT RIGHT VAR LOW MED

PAYLOAD RETENTION LATCHES

READY TO LATCH

1 2 3 4 5

LAT LAT LAT LAT LAT

RELEASE

1 2 3 4 5

LATCH

EVENT TIMER

MIN SET SEC

R R R R R

MODE CONTROL TIMER

UP STARTY SET

TEST STOP RESET

OV104

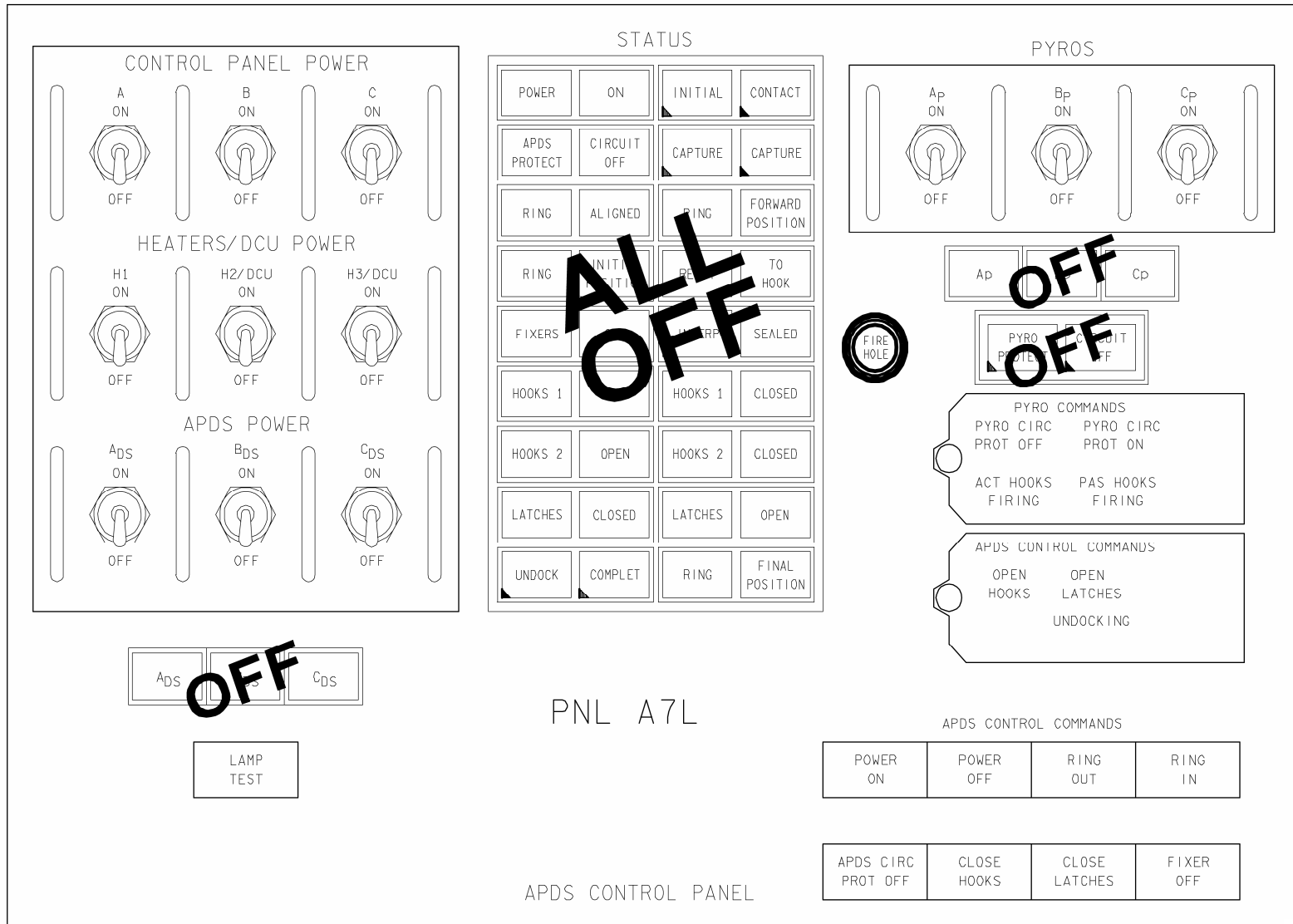

OV104

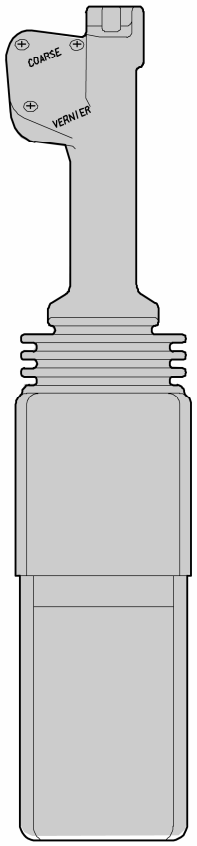
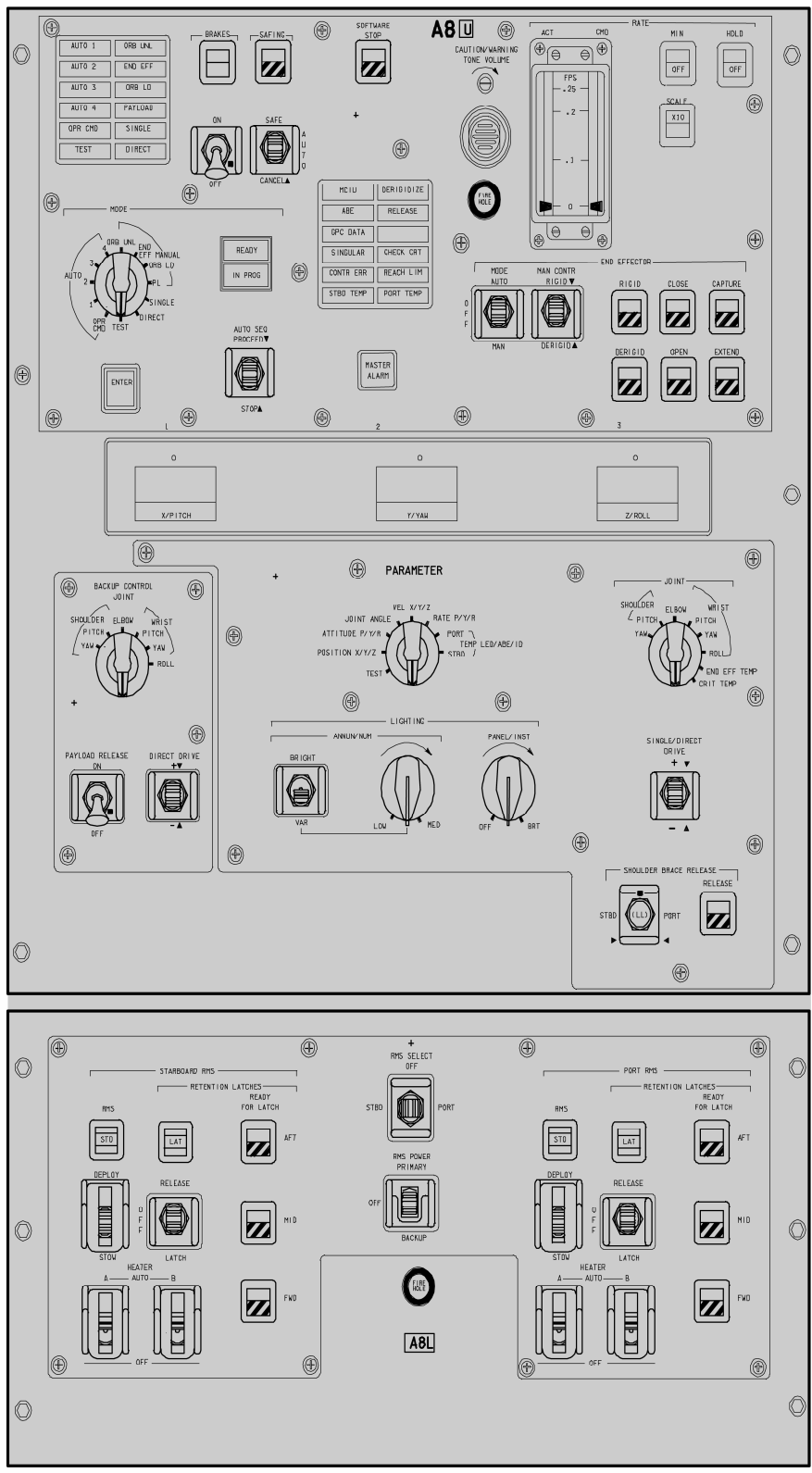

OV104

PNL A13

A11

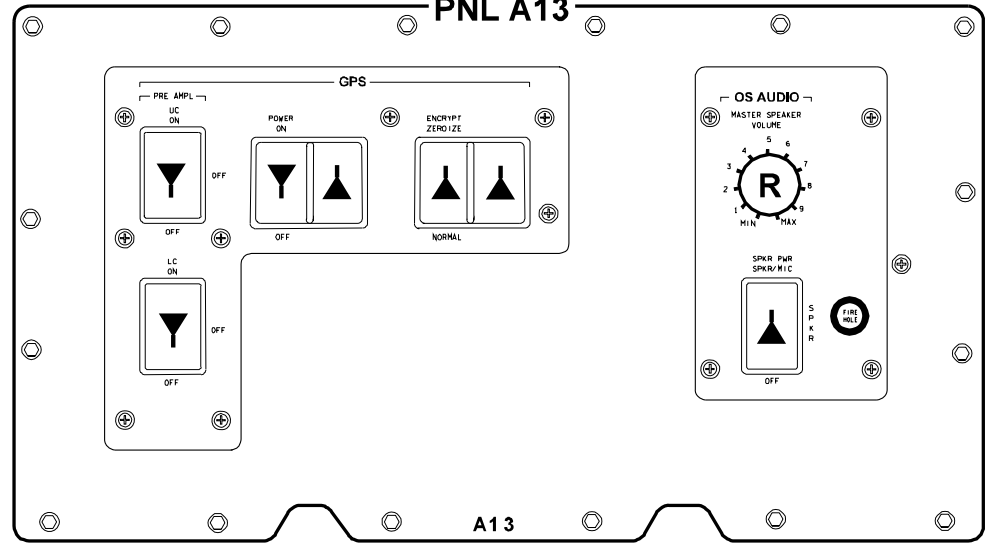
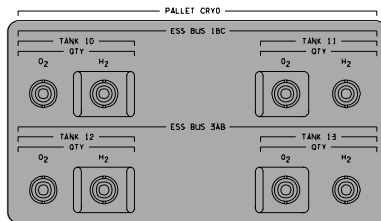
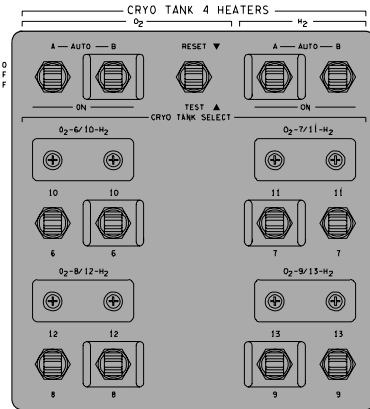

PNL A12

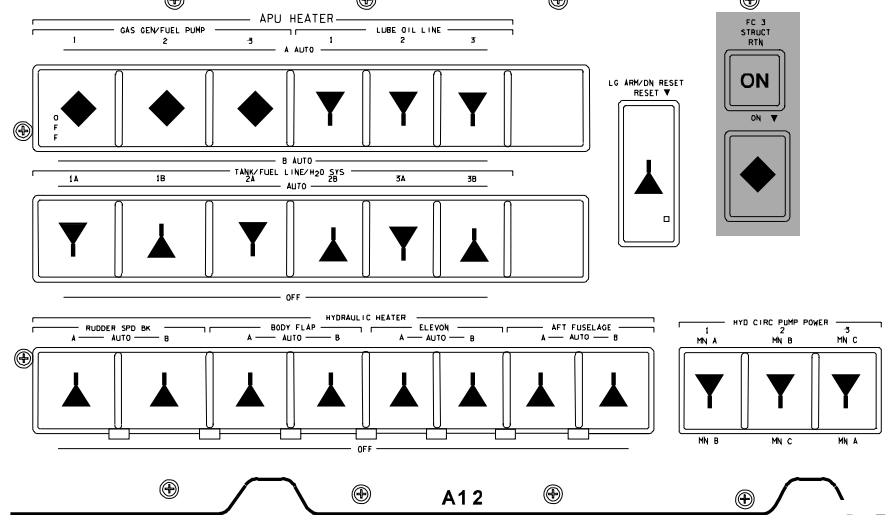

OV104

OV104

A6L

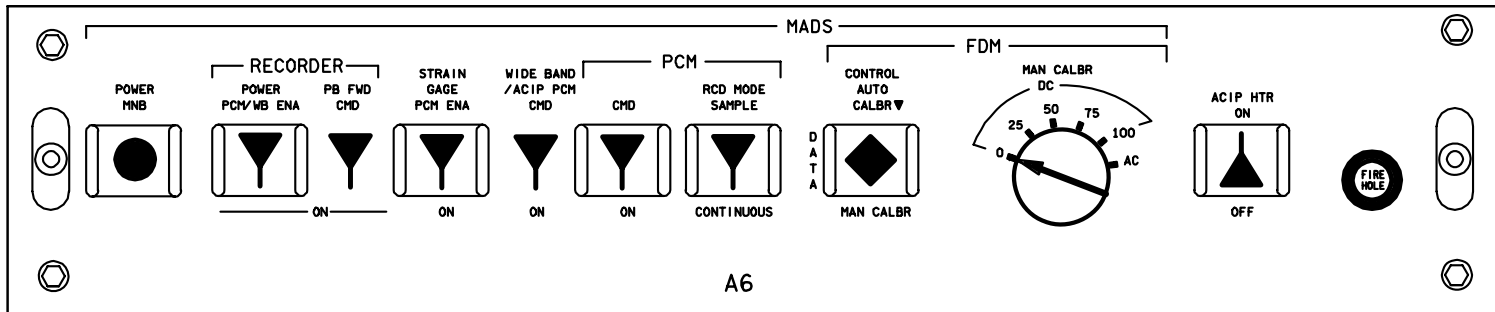
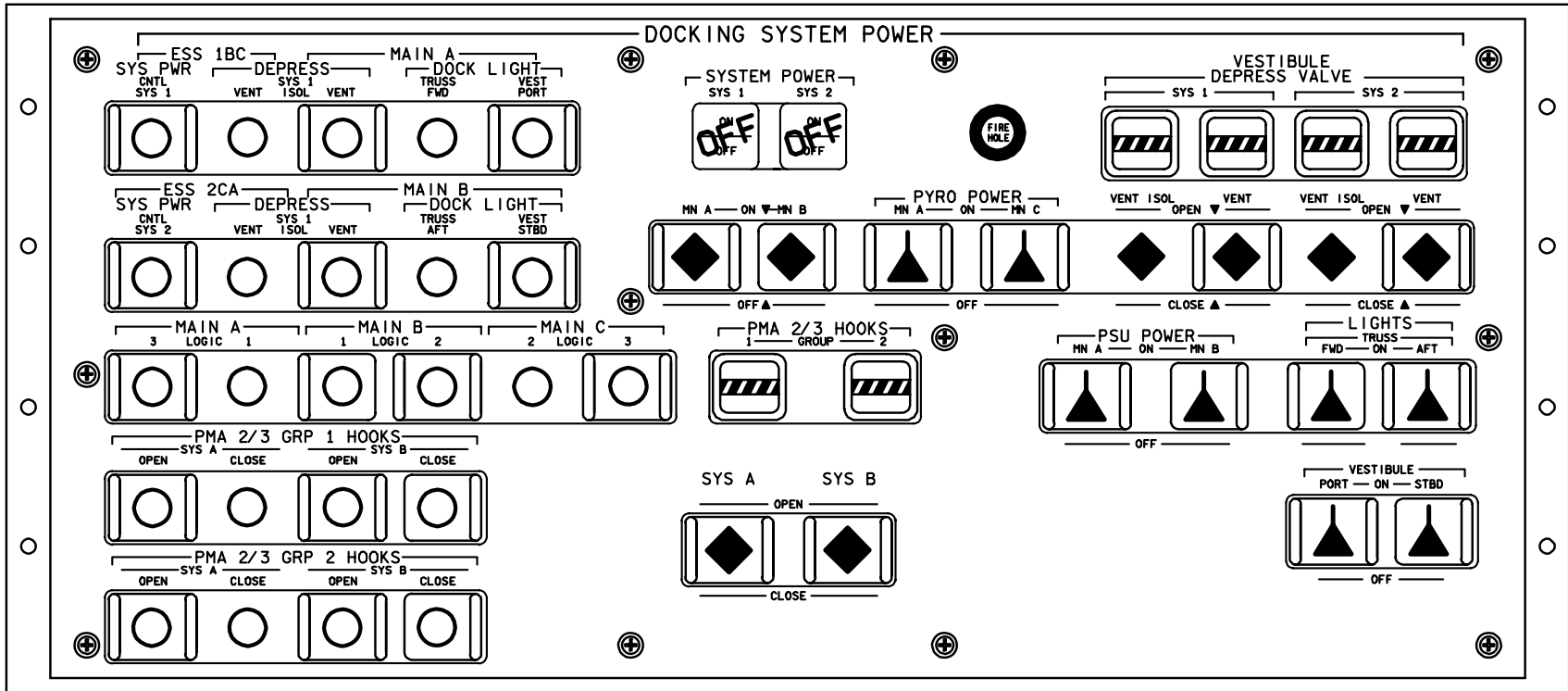

A6

OV104

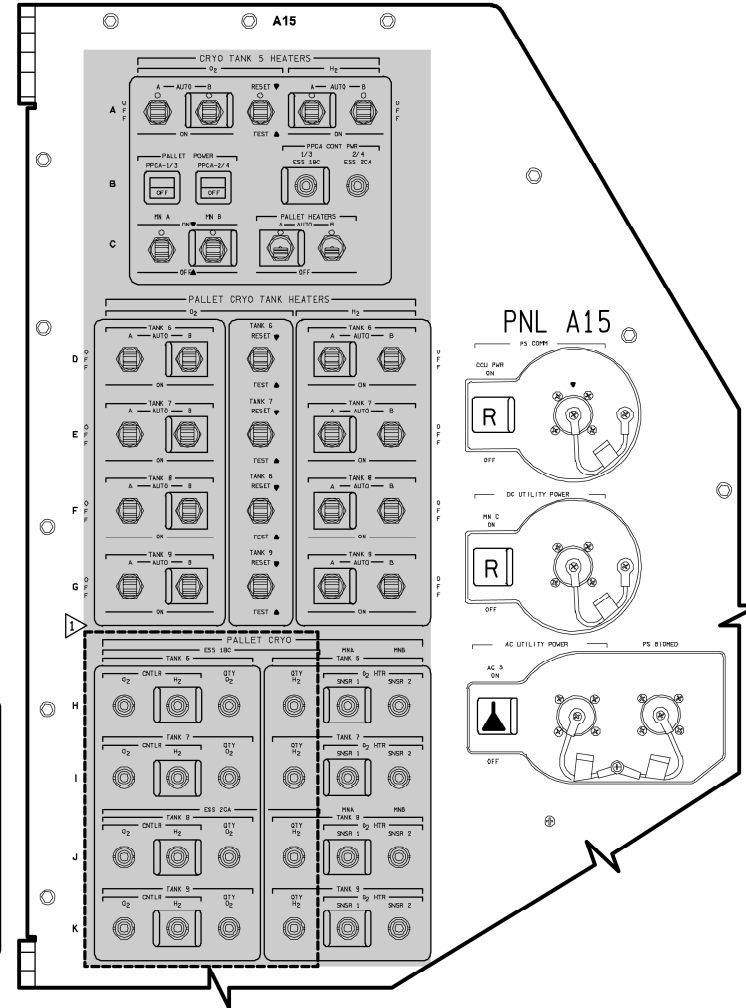
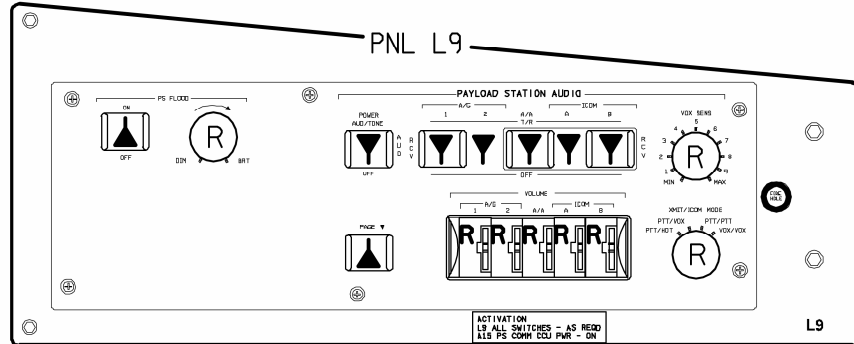
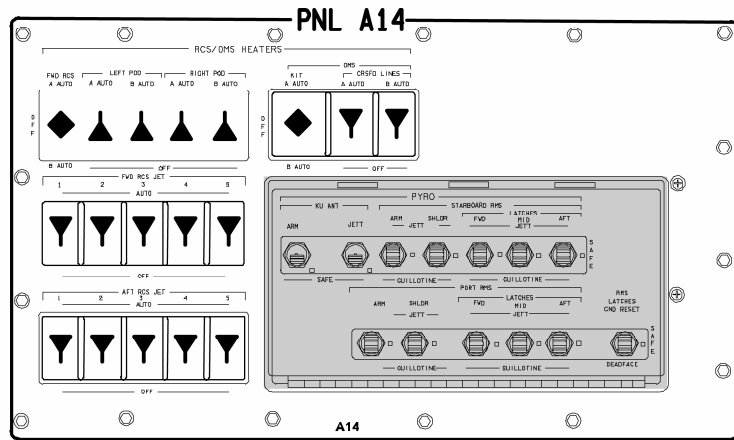

NOTES: CLOSED IF EDO



# OV104

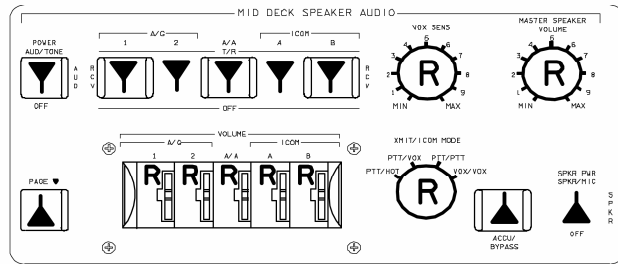

PNL M042F

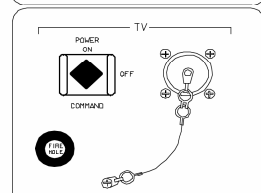
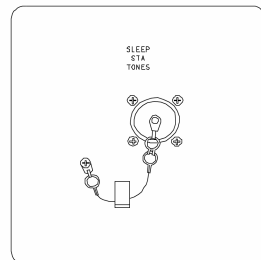
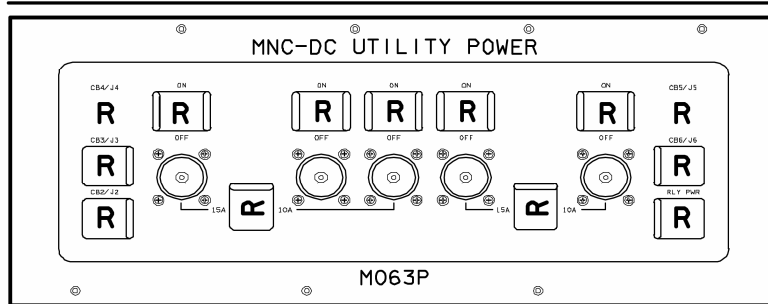
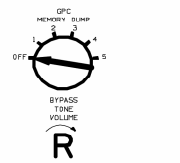

PNL M058F

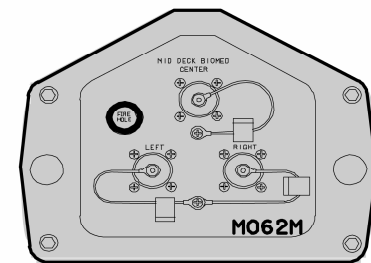
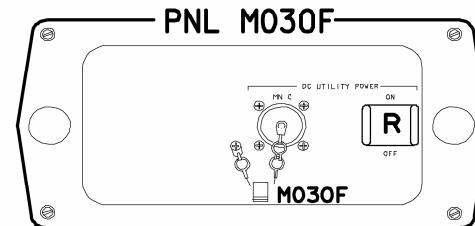
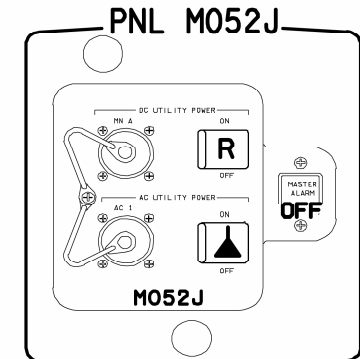
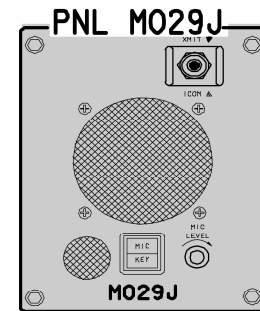
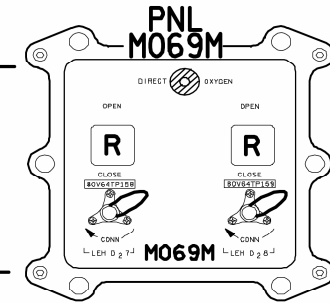
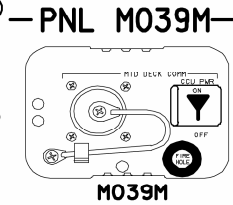
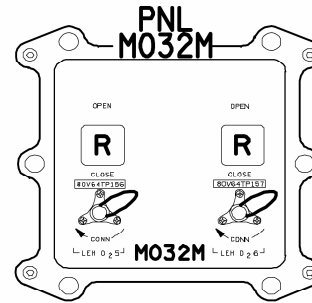

# OV104

OV104

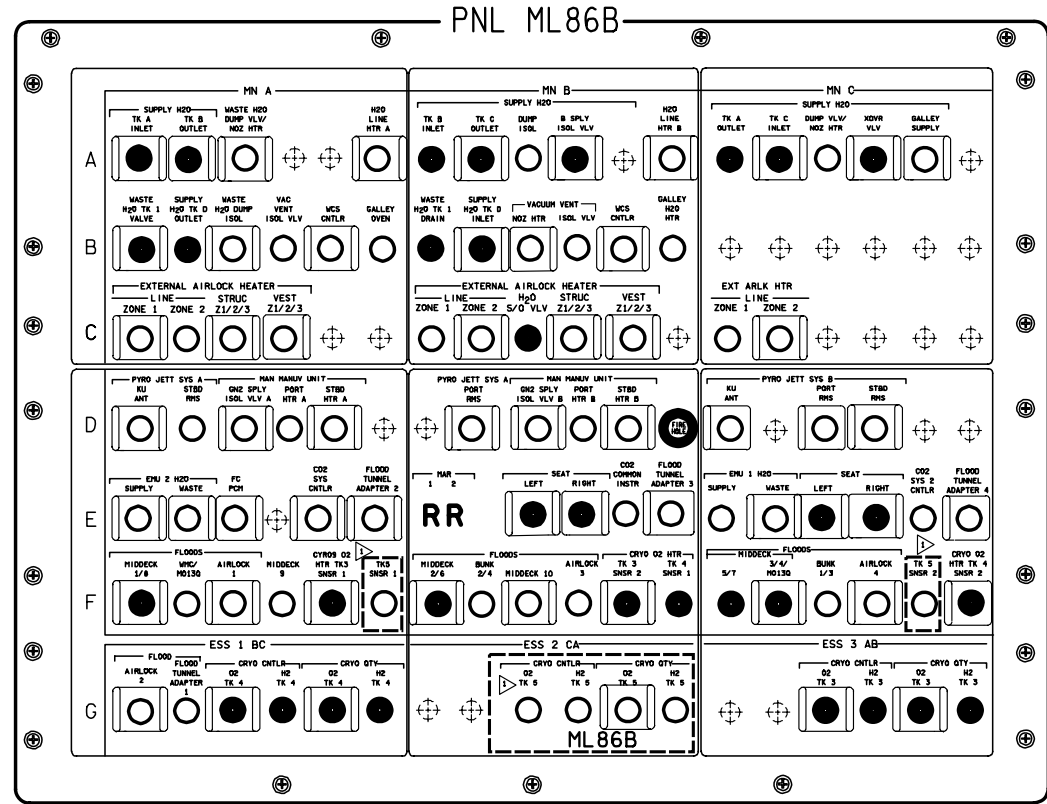
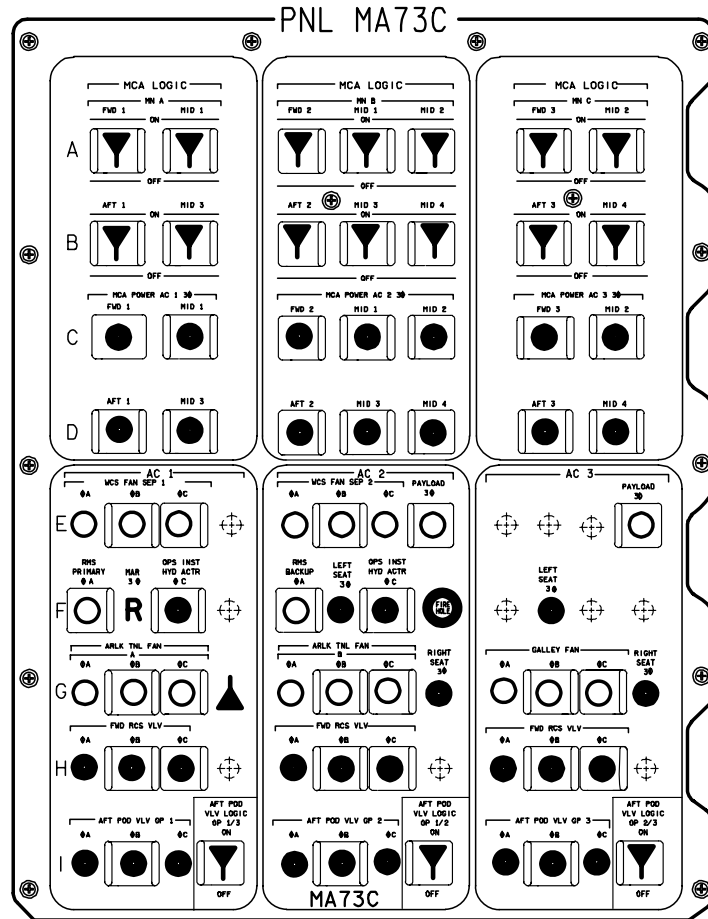

NOTES: ▷ CLOSED IF TK5 FLOWN

OV104

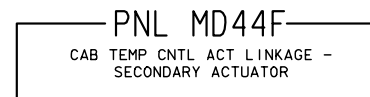
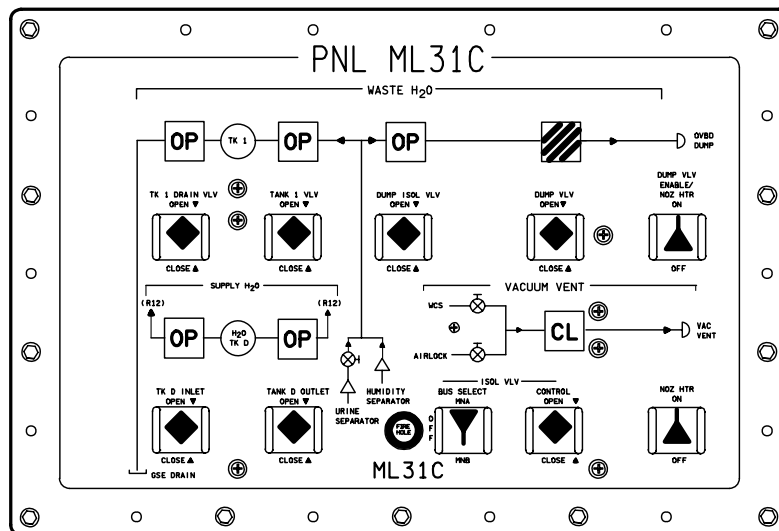
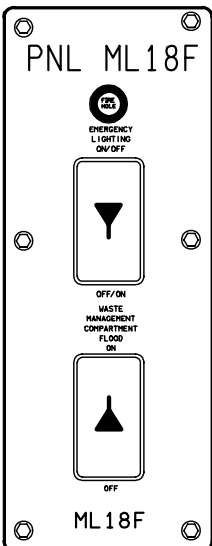
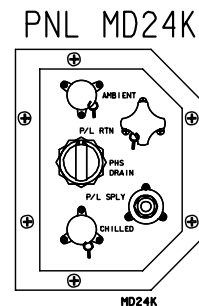
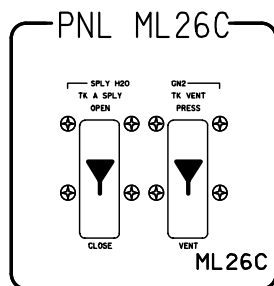
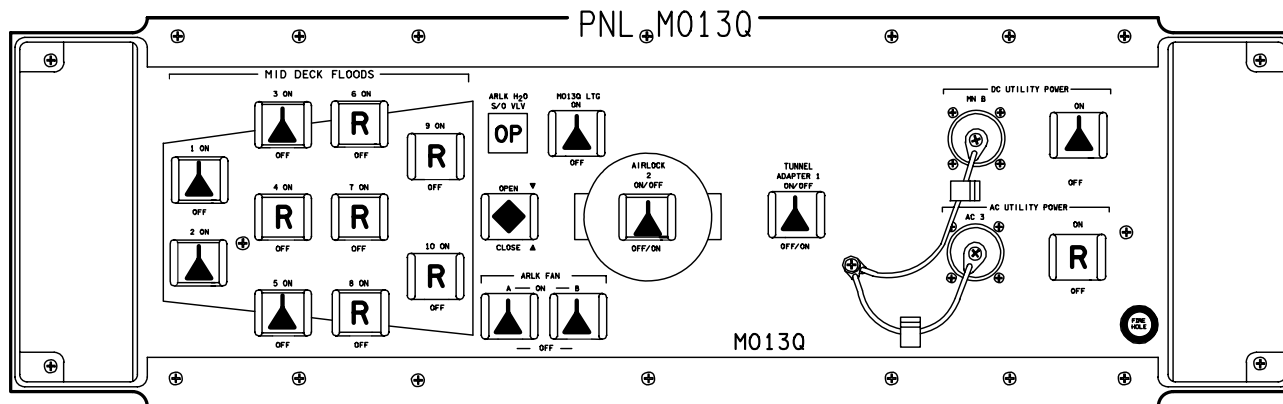

### PNL M010W

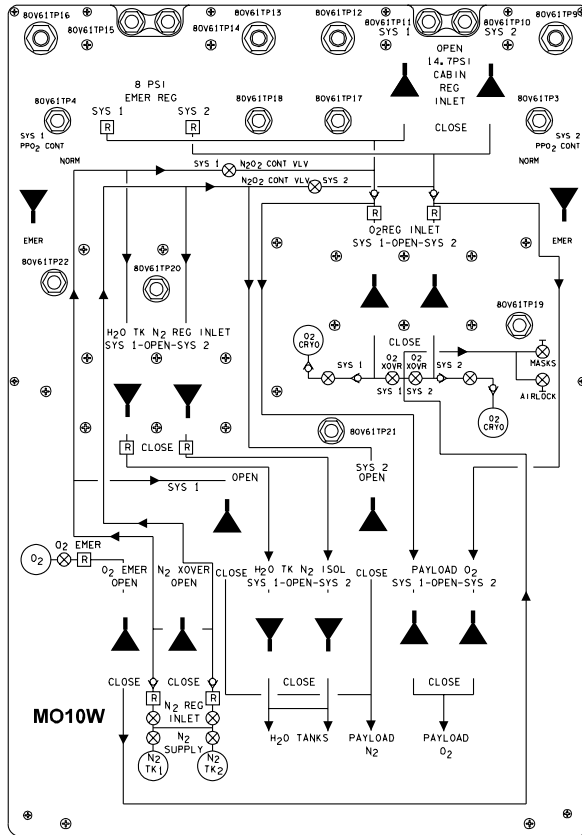

### WCS

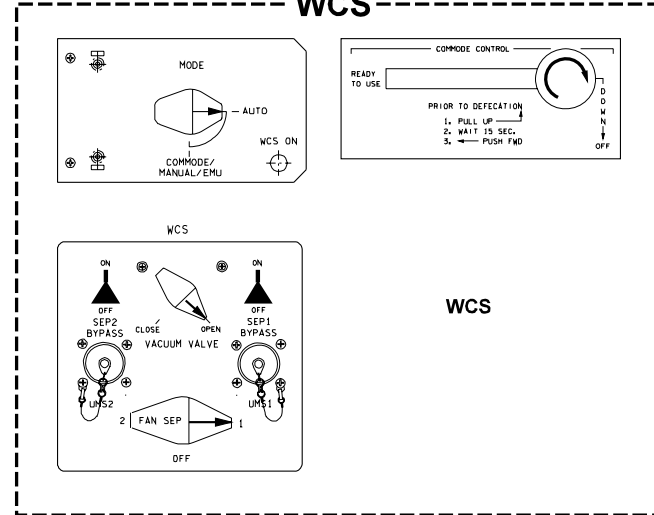

WCS

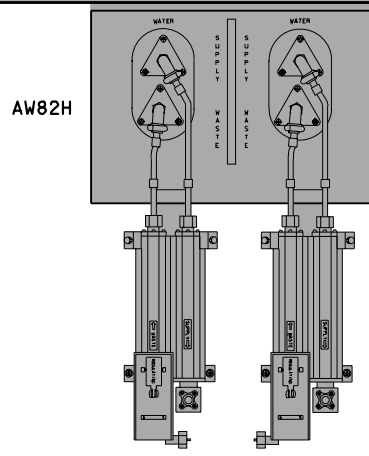
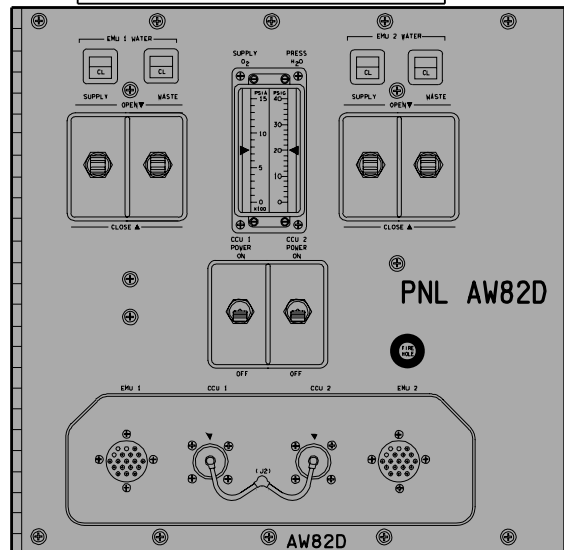
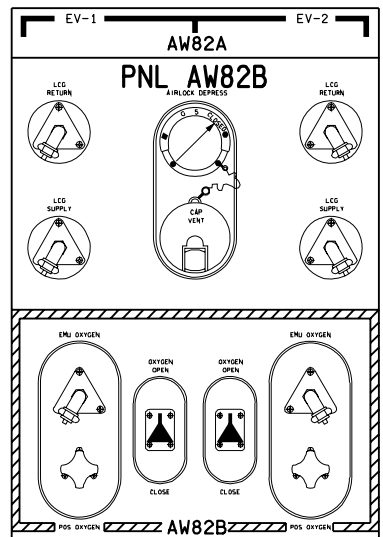
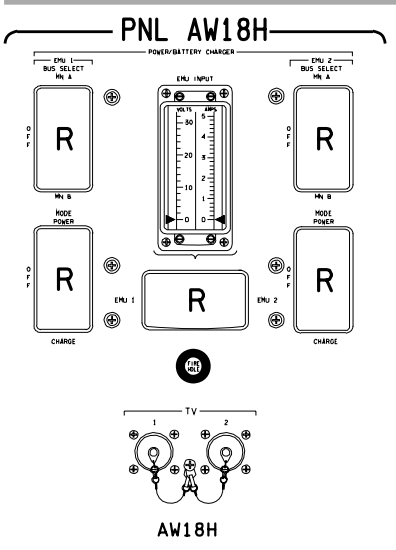
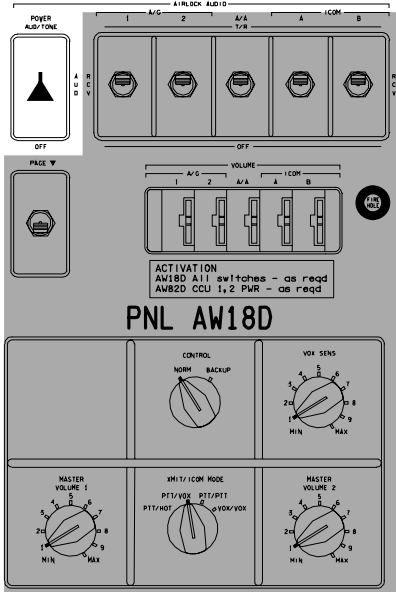
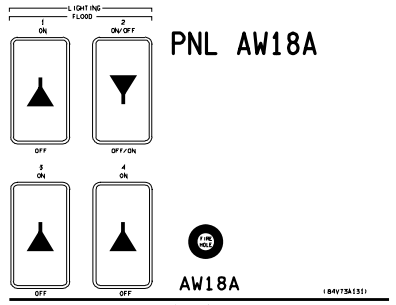

ALL VEH/DATE 07/15/05

48007F331\_121\_PNL\_1

### **Inner Hatch**

Actuator Handle – LATCHED

Lock Lever – LOCKED

Equalization vlv (two) – NORM, capped

OV105

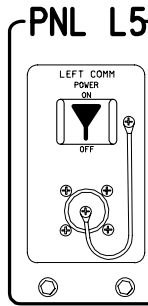

PNL L4

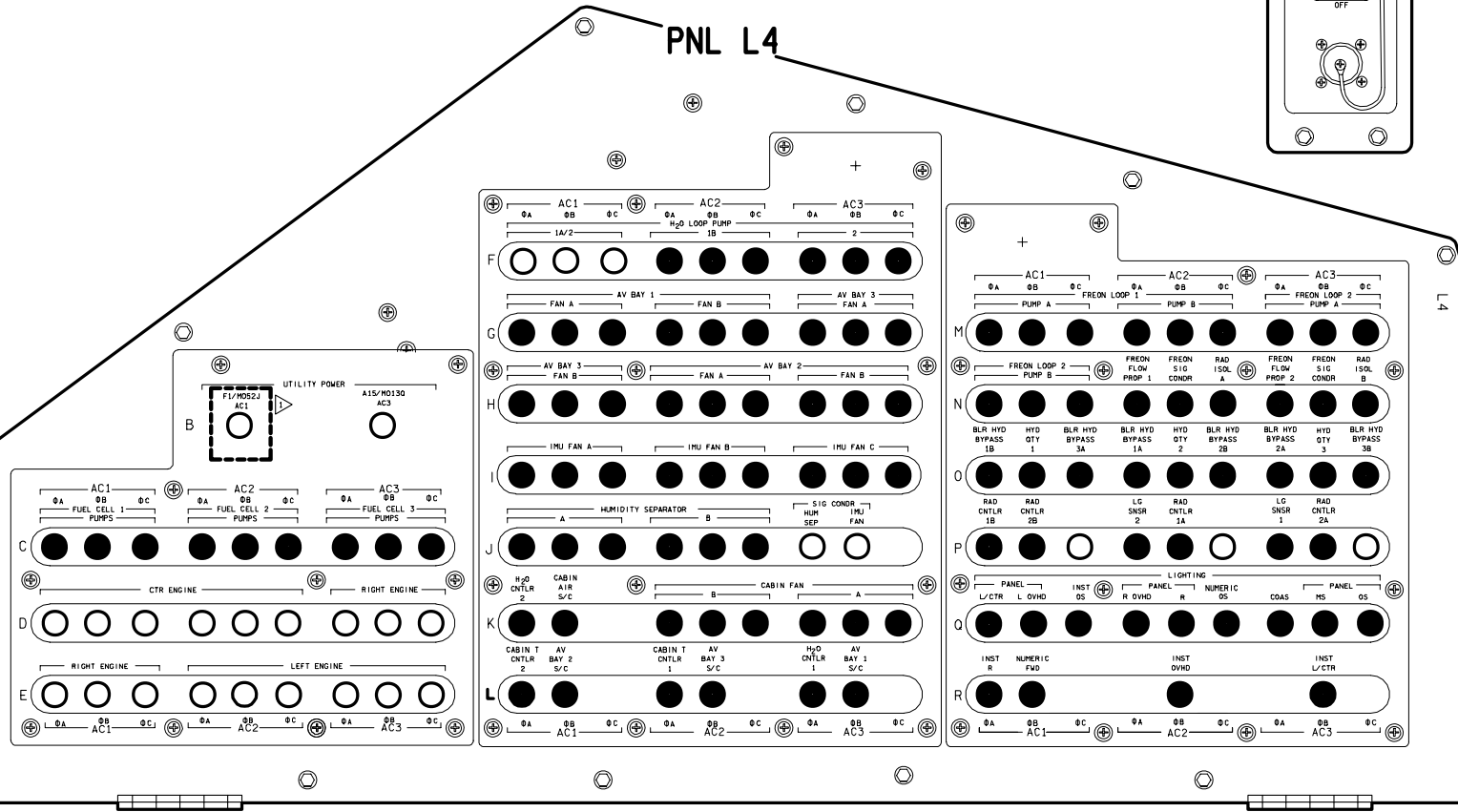

NOTE: ▸ CB CAN REMAIN CLOSED FOR AC PGSC USAGE.  
 CLOSED WHEN PGSC UNPOWERED/STOWED

OV105

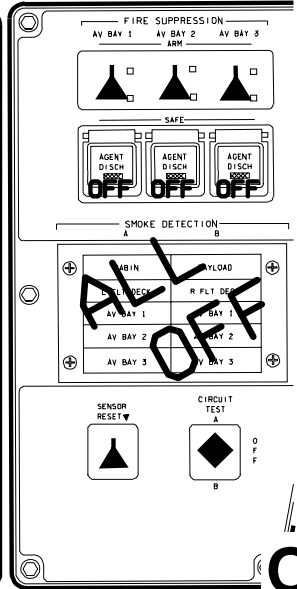
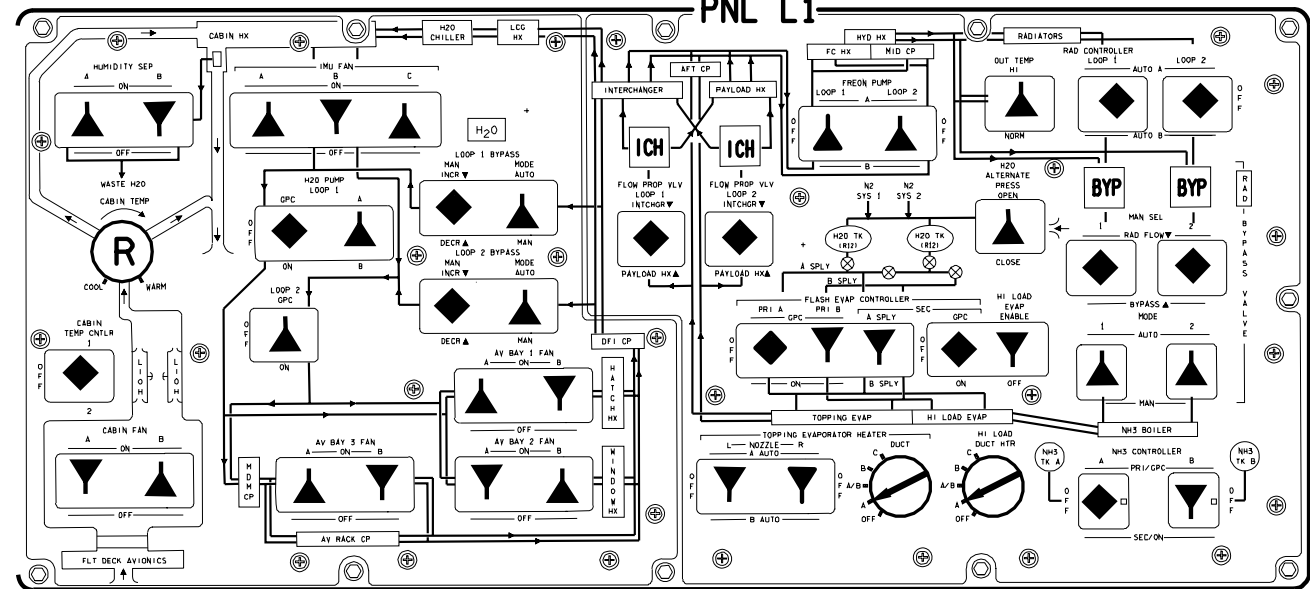
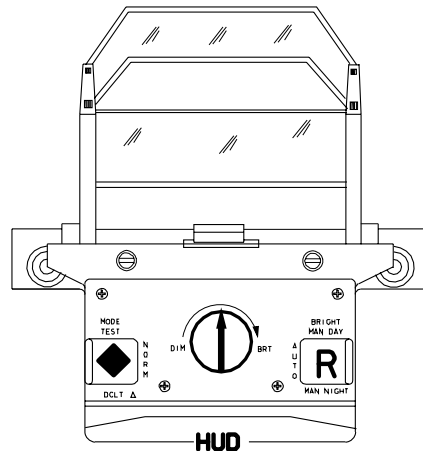
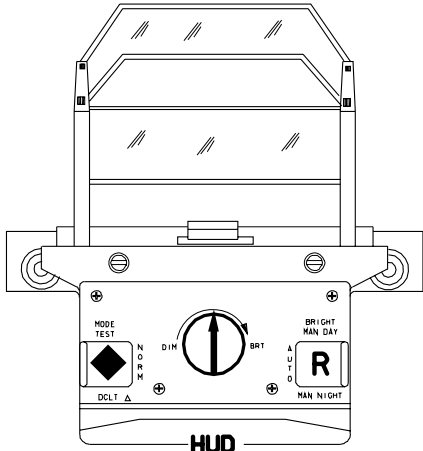
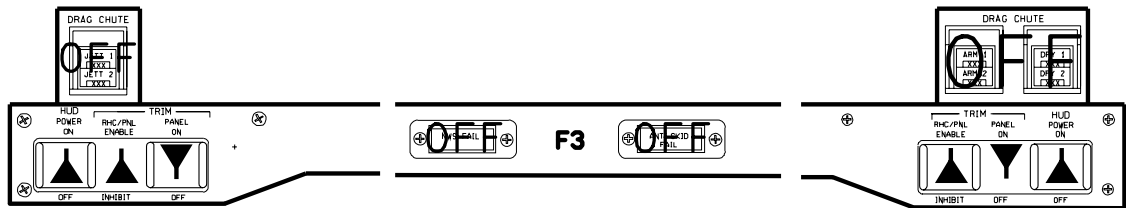



OV105

PNL L2

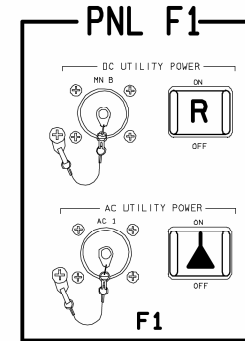
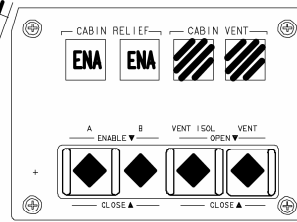

L2

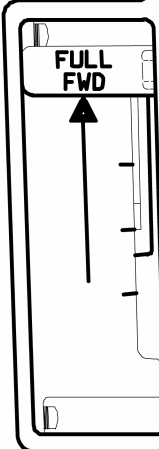
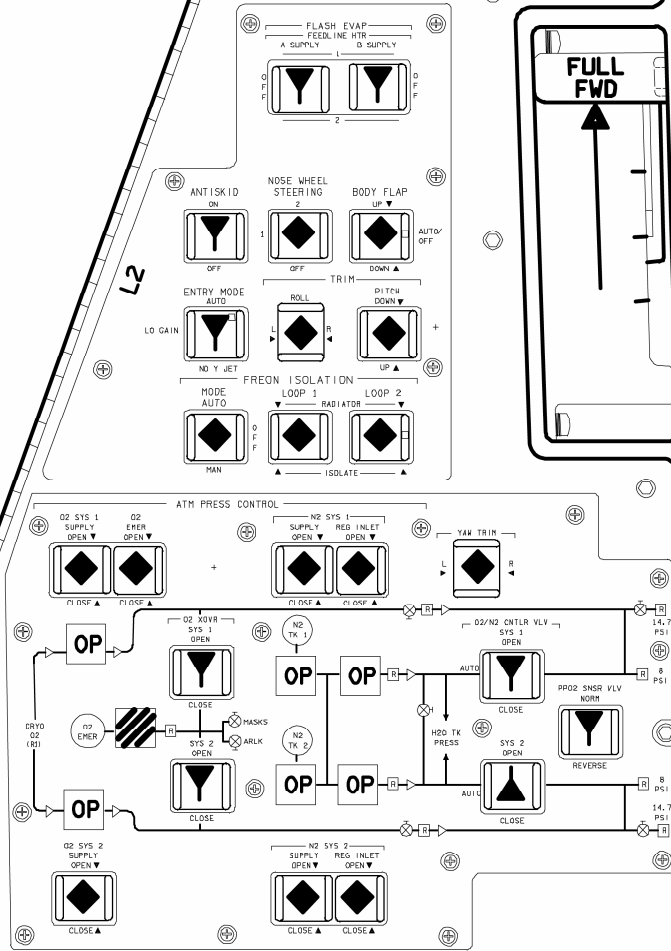

OV105

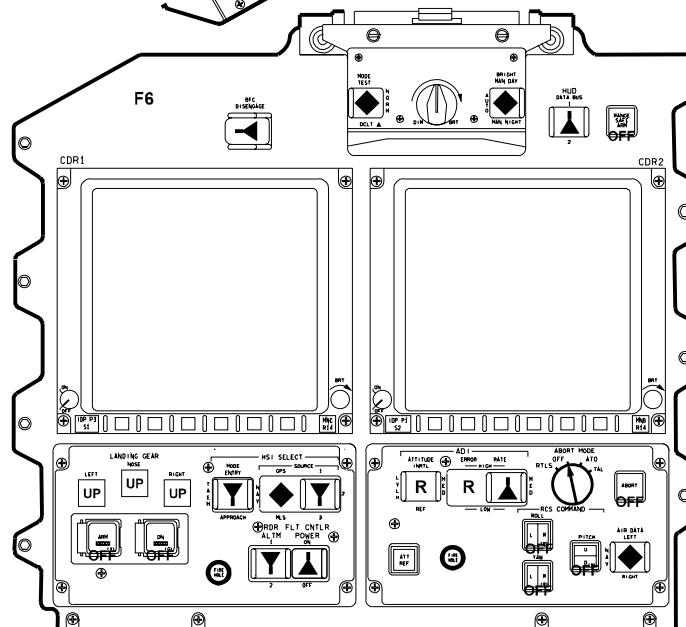
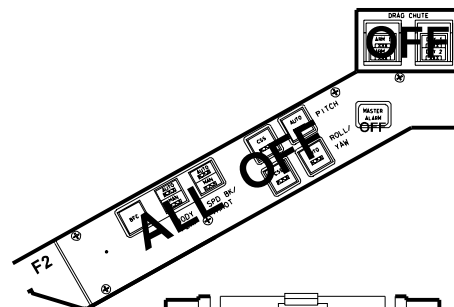
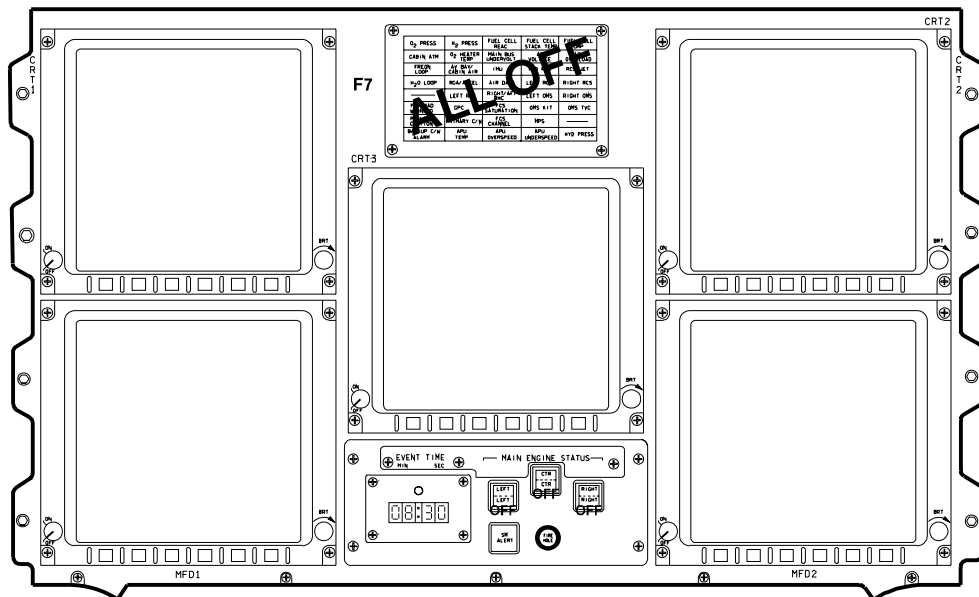

OV105/DATE 04/20/07 480076306-118- PNL 2

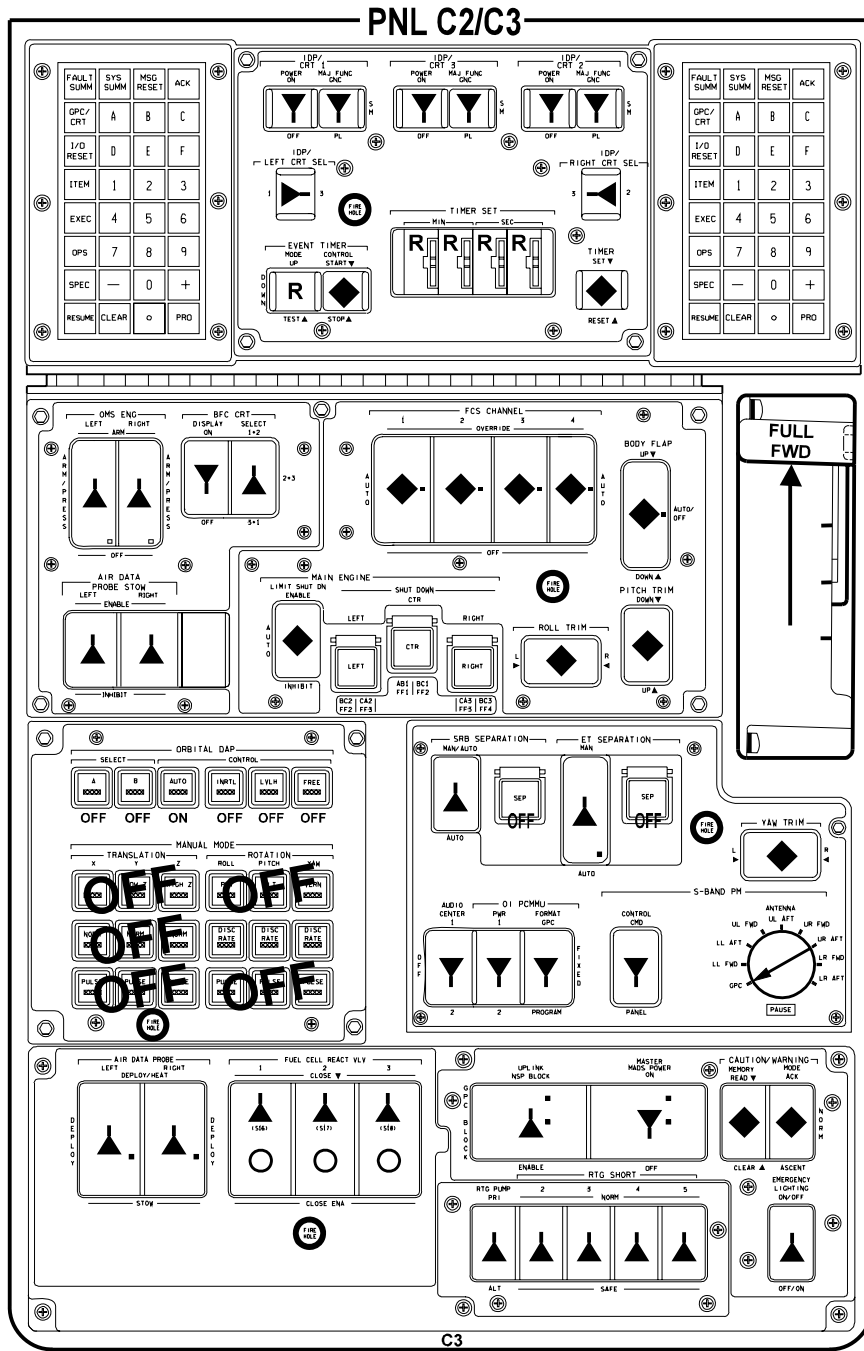

OV105

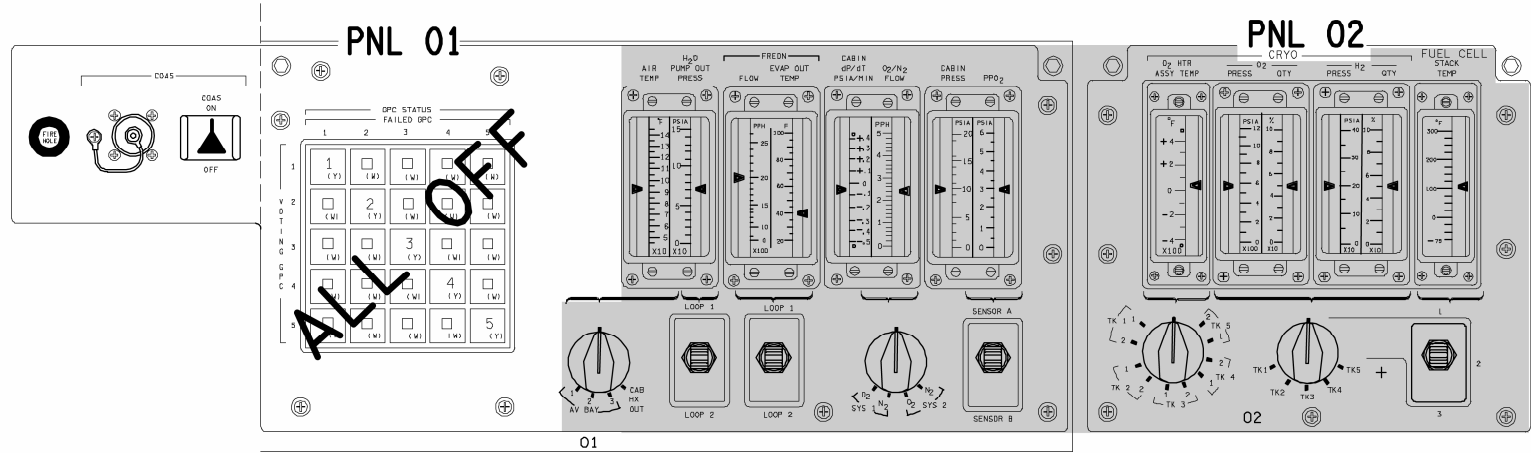

L side OVHD flood - R (MID)

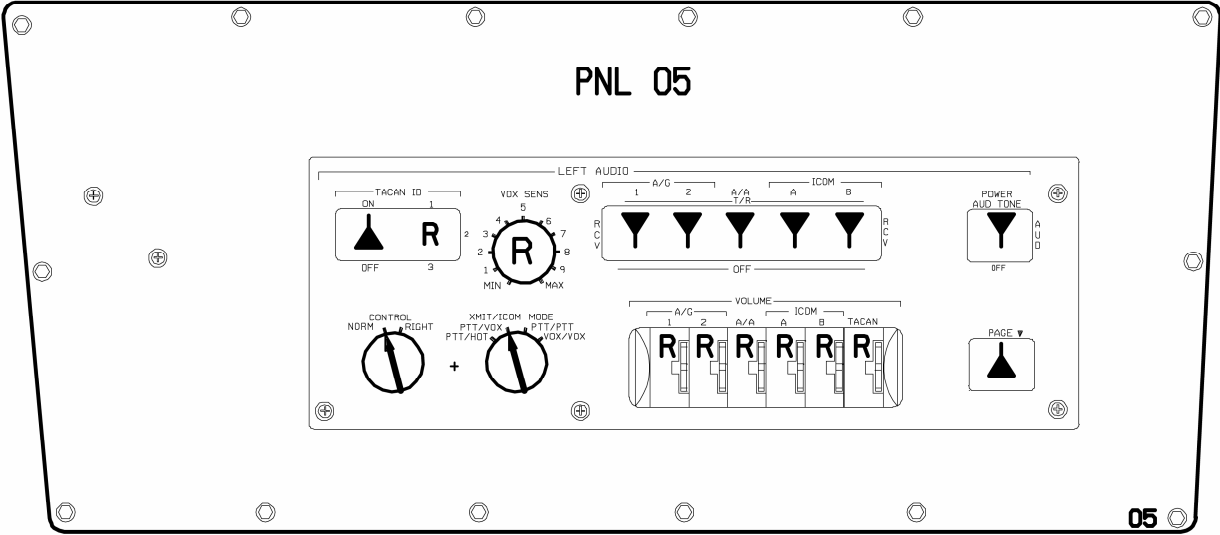

OV105

PNL 06

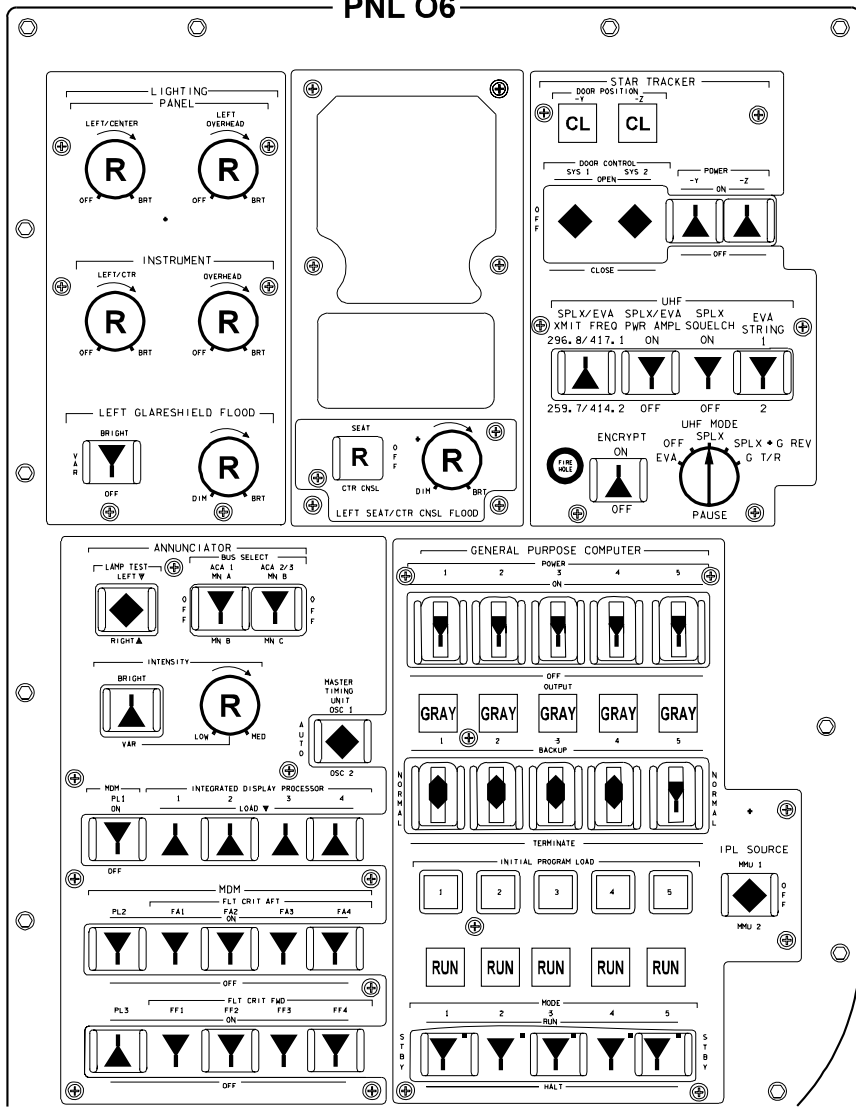

PNL 07

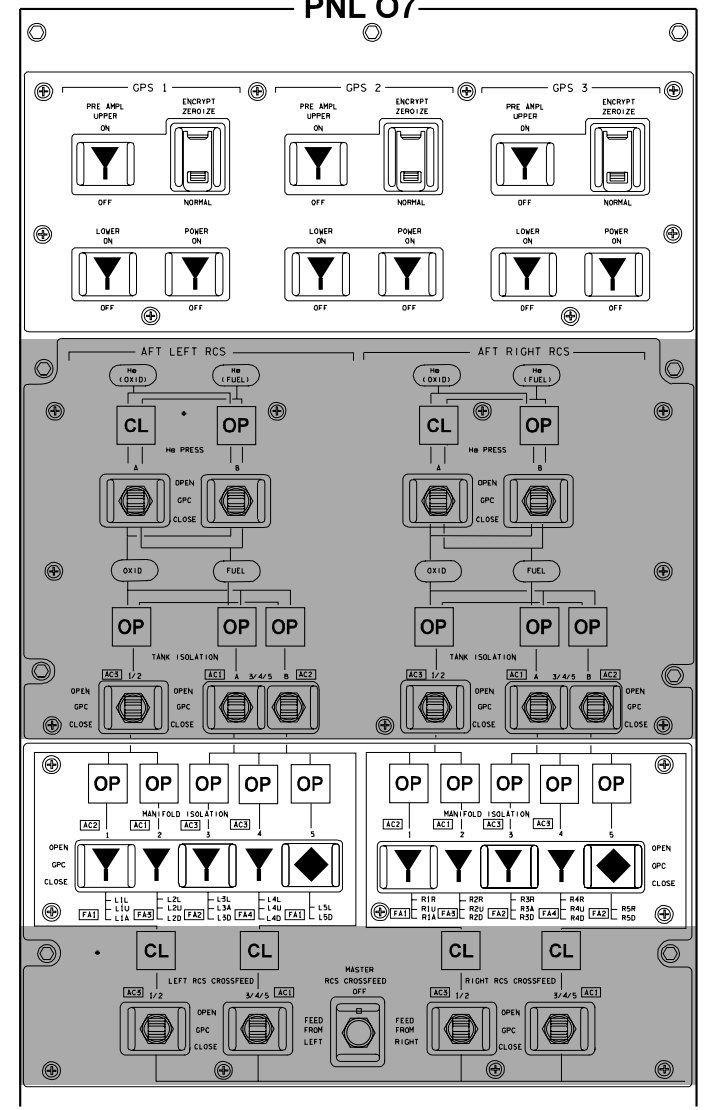

48007G309\_118, PNL 2

OV105

OV105/DATE 03/23/07

# PNL 08

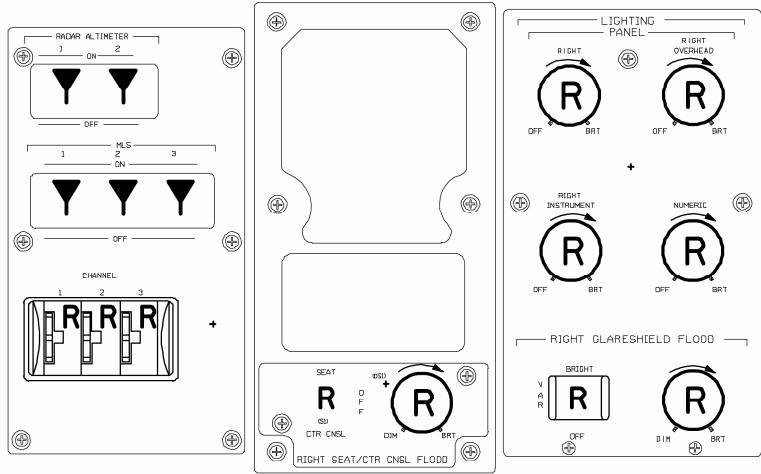

# PNL 09

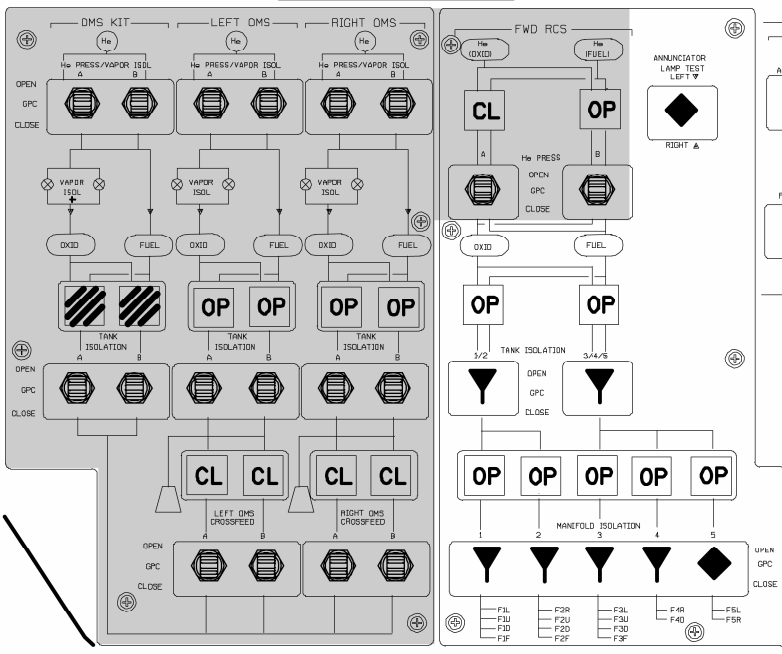
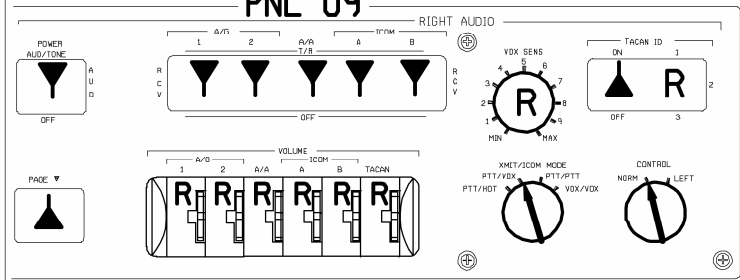

R side OVHD flood - R (MID)

OV105

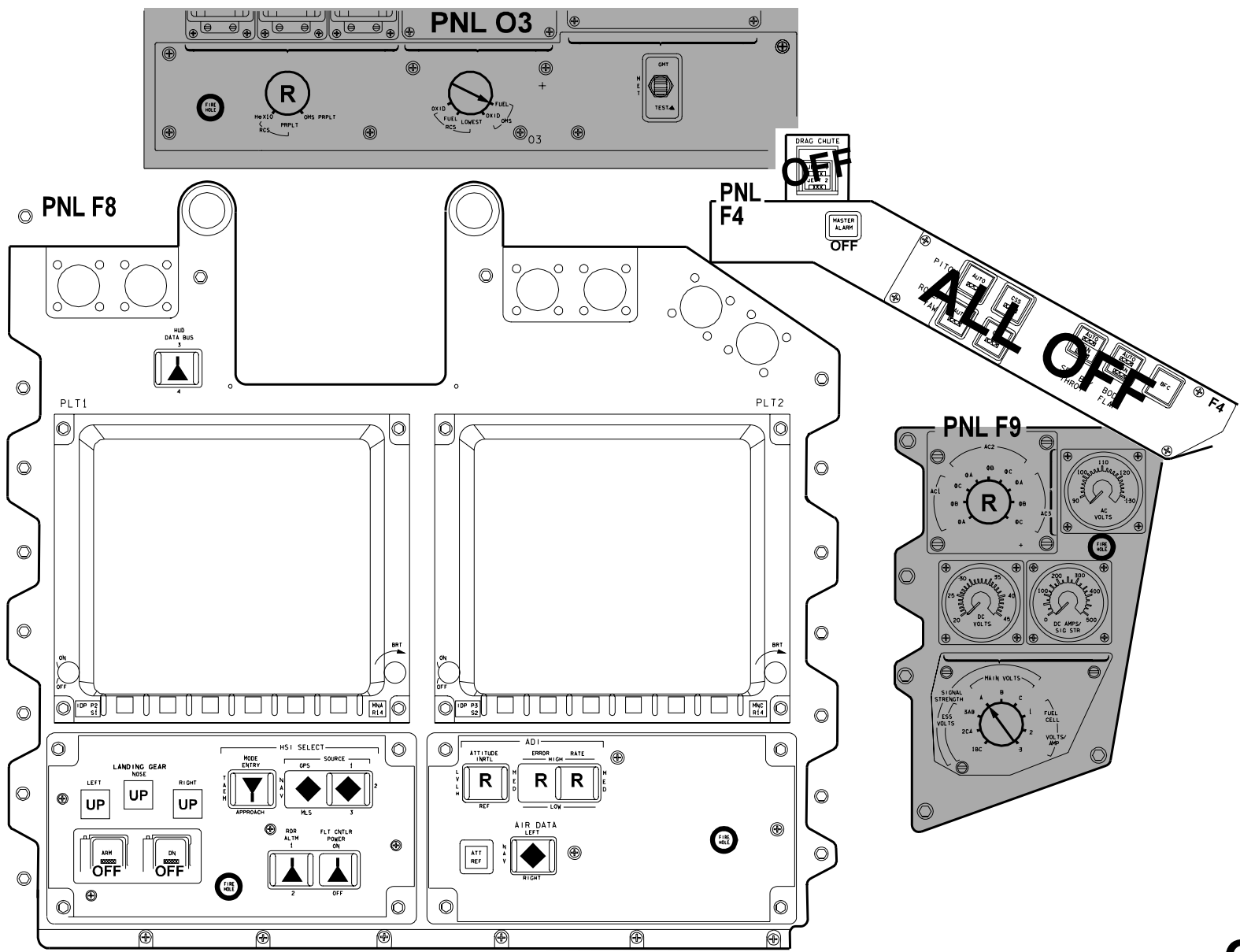

48007G311\_118.PNL# 2

ALL VEH/DATE 05/14/07

OV105

(OV105) C3-11

C D/O/ALL/GEN M

**PNL R1**

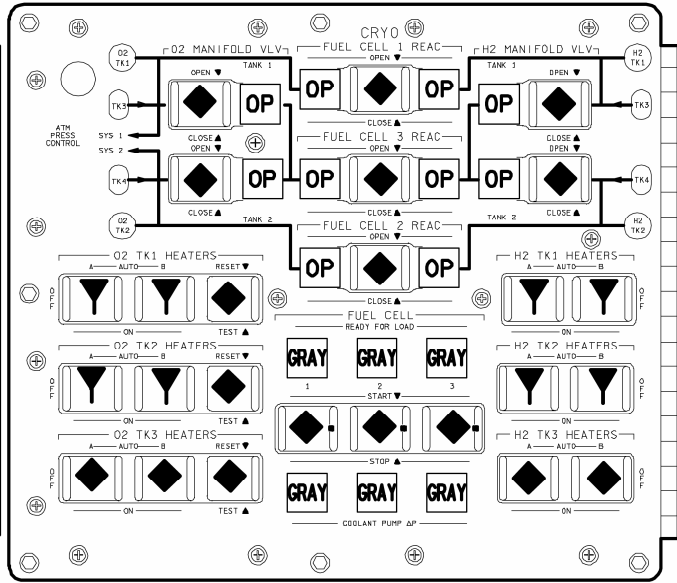
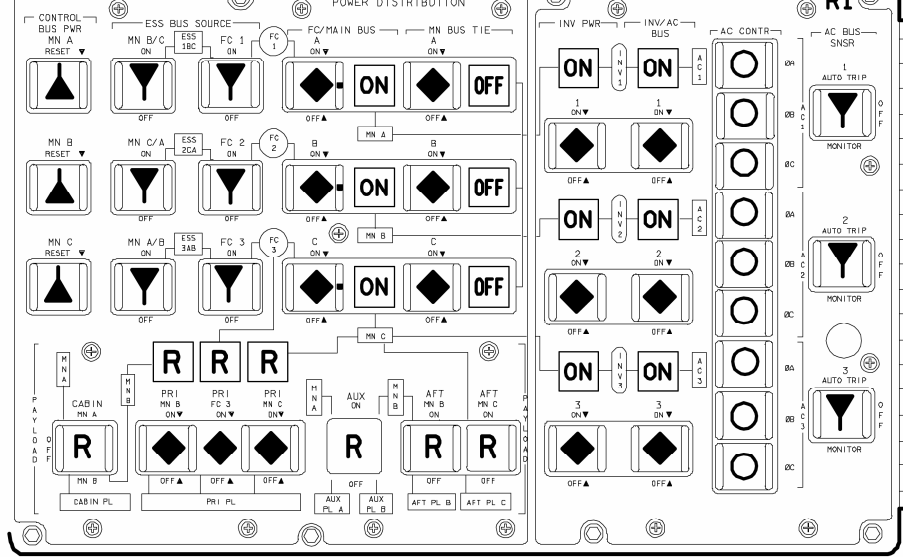



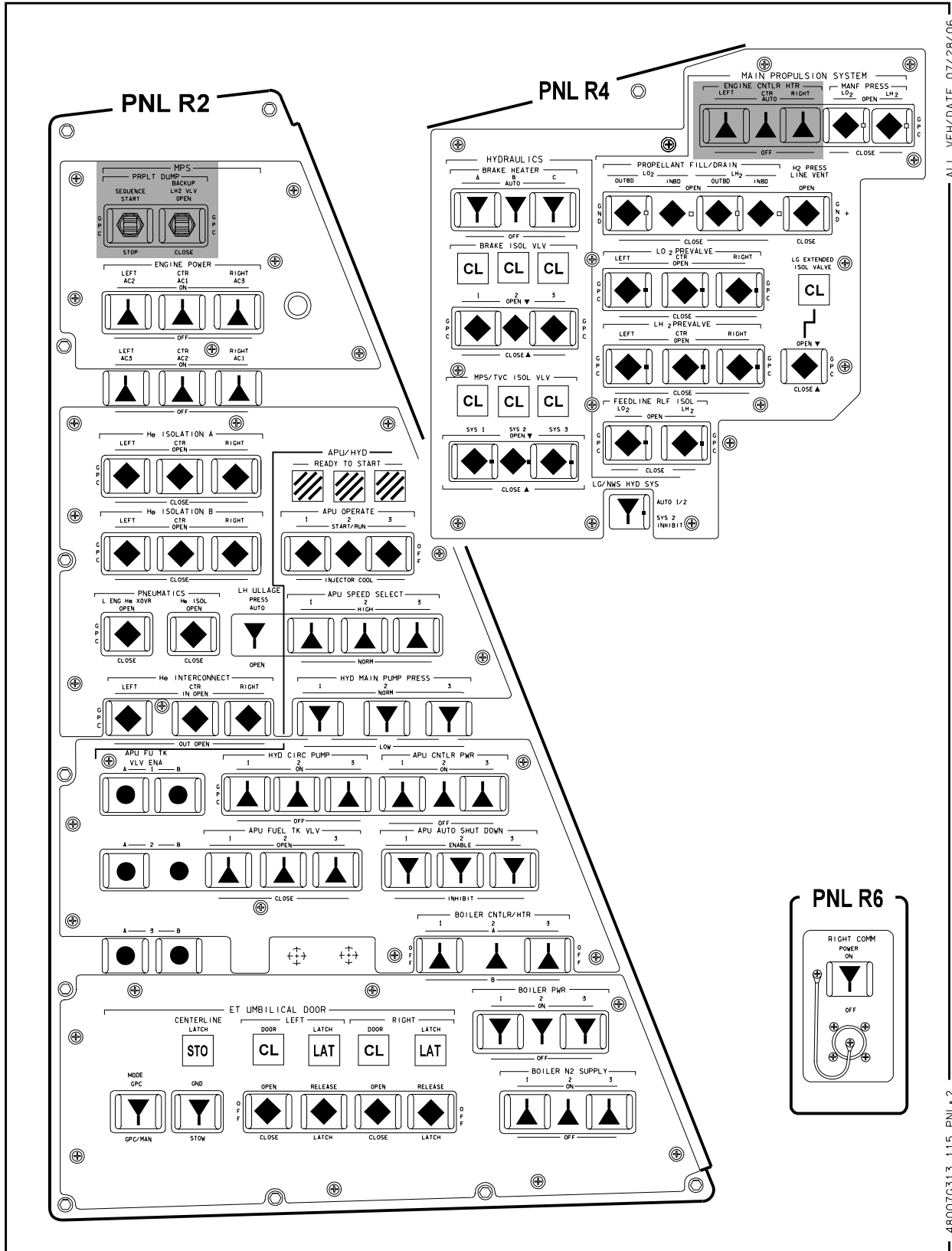

This Page Intentionally Blank

# OV105

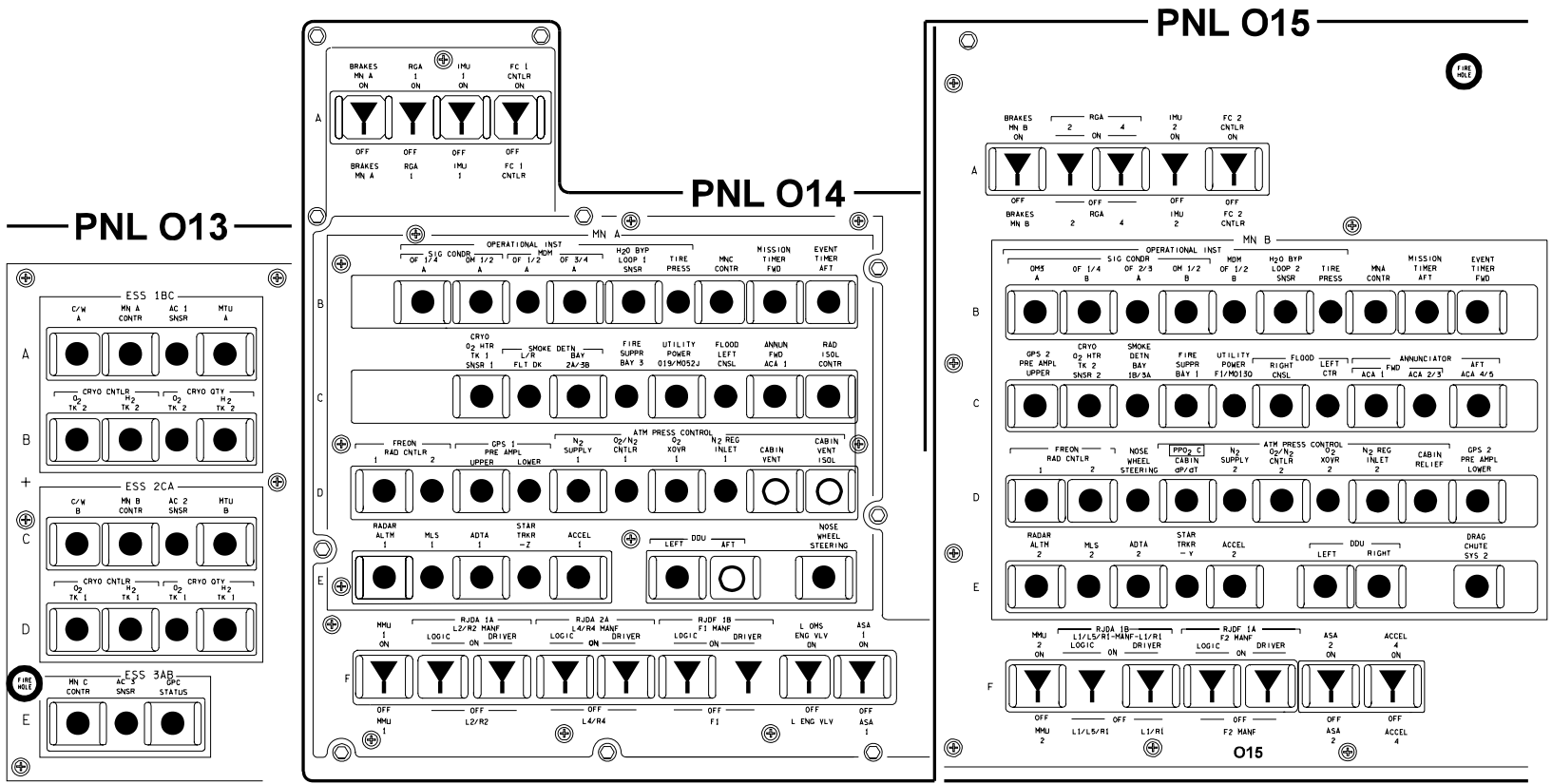

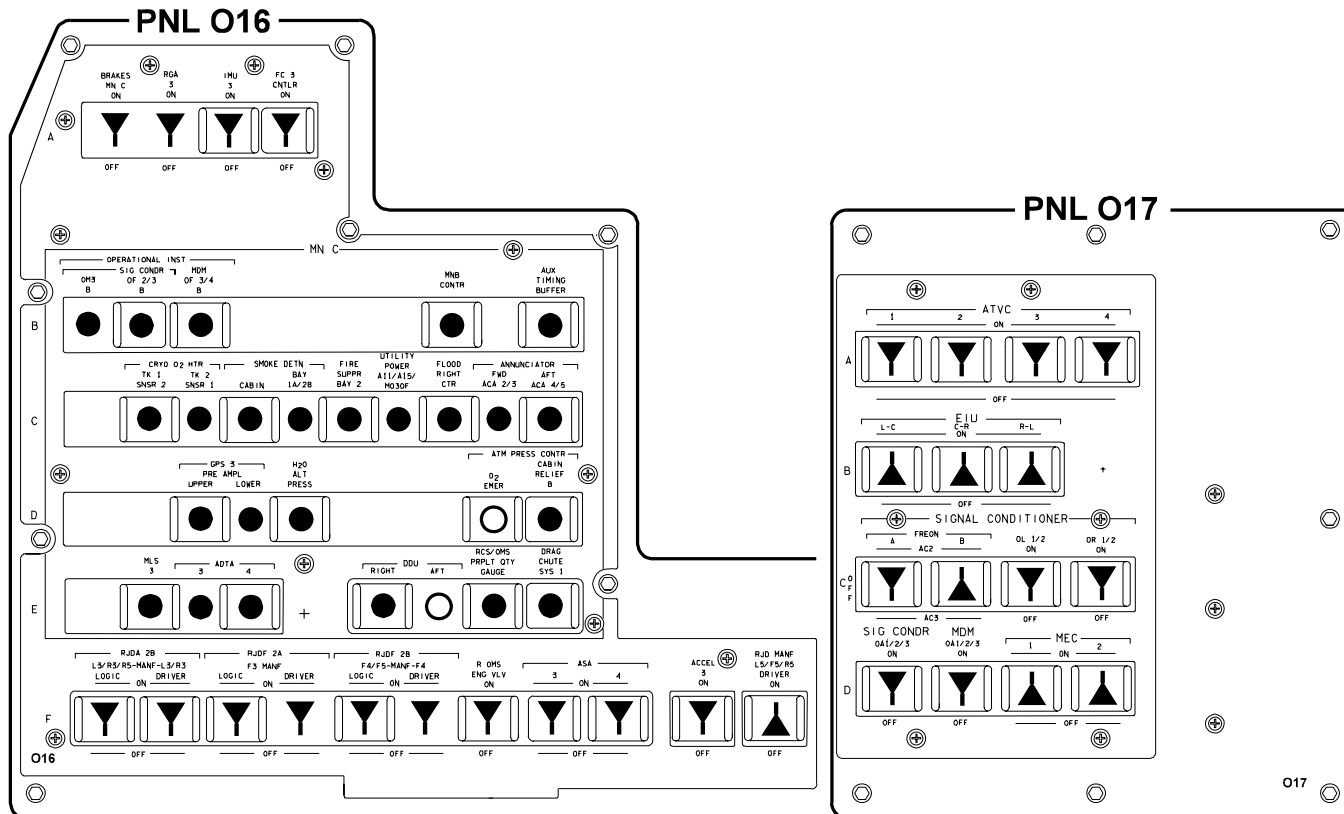

OV105

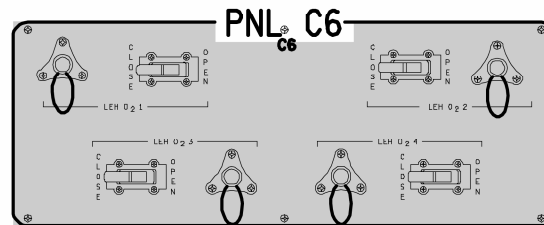
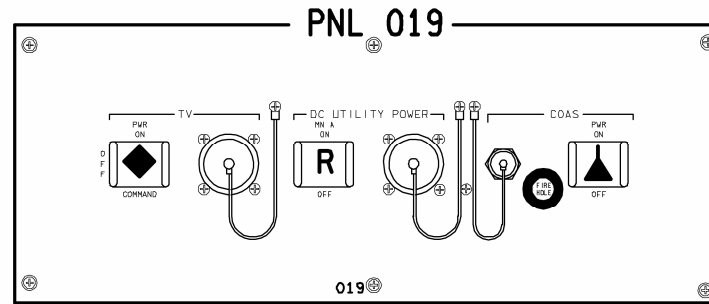

PNL C5

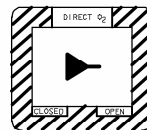

PNL C7

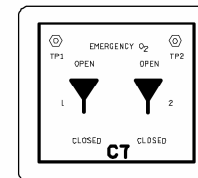

OV105

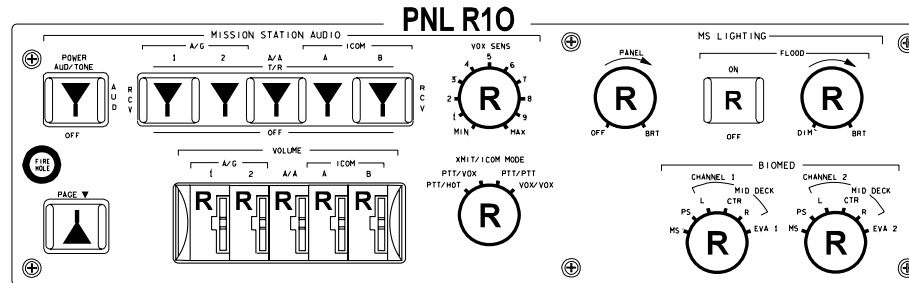

ACTIVATION  
 R10 MS AUD PWR - AUD/TONE  
 All other sws - as reqd  
 R12 MS AUD CNTRL - NORM  
 A11 MS COMM CCU PWR - ON

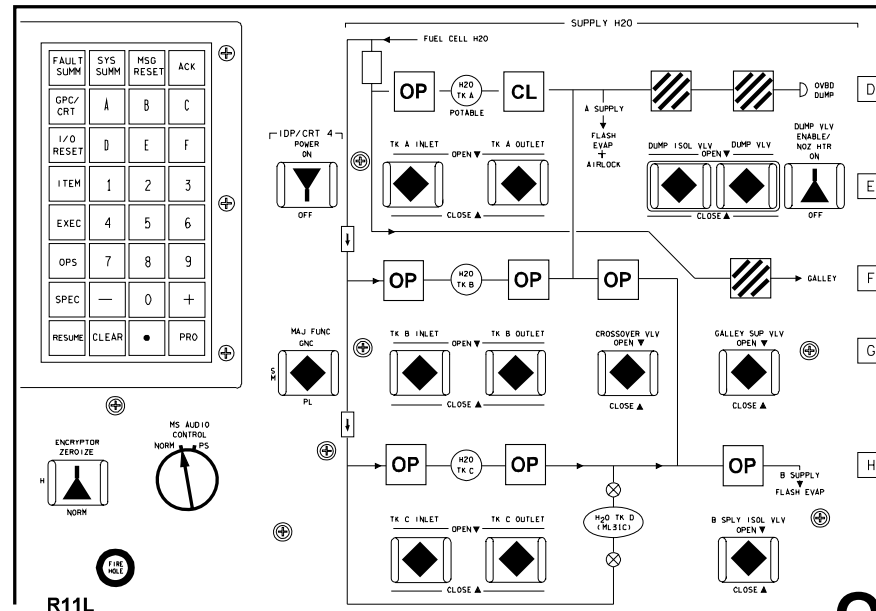
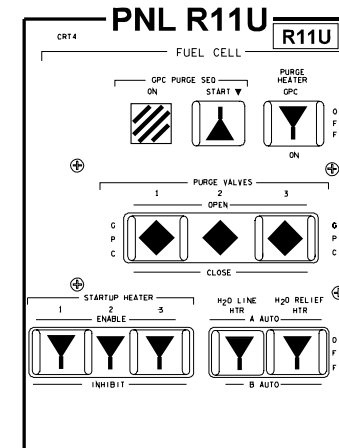

OV105

OV105

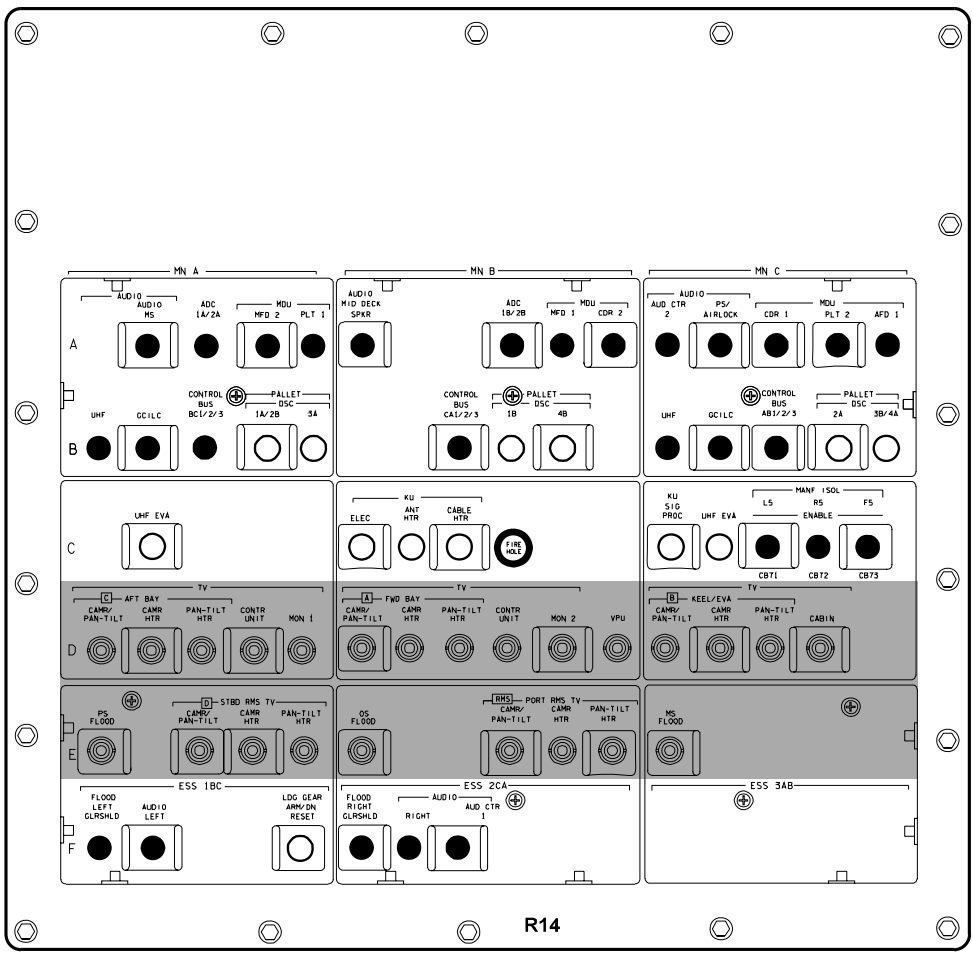
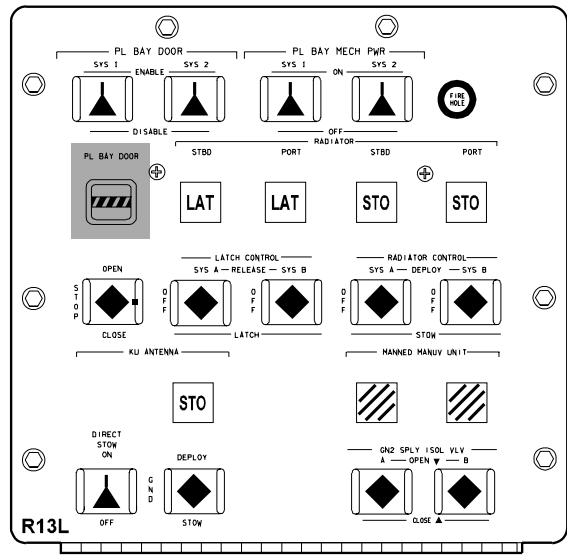
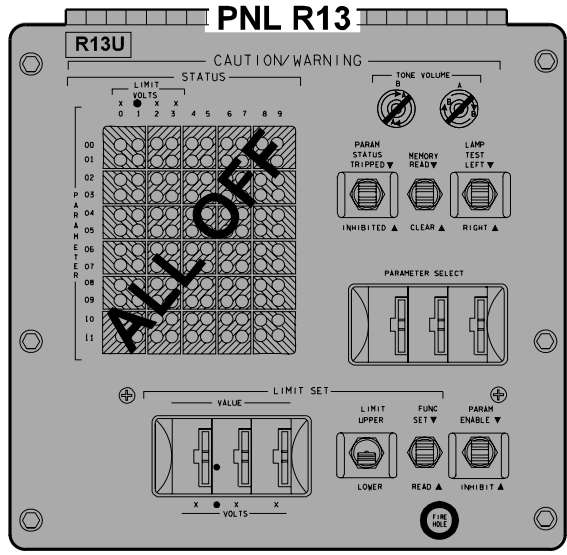

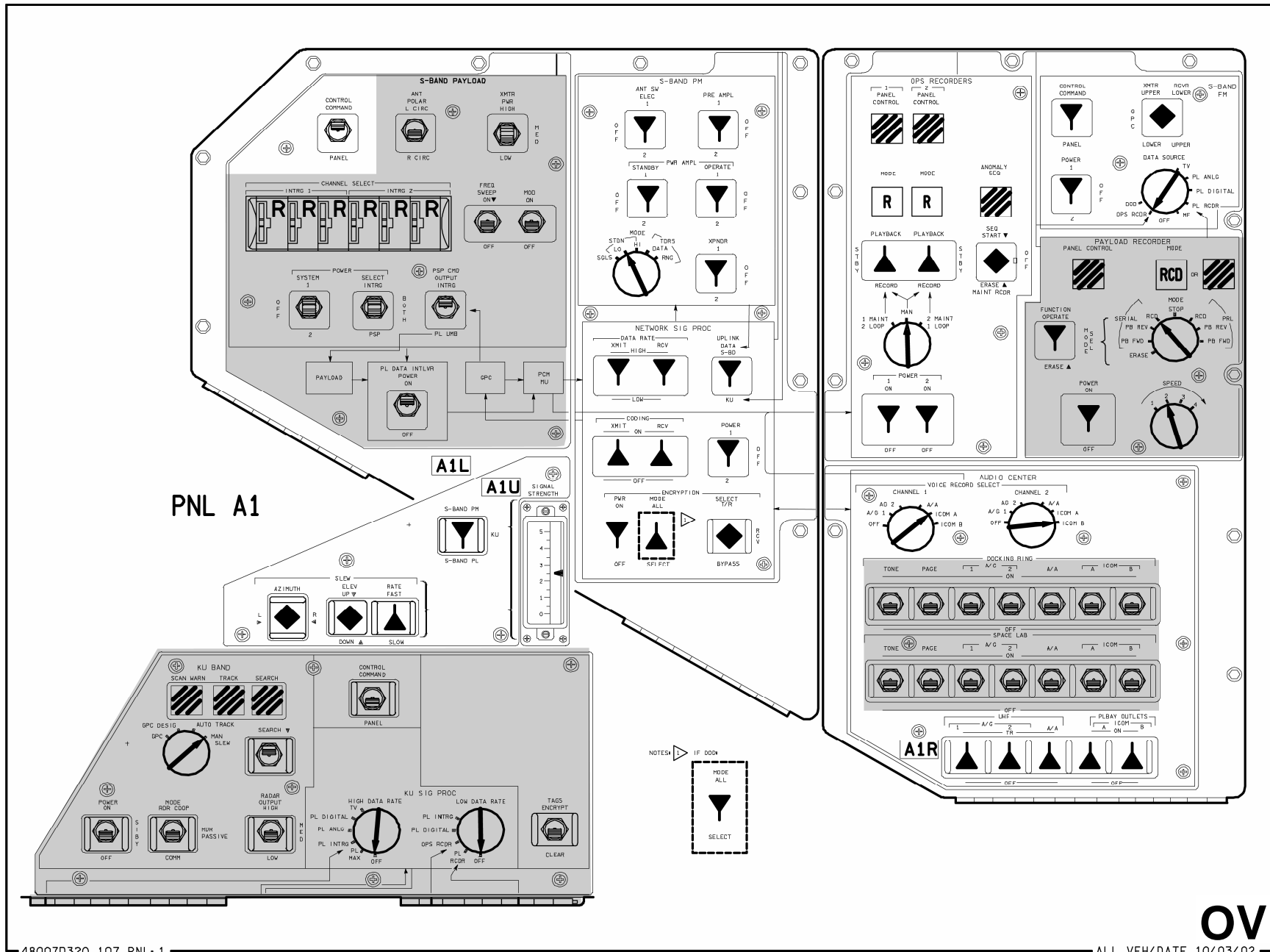



OV105

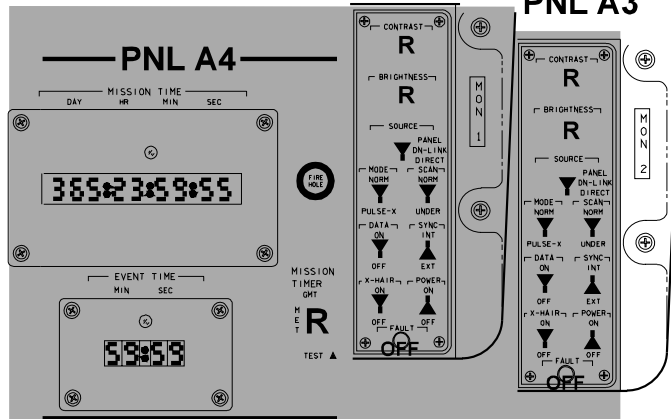

PNL A6U

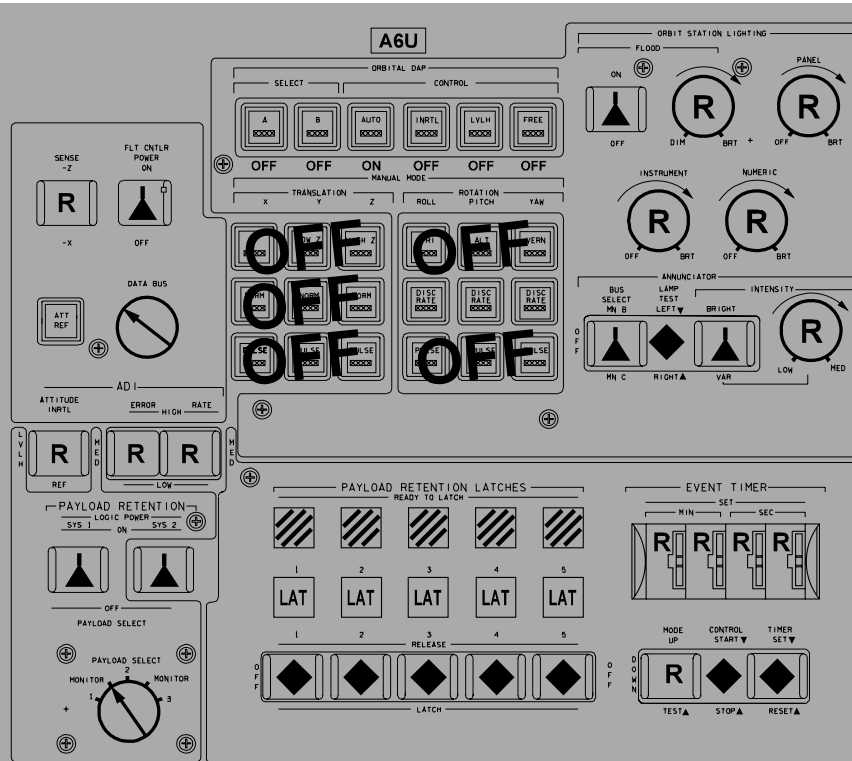

PNL A3

PNL A7U

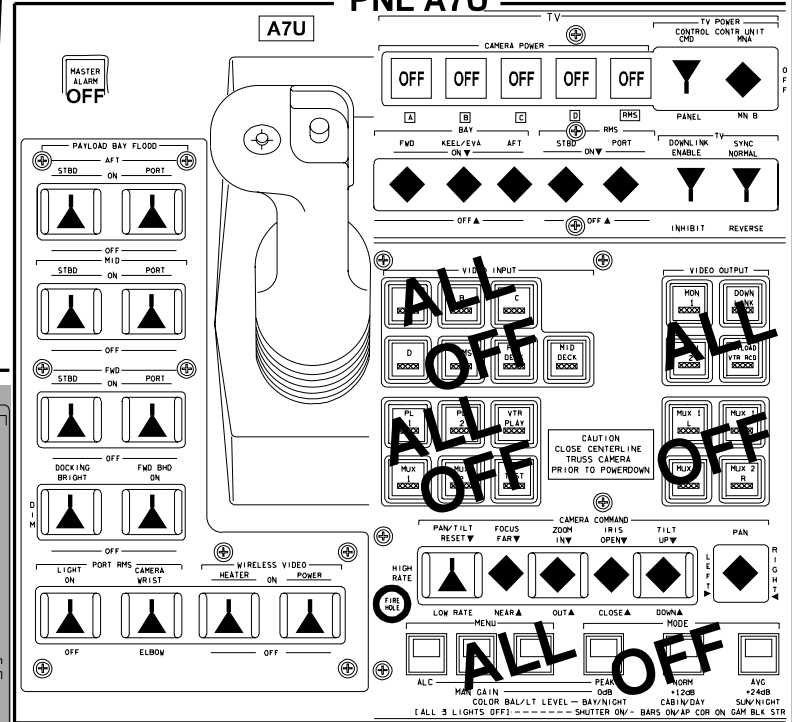

OV105

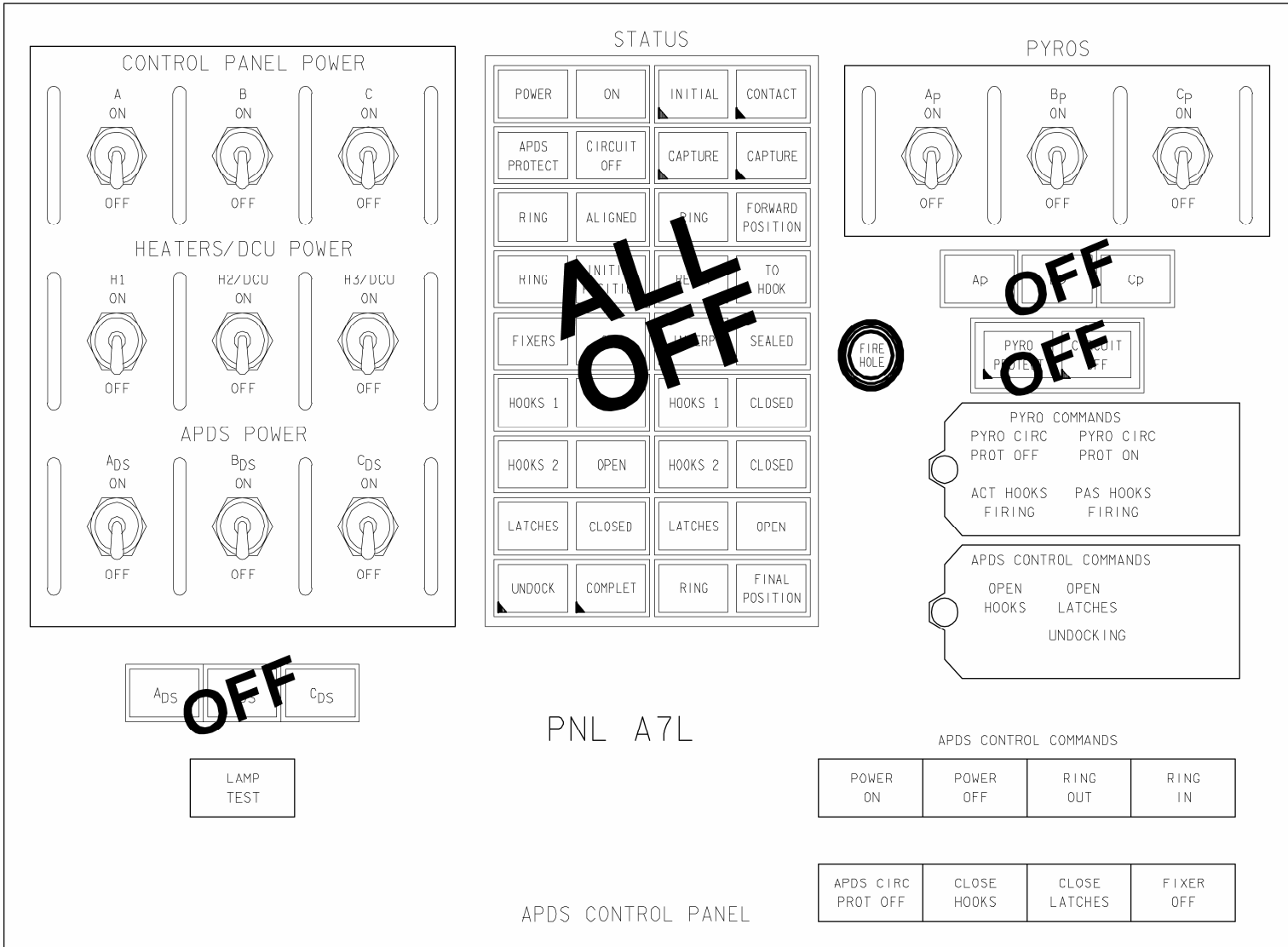

**ALL OFF**

**OFF**

**OFF**

**OFF**

PNL A7L

APDS CONTROL PANEL

**OV105**

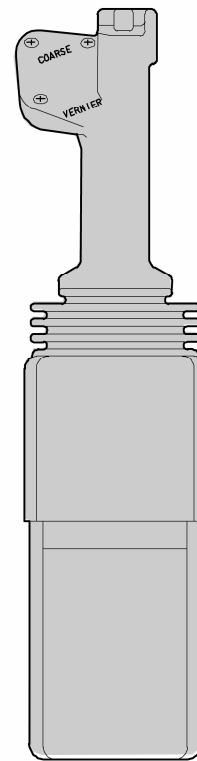
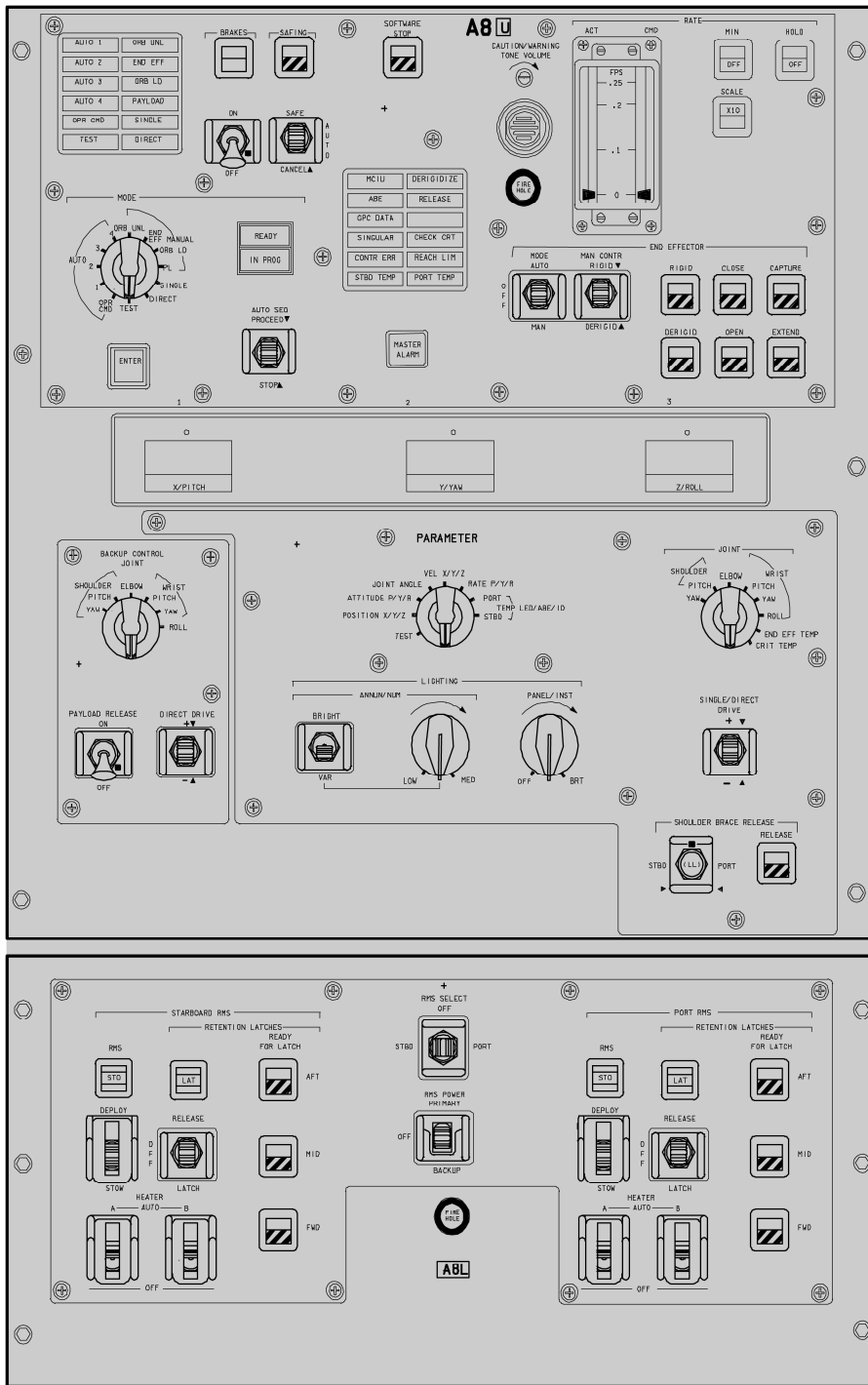

OV105

PNL A11

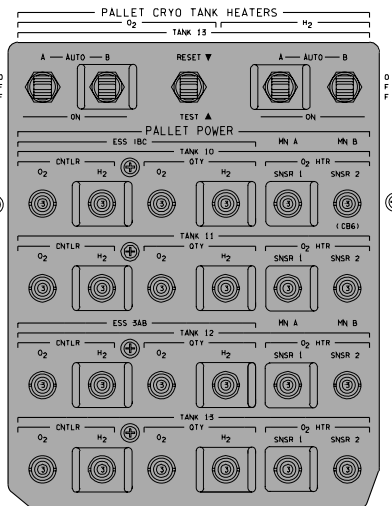
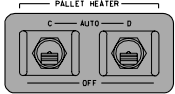
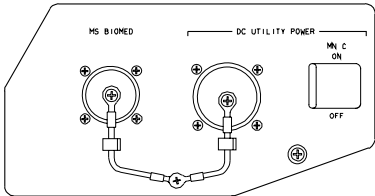
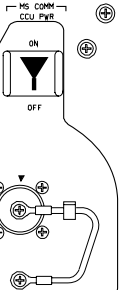
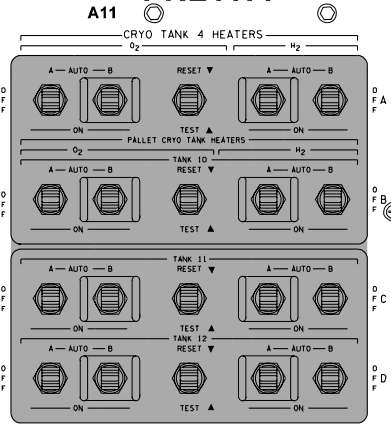

PNL A13

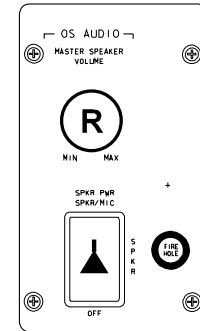

PNL A12

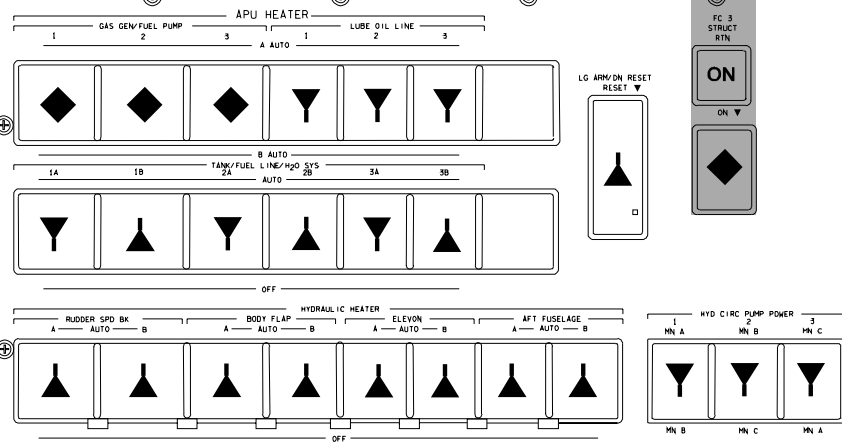

48007G324\_115, PNL 1

OV105/DATE 06/21/06

A6L

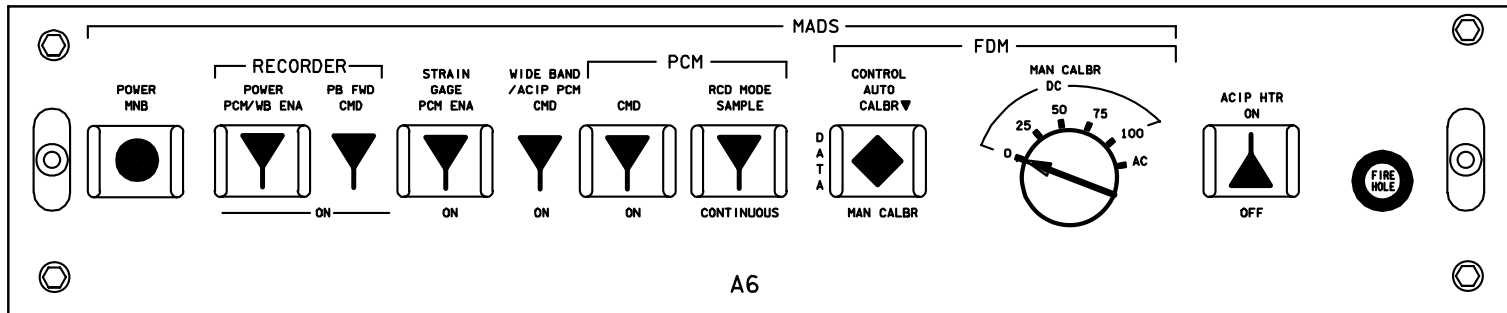
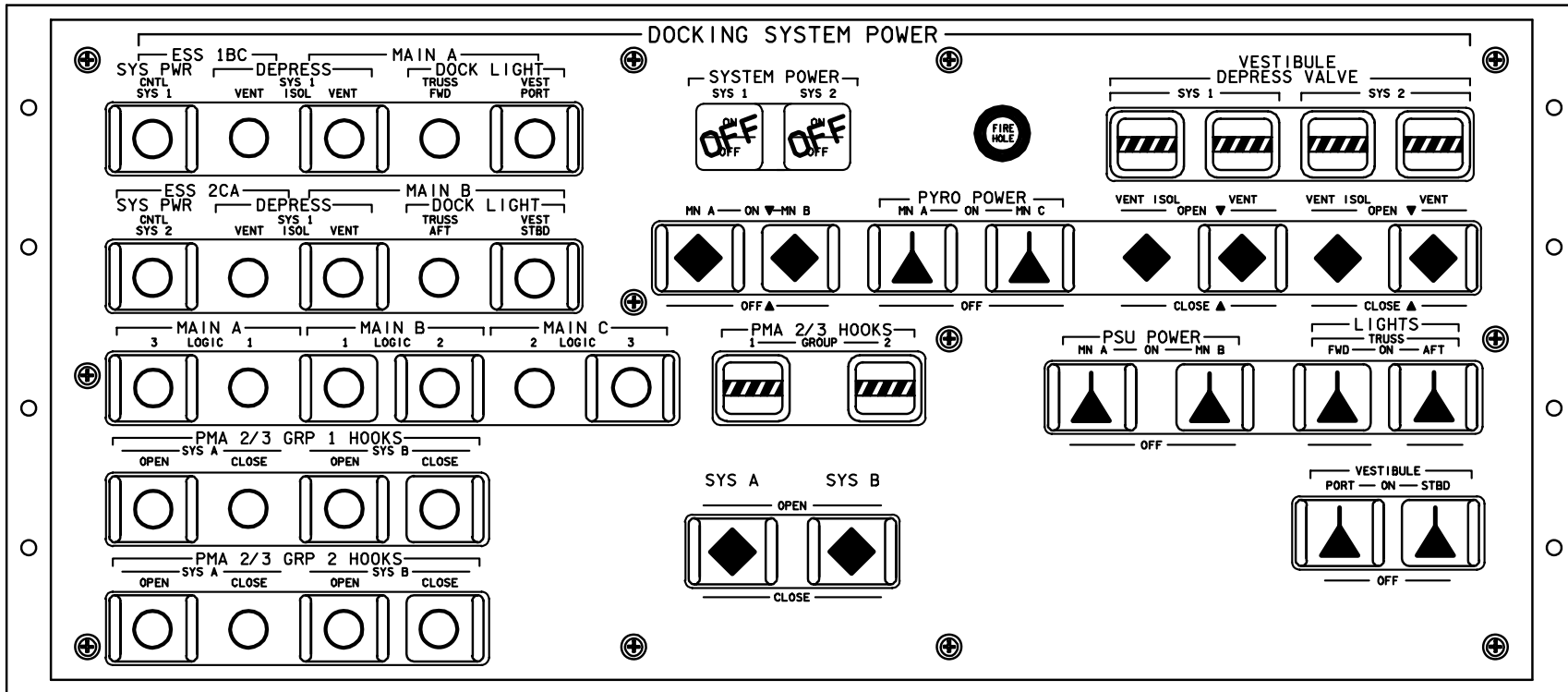

OV105

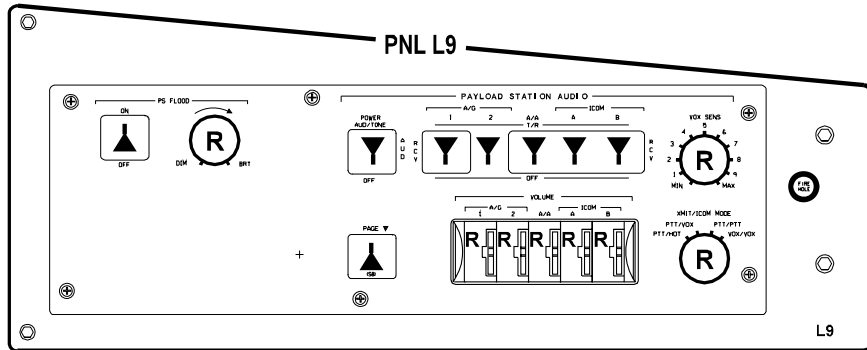
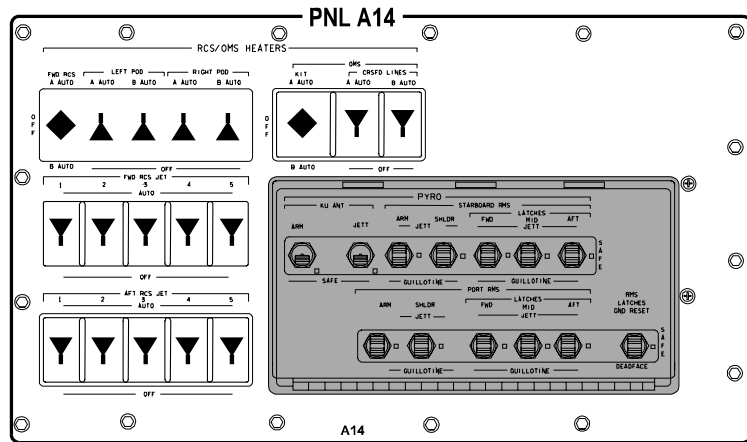

ACTIVATION  
L9 All switches - as read  
A15 PS COMM CCU PWR-ON

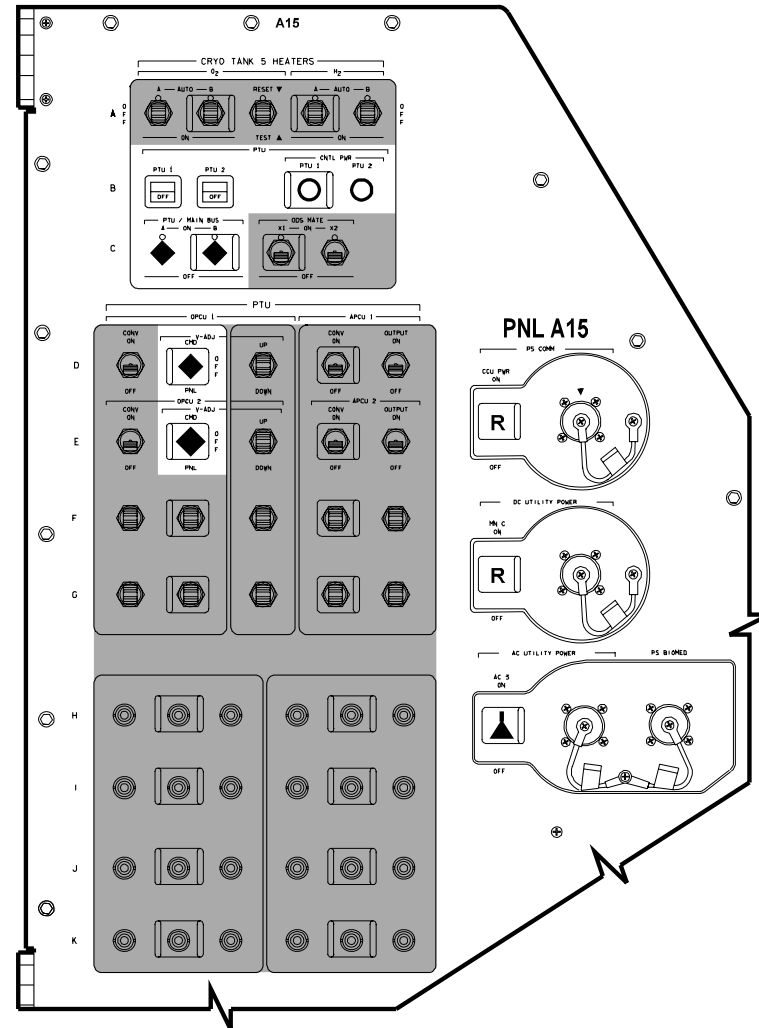

OV105

# OV105

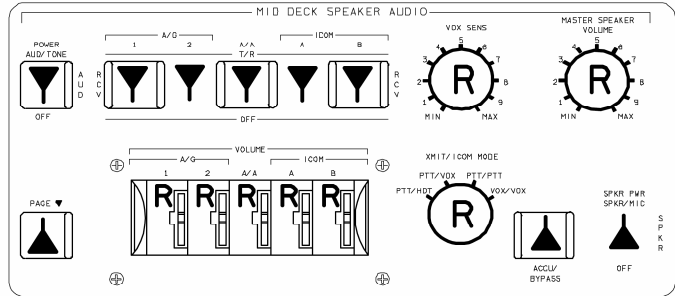

**PNL M042F**

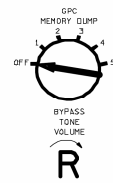

**PNL M029J**

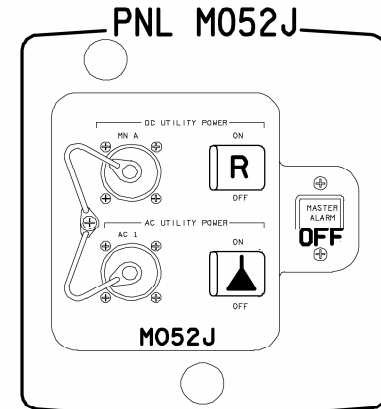
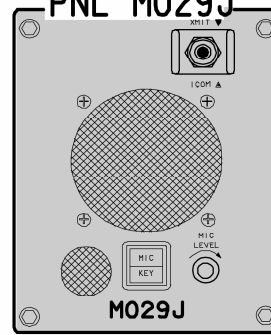

**PNL M052J**

**PNL M058F**

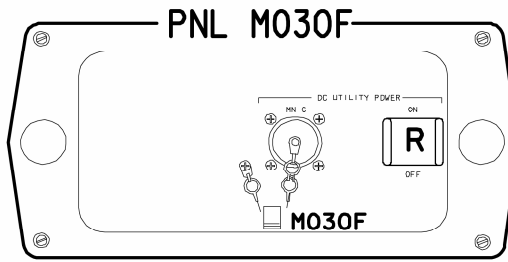
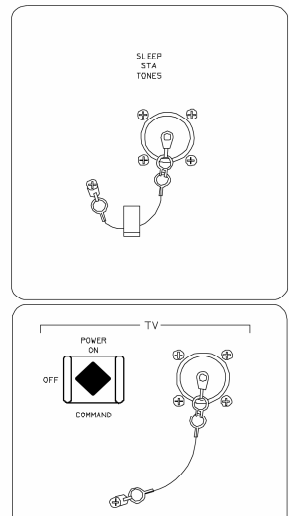

**PNL M030F**

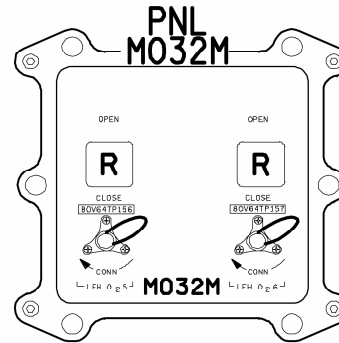

**PNL M032M**

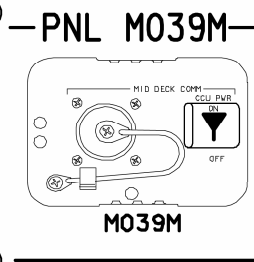

**PNL M039M**

**M039M**

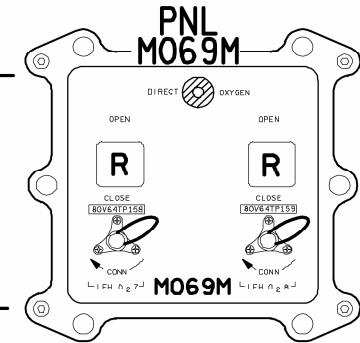

**PNL M069M**

**M069M**

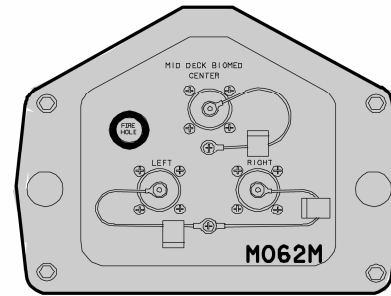

**M062M**

OV105

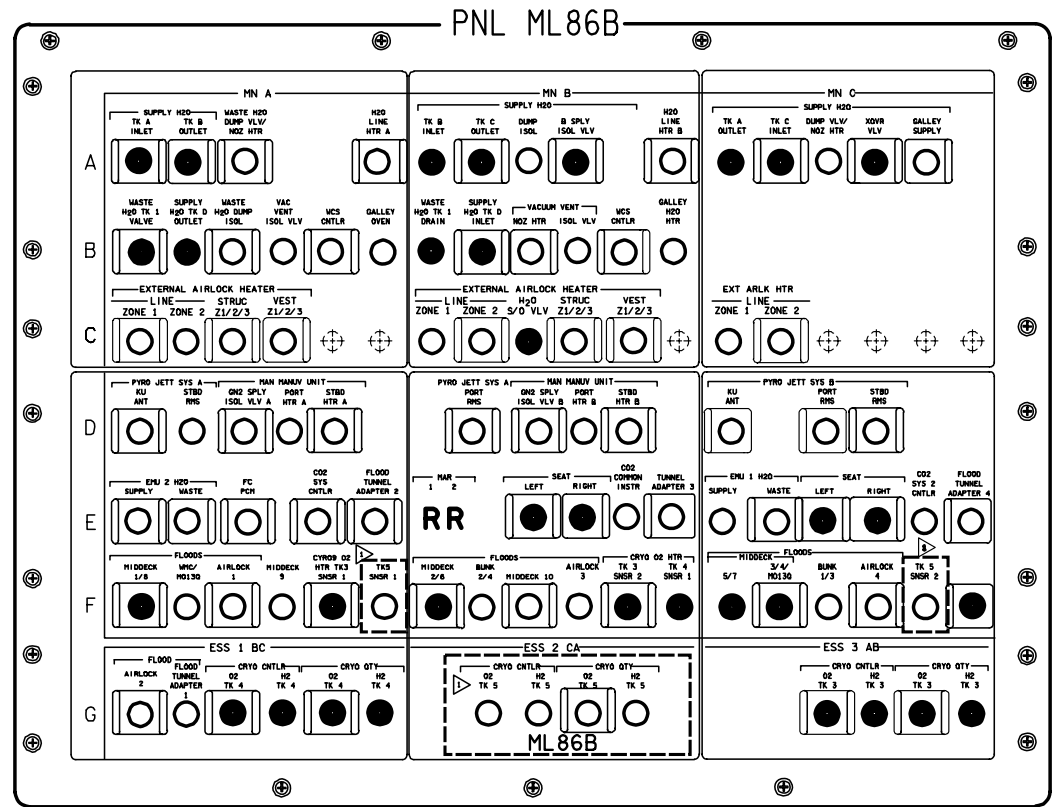
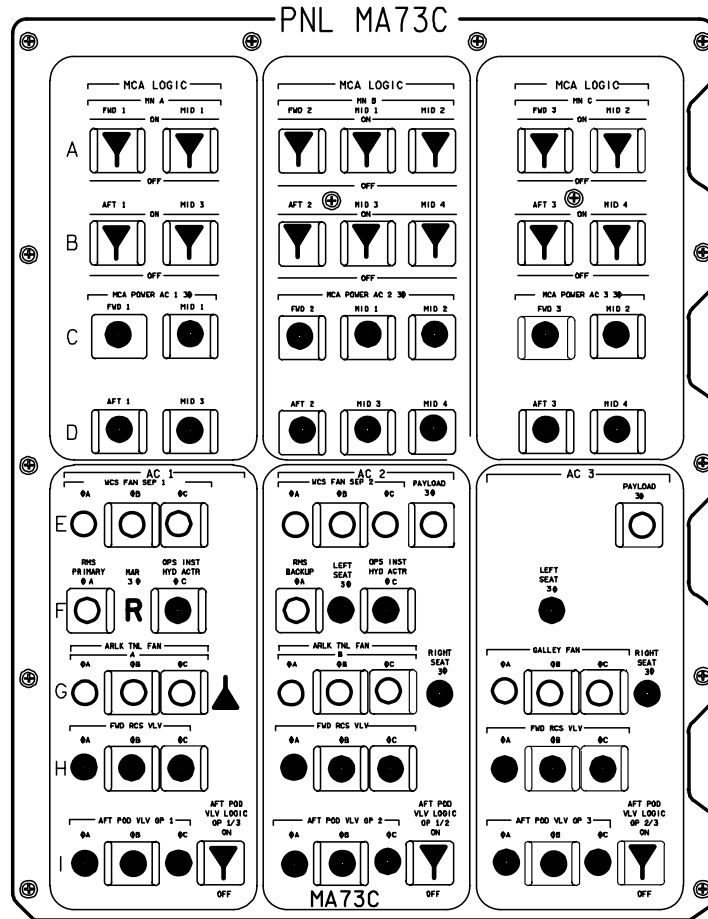

NOTES: ▷ CLOSED IF TK5 FLOWN



OV105

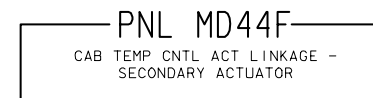
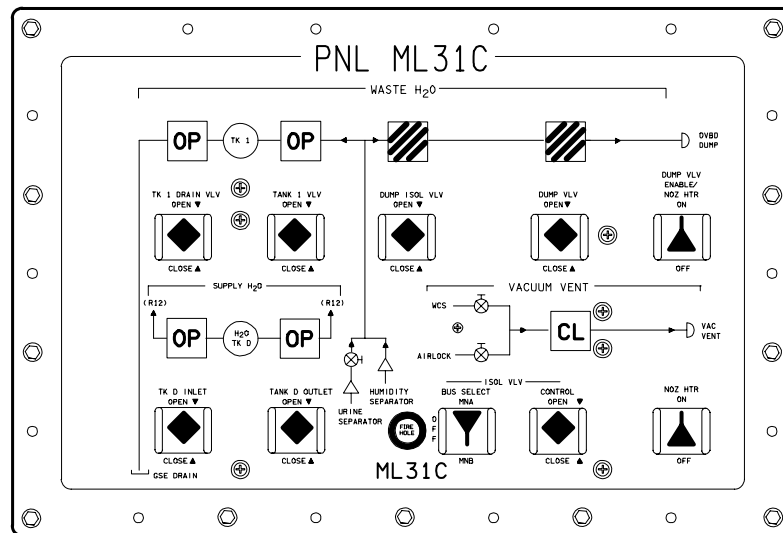
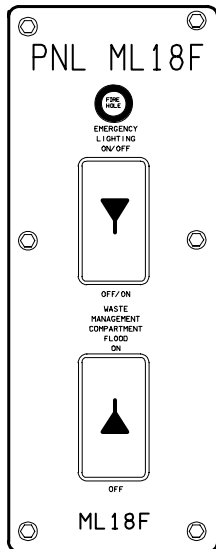
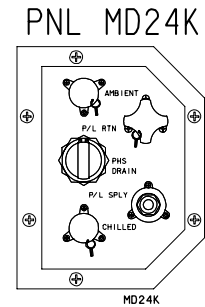
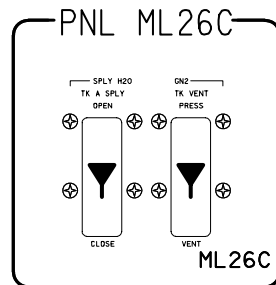
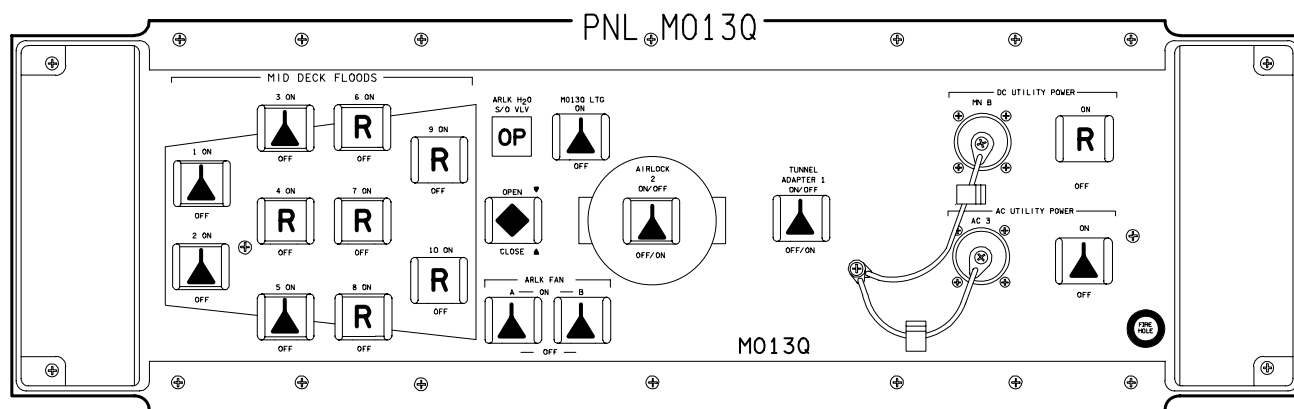

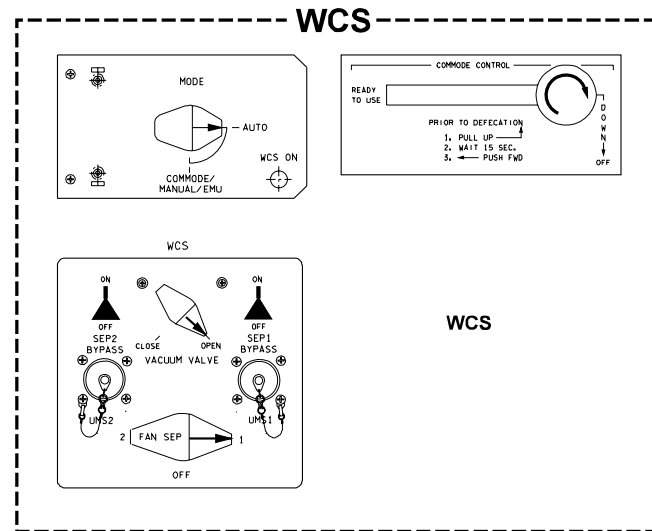
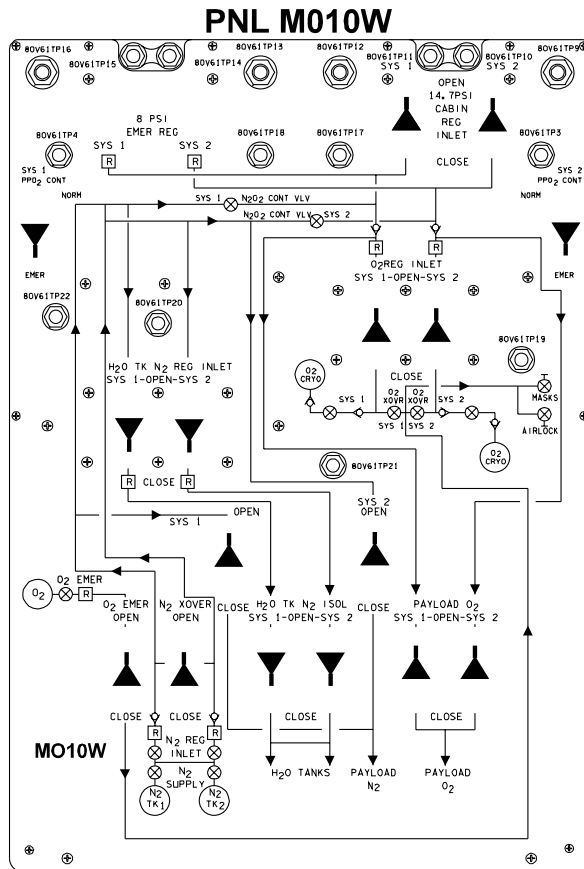

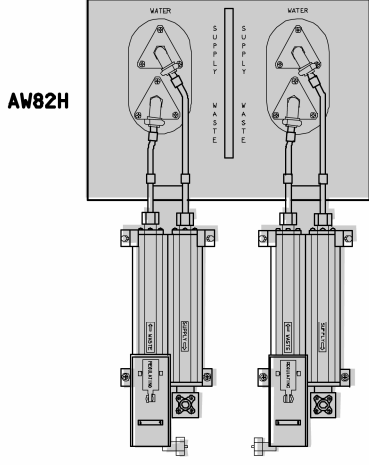
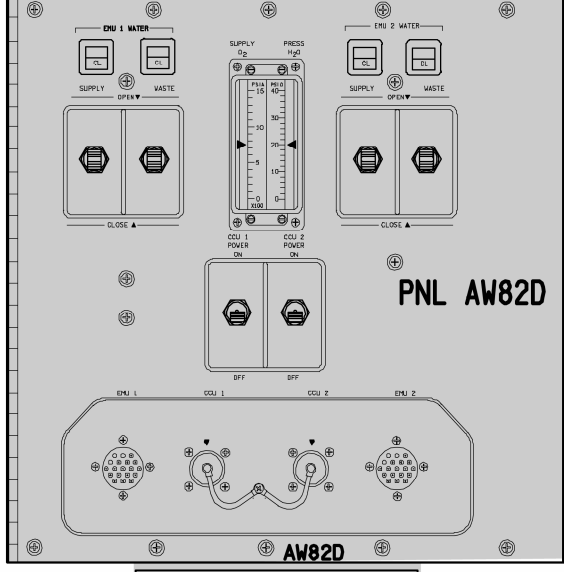
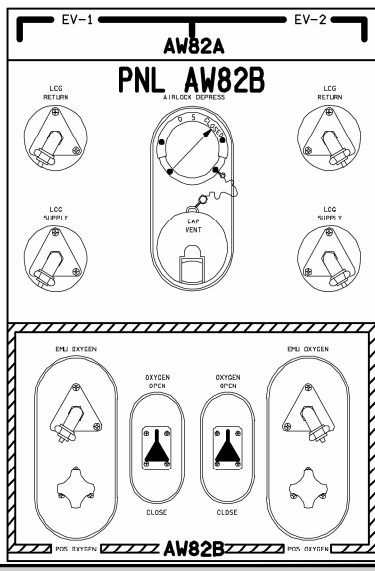
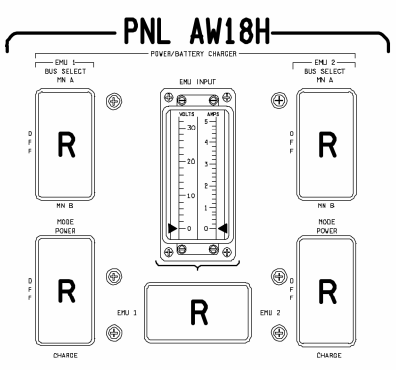
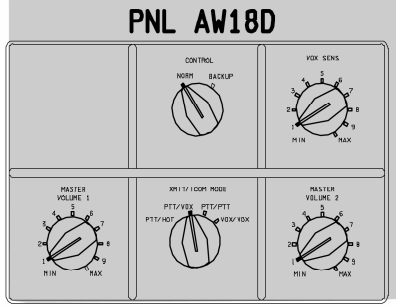
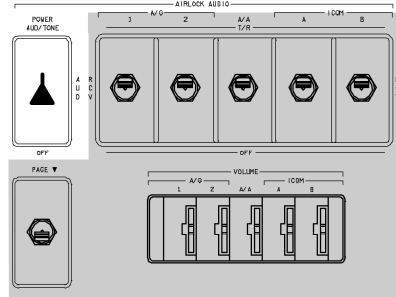
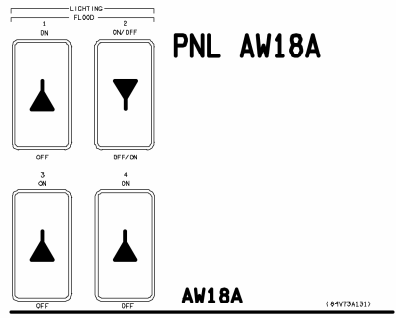

ALL VEH/DATE 10/03/02

480070331\_107, PNL\_1

### **Inner Hatch**

Actuator Handle – LATCHED

Lock Lever – LOCKED

Equalization vlv (two) – NORM, capped

# **LOSS OF 2 FC LAUNCH DAY DEORBIT PREP (ORBIT 2 OR ORBIT 3)**

LOSS OF 2 FC  
ORB 2 OR 3

This Page Intentionally Blank

## **LOSS OF 2 FC LAUNCH DAY DEORBIT PREP (ORBIT 2 OR ORBIT 3)**

### ASSUMPTIONS/INITIAL CONDITIONS

LOSS OF 2 FC LAUNCH DAY DEORBIT assumes LOSS OF 2nd FC (ASC PKT, PWRDN) has been accomplished

Electrical load will be 10-12 kW with transients to 14 kW during Deorbit Prep and Entry

This procedure assumes RAD ACT, PLBD OPENING, and subsequent Post Insertion activities have not been accomplished

### PROBLEM DESCRIPTION/RATIONALE

Orbiter electrical load carried by one fuel cell; therefore, it is a critical component. LRUs may experience undervoltage with accompanying alarms

## LOSS OF 2 FC LAUNCH DAY DEORBIT PREP

### NOTE

1. Use one IDP/CRT with two MDUs whenever possible
2. Maintain minimum lighting
3. A second pass GPC (GPC 4) will be activated at ~TIG-20
4. Landing gear will be deployed with pyros due to loss of landing gear extend isolation valve thru MNA AMC1
5. MS procedures are located on MS PULLOUT PAGES, 4-15 thru 4-18. Extra copies are located in back of PLT's book



W/B STEAM VENT HTR ACT <span style="border: 1px solid black; padding: 0 2px;">1</span>		
P	R2	<ul style="list-style-type: none"> <li>If FC 1 OK:               <ul style="list-style-type: none"> <li>√BLR CNTLR/HTR 1 – A</li> <li>2 – B</li> <li>√3 – A</li> </ul> </li> <li>If FC 2 or FC 3 OK:               <ul style="list-style-type: none"> <li>√BLR CNTLR/HTR 1 – A</li> <li>√2 – A</li> <li>3 – B</li> </ul> </li> <li>BLR PWR (three) – ON</li> </ul>

AC BUS CONFIG <span style="border: 1px solid black; padding: 0 2px;">3</span>		
C	L4:D,E,Q	1. √All cbs (twenty-seven) – op
MS		2. If FC 1 OK: Perform AC3 (3Φ) BUS LOSS ACTIONS (ORB PKT, <u>EPS</u> ). Do only steps in ORB PKT, do not proceed to MAL AC3 is affected bus in step 3  If FC 2 or FC 3 OK: Perform AC1 (3Φ) BUS LOSS ACTIONS (ORB PKT, <u>EPS</u> ). Do only steps in ORB PKT, do not proceed to MAL AC1 is affected bus in step 3
P	R1	3. Affected BUS: cb AC CONTR (three) – cl AC BUS SNSR           – OFF INV/AC BUS           – OFF (tb-OFF) INV PWR               – OFF (tb-OFF) cb AC CONTR (three) – op  4. Connect AC1 to AC3: Perform AC POWER TRANSFER CABLE INSTALLATION (IFM, <u>PROCEDURES A THRU F</u> )

PRE DPS TRANSITION SWITCH CONFIG <span style="border: 1px solid black; padding: 0 2px;">5</span>		
C,P	O14:A	√RGA 1 – ON
	E	√cb MNA ACCEL 1 – cl
	F	√ASA 1 – ON
	O15:A	√RGA 2 – ON
	E	√cb MNB ACCEL 2 – cl
	F	√ASA 2 – ON
	O16:A	√RGA 3 – ON
	F	√ACCEL 3 – ON

DPS ENTRY CONFIG <span style="border: 1px solid black; padding: 0 2px;">6</span>		
C,P	L1	√AV BAY 2 FAN A(B) – ON
	O14:F	√MMU 1 – ON
	O15:F	√2 – ON
	C3	√FCS CH (four) – AUTO
		<u>LOAD ENTRY TFL</u> Perform LOAD PDI DECOM FORMAT and LOAD PCMMU FORMAT (ORB OPS FS, <u>COMM/INST</u> ) for entry config
		<u>SM CHECKPOINT/UL CNTL ENA</u> <span style="border: 1px solid black; padding: 0 2px;">X: SM 60 SM TABLE MAINT</span> <span style="border: 1px solid black; padding: 0 2px;">Y: SM 1 DPS UTILITY</span>
CRTX		MMU ASSIGN 2 SM – ITEM 4 EXEC CKPT INITIATE      – ITEM 18 EXEC √Update of CKPT TIME and STATUS GOOD indicated
CRTX		MMU ASSIGN 1 SM – ITEM 3 EXEC CKPT INITIATE      – ITEM 18 EXEC √Update of CKPT TIME and STATUS GOOD indicated
CRTX		CKPT RETRV ENA – ITEM 12 EXEC (*) UL CNTL ENA       – ITEM 36 EXEC
CRTX		<u>DEACT GPC 4</u> MAJ FUNC – GNC  <u>NOTE</u> All MAJ FUNC should be GNC prior to powering down SM GPC
O6		GPC MODE 4    – STBY,HALT – STBY (tb-RUN) – HALT (tb-bp) OUTPUT 4 – NORM
CRT1		GPC/CRT 04 EXEC 13 EXEC
R11L		IDP/CRT 4 PWR – OFF

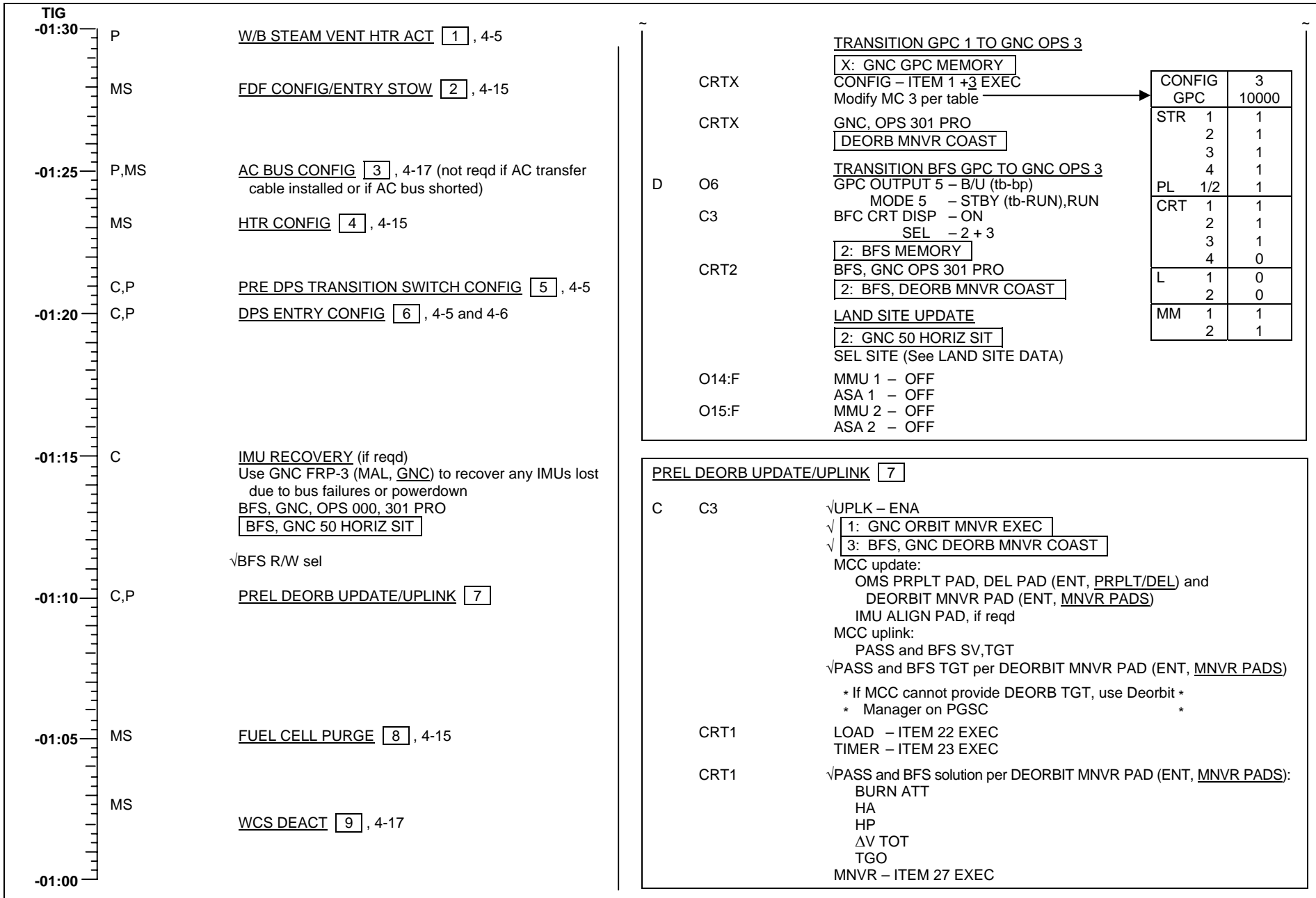

PRE INGRESS CONFIG 12

		<u>MPS/H2 PURGE PREP</u>	
P	R2	MPS He ISOL (six)	- CL
		PNEU He ISOL	- CL
		L ENG He XOVR	- CL
	R4	MANF PRESS (two)	- CL
		<u>ENABLE QTY GAUGE</u>	
C,P	O16:E	cb RCS/OMS PRPLT QTY GAUGE	- cl
		<u>RA CONFIG</u>	
	F8	RDR ALTM	- 1
		<u>MLS CH/TACAN CH/DATA BUS</u>	
	O8	MLS CH tw (three)	- See LAND SITE DATA
		If OV103,4:	
	O7	TACAN CH tw (three)	- See LAND SITE DATA
		<u>ENABLE LG PROXIMITY SENSORS</u>	
C	L4:P	√cb AC2 ΦA LG SNSR 2	- cl
		√AC3 ΦA LG SNSR 1	- cl
		<u>cb CONFIG</u>	
C	L4:J	cb AC3 ΦA SIG CONDR HUM SEP	- op
		ΦB SIG CONDR IMU FAN	- op

TIG	
-01:00	MS <u>COMM CONFIG</u> <span style="border: 1px solid black; padding: 0 2px;">10</span> , 4-16
	MS <u>MCA CONFIG</u> <span style="border: 1px solid black; padding: 0 2px;">11</span> , 4-17
	C,P <u>PRE INGRESS CONFIG</u> <span style="border: 1px solid black; padding: 0 2px;">12</span> , 4-7
-00:55	
	C6      LEH O2 vlv (four) – OP
	C,P <u>SEAT INGRESS</u> Adjust seat (one seat, direction at a time) Exercise brake pedals
-00:50	
	C,P      Perform <u>P&amp;I CHANGES TO ENT</u> , 4-9, 4-10
-00:45	A      Go to ENT, <u>DEORBIT BURN</u>
-00:40	
-00:35	
-00:30	

## LOSS OF 2 FUEL CELLS

### P&I Changes to ENTRY

#### GENERAL

1. AV BAY FANS will be cycled as needed to keep pwr level low
2. GPCs 2,3 remain pwrdn throughout ENTRY

#### SPECIFIC

TIG-45

Delete: **OMS TVC GMBL CHECK**  
**HORIZ SIT CONFIG** ( GNC 51 , BFS GNC 51 )

Delete:  $\sqrt$ SSME REPOS – ITEM 19 (ENA)  
Add: “SSME REPOS – ITEM 19 EXEC (INH)”

TIG-25

Replace VENT DOOR CLOSE with:

“NOTE

VENT DOOR CLOSE must be performed prior to MM302 transition

MA73C:A	MCA LOGIC MNA MID 1 – ON <span style="border: 1px solid black; padding: 0 2px;">2: GNC 51 OVERRIDE</span>
CRT 2	VENT DOOR CNTL CLOSE – ITEM 44 EXEC
MA73C:A	MCA LOGIC MNA MID 1 – OFF MNB MID 1 – ON MNC MID 2 – ON MNB AFT 2 – ON
CRT 2	VENT DOOR CNTL CLOSE – ITEM 44 EXEC
MA73C:A	MCA LOGIC MNA MID 1 – ON MNB MID 1 – OFF MNC MID 2 – OFF”

**LOSS OF 2 FUEL CELLS**  
**P&I Changes to Entry (Cont)**

L1 Insert: "HUM SEP (two) – OFF

**FES HEATER DEACT**  
 TOP EVAP HTR NOZ L,R (two) – OFF  
 DUCT – OFF  
 HI LOAD DUCT HTR – OFF

L2 FLASH EVAP FDLN HTR B SPLY – OFF

O14:F,  
 O15:F,  
 O16:F

**ASA ACT**  
 ASA (four) – ON"

DEORB  
 UPDATE/  
 UPLINK

O6  
 C3

Insert before GNC OPS 302 PRO:  
**"GPC 4 ACT**  
 (1) GPC MODE 4 – STBY/RUN  
 (2) BFC CRT DISP – OFF  
 (3) For OPS 3 TRANS use  
 (4) GNC, OPS 301 PRO  
 (5) BFC CRT DISP – ON; BFS I/O RESET  
 (6) FCS CH (four) – ORIDE  
 (7) G50 √LAND SITE/RWY per DEL PAD"

CONFIG	3
GPC	10040
STR 1	1
2	4
3	1
4	4
PL 1/2	1
CRT 1	1
2	4
3	1
4	0
L 1	0
2	0
MM 1	1
2	4

TIG-20 Delete: **RCS/OMS HTR** steps

TIG-2 Use 2 DDU/FLT CNTLR PWR  
 Add: "**AV BAY FAN CYCLE**

L1 AV BAY FAN (six) – OFF"

DURING BURN If FRCS COMPLETION reqd during burn, perform EI-18 FORWARD RCS RECOVERY steps below prior to fast flip

**LOSS OF 2 FUEL CELLS**  
**P&I Changes to Entry (Cont)**

POST  
BURN

Add before PGSC STOW:  
“FLT CNTLR PWR (two) – OFF  
√DAP: AUTO  
cb MNA,B,C DDU L,R (four) – op”

O14:E,  
O15:E,  
O16:E

L1

Insert after **OMS/RCS POST BURN RECONFIG**:  
“AV BAY FAN 1B,2A,3A [3B vice 3A if FC 1 OK] – ON (3 sec between each start)”

EI-20

C3

**SECONDARY ACTUATOR CHECK**  
Add: “9. FCS CH (four) – ORIDE”

EI-18

O14:F,  
O15:F,  
O16:F

If FORWARD RCS DUMP reqd for off-nominal CG, etc,  
insert FORWARD RCS RECOVERY before dump:  
“**FORWARD RCS RECOVERY**  
RJDF LOGIC,DRIVER (eight) – ON”

**GNC 23 RCS**

“ITEM 1 EXEC (FRCS page)  
OVRD FRCS MANF 1,2,3,4 STAT – OP”

Insert after dump completion:

**GNC 23 RCS**

“ITEM 1 EXEC (FRCS page)  
OVRD FRCS MANF 1,2,3,4 STAT – CL  
RJDF LOGIC,DRIVER (eight) – OFF”

O14:F,  
O15:F,  
O16:F

ENTRY SW  
CHECK

Delete: √ANTISKID,NWS steps  
Delete: √RADAR ALTM,MLS,TACAN steps

**OV103,104**

C D/O/3,4/GEN M

**LOSS OF 2 FUEL CELLS**  
**P&I Changes to Entry (Cont)**

EI-15	A13	GPS PWR – ON If OV103: GPS PRE AMPL (two) – MNC If OV104: GPS PRE AMPL (two) – ON Wait 30 sec GNC I/O RESET <span style="border: 1px solid black; padding: 2px;">GNC 55 GPS STATUS</span> INIT – ITEM 15 EXEC (*) NAV – ITEM 18 EXEC (*)
EI-13		Delete: <b>SSME HYD REPRESS</b>
	ENTRY MNVRS	Replace nominal <u>ENTRY MANEUVERS</u> (Cue Card) with LOSS OF 2 FUEL CELLS ENTRY MANEUVERS, 4-13



## LOSS OF 2 FUEL CELLS ENTRY MANEUVERS

FLIGHT CONDITIONS	MANEUVER
EI-5	BRAKES (three) – ON cb ADTA 1,2,3 – cl GNC I/O RESET √cb MNA,B,C DDU L,R (four) – cl (L) FLT CNTLR PWR – ON Use two IDP/CRTs with four MDUs √LVLH ATT GNC, OPS 304 PRO √OPS 304, wait 1 min  * If PREBANK: R/Y – CSS * * Roll at 1°/sec to <input type="text"/> <input type="text"/> <input type="text"/> * * Maintain PREBANK ± 5° *
'Guidance Box' @ q̄ ~8 or D ~3	CLOSED LOOP GUIDANCE ____:____:____  * If PREBANK: P,R/Y – AUTO *  Begin AIL trim monitoring
D = 11	√DRAG H
ΔAz = 10.5°	FIRST ROLL REVERSAL <input type="text"/> <input type="text"/> <input type="text"/> <input type="text"/>
V = 19K	√HYD MPS/TVC ISOL VLV SYS (three) – CL <input type="text"/> G50 √GPS, INCORPORATE
V = 15K	If FC 1 OK: TACAN 1 MODE – GPC   If FC 2 or FC 3 OK: TACAN 3 MODE – GPC √TACAN ANT SEL – AUTO
V = 12K	RAD BYP VLV MODE (two) – AUTO CNTLR LOOP (two) – AUTO B(A)
V = 10K	√SPDBK to 81%
V = 7K	√TACAN and GPS status  * If ELS,UHF MODE – G T/R *
V = 5K	L AIR DATA PROBE – DPY (Wait 30 sec) R AIR DATA PROBE – DPY (Heat only one probe if reqd) Begin AIL and RUD trim monitoring
M = 3.5	<input type="text"/> G51 VENT DOOR CNTL OPEN – ITEM 43 EXEC

FLIGHT CONDITIONS	MANEUVER
M = 2.9	CAB FAN (two) – OFF AV BAY FAN 2A – OFF 3A(3B) – OFF After ADTA incorporated, TACAN MODE (two) – OFF Use one HUD, one MLS, one RA GNC I/O RESET
M = 2.7	√APUs
	* If M < 2.5, P CSS for ADTA to G&C incorp *
M = 2.0	Ensure ADTA to G&C; else, √theta limits
M < 1.0	* <b>For bailout procedures, go to BAILOUT</b> *  P,R/Y – CSS as reqd √SPDBK CMD vs POS MAX Nz <input type="text"/> <input type="text"/> <input type="text"/> (R) FLT CNTLR PWR – ON Use two IDP/CRTs with six MDUs ANTISKID – ON NWS – 1 Lock Inertia Reels
h = 15K	√MLS
h = 10K	√A/L (KSC – Tabs, Visors, Suit O2)
h = 2K	LDG GEAR ARM pb – push (ARM It on)
h = 300	LDG GEAR DN pb – push (DN It on)
MAIN GEAR TD	√SPDBK – 100%
V = 195 KEAS	DRAG CHUTE ARM,DPY pb (two) – push (simo) (All Its on)
V = 185 KEAS	DEROTATE
NOSE GEAR TD	SRB SEP – MAN/AUTO and depress pb √Auto Load Relief √HYD BK ISOL VLV (three) – OP
V < 120 KGS or 5K' remaining	BRAKE as reqd (8-10 fps <sup>2</sup> , -0.25 to -0.3G)
	* If 5K' remaining and V > 140 KGS – MAX BRAKING *
V = 60 KGS	DRAG CHUTE JETT pb – push (JETT1, JETT2 It on)
V = 40 KGS	BRAKE < 6 fps <sup>2</sup> (-0.2G) (Antiskid cutout)
WHEEL STOP	√All landing/navaids off CAB FAN B – ON (Wait 3 sec, then continue) AV BAY FAN 2A,3A [3B vice 3A if FC1 OK] – ON (3 sec between each start) Go to ENT C/L, <u>POST LDG</u>

# OV103,104

This Page Intentionally Blank

**LOSS OF 2 FUEL CELLS**  
**P&I Changes to Entry (Cont)**

POST  
BURN

Add before PGSC STOW:  
“FLT CNTLR PWR (two) – OFF  
√DAP: AUTO  
cb MNA,B,C DDU L,R (four) – op”

O14:E,  
O15:E,  
O16:E

Insert after **OMS/RCS POST BURN RECONFIG**:  
“AV BAY FAN 1B,2A,3A [3B vice 3A if FC 1 OK] – ON (3 sec between each start)”

L1

EI-20

**SECONDARY ACTUATOR CHECK**  
Add: “9. FCS CH (four) – ORIDE”

C3

EI-18

If FORWARD RCS DUMP reqd for off-nominal CG, etc,  
insert FORWARD RCS RECOVERY before dump:  
“**FORWARD RCS RECOVERY**  
RJDF LOGIC,DRIVER (eight) – ON”

O14:F,  
O15:F,  
O16:F

**GNC 23 RCS**

“ITEM 1 EXEC (FRCS page)  
OVRD FRCS MANF 1,2,3,4 STAT – OP”

Insert after dump completion:

**GNC 23 RCS**

“ITEM 1 EXEC (FRCS page)  
OVRD FRCS MANF 1,2,3,4 STAT – CL  
RJDF LOGIC,DRIVER (eight) – OFF”

O14:F,  
O15:F,  
O16:F

ENTRY SW  
CHECK

Delete: √ANTISKID,NWS steps  
Delete: √RADAR ALTM,MLS steps

**LOSS OF 2 FUEL CELLS**  
**P&I Changes to Entry (Cont)**

EI-15	O7	If FC1 OK: GPS 1,2 PWR (two) – ON PRE AMPL (four) – ON If FC2 or FC3 OK: GPS 2,3 PWR (two) – ON PRE AMPL (four) – ON  Wait 30 sec GNC I/O RESET <span style="border: 1px solid black; padding: 2px;">GNC 55 GPS STATUS</span> INIT – ITEM 14(15,16) EXEC NAV – ITEM 17(18,19) EXEC
EI-13	ENTRY MNVRS	Delete: <b>SSME HYD REPRESS</b>  Replace nominal <u>ENTRY MANEUVERS</u> (Cue Card) with <u>LOSS OF 2 FUEL CELLS ENTRY MANEUVERS</u> , 4-13

## LOSS OF 2 FUEL CELLS ENTRY MANEUVERS

FLIGHT CONDITIONS	MANEUVER
EI-5	BRAKES (three) – ON cb ADTA 1,2,3 – cl GNC I/O RESET √cb MNA,B,C DDU L,R (four) – cl (L) FLT CNTLR PWR – ON Use two IDP/CRTs with four MDUs √LVLH ATT GNC, OPS 304 PRO √OPS 304, wait 1 min  * If PREBANK: R/Y – CSS * * Roll at 1°/sec to <input type="text"/> <input type="text"/> <input type="text"/> * * Maintain PREBANK ± 5° *
‘Guidance Box’ @ q̄ ~8 or D ~3	CLOSED LOOP GUIDANCE ____:____:____  * If PREBANK: P,R/Y – AUTO *  Begin AIL trim monitoring
D = 11	√DRAG H
ΔAz = 10.5°	FIRST ROLL REVERSAL <input type="text"/> <input type="text"/> <input type="text"/> <input type="text"/>
V = 19K	√HYD MPS/TVC ISOL VLV SYS (three) – CL <input type="text"/> G50 √GPS, INCORPORATE
V = 12K	RAD BYP VLV MODE (two) – AUTO CNTLR LOOP (two) – AUTO B(A)
V = 10K	√SPDBK to 81%
V = 7K	* If ELS,UHF MODE – G T/R *
V = 5K	L AIR DATA PROBE – DPY (Wait 30 sec) R AIR DATA PROBE – DPY (Heat only one probe if reqd) Begin AIL and RUD trim monitoring
M = 3.5	<input type="text"/> G51 VENT DOOR CNTL OPEN – ITEM 43 EXEC

FLIGHT CONDITIONS	MANEUVER
M = 2.9	CAB FAN (two) – OFF AV BAY FAN 2A – OFF 3A(3B) – OFF After ADTA incorporated, Use one HUD, one MLS, one RA GNC I/O RESET
M = 2.7	√APUs
	* If M < 2.5, P CSS for ADTA to G&C incorp*
M = 2.0	Ensure ADTA to G&C; else, √theta limits
M < 1.0	* For bailout procedures, go to <b>BAILOUT</b> *  P,R/Y – CSS as reqd √SPDBK CMD vs POS MAX Nz <input type="text"/> <input type="text"/> <input type="text"/> (R) FLT CNTLR PWR – ON Use two IDP/CRTs with six MDUs ANTISKID – ON NWS – 1 Lock Inertia Reels
h = 15K	√MLS
h = 10K	√A/L (KSC – Tabs, Visors, Suit O2)
h = 2K	LDG GEAR ARM pb – push (ARM It on)
h = 300	LDG GEAR DN pb – push (DN It on)
MAIN GEAR TD	√SPDBK – 100%
V = 195 KEAS	DRAG CHUTE ARM,DPY pb (two) – push (simo) (All Its on)
V = 185 KEAS	DEROTATE
NOSE GEAR TD	SRB SEP – MAN/AUTO and depress pb √Auto Load Relief √HYD BK ISOL VLV (three) – OP
V < 120 KGS or 5K' remaining	BRAKE as reqd (8-10 fps <sup>2</sup> , -0.25 to -0.3G)
	* If 5K' remaining and V > 140 KGS – MAX BRAKING *
V = 60 KGS	DRAG CHUTE JETT pb – push (JETT1, JETT2 It on)
V = 40 KGS	BRAKE < 6 fps <sup>2</sup> (-0.2G) (Antiskid cutout)
WHEEL STOP	√All landing/nav aids off CAB FAN B – ON (Wait 3 sec, then continue) AV BAY FAN 2A,3A [3B vice 3A if FC1 OK] – ON (3 sec between each start) Go to ENT C/L, <u>POST LDG</u>

This Page Intentionally Blank

# LOSS OF 2 FC LAUNCH DAY DEORBIT PREP MS AFT FLIGHT DECK ACTIVITIES

## MS PULLOUT PAGE

### NOTE

Wait for GO from CDR or PLT before starting any activity on this page

TIME (TIG-)	MS ACTIONS (AFT)
1:28	<u>FDF CONFIG/ENTRY STOW</u> [ 2 ]
1:23	<u>HTR CONFIG</u> [ 4 ]
1:05	<u>FUEL CELL PURGE</u> [ 8 ]
1:00	<u>COMM CONFIG</u> [ 10 ], 4-16

<p><u>FDF CONFIG/ENTRY STOW</u> [ 2 ]</p> <p><u>FDF CONFIG</u> Unstow,install: ENTRY and DEORBIT BURN Cue Cards ENT ENT PKT √AVAILABLE for ENTRY: LDG SITE CHARTS Handheld Radio STAR CHART ORB OPS CONT DEORB ORB PKT REF DATA MAL Stow all other FDF articles</p> <p><u>ENTRY STOW</u> Stow: Flt Deck Camrs,Accessories VTR Cassettes (one in VTR)</p> <p><u>EGRESS ROUTE CONFIG</u> Tape Foot Loops in egress routes</p>
---

<u>HTR CONFIG</u> [ 4 ]	
R11U	FC PURGE HTR – ON
	<u>NOTE</u> Htr must be on 15 min prior to purge
A12	√APU HTR TK/FU LN/H2O SYS 1A,2A,3A (three) – AUTO √1B,2B,3B (three) – OFF
A14	√HYD HTR (eight) – OFF √RCS/OMS HTR FWD RCS – OFF L POD (two) – A OFF,B OFF R POD (two) – A OFF,B OFF OMS CRSFD LINES (two) – A OFF – B OFF √FWD,AFT RCS JET 5 (two) – OFF

<u>FUEL CELL PURGE</u> [ 8 ]	
<div style="border: 2px solid black; padding: 5px; width: fit-content; margin: 0 auto;"><u>WARNING</u> Do not purge if FC AMPS &gt; 430</div>	
R11U	√FC PURGE HTR ON > 15 min
	FC PURGE VLV X – OP for 2 min, then – GPC HTR – GPC √VLV – GPC

**LOSS OF 2 FC LAUNCH DAY DEORBIT PREP  
Back of MS AFT FLIGHT DECK ACTIVITIES**

**MS PULLOUT PAGE**

COMM CONFIG		10
A1L	S-BD PM MODE	- STDN LO
	NSP DATA RATE XMIT,RCV (two)	- HI
	CODING XMIT,RCV (two)	- OFF
A13	OS AUD SPKR PWR	- OFF
A15	PS COMM CCU PWR	- OFF
R14:C	√cb MNB KU ELEC	- op
	√ANT HTR	- op
	√CABLE HTR	- op
	√MNC KU SIG PROC	- op
	√cb UHF EVA (two)	- op
O5,O9	L,R AUD A/G 2	- T/R
	ICOM B	- T/R
	VOX SENS sel	- as reqd
	VOL tw (six)	- as reqd
	XMIT/ICOM MODE sel	- PTT/VOX
MO42F	MIDDECK SPKR AUD PWR	- AUD/TONE
ML85E	AC S1	- OFF
R10,L9	MS,PS AUD PWR	- AUD/TONE
	A/G 1	- T/R
	2	- T/R
	A/A	- T/R
	ICOM A,B	- T/R
	VOX SENS sel	- as reqd
	VOL tw (six)	- as reqd
	XMIT/ICOM MODE sel	- as reqd



## LOSS OF 2 FC LAUNCH DAY DEORBIT PREP MS MIDDECK ACTIVITIES

### MS PULLOUT PAGE

#### NOTE

Wait for GO from CDR or PLT before starting any activity on this page

TIME (TIG-)	MS ACTIONS (MID)
1:25	<u>AC BUS CONFIG</u> <span style="border: 1px solid black; padding: 0 2px;">3</span> (Not reqd if AC transfer cable installed or if AC bus shorted)
1:03	<u>WCS DEACT</u> <span style="border: 1px solid black; padding: 0 2px;">9</span>
:59	<u>MCA CONFIG</u> <span style="border: 1px solid black; padding: 0 2px;">11</span>

<u>AC BUS CONFIG</u> <span style="border: 1px solid black; padding: 0 2px;">3</span> (Not reqd if AC transfer cable installed or if AC bus shorted)	
C	L4:D,E,Q
	1. √All cbs (twenty-seven) – op
MS	2. If FC 1 OK: Perform AC3 (3Φ) BUS LOSS ACTIONS (ORB PKT, <u>EPS</u> ). Do only steps in ORB PKT, do not proceed to MAL AC3 is affected bus in step 3 If FC 2 or FC 3 OK: Perform AC1 (3Φ) BUS LOSS ACTIONS (ORB PKT, <u>EPS</u> ). Do only steps in ORB PKT, do not proceed to MAL AC1 is affected bus in step 3
P	R1
	3. Affected bus: cb AC CONTR (three) – cl AC BUS SNSR – OFF INV/AC BUS – OFF (tb-OFF) INV PWR – OFF (tb-OFF) cb AC CONTR (three) – op
	4. Connect AC1 to AC3: Perform AC POWER TRANSFER CABLE INSTALLATION (IFM, <u>PROCEDURES A THRU F</u> )

<u>WCS DEACT</u> <span style="border: 1px solid black; padding: 0 2px;">9</span>	
WCS	VAC VLV – CL √MODE – AUTO FAN SEP SEL sw – OFF Unstow hose from cradle, attach hose to WCS housing via Velcro straps Remove, stow: WCS Trash Can Mirror Privacy Curtain Foot restraints – up, locked Close, latch door
ML31C	VAC VENT ISOL VLV BUS SEL – MNB CNTL – CL (tb-CL) NOZ HTR – OFF

<u>MCA CONFIG</u> <span style="border: 1px solid black; padding: 0 2px;">11</span>	
MA73C:A	MCA LOGIC MID (four) – OFF √FWD (three) – ON
:B	MCA LOGIC MID (four) – OFF AFT (three) – OFF
:C	If MNB and AC2 powered: cb MCA PWR AC1, AC3 3Φ FWD 1,3 (two) – op √Minimum middeck lighting

**MS PULLOUT PAGE**

This Page Intentionally Blank

# LOSS OF 2 FUEL CELLS DEORBIT PREP

This Page Intentionally Blank

## LOSS OF 2 FUEL CELLS DEORBIT PREP

### ASSUMPTIONS/INITIAL CONDITIONS

LOSS OF 2 FUEL CELLS DEORBIT PREP assumes one of following pwrdns has been accomplished:

LOSS OF 2nd FC ON-ORBIT (TIG < 4:00) (ORB PKT, PWRDN)

LOSS OF 2nd FC ON-ORBIT (TIG > 4:00) (ORB PKT, PWRDN)

Electrical load will be 10-12 kW with transients to 14 kW during Deorbit Prep and Entry

### IF TIME TO TIG < 4:00

Refer to ACTIVITY PRIORITY TABLE, 5-8

Use EXPEDITED D/O column to determine LOSS OF 2 FC DEORBIT PREP procedures that must be performed (mandatory) and those that should be performed if time permits (optional)

If any portions of Nominal Deorbit Prep have been accomplished, reconfigure systems per LOSS OF 2 FC DEORBIT PREP as reqd

### IF TIME TO TIG > 4:00

Perform all LOSS OF 2 FC DEORBIT PREP procedures

### PROBLEM DESCRIPTION/RATIONALE

Orbiter electrical load carried by one fuel cell; therefore, it is a critical component. LRUs may experience undervoltage with accompanying alarms

## LOSS OF 2 FUEL CELLS DEORBIT PREP

### NOTE

1. Use only one IDP/CRT with two MDUs whenever possible
2. Omit all maneuvers prior to TIG-03:36 if GG from powerdown
3. Maintain minimum lighting
4. A second pass GPC (GPC 4) will be activated at ~TIG-20
5. MS procedures are located on MS PULLOUT PAGES, 5-27 thru 5-32. Extra copies are located in back of PLT's book

## LOSS OF 2 FUEL CELLS OVERVIEW OF CONFIGURATION MANAGEMENT

	OPS 1 ASC PKT					OPS 2 ON-ORBIT WAIT					OPS 2 DEORBIT PREP					OPS 3 DEORBIT PREP											
DPS																											
GPC	1	2	3	4	5	1	2	3	4	5	1	2	3	4	5	1	2	3	4	5							
OPS	G1	-	-	-	BFS	G2	-	-	-	SM	-	G2	-	-	-	SM	-	G3	-	-	-	-	BFS				
POWER	ON	OFF	ON	ON	ON	ON	OFF	OFF	ON	OFF	ON	OFF	ON	ON	OFF	ON	OFF	OFF	ON	ON							
OUTPUT	N	N	N	N	B	N	N	N	T	N	N	N	N	T	N	N	N	N	N	B							
MODE	R	H	H	H	R	R	H	H	R	H	R	H	H	R	H	R	H	H	H	R							
CONFIG																											
GPC	1	2	3	4	0	1	0	0	0	0	1	0	0	0	0	1	0	0	0	0							
STR	1	1				1				0	1				0	1				1							
	2	1				1				0	1				0	1				1							
	3	1				1				0	1				0	1				1							
	4	1				1				0	1				0	1				1							
PL	1/2	1				0				4	0				4	1				1							
CRT	1	1				1				4	1				4	1				1							
	2	1				1				4	1				4	1				1							
	3	1				0				0	0				0	1				1							
	4	0				1				4	1				4	0				0							
L	1	1				0				4	0				4	0				0							
	2	2				0				0	0				0	0				0							
MM	1	1				1 (OFF)				4	1 (ON)				4	1 (OFF)				1 (OFF)							
	2	1				1 (OFF)				4	1 (OFF)				4	1 (OFF)				1 (OFF)							
MDM						FF3; PL2 – ON					ALL ON except FF4					ALL ON except FF4											
D & C	DDU	MDU	IDP	L,R	Two FWD	ALL	AFT	L																			
						Minimize use					Minimize use																
E C L S	AV BAY FAN	CABIN FAN	IMU FAN	WATER LP	FREON LP	RADIATOR	FES	1,2,3	A	B	(A)	1-A,2-A	Stow	ON	OFF	1,2,3	1-OFF,2-ON	ON									
F C S / N A V O A R I S D S	FCS CH	ASA	AA	RGA	ADTA	IMU	MLS	RA	TACAN	AUTO	ON	ON	ON	ON	OFF	OFF	OFF	OFF	OFF	1,2,3	1,2,3	1,2,3					
						AUTO					OFF																
						OFF					OFF					1,2,3											
						OFF					OFF					1,2,3											
						OFF					OFF					1,2,3											
						OFF					OFF					1,2,3											
						OFF					OFF					1,2,3											
						OFF					OFF					1,2,3											
R J D	RJDA	RJDF	VERNIER	ALL ON	ALL ON	OFF	OFF	1A,1B,2B					ALL OFF					ALL OFF									
						OFF					OFF					ALL OFF					ALL OFF						

Ⓐ Water loops cycled as reqd (950 lb/hr)

Ⓑ Primary RJDs will be OFF during sleep periods

NOTE: Maintain minimum lighting

# OV103,104

## LOSS OF 2 FUEL CELLS OVERVIEW OF CONFIGURATION MANAGEMENT (Cont)

		SEAT INGRESS					TIG-20					El-5	V = 15K
DPS													
GPC		1	2	3	4	5	1	2	3	4	5		
OPS		G1	-	-	-	BFS	G3	--	--	G3	BFS		
POWER OUTPUT MODE		ON	OFF	OFF	ON	ON	ON	OFF	OFF	ON	OFF		
		N	N	N	N	B	N	N	N	N	B		
		R	H	H	H	R	R	H	H	R	R		
CONFIG		3					3						
GPC		1	0	0	0	0	1	0	0	4	0		
STR		1	1				1	1					
		2	1				4	1					
		3	1				1	1					
		4	1				4	1					
PL		1/2	1				1	1					
CRT		1	1				1	1					
		2	1				1	1					
		3	1				4	1					
		4	0				0	0					
L		1	0				0	0					
		2	0				0	0					
MM		1	1 (ON)				1 (ON)	1 (ON)					
		2	1 (ON)				4 (ON)	4 (ON)					
MDM		ALL ON except FF4					ALL ON except FF4						
D & C		DDU	L,R				Minimize use						
		MDU	Minimize use				Minimize use						
		IDP	Minimize use				Minimize use						
E C L S		AV BAY FAN	1,2,3				1,2						
		CABIN FAN	A				A						
		IMU FAN	B				B						
		WATER LP	1-OFF,2-ON				1-OFF,2-ON						
		FREON LP	1-A,2-A				1-A,2-A						
		RADIATOR	Stow				Stow						
		FES	ON				ON						
F C S / N A S V O A R I S D S		FCS CH	AUTO				ORIDE						
		ASA	OFF				ON						
		AA	1,2,3				1,2,3						
		RGA	1,2,3				1,2,3						
		ADTA	OFF				ON						
		IMU	1,2,3				1,2,3						
		MLS	OFF				OFF						
		RA	OFF				OFF						
		TACAN	OFF				1, 2 or 2, 3						
R J D		RJDA	1A,1B,2B				1A,1B,2B						
		RJDF	ALL ON				ALL ON						
		VERNIER	ALL ON				ALL ON						



## LOSS OF 2 FUEL CELLS OVERVIEW OF CONFIGURATION MANAGEMENT

		OPS 1 ASC PKT					OPS 2 ON-ORBIT WAIT					OPS 2 DEORBIT PREP					OPS 3 DEORBIT PREP				
DPS																					
GPC OPS		1	2	3	4	5	1	2	3	4	5	1	2	3	4	5	1	2	3	4	5
		G1	-	-	-	BFS	G2	--	--	SM	--	G2	--	--	SM	--	G3	--	--	--	BFS
POWER OUTPUT MODE		ON	OFF	ON	ON	ON	ON	OFF	OFF	ON	OFF	ON	OFF	ON	ON	OFF	ON	OFF	OFF	ON	ON
		N	N	N	N	B	N	N	N	T	N	N	N	N	T	N	N	N	N	N	B
		R	H	H	H	R	R	H	H	R	H	R	H	H	R	H	R	H	H	H	R
CONFIG GPC		1	2	3	4	0	1	0	0	0	0	1	0	0	0	0	1	0	0	0	0
STR		1	1				1	0				1	0				1	0			
		2	1				1	0				1	0				1	0			
		3	1				1	0				1	0				1	0			
		4	1				1	0				1	0				1	0			
PL 1/2		1	1				0	4				0	4				1				
CRT		1	1				1	4				1	4				1				
		2	1				1	4				1	4				1				
		3	1				0	0				0	0				1				
		4	0				1	4				1	4				0				
L		1	1				0	4				0	4				0				
		2	2				0	0				0	0				0				
MM		1	1				1 (OFF)	4				1 (ON)	4				1 (OFF)				
		2	1				1 (OFF)	4				1 (OFF)	4				1 (OFF)				
MDM							FF3; PL2 – ON					ALL ON except FF4					ALL ON except FF4				
D & C		DDU MDU IDP		L,R Two FWD ALL			AFT – – – – –>					L – – – – –>					– – – – –>				
							Minimize use – – – – –>					– – – – –>					– – – – –>				
							Minimize use – – – – –>					– – – – –>					– – – – –>				
E C L S		AV BAY FAN CABIN FAN IMU FAN WATER LP FREON LP RADIATOR FES		1,2,3 A B 2 1 Stow ON			1,3 – – – – –>					1,2,3 – – – – –>					– – – – –>				
							A – – – – –>					– – – – –>					– – – – –>				
							B – – – – –>					– – – – –>					– – – – –>				
							A – – – – –>					1-OFF,2-ON – – – – –>					– – – – –>				
							1-A,2-A – – – – –>					– – – – –>					– – – – –>				
							Stow – – – – –>					– – – – –>					– – – – –>				
							OFF – – – – –>					– – – – –>					ON – – – – –>				
F C S / N A V A R I S D S		FCS CH ASA AA RGA ADTA IMU MLS RA GPS		AUTO ON ON ON ON 2,3 OFF OFF OFF			AUTO – – – – –>					– – – – –>					– – – – –>				
							OFF – – – – –>					– – – – –>					– – – – –>				
							OFF – – – – –>					– – – – –>					1,2,3 – – – – –>				
							OFF – – – – –>					– – – – –>					1,2,3 – – – – –>				
							OFF – – – – –>					– – – – –>					– – – – –>				
							OFF – – – – –>					– – – – –>					– – – – –>				
							OFF – – – – –>					– – – – –>					– – – – –>				
							OFF – – – – –>					– – – – –>					– – – – –>				
R J D		RJDA <sup>ⓐ</sup> RJDR <sup>ⓑ</sup> VERNIER		ALL ON ALL ON OFF			OFF – – – – –>					1A,1B,2B – – – – –>					– – – – –>				
							OFF – – – – –>					– – – – –>					ALL OFF – – – – –>				
							OFF – – – – –>					– – – – –>					ALL OFF – – – – –>				

ⓐ Water loops cycled as reqd (950 lb/hr)      ⓑ Primary RJDs will be OFF during sleep periods      NOTE: Maintain minimum lighting

## LOSS OF 2 FUEL CELLS OVERVIEW OF CONFIGURATION MANAGEMENT (Cont)

		SEAT INGRESS					TIG-20					El-5	V = 15K
DPS													
GPC OPS		1	2	3	4	5	1	2	3	4	5		
		G1	-	-	-	BFS	G3	--	--	G3	BFS		
POWER OUTPUT MODE		ON	OFF	OFF	ON	ON	ON	OFF	OFF	ON	OFF		
		N	N	N	N	B	N	N	N	N	B		
		R	H	H	H	R	R	H	H	R	R		
CONFIG		3					3						
GPC		1	0	0	0	0	1	0	0	4	0		
STR		1	1				1	1					
		2	1				4	1					
		3	1				1	1					
		4	1				4	1					
PL		1/2	1				1	1					
CRT		1	1				1	1					
		2	1				1	1					
		3	1				4	1					
		4	0				0	0					
L		1	0				0	0					
		2	0				0	0					
MM		1	1 (ON)				1 (ON)	1 (ON)					
		2	1 (ON)				4 (ON)	4 (ON)					
MDM		ALL ON except FF4					ALL ON except FF4						
D & C		DDU	L,R				Minimize use						
		MDU	Minimize use				Minimize use						
		IDP	Minimize use				Minimize use						
E C L S		AV BAY FAN	1,2,3				1,2						
		CABIN FAN	A				A						
		IMU FAN	B				B						
		WATER LP	1-OFF,2-ON				1-OFF,2-ON						
		FREON LP	1-A,2-A				1-A,2-A						
		RADIATOR	Stow				Stow						
		FES	ON				ON						
F C S / N A S V O A R I S D S		FCS CH	AUTO				ORIDE						
		ASA	OFF				ON						
		AA	1,2,3				1,2,3						
		RGA	1,2,3				1,2,3						
		ADTA	OFF				ON						
		IMU	1,2,3				1,2,3						
		MLS	OFF				OFF						
		RA	OFF				OFF						
		GPS	OFF				1, 2 or 2, 3						
R J D		RJDA	1A,1B,2B				1A,1B,2B						
		RJDF	ALL ON				ALL ON						
		VERNIER	ALL ON				ALL ON						

## LOSS OF 2 FUEL CELLS DEORBIT PREP

MCC	TIG	CDR	PLT	MS(AFT)	MS(MID)
	-04:00	FES HTR ACT	CRT TIMER SETUP	FDI CONFIG/ENT STOW	ENTRY STOWAGE
		MDM CONFIG			
		AC BUS CONFIG	AC BUS CONFIG	AC BUS CONFIG	AC BUS CONFIG
		FES RESTART	SEL AFT RCS JETS		
		PRESS CNTL ENT CONFIG	MNVR TO TAIL SUN	SEAT INSTALLATION	PRESS CNTL ENT CONFIG SEAT INSTALLATION
					MCA CONFIG
	-03:00	RAD BYPASS		KU-BD ANT STOW	
		PRE DPS TRANS SW CONFIG	PRE DPS TRANS SW CONFIG	PLBD CLOSING	
		DPS ENTRY CONFIG	DPS ENTRY CONFIG		
		PREL DEORB UPDATE/UPLINK HORIZ SIT CONFIG	PREL DEORB UPDATE/UPLINK		
		IMU RECOVERY			FLUID LOADING PREP
	-02:00	ACT STR TRK MNVR IMU ALIGN ATT	W/B STEAM VENT HTR	HTR CONFIG	GALLEY/H2O DISP DEACT
		IMU ALIGNMENT			
		MNVR TO BURN ATT DEACT STR TRK		FC PURGE	WCS DEACT
				C/W, COMM CONFIG	MCA RECONFIG
		LOSS OF 2 FC SW VERIF LIST	LOSS OF 2 FC SW VERIF LIST	LOSS OF 2 FC SW VERIF LIST	LOSS OF 2 FC SW VERIF LIST
		CLOTHING CONFIG	CLOTHING CONFIG		
	-01:00	FLUID LOADING PRE INGRESS SEAT INGRESS STOW ORB PKT	FLUID LOADING PRE INGRESS SEAT INGRESS STOW ORB PKT	WIRELESS STOW FLUID LOADING CLOTHING CONFIG STOW ORB PKT	FLUID LOADING CLOTHING CONFIG
	00:00				

**LOSS OF 2 FUEL CELLS DEORBIT PREP  
ACTIVITY PRIORITY TABLE**

TIG	ACTIVITY	PAGE	EXPEDITED D/O		TIG	ACTIVITY	PAGE	EXPEDITED D/O	
			Mandatory	Optional				Mandatory	Optional
4:00	TIMER SETUP	5-9	1	--	2:24	IMU RECOVERY	5-16	--	--
3:59	ENTRY STOWAGE	5-35	--	2	2:20	FLUID LOADING PREP	5-36	--	18
3:58	FES HTR ACT	5-9	--	--	2:10	GALLEY DEACT	5-36	--	19
3:57	FDG CONFIG/ENT STOW	5-25	4	--	2:09	HTR CONFIG	5-33	20	--
3:54	RCS/OMS HTR ACT	5-10	--	--	2:08	W/B STEAM VENT HTR ACT	5-15	21	--
3:45	MDM CONFIG	5-9	--	--	2:07	S-TRKR ACT	5-16	T/L	--
3:42	AC BUS CONFIG	5-10	6	--	2:04	MNVR TO IMU ATT	5-16	T/L	--
3:36	SELECT AFT RCS	5-10	--	--	2:00	IMU ALIGNMENT	5-17	22	--
3:32	AIRLOCK SW VERIF	5-10	--	T/L	1:44	WCS DEACT	5-36	23	--
3:30	FES RESTART	5-11	--	--	1:40	FUEL CELL PURGE	5-33	24	--
3:29	MNVR TO TAIL SUN	5-12	T/L	--	1:39	MNVR TO BURN ATT	5-18	T/L	--
3:25	PCS ENT CONFIG	5-11	9	--	1:34	S-TRKR DEACT	5-18	25	--
3:24	SEAT INSTALLATION	5-12	T/L	--	1:29	C/W, COMM CONFIG	5-33	26	--
3:14	MCA CONFIG	5-36	10	--	1:27	MCA RECONFIG	5-36	27	--
3:10	KU-BD ANT STOW	5-12	T/L	--	1:25	SWITCH VERIF	5-19	--	T/L
3:00	RAD BYP	5-14	11	--	1:15	CLOTHING CONFIG (C,P)	5-19	--	28
2:59	PLBD CLOSING	5-29	12	--	1:06	WIRELESS STOW	5-33	29	--
2:49	CRYO QTY CONFIG	5-13	--	13	1:05	BEGIN FLUID LOADING	5-19	--	T/L
2:48	PRE DPS TRANS SW CONFIG	5-13	14	--	1:01	CLOTHING CONFIG (MS,PS)	5-34	--	30
2:45	DPS ENTRY CONFIG	5-13	15	--	1:00	PRE INGRESS CONFIG	5-20	31	--
2:35	PREL DEORB UPDATE/UPLINK	5-14	17	--	:52	SEAT INGRESS	5-21	T/L	--
2:32	HORIZ SIT CONFIG	5-14	--	T/L	:45	GO TO ENT WITH P&Is	5-21	T/L	--

T/L procedure located in timeline vice procedure block

**NOTE**

1. This table assumes LOSS OF 2nd FC ON-ORBIT (TIG < 4 hr) (ORB PKT, PWRDN) has been performed
2. Procedure blocks listed in mandatory column are only ones that must be performed if failure occurs on orbit with TIG < 4:00 away
3. At least 1.5 hr is reqd to perform all mandatory activities
4. Those in optional column should be performed if time permits
5. If procedure has a dash in both mandatory and optional columns, it is not reqd for expedited case
6. Some procedures may be deleted if any nominal DEORBIT PREP actions have been accomplished

TIMER SETUP 1

P

1: GNC 2 TIME

SET CRT TIMER TO COUNT DOWN TO TIG (perform for GNC and SM)

ENTRY DAY(HR:MIN:SEC – MET)

ITEM 17 +   +   +

24 HOUR LATE DELAYED DEORBIT

ITEM 17 +   +   +

1: GNC UNIV PTG

FES HTR ACTIVATION 3

C L1 TOP EVAP HTR NOZ (two) – B AUTO  
DUCT – B

L2 FLASH EVAP FDLN HTR (two) – 2

R11L √SPLY H2O TKA OUTLET – CL (tb-CL)  
√TKB OUTLET – OP (tb-OP)  
√B SPLY ISOL VLV – OP (tb-OP)

MDM CONFIG 5

C O6 √MDM PL 1,2 (two) – ON  
√FF 1,2,3 (three) – ON  
√FA 1,2,3,4 (four) – ON

CRTX GNC I/O RESET  
SM I/O RESET

<b>TIG</b> <b>-04:00</b> GRAVITY GRADIENT  <b>-03:55</b>  <b>-03:50</b>  <b>-03:45</b>  <b>-03:40</b>  <b>-03:35</b>  <b>-03:30</b>	P	<u>TIMER SETUP</u> <b>1</b> , 5-9	<u>AC BUS CONFIG</u> <b>6</b> (Not reqd if AC transfer cable installed or if AC bus shorted)
	MS	<u>ENTRY STOWAGE</u> <b>2</b> , 5-35	ALL L4:D,E,Q 1. √All cbs (twenty-seven) – op
	C	<u>FES HTR ACTIVATION</u> <b>3</b> , 5-9	2. If FC 1 OK: Perform AC3 (3Φ) BUS LOSS ACTIONS (ORB PKT, <u>EPS</u> ). Do only steps in ORB PKT, do not proceed to MAL Mark up pictorials in section 6 to match bus loss actions AC3 is affected bus in step 3
	MS	<u>FDF CONFIG/ENTRY STOW</u> <b>4</b> , 5-27	If FC 2 or FC 3 OK: Perform AC1 (3F) BUS LOSS ACTIONS (ORB PKT, EPS). Do only steps in ORB PKT, do not proceed to MAL Mark up pictorials in section 6 to match bus loss actions AC1 is affected bus in step 3
	P	A14 √RCS/OMS HTR AFT RCS JET 1,2,3,4 (four) – AUTO	R1 3. Affected BUS:   cb AC CONTR (three) – cl AC BUS SNSR           – OFF INV/AC BUS           – OFF (tb-OFF) INV PWR               – OFF (tb-OFF) cb AC CONTR (three) – op
		A15 If SSPTS (OV103,105 only): PTU/MAIN BUS A,B (two) – OFF (tb-OFF) cb CNTL PWR PTU 1,2 (two) – op OPCU 1,2 V-ADJ (two) – OFF	4. Connect AC1 to AC3: Go to AC POWER TRANSFER CABLE INSTALLATION (IFM, <u>PROCEDURES A THRU F</u> )
	C	<u>MDM CONFIG</u> <b>5</b> , 5-9	
	A	<u>AC BUS CONFIG</u> <b>6</b> , 5-27 (Not reqd if AC transfer cable installed or if AC bus shorted)	
	P	<u>SELECT AFT RCS JETS</u> <b>7</b> (if GG from pwrn)	<u>SELECT AFT RCS JETS</u> <b>7</b> (if GG from pwrn)
	MS	<u>LOSS OF 2 FC SW VERIF LIST</u> , 6-31, 6-32 (Airlock and Airlock Hatch only)	P O6 √MDM FA 1,2,3,4 (four) – ON <u>GNC 20 DAP CONFIG</u> Select TAIL P,Y OPTION O14:F √RJDA 1A L2/R2 LOGIC, DRIVER – ON O15:F √1B L1/L5/R1 LOGIC – ON √L1/R1 DRIVER – ON O16:F √2B L3/R3/R5 LOGIC – ON √L3/R3 DRIVER – ON <u>X: GNC 23 RCS</u> ITEM 1 EXEC (FRCS page) O7 OVRD FRCS MANF 1,2,3,4 STAT – CL ITEM 2 EXEC (LRCS page) OVRD LRCS MANF 4 STAT – CL ITEM 3 EXEC (RRCS page) OVRD RRCS MANF 4 STAT – CL

FES RESTART 8

C	L1	RAD CNTLR OUT TEMP – HI
	O1	When FREON EVAP OUT TEMP ind > 50 degF:
	L1	FLASH EVAP CNTLR PRI B(A) – ON
		HI LOAD DUCT HTR sel – B
	ML86B:A	√cb MNC SPLY H2O XOVR VLV – cl
	R11L	SPLY H2O XOVR VLV – OP (tb-OP)

PRESS CNTL SYS ENTRY CONFIG 9

MS	MO10W	14.7 CAB REG INLET SYS 1,2 vlv (two) – CL
		H2O TK N2 REG INLET SYS 1,2 vlv (two) – OP
		O2 REG INLET SYS 1,2 vlv (two) – CL
	MO69M	LEH O2 8 vlv – CL
		Remove, stow O2 Bleed Orifice
		LEH O2 7,8 vlv – OP (if reqd)
	MO32M	5,6 vlv – OP (if reqd)
C	L2	√O2 SYS 1,2 SPLY (two) – OP (tb-OP)
		√XOVR SYS 1,2 (two) – OP
		√N2 SYS 1,2 SPLY (two) – OP (tb-OP)
		√REG INLET (two) – OP (tb-OP)
		O2/N2 CNTLR VLV SYS 1 – OP
		2 – CL

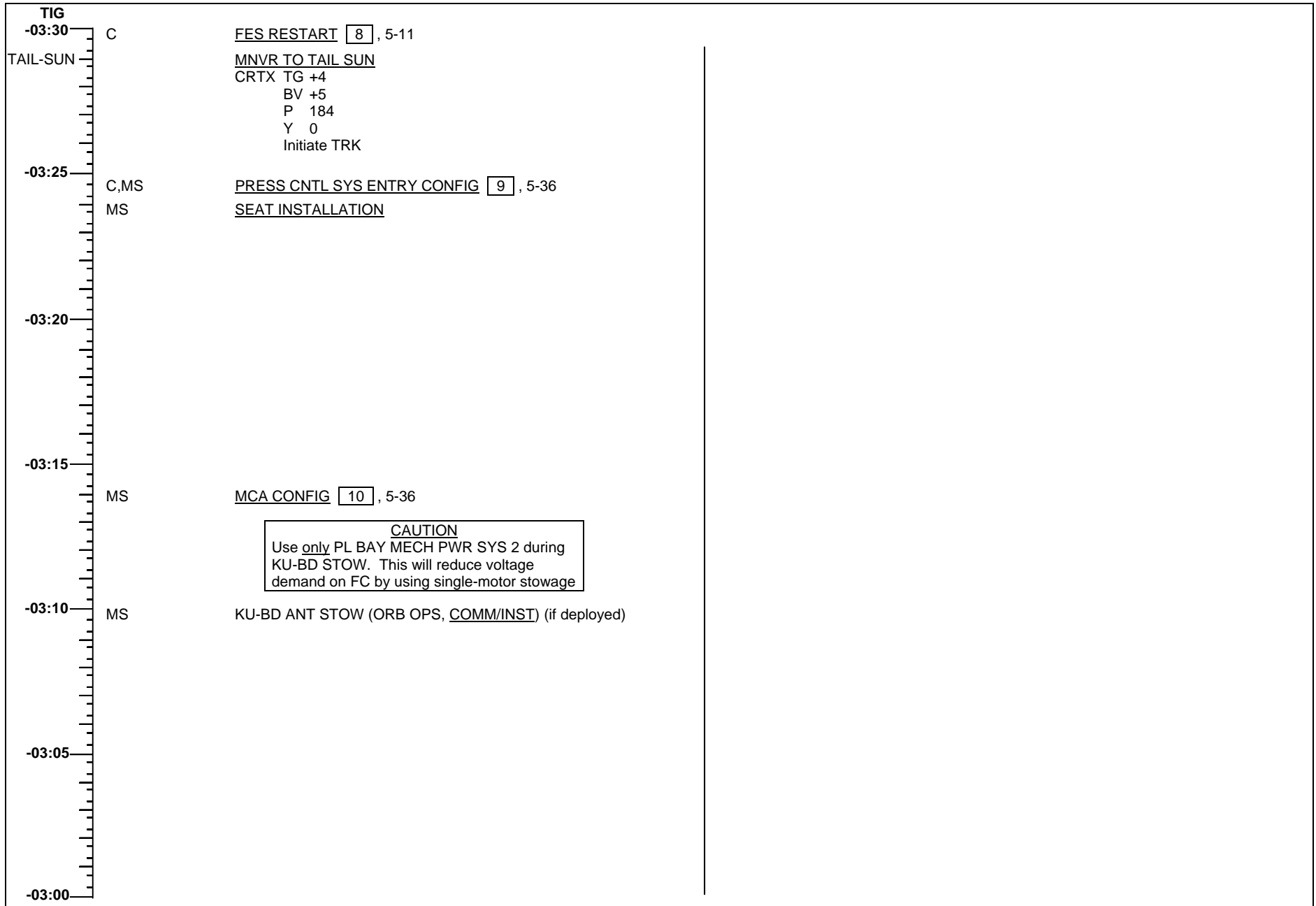



RAD BYP		11
<u>FLASH EVAP CONFIG</u>		
C	L1	√FLASH EVAP CNTLR PRI B(A) – ON √A(B) – OFF √SEC – OFF HI LOAD EVAP – ENA √DUCT HTR sel – B
<u>RAD BYP</u>		
L1		RAD CNTLR OUT TEMP – NORM BYP VLV MODE (two) – MAN MAN SEL (two) – BYP (after 3 sec, tb-BYP) CNTLR LOOP (two) – OFF
L2		FREON ISOL MODE – OFF
O1		√FREON EVAP OUT TEMP ind ~39 ± 1 degF (after 2.5 min)
<u>FREON LOOP CONFIG</u>		
L1		FLOW PROP VLV LOOP (two) – ICH (hold 3 sec, tb-ICH)

CRYO QTY CONFIG		13
C	O13:B	cb ESS 1BC CRYO QTY O2,H2 TK2 (two) – op
	:D	2CA CRYO QTY O2,H2 TK1 (two) – op
MS	ML86B:G	cb ESS 1BC CRYO QTY O2,H2 TK4 (two) – op
		√2CA CRYO QTY O2, H2 TK5 (two) – op
		3AB CRYO QTY O2,H2 TK3 (two) – op

PRE DPS TRANS SWITCH CONFIG		14
C,P	O14:A	RGA 1 – ON
	:E	cb MNA ACCEL 1 – cl
	:F	ASA 1 – ON
	O15:A	RGA 2 – ON
	:E	cb MNB ACCEL 2 – cl
	:F	ASA 2 – ON
	O16:A	RGA 3 – ON
	:F	ACCEL 3 – ON

DPS ENTRY CONFIG		15
C,P	L1	√AV BAY 2 FAN A(B) – ON
	O14:F	√MMU 1 – ON
	O15:F	√2 – ON
	C3	√FCS CH (four) – AUTO
1. <u>LOAD ENTRY TFL</u> Perform LOAD PDI DECOM FORMAT and LOAD PCMMU FORMAT (ORB OPS FS, <u>COMM/INST</u> ) for entry config		
<u>SM CHECKPOINT/UL CNTL ENA</u>		
C2		X: SM 60 SM TABLE MAINT
		Y: SM 1 DPS UTILITY

CRTY	MMU ASSIGN 2 SM – ITEM 4 EXEC
CRTX	CKPT INITIATE – ITEM 18 EXEC √Update of CKPT TIME and STATUS GOOD indicated
CRTY	MMU ASSIGN 1 SM – ITEM 3 EXEC
CRTX	CKPT INITIATE – ITEM 18 EXEC √Update of CKPT TIME and STATUS GOOD indicated
CRTY	CKPT RETRV ENA – ITEM 12 EXEC (*) UL CNTL ENA – ITEM 36 EXEC
C2	2. <u>DEACT GPC 4</u> IDP/CRT X MAJ FUNC – GNC
	<u>NOTE</u> All MAJ FUNC should be GNC prior to powering down SM GPC
O6	GPC MODE 4 – STBY,HALT – STBY (tb-RUN) – HALT (tb-bp) OUTPUT 4 – NORM
CRT1	GPC/CRT 04 EXEC 13 EXEC
	3. <u>TRANSITION GPC 1 TO GNC OPS 3</u> X: GNC GPC MEMORY
CRTX	CONFIG – ITEM 1 +3 EXEC Modify MC 3 per table →
CRTX	GNC, OPS 301 PRO DEORB MNVR COAST
O6	4. <u>TRANSITION BFS GPC TO GNC OPS 3</u> GPC OUTPUT 5 – B/U (tb-bp) MODE 5 – STBY (tb-RUN),RUN BFC CRT DISP – ON SEL – 3 + 1 3: BFS MEMORY BFS, GNC OPS 301 PRO 3: BFS, DEORB MNVR COAST
C3	5. <u>LAND SITE UPDATE</u> X: GNC 50 HORIZ SIT SEL SITE (See LAND SITE DATA)
O14:F	MMU 1 – OFF ASA 1 – OFF
O15:F	MMU 2 – OFF ASA 2 – OFF

CONFIG	3
GPC	10000
STR	1 1
	2 1
	3 1
	4 1
PL	1/2 1
CRT	1 1
	2 1
	3 1
	4 0
L	1 0
	2 0
MM	1 1
	2 1

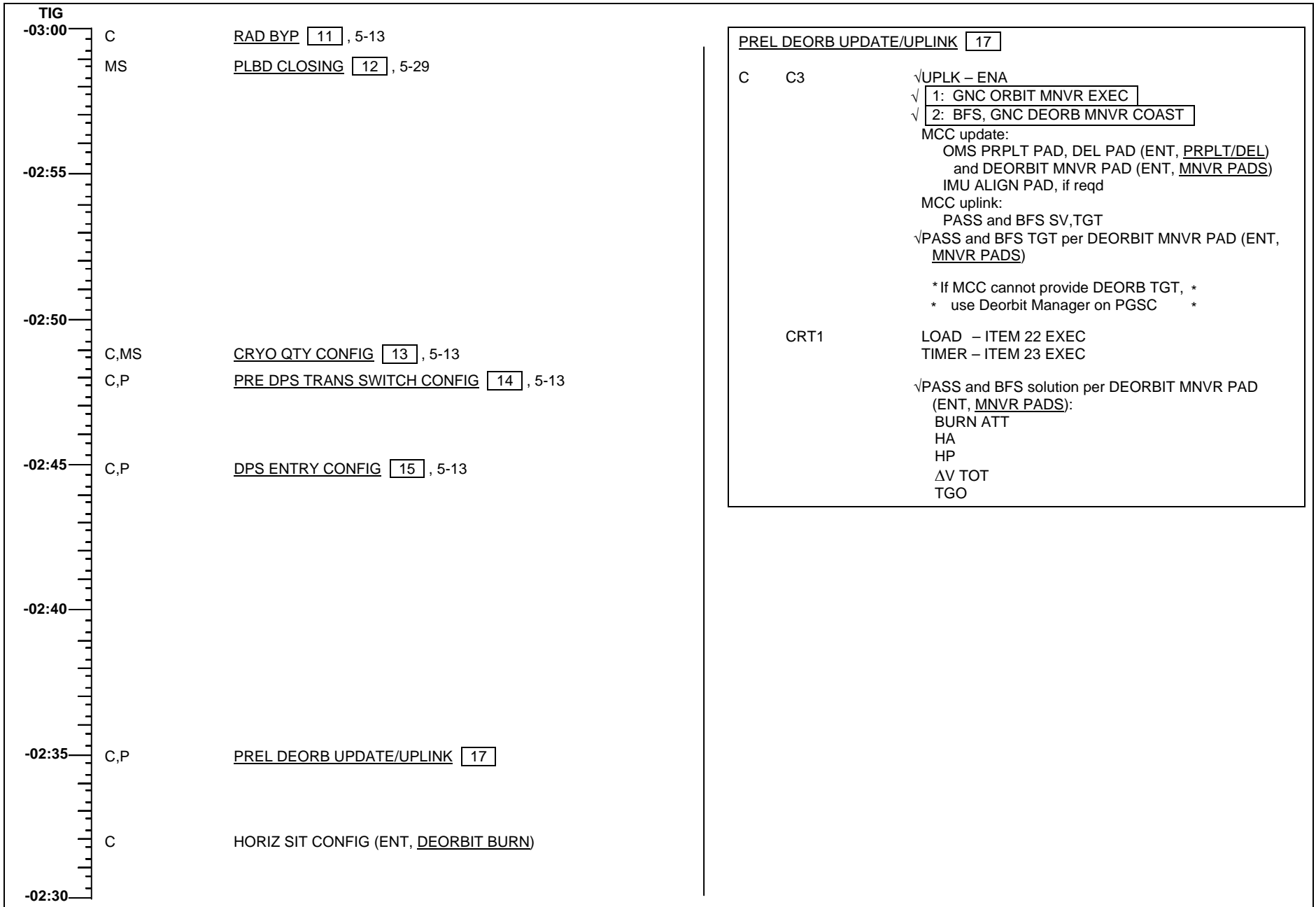

W/B STEAM VENT HTR ACT 21

P R2

If FC 1 OK:

BLR CNTLR/HTR 1 – A  
2 – B  
3 – A

If FC 2 or FC 3 OK:

BLR CNTLR/HTR 1 – A  
2 – A  
BLR CNTLR/HTR 3 – B  
BLR PWR (three) – ON

NOTE

Htr reqd to be on 2 hr prior to APU act

TIG  
 -02:30  
 -02:25  
 -02:20  
 -02:15  
 -02:10  
 -02:05  
 -02:00

C  
 MS  
 MS  
 MS  
 P  
 C  
 C

IMU RECOVERY (if reqd)  
 Use GNC FRP-3 (MAL, GNC) to recover any IMUs lost  
 due to bus failures or powerdown  
 BFS, GNC, OPS 000, 301 PRO  
BFS, GNC 50 HORIZ SIT  
 √BFS R/W sel  
FLUID LOADING PREP 18, 5-36

GALLEY DEACT 19, 5-36  
HTR CONFIG 20, 5-33  
W/B STEAM VENT HTR ACT 21, 5-15  
ACT STAR TRKR (omit if BFS)  
 O6 √S TRK PWR -Z - ON  
 √S TRK PWR -Y - ON  
 CRT1 GNC I/O RESET  
 √STAR TRKR doors open  
MNVR TO IMU ATT (omit if BFS) use pad on this page  
 DAP: AUTO

IMU STAR ALIGN PAD

NOTE  
 For pad data, √MCC or ref STAR PAIRS (ORB OPS, PTG)

STAR ID: -Y \_\_\_\_\_ (TIG - \_\_\_\_ : \_\_\_\_ TO- \_\_\_\_ : \_\_\_\_)  
 -Z \_\_\_\_\_ (TIG - \_\_\_\_ : \_\_\_\_ TO- \_\_\_\_ : \_\_\_\_)  
 ANG DIF: \_\_\_\_\_

ALIGNMENT ATTITUDE (Dual or Single S TRK)  R _____ P _____ Y _____	-Z: _____	2nd ALIGNMENT ATTITUDE (Single S TRK)  R _____ P _____ Y _____
---	-----------	---

IMU STAR ALIGN LOG

REQD ID: -Y \_\_\_\_\_, -Z \_\_\_\_\_ ANG ERR \_\_\_\_ . \_\_\_\_

ANG	1	2	3
ΔX ( )	_____ ( )	_____ ( )	_____ ( )
ΔY ( )	_____ ( )	_____ ( )	_____ ( )
ΔZ ( )	_____ ( )	_____ ( )	_____ ( )

EXECUTE TIME \_\_\_\_ : \_\_\_\_ : \_\_\_\_ (TIG MINUS)

IMU VERIFICATION PAD

NOTE  
 For pad data, √MCC or ref STAR PAIRS (ORB OPS, PTG)

STAR ID: -Y \_\_\_\_\_ (TIG - \_\_\_\_ : \_\_\_\_ TO- \_\_\_\_ : \_\_\_\_)  
 -Z \_\_\_\_\_ (TIG - \_\_\_\_ : \_\_\_\_ TO- \_\_\_\_ : \_\_\_\_)  
 ANG DIF: \_\_\_\_\_

ALIGNMENT ATTITUDE (Dual or Single S TRK)  R _____ P _____ Y _____	-Z: _____	2nd ALIGNMENT ATTITUDE (Single S TRK)  R _____ P _____ Y _____
---	-----------	---

IMU STAR ALIGN LOG

REQD ID: -Y \_\_\_\_\_, -Z \_\_\_\_\_ ANG ERR \_\_\_\_ . \_\_\_\_

ANG	1	2	3
ΔX ( )	_____ ( )	_____ ( )	_____ ( )
ΔY ( )	_____ ( )	_____ ( )	_____ ( )
ΔZ ( )	_____ ( )	_____ ( )	_____ ( )

EXECUTE TIME \_\_\_\_ : \_\_\_\_ : \_\_\_\_ (TIG MINUS)

IMU ALIGNMENT 22

NOTE

Procedure applies for one or two S TRK aligns.  
For one S TRK, a second att mnvr reqd between data takes. See pad on 5-16 for att & stars

- C
- C3 1. 1: GNC 22 S TRK/COAS CNTL
- C3 BFC CRT DISP – OFF
- 3: GNC 21 IMU ALIGN
- CRT1 2. √REQD ID – ITEM 11,12 – 0  
√STATUS (two) – NO BITE  
√SHUTTER (two) – OP
- \* If SHUTTER – CL: \*
  - \* √Att, MET – correct \*
  - \* Visually verify no bright object in FOV \*
  - \* After data collected and before changing \*
  - \* attitude, return shutter to AUTO \*
  - \* To open shutter: \*
  - \* MAN OP – ITEM 15(16) EXEC (\*) \*
  - \* To return shutter to AUTO: \*
  - \* MAN OP – ITEM 15(16) EXEC (no \*) \*
- CRT3 IMU 1,2,3:  
√STAT – blank  
√OPER – ITEM 4,5,6 (\*)
- CRT1 3. √IMU ALIGN ATT (pad)
- CRT1 4. S TABLE CLR – ITEM 20 EXEC
5. Enable Star Tracker:  
√S TRK – ITEM 3,4 EXEC (\*)
6. Verify S TABLE:  
TRK ID 1,2 = STAR ID (pad)  
ANG ERR ≤ 0.08
- Wait approx 1 min for new IMU Δ ANGS
- \* If after 3 min no data (or bad data) in S Table: \*
  - \* √S TRK – ITEM 3,4 (\*) \*
  - \* √ATT/STARS/TIME \*
  - \* √S TRK: TRK ID = STAR ID (pad) \*
  - \* Do S TRK Self Test \*
  - \* If neither tracker fails: \*
  - \* Mnvr to verification att – repeat steps 3,4,5,6 \*
  - \* If one tracker fails: \*
  - \* √TERM/IDLE for failed tracker – ITEM 9(10)(\*) \*
  - \* proceed with one S TRK ALIGN \*
  - \* If both trackers fail, inform MCC \*

For one S TRK align:

S TRK for good tracker – ITEM 3(4) EXEC (\*)  
TABLE CLR – ITEM 20 EXEC, reacquire star with good tracker  
TERM/IDLE for good tracker during maneuvers – ITEM 9(10) EXEC (\*)  
Mnvr to second att (single S TRK): Do not clear S Table  
Repeat steps 3,5,6 with second Star ID

- CRT1 7. √S TABLE SEL – ITEM 17,18 (\*)
- CRT3 ALIGN IMU 1,2,3 – ITEM 10,11,12, EXEC (\*)  
√REF STAR – ITEM 13 (\*)  
√TYPE – ITEM 15 (TORQUE)  
√IMU 1,2,3 – ANG ΔX,ΔY,ΔZ < 0.80
- \* If ANG ΔX,ΔY,ΔZ > 0.80 for two IMUs, do not torque: \*
  - \* Mnvr to verification att, repeat steps 3 thru 7 once \*
  - \* If still > 0.80, report to MCC \*
8. Record ANG ΔX,ΔY,ΔZ,ANG ERR, EXECUTE TIME (use log on 5-16)
- EXEC – ITEM 16 EXEC (\*)
- Alignment complete when:  
EXEC – ITEM 16 (no \*)
- IMU ALIGN VERIFICATION
9. Mnvr per IMU VERIFICATION PAD, 5-16  
DAP: AUTO
10. Perform steps 3,4,5,6 using appropriate stars (pad)
11. √IMU 1,2,3 ANG ΔX,ΔY,ΔZ < 0.1
- \* If ANG ΔX,ΔY,ΔZ > 0.1, perform steps 8 thru 11, \*
  - \* report to MCC \*

NOTE

For alternate stars, √MCC or ref STAR PAIRS (ORB OPS, PTG)

12. Report IMU ALIGN results
- C3 13. BFC CRT DISP – ON
- 3: BFS, GNC DORB MNVR COAST
- 1: GNC DEORB MNVR COAST

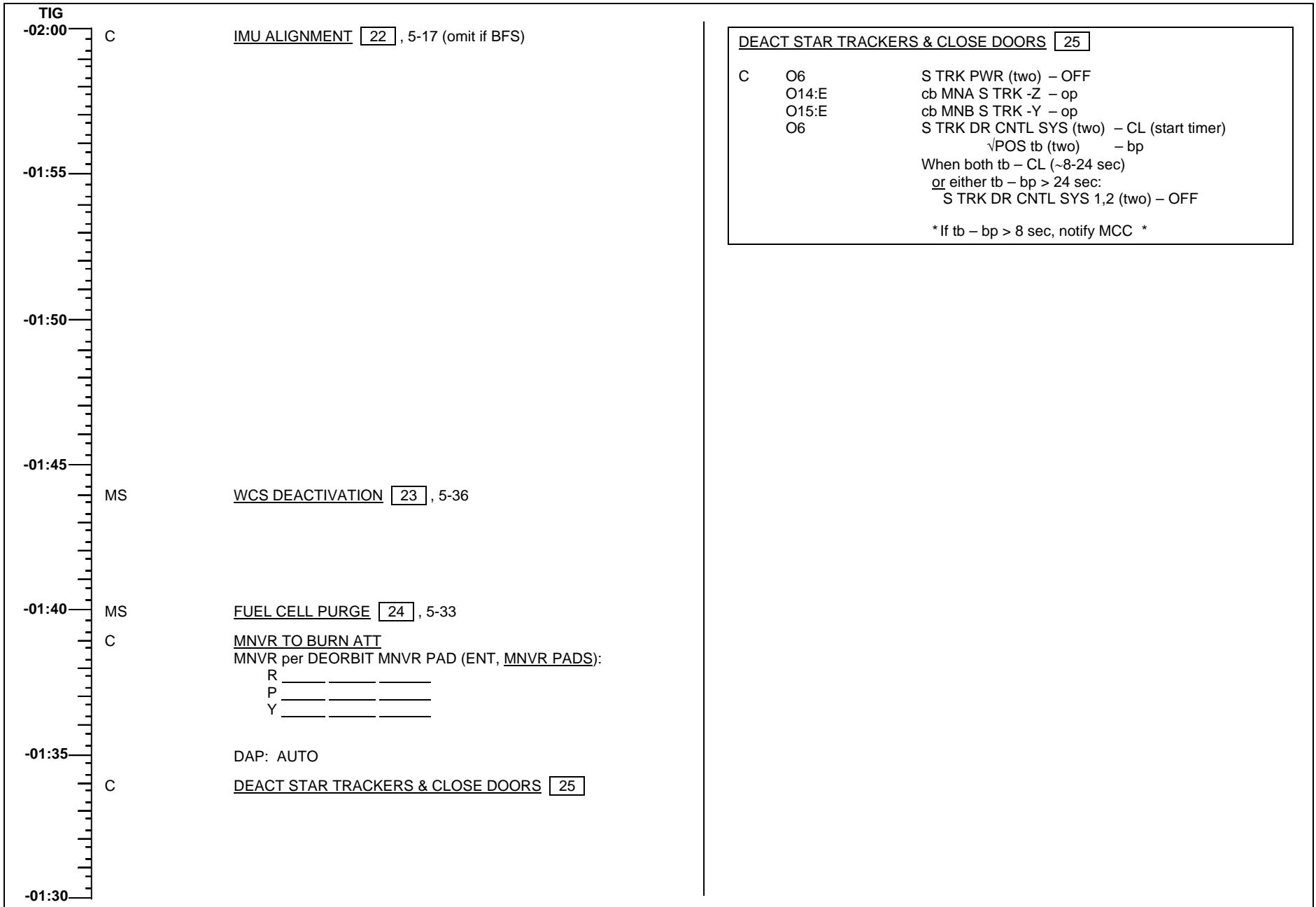

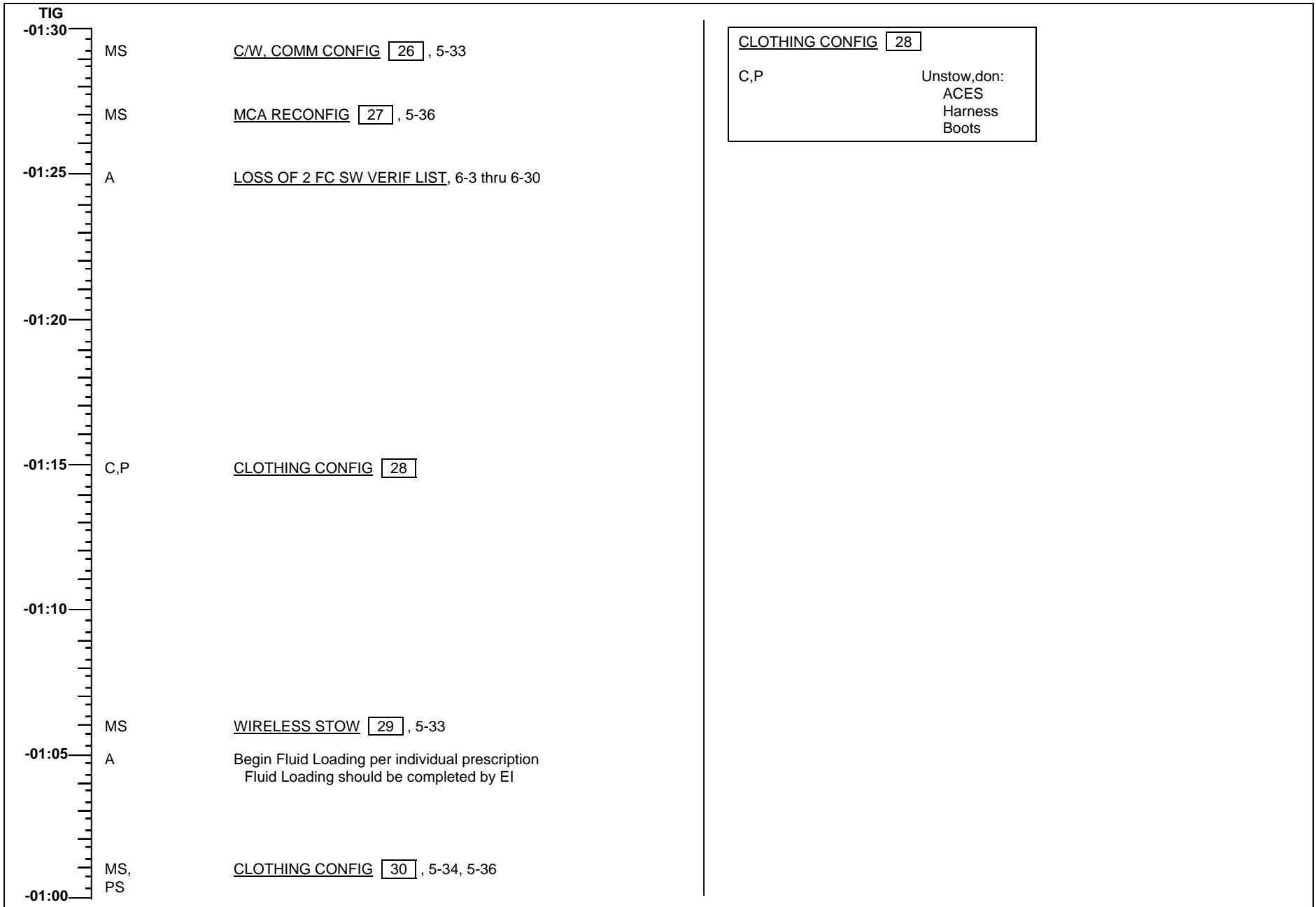

PRE INGRESS CONFIG 31

P R2 MPS/H2 PURGE PREP  
MPS He ISOL (six) - CL  
PNEU He ISOL - CL  
L ENG He XOVR - CL  
R4 MANF PRESS (two) - CL

C,P O16:E ENABLE QTY GAUGE  
cb MNC RCS/OMS PRPLT QTY GAUGE - cl

F8 RA CONFIG  
RDR ALTM - 1

O8 MLS CH/TACAN CH/DATA BUS  
O7 MLS CH tw (three) - See LAND SITE DATA  
TACAN CH tw (three) - See LAND SITE DATA

C L4:P ENABLE PROXIMITY PACKAGE  
√cb AC2 ΦA LG SNSR 2 - cl  
√AC3 ΦA LG SNSR 1 - cl

C L4:J cb CONFIG  
cb AC3 ΦA SIG CONDR HUM SEP - op  
ΦB SIG CONDR IMU FAN - op

HUD SETUP  
Remove, stow HUD covers (two)  
Ensure cloth cover does not obscure light sensor



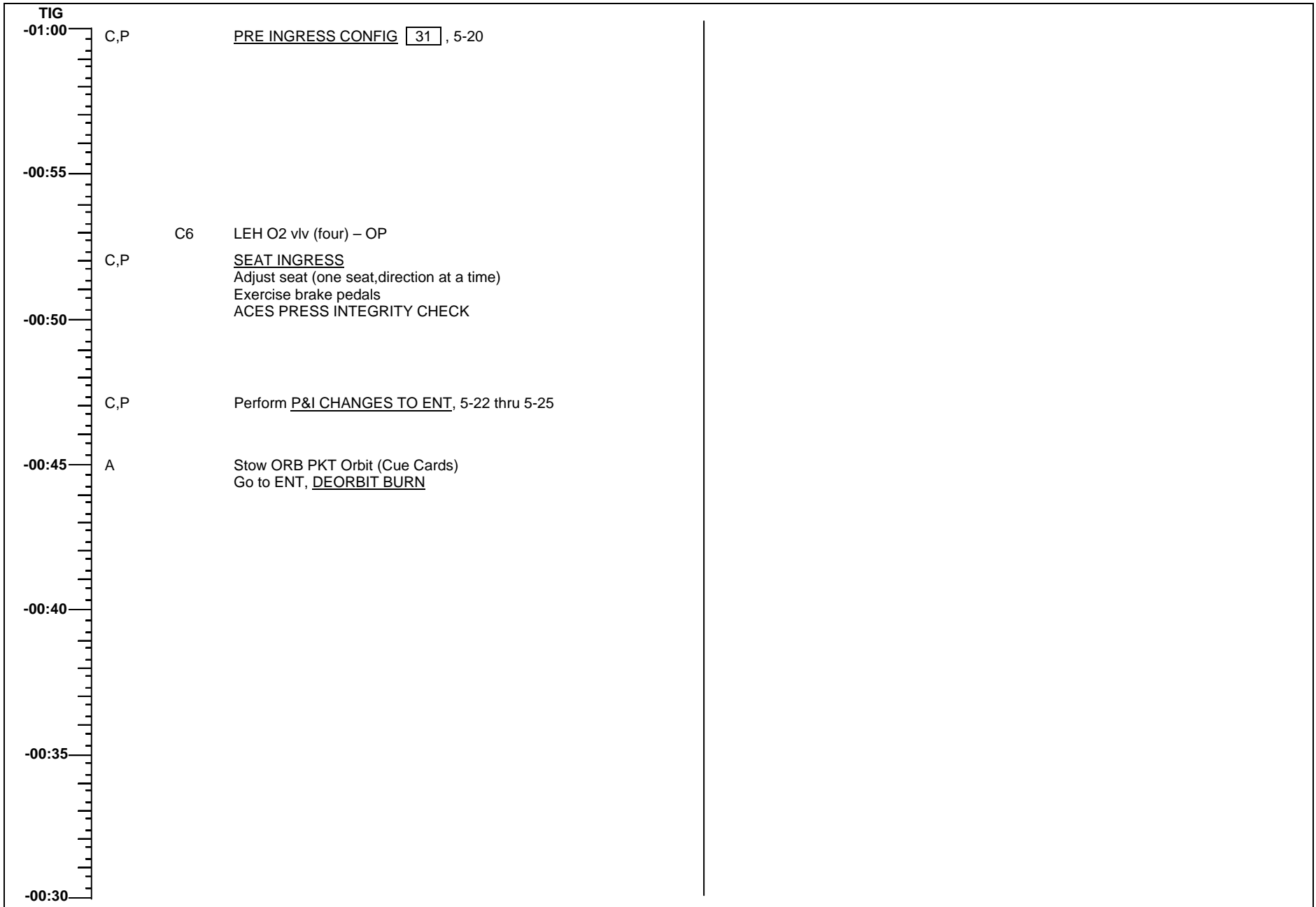

## LOSS OF 2 FUEL CELLS

### P&I Changes to ENTRY

#### GENERAL

1. AV BAY FANS cycled as needed to keep power level low
2. GPCs 2,3 remain pwr dn throughout ENTRY

#### SPECIFIC

TIG-45

R4

Delete: **OMS TVC GMBL CHECK**

Under **APU PRESTART** delete:

√HYD BK ISOL VLV (three) tb – CL

√LG EXTD ISO VLV tb – CL

and associated starred procedures

**HORIZ SIT CONFIG** ( GNC 51, BFS GNC 51 )

Delete: √SSME REPOS – ITEM 19 (ENA)

Add: “SSME REPOS – ITEM 19 EXEC (INH)”

TIG-25

#### “NOTE

VENT DOOR CLOSE must be performed prior to MM302 transition

O6

MDM FF4 – ON

GNC I/O RESET

MA73C:A

MCA LOGIC MNA MID 1 – ON

2: GNC 51 OVERRIDE

CRT 2

VENT DOOR CNTL CLOSE – ITEM 44 EXEC

MA73C:A

MCA LOGIC MNA MID 1 – OFF

MNB MID 1 – ON

MNC MID 2 – ON

MNB AFT 2 – ON

CRT 2

VENT DOOR CNTL CLOSE – ITEM 44 EXEC

MA73C:A

MCA LOGIC MNA MID 1 – ON

MNB MID 1 – OFF

MNC MID 2 – OFF”



## LOSS OF 2 FUEL CELLS

### P&I Changes to ENTRY (Cont)

POST  
BURN

Add: "FLT CNTLR PWR (two) – OFF

√DAP: AUTO

cb MNA,B,C, DDU L,R (four) – op"

Insert after **OMS/RCS POST BURN RECONFIG**:

L1 "AV BAY FAN 1B,2A,3A [3B vice 3A if FC 1 OK] – ON (3 sec between each start)"

EI-20

### SECONDARY ACTUATOR CHECK

C3 Add: "9. FCS CH (four) – ORIDE"

EI-18

If FORWARD RCS DUMP reqd for off-nominal CG, etc,  
insert FORWARD RCS RECOVERY before the dump:

### "FORWARD RCS RECOVERY

O14:F, RJDF LOGIC,DRIVER (eight) – ON

O15:F,  
O16:F

**GNC 23 RCS**

ITEM 1 EXEC (FRCS page)

OVRD FRCS MANF 1,2,3,4 STAT – OP"

Insert after dump completion:

O14:F, "RJDF LOGIC,DRIVER (eight) – OFF

O15:F,  
O16:F

**GNC 23 RCS**

ITEM 1 EXEC (FRCS page)

OVRD FRCS MANF 1,2,3,4 STAT – cl"

ENTRY SW  
CHECK

Delete: √ANTISKID,NWS steps

Delete: √RADAR ALTM,MLS,TACAN steps

# OV103,104

C D/O/3,4/GEN M

**LOSS OF 2 FUEL CELLS**  
**P&I Changes to ENTRY (Cont)**

EI-15	A13	GPS PWR – ON If OV103: GPS PRE AMPL (two) – MNC If OV104: GPS PRE AMPL (two) – ON Wait 30 sec GNC I/O RESET <span style="border: 1px solid black; padding: 2px;">GNC 55 GPS STATUS</span> INIT – ITEM 15 EXEC (*) NAV – ITEM 18 EXEC (*)
EI-13		Delete: <b>SSME HYD REPRESS</b>
	ENTRY MNVRS	Replace nominal <u>ENTRY MANEUVERS</u> (Cue Card) with LOSS OF 2 FUEL CELLS ENTRY MANEUVERS, 5-26

## LOSS OF 2 FUEL CELLS ENTRY MANEUVERS

FLIGHT CONDITIONS	MANEUVER
EI-5	BRAKES (three) – ON cb ADTA 1,2,3 – cl GNC I/O RESET cb MNA,B,C DDU L,R (four) – cl (L) FLT CNTLR PWR – ON Use two IDP/CRTs with four MDUs √LVLH ATT GNC, OPS 304 PRO √OPS 304, wait 1 min MDM FF4 – OFF  * If PREBANK: R/Y – CSS * * Roll at 1°/sec to <input type="text"/> <input type="text"/> * * Maintain PREBANK ± 5° *
'Guidance Box' @ q ~8 or D ~3	CLOSED LOOP GUIDANCE ___ : ___ : ___ * If PREBANK: P,R/Y – AUTO * Begin ALL trim monitoring
D = 11	√DRAG H
ΔAz = 10.5°	FIRST ROLL REVERSAL <input type="text"/> <input type="text"/> <input type="text"/> <input type="text"/>
V = 19K	√HYD MPS/TVC ISOL VLV SYS (three) – CL [G50] √GPS, INCORPORATE
V = 15K	If FC 1 OK: TACAN 1 MODE – GPC   If FC 2 or FC 3 OK: TACAN 3 MODE – GPC √TACAN ANT SEL – AUTO * If ELS,UHF MODE – G T/R *
V = 12K	RAD BYP VLV MODE (two) – AUTO CNTLR LOOP (two) – AUTO B(A)
V = 10K	√SPDBK to 81%
V = 7K	√TACAN and GPS status
V = 5K	L AIR DATA PROBE – DPY (Wait 30 sec) R AIR DATA PROBE – DPY (Heat only one probe if reqd) Begin AIL and RUD trim monitoring

FLIGHT CONDITIONS	MANEUVER
M = 4	MDM FF4 – ON GNC I/O RESET
M = 3.5	[G51] VENT DOOR CNTL OPEN – ITEM 43 EXEC
M = 2.9	CAB FAN (two) – OFF AV BAY FAN 2A – OFF 3A(3B) – OFF After ADTA incorporated, TACAN MODE (two) – OFF Use one HUD, one MLS, one RA GNC I/O RESET
M = 2.7	√APUs TRIM PANEL (two) – OFF RHC/PNL (two) – ENA
* If M < 2.5, P CSS for ADTA to G&C incorp *	
M = 2.0	Ensure ADTA to G&C; else, √theta limits
M < 1.0	*For bailout procedures, go to <b>BAILOUT</b> * P,R/Y – CSS as reqd √SPDBK CMD vs POS MAX N <sub>z</sub> <input type="text"/> <input type="text"/> <input type="text"/> (R) FLT CNTLR PWR – ON Use two IDP/CRTs with six MDUs ANTISKID – ON NWS – 1 Lock Inertia Reels
M = 0.7	√LG EXT D ISO VLV – OP
h = 15K	√MLS
h = 10K	√A/L (KSC – Tabs, Visors, Suit O2)
h = 2K	LDG GEAR ARM pb – push (ARM It on)
h = 300	LDG GEAR DN pb – push (DN It on)
MAIN GEAR TD	√SPDBK – 100%
V = 195 KEAS	DRAG CHUTE ARM,DPY pb (two) – push (simo) (All Its on)
V = 185 KEAS	DEROTATE
NOSE GEAR TD	SRB SEP – MAN/AUTO and depress pb √Auto Load Relief √HYD BK ISOL VLV (three) – OP
V < 120 KGS or 5K' remaining	BRAKE as reqd (8-10 fps <sup>2</sup> , -0.25 to -0.3G)
* If 5K' remaining and V > 140 KGS – MAX BRAKING *	
V = 60 KGS	DRAG CHUTE JETT pb – push (JETT1, JETT2 It on)
V = 40 KGS	BRAKE < 6 fps <sup>2</sup> (-0.2G) (Antiskid cutout)
WHEEL STOP	√All landing/nav aids off CAB FAN B – ON (Wait 3 sec, then continue) AV BAY FAN 2A,3A [3B vice 3A if FC1 OK] – ON (3 sec between each start) Go to ENT C/L, POST LDG

# OV103,104

## LOSS OF 2 FUEL CELLS

### P&I Changes to ENTRY (Cont)

L1 Insert: "HUM SEP (two) – OFF"

**FES HEATER DEACT**  
TOP EVAP HTR NOZ L,R (two) – OFF  
DUCT – OFF  
HI LOAD DUCT HTR – OFF  
FLASH EVAP FDLN HTR B SPLY – OFF

L2

**ASA ACT**  
ASA (four) – ON"

O14:F,  
O15:F,  
O16:F

DEORB  
UPDATE/  
UPLINK

Insert before GNC OPS 302 PRO:

**"GPC 4 ACT**

- (1) GPC MODE 4 – STBY/RUN
- (2) BFC CRT DISP – OFF
- (3) For OPS 3 TRANS use →
- (4) GNC, OPS 301 PRO
- (5) BFC CRT DISP – ON; BFS I/O RESET
- (6) FCS CH (four) – ORIDE
- (7) G50 √LAND SITE/RWY per DEL PAD"

CONFIG	3
GPC	10040
STR	1
2	4
3	1
4	4
PL 1/2	1
CRT	1
2	4
3	1
4	0
L	0
2	0
MM	1
2	4

TIG-20 Delete: **RCS/OMS HTR** steps

TIG-5 Insert after **SINGLE APU START**:

R4 "√HYD BK ISOL VLV X – GPC (tb-CL)  
√LG EXTD ISO VLV – GPC (tb-CL)  
GNC DEORB MNVR EXEC  
R OMS GMBL – SEC (\*)"

TIG-2 Use 2 DDU/FLT CNTLR PWR

L1 Add: "**AV BAY FAN CYCLE**  
AV BAY FAN (six) – OFF"

DURING BURN If FRCS COMPLETION required during burn, perform EI-18 FORWARD RCS RECOVERY steps below prior to fast flip

## LOSS OF 2 FUEL CELLS

### P&I Changes to ENTRY (Cont)

POST  
BURN

Add: "FLT CNTLR PWR (two) – OFF

√DAP: AUTO

cb MNA,B,C, DDU L,R (four) – op"

Insert after **OMS/RCS POST BURN RECONFIG**:

L1

"AV BAY FAN 1B,2A,3A [3B vice 3A if FC 1 OK] – ON (3 sec between each start)"

EI-20

#### **SECONDARY ACTUATOR CHECK**

C3

Add: "9. FCS CH (four) – ORIDE"

EI-18

If FORWARD RCS DUMP reqd for off-nominal CG, etc,  
insert FORWARD RCS RECOVERY before the dump:

#### **"FORWARD RCS RECOVERY**

O14:F,  
O15:F,  
O16:F

RJDF LOGIC,DRIVER (eight) – ON

**GNC 23 RCS**

ITEM 1 EXEC (FRCS page)

OVRD FRCS MANF 1,2,3,4 STAT – OP"

Insert after dump completion:

O14:F,  
O15:F,  
O16:F

"RJDF LOGIC,DRIVER (eight) – OFF

**GNC 23 RCS**

ITEM 1 EXEC (FRCS page)

OVRD FRCS MANF 1,2,3,4 STAT – cl"

ENTRY SW  
CHECK

Delete: √ANTISKID,NWS steps

Delete: √RADAR ALTM,MLS steps



## LOSS OF 2 FUEL CELLS

### P&I Changes to ENTRY (Cont)

EI-15      O7      If FC1 OK:  
                         GPS 1,2 PWR (two) – ON  
                         PRE AMPL (four) – ON  
If FC2 or FC3 OK:  
                         GPS 2,3 PWR (two) – ON  
                         PRE AMPL (four) – ON  
Wait 30 sec  
GNC I/O RESET  
GNC 55 GPS STATUS  
INIT – ITEM 14(15,16) EXEC  
NAV – ITEM 17(18,19) EXEC

EI-13      Delete: **SSME HYD REPRESS**

ENTRY  
MNVRS      Replace nominal ENTRY MANEUVERS (Cue Card) with  
                         LOSS OF 2 FUEL CELLS ENTRY MANEUVERS, 5-26

## LOSS OF 2 FUEL CELLS ENTRY MANEUVERS

FLIGHT CONDITIONS	MANEUVER
EI-5	BRAKES (three) – ON cb ADTA 1,2,3 – cl GNC I/O RESET cb MNA,B,C DDU L,R (four) – cl (L) FLT CNTLR PWR – ON Use two IDP/CRTs with four MDUs √LVLH ATT GNC, OPS 304 PRO √OPS 304, wait 1 min MDM FF4 – OFF  * If PREBANK: R/Y – CSS * * Roll at 1°/sec to <input type="text"/> <input type="text"/> * * Maintain PREBANK ± 5° *
'Guidance Box' @ q ~8 or D ~3	CLOSED LOOP GUIDANCE ___ : ___ : ___ * If PREBANK: P,R/Y – AUTO * Begin ALL trim monitoring
D = 11	√DRAG H
ΔAz = 10.5°	FIRST ROLL REVERSAL <input type="text"/> <input type="text"/> <input type="text"/> <input type="text"/> <input type="text"/>
V = 19K	√HYD MPS/TVC ISOL VLV SYS (three) – CL <input type="text"/> <input type="text"/> <input type="text"/> √GPS, INCORPORATE
V = 15K	* If ELS,UHF MODE – G T/R *
V = 12K	RAD BYP VLV MODE (two) – AUTO CNTLR LOOP (two) – AUTO B(A)
V = 10K	√SPDBK to 81%
V = 5K	L AIR DATA PROBE – DPY (Wait 30 sec) R AIR DATA PROBE – DPY (Heat only one probe if reqd) Begin AIL and RUD trim monitoring

FLIGHT CONDITIONS	MANEUVER
M = 4	MDM FF4 – ON GNC I/O RESET
M = 3.5	<input type="text"/> <input type="text"/> <input type="text"/> VENT DOOR CNTL OPEN – ITEM 43 EXEC
M = 2.9	CAB FAN (two) – OFF AV BAY FAN 2A – OFF 3A(3B) – OFF Use one HUD, one MLS, one RA GNC I/O RESET
M = 2.7	√APUs TRIM PANEL (two) – OFF RHC/PNL (two) – ENA
* If M < 2.5, P CSS for ADTA to G&C incorp *	
M = 2.0	Ensure ADTA to G&C; else, √theta limits
M < 1.0	* For bailout procedures, go to <b>BAILOUT</b> * P,R/Y – CSS as reqd √SPDBK CMD vs POS MAX Nz <input type="text"/> <input type="text"/> <input type="text"/> (R) FLT CNTLR PWR – ON Use two IDP/CRTs with six MDUs ANTISKID – ON NWS – 1 Lock Inertia Reels
M = 0.7	√LG EXT D ISO VLV – OP
h = 15K	√MLS
h = 10K	√A/L (KSC – Tabs, Visors, Suit O2)
h = 2K	LDG GEAR ARM pb – push (ARM It on)
h = 300	LDG GEAR DN pb – push (DN It on)
MAIN GEAR TD	√SPDBK – 100%
V = 195 KEAS	DRAG CHUTE ARM,DPY pb (two) – push (simo) (All Its on)
V = 185 KEAS	DEROTATE
NOSE GEAR TD	SRB SEP – MAN/AUTO and depress pb √Auto Load Relief √HYD BK ISOL VLV (three) – OP
V < 120 KGS or 5K' remaining	BRAKE as reqd (8-10 fps <sup>2</sup> , -0.25 to -0.3G)
* If 5K' remaining and V > 140 KGS – MAX BRAKING *	
V = 60 KGS	DRAG CHUTE JETT pb – push (JETT1, JETT2 It on)
V = 40 KGS	BRAKE < 6 fps <sup>2</sup> (-0.2G) (Antiskid cutout)
WHEEL STOP	√All landing/nav aids off CAB FAN B – ON (Wait 3 sec, then continue) AV BAY FAN 2A,3A [3B vice 3A if FC1 OK] – ON (3 sec between each start) Go to ENT C/L, <u>POST LDG</u>

## LOSS OF 2 FC Back of MS AFT FLIGHT DECK ACTIVITIES

### MS PULLOUT PAGE

#### NOTE

Wait for GO from CDR or PLT before starting any activity on this page

TIME (TIG-)	MS ACTIONS (AFT)
3:57	<u>FDF CONFIG/ENTRY STOW</u> [ 4 ]
3:42	<u>AC BUS CONFIG</u> [ 6 ] (Not reqd if AC transfer cable installed or if AC bus shorted)
3:24	<u>SPECIALIST SEAT INSTALLATION</u> Verify Leg Attach Collars (four) – DOWN/LOCKED <div style="border: 1px solid black; padding: 5px; margin: 5px 0;"> <p style="text-align: center;"><b>CAUTION</b></p> <p>Use <u>only</u> PL BAY MECH PWR SYS 2 during KU-BD STOW. This will reduce voltage demand on FC by using single-motor stowage</p> </div>
3:10	<u>KU-BD ANT STOW</u> (ORB OPS, <u>COMM/INST</u> ) (if deployed)
2:59	<u>PLBD CLOSING</u> [ 12 ], 5-29
2:09	<u>HTR CONFIG</u> [ 20 ], 5-33
1:40	<u>FUEL CELL PURGE</u> [ 24 ], 5-33
1:29	<u>C/W, COMM CONFIG</u> [ 26 ], 5-33
1:25	<u>LOSS OF 2 FC SW VERIF LIST</u> , 6-15 thru 6-26
1:06	<u>WIRELESS STOW</u> [ 29 ], 5-33
1:05	Begin Fluid Loading per individual prescription. Fluid Loading should be completed by EI
1:01	<u>CLOTHING CONFIG</u> [ 30 ], 5-34

<u>FDF CONFIG/ENTRY STOW</u> [ 4 ]
<u>FDF CONFIG</u> Unstow,install: Entry,Deorbit Burn Cue Cards ENT ENT PKT √Available for ENTRY: LDG SITE CHARTS Handheld Radio STAR CHART ORB OPS CONT DEORB ORB PKT REF DATA MAL Stow all other FDF articles
<u>ENTRY STOW</u> Stow: Flt Deck Camrs,Accessories Stow VTR Cassettes (one in VTR) Quick Don Masks
<u>FOOT LOOP CONFIG</u> Tape Foot Loops in egress routes

<u>AC BUS CONFIG</u> [ 6 ]	
A L4:D,E,Q	1. √All cbs (twenty-seven) – op
	2. If FC 1 OK: Perform AC3 (3Φ) BUS LOSS ACTIONS (ORB PKT, <u>EPS</u> ). Do only steps in ORB PKT, do not proceed to MAL Mark up pictorials in section 6 to match bus loss actions AC3 is affected bus in step 3 If FC 2 or FC 3 OK: Perform AC1 (3Φ) BUS LOSS ACTIONS (ORB PKT, <u>EPS</u> ). Do only steps in ORB PKT, do not proceed to MAL Mark up pictorials in section 6 to match bus loss actions AC1 is affected bus in step 3
R1	3. Affected BUS: cb AC CONTR (three) – cl AC BUS SNSR – OFF INV/AC BUS – OFF (tb-OFF) INV PWR – OFF (tb-OFF) cb AC CONTR (three) – op
	4. Connect AC1 to AC3: Go to AC POWER TRANSFER CABLE INSTALLATION (IFM, <u>PROCEDURES A THRU E</u> )

**LOSS OF 2 FC**  
**Back of MS AFT FLIGHT DECK ACTIVITIES**  
**MS PULLOUT PAGE**

This Page Intentionally Blank

## LOSS OF 2 FC MS AFT FLIGHT DECK ACTIVITIES (Cont)

### MS PULLOUT PAGE

PLBD CLOSING 12

STOW RADIATOR(S) (if deployed)

**CAUTION**

Use only PL BAY MECH PWR SYS 2 during RAD STOW. This will reduce voltage demand on FC by using single-motor stowage

Perform RAD STOW (ORB OPS, ECLS)

CONFIG RMS/OBSS (if RMS/OBSS onboard)

√Elbow Camr in aligned posn

- Pan 90° from X-axis
- Tilt per decal

√PORT RMS HTR (two) – OFF

√RMS PWR – OFF

STBD RMS HTR (two) – OFF

RSC PWR – OFF

OBSS SW PWR – OFF

cb OBSS SW PWR CB1 – op

R12 (OBSS)  
(OPP)

**CAUTION**

Verify no obstructions before closing and latching PLBD (Ku ANT, RMS, RAD, etc.)

Use only one PL BAY DR SYS sw during ALL PLBD operations to reduce voltage demand on FC

R13L

- \* If SM GPC fails during this operation: \*
- \* PL BAY DR SYS (two) – DSBL \*
- \* DR – STOP \*
- \* Perform PASS SM GPC FAIL (ORB PKT, DPS) \*
- \* \*
- \* If no motion determined visually or 'OP/CL' not blank \*
- \* within 10 sec after cmd, or \*
- \* \*
- \* If Latch not 'CL' in single-motor time, or \*
- \* if door motion stops and not 'RDY' or 'CL': \*
- \* PL BAY DR – STOP \*
- \* SYS 1 – DSBL \*
- \* 2 – ENA \*
- \* Continue in procedure \*

R11L

1. GPC/CRT 44 EXEC
2. IDP/CRT4 PWR – ON
3. SM, OPS 202 PRO

CRT4

4: SM PL BAY DOORS

R13L

√PL BAY DR – STOP

CRT4

√PBD SW – STOP

√MAN SEL (ten) – (no \*)

√PBD SW BYPASS – (no \*)

4. AC POWER ON – ITEM 1 EXEC (\*)

5. AUTO MODE SEL – ITEM 3 EXEC (\*)

R13L

6. PL BAY DR SYS 1 – ENA

√2 – DSBL

CRT4

√OP/CL STATUS (ten) – OP

**NOTE**

Expect single-motor drive time on all actuators

R13L

7. PL BAY DR – CL

CRT4

\* If PORT DOOR not 'CL' within 6 sec of 'RDY': \*

R13L

\* PL BAY DR – STOP \*

\* Go to PORT BKHD LATCH TROUBLESHOOTING \*

12A, 5-31

CRT4

√PORT DOOR – blank, RDY, CL (~126 sec)

√FWD, AFT LATCHES – blank, CL (~60 sec)

√STBD DOOR – blank

8. When Stbd Door as close as possible to Port Door before contact, perform PLBD fit check:

R13L

PL BAY DR – STOP

Determine C/L Latch clearance on C/L LATCH EXTENDED GUIDE ROLLER TRAJECTORY NO-GO DIAGRAM, 5-30

\* If NO-GO for PLBD CLOSE: \*

\* If no waveoff capability: \*

\* Perform MAL, MECH SSR-3 \*

\* (SIMULTANEOUS PLBD CL) \*

\* If waveoff OK: √MCC \*

9. PL BAY DR – CL

CRT4

\* If STBD DOOR not 'CL' within 6 sec of 'RDY': \*

\* PL BAY DR – STOP \*

\* Go to STBD BKHD LATCH TROUBLESHOOTING \*

12B, 5-31 \*

√STBD DOOR – CL (~126 sec)

√FWD, AFT LATCHES (two) – blank, CL (~60 sec)

√CENTER LATCHES 1-4, 13-16 (two) – blank, CL (~40 sec)

√5-8, 9-12 (two) – blank, CL (~40 sec)

Cont next page

# LOSS OF 2 FC Back of MS AFT FLIGHT DECK ACTIVITIES (Cont)

## MS PULLOUT PAGE

### PLBD CLOSING (Cont)

- R13L 10. PL BAY DR - STOP  
SYS 1 - DSBL  
√2 - DSBL
- CRT4 11. √OP/CL STATUS (ten) - CL  
12. AC POWER OFF - ITEM 2 EXEC (\*)  
13. GPC/CRT4 EXEC
- R11L 14. IDP/CRT4 PWR - OFF  
15. AFD 1 PWR - OFF
- A7U 16. √PL BAY FLOOD (eight) - OFF

### PORT AFT BULKHEAD LATCH GO/NO-GO DIAGRAM

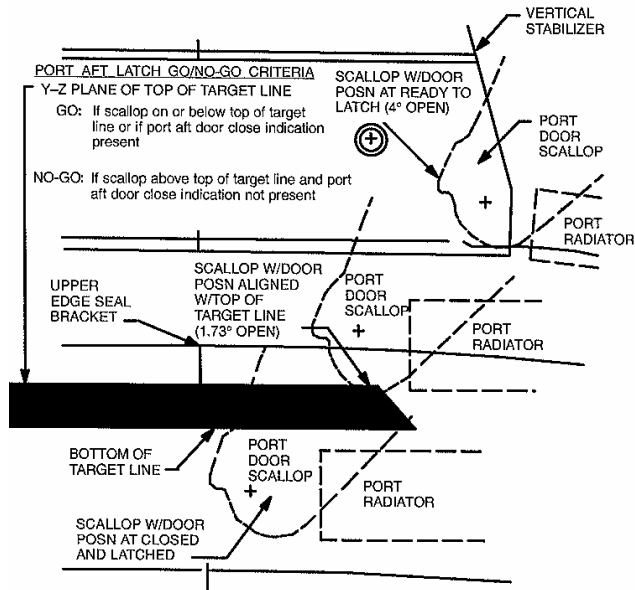

FUNCTION	PLBD CONTROL								PLBD DISPLAY PL MDM								
	Ref: MA73C:C&D for MCA (cb)																
	MTR 1				MTR 2				C	C	O	O	C	R	R	R	O
	AC/MCA	CNTL	MDM	SYS	AC/MCA	CNTL	MDM	SYS	A	B	A	B	A	B	C		
LATCH																	
5-8	1/MID3	AB3/AB2	PL1	2	3/MID2	CA3/CA1	PL2	1	1	2	1	2					
9-12	1/MID1	AB3/AB1	PL1	1	3/MID4	CA3/CA2	PL2	2	1	2	1	2					
1-4	1/MID3	AB3/AB2	PL1	2	3/MID2	CA3/CA1	PL2	1	1	2	1	2					
13-16	3/MID4	CA3/CA2	PL2	2	2/MID2	BC3/BC1	PL1	1	2	1	2	1					
S FWD	1/MID1	AB3/AB1	PL1	1	2/MID4	BC3/BC2	PL2	2	1	2	1	2					
S AFT	3/MID4	CA3/CA2	PL2	2	2/MID2	BC3/BC1	PL1	1	2	1	2	1					
S DOOR	1/MID1	AB3/AB1	PL1	1	2/MID4	BC3/BC2	PL2	2					1	1	2	2	1
													2	1	2	2	2
P FWD	1/MID1	AB3/AB1	PL1	1	2/MID4	BC3/BC2	PL2	2	1	2	1	2					
P AFT	1/MID3	AB3/AB2	PL1	2	3/MID2	CA3/CA1	PL2	1	1	2	1	2					
P DOOR	3/MID4	CA3/CA2	PL2	2	2/MID2	BC3/BC1	PL1	1					2	1	1	2	2
													1	1	1	2	1

### C/L LATCH EXTENDED GUIDE ROLLER TRAJECTORY NO-GO DIAGRAM

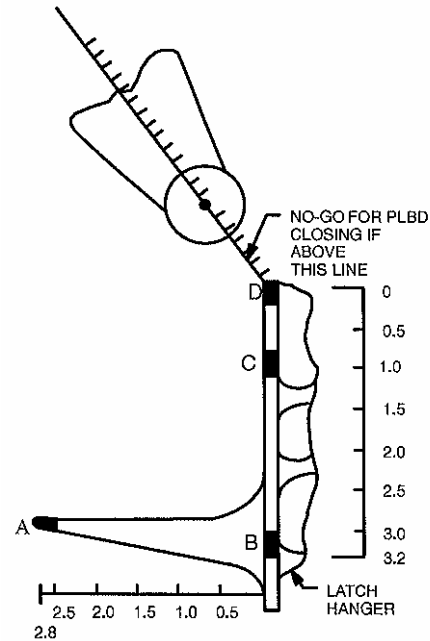

**LOSS OF 2 FC  
MS AFT FLIGHT DECK ACTIVITIES (Cont)**

**MS PULLOUT PAGE**

**PORT BKHD LATCH TROUBLESHOOTING [12A]**

- CRT4 1. √PORT DOOR FWD, AFT MICRO-SW STATs  
If PORT DOOR AFT 'C' = '0':  
: 2. √PORT AFT BULKHEAD LATCH GO/NO DIAGRAM, 5-30  
: If NO-GO:  
L Go to MAL, MECH, SSR-2 (CONTINGENCY PLBD CLOSURE)
- If PORT DOOR FWD 'C' = '0':  
:  
: NOTE  
: Use PLB camera A to view port fwd bkhd latch  
: hook/roller #3 as seen in figures 5-1 and 5-2, 5-32
- R13L 3. PL BAY DR SYS 1 – DSBL  
: 2 – ENA  
:  
: During the following step, monitor latch hook #3 while driving to  
: ensure hook motion and proper roller engagement  
:  
: \* If at any point latch hook #3 stops moving while commanded, \*  
: \* or it appears that the hook is going to miss or jam into its \*  
: \* roller: \*  
: \* PL BAY DR – STOP \*  
: \* Go to MAL, MECH, SSR-2 (CONTINGENCY PLBD \*  
: \* CLOSURE) \*
4. PL BAY DR – CL  
:  
: 5. When proper roller engagement verified for latch #3:  
L PL BAY DR – STOP
6. Go to step 7 of PLBD CLOSING [12], 5-29 ignoring the starred block

**STBD BKHD LATCH TROUBLESHOOTING [12B]**

- CRT4 1. √STBD DOOR FWD, AFT MICRO-SW STATs  
If STBD DOOR AFT (FWD) 'C' = '0':  
:  
: NOTE  
: Use PLB camera C(D) to view stbd aft (fwd) bkhd latch  
: hook/roller #3 as seen in figures 5-1 and 5-2, 5-32
- R13L 2. PL BAY DR SYS 1(2) – DSBL  
: 2(1) – ENA  
:  
: During the following step, monitor latch hook #3 while driving to  
: ensure hook motion and proper roller engagement  
:  
: \* If at any point latch hook #3 stops moving while \*  
: \* commanded, or it appears that the hook is going \*  
: \* to miss or jam into its roller: \*  
: \* PL BAY DR – STOP \*  
: \* Go to MAL, MECH, SSR-2 (CONTINGENCY \*  
: \* PLBD CLOSURE) \*
3. PL BAY DR – CL  
:  
: 4. When proper roller engagement verified for latch #3:  
L PL BAY DR – STOP
5. Go to step 9 of PLBD CLOSING [12], 5-29 ignoring the starred block

**LOSS OF 2 FC  
MS AFT FLIGHT DECK ACTIVITIES (Cont)**

**MS PULLOUT PAGE**

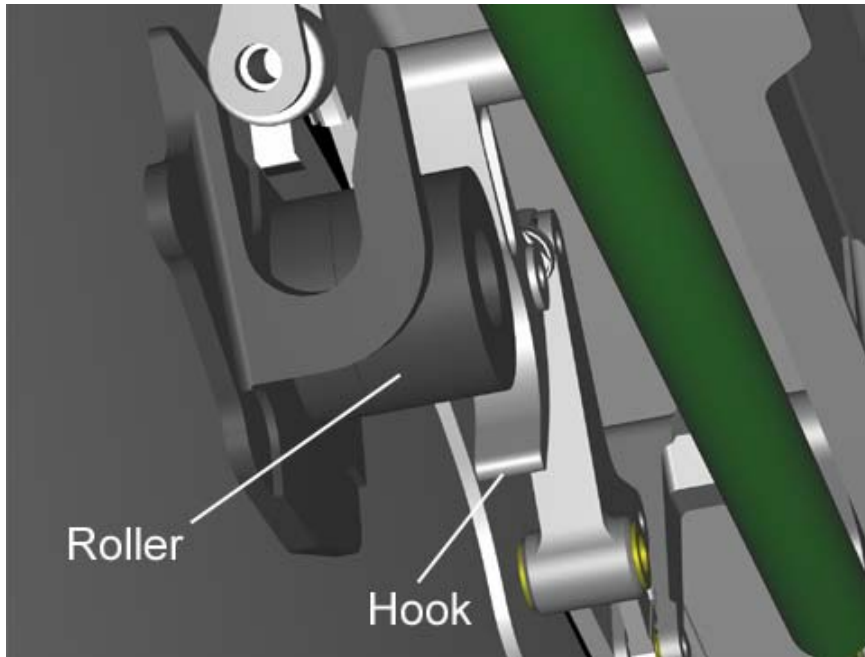

Figure 5-1.- Latch hook/roller #3 typical view from PLB camera

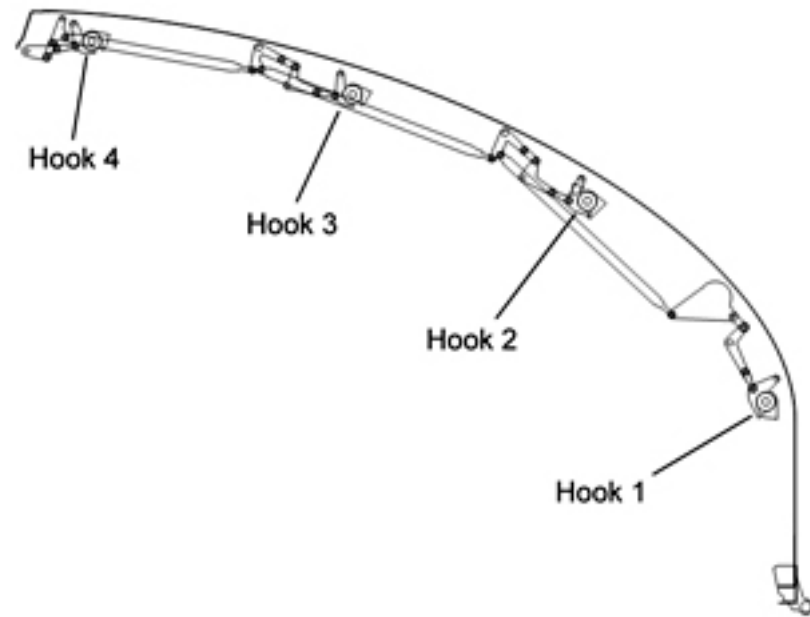

Figure 5-2.- Typical latch hook/roller numbering



## LOSS OF 2 FC MS AFT FLIGHT DECK ACTIVITIES (Cont)

### MS PULLOUT PAGE

**HTR CONFIG** 20

R11U FC PURGE HTR – ON

NOTE  
Htr must be on 15 min prior to purge

A12 √APU HTR LUBE OIL LN (three) – OFF  
TK/FU LN/H2O SYS 1B,2B,3B (three) – AUTO  
√1A,2A,3A (three) – OFF

A14 √HYD HTR (eight) – OFF  
RCS/OMS HTR FWD RCS – OFF  
L POD (two) – A OFF, B OFF  
R POD (two) – A OFF, B OFF  
OMS CRSFD LINES (two) – A OFF  
– B OFF  
FWD, AFT RCS JET 5 (two) – OFF

**FUEL CELL PURGE** 24

**WARNING**  
Do not purge if FC AMPS > 430

R11U √FC PURGE HTR ON > 15 min

VLVS X – OP for 2 min, then  
– GPC  
HTR – GPC  
√VLV – GPC

**C/W, COMM CONFIG** 26

C/W RESET

R13U		
PARAMETER NAME	C/W CH	ENA/ INH
HYD P 1	99	ENA
2	109	ENA
3	119	ENA

COMM CONFIG

O6 √UHF SPLX/EVA PWR AMPL – ON

A1L S-BD PM MODE – STDN LO  
NSP DATA RATE XMIT,RCV (two) – HI  
CODING XMIT,RCV (two) – OFF

A13 OS AUD SPKR PWR – OFF

A15 PS COMM CCU PWR – OFF

R14:C cb KU ELEC – op  
ANT HTR – op  
CABLE HTR – op  
SIG PROC – op  
cb UHF EVA (two) – op

O5,O9 L,R AUD A/G 2 – T/R  
ICOM B – T/R  
VOX SENS – as reqd  
VOL tw (six) – as reqd  
XMIT/ICOM MODE – PTT/VOX

MO42F MIDDECK SPKR AUD PWR – AUD/TONE

ML85E AC S1 – OFF

R10,L9 MS,PS AUD PWR – AUD/TONE  
A/G 1 – T/R  
2 – T/R  
A/A – T/R  
ICOM A,B – T/R  
VOX SENS – as reqd  
VOL tw (six) – as reqd  
XMIT/ICOM MODE – as reqd

**WIRELESS STOW** 29

Disconnect, stow Wireless Headsets (if reqd)

√Minimum aft deck lighting

Cont next page

**LOSS OF 2 FC**  
**Back of MS AFT FLIGHT DECK ACTIVITIES (Cont)**

**MS PULLOUT PAGE**

CLOTHING CONFIG	30
MS,PS	Unstow,don: ACES Harness Boots

## LOSS OF 2 FC MS MIDDECK ACTIVITIES

### MS PULLOUT PAGE

#### NOTE

Wait for GO from CDR or PLT before starting any activity on this page

TIME (TIG-)	MS ACTIONS (MID)
3:59	<u>ENTRY STOWAGE</u> [ 2 ]
3:42	<u>AC BUS CONFIG</u> [ 6 ], 5-36 (Not reqd if AC transfer cable installed or if AC bus shorted)
3:32	<u>SW VERIF</u> (Airlock and Airlock Hatch only), 6-31, 6-32
3:25	<u>PRESS CNTL SYS ENTRY CONFIG</u> [ 9 ], 5-36
3:24	<u>SPECIALIST SEAT INSTALLATION</u> Verify Leg Attach Collars (four) – DOWN/LOCKED Verify LiOH Door Latches (four) – ENGAGED
3:14	<u>MCA CONFIG</u> [ 10 ], 5-36
2:49	<u>CRYO QTY CONFIG</u> [ 13 ], 5-36
2:20	<u>FLUID LOADING PREP</u> [ 18 ], 5-36
2:10	<u>GALLEY DEACT</u> [ 19 ], 5-36
1:44	<u>WCS DEACTIVATION</u> [ 23 ], 5-36
1:27	<u>MCA RECONFIG</u> [ 27 ], 5-36
1:25	<u>LOSS OF 2 FC SW VERIF LIST</u> , 6-27 thru 6-30
1:05	Begin Fluid Loading per individual prescription. Fluid Loading should be completed by EI Verify Side Hatch UV Filter, Locking Device, and Pyro Box Safing Pin removed and stowed
1:01	<u>CLOTHING CONFIG</u> [ 30 ], 5-36

<p><u>ENTRY STOWAGE</u> [ 2 ]</p> <p><u>PERSONAL HYGIENE SYS STOWAGE</u> Stow: Personal Hygiene Kits Hose</p> <p><u>WCS CONFIG</u> Foot restraints – up,locked Privacy Curtain – stow</p> <p><u>AIRLOCK CLOSEOUT</u> Tether soft goods to EVA tether point or A/L Stowage Bag. Gray Tape to floor</p> <p>MO13Q</p> <p>√AIRLK FAN A(B) – OFF if flown Stow all ducts as appropriate</p> <p><u>ESCAPE POLE SETUP</u> Reinstall Stbd Pip Pin Reinstall large Port Pin: Retract and hold Locking Pin (Ring) Reinstall large Pin Release Locking Pin (Ring) Slide forward Safing Latch</p> <p>√Pole Straps secure</p> <p><u>DFD STOWAGE</u> Stow FLIGHT PLAN</p> <p><u>CABIN CONFIG</u> Stow: Backup PGSC Middeck Camrs,Accessories FWD/AFT Shades,Filters,Quick Don Masks Stow Exercise Equipment √Retention net in ASC/ENT config</p> <p><u>EGRESS ROUTE CONFIG</u> Tape Foot Loops in egress routes</p>
---

## LOSS of 2 FC Back of MS MIDDECK ACTIVITIES MS PULLOUT PAGE

**AC BUS CONFIG** 6 (Not reqd if AC transfer cable installed or if AC bus shorted)

A L4:D,E,Q

1.  All cbs (twenty-seven) – op
2. If FC 1 OK:
  - Perform AC3 (3Φ) BUS LOSS ACTIONS (ORB PKT, EPS).
  - Do only steps in ORB PKT, do not proceed to MAL
  - Mark up pictorials in section 6 to match bus loss actions
  - AC3 is affected bus in step 3
- If FC 2 or FC 3 OK:
  - Perform AC1 (3Φ) BUS LOSS ACTIONS (ORB PKT, EPS).
  - Do only steps in ORB PKT, do not proceed to MAL
  - Mark up pictorials in section 6 to match bus loss actions
  - AC1 is affected bus in step 3

R1

3. Affected BUS:
 

cb AC CONTR (three)	– cl
AC BUS SNSR	– OFF
INV/AC BUS	– OFF (tb-OFF)
INV PWR	– OFF (tb-OFF)
cb AC CONTR (three)	– op
4. Connect AC1 to AC3:  
Go to AC POWER TRANSFER CABLE INSTALLATION (IFM, PROCEDURES A THRU F)

**PRESS CNTL SYS ENTRY CONFIG** 9

MS	MO10W	14.7 CAB REG INLET SYS 1,2 vlv (two)	– CL
		H2O TK N2 REG INLET SYS 1,2 vlv (two)	– OP
		O2 REG INLET SYS 1,2 vlv (two)	– CL
	MO69M	LEH O2 8 vlv	– CL
		Remove, stow O2 Bleed Orifice	
		LEH O2 7,8 vlv (two)	– OP (if reqd)
	MO32M	5,6 vlv (two)	– OP (if reqd)
C	L2	<input checked="" type="checkbox"/> O2 SYS 1,2 SPLY (two)	– OP (tb-OP)
		<input checked="" type="checkbox"/> XOVR SYS 1,2 (two)	– OP
		<input checked="" type="checkbox"/> N2 SYS 1,2 SPLY (two)	– OP (tb-OP)
		<input checked="" type="checkbox"/> REG INLET (two)	– OP (tb-OP)
		O2/N2 CNTLR VLV SYS 1	– OP
		2	– CL

**MCA CONFIG** 10

MA73C	MCA LOGIC FWD (three)	– ON
	MID (eight)	– ON

**CLOTHING CONFIG** 30

MS, PS	Unstow, don:
	ACES
	Harness
	Boots

**CRYO QTY CONFIG** 13

C	O13:B	cb ESS 1BC CRYO QTY O2,H2 TK2 (two)	– op
	O13:D	2CA CRYO QTY O2,H2 TK1 (two)	– op
MS	ML86B:G	cb ESS 1BC CRYO QTY O2,H2 TK4 (two)	– op
		<input checked="" type="checkbox"/> 2CA CRYO QTY O2,H2 TK5 (two)	– op
		3AB CRYO QTY O2,H2 TK3 (two)	– op

**FLUID LOADING PREP** 18

- Unstow, fill 4 drink containers (per crewmember) with 8 oz of water each; temp stow near seat
- Unstow 8 salt tablets (per crewmember); temp stow in Flight Suit pocket

**GALLEY DEACT** 19

GALLEY	<input checked="" type="checkbox"/> OVEN/RHS	– OFF
	<input checked="" type="checkbox"/> H2O HTRS (two)	– OFF
	<input checked="" type="checkbox"/> OVEN FAN	– OFF
	<input checked="" type="checkbox"/> REHYD STA lever	– cl (push in)
	<input checked="" type="checkbox"/> OVEN DOOR LATCH	– latched
MA73C:G	cb AC3 GALLEY FAN (three)	– op
ML86B:A	cb MNC SPLY H2O GALLEY SPLY	– op
:B	MNA GALLEY OVEN	– op
	MNB GALLEY H2O HTR	– op

**WCS DEACTIVATION** 23

WCS	VAC VLV – CL	
	<input checked="" type="checkbox"/> MODE – AUTO	
	FAN SEP SEL sw	– OFF
	Unstow hose from cradle, attach hose to WCS housing via Velcro straps	
	Remove, stow: WCS Trash Can	
	Mirror	
	Privacy Curtain	
	Foot restraints	– up, locked
	Close, latch door	

**MCA RECONFIG** 27

MA73C:A	MCA LOGIC MID (four)	– OFF
	<input checked="" type="checkbox"/> FWD (three)	– ON
	MID (four)	– OFF
	AFT (three)	– OFF
	If MNB and AC2 powered:	
	cb MCA PWR AC1, AC3 3Φ FWD 1,3 (two)	– op
MA73C:C	<input checked="" type="checkbox"/> Minimum middeck lighting	

## LOSS OF 2 FC SWITCH VERIFICATION LIST

### LEFT SEAT

L5.....	6-3
L4.....	6-3
L,R HUD .....	6-4
L1.....	6-4
F3 .....	6-4
L2.....	6-5
F1 .....	6-5
F2 .....	6-6
F6 .....	6-6
F7 .....	6-6
C2.....	6-7
C3.....	6-7
O1.....	6-8
O2.....	6-8
L side OVHD flood...	6-8
O5.....	6-8
O6.....	6-9
O7.....	6-9







### RIGHT SEAT

O8.....	6-10
O9.....	6-10
R side OVHD flood ..	6-10
O3.....	6-11
F4 .....	6-11
F8 .....	6-11
F9 .....	6-11
R1 .....	6-12
R2.....	6-13
R4.....	6-13
R6.....	6-13

### AFT

O13.....	6-15
O14.....	6-15
O15.....	6-15
O16.....	6-16
O17.....	6-16
O19.....	6-17
C6 .....	6-17
C5 .....	6-17
C7 .....	6-17
R10.....	6-18
R11U,L.....	6-18
R13U,L.....	6-19
R14.....	6-19
A1U,L,R .....	6-20
A4.....	6-21
A3.....	6-21
A6U.....	6-21
A7U.....	6-21
A6L.....	6-22
A6.....	6-22
A7L.....	6-23
A8U,L.....	6-24
A11.....	6-25
A12.....	6-25
A13.....	6-25
A14.....	6-26
A15.....	6-26
L9.....	6-26

#### LEGEND

	– left		
	– right		
	– up	R	– as reqd
	– center		– cb close
	– down		– cb open

 indicates switch/display not checked during ENT SWITCH LIST/VERIFICATION.

#### CIRCUIT BREAKER SNAPPING COLOR CODES

<u>COLOR</u>	<u>CONFIGURATION</u>
Red	Open at all times
Green	Open on orbit only
Yellow	Open ascent, close per procedure
Orange	Open orbit through entry
Blank (no ring)	Always closed or as reqd

**MIDDECK FWD**

MO42F.....	6-27
MO58F.....	6-27
MO32M.....	6-27
MO39M.....	6-27
MO69M.....	6-27
MO29J.....	6-27
MO52J.....	6-27
MO30F.....	6-27
MO62M.....	6-27
MO63P.....	6-27 (OV104)
ML86B.....	6-28
MD24K.....	6-29
MD44F.....	6-29

**MIDDECK AFT**

MA73C.....	6-28
MO13Q.....	6-29
ML26C.....	6-29
ML18F.....	6-29
ML31C.....	6-29
MO10W.....	6-30
WCS.....	6-30

**AIRLOCK**

AW18A.....	6-31
AW18D.....	6-31
AW18H.....	6-31
AW82A.....	6-31
AW82B.....	6-31
AW82D.....	6-31
AW82H.....	6-31
INNER HATCH.....	6-32

OV103

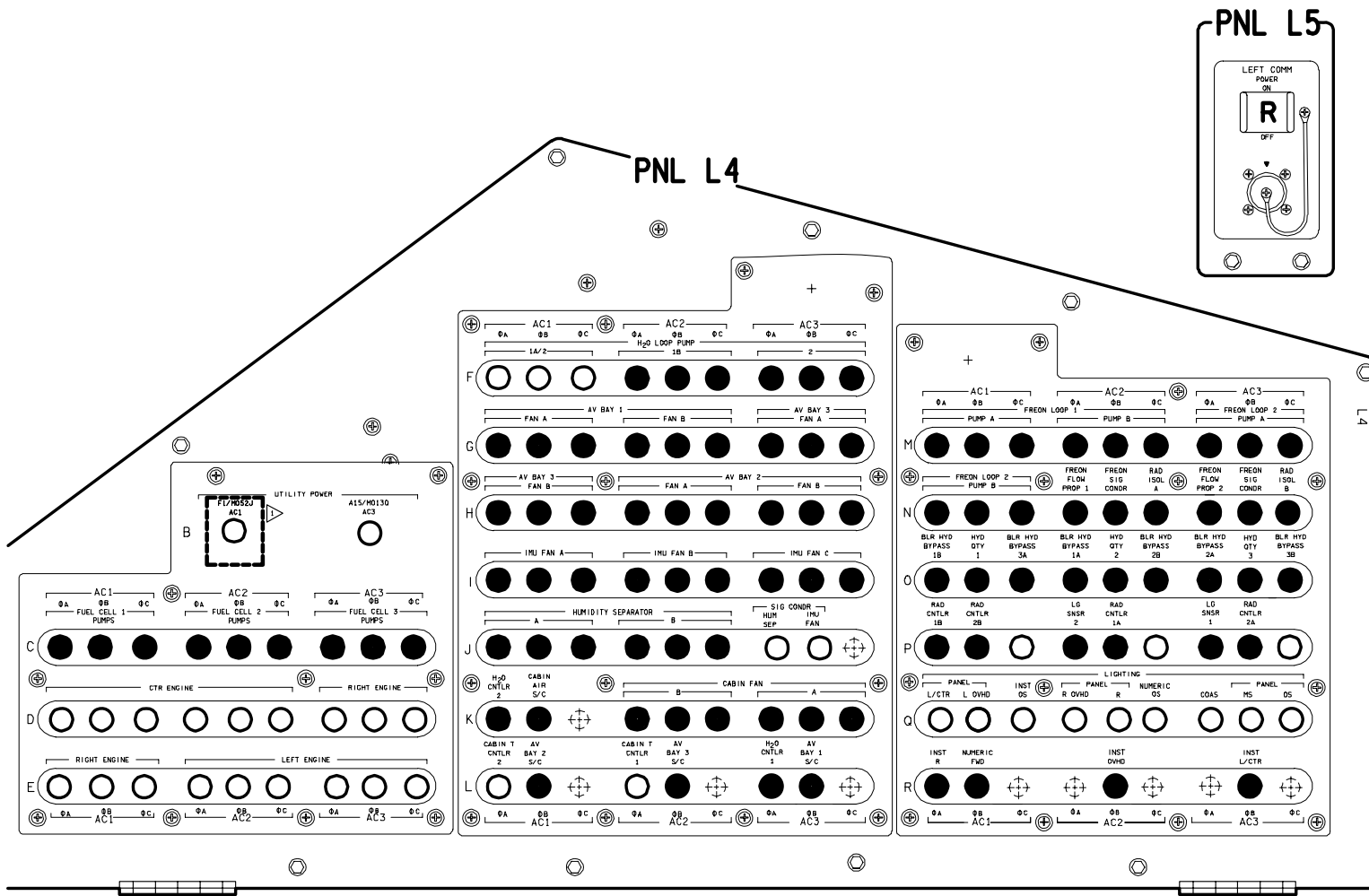

NOTE: ▷ CB CAN REMAIN CLOSED FOR AC PGSC USAGE.  
 OPEN WHEN PGSC UNPOWERED/STOWED

OV103

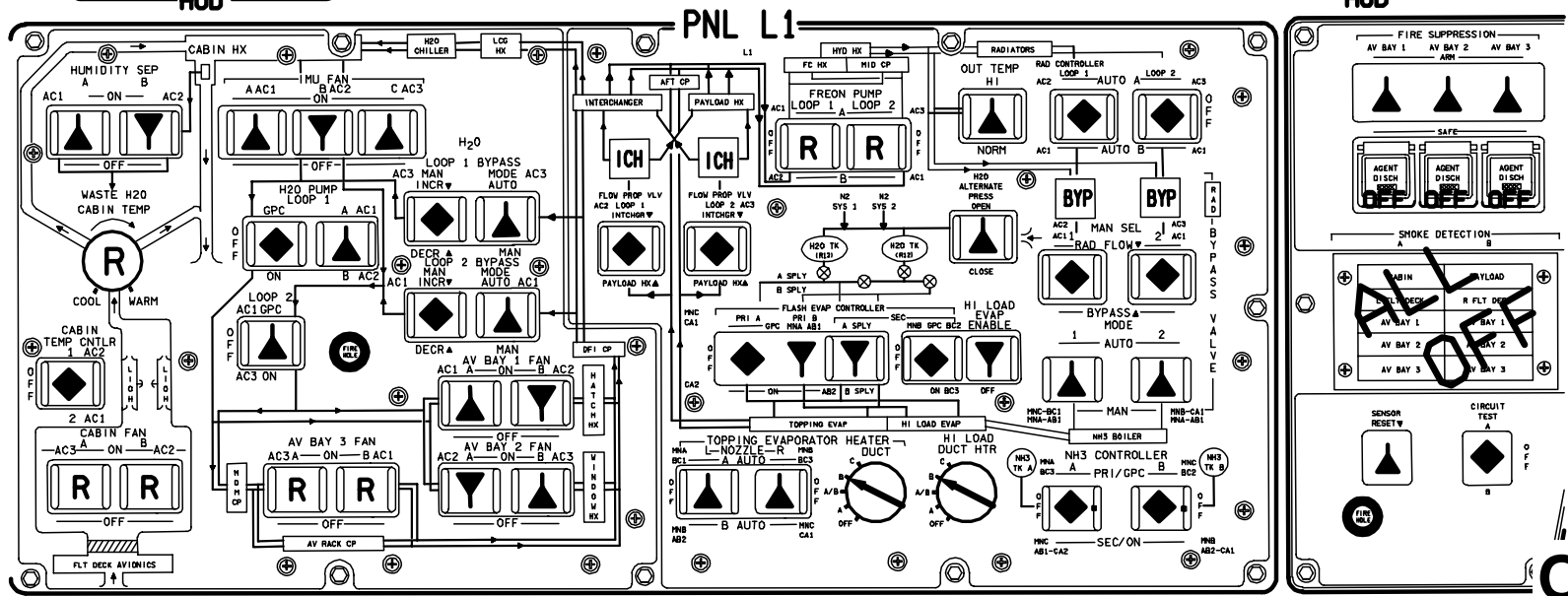
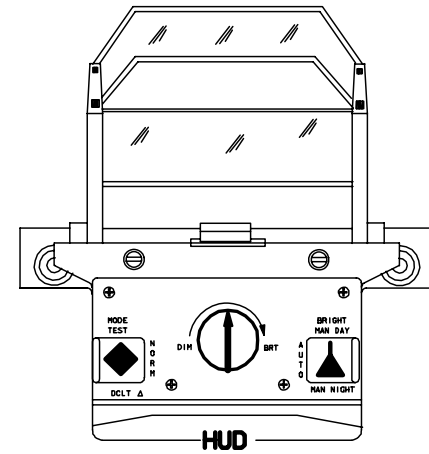
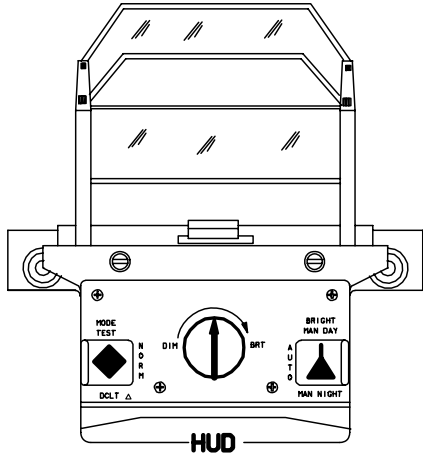
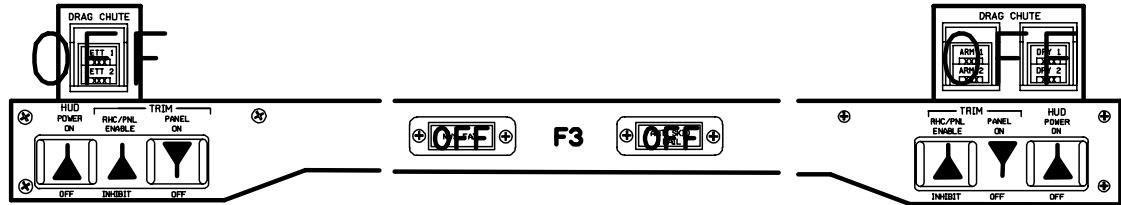

48007E604\_114.PNL\_1

ALL VEH/DATE 04/26/05

(OV103) A6-4

OV103

C D/O/ALL/GEN M



OV103

PNL L2

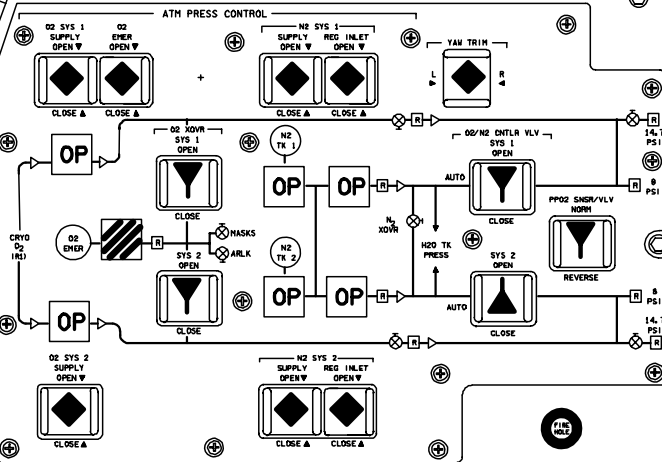
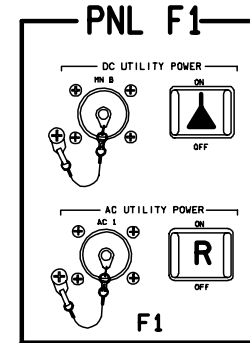
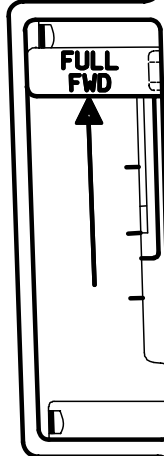
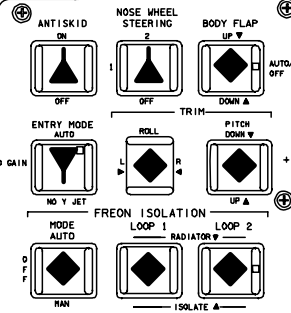
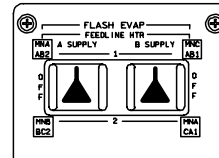
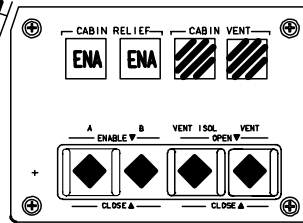

48007E605\_114. PNL, 1

OV103/DATE 04/26/05

(OV103) A6-5

OV103

C D/O/3/GEN M

OV103

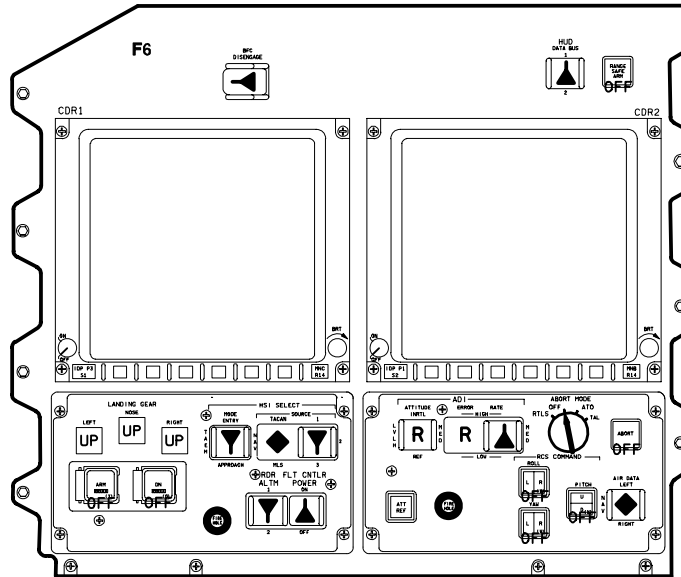
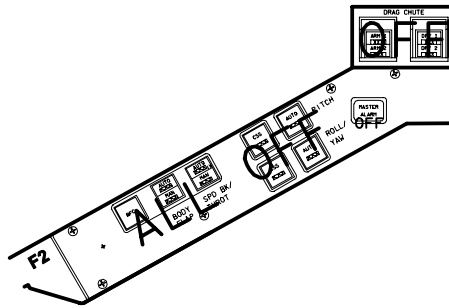
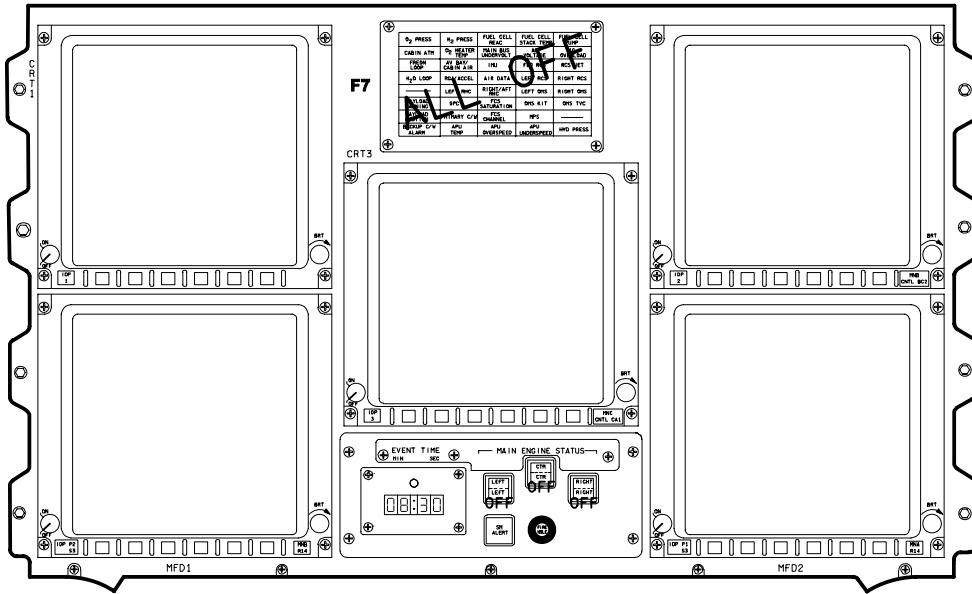

OV103/DATE 06/22/05  
4807E606\_114\_PN1\_3

# OV103

C D/O/ALL/GEN M

(OV103) A6-6

PNL C2/C3

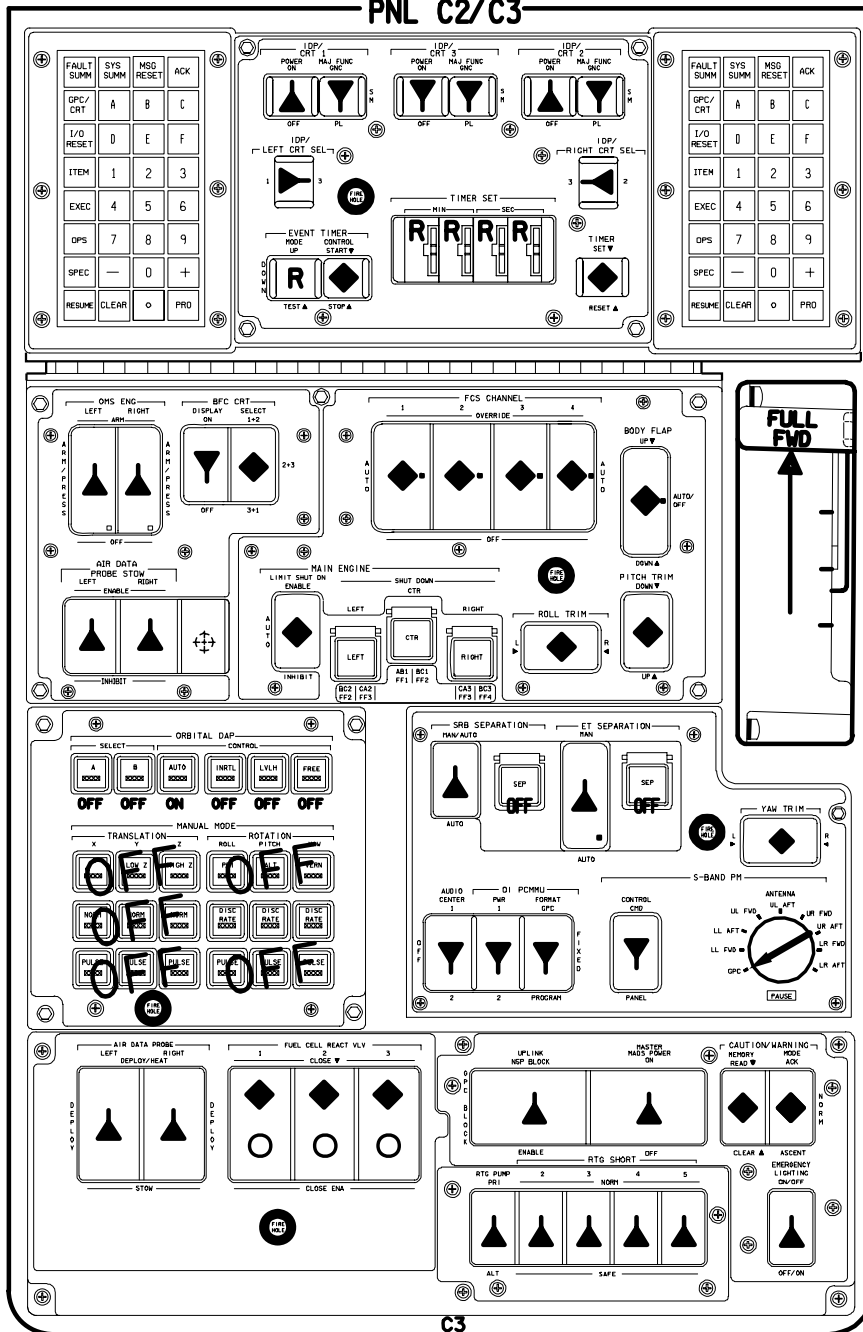

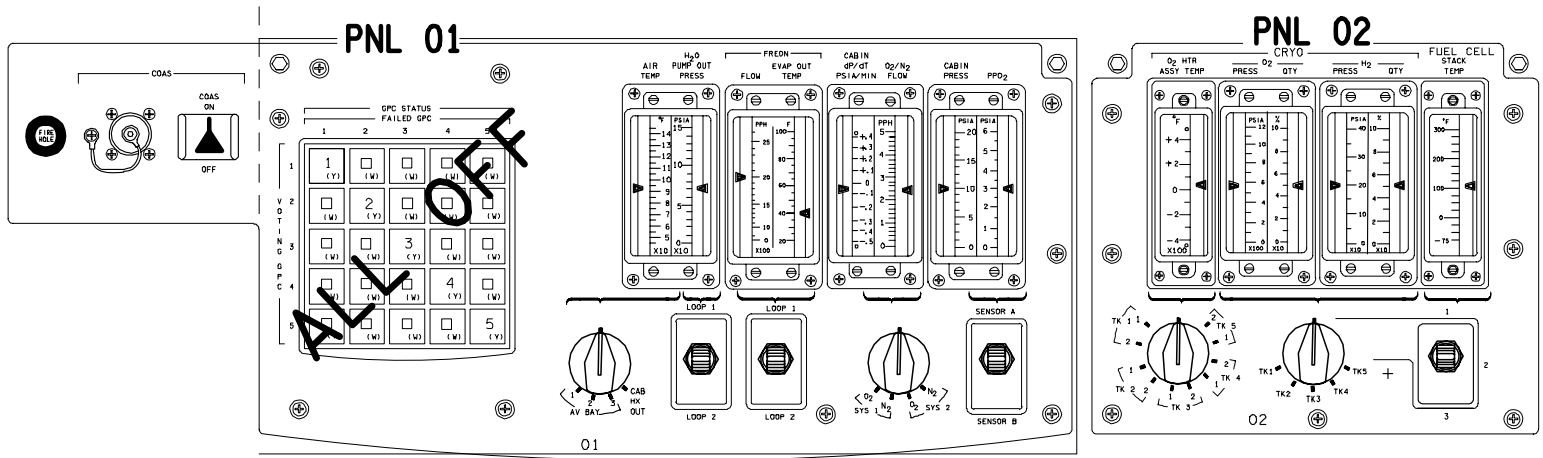

L side OVHD flood - R (MID)

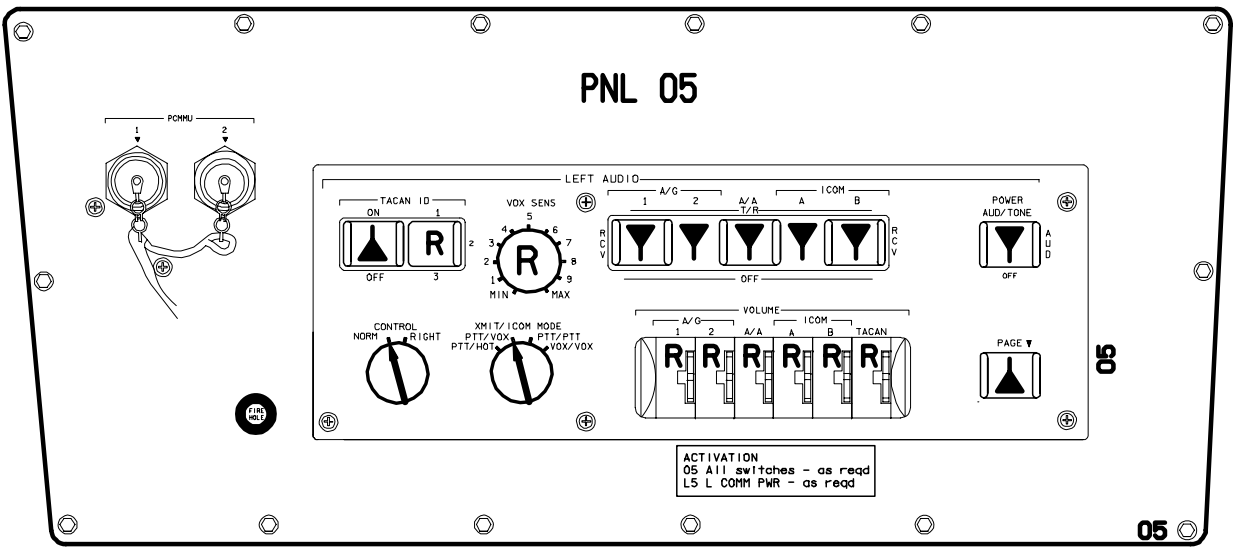

ACTIVATION  
05 All switches - as reqd  
L5 L COMM PWR - as reqd

OV103

PNL 06

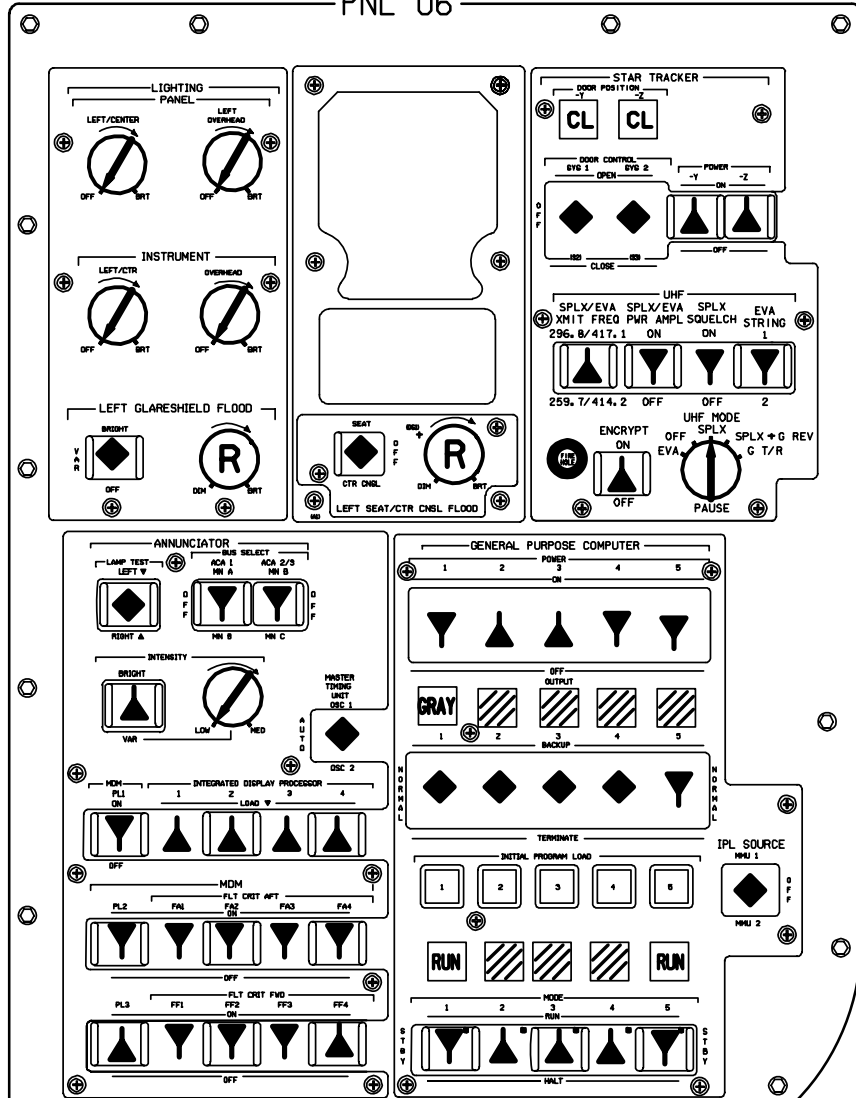

PNL 07

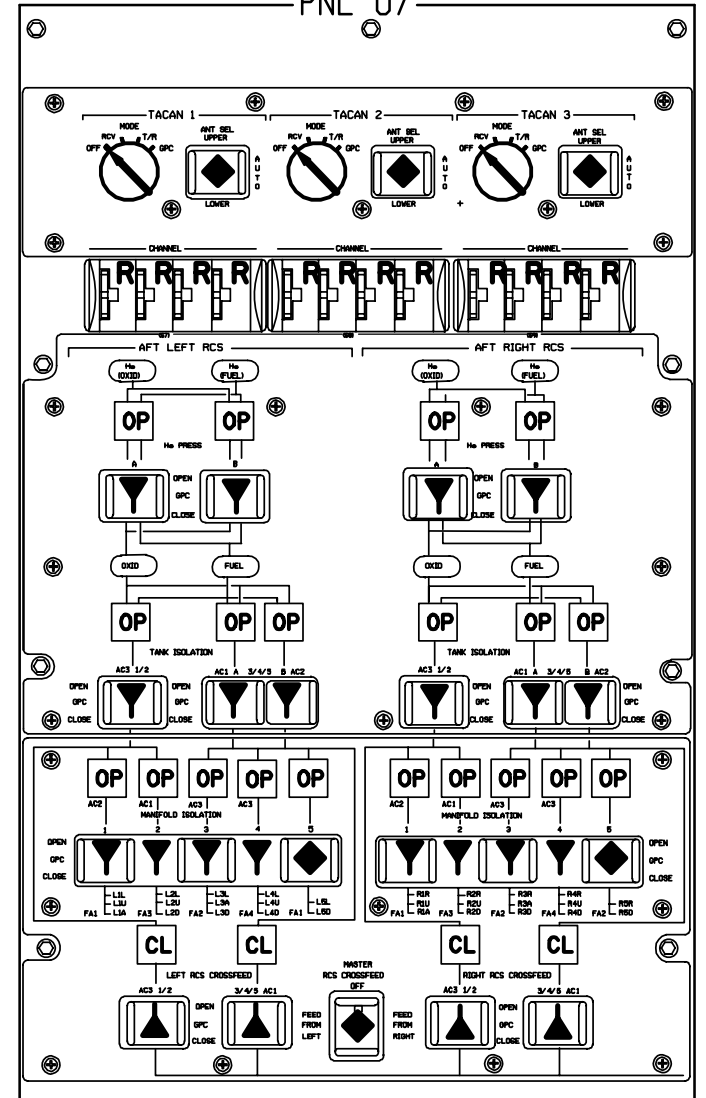

OV103

PNL 08

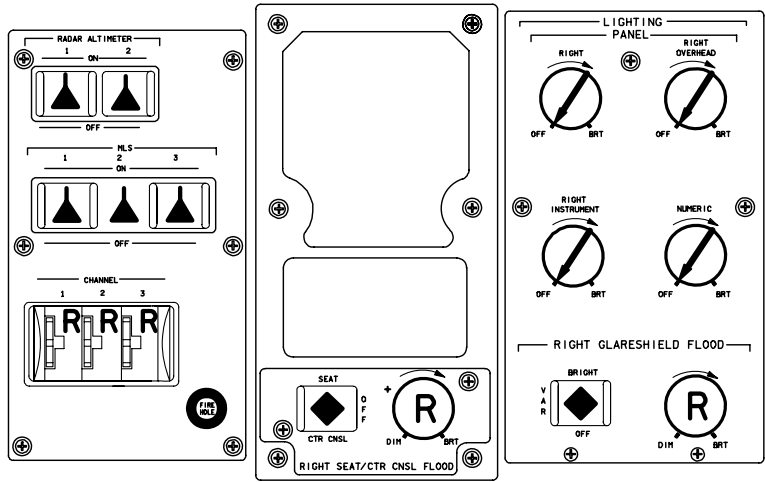

PNL 09

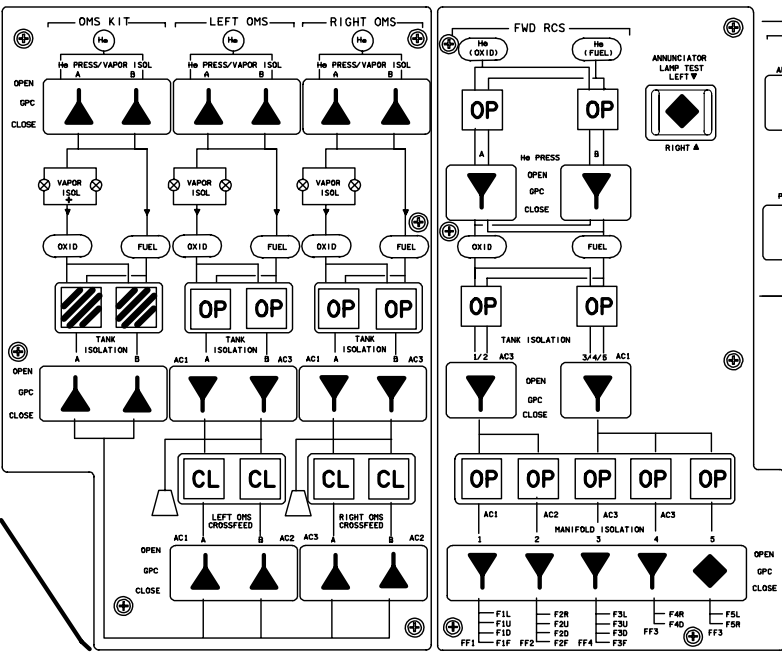
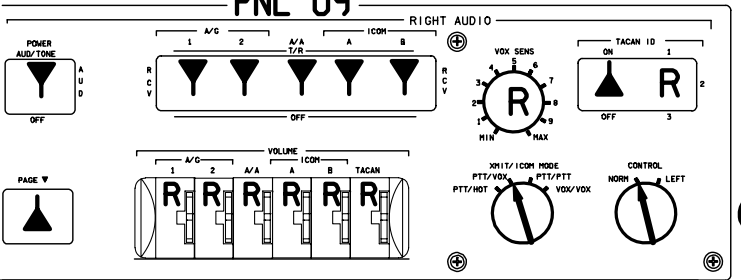

ACTIVATION  
 09 R AUD PWR-AUD/TONE  
 All other sws-as reqd  
 R6 R COMM PWR-as reqd

R side OVHD flood - R (MID)

OV103

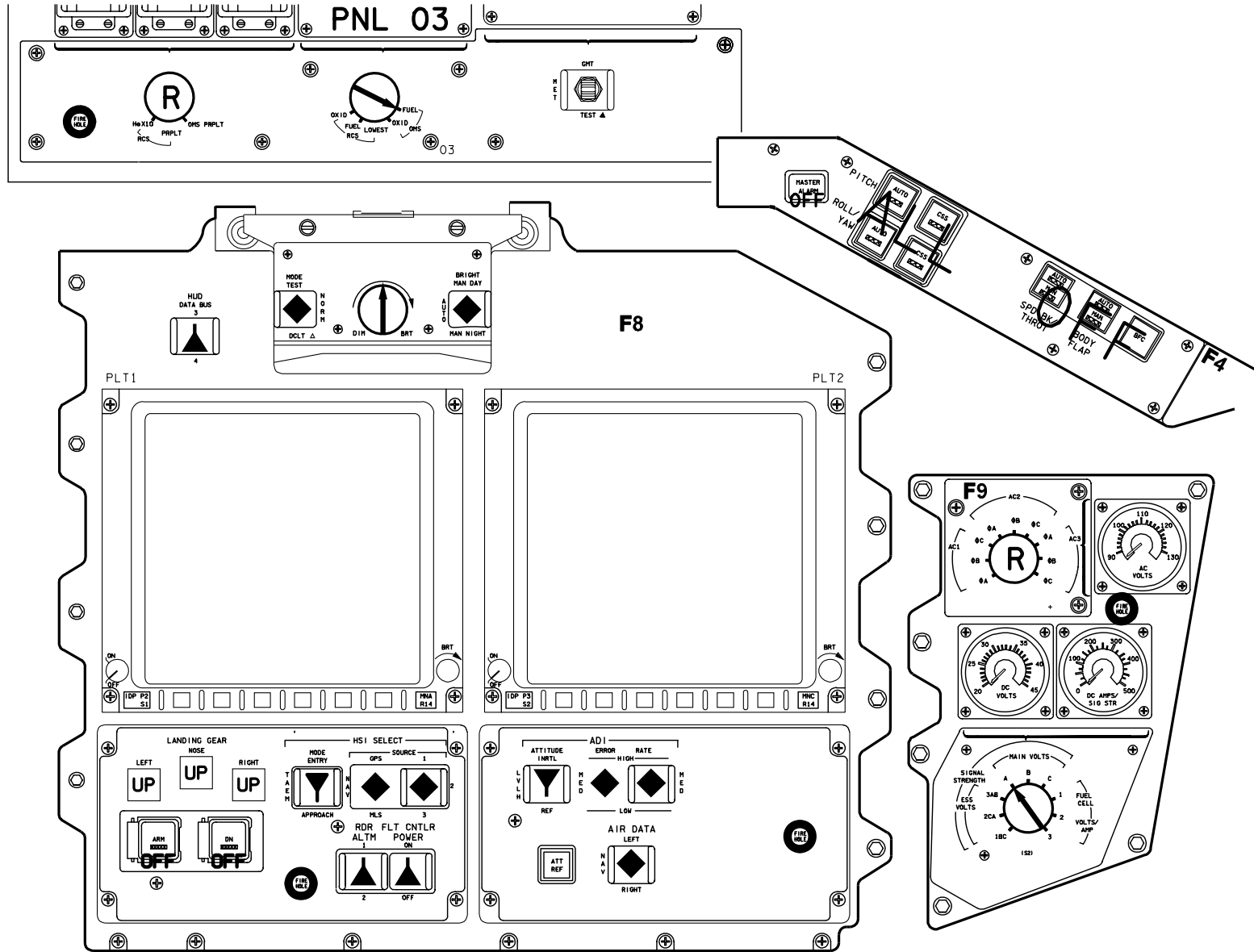

OV103

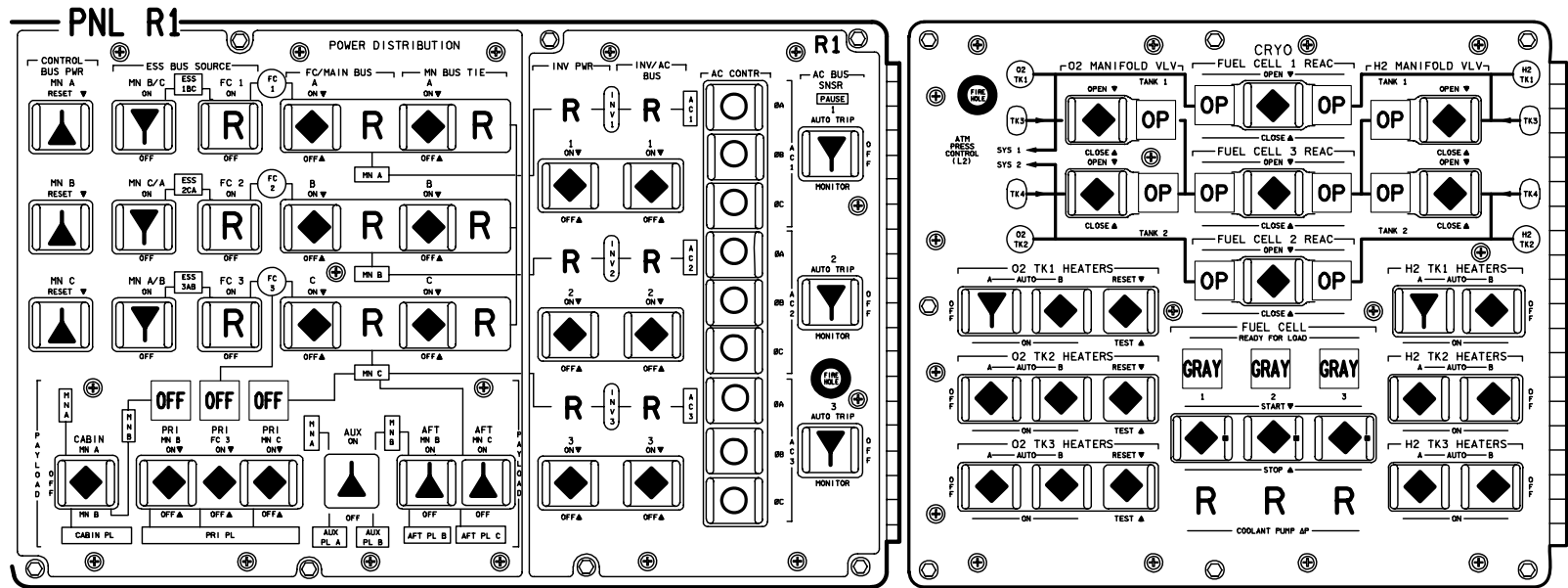

48007E612\_114, PNL, 2

ALL VEH/DATE 04/28/05

OV103

(OV103) A6-12

C D/O/ALL/GEN M



OV103

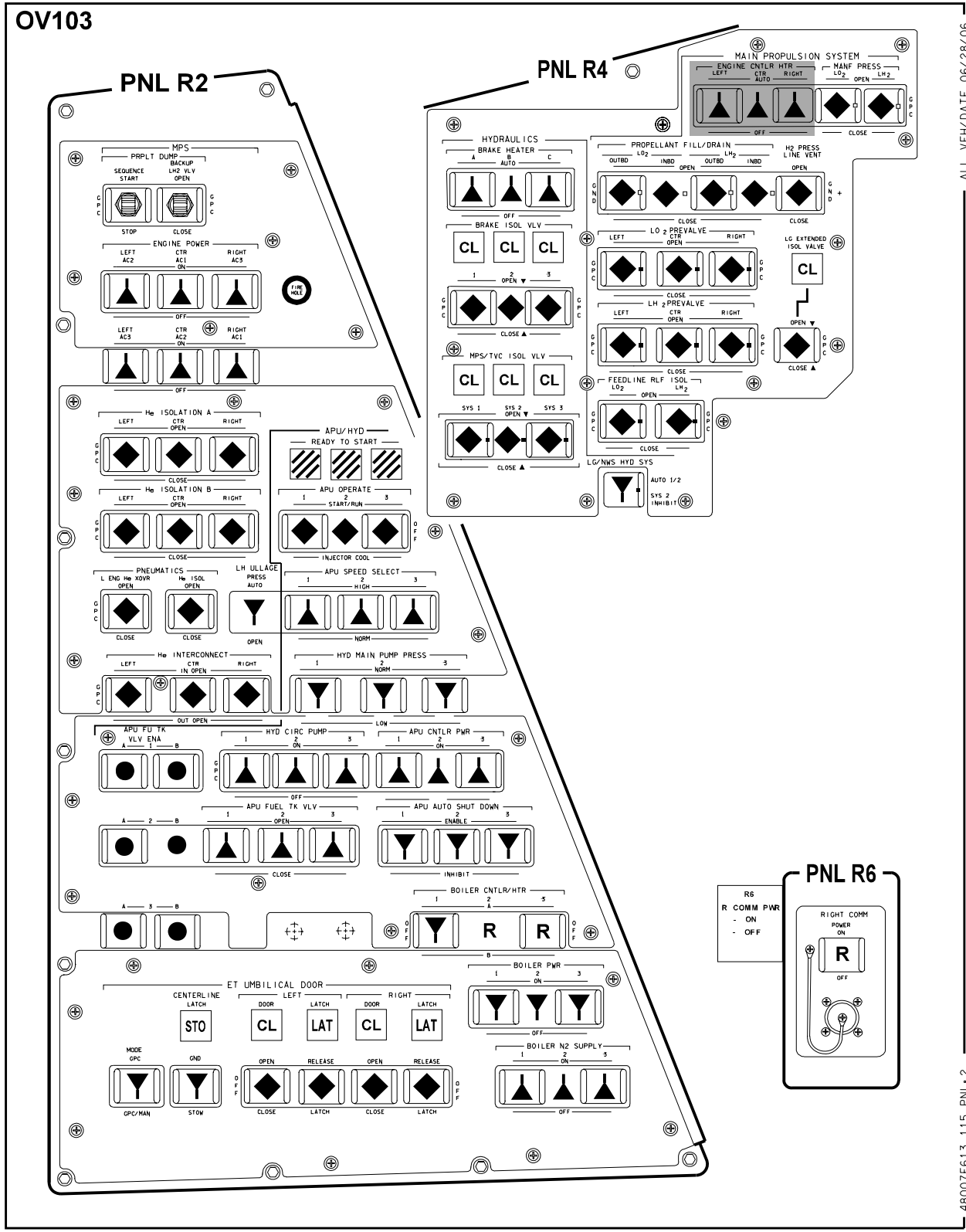

ALL VEH/DATE 06/28/06 48007E6.13\_115\_PNL R 2

This Page Intentionally Blank

# OV103

## PNL 013

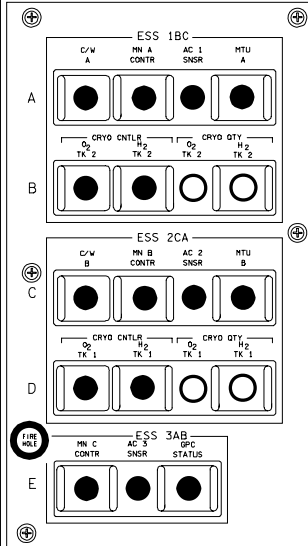

## PNL 014

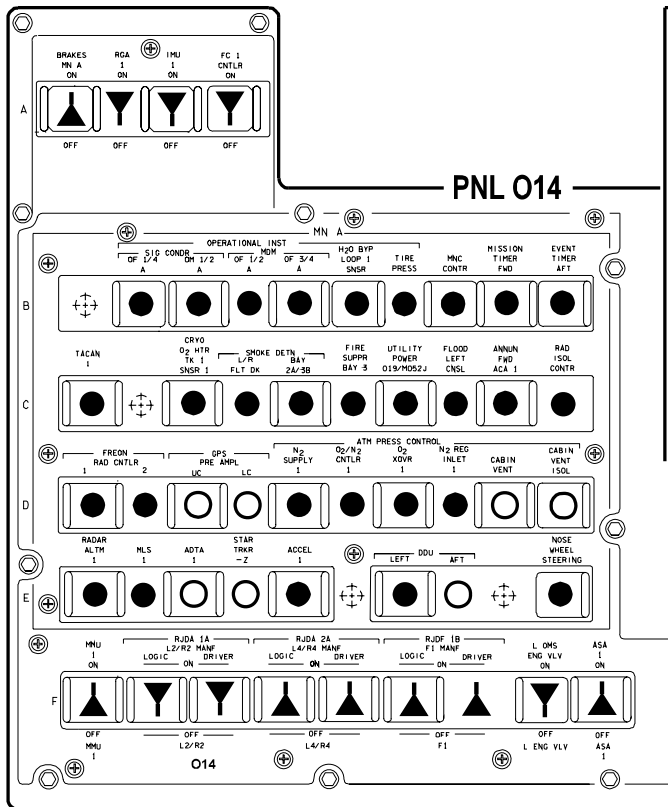

## PNL 015

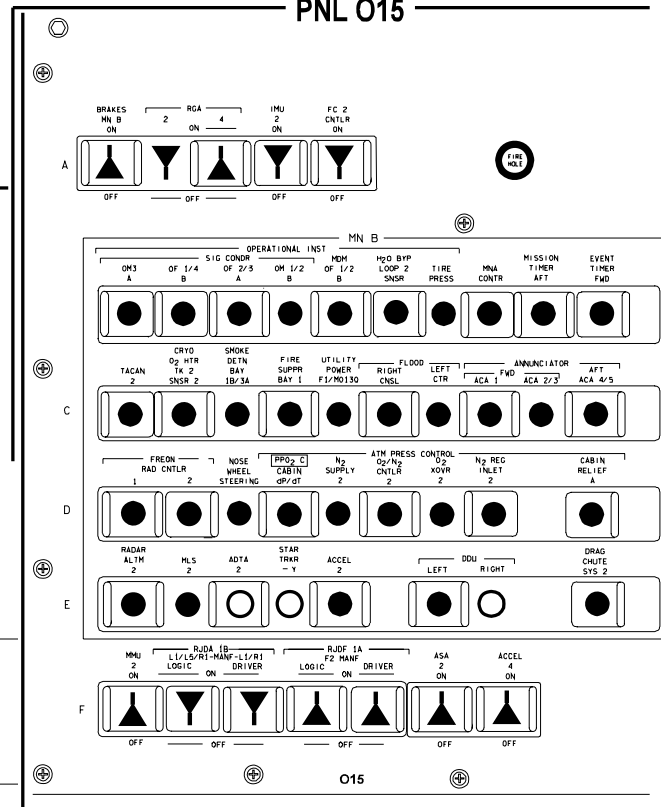

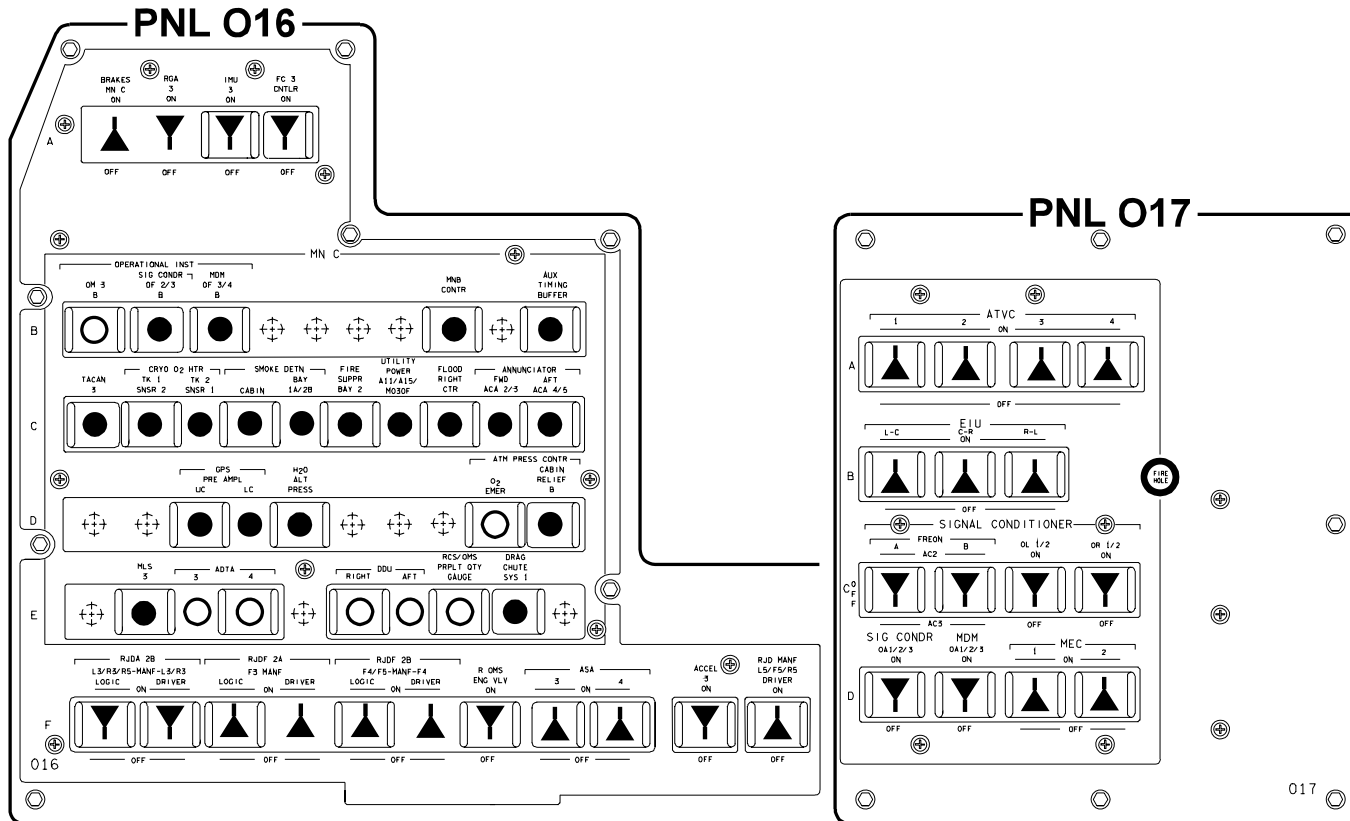

OV103

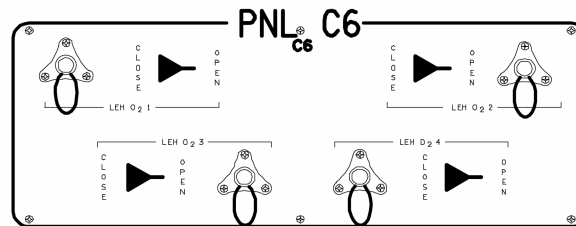
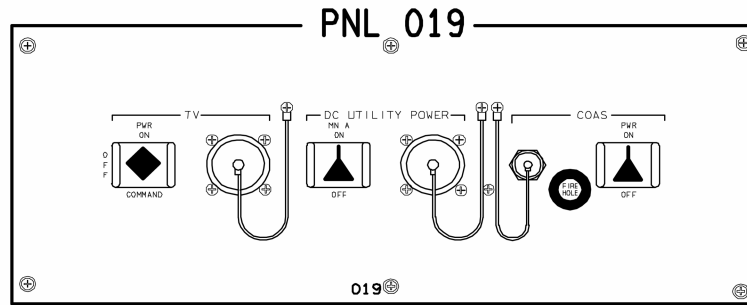

**PNL C5**



**PNL C7**

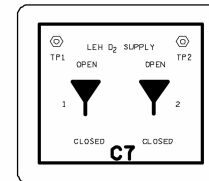

OV103

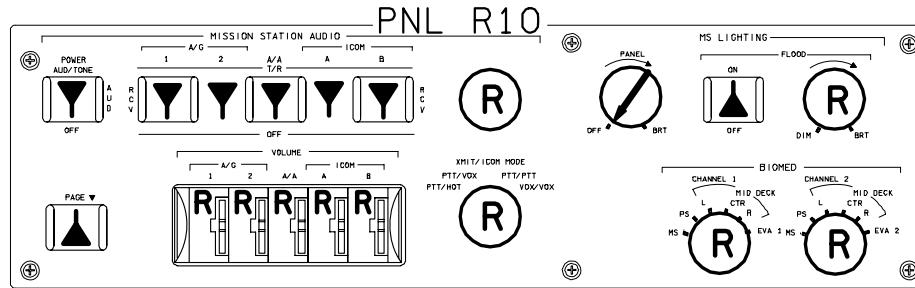

ACTIVATION  
 R10 MS AUD PWR - AUD/TONE  
 All other sws - as reqd  
 R12 MS AUD CONTL - NORM  
 A11 MS COMM CCU PWR - ON

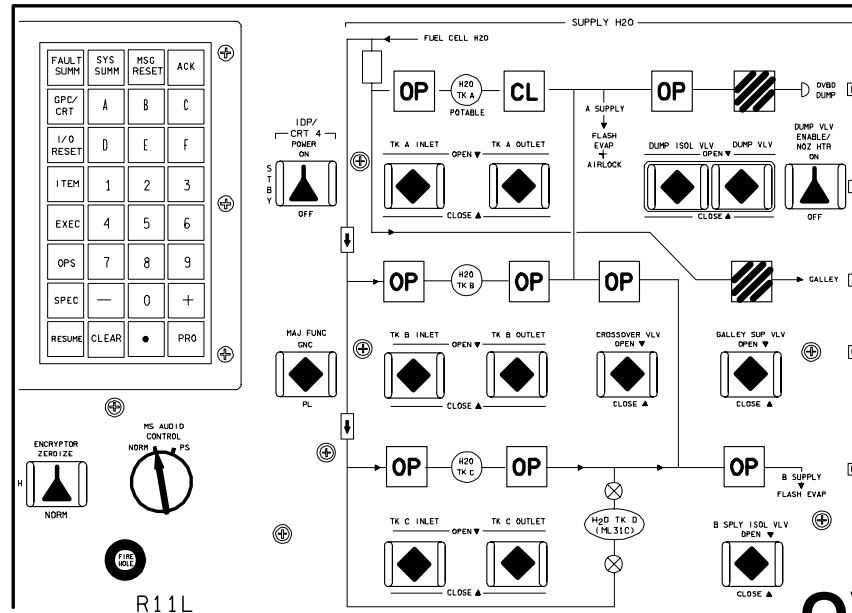
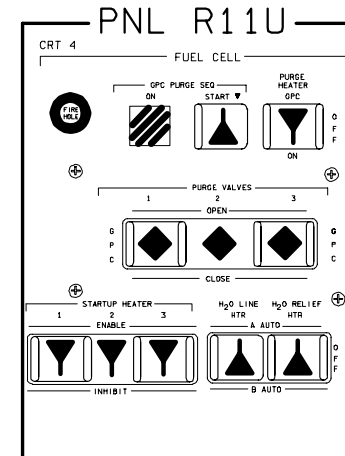

OV103

OV103

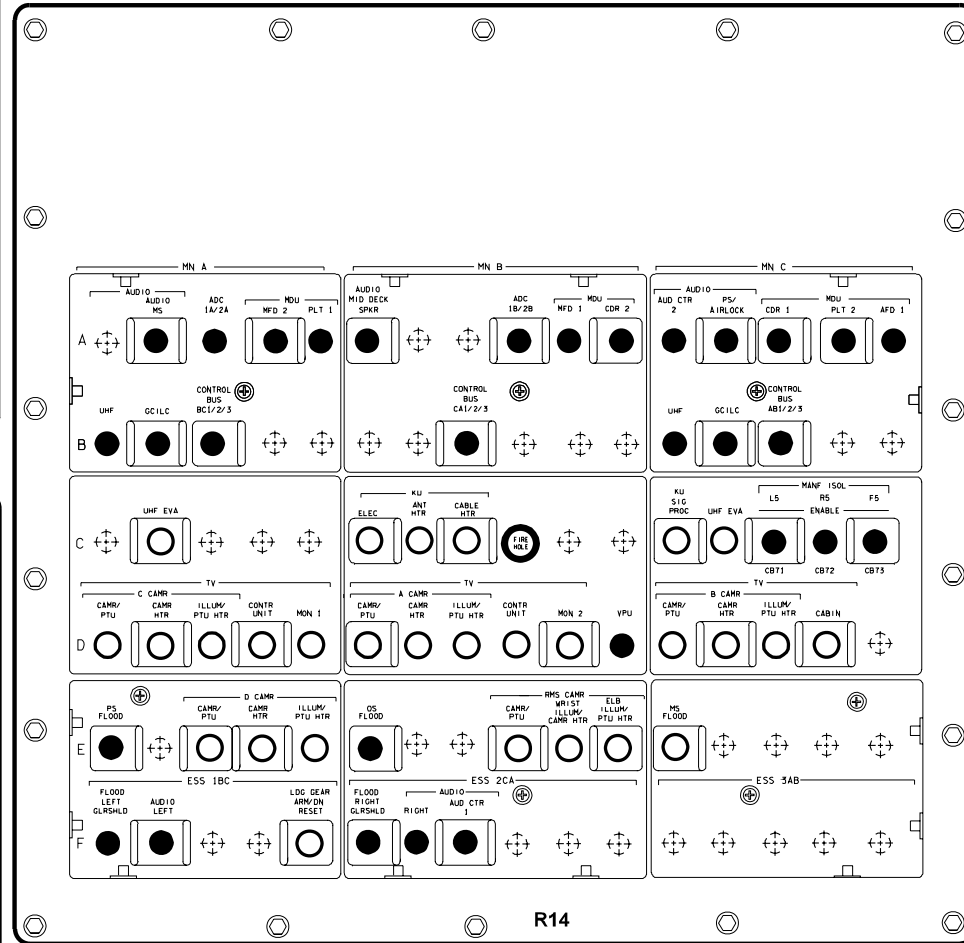
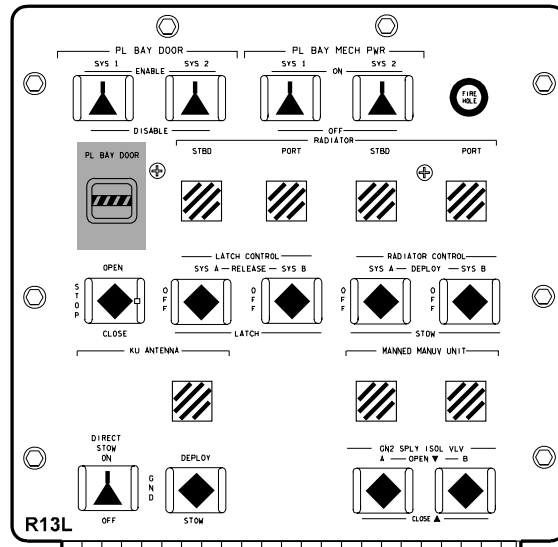
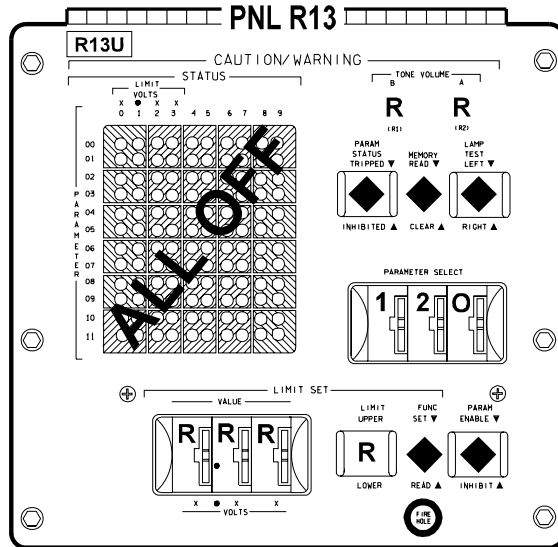

OV103

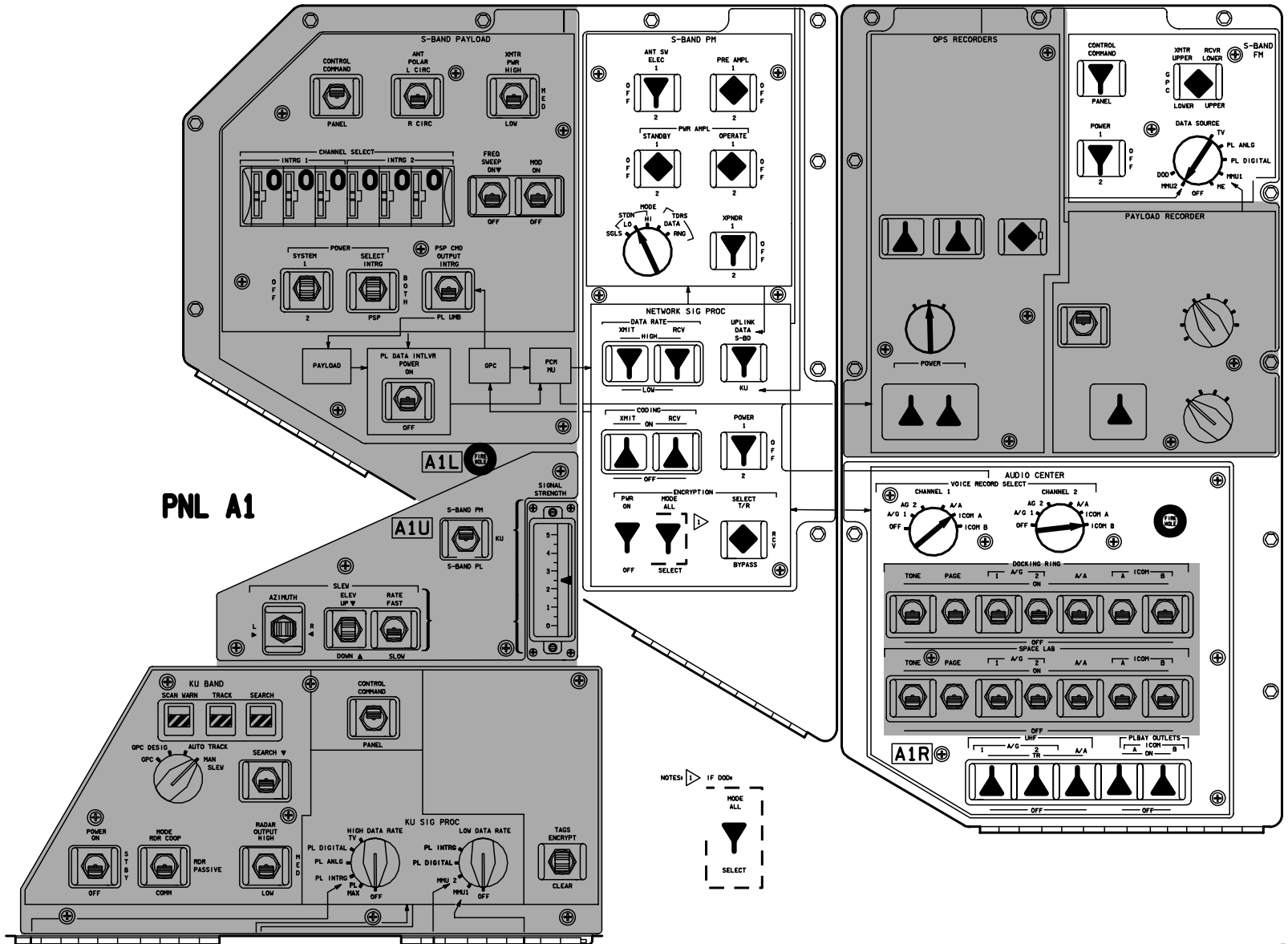

PNL A1

OV103



OV103

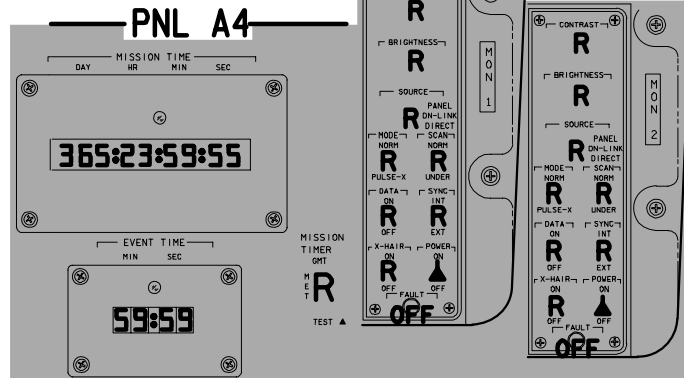

PNL A6U

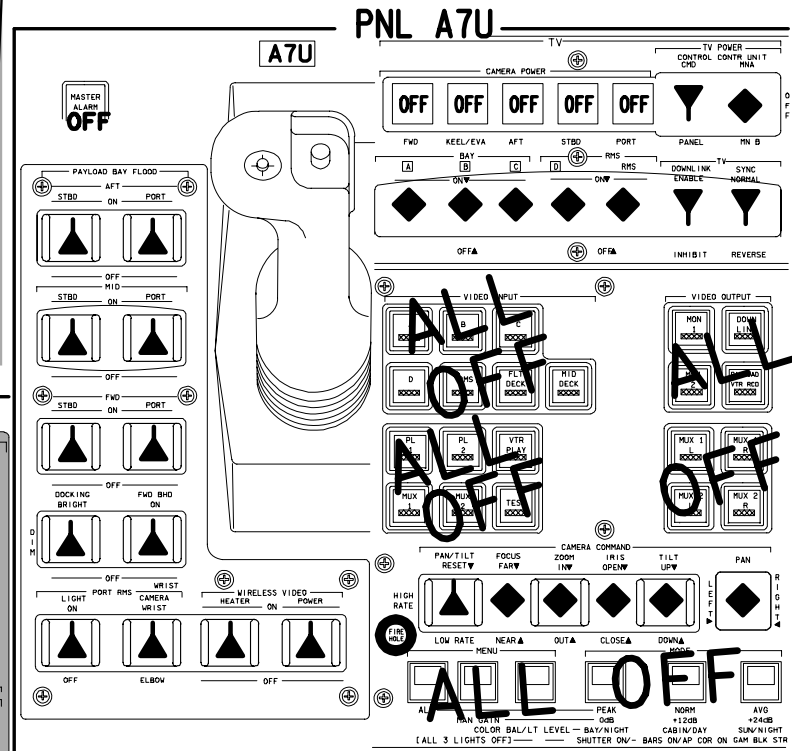
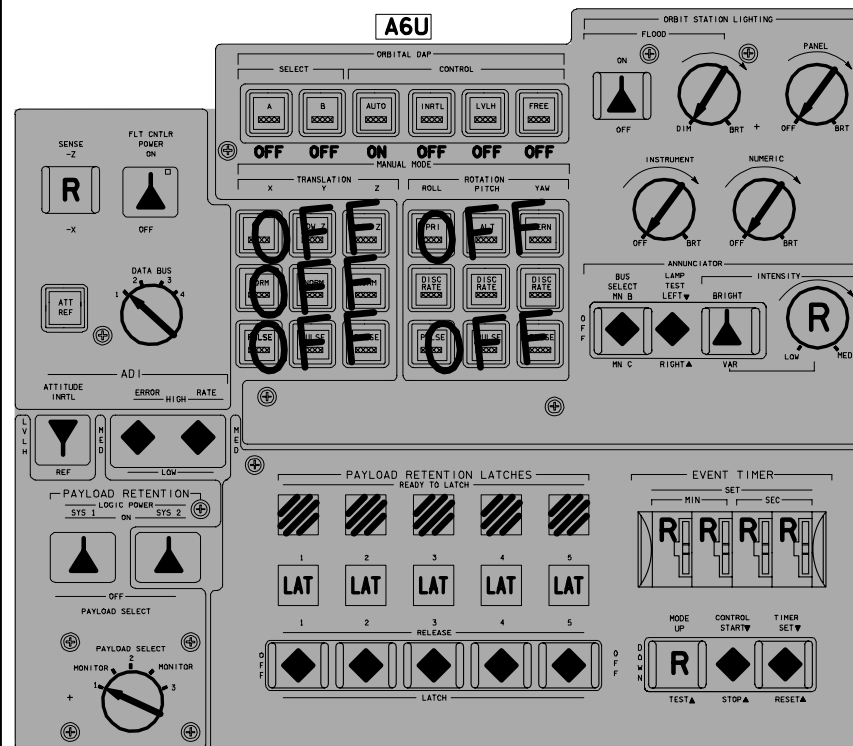

A6L

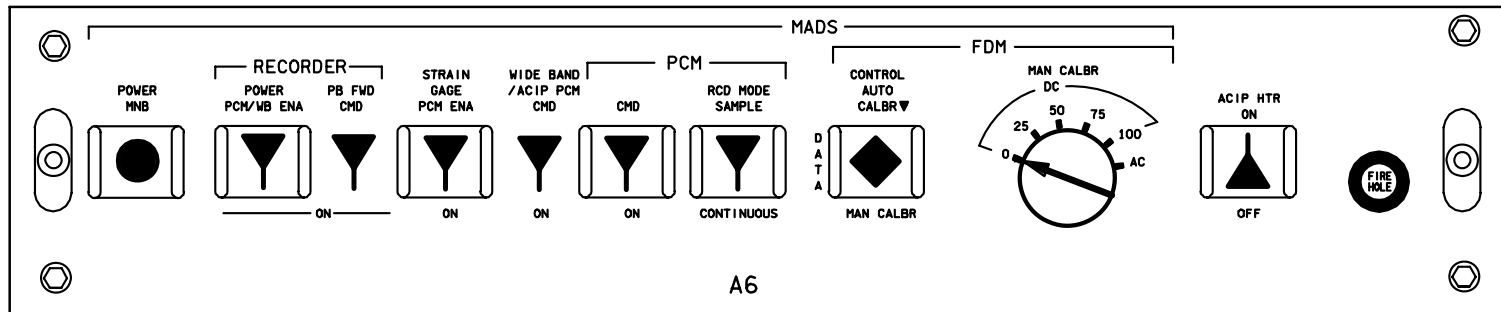
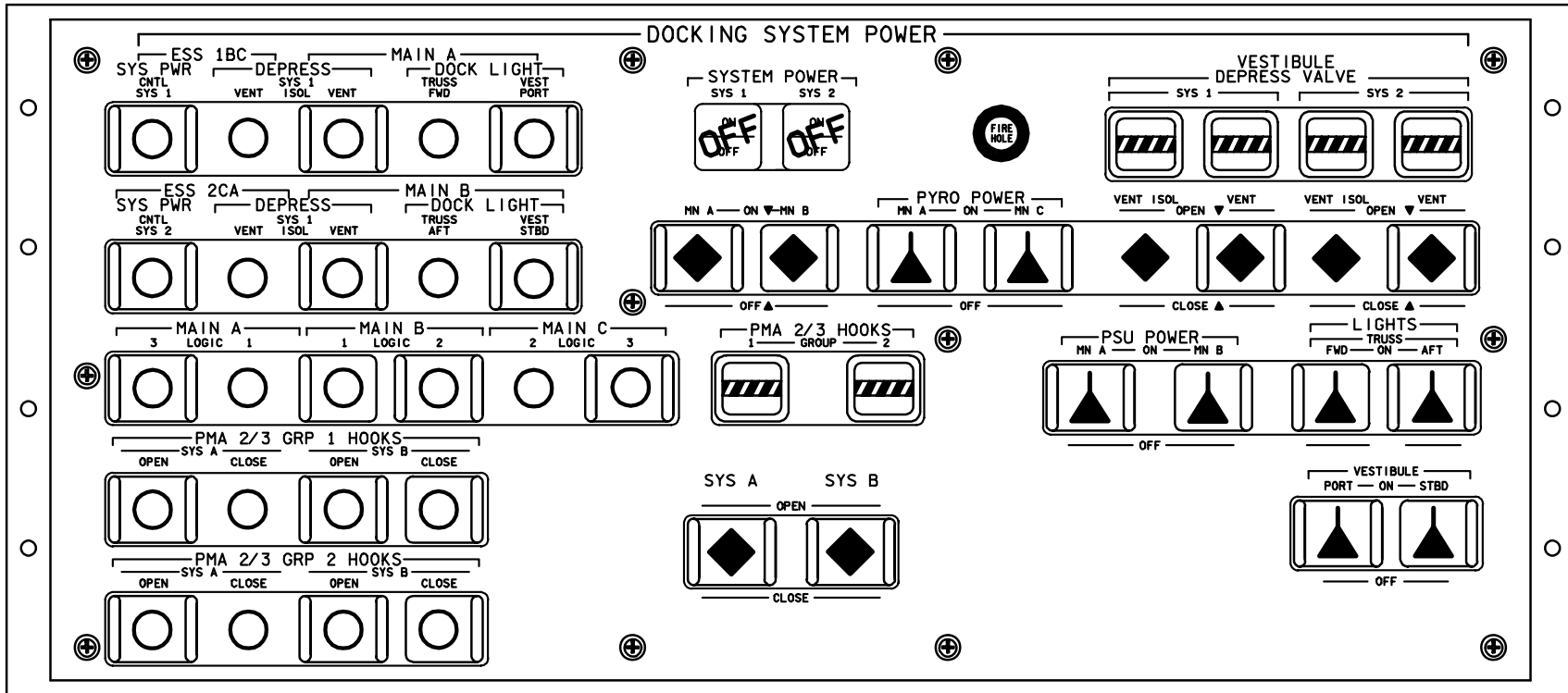

OV103

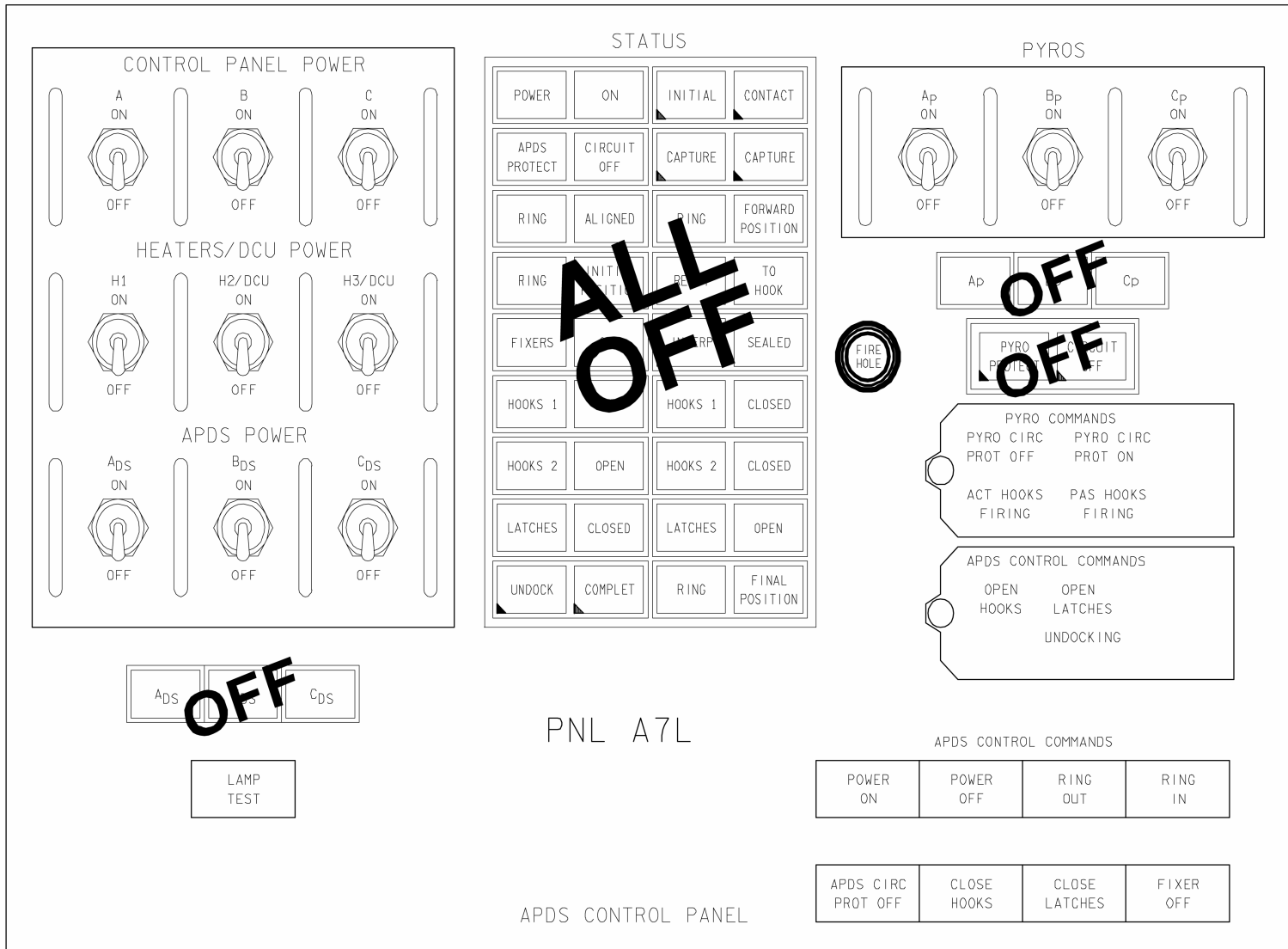

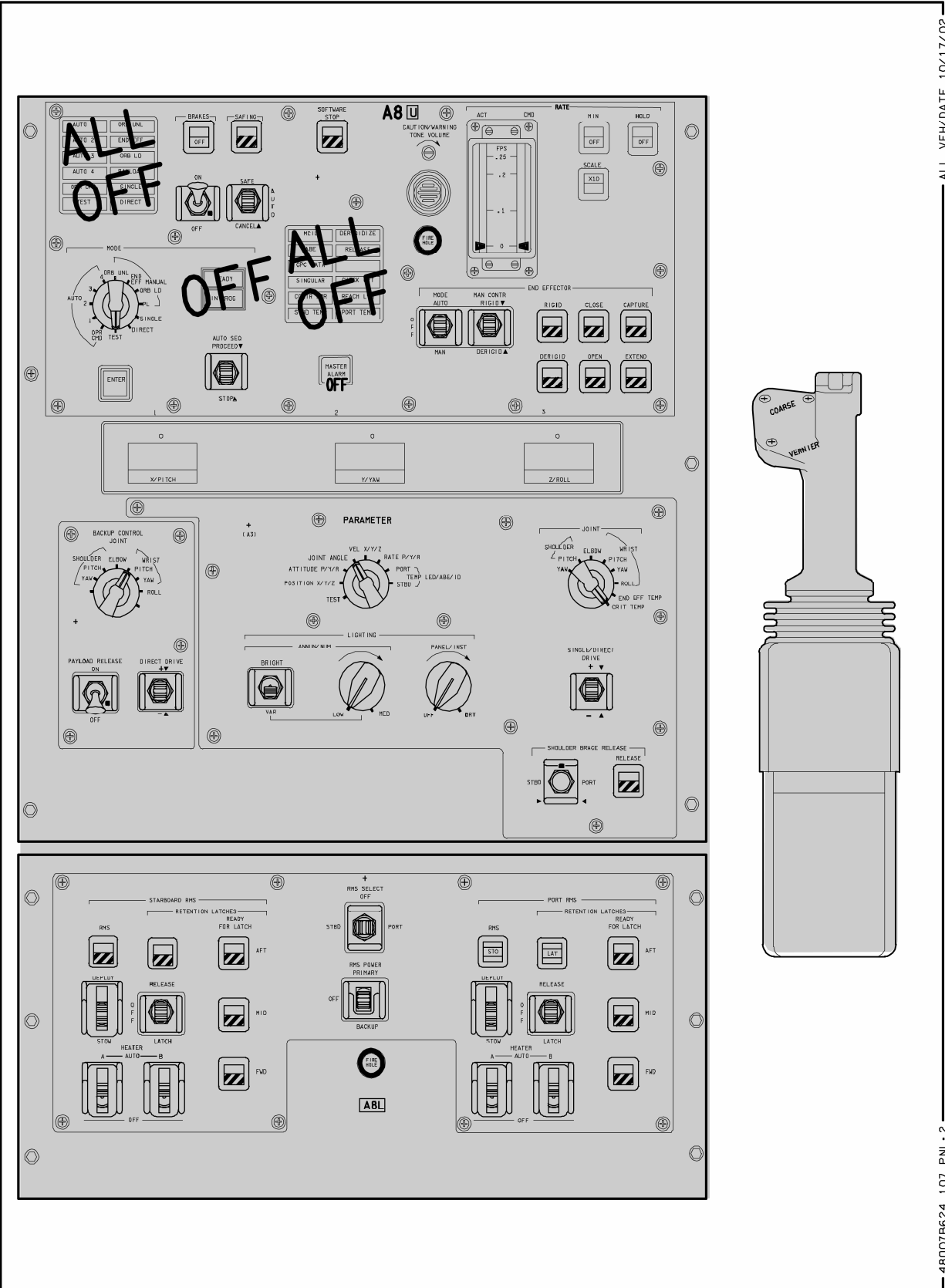

ALL VEH/DATE 10/17/02  
4800TB624\_107\_PNL\_2

OV103

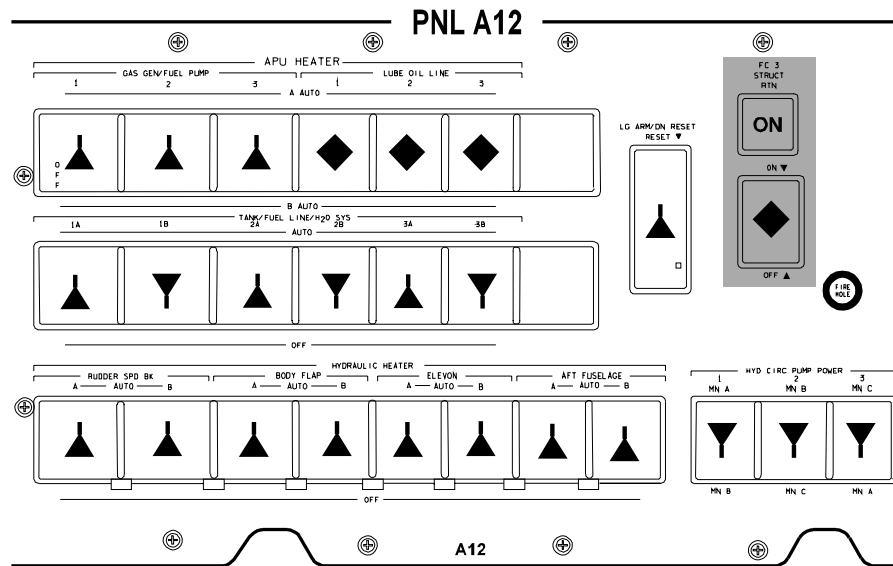
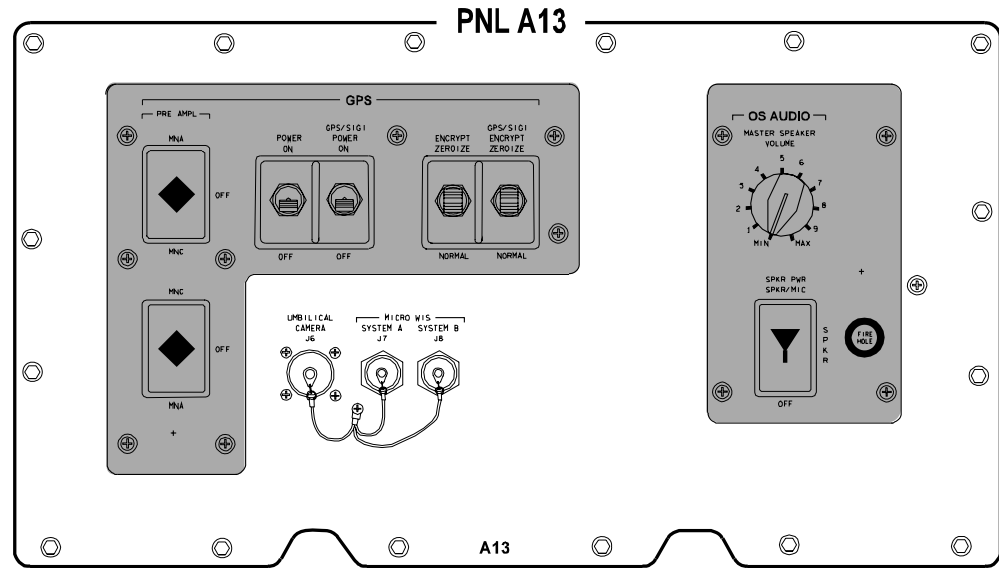
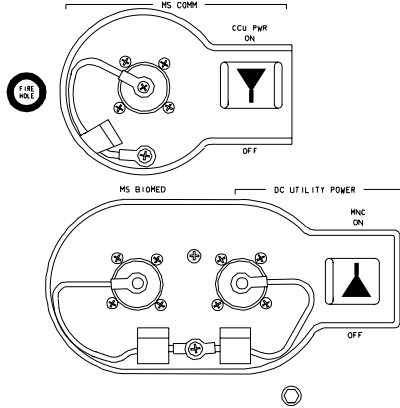
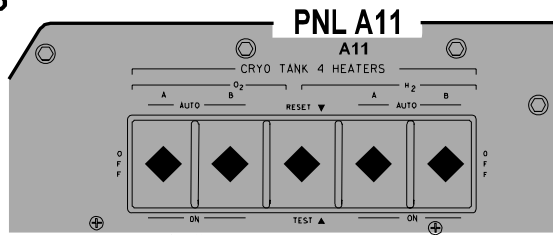

OV103

OV103/DATE 10/05/05

48007E625\_121. PNL: 1

(OV103) A6-25

C D/O/3/GEN M

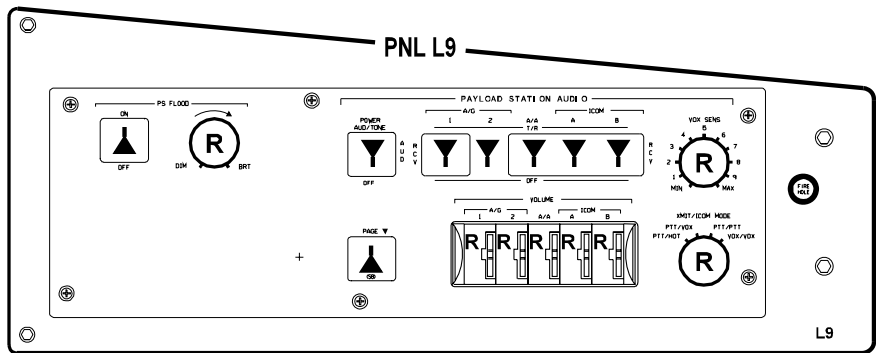
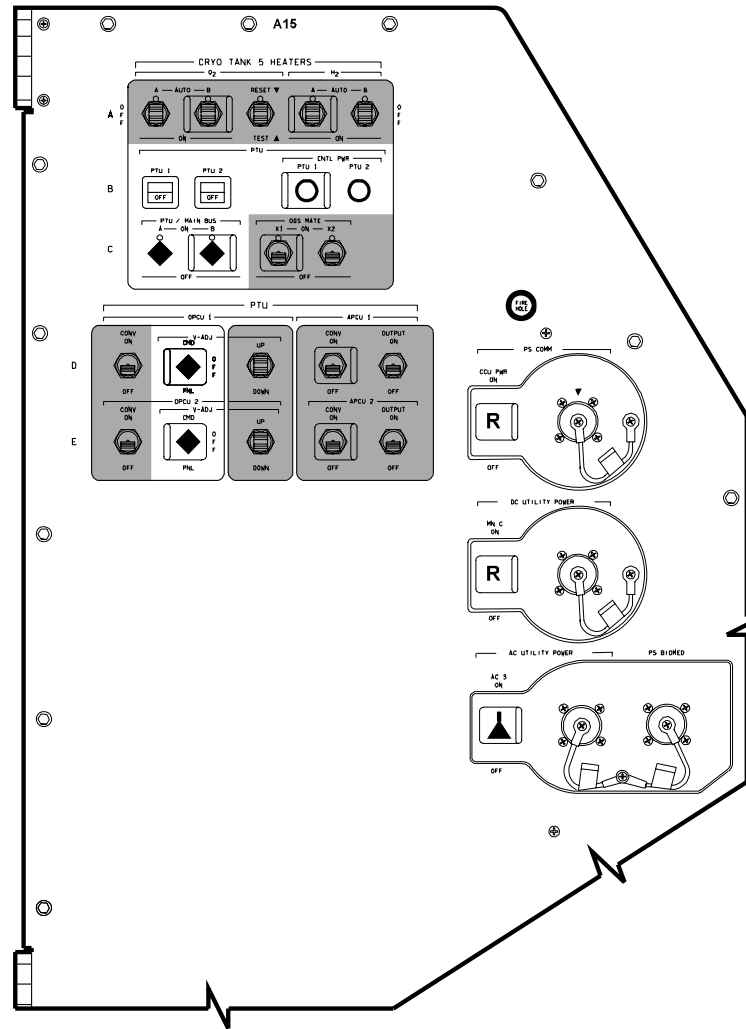
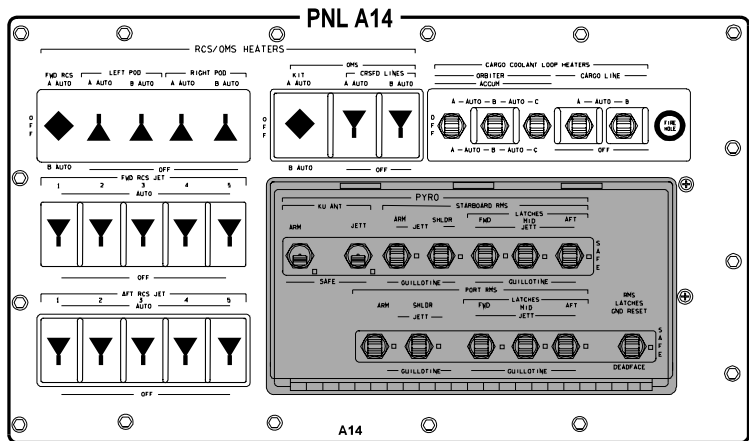

ACTIVATION  
 L9 All switches - as read  
 A15 PS COMM CCU PWR-ON

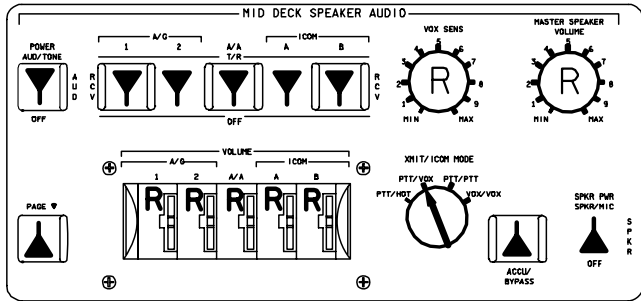

PNL M042F

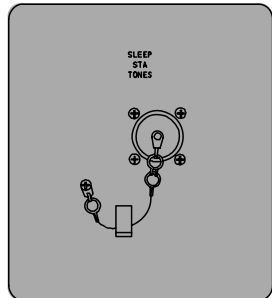
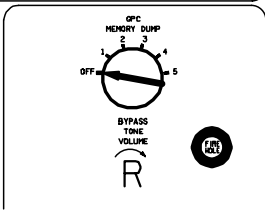

PNL M058F

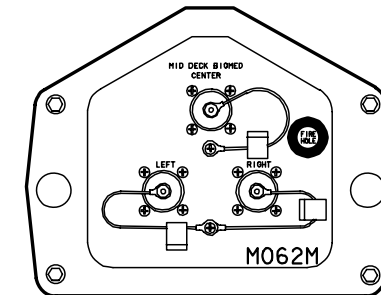
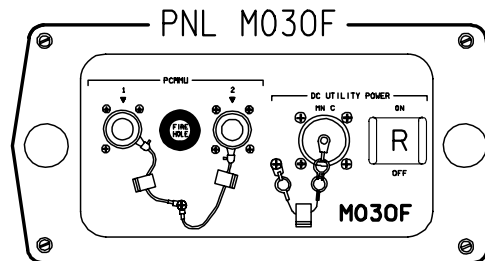
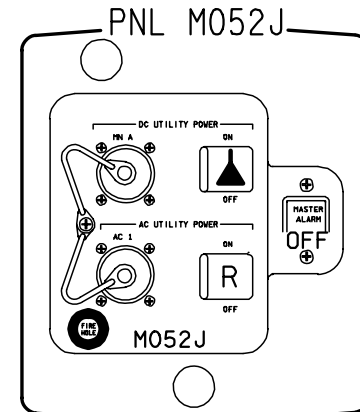
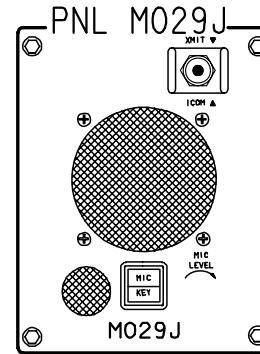
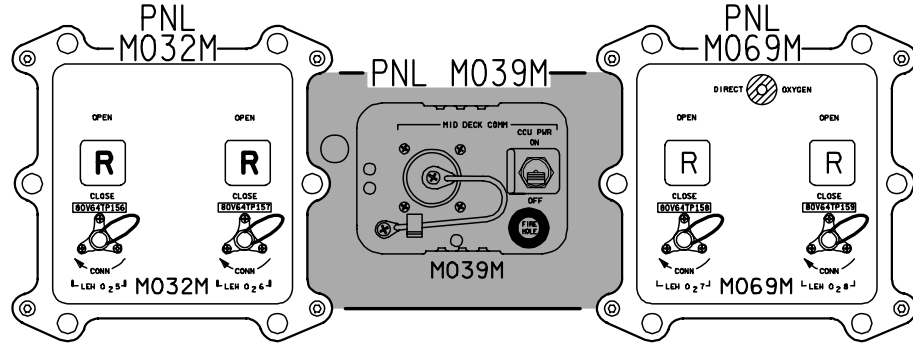
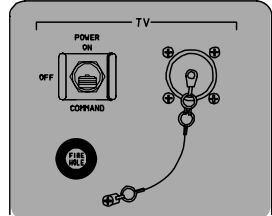

OV103

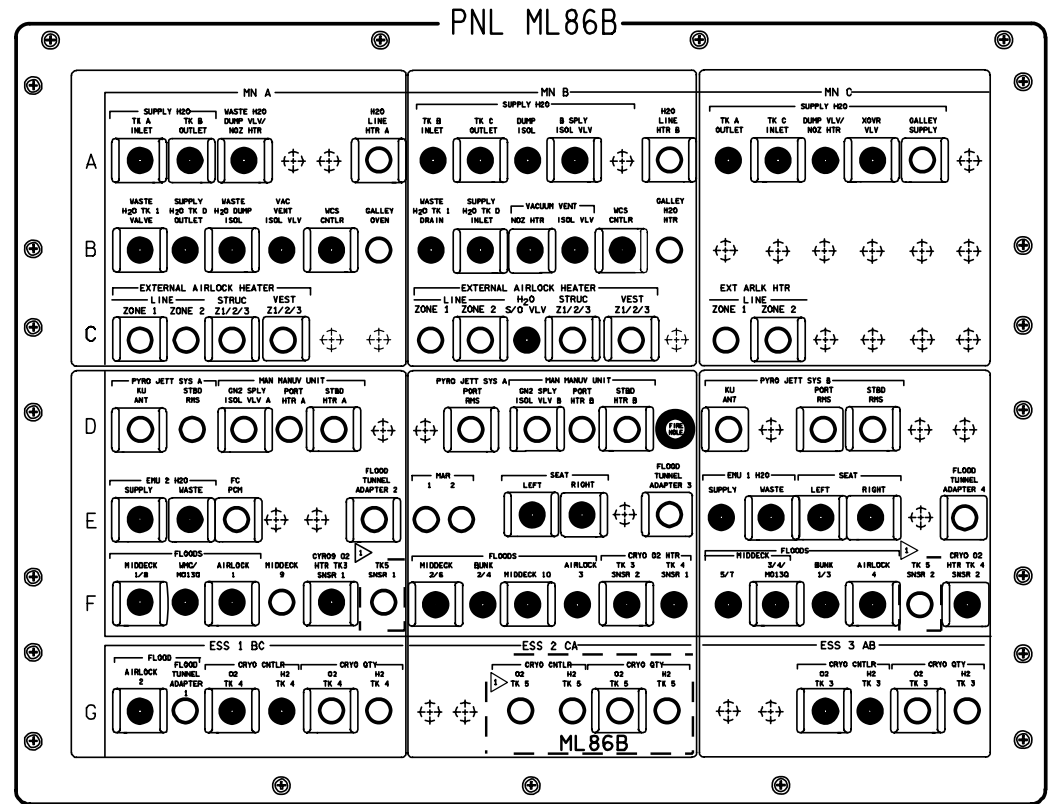
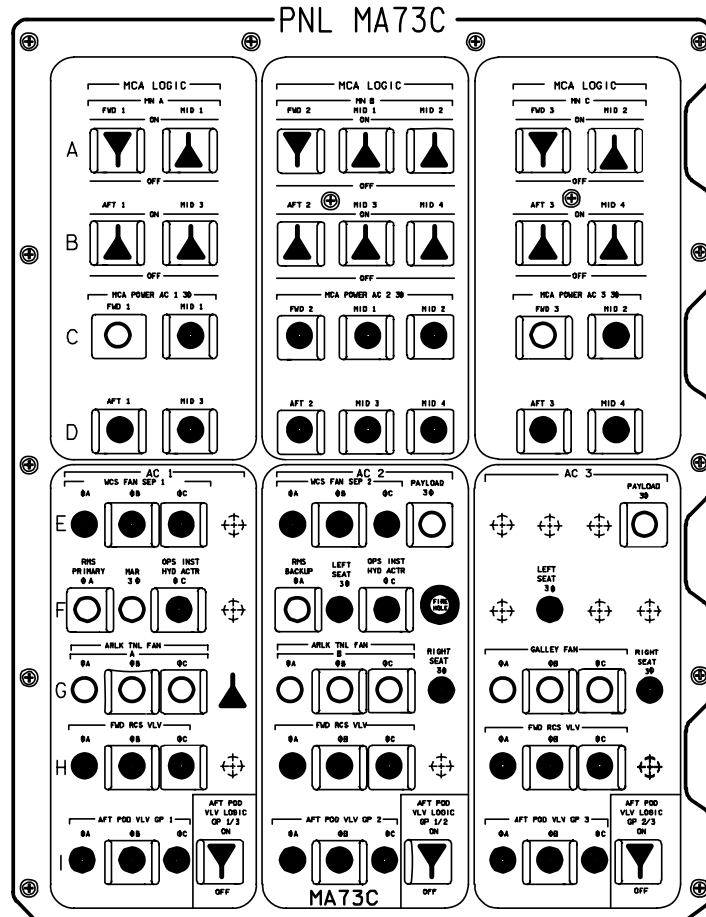

NOTES: ▷ CLOSED IF TK5 FLOWN



OV103

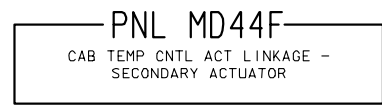
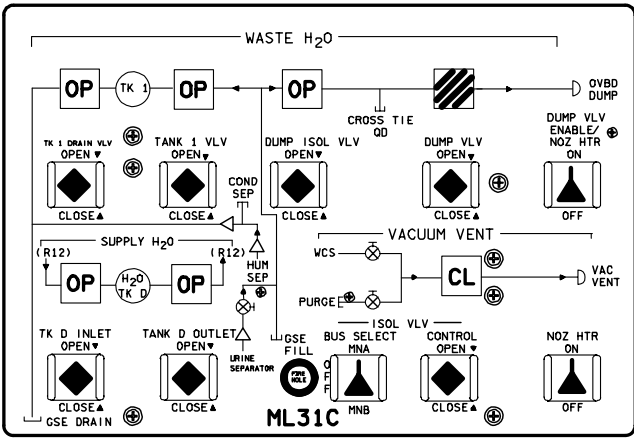
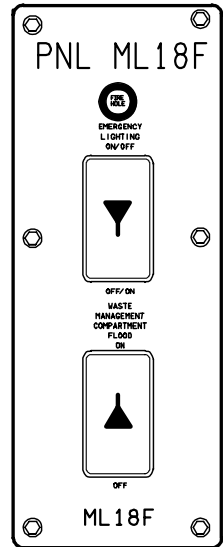
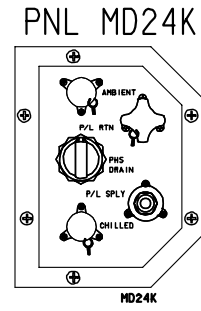
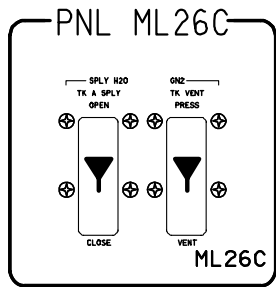
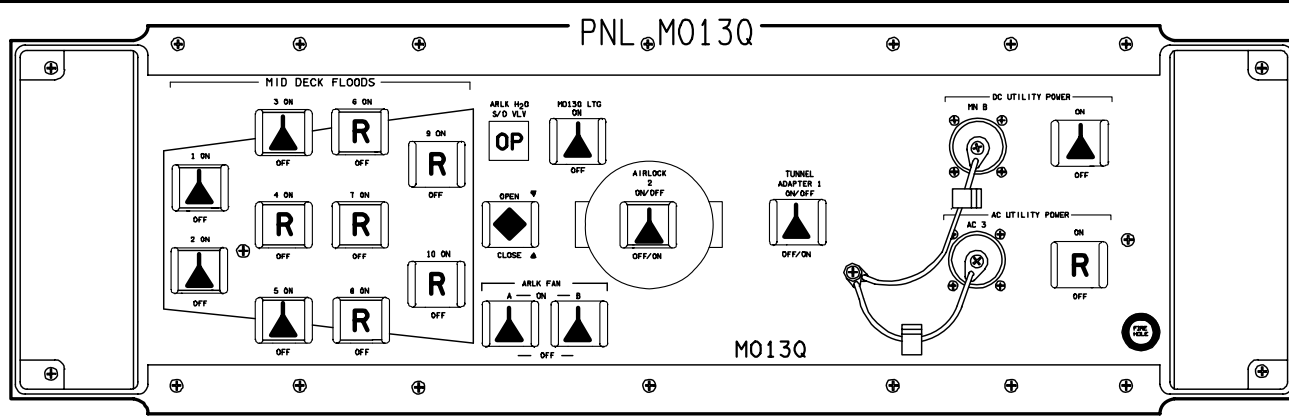

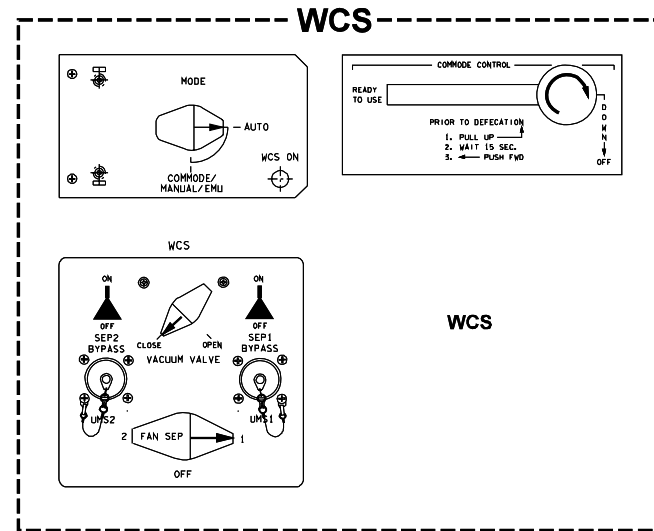
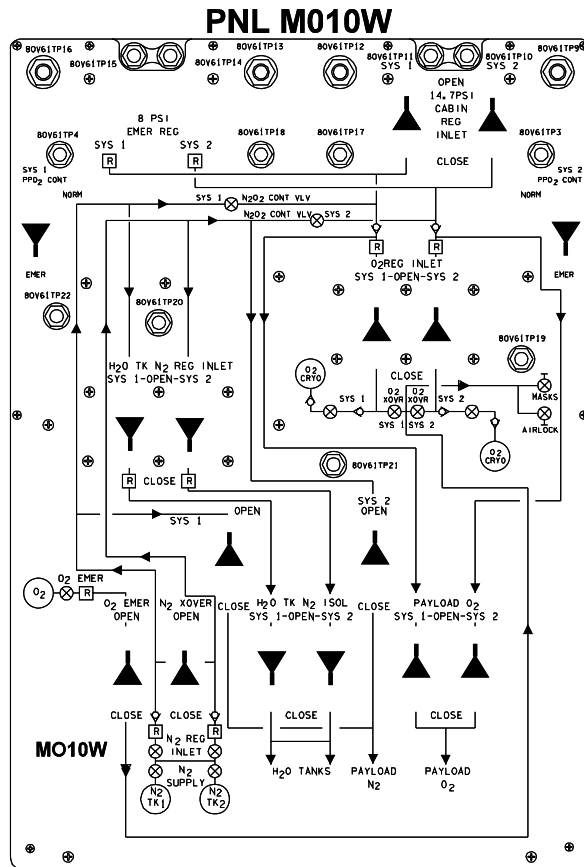

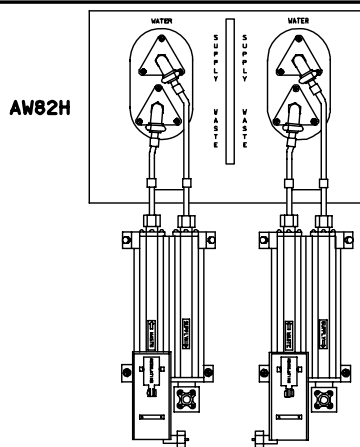
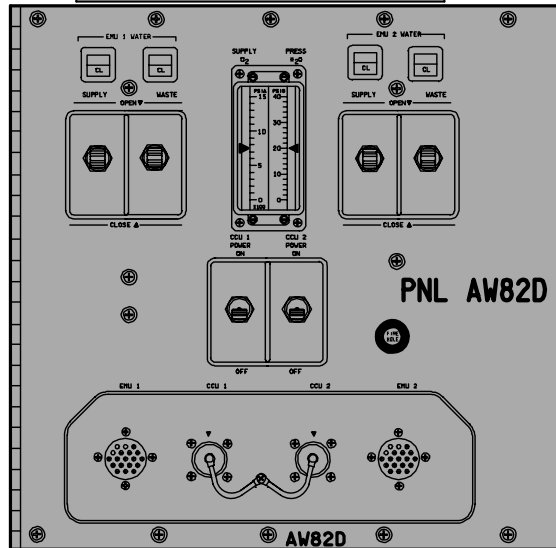
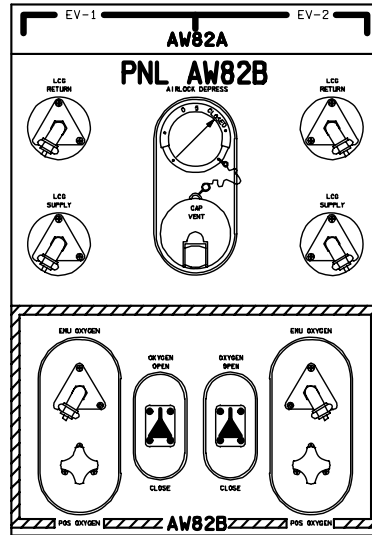
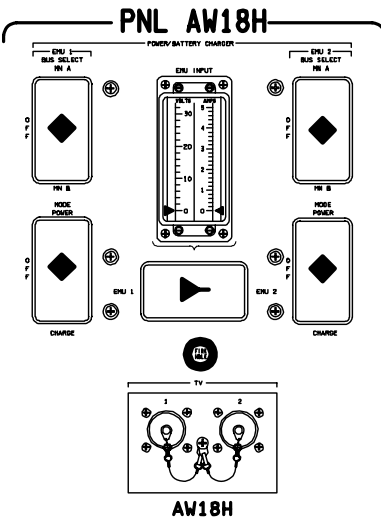
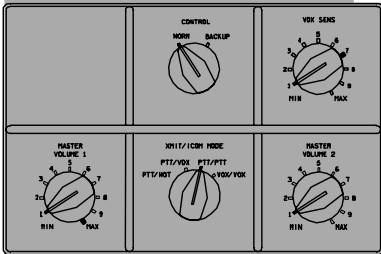
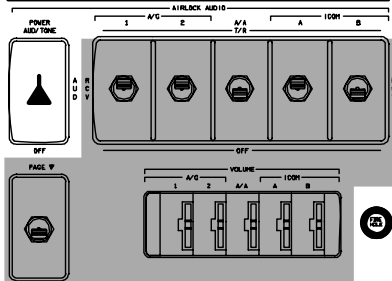
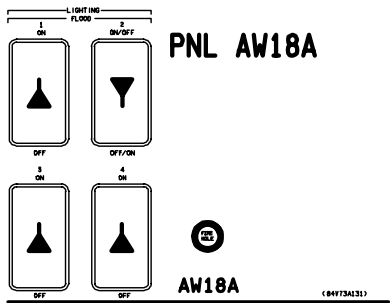

ALL REV/DATE 04/26/05

48007E631\_114\_PNL\_1

### **Inner Hatch**

Actuator Handle – LATCHED

Lock Lever – LOCKED

Equalization vlv (two) – NORM, capped

OV104

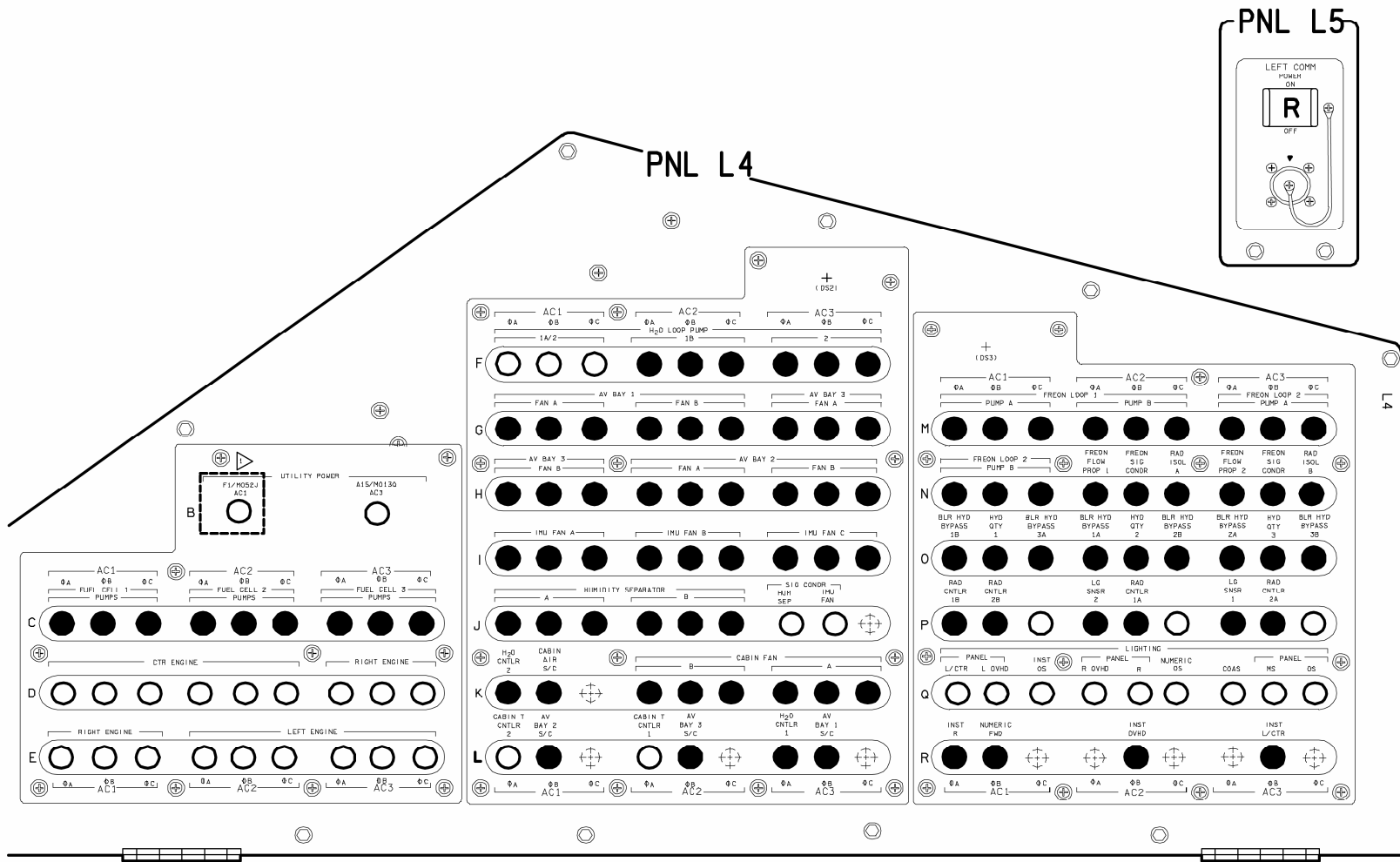

NOTE: ▸ CB CAN REMAIN CLOSED FOR AC PGSC USAGE.  
 OPEN WHEN PGSC UNPOWERED/STOWED

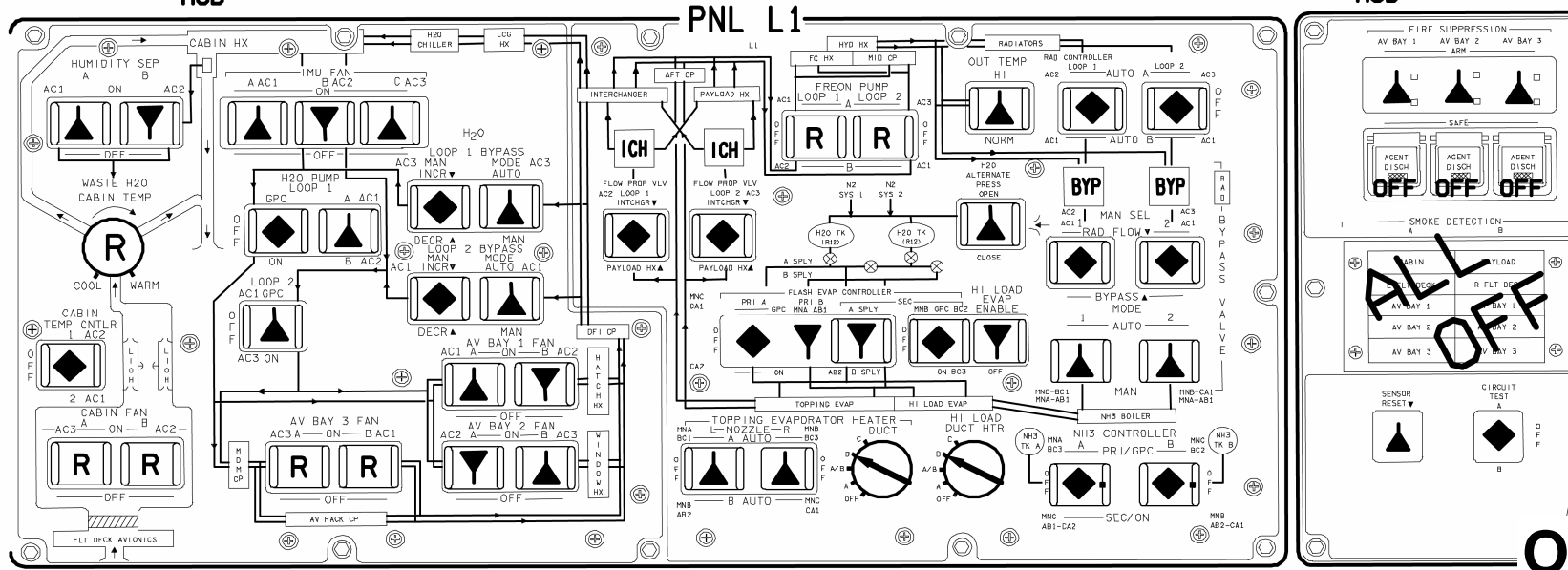
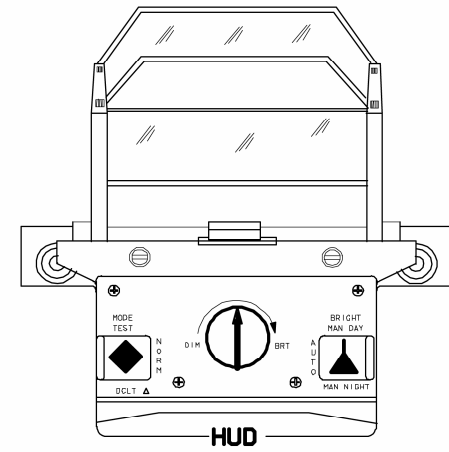
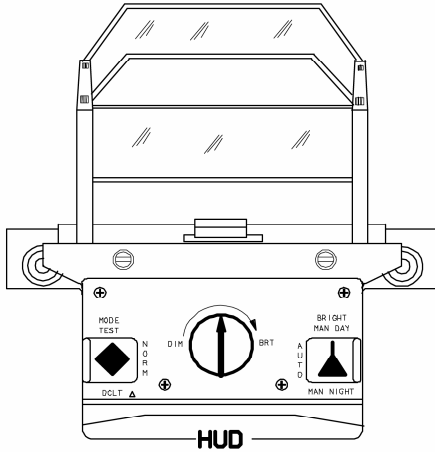
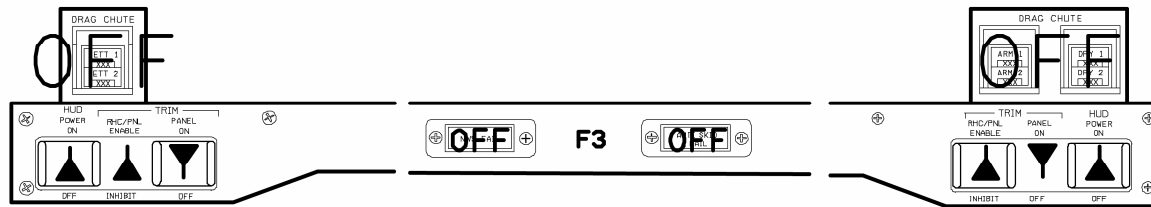

**OV104**

OV104

PNL L2

PNL F1

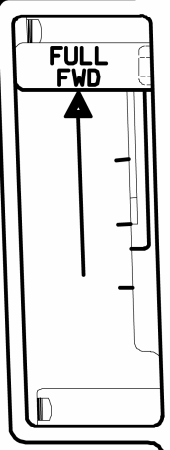
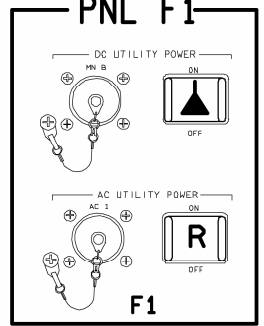
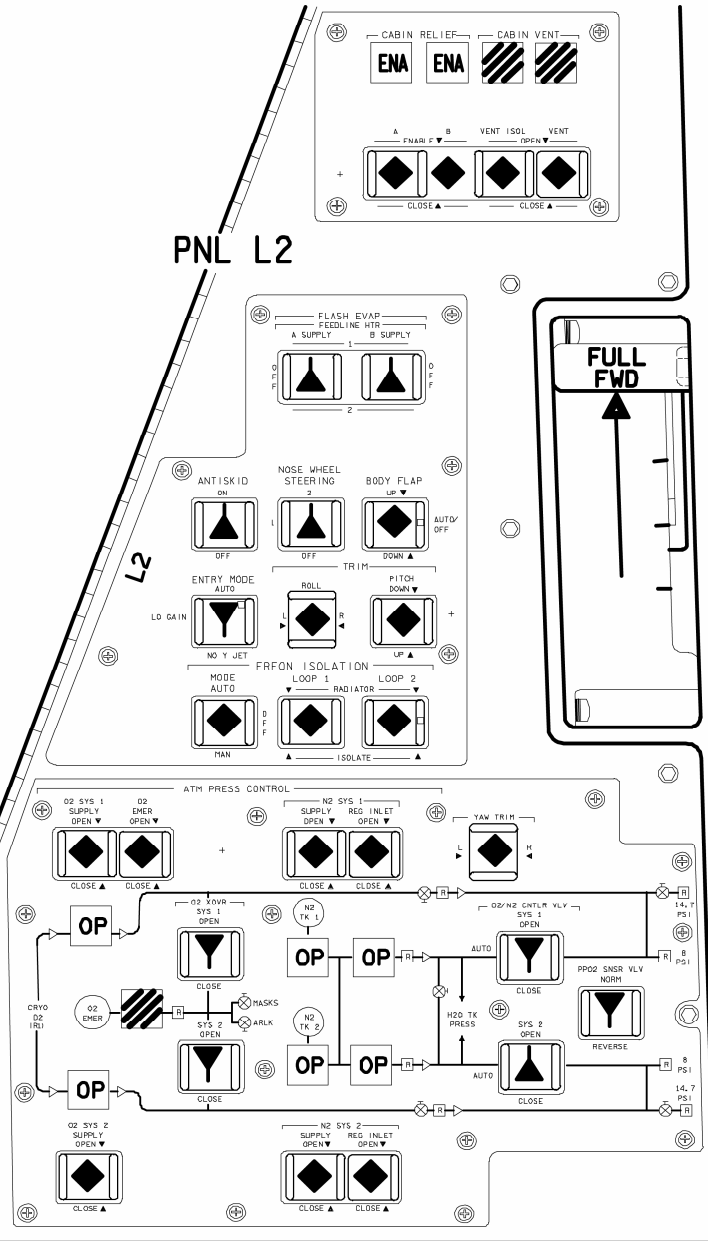

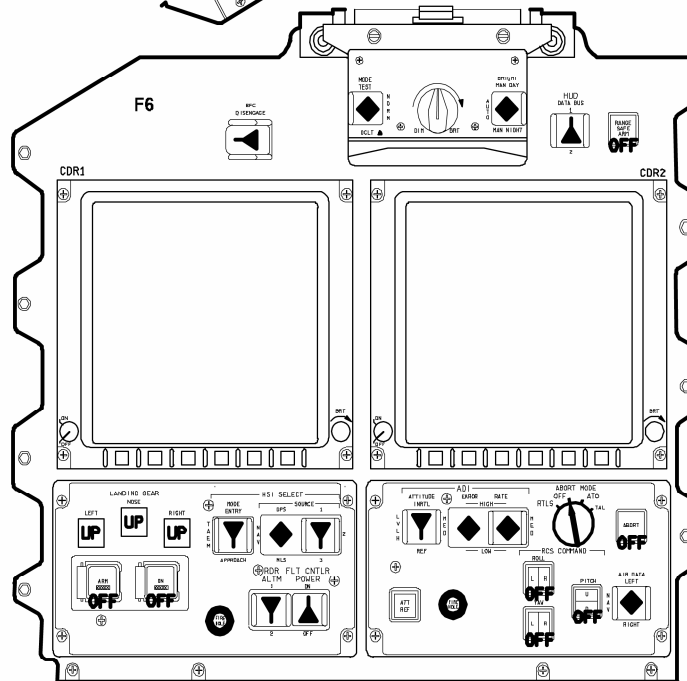
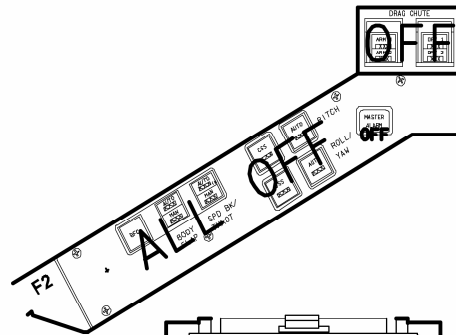
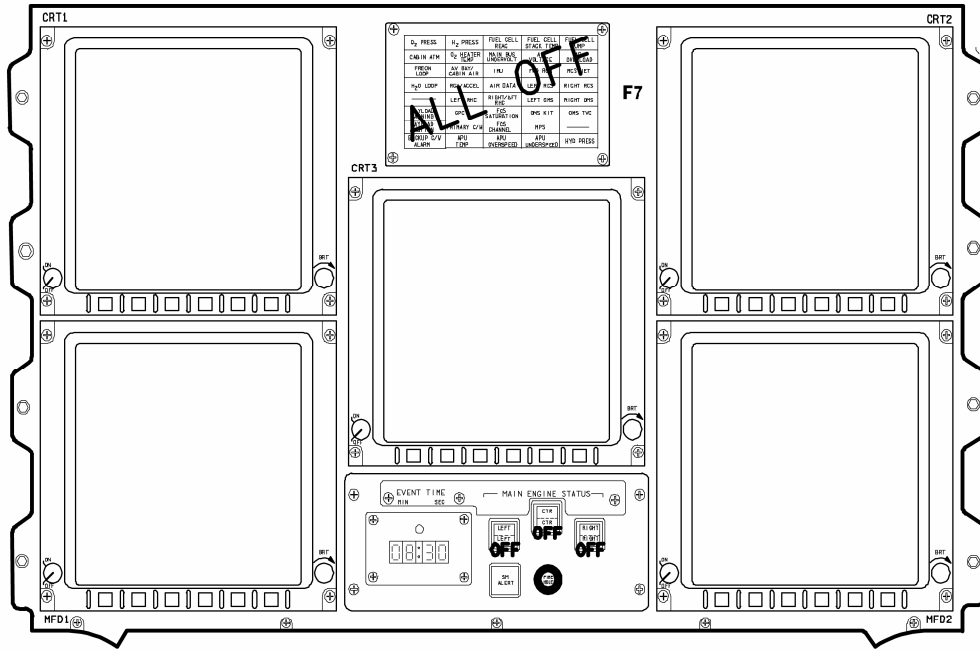



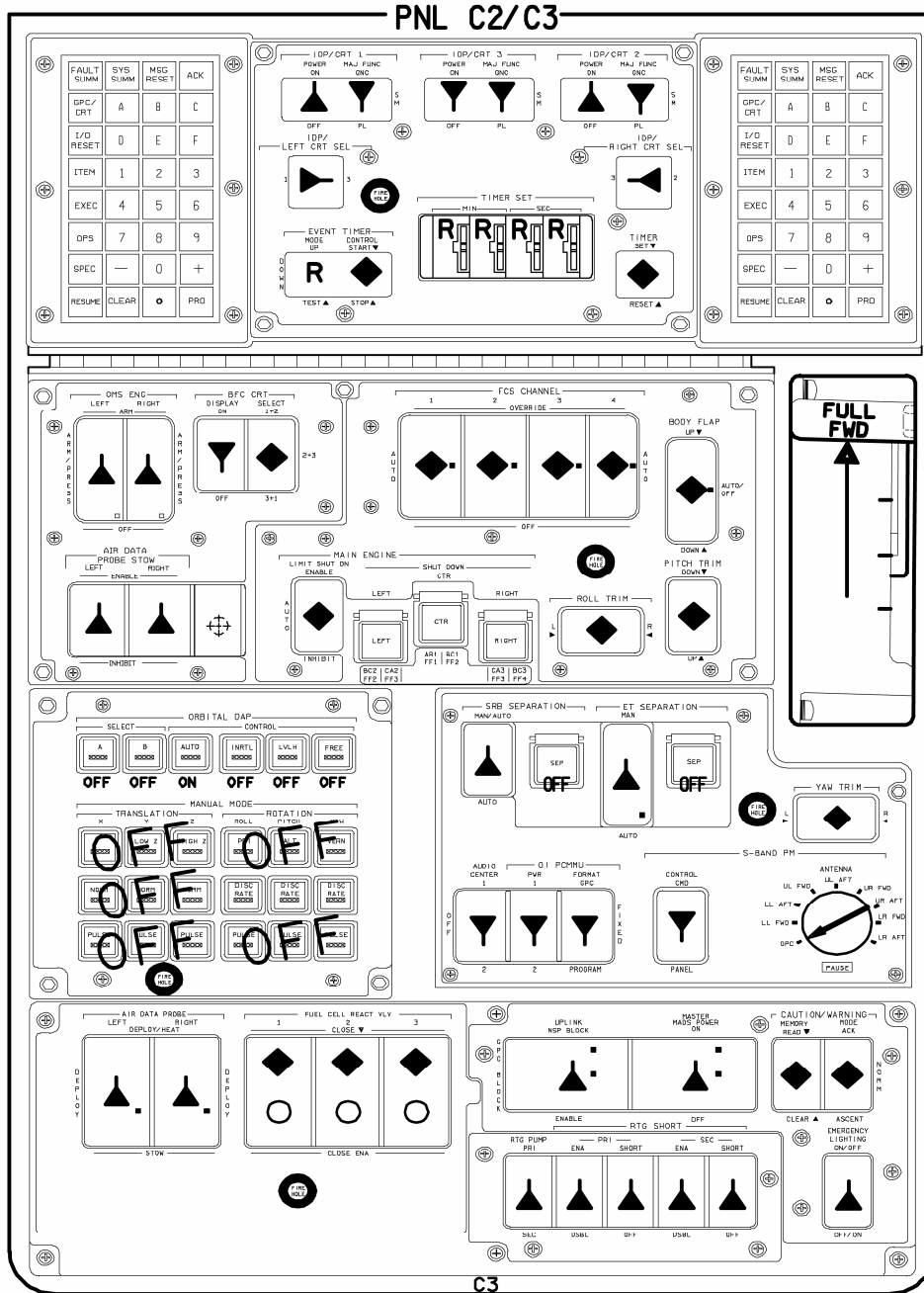

OV104

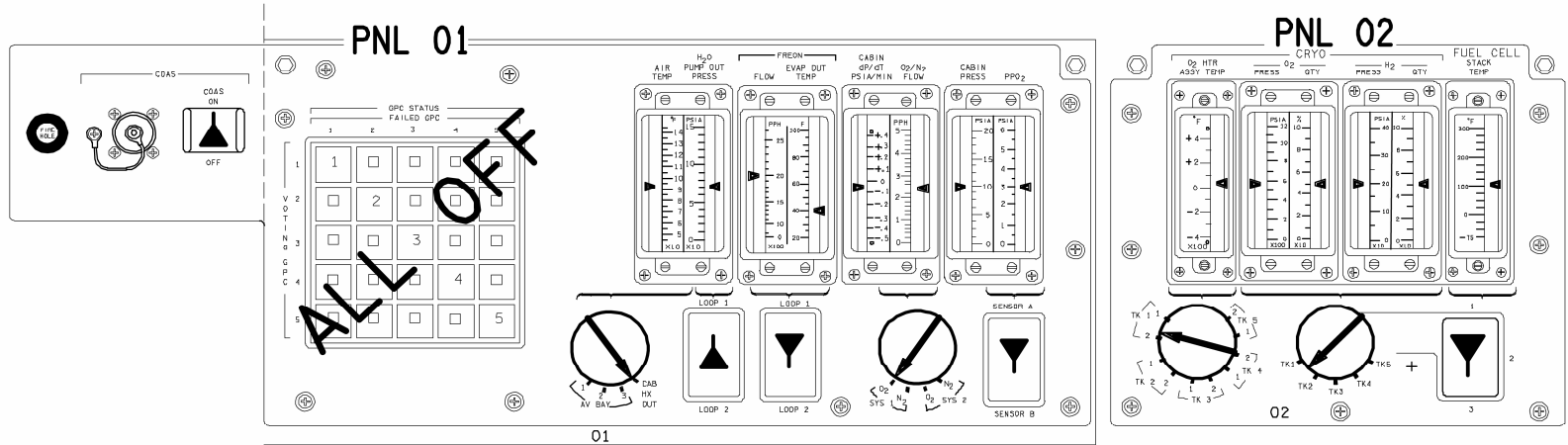

L side OVHD flood - R (MID)

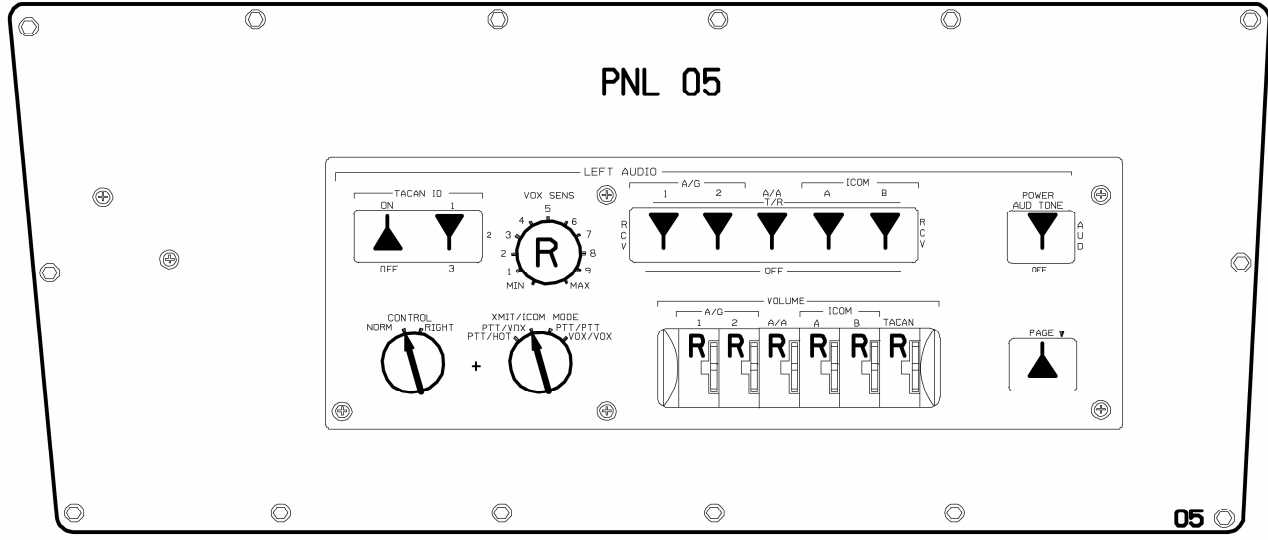

OV104

PNL 06

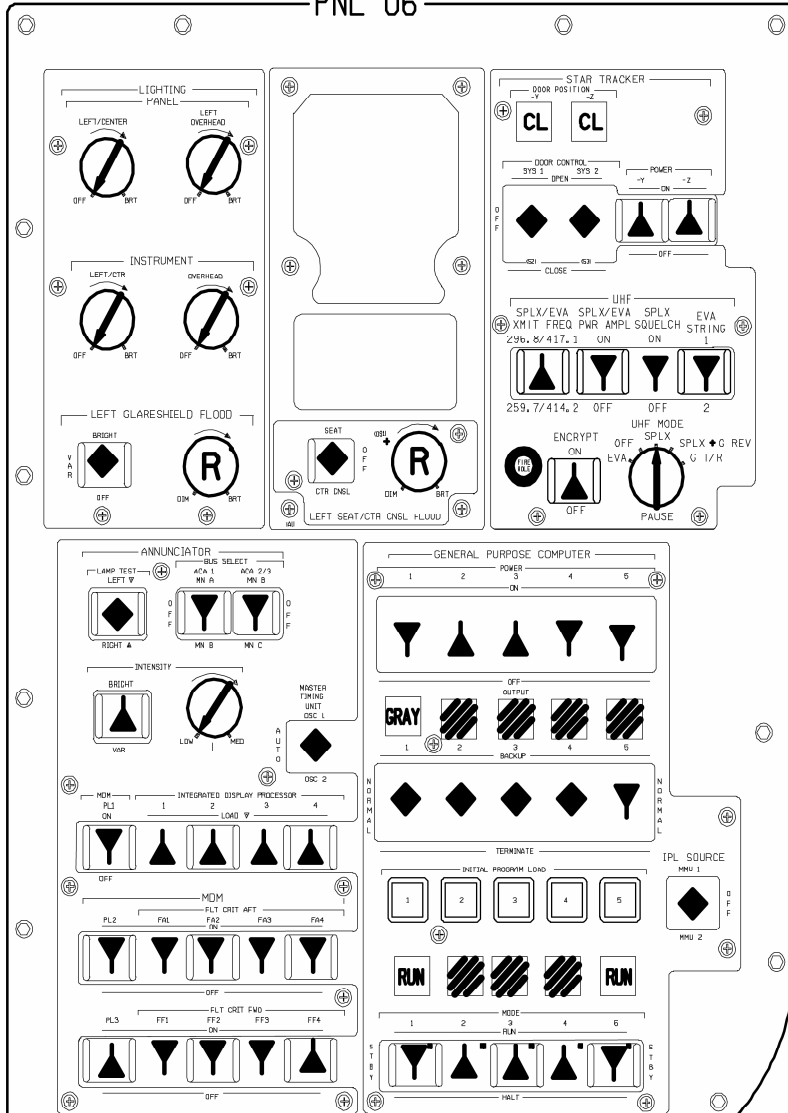

PNL 07

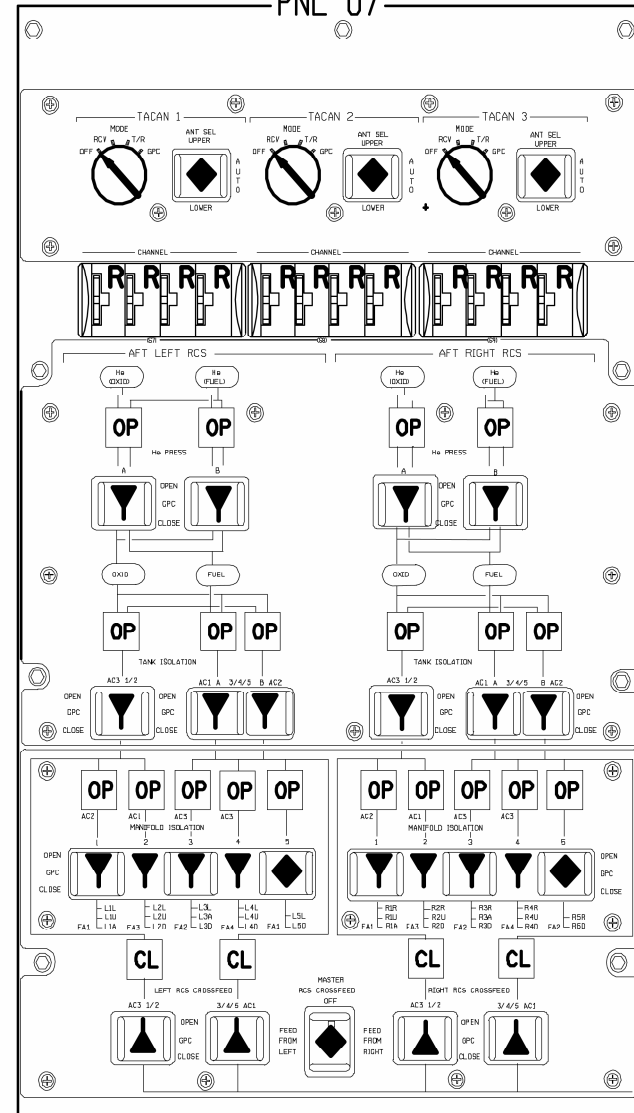

OV104

48007C609\_107\_PNL 1

OV104/DATE 10/08/02

(OV104) B6-9

C D/O/4/GEN M

PNL 08

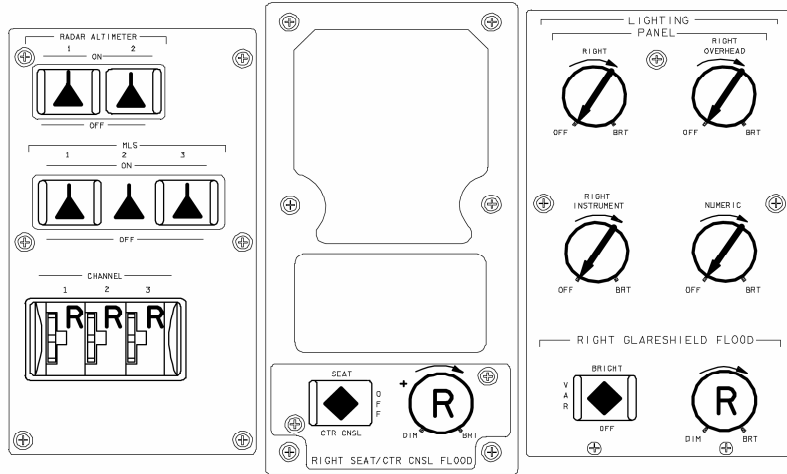

PNL 09

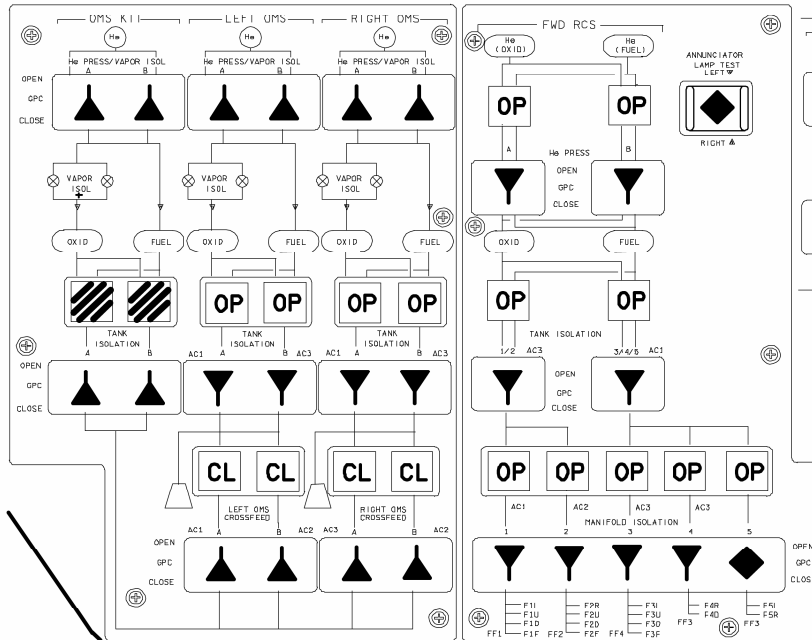
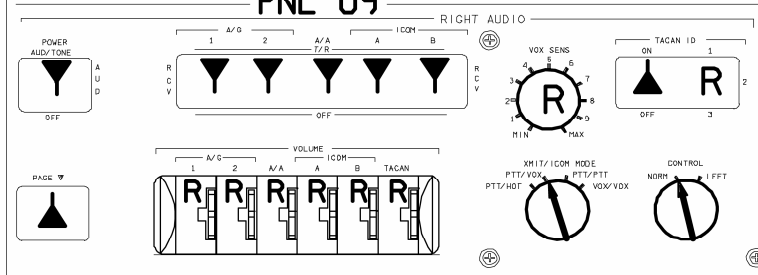

R side OVHD flood - R (MID)

OV104

OV104

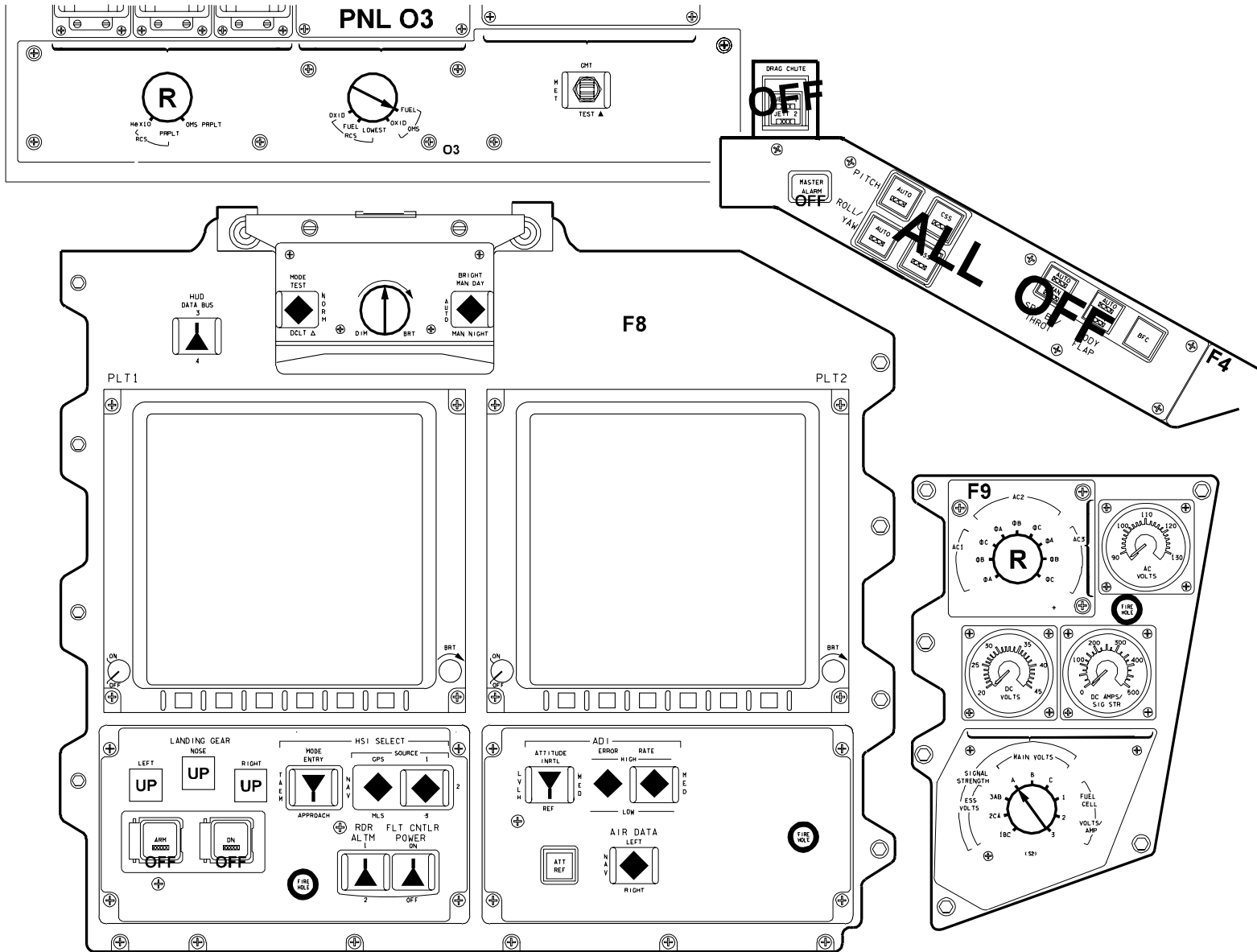

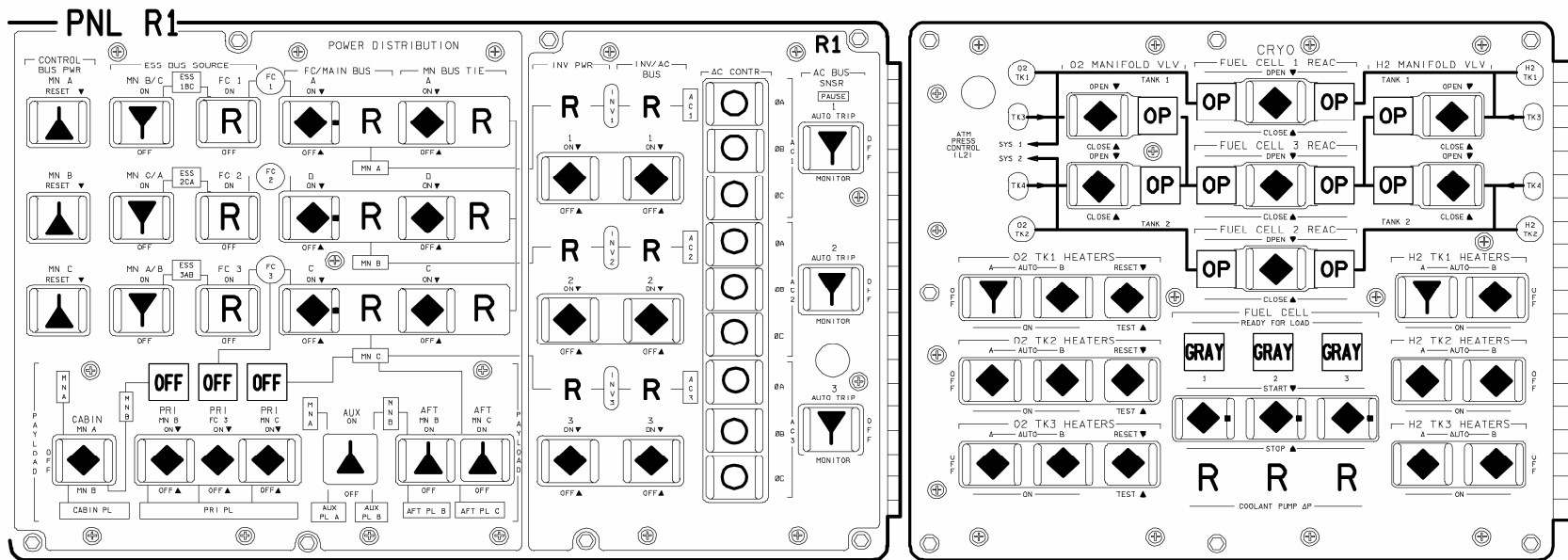

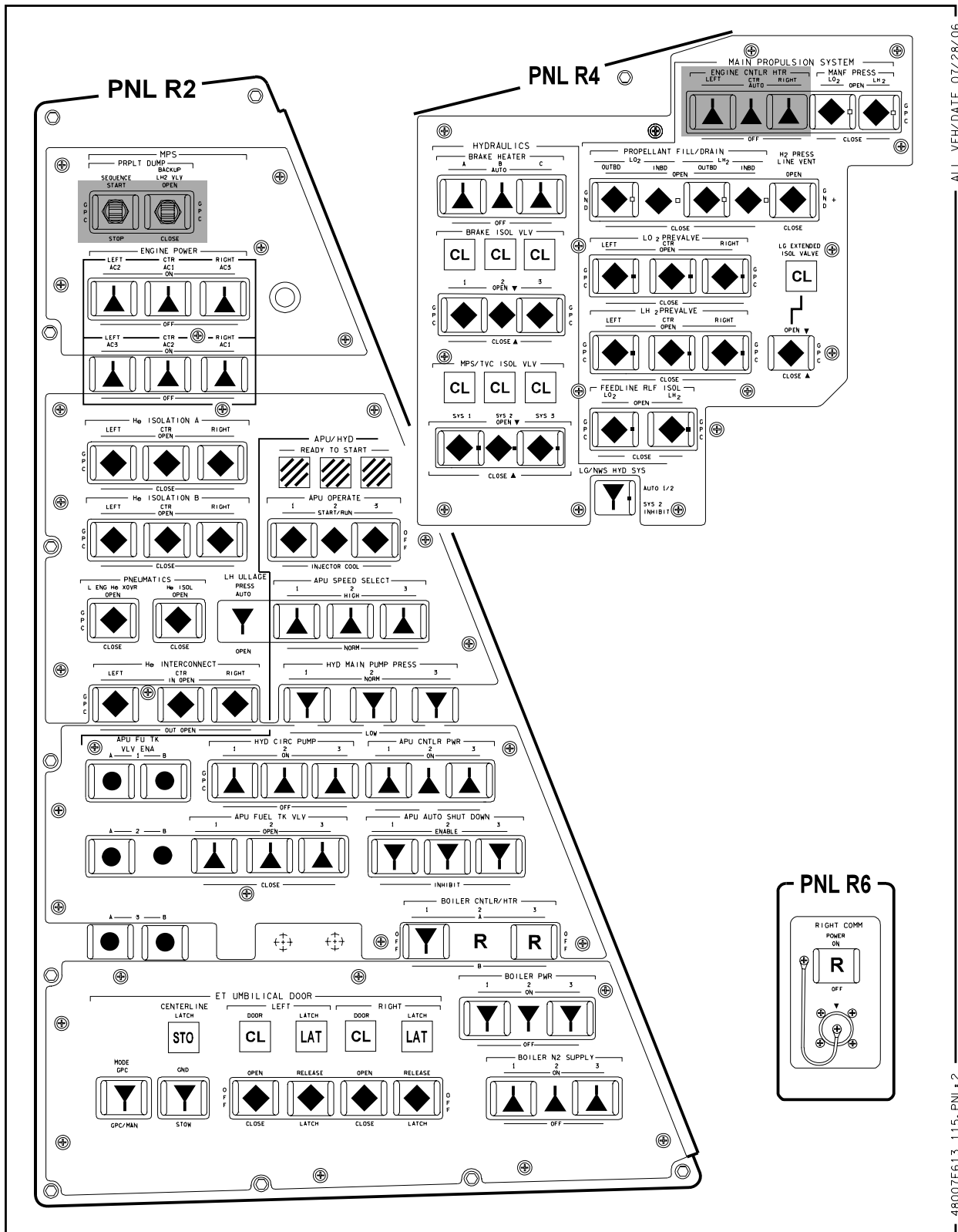

ALL VEH/DATE 07/28/06

48007F613\_115, PNL<sub>3</sub> 2

This Page Intentionally Blank

(OV104) B6-14

**OV104**  
C D/O/ALL/GEN M



PNL 013

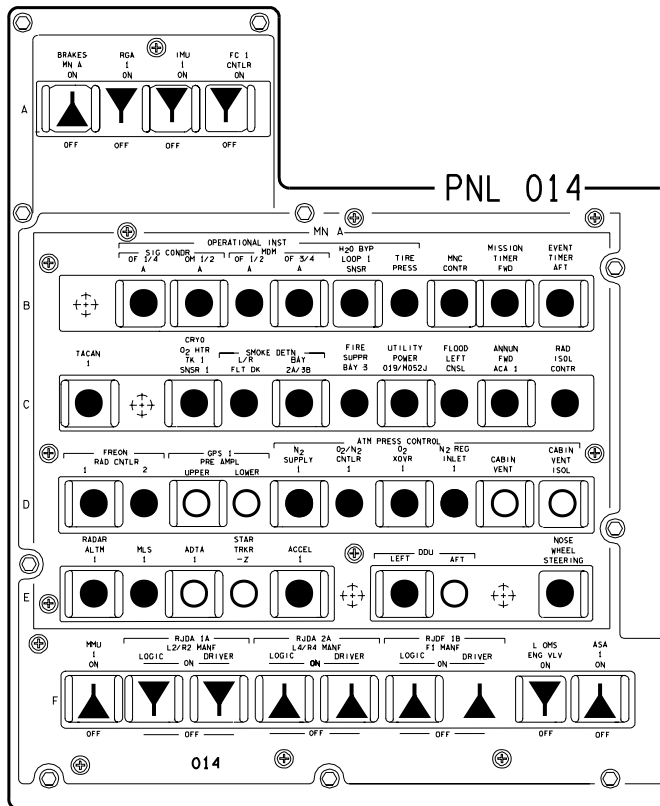
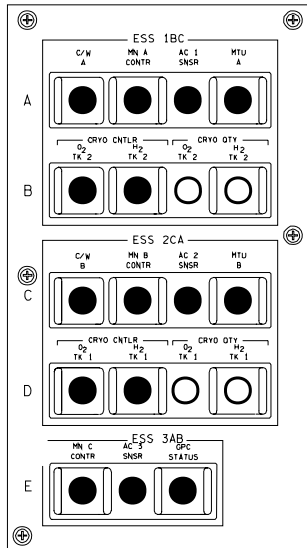

PNL 015

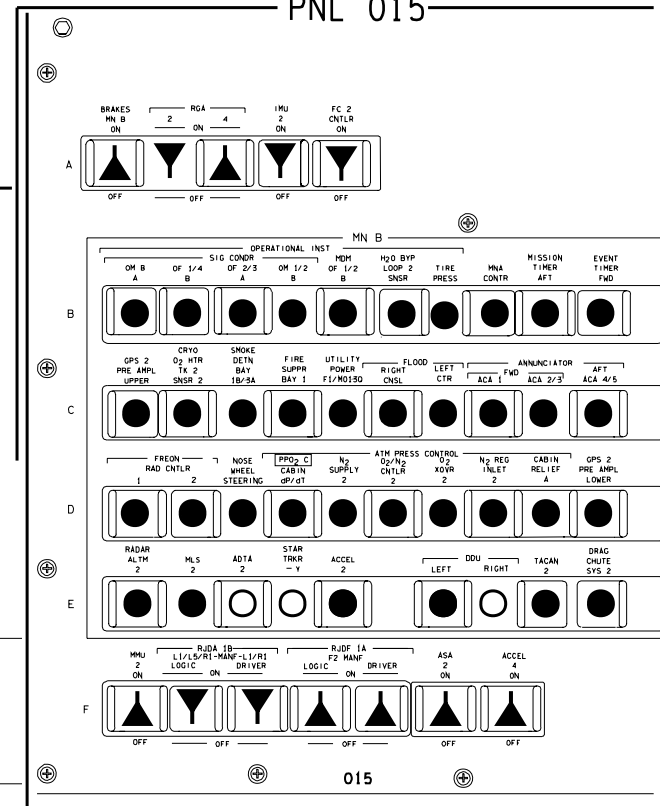

OV104

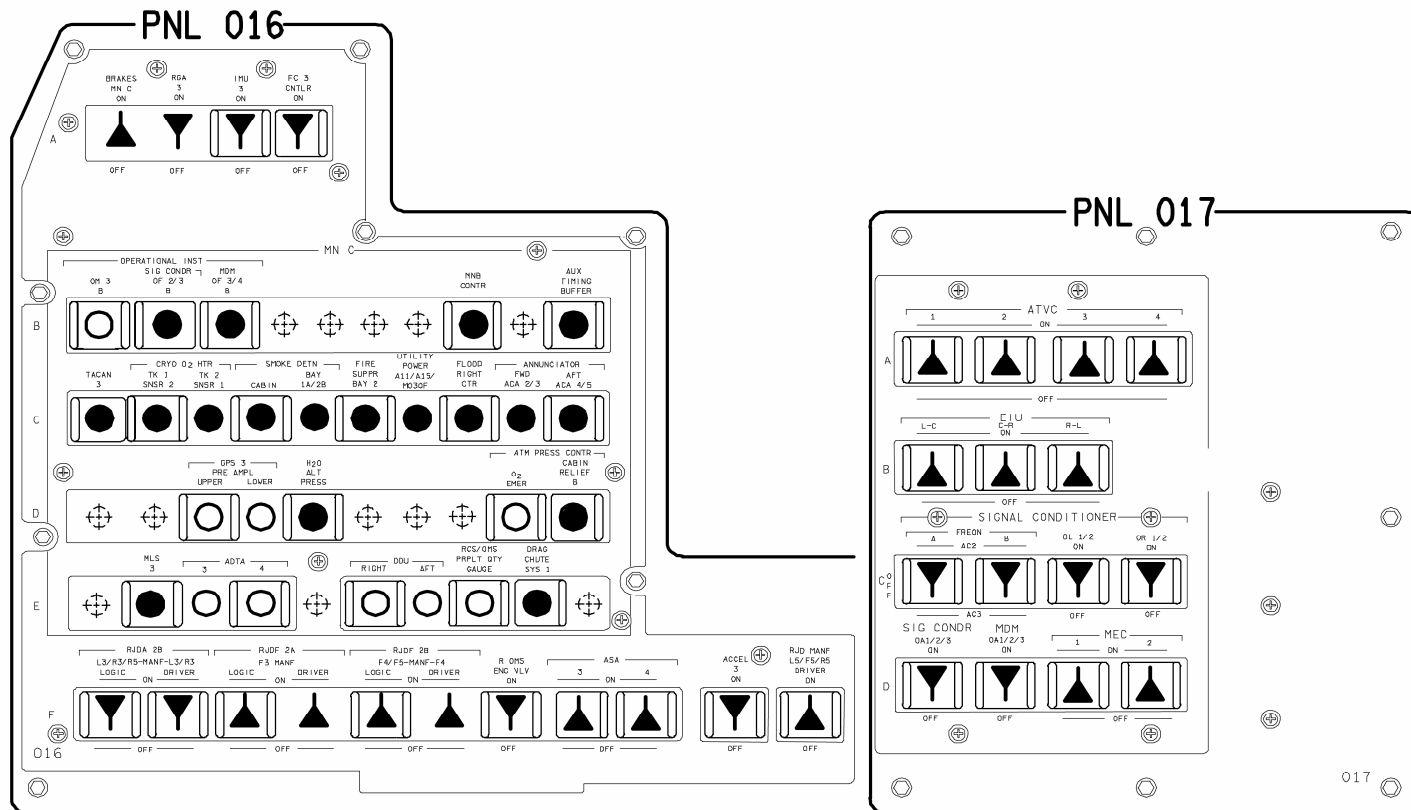

OV104

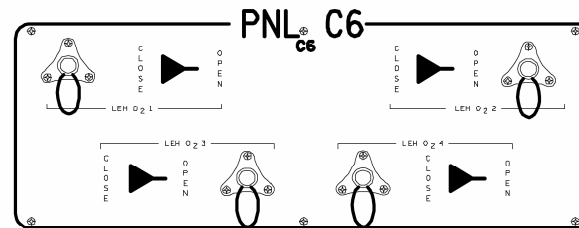
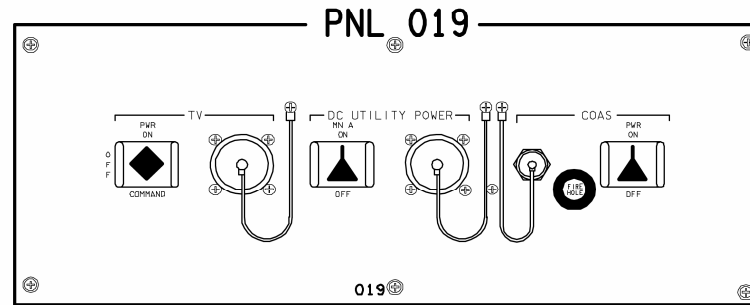

PNL C5

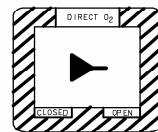

PNL C7

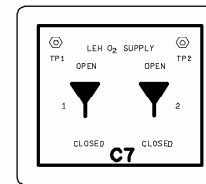

OV104

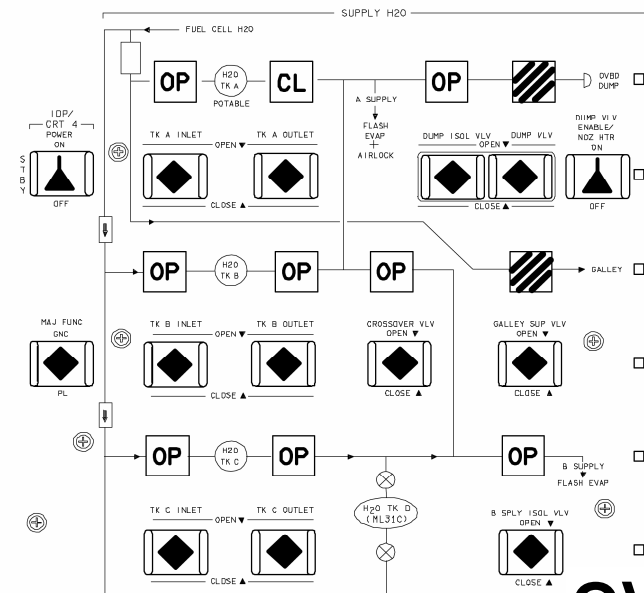
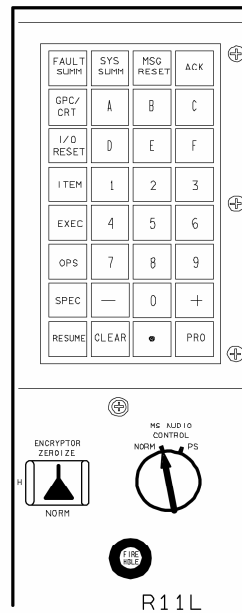
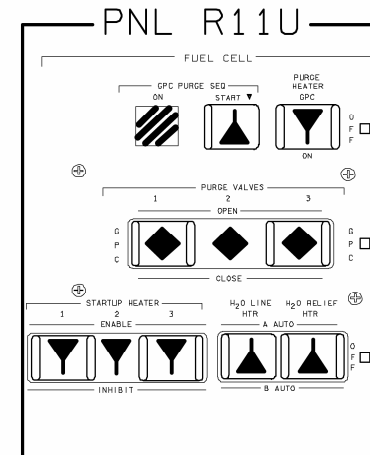
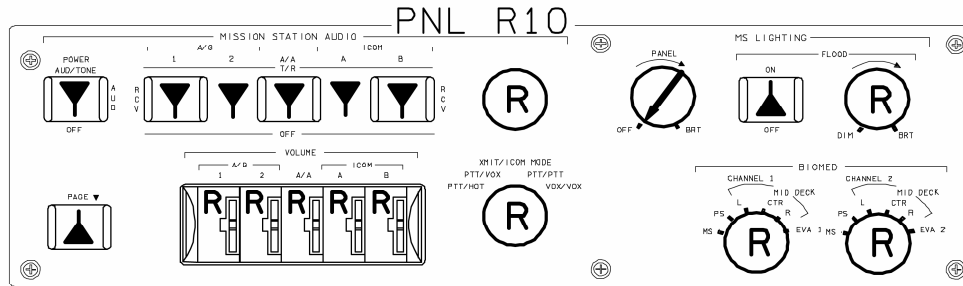

# OV104

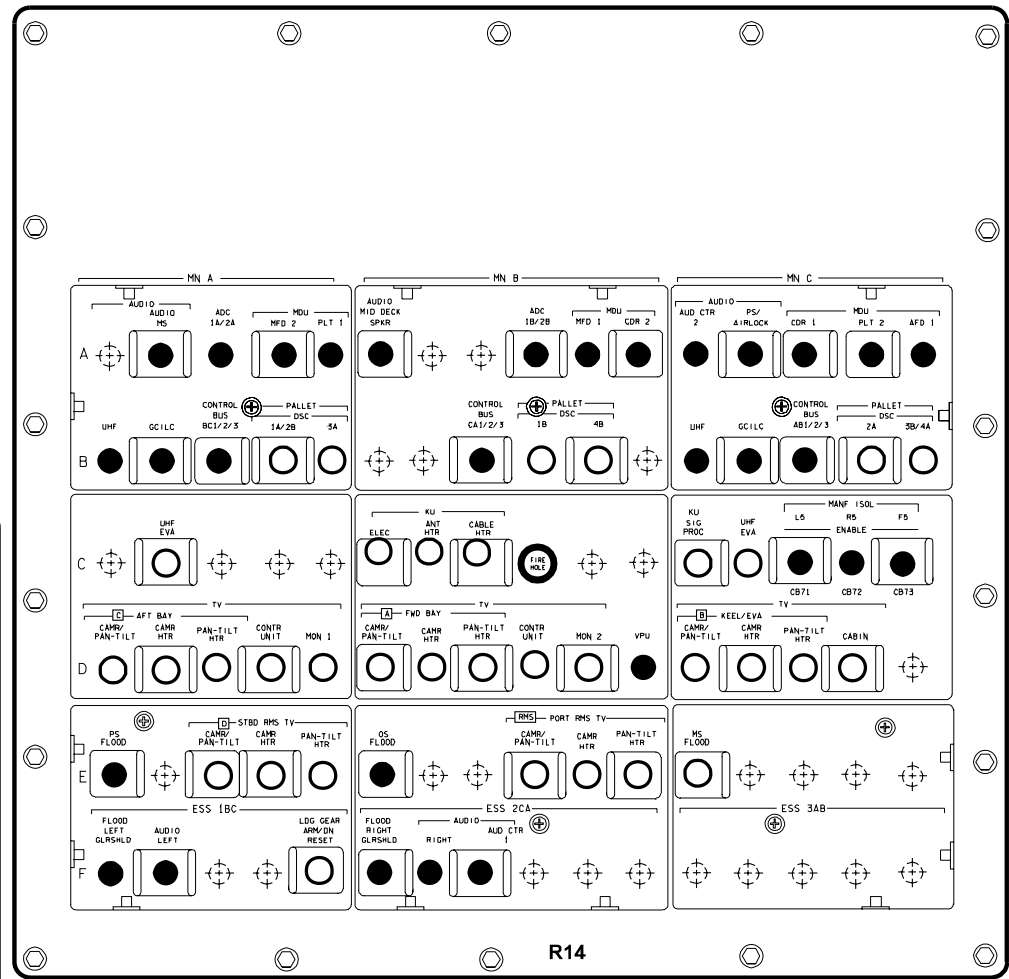
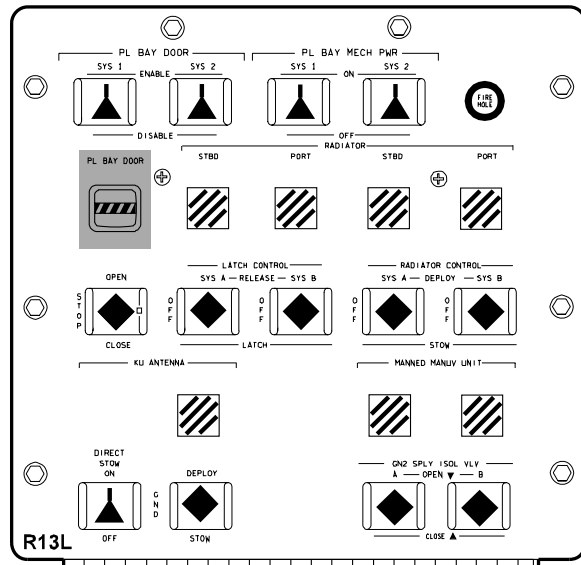
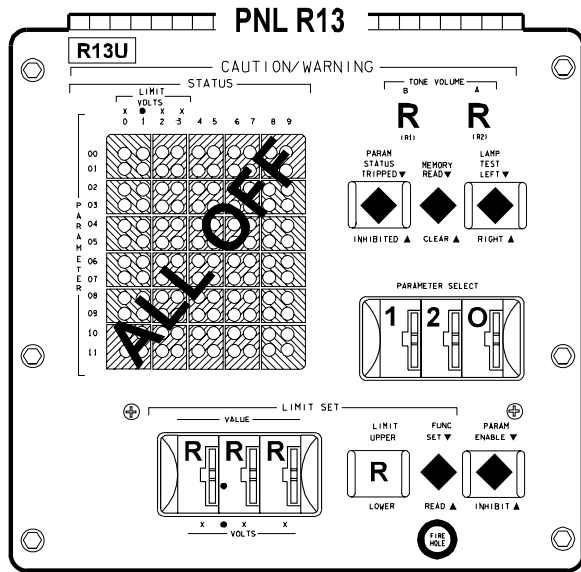

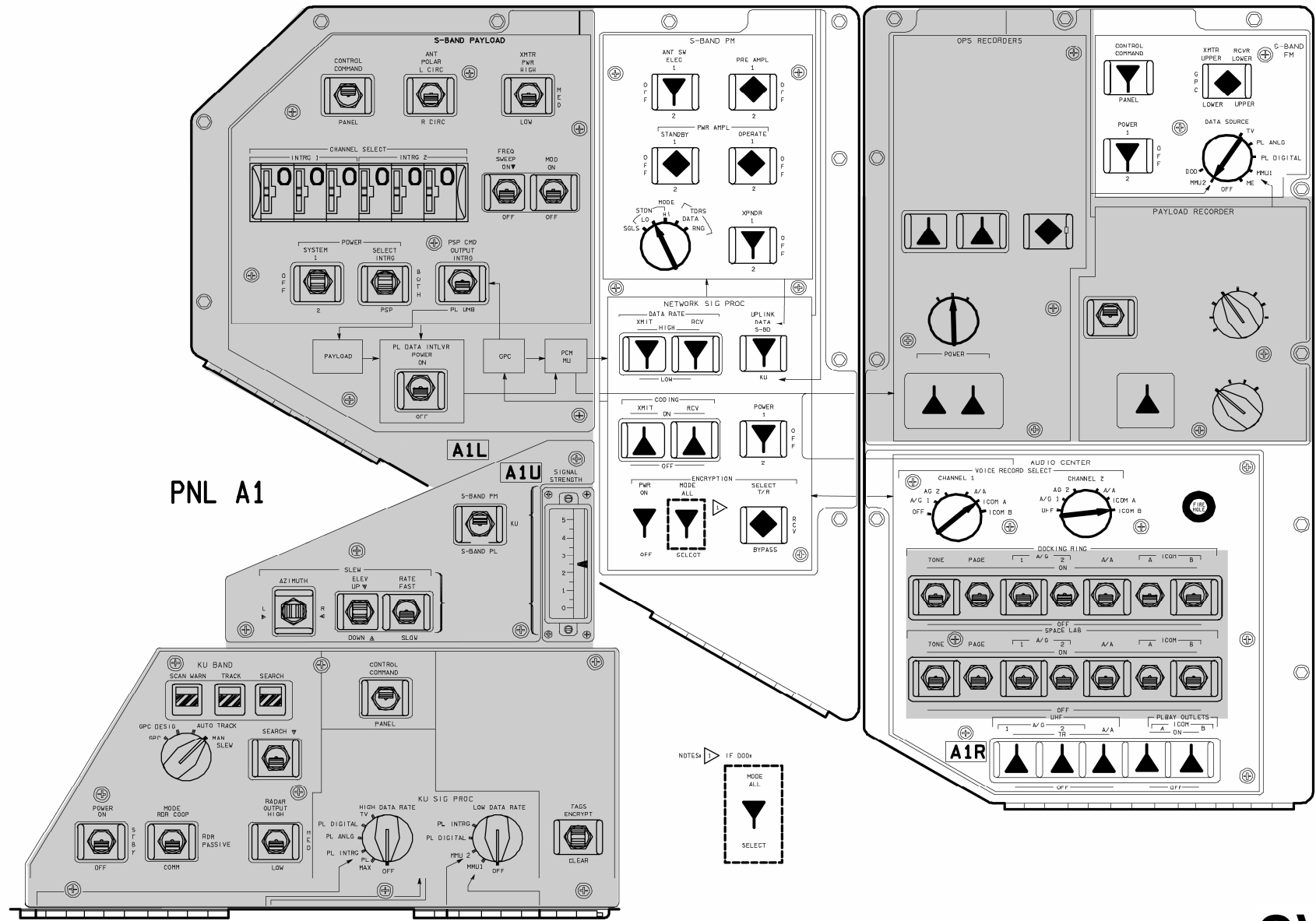

PNL A1

A1L

A1U

A1R

OV104

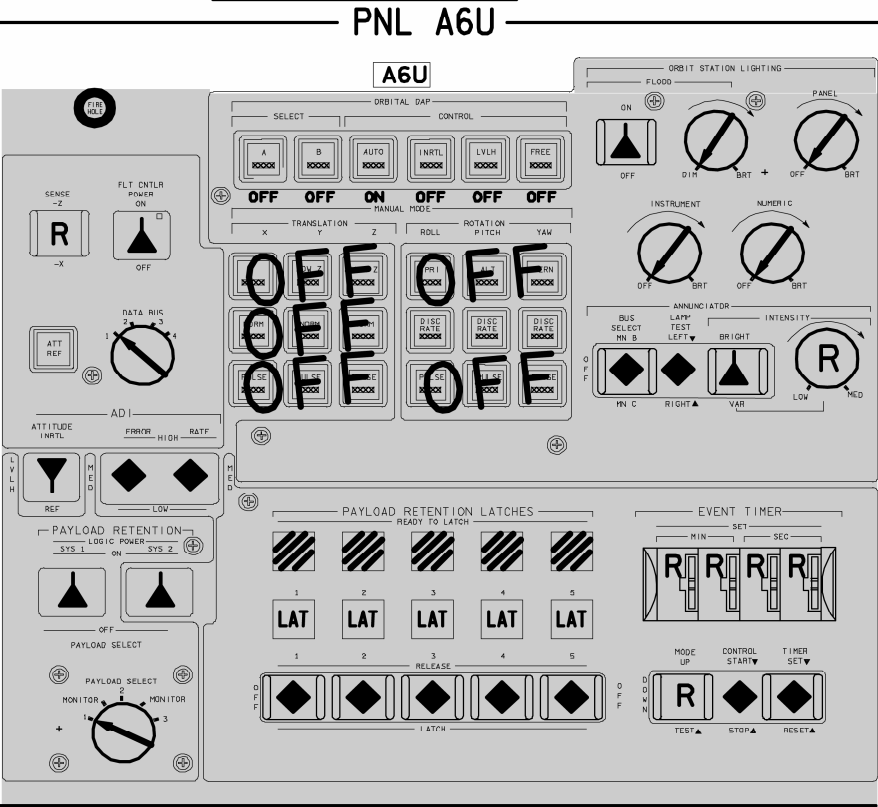
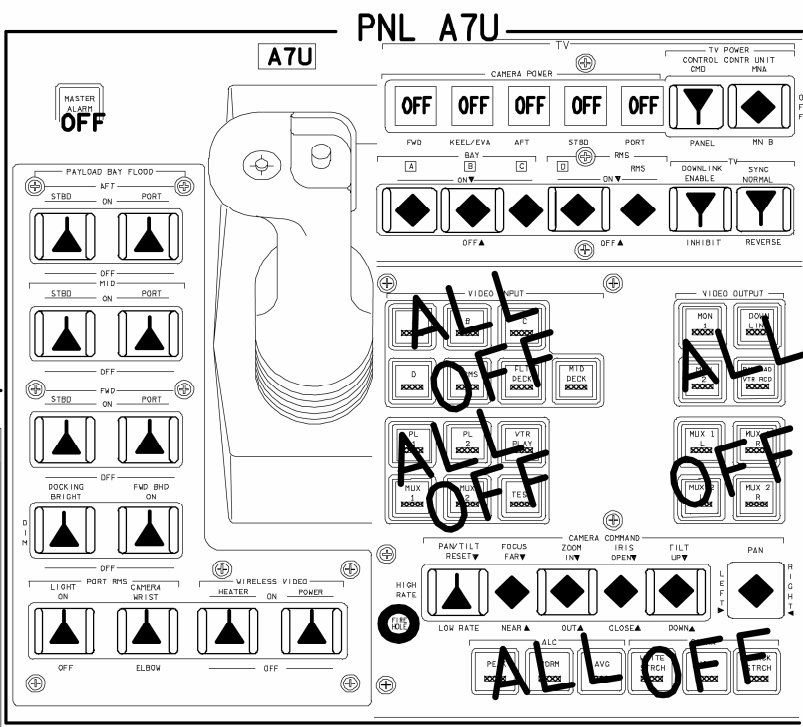
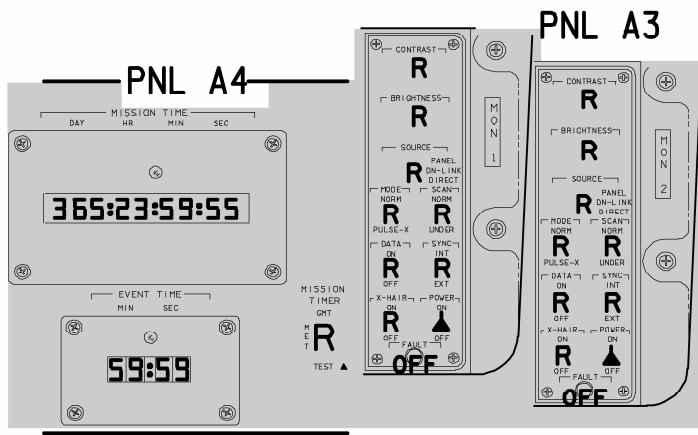

48007G621\_107, PNL, 2

OV104

OV104/ DATE 10/17/02

(OV104) B6-21

C D/O/4/GEN M

OV104

A6L

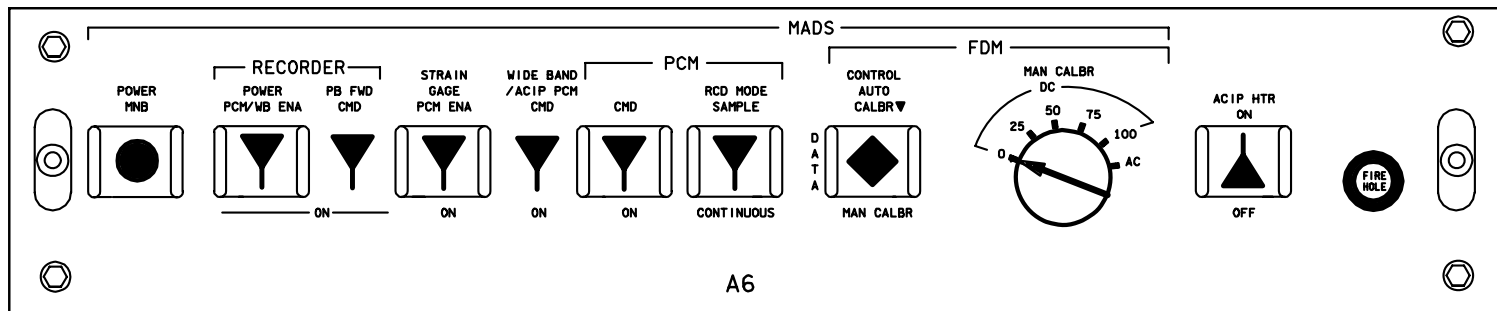
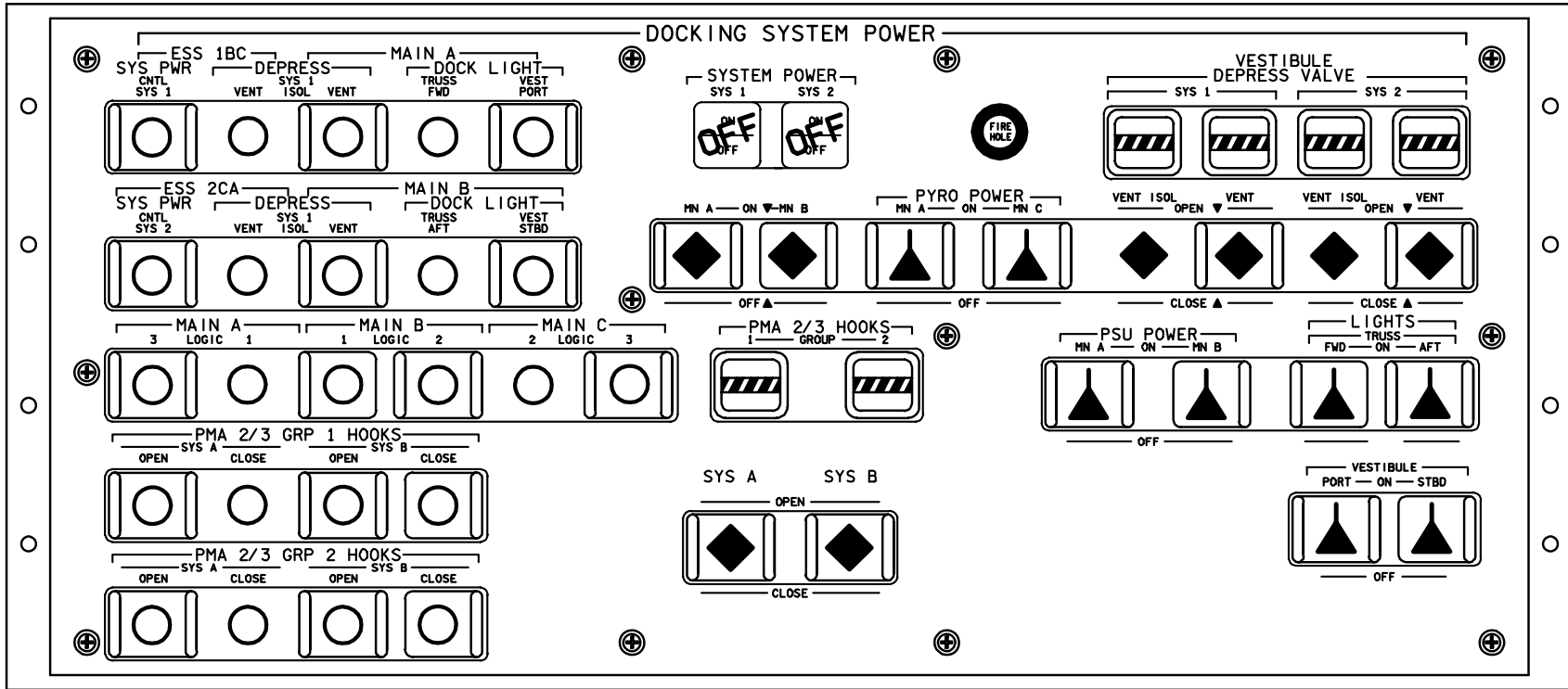

A6



OV104

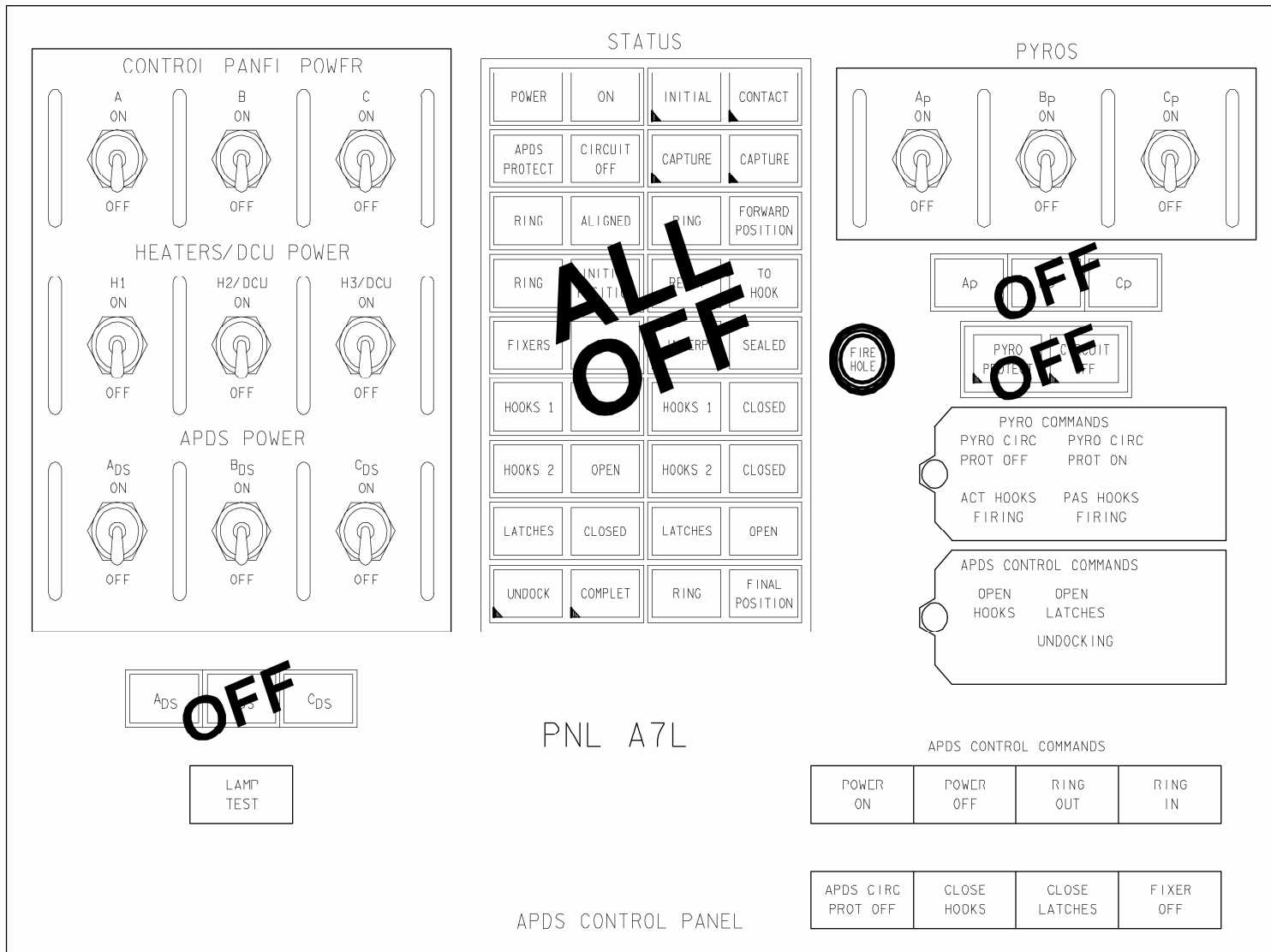

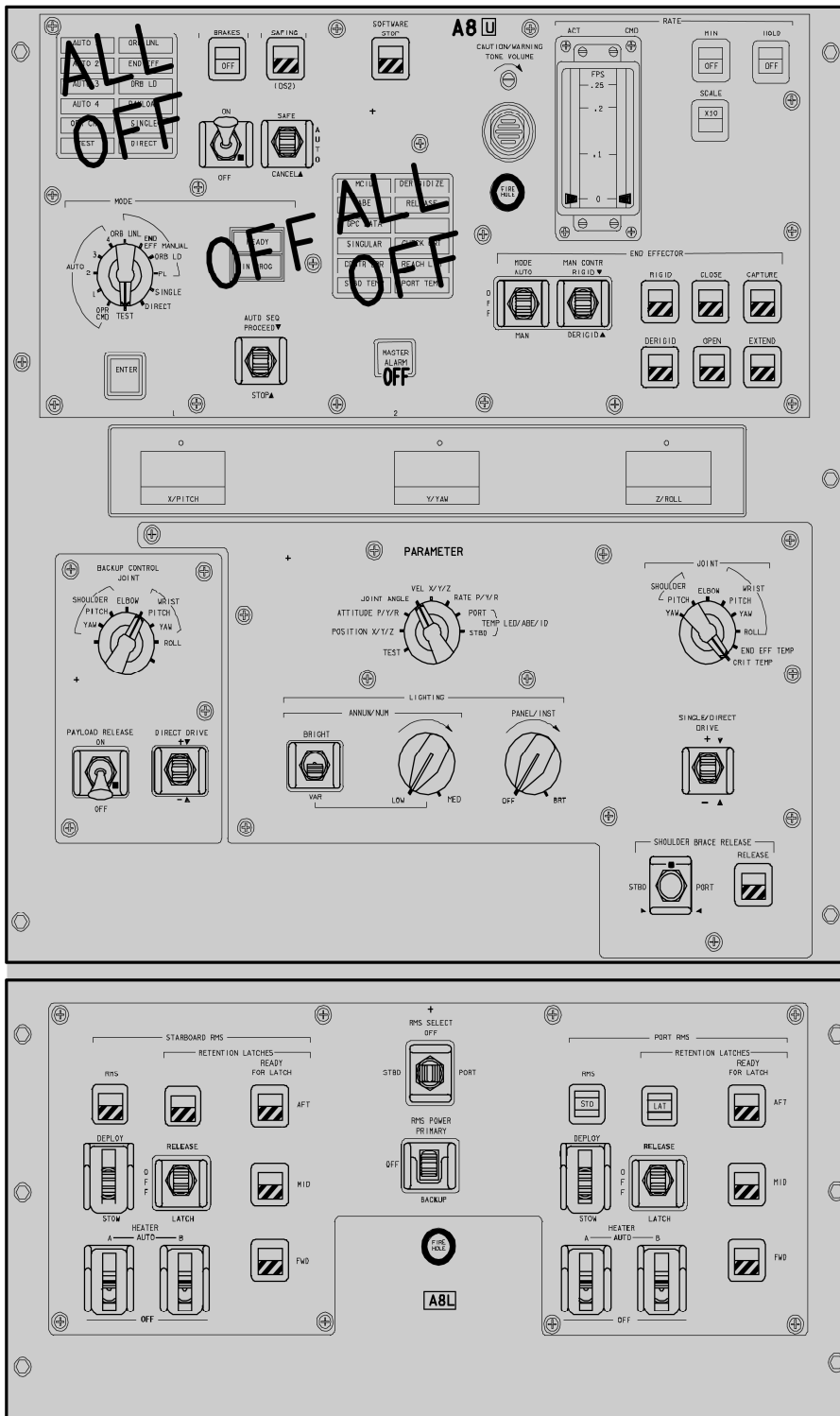

OV104

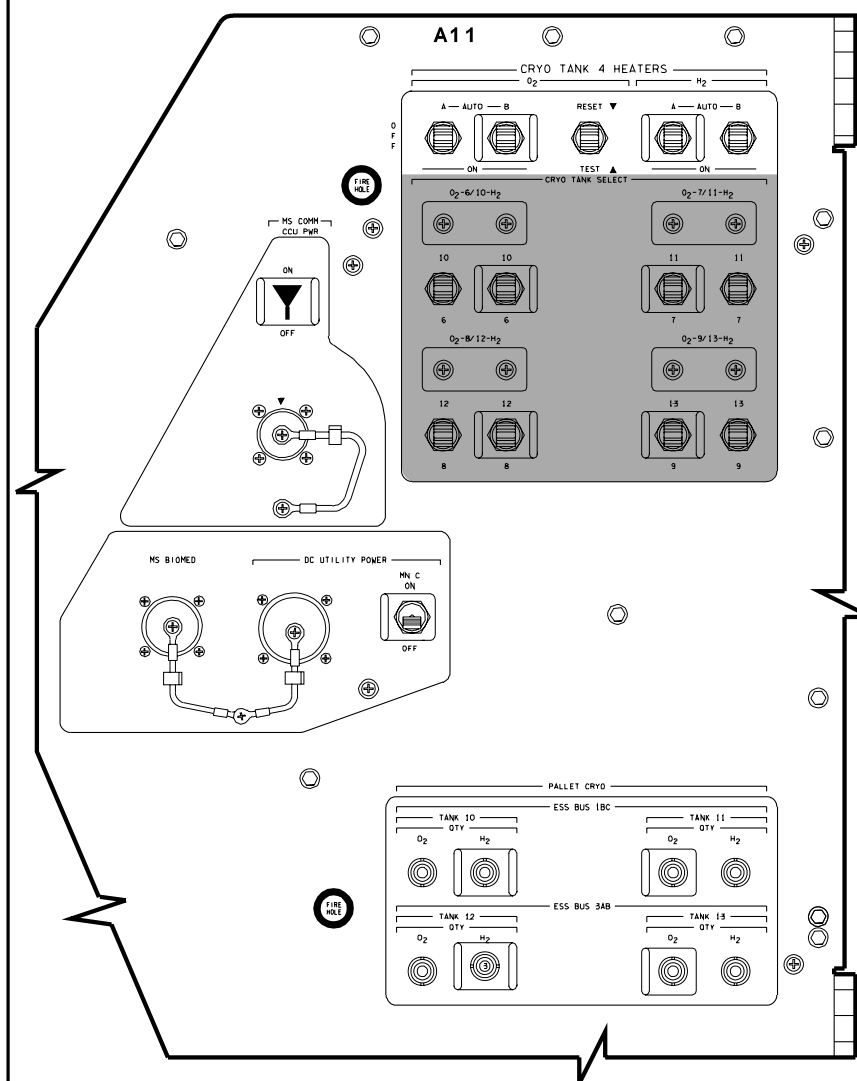

PNL A13

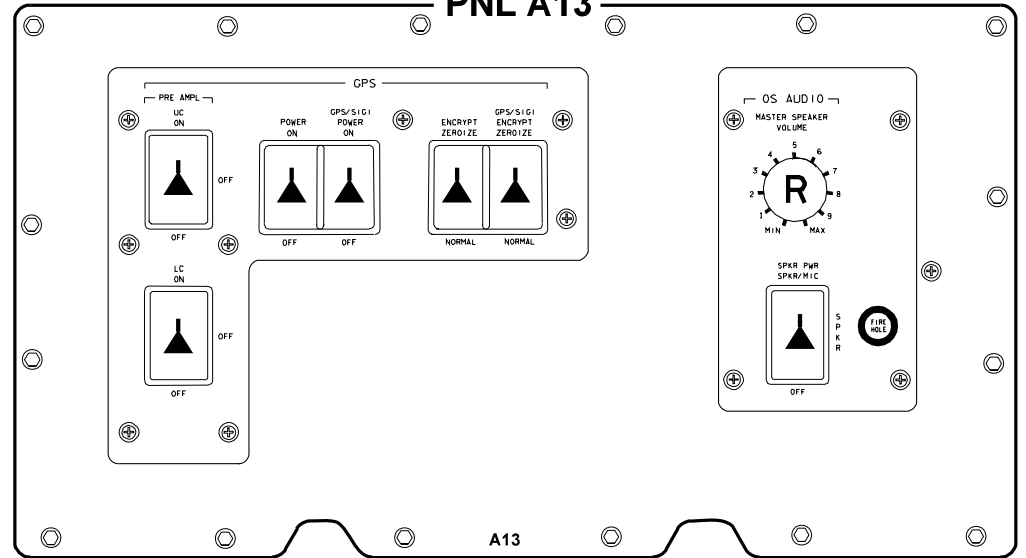

PNL A12

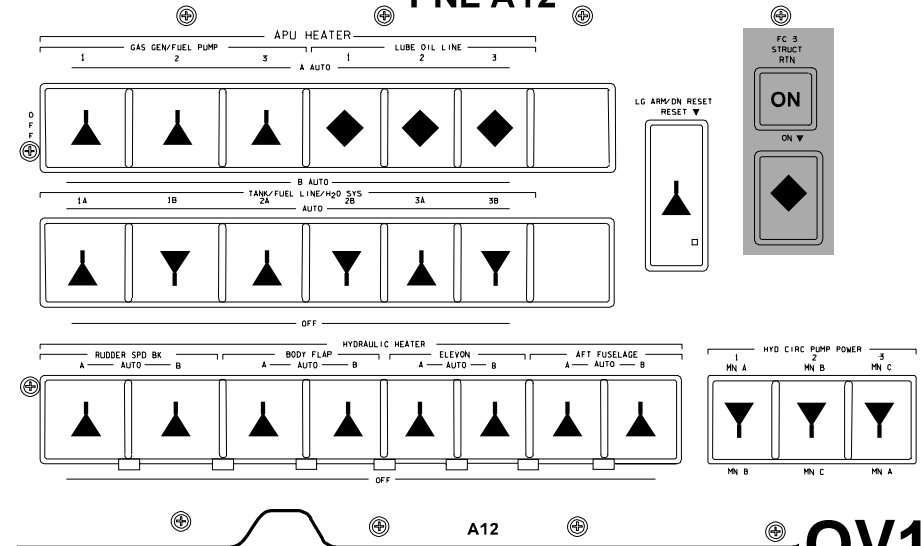

OV104

48007F625\_121, PNL 2

OV104/DATE 10/05/05

OV104

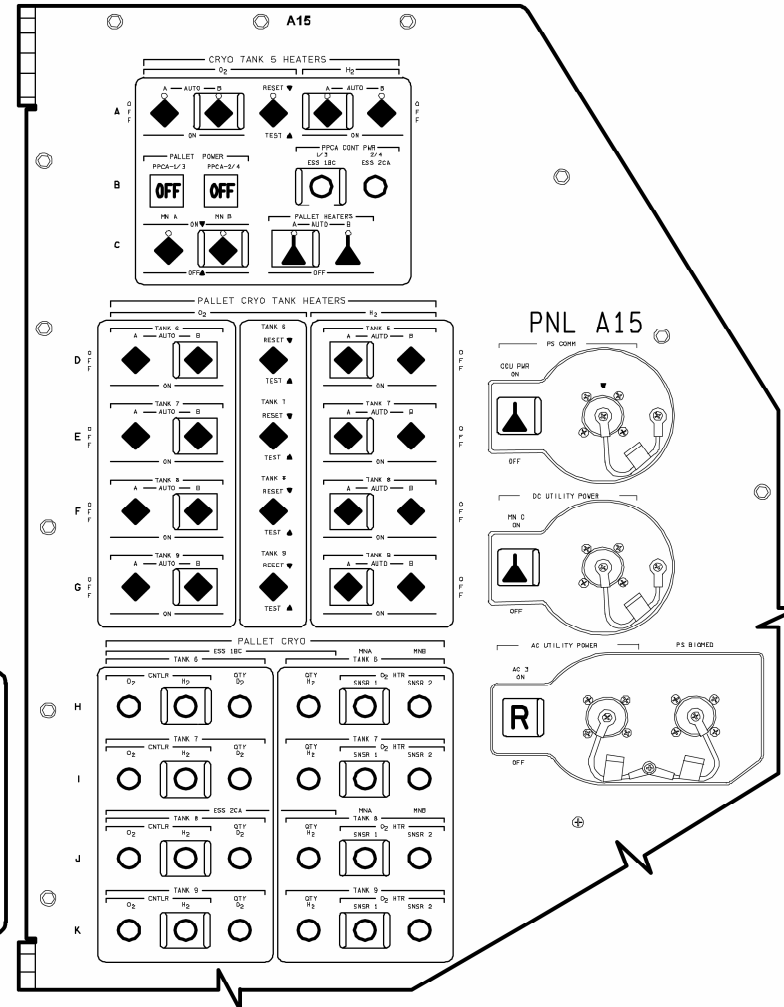
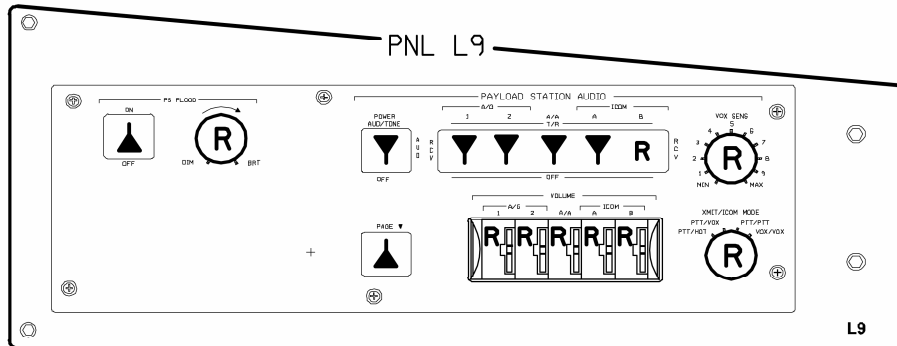
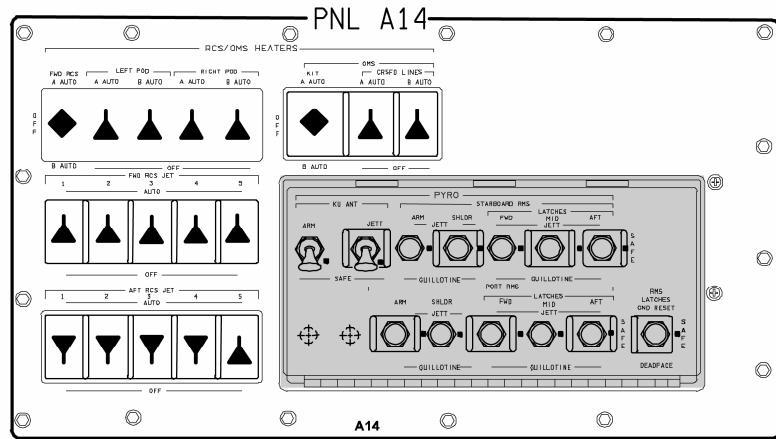

48007C626\_107, PNL 2

OV104/DATE 10/17/02

OV104

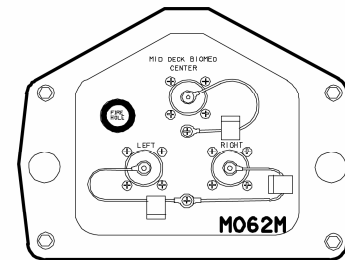
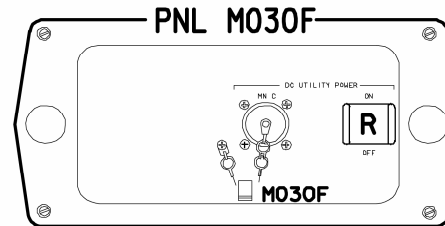
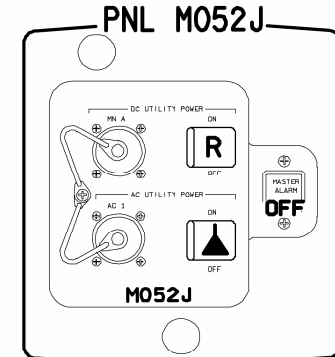
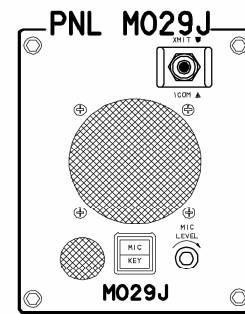
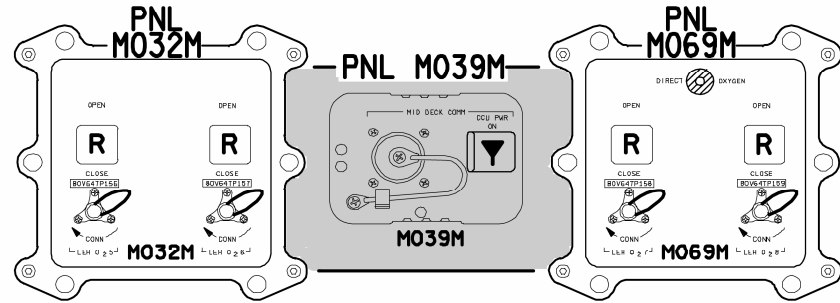
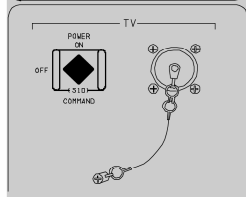
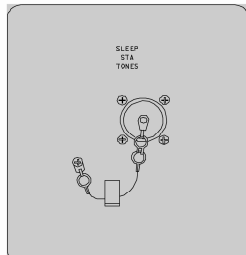
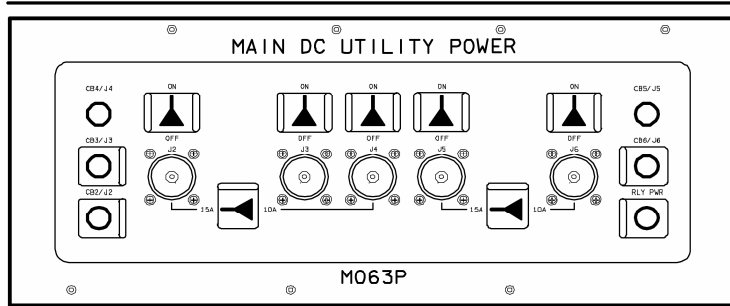
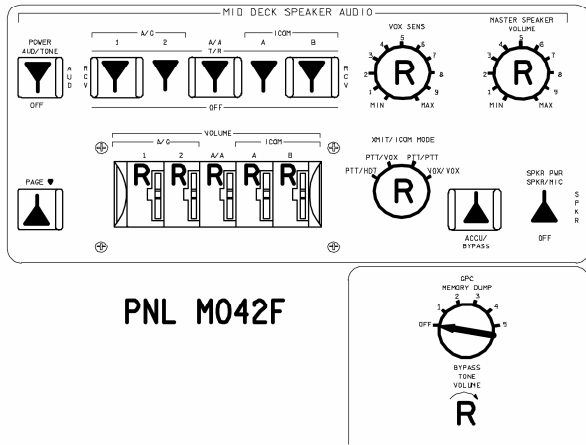

OV104

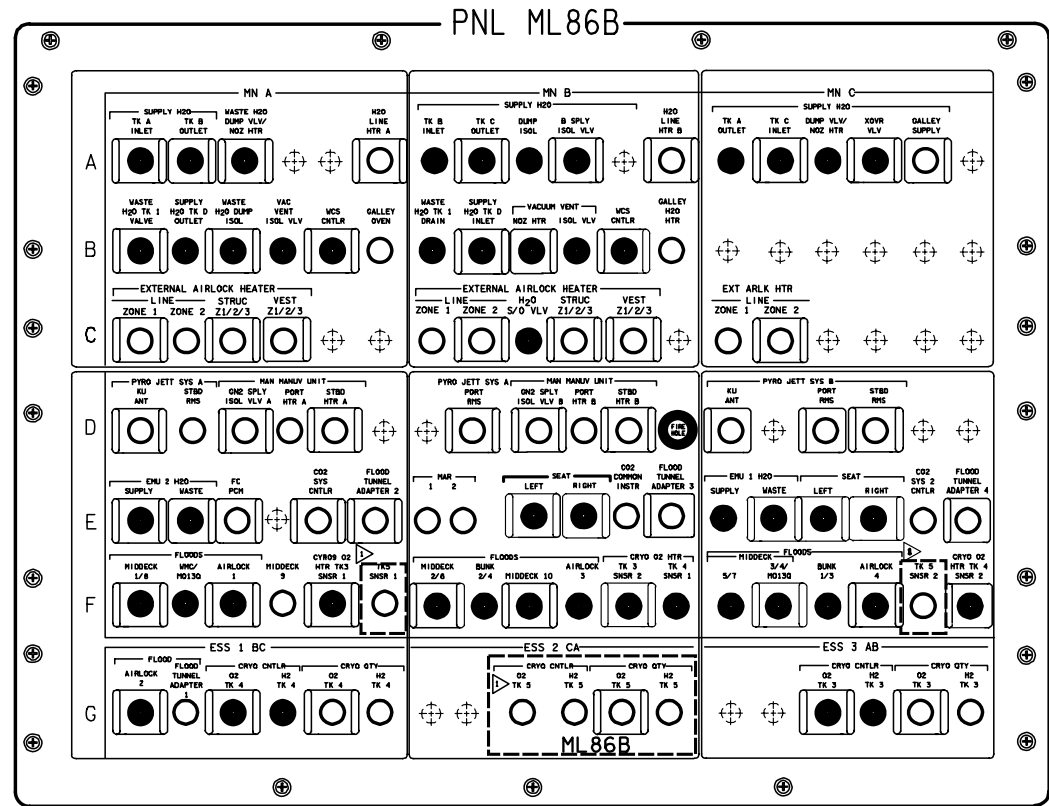
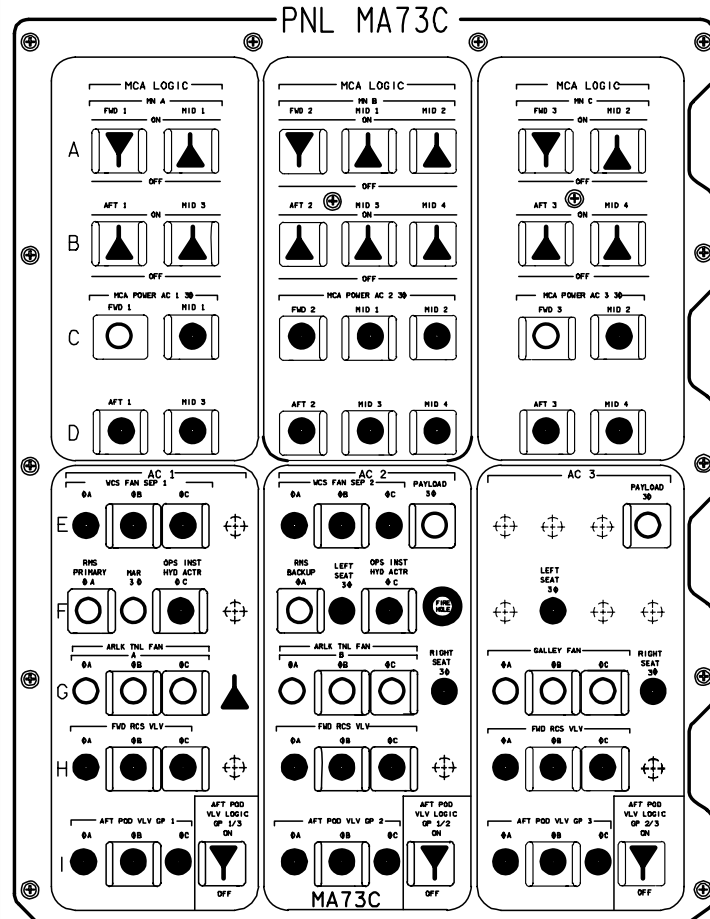

NOTES: ▷ CLOSED IF TK5 FLOWN

OV104

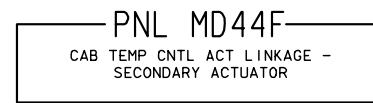
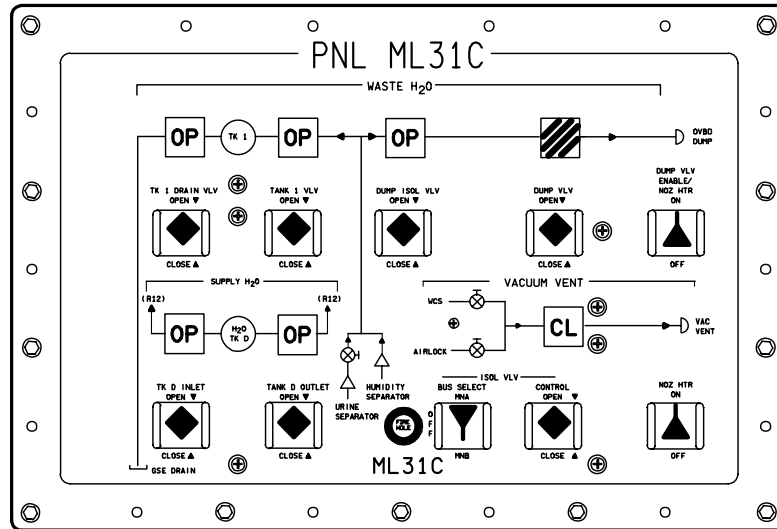
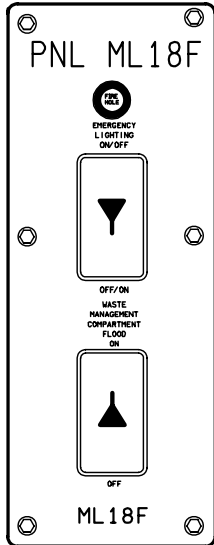
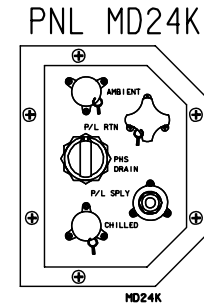
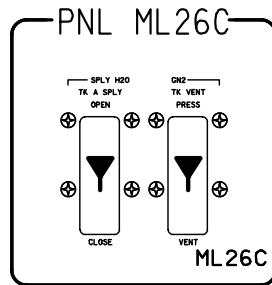
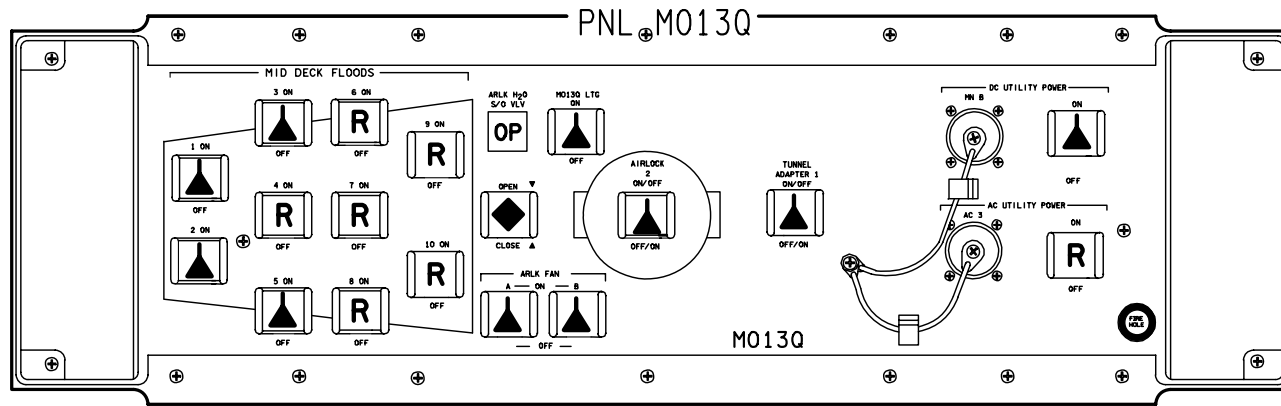

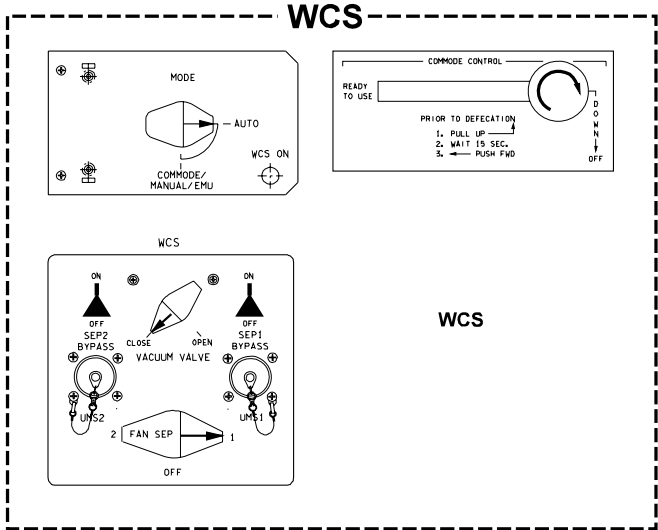
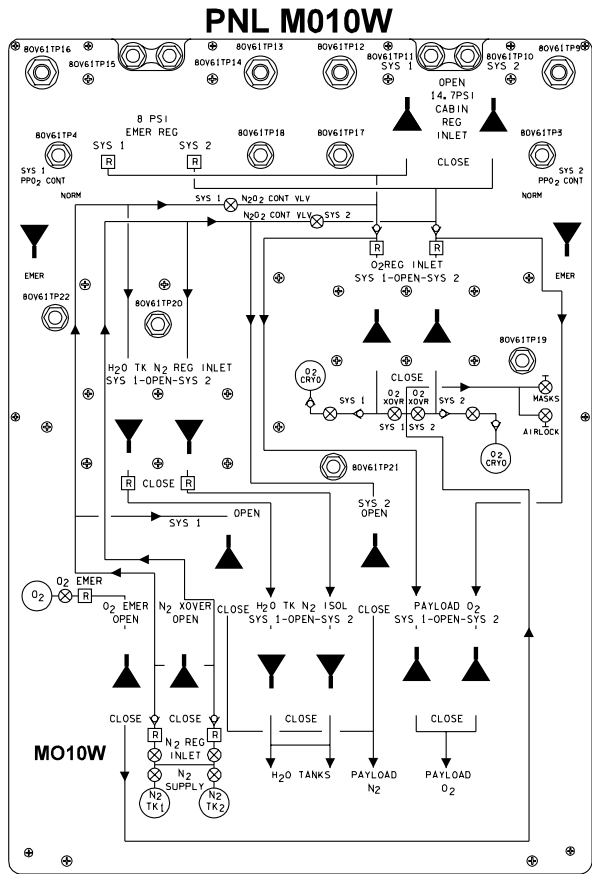



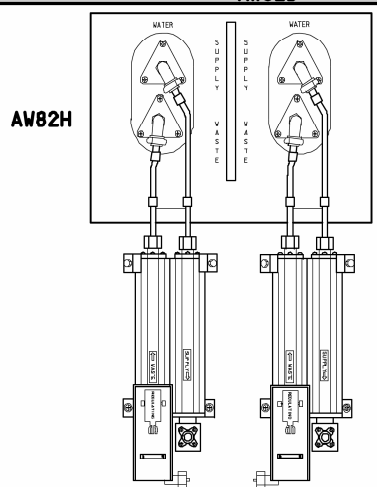
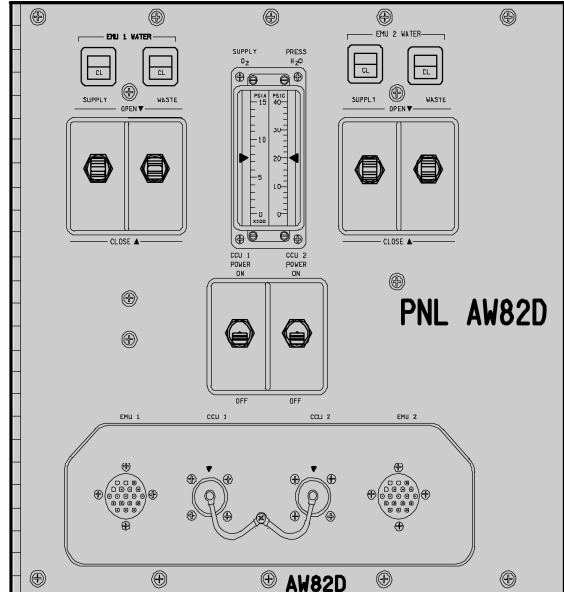
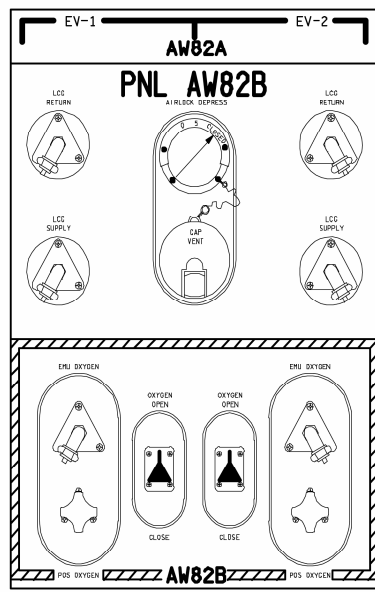
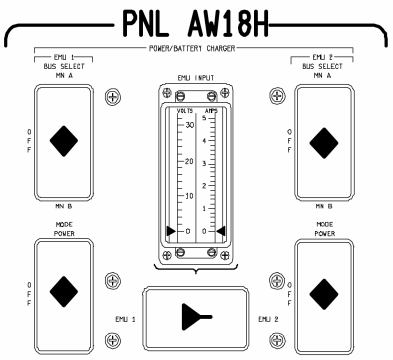
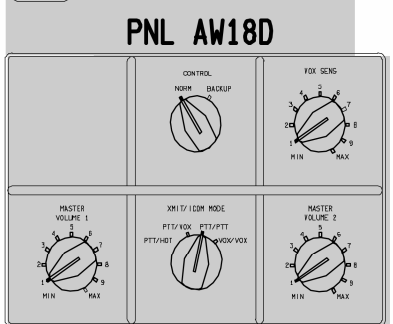
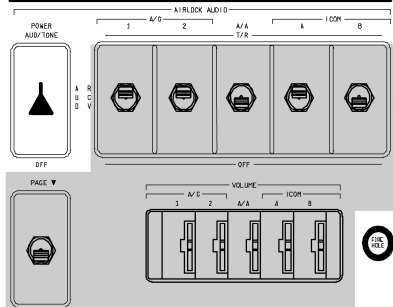
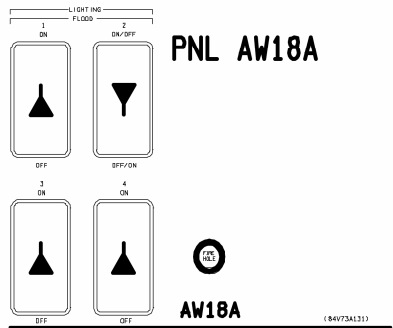

48007C631\_107\_PNL\_1 ALL VEH/DATE 10/08/02

### **Inner Hatch**

Actuator Handle – LATCHED

Lock Lever – LOCKED

Equalization vlv (two) – NORM, capped

OV105

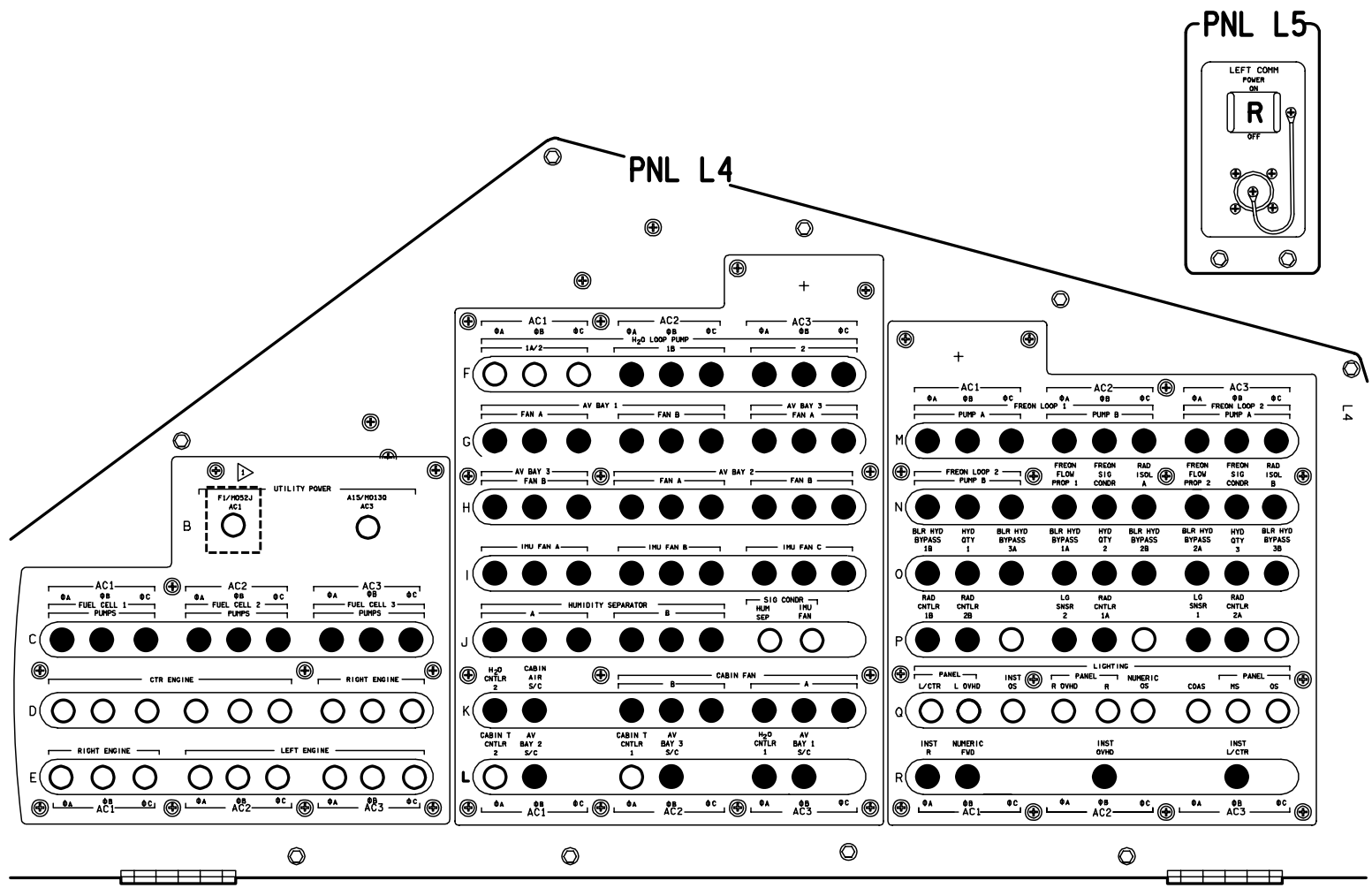

NOTE: ▸ CB CAN REMAIN CLOSED FOR AC PGSC USAGE.  
 OPEN WHEN PGSC UNPOWERED/STOWED

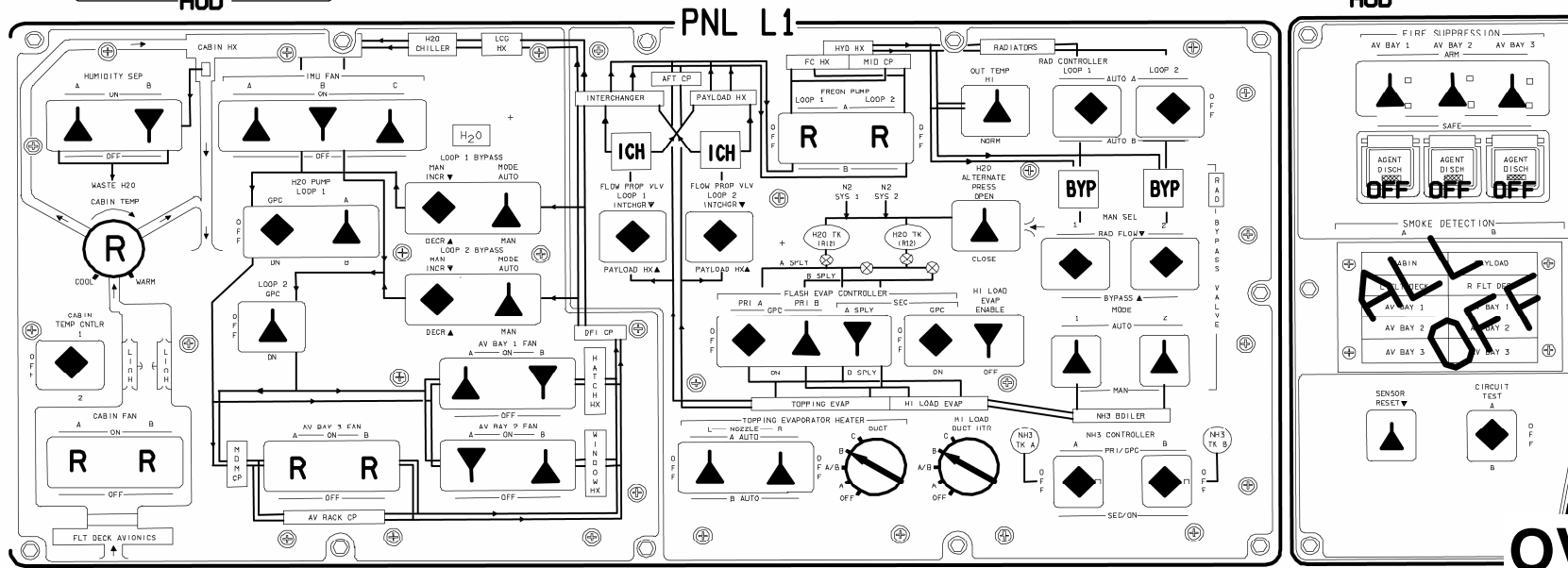
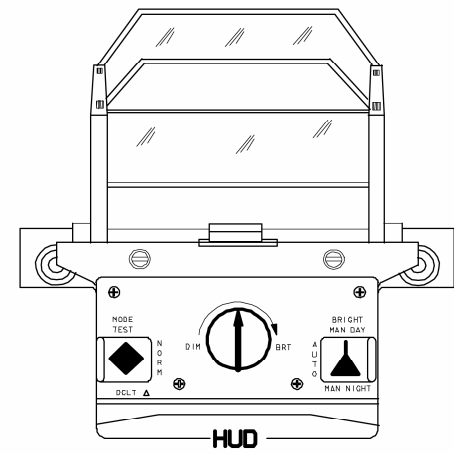
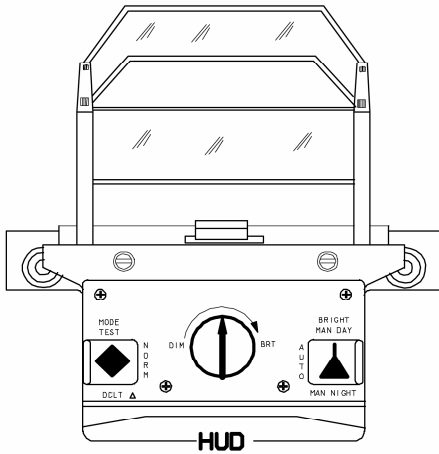
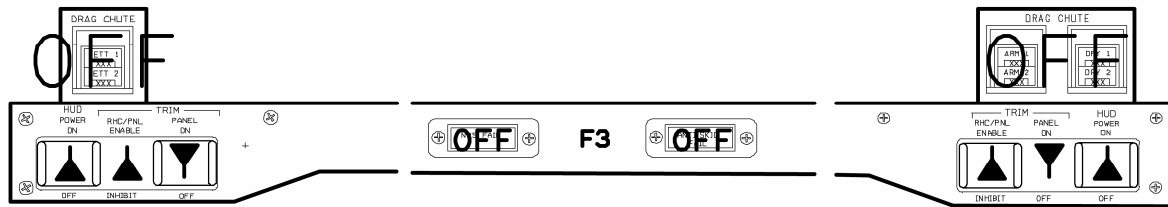

**OV105**

OV105

PNL L2

PNL F1

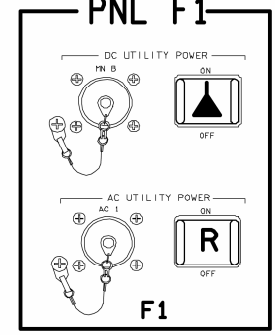
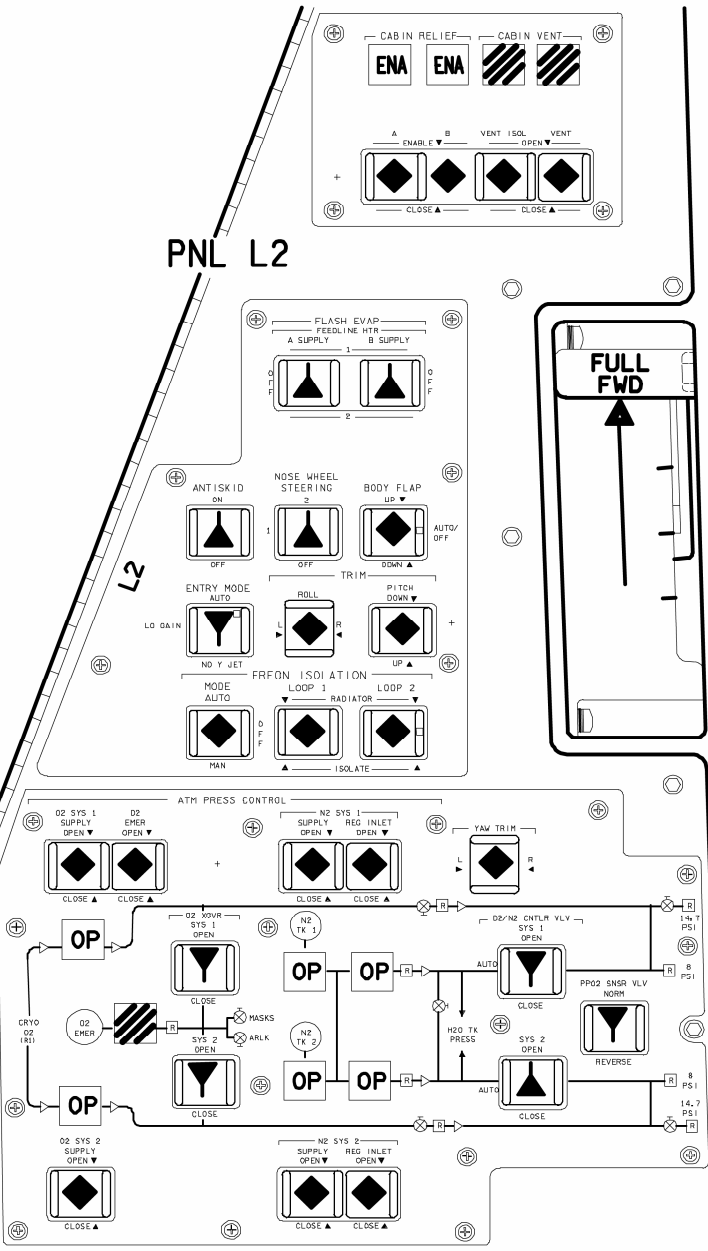

FULL FWD

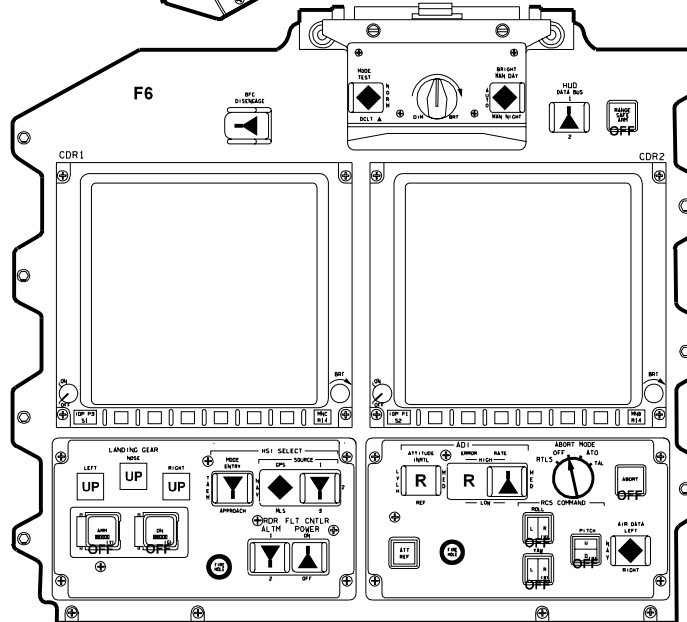
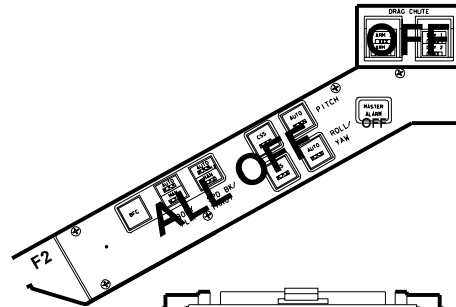
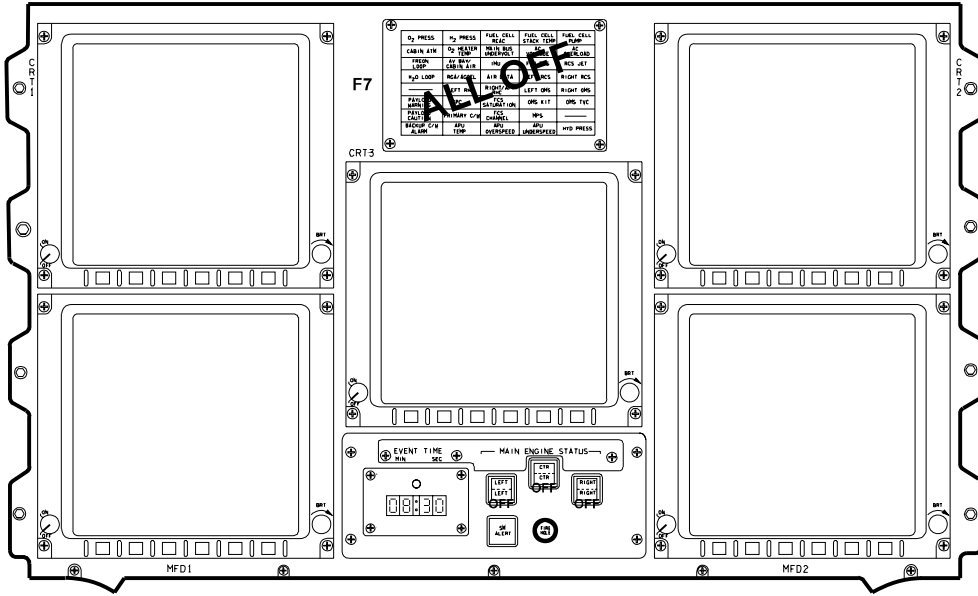

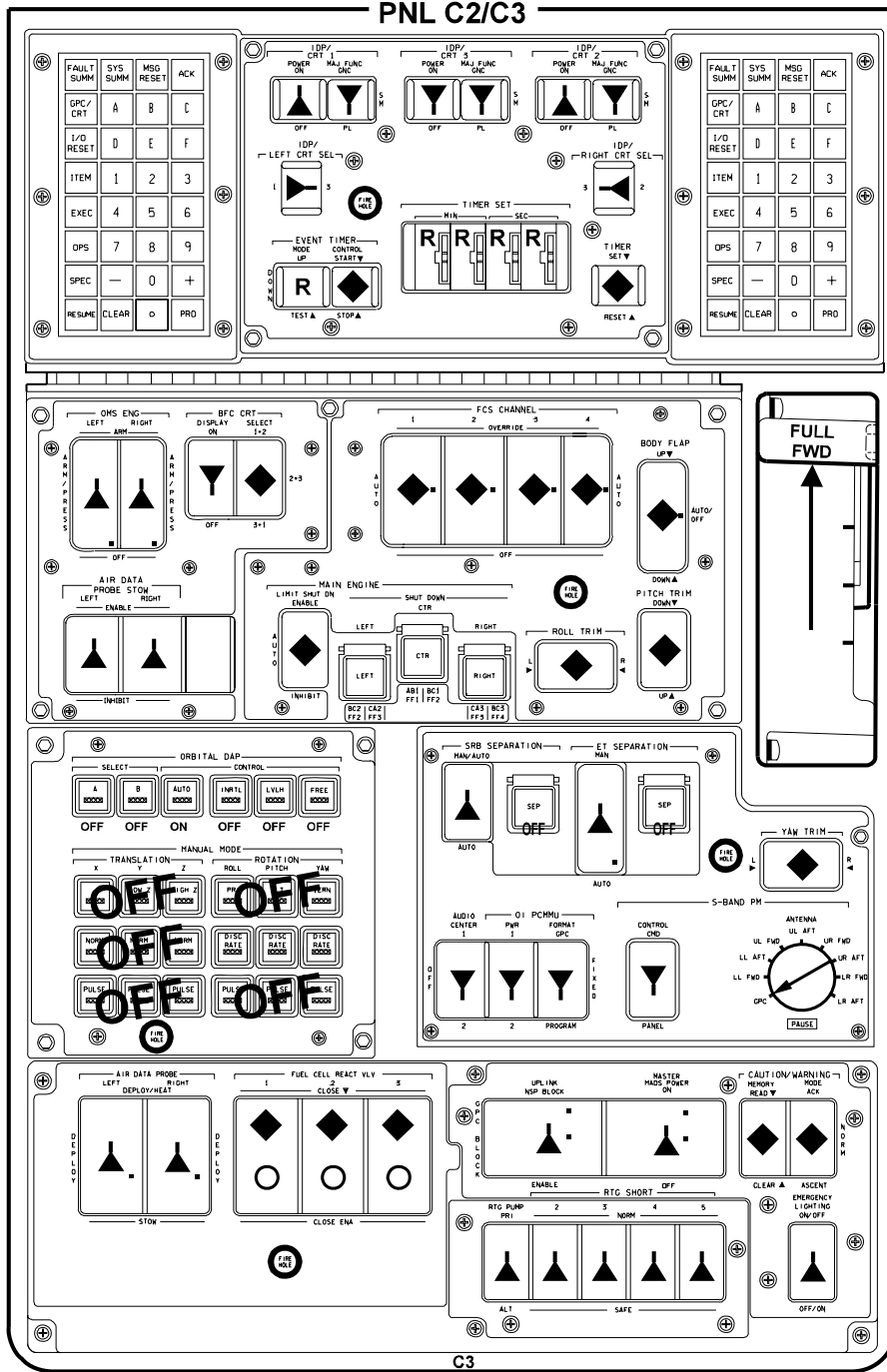

OV105

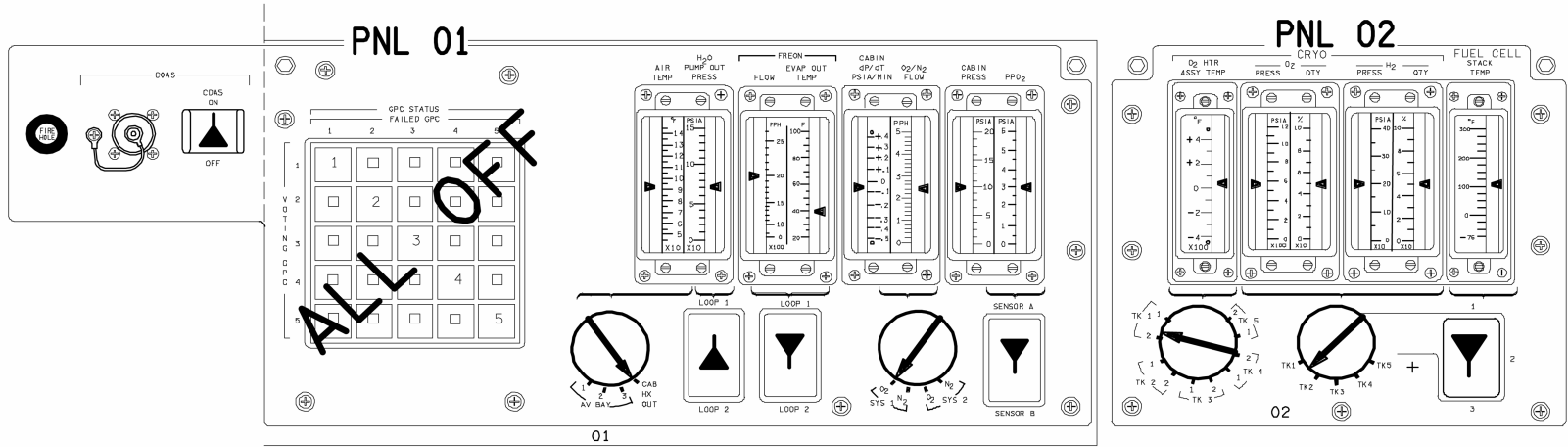

ALL OFF

L side OVHD flood - R (MID)

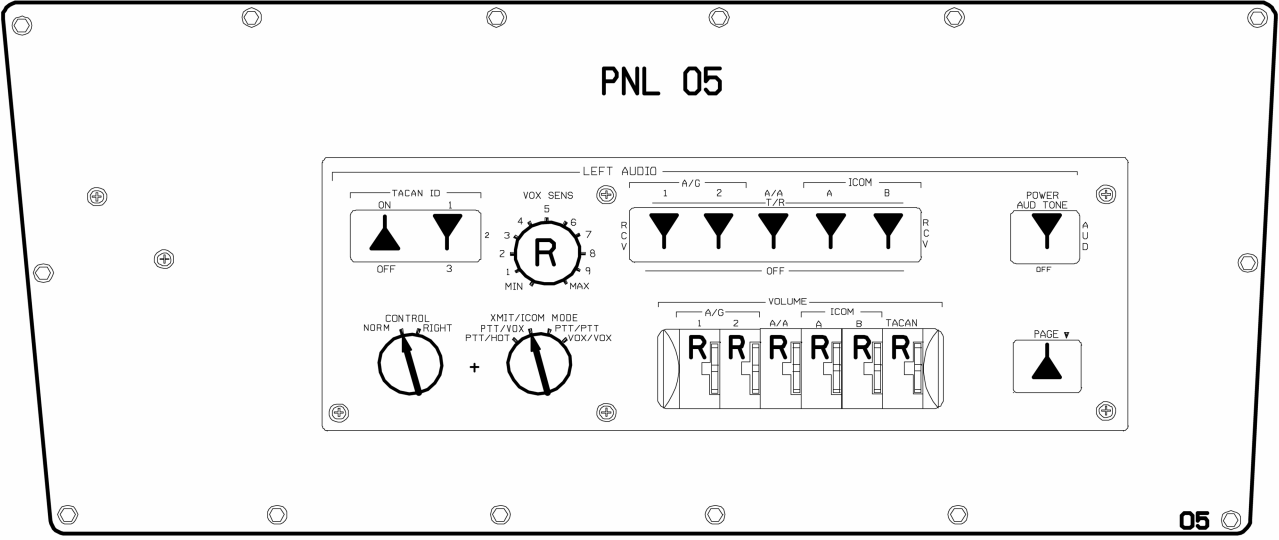

OV105



OV105

PNL 06

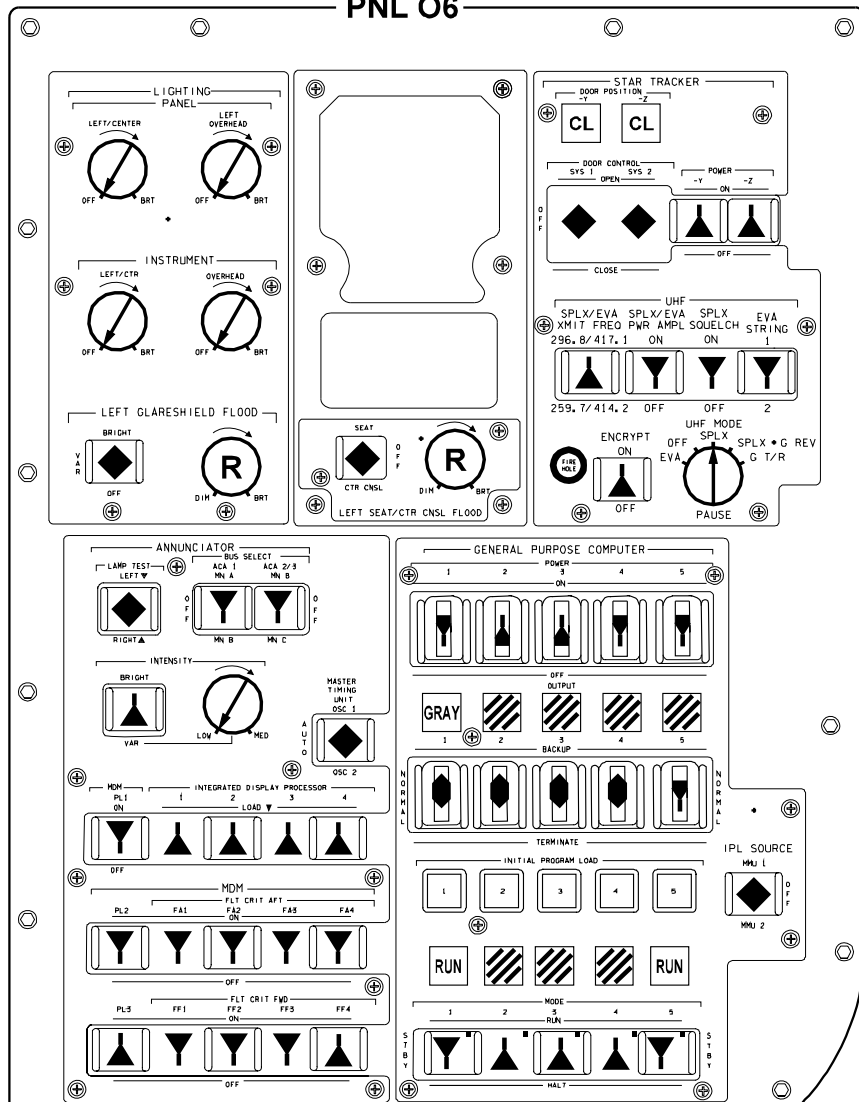

PNL 07

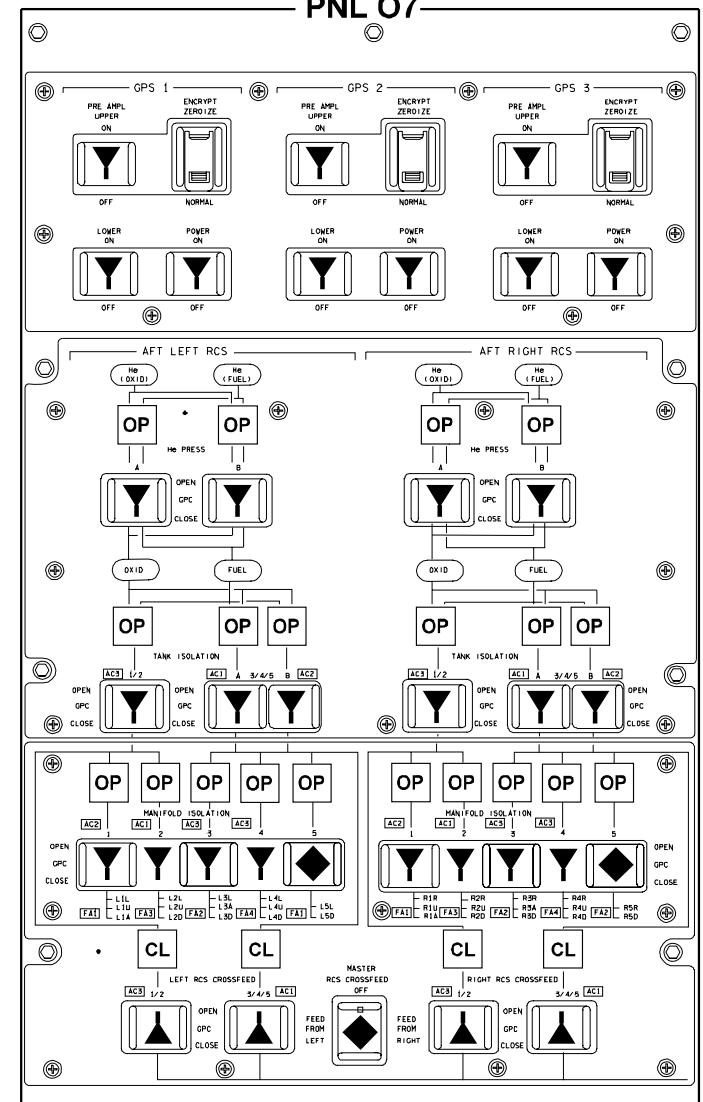

PNL 08

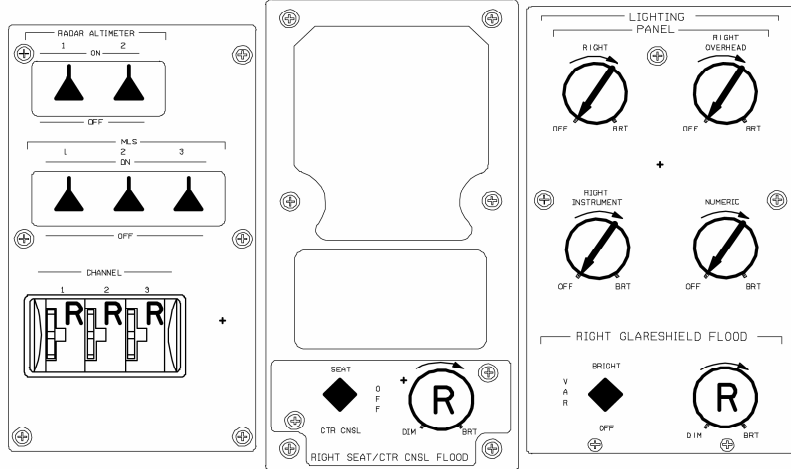

PNL 09

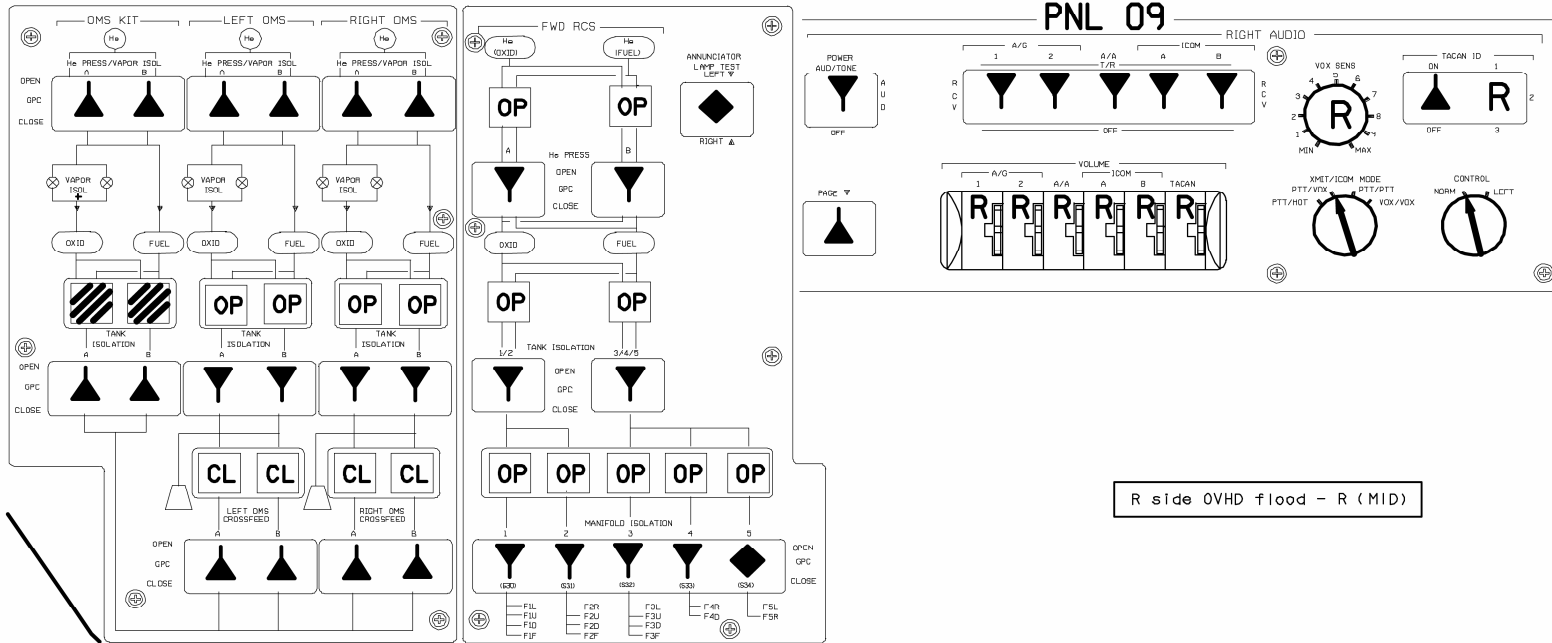

R side OVHD flood - R (MID)

OV105

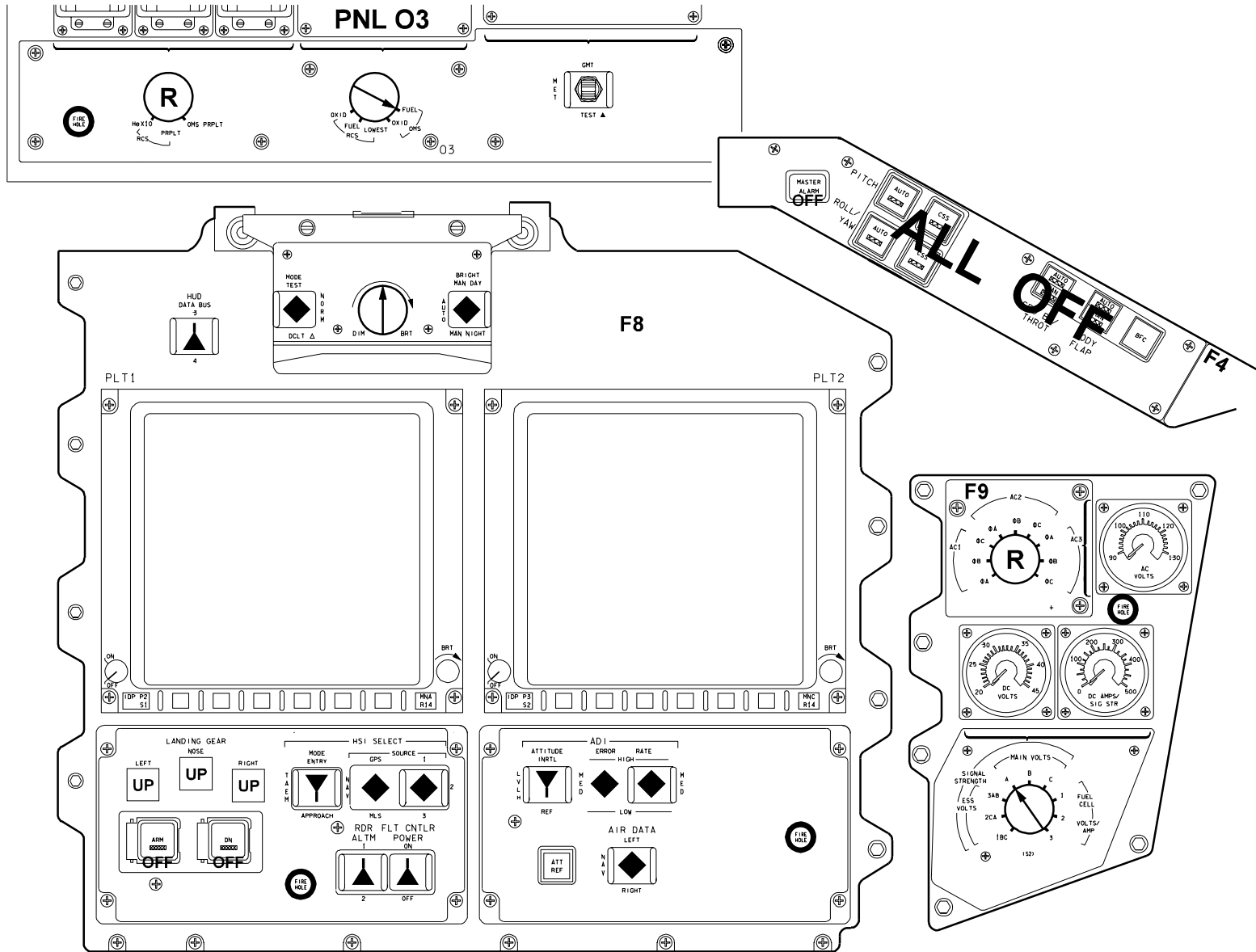

OV105

PNL R1

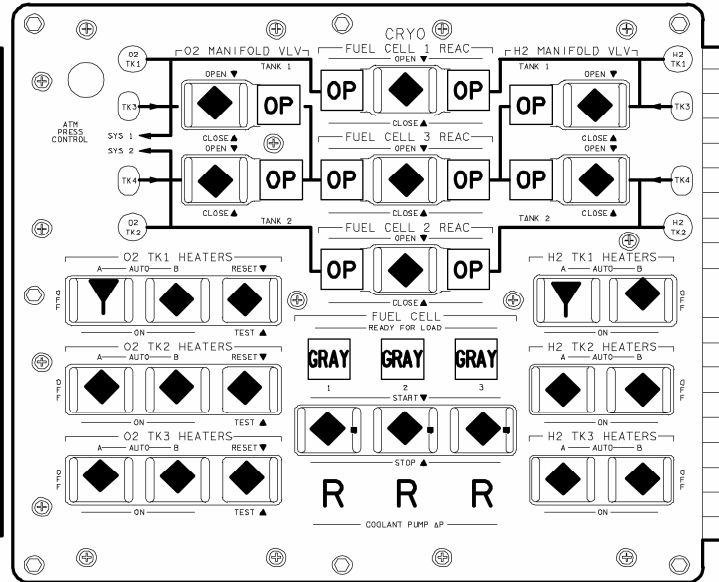
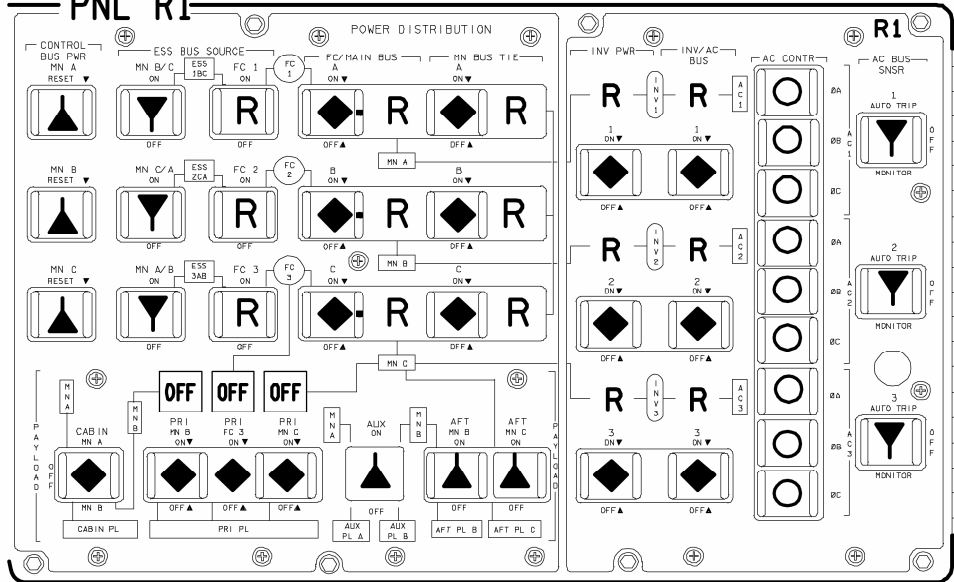

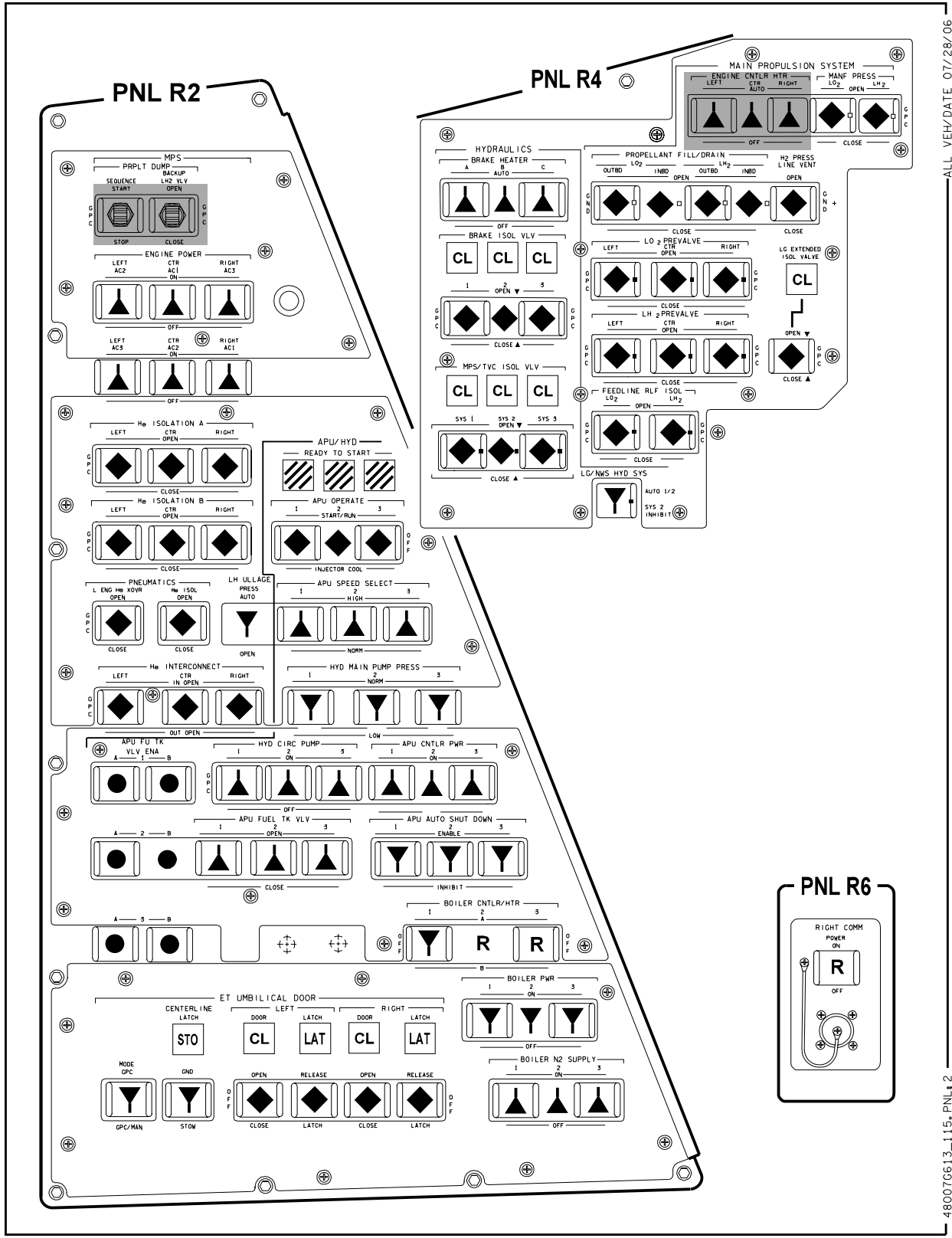

**OV105**

(OV105) C6-13

C D/O/ALL/GEN M

This Page Intentionally Blank

# OV105

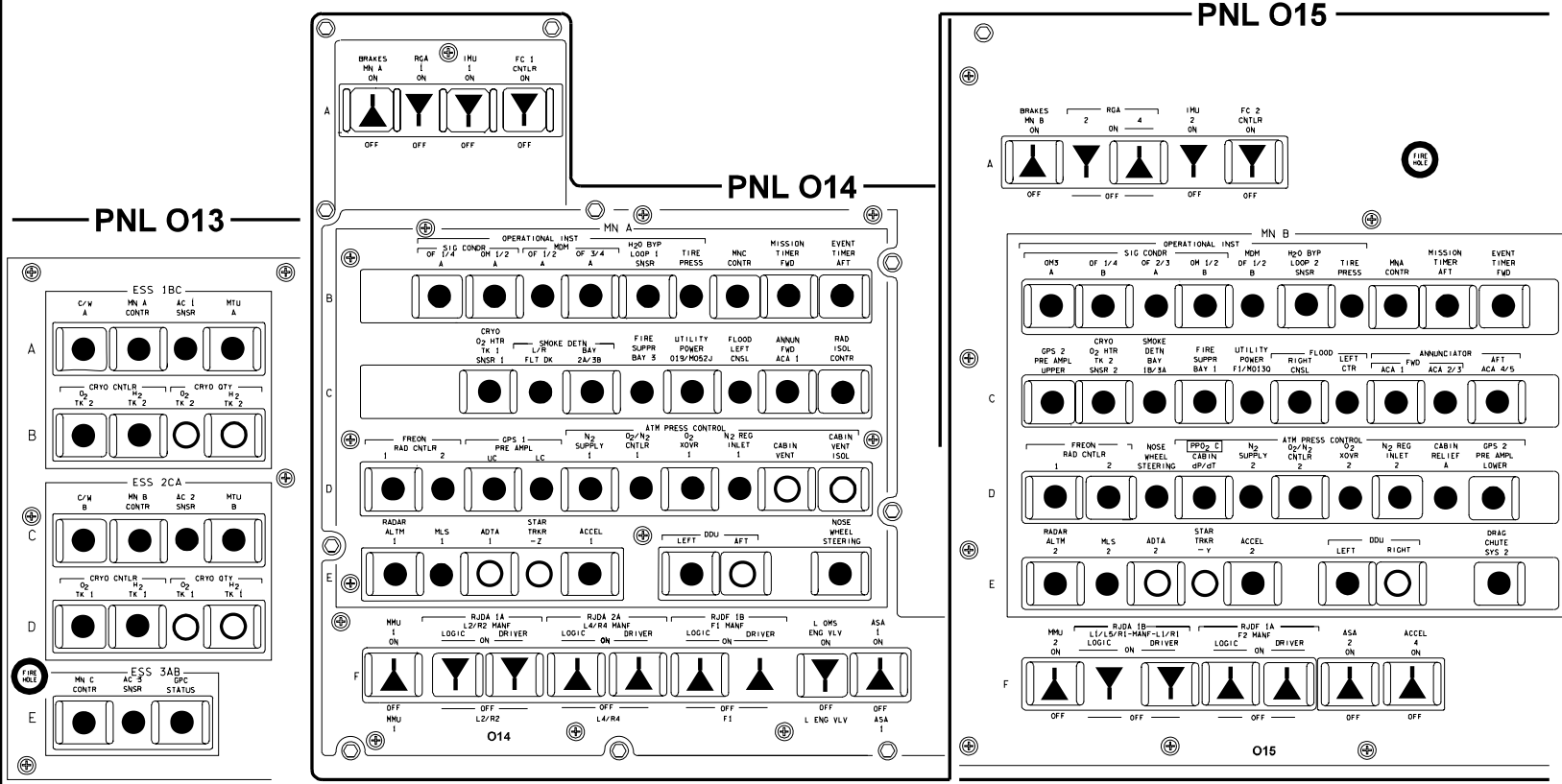

OV105

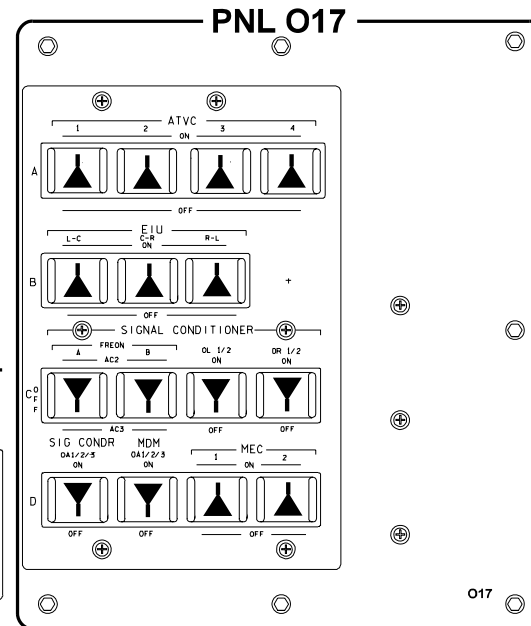
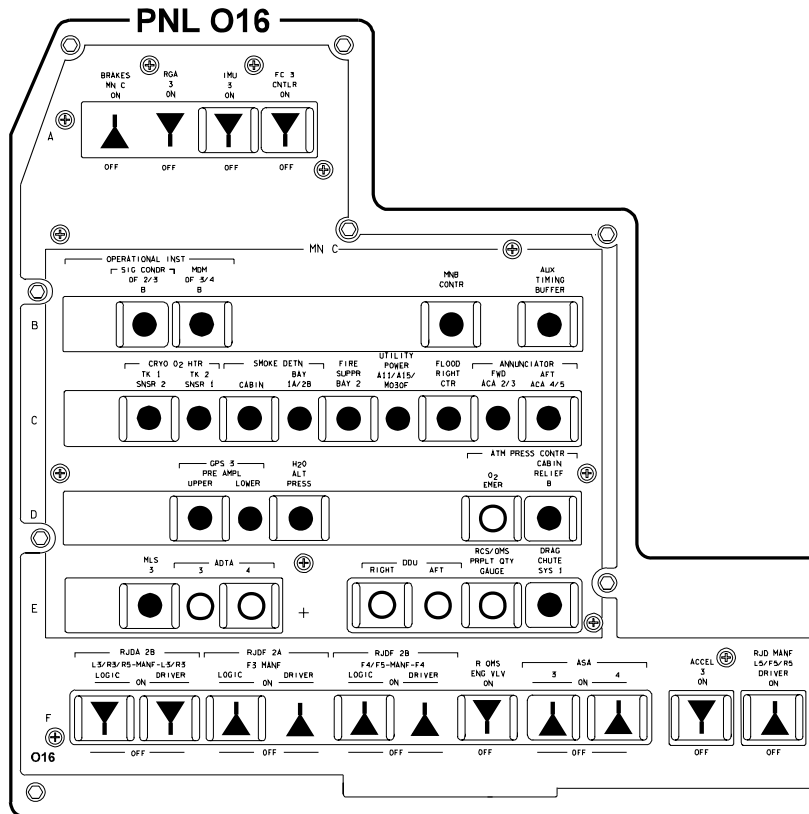



OV105

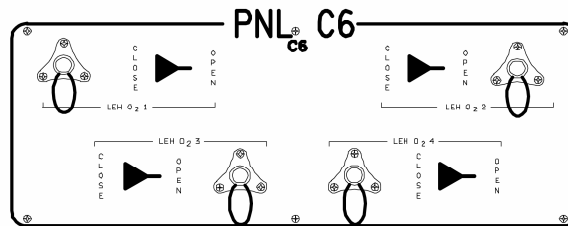
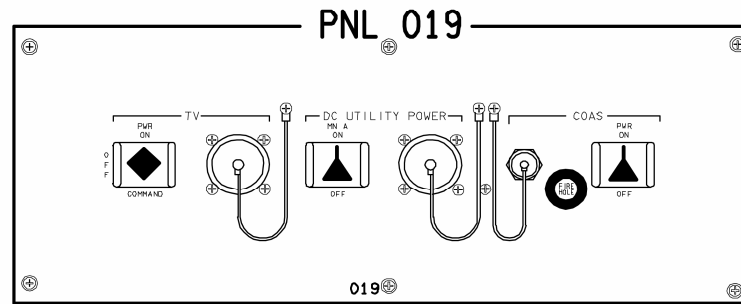

PNL C5

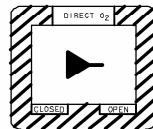

PNL C7

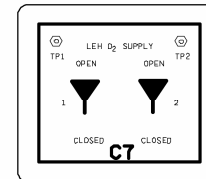

# OV105

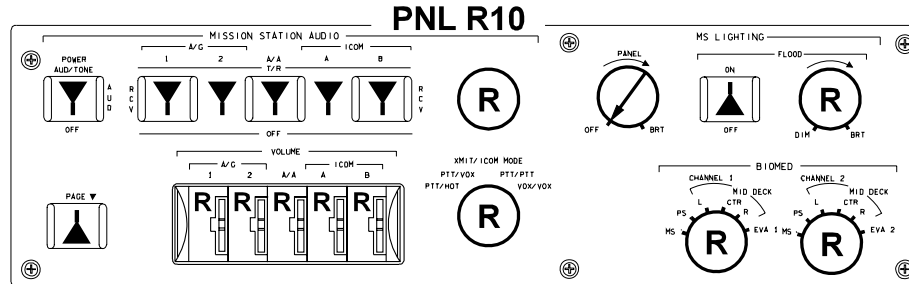

**ACTIVATION**  
 R10 MS AUD PWR - AUD/TONE  
 All other sws - as reqd  
 R12 MS AUD CONTRL - NORM  
 A11 MS COMM CCU PWR - ON

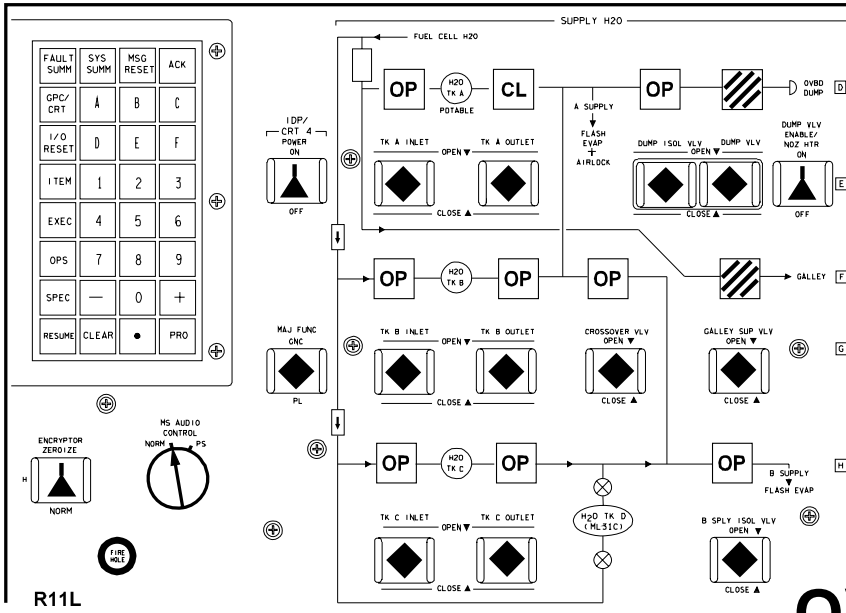
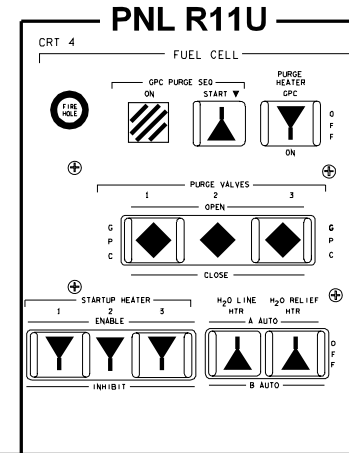

# OV105

OV105

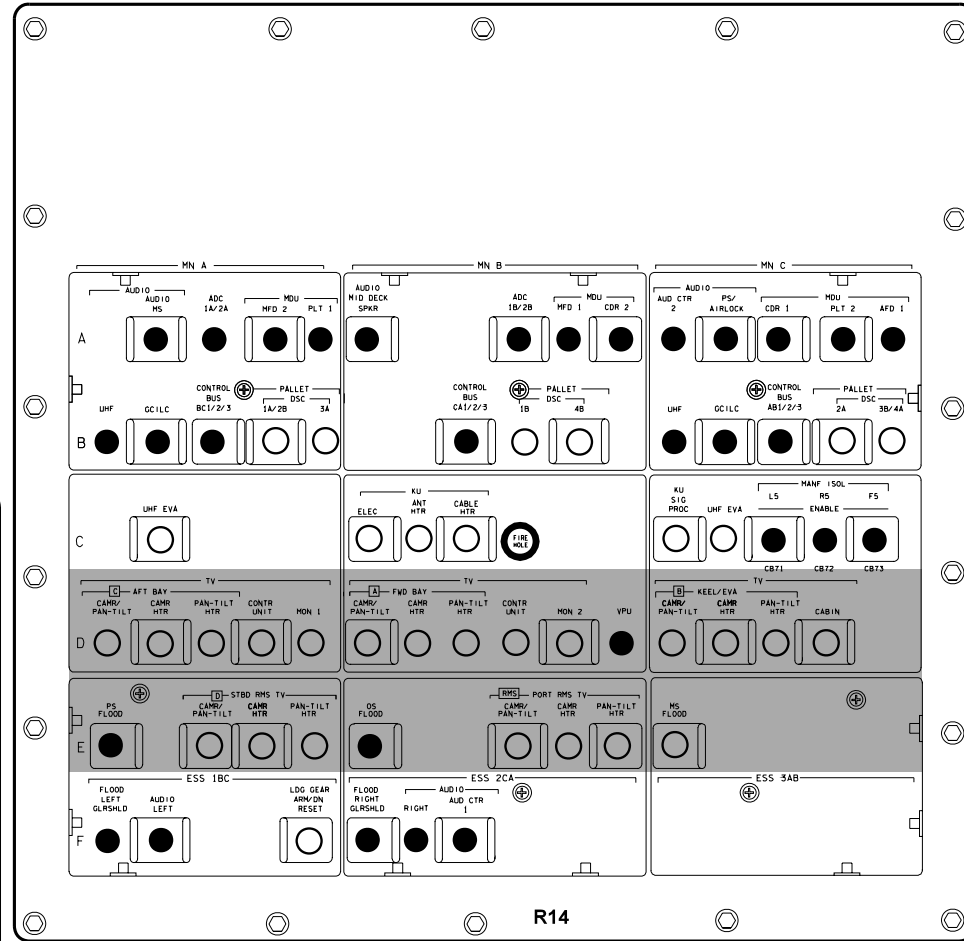
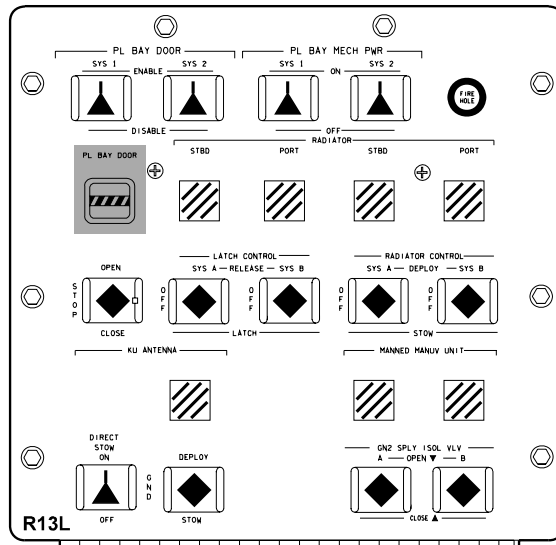
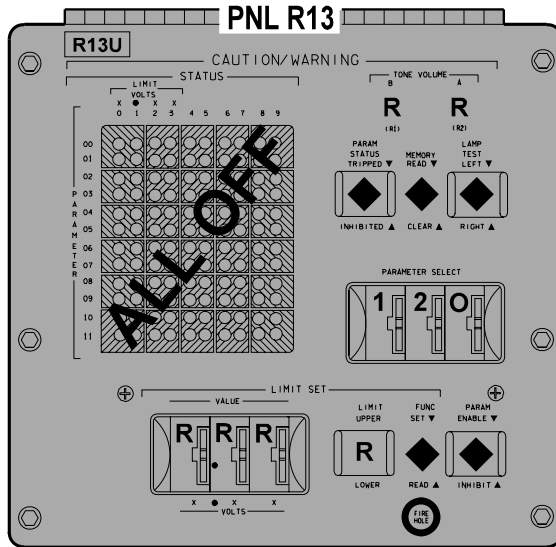

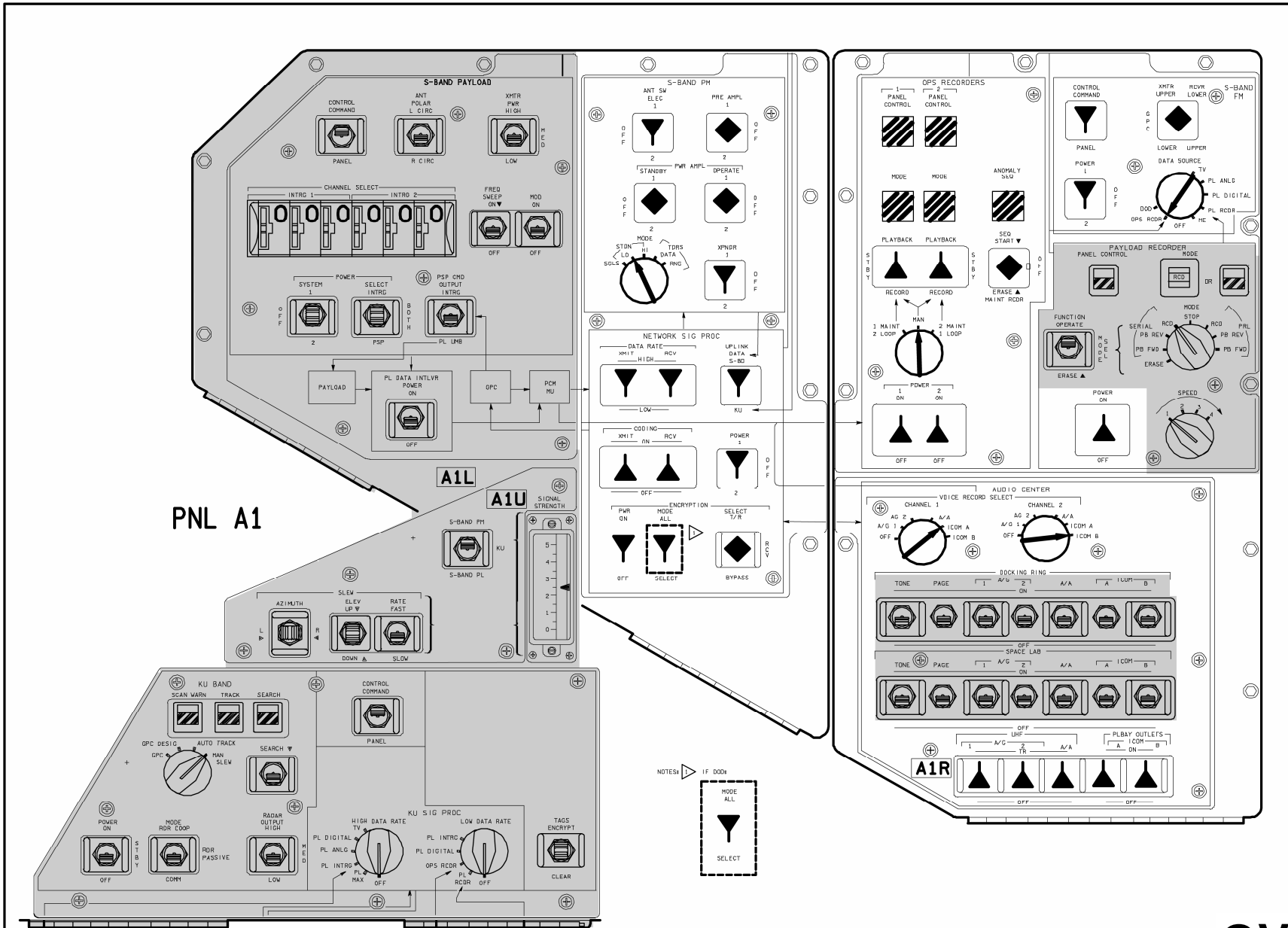

**OV105**

OV105

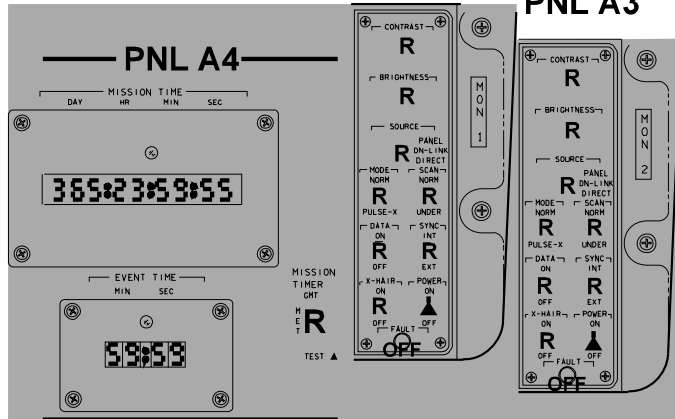

PNL A3

PNL A6U

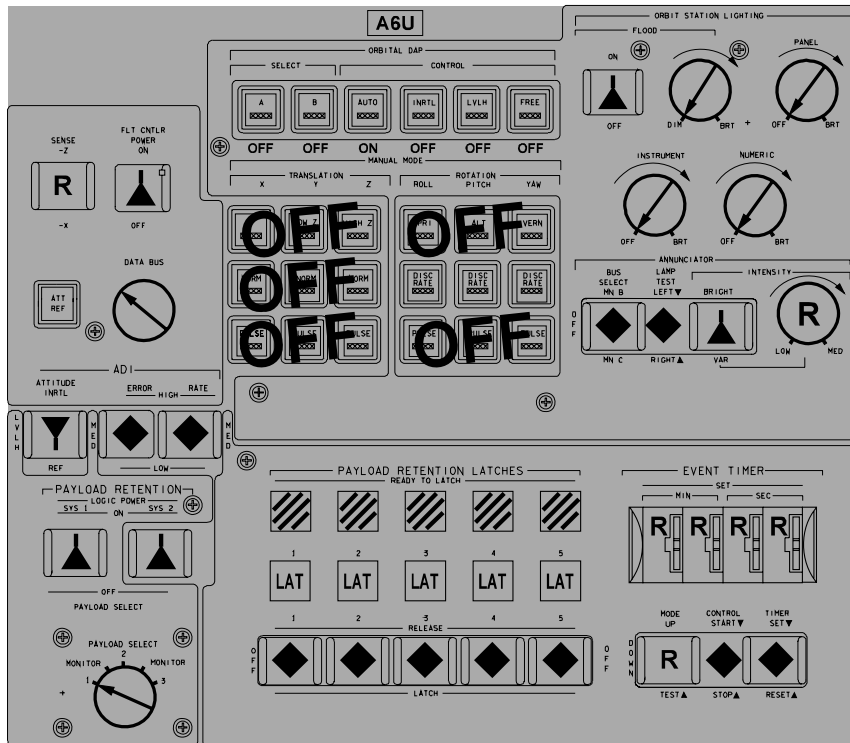

PNL A7U

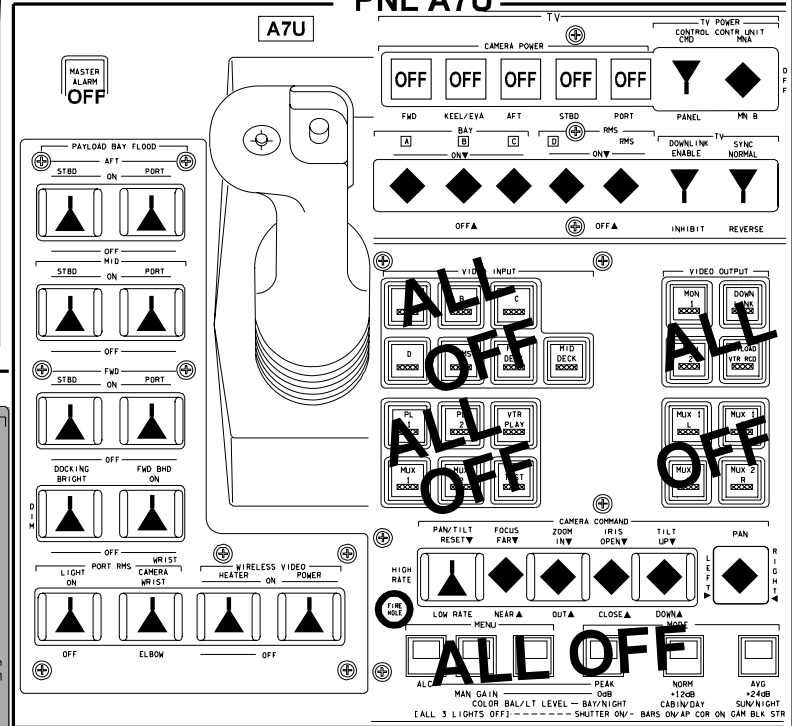

A6L

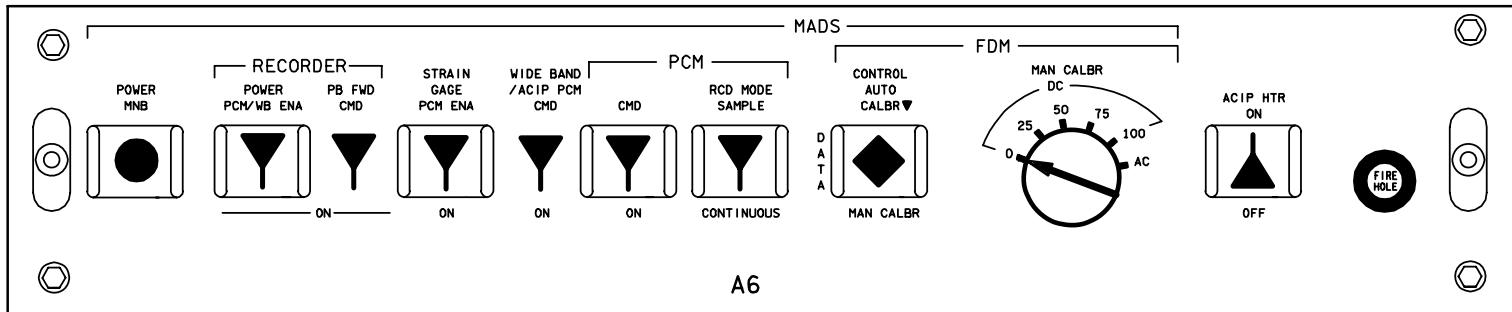
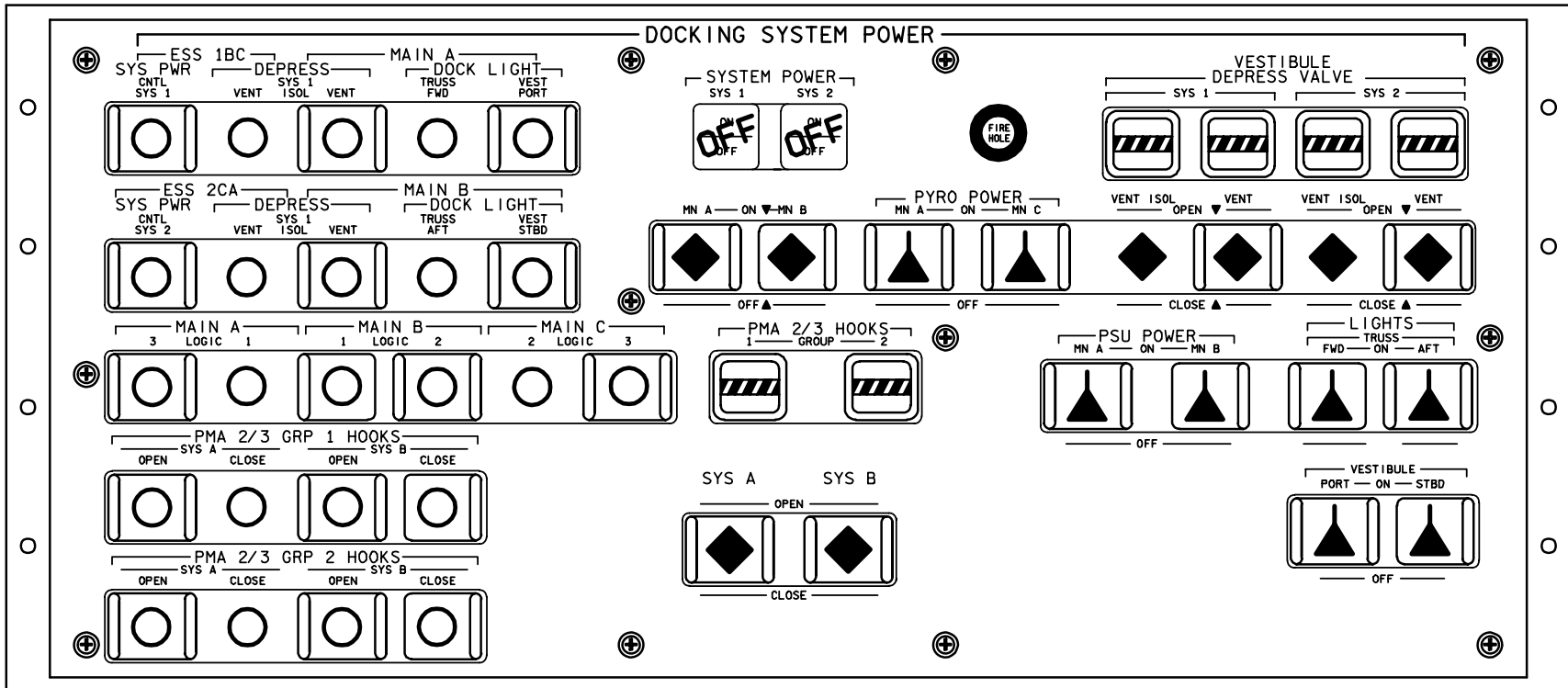

A6

OV105

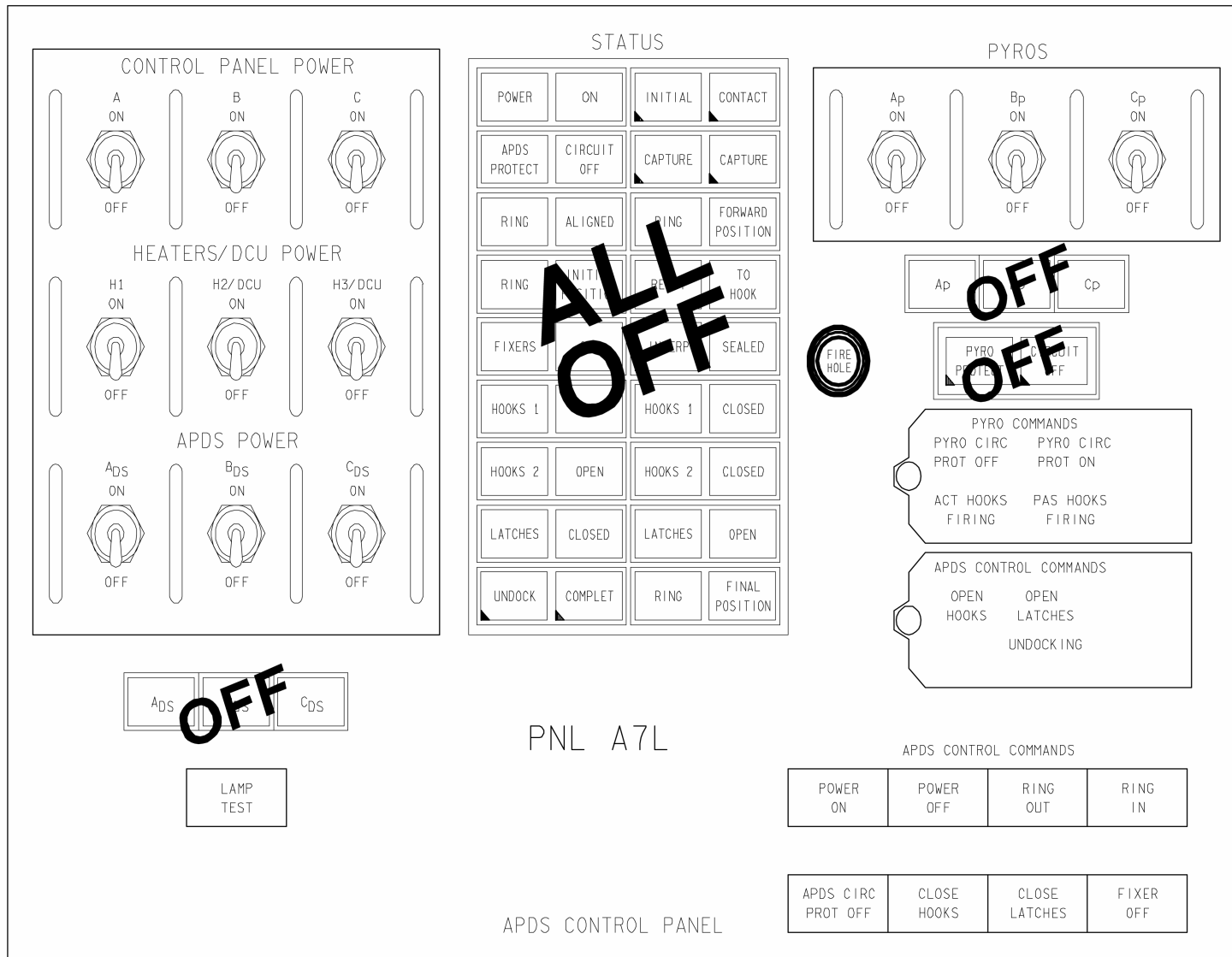

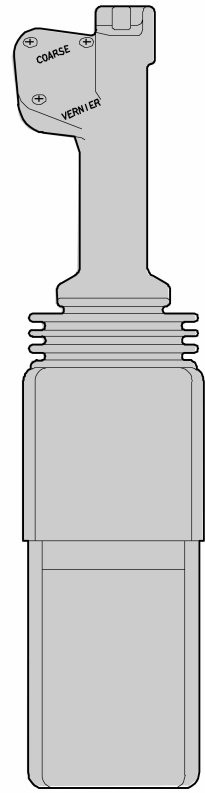
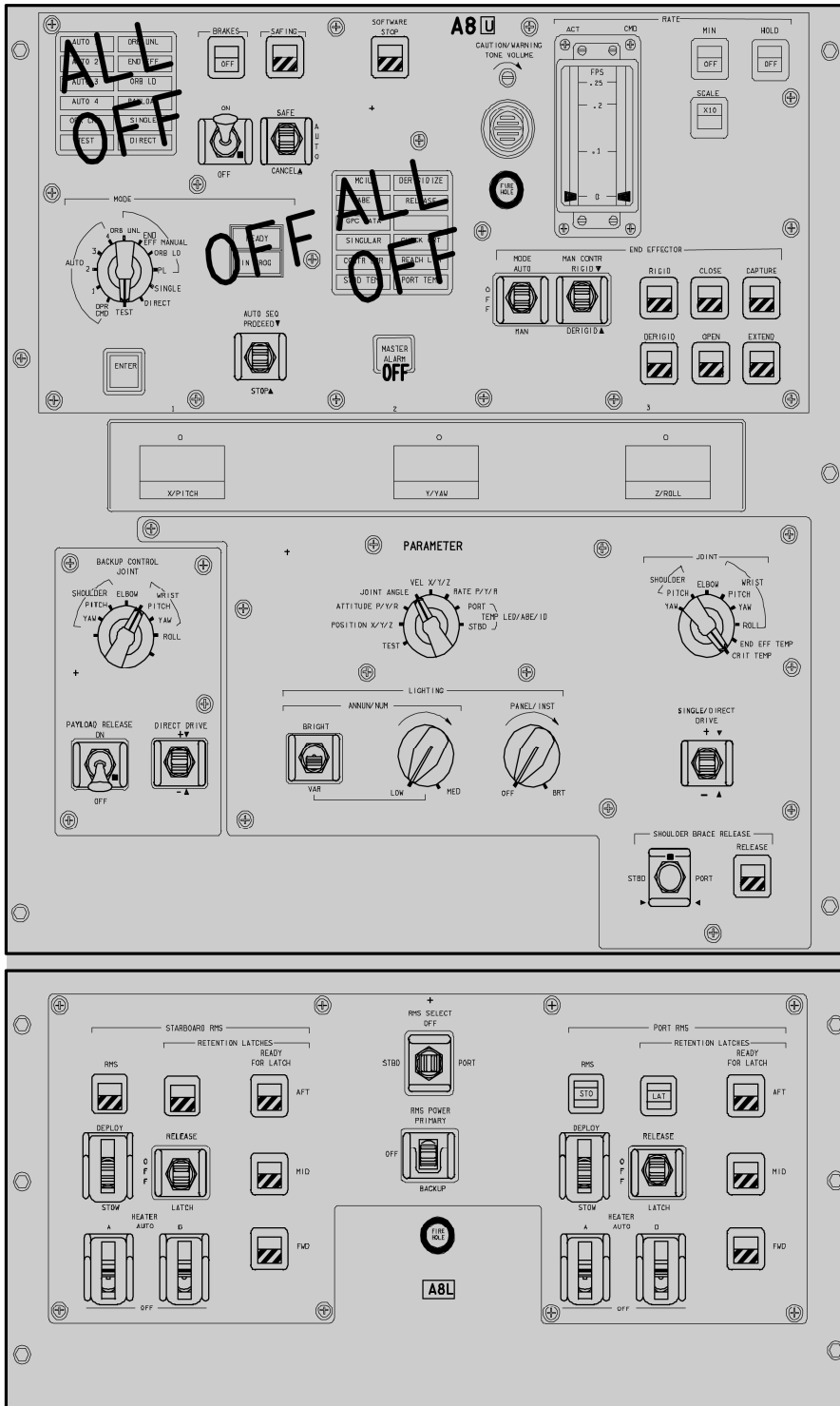



OV105

PNL A11

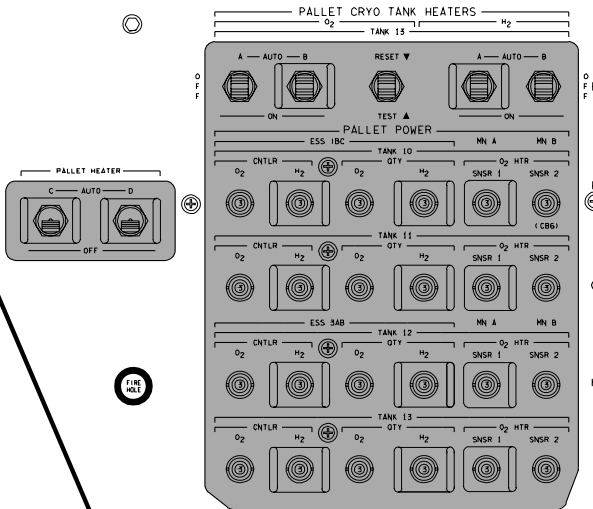
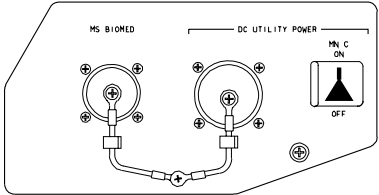
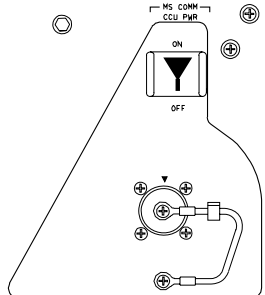
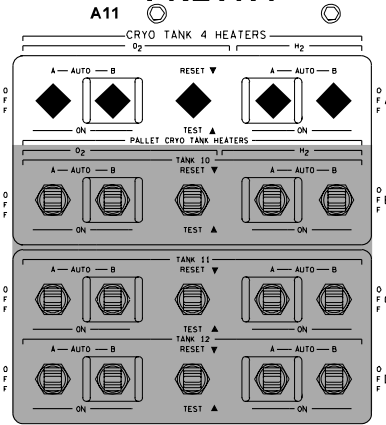

PNL A13

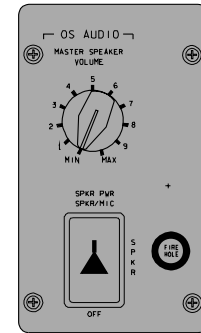

A13

PNL A12

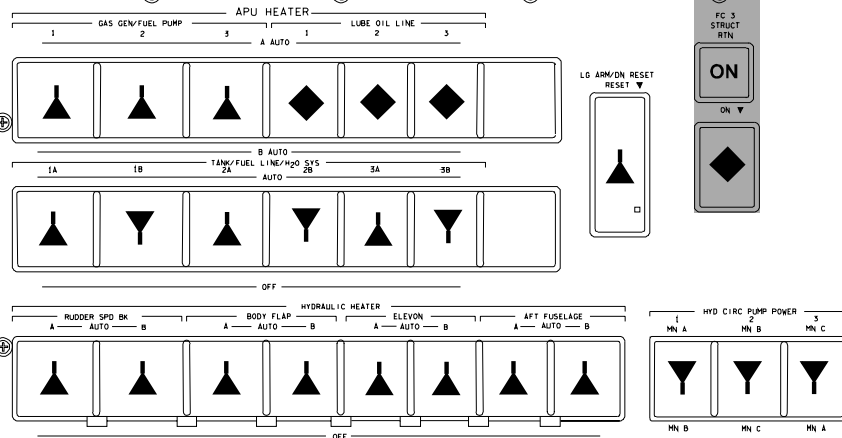

A12

OV105

OV105

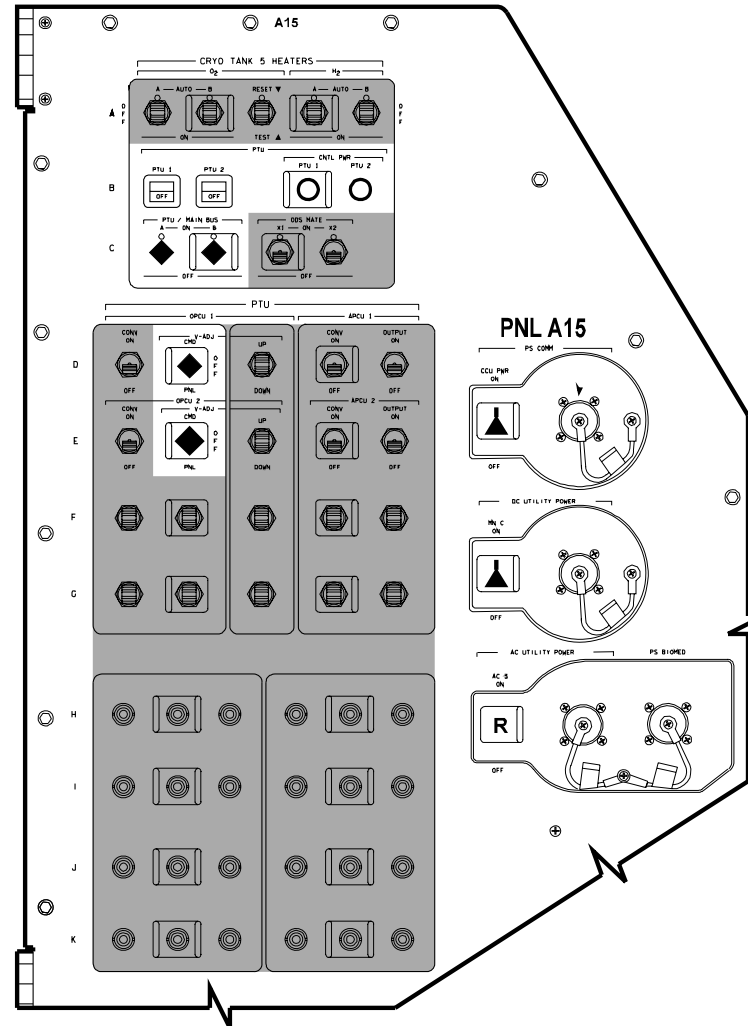
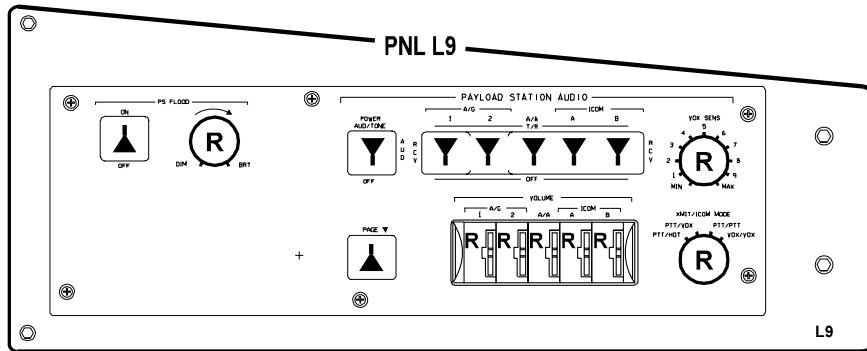
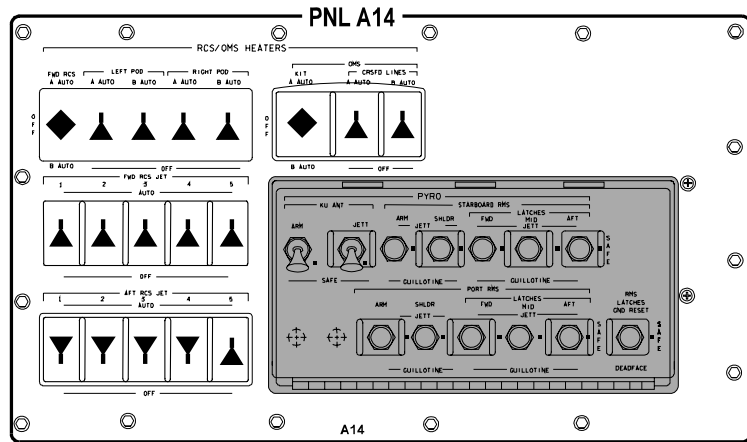

OV105

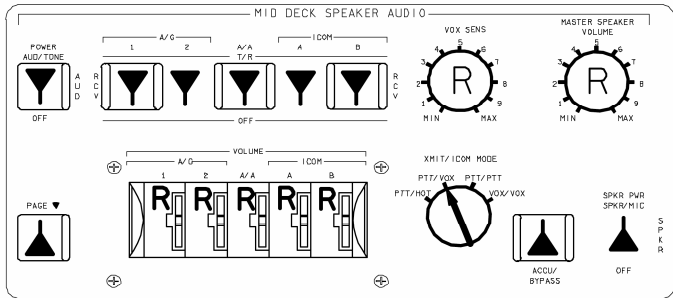

PNL M042F

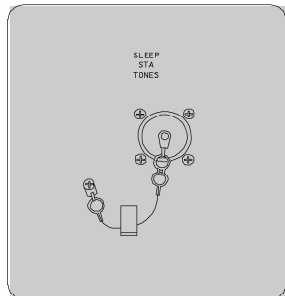
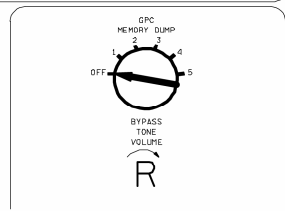

PNL M058F

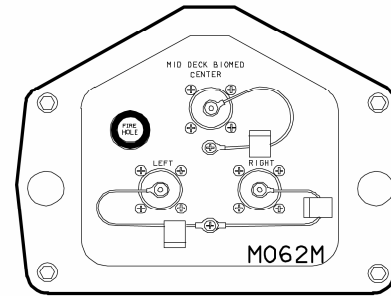
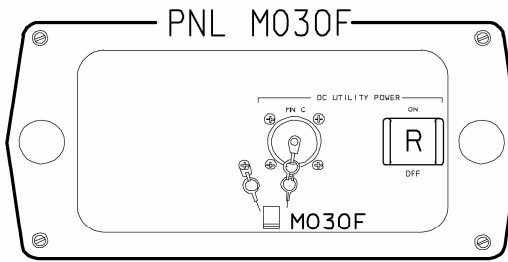
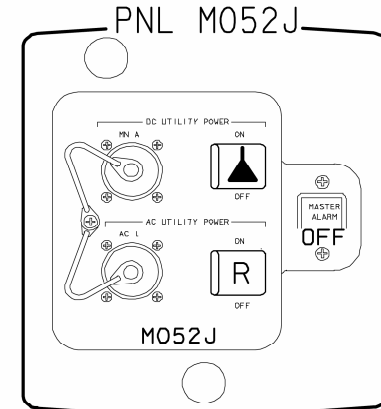
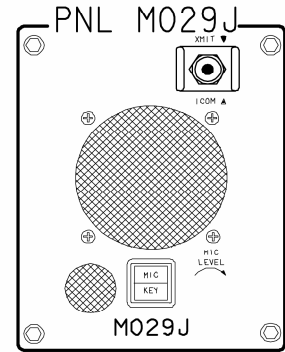
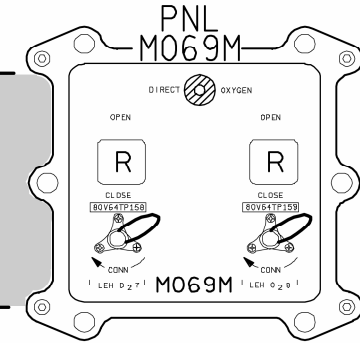
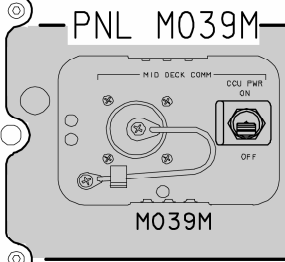
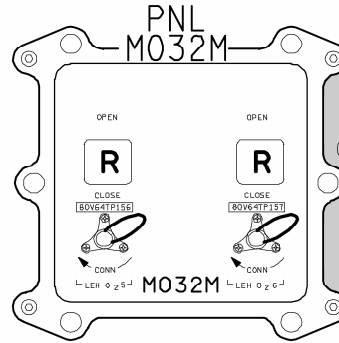
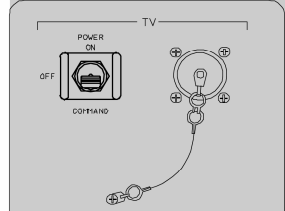

OV105

OV105

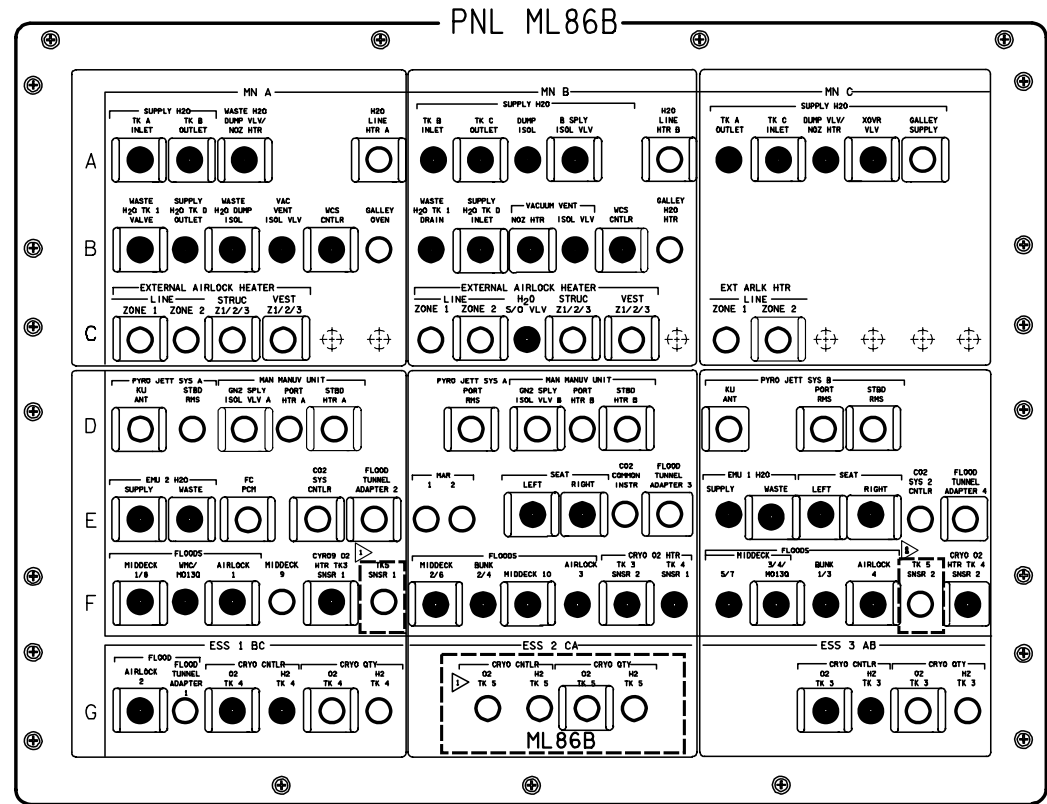
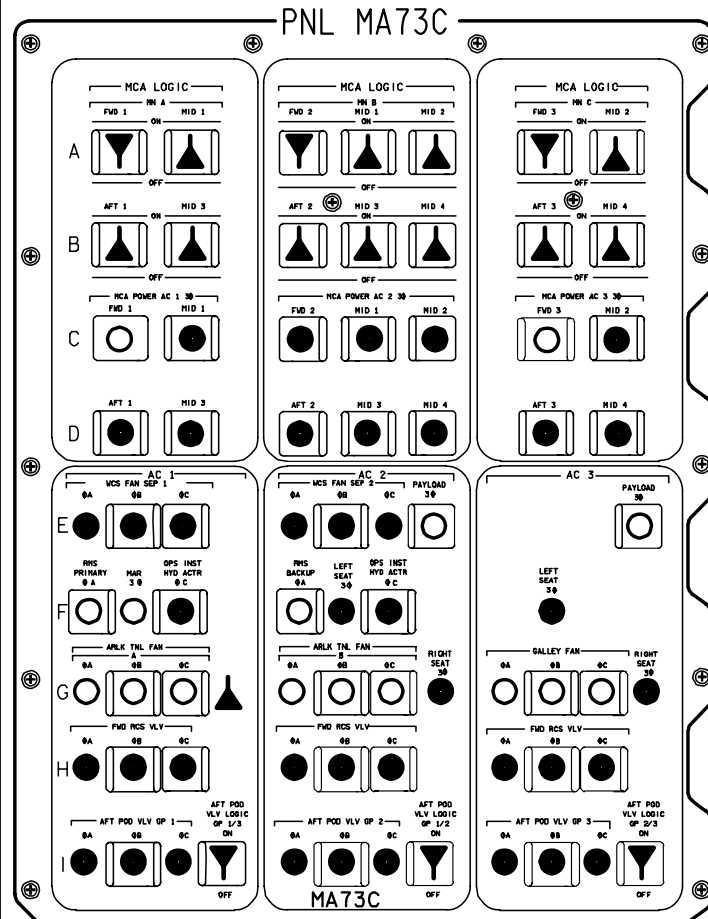

NOTES: ▷ CLOSED IF TK5 FLOWN

OV105

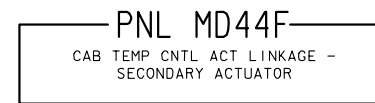
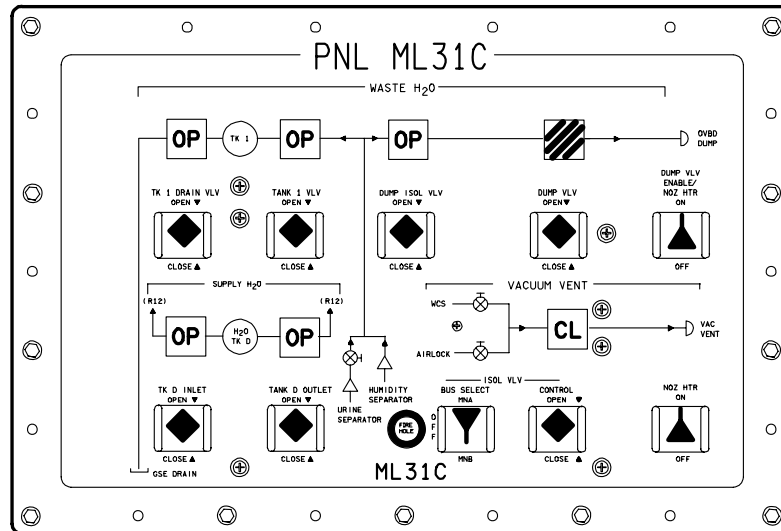
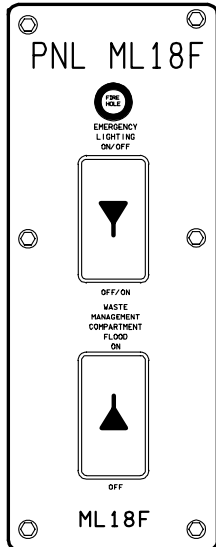
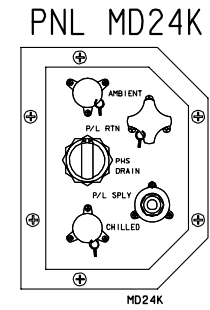
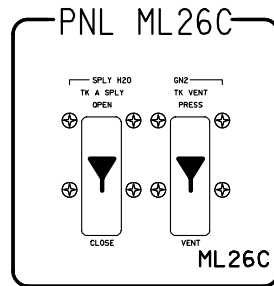
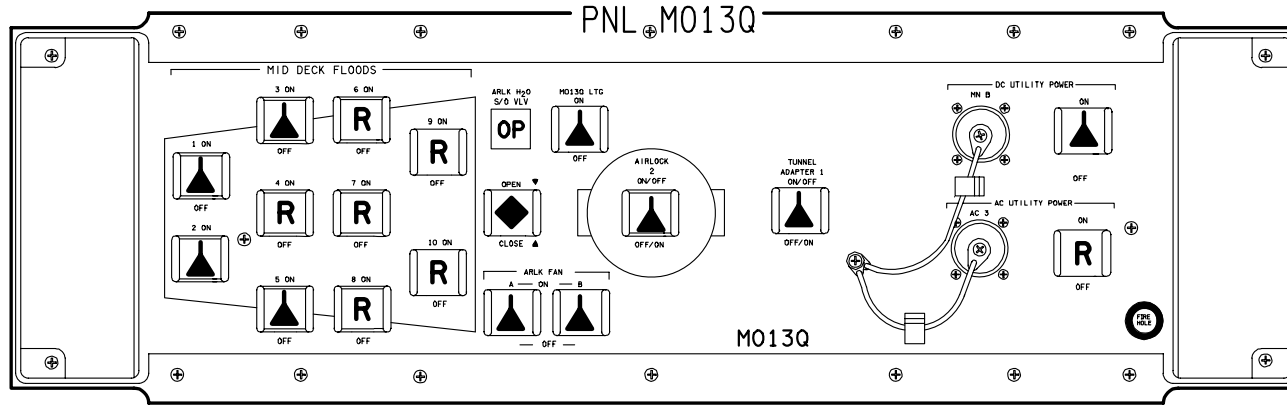

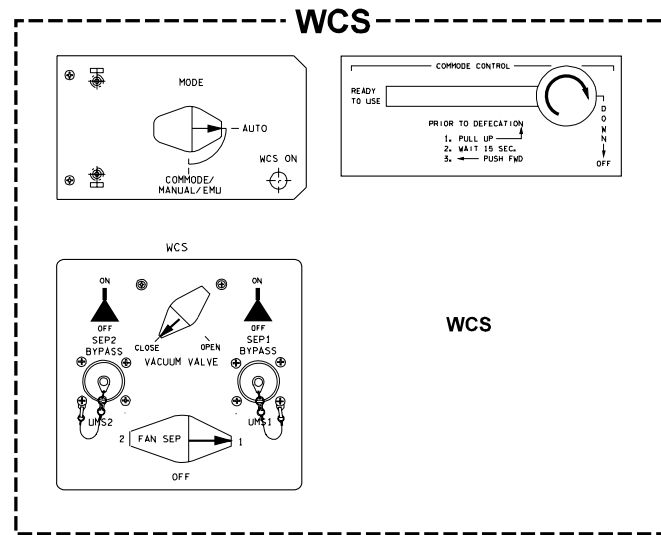
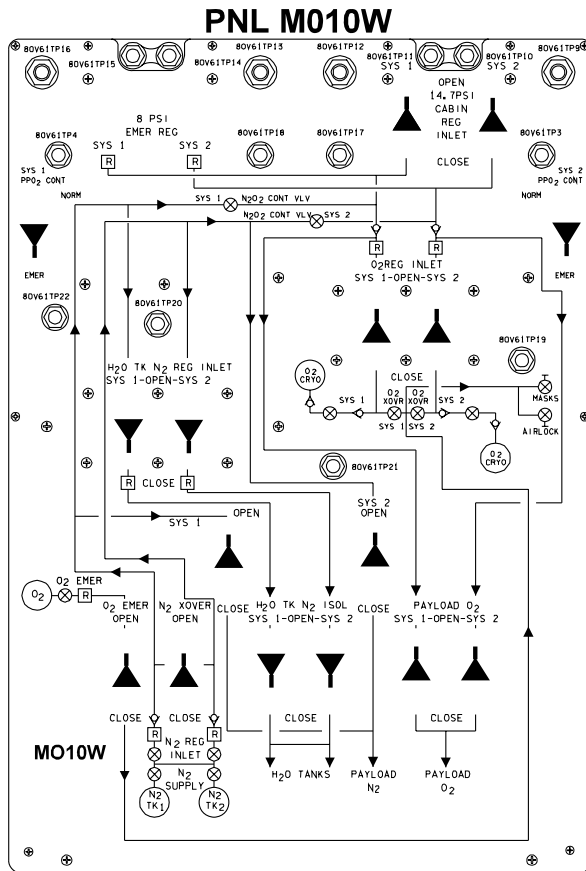

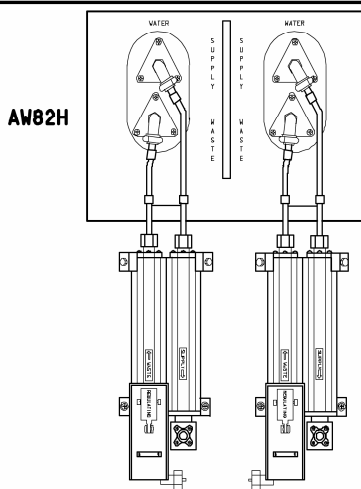
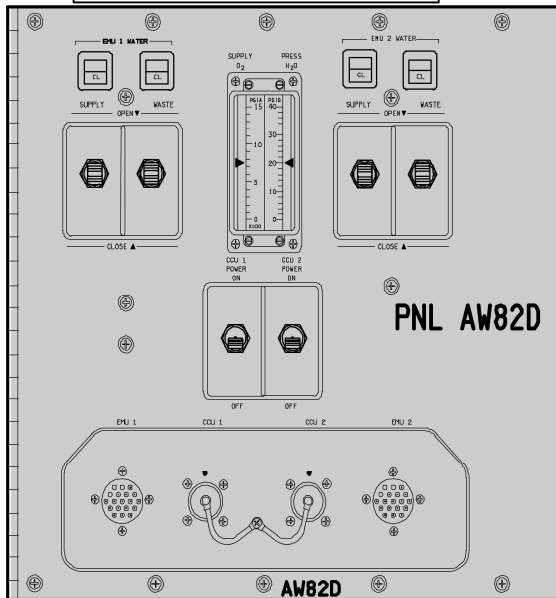
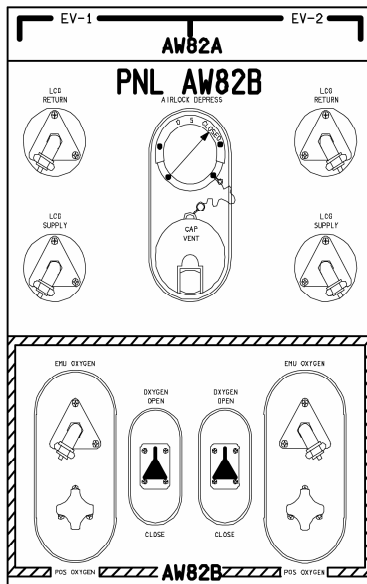
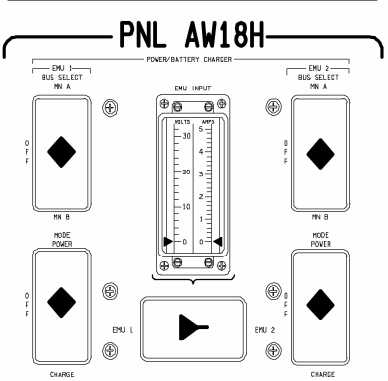
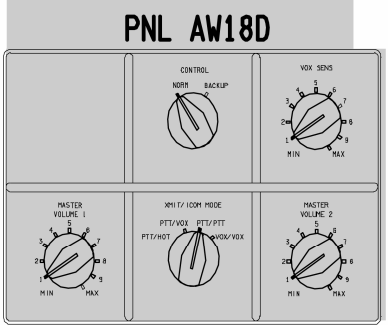
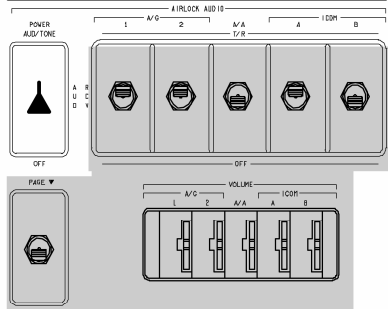
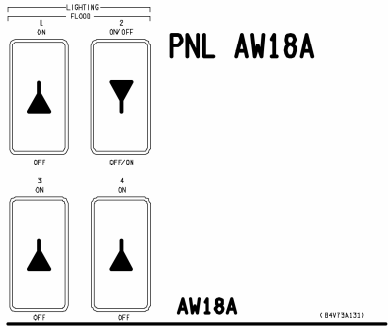

4800D631\_107\_PNL\_1 ALL VEH/DATE 10/09/02

### **Inner Hatch**

Actuator Handle – LATCHED

Lock Lever – LOCKED

Equalization vlv (two) – NORM, capped



# LOSS OF FES DEORBIT PREP

This Page Intentionally Blank

## LOSS OF FES DEORBIT PREP

### ASSUMPTIONS/INITIAL CONDITIONS

This procedure assumes EVAP OUT T HIGH (ORB PKT, ECLS) and LOSS OF FES (ORB PKT, PWRDN) have been performed

If failure occurs after Deorbit Prep entered, compare timeline, beginning at TIG-4 hr, with activities previously accomplished for misconfigurations

### PROBLEM DESCRIPTION/RATIONALE

Immediate deorbit not mandatory if both Freon Loops operating and radiator flow has been established

Heat removal capability of radiators allows for normal on-orbit power levels without thermal problems. However, for Deorbit Prep, to allow some coldsoak of the radiators and vehicle, power levels must be limited

### NOTE

A near normal deorbit prep and entry performed except that:

1. Nav and landing aids powered when needed during entry
2. Limited use of IDPs,MDUs,Flt Cntrl Pwr,PGSC,lighting
3. GPC entry configuration and OPS 3 transition delayed to TIG-45 min to delay full GPC powerup
4. MS continues deorbit prep activities until TIG. CDR/PLT go to ENT at TIG-30
5. Door closure delayed to TIG-10 min
6. Radiator coldsoak attitude (tail sun) maintained until TIG-15 min except for IMU align attitude
7. Ammonia boiler activated at EI
8. HYD circ pump operated for additional cooling

## LOSS OF FES DEORBIT PREP OVERVIEW OF CONFIGURATION MANAGEMENT

	OPS 1 ASC C/L					OPS 2 ON-ORBIT					OPS 2 DEORBIT PREP TIG -03:28					OPS 3 DEORBIT PREP TIG -0:45					TIG					EI-5	V=15K										
DPS																																					
GPC OPS	1 G1	2 G1	3 G1	4 G1	5 BFS	1 G2	2 G2	3 G2	4 SM	5 BFS	1 G2	2 G2	3 G2	4 SM	5 BFS	1 G3	2 G3	3 G3	4 G3	5 BFS	1 G3	2 G3	3 G3	4 G3	5 BFS												
POWER OUTPUT MODE	ON N R	ON N R	ON N R	ON N R	ON B R	ON N R	ON N R	ON N H	ON T R	ON N H	ON N R	ON N H	ON N R	ON T R	ON N S	ON N R	ON N R	ON N R	ON N R	ON N R	ON N R	ON N R	ON N R	ON N R	ON N R	ON N R											
CONFIG GPC	1 1 2 3 4 0					2 1 2 0 0 0					4 (5) 0 0 0 4 0					2 1 2 0 0 0					4 (5) 0 0 0 4 0					3 1 2 3 4 0					3 1 2 3 4 0						
STR	1	1				1	2	3	4	5	1	2	3	4	5	1	2	3	4	5	1	2	3	4	5												
PL	1/2	1				0	0	0	0	0	0	0	0	0	0	1	1	1	1	1	1	1	1	1	1												
CRT	1	1				1	2	3	4	5	1	2	3	4	5	1	2	3	4	5	1	2	3	4	5												
L	1	1				0	0	0	0	0	0	0	0	0	0	0	0	0	0	0	0	0	0	0	0												
MM	1	1				1	2	3	4	5	1	2	3	4	5	1	2	3	4	5	1	2	3	4	5												
MDM	ALL ON					ALL ON					ALL ON					ALL ON					ALL ON																
D & C	DDU MDU IDP		L,R All Forward ALL			L,A ----- Minimize use ----- Minimize use ----- Minimize use -----																															
E C L S	AV BAY FAN CABIN FAN IMU FAN WATER LP FREON LP RADIATOR		1-B,2-A,3-B A ----- B ----- 1-OFF,2-ON 1-B,2-B STOWED ----->			1-GPC,2-ON -----> 1-OFF,2-ON ----- DEPLOY ----->										STOW ----->											1,2 ON										
F C S / N A V A I D S S E N S O R S	FCS ASA AA RGA ADTA IMU RA TACAN UHF MLS		AUTO ----- ALL ON ----- ALL ON ----- ALL ON ----- ALL ON ----- ALL ON ----- ALL ON ----- ALL GPC ----- ON ----- ALL OFF -----			OFF -----> ALL ON ----- OFF -----> ALL ON ----- OFF -----> ALL ON ----- OFF -----> ALL ON ----- OFF -----> ALL ON ----- OFF -----> ALL ON ----- OFF -----> ALL ON ----- OFF -----> ALL ON ----- ON -----> ALL ON ----- ON -----> ALL ON -----										ALL ON -----> ALL ON ----- ALL ON -----> ALL ON ----- ALL ON -----> ALL ON ----- ALL ON -----> ALL ON ----- ALL ON -----> ALL ON ----- ALL ON -----> ALL ON ----- ALL ON -----> ALL ON ----- ALL ON -----> ALL ON ----- ALL ON -----> ALL ON ----- ALL ON -----> ALL ON -----											ON GPC ON										
R J D	RJDA RJDF VERNIER		ALL ON ----- ALL ON ----- OFF ----->			ON ----->										OFF -----> OFF ----->																					

OV103,104

## LOSS OF FES DEORBIT PREP

### ASSUMPTIONS/INITIAL CONDITIONS

This procedure assumes EVAP OUT T HIGH (ORB PKT, ECLS) and LOSS OF FES (ORB PKT, PWRDN) have been performed

If failure occurs after Deorbit Prep entered, compare timeline, beginning at TIG-4 hr, with activities previously accomplished for misconfigurations

### PROBLEM DESCRIPTION/RATIONALE

Immediate deorbit not mandatory if both Freon Loops operating and radiator flow has been established

Heat removal capability of radiators allows for normal on-orbit power levels without thermal problems. However, for Deorbit Prep, to allow some coldsoak of the radiators and vehicle, power levels must be limited

### NOTE

A near normal deorbit prep and entry performed except that:

1. Nav and landing aids powered when needed during entry
2. Limited use of IDPs,MDUs,Flt Cntrl Pwr,PGSC,lighting
3. GPC entry configuration and OPS 3 transition delayed to TIG-45 min to delay full GPC powerup
4. MS continues deorbit prep activities until TIG. CDR/PLT go to ENT at TIG-30
5. Door closure delayed to TIG-10 min
6. Radiator coldsoak attitude (tail sun) maintained until TIG-15 min except for IMU align attitude
7. Ammonia boiler activated at EI
8. HYD circ pump operated for additional cooling

## LOSS OF FES DEORBIT PREP OVERVIEW OF CONFIGURATION MANAGEMENT

	OPS 1 ASC C/L					OPS 2 ON-ORBIT					OPS 2 DEORBIT PREP TIG -03:28					OPS 3 DEORBIT PREP TIG -0:45					TIG					EI-5	V=15K										
DPS																																					
GPC OPS	1 G1	2 G1	3 G1	4 G1	5 BFS	1 G2	2 G2	3 G2	4 SM	5 BFS	1 G2	2 G2	3 G2	4 SM	5 BFS	1 G3	2 G3	3 G3	4 G3	5 BFS	1 G3	2 G3	3 G3	4 G3	5 BFS												
POWER OUTPUT MODE	ON N R	ON N R	ON N R	ON N R	ON B R	ON N R	ON N R	ON N H	ON T R	ON N H	ON N R	ON N R	ON N H	ON T R	ON N S	ON N R	ON N R	ON N R	ON N R	ON N R	ON N R	ON N R	ON N R	ON N R	ON N R	ON N R											
CONFIG GPC	1 1 2 3 4 0					2 1 2 0 0 0					4 (5) 0 0 0 4 0					2 1 2 0 0 0					4 (5) 0 0 0 4 0					3 1 2 3 4 0					3 1 2 3 4 0						
STR	1	1				1	2	3	4	5	1	2	3	4	5	1	2	3	4	5	1	2	3	4	5												
PL	1/2	1				0	0	0	0	0	0	0	0	0	0	1	1	1	1	1	1	1	1	1	1												
CRT	1	1				1	2	3	4	5	1	2	3	4	5	1	2	3	4	5	1	2	3	4	5												
L	1	1				0	0	0	0	0	0	0	0	0	0	0	0	0	0	0	0	0	0	0	0												
MM	1	1				1	2	3	4	5	1	2	3	4	5	1	2	3	4	5	1	2	3	4	5												
MDM	ALL ON					ALL ON					ALL ON					ALL ON					ALL ON																
D & C	DDU MDU IDP		L,R All Forward ALL			L,A ----- Minimize use ----- Minimize use ----- Minimize use -----																															
E C L S	AV BAY FAN CABIN FAN IMU FAN WATER LP FREON LP RADIATOR		1-B,2-A,3-B A ----- B ----- 1-OFF,2-ON 1-B,2-B STOWED ----->			1-GPC,2-ON -----> 1-OFF,2-ON ----- DEPLOY ----->										STOW ----->											1,2 ON										
F C S / N A V A I D S S E N S O R S	FCS ASA AA RGA ADTA IMU RA GPS UHF MLS		AUTO ----- ALL ON ----- ALL ON ----- ALL ON ----- ALL ON ----- ALL ON ----- ALL ON ----- ALL ON ----- ALL OFF -----			OFF -----> ALL ON ----- OFF -----> ALL ON ----- OFF -----> ALL ON ----- OFF -----> ALL ON ----- OFF -----> ALL ON ----- 2 ON, 1 & 3 OFF -----> ALL ON ----- ON -----> ALL ON ----- ALL OFF -----> ALL ON -----															ALL ON ----->						ON										
R J D	RJDA RJDF VERNIER		ALL ON ----- ALL ON ----- OFF ----->			ON ----->																					OFF OFF										

OV105

## LOSS OF FES DEORBIT PREP

MCC	CDR	PLT	MS(AFT)	MS(MID)
TIG				
-04:00	SUPPLY H2O DUMP	CRT TIMER SETUP	SUPPLY H2O DUMP	
	DPS CONFIG FOR D/O			FLUID LOADING PREP
-03:00	AUTO MNVR TO IMU ATT	KU-BD ANT STOW		
	IMU ALIGNMENT			ENT STOWAGE
	PRE D/O UPDATE/UPLINK	HYD THERM COND		
	MNVR TAIL TO SUN	APU STEAM VENT HTR	SEAT INSTALLATION	SEAT INSTALLATION
-02:00	DEACT STAR TRKRS, CLOSE DOORS	DEACT STAR TRKRS, CLOSE DOORS		
	ENT FWD FLT DECK CONFIG	ENT FWD FLT DECK CONFIG	ENT AFT FLT DECK CONFIG	ENT MIDDECK CONFIG
			RESET C/W	
	P&I TO ENTRY C/L	P&I TO ENTRY C/L		
	CLOTHING CONFIG	CLOTHING CONFIG	N2 QTY COMP	
-01:00	BEGIN FLUID LOADING SEAT INGRESS HUD SETUP ADJUST SEAT	BEGIN FLUID LOADING SEAT INGRESS HUD SETUP ADJUST SEAT	BEGIN FLUID LOADING WIRELESS STOW	BEGIN FLUID LOADING WCS DEACT
GO FOR OPS 3 TRANSITION	DED DISPLAY ENT CONFIG DPS ENTRY CONFIG	RCS ENTRY CONFIG DED DISP ENT CONFIG DPS ENTRY CONFIG	STOW RADIATORS CONFIG FOR PLBD CLOSURE EMERG. PLBD CLOSURE POST CLOSING CONFIG CLOTHING CONFIG SEAT INGRESS	CLOTHING CONFIG SEAT INGRESS
00:00	STOW ORB PKT ENT, <u>DEORBIT BURN</u>	STOW ORB PKT ENT, <u>DEORBIT BURN</u>		
	DEORBIT BURN			

**TIG**  
 -04:00  
 A1(B1)  
 AUTO  
 VERN  
 RT 0.2  
 DB 1.0

P      TIMER SETUP [ 1 ]  
 L1    √DAP: A1/AUTO/VERN  
       √DAP B set to B1

-03:55

C,MS    SUPPLY/WASTE WATER DUMP (ORB OPS, ECLS)  
       If no MCC, perform supply dump only  
       Dump TK B to 50%

-03:50    MS      FLUID LOADING PREP MS MID ACTIVITIES [ 2 ], 7-19

-03:45

-03:40

-03:35

-03:30

TIMER SETUP [ 1 ]

[ 1: GNC 2 TIME ]

SET CRT TIMER TO COUNT DOWN TO TIG (perform for GNC and SM)

ENTRY DAY (HR:MIN:SEC – MET)

ITEM 17 +   +   +

24 HOUR LATE DELAYED DEORBIT

ITEM 17 +   +   +

[ 1: GNC UNIV PTG ]



**TIG**  
-03:30

A1(B1)  
AUTO  
VERN  
RT 0.2  
DB 1.0

C

DPS CONFIG FOR D/O PREP **3**

MCC: Update IMU ALIGN PAD if reqd (ORB OPS, PTG)

-03:25

-03:20

UPLINK  
(over STDN)  
(if reqd)  
PASS and BFS  
SV

-03:15

-03:10

-03:05

P

KU-BD ANT STOW (ORB OPS, COMM/INST) (if deployed)

-03:00

DPS CONFIG FOR D/O PREP **3**

ACTIVATE GPC 2 (if in HALT)

O6    √GPC MODE 2 – HALT (tb-bp)  
      √OUTPUT 2 – NORM  
      √PWR 2 – ON  
      MODE 2 – STBY (tb-RUN), RUN

TRANSITION GPCs 1&2 TO OPS 2  
(if GPC 2 just activated)  
**GNC 0 GPC MEMORY**

CONFIG – ITEM 1 +2 EXEC  
Modify MC 2 per table →

CONFIG	2
GPC	12000
STR	1
2	2
3	1
4	2
PL	1/2
CRT	1
2	2
3	0
4	2
L	0
2	0
MM	1
2	2

O6    √GPC PWR 5 – ON  
      MODE 5 – STBY (tb-RUN)

C3    BFC CRT DISP – ON  
      SEL – 2 + 3

**2: BFS, GNC BFS MEMORY or SM THERMAL**

C3    BFC CRT DISP – OFF  
      SEL – 3 + 1

**IMU ALIGNMENT** 5

NOTE

Procedure applies for one or two S TRK aligns. For one S TRK, a second att mnvr reqd between data takes. Ref STAR PAIRS (ORB OPS, PTG)

C

1. X: GNC 22 S TRK/COAS CNTL  
Y: GNC 21 IMU ALIGN

CRTX

2. √REQD ID – ITEM 11,12 – 0  
√STATUS (two) – NO BITE  
√SHUTTER (two) – OP  
\* If SHUTTER – CL: \*  
\* √Att,MET – correct \*  
\* Visually verify no bright object in FOV \*  
\* After data collected and before changing \*  
\* attitude, return shutter to AUTO \*  
\* To open shutter: \*  
\* MAN OP – ITEM 15(16) EXEC (\*) \*  
\* To return shutter to AUTO: \*  
\* MAN OP – ITEM 15(16) EXEC (no \*) \*

CRTY

- √IMU 1,2,3:  
√STAT – blank  
√OPER – ITEM 4,5,6 (\*)

CRTX

3. √IMU ALIGN ATT (pad)
4. S TABLE CLR – ITEM 20 EXEC
5. Enable Star Tracker:  
S TRK – ITEM 3,4 EXEC (\*)
6. Verify S TABLE:  
TRK ID 1,2 = STAR ID (pad)  
ANG ERR ≤ 0.08

Wait approx 1 min for new IMU Δ ANGS

- \* If after 3 min no data (or bad data) in S TABLE: \*
- \* √S TRK – ITEM 3,4 (\*) \*
- \* √ATT/STARS/TIME \*
- \* √S TRK: TRK ID = STAR ID (pad) \*
- \* Do S TRK self-test \*
- \* If neither tracker fails: \*
- \* Mnvr to verification att – repeat \*
- \* steps 3,4,5,6 \*
- \* If one tracker fails: \*
- \* √TERM/IDLE for failed tracker – \*
- \* ITEM 9(10) (\*) \*
- \* Proceed with one S TRK ALIGN \*
- \* If both trackers fail, √MCC \*

For one S TRK align:

S TRK for good tracker – ITEM 3(4) EXEC (\*)  
S TABLE CLR – ITEM 20 EXEC, reacquire star with good tracker  
TERM/IDLE for good tracker during maneuvers – ITEM 9(10) EXEC (\*)  
Mnvr to second att (single S TRK): Do not clear S Table  
Repeat steps 3,5,6 with second Star ID

CRTX  
CRTY

7. √S TABLE SEL – ITEM 17,18 (\*)  
ALIGN IMU 1,2,3 – ITEM 10,11,12 EXEC (\*)  
√REF STAR – ITEM 13 (\*)  
√TYPE – ITEM 15 (TORQUE)  
√IMU 1,2,3 – ANG ΔX,ΔY,ΔZ < 0.80  
\* If ANG ΔX,ΔY,ΔZ > 0.80 for two IMUs, do not torque: \*  
\* Mnvr to verification att & repeat steps 3 thru 7 once \*  
\* If still > 0.80, report to MCC \*
8. Record ANG ΔX,ΔY,ΔZ,ANG ERR,EXECUTE TIME (use log this page)  
ITEM 16 – EXEC (\*)  
Alignment complete when:  
ITEM 16 – EXEC (no \*)  
IMU ALIGN VERIFICATION
9. Mnvr to IMU VERIFICATION STAR ALIGN ATT (pad):  
√DAP: B/AUTO/PRI
10. Perform steps 3,4,5,6 using appropriate stars (pad)
11. √IMU 1,2,3 ANG ΔX,ΔY,ΔZ < 0.1

\* If ANG ΔX,ΔY,ΔZ ≥ 0.1, perform steps 8 thru 11; report to MCC \*

NOTE

For alternate stars, √MCC or ref STAR PAIRS (ORB OPS, PTG)

12. Report IMU ALIGN results

IMU STAR ALIGN LOG

REQD ID: -Y \_\_\_\_\_, -Z \_\_\_\_\_ ANG ERR \_\_\_\_\_

ANG	1	2	3
ΔX ( )	_____	_____	_____
ΔY ( )	_____	_____	_____
ΔZ ( )	_____	_____	_____

EXECUTE TIME \_\_\_\_\_: \_\_\_\_\_: \_\_\_\_\_ (TIG MINUS)

IMU STAR ALIGN LOG

REQD ID: -Y \_\_\_\_\_, -Z \_\_\_\_\_ ANG ERR \_\_\_\_\_

ANG	1	2	3
ΔX ( )	_____	_____	_____
ΔY ( )	_____	_____	_____
ΔZ ( )	_____	_____	_____

EXECUTE TIME \_\_\_\_\_: \_\_\_\_\_: \_\_\_\_\_ (TIG MINUS)

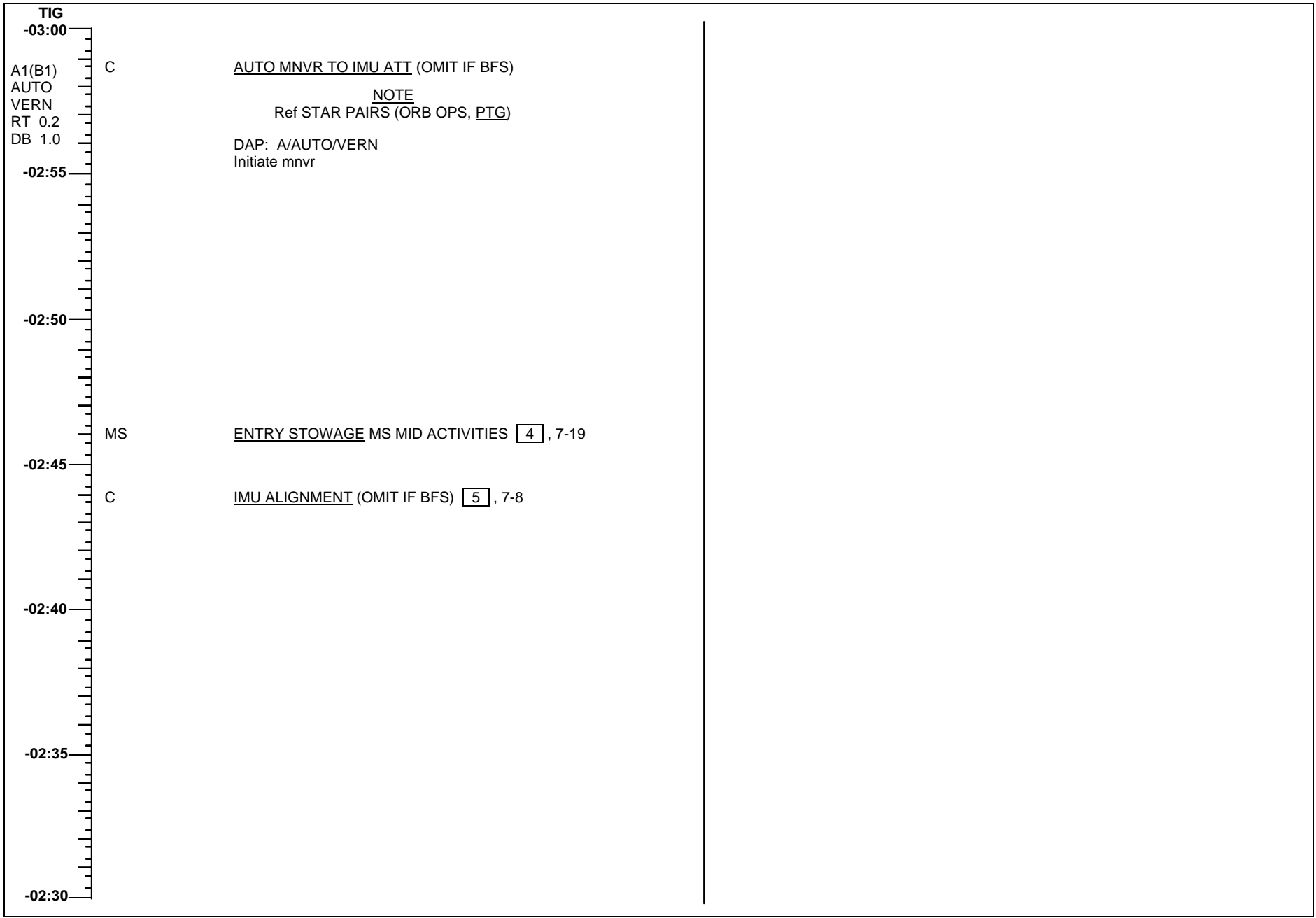

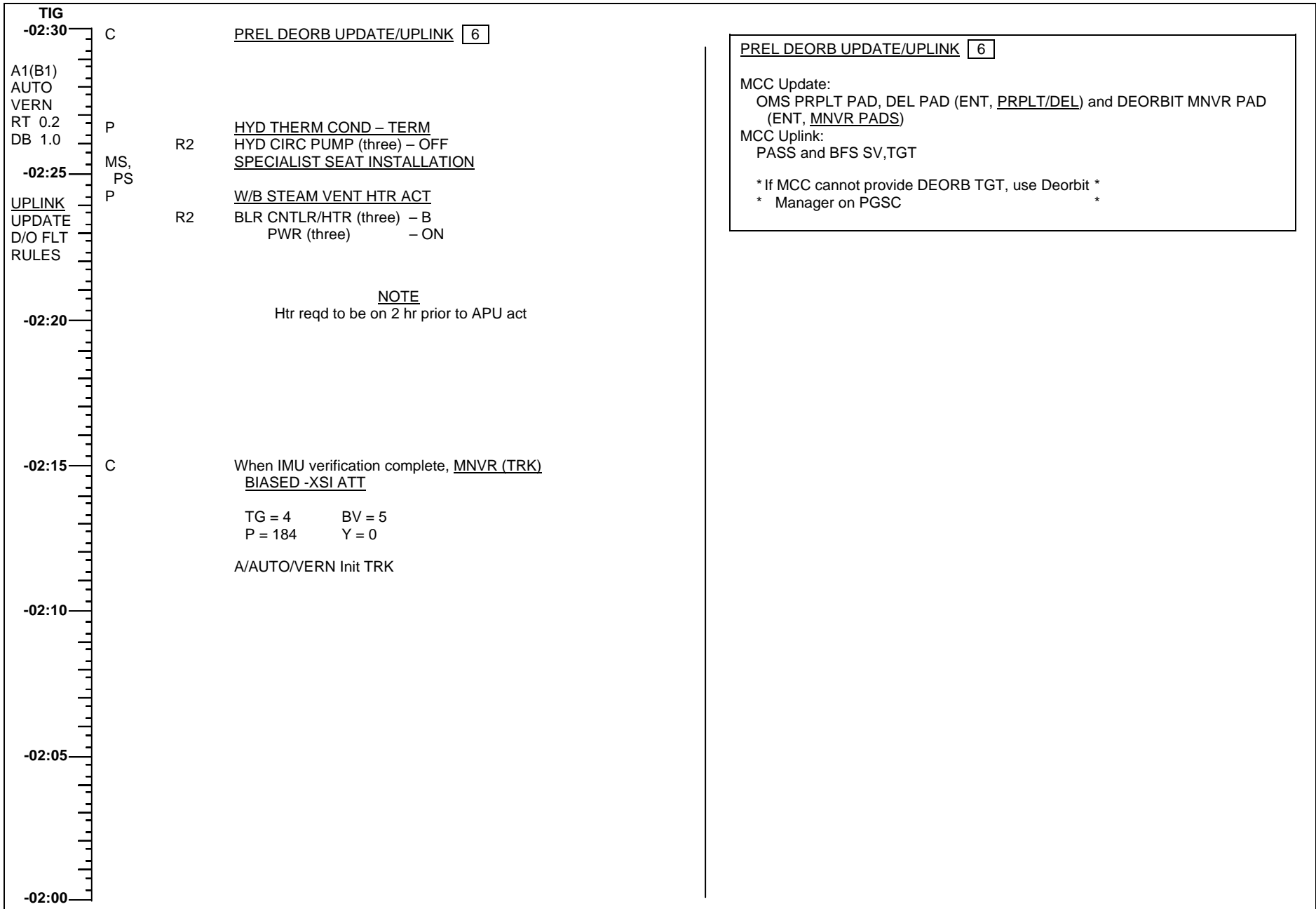

TIG		
-02:00	C,P	<u>DEACT STAR TRKRS &amp; CLOSE DOORS</u> [7]
A1(B1)		
AUTO		
VERN		
RT 0.2		
DB 1.0		
-01:55	C,P	<u>ENT FWD FLT DECK CONFIG</u> [8]
	MS	<u>ENT AFT FLT DECK CONFIG</u>
		MS AFT ACTIVITIES [9], 7-17
	MS	<u>ENT MIDDECK CONFIG</u> MS MID ACTIVITIES [10], 7-20
-01:50		
UPLINK		
TMBU		
-01:45		
-01:40		
-01:35		
-01:30	MS	<u>C/W RESET MS AFT ACTIVITIES</u> [11], 7-17

<u>DEACT STAR TRKRS &amp; CLOSE DOORS</u> [7]	
O6	S TRK PWR (two) – OFF
O14:E, O15:E	cb S TRK -Z,-Y (two) – op
O6	S TRK DR CNTL SYS 1,2 (two) – CL (start timer)
	√POS tb (two) – bp
	When both tb – cl (~8-24 sec)
	or either tb – bp > 24 sec:
	S TRK DR CNTL SYS 1,2 (two) – OFF
	* If tb – bp > 8 sec, √MCC *

<u>ENT FWD FLT DECK CONFIG</u> [8]	
	<u>HYD HTR CONFIG</u>
R4	HYD BK HTR (three) – AUTO
	<u>PCS/ARS CONFIG</u>
L2	√O2 SYS 1,2 SPLY (two) – OP (tb-OP)
	√XOVR SYS 1,2 (two) – OP
	√N2 SYS 1,2 SPLY (two) – OP (tb-OP)
	√REG INLET (two) – OP (tb-OP)
	O2/N2 CNTLR vlv SYS 1 – OP
	2 – CL
C7	√LEH O2 SPLY vlv (two) – OP
L4:J	cb AC3 ΦA SIG CONDR HUM SEP – op
	ΦB SIG CONDR IMU FAN – op
	<u>RAD CONFIG</u>
L2	FREON ISOL MODE – OFF
	<u>MLS CH/TACAN CH</u>
O8	√MLS CH tw (three) – see LAND SITE DATA
O7	√TACAN MODE (three) – OFF
	√ANT SEL (three) – AUTO
	<u>ENT COMM</u>
O5,O9	L,R AUD A/G 2 – T/R
	ICOM B – T/R
	XMIT/ICOM MODE – PTT/VOX
O6	√UHF SPLX/EVA PWR AMPL – ON

**OV103,104**

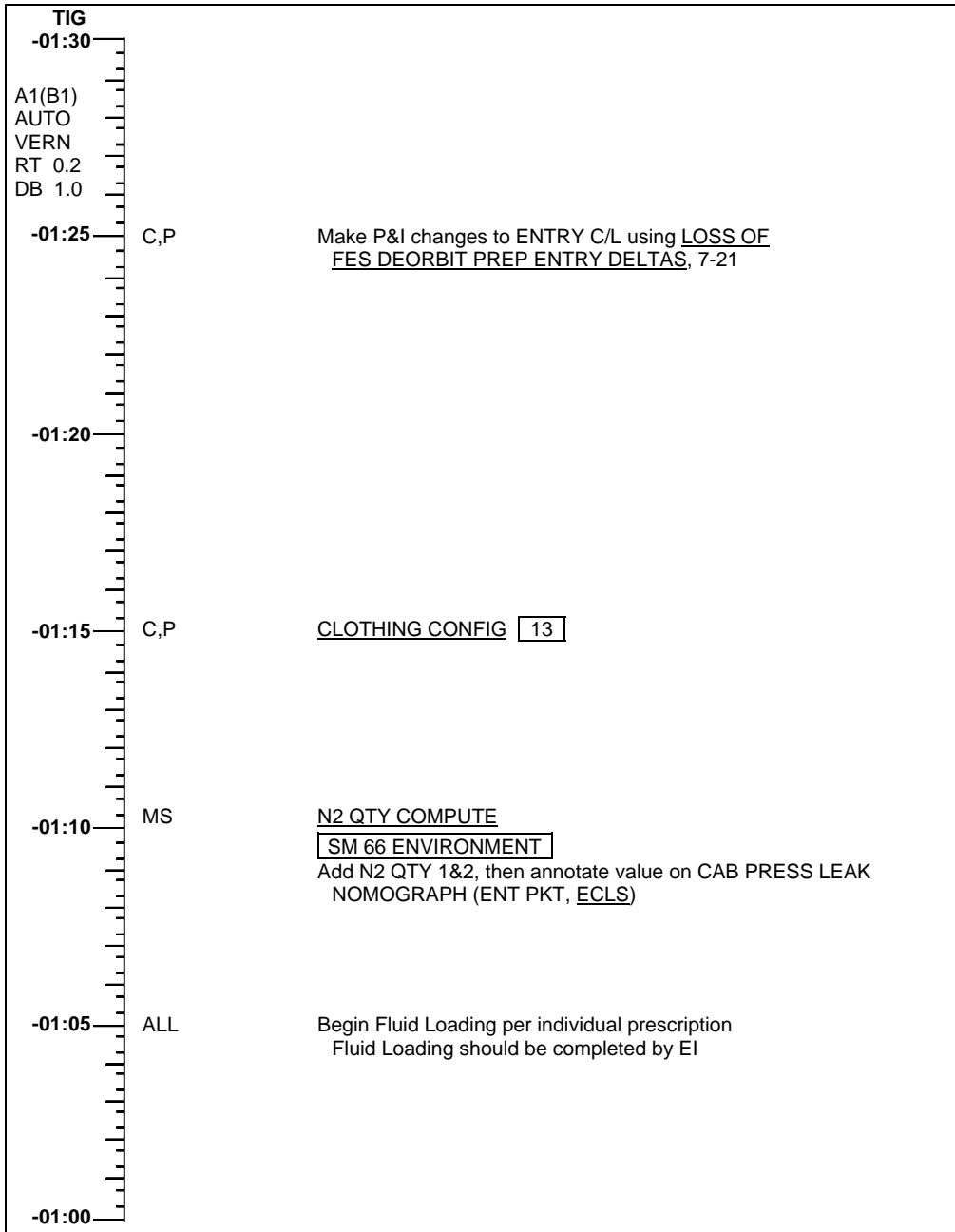

CLOTHING CONFIG 13

Unstow,don:  
ACES  
Harness  
Boots

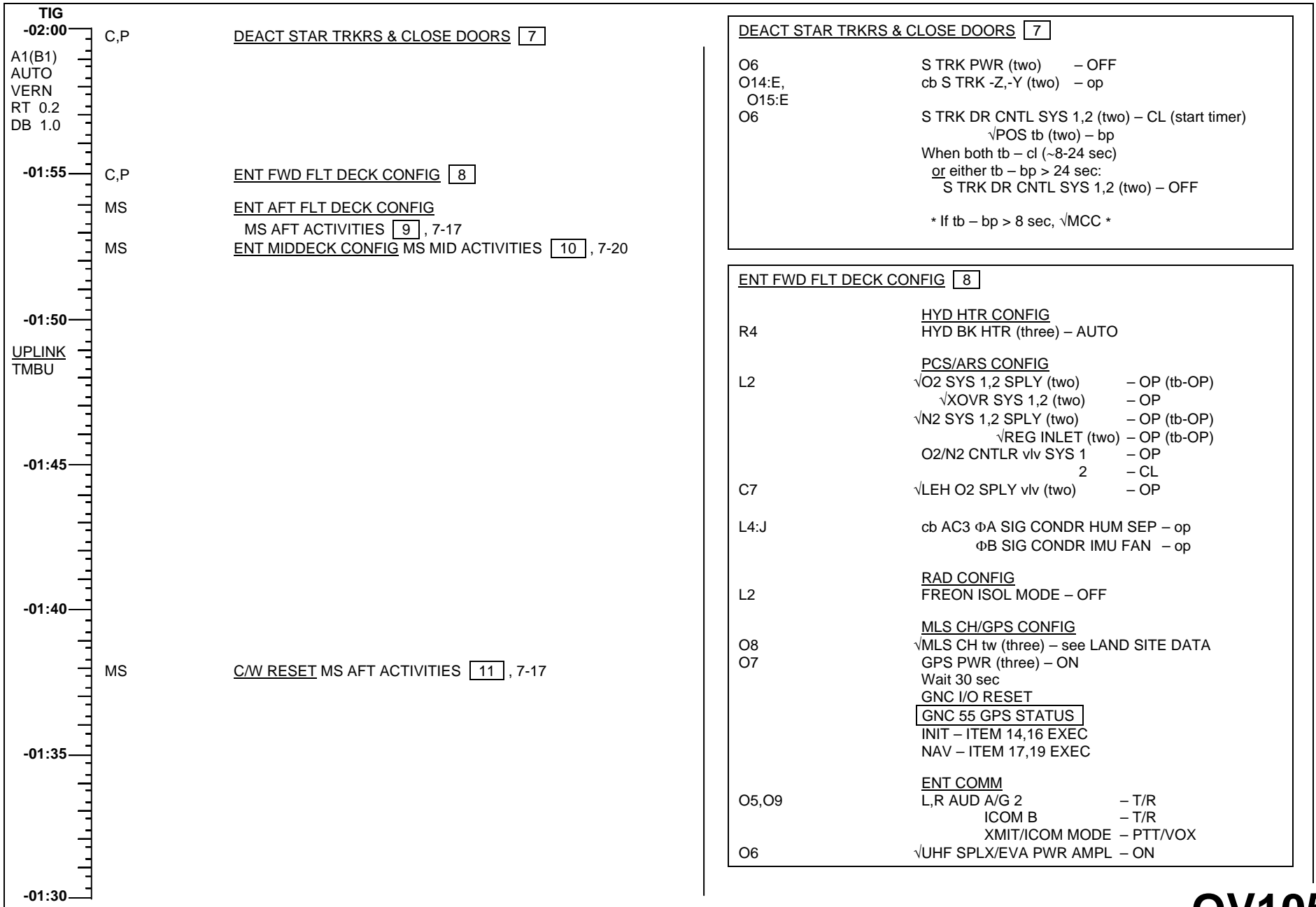

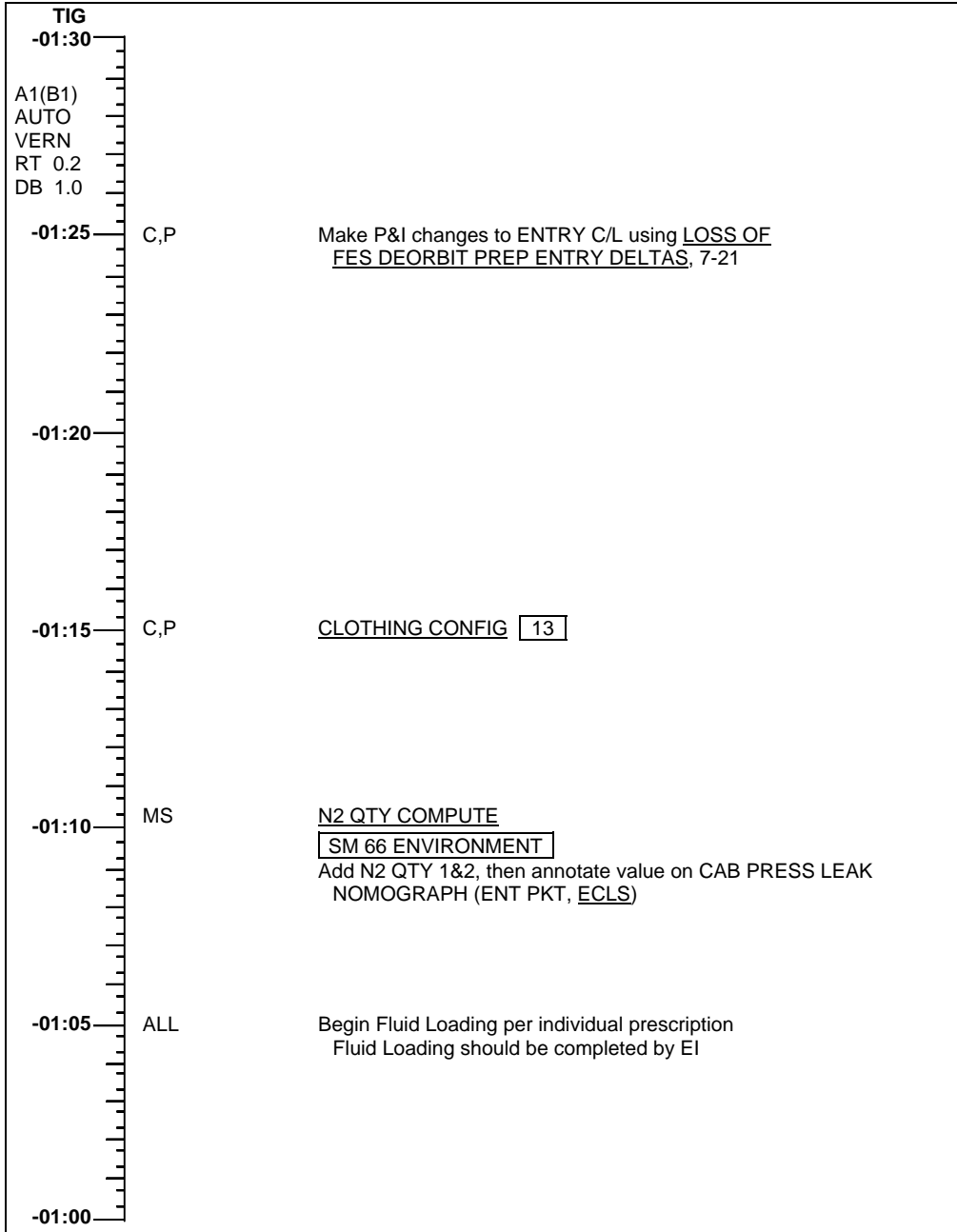

CLOTHING CONFIG 13

Unstow,don:  
ACES  
Harness  
Boots



**HUD SETUP** 14

Remove, stow HUD Covers (two)  
Ensure Cloth Cover does not obscure light sensor

**RCS ENTRY CONFIGURATION** 17

O14:F, O15:F, O16:F  
C3  
√RJDA DRIVER (four) – ON  
√LOGIC (four) – ON  
DAP: A/AUTO/PRI  
GNC 20 DAP CONFIG  
Select TAIL P, Y OPTION

O14:F, O15:F, O16:F  
O8  
RJDF DRIVER (four) – OFF  
LOGIC (four) – OFF  
FWD RCS MANF ISOL 1,2,3,4 (four) – CL (tb-CL)  
5 – CL (mom), (tb-CL)

O16:F  
A14  
RJD MANF L5/F5/R5 DRIVER – OFF  
RCS/OMS HTR FWD RCS JET (five) – OFF  
AFT RCS JET 5 – OFF

**DED DISP ENT CONFIG** 18

O14, O15, O16  
RGA (four) – ON  
cb MNA, B ACCEL 1, 2 (two) – cl  
MNA, C DDU AFT (two) – op  
ASA (four) – ON  
ACCEL 4,3 (two) – ON

If OV103,4:  
O7 TACAN ANT SEL (three) – AUTO  
O8 MLS CH tw (three) – See LAND SITE DATA

F3 TRIM PNL (two) – ON

**DPS ENTRY CONFIG** 19

\* If IMU or RHC dilemma, do not proceed with OPS 3 transition \*

O14, O15, O16  
√RGA, ACCEL, ASA, IMU (all) – ON

VERIFY GPC CONFIG

O6  
√GPC MODE 3 – HALT (tb-bp)  
√PWR 3 – ON  
√OUTPUT 1,2 (two) – NORM (tb-gray)  
√3,5 (two) – NORM (tb-bp)  
√4 – TERM (tb-bp)  
√MODE 1,2,4 (three) – RUN (tb-RUN)  
3 – STBY (tb-RUN)  
√5 – STBY (tb-RUN)

LOAD ENTRY TFL/RECONFIG UPLK  
Perform LOAD PCMMU FORMAT and LOAD PDI DECOM  
FORMAT (ORB OPS FS, COMM/INST) for entry config

O15:B  
cb EVENT TIMER FWD – cl

C2  
Set event timer to count down to TIG

TRANSITION GPC 1&2 to GNC OPS 3  
cb MNA, B, C ADTA (four) – cl

GNC 0 GPC MEMORY

CONFIG – ITEM 1 +3 EXEC  
Modify MC 3 per table →

O14:E, O15:E, O16:E  
GNC, OPS 301 PRO  
3: GNC DEORB MNVR COAST  
cb MNA, B, C ADTA (four) – op

O14:E, O15:E, O16:E

CONFIG	3
GPC	12000
STR	1
2	2
3	1
4	2
PL	1/2
0	0
CRT	1
2	2
3	2
4	0
L	1
2	0
MM	1
2	2

<b>TIG</b>			
-01:00	C,P	<u>HUD SETUP</u> [14], 7-13	
A1(B1) AUTO RT 0.2 DB 1.0	C	C6	LEH O2 vlv (four) – OP
-00:55	C,P	<u>SEAT INGRESS</u> Adjust seat Exercise brake pedals ACES PRESS INTEGRITY CHECK	
	MS	<u>WIRELESS STOW MS AFT ACTIVITIES</u> [15], 7-17	
-00:50	MS	<u>WCS DEACT</u> MS MID ACTIVITIES [16], 7-20	
	P	<u>RCS ENTRY CONFIG</u> [17], 7-13	
-00:45	C,P	<u>DED DISP ENT CONFIG</u> [18], 7-13 MCC: GO FOR OPS 3 TRANSITION	
-00:40	C,P	<u>DPS ENTRY CONFIG</u> [19], 7-13 and 7-14	
	MS, PS	<u>CLOTHING CONFIG</u> MS AFT,MID ACTIVITIES [20], 7-17 and 7-20	
-00:35			
-00:30	C,P	Stow ORB PKT, Orbit Cue Cards Go to ENT, <u>DEORBIT BURN</u>	
<b>SM CHECKPOINT/UL CNTL ENA</b>			
		<u>1: SM 60 SM TABLE MAINT</u>	
		<u>2: SM 1 DPS UTILITY</u>	
CRT2 CRT1		MMU ASSIGN 1 SM – ITEM 3 EXEC CKPT INITIATE – ITEM 18 EXEC	
CRT2		√Update of CKPT TIME and STATUS GOOD indicated CKPT RETRV ENA ITEM 12 EXEC (*) UL CNTL ENA – ITEM 36 EXEC	
C3		<u>TRANSITION BFS GPC TO GNC OPS 3</u> BFC CRT DISP – ON √SEL – 3 + 1	
O6 CRT3		<u>3: BFS, GNC BFS MEMORY</u> GPC OUTPUT 5 – B/U (tb-bp) √TFL ENA – ITEM 29 (*) BFS, GNC OPS 301 PRO	
		<u>3: BFS, GNC DEORB MNVR COAST</u> <u>TRANSITION GPC 1,2,3,4 TO GNC OPS 3</u> SM, OPS 000 PRO	
O6		<u>X: SM GPC MEMORY</u> GPC OUTPUT 4 – NORM (tb-gray) MODE 3,5 (two) – RUN (tb-RUN)	
		<u>GNC 0 GPC MEMORY</u> √CONFIG – ITEM 1 +3 EXEC Modify MC 3 per table →	
		GNC, OPS 301 PRO	
		<u>GNC DEORB MNVR COAST</u>	
CRT3 C3		BFS, GNC OPS 000 PRO BFS, GNC OPS 301 PRO BFC CRT DISP – OFF (GPC 3 commanding IDP 3) BFC CRT DISP – ON	
		<u>LAND SITE UPDATE</u> <u>GNC 50 HORIZ SIT</u> SEL SITE (See LAND SITE DATA)	
		<u>LOAD IN TGTs</u> <u>GNC DEORB MNVR COAST</u>	
		√PASS and BFS TGT per DEORBIT MNVR PAD (ENT, <u>MNVR PADS</u> ) LOAD – ITEM 22 EXEC TIMER – ITEM 23 EXEC	
		√PASS and BFS solution per DEORBIT MNVR PAD (ENT, <u>MNVR PADS</u> ): BURN ATT HA HP ΔVTOT TGO	
O14:F O15:F		MMU 1 – OFF √2 – OFF	

CONFIG	3
GPC	12340
STR	1
	2
	3
	4
PL	1/2
CRT	1
	2
	3
	4
L	1
	2
MM	1
	2

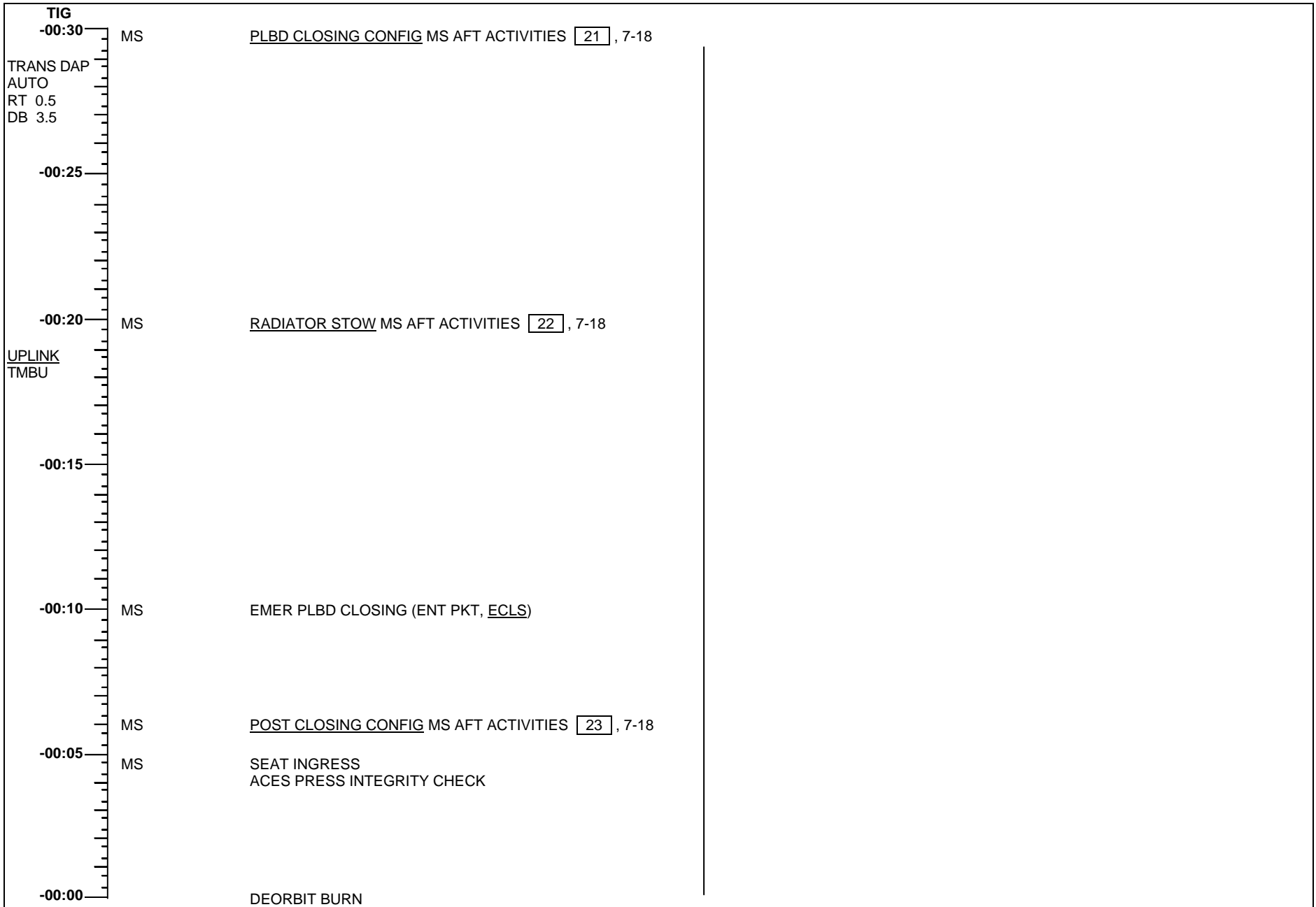

This Page Intentionally Blank

## MS AFT FLIGHT DECK ACTIVITIES MS PULLOUT PAGE

### NOTE

Wait for GO from CDR or PLT before starting any activity on this page

TIME (TIG-)	MS AFT ACTIONS
2:25	<u>SPECIALIST SEAT INSTALLATION</u> Verify Leg Attach Collars (four) – DOWN/LOCKED
1:55	<u>ENT AFT FLT DECK CONFIG</u> [ 9 ]
1:38	<u>C/W RESET</u> [ 11 ]
1:10	<u>N2 QTY COMPUTE</u> [ 24 ]
1:05	Begin Fluid Loading per individual prescription. Fluid Loading should be completed by EI
0:52	<u>WIRELESS STOW</u> [ 15 ]
0:39	<u>CLOTHING CONFIG</u> [ 20 ]
0:30	<u>PLBD CLOSING CONFIG</u> [ 21 ], 7-18
0:20	<u>RADIATOR STOW</u> [ 22 ], 7-18
0:10	<u>EMER PLBD CLOSING</u> (ENT PKT, <u>ECLS</u> )
0:06	<u>POST CLOSING CONFIG</u> [ 23 ], 7-18
0:05	<u>SEAT INGRESS</u>

<u>ENT AFT FLT DECK CONFIG</u> [ 9 ]	
	<u>ENTRY COMM</u>
A1L	S-BD PM MODE – STDN LO NSP CODING XMIT,RCV (two) – OFF
A1R	AUD CTR VOICE RCD SEL CH 1 sel – ICOM A 2 sel – ICOM B
A13	OS AUD SPKR PWR – OFF
R14:C	cb MNB KU ELEC – op ANT HTR – op √CABLE HTR – op MNC KU SIG PROC – op cb UHF EVA (two) – op
R10,L9	MS,PS AUD PWR – AUD/TONE A/G (two) – T/R √A/A – T/R ICOM (two) – T/R

C/W RESET (Contact CDR for additional parameters) [ 11 ]

R13U			
PARAMETER NAME	C/W CH	ENA/ INH	
HYD	P1	99	ENA
	2	109	ENA
	3	119	ENA

WIRELESS STOW [ 15 ]

Disconnect, stow Wireless Headsets (if reqd)  
√Aft deck lts as reqd (minimize use)

CLOTHING CONFIG [ 20 ]

Unstow, don:  
ACES  
Harness  
Boots

N2 QTY COMPUTE [ 24 ]

SM 66 ENVIRONMENT

Add N2 Qty 1 and 2, then annotate value on CAB PRESS LEAK nomograph (ENT PKT, ECLS)

Cont next page

## Back of MS AFT FLIGHT DECK ACTIVITIES MS PULLOUT PAGE

### PLBD CLOSING CONFIG 21

CONFIG RMS/OBSS (if RMS/OBSS onboard)

√Elbow Camr in aligned position

- Pan 90° from X-axis
- Tilt per decal

A8L PORT RMS HTR (two) – OFF  
RMS PWR – OFF

R12 (OBSS) STBD RMS HTR (two) – OFF  
(OPP) RSC PWR – OFF  
OBSS SW PWR – OFF  
cb OBSS SW PWR CB1 – op

R11L SET UP LIGHTS (minimize use)  
CRT2 IDP/CRT4 PWR – ON  
A6U GPC/CRT 5/4 EXEC  
√ANNUN BUS SEL – MNC

NOTE

Minimum operating time for PLB floodlight  
is 10 min (~3 min to full bright)

A7U	PL BAY FLOOD AFT STBD – PORT – MID STBD – PORT – FWD STBD – PORT – BHD –		<div style="border: 2px solid red; padding: 5px; width: fit-content; margin: auto;"> <p style="margin: 0; text-align: center; color: red;">ON</p> <p style="margin: 0; text-align: center; color: red;">ON</p> <p style="margin: 0; text-align: center; color: red;">ON</p> <p style="margin: 0; text-align: center; color: red;">ON</p> <p style="margin: 0; text-align: center; color: red;">ON</p> <p style="margin: 0; text-align: center; color: red;">ON</p> <p style="margin: 0; text-align: center; color: red;">N/A</p> </div>
-----	--	--	---

Record MET \_\_/\_\_:\_\_

- \* If PLB floodlight not ON to full bright within 5 min: \*
- \* (Aff) PL BAY FLOOD – OFF \*

TV/VTR ACT

Activate TV/VTR per Cue Card (only if reqd)

### RADIATOR STOW 22

R13L √RAD LAT CNTL SYS A,B (two) – OFF (tb-REL)  
√CNTL SYS A,B (two) – OFF (tb-DPY)

PL BAY MECH PWR SYS 1,2 (two) – ON  
RAD CNTL SYS A,B (two) – STO (simo)  
(√tb-bp ~50 sec, STO)  
– OFF

RAD LAT CNTL SYS A,B (two) – LAT (simo)  
(tb-bp ~30 sec, LAT)  
– OFF

PL BAY MECH PWR SYS 1,2 (two) – OFF

### POST CLOSING CONFIG 23

NOTE

Lights must be OFF minimum of 10 min  
UNBLOCKED, 16 min BLOCKED prior  
to reuse

A7U After floodlights ON > 10 min:  
PL BAY FLOOD (all) – OFF

Stow Flt Deck Camrs, Accessories

R11L IDP/CRT4 PWR – OFF  
AFD 1 PWR – OFF

DEACT TV/VTR per Cue Card if reqd

FOOT LOOP CONFIG

Tape Foot Loops in egress routes

P & I

## MS MIDDECK ACTIVITIES MS PULLOUT PAGE

### NOTE

Wait for GO from CDR or PLT before starting any activity on this page

TIME (TIG-)	MS MIDDECK ACTIONS
3:50	<u>FLUID LOADING PREP</u> [ 2 ]
2:46	<u>ENTRY STOWAGE</u> [ 4 ]
2:25	<u>SPECIALIST SEAT INSTALLATION</u> Verify Leg Attach Collars (four) – DOWN/LOCKED Verify LiOH Door Latches (four) – ENGAGED
1:55	<u>ENT MIDDECK CONFIG</u> [ 10 ], 7-20
1:05	Begin Fluid Loading per individual prescription. Fluid Loading should be completed by EI Verify Side Hatch UV Filter, Locking Device, and Pyro Box Safing Pin removed and stowed
0:51	<u>WCS DEACT</u> [ 16 ], 7-20
0:39	<u>CLOTHING CONFIG</u> [ 20 ], 7-20
0:05	<u>SEAT INGRESS</u>

<u>FLUID LOADING PREP</u> [ 2 ]
Unstow,fill 4 drink containers (per crewmember) with 8 oz of water each; temp stow near seat
Unstow 8 salt tablets (per crewmember); temp stow tablets in Flight Suit pocket

<u>ENTRY STOWAGE</u> [ 4 ]
<u>PERSONAL HYGIENE SYS STOWAGE</u> Stow: Personal Hygiene Kits Hose
<u>AIRLOCK CLOSEOUT</u> Tether soft goods to EVA tether point or A/L Stowage Bag. Gray Tape to floor
MO13Q
√AIRLK FAN A(B) – OFF if flown Stow all ducts as appropriate Airlock ENT SW VERIF, 3-30 and 3-31

GALLEY

MA73C:G  
ML86B:A  
:B

#### ESCAPE POLE SETUP

Reinstall Stbd Pip Pin  
Reinstall large Port Pin:  
Retract and hold Locking Pin (Ring)  
Reinstall large Pin  
Release Locking Pin (Ring)  
Slide forward Safing Latch

√Pole Straps secure

#### FDF STOWAGE

Stow FLIGHT PLAN

#### CABIN CONFIG

Stow: Backup PGSC  
Middeck Camrs,Accessories  
FWD/AFT Shades,Filters  
Quick Don Masks

Stow Exercise Equipment  
√Retention net in ASC/ENT config

#### EGRESS ROUTE CONFIG

Tape Foot Loops in egress routes

#### GALLEY DEACT

√OVEN/RHS – OFF  
H2O HTRS (two) – OFF  
√OVEN FAN – OFF  
√REHYD STA lever – cl (push in)  
√OVEN DOOR LATCH – latched  
cb AC3 GALLEY FAN (three) – op  
MNC SPLY H2O GALLEY SPLY – op  
MNA GALLEY OVEN – op  
MNB GALLEY H2O HTR – op

Cont next page

## Back of MS MIDDECK ACTIVITIES MS PULLOUT PAGE

### ENT MIDDECK CONFIG 10

	<u>ENTRY COMM</u>	
MO42F	MIDDECK SPKR AUD PWR	- AUD/TONE
	A/G (two)	- T/R
	√A/A	- T/R
	ICOM (two)	- T/R
ML85E	AC S1	- OFF
	<u>MIDDECK PCS</u>	
MO10W	14.7 CAB REG INLET vlv (two)	- CL
	H2O TK N2 REG INLET vlv (two)	- OP
	O2 REG INLET vlv (two)	- CL
MO69M	LEH O2 vlv (two)	- as reqd
MO32M	6 vlv	- as reqd
	<u>RMS PNL LIGHTS</u> (If RMS onboard)	
MA73C:F	cb AC1 RMS PRI ΦA	- op
	AC2 RMS B/U ΦA	- op

### WCS DEACT 16

WCS	VAC VLV	- CL
	√MODE	- AUTO
	FAN SEP SEL sw	- OFF
	Unstow hose from cradle, attach hose to WCS housing via Velcro straps	
	Remove, stow:	WCS Trash Can
		Mirror
		Privacy Curtain
	Foot restraints	- up, locked
	Close, latch door	
ML31C	VAC VENT ISOL VLV BUS SEL	- MNB
	CNTL	- CL (tb-CL)
	NOZ HTR	- OFF
	√Middeck lts as reqd (minimize use)	
MO69M	LEH O2 8 vlv	- CL
	Remove, stow O2 Bleed Orifice	
	LEH O2 8 vlv	- as reqd

### CLOTHING CONFIG 20

Unstow, don:  
ACES  
Harness  
Boots



## LOSS OF FES DEORBIT PREP ENTRY DELTAS MS PULLOUT PAGE

### DELTAS TO ENT, DEORBIT BURN

- |    |   |           |
|----|---|-----------|
| 1. | At TIG-30 min, enter ENT, <u>DEORBIT BURN</u><br>(do all)   | C3<br>O17 |
| 2. | At TIG-15 min, use two IDP/CRTs with four MDUs as reqd for burn<br>Minimize use when possible     | O17       |
| 3. | At TIG-15, do not perform pnl A14 OMS/RCS heater configurations                                   |           |
| 4. | At TIG-5, use MDUs as reqd for APU start, two FLT CNTLR PWR/DDUs as reqd for burn<br>Minimize use |           |

### DELTAS TO ENT, POST BURN

- |    |   |                     |
|----|---|---------------------|
| 1. | Use one FLT CNTLR PWR, one IDP/CRT with three MDUs only as reqd   |                     |
| 2. | Set event timer counting to EI  |                     |
| 3. | At EI-21:<br>HYD CIRC PUMP (one of two on non-operating hyd sys) – ON   | R2                  |
| 4. | At EI-18: If FRCS DUMP reqd:<br>RJDF LOGIC, DRIVER (eight) – ON<br>FWD RCS MANF ISOL 1,2,3,4 (four) – OP (tb-OP)                  | O14,O15,O16:F<br>O8 |
| 5. | After dump completion:<br>RJDF LOGIC, DRIVER (eight) – OFF  | O14,O15,O16:F       |
| 6. | In ENTRY SW CHECK, do not activate ANTISKID, NWS, NAV AIDS  |                     |
| 7. | At EI-13:<br>Operating HYD CIRC PUMP – OFF<br>Start second APU (one only)<br>HYD CIRC PUMP (remaining non-operating hyd sys) – ON | R2<br>R2            |

- |    |  |
|----|--|
| 8. | Prior to SSME HYD REPRESS:<br>√FCS CH (four) – AUTO<br>ATVC (four) – ON<br>When SSME REPRESS complete:<br>ATVC (four) – OFF<br>√EIU (three) – OFF<br>√MEC 1,2 (two) – OFF<br>GNC 51, BFS GNC 51 SSME<br>REPOS – ITEM 19 EXEC (INH) |
|----|--|

### DELTAS TO ENTRY MANEUVERS CUE CARD

- |    |  |
|----|--|
| 1. | At EI-5:<br>Operating HYD CIRC PMP – OFF<br>Start remaining APU<br>BRAKES (three) – ON<br>cb ADTA 1,2,3,4 (four) – cl<br>GNC I/O RESET |
| 2. | At EI: NH3 CNTLR B – SEC/ON<br>Use two IDP/CRTs with six MDUs<br>cb MNA,B,C DDU L,R (four) – cl<br>FLT CNTLR PWR (two) – ON            |
| 3. | If OV103,4:<br>At V = 15K: TACAN MODE (three) – GPC  |
| 4. | At V = 12K: DELETE reference to radiator flow  |
| 5. | At V = 6K: NH3 CNTLR B – OFF<br>A – PRI/GPC  |
| 6. | At M = 2.9:<br>MLS (three) – ON<br>GNC I/O RESET<br>RADAR ALTM (two) – ON<br>HUD PWR (two) – ON<br>NWS – 1<br>ANTISKID – ON            |
| 7. | Post Wheel-Stop, go to EXPEDITED PWRDN   |

**MS PULLOUT PAGE**

This Page Intentionally Blank

# LOSS OF 2 H2O LOOPS

PART 1: ON-ORBIT WAIT .....	8-3
PART 2: ON-ORBIT WAIT BACKOUT .....	8-9
20-MINUTE DE/REPRESS .....	8-17

**LOSS OF 2 H2O  
LOOPS**

This Page Intentionally Blank

## LOSS OF 2 H2O LOOPS

### PART 1: ON-ORBIT WAIT

#### ASSUMPTIONS/INITIAL CONDITIONS

LOSS OF 2 H2O LOOPS assumes one of following pwrdns accomplished:

LOSS OF 2 H2O LOOPS (ORB PKT, PWRDN)

LOSS OF 2 H2O LOOPS (POST OMS-2) (ASC PKT, PWRDN)

IMU 2 and MDM FF2 have been activated

Comm is being cycled per ORB PKT pwrdrn comm pages

#### PROBLEM DESCRIPTION/RATIONALE

Use of H2O loop or air-cooled equipment is minimized or delayed because heat transfer from crew module is lost

Cabin atmosphere purges are done to aid in reducing cabin humidity and temp. This cycle should be started 1 hr 15 min after failure. Attitude control is reqd during purge because venting is propulsive

Av Bay 1 equipment is used as much as possible to keep Av Bays 2 and 3 cool for entry

## **LOSS OF 2 H2O LOOPS (Cont)**

### **PART 1: ON-ORBIT WAIT (Cont)**

#### NOTE

1. MS procedures for PART 1: ON-ORBIT WAIT are located on MS PULLOUT PAGES, 8-7. Extra copies are located in back of PLT's book
2. Maintain minimum lighting
3. Use wristwatches for time reference until GMT/MET UPDATE (COARSE) in PART 2: ON-ORBIT WAIT BACKOUT
4. Alternate between GPC 4 and GPC 1 for each Cabin De/Repress cycle. Minimize time that GPCs are on
5. Each GPC will be powered up for 2 sec each cycle to allow error detection and correction logic to scrub memory of any accumulated errors
6. With MDM FF1/off, panel C3 DAP controls are functional even though lights are not on
7. Perform De/Repress during night pass, if possible. De/Repress should occur within 75 min of failure. Subsequent De/Represses at TIG-1:15 and TIG-:20
8. Monitor crew health by applying temp strip (MED Kit) to forehead and trunk of CDR and PLT. Record body temp every 15 min
9. Use Quick Don Mask as needed to provide relief during periods of high cabin temperature and humidity. Do not use Quick Don Mask during cabin repress. Don ACES, activate O2, and close visor if cabin temp > 95 degF and no evaporative cooling is sensed

RJD CONFIG CHECK 1

O6                   √MDM FA1,2,3,4 (four) – ON  
O14:F,O15:F,       √RJDA LOGIC,DRIVER (eight) – ON  
O16:F               √RJDF LOGIC,DRIVER (eight) – OFF  
                      √RJD MANF L5/F5/R5 DRIVER – OFF

GNC GPC ACTIVATION 2

Alternate between GPCs 4 and 1  
Record MET: 1) \_\_\_\_ / \_\_\_\_ : \_\_\_\_ : \_\_\_\_  
                  2) \_\_\_\_ / \_\_\_\_ : \_\_\_\_ : \_\_\_\_

C2                   IDP/CRT2 PWR     – ON  
                      MAJ FUNC         – GNC  
L1                   AV BAY 1 FAN A(B) – ON  
O6                   √GPC MODE 4(1)   – HALT (tb-bp)  
                      √OUTPUT 4(1)     – NORM (tb-bp)  
                      PWR 4(1)         – ON  
                      MODE 4(1)       – STBY (tb-RUN), RUN

RESTRING TO GNC GPC 3

GNC 0 GPC MEMORY  
CONFIG – ITEM 1 +2 EXEC  
Assign all strings to GPC 4(1)  
GNC, OPS 201 PRO

	ALL	Begin Fluid Loading (one 8 oz container every 15 min, with a salt tablet every other container) and continue through entry
	C,P	Start all <u>CABIN DE/REPRESS</u> cycles approx 20 min before sunrise, if possible
ELAPSED TIME		<b><u>CABIN DE/REPRESS</u></b>
	00:00	C,P <u>RJD CONFIG CHECK</u> [1], 8-5
		C <u>PCS SETUP</u> [A] (20 MINUTE DE/REPRESS), 8-17
		C, MS <u>CABIN DEPRESS SETUP</u> [B] (20 MINUTE DE/REPRESS), 8-17
		C,P <u>GNC GPC ACTIVATION</u> [2], 8-5
	00:05	C,P <u>RESTRING TO GNC GPC</u> [3], 8-5
		C,P <u>TAIL SUN ATT MNVR</u> [4]
		MS <u>CABIN DEPRESS</u> [C] (20 MINUTE DE/REPRESS), 8-17
	00:10	
	00:15	
	C, MS <u>CABIN REPRESS</u> [D] (20 MINUTE DE/REPRESS), 8-17	
	C,P <u>ESTABLISH FREE DRIFT</u> [5]	
	C,P <u>GNC GPC POWERDOWN</u> [6]	
00:20		
	MS If MCC requests data on cab temp and humidity, or Av Bay temp, perform <u>CABIN ENVIRONMENT MONITOR</u> [7], 8-7	
	ALL At TIG-1:30, go to PART 2: ON-ORBIT WAIT BACKOUT, 8-9	

TAIL SUN ATT MNVR [4]

**WARNING**  
Do not turn off FF MDM associated with IMU in operate

CRT GNC UNIV PTG

√TGT ID, ITEM 8 +4  
BODY VECT – ITEM 14 +5 EXEC  
Load Tail Sun Att P = 225, Y = 0, OM = (blank)

C3 DAP: A/AUTO/PRI  
TRK – ITEM 19 EXEC (CUR – \*)  
√ERR TOT – ITEM 23 (\*)

ADI √Att mnvr complete

ESTABLISH FREE DRIFT [5]

C3 √CABIN DEPRESS [C] complete  
DAP: B/AUTO/PRI  
Wait 30 sec  
DAP: FREE

**NOTE**  
Deviations from TAIL SUN att are expected during free drift period. No action reqd

GNC GPC POWERDOWN [6]

CRT GNC, OPS 000 PRO

O6 GPC MODE 4(1) – STBY (tb-bp)  
– HALT (tb-bp)  
– STBY (tb-RUN)  
– HALT (tb-bp)

PWR 4(1) – OFF

C2 IDP/CRT 2 PWR – OFF

L1 AV BAY 1 FAN A(B) – OFF  
Record MET: 1) \_\_\_ / \_\_\_ : \_\_\_ : \_\_\_  
2) \_\_\_ / \_\_\_ : \_\_\_ : \_\_\_

O6 GPC PWR 1(4) – ON,wait 2 sec,OFF  
2 – ON,wait 2 sec,OFF  
3 – ON,wait 2 sec,OFF  
5 – ON,wait 2 sec,OFF



## LOSS OF 2 H2O LOOPS

### PART 1: ON-ORBIT WAIT MS ACTIVITIES

#### MS PULLOUT PAGE

##### NOTE

Wait for GO from CDR or PLT before starting any activity on this page

<u>CABIN ENVIRONMENT MONITOR</u> 7	
	Perform at GSTDN (SGLS) on MCC call
	<u>NOTE</u> Cab or Av Bay fan must be on for good cab air temp and humidity, or Av Bay temp readings as reqd
	If MCC requests data on cab environ:
L1 O15:B L4:K :L	√CAB FAN A(B) – ON cb MNB OI MDM OF 1/2 B – cl √AC1 φB CAB AIR S/C – cl √AC2 φA CAB T CNTLR 1 – cl
	If MCC requests data on Av Bay 1:
L1 O15:B L4:L	√AV BAY 1 FAN B(A) – ON cb MNB OI MDM OF 1/2 B – cl SIG CONDR OF 2/3 A – cl √AC3 φB AV BAY 1 S/C – cl
	If MCC requests data on Av Bay 2:
L1 O14:B O15:B L4:L	√AV BAY 2 FAN A(B) – ON cb MNA OI MDM OF 3/4 A – cl MNB OI SIG CONDR OF 2/3 A – cl √MNBAC1 φB AV BAY 2 S/C – cl
	If MCC requests data on Av Bay 3:
L1 O15:B L4:L	√AV BAY 3 FAN B(A) – ON cb MNB OI MDM OF 1/2 B – cl SIG CONDR OF 1/4 B – cl √AC2 φB AV BAY 3 S/C – cl
	Perform LOSS OF 2 H2O LOOPS COMM POWERUP, steps 1,4,5,6 (ORB PKT, <u>PWRDN</u> )
C3	OI PCMMU PWR – 1
	After comm/data complete: Go to LOSS OF 2 H2O LOOPS COMM PWRDN (ORB PKT, <u>PWRDN</u> ) and pwrdn equipment used in above steps

**MS PULLOUT PAGE**

This Page Intentionally Blank

## LOSS OF 2 H2O LOOPS

### PART 2: ON-ORBIT WAIT BACKOUT MS PULLOUT PAGE

#### ASSUMPTIONS/INITIAL CONDITIONS

LOSS OF 2 H2O LOOPS (ORB PKT, PWRDN) has been accomplished

Orbiter in On-Orbit Wait config – IMU 2 and MDM FF2 activated

Cabin de/repress cycle has been performed during Part 1

Comm is being cycled per ORB PKT pwrtn comm pages

CONUS TIG available in  $\geq 1.5$  hr

#### PROBLEM DESCRIPTION/RATIONALE

IMU reference maintained and heat load minimized during Part 1 by allowing IMU to run uncompensated (GPC off)

During Part 2: ON-ORBIT WAIT BACK OUT, minimum equipment configured to accomplish PLBD closing, IMU alignment, and GMT/MET update. Final powerup to single-fault tolerant entry config initiated at TIG-0:30 min in LOSS OF 2 H2O LOOPS DEORBIT PREP/ENTRY (Sec 9)

#### NOTE

1. MS procedure located on MS PULLOUT PAGE, 8-15. Extra copies located in back of PLT's book
2. Continue Fluid Loading (8 oz water every 15 min, with a salt tablet every other container)

## MS PULLOUT PAGE

FES HTR ACTIVATION		14
C	L1	√TOP EVAP HTR NOZ L,R (two) – B AUTO √DUCT sel – B
	L2	√HI LOAD DUCT HTR sel – A/B
	R11L	√FLASH EVAP FDLN HTR A,B SPLY (two) – 2 SPLY H2O B SPLY ISOL VLV – OP (tb-OP)

RAD BYP CONFIG		15
C	L1	FLASH EVAP CONFIG FLASH EVAP CNTLR SEC – ON PRI B(A) – OFF
	L2	<u>RAD BYP</u> RAD BYP VLV MODE (two) – MAN RAD BYP VLV MAN SEL (two) – BYP (after ~3 sec, tb-BYP)
	O1	RAD CNTLR LOOP 1,2 (two) – OFF FREON ISOL MODE – OFF √FREON EVAP OUT TEMP ind ~62 ± 2 degF (after ~2.5 min)

DEACT GPC 4		16
O6	R11L	√PLBD – closed GPC/CRT – 14 EXEC GPC MODE 4 – STBY (tb-bp),HALT PWR 4 – OFF IDP/CRT4 PWR – OFF

GMT AND MET UPDATE (COARSE)		8
		<u>NOTE</u> This procedure provides for crew autonomous update of onboard GMT and MET. OPS 0 reqd for GMT UPDATE > 15 msec
P	C2 CRT	√PLBD – closed √Depress complete IDP/CRT2 PWR – ON GNC, OPS 000 PRO <b>2: GNC GPC MEMORY</b>
		<u>NOTE</u> Make no kybd entries during TIME SYNC and UPDATE actions. UPDATE causes reinitialization and TIME SPEC will have to be recalled
		1. <b>2: GNC 2 TIME</b> TIME SYNC – ITEM 38 EXEC (takes up to 2 min)
		2. <u>GMT UPDATE</u> Calculate GMT Δ for ITEM 24 as follows: GMT Δ = wristwatch GMT – orbiter GMT (DAY/HR:MIN:SEC)
		ITEM 24 <input type="text" value="±"/> <input type="text"/> <input type="text"/> / <input type="text"/> <input type="text"/> : <input type="text"/> <input type="text"/> : <input type="text"/> <input type="text"/> . <input type="text"/> <input type="text"/>
		UPDATE – ITEM 32 EXEC (takes up to 2 min, SPEC 2 resumes at update)
		3. Record GMT when MET RESET occurs: ____/____:____:____ Reset MET to 0 on an even GMT min
		MET RESET – ITEM 33 EXEC
		4. <u>MET UPDATE</u>
		GMT at liftoff = <input type="text" value="±"/> <input type="text"/> <input type="text"/> / <input type="text"/> <input type="text"/> : <input type="text"/> <input type="text"/> : <input type="text"/> <input type="text"/> . <input type="text"/> <input type="text"/>
		Calculate MET Δ for ITEM 28 as follows: MET Δ = GMT recorded in step 3 – GMT at liftoff √ITEM 2 (*)
		ITEM 28 <input type="text" value="±"/> <input type="text"/> <input type="text"/> / <input type="text"/> <input type="text"/> : <input type="text"/> <input type="text"/> : <input type="text"/> <input type="text"/> . <input type="text"/> <input type="text"/>
		UPDATE – ITEM 32 EXEC (takes up to 2 min)
		GNC, OPS 201 PRO
	C2	IDP/CRT2 PWR – OFF

TIG	
-01:30	
C,P	<u>FES HTR ACTIVATION</u> [14], 8-10
-01:25	C,P <u>FES CHECKOUT</u> [17]
C,P	<u>ACTIVATE GPC 1.4</u> [18]
-01:20	
C	<u>RAD BYP CONFIG</u> [15], 8-10
-01:15	C,MS Perform <u>20 MINUTE DE/REPRESS</u> [A] thru [D], 8-17
MS	<u>PLBD CLOSING</u> [19], 8-15
-01:10	
MS	<u>POST CLOSING CONFIG</u> [20], 8-15
C,P	<u>DEACT GPC 4</u> [16], 8-10
-01:05	P <u>GMT AND MET UPDATE (COARSE)</u> [8], 8-10
-01:00	

FES CHECKOUT [17]

C L1 FLASH EVAP CNTLR PRI A,B,SEC (three) – OFF  
 RAD CNTLR OUT TEMP – HI

O1 When FREON EVAP OUT TEMP ind > 50 degF  
 RAD CNTLR OUT TEMP – NORM (then immediately)  
 FLASH EVAP CNTLR PRI B(A) – ON

After 1 min:  
 √FREON EVAP OUT TEMP ind ~39 degF

ACTIVATE GPC 1.4 [18]

O14:F MMU 1 – ON (wait 34 sec)

C,P GPC 1.4 ACTIVATION  
 L1 AV BAY 1 FAN A(B) – ON  
 O6 √GPC MODE 1,4 – HALT (tb-bp)  
 √OUTPUT 1,4 – NORM (tb-bp)  
 PWR 1,4 – ON  
 MODE 1,4 – STBY (tb-RUN),RUN

C2 MEDS CONFIG  
 IDP/CRT2 PWR – ON  
 GPC/CRT 03 EXEC  
 44 EXEC  
GPC 1(4) TO GNC (SM) OPS 2  
GNC 0 GPC MEMORY  
 CONFIG – ITEM 1 +2 EXEC  
 Deassign GPC4 from target set  
 Assign all strings to GPC1  
 √PL 1/2 not assigned  
 GNC, OPS 201 PRO  
 DAP: B/AUTO/PRI  
TRANSITION GPC 4 TO SM OPS 2

R11L IDP/CRT4 PWR – ON  
 MAJ FUNC – SM

C2 IDP/CRT2 PWR – OFF  
 CRT4 SM, GPC/CRT 44 EXEC  
 SM, OPS 201 PRO  
 Enable Uplink Control  
4: SM 1 DPS UTILITY  
 ITEM 36 EXEC (\*)

O14:F MMU 1 – OFF

O13:A MTU ACTIVATION  
 :C cb ESS 1BC MTU A – cl  
 2CA MTU B – cl  
 (Record MET of cb closure: \_\_\_/\_\_\_:\_\_\_)

IMU STAR ALIGN PAD

NOTE

For pad data, ref STAR PAIRS (ORB OPS, PTG)

STAR ID: -Y \_\_\_\_, \_\_\_\_ (TIG - \_\_\_\_ : \_\_\_\_ TO - \_\_\_\_ : \_\_\_\_)

-Z \_\_\_\_, \_\_\_\_ (TIG - \_\_\_\_ : \_\_\_\_ TO - \_\_\_\_ : \_\_\_\_)

ANG DIF: \_\_\_\_\_

ALIGNMENT ATTITUDE  
(Dual or Single S TRK)

2nd ALIGNMENT ATTITUDE  
(Single S TRK)

-Z: \_\_\_\_\_ -Y: \_\_\_\_\_

R \_\_\_\_\_

R \_\_\_\_\_

R \_\_\_\_\_

P \_\_\_\_\_

P \_\_\_\_\_

P \_\_\_\_\_

Y \_\_\_\_\_

Y \_\_\_\_\_

Y \_\_\_\_\_

MNVR TO IMU ALIGN ATT 9

R11L IDP/CRT4 PWR - ON  
MAJ FUNC - GNC

C

4: GNC UNIV PTG

Load ALIGN ATT from MCC  
or STAR PAIRS (ORB OPS, PTG)

CRT  
C3(A6)  
L1

ITEM 18 EXEC  
DAP: A/AUTO/PRI  
HI LOAD EVAP - ENA  
FLASH EVAP CNTLR PRI B(A) - ON  
SEC - OFF

√Att mnvr complete  
DAP: B/AUTO/PRI

IMU ALIGN 10

C O6

MDM FF1 - ON  
√FF3 - ON

4: GNC 22 S TRK/COAS CNTL

GNC I/O RESET

1. S TABLE CLR - ITEM 20 EXEC  
S TRK - ITEM 3,4 EXEC (\*)
2. √S TABLE: TRK ID 1,2 - STAR ID (PAD)  
√ANG ERR 1: ≤ 0.08  
√SEL ITEM 17,18 (\*)  
4: GNC 21 IMU ALIGN  
√REF STAR - ITEM 13 (\*)  
√TYPE - ITEM 15 (TORQUE)  
√ANG 2 ΔX,ΔY,ΔZ ≤ 2°
3. ALIGN IMU 2 - ITEM 11 EXEC (\*)  
EXEC - ITEM 16 EXEC (\*)  
√EXEC - ITEM 16 (no \*)

WARNING  
Do not turn off FF MDM  
associated with IMU just aligned

O6  
R11L

MDM FF1,3 - OFF  
IDP/CRT4 PWR - OFF

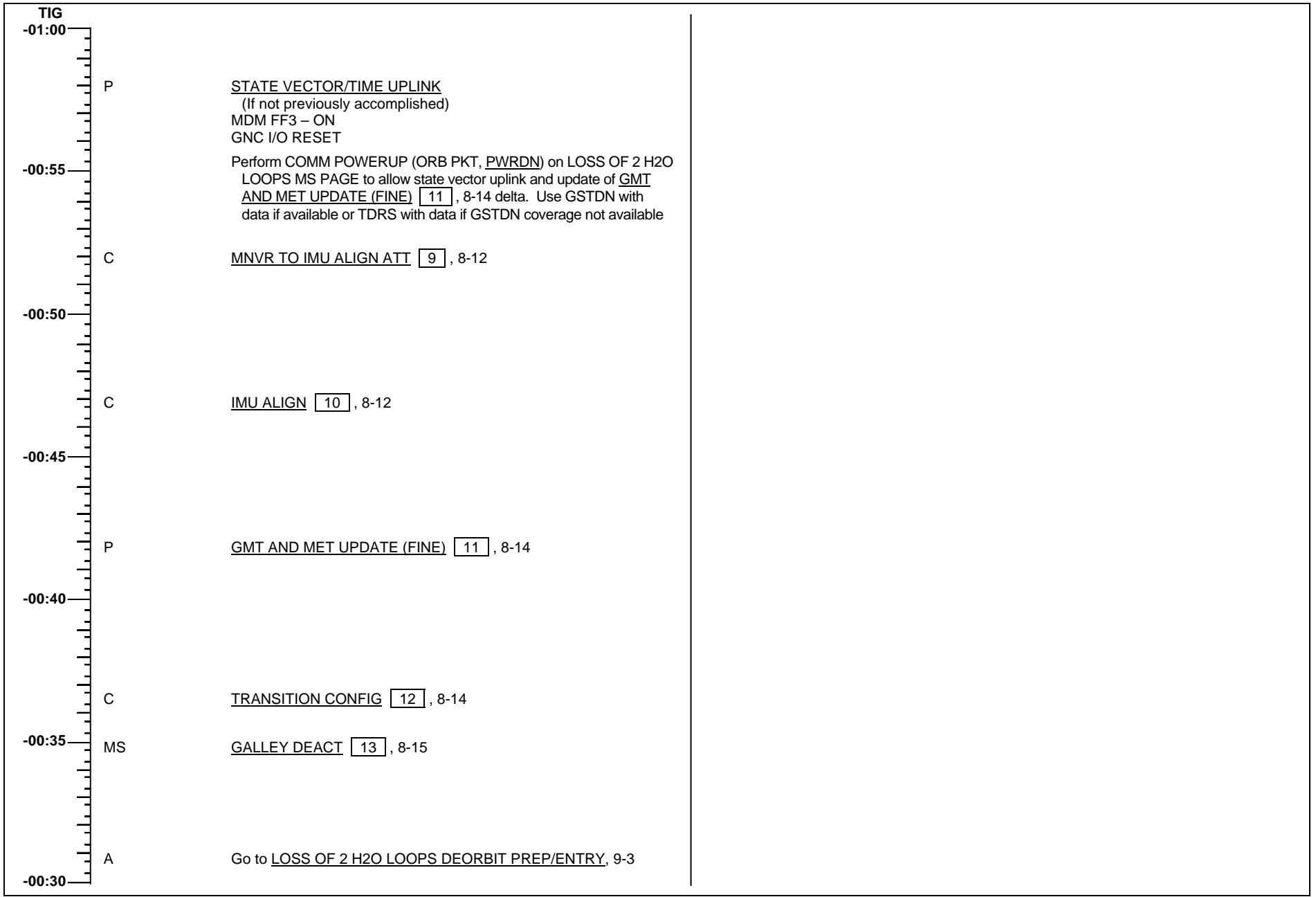

GMT AND MET UPDATE (FINE) 11

**NOTE**

This procedure is for updating onboard GMT and MET to degree of accuracy reqd for ENTRY. Use deltas provided by MCC. OPS 0 reqd for GMT UPDATE > 15 msec

**WARNING**

Remaining in OPS 0 longer than 10 min will cause state vector to be lost

P C2

1. IDP/CRT2 PWR – ON  
GNC, OPS 000 PRO

**NOTE**

Make no kybd entries during TIME SYNC and UPDATE actions. GMT UPDATE causes reinitialization and TIME SPEC will have to be recalled

2. 2: GNC 2 TIME  
TIME SYNC – ITEM 38 EXEC (takes up to 2 min)

3. GMT UPDATE  
Use GMT Δ provided by MCC for ITEM 24 (DAY/HR:MIN:SEC)

ITEM 24 [±] [ ] [ ] [ ] [ ] / [ ] [ ] [ ] [ ] : [ ] [ ] [ ] [ ] : [ ] [ ] [ ] [ ] . [ ] [ ] [ ] [ ]

UPDATE – ITEM 32 EXEC (takes up to 2 min, SPEC 2 resumes at update)

4. When update complete:  
GNC, OPS 201 PRO
5. Calculate MET Δ to be used for ITEM 28 in step 6 as follows:  
MET Δ = GMT – GMT at liftoff – MET

6. MET UPDATE  
√ITEM 2 (\*)

ITEM 28 [±] [ ] [ ] [ ] [ ] / [ ] [ ] [ ] [ ] : [ ] [ ] [ ] [ ] : [ ] [ ] [ ] [ ] . [ ] [ ] [ ] [ ]

UPDATE – ITEM 32 EXEC (takes up to 2 min)

SET CRT TIMER TO COUNT DOWN TO TIG

(HR:MIN:SEC – MET)

COUNT TO – ITEM 17 + [ ] [ ] [ ] + [ ] [ ] [ ] + [ ] [ ] [ ]

C2

TRANSITION CONFIG 12

C O13:E                      cb ESS 3AB GPC STAT – cl  
O14:C                      MNA SMOKE DETN L/R FLT DK – cl



## LOSS OF 2 H2O LOOPS MS ACTIVITIES

### Part 2: ON-ORBIT WAIT BACKOUT MS ACTIVITIES MS PULLOUT PAGE

#### NOTE

Wait for GO from CDR or PLT before starting any activity on this page

TIME (TIG-)	MS ACTIONS
	<u>NOTE</u> Prepare ACES for donning. Don ACES if cabin temp > 95 degF and no evaporative cooling sensed. Inflate anti-G suit as needed for circulatory support
1:13	<u>PLBD CLOSING</u> [19]
1:08	<u>POST CLOSING CONFIG</u> [20]
0:42	<u>STOW COAS</u>
0:35	<u>GALLEY DEACT</u> [13]

<u>PLBD CLOSING</u> [19]	
MA73C:A :B	MCA LOGIC MID (four) – ON MCA LOGIC MID (four) – ON
O6 CRT4	<u>CLOSE PLBD</u> MDM PL1,2 (two) – ON SM I/O RESET SM, OPS 202 PRO [4: SM PL BAY DOORS]
	<u>CAUTION</u> Verify no obstructions before closing and latching PLBD (Ku ANT, RMS, RAD, etc.)
R13L CRT4	PL BAY DR SYS (two) – ENA AC PWR ON – ITEM 1 EXEC AUTO MODE SEL – ITEM 3 EXEC PBD SW BYP – ITEM 14 EXEC CLOSE – ITEM 17 EXEC

	<p>* If 'S63 PBD SEQ FAIL' msg, √AUTO SEQ column: *</p> <p>* If '↓' for CENTER, PORT(STBD) FWD or PORT (STBD) AFT LATCHES, continue in MANUAL mode (skip affected latch gang) *</p> <p>* If '↓' for PORT(STBD) DOOR: *</p> <p>* If PORT DOOR, and DOOR SCALLOP on or below target line, continue in MANUAL mode *</p> <p>* If either AFT LATCHES close MICRO-SW STAT for aff DOOR is '1', continue in MANUAL mode *</p> <p>* Perform MAL, <u>MECH</u>, SSR-2 CONTINGENCY PLBD CLOSURE *</p> <p>After PLBD closed: PBD STOP – ITEM 16 EXEC AC POWER OFF – ITEM 2 EXEC (*) PBD SW BYP – ITEM 14 EXEC (no *) PL BAY DR SYS (two) – DSBL</p>
R13L	

<u>POST CLOSING CONFIG</u> [20]	
A7U	√PL BAY FLOOD (all) – OFF
MA73C:A :B	MCA LOGIC MID (four) – OFF MCA LOGIC MID (four) – OFF
O6	MDM PL1 – OFF
	If no data transmission in progress: MDM PL2 – OFF

<u>GALLEY DEACT</u> [13]	
	<u>NOTE</u> Ensure sufficient containers and salt tablets prepared to continue Fluid Loading thru entry
MA73C:G ML86B:B	cb AC3 GALLEY FAN (three) – op cb MNA GALLEY OVEN – op MNB GALLEY H2O HTR – op REHYD STA lever – cl (push in) OVEN DOOR LATCH – latched

**MS PULLOUT PAGE**

This Page Intentionally Blank

## 20-MINUTE DE/REPRESS MS PULLOUT PAGE

### NOTE

Wait for GO from CDR or PLT before starting any block. Proceed to subsequent blocks unless otherwise directed

PCS SETUP <span style="float: right;">A</span>									
C	<table style="width: 100%; border: none;"> <tr> <td style="width: 10%; vertical-align: top;">L2</td> <td>√O2 SYS 1 SPLY – CL (tb-CL) √2 SPLY – OP (tb-OP)</td> </tr> <tr> <td></td> <td>√XOVR SYS 1 – CL 2 – OP</td> </tr> <tr> <td></td> <td>√N2 SYS 1,2 REG INLET (two) – OP (tb-OP)</td> </tr> <tr> <td></td> <td>O2/N2 CNTLR VLV SYS 1 – OP (N2) 2 – CL (O2)</td> </tr> </table>	L2	√O2 SYS 1 SPLY – CL (tb-CL) √2 SPLY – OP (tb-OP)		√XOVR SYS 1 – CL 2 – OP		√N2 SYS 1,2 REG INLET (two) – OP (tb-OP)		O2/N2 CNTLR VLV SYS 1 – OP (N2) 2 – CL (O2)
L2	√O2 SYS 1 SPLY – CL (tb-CL) √2 SPLY – OP (tb-OP)								
	√XOVR SYS 1 – CL 2 – OP								
	√N2 SYS 1,2 REG INLET (two) – OP (tb-OP)								
	O2/N2 CNTLR VLV SYS 1 – OP (N2) 2 – CL (O2)								
L1	CAB FAN A(B) – ON								

CABIN DEPRESS SETUP <span style="float: right;">B</span>							
MS	<table style="width: 100%; border: none;"> <tr> <td style="width: 10%; vertical-align: top;">MO10W</td> <td>14.7 CAB REG INLET SYS 1 vlv – CL 2 vlv – OP</td> </tr> <tr> <td></td> <td>√O2 REG INLET SYS 1 vlv – CL √2 vlv – OP</td> </tr> </table>	MO10W	14.7 CAB REG INLET SYS 1 vlv – CL 2 vlv – OP		√O2 REG INLET SYS 1 vlv – CL √2 vlv – OP		
MO10W	14.7 CAB REG INLET SYS 1 vlv – CL 2 vlv – OP						
	√O2 REG INLET SYS 1 vlv – CL √2 vlv – OP						
INNER HATCH	Open, stow hatch Unstow flashlight						
C	<table style="width: 100%; border: none;"> <tr> <td style="width: 10%; vertical-align: top;">AW82B</td> <td>AIRLK DEPRESS vlv cap – vent, remove</td> </tr> <tr> <td style="vertical-align: top;">O15:B</td> <td>cb MNB OI SIG CONDR OF 2/3 A – cl</td> </tr> <tr> <td style="vertical-align: top;">O1</td> <td>PPO2 sel – SNSR B</td> </tr> </table>	AW82B	AIRLK DEPRESS vlv cap – vent, remove	O15:B	cb MNB OI SIG CONDR OF 2/3 A – cl	O1	PPO2 sel – SNSR B
AW82B	AIRLK DEPRESS vlv cap – vent, remove						
O15:B	cb MNB OI SIG CONDR OF 2/3 A – cl						
O1	PPO2 sel – SNSR B						

CABIN DEPRESS <span style="float: right;">C</span>	
AW82B MO10W	<p>When attitude control established: During depress, use panel O1 gauges to monitor CABIN PRESS and PPO2 instead of SPEC To start depress, config following valves per 20 MINUTE DE/REPRESS, 8-18</p> <p>AIRLK DEPRESS vlv – 0 14.7 CAB REG INLET SYS 1,2 vlv (two) – configure per Depress/Repress chart 8-18</p> <div style="border: 3px double black; padding: 5px; margin: 10px 0;"> <p style="text-align: center; margin: 0;"><b>WARNING</b></p> <p style="margin: 0;">Cabin O2 concentration must be maintained below 28.5% to protect against increased flammability. If PPO2 &lt; 2.3 psia, don Quick Don Mask</p> </div> <p>Plot CABIN PRESS vs PPO2 every 60 sec. Trend of plot should closely parallel slope of shading lines in each of respective zones. If it does not, immediately verify correct valve config. If plot transitions to another zone during depress, continue. Do not attempt to reach control zone; 10.2 psia is target</p> <p>On call from CDR or if 10.2 psia: AIRLK DEPRESS vlv – CL Go to <u>CABIN REPRESS</u> <span style="float: right;">D</span></p>
AW82B	

CABIN REPRESS <span style="float: right;">D</span>					
	<p style="text-align: center;"><b>NOTE</b></p> <p style="text-align: center;">This procedure takes up to 15 min to perform</p> <div style="border: 3px double black; padding: 5px; margin: 10px 0;"> <p style="text-align: center; margin: 0;"><b>WARNING</b></p> <p style="margin: 0;">Terminate all WCS activity and Quick Don Mask usage during cabin repress to 14.7 psia</p> </div>				
MS	<table style="width: 100%; border: none;"> <tr> <td style="width: 10%; vertical-align: top;">AW82B</td> <td>√AIRLK DEPRESS vlv – CL</td> </tr> <tr> <td style="vertical-align: top;">MO10W</td> <td>14.7 CAB REG INLET SYS 1,2 vlv (two) – OP</td> </tr> </table>	AW82B	√AIRLK DEPRESS vlv – CL	MO10W	14.7 CAB REG INLET SYS 1,2 vlv (two) – OP
AW82B	√AIRLK DEPRESS vlv – CL				
MO10W	14.7 CAB REG INLET SYS 1,2 vlv (two) – OP				
C	<table style="width: 100%; border: none;"> <tr> <td style="width: 10%; vertical-align: top;">L2</td> <td>√O2/N2 CNTLR VLV SYS 1 – OP (N2) 2 – AUTO (O2/N2)</td> </tr> </table> <p>When Cabin P = 14.0: O2/N2 CNTLR VLV SYS 1 – CL 2 – CL</p> <p>When cabin in NORMAL CAB P, PPO2 operating limits, then: cb MNB OI SIG CONDR OF 2/3 A – op</p>	L2	√O2/N2 CNTLR VLV SYS 1 – OP (N2) 2 – AUTO (O2/N2)		
L2	√O2/N2 CNTLR VLV SYS 1 – OP (N2) 2 – AUTO (O2/N2)				
O1	CAB FAN A(B) – OFF				
O15:B					
L1					

20-MIN  
DE/REPRESS

MS PULLOUT PAGE  
20 MINUTE DE/REPRESS

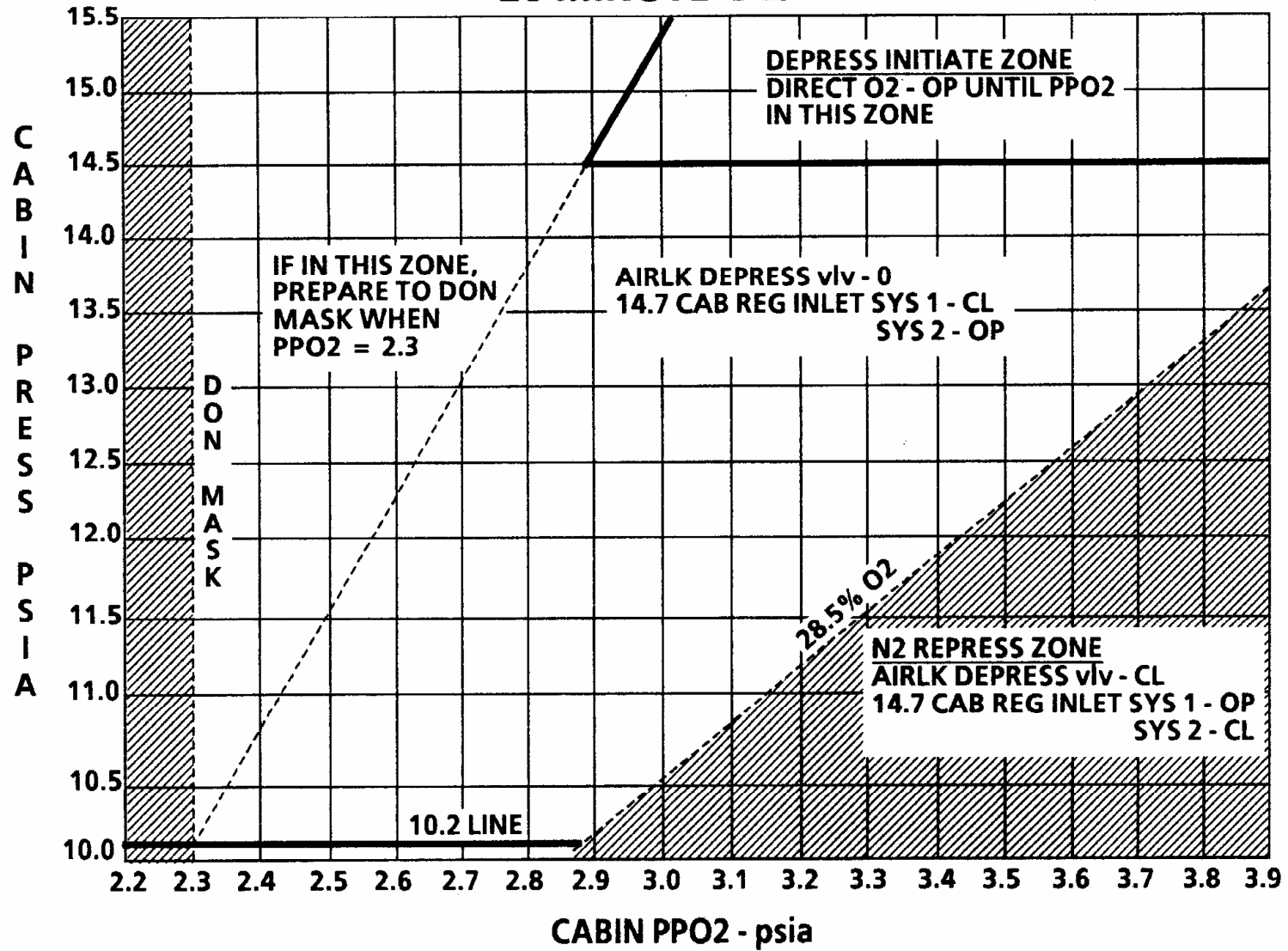

# **LOSS OF 2 H2O LOOPS DEORBIT PREP/ENTRY**

**LOSS OF 2 H2O  
LOOPS D/O PREP**

This Page Intentionally Blank

## LOSS OF 2 H2O LOOPS DEORBIT PREP/ENTRY

### ASSUMPTIONS/INITIAL CONDITIONS

LOSS OF 2 H2O LOOPS DEORBIT PREP/ENTRY is a **STAND-ALONE procedure** that assumes one of the following has been accomplished:

LOSS OF 2 H2O LOOPS (ORB PKT, PWRDN)

LOSS OF 2 H2O LOOPS (POST OMS-2) (ASC PKT, PWRDN)

LOSS OF 2 H2O LOOPS (ORB PKT, PWRDN) and LOSS OF 2 H2O LOOPS Parts 1 and 2 (Section 8)

This procedure assumes 30 min remaining until deorbit burn

### PROBLEM DESCRIPTION RATIONALE

With no H2O loop flow, heat not removed from water and air-cooled equipment. ORB PKT pwrdsn maintained until TIG-30 min to minimize thermal load as long as possible

### NOTE

1. LOSS OF 2 H2O LOOPS DEORBIT PREP/ENTRY configures vehicle for entry as quickly as possible and repowers critical equipment as late as possible to single-fault tolerant level
2. MS procedures located on MS PULLOUT PAGE, 9-5. Extra copies located in back of PLT's book
3. CDR and PLT procedures begin on 9-7
4. Use COMM pages from ORB PKT pwrdsn to cycle COMM if necessary
5. This procedure utilizes modified version of DEORBIT BURN MONITOR and ENTRY MANEUVERS Cue Cards located at end of section

This Page Intentionally Blank



**LOSS OF 2 H2O LOOPS DEORBIT PREP/ENTRY  
MS PULLOUT PAGE**

NOTE: Wait for GO from CDR before accomplishing any action on this page

**TIG-20 MCA CONFIG**

MA73C MCA LOGIC (fourteen) – ON

**CABIN DE/REPRESS**

TIG-20 Perform 20 MINUTE DE/REPRESS, 8-17

**TIG-10 AFT PANEL CONFIG FOR ENTRY COMM**

NOTE

This procedure configures aft panel for landing site comm coverage at V = 12K. If comm cycled post TIG-10 (using ORB PKT pwrn comm pages), this AFT PANEL CONFIG FOR ENTRY COMM must be reestablished

L9,R10	PS,MS AUD PWR	– AUD
R14:B	cb GCILC (two)	– cl
C3	S-BD PM CNTL	– CMD
A1L	ANT SW ELEC	– 2
	MODE	– STDN LO
	XPNDR	– 2
	NSP PWR	– 2
	DATA RATE XMIT	– HI
	RCV	– HI
	√UPLK DATA	– S-BD
	√CODING XMIT	– OFF
	√RCV	– OFF

(Cont in right column)

**TIG-7 AIRLOCK CLOSEOUT (assumes Cabin Depress complete)**

Close INNER HATCH:  
Position handle to preclosing posn per decal  
Hatch – rotate about hinge and push  
Handle – CCW to LATCH  
Lock lever to LOCKED  
Equal vlv – NORM

**TIG-5 LEH VLV CONFIG**

MO69M	LEH O2 8 vlv – CL
	Remove, stow O2 Bleed Orifice
MO32M	LEH O2 7,8 vlv (two) – OP (if reqd)
	5,6 vlv (two) – OP (if reqd)

**CLOTHING CONFIG**

	Don: ACES, Harness, Boots
C6	LEH O2 vlv (two) – OP
EI-10	Stow flight deck PGSC

**MS PULLOUT PAGE**

This Page Intentionally Blank

## LOSS OF 2 H2O LOOPS DEORBIT PREP/ENTRY

	CDR	PLT
	O6      MDM FF1,3 (two) – ON √FF2 – ON I/O RESET	<b>DEORBIT TARGET</b> Use Deorbit Manager on PGSC to compute targets (record on 9-10)
	F6      HUD DATA BUS – 1	<b>W/B STEAM VENT HTR ACT</b>
	<b>CABIN DE/REPRESS</b>	R2      BLR PWR (three) – ON
		<b>SWITCH CONFIG FOR OPS 3</b>
TIG-20	Perform 20 MINUTE DE/REPRESS, 8-17	O14,O15, O16:A      RGA 1,2,3 (three) – ON
	<b>VERIFY DAP/SELECT PRIs</b>	O14,O15:E    cb ACCEL 1,2 (two) – cl
	√DAP: A1/AUTO/PRI	O14,O15, O16:F      ASA (four) – ON
	B set to B1	O16:F      ACCEL 3 – ON
	MCA CONFIG (no earlier than TIG-20)	Verify MCA LOGIC config complete, then:
	Give MS GO for MCA LOGIC config	O8      FWD RCS MANF ISOL 1,2,3,4 (four) – CL (tb-CL)
		<b>IMU ACTIVATION (if IMUs 1,3 off)</b>
		<u>NOTE</u>
		IMU ACT can be performed in OPS 2 or 3
		<u>ACTIVATE IMU 1,3</u>
		O14:A      IMU 1 – ON
		O16:A      3 – ON
		<span style="border: 1px solid black; padding: 2px;">GNC 21 IMU ALIGN</span>
		CRT      IMU 1,3: OPER, ITEM 4,6 EXEC (*) (wait 90 sec for *)
		I/O RESET
		<u>IMU to IMU ALIGNMENT</u>
		√IMU 1,3: STAT – blank
		REF IMU – ITEM 14 +2 (ref IMU) EXEC
		√TYPE, ITEM 15 – TORQUE
		ALIGN IMU 1,3 – ITEM 10,12 EXEC (*)
		2 – ITEM 11 EXEC (no *)
		EXEC – ITEM 16 EXEC (*)
		(Cont next page)

## LOSS OF 2 H2O LOOPS DEORBIT PREP/ENTRY

CDR

PLT

### STAR TRKR DEACT

O6 S TRK PWR (two) – OFF  
 O14:E,  
 O15:E cb S TRK -Z,-Y (two) – op  
 O6 S TRK DR CNTL SYS 1,2 (two) – CL (start timer)  
     √POS tb (two) – bp  
 When both tb – CL (~8-24 sec)  
     or either tb – bp > 24 sec,  
 S TRK DR CNTL SYS 1,2 (two) – OFF

### DPS ENTRY CONFIG (assumes GPC 1 active)

NOTE

Do not perform DPS ENTRY CONFIG  
 if IMU Align in progress

O15:F MMU 2 – ON, wait 34 sec  
 O6 √GPC MODE 2,3,4,5 (four) – HALT (tb-bp)  
     √OUTPUT 2,3,4 (three) – NORM (tb-bp)  
         5 – B/U (tb-bp)  
 PWR 3,5 (two) – ON  
 MODE 3,5 (two) – STBY (tb-RUN)  
     – RUN

CRT

GNC 0 GPC MEMORY

CONFIG – ITEM 1 +3 EXEC  
 Modify MC3 per table →  
 GNC, OPS 301 PRO  
DEORB MNVR COAST

CONFIG	3
GPC	10000
STR 1	1
2	1
3	1
4	1
PL 1/2	1
CRT 1	1
2	1
3	1
4	0
L 1	0
2	0
MM 1	1
2	1

(Cont next page)

### RESELECT IMU 1,3

√ALIGNMENT COMPLETE – ITEM 16 (no \*)  
 IMU 1,3: DES – ITEM 7,9 EXEC (no \*)

Do not proceed until all DPS ENTRY CONFIG  
 steps complete

### CLOSE VENT DOORS

O6 MDM FF4 – ON  
 GNC I/O RESET  
GNC 51 OVERRIDE  
 CRT VENT DOOR CNTL CLOSE – ITEM 44 EXEC  
 (\*), wait 1 min, then  
 O6 MDM FF4 – OFF

### LANDING SITE UPDATE

1: GNC 50 HORIZ SIT

SEL SITE, RWY (PASS/BFS)

### DRAG ALT ATM SELECTION

SEL ATM: incl ≤ 50° √ITEM 22 (\*)  
 incl > 50° SEL ITEM NR (table)

Hemi	Jan	Feb	Mar	Apr	May	Jun	Jul	Aug	Sep	Oct	Nov	Dec
<b>N Desc</b>	<b>23</b>	<b>23</b>	<b>23</b>	<b>23</b>	<b>22</b>	<b>24</b>	<b>24</b>	<b>24</b>	<b>22</b>	<b>23</b>	<b>23</b>	<b>23</b>
<b>S Asc</b>	<b>24</b>	<b>24</b>	<b>22</b>	<b>23</b>	<b>23</b>	<b>23</b>	<b>23</b>	<b>23</b>	<b>23</b>	<b>23</b>	<b>22</b>	<b>24</b>
<b>N Asc</b>	<b>22</b>											
<b>S Desc</b>	<b>22</b>											

### CHECK CG

UPDATE PRPLT ITEM 18 as reqd

(Cont next page)

## LOSS OF 2 H2O LOOPS DEORBIT PREP/ENTRY

CDR

PLT

**GNC 0 GPC MEMORY**

CONFIG – ITEM 1 +3 EXEC

Modify MC 3 per table →

GNC, OPS 301 PRO (√DAP)

BFS: GNC, OPS 301 PRO

GNC, OPS 302 PRO

**GNC 0 GPC MEMORY**

DOWNLIST GPC – ITEM 44

+3 EXEC

CONFIG		3
GPC		10300
STR	1	3
	2	3
	3	3
	4	3
PL	1/2	3
CRT	1	3
	2	3
	3	3
	4	0
L	1	0
	2	0
MM	1	3
	2	3

O6

GPC MODE 1 – STBY (tb-bp)

– HALT

PWR 1 – OFF

GPC/CRT 0/4 EXEC

For any fwd IDP pwrd off:

GPC/CRT 3/X EXEC

O15:F

MMU 2 – OFF

L1

AV BAY 1 FAN (two) – OFF

2 FAN A(B) – ON

(wait 3 sec, then)

3 FAN B(A) – ON

**AFT PANEL CONFIG FOR ENTRY COMM  
(no earlier than TIG-10 min)**

Give MS GO to config AFT panel

Cabin Repress (no earlier than TIG-10)

Give MS GO for CABIN REPRESS

(20 MINUTE DE/REPRESS), 8-17 and

AIRLOCK CLOSEOUT, 9-5

Do not pwr off Cabin Fan A after Repress complete

**OMS BURN PREP**

O7

AFT L,R RCS He PRESS (four) – OP (tb-OP)

TK ISOL (six) – GPC (tb-OP)

XFEED (four) – GPC (tb-CL)

√MSTR RCS XFEED – OFF

O8

√L,R OMS He PRESS/VAP ISOL (four) – CL

√TK ISOL (four) – OP

– (tb-OP)

√XFEED (four) – CL (tb-CL)

FWD RCS He PRESS (two) – OP (tb-OP)

Use two IDP/CRTs with four MDUs for deorbit burn

## LOSS OF 2 H2O LOOPS DEORBIT PREP/ENTRY

### LOAD TGTs AND MNVR

CRT            Enter TGT data from MCC or PGSC → DEORBIT PAD

LOAD – ITEM 22 EXEC  
 TIMER – ITEM 23 EXEC

O14:E,  
 O15:E,  
 O16:E            cb MNA,B,C DDU L,R (four) – cl

Mnvr to burn att

Select right sec gimbals  
 (because FF4 - OFF)  
 RIGHT – ITEM 31 EXEC

### CLOTHING CONFIG

Don: ACES,Harness,Boots

C6            LEH O2 vlv (two) – OP

**TIG-2            Go to Deorbit Burn Cue Cards**

#### NOTE

If FRCS COMPLETION reqd during burn, perform FRCS RECOVERY prior to fast flip.

Use LOSS of 2 H2O LOOPS DEORBIT BURN MONITOR

RECORD DEORBIT OPPORTUNITIES		
SITE	APPROX TIG	XRNG
_____	____/____:____:____	_____
_____	____/____:____:____	_____
_____	____/____:____:____	_____
_____	____/____:____:____	_____

COMPUTE WEIGHT  
 Use Deorbit Manager on PGSC (record below)

COMPUTE TARGET

WT	_____
TIG	____/____:____:____
C1	_____
C2	(-).6000
HT	65.832
θT	_____
ΔVTOT	_____
REI	_____

FRCS RECOVERY (if reqd for FRCS COMPLETION)	
O14,O15,	RJDF LOGIC,DRIVER (eight) – ON
O16:F	
O6	MDM FF4 – ON GNC I/O RESET
O8	FWD RCS MANF ISOL 1,2,3,4 (four) – OP (tb-OP)

# LOSS OF 2 H2O LOOPS

I

## DEORBIT BURN MONITOR

<p><b>OMS TEMP*</b></p> <table style="width: 100%; border-collapse: collapse;"> <tr> <td style="width: 50%; text-align: center;">L</td> <td style="width: 50%; text-align: center;">R</td> </tr> <tr> <td style="text-align: center;">FU IN P ≥</td> <td style="text-align: center;">FU IN P ≥</td> </tr> <tr> <td style="text-align: center;">≤</td> <td style="text-align: center;">≤</td> </tr> <tr> <td style="text-align: center;">or No FU IN P</td> <td style="text-align: center;">or No FU IN P</td> </tr> </table>	L	R	FU IN P ≥	FU IN P ≥	≤	≤	or No FU IN P	or No FU IN P	<table style="width: 100%; border-collapse: collapse;"> <tr> <td style="text-align: center;">219</td> <td style="text-align: center;">220</td> </tr> <tr> <td style="text-align: center;">201</td> <td style="text-align: center;">208</td> </tr> </table> <p>OMS ENG FAIL OMS PRPLT FAIL</p>	219	220	201	208
L	R												
FU IN P ≥	FU IN P ≥												
≤	≤												
or No FU IN P	or No FU IN P												
219	220												
201	208												
<p><b>OMS PC* &amp; OMS ↓</b> (BFS: √accel) ENG VLV 1 or 2 &lt; 70 or OX IN P &gt; 227 OX IN P ≤ 227 or No OX IN P</p>	<p>OMS ENG FAIL OMS PRPLT FAIL</p>												
<p><b>OMS OX/FU TK P</b> (√ENG IN P) OX/FU LOW</p>	<p>He PRESS/VAP ISOL (two) – OP If aff TK P not incr: He PRESS/VAP ISOL (two) – CL At PC &lt; 72 or OMS TEMP: OMS PRPLT FAIL</p>												
<p>OX &amp; FU HIGH</p>	<p>He PRESS/VAP ISOL (two) – CL Cycle He A(B) to maintain TK P 234-284</p>												
<p><b>OMS GMBL</b></p> <table style="width: 100%; border-collapse: collapse;"> <tr> <td style="width: 50%;">PRI fail</td> <td style="width: 50%;"></td> </tr> <tr> <td>SEC fail</td> <td></td> </tr> </table>	PRI fail		SEC fail		<p>L(R) OMS GMBL – SEC If high RCS usage: OMS ENG FAIL</p>								
PRI fail													
SEC fail													
<p><b>GPC 3</b></p>	<p>BFS Engage</p>												
<p><b>I/O ERROR FA</b></p> <table style="width: 100%; border-collapse: collapse;"> <tr> <td style="width: 50%;">1</td> <td style="width: 50%;"></td> </tr> <tr> <td>2 FAs lost</td> <td></td> </tr> </table>	1		2 FAs lost		<p>L OMS GMBL – SEC ♦ I/O RESET (if recov: BFS I/O RESET) If high RCS usage: OMS ENG FAIL √MAN SHUTDN</p>								
1													
2 FAs lost													
<p><b>BCE STRG D</b></p> <table style="width: 100%; border-collapse: collapse;"> <tr> <td style="width: 50%;">1</td> <td style="width: 50%;"></td> </tr> <tr> <td>3</td> <td></td> </tr> </table>	1		3		<p>I/O RESET (if recov: &gt;&gt;) If high RCS usage: L OMS GMBL – SEC If high RCS usage: R OMS ENG FAIL</p>								
1													
3													
<p><b>RM DLMA IMU</b> or <b>2 MN BUSES</b></p> <table style="width: 100%; border-collapse: collapse;"> <tr> <td style="width: 50%;">CUR HP &gt;</td> <td style="width: 50%;"></td> </tr> <tr> <td></td> <td style="text-align: center;">(safe HP)</td> </tr> <tr> <td>IMU dilemma</td> <td></td> </tr> </table>	CUR HP >			(safe HP)	IMU dilemma		<p>STOP BURN: OMS ENG(s) – OFF &gt;&gt;</p> <p>After C/O: √Timer G21 If any IMU ACC &gt; 0.03: aff IMU – desel I'cnct OMS to RCS (√RCS Burn time) THC +X to TGT Hp</p>						
CUR HP >													
	(safe HP)												
IMU dilemma													
<p><b>I/O ERROR PCM</b></p>	<p>OI PCMMU PWR – 1</p>												

\*If XFD, BLDN, or sensor fail, monitor ENG IN P for off-nominal performance

P & I

# LOSS OF 2 H2O LOOPS DEORBIT PREP/ENTRY

	CDR	POST BURN ACTIVITIES	PLT
	O14:E,      cb MNA,B DDU L (two) – op O15:E		O15:E,      cb MNB,C DDU R (two) – op O16:E
	F6            FLT CNTLR PWR – OFF		F8            FLT CNTLR PWR – OFF
	C3            √DAP: AUTO		C3            √DAP: AUTO
	<b>MNVR TO EI-5 ATT</b>		<b>OMS/RCS POST BURN RECONFIG</b>
	CRT1        GNC, OPS 303 PRO		O7            √AFT L,R RCS He PRESS (four) – OP (tb-OP) √TK ISOL (six)        – GPC (tb-OP) √XFEED (four)        – GPC (tb-CL)
TIME TO EI (MIN)	LVLH PITCH (DEG)		O8            √L,R OMS He PRESS/VAP ISOL (four) – CL √TK ISOL (four) – OP (tb-OP) √XFEED (four) – CL (tb-CL)
26	315		
25	319		
24	323		
	327		
	331		
	335		
20	339		
	343		
	347		
	351		
	355		
15	359		
	3		
	7		
	11		
	15		
10	19		
	23		
	27		
	31		
	35		
5	39		
		<b>NOTE</b>	
		Use LVLH table unless <b>INRTL</b> EI-5 attitude (ITEMS 24,25,26) supplied by MCC. Use DDU and FLT CNTLR PWR as reqd for manual mnvr	
		<u>When mnvr complete</u>	
	L4:P      cb LG SNSR (two) – cl		
	O14:A,    BRAKES (three) – ON		
	O15:A,		
	O16:A		
			<b>APU PRE-START</b>
			R2            BLR N2 SPLY (three)        – ON √PWR (three)                – ON √CNTLR/HTR (three)        – A(B) √cb APU FU TK VLV ENA (six) – cl √APU FU TK VLV (three)     – CL √AUTO SHTDN (three)       – ENA √SPEED SEL (three)        – NORM √OPER (three)                – OFF HYD CIRC PUMP (three)     – OFF MN PUMP PRESS (three)    – LO APU CNTLR PWR (three)     – ON



## LOSS OF 2 H2O LOOPS DEORBIT PREP/ENTRY

CDR	POST BURN ACTIVITIES
<p><b>FORWARD RCS DUMP (if reqd)</b>                      (Use for off-nominal Xcg entry using lowest of OX or FU qty)</p> <p>Perform FRCS dump if reqd to maintain Xcg in box                      If FRCS dump not reqd, go to 9-12</p> <p>If FRCS dump reqd, perform FOUR JET DUMP FRCS REACTIVATION:</p> <p>MA73C:A     √MCA LOGIC FWD (three) – ON                      O14:B        cb OI SIG CONDR OF 1/4 A – cl                      :F            RJDF 1B F1 DRIVER – ON                                          LOGIC – ON</p> <p>O15:B        cb OI SIG CONDR OF 2/3 A – cl                      :F            RJDF 1A F2 DRIVER – ON                                          LOGIC – ON</p> <p>O16:F        RJDF 2A F3,2B F4 DRIVER (two) – ON                                          F4/F5 LOGIC (two) – ON</p> <p>O6            √MDM FF1,2,3 (three) – ON                                          FF4 – ON                                          GNC I/O RESET</p> <p>O8            FWD RCS MANF ISOL 1,2,3,4 (four) – OP                                          (tb-OP)</p> <div style="border: 1px solid black; display: inline-block; padding: 2px;">GNC 23 RCS</div> <p>CRT           JET RESET – ITEM 45 EXEC                                          Reselect deselected FRCS jets                                          JET RESET – ITEM 45 EXEC</p>	<p><b>APU START</b></p> <p>C3            OI PCMMU PWR – 1                                          BFS I/O RESET</p> <p>R2            APU FU TK VLV (three) – OP                                          √APU/HYD RDY tb (three) – gray</p> <p style="text-align: center;">* If tb – bp, attempt normal start *</p> <p>                    APU OPER (three) – START/RUN</p> <p>MDU           √HYD PRESS ind (three) – LO green</p> <p>R2            √APU/HYD RDY tb (three) – bp                                          HYD MN PUMP PRESS (three) – NORM</p> <p>MDU           √HYD PRESS ind (three) – HI green</p> <p style="text-align: center;">* If APU OIL OUT P &lt; 25 and APU TEMP *                      * OIL OUT not increasing after APU start *                      * or no start, perform APU SHUTDN *                      * (ENT PKT, <u>APU/HYD</u>) *                      *</p> <p>R4            √HYD BK ISOL VLV (three) – GPC (tb-CL)                                          √LG EXTD ISO VLV – GPC (tb-CL)</p> <p>C3            OI PCMMU PWR – OFF</p>

## LOSS OF 2 H2O LOOPS DEORBIT PREP/ENTRY

### FORWARD RCS DUMP (Cont)

Determine FWD RCS 'DUMP TO %' (calculator, cg wheel, or DEL PAD)

NOTE

During dump, disregard FWD RCS qty

CRT

GNC DEORB MNVR EXEC

  
 FWD RCS ARM – ITEM 36 EXEC  
 DUMP – ITEM 37 EXEC (Start watch)

When dump time achieved:  
 FWD RCS OFF – ITEM 38 EXEC

O8

When dump complete:  
 FWD RCS MANF ISOL  
 1,2,3,4 (four) – CL (tb-CL)

O6

MDM FF4 – OFF  
 O14:B   cb OI SIG CONDR OF 1/4 A – op  
 O14:F   RJDF 1B F1 DRIVER, LOGIC – OFF  
 O15:B   cb MNB OI SIG CONDR OF 2/3 A – op  
 O15:F   RJDF 1A F2 LOGIC, DRIVER – OFF  
 O16:F   2A F3, 2B F4 DRIVER (two) – OFF  
           F4/F5 LOGIC (two) – OFF

### FOUR JET DUMP

FWD RCS PRPLT TO BE DUMPED (%)

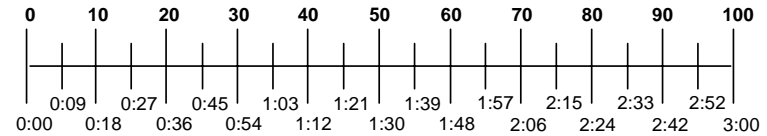

TIME FROM DUMP INITIATION (M:S)

### TWO JET DUMP

FWD RCS PRPLT TO BE DUMPED (%)

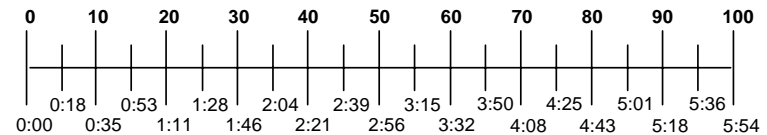

TIME FROM DUMP INITIATION (M:S)

### GPS ACTIVATION (EI-15)

MS	A13	GPS PWR – ON
		Wait 30 sec
		GNC I/O RESET
		GNC 55 GPS STATUS
	CRT	INIT – ITEM 15 EXEC (*)
		NAV – ITEM 18 EXEC (*)

# OV103,104

C D/O/3,4/GEN M

## LOSS OF 2 H2O LOOPS DEORBIT PREP/ENTRY

1: GNC 53 ENTRY CONTROLS	2: BFS, GNC SYS SUMM 2
3: GNC DEORB MNVR COAST	

### SECONDARY ACTUATOR CHECK (if not previously performed and time permits)

#### NOTE

If a port does not bypass during check,  
bypass aff port after check:

SEC ACT BYPASS – ITEM 8 +X X  
EXEC

If aff port still does not bypass:

SEC ACT RESET – ITEM 9 +X X  
EXEC

- |      |   |
|------|---|
| R2   | 1. √HYD MN PUMP PRESS (three) – NORM  |
| CRT3 | SURF DRIVE ON – ITEM 39 EXEC (*), wait at least 5 sec   |
| MDU  | √SPI: Stop drive test when elevon posns within +12° to -27°:<br>SURF DRIVE OFF – ITEM 40 EXEC (*) |
| CRT1 | 2. √POS STIM ENA – ITEM 7 (no *)  |
| C3   | 3. √FCS CH (four) – AUTO  |
| CRT1 | 4. SEC ACT CK, CH 1 – ITEM 1 EXEC (*)<br>CK START – ITEM 5 EXEC                                   |
|      | 5. √All CH 1 ports bypass (↓)<br>STOP – ITEM 6 EXEC (*)   |

- |      |                                       |
|------|---------------------------------------|
| C3   | 6. FCS CH 1 – ORIDE                   |
| CRT1 | √All CH 1 ports reset (no ↓)          |
| C3   | FCS CH 1 – AUTO                       |
|      | 7. Repeat steps 5 thru 7 for CH 2,3,4 |

### EQUIPMENT STOWAGE AND SEAT INGRESS

If not already accomplished:

- Stow equip
- Seat ingress
- Adjust seat, exercise brake pedals

### SPACELAB FINAL DEACT (if flown)

- |   |    |  |
|---|----|--|
| P | R1 | PL PRI MNC,FC3,MNB (three) – OFF (tb-OFF)<br>AUX – OFF<br>CAB – OFF<br>AFT MNB,MNC (two) – OFF |
|---|----|--|

### ENTRY SWITCH CHECK

- |     |       |  |
|-----|-------|--|
| C   | L1    | NH3 CNTLR B – PRI/GPC  |
|     | L2    | √CAB RELIEF (two) – ENA (tb-ENA)<br>√ENTRY MODE – AUTO   |
| C,P | C3    | √SBTC – full fwd<br>√SRB SEP – AUTO<br>√ET SEP – AUTO  |
|     | F6/F8 | √AIR DATA – NAV<br>√ADI ERR – MED<br>RATE – MED<br>√HSI SEL MODE – ENTRY<br>√SOURCE (two) – NAV,1<br>√ – NAV,2 |
| C,P | F3    | √L,R TRIM RHC/PNL (two) – INH<br>√PNL (two) – ON   |

# OV103,104

## LOSS OF 2 H2O LOOPS DEORBIT PREP/ENTRY

CDR

PLT

### HORIZ SIT CONFIG

ALTM – ITEM 9

--	--	--	--	--	--

	<u>PASS ITEM</u>		<u>BFS ITEM</u>	
PTI	INH	√1		
LAND SITE (DEL PAD)		√41	√41	
RWY (DEL PAD)		√3	√3	
		√4	√4	
TACAN (DEL PAD)		√5	√5	
RA	blank	√46		
TAEM TGT				
G&N	OVHD	√6	blank	
HSI	blank		blank	
XEP	NEP	√7	NEP	√7
AIM (DEL PAD)	NOM	√8	NOM	√8
	(or CLSE)		(or CLSE)	
SPD BK	NOM	√39		
TAC	INH	√20	INH	√20
GPS	INH	√43	INH	√43
DRAG H	AUT	√22	AUT	√22
ADTA H	INH	√26	INH	√26
ADTA TO G&C	INH	√29	AUT	√28
DES any failed TACANs		√		√
TAC	DELTA	√35		
AIF_G	INH	√48		

Stow:

Deorbit Burn Cue Cards (C6)

DEORBIT BURN MONITOR (Cue Card) (C6)

**Go to LOSS OF 2 H2O LOOPS ENTRY MANEUVERS  
EI-5, 9-17**

1: GNC DEORB MNVR COAST	2: GNC 50 HORIZ SIT
-------------------------	---------------------

3: GNC 51 OVERRIDE
--------------------

- √ELEVON AUTO – ITEM 17 (\*)
- SSME REPOS – ITEM 19 EXEC (INH)
- √WRAP MODE – ITEM 45 (ENA)
- If PLB holding > 10K lb:
- FILTER ALT – ITEM 21 EXEC (\*)

3: BFS, GNC 51 OVERRIDE
-------------------------

- √ELEVON AUTO – ITEM 17 (\*)
- √SSME REPOS – ITEM 19 (INH)
- √WRAP MODE – ITEM 45 (ENA)
- If PLB holding > 10K lb:
- √FILTER ALT – ITEM 21 EXEC (\*)

- \* DES any failed/comm faulted IMU, \*
- \* RGA, AA, or SURF feedback \*

### G SUIT INFLATION

All Load –1.5

**Go to LOSS OF 2 H2O LOOPS ENTRY  
MANEUVERS EI-5, 9-17**

# OV103,104

## LOSS OF 2 H2O LOOPS ENTRY MANEUVERS

FLIGHT CONDITIONS	MANEUVER
EI-5	cb ADTA 1,2,3 (three) – cl cb MNA,B DDU L (two) – cl (L) FLT CNTLR PWR – ON Use one IDP/CRT with 2 MDUs MDM FF4 – ON GNC I/O RESET √LVLH ATT GNC, OPS 304 PRO  * If PREBANK: R/Y – CSS: * * Roll at 1°/sec to <input type="text"/> <input type="text"/> * * Maintain PREBANK ± 5° * *
'Guidance Box' @ Q̄ ~8 or D ~3	CLOSED LOOP GUIDANCE ____:____:____  * If PREBANK: P,R/Y – AUTO * Begin AIL trim monitoring
D = 11	√DRAG H
ΔAz = 10.5°	FIRST ROLL REVERSAL <input type="text"/> <input type="text"/> <input type="text"/> <input type="text"/>
V = 19K	√HYD MPS/TVC ISOL VLV SYS (three) – CL <input type="text"/> G50 √GPS, INCORPORATE
V = 15K	TACAN 1 MODE – GPC
V = 12K	<u>ACTIVATE ENTRY COMM</u> L,R AUD PWR – AUD AUD CTR – 1 UHF SPLX/EVA PWR AMPL – ON UHF MODE – SPLX (G T/R if ELS) S-BD PM CNTL – PNL,CMD OI PCMMU PWR – 1 √FORMAT – FXD MDM PL2 – ON GNC, BFS I/O RESET
V = 10K	√SPDBK to 81%
V = 7K	√TACAN and GPS status
V = 5K	ADTA PROBES – DEPLOY (√HEAT) Begin AIL and RUD trim monitoring

FLIGHT CONDITIONS	MANEUVER
M = 2.9	CAB FAN A(B) - OFF Power one HUD, one MLS, one RA for landing GNC I/O RESET
M = 2.7	√APUs
	* If M < 2.5, P CSS for ADTA to G&C incorp*
M = 2.0	Ensure ADTA to G&C; else, √theta limits
M < 1.0	* <b>For bailout procedures, go to <u>BAILOUT</u></b> * P,R/Y – CSS as reqd √SPDBK CMD vs POS MAX Nz <input type="text"/> <input type="text"/> <input type="text"/> Use two IDP/CRTs with four MDUs cb MNB,C DDU R (two) – cl (R) FLT CNTLR PWR – ON ANTISKID – ON NWS – 1 Lock Inertia Reels
M = 0.7	√LG EXTD ISO VLV – OP
h = 15K	√MLS (if activated)
h = 10K	√A/L (KSC – Tabs, Visors, Suit O2)
h = 2K	LDG GEAR ARM pb – push (ARM It on)
h = 300	LDG GEAR DN pb – push (DN It on)
MAIN GEAR TD	√SPDBK – 100%
V = 195 KEAS	DRAG CHUTE ARM,DPY pb (two) – push (simo) (All Its on)
V = 185 KEAS	DEROTATE
NOSE GEAR TD	SRB SEP – MAN/AUTO and depress pb √Auto Load Relief √HYD BK ISOL VLV (three) – OP
V < 120 KGS or 5K' remaining	BRAKE as reqd (8-10 fps <sup>2</sup> , -0.25 to -0.3G)
	* If 5K' remaining and V > 140 KGS – MAX BRAKING *
V = 60 KGS	DRAG CHUTE JETT pb – push (JETT1, JETT2 It on)
V = 40 KGS	BRAKE < 6 fps <sup>2</sup> (-0.2G) (Antiskid cutout)
WHEEL STOP	√All landing/nav aids off CAB FAN B – ON (Wait 3 sec, then continue) AV BAY FAN 2A,3A [3B vice 3A if FC1 OK] – ON (3 sec between each start) Go to ENT C/L, <u>POST LDG</u>

# OV103,104

This Page Intentionally Blank

## LOSS OF 2 H2O LOOPS DEORBIT PREP/ENTRY

CDR	POST BURN ACTIVITIES	PLT
<p><b>FORWARD RCS DUMP (if reqd)</b>                      (Use for off-nominal Xcg entry using lowest of OX or FU qty)</p> <p>Perform FRCS dump if reqd to maintain Xcg in box                      If FRCS dump not reqd, go to 9-12</p> <p>If FRCS dump reqd, perform FOUR JET DUMP FRCS REACTIVATION:</p> <p>MA73C:A    √MCA LOGIC FWD (three) – ON                      O14:B        cb OI SIG CONDR OF 1/4 A – cl                                    :F        RJDF 1B F1 DRIVER – ON                         LOGIC – ON</p> <p>O15:B        cb OI SIG CONDR OF 2/3 A – cl                                    :F        RJDF 1A F2 DRIVER – ON                         LOGIC – ON</p> <p>O16:F        RJDF 2A F3,2B F4 DRIVER (two) – ON                         F4/F5 LOGIC (two) – ON</p> <p>O6            √MDM FF1,2,3 (three) – ON                         FF4 – ON                         GNC I/O RESET</p> <p>O8            FWD RCS MANF ISOL 1,2,3,4 (four) – OP                         (tb-OP)</p> <p style="text-align: center;"><span style="border: 1px solid black; padding: 2px;">GNC 23 RCS</span></p> <p>CRT           JET RESET – ITEM 45 EXEC                                       Reselect deselected FRCS jets                                       JET RESET – ITEM 45 EXEC</p>	<p><b>APU START</b></p> <p>C3            OI PCMMU PWR – 1                                       BFS I/O RESET</p> <p>R2            APU FU TK VLV (three) – OP                                       √APU/HYD RDY tb (three) – gray</p> <p style="text-align: center;">* If tb – bp, attempt normal start *</p> <p>                 APU OPER (three) – START/RUN</p> <p>MDU          √HYD PRESS ind (three) – LO green</p> <p>R2            √APU/HYD RDY tb (three) – bp                                       HYD MN PUMP PRESS (three) – NORM</p> <p>MDU          √HYD PRESS ind (three) – HI green</p> <p style="text-align: center;">* If APU OIL OUT P &lt; 25 and APU TEMP *                                       * OIL OUT not increasing after APU start *                                       * or no start, perform APU SHUTDN *                                       * (ENT PKT, <u>APU/HYD</u>) *</p> <p>R4            √HYD BK ISOL VLV (three) – GPC (tb-CL)                                       √LG EXTD ISO VLV – GPC (tb-CL)</p> <p>C3            OI PCMMU PWR – OFF</p>	

## LOSS OF 2 H2O LOOPS DEORBIT PREP/ENTRY

### FORWARD RCS DUMP (Cont)

Determine FWD RCS 'DUMP TO %' (calculator, cg wheel, or DEL PAD)

NOTE

During dump, disregard FWD RCS qty

CRT

GNC DEORB MNVR EXEC

  
 FWD RCS ARM – ITEM 36 EXEC  
 DUMP – ITEM 37 EXEC (Start watch)

When dump time achieved:  
 FWD RCS OFF – ITEM 38 EXEC

O8

When dump complete:  
 FWD RCS MANF ISOL  
 1,2,3,4 (four) – CL (tb-CL)

O6

MDM FF4 – OFF  
 O14:B    cb OI SIG CONDR OF 1/4 A – op  
 O14:F    RJDF 1B F1 DRIVER, LOGIC – OFF  
 O15:B    cb MNB OI SIG CONDR OF 2/3 A – op  
 O15:F    RJDF 1A F2 LOGIC, DRIVER – OFF  
 O16:F    2A F3, 2B F4 DRIVER (two) – OFF  
           F4/F5 LOGIC (two) – OFF

### FOUR JET DUMP

FWD RCS PRPLT TO BE DUMPED (%)

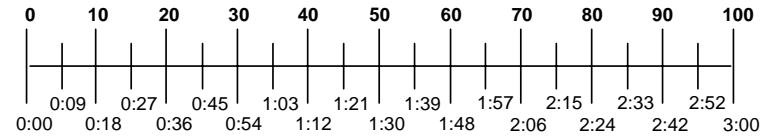

TIME FROM DUMP INITIATION (M:S)

### TWO JET DUMP

FWD RCS PRPLT TO BE DUMPED (%)

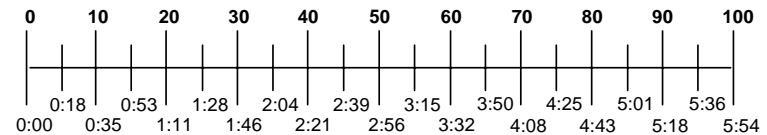

TIME FROM DUMP INITIATION (M:S)

### GPS ACTIVATION (EI-15)

O7           GPS 2,3 PWR (two) – ON  
               Wait 30 sec  
               GNC I/O RESET  
 CRT        

GNC 55 GPS STATUS

  
               INIT – ITEM 15,16 EXEC (\*)  
               NAV – ITEM 18,19 EXEC (\*)



## LOSS OF 2 H2O LOOPS DEORBIT PREP/ENTRY

1: GNC 53 ENTRY CONTROLS	2: BFS, GNC SYS SUMM 2
3: GNC DEORB MNVR COAST	

### SECONDARY ACTUATOR CHECK (if not previously performed and time permits)

#### NOTE

If a port does not bypass during check,  
bypass aff port after check:

SEC ACT BYPASS – ITEM 8 +X X  
EXEC

If aff port still does not bypass:

SEC ACT RESET – ITEM 9 +X X  
EXEC

- |      |   |
|------|---|
| R2   | 1. √HYD MN PUMP PRESS (three) – NORM  |
| CRT3 | SURF DRIVE ON – ITEM 39 EXEC (*), wait at least 5 sec   |
| MDU  | √SPI: Stop drive test when elevon posns within +12° to -27°:<br>SURF DRIVE OFF – ITEM 40 EXEC (*) |
| CRT1 | 2. √POS STIM ENA – ITEM 7 (no *)  |
| C3   | 3. √FCS CH (four) – AUTO  |
| CRT1 | 4. SEC ACT CK, CH 1 – ITEM 1 EXEC (*)<br>CK START – ITEM 5 EXEC                                   |
|      | 5. √All CH 1 ports bypass (↓)<br>STOP – ITEM 6 EXEC (*)   |

- |      |                                       |
|------|---------------------------------------|
| C3   | 6. FCS CH 1 – ORIDE                   |
| CRT1 | √All CH 1 ports reset (no ↓)          |
| C3   | FCS CH 1 – AUTO                       |
|      | 7. Repeat steps 5 thru 7 for CH 2,3,4 |

### EQUIPMENT STOWAGE AND SEAT INGRESS

If not already accomplished:

- Stow equip
- Seat ingress
- Adjust seat, exercise brake pedals

### SPACELAB FINAL DEACT (if flown)

- |   |    |  |
|---|----|--|
| P | R1 | PL PRI MNC,FC3,MNB (three) – OFF (tb-OFF)<br>AUX – OFF<br>CAB – OFF<br>AFT MNB,MNC (two) – OFF |
|---|----|--|

### ENTRY SWITCH CHECK

- |     |       |  |
|-----|-------|--|
| C   | L1    | NH3 CNTLR B – PRI/GPC  |
|     | L2    | √CAB RELIEF (two) – ENA (tb-ENA)<br>√ENTRY MODE – AUTO   |
| C,P | C3    | √SBTC – full fwd<br>√SRB SEP – AUTO<br>√ET SEP – AUTO  |
|     | F6/F8 | √AIR DATA – NAV<br>√ADI ERR – MED<br>RATE – MED<br>√HSI SEL MODE – ENTRY<br>√SOURCE (two) – NAV,1<br>√ – NAV,2 |
| C,P | F3    | √L,R TRIM RHC/PNL (two) – INH<br>√PNL (two) – ON   |

## LOSS OF 2 H2O LOOPS DEORBIT PREP/ENTRY

CDR

PLT

### HORIZ SIT CONFIG

ALTM – ITEM 9

--	--	--	--	--

	<u>PASS ITEM</u>		<u>BFS ITEM</u>	
PTI	INH	√1		
LAND SITE (DEL PAD)		√41	√41	
RWY (DEL PAD)		√3	√3	
		√4	√4	
TAEM TGT				
G&N	OVHD	√6	blank	
HSI	blank		blank	
XEP	NEP	√7	NEP	√7
AIM (DEL PAD)	NOM	√8	NOM	√8
	(or CLSE)		(or CLSE)	
SPD BK	NOM	√39		
NAV				
GPS	INH	√43	INH	√43
DRAG H	AUT	√22	AUT	√22
ADTA H	INH	√26	INH	√26
MLS	AUT	√50		
G&C				
GPS	INH	√48		
ADTA	INH	√29	AUT	√28

Stow:

- Deorbit Burn Cue Cards (C6)
- DEORBIT BURN MONITOR (Cue Card) (C6)

**Go to LOSS OF 2 H2O LOOPS ENTRY MANEUVERS  
EI-5, 9-17**

1: GNC DEORB MNVR COAST	2: GNC 50 HORIZ SIT
3: GNC 51 OVERRIDE	

- √ELEVON AUTO – ITEM 17 (\*)
- SSME REPOS – ITEM 19 EXEC (INH)
- √WRAP MODE – ITEM 45 (ENA)
- If PLB holding > 10K lb:
- FILTER ALT – ITEM 21 EXEC (\*)

3: BFS, GNC 51 OVERRIDE

- √ELEVON AUTO – ITEM 17 (\*)
- √SSME REPOS – ITEM 19 (INH)
- √WRAP MODE – ITEM 45 (ENA)
- If PLB holding > 10K lb:
- √FILTER ALT – ITEM 21 EXEC (\*)

- \* DES any failed/comm faulted IMU, \*
- \* RGA, AA, or SURF feedback \*

### G SUIT INFLATION

All Load –1.5

**Go to LOSS OF 2 H2O LOOPS ENTRY  
MANEUVERS EI-5, 9-17**

## LOSS OF 2 H2O LOOPS ENTRY MANEUVERS

FLIGHT CONDITIONS	MANEUVER
EI-5	cb ADTA 1,2,3 (three) – cl cb MNA,B DDU L (two) – cl (L) FLT CNTLR PWR – ON Use one IDP/CRT with 2 MDUs MDM FF4 – ON GNC I/O RESET √LVLH ATT GNC, OPS 304 PRO * If PREBANK: R/Y – CSS: * * Roll at 1°/sec to <input type="text"/> <input type="text"/> * * Maintain PREBANK ± 5° * *
'Guidance Box' @ q̄ ~8 or D ~3	CLOSED LOOP GUIDANCE ____:____:____ * If PREBANK: P,R/Y – AUTO * Begin AIL trim monitoring
D = 11	√DRAG H
ΔAz = 10.5°	FIRST ROLL REVERSAL <input type="text"/> <input type="text"/> <input type="text"/> <input type="text"/>
V = 19K	√HYD MPS/TVC ISOL VLV SYS (three) – CL <input type="text"/> G50 √GPS, INCORPORATE
V = 12K	<u>ACTIVATE ENTRY COMM</u> L,R AUD PWR – AUD AUD CTR – 1 UHF SPLX/EVA PWR AMPL – ON UHF MODE – SPLX (G T/R if ELS) S-BD PM CNTL – PNL,CMD OI PCMMU PWR – 1 √FORMAT – FXD MDM PL2 – ON GNC, BFS I/O RESET
V = 10K	√SPDBK to 81%
V = 5K	ADTA PROBES – DEPLOY (√HEAT) Begin AIL and RUD trim monitoring

FLIGHT CONDITIONS	MANEUVER
M = 2.9	CAB FAN A(B) - OFF Power one HUD, one MLS, one RA for landing GNC I/O RESET
M = 2.7	√APUs
	* If M < 2.5, P CSS for ADTA to G&C incorp*
M = 2.0	Ensure ADTA to G&C; else, √theta limits
M < 1.0	* <b>For bailout procedures, go to <u>BAILOUT</u></b> * P,R/Y – CSS as reqd √SPDBK CMD vs POS MAX Nz <input type="text"/> <input type="text"/> <input type="text"/> Use two IDP/CRTs with four MDUs cb MNB,C DDU R (two) – cl (R) FLT CNTLR PWR – ON ANTISKID – ON NWS – 1 Lock Inertia Reels
M = 0.7	√LG EXTD ISO VLV – OP
h = 15K	√MLS (if activated)
h = 10K	√A/L (KSC – Tabs, Visors, Suit O2)
h = 2K	LDG GEAR ARM pb – push (ARM It on)
h = 300	LDG GEAR DN pb – push (DN It on)
MAIN GEAR TD	√SPDBK – 100%
V = 195 KEAS	DRAG CHUTE ARM,DPY pb (two) – push (simo) (All Its on)
V = 185 KEAS	DEROTATE
NOSE GEAR TD	SRB SEP – MAN/AUTO and depress pb √Auto Load Relief √HYD BK ISOL VLV (three) – OP
V < 120 KGS or 5K' remaining	BRAKE as reqd (8-10 fps <sup>2</sup> , -0.25 to -0.3G)
	* If 5K' remaining and V > 140 KGS – MAX BRAKING *
V = 60 KGS	DRAG CHUTE JETT pb – push (JETT1, JETT2 It on)
V = 40 KGS	BRAKE < 6 fps <sup>2</sup> (-0.2G) (Antiskid cutout)
WHEEL STOP	√All landing/navaids off CAB FAN B – ON (Wait 3 sec, then continue) AV BAY FAN 2A,3A [3B vice 3A if FC1 OK] – ON (3 sec between each start) Go to ENT C/L, <u>POST LDG</u>

This Page Intentionally Blank

# EMERGENCY DEORBIT PREP/ENTRY

STOW KU-BD ANTENNA ..... 10-7

This Page Intentionally Blank

## **EMERGENCY DEORBIT PREP/ENTRY** **(20 min < time to TIG < 2 hr 40 min)**

### ASSUMPTIONS/INITIAL CONDITIONS

Emergency Deorbit Prep/Entry may be used for any failure case requiring deorbit in less than 2 hr 40 min. For loss of cabin pressure, perform the pwrn on 10-5 if not already completed

This procedure assumes at least 20 min and at most 2 hr 40 min remain until deorbit burn

### PROBLEM DESCRIPTION/RATIONALE

Maximum time to TIG (Tmax) is based on cabin pressure, leak rate, and total N2 quantity, and is determined from CAB PRESS LEAK NOMOGRAPH (ORB PKT, ECLS). Tmax can be exceeded, but cabin pressure will drop below 8 psi

Actual time to TIG based on landing site availability

### NOTE

1. Procedure designed for worst-case scenario, 20 min until TIG. Any activity not absolutely necessary omitted, and any activity not reqd prior to burn delayed until after burn
2. AFT DECK and MIDDECK MS procedures located on MS PULLOUT PAGES, 10-7 and 10-9, respectively. Extra copies located in back of PLT's book
3. CDR and PLT procedures begin on 10-11
4. Nominal DEORBIT BURN MONITOR Cue Card used
5. If landing site available, this procedure exited on 10-21 and nominal ENTRY MANEUVERS Cue Card with P&Is used
6. If landing site not available, bailout procedures beginning on 10-22 are used
7. This procedure baselines single-fault tolerant configuration on most air-cooled equipment. If cabin pressure stabilizes at 8 psi or greater, additional equipment activated as desired
8. If time available, review NOMINAL DEORBIT PREP (DEORBIT PREP) for any additional activities desired

## EMERGENCY DEORBIT PREP/ENTRY MATRIX

The following matrix is for general information only. First and second columns list all nominal deorbit prep activities and times performed, respectively. The third column indicates whether or not activities are performed in emergency deorbit prep, and if so, when performed relative to deorbit burn

ACTIVITY	NOM 4.0 HR D/O PREP	EMERGENCY D/O PREP
FLUID LOADING PREP	FLIGHT PLAN	-√
TIMER SETUP	-03:59	-----
CONFIGURE DAP	-03:58	-√
COLD SOAK INITIATE	-03:56	-----
ENT STOWAGE	-03:52	-----
KU-BD ANTENNA STOW	-03:48	-√
RAD STOW	-03:45	-√
N2 QTY COMPUTE	-03:42	-----
SPECIALIST SEAT INSTALLATION	-03:35	+√
DPS CONFIG FOR D/O PREP	-03:27	-----
APU/HYD CONFIG	-03:25	-√
DED DISP ENT CONFIG	-03:15	+√
AUTO MNVR TO IMU ATT	-02:58	-----
SELECT NORM JETS	-02:56	-√
RAD BYPASS/FES C/O	-02:55	-√
PL DEACT	-02:54	-√
CONFIG FOR PLBD CLOSING	-02:45	-√
IMU ALIGNMENT	-02:44	-----
CLOSE PLBD	-02:40	-√
POST CLOSING CONFIG	-02:25	-----
AUTO MNVR TO COMM ATT	-02:24	-----

ACTIVITY	NOM 4.0 HR D/O PREP	EMERGENCY D/O PREP
SPACELAB FINAL DEACT	-02:19	-----
DPS ENTRY CONFIG	-02:17	-√
DEACT STAR TRKRS & CLOSE DOORS	-01:58	-√
ENT SWITCH CONFIG	-01:55	-√
ENT SWITCH LIST/VER	-01:50	-√
DEORB PAD UPDATE	-01:42	-----
RESET C/W	-01:40	-----
ENTRY REVIEW	-01:39	-----
(C,P) CLOTHING CONFIG	-01:25	+√
(MS) CLOTHING CONFIG	-01:10	+√
IMU/IMU ALIGN	-01:06	-----
FLUID LOADING	-01:04	-√
(C,P) SEAT INGRESS	-00:59	+√
HUD SETUP	-00:57	-----
ADJUST SEAT	-00:55	+√
C6 LEH O2 vlv – OP	-00:53	+√
ACES PRESS INTEGRITY CHECK	-00:52	+√
WIRELESS STOW	-00:50	-----
WCS DEACT, BLEED ORF REMOVAL	-00:49	-----

-√ Indicates accomplished sometime before TIG

+√ Indicates accomplished sometime between TIG and EI



**EMERGENCY DEORBIT PREP/ENTRY  
LOSS OF CABIN PRESSURE**

**LOSS OF CAB PRESS PWRDN**

Perform following powerdown for loss of cabin pressure:

- C3 MSTR MADS PWR – OFF  
Use minimum lighting  
Use one IDP/CRT with one MDU (IDP 4 preferable)  
Use one PGSC as reqd
- If OV103,4:
- O7 √TACAN MODE sel (three) – OFF
- O8 √MLS (three) – OFF  
√RADAR ALTM (two) – OFF
- L1 HUM SEP (two) – OFF  
H2O LOOP 2(1) BYP MODE – MAN  
MAN – DECR (30 sec)
- If FES not ena:  
If EVAP OUT T 41 to 47 degF:  
RAD CNTLR OUT TEMP – HI  
When EVAP OUT T > 50 degF:  
FLASH EVAP CNTLR PRI B(A) – ON,  
then immediately  
RAD CNTLR OUT TEMP – NORM  
If EVAP OUT T < 41 or > 47 degF:  
FLASH EVAP CNTLR PRI B(A) – ON  
Go to MS PWRDN (ORB PKT, LOSS OF CAB PRESS PWRDN) if time permits

This Page Intentionally Blank

**EMERGENCY DEORBIT PREP/ENTRY  
AFT STATION MS  
MS PULLOUT PAGE**

**PL SAFING (if reqd)**

Perform PL SAFING (ORB PKT)

**RMS POWERDOWN (if reqd)**

If unable to cradle RMS, perform QUICK  
RESPONSE JETTISON after KU-BD antenna  
stowed

If RMS powered, perform RMS PWRDN (PDRS  
OPS)

**STOW KU-BD ANTENNA (if deployed)**

A1U	√	KU BD PWR – ON	
		sel – MAN SLEW	
		MODE – RDR PASSIVE	
		CNTL – PNL	
A2		DIGI-DIS SEL – EL/AZ	
R13L		KU ANT – STO	

NOTE

Monitor dish movement after  
elevation/azimuth values obtained

A2	√	R/EL ind: -29.0° (±1°)	
		√R/AZM ind: -125.0° (±1°)	

A1U	*	If dish movement occurs within 35 sec:	*
R13L	*	KU BD PWR – OFF	*
	*	KU ANT – GND, perform QUICK	*
	*	RESPONSE JETTISON, then go to	*
	*	STOW RADIATORS	*

PL BAY MECH PWR SYS 1,2 (two) – ON  
√KU ANT tb – bp

When KU ANT tb – STO (23-46 sec):

A1U	√	KU BD PWR – OFF	
R14:C		cb MNB KU ELEC – op	
R13L		KU ANT – GND	
		PL BAY MECH PWR SYS 1,2 (two) – OFF	
		Go to STOW RADIATORS	

R13L	*	If KU ANT tb not STO, and KU BD not within	*
	*	STO ENVELOPE after 46 sec, cont	*

NOTE

KU ANT CCTV OVERLAY located in  
middeck transparency kit

KU BD PWR – OFF  
cb MNB KU ELEC – op

A1U	*	
R14:C	*	
R13L	*	

**CAUTION**

KU ANT sw must be in  
GND posn prior to use of  
KU ANT DIRECT STO sw  
to prevent phase to phase  
short of STO/DPY motors

---

√MCC to verify gimbals  
locked prior to this Direct  
Stow procedure

KU ANT – GND  
DIRECT STO – ON

√KU ANT tb – bp

If KU ANT tb – STO or antenna within  
STO ENVELOPE after 46 sec:

KU ANT DIRECT STO – OFF  
PL BAY MECH PWR SYS 1,2  
(two) – OFF

Go to STOW RADIATORS

If NO STO indication and KU-BD not  
within STO ENVELOPE:

KU ANT DIRECT STO – OFF  
PL BAY MECH PWR SYS 1,2  
(two) – OFF

Go to QUICK-RESPONSE JETTISON

**EMERGENCY DEORBIT PREP/ENTRY (Cont)**  
**AFT STATION MS**  
**MS PULLOUT PAGE**

**STOW RADIATORS (if deployed)**

- R13L      √RAD LAT CNTL SYS (two)    – OFF (tb-REL)
- √CNTL SYS (two)            – OFF (tb-DPY)
- PL BAY MECH PWR SYS (two) – ON
- RAD CNTL SYS (two) – STO (simo)
- (tb-bp ~50 sec, STO)
- OFF
- RAD LAT CNTL SYS (two) – LAT (simo)
- (tb-bp ~30 sec,
- LAT)
- OFF
- PL BAY MECH PWR SYS (two) – OFF

**CLOSE PLBD (with BFS)**

- If BFS not already in OPS 301:
- C3            S-BD PM ANT sel – as reqd
- O6            √GPC PWR 5        – ON
- MODE 5        – STBY (tb-RUN), RUN
- GPC/CRT 0/4 EXEC
- 4/3 EXEC
- 5/4 EXEC

CRT4      4: BFS, SM 63 PL BAY DOORS

**CAUTION**

Verify no obstructions before closing and latching PLBD (Ku ANT, RMS, RAD, etc.)

- R13L      PL BAY DR SYS (two) – ENA
- CRT4      AC POWER ON      – ITEM 1 EXEC (\*)
- AUTO MODE SEL – ITEM 3 EXEC (\*)
- R13L      PL BAY DR        – CL

(Cont in right column)

- \* If 'S63 PBD SEQ FAIL' msg, √AUTO SEQ column: \*
- \* If '↓' for CENTER, PORT(STBD) FWD or \*
- \* PORT(STBD) AFT LATCHES, continue in \*
- \* MANUAL mode (skip affected latch gang) \*
- \* If '↓' for PORT(STBD) DOOR: \*
- \* If PORT DOOR, and DOOR SCALLOP on or \*
- \* below target line, continue in MANUAL mode \*
- \* If either AFT LATCHES close MICRO-SW STAT, \*
- \* for aff DOOR is '1', continue in MANUAL mode \*
- \* Perform MAL, MECH, SSR-2 CONTINGENCY \*
- \* PLBD CLOSURE \*

After PLBD closed:

- R13L      PL BAY DR – STOP
- CRT4      AC POWER OFF – ITEM 2 EXEC (\*)
- R13L      PL BAY DR SYS (two) – DSBL
- A7U             √FLOOD (eight) – OFF

**RECONFIG FDF**

Unstow: ENT PKT  
DEORBIT BURN MONITOR (Cue Card)  
Entry Cue Cards

**ENTRY SWITCH LIST/VERIFICATION (AFT)**

If time available, 3-15 thru 3-26

If not already accomplished:

- Tape Foot Loops in egress routes
- Stow loose flight deck equipment
- Unstow/install MS seats
- Don: ACES
- Harness
- Boots
- Begin Fluid Loading (if time available)
- Ingress seat
- ACES PRESS INTEGRITY CHECK
- AUD CTR VOICE RCD SEL CH 1 – ICOM A
- 2 – ICOM B

A1R

Stow flight deck PGSC

EI-10

**EMERGENCY DEORBIT PREP/ENTRY  
MIDDECK STATION MS  
MS PULLOUT PAGE**

<p>Fluid Loading Prep (if time available) Remove suits, loose equipment from airlock Close Airlock Hatch:     Position handle to preclosing posn per decal     Hatch – rotate about hinge and push     Handle – CCW to LATCH     Lock lever to LOCKED</p>	<p>√Pole Straps secure</p> <p>MO69M      LEH O2 8 vlv – CL Remove, stow O2 Bleed Orifice</p> <p>MO32M      LEH O2 7,8 vlv (two) – OP (if reqd)                     5,6 vlv (two) – OP (if reqd)</p> <p>Stow: Exercise Equipment Loose middeck equipment</p>
<p><b>ENTRY SWITCH LIST/VERIFICATION (MIDDECK)</b> If time available, 3-27 thru 3-30 with following deltas:</p> <p>ML31C      √VAC VENT ISOL VLV CNTL – CL (tb-CL) MO13Q      √AIRLK FAN A(B) – OFF if flown</p> <p>If not already accomplished Tape Foot Loops in egress routes WCS      Foot restraints – up, locked</p>	<p>After deorbit targeting complete: Stow backup PGSC Remove, stow side hatch UV Filter, Locking Device, Pyro Box Safing Pin Unstow, install MS Seats Don ACES, Harness, Boots Begin Fluid Loading (if time available) Ingress seat ACES PRESS INTEGRITY CHECK</p>
<p><u>ESCAPE POLE SETUP</u></p> <p>Reinstall Stbd Pip Pin Reinstall large Port Pin:     Retract and hold Locking Pin (Ring)     Reinstall large Pin     Release Locking Pin (Ring)     Slide forward Safing Latch</p>	

(Cont in right column)

**MS PULLOUT PAGE**

This Page Intentionally Blank

**EMERGENCY DEORBIT PREP/ENTRY**

CDR

PLT

**VERIFY DAP/SELECT PRI**

O14:F,      √Pri RJD LOGIC,DRIVER (sixteen) – ON  
 O15:F,  
 O16:F

√DAP: A1/AUTO/PRI  
 √B set to B1

**FES HTR ACTIVATION**

L1           HI LOAD DUCT HTR sel           – A/B  
 √TOP EVAP HTR NOZ L,R (two) – B AUTO  
   √DUCT                   – B

**STAR TRKR DEACT**

O6           S TRK PWR -Y,-Z (two) – OFF

S TRK DR CNTL SYS 1,2 (two) – CL (start timer)

√S TRK DR POS -Y, -Z tb (two) – bp

When both tb – CL (~8-24 sec)

or either tb – bp > 24 sec:

S TRK DR CNTL SYS 1,2 (two) – OFF

**DPS ENTRY CONFIG**

O14,O15,    RGA,ACCEL,ASA,IMU (all) – ON  
 O16

UPLINK ENA, GPC DNLIST  
 X: GNC 1 DPS UTILITY

CRTX        UL CNTL ENA – ITEM 36 EXEC  
 C3           OI PCMMU FORMAT – FXD

**DEORBIT TARGET**

Use Deorbit Manager on PGSC to compute targets (record on 10-14)

**W/B STEAM VENT HTR ACT**

R2           BLR PWR (three) – ON

**SWITCH CONFIG**

O6           √UHF MODE sel – SPLX

O13,O14,  
 O15,O16    All switches ON and all cbs closed  
   except following:

O14:E        All orange dot       – op  
                   ADTA 1                   – op  
                   DDU L,AFT (two)   – op  
                   STAR TRKR -Z       – op

O15:E        ADTA 2                   – op  
                   DDU L,R (two)       – op  
                   STAR TRKR -Y       – op

O16:E        ADTA 3,4 (two)       – op  
                   DDU R,AFT (two)   – op

O16:F        RCS/OMS PRPLT QTY GAUGE – op  
                   RJD MANF L5/F5/R5 DRIVER – OFF

**DDU ACTIVATION (no earlier than TIG-15)**

O14:E,      cb DDU L,R (four) – cl  
 O15:E,  
 O16:E

## EMERGENCY DEORBIT PREP/ENTRY

CDR

PLT

CONFIG GPCs

	1	2	3	4	5
PWR	ON	ON	ON	ON	ON
OUTPUT	NORM	NORM	NORM	NORM	B/U
MODE	RUN	RUN	RUN	RUN	RUN

SM, OPS 000 PRO

SM 0 GPC MEMORY

VERIFY MC 3 PER TABLE

CONFIG GPC	3	12340
STR 1	1	
2	2	
3	3	
4	4	
PL 1/2	1	
CRT 1	1	
2	2	
3	3	
4	0	
L 1	0	
2	0	
MM 1	1	
2	2	

TRANSITION TO OPS 3

GNC, OPS 301 PRO

BFS, GNC OPS 301 PRO

GNC, OPS 302 PRO

Use three IDP/CRTs with five MDUs (six for burn)

CRT3

Do not proceed until all DPS ENTRY CONFIG steps complete

**LANDING SITE UPDATE**

1: GNC 50 HORIZ SIT

SEL SITE, RWY (PASS/BFS)

**DRAG ALT ATM SELECTION**

GNC 51 OVERRIDE

SEL ATM: incl  $\leq 50^\circ$   $\sqrt{\text{ITEM 22 (*)}}$

incl  $> 50^\circ$  SEL ITEM NR (table)

Hemi	Jan	Feb	Mar	Apr	May	Jun	Jul	Aug	Sep	Oct	Nov	Dec
<b>N Desc</b>	<b>23</b>	<b>23</b>	<b>23</b>	<b>23</b>	<b>22</b>	<b>24</b>	<b>24</b>	<b>24</b>	<b>22</b>	<b>23</b>	<b>23</b>	<b>23</b>
<b>S Asc</b>	<b>24</b>	<b>24</b>	<b>22</b>	<b>23</b>	<b>23</b>	<b>23</b>	<b>23</b>	<b>23</b>	<b>23</b>	<b>23</b>	<b>22</b>	<b>24</b>
<b>N Asc</b>	<b>22</b>											
<b>S Desc</b>	<b>22</b>											

**CHECK CG**

GNC DEORB MNVR EXEC

UPDATE PRPLT ITEM 18 as reqd



## EMERGENCY DEORBIT PREP/ENTRY

### RAD BYPASS/FES ACTIVATION

L1           √FLOW PROP VLV LOOP 1,2 (two) – ICH  
               (tb-ICH)  
 ML86B:A   √cb MNC SPLY H2O XOVR VLV – cl  
 R11L       SPLY H2O XOVR VLV         – OP (tb-OP)  
 L1         RAD BYP VLV MODE (two)   – MAN  
                                   MAN SEL (two) – BYP (after  
   ~3 sec,  
   tb-BYP)  
  
               √FLASH EVAP CNTLR PRI B(A) – ON  
               HI LOAD EVAP             – ENA  
               RAD CNTLR LOOP 1,2 (two) – OFF  
               CAB TEMP                 – FULL COOL  
               If time permits after 20 min,  
               CAB TEMP CNTLR – OFF  
 L2         FREON ISOL MODE – OFF

### LOAD TGTs AND MNVR

Enter TGT Data from MCC or PGSC →

```

*   For Bailout:   *
*   *             *
*   Enter TIG for desired deorbit time *
    
```

LOAD TARGET IN OPS 3:  
 LOAD     – ITEM 22 EXEC  
 TIMER   – ITEM 23 EXEC  
 MNVR TO BURN ATT

L1           √FLOW PROP VLV LOOP 1,2 (two) – ICH  
               (tb-ICH)

### DEORBIT PAD

RECORD DEORBIT OPPORTUNITIES			
SITE	/	APPROX TIG	XRNG
_____	_____	_____	_____
_____	_____	_____	_____
_____	_____	_____	_____
_____	_____	_____	_____

COMPUTE WEIGHT  
 Use Deorbit Manager on PGSC (record below)

COMPUTE TARGET

WT	_____
TIG	_____ / _____ : _____ : _____
C1	_____
C2	(-).6000
HT	65.832
θT	_____
ΔVTOT	_____
REI	_____

**EMERGENCY DEORBIT PREP/ENTRY**

CDR

PLT

CDR		PLT	
	<b>CLOTHING CONFIG (if time permits)</b>		<b>OMS BURN PREP</b>
	Don: ACES Harness Boots	O7	AFT L,R RCS He PRESS (four) – OP (tb-OP) TK ISOL (six) – GPC (tb-OP) XFEED (four) – GPC (tb-CL) √MSTR RCS XFEED – OFF
C6	LEH O2 vlv (four) – OP		
	ACES PRESS INTEGRITY CHECK	O8	L,R OMS √He PRESS/VAP ISOL (four) – CL √TK ISOL (four) – OP (tb-OP) √XFEED (four) – CL (tb-CL) FWD RCS He PRESS (two) – OP (tb-OP)
TIG-2	<b>Go to DEORBIT BURN Cue Cards</b>		<b>CLOTHING CONFIG (if time permits)</b>
			Don: ACES Harness Boots
		C6	LEH O2 vlv (four) – OP
			ACES PRESS INTEGRITY CHECK
		TIG-2	<b>Go to DEORBIT BURN Cue Cards</b>

## EMERGENCY DEORBIT PREP/ENTRY

	CDR	POST BURN ACTIVITIES	PLT
	O14:E,      cb MNA,B DDU L (two) – op O15:E		O15:E,      cb MNB,C DDU R (two) – op O16:E
	F7            FLT CNTLR PWR – OFF		F8            FLT CNTLR PWR – OFF
	C3            √DAP: AUTO		C3            √DAP: AUTO
	<b>MNVR TO EI-5 ATT</b>		<b>OMS/RCS POST BURN RECONFIG</b>
	CRT1            GNC, OPS 303 PRO		O7            AFT L,R RCS √He PRESS (four) – OP (tb-OP) √TK ISOL (six)     – GPC (tb-OP) √XFEED (four)     – GPC (tb-CL)
TIME TO EI (MIN)	LVLH PITCH (DEG)		O8            L,R OMS He PRESS/VAP ISOL (four) – CL √TK ISOL (four)     – OP (tb-OP) √XFEED (four)     – CL (tb-CL)
26	315		
25	319		
24	323		
	327	<u>NOTE</u>	
	331	Use LVLH table unless <b>INRTL</b>	
	335	EI-5 attitude (ITEMS 24,25,26)	
20	339	supplied by MCC. Use DDU	
	343	and FLT CNTLR PWR as reqd	
	347	for manual mnvr	
	351		
	355		
15	359		
	3		
	7		
	11		
	15		
10	19		
	23		
	27		
	31	<u>When mnvr complete</u>	
	35	BRAKES MNA – ON	
5	39	O14:A            MNB – ON	
		O15:A            MNC – ON	
		O16:A	
			<b>APU PRE-START</b>
			R2            BLR N2 SPLY (three)     – ON √PWR (three)           – ON √CNTLR/HTR (three)   – A(B) √cb APU FU TK VLV ENA (six) – cl √APU FU TK VLV (three) – CL √AUTO SHTDN (three) – ENA √SPEED SEL (three)   – NORM √OPER (three)         – OFF √HYD CIRC PUMP (three) – OFF MN PUMP PRESS (three) – LO APU CNTLR PWR (three) – ON

## EMERGENCY DEORBIT PREP/ENTRY

CDR

PLT

### FORWARD RCS DUMP

(Use for off-nominal Xcg entry using lowest of OX or FU qty)  
Determine FWD RCS 'DUMP TO %' (DEL PAD)

#### FOUR JET DUMP:

FWD RCS PRPLT TO BE DUMPED (%)

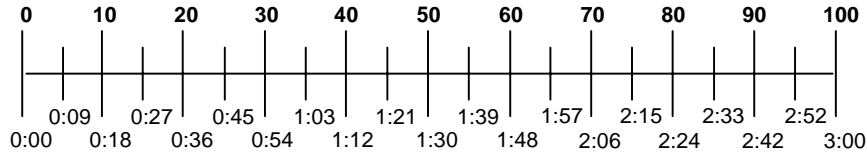

TIME FROM DUMP INITIATION (M:S)

#### TWO JET DUMP:

FWD RCS PRPLT TO BE DUMPED (%)

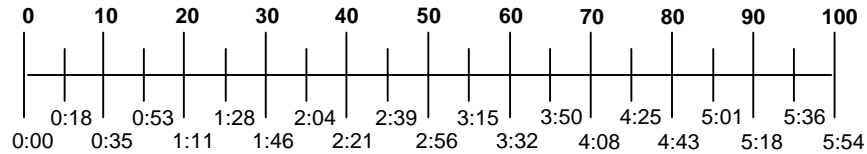

TIME FROM DUMP INITIATION (M:S)

### APU START

R2 APU FU TK VLV (three) – OP  
√APU/HYD RDY tb (three) – gray

\* If tb – bp, attempt normal start \*

APU OPER (three) – START/RUN

MDU √HYD PRESS ind (three) – LO green

R2 √APU/HYD RDY tb (three) – bp  
HYD MN PUMP PRESS (three) – NORM

MDU √HYD PRESS ind (three) – HI green

\* If APU OIL OUT P < 25 and APU TEMP \*  
\* OIL OUT not increasing after APU start \*  
\* or no start, perform APU SHUTDN \*  
\* (ENT PKT, APU/HYD) \*

R4 √HYD BK ISOL VLV (three) – GPC (tb-CL)  
√LG EXTD ISO VLV – GPC (tb-CL)

## EMERGENCY DEORBIT PREP/ENTRY

CDR

PLT

### FORWARD RCS DUMP (Cont)

NOTE

During dump, disregard FWD RCS qty

**GNC DEORB MNVR EXEC**

CRT FWD RCS ARM – ITEM 36 EXEC  
 DUMP – ITEM 37 EXEC (start watch)

When dump time achieved:  
 FWD RCS OFF – ITEM 38 EXEC

1: GNC 53 ENTRY CONTROLS | 2: BFS, GNC SYS SUMM 2

3: GNC DEORB MNVR COAST

### SECONDARY ACTUATOR CHECK (if not previously performed and time permits)

NOTE

If port does not bypass during check,  
 bypass affected port after check:  
 SEC ACT BYPASS – ITEM 8 +X X EXEC  
 If affected port still does not bypass:  
 SEC ACT RESET ITEM 9 +X X EXEC

- CRT3 1. SURF DRIVE ON, ITEM 39 EXEC – (\*), wait at least 5 sec
- MDU SPI: Stop drive test when elevon posns within +12° to -27°:  
 SURF DRIVE OFF, ITEM 40 EXEC – (\*)
- CRT1 2. √POS STIM ENA, ITEM 7 – (no \*)
- C3 3. √FCS CH (four) – AUTO
- CRT1 4. SEC ACT CK, CH 1 – ITEM 1 EXEC (\*)  
 – ITEM 5 EXEC (\*)
- 5. √All CH 1 ports bypass (↓)  
 STOP – ITEM 6 EXEC (\*)
- C3 6. FCS CH 1 – ORIDE
- CRT1 √All CH 1 ports reset (no ↓)
- C3 FCS CH 1 – AUTO
- 7. Repeat steps 5 thru 7 for CH 2,3,4

This Page Intentionally Blank

## EMERGENCY DEORBIT PREP/ENTRY

### EQUIPMENT DONNING AND SEAT INGRESS

If not already accomplished:

Stow equip

Don: ACES

Harness

Boots

C6 LEH O2 1,2,3,4 vlv (four) – OP  
Begin Fluid Loading (if time available)  
Seat ingress  
Install Entry Cue Cards  
Adjust seat, exercise brake pedals

### ENTRY SWITCH CHECK

C	L1	NH3 CNTLR B – PRI/GPC
	L2	√CAB RELIEF A,B (two) – ENA (tb-ENA) ANTISKID – ON NWS – 1
		√ENTRY MODE – AUTO
C,P	C3	√SBTC – full fwd √SRB SEP – AUTO √ET SEP – AUTO
	F6/F8	√AIR DATA – NAV √ADI ERR – MED RATE – MED √HSI SEL MODE – ENTRY √SOURCE (two) – NAV,1 – NAV,2
C,P	F3	√L,R TRIM RHC/PNL (two) – INH √PNL (two) – ON
C	F6	√RADAR ALTM – 1
P	F8	√RDR ALTM – 2

# OV103,104

C D/O/3,4/GEN M

## EMERGENCY DEORBIT PREP/ENTRY

CDR

PLT

### HORIZ SIT CONFIG

ALTM – ITEM 9

--	--	--	--	--

	<u>PASS ITEM</u>	<u>BFS ITEM</u>
PTI	INH √1	
LAND SITE (DEL PAD)	√41	√41
RWY (DEL PAD)	√3	√3
	√4	√4
TACAN (DEL PAD)	√5	√5
RA	blank √46	
TAEM TGT		
G&N	OVHD √6	blank
HSI	blank	blank
XEP	NEP √7	NEP √7
AIM (DEL PAD)	NOM √8	NOM √8
	(or CLSE)	(or CLSE)
SPD BK	NOM √39	
TAC	INH √20	INH √20
GPS	INH √43	INH √43
DRAG H	AUT √22	AUT √22
ADTA H	INH √26	INH √26
ADTA TO G&C	INH √29	AUT √28
DES any failed TACANs	√	√
TAC	DELTA √35	
AIF_G	INH √48	

1: GNC DEORB MNVR COAST	2: GNC 50 HORIZ SIT
-------------------------	---------------------

3: GNC 51 OVERRIDE
--------------------

- √ELEVON AUTO – ITEM 17 (\*)
- SSME REPOS – ITEM 19 EXEC (INH)
- √WRAP MODE – ITEM 45 (ENA)
- If PLB holding > 10K lb:
- FILTER ALT – ITEM 21 EXEC (\*)

3: BFS, GNC 51 OVERRIDE
-------------------------

- √ELEVON AUTO – ITEM 17 (\*)
- √SSME REPOS – ITEM 19 (INH)
- √WRAP MODE – ITEM 45 (ENA)
- If PLB holding > 10K lb:
- √FILTER ALT – ITEM 21 EXEC (\*)

- \* DES any failed/comm faulted IMU, \*
- \* RGA, AA, or SURF feedback \*



## EMERGENCY DEORBIT PREP/ENTRY

CDR

PLT

### EQUIPMENT DOWNING AND SEAT INGRESS

If not already accomplished:

Stow equip

Don: ACES

Harness

Boots

C6

LEH O2 1,2,3,4 vlv (four) – OP

Begin Fluid Loading (if time available)

Seat ingress

Install Entry Cue Cards

Adjust seat, exercise brake pedals

### GPS RECOVERY

P O7

GPS PWR (three) – ON

PRE AMPL (six) – ON

Wait 30 sec

GNC I/O RESET

GNC 55 GPS STATUS

INIT – ITEM 14,15,16 EXEC

NAV – ITEM 17,18,19 EXEC

### ENTRY SWITCH CHECK

C L1

NH3 CNTLR B – PRI/GPC

L2

√CAB RELIEF A,B (two) – ENA (tb-ENA)

ANTISKID – ON

NWS – 1

√ENTRY MODE – AUTO

C,P C3

√SBTC – full fwd

√SRB SEP – AUTO

√ET SEP – AUTO

### ENTRY SWITCH CHECK (Cont)

C,P

F6/F8

√AIR DATA – NAV

√ADI ERR – MED

RATE – MED

√HSI SEL MODE – ENTRY

√SOURCE (two) – NAV,1

– NAV,2

F3

√L,R TRIM RHC/PNL (two) – INH

√PNL (two) – ON

C

F6

√RADAR ALTM – 1

P

F8

√RDR ALTM – 2

## EMERGENCY DEORBIT PREP/ENTRY

CDR

PLT

### HORIZ SIT CONFIG

ALTM – ITEM 9

		.		
--	--	---	--	--

	<u>PASS ITEM</u>		<u>BFS ITEM</u>	
PTI	INH	√1		
LAND SITE (DEL PAD)		√41	√41	
RWY (DEL PAD)		√3	√3	
		√4	√4	
TAEM TGT				
G&N	OVHD	√6	blank	
HSI	blank		blank	
XEP	NEP	√7	NEP	√7
AIM (DEL PAD)	NOM	√8	NOM	√8
	(or CLSE)		(or CLSE)	
SPD BK	NOM	√39		
NAV				
GPS	INH	√43	INH	√43
DRAG H	AUT	√22	AUT	√22
ADTA H	INH	√26	INH	√26
MLS	AUT	√50		
G&C				
GPS	INH	√48		
ADTA	INH	√29	AUT	√28

1: GNC DEORB MNVR COAST	2: GNC 50 HORIZ SIT
-------------------------	---------------------

3: GNC 51 OVERRIDE
--------------------

√ELEVON AUTO – ITEM 17 (\*)  
 SSME REPOS – ITEM 19 EXEC (INH)  
 √WRAP MODE – ITEM 45 (ENA)  
 If PLB holding > 10K lb:  
 FILTER ALT – ITEM 21 EXEC (\*)

3: BFS, GNC 51 OVERRIDE
-------------------------

√ELEVON AUTO – ITEM 17 (\*)  
 √SSME REPOS – ITEM 19 (INH)  
 √WRAP MODE – ITEM 45 (ENA)  
 If PLB holding > 10K lb:  
 √FILTER ALT – ITEM 21 EXEC (\*)

- \* DES any failed/comm faulted IMU, \*
- \* RGA, AA, or SURF feedback \*

## EMERGENCY DEORBIT PREP/ENTRY

Stow:

Deorbit Burn Cue Cards (C6)

DEORBIT BURN MONITOR (Cue Card) (C6)

√Entry Cue Cards installed

If Landing Site available:

Go to ENTRY MANEUVERS (Cue Card) at

EI-5 with following P&I:

### NOTE

If cabin pressure stabilizes at 8 psi or greater, activate additional air-cooled equipment as desired

EI-5

cb ADTA 1,2,3 (three) – cl

GNC I/O RESET

cb MNA,B DDU L (two) – cl

(L) FLT CNTLR PWR – ON

If OV103,4:

V = 15K

TACAN MODE 1,2 (two) – GPC

V = 12K

Do not perform RAD ACTIVATION

M = 2.9

Use one HUD, one MLS, one RA

M < 1.0

cb MNB,C DDU R (two) – cl

(R) FLT CNTLR – ON

## EMERGENCY DEORBIT PREP/ENTRY

If Landing Site not available, perform following bailout procedures:

EI-5

cb ADTA (four) – cl  
MNA,B DDU L (two) – cl  
GNC I/O RESET  
(L) FLT CNTLR PWR – ON  
√ADI ATT – LVLH  
MNVR to R 001, P 039, Y 358

C CRT1

GNC, OPS 304 PRO

C ADI

√ENTRY ATT (R 000, P 040, Y 000)

F2

SPDBK/THROT pb – push (AUTO lt on)

√PITCH pb – AUTO lt on (PASS)

√ROLL/YAW pb – AUTO lt on (PASS)

(CSS if PREBANK)

EI

h = 400K  
(00:00)

$\bar{q} = .5$

PITCH pb – push (CSS lt on)

ROLL/YAW pb – push (CSS lt on)

## EMERGENCY DEORBIT PREP/ENTRY

$\dot{H} = -200$  and increasing (D = 5-6)

Start 3°/sec roll to ENTRY ALPHA (Cue Card)  
ref bank angle while maintaining alpha = 40°

Approaching ref bank angle, bank as necessary  
to center phugoid damper with BIAS = 0

- \* Always null alpha errors from ENTRY \*
- \* TRAJ display or ENTRY ALPHA Cue \*
- \* Card before nulling bank errors \*
- \* \*
- \* When roll reversal reqd or if phugoid \*
- \* damper becomes overly sensitive, use \*
- \* alpha and  $\dot{H}$  from cue card as primary \*
- \* fly-to indications \*
- \* \*
- \* During roll reversal, if phugoid damper \*
- \* commands an  $\dot{H}$  significantly different \*
- \* from cue card, establish approximate \*
- \* cue card  $\dot{H}$  with an  $\ddot{H}$  of  $\pm 3$  to 5 ft/sec<sup>2</sup> \*
- \* and wait for phugoid damper to stabilize \*
- \* before following phugoid damper \*

D = 11

√DRAG H UPDATE ACTIVE

- \* If editing occurs: \*
- \* 2: GNC 50 HORIZ SIT \*
- \* DRAG H FOR – ITEM 24 EXEC \*
- \* \*

If OV103,4:

TACAN MODE 1,2 (two) – GPC

Wings level, follow  $\alpha$  sched

V = 15K

M = 6.0

M = 5.0

2: GNC 51 OVERRIDE

AIR DATA PROBES (two) – DEPLOY(√HEAT)

## EMERGENCY DEORBIT PREP/ENTRY

P

√AIR DATA R,L then NAV

3: GNC 50 HORIZ SIT

RATIO < 1	RATIO > 1	
	ADTA ERRATIC	ADTA STEADY
AUTO	AUTO	FORCE

When ADTA-H AUTO/FORCE:

ADTA to G&C – AUTO

- \* If no Air Data and M < 1.5: \*
- \* Fly theta limits \*
- \* If PRI DME > 80 nm, theta limits \*
- \* unavailable: \*
- \* Maintain theta below limits as \*
- \* determined by SB posn and roll angle \*
- \* Supersonic \*
- \* Theta < -7° for SB = 65% & F = 0° \*
- \* Supersonic \*
- \* Theta < -1° for SB = 0% & Φ = 0° \*
- \* Theta < -12° for SB = 100% & Φ = 0° \*

M = 2.5  
M < 1.0

FLY α = 12°  
Go to BAILOUT

# **LOSS OF 2 FREON LOOPS DEORBIT PREP/ENTRY**

This Page Intentionally Blank



## LOSS OF 2 FREON LOOPS DEORBIT PREP/ENTRY MS PULLOUT PAGE

### ASSUMPTIONS/INITIAL CONDITIONS

Loss of Two Freon Loops Deorbit Prep/Entry is a **stand-alone procedure** that assumes FREON FLOW LOW and LOSS OF 2 FREON LOOPS (ORB PKT, PWRDN) or LOSS OF 2 FREON LOOPS (ENTRY) (ENT PKT, PWRDN) accomplished

This failure requires immediate deorbit to first available landing site while powered down to very low level

If landing site not available, bailout procedures will be reqd

All FCs will be on with continuous purge

### PROBLEM DESCRIPTION/RATIONALE

Source of orbiter cooling is Freon coolant loops. With no Freon flow, heat not removed from Freon and, hence, from water and air-cooled equipment as well

Orbiter Freon Loops are designed to remove heat from fuel cell coolant (FC-40), maintaining FCs at ~200 degF. When the Freon no longer cools FC-40, fuel cell stack temperature rises and electrolyte concentration drops. Byproduct H<sub>2</sub>O not condensed/removed and accumulates in cells, causing fuel cells to flood. Flooding predicted to occur when electrolyte concentration drops below 25% and will result in loss of power to orbiter. Additionally, fuel cell stack can fail allowing mixing and/or escape of reactants if stack temperature becomes excessively high (~250 degF)

If pwrn accomplished to 8 kW total load immediately following failure of second Freon loop, analysis indicates that with continuous purge, orbiter life extended to 120 min

**LOSS OF 2 FREON LOOPS DEORBIT PREP/ENTRY  
MS PULLOUT PAGE**

NOTE

1. MS procedures are located on MS PULLOUT PAGE, 11-5. Extra copies located in back of PLT's book
2. Use COMM pages from ORB PKT pwrn to cycle COMM if necessary
3. Maintain minimum lighting
4. Only two APUs used for entry. APUs will be started at EI-5
5. This procedure utilizes modified DEORBIT BURN MONITOR and ENTRY MANEUVERS Cue Cards located in this section
6. Don Quick Don Mask as needed for additional respiratory cooling. If cabin temp > 95 degF and no evaporative cooling sensed, don ACES, activate O2, and close visor

**LOSS OF 2 FREON LOOPS DEORBIT PREP  
MS PULLOUT PAGE**

NOTE: Wait for GO from CDR before accomplishing any action on this page

Prepare ACES for donning

**~TIG-15 MCA CONFIG**

MA73C:A MCA LOGIC FWD (three) – ON  
:C cb MCA PWR AC1 3Φ FWD 1 – op  
AC3 3Φ FWD 3 – op

**~TIG-10 AFT PANEL CONFIG FOR ENTRY COMM**

NOTE

This procedure configures aft panel for landing site comm coverage at V = 12K. If comm cycled post TIG-10 (using ORB PKT pwrn comm pages), this AFT PANEL CONFIG FOR ENTRY COMM must be reestablished

R14:B cb GCILC (two) – cl  
C3 S-BD PM CNTL – CMD  
A1L ANT SW ELEC – 2  
MODE – STDN LO  
XPNDR – 2  
NSP PWR – 2  
DATA RATE XMI – HI  
RCV – HI  
√UPLK DATA – S-BD  
√CODING XMIT – OFF  
√RCV – OFF

(Cont next column)

**TIG-5 LEH VLV CONFIG**

MO69M LEH O2 8 vlv – CL  
Stow O2 Bleed Orifice  
LEH O2 7,8 vlv (two) – OP (if reqd)  
MO32M 5,6 vlv (two) – OP (if reqd)

~EI-10

Stow flight deck PGSC

**EI GPS POWERUP (OV103,4)**

A13 GPS PWR – ON  
If OV103:  
GPS PRE AMPL (two) – MNC  
If OV104:  
GPS PRE AMPL (two) – ON  
Report Powerup Complete to CDR

**CLOTHING CONFIG**

Don: ACES  
Harness  
Boots  
C6 LEH O2 vlv (two) – OP

**MS PULLOUT PAGE**

This Page Intentionally Blank

# LOSS OF 2 FREON LOOPS DEORBIT PREP

## MS PULLOUT PAGE

NOTE: Wait for GO from CDR before accomplishing any action on this page

Prepare ACES for donning

### ~TIG-15 MCA CONFIG

MA73C:A MCA LOGIC FWD (three) – ON  
 :C cb MCA PWR AC1 3Φ FWD 1 – op  
 AC3 3Φ FWD 3 – op

### ~TIG-10 AFT PANEL CONFIG FOR ENTRY COMM

#### NOTE

This procedure configures aft panel for landing site comm coverage at V = 12K. If comm cycled post TIG-10 (using ORB PKT pwrn comm pages), this AFT PANEL CONFIG FOR ENTRY COMM must be reestablished

R14:B cb GCILC (two) – cl  
 C3 S-BD PM CNTL – CMD  
 A1L ANT SW ELEC – 2  
 MODE – STDN LO  
 XPNDR – 2  
 NSP PWR – 2  
 DATA RATE XMI – HI  
 RCV – HI  
 √UPLK DATA – S-BD  
 √CODING XMIT – OFF  
 √RCV – OFF

(Cont next column)

### TIG-5 LEH VLV CONFIG

MO69M LEH O2 8 vlv – CL  
 Stow O2 Bleed Orifice  
 LEH O2 7,8 vlv (two) – OP (if reqd)  
 MO32M 5,6 vlv (two) – OP (if reqd)

### ~EI-10

Stow flight deck PGSC

### CLOTHING CONFIG

Don: ACES  
 Harness  
 Boots  
 C6 LEH O2 vlv (two) – OP

**MS PULLOUT PAGE**

This Page Intentionally Blank

This Page Intentionally Blank

**LOSS OF 2 FREON LOOPS DEORBIT PREP  
ENTRY CONFIG**

CDR

PLT

**~TIG-15 MCA CONFIG**

Give MS GO to config MCAs

**SW CONFIG FOR OPS 3**

O6           √MDM FF2,3 – ON  
                   √FF1,4 – OFF (CDR GREEN DOT)  
                   √FA2,3 – ON  
                   √FA1,4 – OFF

F6           √RADAR ALTM – 2

O14:B       √cb MNA OI SIG CONDR OF 1/4 A – cl  
   OM 1/2 A – cl  
   √MDM OF 1/2 A       – op  
   √3/4 A               – op

O15:A       RGA 2                                       – ON  
           :B   √cb MNB OI SIG CONDR OF 2/3 A – cl

O16:A       RGA 3                                       – ON

O17:D       SIG CONDR OA 1/2/3                   – ON  
           √MDM OA 1/2/3                       – OFF

**~TIG-15 DEORBIT TARGET**

√MCC or use Deorbit Manager on PGSC to compute targets (record in pad on 11-13)

\* If site not available, target next available \*  
 \* site in LST (designated with a 'G' in \*  
 \* Deorbit Manager) and replace TIG with \*  
 \* desired TIG \*

**W/B STEAM VENT HTR ACT**

R2           √BLR CNTLR/HTR 1,3 (two) – A(B)  
   PWR 1,3 (two)       – ON

**SW CONFIG FOR OPS 3**

F8           √RDR ALTM – 2

O14:F       RJDA 1A L2/R2 LOGIC   – ON  
   DRIVER – ON

O15:F       ASA 2 – ON

O16:F       RJDA 2B L3/R3/R5 LOGIC   – ON  
   L3/R3 DRIVER       – ON  
           √RJD MANF L5/F5/R5 DRIVER – OFF  
           ASA 3 – ON

O7           AFT L,R RCS MANF ISOL 4 (two) – CL  
   (tb-CL)

O8           Verify MCA LOGIC config complete, then:  
           FWD RCS MANF ISOL 1,2,3,4 (four) – CL  
   (tb-CL)



## LOSS OF 2 FREON LOOPS DEORBIT PREP (Cont)

### ENTRY CONFIG

CDR	PLT				
<p><b>STAR TRKR DOOR CLOSURE</b></p> <p>O6      √S TRK PWR (two) – OFF                        DR CNTL SYS 1,2 (two) – CL (start timer)</p> <p>            √S TRK DR POS tb (two) – bp                        When both tb – CL (~8-24 sec)                        <u>or</u> either tb – bp &gt; 24 sec:                        S TRK DR CNTL SYS 1,2 (two) – OFF</p> <p><b>AFT PANEL CONFIG FOR ENTRY COM</b>  <b>(no earlier than ~TIG-10)</b></p> <p style="padding-left: 40px;">Give MS GO to config AFT panel</p> <p><b>DPS ENTRY CONFIG (assumes GPC1 active)</b></p> <p>C3           √FCS CH 2,3 (two) – AUTO            O15,       √RGA 2,3           – ON            O16       √ASA 2,3           – ON            O14:F       MMU 1 – ON, wait 34 sec</p> <p>1. <u>TRANSITION GPC 1 TO</u>  <u>    GNC OPS 3</u></p> <div style="border: 1px solid black; padding: 2px; display: inline-block; margin-left: 20px;">GNC 0 GPC MEMORY</div> CRT      CONFIG – ITEM 1 +3 EXEC Modify MC3 per table → <table border="1" style="display: inline-table; vertical-align: middle;"><tr><td>CONFIG</td><td>3</td></tr><tr><td>GPC</td><td>10000</td></tr></table> GNC OPS 301 PRO <div style="border: 1px solid black; padding: 2px; display: inline-block; margin-left: 20px;">DEORB MNVR COAST</div> <p>2. <u>ACTIVATE GPC 3</u></p> <p>O6           √GPC MODE 3   – HALT (tb-bp)                        √OUTPUT 3 – NORM (tb-bp)                        PWR 3     – ON                        MODE 3   – STBY (tb-RUN), RUN</p>	CONFIG	3	GPC	10000	<p style="text-align: center;">If OMS/RCS interconnected:</p> <p>A6U           √DAP: FREE</p> <p><b>OMS BURN PREP</b></p> <p>O8           √L,R OMS He PRESS/VAP ISOL (four) – CL                                √TK ISOL (four) – OP (tb-OP)                                √XFEED (four) – CL (tb-CL)</p> <p>O7           AFT L,R RCS He PRESS (four) – OP (tb-OP)                                TK ISOL (six) – GPC (tb-OP)                                XFEED (four) – GPC (tb-CL)</p>
CONFIG	3				
GPC	10000				

## LOSS OF 2 FREON LOOPS DEORBIT PREP (Cont)

### ENTRY CONFIG

CDR

PLT

**3. ASSIGN GPC 3 TO MC3 REDUNDANT SET**

CRT → GNC 0 GPC MEMORY  
 CONFIG – ITEM 1 +3 EXEC  
 Modify MC3 per table  
 GNC, OPS 301 PRO  
GNC 0 GPC MEMORY  
 DOWNLIST GPC – ITEM 44  
 +3 EXEC

CONFIG GPC	3 10300
STR 1	3
2	3
3	3
4	3
PL 1/2	3
CRT 1	3
2	3
3	3
4	0
L 1	0
2	0
MM 1	3
2	3

**4. DEACT GPC 1, MMU 1, ASAs**

O6 GPC MODE 1 – STBY, HALT  
 PWR 1 – OFF

O14:F MMU 1 – OFF  
 O15:F ASA 2 – OFF  
 O16:F 3 – OFF

**5. SWITCH AV BAY FANS**

L1 AV BAY 1 FAN A – OFF  
 3 FAN B – ON

**6. ACTIVATE FA4 FOR BURN**

O6 MDM FA4 – ON  
 GNC I/O RESET

Do not proceed until all DPS ENTRY CONFIG steps complete

**ATMOSPHERE SELECT**

GNC 51 OVERRIDE

CRT SELECT ATM: incl ≤ 50° √ITEM 22 (\*)  
 incl > 50° SEL ITEM NR

Hemi	Jan	Feb	Mar	Apr	May	Jun	Jul	Aug	Sep	Oct	Nov	Dec
<b>N Desc</b>	<b>23</b>	<b>23</b>	<b>23</b>	<b>23</b>	<b>22</b>	<b>24</b>	<b>24</b>	<b>24</b>	<b>22</b>	<b>23</b>	<b>23</b>	<b>23</b>
<b>S Asc</b>	<b>24</b>	<b>24</b>	<b>22</b>	<b>23</b>	<b>23</b>	<b>23</b>	<b>23</b>	<b>23</b>	<b>23</b>	<b>23</b>	<b>22</b>	<b>24</b>
<b>N Asc</b>	<b>22</b>											
<b>S Desc</b>												

**LAND SITE UPDATE**

√LAND SITE UPDATE

GNC 50 HORIZ SIT

CRT SEL SITE (See LAND SITE DATA)

**CG CHECK**

DEORB MNVR COAST

CRT UPDATE PRPLT, ITEM 18, as reqd

# LOSS OF 2 FREON LOOPS DEORBIT PREP

## ENTRY CONFIG

### LOAD TGTs AND MNVR

CRT      Enter TGT DATA from MCC or PGSC →  
 LOAD – ITEM 22 EXEC  
 TIMER – ITEM 23 EXEC  
 DAP: AUTO  
 Mnvr to Burn Att

    Select SEC GIMBALS  
 (because FF1,FF4 - OFF)  
 LEFT – ITEM 30 EXEC  
 RIGHT – ITEM 31 EXEC  
 GNC, OPS 302 PRO

### MEDS CONFIG FOR ENTRY

C2      IDP/CRT3 PWR – ON  
         √All other IDP/CRTs – OFF

    Use two MDUs  
 O13:A    cb ESS 1BC MTU A – op  
 O15:E    MNB DDU R      – cl  
 O16:E    MNC DDU R      – cl

### CLOTHING CONFIG

C6      Don: ACES,Harness,Boots  
         LEH O2 vlv (two) – OP

~TIG-3 Go to DEORBIT BURN Cue Cards

NOTE  
 Use LOSS OF 2 FREON LOOPS  
 D/O BURN MONITOR CARD

### PGSC DEORBIT PAD

RECORD DEORBIT OPPORTUNITIES		
SITE	APPROX TIG	XRNG
_____	____/____:____:____	_____
_____	____/____:____:____	_____
_____	____/____:____:____	_____
_____	____/____:____:____	_____

COMPUTE WEIGHT  
 Use Deorbit Manager on PGSC (record below)

COMPUTE TARGET

WT      \_\_\_\_\_

TIG      \_\_\_\_/\_\_\_\_:\_\_\_\_:\_\_\_\_

C1      \_\_\_\_\_

C2      (-).6000

HT      65.832

θT      \_\_\_\_\_

ΔVTOT    \_\_\_\_\_

REI      \_\_\_\_\_

LOAD TARGET IN OPS 3

## DEORBIT BURN MONITOR

### (LOSS OF 2 FREON LOOPS)

<b>OMS PC &amp; OMS</b> ↓	OMS PRPLT FAIL
<b>OMS OX/FU TK P</b> (√ [OMS/MPS]) OX/FU LOW	He PRESS/VAP ISOL (two) – OP If aff TK P not incr: He PRESS/VAP ISOL (two) – CL At PC < 72: OMS PRPLT FAIL
OX & FU HIGH	He PRESS/VAP ISOL (two) – CL Cycle He A(B) to maintain TK P 234-284
<b>OMS GMBL</b>	If high RCS usage: OMS ENG FAIL
<b>I/O ERROR FA</b>	◆ I/O RESET (if recov: >>) If high RCS usage: OMS ENG FAIL √ MAN SHUTDN
<b>BCE STRG D</b>	I/O RESET (if recov: >>) √ If high RCS usage: OMS ENG FAIL

# LOSS OF 2 FREON LOOPS

## ENTRY

CDR

PLT

### MNVR TO EI-5 ATT

O6 MDM FA4 – OFF  
 CRT GNC, OPS 303 PRO  
 O14:E, cb DDU L (two) – cl, as reqd to reach/  
 O15:E maintain EI-5 attitude

TIME TO EI (MIN)	LVLH PITCH (DEG)
26	315
25	319
24	323
	327
	331
	335
20	339
	343
	347
	351
	355
15	359
	3
	7
	11
	15
10	19
	23
	27
	31
	35
5	39

NOTE

Use LVLH table unless **INRTL**  
 EI-5 attitude (ITEMS 24,25,26)  
 supplied by MCC

F8 FLT CNTLR PWR – OFF  
 O15:E, cb DDU R – op  
 O16:E

### OMS/RCS POST BURN RECONFIG

O7 √AFT L,R RCS He PRESS (four) – OP (tb-OP)  
 √TK ISOL (six) – GPC (tb-OP)  
 √XFEED (four) – GPC (tb-CL)

O8 L,R OMS  
 √He PRESS/VAP ISOL (four) – CL  
 √TK ISOL (four) – OP (tb-OP)  
 √XFEED (four) – CL (tb-CL)

### OMS GIMBAL PWRDN (PASS only)

CRT Verify gimbal posns:

	<u>L</u>	<u>R</u>
P	+5.9	+5.9
Y	+6.4	-6.4

GMBL OFF – ITEM 32 EXEC  
 – ITEM 33 EXEC

## LOSS OF 2 FREON LOOPS (Cont)

### ENTRY

CDR

PLT

Perform FRCS dump if reqd to maintain Xcg in box

If no FRCS dump reqd, go to 11-16

#### HORIZ SIT CONFIG

ALTM – ITEM 9 +

--	--	--	--	--

	PASS ITEM		
PTI	INH	√	1
LAND SITE (DEL PAD)		√	41
RWY (DEL PAD)		√	3
		√	4
TACAN (DEL PAD)		√	5
RA	blank	√	46
TAEM TGT			
G&N	OVHD	√	6
HSI	blank		
XEP	NEP	√	7
AIM (DEL PAD)	NOM	√	8
	(or CLSE)		
SPD BK	NOM	√	39
TAC	INH	√	20
GPS	INH	√	43
DRAG H	AUT	√	22
ADTA H	INH	√	26
ADTA TO G&C	INH	√	29
DES any failed TACANs		√	
TAC	DELTA	√	35
AIF_G	INH	√	48

#### FWD RCS RECOVERY

- O14:B      √cb OI SIG CONDR OF 1/4 A – cl  
          :F      RJDF 1B F1 DRIVER – ON  
  LOGIC – ON
- O15:B      √cb OI SIG CONDR OF 2/3 A – cl  
          :F      RJDF 1A F2 DRIVER – ON  
  LOGIC – ON
- O16:F                                    2A F3,2B F4 DRIVER (two) – ON  
  F4/F5 LOGIC (two) – ON
- O6                                    MDM FF1,4 – ON  
  GNC I/O RESET
- O8                                    Reopen FWD RCS  

GNC 23 RCS
- CRTX                                   JET RESET – ITEM 45 EXEC  
  Reselect deselected FRCS jets  
  JET RESET – ITEM 45 EXEC

#### FORWARD RCS DUMP (Use for off-nominal Xcg entry using lowest of OX or FU qty)

Determine FWD RCS 'DUMP TO %' (calculator, cg wheel, or DEL PAD)

#### FOUR JET DUMP:

FRCS PRPLT TO BE DUMPED (%)

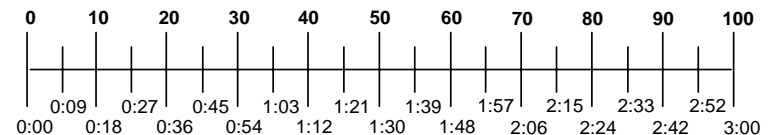

TIME FROM DUMP INITIATION (M:S)

# OV103,104

C D/O/3,4/GEN M

# LOSS OF 2 FREON LOOPS

## ENTRY

CDR

PLT

### MNVR TO EI-5 ATT

O6 MDM FA4 – OFF  
 CRT GNC, OPS 303 PRO  
 O14:E, cb DDU L (two) – cl, as reqd to reach/  
 O15:E maintain EI-5 attitude

TIME TO EI (MIN)	LVLH PITCH (DEG)
26	315
25	319
24	323
	327
	331
	335
20	339
	343
	347
	351
	355
15	359
	3
	7
	11
	15
10	19
	23
	27
	31
	35
5	39

### NOTE

Use LVLH table unless **INRTL**  
 EI-5 attitude (ITEMS 24,25,26)  
 supplied by MCC

F8 FLT CNTLR PWR – OFF  
 O15:E, cb DDU R – op  
 O16:E

### OMS/RCS POST BURN RECONFIG

O7 √AFT L,R RCS He PRESS (four) – OP (tb-OP)  
 √TK ISOL (six) – GPC (tb-OP)  
 √XFEED (four) – GPC (tb-CL)

O8 L,R OMS  
 √He PRESS/VAP ISOL (four) – CL  
 √TK ISOL (four) – OP (tb-OP)  
 √XFEED (four) – CL (tb-CL)

### OMS GIMBAL PWRDN (PASS only)

CRT Verify gimbal posns:

	<u>L</u>	<u>R</u>
P	+5.9	+5.9
Y	+6.4	-6.4

GMBL OFF – ITEM 32 EXEC  
 – ITEM 33 EXEC

## LOSS OF 2 FREON LOOPS (Cont)

### ENTRY

CDR

PLT

Perform FRCS dump if reqd to maintain Xcg in box

If no FRCS dump reqd, go to 11-16

#### HORIZ SIT CONFIG

ALTM – ITEM 9 +

--	--	--	--	--

	PASS ITEM
PTI	INH √1
LAND SITE (DEL PAD)	√41
RWY (DEL PAD)	√3
	√4
TAEM TGT	
G&N	OVHD √6
HSI	blank
XEP	NEP √7
AIM (DEL PAD)	NOM √8
	(or CLSE)
SPD BK	NOM √39
NAV	
GPS	INH √43
DRAG H	AUT √22
ADTA H	INH √26
MLS	AUT √50
G&C	
GPS	INH √48
ADTA	INH √29

#### FWD RCS RECOVERY

- O14:B      √cb OI SIG CONDR OF 1/4 A – cl  
          :F      RJDF 1B F1 DRIVER – ON  
                                  LOGIC – ON
- O15:B      √cb OI SIG CONDR OF 2/3 A – cl  
          :F      RJDF 1A F2 DRIVER – ON  
                                  LOGIC – ON
- O16:F                           2A F3,2B F4 DRIVER (two) – ON  
  F4/F5 LOGIC (two) – ON
- O6                           MDM FF1,4 – ON  
                                  GNC I/O RESET
- O8                           Reopen FWD RCS  

GNC 23 RCS
- CRTX                       JET RESET – ITEM 45 EXEC  
                                  Reselect deselected FRCS jets  
                                  JET RESET – ITEM 45 EXEC

#### FORWARD RCS DUMP (Use for off-nominal Xcg entry using lowest of OX or FU qty)

Determine FWD RCS 'DUMP TO %' (calculator, cg wheel, or DEL PAD)

#### FOUR JET DUMP:

FRCS PRPLT TO BE DUMPED (%)

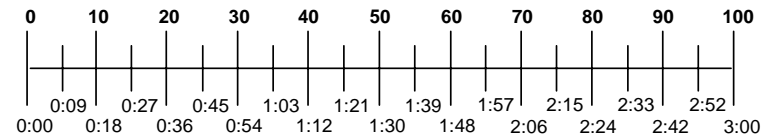

TIME FROM DUMP INITIATION (M:S)



# LOSS OF 2 FREON LOOPS (Cont)

## ENTRY

CDR

PLT

1: GNC DEORB MNVR COAST | 2: GNC 50 HORIZ SIT

3: GNC 51 OVERRIDE

- √ELEVON AUTO – ITEM 17 (\*)
- SSME REPOS – ITEM 19 EXEC (INH)
- √WRAP MODE – ITEM 45 (ENA)
- If PLB holding >10K lb:
- FILTER ALT – ITEM 21 EXEC (\*)

### TWO JET DUMP:

FRCS PRPLT TO BE DUMPED (%)

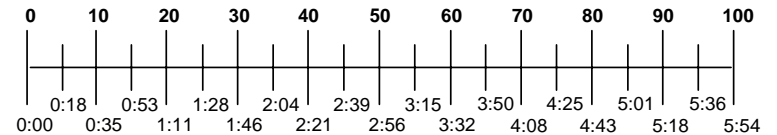

TIME FROM DUMP INITIATION (M:S)

#### NOTE

During dump, disregard FRCS qty

GNC DEORB MNVR EXEC

- FWD RCS ARM – ITEM 36 EXEC
- DUMP – ITEM 37 EXEC
- (start watch)

When dump time achieved:  
OFF – ITEM 38 EXEC

When dump complete:  
O8 FWD RCS MANF ISOL 1,2,3,4 (four) – CL (tb-CL)

- O6 MDM FF1,4 (two) – OFF
- O14:F, RJDF LOGIC,DRIVER (eight) – OFF
- O15:F,
- O16:F

## LOSS OF 2 FREON LOOPS (Cont)

### ENTRY

	CDR	PLT
	Stow: <u>DEORBIT BURN</u> and <u>DEORBIT BURN MONITOR</u> Cue Cards	<b>FC PERFORMANCE CHECK</b>
~EI-10	Give MS GO to stow flight deck PGSC	Two FCs reqd for ENTRY/LANDING Monitor FC performance through landing:
	√ENTRY Cue Cards installed	If any single FC STACK TEMP ≥ 250 degF: Affected ESS BUS SOURCE FC1(2,3) – OFF Affected FC/MN BUS A(B,C) – OFF
	<b>SEAT INGRESS</b>	When FC STACK TEMP within 5 degF of either remaining FC, reconnect FC to buses (MN first, then ESS)
	Adjust seat (one seat and direction at a time)	If all three FC STACK TEMPs ≥ 250 degF: No action
	Exercise brake pedals	
	<b>G-SUIT INFLATION</b>	<b>EI-5 APU PRE-START</b>
	All Load – 1.5	R2 BLR N2 SPLY 1,3 (two) – ON
EI-7	Go to LOSS OF 2 FREON LOOPS ENTRY MANEUVERS, 11-21	√PWR 1,3 (two) – ON
		√CNTLR/HTR 1,3 (two) – A(B)
		√cb APU FU TK VLV ENA 1A,1B (two) – cl
		√3A,3B (two) – cl
		√APU FU TK VLV 1,3 (two) – CL
		√AUTO SHTDN 1,3 (two) – ENA
		√SPEED SEL 1,3 (two) – NORM
		√OPER 1,3 (two) – OFF
		√HYD CIRC PUMP 1,3 (two) – OFF
		MN PUMP PRESS 1,3 (two) – LO
		APU CNTLR PWR 1,3 (two) – ON
		C3 FCS CH 1,4 (two) – OFF
		2,3 (two) – ORIDE
		O14:F, ASA (four) – ON
		O15:F,
		O16:F

# LOSS OF 2 FREON LOOPS (Cont)

## ENTRY

CDR

PLT

### APU START

R2	APU FU TK VLV 1,3 (two) – OP	
	√APU/HYD RDY tb 1,3 (two) – gray	
	APU OPER 1,3 (two) – START/RUN	
MDU	√HYD PRESS ind 1,3 (two) – LO green	
R2	√APU/HYD RDY 1,3 tb (two) – bp	

```

* If APU 1(3) does not start:
* BLR CNTLR/HTR 2 – A(B)
* N2 SPLY 2 – ON
* PWR 2 – ON
* √cb APU FU TK VLV ENA 2A,2B (two) – cl
* √APU FU TK VLV 2 – cl
* √AUTO SHTDN 2 – ENA
* √SPEED SEL 2 – NORM
* √OPER 2 – OFF
* √HYD CIRC PUMP 2 – OFF
* MN PUMP PRESS 2 – LO
* APU CNTLR PWR 2 – ON
* FU TK VLV 2 – OP
* OPER 2 – START/RUN
* √HYD PRESS ind 2 – LO green
* If less than two APUs running:
* APU AUTO SHTDN (one) – INH
* If any APU does not start:
* BLR CNTLR/HTR – OFF
* APU OPER – OFF
* FU TK VLV – CL
* CNTLR PWR – OFF
* HYD MN PUMP PRESS – NORM
  
```

**LOSS OF 2 FREON LOOPS (Cont)**

**ENTRY**

CDR

PLT

**APU START**

HYD MN PUMP PRESS 1,3 – NORM

MDU      √HYD PRESS 1,3 ind (two) – HI green  
INST PWR – OFF

R4        √HYD BRAKE ISOL VLV 1,3 (two) – GPC  
            (tb-CL)  
            √LG EXTEND ISOL VLV – GPC (tb-CL)

## LOSS OF 2 FREON LOOPS ENTRY MANEUVERS

FLIGHT CONDITIONS	MANEUVER
EI-5	MDM FF1,4 – ON CAB FAN B – ON cb MNA,B DDU L (two) – cl cb ADTA 2,3 – cl ACCEL 2 – CL ACCEL 3 – ON GNC I/O RESET * If PREBANK: R/Y – CSS * √LVLH ATT * Roll at 1°/sec to <input type="text"/> <input type="text"/> * GNC, OPS 304 PRO * √OPS 304, wait 1 min * Maintain PREBANK ± 5° * MDM FF1,4 – OFF
EI	After MS reports GPS Powerup complete: GNC I/O RESET <input type="text"/> GNC 55 GPS STATUS INIT – ITEM 15 EXEC (*) NAV – ITEM 18 EXEC (*)
'Guidance Box' @ q ~8 or D ~3	CLOSED LOOP GUIDANCE ____:____:____  * If PREBANK: P,R/Y – AUTO *  Begin AIL trim monitoring
D = 11	√DRAG H
ΔAz = 10.5°	FIRST ROLL REVERSAL <input type="text"/> <input type="text"/> <input type="text"/> <input type="text"/>
V = 19K	√HYD MPS/TVC ISOL VLV SYS (three) – CL <input type="text"/> G50 √GPS, INCORPORATE
V = 12K	BRAKES MNB,MNC (two) – ON UHF MODE – SPLX (G T/R if ELS) AUD CTR – 1 √OI PCMMU FORMAT – FXD L,R AUD PWR – AUD If command or data reqd: OI PCMMU PWR – 2 MDM PL2 – ON S-BD PM CNTL – PNL, then CMD GNC I/O RESET ANT SW – Select best ANT On MCC call: MDM PL2 – OFF OI PCMMU PWR – OFF
V = 10K	√SPDBK to 81%
V = 7K	√GPS INCORPORATE
V = 5K	ADTA PROBES – DEPLOY (√HEAT, only one side if reqd) Begin AIL and RUD trim monitoring

FLIGHT CONDITIONS	MANEUVER
M = 4	MDM FF4 – ON MDM FF1 – ON (if NWS reqd) GNC I/O RESET
M = 2.9	RADAR ALTM 2 – ON CAB FAN (two) – OFF Use no landing aids (HUD,MLS) unless reqd to land vehicle safely (L HUD DATA BUS – 2 reqd)
M = 2.7	√APUs APU SPEED SEL (two) – HI  * If M < 2.5, P CSS for ADTA to G&C incorp *
M = 2.0	Ensure ADTA to G&C; else, √theta limits
M < 1.0	<b>* For bailout procedures, go to <u>BAILOUT</u> *</b>  (L) FLT CNTLR PWR – ON P,R/Y – CSS as reqd √SPDBK CMD vs POS MAX Nz <input type="text"/> <input type="text"/> <input type="text"/> ANTISKID – ON If NWS reqd: cb MNB,C DDU R (two) – cl (R) FLT CNTLR PWR – ON NWS – 1 Lock Inertia Reels Use one IDP/CRT with three MDUs
M = 0.7	LG EXTD ISO VLV – OP HYD BK ISOL VLV 1 – OP
h = 15K	√MLS (if on)
h = 10K	√A/L (KSC – Tabs, Visors, Suit O2)
h = 2K	LDG GEAR ARM pb – push (ARM It on)
h = 300	LDG GEAR DN pb – push (DN It on)
MAIN GEAR TD	√SPDBK – 100%
V = 195 KEAS	DRAG CHUTE ARM,DPY pb (two) – push (simo) (All Its on)
V = 185 KEAS	DEROTATE
NOSE GEAR TD	SRB SEP – MAN/AUTO and depress pb √Auto Load Relief √HYD BK ISOL VLV 1,3 (two) – OP
V < 120 KGS or 5K' remaining	BRAKE as reqd (8-10 fps <sup>2</sup> , -0.25 to -0.3G)  * If 5K' remaining and V > 140 KGS – MAX BRAKING *
V = 60 KGS	DRAG CHUTE JETT pb – push (JETT1,JETT2 It on)
V = 40 KGS	BRAKE < 6 fps <sup>2</sup> (-0.2G) (Antiskid cutout)
WHEEL STOP	Go to <u>EMER PWRDN</u> (Cue Card)

# OV103,104

C D/O/3,4/GEN M

This Page Intentionally Blank

## LOSS OF 2 FREON LOOPS ENTRY MANEUVERS

FLIGHT CONDITIONS	MANEUVER
EI-5	MDM FF1,4 – ON CAB FAN B – ON cb MNA,B DDU L (two) – cl cb ADTA 2,3 – cl ACCEL 2 – CL ACCEL 3 – ON GNC I/O RESET * If PREBANK: R/Y – CSS * √LVLH ATT * Roll at 1°/sec to <input type="text"/> <input type="text"/> <input type="text"/> <input type="text"/> * GNC, OPS 304 PRO * √OPS 304, wait 1 min * Maintain PREBANK ± 5° * MDM FF1,4 – OFF
EI	GPS 2 PWR – ON PRE AMPL (two) – ON Wait 30 sec GNC I/O RESET <input type="text"/> GNC 55 GPS STATUS INIT – ITEM 15 EXEC (*) NAV – ITEM 18 EXEC (*)
'Guidance Box' @ q ~8 or D ~3	CLOSED LOOP GUIDANCE ____:____:____  * If PREBANK: P,R/Y – AUTO *  Begin AIL trim monitoring
D = 11	√DRAG H
ΔAz = 10.5°	FIRST ROLL REVERSAL <input type="text"/> <input type="text"/> <input type="text"/> <input type="text"/> <input type="text"/>
V = 19K	√HYD MPS/TVC ISOL VLV SYS (three) – CL <input type="text"/> G50 √GPS, INCORPORATE
V = 12K	BRAKES MNB,MNC (two) – ON UHF MODE – SPLX (G T/R if ELS) AUD CTR – 1 √OI PCMMU FORMAT – FXD L,R AUD PWR – AUD If command or data reqd: OI PCMMU PWR – 2 MDM PL2 – ON S-BD PM CNTL – PNL, then CMD GNC I/O RESET ANT SW – Select best ANT On MCC call: MDM PL2 – OFF OI PCMMU PWR – OFF
V = 10K	√SPDBK to 81%
V = 7K	√GPS INCORPORATE
V = 5K	ADTA PROBES – DEPLOY (√HEAT, only one side if reqd) Begin AIL and RUD trim monitoring

FLIGHT CONDITIONS	MANEUVER
M = 4	MDM FF4 – ON MDM FF1 – ON (if NWS reqd) GNC I/O RESET
M = 2.9	RADAR ALTM 2 – ON CAB FAN (two) – OFF Use no landing aids (HUD,MLS) unless reqd to land vehicle safely (L HUD DATA BUS – 2 reqd)
M = 2.7	√APUs APU SPEED SEL (two) – HI  * If M < 2.5, P CSS for ADTA to G&C incorp *
M = 2.0	Ensure ADTA to G&C; else, √theta limits
M < 1.0	<b>* For bailout procedures, go to <u>BAILOUT</u> *</b>  (L) FLT CNTLR PWR – ON P,R/Y – CSS as reqd √SPDBK CMD vs POS MAX Nz <input type="text"/> <input type="text"/> <input type="text"/> <input type="text"/> ANTISKID – ON If NWS reqd: cb MNB,C DDU R (two) – cl (R) FLT CNTLR PWR – ON NWS – 1 Lock Inertia Reels Use one IDP/CRT with three MDUs
M = 0.7	LG EXTD ISO VLV – OP HYD BK ISOL VLV 1 – OP
h = 15K	√MLS (if on)
h = 10K	√A/L (KSC – Tabs, Visors, Suit O2)
h = 2K	LDG GEAR ARM pb – push (ARM It on)
h = 300	LDG GEAR DN pb – push (DN It on)
MAIN GEAR TD	√SPDBK – 100%
V = 195 KEAS	DRAG CHUTE ARM,DPY pb (two) – push (simo) (All Its on)
V = 185 KEAS	DEROTATE
NOSE GEAR TD	SRB SEP – MAN/AUTO and depress pb √Auto Load Relief √HYD BK ISOL VLV 1,3 (two) – OP
V < 120 KGS or 5K' remaining	BRAKE as reqd (8-10 fps <sup>2</sup> , -0.25 to -0.3G)  * If 5K' remaining and V > 140 KGS – MAX BRAKING *
V = 60 KGS	DRAG CHUTE JETT pb – push (JETT1,JETT2 It on)
V = 40 KGS	BRAKE < 6 fps <sup>2</sup> (-0.2G) (Antiskid cutout)
WHEEL STOP	Go to <u>EMER PWRDN</u> (Cue Card)

This Page Intentionally Blank



# QUICK-RESPONSE JETTISON

POST-JETTISON CLEANUP ..... 12-7

**QUICK-RESPONSE JETTISON**

ASSUMPTIONS/INITIAL CONDITIONS

Failed KU-BD and/or RMS (possibly with PL attached) must be jettisoned ASAP

At least one G2 GPC up and running

Full RCS and AFT DDU/FLT CNTLR PWR available for use

Hardware jettison and initial sep mnvr may be done in any attitude

PROBLEM DESCRIPTION/RATIONALE

Integrated, rapidly executable procedure to accomplish time-constrained jettison and sep from failed KU-BD and/or RMS

Designed to be used as reqd during time critical pwrdn and/or deorbit scenario

NOTE

1. Deorbit burn is done in place of third sep mnvr if deorbit TIG < 28 min from initial sep mnvr done in an arbitrary attitude, or if deorbit TIG < 45 min from initial sep mnvr done in  $-ZLV \pm 10^\circ$
2. If initial sep mnvr done in  $-ZLV \pm 10^\circ$  attitude, out-of-plane sep mnvr not reqd
3. Initial sep mnvr rate must be between 0.7 and 0.9 fps
4. This procedure divided into CDR actions in left column and MS actions in right column

**QUICK-RESPONSE JETTISON (Cont)**  
**MS PULLOUT PAGE**

1. SET UP FOR JETTISON	1. PREP FOR JETTISON
O14:F, O15:F, O16:F	A8U
O6 MA73C:A O7 O8	A8L
O14:E, O16:E	A7U
A6U	R14:E
DAP: A/LVLH/VERN DAP TRANS: PULSE/PULSE/PULSE, no LO Z	A14
<span style="border: 1px solid black; padding: 2px;">GNC 20 DAP CONFIG</span>	ML86B:D
√DAP A TRANS PLS ITEM 17 +0.10	A14
	~

**1. SET UP FOR JETTISON**

√Primary RJDs DRIVER,LOGIC (sixteen) – ON

√MDM FF,FA (eight) – ON

√MCA LOGIC FWD (three) – ON

Reopen FWD and AFT RCS if reqd

√cb DDU AFT (two) – cl

SENSE – as reqd

DAP: A/LVLH/VERN

DAP TRANS: PULSE/PULSE/PULSE, no LO Z

GNC 20 DAP CONFIG

√DAP A TRANS PLS ITEM 17 +0.10

**1. PREP FOR JETTISON**

If only RMS/payload jettison reqd:

MODE – best available

Mnvr RMS/payload clear of upfiring jets and orbiter structure

BRAKES – ON (tb-ON)

PORT RMS HTR A,B (two) – OFF

RMS SEL – OFF

PWR – OFF

TV CAMR PWR RMS – OFF (tb-OFF)

√PORT RMS LT – OFF

cb MNB RMS PORT RMS TV (three) – op

√PL power thru SPEE connector off

PL PWRDN (ORB PKT, PL SAFING)

√PYRO PORT RMS (five)– SAFE

√RMS LAT – SAFE

cb MNB PYRO JETT SYS A PORT RMS – cl

MNC PYRO JETT SYS B PORT RMS – cl

PYRO PORT RMS ARM – GUILLOTINE

Wait 1 sec, then

PYRO PORT RMS SHLDR – GUILLOTINE

– SAFE

ARM – SAFE

Go to step 2, 12-6

**QUICK-RESPONSE JETTISON (Cont)  
MS PULLOUT PAGE**

CDR

MS

R14:C

If only KU ANT jettison reqd:  
 cb MNB KU ELEC – op  
     ANT HTR – op  
     √CABLE HTR – op  
     MNC KU SIG PROC – op

A1U

√KU BD PWR – OFF  
 CNTL – PNL

A14  
 MA73C:A  
     :B

√PYRO KU ANT (two) – SAFE  
 MCA LOGIC MNC MID 2 – OFF  
     MNB MID 4 – OFF

ML86B:D

cb MNA PYRO JETT SYS A KU ANT – cl  
 MNC PYRO JETT SYS B KU ANT – cl

Go to step 2, 12-6

R14:C

If KU ANT and RMS/payload jettison reqd:  
 cb MNB KU ELEC – op  
     ANT HTR – op  
     √CABLE HTR – op  
     MNC KU SIG PROC – op

R14:E  
 A1U

cb MNB PORT RMS TV (three) – op  
 √KU BD PWR – OFF  
 CNTL – PNL

A14

√PYRO KU ANT (two) – SAFE  
     √PORT RMS (five) – SAFE  
 √RMS LAT – SAFE

**QUICK-RESPONSE JETTISON (Cont)**  
**MS PULLOUT PAGE**

CDR

MS

MA73C:A :B	MCA LOGIC MNC MID 2 – OFF MNB MID 4 – OFF
ML86B:D	cb MNA PYRO JETT SYS A KU ANT – cl MNC PYRO JETT SYS B KU ANT – cl MNB PYRO JETT SYS A PORT RMS – cl MNC PYRO JETT SYS B PORT RMS – cl
A7	TV CAMR PWR RMS – OFF (tb-OFF) √PORT RMS LT – OFF
A8U	RMS MODE – best available  Mnvr RMS/payload clear of upfiring jets and orbiter structure  BRAKES – ON (tb-ON)
A8L	PORT RMS HTR A,B (two) – OFF RMS SEL – OFF PWR – OFF  √PL pwr thru SPEE connector off (PAYLOAD PWRDN)
A14	PYRO PORT RMS ARM – GUILLOTINE Wait 1 sec, then PYRO PORT RMS SHLDR – GUILLOTINE – SAFE ARM – SAFE

QUICK-RESPONSE JETTISON (Cont)  
MS PULLOUT PAGE

CDR

MS

2. INITIAL SEP MNVR

2. KU/RMS/PAYLOAD JETTISON

**WARNING**  
Initial sep mnvr must be  $0.8 \pm 0.1$  fps

A6U

FLT CNTLR PWR – ON  
√DAP TRANS: PULSE/PULSE/PULSE, no LO Z  
DAP: A/FREE/PRI

If payload jettison/deploy,  
complete jettison/deploy procedure  
PL SAFING (ORB PKT)

A14

If KU ANT jettison:  
PYRO KU ANT – ARM  
Wait 1 sec, then:  
PYRO KU ANT – JETT

If RMS/payload jettison:  
PYRO PORT RMS ARM – JETT  
Wait 1 sec, then:  
PYRO PORT RMS SHLDR – JETT

DAP: LVLH

Note MET \_\_/\_\_:\_\_:

THC – +Z 8 PULSES (-X sense – dn)  
(-Z sense – out)

DAP: INRTL

**QUICK-RESPONSE JETTISON (Cont)  
MS PULLOUT PAGE**

CDR

MS

**3. OUT-OF-PLANE SEP MNVR**

If initial sep (step 2) done in  $-ZLV \pm 10^\circ$ , go to step 4, 12-8

CRT

GNC, OPS 202 PRO

**GNC ORB MNVR EXEC**

RCS SEL – ITEM 4 EXEC (\*)

Set TIG to initial sep mnvr from step 2 +4:00 min

TGT PEG 7  $\Delta V_x$  – ITEM 19 +0 EXEC

$\Delta V_y$  – ITEM 20 +4 EXEC

$\Delta V_z$  – ITEM 21 +0 EXEC

LOAD – ITEM 22 EXEC

TIMER – ITEM 23 EXEC

If VGO Z < 0:

TGT PEG 7  $\Delta V_y$  – ITEM 20 -4 EXEC

LOAD – ITEM 22 EXEC

TIMER – ITEM 23 EXEC

$\sqrt{VGO Z} > 0$

Do not mnvr to Burn Att

A6U

$\sqrt{DAP}$ : A/INRTL/PRI

DAP TRANS: as reqd

At TIG, THC – Trim VGO < 0.2 fps

**3. POST-JETTISON CLEANUP**

A14 PYRO KU ANT (two) – SAFE  
PORT RMS SHLDR – SAFE  
ARM – SAFE

MA73C:A  $\sqrt{MCA}$  LOGIC MNA MID 1 – ON  
 $\sqrt{MNB}$  MID 2 – ON  
 $\sqrt{MNC}$  MID 2 – ON  
:B  $\sqrt{MNB}$  MID 4 – ON  
 $\sqrt{MNC}$  MID 4 – ON

**IF RMS JETTISONED, STOW MPM**

**WARNING**

Payload bay door cannot be closed until MPMs stowed

MA73C:C cb MCA PWR AC2 3 $\Phi$  MID 2 – cl  
:D AC3 3 $\Phi$  MID 4 – cl  
R13L PL BAY MECH PWR SYS 1,2 (two) – ON  
A8 PORT RMS – STO (tb-STO) (68 sec max)  
– OFF  
STBD RMS – STO (tb-STO) (68 sec max)  
– OFF

R13L PL BAY MECH PWR SYS 1,2 (two) – OFF

ML86B:D cb MNA PYRO JETT SYS A KU ANT – op  
MNC PYRO JETT SYS B KU ANT – op  
MNB PYRO JETT SYS A PORT RMS – op  
MNC PYRO JETT SYS B PORT RMS – op

Go to post jettison/deploy cleanup steps, if reqd (ORB PKT, PL SAFING)

**QUICK-RESPONSE JETTISON (Cont)**  
**MS PULLOUT PAGE**

CDR

MS

**4. FINAL (POSIGRADE) SEP MNVR**

If Deorbit TIG < 28 min from initial sep done in an arbitrary attitude, go to step 5

If Deorbit TIG < 45 min from initial sep done in -ZLV  $\pm 10^\circ$ , go to step 5

CRT

If MM 201: GNC, OPS 202 PRO

GNC ORB MNVR EXEC

RCS SEL – ITEM 4 (\*)

Set TIG to TIG from previous  
sep mnvr +4:00 min

TGT PEG 7  $\Delta V_x$  – ITEM 19 +3 EXEC

$\Delta V_y$  – ITEM 20 +0 EXEC

$\Delta V_z$  – ITEM 21 -2 EXEC

LOAD – ITEM 22 EXEC

TIMER – ITEM 23 EXEC

Do not mnvr to Burn Att

A6U

√DAP: A/INRTL/PRI

√DAP TRANS: as reqd

At TIG, THC – Trim VGO < 0.2 fps

If VGO Z is neg, Z,X,Y seq; otherwise, X,Y,Z



QUICK-RESPONSE JETTISON (Cont)  
MS PULLOUT PAGE

CDR

MS

5. POST-SEP CLEANUP

CAUTION

If Deorbit TIG < 9 min after initial sep,  
> 500 ft clearance not guaranteed

A6U CRT	FLT CNTLR PWR – OFF If MM 202: GNC, OPS 201 PRO
O7,O8	Perform RCS SECURE (FWD,AFT) (ORB PKT, <u>RCS</u> ) if reqd
MA73C:A O6	MCA LOGIC FWD (three) – as reqd MDM FF,FA (eight) – as reqd
O14:F, O15:F, O16:F	√Primary RJDs DRIVER,LOGIC (sixteen) – as reqd
O14:E, O16:E	cb DDU AFT (two) – op

**MS PULLOUT PAGE**

This Page Intentionally Blank

# BAILOUT

**BAILOUT**

BAILOUT MODE 8	
REPORT POSITION	
√MACH < 1.0	
P, R/Y – CSS	
OPS 305/603 PRO (if reqd)	
SB – AUTO; BF – AUTO	
FLY 185-195 KEAS, $\Phi = 0^\circ$	
ABORT MODE - ATO	
ABORT PBI – PUSH	
P,R/Y – AUTO	
FLT CNTLR PWR (two) – OFF	
<u>~50K FT</u>	
TABS – RELEASE	
VISOR – CLOSE / LOCK	
SUIT O2 – ON	
GREEN APPLE – PULL	
<u>~40K FT</u>	
MS3 – VENT CABIN	
CDR,PLT SEATS – LOWER	
KNEEBOARDS – REMOVE	
COOLING – DISCONNECT	
SEAT RESTRAINT – RELEASE	
D-RING – UNCOVER	
<u>~30K FT</u>	
MS3 – JETTISON HATCH	
COMM – DISCONNECT	
(G-SUIT CLIP – PULL)	
SUIT O2 – DISCONNECT	
EGRESS SEAT	
POLE – DEPLOY	
D-RING – HOOK UP	
BAILOUT	

# MS PAGES

This Page Intentionally Blank

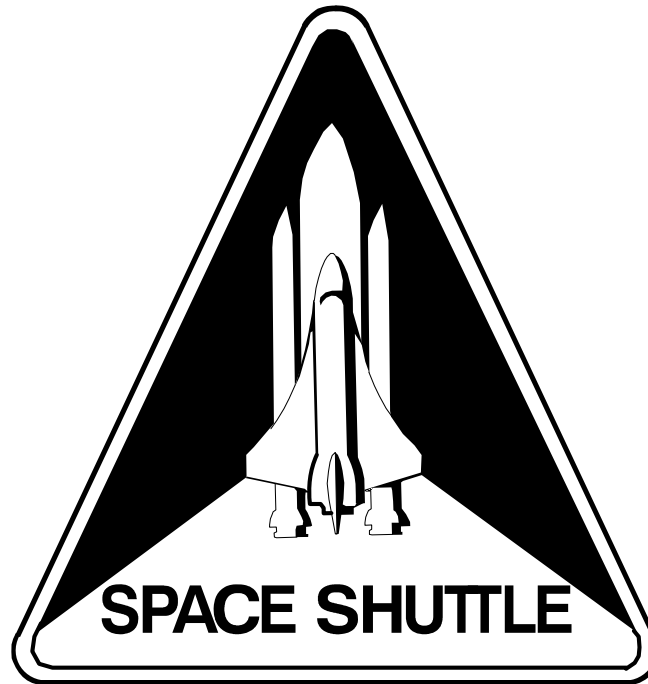

**CONTINGENCY  
DEORBIT**

**STS  
ALL**