

CONTINGENCY SHUTTLE CREW SUPPORT (CSCS)/RESCUE FLIGHT RESOURCE BOOK

	OVERVIEW	1
Mission Operations Directorate	CSCS	2
	RESCUE FLIGHT	3

DA8/Flight Director
Office

Final

July 12, 2005



National
Aeronautics and
Space
Administration

Lyndon B. Johnson
Space Center
Houston, Texas

CONTINGENCY SHUTTLE CREW SUPPORT (CSCS)/RESCUE FLIGHT RESOURCE BOOK

FINAL

JULY 12, 2005

PREFACE

This document, dated May 24, 2005, is the Basic version of the Contingency Shuttle Crew Support (CSCS)/Rescue Flight Resource Book.

It is requested that any organization having comments, questions, or suggestions concerning this document should contact DA8/Book Manager, Flight Director Office, Building 4 North, Room 3039.

This is a limited distribution and controlled document and is not to be reproduced without the written approval of the Chief, Flight Director Office, mail code DA8, Lyndon B. Johnson Space Center, Houston, TX 77058.

Prepared By

Anthony J. Ceccacci
DA8/Shuttle Flight Director
CSCS/Rescue Coordinator

Paul F. Dye
DA8/Shuttle Flight Director
CSCS/Rescue Coordinator

Approved By

Jeffrey M. Hanley
DA8/Chief, Flight Director Office

Philip L. Engelaur
DA8/Deputy Chief, Flight Director Office

1.0 - OVERVIEW

Section 1.0 is the overview of the entire Contingency Shuttle Crew Support (CSCS)/Rescue Flight Resource Book.

This page intentionally blank.

2.0 - CONTINGENCY SHUTTLE CREW SUPPORT (CSCS)

2.1	Procedures Overview.....	2-1
2.1.1 Modified Group C Powerdown	2-1
2.1.2 Contingency Shuttle Crew Support Group C+ Powerdown	2-4
2.1.3 Contingency Shuttle Crew Support Group C+ Powerup	2-11
2.1.4 CSCS/Undock/Separation/Disposal Timeline	2-15
2.1.5 APDS Remote Undock (IFM)	2-33
2.1.6 Docking Target Installation	2-41
2.1.7 Shuttle Egress	2-43
2.1.8 PMA2/ODS Depress and Leak Check	2-47
2.1.9 TCS Alternate Power (IFM)	2-54
2.2	Flight Procedures Handbook (FPH) for Unmanned Undock Timeline	2-56
2.2.1 Overview	2-56
2.2.2 FPH Detailed Procedures	2-56
2.3	Sim Lessons Learned	2-71
2.4	Transfer Tables.....	2-72
Table 2.4.1 Stranded Orbiter to ISS	2-72
Table 2.4.2 ISS to Stranded Orbiter	2-74
Table 2.4.3 Rescue Orbiter to ISS	2-74
Table 2.4.4 ISS to Rescue Orbiter	2-74
2.5	CSCS Docked Duration Assessment.....	2-75
2.5.1 CSCS Docked Duration Assessment Assumptions	2-75
2.5.2	Space Shuttle Mission Power Analysis in Support of Contingency Shuttle Crew Support (CSCS) for STS-114 (LF1).....	2-76
2.5.3 STS-114 CSCS L-5 Month ECLS Consumables Report	2-76
2.6	Other References.....	2-80

This page intentionally blank

2.1 Procedures Overview

The following procedures have been developed specifically for the CSCS scenario. The procedures provide the required Orbiter Powerdowns procedures to maximize the damaged Orbiter docked duration as well as the required procedures to support the Unmanned Orbiter Undocking.

2.1.1 Modified Group C Powerdown

The Modified Group C Powerdown deltas the current Group C Powerdown procedures (located in the Orbiter FDF) and modifies them to reduce Orbiter power (to optimize Cryo savings) while retaining the capability to perform the RMS/OBSS Inspection activities and data downlink requirements.

The Group C, Priority Group 1, and Priority Group 2 Powerdowns are provided with the edits included to show the deltas.

Expected Orbiter Power level approximately 12.1 KW average.

PRIORITY PWRDN GROUP C

PNL	GRP C	PWRDN (MSN EXT)	PWRUP
	1.	Perform PRIORITY PWRDN GROUP 1,2 If prior to first deorbit prep:	
	2.	Perform PRIORITY PWRDN GROUP 3A, then:	
	3.	Turn off all lights except two Middeck lts (use no lts for single-shift sleep or split-shift sleep)	
GALLEY	4.	H2O HTR (two), OVEN FAN – OFF ①	ON ①
	5.	MDUs: Cycle ON when reqd	
O14, O15, O16:F	6.	Pri RJDF DRIVER,LOGIC (eight) – OFF	ON
	7.	Pri RJDA DRIVER,LOGIC (eight) – OFF RJDA 1A L2/R2 DRIVER – ON	ON
O6	8.	MDM PL2 – OFF ②	ON ③
A14	9.	RCS/OMS HTR L POD (two) – A AUTO, B OFF R POD (two) – A AUTO, B OFF	MCC call
A1L	10.	PL DATA INTLVR PWR – OFF S-BD PL PWR SYS – OFF CNTL – PNL,CMD ④	MCC call MCC call
A1R	11.	FM PWR – OFF CNTL – PNL,CMD	1 ⑤
O6	12.	√UHF MODE sel – OFF	
	13.	KU-BAND SYS ⑤	
O14, O15, O16:E	14.	cb DDU L,R,AFT (six) – op	cl
	15.	COLOR PRINTER – OFF	MCC call

- ① Insert drink package to keep water tank pump from cycling (water temp may decrease slightly); if repowering Galley, remove drink package
- ② Before powering off PF2 MDM, √MCC for Antenna Electronics 1 activation
- ③ SM I/O RESET
- ④ If PDI and/or PSP pwrd off, expect 'S62 BCE BYP PL', 'S62 BCE BYP PDI' and/or 'S62 BCE BYP PSP' msgs
- ⑤ As reqd for EVA and Inspection activites, MCC will command

PRIORITY PWRDN GROUP 1

PNL	GRP 1 PWRDN	PWRUP
O15:F	1. Minimize Itg 2. Use only one IDP with three MDUs max If GPC 2 – RUN: 3. Perform G2 SET CONTRACTION (ORB OPS, <u>DPS</u>), then: 4. MMU 2 OFF – (1 of 2 off) 5. GNC 21 IMU ALIGN IMU 2 STBY – ITEM 22 EXEC	① ON ②

① If reqd, go to G2 SET EXPANSION (ORB OPS, DPS)

② Recover IMU 2 (MAL, GNC FRP-3)

PRIORITY PWRDN GROUP 2

PNL	GRP 2 PWRDN	PWRUP
O6	1. S TRK PWR -Y,-Z (two) – OFF	As reqd
	2. MDM FF2,4 (two) – OFF FA4 – OFF	ON ①
C3	3. MSTR MADS PWR – OFF	ON
L1	4. FLASH EVAP CNTLR PRI (two) – OFF SEC – OFF TOP EVAP HTR NOZ (two) – OFF DUCT sel – OFF	② ③ Two ON ② ON
OCAC	5. <u>PGSC</u> - Use as required <u>Wake</u> - OCA, KFX, Windecom, and World Map <u>Sleep</u> - OCA, KFX <u>A31P's</u> - Laptops as needed If OCAC flown: 6. OCAC PWR – OFF	ON

① GNC I/O RESET

② Perform TOPPING FES STARTUP, using Pri A/B (ORB OPS, ECLS)

③ SEC CNTLR ON only if both primary controllers failed

2.1.2 Contingency Shuttle Crew Support Group C+ Powerdown

The Contingency Shuttle Crew Support (CSCS) Group C+ Powerdown, minimizes Cryo usage and maximizes docked capability while protecting the mandatory systems required for undocking. The CSCS Group C+ Powerdown does not protect critical systems required to support a Deorbit/Entry attempt.

Since systems insight is lost while in the Group C+ configuration (FF1, 2, 4 & FA1, 2, 3, 4 - OFF), a daily Orbiter Vehicle health check will be performed using the COMM PWRUP portion of the procedure. Once the Vehicle health check is complete (15 minutes), the COMM PWRDWN will be executed.

Expected Orbiter Power level approximately 7.7 KW average.

CONTINGENCY SHUTTLE CREW SUPPORT GROUP C+ PWRDWN (12/3/04)

WARNING

Contingency Shuttle Crew Support Group C+ Powerdown results in minimum power level required to protect all systems integrity for safe undock and disposal of vehicle.

NOTE: PROCEDURE ASSUMES CURRENTLY IN GRP B PWRDN

PRIOR TO EXECUTING POWERDOWN PERFORM THE FOLLOWING:

- RMS POWERDOWN & DEACT (PDRS OPS C/L)
- RAD STOW (ORB OPS C/L)
- PAYLOAD SAFING (PAYLOAD POWERDOWN C/L)
- SSV PWR - OFF (LED - off)
- Condensate Collection Reconfig (IFM, WATER)
- ECLS SSR-13 ON-ORBIT RAD CNTLR SWAP (MAL, ECLS) for both freon loops "FES not req'd"

CONTINGENCY SHUTTLE CREW SUPPORT GROUP C+ POWERDOWN (CONTINUED)**CONFIGURE RCS JETS FOR SEPARATION**

GNC 23 RCS

ITEM 1 EXEC - forward page
 ITEM 12 EXEC (twice) - F2R to last priority
 ITEM 24 EXEC (twice) - F3D to last priority

ITEM 2 EXEC - left page
 ITEM 14 EXEC (twice) - L1L to last priority
 ITEM 32 EXEC (twice) - L1A to last priority

ITEM 3 EXEC - right page
 ITEM 14 EXEC (twice) - R1R to last priority
 ITEM 30 EXEC (twice) - R1A to last priority

- | | | |
|-------|-----|---|
| C3 | 1. | DAP: FREE |
| O14:F | 2. | RJDA 1A L2/R2 DRIVER - OFF |
| O16:F | 3. | RJD MANF L5/F5/R5 DRIVER – OFF |
| O7 | 4. | L, R RCS He PRESS (four) - CL (tb-CL) |
| O8 | 5. | FWD RCS He PRESS (two) - CL (tb-CL) |
| O6 | 6. | GPC PWR 2,3 (two) – OFF
√MODE 5 – STBY (tb-RUN)
– HALT (tb-bp)
√OUTPUT 5 – NORM
PWR 5 – OFF |
| CRTX | 7. | Use only one IDP/CRT with one MDU |
| C3 | 8. | √OI PCMMU PWR – 1 |
| R2 | 9. | HYD CIRC PUMP (three) – OFF |
| L1 | 10. | HUM SEP B– OFF
A – ON |
| | 11. | H2O PUMP LOOP 1 (two) - GPC, A |
| L1 | 12. | AV BAY 2 FAN A – OFF
1 FAN A – ON
B - OFF |
| | 13. | FREON PUMP LOOP 1, 2 (two)– A |
| | 14. | FLASH EVAP CNTLR PRI A,B (two) – OFF
TOP EVAP HTR NOZ (two) – OFF
DUCT sel – OFF |
| | 15. | HI LOAD DUCT HTR sel – OFF |
| | 16. | CABIN TEMP sel - FULL COOL,
after 4 minutes
CABIN TEMP CNTLR - OFF |
| L5 | 17. | LEFT COMM POWER - OFF |
| O5 | 18. | LEFT AUDIO POWER - OFF |
| O6 | 19. | S TRK PWR -Y,-Z (two) – OFF |
| | 20. | UHF MODE sel - OFF |
| | 21. | ANNUN BUS SELECT ACA 1 - OFF
ACA 2/3 - MNC |

CONTINGENCY SHUTTLE CREW SUPPORT GROUP C+ POWERDOWN (CONTINUED)

- GNC 21 IMU ALIGN
- O14,O15
O16:A 22. IMU 1,2, 3 (three) – desel
IMU 1,2, 3 (three) – OFF
- L1 23. IMU FAN B – OFF
- O6 24. MDM FF1, 2, 4 (three) – OFF
FA1,2, 3, 4 (four) – OFF
PL2– OFF (MAN ANT plan required)
- L4:B 25. cb UTIL POWER (two) - op
:F cb AC 1 H2O LOOP PUMP 1A/2 (three) - cl
:J 26. AC3 Φ B SIG CONDR IMU FAN – op
:L 27. AC1 Φ A CAB T CNTLR 2 – op
 Φ B AV BAY 2 S/C – op
AC2 Φ A CAB T CNTLR 1 – op
:O 28. cb AC1,2,3 HYD QTY 1,2,3 (three) - op
:P 29. AC2,3 Φ A LG SNSR 2,1 (two) – op
- R2 30. BLR CNTLR/HTR 1,2, 3 (three)– OFF
- W1-10 31. Install Window Shades (remove as reqd to monitor att or control cab temp)
- If OCAC flown:
32. OCAC PWR – OFF

MID DECK PULL OUT PAGE

- MA73CF: 1. cb AC1,2 OPS INST HYD ACTR Φ C (two) – op
I: 2. AFT POD VLV LOGIC (three) - OFF
- ML31C 3. VAC VENT NOZ HTR – OFF
- ML86B:C 4. \sqrt cb MNA EXT ARLK HTR (four) – cl
:A 5. cb MNA H2O LINE HTR A – op
MNB H2O LINE HTR B – op

NOTE: Steps 6 & 7 assumes TK5 in use else
 \sqrt MCC for updated CRYO config

- :F 6. CRYO O2 HTR TK 3, 4 SNSR 1, 2 (four) - op
- :G 7. CRYO CNTL O2, H2 TK 3, 4 (four) - op
QTY O2, H2 TK 3, 4 (four) - op
- GALLEY 8. OVEN/RHS – OFF(ON as reqd)
H2O HTRS – OFF
 \sqrt OVEN FAN – OFF
9. Purge both supply, waste H2O lines. Go to SUPPLY(WASTE) H2O PURGE FROM DUMP LINE(S) (IFM, PROCEDURES S THRU Z)
- MO13Q 10. All MIDDECK Its – OFF (ON as reqd)

CONTINGENCY SHUTTLE CREW SUPPORT GROUP C+ POWERDOWN (CONTINUED)

Perform After KU-BD ANT STOW Actions Complete

MA73C:A,

- :B 11. √ MCA LOGIC FWD 1 - ON
 Other MCA LOGIC (thirteen) – OFF

MS OVHD AND AFT PNL CONFIG

- O13:B 1. cb CRYO CNTLR, QTY O2, H2 TK2 (four) – op
 :C 2. cb ESS2CA C/W B – op
 MTU B – op
 :D 3. cb CRYO CNTLR, QTY O2,H2 TK1 (four) – op
 :E 4. cb ESS 3AB GPC STAT – op
- O14:B 5. cb MNA OI Tire Press - op
 MSN TIMER FWD – op
 EVENT TIMER AFT – op
 :C 6. cb MNA UTIL PWR O19/MO52J – op
 CRYO O2 HTR TK 1 SNSR 1 - op
 :D 7. cb GPS PRE AMPL UC,LC (two) – op
 IF PCS 2 active (14.7 CAB REG INLET SYS 2 - OP pnl:MO10W)
 8. cb O2/N2 CNTLR 1 – op
 9. cb CAB VENT – op
 VENT ISOL – op
 :F 10. MMU 1 – OFF
- O15:B 11. cb MNB OI SIG CONDR OM3 A - op
 SIG CONDR OF1/4 B – op
 SIG CONDR OF2/3 A – op
 SIG CONDR OM1/2 B - op
 MDM OF 1/2 B – op
 TIRE PRESS - op
 MSN TIMER AFT – op
 EVENT TIMER FWD – op
 :C 12. cb CRYO O2 HTR TK 2 SNSR 2 - op
 UTIL PWR F1/MO13Q – op
 GPS 2 PRE AMPL UPPER – op
 :D IF PCS 1 active (14.7 CAB REG INLET SYS 1 - OP pnl:MO10W)
 13. cb O2/N2 CNTLR 2 – op
 14. cb GPS 2 PRE AMPL LOWER – op
- O16:B 15. cb MNC OI SIG CONDR OM3 B - op
 MDM OF 3/4 B – op
 AUX TIMING BUFF – op
 :C 16. CRYO O2 HTR TK1 SNSR 2 - op
 CRYO O2 HTR TK2 SNSR 1 – op
 17. cb MNC UTIL PWR A11/A15/MO30F – op
 18. cb MNC ANNUN AFT ACA 4/5 – op
 :D 19. cb ATM PRES CONTR O2 EMER – op
- O16:E 20. cb MNC RCS/OMS PRPLT QTY GAUGE – op
- O17:C 21. SIG CONDR FREON A – AC3
- O19 22. TV PWR – OFF

CONTINGENCY SHUTTLE CREW SUPPORT GROUP C+ POWERDOWN (CONTINUED)

23. COAS PWR – OFF
 24. KU-BD ANT STOW (ORB OPS C/L) - stop before STOW DEPLOYED ASSEMBLY
- A1U 25. KU PWR -OFF
- R13L 26. KU ANT - GND
- A1L 27. S-BD PL PWR SYS - OFF
 PL DATA INTLVR PWR – OFF
 S-BD PL CNTL - PNL,CMD
28. S-BD PM ANT SW ELEC - 2
 PRE AMP - 2
 PWR AMPL STBY - 2
 OPER - 2
 XPNDR - 2
29. NSP PWR - 2

Notify MCC prior to next step (ground reconfig required to recover uplink)

30. NSP ENCRYPTION MODE - SEL
 SEL - BYP
 PWR - OFF
- A1R 31. S-BD FM PWR - OFF
 CNTL - PNL,CMD
- A12 32. APU HTR GAS GEN/FUEL PUMP 1,2, 3 (three) – OFF
 LUBE OIL LINE 1,2,3 (three) – OFF
 APU HTR TK/FU LINE/H2O SYS
 1A,1B,2A,2B,3A, 3B (six) – OFF
33. HYD HTR (eight) – OFF
- A13 34. GPS PWR – OFF
- A14 35. RCS/OMS HTRS
 L POD (two) – A AUTO, B OFF
 R POD (two) – A AUTO, B OFF
- A6U 36. FLT CNTLR PWR – OFF
 37. ANNUN BUS SEL – OFF
 38. Minimize Itg on Aft Flt Deck
- A3 39. MON 1,2 PWR (two) - OFF
- A7U 40. TV PWR CONTR UNIT – PNL
 - OFF
 - CMD
 WIRELESS VIDEO HTR - OFF
- L12/SSP1 41. OIU PWR - OFF (tb - bp)

CONTINGENCY SHUTTLE CREW SUPPORT GROUP C+ POWERDOWN (CONTINUED)

- L10 42. DTV MUX/VTR/CC PWR - OFF (LED - off)
 VIP PWR - OFF (LED - off)
 VTR PWR - OFF (LED - off)
- R12 43. VPU PWR - OFF (LED - OFF)
- R14:A 44. cb MNA ADC 1A/2A – op
 MNB ADC 1B/2B – op
- :B 45. cb MNA UHF - op
 MNC UHF - op
- :C 46. cb MNB KU ELEC - op
 MNC KU SIG PROC - op
- :D 47. TV (fourteen) – op
 VPU - op
- :E 48. RMS TV (six) – op
- L9 49. PS AUD PWR – OFF

If 3 good FCs, shut down FC2 and AC2 per the following:

- R1 50. MN BUS TIE A,B (two) – ON (tb-ON)
51. ESS BUS SOURCE FC2 – OFF
52. FC/MN BUS B – OFF
53. FC2– STOP
54. cb AC2 CONTR (three) – cl
 INV/AC BUS 2 – OFF (tb-OFF)
 INV PWR 2 – OFF (tb-OFF)
 cb AC CONTR (three) – op
55. AC BUS SNSR 2 – OFF
56. Minimize flt deck lighting

NOTE: MCC will Powerdown the S-band COMM System

COMM PWRUP (When required for MCC data snapshots)

- C3 1. S-BD PM CNTL – PNL,CMD (wait 2 min 20 sec for PA warmup)
 SEL Best ANT, F9 METER > 300
- O6 2. MDM FF1, 2, 4 (three) - ON
 MDM FA 1, 2, 3, 4 (four) - ON
- O16:B 3.cb MNC OI SIG CONDR OM3 B - cl
- CRT 4.GNC I/O RESET

CONTINGENCY SHUTTLE CREW SUPPORT GROUP C+ POWERDOWN (CONTINUED)COMM PWRDWN

- O6 1. MDM FF1, 2, 4 (three) - OFF
MDM FA 1, 2, 3, 4 (four) - OFF
- O16:B 2.cb OI MNC SIG CONDR OM3 B - op
3. MCC will power down S-band comm system

2.1.3 Contingency Shuttle Crew Support Group C+ Powerup

The Contingency Shuttle Crew Support (CSCS) Group C+ Powerup provides the systems configuration required to execute the CSCS Undock/Separation/Disposal timeline (Unmanned Undocking).

CONTINGENCY SHUTTLE CREW SUPPORT GROUP C+ PWRUP (2/23/05) (1:30 HR)

1. Perform COMM PWRUP (Group C+ PWRDN)

NOTE

Manual Antennas are required until after IMU align complete

- | | | | |
|---------|-----|-----------------------------------|--|
| MA73C:A | 2. | MCA LOGIC FWD 1,2,3 (three) - ON | |
| | | MNC MID 2 - ON | |
| :B | 3. | MNB MID 4 - ON | |
| :I | 4. | AFT POD VLV LOGIC (three) - ON | |
| | | KU BD RADAR activation | |
| R14:C | 5. | cb MNB KU ELEC - cl | |
| | | MNC KU SIG PROC - cl | |
| A1U | 6. | KU RADAR OUTPUT - LO | |
| | | PWR - ON | |
| R11L | 7. | IDP/CRT 4 - ON | |
| | | <u>SM ANTENNA</u> | |
| CRT | 8. | I/O RESET KU - ITEM 8 EXEC (*) | |
| | | <u>NOTE</u> | |
| | | System warmup takes ~ 4 min | |
| O6 | 9. | ANNUN BUS SELECT ACA 1 - MNA | |
| C3 | 10. | √ DAP: FREE | |
| R1 | 11. | PL CAB - MNA | |
| | | AUX - ON | |
| O14:F, | 12. | √ RJDA 1A L2/R2 MANF DRIVER - OFF | |
| O15:F, | | √ RJD MANF L5/F5/R5 DRIVER - OFF | |
| O16:F | | Pri RJD LOGIC (eight) - ON | |

√ MCC for go to powerup Pri Drivers

On MCC GO:

13. RJD MANF L5/F5/R5 DRIVER - ON
- Pri RJD DRIVER (eight) - ON

CONTINGENCY SHUTTLE CREW SUPPORT GROUP C+ PWRUP (CONTINUED)

- O7 14. AFT L, R RCS He PRESS (four) - OP (tb-OP)
 TK ISOL (six) - GPC (tb-OP)
 XFEED (four) - GPC (tb-CL)
- O8 15. L,R OMS TK ISOL (four) - GPC (tb-OP)
 XFEED (four) - GPC (tb-CL)
 FWD RCS He PRESS (two) - OP (tb-OP)
- O14:F,
O15:F 16. MMU 1, 2 (two) - ON
- L4:B 17. cb UTIL PWR A15/MO13Q AC3 - cl
 :J 18. cb AC3 ΦB SIG CONDR IMU FAN – cl
 :L 19. cb AC1 ΦB AV BAY 2 S/C – cl
- L1 20. AV BAY 2 FAN B - ON
 IMU FAN A - ON
 21. TOP EVAP HTR Duct sel - A
 NOZ L - A AUTO
 NOZ R - B AUTO
- C2 22. IDP/CRT 2 - ON
- 23. Perform GPC IPL-PASS (MAL, DPS SSR-8)
 for GPC 2 then 3

NOTE

Do not perform any keyboard item entries or sw throws 10 sec before and after moding PASS GPCs to RUN or making OPS transition requests

- CRT 24. CONFIG FOR SET EXPANSION
 If MM202: GNC, OPS 201 PRO

GNC 0 GPC MEMORY

 CONFIG – ITEM 1 +2 EXEC
 Assign MC 2 per table →
- C3(A6U)
CRT 25. OPS MODE RECALL
 √DAP: FREE
 GNC, OPS 201 PRO

		TRIPLE G2
CONFIG	GPC	2 12300
STR	1	1
	2	2
	3	3
	4	3
PL	1/2	0
CRT	1	1
	2	2
	3	0
	4	3
L	1	0
	2	0
MM	1	1
	2	2

CONTINGENCY SHUTTLE CREW SUPPORT GROUP C+ PWRUP (CONTINUED)

- O6 26. S TRK PWR -Y,-Z (two) – ON
- L1 27. Perform ACTIVATE IMU(s) (MAL, GNC SSR-1)
Simo IMUs 1,2,3
- O6 28. MDM PL2– ON
- CRT 29. SM I/O RESET
- S88 APU/ENVIRON THERM
30. When EVAP TEMP TOPPING FWD,
AFT > 120, Go for
FES activation steps 31 thru 33
- M 2
- CRT If FREON EVAP OUT TEMP > 41 and ≤ 47 degF:
L1 31. RAD CNTLR OUT TEMP – HI
CRT When FREON EVAP OUT TEMP > 50 degF,
L1 32. RAD CNTLR OUT TEMP – NORM,
then immediately: FLASH EVAP CNTLR PRI B – ON
- CRT If FREON EVAP OUT TEMP ≤ 41 or > 47 degF:
L1 33. FLASH EVAP CNTLR PRI B – ON
- O13:C 34. cb MTU B – cl
:E 35. cb ESS 3AB GPC STAT – cl
- O16:B 36. cb AUX TIMING BUFF – cl
:C 37. cb MNC UTIL PWR A11/A15/MO30F – cl
38. cb MNC ANNUN AFT ACA 4/5 – cl
- A14 39. RCS/OMS HTRS
R POD (two) B AUTO, A OFF
40. SSV pwr - ON
√ SSV outrate - 3
- R14:D 41. TV (fourteen) - cl
42. On MCC call (Wait for REFSMMAT uplink)

GNC 21 IMU ALIGN

Align IMU 1 to IMU 2

ITEM 10 EXEC (*)
√ITEM 11 (no *)
√ITEM 12 (no *)
ITEM 14 +2 EXEC

CONTINGENCY SHUTTLE CREW SUPPORT GROUP C+ PWRUP (CONTINUED)

43. On MCC call

ITEM 16 EXEC

Alignment requires approximately 3 – 6 minutes

Terminate alignment when magnitude of the largest torquing angle < 0.05

ITEM 17 EXEC

44. On MCC call (Wait for REFSMMAT uplink)

Align IMUs 1, 2, and 3 to IMU 1

√ ITEM 10 (*)

ITEM 11 EXEC (*)

ITEM 12 EXEC (*)

ITEM 14+1 EXEC

ITEM 16 EXEC

Alignment requires approximately 6-12 minutes

Allow alignment to complete normally

45. On MCC call

Select IMU 1 (2, 3)

ITEM 7 (8, 9) EXEC

GNC 22 S TRK/COAS CNTL

46. Star Trackers to track mode, Item 3,4 EXEC (*)

C3

47. ON MCC call
S-BD PM ANT sel - GPC

2.1.4 CSCS/Undock/Separation/Disposal Timeline

The unmanned undocking timeline is designed to roll all CSCS procedures into one common timeline, with the overall objective of undocking and safely disposing of a damaged Orbiter. Being an undocking timeline, it uses the familiar rendezvous checklist format. Starting with the Orbiter in its Group C+ powerdown state, the timeline runs through the Group C+ powerup, the APDS remote command IFM, maneuver to undock attitude, Shuttle crew egress, and a gross leak check. The timeline also includes post-undocking commanding, including the procedures by which the Orbiter achieves an initial opening rate, a 1 fps +X burn, and a final dual OMS disposal burn. The timely completion of these post-undocking steps guarantees safe relative motion.

Several assumptions were taken when writing these procedures. First and foremost, it was assumed that except for irreparable tile damage, the Orbiter was otherwise healthy. Redundancy in GNC GPC's, IMU's, attitude control, and command ability was expected. Second, the procedures require the use of TCS for initial range and range rate determination, so the IFM to power TCS from MAIN A is required. Radar data is very desirable, but not required. Third, the procedures assume the successful completion of the numerous powerup and IFM procedures listed on page 2-1. Lastly, the procedures assume the flight control team has picked an undock time that is 1.5 hours prior to a deorbit opportunity that will dispose of the damaged Orbiter in the South Pacific.

This page intentionally blank

CAUTION

Constraints for undocking of unmanned Orbiter:

ISS capable of controlling -Rbar attitude (ISS 90,0,0 LVLH PYR) with 1° deadbands

ISS RWS powerup required to monitor ODS

TCS REPOWER previously performed

SHUTTLE EGRESS, steps 1 - 6, previously performed prior to APDS REMOTE COMMAND

APDS REMOTE COMMAND, steps 1 - 29, previously performed

PMA2 DEPRESSURIZATION AND LEAK CHECK, steps 1 - 4, previously performed

IFM to provide TCS power via MAIN A or MAIN C previously performed

At least 2 GNC GPCs available

At least 2 IMUs available

2 PGSCs available for WinDecom and RPOP/CADS

S-band comm optimized for 7.5 hours

DAP B9 previously configured to include 10 second ALT DAP DELAY

Docking target previously installed on ISS hatch

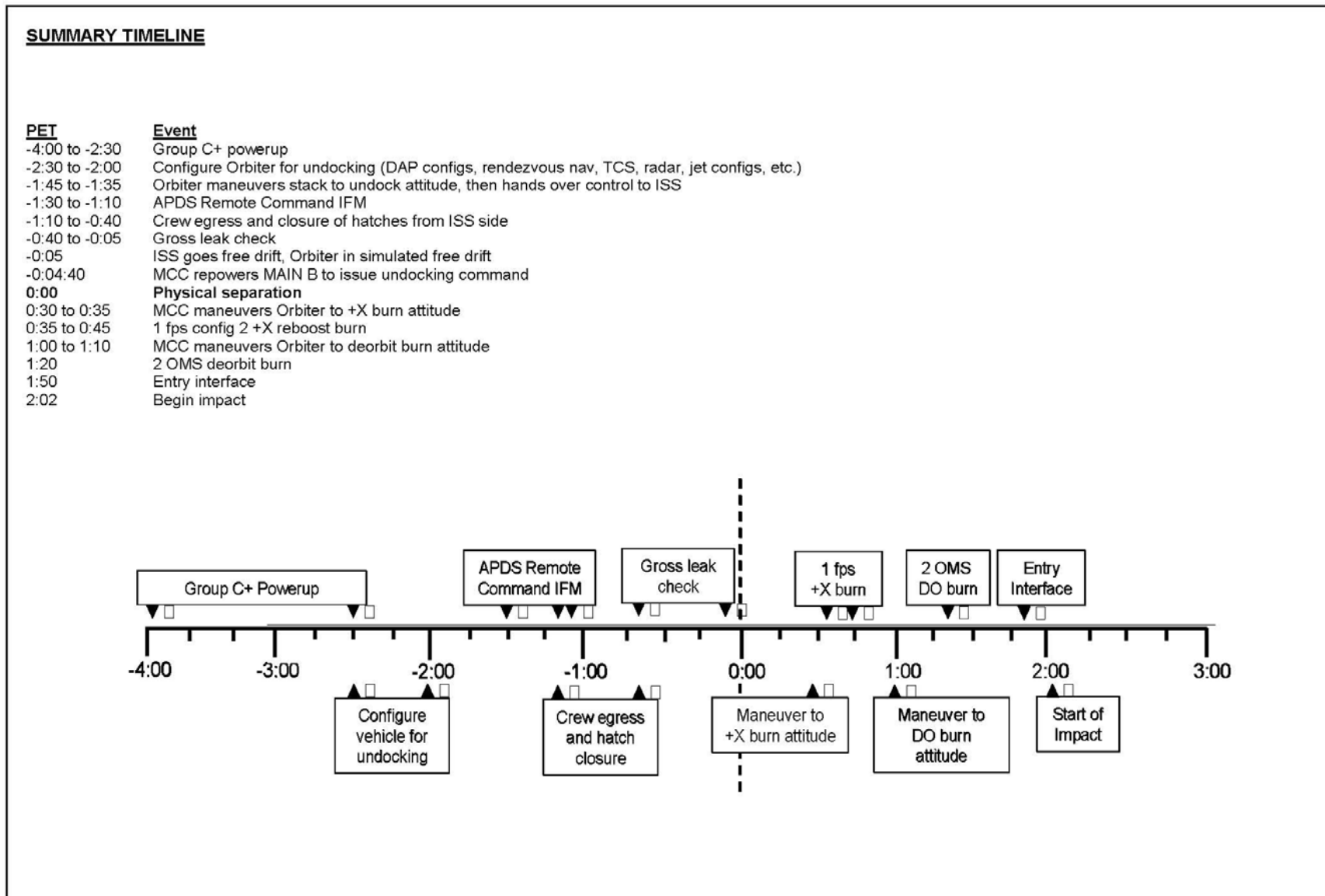

CSCS/Undock/Seperation/Disposal Timeline

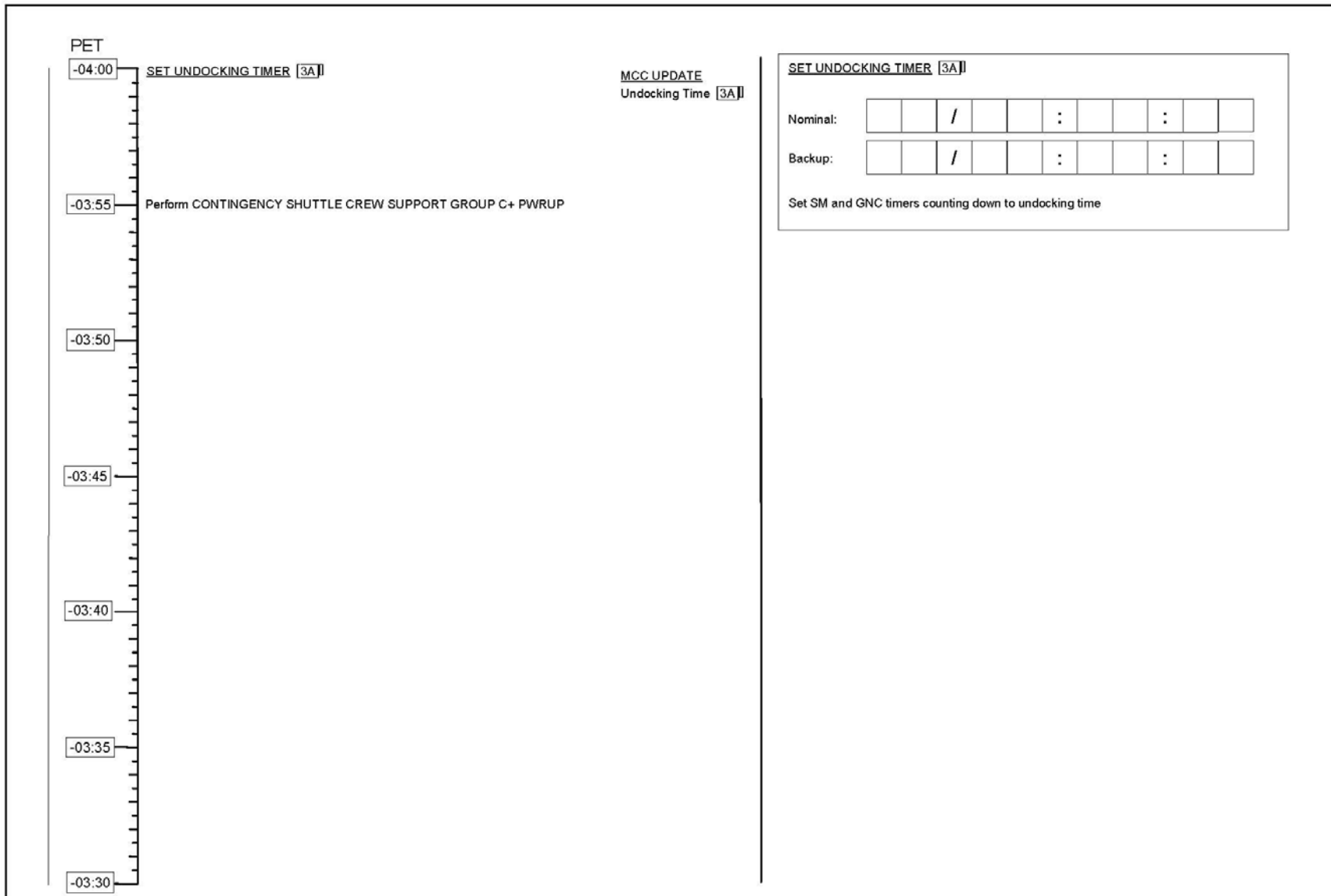

CSCS/Undock/Seperation/Disposal Timeline

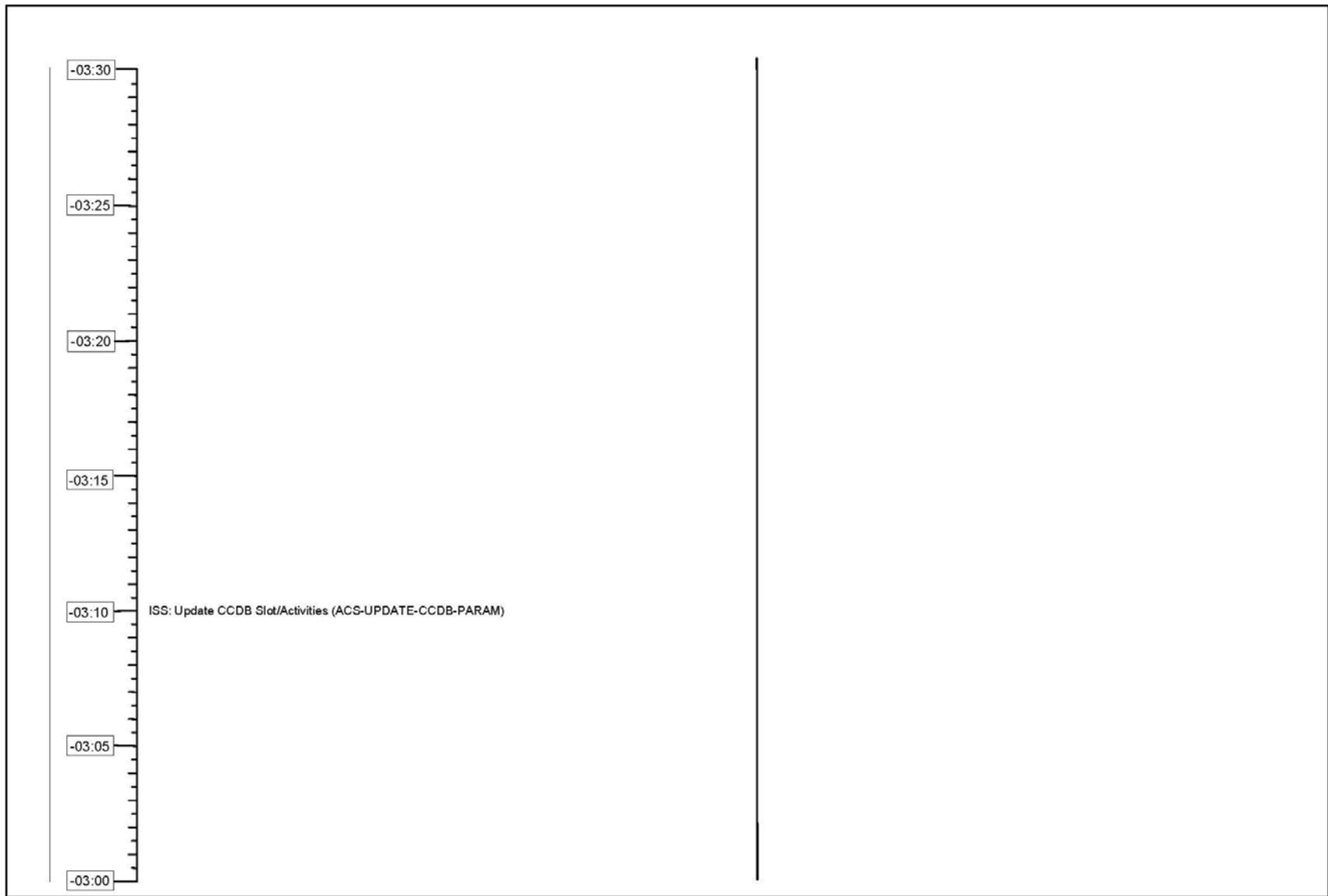

CSCS/Undock/Seperation/Disposal Timeline

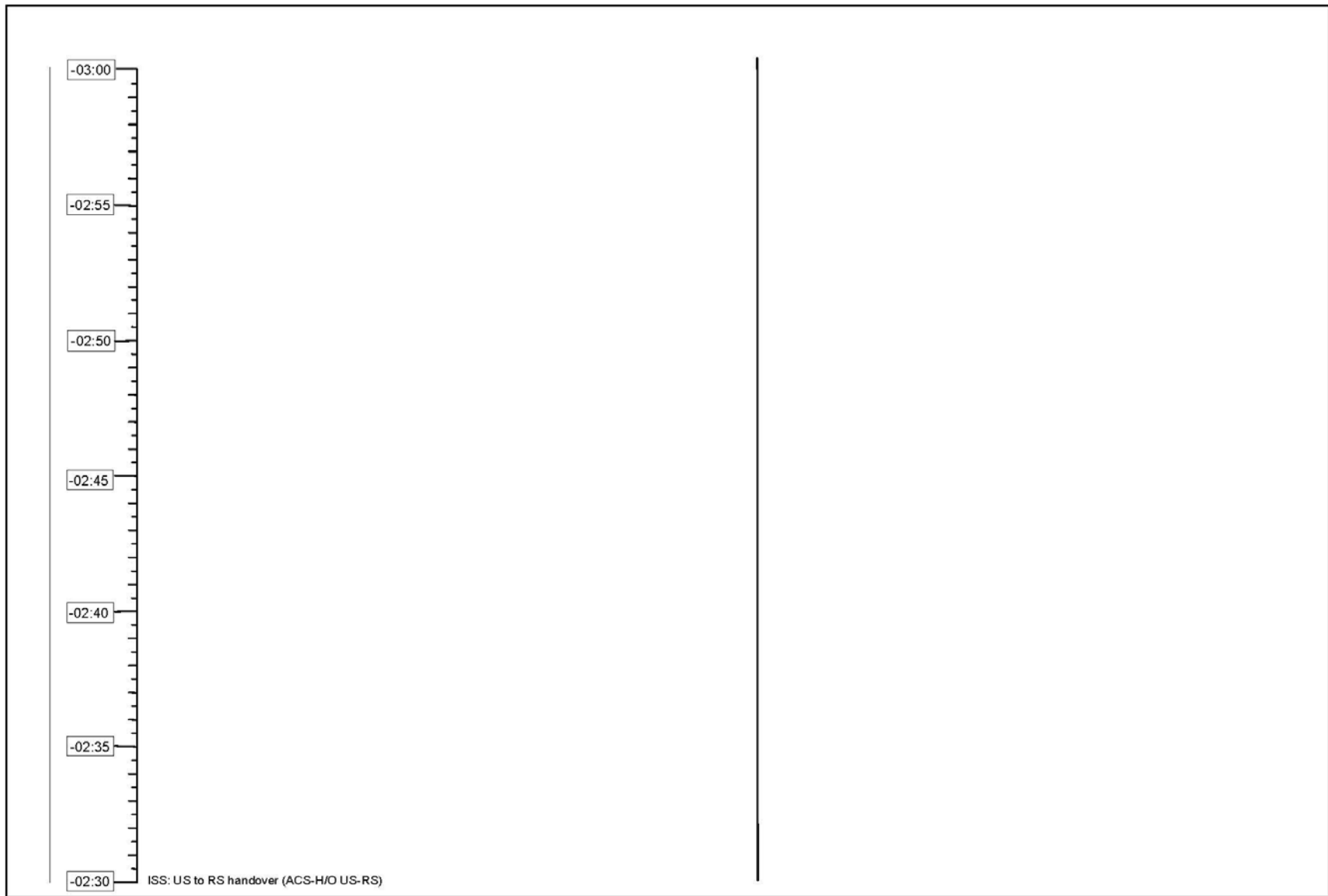

CSCS/Undock/Seperation/Disposal Timeline

5

Final

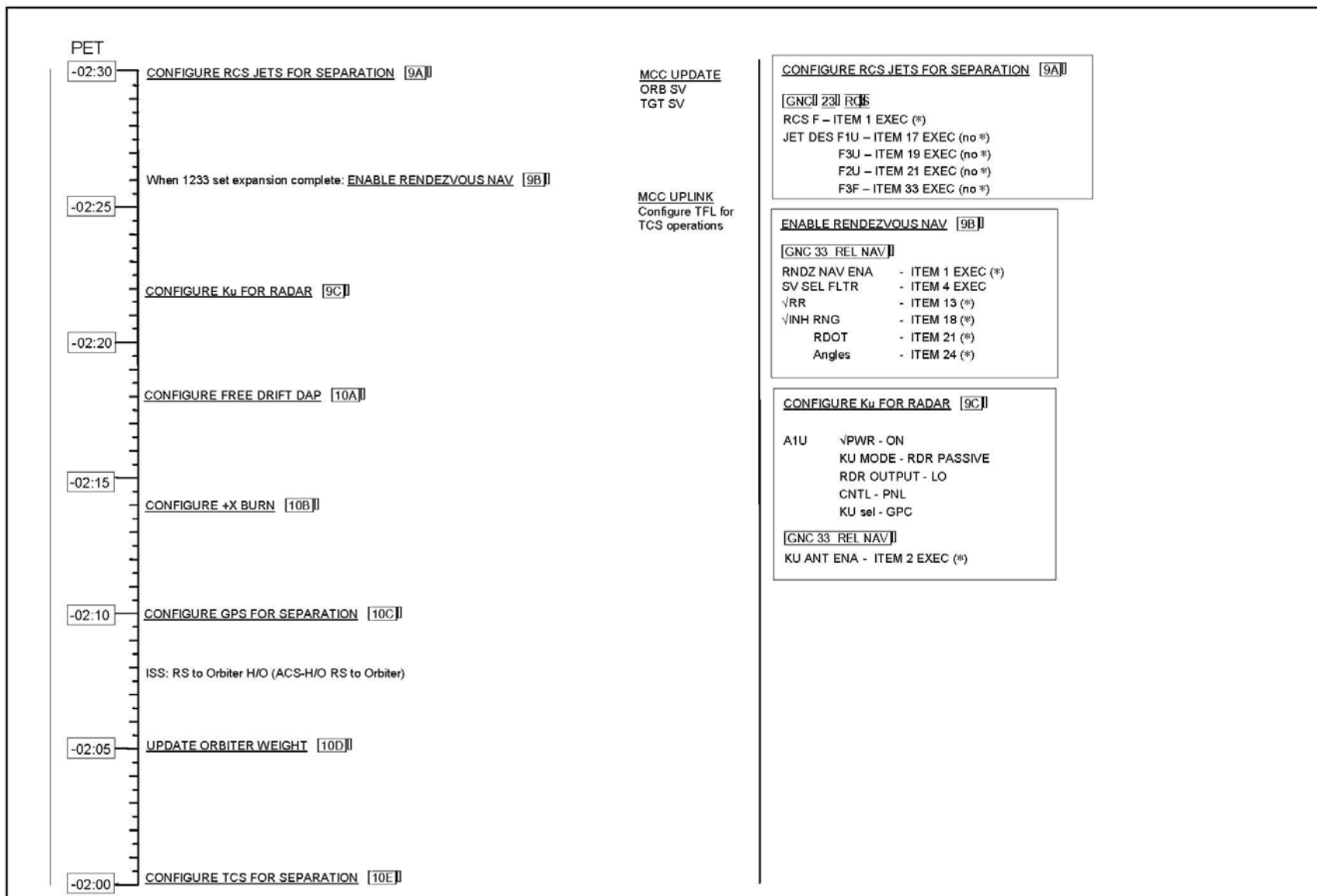

CSCS/Undock/Separation/Disposal Timeline

<p>CONFIGURE FREE DRIFT DAP [10A]</p> <p>[GNC] 20] DAPI] CONFIG ITEM 4 + 8 EXEC ITEM 51 + 4 0 EXEC ITEM 58 + 5 EXEC ITEM 62 + 1 0 EXEC ITEM 5 EXEC</p> <p>CONFIGURE +X BURN [10B]</p> <p>[GNC] 20] DAPI] CONFIG REBOOST CFG - ITEM 8 + 2 EXEC INTVL - ITEM 9 + 2 4 EXEC</p> <p>[GNC] UNIV] PTT DURATION - ITEM 27 + 0 0 + 1 0 + 0 0 0 0 EXEC</p> <p>CONFIGURE GPS FOR SEPARATION [10C]</p> <p>Perform GPS PWRUP (ORBIT OPS, GNC)</p> <p>[GNC] 55] GPS] STATUS DES RCVR - ITEM 27 EXEC (no *) VINH GPS to G&C - ITEM 33 EXEC (*) NAV - ITEM 36 EXEC (*)</p> <p>UPDATE ORBITER WEIGHT [10D]</p> <p>√MCC: Current Orbiter weight _____ GNC, OPS 202 PRO</p> <p>[GNC] ORBIT] MNVR] EXEC Update Orbiter weight Change ΔVx to 1 fps ITEM 19 + 1 EXEC √ITEM 20 + 0 EXEC √ITEM 21 + 0 EXEC Change TIG to 1 hour in the future ITEM 22 - LOAD OPS 201 PRO</p>	<p>CONFIGURE TCS FOR SEPARATION [10E]</p> <p>√PGSCs setup per PGSC Usage Chart (if available) or UTILITY OUTLET PLUG-IN PLAN ORBIT CONFIGURATION (REF DATA FS, UTIL PWR) NOTE: power PGSCs via source not on MAIN B (example: A15 connector)</p> <p>On RPOP PGSCs: Perform RPOP INITIALIZATION (RENDEZVOUS, RNDZ TOOLS), then: Perform RPOP OPS (RENDEZVOUS, RNDZ TOOLS), 7-9, then: In RPOP, set POR - ORB DP to TGT DP, then: set ISS attitude to LVLH TO TGT BODY 90,0,0 PYR, then: Perform TCS ACTIVATION, steps 1 thru 3 (RENDEZVOUS, RNDZ TOOLS), then: Perform TCS MANUAL ACQUISITION (RENDEZVOUS, RNDZ TOOLS) set RANGE = 4 ft, AZIMUTH = 0, ELEVATION = 0</p>
--	--

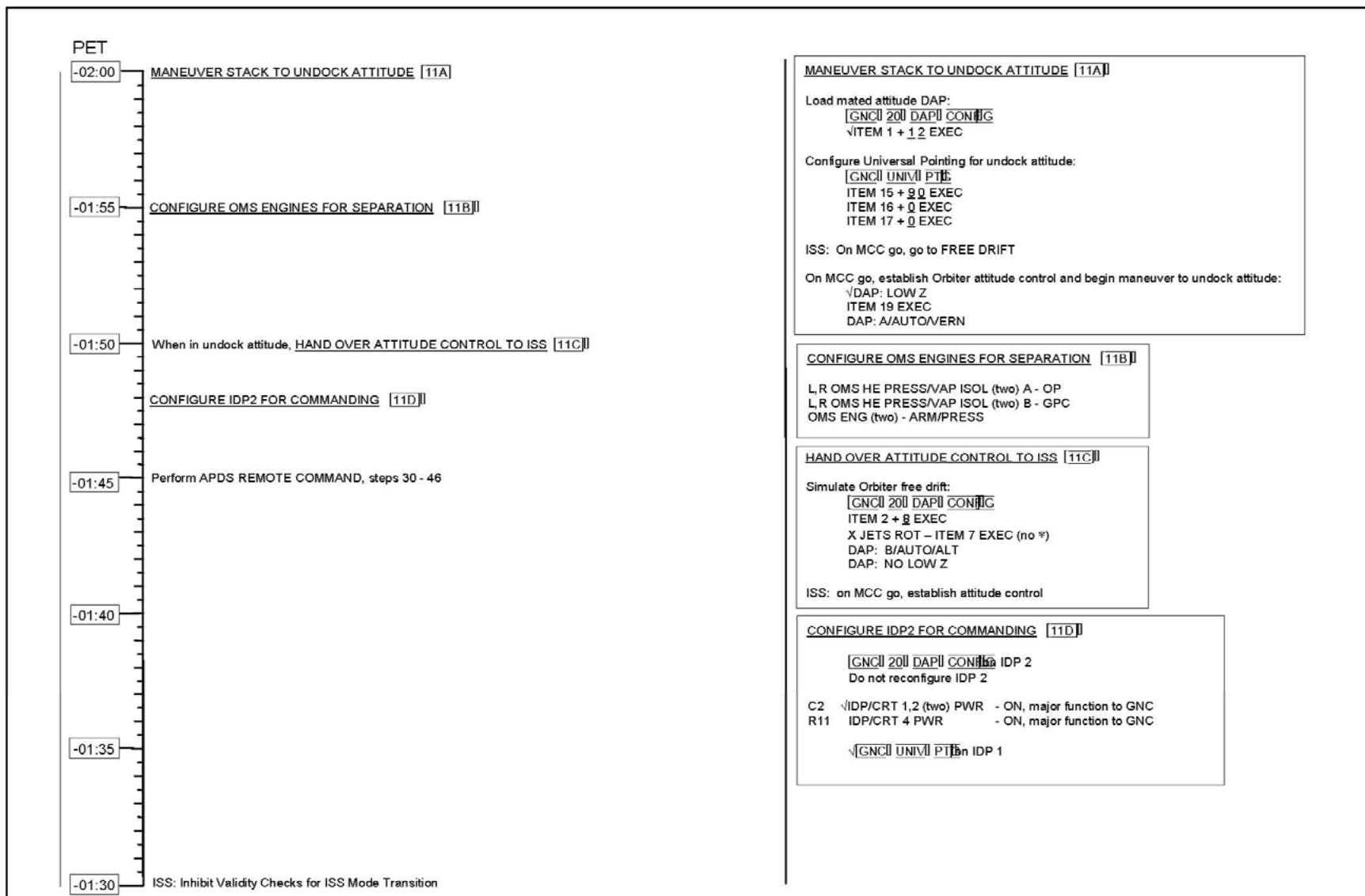

CSCS/Undock/Separation/Disposal Timeline

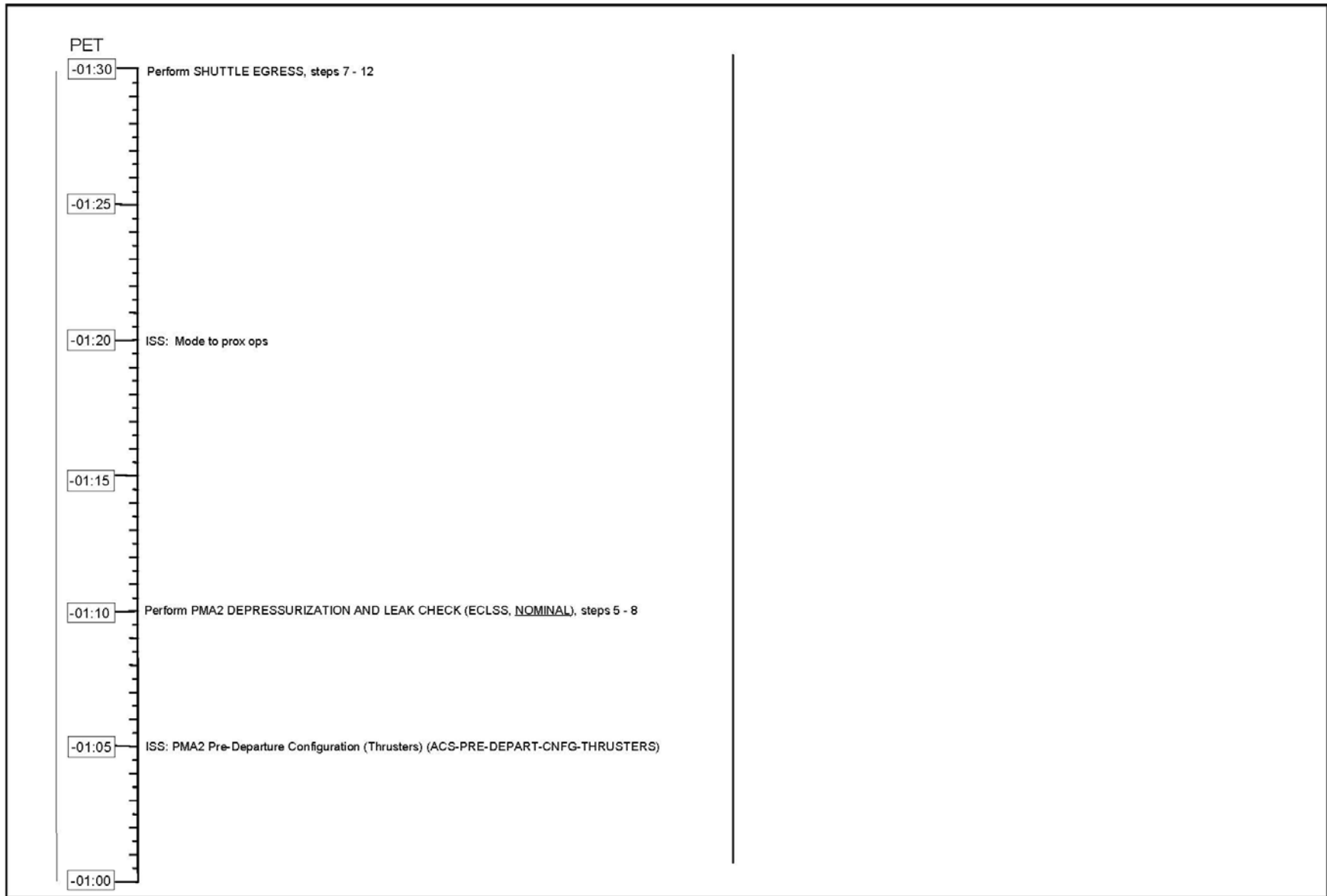

CSCS/Undock/Separation/Disposal Timeline

9

Final

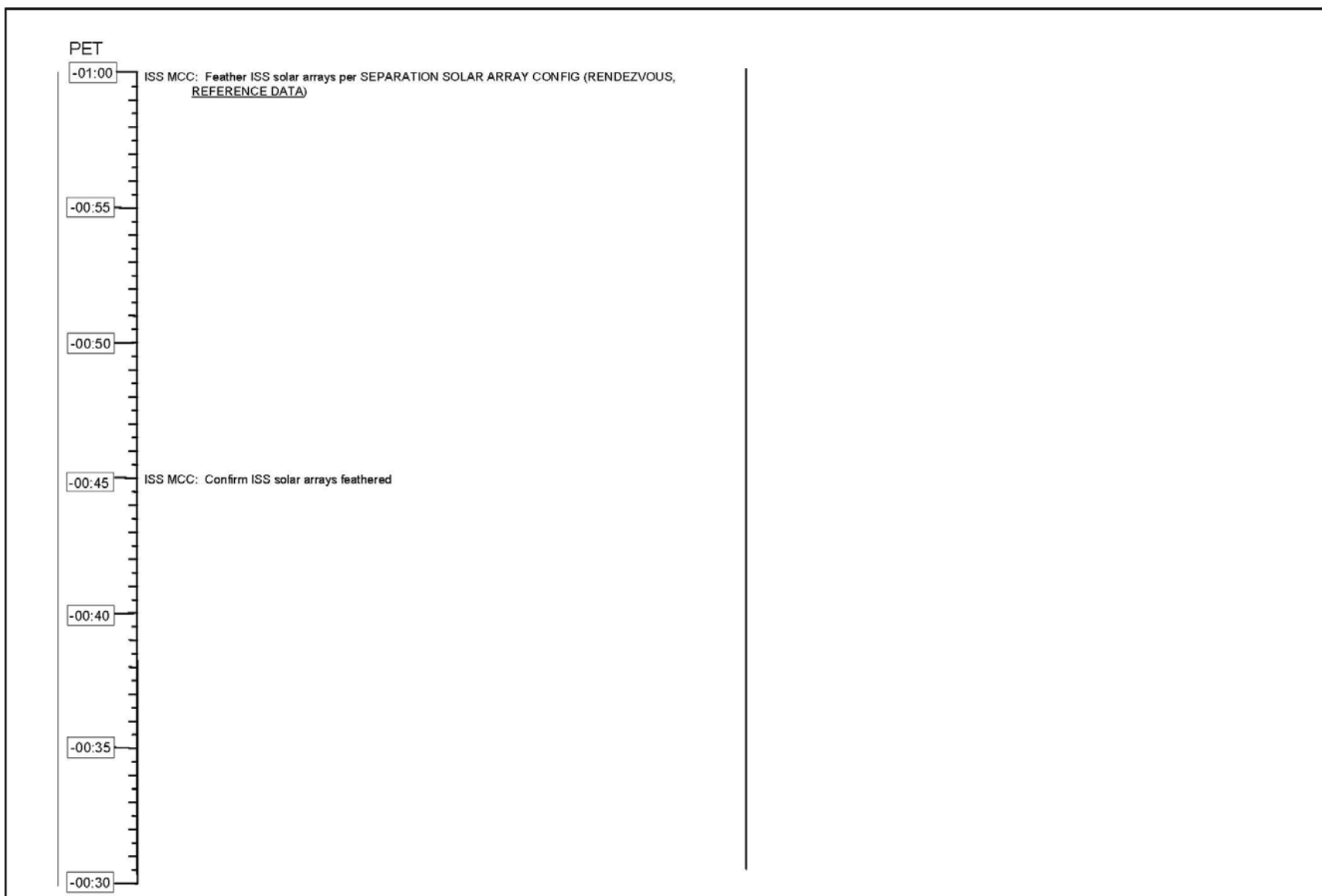

CSCS/Undock/Separation/Disposal Timeline

10

Final

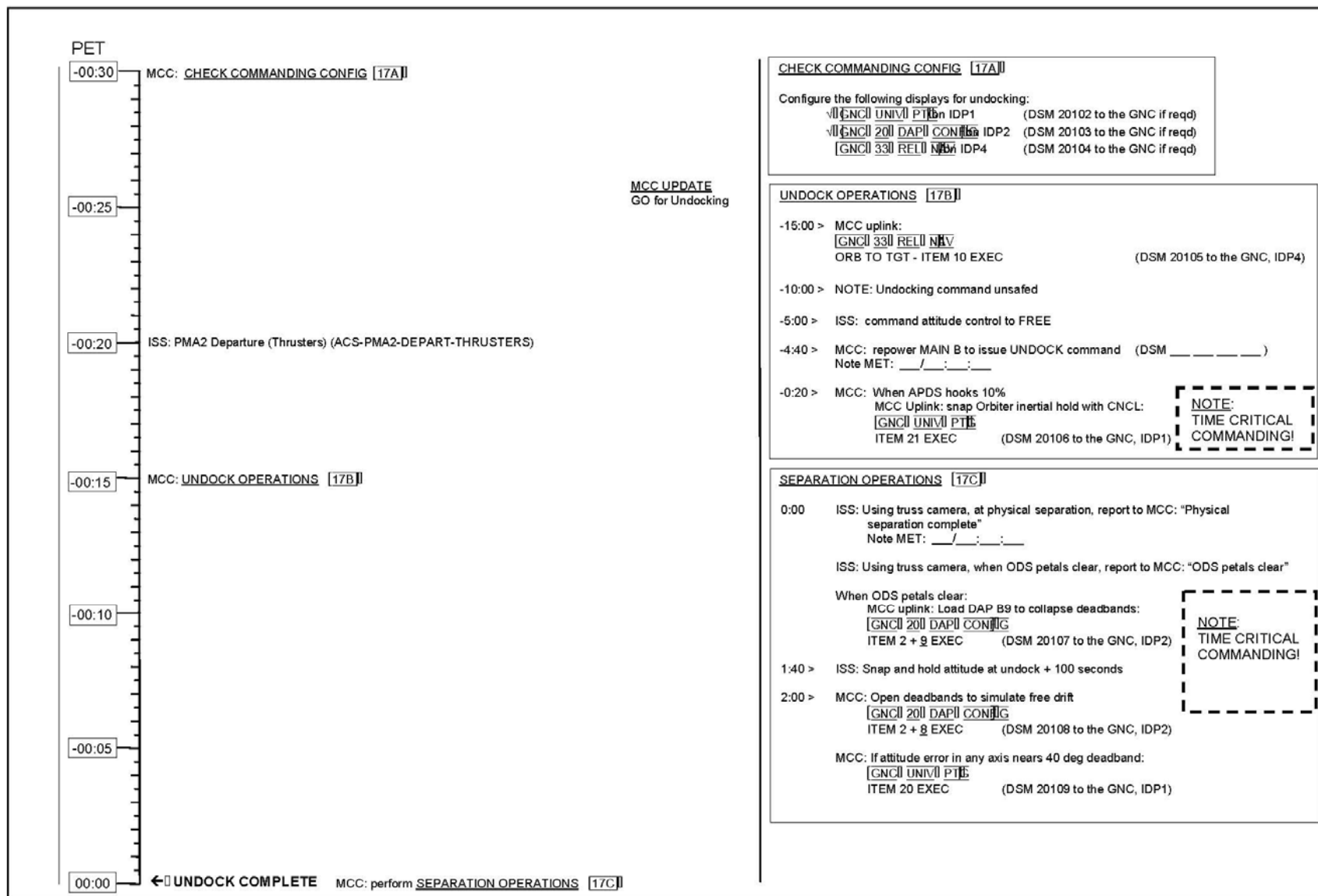

CSCS/Undock/Separation/Disposal Timeline

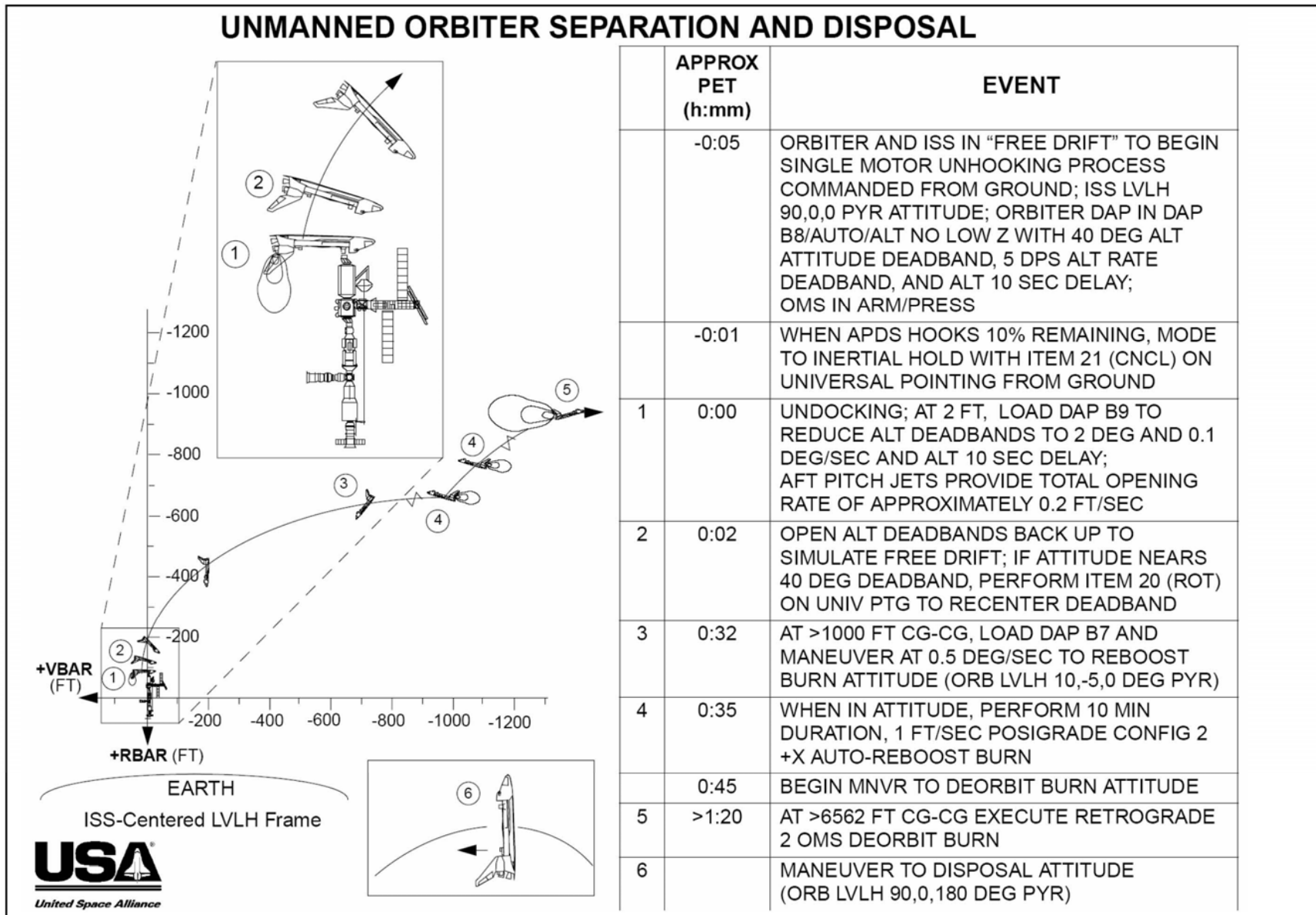

CSCS/Undock/Separation/Disposal Timeline

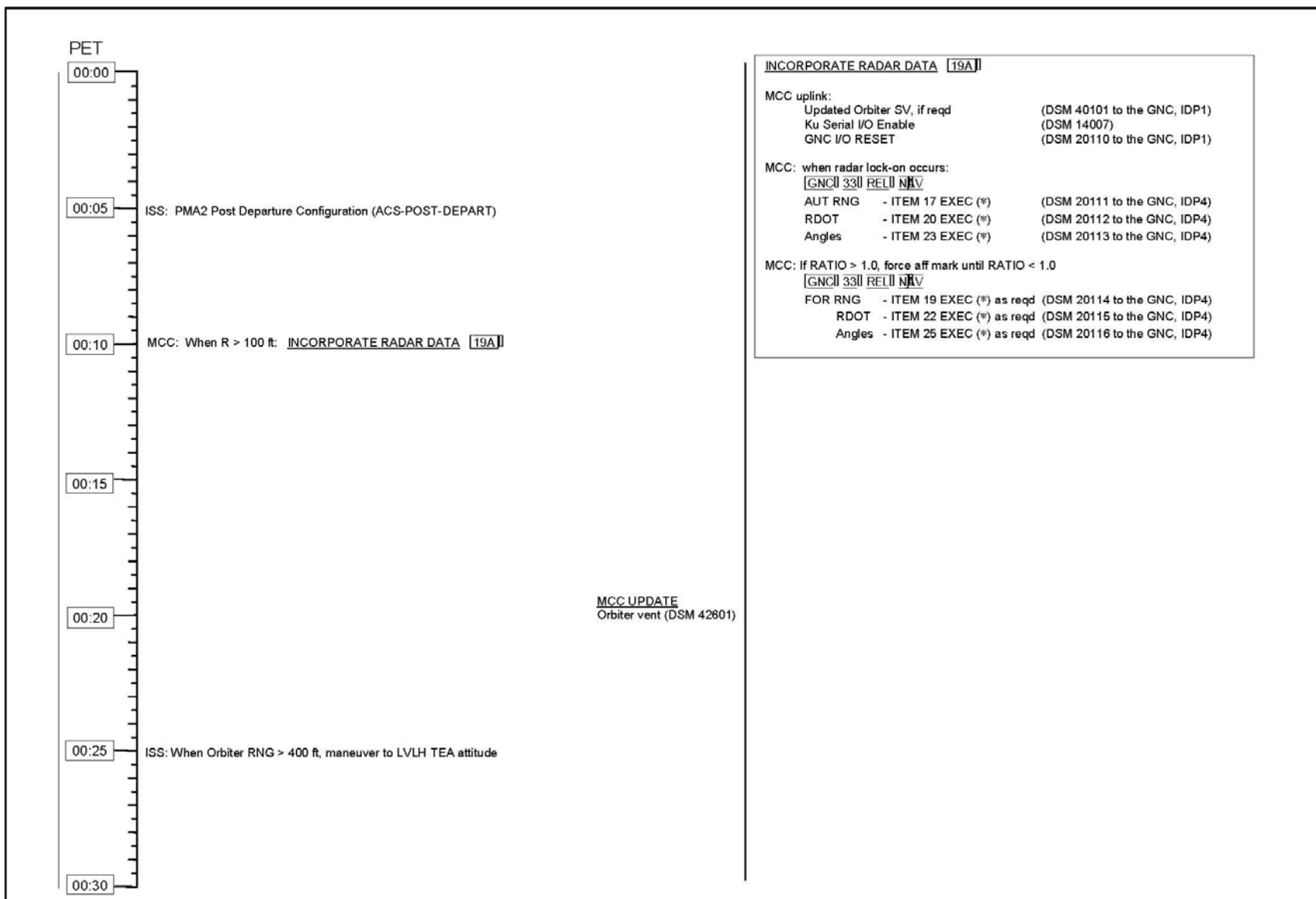

CSCS/Undock/Separation/Disposal Timeline

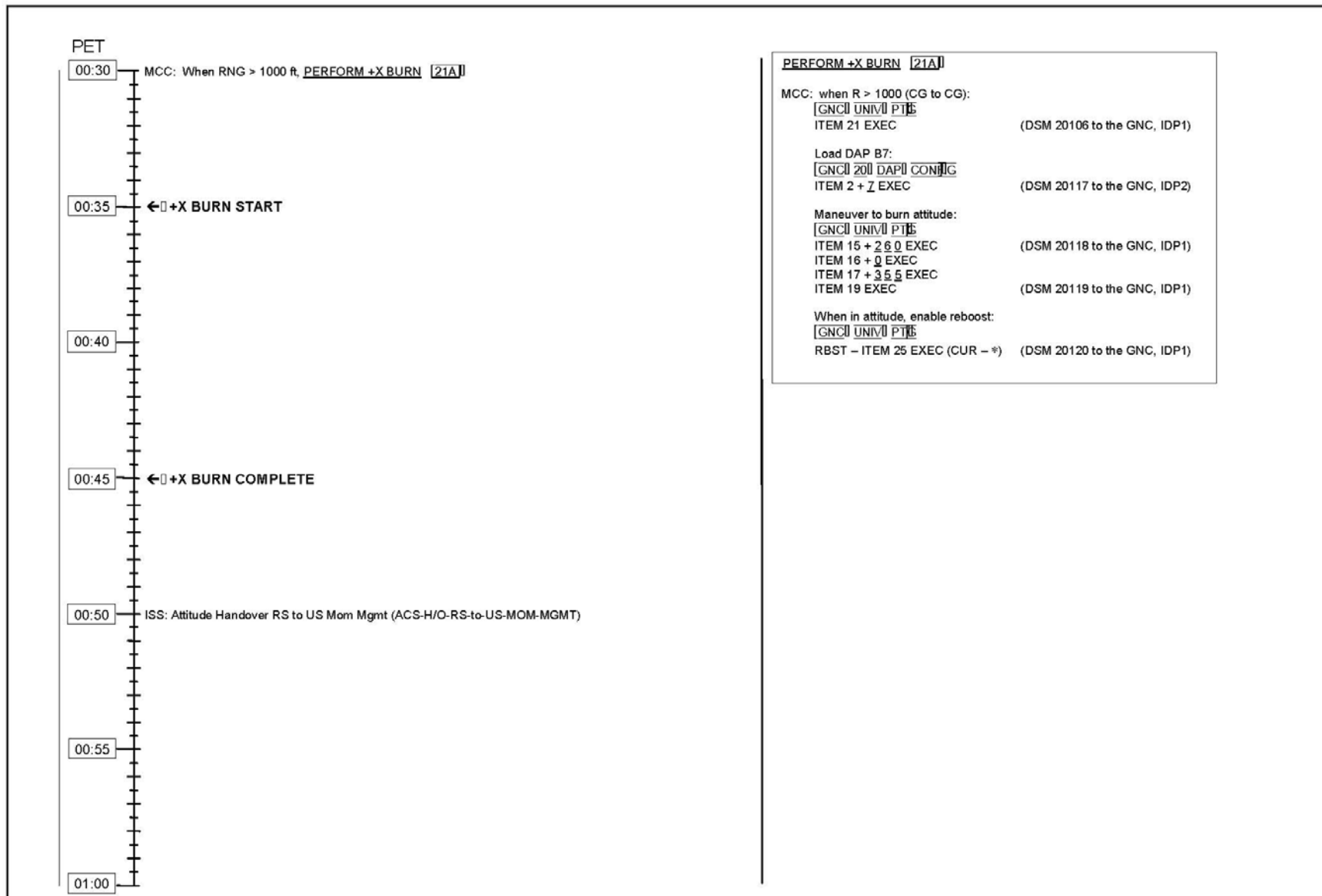

CSCS/Undock/Separation/Disposal Timeline

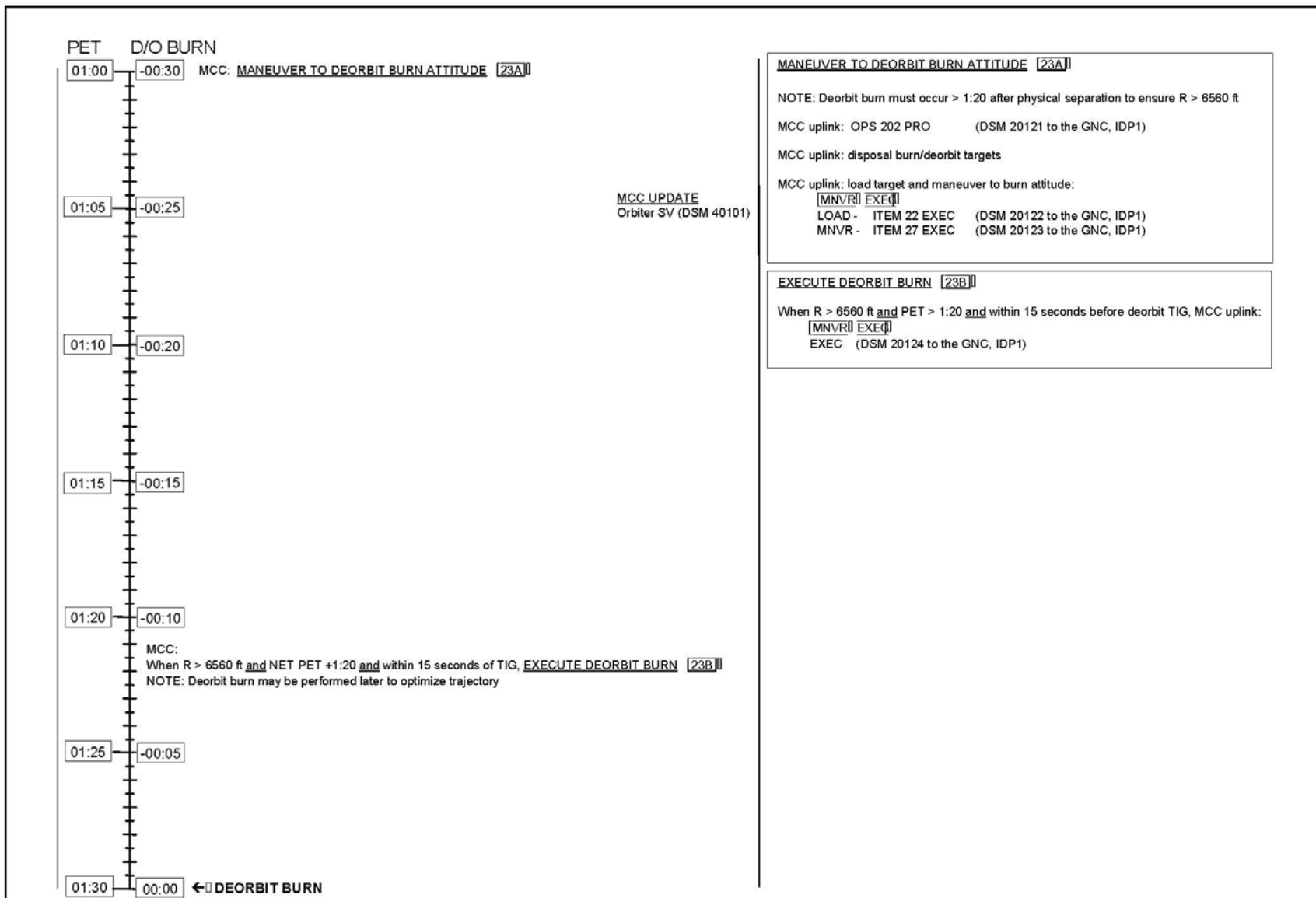

CSCS/Undock/Separation/Disposal Timeline

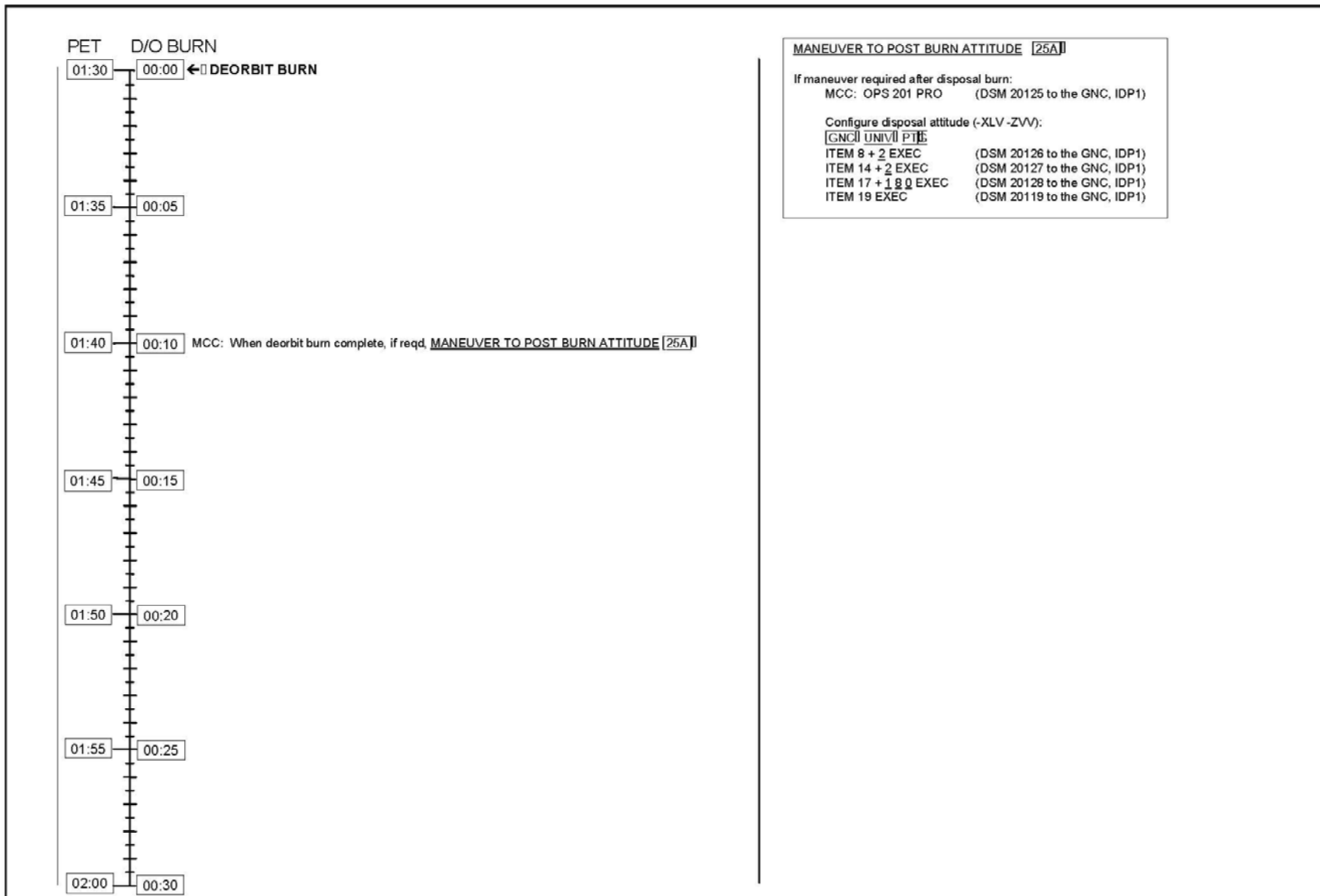

CSCS/Undock/Separation/Disposal Timeline

2.1.5 APDS Remote Undock (IFM)

The APDS Remote Command IFM is a procedure to be set up by the shuttle crew after CSCS has been declared and several days before the planned unmanned undocking. The IFM has the crew access PCA 3 in AV bay 3, a connector behind panel A6L, and MDM LF1 and PL 1 in AV Bay 1. The IFM setup will enable MDM PL1 commanding of a bus tie and enable MDM PL1 to turn on an RPC supplying power to orbiter docking system (ODS) hook motors. These commands will be sent from the ground using RTC's. The procedure's commands will be tested several days before the planned undocking after the IFM has been set up. An hour and a half prior to the planned undocking, the shuttle crew will perform the final APDS portions of the IFM procedure to latch on the APDS undocking command. Once the orbiter vehicle has been vacated and sealed, the MCC will send commands to initiate APDS hook motor drive which will allow the undocking. Once the hooks are open, the orbiter will separate from the ISS. Four spring pushers at the APDS and PMA interface will provide an initial separation rate on the vehicles.

APDS REMOTE COMMAND

3:30 hr

REV. M

OBJECTIVE: Undock Orbiter from Station by commanding the APDS hooks using ground commands after crew has egressed Orbiter.

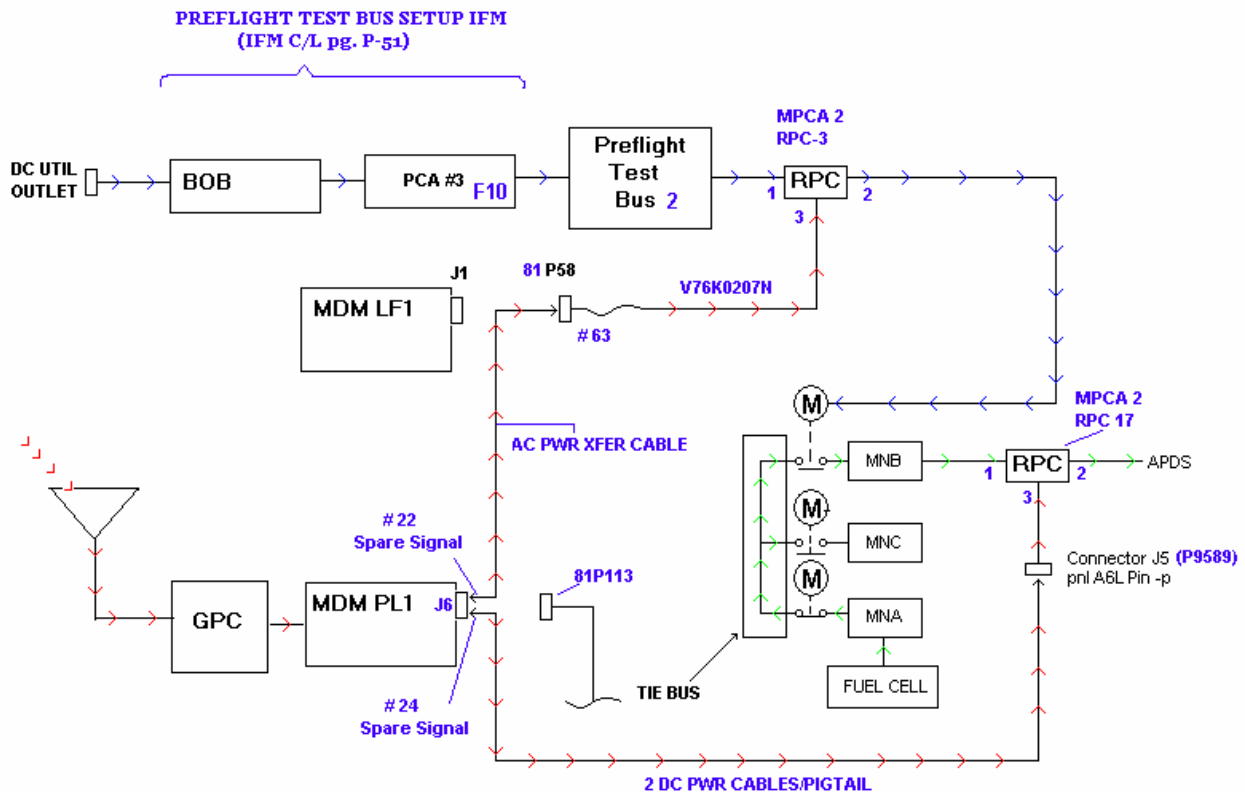

LOCATION: See (COMPONENT LOCATIONS)
 AV BAY 1, Zone 43O (MDM PL1) and 43A (MDM LF1)
 AV BAY 3A, Zone 9N (PCA 3)
 Pnl A6L, A7L

TOOLS REQD:

- TOOL Gray Tape
- Pin Kit
- Locker Tool
- Ratchet Wrench
- 3/8-in. Socket
- Torque Wrench
- BOB IFM Breakout Box
- CHCK DC Pwr Cables (two)
- AC Pwr Cable
- MISC DC Vac. PWR Cable

IFM SET-UP AND COMMAND TEST

- MO30F
1. Remove Vol A (see GENERAL INFORMATION, VOL A REMOVAL) to access MDM LF1
Remove Locker, Thermal Debris Trap MF430 to access MDM PL1 (see GENERAL INFORMATION, SOFT STOWAGE SUPPORT REMOVAL) to access PCA 3
Remove MA9N closeout
 2. DC UTIL PWR MNC – OFF
 3. a. Breakout Box:
AUX – OFF
28V/VAR VOLT – 28V
PWR A,B – OFF
b. Remove fuse Cap from side B
c. Rotate GA SEL B - 22
d. Install 10-Amp Fuse; replace cap
e. Remove fuse from F10 of PCA 3. Stow fuse cap and 5 amp fuse
f. Install a 10 amp fuse from pin kit into Fuse Cap Test Lead and install assembly back into F10 of PCA 3 (See drawing below)

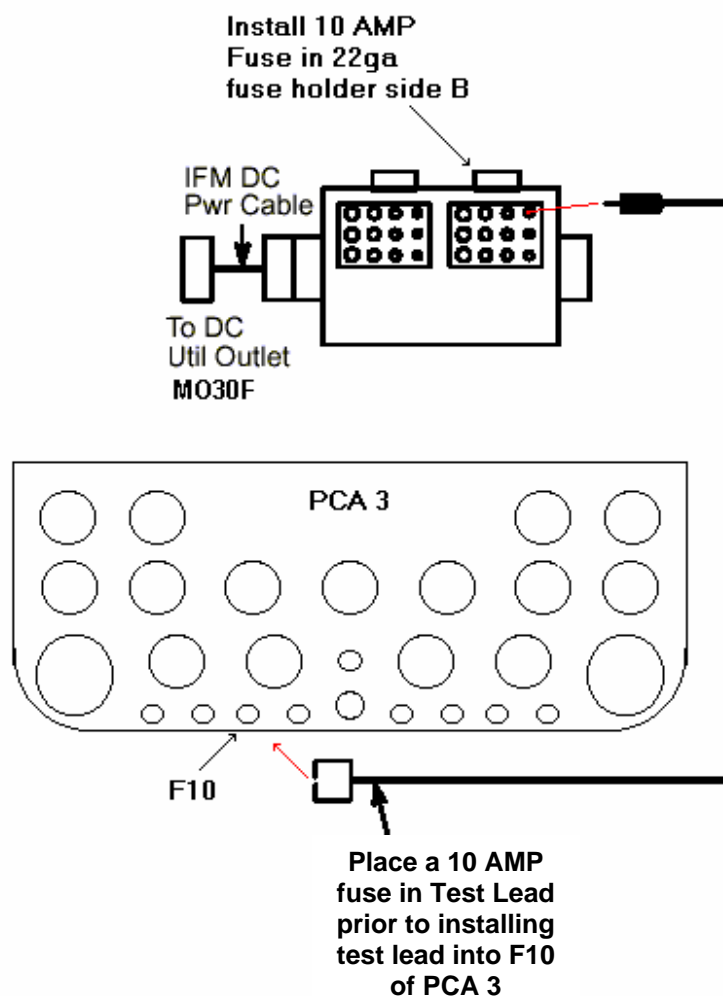

IFM SET-UP AND COMMAND TEST (CONTINUED)

4. a. Obtain two 24in. 22ga. Pin/Socket Test Jumper Leads
 - b. Cut/remove 22ga. Socket from end of each Test Jumper Lead, install 20ga. Socket
5. Demate connector P58 from J1 of MDM LF1
6. Demate connector P113 from J6 of MDM PL1
7. Connect one 22/20ga. Pin/Socket Test Jumper Lead between Socket 63 on connector P58 demated from MDM LF1 and pin A on one end of AC Power Transfer Cable. Tape secure leads and cable (See drawing below)
8. Connect one 22/20ga. Pin/Socket Test Jumper Lead between Socket 22 on connector J6 of MDM PL1, pin A on other end of AC Power Transfer Cable. Tape secure leads and cable (See drawing below)

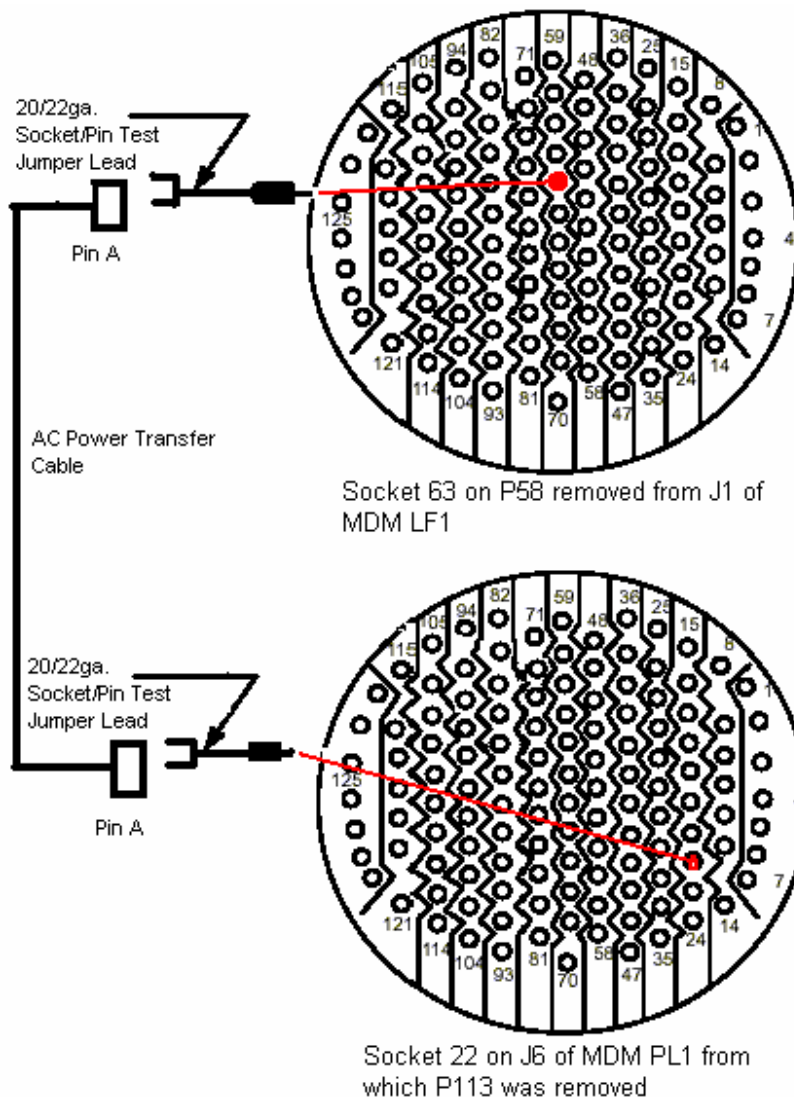

IFM SET-UP AND COMMAND TEST (CONTINUED)

- A7L 9. Perform ORBIT STATION ACCESS (GENERAL INFORMATION) to access connectors behind pnl A6L
- A6L 10. Remove 8 fasteners securing panel A6L (3/8-in. Socket), reposition as required access P9589 on J5
11. Demate connectors P9592, P9591, P9590 from J8, J7, J6 to access P9589.
12. Disconnect J5 from P9589
13. a. Obtain one 24in. 16ga. Socket/Socket Test Jumper Lead, one 24 in. 22ga. Pin/Pin Test Jumper Lead
b. Cut/remove 22ga. Pin from one Test Jumper Lead, install 16ga. Socket
14. Connect 16ga. Socket/Socket Test Jumper Lead between Pin -p of connector P9589 behind Panel A6L, Pin J on end of Vac. DC PWR Cable. Secure jumper leads and cable with gray tape.
15. Connect 16/22ga. Socket/Pin Test Jumper Lead between pin J of IFM DC PWR Cable, Socket 24 on connector J6 of MDM PL1. Secure jumper leads and cable with gray tape.
(See drawing below)

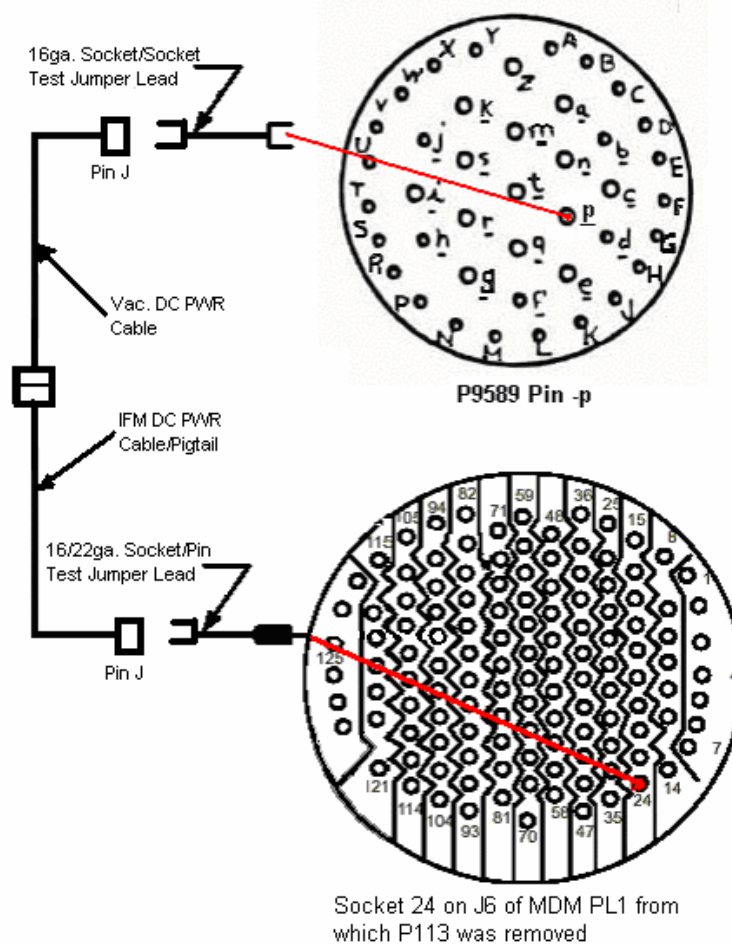

IFM SET-UP AND COMMAND TEST (CONTINUED)

- A6L 16. Remate P9592, P9591, P9590 onto J8, J7, J6 removed in step 11
 17. Reconnect ground strap to back of A7L panel disconnected in step 4 of
ORBIT STATION ACCESS (GENERAL INFORMATION)
- MO30F 18. DC UTIL PWR MNC – ON
 19. Breakout Box PWR B – ON
- R1 20. MN BUS TIE B - OFF (tb off)
 √ MCC to verify bus tie off
- CRT 21. SM 167 DOCKING STATUS
- O13:A 22. cb ESS 1BC MNA CONTR - op
 O15:B 23. cb MNB MNA CONTR - op
- A7L 24. HTRS/DCU PWR (three) – ON
 CRT √HTRS/DCU PWR – A/B/C
25. Inform MCC that APDS is configured for Command Test

NOTE

Command test will be performed by MCC and
 may take up to 20 minutes

On MCC Go:

- A7L 26. Stow Tools on ISS
 27. HTRS/DCU PWR (three) – OFF
 CRT √HTRS/DCU PWR – A/B/C
 MO30F 28. DC UTIL PWR MNC – OFF
 L1 29. H2O PUMP LOOP 1 - OFF

Perform Undocking

- PMA 2 30. IFM CREWMEMBERS INGRESS ORBITER A/L, CLOSE HATCH (may require station crew assistance) APAS
 31. √ APAS EQUAL VLV - CL
 32. CLOSE ODS HATCH
- ODS 33. √ ODS EQUAL VLV (two) - OFF, Caps
 HATCH installed
- R1 34. MN BUS TIE B - OFF (tb off)
 √ MCC to verify bus tie off
- MO30F 35. DC UTIL PWR MNC – ON

IFM SET-UP AND COMMAND TEST (CONTINUED)

- CRT 36. SM 167 DOCKING STATUS
A6L 37. √ SYS PWR SYS 1 tb – ON
√ SYS PWR SYS 2 tb – OFF
√ PSU PWR MN A, MN B (two) – OFF
A7L 38. HTRS/DCU PWR (three) – ON
CRT √HTRS/DCU PWR – A/B/C
A7L 39. CNTL PNL PWR A,B,C (three) – ON
CRT √PWR – A/B/C
A7L 40. APDS PWR A_{DS}, B_{DS}, C_{DS} (three) – ON
√A_{DS}, B_{DS}, C_{DS} lts (three) – on
CRT √APDS PWR – A/B/C
A7L 41. LAMP TEST pb – push
√STATUS lts (eighteen) – on
√PYRO CIRC PROT OFF lts – on

- * Prior to Orbiter egress, if at any time Hooks are observed to be commanded and/or *
* driving inadvertently in the open direction perform the following steps to reverse or stop *
* hook drive: *
* *
* A7L CLOSE HOOKS pb - push *
* CRT √HOOK 1,2 POS (two) incr *
* If hooks still driving open: *
* A7L PWR OFF pb - push *
* PWR ON pb- push *
* CLOSE HOOKS pb - push *
* CRT √HOOK 1,2 POS (two) incr *
* If hooks still driving open: *
* A7L PWR OFF pb - push *
* A6L Remove Pins from J5 connector behind A6L *
* √MCC *
* Note: If inadvertent hook drive occurs in the open direction, docking interface *
* seals will crack after approx 3:40 single motor hook drive. Physical separation *
* will occur after 4:40 single motor hook drive. *

- A7L 42. PWR ON pb – push (lts on)
√RING ALIGNED lts – on
√RDY TO HK lts – on
√INTERF SEALED lts – on
√HOOKS 1, HOOKS 2 CL lts (two) – on
√HOOKS 1, HOOKS 2 OP lts (two) – off
√LAT OP lts – on
√RING FNL POS lts – on

IFM SET-UP AND COMMAND TEST (CONTINUED)

- CRT √RNG DR BUS – blank/blank
 √HKS DR BUS – blank/blank
 √DAMPER BUS – blank/blank
 √FIXER BUS – blank/blank
- A7L 43. √MCC for Go to activate undocking command
 44. APDS CIRC PROT OFF pb – push (lt on)

NOTE

In Step 45, push Undocking pushbutton firmly with 2 fingers for 2 seconds. There will not be status light or discrete confirmation that the command has been successfully set.

45. UNDOCKING pb - push
46. Inform MCC that Docking System has been configured for undocking.

Reference:

Preflight Test Bus/Bus Cross Tie Circuit

SDS - VS70-760309 Zone 38B1

PSU Power Switch (S10)

SSSH -15.2 sheet 1 of 1

SDS – VS70-953104, Sheet 11, Zone 22

A6A3 Panel Installation

SDS – M072-730020

SDS – V828-730150

Verification:

July 2004- Panel A6L connector access verification performed at KSC on OV-104 by IFM personnel (J. Shimp), MMACS personnel (E. Eskola) and CB personnel (F. Caldeiro and A. Poindexter).

August 10,2004- A test of this IFM was performed at the Shuttle Avionics Integrated Laboratory (SAIL). The test verified the PL 1 MDM commands, the ability to powerup the preflight test bus and the MN B bus tie capability using the PL 1 MDM commanding associated with this procedure. SAIL did not have panel A6L or APDS avionics so the RPC 17 command and APDS portion of the procedure was not verified.

January 2005- A test of the ability to set the undocking command on for 1.5 hours and then subsequently drive the APDS hooks by turning on the PSU power was performed at the APDS Brassboard facility at Boeing. The test was successful.

2.1.6 Docking Target Installation

The standard Docking Target Install procedure has been modified in support of CSCS.

SHUTTLE TOOLS AND EQUIPMENT REQUIRED

None

ISS TOOLS AND EQUIPMENT REQUIRED

Rubber Gloves

Hatch Enclosure Assembly P/N 683-60425

PMA2 Docking Mechanism Accessory Kit

 APAS Hatch Tool

 Cleaning Pads

APAS Hatch Cover

Docking Target Standoff Cross Bag

Docking Target Base Plate Cover

1-1/2" Open End Wrench

ISS IVA Toolbox

Drawer 1:

10" Long Adjustable Wrench

DOCKING TARGET INSTALLATION**NOTE**

Docking target installation should be completed prior to APDS REMOTE COMMAND IFM to expedite egress following APDS powerup.

1. INSTALL DOCKING TARGET**CAUTION**

When handling the Docking Target Standoff Cross or the Docking Target Base Plate, rubber gloves should be worn.

PMA2

- 1.1 Release Hatch from PMA APAS Hatch Standoff.
Secure Hatch Standoff to PMA handrail.
Remove APAS Hatch Cover.
Stow cover securely in PMA.
- 1.2 Remove Docking Target Base Plate Cover from Target Base Plate.
Stow cover in PMA2.
Remove Docking Target Standoff Cross from Standoff Cross Bag.
Stow Standoff Cross Bag in PMA2.

NOTE

Ensure key on Standoff Cross shaft is aligned with key-way on mating receptacle, and insert shaft until collar bottoms out on receptacle surface.

- 1.3 Insert Docking Target Standoff Cross into keyed receptacle on Docking Target Base Plate until shaft collar bottoms out.

NOTE

When all mating parts are correctly assembled, a groove on docking target Standoff Cross shaft should be visible above cap nut (not recessed).

- 1.4 Ensure jam nut is positioned onto smaller, non-threaded diameter of Docking Target Base Plate receptacle.

Rotate cap nut ↻ and tighten very firmly onto receptacle (10" Adjustable Wrench, 80-100 in-lbs design torque).

Thread jam nut onto receptacle, rotating ↻ until contact with cap nut occurs.

While maintaining a ↻ torque on cap nut, firmly tighten jam nut ↻ against cap nut (1-1/2" Open End Wrench, 80-100 in-lbs design torque).

- 1.5 Stow 10" Adjustable Wrench in NOD1 D4_G2.
Stow Docking Mechanism Accessory Kit in PMA.

2.1.7 Shuttle Egress

The Shuttle Egress procedure has been modified in support of CSCS.

SHUTTLE TOOLS AND EQUIPMENT REQUIRED

None

ISS TOOLS AND EQUIPMENT REQUIRED

Rubber Gloves

PMA2

Docking Mechanism Accessory Kit

 APAS Hatch Tool

 Cleaning Pads

APAS Hatch Cover

1-1/2" Open End Wrench

Braycote

Face O-Ring

Bore O-Ring

Dry Wipe

ISS IVA Toolbox

Drawer 2:

Ratchet, 1/4" Drive

7/16" Deep Socket, 1/4" Drive

(10-50 in-lbs) Trq Wrench, 1/4" Drive

SHUTTLE EGRESS**NOTE**

Perform steps 1 thru 6 prior to beginning the APDS REMOTE COMMAND IFM.
Steps 7 thru 12 should be completed after the APDS REMOTE COMMAND IFM is complete.

TERMINATE IMV

MO13Q 1. ARLK FAN A - OFF

PCS 2. Deactivating Lab IMV Fwd Stbd Fan
LAB: ECLSS: IMV Fwd Stbd Fan
Lab IMV Fwd Stbd Fan

NOTE

Upon IMV Fan deactivation, rpm sensor register 0 volts.
MDM conversion translates 0 volts (0 counts) to 7164
± 50 rpm. Reference 2A SPN 8437.

2.1 'Off'

cmd Arm (√Status – Armed)

cmd Off (√State – Off)

√Speed, rpm: 7164 ± 50

2.2 sel RPCM LA2B B RPC 09

RPCM LA2B B RPC 09

cmd Open (√RPC Position – Op)

PCS 3. Closing Lab IMV Fwd Stbd Valve
LAB: ECLSS: IMV Fwd Stbd Vlv
Lab IMV Fwd Stbd Valve

3.1 'Close'

cmd Arm (√Status – Armed)

cmd Close

Wait 25 seconds, then:

√Position – Closed

3.2 'Inhibit'

cmd Arm (√Status – Armed)

cmd Inhibit (√State – Inhibited)

SHUTTLE EGRESS (CONTINUED)

3.3 sel RPCM LA1B B RPC 16

RPCM LA1B B RPC 16

cmd Open (√RPC Position – Op)

- Ext A/L 4. Disconnect PMA/ODS Interface Duct Segment from halo inlet flex duct
- PMA2 5. Stow free-end of PMA/ODS Interface Duct Segment on PMA2 handrail.

WARNING

The PMA is unventilated at this time. Limit the amount of time spent in the PMA to the minimum required to complete the egress tasks.

6. REMOVING PMA/LAB DUCTING

- 6.1 PMA2 air duct jumper ←|→ Lab Fwd Stbd IMV flange, leaving V-band clamp on flange (Ratchet, 7/16" Deep Socket.)
- 6.2 IMV cap ←|→ PMA2 launch restraint, leaving V-band clamp on flange (Ratchet, 7/16" Deep Socket.)
- 6.3 Remove face and bore O-Rings on IMV Cap. Clean cap (Dry Wipe)
Don rubber gloves.
Lubricate new O-Rings with Braycote.
Install O-Rings on IMV Cap.
- 6.4 IMV cap →|← Lab Fwd Stbd IMV flange, torque V-Band clamp to 35 in-lb (Ratchet, 7/16" Deep Socket, (10-50 in-lbs) Trq Wrench).
- 6.5 PMA2 air duct jumper →|← PMA2 launch restraint. Secure with V-band clamp (Ratchet, 7/16" Deep Socket.)
Secure rest of flex duct to Closeout with Velcro Straps (two places).
- 6.6 Doff rubber gloves.

7. CONFIGURE ARLK DUCTING AND INNER HATCH

- Ext A/L 7.1 Remove flex duct from ARLK FAN muffler inlet and cabin middeck air fitting, stow in middeck
- MO13Q 7.2 ARLK FAN A –ON
- MDDK 7.3 Inner Hatch EQUAL VLV (two) - OFF, do not cap

SHUTTLE EGRESS (CONTINUED)8. OPEN ODS HATCH

ODS HATCH 8.1 If ODS HATCH ΔP GAGE > 0.5
EQUAL VLV (one) - NORM

8.2. When $\Delta P < 0.5$ OPEN ODS HATCH

9. EQUAL VLV (two) - OFF, capped

OPEN/CLOSE ODS AND APAS HATCH

PMA2 10. APAS EQUAL VLV – OP

11. OPEN APAS HATCH

MDDK/ODS 11.1 Once APAS HATCH OPEN, Close Inner HATCH and ODS HATCH,
egress to ISS

11.2 Inspect APAS Hatch Seals and seal surfaces for debris/damage.
Clean APAS Hatch Seals and surface with Cleaning Pads.
Close APAS Hatch.

Select 'РАБОЧЕЕ ПОЛОЖЕНИЕ' (Working Position) torque setting on
Hatch Tool.

Insert tool in hatch socket (ensure fully seated).

Rotate tool 3 to 4 turns in direction of '3ATP' (Close) arrow until tool clicks.

PMA2 11.3 \checkmark APAS EQUAL VLV \rightarrow OP

12. CLOSING LAB FWD HATCH

12.1 \checkmark All loose equipment removed from PMA2

Lab Fwd 12.2 Perform {1.1.521 U.S. HATCH SEAL INSPECTION}, all
(SODF: ISS IFM: COMMON: PREVENTIVE/S&M), then:
Close LAB Fwd Hatch per decal.

12.3 \checkmark MPEV vlv - CLOSED

12.4 Report to **MCC-H**, "LAB Forward Hatch closed ready to depress the
vestibule."

2.1.8 PMA2/ODS Depress and Leak Check

OBJECTIVE:

Equipment setup and a staged depressurization/leak check of PMA2/ODS vestibule prior to unmanned Shuttle undocking. The first stage depressurization and leak check is designed to take no more than 1 hour total time. PMA/ODS depressurization

TOOLS AND EQUIPMENT REQUIRED

IMS Vacuum Access Jumper (VAJ) 5 ft P/N 683-17111-1
 Vacuum Access Jumper (VAJ) 35 ft P/N 683-17111-2
 Internal Sampling Adapter (ISA) P/N 97M55830-1
 Fluke Scopemeter 105B S/N DM6640155
 Crystal Pressure Module

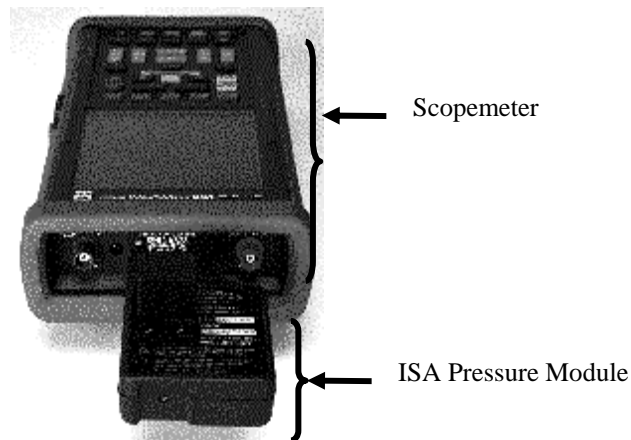

Figure 1.- ISA Pressure Module Inserted into Scopemeter (Unit Selection Switch Faces Away From Scopemeter LCD Screen; ISA Not Shown).

1. CHECKING OUT ISA/SCOPEMETER

ISA 1.1 Uncap one ISA-VAJ Port. |

1.2 ✓Other ISA-VAJ Port (1 of 2) – Capped

NOTE

Scopemeter will be face down with respect to ISA Pressure Module, if installed properly.

1.3 Attach Scopemeter to ISA Pressure Module.

1.4 ✓COM-COM and V-V on Scopemeter to ISA Pressure Module connection

2.1.8 PMA2/ODS Depress and Leak Check (continued)

- 1.5 To perform a Scopemeter master reset
On Scopemeter, while holding down the F5 button, press and release the ON/OFF button only.
Listen for two beeps.
Release F5 button.
- 1.6 Press F5 button to highlight EXT.mV mode.
- 1.7 Press F1 button to close mode change message if required.
- 1.8 ISA Pressure Module – Off
- 1.9 Verify V reading is > 100 mVDC (ISA Pressure Module Battery reading).

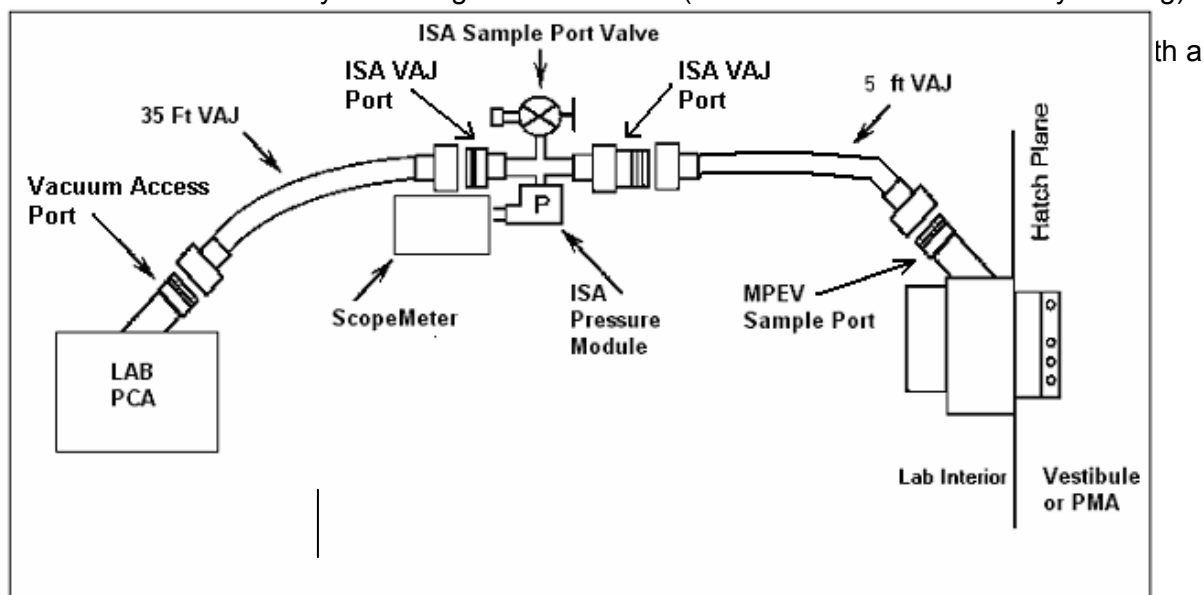

Figure 2.- ISA/VAJ/MPEV Connection.

2. SETTING UP ISA/VAJ/MPEV

- Lab Fwd
- 2.1 Lab Fwd MPEV – Closed
 - 2.2 Uncap Lab Fwd MPEV.
 - 2.3 Uncap VAJ (5 ft) hose ends and inspect soft seals to verify they are properly seated and in good condition (no nicks or cuts).
Report any damage to MCC-H.
 - 2.4 Connect bent end of VAJ (5 ft) to Lab Fwd MPEV.
Connect other end of VAJ to ISA VAJ Port.
Refer to Figure 2.

2.1.8 PMA2/ODS Depress and Leak Check (continued)

2.5 Uncap VAJ (35 ft) hose ends and inspect soft seals to verify they are properly seated and in good condition (no nicks or cuts). Report any damage to MCC-H.

2.6 Uncap the second ISA VAJ Port and connect either end of VAJ (35 ft) to ISA VAJ Port.

LAB1D0-02 Access VRA, uncap PCA Vacuum Access Port and attach other end of VAJ (35 ft).

WARNING

Hoses will move when pressurized or evacuated.
Failure to secure ISA/VAJ Assembly may result in damage to equipment and/or injury to crew.

2.7 Secure ISA/VAJ Assembly as required per crew preference to avoid possible jumper whipping during depressurization.

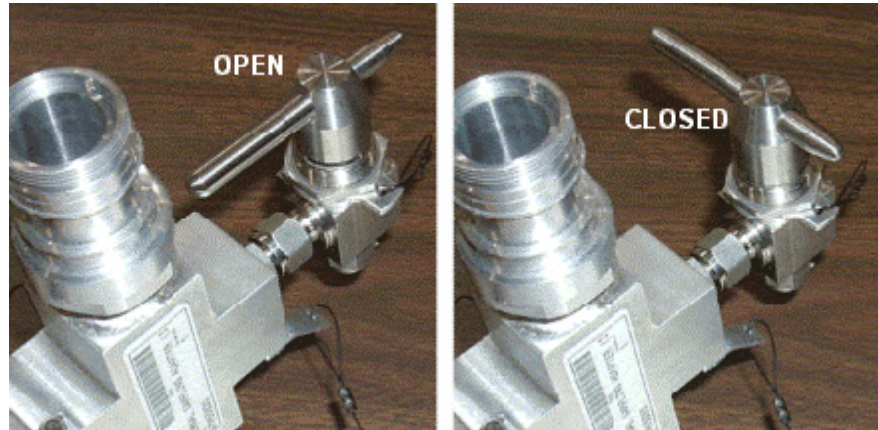

Figure 3.- ISA Sample Port Valve.

2.8 ✓ ISA Sample Port valve – Closed and capped

Refer to Figure 3.

2.1.8 PMA2/ODS Depress and Leak Check (continued)

3. INHIBITING LAB PCA PPR**NOTE**

A 'Positive P Relief Failure - LAB' Caution message will be received after PPR is inhibited. No action is required. This message will return to normal once PPR is reenabled in step 6.

On MCC-H GO

PCS

US Lab: ECLSS: PCA: PCA Commands

Lab PCA Commands

'Positive Press Relief'

'Inhibit'

cmd Arm (√Status – Armed)**cmd** Inhibit (√Positive Pressure Relief State – Inhibited)4. LEAK CHECKING ISA/VAJ ASSEMBLY

4.1 √ISA Sample Port valve – Closed

Refer to Figure 2.

4.2 Opening Lab PCA VRIV**WARNING**

Opening the VRIV will vent the VAJ Assembly to space and may cause a loud hissing noise. Crew in the vicinity should don Ear Plugs.

PCS

US Lab: ECLSS: PCA

Lab ACS

'Pressure Control Assembly'

sel VRIV

LAB PCA VRIV

'Open'

cmd Arm (√Status – Armed)**cmd** Open (√Position – Open)

4.3 Wait 10 minutes.

2.1.8 PMA2/ODS Depress and Leak Check (continued)

4.4 Closing Lab PCA VRIV

US Lab: ECLSS: PCA

Lab ACS

'Pressure Control Assembly'

sel VRIV

LAB PCA VRIV

'Close'

cmd Close (√Position – Closed)

4.5 Monitor ISA pressure for 5 minutes.

If ISA delta pressure is > 10 mmHg

Suspect ISA/VAJ leak.

√**MCC-H** for instructions >>5. PARTIALLY DEPRESSURIZING PMA/ODS

PCS

5.1 Opening Lab PCA VRIV

US Lab: ECLSS: PCA

Lab ACS

'Pressure Control Assembly'

sel VRIV

LAB PCA VRIV

'Open'

cmd Arm (√Status – Armed)**cmd** Open (√Position – Open)**WARNING**

Opening the Lab Fwd MPEV will vent the PMA to space and may cause a loud hissing noise. Crew in the vicinity should don Ear Plugs.

Lab Fwd 5.2 Lab Fwd MPEV → Open

5.3 Wait 20 minutes for depressurization to 250 mm Hg.

2.1.8 PMA2/ODS Depress and Leak Check (continued)

PCS 5.4 Closing Lab PCA VRIV
 US Lab: ECLSS: PCA
Lab ACS
 'Pressure Control Assembly'

 sel VRIV

LAB PCA VRIV
 'Close'

cmd Close (√Position – Closed)

Scopemeter 5.5 √ISA Pressure < 250 mmHg

5.6 Wait 10 minutes for thermal stabilization.

6. ENABLING LAB PCA PPR**On MCC-H GO**

PCS US Lab: ECLSS: PCA: PCA Commands
Lab PCA Commands
 'Positive Press Relief'

cmd Enable (√Positive Pressure Relief State – Enabled)

7. LEAK CHECKING PMA/ODS

Scopemeter 7.1 Record ISA Pressure P1: _____ mmHg
 Record GMT: ____ / ____ : ____ : ____ GMT

7.2 Wait 30 minutes.

7.3 Record ISA Pressure P2: _____ mmHg

If ISA delta P (P2-P1) > 2 mmHg
 Suspect Lab Fwd Hatch leak.

√**MCC-H** for instructions >>

7.4 During next ground communication opportunity, report all pressures and times from previous steps to **MCC-H** (Lab Cab Press, ISA Press, P1, P2).

8. DETACHING AND STOWING EQUIPMENT

Lab 8.1 Lab Fwd MPEV → Closed

Scopemeter 8.2 ISA Pressure Module → Off

2.1.8 PMA2/ODS Depress and Leak Check (continued)

8.3 Scopemeter → Off, detach from ISA Pressure Module

8.4 Uncap ISA Sample Port valve.

8.5 ISA Sample Port valve → Open (in order to stow)

Refer to Figure 3.

8.6 Detach 5 ft VAJ from ISA VAJ Port and MPEV. |

8.7 Cap ISA Sample Port valve, ISA VAJ Ports, VAJ hose ends, and MPEV. |

8.8 Stow ISA, Scopemeter, and VAJ. |

8.9 Detach 35 ft VAJ from PCA Vacuum Access Port.

8.10 Cap PCA Vacuum Access Port and VAJ hose ends.
Stow 35 ft VAJ. |

2.1.9 TCS Alternate Power (IFM)

The APDS remote command IFM procedure unpowers MN B for approximately 1 hour just prior to the undocking time. TCS is powered normally by MN B, and if it is unpowered and repowered, it requires crew PGSC interface to return to an operations mode. TCS is desired for undocking data by rendezvous. The TCS Repower IFM is required to be performed prior to the planned undocking time in order to have TCS data for the unmanned undocking. The TCS repower procedure will power TCS via MN A by jumpering power to its supply wiring behind the payload station distribution panel.

TCS Repower

OBJECTIVE: To repower TCS do to loss of PL AUX B bus.

LOCATION: Flight Deck Aft, at PSDP

TOOLS REQD:

Tool

- Gray Tape
- Pin Kit
- Pwr Screwdriver
- Torque Wrench
- Driver Handle
- 5/32-in Allen Head Driver

- | | | |
|-------|----|--|
| SSP 1 | 1. | √ TCS PWR – OFF
TSC PWR tb - bp |
| R1A1 | | √P/L AUX - OFF |
| L17 | 2. | Remove L17 (17 fasteners, 5/32-in Allen Head Driver) |
| PSDP | 3. | Remove connector P1029 from J29 on PSDP. Tape over face of connector P1029 (Gray Tape) |
| | | <u>Note:</u> |
| | | PL AUX B power to TCS will be lost due to MN B pwr down in CSCS APDS Remote Command Procedure. OIU 2 and APCU 2 will lose power when P1029 is demated. |
| | 4. | Remove connector P1033 from J33 on PSDP. Tape over face of connector P1033 (Gray Tape) |
| | | <u>Note:</u> |
| | | When P1033 is demated PL AUX A pwr will be lost causing DTV, and the MUX to be unpowered. |
| | 5. | Obtain two 24-in 12-ga Pin/Pin Test Jumper Leads (Pin Kit) |
| | 6. | Install one Test Jumper Lead between Socket A of J33 on PSDP, Socket G of J29 of PSDP (this is + lead)
Install other Test Jumper Lead between Socket C of J33 on PSDP, Socket H of J29 of PSDP (this is – lead). See diagrams below |

TCS Repower (Continued)

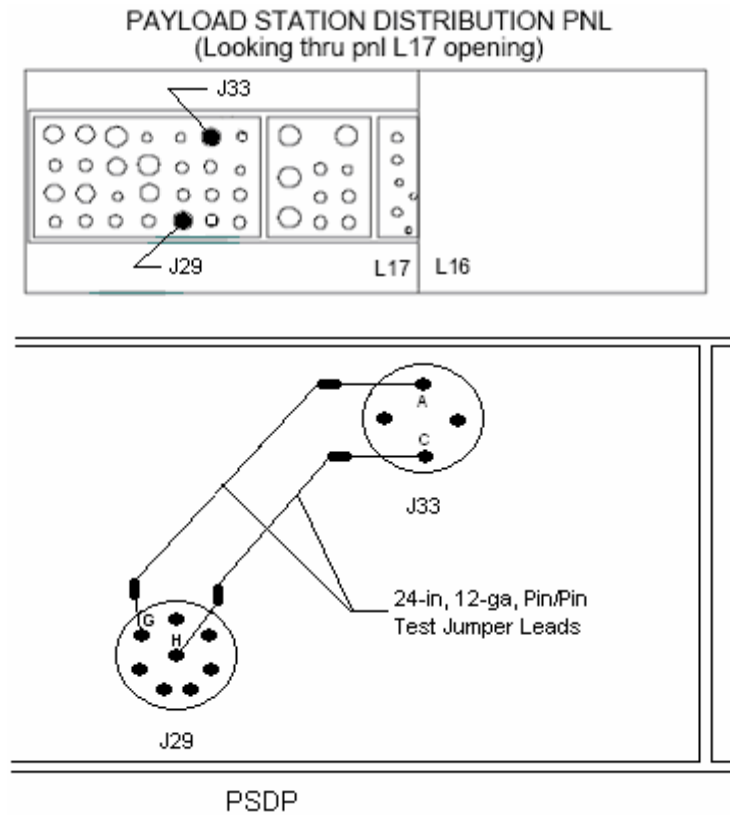

- | | | |
|----------|-----|--|
| PSDP/L17 | 7. | Tape/secure wires/cables (Gray Tape). Reinstall Pnl L17 (torque fasteners to 30 in-lb) |
| R1A1 | 8. | P/L AUX - ON |
| SSP 1 | 9. | TCS PWR – ON
TSC PWR tb - gray |
| | 10. | Stow tools |

2.2 Flight Procedures Handbook (FPH) for Unmanned Undock Timeline

2.2.1 Overview

The Contingency Shuttle Crew Support (CSCS) unmanned undocking timeline is used to safely undock, separate, and deorbit an unmanned Orbiter from ISS. It was developed with the assumption that the Orbiter suffered irreparable damage during ascent, causing the Shuttle crew to use ISS as a “safe haven” until a rescue vehicle can be launched and return them to Earth. Before a rescue vehicle can dock to PMA2, the damaged Orbiter must be disposed of using these procedures.

Over the course of several hours, the Orbiter will be configured for undocking by the Shuttle crew. As part of a pre-undocking IFM, the APDS will be configured for undocking with MAIN B unpowered. The crew will then egress the Orbiter, closing both hatches. After a gross leak check to ensure the integrity of the ISS hatch seal, MAIN B will be repowered by the ground, causing the mechanism to behave as if the undocking button had been pressed. When the APDS hooks open, the Orbiter will achieve approximately 0.2 fps of opening rate via the APDS spring push-off and the use of up-firing tail jets for attitude control. At a range outside of 1000 feet, the Shuttle flight control team will remotely command a 1 fps +X auto-reboost burn, which will increase the Orbiter’s opening rate. Once outside 6560 feet, a deorbit burn will be uplinked and executed with the end result of Orbiter breakup and disposal in the South Pacific Ocean.

2.2.2 FPH Detailed Procedures

CAUTION

Constraints for undocking of unmanned Orbiter:

- ISS capable of controlling -Rbar attitude (ISS 90,0,0 LVLH PYR) with 1° deadbands
- ISS RWS powerup required to monitor ODS
- TCS REPOWER previously performed
- SHUTTLE EGRESS, steps 1 - 6, previously performed prior to APDS REMOTE COMMAND
- APDS REMOTE COMMAND, steps 1 - 29, previously performed
- PMA2 DEPRESSURIZATION AND LEAK CHECK, steps 1 - 4, previously performed
- IFM to provide TCS power via MAIN A or MAIN C previously performed
- At least 2 GNC GPCs available
- At least 2 IMUs available
- 2 PGSCs available for WinDecom and RPOP/CADS
- S-band comm optimized for 7.5 hours
- DAP B9 previously configured to include 10 second ALT DAP DELAY
- Docking target previously installed on ISS hatch

There are several constraints for the use of these procedures. Most importantly, the timeline was developed assuming no degraded control capabilities exist on the Orbiter or ISS. The procedures do not account for jet failures leading to degraded $\pm X$, loss of two forward side- or down-firing jets, etc. At least two GNC GPCs and two IMUs are required. The procedures also require uninterrupted commanding capability for 7.5 hours to provide for two setup, undocking, separation, and deorbit attempts. Station attitude control and the ability to remain in the ISS LVLH PYR 90,0,0 attitude for 2.5 hours are also required.

A large portion of the timeline involves setup of the Orbiter for unmanned operations by the Shuttle crew. In the days preceding the unmanned undocking, the Shuttle crew will perform all procedures possible, leaving only a minimal number of steps to be performed on the day of undocking. Several of the procedures were newly developed specifically for the CSCS project.

2.2.2 FPH Detailed Procedures (continued)

TCS REPOWER changes the power source for the Trajectory Control Sensor (TCS) from MAIN B to MAIN A, since MAIN B will be powered down as part of the procedure and TCS is highly desired for ranging information and situational awareness after undocking. APDS REMOTE COMMAND configures the Orbiter APDS for undocking and remote commanding from the Mission Control Center (MCC). Several established procedures, including ISS RWS, SHUTTLE EGRESS, and PMA2 DEPRESSURIZATION AND LEAK CHECK, customized to support CSCS, will also be used. These procedures will be discussed in detail below.

<u>SET UNDOCKING TIMER</u> 3A										
Nominal:	<input type="text"/>	<input type="text"/>	/	<input type="text"/>	<input type="text"/>	:	<input type="text"/>	<input type="text"/>	:	<input type="text"/>
Backup:	<input type="text"/>	<input type="text"/>	/	<input type="text"/>	<input type="text"/>	:	<input type="text"/>	<input type="text"/>	:	<input type="text"/>
Set SM and GNC timers counting down to undocking time										

A prime and backup undocking time is provided to the Shuttle crew, and a timer is set as a point of reference.

Perform CONTINGENCY SHUTTLE CREW SUPPORT GROUP C+ PWRUP

Four hours before undocking, the Shuttle crew is sent to the GROUP C+ PWRUP procedures, which will also be located in the CSCS FDF. These procedures are used to bring the Orbiter back to full power after several days of reduced power for CSCS docked operations, and take approximately 1.5 hours to perform.

ISS: Update CCDB Slot/Activities (ACS-UPDATE-CCDB-PARAM)

This callout alerts the ISS MCC to begin a series of commands and data loads that update the Station CCDB and attitude parameters for non-mated configurations in the Station attitude control system. This allows ISS to maintain attitude control after undocking.

ISS: US to RS handover (ACS-H/O US-RS)

The ISS attitude control system is handed over from US to Russian segment control.

<u>CONFIGURE RCS JETS FOR SEPARATION</u> 9A									
GNC 23 RCS									
RCS F – ITEM 1 EXEC (*)									
JET DES F1U – ITEM 17 EXEC (no *)									
F3U – ITEM 19 EXEC (no *)									
F2U – ITEM 21 EXEC (no *)									
F3F – ITEM 33 EXEC (no *)									

2.2.2 FPH Detailed Procedures (continued)

Block [9A] configures the Orbiter jets for undock operations, assuming [22A] in the Rendezvous Checklist was performed after docking. Specifically, this block enables the forward up- and forward-firing jets that were disabled after docking to reduce loads on ISS during the docked phase.

<u>ENABLE RENDEZVOUS NAV</u> [9B]	
<u>GNC 33 REL NAV</u>	
RNDZ NAV ENA	- ITEM 1 EXEC (*)
SV SEL FLTR	- ITEM 4 EXEC
√RR	- ITEM 13 (*)
√INH RNG	- ITEM 18 (*)
RDOT	- ITEM 21 (*)
Angles	- ITEM 24 (*)

Rendezvous Nav is required to be enabled so that a target state vector is available for proximity operations. This block is identical to the block in the nominal undock timeline.

<u>CONFIGURE Ku FOR RADAR</u> [9C]	
A1U	√PWR - ON
	KU MODE - RDR PASSIVE
	RDR OUTPUT - LO
	CNTL - PNL
	KU sel - GPC
<u>GNC 33 REL NAV</u>	
	KU ANT ENA - ITEM 2 EXEC (*)

Radar will be used after undocking to provide range and range rate information to the ground. The crew configures the Ku for radar operations in this block. The radar will not actually attempt to track until [19A] is performed.

<u>CONFIGURE FREE DRIFT DAP</u> [10A]	
<u>GNC 20 DAP CONFIG</u>	
	ITEM 4 + 8 EXEC
	ITEM 51 + 4 0 EXEC
	ITEM 58 + 5 EXEC
	ITEM 62 + 1 0 EXEC
	ITEM 5 EXEC

2.2.2 FPH Detailed Procedures (continued)

The unmanned undocking technique uses a “simulated free drift” DAP for the coast phase between the initial sep sequence and the maneuver to the +X burn attitude. This is done to avoid attitude control jet firings at close ranges, which could lead to catastrophic plume loads on ISS, while still keeping the DAP in AUTO for the initial sep, maneuvering to burn attitudes, etc. Since there is no crew onboard to press the FREE button, DAP B8 will be permanently edited to set the maximum angle and rate deadbands, 40° and 5°/second respectively. When free drift is desired, the ground will command the Orbiter to this DAP to simulate free drift. Likewise, when AUTO is desired, the ground will command the Orbiter to DAP B9. In “simulated free drift,” if the deadbands are approached, the ground will uplink an ITEM 21 or ITEM 20 on Universal Pointing to recenter the deadbands.

```

CONFIGURE +X BURN 10B

GNC 20 DAP CONFIG
REBOOST CFG - ITEM 8 + 2 EXEC
INTVL - ITEM 9 + 2 4 EXEC

GNC UNIV PTG
DURATION - ITEM 27 + 0 0 + 1 0 + 0 0 0 0 EXEC

```

The 1 fps +X burn outside 1000 feet is accomplished using a 10 minute config 2 reboost with 24 second intervals. This block configures SPEC 20 and UNIV PTG for the burn.

```

CONFIGURE GPS FOR SEPARATION 10C

Perform GPS PWRUP (ORBIT OPS, GNC)

GNC 55 GPS STATUS
DES RCVR - ITEM 27 EXEC (no *)
√INH GPS to G&C - ITEM 33 EXEC (*)
NAV - ITEM 36 EXEC (*)

```

GPS will not be used for proximity operations, but the entry team will use it to help track the Orbiter after the deorbit burn. This block powers up the Orbiter GPS and enables it so that the entry team can get data on the ground.

```

UPDATE ORBITER WEIGHT 10D

√MCC: Current Orbiter weight _____
GNC, OPS 202 PRO
GNC ORBIT MNVR EXEC
Update Orbiter weight
Change ΔVx to 1 fps
ITEM 19 + 1 EXEC
√ITEM 20 + 0 EXEC
√ITEM 21 + 0 EXEC
Change TIG to 1 hour in the future
ITEM 22 - LOAD
OPS 201 PRO

```

2.2.2 FPH Detailed Procedures (continued)

The Orbiter weight will be updated before undocking to account for the lack of a payload in the bay, assuming the crew was able to unberth and deploy the payload. The Orbiter weight is not normally updated prior to undocking since sensors can accurately determine relative motion and there is a crew onboard to pilot the vehicle, but in this case the weight is updated to ensure the most accurate relmo propagation possible. ΔV_x will be made non-zero and the TIG will be made an hour in the future so that the LOAD can be performed.

CONFIGURE TCS FOR SEPARATION [10E]

√PGSCs setup per PGSC Usage Chart (if available) or UTILITY OUTLET PLUG-IN PLAN ORBIT CONFIGURATION (REF DATA FS, UTIL PWR)

NOTE: power PGSCs via source not on MAIN B (example: A15 connector)

On RPOP PGSCs:

Perform RPOP INITIALIZATION (RENDEZVOUS, RNDZ TOOLS), then:

Perform RPOP OPS (RENDEZVOUS, RNDZ TOOLS), 7-9, then:

In RPOP, set POR - ORB DP to TGT DP, then:

set ISS attitude to LVLH TO TGT BODY 90,0,0 PYR, then:

Perform TCS ACTIVATION, steps 1 thru 3 (RENDEZVOUS, RNDZ TOOLS), then:

Perform TCS MANUAL ACQUISITION (RENDEZVOUS, RNDZ TOOLS)

set RANGE = 4 ft, AZIMUTH = 0, ELEVATION = 0

TCS will also be used after undocking for range and range rate information on the ground. TCS is only expected for the first few minutes after undocking, since the Orbiter will be in INRTL hold after one minute of free flight and TCS reflector 1 will quickly exit the device's field of view. Even a few minutes of TCS data are valuable for confirmation of the expected opening rate and trajectory, so these steps were included in the timeline.

MANEUVER STACK TO UNDOCK ATTITUDE [11A]

Load mated attitude DAP:

[GNC 20 DAP CONFIG]

√ITEM 1 + 12 EXEC

Configure Universal Pointing for undock attitude:

[GNC UNIV PTG]

ITEM 15 + 9 0 EXEC

ITEM 16 + 0 EXEC

ITEM 17 + 0 EXEC

ISS: On MCC go, go to FREE DRIFT

On MCC go, establish Orbiter attitude control and begin maneuver to undock attitude:

√DAP: LOW Z

ITEM 19 EXEC

DAP: A/AUTO/VERN

The mated stack will be maneuvered to the ISS LVLH PYR 90,0,0 undock attitude by the crew. This is done by the Orbiter at the latest possible time before crew egress to reduce the amount of time ISS has to spend in the LVLH 90,0,0 attitude. Using the nominal mated DAP, A12, Universal Pointing is used to maneuver the stack to the -Rbar undock attitude, which allows for improved separation dynamics by maximizing the delta-height between the CGs of the two vehicles.

2.2.2 FPH Detailed Procedures (continued)

CONFIGURE OMS ENGINES FOR SEPARATION 11B

L,R OMS HE PRESS/VAP ISOL (two) A - OP
 L,R OMS HE PRESS/VAP ISOL (two) B - GPC
 OMS ENG (two) - ARM/PRESS

The OMS propellant tanks are pressurized and the OMS engines are set to ARM/PRESS as one of the last steps the crew performs prior to egress to configure the OMS system for the deorbit burn and minimize the time the engines are enabled.

HAND OVER ATTITUDE CONTROL TO ISS 11C

Simulate Orbiter free drift:

GNC 20 DAP CONFIG

ITEM 2 + g EXEC

X JETS ROT – ITEM 7 EXEC (no *)

DAP: B/AUTO/ALT

DAP: NO LOW Z

ISS: on MCC go, establish attitude control

The Orbiter needs to be in free drift prior to undocking, so the simulated free drift DAP is called up prior to the crew's egress from the Orbiter. The DAP is left in B/AUTO/ALT, since those modes are required for the initial sep. ISS assumes control of the stack's attitude at this point, until 5 minutes before undocking, so Orbiter free drift is required.

LOW Z is required on the DAP between 75 and 1000 feet, per plume loads requirements. Since there were no means by which to change the DAP to LOW Z at 75 feet and back to NORM Z at 1000 feet, the crew will leave the DAP in NORM Z before they egress, and the timeline will ensure that no translations or attitude control firings happen until the Orbiter is outside of 1000 feet (CG-CG).

CONFIGURE IDP2 FOR COMMANDING 11D

GNC 20 DAP CONFIG on IDP 2

Do not reconfigure IDP 2

C2 √IDP/CRT 1,2 (two) PWR - ON, major function to GNC

R11 IDP/CRT 4 PWR - ON, major function to GNC

√GNC UNIV PTG on IDP 1

As the last step before crew egress, the various IDPs will be configured for ground commanding.

Perform SHUTTLE EGRESS, steps 7 - 12

An hour and a half before undocking, the Shuttle crew performs the procedures required to transfer to the ISS side and close the hatches.

2.2.2 FPH Detailed Procedures (continued)

ISS: Mode to prox ops

At PET -1:20, ISS modes to prox ops.

Perform PMA2 DEPRESSURIZATION AND LEAK CHECK (ECLSS, NOMINAL), steps 5 - 8

To verify the integrity of the ISS hatch seal, a gross leak check is performed onboard ISS. The procedure is expected to take approximately 50 minutes.

ISS: PMA2 Pre-Departure Configuration (Thrusters) (ACS-PRE-DEPART-CNFG-THRUSTERS)

ISS will mode from CMG control to Russian thruster control for proximity operations.

ISS MCC: Feather ISS solar arrays per SEPARATION SOLAR ARRAY CONFIG (RENDEZVOUS, REFERENCE DATA)

Like with a nominal undocking, the ISS solar arrays will be feathered such that they are edge-on to the Orbiter's departure corridor, to minimize plume loads. This takes approximately 15 minutes, and is done as late as possible to limit power generation impacts to ISS.

ISS MCC: Confirm ISS solar arrays feathered

After waiting a sufficient amount of time for the maneuvering of the ISS solar arrays, the ISS flight control team will verify that the arrays are in the proper configuration for Orbiter departure.

CHECK COMMANDING CONFIG 17A

Configure the following displays for undocking:

- √ GNC UNIV PTG on IDP1 (DSM 20102 to the GNC if reqd)
- √ GNC 20 DAP CONFIG on IDP2 (DSM 20103 to the GNC if reqd)
- GNC 33 REL NAV on IDP4 (DSM 20104 to the GNC if reqd)

The Shuttle flight control team will perform one last check to ensure the Orbiter IDPs are configured properly prior to undock. If not, the undocking can be aborted and the crew can be sent back onboard to set them to the correct configuration, but after undocking, nothing can be done. Considering that safe relative motion would be impossible without commanding from the ground, one last check is imperative.

UNDOCK OPERATIONS 17B

```
-15:00 > MCC uplink:
          GNC 33 REL NAV
          ORB TO TGT - ITEM 10 EXEC (DSM 20105 to the GNC, IDP4)

-10:00 > NOTE: Undocking command unsafed

-5:00 > ISS: command attitude control to FREE

-4:40 > MCC: repower MAIN B to issue UNDOCK command (DSM _____)
          Note MET: ___/___/___;___

-0:20 > MCC: When APDS hooks 10%
          MCC Uplink: snap Orbiter inertial hold with CNCL:
          GNC UNIV PTG
          ITEM 21 EXEC (DSM 20106 to the GNC, IDP1)
```

NOTE:
TIME CRITICAL
COMMANDING!

2.2.2 FPH Detailed Procedures (continued)

Fifteen minutes before physical separation, an ORB TO TGT state vector transfer is performed to update the target state vector with the most accurate Orbiter position. At PET -10:00, the command to repower MAIN B, and thus re-power the APDS and command undocking, will be unsafed.

Five minutes before undocking, ISS will mode to free drift. Since the Orbiter will be in “simulated free drift” with large deadbands at this point, the stack will be considered free drift, as is done prior to all undockings to eliminate the possibility of attitude control jet firings at physical separation.

Due to complexities of the APDS REMOTE COMMAND IFM, the APDS hooks will be driven by a single motor when MAIN B is repowered. The drive time in this case is four minutes and forty seconds.

The MMACS console will monitor the progress of the hooks and annunciate 50%, 25%, and 10% marks to the flight control team. At 10% the Shuttle flight control team will uplink an ITEM 21 CNCL to Universal Pointing to re-center the attitude and rate deadbands just prior to physical separation. This uplink is considered time critical because the physical separation will induce a negative Orbiter pitch rate; centering the deadbands gives the Orbiter time to clear the APDS petals before firing attitude control jets. Executing the ITEM 21 before undocking also makes it possible for only one command to be uplinked in the time-critical period after the petals clear, rather than two.

SEPARATION OPERATIONS [17C]	
0:00	ISS: Using truss camera, at physical separation, report to MCC: “Physical separation complete” Note MET: ___/___:___:___
	ISS: Using truss camera, when ODS petals clear, report to MCC: “ODS petals clear”
	When ODS petals clear: MCC uplink: Load DAP B9 to collapse deadbands: <u>GNC 20 DAP CONFIG</u> ITEM 2 + 9 EXEC (DSM 20107 to the GNC, IDP2)
1:40 >	ISS: Snap and hold attitude at undock + 100 seconds
2:00 >	MCC: Open deadbands to simulate free drift <u>GNC 20 DAP CONFIG</u> ITEM 2 + 8 EXEC (DSM 20108 to the GNC, IDP2)
	MCC: If attitude error in any axis nears 40 deg deadband: <u>GNC UNIV PTG</u> ITEM 20 EXEC (DSM 20109 to the GNC, IDP1)

NOTE:
TIME CRITICAL
COMMANDING!

2.2.2 FPH Detailed Procedures (continued)

Physical separation occurs at PET 0:00. When the APDS petals are clear, which will be verbally confirmed by the Station crew using ISS cameras, the Shuttle flight control team will uplink a command to mode the Orbiter to DAP B9, ending the simulated free drift by putting the Orbiter in attitude control with 2° deadbands. To counteract the negative pitch rate caused by the APDS push-off, the Orbiter will fire up-firing tail jets since DAP B9 uses a TAIL ONLY setting. B9 is also configured with a 10 second ALT delay, which prevents these jets from firing at a frequency that could excite any ISS structure resonant frequencies. The aft upward firings and the APDS spring push-off will both help the Orbiter achieve an opening rate of approximately 0.2 fps. This opening rate, coupled with orbital mechanics effects, will be enough to get the Orbiter out to 1000 feet without stalling. Note that the use this technique at physical separation is similar to that of the nominal sep. The commanding of the Orbiter to attitude control is considered extremely time critical, because without it, the Orbiter will stay in simulated free drift, wandering up to 40° out of attitude while in very close proximity to ISS. Jet firings caused by hitting one of the 40° deadbands in this time period help increase opening rate, but will be avoided for plume loads concerns.

After 100 seconds, ISS will snap and hold its LVLH attitude, as per the nominal separation procedures.

After two minutes, the Orbiter will have successfully damped out the negative pitch rate from the APDS push-off, so no further attitude control jet firings to increase opening rate will be expected. At this time, the Orbiter will be moded back to the simulated free drift DAP to prevent the number of aft up jet firings from exceeding 7, which is the unofficial maximum per ES/Loads. If Orbiter rates are not damped by the time 7 firings are accomplished, the ground should uplink the command to mode the Orbiter to DAP B8.

While in “free drift,” the Orbiter will eventually approach its 40° attitude deadbands, so rather than risk a primary jet attitude control firing pluming ISS, the flight control team will uplink an ITEM 20 ROT on Universal Pointing to inertially re-center the deadbands. A largely unknown fact is that a CNCL will do nothing if the attitude is already canceled, so if an ITEM 21 has already been performed, an ITEM 20 will be required to re-center the deadbands. Multiple ITEM 20s can be uplinked in a row, but not ITEM 21s. Alternating between ITEM 20 and ITEM 21 also works. The Shuttle flight control team will closely monitor the Orbiter’s attitude with respect to the deadbands and uplink ITEM 20s as required, giving sufficient time for commanding, etc. Several of these commands are expected to be required before maneuvering to the +X burn attitude.

ISS: PMA2 Post Departure Configuration (ACS-POST-DEPART)

Disables software used for automatic ACS moding after the Shuttle has departed.

2.2.2 FPH Detailed Procedures (continued)

<u>INCORPORATE RADAR DATA</u> <u>19A</u>	
MCC uplink:	
Updated Orbiter SV, if reqd	(DSM 40101 to the GNC, IDP1)
Ku Serial I/O Enable	(DSM 14007)
GNC I/O RESET	(DSM 20110 to the GNC, IDP1)
MCC: when radar lock-on occurs:	
<u>GNC 33 REL NAV</u>	
AUT RNG - ITEM 17 EXEC (*)	(DSM 20111 to the GNC, IDP4)
RDOT - ITEM 20 EXEC (*)	(DSM 20112 to the GNC, IDP4)
Angles - ITEM 23 EXEC (*)	(DSM 20113 to the GNC, IDP4)
MCC: If RATIO > 1.0, force aff mark until RATIO < 1.0	
<u>GNC 33 REL NAV</u>	
FOR RNG - ITEM 19 EXEC (*) as reqd	(DSM 20114 to the GNC, IDP4)
RDOT - ITEM 22 EXEC (*) as reqd	(DSM 20115 to the GNC, IDP4)
Angles - ITEM 25 EXEC (*) as reqd	(DSM 20116 to the GNC, IDP4)

The Orbiter Ku radar has a minimum operating range of approximately 85 feet. When the Orbiter reaches this range, it will be desirable to attempt lock-on in order to get good range and range rate information on the ground. Since the attitude control jet firings and APDS push-off during the initial separation sequence is below the IMU threshold for incorporation into onboard navigation, nav will not have a good estimate of where to look for the target when the radar begins searching. To alleviate this problem, the ground will uplink a new Orbiter state vector that models the initial opening sequence dynamics. Combined with the steps in [9C], a Ku and GNC I/O RESET will allow the radar to search in the proper location for the target. When the lock-on occurs, MCC will uplink commands to take range, range rate, and angle data into the onboard nav filter. The data will be forced if required.

Note that Ku radar data is not required in this timeframe. Assuming good TCS data is received on the ground in the first few minutes of the opening sequence, the Flight Dynamics team will have enough information to estimate time to 1000 feet, time to 6560 feet, etc.

MCC UPDATE

Orbiter vent (DSM 42601)

To help the onboard nav account for the initial opening sequence, MCC will uplink an Orbiter vent that models the APDS spring push-off and up-firing jet dynamics.

ISS: When Orbiter RNG > 400 ft, maneuver to LVLH TEA attitude

Loads concerns dictate that ISS wait until the Orbiter reaches a range of at least 400 feet before maneuvering to its normal flight attitude. Note that the minimum range for an ISS maneuver for STS-115 (12A) and subs will increase to 600 feet.

2.2.2 FPH Detailed Procedures (continued)

PERFORM +X BURN <u>21A</u>	
MCC: when R > 1000 (CG to CG):	
<u>GNC UNIV PTG</u> ITEM 21 EXEC	(DSM 20106 to the GNC, IDP1)
Load DAP B7:	
<u>GNC 20 DAP CONFIG</u> ITEM 2 + <u>7</u> EXEC	(DSM 20117 to the GNC, IDP2)
Maneuver to burn attitude:	
<u>GNC UNIV PTG</u> ITEM 15 + <u>2 6 0</u> EXEC	(DSM 20118 to the GNC, IDP1)
ITEM 16 + <u>0</u> EXEC	
ITEM 17 + <u>3 5 5</u> EXEC	
ITEM 19 EXEC	(DSM 20119 to the GNC, IDP1)
When in attitude, enable reboost:	
<u>GNC UNIV PTG</u> RBST - ITEM 25 EXEC (CUR - *)	(DSM 20120 to the GNC, IDP1)

The +X burn will be performed at a range greater than 1000 feet, where maneuvering to the burn attitude in NORM Z is allowed by Loads. DAP B7 will be used for the burn to take advantage of the high maneuver rate and deadbands. The ground will uplink the +X burn attitude into Universal Pointing and begin the maneuver to attitude with an ITEM 19. Note that a 5° offset in OM will be used to allow the radar to continue to track during the maneuver to the burn attitude and the burn itself, which is desirable because the reboost acceleration is below the threshold for incorporation into nav. When in attitude, an ITEM 25 on UNIV PTG kicks off the config 2 reboost, which fires alternating left and right side aft-firing jets at 12 second intervals. After 10 minutes, a ΔV of 1 fps is achieved without having a crewmember onboard to deflect the THC. The reboost burn will terminate without intervention from the ground. Due to software limitations, the duration of this burn cannot be reduced.

ISS: Attitude Handover RS to US Mom Mgmt (ACS-H/O-RS-to-US-MOM-MGMT)

ISS can go back to CMG control at this time, if desired.

MANEUVER TO DEORBIT BURN ATTITUDE <u>23A</u>	
NOTE: Deorbit burn must occur > 1:20 after physical separation to ensure R > 6560 ft	
MCC uplink: OPS 202 PRO	(DSM 20121 to the GNC, IDP1)
MCC uplink: disposal burn/deorbit targets	
MCC uplink: load target and maneuver to burn attitude:	
<u>MNVR EXEC</u>	
LOAD - ITEM 22 EXEC	(DSM 20122 to the GNC, IDP1)
MNVR - ITEM 27 EXEC	(DSM 20123 to the GNC, IDP1)

In preparation for the deorbit burn, the ground uplinks the command to mode to OPS202 and the deorbit burn targets. Like several other places in the procedures, this block reminds the flight control team that the dual OMS deorbit burn must occur outside 6560 feet to guarantee plume loads below ISS tolerances. The predicted relative motion resulting from the initial sep and +X reboost burn guarantee that a range of 6560 feet or greater will be achieved after an hour and twenty minutes, so to be conservative, both range and time constraints are levied.

2.2.2 FPH Detailed Procedures (continued)

MCC UPDATE

Orbiter SV (DSM 40101)

The flight control team will update the Orbiter state vector prior to the deorbit burn to ensure the most accurate entry tracking and debris footprint analysis possible.

EXECUTE DEORBIT BURN 23B

When R > 6560 ft and PET > 1:20 and within 15 seconds before deorbit TIG, MCC uplink:

MNVR EXEC

EXEC (DSM 20124 to the GNC, IDP1)

Fifteen seconds before the deorbit burn TIG, the ground will uplink an EXEC command to MNVR EXEC to enable the dual OMS burn. Another reminder about the range and time requirements for the burn is listed. Good comm is required during this time period, but if the deorbit TIG is missed, safe relative motion allows for a backup deorbit opportunity to be used.

MANEUVER TO POST BURN ATTITUDE 25A

If maneuver required after disposal burn:

MCC: OPS 201 PRO (DSM 20125 to the GNC, IDP1)

Configure disposal attitude (-XLV -ZVV):

GNC UNIV PTGITEM 8 + 2 EXEC (DSM 20126 to the GNC, IDP1)ITEM 14 + 2 EXEC (DSM 20127 to the GNC, IDP1)ITEM 17 + 180 EXEC (DSM 20128 to the GNC, IDP1)

ITEM 19 EXEC (DSM 20119 to the GNC, IDP1)

Even though Entry Analysts predict that the Orbiter will completely break up regardless of the entry attitude, this block contains the steps required to maneuver the Orbiter to the -XLV -ZVV (tail down, payload bay into the velocity vector) attitude, which will cause an early breakup and minimize the debris footprint. This is accomplished with a Universal Pointing maneuver in OPS201.

2.2.2 FPH Detailed Procedures (continued)

The following flight note will be provided by DPS for unmanned undocking activities.

MCC FLIGHT NOTE - F001003					
To	FLIGHT				
From	DPS-JHAGIN (Jennifer L. Hagin)	GMT Input	2004/026:21:59	EFN#	F001003
Vehicle	OV 103	SODF	No GMT Req'd	2004/026:22:59	Rev
Activity	Sim	Safety Issue	No MET Req'd	009/19:47	Status Open
Subject	DEU Equivalent Uplink Sheet for CSCS Undock/Sep Timeline				

The attached DEU Equivalent Uplinks will be sent per the CSCS UNDOCK/SEPARATION TIMELINE. The uplinks will be coordinated on the FLT Loop between DPS and INCO. A go will be given by FLT to begin the DEU Equivalent command sequence. Additionally, a go will be given for each of the following uplinks:

- UNIV PTG uplink, go from RNDZ, GNC and FAO
- MNVR EXEC uplink, go from GNC and RNDZ (and FDO for Target Load and D/O Burn)
- SPEC 20 (DAP CONFIG) uplink, go from RNDZ and GNC
- SPEC 33 (REL NAV) uplink, go from RNDZ

The attached DEU Equivalent Uplinks file breaks down each DEU Equivalent Uplink, including the Flight Control Discipline(s) for which a GO will be required.

The affected disciplines will also confirm successful uplink of their respective loads prior to the uplink of the subsequent load.

For each uplink a DSM, destination Major Function (GNC), and target IDP/DEU will be given.

Attachment(s): DEU_EQ_Unmanned_Undock_RevD_020205 (58KB)

2.2.2 FPH Detailed Procedures (continued)

The following is a list of commands that will be uplinked from MCC-H to the unmanned Orbiter.

	DSM # (DPS)	Title (DPS)	Keystrokes* (Max 30)	Comments	Requires Go from DPS and:
1)	20102	RESUME	RESUME	If rqd, Target DEU/IDP 1 (17A)	
2)	20103	SPEC 20 DAP CONFIG	SPEC 20 PRO	Target DEU/IDP 2 (17A)	
3)	20104	SPEC 33 REL NAV	SPEC 33 PRO	Target DEU/IDP 4 (17A)	
4)	20105	ORB TO TGT	ITEM 10 EXEC	Target DEU/IDP 4 (17B)	RNDZ
5)	20106	CANCEL MANEUVER	ITEM 21 EXEC	***, Target DEU/IDP 1 (17B)	GNC, RNDZ, FAO
6)	20107	ATTITUDE CONTROL DAP	ITEM (02) +9 EXEC	***, Target DEU/IDP 2 (17C)	GNC, RNDZ
7)	20108	FREE DRIFT DAP	ITEM (02) +8 EXEC	***, Target DEU/IDP 2 (17C)	GNC, RNDZ
8)	20109	ROTATION	ITEM 20 EXEC	***, Target DEU/IDP 1 (17C)	FLT, GNC, RNDZ, FAO
9)	20110	GNC I/O RESET	I/O RESET EXEC	Target DEU/IDP 1 (19A)	DPS
0)	20111	AUTO RANGE	ITEM 17 EXEC	Target DEU/IDP 4 (19A)	RNDZ
1)	20112	AUTO RDOT	ITEM 20 EXEC	Target DEU/IDP 4 (19A)	RNDZ
2)	20113	AUTO ANGLES	ITEM 23 EXEC	Target DEU/IDP 4 (19A)	RNDZ
3)	20114	FOR RANGE	ITEM 19 EXEC	Target DEU/IDP 4 (19A)	RNDZ
4)	20115	FOR RDOT	ITEM 22 EXEC	Target DEU/IDP 4 (19A)	RNDZ
5)	20116	FOR ANGLES	ITEM 25 EXEC	Target DEU/IDP 4 (19A)	RNDZ
6)	20106	CANCEL MANEUVER	ITEM 21 EXEC	Target DEU/IDP 1 (21A)	GNC, RNDZ, FAO
7)	20117	REBOOST DAP	ITEM (02) +7 EXEC	Target DEU/IDP 2 (21A)	GNC
8)	20118	REBOOST TRACK ATT	ITEM (15) +260 +0 +355 EXEC	Target DEU/IDP 1 (21A)	GNC, RNDZ, FAO
9)	20119	LOAD TRACK ATT	ITEM 19 EXEC	Target DEU/IDP 1 (21A)	FLT, GNC, RNDZ, FAO
0)	20120	LOAD REBOOST BURN	ITEM 25 EXEC	Target DEU/IDP 1 (21A)	GNC, RNDZ
1)	20121	OPS 202 PRO	OPS 202 PRO	Target DEU/IDP 1 (23A)	GNC, RNDZ
2)	20122	LOAD BURN TARGETS	ITEM 22 EXEC	Target DEU/IDP 1 (23A)	GNC, RNDZ, FDO
3)	20123	MNVR TO BURN ATT	ITEM 27 EXEC	Target DEU/IDP 1 (23A)	GNC, RNDZ
4)	20124	EXEC BURN	EXEC	***, Target DEU/IDP 1 (23B)	GNC, RNDZ, FDO
5)	20125	OPS 201 PRO	OPS 201 PRO	Target DEU/IDP 1 (23C)	GNC, RNDZ
6)	20126	TGT ID EARTH CENTER	ITEM (08) +2 EXEC	Target DEU/IDP 1 (23C)	GNC, RNDZ, FAO

2.2.2 FPH Detailed Procedures (continued)

The following is a list of contingency uplinks that may be required during unmanned undocking activities.

	DSM # (DPS)	Title (DPS)	Keystrokes* (Max 30)	Comments
1)	20136	SPEC 21 IMU ALIGN	SPEC 21 PRO	
2)	20137	ALIGN SEL/DES IMU1	ITEM 10 EXEC	
3)	20138	ALIGN SEL/DES IMU 2	ITEM 11 EXEC	
4)	20139	ALIGN SEL/DES IMU3	ITEM 12 EXEC	
5)	20140	STAR ALIGN	ITEM 13 EXEC	
6)	20141	ALIGN EXECUTE	ITEM 16 EXEC	
7)	20142	REFERENCE IMU	ITEM 14 +1 EXEC	Reconfig to IMU1(2,3) as rqd
8)	20143	RM SEL/DES IMU1	ITEM 7 EXEC	
9)	20144	RM SEL/DES IMU2	ITEM 8 EXEC	
10)	20145	RM SEL/DES IMU3	ITEM 9 EXEC	
11)	20146	TERMINATE ALIGN	ITEM 17 EXEC	
12)				
13)	20147	INERTIAL ATTITUDE	ITEM 5 +0+0+0 EXEC	Reconfig to desired attitude
14)	20128	LOAD INERTIAL ATT	ITEM 18 EXEC	
15)	20117	"REBOOST TRACK ATT"	ITEM 15 +260+0+355 EXEC	Reconfig to desired attitude
16)	20118	LOAD TRACK ATTITUDE	ITEM 19 EXEC	
17)				
18)	20134	LEFT OMS SEC TVC	ITEM 30 EXEC	
19)	20135	RIGHT OMS SEC TVC	ITEM 31 EXEC	
20)				
21)	20129	SPEC 22 STAR TRACKER	SPEC 22 PRO	
22)	20130	SEL/DES STAR 1	ITEM 17 EXEC	
23)	20131	SEL/DES STAR 2	ITEM 18 EXEC	
24)	20132	SEL/DES STAR 3	ITEM 19 EXEC	
25)	20133	CLEAR TABLE	ITEM 20 EXEC	

2.3 Sim Lessons Learned

Three (3) Integrated simulations were executed to perform an “end to end” exercise and evaluation of the “Unmanned Undocking” procedures.

- Unmanned Undocking Sim #1 (6/8/04) - Shuttle FCT support.
- Unmanned Undocking Sim #2 (8/3/04) - Shuttle FCT Support.
- Unmanned Undocking Sim #3 2/8/05) - Joint Shuttle and ISS FCT support.

Overall the simulations went very well. The team put together a very good set of initial procedures that required minimal updates resulting in the current revisions included in section 2.1.

The key lesson learned in all the simulations was to ensure that required commands for the “critical” commanding periods (Blocks 17B and 17C of the CSCS /Undock/Separation/Disposal Timeline) are “spring loaded” and ready for execution at the required point/cue in the timeline.

Throughout the CSCS/Undock/Separation/Disposal Timeline, each command has the associated DSM load identified along with the load designation (MF and IDP) included in each execution block. This ensures that the required command is selected and provides a “crosscheck” validation.

The standard Command procedures, located in Section 3 of the Shuttle FCOH, were utilized during the simulations. Emphasis was put on getting the loads into the “cue” as quickly as possible for execution utilizing the FD loop for coordination and confirmation of the required command and designation.

Since the CSCS /Undock/Separation/Disposal timeline is command intensive, the process requires continuous coordination between the FCR operator who has ownership of the command and the DPS and INCO operator for execution of the command. Once the command is sent, the “owner” of the command must quickly provide confirmation that the “end item” is achieved so the next command can be quickly loaded, DSM number and designation confirmed, and command executed per the timeline.

It should be noted that scheduling of the Network communication assets will be optimized to provide required command execution during the critical commanding period identified. Execution of the CSCS /Undock/Separation/Disposal Timeline will be defined as a “critical period” with resources allotted as required.

2.4 Transfer Tables

The following transfer tables are located in NSTS 21519 - Launch On Need Crew Rescue Mission Integration Plan (MIP).

Table 2.4.1

Stranded Orbiter to ISS

ITEM	QTY	USE	COMMENTS
MANDATORY ITEMS			
Advanced Crew Escape Suit (ACES), et al	7	Re-entry	Includes AN/PRC-112 Emerg. Radio, boots, helmet, CCA, gloves, g-suits, diaper, LCG & Patagonias, socks
Personal Parachute Assemblies (PPAs)	7	Re-entry	Includes SARSAT (Search & Rescue Satellite Tracking) and is activated when parachute is deployed

ITEM	QTY	USE	COMMENTS
MANDATORY ITEMS			
Bones Bag with contents	Mission dependent	Re-entry	Contains items used for recumbent positioning utilized with the seats and parachutes
Harnesses	7	Re-entry	EOS's (Emergency O2 Systems) in harnesses, life preservers, water pak
Quick Don Mask Assembly(QDMA)	7	Re-entry	Mask with HIU's attached
Headset Interface Units (HIU's)	7	Re-entry	Attached to QDMA's
LiOH Canisters (Unused)	Real-time	On-Orbit	Quantity determined real-time
Lightweight Seat Assembly (LWSA)	1	Re-entry	Rescue vehicle will launch with all required seats except for 1 LW seat assembly, due to inventory constraints
Individual Cooling Unit (ICU)	1	Re-entry	Required for LWSA above
Food (All remaining)	Real-time	On-Orbit	Quantity determined real-time
Hygiene supplies (all remaining)	All	On-Orbit	Includes Contingency UCD's and contents of Waste Management Compartment (stowed in Vol. G)
Personal Hygiene Kit(s)	8	Re-entry & On-Orbit	PHK's for each crew plus community PHK
Exercise bungees	All	On-Orbit	
Water in CWC's	Real-time	On-Orbit	Quantity determined real-time
O2 remaining	Real-time	On-Orbit	Ref: NSTS 21458, Section 6.8
N2 remaining	Real-time	On-Orbit	Ref: NSTS 21458, Section 6.8
Sleeping Bags (including sleep kits)	7	Re-entry & On-Orbit	
Sneakers (gym/ ergometer shoes)	7 sets	On-Orbit	
Clothing	Real-time	Re-entry & On-Orbit	All contents of clothing lockers. Quantity determined real-time
Shuttle Orbiter Medical System (SOMS)	1	Re-entry & On-Orbit	Contents of MF28H
Crewmember Carry-on Medications	Real-time	Re-entry & On-Orbit	Quantity determined real-time
Crew Personal Radiation Dosimeters (CPRD's)	7	Re-entry & On-Orbit	
Dosimeter Kit (Ion chambers)	2	On-Orbit	
EMU's	1	On-Orbit	To make total of 3 "good" EMU's left on ISS
Mission Specific Items			
Tonopen Kit	1	On-Orbit	STS-300 only
Medical Accessory Kit(s) (MAK's)	2	Re-entry & On-Orbit	Additional medical supplies for extended mission. STS-300 and STS-301
HIGHLY DESIRED ITEMS			
Return to Houston (RTH) Bag	1	Re-entry	
Printer, printer trays and paper	Real-time	On-Orbit	Same printer used on ISS
IFM Tools	Real-time	On-Orbit	Fiberscope, Chem lights

Table 2.4.1

Stranded Orbiter to ISS (Continued)

ITEM	QTY	USE	COMMENTS
HIGHLY DESIRED ITEMS			
Film and video tapes – contents from flight deck dry trash bag and RTH bag	Real-time	Re-entry & On-Orbit	Quantity determined real-time
Digital Camera System (DCS) and Lens (including micro-drives)	Real-time	Re-entry & On-Orbit	May get additional photo ops of ditched vehicle
Video Cameras	Real-time	Re-entry & On-Orbit	Quantity determined real-time
V-10 VTR's	Real-time	Re-entry & On-Orbit	Quantity determined real-time
Camera batteries	Real-time	Re-entry & On-Orbit	Camcorder, DCS-760
PGSC's with any stored data	3	Re-entry & On-Orbit	Quantity determined real-time
Volume E (OFK & PPK)	Real-time	Re-entry	Quantity/items determined real-time
FDF Items	Real-time		Quantity/items determined real-time
Bends Treatment Apparatus (BTA)	1	Re-entry & On-Orbit	For use with ACES suit
Cooling Unit (ICUs) or Thermo Electric Cooling Unit (TELC's)	Real-time	Re-entry	For spare(s)
O2/Comm Hoses	Real-time	Re-entry	Should be pre-routed on rescue vehicle or based on real time mission events
ATCO Cannister	1	On-Orbit	Ambient Temperature Catalytic Oxidizer. Converts CO to CO2. ALSO ABSORBS HYDRAZINE
CWC bags – any unfilled	Real-time	On-Orbit	Can be used to help manage condensate and water supplies.
Contingency Hose and Cable Kit	1	On-Orbit	Kit contains various adapters and hoses that can be used for water ops on ISS.
ACTEX	2	On-Orbit	Can be used to remove iodine from water supplies.
Microbial Check Valve (MCV)	2	On-Orbit	Can be used to iodinate/kill bacteria in water supplies.
Shuttle CCK (Contaminant Cleanup Kit) Contains gloves, masks, bags, goggles, ph strips	1	On-Orbit	Supplements ISS ability to cleanup a toxic spill.
Shuttle CSA-CP Device (compound specific Analyzer - combustion products	1	On-Orbit	CSA-CP measures CO, HCN, HCL. Could be used to supplement the ISS capability to measure combustion products, in case the CSA-CP on ISS fails.

Table 2.4.2

ISS to Stranded Orbiter

ITEM	QTY	COMMENTS
Used LiOH Canisters	Real-time	Quantity/items determined real-time
Trash	Real-time	Quantity/items determined real-time
EMU(s)	Real-time	If certification for use is expired or quantity not usable for ISS

Table 2.4.3

Rescue Orbiter to ISS

ITEM	QTY	COMMENTS
MANDATORY ITEMS		
Advanced Crew Escape Suit (ACES), et al	7	Includes AN/PRC-112 Emerg. Radio, boots, helmet, CCA, gloves, g-suits, diaper, LCG & Patagonias socks
Personal Parachute Assemblies (PPAs)	7	Includes SARSAT (Search & Rescue Satellite Tracking) and is activated when parachute is deployed
Bones Bags with contents	Mission dependent	Contains items used for recumbent positioning utilized with the seats and parachutes
Harnesses	7	EOS's (Emergency O2 Systems) in harnesses, life preservers, water pak
Quick Don Mask Assembly(QDMA)	7	Mask with HIU's attached
Headset Interface Units (HIU's)	7	Attached to QDMA's
Lightweight Seat Assembly (LWSA)	1	Rescue vehicle will launch with all required seats except for 1 LWSA, due to inventory constraints – install Seat 8 position on Rescue Vehicle
Individual Cooling Unit (ICU)	1	Required for LWSA, Seat 8 position on Rescue

ITEM	QTY	COMMENTS
MANDATORY		
Middeck Ceiling Bag (Port 2)	1	Empty bag – contents to be installed in Rescue Orbiter On-orbit
Middeck Ceiling Bag (Stbd 2)	1	Empty bag – contents to be installed in Rescue Orbiter On-orbit
ISS Middeck Storage Lockers	4	Forward of Seat 5 location
CWCs with water	6 max	6 is the number that can be transferred to ISS based on the number of expected remaining silver biocide syringes.
Ergometer	1	
O2 remaining	Real-time	Ref.: NSTS 21458, Section 6.8
N2 remaining	Real-time	Ref.: NSTS 21458, Section 6.8

Table 2.4.4

ISS to Rescue Orbiter

ITEM	QTY	Vehicle	COMMENTS
MANDATORY ITEMS			
Personal Hygiene Kit(s)	8		PHK's for each stranded crewmember plus community PHK
Exercise Bungees	All		
Crew Personal Radiation Dosimeters (CPRD's)	7		
Sleeping Bags (including sleep kits)	7		
Crewmember Carry-on Medications	Real-time		Quantity determined real-time
Medical Accessory Kit(s) (MAK's)	2		
Tonopen Kit	1		
HIGHLY DESIRED ITEMS			
Return to Houston (RTH) Bag	1		
Film and video tapes – contents from flight deck dry trash bag and RTH bag			
Digital Camera System (DCS) and Lens			
Video Cameras			
Camera batteries			
PGSC's with any stored data			
Volume E (OFK & PPK)			
Shuttle Orbiter Medical System (SOMS Kit)	1		

2.5 CSCS Docked Duration Assessment

2.5.1 CSCS Docked Duration Assessment Assumptions

The pre-launch CSCS Docked Duration Assessment is based on a set of assumptions that define the damaged Orbiter's systems capability/requirements to support the CSCS scenario and a "TPS repair timeline" to provide a best estimate of docked capability. As "real-time" events unfold, there is a high probability the timeline assumptions will change, which may have impacts to the docked duration.

Orbiter Assumptions

- No new Orbiter hardware capabilities (SSPTS, etc.)
- STS-114 Timeline & Consumables loadings
- On-time launch and nominal docking (FD3)
- Beta Dependent Attitude Requirements for ISS Power management
 - Launch: May 12, 2005
- No Orbiter systems failures that would impact CSCS duration or Unmanned Undocking.
- Orbiter supports 7 crew and itself for "X" docked days.
 - Crew metabolic/water
 - Orbiter Cabin Leakage/venting
 - Food (12+0+2 supplies can support "X" duration with rationing)
 - Waste management/hygiene
 - Power
- Powered Orbiter Undock and Disposal Burn protected.
 - Limiting Consumable (Cryo) utilized to "Undocking redline"
 - Undocking Redline (Undock on FD "Y"):
 - Group C+ Powerup: Undock - 4 hours to Undock + 4 hours

Timeline Assumptions

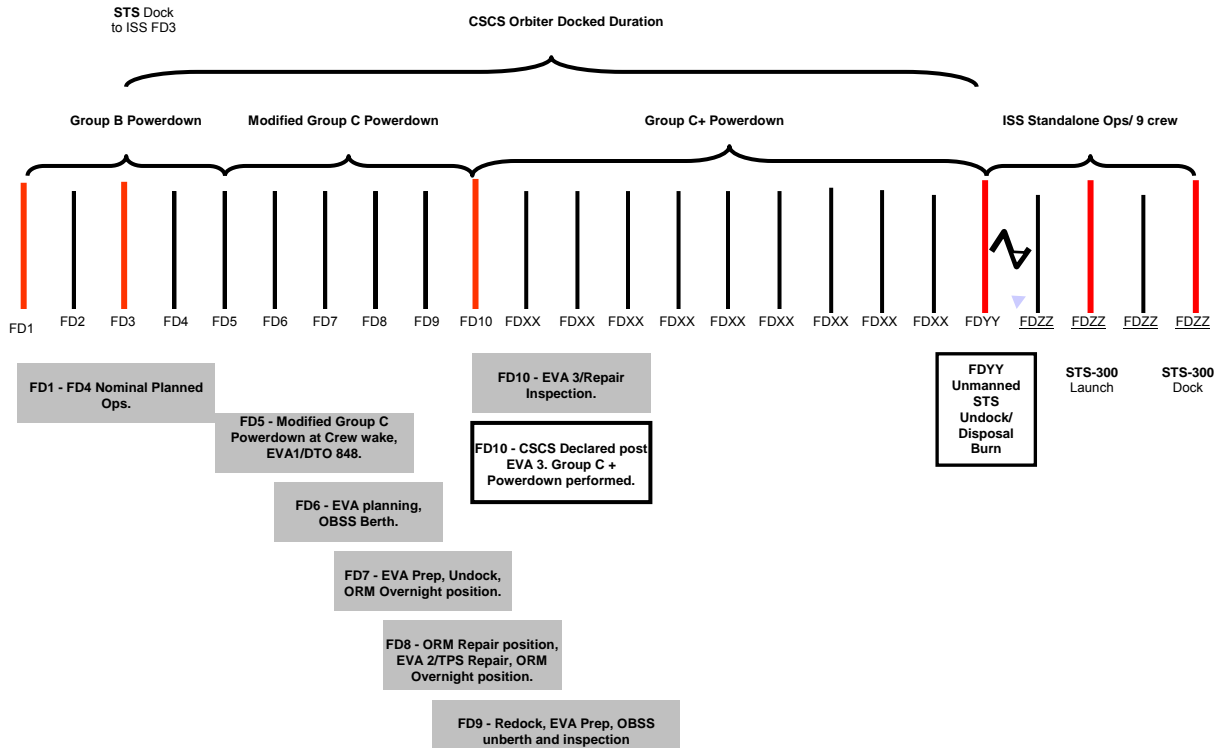

The detailed STS-114 CSCS Orbiter Docked Duration Assessment JPRCB (1/31/05) presentation can be viewed at the PRCB web site

2.5.2 Space Shuttle Mission Power Analysis in Support of Contingency Shuttle Crew Support (CSCS) for STS-114 (LF1)

Questions can be directed to DF73/M.

2.5.3 STS-114 CSCS L-5 Month ECLS Consumables Report

The following set of timeline assumptions were used for the Shuttle ECLS consumables analysis L-5 month JPRCB CSCS Duration Status Report to be presented in January 2005. Mission duration was based on the Shuttle cryo analysis performed by the Electrical Systems Group DF73.

Timeline

FD 1-3	Nominal
FD 4	MPLM Install, OBSS inspect GN2 Transfer init
FD 5	Booster fan bypass SDTO (ARLK Fan - OFF) GRP C powerdown morning of FD5, 3/15:00 MET ISS EVA 1 Tile Repair DTO
FD 6	OBSS inspect
FD 7	Undock grappled Orbiter and flip for repair EVA
FD 8	ISS EVA 2 repair
FD 9	Redock, OBSS inspect
FD 10	ISS EVA 3 to verify repair, post EVA CSCS declared GRP C+ powerdown, 9/00:00 MET
FD 11 ~ 21	Transfer supplies
FD 21	ODS hatch closure 19/16:00 MET, Undock 19/18:00 MET
Deorbit Burn	Burn occurs undock+4 hrs (19/20:50 MET), PLBDs are left open to promote vehicle breakup (Radiator Controllers are active, coldsoak N/A)

Additional consumables reporting is based on the latest STS-114 Vehicle Configuration as defined by NSTS 17462-114 Revision 16 Flight Requirements Document (FRD), NSTS 21075 Space Shuttle Operational Flight Design Standard Groundrules and Constraints Level B, Rev F CH 14, the Increment Definition and Requirements Document (IDRD) for Planning Period 5; Station Manifest, Flight ULF-1, STS-114 Annex 1.

Per the 114 FRD, Level B Ground Rules and Constraints, and the IDRD, the Shuttle has the following:

- 6 GN2 tanks (no offload)
- 31 LiOH cans stowed in the middeck
- 16 LiOH cans stowed in the MPLM
- 180 lbs Supply H2O offload
- 7 shuttle crew members
- OV103

Calculations and methods for determining ECLS consumables can be found in document JSC-19935 Environmental Systems Console Handbook Volumes 1 through 23.

Consumables Available for Transfer to ISS for CSCS:Supply H2O:

A specific ECLS SOCRATES case was built (filename eecom_114_CSCS) to assess the available amount of Supply H2O in a CSCS case. The current flight specific ECLS SOCRATES case as of 12/06/04 called eecom_114_sim was used as a starting point for the CSCS case. Timeline events were added, deleted, and/or moved as required to reflect the current set of CSCS timeline assumptions. In addition a CSCS power profile created by the Shuttle Electrical Systems Group DF73 was used in the development of the ECLS CSCS case.

One additional assumption not listed above was used for the Supply H2O analysis and that is:

- Four nominal PWR fills are completed per the nominal timeline:
 - Two fills on FD 6 & 8
 - (each PWR holds 22 lbs of H2O)
 - It was assumed that two additional PWR fills that are nominally occurring on FD10 would not occur.

Based on the above, the Orbiter will be able to transfer **24 complete CWCs at 95 lbs each** and **4 PWRs at 22 lbs each** for a **total of 2368 lbs**. Depending on the actual time of hatch closure and undocking it may be possible to fill an additional CWC for transfer.

Waste H2O:

Based on the docked duration given above a total of **840 lbs of waste water** will be generated. 420 lbs of the waste water will be condensate and will be collected in a condensate CWC. The remaining 420 lbs of waste water will be collected in the waste tank.

Three waste dumps for the waste tank will be required while docked.

Four CWC dumps will be required for the condensate collected while docked.

LiOH:

It is assumed the Booster Fan Bypass SDTO is implemented per the nominal STS-114 plan. This would include using an expired LiOH cannister from the ISS stockpile every Shuttle sleep period during the docked timeframe. In addition expired cans would be used FD 7 thru 9 when the Orbiter is undocked and grappled to the RMS for tile repair.

Upon declaration of CSCS on FD10, there will be **40 usable LiOH cans** available for transfer to ISS.

GN2:

It is assumed that GN2 Transfer between Shuttle and ISS will be initiated as currently scheduled in the STS-114 flight plan at 2/18:00 MET. It is assumed that 50 lbs of GN2 will be transferred before CSCS is declared on FD10.

It is also assumed the Shuttle will provide the GN2 required for three ISS EVAs. The amount of GN2 budgeted for each ISS EVA is 3.62 lbs. For this analysis there were no Shuttle EVAs assumed. It has recently come to light that Shuttle based EVAs may be required given the issues surrounding the ISS airlock heat exchanger. As of this report, a final decision regarding Shuttle based EVAs has not been made but pending the outcome of that situation could drastically change the GN2 budget.

It is assumed the orbiter 10.2 EVA redline of 44 lbs is not required.

Once CSCS is declared, the redline will not be protected. The redline for this vehicle config is 80 lbs. MER will be protected since this is considered GN2 that cannot be used due to measurement error and residuals.

The predicted GN2 remaining in the tanks the end of FD10 (MET 9/00:00) for CSCS based on the above timeline assumptions would be:

Load	393.3
Prelaunch usage	6.0
Orbiter venting up to 9/00:00 MET (6.02 lbs/day)	54.18
MER	48.9
Redline (not protected for CSCS)	0.0
Orbiter 10.2 EVA (not protected, normally 44 lbs)	0.0
Vest repress	2.28
PMA repress	10.45
MPLM Vest repress	2.72
ISS EVAs (3, 3.62 per EVA)	10.86
ISS N2 transfer	50.0
Vestibule leakage up to 9/00:00 MET	1.06
Qty in the tanks @ 9/00:00 MET	206.85
Number of days N2 can support beyond 9/00:00 MET	34

If there are any questions regarding the results presented in this report, they should be directed to the Shuttle Environmental Systems Group DF82.

The CSCS information is also available on the EECOM Website, SCP, Volumn 23.

2.6 Other References

The following links provide additional information in support of CSCS:

[ISS Safe Haven JOPs](#) -

[Contingency Shuttle Crew Support ECLSS \(ISS\) Reports](#) -

[Mission Integration Plan \(MIP\) Launch on Need Crew Rescue Flight \(NSTS 21519\)](#) -

[Mission Space Shuttle Mission Power Analysis in Support of Contingency Shuttle Crew Support \(CSCS\) for STS-114 \(LF-1\)](#) -

3.0 - RESCUE FLIGHT

3.1	Rescue Flight Overview, Assumptions, and Philosophy	3-1
3.1.1 Purpose	3-1
3.1.2 Overview	3-1
3.1.3 Assumptions	3-2
3.1.4 Philosophy	3-3
3.2	Rescue Flight Lead Flight Director Checklist	3-4
3.3	Call-up to Launch Schedule Template	3-5
3.4	Rescue Flight Training Template	3-6
3.4.1 Background	3-6
3.4.2 Assumptions	3-6
3.4.3 Execution	3-6
3.4.4 Generic LON Training Flow Assumptions	3-7
3.4.5 Generic LON Training Flow Known Events After Call-Up	3-8
3.4.6 Possible Layout of Training w/TCDT	3-10
3.4.7 Back Up Chart for 18 day Turnaround	3-11
3.5	Rescue Flight Flight Data File Plan - Flight Data File Support of Space Shuttle	
	Rescue Flights	3-12
3.5.1 Purpose	3-12
3.5.2 Applicability	

3-12
 3.5.3 Responsibilities
 3-12
 3.5.3.1 Flight Data File Manager 3-12
 3.5.3.2 Flight Data File Coordinator 3-12
 3.5.3.3 FDF Operations Flight Lead 3-12
 3.5.4 Requirements 3-12
 3.5.5 Procedure
 3-12
 3.5.5.1 Prior to Nominal Shuttle Flight 3-12
 3.5.5.2 Rescue Flight Call-up 3-13
 3.5.6 Rescue Flight FDF Matrix
 3-16

 3.6 Rescue Flight Unique Flight Rules 3-17
 3.7 Rescue Flight Contact List Template 3-18
 3.8 Rescue Flight Pre-Call-up Online Information 3-22

This page intentionally blank

3.0 - RESCUE FLIGHT

3.1 Rescue Flight Overview, Assumptions, and Philosophy

3.1.1 Purpose

This procedure will provide guidance for the development and execution of a Rescue Flight should it become necessary to retrieve a Shuttle crew stranded at the International Space Station. The procedure is intended to capture the work which has been done in advance of the call-up, so that a designated Lead Flight Director understands what groundwork has been laid for the flight, and will also serve as a checklist for work which needs to be done to achieve a launch in a minimum time of 35 days after call-up. It is designed to be a roadmap for reaching the launch, and to document the work which was done in the summer and fall of 2004 in preparation for the Return to Flight, so that the preparatory work does not have to be repeated.

3.1.2 Overview

The Rescue Flight is a very simple mission, made up of essentially generic flight elements, comprised of an Ascent, FD3 RNDZ and docking, a single docked day to transfer the rescued crew and any necessary equipment, an undocking, stowage day, and Landing. Since all of these elements are routinely trained by MOD in both Flight Specific and Generic training, a trained and current flight team is assumed to be available. The Flight Crew will be designated in advance by the Astronaut Office and will generally be the crew for the next Shuttle mission. This will ensure that they have already received their preparatory standalone training and have gelled as a crew. They are assumed to be ready for the start of their Integrated training flow with MCC when call-up for the Rescue occurs, and will slide into a custom-designed training flow (detailed in this procedure) to achieve flight readiness in the appropriate time.

The 35 days from call-up to Launch for the rescue flight is a best-estimate of the minimum time it will take the Launch Site to prepare another vehicle for the mission. While the actual time will vary from mission to mission, depending on OPF flows, it has been determined that 35 days is required to turn the launch pad around from one launch and to be ready to support the next – this is the pacing item. The Orbiter, ET, and SRB combination to be used for the Rescue Flight will be designated on a flow-by-flow basis, but will generally be the next-in-line vehicle, as is the crew. Before launch of any Shuttle mission, the launch follow for a Rescue Mission will be determined and available for management review at the FRR.

Flight Loads for a Rescue Flight will be prepared in advance for each Shuttle mission and will use the STS-3xx series of numbers. The first Rescue Flight to be designed is STS-300, the second STS-301, and so on. It is the intent of MOD and Flight Design in particular to use a minimum of resources for each Rescue Flight, as it is hoped that they will never be used, and therefore, the designs will be based on the previous flights – in effect being “reflights” of a previous mission – despite the fact that the previous mission has never flown. Flight Specific loads will be required for at least the first several missions so that at least one rescue Flight is designed for each Orbiter. While it would be ideal if the Flight Design process did not have to repeat again after one design existed for each vehicle, the chances are that OI upgrades will force additional design cycles, and that this overhead will be the price that the program has to pay each time to ensure Rescue capability exists.

3.1.3 Assumptions

In order to execute the Rescue Flight within the 35 days allocated, the following assumptions are made:

1. A crew has been designated (usually the crew for the next scheduled Shuttle flight) and has reached the point in their mission flow where they are ready for integrated training. The crew will consist of a CDR, PLT, and two mission specialists.
2. Flight Data File for the Rescue Mission will be that designated for the next scheduled mission (or the next scheduled mission for the vehicle to be used as the Rescue Vehicle). The FDF office will, upon call-up, produce a set of books appropriate for use in training (initially), and subsequently for Flight. Flight Specific Ascent/Entry pages appropriate to the rescue Flight (STS-3XX) flight design will be the only FDF work done specifically for the rescue flight before call-up. All other work will be done post-call-up.
3. A Flight Design Cycle for the Rescue Flight will be performed prior to the launch of the "initial" or "stranded" mission. This will be designated an STS-3XX flight. The standard L-30 Day design will be performed post-call-up once it is determined to be required.
4. Flight Software will be prepared prior to the call-up for the Rescue Flight, but verification may be part of the 35-day template.
5. Staffing for the Rescue Flight will begin post-call-up by the designation of an Ascent/Entry team who will begin training within the first few days. It is assumed that, for team cohesiveness reasons, this will be the Ascent/Entry team from the stranded mission. An off-line Rescue Flight Lead team may also be designated to work issues and preparation on a daily basis post-call-up.
6. The actual decision to call up the Rescue Flight can be made as late as approximately FD10 of the stranded mission. The 35-day template will be assumed to start at that point. At that time, the stranded Orbiter will be taken to an irreversible power down level, and MOD will have to commit sufficient resources to execute the Rescue Flight. Up until that time, it is understood that dual paths may be pursued, but once the decision is made to power down, all available resources will be put on the Rescue Flight Preparation.
7. A rescue Flight Lead Flight Director will be designated prior to any regular mission and will be responsible for understanding the steps necessary to execute the Rescue Flight if required. He or she will act as the over-all leader of the Rescue Flight Ops preparations post-call-up. Disposal of the stranded Orbiter will also require a Flight Director to be assigned when it is determined that this course of action is necessary, and should be a separate individual from the Rescue Flight Lead.

Verify that this is the correct version before use.

8. All MOD organizations will have documented their own Rescue Flight plans within their console handbooks. Specifically, any procedures which are discipline specific or unique will not be covered (but may be referenced) from this document.

3.1.4 Philosophy

The basic idea behind the rescue Flight is to use pre-existing, generic capabilities to fly a minimal mission – Ascent, RNDZ, docking, Separation, and Deorbit. No special activities are to be performed, and the payload bay is to be flown empty. As little “throw-away work” as possible is to be done – most work will be left until post-call-up. The only pre-call-up work that will be done is Flight Design and load building, which necessarily take longer than might be available post-call-up.

Since MOD is generally well prepared to fly all of the elements of the rescue mission generically, little additional sim time is required – just those sims required by the crew to build coordination and currency with the ground team. The training division has a contingency plan for the Rescue Flight which can be executed in less than the baseline 35 days.

Flight Data File will be prepared post-call-up. Team assignments and flight support personnel will be defined.

3.2 Rescue Flight Lead Flight Director Checklist

TBS

3.3 Call-up to Launch Schedule Template

When the need for a Rescue Flight arises, the first thing that will occur upon call-up will be a team tagup, initiated by the designated Lead Flight Director. This will serve as a kickoff meeting for the flight preparation activity, and will allow dissemination of key dates for the upcoming Rescue flight – dates which will, by their nature, not be known until an actual call-up occurs. The following table, however, gives a baseline plan for the MOD elements to use in planning for a Rescue Flight Call-up. Referenced to Call-up, and representing a 35-day call-up to launch schedule, it shows how the various MOD activities will occur and where the dependencies are.

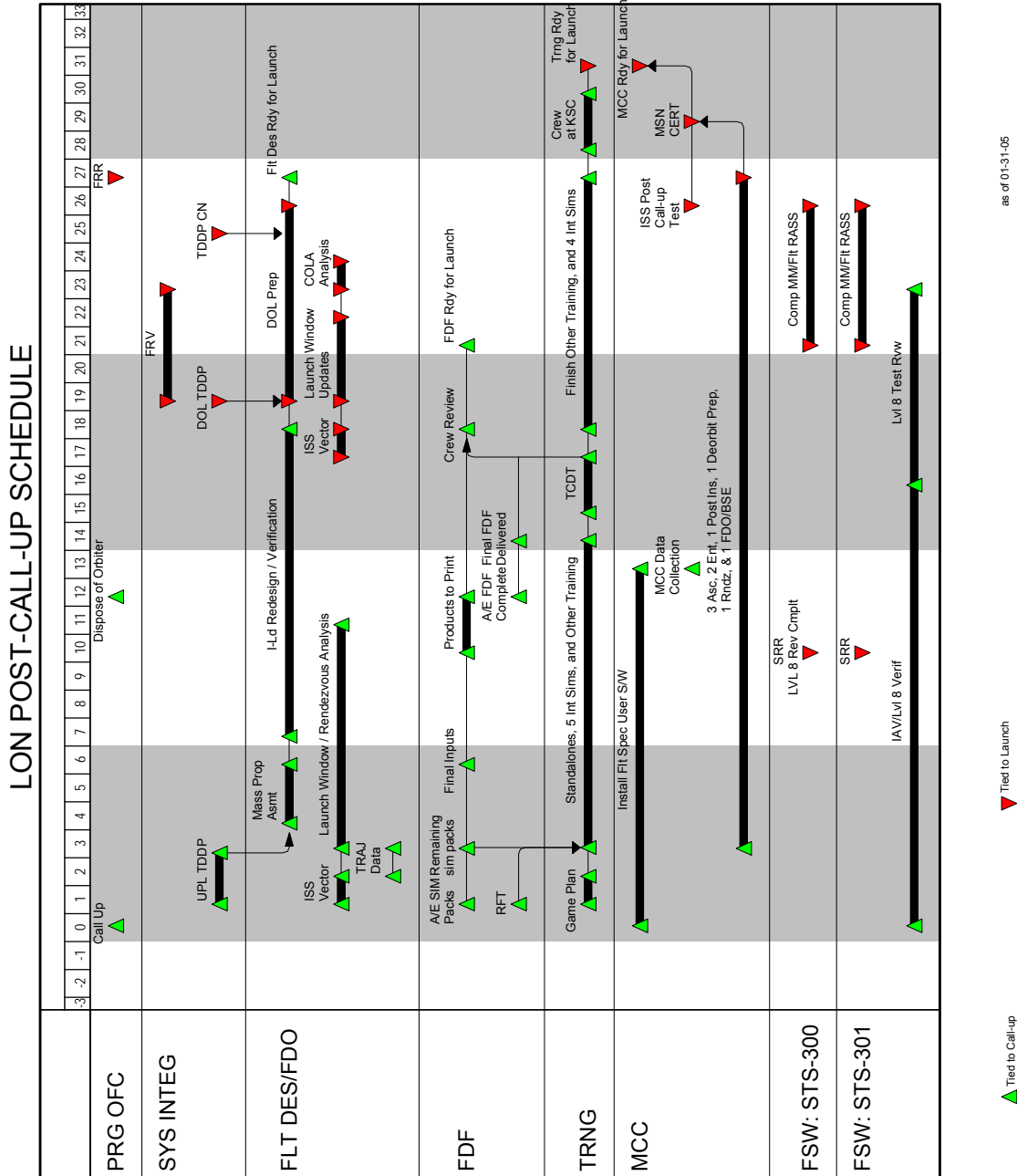

Verify that this is the correct version before use.

3.4 Rescue Flight Training Template - Generic LON Training Flow

3.4.1 Background

This information is to be used by DT/Training Integration in the event that the Launch On Need (LON) Rescue mission is called up for execution. This information may be used as reference material by any and all other parties within MOD that need to know any background materials or additional reference assumptions that would drive other product deliveries and/or milestones. Optimally, this training flow would be looked at within Training Integration prior to each STS mission to the ISS, and any out-of-family assumption would be noted and flagged, in order to make sure the impacts to the severely constrained timeline of the LON would be addressed as soon as possible. These out-of-family assumptions and impacts would then need to be worked by the LON team assigned by MOD/DA8.

3.4.2 Assumptions

All assumptions are clearly defined on the DT-provided attachments/documents that follow. While the LON training flow was worked “generically,” it is important to note that it is impossible to “assume” an accurate “Launch minus” date for the flight crew that is to execute an LON mission. For an accurate assessment of the actual LON crew’s need training flow that remains, it will require an immediate review of training completed and thoughtful tailoring of required training in order to meet this compressed schedule.

3.4.3 Execution

First and foremost, after a thorough review of the assumptions, the training plan must then incorporate any adds/deletes. This should be based upon the following:

1. Where they are relative to the crew’s L-minus date and the baseline generic assumptions.
2. Any specific considerations driven by the Rescue tasks (i.e., flight-specific issues that require specific training)
3. Whether TCDT and/or Bench Review is required
4. Any needed integrated training requirements based upon the circumstances of the LON call-up.

It is important to note that this schedule assumes no “weekends,” no gym time or admin time. From the date of the call-up, training begins 3 days later, with all immediately needed coordination tasks completed for a reasonably smooth start to the training required.

If the crew is sufficiently to the “left” of the generic assumptions in regards to their training flow, due diligence must be followed on those items to the right (number of integrated sims, travel) to prevent unwanted and unsafe levels of crew fatigue prior to this LON mission.

3.4.4 Generic LON Training Flow Assumptions

At call-up, all remaining STS 1XX training would be dropped and LON Crew Training Plan would then become the valid training plan.

Assumptions:

1. Rescue crew trained in OBSS and Tile Repair prior to previous crew's launch *
2. No training necessary in these areas because they are not required for this mission:
 - a. ORM operations/training
 - b. Earth Obs
 - c. DSO's
 - d. PAO events
3. CEIT is done prior to rescued crew's launch
4. Training is complete or completed to a level that does not need further training in these areas: *
 - a. EVA
 - b. PDRS training
 - c. ISS Core Systems Training for Shuttle Crews
5. Ascent/Entry and Orbit Flight Ops Training
 - a. 30000-level is complete and will not need to be repeated
 - b. 90000-level is complete and only the classes called out below will need to be repeated
6. Training will not have to be repeated in these areas except for the classes called out below: *
 - a. PDRS/ROBO
 - b. RNDZ
 - c. Crew Systems (Escape and Hab)
 - d. Med Ops
 - e. Ph/TV flows
7. Fly one STA/wk after call-up
8. There are zero hours in this plan for
 - a. Informal hours (no admin time)
 - b. Gym time

*Details may have to be worked for individual LON flights using splinter groups.

3.4.5 Generic LON Training Flow Known Events After Call-Up

Following are the known events that would take place after call-up with the above assumptions.

Total Training Time **162 hrs.**

Standalone SMS sessions: (14 hrs)

1. APPR/LNDG 91011
2. D/O BURN 91011
3. CONT ABT 91011
4. RNDZ/PO T/L 91012

Integrated Training: (43 hrs)

1. INT ASC = 3, @ 4 hrs each = 12 hours
2. INT ENT = 2, @ 4 hrs each = 8 hours
3. POST INSERTION = 4 hrs
4. Deorbit Prep = 7 hrs
5. 1 RNDZ/Dock = 8 hrs
6. FDO/BSE = 4 hrs

Other Shuttle Training: (31 hrs)

1. Crew Escape classes (17)
 - a. IN/EG T/L 91105
 - b. ESC SYS REFR
 - c. Stowage Review
 - d. Bailout
 - e. PLD EG
 - f. PRL IN/EG
2. Med Ops (4 hrs)
3. Transfer Review (1 hr)
4. RNDZ (7.5)
 - a. RNDZ MAN PH 91069
 - b. PROX OPS T/L 91012
5. ISS/STS Emer Scenario (1.5 hr)

Negotiables: (16 hrs)

1. Shuttle Hab requests (13 hrs)
 - a. HAB EQ PROC 91020
 - b. PI/DO PREP 91020
 - c. CABLE ROUTE 91001
2. Ph/TV requests (3 hrs)
 - d. PHO/TV PROC 93019
 - e. CAMR REVIEW 41001
3. DSO's requests (variable)

Other Required Events: (58 hrs)

1. FD tagups (2 hr)
2. Flight Plan Review session (2 hrs)
3. TCDT = 3 days (24 hrs + 8 hrs travel)* May be deleted or shortened
4. Bench Review (4 hrs)
5. STAs (18 hrs) * Assume one additional suited STA is included in the TCDT time period.

Risks:

1. Any assumption is wrong
2. Turnaround for this flight is less than 30 days
3. Sim plan changes due to content creep
4. Mission content changes
5. Crew member trained for a specific needed task is “bumped”, or if crew size reduces
6. Support of “300” sims could be severely limited during a mission, due to ongoing mission rescue/recovery support of the on-going flight.
7. Assessment was done assuming approximately 8 wks between the rescue crew and the previous crew’s launch. In cases, when this is more than 8-10 weeks, the required training will need to be re-addressed to make sure all necessary training is complete.
8. Crew fatigue may be an issue with not having any days off from intense training in an entire month.
9. Also, some efficacy of training may be lost with training what is usually covered in 3 months into one month.

3.4.6 Possible Layout of Training w/TCDT

162 Training Hours (6.2 hrs/day over 26 days; 43.4 hr/wk)

L-day	Activity	
30	Game Plan: Briefs, First Standalones, Negotiables	
29		
28	D/O BURN 91011	Cable Route
27	Cont Abort 91011	HAB/EQ Proc 91020
26	RNDZ/PO T/L	STA
25	Int Ascent #1	Photo TV Proc 93019
24	PI/DO PREP 91020	
23	Int Ascent #2	
22	Int ENT #1	Bailout
21	PLD EG	Prox Ops T/L 91012
20	Int Post Insertion	STA
19	Escape Sys Refresher	ISS/STS Emer Scenario
18	Int D/O Prep	Flight Plan Review
17	Med Ops	Travel to KSC
16	TCDT	
15		
14		
13	Travel to JSC	FD T/U
12	Camera Review	Transfer Review
11	IN/EG T/L 91105	Bench Review
10	Int RNDZ/Dock	
9	PRL IN/EG	
8	Int FDO/BSE	Stowage Review
7	RNDZ Man Phase	STA
6	Int ENT #2	
5	Int ASC #3	
4	Fly to KSC	
3	At KSC for launch	
2		
1		

3.4.7 Back Up Chart for 18 day Turnaround

Possible Layout of Training w/TCDT

134 Training Hours (8.9 hrs/day over 15 days; this is a 62 hr wk which is red in normal circumstances.)

L-day	Activities	
18	GAME PLAN: Briefs, Standalones, Some Other Shuttle and ISS classes	
17		
16		
15	Int Asc	Bench Review Crew Escape Training Flight Plan Review
14	Int Ent	
13	Int Deorbit Prep	
12	Int Asc	
11	TCDT	
10		
9		
8	Int FDO/BSE	Remaining Other Shuttle Training
7	Int RNDZ/DOCK	
6	Int Post Insertion	
5	Int Ent	
4	Int Asc	
3	At KSC for launch	
2		
1		

Possible Layout of Training w/o TCDT

102 Training Hours (9.3 hrs/day over 11 days [break on weekends]; this is a 47.6 hr wk which is green in normal circumstances)

L-day	Activities	
18	GAME PLAN: Briefs, Standalones, Some Other Shuttle and ISS classes	
17		
16		
15	Int Asc	Flight Plan Review Session Crew Escape Classes Bench Review
14	Int Ent	
13	Int Deorbit Prep	
12		
11	Int Asc	
10		
9	Int FDO/BSE	
8	Int RNDZ/DOCK	
7		
6	Int Post Insertion	
5	Int Ent	
4	Int Asc	
3	At KSC for launch	
2		
1		

Verify that this is the correct version before use.

3.5 Rescue Flight Flight Data File Plan - Flight Data File Support Of Space Shuttle Rescue Flights

3.5.1 PURPOSE

The purpose of this procedure is to outline the tasks necessary for Flight Data File support of Space Shuttle Rescue Flights.

3.5.2 APPLICABILITY

The organizations affected by this procedure include Shuttle Procedures Management and all organizations providing input to the Flight Data File.

3.5.3 RESPONSIBILITIES

3.5.3.1 Flight Data File Manager

The FDF Manager is the primary management point of contact for the flight. Currently, Mike Hurt is FDF Manager, with Mike Shaw as his alternate.

3.5.3.2 Flight Data File Coordinator

The FDF Coordinator is the primary point of contact regarding the flight. Currently, Steve Pruzin is the Rescue Flight FDF Coordinator, with Mike Shaw as his alternate.

3.5.3.3 FDF Operations Flight Lead

The Flight Lead is the FDF Operations person responsible for fabrication of the crew's flight books.

3.5.4 REQUIREMENTS

The FDF requirements for the Rescue Flight are the same as any other Shuttle Flight and are defined in the Crew Procedures Management Plan (CPMP) and its Annexes.

3.5.5 PROCEDURE

The procedure for creating the Flight Data File for the Rescue Flight is similar to a normal flight. The only differences are in the concept of having Rescue Flight unique procedures "on the shelf" that can be implemented into publications upon call up.

3.5.5.1 Prior to Nominal Shuttle Flight

1. The Rescue Flight Coordinator (hereafter referred to as the Coordinator) will agree to a Rescue Flight FDF Manifest with the Crew during the standard FDF Pre-sim Briefing. The manifest lists all of the required Flight Data File (i.e., Books, hardware, office supplies). He will maintain a copy of this manifest in the Rescue Flight folder on FS9, as well as a hard copy in the Rescue Flight binder.
2. The Coordinator will also maintain a FDF Contact List and verify that it is correct prior to flight. This would aid the coordination of a quick response in the event that a Rescue Flight is declared.
3. The Coordinator determines the FDF used for the Rescue Flight using the table below.

Verify that this is the correct version before use.

FLIGHT	STS-114	STS-121	STS-115	STS-116
Vehicle	103	104	104	103
RESCUE FLIGHT	STS-300	STS-301	STS-302	STS-303
Vehicle	104	103	TBD	TBD
fdf	121	114	TBD	TBD

4. Ensure all 482's pertaining to the Rescue Flight to be executed (300, 301, etc.) have been approved and implemented in Rescue Flight PCN's. These PCN's will be published electronically on the FDF web page. No hardcopies will be made available by DO3 prior to a call-up.

3.5.5.2 Rescue Flight Call-up

The following is a day-by-day listing of the activities that will take place after call-up. Some flexibility is available, but these activities will occur in this order.

Two key assumptions are made. First, timeframes used are reasonable minimums. Second, it is also assumed that based on the approved MOD LON Post-Call-up schedule, FDF can adjust some days to the right to account for the actual time from call-up to launch.

Entries that have a ➡ are able to be adjusted based on the actual launch date once the Rescue Flight is called up.

Day 1

1. Upon call-up, the Coordinator will contact the Training Lead to determine when simulations will begin. He will also contact the FDF Ops Flight Lead to prepare a set of FDF to be placed in the crew's office. Initially, this set could be simply a printout of the PCN's, to be followed by incorporation into the books already in the crew's office.
2. The Coordinator will work with the crew's scheduler to schedule the FDF Crew Review at approximately L-2 weeks. If necessary, due to the crew's schedule, this activity can be done in Crew Quarters at Kennedy Space Center (KSC).
3. FDF will support training for the Rescue Flight through the use of simpacks and/or publications as required. Deviations from the standard simpack constraints template of at least five (5) working days will be handled on a case by case basis. Publications will begin as soon as practical upon call-up. **In any event, the FCT should consult the Status Sheet for the appropriate FDF to use.**
4. Sixteen (16) FDF books are Generic and require no work other than changing out book covers to show the Rescue Flight designation. Four (4) FDF books and one (1) Station Operational Data File (SODF) book (Joint Ops) can utilize the next Flight's books (as appropriate). See RESCUE FLIGHT FDF MATRIX for details.

Verify that this is the correct version before use.

5. The five (5) books that will utilize the next flight's FDF/SODF will be reprinted as soon as possible with RESCUE FLIGHT book covers. It should be noted that the page codes will still have the old flight number on them. This will aid DO3 in getting the books out sooner.

Day 2

6. Six (6) books will require work after the Rescue Flight is called up. Procedures applicable to any Rescue Flight will have RESCUE in the Applicability field in the page code per section 20.8, standard g of the FDF Standards. Procedures applicable to a specific Rescue Flight will have that flight's number in the page code (for example, 300, 301, etc.). The Subject Matter Experts (SME) will gather data for FDF products (simpacks/books).

Day 3

7. SME's provide data via 482 for publications.
8. Book Managers simpack data for immediate training (if required).

Day 4

9. 482 processing.
10. Launch Site Support Team (LSST) begin travel coordination.

Beginning with Day 6, the schedule is impacted day-for-day if final inputs are not received.

Day 6

11. Final inputs for FDF books due.
12. Begin word processing.

Day 8

13. Word processing complete
14. Books in QC

Day 9

15. Books in sign-off cycles

Day 10

16. Books to print

Day 12

17. Books from print
18. FDF Ops fabrication begins
19. Book Manager book check
20. Begin CD and EMCC product generation

Verify that this is the correct version before use.

Day 13 ➡

21. LSST departs for KSC.

Day 14 ➡

22. FDF is packed and shipped from JSC

23. LSST receives FDF at KSC

Day 15 ➡

24. Crew Review at KSC (If compressed schedule did not allow for this at JSC)

25. Handover FDF to ASP

Day 16 ➡

26. Middeck packing

Day 18 ➡

27. Launch of Rescue Flight

3.5.6 RESCUE FLIGHT FDF MATRIX

BOOK	BOOK MANAGER	USE GENERIC FDF	USE NEXT MISSION'S FDF	POST CALL-UP WORK REQUIRED	COMMENTS
AESP GE	TV	X			
APCL GE	MEB	X			
ASC FSP	AR-M			X	Will require normal ASC changes due to launch date.
C D/O GE	AB			X	Minor EECOM changes.
D/O GE	YF			X	
DPS GE	RR	X			Book is flown electronically.
ENT FS	MT			X	
ENT GE	MT	X			
EPCL GE	MEB	X			
EVA FS	Not required due to no flight specific EVA activities				
EVA GE	BM	X			
FLT PLN FSP	TC		X	X	Flight Plan would be left up to FAO as to which would be easier.
IFM GE	JS	X			
JOINT OPS (SODF) ¹	JV		X		JEUS, ISS Safing & Comm Config are used from next mission.
MAL GE	HS	X			
MAPS GE	JW	X			
MED GE	JW	X			
OPCL GE	MEB	X			
ORB OPS FS	TZ			X	Changes due to seating for 11 crewmembers
ORB OPS GE	CJG	X			
P/TV FSP	CJG		X		
PDRS FS	Not required due to no flight specific PDRS activities				
PDRS GE	MH	X			
PI FSP	JW		X		
PL PWR FSP	YF		X		May not fly due to no payloads.
REF FS	TV			X	Nominal late updates.
REF GE	TV	X			
RNDZ FSP	RB		X		
SYS AOA GE	AB	X			
SYS DATA GE	CJG	X			Book is flown electronically.

NOTES:

1: Only SODF book required for Rescue Flight.

Verify that this is the correct version before use.

3.6 Rescue Flight Unique Flight Rules

Should a Rescue Flight be required, the Flight Rule Annex will be developed by using the Annex for the upcoming shuttle flight, or, if that is insufficiently mature, the annex for the current (stranded) flight as a baseline. Any payload-related rules may be scrubbed. It is a philosophical decision not to accept an elevated level of risk for the Rescue flight, and therefore, exceptions to existing rules are not generally expected.

The following Flight Rules have been developed to cover specific cases which are rescue flight unique, such as mid-deck configuration. They are documented here so that if a Rescue Flight is required, they can simply be taken from these pages and inserted in the appropriate annex for use.

PROPOSED LON CABIN TEMP FLIGHT RULE

300 (301)_A17-1 ENTRY DAY AND TOUCHDOWN CABIN TEMPERATURE
MANAGEMENT (HC)

EXCURSIONS IN CABIN TEMPERATURE ALLOWED AT TOUCHDOWN ABOVE THE NOMINALLY-ALLOWED 75 DEG F (PER FLIGHT RULES A13-31, CREW CABIN TEMPERATURE LIMITS, AND A17-152, CABIN TEMPERATURE CONTROL AND MANAGEMENT) ARE PERMITTED FOR LON RESCUE FLIGHT CREW RETURN COMPLEMENTS, PROVIDED CABIN TEMPERATURE IS NOT PREDICTED TO BE AT OR ABOVE 80 DEG F.

Due to the larger than normal return crew complements expected for rescue flight (10 or 11 crewmembers), initial analysis predicted cabin temperature at touchdown of approximately 79 deg F. This temperature assumed nominal cabin coldsoak beginning the morning of entry day, suit cooling unit use as required, as well as normal entry day cabin powerdowns and power levels. If entry occurred at lower cabin pressures (10.2 psia), cabin temperature would reach 85-86 deg F. However, by beginning entry cabin coldsoak prior to the sleep period the night before entry, keeping cabin pressure at nominal 14.7 psia conditions, and optimizing suit cooling unit mix, cabin temperature of approximately 78 deg F can be reached. Although this is still above the nominally accepted 75 deg F limit, the difference of 2-3 deg F is not considered excessive especially in view of current suit cooling and orbiter systems hardware capabilities combined with the higher than normal metabolic heat release of 10 to 11 crew.

References: Boeing reports TS-TM-04-018, STS-300 Cabin Entry Temperature Analysis, and TS-TM-04-031, STS-300 Cabin Entry Temperature Analysis - Update, Hazard Control ORBI-321 (Crew Incapacitation from Heat Strain).

3.7 Rescue Flight Contact List Template

The Lead Flight Director should use the following table to create a contact list for the Rescue Flight. These disciplines should be represented at all critical planning meetings to ensure that good situational awareness is maintained during the compressed flight preparation timeframe.

<i>Area</i>	<i>Mail Code</i>	<i>Contact</i>	<i>Phone Number</i>	<i>E-mail</i>
SSP PROGRAM OFFICE				
Flight Manager	MO			
Mission Integration Mngr	MO3			
USA Flight Manager	USA			
ISS PROGRAM OFFICE				
Launch Package Manager	OC			
Launch Package Engineer	OC			
Launch Package Engineer	OC			
Increment Manager	OC3			
Increment Engineer	OC3			
Increment Engineer	OC3			
VIPeR	OM5			
VIPeR (LTA)	OM5			
VIPeR (Energy Balance)	GRC			
SIR/SAR Manager	OM5			
Assembly and Configuration	OM5			
MAGIK	OM			
Payloads	OZ			
Manifest	OC			
ENGINEERING				
TCS	EA			
Energy Balance (for VIPeR)	EA			
EVA PROJECT OFFICE				
EVA Project Manager	XA			
CREW OFFICE				
Shuttle Crewmember (CDR)	CB			
Shuttle Crewmember (PLT)	CB			
Shuttle Crewmember (MS1)	CB			
Shuttle Crewmember (MS2)	CB			

Verify that this is the correct version before use.

<i>Area</i>	<i>Mail Code</i>	<i>Contact</i>	<i>Phone Number</i>	<i>E-mail</i>
BOEING				
Launch Package Manager	BHOU			
Operations Flight Lead	BHOU			
EVA Ops Lead	BHOU			
EVA Ops Backup	BHOU			
C&T Ops Lead	BHOU			
C&DH Ops Lead	BHOU			
Struc&Mech, Robotics Ops Lead	BHOU			
EPS Ops Lead	BHOU			
GNC, SMC Ops Lead	BHOU			
Thermal Ops Lead	BHOU			
ECLSS Ops Lead	BHOU			
TCS Design Lead	BHOU			
Thermal (LTA)	BHOU			
Thermal	BHOU			
SIR Team Manager	BHOU			
Safety	BHOU			
VIPeR	BHOU			
VIPeR	BHOU			
VIPeR (Assembly and Config)	BHOU			
VIPeR (Mass Properties)	BHOU			
GN&C	BHOU			
Structures and Mechanisms	BHOU			
Structures and Mechanisms	BHOU			
P3/S3 Element Manager	BHB			
EVA	BHB			
EVA	BCP			
12A Element Manager	BCP			
EPS	BCP			
EPS Ops	BCP			
Engineering	BCP			
MOD				
Shuttle Flight Director (Lead)	DA8			
Shuttle A/E Flight Director	DA8			
Shuttle Flight Director (O2)	DA8			
Shuttle Flight Director (O3)	DA8			
ISS Flight Director (Lead)	DA8			
MOD Flight Manager	DA6			
ACO	DO5			
ACO Systems	DO5			
ACO Systems	DO5			
ACO Transfer	DO5			
FAO	DO4			
Timeliner	DO4			
Ops Planner	DO4			
Ops Safety	DA8			
FDf Coordinator	DO3			
SODF Coordinator	DO3			
SODF Coordinator Backup	DO3			

Verify that this is the correct version before use.

<i>Area</i>	<i>Mail Code</i>	<i>Contact</i>	<i>Phone Number</i>	<i>E-mail</i>
MOD (CONTINUED)				
EVA Lead	DX32			
EVA Task	DX32			
EVA Systems	DX35			
ROBO (Lead)	DX22			
PDRS	DX22			
ROBO Mission Designer	DX22			
ROBO Mission Designer	DX22			
PDRS Mission Designer	DX22			
CATO	DF23			
DPS	DF22			
ECLSS	DF83			
EECOM	DF82			
EGIL	DF73			
FDO	DM32			
Flight Design Manager	DM			
Flight Design Manager Backup	DM			
GNC	DF61			
INCO	DF24			
MCS (ADCO)	DF64			
MCS (ADCO)	DF64			
MMACS	DF52			
ODIN	DF25			
OSO (Lead/SSAS)	DF53			
OSO (CAS)	DF53			
PHALCON (Lead)	DF74			
PHALCON	DF74			
PRO	DF75			
PRO	DF75			
PRO	DF75			
PROP	DF63			
RIO	DO13			
THOR (Lead)	DF84			
THOR (Lead Backup)	DF84			
TOPO	DM3			
Station Training	DT26			
Shuttle Training (Lead)	DT32			
Training (DPS/Nav)	DT35			
Training (Cntrl/Prop)	DT34			
Training (Comm)	DT37			
Training (Systems)	DT36			
Training (PDRS)	DX25			
Training (Rndz)	DT35			
Training (P/L)	DT37			
Training (P/L)	DT37			
Training (STE)	DT			
Sim Sup	DT32			
Training Manager	DT32			

Verify that this is the correct version before use.

<i>Area</i>	<i>Mail Code</i>	<i>Contact</i>	<i>Phone Number</i>	<i>E-mail</i>
MEDICAL OPS				
STS-115 BME Manager	SD			
Exp 11 BME Manager	SD			
Exp 11 Flight Surgeon	SD			
Shuttle Flight Surgeon	SD			
POIC				
Exp 11 Payload Ops Dir	MSFC			

3.8 Rescue Flight Pre-Call-up Online Information

For each shuttle flight for which the Space Shuttle Program Office has designated that a Rescue Flight capability be provided, a certain amount of work will be done by MOD in the pre-flight timeframe to make sure that a Rescue Mission can be mounted in the approximately 30 days available post-call-up. This includes such work as the Flight Design, Software Load preparation, and consumables analysis. These items are prepared and archived by the preparing organizations and should be referred to by anyone with questions regarding the capability or execution of a Rescue mission. The following Internet links are provided as guidance to finding this material.

The EXCEL spreadsheet at this location has links to the majority of documents used for flight analysis, including the Level A GR&C, EPS Consumables Memo, MIP, etc. The versions of the documents the FIDP is linked to are what all Flight Design analysis is supposed to use for the current production cycle.