

## Space Flight Operations Contract

---

# Entry, TAEM, and Approach/Landing Guidance Workbook 21002

January 23, 2006

Contract NAS9-20000

*Copyright © 2004 by United Space Alliance, LLC. These materials are sponsored by the National Aeronautics and Space Administration under Contract NAS9-20000. The U.S. Government retains a paid-up, nonexclusive, irrevocable worldwide license in such materials to reproduce, prepare derivative works, distribute copies to the public, and to perform publicly and display publicly, by or on behalf of the U.S. Government. All other rights are reserved by the copyright owner.*



## Entry, TAEM, and Approach/Landing Guidance Workbook 21002

Prepared by

*Original approval obtained*

---

J. W. (Wesley) Penny, Entry Guidance/TAEM SME  
DT34/Guidance & Control/Propulsion

*Original approval obtained*

---

Mark A. Veile, Approach/Landing Guidance SME  
DT34/Guidance & Control/Propulsion

Approved by

*Original approval obtained*

---

Miguel A. Sequeira, Manager  
DT34/Guidance & Control/Propulsion

**REVISION LOG**

<b>Rev. letter</b>	<b>Change no.</b>	<b>Description</b>	<b>Date</b>
Basic		USA number issued; supersedes TD357 and TD1008. Current for OI-30	01/23/2006

LIST OF EFFECTIVE PAGES

The status of all pages in this document is shown below:

<u>Page No.</u>	<u>Change No.</u>
Preface	Basic
Foreword	Basic
i - vi	Basic
1-1 – 1-2	Basic
2-1 – 2-56	Basic
3-1 – 3-38	Basic
4-1 – 4-28	Basic
A-1 – A-3	Basic
B-1 – B-4	Basic

## PREFACE

The content of this document was provided by the United Space Alliance (USA) Guidance and Control/Propulsion Department, Space Flight Training and Facility Operations Division, Mission Operations Directorate (MOD), Lyndon B. Johnson Space Center (JSC), National Aeronautics and Space Administration (NASA). Technical documentation support was provided by Integrated Documentation Services (IDS). Any questions concerning this workbook or any recommendations should be directed to the book managers.

This training manual is for training purposes only and should not be used as a source of operational data. All numerical data, display, and checklist references are intended as examples. To determine any prerequisites before using this document, consult your applicable Certification Plan. For shuttle manuals, consult the appropriate flight controller's certification guide (Blue Book) or the Crew Training Catalog. For International Space Station manuals, consult the appropriate Space Station Certification Guide or Training Administration Management System (TAMS). The applicable training package should be studied before attending any classroom session or lesson for which this is a prerequisite.

If this workbook is being read as part of a formal syllabus, the reader should complete the training materials evaluation form at the end of the document. The evaluation form does not need to be signed.

## **FOREWORD**

The purpose of this Entry, TAEM, and Approach/Landing Guidance Training Manual is to familiarize readers with Entry, TAEM, and Approach/Landing guidance techniques for the space shuttle and the Mission Control Center (MCC) at the Johnson Space Center. For a more detailed look at the Entry/TAEM and A/L Guidance software please see the Entry through Landing Guidance Functional Subsystem Software Requirements (FSSR) document. The TAEM section of the FSSR is summarized in the TAEM Guidance Workbook (USA009973).

## CONTENTS

Section	Page
<b>1.0 INTRODUCTION TO DESCENT GUIDANCE .....</b>	<b>1-1</b>
<b>2.0 ENTRY GUIDANCE .....</b>	<b>2-1</b>
2.1 INTRODUCTION.....	2-1
2.2 OBJECTIVES.....	2-1
2.3 WHAT IS ENTRY GUIDANCE? – FROM DEORBIT TO MACH 2.5 .....	2-2
2.4 ENTRY GUIDANCE AT A GLANCE – WHAT YOU REALLY NEED TO KNOW .....	2-3
2.5 DOWNRANGE CONTROL – DESIRED ALTITUDE RATE .....	2-4
2.5.1 Step 1 – How Much Drag Do I Need? .....	2-4
2.5.2 Step 2 – How Do I Get This Drag Level? .....	2-6
2.5.3 How Do I Get to Desired Hdot?.....	2-7
2.5.4 Secondary Drag Control – Alpha Modulation .....	2-7
2.6 CROSSRANGE CONTROL – KEEP DELAZ SMALL .....	2-8
2.6.1 Now You Can Practice What You Have Learned.....	2-8
2.7 HOW NOT TO FLY ENTRY GUIDANCE – BANK UNTIL THE BUG MOVES .....	2-9
2.8 ENTRY GUIDANCE CONSTRAINTS .....	2-10
2.8.1 Constraint 1: Small Changes in Alpha.....	2-10
2.8.2 Constraint 2: Do Not Exceed Maximum Drag .....	2-11
2.8.3 Constraint 3: Minimum Drag – Minimum Lift .....	2-13
2.9 EQUILIBRIUM GLIDE BOUNDARY – NEGATIVE H-DOUBLE-DOT BOUNDARY.....	2-15
2.10 HOW MUCH DRAG IS ENOUGH? – REFERENCE DRAG .....	2-16
2.11 HOW DO YOU STAY ON DRAG PROFILE .....	2-20
2.11.1 Reference Hdot – For No Drag Error .....	2-20
2.12 REFERENCE ROLL – FOR NO HDOT ERROR.....	2-22
2.12.1 Reference Roll as H-Double-Dot Equal to Zero .....	2-23
2.12.2 Reference Roll Angle as an Indication of Your Energy State .....	2-24
2.12.3 Reference Roll as Your Steady-State Bank Angle .....	2-24
2.13 HOW DO YOU GET ON DRAG PROFILE? – HDOT DESIRED .....	2-24
2.13.1 Desired Altitude Rate – All the Time .....	2-25
2.13.2 Alpha Modulation – For Small Drag Errors.....	2-25
2.14 HOW DO YOU CONTROL CROSSRANGE? .....	2-26
2.14.1 Keep Delaz Small – Roll Reversals.....	2-26
2.14.2 If Low Energy – Minimum Bank Angle .....	2-27

<b>Section</b>	<b>Page</b>	
2.15	MONITORING AUTO GUIDANCE DURING A NOMINAL ENTRY.....	2-28
2.15.1	Preentry Guidance – Just Attitude Hold .....	2-28
2.15.2	Closed-Loop Guidance Initiate.....	2-28
2.15.3	The First Roll – Hdot Control.....	2-29
2.15.4	Roll Reversals.....	2-30
2.16	MONITORING AUTO GUIDANCE DURING A TAL ENTRY .....	2-31
2.16.1	While Drag Is Still Zero, Cannot Tell Energy State .....	2-31
2.16.2	Into the Atmosphere – A Big Drag Spike.....	2-31
2.17	DEORBIT BURN AND ENTRY GUIDANCE.....	2-33
2.18	REI TARGETING .....	2-34
2.19	FLIGHTPATH ANGLE TARGETING.....	2-34
2.20	DEORBIT BURN DOWNMODING .....	2-36
2.20.1	Downmoding Before the Deorbit Burn Starts .....	2-36
2.20.2	Downmoding After the Deorbit Burn Starts .....	2-39
2.20.3	The Flight Rule States.....	2-40
2.21	ENTRY GUIDANCE DISPLAYS AND FDF .....	2-41
2.21.1	TRAJ Displays .....	2-41
2.22	ENTRY ALPHA CUE CARD.....	2-49
2.22.1	The Five Phases and Transitions.....	2-50
<b>3.0</b>	<b>TAEM GUIDANCE .....</b>	<b>3-1</b>
3.1	TAEM GUIDANCE OBJECTIVES .....	3-1
3.2	OVERVIEW.....	3-1
3.2.1	TAEM Operation – Start and Stop .....	3-1
3.2.2	TAEM Profile – Heading Alignment Cone .....	3-2
3.2.3	TAEM Guidance Phases.....	3-3
3.2.4	Inputs Required by TAEM .....	3-3
3.3	DISPLAYS .....	3-3
3.3.1	Vertical Situation Display .....	3-4
3.3.2	Horizontal Situation Display (HORIZ SIT – SPEC 50).....	3-7
3.3.3	Attitude Direction Indicator .....	3-9
3.3.4	The Horizontal Situation Indicator .....	3-10
3.3.5	Heads-Up Display .....	3-12
3.4	TAEM GUIDANCE IN DETAIL .....	3-14
3.4.1	Pitch Commands – Glide Slope, Energy, Airspeed (KEAS, qbar), Nz .....	3-14
3.4.2	Roll Commands – Ground Track.....	3-17
3.4.3	Acquisition – Point at the Heading Alignment Cone Tangency ....	3-18
3.4.4	Heading Alignment.....	3-19
3.4.5	Prefinal.....	3-20
3.4.6	Speedbrake Commands .....	3-20



<b>Section</b>	<b>Page</b>
3.5	HIGH ENERGY OPTIONS..... 3-21
3.5.1	Fly Maximum Airspeed..... 3-21
3.5.2	Open the Speedbrake ..... 3-22
3.5.3	S-Turn ..... 3-22
3.5.4	Change Runway..... 3-23
3.5.5	Fly Outside (expand) the HAC ..... 3-23
3.6	LOW ENERGY OPTIONS..... 3-24
3.6.1	Fly Maximum Lift Over Drag ..... 3-24
3.6.2	Close the Speedbrake..... 3-24
3.6.3	Straight-In HAC and Minimum Entry Point ..... 3-24
3.6.4	Change Runway..... 3-29
3.6.5	HAC Shrink ..... 3-29
3.7	MESSAGES AND CAUTION AND WARNING..... 3-30
3.8	LARGE HAC TURN ANGLES ..... 3-30
3.9	NO AIR DATA IN TAEM..... 3-31
3.9.1	Default Air Data..... 3-31
3.9.2	Theta Limits ..... 3-31
3.10	TAEM OPERATIONAL NOTES ..... 3-34
<b>4.0</b>	<b>APPROACH AND LANDING ..... 4-1</b>
4.1	OVERVIEW..... 4-1
4.2	APPROACH AND LANDING TRAJECTORY DESIGN ..... 4-5
4.2.1	Trajectory Capture ..... 4-5
4.2.2	Outer Glide Slope ..... 4-7
4.3	SPEEDBRAKE RETRACTION..... 4-11
4.4	PREFLARE AND INNER GLIDE SLOPE ..... 4-12
4.5	FINAL FLARE AND TOUCHDOWN..... 4-13
4.6	MANUAL PROCEDURES AND MONITORING ..... 4-17

## APPENDIXES

### Appendix

<b>A</b>	<b>ACRONYMS AND ABBREVIATIONS ..... A-1</b>
<b>B</b>	<b>ANSWERS ..... B-1</b>

## TABLES

<b>Table</b>	<b>Page</b>
1-1 Entry events.....	1-2
2-1 TACAN approach and entry guidance .....	2-10
2-2 Display limits.....	2-47
3-1 HSI display parameter/mode switch matrix .....	3-12
3-2 Guidance roll command limits during TAEM phases .....	3-18
4-1 Longitudinal guidance phase description.....	4-5
4-2 Common phrases for WOW and WONG .....	4-16

## FIGURES

### Figure

1-1 Typical ground track .....	1-1
1-2 Typical altitude versus range .....	1-2
2-1 Entry guidance timeline .....	2-2
2-2 Relation of Nav, guidance, and DAP .....	2-3
2-3 Downrange and crossrange.....	2-4
2-4 ENTRY TRAJ 1 display orbiter bug at a drag of 8 and the drag arrow at 8 .....	2-5
2-5 Bank to control vertical lift.....	2-7
2-6 Altitude versus velocity boundaries, the entry corridor .....	2-11
2-7 Maximum drag boundaries .....	2-12
2-8 Lift requirements for different speeds .....	2-13
2-9 Equilibrium glide boundary family of curves.....	2-14
2-10 The equilibrium glide drag boundary .....	2-15
2-11 Nominal drag profile .....	2-17
2-12 High-energy drag profile – small increase throughout entry .....	2-17
2-13 High-Mach reference drag profile .....	2-18
2-14 Mid-Mach reference drag profile.....	2-19
2-15 Low-Mach reference drag profiles .....	2-19
2-16 Entry Alpha cue card .....	2-21
2-17 Depiction of H-double-dot, reference roll, and maintaining drag profile .....	2-23
2-18 Delaz for roll reversal.....	2-26
2-19 TRAJ 1 display at the first nonzero roll command .....	2-29
2-20 TRAJ display during a TAL .....	2-32
2-21 Deorbit maneuver display .....	2-33
2-22 Deorbit burn targets.....	2-34

<b>Figure</b>	<b>Page</b>
2-23 Apollo and shuttle flightpath angle envelopes.....	2-35
2-24 Example of steep reentry target line .....	2-36
2-25 Effect of inclination and weight on the drag boundaries .....	2-37
2-26 Target line for downmode cases.....	2-39
2-27 Prebank table example from the Entry Checklist .....	2-41
2-28 Example of TRAJ 1 .....	2-42
2-29 TRAJ lines in drag versus velocity.....	2-44
2-30 TRAJ lines on TRAJ 1 .....	2-45
2-31 TRAJ lines on TRAJ 2 .....	2-45
2-32 TRAJ lines on TRAJ 3 .....	2-46
2-33 TRAJ lines on TRAJ 4 .....	2-46
2-34 TRAJ lines on TRAJ 5 .....	2-47
2-35 Entry Alpha cue card example.....	2-50
2-36 Entry guidance phase.....	2-51
2-37 Temperature control phase .....	2-52
2-38 Equilibrium glide phase.....	2-52
2-39 Constant drag phase .....	2-53
2-40 Transition phase .....	2-53
3-1 TAEM flight profile .....	3-2
3-2 VERT SIT 1 display .....	3-5
3-3 $\Theta$ limits and E/W scale.....	3-6
3-4 SPEC 50 HORIZ SIT display .....	3-8
3-5 SPEC 50 HORIZ SIT display .....	3-9
3-6 ADI roll, pitch, and yaw rate.....	3-10
3-7 TAEM HSI definitions .....	3-11
3-8 HUD symbology.....	3-14
3-9 Glide slope as seen on the VERT SIT display Pitch command to control glide slope - frame 1) .....	3-15
3-10 Glide slope as seen on the VERT SIT display (Below glide slope - frame 2) .....	3-15
3-11 Glide slope as seen on the VERT SIT display (Above glide slope - frame 3) .....	3-16
3-12 Transonic bank limits.....	3-18
3-13 HAC configuration .....	3-19
3-14 Speedbrake schedule.....	3-21
3-15 Normal S-turn .....	3-22
3-16 S-turn phase – initiation and termination .....	3-23
3-17 Energy saving for straight-in and MEP .....	3-25
3-18 Effect of straight-in approach.....	3-27
3-19 Effect of MEP.....	3-28
3-20 Altitude Error to Trigger HAC shrink .....	3-29
3-21 Theta limits versus roll angle .....	3-33

**Figure**

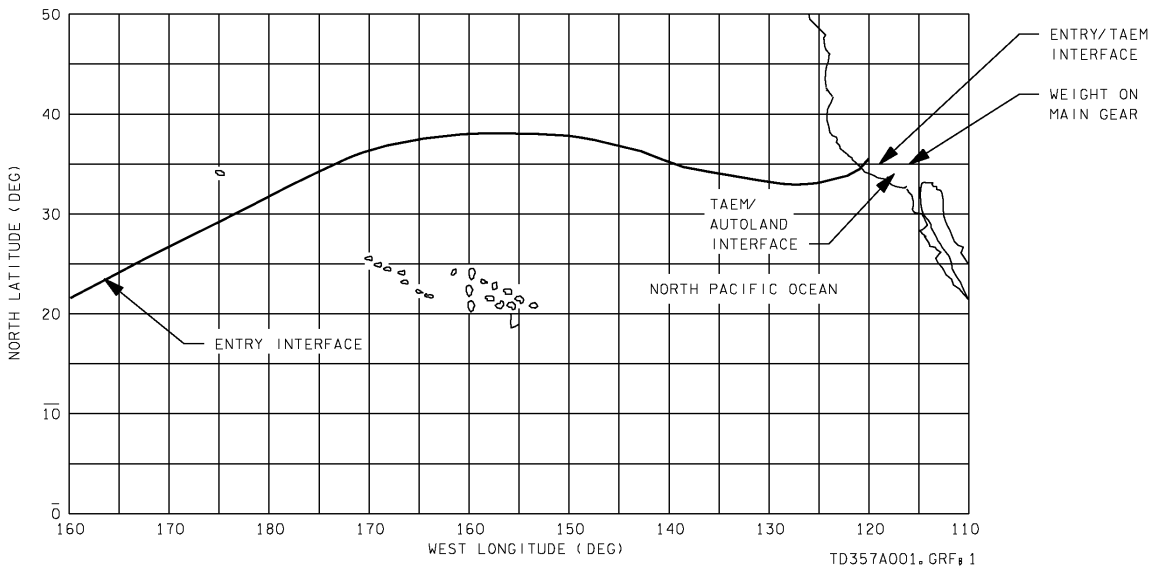
3-22	Low energy above glide slope .....	3-36
3-23	Above glide slope (frame 3).....	3-37
3-24	Low energy below glide slope.....	3-38
4-1	TAEM approach and landing interface .....	4-2
4-2	HUD symbology.....	4-4
4-3	Approach and landing trajectory .....	4-6
4-4	Steep glide slope options.....	4-7
4-5	Weight item on Deorbit Maneuver Coast display.....	4-8
4-6	Aimpoint selection on SPEC 50.....	4-9
4-7	PAPI system geometry for the outer glide slope.....	4-10
4-8	Preflare geometry .....	4-12
4-9	Final flare profile .....	4-14
4-10	NWS schematic.....	4-17
4-11	VERT SIT 2 with A/L displayed.....	4-18
4-12	HUD view at 10,000 ft altitude .....	4-19
4-13	HUD view at 5000 ft altitude, 300 KEAS.....	4-20
4-14	HUD view at 3000 ft altitude .....	4-21
4-15	HUD view at 2000 ft altitude and 310 KEAS.....	4-22
4-16	HUD view at 300 ft and 282 KEAS .....	4-23
4-17	HUD view at 100 ft and 212 KEAS .....	4-24
4-18	HUD view just before main landing gear touchdown .....	4-25
4-19	HUD view just after main landing gear touchdown (WOW set) .....	4-26
4-20	HUD view just after nose gear touchdown (WONG/rollout flag set).....	4-27
4-21	Entry Maneuvers Cue Card .....	4-28

## 1.0 INTRODUCTION TO DESCENT GUIDANCE

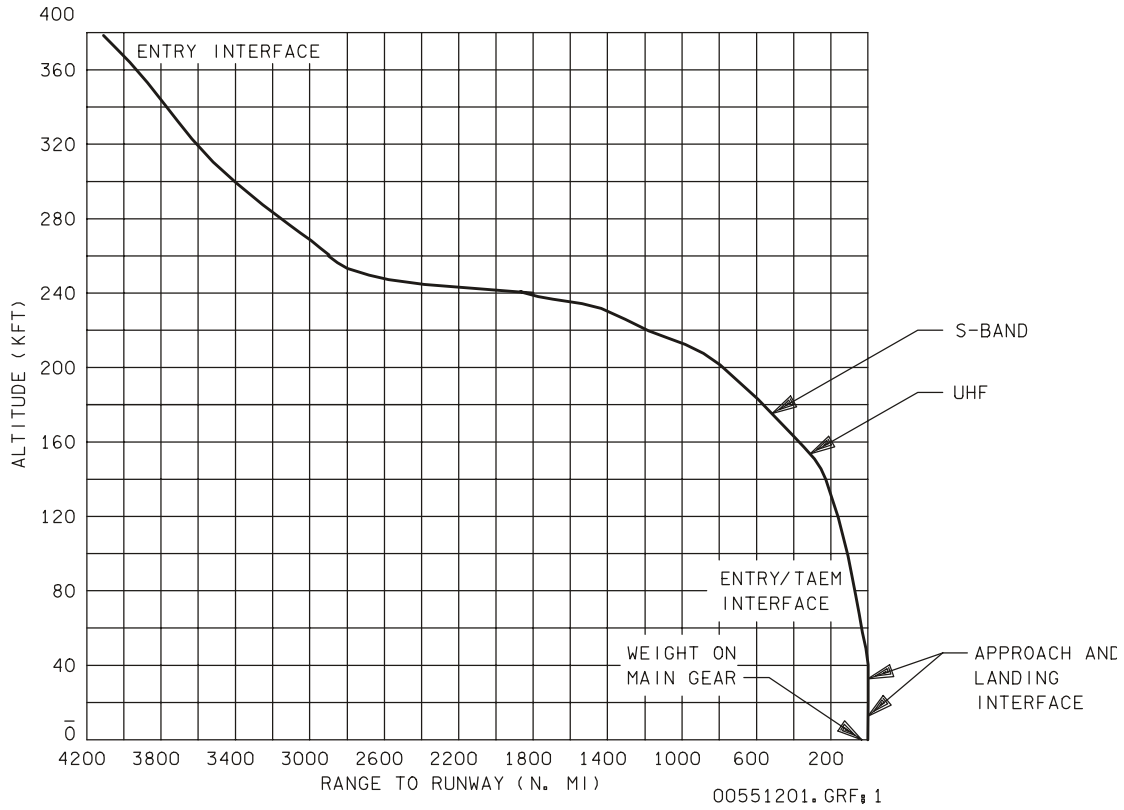
The entry flight phase starts with the Orbital Maneuvering System (OMS) burn that targets the shuttle for the Entry Interface (EI). This burn ensures atmospheric capture within vehicle and guidance constraints. EI occurs at 400,000 ft altitude, typically 4300 nautical miles (nm) from the runway.

Separate computer algorithms are used by the shuttle between EI and wheel stop. They are entry guidance (aerobraking), Terminal Area Energy Management (TAEM, pronounced "tame"), and Approach and Landing (A/L). Entry guidance uses drag to control velocity (kinetic energy). TAEM starts at 2500 fps Relative Velocity (VREL) (Mach 3.2 on Return to Launch Site (RTLS)) and flies the shuttle like a conventional aircraft (unpowered aircraft). Once established on final, A/L guidance takes over until wheel stop.

A typical entry groundtrack for an Edwards Air Force Base (EAFB) landing is shown in Figure 1-1. The altitude versus range-to-go plot for this trajectory is seen in Figure 1-2. Table 1-1 shows the time scale for this entry Trajectory (TRAJ). A complete listing of entry events can be found in the Entry Flight Procedures Handbook.



**Figure 1-1. Typical ground track**



**Figure 1-2. Typical altitude versus range**

**Table 1-1. Entry events**

<b>Event</b>	<b>Time from EI (min: sec)</b>	<b>Velocity (<math>\times 10^3</math> ft/sec) Mach</b>
Entry interface	0:00	24.6
Closed-loop guidance initiate	4:00	24.5
Entry/TAEM interface	25:48	2.5 (3.2 RTLS)
TAEM/approach and landing interface	30:16	300 KEAS

## **2.0 ENTRY GUIDANCE**

### **2.1 INTRODUCTION**

This section of the Entry, TAEM, and Approach/Landing Guidance Workbook covers entry guidance. The other sections of the book cover TAEM and A/L guidance.

This section centers on teaching you how the orbiter flies when entry guidance is trying to get you home. Some of the technical details can be found in the appendixes.

### **2.2 OBJECTIVES**

After completing this section, the student will be able to

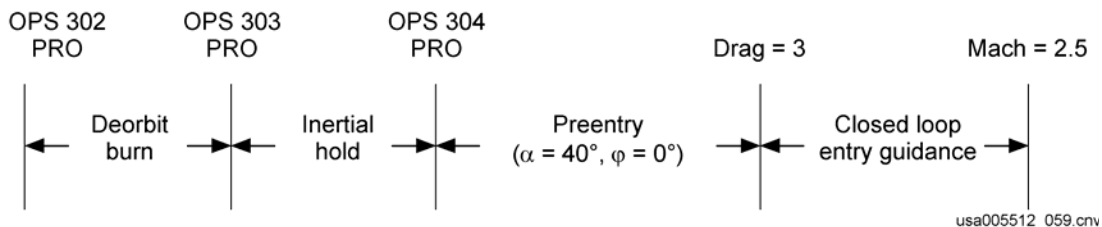
- a. Describe how to determine desired altitude rate
- b. Find the following from the TRAJ displays:
  1. Desired drag – From the drag scale and the orbiter bug
  2. Current drag
  3. Reference  $H_{dot}$  – From the bottom of the display and the lower right corner
  4. Reference alpha
  5. Current alpha
  6. Delta azimuth
  7. Reference roll
  8. Commanded roll
- c. Use a TRAJ display to determine
  1. Desired altitude rate
  2. If a roll reversal is required
  3. If the orbiter is violating a high drag boundary
  4. The energy state of the orbiter
- d. Label the boundaries; given a drag vs. velocity plot that contains the high and low drag boundaries
- e. State the implication of violating any of the drag boundaries

- f. Define high and low energy and state what guidance does in both of these cases
- g. State if Delta Azimuth (Delaz) is harder to control if you are high energy or if you are low energy; explain why
- h. State the two types of prebank

### 2.3 WHAT IS ENTRY GUIDANCE? – FROM DEORBIT TO MACH 2.5

Entry guidance is the guidance software that takes the orbiter from the deorbit burn down to a relative velocity of 2500 fps. It does not really start until the orbiter gets into enough air to generate a drag of 3 ft/sec<sup>2</sup>. Between the deorbit burn and this point, the orbiter is simply in attitude hold.

In a little more detail, the Entry Guidance Standard Operating Procedure (SOP) is not run until Operational Sequence (OPS) 304. From OPS 304, until a total acceleration of 0.132g (4.25 ft/sec<sup>2</sup>), entry guidance is simply holding 0° bank ( $\varphi$ ) and 40° alpha ( $\alpha$ ). Total acceleration of 0.132g occurs at 3 ft/sec<sup>2</sup> of drag. See Figure 2-1.



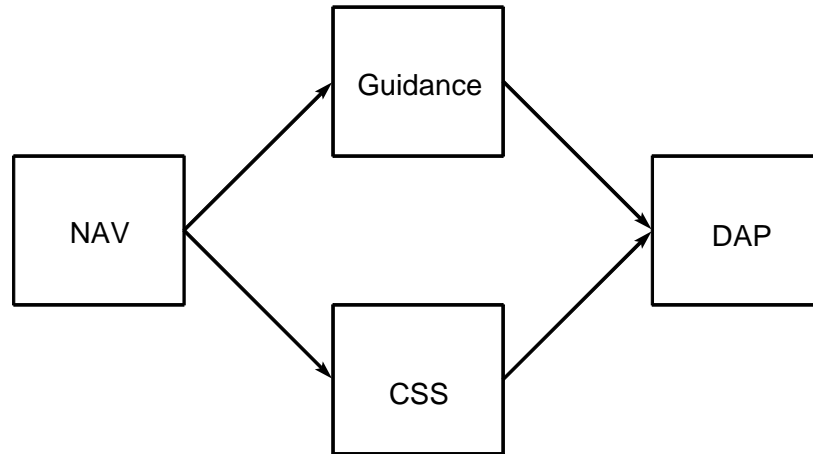
**Figure 2-1. Entry guidance timeline**

Like all the guidance algorithms, entry guidance lives in the General Purpose Computers (GPCs) between Navigation (Nav) and the Digital Autopilot (DAP).

Nav tells guidance where the orbiter is and how fast it is going. Guidance figures out what the orbiter needs to do to get home. DAP then moves the control surfaces and fires the reaction control jets to move the orbiter. The output of guidance is commanded roll angle and angle of attack.

Figure 2-2 shows a schematic of the three major algorithms. Of the three algorithms, guidance is the only one that can be replaced by the crew (Control Stick Steering – CSS).





**Figure 2-2. Relation of Nav, guidance, and DAP**

## **2.4 ENTRY GUIDANCE AT A GLANCE – WHAT YOU REALLY NEED TO KNOW**

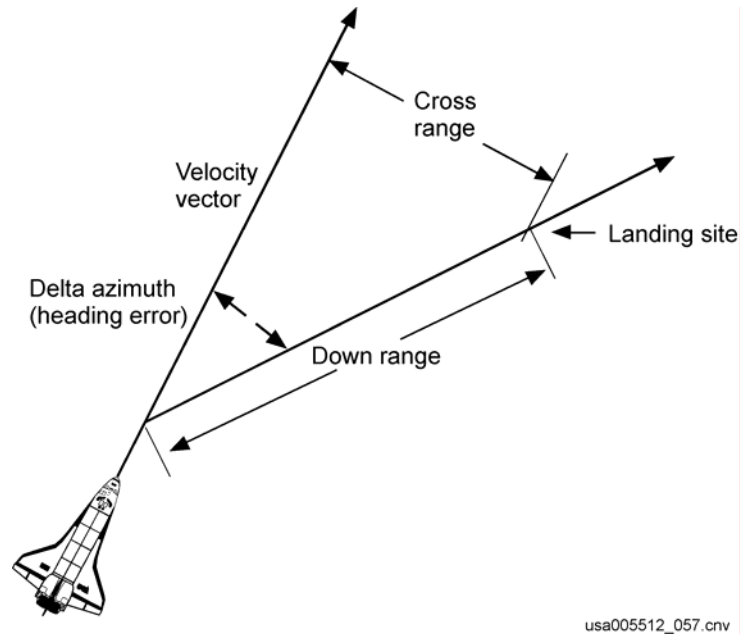
Read this section first. It tells you what you need to know to fly and monitor entry guidance.

This section is written like an instruction manual to tell you how to fly entry guidance. Auto guidance uses the techniques taught here. If you learn these techniques, you will also learn how to monitor auto entry guidance.

This section has two parts

- a. Downrange control
- b. Crossrange control

See Figure 2-3 for a definition of downrange and crossrange. This also shows Delaz. Delaz is the way crossrange is displayed in the cockpit of the orbiter.



**Figure 2-3. Downrange and crossrange**

## 2.5 DOWNRANGE CONTROL – DESIRED ALTITUDE RATE

Downrange control is accomplished through control of drag. There are two major steps in controlling drag

- a. How much drag do I need?
- b. How do I get to this drag level?


### 2.5.1 Step 1 – How Much Drag Do I Need?

The drag you need is called reference drag. It is a function of the current velocity and the current range to the landing site.

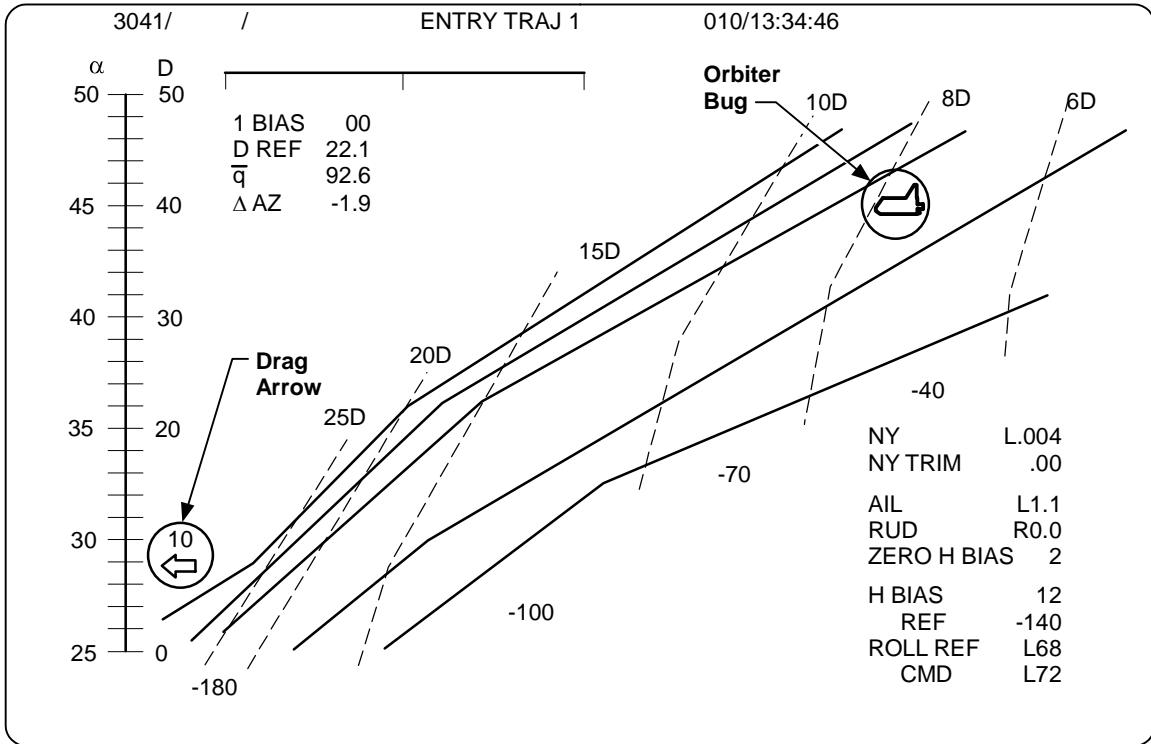
Reference drag is also called desired drag and commanded drag. The three terms (reference, desired, and commanded) all mean the same thing.

For a given velocity, you need more drag as the range to the site is decreased. If you are going Mach 17 and you are 900 miles from the site, you need a lot less drag than if you are 400 miles from the site.

Desired drag is too complex to “memorize,” so the primary entry displays are designed to give you desired drag. These displays are ENTRY TRAJ 1 through 5. See Figure 2-4 for a copy of TRAJ 1.

The nose of the orbiter bug (  ) is placed on the display as a function of velocity and range. Velocity is the vertical placement and range is the horizontal placement. Interpolate between the dashed drag lines to get your desired drag.

Note: The orbiter bug gives you desired drag.



**Figure 2-4. ENTRY TRAJ 1 display orbiter bug at a drag of 8 and the drag arrow at 8**

Note: On ENTRY TRAJ 4 and 5, the orbiter bug is actually placed vertically by total energy instead of velocity. This distinction is not important to the crew. Most of the total energy is contained in velocity.

The entry guidance algorithms are also working real time to calculate your desired drag. This drag is displayed as the arrow on the drag scale on the left side of the TRAJ display.

The example in Figure 2-4 shows that the desired drag is 8. The orbiter bug is at the 8 drag line and the drag arrow is at 8.

**WARNING**

Upper left-hand corner of the TRAJ display is not your reference drag. This is the drag the phugoid damper wants. It is not the drag that will get you home.

The triangle on the drag scale is your current drag. Your goal is to make the current drag equal to the desired drag. If you do this, you will get home!

## 2.5.2 Step 2 – How Do I Get This Drag Level?

The primary way to control drag is to control altitude. The secondary way is to change the angle-of-attack ( $\alpha$ ).

### 2.5.2.1 Primary Drag Control – Hdot

You do not need to think of your actual altitude. Drag is the surrogate altitude; if you like the current drag, you like the current altitude. However, you must always think in terms of altitude rate (Rate of Change of Altitude (Hdot)).

The Hdot you want when you have no drag error is called reference Hdot. It goes from about -40 ft/sec during early entry, to about -250 during late entry.

**Note: Reference Hdot is your no-drag-error Hdot.**

### 2.5.2.2 Where Do I Get Reference Hdot?

You can get it from three places.

- a. Along the bottom of the TRAJ display: This is the lowest quality place, but it is always available.
- b. The Entry Alpha cue card: This is the next highest quality, and it is always available. See Figure 2-35 for an example of the cue card.
- c. The lower right-hand portion of the TRAJ display: Like the reference drag arrow, this is being output by the entry guidance algorithm. If you do not trust auto guidance, you do not trust this number, either. Use one of the other two places to get reference Hdot if guidance is bad.

### 2.5.2.3 How Do I Remove Drag Errors? – Desired Hdot

Reference Hdot is great if you have no drag error. You will, however, need a different Hdot if you do have a drag error.

If you need more drag, you need to get down into the thicker air. You need more Hdot (more negative Hdot).

A good rule of thumb is to bias Hdot by 20 times drag error. (Auto guidance can use over 35 times the drag error, but this is too much for manual flying.)

In the form of an equation,

$$\text{Hdot Desired} = \text{Hdot Ref} + 20 \times (\text{Dcurrent} - \text{Ddesired})$$

You are probably asking, “How am I supposed to fly the fastest manned vehicle in the known universe and do math in my head?” Well, it is not that bad.

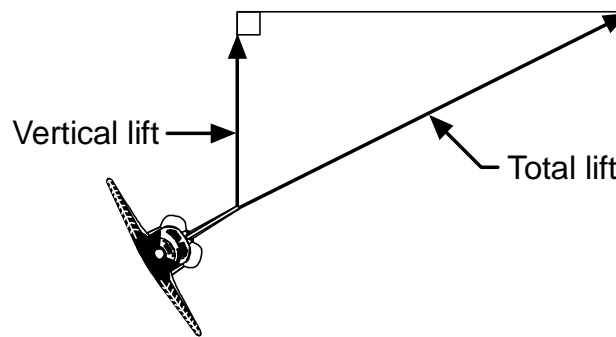
First, after you fly for a while, you will not have to do math. You will see that you need more drag and throw in a handful of Hdot. A big drag error needs a big handful; a small drag error needs a small handful.

Second, you are not alone, so split up the workload. Somebody calculates the desired Hdot; the other flies to desired Hdot.

### 2.5.3 How Do I Get to Desired Hdot?

In most aircraft, if you want to go down, you push on the stick and decrease your lift. In the shuttle at high Mach (>2.5), you must maintain your alpha within a very small window. You cannot use pitch to control lift.

You use bank to control vertical lift. At 90° of bank, vertical lift is zero. See Figure 2-5.



usa005512\_010.cnv

**Figure 2-5. Bank to control vertical lift**

It is a simple flying task to use bank to get to a desired Hdot. The shuttle is equipped with an altitude acceleration (H-double-dot) tape. H-double-dot is immediately changed as bank angle changes. Use bank to drive H-double-dot in the correct direction to get Hdot where you need it.

At first, you may find it difficult to determine the desired Hdot and to fly to this Hdot. Use a little crew coordination and break up the workload. After a while, you will find that you do not need to use the equation precisely, and the task of flying to the desired Hdot will become easier. When this happens, you can do manual entries by yourself.

### 2.5.4 Secondary Drag Control – Alpha Modulation

You can instantly change your drag a little bit by changing your alpha. This immediately removes small drag errors.

However, a perfectly good entry is possible without alpha modulation. In fact, the original entry guidance did not even have alpha modulation. Before STS-1 flew, they decided to add the “vernier” drag control of alpha modulation.

Two rules to follow with alpha modulation are

- a. Never change alpha by more than  $\pm 3^\circ$  from nominal.
- b. Always use the Hdot bias, even if the modulation removes the drag error. This bias is called alpha demodulation.

There is also a third rule. If you are getting busy, stop using it. You do not need it and it adds a lot to your workload. It is mentioned here only because auto entry guidance uses it.

## **2.6 CROSSRANGE CONTROL – KEEP DELAZ SMALL**

Now that you know how to control downrange, you need to know how to control crossrange. Crossrange control is very easy; keep the “pointy” end of the orbiter pointed at the landing site. This pointy end is actually the velocity vector.

Since you are using bank to control altitude, you cannot just point at the site and roll out wings level.

Here is what you do: After you are pointed at the site (Delaz equals zero), you stay banked and Delaz becomes bigger. When it gets too big, you just reverse the direction of bank. You are now banked back toward the site and Delaz will become smaller.

This reversal of the bank direction is called a roll reversal. You do roll reversals when Delaz is between  $10.5^\circ$  and  $17.5^\circ$ .

Delaz is displayed on the upper left portion of the TRAJ display and by the primary bearing pointer on the Horizontal Situation Indicator (HSI). Delaz is negative when the landing site is to the right.

Note: The Backup Flight System (BFS) TRAJ display does not have Delaz. You must use the HSI.

Roll reversals always make Hdot smaller (a smaller negative number) than desired. You will always need a negative H-double-dot after a roll reversal to get back to desired Hdot.

You should also use a large roll rate (5 deg/sec). This minimizes the time spent at a bad (small) bank angle.

### **2.6.1 Now You Can Practice What You Have Learned**

You are now ready to practice what you have just learned. Go through USA007365, Entry Guidance Computer-Based Training (CBT). The CBT teaches you entries in the following five stages:

- a. Drag control once per Mach
- b. Drag control real time
- c. Hdot control once per Mach
- d. H-double-dot control real time
- e. Bank control real time

You may find it difficult when you get to bank control. Get a friend to split up the workload. One of you will calculate the desired Hdot; the other will use bank to get to that Hdot.

## **2.7 HOW NOT TO FLY ENTRY GUIDANCE – BANK UNTIL THE BUG MOVES**

Many people try to fly entry by banking to control the orbiter bug. If the bug is to the left of the nominal line, they will overbank until the bug moves back toward the nominal line. There is a major problem with this technique because there can be up to a 2-minute lag between putting in the bank and the bug moving.

This direct control of the bug and predictors is useful on ascent and in TAEM. The predictors on ascent respond immediately to pitch, as does the orbiter bug pitch attitude in TAEM (about a 5-second lag).

Flying bank to control the orbiter bug in entry guidance is like flying bank to control course on a Tactical Air Navigation (TACAN) approach. If you see yourself left of course, do you bank right until you see yourself on course? No. If you did this, you would have such a large heading-crossing angle that you would overshoot your course. This is exactly what happens if you do the same during entry guidance.

On a TACAN approach, you bank right until you get a heading that will take you back to your desired course. After you are on course, you use bank to get back to a heading that will keep you on course.

On the TACAN approach, heading is your lead term. If you have a course error, you bank until your lead term gives you a correction back to course. On entry guidance, Hdot is your lead term. If you have drag error, you bank until your lead term gives you a correction back to desired drag. See Table 2-1 for a correlation of TACAN approach and entry guidance.

**Table 2-1. TACAN approach and entry guidance**

<b>Term</b>	<b>TACAN</b>	<b>Entry guidance</b>
Primary	Desired course	Desired drag
Lead	Heading	Hdot
Control	Bank/turn rate	Bank/H-double-dot

## **2.8 ENTRY GUIDANCE CONSTRAINTS**

This section describes the constraints placed on entry guidance. It is important to note that alpha is the only “real-time” constraint. The others constrain the deorbit burn and constrain the design of entry guidance. In other words, entry guidance does not have a real-time test to see if desired drag is greater than maximum drag. We just make sure that the deorbit burn prevents desired drag from exceeding maximum.

### **2.8.1 Constraint 1: Small Changes in Alpha**

In most aircraft, you pitch down to go down. Unfortunately, the orbiter must be flown in a narrow alpha envelope ( $\pm 3^\circ$ ). If you pitch down too much, you will go out of control because of a thing called C-N-beta dynamic, or you will burn the tail off.

As Mach drops below about 12, the nominal alpha begins to decrease. This decrease in alpha is allowed because the tail does not burn off at these lower Mach numbers.

As stated earlier, alpha must be kept within  $3^\circ$  of nominal. This small alpha envelope forces us to use bank to control altitude. The next time you hear someone talk about the shuttle doing roll reversals to bleed off energy, do not listen. *The shuttle does roll reversals because it has a very small alpha envelope.*

#### **2.8.1.1 The Entry Corridor – or Why So Much Drag?**

Drag is a unit of force – right? Wrong! It is a unit of acceleration. Forget what you may have learned in school; we measure drag in  $\text{ft}/\text{sec}^2$ . Drag acceleration is, by definition, the rate of change of velocity and is measured by the Inertial Measurement Units (IMUs).

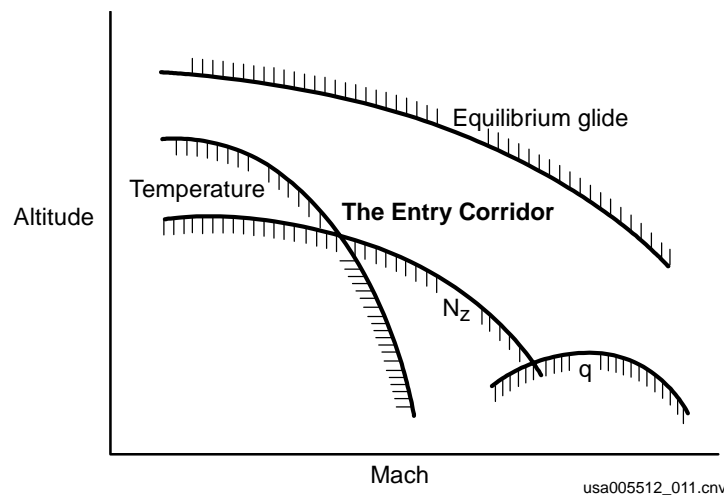
The world of entry requires a lot of thought about drag acceleration. I will not bore you with the math here, but the drag vs. velocity profile you fly defines the range you will fly. This range flown is very important. If you are 4000 miles away from the runway while going Mach 25, it is very important to go 4000 miles while you slow down to landing speed.

Note: Entry guidance takes you down to 2500 fps VREL, 60 miles from the runway. TAEM guidance takes you the rest of the way.



Figure 2-6 shows the entry corridor in terms of altitude. This is the last time you will see it in terms of altitude. You will always see it in terms of drag. However, it is very important that you keep this altitude concept in your head. As you are flying entries, picture an orbiter in your mind. As it moves up and down, you are controlling drag, temperature, normal acceleration ( $N_z$  wing loading), and dynamic air pressure ( $q$ bar) Knots Equivalent Airspeed (KEAS)). This mental picture is very helpful in flying entry guidance.

The high altitude boundary is a “soft” boundary. The orbiter stays in one piece if you violate it. You cannot generate enough lift to stay up in that thin air. It is actually a minimum lift boundary.



**Figure 2-6. Altitude versus velocity boundaries, the entry corridor**

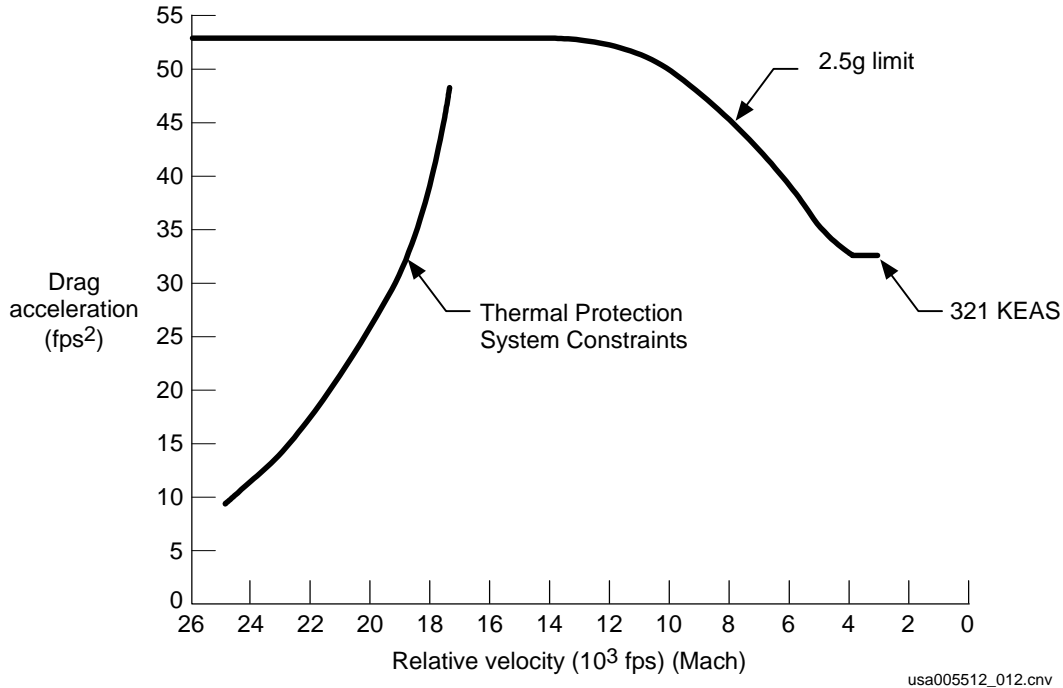
### 2.8.2 Constraint 2: Do Not Exceed Maximum Drag

The low altitude boundaries are all “hard” boundaries. That means that if you violate them, the orbiter could break. At least the engineers will not promise that the orbiter will not break.

The maximum drag (minimum altitude) boundary has three parts

- a. High Mach ( $>16$ ) – Surface temperature boundaries
- b. Medium Mach (16 to 4.5) – Orbiter structure (max.  $N_z = 2.5$  g)
- c. Low Mach ( $<4.5$ ) – Maximum dynamic pressure (320 KEAS)

These boundaries are shown in Figure 2-7.



**Figure 2-7. Maximum drag boundaries**

Figure 2-7 shows the maximum drag boundary on a drag vs. velocity plot. The TRAJ displays give you the boundaries in a different format. The solid TRAJ line furthest to the left is always the high drag boundary. If the orbiter is to the left of the high drag line, you need more drag than the maximum drag. You get to the left of the high drag line by being high energy. This line is usually called the high-energy line.

The temperature boundary is really a composite of many different temperature limits. There are seven control points on the orbiter (e.g., nose cap, wing leading edge, elevon, OMS pods). It turns out that 99 and 44/100 percent of the time, the wing leading edge is the control point that drives entry (i.e., it exceeds its temperature limit before the other six points exceed their limits).

As the orbiter gets heavier, the temperature drag **acceleration** limit is decreased. The drag **force** limit is the same, but the heavier weight results in a smaller acceleration. Remember, we always talk about drag acceleration – not drag force.

On the flip side of high surface temperatures, there are high backface temperatures. If you fly at high temperatures for a long time, heat will flow through the tiles to the aluminum underneath. This can happen if you fly a low drag profile. In fact, backface temperature is the current low limit to the drag profile. However, the backface does not get as hot as we once thought. In the near future, we should go to the equilibrium glide boundary as the low drag boundary.

At Mach 16, the upper temperature limit becomes larger than the Nz limit. The Nz drag limit is based on a g limit of 2.5g on the orbiter structure. The Nz drag limit is about 54 ft/sec<sup>2</sup>. Unfortunately, the drag scale on the TRAJ displays only go up to 50.

Fortunately, the Primary Flight Displays (PFDs) and PASS SPEC 50 display  $N_z$  directly; you can look there to see if you are violating the maximum drag boundary.

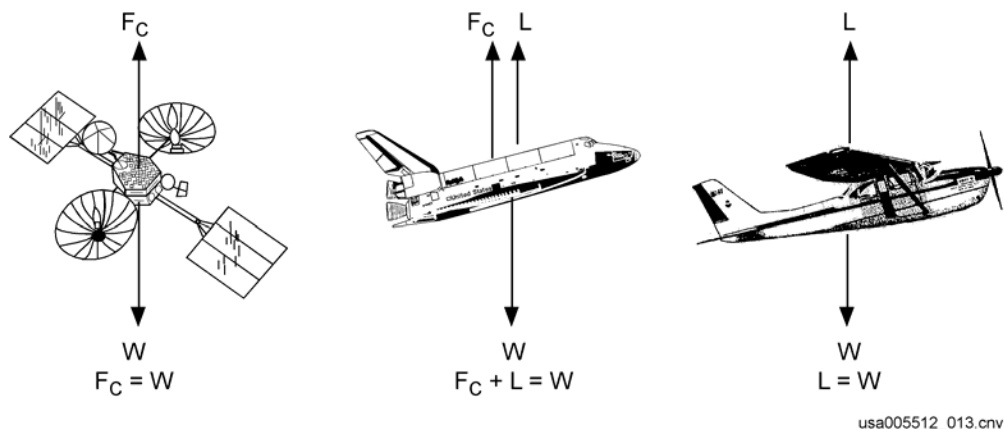
At Mach 12, the  $N_z$  drag boundary starts to come down. This is due to the decrease in  $\alpha$  at this Mach number. If  $\alpha$  were kept constant ( $40^\circ$ ), the  $N_z$  drag boundary would stay constant.

As  $\alpha$  gets smaller and smaller, you finally reach a point that  $q_{bar}$  (KEAS) will be violated before  $N_z$  will be violated. This occurs at about  $\alpha = 22^\circ$  (Mach 4.5). Like the  $N_z$  boundary, you can look at your  $q_{bar}$  on the TRAJ display, or your KEAS tape shows if you are violating  $q_{bar}$  limits.

### 2.8.3 Constraint 3: Minimum Drag – Minimum Lift

The alternate title to this section is: Why Satellites Do Not Need Wings.

At orbital velocity, you do not need to generate any lift to be in equilibrium (forces in balance). Centrifugal force is keeping you up. As you slow down, you must start to generate lift to overcome weight. See Figure 2-8.



**Figure 2-8. Lift requirements for different speeds**

As you slow down, centrifugal force is decreased. Centrifugal force is proportional to the square of the inertial velocity. You must make up for this loss of centrifugal force by generating more lift.

If you get a calculator, you can see

- a. At Mach 11.5, lift must equal 75 percent of weight.
- b. At Mach 5.1, lift must equal 94 percent of weight.

The lift discussed to this point is vertical lift. If you bank, the total lift must increase to maintain the same vertical lift. See Figure 2-5.

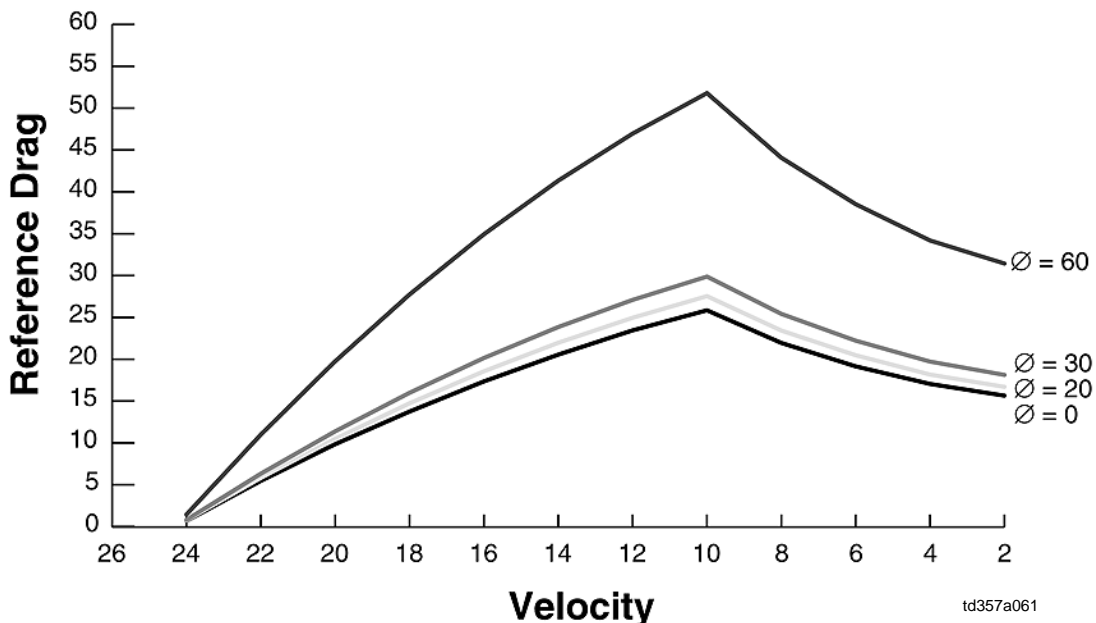
The crossrange requirements of the shuttle require 37° of bank at Mach > 10 and 20° of bank for the rest of entry. The equilibrium glide boundary often uses these bank angles.

The last step is to go from total lift to drag. This is easy. You just divide lift by lift over drag. Here is the final equation for the equilibrium glide drag boundary:

$$D_{eq} = \frac{g \left[ 1 - \left( \frac{v_I^2}{v_{sat}^2} \right) \right]}{\frac{L}{D} \cos \Phi}$$

$g$  = gravity = 32.2 ft/sec<sup>2</sup>  
 $v_I$  = Internal velocity  
 $v_{sat}$  = Velocity of satellite  $\approx$  26,000 ft/sec  
 $L/D$  = Lift over drag  
 $\Phi$  = Bank angle

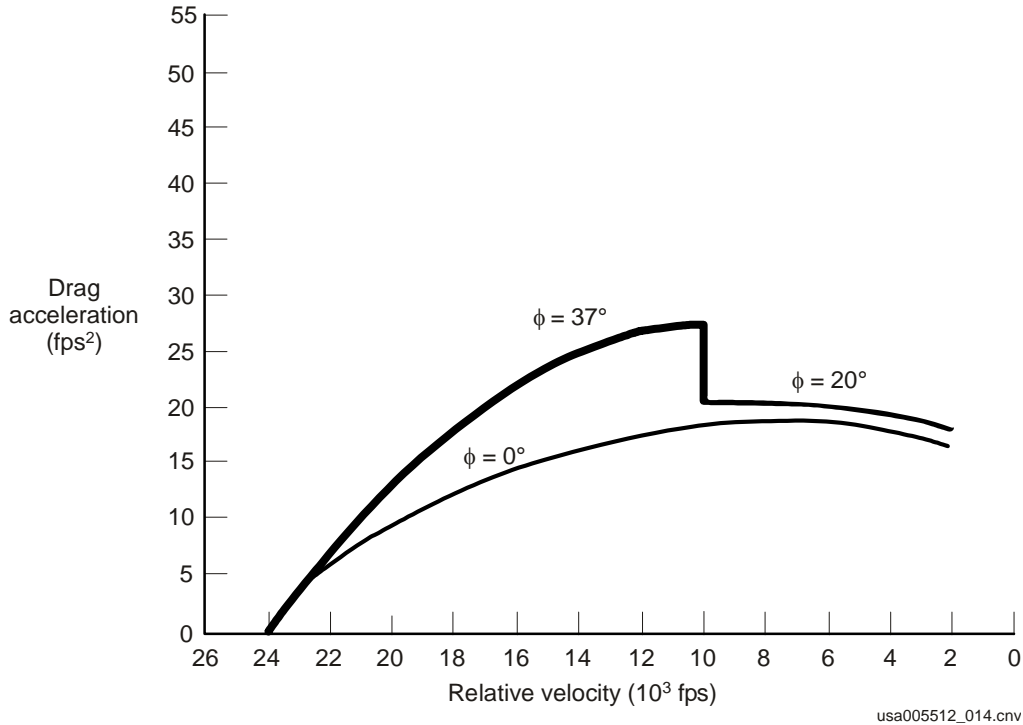
Figure 2-9 shows a family of curves for equilibrium glide drag. The family is bank angle. The chart is generated using the nominal lift over drag schedule. This is why the drag boundary drops at the lower Mach numbers. Please note that low velocity is on the right. This is different from the other charts you see in this book.



**Figure 2-9. Equilibrium glide boundary family of curves**

The equilibrium drag boundary is a “soft” boundary. The orbiter will not break if you violate the boundary. If you violate the boundary, you are not in equilibrium and you will start back down into the thicker air. When you get in the thicker air, you will have enough lift to be in equilibrium.

Figure 2-10 shows the equilibrium glide boundary for the crossrange bank angles and for zero bank angle. Again, the nominal lift over drag was used.



**Figure 2-10. The equilibrium glide drag boundary**

When you violate the equilibrium glide boundary, flightpath angle is decreasing. However, there is no flightpath angle indicator on the shuttle, there are H-dot and H-double-dot indicators. When you violate the equilibrium glide boundary, H-double-dot will be negative at the corresponding bank angle. Negative H-double-dot does not occur at exactly the same place as decreasing flightpath angle, but it is close enough.

## 2.9 EQUILIBRIUM GLIDE BOUNDARY – NEGATIVE H-DOUBLE-DOT BOUNDARY

The TRAJ displays give you the equilibrium glide boundaries. The solid TRAJ line furthest to the right is always the equilibrium glide drag boundary. If the orbiter is to the right of this line, you need less drag than the minimum drag. You get to the right of the equilibrium glide drag line by being low energy. This line is often called the low energy line.

If you are low energy, the correct response is get to the lowest drag possible. It is easy to do this by simply setting the bank angle to some constant (usually twice the Delaz angle). The orbiter will go up into the thin air (above the equilibrium glide boundary), lose lift, and come back down. When it gets back into the thicker air (below the equilibrium glide boundary), it will get more lift and go back up. The pattern will repeat.

This oscillation about the equilibrium glide boundary is called a phugoid. The term phugoid is often used for virtually every H-dot excursion the orbiter makes. Some common uses are

- a. Entry guidance damps the phugoid
- b. Roll reversal excites the phugoid
- c. Pullout on a Transoceanic Abort Landing (TAL) is the first phugoid
- d. Alpha modulation damps the phugoid

In part, some of these uses may be correct, but a phugoid must involve an oscillation. A single pullout, or an  $\dot{H}$  excursion caused by a bank excursion, is not a phugoid. It is less confusing if the term is not overused.

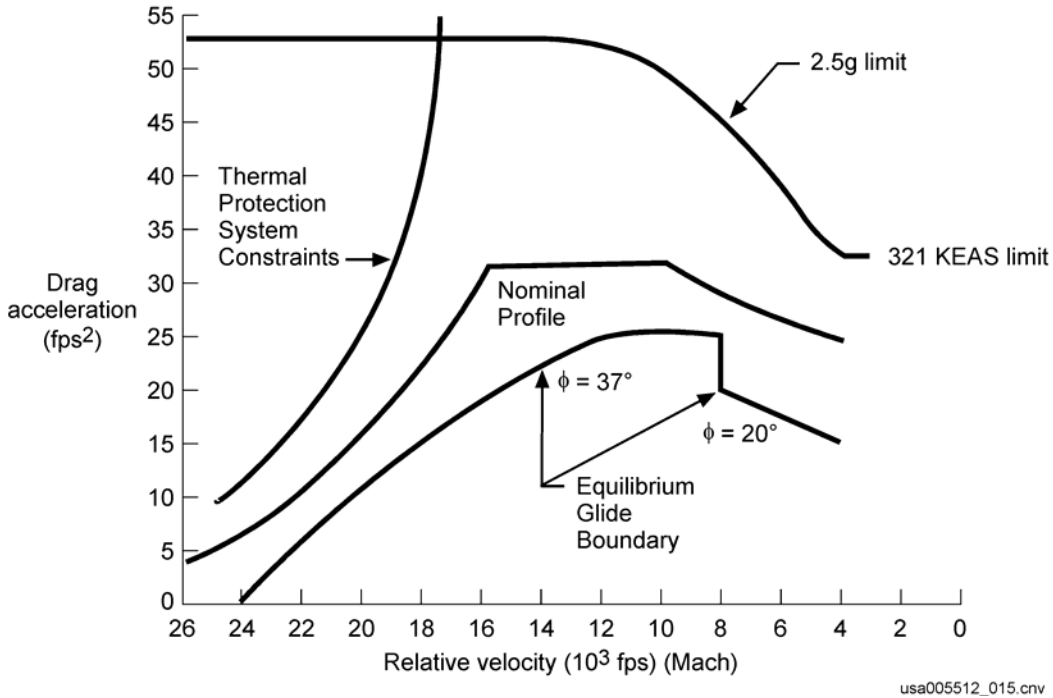
## **2.10 HOW MUCH DRAG IS ENOUGH? – REFERENCE DRAG**

Many very clever people have spent a lot of time coming up with the drag to fly to get you home. The orbiter bug on the TRAJ displays and the arrow on the drag scale displays this drag to you. Thus, you can fly a perfectly good entry without knowing any details of this desired/reference drag. All you have to do is get to this drag and you will get home.

I know some of you are dying to know more about this thing we call reference drag. This section covers reference drag in some detail.

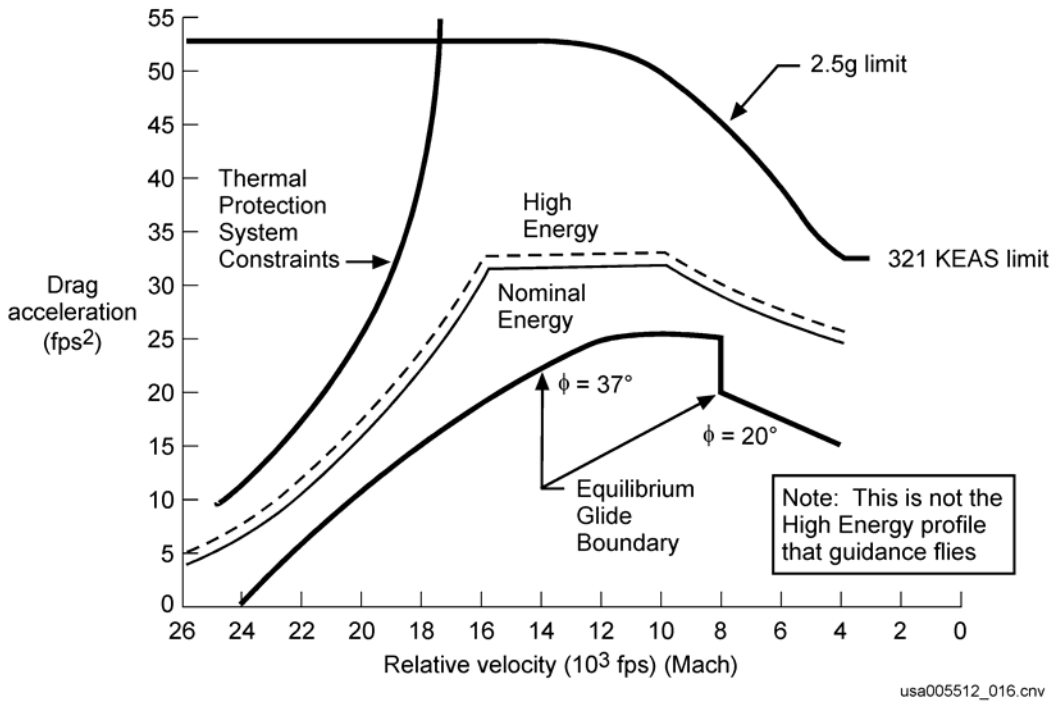
First, let us talk nominal drag. Nominal (Nom) drag is the drag you are targeted to fly. The nominal drag is flight specific. It is a trade between high surface temperatures (high drag) and high backface temperatures (low drag). The nominal drag profile is a primary driver in the deorbit burn targets.

Figure 2-11 shows an example of a nominal drag vs. velocity profile. The high and low drag boundaries are also shown.



**Figure 2-11. Nominal drag profile**

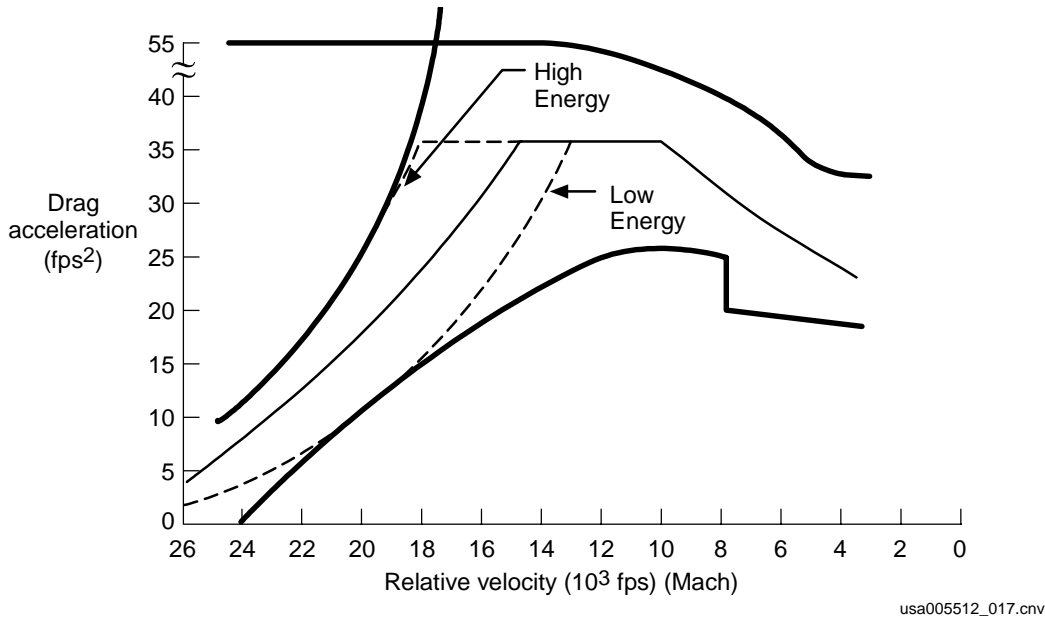
The \$64,000 question is, how much more drag do we need? We could increase our drag a very small amount for the entire entry phase. Our new drag profile would look like Figure 2-12.



**Figure 2-12. High-energy drag profile – small increase throughout entry**

If we do this, however, we will not get back on nominal energy until Mach 2.5, so we must increase drag a little more so we can get back to nominal energy before Mach 2.5.

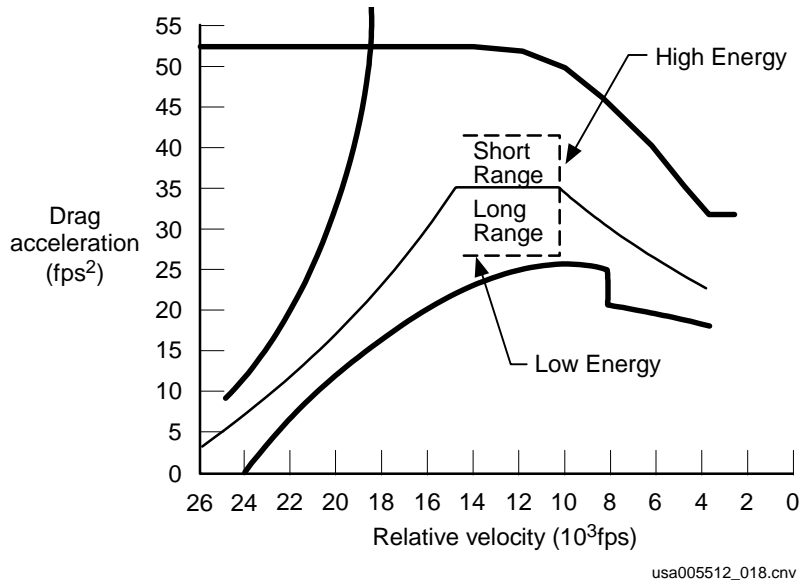
If we are low energy (range to site is greater than nominal), we need to decrease our drag. Figure 2-13 shows the nominal, high (short-range) and low (long-range) energy reference drag profiles.



**Figure 2-13. High-Mach reference drag profile**

In the mid-Mach region (Mach 10 to 14), we are usually in the guidance phase where the drag level is assumed to be constant. This is called the constant drag phase. If we are low energy, we simply adjust the “constant” drag level down. See Figure 2-14.

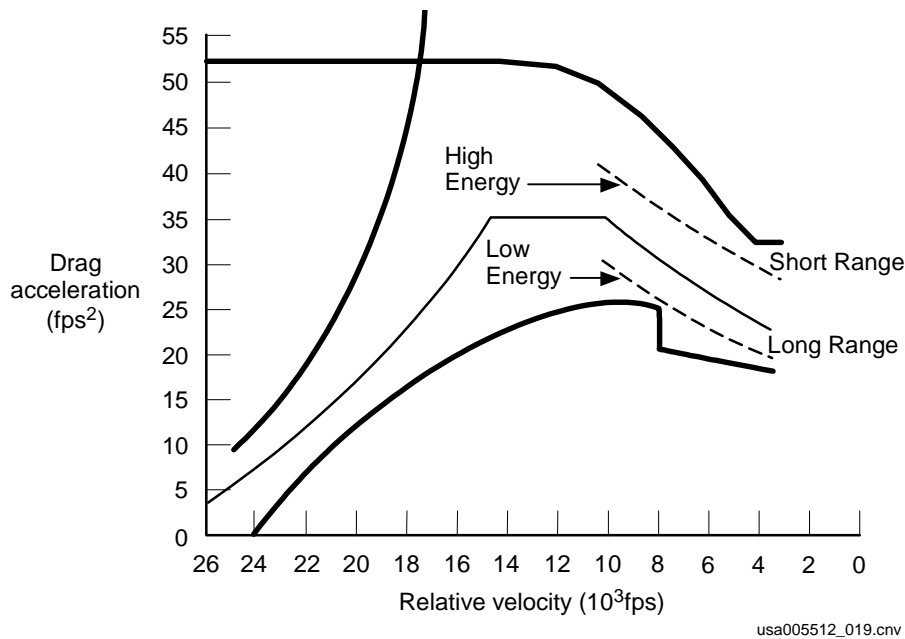




**Figure 2-14. Mid-Mach reference drag profile**

The last phase is the low Mach (Mach 2.5 to 10) region. This is the transition phase of entry guidance. It transitions to TAEM guidance. Figure 2-15 shows the reference drag profile for the low Mach region.

Note: During this region, both the entry guidance algorithms and the TRAJ displays convert from velocity to total specific energy. You will not notice this transition to energy. Most of the total energy is kinetic.



**Figure 2-15. Low-Mach reference drag profiles**

These drag vs. velocity drag profiles look great, but that is not how the data are presented in the orbiter. The TRAJ displays first give you reference drag for a given range and velocity. Then, four to five solid TRAJ lines are put on the display.

One of these lines is the nominal line. If the orbiter bug is to the right of the nominal line, you are low energy and you need less drag than nominal. If the orbiter bug is to the left of the nominal line, you are high energy and you need more drag than nominal.

## 2.11 HOW DO YOU STAY ON DRAG PROFILE

Now we know how much drag we need – reference drag. We must find a way to stay on drag profile, and get back on drag profile when we get off it.

First, let us talk about staying on the drag profile. We will talk about getting on the profile in just a minute.

There are two important concepts to stay on profile

- a. Reference Hdot
- b. Reference roll

Of these two, reference Hdot is much more important.

### 2.11.1 Reference Hdot – For No Drag Error

Reference Hdot is the Hdot you want when you have no drag error. It is the Hdot that will keep you on the drag profile. It will not get you back on the drag profile after you get off of it.

The original entry guidance designers wanted to use reference drag-dot (rate of change of drag), but they decided there was not a good way to measure drag-dot. They did a little calculus and decided that they could use reference Hdot instead of reference drag-dot.

The equation for reference Hdot is

$$H_{ref} = -H_s \left[ \frac{D_{ref}}{D_{ref}} - \frac{2V}{V} - \frac{C_D}{D_{ref}} \right]$$

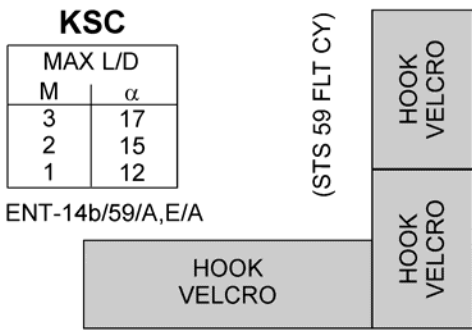
$H_s \Rightarrow \rho = \rho_o e^{-H/H_s}$  (density equation)  
 $D_{ref}$  = Reference drag  
 $V$  = Velocity  
 $C_D$  = Coefficient of drag  
 $(\dot{\phantom{x}}) = d(\phantom{x})/dt \Rightarrow$  derivative with time

Reference Hdot is available in three different places in the orbiter, so you do not need to know this equation.

You can fly a perfectly good entry by using any of these three reference Hdot values. Both the bottom of the TRAJ display and the Entry Alpha cue card are nominal reference Hdot. “Nominal” means the reference Hdot you will have on a nominal entry.

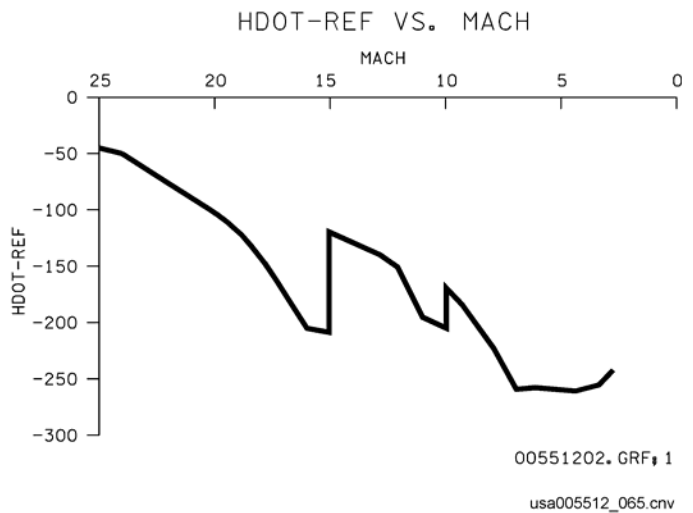
Figure 2-16 shows a copy of an Entry Alpha cue card and a graph of Hdot reference.

VR	$\alpha$	$\rho$	$\phi$	R	H	Href	Rref
25		40		4495	400		
24	HI	40	LO	2632	244	-46	R78
23	43	40	37	2171	237	-62	69
22	43	40	37	1806	231	-82	63
21	43	40	37	1520	223	-104	61
20	43	40	37	1295	216	-122	60
19	43	40	37	1114	209	-146	60
18	43	40	37	970	202	-171	62
17	43	40	37	855	195	-190	63
16	43	40	37	762	189	-202	L64



15	43	40	37	683	187	-119	62
14	43	40	37	612	181	-127	60
13	43	40	37	545	175	-136	59
12	43	40	37	481	170	-153	58
11	42	39	36	423	165	-196	57
10	41	38	35	373	163	-172	R49
9	39	36	33	324	158	-207	44
8	37	34	31	276	150	-239	41
7	33	30	27	228	140	-267	40
6	30	27	24	182	128	-273	43
5	26	23	20	140	115	-273	43
4	22	19	18	104	102	-264	L41
3	19	16	15	73	87	-249	36
2.5		14		60	83	-268	
2		13		50	77	-260	
1.5		10		38	68	-310	
1				28	54	-263	

8



**Figure 2-16. Entry Alpha cue card**

If you are either low or high energy, reference Hdot will be a little different from nominal reference Hdot. It turns out that the differences are small, and you can fly a low or high energy entry with the nominal reference Hdots.

For those who want a little more detail, the following list tells how off-nominal conditions affect  $\alpha$  reference Hdot and actions that can be taken.

- See if Hdot-ref is working real time. If drag is not responding, bias Hdot-ref. This is what auto guidance does.
- Hdot-ref decreases by about 100 ft/sec the instant you go into constant drag. This will usually happen at the bottom of TRAJ 2.

- c. Hdot-ref decreases (smaller negative number) as desired/reference drag decreases.
- d. Hdot-ref increases (larger negative number) as desired/reference drag increases.
- e. Run the Entry Guidance CBT, USA007365, about a hundred times until you see what works and what does not.

## 2.12 REFERENCE ROLL – FOR NO HDOT ERROR

We have just gone over what to do when we have no drag error – go to reference Hdot. What do we do when we have no drag error **and** no Hdot error? We go to reference roll angle.

Note: When flying manual entries, you can use the H-double-dot tape. When you have no Hdot error, you can use the tape to zero the H-double-dot. Entry guidance does not use H-double-dot feed-back. It uses reference roll angle.

It is not critical to know a lot about reference roll to fly entries. You will use H-double-dot instead, and you can pretend that auto guidance is using H-double-dot. It behaves as if it is.

Reference roll is the roll angle you want when you have no drag error and no Hdot error. It is the roll angle that keeps you on profile. It does not remove drag or Hdot errors.

Reference roll angle is available in two places in the orbiter.

- a. Lower right portion of the TRAJ displays. It is labeled ROLL REF. This is the real-time output of entry guidance. A nice thing about this ROLL REF is that it is sensitive to your current lift over drag. If you are in a low alpha stretch, you can use this ROLL REF as an indication of your energy state.
- b. The Entry Alpha cue card; this is reference roll angle if you are on energy.

ROLL REF has three useful functions; it provides

- a. H-double-dot equal to zero
- b. An indication of your energy state
- c. Your steady state bank angle

Before we start, let us go through a little thought experiment that should help you understand reference roll a little better.

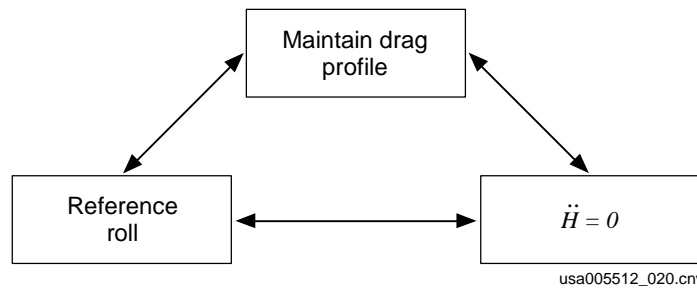
- a. Based on your current range and velocity, find how much drag you need to get home. This is reference drag.

- b. Move the orbiter up and down in the atmosphere until it is generating this much drag. I know the orbiter is too big to move up and down; that is why this is only a thought experiment.
- c. Now roll the orbiter until vertical lift and centrifugal force equal weight (H-double-dot very close to zero).
- d. This final roll is your reference roll angle.

**2.12.1 Reference Roll as H-Double-Dot Equal to Zero**

It is “intuitively obvious to the most casual observer” that it takes very small H-double-dots to maintain the drag profile. Hdot changes very slowly over time, and it only takes about ±1 H-double-dot to make these small changes. Just to make things easy, let us say H-double-dot equals zero to maintain the drag profile.

Okay, it takes zero H-double-dot to maintain the drag profile, and reference roll will maintain the drag profile. So, reference roll results in H-double-dot equals zero. See Figure 2-17 for a depiction of H-double-dot, reference roll, and maintaining profile.



**Figure 2-17. Depiction of H-double-dot, reference roll, and maintaining drag profile**

There is a problem with reference roll as the roll that will give you H-double-dot equal to zero. It is true only if you have no drag error. Remember the thought experiment of moving the orbiter up and down until actual drag is equal to desired drag. Well, if actual drag is not equal to desired drag, H-double-dot will not be zero if actual roll is equal to reference roll.

If you have less drag than desired, you are up in the thin air and not generating enough lift. H-double-dot is negative at reference roll. If you have more drag than desired, you are down in the thick air and generating too much lift. H-double-dot is positive at reference roll.

### **2.12.2 Reference Roll Angle as an Indication of Your Energy State**

When you are low energy, your reference roll angle decreases. Here is why:

As stated earlier, when you are low energy, your reference drag decreases. When you get to this smaller drag level, you also have less total lift. Your vertical lift requirement, however, is still the same. To keep the same vertical lift with the smaller total lift, you must go to a smaller roll angle (see Figure 2-5).

If reference roll is less than  $37^\circ$ , your reference drag is less than the  $37^\circ$  equilibrium glide boundary. The same holds true for  $20^\circ$  and  $0^\circ$  roll angles. If entry guidance sees reference roll go below the required roll for crossrange, you will see a ROLL REF message, get a Systems Management (SM) alert, and get a down arrow next to ROLL REF on our TRAJ display.

The roll required for crossrange is

- a.  $37^\circ$  above Mach 10
- b.  $20^\circ$  below Mach 10

Remember that ROLL REF on the lower right part of the TRAJ display is based on your current lift over drag. If you lower alpha to stretch, ROLL REF gets bigger. The bigger ROLL REF means you are in better shape as far as energy is concerned.

### **2.12.3 Reference Roll as Your Steady-State Bank Angle**

After you get rid of drag and Hdot errors, you will go to reference roll angle. Unless something drastic happens, drag will stay close to drag profile and roll will stay close to reference roll.

Roll reversals take you away from reference roll angle for a few seconds, but guidance quickly removes drag and Hdot errors and puts you back to reference roll.

Why is reference roll important? You must have some roll to remove crossrange (Delaz). If you get the ROLL REF message, your steady-state roll (reference roll) may be too small to remove your current crossrange. That is why you get the ROLL REF message.

The ROLL REF message means you are low energy, and if you are low energy, you may have trouble removing crossrange.

### **2.13 HOW DO YOU GET ON DRAG PROFILE? – HDOT DESIRED**

Reference roll and reference Hdot are great for maintaining the drag profile, but we need more to get back on the drag profile. The primary way to get back on the drag profile is desired altitude rate. The secondary way is alpha modulation.

### 2.13.1 Desired Altitude Rate – All the Time

Assume you have a drag error. If you go to reference Hdot, you will parallel your desired altitude and never get rid of your drag error.

So what do you do? Call desired Hdot!

If you need more drag, go down into the thicker air; i.e., bigger Hdot (bigger negative Hdot).

If you need less drag, stay up in the thinner air; i.e., smaller Hdot.

As stated earlier, bias reference Hdot by about 20 times your drag error. Auto guidance is more aggressive and may use a bias of up to 40 times the drag error.

What happens if guidance goes to the desired altitude rate and it does not get rid of the drag error? It will bias Hdot. This bias is applied a little bit at a time. The longer you have a drag error, the bigger the bias gets. This bias can be seen on the lower right-hand portion of the TRAJ display. You can zero this bias with an ITEM 2 execute.

The only time this bias gets bigger than a few feet/second is when guidance is not flying the orbiter; i.e., CSS. Guidance is not smart enough to know that this huge drag error is not its fault, so it biases Hdot anyway.

### 2.13.2 Alpha Modulation – For Small Drag Errors

There is one small problem with desired altitude rate to control drag. It is slow. It may take a minute or two before you get rid of your drag error.

Originally, entry guidance was designed to fly without alpha modulation. However, before the first shuttle flight, the entry guidance designers decided they wanted to remove drag errors a little sooner. Thus, alpha modulation was developed.

Here is how it works. If you need more drag, increase alpha. If you need less drag, decrease alpha.

Guidance is limited to stay within  $\pm 3^\circ$  of nominal alpha. This small alpha envelope is because of heating and flight control constraints.

With  $\pm 3^\circ$  of alpha modulation, you can change your drag by about 10 percent. With desired altitude rate, you can fly any drag you want. Alpha modulation is useful only for small drag errors.

Alpha modulation is not a permanent fix to drag errors. After the drag error is removed, a bias is added to desired altitude rate. If you are low drag and alpha is modulated up, desired Hdot is increased (a larger negative number). In a couple of minutes, you fly reference drag without alpha modulation. The bias in desired altitude rate is called alpha demodulation.

## 2.14 HOW DO YOU CONTROL CROSSRANGE?

There are two ways to control crossrange. First, keep Delaz small – roll reversals. Second, if low energy – minimum bank angle.

### 2.14.1 Keep Delaz Small – Roll Reversals

In a conventional aircraft, crossrange is controlled by turning until the landing site is on the nose, then rolling to wings level. Pitch is then used to control altitude.

You cannot do this at high Mach in the shuttle. You cannot use pitch to control altitude – remember the small ( $\pm 3^\circ$ ) angle-of-attack envelope. You use bank to control altitude.

Since you always have a little bank (or maybe a lot of bank) to control altitude, the orbiter is always turning, so you let the nose of the orbiter fly past the site a little bit, then turn back toward the site. This is called a roll reversal. Crossrange control is so easy.

As stated in Section 2.6, the decision to do a roll reversal is based on Delaz. Guidance always does the first roll reversal at  $10.5^\circ$ . Guidance does subsequent reversals at  $17.5^\circ$  until below Mach 4. From Mach 4 to 3, guidance ramps the value down from  $17.5^\circ$  to  $10^\circ$ . See Figure 2-18.

Note: Delaz is the angle between the velocity vector and the line of sight to the landing site. Delaz is displayed on the upper right portion of the TRAJ displays and by the primary bearing pointer on the HSI.

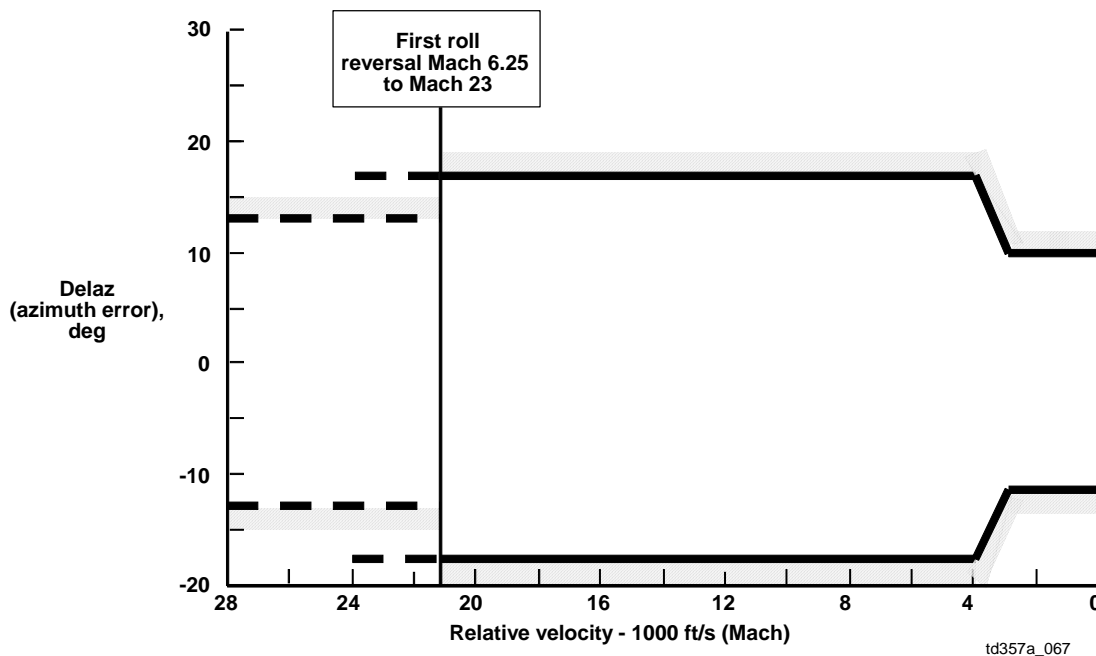


Figure 2-18. Delaz for roll reversal



A common misconception is that we use roll reversals to bleed off energy; i.e., S-turn. We use drag to bleed off energy. To bleed off energy by turning, we would need to delay turning until Delaz became large; thus, the range flown would be increased. The small Delaz that guidance uses does not increase the range flown any significant amount.

The concept of using turns to increase the range flown is called S-turns. TAEM guidance uses S-turns if you are high energy. Entry guidance does not use S-turns.

### **2.14.2 If Low Energy – Minimum Bank Angle**

Usually, guidance does not react to the size of Delaz (other than to command the roll reversal). If Delaz ever gets big, guidance does not care. Delaz may get bigger and bigger, and guidance will do nothing. It only cares that you are banked toward the site.

The exception is minimum bank angle. This minimum bank angle has led many to believe that commanded bank angle is constrained to solve crossrange. For the most part, it is not.

Here is how minimum bank angle works.

If you are low energy, your steady-state roll angle (reference roll) is small. In an extreme low energy case, reference roll is zero. With zero bank, you cannot turn.

In these low-energy cases, guidance sacrifices a little bit downrange, and banks toward the site more than downrange control says. This is called minimum bank angle.

Entry guidance has a minimum bank built in, and we have a manual technique called two times Delaz.

The minimum bank angle built into guidance is too complex to memorize in detail, but it has some concepts you should remember.

- a. It is never used if you are banked away from the site.
- b. It is always in effect if banked toward the site (guidance will never roll wings level if banked toward the site).
- c. It is usually encountered when ROLL REF is small (down arrow and message).

Above Mach 10, guidance uses 15° or 37° of roll. If 15° is not enough, guidance goes to 37°. Below Mach 10, guidance uses a minimum bank angle of 20°. The roll angles 37° above Mach 10 and 20° below Mach 10 should be familiar by now. They are the roll angle for the equilibrium glide boundary and for the ROLL REF message. These are important numbers; memorize them.

The manual minimum bank angle technique is 2.2 times Delaz. The technique is very simple. Bank toward the site at twice your current Delaz. This technique is also used

when no low energy logic, but low energy logic should be used only on a TAL. See Section 2.16, Monitoring Auto Guidance During a TAL Entry, for more details.

## **2.15 MONITORING AUTO GUIDANCE DURING A NOMINAL ENTRY**

This section explains how to monitor guidance through a nominal end-of-mission entry. If you have read the previous sections, you already know a great deal about monitoring entry guidance.

Throughout entry, guidance is flying the orbiter to a desired altitude rate. You must understand desired altitude rate to understand guidance.

In addition to desired altitude rate, it is useful to know what to expect from guidance during certain phases of entry. This section takes you through the following phases:

- a. Preentry guidance
- b. Closed-loop guidance initiate
- c. The first roll
- d. Roll reversals

### **2.15.1 Preentry Guidance – Just Attitude Hold**

In preentry guidance, the orbiter is in attitude hold. Guidance is commanding 40° alpha and 0° bank. The entry guidance software starts running in OPS 304, but it really is not doing much until closed-loop guidance initiates. In fact, I find it difficult to think of preentry guidance as any guidance at all. It does not care where you are or where you are going. It is not much smarter than the inertial hold we fly from the deorbit burn to OPS 304.

Preentry guidance is so stupid it does not even know if the entry is shallow. For shallow entries, you must take CSS after OPS 304 and bank the orbiter (prebank). Otherwise, your initial Hdot will be too small (small negative) at closed-loop guidance.

### **2.15.2 Closed-Loop Guidance Initiate**

This is where the fun starts. At a drag of 3 ft/sec<sup>2</sup>, guidance wakes up and figures out how much drag you need. It then banks to get an Hdot that will get you to this drag level.

The first bank command that guidance gives is zero. The zero roll command is not “hardwired” into the entry guidance software. The flight rules dictate the zero bank command. Fight Rule A4-152 states that the deorbit burn will result in about 15 to 20 seconds zero bank command.

Note: The flight rule and the entry design engineers talk about N-cycles. N-cycles are the number of guidance cycles in which guidance will output 0° commanded roll angle. One cycle is 1.94 seconds. For more information, see Section 2.17, Deorbit Burn and Entry Guidance.

You can tell that guidance has gone closed-loop by the appearance of the guidance box and the reference drag arrow. If you do not get this signature at a drag of 3 and qbar of 8, guidance is broken. Guidance is actually looking for an Accelerometer Assembly (AA)-measured total acceleration of 4.25 ft/sec<sup>2</sup>. The drag acceleration and qbar are based on the same IMU data.

### 2.15.3 The First Roll – Hdot Control

Closed-loop guidance initiate usually occurs at an Hdot of about -400 ft/sec. At about -240 ft/sec, guidance starts a bank in the direction of the landing site. This roll will be at about 3 deg/sec.

The desired drag at this point is usually about 6 fpss, and the current drag will be about 4. Guidance commands the orbiter to a desired Hdot of about -80 ft/sec. See Figure 2-19.

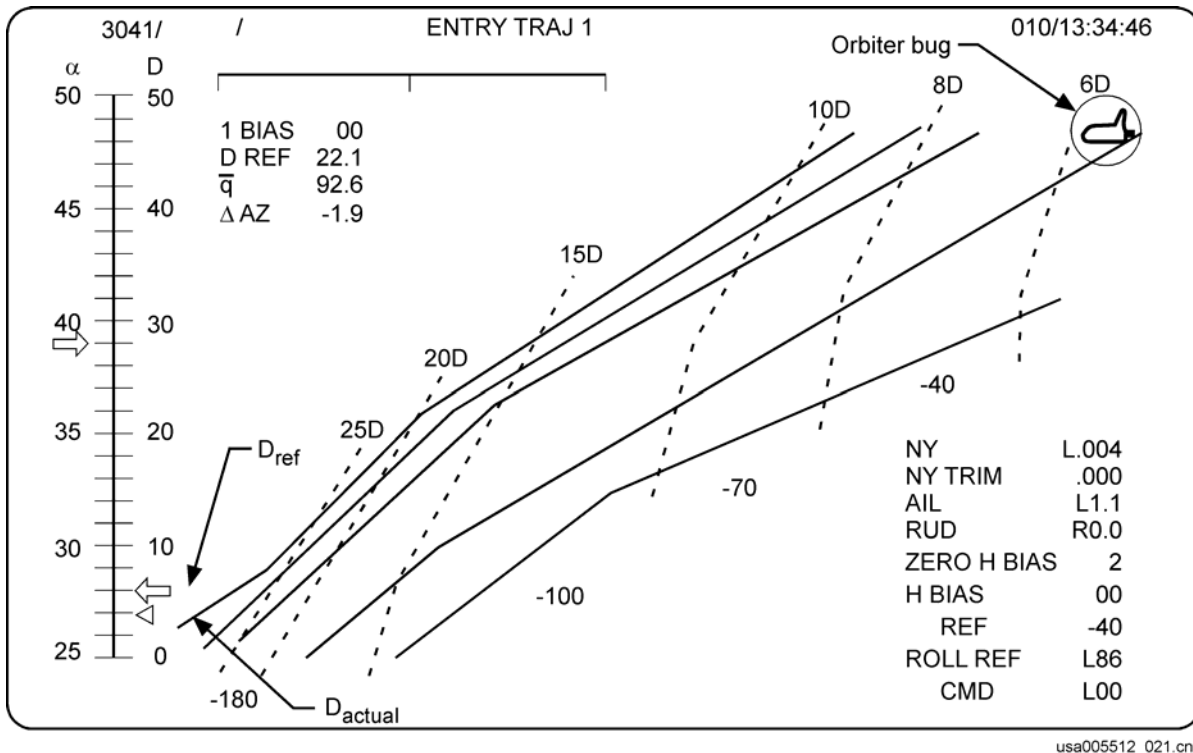


Figure 2-19. TRAJ 1 display at the first nonzero roll command

#### 2.15.4 Roll Reversals

The first roll is always toward the landing site. Delaz goes through zero, and then gets larger on the other side. At a Delaz of  $10.5^\circ$ , guidance commands the orbiter to bank back toward the landing site. This is the first roll reversal.

When a roll reversal is commanded

- a. The orbiter bug on the TRAJ display flashes.
- b. The phugoid damper scale on the TRAJ display flashes.

(Both of these displays flash until you are banked back toward the landing site.)

Note: The phugoid damper, drag, and alpha pointers flash whenever they are trying to display a value off scale. This is not an indication of a roll reversal.

**Note: The first roll reversal is not the same as the first bank command.**

It is obvious that during the roll reversal, the orbiter flies through a roll angle of zero. This small roll angle generates excess vertical lift and  $H\dot{\cdot}$  becomes smaller (a smaller negative number) than the desired altitude rate ( $H\dot{\cdot}$ ).

This error in  $H\dot{\cdot}$  causes the following:

- a. After the roll reversal, guidance goes to a large negative  $H\ddot{\cdot}$  (about -10). This negative  $H\ddot{\cdot}$  removes the  $H\dot{\cdot}$  error very quickly. Guidance overbanks about  $20^\circ$  after the reversal. For example, if guidance was happy with  $60^\circ$  of left bank before the reversal, it will want about  $80^\circ$  of right bank after the reversal.
- b. Guidance keeps this overbank/ $H\ddot{\cdot}$  for about 10 seconds. At this time, you are close to your desired altitude rate. You may overshoot your desired  $H\dot{\cdot}$  a little and guidance may underbank a little and get a small positive  $H\ddot{\cdot}$ .
- c. The  $H\dot{\cdot}$  error becomes a drag error. Guidance uses alpha modulation to remove the drag error. You may go all the way to  $3^\circ$  high on alpha after the roll reversal.
- d. The alpha demodulation term kicks in and biases desired altitude rate down a little. In about a minute, guidance is back on reference drag, with alpha back on schedule.

Guidance uses 5 deg/sec of roll rate to do a roll reversal. This is fast for the orbiter. It keeps the time spent at a small bank angle to a minimum. This keeps the  $H\dot{\cdot}$  and drag errors to a minimum.

Guidance continues to command bank to get to desired altitude rate. Subsequent roll reversals are performed at a Delaz of  $17.5^\circ$ . After Mach 4, the Delaz limit is ramped down to  $10^\circ$ . See Figure 2-18.

## **2.16 MONITORING AUTO GUIDANCE DURING A TAL ENTRY**

Guidance does some very aggressive flying after the pullout of the dive during a TAL. It may be difficult to follow at first, but it can all be explained by desired altitude rate.

### **2.16.1 While Drag Is Still Zero, Cannot Tell Energy State**

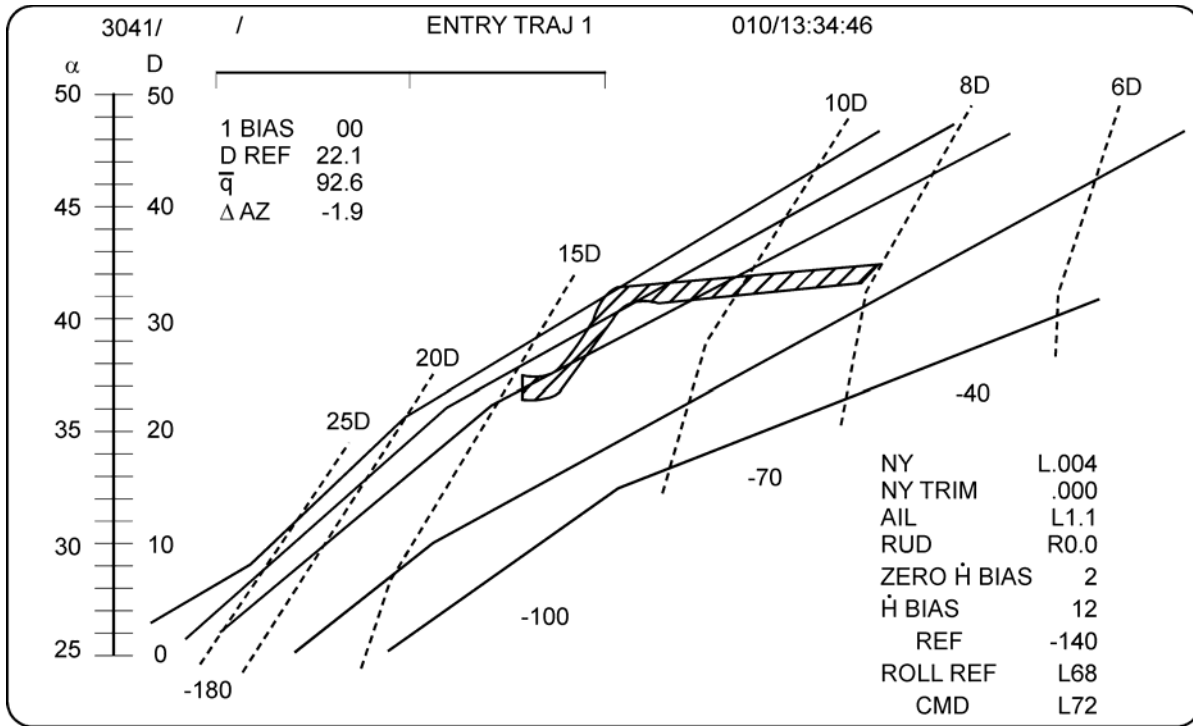
When the main engines cut off, you have zero drag. You will have zero drag until you get across the Atlantic and get back into the atmosphere.

You cannot use the TRAJ display to tell your energy state while you are zero drag. In fact, initially your velocity increases and the orbiter bug moves from left to right, across the display. It then moves across the TRAJ display from right to left, and you will not know how far it will go before it starts down the display.

Note: You can tell your energy state by watching the cutoff bug at Main Engine Cutoff (MECO) and by noticing Time of Main Engine Cutoff (TMECO). You will learn more about this in your TAL class.

### **2.16.2 Into the Atmosphere – A Big Drag Spike**

Remember that you are going much slower than orbital velocity. Gravity is much greater than centrifugal force. You are coming down fast by the time you hit the atmosphere, Hdot at about  $-1000$  ft/sec. You are coming down so fast that you will go through a huge drag spike during the pullout of the dive. This drag spike causes high temperatures and tends to make you go low energy. Guidance will have you fly  $43^\circ$  angle of attack during the pullout; this helps with the temperatures. The MECO targets are designed to give you a little extra energy; this puts you on energy after the drag spike. Figure 2-20 shows a copy of the TRAJ display during a TAL. A trace of the orbiter bug is put on the display. Notice how the bug goes to high energy, then back to nominal.



**Figure 2-20. TRAJ display during a TAL**

Here is a blow-by-blow description of how guidance reacts to a TAL. Keep in mind that guidance still follows the principle of  $\dot{H}$  desired to remove drag errors.

As you get into the atmosphere, you get enough drag to get closed-loop guidance (drag of 3). Desired drag at this point is about 10, but you have a huge negative  $\dot{H}$  (about -1000 ft/sec). This huge  $\dot{H}$  is what causes drag to rise rapidly.

In just a few seconds, drag builds up to about 20. Guidance has 20 units of drag and wants 10 units of drag. Desired  $\dot{H}$  is about +200 ft/sec. Guidance keeps a bank angle of zero until  $\dot{H}$  is about zero. At this point, it banks aggressively toward the landing site.

You also have a large positive  $\ddot{H}$ . This causes  $\dot{H}$  to get big (positive) before the orbiter can bank enough to get to zero  $\ddot{H}$ . The large positive  $\dot{H}$  causes your drag to decrease rapidly. Current drag decreases to desired drag during the first bank. What does this do to desired  $\dot{H}$ ? Remember, when you have no drag error, you desire  $\dot{H}$  reference.  $\dot{H}$  reference is about -180 ft/sec, so  $\dot{H}$  desired is also -180 ft/sec.

Your current  $\dot{H}$ , however, is about +300 ft/sec. Guidance will continue the bank to get to the desired  $\dot{H}$  of about -180 ft/sec. This is usually a little over 90°. In certain cases, this bank may be as high as 120°. This high bank is okay. Look at desired vs. current drag; look at current  $\dot{H}$ . Guidance is doing the right thing.

Meanwhile, the high drag during the pullout has caused the orbiter bug to drop toward low energy on the TRAJ display. This is okay, because the bug should have been very close to the high energy line on the display. The bug should now be on the nominal line.

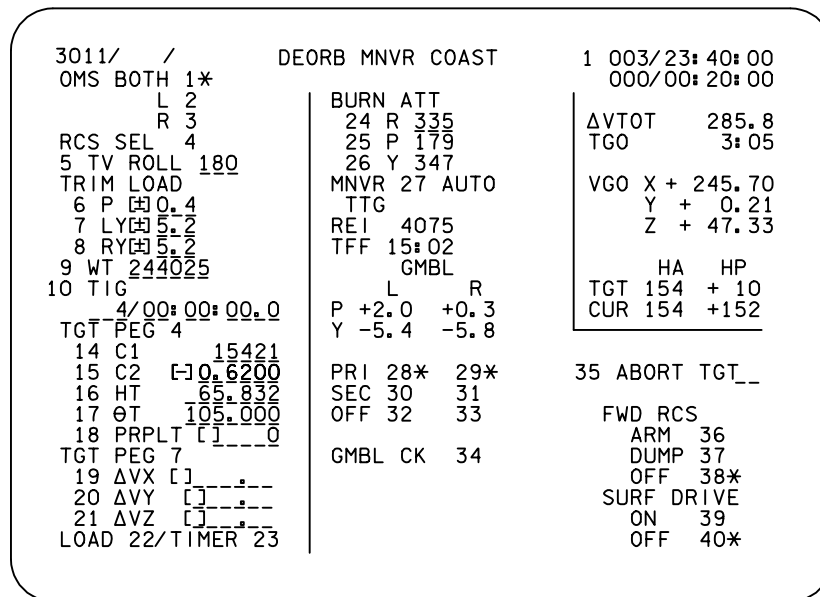
The rest of the entry should be very close to nominal.

## 2.17 DEORBIT BURN AND ENTRY GUIDANCE

You can say that entry guidance really starts by targeting the deorbit burn. It is very important that the burn put the orbiter at the correct Range at Entry Interface (REI) and the correct flightpath angle at EI, where EI is defined as 400,000 ft altitude.

How these two parameters (REI and flightpath angle at EI) are picked is a little complex and beyond the scope of this workbook. For right now, we will just say the deorbit burn targets EI, but the EI conditions are picked to control the conditions at closed-loop guidance initiate. See Section 2.20, Deorbit Burn Downmoding, for more details on how targeting is actually done.

Mission Control Center (MCC) uplinks the deorbit burn targets or the crew puts the deorbit burn targets into the GPCs via the DEORB MNVR display. Figure 2-21 shows a copy of the DEORB MNVR COAST display.



00551204. CRT, 1

**Figure 2-21. Deorbit maneuver display**

The crew is always given the deorbit burn targets. The entry Flight Dynamics Officer (FDO) usually generates them. For an emergency deorbit, the Shuttle Portable Onboard Computer (SPOC) software on the Payload and General Support Computer (PGSC) (an IBM-compatible Personal Computer (PC) carried in the orbiter) can generate the targets.

The FDO is given the nominal, 3-sigma, and two N-cycle values from the descent flight designers. These numbers are very important to the FDO and a lot of entry principles are buried in them. Section 2.20 describes N-cycles in more detail.

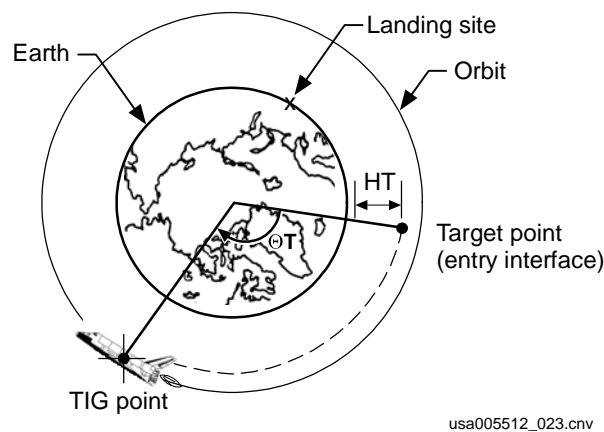
## 2.18 REI TARGETING

The deorbit burn targets that affect REI are

- a. TIG
- b.  $\Theta$ T

Where Time of Ignition (TIG) defines where the burn starts, and  $\Theta$ T defines the angle from the burn start point to the targeted point.  $\Theta$ T is usually about 145°. The targeted point is also defined by HT, which is always 400,000 ft (65.832 nm); 400,000 ft is by definition EI. See Figure 2-22 for a depiction of the burn targets.

Note: In OPS 1,  $\Theta$ T is defined from the launch site. In OPS 3,  $\Theta$ T is defined from the TIG (burn start point). This is why the burn targets must be loaded in OPS 3 on Abort Once Around (AOA).



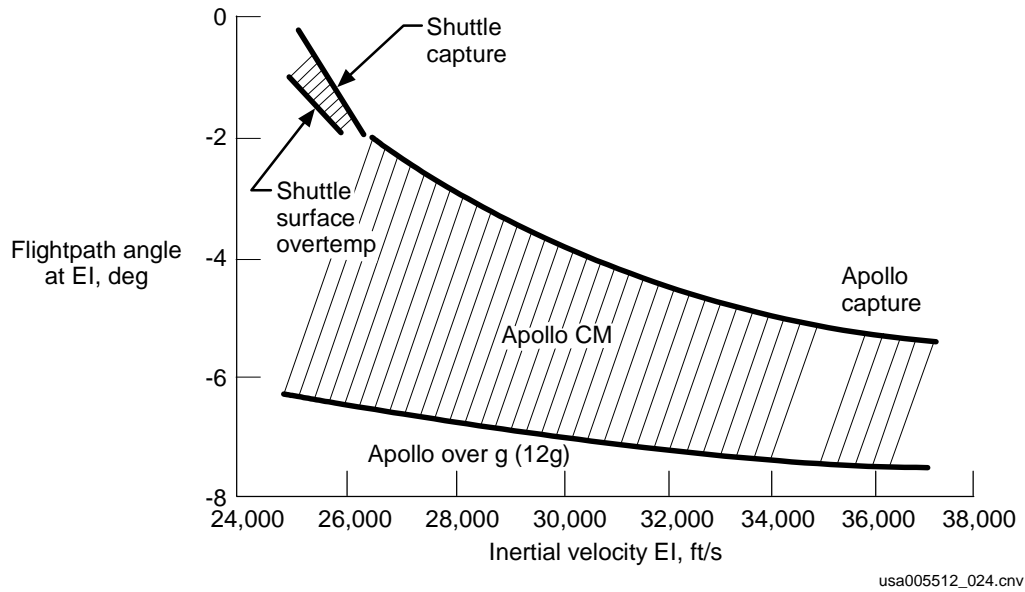
**Figure 2-22. Deorbit burn targets**

REI is calculated in OPS 302 based on the loaded burn targets and is displayed in the middle of the DEORB MNVR EXEC display. When the GPCs are first taken to OPS 303, the current REI is calculated and displayed. If the REI looks wrong, double check the targeted landing site. If you have burn targets for Kennedy Space Center (KSC), but the landing site in the GPCs is EAFB, your REI will be about 2000 miles off.

## 2.19 FLIGHTPATH ANGLE TARGETING

Compared to the earlier United States reentry vehicles, the shuttle has a very shallow reentry. This is needed because the tiles cannot take as much heat as the disposable heat shields could. Figure 2-23 compares the shuttle flightpath angle envelope to the Apollo flightpath angle envelope. Notice that the steep entry limit on Apollo was based on 12g, not surface temperature.





**Figure 2-23. Apollo and shuttle flightpath angle envelopes**

Notice that as velocity is increased, flightpath angle required becomes steeper. This is because centrifugal force is greater for the higher velocities. The increased centrifugal force will tend to keep you out of the atmosphere. This tendency must be overcome with a steeper flightpath angle at EI.

The GPCs (actually deorbit burn targeting) target for a line in flightpath angle vs. velocity.

Here is how it works.

The deorbit burn targets that affect flightpath angle are

- a. C1
- b. C2

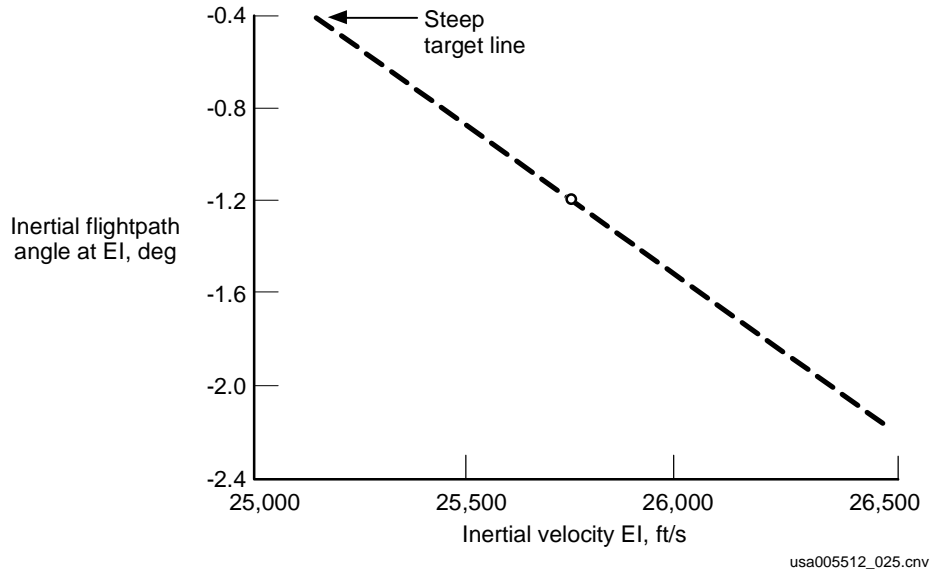
C1 and C2 define the vertical velocity of the orbiter vs. horizontal velocity of the orbiter. The relationship is:

$$\text{Vertical Velocity} = C1 + C2 * \text{Horizontal Velocity}$$

This in turn defines flightpath angle vs. velocity. The relationship (assuming flightpath angle is small) is

$$\text{Flightpath Angle (in Radians)} = C1/\text{Total Velocity} + C2$$

Figure 2-24 shows an example of flightpath angle vs. velocity for a typical shuttle entry. This is only an example. The actual target line is flight dependent and downmode dependent.



**Figure 2-24. Example of steep reentry target line**

## 2.20 DEORBIT BURN DOWNMODING

Although the OMS is very reliable, the shuttle program has developed a set of rules for entry downmoding. The entry downmoding will either

- a. Use the Reaction Control System (RCS) system for the deorbit burn
- b. Live with a shallow flightpath angle and/or short REI

There are two times that downmoding can be done

- a. Before the deorbit burn starts
- b. After the deorbit burn starts

### 2.20.1 Downmoding Before the Deorbit Burn Starts

Flight Rule A4-152 covers the downmoding options that are used before the deorbit burn starts. For this downmoding, we know that there is a problem with the OMS (e.g., loss of propellant) before the burn starts. We then plan the deorbit burn to get the crew and orbiter home. The following is an explanation of some of the terminology used in the flight rule.

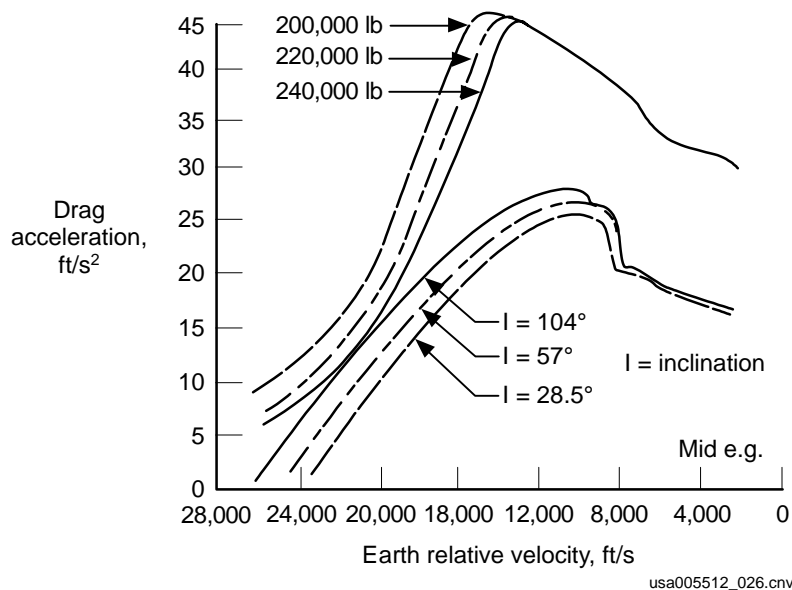
**Nominal N-cycles:** Guidance is expected to command  $0^\circ$  bank for the nominal N-cycles after closed-loop guidance initiate (one N-cycle is 1.94 seconds). This translates to 16 to 20 seconds of planned  $0^\circ$  commanded bank angle.

Descent Flight Design determines nominal N-cycles before the flight launches. The FDO then uses the nominal N-cycles to develop the deorbit burn targets. The way in

which nominal N-cycles are developed is a little complicated, but here are the basic principles followed.

- a. Based on the flight-specific high drag thermal boundary and backface temperature constraint, the nominal drag profile that will be flown through the high Mach portion of entry is determined. Figure 2-25 shows how vehicle weight and inclination affect the high and low drag boundaries.

This targeted nominal profile is a trade-off between high surface temperatures and high backface temperatures. If the drag profile is increased, surface temperature is increased. If the drag profile is decreased, the orbiter spends a longer period of time at a lower temperature. This longer time allows the heat to flow through the tiles to the aluminum structure behind the tiles. This trade-off between high surface and backface temperatures is called the thermal tradeline.



**Figure 2-25. Effect of inclination and weight on the drag boundaries**

The term “D23” is used a lot when flight designers and engineers talk about the targeted drag profile. D23 is the targeted drag for Mach 17. Even if the orbiter is at Mach 25, it calculates this drag level. This is the way that guidance scales the drag profile for the high Mach portion of entry.

- b. A simulation is run, and N-cycles are made bigger and bigger. The larger N-cycles cause the flightpath angle at closed-loop guidance initiate to be steeper. The steepest entry (largest N-cycle) that does not cause the orbiter to go through a drag spike (temperature spike) in the first pullout is selected (the flightpath angle at EI is actually backed off by 0.05° to account for 3-sigma errors in navigation and the atmosphere). An important note: the simulation is still constrained to have guidance pick the drag profile selected in step 1.

Note: It turns out that the backface temperatures were not as bad as we originally thought. This allowed us to decrease surface temperatures by targeting for a lower drag profile through the high Mach region. The current way to find the high drag profile is to target for two drag units above the equilibrium glide boundary. The resulting REI is about 4900 nm instead of the 4100 nm seen previously.

Summary: “Nominal N-cycles” is the steepest entry that can be flown without overshooting the desired drag profile during the first pullout.

**Three-sigma N-cycles:** This assures that the first nonzero roll command will not occur at closed-loop initiation in the presence of 3-sigma dispersions (atmosphere and navigation). The “3-sigma N-cycles” is usually between **7** and **14** (16 to 28 seconds of guidance time).

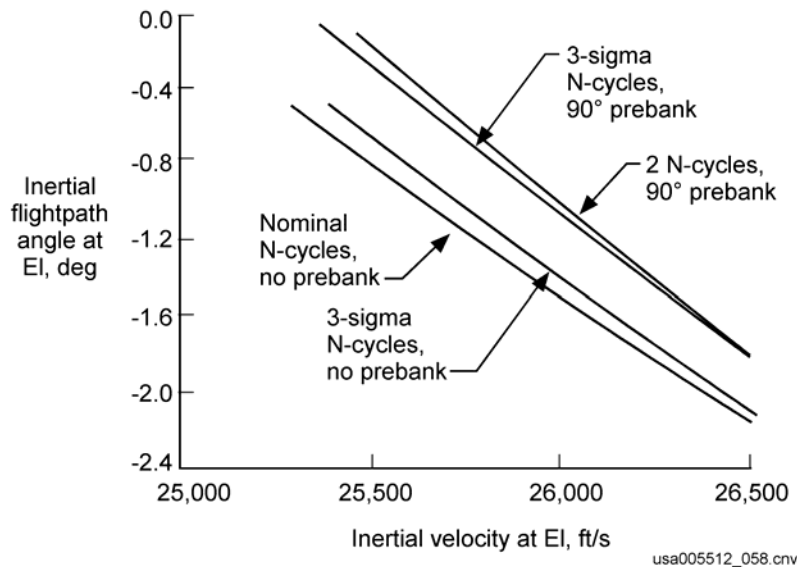
Prebank (shallow entry): Prebank is a bank (roll) that the crew does at EI -5 minutes. It keeps the lift generated by the wings before closed-loop guidance initiates from making the Hdot too small (small negative). Remember that the flightpath angle at EI is shallower, so lift must be dumped to maintain the desired Hdot. At closed-loop guidance initiate, the orbiter will be at roughly the same Hdot and range as for a steep entry. After closed-loop guidance, the prebank is removed and auto can fly the orbiter.

Note: A planned shallow entry (targeted prebank) does not increase surface temperature. There is a small (5° F) increase in backface temperature.

**Three-sigma N-cycles for skipout (2 N-cycles):** This assures that the roll command at closed-loop initiation will not exceed 60° in the presence of 3-sigma dispersions. The “skipout N-cycles” is always 2. This means that you should expect 4 sec of 0° commanded bank, but on a 3-sigma bad day, you should expect to see the first commanded bank angle equal to 60°. Most FDOs and flight designers just call this “2 N-cycles” targeting. This helps to keep from confusing it with the other “3-sigma N-cycles,” which is more conservative by protecting for 25° commanded bank angle.

Figure 2-26 shows the target flightpath angle vs. velocity line for a nominal burn and for three downmodes. The cases are

- a. Nominal N-cycles, no prebank
- b. 3-sigma N-cycles, no prebank
- c. 3-sigma N-cycles, 90° prebank
- d. 2 N-cycles, 90° prebank



**Figure 2-26. Target line for downmode cases**

Notice that the 90° prebank makes a much bigger difference than changing N-cycles. This difference also shows up in the delta velocity required and Height of Perigee (HP) of the deorbit burn. An example of these differences is

Downmode type	Delta V (ft/sec)	HP (nm)
Nominal N-cycles, no prebank	243.8	-8
3-sigma N-cycles, no prebank	227.1	0
3-sigma N-cycles, 90° prebank	164.2	33
2 N-cycles, 90° prebank	156.1	37

### 2.20.2 Downmoding After the Deorbit Burn Starts

Flight Rule A4-202 covers the downmoding options that are used after the deorbit burn starts. This downmoding is very different from the downmoding before the burn starts. In this case, you have a major problem (e.g., OMS propellant fail) after the burn starts. In this case, not only are you shallow, you will be high energy.

In the case of downmoding before the burn starts, you will move your TIG around, you will not be high energy on entry.

### 2.20.3 The Flight Rule States

The following techniques, in order of priority, will be used in the event of delta-V deficiency at OMS cutoff for the deorbit burn maneuver:

- a. ARCS completion to AFT QTY 1
- b. FRCS completion
- c. Prebank to the redesignation limit (3020° F on WLE) for the prime landing site
- d. Redesignate to the backup site (if available) with prebank to the redesignation contingency limit (Northrup is the backup for EAFB landings)
- e. Prebank to the contingency limit (3120° F on WLE) for the prime landing site
- f. ARCS completion to AFT QTY 2

Here is an explanation on the downmode options that affect entry guidance. This explanation does not cover the RCS downmode options.

Prebank to the redesignation limit: The redesignation limit is gives a 200° backoff from the contingency abort databook limit of 3220°. This trades some thermal margin to avoid a NOR ELS landing

The prebank does not actually cause the orbiter to overtemp. The short range to the runway causes the overtemp. The prebank minimizes the surface temperatures for the deorbit underspeed. Many people will tell you that the prebank causes the overtemp.

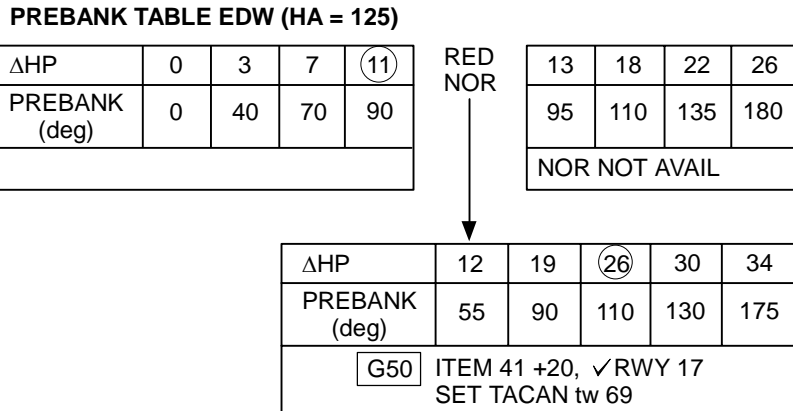
The prebank also protects skipout.

Redesignate to the backup site: If you are landing at EAFB, you can downmode to Northrup. Northrup is farther downrange than EAFB. This increases the range to the landing site – decreasing the desired drag – that decreases the temperatures.

Prebank to the contingency limit: This gives a 100° backoff from the contingency abort databook limit of 3220°. Notice this is last on the list of things we want to do. This means that after all the RCS downmoding, we still have a very shallow entry and will be high energy. To keep from skipping out, we must go to a large prebank. Many people say that this large prebank will result in overheating the orbiter. Being high energy overheats the orbiter. The prebank keeps us from skipping out and actually lowers the temperature of entry.

Both prebank and redesignate procedures can be found in the PREBANK TABLE in the Entry Checklist. Figure 2-27 shows an example of this table.

UNDERBURN  
Determine  $\Delta$ HP  
(CUR HP - TGT HP)  
Record UNDERBURN prebank on  
ENTRY MANEUVERS Cue Card



usa005512\_027.cnv

**Figure 2-27. Prebank table example from the Entry Checklist**

Here is how to use this table.

- a. Determine the amount of underspeed. This is done by determining the difference between the HP you got out of the deorbit burn and the HP you wanted. This difference is called delta HP.
- b. If the delta HP is less than the Redesignate Northrup (RED NOR) point, use the amount of prebank called out in the table and go to Edwards. This means that you are not past the contingency limit.
- c. If the delta HP is bigger than the RED NOR point, go to Northrup if it is available (i.e., it has good weather and TACANs). If Northrup is not available, you must go to Edwards, even though you may overtemp the orbiter (KSC generally does not have a redes point). Remember that the prebank minimizes the temperature; the high energy entry causes the high temperature.

## 2.21 ENTRY GUIDANCE DISPLAYS AND FDF

### 2.21.1 TRAJ Displays

As soon as you go into OPS 304, you will get the TRAJ 1 display. As the orbiter slows down through entry, you will progress through TRAJ displays 1 through 5.

The next display is brought up when the orbiter bug hits the bottom of the current display. This transition occurs as follows:

TRAJ 1 to TRAJ 2 – Mach 17

TRAJ 2 to TRAJ 3 – Mach 14

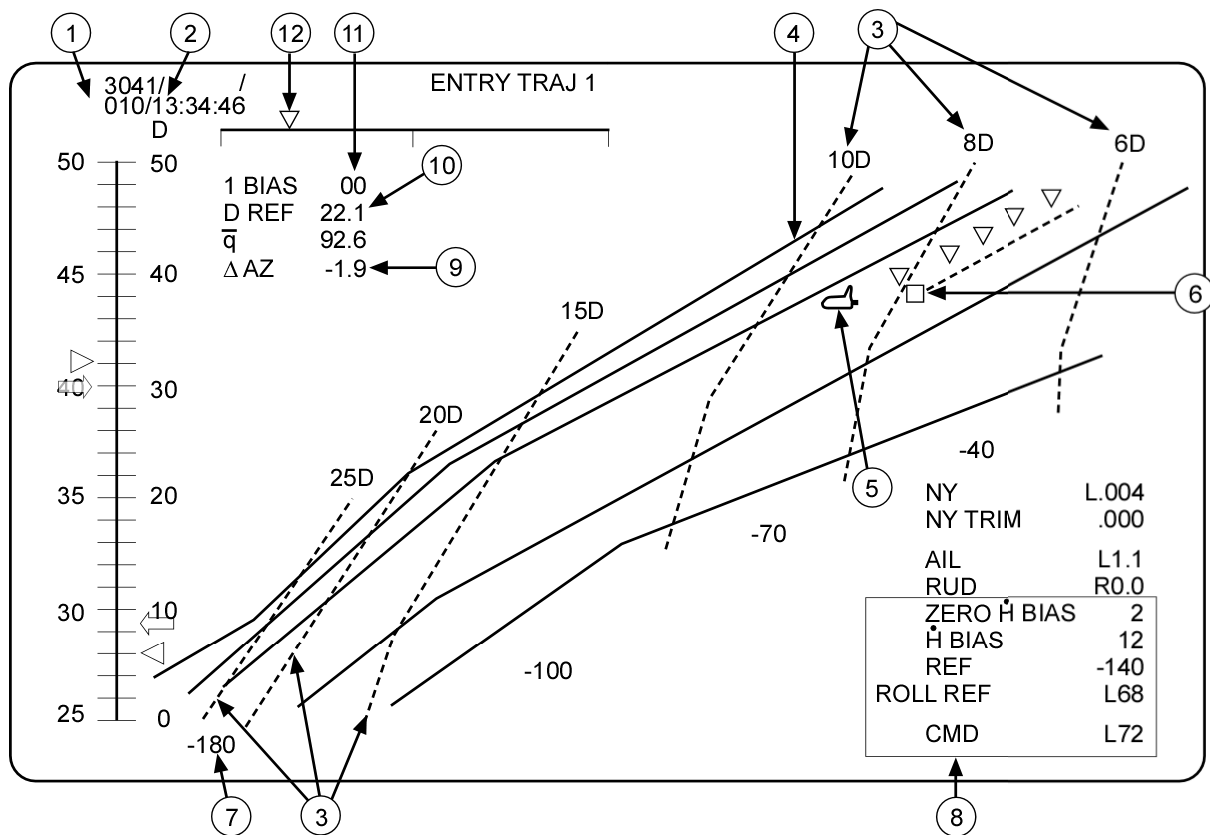
TRAJ 3 to TRAJ 4 – Mach 10

TRAJ 4 to TRAJ 5 – Mach 6.5 (actually based on energy)

Note: The transition from TRAJ 3 to TRAJ 4 also occurs when guidance transitions to the transition phase. This transition usually occurs at Mach 10.

TRAJ 5 is maintained until Mach 2.5. At this time, entry guidance quits and TAEM guidance starts. The new display is VERT SIT 1.

Figure 2-28 is an example of TRAJ 1 with the guidance-related information numbered. An explanation of the numbered items on the TRAJ displays follows. The numbers correspond to circled numbers in Figure 2-28.



usa005512\_055.r1.cnv

**Figure 2-28. Example of TRAJ 1**

1. Alpha scale: The arrow on this scale gives you nominal alpha (reference alpha without alpha modulation). The triangle gives you current alpha. The triangle flashes when the difference between current and nominal is greater than 2°. Remember that maximum alpha modulation is 3°.

Either of the two symbols flash if they go offscale high or low.

Remember, the arrow points to where you need to be.



2. Drag scale: The arrow on this scale gives you reference drag as calculated real time by the entry guidance algorithms. Reference drag is the drag you need to get home.

The triangle gives you current drag. The units are in feet per second per second.

Either of the two symbols flash if they go offscale high or low.

Remember, the arrow points to where you need to be.

3. Reference drag lines: The dashed lines that run through each of the TRAJ displays. Used with the orbiter bug position, they give you reference drag. Reference drag is the drag that the entry guidance algorithms calculate will get you home.

Unlike the drag arrow, these lines are not calculated real time by the entry guidance algorithms. Someone used the algorithms to draw these lines a long time ago. Pretend that they are just grease-penciled on the display.

4. Solid TRAJ lines – There are two major categories of TRAJ lines

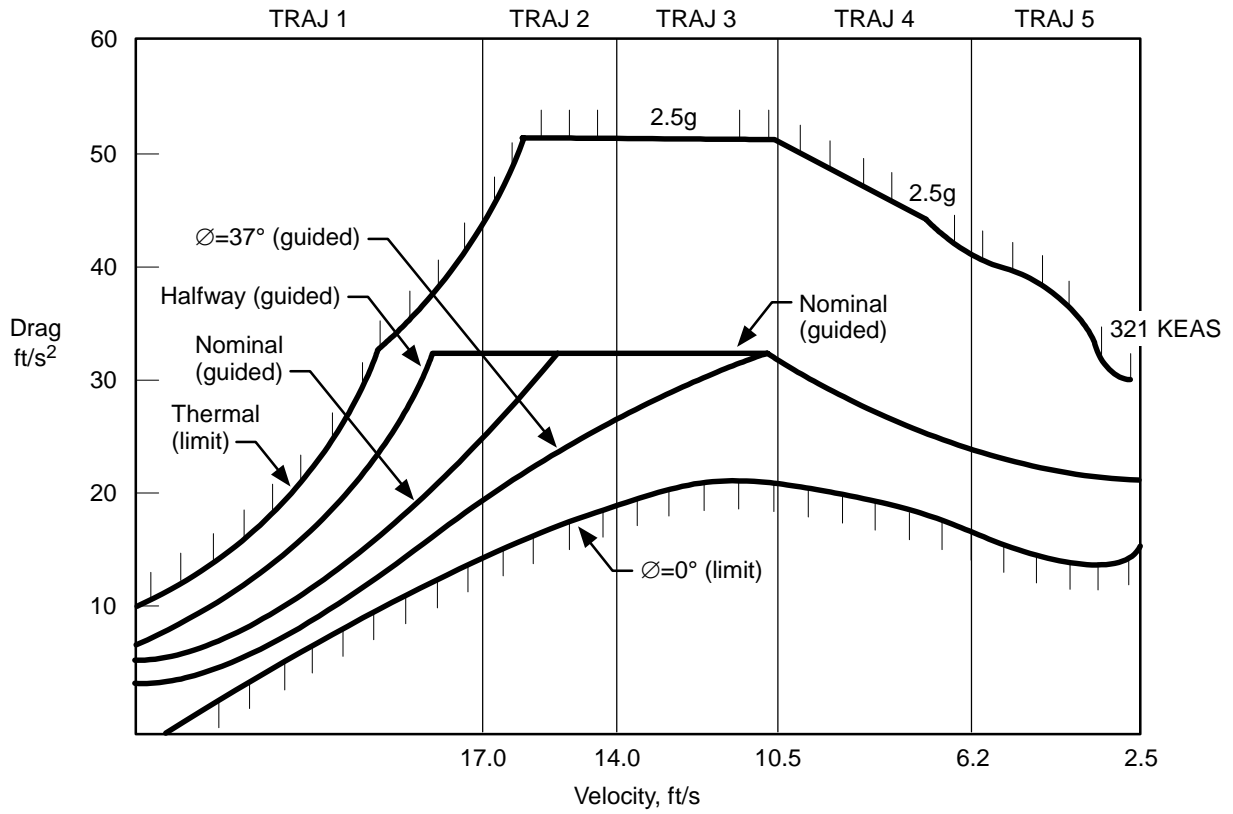
- a. Drag limit lines

- b. Guided TRAJ lines

The line on the left and the line on the right are always drag limit lines. The left line is the high drag line. The line on the right is the low (equilibrium glide) drag line. If the orbiter bug is on either of these two lines, reference drag is at the drag limit.

The middle lines are almost all guided TRAJ lines. A guided line means that if the orbiter bug is on the line and reference drag is flown, the orbiter bug will fly down the line. That is, guidance will fly the bug down a guided line. Importantly, guidance will not fly the bug down a drag limit line.

Figure 2-29 shows the TRAJ lines on a drag vs. velocity plot. Figure 2-30, Figure 2-31, Figure 2-32, Figure 2-33, and Figure 2-34 show all five TRAJ displays with the TRAJ lines labeled.



usa005512\_029.cnv

Figure 2-29. TRAJ lines in drag versus velocity

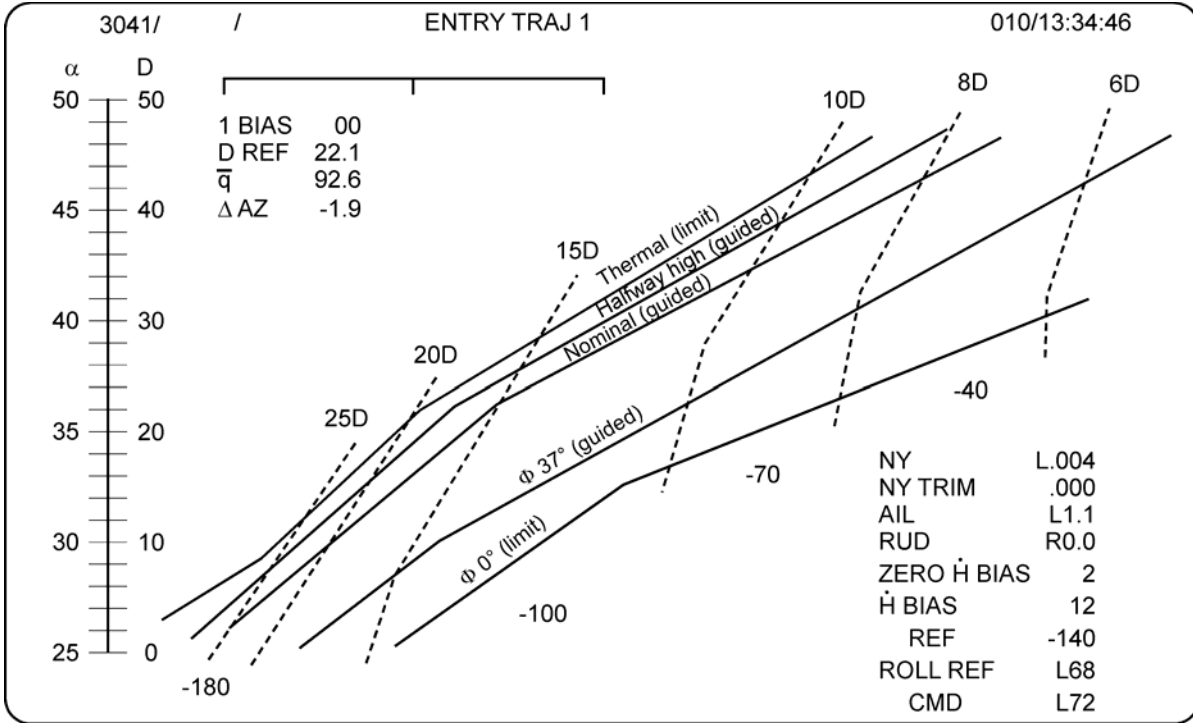


Figure 2-30. TRAJ lines on TRAJ 1

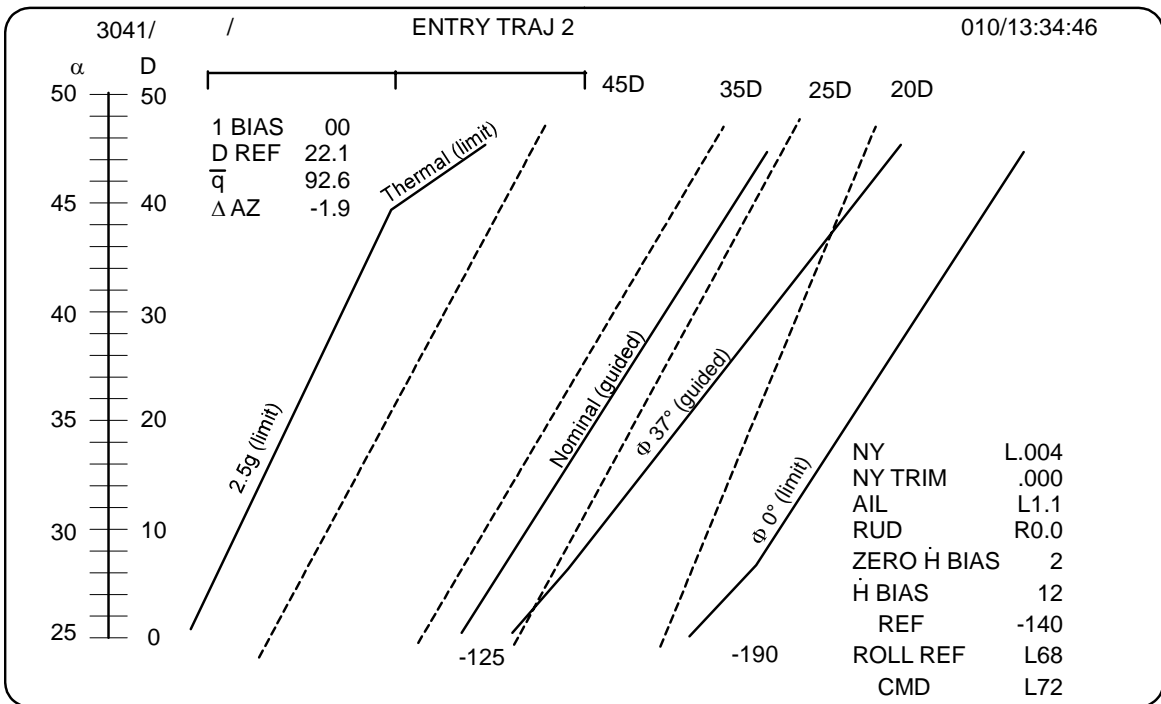
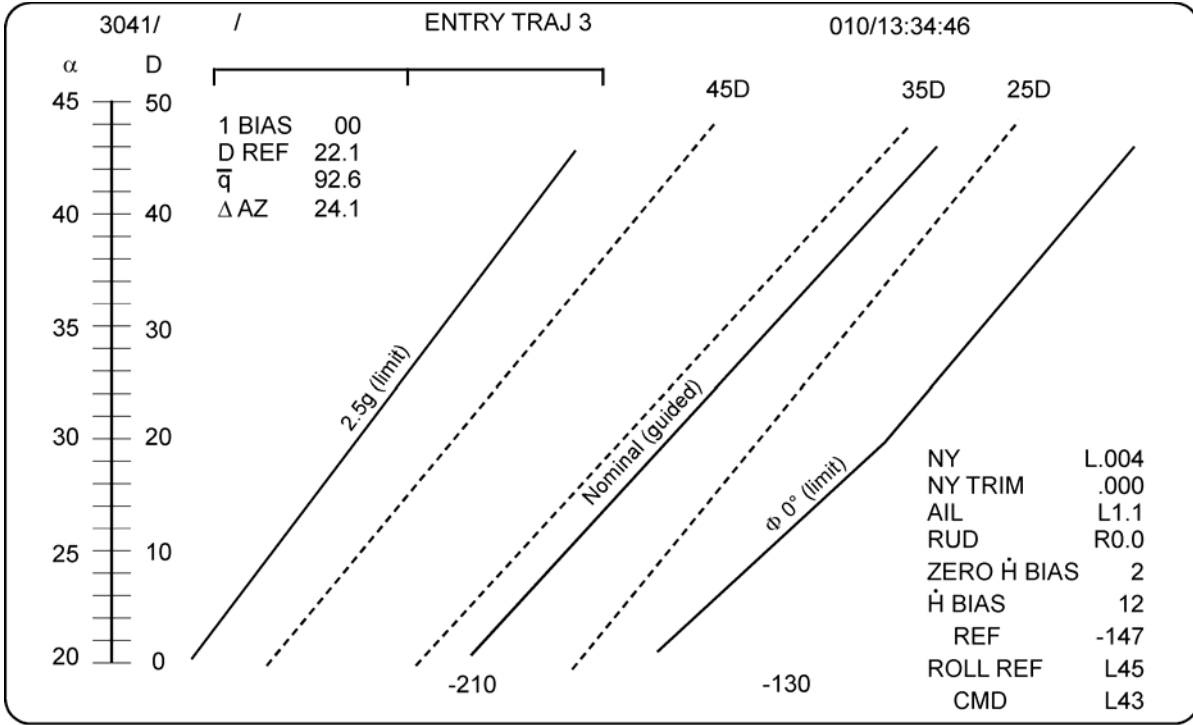
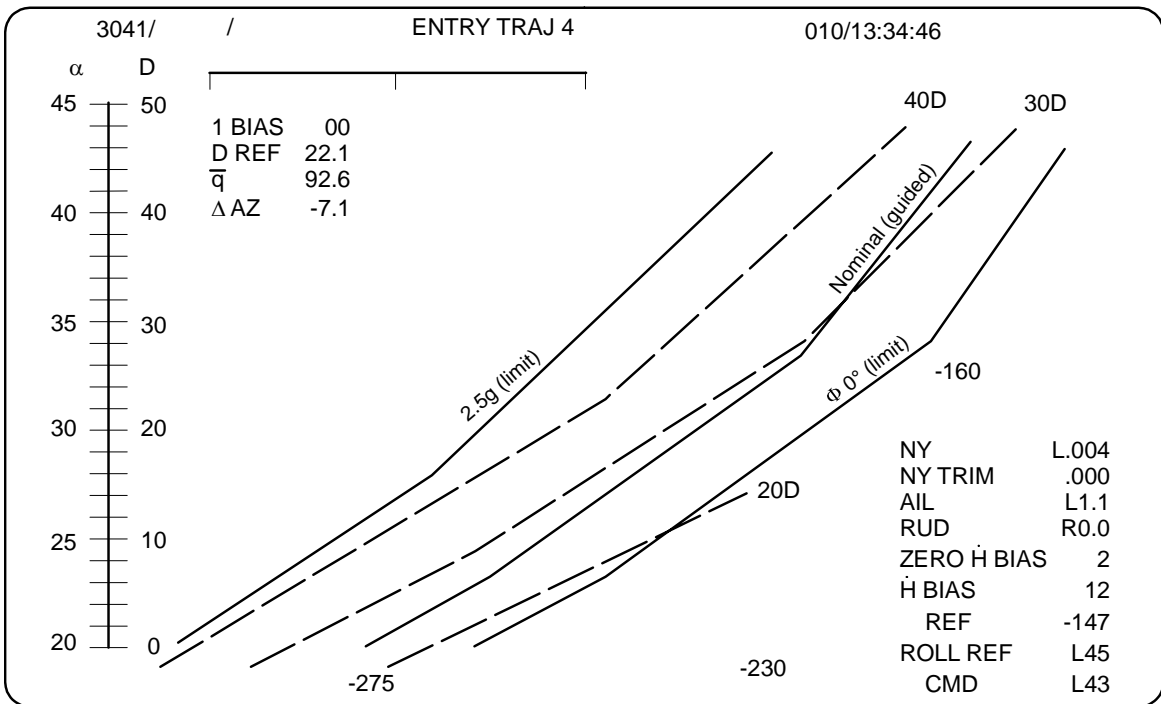


Figure 2-31. TRAJ lines on TRAJ 2



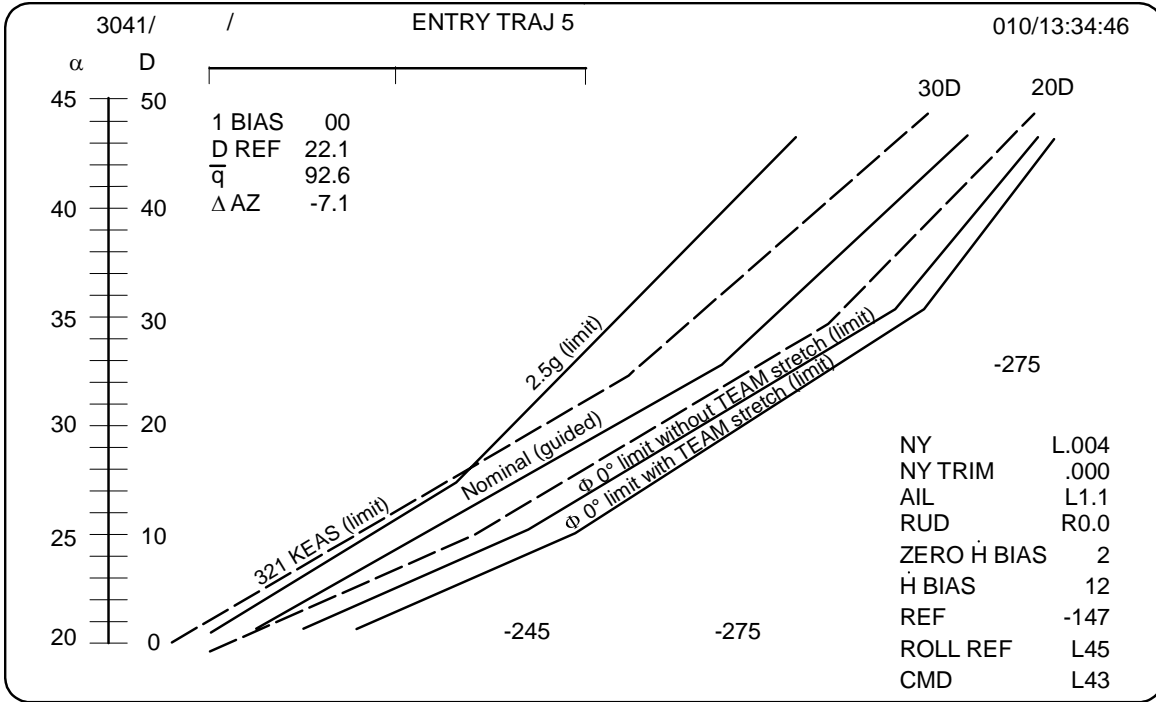
usa005512\_032.cnv

Figure 2-32. TRAJ lines on TRAJ 3



usa005512\_033.cnv

Figure 2-33. TRAJ lines on TRAJ 4



usa005512\_034.cnv

**Figure 2-34. TRA J lines on TRA J 5**

- The orbiter bug and trailers: The orbiter bug is driven by velocity and range (TRAJ 1 through 3) or Energy over Weight (E/W) and range (TRAJ 4 and 5). Table 2-2 gives the display limits for each of the TRA J displays.

**Table 2-2. Display limits**

	<u>Left</u>	<u>Right</u>	<u>Top</u>	<u>Bottom</u>
TRAJ 1	1000 nm	3800 nm	Mach 25	Mach 17
TRAJ 2	500 nm	1500 nm	Mach 17	Mach 14
TRAJ 3	350 nm	700 nm	Mach 14	Mach 10
TRAJ 4	400 nm	180 nm	1.8 Mft (Mach 10)	750 kft (Mach 6.5)
TRAJ 5	50 nm	200 nm	750 kft (Mach 6.5)	200 kft (Mach 2.5)

Note: Mft and kft are the abbreviations for millions and thousands of feet, respectively. A foot is the unit of E/W. Remember, it is more useful to think of the vertical scale of TRA J 4 and 5 in Mach.

The trailers are like pieces of bread crumbs that the bug drops every 29 seconds (15 guidance cycles). The trailers from the orbiter bug are triangles. There will be five trailers at a time. If there are already five trailers, when one is made, the oldest one is taken away.

**CAUTION**

The horizontal position of the orbiter bug goes through a quadratic function. For the most part, you will not notice this, but the function has a maximum point at about the same time the bug gets to the right side of the display. As range gets larger, the bug comes back toward the middle of the display.

If you are very low energy (i.e., a long way from the landing site), the bug can actually lie to you and be nominal (or even high) energy. The signature of this is that the bug will move from the left to the right on the display. After it reaches the right side, it stays there for a while. The bug then starts back to the left (at this time it is correct).

Most people call this a wraparound. It is better to call it a reflection. A wraparound would mean that the bug jumped from the right of the display to the left of it.

6. The guidance box: Used with the orbiter bug, the guidance box gives you drag error. If the box is in front (to the left) of the bug, you need more drag. If the box is behind (to the right) of the bug, you need less drag. The guidance box is always in the same vertical position as the orbiter bug.

The box is also useful as a trend predictor. If the box is to the left of the bug, you are headed toward high energy. If it is to the right of the bug, you are headed toward low energy. There is a major exception to this rule. If the box is on the bug, you have no drag error. If you are off the nominal line, you are headed back to the nominal line when the box is on the bug.

The trailers are dropped by the box every 29 seconds (15 guidance cycles). The trailers from the box are little dots. There will be five trailers at a time. If there are already five trailers, when one is made, the oldest one is taken away when the box is on the bug.

**CAUTION**

The guidance box suffers from reflection just like the bug. However, you cannot use a left-to-right movement to tell that this is happening. If in doubt, use the drag triangle (current drag) and the drag arrow (desired drag) to get your drag error.

7. Reference altitude rate: These numbers are values of reference altitude rate (Hdot). To use them, go straight down from the orbiter bug (do not follow the solid or dashed lines). This is the best method, since reference Hdot is a function of reference drag. You will need to interpolate between the numbers, but never extrapolate. The Entry Alpha cue card gives you nominal reference Hdot; its value will diverge from those obtained using the shuttle bug for high and low energy situations (shuttle bug not on the nominal guided TRAJ line).

8. Digital output from entry guidance: The following digital data are output from entry guidance:
  - a. Hdot BIAS – This is the Hdot bias that builds up over time if there is a drag error. ITEM 2 EXEC will zero the bias.
  - b. Hdot REF – This is reference Hdot from the real-time entry guidance algorithms.
  - c. ROLL REF – Reference roll angle from entry guidance.
  - d. ROLL CMD – Commanded roll angle. This is value that is being sent to the DAP.
9. Delta azimuth: The angle between the velocity vector and the line-of-sight vector to the landing site. Negative is landing site to the right of the nose. Delaz is also available by the bearing pointers on the HSI. BFS TRAJ displays do not have Delaz.
10. Reference drag from the phugoid damper: The drag to which the phugoid damper is commanding you. It is not the drag that will get you to your landing site. It is based on a simple table look-up of drag vs. velocity. It is essentially the nominal drag vs. velocity profile.
11. Phugoid damper drag bias: With ITEM 1, you can bias the drag of the phugoid damper up and down. You are limited to 10 drag units.
12. Phugoid damper roll command: The triangle relative to the roll scale gives you phugoid damper commanded bank angle. If the triangle is in the middle, the phugoid damper likes your current roll. If the triangle is full scale left, the damper wants you to roll 20° left. If the command is off scale, the triangle will flash.

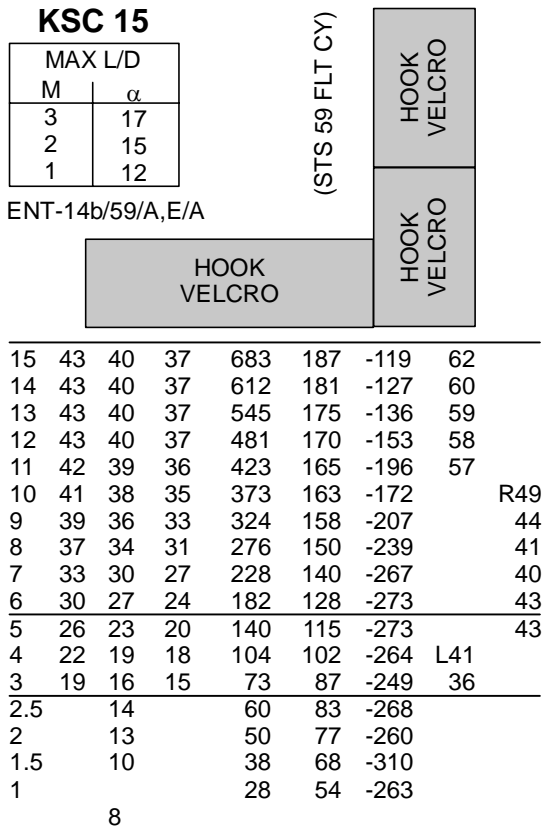
The damper tends to overshoot Hdot and drag. If it is commanding you away from Hdot reference, do not go all the way. It may be easier for you to just manually fly Hdot to the damper's commanded drag level (Reference Drag (DREF) on the upper left corner of the ENTRY TRAJ display).

The direction of bank follows roll reversals to the landing site. The scale flashes when a roll reversal is required, and the bank command reflects the direction of bank.

## 2.22 ENTRY ALPHA CUE CARD

The Entry Alpha cue card comes from the Entry Checklist. It is flight specific and deorbit specific, but most of the data are useful for any entry, including TALs. Figure 2-35 shows an example of the cue card.

VR	$\alpha_{ref}$	R	H	Href	Rref
25	40	4495	400		
24	HI 40	LO 2632	244	-46	R78
23	43 40	37 2171	237	-62	69
22	43 40	37 1806	231	-82	63
21	43 40	37 1520	223	-104	61
20	43 40	37 1295	216	-122	60
19	43 40	37 1114	209	-146	60
18	43 40	37 970	202	-171	62
17	43 40	37 855	195	-190	63
16	43 40	37 762	189	-202	L64



VR is relative in ft/sec. This is also Mach.

Alpha is the alpha seen while simulating the nominal entry. It includes alpha modulation induced by a roll reversal.

Alpha HI and LO are the alpha limits developed a long time ago. It is much easier to keep the triangle within 3° of the arrow on the alpha scale.

R is nominal range to the runway in nautical miles.

H is nominal altitude in kfeet.

Hdot ref is the nominal Hdot reference.

Rref is the nominal roll angle. The direction of bank is useful only for the planned entry. The magnitude of the roll is useful for any entry.

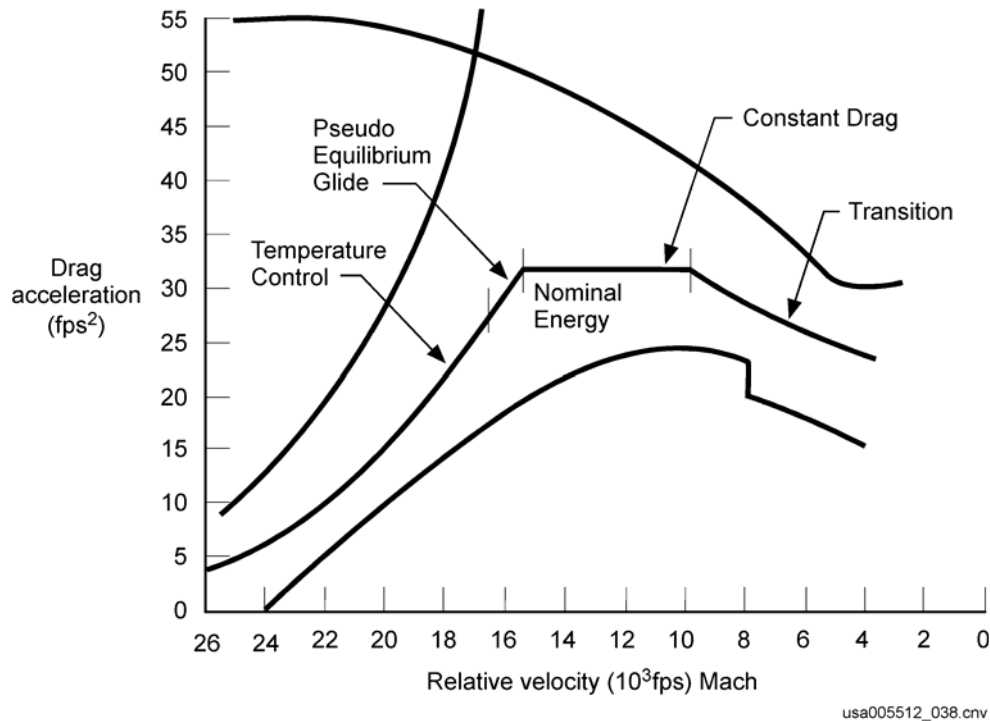
usa005512\_035.cnv

**Figure 2-35. Entry Alpha cue card example**

### 2.22.1 The Five Phases and Transitions

To shape the drag versus velocity profile, closed-loop guidance is divided into four phases based on the different regions of the drag profile. The phases are temperature control, equilibrium glide, constant drag, and transition. In addition, there is a passive guidance phase known as preentry that serves as the attitude control system until closed-loop guidance begins at a total load factor of 0.132g, which is a drag of about 3 ft/sec<sup>2</sup> (Figure 2-36 shows the four active phases).





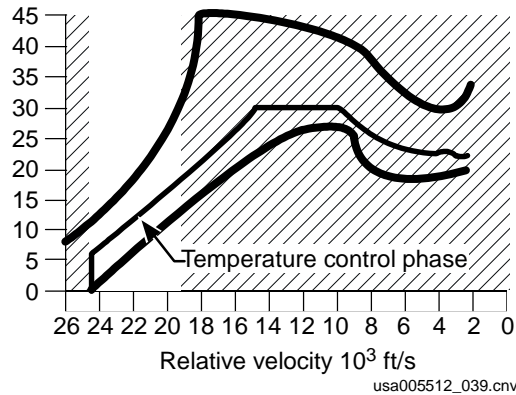
**Figure 2-36. Entry guidance phase**

a. Preentry

Preentry is the simplest phase as far as guidance is concerned. The vehicle is commanded to a Local Vertical/Local Horizontal (LVLH) attitude hold of 40° pitch, 0° roll, and 0° yaw. This position aligns the vehicle to enter the atmosphere when the active closed-loop guidance begins.

b. Temperature Control

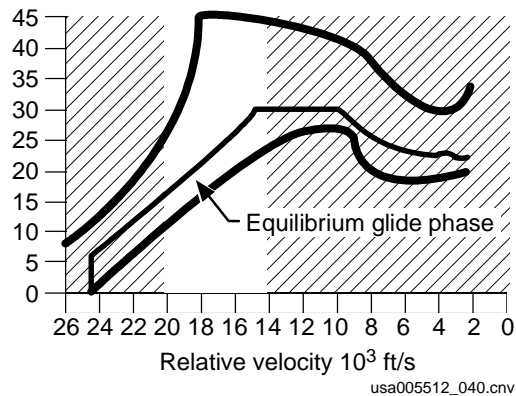
This phase begins at closed-loop guidance initiation and continues until about 19,000 ft/sec. The drag-velocity reference function is based on two quadratic equations, one operates above 22,000 ft/sec and the other operates below 22,000 ft/sec. The temperature control phase is designed to maintain constant temperature that will keep surface and backface temperatures within design limits. The shape of the drag profile is as the temperature high drag limit. See Figure 2-37.



**Figure 2-37. Temperature control phase**

c. Equilibrium Glide

This phase acts as a smooth transition between temperature control and constant drag phases. Nominally, equilibrium glide starts at a velocity of 19,000 ft/sec and ends at a reference drag of 33 ft/sec<sup>2</sup> (Figure 2-38). The shape of the drag profile is very close to the shape of the equilibrium glide boundary.



**Figure 2-38. Equilibrium glide phase**

d. Constant Drag

The constant drag phase begins as the reference drag reaches 33 ft/sec<sup>2</sup> (typically Mach 14) and continues until a velocity of 10,500 ft/sec<sup>2</sup>. As the name implies, the shape of constant drag profile is a flat line that is (nominally) 33 ft/sec<sup>2</sup> (Figure 2-39).

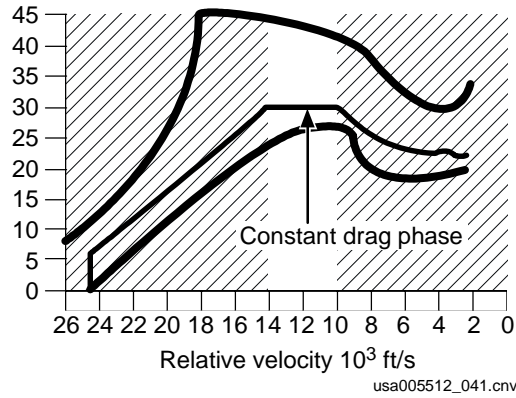


Figure 2-39. Constant drag phase

e. Transition

The transition phase guides the vehicle from the high aerobraking drag level to lower drag levels and lower angle of attack, where the more traditional aerodynamic flight begins. During the transition phase, potential energy becomes a consideration; thus, total energy (kinetic and potential) is used to calculate drag commands. The transition phase begins at a relative velocity of 10,500 ft/sec and ends at a relative velocity of 2500 ft/sec (TAEM) (Figure 2-40).

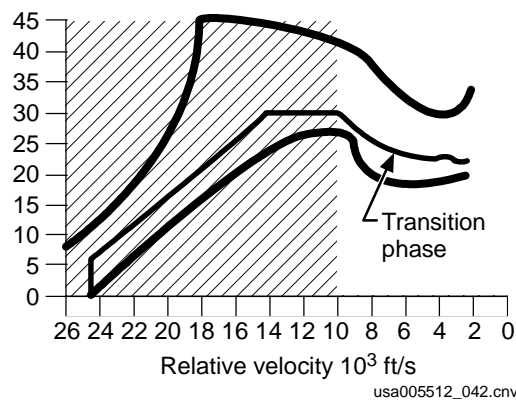
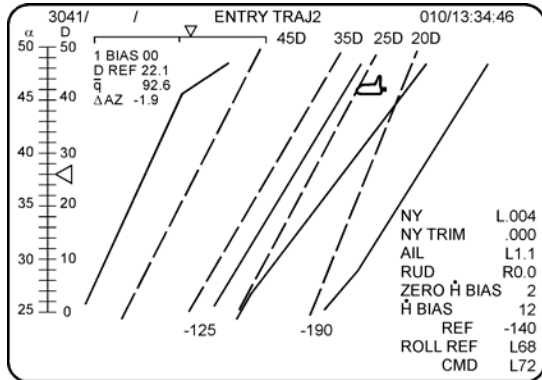


Figure 2-40. Transition phase

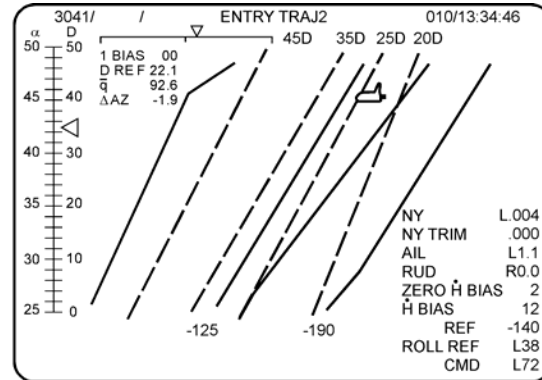
## Questions

1. Given that you have no drag error, you should
  - a. Roll to reference roll angle
  - b. Roll to  $H\text{-double-dot} = 0$
  - c. Fly  $H\text{dot}$  reference
  - d. Alpha modulate
2. The orbiter bug and the drag lines on the TRAJ display give you
  - a. Current drag
  - b. Desired drag
  - c. Reference drag
  - d. Nominal drag
  - e. b and c
3. Using a blank piece of paper and Figure 2-28, label all the numbered items on the TRAJ display.
4. If the orbiter bug and the phugoid damper flash,
  - a. They are off-scale high
  - b. It is a 3-sigma bad day
  - c. You have too much drag
  - d. You need to do a roll reversal
  - e. a and c
5. Using a blank piece of paper, sketch the high and low drag boundaries and label them.

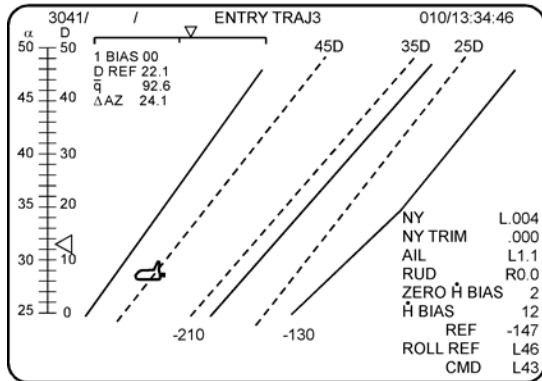
6. If you are high energy
  - a. You are too close to the landing site
  - b. You are going too fast
  - c. The orbiter bug should be to the left of the nominal line on the TRAJ display
  - d. All the above
7. If you are low energy
  - a. You are too close to the landing site
  - b. You are going too fast
  - c. The orbiter bug should be on the left side of the TRAJ display
  - d. You may have a hard time controlling Delaz
8. The two purposes of prebank are to
  - a. Allow the commander and pilot to get a little stick time
  - b. Allow the mission specialist to get a better view of Houston
  - c. Prevent the orbiter from skipping out of the atmosphere
  - d. Minimize the surface temperature of the orbiter on entry
9. Calculate desired altitude rate ( $H_{dot}$ ) for the four examples on the following page.



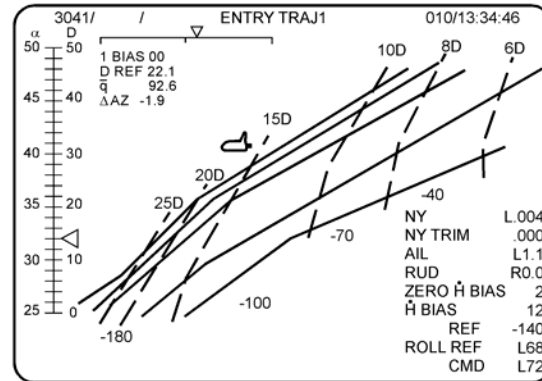
$\dot{H}_{REF}$  \_\_\_\_\_  
 $D_{ERROR}$  \_\_\_\_\_  
 $\dot{H}_{DES}$  \_\_\_\_\_



$\dot{H}_{REF}$  \_\_\_\_\_  
 $D_{ERROR}$  \_\_\_\_\_  
 $\dot{H}_{DES}$  \_\_\_\_\_



$\dot{H}_{REF}$  \_\_\_\_\_  
 $D_{ERROR}$  \_\_\_\_\_  
 $\dot{H}_{DES}$  \_\_\_\_\_



$\dot{H}_{REF}$  \_\_\_\_\_  
 $D_{ERROR}$  \_\_\_\_\_  
 $\dot{H}_{DES}$  \_\_\_\_\_

usa005512\_036.cnv

**Question 9 – calculate altitude rate (Hdot)**

### **3.0 TAEM GUIDANCE**

#### **3.1 TAEM GUIDANCE OBJECTIVES**

After reading the TAEM Guidance section, you will be able to

- a. Recognize the inputs required by TAEM.
- b. Put the pitch channel command drivers in the correct order from a list. State why the order is important.
- c. State the actions TAEM will take if you are high energy.
- d. State the actions TAEM will take if you are low energy.
- e. Describe the speedbrake command. State when the speedbrake command logic changes.
- f. State what happens with a large Heading Alignment Cone (HAC) turn angle.
- g. Use the orbiter bug on the Vertical Situation (VERT SIT) display and current airspeed to determine if you can make the landing site.
- h. Describe how to fly theta limits and state the conditions under which this is required.

#### **3.2 OVERVIEW**

##### **3.2.1 TAEM Operation – Start and Stop**

Entry guidance terminates and TAEM guidance begins when the Earth-relative velocity slows to less than 2500 ft/s (approximately Mach 2.5); the GPCs automatically transition to MM 305. VERT SIT 1 and 2 are the base displays in MM 305. TAEM transition occurs approximately 60 nm from the runway threshold at an altitude of approximately 82,000 ft Above Ground Level (AGL).

Note: For OPS 6 (RTLS or Contingency Abort), TAEM starts at Mach 3.2 (automatic transition to MM603).

Unlike entry guidance, pitch can be used to control altitude in TAEM. This makes TAEM guidance fly the orbiter like a “regular glider.”

TAEM terminates when you are established on the outer glide slope. If you are on glide slope, centerline and airspeed, TAEM will hand over to Approach and Landing guidance (called A/L interface) immediately when altitude < 10,000 ft. If altitude < 5000 ft and these parameters are still not met, A/L takes over (is forced)—no matter how bad the errors are.

### 3.2.2 TAEM Profile – Heading Alignment Cone

The primary purpose of TAEM is to line the orbiter up with the runway and to have A/L interface occur immediately below the nominal 10,000 ft AGL altitude without violating any orbiter constraints. This is nominally accomplished by flying a HAC (pronounced “hack”) placed alongside the extended runway centerline. The typical HAC is referred to as an Overhead (OVHD) HAC, because the trajectory crosses the extended runway centerline to reach the HAC. The OVHD HAC is on the opposite side of the extended runway centerline from the orbiter’s initial position upon transition to MM 304 and the HAC turn angle is between  $180^\circ$  and  $360^\circ$ . The HAC may also be selected (crew item entry) as a straight-in (STRT) approach, placing the HAC on the same side of the extended runway centerline as the orbiter. If the orbiter were to cross the extended runway centerline during entry at any time, a STRT HAC will also swap to be on the same side of the extended runway centerline as the orbiter such that the HAC turn-angle is always less than  $180^\circ$ . (An OVHD HAC will also “swap” automatically to be on the opposite side of the extended runway centerline as the orbiter, but only down to an earth relative velocity of 9,000 fps - it will not swap below this velocity). Figure 3-1 shows the orbiter’s approach to the runway, flying a right OVHD HAC to line up on final at the Nominal Entry Point (NEP), approximately 7 nm from the runway threshold.

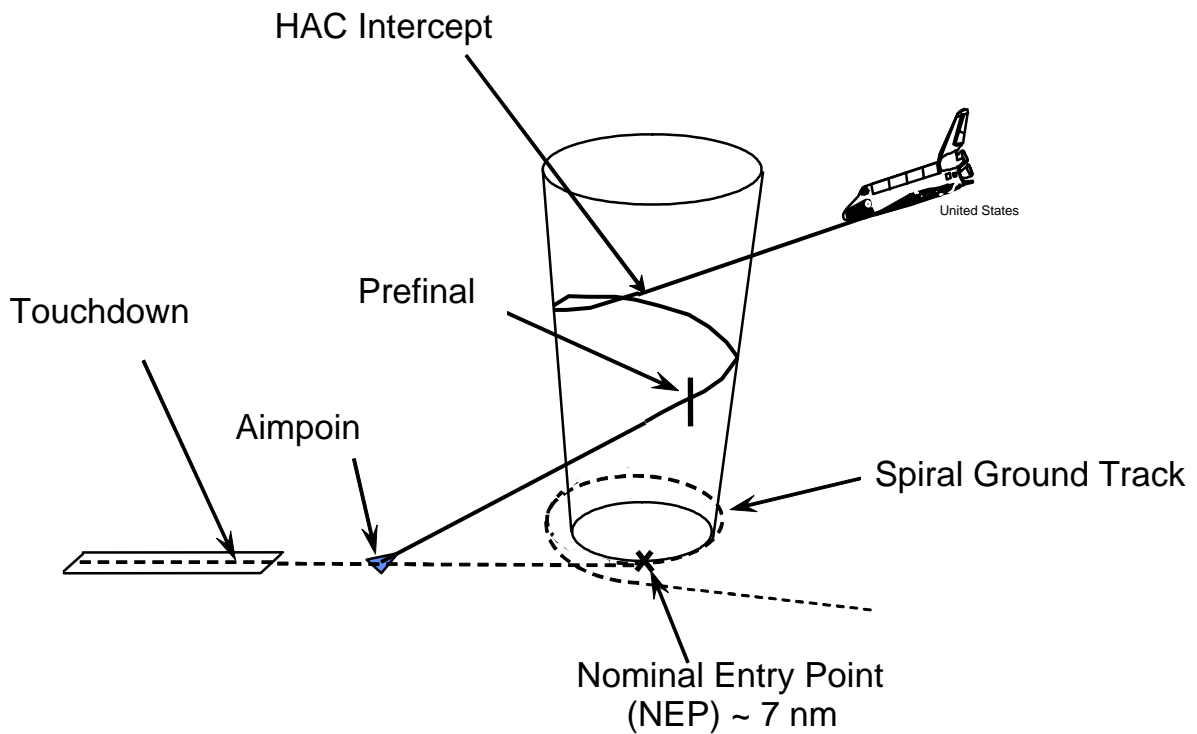


Figure 3-1. TAEM flight profile



### 3.2.3 TAEM Guidance Phases

TAEM guidance nominally has three phases: the Acquisition phase – steering toward the HAC, the Heading Alignment phase – flying the around the HAC and the Prefinal phase – lining the orbiter up with the runway. Should the vehicle have excess energy, a fourth phase, the S-turn phase, will bank the vehicle away from the HAC until sufficient energy is dissipated.

### 3.2.4 Inputs Required by TAEM

The following inputs are required by TAEM. If any of these inputs are bad, TAEM guidance will be compromised and the guidance error needles on the Attitude Direction Indicator (ADI) may be bad. Crew action can be taken for the loss of each input.

**Nav State:** Bad Nav can be a severe problem. The orbiter may experience Loss-of-Control (LOC) because DAP may not be able to fly the orbiter. Manual control or Control Stick Steering (CSS) may not always help since DAP always flies the orbiter, even when in CSS. If the orbiter is flyable, it may be possible to manually fly to the runway using TACAN data, Global Positioning System data (GPS), a Ground Controlled Approach (GCA) or by simply looking out the window.

**Normal Acceleration:** If the normal accelerometers fail (i.e., output of accelerometer Redundancy Management (RM) is bad), you can fly pitch CSS. However, the pitch error needle will be bad and the crew must use secondary pitch cues to cross-check the pitch error needle. The flight rules have you fly pitch CSS if you are fail critical (one failure away from bad accelerometer feedback) on accelerometers (two accelerometers already failed).

**Air Data:** If air data is broken, you must fly theta limits. Without air data, TAEM cannot limit airspeed. Keeping pitch angle within predetermined limits keeps airspeed in limits. This is discussed later in this chapter.

## 3.3 DISPLAYS

There are several displays designed to help you fly TAEM. They are

- a. VERT SIT (1 and 2)
- b. Horizontal Situation display (HORZ SIT – SPEC 50)
- c. ADI
- d. HSI
- e. Flight Instruments:  $\alpha$  tape, KEAS
- f. Heads-Up Display (HUD)

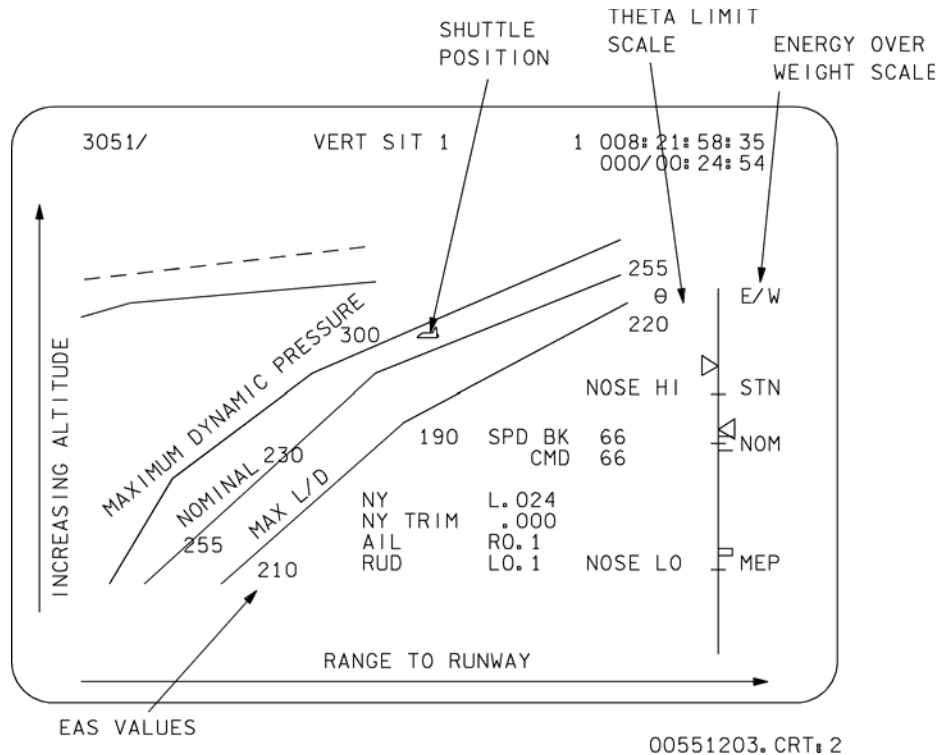
In addition, TAEM guidance can generate two energy-related Caution and Warning (C&W) messages.

The ADI, HSI, Flight Instrument tapes and HUD are discussed in detail in the GNC Dedicated Displays CBT. This is an excellent CBT to further understanding of these displays.

### 3.3.1 Vertical Situation Display

The primary trajectory displays in TAEM are the VERT SIT displays, VERT SIT 1 and VERT SIT 2. Key areas relevant to TAEM guidance are the Energy/Weight (E/W) and theta limit scales along the right-hand side of the display and the vertical situation plot that takes up most of the display (Figure 3-2). The VERT SIT displays also include flight control system information on lateral-directional trim, aileron, rudder, and speedbrake, which is discussed in USA006497, Entry Digital Autopilot Workbook. The solid and dashed lines in the upper left corner of VERT SIT 1 are used for the Glide RTLS (GRTLS) alpha-mach profile flown prior to TAEM and are discussed in USA007151, Intact Ascent Aborts Workbook 21002.

The orbiter bug is plotted using altitude along the vertical axis and range to the runway along the horizontal axis and represents the orbiter's position with respect to the desired glide slope. The three trajectory lines on the VERT SIT plot represent maximum dynamic pressure (upper line on the left), nominal trajectory (center), and maximum Lift-to-Drag ratio ((L/D) lower line to the right). The numerical values along these lines represent the maximum KEAS (Maximum  $q_{bar}$  – TAEM guidance uses smaller airspeed limits than the 321 KEAS limit the crew uses), nominal KEAS, and minimum KEAS (maximum L/D). The pitch attitude of the orbiter bug is an indication of  $H_{dot}$ . The bug orientation can be used to help climb or descend to the nominal line, by pitching the nose up or down, while being careful to not violate the maximum or minimum airspeed ( $q_{bar}$ ) limits.



**Figure 3-2. VERT SIT 1 display**

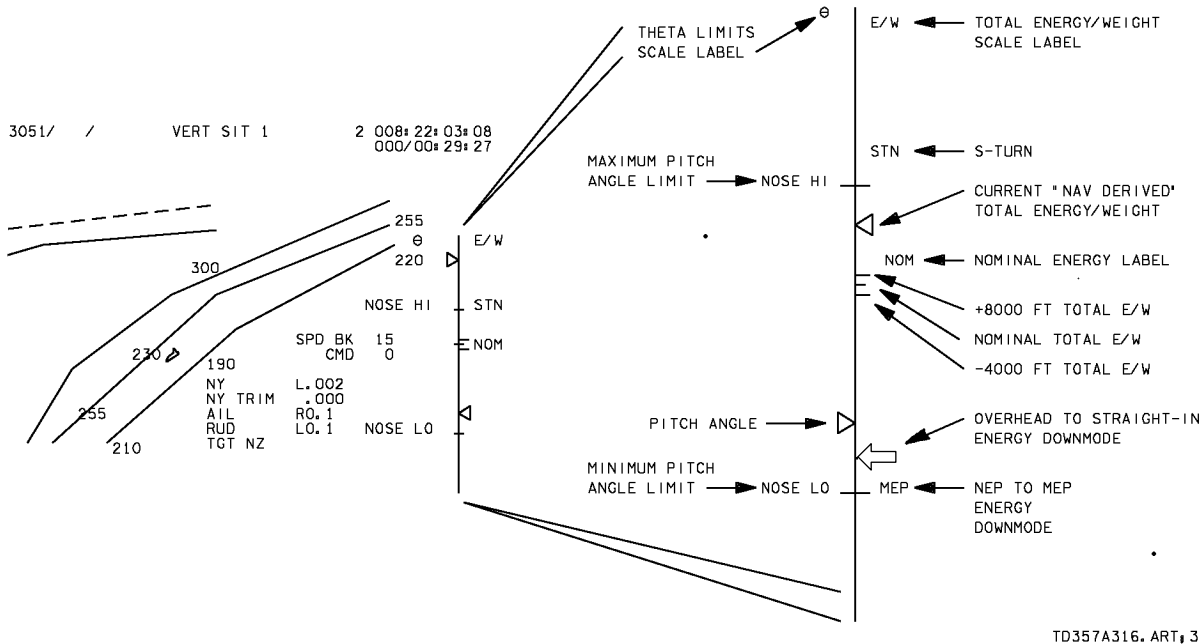
The E/W and theta limits scales are on the right-hand side of the VERT SIT display. (See Figure 3-2 and Figure 3-3).

If Air Data Transducer Assembly (ADTA) air data are not available, the theta NOSE HI and NOSE LO limits are used to keep the orbiter within the airspeed limits. This is discussed in more detail later in this chapter.

To the right of the theta limits scale is the E/W scale (in feet), which displays the orbiter's total energy (kinetic and potential). In the center of this scale are three overbright tick marks with the abbreviation NOM (for nominal) to the right. (The NOM label may not line up with the nominal tick marks - the label is static, but the tick marks are dynamic.) The middle (shorter) tick mark represents the nominal energy reference, and the overbright tick marks above and below this represent +8000 ft and -4000 ft E/W, respectively.

+8000 and -4000 do not need to be memorized, but may be thought of as an energy corridor. If the energy bug is within the high and low marks, the TAEM guidance pitch command is not being constrained by energy considerations.

Above the overbright energy tick marks is a tick mark labeled STN (for S-turn). Toward the bottom of the scale is a tick mark labeled MEP (Minimum Entry Point) and a hollow arrow to signify downmode to a straight-in approach. These energy downmode options are discussed later when addressing high and low energy options.



**Figure 3-3.  $\Theta$  limits and E/W scale**

If the E/W bug is outside the overbright tick marks and the orbiter bug is on the VERT SIT high or low glide slope trajectory line, the orbiter bug will continue to fly down that high or low line (assuming you are at maximum or minimum KEAS respectively). The high and low lines converge close to nominal at the bottom of VERT SIT 2, which means you are also converging on the nominal glide slope line as you fly down.

**IMPORTANT**

If the orbiter bug is to the left of the maximum qbar (high energy) line AND your KEAS is already at maximum KEAS, you must change your ground-track (i.e., S-turn) to bleed off excess energy. If the bug is to the left of the high line and your KEAS is less than maximum KEAS, you may be okay, but need to pitch down to attain maximum KEAS now.

If the orbiter bug is to the right of the low line and your KEAS is already at minimum KEAS (maximum L/D), you must change your groundtrack (by selecting MEP and/or straight-in HAC) to decrease the range to be flown. If the bug is to the right of the low energy line and your KEAS is greater than the minimum KEAS (maximum L/D) you may be okay, but need to pitch up to the maximum L/D alpha now.

Note: The above-mentioned technique, comparing the orbiter's position and airspeed with respect to the VERT SIT TRAJ lines, is the only way to tell if you are "going to make it." The energy bug is not always useful to tell if you are going to make it. However, the trajectory lines were developed with zero winds; winds may help or hurt.

### 3.3.2 Horizontal Situation Display (HORIZ SIT – SPEC 50)

As stated earlier, TAEM is always initialized to the OVHD NEP HAC. This positions the HAC at the ~12,000 ft altitude entry point, ~7 nm from the runway threshold and on the opposite side of the runway centerline from the vehicle. The OVHD HAC turn-angle is between 180° and 360°. The STRT HAC is also anchored to the NEP but is on the same side of the centerline as the vehicle. The STRT HAC turn-angle is between 0° and 180°.

The graphic portion of SPEC 50 is the active groundtrack projection. This display gives you a “God’s-eye view” of the shuttle and the runway approach. The shuttle is fixed at the bottom of the display – pointed straight up. The “world” rotates and moves relative to the fixed shuttle.

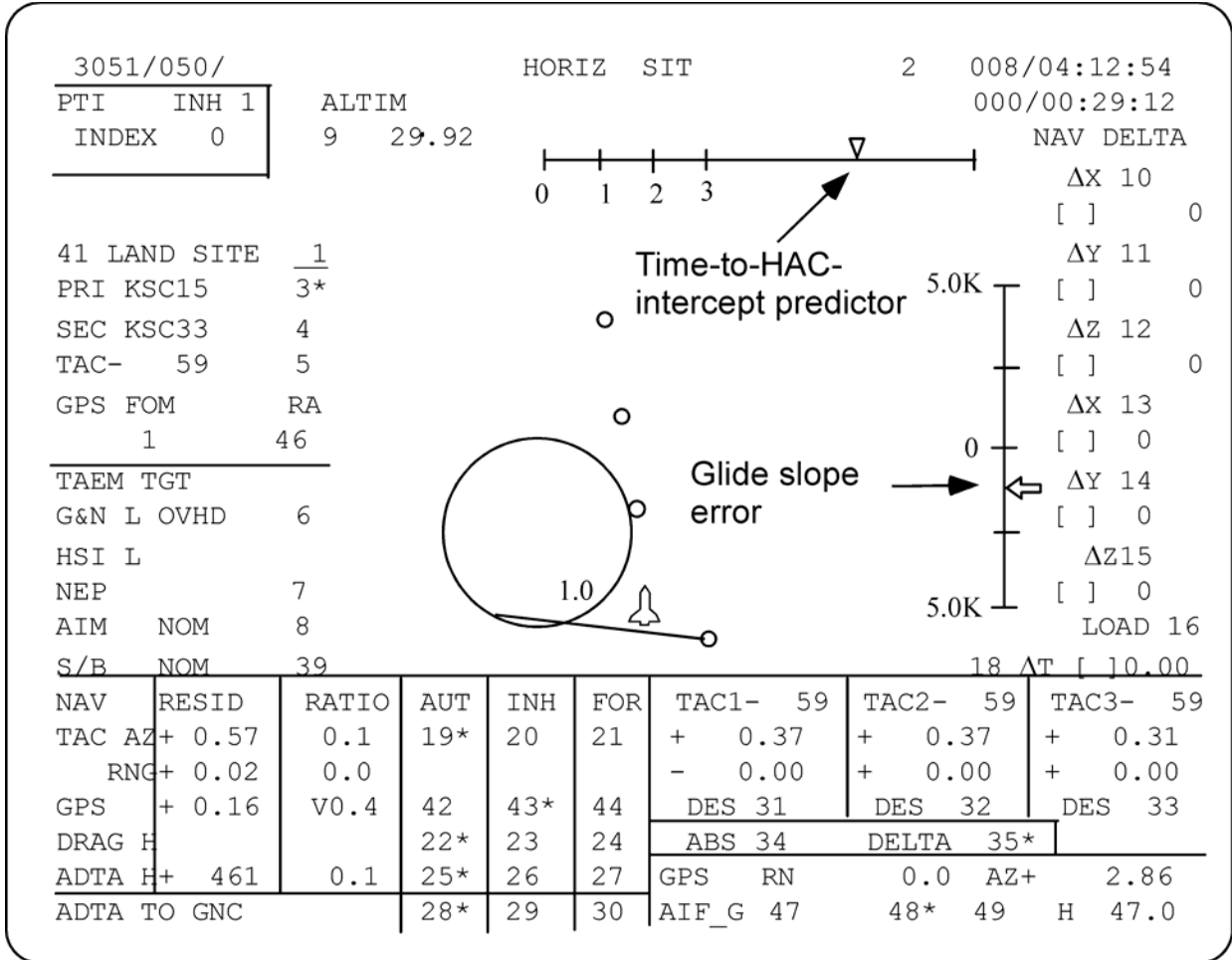
There are 20-, 40-, and 60-second heading predictors, the extended runway centerline and the HAC. SPEC 50 displays all this information on an expanding scale, allowing the runway to be seen during entry but increasing the scale to display a larger HAC and runway centerline as the vehicle approaches the runway (see Figure 3-4).

The Time-to-HAC Intercept predictor is depicted on a horizontal bar at the top of SPEC 50 before HAC Intercept. The triangle appears (flashing) 20 seconds before the predicted HAC Intercept. Ten seconds before intercept, the triangle starts moving and reaches the zero point at HAC Intercept. The numerals 0 through 3 correspond to the seconds until HAC Intercept. For a left-hand HAC, the zero point will be on the left side of the scale (as shown on Figure 3-4). For a right-hand HAC, the zero point is on the right.

At HAC Intercept, the scale changes to depict HAC radial error, as shown in Figure 3-5. The HAC radial error indicator is simply an expansion of the orbiter bug and HAC depiction in the center of the SPEC 50 display. The scale is  $\pm 5000$  feet as shown and rescales to  $\pm 2500$  feet at prefinal and is labeled on SPEC 50. The HAC radial error becomes crosstrack error during the Prefinal phase.

The glide slope error shown on the glide slope indicator (GSI) vertical scale is the altitude error from TAEM guidance. The scale is normally  $\pm 5000$  ft as shown and rescales on final. Like the HAC radial error, the GSI scale limits are always labeled and disappears on final along with the crosstrack error. The GSI on SPEC 50 is functionally similar to the GSI on the HUD (but has a different scaling on final).

Since the HAC is conical, the flightpath around the HAC when projected onto the ground, becomes a spiral. For SPEC 50 a circle represents the HAC, with the diameter of the circle being the diameter of the HAC at HAC Intercept during the acquisition phase, or the current vehicle altitude during the heading alignment phase. The HAC on SPEC 50 always agrees with the HAC that TAEM is flying.



usa005512\_066.crv

Figure 3-4. SPEC 50 HORIZ SIT display



"Roll Rate" - Time-to-HAC-intercept predictor, then blanks after HAC intercept

Theta Limits Bracket - shows below M 2.0 if ADTA not incorporated or in DLMA



"Pitch Rate" - shows glide slope error (fly to)

"Yaw Rate" - shows crosstrack error (fly to) (Opposite SPEC 50)

Figure 3-6. ADI roll, pitch, and yaw rate

### 3.3.4 The Horizontal Situation Indicator

The HSI (Figure 3-7) is driven by Area Navigation software (Area Nav), which acts independently of shuttle guidance software. This causes the HSI information to sometimes be a little different from SPEC 50, the ADI and HUD (these always display Nav and guidance data). Though the GSI on the HSI is driven by area navigation rather than TAEM guidance, it is functionally similar to the other available GSIs.

The HSI and Area Nav are driven according to the HSI source switch on Panels F6 and F8. This switch has three positions

- Nav – Supplies the onboard Nav state to area Nav. With the switch in this position, the HSI is not an independent source of Navigation data. The HSI source is normally driven in Nav unless there is a problem with the onboard Nav state.
- TACAN – Supplies "raw" TACAN data to Area Nav. With the switch in this position, the HSI is an independent source of Navigation data.

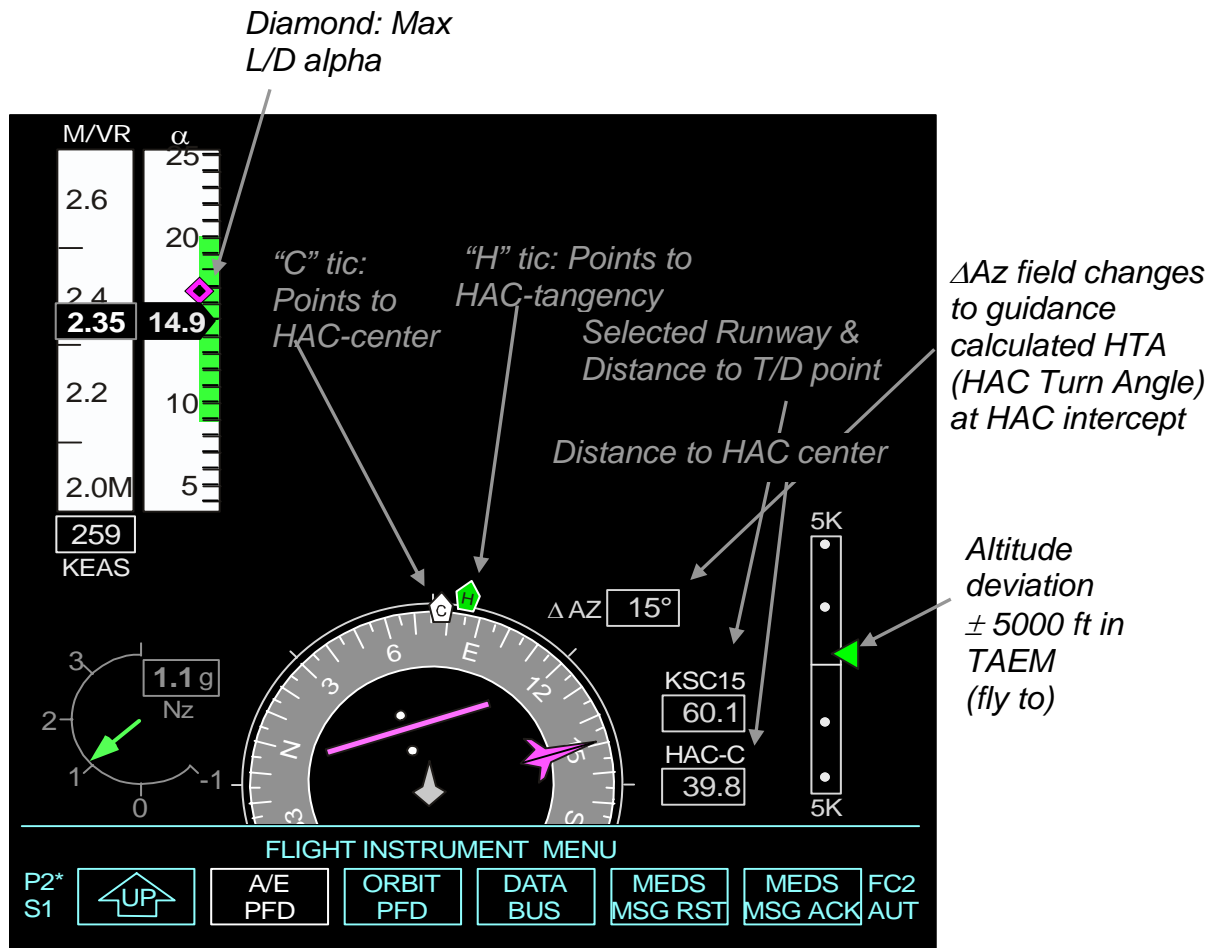


The HSI displays “raw” TACAN data, but not in the manner that the T-38 HSI displays TACAN data. The bearing pointer never points at the TACAN station, and the range display never shows Distance Measuring Equipment (DME) range. These data are available on SPEC 50, but are rarely used.

**CAUTION**

When selecting TACAN as the source, be careful to select a TACAN station that will avoid the cone of confusion. It may be better to have the secondary TACAN selected on SPEC 50 if the secondary is located away from the landing site.

- c. MLS – Supplies “raw” Microwave Scanning Beam Landing System (MSBLS) data to Area Nav.



**Figure 3-7. TAEM HSI definitions**

The HSI displays different information, based on three phases: entry from Mach 25 to 2500 fps, TAEM from 2500 fps to approach and land scaling (12,000 ft) and A/L the rest of the way. Table 3-1 shows what the HSI is displaying during the different phases.

Note: HSI approach and land scaling is not the same as guidance transition to Approach and Landing. HSI A/L scaling occurs at about the same time that TAEM guidance modes to prefinal.

**Table 3-1. HSI display parameter/mode switch matrix**

Display mode	Primary bearing "H"	Primary range	Secondary bearing "C"	Secondary range	Course deviation (CDI)	Glide slope deviation (GSI)	Compass card (heading)
ENTRY	HAC tangency point (WP1)	Range to the runway via the HAC in nm	Same as primary bearing	Same as primary bearing	Always centered	Not computed, GSI_FLAG set invalid	Magnetic heading of orbiter relative velocity vector
TAEM	HAC tangency point (WP1)	Range to the runway via the HAC in tenths of a mile	Center of the HAC	Range to center of the HAC in tenths of a mile	Deviation from extended runway centerline (full scale = $\pm 10^\circ$ )	Altitude error (full scale = $\pm 5,000$ ft)	Magnetic heading of body X-axis
A/L	Runway threshold	Range to the runway in tenths of a mile	Same as primary bearing	Same as primary range	Deviation from extended runway centerline (full scale = $\pm 2.5^\circ$ )	Altitude error (full scale = $\pm 1,000$ ft)	Magnetic heading of body X-axis

### 3.3.5 Heads-Up Display

This workbook only goes over some of the highlights of TAEM guidance and the HUD. To learn about the details of the HUD, run the Head Up Display (HUD) CBT. The guidance phase you are in is displayed in the lower left-hand corner of the HUD (see Figure 3-8). This display will read one of the following in TAEM:

- a. S-TRN – S-turn
- b. ACQ – Acquisition
- c. HDG – Heading Alignment
- d. PRFNL – Prefinal

This display will read one of the following in approach and landing guidance (see Section 4.0 for more information):

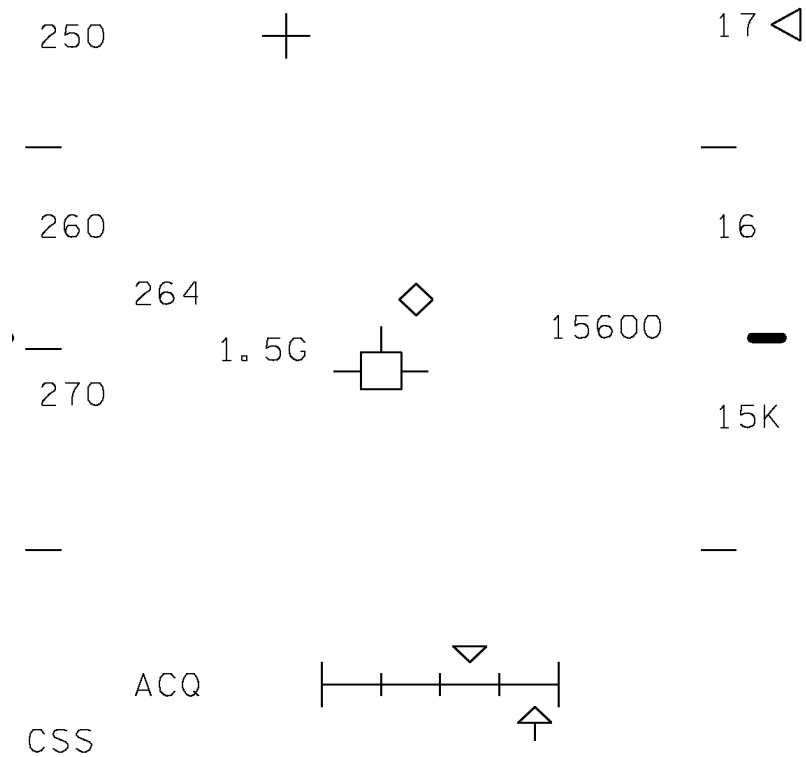
- a. CAPT – Capture
- b. OGS – Outer Glide Slope
- c. FLARE – Preflare
- d. FNLFL – Final Flare

Guidance roll and pitch errors are displayed by the difference between the flight director symbol and the guidance diamond. If the diamond is above the flight director symbol, you need to pitch up. If the diamond is to the left of the flight director symbol, you need to roll left.

Very small deflections of the guidance diamond can indicate a large error. Figure 3-8 shows that you need a large pitchup and a large right roll. When flying the HUD diamond, you must keep it centered.

The flight director symbol starts off as a small square with little wings and a tail. At this point, the symbol is frozen in the center of the HUD. When TAEM goes into the prefinal phase, the flight director symbol becomes a velocity vector and changes to a circle.

The last thing to talk about on the HUD that relates to TAEM guidance is the GSI on the right side of the HUD next to the altitude scale as shown by the left-pointing triangle. There is no actual scale depicted for the HUD GSI. The scale is  $\pm 5000$  ft until you go below 10,000 ft altitude. The HUD GSI becomes more sensitive from 10,000 ft to 5000 ft. At 5000 ft, the sensitivity is  $\pm 500$  ft. Figure 3-8 shows you about 5000 ft below glide slope. The HUD GSI shows altitude error with respect to the same TAEM reference glide slope as SPEC 50 and the ADI.



TD357A150, ART. 2

**Figure 3-8. HUD symbology**

### 3.4 TAEM GUIDANCE IN DETAIL

The three outputs of TAEM are commanded pitch, roll and speedbrake.

#### 3.4.1 Pitch Commands – Glide Slope, Energy, Airspeed (KEAS, $q_{bar}$ ), $N_z$

TAEM calculates a reference altitude (glide slope) based on range to go. If you're on this desired glide slope, guidance commands a pitch to maintain reference Hdot (reference Hdot is the Hdot that will maintain your glide slope). If you're below the glide slope, TAEM commands a pitch that results in a smaller Hdot (absolute value) than reference Hdot to get you back to glide slope.

Figure 3-9 and Figure 3-10 show how this process looks on a VERT SIT display. In Figure 3-9, the orbiter bug is on glide slope. Guidance will command a pitch to maintain the glide slope and you will see the orbiter bug on the VERT SIT rotate parallel to the nominal line (the orbiter bug rotates based on Hdot). In Figure 3-10, the orbiter bug is below the nominal line (below glide slope). Guidance will command a pitch up and you will see orbiter bug rotate to point up at the nominal line. In Figure 3-11, the orbiter bug is above the nominal line (above glide slope). Guidance will command a pitch down and you will see orbiter bug rotate to point down at the nominal line.

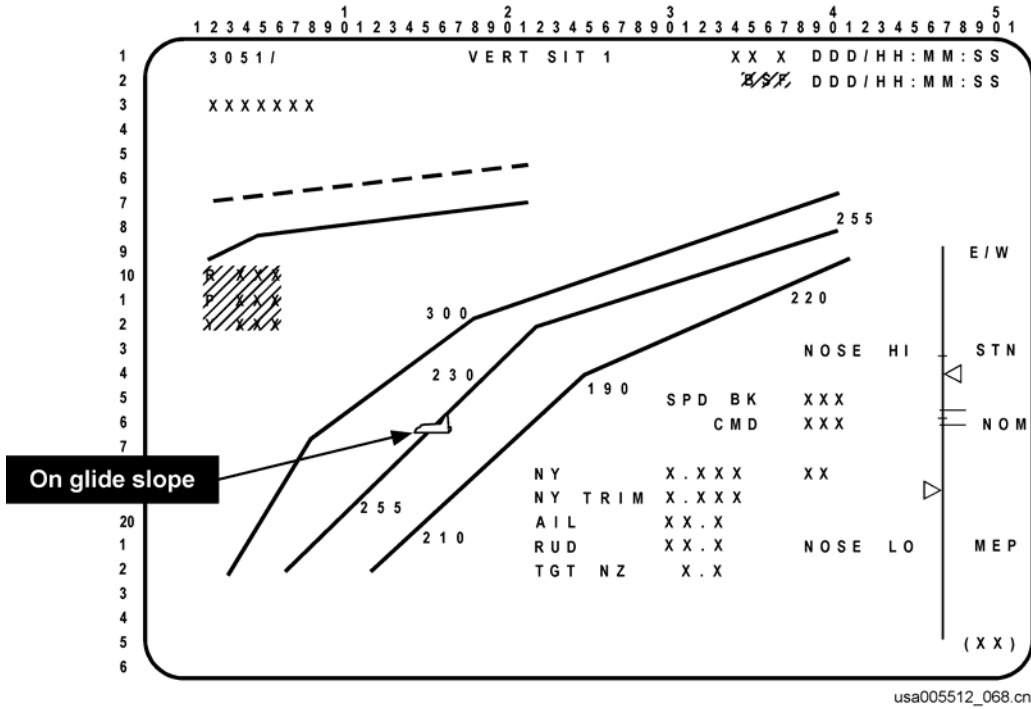


Figure 3-9. Glide slope as seen on the VERT SIT display  
Pitch command to control glide slope - frame 1)

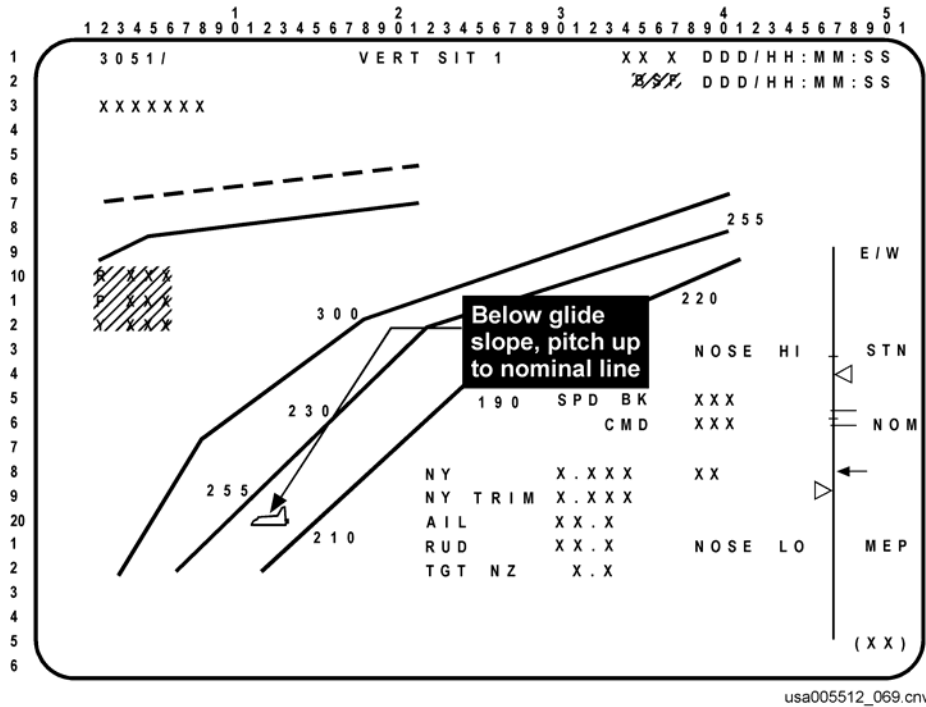
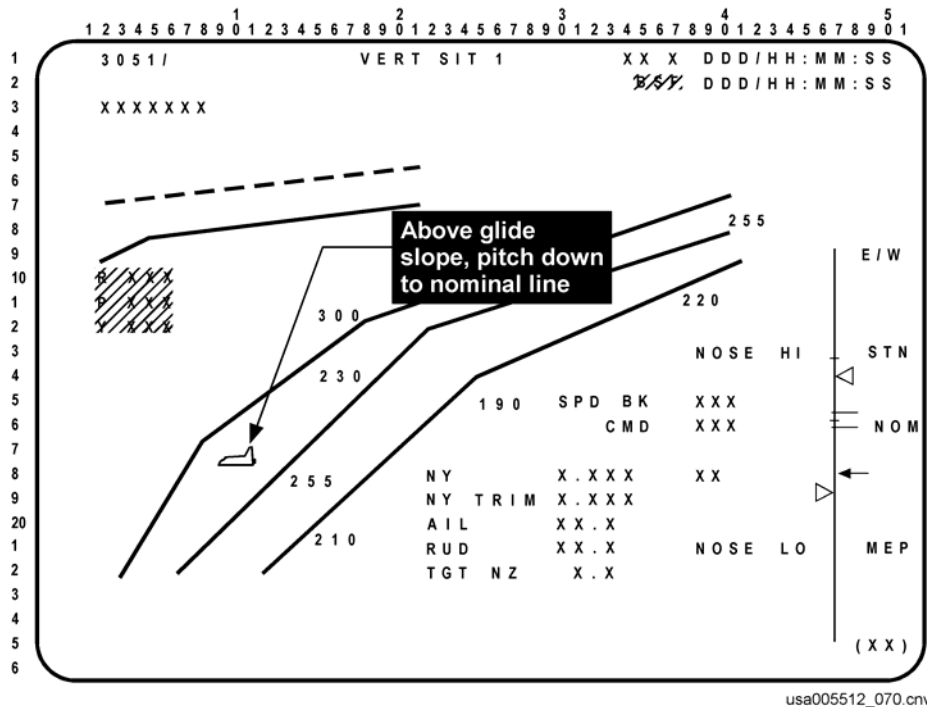


Figure 3-10. Glide slope as seen on the VERT SIT display  
(Below glide slope - frame 2)



**Figure 3-11. Glide slope as seen on the VERT SIT display  
(Above glide slope - frame 3)**

The above discussion is true only for small glide slope errors. If you have large errors, one of three pitch command filters may modify the pitch command. These filters are (in order):

- a. Energy
- b. Airspeed/qbar
- c. Alpha

If low on energy (the E/W bug is below the -4000 ft E/W tick mark), the energy filter will override the glide slope command and pitch the orbiter up. It will do the opposite if high energy (the E/W bug is above the 8000 ft E/W tick mark). The glide slope and energy commands usually agree with each other, but if they do not, energy will always override glide slope if the energy error is outside the overbright high and low lines. The overbright energy tick marks on VERT SIT are your insight to whether or not energy is overriding glide slope.

The next filter is the qbar (KEAS filter). This filter is essential if you are low or high energy and will override both glide slope and energy. This filter prevents the orbiter from pitching up (pitch up divergence) or down (exceed maximum airspeed) too much. If air data are not available to TAEM guidance, the filter will not work. You must fly theta limits.

The last filter for alpha is available in OPS 6 only. It protects the orbiter from exceeding alpha constraints as the vehicle transitions to “normal” flight during the alpha transition phase.

**WARNING**

Experience has shown that pitchup divergence is much easier to violate than is maximum KEAS. At Mach 1.5, the orbiter pitch up diverges at alpha 15°. This is only a few degrees above nominal alpha.

**WARNING**

If TAEM does not have good airspeed feedback, you must fly theta limits. Theta limits are covered in Section 3.9, No Air Data in TAEM.

In all cases the pitch command is limited +/- 0.5g. This keeps TAEM from overstressing the orbiter. When this 0.5 is added to the 2.0g required to maintain “level” flight at 60° bank, it results in 2.5g - the maximum allowed.

**WARNING**

The TAEM pitch channel works in the world of Nz, not pitch rate. If Nz feedback is lost, the ADI pitch error needle will be bad. If you lose two of the four Nz accelerometers, you should fly the pitch channel manually (CSS). This protects for the failure of the third Nz accelerometer.

### 3.4.2 Roll Commands – Ground Track

During the acquisition phase, roll commands are a function of the heading error referenced to the HAC tangency point (waypoint 1). During the heading alignment phase, roll commands are a function of HAC radial error. If the HAC radial error is greater than 7000 ft, the acquisition phase roll command logic is again used. During the prefinal phase, roll command is a function of the lateral distance and rate errors referenced to the runway centerline. For S-turns, the maximum roll angle is commanded in a direction that decreases the HAC turn angle (unwraps the HAC).

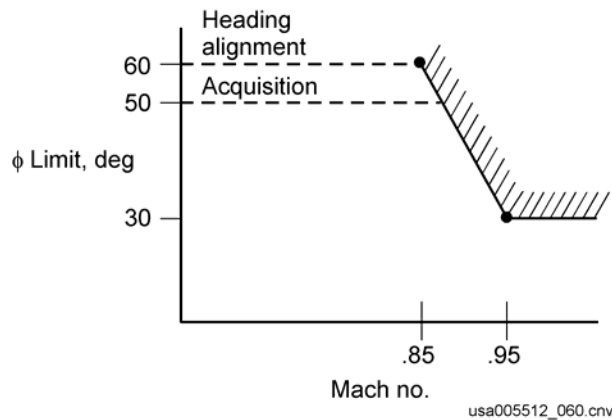
**Table 3-2. Guidance roll command limits during TAEM phases**

	<b>EOM</b>	<b>GRTLS</b>
S-turn or acquisition (subsonic)	50	45
Heading alignment (subsonic)	60	55
All phases supersonic	30	45

Guidance roll commands during TAEM are limited by current phase and Mach number (Table 3-2). In all cases, TAEM will limit the roll command to avoid exceeding 1.8 Gs (referred to as Nz limiting). Upon transition to TAEM, the shuttle software is nominally in the acquisition phase (will be in the S-turn phase if too high energy). The shuttle is still supersonic at this point and the commanded bank angle will be limited to 30° (the 30° limit minimizes the sonic boom footprint). As the shuttle goes subsonic, the limit increases from 30° to 50° by Mach 0.85 for both the acquisition and S-turn phases (Figure 3-12). At HAC Intercept, the heading alignment phase starts and the limit becomes 60° to allow the turn rate required for the HAC.

**WARNING**

A HAC cannot be flown with 30° of roll. This is a problem only for large (>315°) HAC turns. TAEM should get you subsonic before HAC Intercept, but if it does not, take CSS and fly > 30° of roll.



**Figure 3-12. Transonic bank limits**

### 3.4.3 Acquisition – Point at the Heading Alignment Cone Tangency

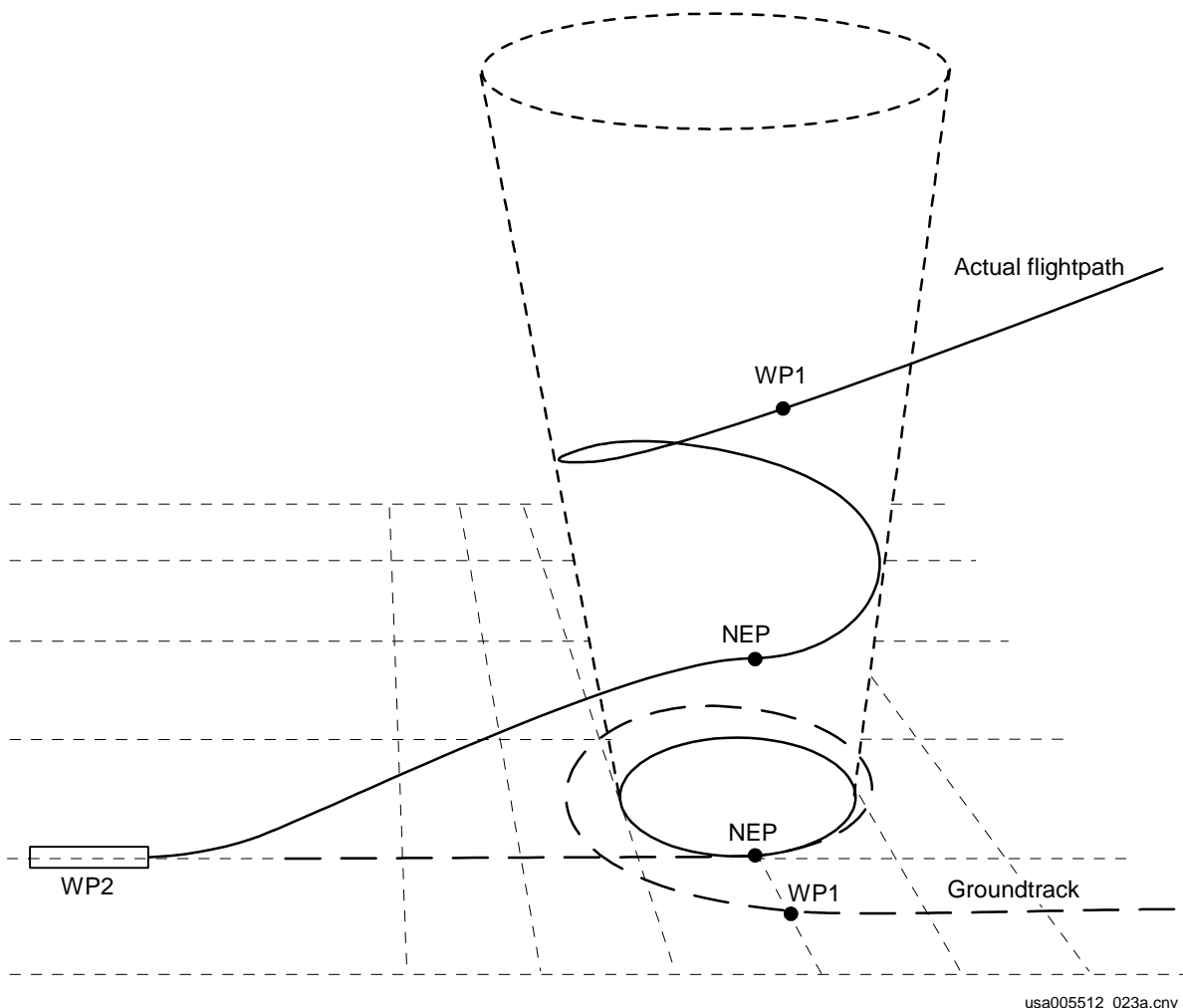
At TAEM interface, guidance nominally enters the acquisition phase and simply steers the vehicle toward the heading alignment intercept point, titled waypoint 1 (waypoint 2 is the touchdown point, 1000 ft beyond the runway threshold).



### 3.4.4 Heading Alignment

Heading alignment is the phase that flies the shuttle around the HAC. The HAC is an imaginary inverted cone tangent to the runway centerline and is nominally about 7 nm. from the runway threshold. As stated before, waypoint 1 is the position where the shuttle enters the HAC. The point where the HAC is tangent to the runway centerline is called the entry point. For a nominal HAC configuration (7 nm from the runway threshold), the Nominal Entry Point (NEP) corresponds to ~12,000 ft altitude. If low energy, guidance generates the message “SWITCH TO MEP” and the crew can select the Minimum Entry Point (MEP) on the HORIZ SIT display (SPEC 50). This moves the entry point to about 4 nm from the runway, anchored at ~6,000 ft.

As the shuttle flies around the HAC, its path, as seen in the groundtrack, is a spiral with the vehicle flying an arc of decreasing radius as illustrated in Figure 3-13.



**Figure 3-13. HAC configuration**

### 3.4.5 Prefinal

The prefinal phase steers the orbiter to the runway centerline. It starts at a certain range from the runway (approximately 8 nm if NEP is selected or approximately 5 nm if MEP is selected) or when below 7,000 ft altitude.

Once below 10,000 ft and “in the box” (within certain airspeed, glide slope and cross-track error limits), TAEM guidance “transitions” to Approach and Landing (A/L) guidance. The TAEM prefinal phase is better at taking out large errors than A/L guidance is, which is why the transition is delayed if errors are still large.

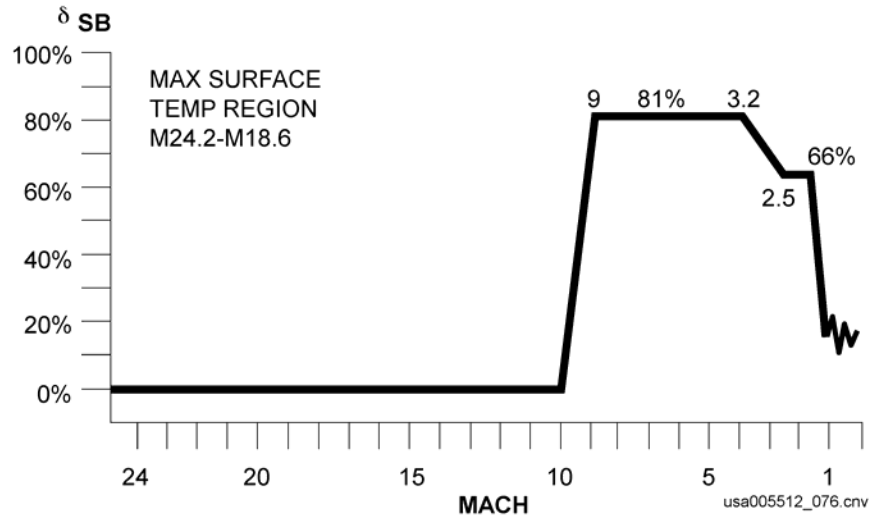
### 3.4.6 Speedbrake Commands

While supersonic, the speedbrake is commanded to an I-loaded position as a function of Mach number and is primarily providing pitch trim. When subsonic, the speedbrake initially modulates based on energy. By 9000 ft, the speedbrake is directly controlling QBAR (KEAS). The transition from controlling energy to controlling QBAR occurs from 14,000 to 9000 ft. See Figure 3-14.

The energy speedbrake was developed to help fly in high winds. For example, when flying with a tailwind, your ground speed increases, which increases energy. This results in the speedbrake opening and slowing you down again, which is good because you need to slow down to better make turns.

The energy bug on the VERT SIT is useful for monitoring speedbrake commands above 14,000. If the E/W bug is below the nominal energy mark, the speedbrake will close ( $<65^\circ$ ); if the E/W bug is above the nominal energy mark, the speedbrake will open ( $>65^\circ$ ).

The speedbrake transition between energy and QBAR does not occur with guidance transitions. A/L transition may occur as late as 5000 ft but the speedbrake is still controlling QBAR by 9000 ft.



**Figure 3-14. Speedbrake schedule**

### 3.5 HIGH ENERGY OPTIONS

There are several options in TAEM if you are high energy. Some of them are fully automatic; some are fully manual. These options are

- a. Fly maximum airspeed – Automatic
- b. Open the speedbrake – Automatic
- c. S-turn – Automatic (if range and HAC turn angle constraints are met)
- d. Change runway – Manual
- e. Fly outside (expand) HAC – Manual

Using the orbiter bug on VERT SIT and your current airspeed, you can determine whether you are so high energy that flying maximum airspeed and opening the speedbrake will be sufficient or not. For more information, see the VERT SIT discussion in this section.

#### 3.5.1 Fly Maximum Airspeed

If you are high energy, the first thing guidance will do is pitch the nose down. This increases airspeed and flies at a lower L/D, causing you to lose energy. In an extreme case, TAEM will pitch the nose down until you are at maximum airspeed. The air data probes are essential for TAEM to know when you are at maximum airspeed. For more information, see Section 3.9, No Air Data In TAEM.

### 3.5.2 Open the Speedbrake

Guidance will also open the speedbrake if you are high energy, but only when you are below Mach .95. For more information, see Section 3.4.6, Speedbrake Commands.

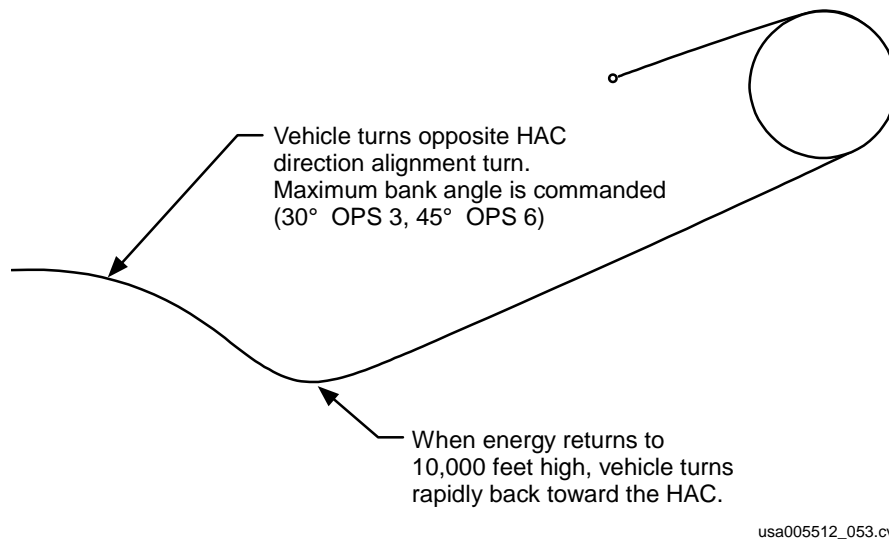
### 3.5.3 S-Turn

If high energy, more than ~ 26 nm from the runway and the HAC turn angle is less than 200°, TAEM will enter the S-turn phase (OPS 6 has no HAC turn angle restriction but you must be at least ~ 34 nm from the runway). This phase steers the vehicle away from the HAC until excess energy is dissipated (Figure 3-15).

Note: (1) Roll reversals in entry are not energy control devices; they simply control crossrange and do not appreciably increase the range flown.

Note: (2) An S-turn is an energy control device. The range-to-go calculated by TAEM guidance is based on the predicted path to the runway and therefore includes maneuvers such as S-turns.

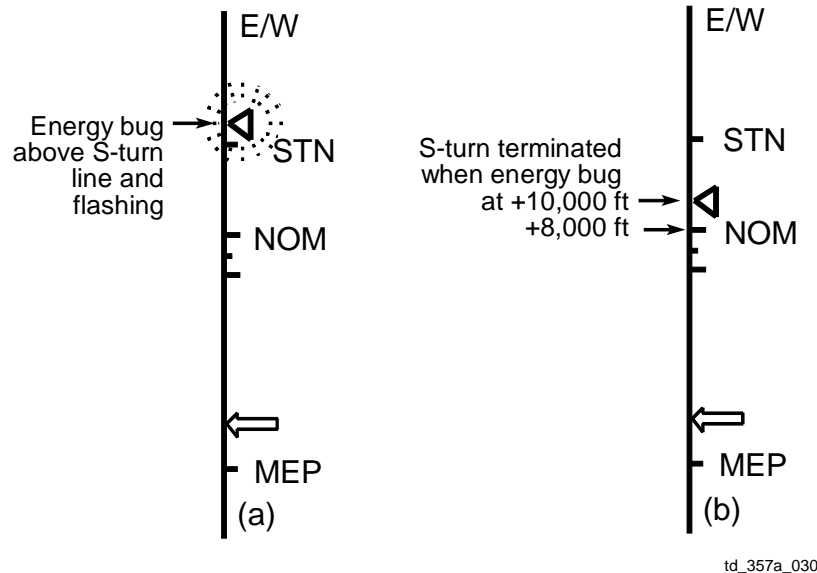
The minimum HAC turn constraint of 200° in OPS 3 is a major constraint since OVHD HACs are usually greater than 200°.



**Figure 3-15. Normal S-turn**

The E/W scale is very handy for monitoring or performing an S-turn. If the triangle is above the S-turn (STN) mark, the triangle flashes and an S-turn is commanded (if range and HAC turn angle constraints are met). The triangle continues to flash until the energy bug is +10,000 ft high on energy, just above the +8000 ft overbright tick mark (see Figure 3-16). In practice, the energy bug may seem slow to dump energy at first (and stay above the S-turn marker) but it will move quickly once it starts to move down the scale. The rate at which the vehicle will dump energy is dependent on the vehicle heading error relative to the HAC.

Caution: When S-turn is terminated the orbiter must be immediately turned back toward the HAC to avoid going low energy



**Figure 3-16. S-turn phase – initiation and termination**

### 3.5.4 Change Runway

You can also select a different runway if high energy. This option would be entirely at the discretion of the crew/ground (i.e., no onboard alerts or messages). EDW has available lakebed runways and gives you more options than KSC. At KSC you can only pick the opposite end of the runway.

You must select the different runway early. If done too late, the geometry may not allow you to turn sufficiently to acquire the new HAC. The HORIZ SIT (SPEC 50) display is very useful for assessing the geometry on which runway to use.

### 3.5.5 Fly Outside (expand) the HAC

This is also a purely manual technique if high energy; TAEM will not do this. Flying outside the HAC will increase the range-to-go and ultimately bleed off energy. Be careful not to fly too far outside the HAC or you could easily end up low energy.

### **3.6 LOW ENERGY OPTIONS**

There are several options in TAEM if you are low energy. Some of them are fully automatic, some give you a message and an SM alert (but are manually selected), and some are fully manual. These options are

- a. Fly maximum L/D – Automatic
- b. Close the speedbrake – Automatic
- c. Select the straight-in HAC – Message and SM alert, then manual selection
- d. Select MEP – Message and SM alert, then manual selection
- e. Change runway – Manual
- f. Shrink HAC – Automatic

Using the orbiter bug on VERT SIT and your current airspeed, you can determine whether you are so low energy that flying maximum L/D and closing the speedbrake will be sufficient or not. If you are below the maximum L/D line and have insufficient speed to get above the line, you will probably not be able to make the runway without changing your ground track.

#### **3.6.1 Fly Maximum Lift Over Drag**

The first thing TAEM will do if low energy is pitch the nose up. This decreases airspeed and flies closer to maximum L/D. As a result, you “gain” energy (actually, you lose energy at a slower rate). In an extreme case, TAEM will pitch the nose up until you are at maximum L/D. The air data probes are essential for TAEM to know when you are at maximum L/D. For more information, see Section 3.4.1 Pitch Commands – Glide Slope, Energy, Airspeed (KEAS, qbar), Nz and Section 3.9, No Air Data in TAEM.

#### **3.6.2 Close the Speedbrake**

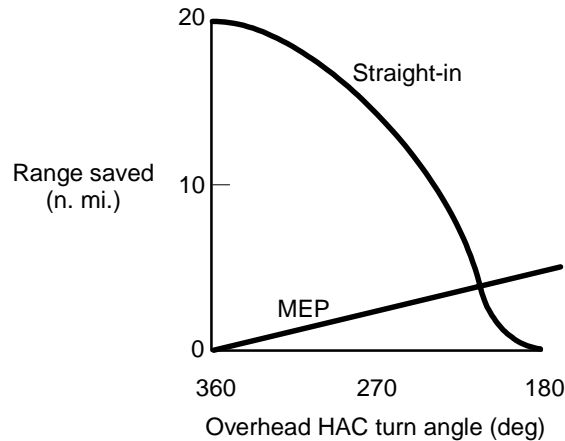
TAEM will also close the speedbrake if low energy. This occurs only when below Mach 0.95. For more information, see Section 3.4.6, Speedbrake Commands.

#### **3.6.3 Straight-In HAC and Minimum Entry Point**

Starting with STS-5, TAEM guidance was modified to include Optional TAEM Targeting (OTT), which greatly increased flexibility for low energy cases. TAEM is always initialized with an overhead HAC (180° to 360°) and NEP. If low energy, you can select the following two options:

- a. Straight-in HAC
- b. MEP

The bigger the overhead HAC, the more energy buy-back you get from selecting the straight-in HAC (Figure 3-17). The only difference between a flying straight-in and overhead HAC is the turn angle, although swapping from overhead to straight-in will result in a HAC turn in the opposite direction. An MEP, however, greatly decreases your time on final. There is a high likelihood that A/L transition will be forced when using MEP and should only be used if necessary.



usa005512\_054.cnv

**Figure 3-17. Energy saving for straight-in and MEP**

Figure 3-18 shows how the straight-in HAC affects geometry. The example shown is for a 270° overhead HAC. After selecting straight-in, you will have a ~110° HAC.

If the E/W bug on the VERT SIT is below the hollow arrow on the energy scale (Figure 3-3 in the VERT SIT section), range is greater than ~45nm and the HAC turn is greater than 200°, you will get an SM alert and message “OTT ST IN”, suggesting optional TAEM targeting to a straight-in HAC. You select the straight-in HAC by performing ITEM 6 EXEC on SPEC 50. Once the straight-in HAC is selected, you will immediately see an increase in energy and glide slope. If energy or glide slope gets worse, you are too close to the HAC to make the change from overhead to straight-in. The straight-in arrow disappears when range-to-go is less than 45 nm.

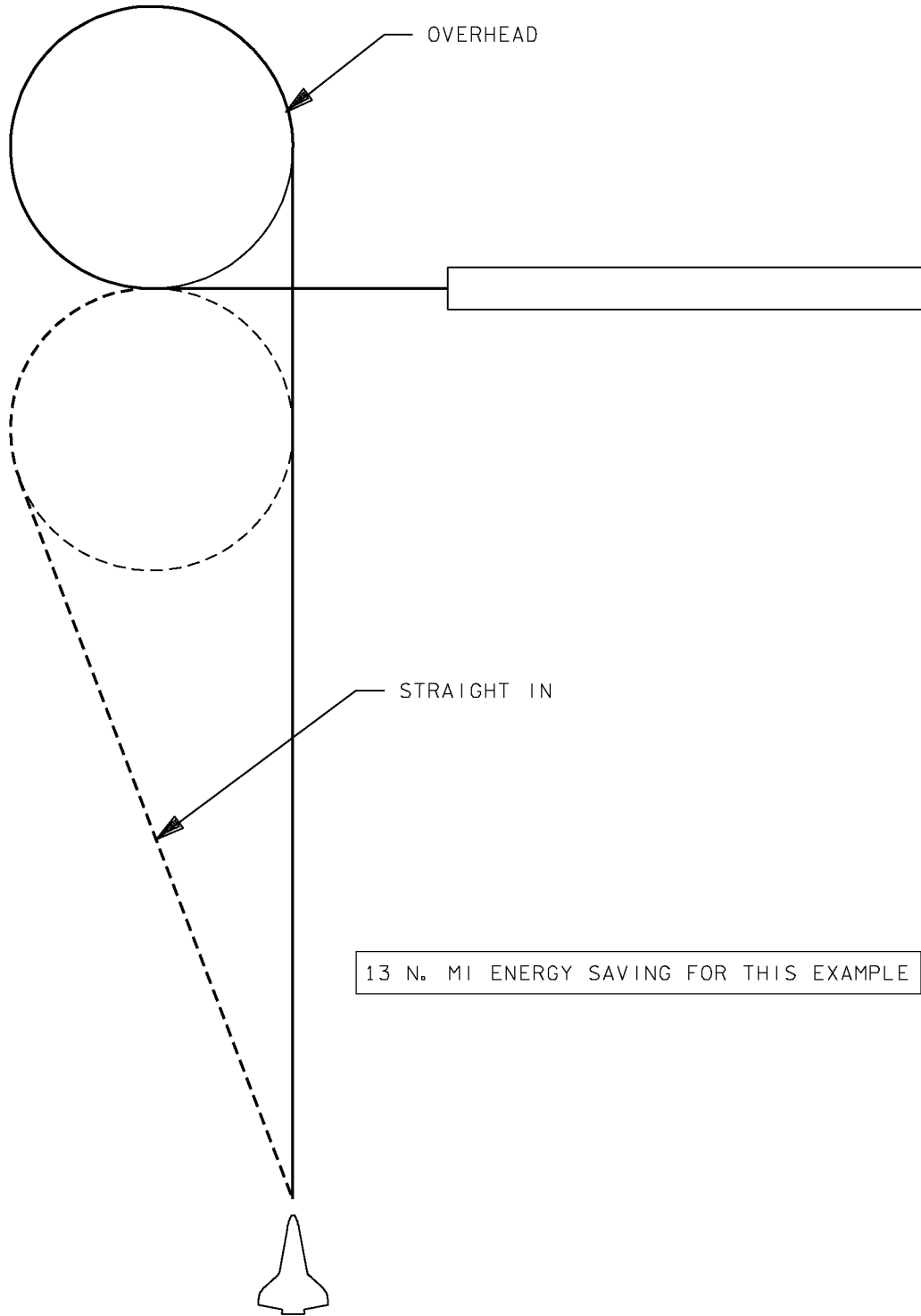
If selecting the straight-in HAC does not buy back sufficient energy, you can select MEP. The smaller the overhead HAC and the larger the straight-in HAC, the more energy buy-back you get from selecting MEP. Figure 3-19 shows how the geometry changes when selecting MEP. As stated above, MEP will have you roll out on final much closer to the runway and much lower; you are usually ~7000 ft altitude when you roll out. You need to adjust down the altitude rules of thumb by 5000 ft when MEP is selected (e.g., 28,000 ft at the 180° point becomes 23,000 ft). If in doubt, check the VERT SIT.

If the E/W bug on the VERT SIT is below the MEP tick mark on the energy scale (see Figure 3-3 in the VERT SIT section), you will get an SM alert and message “SW TO MEP.” If you cannot fix your energy by selecting the straight-in HAC or changing runways, you should select the MEP HAC by performing ITEM 7 EXEC on SPEC 50. Once you select MEP, you will immediately see an increase in energy and glide slope appropriate to the particular HAC geometry.

**CAUTION**

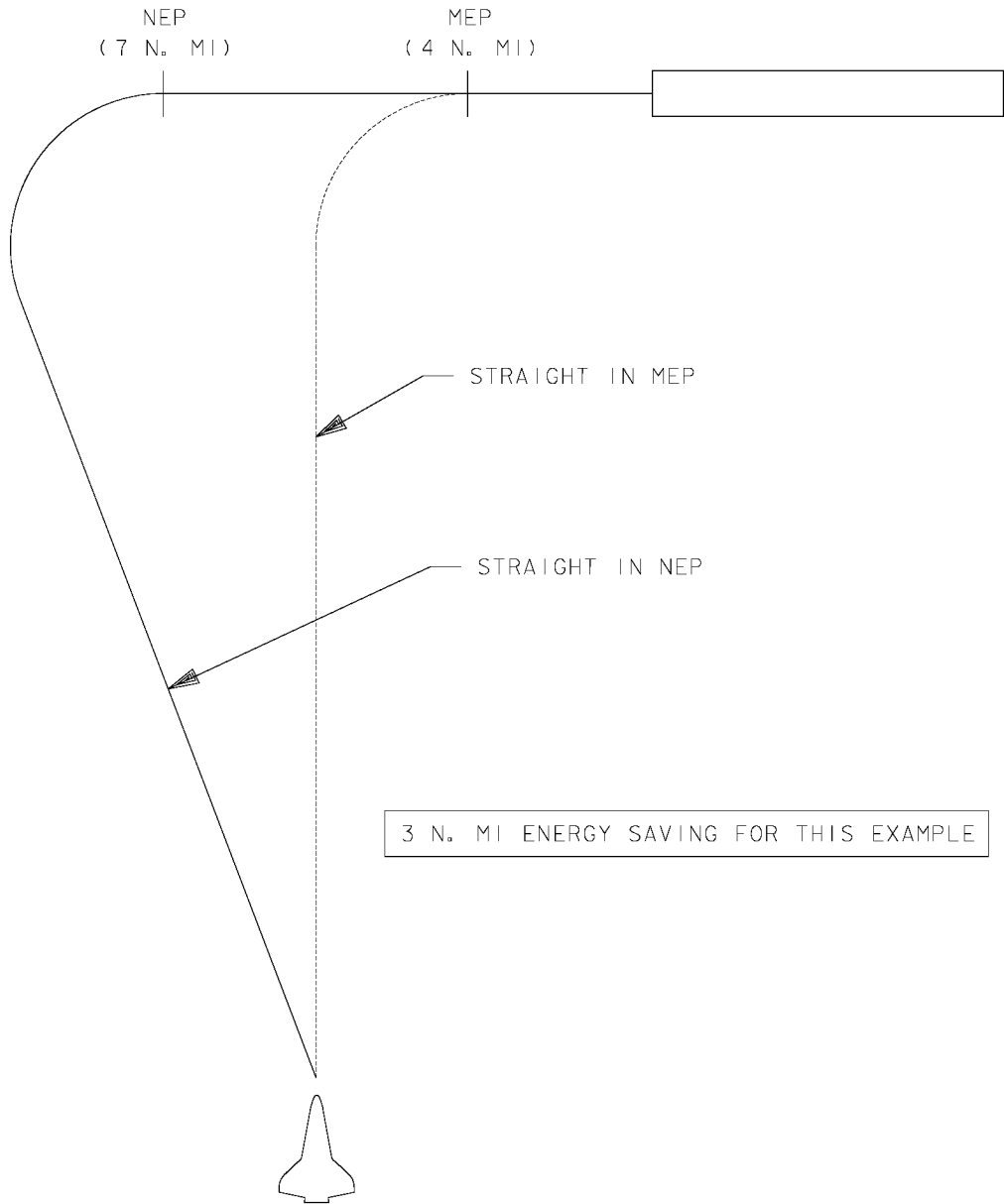
Selecting MEP while on the HAC may cause guidance to want to go the wrong way. See TAEM Ops note.





TD357A016. ART. 3

**Figure 3-18. Effect of straight-in approach**



TD357A017. ART 2

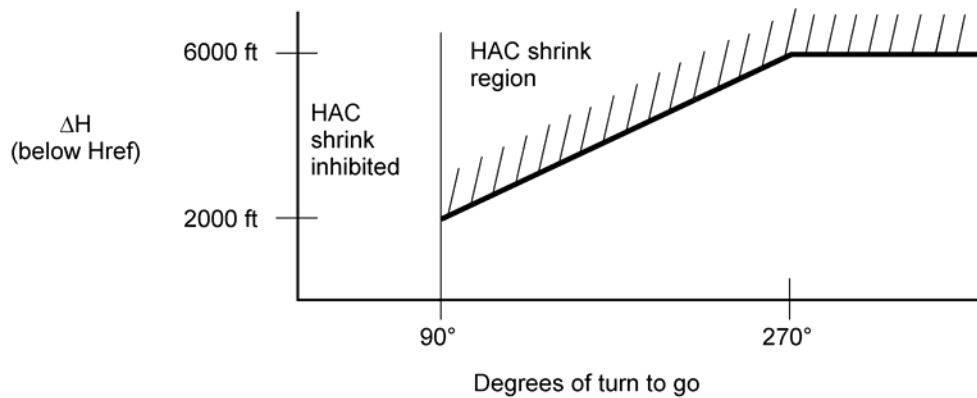
**Figure 3-19. Effect of MEP**

### 3.6.4 Change Runway

If you are low energy, you can select a different runway. This operation is completely manual (i.e., no alert and no message). If you are going to EDW, you can choose from the available runways. If you are going to KSC, you can try the other end of the runway.

### 3.6.5 HAC Shrink

If very low altitude during the heading alignment phase, TAEM may shrink the diameter of the HAC to decrease range. The amount of HAC shrink is based on altitude error and remaining HAC turn angle. HAC shrink is inhibited when the remaining HAC turn is less than 90°. Figure 3-20 shows how far below the glide slope you have to be to trigger a HAC shrink. A good indication of a HAC shrink is the circle on SPEC 50 shrinking away from the shuttle at HAC Intercept.



Spiral size frozen when HAC turn angle  $\leq 90^\circ$

usa005512\_061.crv

**Figure 3-20. Altitude Error to Trigger HAC shrink**

### 3.7 MESSAGES AND CAUTION AND WARNING

There are two messages that TAEM guidance can generate. You will get an SM alert with each. The messages are

- a. OTT ST IN – Optional TAEM targeting straight-in
- b. SW TO MEP – Switch to MEP

Both are generated when you are low energy. Guidance is asking you to select a different HAC which can only be done manually on SPEC 50.

Message “OTT ST IN” is generated whenever E/W falls below a calculated limit (represented on the VERT SIT as a hollow arrow on the energy scale), the HAC turn angle is greater than  $200^\circ$  and range is greater than 45 nm. These conditions apply for both OPS 3 and OPS 6. At a range less than 45 nm, the hollow arrow disappears and the C&W message is no longer generated. The “SW TO MEP” message occurs any time E/W falls below a calculated limit (the MEP tick mark on the VERT SIT).

These messages neither guarantee that you will make the runway if you take action, nor do they necessarily indicate that you will fall short if you do not take action. The energy buy-back for either option will depend upon the particular HAC geometry.

### 3.8 LARGE HAC TURN ANGLES

Large HAC turn angles have additional dynamics associated with them to ensure that you are subsonic before you get to the HAC since TAEM cannot fly the HAC supersonic. We generally avoid HAC turn angles greater than  $\sim 300^\circ$  since these dynamics start with HACs  $\sim 325^\circ$  and get more pronounced for HAC turns increasing to  $360^\circ$ .

- a. Energy dump: TAEM will shift the energy corridor down for large HACs. This shift or “dump” occurs immediately at TAEM interface and is seen on the VERT SIT display by an abrupt shift downward of the overbright energy ticks. If shifted enough (bigger shift for bigger HACs), the vehicle E/W can end up above the +8,000 ft high energy line. We know from previous discussion that anytime the vehicle E/W is outside the energy corridor, the energy filter will override the glide slope command. Essentially, this energy dump “tricks” the vehicle into a high energy state and, as a result, TAEM pitches the nose down to lose altitude. Again, the shift may not always be enough to affect the pitch channel, and even if it does it is very difficult to see in the cockpit (basically seen as a slower convergence to glide slope since TAEM always starts below the glide slope by design). The energy dump is designed to protect the pull-up maneuver from getting too high energy.
- b. Pull-up maneuver: This maneuver occurs just prior to HAC init ( $\sim$  Mach 1.2) and is abrupt (G increase, loft above the glide slope up to  $\sim 5,000$  ft and decreased airspeed). At about the  $270^\circ$  on the HAC, TAEM terminates the pullup and commands a pitchdown. TAEM typically overshoots the glide slope and ends up

below glide slope. The nose may drop to 30° nose low and the g's may build up to 1.8 g. As a result of all this, you will start the HAC above glide slope and often end below glide slope at ~ 180° on the HAC.

### 3.9 NO AIR DATA IN TAEM

About all you have to know about theta limit is: if you have not taken air data to Guidance and Control (G&C) by Mach 2.0, you must fly theta limits. The steps for flying theta limits are

- a. Take CSS in both pitch and roll/yaw.
- b. Follow guidance but do not exceed the theta limit bracket on the ADI or VERT SIT scale.
- c. Do not exceed 50° angle of bank.

#### 3.9.1 Default Air Data

Prior to taking air data from the ADTA probes, this information is derived from the vehicle's Nav state (NAVDAD). Below Mach 3.5, once incorporated via SPEC 50, air data replaces NAVDAD.

If down to one ADTA, air data is NOT incorporated to Guidance and Control (G&C) unless on the BFS, the NAV state is bad, winds on the HAC exceed 80 kts or if the CDR feels that flying theta limits would result in too high a work load. Air data may also not be available if it goes in dilemma after incorporation.

If air data is not available to G&C, NAVDAD continues to be used. However, NAVDAD may develop significant errors as the vehicle slows, especially if high winds are present. This is because NAVDAD assumes that the VREL it computes is the same as true airspeed; this would be true only if the winds at altitude were calm. Since the entry DAP also relies on air data to set flight control gains, erroneous air data may adversely affect the flight controls to the point of possible loss of control.

To prevent this loss of control, a default set of air data (DEFAD) are substituted for NAVDAD below VREL 1500 fps. DEFAD is basically NAVDAD except for two parameters: alpha is constant at 7.5° and KEAS is set to a nominal value based on VREL (approximately 250 KEAS). This default air data is sent to both DAP and TAEM.

#### 3.9.2 Theta Limits

The good news is that default air data keeps DAP healthy. DAP will safely fly the orbiter, even if actual qbar (KEAS) and alpha differ from default air data.

The bad news is that default air data breaks the TAEM airspeed/qbar filter. The lack of airspeed limiting is not a problem if the vehicle is on energy because TAEM will make relatively small pitch changes and qbar will remain close to nominal. However, if the

orbiter is significantly high or low energy, TAEM will command large pitch changes that could result in exceeding airspeed limits. This is especially true for pull-up maneuvers with a large HAC because they are performed by flying minimum airspeed.

**WARNING**

TAEM is very sensitive to low energy. Nominal alpha is 10° to 12° and pitchup divergence can occur for alpha above 15° between Mach 1 and 2. TAEM will often pitch up to an LOC if air data are not taken by Mach 1.5. The smallest amount of low energy will cause a pitchup divergence at Mach 1.5 – if air data is not taken to G&C.

To protect the vehicle from these airspeed violations, theta limits were devised (theta is the orbiter pitch angle relative to the horizon). The scale on VERT SIT 1 and 2 displays a nose high limit and a nose low limit. The tick marks for the limits are stationary; the theta bug travels vertically along the scale showing current theta relative to the computed high and low limits. The bug flashes if it exceeds either limit.

The nose high limit corresponds to the theta (pitch attitude) that gives (steady state) maximum L/D airspeed (minimum qbar) with a small pad for uncertainties. The nose low limit corresponds to the theta that gives maximum airspeed (maximum qbar); this theta also includes a small pad. This same information is represented by the theta limits bracket on the ADI (introduced in OI-30).

The GPCs compute these limits based on VREL, bank angle, and speedbrake setting. How do changes in VREL, bank angle, and speedbrake setting affect theta limits?

- a. VREL is the Nav-derived estimate of Mach number (remember, the probes are broken). Mach affects theta limits in two ways.
  1. The aerodynamics of the orbiter are very different between super, trans, and subsonic regions. The theta required to fly maximum L/D (minimum qbar) or maximum qbar is, therefore, a function of Mach.
  2. Minimum qbar and maximum qbar are both functions of Mach.
- b. As you increase bank angle, nose low and nose high limits converge. They will converge at a bank angle of 57° (see Figure 3-21).

While flying theta limits:

1. Do not exceed 50° of bank. Flying theta limits is virtually impossible beyond this bank angle.
2. The NOSE HI and NOSE LO tick marks on the VERT SIT display are stationary, even though the values which they represent can be very dynamic. The difference between the NOSE HI and NOSE LO theta limit can vary from 15° wings level to 0° at 57° bank. What this means to the pilot trying to fly theta

limits is that the theta bug becomes more sensitive with increasing bank angle. The ADI theta limits bracket is dynamic and will shrink and stretch as the nose high and low limits vary. At bank angles above 50°, the bracket shrinks to a point where it is unusable.

Note that a theta of 10° nose low is within the theta limits for most combinations of speed brake and bank angle.

- c. Speedbrake changes your drag. As you increase drag, the steady state flight path angle decreases (more nose low). Open the speedbrake and the theta limits go down (more nose low). Close the speedbrake and the theta limits go up (see Figure 3-21).

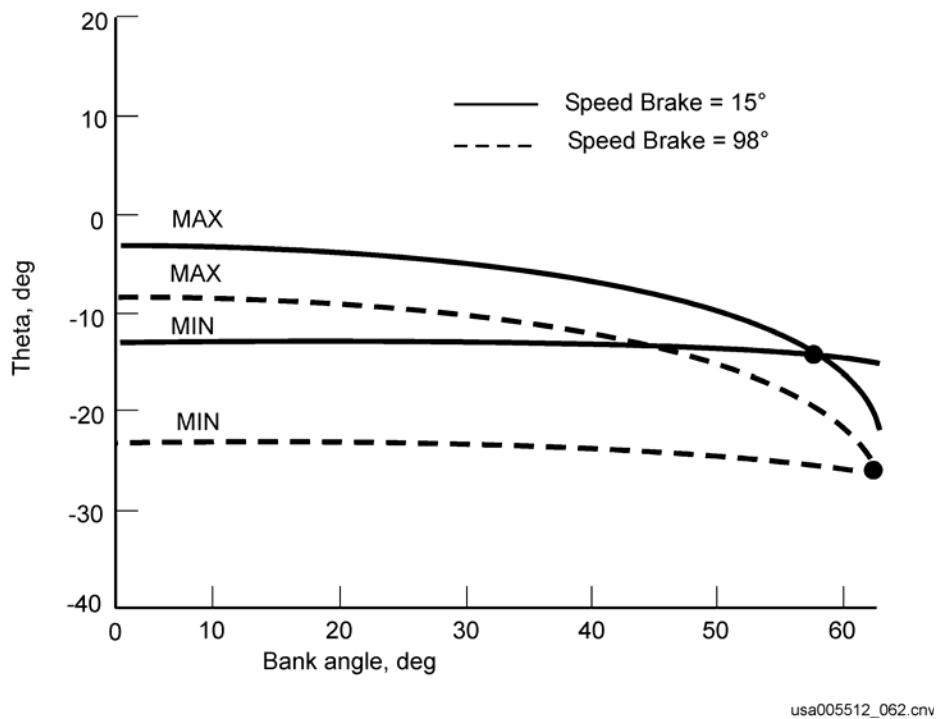


Figure 3-21. Theta limits versus roll angle

## How to fly theta limits

Step 1: Take CSS in both pitch and roll/yaw.

Step 2: Follow the needles, but do not exceed the NOSE HI or NOSE LO limits on the ADI bracket or VERT SIT scale. If the nose is pitched up too high, you will exceed the ADI bracket and the theta bug will go above the NOSE HI limit on the VERT SIT scale and flash. If this happens, you must pitch the nose down to get the theta bug back within limits. The reverse is true for the NOSE LO limit.

Step 3: Do not exceed 50° angle of bank. Note that while supersonic, pitch CSS is sufficient to maintain theta limits, but roll/yaw CSS will be required once subsonic and rolling onto the HAC to limit the bank to 50°.

Even when on default air data, TAEM guidance should be good - it just can't protect airspeed limits. Continue to follow guidance, unless guidance commands an attitude beyond the nose high or nose low limit. In that case, hold the theta that keeps the bug just within the limit. Additionally, TAEM may try to command up to 60° bank on the HAC. To protect the minimum and maximum limits from converging, do not follow the roll error needle beyond 50° bank angle. After you roll out on final, you can stop following theta limits.

If there is one ADTA remaining but not incorporated, it can be displayed on the tapes by taking the air data select switch to either left or right, whichever corresponds to the side with the remaining probe. In addition, since flying theta limits is very workload intensive, the CDR may choose to incorporate air data from a single ADTA. This may also be required for high winds due to the 50° bank angle limitation. REMEMBER: Anytime air data are not incorporated to G&C, you must fly theta limits. If air data are incorporated, theta limits are not required, even if only on one ADTA. The ADI bracket drives this point home since it is only displayed when theta limits must be flown.

### 3.10 TAEM OPERATIONAL NOTES

With respect to TAEM guidance, the following two notes are of interest.

- a. If VERY low energy, TAEM guidance will show the orbiter bug high on the VERT SIT glideslope lines (altitude versus range). This is a display limitation where a very long range-to-go (which should be off-scale right) is reflected back from the right-hand side of the display on to the trajectory lines. This is usually not a problem because situational awareness is maintained by the E/W bug which correctly displays the energy status showing that you are really very low energy.
- b. MEP trap in guidance causes HAC wraparound.

There are cases of improper guidance if MEP is selected after intercept of the NEP spiral. These cases are limited to extremely low energy overheads.



**Operational Note (b) – Case 1**

1. The vehicle is well below the altitude reference at HAC Intercept. The HAC shrinks to minimum radius, and the vehicle heads to the new HAC.
2. Crew selects MEP due to low energy, and a new range is calculated by Nav. That range is below 5 nm, and guidance modes to TAEM prefinal.
3. Prefinal bank angle algorithm assumes that the heading is within 90° of runway. Since this is not true, guidance commands a bank in the wrong direction.
4. Once the vehicle turns toward the centerline, guidance checks for a maximum rate of closure. When the rate limit is reached, guidance commands wings level even though the vehicle is not aligned with the runway centerline and may not reach the extended runway centerline before crossing the runway threshold.

**Operational Note (b) – Case 2**

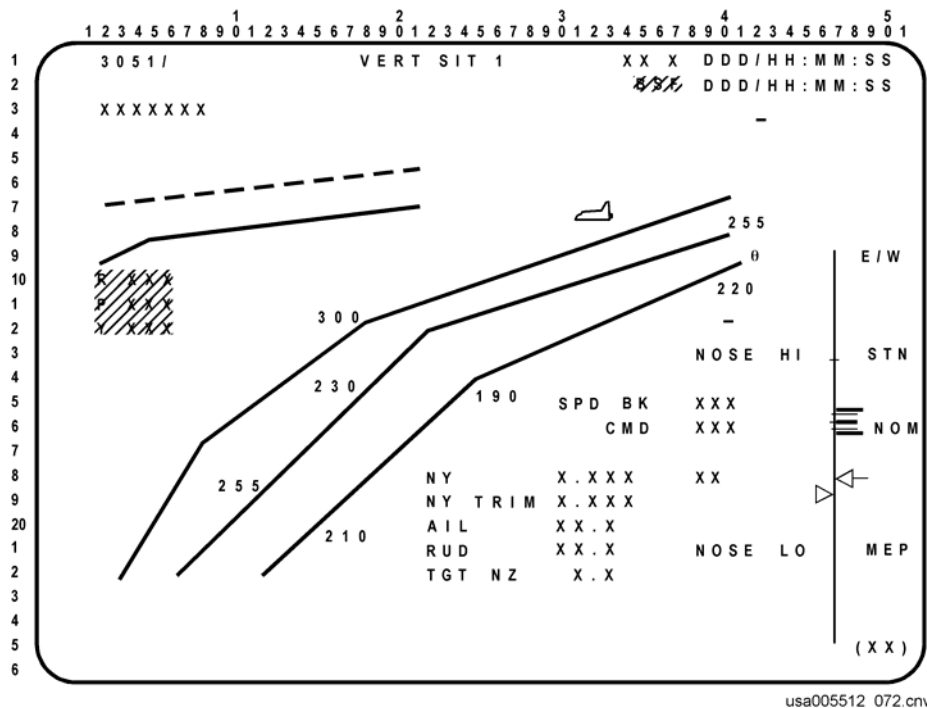
Guidance projects the vehicle current position to define a new MEP spiral acquisition point, if, as in case 1, MEP is reselected in response to HAC shrink, the range to go is greater than 5 nm, and the vehicle groundtrack is inside the MEP spiral. If that projection causes the HAC turn angle to be  $>180^\circ$  to align with the runway centerline, wings level is commanded until Y and Y errors reach a limit, then the turn is resumed. This maneuver requires more energy than is available. If a manual turn is flown to intercept the MEP spiral, guidance will not recognize this intercept as the new acquisition point but will try to fly toward a different acquisition point. This maneuver also requires more energy than is available.

Possible software/Initial Load (I-load) changes to correct this have been suggested. There are no restrictions on MEP selection for straight-in approaches. For overhead approaches, the following apply:

- a. Try to select MEP early in TAEM. Avoid making a MEP selection with less than 20 seconds to HAC Intercept.
- b. After intercepting the HAC, do not downmode to MEP as a response to a HAC shrink until you are at or inside the  $180^\circ$  turn-to-go point.
- c. If guidance appears lost following a MEP selection, toggling from overhead to straight-in will regain valid guidance.

## Questions

1. Which of the following are required inputs by TAEM?
  - a. TACAN data
  - b. Normal acceleration feedback
  - c. Nav state
  - d. Microwave Landing System (MLS) data
  - e. Air data
  
2. You see the following VERT SIT display (Figure 3-22). Guidance is trying to fly you even higher on the TRAJ display. What should you do?
  - a. Call MAC.
  - b. Take CSS and save the day. Pitch the nose down to get the orbiter bug back on the nominal line.
  - c. Do nothing; everything is okay.



**Figure 3-22. Low energy above glide slope**

3. What actions should you take if high energy? Which actions will TAEM do automatically?

4. What actions should you take if low energy? Which actions will TAEM do automatically?
5. What is the speedbrake doing while supersonic?
  - a. It is closed.
  - b. It is full open.
  - c. It is following an I-loaded profile vs. Mach.
6. Based on the following VERT SIT display (Figure 3-23), what would you expect the speedbrake to do when you go subsonic?
  - a. Go full closed
  - b. Go full open
  - c. Can't tell
  - d. Maintain 65°

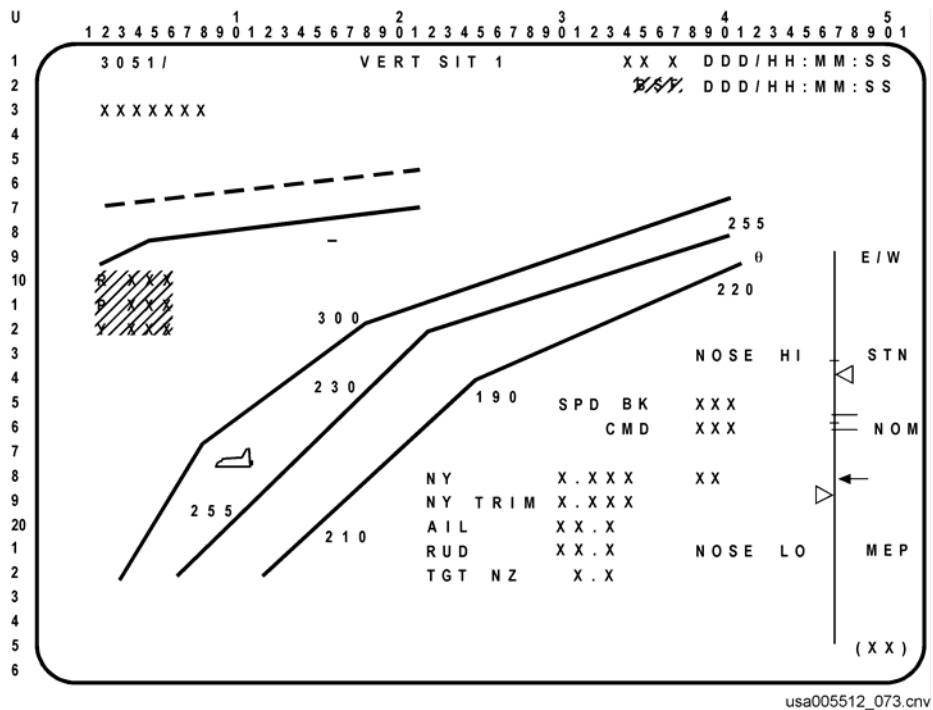
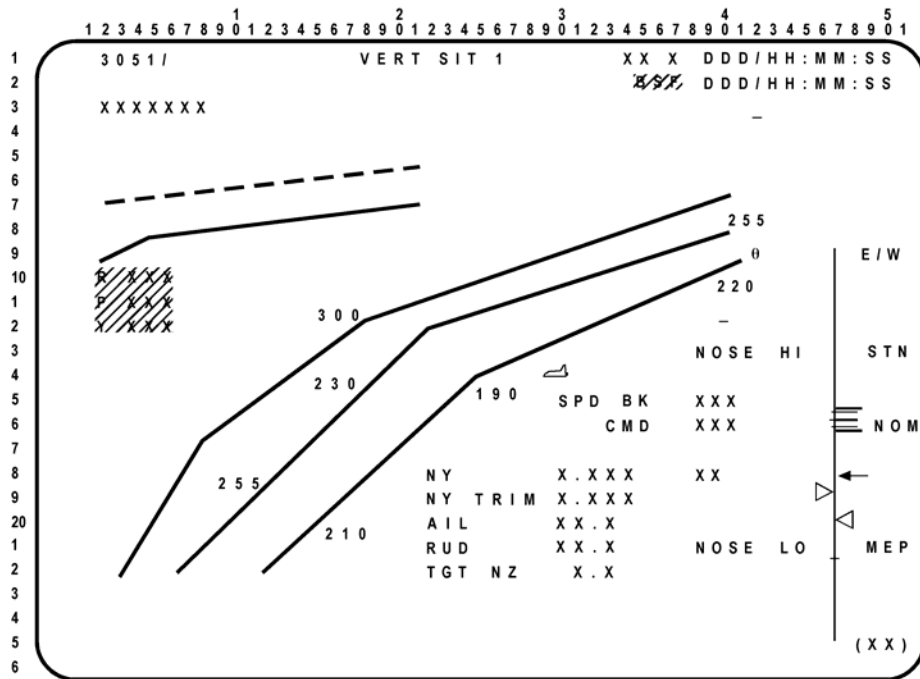


Figure 3-23. Above glide slope (frame 3)

7. What two additional maneuvers do you expect on a 360° HAC?

8. Based on a VERT SIT showing low altitude and low energy but above the MEP line (Figure 3-24), can you make the runway (assuming you do not change the HAC or runway)?
- a. No, the orbiter bug is below the lower line.
  - b. Yes, the energy bug is above the MEP line.
  - c. Cannot tell by what is shown.



usa005512\_074.cnv

Figure 3-24. Low energy below glide slope

## 4.0 APPROACH AND LANDING

### 4.1 OVERVIEW

The final flight phase of entry is Approach and Landing (A/L). This phase generally begins at 10,000-ft altitude and ends at wheels stop. Although the crew generally flies this phase, the basic profile is the same for auto or CSS; the guidance commands and aids are used extensively by the pilot. A simplified flight profile is shown in Figure 4-1.

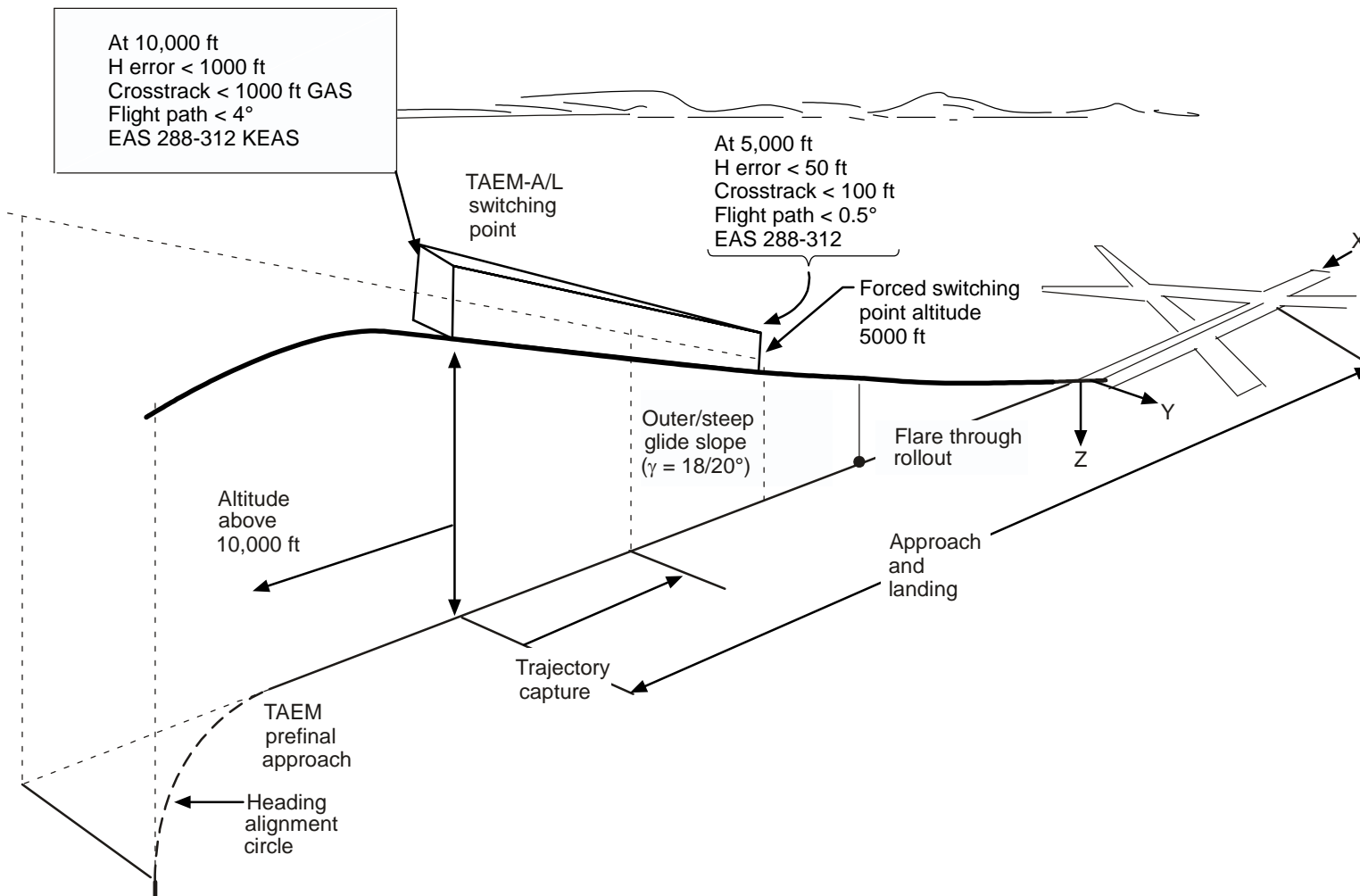
Because the shuttle has to make an unpowered landing within vehicle constraints and the low L/D vehicle design, a two-glide slope, two-flare landing trajectory was selected.

- a. Outer glide slope (steep)
- b. Inner glide slope (shallow)

The outer or steep glide slope (either 20° or 18°, depending on weight) is required to build airspeed up to 300 KEAS to use during the inner (or shallow) glide slope.

The preflare phase is initiated at approximately 2000 ft to transition from the steep (18°/20°) to the shallow glide slope, 1.5°. At about 80 feet, A/L goes into final flare – an Hdot (sink rate) control mode. Details of these phases are covered in the following sections.

After touchdown, guidance derotates the nose onto the runway and steers the orbiter onto the center line of the runway. (Guidance does not lower the gear, deploy the drag chute, or apply brakes.)



usa005512\_001.cnv

Figure 4-1. TAEM approach and landing interface

Before the details of guidance and the A/L trajectory are discussed, it is best to review or introduce some related elements.

To allow the proper touchdown trajectory, both the Commander (CDR), who is flying the vehicle, and guidance need a good source of navigation. The MLS is mandatory for the navigation accuracy required for auto guidance to land the vehicle. The MLS is acquired at an altitude of around 15,000 ft and is used through touchdown. For a detailed explanation of the MLS system, refer to the Navigation Aids Workbook, USA006055.

You should also take the HUD CBT. A quick review of some HUD symbology is given in Figure 4-2. A more thorough review of HUD symbols and functions is given in the Entry Flight Procedures Handbook.

The objective of A/L is to deliver the vehicle to touchdown on the runway within specified constraints. These constraints include downrange (from the runway threshold), airspeed, groundspeed, and altitude rate. The maximum groundspeed is 225 knots, which represents the maximum tire speed. The targeted airspeed is 195 or 205 KEAS, depending on vehicle weight. The altitude rate should be less than 4 ft/sec.

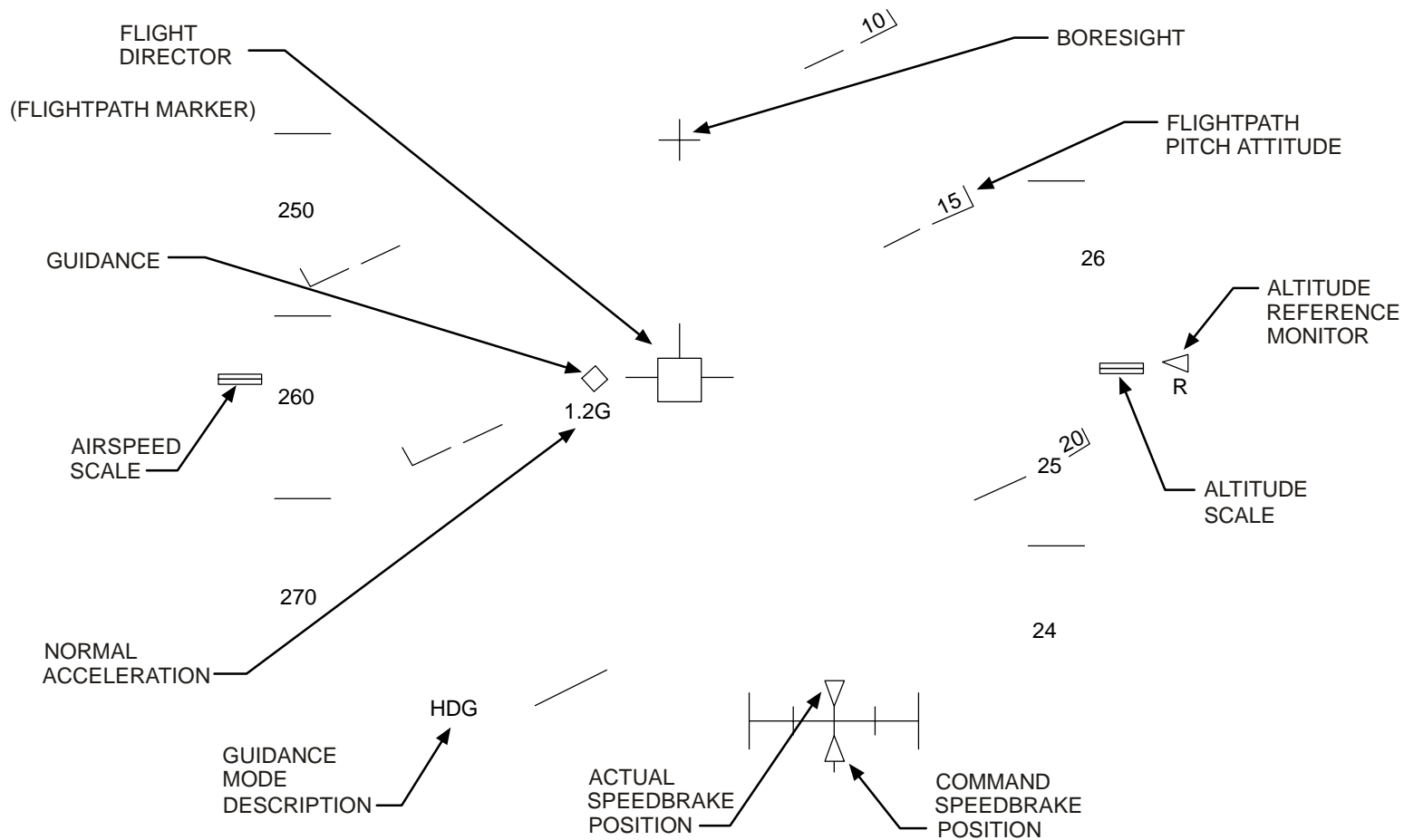


Figure 4-2. HUD symbology

usa005512\_002.cnv



## 4.2 APPROACH AND LANDING TRAJECTORY DESIGN

As earlier stated, a two-flare, two-glide slope trajectory was designed for the shuttle A/L phase (Table 4-1). Consistent with the earlier flight phases, A/L guidance is divided into the five phases: trajectory capture, outer glide slope, flare and shallow glide slope, final flare, and rollout. As the vehicle transitions through each of these phases, the HUD will indicate the current phase in the lower left corner.

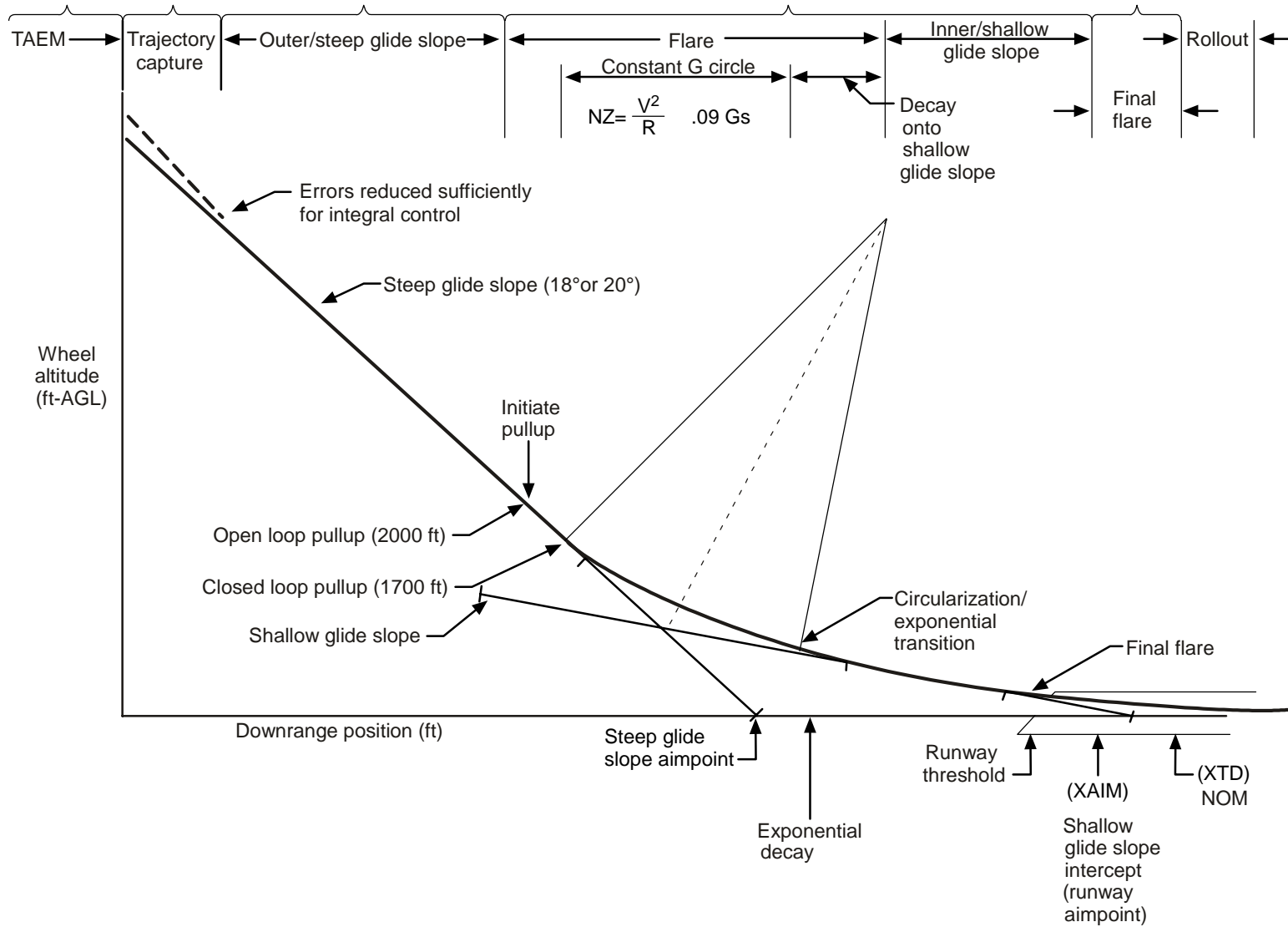
**Table 4-1. Longitudinal guidance phase description**

<b>Phase</b>	<b>Description</b>
Trajectory capture	Pitch command to guide orbiter to steep glide slope
Outer/steep glide slope	Pitch command to guide orbiter along steep glide slope trajectory
Flare and inner/shallow glide slope	Pitch command to guide orbiter from steep to shallow glide slope
Final flare	Pitch command to reduce orbiter's altitude rate before touchdown
Rollout	Derotation and autoloading relief

Guidance also outputs roll, speedbrake, and body flap commands. The roll command calculation for all the A/L phases, until the weight-on-wheels flag is set, is based on lateral position and rate errors. Speedbrake commands are based on errors from the 300 KEAS.

### 4.2.1 Trajectory Capture

The trajectory capture phase is designed to fly the vehicle from TAEM interface and acquire the steep glide slope (Figure 4-3). At the beginning of the phase, the body flap is commanded to the trail position; this action effectively stows the body flap for the remainder of the flight. The final phase of TAEM (prefinal) is better at removing large errors. If there are large errors present, the transition to trajectory capture is delayed until the errors are reduced or at 5000 ft, whichever occurs first (Figure 4-1).



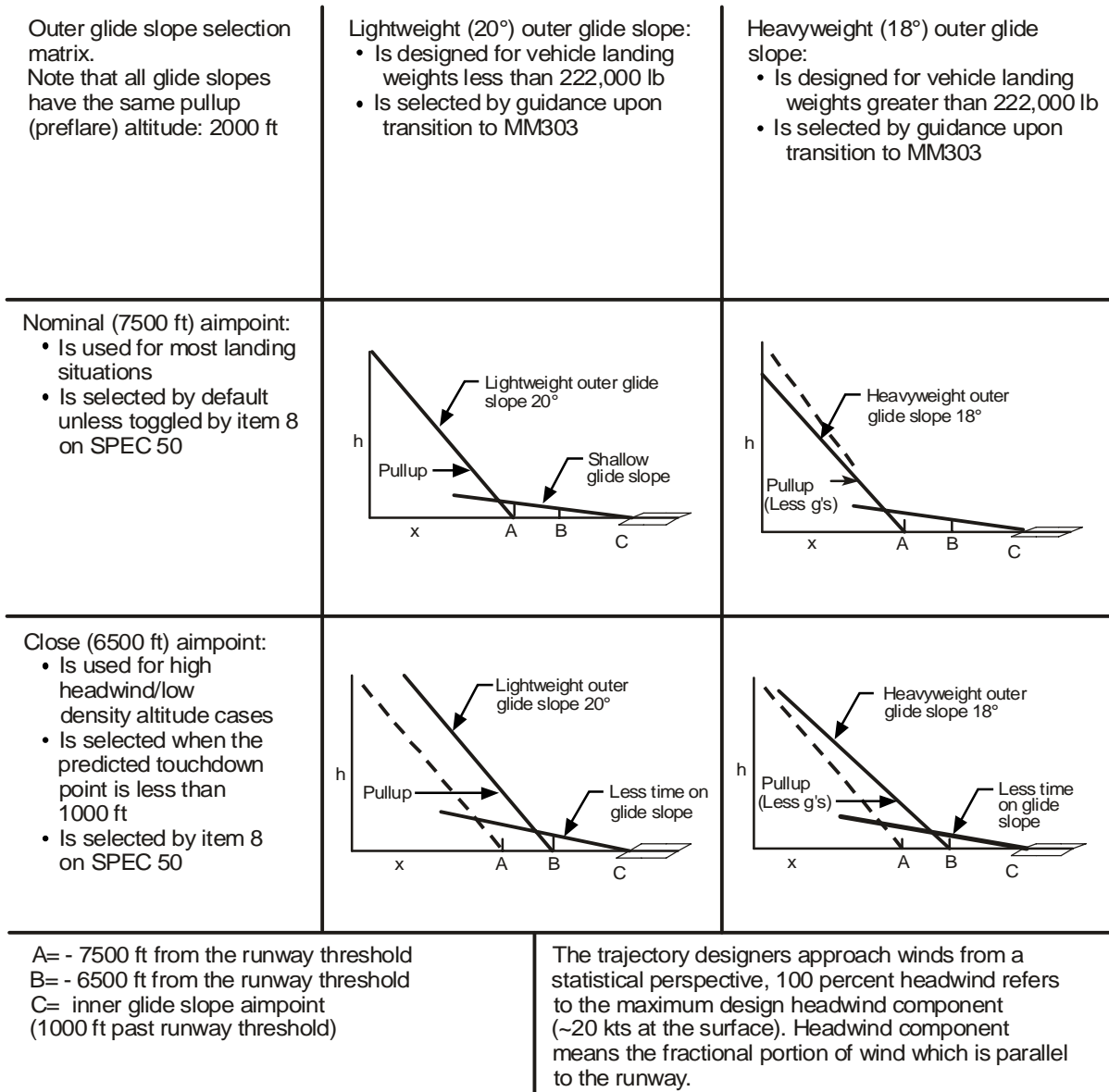
usa005512\_003.cnv

Figure 4-3. Approach and landing trajectory

### 4.2.2 Outer Glide Slope

The outer glide slope phase is used to accelerate to a high airspeed and to ensure that the vehicle is at the proper position for preflare and the inner glide slope (Figure 4-4).

The outer glide slope angle varies according to vehicle weight. For lightweight vehicles, usually EOM, the outer glide slope is at a 20° angle. Specifically, lightweight is defined as vehicle weight less than 222,000 lb. For heavyweight vehicles (orbiter weight greater than 222,000 lb), the outer glide slope is an 18° angle.



usa005512\_004.cvx

Figure 4-4. Steep glide slope options

The vehicle weight used for this decision is taken from the Deorbit Maneuver display when the flight software is PROed to MM303 (Figure 4-5). For Glide Return to Launch Site (GRTLS), the outer glide slope is I-loaded for that flight.

The point at which the outer glide slope intersects the ground is called the aimpoint. The aimpoint is nominally placed at 7500 ft from the runway threshold. However, if the predicted runway touchdown point is less than 1000 ft past the runway threshold, the close-in aimpoint will be used. The close-in aimpoint is placed at 6500 ft from the runway threshold. Selection of the nominal/close-in aimpoint is changed by an ITEM 8 EXEC on SPEC 50 (Figure 4-6). This item toggles between the nominal and close-in aimpoints and may be executed until A/L interface, although it is normally set at about 30 minutes before the deorbit burn.

```

XXXX/          XXXXX MNVR YYYYY  XX X DDD/HH: MM: SS
OMS BOTH 1X          BFS DDD/HH: MM: SS
          L 2XS          BURN ATT          XXXX
          R 3XS          24 R XXX          XXXX
RCS SEL 4X          25 P XXX          XXXX
5 TV ROLL XXX          26 Y XXX          XXXX
TRIM LOAD          MNVR 27          XXXX
6 P [+] X.X          REI XXXX          XXXX
7 LY[+] X.X          TXX XX:XX          XXXX
8 RY[+] X.X          GMBL          XXXX
9 WT XXXXXX          L R          XXXX
10 TIG          P +X.XS +X.XS          XXXX
          XXX/XX: XX: XX.X          Y ±X.XS ±X.XS          XXXX
TGT PEG 4          PRI 28X 29X          35 ABORT TGT XX
14 C1 XXXXX          SEC 30X 31X          FWD RCS
15 C2 [+] X.XXXX          OFF 32X 33X          ARM 36X
16 HT XXX.XXX          GMBL CK 34X          DUMP 37X
17 ΘT XXX.XXX          XXXXXXX          OFF 38X
18 PRPLT[+] XXXXX          SURF DRIVE          ON 39X
TGT PEG 7          OFF 40X          (XX)
19 ΔVX[+] XXXX.X          XXXXXXX
20 ΔVY [+] XXXX.X
21 ΔVZ [+] XXXX.X
XXXX 22/TIMER 23

```

4748. CRT; 4

**Figure 4-5. Weight item on Deorbit Maneuver Coast display**

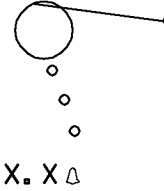
```

      XXXX/050/                HORIZ SIT                XX X DDD/HH: MM: SS
                                     DDD/HH: MM: SS
PTI   XXX1                   ALTM
INDEX XX                     9 XX.XX
  XXX
XXXXXXXXXXXXXXXX X
41 XXXX SITE XX
PRI XXXX 3X
SEC XXXX 4X
TAC XXX  5X

      TAEM TGT
G&N X XXXX 6
HSI X
XEP      7
AIM      XXXX 8
S/B      XXXXX 39
                                     18 ΔT ±XX.XX

NAV   RESID RATIO AUT INH FOR  TAC1 XXX TAC2 XXX TAC3 XXX
TAC AZ ±XX.XX ±XX.XS 19X 20X 21X ±XX.XXS ±XX.XXS ±XX.XXS
      RNG ±XX.XX ±XX.XS
DRAG H ±XXXXXX XX.XS 22X 23X 24X
ADTA H ±XXXXXX XX.XS 25X 26X 27X HUD37LX ABS 34X
ADTA TO G&C 28X 29X 30X 38RX XXXX DELTA 35X
                                     (XX)

```



X.XΔ

4713. CRT; 3

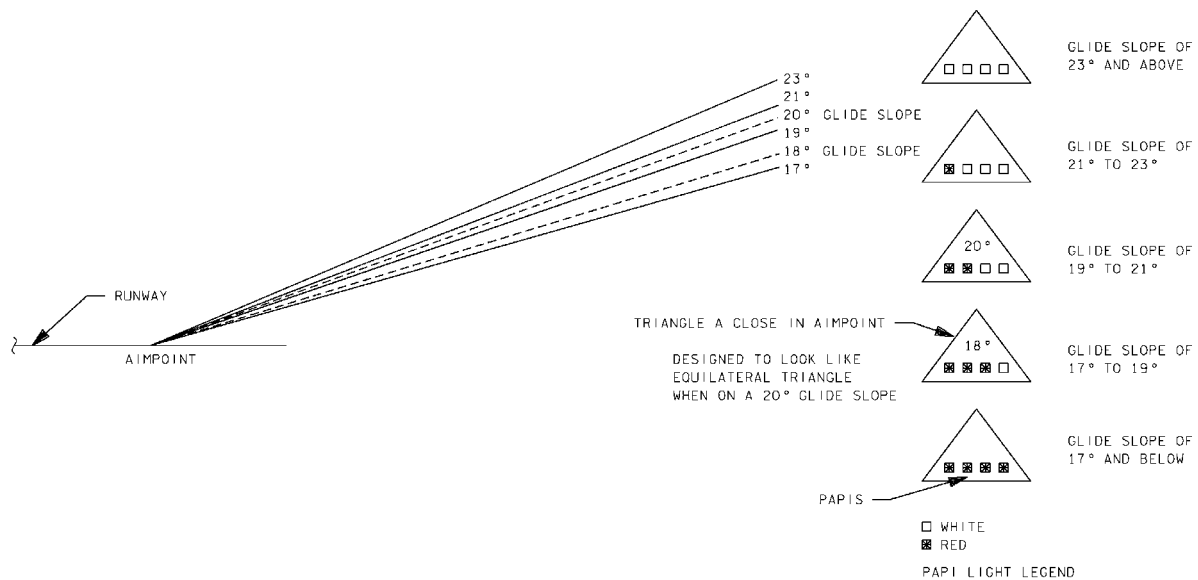
**Figure 4-6. Aimpoint selection on SPEC 50**

For the CDR, ground-based out-the-window visual aids are used. For the steep glide slope, the Precision Approach Path Indicator (PAPI) is used. The PAPI consists of lights located at the nominal and close-in aimpoint.

Each light is designed to appear white if you are above a certain glide slope angle and appear red if below the glide slope angle. The lights transition from white to red at the following angles (left to right):

1. 23°
2. 21°
3. 19°
4. 17°

Figure 4-7 shows how the PAPI should look for an 18° and a 20° glide slope.



**Figure 4-7. PAPI system geometry for the outer glide slope**

The other requirement for the outer glide slope is that the vehicle fly 300 KEAS, providing the velocity required for the flare and inner glide slope phase. Guidance (and the CDR) achieves both glide slope and airspeed through a combination of pitch and speedbrake commands. Specifically, the pitch commands try to maintain the glide slope and aimpoint; the speedbrake commands try to maintain 300 KEAS.

### 4.3 SPEEDBRAKE RETRACTION

There is one retract altitude (3000 ft) and one adjustment altitude (500 ft). At 3000 ft, guidance calculates a speedbrake setting to touch down at 195/205 KEAS 2500 ft down the runway (195 KEAS at 2500 ft if short field speedbrake is selected, 195 KEAS at 1000 ft if Emergency Landing Site (ELS) speedbrake is selected). The maximum setting at 3000 ft is 80 percent. The setting is based on the following:

- a. Wind
- b. Density altitude
- c. Weight
- d. KEAS
- e. Speedbrake option (nominal or short field, or ELS)
- f. Aimpoint selection (nominal or close)

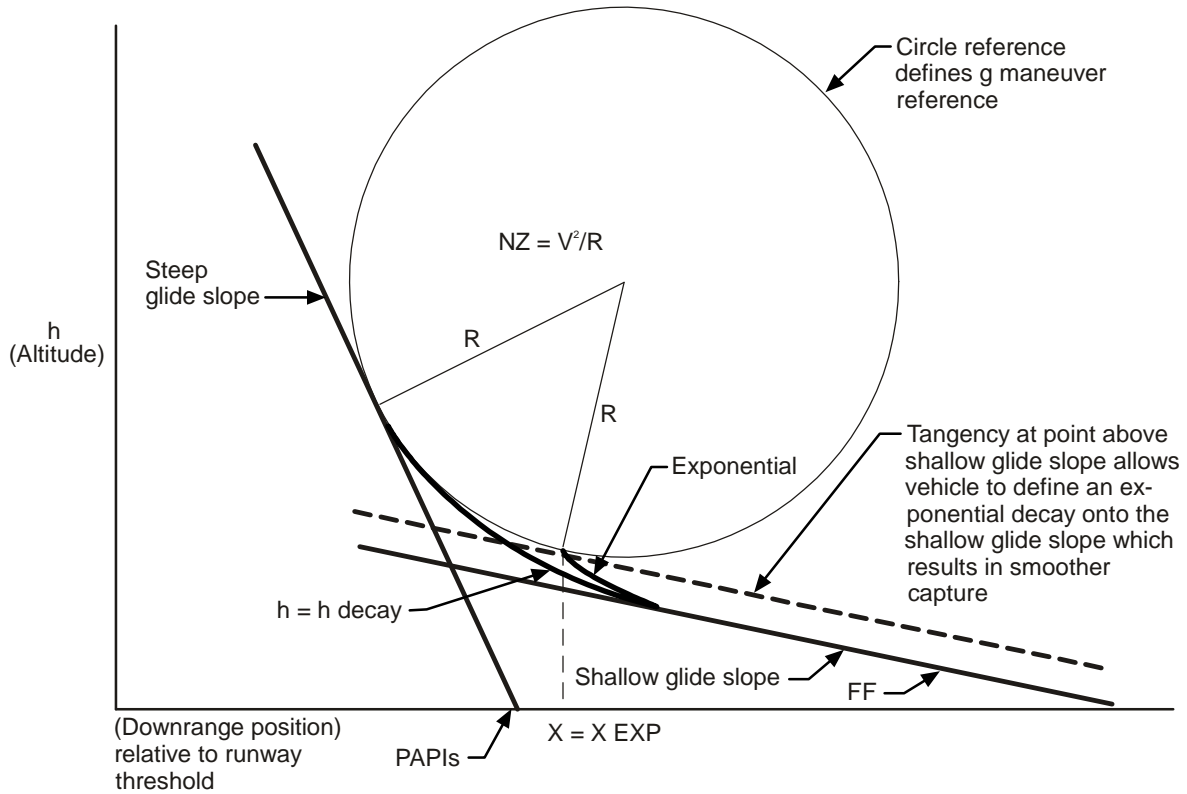
At 500 ft, this process is repeated using updates to wind and density altitude calculations, with the speedbrake command limited to 50 percent if nominal speedbrake is selected and 80 percent if short field or ELS speedbrake is selected.

The speedbrake setting at 3000 ft is a good indication of your energy state. Use guidance commanded, not actual speedbrake. Actual speedbrake never goes below 15 percent, but guidance commanded does. Moreover, if the speedbrake is being commanded to zero, you may be low energy. In addition, actual lags behind commanded. By the time the speedbrake actually retracts, you are close to 2000 ft, and landing gets very busy from 2000 ft on down.

The MCC will give you the expected actual 3000-ft setting in the DEL pad. If MCC reads up 15 percent, you know that the expected command is  $\leq 15$  percent, but you do not know how much less. The expected command may be zero percent.

#### 4.4 PREFLARE AND INNER GLIDE SLOPE

At a 2000-ft altitude, the transition from the outer/steep glide slope is made. This transition is called the preflare maneuver. This maneuver is essentially a 1.3g pullup to go from the outer/steep glide slope to the inner/shallow glide slope (see Figure 4-8). If you want to know the details, keep reading. If not, skip the next four paragraphs.



Runway coordinates - centered at R/W threshold

Open-loop pullup altitude	2000 ft
Closed-loop pullup	1700 ft
Exponential flare	176 ft
Final flare	80-30 ft
X nominal G/S	-7500 ft
X high-wind G/S	-6500 ft

usa005512\_006.cnv

**Figure 4-8. Preflare geometry**

The open-loop pullup is used to start the initial vehicle rotation and to establish an approximate constant g rotation. The open-loop command is a function of the velocity squared divided by the pullup circle radius.

The closed-loop pullup is a feedback term, added to the open-loop command that is a function of altitude and altitude rate errors relative to the reference trajectory. The closed-loop pullup is initiated at 1700 ft altitude.



To ensure a smooth transition to the inner glide slope, an exponential term is initiated at 4562 ft from the runway threshold for a lightweight vehicle using the nominal aimpoint. The exponential trajectory matches the pullup circle in altitude, altitude rate, and acceleration at the 4562 ft point.

The exponential flare subfunction uses the same Nz commands as the closed-loop pullup subfunction, with the exception that, instead of a circle, the reference trajectory is an exponential curve that converges on the 1.5° glide slope.

The preflare is monitored in the HUD by following two reference triangles. These triangles start at the bottom of the display and move up both sides of the velocity vector. As the triangles reach and pass the reference pointer, the preflare begins. The reference pointer follows the preflare triangles to the touchdown point.

The shallow glide slope out-the-window visual aid is called the ball bar. The ball bar consists of a horizontal bar of bright red lights placed 2200 ft from the runway threshold and a single white ball light placed 1700 ft from the runway threshold. The bar and the ball are placed at a certain height so that the pilot will see the ball imposed against the bar when on the shallow glide slope. If the ball is below the bar, the vehicle is above the shallow glide slope. If the ball is above the bar, the vehicle is below the shallow glide slope.

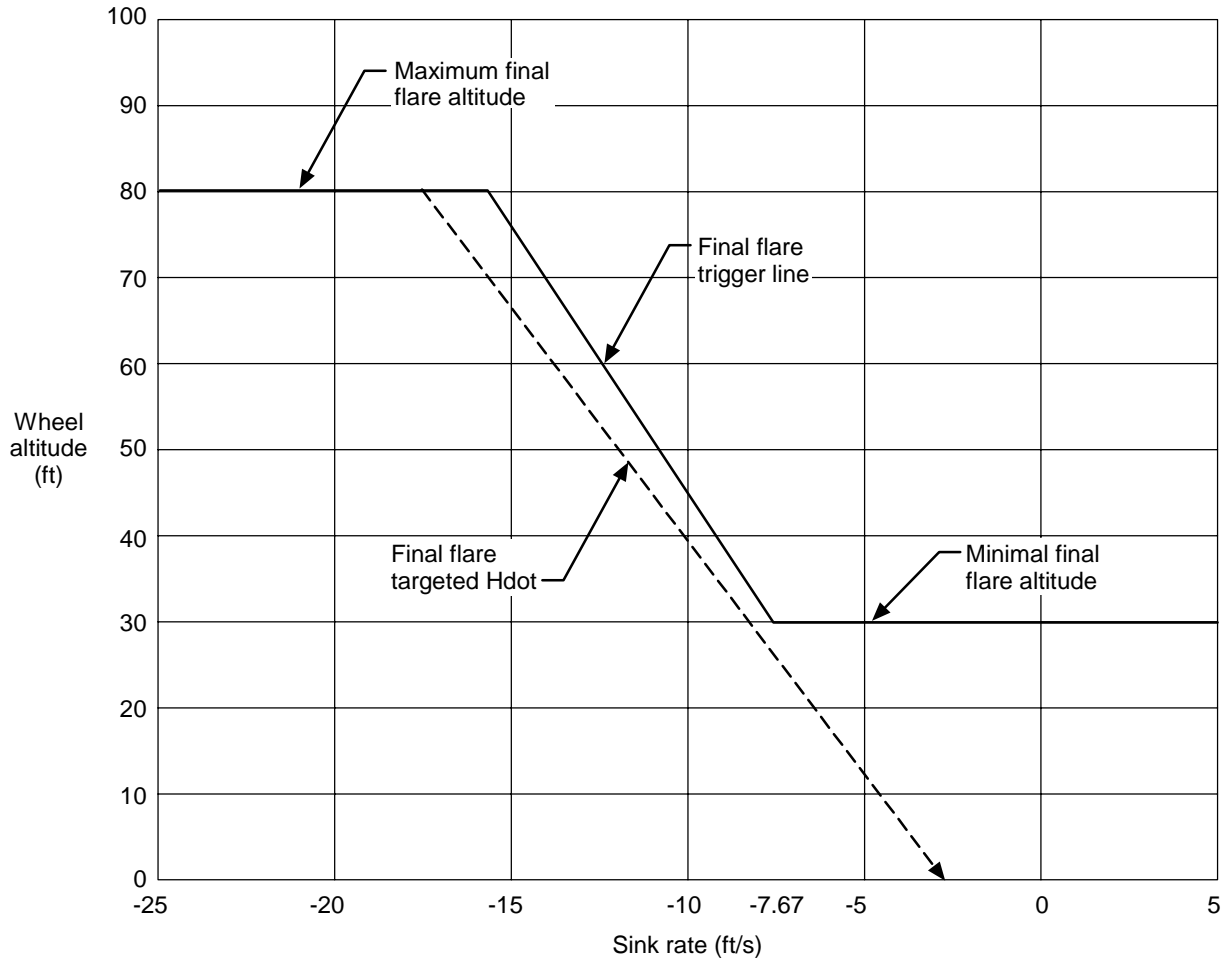
#### **4.5 FINAL FLARE AND TOUCHDOWN**

The final flare phase is designed to reduce the altitude rate to 3 ft/sec at touchdown. The final flare begins as a function of altitude versus altitude rate profile, as shown in Figure 4-9. The final flare phase targets for an altitude rate of 3 ft/sec at touchdown.

The CDR should anticipate the start of ground effects as the altitude decreases through 50 ft in the flare. Orbiter aerodynamic data indicate a relatively strong ground effect, which is a result of the cushion of air underneath the vehicle. This air causes a significant increase in the lifting force on the vehicle as a function of altitude.

The 1.5° reference inner glide slope was chosen because it provides an acceptable descent rate requiring a small flare maneuver. The nominal angle of attack for touchdown is approximately 8°, not to exceed approximately 14°.

Touchdown is designated when flight control sets the Weight-on-Wheels (WOW) flag. This software flag is set by the tripping of the proximity and speed sensors on the main gear. Once WOW is set, guidance commands an attitude hold and derotates at 180 KEAS. The CDR actually performs the derotation at 185 KEAS using the Rotational Hand Controller (RHC) beep trim switch.



usa005512\_045.cnv

**Figure 4-9. Final flare profile**

WOW initiates a sequence of commands.

1. Speedbrake full open
2. Reconfiguring the HUD display as shown in Figure 4-19
3. Changing the pitch command RHC gains
4. Setting the touchdown and rollout phase within guidance
5. Initiating AUTO LOAD BALANCE
6. Flat turn commanding
7. Opening the main wheel brake isolation valves

The full open speedbrake increases stability during derotation and helps shorten the rollout/braking distances.

Ailerons will be commanded to move to balance the load on the main gear due to crosswind effects.

Note: The WOW HUD reconfiguration takes a little while to get used to. It makes your airspeed jump to the top of the HUD just about the time you need it to start the derotation.

After main gear touchdown, the drag chute is deployed. The drag chute deploy options are:

1. Early Deploy - at main gear touchdown
2. Nominal Deploy - at 195 KEAS
3. Late Deploy - after nose gear touchdown (for crosswind DTO)
4. Emergency Deploy - no deploy except at CDR's call (due to no main engine repositioning)

At nose gear touchdown, the Weight on Nose Gear (WONG) flag is set. If the IMUs are indicating that the pitch angle is less than  $0^\circ$ , groundspeed enable and the rollout flag are both set. At this time

1. The elevons are commanded down to offload the main landing gear (load relief). Pitch automatically goes back to AUTO.
2. The HUD is reconfigured – again.
3. Nosewheel steering is activated.

Note: Maximum main gear loading does not occur during load relief. It occurs just before the nose touches down. The load is caused by the elevons going up to prevent a high slapdown rate. If you try to decrease the slapdown rate too much, the main gear is loaded too much. If you try to save the load on the main gear, the nose gear is loaded by a high slapdown rate.

The approved derotation method is

1. Start the nose down at 185 KEAS using the RHC beep trim switch.
2. Keep the 2 deg/sec rate until the nose hits the ground.

At nosewheel touchdown, the crew takes the External Tank (ET) or Solid Rocket Booster (SRB) Separation (SEP) switch to Manual (MAN) and pushes the SEP button. This sets both the WOW and WONG flags. If the nose of the orbiter is below the horizon, groundspeed enable will also be set. This action is commonly called setting WOW/WONG. See Table 4-2 for a summary of common phrases used for WOW and WONG.

**Table 4-2. Common phrases for WOW and WONG**

Event	Common phrase
Weight-on-main-gear	WOW, WOWLON
Weight-on-nose-gear	WONG, WOW/WONG, groundspeed enable

We used to set WOW/WONG manually because we had no fault tolerance in the hardware to set WOW. We now use the speed sensors, and it is almost impossible to not get WOW. However, a combination of two failures may prevent WONG from getting set, so we still set WOW/WONG with the ET or SRB SEP switch and button.

### **Nosewheel Steering**

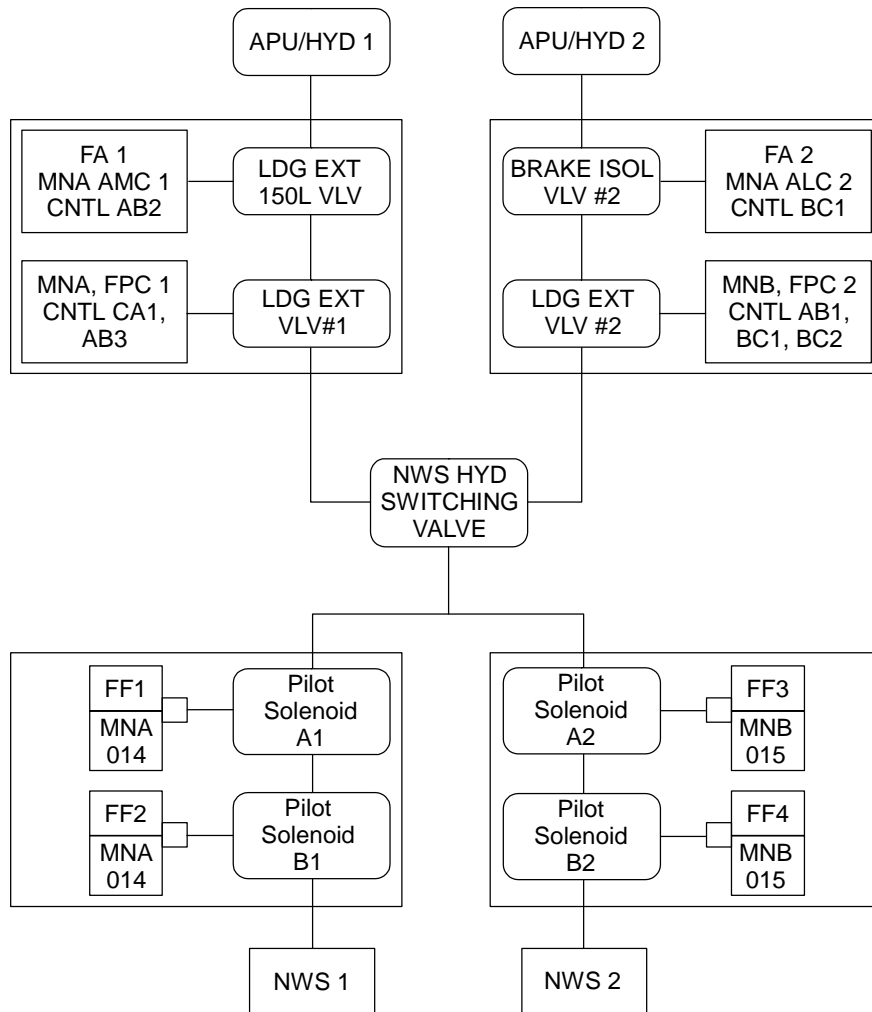
After ground speed enable is set, Nosewheel Steering (NWS) is activated. Use the rudder pedals (Rudder Pedal Transducer Assemblies (RPTAs)) to steer the orbiter.

NWS is a lateral acceleration command system. If the RPTAs are not deflected, you are commanding zero lateral acceleration. The GPCs may sense acceleration via the Nz accelerometers due to crosswind or differential braking, then move the nosewheel to remove the uncommanded acceleration. If an RPTA is deflected, the GPCs will command a lateral acceleration (command a turn).

There are two NWS systems on the orbiter. Either can work with either hydraulic system 1 or 2. For NWS 1 to work, both FF1 and FF2 must be functional. For NWS 2 to work, both FF3 and FF4 must be functional. See Figure 4-10.

There are other single-point control bus and Direct Current (DC) bus failures that will fail either NWS system. Use REF DATA to see if the NWS system has failed. Do not trust the NWS light until WONG. The light does not test the NWS system until WONG.

If NWS 1 fails before you land, you should select NWS 2. If it fails after you land, the flight rules say you should continue the rollout without NWS, unless you have control problems. You can tell that it has failed by looking at the NWS light on the eyebrow panel, but the light will probably not come on until the NWS is activated at nosewheel touchdown. With no NWS, asymmetric braking is used to steer the vehicle.



usa005512\_007.cnv

**Figure 4-10. NWS schematic**

#### 4.6 MANUAL PROCEDURES AND MONITORING

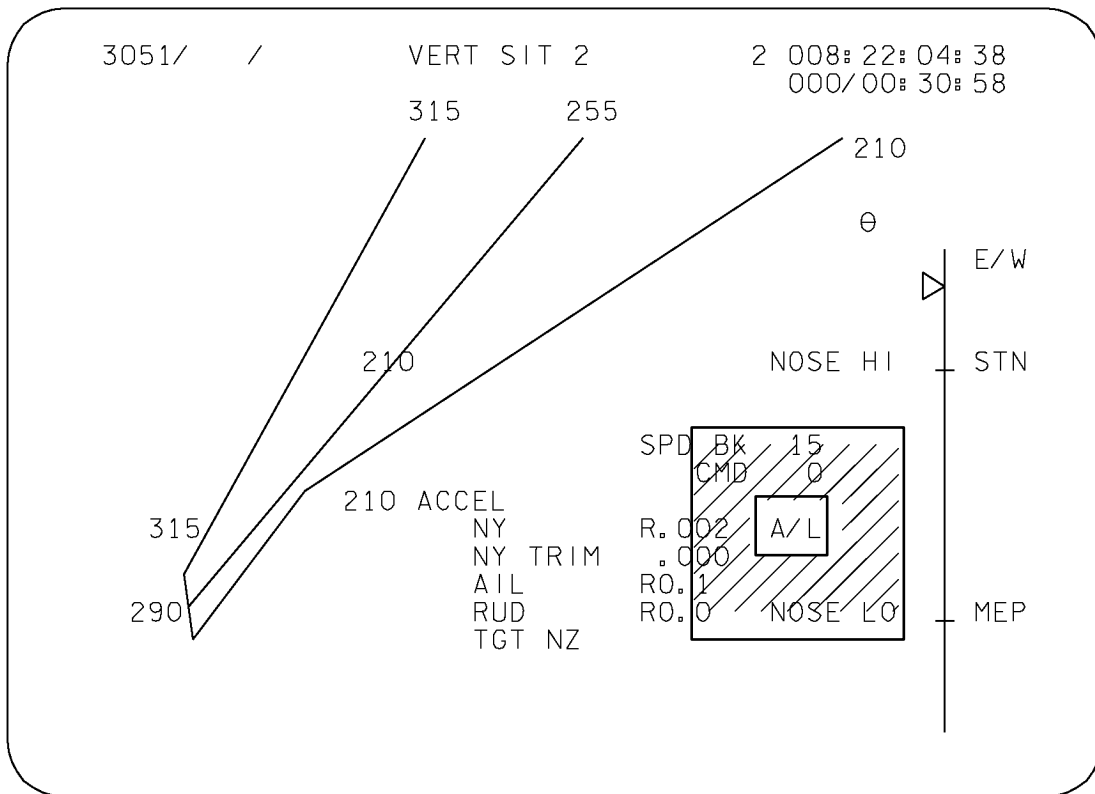
Although the above description of A/L describes how the guidance software would fly the A/L phase, auto does not usually get a chance to fly. For normal flight operations, the CDR takes CSS when the vehicle becomes subsonic, usually around 45,000 ft in the TAEM phase of flight.

For the A/L phase of flight, crew techniques and monitoring become a team effort, with the CDR flying the vehicle; the Pilot (PLT) making gear, airspeed, and altitude calls; and the Mission Specialists (MSs) watching the overall vehicle configuration. This section discusses the overall sequence of events and identifies the person responsible for calling certain items.

Once in CSS (CDR call), the CDR flies around the HAC using the procedures discussed earlier. At this point, the CDR usually wants the SPEC 50 display on CRT 1 and VERT SIT on CRT 2. The HUDs are generally decluttered, as desired,

when approaching the runway centerline. As the vehicle approaches the runway centerline, MLS data acquisition should be noted (by MS 2), and the HSI should reconfigure to the A/L phase.

When A/L interface is achieved, a flashing A/L is displayed on VERT SIT 2 (MS 2 call). The HUD also displays capture (CAPT), then OGS on the lower left corner (see Figure 4-11 and Figure 4-12).



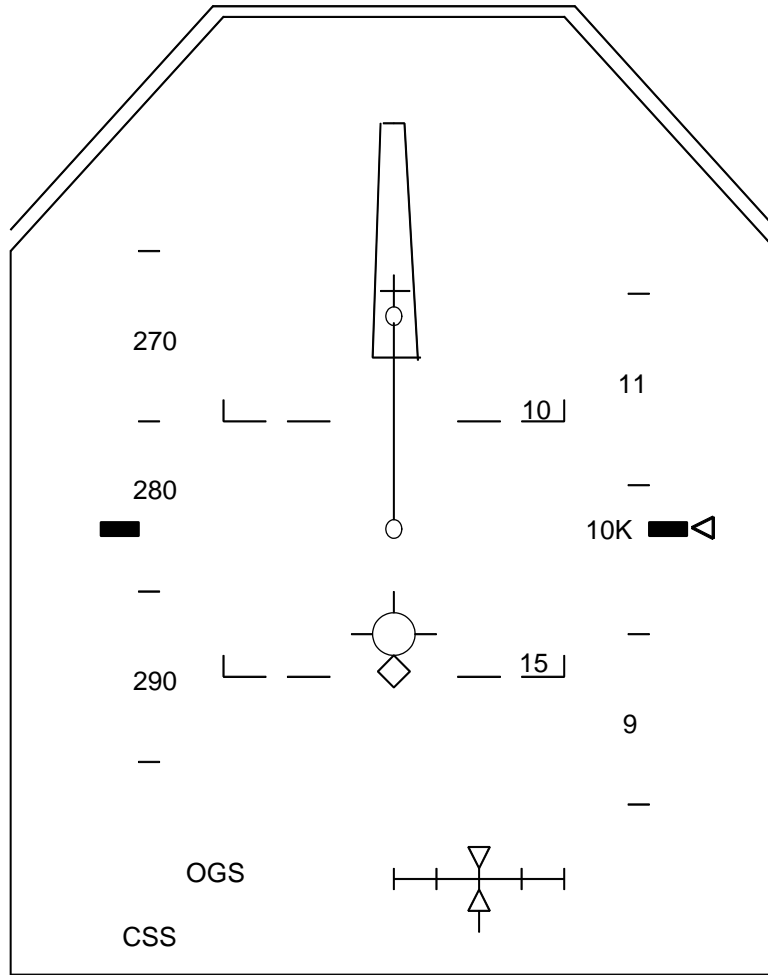
TD357A152. CRT: 2

**Figure 4-11. VERT SIT 2 with A/L displayed**

(Note that the A/L would flash on a real IDP.)

Rolling out on final, the CDR checks the PAPIs and the visual aimpoint to confirm the proper glide slope. The glide slope is maintained by using pitch to keep two red and two white lights visible (for lightweight vehicles). The CDR will usually call “two red and two white” lights.

Also at A/L transition, the body flap goes to the trail position (MS 2 call).

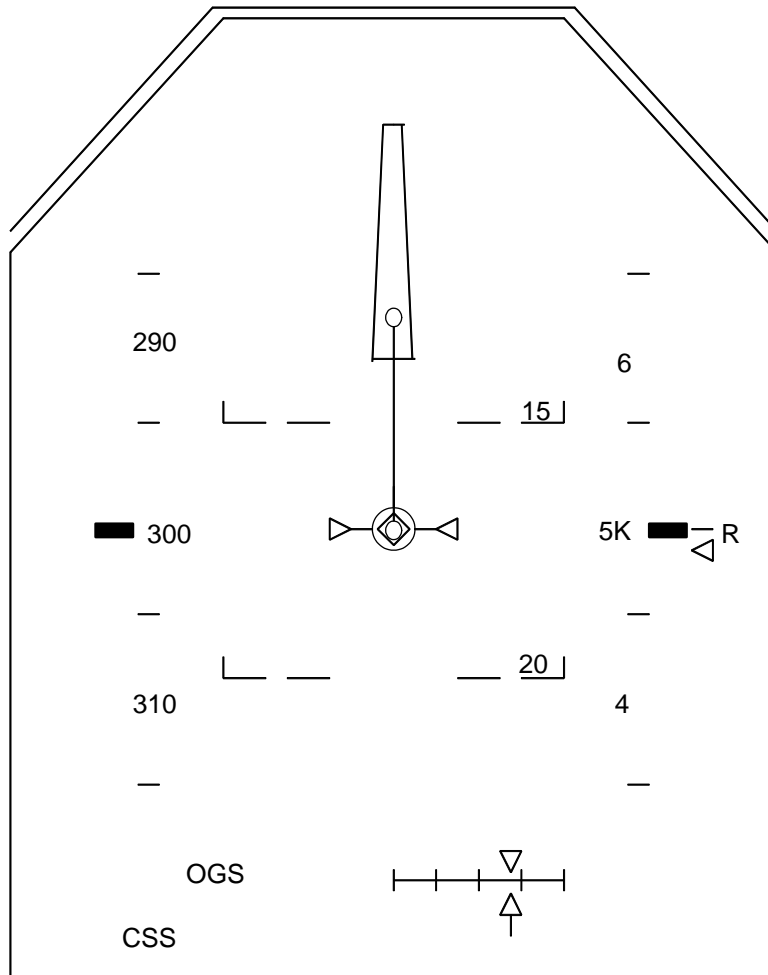


td\_357a\_041

**Figure 4-12. HUD view at 10,000 ft altitude**

On the outer glide slope, the PLT usually calls airspeed and altitude at 7000 ft and 5000 ft (or whatever altitudes the particular crew selects).

At 5000 ft (Figure 4-13), the CDR is still working to maintain glide slope. The MS 2 is surveying the cockpit for fault messages and problems while providing support.



td\_357a\_043

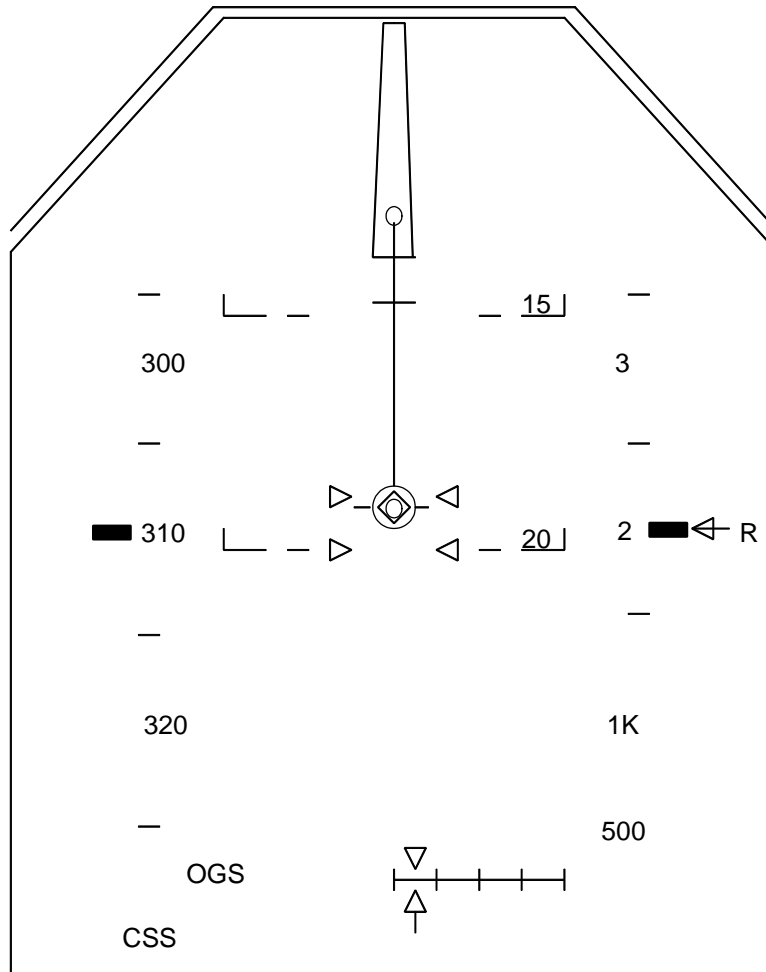
**Figure 4-13. HUD view at 5000 ft altitude, 300 KEAS**

(Vehicle is on the outer glide slope. The radar altimeter is now active.)





At 2000 ft, the preflare maneuver is initiated (CDR call). On the outer glide slope, the vehicle pitch attitude is approximately  $-14^\circ$ . The preflare command will be a pitchup of about 1 deg/sec until the pitch angle is approximately on the horizon (see Figure 4-15). It is at preflare that the CDR calls for the gear to be armed.



td\_357a\_045

**Figure 4-15. HUD view at 2000 ft altitude and 310 KEAS**

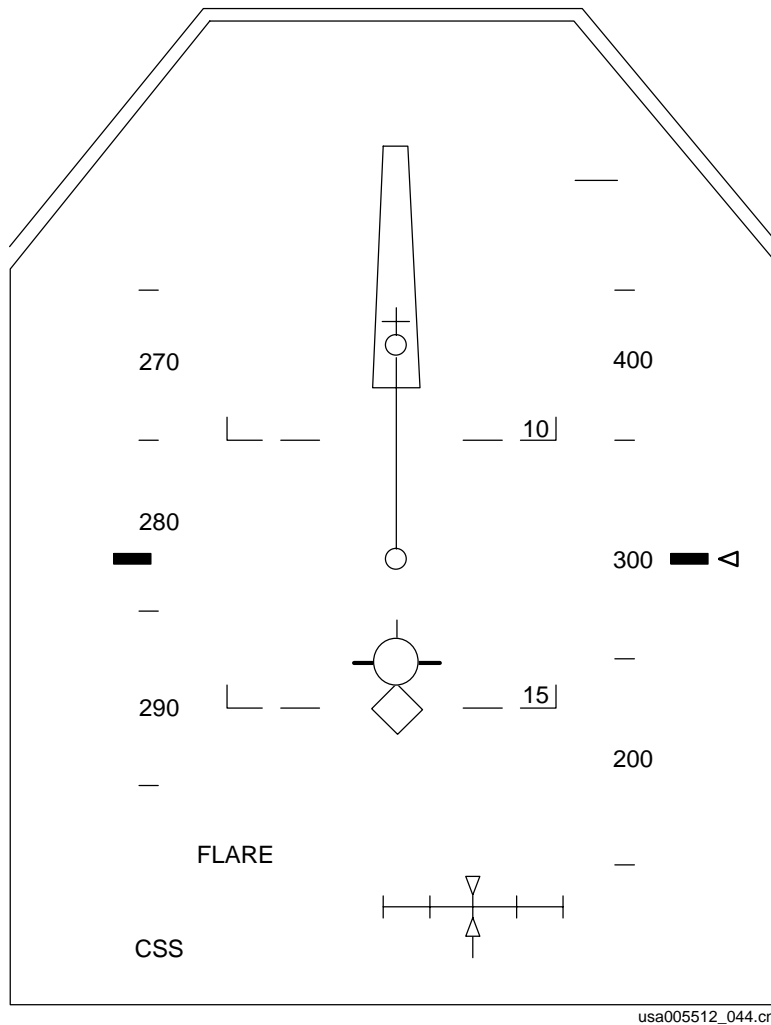
(The preflare maneuver is being initiated.)

As the vehicle rotates through the preflare maneuver, the PLT should begin calls of altitude and airspeed, read from the HUD or the Ascent/Entry Primary Flight Display (A/E PFD). These calls should be made at specific altitudes (which were agreed upon by the crew), but the calls are usually made at 1000, 500, 300, 200, 100, and 50 ft, with 10-ft increments below 50 ft.

As the vehicle approaches the ground, the PLT should continue the calls approximately every 3 seconds. This reporting provides a cadence for the CDR to audibly verify the trajectory.

As the vehicle ends the preflare maneuver, the ball bar should be used to acquire the shallow glide slope.

At 300 ft, the CDR gives the command for (landing) “gear down,” the PLT pushes the gear-down button and acknowledges the action (see Figure 4-16).

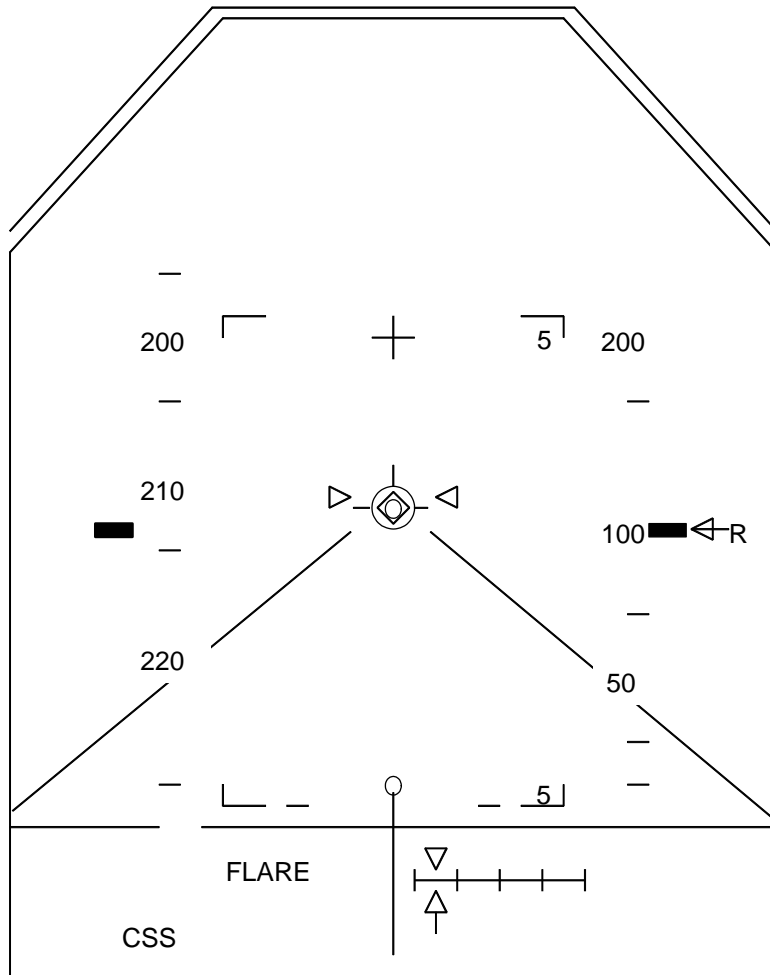


**Figure 4-16. HUD view at 300 ft and 282 KEAS**

(The shuttle is in the late phase of preflare.)

It is important to lower the gear at the specified altitude because the increase in drag significantly increases the energy dissipation rate.

As the vehicle approaches the runway threshold, the ball should be lined up and appear to move along the light bar (see Figure 4-17).



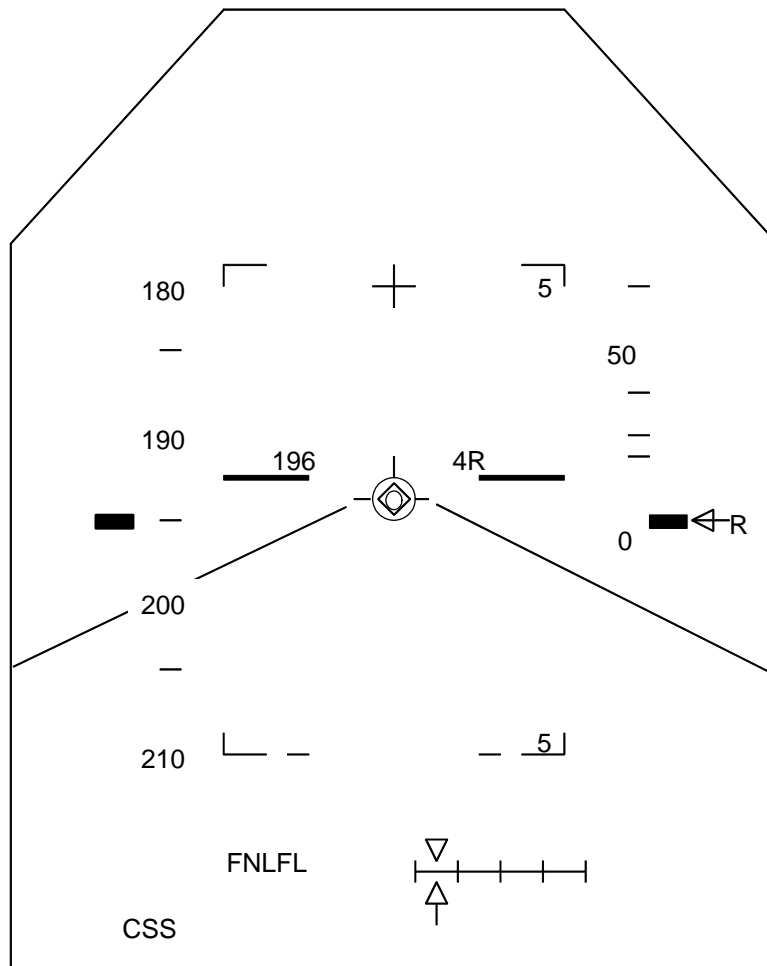
td\_357a\_047

**Figure 4-17. HUD view at 100 ft and 212 KEAS**

(The shuttle is on the inner glide slope.)

The final flare should be a smooth increase in pitch attitude started at an altitude high enough to allow the CDR to perform a safe landing. The shallow trajectory added to the ground effect dictates that a relatively small maneuver is required for landing.

The HUD velocity vector symbol may be used to assist in setting up a smooth touchdown (see Figure 4-18).



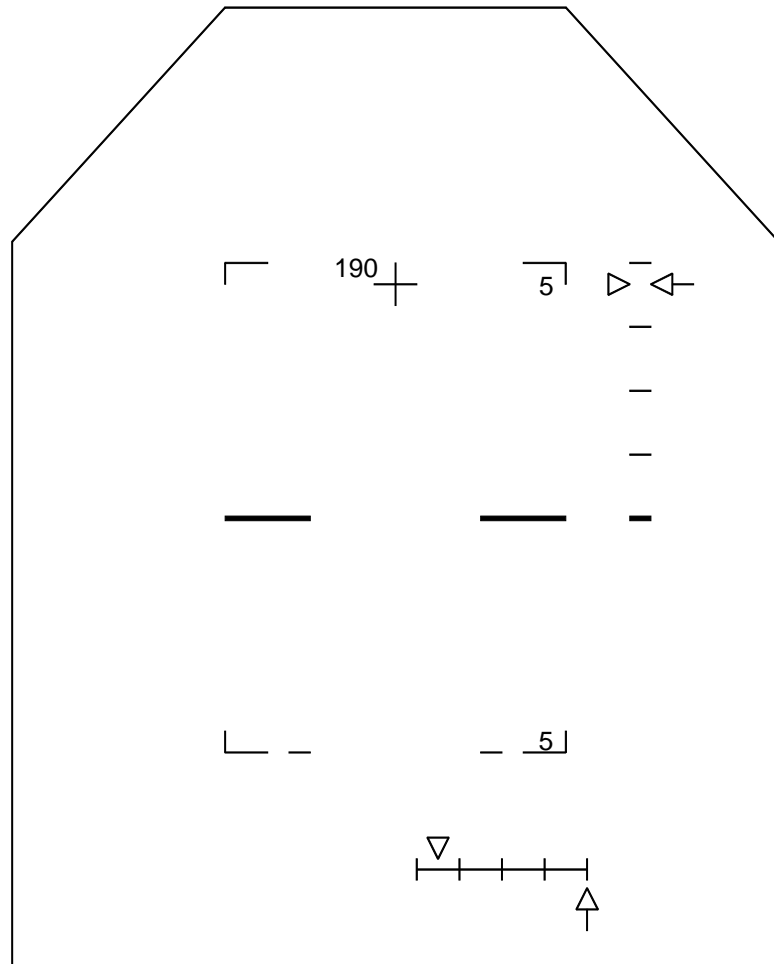
td\_357a\_048

**Figure 4-18. HUD view just before main landing gear touchdown**

(Note the 196 KEAS and 4-ft radar altimeter data being displayed in the center of the display.)

If the upper limb of the velocity vector is tangent to, or just below, the horizon line as the vehicle crosses the runway threshold, a touchdown sink rate of less than 2 ft/sec should be produced.

At vehicle touchdown, the PLT continues to call airspeed, at 10-knot increments, through nose-gear touchdown and until braking is initiated (see Figure 4-19).

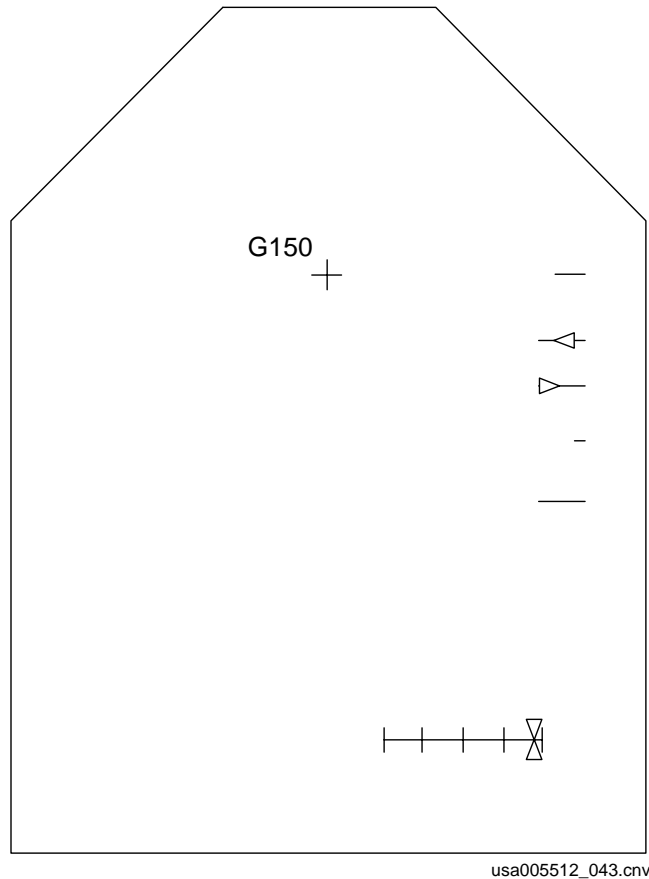


td\_357a\_049

**Figure 4-19. HUD view just after main landing gear touchdown (WOW set)**

The drag chute is deployed at 195 KEAS (after main gear touchdown) by depressing the Drag Chute ARM and DEPLOY pushbuttons simultaneously.

At 185 KEAS (using beep trim), the CDR begins to derotate the vehicle. At nose gear touchdown, the PLT or MS2 backs up the WOW and WONG discrettes by placing the SRB SEP or ET SEP switch in MANUAL and depressing the SRB or ET SEP Pushbutton Indicator (PBI). This procedure ensures that the sequences and flight control changes necessary for rollout are initiated (see Figure 4-20).



**Figure 4-20. HUD view just after nose gear touchdown (WONG/rollout flag set)**

The braking cue is in the upper right corner.





**APPENDIX A      ACRONYMS AND ABBREVIATIONS**

A/L	Approach and Landing
AA	Accelerometer Assembly
ACQ	Acquisition
ADI	Attitude Direction Indicator
ADTA	Air Data Transducer Assembly
AGL	Above Ground Level
AOA	Abort Once Around
BFS	Backup Flight System
C&W	Caution and Warning
CAPT	Capture
CBT	Computer-Based Training
CDI	Course Deviation Indicator
CDR	Commander
CRT	Cathode Ray Tube
CSS	Control Stick Steering
DAP	Digital Autopilot
DC	Direct Current
DEL	Descent Entry Landing
Delaz	Delta Azimuth
DME	Distance Measuring Equipment
DREF	Reference Drag
E/W	Energy over Weight
EAFB	Edwards Air Force Base
EI	Entry Interface
ELS	Emergency Landing Site
EOM	End of Mission
ET	External Tank
FDO	Flight Dynamics Officer
FNL	Final
fps	Feet per second
G&C	Guidance and Control
GCA	Ground Controlled Approach
GPC	General Purpose Computer
GPS	Global Positioning System
GRTLS	Glide Return to Launch Site
GSI	Glide Slope Indicator

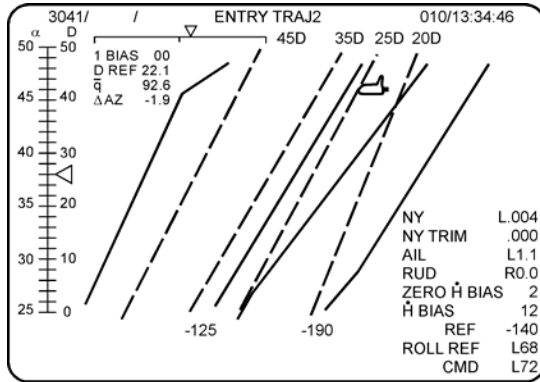
HAC	Heading Alignment Cone
HDG	Heading
HORIZ SIT	Horizontal Situation
HP	Height of Perigee
HSI	Horizontal Situation Indicator
HUD	Heads-Up Display
I-load	Initial Load
IDP	Integrated Display Processor
ILS	Instrument Landing System
IMU	Inertial Measurement Unit
JSC	Johnson Space Center
KEAS	Knots Equivalent Airspeed
KSC	Kennedy Space Center
L/D	Lift Over Drag
LOC	Loss of Control
LVLH	Local Vertical/Local Horizontal
MAN	Manual
MCC	Mission Control Center
MECO	Main Engine Cutoff
MEP	Minimum Entry Point
MLS	Microwave Landing System
MM	Major Mode
MOD	Mission Operations Directorate
MS	Mission Specialist
MSBLS	Microwave Scanning Beam Landing System
NASA	National Aeronautics and Space Administration
NAV	Navigation
NAVDAD	Nav-Derived Air Data
NEP	Nominal Entry Point
nm	nautical mile
NOM	Nominal
NWS	Nosewheel Steering
Nz	Normal Acceleration
OGS	Outer Glide Slope
OMS	Orbital Maneuvering System
OPS	Operational Sequence
OTT	Optional TAEM Targeting
OTT ST IN	Optional TAEM Targeting Straight-In
OVHD	Overhead

PAPI	Precision Approach Path Indicator
pbi	pushbutton indicator
PC	Personal Computer
PFD	Primary Flight Display
PGSC	Payload and General Support Computer
PRFNL	Prefinal
qbar	Dynamic Air Pressure
RCS	Reaction Control System
RED NOR	Redesignated Northrup
REI	Range at Entry Interface
RHC	Rotational Hand Controller
RM	Redundancy Management
RPTA	Rudder Pedal Transducer Assembly
RTLS	Return to Launch Site
SEP	Separation
SM	Systems Management
SOP	Standard Operating Procedure
SPOC	Shuttle Portable Onboard Computer
SRB	Solid Rocket Booster
STN	S-turn
STRT	Straight-In
SW	Switch
TACAN	Tactical Air Navigation
TAEM	Terminal Area Energy Management
TAL	Transoceanic Abort Landing
TAMS	Training Administration Management System
TIG	Time of Ignition
TMECO	Time of Main Engine Cutoff
TRAJ	Trajectory
USA	United Space Alliance
VERT SIT	Vertical Situation
VREL	Relative Velocity
WONG	Weight On Nose Gear
WOW	Weight On Wheels
WOWLON	Weight On Wheels Latched On
WP	Waypoint

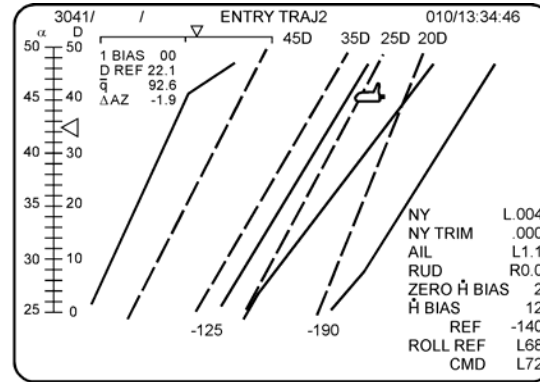
## APPENDIX B ANSWERS

### Answers to Section 2

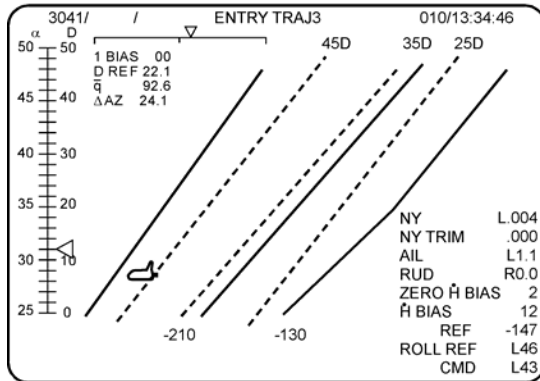
1. c. Given that you have no drag error, you should fly Hdot reference. Hdot reference is by definition the Hdot you should fly when you have no drag error.
2. e. The orbiter bug and the drag lines on the TRAJ display give you desired drag and reference drag.
3. See Figure 2-28 and the discussion following.
4. d. Most things flash when they are off-scale high, but the bug and the phugoid damper scales are different. They flash when you need a roll reversal.
5. See Figure 2-7 and Figure 2-10.
6. d. All are true if you are high energy.
7. d. If you are low energy, your steady state bank will be less. You will have a hard time removing Delaz.
8. c and d. The two purposes of prebank are to prevent the orbiter from skipping out of the atmosphere and to minimize the surface temperature of the orbiter on entry. If you did not bank, you might skip and/or overheat the orbiter.
9. See the drawings on the following page.



$$\begin{aligned} \dot{H}_{REF} &= -190 \\ D_{ERROR} &= 26 - 26 = 0 \\ \dot{H}_{DES} &= -190 + 20(0) = -190 \end{aligned}$$

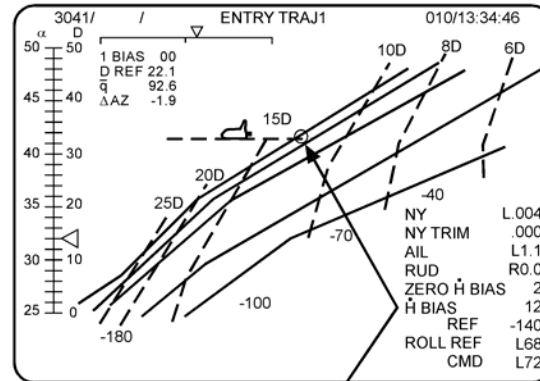


$$\begin{aligned} \dot{H}_{REF} &= -190 \\ D_{ERROR} &= 35 - 26 = 9 \\ \dot{H}_{DES} &= -190 + 20(9) = -10 \end{aligned}$$



$$\begin{aligned} \dot{H}_{REF} &= -210 \\ D_{ERROR} &= 12 - 50 = -38 \\ \dot{H}_{DES} &= -210 + 20(-38) = -970 \end{aligned}$$

Note: -970 is a very big Hdot.  
If you go to such a big Hdot you must immediately start back to a smaller Hdot or you could go to about -500 Hdot.



$$\begin{aligned} \dot{H}_{REF} &= -120 \\ D_{ERROR} &= 14 - 13 = 1 \\ \dot{H}_{DES} &= -120 + 20(1) = -100 \end{aligned}$$

13 is maximum drag allowed

usa005512\_037.cnv

**Answer 9 - calculate altitude rate (Hdot)**

### Answers to Section 3

1. The required inputs by TAEM are
  - b. Normal acceleration feedback
  - c. Nav state
  - e. Air data

Note: Technically, the normal acceleration feedback goes into the DAP SOP, so taking CSS removes the requirement for normal acceleration feedback.

2. You see the following VERT SIT display (Figure 3-22). Guidance is trying to fly even higher on the TRAJ display, you should
  - c. Do nothing; everything is okay.

Notice you are low energy. Energy is in control of the pitch channel (energy bug below the overbright line).

3. What actions should you take if high energy? Which actions will TAEM do automatically?
  - Fly maximum airspeed – Automatic
  - Open the speedbrake – Automatic
  - Fly an S-turn – Automatic if HAC <200 and range > ~26 nm (> ~34 nm OPS 6)
  - Change runway – Manual
  - Fly outside (expand) the HAC – Manual
4. What actions should you take if low energy? Which actions will TAEM do automatically?
  - Fly maximum L/D – Automatic
  - Close the speedbrake – Automatic
  - Select straight-in – Manual but SM alert and message
  - Select MEP – Manual but SM alert and message
  - Change the runway – Manual
  - Shrink the HAC – Automatic

5. What is the speedbrake doing while supersonic?

c. It is following an I-loaded profile vs. Mach.

While supersonic, the speedbrake is not effective at controlling drag and is used mostly as a pitch trim device. It opens to 80° at Mach 10 and closes to 65° at Mach 3.2.

6. Based on the VERT SIT display (Figure 3-23), when you go subsonic the speedbrake should

b. Go full open (to drive energy back to nominal).

You are very high energy (above the overbright line).

7. The two additional maneuvers expected on a 360° HAC are an energy dump and pull-up maneuver.

8. Based on a VERT SIT showing low altitude and low energy but above the MEP line, you

c. Cannot tell by what is shown.

You need to know your current airspeed. If airspeed is well above maximum L/D KEAS, you will probably make the runway. If it is at or below maximum L/D KEAS, you probably won't make it.

## TRAINING MATERIALS EVALUATION

Please answer the following questions regarding the lesson you just completed. Your feedback will allow us to produce more effective training materials. *When completed, mail to: **Manager, DT34.***

**TITLE/CODE OF LESSON:**                    **Entry, TAEM, and Approach/Landing Guidance Workbook 21002**

**SIZE OF AUDIENCE/CLASS:**

**1. How well did this lesson meet its purpose?**

For each statement below, mark one box on the scale:

- a. *The lesson objectives are clearly stated.*
- b. *The lesson objectives are clearly defined.*
- c. *The lesson effectively teaches skills and information.*
- d. *The lesson meets its purpose and objectives.*

Strongly Disagree					Strongly Agree
<input type="checkbox"/>	<input type="checkbox"/>	<input type="checkbox"/>	<input type="checkbox"/>	<input type="checkbox"/>	<input type="checkbox"/>
<input type="checkbox"/>	<input type="checkbox"/>	<input type="checkbox"/>	<input type="checkbox"/>	<input type="checkbox"/>	<input type="checkbox"/>
<input type="checkbox"/>	<input type="checkbox"/>	<input type="checkbox"/>	<input type="checkbox"/>	<input type="checkbox"/>	<input type="checkbox"/>
<input type="checkbox"/>	<input type="checkbox"/>	<input type="checkbox"/>	<input type="checkbox"/>	<input type="checkbox"/>	<input type="checkbox"/>

**2. How satisfying is the content of this lesson?**

For each statement below, mark one box on the scale:

- a. *The information is structured in a logical flow.*
- b. *The content is clear.*
- c. *The content is complete.*
- d. *The level of detail is correct for this information.*
- e. *The amount of information is effective.*
- f. *The graphics contribute to my understanding.*

Strongly Disagree					Strongly Agree
<input type="checkbox"/>	<input type="checkbox"/>	<input type="checkbox"/>	<input type="checkbox"/>	<input type="checkbox"/>	<input type="checkbox"/>
<input type="checkbox"/>	<input type="checkbox"/>	<input type="checkbox"/>	<input type="checkbox"/>	<input type="checkbox"/>	<input type="checkbox"/>
<input type="checkbox"/>	<input type="checkbox"/>	<input type="checkbox"/>	<input type="checkbox"/>	<input type="checkbox"/>	<input type="checkbox"/>
<input type="checkbox"/>	<input type="checkbox"/>	<input type="checkbox"/>	<input type="checkbox"/>	<input type="checkbox"/>	<input type="checkbox"/>
<input type="checkbox"/>	<input type="checkbox"/>	<input type="checkbox"/>	<input type="checkbox"/>	<input type="checkbox"/>	<input type="checkbox"/>
<input type="checkbox"/>	<input type="checkbox"/>	<input type="checkbox"/>	<input type="checkbox"/>	<input type="checkbox"/>	<input type="checkbox"/>

**3. How appealing was the presentation of this lesson?**

For each statement below, mark one box on the scale:

- a. *The overall presentation is appealing.*
- b. *The visuals chosen are appropriate for the lesson.*
- c. *The visuals make the information more interesting.*
- d. *The graphics are legibly reproduced.*
- e. *The audio/visual or print quality is good.*

Strongly Disagree					Strongly Agree
<input type="checkbox"/>	<input type="checkbox"/>	<input type="checkbox"/>	<input type="checkbox"/>	<input type="checkbox"/>	<input type="checkbox"/>
<input type="checkbox"/>	<input type="checkbox"/>	<input type="checkbox"/>	<input type="checkbox"/>	<input type="checkbox"/>	<input type="checkbox"/>
<input type="checkbox"/>	<input type="checkbox"/>	<input type="checkbox"/>	<input type="checkbox"/>	<input type="checkbox"/>	<input type="checkbox"/>
<input type="checkbox"/>	<input type="checkbox"/>	<input type="checkbox"/>	<input type="checkbox"/>	<input type="checkbox"/>	<input type="checkbox"/>
<input type="checkbox"/>	<input type="checkbox"/>	<input type="checkbox"/>	<input type="checkbox"/>	<input type="checkbox"/>	<input type="checkbox"/>

**4. How valuable is this information?**

For each statement below, mark one box on the scale:

- a. *The lesson teaches skills and information I need.*
- b. *The lesson meets my expectations.*
- c. *This information is useful for later reference.*
- d. *I would recommend this lesson to others.*

Strongly Disagree					Strongly Agree
<input type="checkbox"/>	<input type="checkbox"/>	<input type="checkbox"/>	<input type="checkbox"/>	<input type="checkbox"/>	<input type="checkbox"/>
<input type="checkbox"/>	<input type="checkbox"/>	<input type="checkbox"/>	<input type="checkbox"/>	<input type="checkbox"/>	<input type="checkbox"/>
<input type="checkbox"/>	<input type="checkbox"/>	<input type="checkbox"/>	<input type="checkbox"/>	<input type="checkbox"/>	<input type="checkbox"/>
<input type="checkbox"/>	<input type="checkbox"/>	<input type="checkbox"/>	<input type="checkbox"/>	<input type="checkbox"/>	<input type="checkbox"/>

**PLEASE WRITE YOUR COMMENTS/QUESTIONS ON THE BACK OF THIS FORM.  
EXPLAIN ANY NEGATIVE ANSWERS IN SPECIFIC TERMS.  
THANK YOU IN ADVANCE FOR YOUR ASSISTANCE!**



TITLE: Entry, TAEM, and Approach/Landing Guidance Workbook 21002

---

NASA-JSC

\*DA83           MOD Library - Training (2)  
\*DT34           Library

USA-HOUSTON

\*USH-121G      SFOC Technical Library

\*Hard copy distribution.

Submit distribution changes to the DT34 manager. Most documents are available electronically via USA Intranet Web ([usa1.unitedspacealliance.com](http://usa1.unitedspacealliance.com)), Space Flight Operations Contract (SFOC), SFOC Electronic Library System (SELS II).