

Flight Procedures Handbook

Approach, Landing and Rollout

Mission Operations Directorate
Flight Design and Dynamics Division
Ascent/Descent Dynamics Branch

Revision B
May 2005

Verify that this is the correct version before use.



National Aeronautics and
Space Administration

Lyndon B. Johnson Space Center
Houston, Texas

Mission Operations Directorate

Approach, Landing and Rollout Flight Procedures Handbook
Revision B

May 2005

Prepared by

Original signed by

Scott A. Hartman

Ascent/Entry Guidance and Procedures Officer
Approach, Landing and Rollout Flight Procedures Handbook Book Manager

Approved by

Original signed by

Glenn E. Pogue

Group Lead, Ascent/Entry Guidance and Procedures

Original signed by

Gregory T. Oliver

Chief, Ascent/Descent Dynamics Branch

Original signed by

Michael F. Collins

Chief, Flight Design and Dynamics Division

National Aeronautics and Space Administration
Lyndon B. Johnson Space Center
Houston, Texas

Acknowledgment

Major contributions to the Approach, Landing and Rollout Flight Procedures Handbook were made by the following individuals:

William Anderson
Mike Baker
Cathy Boyd
LeRoy Cain
Kenneth Cockrell
Steven Elsner
Alan Hochstein
Martin Linde
Ken Patterson
Glenn Pogue
Wayne Hensley
Keith Walyus
Des Welch
Jim Wetherbee
Gus Loria
Don Hannsz
Chris Ramsay
Dave Allega
Norm Knight
Jeff Wyrick
Chris Lessmann
Mark Veile
Laura Slovey
Kevin McCluney

FLIGHT PROCEDURES HANDBOOK PUBLICATIONS

The following is a list of the Integrated Flight Procedures Handbooks of which this document is a part. These handbooks document integrated and/or flight procedural sequences covering major shuttle crew activity plan phases.

<u>Title</u>	<u>JSC document no.</u>
Ascent/Aborts	10559
OMS/RCS On-Orbit Operations	10588
Entry	11542
Inertial Measurement Unit Alignment	12842
Ascent/Orbit/Entry Pocket Checklists, Ascent/Entry Systems	16873
Procedures and Cue Cards with Rationale	
Post Insertion	18219
Inertial Upper Stage	18392
Deorbit Prep	18817
Contingency Deorbit Prep	20232
Reference Data Book	23204
Approach, Landing and Rollout	23266

Change Record

Revision	Date	Originator/Phone	Description
Basic	November, 1992	Ken Patterson/3-1987	Initial Release
Rev A	May, 2001	Scott Hartman/3-3559	Update document through OI-28, including: <ul style="list-style-type: none"> • Updated glide slopes • Updated landing aids • Updated derotation section • Updated speedbrake section • New drag chute section • Updated nose wheel steering section • New single APU landing technique • New Very Short Runway Landing technique • Updated Flight Rule numbers • Updated crew communication procedures to include drag chute • Update Rollout Margin and Brake Energy sections • Updated acceleration scaling on AMI • Deleted Appendix B • Added document change process
Rev B	May, 2005	Scott Hartman/3-3559	Update document through OI-30, including: <ul style="list-style-type: none"> • New Failed Tire Landing Technique • New ELS Speedbrake Option • Deletion of SOAS Capability • Description of new MEDS Displays • Update NWS Section • Update Crew Procedures on Entry Maneuvers Cue Card

Change Process

The following process assumes a basic knowledge of Microsoft Word for Windows. If you are not familiar with this application, you may submit redlines to the Book Manager on a paper copy with rationale attached.

1. Access the document through the Ascent/Entry Guidance and Procedures Office web site (<https://mod.jsc.nasa.gov/DM/AEGPO/AEGPOhome.html>) under Console Documentation. Electronically copy the pages or sections of interest into a new Microsoft Word document. Open the newly saved document.

2. Select “Revisions” from the Tools menu and check the “Mark Revisions While Editing” box. Then select “Accept All” and “OK” so that your copy contains no revision marks until you enter your changes.

Note: If “Accept All” is not available (i.e. “grayed out”) then there were no previous revisions. Simply check the “Mark Revisions While Editing” box and select “OK”.

3. Select “Options” from the Tools menu and select the “User Info” tab. Enter your name and initials.

4. Enter your changes. After each technical change, select “Comment” from the Insert menu. The word in the document, where the cursor is, will be highlighted and your initials will be placed inside brackets next to the highlighted word. A window at the bottom of the screen will appear for you to type your comment. In this window, enter the rationale for the change. Include 482 or Flight Software CR numbers, etc. as appropriate. Spelling corrections and other editorial changes do not require a “Comment.”

5. Insert this revised Word document into an E-mail addressed to the Book Manager (see the A/E GPO web site, for the current Book Manager and e-mail address).

6. The Book Manager will then review the change and incorporate it as appropriate into the electronic version contained in the Al_fph/working directory. Working versions will be forwarded to subject matter experts for review.

7. On a periodic basis, a PCN or Revision will be submitted to the Ascent/Descent Dynamics Branch Chief for approval. The new version will be moved into the Al_fph directory and mailed to the distribution list.

Table of Contents

1. INTRODUCTION.....	1-1
1.1. PURPOSE	1-1
1.2. SCOPE	1-1
2. GUIDANCE, NAVIGATION, AND CONTROL ONBOARD SYSTEMS AND DEDICATED DISPLAYS	2-1
2.1. AIR DATA.....	2-1
2.2. ACCELEROMETER ASSEMBLIES	2-2
2.3. ELEVONS.....	2-3
2.4. BODY FLAP	2-4
2.5. SPEEDBRAKE	2-5
2.6. RUDDER	2-6
2.7. TOUCHDOWN AND ROLLOUT DISCRETES	2-7
2.8. NOSE WHEEL STEERING.....	2-8
2.9. PRIORITY RATE LIMITING.....	2-9
2.10. NAVIGATION.....	2-11
2.11. DEDICATED DISPLAYS.....	2-13
2.11.1. Attitude Display Indicator (ADI).....	2-15
2.11.2. Horizontal Situation Indicator (HSI).....	2-21
2.11.3. Alpha/Mach Indicator (AMI).....	2-27
2.11.4. Altitude Vertical Velocity Indicator (AVVI).....	2-29
2.11.5. Surface Position Indicator (SPI).....	2-31
2.11.6. RCS Command Lights.....	2-32
2.11.7. Normal Accelerometer (G-Meter)	2-32
2.11.8. FCS Configuration and Major Mode.....	2-33
2.12. HEADS UP DISPLAY	2-35
2.12.1. HUD Overview	2-35
2.12.2. BFS Differences	2-39
2.12.3. HUD Power Distribution.....	2-39
2.12.4. HUD System Moding.....	2-40
2.12.5. HUD Brightness.....	2-40
3. LANDING AIDS	3-1
3.1. TACTICAL AIR NAVIGATION.....	3-1
3.2. MICROWAVE LANDING SYSTEM - GROUND STATION (MLS - GS).....	3-2
3.2.1. MLS-Junior.....	3-2
3.2.2. MLS Site Location.....	3-2
3.3. AIMPOINTS	3-4
3.4. PAPI LIGHT – OUTER GLIDE SLOPE	3-6
3.5. BALL/BAR LIGHTS – INNER GLIDE SLOPE SYSTEM.....	3-8
3.6. RUNWAY LIGHTING.....	3-11
3.7. NAVAIDS AND LANDING SITES	3-12

4. A/L TRAJECTORY DESIGN	4-1
4.1. APPROACH AND LANDING	4-1
4.1.1. A/L Geometry	4-1
4.2. HEADING ALIGNMENT CONE AND PREFINAL	4-6
4.2.1. Overview	4-6
4.2.2. Transition.....	4-6
4.3. OUTER GLIDE SLOPE	4-8
4.3.1. Overview	4-8
4.3.2. Guidance and Control.....	4-8
4.3.3. Phase Switching	4-8
4.4. SPEEDBRAKE	4-9
4.4.1. Overview	4-9
4.4.2. SB Control During Heading Alignment and OGS	4-9
4.4.3. SB Retract	4-11
4.4.4. SB at T/D.....	4-15
4.5. FLARE AND SHALLOW GLIDE SLOPE	4-16
4.5.1. Overview	4-16
4.5.2. Landing Gear Deployment.....	4-17
4.5.3. Sloped Runways.....	4-19
4.5.4. Transition.....	4-19
4.6. FINAL FLARE	4-20
4.6.1. Overview	4-20
4.7. LANDING.....	4-21
4.7.1. Overview	4-21
4.7.2. Landing Dispersions	4-25
4.8. ROLLOUT	4-28
4.9. CONSTRAINTS AND FLIGHT RULES.....	4-30
4.10. ATTITUDE HOLD.....	4-31
4.11. DRAG CHUTE.....	4-33
4.12. DEROTATION.....	4-34
4.13. COAST.....	4-36
4.14. BRAKING.....	4-37
4.14.1. Flight Experience	4-37
5. FLIGHT PROCEDURES	5-1
5.1. LANDING AND ROLLOUT SUMMARY	5-1
5.2. FLIGHT DATA FILE.....	5-2
5.2.1. Landing and Rollout Briefing.....	5-2
5.2.2. Entry Maneuvers Cue Card	5-2
5.2.3. Other FDF.....	5-6
5.2.4. Flight Rules Summary	5-12
5.3. NOMINAL END OF MISSION LANDING	5-16
5.3.1. Flight Control Summary	5-16
5.3.2. Handling Qualities	5-21
5.3.3. Guidance Summary	5-21

5.3.4. Area Navigation Summary.....	5-26
5.3.5. Speedbrake	5-28
5.3.6. Crew Procedures.....	5-28
5.3.6.1. Mach < 1 Until HAC Intercept.....	5-33
5.3.6.2. On the HAC	5-35
5.3.6.3. Approaching the OGS.....	5-37
5.3.6.4. On the OGS.....	5-39
5.3.6.5. Preflare and IGS	5-42
5.3.6.6. Final Flare.....	5-44
5.3.6.7. T/D and Rollout.....	5-45
5.3.6.8. Drag Chute.....	5-48
5.4. RTLS ABORT LANDING	5-51
5.4.1. Overview	5-51
5.4.2. RTLS Guidance Differences	5-51
5.4.3. RTLS Flying Technique.....	5-52
5.5. OFF NOMINAL CONDITIONS.....	5-53
5.5.1. Overview	5-53
5.5.2. BFS Engaged	5-53
5.5.2.1. Overview	5-53
5.5.2.2. Guidance and Navigation.....	5-53
5.5.2.3. Controls and Displays	5-53
5.5.2.4. BFS Flying Technique.....	5-54
5.5.3. HUD Failed.....	5-55
5.5.4. Theta Limits.....	5-55
5.5.5. Stuck SB.....	5-56
5.5.6. MLS Dilemma.....	5-57
5.5.7. APU/Hydraulic System Failures.....	5-58
5.5.8. Tire Failures	5-59
5.5.8.1. Leaking/Failed Tire.....	5-59
5.5.8.2. Vehicle Control With Tire Failures and Crosswind.....	5-60
5.5.9. Inadvertent Early Deploy of Landing Gear.....	5-61
5.5.10. No Deploy of Landing Gear	5-61
APPENDIX A.1 LANDING SITES	A-1
APPENDIX B.1 HEADING ALIGNMENT CONE AND PREFINAL.....	B-1
APPENDIX B.2 OUTER GLIDE SLOPE.....	B-3
APPENDIX B.3 FLARE AND SHALLOW GLIDE SLOPE.....	B-7
APPENDIX B.4 FINAL FLARE.....	B-11
APPENDIX B.5 BASIC CONSTRAINTS	B-16

APPENDIX C.1 ROLLOUT MARGINS AND BRAKE ENERGY C-1

APPENDIX C.3 BRAKING PROCEDURES AND BRAKE ENERGY C-8

APPENDIX C.4 NORMALIZATION C-14

APPENDIX D.1 ACRONYMS AND ABBREVIATIONSD-1

1. INTRODUCTION

1.1. PURPOSE

The purpose of this document is to present shuttle approach, landing and rollout procedures with sufficient rationale and background information to give the user a good understanding of the crew task for this mission phase. This handbook is intended primarily for use by the crew and flight support personnel, during training as well as during real-time support. This publication is written using generic landing data, results from Shuttle Training Aircraft (STA) training, decisions from the Ascent/Entry Flight Techniques Panel, results from space shuttle missions, and techniques developed in the simulators.

1.2. SCOPE

The Approach, Landing and Rollout Handbook covers the final subset of the entry phase starting at Heading Alignment Cone (HAC) interface and terminating at wheels stop (approximately 4 minutes of mission time). The Guidance, Navigation, and Control (GNC) onboard systems, the landing aids, the trajectory design for Approach and Landing (A/L), and the landing constraints are summarily covered prior to the detailed discussions of nominal and off-nominal landing procedures.

The crew procedures for the entry, approach, and landing phases may be found in a companion document, Entry Checklist (JSC-48019). For a discussion of the overall entry phase, starting 30 minutes prior to the Deorbit (D/O) burn, and continuing through crew egress, refer to the Entry Flight Procedures Handbook (JSC-11542).

This document is written under the authority vested in the Mission Operations Directorate, Flight Design and Dynamics Division, for definition, development, validation, and control of crew procedures for orbiter operations, for NASA manned missions, as specified by Space Shuttle Program Manager Directive 9A, dated September 23, 1974.

2. GUIDANCE, NAVIGATION, AND CONTROL ONBOARD SYSTEMS AND DEDICATED DISPLAYS

The following discussion describes the orbiter GNC onboard systems (hardware and software), which have particular importance in their function during the A/L and rollout phases. This includes an overview of the onboard dedicated displays and their respective functions during A/L and rollout. The more detailed discussions of the crew procedures and monitoring techniques for these systems are contained in Section 5.

2.1. AIR DATA

The Flight Control System (FCS) functions best when good Air Data Transducer Assembly (ADTA) data are available. FCS gains within the aerjet Digital Auto Pilot (DAP) are scheduled as a function of Mach number and dynamic pressure (Q-bar). Without ADTA data, bad Navigation Derived Air Data (NAVDAD) can cause severe flight control problems by causing the FCS gains to be out of sync with the environment. With good ADTA data incorporated to Guidance and Control (G&C), auto flight control will (1) command the angle of attack (alpha) to control normal acceleration (Nz) and keep Q-bar within limits, and (2) limit the alpha so as to not stall the vehicle.

Flying with NAVDAD and default air data constrains the capability of the flight control system and places more of the flying responsibility on the commander and pilot. With default air data, alpha is a fixed value of 7.5° and Q-bar is derived from an I-loaded table as a function of navigation earth-relative velocity (VREL). With these default gains, guidance no longer limits alpha by protecting the high Q-bar boundary, or the high alpha limit for stall. Procedurally, when on default air data, the crew must fly theta limits keeping the pitch attitude between the NOSE HI and NOSE LOW limits on the vertical situation display (VSD). The lower limit protects for maximum vehicle Q-bar and the upper limit avoids stall (maximum lift to drag ratio (L/D)). The speedbrake (SB) will automatically open or close as required. See Section 2.5 for more information.

Theta limits are a function of VREL, roll angle, and SB position. SB position affects the limits by causing both limits to increase/decrease by the same amount. Increasing roll angle causes the allowable range for pitch attitude to decrease such that at about 50° bank angle the limits are equal. In this case, flying theta limits is very difficult, if possible. For reference, at Mach 0.9 and zero degree roll angle, the theta limits for 100 percent and 0 percent SB are -33 to -10 and -16 to -6, respectively. If ADTA data is not incorporated to G&C, then flying theta limits is required from Mach 1.5 to below 10k ft on the Outer Glide Slope (OGS).

2.2. ACCELEROMETER ASSEMBLIES

The flight control Accelerometer Assemblies (AA's) provide normal (Nz) and lateral (Ny) acceleration feedback data to guidance and to the aerojet DAP, respectively. The Ny feedback is used in the aerojet DAP for turn coordination to help prevent roll off during stability axis maneuvers. Roll off can be caused by Inertial Measurement Unit (IMU) errors introduced into the calculation of the stability axis (derived from alpha, which is derived from IMU data), and the Ny feedback is used to counter the effects of IMU errors by preventing BETA buildup. Once ADTA data has been incorporated into G&C, alpha error (and thus stability axis error) is eliminated and the requirement for Ny feedback is reduced. However, the Ny feedback is still used in the ROLL/YAW channel of the DAP, and in addition provides feedback for General Purpose Computer (GPC) Nose Wheel Steering (NWS) during rollout.

In Major Mode (MM) 304, the Nz feedback is used for alpha error indications on the Attitude Display Indicator (ADI). In MM305 (and MM602 Nz hold), the normal axis feedback is used by guidance to provide Nz commands to the flight control system. Engaging Control Stick Steering (CSS) in the pitch axis can remove bad Nz feedback during MM305.

Failed AA's can be deselected in OPS 3 on SPEC 53 (CONTROLS), and for Nz failures consideration should be given to not deselecting the failed feedback. Rather, after two Nz failures the crew can fly CSS in pitch in MM305 and avoid deselection of a good lateral feedback on that AA. This makes it possible to maintain the required redundancy (3 of 4 lateral axis AA's) for the use of GPC NWS.

2.3. ELEVONS

In MM305 pitch attitude commands are generated as a function of altitude error and altitude rate error. Elevon pitch commands are constrained by Q-bar limits during the prefinal guidance phase. In the A/L phase, both Q-bar and Energy/Weight (E/W) limits are applied. The normal axis acceleration is also filtered to constrain rate of change of E/W to provide further insurance that vehicle Q-bar limits are not exceeded. In other words, the pitch command delta is limited so as to not change N_z by more than 0.5g. The logic in the pitch channel results in a control system that causes the vehicle to appear to fly airspeed as a function of energy.

Roll commands are a function of lateral position (groundtrack) error and are constrained to control altitude rate (H-DOT). A summary of the roll command limits is shown in Table 2.3-I for both nominal End of Mission (EOM) and for Glided Return to Launch Site (GRTLS).

Table 2.3-I Roll Command Limits

	Velocity > Mach 1	TAEM (Velocity < Mach 1)	HAC (Velocity < Mach 1)
Nominal EOM	30°	50°	60°
GRTLS	45°	45°	55°

At Main Gear Touchdown (MGTD), aileron commands are generated through the roll channel to balance the loads on the main gear and tires. These commands are computed as a function of true airspeed, N_y , and vehicle yaw rate. Asymmetric loading on the gear/tires is most likely to occur in a crosswind landing. The aileron deflection causes the vehicle to roll into the wind, reducing the sideslip angle, and producing differential lift on the wings.

At MGTD the pitch rate commands for derotation are generated as a function of pitch angle, equivalent airspeed, and vehicle weight. In CSS the pitch axis information drives only the ADI rate needles.

At Nose Gear Touchdown (NGTD), the aileron trim loop is opened (at rollout), so that the load balance command is faded out over the next 100 sec. The elevon feedback loop is opened, making the elevator command proportional to the Rotational Hand Controller (RHC) deflection. The software automatically commands the elevons down to relieve main gear loads (Primary Avionic Software System (PASS) and Backup Flight System (BFS)) if the pitch axis is in AUTO. At post-NGTD, the DAP modes to AUTO in pitch once the load relief flag is set. This flag is set after the ROLLOUT flag is set. It is important to allow load relief to be performed in AUTO (elevons 10° down) instead of manual (elevons 18° down with RHC forward to hardstop) to ensure that the nose gear load increase is balanced by the main gear load decrease. Also, during rollout, the RHC pitch detent limit increases 21° to prevent an inadvertent downmode to pitch CSS. Pitch CSS can be reentered by breaking detent or depressing either CSS push button (pb) on panel F2 or F4. AUTO load relief can then be reentered (if desired) by depressing the pitch AUTO pb. After the nose gear is on the ground, turn coordination is no longer used and NWS is enabled if the NWS 1 or 2 mode is selected.

2.4. BODY FLAP

When guidance transitions to the A/L phase (between 10 kft and 5 kft), the Body Flap (BF) is commanded to trail, the 34% position. If the BF is not in the auto mode, the crew should return to auto BF, or manually move the BF to trail. Having the BF at trail protects for tailsrape and ensures good pitch axis control. For the nominal case of the BF at trail (at T/D), pitch attitude (θ) must be less than 14.6° in order to avoid scraping the BF.

2.5. SPEEDBRAKE

The SB command is scheduled above Mach 0.9. Below this, terminal area energy management (TAEM) modulates the SB to control energy until an altitude of 14,000 ft. At 14,000 ft, the speedbrake begins to phase in Q-bar control and phase out energy control in preparation for transition to A/L. A/L guidance modulates the speedbrake to maintain 300 knots on the outer glide slope, until an altitude of 3,000 ft. At 3,000 ft, the speedbrake is retracted to a computed value based on wind, weight, density altitude, velocity error, outer glide slope aimpoint, and short-field option to achieve the targeted touchdown energy. At 500 ft altitude, guidance commands the final adjustment of the speedbrake position based on density altitude and average wind velocity between 3,000 and 500 ft. The SB position is constrained to a lower limit of 15° to prevent physical binding of mechanical linkages at large rudder deflections and to improve rudder effectiveness.

When ADTA is not incorporated into G&C, the speedbrake logic uses NAVDAD Q-bar and VREL. Winds and nonstandard atmospheres cause errors in the navigation derived estimates for Q-bar and VREL. Since these errors do not significantly affect the TAEM energy over weight speedbrake calculation, the speedbrake should be left in auto during TAEM. Furthermore, 3 Degree of Freedom (DOF) off-line simulations have shown that even when ADTA is not used by G&C, A/L performance (including touchdown conditions) is generally better when the speedbrake is left in auto. Dynamic pressure violations above 350 psf (321 KEAS) can occur after the speedbrake retract at 3K for extreme wind and atmosphere conditions, but these violations are worse if the speedbrake is manually retracted to the Deorbit, Entry, and Landing Preliminary Advisory Data (DELPAD) setting. Evaluation of actual flight environments have shown no violations when ADTA is not used by G&C with the speedbrake in auto. Therefore, the speedbrake will be left in auto and the setting evaluated for reasonableness. If the speedbrake setting is unreasonable, the crew may select manual speedbrake and set it as necessary.

When Weight on Wheels Latched ON (WOWLON) is set just after main gear T/D, the SB is commanded full open for energy and pitch trim control. The crew should, per procedure, check that the SB commands to full open. The full open SB is required in order to decrease vehicle derotation rate. Manual SB may be selected to command the SB full open in the event of a Weight on Wheels (WOW) dilemma.

2.6. RUDDER

The rudder becomes active at Mach 5 and is used to provide turn coordination. The Rate Gyro Assembly (RGA) rates (roll and yaw), Ny AA feedback, and Rudder Pedal Transducer Assembly (RPTA) commands are used to form a rudder surface command. The corrected body roll rate (from RGA's) is used in the aerojet DAP to compute a yaw rate. This yaw rate is summed with the corrected body yaw rate (from RGA's), to form a yaw rate error. The rudder pedal deflection is gained (to zero, unless $M < 3.5$ and roll/yaw CSS) as a function of Equivalent Airspeed (EAS), and then summed with the Ny feedback (Ny AA) and the Ny trim to form an initial Ny command. This Ny command is compared to the yaw rate error from above, and a new yaw rate command is formed. This command is summed with the rudder trim command (if any) to form the final rudder surface command. Prior to runway rollout, the RPTA inputs will ultimately have relatively minor effects on the rudder surface command.

2.7. TOUCHDOWN AND ROLLOUT DISCRETES

T/D and rollout are two distinct phases of the orbiter landing. At MGTD, the No-WOW discrete on each gear is set to false (zero). When both WOW discrettes on one main gear are set false for more than 1 second, the WOWLON discrete is set true. If the other main gear discrettes are not set false within 7.2 sec, a WOW dilemma is annunciated. To clear a WOW dilemma (set WOWLON), the crew must manually mode to ROLLOUT by depressing either the Solid Rocket Booster (SRB) or External Tank (ET) separation (SEP) pb. A WOW dilemma results from crosswind landings, electrical bus failures, commfaults, or prox box failures. If any No-WOW discrettes are commfaulted or set false (WOW = 0) when the landing Subsystem Operating Program (SOP) becomes active at A/L interface, a Redundancy Management (RM) dilemma (DLMA) WOW is annunciated. If the discrettes are commfaulted but no other discrettes are set, then a WOW dilemma occurs but is not annunciated by the GN&C/Annunciation Interface (GAX).

When WOWLON is set, the FLATTURN and Heads Up Display (HUD) WOWLON discrettes are also set. WOWLON and FLATTURN cause certain mode changes to occur in the aerojet DAP and on the HUD. The pitch channel modes to slapdown logic. In the Roll/Yaw (R/Y) channel the following happens: rudder trim goes to zero, aileron trim goes to zero (if in CSS R/Y), and autoload balancing logic becomes active. Procedurally, manual depression of the ET or SRB sep pb to set WOWLON is done at NGTD (versus MGTD). The delay from MGTD is to prevent DAP mode changes from occurring during the derotation, since after pressing the button, the transition to ROLLOUT occurs when theta becomes less than zero.

The flight software performs checks to ensure that WOWLON is not set prematurely, which would likely be catastrophic because of the DAP mode changes. If both weight-on-main-gear and WONG indications are set simultaneously, a WOW dilemma is declared. This logic protects against two ac bus shorts within 7.2 sec, causing WOWLON to be set.

The HUD rollout and ground speed enable discrettes are nominally set at NGTD. The flight software checks that WOWLON has been set for 2.08 sec, that the pitch attitude is less than zero degrees, and the no-WONG discrete is set false (indicating NGTD).

When WOWLON is set manually at NGTD, the rollout discrettes are set 2.08 sec later. (If a manual sep pb is depressed at MGTD in response to a WOW dilemma, the rollout discrettes would be set when pitch attitude (theta) decreases to less than zero.) Upon initiation of the rollout discrettes, the DAP no longer performs turn coordination.

2.8. NOSE WHEEL STEERING

NWS is available once Ground Speed Enable (GSENL) is set to provide lateral directional control of the orbiter. Three modes are available: OFF, NWS 1, and NWS 2. In OFF, no steering commands are accepted and the nose wheel simply casters. In this case, steering is accomplished with rudder deflection and differential braking.

NWS 1 and NWS 2 are functionally equivalent. In the NWS 1 or 2 mode, either automatic or manual steering is available. The choice is made via the AUTO R/Y or CSS R/Y pb's on the eyebrow panels (F2, F4). In CSS R/Y, rudder pedal deflections (through RPTA's) are incorporated as biases to the lateral acceleration feedback. This approach prevents over control and aids in responding to tire failures. In AUTO R/Y, steering commands are generated from Ny feedback and Azimuth (AZ) information from the Microwave Landing System (MLS), also known as the Microwave Scanning Beam Landing System (MSBLS). NWS 1 or 2 should not be used if the lateral acceleration feedback, or the RPTA's are zero fault tolerant. This avoids exposure to the next failure and the MCC will direct the NWS be switched OFF for most of these cases. There are exceptions (abort scenarios) where the risks associated with NWS OFF are greater than the risks associated with the next failure, and for those cases the active steering NWS 1 or 2 mode is GO.

2.9. PRIORITY RATE LIMITING

Aerosurfaces (except the body flap) are rate command limited by Priority Rate Limiting (PRL) software (available in MM's 101 to 103, 601 to 603, 304, and 305), to take full advantage of the available hydraulic system muscle while not overloading these systems. The surface rate limits imposed by PRL as a function of the number of hydraulic systems available is shown in Table 2.9-I.

Table 2.9-I Surface Rate Limit
(Deg/sec)

NHSF ^a	Elevators	Ailerons	SB		Rudder ^c
			CL	OP	
0	20.0 ^b	20.0	10.86	6.1	14.0
1	20.0 ^b	20.0	10.86	6.1	12.0
2	13.9	13.9	6.06	5.43	7.0

^a NHSF - number of hydraulic systems failed

^b The elevon rate is 30 deg/sec if true airspeed is less than 600 ft/sec, and 20 deg/sec if true airspeed is > 600 ft/s.

^c Rates listed are PRL limits. If the panels are commanded to greater than 52.9 deg, the drive rates are decreased to the SUMLIM limits of speedbrake close 3.8 (NHSF 2), rudder 5.43/5.43/1.9 (for NHSF 0/1/2).

Elevon and SB drive rates are not reduced if one hydraulic system fails, but rudder drive rates are reduced slightly. If two systems fail, the rates are significantly reduced on all six surfaces.

Each hydraulic system has three supply pressure transducers. Pressure signals are passed to the GPC's through the Flight Aft (FA) Multiplexers/Demultiplexers (MDM's). The Hydraulic Subsystem Operating Program (HYD SOP) provides RM for fault detection and isolation of failed transducers. A selection filter is also provided to generate a selected pressure. At the three level, RM will fail a transducer if it differs from that selected by more than 250 pounds per square inch (psi). At the two level, RM annunciates an RM DLMA PRL if the two transducers differ by >250 psi. When a DLMA is declared, the hydraulic system status remains as it was prior to the DLMA.

The HYD SOP declares a hydraulic system failed if the selected system supply pressure drops below 1760 psi. These fail flags are provided to the PRL software, which then rate-limits aerosurface commands based on the number of good systems.

The PRL and hydraulic system statuses are displayed on the GNC 51 OVERRIDE display. For each of the three hydraulic systems, auto (AUT) and deselect (DES) items are provided to allow the crew to (1) place the system in automatic systems management, (2) manually DES (declare failed) a system, or (3) place a system in manual systems management. A system which is automatically downmoded; i.e., declared failed by PRL, displays a down arrow (↓) in the system status column. The failed system is forced back into PRL availability by executing its AUT item entry, which blanks the "↓" in the status column and blanks the asterisk "*" next to AUT. This establishes manual systems management. A repeat execution of the AUT item entry restores automatic systems management and restores an "*" in the AUT column.

The DES item entry allows the option of forcing the HYD SOP to declare a system failure. Executing the DES while an "*" is displayed next to AUT removes automatic system management; i.e., an "*" appears next to DES, the "*" next to AUT blanks, and a "↓" appears in the system status column. A repeat execution of DES establishes manual systems management by blanking both the "↓" and the "*" next to DES. Automatic management, manual

deselection, and manual systems management are mutually exclusive modes. Hydraulic system status is initialized in the automatic mode.

A question mark (?) is displayed in the status column when an RM DLMA is declared. The one exception to this occurs when a system is previously declared failed, in which case a "↓" is displayed, taking precedence over the "?". When a DLMA is declared (indicated by the RM DLMA PRL fault message), PRL leaves the system status (good or failed) as it was prior to the DLMA.

2.10. NAVIGATION

The entry navigation software processes inputs from the IMU's, ADTA, Tactical Air Navigation (TACAN) system, and MSBLS, using a Kalman filter to maintain an estimate of the orbiter state vector. Operating cyclically, the navigation software selects the available sensor measurements each cycle, computes the proper state vector gain based on the measurement via a covariance matrix, applies that gain to the state vector, and then adjusts the covariance matrix to reflect the update.

The navigation software is divided into entry and preland. Entry navigation begins at MM301 and uses sensed change in velocity (ΔV) from the IMU's to propagate the state vector. Actually, three separate state vectors are maintained by entry navigation (three string), one associated with each IMU. A selected state vector consisting of the midvalue (component-by-component three vectors) is then sent to User Parameter Processing (UPP) for use by guidance and other principle functions. In MM304, drag altitude processing begins when drag = 11 feet per second squared (fps^2) (approximately 235,000 ft altitude) and continues until 85,200 ft.

At an altitude of approximately 150,000 ft, TACAN processing begins. TACAN provides range and bearing data to the navigation solution, primarily reducing downtrack and crosstrack errors. TACAN processing continues until an altitude of 1500 ft or until the preland navigation phase begins.

At Mach 2.5, altitude measurements from the ADTA probes are also factored into the navigation solution to reduce the altitude errors. ADTA processing is in effect from Mach 2.5 to Mach 1.6, and then continues from Mach 1.1 to 500 ft or until preland navigation begins. Between Mach 1.6 and 1.1, the probes are in the Mach jump region and the pressure static (P_{static}) information for altitude computations becomes invalid.

Entry navigation has proven to be very accurate. By HAC acquisition the navigation filter has nominally converged with errors on the order of 1500 ft. As the orbiter flies around the HAC, errors should continue to improve as better geometry is obtained with respect to the TACAN station (depending on the location of the station).

If azimuth and range data good flags are sent to navigation from the MSBLS SOP, then preland navigation has begun. Unlike entry navigation, preland navigation maintains only one state vector (single string), but executes twice as fast as entry (every 1.92 sec vs. 3.84 sec). Preland navigation is designed to process MSBLS data and support the requirements of autoland. Still using a Kalman filter scheme, the extremely accurate Az, range, and elevation measurements from MSBLS are used to correct the navigation state and results in one sigma errors of about 5 ft in altitude, 21 ft in downtrack, and 17 ft crosstrack at T/D. Note that both range and Az data good flags are required in order to process any MSBLS data. Without an elevation data good flag, Az and range are still processed, but if either the Az or the range data good indicator is lost, all MSBLS processing ceases. The loss of MSBLS processing is known onboard by blanking of the MLS residuals and ratios on SPEC 50, absence of double overbright "MLS" at the bottom of the graphical portion of SPEC 50, or the presence of "M LS NV" on the HUD. It should be noted that there is a scenario where the "MLS NV" message on the HUD can trick the crew into believing that MSBLS is not being processed. As mentioned, for the case where there is no elevation data good flag, azimuth and range will still be processed, however, the HUD will display an "MLS NV" message. The Entry Navigation Functional Subsystem Software Requirements (FSSR) says that this message is annunciated when going to a landing site with MLS, and the MLS data (any component) is missing for 6 seconds after the vehicle has passed below 12Kft (with the exception of not annunciating the message if the vehicle has an elevation angle less than 1.5 degrees. So the crew should not use the MLS NV message in the HUD, as the sole cue to determine that MLS is not being processed. The MLS residuals and ratios as well as the double overbright "MLS" on SPEC 50 will always provide an accurate cue for MLS processing. If MSBLS data is lost for any reason (above 1500 ft) after processing has begun, TACAN and ADTA will again become available until 1500 ft and 500 ft, respectively. If MSBLS data is lost below 1500 ft, ADTA processing is not possible. Note, also, that if TACAN data is in the force mode, MSBLS data cannot be processed. Forcing TACAN data or powering OFF MLS (also changing the MLS channel) are the only ways to inhibit processing of MLS, if so desired. The preferred method is powering off the MLS.

OV-103 and OV-104 are equipped with a Global Positioning System (GPS) receiver in a single string configuration as described in Flight Rule A2-265, Single String GPS Operations. OV-105 is currently being modified to include a three-string GPS system (with associated removal of existing three-string TACAN hardware). GPS has been certified for use in navigation, but is currently used only for incorporation to the navigation state in contingency scenarios. For purposes of various flight rules and launch commit criteria, the single-string GPS receiver is also used as a redundant 'string' for onboard and ground TACAN hardware failures. In order to prepare for the first flight of the three-string GPS system on OV-105, an operational ramp-up plan is scheduled to begin no earlier than STS-121. The ramp-up plan calls for incorporation of GPS into the BFS and/or PASS navigation systems for larger duration periods of the entry, eventually leading to full use of GPS to navigation in the PASS and BFS throughout all of OPS 3 (except during the de-orbit burn). Differences between the GPS selected navigation state and the current orbiter navigation state are displayed to the crew on SPEC 55. For purposes of approach and landing, if the GPS to Nav auto/inhibit/force flag is in auto, and the GPS is being used to update the navigation state, GPS will cease updating the orbiter navigation state at 500 ft or when MLS is processed, whichever occurs first.

2.11. DEDICATED DISPLAYS

This is a brief overview of the orbiter dedicated displays including meters/tapes used during the A/L phases of entry. The following are considered to be GNC dedicated displays: Multifunction Electronic Display System (MEDS) Ascent/Entry Primary Flight Display (A/E PFD) which includes the ADI, Horizontal Situation Indicator (HSI), Alpha/Mach Indicator (AMI), Altitude/Vertical Velocity Indicator (AVVI), and the normal accelerometer (g-meter); Surface Position Indicator (SPI) and the Reaction Control System (RCS) command lights. The descriptions in this document will focus on the PFD configuration that is available in PASS and BFS in MM 305. It is assumed that the reader has a general familiarity with the orbiter crewstation and the location of these displays. Details such as the display locations, power sources, data validity/invalidity, and GPC/data bus interfaces also are not discussed. Detailed descriptions of the PFD during other flight phases is available in the FDF DPS Dictionary and the GNC MEDS Dedicated Displays Systems Brief. Figure 2.11-1 is a drawing showing the different parts that make up the A/E PFD. Figure 2.11-2 is an example of what the A/E PFD would look like during a typical approach/land.

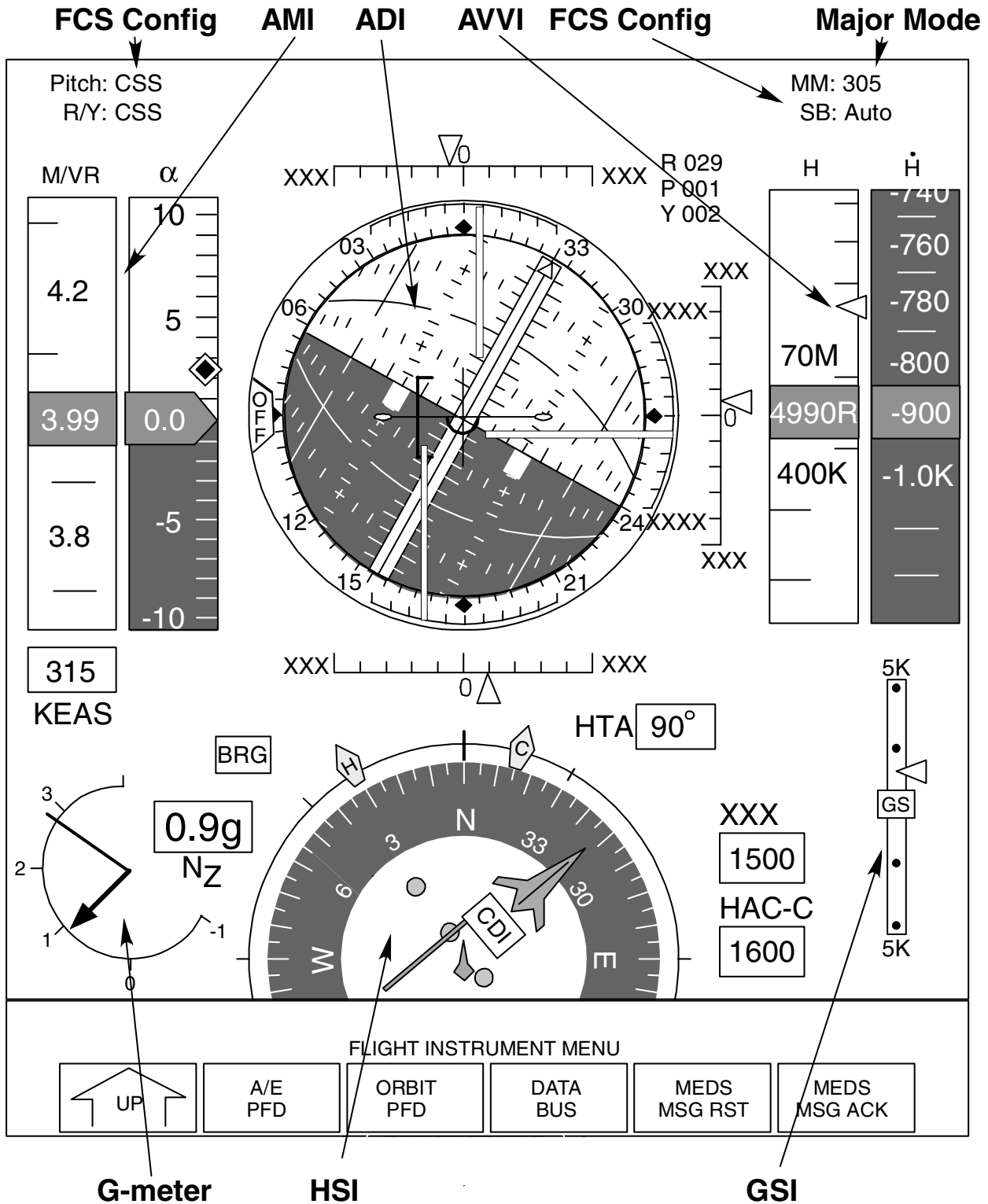

Figure 2.11-1 A/E PFD General Format for MM 305



Figure 2.11-2 Typical A/E PFD during approach/land

For more information on the MEDS display formats, consult the Software Requirements Specifications document for the Integrated Display Processor (IDP) of the MEDS (Document No. MG070100A1012E2).

2.11.1. Attitude Display Indicator (ADI)

The ADI provides attitude, rate, and error information similar to every other phase of flight. For this discussion reference Figure 2.11.1-1 for a picture of the ADI. In general, the orbiter attitude is read from the numbers on the ball for pitch and yaw, and on the fixed ADI case for roll. The attitude displayed is a function of the position of the ADI ATTITUDE switch, which allows selection of different attitude reference frames (Inertial (INRTL), Local Vertical Local Horizontal (LVLH), and Reference (REF)). However, during MM 304/305 (and MM 602/603) the ADI ATTITUDE switch function is overridden in the software, and the attitude processor displays the topodetic pitch and roll attitude, with the yaw driven to zero. In this way the ADI is a "wings-level" display during A/L.

The vehicle rates are displayed as deflections of the ADI roll, pitch, and yaw rate pointers as in other phases of flight. The ADI RATE switch allows selection of the full scale value for the orbiter rates, and in some phases of flight, allows display of critical information for that particular phase. Table 2.11.1-I shows ADI rate and error scale definitions for full deflection of the rate needle. Note that beginning with TAEM, full deflection for the HIGH and LOW switch positions is always 5°/sec, but that the type of information displayed with the MED switch position, changes. Also, the ADI pitch rate is the selected RGA pitch rate (body axis), the same as in other phases of flight. However, the roll and yaw rates are stability axis roll and yaw rates (vice body axes rates).

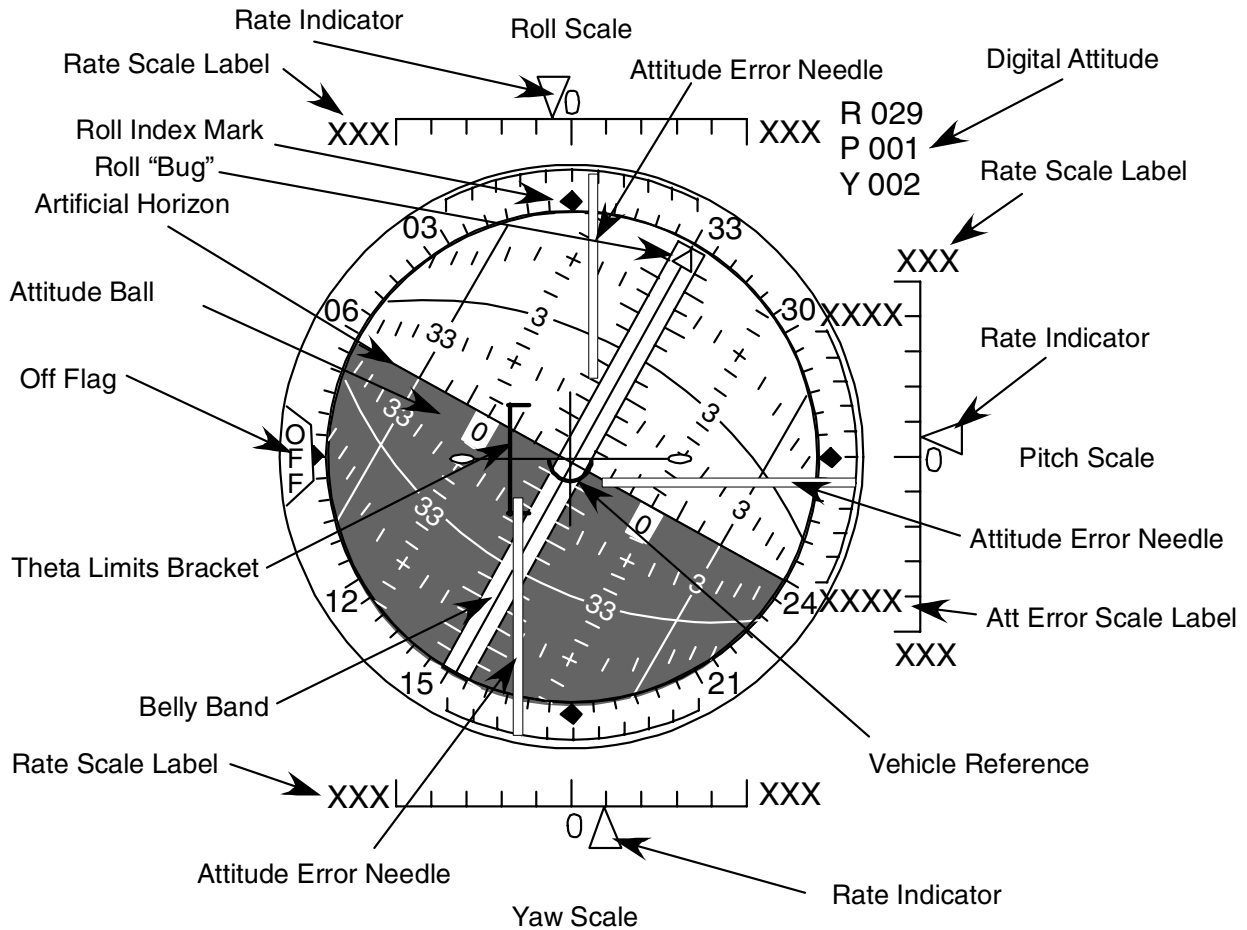

Figure 2.11.1-1 ADI Display

The information displayed by the ADI error needles (also referred to as guidance needles) is affected by the ADI ERROR switch (scaling), and it is also dependent on the flight phase. The full scale values for the ERROR needles during A/L prior to main gear touchdown (WOWLON = 0) are 25/25/10° for roll, 1.25/ 1.25/0.5 g's for pitch, and 2.5/2.5/2.5 jets for YAW, for HIGH/MED/LOW, respectively. The 2.5 jets refers to the equivalent of the yawing moment of 2.5 yaw jets. The full scale values for the ERROR needles after MGTD (WOWLON = 1) are 20/5/1° for roll, 10/5/1 deg/sec for pitch, and 2.5/2.5/2.5 jets for YAW, for HIGH/MED/LOW, respectively. Note that the pitch error needle actually displays a rate error during derotation, this is the slapdown pitch rate error.

Table 2.11.1-I ADI Rate/Error Scale Definition and Full Scale Deflection

GNC Major Mode	Switch Position	Attitude Rate Full Scale			Attitude Error Full Scale		
		Roll	Pitch	Yaw	Roll	Pitch	Yaw
Ascent (101-106, 601) On-Orbit (201, 202, 801) Transition (301-303)	High	Deg/s 10	Deg/s 10	Deg/s 10	Deg/s 10	Deg/s 10	Deg/s 10
	Med	5	5	5	5	5	5
	Low	1	1	1	1	1	1
Entry (304, 602*) <i>*α Transition and α Recovery</i>	High	Deg/s 10	Deg/s 10	Deg/s 10	Deg 25	Deg 5	Jets 2.5
	Med	5	5	5	25	2	2.5
	Low	1	1	1	10	1	2.5
MM 602* <i>*N_Z Hold</i>	High	Deg/s 10	Deg/s 10	Deg/s 10	Deg 25	G's 1.25*	Jets 2.5
	Med	5	5	5	25	1.25*	2.5
	Low	1	1	1	10	0.5	2.5
TAEM (MM 305, 603) WOWLON = 0	High	Deg/s 5	Deg/s 5	Deg/s 5	Deg 25	G's 1.25*	Jets 2.5
	Med	5	5	5	25	1.25*	2.5
	Low	5	5	5	10	0.5	2.5
HAC Phases (MM 305, 603)	High Low	5 Deg/s 5 Deg/s	5 Deg/s 5 Deg/s	5 Deg/s 5 Deg/s			
S Turn & Acquisition	Med	Time to HAC (10 sec)	Altitude Err (\pm 5K ft)	Heading Err (\pm 5 Deg)			
Heading Alignment	Med	N/A - Blanked	Altitude Err (\pm 5K ft)	Radial Err (\pm 5 Deg)			
Prefinal	Med	N/A - Blanked	Altitude Err (\pm 1K ft)	Y-Posn Err (\pm 2.5 K ft)			
Alt_Wheels \geq H_Blank	Med	N/A - Blanked	Altitude Err (\pm 1K ft)	Y-Posn Err (\pm 2.5 K ft)			
Alt_Wheels $>$ H_Blank	Med	N/A - Blanked	N/A - Blanked	N/A - Blanked			
Alt_Wheels $<$ H_Blank	Med	5 Deg/s	5 Deg/s	5 Deg/s			
WOWLON = 1 Rollout (MM 305, 603)	High	Deg/s 5	Deg/s 5	Deg/s 5	Deg 20	Deg 10	Deg 2.5
	Med	5	5	5	5	5	2.5
	Low	5	5	5	1	1	2.5

*When full scale error is 1.25g's, label on error scale actually says 1.2 g due to space limitations and truncation.

Rate scales are labeled for all axes and are in deg/sec unless indicated by a suffix. For example, "5K" indicates the rate scale now serves purpose of being a lateral deviation indicator with max scale deflection of 5000 feet. Only the pitch error scale is labeled and is assumed to denote degrees of error except when a suffix is indicated; i.e., 1.2 g.

The yaw error needle has the same meaning throughout MM's 304 and 305: estimated sideslip (β). For q -bar $<$ 20 psf, the sideslip angle is INRTL β ; i.e., the angle between the +X body axis and the Earth relative velocity. For q -bar \geq 20 psf, estimated beta is based on N_Y and yaw jet effectiveness. Full scale on the display is equivalent to the yaw produced by the side force of 2.5 yaw jets.

The source of the actual information displayed by the guidance needles is more complicated than in the case of the ADI rates. The ADI roll error is the body roll attitude error; it is computed in the ADI processor by differencing the body roll attitude with the limited roll command from guidance. The pitch error represents the Nz error computed in the AEROJET DAP (compensated pitch rate trim is subtracted from the body pitch rate, and added to the Nz error). The result is the ADI pitch error signal in g's. At WOW, the pitch error needles assume another meaning, that of slapdown pitch rate error (body pitch rate minus commanded pitch rate of 2 deg/sec.) The yaw error needle has the same meaning throughout MM's 304 and 305, that of estimating the sideslip (BETA). For $Q\text{-bar} > 40$ pounds per square foot (psf), BETA is computed in the DAP and sent to the ADI processor. The algorithm for estimated BETA ($Q\text{-bar} > 40$ psf) is based on N_y and yaw jet effectiveness. Full scale on the display is equivalent to the yaw produced by the side force of 2.5 yaw jets (reference ENTRY FPH for more details on ADI yaw error and scaled lateral acceleration (A_y) during entry). Tables 2.11.1-II and 2.11.1-III summarize the PASS and BFS ADI displayed information for different entry phases. The BFS has some slight differences in the ADI processing. The major differences to remember are that the full scale values for the rates and errors cannot be changed, and that the guidance needles are stowed at 2000 ft altitude when BFS guidance terminates. Table 2.11.1-IV shows the BFS ADI RATE and ERROR full range deflections as a function of ADI switch position and flight phase.

Table 2.11.1-II ADI Display Sequence

Major Mode	101-103		104-106, 301-303	201& 202	304/602	305/603		
Phase	Ascent		Transition	Orbit	Entry	TAEM	A/L	Touchdown
Attitude	INRTL	Inertial Reference Frame			Roll	Topodetic Roll		
	LVLH	LVIY*	LVLH		Pitch	Topodetic Pitch		
	REF	Stored Reference Frame			Yaw	Fixed at Zero		
Errors	Launch Guidance Command Errors		Total Attitude Errors		Roll	Roll Total Attitude Error ($\Phi - \Phi_{CMD}$)		
					Pitch	Angle of Attack (α) Error	Normal Acceleration Error (N_z)	Slapdown Pitch Rate Error
					Yaw	Estimated Sideslip (β)		
Rates	Selected RGA Roll, Pitch, & Yaw Rates (Body Axis)			IMU Derived Body Rates	Roll	Stability Roll Axis Rate		
					Pitch	Selected RGA Pitch Rate		
					Yaw	Stability Yaw Axis Rate		

* LVIY is a specialized convention similar to LVLH. LVIY fixes yaw at zero, is referenced to MECO targets, and uses a YAW, PITCH, ROLL rotational sequence. In contrast, LVLH is based on the current (instantaneous) position and uses a PITCH, YAW, ROLL rotation sequence.

Table 2.11.1-III BFS ADI Sequencing

Major Mode	101-103		104-106, 301-303	201& 202	304/602	305/603		
Phase	Ascent		Transition	Orbit	Entry	TAEM	A/L	Touchdown
Attitude	INRTL	Inertial Reference Frame			Roll	Topodetic Roll		
	LVLH	LVIY	LVLH		Pitch	Topodetic Pitch		
	REF	Stored Reference Frame			Yaw	Fixed at Zero		
Errors	Launch Guidance Command Errors		Total Attitude Errors		Roll	Roll Total Attitude Error ($\Phi - \Phi_{CMD}$)		
					Pitch	Angle of Attack (α) Error	Normal Acceleration Error (N_z)	Slapdown Pitch Rate Error
					Yaw	Estimated Sideslip (β)		
Rates	Selected RGA Roll, Pitch, & Yaw Rates (Body Axis)			IMU Derived Body Rates	Roll	Stability Roll Axis Rate		
					Pitch	Selected RGA Pitch Rate		
					Yaw	Stability Yaw Axis Rate		

Table 2.11.1-IV BFS Rate and Error Scaling

Item	101-106; 301 - 303	304	305
Error			
Roll	5°	5°	5°
Pitch	5°	5°	5 deg/1.25 g/sec
Yaw	5°	5°	5°
Rate			
Roll	5°	5°	5°
Pitch	5°	5°	5°
Yaw	5°	5°	5°

2.11.2. Horizontal Situation Indicator (HSI)

The HSI serves several functions including an independent source to compare entry auto guidance, a means of assessing the health of individual Navigation Aids (NAVAID's) during entry and crew display for flying manually when required. Figure 2.11.2-1 is an HSI display. The HSI displays magnetic heading (angle between magnetic North and vehicle direction), course direction (primary runway heading with respect to magnetic North), course deviation (angular measure of vehicle displacement from extended runway centerline), Glide Slope (GS) deviation (distance above or below GS), primary and secondary bearing (degrees), and primary and secondary range (miles).

The HSI SELECT SOURCE switches allow selection of the data driving the HSI to come from TACAN, Navigation (NAV), or MLS. For TACAN and MLS, the individual unit can be selected by selecting Line Replaceable Unit (LRU) 1, 2, or 3. If the first switch is in the TACAN position, TACAN slant range and bearing and drag or ADTA altitude are used in the HSI computations. If the switch is in the navigation position, then the orbiter state vector is used in the HSI computations. If the switch is in the MLS position, then MLS slant range, azimuth, and elevation are used. The second switch determines which LRU the TACAN or MLS data is obtained from when the first switch is in the TACAN or MLS position.

The HSI SELECT MODE switch allows the crew to specify the phase (ENTRY, TAEM, or A/L) for which the HSI display is representative. If the switch is in the ENTRY position, the HSI automatically changes mode from Entry to TAEM at MM 305 or MM 603 transition. It will also automatically change the mode from TAEM to A/L when altitude is less than 18,000 ft and course deviation is less than 2.5°, or at 12,000 ft altitude if the course deviation criterion is still not met. The automatic moding may be overridden by taking the switch to the TAEM or A/L position. Each position of the MODE switch calls for a different set of definitions for the HSI display parameters, which are defined below and summarized in Table 2.11.2-I. A more detailed explanation of the display parameter definitions can be found in the G&C Systems Briefs.

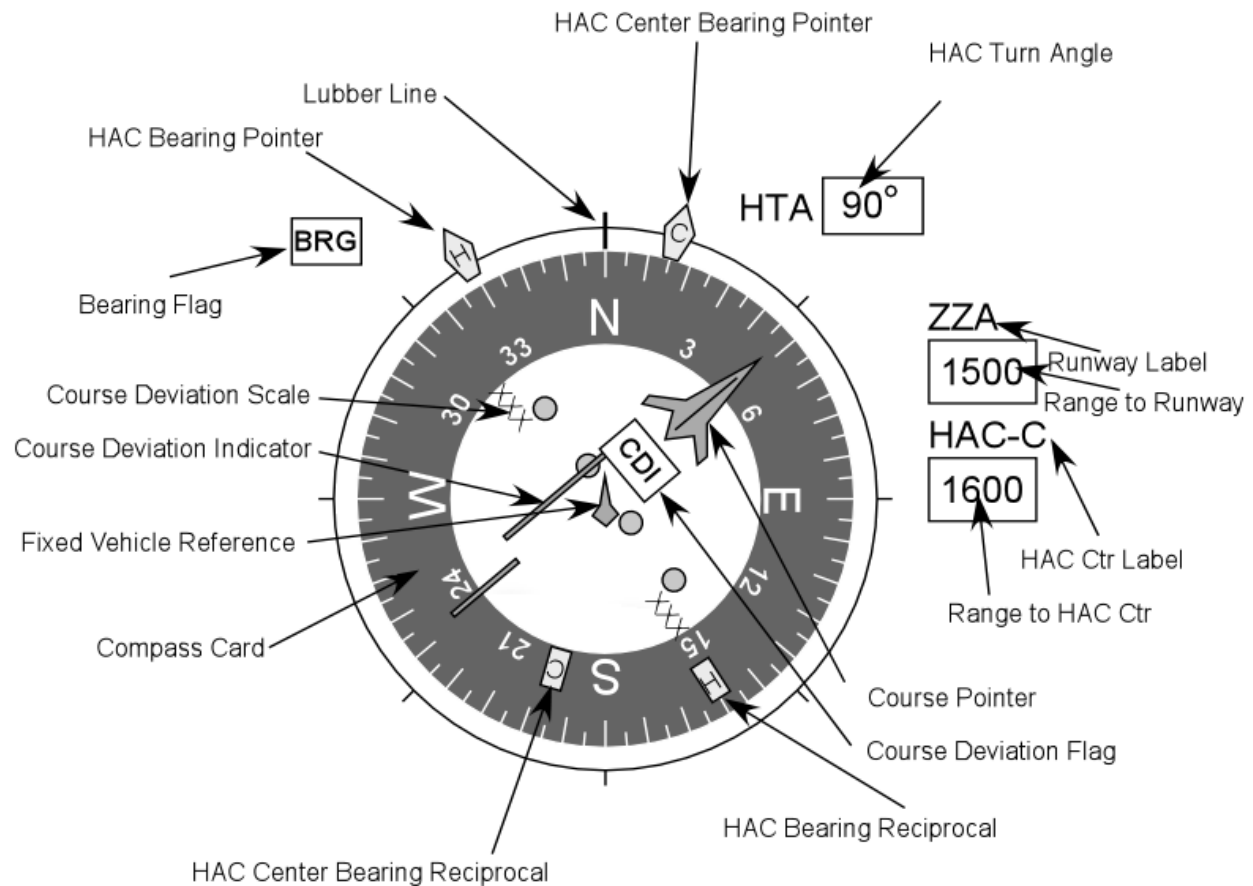

Figure 2.11.2-1 HSI Display

Heading

The magnetic heading is the angle between magnetic north and the vehicle direction measured clockwise from magnetic north, is displayed under the lubber line. During MM 304 and MM 602, the software uses the relative velocity vector for the vehicle direction, while in MM 305 and MM 603, the body +X axis is used instead.

Course Pointer

The Course Pointer represents the magnetic heading of the selected runway. For example, if KSC 33 is the selected runway, the Course Pointer would point to 330° on the compass card.

Course Deviation Indicator (CDI)

The CDI is not driven in MM 304 and MM 602 and remains centered until Major Mode 305 or 603 is entered. During MM 305 and MM 603, it represents the deviation from the extended runway centerline. Full scale deflection is 10° during TAEM and 2.5° during the HSI Approach and Landing scaling mode (HSI A/L scaling occurs earlier than guidance A/L near the A/L guidance prefinal phase). The CDI is a fly-to indicator for flying the vehicle to the extended runway centerline. A slight jump of the CDI can be seen when it becomes active at TAEM.

Glide Slope Indicator (GSI)

The GSI (shown in Figure 2.11.2-2) is displayed in Major Mode 305 or 603, replacing the altitude acceleration scale. During MM 305 and MM 603, it represents the altitude error of the vehicle assuming a circular HAC with a radius equal to 15,500 ft. The pointer is a fly-to indicator, i.e., if the pointer is at the bottom of the scale, the vehicle is high on altitude or above the glide slope but if the pointer is at the top of the scale, the vehicle is low on altitude or below the glide slope. Full scale deflection is 5,000 ft during TAEM and 1000 ft during the HSI Approach and Landing scaling mode (HSI A/L scaling occurs earlier than guidance A/L near prefinal). Below an

altitude of 1500 ft, the glide slope deviation is not computed, the GSI is driven to zero, and GS OFF flag becomes visible. This prevents invalid elevation data during landing and rollout.

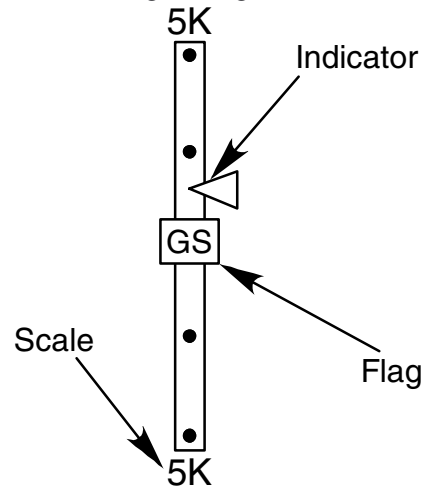

Figure 2.11.2-2 GSI Display

HAC Bearing Pointer

During entry and TAEM, a green pointer labeled “H” is the great circle bearing in degrees to the HAC tangency point, Way Point 1 (WP1), of the selected HAC at the selected runway. In the A/L mode, the HAC bearing pointer is the bearing to Way Point 2 (WP2), where WP2 is 1000 ft past the threshold of the selected runway. During Entry and TAEM, the delta azimuth (ΔAz) angle is displayed digitally to the upper right of the HIS. Once in the Heading Alignment phase of TAEM, the ΔAz is replaced by the HAC Turn Angle (HTA) digital display. HTA is the amount of turn remaining, in degrees. The HTA display is removed in the A/L mode. An example of the HAC bearing pointer prior to HAC intercept is shown in Figure 2.11.2-3. An example of the HAC bearing pointer during approach/land is shown in Figure 2.11.2-4.

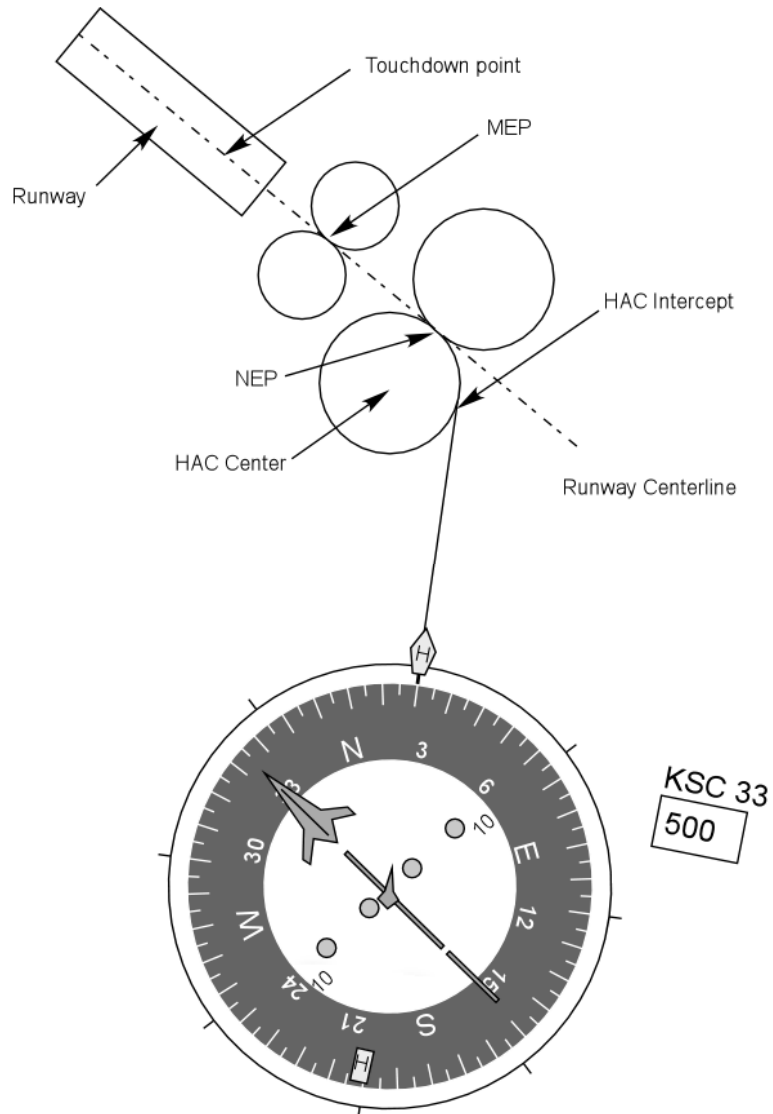

Figure 2.11.2-3 HAC Bearing Pointer Prior to HAC Intercept

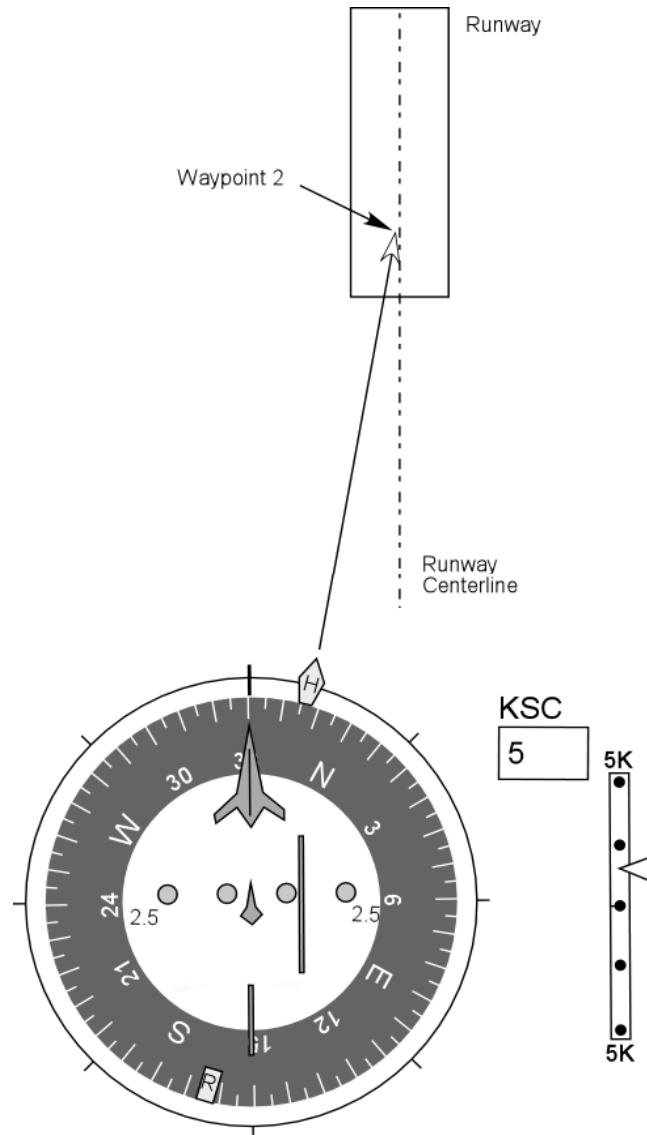

Figure 2.11.2-4 HAC Bearing Pointer During Approach/Land

HAC Center Pointer

The HAC Center pointer is not displayed during most of the entry, approach, or landing. However, during TAEM, the HAC Center pointer is the bearing to the center of the selected HAC at the selected runway, labeled “C”. The pointer is removed in A/L mode.

Range to Runway

During entry, the Range to Runway displayed is the range to WP2, including the great circle distance to the HAC tangency point and the distance around the HAC to WP2. WP2 is located 1000 ft from the threshold down the runway. During TAEM, Range to Runway is the horizontal distance to WP2, including the range around the HAC to WP2. During the A/L mode, it is simply the horizontal distance to WP2. In summary, Range to Runway is the distance to fly to reach the runway. Although there are difference between the HSI’s range to go and TAEM guidance’s range to go, TAEM guidance range to go is not precisely displayed to the crew. Therefore, this difference will not be observed by the crew directly; only indirectly as a difference between the HSI glide slope error and the ADI pitch rate pointer (guidance computed altitude error).

HAC Center Range

During TAEM, the secondary range is the horizontal distance to the center of the selected HAC for the selected runway. The digital range to the HAC center, labeled "HAC-C", is displayed to the right of the HIS. The HAC used by the HSI and TAEM guidance varies between ~2.3 NM and ~4.5 NM. The HAC-C display is removed in A/L mode.

There are a few differences between the PASS and BFS HSI display processing. In the BFS, both HSI's are driven with the same set of commands (no difference between left and right sides). The BFS SOURCE and MODE switch processing is very limited; the MODE switch information is not used, the SOURCE switch works in TACAN or NAV, and the SOURCE (LRU 1, 2, 3) switch information is not used. All HSI parameter definitions are the same as given for the PASS.

Table 2.11.2-I Entry HSI Parameter Definition

HSI Parameter	HSI Mode		
	ENTRY	TAEM	A/L
Lubber Line	Magnetic heading of V_{REL} vector	Magnetic heading of +X body axis	Magnetic heading of +X body axis
Course Pointer	Magnetic heading of selected runway	→	→
Course Deviation Indicator (CDI)	Driven to Zero (no CDI flag)	Deviation from extended runway CL (full scale = $\pm 10^\circ$)	Deviation from extended runway CL (full scale = $\pm 2.5^\circ$)
Glide Slope Indicator (GSI)	Not displayed. Replaced by altitude acceleration tape	Altitude Error wrt circular HAC (full scale = $\pm 5,000$ ft)	Altitude Error (full scale = $\pm 1,000$ ft)
HAC Bearing	Spherical bearing to HAC tangency point of selected HAC	Bearing to HAC tangency point of selected HAC	Bearing to WP2 (1,000 ft past rwy threshold)
HAC Center Bearing	N/A	Bearing to center of selected HAC	N/A
Runway Range	Spherical surface range to WP2, including range around HAC	Horizontal distance around HAC to WP2	Horizontal distance to WP2
HAC Center Range	N/A	Horizontal distance to center of selected HAC	N/A

2.11.3. Alpha/Mach Indicator (AMI)

The AMI (Figure 2.11.3-1) portion of the MEDS A/E PFD displays the angle of attack (ALPHA, degrees), the Mach/Earth-Relative Velocity (M/VR, ft/sec) and Knots Equivalent Airspeed (KEAS, knots). This display consists of two separate moving tape scales, appropriately marked for the range of the respective parameters. The AMI is driven with NAV derived parameters during MM 304 and MM 602. They are driven by NAV derived parameters or Air Data probe data in MM 305 and MM 603 depending on the ADTA switch position and Mach number. A digital display of Beta is provided in powered flight only and located below the velocity tape, but is not available in glided flight (MM 304, MM 305, or MM 603).

The M/VR tape displays Mach number and relative velocity (vehicle airspeed) when the vehicle speed is greater than $M=0.9$. This is a moving tape, with the M/VR displayed in the fixed box at the center of the tape. If air data is not available, Mach number is simply calculated by dividing VREL by 1000. The tape is scaled from Mach 0 to Mach 4, and then re-scaled for Mach numbers greater than 4, to a maximum of Mach 27. The KEAS is displayed digitally below the tape.

For Mach less than 0.9, the M/VR tape changes to the KEAS tape. This is the airspeed corrected for instrument error, position error, and compressibility. This is a moving tape, with the EAS displayed in the fixed box at the center of the tape. The range of the tape is from 0 to 500 knots (kts), where 1 inch of tape is equal to 10 KEAS. M/VR is now displayed below the tape.

The angle of attack (ALPHA) display uses a tape ranging from -180° to $+180^\circ$ with no scale changes. The tape has black markings on a white background for positive numbers, and vice versa for the negative ALPHA values. The current alpha is displayed in the fixed box at the center of the tape. A green band on the right side of the tape displays the range of alphas allowed to be flown at the current Mach/EAS. This band is initially set at ± 4 deg in

MM304 and adjusts per a table of allowable values based on Mach. The band is available in both PASS and BFS in MM 304, MM 305, MM 602, and MM 603. Note: When using low alpha techniques during aborts, the green band may not be visible. At Mach 3.0 a magenta maximum lift over drag (Max L/D) diamond appears on the display. This Max L/D indicator is displayed on the alpha tape at the maximum L/D for the current Mach/EAS being flown. For low energy cases the vehicle will fly this alpha in AUTO and the crew should fly this alpha if CSS. Max L/D provides the best gliding range for the orbiter by flying the best trade of lift verses the drag generated at that speed.

The data driving the AMI tapes are a function of the position of the AIR DATA switch (LEFT, NAV, or RIGHT). With the AIR DATA switch in the LEFT or RIGHT position, the ALPHA, M/VR, and EAS are driven with the selected data from the left or right probe assembly, assuming the probe is deployed and the data is valid. With the AIR DATA switch in the NAV position, the ALPHA, M/VR and EAS are driven from the same data being sent to the guidance, flight control, and NAV software users. This is determined by the ADTA SOP parameters, or NAV derived parameters, depending on the probe status, the Mach number, ADTA validity, and the status of the active ADTA to G&C item entry on the HORIZ SIT display (SPEC 50). A summary of the AMI display vs. controls can be found in Table 2.11.3-I.

When invalid, the tapes will be replaced by a blank (black) rectangle with a red border.

The BFS has some differences for AMI display processing from the PASS. The major differences are that the AIR DATA switch function is only available from the left, or Commander's (CDR's) side, and the AMI displays the average of the left and right probe data when in either the LEFT or RIGHT AIR DATA switch positions.

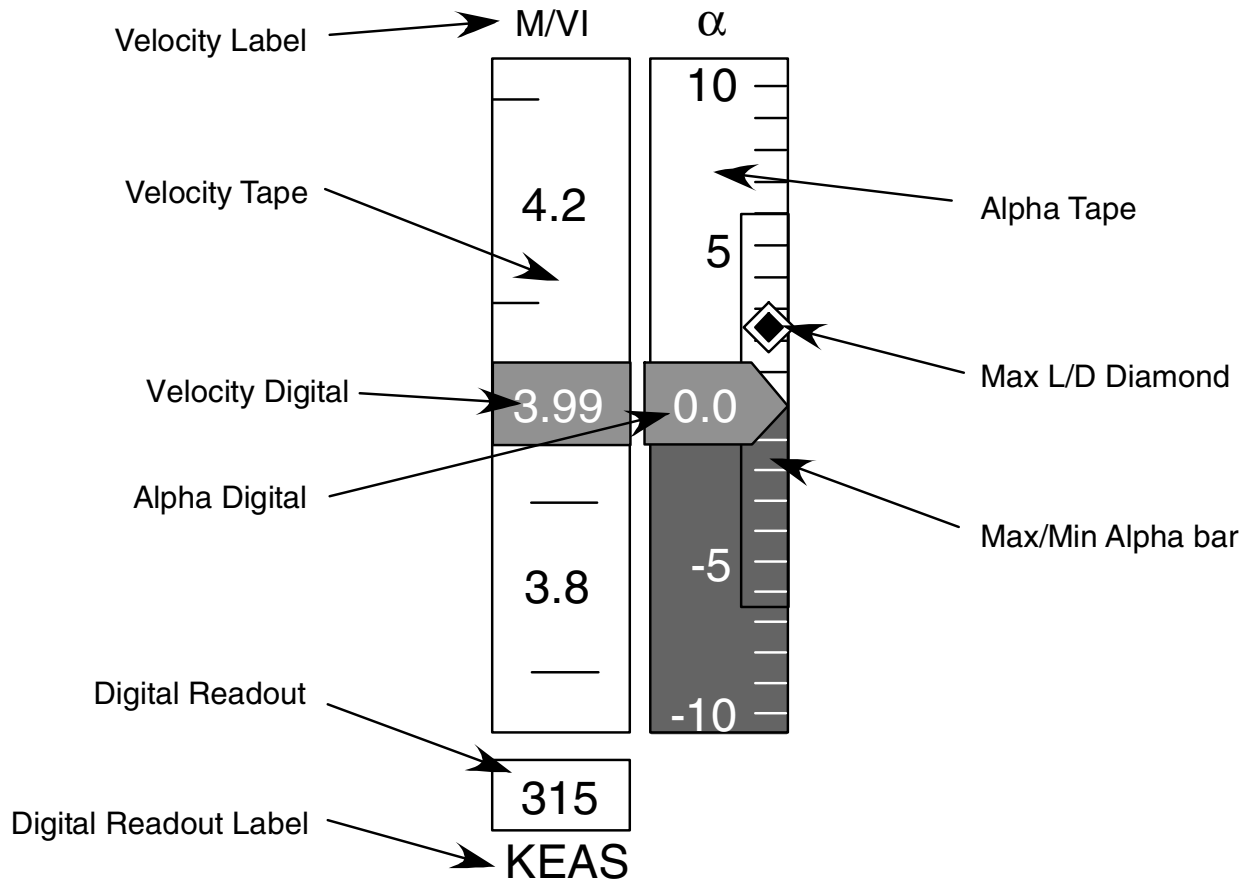

Figure 2.11.3-1 AMI Display

Table 2.11.3-I AMI Display Versus Controls

Air data switch	Prior to probe deploy	Probe deployed, before Mach 2.5	After Mach 2.5
	ALPHA, M/VR, EAS	ALPHA, M/VR, EAS	ALPHA, MACH, EAS
Left/right	Frozen w/ flags	Left/right probe data, no flags unless commfaults	Left/right probe data, no flags unless commfaults
AUT/FOR/NAV	NAV data	NAV data	Center air data unless RM dilemma, then NAV data
Inhibit (INH)	NAV data	NAV data	NAV data

2.11.4. Altitude Vertical Velocity Indicator (AVVI)

The AVVI (Figure 2.11.4-1) displays the navigation or barometric altitude (H, ft), and the altitude rate (Hdot, ft/s). Below 5000 feet, the radar altimeter altitude is displayed on the altitude tape (R, ft).

The altitude scale, H, is a moving tape read against a fixed digital display which displays the altitude of the orbiter above the runway (Navigation or Barometric altitude). The scale ranges from -1100 ft to +165 nautical miles (NM), with scale changes at 400k ft, 100k ft, 30k ft, 2000 ft, 200 ft, 0 ft, and -100 ft. The scale is in ft from -1000 to +400k ft, and in nautical miles from +65 to +165 NM. The digital altitude display may have a letter suffix. M is for miles altitude, K means thousands of feet altitude, and R indicates radar altitude is being displayed.

Radar altitude is displayed as a green triangle to the right of the altitude tape which displays radar altimeter ALT (corrected for main gear) below 5000 ft. The green indicator allows comparison of navigation or barometric altitude, indicated by the center of the fixed digital altitude box, and the radar altitude. Additionally, the digital altitude will have the "R" suffix, indicating the digital reading is the radar altitude. The data displayed is a function of the Radar Altimeter (RA) switch position, and reflects RA 1 or RA 2 data in position 1 or 2, respectively.

The next scale to the right, ALT RATE is also read on the fixed digital box. The scale range is from -3000 to +3000 ft/s, with scale changes at -1000 and +1000 ft/s. The negative numbers are white on a gray background, and the positive values are black on a white background.

The leftmost scale is the ALT ACCEL and is read where the moving pointer intersects the fixed scale. The scale ranges from -13.3 to +13.3 ft/s², where 1 inch is equal to 6.67 ft/s². The software limits the ALT ACCEL to +/- 12.75 ft/s².

Below the H and Hdot tapes are the Altitude Acceleration (H double-dot) in MM304 or the Glideslope Indicator for MM305. Altitude acceleration indicates the rate of change of Hdot. The scale ranges from -13.3 to +13.3 ft/sec², however the tape display limits are +/- 10 ft/sec². There is no digital display.

The Glideslope Display is actually part of the HSI and replaces the altitude accel tape in MM305.

The source of the data driving the AVVI tapes (except for the RDR ALT) is a function of the AIR DATA switch position. With the switch in the LEFT or RIGHT position, the ALT RATE and ALT will be based on the left or right probe data, assuming the probes are deployed and the data is valid. ALT ACCEL is always driven by NAV derived data, and RDR ALT is always driven by the RA data via the RADAR ALTM switch. With the AIR DATA switch in the NAV position, all tapes (except RDR ALT) are driven by NAV derived data. Unlike the AMI display the AVVI does not depend on the SPEC 50 ADTA to G&C item entries; the AVVI never reflects probe data when the AIR DATA switch is in the NAV position. A summary of the AVVI data sources is referenced in Table 2.11.4-I.

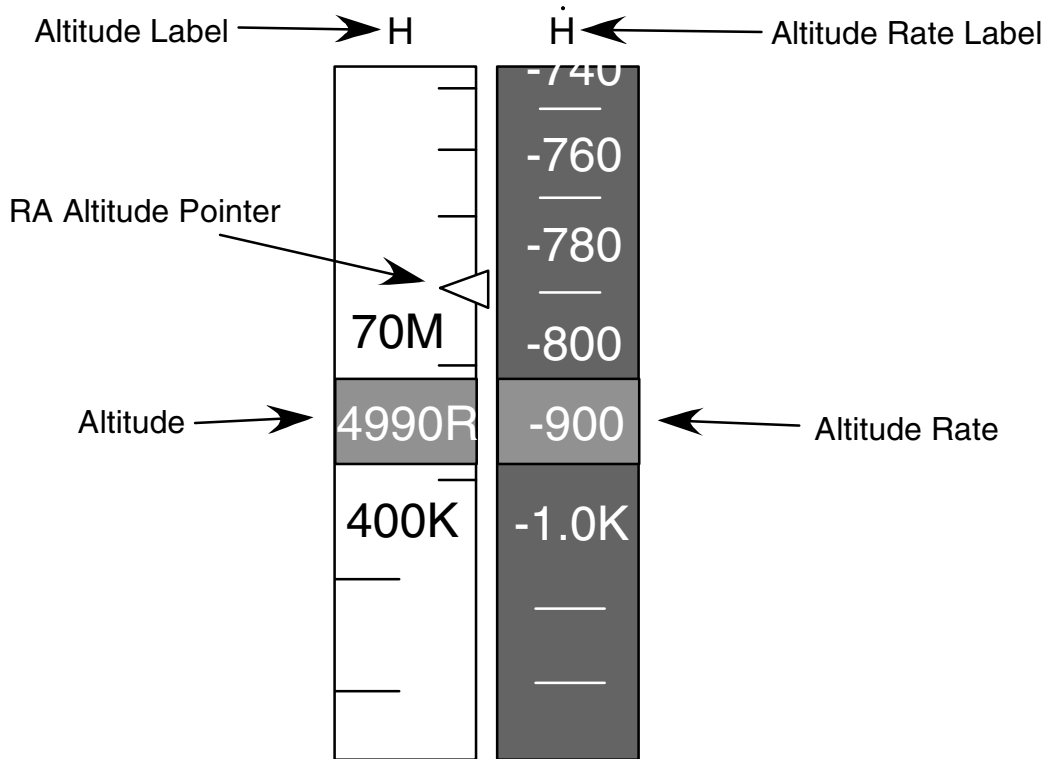

Figure 2.11.4-1 AVVI Display

Table 2.11.4-I AVVI Data Source

AVVI parameter	AIR DATA switch	
	LEFT or RIGHT	NAV
ALT ACCEL	NAV derived	NAV derived
ALT RATE	Left or right probe	NAV derived
ALT	Left or right probe	NAV derived
RDR ALT	RA 1 or RA 2	RA1 or RA 2

In the BFS, the AVVI processing is slightly different. The ALT ACCEL, ALT RATE, and ALT have the same physical quantities as the PASS. The RDR ALT tape is driven by data from RA 1, unless the data is invalid, and then it is driven by RA 2. Similar to the AMI in the BFS, when the AIR DATA switch is in the LEFT or RIGHT position, the average of the probe data drives the tapes for the ALT RATE and ALT (recall ALT ACCEL is NAV derived only). Also similar to the AMI processing, only the left side (CDR) AIR DATA switch is functional.

2.11.5. Surface Position Indicator (SPI)

The discussion of the SPI is very limited here, since this display and the processing of the data does not change for the A/L phase from the other phases of entry. The only exception is the SB. The SB position (actual position from feedback SOP) and the SB command are displayed on the SPI by a graphical scale as well as a digital value. Prior to TAEM, the SB command displayed is the DAP auto command (Mach scheduled SB command), and post TAEM, the SB command displayed on the SPI is the auto guidance SB command. The BFS SPI is no different from the PASS, except that the SB command displayed is driven to zero during A/L since there is no BFS A/L guidance. An example of the SPI is shown in Figure 2.11.5-1.

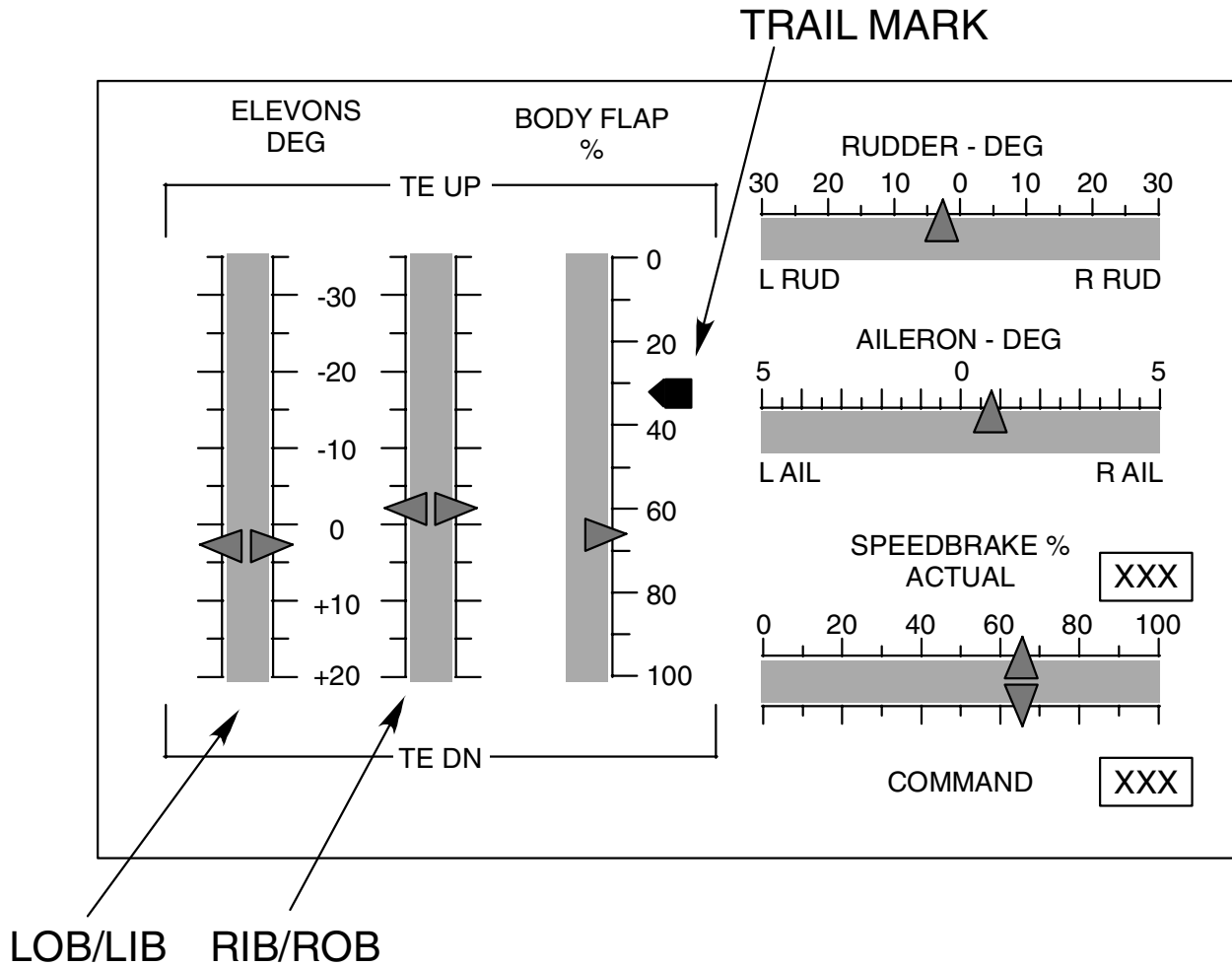

Figure 2.11.5-1 SPI

2.11.6. RCS Command Lights

This discussion is also limited due to the fact that once the yaw jets are disabled (Mach = 1), the YAW L and R and the ROLL L and R lights no longer have a function. At this point, the PITCH U and D lights are the only lights that are still functioning. The PITCH U and D lights take on a new meaning after Q-bar > 50 psf. Both lights (U and D) are lit whenever the elevon surface drive rate exceeds 20 deg/sec (10 deg/sec for only one hydraulic system remaining). Thus, for A/L (or for entry and Q-bar > 50 psf), these lights will provide indication of high surface drive rates.

2.11.7. Normal Accelerometer (G-Meter)

The g-meter is displayed in the lower left corner of the A/E PFD. During glided flight, the g-meter displays Nz from the selected AA, both digitally and on the “dial” gauge. The scale ranges from -1 to +4 g’s. During landing rollout, after WOWLON, the scale displays drag acceleration, in g’s, to indicate the level of deceleration during rollout on the runway. An example of the g-meter is shown in Figure 2.11.7-1.

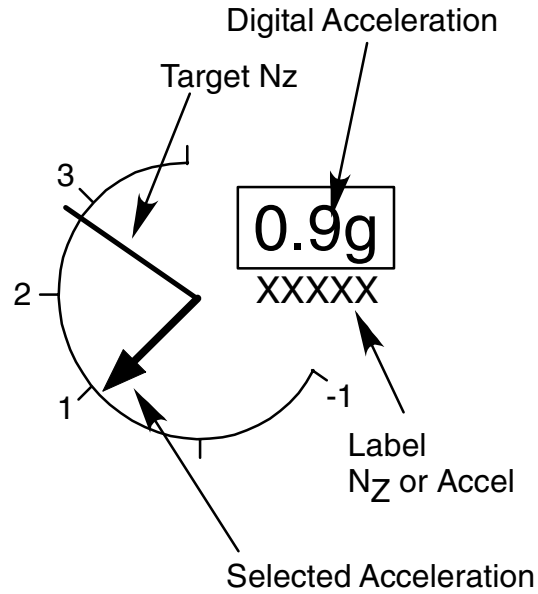

Figure 2.11.7-1 G-Meter

2.11.8. FCS Configuration and Major Mode

During Entry (MM 304, 305, 602, & 603), the fields display the Pitch and Roll/Yaw DAP mode (AUTO or CSS) in the upper and lower fields, respectively. Additionally, a yellow box is drawn around the field if CSS is selected prior to $M=1$. For PASS, Table 2.11.8-I summarizes this field. The field below the major mode shows the applicable CDR or PLT ADI attitude selected, i.e. INRTL, LVLH, or REF (MM 101-106 and 601, and 301-303), or SB mode, i.e. AUTO or MAN (MM 304 and 305, and 602 and 603). A yellow box is drawn around the indicator if MAN SB is selected.

The current major mode is identified in the upper right hand corner of the display. If an abort has been declared, an indicator will verify the abort mode selected (R for RTLS, T for TAL, AOA for AOA, ATO for ATO, and CA for contingency aborts).

Table 2.11.8-I FCS Configuration by Major Mode

Indicator		Major mode												
		102	103*	104	105	106	301	302	303	304	305	601	602	603
DAP	ASC DAP AUTO/CSS	X	X									X		
	TRANS DAP AUTO/INRTL			X	X	X	X	X	X					
	AEROJET DAP P AUTO/CSS									X	X		X	X
	AEROJET DAP R/Y AUTO/CSS									X	X		X	X
SBTC	ASC DAP Throttle AUTO/MAN	X	X									X		
	AEROJET DAP SB AUTO/MAN									X	X		X	X
ADI Attitude Switch Position		X	X	X	X	X	X	X	X			X		
Major Mode		X	X	X	X	X	X	X	X	X	X	X	X	X
Abort Modes		X	X	X	X	X	X	X	X	X	X	X	X	X

* Due to a software programming limitation, if the DAP is moded to INRTL in MM 103 post MECO, DAP will indicate CSS when, in fact, it should indicate INRTL.

2.12. HEADS UP DISPLAY

The data presented in this section explains the layout and sequence of the parametric and situational data that is displayed on the HUD during the A/L phase. Data sources will also be presented where applicable. Information on specific crew techniques for flying the HUD guidance are explained in Section 5.

2.12.1. HUD Overview

The HUD symbology displays in Figure 2.12.1-1 and Figure 2.12.1-2 are designed to provide the CDR and Pilot (PLT) with the guidance and vehicle configuration information required to accomplish precise and repeatable orbiter A/L. The HUD is designed to sequence different sections of the display area in order to avoid display clutter and to provide an orderly progression of information from the TAEM flight phase to postlanding rollout. The benefit of the HUD is obvious in that it provides the opportunity for integrating the real-world "out the window" scene with parametric guidance and situational information. Redundant data that is displayed on both the HUD and the dedicated displays has the same data source, when practical. When a different data source is used, the source change was made to acquire data for the HUD at a higher update rate than used for the dedicated displays. The following sections reference the numbered display areas shown in Figures 2.12.1-1 and 2.12.1-2.

1. Boresight - The boresight symbol position in the display depicts an extension of the orbiter body X-axis. The horizontal bar of the symbol remains parallel to and lies on the orbiter body Y-axis at all times. The symbol is positioned 5° above the center of the HUD Field of View (FOV).
2. Runway - The runway symbol consists of a four-sided representation of a 300 ft wide by no greater than 15,000 ft long runway with a line along the centerline starting at the steep GS intercept point and ending at the shallow GS intercept point. The ends of this line have aimpoint circles on them. The runway symbol is a 1:1 representation and appears as soon as any part of the runway is in the HUD FOV. A partial, as well as a total runway can be displayed. The symbol is displayed at any time during A/L when the runway is in the FOV, however, once WOW occurs, the runway symbology is blanked. The runway position is determined by the NAV state, so any errors in the state vector appear as an offset between the real (visible) runway and NAV-propagated runway on the HUD.
3. Upper right windows and situation line - this symbol is composed of two 5-character windows in the upper right corner of the display and a 29-character window at the bottom of the FOV in the center. The upper right windows use large characters while the lower situation lines uses small characters. The messages in the upper right windows are used to display flight control cues or failures. The situation line in the lower center of the HUD is used to display items that persist for more than 5 sec. Both the upper right windows and situation line are blanked at WOW.

<u>Cue/Alert</u>	<u>Comment</u>
CSS	CSS control in all axes
MLSNV	NAV is not processing MLS data
B/F	B/F not at trail

4. Digital altitude - This symbol displays the current altitude (in ft) from the main-gear wheels to the runway altitude. A large "R" is displayed next to the digital altitude whenever RA data is used as the data source. To make this symbol easy to read it remains at a fixed distance from the Flight Director (FD)/Velocity Vector (VV) symbol and moves with it throughout the HUD FOV. Remember when looking at the following parameter:

(1) The data is always driven by RA data if available (H < 5K ft), and

(2) The digital RA data replaces the altitude tape if the altitude to the wheels is unavailable, but RA data is available.

The numbers for digital altitude are scaled as follows:

1000 ft < H ≤ 32767 ft:	truncated to two hundreds of ft
400 ft < H ≤ 1000 ft:	truncated to hundreds of ft
50 ft < H ≤ 400 ft:	truncated to tens of ft
0 ft < H ≤ 50 ft:	truncated to ft

5. GS indicator - This symbol shows the error between the guidance computed reference trajectory altitude and actual altitude. The pointer is referenced to and moves vertically along the right side of the altitude tape. The symbol is displayed prior to WOW.
6. Altitude tape - This tape displays the current orbiter wheel altitude above the NAV-derived runway altitude. This tape is fixed in length and is symmetrical about the HUD horizontal centerline. The tape is made up of alternating numbers and tic marks. The numbers appear at the following increments:

10,000 ft increments above 100,000 ft
1000 ft increments between 1000 ft and 100,000 ft
100 ft increments between 500 ft and 1,000 ft
50 ft increments between 0 ft and 500 ft

The letter "K" is used to symbolize thousands of feet between 1000 ft and 400,000 ft. An altitude pointer (rectangle) is fixed at the vertical center of the tape. This tape is blanked at WOW.

7. FD/VV - The flight director is a square shaped stationary symbol until I_PHASE = 3 (TAEM prefinal), when it is automatically uncaged (moved) in the pitch axis. The symbol can then be uncaged/caged in the horizontal axis by depressing the associated attitude (ATT) REF pb (good for crosswind landings). When uncaged in both axes, the symbol becomes a VV (circular), and is a representation of the vehicle flight path.
8. Attitude reference - This symbol displays the current orbiter pitch angle. Attitude reference lines are displayed relative to the horizon line which is a double width line. The entire symbol is rotated about the center of the HUD FOV corresponding to the vehicle roll angle (positive roll angle results in counter-clockwise direction). The symbol is then adjusted so that the correct pitch angle is read from the boresight. The attitude reference is displayed until WONG.
9. SB scale - This symbol displays the orbiter SB actual and commanded positions. The scale is a fixed length and has five equally space tic marks that are centered vertically about the scale. Actual SB position is represented by a triangular point above the scale. The SB command (auto or manual) is represented by an arrow pointer below the scale. Any delta of > 20° between the command and position causes the position point to flash. This scale is available throughout A/L.
10. Lower left window - The lower left window is used to display the guidance mode descriptor prior to WOW.

Mode descriptors are as follows:

S-TRN for I_PHASE = 0

ACQ for I_PHASE = 1
 HDG for I_PHASE = 2
 PRFNL for I_PHASE = 3
 CAPT for P_MODE = 1
 OGS for P_MODE = 2
 FLARE for P_MODE = 3
 FNLFL for P_MODE = 4

11. OGS references/flare indices - The OGS/flare reference consists of two pairs of opposed triangle indices. These triangles provide the following information:

(1) The flight path angle references information after prefinal TAEM for OGS acquisition and tracking

(2) The flight path angle pitch up from preflare to Final Flare (FF) initiation. The two pairs of triangles are free to move vertically, but are laterally tied to the VV when no roll exists. The OGS indices are blanked when the flare indices cross them.

12. Nz - Nz readout is below and left of the VV symbol, and tracks along the HUD FOV at the same distance from the VV. Data is shown in g's, and the range of the scale is from +9.9 to -5.1 g's. This data is displayed around the HAC and is blanked at TAEM preflare.
13. Airspeed tape - This tape displays the orbiter EAS. The tape is a mirror image of the altitude tape and is located on the left side of the HUD FOV. The range of the tape is from 0 to 500 kts, numeric values appear in ten knot increments with an additional tic mark at every five knots. An airspeed pointer is fixed vertically in the center of the tape. The tape works throughout A/L and is blanked at WOW.
14. Digital airspeed - Digital airspeed is displayed in numeric form (corresponds with tape (13)) at a fixed distance left of the VV symbol and moves with it throughout the FOV. The range of values is 0 to 500 kts in increments of one. After WOW, it moves to the upper left corner of the boresight. When WONG occurs, a 'G' appears in front of the readout to indicate a change to ground speed. Before WOW, the symbol is displayed when the altitude is ≤ 1000 ft or declutter = 2, EAS is available, and the FD/VV is displayed.
15. Guidance - The guidance symbol is diamond shaped and depicts the direction the orbiter must be flown to satisfy the GPC derived guidance solution. The guidance diamond is constrained to remain in the FOV and flashes when limited to the total FOV. The guidance diamond is available prior to WOW.
16. Upper left window - The upper left window is used to display gear-oriented cues. The window is available prior to WOW and is located above center FOV and to the left of the vertical center.

The gear annunciation (GEAR (GR)) is set whenever the GR is up and the altitude is less than 300 ft (I-load) and airspeed is less than 300 kts (I-load). When set the mnemonic GEAR flashes. The GR mnemonic is set when the gear is in transit. The gear-down (GR-DN) mnemonic is set when all three main landing gears are down and locked as sensed by 28-V discretes from the landing gear prox boxes. The GR-DN mnemonic only remains on for 5 sec.

17. Deceleration rate - The deceleration scale displays actual and commanded vehicle deceleration. The scale is fixed in length, with five equally spaced tic marks centered horizontally about the scale. Actual vehicle deceleration is represented by a triangular pointer on the left side of the scale. Commanded brake deceleration is represented by an arrow pointer on the right side of the

scale. This scale is displayed after WOW. Commanded deceleration is a navigation derived guide to braking which results in wheel stop 1000 ft from the end of the runway. Runway length is defined as in 2, Runway, above.

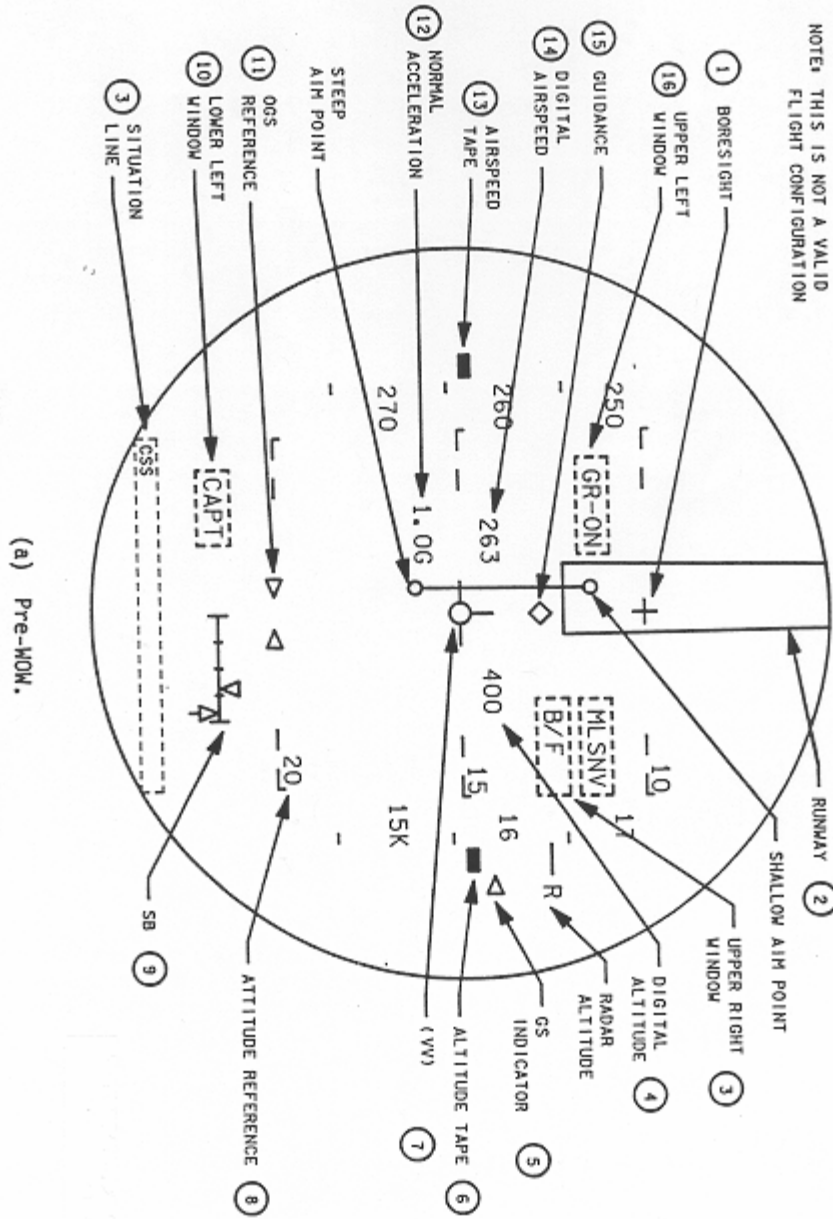

Figure 2.12.1-1 HUD Display Format

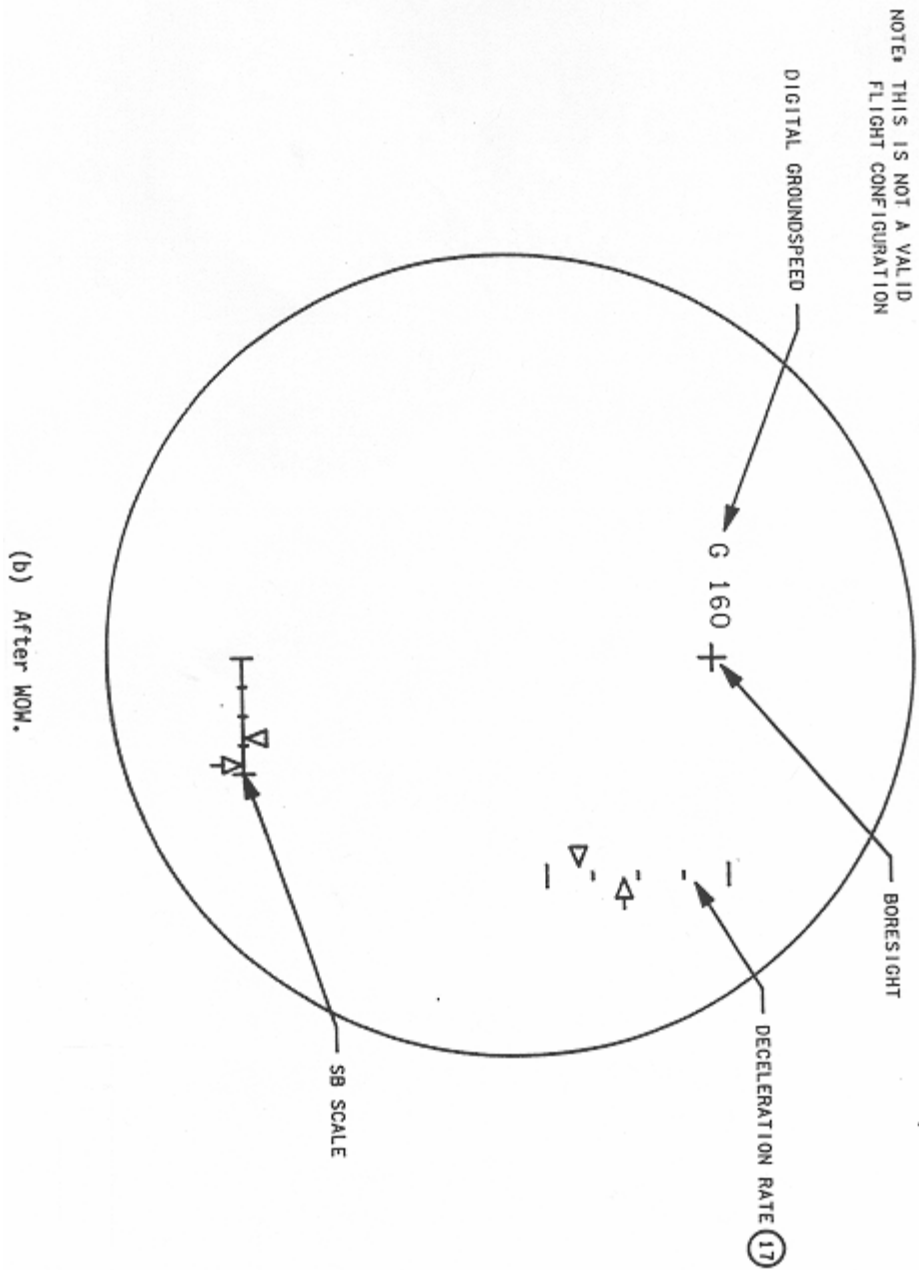

Figure 2.12.1-2 HUD Display Format

2.12.2. BFS Differences

The HUD is not supported by the BFS.

2.12.3. HUD Power Distribution

HUD systems power is provided through a HUD POWER switch located inboard of the Pilot Display Unit (PDU) on Panel F3. Power for the CDR's HUD is from MAIN A through control bus AB2. Power for the PLT's HUD is from MAIN C through control bus BC1.

2.12.4. HUD System Moding

A three position MODE switch is located on the front of the HUD. Switch positions are up, TEST; center, NORM; and down, declutter (DCLT). The DCLT position is momentary; the switch is spring loaded to return to NORM from that position. In the NORM position, automatic sequencing of formats and symbology is provided.

The TEST position is used for HUD checkout during on-orbit FCS checkout and is not discussed further. Activation of the MODE switch to the DCLT position initiates a symbol blanking routine. This routine selectively removes different symbols from the currently displayed format. Successive operation of the DCLT switch serially removes display elements in accordance with Program Read-Only Memory (PROM) logic until only the boresight remains. The next operation of the switch, reintroduces the original format and reinitialize the DCLT logic.

The DCLT logic prior to T/D (WOWLON flag set)

<u>DCLT level</u>	<u>Result</u>
1	Blanks runway
2	Blanks airspeed scale, alt tape, GS indication attitude scales. Forces digital airspeed and altitude
3	Only the boresight remains
4	Reintroduces full-up display

The declutter logic after WOW

<u>DCLT level</u>	<u>Result</u>
1	Blanks attitude scales and horizon
2	Only boresight remains
3	Reintroduces full-up display

2.12.5. HUD Brightness

The brightness of the HUD symbology is adjusted by using the rotary brightness control on the front of the HUD PDU (electronics box). The range of the brightness control is determined by a three-position switch labeled BRIGHT. In the top (MAN DAY) position, the rotary control covers the full range of HUD brightness. In the bottom (MAN NIGHT) position, the rotary control covers the range from 0 to 2 percent of HUD brightness. In the center (AUTO) position, the rotary control sets a relative contrast level between the HUD symbology and the outside lighting conditions.

3. LANDING AIDS

3.1. TACTICAL AIR NAVIGATION

Tactical Air Navigation (TACAN) is a military omni bearing and distance measuring system. Bearing and distance information is made available to the orbiter navigation system for updating the state vector. The NSTS 07700 Volume X, Book 3 defines the calibration accuracy requirements for NASA controlled TACANs as $<1.0^\circ$ in bearing and <0.1 NM in range. It defines the calibration accuracy requirements for Federal Aviation Administration (FAA)/Department of Defense (DOD) controlled TACANs as $<1.0^\circ$ in bearing (225° to 315° quadrant only) and <0.5 NM in range.

During entry, TACAN data are required to update the navigation state and guidance. Without this, the IMU-only state vector does not provide the degree of accuracy necessary for the orbiter to make it safely to the runway.

3.2. MICROWAVE LANDING SYSTEM - GROUND STATION (MLS - GS)

The MLS (also known as MSBLS) GS provides azimuth (AZ), elevation (EL), and distance (DME) information to the orbiter as it is approaching the landing site. The MLS-GS consists of two equipment shelters (Figure 3.2-1), two monitor poles, and a remote control unit. Physically, a side-by-side configuration is used, one shelter containing the AZ and DME assemblies, the other containing the EL assemblies. Each shelter contains dually redundant sets of equipment, one set forming a primary string, the other a backup string. Field monitor sets are triply redundant. All MLS sites are calibrated to a 0.15° in average alignment error.

3.2.1. MLS-Junior

The MLS-Junior (MLS-JR) is a derivative of the MLS-GS system. The JR was intended as a nonredundant approach aid for use at the Transoceanic Abort Landing (TAL) sites. It is also used at Edwards and White Sands landing facilities.

The single-string JR uses most of the same components as the MLS-GS, with the redundant circuit elements removed. The single AZ, EL and DME components have been collocated within one shelter.

The MLS-JR station located at the approach end of the runway provides coverage up to the runway threshold but cannot support vehicle rollout. Redundant MLS operation is available at Istres, White Sands and Edwards, by two JR's operating side-by-side to provide the same automatic backup capability as the MLS-GS installation. Two units at Edwards are portable, mounted on trailers. These are installed on runway 04. The Istres units support runway 33 only. White Sands has two redundant units on runways 17 and 23.

3.2.2. MLS Site Location

The MLS-GS is typically located 300 ft left or right of the runway centerline (500 ft right or left on military installations), with the EL station 3360 ft down the runway from the approach threshold. The AZ and DME station is located 1300 ft beyond the rollout end of the runway. This type of arrangement provides EL information through T/D and AZ/DME information throughout the rollout.

More recent MLS-GS installations have been located 300 ft right or left of runway centerline (500 ft military), with the EL station 1500 ft down the runway from the approach threshold and the AZ/DME located 1500 ft prior to the rollout end of the runway. This type of installation allows the use of either an MLS-GS or JR on the same foundation pads.

The MLS-JR installations are single or dual redundant, side-by-side configuration, and all are 300 ft right or left of centerline (500 ft military) and 1500 ft down the runway from the approach threshold.

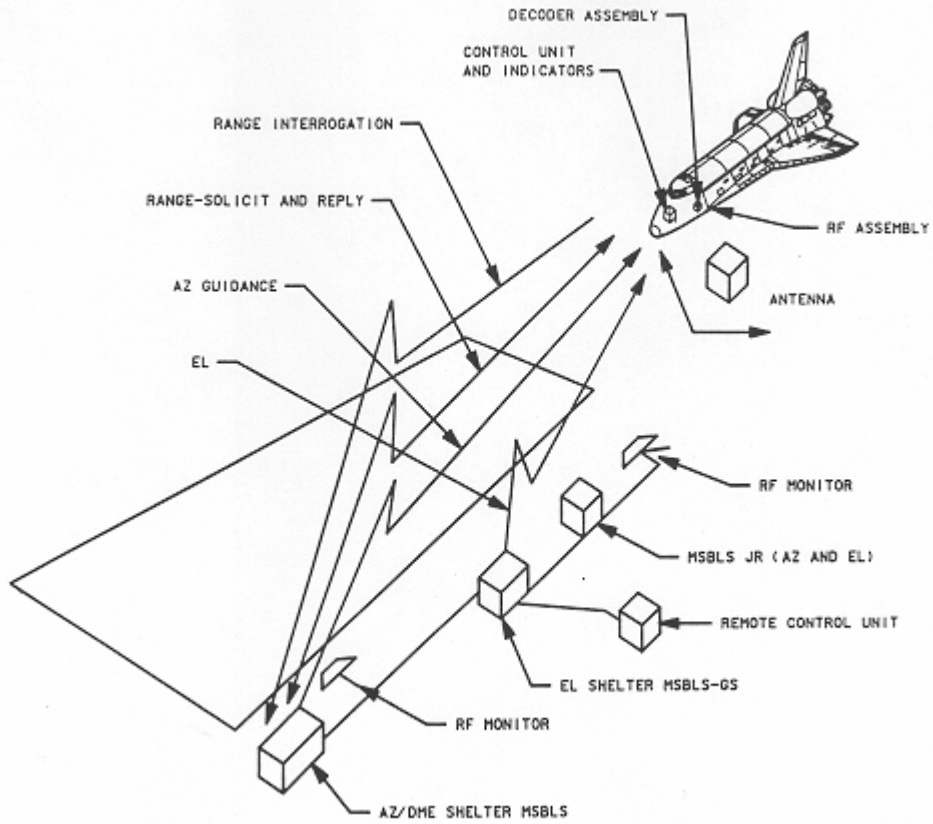

Figure 3.2-1 MLS Ground System

3.3. AIMPOINTS

The visual aimpoint is a triangle (110 ft by 240 ft) located at the close-in aimpoint, where practical, to provide visual cues for the OGS during daylight hours. The color is to contrast with the local terrain. A rectangle (100 ft by 200 ft) is located at the nominal aimpoint. The only TAL site that had marked close-in and nominal aimpoints was Ben Guerir. However, Ben Guerir is currently not being used as a TAL site. For Continental United States (CONUS) sites, all White Sands runways and Edwards runways 15, 33 and 18L have marked aimpoints. These are the only Edwards lakebed runways being maintained for shuttle use. Neither runway at Kennedy Space Center (KSC) has aimpoint markers.

There is a requirement to provide a dark background for the Precision Approach Path Indicator (PAPI) lights. If the natural terrain is light, a darkened rectangle, as specified in Figure 3.3-1, is required. Figure 3.3-2 shows PAPI locations

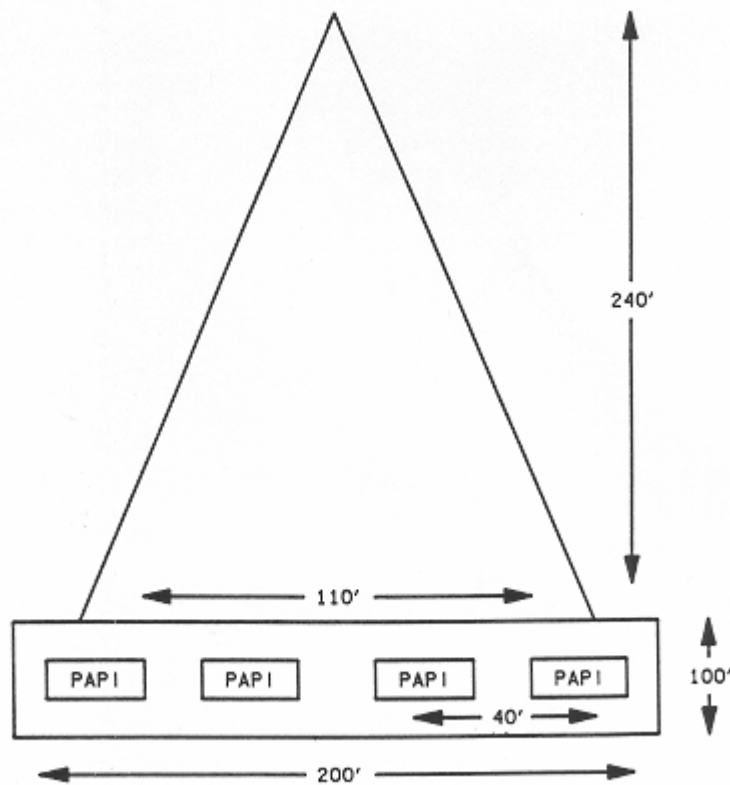

Figure 3.3-1 Typical visual aimpoint and PAPI

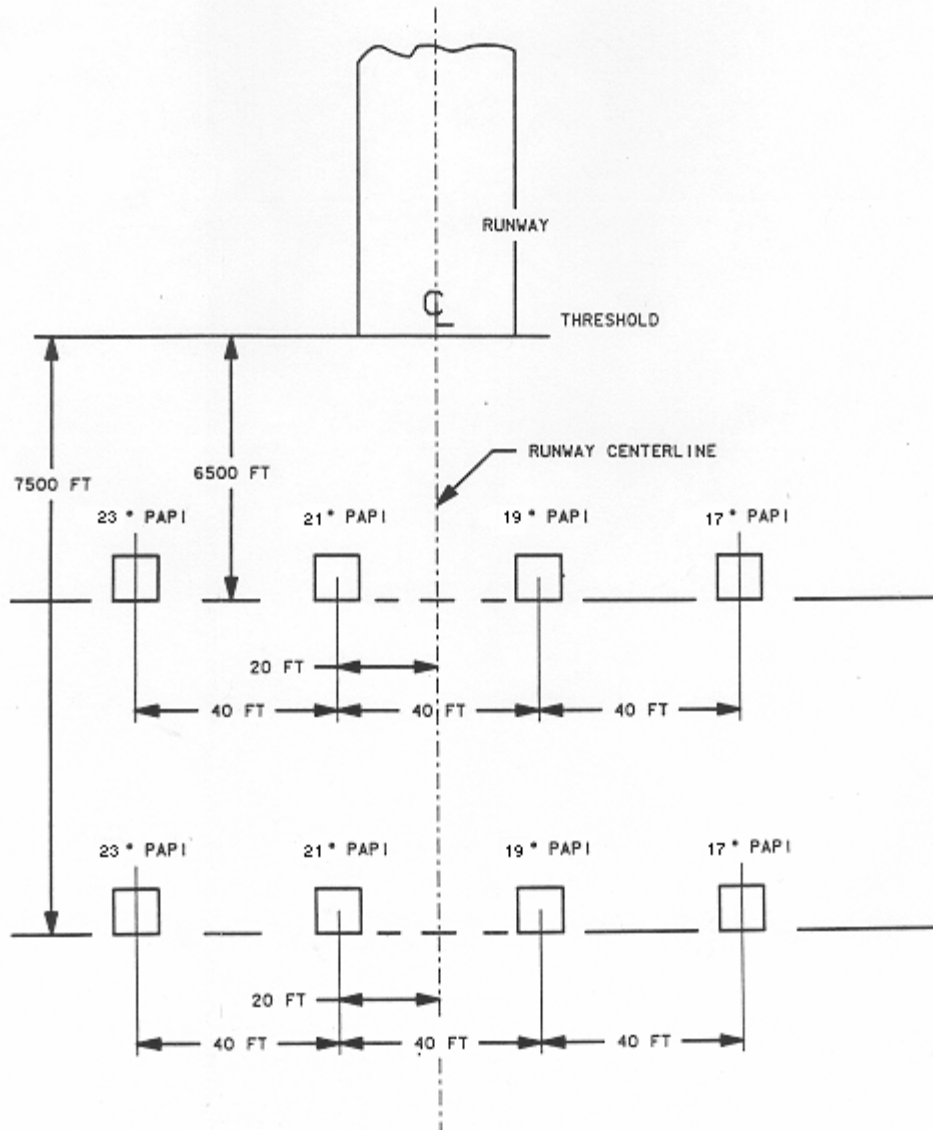

Figure 3.3-2 PAPI light locations

3.4. PAPI LIGHT – OUTER GLIDE SLOPE

To assist the crew in identifying the OGS, PAPI lights are installed 6500 ft and 7500 ft from the threshold of the runway, Figure 3.4-1. The PAPI lights are highly directional and OGS cueing is a function of the apparent change in PAPI light color.

There are four PAPI light units, spaced 40 ft apart, at both the 6500 ft (close-in aimpoint) and 7500 ft (nominal aimpoint) locations, perpendicular to-the runway centerline (due to local conditions and constraints, some PAPI sites may be offset slightly; refer to specific runway layouts in Table A-II, in Appendix A, for details). When the orbiter is on the 20° GS the pilot sees two red and two white PAPI lights. Each of the PAPI light units is set to a different angle: 23°, 21°, 19°, and 17° from left to right as viewed by the pilot.

If the vehicle is higher than the nominal glide slope, the pilot sees three white and one red or four white lights. If the vehicle is lower than the nominal glide slope, the pilot sees one white and three red or four red lights.

The PAPI system has the capability to vary the light intensity with bright and dim settings to account for atmospheric conditions. The settings are: day (100 percent rated, 5.7 amps for dim and 6.6 amps for bright), dawn/dusk (75 percent, 3.8 amps for dim and 4.7 amps for bright), and night (50 percent rated, 3.0 amps for dim and 3.5 amps for bright). KSC does not have a dusk/dawn dim capability.

Two of the TAL sites have slight changes in PAPI set up. At Zaragoza, the PAPIs are offset 170ft to the right of the runway centerline at the standard distance to the runway threshold. And, at Istres, due to the difference in elevation between the location of the PAPIs and the runway threshold (the PAPIs are located approximately 32ft below the runway threshold), the PAPIs have been placed at approximately 6414ft and 7414ft (vice the normal 6500ft and 7500ft). This was done in order to preserve the correct glideslope angle at the lower PAPI elevation.

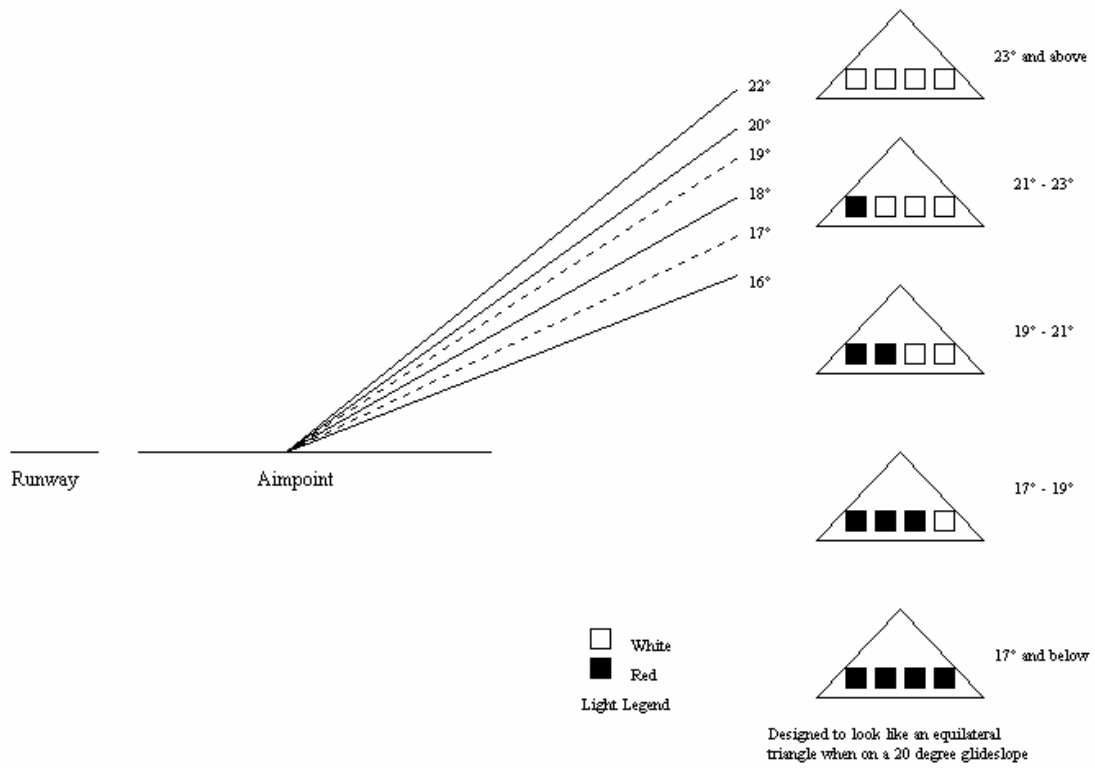

Figure 3.4-1 PAPI system geometry

3.5. BALL/BAR LIGHTS – INNER GLIDE SLOPE SYSTEM

The ball/bar light system provides the orbiter pilot with a visual means of attaining and maintaining the proper Inner Glide Slope (IGS) angle during shuttle landing operations up to the point of T/D.

The geometry of the height and spacing of the ball/bar is such that when the white ball lights are superimposed on the red bar lights, they exhibit a $1\ 1/2^\circ$ IGS, as viewed by the pilot during his approach. If the energy managed GS is maintained, the ball lights appear to move from the inner bar light to the left, superimposing the white ball lights on each set of red bar lights consecutively as the orbiter nears T/D.

The IGS angle of $1\ 1/2^\circ$ is identified by the use of precisely positioned ball/bar light assemblies.

The bar lights comprise six assemblies mounted on frangible stanchions; each assembly has four 200-watt lamps with red filters. The bar light assemblies are spaced 15 ft from each other, perpendicular to the runway centerline at 2200 ft from the threshold. The first bar segment is 200 ft off the runway centerline. The elevation of the bar lights is 2 ft above the runway centerline elevation at 2200 ft from threshold (Figure 3.5-1).

The ball light assembly consists of three 200-watt white lamps affixed to a single frangible stanchion (Figure 3.5-2). The stanchion is located 200 ft to the left of the runway centerline, 1700 ft from the threshold. Because of variations in runway elevations, the elevation of the lamps are 15 ft, referenced to the runway centerline elevation at 2200 ft from the threshold.

All lights are angled up 4° (plus or minus 15 min) from the horizontal.

The ball/bar system is capable of varying the light intensity from a day setting to a dawn/dusk setting and to a night setting in both a bright and dim mode.

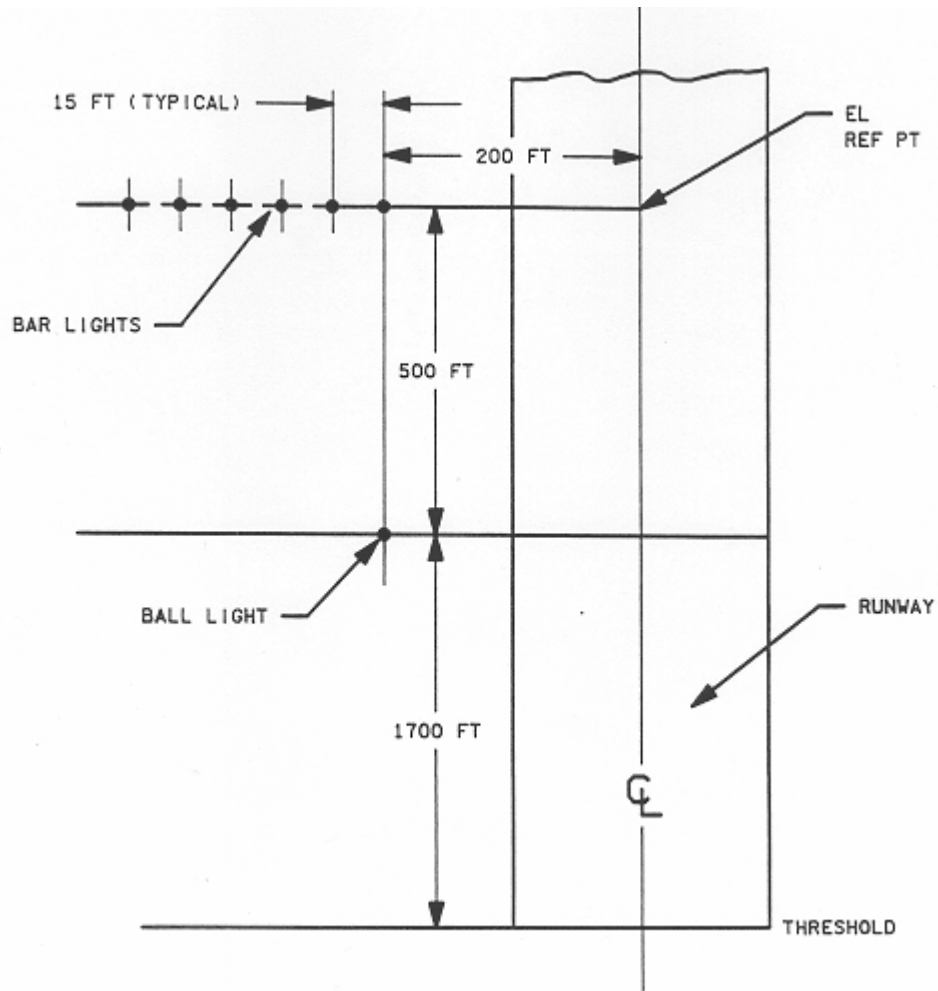

Figure 3.5-1 Bar and Light assembly locations

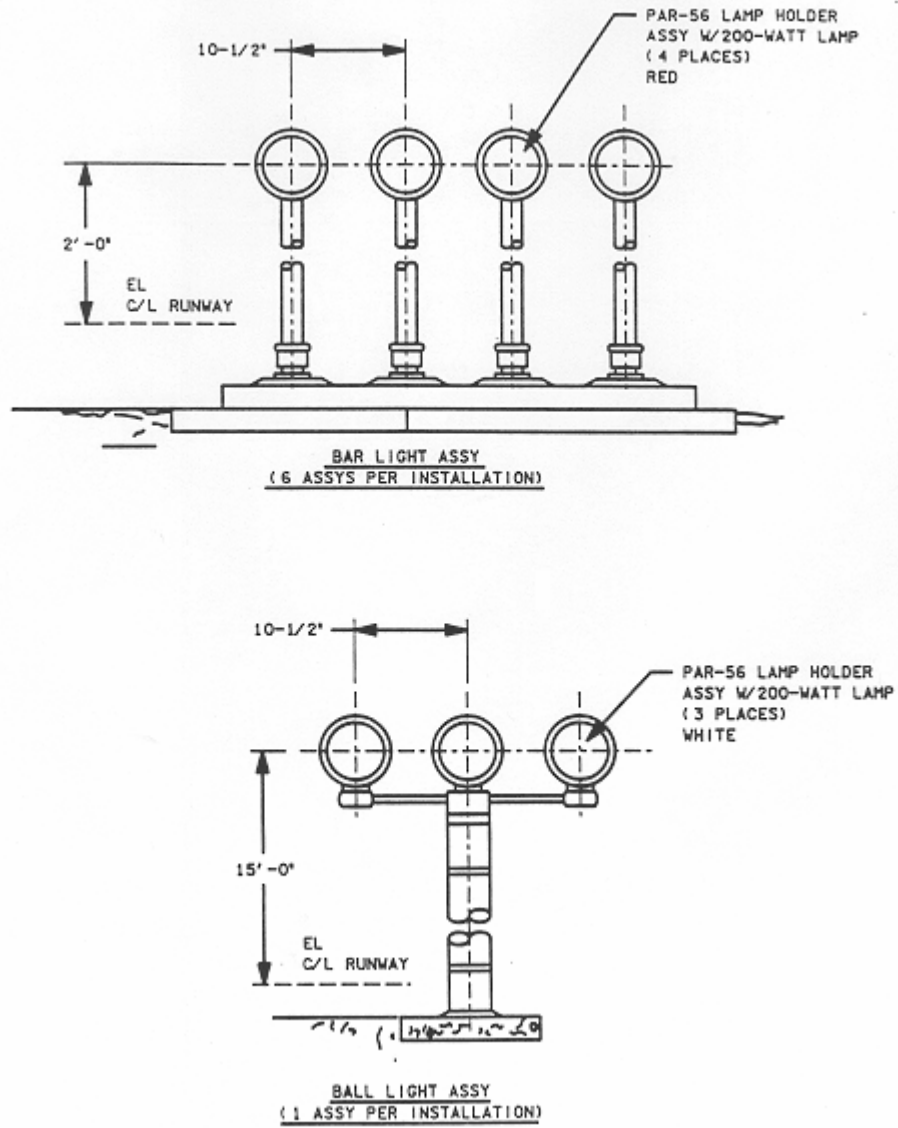

Figure 3.5-2 Ball/Bar light assemblies

3.6. RUNWAY LIGHTING

Where available, the existing runway edge lights are used for night operations. Reflective edge markers are spaced at 200 ft intervals on the MSBLS equipped lakebed runways. A setting of three on a five-step control is desired for orbiter night landing operations.

Approach lighting is required for night landing operations. An FAA, military, or International Civil Aviation Organization (ICAO) approach lighting system is adequate for night landing operations. If no approach lighting system is available, it is necessary to implement a portable, fluorescent lantern-type system developed for EDW as described in the attachment.

Xenon lights are used for night landing opportunities only. Lights are placed on each side of the runway and elevated to a height necessary to illuminate the T/D and rollout area from behind the orbiter.

Runway distance remaining markers provide information to pilots during takeoff and landing operations. The marker inscriptions consist of a number denoting in thousands of feet the runway distance remaining. At Istres, the distance remaining markers are in meters remaining.

KSC has also added runway centerline lighting. The centerline lights are spaced at 200 ft intervals and are installed on the middle 10,050 ft of the runway. The intensity of the lights is variable with five separate power settings. The lights are FAA approved, 0.25 inch low profile with alternating, independent power circuits to provide redundancy. These lights precisely define the runway centerline and allow the Commander to readily detect and respond to drift rates for night landings.

3.7. NAVAIDS AND LANDING SITES

Table A-I (Appendix A) shows the Space Shuttle Program approved landing sites, as documented in NSTS 7700 Vol X, Book 3 for OI-30. Refer to NSTS 7700 Vol X, Book 3 for the latest information. All landing sites have at least a TACAN or DME available, while some sites have additional NAVAIDS and landing aids.

Table A-II shows an example of landing aids and navigation aids for primary CONUS and TAL landing sites from a recent flight.

4. A/L TRAJECTORY DESIGN

Approach, landing, and rollout constitute the final phases of the orbiter flight profile. The A/L trajectory was designed to T/D the vehicle safely on the runway within specified constraints. The major constraints at T/D are downrange distance, airspeed, and altitude rate. During rollout, the crew will bring the orbiter to a stop within a specified stopping margin, using a deceleration profile designed to prevent the brakes from overheating.

A typical entry profile enters the atmosphere at an altitude of 400,000 ft, a range from the runway of 4350 NM, and a velocity of Mach 26. Thirty minutes later, the vehicle will line up with the runway heading, 40,500 ft downrange of the runway threshold at an altitude of 12,000 ft. At 10,000 ft, the vehicle flies to a reference dynamic pressure of 305 lb/ft², which corresponds to an EAS of 300 kts. T/D occurs 75 seconds later. After T/D, the vehicle rolls out and nominally stops 9,000 to 11,000 ft down the runway.

4.1. APPROACH AND LANDING

A/L, as defined in this text, is the approach to the runway beginning at an altitude of approximately 34,000 ft on the HAC and ending at T/D.

The A/L trajectory design allows the orbiter to handle a large variety of dispersions and land safely while adhering to specified ground rules and constraints, including orbiter parameters such as weight (WT) and c.g. Also included are aerodynamic limits and T/D parameters such as distance past the runway threshold, velocity, altitude rates, lateral rates, and energy reserve margin.

4.1.1. A/L Geometry

The A/L trajectory geometry is divided into five segments, which are jointly designed to allow the orbiter to handle dispersions and land safely. The first segment is defined in this text as the HAC geometry, from 34,000 to 12,000 ft; the second segment is the prefinal geometry, from 12,000 to 10,000 ft. The other three segments are the OGS, Flare and Shallow Glide Slope (FSGS), and FF segments, which are defined as the autoland geometry from 10,000 ft to the surface. The A/L geometry is shown in the two parts of Figure 4.1.1-1. The first part is a perspective of the HAC at prefinal and the three autoland segments. The second part depicts these four segments from 12,000 ft to T/D.

The first trajectory segment is the HAC, which is designed to align the orbiter with the runway from any approach heading. The overhead HAC design also provides a geometric means of responding to low-energy dispersions. The second segment is the prefinal geometry, designed to align the orbiter with the runway centerline and provide a transition to autoland guidance.

These two geometries correspond to the last two phases of TAEM guidance. The purposes of these two phases of TAEM guidance are to maintain a reference energy profile and to meet the autoland transition criteria, reference geometry, and velocity shortly after acquiring the runway centerline. Normally, this portion of the approach is flown manually with CSS, while the pilot monitors the guidance commands. A partial summary of TAEM guidance is shown in Table 4.1.1-I.

The remaining three geometry segments were designed to allow A/L guidance to control the orbiter energy state, enabling the vehicle to meet the landing ground rules and constraints. These segments correspond to the autoland guidance subphases. A summary of autoland guidance laws is shown in Table 4.1.1-II. This portion of the trajectory is generally flown in CSS. The OGS (steep) is designed to maintain an equilibrium glide path, which should provide sufficient energy at preflare to result in a safe landing. The FSGS provides a smooth transition

between the OGS and IGS. The IGS (shallow) is designed to provide time for final adjustments to prepare for landing. FF is designed to reduce the altitude rate for T/D.

Appendix B lists the vehicle constraints during A/L. Detailed discussions of the A/L geometry are in Sections 4.2 through 4.7. These discussions include design history, current design, and performance. Section 4.4 is a discussion of the SB operation, which is the energy controller for the orbiter during the A/L trajectory. The final discussion, Section 4.7, is the overall landing performance capability for A/L.

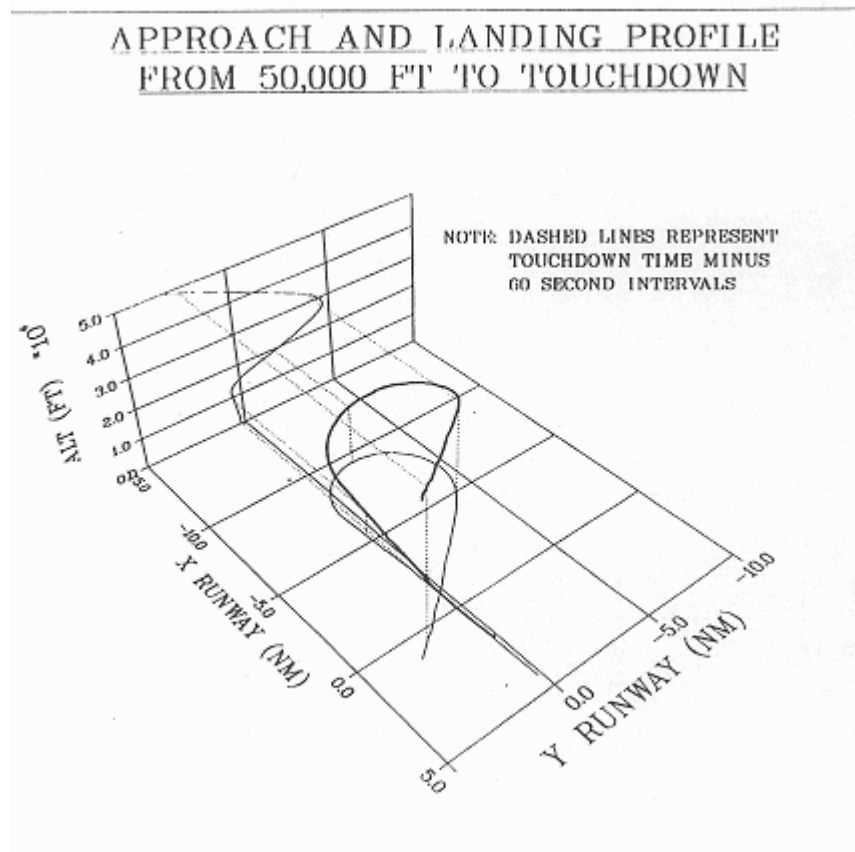

Figure 4.1.1-1 A/L profile from 50,000 ft to T/D (part 1 of 2)

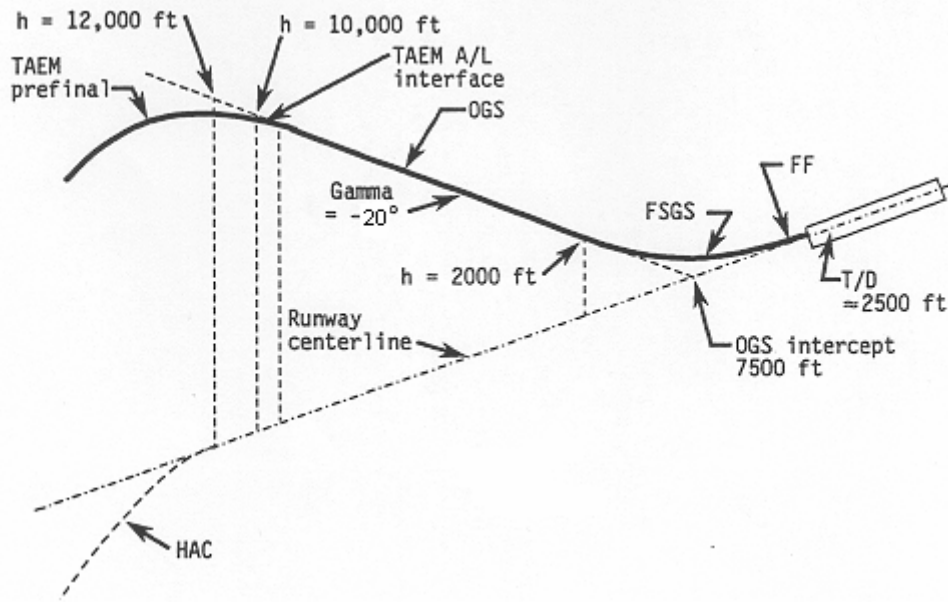

Figure 4.1.1-1 A/L profile from 50,000 ft to T/D (part 2 of 2)

Table 4.1.1-I Partial TAEM Guidance Summary

Phase	Heading alignment IPHASE = 2	Prefinal IPHASE = 3
Purpose	Final energy adjustment, line up for autoland	Acquire center line. Prepare for autoland
Guidance laws	<p style="text-align: center;">L o n g i t u d i n a l</p> $Nz_C = F(\Delta H, \Delta R)$ <p>limited by \bar{q} and, energy over-weight (E/W) corridors vs. Mach priority $\bar{q} \rightarrow EOW \rightarrow$ (altitude) H δSB is const, $M > .95$ $\delta SB = NOM - G1\Delta\bar{q} - G2f\Delta\bar{q}$, $M < .g$</p>	<p style="text-align: center;">limited by \bar{q} corridor</p>
	<p style="text-align: center;">L a t e r a l</p> $\phi_C = [YSGN^* \tan^{-1} \frac{V^2}{g r_{turn}} + GR \Delta R + GR \Delta R]$ <p>YSGN=+1 RT HAC, -1 LT HAC</p>	$\phi_C = -G\gamma Y - G\gamma T$
Exit transition logic	$RPRED < RPRED3$ or $H < HMIN3$ $(RPRED3 = -XHAC + DR3)$	$\{ HERROR < (H D1 - D2)$ $ Y < (H Y1 - Y2)$ $ GAMMA ERR < (HG1 - G2)$ $ QBERR < Q1$ $(H1 > H)\}$ or $H < H2$
Nav sensors	IMU's ¹ TACAN MSBLS	IMU's TACAN MSBLS

¹Inertial measurement units.

Table 4.1.1-II Autoland Guidance Summary

Subphase	Subfunction	TRAJ. capture PMODE=1			Steep glide PMODE=2			Circularize PMODE=2			Exp. capture PMODE=3			FF PMODE=4			
		N.A.			N.A.			Track OGS and establish preflare speed			Track constant load flare circle			Exp. capture of IGS			N.A.
Purpose	Acquire OGS	N.A.			Track OGS and establish preflare speed			Initiate first flare			Exponential capture of IGS			Reduce HDOT to desired T/D value			
	($\Delta NZC_{max} = 1.0g$)	$KH\Delta H + KH\Delta H$			$KH\Delta H + KH\Delta H$ SEE NOTE 2			Open loop $f(t_{lim}, speed, \text{and radius})$			$KH\Delta H + KH\Delta H$ + NZOPENLOOP + $Kf/\Delta H$			$KH\Delta H$ + NZOPENLOOP			
Guidance laws	δ	$KEAS\Delta EAS + SB_REF + Kf/\Delta EAS$			$KEAS\Delta EAS + SB_REF + Kf/\Delta EAS$ SEE NOTE 3			SB retract at $H = 3000$ ft			SB adjust at $H = 500$ ft			$\delta SBC = 98.6^\circ$ at $WOWLON$			
	ϕ	$KY\Delta Y + KY\Delta Y + Kf/\Delta Y$			$KY\Delta Y + KY\Delta Y + Kf/\Delta Y$ SEE NOTE 1			$\delta SBC = \text{const}$ $f_{wind dt}$			50° max. limit; TAL no limit			$\delta SBC = \text{const}$			
Exit transition logic	$\phi_{MAX} = 45^\circ$	$\Delta Y < 2^\circ$ and $\Delta H < 50$ ft			$\Delta Y < 2^\circ$ and $\Delta H < 50$ ft			↑			↑			↑			
	$\phi_{max} = 20^\circ$	$\Delta Y < 2^\circ$ for 4 sec (continuously)			$\Delta Y < 2^\circ$ for 4 sec (continuously)			H<H_CLOOP (1700')			X>X_EXP (-4951') [lightweight, nominal X_zero]			H<H_FF (80') and H<H_FINAL [A f(HDOT)] or H < H_MIN (30')			
Navigation sensors		The IMU is used to propagate the state vector. TACAN AND BARD altitude OR MSBLS are used for refinement via the Kalman filter. MSBLS is always prime if date good. If MSBLS is lost above 1500 ft or never acquired, use TACAN to 1500 ft and BARD to 500 ft. If MSBLS is lost below 1500 ft, just propagate the IMU only.			H<H_CLOOP (1700')			H<H_FF (80') and H<H_FINAL [A f(HDOT)] or H < H_MIN (30')			Flat turn = 1 and NZC = 0. at $WOWLON = 1$.						

- Notes:
- If autogyro-off; $Y_INT=0$.
 - If autops-off; $NZ_C21=0$.
 - If $\delta SBC > 98.6$ OR < 0 .; $DEL_INT=0$.
- ΔNZC controls alpha
 - δSBC controls EAS on the ...
 - δSBC retract angle controls T/D energy
 - Landing gear deployed at $H = 300$ ft (NON FSSR)
 - Body flap retracted first pass in autoland

4.2. HEADING ALIGNMENT CONE AND PREFINAL

4.2.1. Overview

After the orbiter speed decreases below Mach 2.5, the vehicle enters the TAEM phase of descent guidance. TAEM guidance delivers the vehicle from an altitude of 85,000 ft, at a range to the runway of 60 NM and a speed of Mach 2.5, down to an altitude of 10,000 ft, a range of 6 NM, and a speed of 300 KEAS. The orbiter should be ready to enter the final A/L phase of descent guidance. This document addresses only the last two segments of TAEM guidance (the heading alignment segment for descending around the HAC and the prefinal segment used to align the trajectory for A/L). Appendix B.1 contains a discussion of the design and history of the HAC and prefinal portions of the trajectory.

4.2.2. Transition

The orbiter nominally acquires A/L guidance at 10,000 ft. Under certain conditions, though (trajectory errors, navigation errors, excessive HAC winds), the orbiter may fall outside the A/L transition envelope listed in Table B.1-I (Appendix B.1). Figures 4.2.2-1 and 4.2.2-2 show maximum in-plane, out-of-plane trajectory errors which can be tolerated and still allow the orbiter to achieve a safe T/D energy.

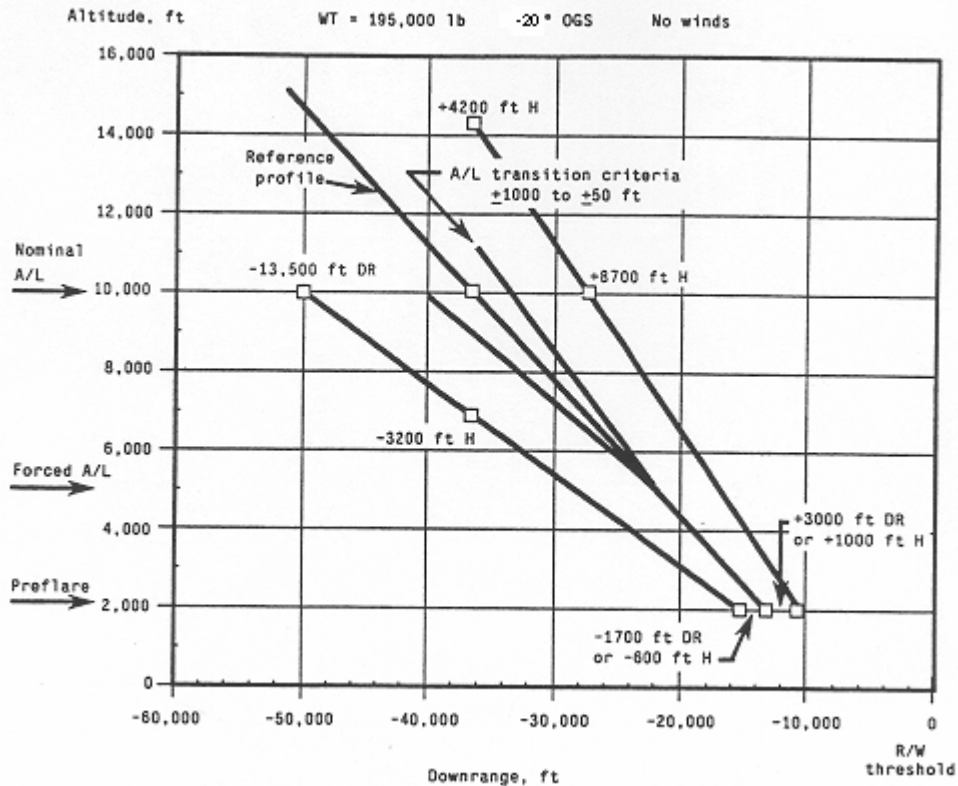

Figure 4.2.2-1 Maximum in-plane dispersion capability

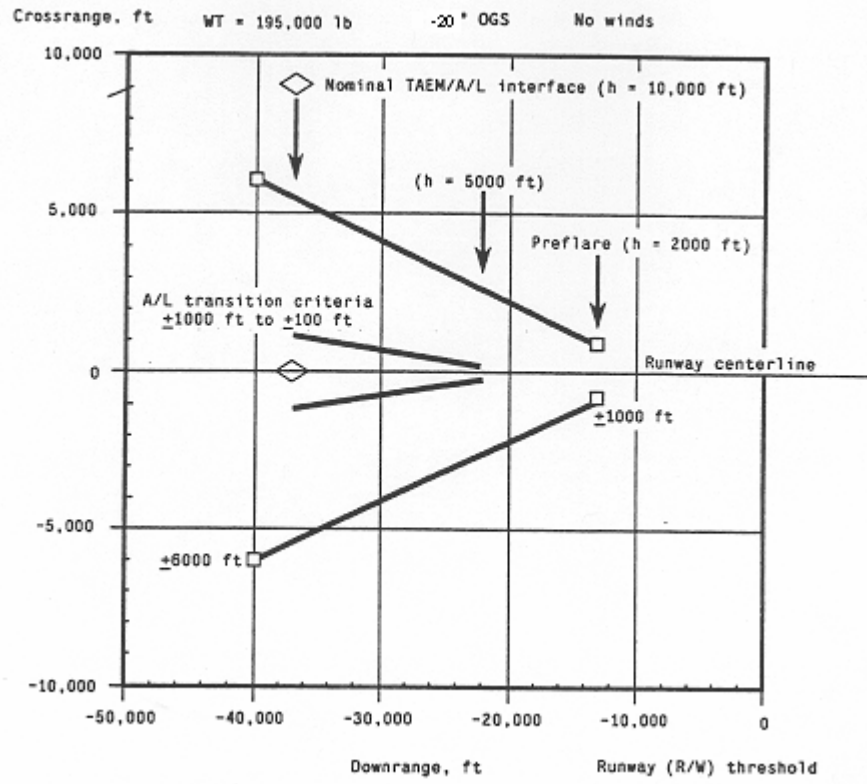

Figure 4.2.2-2 Maximum out-of-plane dispersion capability

4.3. OUTER GLIDE SLOPE

4.3.1. Overview

The main purpose of the OGS is to provide an equilibrium glide path that results in sufficient energy at preflare, which is one of the prerequisites for a safe landing. Preflare is defined as a constant g pull up maneuver, beginning at 2000 ft to arrest the vehicle altitude rate.

The OGS consists of a sloped-line segment that intercepts the ground at a specified distance from the runway threshold. The OGS is nominally acquired at 10,000 ft, autoland interface, but the OGS may be acquired as early as 12,000 ft, which is the altitude of HAC tangency to the runway centerline. The vehicle flies the OGS while maintaining a constant reference velocity until the speedbrake retract altitude at 3000 ft. The OGS ground intercept is also referred to as the aimpoint.

Appendix B.2 contains a discussion of the design and history of the OGS portion of the trajectory.

4.3.2. Guidance and Control

The goal of guidance during the OGS is to maintain the reference airspeed of 300 KEAS and the reference GS of -20° or -18° . Guidance computes a normal acceleration command to guide the orbiter along the steep GS trajectory. This is converted to a pitch command. If the pitch command results in a velocity that is different from the reference, the SB responds to correct the velocity error. If the filtered velocity is below the reference velocity, the SB closes proportional to the velocity error. If the filtered velocity is higher than the reference, the SB opens.

Generally, the pilot will fly Pitch and Roll/Yaw in the CSS flight control mode and leave the SB in the auto mode. Section 4.4 discusses the SB in detail. The BF is also flown in AUTO and is commanded to retract to the trail position (0°) on the first autoland guidance pass.

4.3.3. Phase Switching

The OGS normal altitude range is from 10,000 to 2000 ft. The beginning of the OGS is a function of meeting autoland interface transition criteria. This is discussed in the heading alignment section (Section 4.2). The termination of the phase is at preflare, which in autoland guidance is the beginning of the FSGS geometry phase (altitude less than 2000 ft).

4.4. SPEEDBRAKE

4.4.1. Overview

The purpose of the speedbrake (SB) during A/L is to actively control the orbiter energy on the HAC, transition to an EAS control on the OGS, retract to a fixed setting that targets the orbiter for a nominal 2500 ft T/D, and aid in stopping the vehicle by going to the full open position at MGTD. On the OGS the SB responds directly to errors in EAS to maintain the reference value of 300 KEAS. To control the orbiter T/D energy, the SB is retracted at 3000 ft altitude to a value calculated by onboard guidance that targets the remaining velocity profile to a fixed T/D energy. This calculated SB retract angle is a function of the OGS aimpoint, SB option, wind speed, vehicle weight, velocity error, and density altitude. The retract value is maintained until 500 ft altitude, when the autoland guidance calculates an adjustment to the retract angle. This adjustment is based on any changes in winds and density altitude since the 3000 ft calculation. No more adjustments are made until T/D. At the WOWLON indication the SB is commanded full open. Generally, the SB is in auto throughout A/L. Figure 4.4.1-1 is a block diagram of the SB commands during A/L. The logic depicted in the block diagram is the same for both the Descent Design System (DDS) analysis tool and the onboard flight software.

4.4.2. SB Control During Heading Alignment and OGS

SB commands during the heading alignment phase are proportional to the difference between the navigated energy state and the energy reference profile. However, in the event of an S-turn (high energy), the SB is commanded to its full open position of 98.6°. At 14,000 ft altitude, guidance begins to blend the Q-bar error into the calculation. This error is the difference between the actual Q-bar and the reference Q-bar, which is a function of range. The reference Q-bar profile is designed to ramp up to the same velocity as the autoland reference EAS to ensure a smooth SB command transition at autoland guidance interface.

From A/L interface to 3000 ft altitude the SB is modulated to maintain the reference EAS. The SB and pitch commands on the OGS are interrelated. If the pitch command results in an airspeed that is different from the OGS reference value of 300 KEAS, the SB responds to correct the error. Onboard the airspeed is filtered before it is used in guidance calculations to avoid over controlling for small wind gusts. When the filtered airspeed is below or above the reference value, the SB closes or opens, respectively, proportional to the error magnitude.

Since the OGS design results in a mid-SB effectiveness of 65° for a midrange weight, the SB can respond to both high and low energy dispersions. Figure B.2-2 (presented in the OGS section of Appendix B.2) shows the variation of trimmed SB with weight along constant glideslope lines.

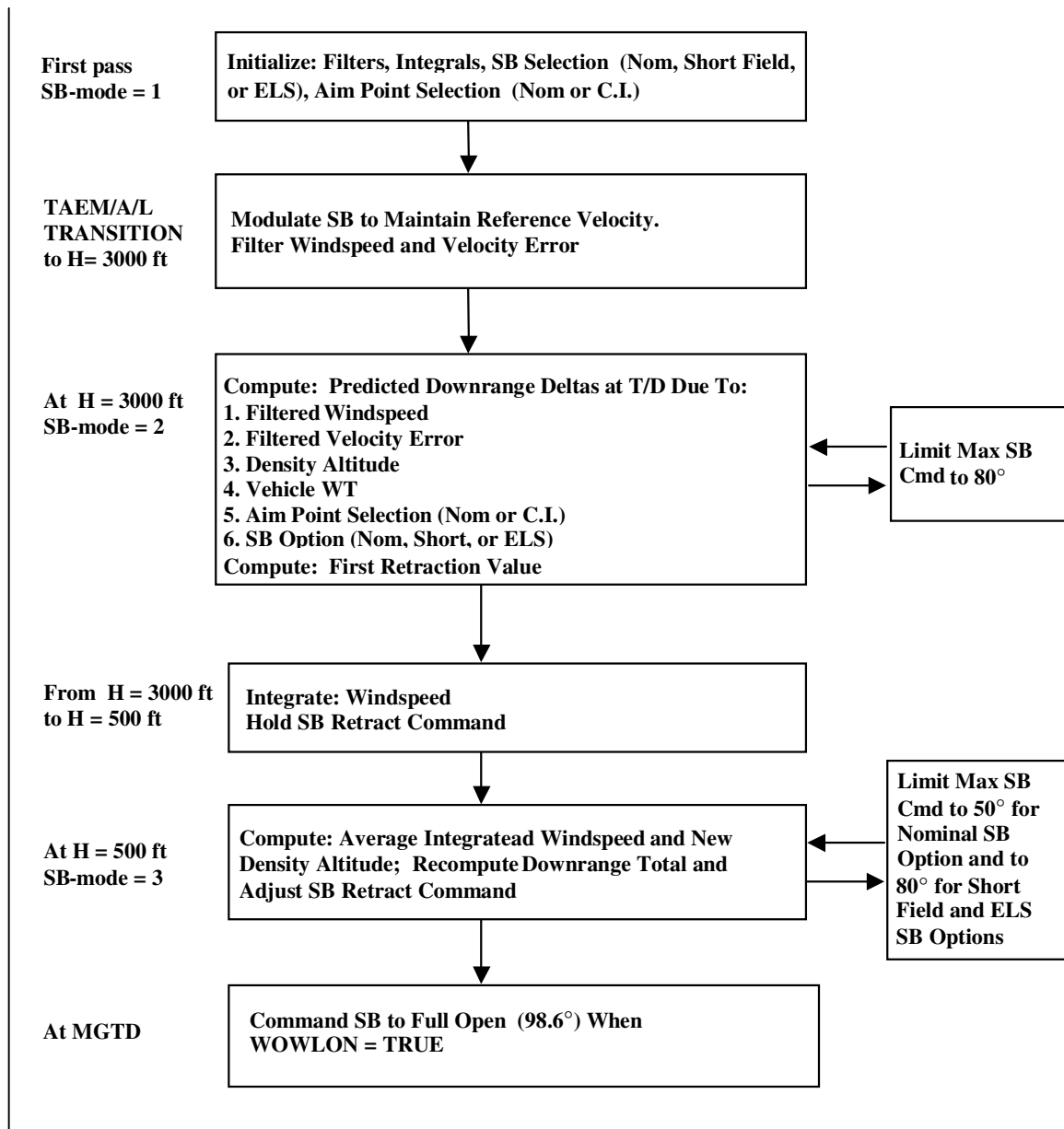

Figure 4.4.1-1 SB command block diagram

4.4.3. SB Retract

The smart SB retract logic was first used on STS-51D. This logic was modified with OI-30 to add the ELS SB option. The SB is retracted at 3000 ft altitude to an angle that is a function of the OGS aimpoint, SB option, wind speed, vehicle weight, velocity error, and density altitude. The retract angle is maintained until 500 ft altitude when an adjustment is made that is a function of any changes in winds and predicted density altitude that occurred since the 3000-ft calculation.

a. Development of current retract logic

The current SB retract logic was developed to reduce T/D energy dispersions. The first step in developing the logic was determining the major parameters that caused errors in T/D energy. These were identified as winds, vehicle weight, velocity error, and density altitude.

The next step was to build into autoland guidance the sensitivity of each of these parameters on T/D performance, and then develop an algorithm to calculate a SB retract value which would result in a constant T/D energy. An early concept which used wind and density altitude data, measured by balloon, and known vehicle weight, converted each parameter effect into a downrange delta. The downrange deltas were added together, and if the total delta was positive, then excess energy existed and a SB retract position was calculated that would eliminate this delta. If the downrange delta was negative, the SB was retracted to the minimum position (15°) so as to minimize the velocity losses. Also included in this overall downrange delta, besides the previously mentioned parameters, were the aimpoint selection and SB option effects.

The final step was determining a method to predict this information onboard using available data. The downrange delta concept was rewritten to use onboard parameters to calculate the perturbing factors, the downrange deltas, and the retract position.

The SB logic uses one retraction altitude, 3000 ft. An adjustment to the SB retract angle is made at 500 ft altitude. The 500 ft adjustment altitude was selected because the time to fly from 3000 to 500 ft is approximately the same as the time to fly from 500 ft to the surface. This altitude selection allows time for the adjustment to have an effect on the vehicle energy state. Nominally, it takes approximately 16 seconds to fly from 3000 to 500 ft and approximately 23 seconds from 500 ft to the surface.

The downrange sensitivities of the parameters used to calculate the SB retract angle are presented in Figure 4.4.3-1. Each of the parameters used in calculating the downrange total for this logic is discussed below.

b. Downrange delta sensitivities

(1) Wind speed

Wind speed is the major driver of SB position. Wind speed can dramatically change the energy state of the vehicle. The effects of wind must be measured over time. Predicting downrange deltas based on an instantaneous value of wind does not account for wind shears and direction changes. This was the primary reason for adding the SB retract adjustment at 500 ft.

The filtered wind speed is used to predict a downrange delta for the 3000 ft SB retraction calculation. The wind speed equation computes the difference between the horizontal component of the filtered True Airspeed (TAS) and the ground speed. The calculated wind speed is filtered to reduce the effects of wind gusts, particularly for the 3000 ft retraction calculation. Starting at 3000 ft, the filtered wind speed is integrated until 500 ft, when the accumulated total is divided by the total time of guidance passes. This average integrated wind speed is used in the 500 ft adjustment to the SB retract angle. An assumption made in calculating the downrange delta, based on calculated wind speed, was the shape of the remaining (last 500 ft) wind profile. The design profile shape is assumed to exist. The design wind profile is shown in Figure 4.4.3-2. If the actual wind profile differs

significantly from the design profile shape, the downrange delta for wind speed may be overcompensating (or under compensating).

The predicted downrange delta for wind speed works best for large winds. The guidance-calculated wind speed for small winds may be inaccurate, but the corresponding downrange delta is small and insignificant.

(2) Velocity error

The downrange delta term for velocity error is added to correct for velocity errors that occur at 3000 ft due to off-nominal trajectory deviations or wind gusts. This downrange delta is determined by differencing the filtered EAS and the reference value of 300 KEAS at 3000 ft. This term does not change at 500 ft, since velocity error is no longer calculated onboard after 3000 ft. There is no reference velocity profile after 3000 ft.

(3) Density altitude

The downrange delta for density altitude is added to account for the fairly significant effect it has on T/D energy. The density altitude is calculated as the squared ratio of filtered EAS divided by the filtered TAS. The Air Data Subsystem Operating Program (ADSOP) calculates the EAS and TAS used in guidance. There are slight errors in this calculation onboard, since the TAS is a function of temperature, and temperature is a table lookup from onboard I-loads instead of the air-data-probe-measured temperature. The accuracy of the density altitude prediction depends on the slope of the actual atmosphere being similar to the 1962 standard atmosphere slope. This slope is used to predict the density at the surface. The downrange delta term is recalculated at 500 ft to account for any temperature and density slope changes since 3000 ft.

There is an interrelationship between the wind calculation and density altitude calculation. This relationship is advantageous; if one under compensates, the other over compensates. Approximately half the downrange delta prediction error due to density altitude is counterbalanced by an error in wind speed calculation. These errors are due to using one ADSOP temperature profile for all flights.

(4) Vehicle weight

The downrange delta for vehicle weight targets lightweight vehicles to land at 195 KEAS and heavyweight vehicles to land at 205 KEAS. These fixed target energies were designed to reduce T/D dispersions and allow for better velocity monitoring after preflare compared to the previous retract logic.

(5) Close-in aimpoint

When the close-in aimpoint is selected, the OGS reference is moved 1000 ft closer to the runway threshold. A corresponding 1000 ft is directly added to the downrange total. The same T/D energy target is used. The result is a larger SB command. If the larger SB command is greater than the closed SB position (15°), then some or all of the added energy will be dissipated. If the resulting SB command is less than the closed SB position, then the vehicle will land approximately 1000 ft further downrange.

(6) SB option

Starting with OI-30, the nominal SB option is always the default option. The short field SB options may be selected manually on any mission phase prior to A/L interface. When the short field SB option is selected, 1000 ft is directly added to the downrange total. This decreases the target T/D energy since no trajectory geometry was changed. The short field SB option may be used when one of the following parameters is predicted to violate the flight rule limit: 1) rollout margin, 2) brake energy, or 3) T/D ground speed. The short field SB option may also be used to reduce the T/D ground speed in the event of a failed or leaking main gear tire. When the short field SB option is selected during an intact abort or EOM landing, the CDR should land 10 kt slower than the nominal T/D target velocity and maintain the 2500 ft nominal T/D range. Landing 10 kt slower is approximately equivalent in T/D energy to landing 1000 ft shorter. Since the slower T/D velocity is mandatory for protection against a fast tire

speed, the short field SB landing technique was standardized to that requirement because it is the most likely scenario requiring this option on an EOM landing. This 10 kt slower T/D technique also enables the crew to fly the same nominal altitude-range geometry, which maintains the same ball-bar/IGS/out the window scene and final flare technique. The only exception is when the vehicle weight exceeds 245,000 lb and landing 10 kt slower would result in a less than 4 second energy reserve. If the super heavyweight vehicle is predicted to violate rollout margin or brake energy, the short field SB option can still be used, but the T/D target would change to 205 KEAS at 1500 ft downrange. The short field SB option cannot be used to add tire speed protection for these super heavyweight landings.

In an emergency, the orbiter may land at one of the various landing sites around the world, which may be shorter and/or narrower than Space Shuttle Program augmented landing sites. The runway must meet the criteria established in FR A2-264. In cases where these sites do not have balloon or upper winds forecast support or the nature of the abort does not allow time to obtain T/D performance predictions, the SB option (nominal, short field, or ELS) is determined based on the OGS I-Loads and the usable runway length (refer to FR A4-110). Usable runway length is the distance from the approach threshold (actual or I-Load displaced) to the end of the usable overrun. Whichever SB option is selected, these contingency aborts require an early chute deploy, immediate derotation, and braking at NGTD. The short field and ELS SB options require maximum braking at NGTD. When the nominal SB is selected, the nominal T/D targets are used (205 KEAS at 2500 ft for heavyweights; 195 KEAS at 2500 ft for lightweights). When the short field SB is selected, the nominal T/D speed is targeted with a reduced T/D position of 1500 ft. This allows for a quicker drag chute deploy, derotation, and maximum braking initiation. When the ELS SB option is selected (heavyweight orbiters only), 2500 ft is directly added to the downrange total used in the SB retract calculation. Since landing at the nominal T/D speed of 205 KEAS would result in targeting the runway threshold, the crew lands 10 kt slower, resulting in a T/D target of 195 KEAS at 1000 ft downrange.

d. Maximum SB

The maximum allowable SB retract angle from 3000 ft to 500 ft is 80°, regardless of the SB option. The maximum allowable SB retract angle from 500 ft to T/D is 50° for the nominal SB option and 80° for the short field and ELS SB options. This maximum value is set because of the degradation of orbiter handling qualities near T/D. The short field and ELS SB limit prevents T/D energy overkill, providing a balance between the risks of landing short of the runway and of rolling off the end of a short runway.

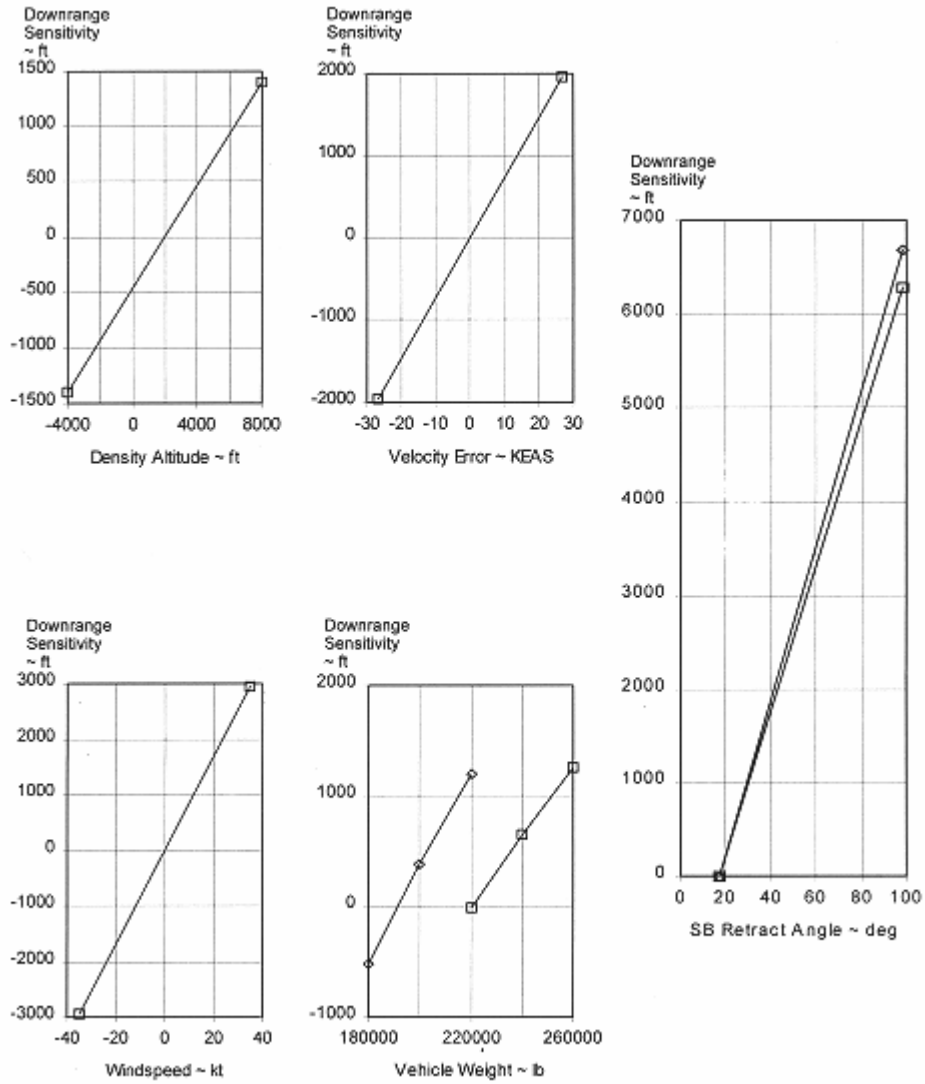

Figure 4.4.3-1 SB Command Downrange Sensitivity

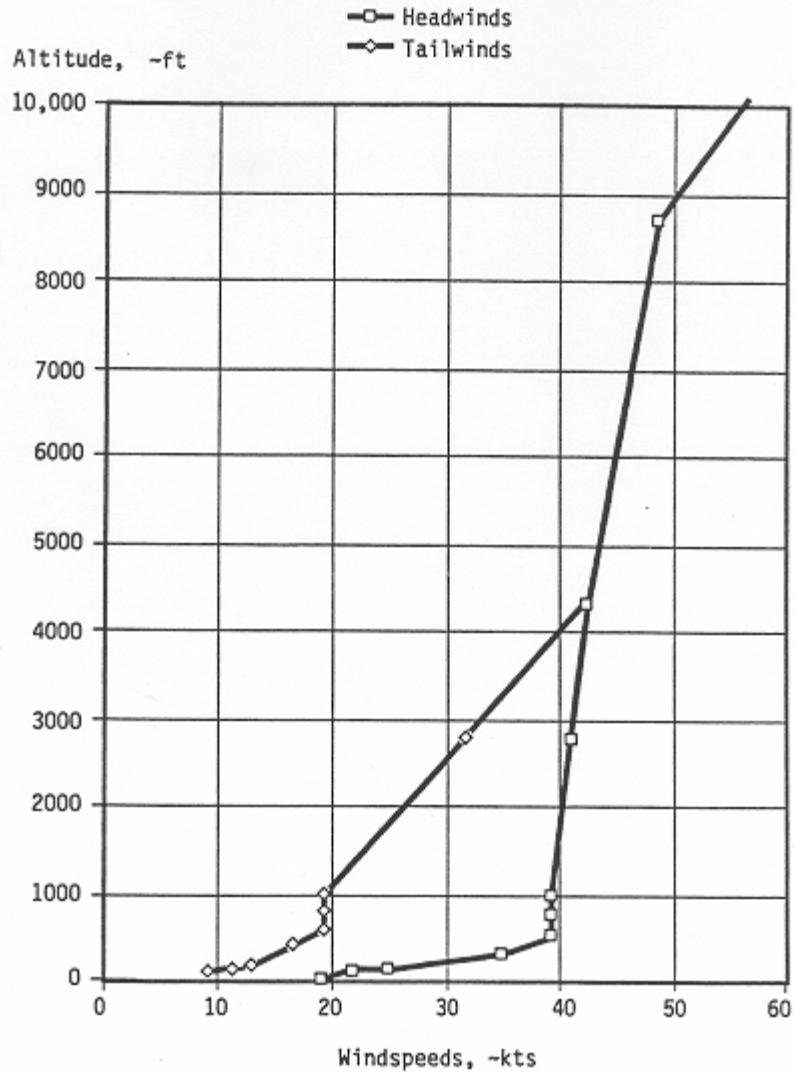

Figure 4.4.3-2 A/L Design Wind Profiles

4.4.4. SB at T/D

After the SB retract angle is adjusted at 500 ft, the guidance command remains constant until WOWLON. At WOWLON the SB is commanded full open to assist in slowing the vehicle during rollout.

4.5. FLARE AND SHALLOW GLIDE SLOPE

4.5.1. Overview

The purpose of the Flare and Shallow Glide Slope (FSGS) phase is to transition the trajectory from the OGS to the IGS. The flightpath geometry consists of a giant pull up circle and an exponential to the IGS (Figures 4.5.1-1 and 4.5.1-2). On the OGS the altitude rate is approximately -185 fps, which must be arrested to -3 fps at T/D. The FSGS phase nominally reduces the altitude rate to -12 fps, leaving the remainder to be arrested during the FF phase. Appendix B.3 contains a discussion of the design and history of the FSGS portion of the trajectory.

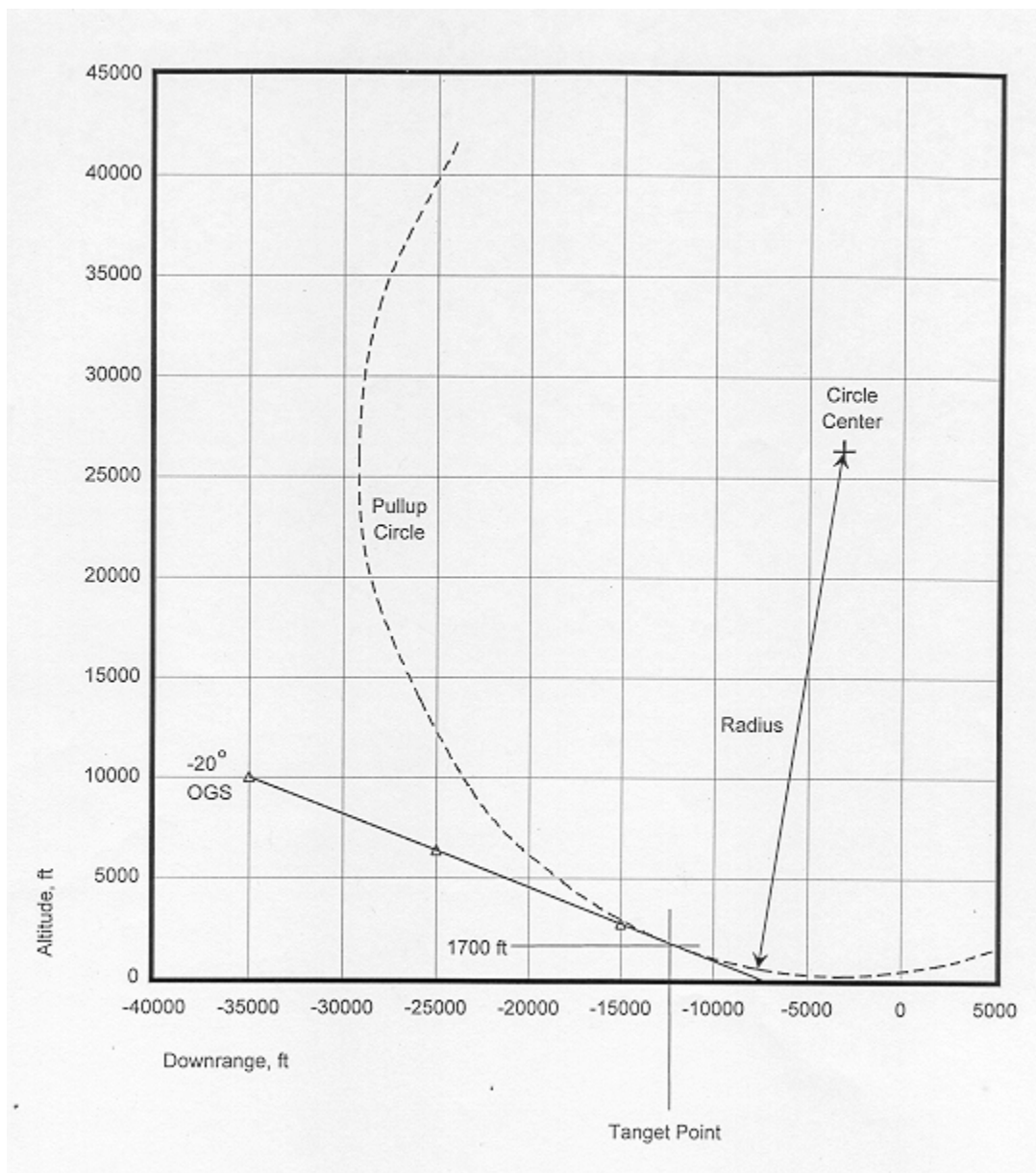

Figure 4.5.1-1 Pull up Circle

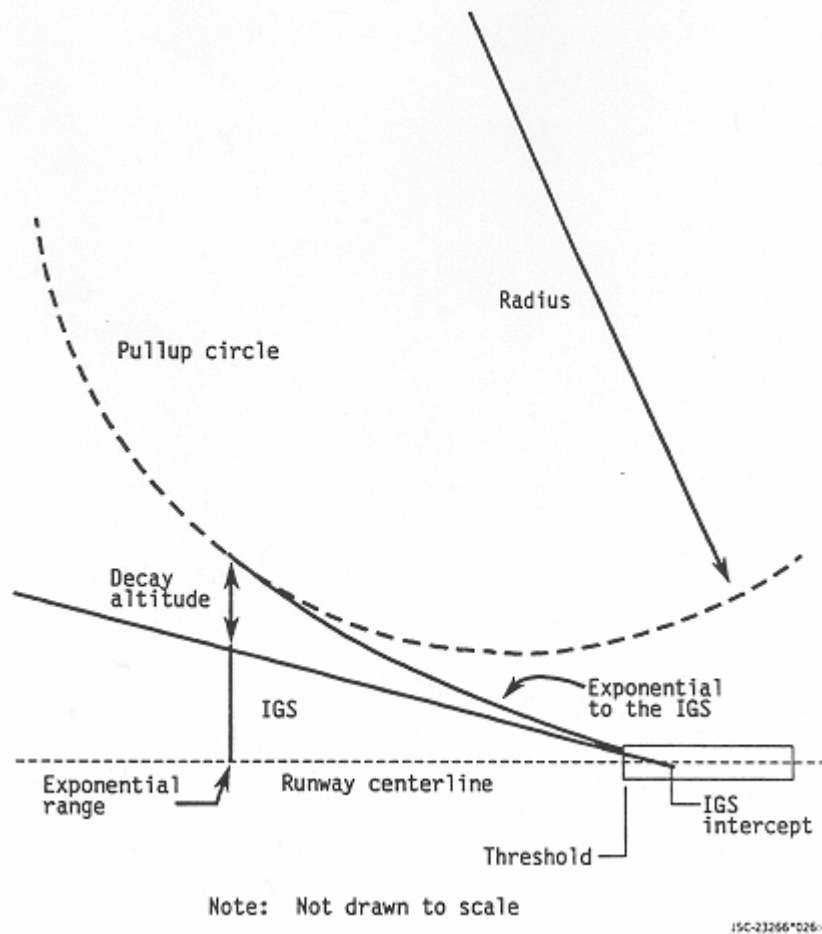

Figure 4.5.1-2 Exponential to the IGS Geometry

4.5.2. Landing Gear Deployment

Another important event that takes place during the latter part of the FSGS is the deployment of the landing gear. Early space shuttle flights used velocity as a deploy cue, but altitude was later selected. The cue is very important because the landing gear is a very large aerodynamic liability. Using the wrong cue can significantly alter the T/D energy. The landing gear deploy cue for STS-1 through STS-4 occurred when the velocity decelerated through 270 KEAS. This corresponded to an altitude of 200 ft on the nominal energy trajectory. Flight STS-1 followed the velocity cue procedure which, due to its much higher than expected energy, did not occur until an altitude of 85 ft. Had the gear been deployed at 200 ft, some of that excess energy would have been dissipated. Flight STS-2 was very low on energy, reaching a maximum velocity of only 274 KEAS at 1100 ft altitude. The 270 KEAS cue occurred at 600 ft, but the actual deploy occurred at 400 ft, adding to the already existing low energy condition. Lower energy occurred since the nominal altitude for gear deploy would have occurred at 200 ft on a nominal trajectory. Flight STS-3 was high on energy, not decelerating through 270 KEAS until an altitude of 87 ft. T/D occurred earlier than expected on STS-3 and the gear was actually down and locked only a couple of seconds before first wheel contact. It was after STS-3 that altitude was selected as the gear deploy cue because it would compensate for off-nominal energy conditions, not make them worse, and still satisfy safety concerns. Downrange was also considered as a gear deploy cue, and it too, had advantages over velocity.

Flight STS-5 was the first to use altitude as the cue to deploy the gear. Still, some pilots preferred to deploy the gear at 400 ft and others at 200 ft. Current flight procedures are to nominally deploy the gear at an altitude of 300 +/- 100 ft. The only requirement in the design was to have the gear down and locked at least 5 seconds before T/D. A typical preflight time between gear deploy and T/D is 20 seconds.

Figure 4.5.2-1 shows the L/D history during the time the gear is deployed and indicates why it affects T/D energy so much. Studies have shown that manually retracting the SB to 40° greater than the commanded value is aerodynamically equivalent to deploying the landing gear. The sensitivity of T/D energy to landing gear deploy altitude is discussed in Section 4.7.2.

Preflight performance predictions from the descent flight design team are based on the following gear deployment algorithm:

- a. Initiate gear deployment at 300 ft altitude
- b. Delay looking-up aero increments for 1 second
- c. Use a constant rate of deployment, which results in the gear's being fully deployed in 3 seconds (4 seconds total)

The 1 second delay simulates the time when the command is given to when the landing gear doors are open. Aerodynamic increments for the landing gear are a function of the deploy angle. Actual flight time between the deploy command and the down-and-locked time may be longer than 4 seconds, but based on visual timings, the 4 second total deploy time is valid to use in simulations from an aerodynamic performance standpoint.

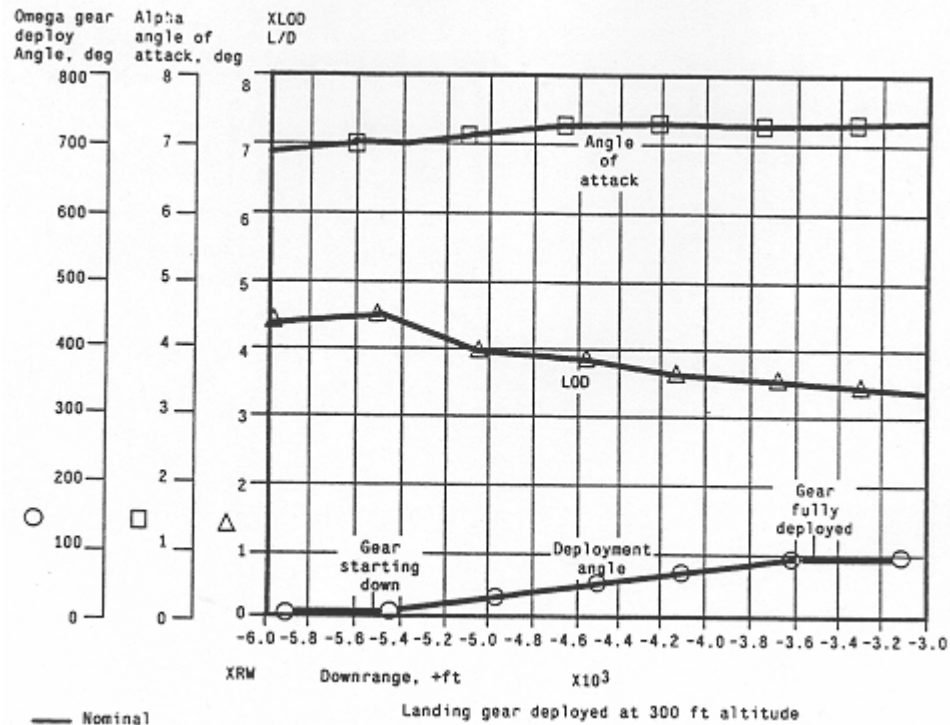

Figure 4.5.2-1 Landing Gear Aerodynamics

4.5.3. Sloped Runways

A change in the onboard, navigated altitude calculation during the FSGS subphase has been incorporated to accommodate sloping runways. The 0.5 deg slope on the Vandenberg AFB (VAFB) runway is the driver for making this change. This change involves fading in the slope of the runway starting at the 10,000 ft range to the threshold. Using the fader resulted in auto-T/D performance that is much closer to the nominal flat runway data, and the fader I-loads chosen results in the least T/D dispersion. Vandenberg AFB launches and landings have since been cancelled. The fader logic is still used every flight but all runway slope I-loads are set to 0°.

4.5.4. Transition

The autoland guidance transition from the FSGS to FF is based on an altitude computation that is a function of altitude rate (Figure B.3-2, Appendix B.3). The higher the altitude rate at a given altitude, the higher the FF altitude. The highest the auto transition can occur is 80 ft. If the transition has not occurred by 30 ft, it is forced. The switching logic is designed to typically occur at 50 ft, but if a higher than nominal altitude rate is present, a higher FF is commanded to allow more time to arrest the high rate. If the altitude rate is below nominal, the FF maneuver is delayed, but never lower than the 30 ft minimum.

4.6. FINAL FLARE

4.6.1. Overview

The FF maneuver reduces the altitude rate on the IGS to an acceptable value at T/D. The design of FF involves determining the altitude at which the flare maneuver is initiated and an altitude-altitude rate reference profile. The FF maneuver should be a smooth increase in pitch attitude started at an altitude high enough to result in a timely decrease in altitude rate before T/D. Appendix B.4 contains a discussion of the design and history of the FF portion of the trajectory.

4.7. LANDING

4.7.1. Overview

The A/L trajectory is designed to nominally T/D the orbiter 2500 ft downrange at a safe speed and small altitude rate. The IGS angle and intercept provide the trajectory path that results in this nominal downrange distance. The autoland SB retract logic guides the orbiter to a targeted T/D energy of 195 KEAS at 2500 ft for lightweight vehicles and 205 KEAS for heavyweight vehicles. Ideally, this normalized T/D energy is achieved if some SB is carried to T/D. If the SB retract angle is 15°, a low-energy situation may exist and the orbiter may land with less than the nominal T/D energy. The SB retract logic is designed to limit the high-energy T/D conditions but can do nothing to help the low-energy conditions when the SB is fully retracted. There are some manual techniques to increase T/D energy on days when the minimum energy is not achieved, but these techniques can be considered only for contingency landings. Off nominal techniques have been used on a few EOM landings, but the predicted T/D energy was initially “GO,” and the manual technique was used to achieve T/D performance nearer the nominal target.

The mission rules were written to limit the minimum T/D energy as a function of the vehicle weight. Lightweight vehicles (less than 222k lb) must have a normalized T/D energy greater than 195 KEAS at 1000 ft downrange. Heavyweight vehicles must have a normalized T/D energy greater than 205 KEAS at 1000 ft downrange. The 1000 ft is intended to cover unforeseen dispersions, including trajectory errors, changing winds and density altitudes, and air data system errors. Pilots have also stated that 1000 ft should be the minimum downrange T/D point. There are two exceptions to the evaluation velocities. First if the vehicle weight is less than 200k lb and the T/D point at 195 KEAS is less than 1000 ft using both aimpoints, the evaluation velocity may be lowered to 185 KEAS. These lightweight vehicles can still meet the minimum energy reserve margin at 185 KEAS. The other exception is for a heavyweight launch when the T/D performance for an intact abort site is the only factor constraining launch. In this situation the evaluation velocity may be reduced to 195 KEAS (the same as when short field speedbrake option is selected).

The wind dispersion allowance is designed to cover wind changes between the final balloon release (approximately 1 hour before landing) and the orbiter landing. Postflight data analysis has shown that another wind component to be considered is the spatial wind dispersion between the balloon path and the orbiter path. Figure 4.7.1-1 shows the STS-31 orbiter trajectory and the path of the T/D balloons. Because of the different flightpaths of the orbiter and the balloons, the wind profile used to predict the orbiter T/D point differed from the wind profile actually seen by the orbiter. As a result of the different wind profiles, the predicted T/D point differs from the actual T/D point by over 800 ft. This spatial wind effect occurs at landing sites where nearby mountainous terrain can give widely varying wind conditions. Landing sites susceptible to spatial wind dispersions include Edwards AFB, Northrup AFB, and Zaragoza AFB. A larger database of flight data will be necessary to better understand the effects of spatial wind dispersions. Analysis of postflight data since STS-26 has proven 1000 ft to still be a good total estimate of the required low-energy T/D margin.

If the predicted SB retraction positions at 3000 and 500 ft, are calculated to be closed at landing, the close-in aimpoint may be selected to achieve a predicted T/D closer to 2500 ft and possibly gain additional speedbrake, provided that rollout margin and brake energy constraints are still satisfied. If the close-in aimpoint is used and the required minimum 1000 ft T/D energy still is not achieved, the runway is considered unusable. Through STS-97, approximately one-quarter of the missions have used the close-in aimpoint. However, the majority of flights using the close-in aimpoint were prior to redesigning the OGS to 300 KEAS and 18°/20°.

Prior to STS-41, the close-in aimpoints were used only if the normalized T/D energy for the nominal aimpoints was less than 1000 ft. On STS-31, spatial wind effects caused the crew to T/D shorter on the runway than expected. To better protect for dispersions which would cause low-energy T/D scenarios, the criteria for using the close-in aimpoint includes the SB retract position.

An exception to the 1000 ft T/D energy requirement occurs for daylight lakebed landings. Since lakebeds have long underruns (greater than 1000 ft), ample distance is available for low energy situations. The T/D energy is evaluated, but the 1000 ft T/D margin requirement can be waived based on the landing conditions and STA recommendations.

The T/D evaluation speeds are used to provide the orbiter with a more consistent energy reserve and vehicle pitch attitude at T/D. The energy reserve is defined as the amount of time after T/D the orbiter could have flown until the pitch attitude reaches the tailscape angle (14.6°). The energy reserve concept and assumptions are described in Figure 4.7.1-2. The tailscape velocity varies with WT, since a heavier vehicle must fly faster than a lighter vehicle has to fly to produce an aerodynamic lift equal to its weight. A consistent energy reserve and a consistent pitch attitude at T/D are two very important factors that help the pilots land with small altitude rates.

The T/D evaluation velocities (Table 4.7.1-I) are used to determine runway acceptability during real-time operations. The evaluation velocity is also the CSS targeted T/D velocity and any off-nominal selection must be communicated to the CDR prior to landing. For a runway to be declared “GO” from a minimum T/D energy standpoint, the predicted velocity at 1000 ft downrange must be greater than the evaluation velocity. There are two exceptions to the guidance target velocities as shown in Table 4.7.1-I. For vehicles weighing less than 200,000 lb, the tailscape velocity is much slower than the nominal 195 KEAS lightweight target velocity. The required energy reserve margin can still be maintained by lowering the CSS T/D target velocity to 185 KEAS. This off-nominal evaluation velocity could be used on a low energy day when the very lightweight vehicle couldn’t achieve the 195 KEAS target. The second exception is for heavyweight vehicles (but not greater than 245,000 lb) not achieving the nominal 205 KEAS T/D velocity for an ascent intact abort site if that is the only factor constraining launch. It is preferable to use the 10 kts slower evaluation velocity rather than delay the launch. There are risks whenever the launch is delayed. The risk of landing 10 kts slower had already been accepted for the short field option to make a TAL “NO GO” day into a “GO” day. The no-heavier-than 245,000 lb restriction was inserted because 195 KEAS is exactly 4 seconds above the tailscape velocity for that weight. One of the basic design concepts was to always provide a minimum of 4 seconds energy reserve at the planned T/D.

The use of the short field speedbrake retract option was expanded beginning with flight STS-69 to provide additional tire speed margin. Prior to that time, the short field option was only considered for TAL missions whenever rollout margin or brake energy were near or exceeded Flight Rule limits. The short field option may now be used to provide the flight rule 11 kts margin from the 225 KGS tire speed certification limit. If the predicted ground speed using the nominal speedbrake is between 214 and 225 kts, the short field speedbrake should be considered to provide the additional tire speed protection against changing winds, air data system errors, and T/D dispersions. If the initial predicted ground speed is greater than 225 kts, the short field speedbrake cannot be used to make that approach to the runway “GO.”

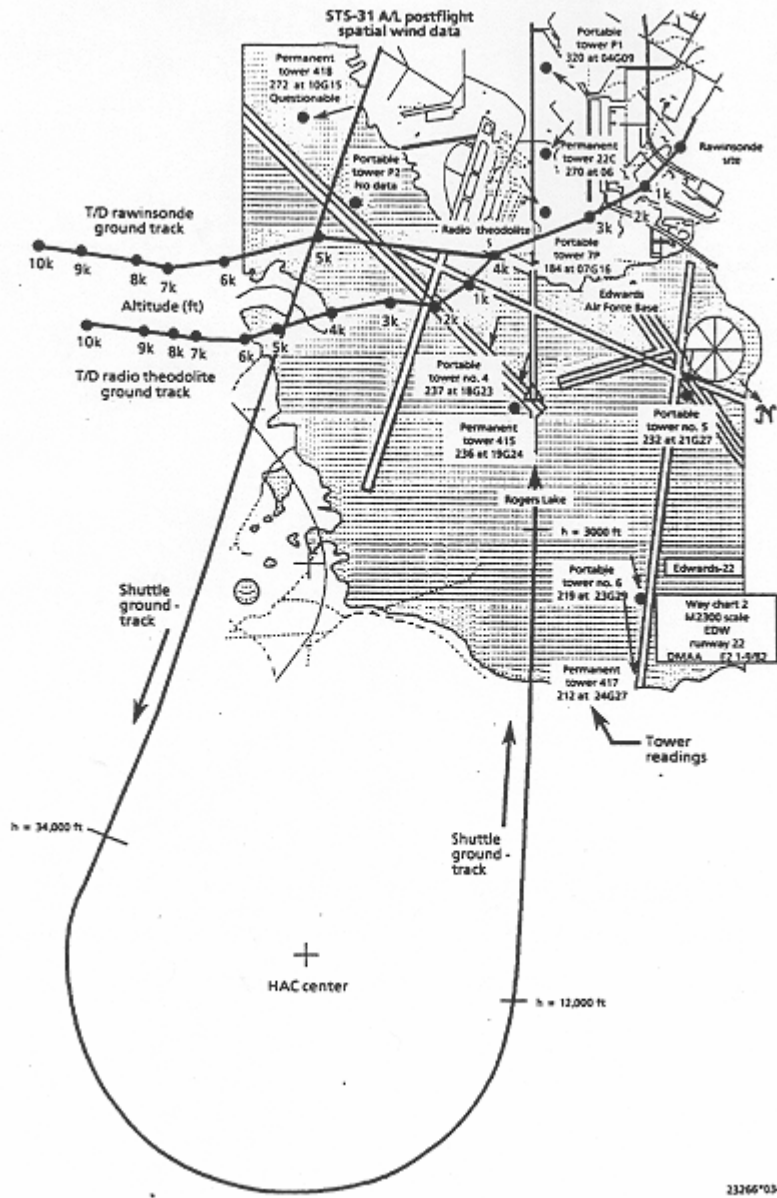

Figure 4.7.1-1 STS-31 A/L Postflight Spatial Wind Data

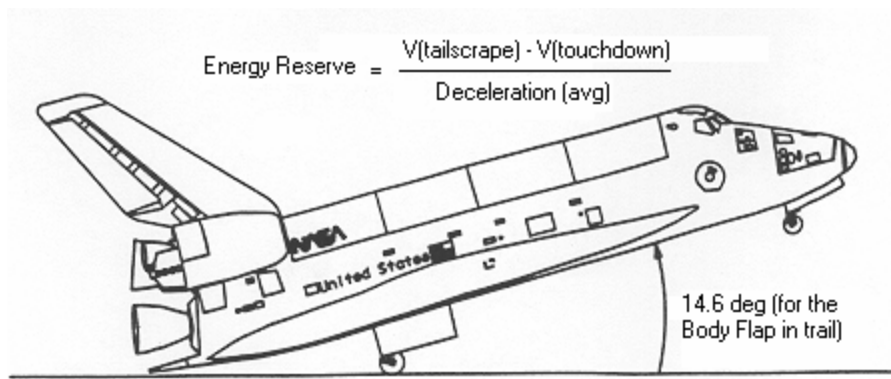

Figure 4.7.1-2 Tailscrape

Table 4.7.1-I. - T/D Evaluation Velocity

Speedbrake Retract Option	I-load Set	Weight Klb	Evaluation T/D Velocity ~ KEAS	Special Criteria
Nominal	Nominal Evaluation T/D EAS			
	Light WT (-20 deg OGS)		195	
	Heavy WT (-18 deg OGS)		205	
	Off-Nominal Evaluation T/D EAS			
	Light WT (-20 deg OGS)	< 200	185	If the T/D point at 195 KEAS is <1000 ft for both the nominal and close-in aimpoints
	Heavy WT (-18 deg OGS)	< 245	195	If ascent intact abort site T/D performance is the only factor constraining launch
Short-field	Light WT (-20 deg OGS)		185	
	Heavy WT (-18 deg OGS)	< 245	195	
	Heavy WT (-18 deg OGS)	> 245	205	(T/D target 205 kts/1500 ft)

4.7.2. Landing Dispersions

There are slight aerodynamic differences in the 4 orbiters from a T/D energy/performance standpoint. OV-103 and OV-104 are nearly identical and the T/D energy I-load design was based on this configuration. OV-102 has the least Advanced Flexible Reusable Surface Insulation (AFRSI) and still has the Shuttle Infrared Lee-Side Temperature Sensing (SILTS) pod attached making it the best performing vehicle (+190 ft T/D energy). OV-105 is aerodynamically “cleaner” than OV-103 and OV-104, resulting in slightly better T/D performance (+153 ft). But there is just one “advertised” T/D energy target, 2500 ft. The high fidelity shuttle simulators use an aerodynamic data base that has a set of vehicle dependent coefficients that when used reflect these small differences in T/D performance.

Although guidance can control some wind and density altitude dispersions, guidance has no provision to handle off-nominal vehicular situations including stuck aerosurfaces, tile damage, or extreme landing gear deployment altitudes. For these situations, T/D energies may vary widely.

Deploying the landing gear increases the total drag on the orbiter. Figure 4.7.2-1 shows the sensitivity of T/D energy to gear deploy altitude. If the landing gear deploys earlier than the 300 ft design altitude, the orbiter experiences higher drag for a longer period of time, resulting in a decrease in the orbiter T/D energy. Conversely if the gear is deployed later than the design altitude, the vehicle has an increase in T/D energy. A 100 ft difference in deploy altitude equals approximately 250 ft of T/D energy.

Studies have shown that added drag can be caused by tile erosion due to orbiter flight through moisture laden clouds. Passage through these clouds increases the drag that corresponds to a trimmed SB setting 10° greater than the nominal setting on the OGS. Since the SB retraction logic (Section 4.4.3) does not account for this added drag, the orbiter T/D energy decreases by 1000 ft. A special Flight Rule (A4-110) was written to add an additional 1000 ft of required minimum T/D energy margin when flying through such clouds is a possibility.

Two potential consequences of off-nominal T/D energies are high T/D ground speed or excessive T/D altitude rates. High ground speed at T/D causes excessive tire wear during the initial spin up, which may result in a tire failure. The shuttle tires are certified to T/D at a ground speed up to 225 kts. Changing winds, air data system errors, and T/D dispersions require an 11 kts operational margin from the certified tire speed limit. It has been proposed several times that a tire capable of landing at 240 to 250 Knots Ground Speed (KGS) is required to provide full 3 sigma protection.

The maximum altitude rate at T/D is designed to protect the main gear struts from unacceptable loads. Each strut can withstand up to 207k lb, although the actual altitude rate is a function of vehicle WT (Figure 4.7.2-2). As explained in Section 4.6 and Appendix B.4, during the FF phase of autoland guidance, the vehicle sink rate is reduced from 12 fps to 2 fps. The flight average, through STS-89, T/D altitude rate has been 2.0 fps, while the maximum rate was 5.7 fps on STS-3.

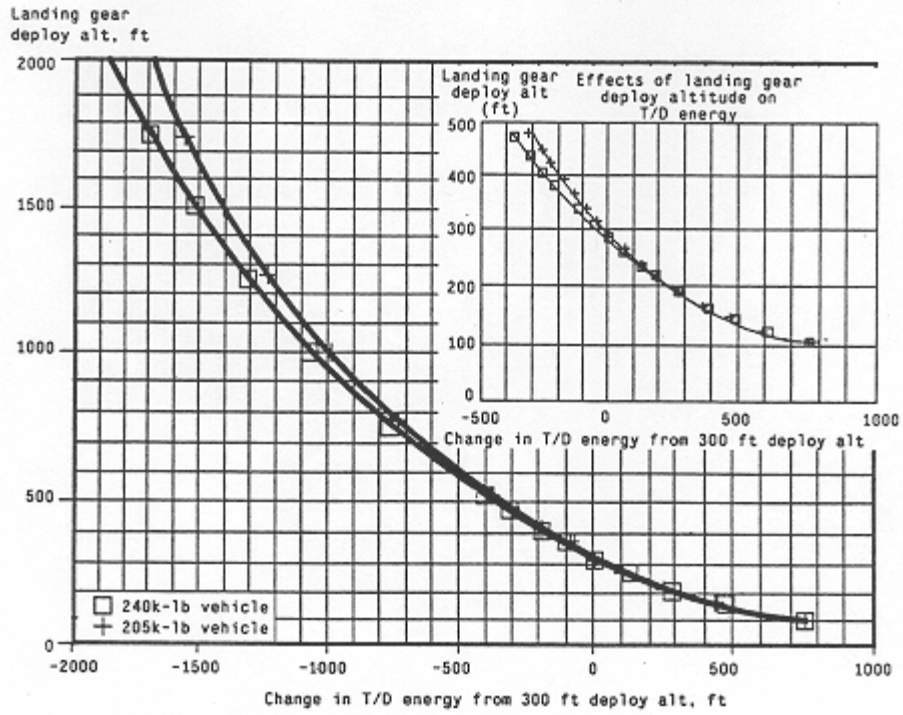
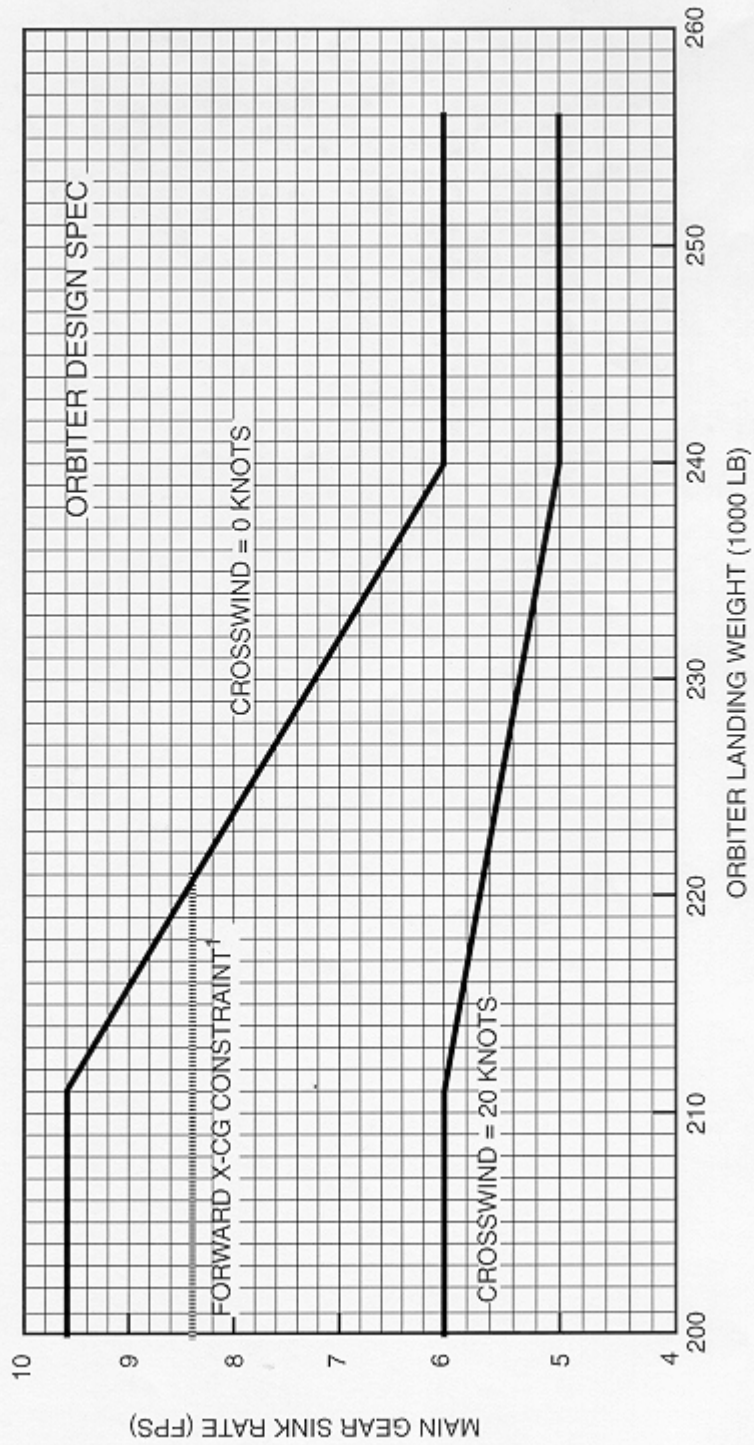

Figure 4.7.2-1 Effects of Landing Gear Deploy Altitude on T/D Energy

ORBITER DESIGN LANDING IMPACT LOADS CRITERIA



¹ - Maximum sink rate restricted to 8.4 fps to protect mid-fuselage body bending for X-cg's between 1074.7 and 1076.7 in.

Figure 4.7.2-2 Maximum Main Gear Sink Rate for Design

4.8. ROLLOUT

The rollout flight phases are depicted in Figure 4.8-1. Rollout starts at T/D of the main gear (WOWLON) and ends at wheels stop. The four phases of the rollout are the attitude hold, derotation, coast, and braking. The addition of the drag chute has significantly shortened the rollout distance. The values shown in Figure 4.8-1 are all used in analysis of the rollout unless otherwise specified.

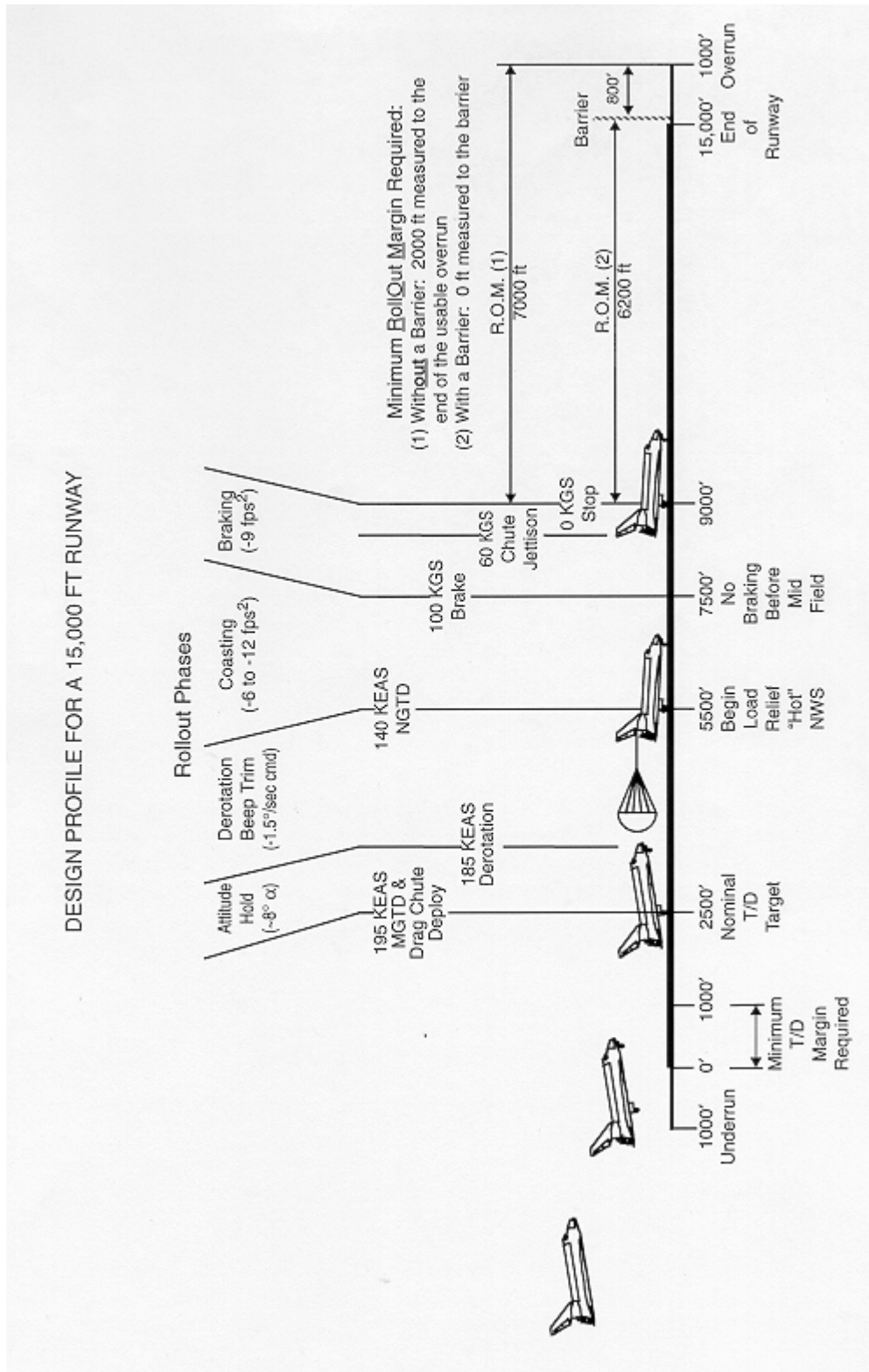

Figure 4.8-1 Rollout Pictorial

4.9. CONSTRAINTS AND FLIGHT RULES

The rollout margin and brake energy limits have been designed to ensure that the orbiter can stop within the runway limitations. The rollout margin is meant to account for environmental and procedural variations that directly impact the vehicle stopping distance. The brake energy limits protect the capability of the brakes to stop the orbiter. Appendix C.1 contains further discussion and data for rollout margin and brake energy limits.

Trajectory simulations are made on the day of launch (and the day of landing) by the real time entry support team to see if using the measured atmospheric conditions of the day result in acceptable T/D and rollout performance. Launch and landing decisions include consideration of these simulations satisfying the Flight Rules. Currently the drag chute model is not used in rollout simulations during real time support. The predicted rollout performance must be “Go” without the drag chute.

4.10. ATTITUDE HOLD

The chief purpose of the attitude hold phase is to reduce the maximum loads that are imposed on the main landing gear. The attitude of the orbiter at T/D is held constant until the EAS decreases to a specified value. This value is selected to achieve a compromise between the maximum load on the main gear and the maximum load on the nose gear. The peak load on the main gear decreases as the derotation is delayed, but the peak load on the nose gear increases. The start of the braking, which cannot occur until the nose gear is on the runway, may be delayed by a later derotation. The significance of such a delay must be determined for each specific case, but the delay is not generally desirable. Another negative to a long time spent in the 2-pt stance, is having to use a sluggish rudder for lateral control. Flight simulators have shown the lateral control to be marginal in the 2-pt stance when large crosswind gusts or flat tire are simulated. Several actual landings have also shown the lateral control using only the rudder to be less than desirable.

The attitude hold phase begins at WOWLON. The Landing Gear WOW RM logic is used to set and latch WOW based on either the left or right NOWOW flag being observed "off" for 3 counts (0.48 seconds). RM monitors three discretes on each landing gear: 1) inboard tire speed, 2) outboard tire speed, and 3) the proximity sensor. Two out of three discretes will set the NOWOW flag. The testing algorithms are much more involved and this is only a high level summary. The Landing SOP will set and latch WOWLON and FLATTURN based on seeing WOW=true (no delay). WOWLON triggers guidance to command the speedbrake to the full-open position and to look at flight control for the pitch channel commands if in the "auto" PITCH mode. FLATTURN triggers the lateral channel of guidance to command zero roll attitude and converts the roll commands to yaw commands, again which are only used if flight control is in the "auto" R/Y mode. In case of a "WOW RM" system failure and a MG DLMA condition exists, the WOWLON is manually overridden to true by depressing either the SRB SEP or ET SEP PBIs after NGTD. This is a standard procedure after every landing.

The present procedure is an attempt to maintain the initial T/D attitude instead of decreasing it to some intermediate value. The deflection of the elevons at the start of the derotation causes an increase in the lift of the orbiter (a decrease in the load on the main gear). This can be seen at the start of each derotation. The increased lift developed during an immediate derotation could possibly exceed the vehicle weight and cause the orbiter to leave the ground for a short time (skip). When the derotation speed is decreased, the decreased incremental lift will not be great enough to cause a skip.

The attitude hold phase ends when the derotation cue is satisfied. Originally this was based on when the airspeed decreased through a specified value but since the drag chute has become operational, derotation initiation nominally occurs 2 seconds after the chute is deployed. New software logic, better rolling friction computer models, and the implementation of the drag chute have allowed derotating at faster velocities. The OI-23 smart elevon logic decreased main gear loading by "latching" the up elevon command during derotation but at some expense to a harder Nose Gear Slap Down (NGSD) rate. The new beep trim derotation logic has standardized the pitch rate commands and reduced the dispersions which results in decreases in both main and nose gear loads. The drag chute also reduces main gear loading and can reduce the nose gear peak load if disreef occurs prior to NGTD.

There is no one safe derotation speed for all vehicle weights and all landing surfaces due to the many variables involved. Early flight history did show a correlation between harder NGSD rates and lakebed landings. The lakebed rolling coefficient increases significantly near NGTD when the vertical loads are the largest. In simulations, the increased pitching moment causes the loads on the nose gear to exceed acceptable limits for certain combinations of the location of the center of mass and the WT. To protect for the higher loads, vehicles with Mass Moments (MM's) greater than 1.54 M ft-lb may exceed the maximum nose gear load limit when landing on a medium-hard lakebed and therefore are required to land on concrete runways. The equation for calculating the MM is:

$$MM = WT (1172.3 - X-c.g.)/12$$

where

MM = Vehicle MM (ft-lb)

WT = Vehicle WT at T/D (lb)

X-c.g. = Vehicle X-c.g. location at T/D (in.)

Since concrete runways have a significantly lower rolling coefficient than the lakebed, landing on a concrete runway yields a lower nose gear load than a lakebed landing.

4.11. DRAG CHUTE

The addition of the drag chute on the Shuttle has been the biggest single improvement made to the rollout phase. The actual flight stopping distance and brake energy have both been significantly reduced with the aid of the drag chute, thus improving the landing safety margins. Nominal drag chute deploy is planned for every flight. Exceptions might include very slow touchdowns and/or very high crosswinds. The pilot initiates nominal chute deploy 2 seconds prior to the start of derotation. For a typical heavyweight landing the nominal sequence would be: land at 205 KEAS, deploy the chute at 195 KEAS, and initiate derotation at 185 KEAS. For lightweight landings at 195 KEAS, the chute is deployed as soon as practical after MGTD and derotation initiated approximately 2 seconds later but never slower than 175 KEAS. This relative timing results in the chute being fully opened prior to NGTD and aids in arresting the NGSD rate. Flight rules allow for an early deploy between MGTD and nominal deploy time for high energy landings when it may be necessary to get the vehicle stopped on the runway. Pivot pins in the attach/jettison mechanism are designed to fail (shear) when the loading is between 105,000-125,000 lbs, resulting in the chute being jettisoned. This is for the case where the chute is inadvertently deployed at too fast of a speed. Loads in excess of 100,000 lbs can be reached if the chute deploys at speeds greater than 205 KEAS. Based on a nominal chute deploy at 195 KEAS, the maximum deceleration during rollout usually occurs at chute disreef which is just prior to NGTD and also when the elevons are at their maximum up position. Typical maximum deceleration values are 11 to 13 fps^2 . Nominal chute jettison occurs at 60 KGS. Jettison at slower speeds could result in the riser lines drooping and making contact with (damaging) the center main engine bell. If the chute hasn't been jettisoned by 40 KGS, don't jettison it.

When the chute is deployed, it first opens to a 40% reefed configuration for approximately 3.5 seconds and then disreefs to its full 40 ft diameter. Based on simulations where nominal braking procedures were followed, the typical stopping distance decreases 1000 ft and the brake energy decreases 16M ft-lb per wheel with the aid of the drag chute. Also based on simulations of worst-on-worst stress cases, the addition of the drag chute performance always resulted in acceptable rollout margins and brake energies based on Flight Rules.

4.12. DEROTATION

The objective of the derotation is, with the main landing gear on the runway, to decrease the pitch attitude of the orbiter at a controlled rate, until the nose gear is on the ground. Furthermore, due to increases in the Orbiter gross weight and Center of Gravity (C.G.) limits, it became necessary to manage main landing gear loads and nose landing gear axle loads during this phase of the landing and rollout. Initially the Orbiter derotations were done manually, with a design pitch rate of $-2^\circ/\text{sec}$. which should be ramped in over 1-2 seconds. These parameters are still true today for Beep Trim failures and BFS landings.

Postflight data analysis revealed that the actual pilot inputs for derotation varied from crew to crew and that the RHC deflections sometimes more closely approximated a step input. This rapid RHC deflection would result in a corresponding rapid elevator deflection and the aerodynamic vertical force spikes would excite the poorly damped landing gear spring action. This 'bounce' effect resulted in increased peak loads to the main landing gear and tire assemblies throughout derotation. Starting with STS-59 the Shuttle Program modified the RHC pitch beep trim acceleration logic resident in the Aerojet DAP to be a semi-automatic derotation function. This logic path is active after WOWLON and before ROLLOUT, which is set after Weight On Nose Gear (WONG). This is the time the vehicle is on the runway in the two-point stance. When two of the vehicle's four squat switches (2 per main landing gear assembly) are set, the Autoland Derotation Control Loop is set.

Nominally at 185 KGS, the Commander initiates derotation by selecting (pushing) and holding the beep trim forward on the RHC. If the beep trim fails, the current training and flight rules aim for the crew to recognize this and initiate manual derotation by 175 KGS. While the beep trim switch is depressed, flight control ramps in a negative rate command at 0.6 deg/sec^2 until a maximum commanded rate of 1.5 deg/sec is achieved (2.5 seconds elapsed). Due to the dynamic behavior of the flight control system, the flight average derotation rate using beep trim is 2.1 deg/sec . The RHC pitch controller remains active and its inputs are additive to the beep trim component. This 'Beep Trim' derotation function and procedure was adopted to standardize the pitch axis derotation initial ramp and steady state value thus reducing dispersions in main and nose gear loads.

For OI-28, a software change was made to increase the fault tolerance of the beep trim switch to single fault tolerant. The software change is for PASS only, and only affects processing of beep trim contacts (two) after WOW. At WOW, the RHC beep trim switch outputs for positive pitch, positive roll and negative roll are inhibited. The software then performs a first pass and sets any RHC trim contact indicating "1" to "0." While the EAS is greater than 195 kts, RHC trim output is logical "and" of the two inputs. While the EAS is less than 195 kts, RHC trim output is logical "or" of the two inputs.

The flight control derotation logic commands a pitch rate that is a function of the WT and the pitch attitude (Figure C.2-1, Appendix C). The division between the light and heavy WT's is approximately 222,000 lb. (6900 slugs). The heavier weight vehicles are allowed to derotate at a higher rate in an attempt to avoid high trailing edge up-elevon deflections, which increase the peak main gear loads at NGTD. The increase in the derotation pitch rate (and consequently elevon trailing edge up elevon deflection) is limited by the resulting increase in the loads on the nose gear at T/D.

As the Orbiter derotates, the wing passes through zero degree angle of attack, which is approximated by a pitch attitude of theta equal to zero. Below theta equal to zero, the aerodynamic loads of the wing and fuselage add to the loads experienced by the landing gear and tire assemblies. This downloading effect decreases as the speed of the orbiter decreases. The trailing edge up position of the Orbiter elevons also increases this downloading effect. Deceleration during the aerobraking (no drag chute) decreases until a minimum value is reached at about 4° pitch and then again increases until the nose gear is on the ground. Maximum non-braking deceleration during the rollout is quite often at NGTD.

For mid to heavy weight orbiters it is impossible to maintain a constant pitch rate at the lower pitch attitudes during derotation, because of factors such as vehicle weight and c.g., decreasing dynamic pressure (which reduces elevon effectiveness), and the coefficient of friction of the runway. No attempt should be made to arrest these increased nose down pitch rates when normal Beep Trim is used, or for the Beep Trim failed or BFS cases.

The aerodynamic pitching moment increment due to elevon deflection is non-linear. For deflections above -20 deg Trailing Edge Up (TEU), there is very little benefit by commanding more up elevon. Moving the elevon from -20 to -33 deg increases the pitching moment increment less than 5%. But the negative lift is increased by 13% and the drag by 221% for this same last 13 deg of up elevon deflection. Therefore in pitch CSS starting with the first flight of OI-8D (STS-40), the upper elevon command during the two point stance was limited to -20 deg TEU.

Dynamic elevon logic (DEC_LIM) was implemented as part of the OI-23 software package (first flight was STS-65) to further balance the trade off between main gear tire loads during derotation and the 90,000 lb. nose gear axial load limit. This logic only functions for the pitch axis in the two-point stance and runs at the flight control's maximum inner loop frequency of 25 Hz. The Dynamic Elevon logic will dynamically "latch" the upper elevon limit based on what the unlimited elevon command is when the vehicle pitch attitude falls below 1.5 deg during derotation. Provisions were made for "unlatching" this dynamic limit if the pitch rate is high enough to warrant it, or should the vehicle pitch back up above the 1.5 deg value during the derotation. A brief overview of the logic follows:

- 1) WOWLON is checked as set (e.g., WOW=+1) and WONG is not set (e.g., WONG=0); or more simply stated, the vehicle is in the "two point" attitude on the runway. On the runway, Dynamic Elevon sets the elevon range to 18° TED to -20° TEU (Note: the elevon software range is set to 18° Trailing Edge Down (TED) to -33° TEU using the NASA sign convention).
- 2) Once Dynamic Elevon is invoked after WOW, it checks for:
 - a) $\theta > 1.5^\circ$ (I-load value iterated and derived from VMS testing), or
 - b) q (pitch rate) $> 7^\circ/\text{sec}$
- 3) If either is true, Dynamic Elevon sets the maximum TEU possible to -20°.
- 4) Dynamic Elevon then checks for:
 - a) $\theta \leq 1.5^\circ$ and if
 - b) $q \leq 4^\circ/\text{sec}$ and if
 - c) current elevon command is $> 20^\circ$ and if
 - d) pitch CSS is set
- 5) Then Dynamic Elevon latches the elevons at their current position.
- 6) The elevons will then not move unless the "Slap Down" rate exceeds $7^\circ/\text{sec}$ at which time it will set (or "unlatch") the elevon maximum TEU command to -20° TEU.
- 7) Elevon limit is set directly to -20° TEU maximum if:
 - a) $\theta > 1.5^\circ$ and if
 - b) $q > 4^\circ/\text{sec}$

Once WONG is set, the Load Relief function takes over and drives the elevons to 10° TED at $20^\circ/\text{sec}$ (rate with 3 Auxiliary Power Units (APUs)). The single APU rate is $13.9^\circ/\text{sec}$.

4.13. COAST

The procedures used between the NGTD and the end of the rollout consists of several compromises between the necessity of stopping on the runway and possible damage that might be caused by heavy braking. The coast phase is considered to begin when the WONG signal is generated. The elevons are moved from the position required to control the derotation to the final position of 10° down to reduce the loads on the main landing gear. The coast phase has been extended somewhat with the use of the drag chute. The procedures still state that nominal braking should not be initiated until after WONG, after passing midfield, and after decelerating through 140 KGS. But the increased deceleration due to the drag chute has allowed crews to delay braking until 110 KGS on average and the flight average stopping distance is still over 700 ft shorter than before the drag chute aided stops.

4.14. BRAKING

4.14.1. Flight Experience

Prior to the carbon brake modifications, the Beryllium brakes of the orbiter experienced some damage on almost every flight. This damage resulted from vibration caused by coupling between hydraulics and brake dynamics and from the thermal energy absorbed by the brakes and tires. The vibration damage occurred at moderate brake pressures and was independent of brake energy; whereas, the thermal structural failures occur after considerable energy has been absorbed. Consequently, the failures caused by thermal energy occur at low speeds (less than 50 KGS). The damage, due to vibration, did not cause the main landing gear wheels to lock, but thermal damage has caused the wheels to lock on two flights and also caused a tire to fail at low speeds on one flight. One of the thermal plugs melted after the rollout was completed on another flight. The design of the system has been changed in an attempt to correct some of these problems, but the thermal energy absorbed by the brakes can be minimized by controlling the braking techniques. Appendix C.2 contains a discussion of the braking procedures, including brake energy discussions and data. Section 5 should also be referenced for more details.

5. FLIGHT PROCEDURES

5.1. LANDING AND ROLLOUT SUMMARY

The landing and rollout phase of flight requires vast knowledge, verbatim recall of Flight Data File (FDF) procedures, a high skill level, and hundreds of practice runs in various landing simulators. The simulation of this phase of flight falls short of duplicating the experience in the orbiter. The STA provides the closest simulation, but simulates orbiter flight only from about 180° of turn to go on the HAC to the instant of T/D. The Shuttle Mission Simulator (SMS) simulates all phases of orbiter flight but the motion and visual cues during landing and rollout are not high fidelity. The Vertical Motion Simulator (VMS) at the Ames Research Center provides excellent motion cues for landing and rollout as well as high fidelity visual cues (VMS visuals were extensively updated in 1994). The simulation and training of a complete orbiter landing cannot be accomplished in a single training asset with consistent fidelity. Consequently, shuttle Commanders and Pilots must blend together the strengths, lessons, and training objectives from the many assets utilized to maximize their preparedness for the demanding landing and rollout task.

5.2. FLIGHT DATA FILE

5.2.1. Landing and Rollout Briefing

The “deorbit prep” timeline allows a period of time for an entry briefing. This period, labeled “Entry Review”, typically occurs about 1 hour 40 minutes before the deorbit burn. Landing and rollout briefing items should include, but are not limited to, the items in the bottom third of the DEL PAD. These are:

- a. Altimeter setting
- b. Type of HAC; overhead or straight-in, left or right turn
- c. Degrees of turn on the HAC
- d. Runway
- e. TACAN and MLS channels
- f. Aimpoint; nominal or close-in
- g. Winds at 50k, 38k, 28k, 20k, 12k, 7k, 3k, 1k and at the surface
- h. The predicted SB setting at 3k ft
- i. Expected aileron trim
- j. X-c.g. at touchdown
- k. Speedbrake; nominal or short field
- l. Time from M<1 to the HAC
- m. Time from the beginning of the HAC to H=20Kft
- n. Maximum Nz on the HAC
- o. Nz limit

The crew will have already developed a standard plan established in training and will use this brief to discuss any changes required by the conditions on landing day.

5.2.2. Entry Maneuvers Cue Card

The Entry Maneuvers Cue Card contains all the required procedures for landing and rollout. The Entry Maneuvers Cue Card is shown in Figure 5.2.2-1, and rationale is given below for the steps beginning at Mach < 1 step.

M < 1.0 (Check) R FLT CNTLR - ON

Power for NWS is provided through the right flight controller power switch, which is verified ON for landing.

P, R/Y - CSS as reqd

The crew takes CSS in all axes to fly the orbiter to a landing. CSS is entered by pushing either set (CDR or PLT) of the two CSS PBI's; one for pitch and one for roll/yaw, or by deflecting either RHC at least 6° out of detent in both axes. The CSS axes are engaged independently. Regardless of the method of engaging, CSS should be verified by observing the illumination of both CSS PBI's.

(Check) SPDBK CMD vs POS

The crew ensures that the SB is moving to its commanded position by checking the SPI or the GNC SYS SUMM 1 display.

(Check) NWS - 1

The NWS system can be selected either to the primary NWS1 or redundant NWS2 position. Normally, NWS1 is used unless system failures render it inoperative, in which case NWS2 is selected.

Lock Inertia Reels

The inertia reels on the seats lock the shoulder harness, so that in the event of a hard landing, the crewmember is restrained against the seat much the same way as seat belts work in a car.

There is a 5 point restraint system on the seat. The restraints consist of shoulder belts, adjustable lap belts, and a strap with a buckle that goes between the legs where all belts attach. The shoulder harness can be retracted by the inertial reels.

MAX Nz _._

This number is transferred from the corresponding block on the DEL PAD. The Mission Control Center (MCC) calculates the maximum predicted normal acceleration on the HAC so that the crew knows the g-loading to expect in the turn.

M = 0.7 (Check) LG EXT D ISO VLV - OP

The hydraulics landing gear extend isolation valve is opened at Mach 0.8 by GPC commands. If the valve does not open, the crew manually takes the valve to the open position. This valve enables hydraulic system 1 flow for landing gear deploy and for Nose Wheel Steering.

h = 15K (Check) MLS

Check GNC SPEC 50 to ensure that "MLS" is displayed double overbright below the graphical portion of the display. This indicates that MLS data is being incorporated into the navigation state. The "M" status for the MLS on GNC SYS SUMM 1 also disappears indicating MLS lock-on. The altitude of 15,000 ft for this call-out is approximate. The actual governing parameters for MLS acquisition are as follows:

- | | |
|-------------------|--|
| a. Azimuth (AZ) | Within 13.5° of approach course |
| b. Elevation (EL) | Between 0.5° and 29° |
| c. Range | Less than 15 NM to the MLS DME station |
| d. Heading | Within 55° of runway heading |

If MLS data is not incorporated by 15,000 ft, and the above parameters are met, the crew should check with the MCC to verify MLS status.

h = 10K (Check) A/L, TABS/VISORS – CL/LES O2 – ON (KSC)

The approach and landing guidance transition can occur as early as 10,000 ft if altitude, Flight Path Angle error, Crossrange error, Altitude error, and Dynamic Pressure error are all within specified limits (Section 5.3.3 and Appendix B.1). Regardless of errors, transition to the approach and land phase will occur (or be "forced") at 5000 ft. The crew should note that the transition has occurred by a flashing "A/L" on the VERT SIT 1 display and a "CAPT" message in the lower left-hand corner of the HUD. The crew will also note that the body flap has begun moving to the trail position.

Visors are lowered for landings at KSC to provide additional protection in the event of a birdstrike to the orbiter windscreen.

h = 2K LDG GEAR ARM pb - push (ARM It on)

There are two pyros on the NLG and two pyros on each of the MLG. The pyros are charged and used as a backup to extend the landing gear in the event that there is a failure with the hydraulic system.

h = 300 LDG GEAR DN pb - push (DN It on)

This pushbutton cues the hydraulic system to extend the landing gear. If a problem/failure occurs such that the hydraulic system does not extend the landing gear within one second, four MLG pyros will fire, deploying the gear. This pushbutton will also nominally arm and fire two assist pyros on the NLG. These pyros are used to assist in the extension of the NLG since it has to overcome increased aerodynamic forces due to its location on the orbiter.

MAIN GEAR TD (Check) SPDBK - 100%

When WOW is set after MGTD, and if the SB is in the AUTO mode, the SB opens to 100 percent. The open SB aids derotation control by reducing the pitching moment required of the elevons, and provides additional deceleration drag.

V = 195 KEAS DRAG CHUTE ARM, DPY pb (two) – push (simo) (All Its on)

The intent of a nominal drag chute deploy is to achieve disreef just prior to nose gear touchdown. Flight data and Ames testing have shown that to achieve this objective, the chute should be deployed 10 kts prior to derotation. Flight Rules A10-143 and A10-144 cover techniques and constraints to drag chute deploy including requirements for early, late and emergency deploy.

V = 185 KEAS DEROTATE

The shuttle pitches down in preparation for nose gear touchdown.

NOSE GEAR TD SRB SEP - MAN/AUTO and depress pb

(Check) Auto Load Relief

(Check) HYD BK ISOL VLV (three) - OP

Taking the SRB SEP switch to auto and depressing the SEP PB (or doing the same with the ET SEP switch and PB) backs up the WOW and WONG discrettes in case one or both have not been set by this time. WOW, WONG, and theta less than zero are required for the GSENBK flag to be set, which enables the NWS and modes the HUD and software to the rollout mode. Auto load relief occurs immediately after the GSENBK flag is set, and is indicated by the illumination of the auto pitch PB's on the eyebrow panel, and by the elevons deflecting to 10° down. Auto load relief reduces main gear loads.

The brake isolation valves are opened at WOW by GPC commands. These valves allow primary and redundant hydraulic pressure to the brake system. Hydraulic brake isolation valve 2 also supplies redundant hydraulics to the Nose landing gear deploy uplocks and Nose Wheel Steering system.

MIDFIELD and V < 140 KGS BRAKE as required (8-10fps², -0.25 to -0.3 G)
*** If 5K remaining and V > 140 KGS - MAX BRAKING ***

Use the nominal profile for V < 140 KGS after passing midfield. If greater than 140 KGS when 5000 ft of runway remains, use maximum braking, which means depressing the brake pedals fully. In addition to braking cues in

fps², cues in g's were added since MEDS configured vehicles will display acceleration in g's. The Heads Up Display will continue to display acceleration in fps².

V = 60 KGS DRAG CHUTE JETT pb – push (JETT1, JETT2 lt on)

The drag chute should be jettisoned at 60 +/- 20 KGS, but no slower than 40 KGS. If the chute is jettisoned below 20 KEAS, there is an increased probability that the drag chute risers will contact and possibly damage the engine bells. All crew procedures after nose gear touchdown that are cued to velocity must use ground speed because the Heads Up Display changes from airspeed to ground speed at WONG. The 40 KGS minimum jettison cue is 20 kts faster than the 20 KEAS constraint to account for wind and atmospheric effects, instrumentation error, and system lag.

V = 40 KGS BRAKE < 6fps² (-0.2G) (Antiskid cutout)

At 40 KGS, reduce braking. Antiskid functions cease at about 9 to 14 KGS and the reduced braking minimizes skid potential.

WHEEL STOP Go to ENT C/L, POST LANDING PROCEDURES

At wheel stop, the crew is directed to the Post Landing Procedure section of the Entry Checklist.

FLIGHT CONDITIONS	MANEUVER
V = 7K	√TACAN status * If ELS: UHF MODE – G TR *
V = 5K	ADTA PROBES – DEPLOY (√HEAT) Begin AIL and RUD trim monitoring
M = 2.7	√APUs HUD PWR (two) – ON
* If M < 2.5; P CSS for ADTA to G&C incorp *	
M = 2.0	Ensure ADTA to G&C else √Theta limits
M < 1.0	√R FLT CNTLR – ON P,R/Y – CSS as reqd √SPDBK CMD vs POS MAX N ₂ <input type="text"/> <input type="text"/> <input type="text"/> √NWS – 1 Lock Inertia Reels
M = 0.7	√LG EXTD ISO VLV – OP
h = 15K	√MLS
h = 10K	√AIL, TABS/VISORS – CLLES O2 – ON (KSC)
h = 2K	LDG GEAR ARM pb – push (ARM It on)
h = 300	LDG GEAR DN pb – push (DN It on)
MAIN GEAR TD	√SPDBK – 100%
V = 195 KEAS	DRAG CHUTE ARM, DPY pb (two) – push (simo) (All Its on)
V = 185 KEAS	DEROTATE
NOSE GEAR TD	SRB SEP – MAN/AUTO and depress pb √Auto Load Relief √HYD BK ISOL VLV (three) – OP
MIDFIELD and V < 140 KGS	BRAKE as required (8-10 fps ² , -0.25 to -0.3G)
* If 5K remaining and V > 140 KGS – MAX BRAKING *	
V = 60 KGS	DRAG CHUTE JETT pb – push (JETT1, JETT2 It on)
V = 40 KGS	BRAKE < 6 fps ² (-0.2G) (Antiskid cutout)
WHEEL STOP	Go to ENT CL, <u>POST LANDING PROCEDURES</u>

Figure 5.2.2-1 Entry Maneuvers Cue Card
(example only – reference flight specific version)

5.2.3. Other FDF

a. DEL PAD (Figure 5.2.3-1)

MCC provides information that the crew transcribes onto the DEL PAD. This includes landing and rollout information such as: altimeter setting, expected aileron trim, the direction of the HAC turn and whether it is overhead or straight-in HAC, the number of degrees of turn on the HAC, and the selected runway. The TACAN and MLS channels, the selected aimpoint (nominal or close-in), the selected speedbrake (nominal or short field), the expected SB setting at 3000 ft, the maximum expected normal acceleration on the HAC, the X-c.g. at touchdown, and the predicted winds at various altitudes from 50,000 ft to the surface are also included in the DEL PAD. The winds are given for 50,000 ft, 38,000 ft (270 degrees of HAC turn remaining), 28,000 ft (180 degrees of turn remaining), 20,000 ft (90 degrees of turn remaining), 12,000 ft (established on final), 7000 ft, 3,000 ft, 1,000 ft and at the surface. The 3,000 ft and 1,000 ft points were recently added to show any low altitude wind shear. In

addition, the amount of time from M<1 to the HAC, as well as the amount of time from the beginning of the HAC to H=20Kft are given to aid the crew in their planning for PLT flying, if desired, as defined by the Subsonic Pilot Flight Control Flight Rule (A2-266). The maximum expected normal acceleration number is transferred to the Entry Maneuvers Cue Card and the winds are transferred to the Orbiter Xwinds Limits Cue Card.

<u>PRE-DEORBIT</u>									
APU START: SINGLE APU START, ATTEMPT <input type="checkbox"/> APU(s) APU START SEQUENCE <input type="checkbox"/> THEN <input type="checkbox"/>									
<u>DEORBIT</u>									
BURN CUE CARD: OMS TIG SLIP – NO EXEC > TIG + [] : [] [] RCS DOWNMODING [] : [] [] STOP/CONTINUE CUES: L OMS FAIL HP R OMS FAIL HP OMS ENG FAIL XFEED QTY CUE %L [] [] %R [] [] ENG FAIL HP [] [] [] SAFE HP [] [] [] TOT AFT QTY 1 (%) [] [] [] TOT AFT QTY 2 (%) [] [] [] PREBANK/FLIP HP [] [] AFT HP [] [] B/U SITE [] [] [] FRCS: DUMP TO % (USE TIME AS CUE) <input type="checkbox"/> OX <input type="checkbox"/> FU [] [] []									
<u>ENTRY/LANDING</u>									
EI - 5 MM303 INRTL ATT R [] [] [] P [] [] [] Y [] [] [] MM304 PREBANK (ENT MNVR Cue Card) <input type="checkbox"/> L <input type="checkbox"/> R [] [] [] ALTM SET [] [] [] . [] [] [] CLG INIT [] [] [] : [] [] [] : [] [] [] EXPECTED AIL TRIM <input type="checkbox"/> L <input type="checkbox"/> R [] [] [] . [] [] [] VREL 1ST REVERSAL [] [] [] [] [] [] XCG AT TD [] [] [] [] [] [] . [] [] [] LAND SITE [] [] RWY [] [] [] [] [] 50K [] [] [] / <input type="checkbox"/> L <input type="checkbox"/> OVHD [] [] [] deg [] [] MLS 38K [] [] [] / <input type="checkbox"/> R <input type="checkbox"/> STRT [] [] [] [] TAC 28K [] [] [] / ΔT MACH < 1 TO HAC MAX Nz [] [] [] Nz LIMIT [] [] [] 20K [] [] [] / [] [] [] : [] [] [] . [] [] [] [] [] [] . [] [] [] 12K [] [] [] / ΔT HAC INIT to H = 20K [] [] [] [] [] [] 7K [] [] [] / [] [] [] : [] [] [] [] [] [] 3K [] [] [] / AIMPOINT SPEEDBRAKE [] [] [] % @ 3K 1K [] [] [] / <input type="checkbox"/> NOM <input type="checkbox"/> NOM <input type="checkbox"/> CLOSE-IN <input type="checkbox"/> S.F. SURFACE [] [] [] /									
REMARKS:									

Figure 5.2.3-1 DEL PAD

b. Drag Chute Deploy, Failed Tire Technique and Upper Level Winds Cue Card (Figure 5.2.3-2)

This card contains a description of the different drag chute deploy conditions, the landing technique when expecting a failed main gear tire, and a table to transcribe the winds from the DEL PAD. For more details on drag chute deploy, see Section 5.3.6.7. The failed tire technique is done in an attempt to prevent the adjacent tire from failing during derotation. If possible, a concrete runway is highly desired, as well as using a runway where the crosswind is coming from the side of the failed tire.

DRAG CHUTE DEPLOY

MCC Call	Flight Condition
Early	Main Gear TD
NOMINAL	195 KEAS
Late	Post-Nose Gear TD Xwind DTO
Emergency Only	No Deploy Except CDR call
NO DEPLOY prior to MGTD > 230 KEAS < 80 KGS Xwind > 15 kts	

FAILED TIRE TECHNIQUE

Post-MGTD	P – AUTO
185 KEAS	Deploy drag chute
180 KEAS	√Auto derotation
NGTD	Max RHC roll away from failed tire

50K	/
38K	/
28K	/
20K	/
12K	/
7K	/
3K	/
1K	/
SURF	/

**ENT-6b/E/T
(Partial)**

Figure 5.2.3-2 Drag Chute Deploy, Failed Tire Technique and Upper Level Winds Cue Card

c. Landing Site Table (Figure 5.2.3-3)

This chart contains landing site locations and a corresponding site number. The site number corresponds to the number used in Item 40/41 on Spec 50. On the Landing Site Table (LST), each site number has an associated primary and secondary runway. The primary and secondary runways correspond to Items 3 and 4 on Spec 50. For each runway, the landing site table lists the primary and secondary (if applicable) TACAN/DME channels, the MLS channel (if applicable), the runway length, and the useable overrun length. Primary and secondary TACANs

are selected via Item 5 on Spec 50. OI-30 flight software expanded the LST from 25 to 45 areas, which allows 90 runways to be available for crew selection.

The Ascent/Entry Flight Techniques Panel (AEFTP) #186 approved a change to the LST format which includes runway threshold displacement and overrun information for crew Emergency Landing Site (ELS) landing procedures. The length column shows runway lengths with black shading for runway thresholds that have been displaced by the I-load process to create a usable underrun for orbiter landings. ELS runway thresholds are displaced 500 feet by the I-load process if a usable underrun of at least 500 feet does not exist. For example, the Gabreski (FOK) runway 06 will have a runway length displayed as "8500" instead of "9000" to indicate a 500 feet displacement. ELS runway thresholds will not be displaced by 500 feet if the resulting usable runway length (displaced length + usable overrun) will require ELS short field speedbrake procedures instead of short field procedures (reference AEFTP meeting #186). This threshold displacement rule affects sites with usable runway lengths between 8500 and 8999 feet. A non-zero overrun length value indicates a usable orbiter rollout surface. The "+" symbol in the overrun column label indicates that the overrun length should be added to the runway length to compute the total usable runway length. The Landing Site Officer (LSO) group determines if an underrun or overrun surface is usable for orbiter landings. Values for runway and overrun lengths are rounded to the nearest 10 feet to aid crew real-time use.

**STS-114 LANDING SITE TABLE
(50° to 63.5° INCLINATION)**

S I T E	LOCATION	RWY	TACANS		MLS CH	LG	+ OVR RUN
				ITEM 5			
16	OTIS ANGB	FMH 32	BOS 74	PVD 103	-	9000	0
		FMH 23			-	7500	0
17	PEASE INT'L	PSM 34	ENE 118	BOS 74	-	10020	0
		PSM 16			-	10020	0
18	HALIFAX INT'L	YHZ 24	UAW 38	YHZ 98 ■	-	8800	0
		YHZ 33			-	7700	0
19	STEPHENVILLE	YJT 09	YJT 78	YDF 80 ■	-	9500	0
		YJT 27			-	9500	0
20	ST JOHNS INT'L	YYT 29	UYT 23	YYT 82 ■	-	8500	0
		YYT 11			-	8500	0
21	GANDER INT'L	YQX 21	YQX 74	IQX 32 ■	-	9700	0
		YQX 31			-	8900	0
22	GOOSE BAY	YYR 26	UYR 40	YYR 120 ■	-	10550	0
		YYR 34			-	9080	0
23	LAJES	LAJ 15	TRM 109	LAJ 45	-	10870	970
		LAJ 33			-	10870	990
24	BEJA	BEJ 01L	MOJ 37	BEJ 105	-	10820	0
		BEJ 19R			-	10820	900
25	KEFLAVIK	IKF 20	KEF 57	HL 44 ■	-	9520	0
		IKF 29			-	9560	0
26	SHANNON	INN 06	SHA 80 ■	CRN 37 ■	-	9540	0
		INN 24			-	9540	0
27	FAIRFORD	FFA 27	FFA 81	BZN 56	-	9490	990
		FFA 09			-	9490	970
28	KOLN/BONN	KBO 14L	GIX 18	DOR 23Y ■	-	12020	0
		KBO 32R			-	12020	0
29	ISTRES	FMI 33	◆FMI 16	NIM 53	◆6	11300	3960
		FMI 15			-	12300	0
30	ESENBOGA	ESN 03R	BAG 78 ■	BUK 90 ■	-	11800	0
		ESN 21L			-	11800	0

◆ Available for TAL Only

■ DME

Length after displaced threshold

Figure 5.2.3-3 Landing Site Table (Page 1 of 3)
(example only – reference flight specific version)

d. Entry alpha cue card (Figure 5.2.3-4)

This card provides information for monitoring the entry using relative velocity and range to the landing site. The crew uses this card to assess their energy state and make decisions concerning the landing and rollout phase of flight, such as whether or not to downmode to a lower energy profile (e.g., straight-in versus overhead HAC). The card also provides the maximum L/D alpha for Mach numbers of 3, 2, and 1. Subsonic maximum L/D is 10° to 11° alpha.

ENTRY ALPHA

VR	α_{ref}	R	H	\dot{H}_{ref}	Rref
25	40	4462	400		
24	HI 40 LO	2639	247	-46	L78
23	43 40 37	2163	239	-63	68
22	43 40 37	1805	232	-82	62
21	43 40 37	1527	226	-104	R59
20	43 40 37	1300	220	-121	58
19	43 40 37	1125	212	-143	60
18	43 40 37	982	206	-165	61
17	43 40 37	862	199	-185	62
16	43 40 37	764	192	-197	64

KSC 15

<table border="1" style="margin: auto;"> <thead> <tr><th colspan="2">MAX L/D</th></tr> <tr><th>M</th><th>α</th></tr> </thead> <tbody> <tr><td>3</td><td>17</td></tr> <tr><td>2</td><td>15</td></tr> <tr><td>1</td><td>12</td></tr> </tbody> </table>	MAX L/D		M	α	3	17	2	15	1	12	HOOK VELCRO
MAX L/D											
M	α										
3	17										
2	15										
1	12										
ASC-14b/114/A,E/C <table border="1" style="margin: auto;"> <tr><td style="text-align: center;">HOOK VELCRO</td></tr> </table>	HOOK VELCRO	HOOK VELCRO									
HOOK VELCRO											

(114 OCFR4 CY)

15	43 40 37	686	185	-118	64
14	43 40 37	613	181	-127	62
13	43 40 37	546	177	-136	60
12	43 40 37	485	172	-151	58
11	43 40 37	429	168	-191	L55
10	41 38 35	376	163	-173	47
9	39 36 33	328	157	-204	43
8	37 34 31	278	149	-237	38
7	33 30 27	230	139	-266	38
6	30 27 24	185	128	-272	39
5	26 23 20	142	115	-273	41
4	22 19 18	106	103	-263	R40
3	19 16 15	75	88	-248	37
2.5	14	61	80	-227	
2	13	50	74	-275	
1.5	10	38	64	-324	
1	8	28	50	-267	

Figure 5.2.3-4 Entry Alpha Cue Card
(example only – reference flight specific version)

e. Entry no - go checklist cue card (Figure 5.2.3-5)

This card specifies no-go criteria for Aero Programmed Test Input (PTI) Detailed Test Objective (DTO), FCS auto mode and crosswind DTO. An “x” in the column is used to show what system or environmental condition has caused the event to be no-go. Rationale for the card is contained in Flight Rule A2-261.

ENTRY NO-GO CHECKLIST

FAILURE OF:	AERO PTI DTO	AUTO FCS MODE	XWIND DTO ①
APU/HYD: 1 APU.....			...X
2 APUs.....	...X		...X
DISPLAYS: 2 ADIs.....	...X		
CDR HUD.....			...X ②
CONTROLLERS:			
RHC: 1L.....			...X
2L & 2R.....	...X		...X
RPTA: 2L or 2R.....			...X
GNC: 2 AAs (LAT).....	...X		...X
2 AAs (NORM).....	X(M < 2.5)	...X ③	...X
2 RGAs.....	...X		...X
2 R DDU PWR SPLY.....			...X
2 IMU (or 1 IMU + BITE).....	...X		...X
2 ADTAs.....			...X
ADTA NOT INCORP			
OR DLMA.....		...X (M < 2)	
MLS NOT INCORP.....		...X (< 6K ft)	
2 FCS CH (same surface).....	...X		...X
DPS: 1 GPC (not restrung).....			...X ④
2 GPC (restrung).....	...X		
2 GPC (not restrung).....	...X	...X ③	...X
1 FF.....			...X ④
2 FF.....	...X	...X ③	...X
2 FA.....	...X		...X
RCS: LEAK (AFT – during ENT).....	...X		
2 YAW JETs (same side).....	...X		
MIN RCS QTY.....	...X		
TRIM: Ail > ± 2.0 deg.....	...X		
DOWNMODE:			
FCS problem.....	...X	...X	...X
AOA.....	...X		...X
PLB: PLBD Latch Gang.....	...X		
LDG/DECEL:			
Tire Leak.....			...X
HYD BRAKE ISOL VLV.....			...X
< 100% Brakes.....			...X
NWS.....			...X
ENERGY – OFF NOMINAL:			
Roll Ref Alert.....	...X		
Above Upper Traj Line.....	...X		
MCC GCA, or VEL & PSN update.....	...X	...X	
No A/L by 6K ft.....		...X	
DATA: SOLID STATE RECORDERS.....	X (LOS)		
XWIND:			
< 10 Knots Peak.....			...X
> 15 Knots Peak.....			...X
> 10 Knots Gust.....			...X
GROUND SYSTEMS:			
No Runway Aim Point.....			...X

NOTES

- ① Consider runway redesignation (M > 6) to avoid Xwind landing
- ② GO if PAPI and BALL BAR available
- ③ Pitch AUTO mode NO-GO for M < 2.5
- ④ GO if only string 4 affected

ENT-7a/E/K

Figure 5.2.3-5 Entry No-Go Checklist Cue Card

5.2.4. Flight Rules Summary

The following flight rules apply to the landing and rollout phase of flight. Consult Volume A of the Flight Rules for detailed rule and rationale information.

a. FR A2-6 LANDING SITE WEATHER CRITERIA

Specifies weather limits for day and night landings, and includes changes in ceiling and visibility requirements based upon ground MLS redundancy.

b. FR A2-206 DEROTATION SPEED

Describes targeted derotation speed, for beep trim cases, beep trim failure cases, as well as leaking/failed main gear tire cases.

c. FR A2-261 ENTRY DTO/AUTO MODE/CROSSWIND DTO GO/NO-GO

Describes what systems failures or external conditions cause PTI's, AUTO FCS mode, or crosswind landing DTO's to be no-go.

d. FR A2-262 LANDING DTO's

Specifies restrictions on DTO's during landing and rollout.

e. FR A2-264 EMERGENCY LANDING FACILITY CRITERIA

Describes the minimum acceptable landing facility requirements for commitment to an emergency landing facility versus a bailout.

f. FR A2-266 SUBSONIC PILOT FLIGHT CONTROL

Describes the conditions for PLT flying when $M < 1$.

g. FR A3-202 MLS

Describes landing site MLS hardware requirements.

h. FR A3-203 LANDING AID REQUIREMENTS

Describes day and night requirements for landing aids at landing sites.

i. FR A4-107 PLS/EOM LANDING OPPORTUNITY REQUIREMENTS

Describes criteria for acceptable approach/land analysis to support PLS/EOM opportunities.

j. FR A4-108 TIRE SPEED, BRAKING, AND ROLLOUT REQUIREMENTS

Specifies tire speed, rollout margin and brake energy constraints.

k. FR A4-110 AIMPOINT, EVALUATION VELOCITY, AND SHORT FIELD SELECTION

Specifies criteria for aimpoint and speedbrake selection.

l. FR A4-111 RUNWAY ACCEPTABILITY CONDITIONS

Describes runways that are grooved/ungrooved, and the conditions that would cause them to be no-go.

m. FR A4-112 UPPER AND LOWER LEVEL MEASURED WIND AND ATMOSPHERIC DATA

Describes lower level wind requirements to assess approach/land performance.

n. FR A4-155 SUN ANGLE LIMITS AND GLARE CRITERIA FOR INNER AND OUTER GLIDE SLOPES

Describes go/no-go criteria for glare during approach/land.

o. FR A4-156 HAC SELECTION CRITERIA

Specifies the priority for HAC selection based on maximum HAC altitude error high and low in 3 DOF and 6 DOF simulations.

p. FR A4-207 ENTRY LIMITS

Describes limits on N_z , Q -bar, and angle of attack (α) during entry and landing.

q. FR A4-208 ENTRY TAKEOVER RULES

Describes conditions that require CSS during entry.

r. FR A8-5 ACCELEROMETER ASSEMBLIES (AA) FAULT TOLERANCE

Describes AA fault tolerance requirements for the pitch axis to remain in AUTO during MM305 and MM603.

s. FR A8-17 EQUIPMENT REQUIRED FOR EMERGENCY AUTOLAND

Lists those onboard systems required to allow the use of AUTOLAND capability to touchdown in emergency situations.

t. FR A8-18 LANDING SYSTEMS REQUIREMENTS

Describes failure modes that require changes to the runway selection due to degraded orbiter capability.

u. FR A8-111 GNC AIR DATA SYSTEM MANAGEMENT

Describes when theta limits procedures are used and the use of CSS during air data incorporation below Mach 2.5.

v. FR A10-141 NOSE WHEEL STEERING (NWS)

Describes how NWS is used on off-nominal situations and describes what systems failures make NWS no-go.

w. FR A10-142 TIRE PRESSURE

Defines the indication for a leaking and a failed tire. Describes downmode requirements for a confirmed leaking or failed tire.

x. FR A10-143 DRAG CHUTE DEPLOY TECHNIQUES

Defines the different type of drag chute deploy techniques.

y. FR A10-144 DRAG CHUTE DEPLOY CONSTRAINTS

Describes the constraints on when the drag chute can be used.

z. FR A10-146 BRAKING

Defines nominal and maximum braking profiles.

5.3. NOMINAL END OF MISSION LANDING

The discussion of the nominal EOM landing and rollout phase of flight is divided into separate subject blocks to provide clarity and easy reference for the reader.

5.3.1. Flight Control Summary

The space shuttle orbiter is a Control Configured Vehicle (CCV) with stabilization and control provided by a redundant, fly by wire digital system. RCS jets in the aft section of the vehicle, in conjunction with aerodynamic surfaces, are used for control during entry. Subsonic, and for all of the approach and landing phase of flight, the aero surfaces are the only source of control; RCS jets are all phased out by Mach = 1.0. Aero surfaces include two elevons on each wing, independently powered, but commanded in unison, a two segment rudder split at the chord line so that it can be opened as a SB, and a body flap which is used as a trim device to drive the elevons to the desired trim position. During rollout, in addition to the aero-surface controls, NWS and differential braking provides directional control.

The Orbiter Entry flight control is a three axis, rate command feedback control system designed to accommodate the unique speed, Q-bar, and angle of attack profiles of the Orbiter, and the changing aerodynamics associated with flight through such a wide range of environments. The flight control system incorporates an inner loop rate command that operates at 25 Hz and an outer loop attitude control. Many feedback loops operate at 12.5 Hz and gain scheduling modules such as air data (Mach, Altitude, Q-bar, and TAS are sampled at 1.04 Hz (for greater detail reference FSSR FCS, GRTLS p 63). The vehicle is required to fly to a certain attitude, which is accomplished by controlling vehicle rates either by pilot input or by automatic command. This inner/outer loop concept is sketched in the following diagram (TD328-010, Entry Flight Training for the Commander and Pilot, August 1985 , p 1-21).

The outer loop may be closed by either the pilot or by the automatic flight control system. The inner loop is always automatic, and functions primarily to provide rate damping, to maintain the commanded rate, and to maintain the proper body roll to body yaw ratio. In flying the orbiter, both the inner and outer loop functions can generate challenges to flying the vehicle. Outer loop anomalies are generally fixed by the pilot taking manual control of the vehicle, while inner loops problems may require modification of the flight itself through FCS down mode options.

In the lateral-directional axis, the vehicle is statically unstable in the hypersonic and supersonic regimes and statically stable in the subsonic regime. In the longitudinal axis, the vehicle is marginally statically stable in the supersonic regime. Subsonic, the vehicle has positive static stability and dynamic stability within the Alpha limits. Flight Rule A4-207 has the MM 305 Angle of Attack boundaries, Figure 5.3.1-1. From Mach 2 to Mach 1, the maximum limit is set to 15°. The limit is then set to 20° for subsonic flight. Boeing Downey data indicates that the vehicle is expected to be unstable in pitch (positive $C_{m_{\alpha}}$) at the “Loss of Control, Pitch-up Angle of Attack” listed in Table 5.3.1-I. The definition of Pitch Up Specification Alpha, is the alpha to which the vehicle is tested and certified. The Loss of Control Pitch Up Alpha, is a manifestation of the delta wing used on the orbiter, and is believed to be the point where the vehicle will depart controlled flight. The longitudinal instability is increased when the main landing gear is on the runway.

Angle of Attack Boundaries - MM305 Only

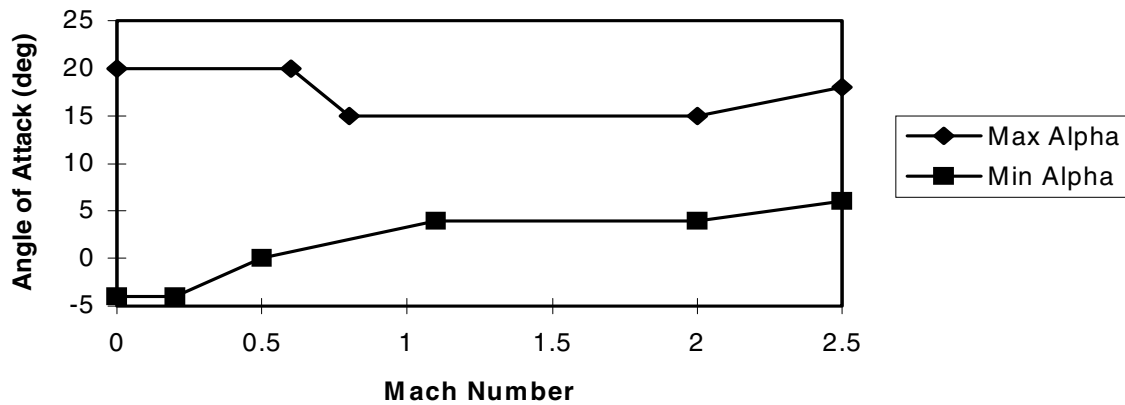

Figure 5.3.1-1 MM305 Angle of Attack Boundaries

Table 5.3.1-I Approach and Landing Alpha Limits

Mach #	Nominal Alpha (degrees)	Max L/D Alpha (degrees)	Pitch-Up Specification Alpha (degrees)	Loss of Control Pitch-Up Alpha (degrees)
1.0	9.0	12.0	15.0	25.0
0.8	8.0	10.5	15.0	25.0
0.6	7.0	10.5	20.0	30.0

Table 5.3.1-II Control Surface Deflection Rates

Control Effector	Deflection Angles	Maximum Rates
Elevons	33° up / +18° down	20°/sec (3&2 APUs)-increases to 30°/sec if TAS<600fps 13.9°/sec (1 APU)
Rudder	Rudder only: +/- 26.6° SB only: 98.6° panel-to-panel Rudder+SB: 52.9°	14°/sec (3 APUs, 5.43°/sec if in SUMLIM) 12°/sec (2 APUs, 5.43°/sec if in SUMLIM) 7°/sec (1 APU, 1.9°/sec if in SUMLIM)
Speedbrake	100% = 98.6° hinge reference line	6.1°/sec OPEN, 10.8°/sec CLOSE 3.8°/sec CLOSE (1 APU)
Body Flap	-11.7° up / +22.5° down Trail = 0° = 34.2%	Depend on amount and direction of aero loads 0.75 – 3.0 °/sec (3 APUs) 0.5 – 2.0 °/sec (2 APUs) 0.25 – 1.0 °/sec (1 APU)

a. Pitch control

The vehicle's pitch control channel is a rate command system that is somewhat independent of the roll and yaw channels above Mach 2.5, but the elevon position schedule (maintained by the body flap and speedbrake interactions) is critical to lateral directional controllability. The Orbiter utilizes three control surfaces to effect pitch axis control; elevons, body flap, and speedbrake. Rates for these control surfaces are shown in Table 5.3.1-

II. All three control effectors are required to trim the vehicles pitching moment, while following a predetermined elevon position schedule. The body flap is a prime contributor because it takes over the task of trimming the body pitching moments after vehicle rates have been controlled by the elevator function of the elevons. In some portions of the Orbiter's flight envelope, the elevon deflection required might be so large (for pitch and lateral-directional control) that they unbalance the pitch axis stabilizing effects of the body flap. For this case, the speedbrake is then used as a contributor to pitch axis control power, to provide a nose up-pitching moment while the elevons are trimmed downward. Below Mach 0.95 the speedbrake function is scheduled at 65% to provide nose up pitching moment when required, and to retain rudder effectiveness.

The outer loop of the pitch FCS receives an angle of attack (Alpha) command at Mach > 2.5, and an Nz command at Mach \leq 2.5 from guidance in the automatic mode. This command is compared to the actual Alpha or Nz to form the error signal. This error signal is then converted to a pitch axis rate command.

During Entry Guidance, the Pitch Auto FCS provides Alpha command and then Nz command during TAEM and Approach and Landing phases.

When the pilot has taken Pitch CSS, he or she is now closing the FCS outer loop and the RHC provides the pitch rate command. The rate command (either auto's error signal, or CSS rate command) then goes to the FCS pitch inner loop where it is differenced with the vehicles actual pitch rate, resulting in a pitch axis rate error signal which is converted to elevon command.

The elevon command is a conventional proportional - plus - integral function, where the integration is implemented as a lagged elevon position feedback. Lagged position feedback is used to avoid trim runaway during periods of actuator stall/control saturation. Pitch rate feedback is filtered by notch filters for body bending attenuation. The aero-surface command is rate and displacement limited by the PRL function.

Manual trim is controlled by either the RHC beep trim (pitch rate trim) in the CSS mode, or the pitch panel trim switch (elevator trim) which is active in both the CSS and auto modes (the roll, pitch, and yaw panel trim switches are on panels L2 (CDR) and C3 (PLT)). The RHC beep trim is the trim switch on the top of the RHC, also referred to as the "cooly hat."

Additional functions include

- (1) SB to elevator interconnect to compensate for pitch transients during SB movement
- (2) Body flap control, auto or manual, to unload the elevon trim
- (3) Up elevon compensation ($r \tan \phi$) for loss of lift in angles of bank
- (4) A nonlinear filter on the RHC input during subsonic flight to minimize Pilot Induced Oscillation (PIO)

b. Pitch control on the runway

The pitch axis control law is reconfigured when WOWLON is set, after MGTD, to incorporate an added forward-loop integral function, a higher forward-loop gain schedule, a landing gear notch filter, and a reduced up-elevon command limit. The RHC pitch sensitivity is cut in half to provide finer control of vehicle derotation rate. WOWLON is set when 1 squat switch detects contact with the runway (2 squat switches per main landing gear assembly) and the spin up of 1 wheel is detected (also 2 wheel spin up detectors per main landing gear assembly). When WOWLON is set by the FCS, the autoland derotation scheme is normally invoked by the commander at 185 KEAS in the HUD by forward Beep Trim. This change was made from the earlier manual derotation performed by the Commander because post flight analysis revealed that manual derotations coupled with vehicle response to main landing gear oleo damping actually increased the peak loads experienced by the Orbiter's tire and wheel assemblies. For these reasons, the beep trim derotation is now the nominal procedure.

As the vehicle derotates (either beep trim or manual derotation), the elevons program up to control the derotation rate. Maximum elevon position is a function of both the pitch rate and theta. Please reference Section 4.12 Derotation, for a more complete discussion. This is necessary to trade off derotation rates, nose landing gear slap down loads, and main gear loads when theta is less than 0° and progressing towards further negative angles of attack.

Once WONG is set, the rollout software is set and the pitch axis is switched to AUTO. The crew observes this by the Pitch Axis push button illuminating "AUTO" vice "CSS" and ground speed being displayed upon the HUD (G170). The RHC deflection required to down mode to CSS is increased from 6° to 20° deflection to prevent an inadvertent hot stick to CSS. The elevons are then commanded to 10° trailing edge down to provide load relief for the main landing gear and tires.

c. Lateral control

Below Mach 1.5 the Orbiter's directional stability $C_{n\beta}$ becomes positive. Roll response to aileron inputs results in roll in the direction of aileron inputs and proverse yaw. Vehicle response to generated β is strong due to the dihedral effect (Cl_β). The rudder is commanded by the AUTO FCS to coordinate turns and in doing so to drive β to zero. When R/Y CSS is taken, the rudder pedals command yaw acceleration and aileron RHC inputs command roll rate.

Cost effective rudder fix (below):

Based upon simulation testing conducted at the Ames VMS after the STS-63 rudder PIO during the two-point attitude in the landing rollout, changes were made to the FCS rudder software. For both in-flight and during rollout, the feedback loop was changed from an Ny feedback filter time delay of 600msec to < 200 msec. The rudder pedal input was changed from a parabolic shaper to a linear shaper and its maximum Ny command was decreased from 2.25 g's to 0.5 g's maximum. Keeping in mind the extremely slow rates at which the rudder moves, particularly when in SUMLIM, this fix made rudder pedal inputs both more predictable and timely. The rudder functions in this fashion during all phases of approach, landing, and rollout while R/Y CSS is invoked.

Roll maneuvers are commanded by the nonlinear, quadratic shaped RHC signal, which is Mach-scheduled to provide the required roll rate per stick deflection. The error signal, shaped roll command minus roll rate feedback, forms the aileron command. The gain of this command is a function of Mach and Q-bar. Notch filters are used to attenuate body bending, similar to the pitch axis.

Body roll rate and attitudes are supplied to the yaw channel and summed with yaw rate, lateral acceleration, and any rudder pedal input to form a yaw command. The gain of this command is scheduled with Mach and Q-bar and, again, notch filters are used to attenuate body bending.

Roll rate trim is available with the RHC beep trim (CSS mode) and aileron trim is available with the roll panel trim switch (CSS or auto modes). Manual rudder trim is available with the yaw panel trim switch in CSS or auto modes to augment the limited authority auto-trim function.

d. Lateral Directional control on the runway

In the roll axis, the aileron is actively controlled after WOWLON using a derived sideslip feedback signal to balance crosswind effects. This process is commonly called load balancing. After WONG, the aileron command for load balancing is faded out over a period of 100 sec. The panel trim and turn coordination functions are disabled after WOWLON.

The yaw axis rudder channel is altered after WOWLON to disable the lateral acceleration and attitude feedbacks, and the auto trim control function is switched out. After WONG, manual rudder pedal commands effect NWS

with filtered lateral acceleration feedback control, and rudder control using proportional yaw rate feedback. The NWS functions through $\pm 10^\circ$ deflection and rates up to $10^\circ/\text{sec}$.

5.3.2. Handling Qualities

Lateral-directional handling qualities are relatively conventional for a large airplane. With large roll rates, significant side force can be generated in the cockpit because of its position above the roll axis. Use of the lateral and directional controls is described in more detail in the crew procedures paragraphs below.

Longitudinal flying qualities are generally good if the pitch task is kept low gain and if the pilot refrains from making aggressive pitch commands. The vehicle has a pronounced tendency for longitudinal PIO if the pilot has high frequency longitudinal RHC inputs. For this reason, the FCS has a PIO compensator in the longitudinal axis that is invoked if the RHC longitudinal inputs attain a frequency of greater than 1 Hz. The PIO compensator will reduce the magnitude of RHC longitudinal inputs, and as the frequency of RHC inputs persists, the PIO compensator has the capability and authority to fade RHC longitudinal inputs to zero. For this reason and so as to not saturate the elevons, pilots train for small amplitude, low gain RHC inputs while piloting the Orbiter during approach, landing, and rollout.

The longitudinal PIO tendency results from a number of factors. The RHC has small deflections, and typically the pilot is experiencing the physiological effects of re-entering the earth's gravity field. This re-adaptation to gravity in some individuals might amplify the sensed accelerations and collaterally slow down an individual's ability to assimilate and process information.

The Orbiter's center of longitudinal rotation is forward of the Commander's and Pilot's stations so that the crew receives poor sensory feedback of the pitch rate being generated. The initial vehicle response to a nose up pitch input is the vehicle and center of gravity initially traveling downward (about 0.5 seconds later) before the increase in angle of attack results in an increase in lift and the consequent vehicle flight path change.

More specifically, there is lag in the vehicle FCS system response time. Pitch axis rotational response has a lag of approximately 40 msec (RHC input to actuator movement), while the vehicle center of gravity has a response lag of 80 msec (RHC input to vehicle c.g. movement). Finally the vehicle translational response in pitch (where the flight path is/has actually changed) lag is approximately 1-2.5 seconds! The HUD also has a lag of ~ 1second behind what navigation and guidance are sensing due to update rates.

The piloting techniques discussed below seek to avoid longitudinal PIO by making the pitch task as simple as possible. Pilots must keep their gains low, especially when the vehicle is close to the ground.

5.3.3. Guidance Summary

For the purpose of this discussion, "guidance" is that portion of software that provides direction for the automatic flight control portion of software when the vehicle is in the AUTO mode, or direction for the pilots, in the form of guidance displays, when the vehicle is being flown manually. This section is intended to summarize the previous, detailed discussion of guidance and provide a pilot's point-of-view description of the task that it is doing in the landing and rollout phase of flight.

a. Prior to HAC Intercept

At the beginning of the landing and rollout phase of flight, the GPC's are processing MM 305 software (TAEM guidance), Acquisition subphase. Guidance is directing the vehicle to the HAC tangency point.

b. Pitch guidance prior to HAC Intercept

Before the HAC, pitch guidance is an Nz command based on altitude error and altitude rate error as a function of range to T/D, measured around the HAC. The Nz command is limited by vehicle constraints of maximum L/D and maximum dynamic pressure, and trajectory constraints of maximum and minimum allowable energy. Beyond

these constraints, the Nz command is independent of airspeed. The Nz command has a delta Nz command limit of $\pm 0.5g$ ($-0.75, -0.5$ for RTLs) above or below the equilibrium body axis Nz. The equilibrium body axis Nz is that Nz required to maintain one g in local vertical coordinates. For example, equilibrium Nz in a stabilized wings level glide is 1g (for small gamma) and the maximum Nz command would therefore be 1.5 g's. The equilibrium Nz in a 60° bank is 2.0 g and the limit Nz command would therefore be 2.5 g's. Figure 5.3.3-1 is a simplified block diagram of the pitch command logic prior to HAC intercept.

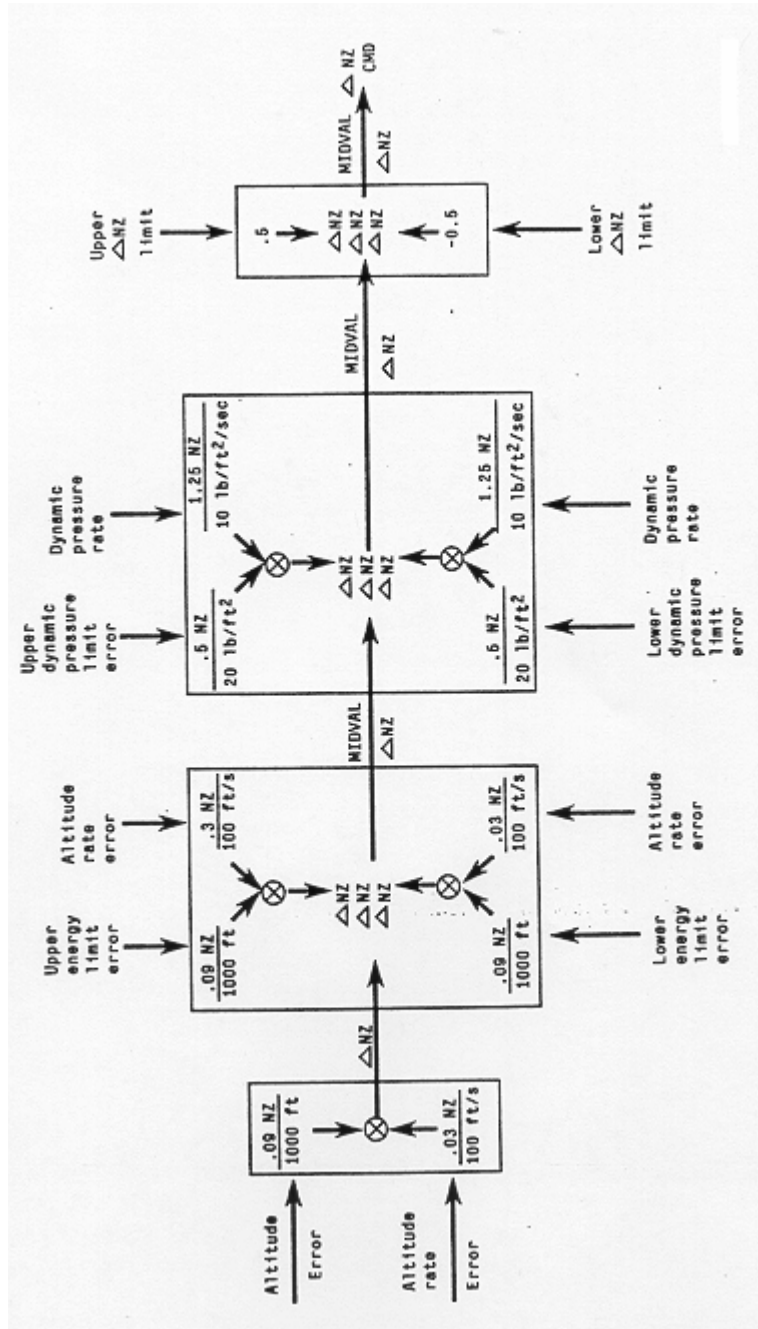

Figure 5.3.3-1 Pitch Command Logic Prior to HAC Intercept

c. Roll guidance prior to HAC intercept

Roll guidance is based on the Delta Azimuth to the HAC tangency point. Subsonic, the roll command is limited to 50° angle of bank on the HAC. After intercepting the HAC, the software modes to the heading alignment subphase where guidance directs the vehicle onto the prescribed spiral path at the appropriate altitude with respect to range to T/D.

d Pitch guidance on the HAC

Pitch guidance on the HAC is unchanged from prior to HAC intercept; there is no maximum Nz limit. Even so, typical predicted maximum Nz command on the HAC is 1.6 to 1.7 g. Actual (flight history) Nz around the HAC has been no more than 0.2 g above prediction, and averages 0.05 g above prediction.

e. Roll command on the HAC

Roll command on the HAC is based on the radial error and radial error rate from the HAC trajectory, and is limited to a maximum bank angle of 60°. If the radial error outside the HAC exceeds 7000 ft, the roll command reverts to the Delta Azimuth reference and is again limited to 50° angle of bank. The reference (no wind) profile, and the size of the HAC are designed to require approximately 43° angle of bank on the HAC.

f. Roll command on the HAC, OI-22 and subsequent

Bank angle command is limited, as a function of Nz command, to constrain the resulting Nz to be within the vehicle certification limit. If the pitch command is approaching the Nz limit on the HAC the roll command will decrease, guiding the vehicle outside the HAC in order to not exceed the Nz limit. The Nz limit is an I-loaded value based on the estimated vehicle weight at the OPS 3 transition, and includes a 1.4 factor of safety.

(1) Prefinal

The last subphase of TAEM guidance is called prefinal and is entered when the range from the HAC tangency point to the approach course intercept point is less than 5300 ft or vehicle altitude is less than 7000 ft above T/D. The pitch command is unchanged except that the trajectory constraints of allowable energy are removed.

(2) Roll command in prefinal

The roll command changes at prefinal from radial error and rate to one based on runway centerline error and error rate. The bank angle limit is still 60°.

(3) Approach and land phase

At the A/L transition, guidance changes to a new set of modes designed to accomplish the remaining tasks of the landing approach. Pilots can think of the A/L transition as the point at which guidance detects that the vehicle is in a position, with sufficient energy, to complete the remaining maneuvers. The transition criteria are:

- (a) Altitude < 10,000 ft above T/D
- (b) Altitude error ± 1000 ft
- (c) Cross range < 1000 ft
- (d) Flight path angle (γ) error $\pm 4^\circ$
- (e) Airspeed 288 - 312 KEAS (or filtered Q-bar error < ± 24 psf)

If the parameters are not met at 10,000 ft altitude, they continue to be sampled as the vehicle descends until they are met. The altitude, crossrange, and gamma error parameters do not remain constant, but gradually decrease as altitude decreases. If the parameters are still not met at 5000 ft altitude, the transition is forced, as TAEM guidance does not control the vehicle sink rate. The first subphase of A/L guidance is the capture phase. The second subphase is designed to track the OGS and is entered when the altitude error is less than 50 ft and the

gamma error is less than 2° , or the gamma error is less than 2° for 4 seconds. Usually, the capture phase lasts a very short time, and can be considered as synonymous to the OGS phase.

g. Pitch command on the OGS

Several changes in the pitch command from TAEM guidance occur in the capture and OGS phases of A/L guidance, but would not normally be detectable by the crew. The pitch command is no longer limited by Q-bar or energy constraints and the 0.5 delta NZ block (last block of Figure 5.3.3-1) is eliminated.

h. Roll command on the OGS

On the OGS, the roll command is based on lateral error and lateral rate error from the runway centerline. The roll command is limited to 45° angle of bank until 7500 ft altitude, after which it is limited to 20° .

i. Preflare

The preflare phase of guidance is entered at 2000 ft above T/D, and is called the FSGS.

j. Pitch command during FSGS

At 2000 ft altitude, an open loop pitch command is issued to break the rate of descent. At 1700 ft the pitch command attempts to track a constant 1.3g pull up circle. This circle is tangent to the OGS and tangent to a point 17.5 ft above the IGS. The open loop command plus the tracking of the pull up circle reduces the 185 fps sink rate to about 12 fps in preparation for tracking the IGS. When the vehicle gets to a point on the circle 35 ft above the IGS, the pitch command tracks an exponential decay path down to the IGS. This takes about 2 seconds and is followed by about 8 seconds of tracking the IGS before the FF phase (Figure 5.3.3-2).

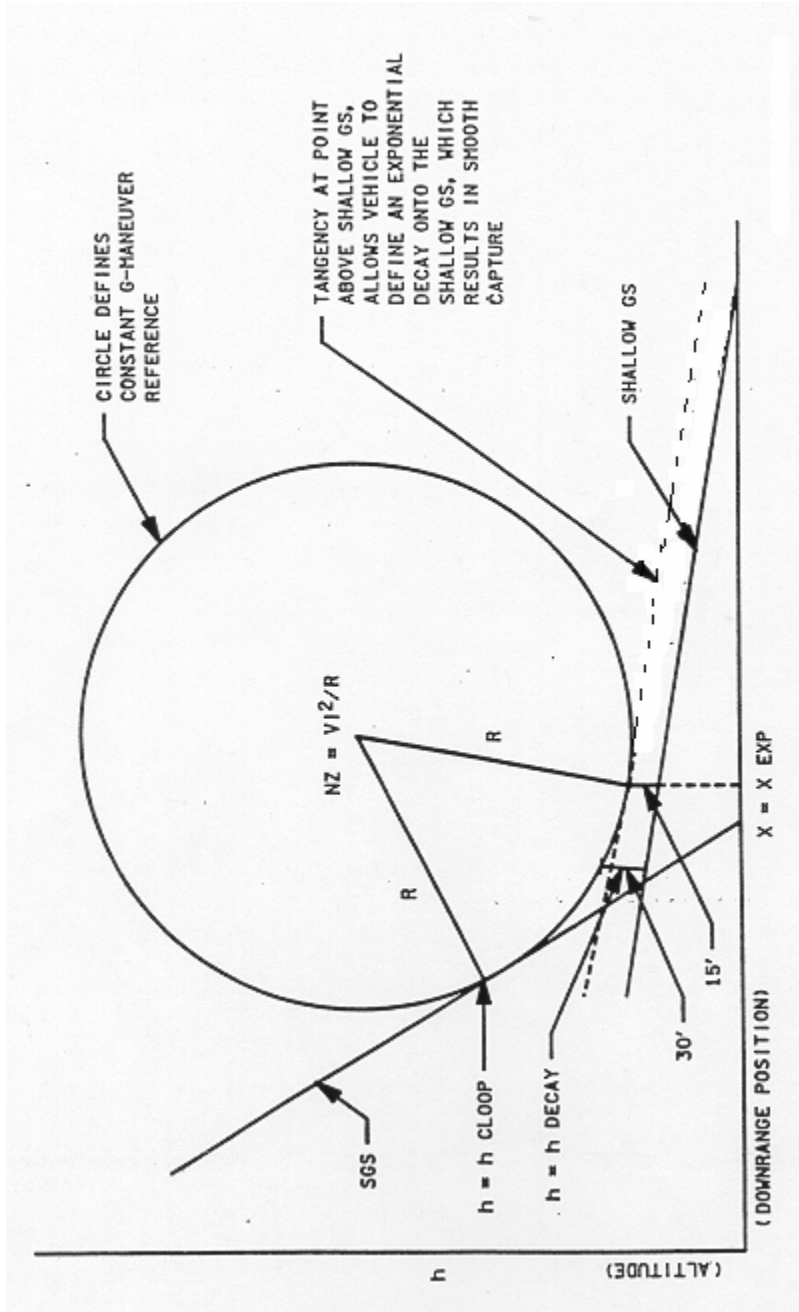

Figure 5.3.3-2 IGS Intercept

k. Roll command during FSGS

There is no change in the roll command from that on the OGS.

l. Final Flare

This phase of guidance is entered at an altitude of 30 to 80 ft, depending on the altitude rate. With the vehicle in CSS, the guidance command is removed from the HUD when the FF phase is entered, so there is effectively no guidance provided from that point on. If the vehicle is in auto, the display of guidance is retained.

m. Pitch command in the FF

In the FF phase, the Nz command is based on altitude rate error referenced to a look-up table of desired altitude rates (sink rates) versus altitude. The table is a linear plot of desired sink rate versus altitude which, for example, has a value of 13 fps at an altitude of 52 ft and 3 fps at 2 ft of altitude. Below 2 ft altitude, the reference is a constant 3 fps. Prior to FF, Nz command tries to keep the vehicle at the correct altitude for the current range to T/D. In the FF, pitch guidance no longer cares where the vehicle is with respect to the reference trajectory, but only wants to achieve a vehicle attitude that results in the reference sink rate at T/D. This is different from the philosophy of autoland guidance systems in powered airplanes. In those systems, the desired trajectory is referenced until the airplane is over the runway, because energy is available to achieve it. In a glider, the FF must be accomplished with the available energy, whether the vehicle is over the runway or not.

n. Roll command in the FF

Roll command remains unchanged from that in the OGS phase.

5.3.4. Area Navigation Summary

Area Navigation can be thought of as the subset of software that provides navigation information for display on the two HSI's. The area navigation information is also provided to the HUD altitude and glide slope scales. See Section 2 for detailed descriptions of the HSI and HUD displays.

a. Before HAC Intercept

Throughout the landing and rollout phase of flight, the HSI compass card is referenced to magnetic north and shows the vehicle heading under the lubber line. The course arrow is aligned with the runway designated on GNC SPEC 50 Horizontal Situation Display (HSD). The course deviation indicator shows the direction to fly horizontally to reach the runway centerline. The altitude reference scale shows the vertical distance above or below the reference altitude profile.

Before HAC intercept, the primary bearing pointer points to waypoint 1, the closest point of HAC tangency ahead of the vehicle, and the secondary bearing pointer points to the center of the HAC. For the purposes of area navigation, the HAC is a circle of fixed 15,500 ft radius. The Primary range window shows range to waypoint 2 measured around the HAC. Waypoint 2 is a point on the runway centerline 1000 ft past the threshold. The secondary range window shows distance to the center of the HAC.

b. On the HAC

The bearing pointers and range windows have the same functions as before the HAC. If the vehicle is on the reference trajectory, the primary bearing pointer is under the lubber line and the secondary bearing pointer is 90° left of the nose (left HAC) or 90° right of the nose for a right HAC. The bearing pointers are not in the above positions rigorously if the vehicle is being flown precisely as commanded by guidance. Guidance uses a variable radius HAC (from 26,000 ft to 5000 ft) based on altitude and energy state, so the bearing pointers, which are referenced to the fixed radius HAC, may not be exactly under the lubber line (primary) and 90° off (secondary).

c. Approach scaling

Approach scaling is the event that prepares the HSI for precisely monitoring glide slope and azimuth on final approach. It should not be confused with the A/L guidance transition. On the HSI, the CDI changes from a scale of 5° AZ per dot to 1 1/4° per dot, and the altitude reference scale changes from 2500 ft altitude error per dot to 500 ft per dot. Both bearing pointers point to waypoint 2, and both range windows show the distance to waypoint 2. Approach scaling occurs when the vehicle is below 18,000 ft (12,000 ft if targeting the Minimum Entry Point (MEP)) and is within 2.5° of the runway course. If the 2.5° course deviation is not satisfied, approach scaling is

forced at 12,000 ft (6000 ft for MEP). It is possible to have approach scaling occur, at an altitude above 12,000 ft, and then fly outside the 2.5° course requirement by, for example, overshooting the final approach course. The HSI reverts to the configuration before approach scaling, and a confusing display results (the HSI thinks it should fly around the HAC again). The primary bearing pointer points to the nearest HAC tangency point and the primary range window shows the distance all the way around the HAC to waypoint 2. Since the vehicle is very low for another trip around the HAC, the altitude reference scale shows full deflection up. Because the pilots are looking outside at this point, it is not likely that the confusing HSI display would be noticed. When the vehicle descends below 12,000 ft (6000 ft for MEP), approach scaling occurs once again, and the confusing display is removed.

d.. Preflare

During the preflare at 1500 ft, one more change occurs on the HSI. The altitude reference scale stops being active and the pointer becomes fixed at the center marker of the display. A small red flag labeled “GS” appears in the lower right corner of the HSI.

Figure 5.3.4-1 provides a summary of guidance phases and area navigation displays from TAEM to T/D.

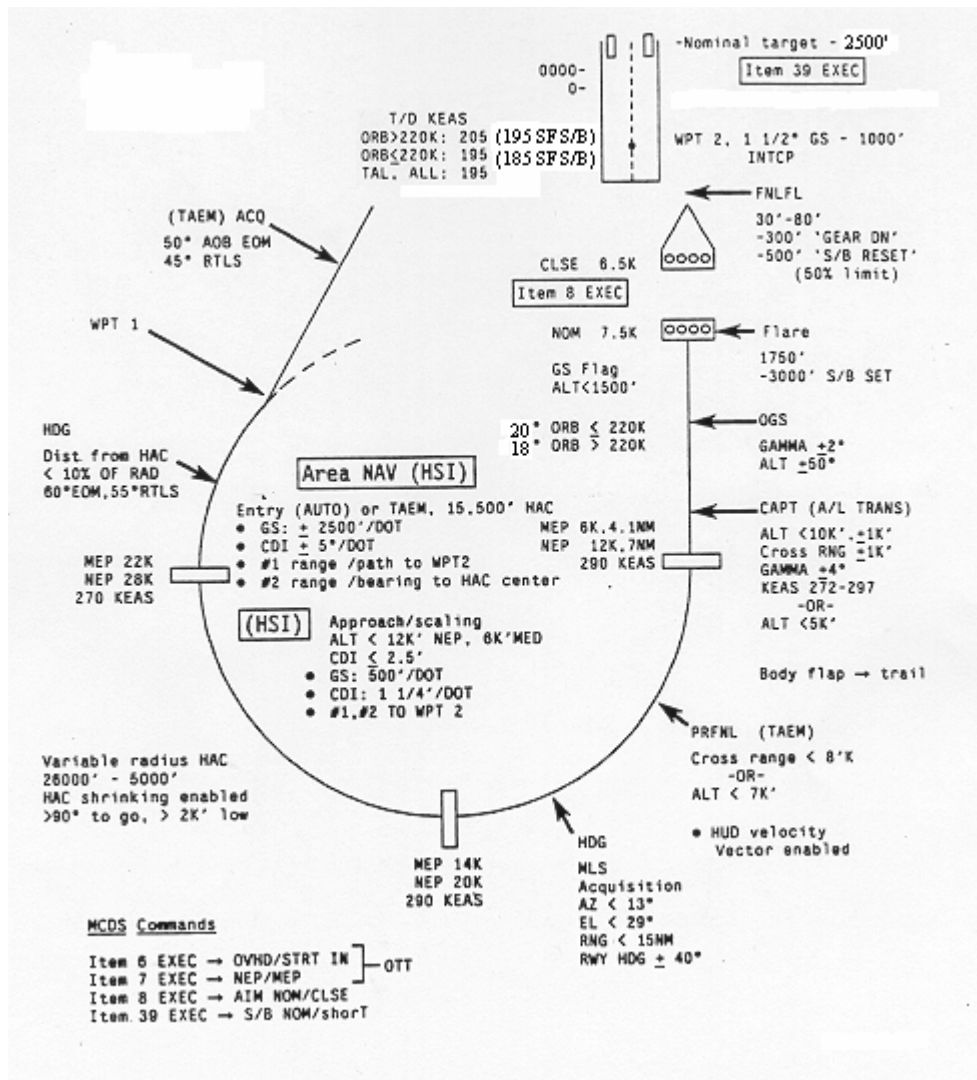

Figure 5.3.4-1 Guidance Phases and Area Navigation Displays

5.3.5. Speedbrake

From Mach 0.95 to an altitude of approximately 14,000 ft (HBLEND gain is set at 9,000 ft Above Ground Level (AGL)) the SB is a function of Orbiter E/W error only. The SB command during approach and landing is based upon dynamic pressure and referenced E/W. This normalized energy term E/W, was chosen for its simplicity and because it includes airspeed and altitude terms. Beginning at 14,000 ft the dynamic pressure term is linearly brought into the SB drivers, becoming the sole input at 9,000 ft.

On the OGS below HBLEND, or at Approach and Land Transition, the SB command is guided solely by dynamic pressure, referenced to 300 KEAS as a function of the velocity error and the integral of the velocity error. For example if the Orbiter is on the OGS but accelerating, the SB will begin to open before the 300 KEAS is reached to protect V_{ne} (321 KEAS). (reference discussion in Orbiter Landing Techniques, JSC-13597)

At 3,000 ft the SB is commanded to a position that targets touchdown at 2,500 ft past the threshold at 205 KEAS if heavyweight and 195 KEAS if lightweight. This command is based upon the following factors:

1. OGS aimpoint
2. SB option
3. Wind speed (as computed at 3,000 ft AGL)
4. Vehicle weight
5. Density altitude
6. Airspeed error (at 3,000 ft AGL)

At 500 ft the guidance computation refines the energy prediction, based upon

1. Average integrated wind speed between 3,000 and 500 ft. AGL
2. Density altitude

5.3.6. Crew Procedures

This section separates the landing and rollout phase of flight into appropriate subphases, or events, and discusses what the crew should be doing at those times during a nominal approach. Relevant displays and controls, as well as changes in guidance and navigation will also be discussed.

A brief summary of crew actions and the approved crew communications protocol is presented (Tables 5.3.6-I and 5.3.6-II):

Table 5.3.6-I Landing/Rollout Crew Procedures

<u>EVENT</u>	<u>CREW PERSON</u>	<u>ACTION</u>
~ 15k ft	CDR & PLT	√ PAPI's and HUD overlay on runway. HUD MODE - DCLT as required.
	MS	√ MLS incorporation (G-50, TACAN ratios and residuals blank)
	ALL	Start <u>LANDING COMM PROTOCOL.</u>
< 10k ft	MS	√ BF to trail and "A/L" on VERT SIT
~5k ft	PLT	Compare RADAR ALT 1 vs 2
3k ft	MS	√ SB command %
2k ft	PLT	<u>LDG GEAR ARM pb - push (√ARM It on)</u>
	CDR	Start PREFLARE and transition onto BALL BAR
500 ft	MS	√ SB command %
On CDR call 300 ± 100 ft	PLT	<u>LDG GEAR DOWN pb - push (√DN It on)</u>
	PLT/MS	√ Gear indicates DOWN
T/D	CDR	Control drift with rudder. Select manual SB full open.
	MS	√ SB opening
	PLT	√ HUD display for WOWLON (pitch bars present, velocity vector disappear)
195 kts	PLT	DRAG CHUTE ARM/DPY pbs - push (simo) (√All Its on)
185 kts	CDR	Derotate using beep trim
NGTD	PLT	SRB SEP or ET SEP- MAN/AUTO, PB-PUSH
	CDR	Maintain and/or correct to centerline with NWS. * If no load relief, RHC full forward *
		* If NWS FAIL light comes on steer with rudder and *
		* brakes. NWS-2 may be selected if needed. Engage *
		* with rudder pedals neutral. *
	MS	√ ELEVONS down and NWS FAIL & antiskid FAIL lights off
	MS	Call "NWS FAIL" as necessary

Table 5.3.6-I - Continued

<u>EVENT</u>	<u>CREW PERSON</u>	<u>ACTION</u>
MIDFIELD	CDR	√ Ground speed and DECEL on HUD. No braking before midfield on concrete runway. When ground speed < 140 kts, brake at 8 to 10 fps (0.25 – 0.3 g's).
< 5k ft remaining	CDR	If ground speed > 140 kts, MAX braking
60 kts	PLT	DRAG CHUTE JETT pb – push (√ JETT1, JETT2 lt on)
< 40 kts	CDR	Reduced braking to < 6 fps ² (<0.2 g's)
WHEEL STOP		SB - CLOSE

Table 5.3.6-II Landing Comm Protocol

<u>EVENT</u>	<u>CREW PERSON</u>	<u>ACTION</u>	
MLS to State Vector	MS	“MLS”	
A/L	MS	“APPROACH & LAND, BF TRAIL”	
~ 5k	PLT	“RADAR ALTIMETER” 1 & 2 CHECK GOOD	
4k	PLT	“4000 ft”	
3k ft	PLT	“3000 ft”	
	MS	“BOARDS _____ %”	
2k ft	PLT	“2,000 ft”, PREFLARE NEXT	
	CDR	“PREFLARE, ARM THE GEAR”	
	PLT	“GEAR IS ARMED”	
1k ft	PLT	“1,000 ft” ____ kts (PLT call max. EAS in preflare)	
500 ft	PLT	“500 ft”	
400 ft	PLT	“400 ft”	
300 <u>+</u> 100 ft	CDR	“GEAR DOWN”	
	PLT	“GEAR COMING”	
	MS	“BOARDS _____ %, GEAR IS DOWN”	
300 200 100 ~ 70 ~ 50 ~ 40 ~ 30 ~ 20 ~ 10 ~ 5	ft	PLT	“_____ ft , _____ kts” (steady rhythm)
TD	PLT	“TOUCHDOWN”	
195 kts	CDR	”CHUTE”	
185 kts	PLT	“185, DEROTATE”	

Table 5.3.6-II - Continued

<u>EVENT</u>	<u>CREW PERSON</u>	<u>ACTION</u>
DEROTATION	PLT	“PITCH RATE _____” (Repeat rate at regular cadence during derotation)
NWTD	PLT	“WOW SET” (Manual backup by depressing ET SEP or SRB SEP PB)
	MS	“Load Relief” or “No Load Relief”
MIDFIELD	PLT	“MIDFIELD”
5k ft remaining	PLT	“5,000 ft remaining”
	MS	“BOARDS _____ %”
	PLT	“_____ kts, _____ (Decel reading)”
140 130 120 110 90 80 70 60 50	ft	
60 kts	CDR	“CHUTE”
40 kts	PLT	“40 kts, EASE OFF”
WHEELS STOPPED	CDR	“WHEELS STOPPED”

5.3.6.1. Mach < 1 Until HAC Intercept

Time = 5:00 minutes before wheels stop
 M < 1.0
 H = 50,000 ft
 R = 25 NM
 GUID = TAEM guidance, acquisition phase, MM 305

a . Discussion

When the Mach number is less than 1.0, the CDR takes manual control of the orbiter by putting the flight control system into CSS. CSS may be engaged by pushing the pitch and roll/yaw PBI's on either the CDR's or PLT's eyebrow panel, or by deflecting either RHC greater than 6° out of detent in both pitch and roll axes. Each axis is placed in CSS independently from the other. The buttons are held depressed for up to 300 milliseconds or the RHC must be held out of detent, in each axis, for up to 300 milliseconds for CSS to be engaged. To ensure that the vehicle is in CSS, the crew should verify that the CSS PBI's are illuminated.

Very little control input is required to follow guidance to the HAC tangency point. Some pilots prefer to fly the ADI guidance cues, rather than the HUD, at this point in the approach. Both sources are cross-checked with each other regardless of the one used for primary reference. A good operating practice is to use the cross-check process to gradually shift the CDR's primary scan from the ADI to the HUD by the time the vehicle is on the OGS.

b . HUD

Normally, the HUD's are in the full display mode; no declutter. The key portions of the display are the flight director symbol (square airplane symbol), guidance diamond, altitude reference pointer, and SB command/position scale. The pilot flies so as to keep the diamond exactly centered in the square airplane, while monitoring altitude error and SB position with respect to command. KEAS and altitude AGL can also be monitored on the vertical scales. Window 3 (lower left corner) displays "ACQ" for the acquisition phase of TAEM guidance.

c. PFD

The Primary Flight Display (PFD) is a MEDS display that combines the old Dedicated Displays into one graphic design. The PFD provides an ADI, an HSI, an AMI, an AVVI, a G-meter, an FCS configuration status, and major mode. The display evolves during MM 305, and specialized readouts include a glide slope indicator, HAC Turn Angle, range to HAC center (NM), and range to the runway (WP 2 in NM). The PFD is the same in PASS and BFS while in MM 304 and 305. An example of the PFD, post HAC intercept is shown in Figure 5.3.6.2-1.

d. ADI

Besides attitude reference, the ADI instrument provides the crew with pitch, roll, and yaw error and rate needles, as well as digital values for LVLH attitude. The rate needles show angular rates on a scale that varies according to the rate sensitivity switch setting. See Section 2 for more detail. The pitch and roll error needles provide the guidance commands described in Section 5.3.3. The yaw error needle is different from the other two in that it does not provide any command. Rather, it displays estimated sideslip angle (Beta) computed from A_y . This display function is enabled throughout Major Modes 304 and 305.

The ADI serves as a second source of guidance command display. The crew should be aware that there could be parallax error in the pitch command display. Every effort should be made to ensure that the pitch (and roll) error needles are held precisely in the center of the scale.

e. HSI

The crew should use the HSI bearing pointers, labeled “H” for HAC intercept (or runway WP2 after HAC intercept) and “C” for HAC center, as a cross check of guidance information and realize that when following guidance toward the HAC tangency point, the HAC bearing pointer is not exactly under the lubber line because of the potentially different HAC sizes being used by guidance and the HSI. The altitude reference scale, when used in conjunction with trajectory and airspeed information, provides the crew with a measure of the vehicle’s energy state. It should be emphasized that the altitude reference error displayed on the HSI is only correct when the vehicle is on the correct trajectory. Because of other differences between the trajectory calculations of guidance and area navigation, the altitude reference scale needle may not be centered when the vehicle is on the guidance derived trajectory.

Range to runway WP2, range to HAC center, and range to HAC intercept are all displayed in nautical miles. HAC turn is displayed in degrees. Labels for the target runway are also provided.

f. AMI and AVVI

The tapes are a second source of airspeed and altitude, and the prime source of angle of attack and altitude rate. On a nominal approach, the crew uses the tapes as an occasional cross check of HUD information.

When subsonic, the AMI tape will display KEAS, while the digital readout below the tape displays the equivalent Mach number. When radar altimeter data is available and valid, an “R” is displayed to the right of the digital value on the altitude tape.

g. Vertical Situation Display (VSD)

The VERT SIT 1 display is the default GNC display at 0.9 Mach, prior to HAC intercept. On a nominal approach, the VERT SIT display provides primarily a cross check for the vehicle’s energy state through the E/W scale and the altitude versus range guidelines.

h. HSD

The Horizontal Situation Display (SPEC 50) is available in PASS or BFS throughout the landing and rollout phase of flight. At Mach = 0.9 on a nominal approach, active crew interface with the display is complete. At this point, the crew can use the display to cross check lateral guidance, by observing that the shuttle trajectory predictor dots are aimed at the nearest point of tangency to the HAC. The navigation state of the BFS is roughly determined by a visual comparison of the PASS and BFS SPEC 50 displays.

5.3.6.2. On the HAC

Time = Approximately 4 minutes 10 seconds before wheels stop
 M = Approximately 0.83
 H = Approximately 40,000 ft
 R = Approximately 20 NM
 GUID = TAEM guidance, heading phase

a. Discussion

The crew ensures that they are headed for HAC tangency by cross-checking guidance with the position of the predictor dots on the HSD. Guidance modes to the heading phase when the vehicle is at the tangency point with a radial error of 10 percent of HAC radius or less. In the heading phase, commanded angle of bank can be up to 60°.

The commanded roll onto the HAC is fairly abrupt and requires significant lateral RHC deflection. The crew should anticipate this command (using the HSD predictor dots) and complete the roll smoothly. The guidance commands should be followed rigorously while on the HAC. A majority of CDR's use the ADI needles to intercept the HAC and fly around it. The HUD should be cross-checked with a goal of using the HUD as the primary guidance reference by the time the vehicle is on final. There is nothing wrong with using the HUD for guidance information throughout TAEM and approach and land guidance. The CDR's that prefer the ADI generally do so because they are more comfortable responding to the large guidance commands (such as those rolling onto the HAC) from the needles rather than the HUD diamond. When the guidance commands are smaller, such as on the HAC or on final, the HUD diamond becomes easier to fly.

Flight on the HAC feels uncomfortable to some crew members because of the sometimes steep bank angle combined with the fairly steep nose down attitude. The key is to follow guidance commands, with a cross check of the HSI, HSD, and VSD to verify that guidance is working okay. In the current software, guidance cannot command more than 0.5 g above the 2.0 g required to fly at 60° bank, so following guidance does not overstress the vehicle (but it may be right on the limit). Future software will provide overstress protection by limiting the bank angle, as discussed in Section 5.3.3 above. An example of what the PFD looks like while on the HAC is shown in Figure 5.3.6.2-1.

b. HUD

The HUD may be used just as it was prior to the HAC. The piloting task is now more dynamic and most of the scan time is spent on the square airplane symbol and the guidance diamond while the CDR tries to fly guidance precisely. Guidance on the HUD has the advantage of having no parallax error. The word "HDG" appears in window 3 when the TAEM heading phase is entered.

c. ADI

As described above, the ADI may be the primary source of guidance on the HAC, depending on crew preference.

d. HSI

At the point of HAC tangency, and for most of the flight around the HAC, the HAC bearing pointer is pointing roughly straight ahead and the HAC Center pointer is roughly 90° left or right. The GSI still shows deviation from the altitude versus range profile and is only valid when the vehicle is on the correct path. For example, with a centered GSI and the vehicle outside the HAC, the vehicle is low energy.

e. VSD

The VERT SIT 1 display is active to HAC intercept and is replaced by VERT SIT 2 when the orbiter symbol descends below 30,000 ft. The trajectory lines provide the crew with a cross check of altitude versus range. The crew can deduce their approximate energy condition by observing their position on the trajectory in conjunction with their current EAS.

The vertical E/W scale shows normalized energy in units of feet. For the nominal approach, the triangle stays very close to the “NOM” reference line. The E/W scale is NOT “fly to”.

The vertical theta limits scale is ignored on approaches in which air data information is incorporated into navigation and GNC. It is also NOT a “fly to” scale.

f. HSD

The HSD draws a circle to represent the current radius of the spiral path being flown around the HAC. This circle gradually shrinks in radius as the vehicle descends. The SPEC 50 circle is not drawn tangent to the final approach course until the vehicle is close to intercepting it. The predictor dots should lie slightly inside the SPEC 50 circle when the vehicle is flying the correct spiral path since the circle is drawn with the radius appropriate for the vehicle’s current, not future, position.



Figure 5.3.6.2-1 View of PFD on HAC

5.3.6.3. Approaching the OGS

Time = 2 minutes 45 seconds before wheels stop
 V = 275 KEAS
 H = 20,000 ft
 R = 9 NM
 GUID = TAEM guidance, heading phase

a. Discussion

At 20,000 ft altitude the vehicle is at the 90° of turn to go point. Several changes in displays, navigation, and guidance begin to occur. The piloting task remains the same; precisely following guidance commands, but the crew workload begins to increase as they monitor the changes in navigation and guidance.

b. MLS acquisition

The vehicle software allows incorporation of MLS data to navigation when vehicle range to the MLS site is less than 15 NM and the vehicle is within the antenna coverage of the MLS transmitters. See Section 2.10 for complete details. MLS data allows a very accurate navigation state to be computed and it is important for the crew to know when the information is being incorporated. The following cues give indication of MLS incorporation:

- (1) TACAN residual and ratio data on the HSD goes blank.
- (2) The missing data "M" flags disappear from system summary 1 display.
- (3) There is a likelihood that a "jump" in the ADI needles and HUD diamond can occur.
- (4) If the HSI data source is selected to MLS before MLS acquisition (not a nominal procedure), the bearing, range, and GS flags disappear from the HSI.

The crew can normally expect to get MLS incorporation at about 18,000 ft altitude. The CDR should anticipate the jump in guidance commands and act as a smoothing filter when it occurs. In particular, the roll command may ask for bank angle changes as it tries to reduce the lateral trajectory error. By observing the runway, if visible, the CDR should make smooth bank angle changes to intercept the extended centerline.

c. Approach scaling on the HSI

When the vehicle is within 2.5° of the final approach course, approach scaling occurs on the HSI (Section 5.3.4). The HAC Center pointer disappears along with the range to HAC center and HAC turn angle. The digital range continues to reflect range to WP 2 in nautical miles. The CDI, which has begun to converge, goes almost full scale and then begins to converge again. If there is any GS error being displayed, the altitude reference needle deflects almost full scale (five times the deflection it had before approach scaling). The crew should be aware that if the vehicle is flown to a position outside 2.5° from the final approach course before reaching 12,000 ft, the HSI reverts to the previous scaling, a condition commonly called wraparound. Wraparound can be avoided, if desired, by placing the HSI mode switch to the approach position. Digitals to the left and right of the CDI indicate the full scale value.

d. VV

When the final phase of TAEM guidance (prefinal) is entered, the flight director symbol (square airplane) on the HUD is replaced with the Velocity Vector (VV, round airplane). The VV displays the actual direction of flight, within the limits of HUD FOV. If the VV is limited by FOV, an "X" appears in the center of the symbol. The

vehicle is typically in an angle of bank, approaching the final approach course, when the transition to VV occurs. The symbol typically “floats” toward the direction of turn, a movement that appears downward because of the angle of bank. At the same time, the roll command begins tracking lateral error to the runway centerline instead of radial error on the HAC. This change can lead to a sudden movement (laterally) of the guidance diamond, usually commanding the vehicle to roll out of the HAC turn and roll towards the runway centerline. Typically, as soon as the roll toward the runway centerline is commanded, the command is reversed as roll guidance senses that the lateral error is being reduced. As with the MLS guidance jump, the CDR should smooth these commands and make a more gradual intercept of runway centerline.

After the VV is active, the pilots have a visual indication of the crosswind component. The VV shows where the vehicle is going, and the boresight cross shows which way the nose is pointed (into the wind) to achieve that flight path.

e. Gamma reference triangles

When the VV becomes active, the gamma reference triangles appear on the display. The triangles are located at an I-loaded value of -20° for lightweight vehicles, or -18° for heavyweight vehicles (>222k lb). As the vehicle intercepts the OGS on a nominal approach, the gamma triangles are positioned next to the selected aimpoint, with the VV between them.

f. Energy scale

At 20,000 ft the E/W scale is removed from the trajectory display.

5.3.6.4. On the OGS

Time = 2 minutes before wheels stop
 V = 300 KEAS
 H = 12,000 ft
 R = 7 NM (41,500 ft to Waypoint 2)
 GUID = TAEM guidance, prefinal phase

a. Discussion

The task of flying the OGS is simple but must be performed precisely in order to guarantee sufficient energy to achieve the desired T/D. The crew is provided with ample guidance and visual information to do the job. During training in the STA, pilots should develop their own techniques of evaluating and assimilating the available information.

Upon intercepting the OGS, the CDR and PLT should note how closely the HUD runway overlay corresponds to the runway position. This gives them a quick assessment of the accuracy of navigation, and therefore, guidance. The level of accuracy determines what tools the crew uses to complete the approach. After checking the runway overlay, the HUD may be decluttered if desired. Many pilots declutter the HUD to the second level to provide a very simple display for the remainder of the approach. This action removes pitch attitude indication from the display. An example of what the PFD looks like while on the OGS is shown in Figure 5.3.6.4-1.

b. MLS available

If MLS data is incorporated, navigation, and therefore guidance, is very accurate. The HUD guidance diamond is the primary flight reference with the PAPI lights as a cross check. The PAPI's are true information but with MLS, the guidance diamond (or needles) provides a simple method of smoothly tracking the OGS and the extended runway centerline. On a nominal approach, the gamma reference triangles are positioned next to the selected aimpoint, and the guidance diamond is centered in the VV which overlays the aimpoint. Of course, there are two red and two white PAPI's for a 20° glide slope, or three red and one white PAPI for an 18° glide slope.

Glide slope errors are shown by the HSI and HUD altitude reference scales, the PAPI lights, and the gamma reference triangles. If the vehicle is shallow, the triangles lie short of the selected aimpoint indicating that the selected glide slope intersects the ground short of the aimpoint. The VV is placed beyond the aimpoint until the triangles are adjacent to the aimpoint. Once the triangles are next to the aimpoint, the VV is returned to a position on the aimpoint. The reverse technique is used for the steep case.

Lineup errors are displayed on the HSI, CDI, and by the visual presentation given by the runway and aimpoints. With MLS, the CDI display is accurate, and the roll command portion of guidance keeps the vehicle on the approach course. It is important to have corrected any lineup errors while still on the OGS. The pitch tasks of the preflare, IGS, and FF are made more complicated if the crew is also working a lateral task created by a lineup error.

c. MLS not available

When MLS data is not available or not incorporated, navigation and guidance information is only as accurate as the TACAN system. This level of accuracy is adequate for flight around the HAC, but is generally not sufficient to precisely track the OGS. Therefore, the PAPI's are used as the primary glideslope reference and the overall visual scene is used to determine lineup errors. Even though guidance cannot be used to precisely follow the OGS, the VV and gamma reference triangles can be used to track the OGS.

d. Radar altimeters

At approximately 5000 ft altitude the radar altimeters lock on and provide altitude readout on the AVVI tapes and HUDs. The typical crew has the PLT evaluate the altitude from both altimeters by selecting each position on the Radar Altimeter (RA) select switch. After the initial evaluation, the PLT continues to monitor RA altitude and informs the CDR if the CDR's altitude appears biased. If information from either RA appears biased, the CDR and PLT should select the other RA.

e. Short Field SB

Starting with OI-30, the nominal SB option is always the default option. With Short Field SB selected the Orbiter guidance objective is to land the vehicle at the nominal 2,500 ft from the threshold, 10 kts slower than for nominal procedures. If the speedbrake is close to 50% past 500 ft AGL the pilot will have to concentrate on a final flare more aggressive than normal to put the vehicle on the ground quickly. For high density altitude situations (Edwards AFB elevation 2,300 ft; Northrop elevation 3,900 ft; Ben Guerir Morocco elevation 1,400 ft; Zaragoza, Spain elevation 830 ft), the Orbiter will not feel much different than for a normal end of mission landing at KSC. For sea level landings on cool days the Orbiter will decelerate very quickly. Piloting the vehicle in a more aggressive manner than when normal speedbrakes are selected and remaining cognizant that the Orbiter will decelerate more rapidly with Short Field Speedbrake selected is recommended.

f. Flare indices

At about 3500 ft altitude, a second set of triangles appear at the bottom of the HUD FOV and move upward toward the gamma reference triangles. These flare indices give the crew warning that the preflare is about to be commanded. At about 2000 ft, the flare indices are superimposed on the gamma reference triangles, which then disappear. The flare indices continue moving up and are a visual indication of the open loop portion of the preflare guidance command.



Figure 5.3.6.4-1 View of PFD on OGS

5.3.6.5. Preflare and IGS

Time = 1 minute 12 seconds before wheels stop
 V = 300 to 310 KEAS
 H = 2000 ft
 R = 14,000 ft to Waypoint 2
 GUID = A/L Guidance, FSGS phase

a. Discussion

The preflare and IGS phase require repetitive practice to ensure consistent, repeatable performance. During the preflare, the individual flying the vehicle must assimilate information from several sources to produce a pitch maneuver that smoothly intercepts the IGS.

During preflare, the entire scan is normally heads up. The HUD provides basic attitude, airspeed, and altitude information plus two bits of command information. The guidance diamond continues to provide pitch and roll commands according to the logic described in Section 5.3.3. The flare indices are based on a look up table of altitude versus distance to the threshold and provide an approximate 1.3 g open loop pull-up command. If the vehicle is on glideslope and course at the beginning of the preflare, and preflare guidance is followed precisely, the guidance diamond, VV, and flare indices smoothly track up the display together. If the preflare is begun early or late, the guidance diamond still represents guidance solutions to the intended point of touchdown. Because of earlier developmental considerations of the AUTOLAND function, and to assist in avoiding longitudinal PIO and possible elevon rate saturation situations, guidance was designed to be extremely low gain. Unlike a normal aircraft's ILS, guidance will not provide cockpit cues (ADI needles or HUD diamond) that will bring the vehicle back onto the nominal glide path. For these reasons, the Commander and Pilot should incorporate into their scan the gamma references (assuming navigation is accurate) as they provide a rough but separate source of information. If the preflare is initiated late making an attempt to correct back to, or at least towards the nominal glide path is vitally important. This can be done by flying slightly higher than guidance diamond for a period of time. Beginning at 1,000 ft AGL the Commander should progressively bring the ball bar into his or her scan and notice the rate at which the ball is approaching the bar. As the ball approaches the bar, the RHC input is a subtle relaxation of the nose up input required during the preflare. The relaxation is a learned input and RHC inputs should continue to be made as a function of velocity vector placement, ball bar and guidance diamond. At this point, flying the ball bar and monitoring trends of ball bar movement become of prime importance. The guidance diamond should be cross referenced as a performance predictor of the Orbiter flight path. Reference Orbiter Landing Techniques, JSC-13597 for a further and more complete description.

The approximately 500 STA approaches completed by the crew before flight serve to cement the sight picture of a good approach into the pilot's mind. Cues present in this sight picture are the rate at which the ball approaches the bar, ground rush, and the change in the runway aspect angle.

Throughout the preflare, it is important to keep lineup under control. This is easier said than done, since major changes in wind direction and speed can occur below 2000 ft. Deviations from centerline should be corrected immediately, before a large correction is required. Keeping the deviations and the corrections small lets the pilot devote the proper attention to the pitch preflare task. In doing so the pilot helps to avoid the common pitfall of allowing the pitch axis and final shallow glide slope to fall from his/her scan which often results in an early, fast, and potentially hard landing.

b. Heads down scan

On rare occasions, it may be appropriate to include the ADI in the preflare scan. If the crosswind component is large enough to cause the VV or guidance diamond to be HUD FOV limited, flying guidance on the HUD is difficult. The pitch task can be completed using only visual references. The lateral task is more difficult because

of the crosswind, so a quick look at the ADI roll error needle helps the pilot determine the size and direction of the lateral correction required.

c. SB

It is important to bring into the discussion that the “smart speedbrake” can cause problems if the Orbiter is not on the correct glide path geometry - e.g. a “high or low wire” or correcting to or diverging away from the correct glide path. For example if the vehicle is significantly low on glide slope, it will descend below 3,000’ while at a distance farther from the threshold than assumed when the “smart speedbrake” function was designed. This has the potential to drive the Orbiter into a low energy state and land short of the targeted 2,500 ft. from the threshold. The crew must actively monitor energy and position relative to the optimum glide slope and manually adjust the speedbrake should it be required.

With large SB angles, the vehicle decelerates rapidly during FF, making the maneuver more difficult.

d. IGS

The shuttle approach IGS serves a different purpose than does the Instrument Landing System (ILS) glide slope for an airplane approach. The IGS is not a path along which a stabilized portion of the approach is flown, but rather a reference path the vehicle is near after the preflare and before the FF. If the vehicle is flown along a path that approaches that of the IGS, it is in a position to be smoothly flown through the FF. However, the vehicle does not spend more than a few seconds on the IGS, and may only touch the IGS momentarily before starting the FF.

The orbiter is not well suited to performing maneuvers that include a close tolerance pitch task. The pitch response time, the vehicle’s characteristic response to longitudinal RHC inputs (vehicle cg initially goes down with a nose up RHC input and vice-versa), and the time delay in HUD updates (including velocity vector position) make flying a smooth, precise vertical profile extremely challenging. The technique for flying the IGS presented next attempts to avoid requiring a high gain pitch task for those reasons, and to avoid the aforementioned PIO tendency and elevon rate saturation. The technique for flying the IGS presented next avoids requiring a close tolerance pitch task for that reason.

The pilot should develop a technique on the IGS that gets the vehicle to a consistent threshold crossing height from which repeatable FF maneuvers can be made. The desired threshold crossing height is between 20 and 30 ft, main wheels to runway. A good method to approach this goal is to use the technique that guidance uses on the IGS. Complete the preflare so that the descent rate is broken with the vehicle slightly above the IGS. The ball is slightly below the bar. The pilot allows the vehicle to slowly settle onto the IGS and, as it approaches the runway threshold, allow it to settle just slightly below the IGS (ball just resting on top of the bar). This settling maneuver is not a close tolerance pitch task. The pilot only has to control the rate the vehicle settles onto, and through the IGS.

5.3.6.6. Final Flare

Time = About 48 seconds before wheels stop
 V = About 240 KEAS
 H = 30 to 80 ft
 R = Just prior to runway threshold
 GUID = A/L Guidance, FF phase

a. Discussion

The FF is used to reduce the sink rate from about 12 fps on the IGS to less than 3 fps for T/D. It is also used to control the time and point of T/D so that the target T/D airspeed is achieved. Consistent FF performance is a product of repetitive practice in the STA. RHC inputs should be kept small to avoid forcing the main wheels into the ground and to keep from over controlling the vehicle in general. Strive to keep the FF a low gain task. This is done by entering the FF with sink rate and lineup under control. Avoid nose down RHC inputs. If the preflare and IGS were flown properly, FF requires only a small pitch attitude change. The amount of pitch is learned through STA practice. A good pilot technique in FF is to shift the scan to the far end of the runway. The HUD VV can also be used to help find the correct pitch attitude. Pilots may develop a habit of using the VV exclusively in simulators (SMS and VMS) because of the poor visual cues compared to the real world. Pilots are strongly discouraged from this practice in the STA. The FF technique should not be dependent on a properly functioning HUD.

At the initiation of FF guidance, if in CSS, the guidance diamond and gamma reference triangles are removed from the HUD display.

Keep in mind that during the last ~5 ft AGL the vehicle is decelerating rapidly and can loose as much as 15 kts. This should emphasize to Commanders and Pilots, especially because the mediocre accuracy displayed on the HUD during actual landings (readings of 4-7 ft AGL in the HUD are common at vehicle WOW) to avoid getting shallow on the IGS and FF. Due to the vehicle's characteristic response to nose up RHC inputs, the crew has for all intents and purposes bought the landing by this time and should refrain from making last ditch nose up RHC inputs at such a low altitude as it will most likely only serve to drive the main wheels into the runway resulting in an even earlier, faster and harder landing.

5.3.6.7. T/D and Rollout

Time = About 38 seconds before wheel stop
 V = 195 KEAS (or 205 KEAS heavyweight; 10 kts slower for short field SB option)
 H = Surface
 R = 2500 ft down the runway
 GUID = A/L Guidance, FF phase

a. T/D

Several parameters characterize the instant of main wheel contact. The key parameter is airspeed. T/D airspeed is designed to provide a reasonable margin between the planned speed at T/D and the airspeed at which tail scrape occurs. This margin provides about five seconds of excess energy beyond the planned T/D. Since this is not a very large margin, airspeed should be given first priority. If the vehicle has nominal energy, the proper T/D x-position is a byproduct of the correct T/D airspeed. The sink rate, roll angle, delta heading, and y-position at T/D are a result of the atmospheric conditions and how well the CDR flies the vehicle through them. Desired values of T/D parameters are:

Airspeed	- Target airspeed for vehicle weight; +5/-10 kts
x-position	- As required to achieve T/D airspeed (nominal energy)
Sink rate	- 2 to 3 fps
y-position	- Centerline
Roll angle	- Zero
Delta heading	- As required by crosswind

The T/D x-position is secondary to T/D airspeed so long as energy is sufficient to land at the target airspeed on the prepared surface. If energy is extremely low, T/D can be safely delayed about five sec, or 22 kts, if required to stretch the glide to the prepared surface. If energy is so low that T/D cannot be made on the prepared surface, quick judgment is required of the CDR to decide how much airspeed is sacrificed to get closer to the runway. In some cases it could be worth risking a tail scrape to get to better terrain or past an obstacle. In general however, it is probably best to T/D near the target airspeed, with the desired sink rate so that the vehicle can be controlled during the ensuing rollout.

b. Crosswind after T/D

It is a good practice to consider every landing a crosswind landing. Even when the crosswind component is small, the pilot who is prepared for this makes a more controlled T/D and rollout. T/D is made in a pure crab, with no lateral drift; therefore, the nose is pointed upwind. During rollout, prior to derotation, the vehicle's response to crosswind is to roll and yaw away from the wind. The wings are held level with lateral RHC and lateral drift is held at zero with rudder into the wind as required.

c. Drag Chute Deploy

Nominal chute deploy by definition (assuming WOW) is 195 KEAS. Early chute deploy is after main gear touchdown and before nominal chute deploy. Late chute deploy is after weight on nose gear. Emergency chute deploy indicates the chute should not be deployed unless the Commander determines it is required.

If the drag chute aggravates lateral directional controllability on the runway, it should be jettisoned immediately. Nominal drag chute jettison is done at 60 KGS.

Chute deploy is initiated nominally by the Pilot simultaneously depressing both the Chute ARM and DEPLOY push buttons. The mortar fires approximately 1 second after the ARM & DEPLOY push buttons are depressed. In another 1.5 seconds (2.5 seconds elapsed), the chute will be in its deployed and reefed position (40% open).

Finally, after another 3.5 seconds (6 seconds elapsed) the chute will disreef to its full 40 ft diameter to assist in controlling the vehicle derotation rate and up elevon position required to control that derotation rate.

See Section 5.3.6.8 for a complete description of the drag chute.

d. Derotation

The highest main gear and nose gear structural loads occur during derotation and have components that are directly related to pilot technique during derotation. The technique recommended here is designed to minimize main gear loads through smooth RHC use, and to minimize nose gear loads by getting the nose on the ground before pitch authority is lost. Derotation is normally performed using Beep Trim, at 185 KEAS regardless of vehicle weight or runway surface. For manual derotations, the RHC should be moved forward about 6° - 10° , or about halfway to the soft stop. The pilot should be prime for monitoring the pitch rate and call it out. The desired manual input is phased in slowly over 1-2 seconds, targeting a final steady state rate of 1.5° - $2.5^{\circ}/\text{sec}$ (0.7° - $2.5^{\circ}/\text{sec}$ is the adequate range). Once the targeted pitch rate is achieved, freeze RHC inputs so as to avoid chasing it, and also as the nose falls through 0° pitch attitude, the derotation rate will increase above the commanded value, and should also not be chased with RHC inputs. This very smooth and somewhat open loop RHC technique minimizes elevon activity, which reduces main gear oscillations that create high peak main gear loads. Excessive nose gear loads occur when elevon authority is lost with the nose high enough to allow a high pitch rate to develop. This is avoided by ensuring that the full $-2^{\circ}/\text{sec}$ derotation rate is positively (and smoothly) developed. The derotation should not be started at an airspeed faster than 185 KEAS. The faster speed creates a higher main gear load component due to aerodynamic force when the pitch attitude goes below zero. In the flight controls, the elevons are programming trailing edge up to control the derotation to the commanded pitch rate. At a $\theta = 1.5^{\circ}$, the elevons are commanded to hold their current position. This is a trade off between slap down rates and consequent nose landing gear loads and main landing gear loads experienced at $\theta < 0^{\circ}$. The maximum elevon trailing edge up allowed by the flight control software in any case is no greater than 10° .

If T/D occurs at or below 185 KEAS, the derotation should be started immediately, but without sacrificing the slow and smooth buildup of derotation rate.

Additional information on derotation is located in Section 4.12.

e. Crosswind during derotation

The vehicle responds to crosswind changes during derotation. As the wing angle of attack falls through zero, the tendency to roll and yaw downwind is greatly reduced. A moment later, at nose wheel T/D (NWS engaged), the response to crosswind is reversed. The vehicle tends to weathervane into the wind in yaw. Rolling tendency due to crosswind with the nose wheel on the ground is small. (The most noticeable component is roll due to rudder deflection, which is opposite to the direction of commanded yaw.) The CDR should anticipate the change in response to crosswind between the two-point and the three-point attitude. If any upwind rudder is being held at the beginning of derotation, the CDR should decrease rudder deflection as the pitch attitude passes through zero, and should be prepared to reverse the rudder input once the nose wheel is on the ground.

f. Rollout

For the nominal case rollout, NWS is considered to be functioning in NWS-1 (NWS2 is functionally identical, but provides less downlisted telemetry). In this case, nose wheel steering is the primary control on the runway. As the nose wheels approach contact with the runway, having the rudder pedals near center is a good practice, if practical. A "fader" protects the vehicle from a sudden NWS input by gradually feeding in any commanded nose wheel deflection over a period of two seconds after nose wheel T/D. However, pilots generally are more comfortable having the pedals in the same position as the nose wheels. The rudder technique described in the preceding paragraph has the pedals near center at nose wheel T/D

Secondary control on the runway is provided by lateral RHC. Deflecting the RHC to the right for example reduces the right elevons (right inboard & right outboard elevons) trailing edge down deflection, reducing the camber on that wing and thereby increasing the load on the right main landing gear and tires. Additionally, lateral RHC inputs cross couple with the directional axis producing yaw in the direction of the roll input. When NWS is functioning this tendency is small. When NWS is failed, lateral RHC inputs will produce noticeable yaw during rollout.

g. Crosswind during rollout

With NWS engaged, the vehicle tends to "weathervane" into the wind. Lateral control is not difficult if lateral deviations are not allowed to get large. The pilot's vision should be focused to the far end of the runway so that lateral rates can be quickly detected and nulled. Lateral RHC should be used to keep the wings level and lateral steering should be accomplished with the rudder pedals, NWS engaged. NWS inputs should be positive, but judicious and smooth. Main gear tire wear, which is expected during a crosswind rollout, is accelerated with lateral steering. If a lateral error develops, do not aggressively recapture the centerline. Instead, smoothly stop the lateral rate, then steer to slowly return to the centerline.

h. Braking

Braking should be accomplished in accordance with the flight specific Entry Maneuvers Cue Card, but generally begins at 140 KGS and past midfield. The level of braking deceleration depends on the amount of runway remaining. Usually, 5000 ft remaining is the decision point. A deceleration of 8 to 10 fps^2 is normally specified for more than 5000 ft remaining and maximum braking is specified if runway remaining is less than 5000 ft. In either case, braking is reduced at 40 KGS to minimize the possibility of locking (or failing) a brake, since the antiskid system is bypassed at ~10 - 15 KGS; while brake torque increases at lower speeds. Locking the brake will likely result in a failed tire. An example of what the PFD looks like at TD is shown in Figure 5.3.6.7-1.



Figure 5.3.6.7-1 View of PFD at TD

5.3.6.8. Drag Chute

The drag chute is a 40 ft diameter parachute which, when deployed, is initially reefed to a 40% diameter, reducing the opening shock on the crew and vehicle. Deployment to the reefed diameter takes about 1.5 seconds. After another 3.5 seconds, the chute is disreefed to full diameter.

The drag chute is housed in a container built into the base of the vertical fin. It is controlled by either of two sets of PBI's located adjacent to the CDR's HUD and the PLT's HUD. The PBI's are labeled ARM, DPLY, and JETT. The ARM PBI must be pushed and illuminated before the chute can be deployed or jettisoned (the ARM and DPLY push buttons are nominally pushed simultaneously). When the ARM and DPLY PBI's (from either set of buttons) are pushed, a mortar is fired which launches the pilot chute rearward, knocking the compartment door off in the process. The pilot chute inflates and extracts the main chute from the compartment. The main chute is restrained to the reefed diameter by a line running the circumference of the chute hem. The chute is disreefed by cutting this line.

5.3.6.8.1. Benefits

The benefits of the drag chute are based on the best information available from the Ames simulations and flight data.

a. Decreased rollout

The drag chute allows rollout with reduced braking requirements or reduced rollout distance when current levels of braking are used.

b. Reduced main gear load

Because the drag chute is attached to the orbiter at a point above the c.g., the deployed chute creates a nose up pitching moment. The equilibrium trim position of the elevons with the chute deployed and the vehicle in the two point attitude, is about 6° further down than it would be without the chute. During derotation with a deployed chute less up-elevon is required to control the derotation rate, and therefore, less load due to elevon deflection is applied to the main gear. Achieving this main gear load reduction requires having the chute deployed (inflated) during the derotation. The amount of main gear load reduction may be sufficient to not cause failure of the tire adjacent to a leaking/failed main gear tire.

c. Reduced tire wear

If the crosswind component is moderate (15 kts or less according to Ames simulation results) a deployed drag chute should decrease tire wear in a nominal landing by decreasing the time of rollout. In landings with blown tires, tire wear on the remaining good tires can be greatly reduced because the chute stabilizes the vehicle laterally and reduces tire slip angle excursions. In crosswinds greater than 15 kts, the stabilizing effect of the chute can be overpowered by the "weathervaning" effect, leading to increased tire slip angle and wear over the no-chute configuration.

d. Directional stability

The deployed drag chute acts as a large vertical fin located behind the orbiter providing powerful, positive directional stability. The presence of this stabilizing force tends to minimize the effects of directional upsets caused by failed tires. However, because of the strong directional stability of the chute, the weathervane tendency may be amplified in response to crosswinds. As a result, the chute itself becomes a directional problem in strong crosswinds and attention should be paid to the drag chute cue card (Figure 5.2.3-2).

5.3.6.8.2. Constraints

a. Crosswind

Handling qualities with a deployed drag chute were investigated in the Ames simulation in crosswinds up to 20 kts steady state with gusts up to 27 kts total crosswind. The tests included runs with failed tires and/or on narrow TAL runways. All simulated landings in 15 kts crosswind were easily controlled and, in the failed tire cases, were better when the chute was deployed. In some runs at 20 kts steady state crosswind with failed tires, the powerful "weathervaning" effect of the chute made control more difficult than without the chute. In some runs without tire failures, main gear strut loads were higher when the chute was deployed in 20 kts crosswind than they were in runs without the chute. The data are not yet conclusive. It is not known at what exact crosswind speed the use of the chute becomes counterproductive. A 15 kts crosswind placard was selected because all 15 kts-runs were easily controlled and the current basic crosswind placard for the vehicle is 15 kts.

5.3.6.8.3. Operational Deployment

There are four methods for deployment of the drag chute that may be used on any landing if the crosswind is less than or equal to 15 kts.

a. Nominal deployment procedure

The CDR should initiate derotation using beep trim and call for chute deployment post main landing gear touchdown at 195 KEAS. This procedure is independent of the Mass Moment placard boundary and should be used for all normal energy landings, at the discretion of the CDR. The intent of a nominal drag chute deploy is to achieve disreef just prior to nose gear touchdown. This alleviates the concern of objectionable vehicle performance which may occur if disreef occurs significantly prior to nose gear touchdown.

b. Contingency deployment procedure

1. Early Deploy - An early deploy occurs between MGTD and the nominal deploy time when insufficient rollout margin exists. The CDR should initiate beep trim derotation at 185 KEAS.
2. Late Deploy - A late deploy will be performed after nose gear touchdown for either a low energy landing or in support of the crosswind DTO. During low energy orbiter landings, the additional large deceleration caused by the chute results in trailing edge-up saturation, and derotation is difficult to control precisely. These factors cause high pitch down rates and excessive nose gear strut loads. Late deployment of the chute reduces initial deceleration but still allows some of the benefits of the chute to be retained.
3. Emergency Deploy - An emergency deploy is defined as nominal/early/late deployment with Space Shuttle Main Engine (SSME) repositioning incomplete. Emergency drag chute deployment is performed only in the event of :
 - a) Leaking/failed tire
 - b) Loss of braking capability
 - c) Landing with insufficient rollout margin
 - d) Single APU landing
 - e) TAL/ELS landing.

Deployment of the drag chute without SSME repositioning, risks damage to engine bells. Analysis shows that the most likely contact point would be between the top edge of the center main engine bell and the risers, when the risers are at full line stretch. Additional analysis shows that drag chute performance is not impaired if SSME repositioning is not performed. For certain cases, the benefits of the chute outweigh the risk of potential damage to the SSME bells. During an RTLS, the engine bells are moved to the RTLS stow position which is the same as the drag chute stow position.

5.4. RTLS ABORT LANDING

5.4.1. Overview

The RTLS abort landing is designed to present the crew with an approach, landing, and rollout that is virtually identical to a nominal EOM case. The GPC's process OPS 6 software instead of OPS 3, but the guidance phase progression through TAEM and A/L guidance is identical in the two cases.

For RTLS, the SB options and the aimpoint selections are based on the same criterion that is used for EOM. Glide slope selection, which is an I-loaded function, is based on vehicle weight, with vehicles above 222,000 lb normally using 18°.

The RTLS approach, landing, and rollout should be flown just as described for the nominal case in Section 5.3. RTLS guidance has some differences from EOM guidance that can result in a low or high energy approach. These differences are described in the following section.

5.4.2. RTLS Guidance Differences

The relevant difference in RTLS guidance is in the Nz command logic. The pitch command in RTLS is structured the same way as in OPS 3. The difference lies in the Nz command limits for high and low dynamic pressure.

Upper limit	= $-(K1 (Q_{max}-Q) - Q_{rate}) K2$
Lower limit	= $-(K1 (Q_{min}-Q) - Q_{rate}) K2$
K1	= .075 for EOM .0557 for RTLS
K2	= EOM: .0625 RTLS: Ranges from .066 at Mach 0.8 to .033 at Mach 0.4 and below
Q	= Orbiter dynamic pressure
Qrate	= Dynamic pressure rate
Qmax	= 350 psf for the A/L phase of flight
Qmin	= $(.0233 \times \text{orbiter weight}) / \cosine \phi$ cosine ϕ has a lower limit of .707 (45° bank) for EOM and .9 (28° bank) for RTLS
ϕ	= Bank angle

Two of the constants used in the calculation of the dynamic pressure limits are changed for RTLS guidance with the effect that the dynamic pressure limits are tighter for RTLS than EOM. This means that RTLS guidance does not provide as large an Nz command as EOM guidance to correct for a low or high energy condition.

a. High energy

In a high energy case, the dynamic pressure upper limit is active and limits the delta Nz pitch down command being generated. For comparison, the following example is given:

Mach	= 0.7
Dynamic pressure	= 250 psf or 271 KEAS and constant
EOM max. delta Nz	= -0.42g
RTLS max. delta Nz	= -0.29g

The upper limit calculation is independent of orbiter weight.

b. Low energy

In a low energy case, the dynamic pressure lower limit would be active and would limit the delta Nz pitch up command being generated. For comparison, the following example is given:

Mach	= 0.48
Dynamic pressure	= 250 psf or 271 KEAS and constant
Orbiter weight	= 240,000 lb (The lower limit calculation uses orbiter mass and bank angle.)
Bank angle	= 20°
EOM max. delta Nz	= +0.30g
RTLS max. delta Nz	= +0.13g

5.4.3. RTLS Flying Technique

Flying the RTLS approach, landing, and rollout is identical to the EOM case if the vehicle energy state is maintained close to nominal. The delta Nz commands that are generated are small and the tighter RTLS dynamic pressure limits are not invoked. If the energy state is above or below nominal far enough to cause the tighter RTLS dynamic pressure limits to be invoked, significant differences are noted between the character of RTLS and EOM Nz commands. In general, below $M = 0.9$, the RTLS Nz command generates a trajectory that takes longer to return to nominal.

a. High energy

In the high energy case, as discussed above, RTLS guidance provides a leisurely return to nominal compared to EOM guidance. The proper pilot response however, is to fly the guidance command. The return to nominal energy may be slower than desired, but an attempt to lead the command with a larger pitch-down input could lead to an overshoot of nominal and a low energy condition. The quicker return to nominal using this technique is not worth the risk of creating a low energy condition, and should not be necessary anyway.

b. Low energy

In the low energy case, the RTLS Nz command returns to nominal so slowly that it creates an unsafe situation. For example, suppose the vehicle is low on the HAC. The Nz command generates a trajectory that has the vehicle back on energy by 10,000 ft. However, at 15,000 ft the strong persistent tailwind around the HAC, drops off steadily and becomes a moderate headwind on the OGS. This is a low energy situation that can be handled if the vehicle is on energy when it is encountered. However, the vehicle is still recovering from the previous low energy condition and a short landing-results.

The solution to this situation is for the crew to lead the guidance command and fly maximum L/D angle of attack until the nominal trajectory is intercepted, then the crew can return to following guidance. This reduces the amount of time the vehicle remains low energy and improves its ability to handle any subsequent low energy conditions.

Experience in the STA shows that when the pilot leads the pitch-up guidance command, the pitch command needle at first deflects downward, reflecting that the pilot is applying more Nz than commanded. However, once the desired angle of attack and pitch attitude is achieved and remains relatively constant, the pitch command needle moves to the center, agreeing with the pilot's input. This is because the desired Nz command is achieved, no significant delta Nz is required, and the dynamic pressure lower limit is no longer being invoked.

5.5. OFF NOMINAL CONDITIONS

5.5.1. Overview

The discussion of off-nominal situations attempts to not repeat that already made for the nominal case. Only the differences in procedures and techniques required by the off-nominal case are presented.

5.5.2. BFS Engaged

5.5.2.1. Overview

For the purposes of this discussion assume that the BFS has been engaged before Mach = 0.9 because of a problem in the PASS or the PASS GPC's. This enables a study of the effect of BFS on flying the approach, landing, and rollout without considering the effect of other failures (such as IMU's) that contributes to the BFS engage decision. Also assume that the crew has correctly managed the use of IMU, TACAN, and air data information to the BFS and that the resulting state vector is reasonable.

5.5.2.2. Guidance and Navigation

The BFS only supports TAEM guidance. There is no A/L guidance and therefore no A/L transition as described in Section 5.3.3. The BF is driven to the trail position based on an altitude of 10,000 ft instead of the A/L guidance transition. In the BFS, TAEM guidance is terminated at 2,000 ft. The preflare, IGS, and FF must be completed using visual reference to the landing aids and runway environment. There is no AUTO capability in the BFS in OPS 3. There is no smart SB logic and no short field or ELS SB option on SPEC 50.

The AUTO SB function (except for smart SB) is supported in BFS. At 2,000 ft the SB is commanded closed regardless of energy state. AUTO load relief is supported in BFS.

Upon reaching Mach = 0.9, the BFS is using TACAN and air data information to propagate the navigation state and to drive the area navigation display on the HSI. The BFS does not support the use of MSBLS data.

5.5.2.3. Controls and Displays

a. RHC

Both RHC's are supported. There is no Fault Detection, Identification, and Reconfiguration (FDIR) or COMMFAULT checks post MECO and for all entry operations there is no AUTO, only CSS.

b. Speedbrake/Thrust Controller

The CDR and PLT Speedbrake/Thrust Controllers (SBTC's) both operate for SB control with BFS engaged in the same way as in PASS. At 3,000 ft the Pilot should manually set the speedbrake to the DEL PAD speedbrake value. A refined speedbrake value may be called up to the crew by the MCC, that takes the predicted speedbrake adjust command at 500 ft and the predicted T/D position into account. At MGTD, the Pilot should manually open the speedbrake to 100%.

c. ADI

Both forward ADI's are supported in BFS operations; the aft ADI is not. The CDR's attitude switch and attitude REF pb controls both of the forward ADI's. The PLT's switches are not functional. The error needles are stowed at 2,000 ft when TAEM guidance is terminated. Pitch Rate needles are supported for both the CDR's and PLT's position. They provide an accurate cross reference for pre-flare pitch rate, nominally 1.5°/sec for a no wind day, closer to 1.0°/sec for head winds and closer to 2.0°/sec for tail wind situations.

d. AMI and AVVI

The tapes work normally in BFS but the right Air Data select switch is not functional. The left switch controls both sets of tapes. The OFF flags are not functional (remain stowed) in BFS.

e. HSI

Both HSI's are functional in BFS and both are controlled by the CDR's switches (SOURCE and DATA). The mode select switches are not supported, however, the BFS provides auto transitions from ENTRY to TAEM (at initiation of TAEM guidance) and from TAEM to A/L (at 10,000 ft).

f. HUD

The HUD's are not supported with BFS engaged.

g. Beep Trim

The CDR's Beep Trim is supported, the PLT's is not.

5.5.2.4. BFS Flying Technique

All entry BFS operations are flown manually. No difference in flying qualities is discernible from a PASS approach.

The main impact of flying a BFS approach is the lack of HUD. This is not a serious impact and the approach is flown just as practiced during no-HUD STA approaches. No guidance is provided below 2,000 ft and consequently the ADI needles will stow. The preflare should be initiated referencing the pitch rate needle and the out the window cues. The IGS and FF are performed just as practiced in no-HUD STA approaches. The remaining instruments and Cathode Ray Tube (CRT) displays provide information in a near-identical format to PASS.

Although not used for navigation in either PASS or BFS, the radar altimeters are supported in BFS. The BFS displays the first RA to lock-on on both AVVI's. The RA select switch is not functional.

At 5,000 ft, the PLT evaluates RA data. If the altitude data appear to be bad (compared with NAV altitude), the PLT attempts to get data from the other RA. Since there is no direct indication of which RA is providing the bad data, the PLT and MS2 will make the determination by trial and error. The first step is to power off RA 1 on panel O8. If there is no data change, then RA 2 is the one that is locked-on and providing the bad data. On panel O8, power off RA 2 and power on RA 1.

Since there is no smart SB function, the SB is not repositioned at 3,000 ft, but continues to attempt to control airspeed to 300 KEAS. The recommended procedure is for the PLT to manually set the speedbrake to the DEL PAD setting at 3000 ft. If energy is high and the rollout margin is too low, the SB can be manually set at 3,000 ft to a position calculated by MCC. If no action is taken, the SB retracts at 2,000 ft. At MGTD, the SB must be manually opened.

After T/D, the derotation should be accomplished using the CDR's Beep Trim (the PLT's Beep Trim is not supported). The SRB SEP switch and PB are used to backup WOW and WONG after NGTD. NWS and antiskid function the same as in the PASS.

5.5.3. HUD Failed

This section expands on the no-HUD discussion in the BFS engaged section (Section 5.5.2). To reiterate, the lack of a HUD display is not a critical safety issue. Flight prior to and around the HAC is virtually unaffected by the lack of a HUD. The crew obviously obtains all guidance information from the ADI and the scan pattern is entirely head down. Approaching the OGS, the crew begins to include the visual landing aids in their scan. The division of attention between the ADI and the landing aids depends on whether MSBLS data has been incorporated or not. With MSBLS data, guidance on the ADI is very accurate and the ADI should remain in the scan. The error needles (along with the altitude reference scale) provide earlier detection of glide slope deviation trends than the PAPI's can. If the guidance is TACAN only, the ADI should be phased out of the scan pattern when on the OGS with the PAPI's visible. Each instantaneous scan of the PAPI lights yields only the current angle above the horizon. The PAPI's are scanned over a period of time to determine the real glide path. Therefore, the PAPI's require a significant percentage of scan time on the OGS.

The preflare is flown heads-up using STA experience for the rate of pull-up. The ADI rate needles should be utilized to set the initial pull-up rate. The Pitch Rate needles provide an accurate cross reference for pre-flare pitch rate, nominally 1.5°/sec for a no wind day, closer to 1.0°/sec for head winds and closer to 2.0°/sec for tail wind situations. The ball bar and the rate at which the ball is approaching the bar are vital tools for flying the no HUD landing. Begin scanning the ball and ball bar beginning no later than 1,000 ft AGL so as to be able to build a scan and detect the rate at which the ball is approaching the ball bar. This helps the Commander utilize the ball bar effectively and make the appropriate, small and timely RHC inputs required for a good, smooth capture of the IGS and transition to the FF. The CDR may rely more on the verbal callout of altitude to initiate the preflare and to call for the landing gear. The IGS and FF should be flown visually, with the CDR focusing on the far end of the runway once the ball bar is no longer used.

5.5.4. Theta Limits

The vehicle is flown within the constraints of theta limits if air data is not incorporated to GN&C by Mach 2.0. Theta limits are also used if only one ADTA is remaining unless

- a. Winds on the HAC are greater than 80 kts.
- b. Navigation is bad.
- c. BFS is engaged.
- d. Crew workload is too high to add another constraint.

Flying theta limits simply means controlling pitch attitude as a method of keeping the vehicle in a safe region when air data are not available, or when air data redundancy is lost.

To fly theta limits, the crew follows guidance until the bug on the theta scale reaches either the nose low or nose high limit, at which time pitch attitude is controlled to keep theta within limits. Once the bug moves away from a limit, guidance is again followed. On the HAC, pitch attitude is constrained when flying theta limits. Additionally, the crew should not exceed 50° angle of bank on the HAC when flying theta limits. Once the vehicle is on the OGS, theta limits are abandoned for the remainder of the approach.

The speedbrake may be left in auto throughout TAEM and A/L while flying theta limits. Although the speedbrake setting is affected by the lack of air data to G&C, off-line simulations have shown that when the speedbrake is left in auto, performance is generally better than when it is set to a predetermined position (reference AEFTP #128, 12/8/95). Therefore, the speedbrake will be left in auto and the setting evaluated for reasonableness. If the speedbrake setting is unreasonable, the crew may select manual speedbrake and set it as necessary.

The ADI will display a theta limits bracket when air data is either in dilemma or inhibited to G&C, and $M < 2$. This bracket will reflect the upper and lower pitch limits displayed on the VERT SIT display. An example of the bracket can be seen on the ADI in Figure 5.5.4-1.



Figure 5.5.4-1 View of PFD during Theta Limits (green bracket on ADI)

5.5.5. Stuck SB

The stuck SB procedure outlined in Table 5.5.5-1 is considered a general guide. It is a procedure designed to be applicable to all vehicle weights. However, assigned crews need to refine the procedure in the SMS using their mission mass properties and various wind conditions. For example, with vehicle WT between 205,000 and 220,000 lb (heavy end of the 20° OGS) the tendency is to overspeed the vehicle on final during the stuck-greater than 50 percent case. The crew may want to compensate by flying one dot high instead of two. Conversely, in the stuck 30 to 40 percent case for the same vehicle, the tendency is to land short and slow.

Table 5.5.5-I Stuck Speedbrake Procedure

SB setting (stuck)	TAEM	A/L	Aimpoint
> 60	Fly 1 to 2 dots hi throughout TAEM	< 222K : 25° GS > 222K : 21° GS	* 4000 ft
40 to 60	AUTO P, R/Y	Fly needles	CLSE
30 to 40	FLY 1 to 2 dots lo Maintain EAS < 300	15° GS	CLSE
< 30	AUTO P, R/Y At M < .95 deploy gear	Fly needles	CLSE

* Aim 1/2 way between 7500 ft aimpoint and threshold.

5.5.6. MLS Dilemma

Miscompares of MLS data is annunciated as RM DLMA MLS in OPS 305. There is no MLS FDIR in OPS 603 and MLS is not supported in the BFS.

The specific MLS parameter (Range, Azimuth, or Elevation) that is in dilemma is determined by the rules and sequence of data incorporation and by observing the TACAN residual and ratio window on the SPEC 50 display. The software incorporates MLS data to navigation (which causes the TACAN residuals and ratios to go blank) only if MLS Range and Azimuth are both good. From this, the following is deduced:

- a. Residuals blank + RM DLMA MLS = Dilemma in Range and/or Azimuth
- b. Residuals present + RM DLMA MLS = Dilemma in Elevation

Since range data is available for incorporation before AZ and EL data, time of occurrence and SPEC 50 can be used to further define the parameter in dilemma with the following rules:

- a. Heading > 55° to runway + Residuals present = Range
- b. Heading < 55° to runway + residuals present = Azimuth or Range
- c. Heading < 55° to runway + residuals blank = Elevation

Determining the specific parameter in dilemma is largely academic for the crew, but cues them to which parameter to watch while performing the procedure presented below. If the runway and landing aids are in sight, the crew may choose to ignore the dilemma and complete the landing. If the MLS data are needed or desired, the crew must quickly determine which is the offending MLS unit and secure the power to that unit. The following procedure can be used:

- a. Note previous losses: i.e., define which two LRU's are in dilemma
- b. HSI source switches: Select first LRU number
- c. HSI source switches: Select NAV
- d. HSI source switches: Select MLS
- e. HSI: Watch for a jump in the appropriate parameter
- f. HSI source switches: Reselect NAV
- g. HSI source switches: Select second LRU number
- h. HSI source switches: Select MLS
- i. HSI: Watch for a jump
- j. Which LRU showed the worst jump?
- k. Remove power from the LRU
- l. PASS I/O reset

5.5.7. APU/Hydraulic System Failures

Hydraulic power is required for flight control surface actuation including SB, BF, and elevons, for landing gear extension (primary method), for NWS, and for braking. Loss of one APU/hydraulic system usually has little effect. Loss of two systems may have significant effects and requires crew action to help ensure satisfactory system performance.

This book does not attempt to detail all the off-nominal procedures required by APU/hydraulic system failures, but describes the basic actions that are required and the flight characteristics that result from these failures.

a. Single system failure

A single failure causes no change in flight control capability and there are no changes to the way the vehicle is flown for the A/L. The remaining two APU's are taken to high speed at TAEM interface to protect against the failure of another APU/hydraulic system; PRL assumes the higher flow rate provided by high speed is available with only a single system operating.

b. Two systems failed

Operating with only one hydraulic system is a more serious situation, however, the Shuttle software is designed to allow a landing with only one of three APUs operating. It does this by reducing the aerosurface drive rates to values that can be supported by a single APU. The software responsible for this function is called PRL. Reference Section 2 for more information on PRL. When this software was developed it was understood that single APU landings involved risk because they require that the remaining APU perform at its operational limits. Studies have shown that PRL software consistently allowed APU overdemands in excess of 20 gallons per minute during certain flight phases. Severe hydraulic system pressure drops (and probably loss of vehicle control) were expected under these circumstances. Most of these overdemands occurred after WOW but some (less significant) problems were also identified during gear deploy. One of the primary culprits for this problem is a sluggish speedbrake. That leads to the speedbrake procedure described below.

The remaining APU's automatic shutdown feature is inhibited and the APU is run at high speed to provide maximum hydraulic flow. Rapid, aggressive, or large ($> 10^\circ$ deflection, which is halfway to the soft stop) RHC inputs frequently cause elevon saturation by exceeding the hydraulic power available. However, if a smooth open loop approach is flown, the pilot may not detect any difference in flying qualities.

At 3,000 ft the Pilot should manually set the speedbrake to the DEL PAD speedbrake value. This is to avoid any chance of normal RHC inputs, landing gear deploy, and SB repositioning at, or about the same time during the approach which could over demand the hydraulic system flow rate capability. A refined speedbrake value may be called up to the crew by the MCC, that takes the predicted speedbrake adjust command at 500 ft and the predicted T/D position into account.

In order to keep the manual speedbrake procedure as simple as possible and thereby minimize crew distractions, the pilot sets the SBTC to the proper position using the cue card located next to the SBTC handle. This action is performed during a quiescent period early in the entry profile in preparation for the manual 3 kft setting. The SB remains in AUTO during this time. At 3 kft, the pilot engages the SBTC manual takeover push button on the SBTC handle to invoke manual SB control. Since the SBTC is already properly positioned, the SB will be commanded to the correct setting. No further action is required by the crew other than to confirm that the SB is at the desired position using the SPI.

The FDO will round the preferred SB position to the nearest 5% to make it easier for the crew to set the SB. The crew should make a best effort to achieve the proper position since any errors will have impacts on landing energy. However, the crew should not allow themselves to become distracted by attempting to fine tune the SB position. Not only would such activity divert the crew's attention from the higher priority activities of landing, but it would

also introduce the possibility of SB motion during gear deploy or close to the ground when the elevons are making last minute adjustments. In both cases, SB motion could result in hydraulic system overdemand. The most important thing for the crew is to get the SB set reasonably close to the desired value and then leave it alone. Once the SB has been positioned to the 3k ft setting, the crew should not move it again until after wheel stop.

There may be landing scenarios where runway length is limited and opening the SB after touchdown to reduce rollout distance becomes highly desirable. This would only be a concern for landings at Emergency Landing Sites with short runways. Since a single APU landing in combination with an abort to a short runway is unlikely, the manual SB procedure was not developed to accommodate this scenario. However, if such a situation occurs, the crew may safely open the SB during rollout if they wait at least four seconds after WONG. A four second delay will ensure that the elevons have completed the movement from a full up position of -11.7° (typical during derotation) to a full down position of $+22.5^\circ$ (for load relief), and that system overdemand is no longer a threat. The crew should be especially careful not to move the SB between WOW and WONG since this is the period of greatest hydraulic system stress and of flight control instability.

The goal of the single APU approach is to fly a low gain pass, but on the optimum profile, targeting the nominal 26 ft threshold crossing height. **Do not touchdown slow, or derotate late.** This is to avoid exceeding the hydraulic power available during the derotation and load relief portions of the landing rollout.

Once the nose landing gear is on the deck (WONG set), the pilot should wait approximately 4 seconds then manually open the speedbrakes fully. This reserves hydraulic system volume for the elevons to perform their load relief function and rudder and aileron function for un-commanded roll during the two point stance and initial three point attitude.

NWS is unavailable if Systems 1 and 2 are failed. If Systems 1 and 3 (or 2 and 3) are failed, braking power is one half of normal.

Beginning with OI-28, the minimum SB setting at touchdown was changed from 25 degrees to 15 degrees, and eliminated the risk of the SB causing an overdemand at WOW. With OI-29, PRL modifications further increased hydraulic margins by adding additional leakage terms to the hydraulic demand budget, and by constraining aerosurface rates. However, even with these upgrades it is still important to perform a manual SB at 3 kft to avoid overdemand due to gear deploy and post-WOW derotation.

5.5.8. Tire Failures

Origin of Procedures

All of the recommended procedures for dealing with tire failures have been developed at the Ames Research Center's VMS. The one tire failure that has occurred on an orbiter occurred near enough to the end of rollout to not require any crew action. Consequently, these procedures are not flight proven. The magnitude of the control inputs differs between what is determined in the simulator and what is needed in the real world. Pilot perception of vehicle behavior and response is also different in the real world. However, for this phase of flight, the VMS is the best emulator of the shuttle available and it is believed that the procedures developed there allow control of the vehicle with tire failures.

5.5.8.1. Leaking/Failed Tire

If a main tire is known to be leaking or failed prior to landing, it is very likely that it, and the tire adjacent to it, will fail during the derotation. If possible, a concrete runway is selected and a landing is planned such that any crosswind comes from the same side as the bad tire(s). The crosswind tends to lift the upwind wing, reducing main gear strut loads, and possibly preventing the remaining good tire from failing during derotation. If after

derotation both tires fail, having the failed tires on the upwind side is the better case for vehicle control. See Figure 5.2.3-2 for the cue card that the crew uses for landing with a failed tire.

The failed tire procedure uses techniques designed, in addition to the crosswind technique previously described, to offload the failed tire to the maximum extent. The auto derotation function in the DAP is utilized to provide a smooth transition from the two to three-point stance. This technique was verified as the most acceptable option in the VMS, and minimizes excessive tire loading that can result from a manual or beep trim technique. Auto derotation is I-loaded to execute at 180 KEAS. The drag chute is also used to mitigate NG slapdown rates and provide additional directional control. The final action of the procedure commands a full RHC deflection toward the good tire to provide additional reduction of loads on the side with the failed tire.

5.5.8.2. Vehicle Control With Tire Failures and Crosswind

a. Before derotation

Before derotation, the yaw force due to tire failures is not strong. The effect of any crosswind is likely to be larger. The vehicle tends to roll and yaw away from the wind. The RHC is used to hold the wings level (upwind deflection) while the rudder is used to track straight down the runway. In the VMS, a small brake application (tap) is used to quickly stop a yawing motion. The crew must not allow any lateral error or rate to build before or during derotation. See the discussion in Section 5.3.6.7.

b. After derotation

Serious directional control problems begin at the completion of derotation. The yawing force of the failed tires increases, and the yawing force due to crosswind reverses from what it was before the derotation NWS operation. If the failed tires are upwind, the yawing forces due to failed tires and due to crosswind are upwind and a large rudder pedal input may be required to maintain control. Even though the control input is large, fewer cases of loss of control or runway departure occurs during VMS runs with failed tires on the upwind side. If the failed tires are on the downwind side, the yawing forces of the failed tires and of the crosswind are opposite to each other (balancing) and the rudder pedal input required for control is small. If the crosswind component is large, the required pedal deflection may even be in the direction of the failed tires. During VMS runs, pilots have a tendency to overcontrol the first rudder pedal input and subsequently lose control and/or depart the runway. The higher frequency of control loss during VMS runs with failed tires on the downwind side, along with the beneficial effects for strut loads of having the failed tires upwind, has led to the policy of placing a leaking or flat tire on the upwind side.

c. Rudder pedal inputs

The space shuttle rudder is a large, slow moving control surface that cannot respond rapidly to large pilot inputs. Pilots who use small rudder pedal inputs perform the best during VMS runs. Large inputs can be used, and may be necessary for upwind tire failures, but are taken out before an undesired yaw rate develops. If a large pedal input is sustained until the yaw rate is well under way, loss of control is probable; the slow surface rate does not allow an opposite input to be effected quick enough. Large rudder deflections cause roll opposite to yaw which should be countered by RHC deflection in the same direction as the pedal input.

Tire failures on the downwind side requires very cautious use of the rudder. At the moment of failure the vehicle appears to lunge toward the failed tires, stimulating an instinctive reaction by the pilot of rudder opposite the failure. As previously discussed, this reaction can easily be too large, or even in the wrong direction. Pilots must be very alert to the development of yaw rates and make quick, small rudder inputs in response.

d. RHC inputs

After nose wheel T/D, differential elevon (aileron) deflection is a useful tool for directional control. The wing is at a negative angle of attack, about 4° during rollout. As seen by the relative wind, wing camber is increased by up-elevon deflection and decreased by down-elevon deflection. Aileron deflection, therefore, has proverse yaw; the vehicle yaws in the direction of RHC deflection. Additionally, the main gear in the direction of RHC deflection is loaded more, all other factors being equal, than the gear on the other side. The increased normal force creates more friction (drag) force and tends to yaw the vehicle in the direction of RHC deflection. The elevon surfaces have quicker response than the rudder and directional control with aileron can feel more responsive. After nose wheel T/D, lateral RHC is used to hold the wings level, if required, and to augment the rudder/NWS for directional control. With failed tires, the vehicle is in a small angle of bank. Holding lateral RHC in an attempt to level the wings creates the desired yawing force away from the failed tires and unloads the failed side, possibly reducing further damage.

e. Brake inputs

Differential braking is required to augment rudder, NWS, and aileron for directional control, and is required for control if NWS is not available. In VMS runs, some pilots use brief taps of one brake to stop a developing yaw rate. This method may be quicker than rudder or aileron inputs. Braking is not required or desired on the wheels with the failed tires. In order to be ready to use the brakes, pilots need to consider taking their heels off the floor and placing their toes on the brakes after MGTD and before derotation.

5.5.9. Inadvertent Early Deploy of Landing Gear

For certain failures, the MCC will ask the crew to arm the gear at $M=0.95$. At that point, failures of the contacts within the landing gear ARM Push Button Indicators (PBI) can cause the gear to inadvertently deploy early. If this occurs, continue to fly the needles. Select Close-in aimpoint and manually close the speedbrake at 3000 ft.

5.5.10. No Deploy of Landing Gear

Failure of hydraulic system one, and both pyrotechnic systems results in failure of the landing gear to deploy. Although this is considered unlikely, the subject is worth a few brief notes. Of course if the failures occur too late, a gear-up landing is the only alternative. Little is known about the consequences of a gear-up landing, but many in the community would expect the orbiter to break up. If the problem with hydraulic system one is the APU, hydraulic circulation pump 1 will not provide enough power to release the gear uplock hooks. If the failures are discovered early enough MCC would likely call for a bailout and provide a heading to fly.

APPENDIX A.1 LANDING SITES

Table A-I Space Shuttle Approved Landing Sites (check NSTS 07700 Vol X, Book 3 for latest version)

	EOM	RTLS	AOA	TAL	ECAL	ELS LOW/ MID	ELS HIGH	REMARKS
Amberly RAAFB, Australia						X	X	
Amilcar Cabral International, Cape Verde						X		
Andersen AFB, Guam, USA						X	X	
Arlanda, Sweden							O	Above 57°
Ascension AUX AF, Ascension Is, UK						X	X	
Atlantic City Intl, Atlantic City, NJ, USA					X		X	
Banjul International, The Gambia						X		
Beja, Portugal						X	X	
Ben Guerir AB, Morocco				X		X	X	
Bermuda Intl, St. David's Island, Bermuda						X		
Cape Canaveral AFS Skid Strip, Cocoa Beach, FL, USA						X		
Cecil Field, Jacksonville, FL, USA						X		
Cherry Point MCAS, NC, USA					X		X	
China Lake NAWS, Ridgecrest, CA, USA						X		
Diego Garcia NSF, Chagos Archipelago, UK						X	X	
Dover AFB, DE, USA					X		X	
Dyess AFB, TX, USA						X		NOR AOA Wx Alternate
Edwards, CA, USA	X		X			X	X	
Ellsworth AFB, SD, USA							O	
Elmendorf AFB, Anchorage AK, USA							X	
Esenboga, Turkey						X	X	
Fairford, England							X	Ascent Only
Gander International, Newfoundland, Canada					X		X	
Goose Bay, Newfoundland, Canada					X		X	
Gran Canaria, Las Palmas, Canary Islands, Spain						X		
Grant County/Moses Lake, WA, USA							O	
Halifax Intl, Nova Scotia, Canada					X		X	
Hao Atoll, Tuamotu Arch. Fr Polynesia, France						X	X	
Hoedspruit AFS, South Africa						X		
Honolulu International, HI, USA						X	X	
Keflavik NAS, Iceland							X	
King Khalid Intl, Riyadh, Saudi Arabia						X	X	
Kinshasa/N'Djili International, Zaire						X		
Koln-Bonn, Germany							X	
KSC (SLF), FL, USA	X	X	X			X	X	
Lajes, Azores, Portugal						X	X	Approved High & Mid Inc Only
Le Tube, Istres, France						X	X	Ascent Only

Table A-I Continued

	EOM	RTLS	AOA	TAL	ECAL	ELS LOW/ MID	ELS HIGH	REMARKS
Lincoln Municipal, NE, USA							O	
MacDill AFB, Tampa, FL, USA						X		
Mataverí International, Easter Is, Chile						X		
Monrovia/Roberts International, Liberia						X		
Moron AB, Spain				X		X	X	
Mountain Home AFB, ID, USA							O	
Myrtle Beach International, SC, USA					X		X	
Nassau Intl, New Providence Island, Bahamas						X	O	Underburn in Software
Northrup (WSSH), NM, USA	X		X			X	X	
Oceana NAS, Virginia Beach, VA, USA					X		X	
Orlando International, FL, USA						X	O	Underburn in Low Software
Otis ANGB, MA, USA					X		X	
Pearce, Australia						X		
Pease International Tradeport, Portsmouth, NH, USA					X		X	
Piloto Civil Norberto Fernandez, Rio Gallegos, Argentina							X	Government Approval Pending
St. Johns Newfoundland, Canada					X		X	
Shannon, Ireland							X	Ascent Only
Souda, Chania, Greece						X		Above 40° Inclination only
Stephenville, Newfoundland, Canada					X		X	Prior coordination for night use
Tamanrasset, Algeria						X		Mid Inclination Ascent Only
The Francis S. Gabreski, Westhampton Beach, NY, USA					X		X	
Tindal RAAF, Australia						X	X	
Vandenberg, CA, USA						X		
Wake Island AAF, Wake Island, USA						X	X	
Wallops Flight Facility, Wallops Island, VA, USA					X		X	
Wilmington Intl, Wilmington, NC, USA					X		X	
Yokota, Tokyo, Honshu Island., Japan						X	X	
Zaragoza AB, Spain				X		X	X	

Sites not currently being used on the Landing Site Table

ELS LOW/MID – Emergency Landing Sites available for low inclination KSC launches

ELS HIGH – Emergency Landing Sites available for low inclination KSC launches

O – Downrange abort or deorbit underburn sites; coordinates not carried in onboard software

Table A-II Navigation and Landing Aid Reference Chart
(example only – reference flight specific version)

NAV/LANDING AIDS REFERENCE CHART
STS-114

SITE	MLS	PAPI 7500' (NOMINAL)	PAPI 6500' (CLOSE-IN)	MARKING 7500'	MARKING 6500'	BALL- BAR	TACAN (PRIMARY)	TACAN (BACK-UP)	REMARKS
EDW 04	2 JRS - CH 6	✓	✓	■	▲	✓	EDW 111 (SS)	LHS 21 (SS)	XENON - Shoulders Non-Load Bearing
EDW 22	SR - CH 8	✓	✓	✓	✓	✓	→	→	XENON - Shoulders Non-Load Bearing
EDW 15	☒	✓	✓	✓	✓	✓	→	→	ELS ONLY - Wet
EDW 33	☒	-	-	✓	✓	-	→	→	ELS ONLY - Wet
EDW 18L	☒	-	-	✓	✓	-	→	→	ELS ONLY - Wet
KSC 15	SR - CH 8	✓	✓	-	-	✓	TTS 59Y (DS)	GMN 71 (SS) CGF 99 (SS)	XENON - CENTERLINE LIGHTS
KSC 33	SR - CH 6	✓	✓	-	-	✓	→	LAL 107 (SS)	XENON - CENTERLINE LIGHTS
NOR 17	LAKE	✓	✓	✓	✓	✓	SNG 121Y (DS)	HMN 92 (SS)	XENON
NOR 35	LAKE	✓	✓	✓	✓	✓	→	→	DAY ONLY
NOR 05	LAKE	-	-	✓	✓	-	→	→	DAY ONLY
NOR 23	LAKE	✓	✓	✓	✓	✓	→	→	SOAS WILL NO LONGER BE INSTALLED.
ZZA 30L	SR - CH 6	✓	✓	-	□	✓	ZZA 64 (DS)	ZZA 77 (DME)	SOAS WILL NO LONGER BE INSTALLED.
ZZA 12R	-	-	-	-	-	-	→	→	SOAS WILL NO LONGER BE INSTALLED.
MRN 20	SR - CH 6	✓	✓	-	□	✓	MRN 100 (SS)	AOG 23 (DS)	SOAS WILL NO LONGER BE INSTALLED.
MRN 02	-	-	-	-	-	-	→	→	WILL NO LONGER SUPPORT
BEN 36	☒	-	-	-	-	-	-	CBAL16 (DME)	WILL NO LONGER SUPPORT
BEN 18	☒	-	-	-	-	-	-	→	WILL NO LONGER SUPPORT
FMI 33	2 JRS - CH 6-	✓	✓	-	-	✓	FMI 16 (DS)	NIM 53 (SS)	δ
FMI 15	-	-	-	-	-	-	→	→	δ

- - CHANGE FROM LAST CHART
- LAKE - LAKEBED RUNWAY
- ☒ - WILL NOT SUPPORT THIS MISSION
- ☐ - AIM POINT IDENTIFICATION LIGHT SYSTEM (APILS) NOT TURNED ON
- ⊕ - SURVEYED POINTS WHERE PAPIs / BALL BARS CAN BE INSTALLED
- (DS) - DUAL STRING TACAN TRANSPONDER
- (SS) - SINGLE STRING TACAN TRANSPONDER
- ☒ - XENON LIGHTS ON RUNWAY HAMMERHEAD - SET UP IN TWO HOURS
- δ - XENON LIGHTS CAN BE INSTALLED AT THESE LOCATIONS
- ◆ - NAV / LANDING AIDS REMOVED DUE TO WET LAKEBED CONDITION

CONUS XENON LIGHTS WILL SUPPORT LANDINGS BETWEEN SUNSET AND SUNRISE
TAL XENON LIGHTS WILL SUPPORT LANDINGS BETWEEN SUNSET + 15 MINUTES AND SUNRISE - 15 MINUTES

APPENDIX B.1 HEADING ALIGNMENT CONE AND PREFINAL

Before STS-5 the orbiter flew around a heading alignment circle. After STS-4 the reference profile was changed from a circle to an inverted cone (Figure B.1-1), where the orbiter would fly a 42° bank angle. This allowed the orbiter to fly more constant bank angles during large turns and also to better manage high-energy situations.

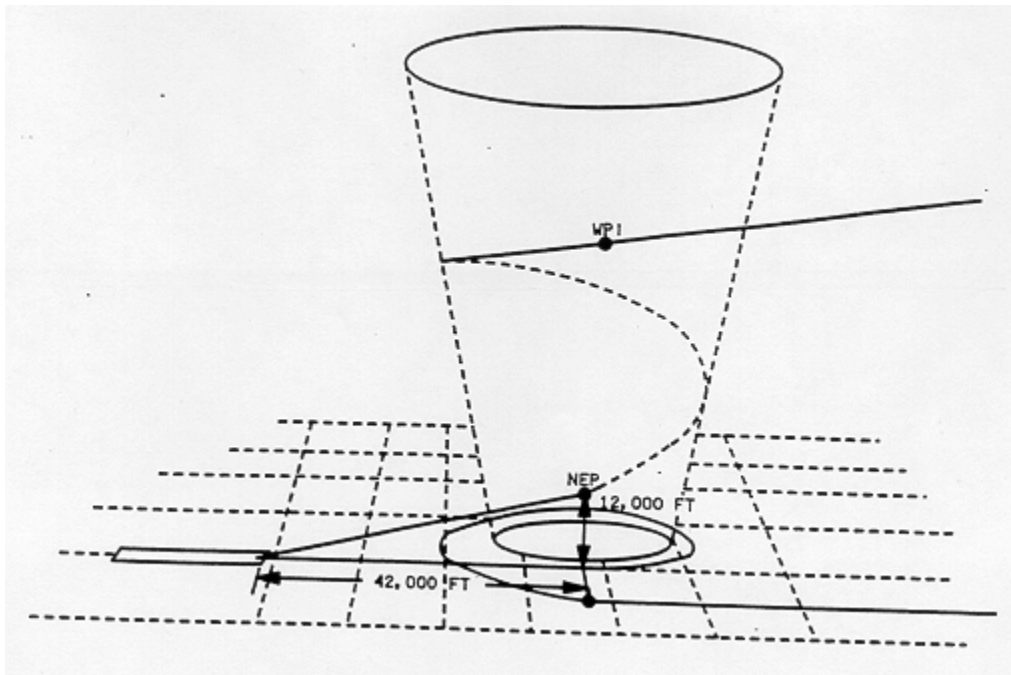

Figure B.1-1 HAC Profile

Profile options were also included to improve low-energy situations. These options included straight-in approach, radius adjust, and MEP HAC. Of the three, only the radius adjust occurs automatically in guidance. In a straight-in approach, the HAC turn angle is never greater than 180° (Figure B.1-2). For a radius adjust the HAC radius shrinks allowing the orbiter to fly a shorter approach profile. A radius adjust will never occur if the HAC approach angle is less than 90° . The MEP option moves the HAC center point 3 NM closer to the runway. The range savings when using a straight-in approach or flying the MEP will vary according to the HAC approach angle (Figure B.1-3). These three changes are not nominal procedures and will be used only when the vehicle is in a low-energy situation.

Prior to reaching the nominal entry point (NEP), the orbiter enters the prefinal phase of TAEM guidance. Guidance now manages the altitude, crossrange, and dynamic pressure until the vehicle acquires A/L guidance, which nominally occurs at 10,000 ft. To acquire A/L guidance at 10,000 ft, trajectory errors must fall within the parameters listed in table B.1-I. Except for the dynamic pressure error, the error limits decrease gradually as a function of altitude until the altitude decreases to 5000 ft. A/L guidance is forced at 5,000 ft regardless of the trajectory errors.

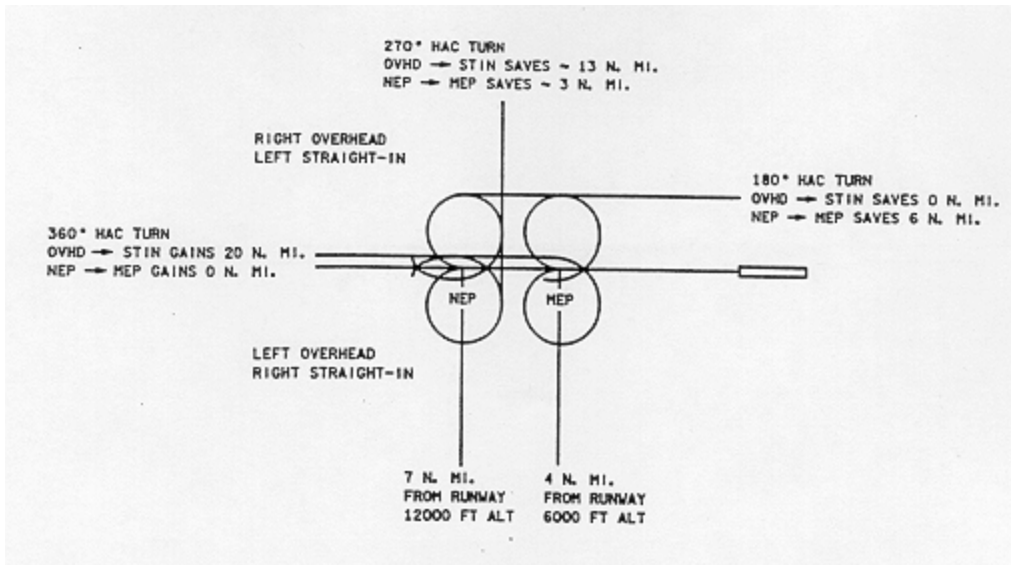

Figure B.1-2 HAC Groundtrack

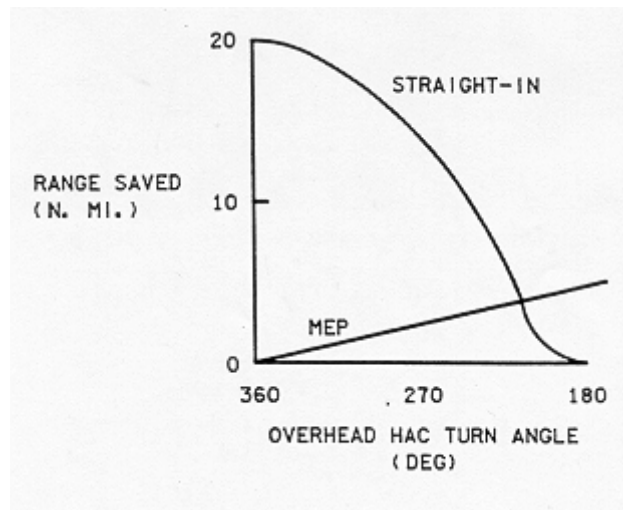

Figure B.1-3 Difference in Range Between a Straight-In and an Overhead HAC

Table B.1-I TAEM A/L Transition Criteria

10,000 ft	TAEM A/L Transition Criteria	5,000 ft
< 4°	Flight Path Angle Error	< 0.5°
< 1000 ft	Crossrange Error	< 100 ft
< 1000 ft	Altitude Error	< 50 ft
< 24 lb/ft ²	Dynamic Pressure Error	< 24 lb/ft ²

APPENDIX B.2 OUTER GLIDE SLOPE

The main design goal for the OGS is to develop an equilibrium glide path that provides sufficient energy at preflare for a safe landing. Sufficient energy is defined as enough energy to compensate for the deceleration between preflare and T/D and to provide the pilots with adequate time on the IGS to make any final corrections before T/D. Deceleration is a consequence of reducing the -185 fps altitude rate on the OGS to -3 fps at T/D and of allowing for 5 sec of stable flight time on the IGS.

In order to provide sufficient energy at preflare, the OGS design has to handle both high and low energy dispersions over the entire WT span of the orbiter. Since all three OGS components (slope, aimpoint, and reference velocity) directly affect the preflare energy, a design had to be found that best satisfied the requirements and yet did not violate any of the restrictions.

a. Altitude

Time to correct trajectory dispersions is provided by the altitude at which the OGS is acquired. The straight-in portion of the OGS was designed to start at an altitude of 12,000 ft to allow sufficient time to correct for expected trajectory dispersions after completing the HAC turn. The prefinal phase of TAEM guides the orbiter to the same OGS and reference airspeed that autoland guidance uses. Transition from TAEM to autoland normally occurs at 10,000 ft. but if the transition criteria have not been satisfied by 5000 ft, transition is forced. The 5000 ft altitude allows autoland equations time to cycle through the initial transients and time for the rate terms to reach their damping values before preflare.

b. Reference velocity

The reference velocity of the OGS is 300 KEAS. This velocity is required to compensate for the expected deceleration on the IGS. The design goal is to fly as fast as possible without hitting vehicle maximum Q-bar limits.

The reference velocity has varied 5 to 15 kts since the original design. Two hundred and ninety KEAS was the original velocity of the early STS-1 design period. However, after the STS-1 I-loads were frozen, the maximum tire speed was reduced significantly. Since the flight was to be flown manually during A/L, the reference velocity trained to and actually flown was reduced to 280 KEAS to protect the maximum tire speed at T/D. The reference velocity was set at 285 KEAS and remained fixed through STS 51-C. The velocity was then increased by 5 kts to 290 with the introduction of the Operational Increment (OI-5) SB logic (discussed in Section 4.4). This was to increase the energy state before preflare and provide more margin for low energy dispersions. A portion of this speed is converted to more stable time on the IGS, which is also part of the design goal. The reference velocity was finally increased to 300 KEAS to better protect against low energy landings.

c. Slope

Two slopes are used for light and heavyweight vehicles, - 20° and - 18°, respectively; 220,000 lb is the breakpoint between light and heavy (Figure B.2-1). Current geometry (I-loads) is designed for orbiter WT's between 190,000 and 248,000 lb. If WT's ever become less than 185,000 lb or heavier than 250,000 lb, serious considerations should be given to changing the OGS to retain dispersion capability.

In the early STS-1 design period, the reference slope was -22°. Pilots expressed a concern that the resulting altitude rate, -220 fps, was almost unacceptably high. An aerodynamic data update based on wind tunnel results allowed a reduction of the OGS from -22° to -20°. Due to better L/D than predicted from Approach and Land Test (ALT) flights, STS-2 OGS was reduced to -19 deg, where it remained until STS-58. When the reference velocity was increased to 300 KEAS, the trimmed speedbrake on the OGS

became $< 50^\circ$ which was in conflict with the basic design philosophy. Increasing the OGS angles by 1° not only recentered the trimmed speedbrake but added 200 - 300 ft more needed T/D energy.

The primary design consideration of the OGS slope is to make it as shallow as possible while still maintaining sufficient SB reserve to cope with winds and initial trajectory dispersion. The slope of the OGS is to provide capability to compensate for both high and low energy dispersions. This capability is obtained by selecting a slope which results in the mid-SB effectiveness value of 65° for a midrange WT. Figure B.2-2 shows the variation of trim SB with WT and GS values.

The slope must not be too shallow, since it is necessary that the vehicle stay on the front side of the L/D curve. To protect this, the vehicle must not fly slower than the minimum Q-bar profile. In autoland the guidance equations limit the maximum value of altitude error used in the Nz commands c to ± 300 ft. The smaller altitude error in combination with the altitude rate error damping term and the associated gains provide a pseudo minimum Q-bar protection. One of the reasons for not forcing TAEM transition to autoland guidance until 5000 ft, in the presence of large trajectory errors, is that TAEM has direct Q-bar control limits that keep the orbiter on the front side of the L/D curve.

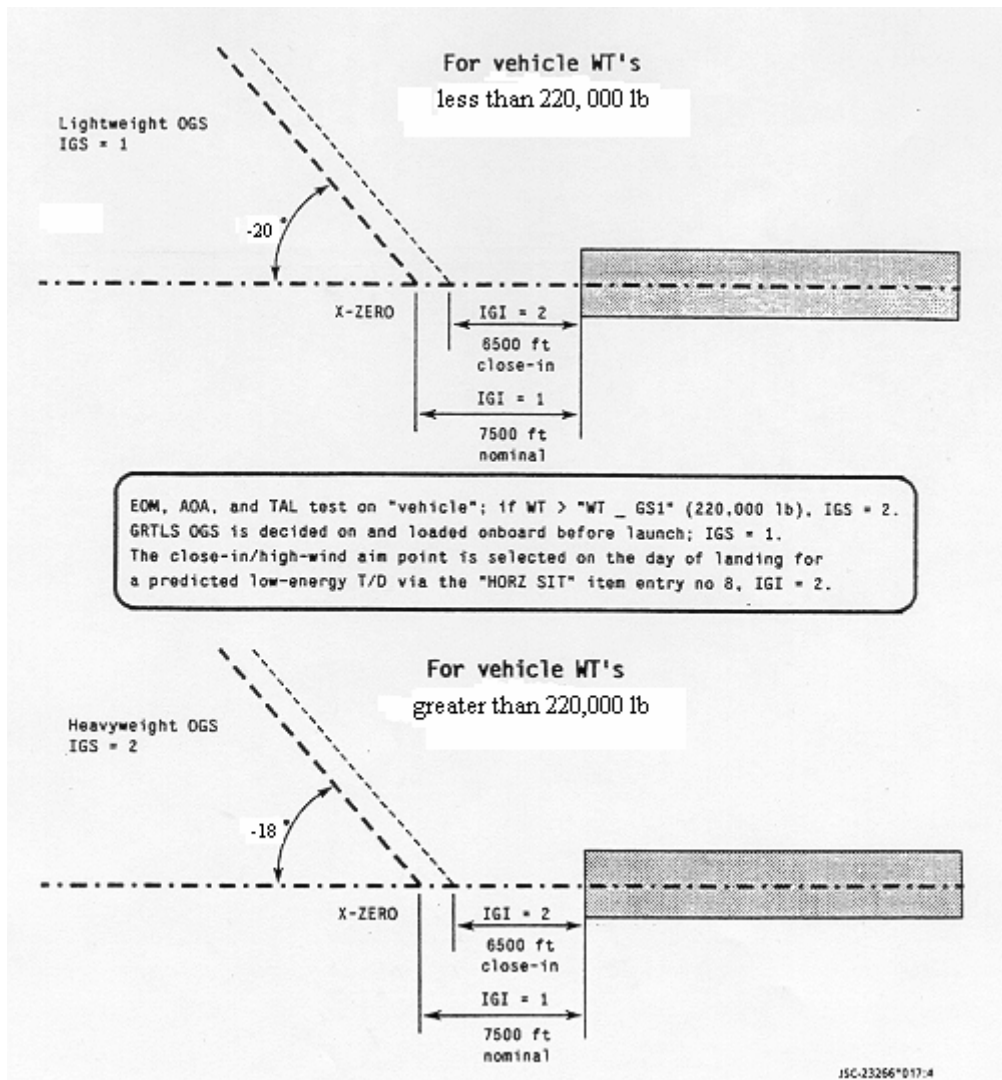

Figure B.2-1 OGS Geometries

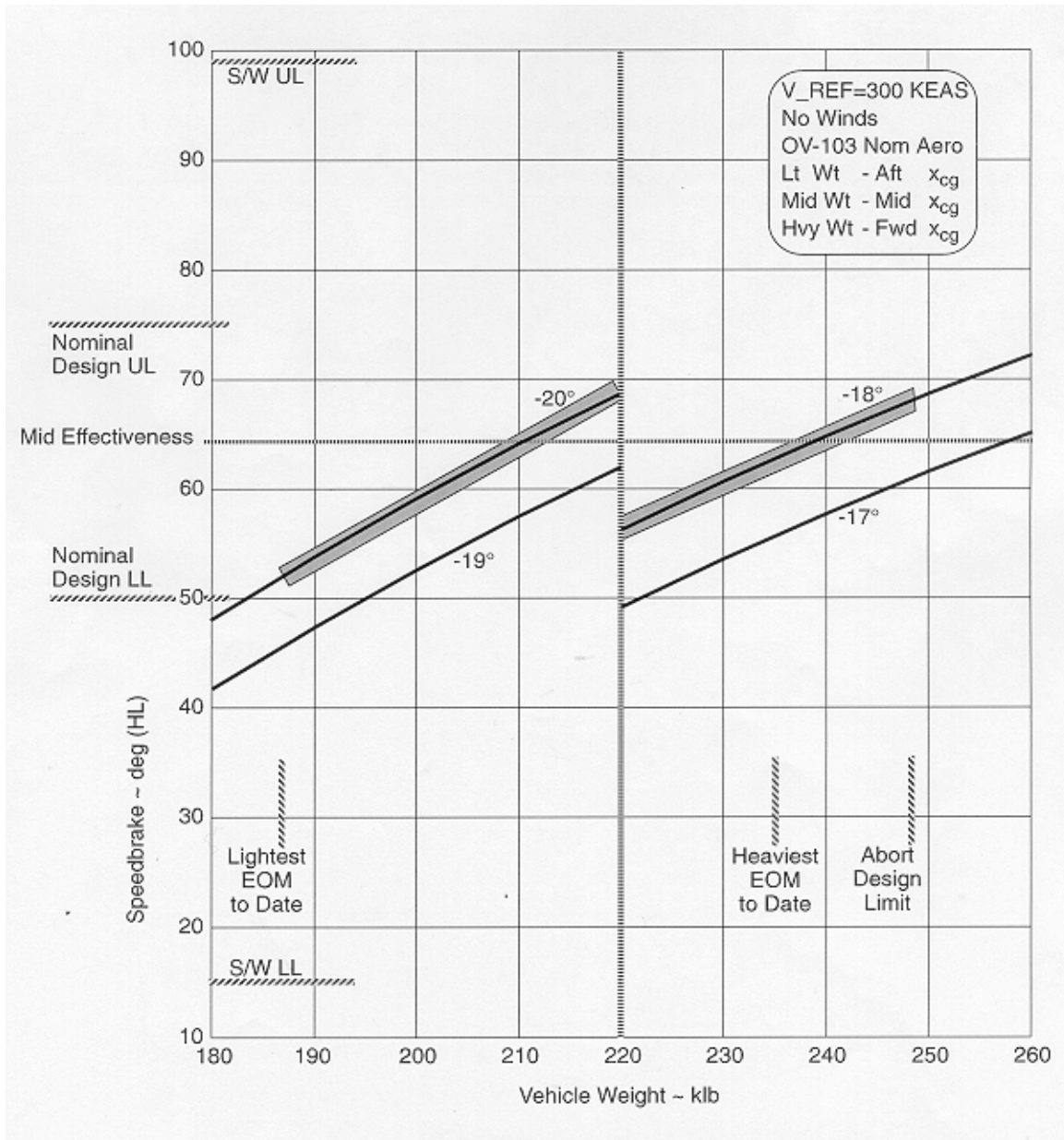

Figure B.2-2 Trimmed Speedbrake on the OGS

d. Aimpoint

The OGS aimpoint or intercept location is determined by energy requirements for landing and geometry constraints for transition between the two GS's. The distance from preflare to T/D is proportional to the vehicle deceleration time. This distance is directly related to the aimpoint location. The current nominal aimpoint value is 7500 ft before the runway threshold. Another aimpoint for off-nominal or low-energy situations is the close-in or high-wind aimpoint. This is located at 6500 ft before the runway threshold. Use of the close-in aimpoint provides immediate energy increase by moving the OGS intercept 1000 ft closer to the runway. The close-in aimpoint is often selected because landing in high headwind is preferred over landing in high tailwind or crosswind.

STS-1 and STS-2 used 6500 ft as the nominal aimpoint. STS-1 post flight results allowed the nominal aimpoint to be moved out an additional 1000 ft, again due to better than predicted aerodynamic L/D ratio. STS-3 and all subsequent flights have had a 7500-ft nominal aimpoint.

APPENDIX B.3 FLARE AND SHALLOW GLIDE SLOPE

In the early design of the FSGS geometry, it was decided to use a two-flare approach instead of one flare. The one flare design was more sensitive to trajectory and vehicle disturbances near the ground, and it provided no stable flight time just prior to T/D. Using an initial pullup circle for a reference profile minimizes the maximum load factor and eases the monitoring task because the pullup g's are nearly constant. Also, using an IGS before an FF provided a stable flight time, which was strongly desired by the shuttle pilot in both the CSS and AUTO mode of flight. This time is used to make a final energy assessment and to establish a controlled approach to the runway T/D zone.

With the decrease of the OGS from -24° in the pre-ALT days to the current -20° , the pullup circle radius has increased so that the nominal pullup g's are now approximately 0.33 compared to 0.5 pre-ALT. The 0.5g value is the nominal design limit, but with today's geometry it no longer affects the trajectory design. The initial preflare altitude has increased since that same time, due to the pilot's concern that a few seconds delay in the start of the flare while descending at -185 fps can make the pullup maneuver very demanding and can result in an uncomfortably low pullout altitude.

The autoland guidance FSGS phase starts at 2000 ft altitude. In the reference geometry the pullup circle tangent to the OGS is at 1700 ft altitude. An early STS-1 design had the flare altitude at 1750 ft because, among other reasons, that was halfway between the cockpit instrumented altitude readouts.

During the early part of the FSGS phase, the velocity is increasing to ≈ 310 KEAS due to the SB's retraction at 3000 ft altitude. As the flightpath angle nears the minimum steady-state value (approximately -12 deg at approximately 1300 ft altitude), the velocity begins to decrease. Generally the transition to the IGS begins at 200 ft altitude.

The FSGS exponential and the FF trigger geometries are designed to give the pilot at least 5 sec of stable flight time on the IGS before the FF maneuver on the nominal trajectory. Stable flight time is defined as the time when the pitch rate is less than 0.5 deg/sec (Figure B.3-1). The lightweight nominal trajectory yields 8 sec stable time on the IGS. Once the vehicle is on the IGS and the landing gear is down and locked, the deceleration is fairly constant at just over 4 KEAS/sec. Each additional second the vehicle remains airborne results in a 4 kts slower T/D velocity. The stable flight time must be curtailed due to the velocity lost during that time. But a minimum amount of stable time is required for the crew to assess the trajectory energy state and to make any final adjustments necessary to achieve a smooth, safe landing. For an autoland to T/D flight mode, this stable time is also required for the crew to assess the auto guidance final approach to the runway.

Another time measurement that has a similar connotation is stable time to T/D. Stable time to T/D is defined as when the pitch rate is less than 0.5 deg/sec until T/D. The nominal trajectory yields 17 sec of stable time to T/D. There are several conditions which compress these stable times: winds, atmosphere, energy, SB retract angle, and the close-in aimpoint geometry. The main reason for using the close-in aimpoint is to increase T/D energy by 1000 ft. This is partially achieved by cutting in half the time spent on the IGS. Any attempt by the crew to try to maintain the normal 8 sec of stable time on the IGS, when flying the close-in aimpoint, will negate some of the expected T/D energy gain.

The pilot can visually monitor the tracking of the IGS with the ball/bar landing aid. The height and separation of these lights are computed so that the pilot's eye position is such that he sees the ball superimposed on the bar if the vehicle is ideally tracking the reference IGS geometry. Most runways also have painted markers at the nominal 2500-ft T/D location to give the pilot's a downrange point of reference.

The IGS intercept is currently anchored at 1000 ft downrange. The intercept used for the first two space shuttle flights was 1500 ft. The stronger than predicted aerodynamic ground effects are the reason for moving the IGS back 500 ft. The STS-2 preflight predicted auto T/D range was 4000 ft, which was beyond the nominal designed range of 3000 ft predicted for STS-1. Using the current aerodynamic data modifications results in a nominal T/D range of 2500 ft.

The IGS has buried in it a concept explained by the late A. Moyles/ Rockwell International that involves time to go and a comfort zone. Time to go is the altitude divided by the altitude rate. Coming off the pullup circle to the exponential, the pilot is comfortable with a trajectory that has 4 to 7 sec time to go. Trajectories that have less than 4 sec time to go give the pilot a feeling that there is not enough time to make a correction before the vehicle hits the ground. Conversely when the time to go is greater than 7 sec, the pilot feels that the trajectory is being stretched and too much energy is being dissipated before T/D. The nominal trajectory is designed to stay between 4 and 7 sec time to go on the IGS and generally triggers FF as it decreases from 5 to 4 sec. (Figure B.3-2).

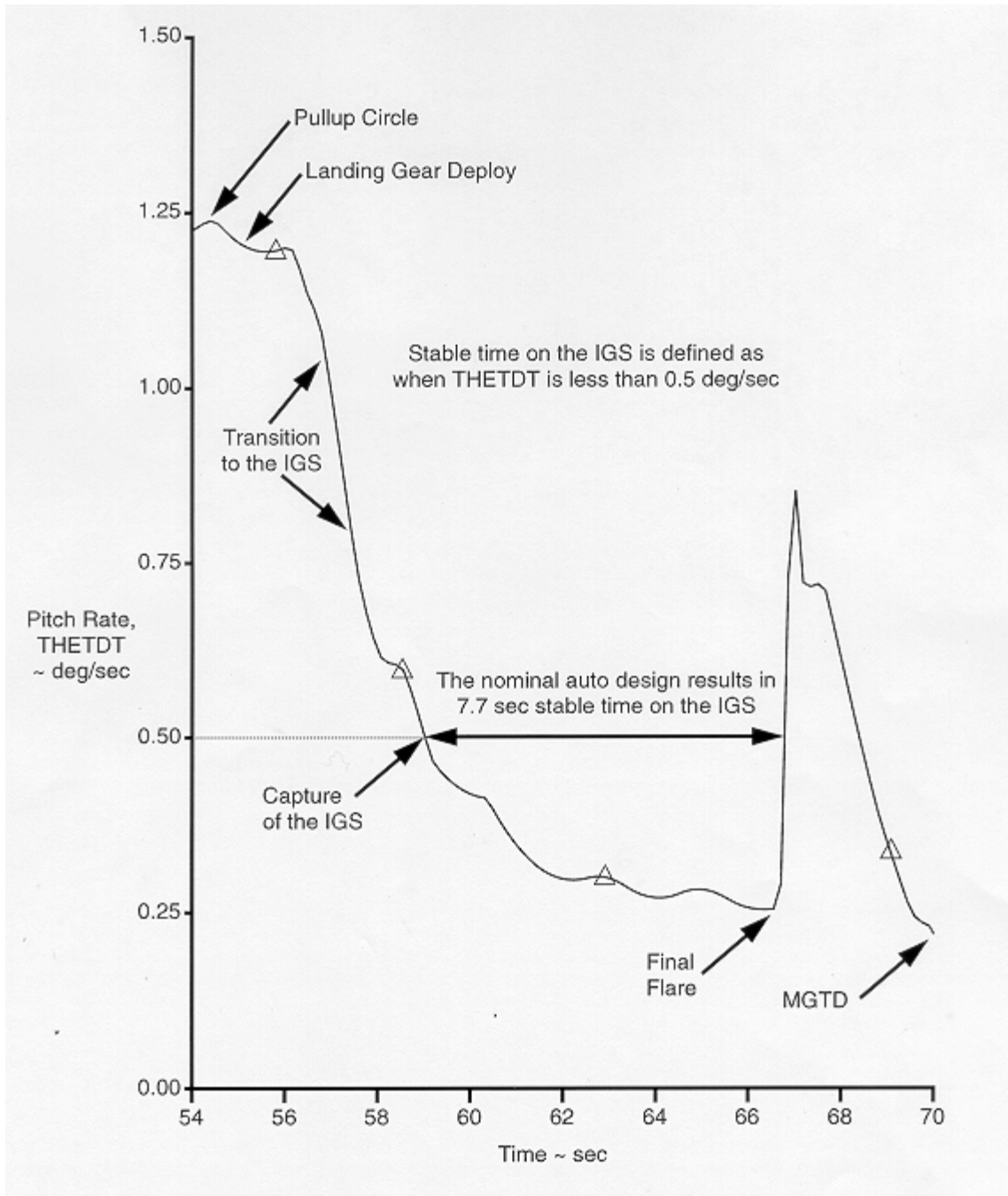

Figure B.3-1 Stable Time on the IGS (5 sec minimum)

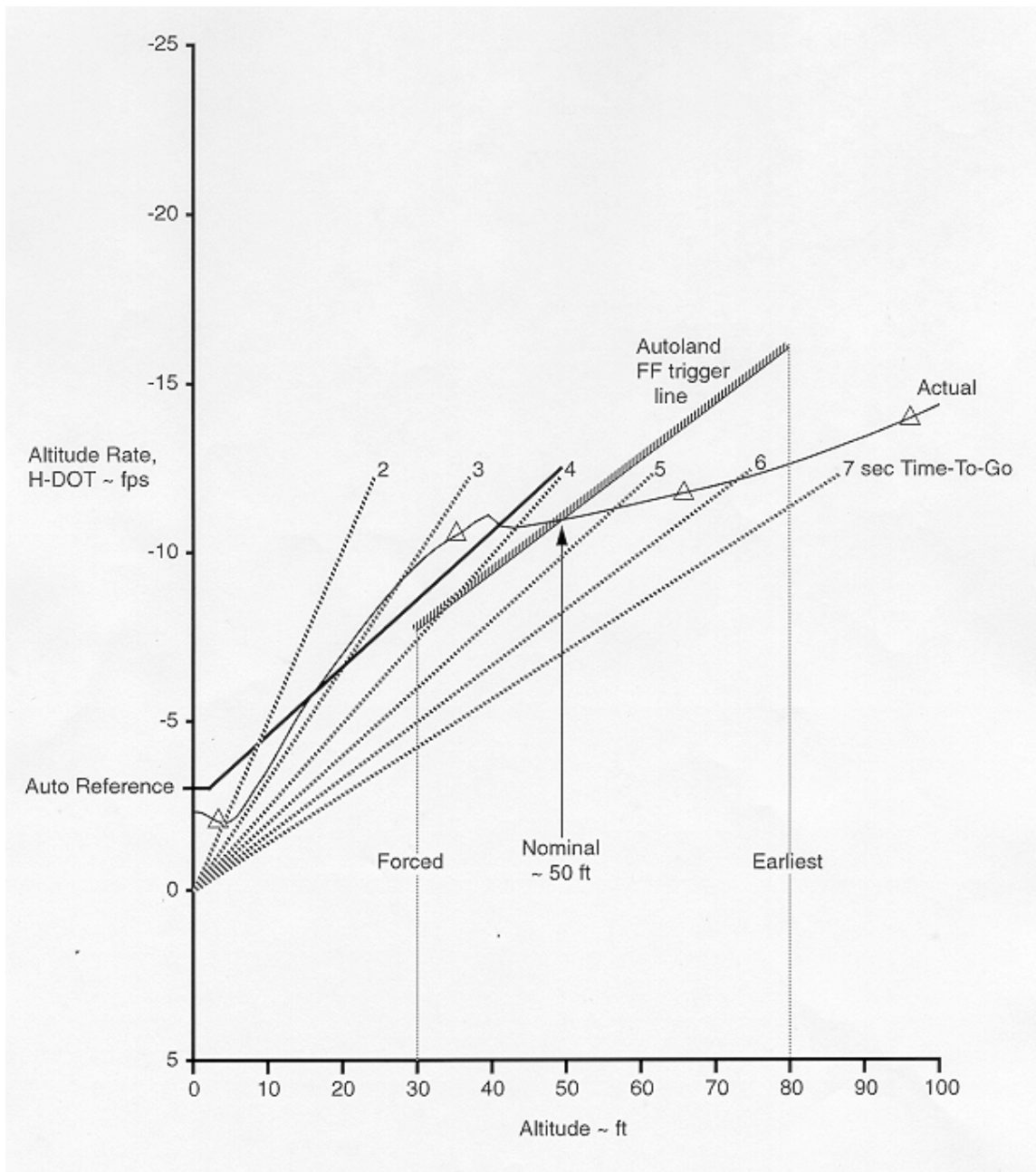

Figure B.3-2 IGS Altitude – Altitude Rate Design Philosophy

APPENDIX B.4 FINAL FLARE

Very important factors in arresting the altitude rate are the powerful aerodynamic ground effects of the orbiter. These ground effects grow exponentially as the altitude decreases, and the resulting increase in L/D is approximately 25 percent, which eases the landing task for the pilot (and guidance) at this very critical stage of flight. Figure B.4-1 compares the altitude-altitude rate history of two trajectories, one with ground effects and one without ground effects; the resulting altitude rate at T/D without ground effects is marginally acceptable. Another trajectory was simulated which was forced to never initiate the FF phase. The resulting altitude history is compared to a nominal profile in Figure B.4-2. Again the T/D altitude rate is marginal and to quote one pilot, "It would be a very scary ride." The altitude range profiles of a nominal and of the two off-nominal simulations is shown in Figure B.4-3. The -1.5° IGS design is a compromise in that it does not require a large maneuver to land and yet maintains a reasonable ground clearance when coming out of preflare.

A negative landing/handling of the shuttle is the initial vehicle response to pitch control inputs is backwards from the desired end condition due to the relative locations of the c.g., the aerodynamic center, the control surfaces, and the pilot seat. For example, if a positive $(Nz)_c$ input is given, the first response is that the elevons deflect upward. The up elevon initially causes a decrease in lift, approximately 2000 lb/deg, and the wheels actually move closer to the ground at a faster rate. A pilot trying to arrest a high altitude rate, in fact increases the rate initially and if timed wrong, can cause T/D to occur sooner than expected when the opposite is intended. That expected positive lift increment does not occur until the vehicle rotates and a higher angle of attack is achieved. To make matters worse, the pilot altitude history just prior to landing is almost constant; therefore, the out-the-window observation is that very little is happening to the altitude or altitude rate after a positive input is made. In summary, all inputs are kept to a minimum as the shuttle nears the ground to avoid early T/D or balloon effects.

It should be noted that the CSS pilot technique for the final phase of landing is somewhat different from what auto FF is doing. This does not mean that either should be changed, because they both achieve the same end condition, a small altitude rate at T/D. Certain auto commands are incorporated to aid the pilots in monitoring a pure auto T/D. Visual cues can be used by the pilots to achieve the desired T/D attitude; whereas, autoland guidance uses only navigated altitude and altitude rate data. The resulting auto FF must be smooth and predictable so that a pilot monitoring its performance feels comfortable with what auto is doing. Moving base simulations, set up to study late pilot takeovers, have shown that the lower the altitude when takeover occurs, the harder the task to perform a good landing. Also, large deviations in T/D position to offset large energy dispersions can and have been performed by the pilots in the CSS mode; whereas, autoland has no capability to alter the reference profile based on low-energy conditions. Autoland guidance inherently lands short in low-energy situations and long in high-energy conditions but not to the extent desired in extreme situations. The first two shuttle flights landed approximately 3000 ft long and short, respectively, to offset relatively large unexpected energy deviations. Both flights landed fairly close to the targeted T/D velocity. If those same two flights had landed in auto, the ranges would have been closer to the predicted value, but the T/D velocities would have been quite fast and quite slow, respectively.

A special study was conducted by four shuttle pilots, to gather information on how they fly the FF profile. The STA was used, and the pilots were asked to save the flight data from four CSS approaches for which they felt comfortable. The sets of four runs were averaged and compared to a nominal autoland guidance profile (Figure B.4-4). The autoland nominal profile generally falls inside the four averaged profiles, lending support to the present design.

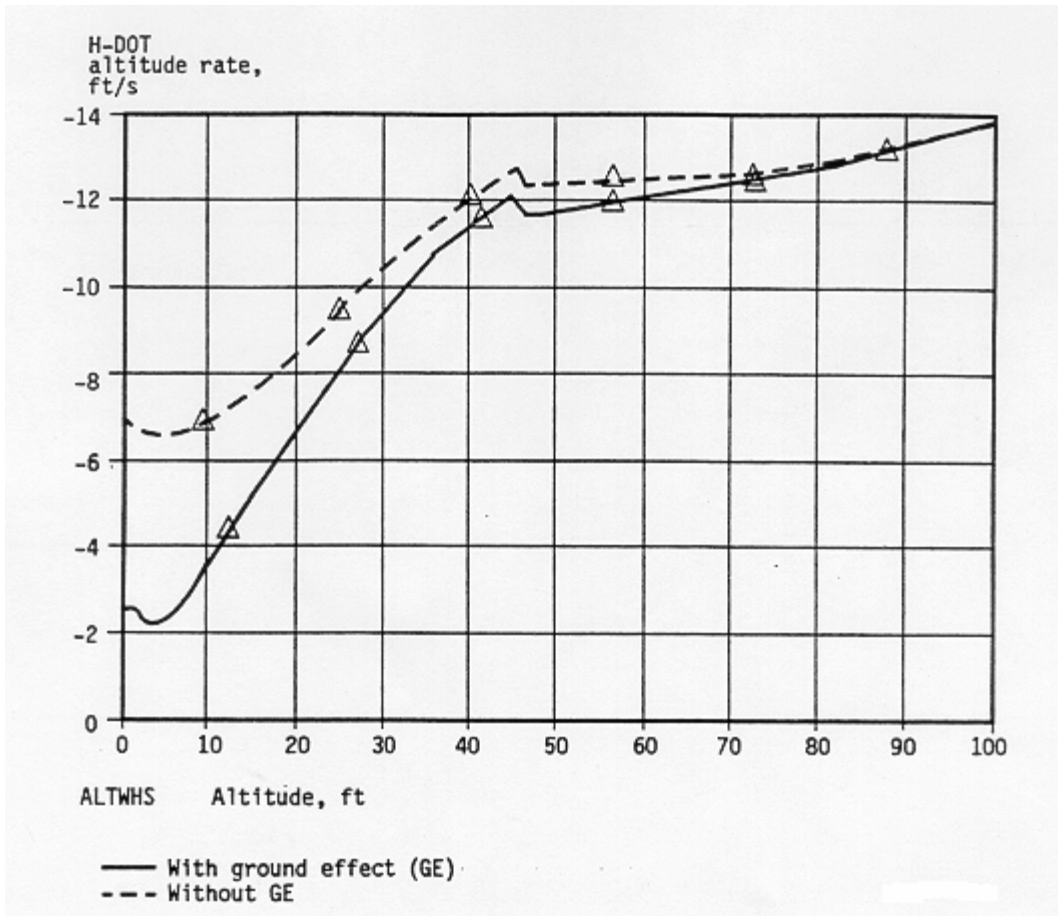

Figure B.4-1 Altitude Rate Profile with no Ground Effect

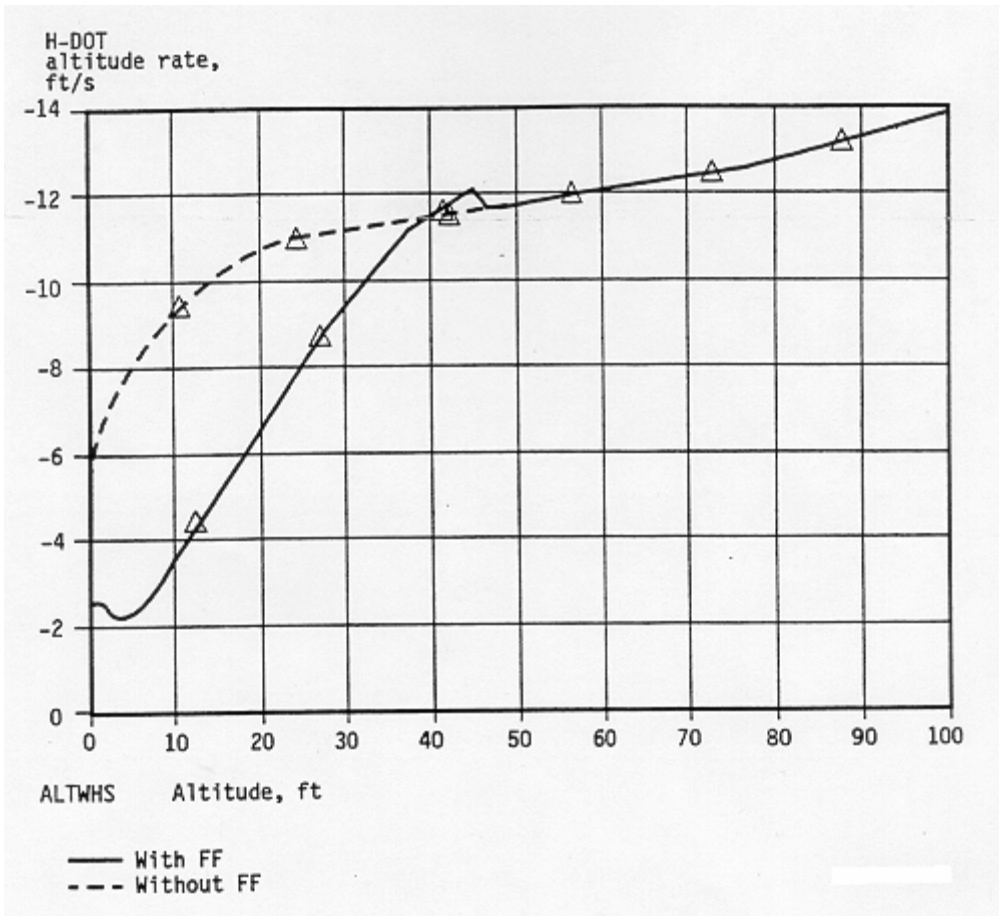

Figure B.4-2 Altitude – Altitude Rate Profile without Final Flare

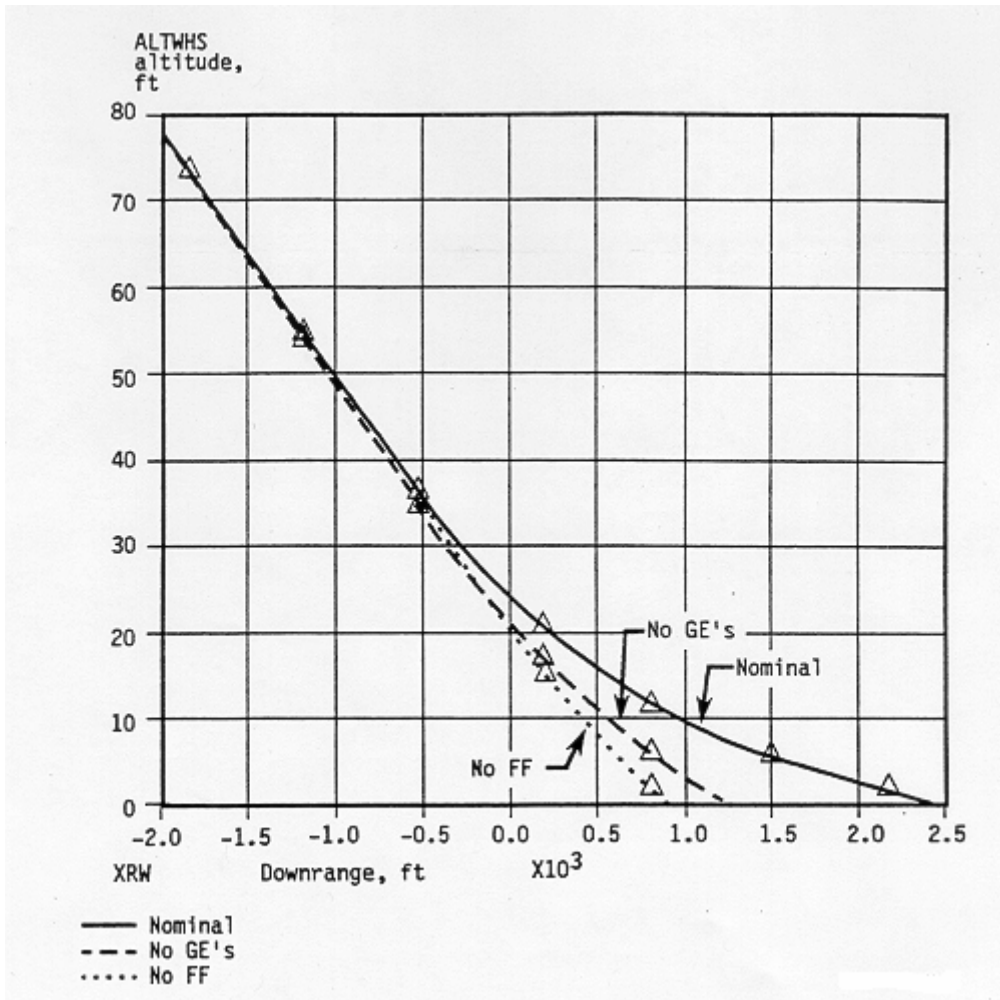

Figure B.4-3 Altitude Profile Near Touchdown

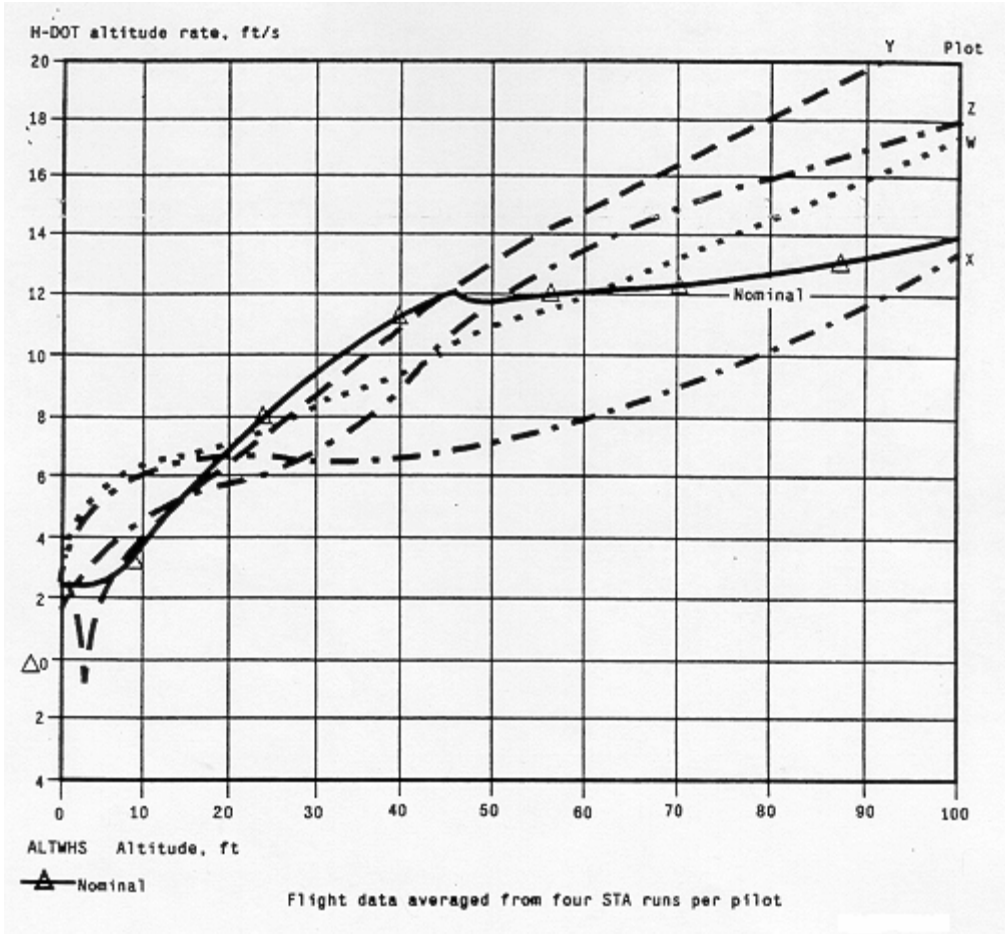

Figure B.4-4 Final Flare Altitude – Altitude Rate Design Profile

APPENDIX B.5 BASIC CONSTRAINTS

a. Weight

Weight is one of the most important factors in designing the orbiter reference trajectory profiles. The current A/L geometry (I-loads) are designed for orbiter weights between 190k lb and 248k lb. Heavier weights have been tested many times, but the resulting performance was always degraded. When weights become lighter than 185k lb or heavier than 250k lb, serious consideration will have to be given to changing the OGS geometry and/or the targeted T/D speeds to retain the desired dispersion capability and energy margins. Other areas of A/L will also have to be investigated, particularly rollout.

b. Center of Gravity

The longitudinal center of gravity (X-c.g.) limits for the orbiter have more influence on the design of the earlier phases of entry than A/L. The aft X-c.g. limit is 1109 in. (67.5%) and the forward limit is 1075.2 in (64.9%). During A/L, the X-c.g. position effects the trimmed elevon deflection, and its biggest handling ramifications occur immediately prior to T/D and during derotation. Landing with a forward X-c.g. typically results in higher T/D altitude rates and makes the derotation task more demanding.

c. Dynamic Pressure

There are several areas which have a maximum Q-bar constraint during A/L (Mach < 1). The flight control certified limit is 375 psf (333 KEAS). The Flight Rule operational limit on Q-bar is 350 psf (321 KEAS). The landing gear door Q-bar limit is 330 psf. The minimum Q-bar is not directly computed by A/L guidance as it was in TAEM guidance. However, A/L guidance does limit the maximum altitude error to 300 ft (H_ERROR_MAX), which, in effect, limits the minimum flightpath angle “auto” would fly and, indirectly, the minimum Q-bar. Regardless of the mode of flight, manual or auto, there is a Q-bar lower limit. This limit is a function of vehicle weight, which results in a trajectory that puts the vehicle aerodynamically at the maximum L/D configuration. The resulting EAS lower limit varies from approximately 215 kts for lightweight vehicles to 230 kts for heavyweight vehicles. These values are based on the speedbrake being fully closed, the landing gear not deployed, and no winds.

d. Load Factor

The load factor constraints have a more direct application on the earlier phases of entry, particularly GRTLs. The original A/L design constrained the pullup circle design due to the 0.5g nominal design limit. Flying the current nominal trajectory profile results in approximately 0.33g during pullup; therefore, the 0.5g load limit did not influence the current design.

e. Other Constraints

Many of the A/L constraints have several qualifiers or are not single valued.

- | | |
|---|------------------------|
| 1. Gear deploy initiate | >15 seconds before T/D |
| 2. T/D pitch angle | <14.6° |
| 3. Maximum certified T/D ground speed ^a | <225 kts |
| 4. Minimum T/D speed at 1000 ft downrange ^{*b} | |
| Weight ≤ 220k lb | = 185 KEAS |
| 220k lb < Weight < 245k lb | = 195 KEAS |
| Weight ≥ 245k lb | = 205 KEAS |
| 5. Surface tailwind ^{cd} | ≤ 15 kts |

6. Surface crosswind ^{cc}	≤ 15 kts
7. Surface headwinds ^c	≤ 25 kts
8. Energy reserve	≈ 5 seconds
9. Main gear T/D altitude rate	< 9.6 fps
10. Peak vertical main gear strut load	<207k lb/strut
11. Pitch attitude rate at NGTD ^f (but not to exceed load in #12)	< 8.5 – 11.5 degrees/second
12. Nose gear strut load	<90k lb
13. Nose gear ground speed	<217 kts
14. Brake energy (per wheel)	<42M ft-lb EOM <82M ft-lb Aborts
15. Rollout margin	>2000 ft without barrier >0 ft with barrier

^aEngineering hardware tests have included successful runs at much higher speeds:

VGS = 255 kts with 240k lb load and 10 kts crosswind effects

VGS = 240 kts with 256k lb load and 15 kts crosswind effects

^bThese constraints may be relaxed for daylight lakebed landings.

^cThese are peak winds which include gusts.

^dThe steady-state tailwind must be ≤ 10 kts

^eThere are reduced limits for night landings, extended duration orbiter missions, and TAL to Ben Guerir when no low-level wind data are available.

^fThis range covers a combination of X-c.g. locations and vehicle weights. The lower value applies to heavy weights with forward X-c.g.'s. The resulting maximum strut load must always be protected.

APPENDIX C.1 ROLLOUT MARGINS AND BRAKE ENERGY

a. Rollout Margin

When rollout margin was first used in the flight rules, the value used was based on the data shown in Table C.1-I. The 2000 ft limit was used for runways with or without barriers until STS-50, when a Monte Carlo analysis was performed to see if the limit could be reduced for runways with barriers. This analysis assumed all of the same error sources but randomly selected each one based on new statistical models that represented flight performance/history. The standard braking procedures were followed and the resulting dispersions in rollout margin were much smaller than anticipated. When a high energy dispersed T/D reaches 5000 ft to go, the nose was always on the ground and the brakes were applied. The ground speed in these cases was always greater than 140 kts. This scenario does result in higher brake energies but never came close to needing 2000 ft for dispersion protection. Of the 200 dispersed Monte Carlo cases simulated, the longest dispersed rollout distance was only 324 ft longer than nominal. After rounding this value to 500 ft and then doubling it for unforeseen events, the 1000 ft limit was used from STS-50 to STS-69.

Prior to STS-69 it was very unlikely a launch would be held-up due to not satisfying the 1000 ft rollout margin for runways with a barrier. Starting with STS-69, a change in the short field logic I-loads to dissipate 500 ft less T/D energy for heavy weight landings now had the potential of resulting in longer rollout distances on high energy days. The 1000 ft barrier rule was revisited and the limit was changed to zero ft. Barrier engagement is not desirable, however, it is safe at speeds up to 100 KGS. The very low odds of declaring a TAL and having everything add up in the wrong direction led to this decision given that there area couple of offsetting factors. First, the drag chute is not used in real-time rollout margin predictions and second, the brakes could be applied at a faster speed and at a harder deceleration than 9 fps^2 . These two factors could add an additional 800 to 2000 ft rollout margin.

The same Monte Carlo analysis also confirmed the 2000 ft rollout margin used for runways without a barrier was more than required. Another set of 200 cases resulted in a maximum dispersed rollout of only 556 ft. Some have rounded this number up to 700 ft, but the previous 2000 ft limit was retained to again cover any unforeseen events.

b. Brake Energy Limits

For a planned EOM with a fully operational NWS system, the brake energy limit is 42M ft-lb. The fully operational NWS system implies differential brakes will not be required to steer the vehicle during rollout and the brake energy required to stop the vehicle will be evenly distributed between the 4 sets of brakes. The 42M ft-lb value is based on the wheel/rim fuse plug limit. To protect against a tire blow out due to too much brake energy heat transferring into the wheels causing high tire pressure, the fuse plugs will melt and allow the tires to deflate. Neither a tire blowout nor having to change the tires before the vehicle could be taxied off the runway is desirable for a nominal EOM. This limit may be avoided by delaying brake initiation until 120 KGS if the rollout margin is maintained per the flight rules. This delay option is preferred over runway redesignation.

Differential brakes are required to steer the vehicle if there has been a NWS failure. The trajectory simulation program used for real-time predictions also computes an estimate of the additional brake energy required assuming no NWS. This is referred to as the “hot” brake energy. Again, for a planned EOM with a fully operational NWS system, there must be a least one “go” runway at the landing site where the “hot” brake energy is less than 70M ft-lb. This higher value is based on the tire fire limit. In

the event NWS is lost after the commit to deorbit, it is acceptable to have the fuse plugs melt but it is not acceptable to have a tire fire in that event.

If pre-deorbit it is known the NWS system has failed, the “hot” brake energy limit is 42M ft-lb. If the NWS system fails post-commit to deorbit and the predicted “hot” brake energy is greater than 42M ft-lb, runway redesignation (at the same complex) will be considered prior to Mach 6 to reduce the crosswind component during rollout. Redesignation may not be the better option if the reduction in brake energy is not significant or if the alternate runway is less desirable for other reasons (no landing aids, runway conditions, etc.).

For aborts all of the above limits increase to 82M ft-lb. This level of brake capability has been demonstrated in testing. A block diagram of the brake energy logic is presented in Figure C.1-1. It is very unlikely 70M ft-lb will ever be exceeded and 82M ft-lb is even more remote.

Table C.1-I Budget for High Energy Rollout Margin Placard

	Error source	Est. 3 sigma, ft	Comments
Environment	Average wind (3K ft to surface)	200	20 kts decreasing to 15 kts
	Wind shear below 500 ft	350	Fools smart SB
	Surface wind deviation	600	- 5 kts through rollout
	Density altitude	200	Including T/D and rollout
	Air data system error	400	6 KEAS (2 percent of 290)
		1750 WOW	
Procedure	Trajectory deviations	150	Off-nominal H/R profile
	Rollout SB opening	200	Delayed SB opening
	Late landing gear deploy	250	At 200 ft instead of 300 ft
	Pitch over procedure	150	Low rate pitch over from T/D
	Braking procedure	700	Differential brake or decel
		1450 WOW	
		3200 WOW 1633 RSS 1934	Includes 1.4 sample size factor ADTA bias + remaining 3-sig RSS

Notes: Additional margin is provided by real-time prediction assumption of 9 fps² as maximum braking deceleration.
Correction factor of 1.4 adjusts for limited flight experience.
MSBLS assumed to be available.

Recommendation: Use 2000-ft placard.

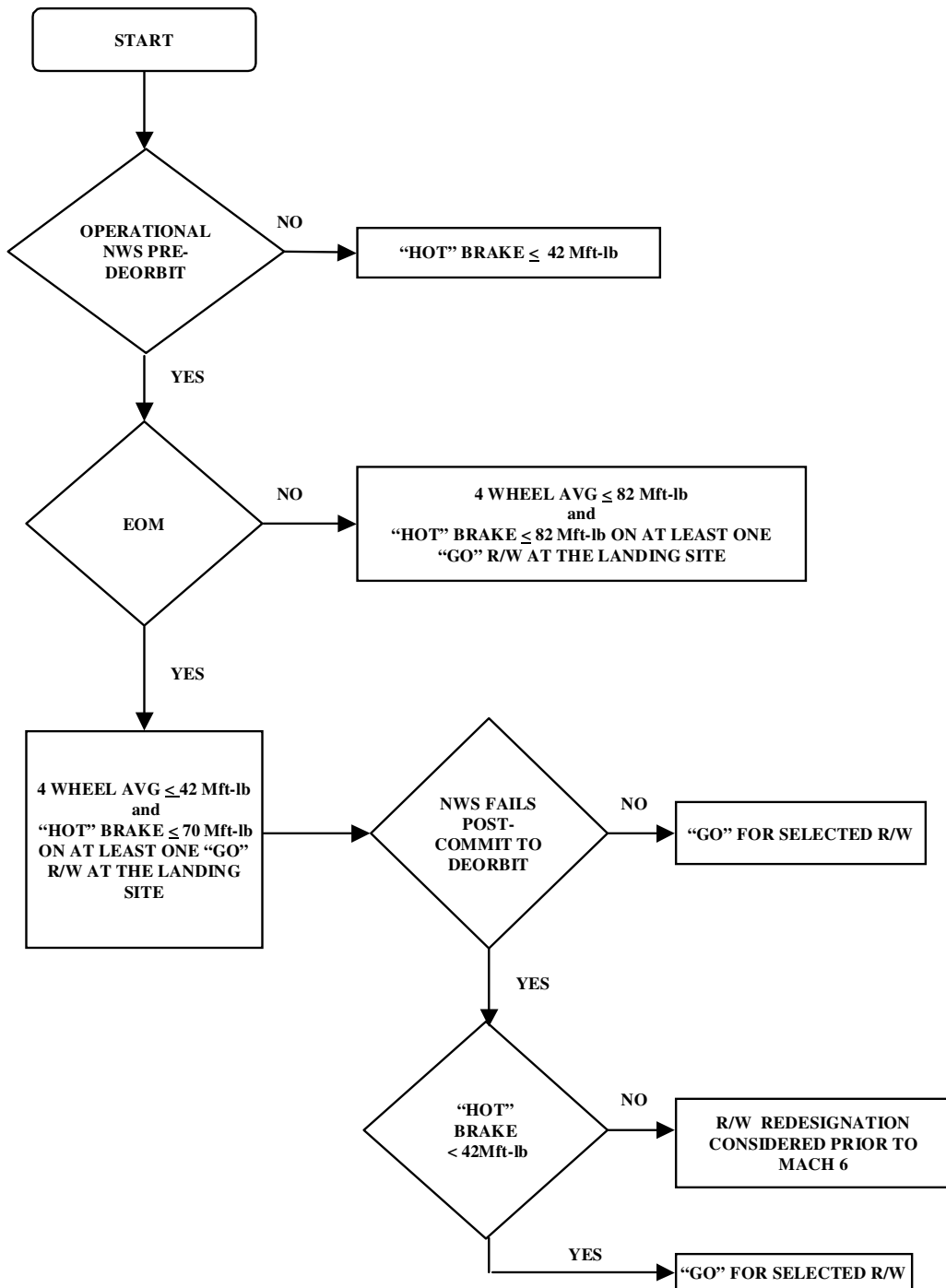

1. It is allowable to delay braking initiation until 120 KGS to satisfy the brake energy constraints above. This will only be done if violations are predicted with the 1490 KGS procedure and the rollout margin requirements are satisfied. This action is preferred over runway redesignation.

2. For all cases, real-time analysis will model the standard braking procedures. The deceleration used in the braking analysis is 9.0 fps².

Figure C.1-1 Logic Used to Evaluate the Brake Energy Limits

APPENDIX C.2 DEROTATION

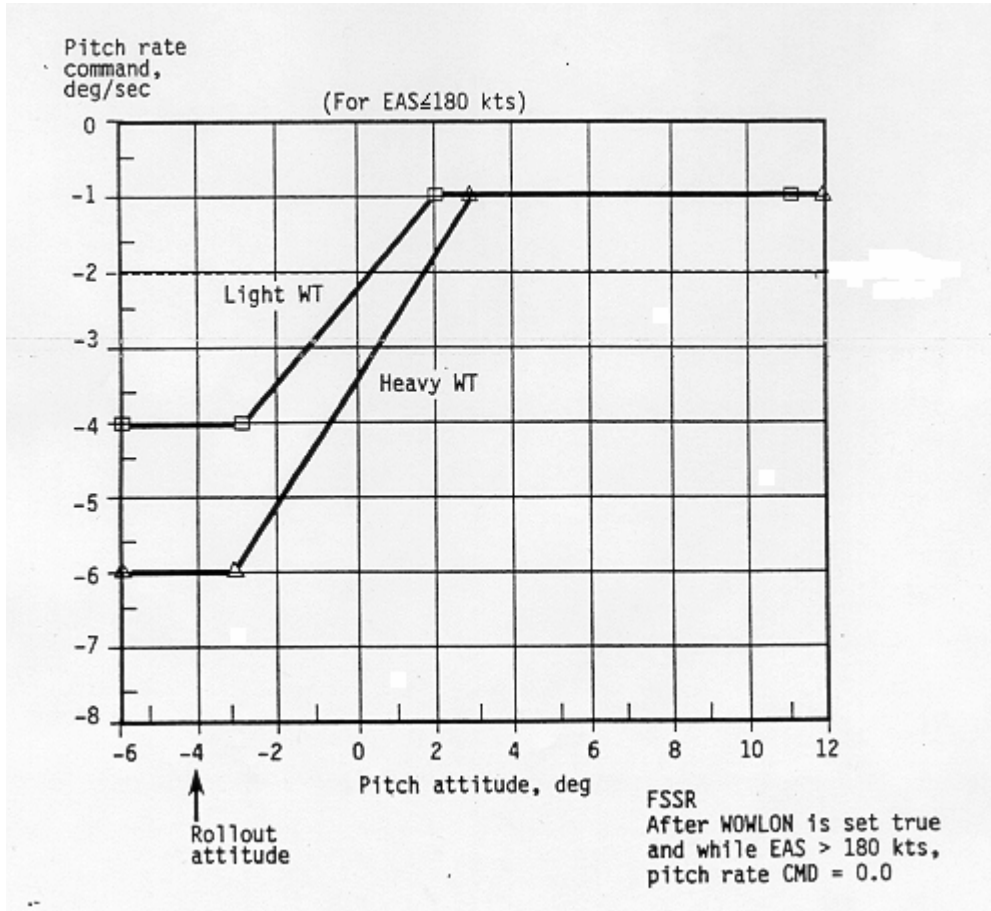

Figure C.2-1 FSSR Pitch rate command during rollout

- Pre OI-23
- Maintaining 0° angle of attack
- Rolling friction coefficient = 0.025
- Speed at which elevon deflection went through 20° (Up)
- Data applicable for vehicle weights 190k lb to 200k lb

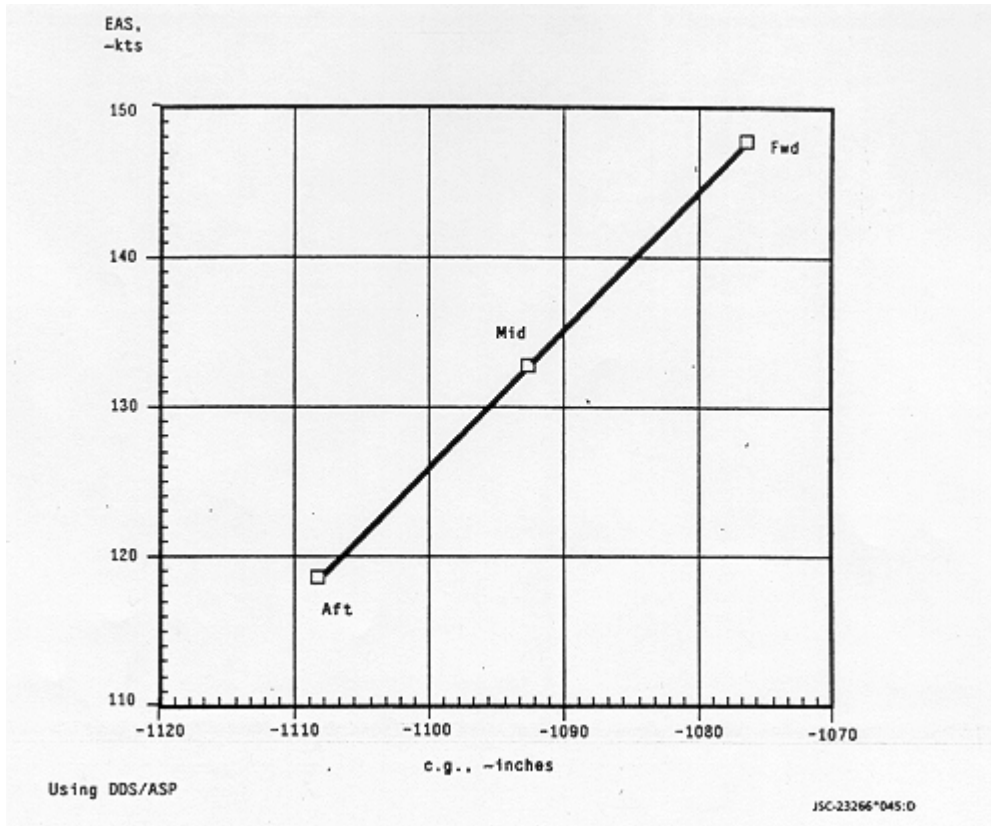

Figure C.2-2 Airspeed at which loss of elevon effectiveness occurs during rollout

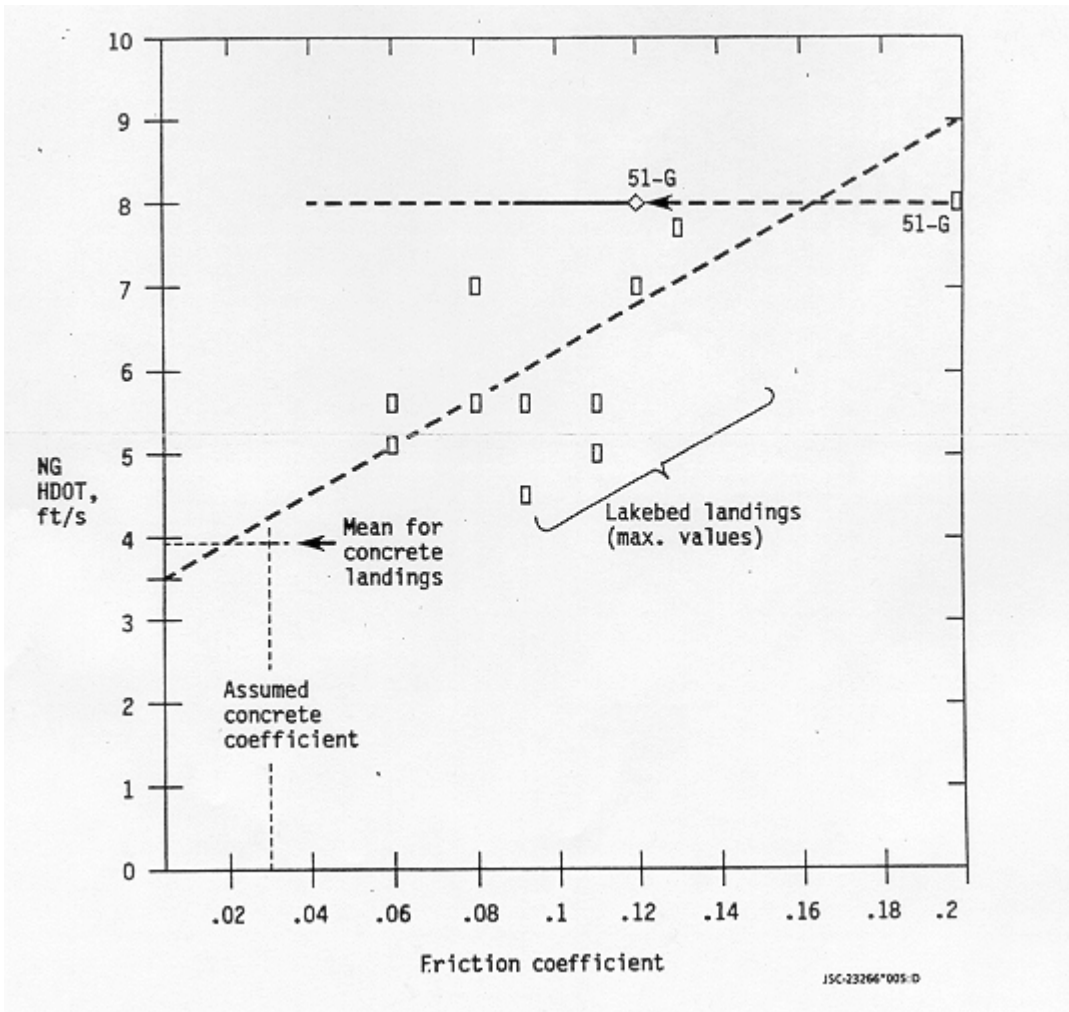

Figure C.2-3 Vertical speed of the nose gear at T/D as a function of rolling distance

Table C.2-I Lakebed Rolling Coefficients

Flight	Date	Vehicle	Runway	Roll Coeff
STS-1	4/14/81	OV-102	EDW 23	0.062*
STS-2	11/14/81	OV-102	EDW 23	0.062*
STS-7	6/24/83	OV-099	EDW 15	0.110
STS-9	12/8/83	OV-102	EDW 17	0.090
STS-41C	1/23/84	OV-099	EDW 17	0.090
STS-41D	9/5/84	OV-103	EDW 17	0.090
STS-51B	5/6/85	OV-099	EDW 17	0.120
STS-51G	6/24/85	OV-103	EDW 23	0.120
STS-51F	8/6/85	OV-099	EDW 23	0.080
STS-51I	9/3/85	OV-103	EDW 23	0.110
STS-51J	10/10/85	OV-104	EDW 23	0.085
STS-61A	11/6/85	OV-099	EDW 17	0.120
STS-26	10/3/88	OV-103	EDW 17	0.120
STS-27	12/6/88	OV-104	EDW 17	0.110
STS-28	8/13/89	OV-102	EDW 17	0.110
STS-34	10/23/89	OV-103	EDW 23L	0.105

*Presupposed 0.062 maximum possible rolling coefficient. New runway 23L parallel to previous runway 23.

APPENDIX C.3 BRAKING PROCEDURES AND BRAKE ENERGY

a. Brake Procedures

The start of braking is determined by the ground speed, although the position on the runway is also considered. The braking begins when the ground speed decreases to 140 kts and the orbiter has passed the midfield point. The braking starts if the distance to the end of the runway decreases to 5000 ft before the ground speed decreases to 140 kts. The selection of 140 kts for the nominal start of braking is an arbitrary compromise between the maximum possible braking speed, the necessity of limiting the energy absorbed by the brakes, and the desire to stop the orbiter quickly. Nominal braking begins after the NGTD. The start of the braking is limited by the energy that the brakes can absorb. Originally, this limit was 36M ft-lb if the brakes were to be reused. The selected value of 140 KGS is a value optimizing both rollout performance and ease of operations.

A deceleration between 8 and 10 fps^2 is attempted during the braking unless the braking is started because the distance remaining is less than 5000 ft. In this case, the maximum braking force is applied. The average torque developed by each brake is approximately 25,000 ft-lb. This torque and the other forces are sufficient to achieve the desired deceleration (9 fps^2) at the start of the braking, but it may not be sufficient when the aerodynamic forces decrease.

b. Brake Energy

The NWS is used to control the orbiter after the nose gear is on the ground. With NWS the total brake energy is distributed equally between the four sets of brakes, wheels, and tires. Differential braking is used to control the orbiter if the NWS is not working and may be required before the nominal start of braking. The need for steering is caused by the crosswind, the crown of the runway, lateral forces generated by the tires, and other causes. Generally, the energy is be distributed equally between the brakes, so it is necessary to be able to estimate the maximum energy absorbed by a single brake. The percent of the total brake energy absorbed by the worst pair of brakes is shown in Figure C.3-1 as a function of the crosswind. The upwind pair of brakes absorbed the most energy on all of the flights except two. The line on the figure represents the linear least-squares approximation to the relation of the ratio of the energy to the crosswind. This approximation is used to estimate the crosswind that causes one of the brakes to reach the energy limit.

The energy distribution predicted by the mean line is not equal when there is not any crosswind. Seven landings did not have any measurable because the large unbalance caused doubt about the validity of the results. The remaining six flights were evenly divided between landings on a lakebed and landings on a runway. The right set of brakes absorbed the most energy on four flights. It is not possible to explain the unbalance with the data available, but it could be caused by things such as the crown of the runway or the construction of the tires. The unbalance for at least two of the flights may be the result of inaccuracies in the calculation of the energy.

There is not any convenient method to accurately predict the information in Figure C.3-1. The total energy absorbed by all of the brakes can be calculated with reasonable accuracy, and the least-squares approximation can be calculated based on the maximum energy absorbed by a single brake. This comparison is shown in Figure C.3-2 for brake energy limits of 42, 55, and 65M ft-lb. The average energy absorbed by a single brake would be 40M ft-lb if the total energy were 160M ft-lb. The maximum energy absorbed by a single brake is 55M ft-lb if the crosswind is approximately 7.7 kts (Figure C.3-2).

c. Differential Braking

It may be necessary to begin differential braking shortly after NGTD if the NWS has failed. The two extremes are to apply the brakes just enough to steer or to begin the nominal deceleration immediately. Although the brakes absorb more energy in either case, the latter option is the most severe. The effects of beginning the nominal deceleration above 140 kts are shown in Figure C.3-3 for a 240,000 lb orbiter at a density altitude of 3000 ft. The crosswind is 0, 5, or 10 kts, and the tailwind is 0, 4, or 8 kts. The brake energy placard pre-deorbit is 42M ft-lb. The use of differential braking to control the rollout to the centerline increases the rollout distance by less than 200 ft for the worst case.

d. Brake Failure (Loss of Torque)

The increase in the rollout distance expected because of a decrease in the braking is presented in Figure C.3-4. If a failure results in a 50 percent loss in braking, there is 40 percent decrease in the braking torque. In this figure, a loss of either 12.5 or 25 percent braking corresponds to an equal loss in the braking torque. The largest increase in the rollout distance is approximately 1600 ft for a 260,000 lb orbiter and a 10-kt tailwind. The increase in the rollout distance is 520 ft for a vehicle WT of 180,000 lb. The maximum effect of a change in the density altitude is approximately 50 ft for a 1000-ft increase in the density altitude.

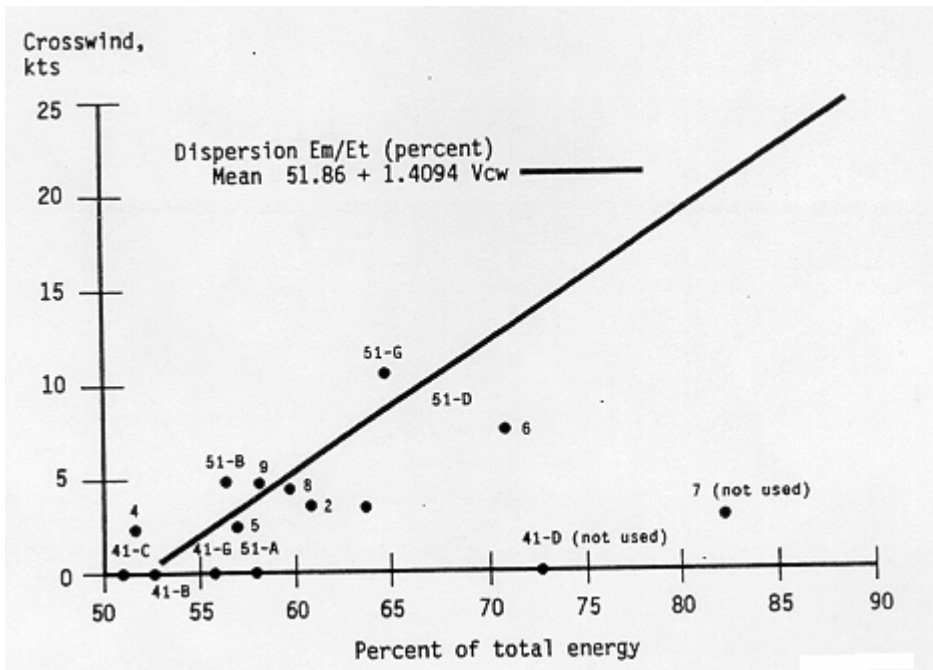

Figure C.3-1 Percent of Total Energy Absorbed

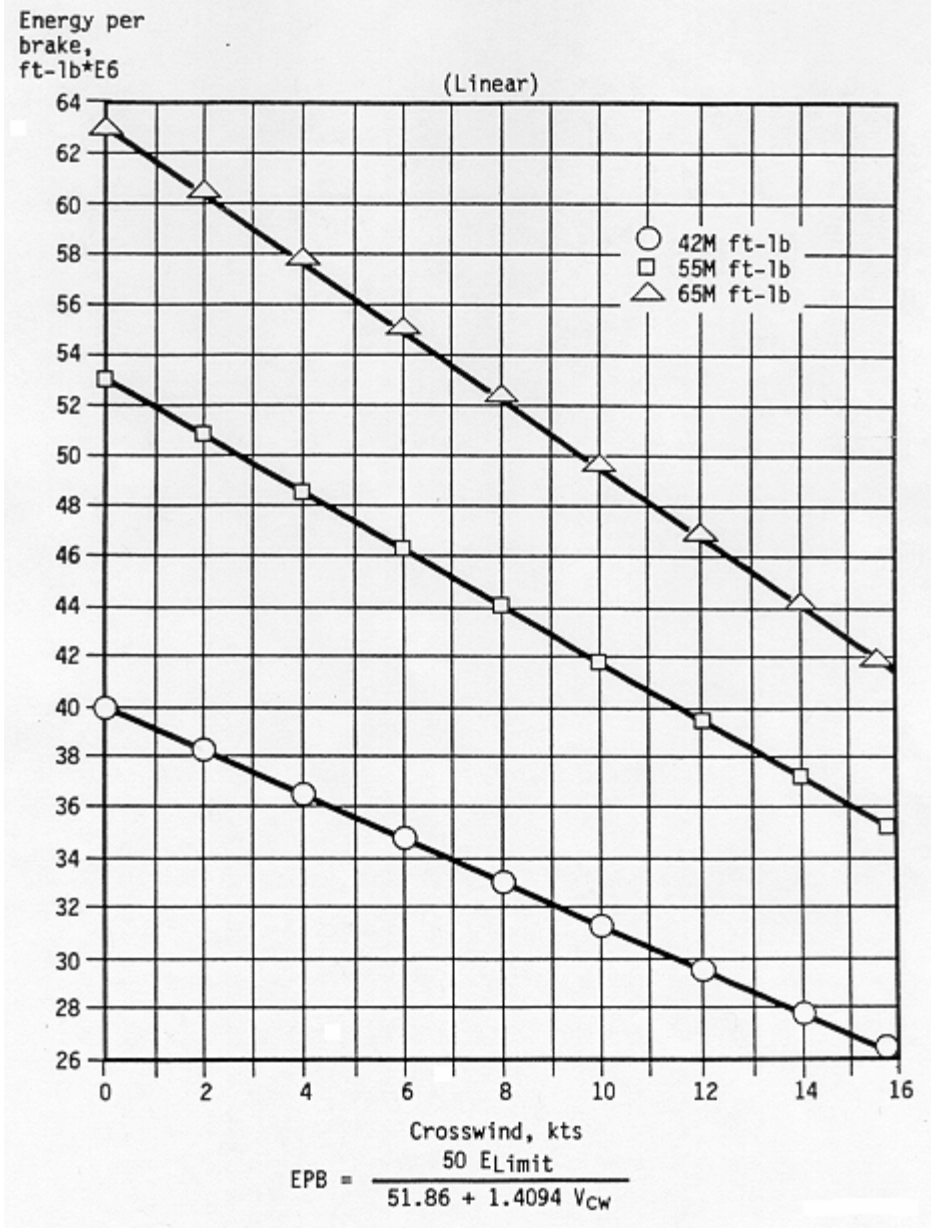

Figure C.3-2 Maximum Allowable Energy Per Brake

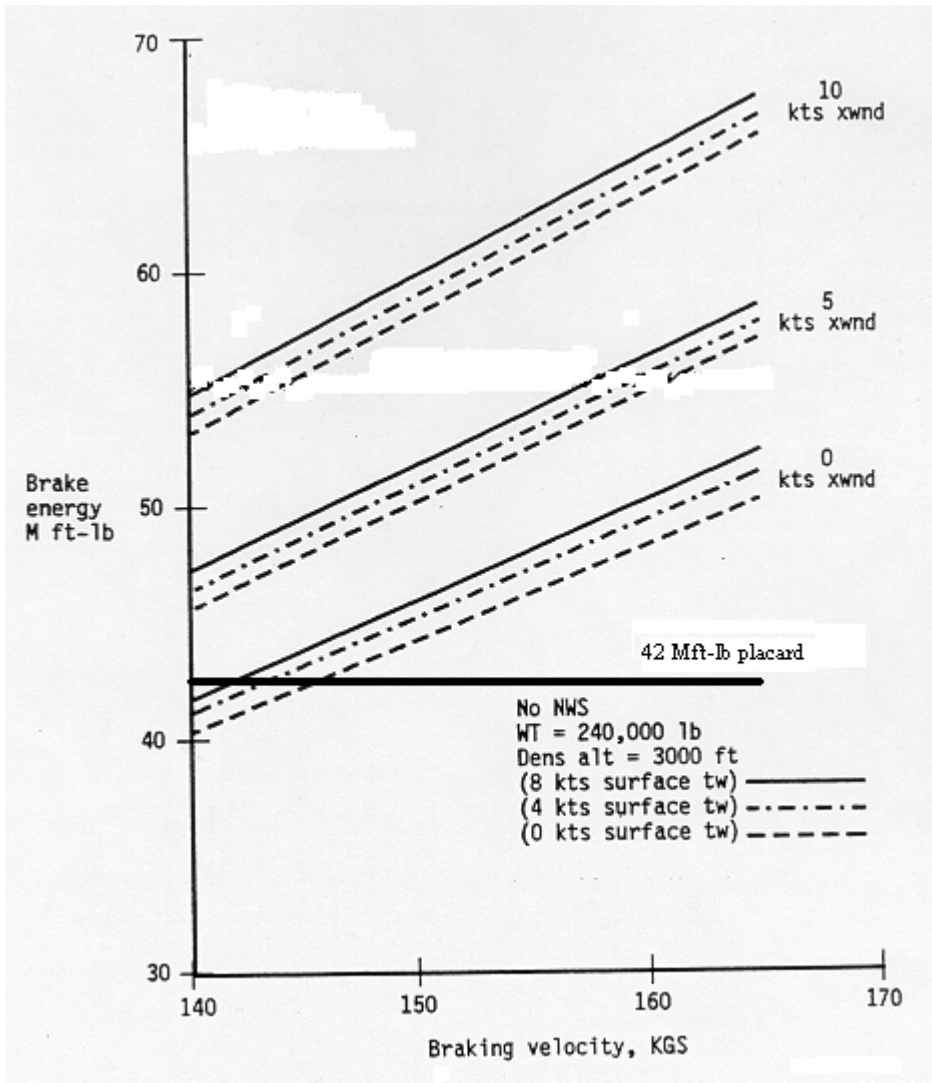

Figure C.3-3 Brake Energy/Velocity Relationship for a Deceleration of 9.0 fps²

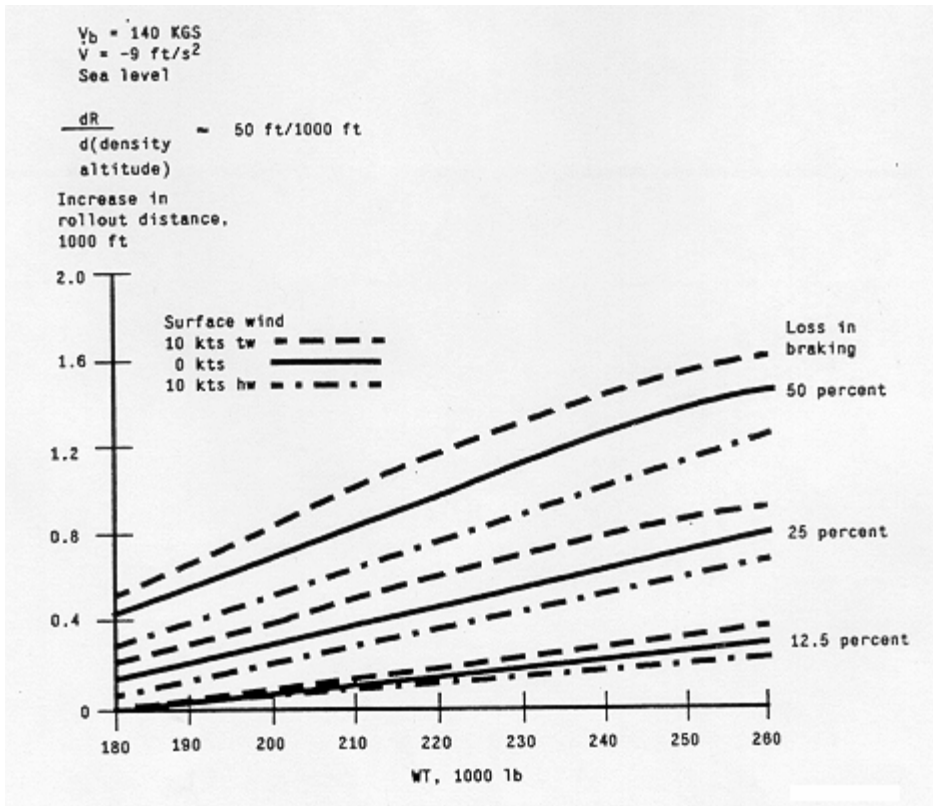

Figure C.3-4 Increase in Rollout Distance Caused by Loss in Braking

APPENDIX C.4 NORMALIZATION

a. Normalization

There were two basic parameters that were normalized, downrange and velocity. The early crew input was to normalize to velocity because they wanted to land at a velocity that resulted in an angle of attack of approximately 7° to 8° . This angle of attack relates to an acceptable energy margin and generally a small altitude rate at T/D. The task was to determine the downrange at which the vehicle would decelerate through that desired T/D velocity. This normalized downrange would be very beneficial information to the pilot in setting up the final approach and aimpoint so that T/D would occur at that downrange. Ideally, this results in landing at the desired velocity and angle of attack. This discussion has already referred to the real-time support aspect of A/L; it is one of the most important applications of the normalization process.

There are some assumptions made about the trajectory that allow this concept to yield accurate results. First, the shape of the velocity profile just prior to T/D is nearly linear with respect to downrange. Any wind gust/twist/shear during that timeframe degrades that linearity. The first assumption is that the data used to normalize should contain only steady state winds. Secondly, the shape of the velocity profile is nearly the same whether the vehicle is in the air or has already touched down in the attitude hold phase. If the vehicle remains in the air, it must increase the angle of attack to maintain lift equal to WT, since the velocity is decreasing over 4 KEAS/sec. This is not bad because the vehicle angle of attack is nearing its maximum L/D attitude. The end result is that deceleration remains almost constant. After the vehicle has made contact with the ground, the first phase of the rollout calls for constant attitude hold. During this phase the decelerations nearly constant and is almost equal to the deceleration that the vehicle experiences while in the air. It is this nearly constant deceleration relationship that allows the normalization concept to work.

Normalizing a given trajectory velocity/range profile to a given velocity and then calling that the normalized T/D range does not mean to imply that T/D occurred at that range. It simply means that if one interpolates the downrange/velocity data, that was the range where the velocity passed through the desired value. Figure C.5-1 has three velocity profiles shown, and their normalized T/D energies can be assessed by comparing the three normalized ranges at the given 195 KEAS value. The method used by the Descent Design group for normalizing is to save velocity/range data pairs from a simulation at 50 ft altitude, down to T/D. A linear regression of the data yields an equation that can be used to normalize T/D conditions to some fixed velocity or range. If the given range happens to be greater than the actual T/D range or the velocity less than the actual T/D velocity, the equation is still used because it is assumed that the deceleration is fairly constant and equal on either side of the actual T/D point. It is highly probable that the normalized T/D point is never the simulated or actual T/D point. The normalized data is accurate if the extrapolation does not go backwards past the landing gear down-and-locked point or beyond the derotation point during rollout.

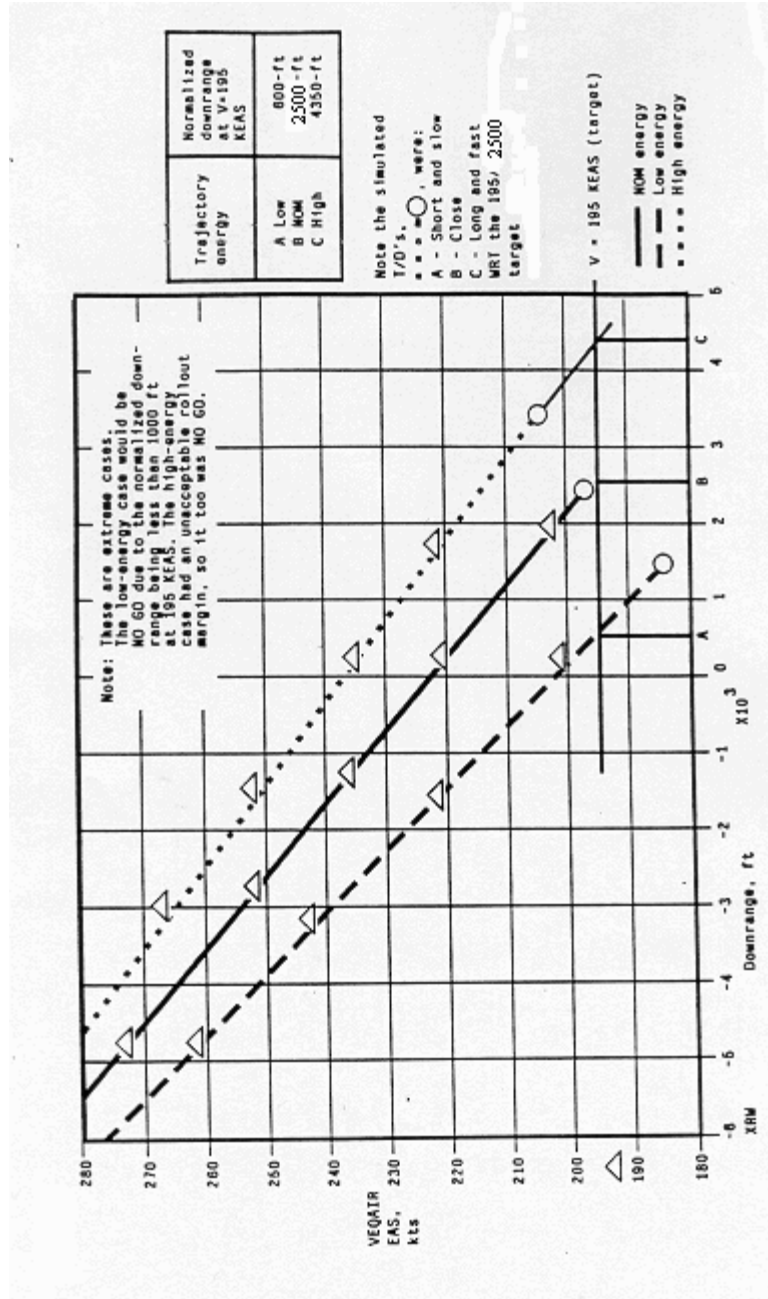

Figure C.4-1 Normalized Touchdown Energy

APPENDIX D.1 ACRONYMS AND ABBREVIATIONS

A/L	approach and landing
AA	accelerometer assembly
ACCEL	acceleration
ADI	attitude display indicator
ADSOP	air data subsystem operating program
ADTA	air data transducer assembly
AEFTP	ascent/entry flight techniques panel
AEPFD	ascent/entry primary flight display
AFRSI	advanced flexible reusable surface insulation
AGL	above ground level
ALT	altitude; approach and landing test
AMI	alpha/mach indicator
AOA	abort once around
APU	auxiliary power unit
ATT	attitude
AUT	auto
AVVI	altitude/vertical velocity indicator
Ay	lateral acceleration
AZ	azimuth
BF	body flap
BFS	backup flight system
CCV	control configured vehicle
CDI	course deviation indicator
CDR	commander
C.G.	center of gravity
CONUS	continental United States
CRT	cathode ray tube
CSS	control stick steering
D/O	deorbit
DAP	digital auto pilot
DCLT	declutter
DDS	descent design system
DELPAD	deorbit, entry and landing preliminary advisory data
DES	deselect
DLMA	dilemma
DME	distance measuring equipment
DOD	Department of Defense
DOF	degree of freedom
DPS	data processing system
DTO	detailed test objective
E/W	energy to weight ratio
EAS	equivalent airspeed
EL	elevation
ELS	emergency landing site

ENA	enable
EOM	end of mission
ET	external tank
FA	flight aft
FAA	Federal Aviation Administration
FCS	flight control system
FD	flight director
FDF	flight data file
FDIR	fault detection, identification, and reconfiguration
FF	final flare
FOV	field of view
FPS	feet per second
FPS ²	feet per second squared
FSGS	flare and shallow glide slope
FSSR	functional subsystem software requirements
FT	feet
FT-LB	foot-pounds
G&C	guidance and control
GAX	GN&C annunciation interface
GNC	guidance, navigation and control
GPC	general purpose computer
GPS	global positioning system
GR	gear
GR-DN	gear down
GRTLS	glided return to launch site
GS	glide slope
GSENB	ground speed enable
GSI	glide slope indicator
HAC	heading alignment cone
HDG	heading
HDOT	altitude rate
HSD	horizontal situation display
HSI	horizontal situation indicator
HTA	HAC turn angle
HUD	heads up display
HYD SOP	hydraulic subsystem operating program
ICAO	International Civil Aviation Organization
IDP	integrated display processor
IGS	inner glide slope
I-load	initialization load
ILS	instrument landing system
IMU	inertial measurement unit
IN	inch
INH	inhibit
INRTL	inertial
KEAS	knots equivalent airspeed
KGS	knots ground speed
KSC	Kennedy Space Center
KTS	knots

L/D	lift to drag ratio
LB	pound
LRU	line replaceable unit
LSO	Landing Site Officer
LST	Landing Site Table
LVLH	local vertical, local horizontal
M/VEL	mach/velocity
MCC	mission control center
MDM	multiplexer/demultiplexer
MEDS	multifunction electronic display system
MEP	minimum entry point
MGTD	main gear touchdown
MLS	microwave landing system
MM	major mode; mass moment
MSBLS	microwave scanning beam landing system
MLS-GS	microwave landing system – ground station
MLS-JR	microwave landing system - junior
NAV	navigation
NAVAID	navigation aid
NAVDAD	navigation derived air data
NEP	nominal entry point
NGSD	nose gear slap down
NGTD	nose gear touchdown
NM	nautical miles
NWS	nose wheel steering
Ny	lateral acceleration
Nz	normal acceleration
OGS	outer glide slope
OI	operational increment
PAPI	precision approach path indicator
PASS	primary avionic software system
PB	push button
PBI	push button indicator
PDU	pilot display unit
PFD	primary flight display
PIO	pilot induced oscillation
PLT	pilot
PROM	program read only memory
PRL	priority rate limiting
PSF	pounds per square foot
PSI	pounds per square inch
PTI	programmed test input
Q-bar	dynamic pressure
R/Y	roll/yaw
RA	radar altimeter
RCS	reaction control system
RDR	radar

REF	reference
RGA	rate gyro assembly
RHC	rotational hand controller
RM	redundancy management
RPTA	rudder pedal transducer assembly
RTLS	return to launch site
SB	speedbrake
SBTC	speedbrake/thrust controller
SEP	separation
SILTS	shuttle infrared lee-side temperature sensing
SMS	shuttle mission simulator
SOP	subsystem operating program
SPI	surface position indicator
SRB	solid rocket booster
SSME	space shuttle main engine
STA	shuttle training aircraft
T/D	touchdown
TACAN	tactical air navigation
TAL	transoceanic abort landing
TAS	true airspeed
TAEM	terminal area energy management
TED	trailing edge down
TEU	trailing edge up
UPP	user parameter processing
VAFB	Vandenberg Air Force Base
VSD	vertical situation display
VMS	vertical motion simulator
VREL	earth relative velocity
VV	velocity vector
WONG	weight on nose gear
WOW	weight on wheels
WOWLON	weight on wheels latched ON
WP1	way point 1
WP2	way point 2
WT	weight
X-C.G.	longitudinal center of gravity

Distribution List:

***** JSC *****

***** U.S. MAIL *****

NASA-JSC

CB/Chief (5)
CB/D. Hurley
CB/E. Boe
CC5/STA Ops Head
DA8/Chief (5)
DA8/L. Cain
DA8/S. Stich
DA8/N. Knight
DF22/DPS Group Lead
DF52/MMACS Group Lead
DF55/Booster Group Lead
DF62/GNC Group Lead
DF63/Prop Group Lead
DF73/EGIL Group Lead
DF82/EECOM Group Lead
DM/Chief, Flight Design and Dynamics
DM/DM Console Library (2)
DM2/Chief, Flight Design Requirements
DM4/Chief, Ascent/Descent Dynamics
DM42/Descent Analysis Lead
DM43/AEGPO Group Lead (2)
DM43/S. Hartman (10)
DM44/Ascent Analysis Lead
DM46/AEFDO Group Lead (2)
DM46/LSO
DT32/Sim Sup
DT34/Control Prop (5)
DT35/DPS-Navigation
DT36/Systems Training
EG4/H. Law
IS23/STIC

Boeing – Huntington Beach

5301 Bolsa Avenue
Huntington Beach, CA 92647
H010-C012/D. Gavert (5)

***** JSC OFFSITE *****

NASA-Ames Research Center

AF/E. Hernandez (3)

Jacobs Sverdrup

5WB/B. Bihari
5WB/P. Dailey
5WB/M. Galloway

USA-Houston

USH482L/K. Houston
USH482L/S. Chicco
USH482L/B. Mader
USH482L/C. Lessmann(2)
USH482L/K. Hagee
USH482L/D. Kyle
USH481A/FDD Library/T. Davies

