

Flight Procedures Handbook

Ascent/Aborts (OI-30)

Flight Design and Dynamics Division
Trajectory Operations Branch

Revision F
March 2005

National Aeronautics and
Space Administration

Lyndon B. Johnson Space Center
Houston, Texas

VERIFY THIS IS THE CORRECT VERSION PRIOR TO USE

Mission Operations Directorate

Ascent/Aborts Flight Procedures Handbook
Revision F

March 2005

Prepared by

Original signed by
Joseph Jones
Ascent/Aborts Flight Procedures Handbook Book Manager

Approved by

Original signed by
Glenn Pogue
Lead, Ascent/Entry Guidance and Procedures

Original signed by
Greg Oliver
Chief, Ascent/Descent Dynamics Branch

National Aeronautics and Space Administration
Lyndon B. Johnson Space Center
Houston, Texas

ACKNOWLEDGMENT

Major contributions to the Ascent/Aborts Flight Procedures Handbook were made by the following individuals:

Dennis L. Bentley
P. Jeffery Bertsch
John E. Blaha
Michael L. Coats
Ron J. Herdrich
Richard A. Schmidgall
Jerry J. Sellers
John V. Turner
Charles Precourt
Rick Mastracchio
Ed Gonzalez
Mark West
Bill Jacobs
Dan Adamo
Colleen Crawford

It is requested that any organization having comments concerning this document contact Joseph Jones/DM43 at 483-1170.

FLIGHT PROCEDURES HANDBOOK PUBLICATIONS

The following is a list of the Integrated Flight Procedures Handbooks of which this document is a part. These handbooks document integrated and/or flight procedural sequences covering major shuttle crew activity plan phases.

<u>Title</u>	<u>JSC document no.</u>
Ascent/Aborts	10559
Entry	11542
Rendezvous/Orbital Navigation	10589
Orbital Translation	10588
Attitude and Pointing	10511
STS Workday	10541
Spacelab Activation	10545
Spacelab Deactivation	12803
Crew Data Management	12985
Proximity Operations	12802
IMU Alignment	12842
Deployed Payload	16191
Post-Insertion Deorbit Preparation	16219

Table of Contents

<u>INTRODUCTION</u>	1-1
1.1 PURPOSE	1-1
1.2 SCOPE	1-1
1.3 DESCRIPTION	1-1
1.4 Post OI-26 Flight Software	1-2
1.5 OI-27 Flight Software.....	1-2
1.6 OI-28 Flight Software.....	1-2
1.7 OI-29 Flight Software.....	1-4
1.8 OI-30 Flight Software.....	1-6
<u>ASCENT FLIGHT PHASE DESCRIPTION</u>	2.1-1
2.1 OVERVIEW	2.1-1
2.2 NOMINAL SUMMARY.....	2.2-1
2.2.1 First Stage.....	2.2.1-1
2.2.1.1 Overview	2.2.1-1
2.2.1.2 Adaptive Guidance.....	2.2.1-5
2.2.1.3 Load Relief	2.2.1-8
2.2.2 Second Stage	2.2.2-1
2.2.2.1 Overview	2.2.2-1
2.2.2.2 Ground-Up Rendezvous Launch Window and Targeting	2.2.2-4
2.2.3 Post-MECO	2.2.3-1
2.2.4 OMS 1 Insertion Burn.....	2.2.4-1
2.2.5 OMS 2 Insertion Burn.....	2.2.5-1
2.3 ABORT TO ORBIT (ATO)	2.3-1
2.3.1 Pre-MECO ATO Selection.....	2.3.1-1
2.3.2 Post-MECO ATO Selection	2.3.2-1
2.4 ABORT ONCE AROUND (AOA).....	2.4-1
2.5 TRANSOCEANIC ABORT LANDING (TAL)	2.5-1
2.5.1 Powered Flight.....	2.5.1-1
2.5.2 TAL Droop.....	2.5.2-1
2.5.3 Entry.....	2.5.3-1
2.6 RETURN TO LAUNCH SITE (RTL).....	2.6-1

2.6.1	Powered RTLS	2.6.1-1
2.6.1.1	Fuel Dissipation	2.6.1-1
2.6.1.2	Flyback	2.6.1-2
2.6.1.3	Powered Pitchdown	2.6.1-3
2.6.2	Glided RTLS.....	2.6.2-1
2.6.2.1	Alpha Recovery	2.6.2-1
2.6.2.2	Nz Hold.....	2.6.2-2
2.6.2.3	Alpha Transition Phase.....	2.6.2-2
2.6.2.4	TAEM	2.6.2-3
2.7	CONTINGENCY ABORT (CA).....	2.7-1
2.7.1	Powered Contingency	2.7.1-1
2.7.1.1	CONT 2 E/O BLUE and RTLS 2 E/O BLUE (CA Mode 1).....	2.7.1-3
2.7.1.2	CONT 2 E/O GREEN and RTLS 2 E/O YELLOW (CA Mode 2).....	2.7.1-4
2.7.1.3	RTLS 2 E/O ORANGE (CA Mode 3).....	2.7.1-5
2.7.1.4	RTLS 2 E/O GREEN (CA Mode 4).....	2.7.1-5
2.7.1.5	RTLS 2 E/O RED (CA Mode 5)	2.7.1-5
2.7.2	Contingency 3 Engine Out (Mated Coast and ET Separation).....	2.7.2-1
2.7.2.1	ET Separation Method Selection.....	2.7.2-5
2.7.2.1.1	3 E/O Auto Contingency Logic Disabled.....	2.7.2-5
2.7.2.1.2	3 E/O Auto Contingency Logic Enabled.....	2.7.2-7
2.7.2.2	3 E/O BLUE (Region 102).....	2.7.2-9
2.7.2.3	3 E/O GREEN (Region 1).....	2.7.2-9
2.7.2.4	3 E/O ORANGE (Region 2)	2.7.2-10
2.7.2.5	3 E/O YELLOW (Region 3)	2.7.2-10
2.7.2.6	3 E/O RED (Region 4).....	2.7.2-11
2.7.3	Entry.....	2.7.3-1
2.7.3.1	Alpha Recovery	2.7.3-2
2.7.3.2	Nz Hold.....	2.7.3-3
2.7.3.3	Alpha Transition	2.7.3-4
2.7.3.4	ECAL/BDA landing or bailout	2.7.3-4
2.7.4	Orbiter Limits and Black Zones	2.7.4-1
2.7.4.1	ET Separation Limitations.....	2.7.4-1
2.7.4.2	Nz Hold and Max QBAR Limitations.....	2.7.4-1
2.7.4.2.1	NZ and QBAR Limits of Contingency Aborts	2.7.4-2
2.7.4.2.2	Maximum Target NZ I-load	2.7.4-4
2.7.4.2.3	Manual Body Flap Schedule.....	2.7.4-4
2.7.4.2.4	Black Zones.....	2.7.4-5
<u>ASCENT CREW MONITORING AND CONTROL DEVICES</u>		3.1-1
3.1	OVERVIEW.....	3.1-1
3.2	ONBOARD ASCENT EVENT REFERENCE.....	3.2-1
3.3	COCKPIT CRT DISPLAYS	3.3-1

3.4 DEDICATED DISPLAYS	3.4-1
3.4.1 Attitude Director Indicator (ADI)	3.4.1-1
3.4.1.1 Attitude	3.4.1-2
3.4.1.2 Rates	3.4.1-6
3.4.1.3 ADI Errors	3.4.1-7
3.4.2 Horizontal Situation Indicator	3.4.2-1
3.4.2.1 Ascent HSI	3.4.2-2
3.4.2.2 Entry HSI	3.4.2-4
3.4.3 Alpha/Mach Indicator.....	3.4.3-1
3.4.4 Altitude Vertical Velocity Indicator	3.4.4-1
3.4.5 Surface Position Indicator	3.4.5-1
3.5 FCS MODE PBIs.....	3.5-1
<u>CREW OPERATIONS</u>	4.1-1
4.1 OVERVIEW.....	4.1-1
4.2 PRELAUNCH PROCEDURES	4.2-1
4.2.1 Recycle Procedures	4.2.1-1
4.2.2 Switch Config and Crew Ingress	4.2.2-1
4.2.3 IMU Preflight Align	4.2.3-1
4.2.4 Comm Checks.....	4.2.4-1
4.2.5 Cabin Leak Check	4.2.5-1
4.2.6 PASS/BFS Transfer Preparation.....	4.2.6-1
4.2.7 GN2 Activation.....	4.2.7-1
4.2.8 Air to Ground Voice Checks	4.2.8-1
4.2.9 Cabin Vent Configuration.....	4.2.9-1
4.2.10 Trajectory Update	4.2.10-1
4.2.11 OPS 1 Transition.....	4.2.11-1
4.2.12 Horizontal Sit and Contingency Yaw Steer Configuration.....	4.2.12-1
4.2.13 MPS, OMS/RCS Configuration.....	4.2.13-1
4.2.14 T-9 Hold	4.2.14-1
4.2.15 Essential Buses and APU Start	4.2.15-1
4.2.16 Final Prelaunch Actions	4.2.16-1
4.3 NOMINAL/ATO ASCENT	4.3-1
4.3.1 Ascent Procedures Card	4.3.1-1
4.3.1.1 Lift-off.....	4.3.1-3
4.3.1.2 Roll Program	4.3.1-4
4.3.1.3 Load Relief	4.3.1-6
4.3.1.4 SRB Separation	4.3.1-10
4.3.1.5 Second Stage Guidance Convergence.....	4.3.1-13
4.3.1.6 OMS Assist.....	4.3.1-16

4.3.1.7	Post SRB Separation Systems Configuration.....	4.3.1-17
4.3.1.8	Systems Aborts	4.3.1-18
4.3.1.9	Roll Heads Up	4.3.1-20
4.3.1.10	Manual Throttle/MECO Actions	4.3.1-21
4.3.1.11	MECO	4.3.1-23
4.3.1.12	ET Separation.....	4.3.1-24
4.3.1.13	Major Mode 104.....	4.3.1-27
4.3.2	Abort Selection for Systems Failures	4.3.2-1
4.3.2.1	Loss of OMS Capability.....	4.3.2-2
4.3.2.2	APU/Hydraulic Failures	4.3.2-3
4.3.2.3	Cabin Leak.....	4.3.2-4
4.3.2.4	Loss of Cryo	4.3.2-5
4.3.2.5	Loss of 2 Freon Loops	4.3.2-6
4.3.2.6	Loss of 2 Main Buses.....	4.3.2-7
4.3.2.7	Loss of a Thermal Window Pane.....	4.3.2-8
4.3.3	Abort Selection for Performance	4.3.3-1
4.3.3.1	SSME Failure	4.3.3-2
4.3.3.2	NO COMM MODE BOUNDARIES Card.....	4.3.3-4
4.3.3.3	Ascent/Abort Summary Card	4.3.3-12
4.3.4	OMS 1/2 Targeting	4.3.4-1
4.3.4.1	Standard Insertion OMS 1 Targeting Card for Systems Failures	4.3.4.1-1
4.3.4.2	Standard Insertion OMS 2 Targeting Card for Systems Failures	4.3.4.2-1
4.3.4.3	Direct Insertion OMS 2 Targeting Card for Systems Failures	4.3.4.3-1
4.3.4.4	OMS 1/2 Targeting for Performance	4.3.4.4-1
4.3.4.4.1	OMS 1/2 Targeting Card	4.3.4.4-1
4.3.4.4.2	Rendezvous Recovery Card	4.3.4.4-6
4.3.4.5	OMS Required for OMS 2 and Deorbit.....	4.3.4.5-1
4.3.4.6	OMS Targets	4.3.4.6-1
4.3.5	OMS 1 Burn Card.....	4.3.5-1
4.3.5.1	MPS Dump and APU Shutdown	4.3.5-4
4.3.5.2	Feedline Failure.....	4.3.5-5
4.3.5.3	1 OMS Engine Fail and VTOT > 500 fps	4.3.5-7
4.3.5.4	Pre-burn Procedures	4.3.5-8
4.3.5.5	OMS Engine Fail	4.3.5-10
4.3.5.6	RCS Completion.....	4.3.5-12
4.3.5.7	Cutoff.....	4.3.5-13
4.3.6	OMS/RCS ΔV	4.3.6-1
4.3.6.1	OMS He PRESS/ ΔV /Burn Time	4.3.6-3
4.3.6.2	ΔV Capability	4.3.6-4
4.3.7	Post OMS 1	4.3.7-1
4.3.7.1	ET Photo Maneuver / MPS Dump	4.3.7-1
4.3.7.2	Feedline Fail.....	4.3.7-4
4.3.7.3	Post Burn Status	4.3.7-6
4.3.7.4	HYD/MPS TVC ISOL Closed	4.3.7-8
4.3.7.5	If AOA	4.3.7-9

4.3.7.6	Auxiliary Power Unit/Hydraulics Shutdown	4.3.7-10
4.3.7.7	Check MCC for TAIL ONLY Control	4.3.7-11
4.3.7.8	Flash Evaporator System and Heater Activation	4.3.7-12
4.3.7.9	AC Bus Sensor Configuration	4.3.7-13
4.3.7.10	Major Mode Change and OMS 2 Burn Setup	4.3.7-14
4.3.7.11	MPS Powerdown/Isolation and MPS GH2 Inerting	4.3.7-16
4.3.7.12	External Tank Umbilical Door Closure	4.3.7-17
4.3.7.13	OMS Burn Prep	4.3.7-19
4.3.7.14	OMS 2 Burn Maneuver to Burn Attitude	4.3.7-20
4.3.7.15	Seat Safing and Adjustment	4.3.7-21
4.3.8	OMS 2 Burn Procedures	4.3.8-1
4.3.8.1	Pre-Burn Configuration Checks	4.3.8-3
4.3.8.2	OMS Engine Switch Configuration and Burn Enable	4.3.8-4
4.3.8.3	OMS Propellant Fail	4.3.8-7
4.3.8.4	OMS Engine Fail	4.3.8-9
4.3.8.5	RCS Completion	4.3.8-11
4.3.8.6	Cutoff	4.3.8-12
4.3.9	OPS 1 RCS BURN	4.3.9-1
4.3.9.1	AFT RCS Burn	4.3.9-2
4.3.9.2	FWD RCS Burn	4.3.9-4
4.3.10	Post OMS 2 Procedures	4.3.10-1
4.3.10.1	Post Burn Status	4.3.10-1
4.3.10.2	OMS Thrust Vector Control Gimbal Check	4.3.10-2
4.3.10.3	OMS/RCS Post OMS 2 Reconfiguration	4.3.10-4
4.3.10.4	Major Mode Change	4.3.10-5
4.4	AOA PROCEDURES	4.4-1
4.4.1	Direct Insertion versus Standard Insertion	4.4.1-1
4.4.2	AOA DEL PAD	4.4.2-1
4.4.3	AOA Procedures	4.4.3-1
4.4.3.1	Hydraulic Depress	4.4.3-2
4.4.3.2	Flash Evaporator System and Heater Activation	4.4.3-3
4.4.3.3	AC Bus Sensor Configuration	4.4.3-4
4.4.3.4	Major Mode Change	4.4.3-5
4.4.3.5	APU Steam Vent Heater Activation	4.4.3-7
4.4.3.6	MPS Isolation and MPS GH2 Inerting	4.4.3-8
4.4.3.7	External Tank Umbilical Door Closure	4.4.3-9
4.4.3.8	DPS Entry Configuration	4.4.3-11
4.4.3.9	OMS 2 Burn Setup	4.4.3-13
4.4.3.10	OMS Thrust Vector Control Gimbal Check	4.4.3-15
4.4.3.11	Seat Adjustment and OMS Burn Prep	4.4.3-17
4.4.3.12	OMS Burn TIG Adjust	4.4.3-19
4.4.3.13	Maneuver to Deorbit Burn Attitude	4.4.3-20
4.4.4	Post Deorbit Burn Procedures	4.4.4-1
4.4.4.1	DAP and OMS/RCS Post Burn Reconfiguration	4.4.4-1

4.4.4.2	Recovery Prebank Determination and Post Burn Status.....	4.4.4-3
4.4.4.3	Major Mode 303 Transition and MPS LH2 Inerting	4.4.4-5
4.4.4.4	OMS Gimbal Powerdown	4.4.4-7
4.4.4.5	Secondary Actuator Check.....	4.4.4-8
4.4.4.6	Forward RCS Dump	4.4.4-10
4.4.4.7	Horizontal Situation Display Configuration	4.4.4-13
4.4.4.8	Entry Switch Check	4.4.4-15
4.4.4.9	APU Restart (If APUs shutdown)	4.4.4-17
4.4.4.10	Off nominal APU and FCS Channel Pre EI Configuration.....	4.4.4-18
4.4.4.11	Nominal EI - 5 Actions	4.4.4-20
4.5	TAL PROCEDURES	4.5.1-1
4.5.1	TAL Procedures Card	4.5.1-1
4.5.1.1	Abort Initiation	4.5.1-3
4.5.1.2	Site and Contingency Yaw Steer Selection	4.5.1-5
4.5.1.3	OMS Dump and Auto Throttles	4.5.1-7
4.5.1.4	Second Engine Failure (CDR)	4.5.1-8
4.5.1.5	Second Engine Failure (PLT)	4.5.1-9
4.5.1.6	Roll Heads Up	4.5.1-11
4.5.1.7	MECO and ET Separation	4.5.1-12
4.5.1.8	OPS 3 Transition	4.5.1-13
4.5.1.9	TAL Capability Bar Chart	4.5.1-16
4.5.1.10	MM304 GN&C Configuration	4.5.1-20
4.5.1.11	Low Energy Guidance.....	4.5.1-21
4.5.1.12	Entry Systems Configuration.....	4.5.1-22
4.5.1.13	Entry GN&C Configuration	4.5.1-24
4.5.2	TAL Redesignation Cards	4.5.2-1
4.5.2.1	First Engine Out V_1 (MCC Call or from PASS TRAJ)	4.5.2-5
4.5.2.2	Single Engine OPS 3 [in-plane TAL Site] 109%	4.5.2-5
4.5.2.3	Main Engine Limits Enable/Auto (MCC call only).....	4.5.2-5
4.5.2.4	Single Engine [ACLS or prime TAL if in-plane] 104%	4.5.2-5
4.5.2.5	Single Engine [prime TAL] 109% (N/A if in-plane site is prime TAL)	4.5.2-5
4.6	HIGH ENERGY TAL and HIGH ENERGY GANDER PROCEDURES	4.6.1-1
4.6.1	High Energy TAL Procedures	4.6.1-1
4.6.1.1	Major Mode 104 Procedures	4.6.1-3
4.6.1.2	Initial MM304 Attitude.....	4.6.1-5
4.6.1.3	OMS Dump.....	4.6.1-8
4.6.1.4	BFS OPS 3 Transition and Site Selection.....	4.6.1-9
4.6.1.5	Pitch Down to Alpha 55°	4.6.1-10
4.6.1.6	Roll Heads Up	4.6.1-11
4.6.1.7	Active Guidance Initiation	4.6.1-12
4.6.1.8	Roll/Yaw Return to Auto	4.6.1-14
4.6.1.9	Pitch Return to Auto	4.6.1-15
4.6.1.10	Entry Systems Configuration	4.6.1-16
4.6.1.11	TAEM Preparation	4.6.1-18

4.6.2 High Energy Gander Procedures	4.6.2-1
4.6.2.1 Major Mode Transition	4.6.2-4
4.6.2.2 Initial MM304 Attitude.....	4.6.2-6
4.6.2.3 BFS OPS Transition, Site Selection, and ET Door Closure	4.6.2-8
4.6.2.4 Roll Towards Gander	4.6.2-9
4.6.2.5 Return to AUTO Guidance.....	4.6.2-11
4.6.2.6 Entry Systems Configuration	4.6.2-13
4.7 RTLS PROCEDURES	4.7-1
4.7.1 Abort Initiation	4.7-3
4.7.2 Fuel Dissipation Attitude and Throttling.....	4.7-4
4.7.3 Guidance Convergence and Powered Pitcharound	4.7-6
4.7.4 OMS Dump	4.7-8
4.7.5 Flyback Attitude and Throttles	4.7-9
4.7.6 Powered Pitchdown	4.7-11
4.7.7 MECO	4.7-12
4.7.8 ET Separation.....	4.7-14
4.7.9 Alpha Recovery Phase.....	4.7-16
4.7.10 Flight Control Configuration	4.7-19
4.7.11 ET Door Closure and ET/SRB Switch Configuration	4.7-21
4.7.12 TACAN Management	4.7-22
4.7.13 NZ Hold Phase.....	4.7-23
4.7.14 Alpha Transition Phase.....	4.7-24
4.7.15 TAEM Interface.....	4.7-26
4.7.16 TAEM and Post Landing Procedures.....	4.7-28
4.8 CONTINGENCY ABORT.....	4.8-1
4.8.1 Contingency Abort Cue Card	4.8.1-1
4.8.1.1 Two Engines Out	4.8.1.1-1
4.8.1.1.1 Two Engine Out First Stage.....	4.8.1.1-3
4.8.1.1.2 Two Engine Out Second Stage	4.8.1.1-6
4.8.1.1.3 Two Engine Out BLUE Monitor.....	4.8.1.1-10
4.8.1.1.4 Two Engine Out GREEN Monitor.....	4.8.1.1-12
4.8.1.1.5 Two Engine Out Droop	4.8.1.1-14
4.8.1.2 One Engine Stuck at Minimum Throttle and One Engine Out.....	4.8.1.2-1
4.8.1.2.1 Stuck First	4.8.1.2-2
4.8.1.2.2 Stuck RTLS.....	4.8.1.2-3
4.8.1.2.3 Stuck Droop	4.8.1.2-5
4.8.1.2.4 Stuck TAL.....	4.8.1.2-7
4.8.1.3 Three Engine Out Contingency Abort (OI-25 3 E/O Auto Guidance)	4.8.1.3-1
4.8.1.3.1 Three Engine Out First Block	4.8.1.3-2
4.8.1.3.2 Three Engine Out Second Block	4.8.1.3-4
4.8.1.3.3 Three Engine Out Blank Block	4.8.1.3-5
4.8.1.3.4 Three Engine Out BLUE	4.8.1.3-6
4.8.1.3.5 Three Engine Out GREEN.....	4.8.1.3-8
4.8.1.3.6 Three Engine Out ORANGE.....	4.8.1.3-10

4.8.1.3.7 Three Engine Out YELLOW and RED	4.8.1.3-12
4.8.1.4 Contingency Entry Procedures	4.8.1.4-1
4.8.1.4.1 Before NZ Hold Steps	4.8.1.4-2
4.8.1.4.2 After NZ Hold Steps.....	4.8.1.4-4
4.8.2 RTLS Contingency Abort Cue Card.....	4.8.2-1
4.8.2.1 Two Engine Out RTLS	4.8.2.1-1
4.8.2.1.1 Two Engine Out RTLS Procedures (2 OUT COLOR)	4.8.2.1-2
4.8.2.1.2 Two Engine Out RTLS BLUE.....	4.8.2.1-6
4.8.2.1.3 Two Engine Out RTLS YELLOW.....	4.8.2.1-8
4.8.2.1.4 Two Engine Out RTLS ORANGE.....	4.8.2.1-11
4.8.2.1.5 Two Engine Out RTLS GREEN	4.8.2.1-13
4.8.2.1.6 Two Engine Out RTLS RED	4.8.2.1-15
4.8.2.1.7 Two Engine Out RTLS BLANK.....	4.8.2.1-18
4.8.2.2 Three Engine Out RTLS Contingency Abort (OI-25 3 E/O Auto Guidance).....	4.8.2.2-1
4.8.2.2.1 Three Engine Out Procedure Block.....	4.8.2.2-2
4.8.2.2.2 Three Engine Out GREEN.....	4.8.2.2-3
4.8.2.2.3 Three Engine Out ORANGE.....	4.8.2.2-5
4.8.2.2.4 Three Engine Out YELLOW and RED	4.8.2.2-7
4.8.2.3 RTLS Contingency Entry Procedures.....	4.8.2.3-1
4.8.3 BDA/ECAL Procedures	4.8.3-1
4.8.3.1 Powered ECAL (Bermuda) Procedures (28.5, 39, 51.6, 57° Inclination)	4.8.3-6
4.8.3.2 Powered Flight No Yaw Procedures (39° Inclination Only).....	4.8.3-8
4.8.3.3 MECO and ET Separation	4.8.3-10
4.8.3.4 ECAL (Bermuda) Entry Procedures (Before NZ Hold)	4.8.3-12
4.8.3.5 ECAL (Bermuda) Entry Procedures (NZ Hold to TAEM).....	4.8.3-14
4.8.3.6 Roll Maneuver and Post-NZ Hold Actions (Pre-OI-28 Flight S/W)	4.8.3-17
4.8.3.7 ECAL (Bermuda) Entry Procedures (TAEM)	4.8.3-20
4.9 POWERED CSS PROCEDURES.....	4.9-1

BACKUP FLIGHT SYSTEM

5.1 OVERVIEW.....	5-1
5.2 PASS/BFS DIFFERENCES	5-3
5.2.1 SSME Throttle Setting.....	5-3
5.2.2 MPS Guidance Cutoff Task.....	5-4
5.2.3 G-limiting.....	5-4
5.2.4 Powered Explicit Guidance	5-4
5.2.5 Range to Landing Site Task	5-5
5.2.6 Maneuver Execute Display Interface Processing (DIP)	5-5
5.2.7 Restart	5-5
5.2.8 I-loads.....	5-5
5.2.9 RTLS Manual Turnaround	5-6

5.2.10 Transfer Data5-6

5.2.11 AOA/ATO Targeting5-6

5.2.12 Contingency Abort/Single Engine Roll Control.....5-6

5.2.13 MPS Dump5-7

5.2.14 CRTs5-7

5.2.15 Dedicated Flight Instruments5-7

5.2.16 Entry Guidance and Navigation5-7

5.2.17 SRB and ET Separation5-7

5.2.18 Caution and Warning (C&W)5-7

5.2.19 AUTO/CSS and TRANS DAP5-7

5.2.20 Redundancy Management (RM)5-7

5.2.21 Switches.....5-7

ACRONYMS..... A-1

CHANGE CONTROL..... B-1

List of Figures

<u>Figure</u>		<u>Page</u>
2.1-1	Ascent Flight Phase	2.1-1
2.1-2a	Space Shuttle Landing Sites	2.1-2
2.1-2b	Space Shuttle Landing Sites	2.1-3
2.1-3	Bermuda, ECAL, and Canadian Sites	2.1-4
2.2-1	Major Mode Flow	2.2-1
2.2.1.2-1	VREF Adjust versus TREF Adjust	2.2. 1-5
2.2.1.2-2	Throttle Bucket for Nominal and Dispersed SRBs for a Single Stage Bucket	2.2. 1-6
2.2.1.2-3	Throttle Bucket for Nominal and Dispersed SRBs for a Two Stage Bucket	2.2. 1-6
2.2.1.2-4	Adaptive Guidance Pitch Adjustment.....	2.2. 1-7
2.2.2.2-1	Delta Performance vs Launch Time	2.2.2-4
2.2.2.2-2	Phase Angle Definition	2.2.2-5
2.2.2.2-3	Composite Rendezvous Launch Window	2.2.2-5
2.2.2.2-4	Example 2 Planar Window Day	2.2.2-6
2.3-1	ATO Versus Nominal Orbit.....	2.3-1
2.3-2	Panel F6.....	2.3-2
2.4-1	Mid altitude DI AOA	2.4-2
2.4-2	High altitude DI AOA	2.4-2
2.4-3	Θ_T Definition.....	2.4-3
2.4-4	TIG Adjust Logic.....	2.4-4
2.4-5	AOA Trajectory	2.4-5
2.5-1	TAL Versus Nominal Ascent.....	2.5-1
2.5-2	TAL Guidance Events.....	2.5-2
2.5.1-1	TAL Landing Sites	2.5.1-2
2.5.2-1	Droop Boundary	2.5.2-1
2.6-1	RTLS Trajectory and Flight Phases	2.6-1
2.6-2	RTLS Ascent Guidance Events	2.6-2
2.6.1.2-1	RTLS Pitcharound Maneuver	2.6.1-2
2.6.1.3-1	Mated Coast and ET Separation.....	2.6.1-4
2.6.2.1-1	Angle of Attack and Normal Load Factor Profiles	2.6.2-2
2.6.2.4-1	MM603 Angle of Attack Limits.....	2.6.2-4
2.7.1.1-1	Two Engines Out Prior to Approximately $V_1 = 7000$ fps.....	2.7.1-3
2.7.1.2-1	Two Engines Out Between 7000 and 12,000 fps	2.7.1-4
2.7.2-1	Successful ET Sep.....	2.7.2-1
2.7.2-2	ET/Orbiter Clearances for Fast Sep	2.7.2-3
2.7.2-3	Rate Separation.....	2.7.2-4
2.7.2.1.2-1	3 E/O Auto Contingency Use for Uphill Cases.....	2.7.2-8
2.7.2.1.2-2	3 E/O Auto Contingency Use for RTLS Cases	2.7.2-8
2.7.4.2.1-1	Orbiter Capability Assessment Envelopes (Nov 2001)	2.7.4-3
2.7.4.2.4-1	Body Flap/Elevon Loads Comparison (Two Engines Out at 11,600 fps V_1).....	2.7.4-6
2.7.4.2.4-2	Body Flap/Elevon Loads Comparison (Three Engines Out at 11,600 fps V_1).....	2.7.4-7
2.7.4.2.4-3	Body Flap/Elevon Loads Comparison (Three Engines Out RTLS at $V_{REL}=0$)	2.7.4-8
3.3-1	Major Mode Flow	3.3-4
3.4-1	A/E Primary Flight Display.....	3.4-1

3.4.1-1	Attitude Director Indicator and Associated Switches	3.4.1-1
3.4.2-1	Horizontal Situation Indicator	3.4.2-1
3.4.2.2-1	HSI Controls.....	3.4.2-4
3.4.3-1	Alpha Mach Indicator and ADTA Switch.....	3.4.3-1
3.4.4-1	Altitude Vertical Velocity Indicator and Associated Switches	3.4.4-1
3.4.5-1	Surface Position Indicator	3.4.5-1
4.3.1-1	STS-110 Ascent Procedures Card (DI Flight).....	4.3.1-2
4.3.1.3.4-1	SRB Performance Effects on a One Step Throttle Bucket.....	4.3.1-7
4.3.1.3.4-2	SRB Performance Effects on a Two Step Throttle Bucket.....	4.3.1-8
4.3.1.4.4-1	SRB Sep Sequence.....	4.3.1-12
4.3.2-1	STS-110 SYS FLIGHT RULES Card	4.3.2-1
4.3.3.2-1	STS-110 NO COMM MODE BOUNDARIES Card	4.3.3-4
4.3.3.2-2	STS-111 Abort Coverage.....	4.3.3-6
4.3.3.3-1	STS-110 Ascent/Abort Summary Card.....	4.3.3-12
4.3.3.3-2	Abort Boundaries Flowchart	4.3.3-13
4.3.4.1-1	STS-30 OMS 1 TARGETING Card (Standard Insertion).....	4.3.4.1-1
4.3.4.2-1	STS-30 OMS 2 Targeting Card (Standard Insertion).....	4.3.4.2-1
4.3.4.3-1	STS-114 OMS 2 TARGETING Card (Direct Insertion)	4.3.4.3-1
4.3.4.4.1-1	STS-88 OMS 1/2 TGTING Card (Direct Insertion).....	4.3.4.4-1
4.3.4.4.1-2	STS-30 OMS 1/2 TGTING Card (Standard Insertion)	4.3.4.4-2
4.3.4.4.2-1	STS-86 Rendezvous Recovery Card (Direct Insertion)	4.3.4.4-6
4.3.4.5-1	Post-ATO OMS 1 OMS Required.....	4.3.4.5-2
4.3.4.6.1-1	STS61-C OMS Targets - On Time	4.3.4.6-2
4.3.4.6.1-2	STS61-C OMS Targets - Delayed	4.3.4.6-3
4.3.4.6.2-1	STS-75 OMS Targets (Direct Insertion).....	4.3.4.6-9
4.3.4.6.2-2	STS-75 OMS Targets (With OMS 1)	4.3.4.6-10
4.3.5-1	STS-114 OMS 1 BURN Card	4.3.5-2
4.3.6-1	STS-110 OMS He PRESS/DV/BURN TIME Card	4.3.6-1
4.3.8-1	STS-114 OMS 2/ORBIT OMS BURNS Card	4.3.8-2
4.3.9-1	STS-114 OPS 1 RCS BURN Card	4.3.9-1
4.4.1-1	Nominal EOM Deorbit Burn	4.4.1-1
4.4.1-2	Direct Insertion AOA Deorbit Burn.....	4.4.1-2
4.4.1-3	Standard Insertion AOA Deorbit Burn.....	4.4.1-2
4.4.2-1	Direct Insertion AOA DEL PAD	4.4.2-1
4.4.2-2	W/OMS 1 AOA DEL PAD	4.4.2-2
4.5.1-1	STS-114 TAL CDR Card.....	4.5.1-1
4.5.1-2	STS-114 TAL PLT Card.....	4.5.1-2
4.5.2-1	STS-114 Zaragosa TAL Redesignation Card	4.5.2-2
4.5.2-2	STS-114 Zaragosa ECAL Redesignation Card	4.5.2-3
4.5.2-3	STS-69 Moron TAL Redesignation Card	4.5.2-4
4.6.1-1	STS-114 High Energy TAL CDR Card	4.6.1-1
4.6.1-2	STS-114 High Energy TAL PLT Card	4.6.1-2
4.6.1.2-1	Orbiter Prebank Attitudes.....	4.6.1-7
4.6.2-1	STS-114 High Energy Gander CDR Card.....	4.6.2-2
4.6.2-2	STS-114 High Energy Gander PLT Card.....	4.6.2-3

4.7-1	STS-114 RTLS CDR Card.....	4.7-1
4.7-2	STS-114 RTLS PLT Card.....	4.7-2
4.8.1-1	STS-114 Contingency Abort Cue Card.....	4.8.1-1
4.8.2-1	STS-114 RTLS Contingency Abort Cue Card	4.8.2-1
4.8.3-1	Powered ECAL Procedures.....	4.8.3-3
4.8.3-2	Powered Bermuda Procedures.....	4.8.3-4
4.8.3-3	ECAL/Bermuda Entry Procedures.....	4.8.3-5
4.9-1	STS-114 Powered CSS - Uphill/TAL Card.....	4.9-1
4.9-2	STS-114 Powered CSS - RTLS Card.....	4.9-2

List of Tables

<u>Table</u>		<u>Page</u>
2.2.1.1-I	First Stage Guidance Events.....	2.2.1-4
2.5.1-I	Maximum TAL Crossrange	2.5.1-3
2.6.1.3-I	Orbiter/ET RTLS Abort Design Conditions.....	2.6.1-4
2.7.1-I	2 E/O Contingency Abort Mode versus Color Code	2.7.1-1
2.7.1-II	Non-RTLS Mode Selection Summary (51.6° except as noted).....	2.7.1-2
2.7.1-III	RTLS Mode Selection Summary	2.7.1-3
2.7.2.1.1-I	“Old” 3 E/O Contingency Abort Mode versus Color Code	2.7.2-6
2.7.2.1.1-II	“Old” Non-RTLS 3 E/O Mode Selection Summary	2.7.2-6
2.7.2.1.1-III	“Old” RTLS 3 E/O Mode Selection Summary	2.7.2-7
2.7.2.1.2-I	OI-25 3 E/O Contingency Abort Mode versus Color Code.....	2.7.2-7
2.7.3-I	Alpha Recovery Angle versus Relative Velocity	2.7.3-1
2.7.3-II	Major Mode 602 Transition Criteria	2.7.3-2
2.7.4.2.3-I	Aerosurface Hinge Moment Limits	2.7.4-4
3.3-I	“OPS” CRT Displays	3.3-2
3.3-II	“SPEC” and “DISP” Cockpit CRT Displays	3.3-3
3.4-I	Ascent Dedicated Displays Summary.....	3.4-3
3.4.1.1-I	ADI Attitude Definition Summary	3.4.1-5
3.4.1.2-I	ADI Rate Pointer Sense	3.4.1-6
3.4.1.2-II	ADI Rate Scale Definition and Full Scale Deflection.....	3.4.1-7
3.4.1.3-I	ADI Error Needle Definition and Full Scale Deflection.....	3.4.1-8
3.4.2.1-I	Ascent HSI Parameter Definitions	3.4.2-3
3.4.2.2-I	Entry HSI Parameter Definition.....	3.4.2-6
3.4.3-I	Alpha Mach Indicator Parameter Definition.....	3.4.3-2
3.4.3-II	AMI Source Based on ADTA Switch Position (entry only)	3.4.3-3
3.4.4-I	Altitude Vertical Velocity Indicator Parameter Definition	3.4.4-2
3.4.4-II	AVVI Source Based on ADTA Switch Position (entry only)	3.4.4-3
4.3.4.6.1-I	STS 61-C OMS Burn Targets	4.3.4.6-1
4.3.4.6.2-I	Direct Insertion Target Options	4.3.4.6-8
4.7.8.4-I	RTLS ET Separation Inhibit I-loads	4.7-15

SECTION 1

INTRODUCTION

1.1 PURPOSE

The purpose of the Ascent/Aborts Flight Procedures Handbook (FPH) is to describe and provide rationale for the flight procedures used during space shuttle ascent and abort flight phases. It was prepared for shuttle flight crews and ground operations personnel as an ascent flight training supplement and reference source. Upon completion of the Ascent/Aborts FPH, the reader should have a thorough understanding of all aspects of shuttle ascent flight.

1.2 SCOPE

The Ascent/Aborts FPH covers nominal ascent, orbital insertion, and all abort flight phases that can occur during ascent. The entry and landing portions of the aborts are included. The Ascent/Aborts FPH represents Space Shuttle Program (SSP) guidance and procedures as of OI-30 (first flight, STS-114).

The Ascent/Aborts FPH includes trajectory (TRAJ) and guidance-related flight procedures only. It does not address procedures to be used in the event of systems failures. Systems failures are covered in the Ascent/Orbit/Entry Pocket Checklist and Cue Cards Handbook.

1.3 DESCRIPTION

This document covers the following flight phases:

- a. Nominal ascent
- b. Abort to orbit (ATO)
- c. Abort once around (AOA)
- d. Transoceanic abort landing (TAL)
- e. Return to launch site (RTL)
- f. Contingency abort (CA)

Section 2 of this FPH provides a general description of each flight phase, including an explanation of the trajectory and guidance phases.

Section 3 describes ascent and abort crew monitoring and control devices. This section includes the CRT displays used and provides a description of the dedicated displays. Note that the CRT displays are described in detail in the DPS Dictionary and are not duplicated in this document.

Section 4 describes the actual crew operations for ascent/aborts. This section includes procedures and rationale for prelaunch, nominal ascent/ATO, AOA, TAL, High Energy TAL, High Energy Gander, RTLS, and Contingency Abort.

Section 5 includes an overview of the backup flight system (BFS) for ascent.

1.4 POST-OI-26 FLIGHT SOFTWARE [AFPH1-1]

The following sections briefly describe the flight software changes implemented since the last release of this flight procedures handbook. OI-27, 28, 29, and 30 flight software impacts will be discussed in this release. Note that only those changes that may be perceivable to the crew or the MCC will be discussed in more detail in sections 2 through 5 of this document.

1.5 OI-27 FLIGHT SOFTWARE [AFPH1-2]

The OI-27 flight software delivery consisted mainly of GPS flight software updates to allow 3-string GPS incorporation into the Shuttle GN&C. Although the flight software has been updated to handle 3-string GPS, only a single string GPS configuration has been implemented into the Shuttle fleet. The first 3-string GPS flight is currently scheduled for STS-117 with OV-105 with a preliminary launch date of May 2006. The OI-27 flight software release had other minor flight software changes, however, none impacted the Ascent/Aborts flight procedures and aren't discussed here

1.6 OI-28 FLIGHT SOFTWARE

The OI-28 flight software delivery included approximately 92 CR's in the baseline, of these only a few had major impacts to the Ascent /Aborts flight regimes. They are discussed here briefly and more indepth in later sections where applicable. Unlike the performance enhancements implemented in OI-26 which phased in the capabilities, most of the capabilities in OI-28 were used on the first flight of the new software (STS-98).

OPS 6 Entry ECAL Automation (CR90724D)

This CR automated the logic for the entry portion of the ECAL aborts. Along with automating the entry logic, optimizations for energy management as well as loads management were also put into place. Minor correction CR's were also implemented as part of the ECAL Automation package (CR's 92264B and 92305). The ECAL Automation logic will be discussed further in section 2.7.

Delay MOV MPS Dump/FRCS Dump at MM602 (CR90914C) and MPS Dump Sequence Doc Changes (CR92256B)

These CR's provide flexibility to adjust the MPS LO2 and FRCS propellant dump initiation times wrt MM602. This helps expand manifesting capabilities and assists in managing vehicle weight and Xcg during an RTLS entry. These changes do not warrant any changes to ascent/abort crew procedures.

Single Engine RTLS Roll-off Elimination (CR92186A) and Clean Up Variable Initialization for CR 92186A (CR92373)

This CR helps to eliminate 2 out RED region roll off for RTLS. This CR modifies G/C Steer by adding an I-loaded roll attitude increment (+/- 3.5 deg) during RTLS flyback with a side engine out to reduce the sideslip angle. The CR also modifies G/C Steer to inhibit step changes greater than 1 degree in the net yaw trim thrust angle which typically occur upon second engine failure. This is an abort improvement, but no changes to crew procedures are necessary.

SERC OMS/RCS Interconnect Delay (CR92198)

This CR modifies the Abort Control Sequencer by introducing an I-loaded delay (4 seconds) between the detection of a second engine failure and the initiation of the OMS/RCS interconnect. This allows access to the RCS jets for single engine roll control maneuvers. This is an abort improvement, but no changes to crew procedures are necessary.

Runway and Navaid Location Data Uplink Capability in OPS 1/6/3 – PASS/BFS (CR92209D)

This CR adds the capability to uplink runway and TACAN location data in OPS 1/6 (OPS 3 capability already existed) and adds the capability to uplink MSBLS location data in OPS 1/6/3. These capabilities can expand landing coverage for emergency situations by allowing ELS runways/TACANs to be uplinked realtime during a contingency abort. No new crew procedures are required for this update, however, reselection of a landing site number may be required to pull in new uplinked data.

DOLILU Uplink Updates (Uplink Second Stage I-loads (CR92175D), Inconsistent DOLILU and BFS Oneshot Contiguous Memory (CR92263A), Uplink V_MSSN_CNTN Iload (92201C)). CR92175D adds ascent abort dump timers and mission mass property I-loads to the OMS assist Command load (DSM396). These changes allows for flexibility in payload manifesting and possible template reductions. CR92236A reorders the parameters in the OMS Assist uplink command and reorders the parameters in the PASS/BFS oneshot to minimize PASS impacts. CR92201C adds ascent velocity for ATO mission continue to the OMS assist uplink command. These changes have no impact to crew procedures.

Variable Intact Abort Throttle limits (CR92232B)

This CR adds a second intact abort maximum throttle limit and corresponding uplinkable velocity switch breakpoints to allow intact RTLS abort throttles to be set at a lower maximum as compared to TAL/PTA (106% for RTLS and 109% for TAL/PTA). Provided these higher intact throttle settings are certified at some time in the future. Additionally, a second uplinkable velocity switch breakpoint for late uphill SSME failures is provided to preclude unnecessary use of higher intact abort throttles when the increase in performance is not necessary to achieve the design underspeed with nominal throttles (Press-to-MECO 104). These uplinkable I-loads form the Variable Intact Abort Throttle Limit Velocities Load. Also, in the event of systems and/or contingency aborts, crew flexibility is maintained through placement of nominal and abort maximum throttle limit selection item entries on the PASS and BFS Override Displays (Items 50 and 51, for abort and nominal throttles, right below the Item 4 for max throttles). This allows for automatic throttle limit adjustments after the Item 4 is performed. Also, by changing with the

item entries after max throttles are engaged, the BFS can recognize this (since it doesn't recognize manual throttles). Currently it has not been determined when the use of higher intact abort throttles will be used or when the Spec 50 (Override) - Item 50/51 Entries will be used. When changes to crew procedures for these capabilities are determined, this document will be updated.

Preserve MECO VI, Altitude, and Altitude rate in MM104 (CR92331A)

MECO VI, H, and H_DOT are used by the crew to assess magnitude of MECO underspeed to determine TIG for the OMS-1 burn. In a MEDS configured Orbiter the crew had approximately 18 seconds between MECO and MM104 transition to view this data before it was blanked. This CR allows the critical flight parameters to remain displayed in MM104 for MEDS, as well as non-MEDS configured vehicles.

Incorporate G on meds Displays (CR92395)

This CR will convert the ACCEL flight instrument tape units from FPS2 units to G units for MEDS composite and AMI displays and for non-MEDS AMI displays. G units are more intuitive to crew members for displays in the cockpit and eliminates the need for complex mental calculation during critical phases of flight.

Several other CR's with minor implications to GNC were incorporated into the flight software for OI-28; however, none impact ascent/abort flight procedures and will not be discussed here.

1.7 OI-29 FLIGHT SOFTWARE

The OI-29 flight software delivery only included minor impacts to the Ascent /Aborts flight regimes. The CR's with impacts are discussed here briefly and more in depth in later sections where applicable. First flight of OI-29 flight software was STS-110.

Automatic Reanchoring of an Upmoded IMU (CR 90662)

This CR provides a direct method for IMU state recovery in the event of an IMU bypass. The IMU state is automatically reanchored to the selected Nav state when a bypass is removed and IMU upmode occurs (reselected). This preserves the PASS covariance matrix. Previously the crew would have to perform an Nav Zero Delta State Update to reset the IMU state which changed the PASS covariance matrix.

Fix PASS and BFS Maneuver Display Burn Attitude (CR 90763)

Onboard guidance cannot compute a valid roll and pitch burn attitude if the desired yaw attitude is close to ± 90 degrees. PASS will blank the displayed burn attitude and BFS will display previous burn attitude or initial value. This CR will blank the roll and pitch burn attitude and display a yaw angle of 90 or 270 degrees in the PASS and BFS.

Elimination of PASS/BFS Timing Skew for Ascent Target Calculations (CR 92319)

Prior to OI-29, if liftoff occurred at exactly T_GMTLO_PHASE (time to change orbit phase angle), PASS and BFS could target different launch panes due to timing skew. BFS guidance could go unconverged (BFS DR 109688). Launch window cutout around pane swap time is performed as a workaround. This CR uses transfer data from the PASS to sync up the PASS and

BFS target adjust calculations. This ensures PASS and BFS will fly to similar guidance targets and closes DR 109688. This CR also improves DELTA_PSI (launch azimuth) calculations and closes PASS DR 110444 condition (GPC error) for due East inplane launches.

Onboard Calculation of RNP Matrix (CR 92329)

Onboard software used preflight determined I-Loads for RNP matrix. CR 92329 computes RNP matrix prelaunch based on simplified algorithm and eliminated 100 I-Loads. PASS and BFS use same I-Loads and algorithm. RNP year and day I-Loads can be uplinked to handle launch slips.

Automated Alpha-Beta Management During Mated Coast and MM104 (CR 92353)

ET debris hit probability requirements may not be satisfied if alpha-beta management is not performed in MM 104 for TAL aborts. Entering MM 304 with low alpha and large beta will produce undesired roll maneuver (control problem) which delays start of OMS burn. Manual crew procedure in Ascent Checklist ensures good attitude prior to OPS 3 (pitch > 15 deg, yaw = 0 ± 30 deg, rates < 0.5 deg/sec). CR 92353 automates maneuvers required during a TAL abort to achieve desired attitude for OMS dump start. One maneuver performed during mated coast and one during MM 104. Ascent GNC Abort Panel recommended Ascent Checklist change for Orbiter attitude check by crew: RATES < .5 °/sec, q > 20°, Y = $0 \pm 20^\circ$.

Just in Time Flight Design (JITFD) I-Load Uplink Expansion (CR 92364)

CR 92364 modifies PASS software to accept 24 additional I-Loads via uplink prelaunch (OPS 9). Provides Shuttle Program flexibility to support manifest changes and mission redesigns. It creates three new uplink command loads and expands two existing loads. Ascent Pseudo and ATO MECO Targets (new), Variable Intact Abort Throttle Limit Velocities (new), RTLS Guidance Parameters (new), OMS Assist, Abort Dump Timers, Masses, and Velocities (expanded), RNP Matrix (year and day) and GPS Time Parameters (expanded). This CR also provides PASS to BFS one-shot transfer for 22 uplink MSIDs.

PASS GPS Operational Enhancements (CR 92369)

CR 92369 provided several PASS GPS operational enhancements. It ensured two receivers with bad FOMs can't "vote out" a good receiver (3 string). QA2 failure (PASS vs. GPS) will now allow receiver state to be considered for selected GPS state process. QA2 threshold limits at OPS transitions now based on time of last GPS update. The CR eliminates (blanks) stale data on GPS Status display (FOM, GDOP, satellite tracking), and scrubs reference state and IMU restringing logic. Receiver states and single reference state propagated with selected IMU delta-v's. The CR deletes all automatic GPC commanded filter restarts at OPS transitions and has several other minor enhancements and DR closures.

BFS GPS Operational Enhancements (CR 92370)

CR 92370 provides several BFS GPS operational enhancements, it allows crew item entries for receiver initialization and FOM override. The QA2 threshold limits at OPS 1/3 transition are increased based on I-Load value. Several display changes were made: GPS status indicators added to Horiz Sit and GPS Status displays, GPS minus Nav state vector differences (UVW) added to GPS Status display and replaced receiver lat, long, alt data with selected data on GPS

Status display, and Satellites tracked by each receiver added to GPS Status display. Several other minor enhancements were also made.

Spiral HAC in TAEM Area Navigation (CR 92389)

Previous Area Nav logic which drove TAEM HSI displays was based on a circular HAC instead of the guidance spiral. It did not include acquisition turn arc. HSI range and altitude information was in error with respect to guidance. Crews were trained not to use HSI glide slope for HAC turns > 270 degrees (could result in low altitude if followed). CR 92389 replaced circular HAC logic with spiral logic in PASS and BFS. HSI display is now compatible with guidance for HAC shrinks if source is Nav. Acquisition arc is included in range computation if source is Nav or GPS.

Protect Against GPS Receiver Non-Homogeneous Data (CR 92430)

Previous MAGR/S3S firmware did not ensure GPS state vector would be time consistent with its associated validity variables (Nav data valid and FOM). When non-homogeneous data existed the validity variables preceded the updated receiver state vector (by one GPC read cycle). GPS could indicate good FOM but have a bad state vector. CR 92340 modified PASS and BFS software to delay the clearing of the QA1 fail flag (FOM check) until the FOM has passed the QA1 threshold for an I-Loaded number of cycles.

1.8 OI-30 FLIGHT SOFTWARE

The OI-30 flight software delivery included some significant impacts to the Ascent /Aborts flight regimes. The CR's with impacts are discussed here briefly and more in depth in later sections where applicable. First flight of OI-30 flight software is scheduled for STS-114.

Expanded Landing Site Table (CR 92517C)

Expanded landing site table from 50 to 90 runways and corresponding TACANs. Allows for more ECAL landing sites to be onboard during the critical launch phase so there is less of a need for uplinks should a contingency situation arise.

Shortfield Speedbrake Upgrade (CR 92551B)

The CR automated the super short field manual crew procedures that allowed braking on short runways. The logic adds approximately 30 deg to the speedbrake retract value at 3000 ft and will also adjust properly at 500 ft. The logic targets 195 kts at 1000 ft down the runway and will automatically open the speedbrake at MGTD. The current ITEM 39 on SPEC 50 is used to cycle through the 3 speedbrake options (Nominal, Shortfield, ELS).

Alleviate ET Recontact for RTLS 2 OUT Yellow and Orange (CR 92504G)

This CR automates the portion of the RTLS trajectory around VREL 0 for 2 engines out to help the ET SEP conditions so that recontact margins between the Orbiter and Et are increased. The automation of the crew procedure (to go CSS and invoke the contingency abort and return to

AUTO) was only a portion of the logic that improves this abort region. Improved dump logic for fuel slosh concerns as well as getting to a lower angle of attack at SEP to prevent ET shadowing and allow better relative motion off the tank are also part of this logic.

MEDS Composite Flight Instrument Enhancements (CR 92522D)

This CR enhanced the primary flight displays to improve crew situation awareness by tailoring the displays to major mode and optimizing location of needed data. Other minor CR's also added display changes helpful to the crew (ie theta limits brackets added to the ADI, a velocity of a second SSME failure was added to the TRAJ display, and some minor maneuver exec display changes were incorporated).

ECAL Automation Updates (CR 92550B)

Modifies ECAL S-Turn logic to prevent high-energy trajectories from becoming low energy. Also, can allow for a modified pullout NZ to minimize vertical tail thermal violations and allows lower alpha profile at higher mach numbers for increased ranging.

Variable Low Alpha for Low Energy (CR 92671A)

The CR modified the OPS 3 low energy logic used on TAL aborts. The logic lowers and raises the alpha profile appropriately to optimize stretch capability while protecting for thermal violations of the Orbiter wing leading edge and vertical tail. The Orbiter pitches up while "digging in" to the phugoid and pitches down while "bouncing out" of the phugoid. The logic was supposed to have eliminated a manual procedure needed in some cases for the previous low energy logic - but recent analysis indicates the manual procedure will still be required.

Prevent Erroneous Droop Guidance Engagement (CR 92668C)

This CR will prevent Droop guidance from automatically engaging for a single engine failure. Previously for very high performance missions if an engine fail occurred early in flight, Droop would engage unnecessarily. The droop logic would needlessly pitch the Orbiter up to protect the droop altitude and this maneuver would eliminate performance and prevent TAL capability. The new logic allows for automatic droop initiation for 2 engines failed. If droop logic is desired for a case with less than 2 engines failed (ie 1 engine out and another stuck engine), an ITEM 7 on the TRAJ display enables the droop logic.

Single Engine Increased Pitch Authority (CR 92565A)

Use FRCS jets to improve pitch authority for case where only a side SSME remains for RTLS PPD. Fires all up-firing RCS jets if pitch error is too large between Hdot +100 and Powered Pitchdown.

Abort Improvements to Improve TAL Performance (CR 92670D)

This CR (a.k.a. Abort Performance Enhancements) relies on several ascent guidance enhancements to improve performance for intact TAL aborts. First stage improvements included first stage lofting, first stage yaw steering, pitch trim improvements, and constant pitch rate steering is delayed to an I-loaded MET (formerly, this MET was hardcoded to 100 sec). In MM103, as part of PEG initialization, the IY target is reset to the current IY instead of the nominal MECO IY. Second stage enhancements also included TAL target line changes and G-

load limit throttling. While there is some first TAL boundary improvement using these improvements with a 104.5% throttle setting, these improvements coupled with 109% Intact abort throttling significantly improve first TAL boundary capability. The goal was to reduce RTLS exposure and not impact nominal ascent performance. These software options are available in the OI-30 flight software but are not planned to be utilized primarily since flying OI-30 Abort PE trajectories at 109% is not currently certified due to SSME certification concerns and the value added at 104.5% abort throttle was not worth the certification cost. The discovery of MPS flowliner cracks, which until further understood, eliminates any possibility of using throttle settings higher than 104.5% for intact aborts. The enhancements are currently I-loaded to off, but might be used in future missions (potentially on a piecemeal basis) if warranted and certified.

SECTION 2

ASCENT FLIGHT PHASE DESCRIPTION

2.1 OVERVIEW

The ascent flight phase consists of those activities a crew performs to prepare for launch, to monitor ascent performance, and to perform OMS burns required for the ascent flight phase through OMS 2 of a nominal, Abort to Orbit (ATO), or Abort Once Around (AOA). The ascent flight phase is shown in figure 2.1-1. Groundtracks for 28.5°, 39°, 51.6°, and 57° inclination missions and shuttle landing sites are shown in figure 2.1-2a and 2.1-2b. A closer view of the groundtracks with respect to Bermuda, the east coast abort landing (ECAL) sites, and Canadian sites are shown in figure 2.1-3.

This section provides a general description of each flight phase, including an explanation of the trajectory and guidance phases of each. Nominal ascent begins prior to lift-off and ends after OMS 2. The ATO ascent phase begins after abort selection and ends shortly after OMS 2 (ATO 2), inserting the vehicle into an orbit with an apogee of 105 nm and a perigee of at least 85 nm. AOA begins at abort selection or failure identification and continues through landing. The Transatlantic Abort Landing (TAL) and Return to Launch Site (RTL) phases begin at abort selection and continue through landing. The Contingency Abort (CA) begins at second engine failure and continues through landing or bailout. CA landing may be achieved at Bermuda for low and mid inclination trajectories or at ECAL or Canadian sites for high inclination trajectories.

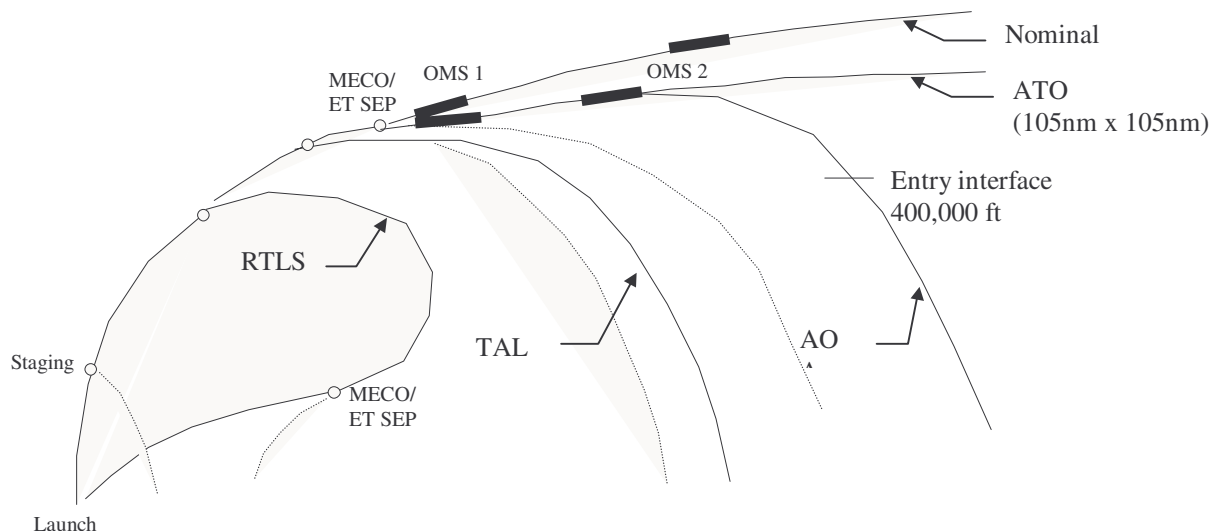

Figure 2.1-1: Ascent Flight Phase

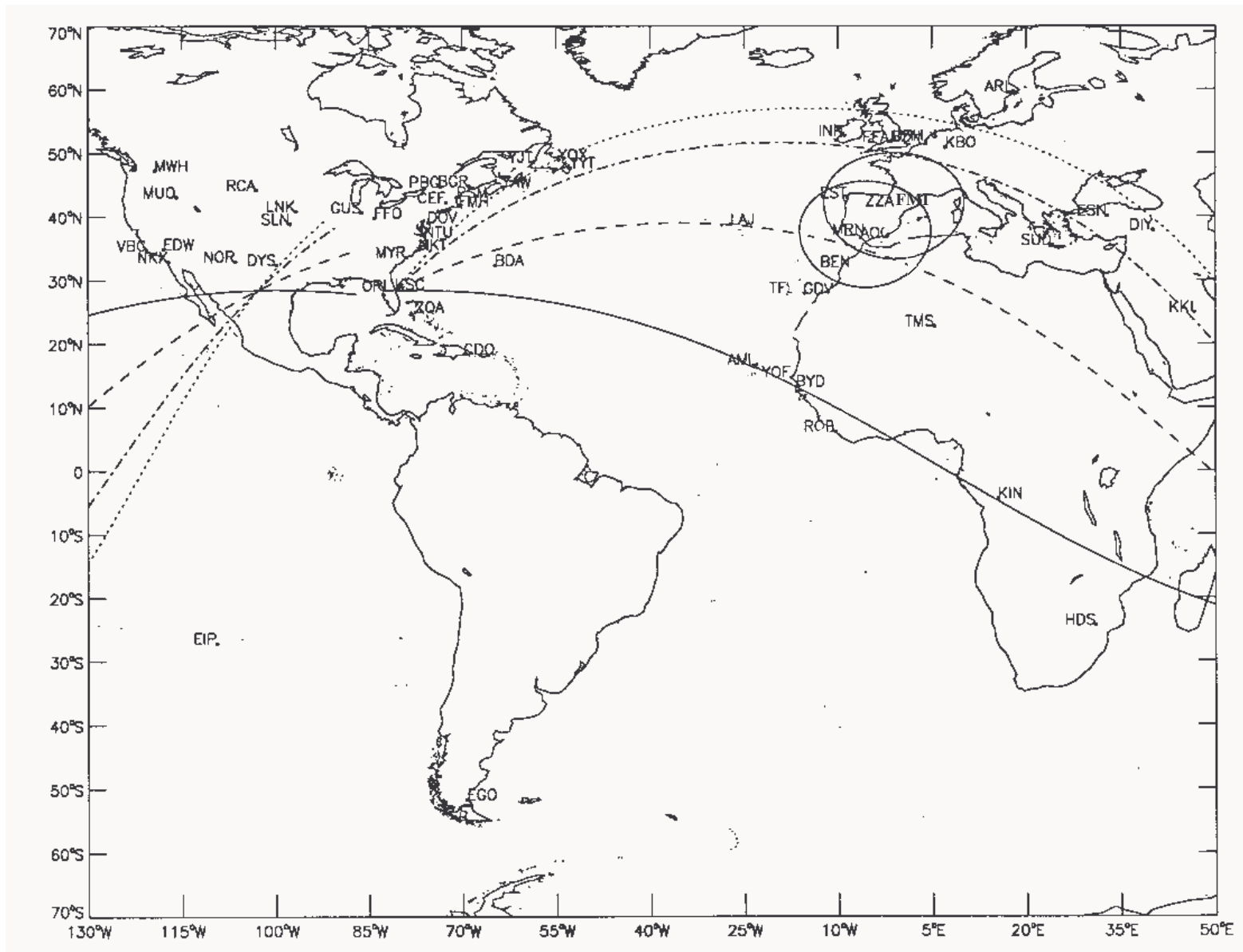

Figure 2.1-2a: Space Shuttle Landing Sites

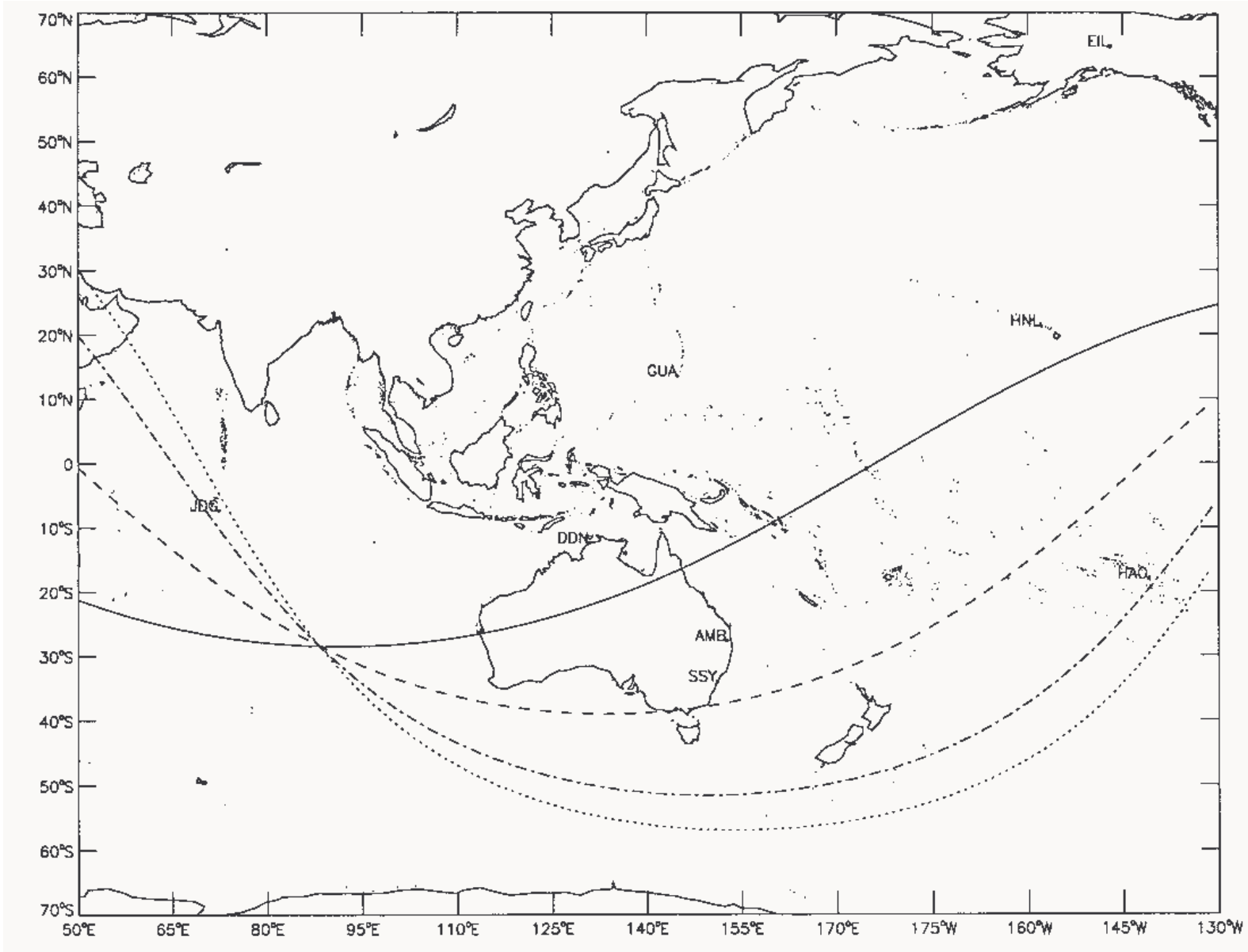

Figure 2.1-2b: Space Shuttle Landing Sites

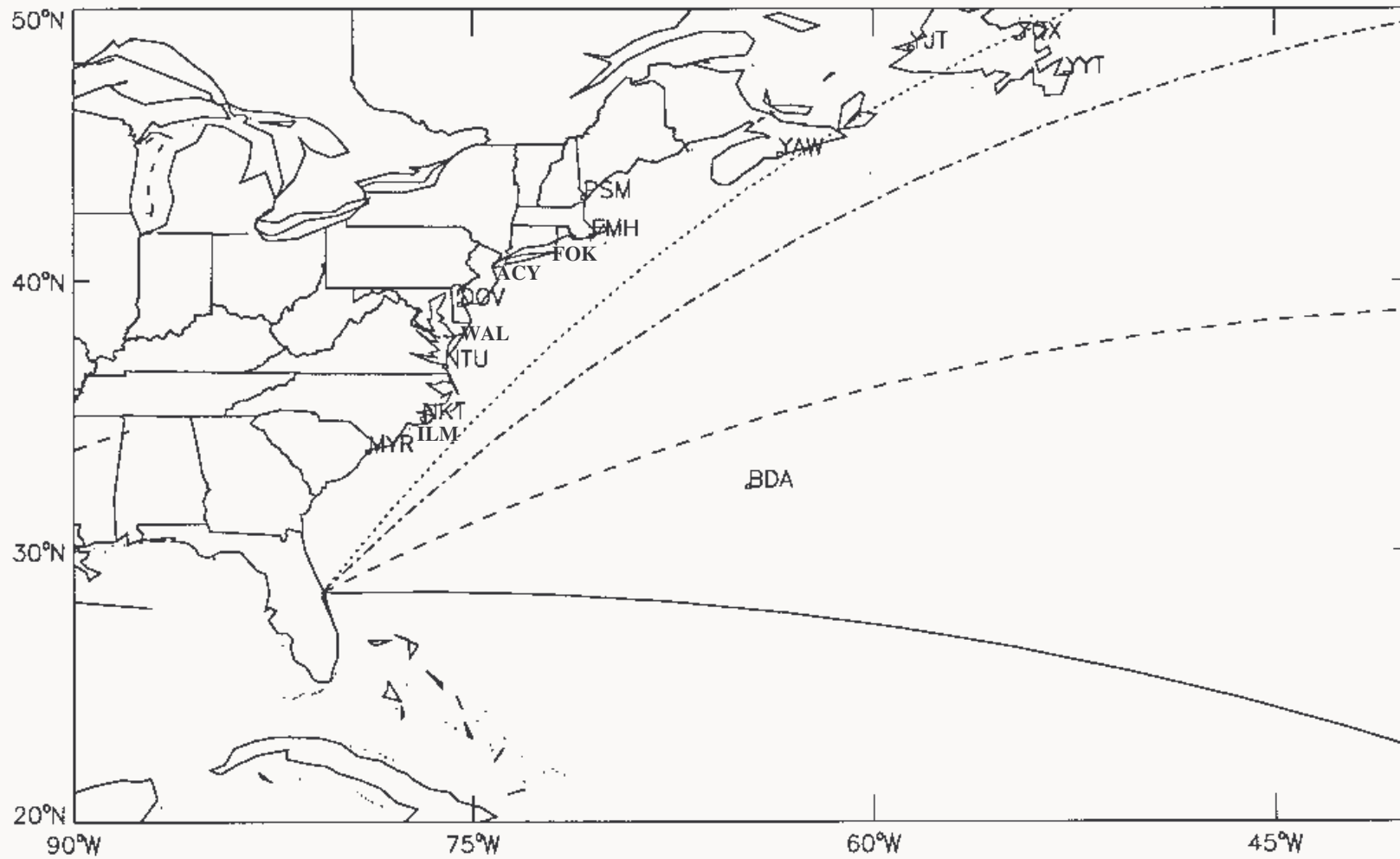
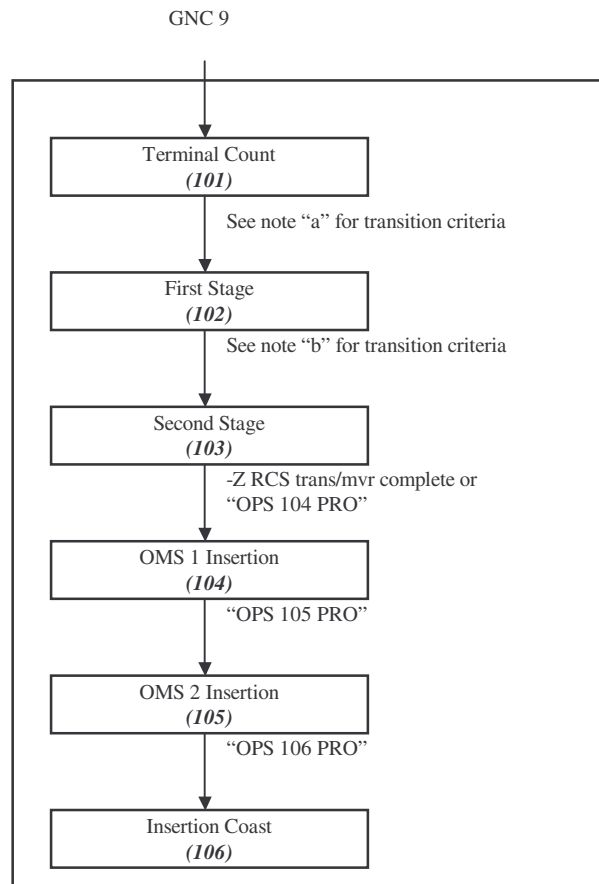

Figure 2.1-3: Bermuda, ECAL, and Canadian Sites

2.2 NOMINAL SUMMARY

The guidance software for nominal ascent is contained in Operational Sequence (OPS) 1. OPS 1 is composed of major modes (MMs) 101, 102, 103, 104, 105, and 106. A summary of MM flow is contained in figure 2.2-1.



^aAll SSMEs 90% RPL, no countdown holds, +2/5 sec time delay, and no FRF flag (SRB ignition).

^b(PC ≤ 50 or MET ≤ 129.8 + -8 sec and attitude rates within limits or manual switch enabled and closed (SRBSEP complete).

(Information from this figure is from COMPUTER PROGRAM DEVELOPMENT SPECIFICATION, Vol. V, Book I, GNC.)

Figure 2.2-1: Major Mode Flow

2.2.1 First Stage

2.2.1.1 Overview

Thirty minutes prior to launch or one hour prior to launch for 51.6° missions, the flight software is moded to OPS 1 MM 101 from OPS 9 in preparation for lift-off. The T-9 hold was extended by thirty minutes for 51.6° missions with such small launch windows to allow extra time to react to ground system failures that occur during the launch countdown. At T - 6.6 seconds, the redundant set launch sequencer (RSLS) commands the space shuttle main engine (SSME) start, and all three SSMEs are commanded to throttle up to 100%. If all three engines are detected to have a thrust level greater than 90%, then the solid rocket booster (SRB) ignition is commanded at T - 0, and the flight software changes to MM 102, first stage guidance. Table 2.2.1.1-I is a summary of first stage guidance events.

First stage guidance is an open loop scheme. Therefore, guidance commands are not a direct function of vehicle performance but based on the vehicle's Earth Relative velocity. Earth Relative velocity, V_{REL} , is computed in navigation user parameter processing (UPP) and is derived by propagating the equations of motion using sensed velocity deltas from the inertial measurement units (IMUs). The UPP sequencer initializes, terminates, and controls computation repetition rates of functions such as state propagation, IMU data snap, acceleration/gravity/drag models, and integration of state equations of motion. First stage guidance adjusts the velocity from UPP using the uplinked winds and scales it by the ratio of the speed of sound at sea level to the speed of sound at the current altitude. [AFPH2-1] This velocity triggers many first stage guidance events. For example, at a velocity of 60 feet per second (fps), the first throttle command (in this case, 104%) event occurs (table 2.2.1.1-I). The value which triggers an event can be changed or "I-loaded" from mission to mission. The term I-load, which stands for Initialization Load, refers to a variable in shuttle computer code, which may be adjusted as mission design constraints change from flight to flight. In this case, the name of the I-load is QPOLY(1) (table 2.2.1.1-I).

First stage guidance uses an attitude versus velocity table to command the appropriate vehicle attitude needed to maximize vehicle performance within system constraints. Guidance maintains vehicle launch pad orientation until the roll maneuver is commanded at another I-loaded velocity, PPOLY(2) (standardized to 118.45 fps for OI-23 and subs). At this velocity, a roll maneuver places the vehicle in a heads down attitude aligned with the desired launch azimuth. The heads down attitude makes the horizon visible to the crew during ascent and makes the vehicle antennae visible to ground receivers. The tail south launch orientation is necessitated by the structural configuration of the launch tower, inherited from the Apollo program. The pitch and yaw tables are determined prelaunch using the measured upper level winds and atmosphere data collected from a weather balloon released at launch minus 4 ½ hours. These tables are uplinked to the PASS in OPS 9 at approximately 2 ½ hours prior to launch and later transferred to the BFS via the one shot transfer. This procedure of generating and uplinking the pitch and yaw data is known as Day of Launch I-load Update (DOLILU). Beginning with STS-70, the throttle bucket velocities, adaptive guidance reference time (discussed in section 2.2.1.2), and a course representation of the winds, are also uplinked to allow additional optimization and flight design standardization (known as DOLILU II but often referred to simply as DOLILU). The flight

software also supports uplink of the throttle levels on launch day but this feature has not been used operationally. Beginning with OI-26 the capability to perform an OMS dump 10 seconds after transition to MM103 on performance critical missions was implemented. The ability to uplink the OMS Assist command load was also implemented. This allows uplink of the OMS Assist and ATO dump I-loads for late mass property updates. Beginning with OI-28 the OMS Assist command load was also updated to include ascent abort dump timers and mission mass property I-loads to allow for more flexibility in payload manifesting and possible flight design template reductions. [AFPH2-2]

Prior to OI-26, first stage guidance performed no inertial steering since there were originally no plans for high inclination rendezvous missions. Even though an adjustment to the yaw table, referred to as delta psi, could be uplinked prelaunch with the second stage IYs (unitized representation of the angular momentum vector), this was not used operationally to perform first stage steering. However, beginning with STS-86, the capability was added by CR 90958 where the onboard computes the launch azimuth just prior to SRB ignition for inertially targeted missions to perform first stage yaw steering. [AFPH2-3]

During the early part of first stage as the vehicle flies through the densest part of the atmosphere, dynamic pressure (QBAR) builds rapidly. The open loop first stage pitch and throttle commands are designed to keep aerodynamic loads within limits. However, unexpected winds and SRB burn rate dispersions can stress the vehicle beyond the ability of the open loop scheme to limit aerodynamic loads. For this reason, additional load relief is achieved by logic called adaptive guidance, normal load factor (Nz)/lateral load factor (Ny) nulling, and elevon load relief. Refer to sections 2.2.1.2 and 2.2.1.3 for additional information.

Prior to OI-26, as the vehicle approached SRB separation, the pitch rate command trended toward zero in the SRB tailoff region since the commanded pitch rate followed the slope of the pitch attitude versus velocity table uplinked prelaunch. This resulted in the vehicle essentially being in an attitude hold for several seconds prior to the software commanding an attitude hold at SRB separation. Second stage guidance then had to compensate for the extended hold. However, CR 91015 Pitch Steering During SRB Tailoff, incorporated into OI-26, decreases the pitch command when MET \geq 1:40 at a constant rate so that the pitch command rate stays at a constant .44°/sec (.5°/sec for an engine out prior to 1:40 MET) for an I-loaded number of seconds past the point at which the Ny feedback is faded out. This provides about 50 lbs of performance as well as a more benign transient at second stage guidance initiation. The only potentially observable difference is that the angle of attack at SRB separation is approximately 3.5 degrees more positive with this CR enabled. [AFPH2-4]

The SRB separation sequence is initiated when SRB chamber pressure (Pc) \leq 50 psi or MET \geq SRB_SEP_BACKUP_CUE_T (I-load = 131.28 seconds), whichever comes first. During the separation sequence, the vehicle is in a three axis attitude hold. After an I-loaded time delay has expired, the SRB separation sequence commands separation, causing fire commands to be issued to the SRB sep pyro initiator controller (PIC). SRB separation nominally occurs at approximately 2:06 MET. If the SRB separation sequence is initiated based on the backup cue, SRB separation will occur at approximately 2:18 MET for three engines running or 2:15 MET for one or two

engines running. The attitude hold, commanded for SRB sep, is maintained until the second stage guidance solution converges in MM103. It typically takes second stage guidance about 2 to 4 cycles (4 to 8 seconds) to converge. Once guidance is converged, active steering and throttle settings are commanded. [AFPH2-5]

Table 2.2.1.1-I: First Stage Guidance Events

Event	MET	V _{REL} (fps)	V _I (fps)	K (%)	ALT (ft)
First throttle command (V _{REL} ≥ QPOLY(1) = 60 fps, KCMD = THROT(1) = 104%)	00:03	60	1342	104	73
Tower clear/begin SAR (V _{REL} ≥ PPOLY(2) = 118.45 fps)	00:06	118	1347	104	318
READ AGT (V _{REL} > VREF_ADJUST = 368 fps)	00:16	368	1446	104	2772
Second throttle command (V _{REL} ≥ QPOLY(2) = 384 fps, KCMD = THROT(2) = 104%)	00:17	384	1458	104	2986
Ramp in load relief (V > VREL_GAIN_TAB(2) = 547 fps)	00:23	547	1579	104	5463
Third throttle CMD (V _{REL} ≥ QPOLY(3) = 617 fps, KCMD = THROT(3) = 72%)	00:26	617	1629	104	6765
Third throttle attained	00:29	714	1702	72	9060
Begin maximum load relief (V > VREL_GAIN_TAB(3) = 900 fps)	00:37	900	1856	72	14992
Engine out switch velocity (V > V_EO_SW = 900 fps)	00:37	900	1856	72	14992
Begin load relief termination (V > VREL_GAIN_TAB(4) = 1335 fps)	00:57	1335	2246	72	33795
Fourth throttle CMD (V ≥ QPOLY(4) = 1397 fps, KCMD = THROT(4) = 104%)	01:00	1397	2302	72	36415
Fourth throttle attained	01:04	1517	2409	104	40876
Load relief off (V > VREL_GAIN_TAB(5) = 2628 fps)	01:27	2628	3495	104	76695
SRB staging	02:04	4171	5081	104	152545

Note: Values shown are for example purposes only and vary from flight to flight.

2.2.1.2 Adaptive Guidance

To decrease structural loading, the open loop scheme commands the SSMEs through a single or multistep throttle profile to an I-loaded minimum throttle setting (normally 72%). The throttle bucket steps are once again based on V_{REL} I-loads. Prior to this phase of open loop load relief, only SRB dispersions significantly alter the velocity-time history. To account for hot or cold SRB burn rate dispersions, adaptive guidance compares the predicted time ($TREF_ADJUST$) that a predetermined velocity ($VREF_ADJUST$) is to be reached to the actual time that this velocity was reached. Both $TREF_ADJUST$ and $VREF_ADJUST$ are I-loads but $TREF_ADJUST$ may be updated prelaunch via uplink. The time difference ($TDEL_ADJUST$) indicates the magnitude and direction of the SRB dispersion.

$$TDEL_ADJUST = MET - TREF_ADJUST$$

where MET = current time - lift-off time
 $TREF_ADJUST$ = I-load

Based on this information, guidance then makes trajectory adjustments by varying the throttle profile and the commanded pitch profile. When the MET is equal to $TREF_ADJUST$ at a velocity of $VREF_ADJUST$, the SRBs are performing per the nominal design. If $TDEL_ADJUST$ is positive, then actual SRB performance is low (cold SRBs) since it took longer than expected to reach the reference velocity. In order to minimize QBAR dispersions, adaptive guidance pitches down and maintains a higher throttle bucket thrust setting. If $TDEL_ADJUST$ is negative, actual SRB performance is high (hot SRBs) since it took less time than expected to reach the reference velocity. Adaptive guidance pitches up and commands a “two stage” bucket or adjusts the second step of the bucket for a planned two stage bucket.

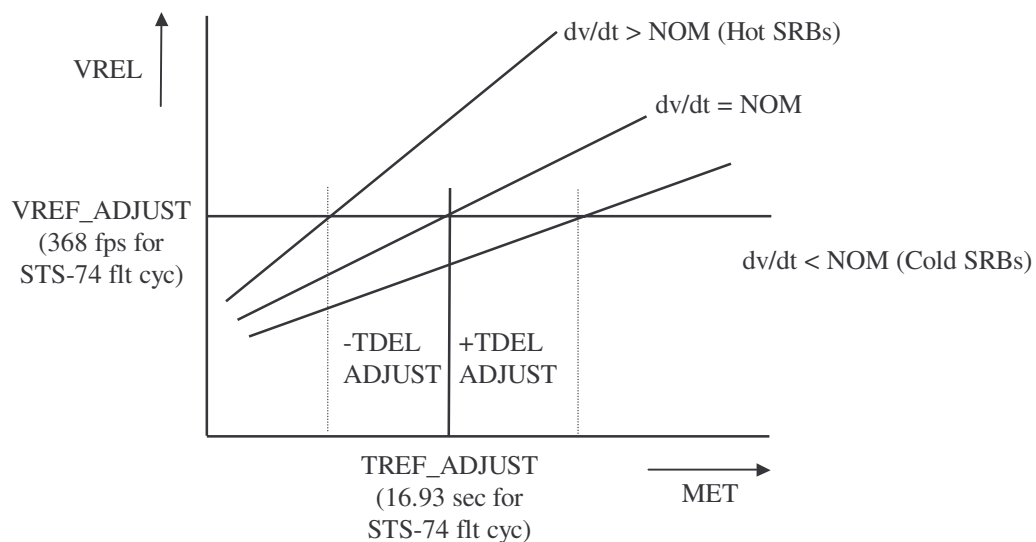

Figure 2.2.1.2-1: $VREF$ Adjust versus $TREF$ Adjust

These pitch and throttle adjustments are based totally on a single check performed at $V_{REL} = VREF_ADJUST$, which occurs at ≈ 20 second mission elapsed time (MET). Figure 2.2.1.2-2 shows a typical throttle bucket for nominal, dispersed hot, and dispersed cold SRBs for a designed one step or single stage bucket.

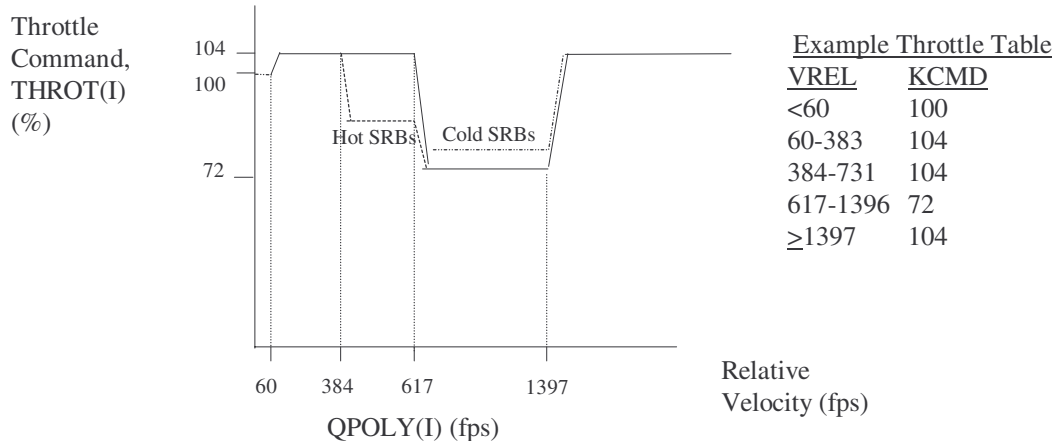

Figure 2.2.1.2-2: Throttle Bucket for Nominal and Dispersed SRBs for a Single Stage Bucket

Note that for two step throttle buckets, the first step is a function of SRB performance and the second step is constant as shown in figure 2.2.1.2-3. Most missions are designed with a one step bucket.

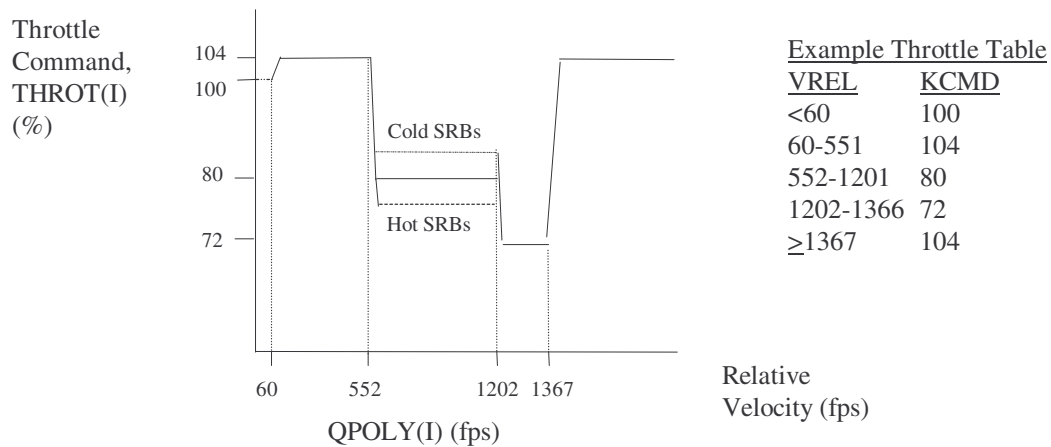

Figure 2.2.1.2-3: Throttle Bucket for Nominal and Dispersed SRBs for a Two Stage Bucket

The adjustment made to the pitch command is a function of TDEL_ADJUST, a pitch scaling factor, and load relief. A typical pitch delta is shown in figure 2.2.1.2-4. As load relief is terminated, the pitch adjustment is ramped out. If an engine fails prior to the velocity breakpoint for the beginning of maximum load relief, the pitch scaling factor is set to zero. Some ascent trajectories are designed so that only the throttle profile is modified, with no pitch adjustments (the pitch scaling factor I-load is set to zero) for the cold SRB case. Even for the case where pitch is adjusted for hot or cold SRBs, the change in pitch is relatively small and usually not noticed.

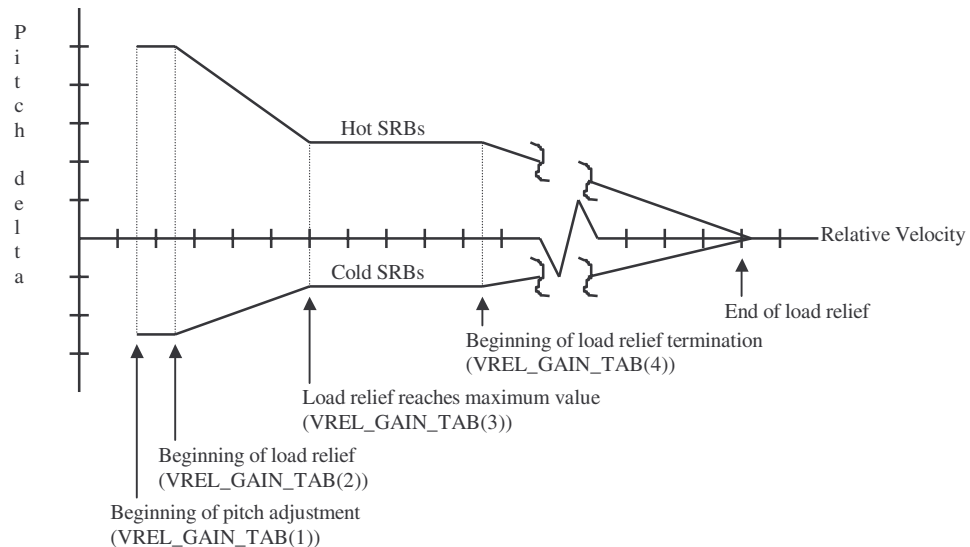

Figure 2.2.1.2-4: Adaptive Guidance Pitch Adjustment

In the event of an SSME failure during the first stage, guidance automatically commands the remaining two SSMEs to throttle to 104%, regardless of where you are in the thrust bucket, to obtain maximum performance. Pitch biases are then added to the I-loaded nominal pitch attitude table in order to loft the trajectory. Pitch bias magnitudes are a function of the engine out velocity. The lofted trajectory is needed to prevent a subsequent RTLS abort from sinking too low into the atmosphere during flyback phase. This is commonly referred to as protecting the RTLS PTOTAL constraint.

2.2.1.3 Load Relief

First Stage load relief is accomplished by flying a normal acceleration (N_z) profile while nulling lateral acceleration (N_y) and driving the elevons as required. When a V_{REL} of approximately 547 fps ($V_{REL_GAIN_TAB}(2)$ I-load) is reached ($\approx T + 25$ seconds), the normal and lateral acceleration control biases are gradually increased with a ramp function. Throughout the high QBAR region ($547 < V_{REL} < 2628$ fps), flight control prioritizes lateral acceleration over attitude while simultaneously flying the reference normal acceleration profile. This phase of load relief is designed to make the vehicle more responsive to acceleration errors induced by wind effects in the high QBAR region. The vehicle actually steers off course (into the wind) out of the planned trajectory plane in order to fly out lateral acceleration errors and thus reduce aerodynamic loading. Depending on the severity of the winds, the vehicle can experience a noticeable deviation from the planned trajectory plane. Since the acceleration control biases are applied down stream of the guidance needles, deflection of the ADI error needles is a signature of this type of load relief. Because this important function isn't included in the error needles, the crew cannot successfully fly the shuttle manually until 90 seconds after lift off.

The elevons are normally driven to an I-loaded schedule as a function of V_{REL} . During the region of maximum QBAR, the elevons may be driven off schedule in order to reduce aerodynamic loading. The elevons will be driven off schedule when the primary delta pressure in the elevon's actuator becomes excessive. This phase of load relief is actually closed loop since the elevons respond to a sensed aerodynamic loading.

First Stage structural loading is minimized by designing and uplinking the pitch and yaw steering values based on the measured upper level winds and atmosphere data collected from weather balloons on launch day. This procedure is called day of launch I-load uplink (DOLILU). Beginning with STS-70, DOLILU II allowed additional optimization and flight design standardization by uplinking a coarse representation of the wind profile, along with the throttle velocities (QPOLYs), and the SRB adaptive guidance value (TREF_ADJUST) to the first stage guidance. As an additional control variable, the flight software supports uplink of the throttle levels (THROT) on launch day. However, this feature has not been used operationally.

2.2.2 Second Stage

2.2.2.1 Overview

Second stage guidance functions very differently from first stage guidance in that second stage guidance is closed loop. Second stage guidance computes the control variables (essentially commanded attitude and attitude rates) and burn time to go (TGO) in such a way that the vehicle flies from the current state to the prescribed target conditions (altitude, velocity, flight path angle, and orbit plane) within trajectory constraints. It solves this two point boundary value problem each cycle (every 1.92 seconds). One limitation of second stage guidance is that it doesn't calculate if there is enough propellant to reach the desired MECO conditions.

The powered explicit guidance (PEG) scheme used by second stage guidance nominally operates in two phases. The first phase computes throttle and attitude commands based on three SSMEs and a constant thrust requirement until an acceleration of 3g is reached. At that time, the second phase, which uses variable throttle to maintain a constant acceleration, is entered. If an engine failure is detected, a third phase of PEG, which computes the necessary guidance commands using constant thrust to aim for the desired targets using two SSMEs, is entered (assuming no RTLS or TAL abort).

During current shuttle operations, only two phases of PEG are used, constant thrust through 3g and then variable thrust through main engine cutoff (MECO). STS-1 and STS-26, in order to prevent or reduce abort gaps, flew higher than normal trajectories, called lofted or abort shaped. This method required the third PEG phase, which ran from SRB sep to T_FAIL (I-loaded MET) and achieved lofting by assuming that an engine would fail causing loss of performance at the time T_FAIL. When T_FAIL occurred, PEG stopped assuming that an engine would fail. A drawback with this method was discovered later, however. The lofted trajectories caused "black zones," or regions where an unsurvivable entry/pullout condition would be created if two engines actually did fail (CA). For this reason and the fact that abort shaping costs thousands of pounds of nominal ascent performance (payload), the I-load, T_FAIL is now set to zero, and lofted trajectories are not currently planned.

Second stage guidance performs yaw steering to achieve the desired orbit plane. The desired orbit plane is defined by the unitized negative angular momentum vector (I-loads), commonly referred to as the IY vector. The x and y components of the IY vector define the nodal crossing, while the z component defines the inclination. For missions which do not involve rendezvous with a vehicle already in orbit (referred to as the "target"), the IYs are defined during the flight design process approximately 6 months prior to launch. These missions employ "earth fixed" yaw steering since the trajectory relative to the earth remains the same regardless of launch time. In order to successfully launch into orbit and rendezvous with another vehicle already in space, the orbiter must end up in the same orbital plane and altitude as the other vehicle. This type of mission is referred to as a "ground-up" rendezvous mission since the launch is targeted for a rendezvous all the way from the ground up through orbit. Ground-up rendezvous missions employ "inertial targeting" where guidance must steer the orbiter to an inertial plane in order to perform the rendezvous. For these missions, the IYs are uplinked on day of launch so that the

best estimate of the target's orbit can be used to define the orbiter's target plane. Refer to section 2.2.2.2 for more information on ground-up rendezvous missions.

An OMS assist burn will be performed on some performance critical missions. This capability was added in OI-26 with CR 91014 and can be I-loaded ON or OFF. If I-loaded ON, the OMS assist burn will begin ten seconds after MM103 transition and continue for an I-loaded duration. A 4000 lb OMS assist provides a performance gain of approximately 250 lbs. Both the ON/OFF and dump duration I-loads can be uplinked prelaunch. However, there are no plans to change the state of the ON/OFF I-load with a prelaunch uplink. The standard now is for the OMS assist flag to always be set to ON, even for zero duration dumps. This allows the same procedures to always be used for OMS failure cases^[AFPH2-6]. The ATO dump I-loads are also included in the OMS assist uplink and can be modified day of launch to reflect late mass property updates.

^[AFPH2-7]

For STS-87 and subsequent missions, a roll to heads up is performed during nominal ascent at a relative velocity of 12,200 fps. The roll to heads up capability was added in OI-26 with CR 91019 which converted three guidance K-loads to I-loads (second stage roll angle = 0°, roll velocity = 12,200 fps, and insertion/deorbit roll angle = 0°). The purpose of the roll to heads up during ascent was to allow an early handover from the MILA ground station to TDRS East, in anticipation that the Bermuda ground station would no longer support Space Shuttle missions as a cost savings. This change is not a performance enhancement and in fact, results in a performance loss of approximately 35 lbs. Since this change was included in the Performance Enhancement (PE) certification, the roll to heads up is required for 28.5 and 39 degree inclination missions^[AFPH2-8] even if Bermuda is available. Otherwise, a recertification effort would be required. Note that the insertion/deorbit roll angle was also changed from 180° to 0° to minimize the time to attitude in case an OMS 1 burn was required. Operationally, the deorbit targets will be uplinked with a roll angle of 180° so that the crew still has the horizon reference during deorbit burn operations. ^[AFPH2-9]

Forty seconds prior to MECO, guidance no longer seeks to achieve the altitude and orbital plane position targets. Common terminology is, "at MECO minus 40 seconds, the position constraints are released." Without this constraint release, when TGO becomes small, a small change in position error would produce large changes in the thrust turning rate vector and over controlling would result. Note also that the cutoff time (TGO) calculation includes the predicted velocity change from the time minimum throttle is commanded to burnout. This corresponds to the predicted tailoff impulse from each active SSME and is known as fine count. Fine count occurs 10 seconds prior to MECO for nominal ascent, ATO, and TAL and 6 seconds prior to powered pitchdown for RTLS. It is at fine count where second stage, closed loop guidance is terminated and the SSMEs are commanded to a lower power level, usually 67% for three engines running or 91% for one or two engines running (note that the SSMEs aren't throttled back until powered pitchdown during an RTLS). ^[AFPH2-10] Thereafter, the flight path angle constraint is released, such that TGO is computed solely on the desired velocity change (VGO). When guidance sees the shuttle at the correct inertial velocity (V_1), all SSMEs are commanded to shut down.

A throttle down to 67% may occur prior to fine count if the center engine is failed due to the incorporation of CR 91042 Second Stage Pitch Gimbal Relief in OI-26. This CR compensates for potential gimbal saturation due to the super light weight tank (SLWT). The SLWT is about 8,000 lbs lighter and causes the vehicle center of gravity (cg) to move about 6 to 8 inches further up into the Z-axis at MECO. This higher cg makes controlling the vehicle difficult for press to MECO cases with the center engine out when the orbiter Zcg is near the top of the entry cg box. A throttle down to KMIN (67%) will occur if the center engine is failed, a pitch gimbal command exceeds 10 degrees (I-load), and the vehicle mass is less than an I-loaded mass (this occurs at about 15 seconds prior to MECO). This throttle down is performed to provide pitch gimbal relief by reducing the deformation of the thrust structure. For early engine out cases which result in low level cutoff, the throttle down to 67% causes an underspeed that is about 15 fps greater than that for the 91% throttle case. This results in a 5 to 7 nm reduction in apogee altitude. The larger underspeed occurs because 300 additional lbs of LO2 is in the propellant line when the LO2 low level cutoff is commanded at 67% versus 91%. [AFPH2-11]

2.2.2.2 Ground-up Rendezvous Launch Window and Targeting

The optimum time to launch into the correct plane to perform a ground-up rendezvous is when the target vehicle's orbit is nearly over the launch site. Launching at other times costs more performance due to out-of-plane (yaw) steering costs to insert into the correct plane as shown in figure 2.2.2.2-1. The optimum launch time is biased earlier from the analytical "in-plane" time. This bias is due to the earth's rotational velocity causing an out-of-plane velocity component that would later have to be corrected if launch occurred at the analytical "in-plane" time.

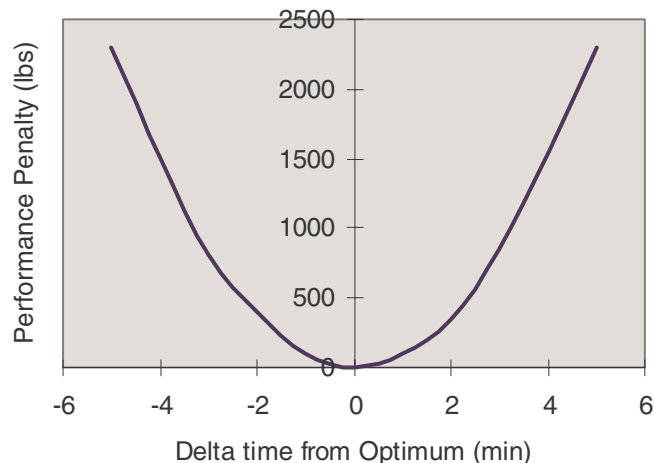

Figure 2.2.2.2-1: Delta Performance vs Launch Time (51.6° inclination w/Auto Del ψ)

The rendezvous launch window is the composite of two separate components: the planar window and the phase pane (or window). For high-inclination rendezvous missions, the planar window is centered about the optimum liftoff time. The limiting constraints for the planar window are either performance (yaw-steering), ET thermal, or ET impact. Launch must occur between the opening and closing of the planar window.

The phase pane is the period of time that the shuttle can launch and be within phasing capability to rendezvous with the target at the desired time. The phase angle is the earth centered central travel angle from the shuttle to the target (see figure 2.2.2.2-2). The phase angle is gradually decreased until it is zero degrees at the time of rendezvous. In order to decrease the phase angle, the shuttle launches into a lower orbit (smaller period) to phase (or catch up) from below and behind the target. Some missions have much more phasing capability than other resulting in larger phase panes.

All orbiting vehicles are affected by the fact that the Earth is not a perfect sphere. The equatorial bulge results in a force that modifies the orbit. The result of this is that the line of nodes rotates in inertial space. This is called nodal regression. The rate of nodal regression varies with inclination and altitude. The higher the altitude, the lower the nodal regression rate. The fact that the shuttle is launching into a lower orbit than the target results in a higher rate of nodal regression for the shuttle than the target vehicle. This has to be compensated for in order for the shuttle to be in the

correct plane at the time of rendezvous. This is done by not inserting directly into the target plane, but instead inserting into a “phantom” plane that will regress into the target plane on the day of rendezvous.

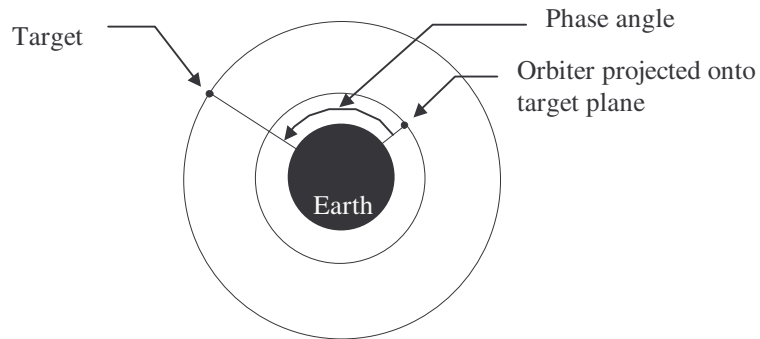

Figure 2.2.2.2-2: Phase Angle Definition

In order to launch and perform the rendezvous, the launch must occur in the composite window where there is an overlap between the planar window and the phase pane. On some days, it may be impossible to launch since no overlap exists. See figure 2.2.2.2-3.

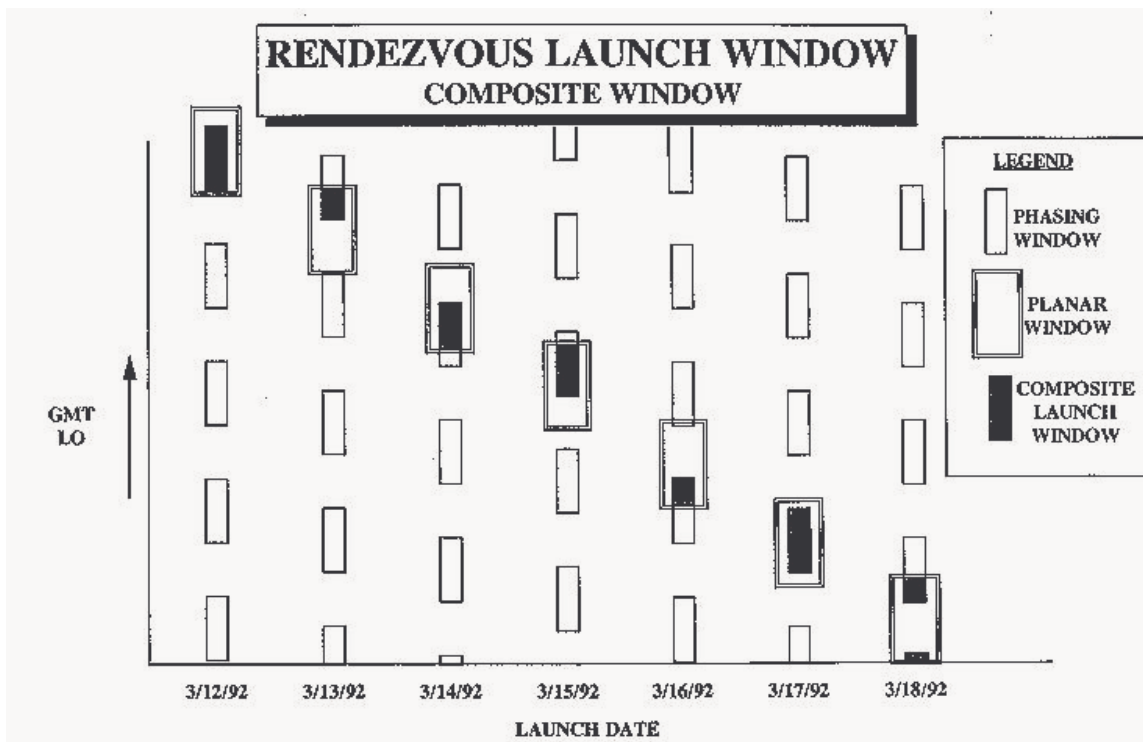

Figure 2.2.2.2-3: Composite Rendezvous Launch Window

On some days, two planar windows exist. This happens because the capability to phase is increased by adding 360° to the phase angle. This extra phasing is usually handled by adding an

extra day prior to rendezvous. With the extra 360° added to the phase angle, much more phasing is required. Therefore, much more nodal regression at a different rate must be taken into account. This results in an optimum liftoff time that is approximately 3 minutes different for each planar window. The first planar window is usually for a Flight Day (FD) 3 rendezvous while the second planar window is usually for a FD4 rendezvous. See figure 2.2.2.2-4.

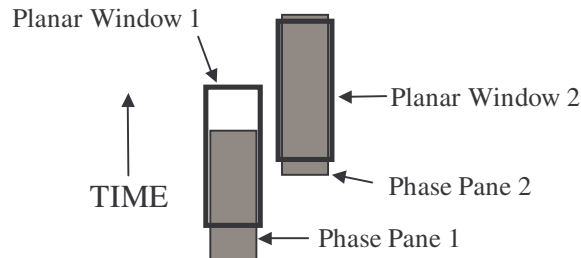

Figure 2.2.2.2-4: Example 2 Planar Window Day

Prior to OI-26, a set of IY targets was built for each pane. Since the planned launch time was the opening of the launch window, the IY targets for the first pane were uplinked to the Orbiter at approximately launch minus two hours. If a launch hold occurred where the launch time would occur after the end of the first pane, a second set of IY targets for the second pane would be uplinked prior to liftoff. The uplink process took approximately one minute to complete such that there was a one minute “cutout” in the launch window.

In OI-26, CR 90958 Onboard Auto Delta Psi, was incorporated. In addition to providing the capability to perform first stage yaw steering, this CR added two new parameters to the IY target uplink. These include the switch time for the second pane and the corresponding node adjustment which eliminated the need to build a separate set of IY targets for the second pane. Instead of uplinking the second set of IY targets when the launch slips past the end of the first pane, the onboard guidance will apply the uplinked node adjustment to the IY targets uplinked for the first pane if launch occurs after the pane switch time (GMT). In theory, this should eliminate the one minute cutout in the launch window which was reserved for uplinking the second set of IY targets. However, if launch occurred within a few seconds of the pane switch time, it was possible that the PASS would adjust the IY target assuming a slip into the second pane, while the BFS assumed launch occurred in the first pane. Launching under these conditions would have resulted in the PASS and BFS targeting two different planes, causing BFS guidance to go unconverged and become unavailable for engage. To avoid this scenario, a 10 second cutout, 5 seconds before and 5 seconds after the pane switch time, still remains. [AFPH2-12] Also, a change implemented in OI-29, Elimination of PASS/BFS Timing Skew for Ascent Target Calculation (CR 92319), uses transfer data from the PASS to BFS to sync up the PASS and BFS target adjust values. This eliminates the possibility of PASS/BFS targeting differences. However, the 10 second cutout around the pane switch time is still used for two reasons. First, it guarantees launch pane agreement between the onboard and the ground. Secondly, it reduces the likelihood of having to re-uplink Launch Targets at L-30 minutes for an updated pane switch time [AFPH2-13].

2.2.3 Post-MECO

Approximately 4 seconds after MECO, the transition (TRANS) digital autopilot (DAP) issues commands to hold attitude using the reaction control system (RCS). At MECO + 10 seconds, a liquid hydrogen (LH₂) venting dump is performed out of the RTLS dump port for approximately 4 minutes. The dump relieves any high pressure found in the LH₂ feedlines prior to the initiation of and during the main propulsion system (MPS) dump.

The external tank separation (ET sep) sequencer performs several tasks during the coasting period between MECO and ET sep. These include driving the main engines to stow position and performing several software tests to determine whether the structural separation should be inhibited. The software tests check to see that the vehicle rates are within the prescribed 0.7 °/sec deadband limits and the feedline disconnect valves are closed. If these constraints are met, then ET sep is commanded at approximately MECO + 20 seconds. The TRANS DAP automatically initiates a -Z RCS translation burn just prior to structural separation to move the orbiter away from the ET. Note that in MM 103, prior to ET sep, the RCS jets are active in response to manual crew inputs. This is different from RTLS fast ET sep, where jets are inhibited until after separation.

2.2.4 OMS 1 Insertion Burn

Once the -Z translation achieves 4 fps, the software transitions to the insertion MM 104. Once in MM104 the crew performs an 11 sec THC +X translation maneuver in preparation for the ET photo maneuver performed during the MPS dump. For failures resulting in a loss of propellant/delta-V capability, the +X maneuver will be called off, along with the ET Photo maneuver. In MM104 the OMS 1 MNVR EXEC display comes up on the MEDS Multifunction Display Unit (MDU_[AFPH2-14]) with I-loaded dummy OMS 1 targets. These dummy targets represent the desired post MPS dump condition and provide the crew a means of comparing actual MECO state with the desired state. A nominal MECO results in a dummy target delta V of about 11 fps corresponding to the MPS dump, which is yet to be performed. If an OMS 1 burn is required, the crew selects or verifies the appropriate OMS 1 burn targets, confirms both PASS and BFS solutions, and maneuvers to burn attitude. If the crew does an automatic (AUTO) maneuver using the DAP, the burn attitude is maintained within a 3.5° deadband.

Standard insertion (SI) missions require two OMS insertion burns. The most recent SI mission was STS-33, and SI missions are no longer planned. The first burn (OMS 1) establishes the desired height of apogee (HA), and the second burn (OMS 2) either circularizes the orbit or raises the height of perigee (HP) to a desired mission altitude. For this reason, desired SI MECO conditions are the same for all SI flights on a given inclination, regardless of target altitude. An example of SI MECO conditions for a 28.5° inclination mission follows:

$$\begin{aligned} V_{TGT} &= 25,670 \text{ fps} \\ \Theta_{TGT} &= 0.65^\circ \\ H_{TGT} &= 57 \text{ nm} \\ \text{HA by HP} &= 85 \text{ by } 3 \text{ nm} \end{aligned}$$

Direct Insertion (DI) missions make use of the main engines to achieve a desired apogee altitude, eliminating the need to do an OMS 1 burn and conserving OMS propellant for orbit/deorbit usage. This technique is now used exclusively and only one OMS burn, performed near the MECO apogee, is required to raise the perigee. Desired DI MECO conditions are a function of both inclination and target altitude. Note that for any DI MECO underspeed, OMS 1 is not required unless MECO HA < 95 nm.

28.5° inc to 160 nm	51.6° inc to 122 nm	57° inclination to 160 nm
$V_{TGT} = 25,880 \text{ fps}$	$V_{TGT} = 25,819 \text{ fps}$	$V_{TGT} = 25,830 \text{ fps}$
$\Theta_{TGT} = 0.76^\circ$	$\Theta_{TGT} = 0.60^\circ$	$\Theta_{TGT} = 0.99^\circ$
$H_{TGT} = 57 \text{ nm}$	$H_{TGT} = 52 \text{ nm}$	$H_{TGT} = 57 \text{ nm}$
HA x HP = 156 x 35 nm	HA x HP = 119 x 31 nm	HA by HP = 157 by 19 nm

During the insertion coast, the Mission Control Center (MCC) informs the crew if the navigation (NAV) state vector needs to be updated or if new OMS burn targets are required. If either action is taken, a reload of the OMS 1 targets is performed to update the burn solution. On nominal SI missions, the OMS 1 ignition time is 1 minute 42 seconds from ET sep or approximately MECO +

2 minutes. On DI missions if an underspeed results at MECO, an OMS 1 may be required. Very large underspeeds can result in an OMS 1 burn at MECO + 2 minutes. Smaller underspeeds that require an OMS 1 burn will generally be performed at apogee - 2 minutes. The MPS liquid oxygen (LOX) and liquid hydrogen (LH₂) dumps start automatically two minutes after MECO confirmed providing the MPS DMP SEQ switch is in GPC. The MPS dump is terminated after the ≈2 minute I-loaded dump time has expired.

The OMS cyclic guidance initiates 15 seconds prior to OMS ignition, updating the delta V solution and requesting that the crew enable the burn. The request is enunciated by a flashing EXEC which appears on the maneuver display 15 seconds before ignition. Ignition is inhibited until the keyboard EXEC is depressed. Depressing the keyboard EXEC less than 15 seconds prior to time of ignition (TIG) allows the burn to start automatically at TIG, while a keyboard EXEC after TIG enables the burn immediately. Valid values of TIG are less than 5 minutes in the past and less than 12 hr in the future. An invalid TIG may be entered but will result in an ILLEGAL ENTRY if an attempt is made to load this invalid TIG. Once the burn is enabled, the crew can monitor the status of the burn by checking the OMS 1 MNVR EXEC, the BFS GNC SYS SUMM 2 display, and the dedicated gauges. Upon completion of the burn, the crew should note any anomalies and null out any burn residuals greater than 2 fps by using the translational hand controller (THC). The OMS cyclic guidance remains active until transition to the OMS 2 insertion mode (MM 105).

If required, multiple OMS burns can be performed without first transitioning to the next major mode. Note also, that while in a particular OPS 1 major mode, the previous modes cannot be selected.

2.2.5 OMS 2 Insertion Burn

Following any OMS 1 burn or following MECO if OMS 1 is not required, the crew performs several steps prior to transitioning the software to MM 105. During the MPS dump the crew performs the ET Photo maneuver (if applicable). Then the crew performs auxiliary power unit (APU) shutdown, FRCS manifold closure (if Tail Only Control desired to save FRCS gas), FES [AFPH2-15] and heater activation, and takes the AC bus sensors off. A manual (MAN) transition to MM 105 is performed causing the OMS 2 MNVR EXEC display to appear on the MEDS MDU with the I-loaded OMS 2 burn targets. The OMS 2 targets are loaded and the burn solution is verified by the crew. The OMS 2 TIG should be checked to center the burn about apogee for the most fuel optimal burn solution. During the maneuver coast, the crew performs the MPS GH2 vacuum inerting procedure and closes the ET umbilical doors. The crew can maneuver to the OMS 2 burn attitude automatically, or they can use the rotational hand controller (RHC) for a manual maneuver if required. The automatic maneuver is preferred and if used, the burn attitude is maintained within a 3.5° deadband during the coast. OMS guidance initiates 15 seconds prior to the OMS 2 burn requesting that the crew enable the burn (with a flashing EXEC). The crew monitors the OMS 2 burn as they did for OMS 1 with guidance computing the PEG solution actively until the next MM transition. The burns are normally flown automatically. However, the crew can take control with the RHC and fly manually if required. The crew notes the postburn status, reconfigures the OMS/RCS for orbit usage, and performs the MPS LH2 vacuum inerting. A manual transition to the insertion coast (MM 106) is then performed, terminating the ascent phase.

2.3 ABORT TO ORBIT (ATO)

The ATO is designed to achieve a temporary orbit that is lower than the nominal orbit (fig. 2.3-1). This abort mode requires less OMS propellant than the nominal scenario and allows time for problem evaluation.

The ATO may be selected pre-MECO by using either the abort rotary switch (sw) and push button (pb) on panel F6 (fig. 2.3-2) or by using the OVERRIDE display (GNC SPEC 51). The main purpose of the pre-MECO ATO selection is to keep the ET off of a critical land mass. The point in the trajectory where this capability is achieved is the Press to ATO boundary. Selecting ATO pre-MECO usually initiates a pre-MECO OMS dump, switches to abort MECO targets (currently I-loaded the same as nominal targets), and invokes variable inertial plane (IY) steering (if enabled). The Press to ATO boundary protects the design MECO underspeed with a 2σ low ascent performance reserve (approximately 120 fps). The design MECO underspeed protects the following: ET impact constraints (protects critical land masses), minimum performance capability (either AOA steep or ATO/MIN HP with Flight Day 1 (FD1) shallow deorbit, whichever provides the earliest Press to ATO time), minimum altitude constraint (protects a minimum altitude of 55 nm between OMS 1 cutoff and OMS 2), and minimum SSME net positive suction pressure (NPSP) constraints. For most flights, the minimum performance capability protected by the design MECO underspeed is based on ATO/MIN HP and with very few exceptions, design underspeed is based on ET impact.

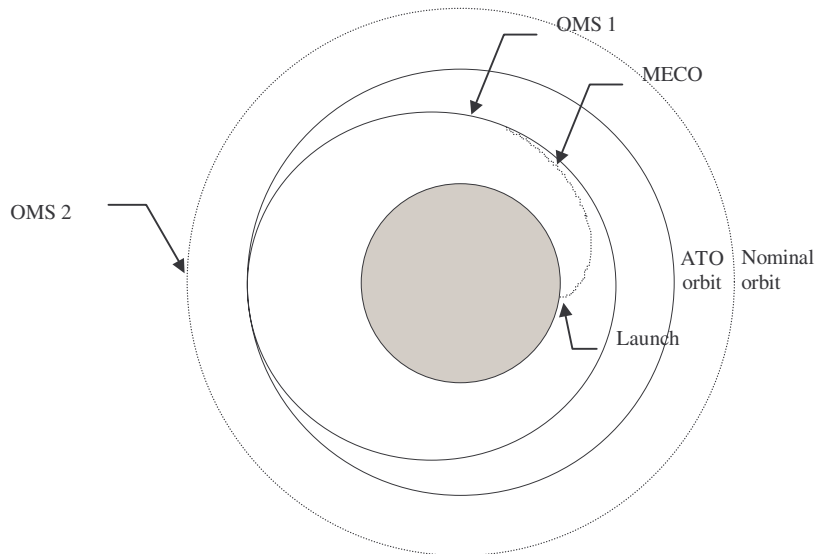

Figure 2.3-1: ATO Versus Nominal Orbit

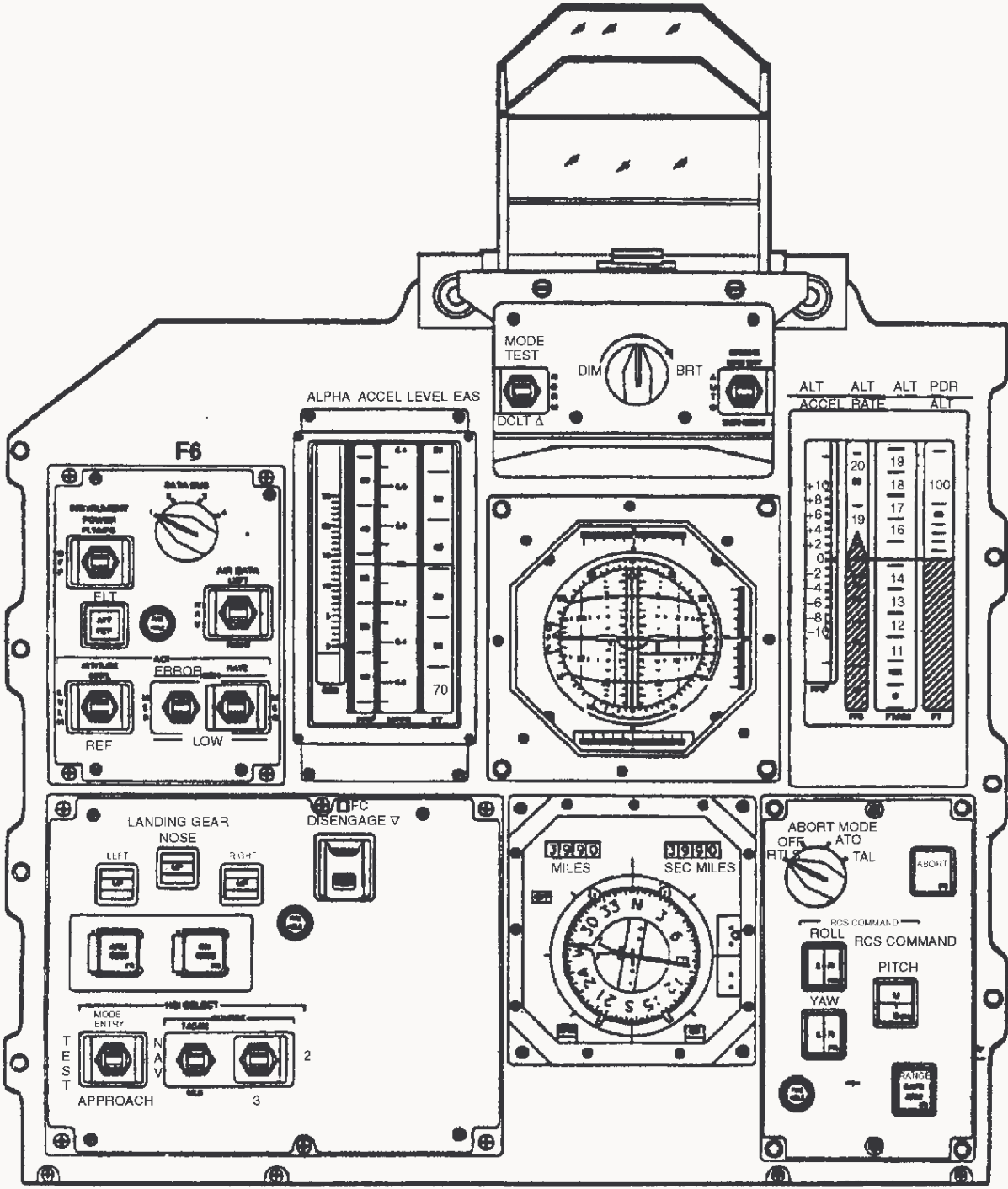

Figure 2.3-2: Panel F6

2.3.1 Pre-MECO ATO Selection

The pre-MECO OMS dump initiates immediately upon ATO abort selection and terminates based on either a constant or ramp dump timer. An exception might be a mission with OMS critical loading, such that the dump is inhibited. The software actually calculates the OMS dump time (OMS_DT) as a function of the engine out velocity. If the SSME fails close to the Press to ATO boundary, a full dump will be performed. If the SSME fails close to the Press to MECO boundary, a small dump will be performed. For failures between Press to ATO and Press to MECO, the dump will ramp down linearly. This type of dump is used to prevent the waste of OMS propellant in late engine failures cases (just prior to Press to MECO). If a full dump was performed for an SSME failure close to Press to MECO, the OMS prop would be wasted and the shuttle would reach MECO with unused main engine propellant. Without this OMS propellant, it is highly unlikely the mission could be successful. The ATO OMS dump is normally performed using both of the OMS engines interconnected with 24 RCS jets, but can be performed using only the two OMS engines if that provides for the earliest Press to ATO time.

Depending on the flight, the pre-MECO ATO selection may also invoke variable IY steering and/or abort MECO targets. Depending on the engine failure time, variable IY steering retargets the vehicle to either its current or a specified minimum inclination in order to gain performance to achieve the design MECO underspeed earlier. This option is used for high inclination missions where performance gains are realized by allowing the vehicle to fly in a more easterly direction, due to the Earth's rotation. The abort MECO targets include altitude, velocity, and flight path angle targets which can differ from the nominal targets. However, the abort targets are always set equal to the nominal targets.

2.3.2 Post-MECO ATO Selection

ATO may be selected post-MECO by using the abort rotary switch and push button on panel F6 or by I-loaded target (TGT) selection on the OMS MNVR display. Target selection on the OMS MNVR display is the preferred method post-MECO. If ATO is selected prior to OMS 1, the software automatically downmodes to the ATO OMS 1 targets (TGT 1). The ATO OMS 1 target set is designed to be used as a common target in which either an ATO circularization burn or an AOA deorbit burn can be performed at OMS 2. This allows an evaluation to be performed post-OMS 1 prior to committing to either an ATO or AOA.

In order to provide the most optimum burn, the ATO OMS 1 must be initiated at time to apogee (TTA) = 2 minutes. Since the I-loaded TIG is at MECO + 2 minutes, it may be necessary to enter a new TIG and reload the OMS 1 targets. For extreme cases, TTA = 2 minutes is prior to MECO + 2 minutes and the burn should be delayed until MECO + 2 minutes. The MCC computes the best TIG for OMS 1.

After completion of the ATO OMS 1, the HA is 105 nm. The ATO OMS 2 targets automatically appear upon transition to MM 105 and are designed to circularize at 105 nm. As mentioned above, an AOA burn can also be done after the ATO OMS 1. Both AOA steep and AOA shallow targets are available for use in this case. The other options for OMS 2 after the ATO OMS 1 are raising perigee to the MIN HP or no burn at all. For a range of underspeeds, the post-OMS 1 orbit will be 105 by X, where X is at or above the MIN HP. In these cases, OMS 2 may be canceled. The ATO/MIN HP orbit provides enough orbital lifetime to allow staying orbit up to the FD1 primary landing site (PLS) opportunity. The 105 nm circular orbit allows 24 hour orbit stay capability. Additional burns are required to raise the orbit in order to further extend the orbital lifetime.

2.4 ABORT ONCE AROUND (AOA)

The AOA is designed to allow the orbiter to fly once around the Earth and make a nominal entry and landing instead of continuing uphill into orbit. In some cases this mode involves two OMS burns, with the second burn being a retrograde deorbit maneuver. In other cases, when the MECO HA > 95 nm, only one burn is performed. This burn is mostly a radial burn to shift the line of apsides.

Edwards Air Force Base (EDW), Northrup Strip (NOR), and KSC are AOA landing sites for Eastern Range (ER) launches. Prime site selection is based on several factors that are flight specific, such as crossrange, runway length, runway surface, and lighting. A second or even third site may be available as a weather alternate.

There are two types of AOA trajectories, a steep AOA and a shallow AOA. The entry trajectory for the steep AOA is similar to the nominal entry trajectory. The shallow AOA results in a flatter trajectory that is less desirable than that of the steep AOA but requires less OMS propellant. The shallow entry trajectory is less desirable because it exposes the vehicle to a longer period of atmospheric heating and to less predictable aerodynamic drag forces.

An AOA may be required due to performance problems (SSME failure) or due to certain systems failures as identified in the Flight Rules. Systems and performance abort groundrules are defined by the OMS TGTING cards discussed in section 4.3.4.

For DI flights that result in a MECO HA greater than 95 nm, an OMS 1 is not required. For these cases, only one burn is required to perform an AOA. However, for these cases the AOA shallow TIGs are very early (≈ 34 minutes MET). As mentioned previously, these cases are more of a radial burn than a retrograde burn. This is done to shift the line of apsides to set up the entry. The examples in figure 2.4-1 and 2.4-2 show the OMS 2 thrust vector for two steep AOA cases after a nominal MECO. The example in figure 2.4-1 is from STS-50, which was a DI flight to 160 nm, 28.5° inclination. The example in figure 2.4-2 is from STS-48 which was a DI flight to 292 nm, 57° inclination. In figure 2.4-1, the thrust vector is almost all radially up. This resulted in a forward shift of the line of apsides and a fairly small change in HP. This is typical for cases where the HA is below ≈ 250 nm. The example in figure 2.4-2 shows the opposite effect. There the thrust vector is almost all radially down and the line of apsides is shifted in the opposite direction.

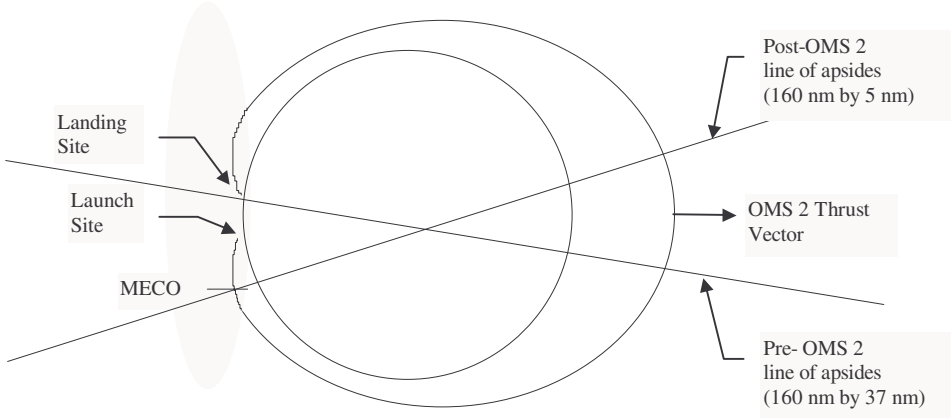

Figure 2.4-1: Mid altitude DI AOA

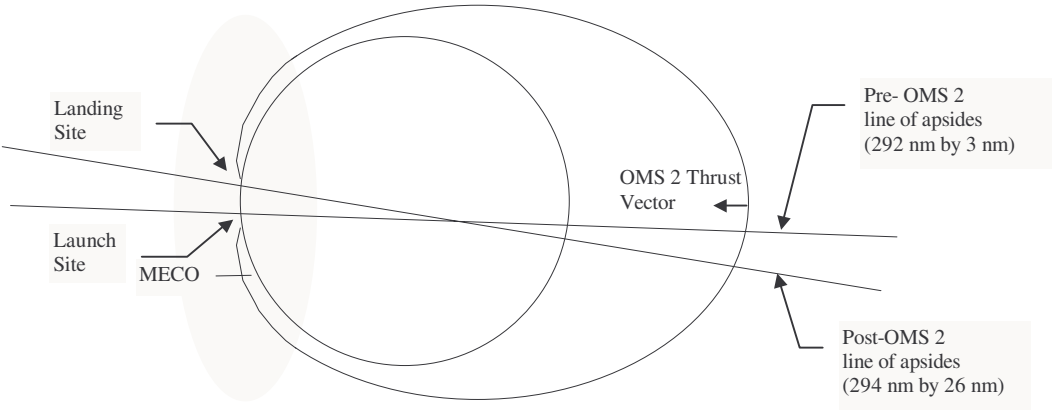

Figure 2.4-2: High altitude DI AOA

AOA can only be selected post-MECO by TGT selection on the OMS MNVR display. The AOA procedures are not entered until post-OMS 1. If an OMS 1 was required, there may be a large radial velocity component. The line of apsides is shifted in order to adjust the post-OMS 1 orbit to support entry or uphill.

Once the decision has been made to AOA, any software resident (I-loaded) AOA deorbit target set is entered to set the AOA flag. Even if key-in targets are required, it is important to first select any I-loaded AOA target set in OPS 1 and then key-in the desired targets. TGT selection is required to set the AOA abort flag and set the AOA navigation filter covariance matrix for entry. The targets are verified in OPS 1 and carried across the transition to OPS 3. The targets are not loaded until after the OPS 3 transition to utilize the OPS 3 guidance targeting logic. In OPS 1, the theta target is measured from the launch site to the target. In OPS 3, the theta target is measured from the location of the deorbit TIG to the target (entry interface (EI)). This relationship between TIG, Θ_T , and EI is the reason why TIG should not be updated if ignition is delayed past TIG in OPS 3. If TIG is updated without a corresponding update in Θ_T , the range at EI will be incorrect. [AFPH2-16] See figure 2.4-3. Then the targets may be changed by keystroke entry in OPS 1 (or OPS 3) and loaded in OPS 3.

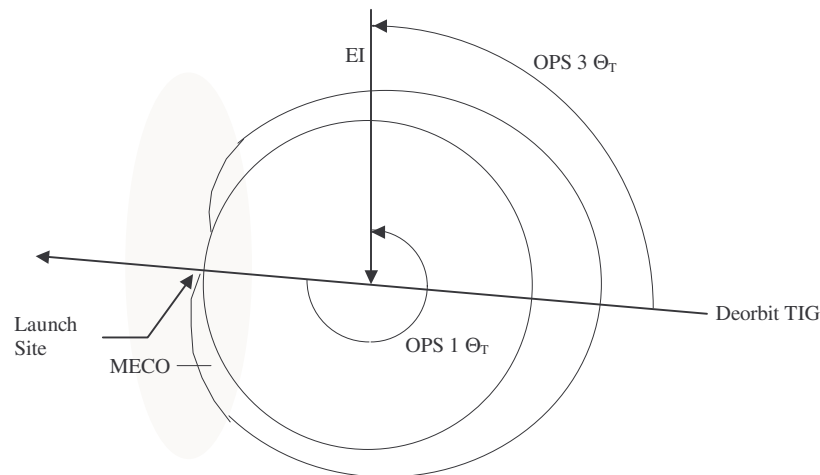
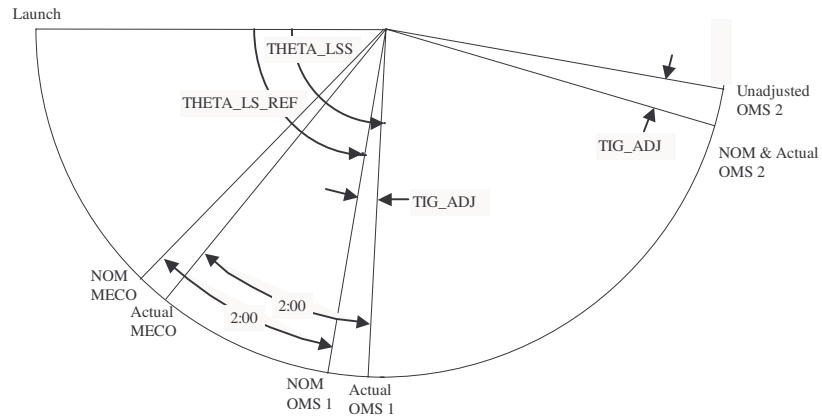

Figure 2.4-3: Θ_T Definition

In calculating the deorbit OMS 2 TIG, the AOA software takes into account any downrange dispersions at MECO by comparing the angle between the launch site and OMS 1 TIG to an I-loaded reference angle in the software. This TIG adjust logic is required since the OMS ignition times are based on an I-loaded delta time from ET sep. The goal of the TIG adjust logic is to fix the OMS 2 TIG so that the resulting range to entry interface (REI) is correct. Failure to do so would result in an REI that is too small. Figure 2.4-4 provides a visual description of how the TIG adjust logic works.



$$\text{TIG_ADJ} = (\text{THETA_LSS} - \text{THETA_LS_REF}) / \text{ORB_RATE}$$

$$\text{AOA OMS 2 TIG} = \text{DTIG} - \text{TIG_ADJ} + \text{T_ET_SEP}$$

where DTIG = I-loaded OMS2 time from ET SEP

Figure 2.4-4: TIG Adjust Logic (Not drawn to scale)

In figure 2.4-5 the approximate orbital position of the AOA OMS burns is shown. If an OMS 1 is required, the OMS 1 maneuver establishes a temporary orbital trajectory, and the OMS 2 maneuver is a deorbit burn. The AOA software also computes the amount of excess OMS that may be burned out of plane during the deorbit maneuver by subtracting from the usable OMS load the amount used during the pre-MECO OMS dump and the OMS 1 burn and the amount reserved for center of gravity (c.g.) control. The crew can change the amount of OMS propellant to be wasted and the direction of the out of plane wasting through keyboard entries on the OMS MNVR display.

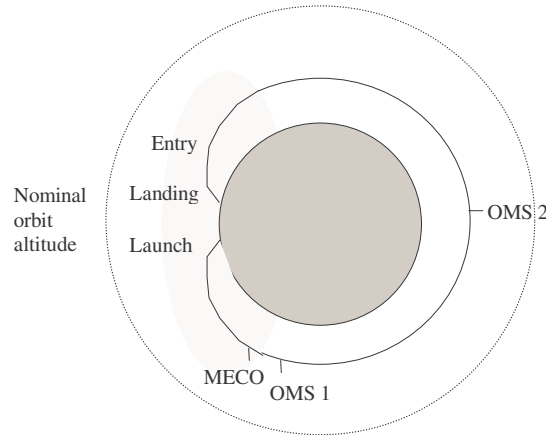

Figure 2.4-5: AOA Trajectory

After the deorbit targets are loaded on the MNVR display, the deorbit solution should be checked against the OMS target cards for any discrepancies. The TIG of the burn may need to be adjusted so that the range from EI to the targeted landing site is approximately the reference range listed in the OMS target cards. The MCC also determines any TIG adjust and may recommend a specific TIG. The deorbit burn attitude can then be maneuvered to automatically using the DAP and is maintained within a 3.5° deadband. The OMS cyclic guidance initiates at TIG - 15 seconds and remains active calculating a PEG solution until the MM transition to MM 303.

2.5 TRANSOCEANIC ABORT LANDING (TAL)

The TAL is designed to provide for the safe return of the orbiter cargo and crew to a designated TAL site in the event of an engine failure occurring in the region before first AOA/ATO. During a TAL abort, the vehicle continues on a trajectory across the Atlantic and lands at a predetermined runway. Landing occurs approximately 35 minutes after launch. Figure 2.5-1 compares a TAL trajectory with a nominal trajectory.

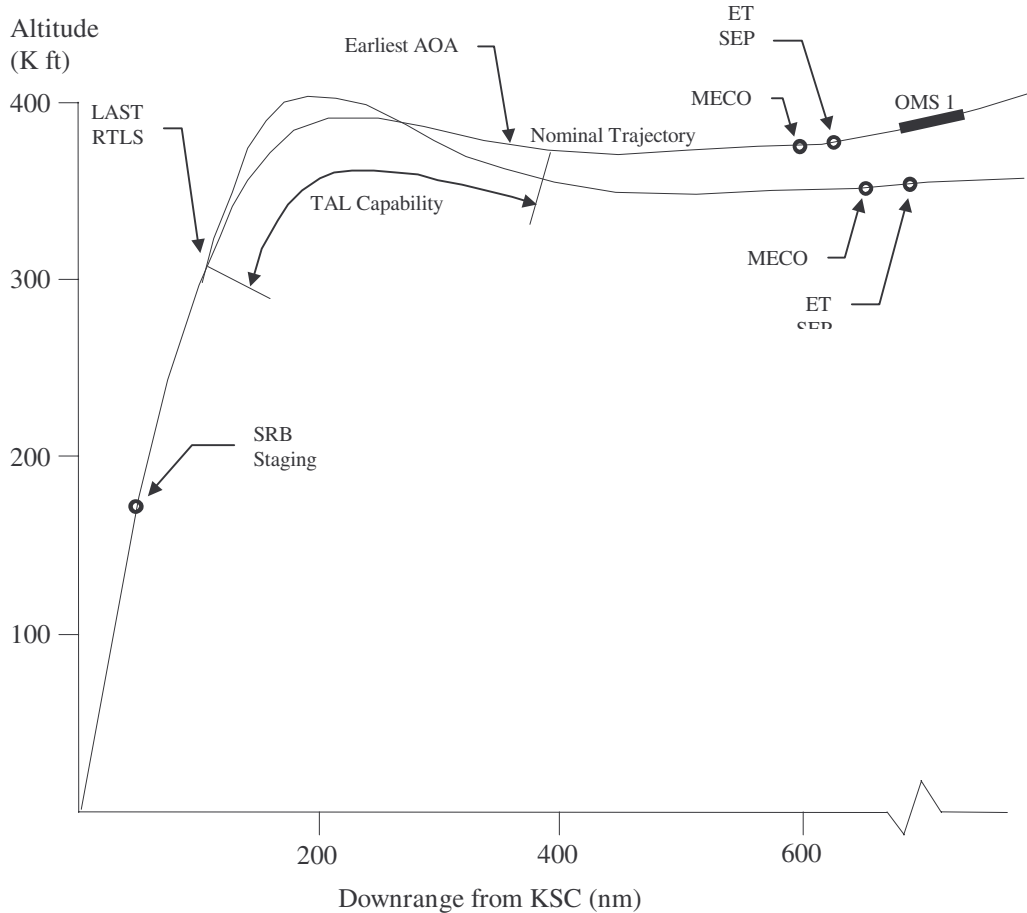

Figure 2.5-1: TAL Versus Nominal Ascent

To select the TAL abort mode, the crew places the abort rotary switch in the TAL position and depresses the ABORT push button. TAL may also be selected via the OVERRIDE display (SPEC 51). Upon abort initiation, the title of the ASCENT TRAJ display changes to TAL TRAJ, providing a cue to the crew that the software has moded properly. An overview of guidance related events occurring during a typical TAL trajectory is shown in figure 2.5-2.

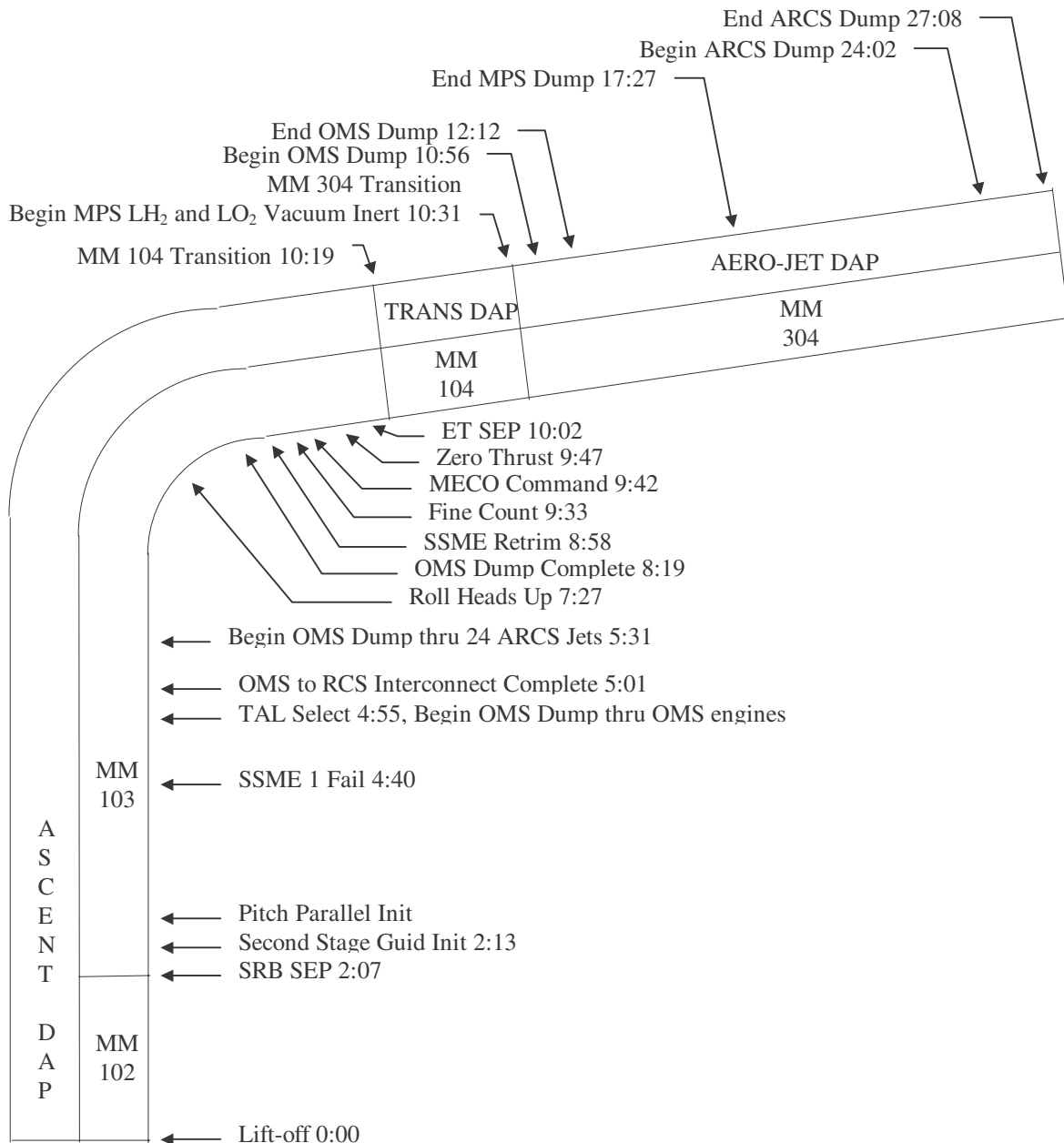

Figure 2.5-2: TAL Guidance Events
(METs shown are for example purposes only)

2.5.1 Powered Flight

At abort selection, an OMS propellant dump is initiated. This dump may be an extension of the OMS assist dump if the abort is selected prior to the expiration of the assist dump timer. If the TAL abort is selected after the assist dump is complete, the earliest this dump will start is 30 seconds after assist complete due to a built in software delay.^[AFPH2-17] OMS propellant may be dumped through the two OMS engines only or through both OMS engines plus 24 aft RCS jets (20 null jets and 4 +X jets) interconnected to the OMS propellant tanks. Depending on the flight, the OMS/RCS interconnect may be enabled or inhibited prior to lift-off. The dump is set to a predetermined I-loaded time duration and terminates automatically at MECO prep (fine countdown), MECO confirmed, or the timer, whichever comes first. When the dump is initiated with the interconnect enabled, the dump time is adjusted with an I-load bias to account for the extra flow rate through the RCS jets.

Starting with STS-110 (April 2002) a new technique referred to as “TAL Delay” is used for TAL Aborts on 51.6° missions. This technique delays the initiation of the TAL abort, keeping the trajectory closer to the east coast for a longer period of time. This allows for more ECAL coverage should a second engine problem occur prior to reaching single engine capability across the ocean using ascent droop guidance (discussed in section 2.5.2) and OPS 3 entry capability. Should an engine failure occur warranting a TAL abort the abort will be delayed to the earliest of: 1) the velocity at which aborting TAL provides 3 sigma protection of making the TAL site with 2 engines running or 2) the velocity of the first single engine OPS 3 capability (this is generally the first capability to an OPS 3 ELS site depending on weather). For the “TAL Delay” procedures an OMS propellant dump is initiated via an item 9 entry on the Override Display (Spec 51). The dump is performed when it is decided a TAL abort will be required, usually this will be well in advance of the actual initiation of the TAL abort. This dump will be initiated as an OMS only dump and will dump to the contingency dump quantity. The “TAL Delay” technique greatly enhances ECAL capability for a second engine fail case, yet still provides 3 sigma intact coverage and only very minor reductions in 2 engine out OPS 3 coverage^[AFPH2-18].

TAL landing sites are selected based on several criteria, including weather, navigation and landing aid availability, runway dimensions, and runway load bearing capability. For some emergency landing sites (ELs), political suitability is also considered. Powered flight guidance allows selection of alternate TAL and RTLS targets and landing sites. Up to 10 stored target sets are shared by TAL and RTLS landing areas and are indexed to ensure that compatible targets and runways are selected.

Figure 2.5.1-1 shows 28.5°, 39°, 51.6°, and 57° inclination groundtracks and surrounding TAL sites. The solid circles represent the 500 nm orbiter entry crossrange capability. Since the ability of the orbiter to reduce crossrange is more effective in powered than in gliding flight, some single engine TAL completion cases require the selection of low crossrange targets. The low crossrange targets may be selected by the crew in powered flight if it is determined that gliding flight crossranging cannot achieve the runway.



Figure 2.5.1-1: TAL Landing Sites

At abort selection, TAL guidance begins steering the vehicle toward the plane of the landing site. Upon TAL initiation a table lookup is performed to select the guidance and navigation I-loads associated with the selected landing site. The navigation I-loads (e.g., runway geodetic latitude and longitude) are transformed into an Earth fixed landing site position vector for guidance targeting. The desired MECO inertial velocity (V_I) magnitude is computed with a third order polynomial equation. This polynomial is a function of the surface range between the predicted MECO position vector and the aim point vector associated with the TAL Earth fixed landing site vector at the predicted MECO time.

Variable IY TAL steering is designed to reduce the crossrange to the TAL site within an acceptable limit at MECO. If the calculated crossrange, based on the current TAL IY and TAL aim point, exceeds the I-loaded maximum allowed crossrange, the TAL aim point is adjusted so that the crossrange equals the maximum crossrange. The maximum allowed crossrange is a function of both inclination and TAL site. The table below shows the current I-loaded maximum crossrange values^[AFPH2-19].

Table 2.5.1-I Maximum TAL Crossranges

Inclination (deg)	Banjul ¹ (nm)	Ben Guerir ² (nm)	Istres (nm)	Moron (nm)	Zaragosa (nm)	Low XR Targets (nm)
28.5 - 39	412.5	418.7	N/A	423.5	442.7	375.
>39 - 57	N/A	449.0	300.0	459.4	469.7	400.

Note: 1. Banjul is shown here for historical purposes. It was previously the prime TAL site for due east missions (most inplane site). However, the Shuttle program eliminated Banjul as a TAL site in 2002 as a method of cost-savings for TAL support ^[AFPH2-20].

2. Ben Guerir is no longer carried as a TAL site; the site was not being supported due to the political climate there. Istres, France replaces Ben Guerir as the 3rd TAL site starting with STS-114. At the time of this release, work was in progress to make Istres a full up TAL site. Even though Ben Guerir targets will still reside in the onboard guidance there are no plans to support that site real-time or attempt that site in a TAL situation.

A new IY is then defined so that the crossrange equals the maximum crossrange and a new IY is defined so that the target plane passes through the new aim point vector. In this manner the vehicle begins to steer closer to the landing site. If the calculated crossrange is less than the maximum allowed crossrange, the targeted orbital plane defined by the IY vector is not changed.

In addition to the range-velocity (R-V) and crossrange targets, a desired flight path angle and radius/altitude target must also be achieved at MECO. Currently, guidance aims for a MECO flight path angle and altitude that yield a flight path angle of $\approx 0^\circ$ and an altitude of 360,000 ft at ET separation.

The only maneuver performed during TAL powered flight is a roll to heads up. This roll is done to put the vehicle in the correct entry attitude at ET sep. When the Earth relative velocity, V_{REL} , of the vehicle is greater than the I-loaded reference velocity of 14,000 fps (converted to V_I for use in the TAL crew procedures), the vehicle begins rolling to heads up at $5^\circ/\text{sec}$. The roll maneuver is done at this time to distribute ET heating evenly and prevent thermal exceedances^[AFPH2-21]

Once all the powered flight guidance targets have been achieved, MECO is commanded. Following MECO confirmed, after a time period of 3.75 seconds, SSME OPS declares software zero thrust, which is the signal to the master sequence controller (MSC) to terminate the ascent DAP and initialize the transition DAP. ET structural release is commanded automatically 0.16 seconds after -Z command (MECO command plus approximately 20 seconds), beginning the -Z translation, ET sep phase. When the velocity in the -Z direction exceeds 11 fps, the separation complete discrete is set, at which time transition to MM 104 takes place.

2.5.2 TAL Droop

When a substantial loss of thrust occurs (second main engine failure, or one engine fail with another stuck in the throttle bucket), the Orbiter can continue downrange if past the “droop” boundary. This boundary is described as follows: Whenever two engines fail early in ascent, the thrust to weight of the shuttle is instantly reduced to less than 1.0 and a dip (or droop) in the trajectory begins. As fuel is burned by the remaining engine, the vehicle thrust to weight increases until it is once again greater than 1.0 and a climb can resume. If the vehicle descends no lower than 265,000 ft in this process, it does not violate ET heating constraints. Staying above 265,000 ft allows the abort to continue in powered flight until fuel depletion, thus getting closer to TAL sites. Prior to this droop boundary, if two engines fail, the shuttle does not have sufficient energy to stay above 265,000 feet, so separation from the ET must be immediate, terminating powered flight with fuel still remaining. This boundary is usually near 12,000 fps.

If two engines fail prior to the droop boundary as in line a (fig. 2.5.2-1), the vertical thrust attitude cannot “turn around” the sink rate until below 265,000 ft where the ET begins overheating. The first point in the nominal trajectory where (if two engines fail) a near vertical thrust attitude can prevent descending below 265,000 ft is the point called the droop boundary. The droop in the trajectory bottoms out when thrust to weight returns to greater than one due to fuel burnoff. Achieving the droop boundary allows a safe downrange abort and is the basis of the two engine out droop maneuver (contingency abort cue card).

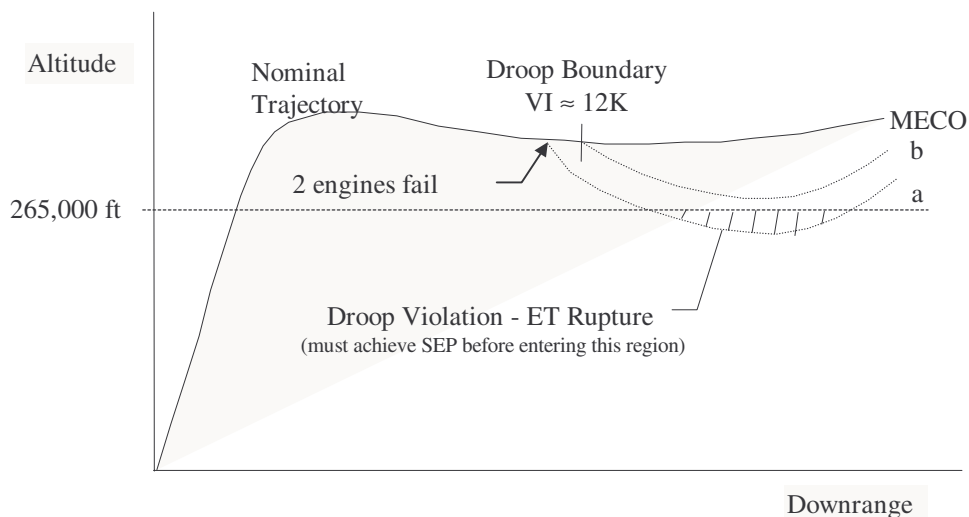

Figure 2.5.2-1: Droop Boundary

The droop boundary is also significant in that, once past it, the orbiter can enter using normal OPS 3 software since entry loads become sufficiently low. Prior to this boundary, OPS 6 contingency software is used and much higher (3.5 versus 2.5) Nz loading can be expected.

The TAL Droop Control CR, 90122, was incorporated in OI-22 to automate the manual droop procedures. Prior to OI-22, onboard guidance did not fly an optimal trajectory in low thrust to weight scenarios since it tended to fly too high of a thrust attitude. Improved droop performance is achieved by pitching lower, increasing downrange velocity and increasing the droop altitude. The other reason the Droop Control CR was added was to provide the crew with insight into the minimum droop altitude other than pre-flight generated data.

The following information was taken from McDonnell Douglas Space Systems Company Transmittal Memo TM-5.23.02-04, written by CR author, Daniel Weed, dated October 10, 1990, as well as from the CR itself.

The Droop logic consists of a hypothetical droop prediction mode and an actual control mode. The minimum droop altitude is predicted assuming the remainder of the trajectory will be flown with only one active SSME at the current throttle command at a pitch attitude of 84°. This prediction is always conservative since it does not assume maximum throttle (unless max throttles enabled) and does not account for the OMS dump. The predicted minimum droop altitude is displayed in thousands of feet on the PASS TRAJ.

The hypothetical mode is terminated and droop guidance takes over when the predicted droop altitude of the vehicle is below the I-loaded limit (265K ft) assuming a pitch attitude of 60°. When droop guidance is active, the predicted minimum droop altitude is displayed double bright on the PASS TRAJ. New pitch attitudes (between 68° and 84°) will be commanded by the droop logic to ensure the minimum altitude is maintained above the limit. If the droop logic is engaged and the TAL flag set, the MECO targets will be updated with a lower altitude of 330K ft and a smaller crossrange (375 nm for low inclination, 400 nm for mid and high inclinations). If the droop logic cannot maintain the minimum altitude above the limit, the altitude display on the PASS TRAJ will flash.

The droop logic will be “disengaged” and control returned to PEG if the PEG solution is acceptable and the predicted droop altitude is greater than the limit. The PEG solution is considered acceptable if it is converged, not elevation limited, and the commanded attitude from PEG is less than the droop commanded attitude.

2.5.3 Entry

A nominal TAL entry is procedurally very similar to an EOM entry as described in the Entry Flight Procedures Handbook, JSC 11542. The major differences are that for TAL a post-MECO OMS dump will be performed to provide 100 fps of delta velocity between the orbiter and the external tank and an initial angle of attack of 43° is flown during the TAL pullout instead of 40° . The pullout is a result of the suborbital velocities achieved by a TAL at MECO. In addition, the ET Umbilical Doors are automatically closed via the PASS or BFS Software 1.5 minutes after the MM304 transition.

If an underspeed condition results such that energy is too low for nominal TAL guidance to reach the runway, the crew may enable the Low Energy logic via ENTRY TRAJ ITEM 3 EXEC. Low energy guidance was added to the OI-22 software by CR 90152 to replace the manual low alpha stretch procedures. The OI-22 logic was updated in OI-30 with the Variable Low Alpha for Low Energy CR (CR 92671A_[AFPH2-22]). The following information was taken from STSOC Transmittal DFD-93-520-124, written by Washington Wedderburn, dated November 29, 1993. The transmittal documents the OI-22 low energy logic. Minor modifications were made to the following paragraphs to account for the OI-30 Variable Low Alpha logic.

The main objective of low energy guidance is to maximize the orbiter's ranging capability by increasing the lift to drag ratio and by minimizing the amount of bank required to control crossrange. Since low energy guidance is not attempting to fly a reference drag profile but is simply flying a velocity and drag dependent angle of attack schedule and azimuth error dependent roll command, a phugoiding trajectory results.

The angle of attack schedule is primarily driven by thermal constraints. The optimum angle of attack to maximize L/D at higher velocities is approximately 17° . However, it is thermally unacceptable to fly this low of an angle of attack until lower Mach numbers. To avoid exceeding the contingency abort thermal limits, low energy guidance commands the initial angle of attack to a value between 42° and 38° (dependent upon MECO velocity) until the first pullout is complete ($H_{dot} > 400$ fps). (For higher velocity aborts, where an H_{dot} of 400 fps may not be achieved, a velocity check is used instead.) At this point, it is thermally acceptable to ramp the angle of attack down. During the 2nd and subsequent phugoids the angle of attack is ramped down to a minimum of 31° while the vertical acceleration is negative. The alpha is ramped back up while the vertical acceleration goes positive. This allows the lower alphas to be flown while the drag is low and building and thermal concerns aren't significant, then at the bottom of the phugoid where vertical acceleration turns around the alpha is ramped back up. This is where the drag and q_{bar} are really starting to build, and temperatures on the vehicle are maxing out. The higher alpha protects thermal limits on the vehicle. At approximately Mach 8, nominal guidance's alpha modulation lower limit (α LO on the Entry Alpha cue card) becomes less than 31° . Therefore, below Mach 8, low energy guidance commands angle of attack equal to α LO.

Low energy guidance commands the roll angle of the vehicle based on a simplified approximation of the analytically derived minimum bank angle to reduce crossrange. The roll command is initially 2.2 x azimuth error and is limited to a maximum of 70° . If energy approaches nominal

(reference drag within 2.5 fps^2 of the approximated equilibrium glide boundary), the roll command may be increased if required by increasing the multiplication factor. If the azimuth error is greater than 17° and increasing, the multiplication factor (initialized to 2.2) is increased until the roll command is limited to 70° , azimuth error begins to converge, or low energy guidance disengages. If azimuth error is greater than 17° but converging, then the multiplication factor remains constant. When azimuth error falls below 17° and is converging, the multiplication factor is decremented until it reaches 2.2, azimuth error begins to diverge, or low energy guidance disengages.

Low energy guidance monitors the nominal TAL guidance computed drag reference profile to determine whether low energy guidance should disengage. Normally, entry guidance computes the drag reference profile as a function of the great circle range to the runway. However, when the low energy logic is engaged, the great circle range is replaced with a biased range to account for crossrange. This causes low energy guidance disengagement to be delayed for cases with nominal range but high crossrange. Low energy guidance disengages when the drag reference computed based on the biased range is greater than the approximated $37^\circ/20^\circ$ equilibrium glide boundary. If the low energy logic disengages, the commanded angle of attack is ramped from the value commanded by the low energy logic to that commanded by nominal TAL entry guidance. The roll command is limited to provide a smooth transition from low energy to nominal TAL guidance. If the drag error is greater than 2.0 fps^2 , the roll command will be limited to 90° . This is required since the crossrange bias applied to the great circle range used in the reference drag computation is removed once low energy guidance disengages. Except for low crossrange cases, the removal of this bias causes nominal guidance to perceive a high energy condition and therefore command a significantly larger roll angle. Therefore, roll command will be limited to 90° until the drag error is less than 1.0 fps^2 for 10 consecutive guidance cycles (≈ 20 seconds). Once this convergence criteria is met, guidance works as if low energy guidance was never engaged.

2.6 RETURN TO LAUNCH SITE (RTLS)

The RTLS abort is designed to provide intact abort capability for a suborbital return of the orbiter, crew, and payload directly to the KSC landing field in the event of an engine failure after lift-off and prior to negative return (NR). The RTLS abort mode must be initiated approximately within the first 245 seconds of ascent (prior to NR) and requires approximately 22 minutes to return and land after lift-off.

RTLS consists of several flight regimes: powered flight, ET separation, and gliding flight. The RTLS ET sep maneuver makes the transition from the orbiter/ET powered flight configuration to the orbiter gliding flight configuration. A typical RTLS trajectory profile indicating the associated flight phases is presented in figure 2.6-1. An overview of guidance related events during the powered flight portion of a typical RTLS is shown in figure 2.6-2.

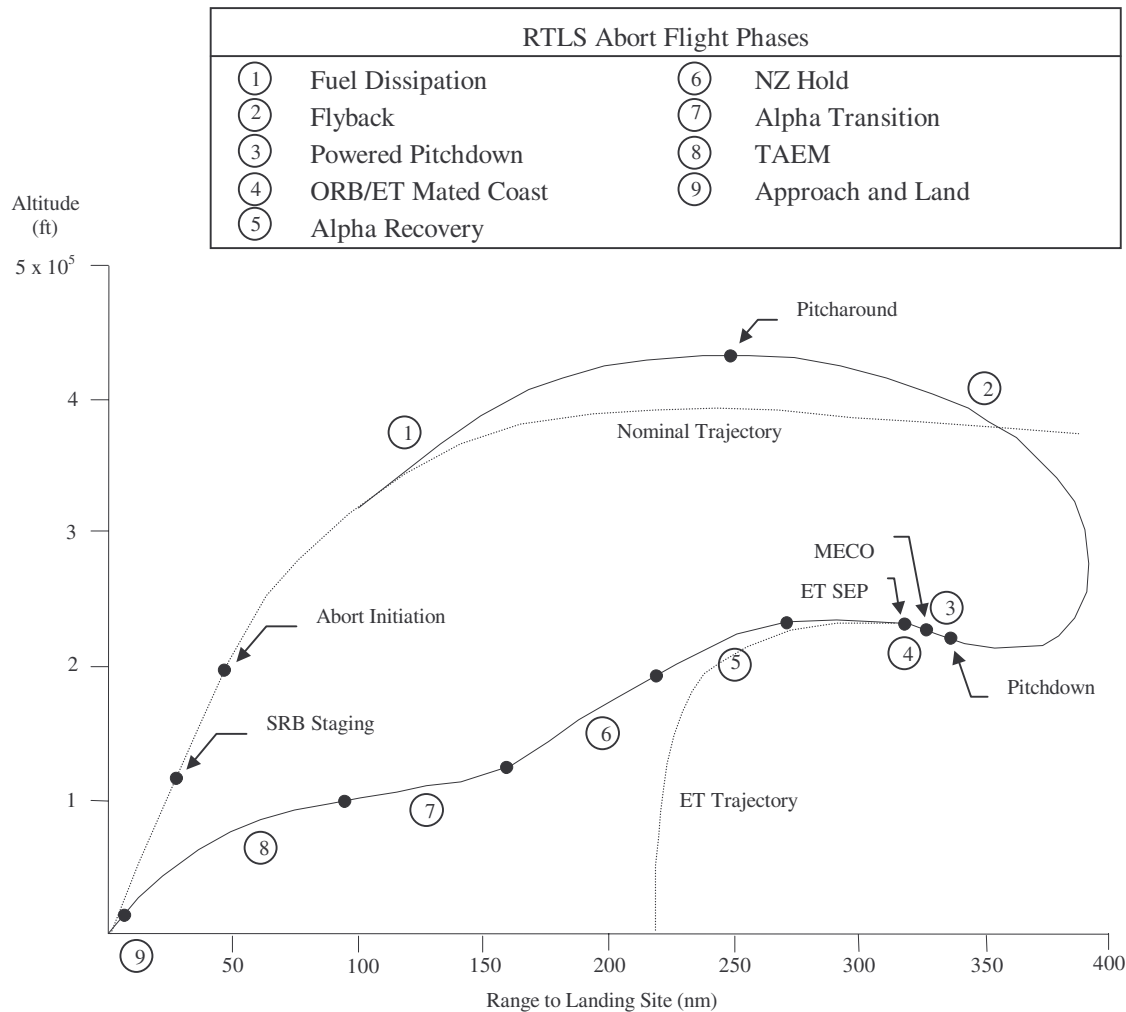

Figure 2.6-1: RTLS Trajectory and Flight Phases

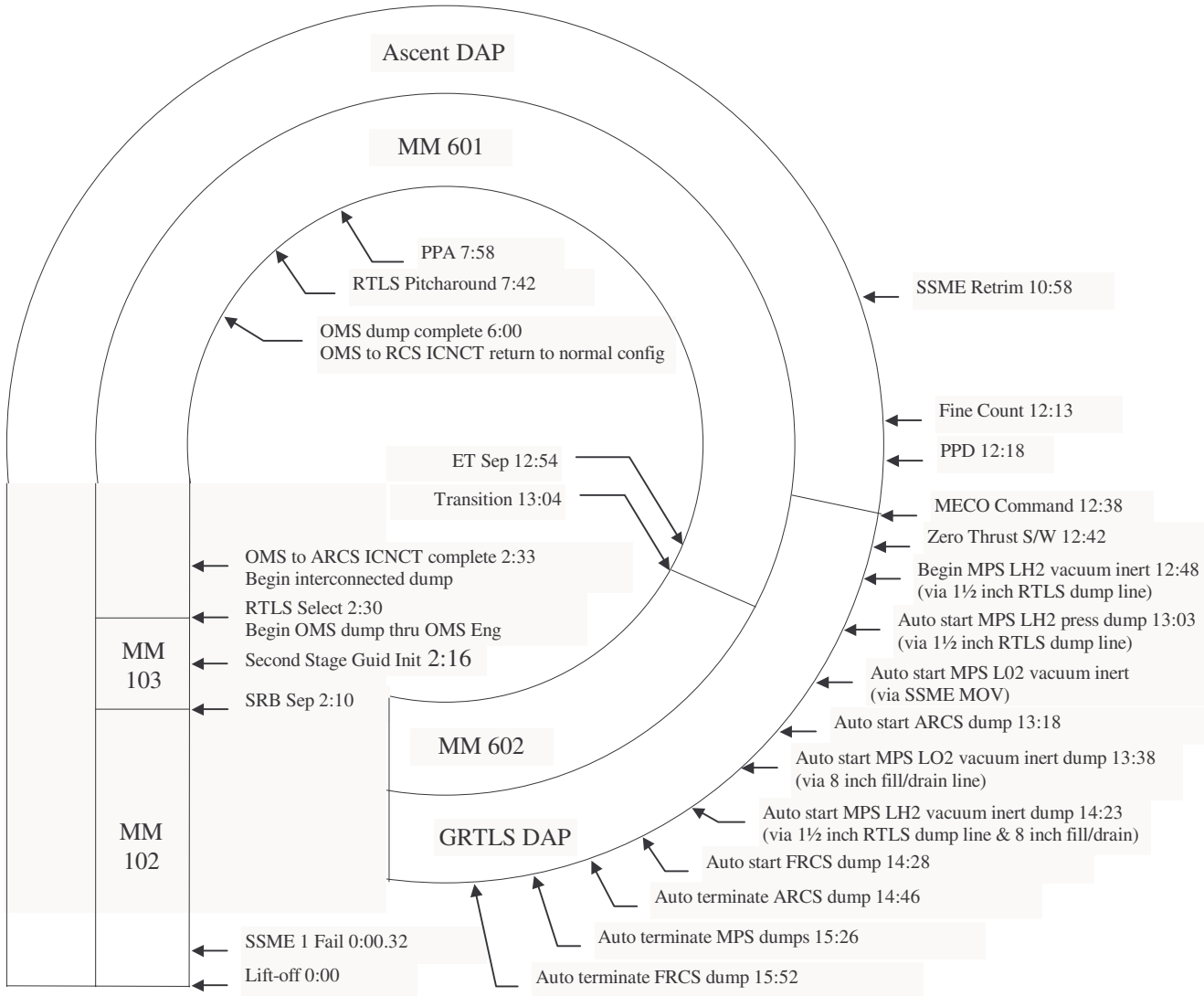

Figure 2.6-2: RTLS Ascent Guidance Events

2.6.1 Powered RTLS

The decision to return to the launch site can be made during ascent prior to Negative Return. The Negative Return boundary represents the last opportunity to abort RTLS and still achieve the desired R-V MECO targets and incorporates the following assumptions: single engine out, 3σ main engine flight performance reserve (FPR), 3σ entry dispersions, abort throttles, and 15 second abort decision delay. Onboard software does not initiate RTLS aborts prior to SRB sep (2:05 MET). Delaying the abort selection until 2:30 MET allows time for SRB sep induced transients to damp out, for second stage guidance to converge, and for engine out confirmation. For RTLS aborts after the two engine TAL call, RTLS selection is performed at 3:40 MET to allow for any problems that may dictate TAL over RTLS.

RTLS is initiated by placing the abort rotary switch in the RTLS position and depressing the ABORT push button or by typing OPS 601 PRO on a CRT. At this time, the title of the TRAJ display changes from ASCENT to RTLS, and the MM indicator changes from MM 103 to MM 601 (OPS 1 to OPS 6). At abort selection an OMS propellant dump is automatically initiated. The dump can be performed using OMS only or OMS plus 24 aft RCS jets (20 null jets and 4 +X jets). Depending on the flight, the OMS/RCS interconnect may be enabled or inhibited prior to lift-off. The dump is set to a predetermined I-loaded time duration. When the dump is interconnected, the dump time is adjusted with an I-loaded bias to account for the additional flow rate through the RCS jets.

Powered RTLS (PRTLS) is normally composed of three flight phases: fuel dissipation, flyback, and powered pitchdown (PPD). During the fuel dissipation phase, the vehicle continues heading downrange at a fixed inertial thrust attitude while cyclic computations are performed to determine the proper time to initiate powered pitcharound (PPA). The flyback phase, which includes PPA, guides the vehicle to the powered pitchdown (PPD) targets achieved at MECO-20 seconds. Throttling for mass control is performed during the flyback phase. The PPD maneuver serves two functions. It commands the orbiter/ET to the angle of attack required for separation and computes the SSME cutoff time. The SSME thrust is terminated at this cutoff time by the SSME OPS principle function. The following paragraphs describe each of the three flight phases in more detail.

2.6.1.1 Fuel Dissipation

The first maneuver in the fuel dissipation (FD) phase is a pitch attitude change to loft the vehicle and to deplete propellant. An I-loaded velocity breakpoint called V_SWITCH is used to determine whether first or second stage algorithms are used to compute fuel dissipation thrust attitude. For engine failures prior to SRB sep (in first stage), FD attitude is calculated as a function of V_{REL} and altitude rate (\dot{H}) at SRB staging. For engine failures after SRB sep (in second stage) and prior to V_SWITCH , FD attitude is a function of V_{REL} and \dot{H} at engine out. For engine failures in second stage and after V_SWITCH , FD attitude is a linear function of engine out V_{REL} alone. For three engine RTLS, FD attitude is computed from the V_{REL} and \dot{H} at abort initiation.

During fuel dissipation, cyclic computations are performed to determine the PPD state if turnaround were instantaneously initiated. The vehicle position, acceleration, and time are extrapolated to the estimated end of the turn, and PEG is called to obtain the velocity required to achieve the PPD targets. This velocity is summed with the estimated velocity gained during the turn and is used in the ideal rocket equation to predict the final mass at PPD.

In equation form,

$$MF = MEXP [VGOMAG + (ESTACC)(DTTURN)/VEX] - MBIAS$$

Where MF = Final mass at PPD

MEXP = Units conversion term

VGOMAG = Velocity required to achieve PPD targets

ESTACC = Estimated acceleration during PPA

DTTURN = Estimated time of PPA maneuver duration

VEX = Total effective exhaust velocity

MBIAS = Final mass bias to prevent late PPA

If PEG is converged, the predicted final mass is less than or equal to the I-loaded desired final mass, and the desired flyback attitude satisfies initial flyback attitude constraints (i.e., the flyback thrust attitude is toward the landing site), then PPA is initiated. Note that fuel dissipation is not initiated for late RTLS aborts (RTLS initiated later than the I-loaded velocity, V_LATE). In these cases, PPA occurs immediately after RTLS abort selection.

2.6.1.2 Flyback

The PPA maneuver is performed at approximately $10^\circ/\text{sec}$ and marks the beginning of the flyback phase. The RTLS PPA maneuver is shown in figure 2.6.1.2-1.

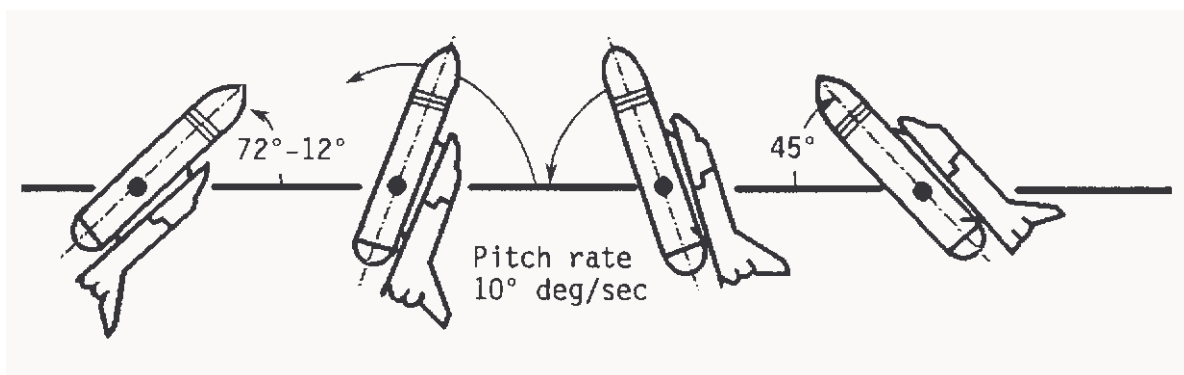

Figure 2.6.1.2-1: RTLS Pitcharound Maneuver

Once the PPA occurs, flyback guidance is initiated to arrest the downrange velocity and add sufficient uprange velocity for the orbiter to return. During the flyback phase, guidance cyclically attempts to achieve PPD targets, which consist of altitude, flight path angle, and R-V line. The I-loaded PPD targets are biased from the desired ET sep conditions, where the amount of bias depends on the number of engines running, the time of engine failure, and center versus side engine out. Active SSME throttling is performed to make final adjustments to the MPS propellant remaining to allow for a satisfactory ET sep (less than 2% excess MPS propellant remaining in the ET) and to remain below the 3g acceleration level. The engines should maintain a throttle setting of approximately 100% during flyback for two engine RTLS aborts. If guidance computes a throttle setting of 104%, MAX THROTTLE is enabled on the OVERRIDE display to allow guidance to command up to 109%. This condition could be caused by low staging altitude rate. The minimum SRB sep altitude rate ranges between 1400 and 1550 fps depending on the staging velocity required to satisfy the 20 pounds per square foot (psf) flyback QBAR limit. For three engine RTLS aborts, the engines should maintain a throttle setting of approximately 69%.

2.6.1.3 Powered Pitchdown

The final powered RTLS phase is the PPD phase. The PPD phase is initiated approximately 20 seconds before MECO. During this phase the main engines are throttled down to minimum thrust (usually 67%), and the vehicle angle of attack is reduced from about 50° to the ET separation alpha of -2°. MECO is commanded based on TGO to the desired cutoff velocity magnitude.

The mated coast phase of ET separation begins at the MECO command event, at which time the glide RTLS (GRTLS) DAP is activated. The ASC DAP, however, continues to control the MPS gimbals until the software zero thrust event. During the overlap, both DAPs use an attitude hold scheme. The overlap is provided to ensure that authority is always adequate to control aerodynamic loads during MPS tailoff.

When the separation sequencer has completed all the tasks of the mated coast phase, the DAP begins to interrogate the state vector for compliance with the structural release inhibit values, which are shown in table 2.6.1.3-I. If the inhibit values are satisfied, the ET separation command is issued, the structural release pyros are fired, and the four forward and six aft down firing RCS jets are fired for 10 seconds for -Z translation. If the inhibit values are not satisfied, the ET sep inhibit is overridden and separation commanded after a 6 second timer expires. Figure 2.6.1.3-1 illustrates the ET and Orbiter during mated coast and ET separation. The ET Umbilical Doors are automatically closed by either the PASS or BFS software 1.5 minutes after MECO.

Table 2.6.1.3-I: Orbiter/ET RTLS Abort Design Conditions

Event Parameter	MECO	Structure Release	Separation Termination	Auto Sep Limits
Angle of attack - α	$-3 \pm 1.5^\circ$	$-2.5 \pm 1^\circ$	$>10^\circ$	$-89.0 < a < -2.0^\circ$
Roll angle - ϕ	$0 \pm 2^\circ$	$0 \pm 20^\circ$	$0 \pm 30^\circ$	
Sideslip angle - β	$0 \pm 2^\circ$	$0 \pm 2^\circ$	$0 \pm 3^\circ$	$-2.0 < b < 2.0^\circ$
Yaw rate - r	$0 \pm 0.5^\circ/\text{sec}$	$0 \pm 0.5^\circ/\text{sec}$	$0 \pm 1^\circ/\text{sec}$	$-0.5 < r < 0.5^\circ/\text{sec}$
Pitch rate - q	$0 \pm 0.5^\circ/\text{sec}$	$-0.25 \pm .5^\circ/\text{sec}$	$0 \pm 2^\circ/\text{sec}$	$-5.0 < q < 5.0^\circ/\text{sec}$
Roll rate - p	$-0.25 \pm 0.5^\circ/\text{sec}$	$0 \pm 2^\circ/\text{sec}$	$2.5 \pm 2.5^\circ/\text{sec}$	$-5.0 < p < 0.25^\circ/\text{sec}$
Dyn. pressure - QBAR		$6 \leq \text{QBAR} \leq 9.5 \text{ psf}$		

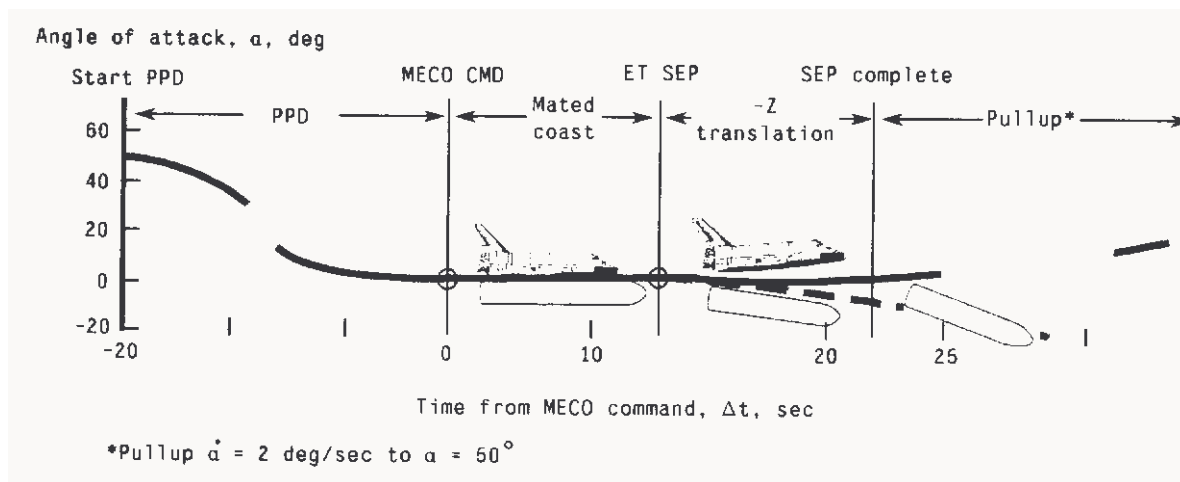

Figure 2.6.1.3-1: Mated Coast and ET Separation

2.6.2 Glided RTLS

The GPCs transition to MM 602 at the end of the orbiter -Z translation maneuver when angle of attack is greater than 10° and time since ET structural release is greater than 10 seconds. If automatic transition does not occur, the crew selects OPS 602 via the keyboard. MM602 Glided RTLS consists of the Alpha Recovery, Nz Hold, and Alpha Transition phases. At Mach 3.2, the software automatically modes to Major Mode 603 which includes the normal TAEM S-turn (if required for excessively high energy), Acquisition, Heading Alignment, and Prefinal phases. There are a few differences between MM603 and MM305 TAEM but Approach and Landing is identical.

2.6.2.1 Alpha Recovery

During the Alpha Recovery phase, the vehicle continues to pitch up to a guidance commanded angle of attack of 50° and remains wings level. This attitude is maintained until normal acceleration (Nz) is within .35 g's of the target Nz and guidance transitions to the Nz Hold phase. Guidance will also mode to the Nz Hold phase if the angle of attack drops below $35_{[AFPH2-23]}^\circ$ after initially exceeding 35° . This could be possible when the crew is flying CSS. The crew pitches the vehicle up to the commanded 50° alpha such that alpha exceeds 35° . If alpha then drops below 35° , guidance will prematurely transition to the Nz Hold phase. Figure 2.6.2.1-1 illustrates the angle of attack and normal load factor profiles flown during MM602.

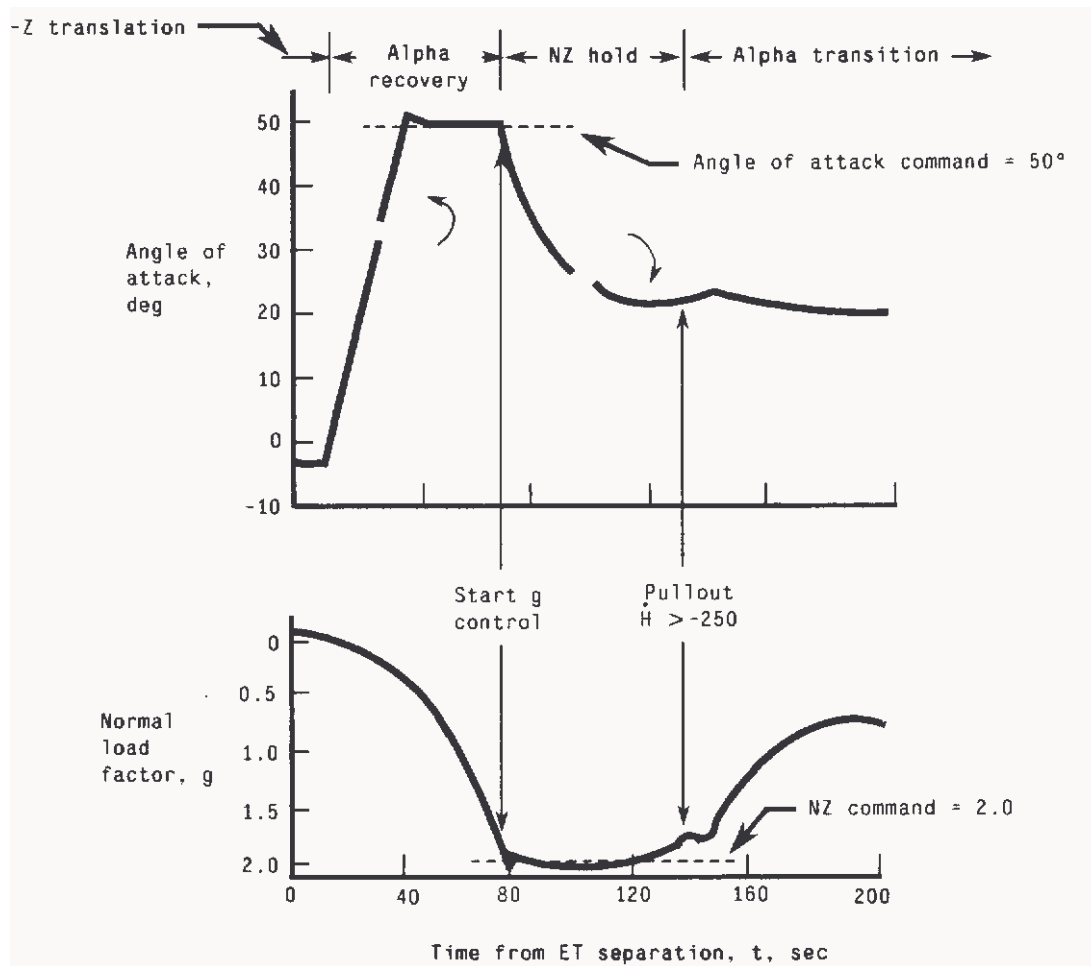

Figure 2.6.2.1-1: Angle of Attack and Normal Load Factor Profiles

2.6.2.2 *Nz Hold*

Once the Nz Hold phase is entered, a wings level attitude is held and a Nz command is sent to flight control instead of an alpha command to maintain the target Nz level. The target Nz is usually between 2 and 2.2 g's, such that transition to the Nz Hold phase occurs when Nz is about 1.8g. During the Nz Hold phase, the altitude rate (Hdot) typically peaks at about -1500 fps before being arrested. The Nz Hold phase is maintained until the altitude rate is greater than -320 fps and alpha is greater than the reference angle of attack.

2.6.2.3 *Alpha Transition Phase*

Once altitude rate exceeds -320 fps and alpha is greater than alpha reference, the pullout is complete and guidance modes to the Alpha Transition phase. During this phase, the commanded alpha is a function of Mach number to reduce altitude rate and transition to the front side of the L/D curve in preparation for normal TAEM. The roll command is issued to null heading errors to the HAC tangency point (roll cmd = 2.5 x heading error, limited to 45°) or to execute S-turns (roll command = 45°) for excessively high energy management. The Alpha Transition phase is the first phase of GRTLS guidance where the actual energy over weight, S-turn, overhead to straight-

in HAC downmode, and minimum entry point (MEP) HAC reference profiles are computed. At this point, guidance may issue low energy alerts for downmode to straight-in or switch to MEP.

2.6.2.4 TAEM

At Mach 3.2, the software transitions to MM603 and TAEM guidance becomes active. The GRTLS TAEM guidance phases (S-turn, acquisition, heading alignment, and prefinal) are identical to the nominal entry TAEM guidance except:

- (a) The energy over weight, altitude, and dynamic pressure references are extended to higher speeds to include all possible conditions existing when the trajectory is stabilized following the load relief maneuver.
- (b) To provide greater energy control, the bank angle limit during S-turn is increased from 30° to 45°.
- (c) Nz Command is also limited by angle of attack in MM603 (see figure 2.6.2.4-1) and not just by energy over weight and dynamic pressure as in MM305.
- (d) The subsonic bank angle limit while on the HAC is decreased from 60° to 55°.
- (e) S-turns are allowed for all HAC turn angles if excessively high energy conditions exist, whereas for MM305 S-turns are only allowed for HAC turn angles below 200°.

See the Entry Flight Procedures Handbook, JSC 11542, for detailed information on the TAEM guidance phases.

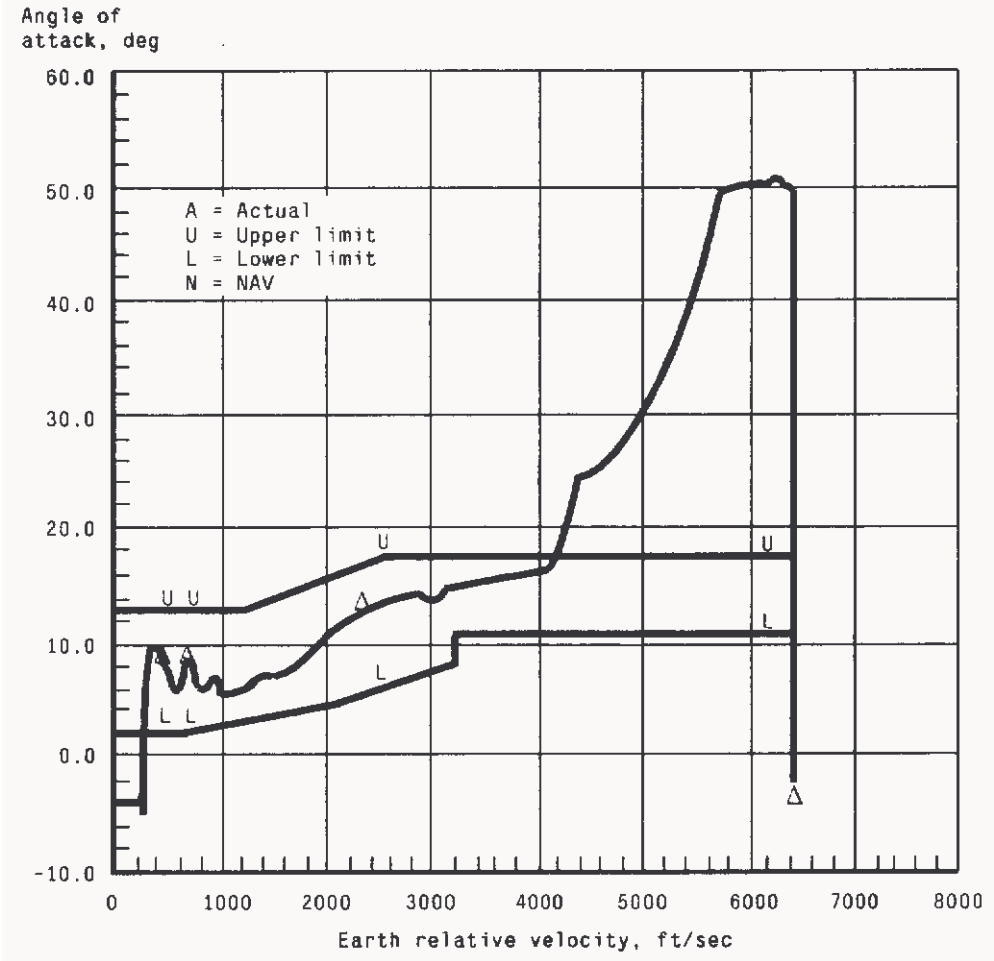

Figure 2.6.2.4-1: MM603 Angle of Attack Limits

2.7 CONTINGENCY ABORT (CA)

The primary space shuttle abort modes, known as intact aborts, are the RTLS abort, the TAL, the AOA, and the ATO. A CA must be performed whenever the shuttle thrust to weight ratio is less than that needed for achieving orbit or an intact abort. This abort can occur if three SSMEs fail prior to the AOA velocity boundary (approximately 25,000 fps) or if two SSMEs fail prior to single engine TAL capability (approximately 13,500 fps). In general, aborts other than auto completion RTLS, auto completion TAL, AOA steep, or ATO, are considered CAs. For example, a late TAL to a contingency site requiring manual procedures or a low energy TAL requiring low energy guidance is a CA even though a landing may be achieved. A CA may also be needed for a single engine failure if the remaining two engines are not operating at full performance. For example, if one engine is failed and another engine's throttle is stuck "in the bucket", a CA procedure is needed. MCC calls and the no comm mode boundaries cue card indicate when intact abort capability is available.

The purpose of CA is to guide the vehicle to a safe gliding flight condition where an ECAL, a Bermuda (BDA) landing, a landing at a downrange TAL site or ELS, or a bailout can be performed. Two engine and three engine out CAs are automated for both powered flight and the entry pullout. OI-28 software added the OPS 6 Entry ECAL Automation logic (CR90724D). This logic automates the entry portion of ECAL/Bermuda aborts while providing better energy management and loads management schemes than the previous manual procedures. ECAL/Bermuda landing capability was also improved with the automation. [AFPH2-24].

The CA is a very dynamic flight mode that often takes the orbiter to the limits of its structural and flight control envelopes. In some cases, the orbiter is left without thrust at such high altitudes and low velocities that the entry may not be survivable (too steep an entry angle to achieve pullout within structural limits). The regions where entry success is questionable are commonly referred to as black zones (described later).

Orbiter features supporting the CA mode include single engine roll control (SERC), contingency OMS and MPS dumps, fast ET sep, and automated abort guidance in PASS. Automatic ET Umbilical Door closure also occurs 1.5 minutes after MECO during OPS 6, 1.5 minutes after MM 304 transition, or for a fast ET sep as long as not initiated in MM 102. BFS software does not support CA or SERC (it does provide fast sep in MM 102).

CA may be divided into three major phases: (1) powered contingency, (2) ET sep and mated coast, and (3) entry. A detailed description of each of the three CA abort phases follows.

2.7.1 Powered Contingency

The Single Engine Auto Contingency Abort logic was added to the Flight Software in OI-21 with CR 89990. This CR was incorporated to completely automate the powered flight portion of two engine out contingency aborts. Once invoked, the auto contingency logic commands the appropriate pitch/yaw attitude and the roll to heads up. The roll to heads up orients the bottom of the orbiter/ET in the direction of the velocity vector, which is the proper attitude to start the ET sep and prepare for entry into the atmosphere. The type of ET separation and length of -Z translation is also determined but may be “overridden” by the auto three engine out contingency logic if required. The auto contingency logic also starts single engine roll control (if not already active) and automatically initiates the OMS dump, which reduces the orbiter weight and moves the X c.g. forward. Reducing weight decreases the peak QBAR that occurs during pullout. Moving the X c.g. forward reduces the elevon and body flap deflections required during pullout, which decreases the probability of aerosurface saturation or actuator stall. The auto contingency software is also invoked when an engine is stuck in the throttle bucket and another fails prior to stuck RTLS capability.

If two SSMEs fail during first stage, the SRBs are gimbaled to achieve trajectory lofting (autoloft) to compensate for the loss of thrust from the failed main engines. No further abort maneuvering is performed until after SRB sep, at which point Powered Contingency takes over.

The type of powered Contingency Abort maneuver is determined based on the abort after the first SSME failure (non-RTLS versus RTLS) and trajectory parameters such as altitude rate, inertial velocity, and equivalent airspeed. The type of maneuver, referred to as CA mode, is color coded for reference and displayed on the ASCENT TRAJ as shown in table 2.7.1-I.

Table 2.7.1-I: 2 E/O Contingency Abort Mode versus Color Code

CA Mode	Abort	ASCENT TRAJ Color Code
0	CONT	blank
1	“	BLUE
2	“	GREEN
0	RTLS	blank
1	“	BLUE
2	“	YELLOW
3	“	ORANGE
4	“	GREEN
5	“	RED

If RTLS was not selected prior to the second engine failure, the CA mode will be either 0, 1, or 2. The CA mode is set to zero and the 2 engine out color region on the ASCENT TRAJ blanked when inertial velocity is greater than 22K fps. At such high velocities the powered contingency logic is no longer needed since a TAL abort can be performed. Prior to 22K fps, if the altitude

rate is greater than 1330 fps, the CA mode is set to 1 (CONT BLUE). For high inclination missions, mode 1 yaw steering is allowed if the altitude rate is greater than 1850 fps to improve the probability of an ECAL for low speed CAs. Yaw steering is open loop. The shuttle reduces the crossrange to the site by commanding a fixed yaw attitude and does not target an R-V line. Yaw steering generally increases entry pullout loads by approximately 0.1g. Yaw steer in mode 1 for low and mid inclination missions is no-opted since their groundtracks are too far from the east coast to attempt an ECAL which does not warrant the increase in pullout loads. Once altitude rate drops below 1330 fps or the yaw steer inertial velocity window is entered, the CA mode is set to 2 (CONT GREEN). If the velocity is within the yaw steer inertial velocity window, then mode 2 yaw steer will be performed. If the velocity is not within this window and the altitude rate is between 1330 fps and 800 fps (early portion of CONT GREEN), a combination of mode 1 and mode 2 will be performed for two engine failures. The mode 1 maneuver will be performed until altitude rate is less than 500 fps. At this point, the mode 2 maneuver will begin. Notice that in this region the two engine out color region on the ASCENT TRAJ will be GREEN. The only insight the crew has that they are in the combined maneuver region is that the vehicle pitch will be commanded to 0° for a short period of time and then pitch up to 100° as discussed in sections 2.7.1.1 and 2.7.1.2. Table 2.7.1-II summarizes CA mode selection when an RTLS abort is not performed after the first engine failure.

Table 2.7.1-II: Non-RTLS Mode Selection Summary (51.6° except as noted)

CA Mode	Mode Select Criteria	Yaw Steer Criteria
0 (blank)	VI > 22K	N/A
1 (BLUE)	HDOT > 1330 and VI ≤ ¹ 6.5K	HDOT > ² 1850
2 (GREEN)	HDOT ≤ 1330 or VI > ¹ 4.5K	4.5K < VI < ³ 23.0 [AFPH2-25]
2 (GREEN - comb mnvr)	800 < HDOT ≤ 1330 and VI ≤ ¹ 6.5K	N/A

¹9.4K for 28.5°, 9.2K for 39°, 4.5K for 51.6°, and 5.5K for 57° inclination missions.

²10,000 for 28.5° and 39°, 1850 for 51.6° and 57° inclination missions.

³12.2K for 28.5°, 11.2K for 39°, 23.0K for 51.6°, 23.0K for 57° inclination missions.

If an RTLS abort was declared prior to the second engine failure, there are six possible CA modes including 0, 1, 2, 3, 4, and 5. The RTLS CA mode is set to zero and the 2 engine out color region on the ASCENT TRAJ blanked when fine countdown occurs. If the powered pitcharound (PPA) maneuver has not occurred prior to the loss of two SSMEs, the RTLS CA mode will be either 1 or 2 depending on the altitude rate. If altitude rate is greater than 1450 fps, then the CA mode is 1 (RTLS BLUE). Otherwise, the RTLS CA mode is set to 2 (RTLS YELLOW). Once PPA has occurred, the RTLS CA mode may be equal to 2, 3, 4, or 5. The transition from RTLS CA mode 2 (RTLS YELLOW) to mode 3 (RTLS ORANGE) occurs approximately 10 seconds prior to $V_{REL} = 0$. It actually occurs when the horizontal component of downrange velocity is less than or equal to 350 fps. The transition from mode 3 (RTLS ORANGE) to 4 (RTLS GREEN) occurs when equivalent airspeed exceeds 20 knots. The final RTLS CA mode, mode 5 (RTLS RED) occurs when altitude rate exceeds 100 fps. Table 2.7.1-III summarizes CA mode selection when an RTLS abort is performed after the first engine failure.

Table 2.7.1-III: RTLS Mode Selection Summary

CA Mode	Mode Select Criteria	Yaw Steer Criteria
0 (blank)	Fine Countdown	N/A
1 (BLUE)	HDOT > 1450 (prior to PPA)	HDOT > 10,000 (no-opt)
2 (YELLOW)	HDOT ≤ 1450 (prior to PPA) & V_HORIZ_DNRNG > 350	N/A
3 (ORANGE)	V_HORIZ_DNRNG ≤ 350	N/A
4 (GREEN)	EAS ≥ 20	N/A
5 (RED)	HDOT ≥ 100	N/A

2.7.1.1 CONT 2 E/O BLUE and RTLS 2 E/O BLUE (CA Mode 1)

If two SSMEs are failed, the remaining thrust is used after staging to reduce the sink rate that occurs during entry. This reduction can be done by directing the thrust vector to lower the altitude and/or bring the flight path angle (gamma) to zero before separation. To describe this another way, the thrust should minimize the calculated apogee altitude since apogee altitude combines the effects of current altitude and flight path angle. For early failures (before approximately 7,000 fps) the orbiter trajectory is still very steep, so the vehicle is pitched down to the horizon to reduce apogee. This attitude also effectively uses the remaining thrust to increase the horizontal component of velocity which shallows out the entry flight path angle (gamma), reduces the severity of the entry pullout, but possibly increases entry heat loads. If a vertical thrust attitude were used, the flight path angle would remain steep, resulting in the ballistic trajectory in dotted line a (fig. 2.7.1.1-1). This trajectory creates severe entry pullout loads. Instead, by thrust vectoring to a horizontal attitude, the apogee is reduced and the entry angle is minimized as in dotted line b. This is the basis for the two engine out BLUE or CA mode 1 maneuver.

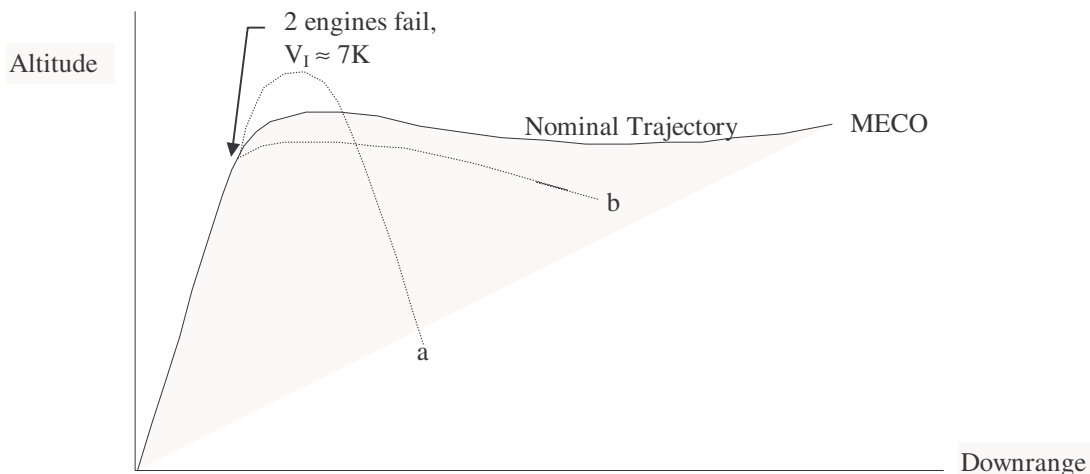

Figure 2.7.1.1-1: Two Engines Out Prior to Approximately V₁ = 7000 fps

If CA Mode 1 yaw steering is not performed, the vehicle pitch and yaw attitude will be approximately 0°. If Mode 1 yaw steering is performed, the vehicle will be pitched slightly higher

to 15° and yawed out of plane 30° toward the east coast. The vehicle remains in a heads down position until 2 seconds has elapsed since the sensed thrust vector was within about 5° of the commanded thrust vector. At that time, the roll to heads up is commanded and is considered complete when the roll error is less than 5° . If yaw steering is being performed, the vehicle will yaw back in plane when altitude rate becomes less than 500 fps. The pitchdown at $3^\circ/\text{sec}$ [AFPH2-26] will be initiated 3 seconds after the sensed thrust vector is within about 5° of the commanded thrust vector. If yaw steering is not being performed, the vehicle will begin the pitchdown at $3^\circ/\text{sec}$ when altitude rate becomes less than 0 fps. An alpha -2° separation followed by a 5 second $-Z$ translation is commanded in this region (3 E/O Contingency can “override” Powered Contingency’s ET separation selection if required).

2.7.1.2 CONT 2 E/O GREEN and RTLS 2 E/O YELLOW (CA Mode 2)

If two SSMEs fail at a V_I between approximately 7,000 and 12,000 fps, a vertical thrust vector is used because, by this point, the nominal trajectory has leveled off and the flight path angle is already close to zero (powered flight apogee reached). Loss of thrust here results in an increase in negative altitude rate (dotted line a, fig. 2.7.1.2-1). If a pitchup to a vertical thrust angle (approx. $100^\circ \Theta$) is used, the trajectory in dotted line b results and entry pullout loads are reduced. This is the basis for the two engine out CONT GREEN and RTLS YELLOW maneuver.

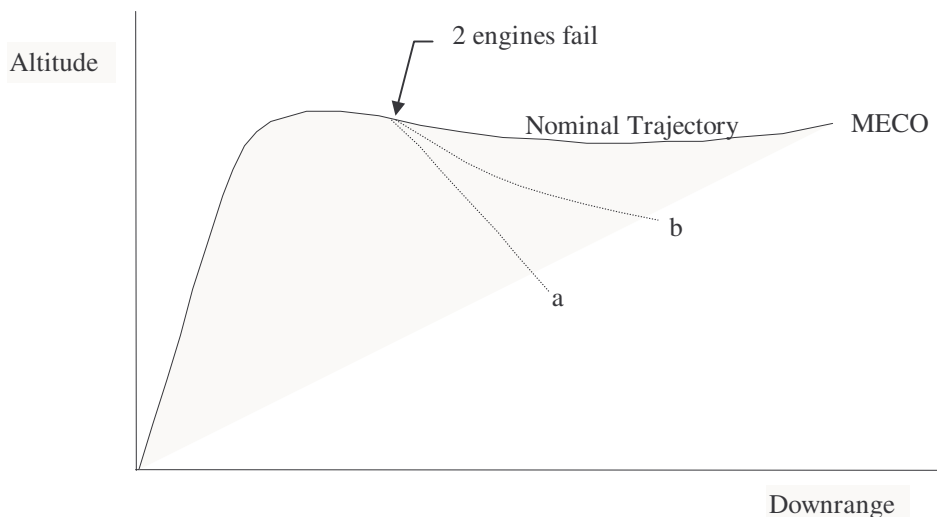

Figure 2.7.1.2-1: Two Engines Out Between 7000 and 12,000 fps

If CA Mode 2 yaw steering is not performed, the vehicle pitch attitude will be approximately 100° and with a 0° yaw attitude. If Mode 2 yaw steering is performed, the vehicle will be pitched to 60° and yawed out of plane 45° toward the east coast or Bermuda. The vehicle remains in a heads down position until 2 seconds has elapsed since the sensed thrust vector was within about 5° of the commanded thrust vector. At that time, the roll to heads up is commanded and is considered complete when the roll error is less than 5° . If yaw steering is being performed, the vehicle will be commanded back in plane when altitude rate is negative and EAS is greater than 3.3 knots if the center engine is running or 5.3 knots if a side engine is running. The pitchdown at

3°/sec will be initiated 3 seconds after the sensed thrust vector is within about 5° of the commanded thrust vector. If yaw steering is not being performed, the vehicle will begin the pitchdown at 3°/sec when altitude rate is negative and EAS is greater than 10 knots. A high rate separation followed by a 8 second -Z translation is commanded in this region (3 E/O Contingency can “override” Powered Contingency’s ET separation selection if required).

2.7.1.3 RTLS 2 E/O ORANGE (CA Mode 3)

Until reaching $V_{REL} = 0$ on the RTLS trajectory, the two engine out abort maneuvers are the same as for the nominal uphill case. For the loss of 2 SSMEs near $V_{REL} = 0$, the vehicle is initially kept in an in plane pitch attitude. A wings level and zero beta attitude is maintained until altitude rate becomes negative and EAS exceeds 10 knots. At this point the vehicle is pitched down at 3°/sec in preparation for a high rate separation followed by a 5 second -Z translation (3 E/O Contingency can “override” Powered Contingency’s ET separation selection if required).

2.7.1.4 RTLS 2 E/O GREEN (CA Mode 4)

If two engine failures occur after an EAS of 20 knots and prior to reaching an altitude rate of 100 fps, an immediate pitchdown is required. An alpha -2° separation followed by a 5 second -Z translation is commanded (3 E/O Contingency can “override” Powered Contingency’s ET separation selection if required).

2.7.1.5 RTLS 2 E/O RED (CA Mode 5)

Once an altitude rate of 100 fps is reached on an RTLS, a runway landing should be possible if a second engine fails in this region. The pitch attitude of the vehicle is commanded (maximum of 75°) to reach the desired altitude rate of 400 fps prior to powered pitchdown. Even though a runway landing is expected in the RED region, there may be insufficient propellant to reach the RTLS R-V line. If SSME cutoff occurs prior to the desired alpha of -2°, ET recontact may occur. Therefore, powered contingency guidance monitors the time to guided MECO as well as the time to MPS propellant depletion to determine when to command pitchdown to alpha -2°.

The time to guided MECO is estimated as the time for the RTLS TRAJ display cutoff bug to reach the cutoff mark. The time remaining before MPS propellant depletion (TGO_EMPTY) is computed based on the mass flow rate and the current vehicle mass less the empty vehicle mass and less the mass of the propellant used for single engine roll control. The time to powered pitchdown (TGO) is then computed as the time to guided MECO or depletion, whichever is expected first, less the estimated time to complete the powered pitchdown maneuver (between 10 and 16 seconds). If the time to MPS propellant depletion (TGO_EMPTY) is less than 24 seconds and manual throttling is not being performed, a special set of commands are issued to permit completion of the powered pitchdown at a safe throttle level. This special set of commands includes a throttle level of 91% and setting fine countdown such that powered pitchdown will occur six seconds later. This ensures MECO after powered pitchdown is completed at a safe throttle level. If the time to MPS propellant depletion is greater than 24 seconds, this special set of commands is not issued since sufficient propellant exists to MECO at 104%. Fine countdown is set when TGO is less than six seconds. Powered pitchdown is initiated when TGO is less than or equal to zero, which is similar to an intact RTLS. Note that manual throttle also precludes this special set of commands. Even if throttles are manually taken to 91%, it is undesirable to use

manual throttle control in the RED region since the powered pitchdown will not be commanded until the time to complete the pitchdown is equal to the time to propellant depletion. This procedure has no conservatism and could result in propellant depletion prior to completion of powered pitchdown.

2.7.2 Contingency 3 Engine Out (Mated Coast and ET Separation)

Safe ET sep is a function of alpha and QBAR. Rockwell analysis results are shown in figure 2.7.2-1. As the shuttle continues to fall during CA powered flight, QBAR increases, and separation from the ET must occur. The orbiter can separate from the ET at QBARs up to 10 psf. At dynamic pressures above 10 psf, the ET may recontact the orbiter after separation. From 2 to 10 psf the orbiter should be at a small (originally -4° , currently -2°) negative angle of attack to ensure successful separation. This separation technique is used for normal RTLS. Below 2 psf, the orbiter can be at positive angles of attack but the $-Z$ translation time is increased to prevent recontact.

Rule of thumb:
$$QBAR = \frac{EAS^2}{1000} \times 3.3$$

Commonly used QBARs:

9 KEAS	= .25 psf QBAR
25 KEAS	= 2 psf QBAR
55 KEAS	= 10 psf QBAR
77 KEAS	= 20 psf QBAR

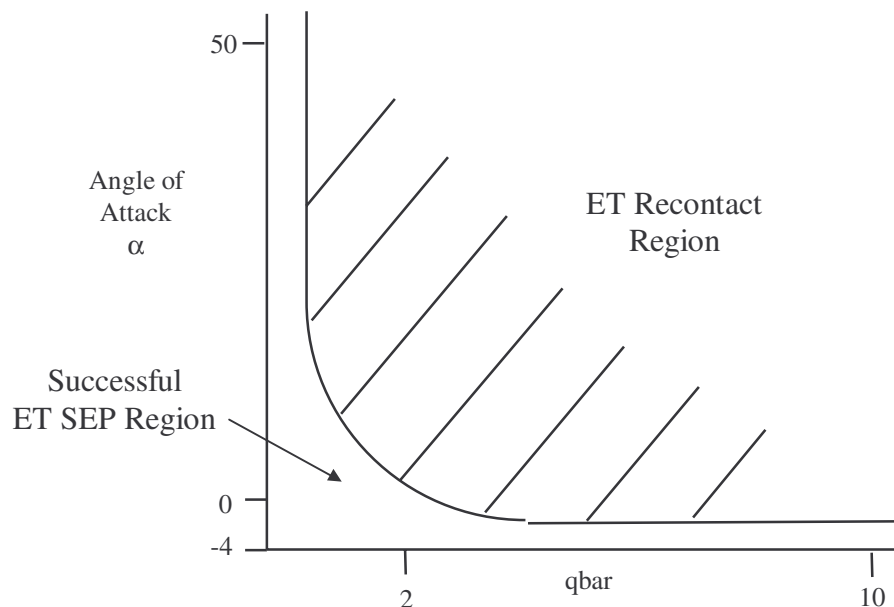
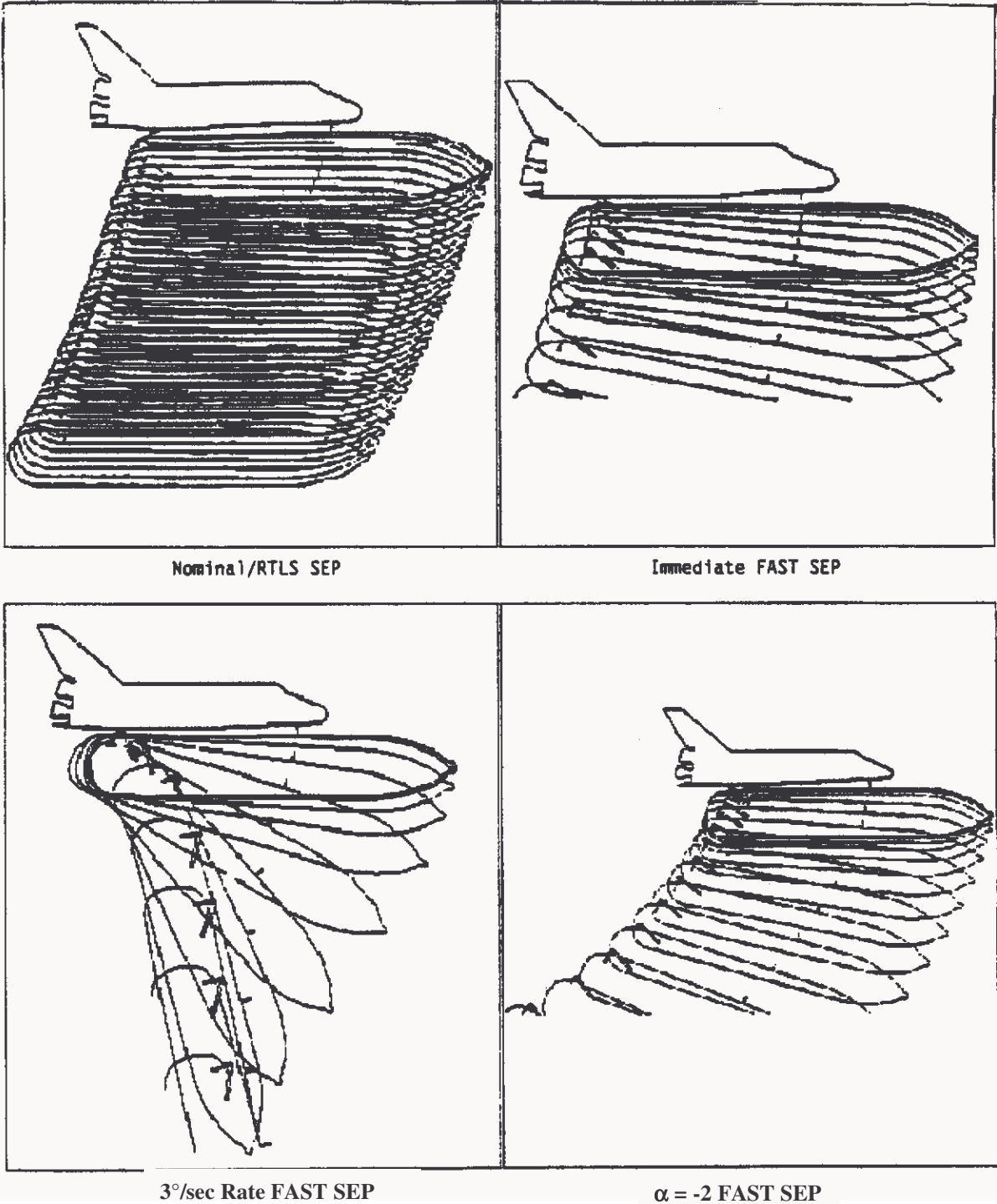

Figure 2.7.2-1: Successful ET Sep

Based on this data, the nominal ET sep maneuver was shown to be unsatisfactory for all contingency scenarios except for three engines out in second stage, when QBAR is sufficiently low (three engine out GREEN) and two engines out past droop, when a TAL is attempted. Furthermore, many CAs result in such rapid entry into the atmosphere (and rapid increase in QBAR), that the nominal RTLS ET sep maneuver (-2° α , 14 second separation) is also insufficient to avoid recontact. Using this procedure in many two engine out scenarios would

require terminating powered flight at higher altitudes and would increase the severity of the pullout. It is therefore only used in contingency aborts that are close to the nominal RTLS trajectory (RTLS two engine out after HDOT +100 (RED) and stuck RTLS).

To improve these recontact problems, a fast separation was developed for CAs and takes only 5 seconds. Fast separation can be performed in one of three methods, depending on the vehicle attitude and QBAR at the time separation is required. The first method is the “immediate” fast separation when no time (or thrust) is available to maneuver to a better attitude. The second method is an “ $\alpha -2^\circ$ ” fast sep, when sufficient time exists to achieve the attitude before QBAR exceeds 10 psf. The third method is a “rate” fast sep when the vehicle is already at the high angle of attack desired for entry and insufficient time is available to get to $-2^\circ \alpha$, before 10 psf. In the rate separation, instead of pitching to a negative angle of attack, which could take as much as 30 seconds, the separation is commanded while at a high angle of attack and a $-3^\circ/\text{sec}$ pitch rate, effectively “pushing” the tank away from the orbiter. Figure 2.7.2-2, on the following page, shows representative ET/orbiter clearances for each type of fast sep.



[AFPH2-27]

Figure 2.7.2-2: ET/Orbiter Clearances for Fast Sep

The rate sep procedure offers distinct advantages in many CA scenarios. First, for two engine out scenarios, it allows separation to be delayed as long as possible and extends the time available for powered flight. Second, in many cases the orbiter is already near the angle of attack that is required for entry, and the $-3^\circ/\text{sec}$ pitch rate needs only to be slowed as the proper angle of attack is reached. If the orbiter were taken to a negative angle of attack for separation, it would require two pitch maneuvers, a negative pitch to the separation angle of attack followed by a pitch back up to the entry alpha. The $-3^\circ/\text{sec}$ pitch rate used for the rate sep is a compromise between the need for a rapid pitchdown to get ET sep with the need to maintain control and slow the pitch rate after separation. Simulations have shown that pitch rates exceeding $-6^\circ/\text{sec}$ may result in loss of control. Figure 2.7.2-3 illustrates the rate sep maneuver.

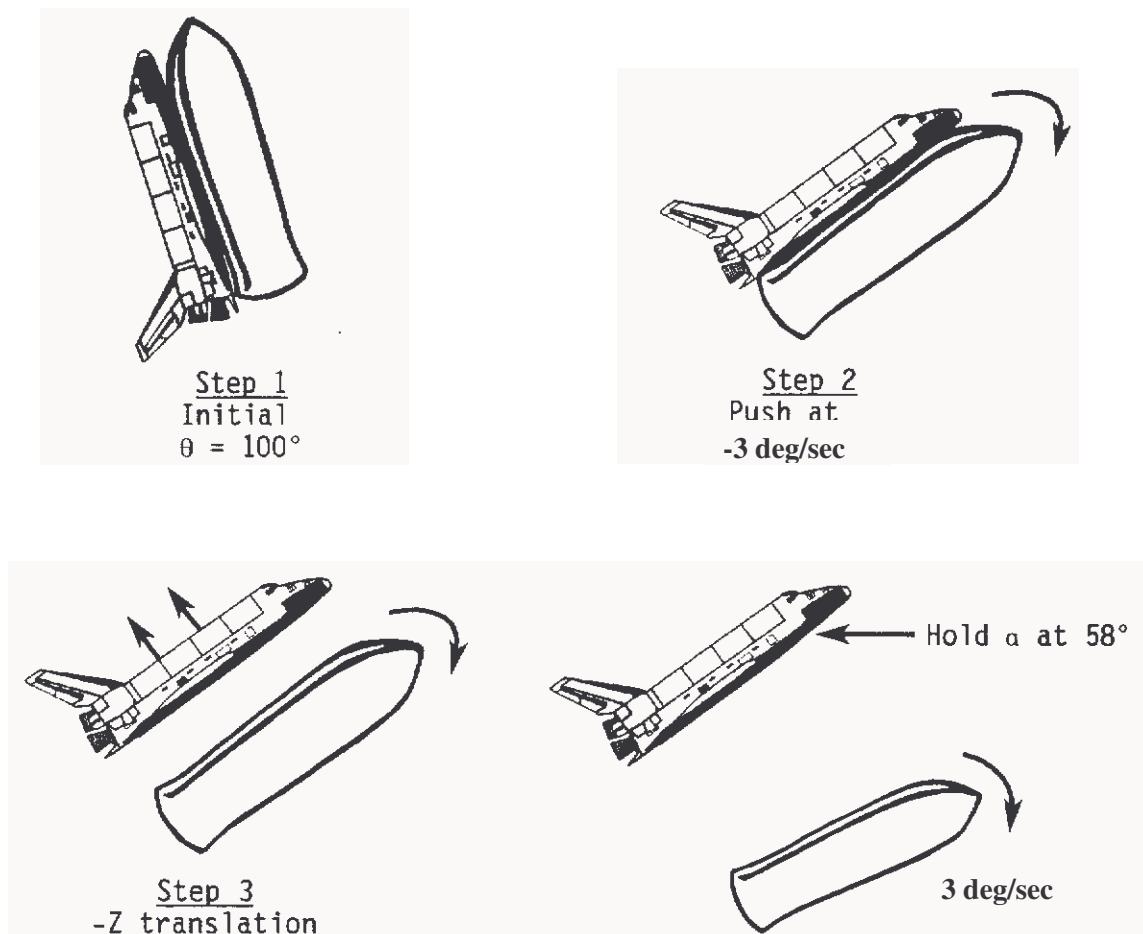

Figure 2.7.2-3: Rate Separation

The correct separation is commanded by the automated abort software for two engine out scenarios but may be overridden at MECO by the 3 engine out auto contingency logic. CR 90705, approved for OI-25, automated the manual contingency abort procedures for 3 engines out any time during powered flight. The nominal role of Contingency 3 E/O Guidance is to provide the crew with feedback during MM103 and MM601 on what type of maneuver would be commanded if all remaining engines were to fail at the current time. The type of maneuver is based on current and predicted dynamic pressure and other vehicle parameters. If the MECO confirmed flag is set and 3 E/O logic is required, then CONT 3 E/O GUID will automatically be invoked. Once invoked, contingency 3 E/O guidance determines the type of mated coast maneuver required, selects RTLS abort if currently in MM103, performs the appropriate mated coast maneuver, commands ET separation at the earliest safe time, commands -Z translation, initiates an automatic post-sep OMS dump if required, commands an automatic maneuver to entry attitude in MM601, and commands an automatic transition to MM602 at maneuver completion.

There was substantial debate as to whether the contingency 3 out guidance should be invoked automatically or manually by the crew. The original proposal invoked the logic via Item 3 (arm)/Item 4 (start) on the ASCENT TRAJ display. However, SES testing in May 92 showed that 10 to 20% of the cases required auto invoke to avoid major control problems. It was decided that the MECO confirmed flag would be the best parameter to use to invoke the logic automatically since when MECO confirmed is set, MECO has actually occurred or will occur immediately.

2.7.2.1 ET Separation Method Selection

2.7.2.1.1 3 E/O Auto Contingency Logic Disabled

A no-opt feature was built into the OI-25 software so that an I-loaded flag can be set to disable the three engine out auto contingency logic. The OI-21 through OI-24 3 E/O mode select logic, incorporated with the automation of 2 engines out powered contingencies, will drive the 3 E/O color region on the PASS TRAJ display if the OI-25 logic is disabled. The three engine out color region is displayed to the crew to direct them to the appropriate manual procedure for the loss of three main engines. Table 2.7.2.1.1-I lists the 3 E/O CA mode, the color code, and the type of ET separation for non-RTLS and RTLS aborts after the first engine failure.

Table 2.7.2.1.1-I: “Old” 3 E/O Contingency Abort Mode versus Color Code
(Pre-OI-25 or Post-OI-25 with 3 E/O Auto Contingency Logic Disabled)

CA Mode	Abort	ASCENT TRAJ Color Code	ET Sep Procedure
0	CONT	blank	Nominal 103 ET sep
1	“	BLUE	Sep during SRB tailoff
2	“	GREEN	Nominal 103 ET sep
1	RTLS	BLUE	$\beta = 0^\circ$, pull at $3^\circ/\text{sec}$, fast sep at $\alpha - 10^\circ$
2	“	YELLOW	$\beta = 0^\circ$, immediate sep
3	“	ORANGE	$\beta = 0^\circ$, push at $4^\circ/\text{sec}$ then fast sep
4	“	GREEN	$\beta = 0^\circ$, push at $4^\circ/\text{sec}$, fast sep at $\alpha 5^\circ$

The “old” 3 EO CA mode or color region is determined based on the abort after the first SSME failure (non-RTLS versus RTLS), events such as SRB separation and PPA, and trajectory parameters such as downrange velocity and equivalent airspeed. If RTLS was not selected after the first engine failure, the CA mode will be either 0, 1, or 2. The CA mode is set to zero and the 3 engine out color region on the Ascent TRAJ blanked when inertial velocity is greater than 22K fps. At such high velocities the contingency logic is no longer needed since a TAL abort can be performed. Prior to 22K fps, the CA mode is 1 (BLUE) in first stage or 2 (GREEN) after SRB separation. Table 2.7.2.1.1-II summarizes the “old” 3 engine out mode selection logic when RTLS was not selected after the first engine failure.

Table 2.7.2.1.1-II: “Old” Non-RTLS 3 E/O Mode Selection Summary

CA Mode	Mode Select Criteria
0 (blank)	$VI > 22,000$
1 (BLUE)	Prior to SRB Separation
2 (GREEN)	After SRB Separation when $VI \leq 22K$

If RTLS was selected after the first engine failure, the “old” 3 E/O RTLS CA mode will be 1, 2, 3, or 4. The CA mode will be 1 (BLUE) until PPA at which time it changes to 2 (YELLOW). When the horizontal component of the downrange velocity becomes less than or equal to 1000 fps, the CA mode changes to 3 (ORANGE) until the equivalent airspeed builds to 20 knots. At an EAS of 20 knots, the 3 E/O CA mode changes to 4 (GREEN). Table 2.7.2.1.1-III summarizes the “old” 3 engine out mode selection logic when RTLS was selected after the first engine failure.

Table 2.7.2.1.1-III: “Old” RTLS 3 E/O Mode Selection Summary

CA Mode	Mode Select Criteria
1 (BLUE)	Prior to PPA
2 (YELLOW)	After PPA and $V_HORIZ_DNRNG > 1000$
3 (ORANGE)	$V_HORIZ_DNRNG \leq 1000$ and $EAS < 20$
4 (GREEN)	$EAS \geq 20$

2.7.2.1.2 3 E/O Auto Contingency Logic Enabled

In OI-25, when the 3 E/O auto contingency logic is enabled (standard configuration), there are six “color regions” which include BLUE, GREEN, YELLOW, ORANGE, RED, and blank. The Contingency 3 EO Mode Select Task defines a region indicator based on trajectory conditions and passes this indicator to the PASS TRAJ which displays the appropriate text string. Table 2.7.2.1.2-I lists the 3 E/O region, the color code, and the type of ET separation.

Table 2.7.2.1.2-I: OI-25 3 E/O Contingency Abort Mode versus Color Code
(3 E/O Auto Contingency Logic Enabled)

Region	Character String	ET Sep Maneuver
102	BLUE	sep during SRB tailoff
1	GREEN	attitude independent separation
2	ORANGE	maneuver to $\beta = 0^\circ$, establish $-3^\circ/\text{sec}$ pitch rate, and sep
3	YELLOW	maneuver to $\beta = 0^\circ$, $\alpha = -2^\circ$ and separate
4	RED	maneuver to $\alpha = 125^\circ$, establish negative pitch rate, and separate
0	(blank)	Nominal 103 or 601 ET sep

The logic to determine which ET separation maneuver, designated by the colors listed above, is much more complex than the pre-OI-25 crew procedures. For three engines failed in first stage, the region index is simply set to 102 (BLUE). For three engines failed in second stage after an inertial velocity of 22K fps, the region index is set to zero and the color region blanked on the PASS TRAJ since the 3 engine out auto contingency logic is not required. When inertial velocity is between 22K and 14K fps, this logic may or may not be required depending on the predicted apogee conditions. An OPS 3 TAL completion will be performed rather than an OPS 6 fast separation, if the loads during the OPS 3 entry pullout are predicted to be below 3.5g. This prediction is made by comparing the predicted apogee altitude with a 3.5g apogee altitude versus velocity profile. If the predicted apogee altitude is below this profile, then OPS 3 entry pullout loads will be less than 3.5g and a fast separation is not required. The region index is set to zero and the 3 engine out color region blanked on the PASS TRAJ. If the predicted apogee altitude is above the 3.5g altitude versus velocity profile or inertial velocity is less than 14K fps, then an OPS 6 fast separation is required. The following figure summarizes the use of the 3 E/O auto contingency logic for uphill cases (nominal, ATO, TAL).

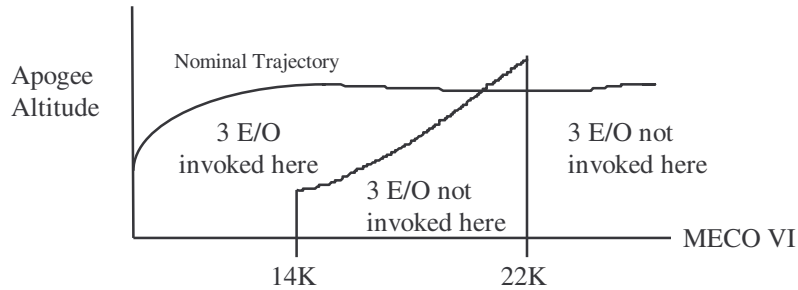

Figure 2.7.2.1.2-1: 3 E/O Auto Contingency Use for Uphill Cases

If an RTLS abort is declared after the first engine failure, range to the R-V target line is used to determine if the 3 engine out auto contingency logic is required. If past $V_{REL} = 0$ and the range to the target line is less than 35 nm, the region index is set to zero and the 3 engine out color region is blanked on the PASS TRAJ. If the range to the R-V line is greater than 35 nm, the 3 engine out auto contingency separation is required. Figure 2.7.2.1.2-2 illustrates when the 3 engine out auto contingency logic is required for an RTLS abort.

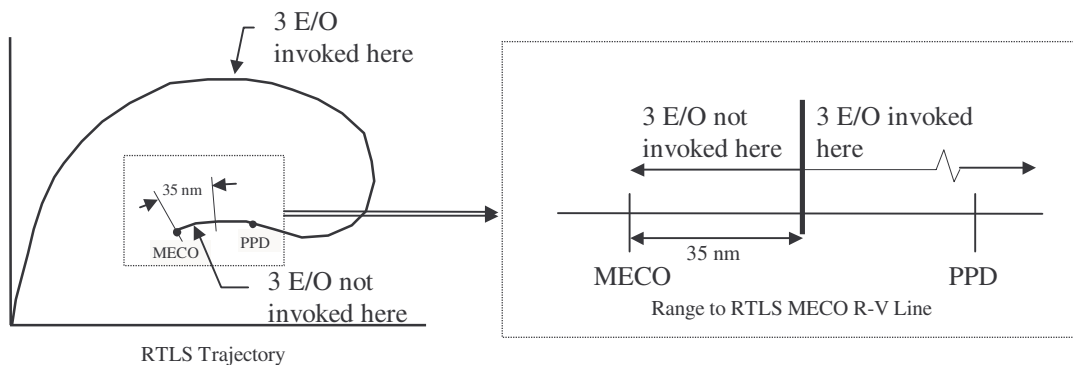

Figure 2.7.2.1.2-2: 3 E/O Auto Contingency Use for RTLS Cases

The type of 3 engine out auto contingency separation (for both RTLS and non-RTLS cases) will be based on the dynamic pressure region. If the minimum dynamic pressure is predicted to be greater than 2 psf (25 KEAS), then the region index is set to 3 (YELLOW) to command an alpha -2° sep. The alpha -2° separation is required in this region since the Orbiter must be at a small negative angle of attack to ensure a successful separation between 2 and 10 psf. At dynamic pressures above 10 psf (55 KEAS), there may be ET recontact problems even at alpha -2° . A downmode from region 3 (YELLOW) to region 4 (RED) may be required if there is not enough pitch authority to reach the -2° targeted angle of attack. In this case, the vehicle will either not

pitch at all or have a slight positive pitch rate. Therefore, a downmode to the RED region is performed and the vehicle is pitched to an angle of attack of 125° for ET separation.

If dynamic pressure is expected to be below 2 psf for ET separation, either a high rate sep or an attitude independent sep will be commanded. If current dynamic pressure is greater than .25 psf (9 kts KEAS) and increasing and the vehicle is at a positive angle of attack, a high rate separation is required and the region index is set to 2 (ORANGE). The region index will also be set to 2 (ORANGE) if a rate sep is already in progress when the 3 engine out logic assumes control from the 2 engine out auto contingency logic. If angle of attack is negative, the vehicle is already in an acceptable attitude for separation so that the pitchdown is not required and an attitude independent separation will be commanded (region 1, GREEN). An attitude independent separation will also be commanded if dynamic pressure is greater than .25 psf but decreasing since dynamic pressure will be sufficiently low at ET separation.

Note that no matter which region is selected, if three engines fail after SRB separation and dynamic pressure is greater than 20 psf (77 KEAS) and increasing, an immediate separation (referred to as emergency sep) will be commanded. The color region will not change on the PASS TRAJ display but a downlisted emergency separation flag will be set.

If MECO confirmed occurs when the 3 engine out region index is nonzero, the 3 engine out auto contingency logic will be automatically executed. If velocity is less than 2500 fps or the vehicle heading is away from KSC, the contingency abort flag is set so that the auto Nz guidance is used during entry. If the ADI error needles are stowed, they will be unstowed. The onboard software is automatically transitioned to MM601, if not already in MM601, since the GRTLS DAP is required for maximum RCS jet control authority. New jet selection logic was added for contingency aborts to maximize control authority by adding forward upward firing jets.

2.7.2.2 3 E/O BLUE (Region 102)

For three engines failed during first stage, an OMS dump will be automatically started when altitude is greater than 70,000 ft. For three engines failed late in first stage after an MET of 1:50, this dump will not be performed. Autoloft guidance steers the vehicle until contingency 3 E/O guidance commands fast ET separation just prior to SRB sep at tailoff (SRB PCs < 25 psia and MET \geq 1:47). ET sep will also be commanded at an MET of 2:10 if the PC check has not been satisfied (e.g. PC transducer failure). A five second -Z translation will be performed after structural release. If pitch rate exceeds $4^\circ/\text{sec}$ or roll rate exceeds $5^\circ/\text{sec}$, then rotational control will be allowed once 2 seconds of pure -Z has been performed.

2.7.2.3 3 E/O GREEN (Region 1)

An attitude independent separation is performed in the 3 E/O GREEN region. The 3 E/O guidance logic determines whether there is enough time for the longer RTLS separation sequence or if the rapid rate of descent and the maneuver time to entry attitude after separation requires a fast separation. If the dynamic pressure at the time of MM602 transition (estimated as 45 seconds in the future) is predicted to be greater than .25 psf (9 KEAS) and dynamic pressure is expected to increase in less than 30 seconds, then a fast separation is required. If the dynamic pressure at

MM602 is expected to be less than .25 psf or dynamic pressure is not expected to begin increasing until at least 30 seconds, then the longer RTLS separation sequence is allowed.

If a fast separation is required, ET separation will be commanded at the current attitude when rates are within limits (roll $< 1.5^\circ/\text{sec}$, pitch and yaw $< 2^\circ/\text{sec}$) and dynamic pressure is less than 2 psf (25 KEAS). ET separation will also be commanded when rates are within limits and altitude rate is negative since dynamic pressure will only increase and worsen ET sep conditions. If a fast separation is not required, an additional constraint to command ET separation is a 14 second timer to permit time for the mated coast RTLS separation sequence to complete. An eight second -Z translation is performed at structural release.

If dynamic pressure is greater than 20 psf (77 KEAS) and increasing (negative altitude rate), then an immediate separation (emergency sep) will be performed followed by a five second -Z translation at structural release. This scenario is usually only encountered in region 3 (YELLOW) and 4 (RED) but the logic is available in any region except 3 E/O BLUE. [AFPH2-28]

2.7.2.4 3 E/O ORANGE (Region 2)

A high rate separation is performed in the 3 engine out ORANGE region unless the sideslip angle is greater than 8° . If sideslip is greater than 8° , it will take too long to zero beta before the dynamic pressure builds to an unsafe level. Therefore, an attitude independent type of ET separation will be performed as discussed in section 2.7.2.3. If the attitude independent separation is not required, then a $3^\circ/\text{sec}$ pitch down is commanded once sideslip is less than 3° and roll and yaw rates are less than $3^\circ/\text{sec}$. Once the pitch rate is between $-3.2^\circ/\text{sec}$ and $-4.8^\circ/\text{sec}$ or 10 seconds has elapsed since the beta and rate constraints were met, ET separation will be commanded. An eight second -Z translation will be performed at structural release.

If dynamic pressure is greater than 20 psf (77 KEAS) and increasing (negative altitude rate), then an immediate separation (emergency sep) will be performed followed by a five second -Z translation at structural release. This scenario is usually only encountered in region 3 (YELLOW) and 4 (RED) but the logic is available in any region except 3 E/O BLUE.

2.7.2.5 3 E/O YELLOW (Region 3)

The mated maneuver in the 3 E/O YELLOW region consists of a pitch (usually down) to an angle of attack near zero with a slight pitch rate to nullify the effect of flight path angle derotation, followed by ET separation. When angle of attack is within 3° of the commanded value, sideslip angle less than 3° , and roll, pitch, and yaw rates less than $2^\circ/\text{sec}$, ET separation will be commanded. If angle of attack is within limits but later exceeds limits prior to the sideslip or rate constraints being satisfied, then ET separation will also be commanded. A five second -Z translation will be performed at structural release.

If 2 seconds (I-load) have passed since starting the region 3 (YELLOW) maneuver and there is either no rate or a slightly positive pitch rate on the vehicle, then there is insufficient negative pitch authority to reach the -2° targeted angle of attack. Therefore, the region will be updated to region 4 (RED) when the aerodynamic pitching moment is too high for the RCS jets to overcome. ET separation will be performed at an angle of attack of 125° .

If dynamic pressure is greater than 20 psf (77 KEAS) and increasing (negative altitude rate), then an immediate separation (emergency sep) will be performed followed by a five second -Z translation at structural release. This scenario is usually only encountered in region 3 (YELLOW) and 4 (RED) but the logic is available in any region except 3 E/O BLUE.

2.7.2.6 3 E/O RED (Region 4)

As discussed in section 2.7.2.5, a downmode to the RED region is required if the Orbiter has insufficient negative pitch authority to reach the alpha -2° targeted attitude in the YELLOW region. The vehicle is pitched toward alpha 125° . Once the angle of attack error is less than 20° or the current angle of attack is negative, and vehicle rates are within limits (roll and yaw $< 3^{\circ}/\text{sec}$, pitch $< 1^{\circ}/\text{sec}$), the GRTLS DAP establishes a negative pitch rate just prior to structural release. Once the negative pitch rate is established, ET separation is commanded. A five second -Z translation will be performed at structural release.

If dynamic pressure is greater than 20 psf (77 KEAS) and increasing (negative altitude rate), then an immediate separation (emergency sep) will be performed followed by a five second -Z translation at structural release. This scenario is usually only encountered in region 3 (YELLOW) and 4 (RED) but the logic is available in any region except 3 E/O BLUE.

2.7.3 Entry

If a significant amount of OMS propellant remains at ET separation, then the FRCS dump is inhibited, the MPS LO2 dump delay is zeroed (MPS dump begins in MM602), and an interconnected OMS dump initiated to minimize the aft cg concern. An OMS dump will not be performed post ET separation for a 3 engine out abort in first stage since there is too little time between dump stop in first stage and dump restart post-separation. For all other three engine out regions, an interconnected OMS dump will be started if dynamic pressure is less than 2.5 psf (28 KEAS). The dump is started in MM601 instead of MM602 because more time is spent in MM601 since the maneuver to entry attitude is performed in MM601. Delaying the dump start to the initiation of MM602 resulted in black zones that were not present using the old manual procedures. Therefore, a modification was made to the Abort Control Sequencer to automatically initiate the dump in MM601. Note that the 3 engine out guidance logic changes the .05g dump termination criteria to .1g to avoid pre-mature cutoff when forward RCS jets fire for control.

The check to determine whether a significant amount of OMS remains is actually based on the manual OMS dump timer and the OMS equivalent on time. If the difference between the dump timer and the equivalent on time is greater than 30 seconds, then the FRCS dump will be inhibited and the MPS LO2 dump will not be delayed. The OMS equivalent on time is not necessarily the amount of time the OMS engines have been burning. That is only the case for a 2 OMS only dump. The OMS equivalent on time is incremented 1 second per second of “clock time” for a 2 OMS only dump and about 2.7 seconds per second of “clock time” for an interconnected dump (2 OMS + 24 RCS). When the OMS equivalent on time is within 30 seconds of the manual OMS dump timer, there is approximately 5% left to dump. 20% is a typical value for OMS quantity when the dump timer expires.

The maneuver to entry attitude occurs in MM601 since there is better auto maneuver capability in MM601 than MM602. The vehicle is maneuvered heads up and pitched to the alpha recovery angle, which is a function of velocity as shown below to maximize lift.

Table 2.7.3-I: Alpha Recovery Angle versus Relative Velocity

Relative Velocity (fps)	≥3.5K	3K	2.5K	2K	≤1.5
Alpha Recovery Angle (°)	58	49	39	30	20

When angle of attack, roll attitude, sideslip angle, and vehicle rates are within limits as shown in the table below, the software will transition to MM602. However, if these constraints are not satisfied and dynamic pressure exceeds 20 psf (77 KEAS), the transition to MM602 will also occur to provide vehicle control under aerodynamic forces.

Table 2.7.3-II: Major Mode 602 Transition Criteria

All of the following:		Or:
α error	< 5°	Dynamic Pressure > 20 psf (77 KEAS)
Roll	< 20°	
β	< 2.5°	
Roll Rate	< 3°/sec	
Pitch Rate	< 5°/sec	
Yaw Rate	< 3°/sec	

The CA entry is similar to that of an RTLS but the wide range of initial velocities, high sink rates, and altitudes can result in high normal load factors, QBARs, and heating rates. The goal of CA powered flight and ET sep is to deliver the orbiter to acceptable entry conditions without loss of control. In general, reducing separation altitude and sink rate improve the entry. Any dispersions in powered flight or separation manifest themselves in entry. Entry phases include Alpha Recovery, Nz Hold, Alpha Transition, and ECAL/BDA landing, a downrange ELS landing, or bailout. These phases are described in the following paragraphs:

2.7.3.1 Alpha Recovery

After separation is complete, the maneuver to entry attitude is continued to the alpha recovery angle which maximizes lift and drag. This angle of attack is dependent on velocity and can range from 20° to 58° as shown in table 2.7.3-I. This ramp down is required for flight control (pitching moment/stability) constraints at low Mach numbers. A maximum of 58° (Mach \geq 3.5) was chosen since the alpha tape on the AMI only shows a maximum of 60°. Also, beyond 60° alpha, the total vertical force that the shuttle can generate begins to decrease, so alpha recovery would be less effective.

The speedbrake should be set in the alpha recovery phase before the critical load relief phase (Nz hold) begins. The body flap is left in auto since the incorporation of CR 90711 in OI-26 eliminated the need for a manual body flap setting. [AFPH2-29] Both of these surfaces affect the maximum QBAR and the hinge moment loads on the elevon during the critical load relief phase. The speedbrake can be opened to increase the vehicle drag, slow the orbiter, and reduce loads. Opening the speedbrake also induces a pitching moment that forces the elevons to a lower trim position where they are more effective for directional control (in the flow stream). The speedbrake should not be opened above Mach 10, however, because of thermal constraints.

If Nz hold is entered below Mach 3, the elevons are forced to a higher trim position due to a nose down pitching moment change in this region. As a result, the procedures call for manually opening the speedbrake to 65% for this case to take advantage of the nose up pitching moment it creates. Loss of control may occur in the pullout due to insufficient elevon deflection into the flow stream (loss of lateral control authority) if the speedbrake is not set to 65% for Mach numbers less than three. However, the speedbrake setting is not changed during Nz hold as Mach slows (i.e., if the Mach slows below three during the pullout). The requirement to set it is based

only on the Mach at entry into the Nz hold phase (onset of g). This is because for higher initial Mach numbers, Nz hold is nearly completed and therefore lower g (less nose up) is being commanded by Mach 3. Also, the speedbrake automatically opens just prior to completing the pullout in all cases ($\dot{H} = -600$ fps), to help slow the pitchdown and keep the elevons down in the flow for better control.

During the pullout region of a CA, the control surfaces can experience severe aerodynamic loading. In some scenarios, the loading can be so great that it must be very precisely distributed between the body flap and the elevons to prevent structural failure. The loading can also be very abrupt, giving the surfaces very little time to respond. If the body flap is too far from an acceptable position at the onset of the loading, it is not able to react and reposition itself in time to avoid failure. This is because it moves at only $0.3^\circ/\text{sec}$ in AUTO. Therefore, it is important to position the body flap before the loads build to a position that optimizes loads distribution.

Prior to incorporation of CR 90711, a CA body flap schedule was developed for each mission. This body flap versus Mach schedule was located on the entry portion of the contingency abort cue card. Once in MM 602 and before Nz hold began, the body flap was set according to the schedule by pushing the manual body flap push button indicator (PBI) on either eyebrow panel and then driving the body flap into position using the switch on panel C3 or L2. The actual body flap position can be read on the surface position indicator (SPI). The body flap was set only once, upon entry into Nz hold, the same as the speedbrake. The body flap was returned to AUTO using the body flap AUTO PBI on the eyebrow panels after the pullout was complete and Nz had reduced to less than 2g. The manual body flap steps are no longer required since the flight software now attempts to balance the loads between the body flap and the elevons automatically.

[AFPH2-30]

The last critical item during alpha recovery is to correct for potential aileron rudder force fights. If the rudder is at its full trim position of 6° (either direction) and the ailerons begin to trim more than 1° in the same direction, an aileron rudder force fight is developing and can result in a loss of control if not corrected prior to Nz hold. This phenomenon is only prevalent for entry Mach numbers less than five. It is caused by a residual sideslip (beta) after ET sep, which drives the rudder trim out to attempt to null the beta. In some flight conditions (low QBAR, high altitude, low Mach), the rudder is not powerful enough to null the beta but causes a roll opposite its deflection (due to rudder being above the c.g.). The ailerons then attempt to null this roll, but in doing so they also produce adverse yaw, which adds to the original beta. The ailerons are, therefore, moving in the same direction as the rudder. This standoff can be solved and control regained only by manually nulling out the aileron trim, which allows the rudder to finish the job of nulling the beta. The rudder then regains effectiveness as QBAR builds in the pullout and eventually nulls beta in a controlled manner.

2.7.3.2 Nz Hold

The altitude rate continues to increase negatively during alpha recovery until the orbiter drops low enough in the atmosphere to develop sufficient QBAR and lift for equilibrium flight. As lift increases, the Nz on the orbiter increases. When the Nz reaches one, the orbiter is developing enough lift to support its own weight, and altitude rate reverses (i.e., becomes less negative).

This is called the point of maximum altitude rate. At this point altitude acceleration passes through zero.

The maximum negative altitude rate is a good indicator of how severe the CA entry is and is used to calculate a target Nz that is required for pullout. As Nz increases, the angle of attack is decreased to maintain the target Nz. This Nz is held until the orbiter has completed a pullout from its dive into the atmosphere.

The equation used to estimate target Nz is:

$$\text{Nz target} = -\text{Alt Rate max}/1000 + 0.65$$

For example, if the altitude rate maximum were -2,500 fps, the target Nz would be 3.2. The Nz target is calculated and displayed on the VERT SIT display. This Nz target has been found to provide a good balance between structural Nz limits and QBAR limits. The structural load factor limit is actually a function of orbiter weight and wing root bending moment but the software currently does not target more than 3.9g. (See further discussion in section 2.7.4.2, Nz Hold Limitations.) CA maneuvers are also designed to keep the X c.g. forward of 1,115 inches due to the saturation of elevon and body flap during Nz hold at aft c.g. The c.g. is controlled with the dump of OMS and RCS propellants.

The auto Nz hold software begins its target Nz calculation upon transition to MM 602. In some dispersed cases, an anomaly can occur which precludes the calculation from converging and the target Nz displayed remains at 0.0. This can happen if the orbiter has already begun a pullout (hit the atmosphere) at the 602 transition (late transition). The software assumes that sink rate is increasing at the 602 transition so that it can look for the maximum sink rate (discussed above). If, however, the sink rate were already decreasing, a target Nz would never be found. If this should occur, the crew has to compute target Nz (from the above equation) and then fly the Nz hold in control stick steering (CSS).

2.7.3.3 Alpha Transition

When the sink rate has reduced to -320 fps, the orbiter has achieved pullout, and transitions to flying a wings level angle of attack schedule based on Mach number. The contingency abort Alpha Transition entry phase is similar to a nominal RTLS entry. It is designed to keep the orbiter within temperature, Nz, and QBAR constraints during the glide into the atmosphere. In some cases, the pullout excites a large phugoid which results in second and third, smaller pullouts. When evaluating energy available to reach a landing site, the crew should wait until the phugoid fully damps to get an accurate range/altitude energy picture.

2.7.3.4 ECAL/BDA landing or bailout

Bermuda, ECAL, and Canadian landing sites are available during certain portions of ascent should a contingency abort be required. The ECAL landing sites are: Myrtle Beach Air Force Base (AFB), South Carolina; Wilmington International Airport, North Carolina; Marine Corps Air Station Cherry Point, North Carolina; Naval Air Station Oceana, Virginia; Wallops Island Flight Center, Virginia; Dover AFB, Delaware; Atlantic City International Airport, New Jersey; Francis

S. Gabreski Airport, New York; Otis AFB, Massachusetts; and Pease AFB, New Hampshire. These sites are available only on high inclination launches (greater than 50° inclination). On lower inclination launches (40° or less) Bermuda is available. The four Canadian sites are Halifax, St. John's, Gander, and Stephenville. Capability to these sites has been analyzed for three simultaneous engine failures on 51.6° and 57° inclination missions.

For due east ascent trajectories (28.5°), analysis has shown there is no capability to land at BDA unless a TAL abort is first declared to Ben Guerir (BEN) or Moron (MRN). The yaw steering that occurs on these TAL profiles provides the plane change required to reduce the entry crossrange to BDA to an acceptable value. If a second engine fails during these TAL scenarios, BDA is available. A TAL to Banjul, however, results in no yaw steering to the north. In this case, BDA is not available for a second engine failure. However, even if capability to Banjul does not exist, 2 OUT SECOND procedures would still be run and BDA attempted in an effort to get as close to land and search and rescue teams as possible. As noted earlier Banjul has been decommissioned as a TAL site, but should another inplane site be designated as a TAL site in the future, the same would hold true. For mid inclination trajectories (39°), BDA is in-plane and does not require the prior TAL to BEN or MRN.

The velocity ranges where Bermuda, ECAL, or Canadian sites are available are also dependent on orbiter weight and c.g. These velocities are provided for the crew on the contingency abort cue card and the BDA/ECAL CA page of the Ascent Flip Book. Generally, for high inclination missions, ECAL sites are available for two engine out scenarios from a V_1 of approximately 6,000 fps (just past staging) until approximately 12,500 fps (just past single engine droop). ECAL capability for high inclination inertially targeted missions is also dependent on where in the launch window lift-off occurs. In general, a 10 minute launch window exists and launch is planned to occur at the Inplane time. Inplane - 5 minutes or open of the window provides little to no 2 engine out ECAL capability (just a small Otis window), while Inplane + 5 minutes or close of the window provides the most coverage, with overlapping capability to several sites. ECAL sites (Cherry Point and Oceana only) are also available on RTLS profiles if a second engine fails during fuel dissipation between a V_1 of about 5,700 fps up until initiation of PPA. Canadian sites are available for high inclination three engine out scenarios from a V_1 of approximately 14,200 fps to approximately 19,000 fps (until 3 EO TAL capability) for Inplane launches. For due east launches, Bermuda is generally available during a MRN or BEN TAL between $V_1 = 9,000$ and 12,000 fps (droop). Also, on a 39° inclination, BDA is available between approximately $V_1 = 9,000$ and 12,500 fps.

The software contains I-loaded velocities which define the windows to ECAL and BDA. These I-loads are set to provide the necessary yaw steering while still on one engine during the CA. If the orbiter suffers a second engine failure outside these windows, yaw steering is not performed; however, for contingency abort scenarios the Entry ECAL Automation logic is I-loaded to ON. With this logic ON the entry portion of flight will utilize the ECAL logic and fly towards whatever site is selected in guidance. A few scenarios do require the crew to disable this logic and fly straight ahead and bailout. These areas will be discussed in section 4_[AFPH2-31]. The primary cue to the crew that ECAL/BDA is available is the presence of yaw steering when the two engine out

auto contingency abort mode is invoked. The contingency abort cue card at this point directs the crew to the ECAL/BDA page of the Ascent Flip Book.

Analysis has shown that the orbiter cannot survive a gear-up water landing. Therefore, if a runway landing is not available, the crew places the orbiter in an attitude hold and then bails out. For this purpose, an attitude hold mode was added to the MM 603 and MM 305 software. It is available when Mach is less than 1.0 and is activated by moving the abort rotary switch to ATO and pressing the abort PBI. When the crew switches from CSS to AUTO, guidance snapshots the current airspeed and roll angle and attempts to hold both constant. If a new airspeed or roll is desired, control can be taken back to CSS. When AUTO is selected again, a new snapshot is taken.

After the attitude hold is established and an altitude of about 30,000 ft is reached, the crew depressurizes the cabin, blows the hatch, and bails out.

2.7.4 Orbiter Limits and Black Zones

There are many limitations to the CA design, most notably the existence of black zones (regions where structural failure or loss of control are unavoidable) for some orbiter configurations. But even for those simulations which predict success for a CA scenario, there were several limiting assumptions made in the analysis. These assumptions center around the critical events of ET sep (recontact avoidance), Nz hold (structural failure avoidance), and maximum pullout QBAR (loss of control avoidance). These limitations are outlined below and should be kept in mind when conducting CA crew training.

2.7.4.1 ET Separation Limitations

CA is the only case where ET sep can occur with significant fuel remaining in the tank. Intact RTLS and TAL aborts are designed to deplete this propellant. However, on a CA there is often not enough time before entry (because of insufficient thrust) for a single engine to use the remaining propellant. The orbiter must be off of the ET prior to significant thermal heating which could occur as the orbiter droops into the atmosphere. Otherwise, the tank may rupture prior to safe separation from the orbiter.

The major unknown about ET SEP with propellant remaining is the effect of slosh dynamics on the separation trajectories. The analysis done to arrive at the fast sep and fast rate sep ($3^\circ/\text{sec}$) techniques was performed with rigid body simulations and no dispersions. The automated sep software begins translating away from the tank 5 seconds after commanded MECO. Since tailoff will maintain some level of force on the tank for most of that period, it has been concluded by “engineering judgment” that a safe separation distance will be achieved before the remaining propellant sloshes forward in the zero g conditions and affects the motion of the tank. Implementation of a high fidelity slosh model by Boeing Reusable Space Systems (BRSS) Huntington Beach made it possible to evaluate propellant slosh effects with high residuals. The Flow 3D slosh model was used in conjunction with a high fidelity ET SEP simulation to evaluate propellant slosh ET SEP clearance margins. In an October 2001 presentation to the Abort/GNC panel, a small representative set of high pitch rate ET SEP contingency abort trajectories were evaluated. 2 EO RTLS cases near VREL 0 were evaluated and 2 EO ECAL cases with large residuals were evaluated. The 2 EO ECAL cases evaluated all provided acceptable clearance margins when slosh effects were included. This was always thought to be a concern for ECAL trajectories, but now may appear to be a non-issue (although only 4 representative cases were evaluated). The 2 EO RTLS cases near VREL 0 had 1 case of 4 exhibit recontact of the forward strut. This indicated that propellant slosh did affect the ET SEP dynamics for the cases near VREL 0. A CR proposed for OI-30 (CR 92504 Alleviate ET Separation Recontact Issues) helps to improve clearance margins for these cases and some I-load modifications for that proposed CR may eliminate these recontact concerns^[AFPH2-32]. In the sections of this handbook which discuss each CA region and its associated maneuver, typical ET SEP parameters are provided for reference.

2.7.4.2 *Nz Hold and Max QBAR Limitations*

If the orbiter can successfully separate from the ET during a CA, the next major hurdle is to achieve a pullout without structural failure or loss of control. Here again the CA design process provides for no environmental or system dispersions. The orbiter is pushed to its limits in many cases even without these dispersions. The only tools available to control pullout severity and hence avoid loss of control and/or structural failure are the target Nz and proper positioning of the body flap.

2.7.4.2.1 NZ and QBAR Limits of Contingency Aborts

The orbiter is certified to a QBAR that is a function of V_{REL} which peaks at 471 psf and an Nz that is a function of landing weight which ranges from 2.06g at 256,000 lbs to 2.5g at 210,000 lbs. Exact certification envelopes are shown in the Level B Groundrules and Constraints in Sections 5.1.4 and 5.1.5. Certification means that there is a 1.4 factor of safety or greater at the certified limits. Exact failure points are not known but for CAs these certified limits are exceeded in many cases so that entry can be accomplished.

During early CA development work, an attempt was made to establish orbiter limits for Nz and QBAR which would represent structural and control boundaries. The original Contingency Abort Training Manual (dated January 1986) quotes 3.5g and 800 psf as limits which the CA procedures attempt to protect. However, these values are misleading in that they were based not on structural analysis. Instead, 3.5 g represents the 1.4 factor of safety times the 2.5g limit, and 800 psf represents the maximum QBAR that would allow control to be maintained in the available simulations. Later studies have shown that control can sometimes be maintained with pullout QBAR as high as 1000 psf but since no surface bending is modeled in the sims, it is difficult to predict if the reaction of the real vehicle in these situations would be as modeled.

As part of the Shuttle Program's Contingency Abort Upgrades effort, a FY2000 Abort Improvement task was to more accurately define contingency abort structural limits in order to better understand and possibly improve Orbiter capabilities for 2 EO blackzones. The Orbiter Capability Assessment task provided a more comprehensive understanding of vehicle abort capabilities (Nz and Qbar) for CA pullout maneuvers between Mach 3.5 and 15. The resultant product of this task (delivered 12/01) is a Load Indicator Program which combines load indicator equations and redlines, an inertia database, and an aerodynamic pressure database. The load indicators are selected external load components that can be readily computed for trajectories and used to judge acceptability to structure. The redlines are the pass/fail limit for each indicator to maintain positive margins on the critical structure including an appropriate factor of safety (if applicable). The Load Indicator Program combines all these data into simplified NZ-QBAR diagrams to define bounds of Orbiter structural capability. Figure 2.7.4.2.1-1 shows the representative diagrams which vary with Mach number and mass properties. The load indicators represented in the loads indicator program include: wing and tail root moments, wing and tail root shears, inboard and outboard elevon hinge moments (hydraulic and mechanical), inboard and outboard elevon shears, bodyflap hingemoments (hydraulic and mechanical) and shears, speedbrake hingemoments (hydraulic and mechanical), forward fuselage pressure (top and bottom), forward fuselage Nz, mid fuselage longeron loads, payload bay door pressure, side

window crush pressure, top window burst pressure, wing leading wedge shear, nose cap axial load, OMS pod NZ, and OMS pod landing sink rate. The load indicator analysis code has been developed for NASA/USA incorporation into flight simulator software. These indicators should be used in parallel with thermal indicators and flight control checks. These new capability boundaries will warrant new investigations into the CA entry profiles to determine if any changes to current published capabilities are required (ie OPS 6 CA pullout target NZ equations, OPS 6 ECAL boundaries, OPS 3 TAL boundaries, etc)

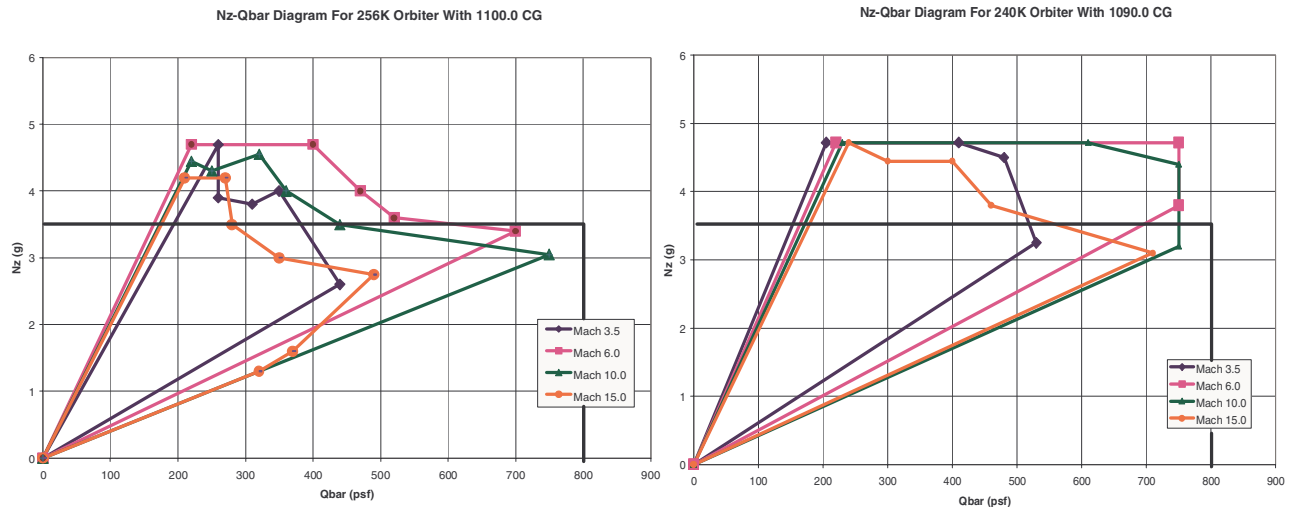

Figure 2.7.4.2.1-1 Orbiter Capability Assessment Envelopes (Nov 2001)

Note the higher g limits that may now be available during a CA pullout, although the Qbar values will in general have to be lower since most CA cases exhibit an Xcg aft of 1100 in. The forward fuselage (crew module) is constrained to 4.72g and the maximum Qbar limit of 750 psf is constrained by the Nose Cap pressure limit. The crew module, as well as the OMS pods, impose absolute Nz upper bounds independent of the aerodynamic loading. For the OMS pods the max Nz is 5g, 75% fill Nz limit is 4.24g, 100% fill Nz limit is 3.22g_[AFPH2-33].

2.7.4.2.2 Maximum Target NZ I-load

In the current onboard OPS 6 software, QBAR is not constrained by Nz hold software. Instead, only the target Nz is constrained (originally 3.5g or less, currently 3.9g or less), although the maximum QBAR which results from a given trajectory can be reduced by increasing the maximum Nz. The original value of 3.5g was chosen to coincide with the 3.5g contingency abort limit mentioned above. However, in some cases (3 engines out near PPA on a RTLS), this resulted in trajectories that lost control due to excessively high pullout QBAR. It was discovered that a slight increase of NZ hold would lower the QBAR enough to maintain control. A new maximum

target NZ of 3.9g was selected because this allowed most simulated cases to maintain control. Although there is no guarantee that the vehicle can survive loads at that level, it was obviously better to take that chance than a sure loss of control. Note that the increase in the NZ hold value does not significantly affect the pullout g level except in the limiting cases where the higher g's are needed to avoid high QBARs.

As stated in the previous section, the Orbiter Capability Assessment envelopes will now have to be used to determine what if any changes need to be made to CA pullout logic (flight software or procedures) and what trajectory impacts will results from any changes that are made.

2.7.4.2.3 Body Flap Schedule

Once the NZ Hold value is set, the only remaining control is the body flap schedule setting. A proper body flap setting is required to balance the loads between the body flap and the elevons, since what is known is the failure point for the body flap and elevons as a function of hinge moments. These load limits are expressed as design, limit, and ultimate values in table 2.7.4.2.3-I. The values in this table reflect the reduction from the previous design limit of 1,420,00 in/lb to the currently accepted design limit of 1,116,667 in/lb. This reduction was made since ascent instrumentation indicates that the body flap loading is not equally distributed across the four actuators. Instead, the two outer actuators experience higher loading than the inner actuators. It should be noted that the body flap setting and QBAR, rather than total vehicle g loading, determine the hinge moments experienced during pullout. Higher g loads reduce QBAR and result in lower aerosurface loads.

Table 2.7.4.2.3-I: Aerosurface Hinge Moment Limits

	Body Flap	Outboard elevons	Inboard elevons
Design	1.116667	0.427	0.899
Limit	1.407	0.538	1.133
Ultimate	1.563	0.598	1.259

Note: Numbers in millions of in/lb
 Limit = 1.26x design (or 90% of ultimate)
 Ultimate = 1.4x design

Prior to incorporation of CR 90711 Auto Body Flap PE in OI-26, body flap positioning software was used in the SES to provide feedback on the hinge moments for each elevon and body flap surface during a CA simulation. Runs were repeated to balance the loads between the elevon and body flap to find a body flap versus Mach schedule which kept the loads of all surfaces well below design levels. With the incorporation of CR 90711, the proper body flap setting is commanded automatically to balance the loads on the body flap and elevons. This is done by driving the body flap at a bias off of the elevons. The body flap will take on more of the load to allow the elevons

to maintain control. Even though a complete black zone analysis has not been performed, it is expected that in some cases, the loads may exceed the limit and even the ultimate levels. If a body flap setting cannot sufficiently handle entry loads, then excessive QBAR, actuator stall, loss of control, and/or structural failure may occur, resulting in a black zone. [AFPH2-34]

2.7.4.2.4 Black Zones

Loss of control in a black zone can result from a number of things. In some cases, the aerodynamic moments are so high that, even at maximum aerosurface deflection and/or maximum jet firings, the vehicle rates cannot be controlled (control saturation). Additionally, in some cases the aerosurface loads are so high that the aerosurface actuators cannot drive the control surfaces. This condition is often referred to as actuator stall. The flight control gains were designed for much lower QBARs than seen during contingency aborts. Therefore, the system is often overgained and underdamped in contingency cases. This control limitation often leads to an overshoot of the target Nz. In extreme situations actual peak Nz as high as 3.9 has been seen. Overly high control gains also often result in control surface oscillations since the control system has difficulty finding a proper command position.

The Nz and QBAR conditions are most severe for three engines out uphill in a velocity range of 8,000 to 12,000 fps. For heavy payloads with aft c.g. (such as STS-48) the black zone can be as large as 7,000 to 18,000 fps. Success depends primarily on weight, c.g., and OMS load. The lighter the orbiter and the more forward the X c.g. during the Nz hold, the more benign the loading. Since there is little or no time to dump OMS propellant for 3 simultaneous engine failures, missions with large OMS loads can have black zones even if the intact aborts do not have aft c.g.'s. Some flights have a very benign hinge moment situation for all abort scenarios and have no black zones in second stage (such as STS-47), whereas others have significant black zones (such as STS-49). A comparison of three CA cases for these two flights is shown in the control surface loading strip charts in figures 2.7.4.2.4-1, 2.7.4.2.4-2, and 2.7.4.2.4-3. This data was taken during piloted simulations in the SES. Note that the following information was gathered prior to OI-25 and does not reflect 3 Engine Out or Body Flap Automation CRs. Since there has been little to no Program funding for contingency abort analysis, it is unclear how recent changes will affect black zones.

Figure 2.7.4.2.4-1 compares the body flap and elevon loads between STS-49 and STS-47 for the case where two engines fail at 11,600 fps, or just prior to the droop boundary. Although this is not typically a black zone, the effect of varying weight and c.g. can be seen in the body flap loads plot. For STS-49, which is a further aft c.g., the body flap was briefly at the design limit. (Note that surface limits have been reduced recently and the limits in Table 2.7.4.2.3-I may not correspond to limits shown in data from past flights.) Also of note is the difference in the magnitude of the loads: The STS-47 loads are much lower on both the elevon and the body flap, even though both vehicles had close to the same Nz during the pullout (2.9 vs. 3.0). Of particular note is the fact that the STS-47 body flap setting was AUTO, due to the benign nature of the vehicle mass properties. The STS-49 body flap required a manual setting. (Note: Peak Nz refers to maximum observed; target Nz is the software computed target pullout.)

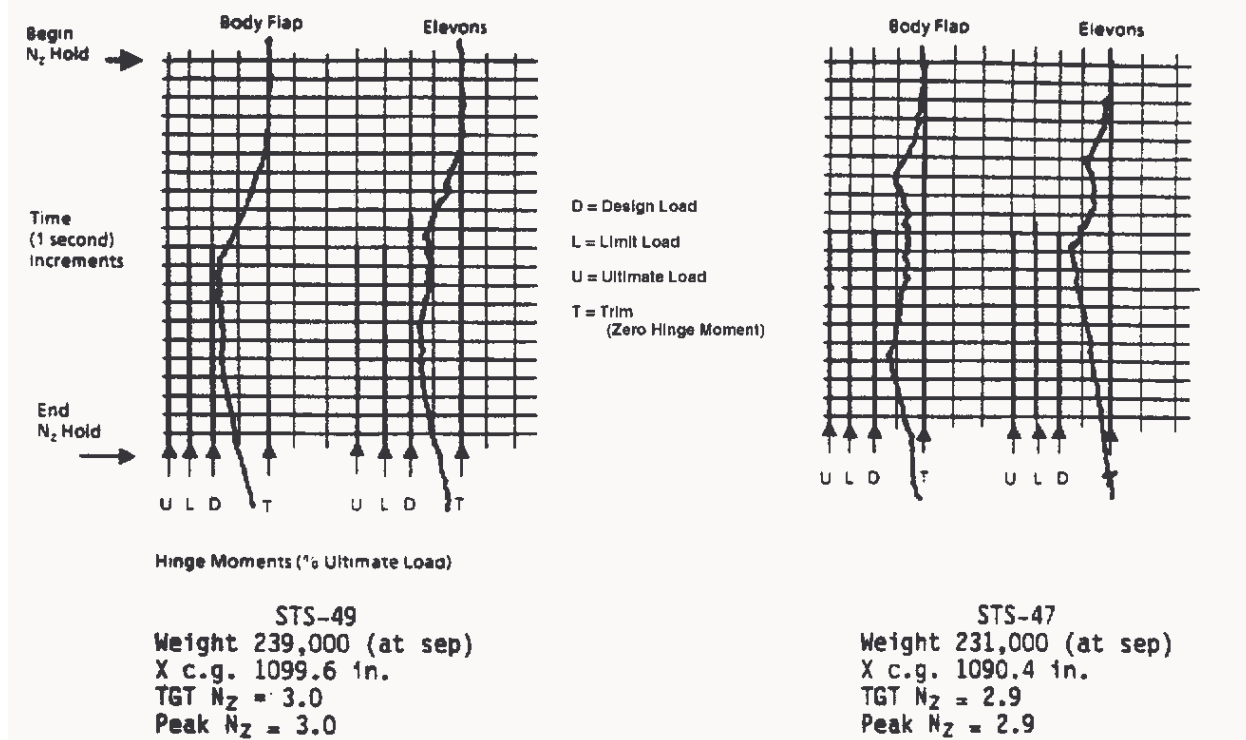

Figure 2.7.4.2.4-1: Body Flap/Elevon Loads Comparison (Two Engines Out at 11,600 fps V_I)

Figure 2.7.4.2.4-2 can be compared with figure 2.7.4.2.4-1 to show the effect of loads being more severe for three engines out than two. The failures are at the same V_I , which is typically a black zone for the three engine out case. For the STS-49 vehicle, this case did result in a failure, as the loads exceeded ultimate. (In this particular case the simulator barely managed to fly out of the N_z hold phase without losing control. This is due to the fact that the simulator does not model structural failure of the aerosurfaces when hinge moment limits are exceeded. It is doubtful the flight vehicle would have done as well with an actual body flap failure). The effect of weight and c.g. on black zones is very pronounced here. The more forward c.g. condition of STS-47 demonstrated no loads or control problems throughout the same pullout. The target N_z was also higher for both vehicles than the two engine out case (steeper gamma).

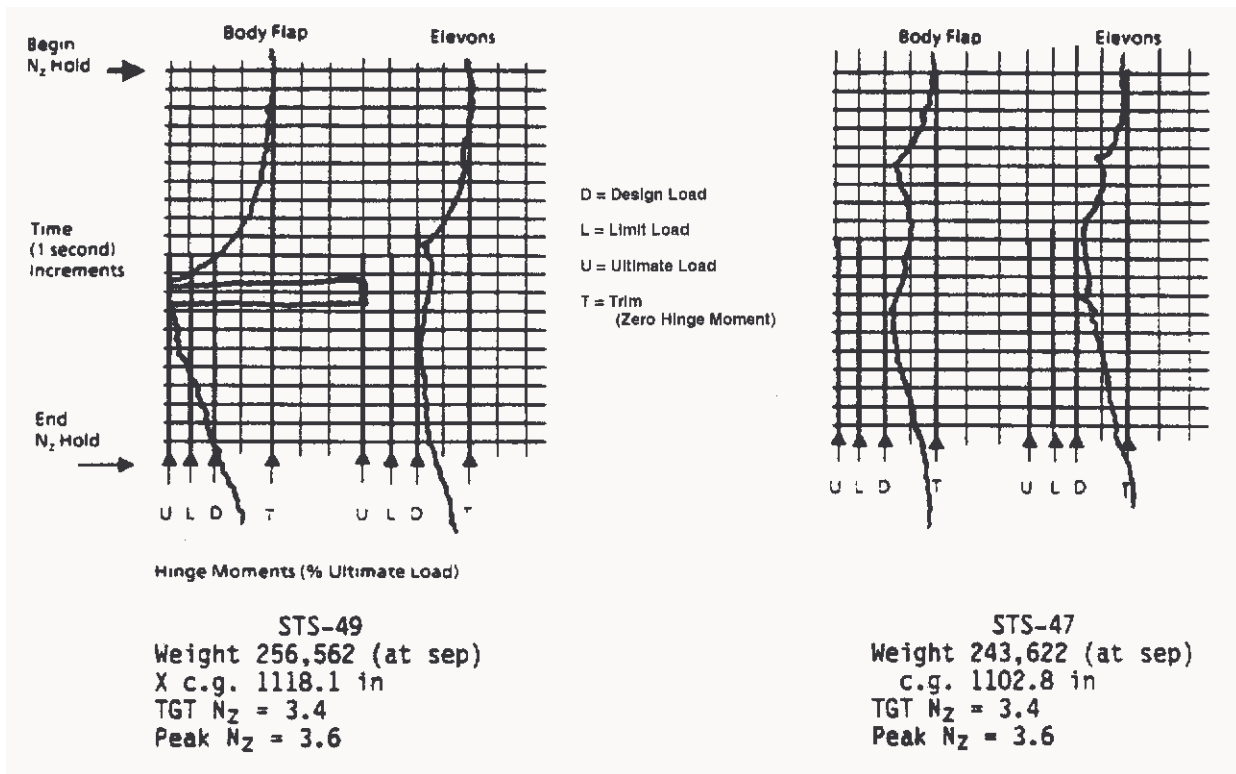

Figure 2.7.4.2.4-2: Body Flap/Elevon Loads Comparison (Three Engines Out at 11,600 fps V_i)

Figure 2.7.4.2.4-3 shows a three engine out failure at $V_{REL} = 0$ on an RTLS, a case that used to typically be a black zone due to control problems. This case can be compared with figure 2.7.4.2.4-2 (three engines out at 11,600 fps) to demonstrate the difference between a loads exceedance in a black zone and a control oscillation in a black zone. In this case the elevons demonstrate a severe limit cycle oscillation even though the hinge moments are not excessive. This is due to the flight controls being overgained due to the high QBAR in this region. Although the pullout was successful, control was very marginal throughout. The effect of a more forward c.g. on the same flight conditions is evident in the STS-47 plot, which shows a relatively benign pullout and no control problems. The loads spike on the elevon plot represents the end of N_z hold, when the elevon is commanded to reduce g loads.

A flight control gamma-dot correction term was included in the 3 engine out automation CR which was to eliminate or reduce black zones in the $V_{REL} = 0$ region of RTLS. There have been no comprehensive black zone definition studies done since incorporation of this CR to quantify the actual results of this fix.

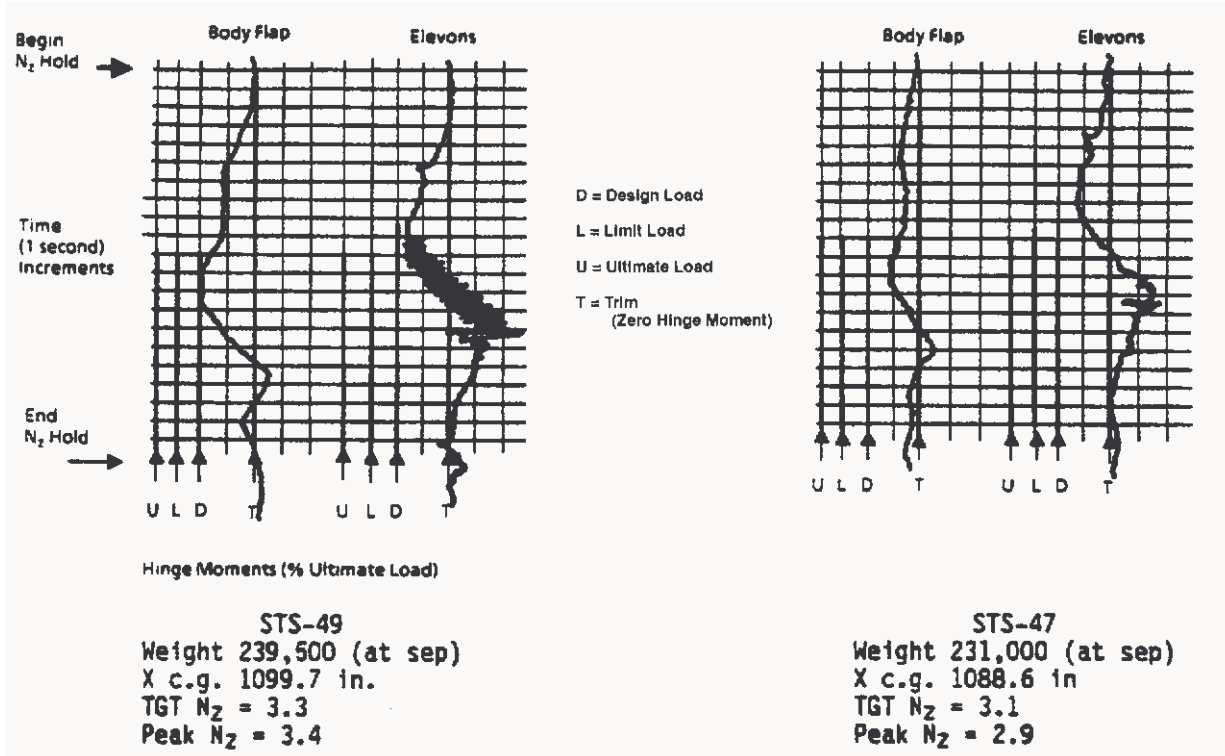

Figure 2.7.4.2.4-3: Body Flap/Elevon Loads Comparison (Three Engines Out RTLS at $V_{REL}=0$)

Another black zone existed for three engines out in first stage, due to the loads on the ET to orbiter attachment struts. It was highly unlikely that the orbiter would remain on the stack with three engines out throughout most of first stage. Part of the Fiscal Year 2000 Aborts Improvement Initiative was a task to beef up the ET to orbiter attachment struts. This task was completed and the black zone for three engines out in first stage is now considered a bailout region^[AFPH2-35]. (Though official runs clearing the region have not been performed.) A black zone also may exist for three engines out during the PPA region of RTLS. Again, the actual size of the velocity windows for this black zone varies as a function of orbiter weight and c.g. However, this black zone has been greatly reduced by the previously discussed change which increased the maximum target N_z I-load from 3.5 to 3.9g (assuming the vehicle survives the higher g loads).

For two engine out scenarios, there are no known black zones. However, there is some potential for recontact with the SRBs at separation if two engines fail in first stage. This potential is greatest for failures at lift-off but the severity and consequences of the recontact are not known. Control is also marginal for two engines out near PPA.

A final limitation of CA design for the N_z hold and pullout phase is flight control gains. Since normal and RTLS entries are designed to a QBAR of 375 psf or less and 2.5g or less, the flight controls are overgained and underdamped for regimes above these values. Most CAs will exceed these values, many by a significant amount. No uncertainties have been designed into the pullout phase to protect for these QBAR or N_z effects upon vehicle stability or structural integrity. This

flight control limitation makes flying the target Nz very difficult should manual control ever be required. Initially the pitch attitude (α) can be held with near detent (null) stick position. As the g level builds, the stick must be pushed forward to keep from overshooting and held forward until the pullout is complete (as altitude rate comes through -320 fps). The pitch axis control is extremely sensitive throughout this maneuver.

[AFPH2-36]

SECTION 3

ASCENT CREW MONITORING AND CONTROL DEVICES

3.1 OVERVIEW

The primary role of the crew during ascent is to monitor the performance of the automatic sequencing, guidance, navigation, flight control, propulsion, and other critical systems. If performance is not acceptable, the crew intervenes as required to ensure mission success and personnel and vehicle safety. Displays that present critical ascent parameters for determining vehicle performance and trajectory state are available. Uplinked advisory data and the onboard Flight Data File are also available to assist the crew in the monitoring and control task.

The purpose of this section is to present data on the crew use of the cockpit flight displays and controls during ascent and aborts.

3.2 ONBOARD ASCENT EVENT REFERENCE

During ascent, the events in the Flight Data File are usually referenced to either MET or the TIG of the OMS burns. The following explains the reference notation and tells when each reference is used:

- a. The MET is the primary event reference throughout ascent. The MET is set to zero at SRB ignition and is shown on the mission timer on the first line of all CRTs and on panel 03 and on the event timer on panel F7. Prelaunch, the MET on the CRT and panel 03 shows Greenwich mean time (GMT).
- b. The TIG of the OMS burns is used at times close to the OMS burns. This time is displayed on the CRT timer (second line on the CRT). It counts down to the ignition of the OMS, then counts up. Prelaunch and during powered flight, this timer is zeroed.
- c. The EVENT TIME on panel F7 can be controlled by the crew. It is set to count down to launch from T - 9 minutes. The EVENT TIMER resets at SRB ignition and then shows MET.

Before launch (while in OPS 9), the crew can set the CRT timer. However, after transition to OPS 1, a launch hold or recycle will invalidate the time because the CRT timer cannot be reset in MM 101. The CRT timer is not reset at lift-off but the EVENT TIME and MET are reset. Therefore, the CRT timer is not used prelaunch or during powered flight.

The event references for AOA entry are the same as in nominal entry. For further information, see the Entry Procedures Handbook, JSC-11542.

3.3 COCKPIT CRT DISPLAYS

The display titles used by the crew for ascent and aborts are shown in tables 3.1-I and 3.1-II. For drawings and detailed descriptions of onboard displays and their uses, refer to JSC-17322, Data Processing System Dictionary. Since the displays available depend on the MM, the MM flow is shown in figure 3.1-1. The three CRT displays on the forward panels are managed by the crew to maximize crew insight into the status of orbiter operations. CRT displays are called as necessary to monitor, check status, or reconfigure systems, but the basic configuration assumed for normal operations is:

- a. CRT 1 (left) - XXXXX TRAJ or XXXXXX MNVR XXXXX
- b. CRT 2 (right) - GNC SYS SUMM 1 or XXXXXX MNVR XXXXX
- c. CRT 3 (center) - [BFS] XXXXX TRAJ X or XXXXXX MNVR XXXXX
(SM or GNC SYS SUMM as required)

The configuration for an ATO is the same as for normal ascent. For an AOA, the configuration through the first OMS burn is the same as normal ascent and then is the same as normal entry. For TAL and RTLS, the configuration during the powered phase corresponds to ascent, and during the glide phase the configuration corresponds to entry.

When the BFS is engaged, there are only two CRTs available automatically. Preengage, no more than one CRT is normally driven by the BFS. Any CRT can be driven by the BFS if the GPC/CRT function on the keyboard is used. The BFC DISP SEL switch is set in 3 + 1 so that CRT 3 can be driven by BFS pre-engage, and CRT 3 and CRT 1 are driven automatically postengage. The configuration for the displays with the BFS engaged are:

- a. CRT 1 (left) - XXXXX TRAJ X or XXXXX MNVR XXXXXX
- b. CRT 2 (right) - Assigned to BFS when time permits; then the CRT is used as needed to monitor systems.
- c. CRT 3 (center) - As required to check the status of systems, any reconfiguration change required, or XXXXX TRAJ or XXXXX MNVR XXXXXX.

Table 3.3-I: “OPS” CRT Displays

Major Mode	Display No.	CRT Display Title	PASS	BFS
0	0001	GPC MEMORY BFS MEMORY THERMAL	X	X X (SM)
101	1011	LAUNCH TRAJ LAUNCH TRAJ 1	X	X
102	1021	¹ XXXXXX TRAJ ¹ XXXXXX TRAJ 1	X	X
103	1031	¹ XXXXXX TRAJ ¹ XXXXXX TRAJ 2	X	X
104	1041	² XXXXX MNVR EXEC	X	X
105	1051	^{2,3} XXXXX MNVR YYYY	X	X
106	1061	⁴ XXXXX MNVR COAST	X	X
301	3011	DEORB MNVR COAST	X	X
302	3021	DEORB MNVR EXEC	X	X
303	3031	DEORB MNVR COAST	X	X
304	3041	ENTRY TRAJ 1 ENTRY TRAJ 2 ENTRY TRAJ 3 ENTRY TRAJ 4 ENTRY TRAJ 5	X X X X X	X X X X X
305	3051	VERT SIT 1 VERT SIT 2	X X	X X
601	6011	RTLS TRAJ RTLS TRAJ 2	X	X
602	6021	VERT SIT 1 VERT SIT 1 (GRTLS)	X	X
603	6031	VERT SIT 1 VERT SIT 2 VERT SIT 2 (GRTLS)	X X	X
901	9011	GPC MEMORY	X	

¹XXXXXX = “ASCENT”, “ATO”, “AOA”, or “TAL”

²XXXXX = “OMS 1”, “ATO 1”, or “AOA 1”

³YYYYY = “EXEC” (nominal or ATO) or “TRANS” (AOA)

⁴XXXXX = “OMS 2” or “ATO 2”

Table 3.3-II: "SPEC" and "DISP" Cockpit CRT Displays

Display No.	CRT Display Title	OPS 0	OPS 9 (GNC)	OPS 1	OPS 6 (RTLS)	OPS 3	BFS
0	GPC MEMORY	X	X	X	X	X	
1	DPS UTILITY	X	X	X	X	X	
2	TIME	X	X				
6	GPC/BUS STATUS	X	X	X	X	X	
18	¹ GNC SYS SUMM 1			X	X	X	X
19	¹ GNC SYS SUMM 2			X	X	X	X
20	DAP CONFIG					X	
50	HORIZ SIT			X	X	X	X
51	OVERRIDE			X	X	X	X
55	GPS STATUS		X	X	X	X	X
78	SM SYS SUMM 1						SM
79	SM SYS SUMM 2						SM
99	FAULT	X	X	X	X	X	X
100	GTS DISPLAY		X				
101	SENSOR SELF-TEST		X				
102	RCS/RGA/ADTA TEST		X				
104	GND IMU CNTL/MON		X				
105	TCS CONTROL		X				
110	BUS/BTU STATUS		X				

¹GNC SYS SUMM displays in the BFS are not the same as the PASS.

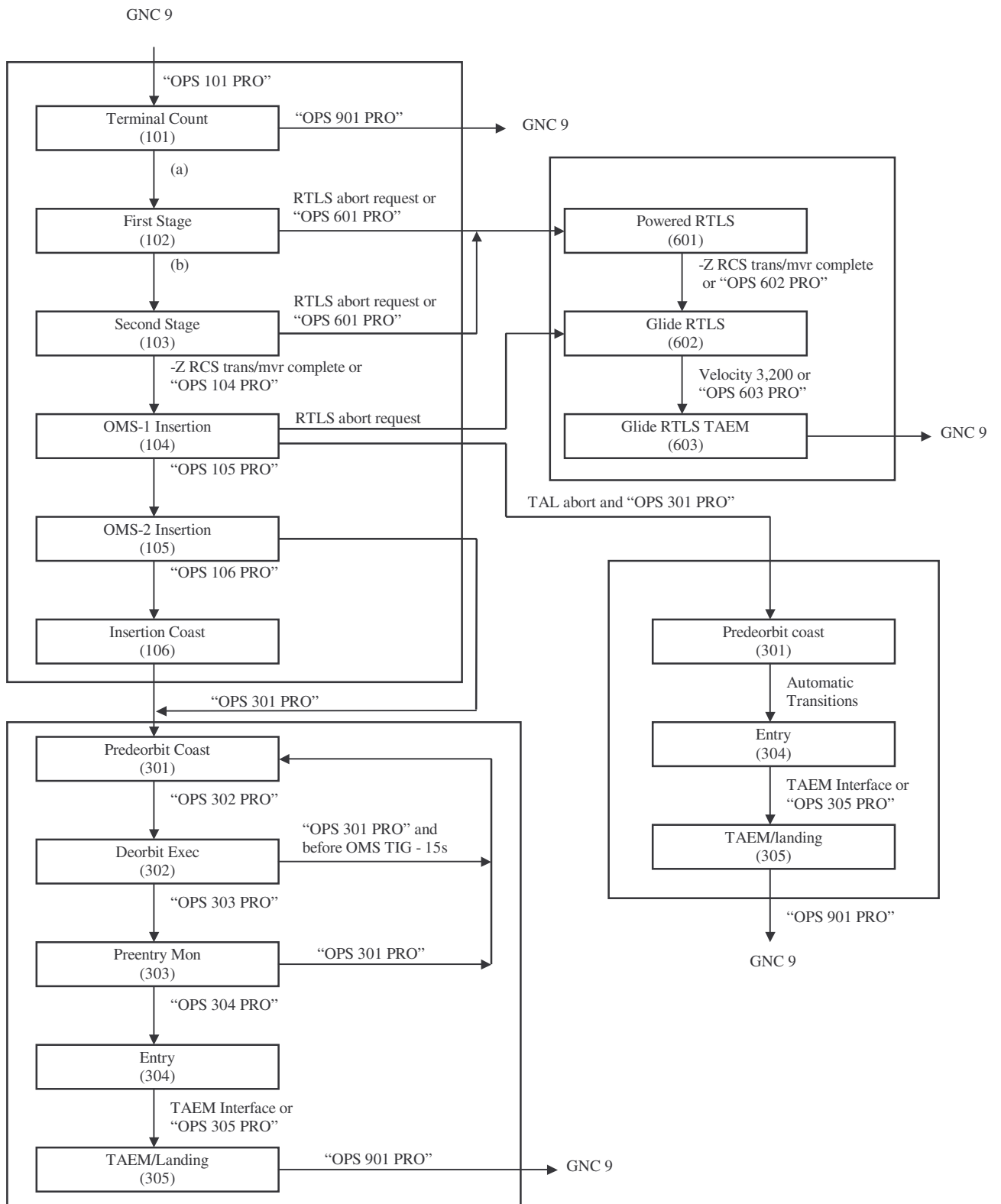

^aAll SSMEs 90% RPL, no countdown holds, +2/5 second time delay, and no FRF flag (SRB ignition).
^b(PC ≤ 50 or MET ≤ 129.8 + ~8 seconds and attitude rates within limits or manual switch enabled and closed (SRB sep complete).
 (Information from this figure is from COMPUTER PROGRAM DEVELOPMENT SPECIFICATION, Vol. V, Book I, GNC.)

Figure 3.3-1: Major Mode Flow

3.4 DEDICATED DISPLAYS

In addition to the CRT displays, dedicated displays are used in ascent to monitor the orbiter performance or to fly the orbiter. In this section, the displays normally used during ascent and aborts are briefly described. For more information, refer to the GNC DED DISP CBT and the HSI CBT. Additional details may be found in STS 83-0020, Displays and Controls FSSR, vol. 1. Dedicated displays for glided RTLS (MMs 602 and 603) are basically the same as entry (MMs 304 and 305) but any exceptions are noted in this document. The Shuttle fleet is in the process of upgrading it's existing electro-mechanical flight instruments, servo driven meters, and CRT display units with a state-of-the-art integrated display system utilizing color multifunction flat panel displays. The Multifunction Electronics Display Subsystem (MEDS) system has been integrated into OV-103 and OV-104, and OV-105 is being upgraded while in Orbiter Major Modification at the time of this release. Eleven multifunction display units (MDU's) will replace the existing CRT's, flight instruments, and the servo-driven tape meters. While the MEDS system is new it's functionality for the dedicated displays to be discussed in this section is essentially the same as the older devices, with only minor differences in some terminology and color scheme [AFPH3-1]. The ascent guidance and navigation computer (GNC) primary flight displays are shown in figure 3.4-1. A summary of each of these dedicated displays and lights is given in table 3.4-I.

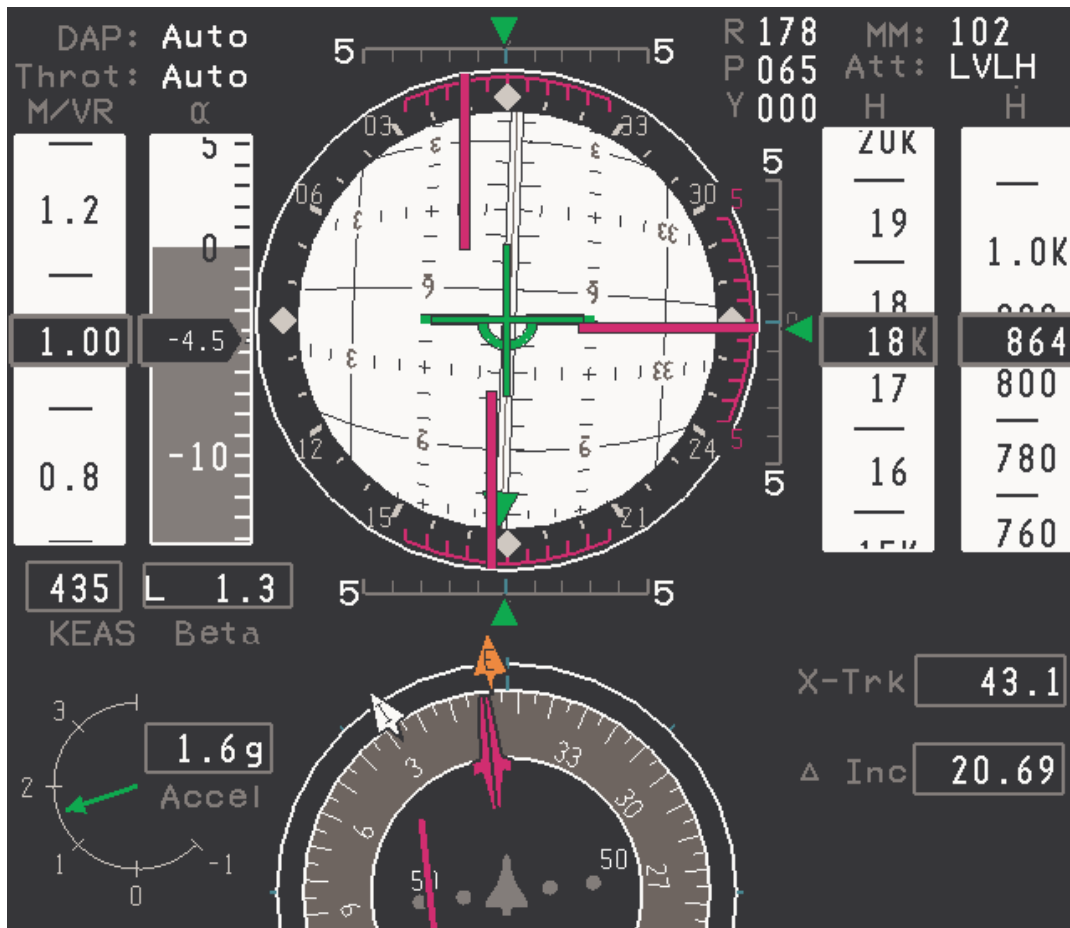

Figure 3.4-1 A/E Primary Flight Display

Table 3.4-I: Ascent Dedicated Displays Summary

Name	Location	Use
ADI	F6, F8 (Can be called up on any MDU)	Displays attitude (roll, pitch, and yaw), attitude rates, and attitude errors (flight director information).
ADI ATTITUDE switch	F6, F8	Selects the coordinate system and Euler sequence in which the roll, pitch, and yaw attitudes are displayed on the ADI.
ADI ERROR and RATE switches	F6, F8	Determines full scaling for ADI error needles and rate pointers
HSI	F6, F8 (Can be called up on any MDU)	Displays heading information with respect to the target insertion plane in ascent and heading and altitude error information during entry. See section 3.4.2 and HSI CBT for details.
HSI SOURCE switches	F6, F8	Determines source of vehicle position data (NAV, TACAN or MLS) and which of the three TACAN or MLS receivers to use if TACAN or MLS selected (entry only, ascent always uses NAV).
HSI MODE switch	F6, F8	Determines display mode - ENTRY, TAEM, APPROACH (entry only).
ALPHA/MACH Ind (AMI)	F6, F8 (Can be called up on any MDU)	Displays angle of attack, acceleration, Mach/velocity, and equivalent airspeed. See section 3.4.3 and the GNC DED DISP CBT for details.
ALTITUDE/VERTICAL VELOCITY Ind (AVVI)	F6, F8 (Can be called up on any MDU)	Displays altitude, altitude rate, altitude acceleration, and radar altimeter. See section 3.4.4 and the GNC DED DISP CBT for details.
AIR DATA switch	F6, F8	Selects data source to drive the AMI and AVVI (NAV, or "raw" air data). Entry only, ascent always uses NAV.
RADAR ALTM switch	F6, F8	Selects data source to drive the radar altimeter tape on the AVVI (radar altimeter 1 or 2).
ABORT light	F6	Indication to abort. Only the control center can illuminate this light.
RCS COMMAND light	F6	Indication of the RCS activity during entry.
MPS PRESS gauges	F7	Engine throttle level. NOTE: unlike most gauges in the cockpit, these gauges are driven by the GPC via FF MDMs.
MAIN ENGINE STATUS lts	F7	Amber lights indicate hydraulic lockup, electronic lockup, command path failure, or data path failure. Red lights indicate an engine has shutdown or, if main engine limits are inhibited, an engine is running out of limits. Lights extinguish when ET sep is commanded.
OMS PRESS gauges	F7	Pressure in the OMS engine.
RANGE SAFE ARM light	F7	Warning of range safety system (RSS) being armed.
Surface position indicator (SPI)	F7	Not driven in ascent but SPI provides position indication of aerosurfaces during entry. See section 3.4.5.
HYDRAULIC gauges	F8	Hydraulic pressure and quantity.
APU gauges	F8	APU fuel and WSB water quantity, exhaust gas temperature, fuel pressure, and oil temperature.
FREON EVAP OUT TEMP gauge	O1	Flash evaporator activation indication.
FCS MODE light	F2, F4 (Eyebrow panels)	Indicates the mode (AUTO/CSS) for pitch and roll/yaw. Indicates the mode (AUTO/MAN) for bodyflap and speedbrake/thrust control. BFC light indicates when BFS is engaged. The BODYFLAP light extinguishes when the MPS dump is complete.
ACCEL (g meter)	F6, F8	Normal (Z-body) acceleration in g's.

3.4.1 Attitude Director Indicator (ADI)

The ADIs are used during ascent and aborts. For MEDS vehicles the ADI is called up with the composite A/E primary flight display which encompasses the ADI/HSI/AMI/AVVI_[AFPH3-2]. The primary flight displays are generally called up on MDU's 2 and 8, which are on panels F6 and F8 respectively. The ADIs provide orbiter attitude, attitude rate, and attitude error information as shown in figure 3.4.1-1. Each ADI has dedicated switches which affect only half the cockpit. The exception is the attitude reference (ATT REF) push button which affects all ADIs as described in section 3.4.1.1.

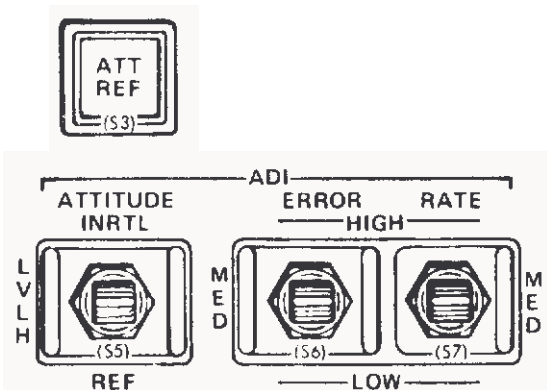
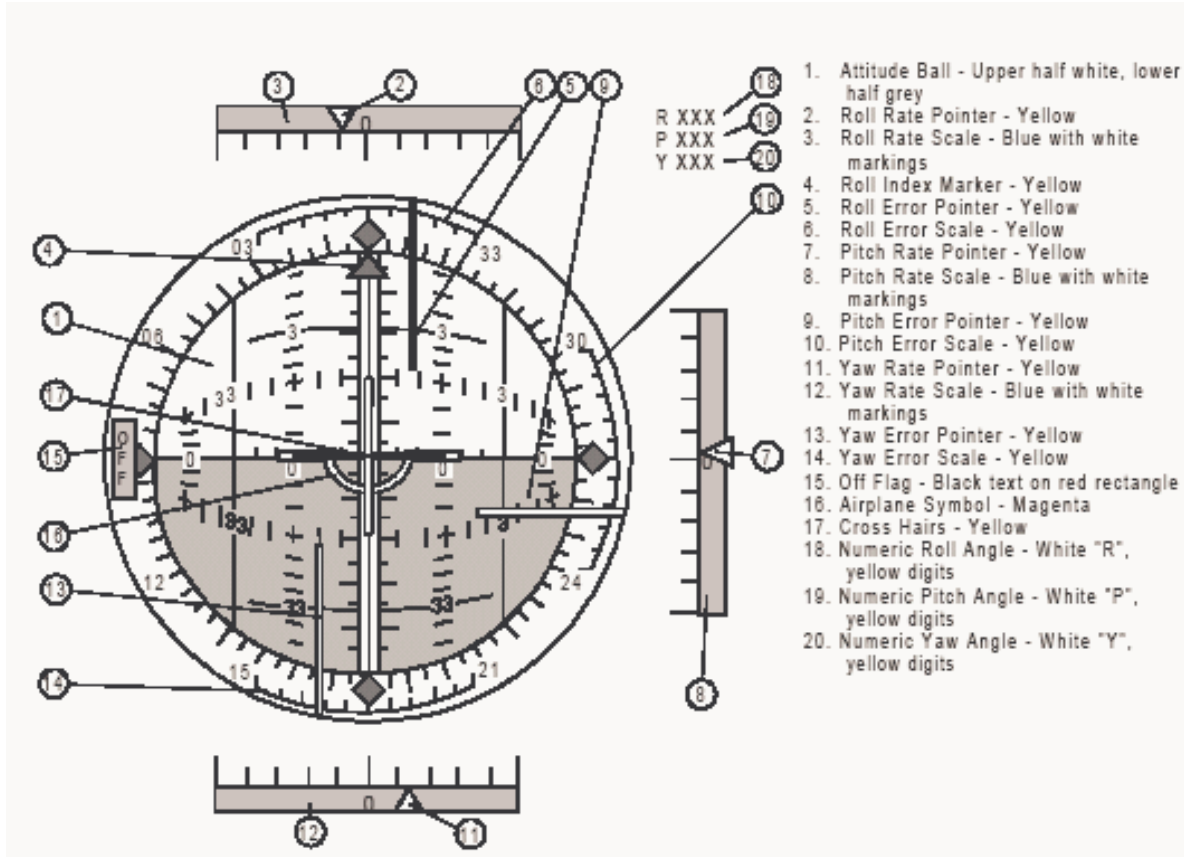

Figure 3.4.1-1: Attitude Director Indicator and Associated Switches

3.4.1.1 Attitude

The Orbiter's pitch, roll, and yaw attitude are displayed by means of a gimballed ball. The source of attitude knowledge is one of the IMUs selected by an algorithm based on IMU to IMU misalignment. The ADI is marked for pitch angle with great circles every 30° from 0° to 360° . Pitch attitude is read behind the pitch/yaw index (sometimes referred to as the "airplane") at the center of the display. The 0° pitch line, where black and white meet, can be thought of as a horizon line. Therefore, when the "airplane" is against the white background, pitch attitude is positive and when it is read against the black background, pitch attitude is negative. Yaw markings include the 0° line ("belly band") and great circles at 30° , 60° , 300° , and 330° . The roll markings are not on the ball itself but are fixed to the ADI case. The scale runs counterclockwise, 0° to 360° , with 90° intervals marked by black diamonds. The roll angle is read where the roll bug (yellow arrow) intersects the roll scale. An easy method of determining the roll direction from the ADI is to visualize the 0° pitch line as the horizon and the pitch/yaw index or "airplane" as the vehicle's wings. If the right side of the pitch/yaw index is against the black background, it is below the horizon and therefore the vehicle is in a right roll.

The ADI ATTITUDE switch selects the frame of reference for the attitude display of the corresponding ADI. There are three switch positions: INRTL, LVLH, and REF whose coordinate systems are described below.

Inertial (INRTL)

The INRTL reference frame is the M50 coordinate system. Therefore, the ADI reads M50 coordinates when the ADI ATTITUDE switch is in the INRTL position. For OMS 1 and OMS 2 burns, the burn attitude on the MNVR display is in inertial coordinates, so that the ADI in INRTL should match those coordinates within the attitude deadbands ($\pm 3.5^\circ$) when in attitude for the burn. The Euler sequence for the INRTL ADI is pitch, yaw, roll.

Local vertical/local horizontal (LVLH)

In LVLH, the ADI during ascent works much like a conventional aircraft's ADI that doesn't display heading information. It displays pitch and roll in a manner familiar to all pilots. The major exception is that the ADI will tumble as pitch of 90° is approached. This is because the ADI hardware was built for a pitch, yaw, roll sequence and compensates for singularities at 90° yaw. This compensation prevents the ADI from tumbling when near 90° yaw. Since the LVLH sequence is yaw, pitch, roll, the singularity occurs at 90° pitch. However, the hardware is not built to compensate for pitch singularities so that the LVLH ADI tumbles when near 90° pitch.

During powered ascent (MMs 102, 103, and 601), the LVLH position is called LVIY, where IY is a unit vector that defines the desired orbital plane. This makes LVIY a rotating reference frame defined by Z = down (vector toward center of the earth), X = downrange (normal to plane formed by the vector toward the center of the earth and a

unit vector normal to the desired insertion plane), and Y completing the right hand system. For LVIY, the attitude is processed in a yaw/pitch/roll sequence. However, the ADI is driven to zero in yaw so that the ball becomes simply a pitch/roll display. The yaw angle is shown on the HSI display and represents yaw (heading) with respect to the desired insertion plane. Therefore, the LVIY shows a simple Earth referenced pitch/roll display on the ADI.

During MMs 104 through 106, the LVLH ADI reverts to three axis drive and a pitch/yaw/roll sequence. The reference frame is defined as +Z toward the Earth center, +Y in the opposite direction of the orbiter momentum vector (roughly south for low inclination flights), and +X completing the right hand system (roughly downrange). The LVLH frame is not a fixed system. It rotates as the orbiter rotates around the earth.

REF

REF position causes the ADI attitude to be based on an INRTL reference frame. The REF frame at lift-off is fixed at lift off to the LVLH (really LVIY) frame. The LYLH frame rotates as the orbiter rotates around the earth, but the REF frame stays fixed in inertial space. This results in about an 8° difference between the REF and LYLH frames at MECO ($\approx 4^\circ/\text{min}$). Even though the difference in the REF and LVLH frames is small, the difference in the Euler sequence can lead to very different ADI displays for an orbiter in the same attitude. The major differences are:

1. The behavior of the ADI at 90° pitch. Remember the LVLH ADI tumbles at 90° pitch, but the REF ADI doesn't. This is because it is being driven by the Euler sequence that the hardware was built to (pitch/roll/yaw). During some abort scenarios where we know the pitch will stay close to 90°, the crew takes the ADI to REF.
2. Yaw information is displayed. Again, because the Euler sequence and the hardware are compatible, yaw information can be displayed. During some abort scenarios where we know the shuttle will yaw significantly, the crew takes the ADI to REF.
3. When pitched more than 90° in the REF frame (i.e. headed back toward KSC), the REF pitch and roll information will not read anything close to pilot attitude, but the horizon line on the ADI will still reference the earth's horizon correctly. For example, if in level flight heading back to KSC (pitch 0°, roll 0° in pilot attitude), the REF attitude will read pitch 180° and roll will read 180°, even though the horizon line on the ADI will reference the horizon correctly.

Depressing the ATT REF push button updates the REF frame to the current orbiter body axis orientation (i.e. defines your current attitude as 0°/0°/0°). The update is independent of ADI ATTITUDE switch position and affects the REF frame for all ADIs. If an ADI ATTITUDE switch is in the REF position when an attitude REF push button is depressed, the ADI jumps to 0° in all axes. Note that during BFS engaged operations, only the CDR's attitude REF push button is processed.

Table 3.4.1.1-I summarizes the reference frame for each major mode, depending on the attitude switch position. Notice that the switch position does not change the coordinate system used to drive the ADI attitude during entry operations.

Table 3.4.1.1-I: ADI Attitude Definition Summary

Major Mode	Switch Position	Reference Frame		
		Roll	Pitch	Yaw
101-103, 601	INRTL	Inertial	→	→
	LVLH	LVIY	→	= 0
	REF	Reference	→	→
104-106, 301-303	INRTL	Inertial	→	→
	LVLH	LVLH	→	→
	REF	Reference	→	→
304, 602	Switch not effective	Topodetic	→	= 0
305, 603	Switch not effective	Topodetic	→	= 0

Note: During BFS engaged operations, the CDR's attitude switch controls both the CDR's and PLT's ADI.

During ascent, the ADI ATTITUDE switch is manipulated as necessary to give the crew an easy way to monitor orbiter attitude and performance. At lift-off in the LVLH position (LVIY frame), the ADI is at the +90° pitch singularity for an extended period. Therefore, a deadband of ±2° is employed to cause the ADI to remain frozen in roll until after pitch maneuver initiate (yaw is pinned to zero). The frozen roll is 55.3°, which is the LVIY roll angle anticipated when the orbiter breaks out of the 2° deadband in pitch.

Because of this, the LVLH position is not selected at lift-off. Instead, the inertial REF frame with respect to launch is selected until after tower clear and the pitch and roll maneuver is completed. At that time, the LVLH position is selected on at least one ADI for the rest of powered ascent. Prior to the OMS 1 burn, INRTL is used so that the attitude can be checked against the OMS 1 attitude on the OMS-1 MNVR EXEC display. The REF frame can be redefined at the OMS 1 ignition attitude to give the crew an easy means of monitoring the burn.

3.4.1.2 Rates

The vehicle rates are displayed via three meter positioned pointers. Roll, pitch, and yaw rates are indicated by the top, right, and bottom pointers, respectively. Table 3.4.1.2-I summarizes the sense for the rate pointers. A good way to remember the sense is that they are fly-to zero the rates (i.e. a roll rate pointer to the right means you are rolling left).

Table 3.4.1.2-I: ADI Rate Pointer Sense

Axis	Positive Rate	Pointer Deflection
Roll	Right	Left
Pitch	Up	Down
Yaw	Right	Left

The definition and full scale deflection are dependent on the ADI Rate Switch position and major mode. During Major Modes 101 through 106, 301 through 304, 601, and 602, full scale deflection is 1°/sec, 5°/sec, or 10°/sec when the ADI rate switch is in the LOW, MED, or HIGH position, respectively. It is not necessary to memorize these numbers, since they are on a small cue card that is placed around the rate switches. During Major Mode 305 and 603 TAEM, when the rate switch is in the MED (medium) position, the ADI rate pointers display the time to HAC initiation, crosstrack error, and altitude error and revert to rates on final approach. The definition and full scale deflection of the rate pointers are summarized in table 3.4.1.2-II.

Table 3.4.1.2-II: ADI Rate Scale Definition and Full Scale Deflection

Major Mode	Switch Position	Roll	Pitch	Yaw
101-106, 301-303, 601	HIGH MED LOW	RGA body 10°/s ↓ 5°/s 1°/s	→	→
304, 602	HIGH MED LOW	Stability axis 10°/s ↓ 5°/s 1°/s	RGA body 10°/s ↓ 5°/s 1°/s	Stability axis 10°/s ↓ 5°/s 1°/s
305 or 603 S-turn or Acquisition phase	HIGH MED LOW	Stability axis 5°/s Time to HAC 10s Stability axis 5°/s	RGA body 5°/s Alt Error 5K ft RGA body 5°/s	Stability axis 5°/s Hdg Error 5° Stability axis 5°/s
305 or 603 Heading Alignment phase	HIGH MED LOW	Stability axis 5°/s stowed Stability axis 5°/s	RGA body 5°/s Alt Error 5K ft RGA body 5°/s	Stability axis 5°/s Radial Error 5K ft Stability axis 5°/s
305 or 603 Prefinal and A/L phases (alt > 7K ft)	HIGH MED LOW	Stability axis 5°/s stowed Stability axis 5°/s	RGA body 5°/s Alt Error 1K ft RGA body 5°/s	Stability axis 5°/s Y rwy pos. 1K ft Stability axis 5°/s
305 or 603 Alt < 7K ft and 3 sec timer not expired	HIGH MED LOW	Stability axis 5°/s stowed Stability axis 5°/s	RGA body 5°/s stowed RGA body 5°/s	Stability axis 5°/s stowed Stability axis 5°/s
305 or 603 Alt < 7K ft and 3 sec timer expired	HIGH MED LOW	Stability axis 5°/s ↓	RGA body 5°/s ↓	Stability axis 5°/s ↓
WOWLON = 1	HIGH MED LOW	Stability axis 5°/s ↓	RGA body 5°/s ↓	Stability axis 5°/s ↓

3.4.1.3 ADI Errors

The differences between the actual attitude and the desired or commanded attitude are displayed via three meter positioned yellow needles which extend in front of the ADI ball. These needles look and act much like flight director needles on a military aircraft. Roll, pitch, and yaw errors are indicated by the top, right, and bottom needles, respectively. However, the yaw error needle is used for sideslip indication on entry. The sense of the needles are fly-to, which means the RHC must be deflected in the same sense as the needle deflection to null the errors. The first stage ADI errors do not include the accelerometers feedback load relief effects, i.e. the needle deflection cannot be nulled in CSS for about the first 90 seconds of flight without disrupting load relief commands.

The BFS digitally displays its attitude errors on the BFS TRAJ DISPLAY. This digital data is the difference between BFS guidance desired attitude and the current attitude of the shuttle. The ADI attitude errors from the PASS, as read on the ADI, can be compared with the BFS attitude errors, to indicate how closely the PASS and BFS agree.

If guidance is unconverged for 10 consecutive seconds, the error needles stow until guidance reconverges for 10 consecutive seconds. The error needles will also unstow at MM104 or 602, at RTLS fine count if in CSS, or if a two or three engine out CA is initiated. Note that the ADI error needles will remain stowed through MM103 or MM601 if MM103 fine count is reached with the needles stowed or MM601 fine count is reached in AUTO flight control with the needles stowed.

For invalid or missing data in any or all axes, the ADI continues to be driven but the OFF flag appears. If any rate or error parameter is considered invalid, the indicator is driven out of sight. If the parameter later becomes valid, that indicator is driven again.

The definition and full scale deflection of the error needles are summarized in table 3.4.1.3-I. It is not necessary to memorize these numbers, since they are on a small cue card that is placed around the error switches

Table 3.4.1.3-I: ADI Error Needle Definition and Full Scale Deflection

Major Mode	Switch Position	Roll	Pitch	Yaw
101-106, 301-303, 601	HIGH MED LOW	Roll Error 10° ↓ 5° 1°	Pitch Error 10° ↓ 5° 1°	Yaw Error 10° ↓ 5° 1°
304, 602 (Alpha Recovery or Alpha Transition phase)	HIGH MED LOW	Roll Error 25° ↓ 25° 10°	Alpha Error 5° ↓ 2° 1°	*Est. 1°/2.5 jets Side- 1°/2.5 jets slip 1°/2.5 jets
602 (NZ Hold phase)	HIGH MED LOW	Roll Error 25° ↓ 25° 10°	NZ Error 1.25° ↓ 1.25° .5°	*Est. 2.5 jets Side- 2.5 jets slip 2.5 jets
305, 603 (prior to WOWLON)	HIGH MED LOW	Roll Error 25° ↓ 25° 10°	NZ Error 1.25° ↓ 1.25° .5°	*Est. 2.5 jets Side- 2.5 jets slip 2.5 jets
WOWLON = 1	HIGH MED LOW	Roll Error 20° ↓ 5° 1°	Slapdown 10°/s pitch rate 5°/s error 1°/s	*Est. 2.5 jets Side- 2.5 jets slip 2.5 jets

*Estimated sideslip:

QBAR < 40 psf: Sideslip angle in degrees

QBAR > 40 psf: Based on lateral acceleration and yaw jet effectiveness. Full scale deflection is equivalent to the yawing moment produced by 2.5 yaw jets.

3.4.2 Horizontal Situation Indicator

The HSIs are used to monitor auto guidance and provide information needed by the crew to fly manually. For MEDS vehicles the HSI is called up with the composite A/E primary flight display which encompasses the ADI/HSI/AMI/AVVI. The primary flight display is generally called up on MDU's 2 and 8, which are on panels F6 and F8 respectively. The parameters displayed on the HSI are computed in the Area Navigation software module. Each HSI display consists of a case enclosed circular compass card (0° to 360°). At the center of the compass card is an aircraft symbol, fixed with respect to the case, about which the compass card rotates. The ascent/aborts HSI is illustrated in figure 3.4.2-1 below [AFPH3-3].

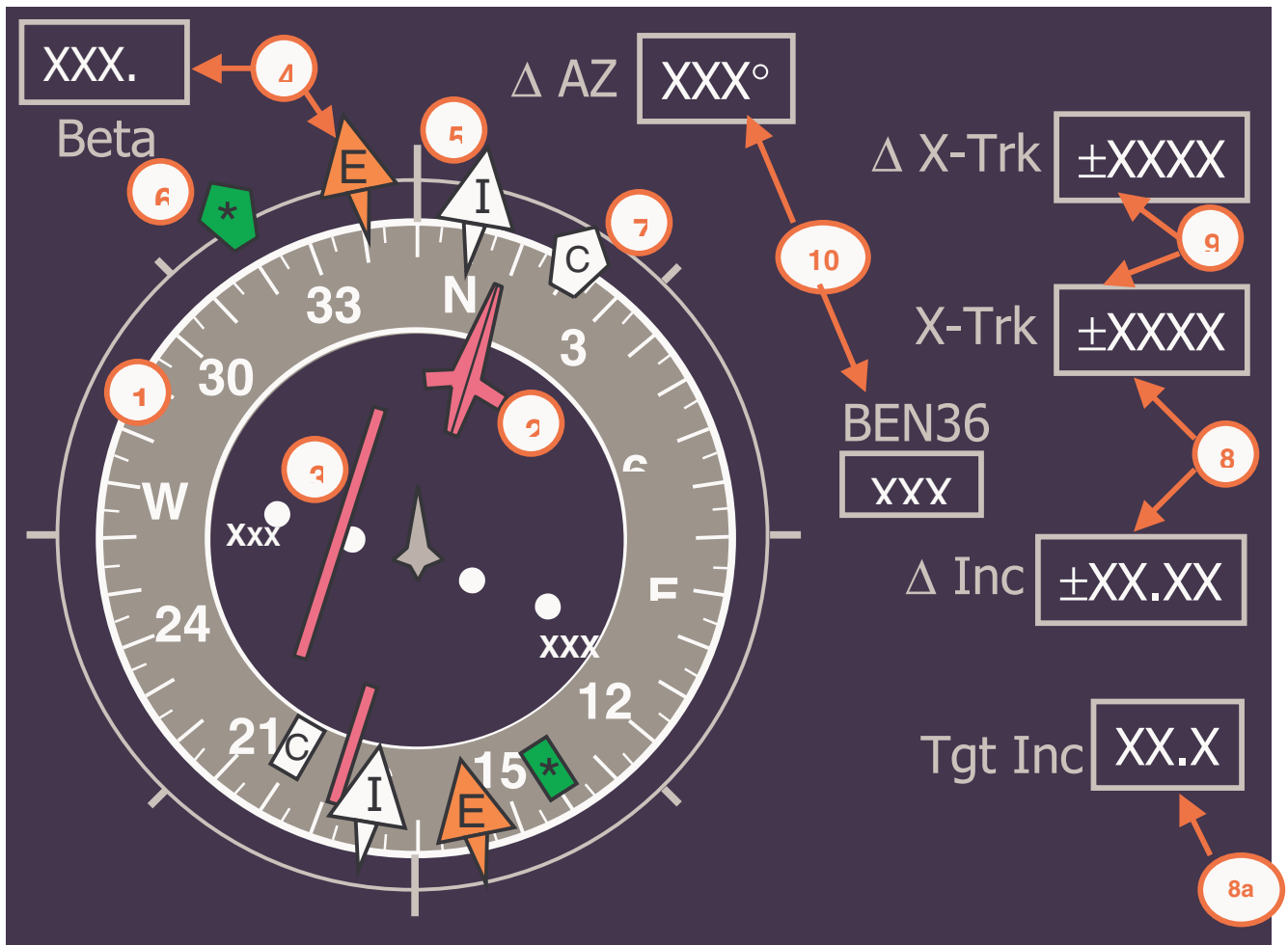

Figure 3.4.2-1: Horizontal Situation Indicator

3.4.2.1 Ascent HSI

During powered ascent (MMs 102, 103, and 601) the HSI provides information relative to the target insertion orbit. The glide slope deviation, primary range, and secondary range are not driven. The Ascent HSI parameters are defined below and summarized in table 3.4.2.1-I.

Heading

The compass card displays heading with respect to the target insertion plane. N,E,S,W is replaced with 0,9,18,27 when referenced to target insertion plane. When numbers visible, 0 always represents pre-flight planned target insertion plane. Indicates magnetic heading for RTLS/ECAL/BDA & N,E,S,W replace numbers to identify card as magnetic.

0° on the compass card points along the target insertion plane. The heading of the body +X axis with respect to the target insertion plane is read at the lubber line. The heading is displayed so that it is always fly-to. For example, if the 0° marker is to the left, the RHC must be twisted to the left (left yaw) to fly the shuttle toward the 0° marker.

Course Pointer

The course pointer provides the heading to the target insertion orbit plane. The target inclination is pinned at 0 for uphill cases. If TAL, the arrow is redefined to point at the tangent of targeted cross-range circle around the TAL site. If ATO and variable IY is active, the arrow is redefined to the new target inclination. If no variable IY, no redefinition, arrow stays on 0. The arrow is blanked for RTLS/ECAL/BDA. The arrow turns white when abort PE yaw steering is active (abort PE is no opted at the time of this release).

Course Deviation Indicator (CDI)

The CDI deflection indicates the lateral off-set from targeted plane/course in nm. Auto re-scale at 50,10, & 1nm and labeled appropriately. One mile scaling only occurs after 6+30 MET. CDI & scale blanked for RTLS/ECAL/BDA & TAL. Turns white when abort PE yaw steering is active (abort PE is no opted at the time of this release).

VREL Bearing Pointer

The VREL Bearing Pointer indicates direction of Earth-relative velocity vector relative to vehicle nose (lubber line) & course (compass card/course arrow). Works in concert with beta digital readout. Pointer & beta only visible before 2+30 or 200K and after RTLS (ECAL/BDA) abort select. Beta & pointer are always fly-to to null, with beta showing an “L” or “R” prefix indicating direction to null.

Inertial Bearing Pointer

The Inertial bearing pointer indicates the direction of inertial velocity vector relative to nose & course. Blanks at gliding flight major mode. It provides the heading of the inertial velocity (V_I) vector with respect to the target insertion orbit plane. One of the primary goals of ascent guidance is to have the Inertial pointer (V_I) pointed at 0 at MECO.

Runway/HAC Bearing Pointer

The Runway/HAC bearing pointer indicates “R” for bearing to the runway in powered flight and “H” for bearing to HAC in gliding flight. Appears at RTLS/TAL abort select & entry. During TAEM a “C” bearing pointer will be displayed, this indicates the bearing to the center of the primary HAC.

X-Trk

Lateral off-set distance (nm) from targeted plane/course. Supplements CDI.

Δ Inc

Difference between current & targeted inclination (deg). Supplements “I” bearing pointer. Both readouts visible for nominal & ATO only.

Tgt Inc

Indicates the value of targeted inclination (deg). Appears with X-Trk & Δ Inc at ATO select. Supplements course arrow. Useful when variable IY active.

Δ X-Trk

X-Trk minus radius of the targeted TAL cross-range circle (nm), showing the distance vehicle must steer to meet TAL cross-range targeting. Only appears with X-Trk at TAL abort. Shows zero if current ground track/plane is inside the TAL cross-range target. Supplements course arrow, “I” bearing pointer, & “R” bearing pointer.

Δ X-Trk, X-Trk, Δ Inc, & Tgt Inc are blanked at RTLS abort select.

Δ AZ (deg) & Range to runway (nm, with SPEC 50 runway selection shown) appear at TAL/RTLS (ECAL/BDA) abort.

Table 3.4.2.1-I: Ascent HSI Parameter Definitions

HSI Parameter	¹ Definition
Lubber Line	Vehicle heading
Course Pointer	Points to target insertion plane
Course Deviation Indicator	Lateral off-set from target plane
Glide Slope Indicator	not driven
VREL Bearing Pointer	VREL heading
Inertial Bearing Pointer	VI heading
Runway Bearing Pointer	² Bearing to runway (TAL and RTLS)
Primary Range	not driven
Secondary Range	not driven

¹All headings with respect to target insertion plane

²Runway bearing pointer is not driven in MMs 101 or 102 and is only driven in MM103 if a TAL/RTLS abort is declared.

3.4.2.2 *Entry HSI*

During entry (MMs 304, 305, 602, and 603), the HSI provides a pictorial view of the vehicle’s location with respect to various navigation points. There are three switches for each HSI which control the HSI computations and input source as shown in figure 3.4.2.2-1.

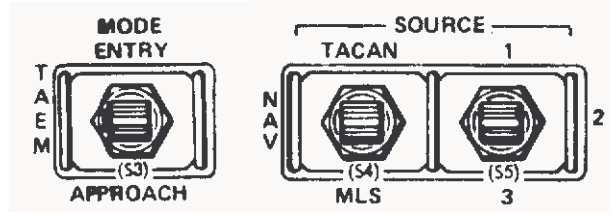

Figure 3.4.2.2-1: HSI Controls

The definition of some HSI parameters are dependent on the HSI mode which may be manually controlled using the HSI Select Mode switch. The Select Mode switch is a three position switch which includes ENTRY, TAEM, and A/L. If the switch is in the ENTRY position, the HSI automatically changes the mode from Entry to TAEM at Major Mode 305 or 603 transition. It will also automatically change the mode from TAEM to A/L when altitude is less than 18,000 ft and course deviation is less than 2.5° or at 12,000 ft altitude if the course deviation criterion is still not met. The automatic moding may be overridden by taking the switch to the TAEM or A/L position, which will change the definition of some HSI parameters.

The HSI Select Source switches control the input data used by the HSI to compute the entry HSI parameters. There are two switches, both of which are three position switches. The first switch includes the TACAN, NAV, and MLS positions, while the other switch includes LRU 1, 2, and 3 positions. If the first switch is in the TACAN position, TACAN slant range and bearing and drag or ADTA altitude are used in the HSI computations. If the switch is in the navigation position, then the orbiter state vector is used in the HSI computations. If the switch is in the MLS position, then MLS slant range, azimuth, and elevation are used. The second switch determines which LRU the TACAN or MLS data is obtained from when the first switch is in the TACAN or MLS position.

The Entry HSI parameters are defined below and summarized in table 3.4.2.2-I.

Heading

The magnetic heading is the angle between magnetic north and the vehicle direction measured clockwise from magnetic north, is displayed under the lubber line. During Major Modes 304 and 602, the software uses the relative velocity vector for vehicle direction, while in Major Modes 305 and 603, the body +X axis is used instead.

Course Pointer

The Course Pointer represents the magnetic heading of the selected runway. For example, if KSC 33 is the selected runway, the Course Pointer would point to 330° on the compass card.

Course Deviation Indicator (CDI)

The CDI is not driven in Major Modes 304 and 602 and remains centered until Major Mode 305 or 603 is entered. During Major Modes 305 and 603, it represents the deviation from the extended runway centerline. Full scale deflection is 10° during TAEM and 2.5° during the HSI

Approach and Landing scaling mode (HSI A/L scaling occurs earlier than guidance A/L near the A/L guidance prefinal phase). The CDI is a fly-to indicator for flying the vehicle to the extended runway centerline.

Glide Slope Indicator (GSI)

The GSI is not driven during Major Modes 304 and 602 and remains centered with the GS flag visible until Major Mode 305 or 603 is entered. During Major Modes 305 and 603, it represents the altitude error of the vehicle. The pointer is a fly to indicator, i.e. if the pointer is at the bottom of the scale, the vehicle is high on altitude or above the glideslope but if the pointer is at the top of the scale, the vehicle is low on altitude or below the glideslope. [AFPH3-4] Full scale deflection is 5,000 ft during TAEM and 1000 ft during the HSI Approach and Landing scaling mode (HSI A/L scaling occurs earlier than guidance A/L near prefinal). Below an altitude of 1500 ft, the glide slope deviation is not computed, the GSI is driven to zero, and the GS OFF flag becomes visible.

HAC Bearing Pointer

During entry and TAEM, the HAC bearing pointer is the great circle bearing in degrees to the HAC tangency point (WP1) of the selected HAC at the selected runway. In the A/L mode, the HAC bearing pointer is the bearing to way point 2 (WP2), where WP2 is 1000 ft past threshold of the selected runway.

HAC Center Bearing Pointer

During entry and the A/L mode, the HAC Center bearing pointer is the same as the primary bearing pointer. However, during TAEM, the HAC Center bearing pointer is the bearing to the center of the selected HAC at the selected runway.

Primary Range

During entry, the primary range displayed is the range to WP2, including the great circle distance to the HAC tangency point and the distance around the HAC to WP2. WP2 is located 1000 ft from the threshold down the runway. During TAEM, primary range is the horizontal distance to WP2, including the range around the HAC to WP2. During the A/L mode, it is simply the horizontal distance to WP2. In summary, primary range is the distance to fly to reach the runway.

Secondary Range

During entry and the A/L mode, the secondary range is the same as the primary range. However, during TAEM, the secondary range is the horizontal distance to the center of the selected HAC for the selected runway.

Table 3.4.2.2-I: Entry HSI Parameter Definition

HSI Parameter	HSI Mode		
	ENTRY	TAEM	A/L
Lubber Line	Magnetic heading of V_{REL} vector	Magnetic heading of +X body axis	Magnetic heading of +X body axis
Course Pointer	Magnetic heading of selected runway		→
Course Deviation Indicator (CDI)	Driven to Zero (no CDI flag)	Deviation from extended runway CL (full scale = $\pm 10^\circ$)	Deviation from extended runway CL (full scale = $\pm 2.5^\circ$)
Glide Slope Indicator (GSI)	Pointer stowed (GS flag displayed)	Altitude Error (full scale = $\pm 5,000$ ft)	Altitude Error (full scale = $\pm 1,000$ ft)
HAC Bearing	Spherical bearing to HAC tangency pt of selected HAC	Bearing to HAC tangency point of selected HAC	Bearing to WP2 (1,000 ft past rwy threshold)
HAC CenterBearing	Same as HAC Bearing	Bearing to center of selected HAC	Same as HAC Bearing
Primary Range	Spherical surface range to WP2, including range around HAC	Horizontal distance around HAC to WP2	Horizontal distance to WP2
Secondary Range	Same as Primary Range	Horizontal distance to center of selected HAC	Same as Primary Range

3.4.3 Alpha/Mach Indicator

The AMIs are driven with NAV derived parameters during powered ascent MMs 102, 103, and 601 and during MMs 304 and 602. They are driven by NAV derived parameters or probe data in MMs 305 and 603 depending on the ADTA switch position and Mach number. The AMI is not driven on orbit (in MMs 104-106 and 301-303). The AMI is not driven by the engaged BFS during ascent since CSS flying is not allowed. Figure 3.4.3-1 illustrates the AMI and the ADTA switch. The AMI parameters are described below and summarized in table 3.4.3-I.

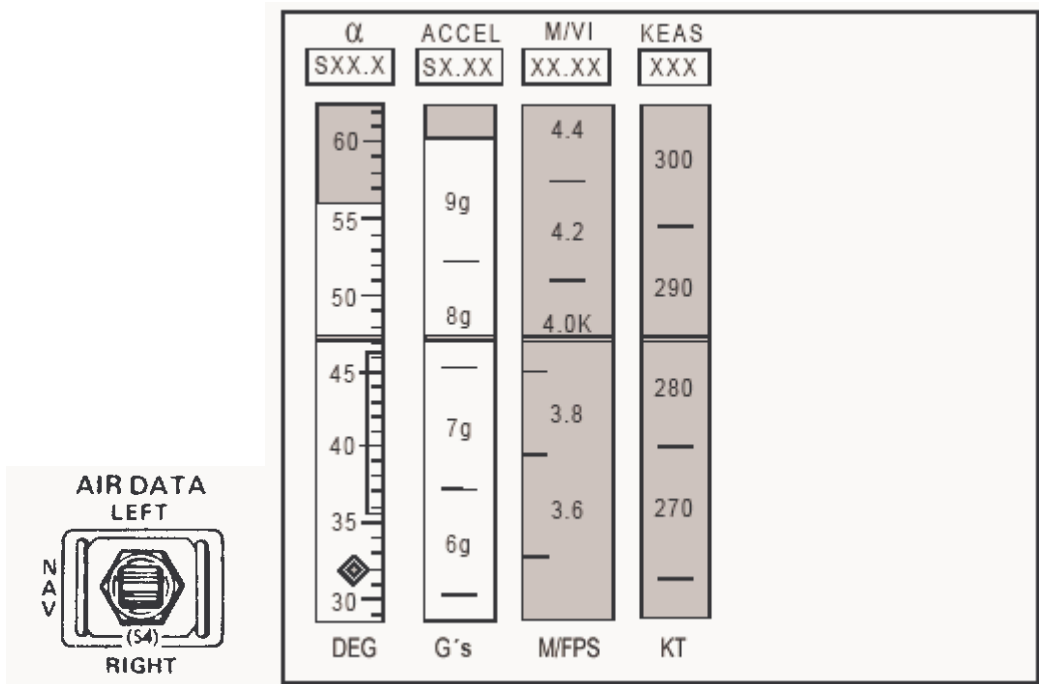

Figure 3.4.3-1: Alpha Mach Indicator and ADTA Switch

Angle of Attack (ALPHA)

The ALPHA tape displays the angle of attack in MMs 103, 304, 305, 601, 602, and 603. The scale is from -180° to $+180^{\circ}$. During MM 102, the ALPHA OFF flag is displayed.

Acceleration (ACCEL)

The ACCEL tape displays the total load factor in g's in MMs 102, 103, and 601. During MM304, MM602 and MMs 305 and 603 prior to weight on wheels, the ACCEL tape displays normal acceleration in g's. Following weight on wheels the drag acceleration in fps^2 is converted to g's and displayed on the ACCEL tape. The scale on the tape is -5.0 to +10.0 $\text{g}'\text{s}_{[\text{AFPH3-5}]}$.

Mach/Velocity (M/VEL)

M/VEL displays the magnitude of the V_{REL} vector during first stage (MM 102) and after PPA on an RTLS abort in MM601. The magnitude of the V_I vector is displayed during second stage (MM103) or on an RTLS abort before PPA. During entry (MMs 304, 305, 602, and 603), Mach number/relative velocity is displayed. If air data is not available, Mach number is simply calculated by dividing V_{REL} by 1000. This simple conversion of Mach to V_{REL} is also used in the Flight Data File and in many other places at NASA. The scale is from Mach 0 to Mach 4 and then rescaled above Mach 4 to range from 4K to 27K fps.

Equivalent Airspeed (EAS)

Current ascent and entry (MMs 102, 103, 304, 305, 601, 602, and 603) EAS displays equivalent airspeed in knots. The scale is from 0 to 500 knots. EAS is an indication of the dynamic pressure.

Table 3.4.3-I: Alpha Mach Indicator Parameter Definition

Major Mode	ALPHA	ACCEL	M/VEL	EAS
102	α (¹ UPP)	total load factor (¹ UPP)	VREL (¹ UPP)	EAS (¹ UPP)
103, 601	α (¹ UPP)	total load factor (¹ UPP)	VI (¹ UPP) VREL if 601 and post-PPA	EAS (¹ UPP)
602	α (NAVDAD)	NZ (UPP)	VREL (NAVDAD)	EAS (NAVDAD)
304, 305, 603	α (² NAVDAD or ADTA)	NZ (¹ UPP)	VREL (² NAVDAD or ADTA)	EAS (² NAVDAD or ADTA)

¹UPP stands for User Parameter Processor and is basically navigation data.

²See table below for source of data displayed on AMI

Table 3.4.3-II: AMI Source Based on ADTA Switch Position (entry only)

ADTA Switch Position	Data Source (ALPHA, M/VEL, EAS)
LEFT	Left Probe
NAV	M > 2.5: NAVDAD M < 2.5: RM Selected ADTA
RIGHT	Right Probe

*Probes must be deployed with valid data and ADTA to GN&C in Auto or Force. Otherwise, NAVDAD will be displayed.

3.4.4 Altitude Vertical Velocity Indicator

The AVVIs are driven with NAV derived parameters during powered flight. During entry, the data source depends on the ADTA Switch position. The AVVI is not driven during BFS engaged ascent operations. Altitude acceleration and radar altitude are not driven during ascent. The AVVI and associated switches are illustrated in figure 3.4.4-1. The AVVI parameters are described below and summarized in table 3.4.4-I.

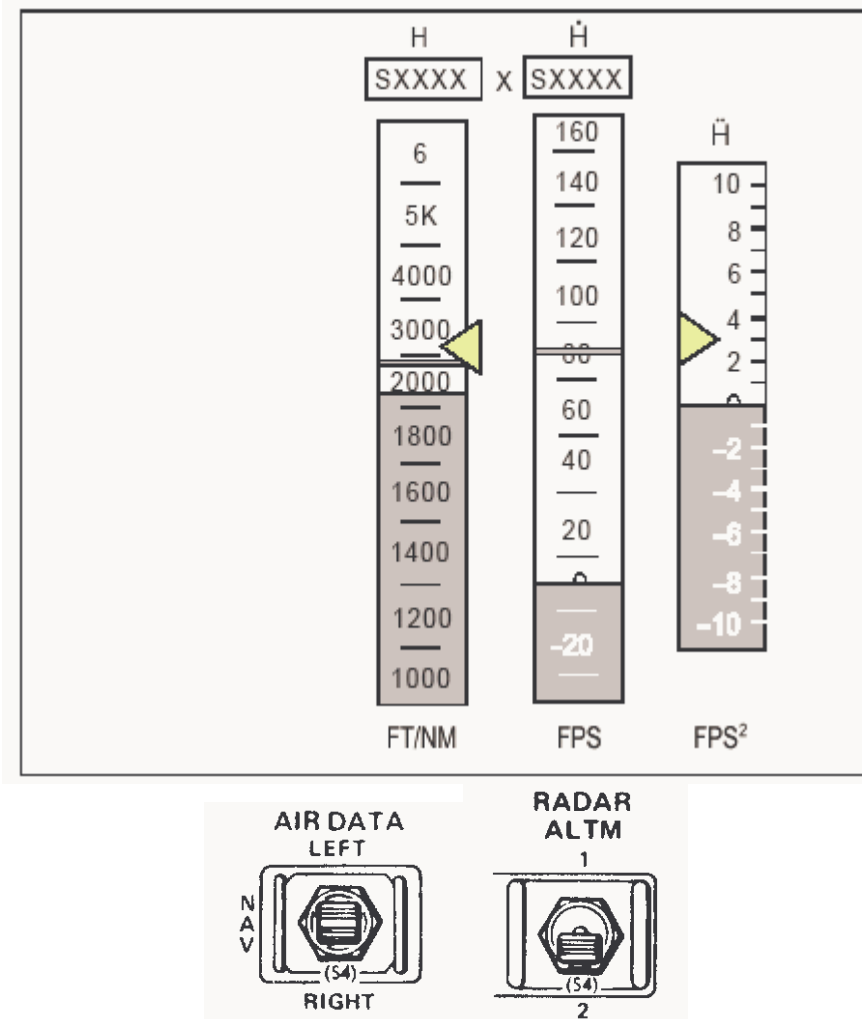

Figure 3.4.4-1: Altitude Vertical Velocity Indicator and Associated Switches

Altitude Acceleration (ALT ACCEL)

ALT ACCEL is not driven during ascent. During entry, it is the navigation derived altitude acceleration with a scale of -13.3 to +13.3 fps^2 , but the maximum value displayed is 12.75 fps^2 . The Shuttle Mission Simulator (SMS) has a known hardware problem, and it will only display to 10.0 fps^2 .

Altitude Rate (ALT RATE)

ALT RATE is the shuttle's equivalent of a vertical velocity indicator. It always displays altitude rate in ft/sec (altitude rate is commonly called Hdot). Altitude rate is the radial component of the V_I vector in MM 103 and HDOT ellipsoid in MM 601. During entry, the source for altitude rate depends on the ADTA switch position. The scale is from -3000 to 3000 fps.

Altitude (ALT)

During ascent and entry (MMs 103, 304, 305, 601, 602, and 603), ALT displays the altitude above the selected runway (KSC during ascent). The scale is from 1,100 to 400,000 ft and 40 to 165 nm. The foot and nautical mile scales overlap between 40 and 61 nm.

Radar Altimeter (RDR ALT)

The ALT tape displays the radar altitude during A/L (MM305 and 603) below about 5,000 ft. The software has the capability to display radar altitude below 9,000 ft but the tape is "parked" at 5K ft until lock-on which not coincidentally occurs at about 5,000 ft altitude.

Table 3.4.4-I: Altitude Vertical Velocity Indicator Parameter Definition

Major Mode	ALT ACCEL	ALT RATE	ALT	RDR ALT
102,103	Not Driven	vert. component of V_I vector (UPP)	Alt above RTLS runway (UPP)	Not Driven
601	Not Driven	HDOT ellipsoid (UPP)	Alt above RTLS runway (UPP)	Not Driven
304, 602	Altitude Accel (UPP)	Altitude Rate (NAVDAD)	Alt above selected runway (NAVDAD)	Not Driven
305, 603	Altitude Accel (UPP)	Altitude Rate ¹ (NAVDAD or ADTA)	Alt above sel rwy ¹ (NAVDAD or ADTA)	Radar Altimeter Alt < \approx 5K ft ² (RA1 or RA2)

¹See table below for source of data displayed on AVVI.

²Source of data is Radar Altimeter 1 or Radar Altimeter 2 depending on position of RADAR ALT switch.

Table 3.4.4-II: AVVI Source Based on ADTA Switch Position (entry only)

ADTA Switch Position	Data Source (ALPHA, M/VEL, EAS)
LEFT	Left Probe
NAV	Mach > 2.5, NAVDAD Mach < 2.5 and valid air data incorporated to G&C, Processed air data
RIGHT	Right Probe

*Probes must be deployed with valid data and ADTA to GN&C in Auto or Force to process air data. Otherwise, NAVDAD will be displayed.

3.4.5 Surface Position Indicator

The Surface Position Indicator (SPI) on panel F7 displays aerosurface positions and the auto speedbrake command. It is active only during entry (Major Modes 301 through 305, 602, and 603). The SPI is illustrated in figure 3.4.5-1. The SPI parameters are described below.

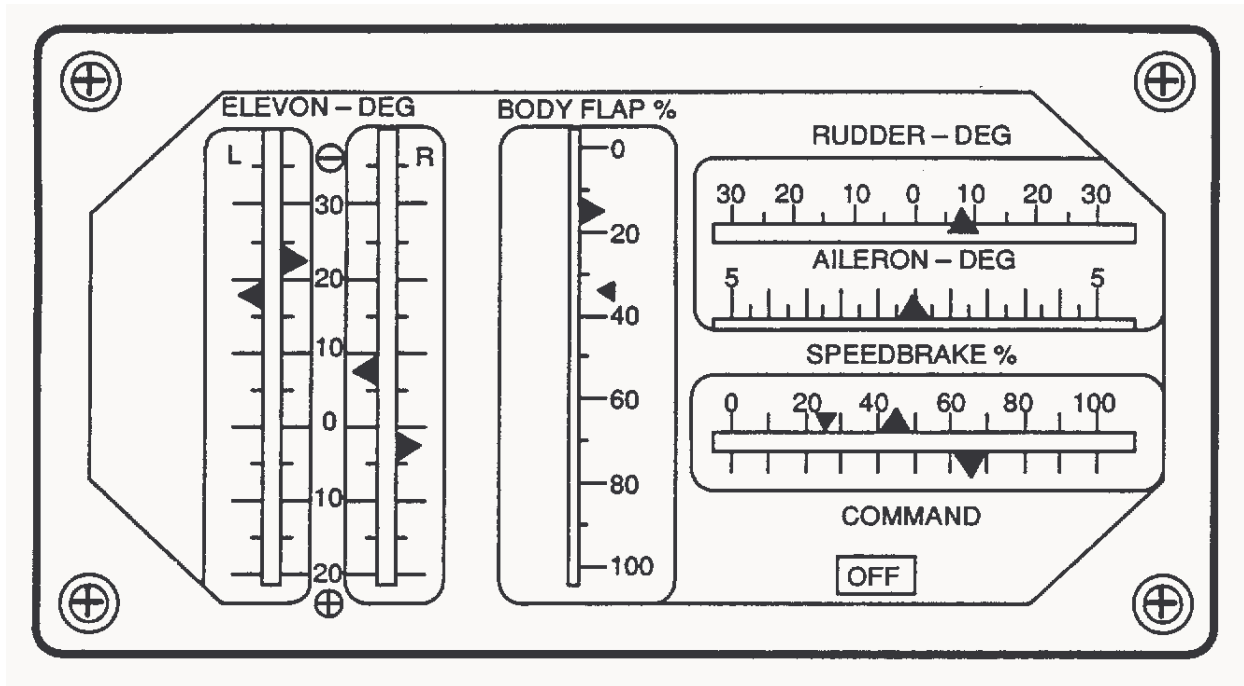

Figure 3.4.5-1: Surface Position Indicator

Elevons

There are four scales which display the elevon positions in the same order as if viewed from behind the vehicle (left outboard, left inboard, right inboard, right outboard). The scales all range from 20° down at the bottom of the scales to 35° up at the top of the scales. Note that positive elevon (lower portion of scale) is below the null line and negative elevon (upper portion of scale) is above the null line.

Body Flap

Body flap position is read and displayed from 0 to 100% of the software allowed travel. 0% at the top of the scale represents full up body flap (-11.7°), and 100% at the bottom of the scale represents full down body flap (+22.5°). The small left pointing triangle is fixed at 35% to show the trail position.

Rudder

Rudder position is displayed as if viewed from the rear of the vehicle. The scale is 30° (left) to 30° (right) but the software limits the rudder between $\pm 27.1^\circ$. Note that a positive rudder position is a deflection to the left and negative rudder position is a deflection to the right.

Aileron

This scale displays the effective aileron function of the elevons:

$$\text{Aileron} = (\text{Average Left Elevon} - \text{Average Right Elevon})/2$$

The scale ranges from -5° (left side) to $+5^\circ$ (right side), where deflection of the pointer to the left side of center indicates a conventional roll left configuration (right elevons down, left elevons up). The aileron command can exceed $\pm 5^\circ$ (max of $\pm 10^\circ$) such that the pointer pegs at the end of the scale.

Speedbrake

The actual speedbrake position is displayed on the upper scale and auto speedbrake command on the lower scale. The position ranges from 0% (full closed) to 100% (fully open). The small downward pointing triangle at 25% is fixed and represents the point at which the speedbrake surfaces and the remainder of the tail form a smooth wedge. This pointer has no useful function in the cockpit.

3.5 FCS MODE PBIs

For ascent, the pitch and roll/yaw axes are both in AUTO or CSS but AUTO and CSS are mutually exclusive of each other. These are initialized in AUTO and can be downmoded for manual steering in all axes by pushing any CSS PBI. The RHC is not hot stick. The control can be returned to the AUTO system by pushing an AUTO PBI. The lights on the PBIs correspond to the control modes.

For entry, the pitch and roll/yaw axes can be in AUTO or CSS individually. Both are initialized in AUTO and can be downmoded for manual steering in each axis by pushing the respective CSS PBI or by deflecting the RHC about 1/3 of its maximum deflection (hot stick). Control can be returned to the AUTO system by pushing the AUTO PBI(s). For OI-28, if the RHC movement beyond detent threshold causes the DAP to downmode from AUTO to CSS (entry DAP and GRTLS DAP) or AUTO to MANUAL (transition and orbit DAP), a class 3 alarm (SM light, tone, and CRT message) will be annunciated to the crew. This is good for cases where the stick is inadvertently bumped^[AFPH3-6].

The speedbrake/throttle (SPD BK/THROT) PBI indicates the mode of the MPS throttle during ascent. Manual throttle is selected by the pilot pushing the takeover push button on the speedbrake thrust controller (SBTC) (the SPD BK/THROT light will go out) and moving the SBTC until the SBTC position matches the auto CMD (the SPD BK/THROT MAN light will illuminate when the SBTC position matches the AUTO CMD). The takeover push button is then released and the crew has manual throttle. The CDR's SBTC does not work during ascent. When the PLT has manual control of the throttle, the PLT's SPD BK/THROT MAN light is illuminated but the CDR's light is not illuminated. The crew must perform MECO if manual throttle is selected. To return throttle to automatic, the SPD BK/THROT PBI is pushed. A different throttle command will not be sent to the SSMEs until guidance changes the auto throttle command. For example, if the engines have been manually throttled to 95% and guidance is commanding 104%, the throttles will usually not immediately throttle up to 104% upon return to AUTO throttle. New throttle commands are issued by guidance during first stage throttling, at abort selection, SSME failure recognition, 3g throttling, fine count, and RTLS flyback.

During entry, manual speedbrake control may be selected by the CDR or PLT by pushing the takeover push button on either SBTC. There is no need to match the speedbrake setting to invoke manual speedbrake control. The auto command pointer on the SPI and the VERT SIT will continue to display the auto commanded speedbrake setting. Control may be returned to auto by depressing either SPD BK/THROT PBI. Unlike returning to AUTO throttle, the speedbrake will immediately move to the auto commanded position.

The bodyflap (BDYFLP) PBI is used during ascent only to indicate when the MPS dump sequence is finished. The BDYFLP PBI is an important cue because the dump must be complete before the APUs are shutdown or the pitch maneuver for the ET photo DTO is started. The other PBIs extinguish at SSME zero thrust (MECO confirmed +3.75 seconds) but the BDYFLP PBI extinguishes when the MPS dump is complete. During entry, the BDYFLP PBI is used to mode between manual and auto bodyflap control.

The BFC light is illuminated when the BFS is engaged via the push button on the RHC or when the BFS goes standalone.

SECTION 4

CREW OPERATIONS

4.1 OVERVIEW

This section describes crew procedures and provides supporting rationale for nominal, ATO, AOA, RTLS, TAL, and CA phases of flight. Procedures for each flight phase are discussed sequentially, as per the Ascent Checklist, with rationale accompanying each procedure.

Sections 4.2 through 4.8 include procedures for Prelaunch, Nominal/ATO, AOA, TAL, High Energy TAL/High Energy Gander, RTLS, and Contingency Abort. Section 4.9 includes a discussion on the POWERED CSS Card. Each set of procedures described in these sections includes the cue used by the crew which tells them when to execute the procedure, displays used, the action to be taken, and additional information to further explain the purpose of the procedures.

This page intentionally left blank

4.2 PRELAUNCH PROCEDURES

Prelaunch activities are controlled by the Launch Control Center (LCC). The LCC gives calls to initiate an activity and expects a call from crew members when an activity is complete. Since a series of automated checks and operations are done during prelaunch, the crew does not manipulate switches or CRTs without LCC concurrence. Note that the active displays for CRTs 1, 2, and 3 are listed at the top of each page of the prelaunch procedures or elsewhere if a display change is required. The first time (T-) listed alongside the procedures in the checklist does not reflect the planned hold times. There are two planned holds after crew ingress: 10 minutes at T - 20 minutes and 10 minutes or 40 minutes at T - 9 minutes. Note that the T - 9 minutes hold is extended from 10 minutes to 40 minutes for Space Station rendezvous missions due to the short launch window (5-10 minutes) to provide more pad in the timeline to address ground/system problems that arise late in the count. The second time (L-) listed in the checklist does reflect the planned hold times and is the actual clock time until liftoff. The single letter prior to the procedure title indicates who will perform the action. For example, C refers to the CDR, P to the PLT, and A for all crew members. An example of the procedures as they appear in the Ascent Checklist and an explanation for the procedures are contained in the following sections.

4.2.1 Recycle Procedures**ABORT/RECYCLE PROCEDURES**NOTE

These recycle procedures will be used inside T-5 min

OTC (or NTD) will call for BFS Safing, SRB Safing, APU Shutdn, Heater Reconfig (Aerosurface positioning complete), MPS He Reconfig, OMS/RCS Reconfig, RCS Driver and OMS Safing, and Main Bus Switch Safing as reqd

C BFS SAFING (On NTD call)

O6 GPC MODE 5 - HALT
Report BFS Safing complete

MS1 SRB SAFING (On NTD call - if reqd)

O17 MEC 1 - OFF
. . . Wait 2 sec, then . . .
MEC 2 - OFF
Report SRB Safing complete

P APU SHUTDN (On OTC call)

R2 APU OPER (three) - OFF
FU TK VLV (three) - CL
√Shutdn (HYD PRESS < 200)
CNTLR PWR (three) - OFF
HYD CIRC PUMP (three) - GPC

Report APU SHUTDN complete

C HEATER RECONFIG (On OTC call)

L2 FLASH EVAP FDLN HTR (two) - 2

Report Heater Reconfig complete

NOTE

Numerous non time-critical steps
for recycle will be individually
called by OTC

P MPS He RECONFIG (On OTC call)

R2 MPS He ISOL A,B (six) - GPC
PNEU He ISOL - GPC

Report MPS He Reconfig complete

P OMS/RCS RECONFIG (On OTC call)

O8 L,R OMS
√TK ISOL (four) - GPC (tb-OP)
√XFEED (four) - GPC (tb-CL)
FWD RCS
He PRESS (two) - GPC (tb-OP)
√TK ISOL (two) - GPC (tb-OP)
√MANF ISOL 1,2,3,4,5 - GPC
(tb-OP)

O7 AFT L,R RCS
He PRESS (four) - GPC (tb-OP)
√TK ISOL (six) - GPC (tb-OP)
√MANF ISOL 1,2,3,4,5 (ten) - GPC
(tb-OP)

Report OMS/RCS Reconfig complete

C, **RCS DRIVER AND OMS SAFING**
MS2 (On OTC call)

MS2 O14:F RJD DRIVER (three) - OFF
 LOGIC (three) - OFF
 L OMS ENG VLV - OFF
 O15:F RJD DRIVER (two) - OFF
 LOGIC (two) - OFF
 O16:F RJD DRIVER (four) - OFF
 LOGIC (three) - OFF
 R OMS ENG VLV - OFF

C C3 OMS ENG (two) - OFF

Report RCS Driver and OMS Safing
Complete

MS2 **MAIN BUS SWITCH SAFING (On OTC call)**

O13:A cb ESS 1BC MNA CONTR - op
 :C 2CA MNB CONTR - op
 :E 3AB MNC CONTR - op
 O14:B MNA MNC CONTR - op
 O15:B MNB MNA CONTR - op
 O16:B MNC MNB CONTR - op

Report Main Bus switch Safing
Complete [AFPH4.2-1]

4.2.1.1 Cue

OTC or NTD call

4.2.1.2 Displays

Switch positioning only

4.2.1.3 Crew Action

Perform actions per OTC or NTD call

4.2.1.4 Discussion

The immediate crew actions to perform a recycle after T - 5 minutes are given in the recycle procedures. These brief, self explanatory procedures are printed on the page preceding the normal prelaunch procedures and include only the time critical steps. The orbiter test conductor (OTC) or NTD calls the individual steps for the remainder of the recycle procedure.

4.2.2 Switch Config and Crew Ingress

1: GNC GPC MEMORY	2: GNC 104 GND IMU CNTL/MON
3: GNC GPC MEMORY	

-3:00:00 **PRE-INGRESS SW RECONFIG**
(Hold)

ASP configures OI PCMMU PWR - 1*** (C3),
INST PWR - FLT/MPS (F6), INST PWR - ON
(F8). ESS BUS SOURCE FC (three) - ON, AC
BUS SNSR (three) - OFF (1 sec) THEN AUTO
TRIP (R1), cb APU FU TK VLV ENA (six) - cl (R2).
OTC will call: (~2min) ESS BUS SOURCE FC
(three) - OFF, AC BUS SNSR (three) - OFF
(1 sec) THEN MON (R1), cb ESS MN CONTR
(three) - cl (O13), cb MN CONTR (three) - cl
(O14, O15, O16), cb AC1 H2O LOOP PUMP
1 A/2(three) - op (L4)

PAYLOAD ACTIVATION

A6U √PL RETEN PL SEL - MON

NAVAIDS ACTIVATION

O8 MLS CH pb/tw (three) - 6
 RADAR ALTM (two) - ON
O7 TACAN CH pb/tw (three) - 059Y
 ANT SEL (three) - AUTO
 MODE (three) - GPC

If OV105:

A13 GPS PRE AMPLUC - MNC
 LC - MNA
 RCVR/PROC ASSY PWR 1 - ON

-2:25:00 A **INGRESS ORBITER & SEATS**
(-3:15:00)

During seat ingress COMM
PWR - ON (L5, R6)
CCU PWR - ON (A11, A15, MO39M)

O5,O9, AUD VOX SENS (as needed) - adj as
R10, L9, reqd
M042F Contact LCC (OTC & NTD) and MCC on A/G 1

Install ASC Flip Cards
 ✓Cue Card positions

-2:10:00 **POST INGRESS SW RECONFIG**
 (-3:00:00)

ASP turns on RCS 1,2,3,4
 DRIVERS (eight) (O14, O15, O16),
 OMS ENG VLV (two) (O14, O16),
 GPC OUTPUT 5 - B/U (O6)

NOTE

ASP doing C/W VOL adjust,
 expect MA

4.2.2.1 Cue

LCC call

4.2.2.2 Displays

Switch and circuit breaker (cb) positioning only

4.2.2.3 Crew Action

Ingress

Contact LCC and MCC on A/G 1

Configure Flip Cards and check Cue Cards

4.2.2.4 Discussion

The Ascent Checklist prelaunch procedures start just prior to crew ingressing the orbiter 3 hours before launch. The computer configuration is four computers running the prelaunch GNC OPS 9 software and a fifth computer loaded with the BFS software in halt. Just prior to crew ingress, the astronaut support personnel (ASP) configure switches for lift-off that the flight crew cannot reach and that need to be configured as close to lift-off as possible. Prelaunch, the ac bus sensors are in the monitor mode during the time no one is in the orbiter and are configured to AUTO/TRIP at this time (placed in MONITOR position 8 minutes prior to launch). The RCS drivers and the OMS engine valves are left off as long as possible as a safety precaution. The ground crew assists the flight crew into the seats and configures switches on the overhead panels.

4.2.3 IMU Preflight Align

-1:57:00 (IDP Equivalent)
(-2:47:00)

NOTE

IMU preflight align begins

4.2.3.1 Cue

Uplink in progress
IDP Equivalent on scratchpad line

4.2.3.2 Displays

SPEC 104 GND IMU CNTL/MON

4.2.3.3 Crew Action

None - information only

4.2.3.4 Discussion

The launch processing system (LPS) calls up SPEC 104 and commands the start of the IMU preflight alignment (GC_ALIGN). Following the alignment, the alignment maintenance phase (GC_ALIGN1) is entered. This phase maintains the earth fixed platform alignment of the IMUs as determined by the GC_ALIGN module until T-4:00. At that time, the IMUs are released to the inertial mode for flight. The addition of the GC_ALIGN1 module for OI-22 and subsequent software releases results in greater onboard navigation accuracy, especially in the out of plane direction, for long launch holds.

4.2.4 Comm Checks

-1:35:00 A **LCC ASTRO COMM CHECK**
 (-2:25:00)

LCC will contact all crew on A/G 1,
 A/G 2, ICOM A, ICOM B then A/A

A MCC A/G VOICE CHECK

B A/G 1 Voice Check
 O5,O9 L,R AUD A/G 2 (two) - OFF
 A/A (two) - OFF
 Voice check with MCC

A/G 2 Voice Check
 L,R AUD A/G 2 (two) - T/R
 1 (two) - OFF
 Voice check with MCC

A/A Voice Check
 L,R AUD A/A (two) - T/R
 A/G 2 (two) - OFF
 Voice check with MCC

A O5,O9, Simo Voice Check (Launch Config)
 R10, L,R AUD A/G 1 (two) - T/R
 L9, 2 (two) - T/R
 M042F Voice check with MCC

NOTE

Side hatch closure

4.2.4.1 Cue

LCC call

4.2.4.2 Displays

N/A

4.2.4.3 Crew Action

Perform voice checks with MCC

4.2.4.4 Discussion

When in the seats, the crew conducts an intercom and air to ground (A/G) voice check with LCC and MCC. The CDR and PLT check each of their loops individually. Since the other crew members do not have access to their comm switches, they also check all loops

simultaneously. Extensive comm checks are also performed pre-ingress (before cryo loading).

The ground crew closes the side hatch by T - 1:10:00. After the side hatch is closed, the cabin pressure is increased (cabin over-pressurized). This is done with the vent valves open and vent isolation valves closed, then later in reverse, so that valve integrity can be verified.

4.2.5 Cabin Leak Check

-1:10:00 C **CABIN LEAK CHECK**
(-2:00:00)

- | | |
|----|--------------------------------|
| L2 | CAB VENT ISOL - OP (tb-OP) |
| | √VENT tb - CL |
| O1 | √CAB PRESS - incr to 16.7 (MA) |

NOTE

Flt crew functions from this point on will be initiated by a call from OTC to proceed. Flt crew will report back to OTC after completion

-45:00 C **CABIN VENT REDUNDANCY CONFIG**
(-1:35:00)

NOTE

Vent vlv operation may occur earlier or later at LCC direction

- | | |
|----|----------------------------|
| L2 | CAB VENT ISOL - CL (tb-CL) |
| | VENT - OP (tb-OP) |

-40:00 C **CABIN VENT**
(-1:30:00)

- | | |
|----|----------------------------|
| L2 | CAB VENT ISOL - OP (tb-OP) |
| | (klaxon) |
| | √VENT tb - OP |
| O1 | √PRESS - decr |

4.2.5.1 Cue

OTC call

4.2.5.2 Displays

Overhead pressure gauge

4.2.5.3 Crew Action

- | | |
|----|--------------------------------------|
| L2 | Configure cabin vent isolation valve |
| O1 | √cabin pressure |

4.2.5.4 Discussion

This procedure checks the two cabin vent isolation valves individually and continues the cabin leak check. The crew then opens the cabin vent valves on a call from the ground to

allow cabin pressure to bleed back to ambient pressure. The crew functions from this point on are initiated by calls from the OTC to proceed. The crew reports back to OTC after the function is complete.

4.2.6 PASS/BFS Transfer Preparation

-32:00 C PASS/BFS TRANSFER PREP
(-1:22:00)

O6 √GPC MODE 5 - STBY (tb-RUN)
C3 √BFC CRT SEL - 3+1
DISP - ON

3: GNC BFS MEMORY

CRT3 PASS/BFS XFER ENA - ITEM 25 EXEC
√ITEM 25 (*)

NOTE

‘*’ blanks when transfer is complete
(~ 10 min)

4.2.6.1 Cue

OTC call

4.2.6.2 Displays

GNC BFS MEMORY

4.2.6.3 Crew Action

Enable PASS/BFS XFER

4.2.6.4 Discussion

At T - 32 minutes, preparation is made for the PASS/BFS transfer (one shot transfer). The BFS display is called (BFS is standalone), and the crew enables the transfer. This presets the BFS to receive the data when the LPS automatically commands the transfer at T - 22 minutes.

At T - 22 minutes, the LPS automatically initiates the one shot PASS/BFS transfer. When the transfer is complete, the asterisk (*) next to PASS/BFS XFER ENA, ITEM 25, on BFS MEMORY display disappears and is verified by the crew on CRT 3. The data transferred to the BFS includes the launch polynomials, IMU calibration data, accelerometer data, SRB chamber coefficients and compensation bias, plus estimated mass of the orbiter with the ET_[AFP4.2-2].

4.2.7 GN2 Activation

-30:00 C OMS GN2 PRESS
(-1:20:00)

C3 OMS ENG (two) - ARM/PRESS

P WSB GN2 SUPPLY ACTIVATION

R2 BLR N2 SPLY (three) - ON

4.2.7.1 Cue

OTC Call

4.2.7.2 Displays

Switch positioning only

4.2.7.3 Crew Action

Configure OMS engine switches and water spray boiler N2 supply

4.2.7.4 Discussion

Placing the OMS ENG switches in ARM/PRESS energizes the engine pressurization valves open. When energized open, the valves allow GN₂ supply tank pressure to be directed into a regulator, through a check valve, into an in-line accumulator, and to both engines. Placing the OMS ENG switches in ARM/PRESS allows the ground to check the OMS status.

4.2.8 Air to Ground Voice Checks

-25:00 A A/G VOICE CHECK
(-1:15:00)

Simo Voice Check (Launch Config)

Voice check with MCC

Update Abort Winds Pad, ASC Flip
Book, and ALTM, 1-10 (if reqd)

4.2.8.1 Cue

OTC Call

4.2.8.2 Displays

N/A

4.2.8.3 Crew Action

Perform voice check
Update Ascent Checklist as required

4.2.8.4 Discussion

At T - 25 minutes, an air to ground voice check is performed on all loops simultaneously. Any updates needed for RTLS, winds, ascent profile, or altimeter settings are given to the crew during the voice check.

4.2.9 Cabin Vent Configuration

NOTE

Cabin Press Reporting and vent vlv closure may occur earlier or later at LCC direction

-22:00 C **REPORT CABIN PRESS** [AFPH4.2-3]
(-1:12:00)

3: BFS, SM SYS SUMM 1

CRT3,O1 Report cabin pressure (two) to OTC

3: BFS, GNC BFS MEMORY

C **CLOSE VENT VLVS**

L2 CAB VENT ISOL - CL (tb-CL)
VENT - CL (tb-CL)

4.2.9.1 Cue

OTC Call

4.2.9.2 Displays

BFS SM SYS SUMM 1

4.2.9.3 Crew Action

Report cabin pressure
Close cabin vent isolation and cabin vent valves

4.2.9.4 Discussion

On request, CDR reads cabin pressure from panel O1 to the OTC. Then, on OTC's call, the crew closes the cabin vent valves. This is done when the cabin reaches ambient pressure.

4.2.10 Trajectory Update

NOTE

At T-20 there will be a planned
10-min hold

TRAJECTORY UPDATE

√MCC for max rates and trajectory
config, 8-7

4.2.10.1 Cue

MCC call

4.2.10.2 Displays

N/A

4.2.10.3 Crew Action

Update Ascent Checklist, pg 8-7 as reqd

4.2.10.4 Discussion

There is a 10 minute planned hold at T - 20 minutes. There are no prescheduled activities during planned holds. This time is set aside to catch up, if required, so that all functions are ready when OPS 1 is initiated. During the hold, the expected maximum vehicle rates and last minute instructions are voiced, if required. At the end of the hold, the LPS transitions the PASS to OPS 1. After OPS 1 has been loaded (indicated by the OPS 1 display appearing on the CRT and a ground call) the crew reports, then clears any faults.

4.2.11 OPS 1 Transition

-20:00 **OPS 1 LOAD (IDP Equivalent)**
 (-1:00:00)

1: GNC LAUNCH TRAJ	2: GNC LAUNCH TRAJ
1: GNC 0 GPC MEMORY	
1: GNC FAULT	

Report faults other than from unpwr'd
 equipment

CRT1 GNC, SPEC 99 PRO

NOTE

Gnd-controlled Fuel Cell purge

-18:30 C **BFS TO OPS 1**
 (-58:30)

3: BFS, GNC FAULT

CRT3 GNC, SPEC 99 PRO
 O6 GPC MODE 5 - RUN (tb-RUN)

CRT3 GNC, OPS 101 PRO

3: BFS, GNC LAUNCH TRAJ
3: BFS, GNC FAULT

Report faults other than from unpwr'd
 equipment

CRT3 GNC, SPEC 99 PRO

4.2.11.1 Cue

PASS OPS 1 load:
 Uplink in progress
 IDP equivalent on scratchpad line
 BFS to OPS 1:
 OTC Call

4.2.11.2 Displays

GNC Launch TRAJ
 GNC 0 GPC MEMORY
 GNC FAULT

BFS, GNC LAUNCH TRAJ
BFS, GNC FAULT

4.2.11.3 Crew Action

Monitor PASS transition to OPS 1

Confirm no unexpected fault messages and then clear the PASS Fault page

Clear BFS Fault page and then mode BFS to run and PRO to OPS 101

Confirm no unexpected fault messages and then clear the BFS Fault page

4.2.11.4 Discussion

The IMU software configures from a velocity tilt mode to a biased inertial mode at the transition to OPS 1. One g and Earth rate drift compensation factors are used to determine platform torquing requirements to cover the mode transition period and to maintain a predefined launch alignment until the platform becomes inertial at T - 8 seconds. In the inertial mode, compensation is limited to the zero g factors used to ensure accurate inertial operation.

The PASS OPS 1 transition occurs via IDP Equivalent. When the transition is complete, the CDR will clear the PASS fault page so that all subsequent faults can be more easily identified. On call, the CDR clears the BFS fault page, then places the BFS GPC in RUN, and transitions it to OPS 1. The BFS fault page is cleared again, so that any subsequent fault message is not confused with faults occurring during the OPS 1 transition.

4.2.12 Horizontal Sit and Contingency Yaw Steer Configuration

1: GNC FAULT	2: GNC LAUNCH TRAJ
3: BFS, GNC FAULT	
2: GNC 50 HORIZ SIT	
3: BFS, GNC 50 HORIZ SIT	

-17:00 P **HORIZ SIT CONFIG**
 (-57:00)

ALTM - ITEM 9 + .

	<u>PASS ITEM</u>		<u>BFS ITEM</u>	
PTI	INH	√1		
TAL SITE (MCC)	3(4,29)	√40	3(4,29)	√40
RTLS SITE	1	√41	1	√41
PRI (MCC)	KSC 15	√3	KSC 15	√3
SEC (MCC)	KSC 33	√4	KSC 33	√4
TAC	-59	√5	-59	√5
RA	blank	√46		
TAEM TGT				
G&N	OVHD	√6	OVHD	√6
HSI	blank		blank	
XEP	NEP	√7	NEP	√7
AIM	NOM	√8	NOM	√8
	(or CLSE)		(or CLSE)	
[AFPH4.2-4] TAC	INH	√20	INH	√20
GPS	INH	√43	INH	√43
DRAG H	AUT	√22	AUT	√22
ADTA H	INH	√26	INH	√26
ADTA TO G&C	INH	√29	AUT	√28
TAC	DELTA	√35		
AIF_G	INH	√48 [AFPH4.2-5]		

1: GNC LAUNCH TRAJ	2: GNC SYS SUMM 1
3: BFS, GNC SYS SUMM 2	

C CONFIG CONT ABORT YAW STEER

CRT1 ITEM 5 E N A

4.2.12.1 Cue

OTC Call

4.2.12.2 Displays

GNC 50 HORIZ SIT

GNC LAUNCH TRAJ

BFS, GNC 50 HORIZ SIT

4.2.12.3 Crew Action

Configure SPEC 50

Configure contingency yaw steer

4.2.12.4 Discussion

After entering OPS 1, the crew enters the altimeter settings for the RTLS site and checks the horizontal situation display (HSD) setup. The HSD should be initialized in the correct configuration but may vary from flight to flight. If winds or weather require KSC 33 instead of KSC 15, ITEM 4 is executed. The MLS channel is always set to 6 for lift-off. Since the TAL target changes depending on the flight inclination, it is not called out in the procedure.

CA yaw steering is enabled for all flights. With yaw steer enabled, if Auto contingency software is initiated within a yaw steer window, controlled by the I-loads VI_YAW2_MIN and VI_YAW2_MAX, ascent ECAL yaw steering will commence. On low inclination missions, the yaw I-loads are set to 9.4K and 12.2K fps, respectively. This is the approximate window of Bermuda capability. On high inclination missions, the I-loads are set to 4.5K and 23K fps. The I-loads are opened up on high inclination missions since ECAL capability begins shortly after SRB SEP. And even if capability doesn't exist, steering towards the east coast is better for crew search and rescue efforts. [AFPH4.2-6]

4.2.13 MPS, OMS/RCS Configuration

-16:00 P **MPS He RECONFIG**
 (-56:00)

R2 MPS He ISOL A,B (six) - OP
 PNEU He ISOL - OP

-15:00 **CONFIG OMS/RCS XFEED VLVS**
 (-55:00)

NOTE

OMS/RCS XFEED vlvs
 reconfigured for launch by LPS.4.2.13.1 *Cue*

OTC Call

4.2.13.2 Displays

Switch positioning only

4.2.13.3 Crew Action

R2 Open MPS Helium and pneumatic helium isolation valves
 O8 Monitor OMS/RCS crossfeed valve configuration

4.2.13.4 Discussion

The crew sets the onboard switches to correspond to the LPS commanded positions. This protects the SSMEs from shutting down (possibly catastrophically) due to an inadvertent loss of the GPC open commands to the helium isolation valves^[AFPH4.2-7].

4.2.14 T-9 Hold

At T-9 there will be a planned
40-min hold

WEATHER UPDATE (if reqd)

Update Abort winds, RWY and ALTM
Setting

-9:00

(~17:00)

CLEAR HARDWARE C/W MEMORY_[AFPH4.2-8]

C3 C/W MEM - CLEAR

-9:00

(~15:00)

MS1

Activate V10 Recorder

-9:00

'GO FOR LAUNCH' (All)

C2 EVENTTIMER - START

F7 √TIME ind - counting down

NOTE

GLS starts

4.2.14.1 Cue

T - 9:00

4.2.14.2 Displays

CRT Timer

Event timer

4.2.14.3 Crew Action

Monitor

Clear hardware caution/warning memory

Activate the V10 Recorder

Start event timer

Update winds, runway, and altimeter setting as required

4.2.14.4 Discussion

At T - 9 minutes, there is either a planned 40 minute (Space Station flights) or 10 minute hold which is the last planned hold. The GO/NO GO for launch calls are given. If required, the RTLS winds, runway, or altimeter will be updated. The ground launch sequencer (GLS), takes control at T - 9 minutes. Hardware caution/warning memory is cleared and the crew starts the V10 recorder. The software caution/warning will be

cleared at T-2:30. The EVENT TIMER is set up even though the CRT timer will also be counting to lift-off.

4.2.15 Essential Buses and APU Start

-8:00 P **CONNECT ESS BUSES TO FC (GLS √ T-7:24)**

R1 ESS BUS SOURCE FC (three) - ON

-7:30

NOTE

Access arm retract

- √Seat in launch position
- √LES zippers and gloves
- Cinch down shoulder harness and lap belt

1: GNC LAUNCH TRAJ	2: GNC SYS SUMM 1
--------------------	-------------------

3: BFS, GNC SYS SUMM 2

3: BFS, SM SYS SUMM 2

-6:15 P **APU PRE START (GLS √ @ T-5:25)**

- R2
- √BLR N2 SPLY (three) - ON
 - √PWR (three) - ON
 - √CNTLR/HTR (three) - A
 - √HYD CIRC PUMP (three) - GPC
 - √cb APU FU TK VLV ENA (six) - cl
 - √APU FU TK VLV (three) - CL
 - √AUTO SHUTDN (three) - ENA
 - √SPEED SEL (three) - NORM
 - √OPER (three) - OFF
 - HYD MN PUMP PRESS (three) - LO
 - APU CNTLR PWR (three) - ON
 - FU TK VLV (three) - OP
 - √APU/HYD RDY tb (three) - gray

- * If any tb not gray, consult *
- * LCC before continuing *

-5:00 P **APU START (GLS √ @ T-4:05)**

R2 APU OPER (three) - START/RUN

HYD/ APU

√HYD PRESS ind (three) - LO green

R2

- √APU/HYD RDY tb (three) - bp
- HYDMN PUMP PRESS (three) - NORM

HYD/ APU	√PRESS ind (three) - HI green
R2	CIRC PUMP (three) - OFF
F7	√PRESS lt - off

4.2.15.1 Cue

OTC Call

4.2.15.2 Displays

GNC LAUNCH TRAJ

GNC SYS SUMM 1

BFS, GNC SYS SUMM 2

HYD/ APU	display of MEDS.
-------------	------------------

4.2.15.3 Crew Action

Connect essential buses to fuel cells

Perform APU pre start

Perform APU start

4.2.15.4 Discussion

After the essential buses are connected to the fuel cells, the access arm is retracted. The crew then checks to see that their seats are in the launch position. The OTC does not call this out because the seats are set when the crew ingresses the vehicle.

All APUs have to be running and hydraulic pressure up at T - 4 minutes or an AUTO launch hold will be initiated by the ground launch sequencer (GLS). However, APU fuel needs to be conserved for use in flight. Therefore at T - 6 minutes, APU prestart is performed to allow enough time for the start sequence while minimizing fuel usage.

To get the ready to start talkback (tb) gray, four conditions have to be met:

- a. Gas generator bed temperature > 190° F and turbine speed < 80%.
- b. Either one of the fuel tank isolation valves open. This allows fuel to flow from the fuel tank to the APU assembly.
- c. Hydraulic main pump press in LO position. This reduces hydraulic system main pump discharge pressure from 2950 + 50 psig to <1000 psig which precludes loading the APU at startup and reduces the turbine spin up time.
- d. Water spray boiler (WSB) system activated, requiring the following conditions to be met:
 - (1) WSB controller A or B powered on
 - (2) WSB steam vent temperature > 130° F

- (3) WSB gaseous nitrogen (N₂) shutoff valves open
- (4) Hydraulic bypass valve in the proper position

The fuel tank valves remain closed until APU start. The valves are insulated and, with no fuel flow, overheat due to the heat from the solenoids which control the valves.

All three APUs have to be started and the hydraulics pressured by approximately T - 4 minutes or an AUTO launch hold and probable scrub will occur. The check at T - 4 minutes occurs because the main engine purge sequence, gimbal checks, and start sequences are performed between T - 4 minutes and T - 3.8 seconds and require all three hydraulic systems. In addition, hydraulic pressure is required to perform the aerosurface slew test and to move the aerosurfaces to their launch positions at T - 3:45. All three APUs are started simultaneously. The first step resets prestart conditions, turns gas generator (GG)/fuel pump heaters off, starts a 10.5 second timer inhibiting an underspeed shutdown during startup due to slow spinup, opens the secondary fuel control valve and inhibits circulation pump power logic. After the APUs are started, the pump press is returned to normal. The circulation pump is turned off by the APU start, so the switch is placed in the OFF position to prevent inadvertent activation.

4.2.16 Final Prelaunch Actions**C HTR RECONFIG**

L2 FLASH EVAP FDLN HTR (two) - OFF

NOTE

Motion/Vibration may be felt in crew module due to Main Engine gmb1 profile cks at -3:25 and move to start at -3:10

-2:30 P CLEAR C/W MEMORY

2: GNC FAULT

3: BFS, GNC FAULT

Verify no unexpected errors
 CRT2, GNC, SPEC 99 PRO
 CRT3

2: GNC SYS SUMM 1

3: BFS, GNC SYS SUMM 1

C3 C/W MEM - CLEAR

-2:00 A SUIT PREP

√Tabs/visor - cl/LES 02 - ON

MS1 ICOM RCDR - ON (if reqd)

4.2.16.1 Cue

OTC Call

4.2.16.2 Displays

GNC FAULT

GNC SYS SUMM 1

BFS, GNC FAULT

BFS GNC SYS SUMM 1

4.2.16.3 Crew Action

Power off Flash Evaporator feedline heaters

Verify no unexpected fault messages and then clear both PASS and BFS Fault pages

Clear caution and warning

Close visors

Power on ICOM recorder if required

4.2.16.4 Discussion

To reduce the electrical power load at the SRB interface, heaters are turned off during ascent.

The crew clears the PASS and BFS fault summary pages and clears the C&W memory so that any faults which occur after lift-off are not confused with faults that occurred prelaunch.

All crew members close their visors at T - 4 minutes. A difference can be seen in the O₂ flow when this happens. Closing visors close to launch ensures no prelaunch limit violation on PPO₂.

On some flights, 16mm cameras are used to record ascent. Since the cameras have a limited amount of film, they are turned on via remote controller as close to lift-off as possible.

At T - 35 seconds, the vent doors start opening for launch. The vent opening is staggered at six 5 second intervals. The position of the vents is verified prior to launch by the redundant set (RS) launch sequencer. The crew has no way to monitor or control the vent doors during OPS 1.

The LPS controls the countdown sequence until T - 35 seconds when the flight software takes control of the sequence. The flight software continues to watch for an LPS generated hold through main engine start and until it commands SRB ignition. Nominal CRT configuration for launch should be PASS TRAJ on CRT 1, PASS SYS SUMM on CRT 2, and BFS TRAJ on CRT 3. The BFS CRT SEL switch should be in 3+1 so that if the BFS is engaged, CRT 1 picks up the BFS TRAJ display. The complete switch configuration is defined in the Ascent Checklist switchlist.

4.3 NOMINAL/ATO ASCENT

This section contains each of the Ascent Checklist sections that are used during a nominal ascent. Since there are few procedural differences between a nominal ascent and an ATO, this section is also applicable to an ATO. The targeting sections also include a discussion of AOA targets but once an AOA is declared, the procedures from that point on are discussed in section 4.4.

|

4.3.1 Ascent Procedures Card

The ascent procedures card (fig. 4.3.1-1) is a very highly abbreviated outline of actions to be taken and items to be monitored during ascent. The nominal crew task from SSME start until MM104 is one of monitoring, with the exception of possible systems activation after SRB staging. However, the crew should be prepared to take whatever action is necessary in off-nominal situations, as defined by the flight rules built into the Flight Data File cue cards and checklists.

This section expands on the Ascent Procedures card and provides further explanation of some of the steps. STS-114, a Direct Insertion mission, is used as an illustrative example. The main difference between the SI and DI ascent cue cards is that while the SI card automatically refers the crew to the OMS 1 burn section post-MECO, the DI card refers the crew there only if an OMS 1 is required based on the OMS 1/2 TGTING chart on page 2-7.

ASCENT PROCEDURES		HOOK
R180	LVLH	
.83M	√P _c → 72%	
1.17M	√P _c → 104%	
P _c < 50+5 s	√SRB SEP (Backup AUTO SEP 2:21)	
	√TMECO	
	* If <u>NOT STABLE</u> (10 sec):	*
	* NO COMM – CSS & MAN THROT	*
MM103+10 s	√OMS assist	
	Close suit O2, open visor	
3:00	√EVAP OUT (T < 60)	
	* If Systems ABORT reqd:	*
	* RTLS at 3:40 or	*
	* TAL Select prior to <u>23000</u>	*
	* Otherwise Manual MECO <u>23700</u>	*
V _I = <u>13.2K</u>	√Roll Heads Up	
	* If Man Throttle (3 eng):	*
	* Man Shutdn at <u>25700</u>	*
	* If 1 eng:	*
	* <u>TRAJ</u> √SERC ON	*
	* When MPS PRPLT = 2%:	*
	* MAN THROT, P _c → 67%	*
	* Man MECO @ CO mark BFS	*
MECO	√V _I = <u>25819</u>	
MECO+20 s	√ET SEP	
	* If 'SEP INH':	*
	* ET SEP – MAN	*
	* If Rates > .7,.7,.7:	*
	* MPS PRPLT DUMP SEQ – STOP	*
	* Null rates	*
	* ET SEP – SEP	*
	* Post ET Sep -Z xlation:	*
	* MPS PRPLT DUMP SEQ – GPC	*
	* If Rates < .7,.7,.7:	*
	* Assume Feedline Fail	*
	* If V _I < <u>25760</u> or BFS Engaged:	*
	* OPS 104 – PRO (√BFS 104)	*
	* <u>Note</u> : Expect – 'Illegal Entry' (PASS)	*
	* 'Illegal TIG' (BFS)	*
▶ MM104+2 s	If ET Sep complete and HA > <u>72</u> :	
	+X xlation for 11 sec	
	√TGTS	
	√ASC PKT for failures	
	If OMS 1 not reqd:	
	OMS ENG (two) – OFF	
	Go to <u>POST OMS 1</u>	
	FB 2-5	ASC/114/FOR

Figure 4.3.1-1: STS-114 [AFPH4.3.1]Ascent Procedures Card (DI Flight) [AFPH4.3.2]

4.3.1.1 *Lift-off*

4.3.1.1.1 Cue

SRB Ignition, MM102

4.3.1.1.2 Displays

Any CRT for Major Mode
MPS PRESS Pc Gauges

4.3.1.1.3 Crew Action

≈T- 6.6s,

F7 √MPS PRESS Pc (three) → 100%

@VREL = 60 fps,

F7 √MPS PRESS Pc (three) → 100% or 104%

4.3.1.1.4 Discussion

The crew monitors the sequential SSME start on the PC gauges. The SSME start time is 6.6 seconds before the SRB ignition, allowing 4 seconds for SSMEs to reach 90% and 2.6 seconds for twang. The twang is the swaying of the stack at ignition, due to main engine position (moment arm). If any SSME chamber pressure is less than 90% after 4.6 seconds or any MAIN ENG STATUS light is amber prior to SRB ignition, sequential shutdown occurs. The MAIN ENG SHUT DN push buttons (pbs) do not work until SRB ignition.

Lift-off is defined at SRB ignition. At lift-off, the MM changes to first stage (MM 102) which has an open loop guidance scheme based on V_{REL} (I-loads), adjusted to account for solid rocket motor (SRM) performance dispersions. The nominal crew task from SSME start until MM 104 is one of monitoring. However, they should be prepared to take whatever action is necessary in off-nominal situations, as defined by the Flight Rules and Flight Data File (cue cards and checklists).

The SSMEs are initially commanded to 100%, and when $V_{REL} > 60$ fps, the command is changed to 104% or may remain at 100% for SRB apogee control depending on the flight.

4.3.1.2 Roll Program

R180 LVLH

4.3.1.2.1 Cue

ADI Attitude

4.3.1.2.2 Displays

ADI

BFS ASCENT TRAJ 1

4.3.1.2.3 Crew Action

When roll = 180°,

F6, F8 ADI ATTITUDE (two) - LVLH

Report Roll Program

- * If no roll maneuver initiated: *
- * √BFS ADI Errors on BFS TRAJ *
- * If large, engage BFS *

4.3.1.2.4 Discussion

The crew observes a vertical rise while guidance commands a constant pad referenced attitude until $V_{REL} > 127$ fps (I-loaded) to prevent vehicle recontact with the tower. LCC to MCC handover occurs at tower clear. The termination of the vertical rise is indicated by a roll, pitch, and yaw maneuver (primarily roll) which puts the vehicle heads down and aligned with the launch azimuth. The crew should report the start of the roll program to MCC. Roll attitude is 180° when on the launch azimuth. Failure to initiate the roll maneuver at the corresponding V_{REL} indicates incorrect subtask sequencing within guidance. Therefore, if the maneuver is not initiated by the PASS but the BFS is commanding the maneuver, the BFS is engaged. The BFS ADI error digitals, displayed on the BFS TRAJ, will be very large when the BFS is commanding the maneuver but the PASS is not. BFS engage is required since the onboard displays are inadequate for the crew to execute the roll/pitch profile manually through the critical high QBAR regime.

At lift-off both ADI ATT switches are in REF and the ADI ERROR and ADI RATE switches in the MED position. The LVLH position is not usable for monitoring the initial roll maneuver because of a discontinuity at pitch = 90°. This discontinuity is the result of a mathematical singularity in the LVLH reference frame transformation equations. As soon as the roll maneuver is complete (180° roll on ADI) ($\approx T + 20$ seconds) both ADI ATT switches should be moded to LVLH to simplify monitoring and piloting tasks. LVLH pins the ADI yaw to zero but yaw is displayed on the HSI as a delta from NORTH. LVLH presents a true roll attitude ADI. Throughout first stage flight, the crew should check vehicle attitude against the ADI cue card and attitude rates against the Ascent Procedures card. Attitude errors in first stage are not always a good indicator of flight dynamics because of load relief (see section 4.3.1.3) and should not be heavily weighed. Rates are the only parameters requiring crew action. Prior to 90 seconds MET, if pitch or

yaw rates exceed $5^{\circ}/\text{sec}$ (full scale deflection with switch in MED position), the crew should engage the BFS. If this occurs after 90 seconds MET, the crew should select CSS. If control cannot be regained with CSS, the BFS should be engaged.

4.3.1.3 Load Relief

0.83M	$\sqrt{P_c} \rightarrow 72\%$
1.17M	$\sqrt{P_c} \rightarrow 104\%$

4.3.1.3.1 Cue

Mach

4.3.1.3.2 Displays

AMI

MPS PRESS P_c Gauges

4.3.1.3.3 Crew Action

@Mach .83,

F7 $\sqrt{\text{MPS PRESS } P_c \text{ (three)}} \rightarrow 72\%$

@Mach 1.17,

F7 $\sqrt{\text{MPS PRESS } P_c \text{ (three)}} \rightarrow 104\%$

4.3.1.3.4 Discussion

As QBAR rises, the loads on the vehicle rise. QBAR is indicated by the KEAS tape on the alpha Mach indicator (AMI). In first stage, the onboard calculation of KEAS uses the Patrick atmosphere model ($\text{KEAS} \approx 17.5 \sqrt{\text{QBAR}}$) whereas other flight phases use the 1962 standard atmosphere model ($\text{KEAS} \approx 17.2 \sqrt{\text{QBAR}}$). Therefore, in first stage KEAS may read higher than in other flight phases for a given QBAR.

Load minimization begins at approximately 20 to 30 seconds MET and includes adaptive guidance throttling and pitch adjustments, normal/lateral acceleration nulling, and elevon load relief.

The SSMEs are throttled down through a single or multistep (mission dependent) throttle bucket to avoid exceeding the maximum limit of the vehicle. A throttle bucket is built into the SRBs by physically shaping the solid rocket propellant during construction. Since active SRB throttling is not possible, SRB performance dispersions must be accounted for by adjusting the throttle and pitch commands, referred to as Adaptive Guidance.

Adaptive Guidance compares the predicted time that a predetermined velocity is to be reached to the actual time that this velocity was reached. The time difference (TDEL_ADJUST) indicates the magnitude and direction of the SRB dispersion. This computation is performed only once. Based on this time difference and some I-loaded scaling factors, the first stage throttle and pitch profiles are modified. When the MET is equal to the reference time at the reference velocity, TDEL_ADJUST is equal to zero and the SRBs are performing as per the nominal design. When the reference velocity is reached sooner than expected (negative TDEL_ADJUST), SRB performance is high (hot

SRBs), the throttle level is decreased, and the vehicle is pitched up. When the reference velocity is reached later than expected (positive TDEL_ADJUST), SRB performance is low (cold SRBs), the throttle level is increased, and the vehicle is pitched down.

The I-loaded throttle level that is increased or decreased by Adaptive Guidance depends on whether the design was a one step or two step bucket and whether SRBs are hot or cold. Most missions are designed with a one step throttle bucket (104, 104, 72, 104). In these cases, hot SRBs cause the second 104 in the sequence to be lowered, while the third level of 72 is held constant. Cold SRBs cause the third level of 72 to be increased, while the second 104 in the sequence is held constant. Figure 4.3.1.3.4-1 illustrates the throttle levels for cold and hot SRBs.

	First Stage VREL					First Stage VREL			
	384	732	1220			384	732	1220	
Design SRB Performance	104	104	72	104	Design SRB Performance	104	104	72	104
1σ hot SRB Performance	104	97	72	104	1σ cold SRB Performance	104	104	74	104
2σ hot SRB Performance	104	90	72	104	2σ cold SRB Performance	104	104	76	104
3σ hot SRB Performance	104	83	72	104	3σ cold SRB Performance	104	104	80	104

Figure 4.3.1.3.4-1: SRB Performance Effects on a One Step Throttle Bucket

For a two step throttle bucket, the first step is a function of SRB performance and the second step is held constant as shown in figure 4.3.1.3.4-2.

		First Stage VREL					First Stage VREL		
		552	1202	1367			552	1202	1367
Design SRB Performance	104	80	72	104	Design SRB Performance	104	80	72	104
1σ hot SRB Performance	104	77	72	104	1σ cold SRB Performance	104	82	72	104
2σ hot SRB Performance	104	75	72	104	2σ cold SRB Performance	104	84	72	104
3σ hot SRB Performance	104	75	72	104	3σ cold SRB Performance	104	86	72	104

Figure 4.3.1.3.4-2: SRB Performance Effects on a Two Step Throttle Bucket

With the addition of Day of Launch I-loads II (DOLILU II), new first stage I-loads, based on the measured winds 4½ hours prior to launch, are uplinked. These I-loads include the pitch and yaw attitudes, wind N-S and E-W components, throttle bucket velocities and thrust levels, and the reference time used by adaptive guidance to determine SRB performance. Therefore, the velocity and throttle settings printed on the Ascent Procedures card, which are the premission I-loaded values, may be updated day of launch to reflect the uplinked I-load values. The throttle levels should be monitored on the Pc gauges and on the CRT and used as indicators of actual performance. Crew action is not required except for the extremely unlikely case where there is a guidance malfunction such that guidance does not command a throttle down for the bucket or does not throttle back to 104% at the end of the bucket. In this failure scenario, manually throttling to 72%, then back to 104% at the correct time is sufficient. The crew need not perform a two step bucket manually. Keep in mind that this failure mode (bad 1st stage guidance algorithm or bad I-loads) is extremely remote. Although DOLILU II minimizes the chances of an off-nominal bucket, it is more likely that a disagreement between the actual throttle profile and the updated Ascent Procedures card is due to adaptive guidance throttling and not a guidance failure. In this case, guidance is reacting to 1st stage performance and adjusting the throttle profile accordingly. Crew action is not required in this case and is not desired.

Vehicle normal and lateral accelerations (Nz and Ny) are measured by the accelerometer assemblies (AAs), and nominal guidance commands are modified to keep loads acceptable. The net result is that the vehicle will turn into an unexpected wind. A less than expected tailwind will appear as a headwind to flight control. If the vehicle yaws into a crosswind, it also rolls to keep the thrust vector in the desired plane. As discussed in section

4.3.1.2.4, attitude errors may result during load relief and only rates need close monitoring. The crew is briefed prelaunch on winds and expected dynamic response through the load relief region.

For control problems, taking CSS and BFS engage are onboard decisions and may result from impending loss of control (LOC), lack of vehicle response to expected maneuvers, or any unexplained attitude rate excursions greater than $5^\circ/\text{sec}$. BFS engage is required for loss of control prior to the end of load relief (1 minute 30 seconds). After 1 minute 30 seconds, CSS may be attempted before the BFS is engaged. Manual throttle accompanies any CSS takeover.

See section 2.2.1 for more information pertaining to first stage guidance.

4.3.1.4 SRB Separation

$P_c < 50 + 5 \text{ s}$ $\sqrt{\text{SRB SEP (Backup AUTO SEP 2:21)}}$ [AFPH4.3-3]

4.3.1.4.1 Cue

“PC < 50” flashing

4.3.1.4.2 Displays

PASS ASCENT TRAJ
BFS ASCENT TRAJ 1

4.3.1.4.3 Crew Action

@ “PC < 50” + 5s:

CRT $\sqrt{\text{MM}} = 103$ (SRB sep)

Expect Delayed Sep (2:21) for PC transducer failures

4.3.1.4.4 Discussion

At approximately 2 minutes MET, the crew should see the “Pc < 50” flashing on the PASS ASCENT TRAJ and BFS ASCENT TRAJ 1 displays. SRB sep is indicated by a flash, which is visible out the window, and by the Major Mode change from 102 to 103, visible on the CRT displays.

Auto SRB sep nominally occurs at approximately 2:06 MET. The crew should expect it shortly after “Pc < 50” appears on the TRAJ displays. However, the SRB sep sequence occurs only if MECO (three engines out) has not yet occurred. Loss or shutdown of three SSMEs during first stage flight sets a software MECO CONFIRMED flag which prevents the SRB sequence from commanding physical separation of the SRBs from the external tank.

After T0 + 100 seconds, the SRB separation sequence begins to monitor both the left and right SRB chamber pressures and begins the physical separation sequence when the middle value of the three Pc transducers on each SRB drops below 50 psia or a backup timer is expired, whichever comes first. Should all Pc sensors on one SRB fail “low” prematurely or “high”, the physical separation sequence does not begin until the backup timer is expired, ensuring that separation is not attempted with excessive SRB thrust. The backup timer represents the latest time that a slow burning SRB could have some residual tailoff thrust from combustion Pcs exceeding 50 psia.

The SRB sep sequence includes time delays for thrust decay to acceptable limits (3.2 seconds) and delays to permit nulling of the SRB nozzles (4.9 seconds).

The auto SRB sep sequence previously monitored selected rate gyro roll, pitch, and yaw rates and dynamic pressure (QBAR) and compared their absolute values to stored limits. If the RGA rates or the QBAR exceeded I-loaded limits, SRB sep was inhibited and the crew alerted (SEP inhibit (INH) flashed on the TRAJ display). The QBAR and rate limits

were $QBAR < 63 \text{ lb/ft}^2$, roll rate $< 5^\circ/\text{sec}$, pitch rate $< 2^\circ/\text{sec}$, and yaw rate $< 2^\circ/\text{sec}$. If a SEP INH occurred, the sequence halted and resumed when the out of limit condition had been corrected or the crew manually overrode the INH by selecting SRB SEP - MAN/AUTO and depressing the SRB SEP pb. If an INH condition occurred due to vehicle rates but the rates were converging, the crew would take no action. If the rates were divergent, the crew would perform a manual separation 5 seconds after SEP INH occurred. This time preserved the abort mode overlap even if the sequence was started on the backup timer.

The SRB SEP Sequence was modified slightly for STS-73 and subsequent flights. The expected SRB separation envelope required to meet separation clearance was cut roughly in half. Once the control capability of the SSMEs and the SRBs were applied to the new envelope, it was shown that the likelihood of high Qbar or high rates causing recontact of an SRB with the shuttle during separation, was extremely remote. Consequently, the stored Qbar and rate limits were assigned very large values, preventing them from ever being violated. With the limits no-opted in this manner, an SRB separation inhibit during flight is not possible.

A simplified SRB sep sequence is shown in figure 4.3.1.4.4-1.

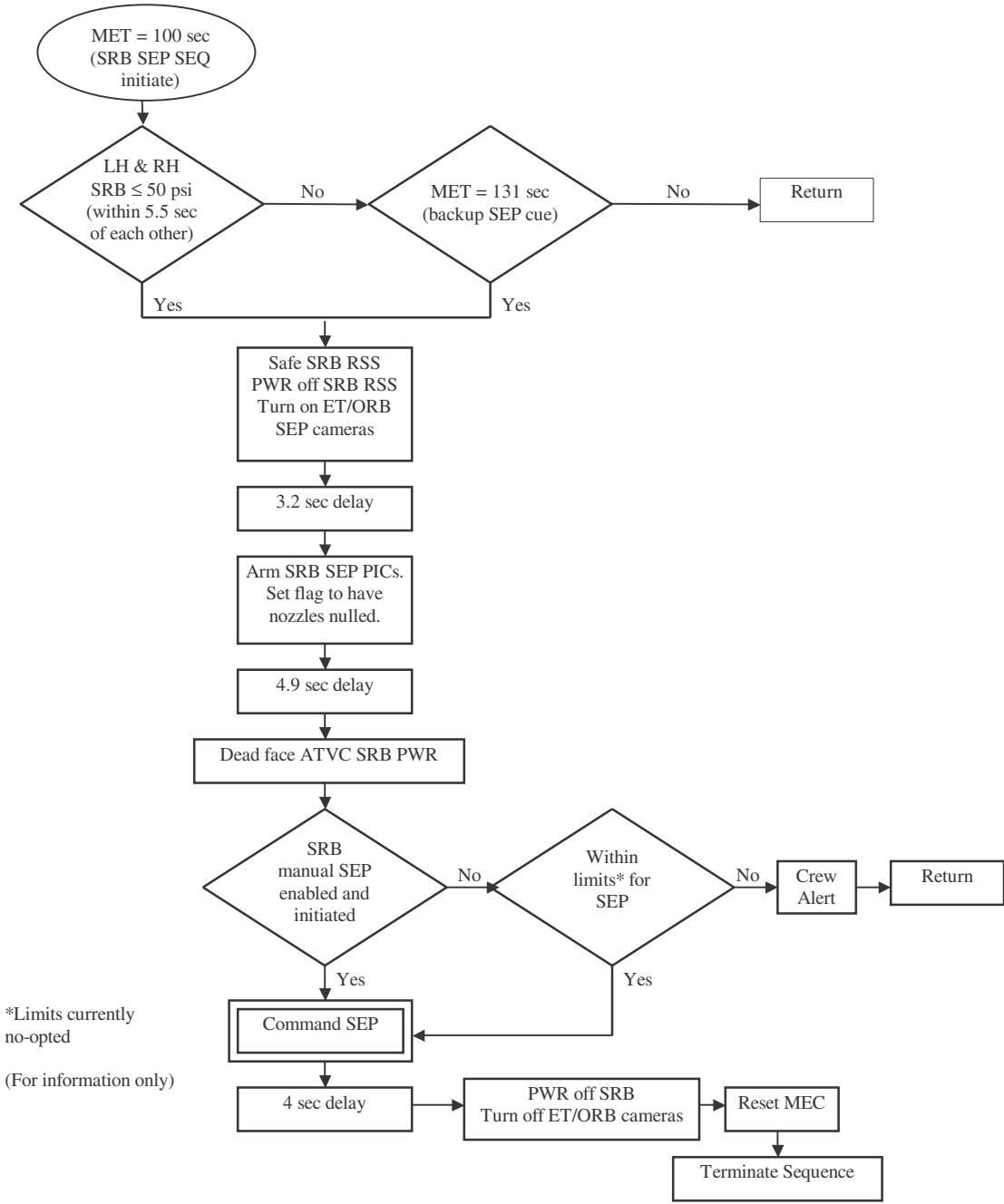

Figure 4.3.1.4.4-1: SRB Sep Sequence

4.3.1.5 Second Stage Guidance Convergence

√TMECO

- * If NOT STABLE (10 sec): *
- * NO COMM - CSS & MAN THROT*

4.3.1.5.1 Cue

MM103

4.3.1.5.2 Displays

PASS ASCENT TRAJ
BFS ASCENT TRAJ 2
ADI

4.3.1.5.3 Crew Action

Monitor only, unless TMECO not stable within 10 seconds.

TRAJ √TMECO

If not stable within 10 seconds or ADI error needles stowed:

CDR:

BFS TRAJ	Fly Θ using BFS TRAJ
HSI	Yaw to inertial [AFPH4.3-4] bearing pointer ~90 seconds to MECO, fly Hdot on ADI cue card

PLT:

SBTC	Depress button, match throttle <i>command</i> , release button
F4	√SPD BK/THROT - MAN
BFS TRAJ	@3g's: manual 3g throttling
PASS TRAJ	@2% PROP remaining: PC MAN 67%
AMI	@Desired MECO V_1 - 120 fps: MAIN ENGINE SHUT DOWN pbs (three) - push

4.3.1.5.4 Discussion

[AFPH4.3-5]

After staging, the crew monitors closed loop guidance convergence by noting that TMECO on the TRAJ display becomes stable within a couple of seconds of the expected MECO time. If it has not stabilized 10 seconds after staging or the ADI error needles stow (guidance unconverged for 10 seconds), the MCC is consulted. If no COMM, CSS and manual throttle are selected.

Throughout second stage flight, the crew monitors the trajectory using the BFS ASCENT TRAJ 2 display or with the flight instruments and ADI cue card if the display is not available. They also continuously monitor abort mode capability as defined on the no comm mode boundary, contingency abort, and TAL redesignation cue cards, and as called

from the ground. The nominal monitoring task also includes 3g throttling which begins about 60 seconds prior to MECO. MECO should be observed at the guidance predicted time and at the design MECO velocity.

During MM 103 (and 601), checks are performed internal to the PEG task to ensure that the current steering solution and resultant predicted burnout state are converged within an acceptable envelope of the desired target conditions. At the initiation of each major mode, the convergence checks are usually satisfied within two or three guidance cycles (4-6 seconds). A sudden change in the actual acceleration (engine failure) after initial convergence usually causes the convergence checks to fail for one guidance cycle. Allowing two guidance cycles as pad, 10 seconds is the longest reasonable interval for PEG to fail convergence. Failure to achieve convergence for more than 10 seconds indicates an internal problem which prevents the PEG solution from satisfying the target conditions. This causes the ADI error needles to stow. Manual guidance/throttle is initiated for this failure.

If CSS is required per Flight Rule A4-58 AUTO GUIDANCE NO-GO, CSS is selected by either CDR or PLT by depressing any one of the CSS PBIs on the eyebrow panel. Any PBI gives CSS in all axes to both RHCs. The control system is rate control attitude hold with a maximum rate of approximately 12°/sec in pitch and roll, and 6°/sec in yaw. When the RHCs are in detent, the attitude when rates fall below 3°/sec is held so that large attitude overshoots do not occur. If both RHCs are out of detent at the same time, the commands are summed.

To fly to nominal MECO in CSS, roll should be maintained at 180° and yaw should be commanded to keep the V_1 vector on the nose (inertial bearing pointer on the HSI under the lubber line). This is the most efficient yaw profile to fly. Pitch may be flown using the ADI cue card but the easiest way is to use the BFS ASCENT TRAJ 2 display. It is best to keep the current vehicle state bug and the two predictor bugs on the TRAJ line and make small (<5°) attitude changes. The results should be observed for a couple of data update cycles before making larger corrections. Since altitude rate is an extremely critical MECO target, it is recommended to abandon altitude and pitch attitude targets after about 20,000 fps and concentrate on controlling altitude rate as read on the AVVI to the MECO altitude rate reference found on the Ascent ADI cue card.

Manual throttles are required any time CSS is selected, if 3g throttling does not occur automatically, or any other scenario included in Flight Rule A4-59 MANUAL THROTTLE SELECTION. The PLT can select manual throttle by depressing the takeover button on the SBTC and moving the lever to match the current commanded throttle setting. When the takeover button is depressed, both AUTO SPD BK/THROT lights on eyebrow panels F2 and F4 extinguish. When the SBTC matches the commanded throttle setting within 4%, the PLT's MAN SPD BK/THROT light comes on. The takeover button is then released and the PLT should confirm that the MAN SPD BK/THROT light remains on. The PLT then has manual control of the throttles. The CDR's SPD BK/THROT light is not illuminated. The PLT should fly full throttle until

3gs. At that point, the PLT must manually throttle to maintain 3g and must manually shut down the engines via the MAIN ENGINE SHUTDOWN pbs at the V_1 indicated on the Ascent Procedures card. Engine shutdown should occur at approximately 120 fps before the targeted MECO V_1 . System lag time plus engine tailoff should result in achieving the desired MECO V_1 . The PLT may also use the cutoff bug on the BFS Ascent TRAJ 2 display, assuming BFS navigation is good.

Pushing the SPD BK/THROT PBI on the eyebrow panel returns control to AUTO throttle. The throttle setting remains at the last manually commanded value, unless a new guidance throttle command is issued, and a AUTO shutdown at MECO will occur. Section 4.9 will discuss the Powered CSS card which covers bad guidance cases (assuming nav is good) for the nominal uphill cases, as well as intact TAL and RTLS trajectories. Failure of two or more main engines would direct the crew to the contingency abort cue cards.

4.3.1.6 OMS Assist [AFPH4.3-6]

MM103 + 10s √OMS Assist Dump

4.3.1.6.1 Cue

MM103 transition + 10 seconds

4.3.1.6.2 Displays

OMS PRESS Pc gauge
 RCS/OMS PRPLT QTY
 SPEC 51
 SYS SUMM 2

4.3.1.6.3 Crew Action

Monitor

F7 OMS PRESS Pc
 O3 RCS/OMS PRPLT QTY
 G51 DTG → 0
 SYS SUMM 2

4.3.1.6.4 Discussion

An OMS assist burn during nominal ascent may be manifested on some performance critical missions. A 4000 lb OMS assist burn takes about 1:42 to complete and provides a 250 lb performance gain. For OMS assist flights, SPEC 51 will display the manual dump quantity and timer until the OMS assist initiates. Then, the OMS assist information will be displayed. For a 4000 lb OMS assist, SPEC 51 will display 15% for the Item 9 Quantity and 1:42 for the initial DTG (dump time to go). The crew should verify the OMS assist by monitoring the OMS PRESS Pc gauges, OMS quantity, and DTG on SPEC 51 counting down. When the OMS assist completes, DTG should display 0. Note that the 15% will still be displayed once the assist has successfully completed, until either a pre-MECO abort is selected or the crew enters an Item 9 Quantity. For OMS assist missions, if an ATO abort is selected pre-MECO, the Item 9 Quantity will reflect the calculated ATO abort dump quantity plus the OMS assist quantity. However, DTG will reflect any amount of OMS assist completed. In other words, if the OMS assist completed, DTG would only reflect the ATO dump since the dump time during the OMS assist has already been decremented.

4.3.1.7 Post SRB Separation Systems Configuration

3:00 Close suit O2, open visor
 √EVAP OUT (T < 60)

4.3.1.7.1 Cue

MET = 3:00

4.3.1.7.2 Displays

DISP 79 SM SYS SUMM 2

4.3.1.7.3 Crew Action

Close Suit O2 and open visor
O1 √EVAP OUT T < 60

4.3.1.7.4 Discussion

After SRB staging and the guidance checks are complete, the crew turns off the oxygen flow to the suits and opens the helmet visors. By this time, sufficient differential pressure exists between the cabin and ambient atmosphere to make a cabin leak obvious. Unless a cabin leak exists, crews prefer to operate the remainder of powered flight with the visors up.

At 3 minutes the EVAP OUT temp meter on panel O1 is expected to show temperature below 60°. By this time, the primary flash evaporator system (FES PRI A) controller should have lowered the evaporator outlet temperature to below 60°. If the temperature is not below 60°, the crew refers to evap out temp high cue card.

The FES is only effective above 100,000 ft, and there is no orbiter cooling before the FES is activated. The GPC position of the FES controllers allows the BFS to automatically turn on the FES at transition to MM 103.

4.3.1.8 Systems Aborts

- * If Systems ABORT reqd: *
- * RTLS at 3:40 or *
- * TAL Select prior to 23000 *
- * Otherwise Manual MECO 23700 *

4.3.1.8.1 Cue

MCC call or SYS FLIGHT RULES (section 4.3.2)

4.3.1.8.2 Displays

AMI

Event or CRT Timer

4.3.1.8.3 Crew Action

If reqd:

- F6 ABORT MODE - as reqd
- ABORT pb - push

4.3.1.8.4 Discussion

The above group of procedures is set apart by stars, denoting that they are reminders for off-nominal situations.

If an abort is declared for nonperformance reasons, i.e. systems failures (defined in Flight Rule A2-54 RTLS, TAL, AND AOA ABORTS FOR SYSTEM FAILURES and discussed in section 4.3.2), a reminder is provided to abort RTLS no later than 3:40 MET. The time 3:40 ensures RTLS selection prior to Negative Return (NR) while preserving the TAL option as long as possible. During the RTLS/TAL overlap region, RTLS is performed for systems failures requiring quick return to the ground. For systems failures after NR and prior to the last pre-MECO TAL velocity, TAL is declared. This last pre-MECO TAL velocity, or last AUTO TAL velocity, represents the last mission specific opportunity to abort to an ACLS or prime TAL site, remain in AUTO, and still achieve the desired TAL MECO R-V targets. Assumptions made in determining this velocity are: one SSME at abort throttle (104%) or two or three SSMEs at minimum throttle (usually 67%), 3σ entry dispersion protection, 15 second abort decision delay, and contingency c.g. box protection.

If the timing of the systems failure prevents TAL selection prior to last AUTO TAL, a manual MECO must be performed, followed by TAL selection post-MECO. The manual MECO V_I cue is a reasonable mission specific approximation of the desired TAL MECO condition. Manual MECO does incur the risk of missing the targeted MECO V_I and creating an underspeed or overspeed condition. In addition, a complete OMS dump is not possible, which may result in landing weight or c.g. constraint violations. The risks associated with manual MECO TAL, however, are considered less than those associated with continuing toward nominal MECO targets with critical systems failures.

The last pre-MECO TAL (or last AUTO TAL) velocity is about 1500 fps lower for 57° inclination missions than for lower inclination missions due to the out of plane steering required to reduce crossrange. For 57° inclination missions, if a systems abort is required after the last pre-MECO TAL velocity, an AOA is performed rather than manual MECO and post-MECO TAL select. For 57° inclination missions, the risk associated with proceeding on an AOA with critical systems failures is deemed less than performing a manual MECO TAL to a downrange, high inclination TAL site (Köln Bonn, Germany; Fairford, England; or King Khalid, Saudi Arabia). The difference in philosophies is due to acceptability of landing sites.

4.3.1.9 Roll Heads Up*28.5° Inclination version:*

VI = 13.6K √Roll Heads Up

39° Inclination version:

VI = 13.4K √Roll Heads Up

51.6° Inclination version:

VI = 13.2K √Roll Heads Up

57° Inclination version:

VI = 13.0K √Roll Heads Up

[AFPH4.3-7]

4.3.1.9.1 Cue

VI corresponding to VE = 12,200 fps (shown above)

4.3.1.9.2 Displays

AMI

ADI

4.3.1.9.3 Crew Action

At the VI cue, √Roll heads up

4.3.1.9.4 Discussion

Beginning with STS-87, a roll to heads up is performed during nominal ascent to allow an early handup from MILA to TDRS East in anticipation that the Bermuda ground station will close as a cost savings. [EPG8]The I-loaded roll to heads up relative velocity is converted to inertial velocity for use in the checklist since this is the cue available onboard. The roll maneuver is performed at 5°/sec and is accompanied by a pitch attitude change of 20° to 30° as the vehicle rolls about the X body axis, changing the thrust vector direction.

4.3.1.10 Manual Throttle/MECO Actions

- * If Man Throttle (3 eng): *
- * Man Shutdn at 25700 *
- * If 1 eng: *
- * TRAJ $\sqrt{\text{SERC ON}}$ *
- * When MPS PRPLT = 2%: *
- * MAN THROT, $P_c \rightarrow 67\%$ *
- * Man Shutdn at C/O mark BFS *

4.3.1.10.1 Cue

Manual Shutdown: V_1

Single Engine: MAIN ENGINE STATUS lights, SERC ON

4.3.1.10.2 Displays

AMI

PASS ASCENT TRAJ

BFS ASCENT TRAJ 2

Event or CRT Timer

4.3.1.10.3 Crew Action

If manual throttle (3 eng):

@VI cue: C3 MAIN ENGINE SHUT DOWN pbs (three) - push

If single engine:

PASS TRAJ $\sqrt{\text{SERC ON}}$

@PRPLT = 2%:

SBTC Depress button

Match throttle *command*

Release button

F4 $\sqrt{\text{SPD BK/THROT - MAN}}$

SBTC full back (min throttle)

BFS TRAJ @C/O Mark: MAIN ENGINE SHUT DOWN pbs (three) - push

4.3.1.10.4 Discussion

The above group of procedures is set apart by stars, denoting that they are reminders for off-nominal situations.

Any time manual throttle is selected, manual MECO must also be performed. The mission specific, three engine shutdown velocity cue provides about 120 fps (40 fps per engine) lead time from the nominal MECO V_1 to allow for reaction time and thrust tailoff. This lead time assumes the engines are shut down from minimum throttles (67%).

The final reminder in this section applies to the loss of two main engines after single engine press capability has been achieved. For loss of two main engines prior to single engine capability, the Contingency Abort cue card is consulted (see section 4.8.1). The

procedures on the Ascent cue card provide steps for maintaining vehicle control and safe operation of the remaining engine. Enabling SERC allows flight control to use single engine gimbal gains, without which LOC would soon result. The running engine is also throttled to 67%, at 2% propellant remaining, to protect MECO LOX NPSP, which prevents uncontained engine damage at shutdown. The 2% propellant remaining throttle down cue allows sufficient time to throttle back while simultaneously minimizing performance impacts.

The crew must use the cutoff (CO) mark on the BFS ASCENT TRAJ 2 display as the manual MECO cue because the PASS TRAJ was designed as an RTLS tool and is not used after about 10k fps V_1 (RTLS velocities do not exceed 9k fps). The BFS ASCENT TRAJ 2 cutoff mark scale is a V_1 scale with mission specific maximum and minimum values 1000 fps apart. The CO tick mark represents zero delta V to go to the velocity target and a moving triangle depicts the current, navigated delta V to go to the target.

[AFPH4.3-9]

4.3.1.11 MECOMECO $\sqrt{V_1} = \boxed{25819}$ 4.3.1.11.1 Cue

Lack of engine noise
 sensed loss of acceleration
 MPS PRESS Pc \rightarrow 0%
 MAIN ENGINE STATUS lights - red
 BFS C/O bug at C/O mark

4.3.1.11.2 Displays

MPS PRESS Pc
 MAIN ENGINE STATUS lights
 BFS ASCENT TRAJ 2

4.3.1.11.3 Crew ActionAMI $\sqrt{\text{MECO } V_1}$ 4.3.1.11.4 Discussion

Simultaneous MECO cues are (1) lack of engine noise, (2) sensed loss of acceleration, (3) SSME Pc meter tapes show zero, (4) SSME status lights illuminate red, and (5) BFS TRAJ velocity bug arrives at CO. MECO velocity will vary, depending on the mission inclination and targeted insertion altitude. The MECO CONFIRMED flag must be set in the flight software before ET sep is commanded, and the illumination of the DAP lights on PNL C3 is a good cue that MECO CONFIRMED is set. If bus failures or other malfunctions prevent MECO CONFIRMED, all three shutdown pbs are pushed.

4.3.1.12 ET Separation

MECO+20 S_[AFPH4.3-10]√ET SEP

- * If 'SEP INH': *
- * ET SEP - MAN *
- * If Rates > .7, .7, .7: *
- * MPS PRPLT DUMP SEQ - STOP_[AFPH4.3-11] *
- * Null rates *
- * ET SEP - SEP *
- * Post ET Sep -Z xlation: *
- * MPS PRPLT DUMP SEQ - GPC *
- * If Rates < .7, .7, .7: *
- * Assume Feedline Fail *
- * If VI < 25760 or BFS Engaged: *
- * OPS 104 - PRO (√BFS 104) *
- * Note: Expect - 'Illegal Entry' (PASS) *
- * 'Illegal TIG' (BFS) *

4.3.1.12.1 Cue

MAIN ENGINE STATUS lights - off
ADI rates

4.3.1.12.2 Displays

PASS ASCENT TRAJ
BFS ASCENT TRAJ 2
ADI

4.3.1.12.3 Crew Action

Monitor, unless ET sep Inhibit Occurs

TRAJ IF 'SEP INH':

C3 ET SEPARATION - MAN

F6,F8 ADI RATE - LOW

ADI √Rates

If Rates > .7, .7, .7:

R2 MPS PRPLT DUMP (two) - STOP

Null Rates

C3 ET SEPARATION SEP pb - push

Post ET Sep -Z xlation: R2 MPS PRPLT DUMP (two) - GPC

If Rates < .7, .7, .7:

Assume Feedline Fail (see section 4.3.5.2 for crew action)

4.3.1.12.4 Discussion

ET sep normally occurs automatically at approximately 20 seconds after MECO, and is indicated by the red main engine status lights extinguishing, followed by an automatic -Z

translation. The software transitions to MM104 and the MNVR display appears on the CRTs when -4 fps separation ΔV is achieved. If the THC is moved out of detent prior to the completion of the -Z, the maneuver terminates without moding. If for any reason the -Z maneuver is not completed automatically, the crew can mode guidance by completing the -Z maneuver manually via the THC or by doing an OPS 104 PRO.

The crew has the ability to start the auto ET sep sequence, to inhibit it, or to override automatic inhibits with the ET sep switch and pb. The nominal ET sep sequence is initiated when the SSME OPS sequence sets the MECO CONFIRMED flag. The ET sep sequence then runs cyclically, performing major functions such as umbilical unlatch and retract, engine prevalves commanded closed, electrical deadfacing, inhibit and separation mode checks, and structural separation. The sequence checks pitch, roll, and yaw rates, LH₂ and LOX feedline disconnect valve positions, and the status of flight aft MDMs 2, 3, and 4. If a rate of 0.7°/sec (I-load) is exceeded or if a valve or multiple MDM malfunction is detected, separation is inhibited and a crew alert generated. The crew is alerted by flashing SEP INH on the PASS ASCENT TRAJ and BFS ASCENT TRAJ 2 displays. The condition that caused the inhibit must be satisfied or overridden before the sequence can continue. Unlike RTLS ET sep, there is no timed bypass of inhibiting conditions.

If a SEP INH condition occurs, the ET SEP switch is set in the manual position. ET SEP switch to MAN precludes an unexpected separation if the SEP INH condition suddenly clears. The rates are checked by placing the ADI rate switch in the low position (1°/sec full scale deflection). If the SEP INH is due to excessive rates ($> 0.7^\circ/\text{sec}$), the crew sets the MPS propellant dump sequence to STOP and nulls the rates. The dump sequence is stopped since the dump will induce rates on the vehicle, making it difficult to null the existing rates that caused the SEP INH message in the first place. In general, the crew has time to null the rates and perform the ET sep prior to the MPS dump beginning (MECO + 2:00), but certain failures could cause the dump to begin early. After the rates have been stopped the crew will manually separate from the tank. If manual ET sep is attempted with high rates, recontact could occur. Following ET sep and the -Z translation the MPS propellant dump sequence is set to GPC so the automatic dump process can proceed.

If rates are less than 0.7°/sec with a SEP INH indication, the crew assumes a feedline disconnect valve failure has occurred. Since there is no foolproof way to determine if valve closure was hidden by dual FA MDM failure or to differentiate between a sensor failure and a feedline disconnect valve failing to close, the crew assumes the valve failed to close. ET separation will be delayed 6 minutes to allow residual propellant pressure in the orbiter and ET vent to a level where the venting force is less than 1800 lbf [AFPH4.3-12] from a stuck open valve. This minimizes the possibility of recontact after separation due to the impulse of escaping propellant from the ET. See section 4.3.5.2 for more information.

For the case of a significant underspeed at MECO which requires an early OMS 1 burn, the ET separation will only be delayed until TIG - 1:30 since it is desirable to perform the sep prior to the OMS burn. This will be covered more on the OMS 1 Burn card discussion. For the underspeed case which requires an OMS 1 burn as well as a BFS engage case, the software is transitioned manually to MM104. The early transition in the

PASS allows the crew to get to MM104 and load targets to prepare for the upcoming OMS 1 burn. The BFS engage case requires the transition to MM104 since the BFS doesn't display velocity tapes during ascent so the crew has to transition to MM104 to see HA for targeting information. An HA < 95nm will require an OMS 1 burn. For cases where the transition to MM104 is performed prior to ET separation the 'Illegal Entry' (PASS) and 'Illegal TIG' (BFS) messages are expected since the auto loaded targets in MM104 are referenced from ET sep and ET sep has not yet occurred. The following discusses the OMS targeting logic involved^[AFPH4.3-13].

OMS Maneuver TIGs are I-loaded as a Delta TIG from ET sep. This DTIG is used along with the Time of ET sep to compute the TIG in GMT of the Maneuver. This TIG is then converted to MET for display on the OMS Maneuver Display. When MM104 is entered while the Orbiter is still on the ET, the Time of ET sep is Zero. Thus the TIG in GMT will be a very small number. When this is converted to MET for use on the OMS Maneuver Display, the result is a large negative number.

One feature of the OMS Targeting logic is an automatic load of the targets at the MM104 transition. When the load is performed, the TIG in MET is converted back to GMT (Note: it is done this way since maneuver TIGs are input by the crew in MET). This TIG is then checked against current GMT. The TIG must be no more than 5 minutes in the past nor more than 12 hr in the future to be legal. If this check fails, an Illegal Entry message is written, and the load computations are terminated.

Changing the TIG or other target parameters manually (or performing an uplink) does not result in an automatic load. Thus, an entry of a correct TIG (MET) will result in a normal LOAD FLASH and targets can be successful loaded.

4.3.1.13 Major Mode 104

- ▶ **MM104+2 s** If ET Sep complete and HA > 72 :
 - +X xlation for 11 sec
 - √TGTS
 - √ASC PKT for failures
 - If OMS 1 not reqd:
 - OMS ENG (two) - OFF
 - Go to POST OMS 1

4.3.1.13.1 Cue

Major Mode

4.3.1.13.2 Displays

XXX 1 MNVR EXEC

where XXX = OMS or ATO

4.3.1.13.3 Crew Action

- MNVR √HA
 - If > 72: push THC forward (+X) 11 seconds
 - √HA + HP against OMS1/2 Targeting card (see section 4.3.4)
- √Ascent Pocket Checklist for failure procedures
- If OMS 1 not required:
 - C3 OMS ENG (two) - OFF
 - Go to POST OMS 1

4.3.1.13.4 Discussion

A +X translation will be manifested for most missions to photograph the ET if there is sufficient RCS propellant margin. [AFPH4.3-14] The HA cue corresponds to a conservative design MECO underspeed (~ 160 fps). Assuming a full ATO dump, if the underspeed is greater than the design MECO underspeed the result would be an AOA shallow. For these propellant critical cases, it isn't prudent to perform the +X maneuver[AFPH4.3-15]. HA is available on the MNVR display.

The OMS 1/2 TGTING card is used to determine targets. If comm is available, the MCC will recommend targets. If an OMS 1 burn is required, the OMS 1 BURN cue card is consulted. If not, the OMS engines are turned off and the crew should proceed directly to the POST OMS 1 procedures.

4.3.2 Abort Selection for Systems Failures

There are two kinds of events which require the selection of an abort: 1) failures of critical shuttle systems such as OMS, RCS, and environmental control and life support system (ECLSS) that can preclude the successful completion of a nominal mission, and 2) a significant loss of thrust due to the loss of one or more main engines or degradation of engine performance. This section discusses the systems failures requiring an abort. The SYS FLIGHT RULES card contains a list of critical systems failures which require a RTLS or TAL abort per the flight rules. This card is illustrated in figure 4.3.2-1 below for STS-114. Note that flight rules regarding those failures into which the crew does not have insight onboard are not referenced on the card.

SYS FLIGHT RULES		
	RTLS	TAL
OMS – 2 He TKs		X
– 1 OX & 1 FU TKs (diff pods)		X
– 2 OX or 2 FU TKs		X
APU/HYD – Impending loss of all capability	X	X
CABIN LEAK – ($-EQ \, dP/dT > .15$)	X	X
CRYO – All O ₂ (H ₂)	X	X
2 FREON LOOPS ↓ [Accum Qty (↓ and decr) and/or Flow (↓)]	X	X
2 MAIN BUSES ↓	X	
THERMAL WINDOW PANE	X	

Figure 4.3.2-1: STS-114 SYS FLIGHT RULES Card

4.3.2.1 Loss of OMS Capability

4.3.2.1.1 Cue

Loss of 2 OMS Helium Tanks

Loss of 1 OX and 1 FU tank in different pods

Loss of 2 OX or 2 FU tanks

4.3.2.1.2 Displays

BFS GNC SYS SUMM 2

4.3.2.1.3 Crew Action

F6 ABORT MODE - TAL

ABORT pb - push

4.3.2.1.4 Discussion

If there is a severe loss of OMS propellant, it is not possible to continue uphill and deorbit. In this case a TAL is required. This loss of OMS capability can result from several possible failures: (1) a loss of both He tanks, (2) a loss of one OMS prop tank on each side, and (3) a loss of both oxidizer (OX) or both fuel (Fu) tanks.

A loss of He pressurant in both pods renders the propellant system useless (insufficient blowdown capability). A mixed crossfeed, in the two propellant tanks failure scenario, cannot guarantee delta V capability since He may leak through the damaged propellant tanks and not provide sufficient tank pressurization (only mixed crossfeed blowdown capability guaranteed). Lastly, if there is a loss of both Ox and Fu tanks, there is insufficient OMS capability to continue uphill.

4.3.2.2 APU/Hydraulic Failures

4.3.2.2.1 Cue

Two APUs failed and the last one failing

4.3.2.2.2 Displays

BFS DISP 79 SM SYS SUMM 2
BFS GNC SPEC 51 OVERRIDE
F8 APU and HYDRAULIC METERS
F7 Status Lights

4.3.2.2.3 Crew Action

F6 ABORT MODE - RTLS or TAL
ABORT pb - push

4.3.2.2.4 Discussion

In the case of 2 APU/hydraulic systems down and the third failing, the trajectory option with the minimum time to the ground is desired in order to land prior to a complete loss of hydraulics. Since this is so time critical, a nominal MECO followed by deorbit would be least desirable.

4.3.2.3 Cabin Leak

4.3.2.3.1 Cue

-EQ $dP/dT > 0.15$

4.3.2.3.2 Displays

DISP 78 SM SYS SUMM 1

4.3.2.3.3 Crew Action

F6 ABORT MODE - RTLS or TAL
ABORT pb - push

4.3.2.3.4 Discussion

The loss of cabin pressure integrity ($dP/dT > 0.15$) impacts both breathing oxygen and equipment cooling. The option requiring the minimum time to the ground is required. A systems RTLS will result in a landing time of approximately 20 minutes MET while TAL results in a landing around 35 minutes.

4.3.2.4 *Loss of Cryo*

4.3.2.4.1 Cue

The loss of all O₂ or H₂ cryo

4.3.2.4.2 Displays

SM SYS SUMM 2 (DISP 79)

CRYO PALLET (DISP 168 - EDO CRYO PALLET)

4.3.2.4.3 Crew Action

F6 ABORT MODE - RTLS or TAL

ABORT pb - push

4.3.2.4.4 Discussion

In the case of a loss, or impending loss, of all cryogenic (cryo) O₂ or H₂ tanks, an RTLS or TAL is required. A loss of cryo O₂ or H₂ results in a loss of fuel cells and electrical power.

4.3.2.5 Loss of 2 Freon Loops

4.3.2.5.1 Cue

Accum Qty (↓ and decreasing) and/or Flow (↓)

4.3.2.5.2 Displays

OPS 0001 THERMAL

SPEC 79 SM SYS SUMM 2

4.3.2.5.3 Crew Action

F6 ABORT MODE - RTLS or TAL

ABORT pb - push

4.3.2.5.4 Discussion

The loss of two Freon loops eventually results in the loss of all three fuel cells due to a lack of cooling. Even with an extensive powerdown and a fuel cell purge, the lifetime of electrical power production is very limited due to the temperature and water buildup resulting from the loss of Freon loop cooling. Due to the time critical nature of this failure, RTLS is preferable over TAL.

4.3.2.6 Loss of 2 Main Buses

4.3.2.6.1 Cue

2 main buses ↓

4.3.2.6.2 Displays

SM SYS SUMM 1

4.3.2.6.3 Crew Action

F6 ABORT MODE - RTLS
ABORT pb - push

4.3.2.6.4 Discussion

The failure of two main buses precludes ET door closure. Due to the thermal severity of TAL entry trajectories, RTLS is preferred to TAL. An uphill press is preferable to TAL if RTLS is no longer possible.

4.3.2.7 Loss of a Thermal Window Pane

4.3.2.7.1 Cue

Thermal window pane missing pieces of glass

4.3.2.7.2 Displays

N/A

4.3.2.7.3 Crew Action

F6 ABORT MODE - RTLS
 ABORT pb - push

4.3.2.7.4 Discussion

Heating during nominal, TAL, or late TAL entries is severe. In the case of a failed thermal window pane, the RTLS is preferable due to its benign heating characteristics. Thermal window pane is not considered failed if it is only cracked but remains intact.

4.3.3 Abort Selection for Performance

This section discusses abort selection for the loss of performance, either due to the loss of one or more main engines or engine performance degradation. The NO COMM MODE BOUNDARIES card, discussed in section 4.3.3.2, contains the abort boundaries used when there is no communication with the MCC for one engine failure, a second engine failure after Press to ATO (i.e. TAL abort not declared after the first engine failure), or two simultaneous engine failures. The appropriate TAL REDESIGNATION Card, discussed in section 4.5.2, is used when there is no communication with the MCC for a second engine failure following a TAL abort. The ASCENT ABORT SUMMARY card, discussed in section 4.3.3.3, summarizes one engine out, two engine out simo, and three engine out simo capability.

4.3.3.1 SSME Failure

4.3.3.1.1 Cue

Red or amber status lights
 SSME chamber pressure decay
 SM alert
 MCC call
 Physical cues (loss of thrust or acceleration)

4.3.3.1.2 Displays

MAIN ENGINE STATUS light(s)
 MPS PRESS Pc gauge
 SSME FAIL message
 BFS GNC SYS SUMM 1

4.3.3.1.3 Crew Action

If required per MCC or Checklist:

F6 ABORT MODE - as reqd
 ABORT pb - push

Check with MCC, or if No Comm:

C3 MAIN ENGINE LIMIT SHUT DN - ENABLE
 - AUTO

4.3.3.1.4 Discussion

The amber MAIN ENGINE STATUS lights on panel F7 are lit and an SM alert is issued for any of the following conditions:

- Command path failure - Two command channels lost
- Data path failure - Both PRI and SEC data lost
- Electric lockup - Loss of flowmeter data used for mixture ratio control results in main engine controller freezing the engine at the last commanded position.
- Hydraulic lockup - One or more of the following engine valves is outside of position limits. Throttling capability is lost. If an engine is running in hydraulic lockup at MECO, it will be shut down pneumatically.
 - Main fuel valve
 - Main oxidizer valve
 - Oxidizer preburner valve
 - Chamber coolant valve

The red MAIN ENGINE STATUS light is lit if an engine redline limit has been exceeded or if the engine is in shutdown phase.

The LIMIT SHUT DN switch on PNL C3 enables or inhibits the engine controller initiated shutdown based on engine redline limits. If the switch is in the ENABLE position, the limit logic shuts down any engines exceeding redline limits. If the switch is in

INHIBIT, the limit logic inhibits the shutdown of engines exceeding redline limits. If the switch is in the AUTO position and a main engine shuts down, the shutdown of a second engine is inhibited automatically. The crew can mode this switch to ENABLE then back to AUTO, in order to reenable the main engine limit shutdown logic, this is done as soon as possible after the first engine failure unless the MCC determines that one of the redline sensors has failed and either of the remaining engines is one redline sensor away from an erroneous shutdown. In this case the limits will be set to ENABLE and then AUTO when an abort boundary (as defined in Rule {A4-56}, PERFORMANCE BOUNDARIES) is reached such that a single-engine abort can be accomplished to the desired site. Reference Flight Rule A5-103 (LIMIT SHUTDOWN CONTROL_[AFPH4.3-16]). This allows a second engine to shutdown, if limits are violated, while inhibiting the third and last remaining engine from shutdown.

If a main engine fails, the PLT turns off the ac bus sensors to preclude a second engine shutdown due to a faulty ac bus sensor if an ac phase is lost. Additional crew actions for an engine failure depend upon the abort performance capability remaining after the failure.

4.3.3.2 NO COMM MODE BOUNDARIES Card

The NO COMM MODE BOUNDARIES card contains flight specific abort capability data based on inertial velocity. STS-114 (figure 4.3.3.2-1) is used as an illustrative example. Constructed prelaunch, the no comm mode boundaries do not reflect off-nominal performance such as that resulting from a Pc shift or stuck throttle. During ascent the MCC Abort Region Determinator (ARD) calculates abort mode boundaries based on actual vehicle performance. The ARD takes actual performance into account when computing the real time boundaries. The abort boundary calls, except for Single Engine OPS 3, are made in real-time by the Flight Dynamics Officer (FDO) using the ARD. The Single Engine OPS 3 boundary call is made by the Guidance and Procedures Officer (GPO) using pre-flight generated data.

Some of the abort boundaries are designed with flight performance reserve (FPR) margins. The FPR is an MPS propellant allowance for such uncertainties as engine performance and propellant loading. On an RTLS with nominal performance (0σ dispersions), the RTLS 3σ FPR remains unburned in the ET at MECO. On an RTLS with 3σ dispersions, the 3σ FPR is burned. FPR requirements are developed by the Space Shuttle Program Office (SSPO) and published in the trajectory design data package (TDDP) at the start of each trajectory design cycle.

NO COMM MODE BOUNDARIES			
NEG RETURN (104)	8100	2 ENG ZZA (104)	6000
PRESS TO ATO (104)	10400	ABORT TAL ZZA (4)	
SE OPS 3 (109)	12100	EO VI	<input type="text"/>
SE ZZA (104)	14300	SE OPS 3 ZZA (109) (14)	<input type="text"/>
PRESS TO MECO (104)	16400	SE ZZA (104) (4)	<input type="text"/>
NEG BEN (2 @ 67)	18300	<hr/>	
SE PRESS (104)	18800	2 ENG MRN (104)	5800
NEG MRN (2 @ 67)	20000	ABORT TAL MRN (3)	
LAST PRE MECO TAL	23000	EO VI	<input type="text"/>
LAST TAL		SE OPS 3 MRN (109) (13)	<input type="text"/>
YJT	20000	SE MRN (104) (3)	<input type="text"/>
YYT	20200	<hr/>	
YQX	21900	2 ENG BEN (104)	5900
LAJ	23400	ABORT TAL BEN (2)	
IKF	23800	EO VI	<input type="text"/>
INN	24000	SE OPS 3 BEN (109) (12)	<input type="text"/>
FFA,BEJ	24200	SE BEN (104) (2)	<input type="text"/>
MRN	24300	<hr/>	
KBO	24400		
FMI	24500		
ESN	24900		
ZZA	25000		
KKI	25100		
JDG	25200		

FB 2-4

ASC/114/FIN 3

Figure 4.3.3.2-1: STS-114 NO COMM MODE BOUNDARIES Card

The ascent abort mode boundaries change, both in definition and time of occurrence, on a mission to mission basis. The mode boundary times change significantly flight to flight due to differences in mass properties, environmental modeling, and performance characteristics. (See figure 4.3.3.2-2 for example abort coverage). The boundary names may also change. For example, the TAL landing sites may change.

Other factors significantly affect the definition and complexity of ground mode boundary assessment and calls and crew procedures. For example, if the prime TAL site is an out of plane site (e.g. Ben Guerir for low inclination missions), the reduced ascent performance during powered flight requires that the crew perform a TAL landing site redesignation to a contingency inplane site when the downrange energy exceeds capability to the out of plane site. The out of plane site provides less TAL coverage than the in plane site. In these cases, a negative out of plane site boundary is provided in the NO COMM MODE BOUNDARIES.

The NO COMM MODE BOUNDARIES in the Ascent Checklist for ISS rendezvous missions assume a launch at open of the window. Launch at other times in the launch window result in possible updates to the NO COMM MODE BOUNDARIES due to the yaw steering for rendezvous. These updates would be passed up to the crew via the Air-to-Ground. For the usual planned Inplane Launch the updates are passed to the crew in the prelaunch timeframe but for late launch slips the updates could be called during powered flight. Also, the NO COMM MODE BOUNDARIES may be updated pre-launch factoring in day of launch performance results from simulations^[AFPH4.3-17].

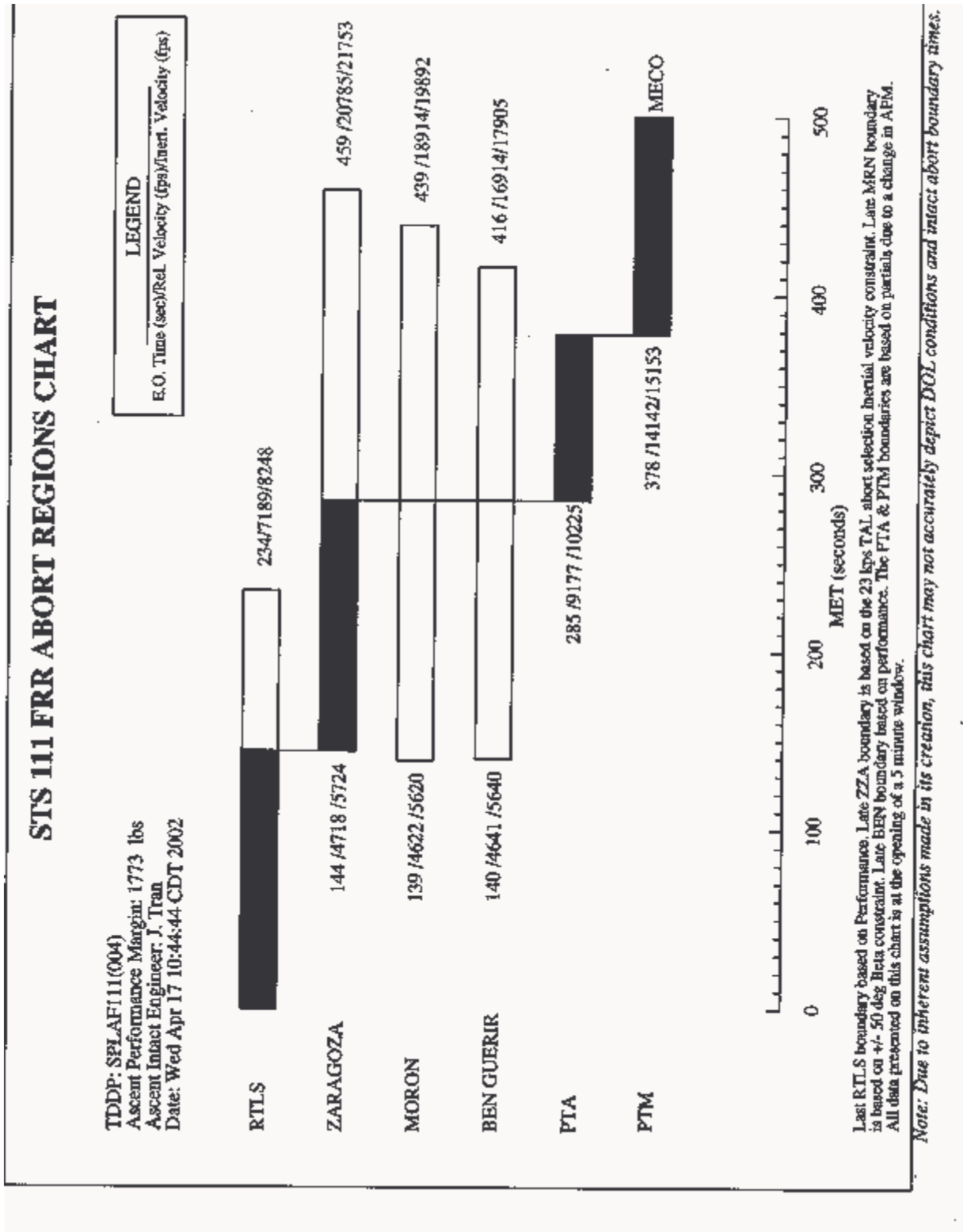

Figure 4.3.3.2-2: STS-111 [AFPH4.3-18]Abort Coverage

Another factor in the prediction and design of abort boundaries is the use (or omission) of abort shaping via three phase PEG or pseudo MECO targeting. This has the effect of lofting the trajectory and closing down (shortening) exposure to TAL. For further detail on abort shaping, refer to section 2.2.2. Also note that higher inclination flights may require a slightly different philosophy of calls and checklist mode boundaries than low inclination flights.

The following sections describe each of the abort boundaries which appear on the NO COMM MODE BOUNDARIES Card or are called by the MCC. Note that section 4.5.2 contains the mode boundary calls made when a TAL abort is in progress. Also note that the MCC calls take precedence over the NO COMM MODE BOUNDARIES since the MCC ARD accounts for actual SSME performance. Any questions concerning the intact abort mode boundaries or contingency abort boundaries should be addressed to the FDO or GPO office, respectively.

[AFPH4.3-19]4.3.3.2.1 Two Engine [Prime TAL Site]

The two engine TAL boundary is the earliest engine failure time or V_1 for which auto guidance can achieve the TAL site Range-Velocity (R-V) targets at MECO. This boundary assumes 2σ low ascent performance, abort throttles (104%), 3σ entry dispersions, and a 15 second abort delay. Using 2σ instead of 3σ ascent performance significantly reduces RTLS exposure without compromising abort success, since a 3σ low ascent can be easily made up on the entry side due to the 3σ protection it retains for this case. The delay allows time for MCC confirmation of the engine failure, evaluation of the required abort mode, and abort execution.

For high inclination missions, two engine capability to the out of plane TAL sites (MRN and BEN) is achieved a few seconds earlier than capability to the inplane TAL site (ZZA). This is because both of these sites are south and west of ZZA. If the ZZA is the prime TAL site but MRN or BEN is also a “Go” TAL site, a “2 Engine TAL” call will be made at first capability to a “Go” TAL site, rather than a “2 Engine ZZA” call. If an engine failure occurred right at the 2 engine TAL call, a redesignation may be required.

There is usually an overlap of RTLS and TAL capability. TAL is the preferred abort mode for engine failures in this overlap region since single engine completion capability is attained much earlier for TAL than RTLS.

4.3.3.2.2 Negative Return

The Negative Return (NR) boundary represents the latest engine failure time or V_1 for which an RTLS abort can be declared and achieve MECO R-V targets. This boundary assumes 3σ low ascent performance, abort throttles (104%), 3σ entry dispersions, and a 15 second abort decision delay. Past this V_1 , the orbiter has too much downrange energy to successfully return to KSC.

For engine failures prior to the two engine TAL call, RTLS is selected at 2 + 30 MET or as soon as possible after the engine failure, whichever is later. There is no need to select RTLS earlier since active guidance does not commence until alpha limiting is terminated at about 2 + 30 MET. RTLS aborts for systems problems are selected at 3 + 40 MET. This

is done in order to delay a commitment to RTLS until the last possible moment to allow for any systems analysis and/or reconfiguration which may dictate TAL over RTLS.

For an SSME out during first stage, maximum throttle will be selected prior to RTLS selection if the altitude rate at SRB sep is less than the PRTLS minimum performance constraint. This separation altitude rate limit, which is a function of staging velocity, corresponds to the minimum SRB sep altitude rate required to satisfy the 20 psf flyback QBAR, (or pressure $(P)_{TOTAL}$) limit. Thus, maximum throttle is required to avoid unacceptable P_{TOTAL} conditions due to the depressed staging conditions.

If the ARD indicates a loss of uphill capability with a 2σ confidence level with three engines running at NR, the MCC calls for an RTLS abort unless TAL capability exists to the prime site.

4.3.3.2.3 Press to ATO

The Press to ATO (PTA) boundary represents the earliest engine out time or V_1 at which the orbiter can successfully reach the design underspeed at MECO, assuming 2σ low ascent performance and abort throttles (104%) for the remaining two engines, pre-MECO ATO abort selection (may invoke a pre-MECO OMS dump, abort MECO targets, and/or variable IY steering), and a 15 second abort delay. Design underspeed is the largest underspeed from the nominal targeted MECO VI which protects the most constraining of: 1) ET impact constraints, 2) minimum performance capability (AOA steep or better), 3) minimum altitude (55 nm prior to OMS 2), 4) minimum NPSP limit, and 5) contingency c.g. envelope protection.

If the prime TAL site is an out of plane site, a call to select the in plane TAL site is made directly after the Press to ATO call (i.e. "Press to ATO, Select Zaragoza"). Note that Zaragoza is the in-plane TAL site for high inclination_[AFPH4.3-20]. If the Press to ATO call is not made, the in-plane TAL site should be selected at Press to MECO. The in-plane site is selected at uphill capability since TAL would only be required for multiple engine failures, in which case the in-plane site is desired.

An ATO with a SPEC 51 ITEM 9 dump is used for executing an ATO during powered flight and over-writing the quantity of the OMS to be dumped. After the ATO is initiated, the Item 9 on SPEC 51 display allows the crew to change the percentage of OMS to dump. This procedure would only be done on MCC call. The purpose of changing the dump quantity is to dump more or less propellant than what the software would dump automatically. This change in the dump quantity may allow continuing to orbit versus going TAL or reduce the likelihood of dumping too much propellant_[AFPH4.3-21]

The first step of the procedure involves calling up the SPEC 51 and preparing to execute the ITEM 9. The ITEM 9 + X is typed into the keyboard, where X is the new dump quantity that is supplied by the MCC. After ATO abort is selected, the EXEC key is depressed to update the ATO dump quantity. If the EXEC key is depressed prior to the abort, the ATO dump quantity will default to the I-loaded value at abort initiation.

4.3.3.2.4 Press to MECO

The Press to MECO boundary represents the earliest engine out time or V_1 at which the orbiter can successfully reach the design underspeed at MECO, assuming 2σ low performance and abort throttles (104%) without an OMS dump. See the previous section for a definition of design underspeed.

4.3.3.2.5 Single Engine OPS 3 109%_[AFPH4.3-22]

The single engine OPS 3 109% boundary is the breakpoint between performing the 2 engine out Second Stage procedure and the 2 engine out Droop procedure. If a second engine fails prior to this boundary, the 2 engine out Second Stage procedure will be performed. If a second engine fails after this boundary, the 2 engine out Droop procedure will be performed. When last ECAL/Bermuda capability occurs before the droop 109% boundary, the single engine OPS 3 109% boundary simply represents the single engine droop 109% boundary. The single engine droop 109% boundary represents the earliest time or V_1 after which a two engine out trajectory will not fall (droop) below 265,000 ft. Vehicle trajectories which droop below 265,000 ft during powered flight violate ET heating constraints, and loss of vehicle is expected. It is the earliest point at which executing a single engine TAL is acceptable. Since the droop boundary does not guarantee a runway landing, the breakpoint between the 2 engine out Second Stage and the 2 engine out Droop procedures may be delayed to provide a runway landing rather than bailout. When runway capability to an ECAL site (high inclination) or Bermuda (low and mid inclination) exists above the droop boundary, the breakpoint between performing a 2 engine out ECAL/Bermuda and a 2 engine out Droop is extended. In this case, the single engine OPS 3 boundary is based on the earliest of the following: 1) last ECAL/Bermuda capability, 2) single engine limits boundary (assumes max throttle, 15 second abort decision delay, low energy guidance to an ACLS or TAL site), or 3) first low energy capability to an acceptable downrange ELS using maximum throttles, 2σ low MPS performance, and the use of low energy guidance for entry. An ELS is acceptable if crosswinds are less than 15 knots, ceiling and visibility are greater than 8,000 ft/5 nm, and there are no thunderstorms at the site. For two engines out in this region, which extends to SE TAL capability, an ELS or possible ACLS runway landing should be achievable using the droop software and low energy entry guidance. Note that the Single Engine OPS 3 109% boundary in the NO COMM MODE BOUNDARIES Card assumes the downrange ELS is a “Go” site. If the ELS is “No Go”, the Single Engine OPS 3 109% boundary may be updated prelaunch.

4.3.3.2.6 Main Engine Limits Enable/Auto (MCC Call only)

If the MAIN ENGINE SHUT DN switch is in the AUTO position and a main engine shuts down, the shutdown of a second engine is inhibited automatically. The call to reconfigure the limits switch after an engine failure is currently made as soon as possible after the first engine failure as defined in the section above when all sensors are valid. If one sensor is bad, the call must satisfy Flight Rule A5-103 (for weather requirements). If two sensors are bad, this call is not made and shutdown remains inhibited. The MCC call is worded, “Main engine limits ENABLE/AUTO.” The crew modes the MAIN ENGINE LIMIT SHUT DN switch to ENABLE, then back to AUTO in order to reen able the main engine

limit shutdown logic. This allows a second engine to shut down, if limits are violated, while inhibiting the third engine from shutdown. [AFPH4.3-23]

4.3.3.2.7 Single Engine [in-plane TAL site] 104%

The single engine TAL 104% boundary represents the earliest time or V_1 at which auto guidance can be used to achieve the desired TAL site R-V target line with the simultaneous failure of two main engines. This boundary assumes 2σ low ascent performance, abort throttles (104%), and a 15 second decision delay. Note that the TAL redesignation card, used when a TAL abort has been declared, is discussed in section 4.5.2.

4.3.3.2.8 Single Engine Press to MECO

This boundary represents the earliest time or V_1 after which the critical underspeed can be attained with two engines out, assuming abort throttles (104%) and 2σ low performance from the remaining engine. AFT RCS to the AFT Press quantity may be committed from post-MECO delta V purposes since it can reduce TAL exposure while protecting for a nominal reentry. The critical underspeed is defined in the same manner as the design underspeed, less the ET impact constraint. If there is a gap between single engine press to MECO and last single engine TAL, this call will be based in real time on the following changes in the groundrules, in order of preference:

- Commit OMS Ballast to contingency CG limit
- Accept AOA/PLS to NO-GO site
- Maximum throttle
- Accept AOA shallow
- Nominal performance from the remaining engine (0σ)

4.3.3.2.9 Negative [TAL Site] 104%

This boundary represents the last opportunity to abort to the prime TAL site and still achieve the desired R-V line within crossrange limitations. This boundary assumes 2σ low ascent performance, two SSMEs at abort throttles (104%), 3σ entry dispersions, and a 15 second abort decision/TAL reselection delay. This call is not usually provided by the MCC since the in-plane TAL/ACLS should be selected by this point (PTA usually occurs prior to negative TAL). However, the negative out of plane TAL boundaries are included in the NO COMM MODE BOUDARIES card.

4.3.3.2.10 Last Pre-MECO TAL

This boundary represents the last time that AUTO guidance can be used to achieve the designated TAL/ACLS landing site R-V line. This boundary assumes two engines or three engines at 67% or one engine at 104%, 2σ low ascent performance, 3σ entry dispersions, a 15 second abort decision delay, and protection of the contingency c.g. box. If a sufficient amount of OMS is not dumped pre-MECO, the dump may be completed in MM 304. The engines are throttled down to 67% for three engine and two engine cases when the TAL initiation V_1 is greater than a flight specific I-loaded velocity, allowing additional time for the pre-MECO dump.

4.3.3.2.11 Last TAL

This boundary represents the latest MECO velocity which will allow for an entry to an ELS or ACLS, assuming three engines out simultaneously, protection of the contingency c.g. box, and post-MECO roll to heads up. Note that if an in-plane ACLS is not available, an AOA has priority over a manual MECO to an ELS.

4.3.3.3 Ascent/Abort Summary Card

The Ascent/Abort Summary card summarizes 1 engine out, 2 engine out, and 3 engine out abort modes as shown in figure 4.3.3.3-1. Note that the 2 engine out and 3 engine out boundaries assume simultaneous engine failures. Figure 4.3.3.3-2 on the following page illustrates the abort boundaries in flowchart format.

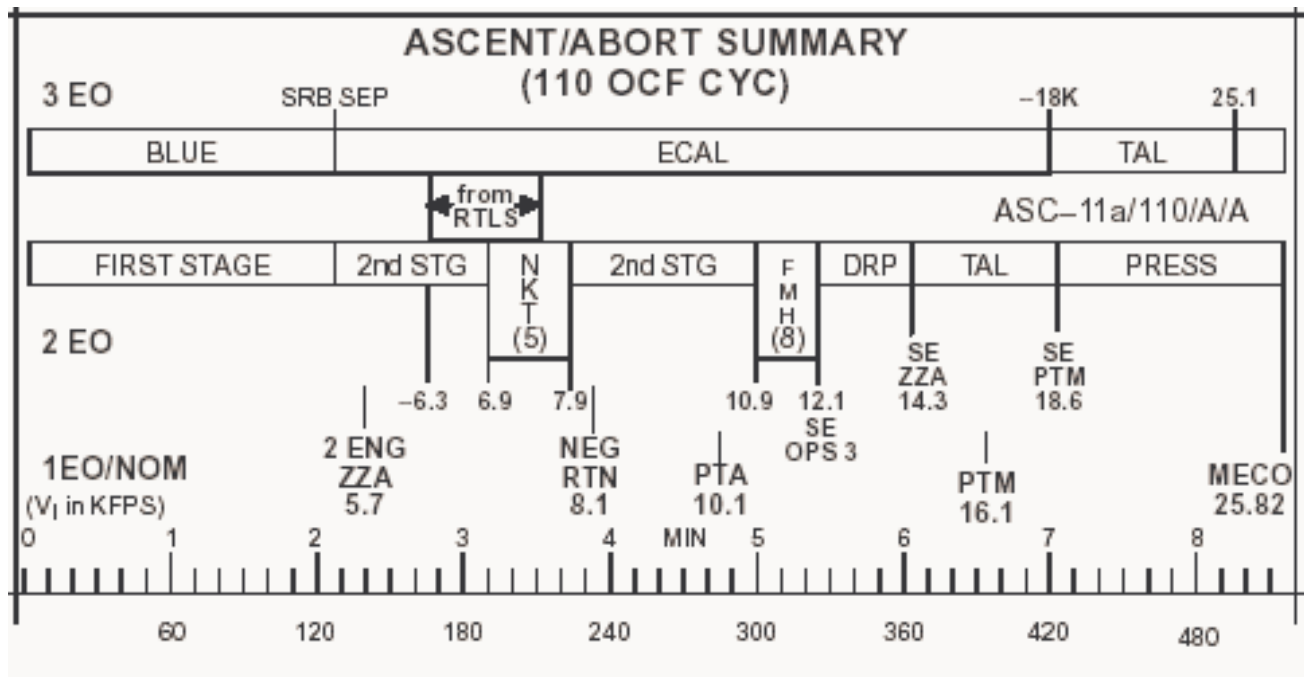

Figure 4.3.3.3-1: STS-110 Ascent/Abort Summary Card [AFPH4.3-24]

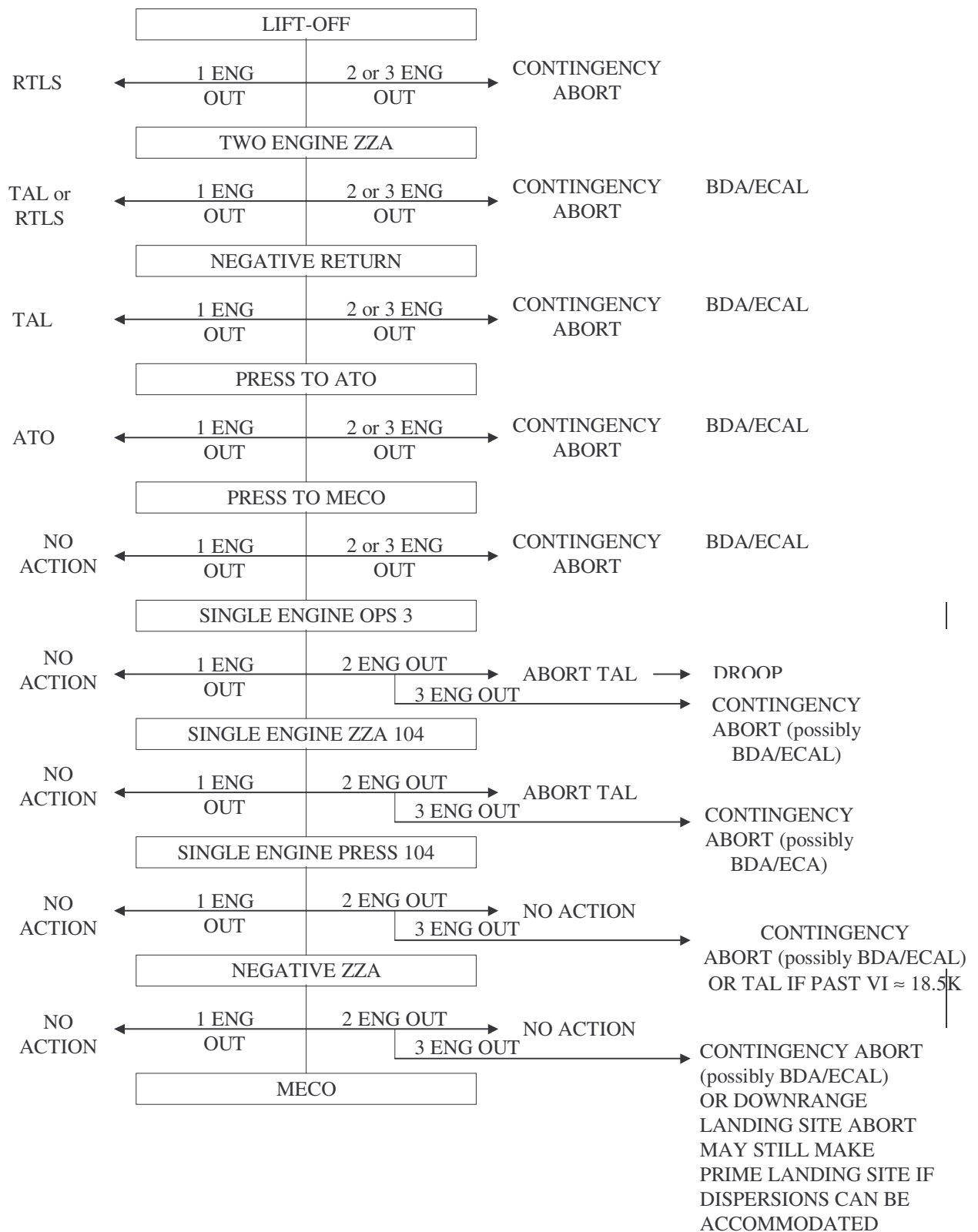

Figure 4.3.3.3-2: Abort Boundaries Flowchart

4.3.4 OMS 1/2 Targeting

The shuttle is deliberately targeted to be suborbital at MECO so that the ET reenters and impacts in a safe target area. As discussed in section 2.2.4 there are two methods of insertion: 1) Standard Insertion (SI) and 2) Direct Insertion (DI). SI missions are no longer manifested but the procedures used on past SI missions are included in this section for historical purposes.

SI flights require a two burn sequence to achieve orbit or AOA deorbit. The SI nominal OMS 1 maneuver is done prior to reaching the MECO apogee. This creates a shift in the line of apsides with most of the OMS 1 “kick” to apogee. Apogee is raised to the final desired orbital radius while perigee is raised close to the MECO apogee. The nominal OMS 2 burn then raises perigee and circularizes the orbit.

DI flights require only one OMS burn (OMS 2) to complete the insertion. The OMS 2 is centered about the apogee established at MECO. Because of this there is very little shift in the line of apsides and thus higher burn efficiency. OMS 2 raises perigee and the desired final orbit is nominally achieved after this single burn.

During second stage powered flight the orbiter is guided toward a MECO state defined by altitude (h), inertial flightpath angle (γ_i), V_i , and planar (IY) targets. Any underspeed at MECO will result in a lower than planned apogee and will impact the insertion burn plan. .

The OMS burn or burns are normally performed using Powered Explicit Guidance 4 (PEG 4) which is a closed loop scheme where specific targets are achieved. PEG 4 target I-loads include time of ignition (TIG), C1, C2, HT and ΘT . C2 and C1 are the slope and intercept that define the linear relationship between the horizontal (V_{HOR}) and vertical (V_{VER}) components of the burn velocity ($V_{VER} = C2 V_{HOR} + C1$). HT is the height of the target above the Earth’s surface, and ΘT is the angular location of the target. In OPS 1, ΘT is the downrange angle from the launch site to the radius target vector. In OPS 3, ΘT is measured from TIG to the target (entry interface, EI). OMS burns can be performed using PEG 7 which is the external ΔV guidance mode. However, PEG 7 is designed to guide the vehicle through a constant inertial thrust attitude maneuver that achieves a specified velocity change. It does not achieve a specific target but simply achieves a certain ΔV . PEG 7 is used primarily for orbit adjust maneuvers but can be used as a back-up for insertion burns.

Upon transition into MM104, OMS 1 targets appear on the MNVR display. Nominally, on DI flights, these targets are a dummy set, which represent the approximate delta V expected from the MPS dump, and are not to be used. Nominally, on Standard Insertion flights, the MM104 targets are the nominal OMS 1 targets. If ATO was selected pre-MECO, an ATO target set will appear instead. If ATO is required post-MECO, the target set is selected by entering the target set number. The ATO target is designed for a lower than normal orbit (105 nm circular). This is a safe orbit with a lifetime of at least 1 day. A number of PEG 4 targets for the prime AOA landing site are in the onboard software and are selected by entering the target set number. However, the crew must key in customized targets for delayed ignition cases (standard insertion) and for alternate AOA landing sites. The MCC is prime for target selection especially for combinations of

failures (i.e., MECO underspeeds plus OMS leaks). In these cases, the MCC may compute a more optimal real time targeting solution for uplink. However, if there is a loss of comm, the crew makes the target selection decision as discussed in the following sections.

4.3.4.1 Standard Insertion OMS 1 Targeting Card for Systems Failures

* For Historical Purposes Only *

The Standard Insertion OMS 1 targeting card is used to determine the OMS 1 and 2 targets for certain systems failures as shown in figure 4.3.4.1-1. This card assumes no underspeed at MECO and no other major failure (i.e., combination of OMS and APU/hydraulic failures are not considered). Note that targets required due to an underspeed take precedence over systems failures.

**OMS 1 TARGETING
(STD INSERTION)**

DELAY DO NOT delay burn if CUR HA < 70**		
FAILURE	OMS 1 TARGET	OMS 2
OMS - 1 He TK - 1 PRPLT TK - 2 OMS ENG - 2 N2 TKS (Connect to RCS) EPS - MNA & B - MNA & C - MNB & C ET SEP	<u>DELAYED ATO</u>	N/R
FEEDLINE DISC VLV	<u>DELAYED NOM</u>	NOM
OMS - 1 OX & 1 FU TK diff PODS 2 OX or 2 FU TK or 2 He TKS	<u>DELAYED AOA-S</u>	AOA/ AOA-S
ON TIME 2 FREON LOOPS 2 H2O LOOPS CABIN LEAK (EQ dP/dT ≥ .08)	<u>NOMINAL</u>	AOA
APU/HYD - 2 ↓ & 1 failing	<u>NOMINAL</u>	AOA
CRYO - ALL O ₂ (H ₂)	<u>NOMINAL</u>	AOA

Figure 4.3.4.1-1: STS-30 OMS 1 TARGETING Card (Standard Insertion)

4.3.4.1.1 Delayed ATO OMS 1/OMS 2 Not Required

4.3.4.1.1.1 Cue

Loss of 1 OMS Helium tank
 Loss of 1 OMS Propellant tank
 Loss of 2 OMS Engines
 Loss of 2 OMS N2 tanks
 Loss of 2 main buses
 ET Separation Failure

4.3.4.1.1.2 Displays

PASS MNVR EXEC
 BFS MNVR EXEC

4.3.4.1.1.3 Crew Action

Delay ATO OMS 1
 Do not perform an OMS 2

4.3.4.1.1.4 Discussion

Some failures, especially those which interfere with the orbit insertion process, tolerate a delay of the OMS 1 burn to allow a better evaluation of the extent of the failure. Analysis of delta V requirements for delayed SI cases indicates that the OMS 1 burn can be delayed to approximately 20 minutes MET, as long as a nominal MECO is achieved. This allows the crew time to check the failure, accurately assess the situation, and retarget the OMS 1 burn without rushing. A deorbit burn is performed at apogee and must meet certain entry conditions. Note that for all large underspeeds at MECO the OMS 1 burn should not be delayed. The note at the top of the OMS 1 targeting card indicates when the burn should not be delayed. Current HA is a quick way to check the severity of the underspeed at MECO.

A delay of the ATO OMS 1 burn causes a decrease in the OMS 1 ΔV because the OMS 1 burn for an apogee preserving AOA deorbit is more optimal when performed closer to nominal MECO apogee (due to geometry and requirement for radial component on OMS 1, total delta V approximately the same). The Standard Insertion delayed ATO OMS 1 target is unique in that the orbit obtained by this burn is 105 by 80 nm and does not require an OMS 2 burn unless desired, since an 80 nm perigee is considered safe for at least three orbits.

For SI missions, those failures that cause the loss of half of the OMS capability may still make ATO feasible, depending on the remaining propellant available for insertion and deorbit. These failures include the loss of a single propellant or helium tank. High leak rates that cannot support an entire OMS 1 burn are considered totally failed. If a different propellant tank on each pod has failed, a mixed crossfeed procedure must be worked before a burn can be done.

The OMS can also be incapacitated by a loss of electrical power for motors that drive valves and thrust vector control (TVC) gimbals. The loss of main buses A and B takes out both ignition paths for the left OMS engine and crossfeed capability from that side. The loss of main buses A and C takes out both ignition paths for the right OMS engine. The loss of main buses B and C takes out the right OMS ignition and crossfeed capability. These three main bus failure combinations each leave half the OMS capability and only one operable OMS engine and can be treated like the other OMS failures as far as targeting is concerned.

For loss of both OMS engines because of engine failures or loss of OMS N₂, the OMS propellant is interconnected to the RCS jets. For a failed OMS N₂ tank, the associated engine is not used until the deorbit burn in order to conserve the final engine restart. If N₂ REG PRESS > 328 psia, two restarts are possible. Even though all the propellant is available, for failures requiring RCS jets to be used, the cheaper target is burned since the RCS is not as efficient as the OMS.

Failure to separate from the ET requires additional time to work the required procedures.

4.3.4.1.2 Delayed Nominal OMS 1/Nominal OMS 2

4.3.4.1.2.1 Cue

ET Separation Inhibit not due to rate exceedances

4.3.4.1.2.2 Displays

PASS MNVR EXEC

BFS MNVR EXEC

4.3.4.1.2.3 Crew Action

Delay nominal OMS 1

Burn nominal OMS 2 on time

4.3.4.1.2.4 Discussion

For a failure of the ET feedline disconnect valve, a delayed nominal OMS burn is desired to allow enough time for pressure to be bled for the 17 inch disconnect line prior to ET sep. Attempting to ET sep with a large pressure buildup may induce undesirable vehicle rates. Delaying the nominal OMS 1 burn causes a slight increase in delta V required.

4.3.4.1.3 Delayed AOA Shallow OMS 1/AOA Steep or Shallow OMS 2

4.3.4.1.3.1 Cue

Loss of 1 OMS Oxidizer tank and 1 OMS fuel in different pods

Loss of 2 OMS Oxidizer tanks

Loss of 2 OMS Fuel tanks

Loss of 2 OMS Helium tanks

4.3.4.1.3.2 Displays

PASS MNVR EXEC

BFS MNVR EXEC

4.3.4.1.3.3 Crew Action

Delay AOA Shallow OMS 1

Burn AOA or AOA Shallow OMS 2

4.3.4.1.3.4 Discussion

For SI missions, the delayed AOA-S/AOS-S target set provides the most optimum ΔV scenario for no underspeed at MECO and is used when not enough ΔV is available to support any other option (shallow AOAs are sensitive to NAV errors and entry capture/heating and are therefore undesirable).

In the case of a helium leak with a successful mixed crossfeed, enough helium may be lost to degrade the total OMS capability below 50%. In this case a delayed AOS-S/AOS-S is the only option.

If the total OMS capability is gone, then the RCS thrusters must provide the necessary control. The loss of different propellants from different pods is essentially equivalent to the loss of both pods due to the lack of time to handle the reconfiguration of the OMS for mixed crossfeed procedure before OMS 1 on a SI mission. For some of these cases the use of aft and forward RCS for the minimum ΔV target to get the orbiter to the ground is the best that can be done.

4.3.4.1.4 Nominal OMS 1/AOA OMS 2

4.3.4.1.4.1 Cue

Loss of 2 freon loops
Loss of 2 water loops
Cabin Leak
2 APUs failed and the third one failing
Loss of all O₂ and H₂

4.3.4.1.4.2 Displays

PASS MNVR EXEC
BFS MNVR EXEC

4.3.4.1.4.3 Crew Action

Perform nominal OMS 1
Perform AOA OMS 2 deorbit

4.3.4.1.4.4 Discussion

Some critical failures could affect both the primary and redundant systems prompting the crew's return to Earth as quickly as possible (AOA). These system failures include the loss of two Freon coolant loops or two H₂O loops. Additionally, a cabin leak rate that exceeds a dP/dT of -0.08 psi/min is considered a critical loss of cabin integrity. A dP/dT of -0.08 provides sufficient nitrogen (N₂) margin to reach the primary landing site on orbit 3 (rev 3). If a leak rate greater than -0.08 occurs, an AOA must be performed. Other scenarios requiring an AOA are the loss of all O₂ or H₂ cryo and the loss of two APUs with the third failing. If none of these failures impact OMS capability to deorbit, an AOA is declared. A Standard Insertion mission would employ a nominal OMS 1 burn followed by an AOA steep OMS 2 burn. The nominal OMS 1 burn allows the crew to retain the option to go to orbit as long as possible.

4.3.4.2 Standard Insertion OMS 2 Targeting Card for Systems Failures

* For Historical Purposes Only *

The OMS 2 TARGETING card (figure 4.3.4.2-1) covers failures that occurred during or after the OMS 1 burn that would impact the OMS 2 target selection.

**OMS 2 TARGETING
(STD INSERTION)**

FAILURE	OMS 2 TARGET
OMS - 1 PRPLT TK - 2 N2 TKS (connect to RCS) - 2 OMS ENG - 1 He TK EPS - MNA & B MNB & C MNA & C	PEG 7; TTA=1 CUTOFF HP=85
OMS - 2 OX or 2 FU TKs or 2 He TK - 1 OX & 1 FU TKs diff PODS	AOA/AOA-S
2 FREON LOOPS 2 H2O LOOPS CABIN LEAK (EQ dP/dT ≥ .08)	AOA
APU/HYD - 2↓ & 1 failing	AOA
CRYO - ALL O ₂ (H ₂)	AOA

He	%	He	%
N/A	90	3030	40
N/A	80	2715	30
4004	72	2405	20
3670	60	2100	10
3350	50		

Figure 4.3.4.2-1: STS-30 OMS 2 Targeting Card (Standard Insertion)

4.3.4.2.1 OMS 2 to Minimum HP

4.3.4.2.1.1 Cue

Loss of 1 OMS Propellant tank
 Loss of 2 OMS N2 tanks
 Loss of 2 OMS Engines
 Loss of 1 Helium tank
 Loss of 2 main buses

4.3.4.2.1.2 Displays

PASS MNVR EXEC
 BFS MNVR EXEC

4.3.4.2.1.3 Crew Action

Perform PEG 7 OMS 2 burn 1 minute prior to apogee to raise perigee to minimum value

4.3.4.2.1.4 Discussion

Some OMS propellant failures retain partial delta V capability and allow insertion to the minimum perigee altitude instead of the less desirable AOA. For example, the loss of one propellant tank or one helium tank is cause to lower the post OMS 2 perigee to the minimum value (usually 85 or 90 nm). A greater loss of OMS capability occurs if both OMS engines fail or both N2 tanks fail, leaving the propellant available but only through the RCS jets. For these situations, the delta V requirement for OMS 2 must be minimized to provide no more delta V than needed to raise perigee to the lowest acceptable altitude (usually 85 or 90 nm). The minimum perigee (HP) was chosen to only protect for day 1 deorbit_[AFPH4.3-25].

The loss of electrical buses shuts down OMS related valve motors and TVC gimbals. One of the OMS engines is lost if either main buses A and B or A and C or B and C fail. Assuming a nominal OMS 1 burn, the OMS 2 maneuver should be targeted to raise perigee to the minimum altitude via PEG 7 guidance to allow time to reconfigure the electrical load or recover the lost buses. This option permits raising the orbit if the problem is resolved but also permits a minimum delta V deorbit if necessary. Note that if comm is available, the MCC will provide a PEG 4 target.

4.3.4.2.2 AOA/AOA-S

4.3.4.2.2.1 Cue

Loss of 2 OMS Oxidizer tanks

Loss of 2 OMS Fuel tanks

Loss of 2 Helium tanks

Loss of 1 OMS Oxidizer tank and 1 OMS Fuel tank in different pods

4.3.4.2.2.2 Displays

PASS MNVR EXEC

BFS MNVR EXEC

4.3.4.2.2.3 Crew Action

Perform AOA steep or AOA shallow deorbit burn

4.3.4.2.2.4 Discussion

The loss of all OMS oxidizer or fuel, the loss of all OMS Helium, or the loss of oxidizer and fuel in different pods, eliminates future OMS propellant usage and requires that the RCS provide the deorbit capability for an AOA. For these failures the AOA steep is performed if sufficient RCS capability exists. Otherwise, the AOA shallow must be used.

4.3.4.2.3 AOA

4.3.4.2.3.1 Cue

Loss of 2 freon loops

Loss of 2 water loops

Cabin Leak

2 APUs failed and the third failing

Loss of all Cryo

4.3.4.2.3.2 Displays

PASS MNVR EXEC

BFS MNVR EXEC

4.3.4.2.3.3 Crew Action

Perform AOA steep deorbit burn

4.3.4.2.3.4 Discussion

As discussed earlier, certain system failures that eliminate the primary and backup system require immediate attention and the soonest possible return to Earth. If this return is combined with a nominal OMS 1 burn, then an AOA steep is performed. The failures that require this action are the loss of both Freon loops, loss of both water coolant loops, a cabin leak rate in excess of dP/dT -0.08 psi/min, 2 APU/hydraulic systems down and the third failing, and loss of all O₂ or H₂ cryo.

4.3.4.2.4 OMS Helium Pressure versus Quantity Table

4.3.4.2.4.1 Cue

N/A

4.3.4.2.4.2 Displays

BFS SYS SUMM

4.3.4.2.4.3 Crew Action

Use Pressure versus Quantity table as a backup to the OMS Quantity gauges

4.3.4.2.4.4 Discussion

The OMS He pressure versus OMS quantity table is used by the crew as a backup to the OMS gauges in the event of gauge or pressure transducer failures for either or both of the OMS propellant tanks. The OMS He pressure quantities can be obtained from the BFS SYS SUMM display and may be consulted prior to the OMS 1/OMS 2 burn as a gauge check.

4.3.4.3 Direct Insertion OMS 2 Targeting Card for Systems Failures

The Direct Insertion OMS 2 targeting card is used to determine the OMS 2 targets for certain systems failures as shown in figure 4.3.4.3-1. This card assumes no underspeed at MECO (i.e. no OMS 1 required) and no other major failure. Note that targets required due to an underspeed take precedence over systems failures.

OMS 2 TARGETING (DIR INSERTION)	
FAILURE	OMS 2 TARGET
OMS - 2 N2 TKs (Perform burn Single OMS Eng)	NOM
OMS - 2 OMS ENGs - 1 He TK - 1 PRPLT TK EPS - MNA & B, MNB & C MNA & C ET SEP	PEG 7; TTA = 1 CUTOFF HP = 85
OMS - 2 OX or 2 FU TKs - 1 OX & 1 FU TK diff PODs - 2 He TKs	AOA-S
2 FREON LOOPS [Accum Qty (↓ and decr) and/or Flow (↓)] 2 H2O LOOPS CABIN LEAK (-EQ dP/dT ≥ .08)	AOA
APU/HYD - impending loss of all capability	AOA
CRYO - All O2(H2)	AOA

OMS			
He	%	He	%
4800	96	2960	50
4560	90	2560	40
4160	80	2160	30
3760	70	1760	20
3360	60	1360	10
		960	0

FB 2-10	ASC/114/FIN
---------	-------------

Figure 4.3.4.3-1: STS-114 OMS 2 TARGETING Card (Direct Insertion)

4.3.4.3.1 Nominal OMS 2

4.3.4.3.1.1 Cue

2 N2 Tanks failed

4.3.4.3.1.2 Displays

PASS MNVR EXEC

BFS MNVR EXEC

4.3.4.3.1.3 Crew Action

Perform OMS 2 burn with single engine

4.3.4.3.1.4 Discussion

If both OMS N2 tanks are failed, the nominal OMS 2 target may be burned but it is performed with only one OMS engine. This preserves the start capability on the other OMS engine for the deorbit burn.

4.3.4.3.2 Cutoff at Minimum HP

4.3.4.3.2.1 Cue

Loss of 2 OMS engines
 Loss of 1 OMS Helium tank
 Loss of 1 OMS Propellant tank
 Loss of 2 main buses
 ET Separation failure

4.3.4.3.2.2 Displays

PASS MNVR EXEC
 BFS MNVR EXEC

4.3.4.3.2.3 Crew Action

Perform PEG 7 OMS 2 burn 1 minute prior to apogee to raise perigee to minimum value (MIN HP)

4.3.4.3.2.4 Discussion

Some OMS propellant failures retain partial delta V capability and allow insertion to the minimum perigee altitude instead of the less desirable AOA. For example, the loss of one propellant tank or one helium tank is cause to lower the post OMS 2 perigee to the minimum value (usually 85 or 90 nm). A greater loss of OMS capability occurs if both OMS engines fail, leaving the propellant available but only through the RCS jets. For these situations, the delta V requirement for OMS 2 must be minimized to provide no more delta V than needed to raise perigee to the lowest acceptable altitude (usually 85 or 90 nm). The minimum perigee (HP) was chosen to only protect for day 1 deorbit^[AFPH4.3-26].

The loss of electrical buses shuts down OMS related valve motors and TVC gimbals. One of the OMS engines is lost if either main buses A and B or A and C or B and C fail. Assuming a nominal MECO, the OMS 2 maneuver should be targeted to raise perigee to the minimum altitude via PEG 7 guidance to allow time to reconfigure the electrical load or recover the lost buses. This option permits raising the orbit if the problem is resolved but also permits a minimum delta V deorbit if necessary. Note that if comm is available, the MCC will provide a PEG 4 target. Failure to separate from the ET requires additional time to work the required procedures.

4.3.4.3.3 AOA-S

4.3.4.3.3.1 Cue

Loss of 2 OMS Oxidizer tanks

Loss of 2 OMS Fuel tanks

Loss of 2 Helium tanks

Loss of 1 OMS Oxidizer tank and 1 OMS Fuel tank in different pods

4.3.4.3.3.2 Displays

PASS MNVR EXEC

BFS MNVR EXEC

4.3.4.3.3.3 Crew Action

Perform AOA shallow deorbit burn

4.3.4.3.3.4 Discussion

The loss of all OMS oxidizer or fuel, the loss of all OMS Helium, or the loss of oxidizer and fuel in different pods, eliminates future OMS propellant usage and requires that the RCS provide the deorbit capability for an AOA return. For these failures the AOA shallow must be performed since there is inadequate RCS capability to complete the AOA steep deorbit burn.

4.3.4.3.4 AOA

4.3.4.3.4.1 Cue

Loss of 2 freon loops

Loss of 2 water loops

Cabin Leak

2 APUs failed and the third failing

Loss of all Cryo

4.3.4.3.4.2 Displays

PASS MNVR EXEC

BFS MNVR EXEC

4.3.4.3.4.3 Crew Action

Perform AOA steep deorbit burn

4.3.4.3.4.4 Discussion

As discussed earlier, certain system failures that eliminate the primary and backup system require immediate attention and the soonest possible return to Earth. If none of these failures impact OMS capability to deorbit, an AOA is declared. For a DI flight, an AOA OMS 2 deorbit burn would be performed. The failures that require this action are the loss of both Freon loops, loss of both water coolant loops, a cabin leak rate in excess of dP/dT -0.08 psi/min, 2 APU/hydraulic systems down and the third failing, and loss of all O_2 or H_2 cryo.

4.3.4.3.5 OMS Helium Pressure versus Quantity Table

4.3.4.3.5.1 Cue

N/A

4.3.4.3.5.2 Displays

BFS SYS SUMM 2

4.3.4.3.5.3 Crew Action

Use Pressure versus Quantity table as a backup to the OMS Quantity gauges

4.3.4.3.5.4 Discussion

The OMS He pressure versus OMS quantity table is used by the crew as a backup to the OMS gauges in the event of gauge or pressure transducer failures for either or both of the OMS propellant tanks. The OMS He pressure quantities can be obtained from the BFS SYS SUMM 2 display and may be consulted prior to the OMS 1/OMS 2 burn as a gauge check. For OMS assist missions, the first line of the OMS He pressure table is pre-OMS assist and the second line is post-OMS assist. [AFPH4.3-27]

4.3.4.4 OMS 1/2 Targeting Card for Performance

4.3.4.4.1 OMS 1/2 Targeting Card

The OMS 1/2 targeting chart provides the crew with information describing the appropriate OMS 1/OMS 2 target sets as a function of MECO underspeed. Examples for a Direct Insertion flight and a Standard Insertion flight are illustrated in figures 4.3.4.4.1-1 and -2. This chart assumes no system failures but does account for any dump performed pre-MECO.

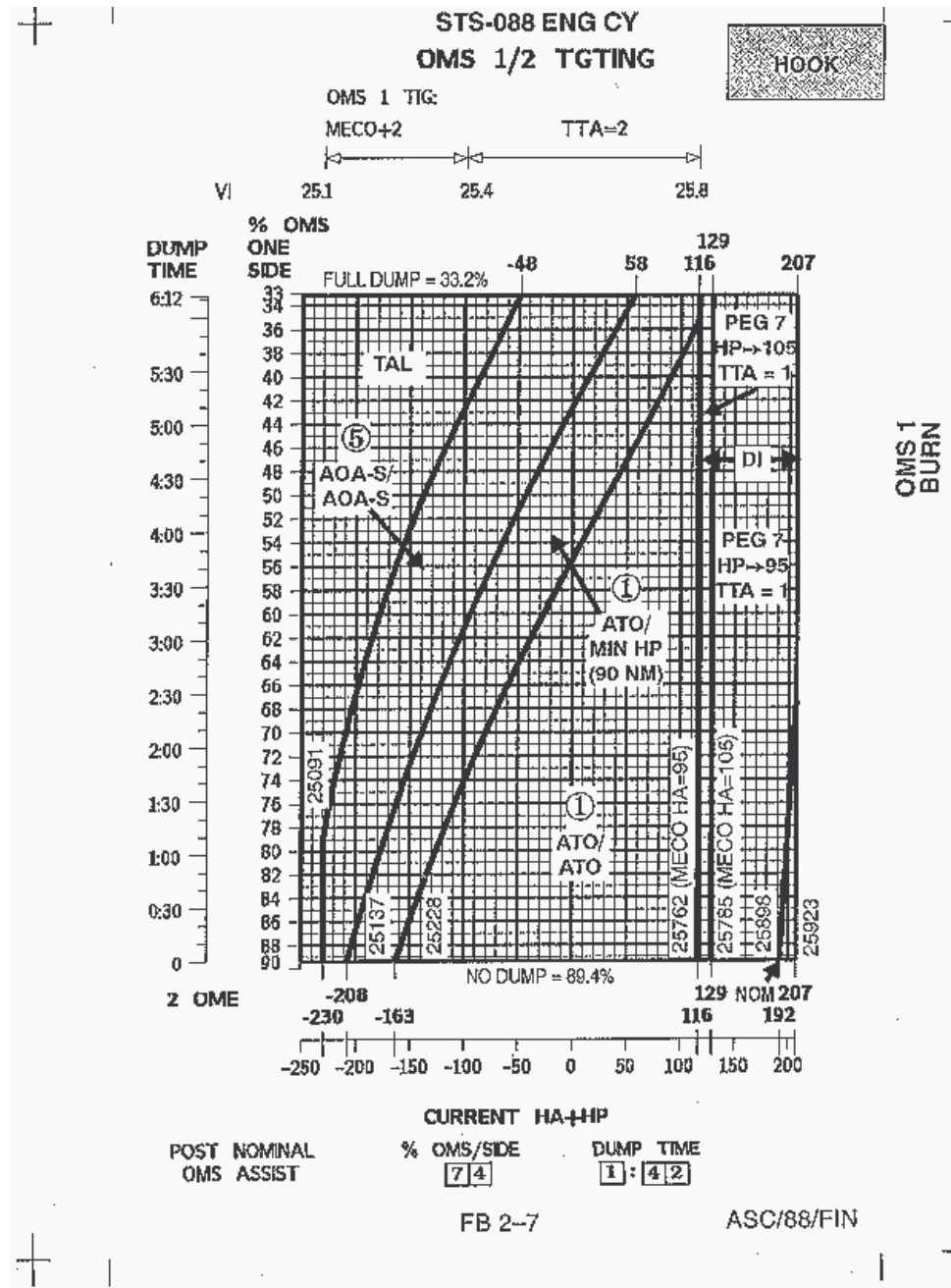

Figure 4.3.4.4.1-1: STS-88 OMS 1/2 TGTING Card (Direct Insertion) [AFPH4.3-28]

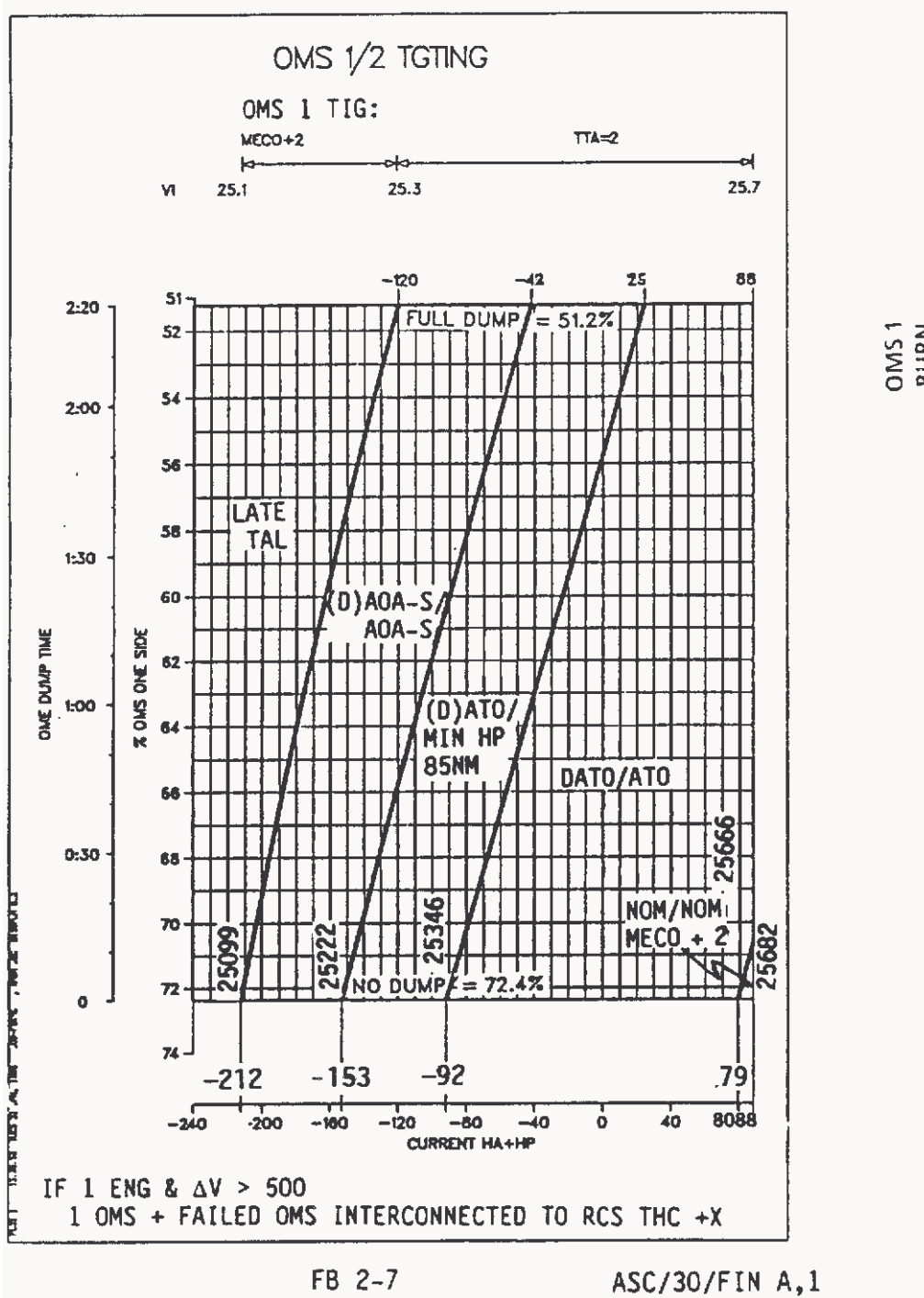

Figure 4.3.4.4.1-2: STS-30 OMS 1/2 TGTING Card (Standard Insertion)

* For Historical Purposes Only *

4.3.4.4.1.1 Cue

MM104

4.3.4.4.1.2 Displays

OMS 1 MNVR EXEC

OMS Quantity gauges or SPEC 51

4.3.4.4.1.3 Crew Action

Add CUR HA and HP

Determine %OMS One Side

Determine OMS 1 and OMS 2 targets based on HA + HP and %OMS One Side

4.3.4.4.1.4 Discussion

The correct target set may be obtained by the crew as a function of orbital energy (HA + HP) and the amount of OMS propellant remaining at the MM 104 transition. The current HA and HP is obtained from the OMS 1 MNVR EXEC display after the MM 104 transition. The OMS 1/2 Targeting card also carries MECO V_1 numbers for the no dump case as a backup for the HA + HP calculations.

The correct OMS quantity to use with the OMS 1/2 Targeting card can be obtained from the quantity gauges if available. Otherwise, the crew can time any pre-MECO dump and use the DUMP TIME scale on the OMS 1/2 Targeting card. Note that if an OMS assist completes, and then an ATO dump is initiated, both dumps must be timed. An alternate method is to use the Item 9 quantity and DTG parameters from SPEC 51. Several examples are described in the following paragraphs to illustrate the use of SPEC 51 and the OMS 1/2 Targeting card. Note that these examples are provided to illustrate the use of SPEC 51 and are not necessarily likely scenarios. Figure 4.3.4.4-1 and STS-88 Engineering Cycle dump data will be used in the examples:

OMS Assist Dump Quantity = 15%, Dump Time = 102 seconds

Full ATO Dump Quantity = 40%, Dump Time = 270 seconds

Example 1: Nominal OMS Assist Flight

	<u>SPEC 51</u>
OMS Assist Initiation:	9 QUAN/SIDE 15 OMS DMP TTG 102
Post nominal OMS Assist:	9 QUAN/SIDE 15 OMS DMP TTG 0

Use % OMS corresponding to the OMS assist quantity remaining (74 % value in the box for POST NOMINAL OMS ASSIST % OMS/SIDE).

Example 2: 20% Additional Dump desired following the OMS Assist

	<u>SPEC 51</u>
OMS Assist Initiation:	9 QUAN/SIDE 15 OMS DMP TTG 102
Post nominal OMS Assist:	9 QUAN/SIDE 15

20% more dump desired: OMS DMP TTG 0
 Enter Item 9 + 35
 9 QUAN/SIDE 35
 OMS DMP TTG 135 (dump time for 20% since
 15% already dumped)
 Extended OMS Assist 9 QUAN/SIDE 35
 Dump Completion: OMS DMP TTG 0
 Use % OMS corresponding to the post OMS assist quantity remaining (value in the box)
 minus 20% (74% - 20% = 54%). Or use the no dump % less 35% (89% - 35% = 54%).

Example 3: ATO Declared at 3:10 MET (1 minute into OMS Assist)

SPEC 51
 OMS Assist Initiation: 9 QUAN/SIDE 15
 OMS DMP TTG 102
 MET 3:09: 9 QUAN/SIDE 15
 OMS DMP TTG 42 (one minute of OMS assist has completed)
 MET 3:10: 9 QUAN/SIDE 55 (full ATO dump + OMS assist)
 (ATO Declared) OMS DMP TTG 312 (270s full ATO timer + 42s of OMS assist)
 Note: On the first cycle where the display updates the OMS DMP TTG, it will reflect
 the total dump. Then on subsequent cycles, it display the OMS DMP TTG correctly
 based on the OME equivalent on time.
 Full Dump Completion: 9 QUAN/SIDE 55
 OMS DMP TTG 0
 Use "Full Dump" % OMS (bottom of chart - 89.4%).

Example 4: OMS Assist Completes then ATO Ramp Dump of 20% (~135s)

OMS Assist Initiation: 9 QUAN/SIDE 15
 OMS DMP TTG 102
 Post OMS Assist: 9 QUAN/SIDE 15
 OMS DMP TTG 0
 At ATO: 9 QUAN/SIDE 35 (ramp ATO dump + OMS assist)
 OMS DMP TTG 135 (ramp + OMS assist timer - OMS on time)
 Ramp Dump Completion: 9 QUAN/SIDE 35
 OMS DMP TTG 0
 Use 54% line (no dump of 89% - 35% = 54%)

Example 5: OMS Assist Completes then 30% ramp ATO dump which does not complete

OMS Assist Initiation: 9 QUAN/SIDE 15
 OMS DMP TTG 102
 Post OMS Assist: 9 QUAN/SIDE 15
 OMS DMP TTG 0
 At ATO: 9 QUAN/SIDE 45 (full ATO dump + OMS assist)
 OMS DMP TTG 202 (ATO + OMS assist timer - OMS on time)
 MECO: 9 QUAN/SIDE 45
 OMS DMP TTG 30 (30 seconds of dump remaining)
 Go to % OMS corresponding to no dump minus 45%, then move down 30 seconds on
 DUMP TIME scale to get proper quantity. Specifically, go to % OMS of 44% (89% -
 45% = 44%), then move horizontally over to DUMP TIME scale which is about 5:00.
 Then move down 30 seconds to 4:30 since 30 seconds of the dump did not complete.
 Then move horizontally over to the % OMS scale. This results in a % OMS of about
 49%.

Once the correct % OMS is determined, the appropriate OMS 1/2 targets can be determined using the sum of HA and HP from the OMS 1 MNVR EXEC display after the MM 104 transition. For example, let us assume that we are flying STS-88 and that the HA by HP at MM 104 is 60 by -100 nm such that $HA + HP = -40$. If we assume that a full pre-MECO OMS dump was performed, then the chart (figure 4.3.4.4-1) shows that the crew should perform an AOA shallow OMS 1 burn (TGT 5) followed by an AOA shallow OMS 2 burn (TGT 5). In the case that no pre-MECO ATO OMS dump is performed (same HA + HP), the chart shows that the crew should perform an ATO OMS 1 burn (TGT 1) followed by an ATO OMS 2 burn (TGT 1) instead of the AOA shallow OMS 1 and OMS 2 option. This chart is used as a backup for the crew in case there is no comm with the ground. When using the chart and the systems failure card together, available performance takes priority over systems failures. [AFPH4.3-29]

4.3.4.4.2 Rendezvous Recovery Card [AFPH4.3-30]

The Rendezvous Recovery chart is included for ground-up rendezvous missions and provides a close-up view of the lower right hand corner of the OMS 1/2 Targeting card. It also includes boxes for the crew to write in the day of launch nominal OMS 2 HT and HP in case comm is lost before OMS 2. An STS-86 example is illustrated in figure 4.3.4.4.2-1.

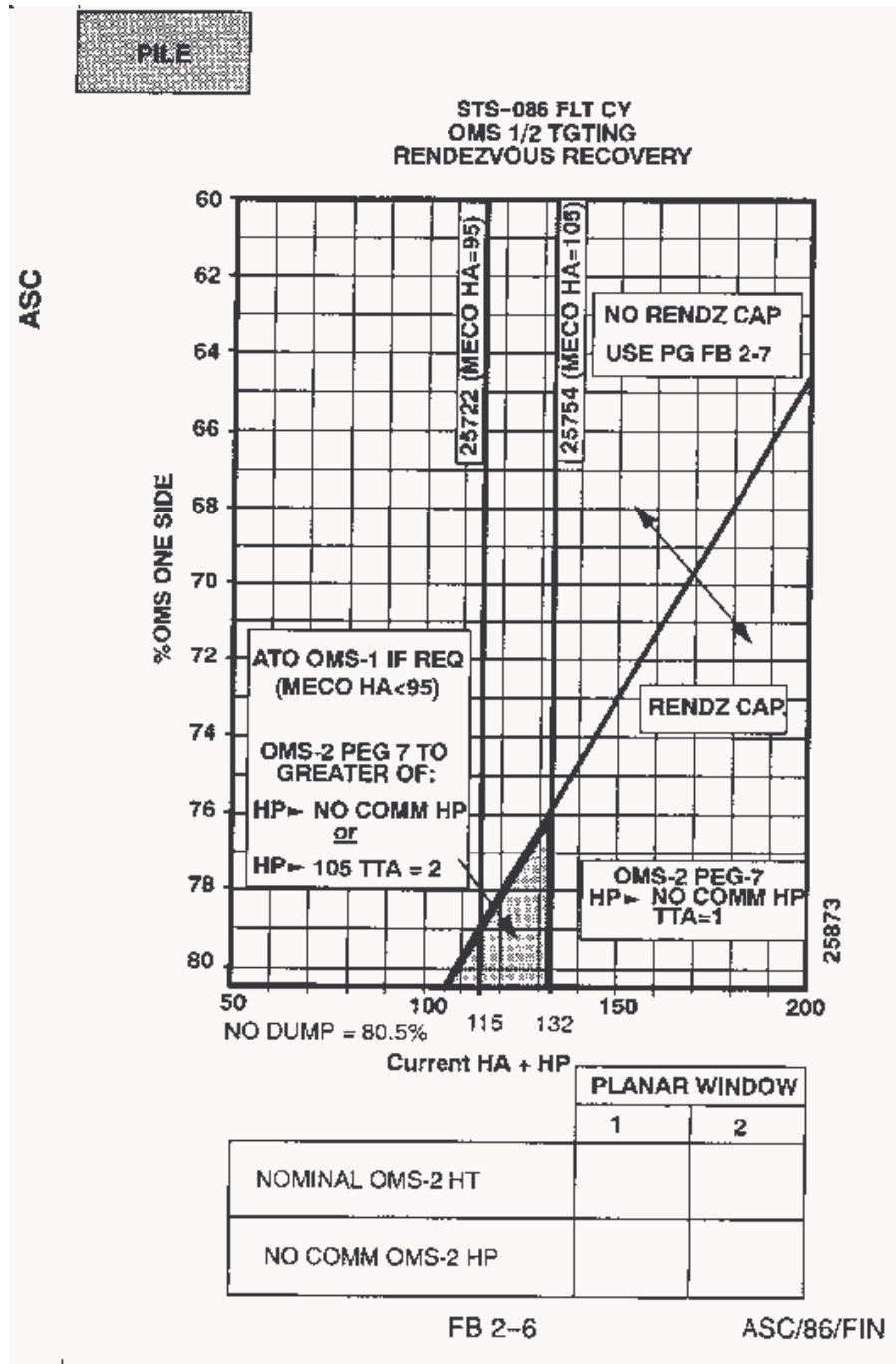

Figure 4.3.4.4.2-1: STS-86 Rendezvous Recovery Card

4.3.4.4.2.1 *Cue*

MM104

4.3.4.4.2.2 *Displays*

OMS 1 MNVR EXEC

OMS Quantity gauges or SPEC 51

4.3.4.4.2.3 *Crew Action*

Add CUR HA and HP

Determine %OMS One Side

Determine OMS 1 and OMS 2 targets based on HA + HP and %OMS One Side

4.3.4.4.2.4 *Discussion*

For ground-up rendezvous flights, the Rendezvous Recovery card is included in the Ascent Checklist and consists of a %OMS ONE SIDE versus Current HA + HP chart, similar to the OMS 1/2 Targeting card, and boxes for the nominal OMS 2 target altitude (HT) and no comm perigee altitude (HP). Both HT and HP are read to the crew prelaunch including both panes if applicable. The target HP is used along with the chart to target the OMS 2 burn in a no comm scenario so that the OMS 2 burn does not preclude rendezvous capability in case comm is later regained. Even though HT is only required when PEG 4 targets are being used (i.e. comm is available), this card was a convenient place for the crew to enter this data since the HT for the NOM targets on the OMS TGTS page may not accurately reflect the value that was uplinked which is driven by actual phasing requirements on day of launch. Note that the no comm HP and the (uplinked) HT may not be consistent because the no comm Hp is valid for the entire launch window and Ht is specifically for the launch window open and could be updated in the event of a delayed launch.

The diagonal line on the Rendezvous Recovery chart delineates between no rendezvous capability and possible rendezvous capability. If the OMS quantity for the current HA + HP is above the diagonal line, then there is no chance of performing the rendezvous since this line assumes no dispersion protection. In this case, the OMS 1/2 Targeting card is used instead to determine the OMS burn targets. If the OMS quantity for the current HA + HP is below the diagonal line, then there is a chance that there is sufficient propellant to perform the rendezvous so the OMS 2 rendezvous burn will be performed. If the OMS quantity is below but near this diagonal line, it still may not be possible to perform the rendezvous but at least the OMS 2 burn does not eliminate this chance.

[AFPH4.3-31]

4.3.4.5 OMS Required for OMS 2 and Deorbit

The OMS REQUIRED tables (figure 4.3.4.5-1) are used to determine the appropriate abort mode in the event of an OMS propellant shortage or to confirm that sufficient OMS propellant is available for completion of the abort mode indicated by the OMS 1/OMS 2 targeting cards. The percent of available OMS fuel required to complete various abort options is listed versus post-OMS 1 HP. It is important to note that this chart is built to accommodate only cases where ATO target 1 was used for OMS 1. If another target set was used, these quantities are not valid. Both the DUAL POD and SINGLE POD tables assume that only OMS propellant is used and include approximately 4½% per pod for gauging error and unusable propellant.

The chart provides information for four different deorbit scenarios: 1) ATO OMS 2 followed by a steep deorbit burn, 2) MIN HP OMS 2 followed by a shallow deorbit burn, 3) AOA steep OMS 2 deorbit burn, and 4) AOA shallow OMS 2 deorbit burn. For example, using figure 4.3.4.5-1, a post-ATO OMS 1 burn HP of 65 nm requires 26.2% remaining in one pod to complete the AOA steep deorbit burn with one pod. To complete this deorbit maneuver with two pods requires 30.5% remaining, or roughly 15.2% per pod.

NOTE

These tables apply only after ATO OMS 1 burn
(ITGT = ①, AOA to [KSC]). Assumes OMS and ARCS deorbit

DUAL POD - OMS REQUIRED				
Includes 9.1 % Unusable (4.6 % per pod)				
POST OMS 1 HP	ATO OMS 2 & STEEP D/O BURN (%)	MIN HP OMS 2 & SHALLOW D/O BURN (%)	AOA STEEP D/O BURN (%)	AOA SHALLOW D/O BURN (%)
95	42.8	26.9	46.4	29.8
90	44.2	24.6	44.1	26.7
85	45.8	23.1	41.7	23.8
80	47.7	22.7	39.2	21.0
75	49.8	24.4	36.1	18.1
70	51.5	26.4	33.1	15.7
65	52.7	27.8	30.7	13.9
60	53.6	29.1	30.1	11.8
55	53.9	30.2	31.0	9.8
50	54.6	31.4	30.8	9.1
45	---	32.8	33.4	9.1

STS-110 PATCH CY

SINGLE POD - OMS REQUIRED				
Includes 4.6 % Unusable				
POST OMS 1 HP	ATO OMS 2 & STEEP D/O BURN (%)	MIN HP OMS 2 & SHALLOW D/O BURN (%)	AOA STEEP D/O BURN (%)	AOA SHALLOW D/O BURN (%)
95	38.3	22.3	41.8	25.3
90	39.6	20.0	39.5	22.1
85	41.3	18.5	37.1	19.3
80	43.2	18.2	34.6	16.5
75	45.2	19.8	31.5	13.5
70	47.0	21.8	28.5	11.2
65	48.1	23.2	26.2	9.3
60	49.0	24.6	25.5	7.2
55	49.3	25.6	26.5	5.2
50	50.0	26.9	26.2	4.6
45	---	28.3	28.8	4.6

OMS BLOWDOWN

LEFT OMS GAGE QTY (%)

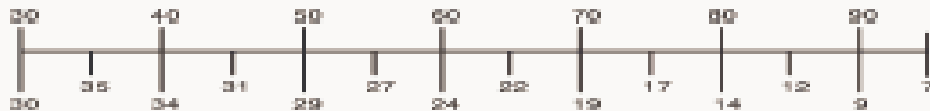

LEFT OMS BLDN EQUIV (%)

RIGHT OMS GAGE QTY (%)



RIGHT OMS BLDN EQUIV (%)

Figure 4.3.4.5-1: Post-ATO OMS 1 OMS Required_[AFPH4.3-32]

4.3.4.6 OMS Targets

4.3.4.6.1 Standard Insertion

* For Historical Purposes Only *

The high efficiency of the Direct Insertion method (single OMS burn to orbit) is the reason it is used on all current shuttle missions. The following section on Standard Insertion is included for historical completeness with STS 61-C data as an illustrative example.

For STS 61-C, the nominal MECO velocity was 25670 fps, and the altitude was 57 nm. The post-MECO orbit was 83 by -2 nm (HA x HP). The OMS 1 and OMS 2 target options discussed in this section are representative of the current targeting options available on Standard Insertion flights. Target data contained in this section, unless otherwise specified, pertains to STS 61-C cycle 1 and is typical of Standard Insertion flights. The target data described below is summarized in table 4.3.4.6.1-I and figures 4.3.4.6.1-1 and -2. Note that the target altitudes are based on spherical Earth models and are slightly higher than actual values.

Table 4.3.4.6.1-I: STS 61-C OMS Burn Targets

ITGT (OMS 1)		ITGT (OMS 2)		AME ICASE	AME IFG	OMS 1				OMS 2						
ONBD	MCC	ONBD	MCC			TGTS	TIG	HT	THETA	TGTS	TIG TIGADJ	MECO+ ETSEP+	C1	C2	HT	THETA
I-load	16	I-load	16	1 7	0	Nom I-load	MECO+2	181	172.2	Nom I-load	46:07	37:44 37:26	0	0.0000	181.1	340.0
I-load	16	12	12	1 9	0	Nom I-load	MECO+2	181	172.2	AOA-ST	49:48 -00:48	40:38 40:20	14823	-.5963	65.8	96.1
I-load	16	11	11	1 10	0	Nom I-load	MECO+2	181	172.2	AOA-SH	29:03 -00:48	19:53 19:35	15178	-.6034	65.8	178.8
KEY-IN	17	KEY-IN	17	1 7	-1	Del-Nom KEY-IN	MECO +12	184	240.0	Del-Nom KEY-IN	1:03:34	55:11 54:53	0	0.0000	184.0	412.0
*KEY-IN	17	10	10	1 9	-1	Del-Nom KEY-IN	MECO +12	184	240.0	AOA-ST	37:06 -00:48	27:56 27:38	15378	-.6174	65.8	148.1
*KEY-IN	17	8	8	1 10	-1	Del-Nom KEY-IN	MECO +12	184	240.0	AOA-SH	33:46 -00:48	24:36 24:18	14719	-.5853	65.8	157.3
1	1	1	1	2 8	1	ATO	MECO+2	112	235.0	ATO	1:03:10	53:18 53:00	0	0.0000	113.0	415.0
1	1	6	6	2 9	1	ATO	MECO+2	112	235.0	AOA-ST	51:51 -00:01	41:59 41:41	16625	-.6658	65.8	85.0
1	1	7	7	2 10	1	ATO	MECO+2	112	235.0	AOA-SH	41:43 -00:01	31:51 31:33	16983	-.6726	65.8	120.4
5	5	5	5	4 10	3	AOA-SH	MECO+2	95	225.0	AOA-SH	49:12 -00:03	39:20 39:02	19072	-.7529	65.8	83.3
1	13	1	13	2 8	-1	Del-ATO KEY-IN	MECO +12	112	235.0	ATO	1:01:43	53:18 53:00	0	0.0000	113.0	415.0
*1	13	6	14	2 9	-1	Del-ATO KEY-IN	MECO +12	112	235.0	AOA-ST	51:11 -00:47	41:59 41:41	16625	-.6658	65.8	86.1
*1	13	7	15	2 10	-1	Del-ATO KEY-IN	MECO +12	112	235.0	AOA-SH	41:03 -00:47	31:51 31:33	16983	-.6726	65.8	121.4
*4	4	4	4	4 10	-1	Delayed AOA-SH	MECO +12	100	175.0	AOA-SH	51:28 -00:47	42:16 41:58	18691	-.7382	65.8	72.7

*Requires OMS 2 TIG to be increased in the MCC AME by approximately 10 minutes, over value shown due to differences in TIGADJ logic. All TIGs referenced from MECO and ET sep are shown before DTIG Adjust is applied.

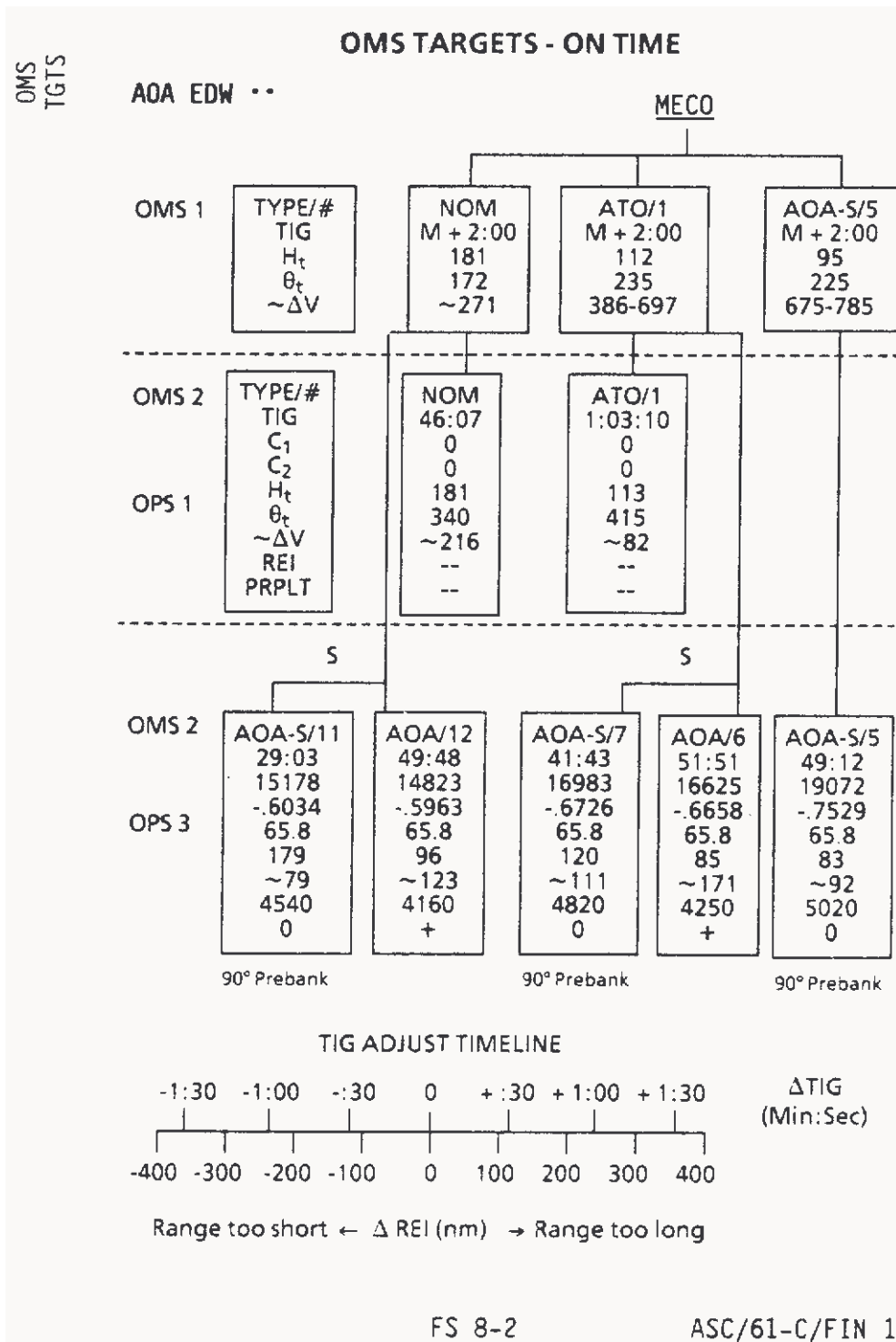

Figure 4.3.4.6.1-1: STS61-C OMS Targets - On Time

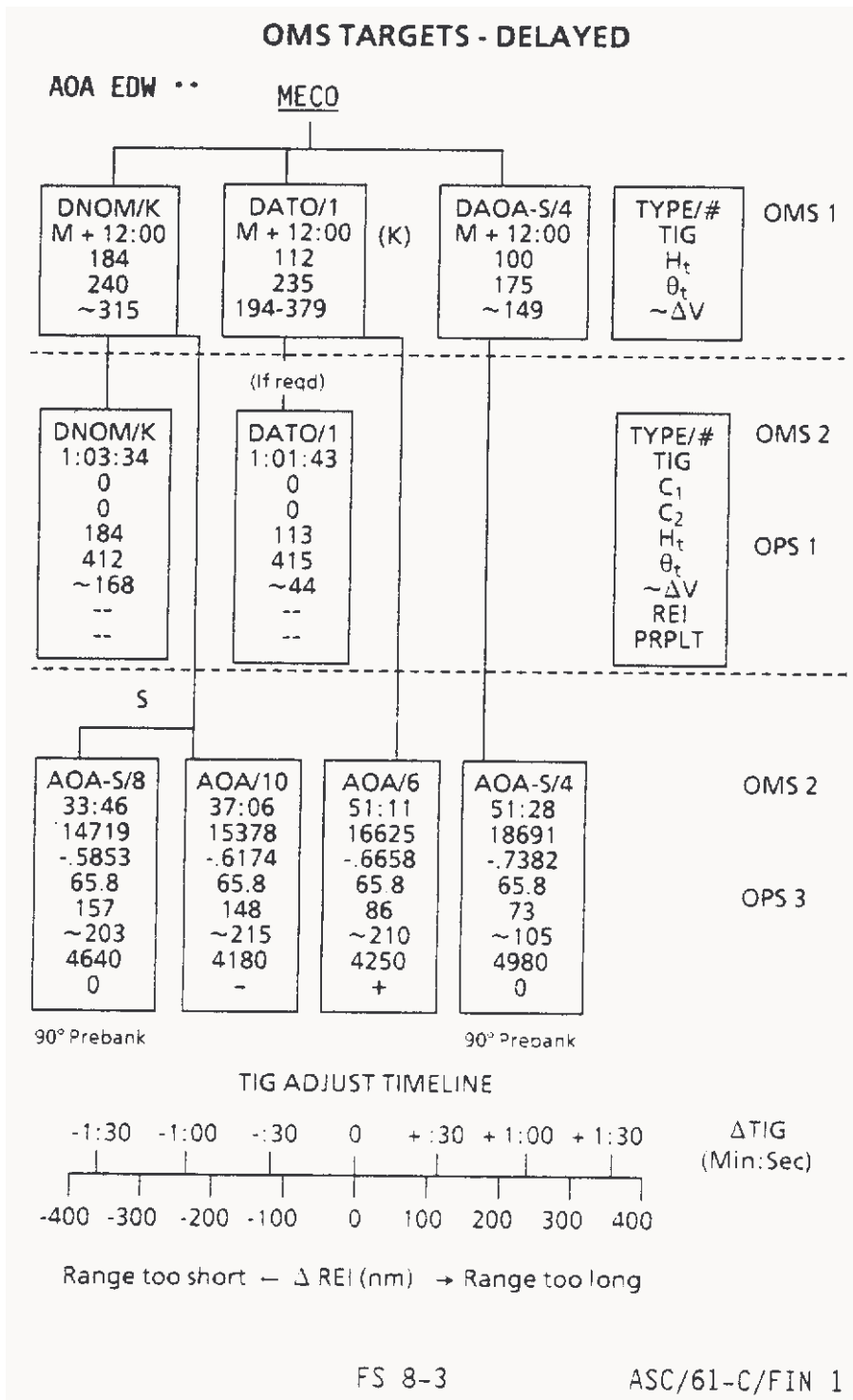

Figure 4.3.4.6.1-2: STS61-C OMS Targets - Delayed

Most targets are available in the software and can be selected by the ABORT MODE rotary switch (ATO only) or by TGT selection (ITEM 35 + # EXEC) on XXXXX MNVR YYYYYY.

4.3.4.6.1.1 Option 1: Nominal OMS 1/Nominal OMS 2

The SI nominal target set, TGT = 0, is I-loaded and appears automatically in MM 104. Note that if an ATO has been selected pre-MECO, ATO targets (TGT = 1) appear. In this case the crew must manually key in nominal targets if they are desired. For STS 61-C the nominal OMS 1 burn occurs at a TIG of MECO + 2 minutes with a total delta V of 240 fps. The post OMS 1 orbit is 160 by 50 nm. For SI flights, the post OMS 1 apogee is positioned to preserve a minimum delta V capability for AOA steep deorbit on OMS 2, if necessary. The nominal SI OMS 2 target set, TGT = 0, is also I-loaded and appears automatically in MM105, assuming no abort was selected. The nominal OMS 2 burn is done near apogee at 00:46:02 (hour:min:sec) MET with a delta V of 196 fps. This burn circularizes the orbit at 160 nm. This target can be used for underspeeds up to 114 fps below the nominal MECO velocity. The OMS budget is built to provide this underspeed capability while protecting for nominal mission completion.

Options 2 and 3, discussed below, use the same OMS 1 target as option 1. The same no comm OMS 1 targeting rationale would apply in those cases as well. Options 2 and 3 provide for systems failures and/or performance degradations requiring AOA that occur post-OMS 1.

4.3.4.6.1.2 Option 2: Nominal OMS 1/Steep AOA

This target set provides for insertion into a 160 by 50 nm orbit with a nominal MECO state and a nominal OMS 1 burn as in option 1. It also provides an AOA steep deorbit OMS 2 burn of 407 fps. This burn is made at a TIG of 00:49:50 MET. MECO underspeeds of up to 114 fps are acceptable. These targets are used when critical, non-OMS failures occur before OMS 2.

The OMS 2 AOA target can be selected in MM 105 via item entry (ITEM 35 + 12 EXEC) on the MNVR EXEC display. The required deorbit I-load target data (TIG, C1, C2, Θ T, HT) appears and is transferred to the DEORB MNVR COAST display after moding the software from MM 105 to MM 301. If necessary, the crew may key in the desired AOA deorbit targets after proceeding from MM 105 to OPS 3 on the MNVR EXEC display. For AOA OMS 2, the crew should not do a load (ITEM 22 EXEC) until OPS 3 since Θ T is measured differently between OPS 1 and OPS 3. In OPS 1, Θ T is the downrange angle from the launch site to the radius target vector in degrees. In OPS 3, Θ T is the angle from OMS 2 TIG to EI.

4.3.4.6.1.3 Option 3: Nominal OMS 1/Shallow AOA

This target set provides for insertion into a 160 by 50 nm orbit with a nominal MECO state and a nominal OMS 1 burn as in options 1 and 2. However, this target set utilizes a shallow AOA deorbit OMS 2 target. The OMS 2 delta V is 53 fps and TIG is nominally set at 00:29:05 MET. This target set would only be used in the event of a severe delta V capability loss after the OMS 1 burn. This deorbit target (ITEM 35 + 11 EXEC) is the

minimum delta V target available after a nominal OMS 1 and can be selected via the MNVR EXEC. A steep deorbit target is preferred over a shallow one, if performance allows, since shallow targeting assumes 90° prebank from EI - 5 minutes through first roll command.

4.3.4.6.1.4 Option 4: Delayed nominal OMS 1/Nominal OMS 2

This set of targets is similar to option 1 except that the OMS 1 burn is delayed for 12 minutes after MECO and is used for the feedline disconnect failure case. In this scenario, the orbiter remains attached to the ET until the ET has vented enough hydrogen and oxygen to avoid the danger of a vent pressure induced recontact at ET sep. This target is designed for a nominal MECO energy state and does not provide for situations involving underspeeds or other failures requiring downmode to ATO. Both OMS targets are key-in (manually entered) targets. The OMS 2 TIG should be selected as TTA - 1 minutes to center the burn about apogee.

For STS 61-C, the OMS 1 delta V is 288 fps, which places the orbiter in a 161 by 81 nm orbit post OMS 1 with apogee 240° from the launch site. The OMS 2 burn of 142 fps would circularize the orbit at 160 nm. This burn is initiated at 01:02:22 MET.

4.3.4.6.1.5 Option 5: Delayed nominal OMS 1/Steep AOA

This target set utilizes the same OMS 1 target as option 4 but a steep AOA deorbit target is used for OMS 2. The same no comm OMS 1 targeting rationale apply in this case as well. The OMS 2 burn of 351.2 fps is initiated at 00:37:08 MET, 148° from EI. This option is used if a failure and/or performance degradation requiring AOA occurs after the delayed nominal OMS 1 burn is started. The OMS 2 targets are entered by performing an ITEM 35 + 10 EXEC on the MNVR display.

4.3.4.6.1.6 Option 6: Delayed nominal OMS 1/Shallow AOA

This target is similar to option 4 except that a shallow AOA entry is made. The OMS 2 burn of 177 fps is made at 00:33:48 MET and 157° ahead of EI. Like option 3, this option is only used when severe loss in delta V capability occurs after OMS 1 burn ignition. On flights with similar OMS 2 delta V requirements for options 5 and 6, this OMS 2 target (TGT 8) is not used. If the velocity requirement for steep is similar to shallow, it is hard to justify a shallow deorbit with the reduced level of confidence inherent to the shallow option.

4.3.4.6.1.7 Option 7: ATO OMS 1/ATO OMS 2

This set of targets is used for MECO underspeed conditions that fall within the specified ATO underspeed range requiring a downmode from the nominal OMS 1 burn. On STS 61-C (cycle 1), the maximum ATO underspeed was 466 fps. For an underspeed of 404 fps, an OMS 1 burn of 571 fps is made 2 minutes after MECO and is targeted to raise the orbit to 105 by 60 nm and place apogee at 235° from the launch site to preserve the AOA capability. The OMS 2 burn of 82 fps raises the orbit to 105 by 105 nm. This burn is initiated near apogee at 01:03:10 MET.

These targets are loaded automatically when the ATO mode is selected on the ABORT rotary switch. They may also be selected using an ITEM 35 + 1 EXEC on the MNVR display and loaded using ITEM 22 EXEC. The OMS 2 targets are displayed on the MNVR display after the crew modes into OPS 105. OMS 2 TIG occurs in the vicinity of apogee to maximize burn efficiency.

4.3.4.6.1.8 Option 8: ATO OMS 1/Steep AOA

This target set utilizes the ATO common target (as does option 7) but includes a steep AOA deorbit OMS 2 maneuver. This options provides for systems failures and/or performance degradations requiring AOA that occur post OMS 1. Additionally, burning the ATO common target allows the crew to hold off committing to an AOA until after the first burn. The OMS 2 burn of 171 fps begins at 00:51:51 MET, 85° from EI. The lower propellant requirement increases underspeed capability to allow the MECO underspeed coverage to be increased to 523 fps. The OMS 2 targets are entered by performing an ITEM 35 + 6 EXEC.

4.3.4.6.1.9 Option 9: ATO OMS 1/Shallow AOA

This target set utilizes the ATO common target (like options 7 and 8) but requires a shallow AOA deorbit target for OMS 2. The OMS 2 burn of 110 fps is made at 00:41:42 MET, 120° from EI. This target gives the same underspeed coverage as option 8 but utilizes less propellant and is intended for use in performance critical cases such as propellant failures occurring post-OMS 1 ignition. The OMS 2 targets are selected via keyboard entry of ITEM 35 + 7 EXEC.

4.3.4.6.1.10 Option 10: AOA Shallow OMS 1/Shallow AOA

This set of targets is used only for severe MECO underspeed where the ATO OMS 1 burn cannot be used because of the high delta V requirement from either the nominal or the abort MECO. The OMS 2 target set protects for a maximum change in HA + HP between OMS burns of 5 nm. In this way, a drag limit is imposed on the postburn target.

For STS 61-C, the AOA-S OMS 1 target was designed to raise the orbit to 84 by 54 nm. The target orbit for the AOA-S/S is flight dependent but does not violate the basic groundrules described above. On STS 61-C, this target provides coverage to an underspeed of 600 fps. For an underspeed of 559 fps, the required delta V is 741.9 fps. The OMS 2 burn of 92 fps is initiated at 00:49:12 MET, 83.3° from EI.

The crew selects the AOA shallow abort mode by keying in the AOA shallow OMS 1 target via ITEM 35 + 5 EXEC. The deorbit targets automatically appear on the MNVR display after entering MM 105 and are carried across the OPS transition.

4.3.4.6.1.11 Option 11: Delayed ATO OMS 1/ATO OMS 2

This set of targets is used for failures occurring prior to OMS 1 resulting in a significant decrease in available onboard delta V (e.g., one OMS pod out). Delaying the burn to MECO + 12 minutes allows additional time to evaluate the failures. For STS 61-C, delayed ATO OMS 1 burn coverage existed for MECO underspeeds up to 140 fps. If no

underspeed condition exists at MECO, the OMS 1 delta V is approximately 192 fps. This puts the orbiter in a 104 by 81 nm orbit with apogee at 235° from the launch site. This orbit can be maintained for three orbits if needed before deorbiting. If sufficient propellant is available, an OMS 2 burn of 44 fps can circularize the orbit at 103 nm and thus extend the flight time to about 24 hr. The ATO OMS 2 burn would be made near apogee at 01:01:43 MET.

The OMS 1 target may be entered manually, selected using ITEM 35 + 1 EXEC on the MNVR EXEC display, or selected automatically via ATO selection with the ABORT MODE rotary switch. If either of the latter two methods are employed, the TIG has to be changed. If the rotary switch is used, both OMS 1 and OMS 2 targets are automatically selected. The TIG for OMS 2 should be 30 seconds prior to apogee.

4.3.4.6.1.12 Option 12: Delayed ATO OMS 1/Steep AOA

This target set utilizes the same OMS 1 target as option 11 but a steep AOA deorbit is used for OMS 2. The OMS 2 target is similar to option 8 and is used when a failure requiring AOA occurs after the delayed OMS 1 burn. The OMS 2 burn of 210 fps is started at 00:51:11 MET, 86.1° from EI. The crew performs an ITEM 35 + 6 EXEC on the MNVR EXEC display once in MM105 to select the deorbit targets.

4.3.4.6.1.13 Option 13: Delayed ATO OMS 1/Shallow AOA

This target set is similar to option 12 except that a shallow AOA deorbit is used for OMS 2. The same rationale for target selection applies except that this target set is used if a severe delta V shortage occurs post-OMS 1. The OMS 2 burn of 139 fps is initiated at 00:41:03 MET and utilizes targets similar to option 9, which the crew enters by performing an ITEM 35 + 7 EXEC on the MNVR EXEC display. This target set can be used if an OMS loss occurs after the OMS 1 burn has started.

4.3.4.6.1.14 Option 14: Delayed AOA shallow OMS 1/Shallow AOA

This target set is used when nominal MECO conditions have been achieved but the onboard delta V capability has been severely degraded (i.e., the loss of two He tanks) prior to MECO. OMS 1 TIG occurs closer to apogee of the MECO orbit due to the TIG delay (MECO + 12 minutes), thus reducing the delta V requirement. For mission STS 61-C, an OMS 1 burn of 148.7 fps is required and places the orbiter in a 94 by 68 nm orbit with the apogee 175° from the launch site. An AOA shallow deorbit burn is performed to minimize the OMS 2 velocity requirement. This burn of 105 fps is started at 51:23 MET targeting for EI 73° away. These targets are selected by performing an ITEM 35 + 4 EXEC or keying in the targets on the MNVR display.

4.3.4.6.2 Direct Insertion

The Direct Insertion method is currently used on all shuttle missions. The following section includes STS-75 data as an illustrative example.

On STS-75, nominal MECO occurred at a velocity of 25,873 fps and an altitude of 57 nm. The post-MECO orbit was 156 by 35 nm. (HA x HP). The OMS 1 and OMS 2 target options discussed in this section represent the current targeting options available on Direct Insertion flights. Target data contained in this section, unless otherwise specified, pertain to STS-75 flight cycle and are typical of Direct Insertion flights. The target data described in the following paragraphs are summarized in table 4.3.4.6.2-I and figures 4.3.4.6.2-1 and -2. Note that the target altitudes are based on spherical Earth models and are slightly higher than actual values.

Table 4.3.4.6.2-I: Direct Insertion Target Options

STS-75 Flight Cycle				AOA TO EDWARDS (PRIMARY)			OMS TARGET SUMMARY TABLE										
ITGT (OMS 1)		ITGT (OMS 2)		AME	AME	MECO APOGEE DESIGN RANGE	OMS 1				OMS 2						
ONBD	MCC	ONBD	MCC	ICASE	IFG		TGTS	TIG	HT	THETA	TGTS PRPLT	TIG TIGADJ	MECO+ ETSEP+	C1	C2	HT	THETA
	16	I-load	16	1 7	0 0	157 157-145					Nom 0	39:56 00:00	31:17 31:05	0	0.0000	167.0	326.0
	18	KEY-IN	18	1 7	-1 -1	157					HP 105 0	39:56 00:00	31:17 31:05	0	0.0000	112.3	326.0
	20	KEY-IN	20	1 7	-1 -1	157					HP 85 0	39:56 00:00	31:17 31:05	0	0.0000	93.0	326.0
	10	10	10	3 9	-1 -1	200-150					AOA-ST +	43:17 -00:46	33:32 33:20	14843	-.5968	65.8	125.4
	11	11	11	4 10	-1 -1	200-150					AOA-SH 0	23:04 -00:46	13:19 13:07	15580	-.6201	65.8	205.0
	-	8	8	9	-1	150-95					AOA-ST -	35:39 00:08	25:30 25:18	15620	-.6269	65.8	159.6
	-	9	9	10	-1	150-95					AOA-SH 0	23:28 00:08	13:19 13:07	14821	-.5905	65.8	204.7
4	4	4	4	3 9	-1 -1		OPT-AOA	MECO+4	146.0	170.0	AOA-ST +	56:02 00:05	45:53 45:41	15657	-.6284	65.8	73.1
3	3	3	3	4 10	-1 -1		OPT-AOA	MECO+4	146.0	170.0	AOA-SH 0	40:03 00:05	29:54 29:42	16012	-.6356	65.8	133.6
1	1	1	1	2 8	-1 -1		ATO	MECO+2 TTA=2	114.0	235.0	ATO 0	1:03:27 00:00	53:12 53:00	0	0.0000	113.0	415.0
1	2	2	2	2 8	1 1		ATO	MECO+2 TTA=2	114.0	235.0	MIN HP 0	1:03:27 00:00	53:12 53:00	0	0.0000	93.0	415.0
1	6	6	6	3 9	2 2		ATO	MECO+2 TTA=2	114.0	235.0	AOA-ST +	52:02 00:05	41:53 41:41	16625	-.6658	65.8	86.1
1	7	7	7	4 10	3 3		ATO	MECO+2 TTA=-2	114.0	235.0	AOA-SH 0	41:54 00:05	31:45 31:33	16983	-.6726	65.8	121.4
5	5	5	5	5 11	4 4		AOA-SH	MECO+2 TTA=-2	95.0	225.0	AOA-SH 0	49:24 00:02	39:14 39:02	19072	-.7529	65.8	83.5

All TIGs referenced from MECO and ET sep are shown before DTIG Adjust is applied. Note that the TIGs shown with respect to MECO and ET sep indicate ET sep occurs 12 seconds from MECO. ET sep actually occurs 18 seconds after MECO, but 12 seconds is used in the MCC Abort Maneuver Evaluator (AME).

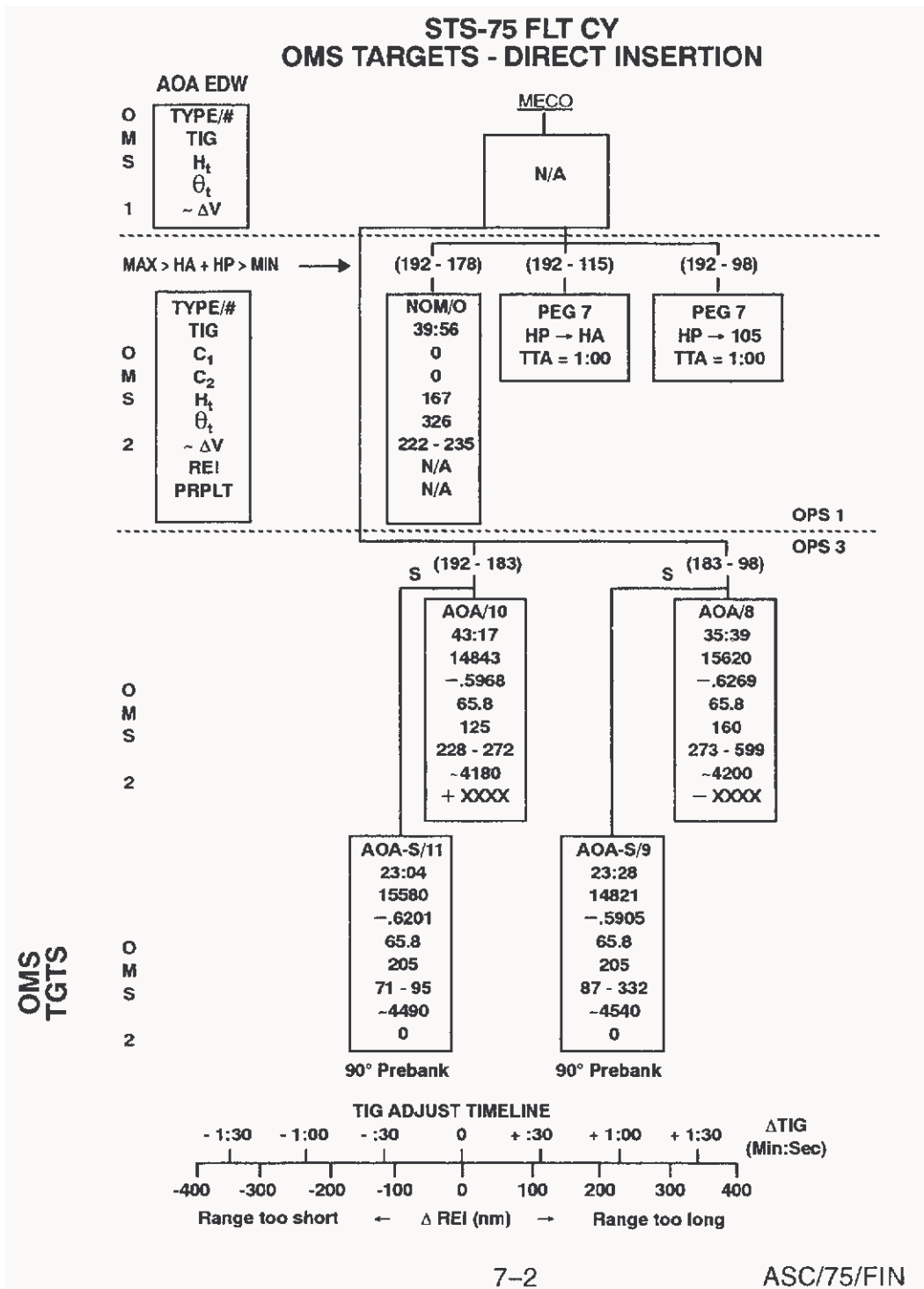

Figure 4.3.4.6.2-1: STS-75 OMS Targets (Direct Insertion)

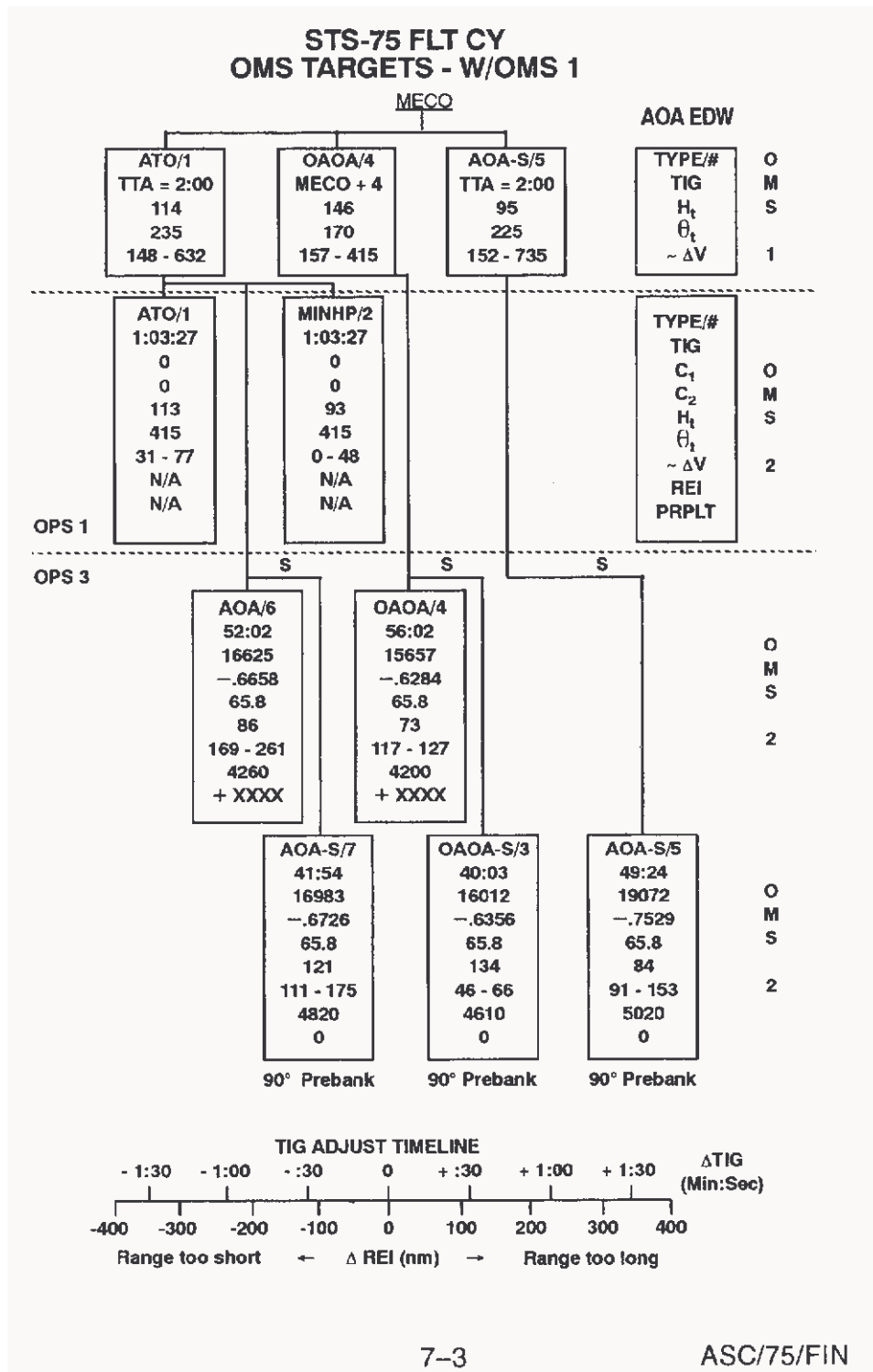

Figure 4.3.4.6.2-2: STS-75 OMS Targets (With OMS 1)

Most targets are available in the software and can be selected by the ABORT MODE rotary switch (ATO only) or by TGT selection (ITEM 35 + # EXEC) on XXXXX MNVR YYYYYY.

4.3.4.6.2.1 Option 1: DI/Nominal OMS 2

In MM 104, a nominal OMS 1 target set is automatically loaded by the software. This target is a dummy target which represents the nominal post-MECO MPS dump and is not executed by the crew. The nominal OMS 2 target is I-loaded and appears automatically in MM 105. Note that if ATO is selected pre-MECO, ATO OMS 1 targets appear (TGT 1). In this case the crew must manually key in nominal targets if they are desired. Nominally, the OMS 2 burn is done near apogee to increase burn efficiency. This target set can be used for MECO underspeeds from 0 to 25 fps with the nominal OMS 2 TIG.

For STS-75, the nominal OMS 2 burn occurred at a TIG of 39:56 with a total delta V of 221 fps. This burn circularized the orbit at 160 nm.

4.3.4.6.2.2 Option 1A: DI/Safe HP

The DI/safe HP maneuver is required for the MECO underspeed range of 25 to 165 fps. If the nominal PEG 4 OMS 2 targets were burned in this underspeed region, the theta target would produce a large undesirable apsidal rotation, making the burn nonoptimum. The MCC usually uplinks a target for the burn for this underspeed range. The alternate approach is to use the PEG 7 external delta V, in which the crew can load a ΔV_X component (along the velocity vector) and initiate the burn 1 minute prior to apogee (TTA = 1 minute). In this case, during the OMS burn, the crew monitors the current perigee and shuts down the OMS engines via the arm/press switches when current perigee (CUR HP) equals target perigee (TGT HP). In the underspeed range of 25 to 125 fps, this maneuver circularizes at MECO HA. For underspeeds of 125 to 165 fps, this maneuver raises perigee to 105 nm. The crew may then elect to perform additional OMS burns to continue the mission or perform a deorbit maneuver at a later time.

4.3.4.6.2.3 Options 2 and 3: DI/Steep AOA

Options 2, 3, 4, and 5 use the same dummy OMS 1 target as option 1 (i.e. dummy target reflecting MPS dump). Options 2 to 5 are used for systems problems requiring immediate deorbit from a nominal MECO state. These failures are listed on the OMS 1 and OMS 2 targeting pages of the checklist. These OMS 2 targets are selected using ITEM 35 on the MNVR EXEC display in MM 105 but are not loaded until OPS 3. This is due to the fact that θT is measured differently in OPS 1 than in OPS 3. In OPS 1, θT is the downrange angle from the launch site to the radius vector of the target in degrees. In OPS 3, θT is the angle from OMS 2 TIG to EI.

For STS-75, option 2 (TGT 10) provided coverage for $192 > (HA + HP) > 183$. The option 2 burn would have occurred at a TIG of 43:17, 125° from EI. Option 3 (TGT 8) provided coverage for $183 > (HA + HP) > 98$. The option 3 burn would have occurred at a TIG of 35:39, 160° from EI. [AFPH4.3-33] Due to the apogee range covered by the both targets, the specific delta V value could vary substantially.

4.3.4.6.2.4 Options 4 and 5: DI/Shallow AOA

As with the AOA steep targets (options 2 and 3), these targets are used for systems problems requiring immediate deorbit from a near nominal MECO energy state. Since shallow deorbit is less desirable than steep, these targets are reserved for performance critical cases where sufficient ΔV does not exist to do an AOA steep. Failures requiring AOA are listed on the OMS 1 and OMS 2 targeting pages of the checklist. These targets are selected using ITEM 35 on the MNVR EXEC display in MM 105 but are not loaded until OPS 3. This is due to the fact that ΘT is measured differently in OPS 1 than in OPS 3. In OPS 1, ΘT is the downrange angle from the launch site to the radius vector of the target in degrees. In OPS 3, ΘT is the angle from OMS 2 TIG to EI.

For STS-75, option 4 (TGT 11) provided coverage for $192 > (HA + HP) > 183$. The option 4 burn of 92 fps would have occurred at TIG of 23:04, 205° from EI. Option 5 (TGT 9) provided coverage for $183 > (HA + HP) > 98$. The option 5 burn would have occurred at a TIG of 23:28, 205° from EI. [AFPH4.3-1] Due to the apogee range covered by both targets, this delta V value could vary substantially.

4.3.4.6.2.5 Option 6: Optimum AOA/Steep AOA

This AOA target set is designed to be optimal for performance aborts with underspeeds near the design underspeed. The design underspeed is a condition used in defining the earliest point during second stage when the vehicle can perform either an ATO or an AOA abort. The OPT OMS 1 burn targets are selected using ITEM 35 +4 EXEC on the MNVR EXEC display in MM104. This burn is executed at MECO + 4 minutes. Unlike the ATO OMS 1 target, no “uphill” options exist after performing the OPT OMS 1 burn. This means that the crew is committed to performing an AOA after the OPT OMS 1 burn. For option 6, the optimum AOA OMS 1 is followed by a steep deorbit. These OMS 2 targets are selected using ITEM 35 + 4 EXEC on the MNVR EXEC display in MM 105 but are not loaded until OPS 3. This is due to the fact that ΘT is measured differently in OPS 1 than in OPS 3. In OPS 1, ΘT is the downrange angle from the launch site to the radius vector of the target in degrees. In OPS 3, ΘT is the angle from OMS 2 TIG to EI.

For STS-75, this target was designed for the 30 to 377 fps MECO underspeed range. Apogee would have been 170° downrange from the launch site. The option 6 (TGT 4) OMS 2 burn would have occurred at 56:02, 73° from EI.

4.3.4.6.2.6 Option 7: Optimum AOA/Shallow AOA

This AOA shallow target set is used as a downmode from the Optimum AOA/Steep AOA case for performance critical cases. It uses the same OMS 1 target set as the Optimum AOA/AOA Steep case but the OMS 2 deorbit burn uses TGT 3. The Optimum AOA Shallow OMS 2 targets are selected using ITEM 35 + 3 EXEC on the MNVR EXEC display in MM 105 but are not loaded until OPS 3. This is due to the fact that ΘT is measured differently in OPS 1 than in OPS 3. In OPS 1, ΘT is the downrange angle from the launch site to the radius vector of the target in degrees. In OPS 3, ΘT is the angle from OMS 2 TIG to EI.

For STS-75, the option 7 (TGT 3) OMS 2 burn would have occurred at 40:03, 134° from EI.

4.3.4.6.2.7 Option 8: ATO OMS 1/ATO OMS 2

For STS-75, this target was designed for the 169.2 to 532.1 fps MECO underspeed range. This target set is selected using ITEM 35 + 1 EXEC or appears automatically if an ATO abort was performed pre-MECO. The TIG contained in the ATO OMS 1 targets is at MECO + 2 minutes. To optimize the burn (minimize delta V), it is best to burn in the vicinity of apogee because this minimizes the apsidal shift. As a rule of thumb, the larger the underspeed at MECO, the smaller the time to apogee (TTA) of the MECO orbit. Therefore, if the TTA is less than 2 minutes after MECO, the burn will be performed at MECO + 2 minutes. Otherwise, the crew keys in the delayed TIG at TTA = 2 minutes and performs the burn near apogee. Options 7 and 8 provide steep and shallow deorbit opportunities, respectively, for deorbit after performing an ATO OMS 1 burn.

If a 256 fps underspeed occurred on STS-75, the ATO OMS 1 burn of 235 fps would have occurred 2 minutes prior to apogee (but no earlier than MECO + 2 minutes) with apogee 235° downrange from the launch site. The OMS 2 burn of 53 fps would have occurred at 1:03:27 with target apogee 415° from the launch site.

4.3.4.6.2.8 Option 8A: ATO OMS 1/MIN HP

This option is similar to the ATO OMS 1/ATO OMS 2 option in that it uses the same OMS 1 burn targets. However, the subsequent OMS 2 burn raises apogee to 85 nm for low inclination missions or to 90 nm for high inclination missions. This allows the orbiter to maintain a safe orbit for several revolutions. These OMS 2 targets are selected using ITEM 35 + 2 EXEC on the MNVR EXEC display in MM105.

4.3.4.6.2.9 Option 9: ATO OMS 1/Steep AOA

After the TTA = 2 minutes ATO OMS 1 burn is complete (same OMS 1 target as options 6, 8, and 8A), the crew uses the dual or single pod OMS required tables on page 2-9 of the Ascent Checklist to determine whether sufficient propellant remains to continue uphill via ATO or whether deorbit with OMS 2 is required. Option 9 provides an opportunity for steep deorbit after the ATO OMS 1 burn. The Steep AOA OMS 2 targets are selected via ITEM 35 + 6 EXEC on the MNVR EXEC display in MM105 but are not loaded until OPS 3. This is due to the fact that ΘT is measured differently in OPS 1 than in OPS 3. In OPS 1, ΘT is the downrange angle from the launch site to the radius vector of the target in degrees. In OPS 3, ΘT is the angle from OMS 2 TIG to EI.

For STS-75, this OMS 2 (TGT 6) deorbit burn would have occurred at 56:02 MET, 86° from EI. [AFPH4.3-1]

4.3.4.6.2.10 Option 10: ATO OMS 1/Shallow AOA

After the TTA = 2 minutes ATO OMS 1 burn is complete (same OMS 1 target as option 6, 8, 8A, and 9), the crew uses the dual or single pod OMS required tables on page 2-11 of the checklist to determine whether sufficient propellant remains to continue uphill via

ATO or whether deorbit with OMS 2 is required. Option 8 provides a shallow deorbit opportunity. These OMS 2 targets are selected using ITEM 35 + 7 EXEC on the MNVR EXEC display in MM 105 but are not loaded until OPS 3. This is due to the fact that θT is measured differently in OPS 1 than in OPS 3. In OPS 1, θT is the downrange angle from the launch site to the radius vector of the target in degrees. In OPS 3, θT is the angle from OMS 2 TIG to EI.

Since AOA steep is preferred over AOA shallow, the steep deorbit (option 7) is used for deorbit after the TTA = 2 minutes ATO OMS 1 burn if possible. The shallow target is used in performance critical cases where there is not sufficient propellant to complete a steep deorbit burn.

For STS-75, the OMS 2 (TGT 7) burn of 138 fps would have been initiated 41:54 MET, 121° from EI. [AFPH4.3-1]

4.3.4.6.2.11 Option 11: AOA-Shallow OMS 1/Shallow AOA

This target set is used for severe MECO underspeeds where the ATO OMS 1 burn cannot be used because of the high delta V requirements from either the nominal or abort MECO. The shallow OMS 1 burn targets are designed to minimize OMS propellant usage while satisfying the post OMS 1 drag constraint. The drag constraint requires that the change in HA + HP between OMS 1 cutoff and OMS 2 ignition does not exceed 5 nm. The crew selects the AOA shallow OMS 1 targets by performing an ITEM 35 + 5 EXEC on the MNVR EXEC display in MM104. The shallow OMS 2 deorbit targets automatically appear on the MNVR EXEC display after entering MM 105. They are carried across the OPS 3 transition and loaded once in OPS 3. They are not loaded in OPS 1 since θT is measured differently in OPS 1 than in OPS 3. In OPS 1, θT is the downrange angle from the launch site to the radius vector of the target in degrees. In OPS 3, θT is the angle from OMS 2 TIG to EI.

For STS-75, the AOA shallow OMS 1 target was designed to raise the orbit to 87 by 59 nm. This target provided coverage to an underspeed of 771 fps assuming no pre-MECO OMS dump. For an underspeed of 771 fps, the required delta V is 737 fps. The OMS 2 burn of 94 fps would have been initiated at 49:24 MET, 84° from EI. [AFPH4.3-1]

4.3.5 OMS 1 Burn Card

On a Standard Insertion (SI) mission, both OMS 1 and OMS 2 burns are required nominally since the SI MECO occurs at a lower VI (earlier) and therefore at a lower HA than Direct Insertion (DI). On a nominal Direct Insertion mission, the orbiter attains mission HA - 5 nm at MECO so that OMS 1 is not required. The post-MECO MPS dump performed at MECO + 2 minutes raises HA the last 5 nm to the nominal mission altitude. The nominal OMS-2 target altitude on a ground up rendezvous mission will vary significantly through the launch window, depending upon what is required for rendezvous phasing. For underspeed cases, an OMS 1 may be required since the desired MECO VI/HA was not achieved. In either the DI underspeed or SI case, the OMS 1 maneuver is done near orbital apogee and is time critical due to the low altitude of the post-MECO orbit (TIG as early as MECO + 2 minutes).

Note that even on a nominal DI mission, I-loaded OMS targets appear automatically at MM 104 transition, with ignition times corresponding to MECO + 2 minutes. If an OMS 1 is required, it is important to manually enter a TIG 2 minutes prior to apogee to prevent burning too early. MCC assists in this function by calling the desired TIG as well as the target set to be burned. The MCC also provides information concerning any NAV state anomalies. If the NAV state is bad, the information from the OMS MNVR EXEC display and the OMS Targeting card may be inaccurate. The MCC provides information on the appropriate action; i.e., burn on time or delayed, expect a NAV update, or burn an external ΔV burn.

To select the required OMS 1 targets, the crew evaluates the status of orbiter critical systems and the MECO energy state (V_I , HA, HP). Target selection is discussed in section 4.3.4 of this document.

OMS 1 BURN	
* IF TIG LATER THAN MECO + 6 min:	*
* MECO + 4 min: ✓BDY FLP pb - It off (MPS dump complete)	*
* ✓MCC for APU shutdn (if time permits)	*
* FEEDLINE FAIL:	*
* Expect 'Illegal Entry' (PASS)/'Illegal TIG' (BFS) @ tgt select	*
* pre ET Sep; input TIG manually & LOAD tgt	*
* If TIG > MECO + 6 min:	*
* TIG-1:30 or MECO + 6 min (whichever comes first):	*
* ET SEP - SEP >>	*
* If TIG < MECO + 6 min:	*
* MPS PRPLT DUMP SEQ - STOP	*
* TIG-1:30: ET SEP - SEP	*
* Post ET SEP -Z xlation:	*
* MPS PRPLT DUMP SEQ - GPC	*
* 1 OMS ENG FAIL and $\Delta VTOT > 500$:	*
* Burn good OMS + l'cnct both OMS to RCS, THC +X at TIG	*
DAP - AUTO/DISC	
MNVR - BURN ATT (✓INRTL)	
OMS XFEED (four) - OP	
✓CNTRLR PWR (two) - ON	
✓OMS ENG (two) - ARM/PRESS	
Note $\Delta VTOT$ _____ TIG <input type="text"/> : <input type="text"/>	
-:15 EXEC	
:00 TIG; start watch (✓P _c , $\Delta VTOT$, ENG VLVs)	
* OMS ENG FAIL:	*
* Failed ENG - OFF	*
* If $\Delta VTOT < 500$:	*
* At QTY = 5%, good OMS TK ISOL (two) - CL	*
* If $\Delta VTOT > 500$:	*
* RCS XFEED (four) - OP	*
* RCS TK ISOL (six) - CL	*
* THC +X	*
* At first QTY = 5%, good OMS TK ISOL (two) - CL	*
* At second QTY = 5%, THC - Release	*
* RCS COMPLETION:	*
* Interconnect to either	*
* OMS that was ENG FAIL	*
* THC +X (OMS% vs RCS ΔV)	*
* OMS TK SW (if reqd)	*
CUTOFF	
+ :02 OMS ENG (two) - OFF	
Trim inplane X,Z residuals < 2 fps	
OMS XFEED (four) - CL (✓RCS straightfeed)	
FB 2-8	ASC/114/FIN 3

Figure 4.3.5-1: STS-114 [AFPH4.3-34]OMS 1 BURN Card

There is only one OMS 1 burn card as shown in figure 4.3.5-1. However, two engine, one engine, and RCS varieties are available for other burns. The OMS procedures in the PLT Overhead Flipbook are used for any OMS malfunctions prior to OMS 1 but during OMS 1 the OMS burn monitor card is used. These procedures are discussed in the Ascent/Orbit/Entry Pocket Checklist Handbook.

[AFPH4.3-35]

The following pages describe each portion of the OMS 1 Burn Card.

4.3.5.1 MPS Dump and APU Shutdown_[AFPH4.3-36]

* **IF TIG LATER THAN MECO + 6 min:** *

* MECO + 4 min: √BDY FLP pb – lt off (MPS DUMP complete) *

* √MCC for APU Shutdn (if time permits) *

* *

4.3.5.1.1 Cue

MECO + 4 minutes

4.3.5.1.2 Displays

BODY FLAP light

4.3.5.1.3 Crew Action

F2, F4 √BODY FLAP lt - out
Shutdown APUs if directed by MCC

4.3.5.1.4 Discussion

The MPS dump will automatically start at MECO confirmed plus 2 minutes and takes 2 minutes to complete (prior to OI-23, the crew had to start the dump manually). Therefore, the crew need only check that the MPS dump is complete, prior to APU shutdown. Since the body flap lights are cued to MPS dump complete and SSMEs to stow and the MPS dump is performed in the stow position, the body flap lights extinguish upon dump completion. Depending on OMS 1 TIG and whether or not AOA is required, the MCC may direct the crew to perform APU shutdown. If TIG occurs too early and an AOA is not expected, APU shutdown will be delayed until after the OMS 1 burn. If an AOA is expected, the APUs will not be shutdown but taken to low pressure.

4.3.5.2 Feedline Failure

```

* FEEDLINE FAIL: *
* Expect 'Illegal Entry'(PASS)/'Illegal TIG'(BFS) @ tgt select *
* pre ET Sep; input TIG manually & LOAD tgt *
* If TIG > MECO + 6 min: *
*   TIG - 1:30 or MECO + 6 min (whichever comes first): *
*   ET SEP - SEP >> *
* If TIG < MECO + 6 min: *
*   MPS PRPLT DUMP SEQ - STOP *
*   TIG - 1:30: ET SEP - SEP *
*   Post ET SEP -Z xlation: *
*   MPS PRPLT DUMP SEQ - GPC

```

4.3.5.2.1 Cue

ET Separation Inhibit but rates within limits

4.3.5.2.2 Displays

ASCENT TRAJ 2

C&W class 3 message

4.3.5.2.3 Crew Action

TRAJ If SEP INH:

ADI If Rates < .7,.7,.7:

Assume Feedline Fail

If Feedline Fail:

Expect 'Illegal Entry'(PASS)/'Illegal TIG'(BFS) @ tgt select
pre ET Sep; input TIG manually & LOAD tgt [AFPH4.3-37]

If TIG > MECO + 6 min:

@earlier of TIG - 1:30 and MECO + 6 min:

C3 ET SEPARATION SEP pb - push

If TIG < MECO + 6 min:

R2 MPS PRPLT DUMP (two) - STOP

@TIG - 1:30:

C3 ET SEPARATION SEP pb - push

Post ET sep -Z translation:

R2 MPS PRPLT DUMP (two) - GPC

4.3.5.2.4 Discussion

After MECO and prior to ET sep, LOX and LH₂ valves on either side of the ET and the orbiter close, isolating both sides. If at ET sep the ET LOX and LH₂ tanks are pressurized and either of the feedline disconnect valves have failed to close, a propulsive moment is induced at separation by venting out of the open valves. The resulting motion, depending on its magnitude, can cause orbiter/ET recontact. For the LOX line, assuming a pressure

of 22 psi in the tank, an open 17 inch line can deliver about 6000 lb of thrust. For the LH₂ tank, assuming a pressure of 34 psi in the tank, an open 17 inch line can deliver about 10,000 lb of thrust.

To avoid this problem, the software checks the position of the valves prior to separation. If the valves have not closed, a SEP INH message is flashed on the CRT. This message also appears if rates in any of the three axes exceed 0.7°/sec or if there are multiple flight aft (FA) MDM failures.

If the SEP INH message occurs, the crew checks the pitch, yaw, and roll rates. If the rates are <0.7°/sec, then it is assumed that there must be a problem with closure of the feedline disconnect valves. As per the ascent procedures card, after moding ET SEP switch to MAN and referring to the OMS 1/2 TGTING card for targets, the crew proceeds to either the OMS 1 BURN or POST-OMS 1 sections of the checklist.

If an OMS 1 burn is required the crew can expect an 'Illegal Entry'(PASS)/'Illegal TIG'(BFS) @ tgt select. These messages are expected since the auto loaded targets in MM104 are referenced from ET sep and ET sep has not yet occurred. Section 4.3.1.12 ET Separation discusses this error logic in more detail.

If an OMS 1 burn is required with TIG later than MECO + 6 minutes, the MPS dump is allowed to occur at MECO + 2 minutes and ET sep is manually initiated at MECO + 6 minutes or TIG -1:30, whichever occurs first. Since the dump takes 2 minutes to complete it will not perturb the vehicle during the ET sep maneuver.

In the case where the TIG is to occur earlier than MECO + 6 minutes, the crew must move the MPS dump switch to the stop position until after the ET sep translation maneuver. This will prevent the dump from perturbing the vehicle during the separation maneuver. However this does not prevent the thrust from the open disconnect from perturbing the vehicle. This is the reason the crew waits until TIG - 1:30 before separating from the ET to allow as much time for the ET venting as possible to minimize the risk of an orbiter/ET recontact due to thrust generated by the open ET feedline disconnect.

4.3.5.3 1 OMS Engine fail and $\Delta VTOT > 500$ fps_[AFPH4.3-38]

*	1 OMS ENG FAIL and $\Delta VTOT > 500$:	*
*	Burn good OMS + l'cnct both OMS to RCS, THC +X at TIG	*

4.3.5.3.1 Cue

OMS ENG FAIL determined by performance during OMS Assist burn (if applicable)

4.3.5.3.2 Displays

BFS SYS SUMM 2
FAULT Messages

4.3.5.3.3 Crew Action

IF $\Delta V > 500$:
Interconnect both OMS to RCS
THC +X at TIG

4.3.5.3.4 Discussion

If $\Delta V > 500$ fps, the card calls for interconnecting OMS to RCS and burning the +X RCS jets as well as the single OMS engine. This is because the burn arc is twice as long with one engine as with two engines. An OMS 1 with a $\Delta V > 500$ fps implies a very low MECO orbital energy condition and the RCS thrust is needed to prevent aerocapture.

An OMS 1 delta V greater than 500 fps represents a large underspeed which requires either an ATO or an AOA. Four +X RCS jets deliver a little more than half the thrust of one OMS engine. However, since an OMS + RCS burn is less efficient than an OMS only burn, the total thrust is increased only about 50%. Even though guidance and thrust vector control (TVC) do not recognize that the +X engines are burning, the burn TGO decrements correctly because TGO is based on velocity remaining to the target, VGO.

4.3.5.4 Pre-burn Procedures

DAP - AUTO/DISC
 MNVR - BURN ATT ($\sqrt{\text{INRTL}}$)
 OMS XFEED (four) - OP_[AFPH4.3-39]
 $\sqrt{\text{CNTLR PWR}}$ (two) - ON

$\sqrt{\text{OMS ENG}}$ (two) - ARM/PRESS

Note ΔVTOT ____ : ____ TIG :
 -:15 EXEC
 :00 TIG; start watch ($\sqrt{\text{Pc}}$, ΔVTOT , ENG VLVs)

4.3.5.4.1 Cue

OMS 1 Required

4.3.5.4.2 Displays

ADI
 PASS MNVR EXEC
 BFS MNVR EXEC
 BFS GNC SYS SUMM 2

4.3.5.4.3 Crew Action

C3 DAP CONTROL - AUTO
 DAP MANUAL MODE ROTATION - DISC
 MNVR ITEM 27 EXEC
 F6,F8 ADI ATTITUDE - INRTL
 $\sqrt{\text{burn attitude}}$
 08 Crossfeeds to open
 F7,F8 $\sqrt{\text{FLT CNTLR POWER}}$ - ON
 $\sqrt{\text{OMS ENG}}$ (two) - ARM/PRESS
 Note ΔVTOT and TIG
 MNVR EXEC
 @TIG Start watch
 F7 $\sqrt{\text{OMS PRESS Pc}}$
 MNVR $\sqrt{\Delta\text{VTOT}}$ decreasing (≈ 2 fps per second for two OMS)
 BFS GNC SYS SUMM 2 $\sqrt{\text{ENG VLVs}}$

4.3.5.4.4 Discussion

The DAP is activated at MECO zero thrust and is usually in the auto mode for maneuver to burn attitude. However, a manual maneuver is performed if a higher rate is needed to attain burn attitude on time, although the burn can generally be up to 2 minutes late (depending on TIG slip capability). The manual mode is entered by moving the stick out of detent and a higher rate commanded by taking the RHC to the hard stop. The manual mode remains in effect until the RHC is returned to detent and the C3 DAP AUTO pb is

depressed. If a manual maneuver to attitude is used, the crew returns the DAP to AUTO prior to OMS ignition. Only manual mode is available in BFS.

The OMS 1 MNVR EXEC display is used for target selection and burn configuration and appears automatically at transition to MM 104. Once the proper OMS 1 target solution is available (both PASS and BFS), the crew should begin an AUTO maneuver to burn attitude using ITEM 27 EXEC on the MNVR display. Since the attitude for OMS burns is displayed in the inertial coordinate system on the MNVR display, the crew should mode the ADI to INRTL. When the correct attitude is reached, the error needles will be centered, and the ADI attitude and the commanded attitude on the MNVR display should match.

The crossfeeds are opened preburn to protect for main bus failures which could prevent a configuration change to crossfeed for an engine failure case.

Since the switches are configured for OMS 1 at launch, no OMS switches require manipulation (nominally) prior to OMS 1. However, the cue card does contain reminders to the crew to confirm several switch positions. The flight controller power is checked ON in case manual takeover during the burn is necessary. OMS 1 trims are I-loaded and manual trim entries via item entry have no effect on the vehicle burn configuration. Additionally, the OMS ENG switches are confirmed to be in the ARM/PRESS position. This allows engine ignition and a 2 second N₂ purge upon cutoff.

The OMS 1 BURN card calls explicitly for a notation of $\Delta VTOT$ and TIG prior to ignition. This is due to the extremely short timeline between MECO and OMS 1 ignition (can be as little as 2 minutes). In other burn scenarios, there is usually plenty of time for the crew to study the MNVR EXEC display and note $\Delta VTOT$. The OMS 1 $\Delta VTOT$ required is highly flight specific and can exhibit large variations depending on the MECO state.

Fifteen seconds before TIG, a flashing EXEC appears on the OMS MNVR EXEC display signaling the crew to enable the burn by pressing the EXEC key. At ignition the crew confirms that the burn is proceeding nominally. The OMS Pc gauges read approximately 104%. The BFS GNC SYS SUMM 2 display is examined for three things: the engine control valves (ENG VLV 1 and 2) read approximately 100%, which corresponds to fully open; He pressure decreases slowly as the propellant is expended; and the engine inlet pressures drop to approximately 200 psi during the burn. The OMS quantity gauges begin to function 15 seconds after ignition. Also, $\Delta VTOT$ should decrement nominally.

4.3.5.5 OMS Engine Fail

```

* OMS ENG FAIL: *
* Failed ENG – OFF *
* If  $\Delta VTOT < 500$ : *
*   At QTY = 5%, good OMS TK ISOL (two) – CL *
* If  $\Delta VTOT > 500$ : *
*   RCS XFEED (four) – OP *
*   RCS TK ISOL (six) – CL *
*   THC +X *
*   At first QTY = 5%, good OMS TK ISOL (two) – CL *
*   At second QTY = 5%, THC – Release *

```

4.3.5.5.1 Cue

OMS ENG FAIL determined based on OMS 1 BURN MONITOR card (see Ascent/Orbit/Entry Pocket Checklist Handbook for OMS 1 BURN MONITOR rationale)

4.3.5.5.2 Displays

BFS SYS SUMM 2
FAULT Messages

4.3.5.5.3 Crew Action

C3 Failed OMS ENG - OFF
MNVR IF $\Delta V < 500$ fps:
 At QTY =5%, close the good OMS TK ISOLs.
 IF $\Delta V > 500$:
 Open RCS Xfeeds
 Close RCS TK ISOLs
 THC +X
 When 1st QTY = 5%, close the good OMS TK ISOLs
 When 2nd QTY = 5%, release the THC.

4.3.5.5.4 Discussion

Turning the engine off with the OMS ENG switch causes guidance to downmode to a single engine burn, with a resulting attitude and error needle change. If $\Delta VTOT < 500$ fps at the time of an engine failure, the burn is completed with the single remaining OMS engine. Because the Xfeeds are opened preburn to protect for main bus failures which could prevent configuring to Xfeed for an engine fail case, the crew allows the good OMS propellant to preferentially flow to the good OMS engine until the quantity has decreased to 5%. At 5% the good OMS tank isolation valves are closed and the OMS propellant from the failed engine side continues to feed the good OMS engine. Any resulting imbalance in the prop systems will have to be corrected in the subsequent OMS2 or Deorbit burn.

In the event of an engine failure the crew may freeze the present CRT readout for future reference if there is not enough time to note this information immediately. This may be accomplished by depressing the SPEC key on CRT 1 or 2 at the time of the engine failure. This freezes the MNVR EXEC display. Similarly, freezing the BFS GNC SYS SUMM 2 display on CRT 3 allows the failed OMS engine switch to be moved to OFF while retaining the present engine ball valve condition for failure diagnosis. After these actions are accomplished, the crew should RESUME the displays to monitor the remainder of the burn.

If $\Delta V > 500$ fps, the card calls for interconnecting OMS to RCS and burning the +X RCS jets as well as the single OMS engine. This is because the burn arc is twice as long with one engine as with two engines. An OMS 1 with a $\Delta V > 500$ fps implies a very low MECO orbital energy condition and the RCS thrust is needed to prevent aerocapture. The RCS jets are interconnected to the OMS propellant on the side of the failed engine to meet OMS tank constraints and to help balance propellant.

An OMS 1 delta V greater than 500 fps represents a large underspeed which requires either an ATO or an AOA. Four +X RCS jets deliver a little more than half the thrust of one OMS engine. However, since an OMS + RCS burn is less efficient than an OMS only burn, the total thrust is increased only about 50%. Even though guidance and thrust vector control (TVC) do not recognize that the +X engines are burning, the burn TGO decrements correctly because TGO is based on velocity remaining to the target, VGO.

In AUTO flight control, the crew should expect small error needle displacements. Flying out the errors in manual mode would result in an arcing, less efficient burn.

4.3.5.6 RCS Completion

* RCS COMPLETION:	*
* Interconnect to either	*
* OMS that was ENG FAIL	*
* THC +X (OMS% vs RCS ΔV)	*
* OMS TK SW (if reqd)	*

4.3.5.6.1 Cue

OMS 1 Burn residuals > 2 fps due to PRPLT or ENG failure(s)

4.3.5.6.2 Displays

PASS MNVR EXEC

BFS MNVR EXEC

4.3.5.6.3 Crew Action

Interconnect to either OMS that was ENG FAIL

Determine RCS burn time from OMS He PRESS/ΔV/Burn Time Card (section 4.3.6)

THC +X until target achieved or burn time complete

If required, interconnect to other OMS engine (if ENG FAIL)

4.3.5.6.4 Discussion

The standard interconnect is used for an RCS completion of an OMS burn. OMS 1 is completed whenever possible. In this case, the CDR completes the burn with +X RCS via the THC. The completion of the interconnect by the PLT should be confirmed before the CDR deflects the THC. Otherwise, RCS propellant would be used instead of OMS propellant. OMS propellant balancing is accomplished during an RCS interconnect burn by switching the interconnect from one OMS pod to the other using the procedure on the interconnect card in the PLT Overhead Flipbook.

The interconnect is performed to the OMS that was an ENG FAIL first, as this should be the OMS with the most propellant available, helping to balance the propellant levels and Y-cg of the vehicle. Note that if one engine was shut down because of a propellant failure rather than an engine failure, a tank switch cannot be performed.

4.3.5.7 Cutoff

CUTOFF

+ :02 OMS ENG (two) - OFF
 Trim inplane X,Z residuals < 2 fps
 OMS XFEED (four) - CL ($\sqrt{\text{RCS}}$ straightfeed)

4.3.5.7.1 Cue

OMS Pc \rightarrow 0
 TGO, Δ VTOT \approx 0

4.3.5.7.2 Displays

PASS MNVR EXEC
 BFS MNVR EXEC
 OMS PRESS Pc

4.3.5.7.3 Crew Action

C3 OMS ENG (two) - OFF
 If Δ VX or Δ VZ > 2 fps,
 THC to trim residuals within 2 fps
 08 Crossfeeds to close

4.3.5.7.4 Discussion

The GN₂ subsystem is used to operate the engine control valves and to purge the fuel lines and passages after a burn to prevent freezing in the lines. If the OMS engine switches are in the ARM/PRESS position, a 2 second nitrogen purge occurs automatically at cutoff. If the OMS engine switches are in the ARM position, the engines still fire but the purge does not occur. The crossfeed lines are returned to straightfeed after the burn.

An off-nominal performance OMS 1 burn requires nonstandard OMS 2 targets.

4.3.6 OMS/RCS ΔV

The OMS/RCS ΔV card includes the OMS Helium pressure table and the ΔV capability of RCS and OMS as shown for STS-110 in figure 4.3.6-1.

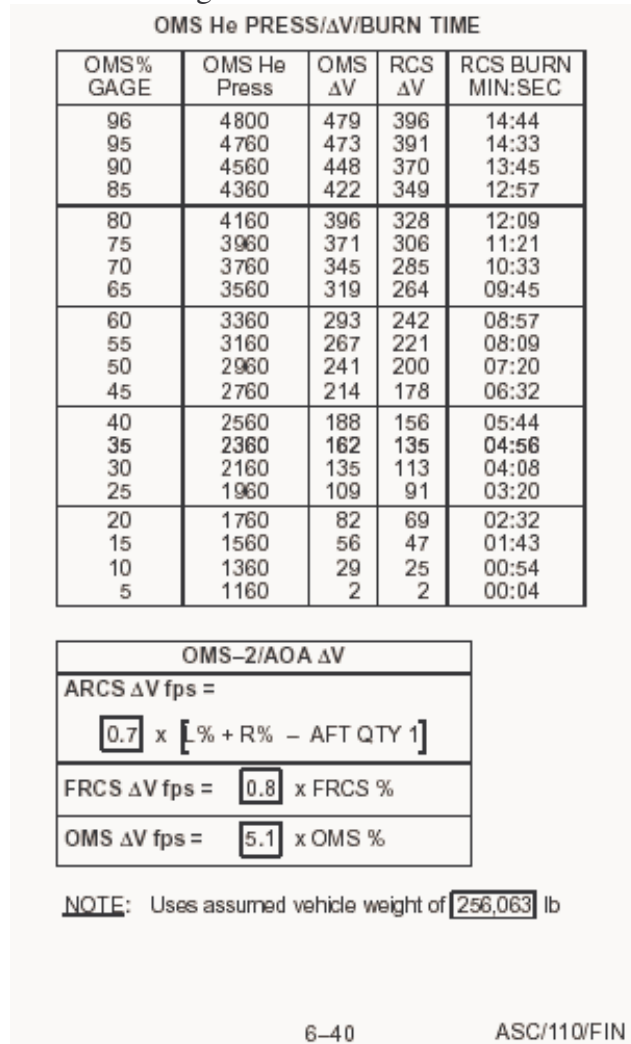

Figure 4.3.6-1: STS-110 OMS He PRESS/DV/BURN TIME Card

4.3.6.1 OMS He PRESS/ ΔV /Burn Time

OMS% GAGE	OMS He Press	OMS ΔV	RCS ΔV	RCS BURN MIN:SEC
96	4800	479	396	14:44
95	4760	473	391	14:33
90	4560	448	370	13:45
85	4360	422	349	12:57
80	4160	396	328	12:09
75	3960	371	306	11:21
70	3760	345	285	10:33
65	3560	319	264	09:45
60	3360	293	242	08:57
55	3160	267	221	08:09
50	2960	241	200	07:20
45	2760	214	178	06:32
40	2560	188	156	05:44
35	2360	162	135	04:56
30	2160	135	113	04:08
25	1960	109	91	03:20
20	1760	82	69	02:32
15	1560	56	47	01:43
10	1360	29	25	00:54
5	1160	2	2	00:04

4.3.6.1.1 Cue

RCS Completion

4.3.6.1.2 Displays

OMS PRESS He gauges

OMS Quantity gauges

4.3.6.1.3 Crew Action

If RCS completion required:

F7 \sqrt OMS He PRESS

Determine RCS burn time from table

Do not exceed RCS burn time during RCS completion

4.3.6.1.4 Discussion

The OMS He PRESS/ ΔV /Burn Time Card is a table containing OMS quantity, OMS helium pressure, OMS ΔV , RCS ΔV and RCS burn time. When RCS completion using OMS propellant is required, the RCS burn time must be determined since the OMS quantity gauges only update when an OMS burn is performed. The RCS burn time is determined from the table based on OMS quantity or OMS helium pressure. To prevent OMS propellant depletion and helium ingestion into the RCS jets, the RCS burn time

obtained from the table must not be exceeded when performing RCS completion using OMS propellant. Note that OMS helium pressure is typically more accurate than the OMS quantity gauges and should be used if available. This table can also be used to determine the available delta V using the OMS or RCS jets.

4.3.6.2 ΔV Capability

OMS-2/AOA ΔV	
ARCS ΔV fps =	$0.7 \times [L\% + R\% - \text{AFT QTY } 1]$
FRCS ΔV fps =	$0.8 \times \text{FRCS } \%$
OMS ΔV fps =	$5.1 \times \text{OMS } \%$
NOTE: Uses assumed vehicle weight of 256,063 lb	

4.3.6.2.1 Cue

N/A

4.3.6.2.2 Displays

PASS MNVR EXEC

BFS MNVR EXEC

4.3.6.2.3 Crew Action

Information only

4.3.6.2.4 Discussion

This table provides the equations necessary to calculate the delta V capability given the amount of ARCS, FRCS, and OMS propellant remaining. The equations use the assumed vehicle weight shown below the table. This assumed vehicle weight is a mission specific number.

4.3.7 Post OMS 1

The OMS 1 burn is completed with either OMS + OMS, OMS + RCS, or RCS + RCS. After completion, the crew prepares systems for orbit, prepares for the OMS 2 burn, and performs the MPS Powerdown / Isol and GH₂ inerting process. The Post OMS 1 burn procedures are illustrated in the following sections.

4.3.7.1 ET Photo Maneuver/MPS Dump [AFPH4.3-40]

1: GNC OMS 1 MNVR EXEC		2: GNC OMS 1 MNVR EXEC	
3: BFS, GNC SYS SUMM 2			
ET PHOTO MANEUVER/MPS DUMP			
* If OMS 1 Burn performed, go to *			
* POST BURN STATUS *			
B	√MCC, ADI – REF		
If NO-GO for Photo Pitch Mnvr, go to MPS DUMP complete; do not pitch			
* If Feedline Fail: *			
* √MCC GO for +X and Pitch Mnvr *			
* At MECO + 6 min: (14:23 Nom) *			
* ET SEP – SEP *			
* At MM104 + 2 sec *			
* +X xlation for 11 sec *			
* At OMS 1 TIG: (16:05 Nom) *			
* Pitch up at 2°/sec until ET in O/H *			
* window (P~100°) *			
* Go to MPS DUMP complete *			
MPS DUMP start		(MECO + 2:03)	
		(10:26 Nom)	
C	At OMS 1 TIG + 0 sec:	(MECO + 2:03)	
C3	DAP – INRTL: R (DISC), P (PULSE), Y (DISC), Orbiter pitches up		
Control pitch rate 2°/sec max (P down – accel)			
* If no pitch rate, go to MPS DUMP complete *			
When ET in O/H window (MS call or P ~125°):			
P – DISC			
Adjust pitch photo att as reqd for MS			
P	MPS DUMP complete		
F4	√BDY FLP pb – It off (MECO + 4 min) (12:24 Nom)		
* C		If no pitch rate, *	
* P – DISC		*	
* Pitch up at 2°/sec until ET		*	
* in O/H window (P ~100°)		*	
3-2		ASC/114/FIN A	

4.3.7.1.1 Cue

If OMS1 Burn performed, the underspeed was greater than 26 fps and the crew is No-Go for the ET Photo pitch maneuver and can proceed to POST BURN STATUS.

√ MCC to determine if Go/No-Go for the ET Photo pitch maneuver.

If No-Go, go to MPS DUMP complete and do not pitch.

If Go and Feedline fail: work Feedline failed starred block (see Section 4.3.7.2)

√ XXX 1 MNVR EXEC display for flashing EXEC.

where XXX = OMS or ATO

Monitor Orbiter pitch up after dump start.

Monitor ET in overhead window

Monitor when MPS dump is complete: F2,F4 BODY FLAP lt - off

4.3.7.1.2 Displays

XXX 1 MNVR EXEC

ADI

4.3.7.1.3 Crew Action

ADI - REF

C3 DAP - INRTL: R (DISC), P (PULSE), Y (DISC)

Monitor Orbiter pitch rate on ADI, if $> 2^\circ/\text{sec}$ pitch down to control rate

When ET in OH window: P - DISC (adjust pitch attitude as required for photos)

F4 √ BDY FLP pb - lt off

If no pitch rate observed on ADI, then perform a manual pitch maneuver after the MPS dump completes.

4.3.7.1.4 Discussion

If an OMS 1 burn has been performed then the ET Photo pitch maneuver will not be performed and the crew can proceed to POST BURN STATUS. Flight Rule LF1_A2-3 ET PHOTOGRAPHY dictates that for underspeeds greater than 26 fps the pitch maneuver will not be performed. Generally, an OMS 1 burn will be performed for underspeeds greater than 60 fps. The flight rule listed above defines the GO, NO-GO criteria for both the +X maneuver as well as the ET Photo pitch maneuver.

The crew checks with the MCC to verify whether the ET Photo pitch maneuver will be performed. The ADI is taken to REF to monitor the pitch maneuver. If NO-GO for the ET photo pitch maneuver the crew is instructed to go to MPS DUMP Complete (wait for the end of the MPS dump) and not perform the ET photo pitch maneuver. If GO for the pitch maneuver and a feedline fail has occurred, the crew will work the feedline fail starred block. The feedline fail case will be discussed in the next section.

The main propulsion system (MPS) dump is performed automatically at MECO confirmed + 2 minutes and takes 2 minutes to complete. The main oxidizer valve is opened to allow residual liquid oxygen to be dumped overboard and the liquid hydrogen fill/drain valves and the fuel bleed valve are opened to allow residual liquid hydrogen to drain overboard. As part of the new ET Photo pitch maneuver being implemented for STS-114 and subsequent flights, the MPS dump is used to impart a pitch moment on the Orbiter. This allows the vehicle to pitch towards the ET Photo pitch attitude, where the crew uses a handheld camera to photograph the ET. Using the MPS dump for the pitch up allows the pitch to occur at least 2 minutes earlier and results in a closer range to the ET than the previous procedures, this should allow for greater detail in the crew handheld ET photos.

At MECO + 1:48 the flashing EXEC should be monitored on the XXX 1 MNVR EXEC display. This indicates the MPS dump is within 15 seconds of initiation. (Note the MPS dump nominally begins at MECO + 2:03.) The crew takes the DAP to inertial at the OMS1 TIG (which is also at MECO + 2:03). The Roll and Yaw axis' are in discrete mode while the pitch axis is in PULSE mode. This allows the roll/yaw axis to maintain an attitude hold while the pitch axis goes to free drift. Once the dump begins the MPS dump causes the nose up pitching moment. The crew monitors the pitch rate, keeping the rate limited to 2° /sec max. The crew can pitch down in the accel mode to control the pitch rate.

Once the ET is in the overhead window (either the mission specialist voices this to the CDR or the pitch attitude is ~ 125°) the DAP will be placed in discrete mode for the pitch axis. This will cause the pitch axis to go into an attitude hold. Some overshoot will occur, but the vehicle will slowly come back to the captured attitude. The CDR can adjust the attitude as necessary for the photos.

If no pitch rate is observed the crew is instructed to go to MPS DUMP complete. This may be an indication that there has been a DAP switch failure so the PULSE mode may not have been moded to properly. The photo maneuver can still be performed after the dump is complete by utilizing the discrete mode and pitching to attitude. The pitch up should be 2°/sec until ET is in the overhead window (pitch attitude ~100°). This is the way the maneuver was performed in the past prior to allowing the MPS dump to pitch the Orbiter up.

At MECO + 4:00 the MPS dump should complete. This is observed by watching the bodyflap lights extinguish on panel F4.

4.3.7.2 Feedline Fail

* If Feedline Fail:	*
* √MCC GO for +X and Pitch Mnvr	*
* At MECO + 6 min: (14:23 Nom)	*
* ET SEP – SEP	*
* At MM104 + 2 sec	*
* +X xlation for 11 sec	*
* At OMS 1 TIG: (16:05 Nom)	*
* Pitch up at 2°/sec until ET in O/H	*
* window (P~100°)	*
* Go to MPS DUMP complete	*

4.3.7.2.1 Cue

ET Separation Inhibit but rates within limits
MCC GO/N0-GO for +X and ET photo pitch maneuver.

4.3.7.2.2 Displays

ASCENT TRAJ 2
XXX 1 MNVR EXEC
where XXX = OMS or ATO
ADI

4.3.7.2.3 Crew Action

TRAJ If SEP INH:
ADI If Rates < .7,.7,.7:
Assume Feedline Fail

If Feedline Fail:

At MECO + 6 min:
C3 ET SEPARATION SEP pb - push

If GO for +X: then at MM104 + 2 sec - perform an 11 sec +X translation

If GO for ET photo pitch maneuver: then at OMS 1 TIG (ET SEP + 1:42) - pitch up at 2° /sec until ET in overhead window.

Go to MPS Dump complete step.

4.3.7.2.4 Discussion

These steps assume an OMS 1 burn was not required. If a feedline fail case has occurred the crew checks the MCC for a GO on the +X and ET photo pitch maneuver. At MECO + 6:00 the ET Separation pushbutton can be pushed to command an ET SEP. MECO +

6:00 allows enough time for residual propellant pressure in the orbiter and ET to vent to a level where the venting force is less than 1800 lbf from a stuck open valve. This delay minimizes the possibility of recontact after separation due to the impulse of escaping propellant from the ET. The transition to MM104 should occur automatically. Two seconds after the transition, the +X maneuver can be performed for 11 sec for the ET umbilical camera photographs (provided a GO was given from the MCC). If for some reason the crew had PRO'd to MM104 earlier (prior to working the Feedline Fail procedures in the Post OMS 1 section, than the +X and Photo Maneuver should be called off. The reason being that the MM104 cue was to be used as the cue that the automatic ET SEP sequence had completed and it was safe to begin the +X. But if the crew had already transitioned to MM104 then there isn't a true indication of when the ET SEP sequence is complete. Doing the +X too soon after ET SEP is undesirable as not enough clearance is established between the Orbiter and ET.

At the OMS 1 TIG (~16:05 MET) a manual pitch up at $2^\circ/\text{sec}$ can be performed until the ET is in the overhead window (provided a GO was given for the ET photo pitch maneuver). Note that the umbilical camera and overhead ET photos for the feedline fail case will provide about the same results as the older nominal +X/ET Photo procedures. Since the MPS dump should be finished prior to performing these steps the crew is directed to the MPS DUMP complete step.

4.3.7.3 Post Burn Status

1: GNC OMS 1 MNVR EXEC	2: GNC OMS 1 MNVR EXEC
3: BFS, GNC SYS SUMM 2	

C POST BURN STATUS

NOMINAL OMS 1 TIG TO MCC :

- * C ALPHA MANAGMENT (If reqd) *
- * If underspeed (ATO or AOA-S) OMS 1 *
- * and Post OMS 1 HP ≤ 75 nm: *
- * Maneuver to LVLH R000, P340, Y000 *
- * (maintain LVLH P = 0 ± 20) *
- * After 10 min: *
- * Maneuver to LVLH P = 340 *
- * After 10 min: *
- * Maneuver to Burn Attitude *

4.3.7.3.1 Cue

OMS 1 Complete and HP ≤ 75
AOS for burn status

4.3.7.3.2 Displays

PASS MNVR EXEC
BFS MNVR EXEC

4.3.7.3.3 Crew Action

Report OMS 1 TIG and any anomalies that occurred
If Alpha Management required:

- C3 DAP CONTROL - MAN
- Maneuver to LVLH R000, P340, Y000 (heads up, nose 20° below horizon)
- After 10 minutes (nose now 20° above horizon):
- Maneuver back to LVLH P340 (heads up, nose 20° below horizon)
- After 10 minutes (nose now 20° above horizon):
- Maneuver to burn attitude

4.3.7.3.4 Discussion

After the OMS 1 burn and the procedures on the OMS 1 burn card are completed, the crew notes the burn status. If it was initiated late and without comm, the actual ignition time should be passed to MCC when comm is re-established. This information is used by the FDO in the OMS 2 calculations. Note that comm should be available via TDRS-E during the OMS 1 burn.

Following a MECO underspeed condition, the orbiter trajectory could be low enough that drag effects of the upper atmosphere significantly affect the ability of the vehicle to remain in orbit. LVLH pitch = 0 reduces wetted surface area and minimizes drag. This procedure is not always necessary but should be performed when an off-nominal OMS 1 is performed and the post burn perigee is less than or equal to 75 nm. The procedure calls for a maneuver to pitch 340° (-20°) followed by orbiter drift for 10 minutes. After 10 minutes at 4°/min drift rate, the orbiter will be +20° in pitch. The crew again maneuvers to -20°. After 10 more minutes, the crew can then maneuver to the OMS 2 burn attitude.

4.3.7.4 HYD MPS/TVC ISOL closed/ Flight Control Power Off

R4 HYD MPS/TVC ISOL VLV (1,2,3: 5 sec interval) –
CL (hold each 5 sec) √tb – CL

B F7,F8 FLT CNTLR PWR (two) - OFF
C3 √DAP - AUTO

4.3.7.4.1 Cue

Post MPS dump

4.3.7.4.2 Displays

Switch positioning on;y

4.3.7.4.3 Crew Action

Close MPS/TVC isolation valves.

F7,F8 √FLT CNTLR PWR (two) - OFF

C3 √DAP CONTROL - AUTO

4.3.7.4.4 Discussion

The MPS/TVC isolation valves are closed in sequence to facilitate an inflight checkout of the main engine hydraulic switching valves^[AFPH4.3-41].

Both flight controller power switches are turned off to prevent inadvertent inputs to the RHC, thus downmoding the DAP to manual. This also prevents RCS jet firings or DAP downmode caused by hardware problems. Erroneous firing of the jets is not a serious problem, however, if the magnitude of the input is small. Following the ET photo maneuvering the DAP is returned to AUTO.

4.3.7.5 If AOA

<p>IF AOA</p> <p>If two Freon Loops ↓ or two H2O Loops ↓ :</p> <p> Go to SYS AOA</p> <p>Otherwise, go to <u>AOA</u></p>

4.3.7.5.1 Cue

AOA Required

4.3.7.5.2 Displays

DISP 079 SM SYS SUMM 2

4.3.7.5.3 Crew Action

Go to SYS AOA Checklist if two freon loops or two water loops are failed
 Go to Section 6 of the Ascent Checklist if AOA required for other reasons

4.3.7.5.4 Discussion

This block is included to assist the crew in the event of a late systems problem which requires immediate return to Earth. The systems AOA (SYS AOA) book provides detailed steps for the loss of two Freon or water loops since these failures require the most complicated procedures. For any other systems problem, such as a cabin leak, two APUs failed and a third failing, or loss of cryogenics, the crew is sent to the Ascent Checklist, section 6, AOA procedures. Note that this section was designed to handle low performance (MECO underspeed) AOA and does not address systems malfunctions (although nominal systems maintenance steps are duplicated for ease of use). In these cases, the MCC, Ascent Pocket (ASC PKT) Checklist, or Ascent/Entry Systems Procedures (AESP) may be consulted to supplement section 6, AOA.

4.3.7.6 Auxiliary Power Unit/Hydraulics Shutdown

- * If no comm and MPS dump complete: *
- * HYD MN PUMP PRESS (three) - *
- * LO (MA) *

P APU/HYD SHUTDOWN

R2	√APU AUTO SHUTDN (three)	- ENA
	BLR PWR (three)	- OFF
	N2 SPLY (three)	- OFF
	APU OPER (1,2,3; 5 sec interval)	- OFF (MA)
	FUEL TK VLV (three)	- CL
	√Shutdn (HYD PRESS < 200)	
	CNTLR PWR (three)	- OFF
	√HYD MN PUMP PRESS (three)	- NORM

4.3.7.6.1 Cue

Post MPS dump on MCC call

4.3.7.6.2 Displays

Switch positioning only

4.3.7.6.3 Crew Action

Perform APU/HYD SHUTDOWN

4.3.7.6.4 Discussion

Due to the limited amount of APU fuel onboard the orbiter, it is necessary to shut down the APUs as soon as they are no longer needed, after the completion of the MPS dump sequence. Prior to LOS, the MCC gives a “GO for APU shutdown”. This call is made only if all systems will support at least an ATO. The water spray boiler (WSB) is turned off to ensure that water, which could freeze on orbit, does not remain in the boiler assembly, and the WSB is secured by turning off the nitrogen supply.

At this point, there is no cooling for APU lube oil or hydraulic fluid. However, the next step shuts down all three APUs sequentially to support the inflight checkout of the elevon and rudder/speedbrake hydraulic switching valves. The APU RUN command is removed to shut off fuel flow at the gas generator valve module, and the fuel tank isolation valves are closed to secure the APUs. A master alarm (MA) is generated as the hydraulic pressures drop. If APUs are shut down and an AOA is subsequently required, an APU must be cooled down and restarted.

4.3.7.7 Check MCC for TAIL Only Control

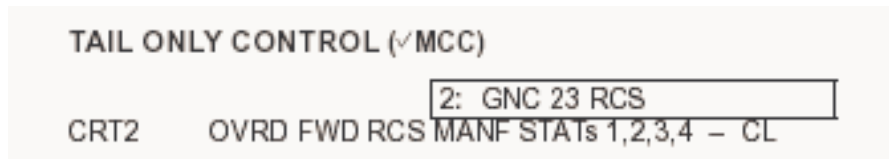

4.3.7.7.1 Cue

Check MCC if required

4.3.7.7.2 Displays

SPEC 23

4.3.7.7.3 Crew Action

Override FWD RCS manifolds to close

4.3.7.7.4 Discussion

Rendezvous missions require more forward RCS gas for attitude control. If Aft RCS propellant is sufficient, the MCC will make the call for TAIL Only control and the forward RCS manifolds will be overridden to closed to preserve the forward RCS^[AFPH4.3-42].

4.3.7.8 Flash Evaporator System and Heater Activation

FES & HEATER ACTIVATION

C	L1	FLASH EVAP CNTLR PRI A	- ON
	L2	FDLN HTR (two)	- 1
P	R1	O2 TK1,2 HTRS B (two) - AUTO	
		H2 TK1,2 HTRS B (two) - AUTO	
MS1	A12	APU HTR TK/FU LINE/H2O SYS 1A,2A,3A (three) - AUTO	

4.3.7.8.1 Cue

APU Shutdown Complete

4.3.7.8.2 Displays

Switch Positioning only

4.3.7.8.3 Crew Action

Perform FES and Heater activation (requires CDR, PLT, and MS1)

4.3.7.8.4 Discussion

The flash evaporator system (FES) is controlled by the BFS during the dynamic part of flight. However, the controller power needs to be turned on before the transition to OPS 2 where the BFS is then turned off. For AOA the FES is left in GPC.

Due to the constraints on powered flight electrical consumption, the tank heaters are left off during powered flight to prevent low voltage at the SRB interface. The heaters for the flash evaporator feedlines and cryo tanks need to be activated soon after powered flight to prevent damage to these systems. A set of cryo heaters is activated during powered flight but these heaters do not have sufficient capability to keep the cryo system from freezing long after powered flight, even though the cryo system is pressurized to ensure flow of reactants.

The APU heaters are activated to prevent hydrazine from freezing in fuel lines and components due to fuel no longer flowing.

4.3.7.9 AC Bus Sensor Configuration

AC BUS SNSR

R1 AC BUS SNSR (three) - OFF (1 sec),
then AUTO TRIP

4.3.7.9.1 Cue

FES & Heater Activation complete

4.3.7.9.2 Displays

Switch Positioning only

4.3.7.9.3 Crew Action

Turn AC Bus sensors off and then to AUTO TRIP

4.3.7.9.4 Discussion

The AC BUS SENSOR switches are in MONITOR for launch to prevent the loss of SSME power redundancy resulting from a bus being shut down by the AUTO system. However, once the SSMEs are no longer operating, the normal operating mode for this switch is AUTO TRIP.

4.3.7.10 Major Mode Change and OMS 2 Burn Setup

MAJOR MODE CHANGE

CRT1 GNC, OPS 105 PRO

1: GNC OMS 2 MNVR EXEC	2: GNC OMS 2 MNVR EXEC
3: BFS, GNC OMS 2 MNVR EXEC	

B OMS 2 BURN SETUP

√OMS 2 TARGETING, Flip Book

CRT1 TRIM LOAD - ITEM 6 +0.4 -5.7 +5.7 EXEC

- * For single eng burn (good eng): *
- * TRIM LOAD LY - ITEM 7 +5.2 EXEC *
- * RY - ITEM 8 -5.2 EXEC *
- * OMS L - ITEM 2 EXEC *
- * R - ITEM 3 EXEC *
- * For RCS burn: *
- * RCS SEL - ITEM 4 EXEC *

NOTE

Onboard computed TIG may vary slightly but is acceptable

√Targets, OMS TARGETS

LOAD - ITEM 22 EXEC
 TIMER - ITEM 23 EXEC

CRT3 √BFS TGT

4.3.7.10.1 Cue

MPS Dump, APU/HYD Shutdown, FES & Heater Activation, and AC Bus sensor actions complete

4.3.7.10.2 Displays

PASS MNVR EXEC
 BFS MNVR EXEC

4.3.7.10.3 Crew Action

PRO to Major Mode 105
 Select OMS 2 targets if required

Load OMS 2 targets and verify PASS and BFS solution

4.3.7.10.4 Discussion

After completion of the OMS 1 burn, the crew proceeds to MM 105 to prepare for the OMS 2 burn. Note that multiple OMS burns can be done in MM 104 but OMS 2 targets do not automatically appear until MM 105.

The OMS gimbals should be trimmed to the appropriate values before the OMS 2 burn. Prior to the OMS 1 burn, these trim values are set by I-loads. For subsequent burns, the setting at the completion of the previous burn is used unless manually changed. If the BFS is not engaged, the BFS trim is not updated through the OMS burn. The gimbals do not actually move to the trim angles until guidance becomes active 15 seconds before the burn begins. After the appropriate target and trims are entered, they are loaded. The solution is verified in both the PASS and BFS. The ΔV should be approximately equal to the value on the OMS TGTS card. If the loaded targets were provided by the MCC, 1 or 2 seconds difference may be observed between the ground and onboard computed TIG. This is because the ground software uses a slightly different method for computing TIG.

4.3.7.11 MPS Powerdown/Isolation and MPS GH2 Inerting

1: GNC OMS 2 MNVR EXEC | 2: GNC OMS 2 MNVR EXEC

3: BFS, GNC OMS 2 MNVR EXEC

P MPS PWRDN/ISOL

R2 MPS ENG PWR L (two) - OFF
 CTR (two) - OFF
 R (two) - OFF
 He ISOL (six) - GPC
 PNEU He ISOL - GPC
 $\sqrt{\text{He}}$ I'CNCT (three) - GPC

NOTE

Expect multiple MAs for MPS He P
 as regs bleed down

MPS GH2 INERTING

R4 MPS H2 PRESS LINE VENT - OP
 (Start watch)
 After 1 min:
 MPS H2 PRESS LINE VENT - GND

4.3.7.11.1 Cue

MM105 and OMS 2 Burn Setup Complete

4.3.7.11.2 Displays

Switch Positioning only

4.3.7.11.3 Crew Action

Perform MPS Powerdown/Isolation
 Perform MPS GH2 Inerting

4.3.7.11.4 Discussion

After completion of the MPS dump, the MPS power down/isolation and GH₂ inerting steps are performed by the PLT. The manual GH₂ inerting procedure vents residual GH₂ from the press line that was used to pressurize the ET LH₂ tank. The GPCs do not have the capability to control this valve.

At approximately MECO + 19 minutes the automated vacuum inert starts. The automatic vacuum inerting allows any traces of LO₂ and LH₂ left after the propellant dump to be vented into space. Both the LO₂ lines and the LH₂ lines are inerted simultaneously. The inerting is performed for two minute. During the inerting process, a pressure decay may

be noted in both the LO₂ and LH₂ manifolds on the BFS (GNC SYS SUMM 1 display). Vacuum inerting ensures that the MPS system does not become pressurized and rupture or outgas on orbit, contaminating sensitive experiments.

A final automatic vacuum inert is performed on the LH₂ manifold at the transition into MM106. This vacuum inert also lasts for two minutes. At the completion of this inert, the GPCs then pressurize the LH₂ manifold with helium for an inflight pressure decay check of the LH₂ manifold.

4.3.7.12 External Tank Umbilical Door Closure

1: GNC OMS 2 MNVR EXEC	2: GNC OMS 2 MNVR EXEC
3: BFS, GNC OMS 2 MNVR EXEC	

P ET UMBILICAL DOOR CLOSURE

* If Feedline fail - √MCC before closure *

WARNING
 ET CTRLINE LATCHES must be stowed prior to L,R DR closure to prevent door drive damage

NOTE

Double times for single motor operation

R2 ET UMB DR

MODE - GPC/MAN
 CTRLINE LAT - STO
 √After 6 sec, CTRLINE LAT tb - STO

* If CTRLINE LAT does not *
 * stow within 12 sec, *
 * CTRLINE LAT - GND *
 * √MCC *

CTRLINE LAT - GND
 L,R DR (two) - CL (tb-bp)
 √After 24 sec, L,R DR tb (two) - CL

* If doors do not close within 48 sec: *
 * L, R DR (two) - OFF *
 * √MCC *

L, R DR (two) - OFF
 LAT (two) - LAT (tb-bp)
 √After 6 sec, L,R LAT tb - LAT

* If doors do not latch within 12 sec: *
 * L, R LAT (two) - OFF *
 * √MCC *

L, R LAT (two) - OFF
 MODE - GPC

4.3.7.12.1 Cue

MPS GH2 Inerting Complete

4.3.7.12.2 Displays

Switch Positioning only

4.3.7.12.3 Crew Action

Close and latch ET Doors

4.3.7.12.4 Discussion

In the MPS GH₂ INERTING procedure the MPS H₂ PRESS LINE VENT is opened to expel hydrogen in the line out through the umbilical door (opened for at least 1 minute). The ET umbilical doors should not be closed until this line has been closed to avoid trapping any hydrogen in the well.

The ET UMB DR MODE switch is placed in GPC/MAN to enable the manual switches and to provide power to the door motors. After the doors are closed and latched, the switch is returned to GPC to disable the power.

4.3.7.14 OMS 2 Burn Maneuver to Burn Attitude**OMS 2 BURN ATTITUDE MNVR**

- B F6,F8 √ADI ATT (two) - INRTL
 RATE (two) - 1
- C Mnvr to OMS 2 Burn Attitude

3: BFS, GNC SYS SUMM 2

4.3.7.14.1 Cue

OMS Burn Prep Complete

4.3.7.14.2 Displays

PASS MNVR EXEC
 BFS MNVR EXEC

4.3.7.14.3 Crew Action

F6,F8 √ADI ATTITUDE (two) - INRTL
 RATE (two) - LOW

MNVR	ITEM 27 EXEC
------	--------------

4.3.7.14.4 Discussion

Maneuvering to the burn attitude is generally done via the AUTO MNVR option (ITEM 27 EXEC on OMS 2 MNVR EXEC). The OMS MNVR display burn attitude is in inertial coordinates, so the ADI must be in INRTL to crosscheck the display attitude. After attaining the burn attitude, the ADI ATT REF button is depressed, redefining the current attitude as 0,0,0 on the REF ball.

If the orbiter attitude differs by more than 5° from the desired burn attitude at ignition, the OMS TVC corrects the attitude and completes the burn. It is not necessary to waste RCS propellant keeping the orbiter attitude exactly at the desired burn attitude prior to ignition, although a transient does cause higher propellant usage.

4.3.7.15 Seat Safing and Adjustment

B SEAT SAFING AND ADJUSTMENT

Adjust Back Angle

TIG-2> B Go to OMS 2/ORBIT BURN (Cue Card)

4.3.7.15.1 Cue

TIG - 2 minutes

4.3.7.15.2 Displays

N/A

4.3.7.15.3 Crew Action

Adjust seat back angle at crew's convenience

Go to OMS 2/ORBIT BURN Cue Card

4.3.7.15.4 Discussion

At a convenient time before the crew gets out of their seats, the panel jettison T handle is safed, and anti-motion sickness medication is taken. The crew is sent to the OMS 2/orbit burn cue card.

|

4.3.8 OMS 2 Burn Procedures

On a DI mission, the orbiter attains the mission HA post-MPS dump. On a SI mission, the orbiter attains mission HA after the OMS 1 maneuver. In both these cases, while HA is well above the atmosphere, HP is too low for the vehicle to remain in orbit. The nominal OMS 2 maneuver usually circularizes the orbit at the mission altitude. The nominal OMS 2 target altitude on a ground up rendezvous mission will vary significantly through the launch window, depending upon what is required for rendezvous phasing. For an ATO, the OMS 2 burn raises the HP to a safe height which allows the orbiter to stay in orbit while problems are being corrected. If severe problems have necessitated an AOA, the OMS 2 is a deorbit burn (see section 4.4).

As long as the HP is sufficient for the orbiter to remain in orbit for a few orbits, the cutoff conditions of a nominal or ATO OMS 2 burn are relatively unconstrained, in contrast to the tight REI, ΔV , and Y c.g. constraints of a deorbit burn. Of course, it is desirable to achieve the planned orbit but this is an issue of mission success rather than safety. Because the cutoff conditions of an OMS 2 burn are less constrained, a lot of the complicated burn completion procedures in the deorbit burn cue cards are unnecessary for OMS 2. In addition, no special propellant balancing procedures, such as the unbalanced propellant deorbit burn, are necessary for OMS 2, since a small c.g. offset poses no problem on orbit. Any offset can be corrected by crossfeeding on orbit or during the burn. Because of these simplifications, the OMS 2 burn card procedures are the same as the Orbit Procedures and, in general, are a subset of the deorbit burn card procedures. Only OMS 2/ORBIT OMS (figure 4.3.8-1) or OPS 1/RCS (see section 4.3.9) cards are used for OMS 2.

Note that the OMS burn monitor card is used during OMS 2 and is discussed in the Ascent/Orbit/Entry Pocket Flight Procedures Handbook. In contrast to the relative simplicity of the OMS 2 burn card, the OMS burn monitor card is more complex than the deorbit burn monitor card. This is because the ascent procedures are designed to preserve the capability of at least one more OMS burn (deorbit), whereas this is not a concern in the deorbit procedures.

The OMS 2 TARGETING card contains the information necessary to determine whether the OMS 2 burn should be nominal, ATO, or AOA. This decision to downmode is based either on excessive ΔV requirements after OMS 1 or on systems failures. The OMS 2/ORBIT OMS BURN card covers either the two engine or one engine burn. Most of the setup for the OMS 2 burn is completed before working this card.

4.3.8.2 OMS Engine Switch Configuration and Burn Enable

L,R OMS He PRESS/VAP ISOL A (two) - OP

. . . Wait 2 sec . . .

L,R OMS He PRESS/VAP ISOL B (two) - GPC (OP for SE burn)

		GPC	OP	CL
ORB BURN	A			
	B			

TIG-2 SEL OMS ENG(s) - ARM/PRESS (\sqrt{P} VLVs OP)

If P VLV CL: Aff OMS ENG - OFF

<u>WARNING</u>
Do not burn aff engine if:
OMS N2 TK P < 470 (564) (NONCRIT
He TK P < 640 BURN)
FU ENG IN P < 216(244)
OX ENG IN P < 151(244)



Δ VTOT: OMS XFEED RETURN (Planned Single Engine)

-:15 EXEC

If OMS ENG P_c MSG and non critical burn: Aff ENG - OFF

If Leaking OMS PROP, burn RCS +X TIG - 15 sec to

OMS IGN + 1 sec

:00 TIG; start watch ($\sqrt{P_c}$, Δ VTOT, ENG VLVs)

4.3.8.2.1 Cue

TIG - 2 minutes

4.3.8.2.2 Displays

PASS MNVR EXEC

BFS MNVR EXEC

BFS SYS SUMM 2

4.3.8.2.3 Crew Action

O8 L,R OMS He PRESS/VAP ISOL A (two) - OP

Wait 2 seconds and then

L,R OMS He PRESS/VAP ISOL B (two) - GPC (2 eng) or OP (SE)

C3 OMS ENG (two if 2 eng) - ARM/PRESS

SYS SUMM $\sqrt{N2}$ P VLV

If closed: C3 Aff OMS ENG - OFF

\sqrt{OMS} N2 TK P < 470

\sqrt{He} TK P < 640

\sqrt{FU} ENG IN P < 216

\sqrt{OXID} ENG IN P < 151

If limits violated: C3 Aff OMS ENG - OFF

	Note Δ VTOT and TIG
MNVR	EXEC
@TIG	Start watch
F7	$\sqrt{\Delta}$ OMS PRESS Pc
MNVR	$\sqrt{\Delta}$ VTOT decreasing (\approx 2 fps per second for two OMS)
BFS GNC SYS SUMM 2	$\sqrt{\Delta}$ ENG VLVs

4.3.8.2.4 Discussion

The OMS 2 MNVR EXEC display is used for target selection and burn configuration and appears automatically at transition to MM 105. Since the attitude for OMS burns is displayed in the inertial coordinate system on the MNVR display, the crew should mode the ADI to INRTL. When the correct attitude is reached, the error needles will be centered, and the ADI attitude and the commanded attitude on the MNVR display should match. The Attitude reference pb may be depressed to update the REF reference frame to the current attitude. If the vehicle is in burn attitude when the pb is depressed, then burn attitude is displayed as 0° , 0° , 0° on the ADI in the REF system.

The engine selection (both OMS, L OMS, or R OMS) is verified on the MNVR display. The crew should verify that the gimbal trims match the engine configuration. If the gimbal trims do not match (e.g. L OMS selected but with 2 engine trims), the ADI error needles will reflect an attitude error even when the vehicle is in the proper attitude.

The DAP is usually in the auto mode for maneuver to burn attitude. However, a manual maneuver is performed if a higher rate is needed to attain burn attitude on time, although the burn can generally be up to 2 minutes late (depending on TIG slip capability). The manual mode is entered by moving the stick out of detent and a higher rate commanded by taking the RHC to the hard stop. The manual mode remains in effect until the RHC is returned to detent and the C3 DAP AUTO pb is depressed. If a manual maneuver to attitude is used, the crew returns the DAP to AUTO prior to OMS ignition. Only manual mode is available in BFS. The flight controller power is turned ON in case manual takeover during the burn is necessary.

After the OMS has been inactive for a period of time, it is possible that small leaks in the system could lead to reduced pressure between the He PRESS valves (closed when the OMS is not in use) and the check valves. With the lines in this condition, there is a concern that if both the A and B valves open together, the resultant pressure surge will create a “water hammer” effect that could break the tank pressure relief valve. The procedures specify the opening of the A and B valves separately to prevent a pressure surge. If an OMS 1 burn was not required, the OMS engine switches will be off and are taken back to ARM/PRESS two minutes prior to TIG. This allows engine ignition and a 2 second N_2 purge upon cutoff. Several OMS related parameters are verified to ensure they are within limits. If any of them are out of limits, the affected engine should be taken to OFF.

The OMS 2/ORBIT BURNS card calls explicitly for a notation of $\Delta VTOT$ prior to ignition. One half of this value is used as the OMS crossfeed return cue if the burn is a planned single engine burn.

Fifteen seconds before TIG, a flashing EXEC appears on the OMS MNVR EXEC display signaling the crew to enable the burn by pressing the EXEC key. At ignition the crew confirms that the burn is proceeding nominally. The OMS Pc gauges read approximately 104%. The BFS GNC SYS SUMM 2 display is examined for three things: the engine control valves (ENG VLV 1 and 2) read approximately 100%, which corresponds to fully open; He pressure decreases slowly as the propellant is expended; and the engine inlet pressures drops to approximately 200 psi during the burn. The OMS quantity gauge begins to function 15 seconds after ignition. Also, $\Delta VTOT$ should decrement nominally.

4.3.8.3 OMS Propellant Fail

```

* OMS PRPLT FAIL: *
* HP < 85 (CONTINUE BURN): *
* Failed OMS ENG - OFF *
*      √XFEED (two) - CL *
*      TK ISOL (two) - CL *
*      He PRESS (two) - CL *
* HP > 85 (STOP BURN): *
* OMS ENG (two) - OFF *
* √Failed OMS XFEED (two) - CL *
*      TK ISOL (two) - CL *
*      He PRESS (two) - CL *
* *

```

4.3.8.3.1 Cue

OMS PRPLT FAIL determined based on OMS 2 BURN MONITOR card (see Ascent/Orbit/Entry Pocket Checklist Handbook for OMS 2 BURN MONITOR rationale)

4.3.8.3.2 Displays

BFS SYS SUMM 2
 FAULT Messages
 PASS MNVR EXEC
 BFS MNVR EXEC

4.3.8.3.3 Crew Action

If below minimum HP:

Continue burn
 C3 Failed OMS ENG - OFF
 O8 √XFEED (two) - CL
 TK ISOL (two) - CL
 He PRESS/VAP ISOL (two) - CL

If above minimum HP:

Stop burn
 C3 OMS ENG (two) - OFF
 O8 √Failed OMS XFEED (two) - CL
 TK ISOL (two) - CL
 He PRESS/VAP ISOL (two) - CL

4.3.8.3.4 Discussion

The decision that a loss of engine Pc is a propellant failure rather than an engine failure is based on criteria specified on the OMS burn monitor card (ASC/ORB/ENT PKT C/L PROC handbook).

The uncertainty of the propellant status in this situation makes it prudent not to go higher than is absolutely necessary to achieve a stable orbit for a few orbits. This gives the crew time to analyze the propellant situation. It may be possible to raise the orbit and continue the mission. If this is impossible, then the orbiter can do a deorbit burn on orbit 3. If the thermal environment, as a result of propellant leakage, prohibits immediate use of the pod, then the safe orbit allows time for propellant sublimation and subsequent pod reuse when the thermal environment is acceptable. The MIN HP of 85 or 90 nm (inclination dependent) gives at least eight orbits retention time on orbit. Hence, the crucial observation after a propellant failure is whether the current HP is less than or greater than MIN HP. Current HP (CUR) is displayed in the upper right hand box on the OMS 2 MNVR EXEC display along with targeted HP (TGT) as shown below. The crew scans this data during a burn to keep aware of the present condition of the vehicle in the event of a critical systems failure requiring immediate action.

	HA	HP
TGT	XXX	XXX
CUR	XXX	XXX

With the switch actions indicated, the failed propellant system is isolated and secured. For a propellant failure, turning the OMS ENG switch to OFF is important. This closes the bipropellant valves and prevents a potentially harmful propellant mixture from entering the combustion chamber. It also modes guidance so that it recognizes the correct engine configuration.

When the burn is terminated early at MIN HP, guidance senses a large $\Delta VTOT$ remaining. Guidance assumes that the crew is going to do an RCS +X completion and reconfigures TGO and the ADI error needles accordingly. While in MM 105, the option remains open to retarget for another OMS burn, possibly with just one OMS engine. An OMS burn cannot be done in OPS 1 after a proceed (PRO) to MM 106, and it is not possible to return to MM 105 (illegal OPS transition). The nominal OMS 2 postburn procedures in the Ascent Checklist tell the crew to PRO to OPS 106 following the OMS/RCS postburn reconfiguration.

4.3.8.4 OMS Engine Fail

* OMS ENG FAIL:	*
* ASCENT or CRIT O/O (Continue Burn)	*
* Failed ENG - OFF	*
* OMS XFEED at → 1/2 Δ VTOT	*
* at FAIL	*

4.3.8.4.1 Cue

OMS ENG FAIL determined based on OMS 2 BURN MONITOR card (see Ascent/Orbit/Entry Pocket Checklist Handbook for OMS 2 BURN MONITOR rationale)

4.3.8.4.2 Displays

BFS SYS SUMM 2
 FAULT Messages
 PASS MNVR EXEC
 BFS MNVR EXEC

4.3.8.4.3 Crew Action

Continue Burn (if OMS 2 or orbit critical burn)

C3 Failed OMS ENG - OFF

MNVR $\sqrt{\Delta}$ VTOT at fail

OMS XFEED at 1/2 of Δ VTOT at FAIL

4.3.8.4.4 Discussion

If one engine fails (bipropellant valve closes), there is no change in the total OMS Δ V capability for the mission since all the propellant on the failed engine side can be burned through the good engine via crossfeed. Hence, if an engine fails, the crew continues the burn and switches the failed engine off. Switching off the failed OMS ENG signals guidance and flight control to downmode to a single engine burn.

When the crew is satisfied that the reconfiguration has been successfully accomplished, they begin crossfeeding OMS propellant from the failed side, at the proper delta V remaining, to keep the Y c.g. balanced. Crossfeeding during OMS 2 is not as critical as during a deorbit burn because c.g. balance on orbit is not as critical. However, it is best to keep propellant quantities on the two sides in rough balance during the mission so that a subsequent propellant failure does not deprive the orbiter of more than half its remaining propellant.

Δ VTOT is used as the cue to begin crossfeeding. During OMS 2, each 1% of OMS propellant corresponds to approximately 5.5 fps of delta V. To use the Δ VTOT cue the crew must note the Δ VTOT at the time of the failure. Equalization of propellant usage is accomplished by dividing the remaining Δ VTOT between the two propellant pods. Depressing the SPEC key on the CRT when an engine fails saves the OMS 2 MNVR

EXEC display so that the information is available to the crew as they need it. Similarly, freezing the BFS GNC SYS SUMM 2 display on CRT 3 allows the failed OMS engine switch to be positioned to OFF and still preserve the engine ball valve condition for failure diagnosis.

4.3.8.5 RCS Completion

- * **RCS COMPLETION:** (HP < 85 or CRIT O/O) *
- * Interconnect to either OMS that was ENG FAIL *
- * THC +X (HP = 85) *
- * Post burn, AFT RCS RECONFIG *

4.3.8.5.1 Cue

OMS 2 Burn residuals > 2 fps due to PRPLT or ENG failure(s)

4.3.8.5.2 Displays

PASS MNVR EXEC

BFS MNVR EXEC

4.3.8.5.3 Crew Action

Interconnect to either OMS that was ENG FAIL

THC +X until to minimum HP

Perform AFT RCS RECONFIG post-burn

4.3.8.5.4 Discussion

Since an HP below the minimum value (usually 85 or 90 nm) is not considered a safe orbit, the burn is completed with RCS if HP is less than the minimum value. The standard interconnect is used for an RCS completion of an OMS burn. The CDR completes the burn with +X via the THC. The completion of the interconnect by the PLT should be confirmed before the CDR deflects the THC. Otherwise, RCS propellant would be used instead of OMS propellant. The RCS is reconfigured to straight feed after the OMS 2 burn to support orbital attitude control.

4.3.8.6 Cutoff

[AFPH4.3-44]

CUTOFF		
+:02 OMS ENG(s) – OFF (if < 3 IMU, at <input type="text"/> : <input type="text"/>)		
Trim		
Residuals:	OMS 2	TAIL ONLY CNTL
	VGO X < 0.2 fps	VGO X < +0.2 fps
	VGO Y,Z < 2fps	All axes < 0.2 fps
		Orbit

4.3.8.6.1 Cue

OMS Pc → 0

TGO, $\Delta VTOT \approx 0$

4.3.8.6.2 Displays

PASS MNVR EXEC

BFS MNVR EXEC

OMS PRESS Pc

4.3.8.6.3 Crew Action

C3 OMS ENG (two) - OFF

For OMS 2,

THC to trim residuals as required per the table.

4.3.8.6.4 Discussion

After engine shutdown (CO) the N₂ purge valves open for 2 seconds to clear out the engine intake and regenerative cooling fuel lines, preventing fuel from freezing in the lines. The purge can only take place if the OMS ENG switch is in the ARM/PRESS position. Therefore, the crew waits 2 seconds after engine shutdown (Pc = 0 is the actual shutdown cue) to switch the OMS ENG to OFF. For cases with less than 3 IMU's the timer (TGO + 5 sec for 2 eng burns and TGO + 10 sec for 1 eng burns) should also be monitored to prevent an overburn due to IMU dilemma or bad guidance. Trim requirements are shown for the OMS 2/TAIL ONLY Control/ and Orbit OMS burns.

4.3.9.1 AFT RCS Burn**AFT RCS**

√RCS BURN CONFIG:
 OMS TK ISOL (all) - OP OMS TK
 L(R) OMS XFEED (two) - OP switch at
 R(L) OMS XFEED (two) - CL 1/2 ΔVTOT
 AFT L,R RCS XFEED (four) - OP (if reqd)
 TK ISOL (six) - CL

TIG -2 L,R OMS He PRESS/VAP ISOL A - OP
 . . . Wait 2 sec . . .
 L,R OMS He PRESS/VAP ISOL B - OP
 √MM105
 √CNTLR PWR (two) - ON
 √BURN ATT (INRTL) then REF, pb - push
 √RCS SEL
 :00 + X
 Maintain PITCH ATT ERR ± 3°
 Monitor OMS data
 Monitor ΔVTOT

CUTOFF Release THC
 CNTLR PWR (two) - OFF [AFPH4.3-45]

4.3.9.1.1 Cue

2 OMS Engines failed or 2 OMS Propellant failures

4.3.9.1.2 Displays

PASS MNVR EXEC
 BFS MNVR EXEC
 BFS SYS SUMM 2

4.3.9.1.3 Crew Action

Perform AFT RCS burn actions

4.3.9.1.4 Discussion

This burn is only performed if at least two ENG or PRPLT failures occur prior to OMS 2. For all failures except a dual OMS PRPLT FAIL, the OMS 1 burn will have been completed with the RCS interconnected to the remaining good OMS propellant system. This configuration is not changed between OMS 1 and OMS 2. However, the RCS OMS 2 burn card requires confirmation of the interconnect switch configuration. The crew selects RCS (ITEM 4 EXEC on the MNVR display) as part of the OMS 2 burn setup.

AUTO flight control is not supported for RCS burns. However, closed loop guidance is active and the ADI error needles indicate the proper orbiter attitude to achieve the desired cutoff velocity.

Nominally, only the pitch errors affect the in plane velocity component and this, in turn, affects the HP at cutoff. Yaw errors induce an out of plane component of the burn which has almost no effect on the resulting orbit. For this reason, pitch errors are more critical than yaw errors. However, any propellant burned out of plane is wasted, and this loss is undesirable in a performance critical situation. For instance, if a planned RCS burn is the result of a propellant failure, propellant efficiency is critical and out of plane fuel wasting is undesirable. Therefore, the crew restricts yaw attitude errors, as well as pitch, to less than $\pm 3^\circ$.

Since the OMS propellant system is being used, all propellant checks that the crew performs during an OMS engine burn are performed here as well.

There is no guided cutoff of an RCS burn. The burn is terminated by the CDR releasing the THC. Since the purpose of the OMS 2 RCS burn is merely to get into a stable orbit for a few revs, the crew uses the CUR HP = TGT HP as the cutoff cue. Depending on the ascent scenario, the burn may be terminated at or above MIN HP (85 or 90 nm depending on inclination). After cutoff, the PLT reconfigures ascent/entry RCS attitude control for AFT RCS propellant use, following the procedures in the interconnect, OMS XFEED card. The flight controller power is also powered off.

There is no gray failure section on this card. If a planned RCS OMS 2 is being done, there is not much else that can go wrong. The exception occurs if both OMS engines had failed and both propellant systems were good at the start of the burn and the OMS propellant system to which the RCS is interconnected subsequently failed. In this scenario the crew attempts switching to the other OMS propellant system. It is quite possible that the RCS +X jets will be damaged as a result of the propellant failure. However, this is the only action available.

4.3.9.2 FWD RCS Burn**FWD RCS****FRCS BURN PREP**

Load DUMMY target for FRCS

attitude

RCS SEL - ITEM 4 EXEC

TIG @ TTA = 2:00 or as reqd

 $\Delta VX = -2.1$ (ITEM 19) $\Delta VY = 0$ (ITEM 20) $\Delta VZ = +1.0$ (ITEM 21)

LOAD - ITEM 22 EXEC

LOAD - ITEM 23 EXEC

TIG-10 Auto Mnvr to ATT

When in attitude:

ADI ATT - REF (push)

Load External ΔV Burn Target $\Delta VX = +80$ $\Delta VY = 0$ $\Delta VZ = 0$

LOAD - ITEM 22 EXEC

TIMER - ITEM 23 EXEC

 $\sqrt{VGOX} = \text{negative}$ $\sqrt{VGOY} = 0$ $\sqrt{VGOZ} = +21 \pm 2$ $\sqrt{\text{REF ball}} = 0,0,0$ NOTE

Error needles invalid during burn

Burn time = $\sim 2 \times TGO$ TGT Hp = for ASCENT

-:30 CNTLR PWR (two) - ON
 DAP: INRTL/DISC

:00 -X

CUTOFF CUR HP = TGT HP , Release THC
 CNTLR PWR (two) - OFF

4.3.9.2.1 Cue

Forward RCS burn required

4.3.9.2.2 Displays

ADI

PASS MNVR EXEC

BFS MNVR EXEC

4.3.9.2.3 Crew Action

Perform FRCS Burn procedures if required

4.3.9.2.4 Discussion

A FWD RCS burn is an inertial burn and is always done in the external velocity (PEG 7) mode. To get to the proper attitude, a dummy target is loaded and puts the thrust vector in the desired direction. This dummy target must have a positive ΔVZ when performing this burn in a heads up attitude (negative value if heads down, i.e. pre-STS-87). An Item 27 Exec is used on the MNVR EXEC display to maneuver to attitude. After maneuvering to attitude, the REF pb is pushed to establish a 0,0,0 ADI. The desired PEG 7 targets are then loaded, and the burn is done at 0,0,0 on the ADI ball. Once the desired PEG 7 targets are loaded, the error needles are erroneous and should be ignored throughout the remainder of this procedure. At TIG - :30 flight controller power is taken to on and the DAP is moded to inertial. $_X$ THC is performed at TIG :00 until the cut-off cue is reached, this is generally a target HP read up to the crew (usually 85 nm).

4.3.10 Post OMS 2 Procedures

The OMS 2 burn is completed with either OMS + OMS, OMS + RCS, or RCS + RCS. After completion, the crew provides a post burn status if required, performs OMS TVC gimbal check, reconfigures the OMS/RCS systems, and modes the software to MM106. The Post OMS 2 burn procedures illustrated in the following sections use STS-76 as an example.

4.3.10.1 Post Burn Status

1: GNC OMS 2 MNVR EXEC	2: GNC OMS 2 MNVR EXEC
3: BFS, GNC SYS SUMM 2	

C POST BURN STATUS

NOMINAL

Δ TIG

	:		
--	---	--	--

B F7,F8 FLT CNTLR PWR (two) - OFF
C3 \surd DAP: AUTO

4.3.10.1.1 Cue

OMS 2 Complete

4.3.10.1.2 Displays

N/A

4.3.10.1.3 Crew Action

Report TIG slip and any anomalies that occurred during the burn

4.3.10.1.4 Discussion

After OMS 2 cutoff, the crew proceeds to the post OMS 2 procedures. At this time the crew notes any deviation from the planned OMS 2 TIG and passes it to the MCC. Flight controller power is turned off to avoid inadvertent downmodes to manual DAP by deflecting the RHC out of detent. The DAP control mode is verified as AUTO.

4.3.10.2 OMS Thrust Vector Control Gimbal Check

C OMS TVC GMBL CHECK

CRT1 SECONDARY CHECK

Perform SEC L,R then PRI L, R GMBL CK

4.3.10.2.1 Cue

OMS 2 Complete

4.3.10.2.2 Displays

PASS MNVR EXEC

BFS MNVR EXEC

4.3.10.2.3 Crew Action

Select secondary gimbals:

MNVR ITEM 30 EXEC
 ITEM 31 EXEC
 √asterisks by SEC

Initiate secondary gimbal check:

MNVR ITEM 34 EXEC
 √asterisk by GMBL CK
 √P and Y GMBL for movement

Secondary gimbal check finished:

MNVR √no asterisk by GMBL CK

Select primary gimbals:

MNVR ITEM 28 EXEC
 ITEM 29 EXEC
 √asterisks by PRI

Initiate primary gimbal check:

MNVR ITEM 34 EXEC
 √asterisk by GMBL CK
 √P and Y GMBL for movement

Primary gimbal check finished:

MNVR √no asterisk by GMBL CK

4.3.10.2.4 Discussion

The gimbal check prior to orbit burns is performed in OPS 1 because the data sample rate in OPS 1 is higher than in OPS 2. The post OMS 2 gimbal check is the only planned execution (nominally) of this procedure until just before the deorbit burn due to lube considerations.

The secondary gimbals are checked first so that the primary drives may be left in control for the burn without any further reconfiguration unless one of the primary gimbals fails the check.

The gimbal angle readout on the display is only sufficient to confirm that the gimbal check is in progress. Information from this readout is insufficient to confirm independently that the gimbals are working properly. The crew relies largely on automatic fault detection and MCC to identify problems. Malfunctions are annunciated by down arrows.

4.3.10.3 OMS/RCS Post OMS 2 Reconfiguration**P OMS/RCS POST BURN RECONFIG**

O7	AFT L,R RCS	
	He PRESS A (two)	- GPC (tb-OP)
	B (two)	- CL (tb-CL)
	TK ISOL (six)	- OP (tb-OP)
	MANF ISOL 1,2,3,4 (eight)	- OP (tb-OP)
	XFEED (four)	- CL (tb-CL)
O8	FWD RCS	
	He PRESS A	- GPC (tb-OP)
	B	- CL (tb-CL)
	TK ISOL (two)	- OP (tb-OP)
	MANF ISOL 1,2,3,4 (four)	- OP (tb-OP)
	L,R OMS	
	He PRESS/VAP ISOL (four)	- CL
	TK ISOL (four)	- OP (tb-OP)
	XFEED (four)	- CL (tb-CL)

4.3.10.3.1 Cue

OMS 2 complete

4.3.10.3.2 Displays

Switch Positioning only

4.3.10.3.3 Crew Action

Reconfigure OMS and RCS for orbit operations

4.3.10.3.4 Discussion

The PLT safes the OMS after the OMS 2 burn and configures the RCS for orbit use. The OMS He PRESS/VAPOR ISOL valves should be closed except during OMS burns to prevent loss of the high pressure He in the event of a leak in the propellant system and to prevent possible mixing of fuel and oxygen in the lines.

[AFPH4.3-46]

4.3.10.4 Major Mode Change

1: GNC OMS 2 MNVR EXEC	2: GNC OMS 2 MNVR EXEC
3: BFS, GNC SYS SUMM 2	

MAJOR MODE CHANGE

CRT1 GNC, OPS 106 PRO

1:GNC OMS 2 MNVR COAST	2: GNC OMS 2 MNVR COAST
------------------------	-------------------------

B C4A, Stow ASC PKT C/L (Helmet Bag)
 R3A Unstow ORBIT Cue Cards & ORB PKT C/L

- * If ATO, \sqrt{MCC} for procedure changes *
- * If Rev 3 deorbit reqd, go to CONT *
- * DEORB, LAUNCH DAY ORBIT 3 *

Go to POST INSERT, POST INSERTION

4.3.10.4.1 Cue

Post OMS 2 Procedures complete

4.3.10.4.2 Displays

Any PASS CRT (BFS CRT if BFS engage)

4.3.10.4.3 Crew Action

PASS CRT OPS 106 PRO

Stow Ascent Pocket Checklist and unstow Orbit Cue Cards and Orbit Pocket Checklist
 Go to Post Insertion or Contingency Deorbit Prep Checklist as required

4.3.10.4.4 Discussion

Once the rest of the post-OMS 2 procedures are complete, the software is moded to MM106 in preparation for the OPS 2 transition. The Ascent Checklist and Pocket Checklist is stowed and the Post Insertion Checklist, Orbit cue cards, and Orbit Pocket Checklist are unstowed. If a Rev 3 deorbit is required, the Contingency Deorbit Checklist is used instead of the Post Insertion Checklist.

[AFPH4.3-48]

4.4 AOA PROCEDURES

Immediately following MECO, unless an abort has been declared, the crew and MCC determine if an OMS 1 burn is required. Most missions are planned as Direct Insertion so that OMS 1 is nominally not required. If OMS 1 was planned or is required as the result of Direct Insertion MECO underspeed, the crew performs the OMS 1 burn procedures. If OMS 1 is not required, the crew proceeds directly to the post OMS 1 procedures. If an AOA is required for two failed Freon or water loops, the crew enters the systems AOA (SYS AOA) book. If an AOA is required for any other reason, they complete the post OMS 1 procedures prior to the AOA decision block and then switch to the AOA procedures.

4.4.1 Direct Insertion versus Standard Insertion

An important difference exists between the two burn (with OMS 1) AOA and the single burn (DI) AOA and is evidenced by the two separate AOA DEL PADs. The source of this difference is the unique shape and energy of each initial (post-MECO) orbit. For this reason Direct Insertion DEL PAD cues are based on ΔV , whereas with OMS 1, DEL PAD cues are based on HP.

Prior to a nominal end of mission (NEOM) deorbit burn (fig. 4.4.1-1), the orbit is approximately circular and current HP is greater than target HP. The deorbit burn is mostly retrograde. If an underburn occurs, orbital energy reduction is less than expected and the resulting perigee is higher than expected. If no correction is made, range to the runway at entry interface (REI) is shorter than expected. In this case prebank is used to steepen the pre-EI flightpath angle to achieve the expected altitude and range at EI.

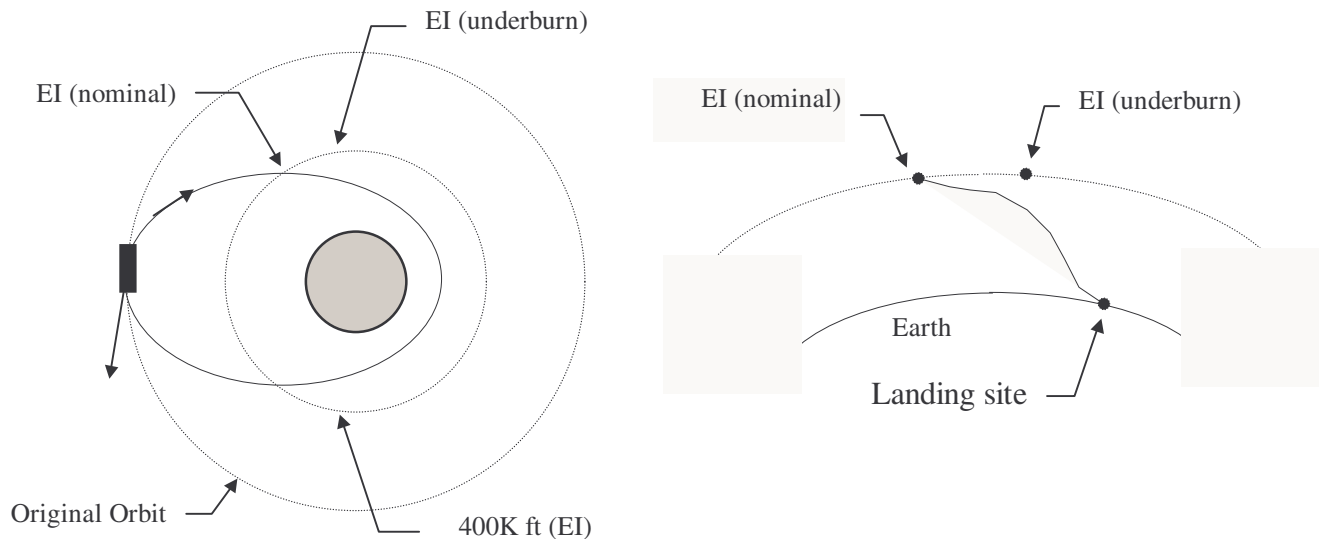

Figure 4.4.1-1: Nominal EOM Deorbit Burn

The typical Direct Insertion orbit, if left uncorrected, has a perigee altitude which is nearly equal to the desired HP for deorbit. However, it places EI too far away from the runway (figure 4.4.1-2). To move perigee, and therefore EI, closer to the runway, a radial burn upwards (away from the Earth) is performed to rotate the line of apsides. This does not subtract energy from the orbit as the retrograde burn does but shifts it with respect to the Earth's surface. Therefore, the Direct Insertion AOA DEL PAD cues are based on ΔV rather than altitude. If an underburn occurs, the perigee shift (closer to the runway) is less than expected and REI is greater than expected. Remember that prebank steepens the flightpath angle and achieves EI altitude sooner, increasing the range at EI. This is exactly the opposite effect desired for this Direct Insertion case. Prebank worsens the high range EI condition resulting from Direct Insertion AOA underburn.

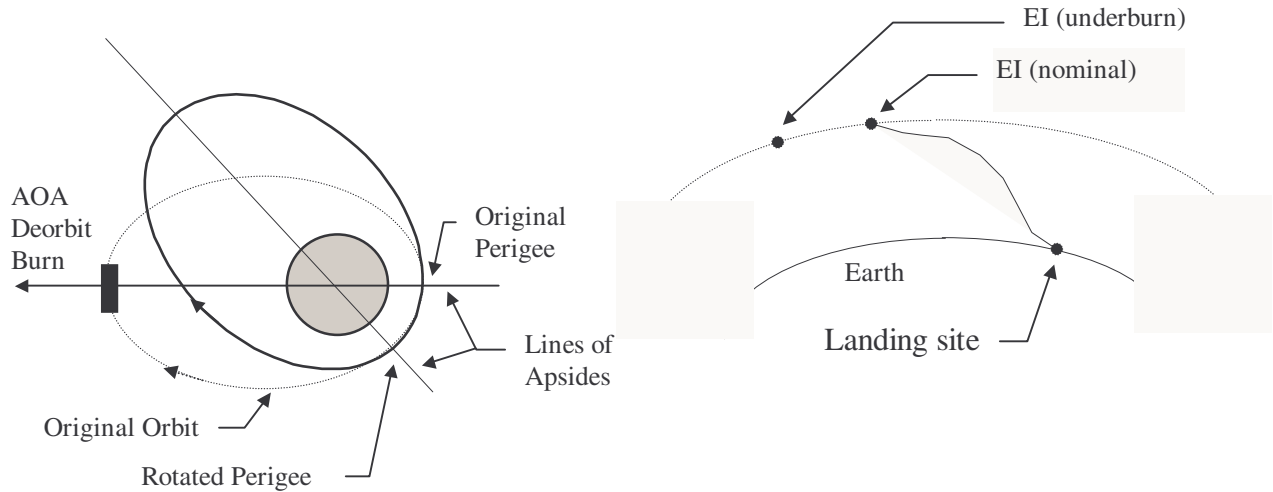

Figure 4.4.1-2: Direct Insertion AOA Deorbit Burn

An example Standard Insertion orbit is 80 by -4 nm after MECO and 80 by 160 nm after OMS 1 (figure 4.4.1-3). Since current HP is greater than target HP, the AOA deorbit burn is mostly retrograde, as in the EOM case. Again, an underburn results in less orbital energy reduction than expected and if no correction is made, EI is closer to the runway than expected. Prebank steepens the flightpath angle and increases the REI back to the expected value. For this reason, the WITH OMS 1 AOA DEL PAD cues are based on perigee altitude.

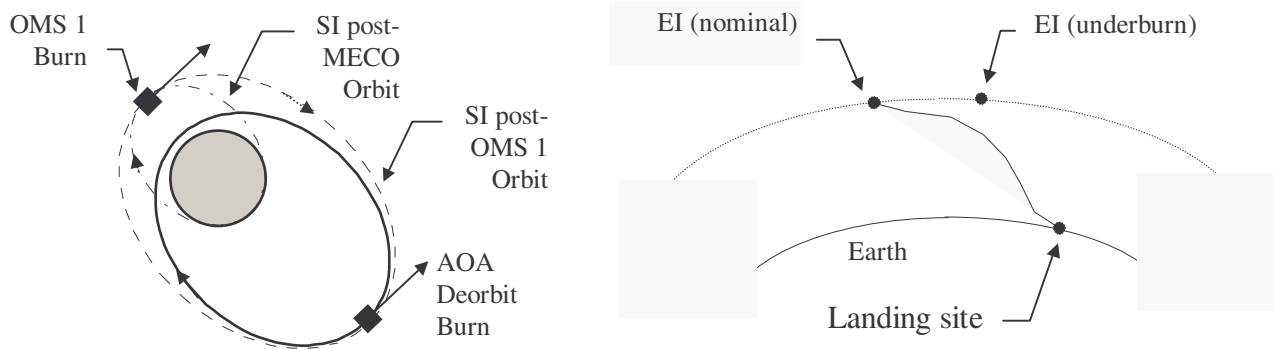

Figure 4.4.1-3: Standard Insertion AOA Deorbit Burn

4.4.2 AOA DELPAD

The DEL PAD provides a convenient format from which to read critical decision points and capabilities to the crew. The crew transfers these cues to their burn cards. The AOA deorbit, entry, and landing (DEL) preliminary advisory data (PAD) for direct insertion and with an OMS 1 burn are illustrated in figures 4.4.2-1 and -2, respectively[AFPH4.4-1].

DIRECT INSERTION AOA DEL PAD

<u>DEORBIT</u>									
PRPLT	()								
BURN CUE CARD:									
OMS ENG FAIL XFEED QTY CUE					%L	%		%R	
TOT AFT QTY 1 (%)					1		0		1
TOT AFT QTY 2 (%)					5		3		
FLIP ΔV					4		8		
AFT ΔV					1		9		
B/U SITE					N		/		A
FRCS: DUMP TO % (USE TIME AS CUE)					<input type="checkbox"/> OX		<input type="checkbox"/> FU		
<u>ENTRY / LANDING</u>									
EI - 5 MM303 INRTL ATT (6-30)			R		P		Y		
MM304 PREBANK (ENT MNVR Cue Card)									
ALTM SET (6-34)									
CLG INIT									
EXPECTED AIL TRIM					<input type="checkbox"/> L		<input type="checkbox"/> R		
VREL 1ST REVERSAL									
XCG AT TD									
LAND SITE		RWY		50K		/			
<input type="checkbox"/> L		<input type="checkbox"/> OVHD		deg		MLS		3BK	
<input type="checkbox"/> R		<input type="checkbox"/> STRT		TAC		2BK		/	
ΔT MACH < 1 TO HAC			MAX Nz		Nz LIMIT		20K		/
:			:		:		7K		/
ΔT HAC INIT TO H = 20K									
:			:		:		3K		/
AIMPOINT		SPEEDBRAKE		%		@ 3K		1K	
<input type="checkbox"/> NOM		<input type="checkbox"/> NOM		<input type="checkbox"/>		<input type="checkbox"/>		SURFACE	
<input type="checkbox"/> CLOSE-IN		<input type="checkbox"/> S.F.							
REMARKS:									

Figure 4.4.2-1: Direct Insertion AOA DEL PAD

listed for PRPLT for all shallow AOA deorbit targets, since shallow targets would only be used in a propellant critical situation and propellant wasting is neither required nor desired. For steep AOA deorbit targets, a + or - is listed indicating the correct sign of the PRPLT quantity. The magnitude is not included in the checklist since the amount of propellant remaining is unknown until post-MECO or post-OMS 1.

The burn cue card information includes total aft quantities 1 and 2, the flip ΔV or HP, aft ΔV or HP, and the backup site. Total aft quantities 1 and 2 are defined in Flight Rule A6-305. Total aft quantity 1 is the aft RCS quantity, in percent, of the left and right sides added together which guarantees sufficient RCS propellant at EI for a 3σ dispersed entry. Total aft quantity 2 is the aft RCS quantity, in percent, of the left and right sides added together which ensures sufficient RCS propellant to reach a dynamic pressure of 20 psf (protects aero capture). Both Total Aft Quantity 1 and 2 are already printed on the DELPAD since the required RCS quantities are known prelaunch.

For direct insertion AOAs, Flip ΔV and Aft ΔV are used instead of Flip HP and Aft HP. As described in section 4.4.1, a direct insertion AOA deorbit burn is mostly radial and moves perigee closer to the landing site. The height of perigee does not change significantly so that HP cues are not valid for RCS completion actions. The Flip ΔV cue is used to determine whether the deorbit burn completion will require both ARCS and FRCS. The Aft ΔV cue is used to determine when the deorbit burn can be completed without the use of the FRCS. Flip ΔV and Aft ΔV are already printed in the direct insertion AOA DEL PAD.

For an AOA where an OMS 1 was performed, HP cues are used instead of ΔV cues. Flip HP is the cue used to determine when deorbit burn completion will require FRCS, recovery prebank, and redesignation if available. It is computed by adding to the target HP, the ΔHP that can be made up using prebank (to primary site or backup site if available) and the ΔHP that can be made up using FRCS. The target HP is either provided by the MCC or read from the GNC DEORB MNVR EXEC CRT display. Four different ΔHP prebank values are listed in the DEL PAD. The value selected to compute Flip HP depends on whether a backup site is available (applies to AOA to EDW only) and whether steep or shallow targets are used. The ΔHP that can be made up using FRCS is already written in and is calculated as Flip $\Delta V/2$ (1 nm HP \approx 2 fps ΔV).

Aft HP is the cue used to determine when the deorbit burn can be completed using only ARCS jets. Below the Aft cue, the propellant which would have been used to perform the fast flip and maintain attitude during the FRCS translation can be committed to completing with the aft jets. Aft HP is computed by adding the ΔHP that can be made up using aft RCS to the target HP. The target HP is either provided by the MCC or read from the GNC DEORB MNVR EXEC CRT display. The ΔHP that can be made up using aft RCS is already written in and is calculated as Aft $\Delta V/2$ (1 nm HP \approx 2 fps ΔV).

Forward RCS dump information is also provided on the DELPAD. The FRCS quantity at dump stop and which gauges should be used (fuel or oxidizer) are included. The FRCS dump is almost always done to 0% post burn.

The EI-5 attitude is provided on the DELPAD and will be verified or loaded upon transition to MM303. This attitude may be entered using ITEMS 24 (Roll), 25 (Pitch), and 26 (Yaw) on the DEORB MNVR COAST CRT display. It is not necessary to enter the attitude if the deorbit targets were uplinked since the EI-5 attitude is part of the PEG4 Deorbit Target uplink. However, if the burn targets were selected or keyed in, the crew must enter the attitude via the ITEM Entries.

The magnitude and direction of the targeted prebank is included for use on the Entry Maneuvers Cue Card. This value will be 0° for steep targets or 90° for shallow targets.

DELPAD runway information includes the altimeter setting, closed-loop guidance initiation time, expected aileron trim, velocity of first roll reversal, runway, HAC turn direction (L or R), OVHD/STRT selection, HAC turn angle, max Nz, time from Mach < 1 to the HAC and time from HAC to 20k altitude, aimpoint (NOM or CLOSE IN), speedbrake (NOM or Shortfield), 3K speedbrake setting and the winds aloft and at the surface.

4.4.3 AOA Procedures

Preparing for AOA deorbit is a very high workload exercise for the crew. There are several steps that must be performed to prepare for deorbit. Once the Post OMS 1 procedures are complete and the AOA decision has been made, the AOA procedures are entered. The following paragraphs provide an illustration and description of these procedures.

4.4.3.1 Hydraulic Depress

1: GNC OMS 2 MNVR EXEC	2: GNC OMS 2 MNVR EXEC
------------------------	------------------------

3: BFS, GNC OMS 2 MNVR EXEC

P HYD DEPRESS

R4 √HYD MPS/TVC ISOL VLV (three) - CL

R2	√APU SPEED SEL (three)	- NORM
	√AUTO SHUTDN (three)	- ENA
	HYD MN PUMP PRESS (three)	- LO (MA)

4.4.3.1.1 Cue

AOA Declared

4.4.3.1.2 Displays

Switch Positioning only

4.4.3.1.3 Crew Action

Depress hydraulics

4.4.3.1.4 Discussion

If an AOA is declared, the APUs are left operating to preclude the need for a restart. Once the MPS dump has completed post-MECO, hydraulic pressure downstream of the MPS/TVC isolation valves is not needed until SSME repositioning is required. These isolation valves are, therefore, closed. Additionally, hydraulic pressure for aerosurface actuator control is not required until a QBAR of about 1.0. Therefore, the hydraulic main pumps are taken to low pressure. Closing the MPS/TVC isolation valves, and depressing the main pumps minimizes the demand on the APU/HYD systems, thereby conserving the available APU fuel and Water Spray Boiler water usage.

4.4.3.2 Flash Evaporator System and Heater Activation**FES & HEATER ACTIVATION**

C	L2	FLASH EVAP FDLN HTR (two) - 1
P	R1	O2 TK1,2 HTRS B (two) - AUTO H2 TK1,2 HTRS B (two) - AUTO
MS1	A12	APU HTR TK/FU LINE/H2O SYS 1A,2A,3A (three) - AUTO

4.4.3.2.1 Cue

Hydraulic Depress Complete

4.4.3.2.2 Displays

Switch Positioning only

4.4.3.2.3 Crew Action

Perform FES and Heater activation (requires CDR, PLT, and MS1)

4.4.3.2.4 Discussion

For AOA, the FES is left in GPC rather than turned ON as in the post OMS 1 procedures. The FES is left in GPC so that it will automatically disable itself when entering the atmosphere. Due to the constraints on powered flight electrical consumption, the tank heaters are left off during powered flight to prevent low voltage at the SRB interface. The heaters for the flash evaporator feedlines and cryo tanks need to be activated soon after powered flight to prevent damage to these systems. A set of cryo heaters is activated during powered flight but these heaters do not have sufficient capability to keep the cryo system from freezing long after powered flight, even though the cryo system is pressurized to ensure flow of reactants. Also, one set of APU fuel line heaters is activated to prevent fuel freezing and line rupture, which can occur shortly after MECO.

4.4.3.3 AC Bus Sensor Configuration

AC BUS SNSR

R1 AC BUS SNSR (three) - OFF (1 sec),
then AUTO TRIP

4.4.3.3.1 Cue

FES & Heater Activation complete

4.4.3.3.2 Displays

Switch Positioning only

4.4.3.3.3 Crew Action

Turn AC Bus sensors off and then to AUTO TRIP

4.4.3.3.4 Discussion

The AC BUS SENSOR switches are in MONITOR for launch to prevent the loss of SSME power redundancy resulting from a bus being shut down by the AUTO system. However, once the SSMEs are no longer operating, the normal operating mode for this switch is AUTO TRIP.

4.4.3.4 Major Mode Change**MAJOR MODE CHANGE**

CRT1 GNC, OPS 105 PRO

Select any AOA I_TGT (3-12) to set AOA flag,
but do not LOAD until OPS 3

1: GNC OMS 2 MNVR EXEC	2: GNC OMS 2 MNVR EXEC
3: BFS, GNC OMS 2 MNVR EXEC	

NOTE

Manually entered tgt data will be carried
over to OPS 3 except: PASS, BFS ITEMS 5 and 18
(ILL ENTRY)

Transition to OPS 3 NLT TIG-10 min

C4F, Stow ASC PKT
R3A Stow ASCENT Cue Cards
R3F Unstow ENT PKT

F6,F8 Install AOA DEORBIT BURN and DEORBIT
BURN MONITOR Cue Cards (R3A)

4.4.3.4.1 Cue

Hydraulic Depress, FES & Heater Activation, and AC Bus sensor actions complete

4.4.3.4.2 Displays

PASS MNVR EXEC
BFS MNVR EXEC

4.4.3.4.3 Crew Action

CRT1 OPS 105 PRO
MNVR ITEM 35 + # EXEC to select any AOA I_TGT

4.4.3.4.4 Discussion

After the computers are moded to MM105, it is important for the crew to select any AOA target set, numbered 3 through 12 (ITEM 35 + # EXEC) prior to the OPS 3 transition. This is the only method of selecting an AOA and setting the AOA flag in the software. When the AOA flag is set, the AOA navigation covariance matrix will be selected by the onboard software upon transition to OPS 3. The AOA covariance matrix accepts larger updates to NAV than the EOM covariance matrix to account for the longer time at lower altitude than EOM. If this step is omitted, the OPS 3 covariance matrix is automatically

selected by onboard software upon OPS 3 transition, and large NAV errors would result during entry. If a key-in target is required, the crew must first select any AOA target and then key in the correct target set. The desired deorbit burn targets are not loaded until OPS 3 for several reasons. First, Θ is defined differently in OPS 1 and 3. In OPS 1, it is the angle between the launch pad and the target point while in OPS 3, it is the angle between TIG and EI. Furthermore, ITEMS 5 (TV ROLL - not typically updated) and 18 (propellant quantity) cannot be changed until OPS 3. Note that TV Roll cannot be updated via item entry in OPS 3 but only with an uplink of a PEG 4 deorbit target. An attempt to enter TV ROLL or PRPLT in OPS 1 or TV ROLL in OPS 3 will result in an ILLEGAL ENTRY message. [AFPH4.4-2]

At this time, the crew stows the Ascent Pocket Checklist and Ascent Cue Cards and unstows the Entry Pocket Checklist. The Deorbit Burn and Deorbit Burn Monitor Cue Cards are installed.

4.4.3.5 APU Steam Vent Heater Activation

IF APUs ARE SHUTDN:

WARNING
Ice in WSB Steam Vent may
cause loss of APU/HYD

P W/B STEAM VENT HTR ACT

3: BFS, SM SYS SUMM 2

√APU OIL IN TEMP (three) < 230 degF
√OUT TEMP (three) < 230 degF

NOTE
If any temp > 230, wait until
temp < 230 in aff system

R2	√BLR CNTLR/HTR (three)	- A
	PWR (three)	- ON
	N2 SPLY (three)	- ON

[AFPH4.4-3]

4.4.3.5.1 Cue

APUs shutdown

4.4.3.5.2 Displays

BFS SM SYS SUMM 2

4.4.3.5.3 Crew Action

Perform APU steam vent heater activation

4.4.3.5.4 Discussion

If the APUs have been shut down prior to the decision to abort AOA, the APU steam vent heaters are activated. If the lube oil temperatures have not dropped below 230° F, turning the heaters on will be delayed until the temperature of the affected system drops below this value. If a steam vent heater is activated when temperatures are above 230° F on a non-operating system, the Water Spray Boiler (WSB) logic may command spraying, resulting in ice and subsequent loss of the WSB cooling.

4.4.3.6 MPS Isolation and MPS GH2 Inerting

1: GNC OMS 2 MNVR EXEC	2: GNC OMS 2 MNVR EXEC
3: BFS, GNC OMS 2 MNVR EXEC	

P MPS ISOL

R2 MPS He ISOL (six) - GPC
 PNEU He ISOL - GPC
 √He I'CNCT (three) - GPC

NOTE

Expect multiple MAs for MPS He P
as regs bleed down

MPS GH2 INERTING

R4 MPS H2 PRESS LINE VENT - OP
 (Start watch)
 After 1 min:
 MPS H2 PRESS LINE VENT - GND

4.4.3.6.1 Cue

MM105 and APU Steam Vent Heater Activation (if required) complete

4.4.3.6.2 Displays

Switch Positioning only

4.4.3.6.3 Crew Action

Perform MPS Isolation
Perform MPS GH2 Inerting

4.4.3.6.4 Discussion

See section 4.3.7.9.4 for a discussion of the MPS Isolation and MPS GH2 Inerting procedures. NOTE: MPS powerdown is not performed during an AOA, to allow SSME bleed valve operation during entry.

4.4.3.7 External Tank Umbilical Door Closure

1: GNC OMS 2 MNVR EXEC	2: GNC OMS 2 MNVR EXEC
3: BFS, GNC OMS 2 MNVR EXEC	

P ET UMBILICAL DOOR CLOSURE

* If Feedline fail, √MCC before closure *

WARNING
 ET CTRLINE LATCHES must be stowed prior to L,R DR closure to prevent door drive damage

* If ET Doors will not manually close and *

* latch, prior to OPS 3 transition: *

* 2: GNC 51 OVERRIDE *

* ET UMB DR CLOSE - ITEM 40(30)*

* EXEC *

NOTE

Double times for single motor operation

R2 ET UMB DR

MODE - GPC/MAN

CTRLINE LAT - STO

√After 6 sec, CTRLINE LAT tb - STO

* If CTRLINE LAT does not stow within 12 sec *

* CTRLINE LAT - GND *

* √MCC *

CTRLINE LAT - GND

L,R DR (two) - CL (tb-bp)

√After 24 sec, L,R DR tb (two) - CL

* If doors do not close within 48 sec: *

* L, R DR (two) - OFF *

* √MCC *

L, R DR (two) - OFF

LAT (two) - LAT (tb-bp)

√After 6 sec, L,R LAT tb - LAT

* If doors do not latch within 12 sec: *

* L, R LAT (two) - OFF *

* √MCC *

L, R LAT (two) - OFF
MODE - GPC

4.4.3.7.1 Cue

MPS GH₂ Inerting Complete

4.4.3.7.2 Displays

SPEC 51 OVERRIDE

4.4.3.7.3 Crew Action

Close and latch ET Doors

4.4.3.7.4 Discussion

In the MPS GH₂ INERTING procedure the MPS H₂ PRESS LINE VENT is opened to expel hydrogen in the line out through the umbilical door (opened for at least 1 minute). The ET umbilical doors should not be closed until this line has been closed to avoid trapping any hydrogen in the well.

The ET UMB DR MODE switch is placed in GPC/MAN to enable the manual switches and to provide power to the door motors. After the doors are closed and latched, the switch is returned to GPC to disable the power. SPEC 51 ITEM 40 is only available in OPS 1 to command the doors via ITEM entry as a work around for a switch failure. Therefore, door closure should be ensured prior to transitioning to OPS 3.

4.4.3.8 DPS Entry Configuration

1: GNC OMS 2 MNVR EXEC	2: GNC OMS 2 MNVR EXEC
3: BFS, GNC OMS 2 MNVR EXEC	

RECONFIG DPS FOR ENTRY

CAUTION

If recovering string(s) due to failed GPC(s), all FCS CH(s) to AUTO prior to OPS 301 PRO

CRT1 GNC OPS 301 PRO (√DAP)
 CRT3 BFS, GNC OPS 301 PRO

CRT1 GNC, OPS 302 PRO

1: GNC 50 HORIZ SIT	2: GNC DEORB MNVR EXEC
3: BFS, GNC DEORB MNVR EXEC	

√RWY Selection
 AOA RWY OPTIONS

ALL INCLINATIONS				
SITE	RWY	TACANS	ITEM 5	MLS
1	KSC 15	TTS 59Y	OMN 73	8
	KSC 33			6
42	NOR 17	SNG 121Y	HMN 92	6
	NOR 23			6
43	NOR 05	SNG 121Y	HMN 92	-
	NOR 35			-
44	EDW 15	EDW 111	LHS 21	-
	EDW 18L			-
45	EDW 22	EDW 111	LHS 21	8/†
	EDW 04			6

† MSBLS Jr. Channel 8 - Requires Uplink_[AFPH4.4-4]

4.4.3.8.1 Cue

ET Doors Closed and Latched

4.4.3.8.2 Displays

SPEC 50 Horizontal Sit
 BFS SPEC 50 Horizontal Sit

4.4.3.8.3 Crew Action

CRT1 OPS 301 PRO

CRT3 OPS 301 PRO

CRT1 OPS 302 PRO

G50 √Runway

4.4.3.8.4 Discussion

Once the ET Doors are closed, the crew reconfigures the DPS for entry. When the OPS 3 transition is initiated to PASS, all 4 GPCs will transfer the G3 software from upper memory down to lower memory (G3 archive). The BFS does not have G3 archive and the OPS 3 software is already resident in lower memory along with the OPS 1 software. The crew must enter OPS 301 PRO in order for the BFS to transfer to the G3 software and begin tracking PASS. Although PASS must be manually moded to OPS 302, the BFS does not. It will DK listen to the PASS and automatically PRO to OPS 302 on its own.

Once in OPS 3 the crew checks the runway selection. For low and mid inclinations, all three AOA sites are usually accessible with respect to entry crossranging limitations. Only Kennedy Space Center and Northrup are available for 51.6° inclination missions, while Northrup is the only AOA available site for 57° inclination missions.

4.4.3.9 OMS 2 Burn Setup

1: GNC 50 HORIZ SIT	2: GNC DEORB MNVR EXEC
3: BFS, GNC DEORB MNVR EXEC	

1: GNC DEORB MNVR EXEC

B OMS 2 BURN SETUP

CRT1 √Or enter Target (steep or shallow based on ΔV capability) from OMS TARGETS or MCC

TRIM LOAD - ITEM 6 + 0.4 - 5.7 + 5.7 EXEC

- * For single eng burn (good eng): *
- * TRIM LOAD LY - ITEM 7 + 5.2 EXEC *
- * RY - ITEM 8 - 5.2 EXEC *
- * OMS L - ITEM 2 EXEC *
- * R - ITEM 3 EXEC *
- * For RCS burn: *
- * RCS SEL - ITEM 4 EXEC *

NOTE

Onboard computed TIG and Θt may vary slightly and are acceptable if REI is correct

LOAD - ITEM 22 EXEC
 TIMER - ITEM 23 EXEC

CRT3 √BFS TGT

Fill in AOA DEORBIT BURN CARDS from AOA DEL PAD, 6-2 or 6-3

4.4.3.9.1 Cue

MM302

4.4.3.9.2 Displays

PASS GNC DEORB MNVR EXEC
 BFS GNC DEORB MNVR EXEC

4.4.3.9.3 Crew Action

Check or enter deorbit targets
 Verify trims, load targets, and start timer

Check PASS and BFS burn solutions
Fill in AOA DEORBIT BURN CARDS

4.4.3.9.4 Discussion

The deorbit targets are verified or entered if not previously selected in OPS 1. In a no comm situation the crew uses the OMS Targets card for the appropriate AOA site to determine the deorbit targets. The target is chosen based on the OMS 1 burn performed (if any) and ΔV capability for steep versus shallow targets. Two engine or single engine trims are verified or entered as appropriate. Note that the trims must match the engine configuration (OMS BOTH, L, or R), so that attitude errors are displayed properly on the ADI.

Once the deorbit targets and trims are verified or entered, the crew loads the targets via ITEM 22 EXEC and sets the timer via ITEM 23 EXEC. The crew then transfers the deorbit burn related DELPAD information to the Deorbit Burn Cards.

4.4.3.10 OMS Thrust Vector Control Gimbal Check

1: GNC DEORB MNVR EXEC

2: GNC DEORB MNVR EXEC

3: BFS, GNC DEORB MNVR EXEC

C OMS TVC GMBL CHECK

(Perform during S-band AOS)

CRT1 SECONDARY CHECK

Perform SEC L,R then PRI L,R GMBL CK

- * If down arrow(s) or M(s): *
- * Select good GMBL *

4.4.3.10.1 Cue

OMS 2 Burn Setup complete

4.4.3.10.2 Displays

PASS DEORB MNVR EXEC

BFS DEORB MNVR EXEC

4.4.3.10.3 Crew Action

Select secondary gimbals:

MNVR ITEM 30 EXEC
 ITEM 31 EXEC
 ✓asterisks by SEC

Initiate secondary gimbal check:

MNVR ITEM 34 EXEC
 ✓asterisk by GMBL CK
 ✓P and Y GMBL for movement

Secondary gimbal check finished:

MNVR ✓no asterisk by GMBL CK

Select primary gimbals:

MNVR ITEM 28 EXEC
 ITEM 29 EXEC
 ✓asterisks by PRI

Initiate primary gimbal check:

MNVR ITEM 34 EXEC
 ✓asterisk by GMBL CK
 ✓P and Y GMBL for movement

Primary gimbal check finished:

MNVR ✓no asterisk by GMBL CK

4.4.3.10.4 Discussion

The secondary gimbals are checked first so that the primary drives may be left in control for the burn without any further reconfiguration unless one of the primary gimbals fails the check.

The gimbal angle readout on the display is only sufficient to confirm that the gimbal check is in progress. Information from this readout is insufficient to confirm independently that the gimbals are working properly. The crew relies largely on automatic fault detection and MCC to identify problems. Malfunctions are enunciated by down arrows.

4.4.3.11 Seat Adjustment and OMS Burn Prep

SEAT ADJUSTMENT

Adjust Back Angle

P OMS BURN PREP

- * For single eng burn/No PROP failures: *
- * XFEED failed eng PROP to good eng *

- O8 L,R OMS
- √He PRESS/VAP ISOL A (two) - GPC
 - B (two) - CL
 - √TK ISOL (four) - GPC (tb-OP)
 - √XFEED (four) - GPC (tb-CL)

RCS BURN PREP (I'CNCT OMS to RCS)

P O8 L,R OMS

- He PRESS/VAP ISOL (four) - CL
- TK ISOL (four) - OP (tb-OP)
- L OMS XFEED (two) - OP (tb-OP)
- R OMS XFEED (two) - CL (tb-CL)

O7 AFT L,R RCS

- XFEED (four) - OP (tb-OP)
- TK ISOL (six) - CL (tb-CL)

4.4.3.11.1 Cue

OMS TVC Gimbal Check Complete

4.4.3.11.2 Displays

Switch Positioning only

4.4.3.11.3 Crew Action

Configure OMS and RCS valves as required

4.4.3.11.4 Discussion

A reminder to crossfeed propellant from the failed engine to the good engine is provided for single engine burns.

For nominal OMS operations, the OMS TK ISOLs are open (tb-OP) and the XFEEDS are closed (tb-CL). Only the He PRESS/VAP ISOLs are reconfigured before and after a

burn. The preburn reconfiguration is not done until 2 minutes before the burn, and this configuration check is the same for either a two engine or a one engine OMS burn.

4.4.3.12 OMS Burn TIG Adjust

1: GNC DEORB MNVR EXEC	2: GNC DEORB MNVR EXEC
------------------------	------------------------

3: BFS, GNC DEORB MNVR EXEC

OMS BURN TIG ADJUST (if reqd)

CRTX LOAD - ITEM 22 EXEC
 TIMER - ITEM 23 EXEC

Determine Δ TIG (if REI - REF > 50)
 from OMS TARGETS

CRTX Enter new TIG

LOAD - ITEM 22 EXEC
 TIMER - ITEM 23 EXEC

Repeat until Δ RANGE < 50

CRT3 \sqrt BFS TGT

4.4.3.12.1 Cue

OMS Burn Prep complete

4.4.3.12.2 Displays

PASS DEORB MNVR EXEC
 BFS DEORB MNVR EXEC

4.4.3.12.3 Crew Action

MNVR	ITEM 22 EXEC
	ITEM 23 EXEC

Compute Δ REI:

$$\Delta\text{REI} = \text{MNVR REI} - \text{REF REI}$$

where REF REI from OMS TARGETS Card

IF Δ REI > 50:

determine Δ TIG from TIG ADJUST TIMELINE on OMS TGTS Card

4.4.3.12.4 Discussion

When the deorbit burn solution is displayed, the REI is checked against the expected REI on the OMS TGTS card. If they do not agree within 50 nm, TIG is adjusted per the targets card and a new solution computed until the numbers do agree. If the range is too long, time is added to the TIG. If the range is too short, time is subtracted from TIG. A 30 second change in TIG results in a change in REI of approximately 100 nm. This is done to make the onboard solution compatible with the ground solution.

4.4.3.13 Maneuver to Deorbit Burn Attitude**MNVR TO DEORBIT BURN ATTITUDE**

- B F6,F8 √ADI ATT (two) - INRTL
 √ERR (two) - 5
 √RATE (two) - 5
- C Mnvr to Deorbit Burn Attitude
 (√ADI ATT with CRT BURN ATT)

3: BFS, GNC SYS SUMM 2

TIG - 2 B R3A Go to AOA DEORBIT BURN (Cue Card)

4.4.3.13.1 Cue

OMS Burn Prep Complete

4.4.3.13.2 Displays

ADI
 PASS DEORB MNVR EXEC
 BFS DEORB MNVR EXEC

4.4.3.13.3 Crew Action

F6,F8 √ADI ATTITUDE (two) - INRTL
 RATE (two) - LOW

MNVR	ITEM 27 EXEC
------	--------------

4.4.3.13.4 Discussion

When the onboard solution is satisfactory, the crew begins the maneuver to burn attitude. Maneuvering to the burn attitude is generally done via the AUTO MNVR option (ITEM 27 EXEC on DEORB MNVR). The DEORB MNVR display burn attitude is in inertial coordinates, so the ADI must be in INRTL to crosscheck the display attitude. After attaining the burn attitude, the ADI ATT REF button is depressed, redefining the current attitude as 0,0,0 on the REF ball. If the orbiter attitude differs by more than 5° from the desired burn attitude at ignition, the OMS TVC corrects the attitude and completes the burn. It is not necessary to waste RCS propellant keeping the orbiter attitude exactly at the desired burn attitude prior to ignition, although a transient does cause slightly higher propellant usage.

The AOA procedures direct the crew to the AOA Deorbit Burn card at TIG - 2. Procedures for the deorbit burn itself are covered in the Entry Flight Procedures Handbook, JSC 11542. The only difference between AOA and EOM deorbit is that the AOA cards contain RCS completion steps for direct insertion using ΔV cues in addition to the typical RCS completion steps using HP cues when an OMS 1 burn was performed.

4.4.4 Post Deorbit Burn Procedures

See the Entry Flight Procedures Handbook for a discussion of the Deorbit Burn procedures. Once the deorbit burn is complete, the Vx and Vz residuals are trimmed with the THC if required to less than 2 fps for steep deorbit targets or 0.5 fps for shallow deorbit targets. The crew then proceeds to the post deorbit burn section of the Ascent Checklist.

4.4.4.1 DAP and OMS/RCS Post Burn Reconfiguration

1: GNC DEORB MNVR EXEC	2: GNC DEORB MNVR EXEC
3: BFS, GNC SYS SUMM 2	

B F7,F8 FLT CNTLR PWR (two) - OFF
 C3 √DAP: AUTO

P OMS/RCS POST BURN RECONFIG

IF I'CNCT
 Perform I'CNCT RETURN
 (ENT PKT, RCS)

O7 AFT L,R RCS
 √He PRESS (four) - OP (tb-OP)
 √TK ISOL (six) - GPC (tb-OP)
 MANF ISOL 1,2,3,4 (eight) - OP (tb-OP)
 √XFEED (four) - GPC (tb-CL)

O8 FWD RCS
 TK ISOL (two) - OP (tb-OP)
 L,R OMS
 He PRESS/VAP ISOL (four)- CL
 TK ISOL (four) - OP (tb-OP)

* If OMS PRPLT FAIL: *

* √Aff TK ISOL (two) - CL *

XFEED (four) - CL (tb-CL)

4.4.4.1.1 Cue

Deorbit burn complete and residuals trimmed (if required)

4.4.4.1.2 Displays

DAP Lights

4.4.4.1.3 Crew Action

F7,F8 FLT CNTLR POWER (two) - OFF

C3 √DAP CONTROL - AUTO

Perform OMS/RCS Reconfiguration

4.4.4.1.4 Discussion

Flight Controller power is taken off to avoid inadvertent downmodes to manual DAP. The OMS/RCS systems are reconfigured for the postburn flight phase. If an interconnect was performed, I'CNCT RETURN procedure in the Entry Pocket Checklist must be executed to break the interconnect in preparation for entry RCS usage.

4.4.4.2 Recovery Prebank Determination and Post Burn Status

Determine Prebank
 Determine Δ HP (CUR HP - TGT HP)

Use RECOVERY PREBANK TABLES
 Record Prebank on ENTRY MANEUVERS Cue Card

1: GNC DEORB MNVR EXEC	2: GNC DEORB MNVR EXEC
3: BFS, GNC SYS SUMM 2	

* **RECOVERY PREBANK TABLES (KSC)** *

* NOTE: APPLICABLE ONLY IF OMS 1 REQD *

* (ATO/AOA steep entries) **KSC** *

Δ HP	0	2	5	7	12	17	21	26	35
PREBANK	0	20	45	60	80	90	100	110	175

* (ATO/AOA shallow entries) **KSC** *

Δ HP	0	2	3	4	5	7	9	11	13
PREBANK	90	95	100	105	110	120	135	155	180

C POST BURN STATUS

NOMINAL

--

Δ TIG

	:		
--	---	--	--

4.4.4.2.1 Cue

OMS 1 Performed and post deorbit burn Δ HP > 2 nm for prebank AOS for Burn Status

4.4.4.2.2 Displays

PASS DEORB MNVR EXEC
 BFS DEORB MNVR EXEC

4.4.4.2.3 Crew Action

Determine prebank and enter in Entry Maneuvers Card
 Report Burn Status

4.4.4.2.4 Discussion

For an AOA with an OMS 1, deorbit underburns require a recovery prebank to dissipate excess energy as outlined by the recovery prebank tables in the Ascent Checklist. Recovery prebank and targeted prebank are two different uses of prebank. Recovery prebank is only used for AOA deorbit underburns where an OMS 1 burn was performed.

However, shallow AOA deorbits always employ a planned 90° prebank to reduce the risk of skipout, regardless whether an OMS 1 burn was performed or not. The prebank tables included for ATO/AOA steep and shallow entries are included in the checklist for the primary AOA site. The prebank value is copied into the Entry Maneuvers Cue Card.

The post burn status is given as required and includes whether the burn was nominal and the difference between the planned and actual TIG.

4.4.4.3 Major Mode 303 Transition

P CRT2 GNC, OPS 303 PRO

[AFPH4.4-5]

1: GNC DEORB MNVR COAST	2: GNC DEORB MNVR COAST
3: BFS, GNC SYS SUMM 2	

C CRT1 √Uplinked INRT EI-5 MM303 ATT with DEL PAD

- * If no Deorbit TGT uplink, enter INRTL EI-5 *
- * MM303 ATT from DEL PAD *
- * R - ITEM 24 + _____ *
- * P - ITEM 25 + _____ *
- * Y - ITEM 26 + _____ *

Mnvr to EI-5 ATT - ITEM 27 EXEC

- * If UNDERBURN or no DEL PAD, manually *
- * mnvr to LVLH R001, Y358, P per table *

[AFPH4.4-6]

TIME to EI (min)	LVLH PITCH (deg)
20	339
	343
	347
	351
	355
15	359
	3
	7
	11
	15
10	19
	23
	27
	31
	35
5	39

4.4.4.3.1 Cue

OMS/RCS Post Burn Reconfiguration complete

4.4.4.3.2 Displays

ADI
PASS DEORB MNVR COAST
BFS DEORB MNVR COAST

4.4.4.3.3. Crew Action

PASS CRT OPS 303 PRO
MNVR √ or enter EI - 5 attitude
ITEM 27 EXEC

4.4.4.3.4 Discussion

The crew transitions to OPS 303 and then loads the EI-5 attitude from the DEL PAD if the deorbit targets were not uplinked, and maneuvers to attitude (ITEM 27 EXEC). If these inertial attitude numbers are not available, the crew manually maneuvers to the LVLH attitude in the Ascent Checklist LVLH pitch versus time to EI table.

4.4.4.4 OMS Gimbal Powerdown

1: GNC DEORB MNVR COAST

2: GNC DEORB MNVR COAST

3: BFS, GNC SYS SUMM 2

C OMS GMBL PWRDN (PASS ONLY)

CRT1 Verify GMBL positions:

	L	R
P	+5.9	+5.9
Y	+6.4	-6.4

GMBL OFF - ITEM 32 EXEC
 - ITEM 33 EXEC

4.4.4.4.1 Cue

Maneuver to EI - 5 attitude initiated

4.4.4.4.2 Displays

PASS DEORB MNVR COAST
 BFS DEORB MNVR COAST

4.4.4.4.3 Crew Action

MNVR Verify gimbal positions
 Power gimbals off

4.4.4.4.4 Discussion

The OMS gimbal positions are checked and the gimbals powered down for entry. The engines are moved to the stow position automatically at the MM 302-303 transition to avoid possible damage due to aerodynamic heating/pressure during entry. The gimbals are turned off to preclude any position sensor failure from causing the engines to move out of the stow position.

4.4.4.5 Secondary Actuator Check

1: GNC 53 CONTROLS	2: BFS, GNC SYS SUMM 2
3: GNC DEORB MNVR COAST	

C SECONDARY ACTUATOR CHECK
(IF TIME PERMITS)

NOTE

If port does not bypass during check, bypass affected port after check:

SEC ACT BYPASS - ITEM 8 + X X EXEC

If affected port still does not bypass:

SEC ACT RESET - ITEM 9 + X X EXEC

- R2 1. HYD MN PUMP PRESS (one) - NORM
- CRT3 2. SURF DRIVE ON, ITEM 39 EXEC (*), wait at least 5 sec
- SPI $\sqrt{\text{SPI}}$: Stop drive test when elevon posns within +12° to -27°:
SURF DRIVE OFF, ITEM 40 EXEC (*)
- CRT1 3. $\sqrt{\text{POS STIM ENA}}$, ITEM 7 - (no *)
- C3 4. $\sqrt{\text{FCS CH 1,2,3,4}}$ - AUTO
- CRT1 5. SEC ACT CK, CH 1 - ITEM 1 EXEC (*)
CK START - ITEM 5 EXEC (*)
- 6. $\sqrt{\text{All CH 1 ports bypass '↓'}}$
STOP - ITEM 6 EXEC (*)
- C3 7. FCS CH 1 - ORIDE
- CRT1 $\sqrt{\text{All CH 1 ports reset no '↓'}}$
- C3 FCS CH 1 - AUTO
- 8. Repeat steps 5 thru 7 for CH 2,3,4
- R2 9. HYD MN PUMP PRESS (three) - LO

[AFPH4.4-7]

4.4.4.5.1 Cue

OMS Gimbal Powerdown complete

4.4.4.5.2 Displays

SPEC 53 CONTROLS

4.4.4.5.3 Crew Action

Perform secondary actuator check if time permits

4.4.4.5.4 Discussion

This procedure is only performed if the normal OPS 8 FCS Checkout was not completed on orbit which would be the case for an AOA. It is performed to ensure the automatic fault detection circuitry of the ASAs is functioning properly, and to ensure no ASAs have a failed-off command channel (or “null driver”). First, the ASAs are supplied with sufficient pressure to bypass ports by moding an APU to normal pressure. Step 2. Allows the speedbrake to open at least 10 degrees prior to performing the secondary actuator check to provide the speedbrake panels with sufficient clearance to avoid spurious contact and potential damage during this check. With the START ITEM entries, all aerosurface actuators are delivered a biased command to intentionally bypass all ASA ports on the corresponding channel. After confirming that all ports on this channel have properly isolated, the test is stopped, and the FCS channel is moded to Override, resetting (closing) all the failed-open isolation valves. This test is repeated for all four channels. If any port does not bypass automatically, the crew attempts a manual bypass via ITEM entry (the manual isolate command is not dependent on the ASA’s fault detection circuitry).

4.4.4.6 Forward RCS Dump

1: GNC 53 CONTROLS	2: BFS, GNC SYS SUMM 2
3: GNC DEORB MNVR COAST	
1: GNC 23 RCS	2: GNC DEORB MNVR COAST
3: BFS, GNC SYS SUMM 2	

P FRCS DUMP

[AFPH4.4-8]

Determine FRCS 'DUMP TO%' using lowest of
OX or FU qty (calculator or DEL PAD)

FOUR JET DUMP:

FRCS PRPLT TO BE DUMPED (%)

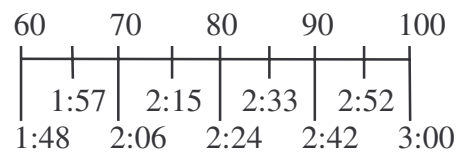
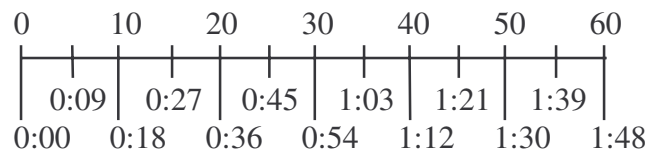

TIME FROM DUMP INITIATION (M:S)

NOTE

During dump, disregard FRCS qty

1: GNC 23 RCS	2: GNC DEORB MNVR COAST
3: BFS, GNC SYS SUMM 2	

TWO JET DUMP:

FRCS PRPLT TO BE DUMPED (%)

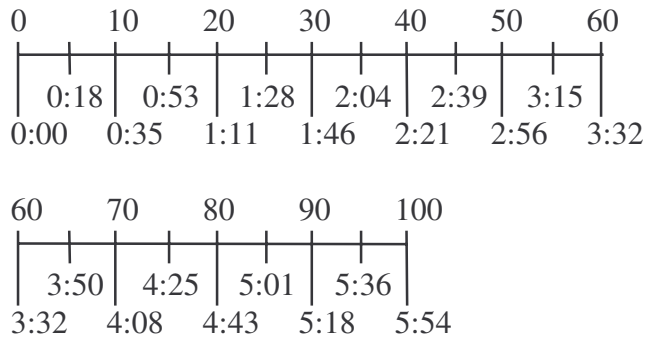

TIME FROM DUMP INITIATION (M:S)

NOTE

During dump, disregard FRCS qty

CRT2 FWD RCS ARM - ITEM 36 EXEC
 DUMP - ITEM 37 EXEC

(Start watch)

When dump time achieved:

FWD RCS OFF - ITEM 38 EXEC

4.4.4.6.1 Cue

Secondary Actuator check complete if performed, otherwise OMS gimbal powerdown complete

4.4.4.6.2 Displays

DEORB MNVR COAST

4.4.4.6.3 Crew Action

Determine time to dump based on four jet or two jet dump as appropriate

Arm and Start FRCS dump

Stop dump when dump time expired

4.4.4.6.4 Discussion

The amount of FWD RCS to be dumped is determined from the DEL PAD “Dump to %” quantity (usually 0%) and the current forward RCS quantity. The amount to be dumped is the current quantity less the DELPAD “Dump to %” quantity. The crew starts

the dump via ITEMS 36 and 37 on the MNVR display and stops the dump (ITEM 38 EXEC) at the appropriate time per the table in the checklist.

The four jet and two jet dump tables list the dump times associated with a desired dump quantity (percent) for four and two jet FRCS dumps.

The FRCS manifolds are left open for entry. If the FRCS manifolds are closed during entry, the propellant shrinks causing low manifold pressures. When these manifolds are opened post-landing, surge pressures could cause the RCS thruster valves to bounce, releasing toxic fumes and potentially injuring KSC convoy personnel.

[AFPH4.4-9]

4.4.4.7 Horizontal Situation Display Configuration

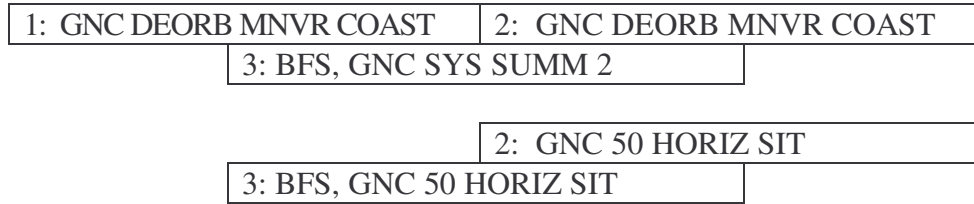

HORIZ SIT CONFIG

ALTM - ITEM 9 +

		.		
--	--	---	--	--

	<u>PASS ITEM</u>		<u>BFS ITEM</u>	
PTI	INH	√1		
LAND SITE (AOA DEL PAD)		√41		√41
RWY (AOA DEL PAD)		√3		√3
		√4		√4
TAC (per AOA RWY)		√5		√5
RA	blank	√46		
TAEM TGT				
G&N	OVHD	√6	blank	
HSI	blank		blank	
XEP	NEP	√7	NEP	√7
AIM (AOA DEL PAD)	NOM	√8	NOM	√8
		(or CLSE)		(or CLSE)
SPDBK	NOM	√39		
TAC	INH	√20	INH	√20
GPS	INH	√43	INH	√43
DRAG H	AUT	√22	AUT	√22
ADTA H	INH	√26	INH	√26
ADTA TO G&C	INH	√29	AUT	√28
TAC	DELTA	√35		
DES any failed TACANS		√		√
AIF_G	INH	√48		

[AFPH4.4-10]

* If BFS engaged: *

* Set HSD BFS ITEMS to PASS Config *

4.4.4.7.1 Cue

FRCS Isolation complete

4.4.4.7.2 Displays

PASS SPEC 50 Horizontal Situation Display

BFS SPEC 50 Horizontal Situation Display

4.4.4.7.3 Crew Action

Configure SPEC 50 in the PASS and BFS

4.4.4.7.4 Discussion

A final check of SPEC 50 (PASS and BFS) is made and the correct runway verified and loaded. Note in the checklist that the PASS and BFS configurations are listed. If BFS is engaged, it is configured as the PASS.

4.4.4.8 Entry Switch Check

1: GNC DEORB MNVR COAST	2: GNC 50 HORIZ SIT
3: BFS, GNC 50 HORIZ SIT	

ENTRY SW CHECK

- B F6,F8 Stow AOA DEORBIT BURN Cue Cards (R3A)
- R3A Install ENTRY Cue Cards

NOTE

If NAVAIDS 'OFF' due TO PKT C/L PWRDN, switch 'ON' per pwrdn procedure

- P O7 √TACAN MODE (three) - GPC
 - √ANT SEL (three) - AUTO
 - CH (three) -

111

 (EDW)
 - | |
|------|
| 059Y |
|------|

 (KSC)
 - | |
|------|
| 121Y |
|------|

 (NOR)
- O8 √RADAR ALTM (two) - ON
 - MLS (three) - ON (PASS)
 - √CH (three) - 8

EDW 22	KSC 15
--------	--------
 - 6

KSC 33	EDW 04
NOR 17	NOR 23
- I/O RESET
- C L2 √CAB RELIEF (two) - ENA (tb-ENA)
 - √ANTISKID - ON
 - √NWS - 1
 - √ENTRY MODE - AUTO

3: GNC 51 OVERRIDE

- B L2,C3 √ROLL MODE - AUTO
- B L2,C3 √SBTC (two) - full fwd
- C3 √SRB SEP - AUTO
- √ET SEP - AUTO
- F6,F8 √AIR DATA (two) - NAV
- √ADI ERR (two) - 5
- √RATE (two) - 5
- √HSI SEL MODE (two) - ENTRY
- C F6 √SOURCE (two) - NAV, 1
- P F8 √SOURCE (two) - NAV, 2
- B F3 √TRIM RHC/PNL (two) - INH
- √PNL (two) - ON
- F7,F8 √RADAR ALTM (two) - 1(C), 2(P)

4.4.4.8.1 Cue

Horiz Sit Config complete

4.4.4.8.2 Displays

Switch Positioning only

4.4.4.8.3 Crew Action

Verify switch configuration

4.4.4.8.4 Discussion

The AOA Deorbit Burn Cue Cards are stowed and the Entry cue cards installed. A final switch check is done which includes switches for NAVAIDs, flight control and dedicated displays.

4.4.4.9 APU Restart (If APUs shutdown)

1: GNC DEORB MNVR COAST	2: GNC 50 HORIZ SIT
3: BFS, GNC 51 OVERRIDE	

- * **If APUs shutdn:** *
- * Perform APU RESTART *
- * (ENT PKT, APU/HYD), then: *

4.4.4.9.1 Cue

Entry Switch Check complete

4.4.4.9.2 Displays

SM System Summary 2

4.4.4.9.3 Crew Action

R2 Perform APU Restart per Entry Pocket Checklist

4.4.4.9.4 Discussion

If the APUs have been shut down, a restart is required per the Entry Pocket Checklist.

4.4.4.10 Off nominal APU and FCS Channel Pre EI Configuration

PRE EI CHECKLIST

- * If only one APU running: *
- * Good HYD MN PUMP PRESS - LO *
- * Delay MM304 transition to EI-2 *
- * Just prior to transition: *
- * Good HYD MN PUMP PRESS - NORM *
- * APU SPEED SEL - HI *
- * *
- * If less than four PASS GPCs, config FCS *
- * CHs so that each GPC cmds equal number *
- * of CHs. See table on POST OPS 3/ *
- * GRTLs TRANSITION RESTRING (Cue *
- * card) *
- *

GNC 53 CONTROLS

 *
- * *
- * Config SURF FBK (See table on POST *
- * OPS 3/GRTLs TRANSITION RESTRING *
- * (Cue Card)) *

4.4.4.10.1 Cue

Only one APU running for APU actions
Less than four GPCs for FCS channel configuration

4.4.4.10.2 Displays

GNC 53 Controls

4.4.4.10.3 Crew Action

Perform off-nominal actions as required

4.4.4.10.4 Discussion

If only one APU is operating at the time of the pre-EI checklist, the MM304 transition will be delayed until EI-2. Full hydraulic pressure is required at the time of this transition, at which time the aerosurfaces become active. Therefore, delaying the transition helps to conserve APU fuel. The associated hydraulic main pump must be taken to normal pressure prior to the MM304 transition in order to support a large ramped command by the speedbrake software. If the main pump is in low press at that time, the speedbrake cannot respond. When full hydraulic pressure is later enabled, the speedbrake position error would result in a large step command and possible hydraulic line rupture.

If any PASS GPCs are failed, the restring cue card is consulted for the proper FCS channel configuration, to optimize for the next failure during entry. This card directs the crew to configure the FCS Channel switches such that no subsequent GPC failure (and the

resulting force fights) will cause good channels to bypass, which would result in a loss of control. The surface feedback selection status is configured to ensure all invalid (due to being unpowered) channel 1, 2, or 3 feedbacks are deselected. If channel 4 is turned off, its feedbacks are likewise invalid, but they are not deselected so that automatic detection of a subsequent single feedback fault is retained (any channel feedback deselection causes FDIR software to terminate).

4.4.4.11 Nominal EI - 5 Actions

~EI-5 CRT2 VENT DOOR CNTL CL - ITEM 44 EXEC

2: GNC 51 OVERRIDE

2: GNC DEORB MNVR COAST

3: BFS, GNC DEORB MNVR COAST

[AFPH4.4-11]

F7,F8 FLT CNTLR PWR (two) - ON

Go to ENTRY MANEUVERS Cue Card

4.4.4.11.1 Cue

~EI - 5 minutes

4.4.4.11.2 Displays

SPEC 51 Override

4.4.4.11.3 Crew Action

Close vent doors and go to Entry Maneuvers cue card

4.4.4.11.4 Discussion

The vent doors are closed at EI - 5 minutes. The crew is sent to the entry maneuvers cue card for the subsequent entry. A discussion of the entry can be found in the Entry Flight Procedures Handbook.

4.5 TAL PROCEDURES

4.5.1 TAL Procedures Card

Procedures discussed in this section are used in the event of a TAL. STS-114 cards are used as an illustrative example (figs. 4.5.1-1 and 4.5.1-2).

PILE		TAL CDR					
TAL HDG		If $V_1 > [23000]$ manual MECO $[23700]$, go to post MECO					
ZZA 010		ABORT TAL					
MRN 016		$[G50]$ $\sqrt{\text{SITE \& RWY (PASS/BFS)}}$, $\sqrt{\text{HDG}}$					
FMI 008		*LO XRNG					
SITE	RWY	TACANS	ITEM 5	MLS	LENGTH		
2	BEN 36/18	BEN 108	MAK 80 (DME)	8/-	13720/12720		
3	MRN 20/02	MRN 100	AOG 23	8/-	11730/11730		
4	ZZA 30L/12R	ZZA 84	ZZA 77 (DME)	8/-	12200/12200		
12	*BEN 36/18	BEN 108	MAK 80 (DME)	8/-	13720/12720		
13	*MRN 20/02	MRN 100	AOG 23	8/-	11730/11730		
14	*ZZA 30L/12R	ZZA 84	ZZA 77 (DME)	8/-	12200/12200		
19	YJT 09/27	YJT 78	YDF 80 (DME)	-/-	9500/9500		
20	YYT 29/11	UYT 23	YYT 82 (DME)	-/-	8500/8500		
21	YQX 21/31	YQX 74	IQX 32 (DME)	-/-	9700/8900		
23	LAJ 15/33	TRM 109	LAJ 45	-/-	10870/10870		
24	BEJ 01L/19R	MOJ 37	BEJ 105	-/-	10820/10820		
25	IKF 20/29	KEF 57/HL44	(DME)	-/-	9520/9560		
26	INN 06/24	SHA 80 (DME)	CRN 37 (DME)	-/-	9540/9540		
27	FFA 27/09	FFA 81	BZN 58	-/-	9490/9490		
28	KBO 14L/32R	GIX 18	DOR 23Y (DME)	-/-	12020/12020		
29	FMI 33/15	FMI 18	NIM53	8/-	11300/12300		
30	ESN 03R/21L	BAG 78 (DME)	BUK 90 (DME)	-/-	11800/11800		
31	KKI 15R/33L	RIY 92	KIA 80	-/-	13300/13300		
32	JDG 31/13	NKW 57	NKW 57	-/-	12000/12000		
$V_1 = [15.0K]$		* If second eng fails: $[TRAJ]$ $\sqrt{\text{SERC ON}}$				*	
		* $[G50]$ $\sqrt{\text{SITE}}$ ($\sqrt{\text{Redes card}}$) *				*	
		$\sqrt{\text{Roll Heads Up}}$					
----- MECO		$V_1 \sim 24.0K$ @ CO mark BFS		----- MECO			
MECO+20 s		$\sqrt{\text{ET SEP, AUTO-Z TRANS}}$					
MECO+37 s		$\sqrt{\text{MM104}}$					
		Abort TAL (if reqd):					
		$\sqrt{\text{TAL flag set: [G50] ITEM 41 = TAL SITE (any site)}}$					
		$\sqrt{\text{MECO } V_1 \text{ vs HI/LO Energy (TAL PLT)}}$					
		$\sqrt{\text{Rates } < .5^\circ/\text{sec; } \theta > 15^\circ, \gamma = 0 \pm 30^\circ}$					
		PASS, OPS 301 PRO ($\sqrt{304}$)					
		* No joy in 68 sec: BFS - ENGAGE *					
		* BFS, OPS 301 PRO *					
		----- MM304					
		BFS, OPS 301 PRO ($\sqrt{304}$)					
		$[G50]$ $\sqrt{\text{SITE, RWY, TACAN}}$					
		S/B & ALTM (PASS/BFS)					
		$[TRAJ]$ $\sqrt{\text{BUGS, [HSI] } \sqrt{\text{H}}}$ RANGE, $[AMI]$ $\sqrt{\alpha} = 43^\circ$					
		* Low energy: $[TRAJ]$ ITEM 3 (Lo Energy ENA) *					
		* If Variable/man 37: Pitch - CSS at $\alpha = 37^\circ$ *					
		* Pitch - Auto when $H = 0 \uparrow$ (2nd pullout) *					
$V = 10K$		$\sqrt{\text{SPDBK}} \rightarrow 81\%$					
$V = 7K$		Go to ENTRY MANEUVERS SURF WIND					
		(Cue Card) SPDBK @ 3000 FT					
		ALTM					
		AIM PT					
		SPDBK					

Figure 4.5.1-1: STS-114 TAL CDR Card

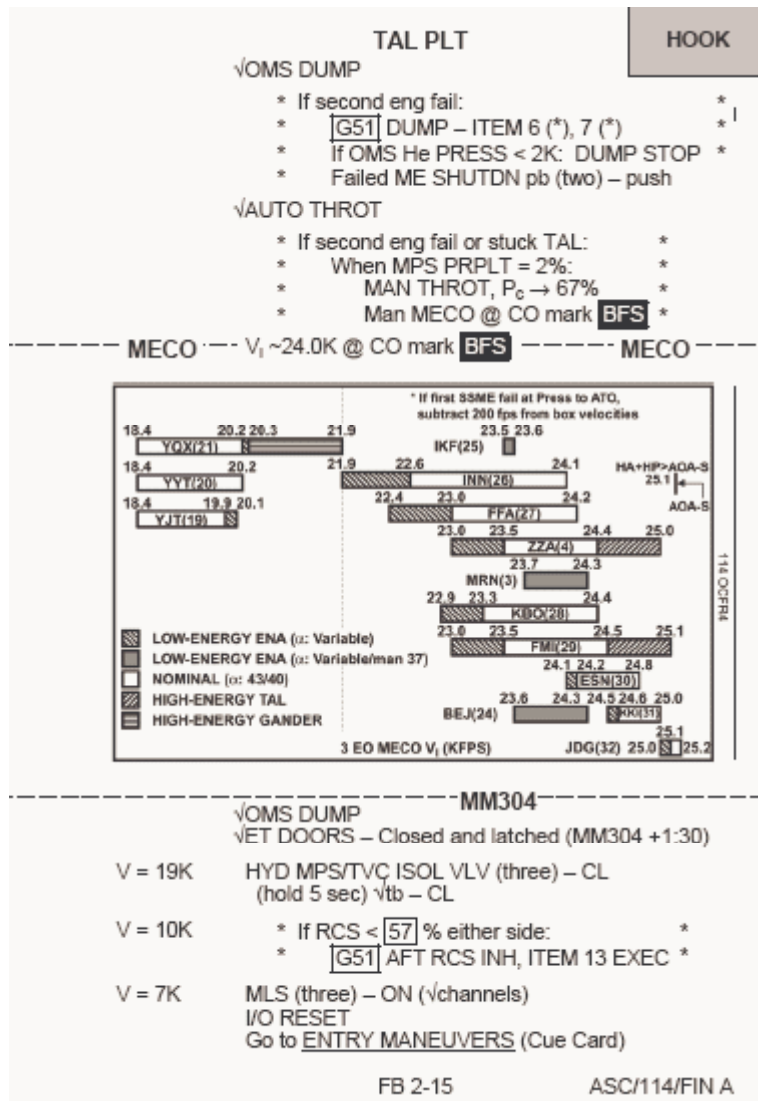

Figure 4.5.1-2: STS-114 TAL PLT Card

4.5.1.1 Abort Initiation

28.5 °, 39 °, and 51.6 ° Inclination Version:

If $V_I > \boxed{23000}$ manual MECO $\boxed{23700}$, go to Post MECO
ABORT TAL

57 ° Inclination Version:

ABORT TAL

4.5.1.1.1 Cue

TAL Required based on MCC or No Comm Mode Boundaries

4.5.1.1.2 Displays

AMI

SSME Status Lights

XXXXXX TRAJ

4.5.1.1.3 Crew Action

If manual MECO required,

C3 ME SHUTDN pb (three) - push
or

CRT OPS 104 PRO

Otherwise,

F6 Abort Mode - TAL
Abort pb - push
or

$\boxed{G51}$ ITEM 1 EXEC
ITEM 3 EXEC

TRAJ \sqrt{TAL}

4.5.1.1.4 Discussion

TAL is selected by placing the abort rotary switch in the TAL position and depressing the abort pb. A backup (ITEM entry) is available on SPEC 51 OVERRIDE display. Successful abort selection can be verified by the display changing from ASCENT TRAJ to TAL TRAJ. TAL selection replaces the nominal MECO targets with TAL targets by redefining the target IY plane with the crossrange circle latitude and longitude of the selected TAL site. Guidance begins steering for the tangency point of the crossrange circle of the selected site and an automatic OMS dump is initiated.

As the orbiter accelerates toward the nominal MECO targets, the point is eventually reached where if TAL abort were declared, AUTO guidance no longer has the steering authority (reaction time, that is) to achieve the TAL targets. This point is called the last AUTO TAL velocity and for 28.5°, 39°, and 51.6° missions is defined as 23,000 fps. If TAL is required past this velocity, the CDR manually MECOs at 23,700 fps per the Ascent Procedures cue card and is directed to the MECO (dashed) line on the TAL card. Note that for 57° inclination missions, there is no in-plane TAL site such that AOA has

priority over a manual MECO to a downrange in-plane ELS. Therefore, the manual MECO step is omitted.

4.5.1.2 Site and Contingency Yaw Steer Selection

28.5°, 39°, 51.6°, and 57° Inclination Version (LST excerpt varies with inclination, 51.6° shown):

[AFPH4.5-1]

TAL HDG		[G50] √SITE & RWY (PASS/BFS), √HDG				
TAL	HDG	SITE	RWY	TACANS	ITEM 5	MLS LENGTH
ZZA	010	2	BEN 36/18	BEN 108	MAK 80 (DME)	6/- 13720/12720
MRN	016	3	MRN 20/02	MRN 100	AOG 23	6/- 11730/11730
FMI	006	4	ZZA 30L/12R	ZZA 64	ZZA 77 (DME)	6/- 12200/12200
*LO XRNG		12	*BEN 36/18	BEN 108	MAK 80 (DME)	6/- 13720/12720
		13	*MRN 20/02	MRN 100	AOG 23	6/- 11730/11730
		14	*ZZA 30L/12R	ZZA 64	ZZA 77 (DME)	6/- 12200/12200
		19	YJT 09/27	YJT 78	YDF 80 (DME)	-/- 9500/9500
		20	YYT 29/11	UYT 23	YYT 82 (DME)	-/- 8500/8500
		21	YQX 21/31	YQX 74	IQX 32 (DME)	-/- 9700/8900
		23	LAJ 15/33	TRM 109	LAJ 45	-/- 10870/10870
		24	BEJ 01L/19R	MOJ 37	BEJ 105	-/- 10820/10820
		25	IKF 20/29	KEF 57/HL44	(DME)	-/- 9520/9560
		26	INN 06/24	SHA 80 (DME)	CRN 37 (DME)	-/- 9540/9540
		27	FFA 27/09	FFA 81	BZN 56	-/- 9490/9490
		28	KBO 14L/32R	GIX 18	DOR 23Y (DME)	-/- 12020/12020
		29	FMI 33/15	FMI 16	NIM53	6/- 11300/12300
		30	ESN 03R/21L	BAG 78 (DME)	BUK 90 (DME)	-/- 11800/11800
		31	KKI 15R/33L	RIY 92	KIA 80	-/- 13300/13300
		32	JDG 31/13	NKW 57	NKW 57	-/- 12000/12000

[AFPH4.5-2]

[AFPH4.5-3]

4.5.1.2.1 Cue

TAL Initiation

4.5.1.2.2 Displays

SPEC 50 Horizontal Situation Display

TAL TRAJ

HSI

4.5.1.2.3. Crew Action

[G50] √ITEM 41 or ITEM 41 + XX EXEC if site change required

√ITEM 3 for primary runway

ITEM 4 EXEC for secondary runway

HSI √HSI for proper TAL heading

4.5.1.2.4 Discussion

The CDR checks the selected TAL site. Note that some sites in the table are duplicated with asterisks denoting low crossrange (LO XRNG). Selection of these sites is requested by the MCC if it is determined that additional powered flight steering is required to achieve the desired landing site. LO XRNG targets in the onboard landing site table

contain I-loaded coordinates of crossrange circles smaller than their nominal counterparts. The low crossrange circle has a radius of approximately 375 nm for low inclination or 400 nm for mid or high inclination, compared to ~460 [AFPH4.5-4]nm for the nominal crossrange targets. This method is used because powered flight steering is more effective than gliding flight in reducing crossrange. If a low crossrange site is selected in powered flight, its nominal crossrange equivalent is subsequently selected in OPS 3 to restore the secondary runway and TACAN in that area. The TAL heading is also checked to ensure proper guidance targeting. The HSI's runway bearing pointer should line up with the proper heading defined in the TAL heading box for the selected TAL site.

Contingency yaw steering is enabled prelaunch for all mission inclinations. For low (28.45°) inclination missions, contingency yaw steering is enabled prior to lift-off as a precaution against a second main engine failure. If two engines fail (CA), yaw steering is enabled, and the orbiter velocity is between an I-loaded window (9,400 to 12,200 fps), the orbiter will yaw 45° to increase the likelihood of a Bermuda landing. For low inclination missions, TAL to BEN or MRN are the only cases where yawing toward Bermuda will possibly enable a landing at Bermuda. A low inclination TAL trajectory to Banjul, the Gambia, for instance, is too far south to reach Bermuda with any amount of yaw steering. Note that Banjul is no longer carried as an official TAL site, but should another site along the low inclination groundtrack be used in the future, Bermuda landing capability would not be achievable for TAL aborts to that inplane TAL site. If two engines fail on a low inclination mission with a TAL to a site along the low inclination groundtrack, it is still preferable to yaw towards Bermuda and try and get as close to a land as possible to assist search and rescue efforts[AFPH4.5-5].

For mid (39°) inclination missions, contingency yaw steering is enabled prior to lift-off because the 45° yaw maneuver always helps steer toward Bermuda in the event of a CA. If two engines fail (CA), yaw steering is enabled, and the orbiter velocity is between an I-loaded window (9,200 to 11,200 fps), the orbiter will yaw 45° to increase the likelihood of a Bermuda landing.

For high (51.6° or 57°) inclination missions, contingency yaw steering is also enabled prior to lift-off since the 45° yaw maneuver always helps steer toward the U.S. coastline for ECAL in the event of a CA. If two engines fail (CA), yaw steering is enabled, and the orbiter velocity is between an I-loaded window (4,500 to 23,000 fps[AFPH4.5-6]), the orbiter will yaw 45° to increase the likelihood of ECAL site landing. The lower velocity I-load is set such that the yaw steering will take place for almost all cases of 2 engines out in early second stage. Even if a landing site can not be achieved, the yaw enables the vehicle to get closer to the coast and helps out for search and rescue efforts.

4.5.1.3 OMS Dump and Auto Throttles

√OMS DUMP

√AUTO THROT

4.5.1.3.1 Cue

TAL Initiation

4.5.1.3.2 Displays

OMS PRESS Pc gauge
RCS/OMS PRPLT QTY
SPD BK/THROT pb

4.5.1.3.3 Crew Action

Monitor

F7 OMS PRESS Pc
O3 RCS/OMS PRPLT QTY
F4 √SPD BK/THROT pb - AUTO

4.5.1.3.4 Discussion

The PLT's nominal TAL duties consist of confirming that the TAL OMS dump started and that throttles are in AUTO. The TAL OMS dump terminates on a mission specific timer.

4.5.1.4 Second Engine Failure (CDR)

- * If second engine fails: TRAJ √SERC ON *
- * G50 √SITE (√Redes card) *

4.5.1.4.1 Cue

SSME Status Lights
 Fault Messages
 Acceleration
 SERC ON

4.5.1.4.2 Displays

TAL TRAJ
 SPEC 50 Horizontal Situation Display

4.5.1.4.3 Crew Action

TRAJ √SERC ON
G50 √ITEM 41 or ITEM 41 + XX per MCC or redes card if site change required

4.5.1.4.4 Discussion

The CDR is responsible for ensuring that single engine roll control (SERC) is on. SERC is required for all two engine out contingency aborts to maintain vehicle control. Enabling SERC is a time critical action after the second engine fails and is now automated in second stage. However, because of its criticality, it should be one of the first steps checked when a second engine failure is suspected.

The GPCs will enable SERC automatically if two engines out are recognized by guidance (NSSME = 1) or if the sensed acceleration falls below a predefined limit in second stage. Note that for two engine failures in first stage, SERC will not be enabled until SRB tailoff.

The crew can enable SERC via an ITEM 6 EXEC on the PASS TRAJ display anytime in MM102, 103 or 601. However, SERC is not used until SRB tailoff or in second stage (MM103, 601). Executing a single engine auto contingency abort via an ITEM 2 EXEC, ITEM 4 EXEC will also enable SERC. Once enabled by the crew, SERC can also be turned off by the crew via an ITEM 6 EXEC. However, if the GPCs enabled SERC by recognizing two engines failed (NSSME = 1), then turning off SERC cannot be done via the ITEM entry. Even if two or three engines are running, enabling SERC reduces main engine pitch and yaw gains to the SERC values and enables RCS jet control of roll.

The onboard TRAJ display will show an asterisk next to the ITEM 6 whenever a crew action has enabled SERC (ITEM 6 or 2,4). The SERC ON will be displayed whenever the ascent DAP is using SERC.

4.5.1.5 Second Engine Failure (PLT)

- * If second eng fail: *
- * G51 DUMP - ITEM 6(*), 7 (*) *
- * If OMS He PRESS < 2K: DUMP STOP *
- * Failed ME SHUTDN pb (two) - push *

- * If second eng fail or stuck TAL: *
- * When MPS PRPLT = 2%: *
- * MAN THROT, P_c → 67% *
- * Man Shutdn at C/O mark XXXXXXXXXX *

4.5.1.5.1 Cue

SSME Status Lights
 Fault Messages
 Acceleration
 SERC ON

4.5.1.5.2 Displays

TAL TRAJ
 SPEC 51
 OMS PRESS He/He TANK
 SPD BK/THROT pb
 MPS PRESS P_c

4.5.1.5.3 Crew Action

- G51 ITEM 6 EXEC
- ITEM 7 EXEC
- Monitor OMS He PRESS
- F7 √OMS PRESS He
- If < 2K:
- G51 ITEM 8 EXEC
- C3 ME SHUTDN pb (two) - push
- Monitor PRPLT
- TRAJ √PRPLT
- If < 2%:
- MAN THROT to 67%
- At BFS C/O mark, ME SHUTDN pb (three) - push

4.5.1.5.4 Discussion

If a second main engine fails, the PLT [AFP4.5-7]arms and starts the contingency OMS dump. The contingency OMS dump also terminates on a mission specific timer, and in addition, automatically enables OMS/RCS interconnect and enables RCS jet mirror RM logic. The mirror logic nulls the opposite firing jet if a jet is declared failed by RM to

maintain vehicle control. It also selectively turns off dumping jets to effect roll control during the dump. Contingency dump logic is honored if CA is declared while a TAL abort is in progress.

If OMS helium pressure drops below 2000 psi, the dump is manually terminated to prevent helium ingestion into the RCS jets. Helium ingestion will cause the jets to fail OFF without possibility of recovery. These jets are critical for control during entry. The main engine pushbuttons for the failed engines are depressed to ensure guidance notification of the engine out condition and to select single-engine gains for thrust vector control. Manual throttle to 67% is performed at 2% propellant remaining to protect NPSP violation, and manual MECO is performed at the BFS TRAJ display cutoff mark. If the expected underspeed is less than 250 fps, the MCC will inform the crew that the manual throttle/manual MECO steps are not required. However, the crew should always perform these steps when on a single engine unless the MCC directs them otherwise.

4.5.1.6 Roll Heads Up

28.5° Inclination Version:

$$V_I = \boxed{15.4K} \sqrt{\text{Roll Heads Up}}$$

39° Inclination Version:

$$V_I = \boxed{15.2K} \sqrt{\text{Roll Heads Up}}$$

51.6° Inclination Version:

$$V_I = \boxed{15.0K} \sqrt{\text{Roll Heads Up}}$$

57° Inclination Version:

$$V_I = \boxed{14.8K} \sqrt{\text{Roll Heads Up}}$$

4.5.1.6.1 Cue

Inertial Velocity

4.5.1.6.2 Displays

AMI

ADI

4.5.1.6.3 Crew Action

Monitor

4.5.1.6.4 Discussion

For STS-87 and subsequent flights, the roll to heads up I-loads are set such that a roll to heads up occurs during a nominal ascent at a *relative* velocity of 12.2K fps. Therefore, if TAL selection occurs after a *relative* velocity of 12.2K fps, the roll to heads up will already be commanded. If TAL is prior to *relative* velocity of 12.2K fps, the roll will not occur until the I-loaded value of 14,000 fps *relative* velocity. This value is converted to inertial velocity for use in the checklist since this is the cue available onboard (equates to 15.4K for low, 15.2K for mid, 15.0 for 51.6°, and 14.8K for 57° inclination missions). The roll maneuver is performed at 5°/sec and is accompanied by a pitch attitude change of 20° to 30° as the vehicle rolls about the X body axis, changing the thrust vector direction.

[AFPH4.5-8]

4.5.1.7 MECO and ET Separation

..... MECO ---V₁ ~ 24.0K @ CO mark [REDACTED] MECO.....
 MECO+20s √ET SEP, √AUTO -Z TRANS
 MECO+37s √MM104 [AFPH4.5-9]

4.5.1.7.1 Cue

MECO

4.5.1.7.2 Displays

TAL TRAJ

4.5.1.7.3 Crew Action

F7 MAIN ENGINE STATUS lights - √Red at MECO
 √Off at ET sep

TRAJ √MM104

4.5.1.7.4 Discussion

MECO coincides with the BFS TRAJ display cutoff bug at approximately 24,000 fps inertial velocity. The cutoff velocity scale for TAL is different from nominal uphill although the display background markings do not change. In addition to MECO altitude, range, and velocity, Hdot at MECO greatly impacts the resultant TAL energy. For instance, a zero or slightly positive Hdot and low altitude MECO conditions are more desirable than a large negative Hdot at the correct altitude.

At 20 seconds after MECO, the CDR checks to see that the external tank has separated and an automatic -Z translation maneuver has started. SEP INH can be caused by rates exceeding 0.7°/sec or a feedline disconnect valve failure. If the SEP INH message occurs, the crew checks the rates and damps them if necessary. The crew manually separates from the tank if the sequence has not resumed since the vehicle enters the atmosphere shortly and it is imperative to get the ET off before the dynamic pressure builds up. The tank will automatically separate 15 seconds after separation inhibit annunciation (for a feedline disconnect fail) on a TAL, to allow the crew to reconfigure the vehicle for entry. The SSMEs automatically move to stow shortly after MECO. A 17 second -Z translation of 11 fps is done automatically giving additional separation distance. This burn should not be interrupted, either with the RHC or THC, since guidance looks for the 11 fps delta V as a cue to mode to MM 104. If the -Z burn is interrupted, it can be manually continued to obtain 11 fps, or the GPCs can be manually moded to MM 104. It is always best to complete the translation rather than simply mode to MM 104, in order to maximize the distance between the tank and the orbiter.

4.5.1.8 OPS 3 Transition

Abort TAL (if reqd)

√ TAL flag set: **G50** ITEM 41 = TAL Site (any site)_

√ MECO Vi vs HI/LO Energy (TAL PLT)

√ Rates < .5°/sec; $\Theta > 15^\circ$, $Y = 0 \pm 30_{[AFPH4.5-10]}^\circ$

PASS, OPS 301 PRO (√304)

* No joy in 68 sec: BFS - ENGAGE *

* BFS, OPS 301 PRO *

4.5.1.8.1 Cue

Cue to Abort TAL post-MECO: no pre-MECO TAL abort performed

Cue to check TAL Onboard: SPEC 50 Item 41 = TAL site

Cue for HI/LO Energy: TAL PLT page (MECO VI and barchart)

Cue to perform OPS 3 Transition: MM104 and attitude/rates within limits

Cue to verify correct transition: MM304

4.5.1.8.2 Displays

ADI

CRT

SPEC 50

SPEC 51

4.5.1.8.3 Crew Action

If post-MECO TAL selection,

F6 ABORT MODE - TAL

ABORT pb - push

√SITE for high or low energy (see section 4.5.1.9)

√Check SPEC 50 for proper TAL site

√Attitude and rates within limits

√TAL barchart for energy (TAL PLT page)

PASS, OPS 301 PRO

√MM304

4.5.1.8.4 Discussion

If TAL selection did not occur pre-MECO, the CDR uses the abort rotary switch to abort TAL while the PLT determines whether high energy procedures or low energy guidance is required. Note that the abort rotary switch will set the TAL flag but the TRAJ display will not change to "TAL TRAJ". The crew can check SPEC 50 to see if the ITEM 41 label has changed to "TAL SITE". SPEC 51 Item 1, 3 is the back-up method of aborting TAL should the abort rotary switch fail. Asterisks on the SPEC 51 display would provide the crew with feedback that the abort has been selected.

Since the period after ET sep is critical, the CDR must verify that vehicle attitude and rates are within prescribed limits and then transition the PASS to OPS 3 all in about three minutes. If the vehicle is out of attitude, the CDR must take CSS to correct it. The only instrument available to check the attitude in MM 104 is the ADI. Although the procedure indicates the pitch attitude should be greater than $+15^\circ$, it's important that pitch attitude is nonzero. At this point in the trajectory, pitch attitude and angle of attack are nearly equal. A zero degree pitch attitude equates to about zero degrees angle of attack. If the OPS 3 transition is initiated with a small alpha, a large roll off or a 360° roll can occur. The roll rate can reach $10^\circ/\text{sec}$ and appear like a loss of control. If alpha is close to zero, the Entry Aerojet DAP has poor control and it can take an extra 45 seconds to get to the entry attitude. This results in a delay in the OMS dump which means the Orbiter can be up to 4000 ft closer to the ET when it ruptures. Analysis indicated a significant improvement in control if alpha is greater than 15° . Although an angle of attack of less than 15° is usually associated with a heads down MECO, it is still possible for a heads up MECO as well. Manual intervention is required to achieve a positive angle of attack to terminate the continuous roll. A different roll transient problem may also occur for a heads up MECO with large yaw angle even if angle of attack is nonzero. In this case, the yaw angle is zeroed upon transition to MM304 by rolling the vehicle. Once the yaw angle is nulled, the roll will be taken back out. This scenario does not require manual intervention since it will eventually achieve the wings level, zero yaw attitude. If an attitude correction is required, the RHC should be moved to the hard stop (ACCEL CMD) since the TRANS DAP only gives $.5^\circ/\text{sec}$ in the soft stop region. In OI-29 the flight software CR 92353 - Automated Alpha-Beta Management During Mated Coast and MM104, was implemented. This CR automated the maneuvering post-MECO to ensure a good attitude was achieved in a timely manner. The sooner a good attitude is achieved the sooner the transition to OPS 3 can occur and the sooner the OMS dump can begin. Initiating the OMS dump sooner decreases ET debris hit probability, allowing for a safer entry. So in most instances the vehicle will achieve a good OPS 3 attitude shortly after MM104 is achieved^[AFPH4.5-11]. Crew intervention should not be necessary unless additional off-nominal scenarios arise.

After checking the vehicle attitude, it is critical to mode the software to OPS 3. While in MM104, the TRANS DAP, which is not designed for atmospheric flight, is controlling the vehicle. Within about 3 minutes after ET sep, dynamic pressure will begin to build. If a significant underspeed occurred, there may be even less time before dynamic pressure builds. Once in OPS 3, the Entry DAP is controlling the vehicle. The Entry DAP has the capability of commanding more jets and unlike the TRANS DAP, can command the aerosurfaces. The Entry DAP will immediately begin moving the vehicle to alpha 43° for the first pullout. All noncritical problems should be ignored until the vehicle has the correct flight control. The proper runway selection should also be postponed until the OPS 3 transition has been made.

Once the OPS 301 PRO is performed, the software automatically cascades to MM 304. If this is not complete in 68 seconds, the BFS is engaged and transitioned to OPS 3. Normally, the OPS 3 transition is performed using G3 archive and will only take

approximately 7 seconds. The 68 seconds quoted in the procedure is the worse case time required if the mass memory units were used for the G3 transition instead of the G3 archive. A wait beyond this time indicates a software malfunction, and the backup flight system is engaged.

If the crew performs an OPS 301 PRO but the GPCs do not automatically proceed to OPS 304, this indicates that the TAL flag has not been set. If the TAL flag is not set, the TAL entry can still be flown but several events and procedures are affected:

- The crew must take CSS in pitch and fly $\alpha = 43^\circ$ during the first pullout
- The targeted landing site must be changed to the desired TAL site
- No automatic ET door closure
- The post-MECO OMS dump will not occur automatically
- The TAL MPS dump will not occur automatically
- The Mach 8 RCS dump will not occur automatically
- Shortfield speedbrake is not automatically selected on SPEC 50

[AFPH4.5-12]

4.5.1.9 TAL Capability Bar Chart

STS-114 Example Shown (actual capability is mission specific):

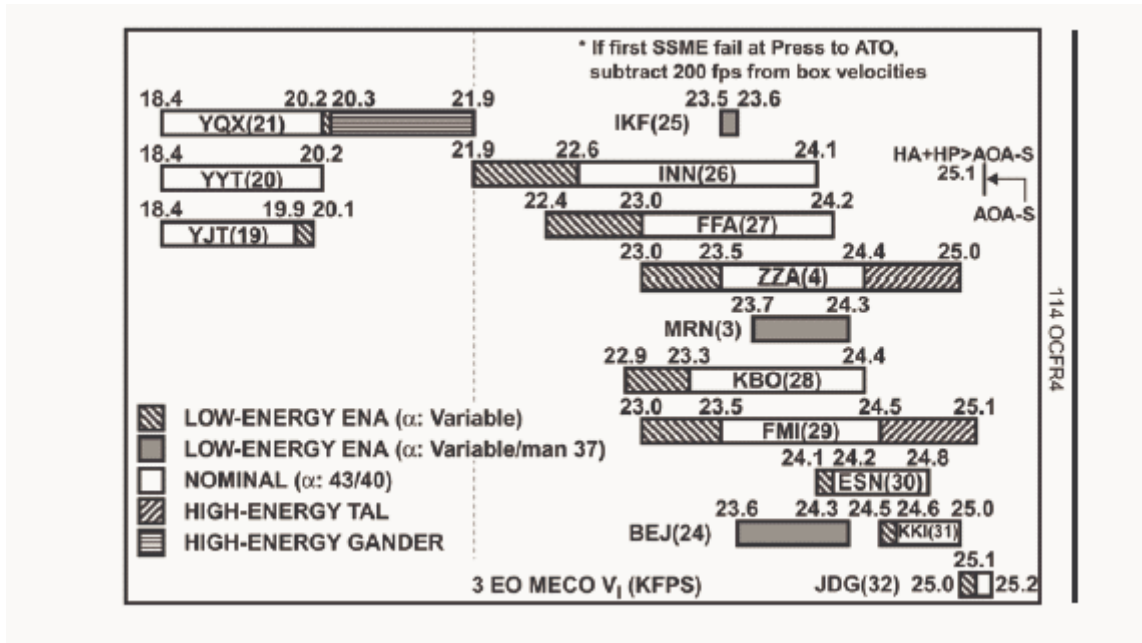

4.5.1.9.1 Cue

MECO

4.5.1.9.2 Displays

AMI

4.5.1.9.3 Crew Action

√MECO VI

√Bar Chart

4.5.1.9.4 Discussion

The TAL PLT card contains a bar chart which depicts ELS capability for early MECO. If the first engine fails at Press to ATO, a 200 fps adjustment is made to the boundaries since TAL capability is achieved earlier in that case. This 200 fps adjustment is applied to the downrange sites shown to the right of the dashed line running vertically down the bar chart. The 200 fps adjustment is not made to the Canadian sites. For both the TAL and the Canadian sites the vehicle will be further downrange for a given velocity for the early engine out cases (after PTA), this should give earlier capability to reach a site. However, for engines out soon after PTA the orbital plane will be frozen and this may impact the ability to get over to the Canadian sites. Even though some adjustment may be warranted for the Canadian sites, this value has not been quantified and thus no adjustment is made. Capability to these downrange sites is based on simultaneous three engine out and includes

vehicle heating constraints. Note that the earliest bar chart MECO velocity does not necessarily correspond with the three engine out TAL region on the contingency abort cue card. The CA cue card assumes three engine out simo but its VI boundary represented the earliest velocity where OPS 3 entry software does not result in structural failure without regard to landing capability. With the automation of three engine out contingency abort in OI-25, this single VI breakpoint was replaced with “3 E/O BLANK”, which refers to the 3 engine out color region text disappearing on the PASS TRAJ display. When the 3 engine out color region text disappears, an OPS 6 fast sep is no longer required. However, a runway landing may not always be achievable.

The five types of capability regions depicted on the bar chart represent the use of (1) nominal TAL entry guidance (no shading), (2) low energy guidance (left crosshatch), (3) low energy guidance with pitch CSS alpha 37° during the second pullout (gray shading), (4) manual high energy procedures (right crosshatch) and (4) high energy Gander procedures (horizontal bars).

Nominal TAL entry guidance flies 43° alpha during the first portion of entry and then ramps down to 40° once the first pullout is complete. Alpha 43° reduces wing leading edge temperatures under nominal energy conditions. Prior to STS-47, TAL entries flew the 40° alpha profile, inherited from EOM entry. It was then discovered that wing leading edge temperature violations commonly occurred with alpha 40° and that the best temperature protection is provided by alpha 43°. However, for low energy conditions, alpha is reduced based on MECO velocity, so some thermal protection is sacrificed to maximize ranging capability. In general, 1° of alpha during the pullout corresponds to approximately 30 nm of entry ranging capability.

Low energy guidance consists of two parts: phugoid logic which commands a contingency abort angle of attack profile, maximizing downrange capability and protecting for vehicle thermal concerns; and roll logic which satisfies crossrange requirements. Low energy guidance was updated in OI-30 with the Variable Low Alpha for Low Energy Logic CR (CR 92671A_[AFPH4.5-13]). The logic flies as low an angle of attack as thermally permissible, based on MECO velocity, through the first pullout. The lower velocities can fly an initial alpha as low as 38°, while MECO velocities above ~ 20,500 fps will fly the standard low energy alpha of 42°. In some instances at these higher velocities if the heading error is significant a 43° will be flown to protect for thermal. Following the initial pullout the angle of attack will be decreased as the altitude rate becomes more negative and the load factor and dynamic pressure are low. This is the portion of the phugoid which has lower temperatures, therefore it is permissible to pitch the nose lower and not exceed wing leading edge or vertical tail temperature limits. After the altitude rate bottoms out and starts back up towards 0 fps, the load factor, dynamic pressure, and temperatures are starting to build. In this region the vehicle is pitched back up. This protects the wing leading edge and vertical tail temperature limits. An internal range bias is also incorporated to account for additional range introduced by high crossrange. When the low energy condition is sufficiently improved, the low energy logic automatically

disengages and converges flight control to the nominal entry reference drag and angle of attack profiles.

In some higher velocity, high crossrange cases outside of the nominal footprint the low energy logic is used accompanied by a manual pitch action. This region is identified with: Variable/Man 37. Variable/Man 37 signifies that the Variable Low Alpha logic should be flown in AUTO for the first pullout. However, for the 2nd pullout the crew will go pitch CSS and attitude hold at $\alpha = 37^\circ$ as the vehicle starts to pitch down for low energy. Pitch control is returned to AUTO at the bottom of the second pullout when the altitude acceleration (H doubledot) goes positive. This is due to thermal concerns that were identified when the OI-30 TAL trajectories were run with a higher fidelity model (6-DOF STAMPS simulation). Certain cases showed that the OI-30 Variable Low Alpha CR didn't protect thermal limits for all regions and a manual technique is required for protection. These regions will generally be small and will occur at higher velocities ($> \approx 23.5K$ fps) when larger initial heading errors/crossranges are present. Note this procedure is not new, previous low energy boundaries also had regions of nominal range/high crossrange where it was believed thermal violations existed, the same technique of flying the 2nd pullout manually at 37° was used.

To avoid politically unstable sites, such as Hoedspruit, South Africa, Roberts Field, Liberia, or Kinshasa, Zaire, which frequently receive Notices to Airmen (NOTAMs) referencing political suitability, high energy procedures were developed to increase capability to the TAL or ACLS site. As such, some additional capability to the in-plane TAL or ACLS may be gained using alpha and roll to reduce energy while keeping the vehicle within thermal limits. This procedure is available on low, mid, and 51.6° inclination missions but not on 57° inclination missions due to excessive crossrange to the TAL/ACLS. Refer to Section 4.6 for High Energy TAL procedures.

In order to close the gap between an OPS 3 entry using nominal guidance to a Canadian site and an OPS 3 entry using low energy guidance to a site across the Atlantic, another set of procedures were developed. These procedures are the High Energy Gander procedures. These procedures involve flying a higher angle of attack and pulling more G's via the roll angle in order to kill off high energy and make a landing at Gander, Newfoundland. These procedures are discussed in section 4.6, and are only valid for 51.6° inclination missions^[AFPH4.5-14].

Flight Rule A2-52 Ascent Mode Priorities for Performance Cases states the site selection priorities which are based on site status (TAL vs ACLS vs ELS) and guidance capability when more than one site is available. Note that an ELS must satisfy Flight Rule A2-264 Emergency Landing Facility Criteria, which includes runway length/width, NAVAID availability, facility readiness, weather, and lighting constraints, to be considered as a potential landing site. The highest priority is given to a TAL site which can be reached using nominal TAL entry guidance. If no TAL site is within nominal TAL entry guidance capability, then an ACLS within nominal TAL entry guidance is preferred. Next, a TAL site using low energy guidance, low energy guidance with manual alpha 37° during the second pullout, or high energy procedures will be considered in that order. If a TAL site

cannot be reached using any of these options, an ACLS site using low energy guidance, low energy guidance with manual alpha 37° during the second pullout, or high energy procedures will be considered in that order. If neither a TAL nor an ACLS site can be reached, then an ELS site within nominal guidance, low energy guidance, or low energy guidance with manual alpha 37° capability will be considered. Since the TAL bar chart on the PLT's page does not indicate site selection priority, the MCC will provide the crew with a recommendation based on this flight rule when more than one site is available. Flight Rule A2-55 Entry Guidance Selection for Use of Low Energy discusses the various uses of nominal TAL guidance, Variable Low Alpha logic, and Variable Low Alpha logic with Man 37 in relation to the TAL DAE footprint.

4.5.1.10 MM304 GN&C Configuration_[AFPH4.5-15]

BFS, OPS 301 PRO (√304)
 [G50] √SITE, RWY, TACAN
 S/B & ALTM (PASS/BFS)
 [TRAJ] √BUGS, [HSI] √ RANGE, [AMI] √ $\alpha = 43^\circ$

4.5.1.10.1 Cue

MM304

4.5.1.10.2 Displays

ADI

SPEC 50 Horizontal Situation Display

Entry TRAJ

HSI

AMI4.5.1.10.3 Crew Action

CRT BFS, OPS 301 PRO

[G50] √ITEM 41 or ITEM 41 + XX EXEC if site change required
 √ITEM 3 or ITEM 3 EXEC for primary runway
 √ITEM 4 or ITEM 4 EXEC for secondary runway
 ITEM 5 EXEC for secondary TACAN
 ITEM 39 EXEC for nominal speedbrake
 ITEM 9 + XX.XX to enter altimeter setting

[TRAJ] √Shuttle bug, guidance box, and trailer symbols for energy evaluation

HSI √HDG (lubber line) and range

AMI √ $\alpha = 43^\circ$

4.5.1.10.4 Discussion

Upon entrance into MM 304, all initializations and discrettes are set and OMS targeting is terminated. If TAL abort was declared after the roll inhibit velocity, the roll to heads up will be performed once in MM 304. The unpressurized MPS dump begins automatically upon entrance to MM 304. LH₂ is vented through the fill/drain and RTLS dump valves. LOX is dumped from the main oxidizer valves through the engine bells and then through the LOX fill drain valves and the engine bells. This dump continues to $V_{REL} = 5300$ fps.

The CDR modes the BFS into OPS 3 and checks the PASS speedbrake option and runway selection. _[AFPH4.5-18]

The CDR checks the predictor bugs on the Entry TRAJ display, the heading and range from the Horizontal Situation Indicator (HSI), and the angle of attack from the Alpha Mach Indicator (AMI). As stated earlier, guidance commands 43° angle of attack during the pullout. If in CSS, the CDR pitches up to 43° .

4.5.1.11 Low Energy Guidance

For All Inclinations:

- * Low energy: TRAJ ITEM 3 (Lo Energy ENA) *
- * If Variable/Man 37: Pitch - CSS at $\alpha = 37^\circ$ *
- * Pitch – AUTO when $\ddot{H} = 0 \uparrow$ (2nd pullout)_[AFPH4.5-19] *

4.5.1.11.1 Cue

MCC Call

If no comm, Entry TRAJ or underspeed at MECO

4.5.1.11.2 Displays

AMI

AVVI

Entry TRAJ

4.5.1.11.3 Crew Action

TRAJ ITEM 3 EXEC if low energy required

Pitch - CSS if required

4.5.1.11.4 Discussion

Low energy guidance is enabled via ITEM 3 EXEC on the TRAJ display. If the bar chart on the PLT's card indicates low energy guidance with manual alpha 37° is required or the MCC recommends this procedure, the crew should take CSS at 37° as alpha ramps down from the initial alpha flown during the first pullout. Alpha should be maintained at 37° until the bottom of the second pullout (\ddot{H} goes positive). At this time, flight control is returned to auto since simulation data has shown this to be thermally acceptable. The low energy logic will actually be starting to increase the alpha command here, since on the back side of the phugoid the dynamic pressure and thus the vehicle temperatures are starting to build more rapidly.

4.5.1.12 Entry Systems Configuration

√OMS DUMP

√ET DOORS - Closed and latched (MM304 + 1:30)

V=19 HYD MPS/TVC ISOL VLV (three) - CL
(hold 5 sec) √tb - CL

V=10 * If RCS < 57 % either side: *

* G51 AFT RCS INH, ITEM 13 EXEC *

4.5.1.12.1 Cue

MM304 for OMS Dump

MM304 + 1:30 for ET Doors

V = 19,000 fps for isolation valves

V = 10,000 fps and RCS Quantity for RCS dump inhibit

4.5.1.12.2 Displays

AMI

OMS PRESS Pc gauge

RCS/OMS PRPLT QTY

4.5.1.12.3 Crew Action

Monitor

F7 √OMS PRESS Pc

O3 √RCS/OMS PRPLT QTY

R2 √ET UMB L,R DR (two) tb - CL
LAT (two) tb - LAT

R4 HYD MPS/TVC ISOL VLV (three) - CL
(hold 5 sec) √tb - CL

O3 √RCS PRPLT QTY
If < checklist value either side:
G51 ITEM 13 EXEC

4.5.1.12.4 Discussion

Once in MM 304, the PLT verifies MM 304 OMS dump which adds ≈100 fps delta V. This separation burn is important because of a possible ET rupture during entry. If necessary, the dump is performed interconnected. Studies have shown that large alpha excursions (to 53°) can be caused by combinations of OMS and RCS dumps or by the interconnected OMS/RCS dump inhibiting of the aft RCS jets.

The PLT verifies that the ET doors have closed and latched approximately 90 seconds after transition into MM304.

At Mach 19, the PLT closes the hydraulic MPS/TVC isolation valves.

At Mach 10, the PLT monitors the TAL aft RCS (ARCS) dump. If this dump is not desired, the dump may be inhibited on SPEC 51. If an RCS dump is not I-loaded (i.e. dump timer set to zero), then N/A is entered in the quantity box.

4.5.1.13 Entry GN&C Configuration

CDR:

V=10 $\sqrt{\text{SPDBK}} \rightarrow 81\%$ V=7 Go to ENTRY MANEUVERS
(Cue Card)

PLT:

V=7 MLS (three) - ON ($\sqrt{\text{channels}}$)

I/O RESET

Go to ENTRY MANEUVERS (Cue Card)4.5.1.13.1 Cue

Mach 10 for speedbrake

Mach 7 for MLS actions and transition to Entry Maneuvers Cue Card

4.5.1.13.2 Displays

SPI

CRT

4.5.1.13.3 Crew Action

Monitor speedbrake

 $\sqrt{\text{Speedbrake \%}} \rightarrow \text{CMD}$

Power MLS On

O8 MLS (three) - ON

 $\sqrt{\text{channels (three)}} - 6 \text{ or } 8 \text{ as applicable per landing site table}$

CRT I/O RESET EXEC

4.5.1.13.4 Discussion

At Mach 10, the CDR checks that the speedbrake opens. At Mach 10, the speedbrake begins to open for use as a pitch trim device which allows more control authority for the ailerons. It should be open to 81% by Mach 9.

The PLT powers the MLS on at Mach 7 and performs an I/O RESET EXEC to establish input. The incorporation of NAVAID data into navigation processing is a Guidance and Procedures Officer (GPO) call if comm exists. The ground recommends the best course of action to improve the accuracy of the PASS and BFS state vectors. From a velocity of 7,000 fps to touchdown, the Entry Maneuvers cue card is used to monitor entry and perform the required procedures. The Entry FPH contains a more complete discussion of entry navigation and the entry maneuvers cue card.

4.5.2 TAL Redesignation Cards

In section 4.3.3.2 the single engine TAL boundaries were discussed in terms of simultaneous failure of two SSMEs. Sequential engine out boundaries are determined real time with the TAL redesignation cue cards and MCC calls. Both simultaneous (simo) and sequential engine failure boundaries assume 2σ performance from the remaining engine, protection of the minimum droop altitude, 0σ entry dispersions, and a 15 second decision delay in abort selection/runway redesignation.

The identification of TAL boundaries for sequential engines out is more complicated than for simultaneous engines out. If there is a loss of COMM, the TAL redesignation cue card indicates to the crew which TAL site is attainable in the case of a sequential engine out TAL. For high inclination missions, ECAL boundaries are also included for second engine failures prior to the Single Engine OPS 3 boundary. If comm is available, the MCC abort mode boundary calls take precedence over the NO COMM MODE BOUNDARIES. An STS-114 (51.6° inclination) example is provided in figures 4.5.2-1 and -2.

**ZZA TAL REDESIGNATION
(114 OCFR2 CYC)**

1st E.O. VI		6000	6100	6200	6300	6400	6500	6600
SE OPS 3 ZZA 109	(14)	10900	10900	11000	11000	11100	11100	11200
SE ZZA 104	(4)	17700	17500	17300	17100	16800	16600	16400

1st E.O. VI		6700	6800	6900	7000	7100	7200	7300
SE OPS 3 ZZA 109	(14)	11200	11200	11300	11300	11400	11400	11400
SE ZZA 104	(4)	16200	16000	15700	15500	15300	15100	14900

1st E.O. VI		7400	7500	7600	7700	7800	7900	8000
SE OPS 3 ZZA 109	(14)	11500	11500	11500	11600	11600	11600	11600
SE ZZA 104	(4)	14700	14500	14400	14200	14100	14000	13900

1st E.O. VI		8100	8200	8300	8400	8500	8600	8700
SE OPS 3 ZZA 109	(14)	11700	11700	11700	11700	11700	11700	11700
SE ZZA 104	(4)	13800	13700	13700	13600	13600	13500	13500

1st E.O. VI		8800	8900	9000	9100	9200	9300	9400
SE OPS 3 ZZA 109	(14)	11700	11800	11800	11800	11800	11800	11800
SE ZZA 104	(4)	13500	13500	13500	13500	13500	13500	13500

1st E.O. VI		9500	9600	9700	9800	9900	10000	10100
SE OPS 3 ZZA 109	(14)	11800	11800	11800	11800	11800	11800	11800
SE ZZA 104	(4)	13600	13600	13600	13600	13600	13600	13600

1st E.O. VI		10200	10300	10400
SE OPS 3 ZZA 109	(14)	11800	11800	11800
SE ZZA 104	(4)	13600	13600	13600

Figure 4.5.2-1: STS-114 Zaragoza TAL Redesignation Card

If TAL to Zaragoza is initiated due to an engine failure, the crew should locate the V_1 of the engine failure, rounding down, in the 1ST EO V_1 row of the redesignation cue card. The two numbers in a column immediately below are the single engine TAL boundaries for that particular scenario and should be entered in the appropriate slots on the mode boundary card. Using figure 4.5.2-1 and assuming that the first engine failed at $V_1 = 7330$ fps, the 1ST EO V_1 would be rounded down to 7300 fps. The sequential TAL boundaries would be 11,400 and 14,900 fps, as indicated in the table. If the second engine failed between a V_1 of 11.4K and 14.9K, the vehicle will be able to perform a contingency droop TAL with Zaragoza selected during powered flight. Post-MECO, a redesignation to an ELS site (in this case Lajes or Santiago) will probably be required. If the second engine failed at a V_1 of 14900 fps, maximum throttles are not required and the Zaragoza R-V line should be achievable with one engine at 104%.

Note that the powered flight landing site area number is listed in parentheses to the right of the site name. Zaragoza area 14 is the low crossrange powered flight TAL target and is used if the second engine fails prior to a single engine TAL 104% R-V capability. Zaragoza area 4 is the

nominal crossrange powered flight TAL target and is used when TAL R-V capability exists. The site name in the SE OPS 3 boundary refers only to the site that should be selected during powered flight. The MCC will recommend a site post-MECO based on the Downrange Abort Evaluator (DAE).

If the second engine out V_1 is prior to the Single Engine OPS 3 boundary, then the ECAL redesignation card is used to determine which ECAL site should be selected. Figure 4.5.2-2 illustrates the ECAL boundaries when Zaragoza is the selected TAL site. With OI-30 the first and second engine failure velocities are available to the crew on the TRAJ display, therefore the 2 out sequential capability to the various ECAL sites can be accessed in the table_[AFPH4.5-20].

ECAL – ZZA or MRN PRIME TAL							
1st EO VI (KFPS)	5.6	5.8	6.0	6.2	6.4	6.6	6.8
CHERRY POINT (7)	6.6 – 6.7	6.5 – 7.0	6.5 – 7.2	6.7 – 7.3	6.8 – 7.4	6.8 – 7.5	6.9 – 7.6
OTIS ANGB (16)		10.5 – 11.0	10.3 – 11.2	10.3 – 11.3	10.3 – 11.5	10.3 – 11.5	10.3 – 11.6
GABRESKI (15)							
PEASE INT'L (17)							
1st EO VI (KFPS)	7.0	7.2	7.4	7.6	7.8	8.0	8.2
CHERRY POINT (7)	7.0 – 7.6	7.2 – 7.7	7.4 – 7.7	6.7 – 7.8	7.8 – 7.9		
OTIS ANGB (16)	10.3 – 11.7	10.3 – 11.7	10.4 – 11.8	10.4 – 11.9	10.4 – 12.0	10.4 – 12.0	10.4 – 12.0
GABRESKI (15)							
PEASE INT'L (17)							
1st EO VI (KFPS)	8.4	8.6	8.8	9.0	9.2	9.4	9.6
CHERRY POINT (7)							
OTIS ANGB (16)	10.5 – 12.1	10.5 – 12.1	10.5 – 12.2	10.5 – 12.3	10.5 – 12.4	10.6 – 12.4	10.7 – 12.5
GABRESKI (15)							
PEASE INT'L (17)							11.7 – 11.8
1st EO VI (KFPS)	9.8	10.0	10.2	10.4	10.6	10.8	11.0
CHERRY POINT (7)							
OTIS ANGB (16)	10.8 – 12.5	10.8 – 12.6	10.8 – 12.6	10.8 – 12.7	10.8 – 12.7	10.8 – 12.8	11.0 – 12.8
GABRESKI (15)			11.2 – 11.2	11.2 – 11.4	11.2 – 11.5	11.3 – 11.6	11.3 – 11.6
PEASE INT'L (17)	11.7 – 12.0	11.8 – 12.1	11.8 – 12.2	11.8 – 12.3	11.9 – 12.4	11.9 – 12.5	11.9 – 12.6
1st EO VI (KFPS)	11.2	11.4	11.6	11.8	12.0	12.2	12.4
CHERRY POINT (7)							
OTIS ANGB (16)	11.2 – 12.9	11.4 – 12.9	11.6 – 13.0	11.8 – 13.0	12.0 – 13.0	12.2 – 13.1	12.4 – 13.2
GABRESKI (15)	11.3 – 11.7	11.4 – 11.7	11.6 – 11.8	11.8 – 11.8			
PEASE INT'L (17)	11.9 – 12.6	12.0 – 12.7	12.0 – 12.8	12.0 – 12.9	12.0 – 13.0	12.2 – 13.0	12.4 – 13.1
1st EO VI (KFPS)	12.6	12.8	13.0	13.2	13.4	13.6	13.8
CHERRY POINT (7)							
OTIS ANGB (16)	12.6 – 13.2	12.8 – 13.3	13.0 – 13.3	13.2 – 13.3	13.4 – 13.4		
GABRESKI (15)							
PEASE INT'L (17)	12.6 – 13.1	12.8 – 13.1	13.0 – 13.1				

ASC-9b/114/A/B

Figure 4.5.2-2: STS-114 Zaragoza ECAL Redesignation Card

The low inclination TAL Redesignation cards differ from high inclination in that no ECAL cards are included since Bermuda is the only OPS 6 CA site and there are additional boundaries for the out of plane sites. A STS-69 sample TAL redesignation card is shown in figure 4.5.2-3 for Moron as the prime TAL site. The SE OPS 3 BEN 109% boundary reflects the first point at which a TAL will be continued following the loss of a second main engine. The single engine 104% boundaries are included for the ACLS sites and the single engine 109% boundary is included for the prime TAL. Note that maximum throttles (109%) will be used to avoid post TAL selection redesignation to an ACLS if possible.

**MRN TAL REDESIGNATION
(69 OCF CY)**

1st E.O. VI		6900	7000	7100	7200	7300	7400	7500
SE OPS 3 BEN 109	(11)	11200	11300	11300	11400	11400	11500	11500
SE BYD 104	(5)	-	-	-	-	-	-	-
SE BEN 104	(2)	16200	16000	15900	15800	15600	15500	15400
SE MRN 109	(3)	17900	17700	17500	17400	17200	16900	16700

1st E.O. VI		7600	7700	7800	7900	8000	8100	8200
SE OPS 3 BEN 109	(11)	11600	11600	11700	11700	11800	11800	11800
SE BYD 104	(5)	-	-	-	-	-	-	-
SE BEN 104	(2)	15200	15100	15000	14900	14700	14700	14600
SE MRN 109	(3)	16600	16400	16200	16000	15900	15700	15600

1st E.O. VI		8300	8400	8500	8600	8700	8800	8900
SE OPS 3 BEN 109	(11)	11900	11900	11900	11900	12000	12000	12000
SE BYD 104	(5)	-	14700	14600	14500	14400	14400	14300
SE BEN 104	(2)	14500	14400	14400	14400	14300	14300	14300
SE MRN 109	(3)	15500	15500	15400	15400	15400	15400	15400

1st E.O. VI		9000	9100	9200
SE OPS 3 BEN 109	(11)	12000	12000	12100
SE BYD 104	(5)	14200	14200	14100
SE BEN 104	(2)	14300	14200	14200
SE MRN 109	(3)	15400	15400	15400

Figure 4.5.2-3: STS-69 Moron TAL Redesignation Card

The following sections summarize the MCC abort related calls during a TAL.

4.5.2.1 First Engine Out V_1 (MCC Call or from PASS TRAJ)

The first engine out V_1 is provided to the crew if the engine failure occurred behind a data path failure since the value displayed on the PASS TRAJ represents the V_1 at engine failure *recognition* (i.e. when main engine shutdown pushbutton is pushed). The engine out V_1 is to be used for the TAL redesignation card.

4.5.2.2 Single Engine OPS 3 [in-plane TAL Site] 109%

This boundary is defined in section 4.3.3.2.6. Note that the Single Engine OPS 3 109% boundaries in the redesignation cards assume the first available ELS is a “Go” site. If a TAL abort is declared and the ELS is “No Go”, the Single Engine OPS 3 109% boundary called by the MCC may differ from the checklist value. Unlike the simo Single Engine OPS 3 109% boundary on the NO COMM MODE BOUNDARIES card, the numbers in the TAL redesignation cards will not be updated prelaunch since there are too many numbers to update.

4.5.2.3 Main Engine Limits Enable/Auto (MCC call only)

See section 4.3.3.2.7 for a discussion of main engine limits management. Although section 4.3.3.2.7 addresses the case where TAL was not selected after the first engine failure, the same rationale applies when TAL is selected after the first engine failure.

4.5.2.4 Single Engine [ACLS or prime TAL if in-plane] 104%

The single engine TAL 104% boundary represents the lowest V_1 at which auto guidance can be used to achieve the desired TAL site range velocity target line with the sequential failure of two main engines. This boundary assumes 2σ low ascent performance, abort throttles (104%), 0σ entry dispersions, and a 15 second decision delay. Note that this boundary is for the prime TAL site only if the prime TAL site is in-plane (e.g. Zaragoza for high inclination or Banjul for low inclination). If the prime TAL site is out of plane, then this boundary reflects the ACLS. As shown in figure 4.5.2-3, when Moron is the prime TAL site, the SE BYD 104 and SE BEN 104 boundaries are included.

4.5.2.5 Single Engine [prime TAL] 109% (N/A if in-plane site is prime TAL)

The single engine TAL 109% boundary is only used when the prime TAL site is out of plane. It represents the lowest V_1 at which auto guidance can be used to achieve the desired TAL site range velocity target line with the sequential failure of two main engines. This boundary assumes 2σ low ascent performance, maximum throttles (109%), 0σ entry dispersions, and a 15 second decision delay. If already past the Negative Return boundary, the protection for this boundary is lowered to zero sigma to close the gap. The 109% boundary is included for the prime TAL site when it is out of plane, since it is deemed safer to throttle up to 109% and continue to the prime TAL site than to perform a yaw maneuver back to the ACLS which may have marginal weather or navigation aids.

4.6 HIGH ENERGY TAL AND HIGH ENERGY GANDER PROCEDURES

4.6.1 High Energy TAL Procedures [AFPH4.6-1]

High Energy TAL procedures are discussed in this section. They are available for 28.5°, 39°, and 51.6°, but not for 57° inclination missions due to excessive crossrange to the TAL/ACLS. Much of the rationale supplied in the following paragraphs has been taken from SOC Transmittal DFD-94-520-048, High Energy TAL Entry Crew Procedures, authored by John A. Carini. STS-114 is used as an illustrative example (figs. 4.6.1-1 and 4.6.1-2).

PILE	HIGH-ENERGY TAL CDR		
MM104	Abort TAL: ✓TAL flag set: G50 ITEM 41 = TAL SITE (any site) ✓Rates < .5°/sec; $\theta > 15^\circ$, $Y = 0 \pm 30^\circ$ PASS, OPS 301 PRO (✓304) <hr style="border-top: 1px dashed black;"/> MM304		
MM304	P, R/Y - CSS ✓VREL		
	VREL	ROLL (CSS)	ALPHA (CSS)
	VREL $\geq 23,800$	180°	80° ($\theta = 280^\circ$)
	$23,300 \leq$ VREL < 23,800	180°	55°
	VREL < 23,300	0°	55°
$\dot{H} = -200 \downarrow$	If Alpha = 80°, push to Alpha = 55° ($\theta = \sim 305^\circ$)		
$\dot{H} = -700 \downarrow$	Roll Heads Up, maintain Alpha = 55°		
$\dot{H} = -500 \uparrow$	R/Y - AUTO (✓Rolls toward site) Limit roll to 90° until V = 6K: TRAJ Roll CMD > 90° R/Y CSS @ 90° < 90° R/Y AUTO		
Orbiter bug below upper line	When Commanded Drag (\leftarrow) < 40: Pitch down at 0.5°/sec, center pitch needle, P - AUTO		
V = 6K	If energy still high: Pitch down at 1°/sec, center pitch needle, P, R/Y - AUTO Go to <u>ENTRY MANEUVERS</u> (Cue Card)		

Figure 4.6.1-1: STS-114 High Energy TAL CDR Card

HIGH-ENERGY TAL PLT	HOOK
MM304	
BFS, OPS 301 PRO (√ 304)	
[G50] If [FMI] GO TAL Site - Select [FMI] - ITEM 41 + [29] Otherwise, select best Wx site [ZZA] (site 4) or [FMI]	
[TRAJ] √BUGS, [HIS], √[H], RANGE	
√ET DOORS – closed and latched (MM304 +1:30)	
Guid Init: (D = 3, q̄ = 8, EAS = 48)	* SELECTED SITE * If no comm & Commanded Drag (←) ≥ 35 , * * [G50] Select [ESN] ITEM 41 + 30 * * *
V = 19K	HYD MPS/TVC ISOL VLV (three) – CL (hold 5 sec) √tb – CL
V = 15K	[G50] √RWY, TACAN, S/B, ALTM (PASS/BFS)
V = 10K	* If RCS < 57 % either side: * * [G51] AFT RCS INH, ITEM 13 EXEC *
V = 10K	√SPDBK → 81%
V = 7K	MLS (three) – ON (√channels) I/O RESET
Go to <u>ENTRY MANEUVERS</u> (Cue Card)	
FB 2-19	ASC/114/FIN A

Figure 4.6.1-2: STS-114 High Energy TAL PLT Card

4.6.1.1 Major Mode 104 Procedures

MM104 ABORT TAL
 √ TAL flag set: G50 ITEM 41 = TAL SITE (any site) [AFPH4.6-2]
 √ Rates < .5°/sec; $\theta > 15^\circ$, $Y = 0^\circ \pm 30^\circ$
PASS, OPS 301 PRO (√304)

4.6.1.1.1 Cue

MM104

4.6.1.1.2 Displays

SPEC 50 Horizontal Sit Display
 Abort Rotary Switch or SPEC 51
 ADI

4.6.1.1.3 Crew Action

F6 ABORT MODE - TAL
 ABORT pb - push
 Or
G51 ITEM 1 EXEC
 ITEM 3 EXEC
 ADI √ Rates, $\theta > 15^\circ$, $Y = 0^\circ \pm 30^\circ$
 CRT PASS, OPS 301 PRO
 √ MM304

4.6.1.1.4 Discussion

MECO velocities between approximately 24K and 25K fps are too low to make an AOA and too high for auto guidance to make an intact abort site. The only option in this window using entry guidance is to abort to an emergency landing site (ELS) or to bailout. This high energy TAL procedure utilizes high angles of attack, prebank, and OMS dumps to dissipate energy and allow the orbiter to land at the TAL site or ACLS.

After transition into Major Mode 104, the CDR uses the abort rotary switch to abort TAL. Note that the abort rotary switch will set the TAL flag, but the TRAJ display will not change to "TAL TRAJ". The selected site (ITEM 41) on SPEC 50 can be used to confirm that TAL abort has been selected. SPEC 51 Item 1,3 can be used as a back-up to abort TAL should the rotary switch fail, asterisks on the SPEC 51 display would provide feedback that the abort has been selected.

For STS-87 and subsequent flights, the vehicle is rolled heads up at a *relative* velocity of 12.2K. Therefore, the steps to pull at 2°/sec to $\theta \sim 305^\circ$ and hold the P, R/Y CSS buttons until MM304 were deleted since the vehicle will already be rolled heads up when entering this procedure. Prior to STS-87, the vehicle was in a heads down attitude such that a pull to $\theta \sim 305^\circ$ was required to achieve an alpha near +55° before transitioning to OPS 3.

The CSS buttons were held to prevent the auto system from commanding the vehicle to a heads up alpha = 43° attitude at transition.

The crew should check that rates are small and pitch is greater than 15° and yaw within 30° to eliminate roll-offs observed for very small alphas or large yaw angles. Automated alpha-beta management for TAL aborts implemented in OI-29 flight software maneuvers the vehicle to the proper attitude for OPS 3, getting to attitude on time will prevent a delay of the OMS separation burn.. Entering MM304 with low alpha and/or large beta will cause the entry FCS to perform a large roll maneuver, this roll maneuver can delay the start of the OMS burn.^[AFPH4.6-3]. Since the CDR no longer has to hold the CSS buttons, he is free to perform the OPS transition.

The PASS is moded to the entry software via an “OPS 301 PRO”, which, if TAL has been selected, cascades the software to Major Mode 304.

4.6.1.2 Initial MM304 Attitude*28.5° Inclination Version:*

MM304 P, R/Y - CSS
√VREL

VREL	ROLL (CSS)	ALPHA (CSS)
VREL ≥ 23,400	180°	80° (θ = 280°)
22,900 ≤ VREL < 23,400	180°	55°
VREL < 22,900	0°	55°

39° Inclination Version:

MM304 P, R/Y - CSS
√VREL

VREL	ROLL (CSS)	ALPHA (CSS)
VREL ≥ 23,600	180°	80° (θ = 280°)
23,000 ≤ VREL < 23,600	180°	55°
VREL < 23,000	0°	55°

51.6° Inclination Version:

MM304 P, R/Y - CSS
√VREL

VREL	ROLL (CSS)	ALPHA (CSS)
VREL ≥ 23,800	180°	80° (θ = 280°)
23,300 ≤ VREL < 23,800	180°	55°
VREL < 23,300	0°	55°

4.6.1.2.1 Cue

MM304

4.6.1.2.2 Displays

AMI
ADI

4.6.1.2.3 Crew Action

F2 PITCH, ROLL/YAW CSS pb - push
√VREL
Roll then pitch to desired attitude

4.6.1.2.4 Discussion

Once in Major Mode 304, the CDR is reminded to take CSS for the off-nominal roll/pitch attitude that will be flown. The CDR checks the relative velocity on the AMI and then maneuvers to the proper roll and alpha attitude. The roll column comes before the pitch column in the table to emphasize that ROLL is the more important step and it should be performed first. This step is more important for the very high energy cases where a roll of 180° is required since the OMS dump will start automatically once in MM304. Because the dump is automatic, pitching first would *add* energy to this high energy procedure. That is, pitching first would, for a short time, put the orbiter in a high pitch attitude with an OMS dump in progress *adding* energy to this high energy profile. The more time spent in the heads up attitude, the more energy that is added to the trajectory due to the OMS dump.

If an alpha of 80° is required, the ADI or the AMI can be used to fly the pitch attitude. An ADI pitch attitude of 280° (theta) can be used or an LVLH alpha value of 80° on the AMI can be used. The ADI was the sole source used prior to OI-30 since the alpha tape on the AMI was limited to 60° . OI-30 upgrades to the MEDS composite display now allows alpha values between $+180^\circ$ and -180° . Since theta of 280° is close to the ADI singularity point, rolling of the ADI may be noticed. The CDR may increase pitch slightly to move away from the singularity point. Note that only one table is contained in the Ascent Checklist depending on the inclination. The difference between the three tables is the shift in the relative velocity breakpoints which equate to approximately the same inertial velocities. Relative velocity is used rather than inertial velocity since relative velocity is displayed on the Alpha Mach Indicator when in glided flight.

Figure 4.6.1.2.-1 illustrates the orbiter's attitude at ET sep along with the alpha 55° /roll 180° and alpha 80° /roll 180° attitudes. For the higher velocity cases, a prebank of 180° is used to negate any lift on the orbiter and achieve atmospheric capture. Since the orbiter is in a heads up attitude at ET sep, a roll maneuver to the 180° prebank is required. However, for the 0° prebank scenarios, a roll to heads up is not required.

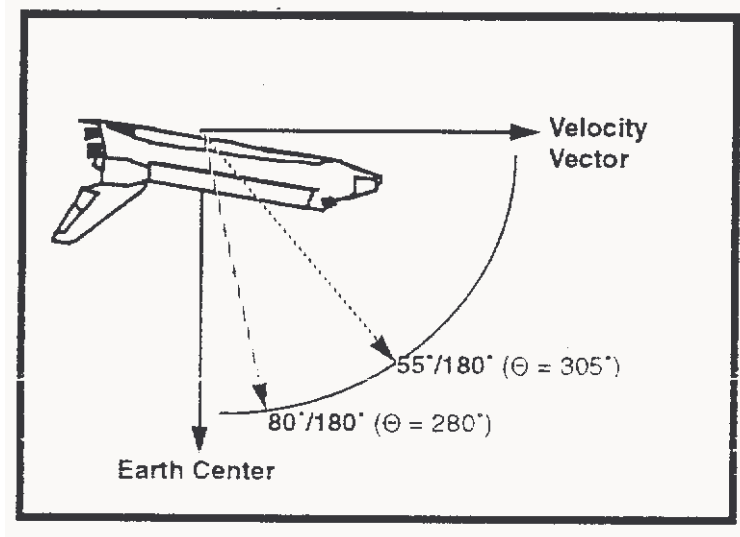

Figure 4.6.1.2.-1: Orbiter Prebank Attitudes

4.6.1.3 OMS Dump

4.6.1.3.1 Cue

MM304

4.6.1.3.2 Displays

SPEC 51 Override
 OMS PRESS Pc gauge
 RCS/OMS PRPLT QTY

4.6.1.3.3 Crew Action

F7 √OMS PRESS Pc
 O3 √RCS PRPLT QTY
 If < 50% either side,
 [G51] ITEM 8 EXEC

4.6.1.3.4 Discussion

There are no OMS dump steps in the current high energy TAL procedures since the vehicle enters MM304 in a heads up attitude. Therefore, the FCS Accept criteria which allows the interconnected OMS dump to start automatically are satisfied. For OMS loads greater than approximately 17,500 lbs, offline analysis has shown that the interconnected dump is better from an energy standpoint than a straight feed dump. Since most OMS loads will be greater than 17,500 lbs and the interconnected dump satisfies OMS tank landing weight constraints, the interconnected dump is desired so that no crew action for the OMS dump is required. Prior to roll to heads up, a step to stop the OMS dump when RCS < 50% was included. Although the OMS dump should have terminated automatically prior to an RCS quantity of 50%, this check was previously include to ensure sufficient RCS for entry. The 50% value was based on RCS propellant usage for SES test cases which required the use of high energy procedures for almost the entire trajectory. 10% was added to the worst case usage of 40% observed in these tests to account for dispersions and differences in pilot efficiency. However, with roll to heads up (STS-87 and subs), this check on RCS quantity is no longer required since the dump is being performed interconnected such that the RCS jets are using OMS propellant rather than RCS propellant.

4.6.1.4 BFS OPS 3 Transition, Site Selection, and ET Door Closure

BFS, OPS 301 PRO (√ 304)

G50 If FMI GO TAL Site - Select FMI - ITEM 41 + 29
 Otherwise, select best Wx site ZZA (site 4) or FMI

[AFPH4.6-4] TRAJ √BUGS, HSI √H, RANGE

√ET DOORS - Closed and latched
 (MM304 + 1:30)

4.6.1.4.1 Cue

BFS OPS 301 PRO: PASS MM304
 SPEC 50 Config and Trajectory verification: BFS MM304
 ET Doors: PASS MM304 + 1min 30 sec

4.6.1.4.2 Displays

SPEC 50 Horizontal Situation Display
 Entry TRAJ
 HSI

4.6.1.4.3 Crew Action

BFS CRT	BFS, OPS 301 PRO
<input type="checkbox"/> G50	√ITEM 41 or ITEM 41 + XX EXEC if site change required
<input type="checkbox"/> TRAJ	√Shuttle bug, guidance box, and trailer symbols for energy evaluation
HSI	√HDG (HAC bearing pointer) and range
R2	√ET UMB L,R DR (two) tb - CL LAT (two) tb - LAT

4.6.1.4.4 Discussion

The BFS is moded to OPS 3 by the PLT and automatically cascades to Major Mode 304 if the TAL flag is set. The PLT then checks both PASS and BFS SPEC 50 for the proper landing site (ITEM 41). For 51.6° inclination missions, Zaragoza and Istres are the inplane TAL sites. If Istres is a Go TAL site, than that site should be selected since it is further downrange and the energy state will not be as high as going to Zaragoza, making for a slightly more benign trajectory. If, however, Istres is not a Go TAL (ACLS or ELS), than the best weather site between Zaragoza and Istres should be chosen. The trajectory and energy situation is monitored using the Entry TRAJ display and the Horizontal Situation Indicator. The ET Doors are checked at this point since the doors should be closed and latched one minute and 30 seconds after MM304 transition and there is sufficient time prior to guidance initiation to perform this check.

4.6.1.5 Pitch Down to Alpha 55°

$\dot{H} = -200 \downarrow$ If Alpha = 80°, push to Alpha = 55° ($\theta = \sim 305^\circ$)

4.6.1.5.1 Cue

Altitude Rate

4.6.1.5.2 Displays

AMI

AVVI

4.6.1.5.3 Crew Action

Pitch down to $\alpha = 55^\circ$ if required

4.6.1.5.4 Discussion

If an initial alpha of 80° was required, the CDR pitches (push on the RHC) to alpha 55° when altitude rate drops below -200 fps. Note that altitude rate is becoming more negative at this point in the procedures (negative altitude acceleration, \ddot{H}). Altitude rate and altitude acceleration are monitored on the Altitude Vertical Velocity Indicator (AVVI). A decrease in alpha to 55° is required to ensure that prior to the start of aerodynamic heating, the orbiter's angle of attack is within the limits of the thermal model used to evaluate these procedures. The thermal model used was incapable of predicting the effects of heating at angles of attack greater than 55°. The ($\theta = \sim 305^\circ$) is included since the alpha tape used to peg at 60° and without the ($\theta = \sim 305^\circ$) as a pointer, only 5° warning was available before alpha = 55° was reached. OI-30 upgrades to the MEDS composite display now allows alpha values between +180° and -180°, so the crew can monitor the alpha tape with plenty of warning prior to alpha 55. The θ value can also be monitored on the ADI.

4.6.1.6 Roll Heads Up

$\dot{H} = -700 \downarrow$ Roll Heads Up, maintain Alpha = 55°

4.6.1.6.1 Cue

Altitude Rate

4.6.1.6.2 Displays

ADI

AVVI

4.6.1.6.3 Crew Action

Roll heads up

4.6.1.6.4 Discussion

The crew continues to monitor altitude rate and at an altitude rate of -700 fps (and becoming more negative), the CDR rolls the vehicle heads up and continues to fly alpha 55°. The roll to heads up is performed earlier than the guidance command to avoid high initial altitude rate levels. The higher the initial altitude rate levels, the more energy is dissipated since drag builds up faster. However, excessive negative altitude rate levels result in increased heat rate on the vehicle since the vehicle is lower in the atmosphere. The -700 value was chosen as a trade-off between energy dissipation and maximum heat rate.

4.6.1.7 Active Guidance Initiation

28.5° Inclination Version:

* If no comm & BYD *
Guid Init: * initial Commanded Drag (\Leftarrow) \geq 40., *
(D = 3, \bar{q} = 8, * G50 Select LRB ITEM 41 + XX *
EAS = 48) * *

39° Inclination Version:

* If no comm & BEN MRN ZZA *
Guid Init: * initial Commanded Drag (\Leftarrow) \geq 38. 38. 36., *
(D = 3, \bar{q} = 8, * G50 Select AAT ITEM 41 + XX *
EAS = 48) * *

51.6° Inclination Version:

* If no comm & Selected Site *
Guid Init: * initial Commanded Drag (\Leftarrow) \geq 35., *
(D = 3, \bar{q} = 8, * G50 Select ESN ITEM 41 + 30 *
EAS = 48) * *

4.6.1.7.1 Cue

Commanded drag accel symbol _[AFPH4.6-5](\Leftarrow) - primary cue
 Guidance box () - secondary cue

4.6.1.7.2 Displays

Entry TRAJ
 SPEC 50 Horizontal Situation Display

4.6.1.7.3 Crew Action

Redesignate if required

4.6.1.7.4 Discussion

When the drag level builds to about 3 fps² (sensed acceleration of 4.25 fps²), active guidance is initiated. This is indicated on the TRAJ display by the appearance of the commanded drag symbol (\Leftarrow) on the vertical drag scale and the guidance box (). Since the guidance box can be hidden off to the left hand side of the display in very high energy scenarios, the commanded drag symbol (\Leftarrow) should be used as the active guidance initiation cue. The PLT checks the commanded drag level at the start of active guidance. If commanded drag exceeds the value specified in the checklist, a redesignation to a downrange emergency landing site (ELS) should be performed. Note for the due east and 39° inclinations, the landing site names and site numbers are for example only. OI-30

flight software updated the landing site table from 25 to 45 landing sites. At the time of the update only 51.6° inclination missions were manifested, so if another due east or 39° inclination mission is manifested the landing site table will have to be reworked and the site names and numbers would then be finalized. Since the commanded drag may continue to increase after guidance initiation, an unnecessary redesignation may be performed if the commanded drag is checked late. Therefore, if comm is available, the MCC can assist with this decision. Note that guidance initiation occurs very near the roll to heads up and may come slightly before or after the Hdot -700 fps cue.

This drag limit and the downrange ELS is inclination dependent. The redesignation drag value is set to limit the maximum constant drag level to 55 fps². Maintaining a constant drag level below 55 fps² is desirable since the highest energy case deemed thermally acceptable by Rockwell International-Downey achieved a constant drag level of 55 fps². Furthermore, higher sustained drag levels result in excessive phugoiding since the gains on the entry guidance lift-over-drag controller equation, which determines the orbiter's roll command, are not suited for flight at high drag levels. These gains, which are used to weight the relative effects of drag error and altitude rate error on the final roll command, can become overly sensitive, causing the orbiter's roll to over-react to null both errors. This may expose the orbiter to possibly dangerous load factor levels. The reduced initial commanded drag limit for Zaragoza (39° and 51.6° inclination missions) is not based on maintaining a constant drag level below 55 fps², but designed to ensure the orbiter is capable of controlling crossrange.

4.6.1.8 Roll/Yaw Return to Auto

$\dot{H} = -500 \uparrow$ R/Y - AUTO ($\sqrt{\text{Roll toward site}}$)
 Limit roll to 90° until $V = 6K$:
 TRAJ Roll CMD $> 90^\circ$ R/Y CSS @ 90°
 $< 90^\circ$ R/Y AUTO

4.6.1.8.1 Cue

Altitude Rate

4.6.1.8.2 Displays

AVVI
 HSI
 Entry TRAJ

4.6.1.8.3 Crew Action

F2 ROLL/YAW AUTO pb - push
 Monitor roll and limit to 90°

4.6.1.8.4 Discussion

As the pullout is arrested and altitude rate becomes less negative (positive \ddot{H}), the CDR continues to fly alpha 55° and monitor altitude rate. When the altitude rate passes through -500 fps (and becoming less negative), the CDR can return to auto. The -500 fps value was again a trade-off between achieving the commanded drag level as quickly as possible and maintaining acceptable maximum heat rates. An altitude rate of -400 fps is actually the best balance between energy dissipation and maximum heat rate, but the cue was set 100 fps earlier to account for the rapidly changing altitude rate.

When Roll/Yaw is returned to auto, the CDR ensures guidance commands a roll toward the site using the primary bearing pointer on the Horizontal Situation Indicator (HSI). The crew must continuously monitor roll command on the Entry TRAJ and limit it to 90° if required. This is done by selecting Roll/Yaw CSS as the vehicle reaches a 90° roll attitude. Control may be returned to auto when the roll command as displayed on the Entry TRAJ is less than 90° . This is essentially a hands off the RHC technique for roll. Roll attitudes in excess of 90° are undesirable since altitude rate will drop far below its reference value and, as drag approaches its command, guidance will command a roll back to 0° to arrest the altitude rate. As the orbiter approaches the heads up roll attitude, drag will begin to drop below its commanded value and guidance will once again command a large roll angle to increase drag. This cycle will continue as guidance attempts to null both the drag and altitude rate errors, causing the orbiter to phugoid excessively. This procedure to limit roll to 90° is not required after $V = 8,000$ fps since entry guidance will limit the roll to 70° . However, to avoid adding another number to the procedures, $V = 6,000$ fps was used instead since it appears in the next step.

4.6.1.9 Pitch Return to Auto

Orbiter bug When commanded drag (\Leftarrow) < 40:
below Pitch down at $0.5^\circ/\text{sec}$, center pitch needle,
upper line P - AUTO

4.6.1.9.1 Cue

Orbiter Bug
 Commanded drag

4.6.1.9.2 Displays

Entry TRAJ
 AMI
 ADI

4.6.1.9.3 Crew Action

Pitch down at $.5^\circ/\text{sec}$ to center pitch needle
 F2 PITCH AUTO pb - push

4.6.1.9.4 Discussion

At the Hdot -500 fps cue, the CDR is still manually flying alpha 55° . The Entry TRAJ display is monitored to determine when alpha may be reduced. When the orbiter symbol is below the thermal line on the Entry TRAJ display and the commanded drag is less than 40 fps^2 , the CDR pitches down to center the pitch needle which will result in flying near Alpha HI as read from the Entry Alpha Cue Card. The orbiter symbol must be below the thermal line to ensure that wing leading edge temperature limits will not be violated. Although this line is based on a single mission limit (2950° F) and not the contingency abort ultimate limit, this line is used since it is a convenient reference and provides some temperature conservatism. The 40 fps^2 commanded drag criterion is used to prevent the excessive phugoiding associated with flight at high drag levels as described earlier. The pitch down is performed slowly at $.5^\circ/\text{sec}$ to avoid inducing a large drag error. Large drag errors should be avoided since they cause the roll to oscillate as guidance attempts to null drag and altitude rate errors, as previously discussed. Performing the pitch down slowly gives the roll command time to compensate for the reduced alpha.

4.6.1.10 Entry Systems Configuration

V = 19K HYD MPS/TVC ISOL VLV (three) - CL
(hold 5 sec) √tb - CL

V = 15K G50 √ RWY, TACAN, S/B, ALTM
(PASS/BFS)

V = 10K * If RCS < 57 % either side: *

* G51 AFT RCS INH, ITEM 13 EXEC *

V = 10K √SPDBK → 81%

V = 7K MLS (three) - ON (√channels)
I/O RESET

Go to ENTRY MANEUVERS (Cue Card)

4.6.1.10.1 Cue

V = 19,000 fps for isolation valves

V = 15,000 fps for runway set-up

V = 10,000 fps and RCS Quantity for RCS dump inhibit

V = 10,000 fps for speedbrake position check

V = 7,000 fps for MLS

4.6.1.10.2 Displays

AMI

SPEC 50 Horizontal Sit Display

RCS/OMS PRPLT QTY

SPI

4.6.1.10.3 Crew Action

R4 HYD MPS/TVC ISOL VLV (three) - CL
(hold 5 sec) √tb - CL

G50 √ITEM 3 or ITEM 3 EXEC for primary runway
√ITEM 4 or ITEM 4 EXEC for secondary runway
ITEM 5 EXEC for secondary TACAN
√ITEM 39 EXEC for nominal or shortfield speedbrake selection
ITEM 9 + XX.XX EXEC to enter altimeter setting

O3 √RCS PRPLT QTY
If < checklist value either side:

G51 ITEM 13 EXEC

F7 √Speedbrake % → 81%

4.6.1.10.4 Discussion

While the CDR is monitoring the trajectory and flying the vehicle, the PLT performs the nominal TAL entry procedures. This includes checking both PASS and BFS SPEC 50 for the proper runway (ITEM 3 or 4 for primary or secondary, respectively), TACAN (primary or secondary), speedbrake (nominal or short field), and altimeter setting. See section 4.5.1.12 and 4.5.1.13 for more information.

4.6.1.11 TAEM Preparation

V = 6K If energy still high:
 Pitch down at 1°/sec, center pitch needle,
 P - AUTO

Go to ENTRY MANEUVERS (Cue Card)

4.6.1.11.1 Cue

V = 6,000 fps

4.6.1.11.2 Displays

AMI
ADI
Entry TRAJ

4.6.1.11.3 Crew Action

Pitch down if required

4.6.1.11.4 Discussion

If the orbiter bug has still not dropped below the thermal line or the commanded drag level is still above 40 fps² by a velocity of 6,000 fps, the CDR must pitch down to center the pitch needle which will result in flying near Alpha HI in preparation for transition to TAEM guidance. The pitch down cue of 6,000 fps and higher rate of 1°/sec are used to ensure the orbiter is at the desired angle of attack by transition to TAEM. It is important to decrease angle of attack before transition to TAEM, since TAEM guidance assumes flight on the front side of the L/D curve.

The Entry Maneuvers cue card is used for the remainder of the entry.

4.6.2 HIGH ENERGY GANDER PROCEDURES

High Energy Gander procedures are discussed in this section. The procedure has only been assessed for 51.6° inclination missions, and the procedure shown here is current through Rev A to the STS-114 Ascent Checklist (Figures 4.6.2-1 and 4.6.2-2) During procedure development, capability did not significantly change as the launch time varied throughout the launch window. The purpose of the procedure was to close the gap between the end of the nominal Gander capability (approx VI = 20.4kfps) and the beginning of low energy capability to Shannon, Ireland (approx VI = 21.9kfps). These procedures are specific to Gander. They do not necessarily work to any of the other Canadian sites (St. Johns, Stephenville), due to differences in energy and DELAZ_[AFP4.6-6].

PILE	HIGH-ENERGY GANDER CDR										
MM104	Abort TAL: ✓TAL flag set: G50 ITEM 41 = TAL SITE (any site) ✓Rates < .5°/sec; $\theta > 15^\circ$; $Y = 0 \pm 30^\circ$ PASS, OPS 301 PRO (✓304)										
MM304											
MM304	P, R/Y - CSS ✓VREL										
	<table border="1" style="margin-left: auto; margin-right: auto;"> <thead> <tr> <th>VREL</th> <th>ROLL (CSS)</th> <th>ALPHA (CSS)</th> </tr> </thead> <tbody> <tr> <td>VREL ≥ 19,900</td> <td style="text-align: center;">0°</td> <td style="text-align: center;">55°</td> </tr> <tr> <td>VREL < 19,900</td> <td style="text-align: center;">0°</td> <td style="text-align: center;">50°</td> </tr> </tbody> </table>	VREL	ROLL (CSS)	ALPHA (CSS)	VREL ≥ 19,900	0°	55°	VREL < 19,900	0°	50°	
VREL	ROLL (CSS)	ALPHA (CSS)									
VREL ≥ 19,900	0°	55°									
VREL < 19,900	0°	50°									
$\dot{H} = -800\uparrow$	Roll towards site ($\phi \sim 80^\circ$), initial target $\dot{H} = -350$, hold initial Alpha per table G50 Hold 3.0g Nz using roll										
	* If Nz ≥ 3.5: * * Reduce Alpha ($40^\circ < \alpha < 55^\circ$) and * * \dot{H} until Nz < 3.5 *										
Orbiter bug below upper line or V = 6K	Pitch down at 1°/sec, center needles, P, R/Y - AUTO										
	Go to <u>ENTRY MANEUVERS</u> (Cue Card)										

Figure 4.6.2-1 STS-114 High Energy Gander CDR Procedure

HIGH-ENERGY GANDER PLT		HOOK
-----MM304-----		
	BFS, OPS 301 PRO (√304)	
	[G50] Select Site YQX) – ITEM 41 + 21	
	[TRAJ] √BUGS, [HIS], √[H], RANGE	
	√ET DOORS – closed and latched (MM304 +1:30)	
Ḣ = -800↑	Monitor Ḣ, Nz	
When Ḣ stabilizes	Ensure Nz stays < 3.5	
Monitor Traj	Report when orbiter bug reaches thermal line	
Orbiter bug Below upper line or V = 6K	Monitor pitchdown at 1°/sec to center needles, √P,R/Y – AUTO	
V = 19K	HYD MPS/TVC ISOL VLV (three) – CL (hold 5 sec) √tb – CL	
V = 15K	[G50] √RWY, TACAN, S/B, ALTM (PASS/BFS)	
V = 10	* If RCS < [57] % either side: * * [G51] AFT RCS INH, ITEM 13 EXEC *	
V = 10	√SPDBK → 81% Go to <u>ENTRY MANEUVERS</u> (Cue Card)	
FB 2-17		ASC/114/FIN A

Figure 4.6.2-2 STS-114 High Energy Gander PLT Procedure

4.6.2.1 Major Mode Transition**MM104 ABORT TAL**

√TAL flag set: **G50** ITEM 41 = TAL SITE (any site) [AFPH4.6-7]

√Rates < .5°/sec; $\theta > 15^\circ$, $Y = 0^\circ \pm 30^\circ$ [AFPH4.6-8]

PASS, OPS 301 PRO (√304)

4.6.2.1.1 Cue

MM104

4.6.2.1.2 Displays

Abort Rotary Switch or SPEC 51

ADI

PASS CRT

4.6.2.1.3 Crew Action

F6 Abort Mode – TAL

Abort Mode pb – push

Or

G51 ITEM 1 EXEC

ITEM 3 EXEC

G50 Check that runways (Items 3&4) change from KSC to TAL runways

ADI √Rates <.5°/sec; $\theta > 15^\circ$, $Y = 0^\circ \pm 30^\circ$

PASS CRT, OPS 301 PRO

√MM304

4.6.2.1.4 Discussion

MECO velocity in this region is too high to make it to Gander using nominal guidance and too low to make it to Shannon, Ireland using low energy guidance. Before this procedure was developed, MECO velocities between approximately 20.4 K and 21.9 K led to a bailout in the North Atlantic Ocean. Note that the velocity boundaries for High Energy Gander are shown on the TAL PLT Bar Chart, and are flight specific.

After transition to Major Mode 104, the CDR declares the TAL abort. The procedure was specifically worded this way, to allow the CDR to abort TAL either with the rotary switch or by SPEC 51. In Major Mode 104, the TRAJ display will not change to “TAL TRAJ” so assuming that the rotary switch is used, the crew will verify that the TAL flag was set, by checking SPEC 50 to see that the TAL runways are in the primary and secondary slots. SPEC 50 will be used by the PLT to select the landing site in the next

step anyway. If SPEC 51 is used, the asterisks on the display (next to ITEM 1 and ITEM 3) provide feedback to the crew that the abort is selected.

The crew should check that the rates are $<0.5^\circ/\text{sec}$, and that pitch is greater than 15° and yaw is within 30° to eliminate roll-offs observed for very small alphas or large yaw angles. Transitioning to MM304 with a large roll-off delays start of the OMS dump needed for separation between the ET and Orbiter prior to ET rupture. Beginning with OI-29, this maneuver to the OPS3 attitude was automated^[AFPH4.6-9].

The PASS is moded to the entry software via an “OPS 301 PRO”, which, if the TAL flag has been set, cascades the software to Major Mode 304.

4.6.2.2 Initial MM304 Attitude

MM304 P, R/Y – CSS
√VREL

VREL	ROLL (CSS)	ALPHA (CSS)
VREL ≥ 19,900	0°	55°
VREL < 19,900	0°	50°

4.6.2.2.1 Cue

PASS MM304
Manual flying

4.6.2.2.2 Displays

ADI
AMI
HSI

4.6.2.2.3 Crew Action

F2 PITCH, ROLL/YAW CSS pb - push
Fly vehicle into initial attitude per the table (Roll = 0°, Alpha = 55° or 50° depending on VREL)
Entry TRAJ √Shuttle bug, guidance box, and trailer symbols for energy evaluation
HSI √Heading (lubber line, HAC bearing pointer) and range for reasonableness

4.6.2.2.4 Discussion

Once in Major Mode 304, the CDR takes CSS and puts the vehicle into attitude for the first pullout. The attitude varies slightly depending on orbiter velocity. For orbiter VREL >19,900, the attitude is: Roll 0°, Alpha 55°. For orbiter VREL < 19,900, the attitude is: Roll 0°, Alpha 50°. This table was developed because during testing of the procedure, possible control problems were found (due to elevon hinge moment exceedences) for the slow speed cases (MECO VI = 20.3k – 20.6k) if alpha got above 55° or if a large pitch up rate was induced at a high alpha. If alpha was allowed to get above 55°, or if a pitch up rate was made in this region, the elevons were unable to provide enough pitch authority to get the nose back down. To avoid this region, the table was developed to fly a lower alpha for the slow speed cases. For these slow speed cases, the lower alpha is still sufficient to dissipate the high energy condition, and it gets the vehicle away from the possible "cliff" for pitch control. Since the TAL flag is set, the vehicle will automatically fly to wings level and 43° alpha when it enters Major Mode 304. The CDR can either take CSS right away and fly to 55° (or 50°) alpha and wings level, or the CDR can allow the vehicle to reach wings level and 43° alpha, then take CSS and pitch up the rest of the way to 55° (or 50°) alpha.

The PLT and CDR confirm high energy using the shuttle bug on the Entry TRAJ. The HSI is used to check heading and range to Gander for reasonableness. The DELAZ should be approximately 5°-15° left at a range of approximately 1000 nm just after MM304 transition. The range will decrease and the DELAZ will increase during the first pullout.

4.6.2.3 BFS OPS 3 Transition, Site Selection, and ET Door Closure

BFS, OPS 301 PRO (√304)
G50 Select Site Gander (YQX) - 21 (√BFS)

TRAJ √BUGS, HSI √H, RANGE

√ET DOORS - Closed and latched
 (MM304 + 1:30)

4.6.2.3.1 Cue

BFS OPS 301 PRO: PASS MM304
 SPEC 50 Config and Trajectory verification: BFS MM304
 ET Doors: PASS MM304 + 1min 30 sec

4.6.2.3.2 Displays

SPEC 50 Horizontal Situation Display
 Entry TRAJ
 HSI

4.6.2.3.3 Crew Action

BFS CRT	BFS, OPS 301 PRO
<input type="checkbox"/> G50	ITEM 41 + 21 EXEC (for Gander)
<input type="checkbox"/> TRAJ	√Shuttle bug, guidance box, and trailer symbols for energy evaluation
HSI	√HDG (lubber line and HAC bearing pointer) and range
R2	√ET UMB L,R DR (two) tb - CL LAT (two) tb - LAT

4.6.2.3.4 Discussion

The BFS is moded to OPS 3 by the PLT and automatically cascades to Major Mode 304 if the TAL flag is set. The PLT then checks both PASS and BFS SPEC 50 for the proper landing site (ITEM 41). Expect the MCC to uplink additional Canadian runways and TACANs (including additional Gander runways) during the entry phase.

The trajectory and energy situation is monitored using the Entry TRAJ display and the Horizontal Situation Indicator. The ET Doors are checked at this point since the doors should be closed and latched one minute and 30 seconds after MM304 transition and there is sufficient time prior to guidance initiation to perform this check.

4.6.2.4 Roll Toward Gander

CDR:

Hdot = -800 ↑ Roll towards site ($\phi \sim 80^\circ$), initial target Hdot = -350_[AFPH4.6-10],
hold initial Alpha per table
G50 Hold 3.0 g Nz using roll

- | | |
|---|---|
| * If Nz \geq 3.5: | * |
| * Reduce Alpha ($40^\circ < \alpha < 55^\circ$) and | * |
| * Hdot until Nz < 3.5 | * |

If reqd, reconfig IDPs for entry

PLT:

Hdot = -800 ↑ Monitor Hdot, Nz
When Hdot Ensure Nz stays < 3.5
stabilizes

4.6.2.4.1 Cue

Hdot = -800 ↑

4.6.2.4.2 Displays

AVVI
AMI
ADI
SPEC 50

4.6.2.4.3 Crew Action

CDR: Roll vehicle towards site (left) when Hdot = -800 fps and is becoming more positive, then hold 3.0 g Nz.

PLT: Monitor Hdot and Nz
When Hdot stabilizes – Ensure Nz stays < 3.5

4.6.2.4.3 Discussion

Hdot will bottom out anywhere between -1000 fps and -2000 fps during the first pullout. When Hdot reaches -800 fps on its way back up, the CDR should roll the vehicle to the left (towards Gander). The goal is to hold 3.0 g Nz, which can best be gained by targeting to hold an initial Hdot of approximately -350 fps. The amount of roll that is required to capture -350 fps Hdot is dependent on roll rate. A specific roll rate is not called out, but a smooth roll-in will generally capture -350 fps Hdot at about 70-80 degrees of roll. Faster roll-in's will capture an Hdot that is more negative, and slower roll-in's will capture an Hdot that is more positive. An Hdot of -350 fps is the target because that leads to an Nz of about 3.0 g's, but if a more positive or more negative Hdot is captured (Hdot steady,

i.e., $H_{\ddot{}} = 0$), disregard the -350 fps number, and start working to obtain 3.0 g's, by slowly changing roll (more roll for more g's, less roll for less g's). At the beginning of the roll, $H_{\ddot{}}$ will be pegged at $+10$ fps². The CDR can use $H_{\ddot{}}$ as a good indicator of roll capture. When $H_{\ddot{}}$ becomes unpegged, and begins to decrease, the CDR should be ready to shallow the roll. The CDR's goal is an $H_{\ddot{}}$ of 0 , with an $H_{\dot{}}$ near -350 fps. It is important to maintain the assigned alpha (55° or 50°) during this roll. However, do not exceed 55° at the beginning of the roll, as the combination of the high alpha and the g's can sometimes cause alpha to spike up above 60° and be difficult to recover. It's common, especially for MECO velocities at the beginning of the capability window, for the g's to build before the roll is started. The roll should not be delayed. Once the $H_{\dot{}}$ is stable, the CDR should then use roll to hold 3.0 g's (increasing roll, increases g's, and decreasing roll, decreases g's). Increasing/Decreasing the roll, moves $H_{\dot{}}$ more/less negative. The CDR should attempt to make smooth, small corrections in $H_{\dot{}}$ to increase/decrease g's, and should keep an eye on $H_{\ddot{}}$ to avoid a severe oscillation of $H_{\dot{}}$, that could lead to positive $H_{\dot{}}$ (phugoid, which would add energy to an already high energy case), or excessively negative $H_{\dot{}}$ (which would lead to an over-g situation). Achieving 3.0 g's of N_z , and holding it, is imperative in order to bleed off the high energy, especially for MECO velocities near the end of the capability window. If N_z reaches 3.5 g's, alpha can be decreased to immediately reduce the g's. However, alpha less than 55° will increase the thermal stress on the vehicle, so lowering alpha should be avoided unless g's cannot be controlled with roll. This flying technique can be tricky and requires excellent coordination within the cockpit. The Ascent/Entry Trainer is an excellent tool to practice this procedure.

The crew is also reminded to reconfigure IDPs (MEDS) or CRTs (non-MEDS) for entry, if required. This step is only included in the procedure if the crew has chosen the Alternate CRT Configuration for ascent (the STS-114 crew did not choose the Alternate CRT Configuration, so FDF shown does not require this call out). This is the same call out that is made in the RTLS, TAL and ECAL procedures if the Alternate CRT Configuration is chosen.

4.6.2.5 Return to Auto Guidance

CDR:

Orbiter bug Pitch down at 1°/sec, center needles
below upper line P, R/Y AUTO
OR V = 6K

Go to ENTRY MANEUVERS (Cue Card)

PLT:

Monitor

Traj Report when orbiter bug reaches thermal line

Orbiter bug Monitor pitch down at 1°/sec to center needles,
below √P, R/Y AUTO
upper Line
or V = 6K

4.6.2.5.1 Cue

Pitch down, center needles: Orbiter bug reaches thermal line on Entry TRAJ (upper line) or V=6K.

4.6.2.5.2 Displays

Entry TRAJ
 ADI
 HSI

4.6.2.5.3 Crew Action

CDR: F2 PITCH, ROLL/YAW AUTO pb – push

PLT: Report to CDR when orbiter bug reaches thermal line on Entry TRAJ (upper line) or when V=6K, whichever occurs first

4.6.2.5.4 Discussion

The vehicle is pitched down to center the error needles and returned to auto guidance as soon as the shuttle bug reaches the upper line on the Entry TRAJ, or the velocity reaches 6,000 fps, whichever comes first. For MECO velocities near the beginning of the capability window, this will happen quickly, usually near the top of Entry TRAJ 2. For higher MECO velocities, it can happen much later, even near the bottom of Entry TRAJ 4. It is important to recognize when the orbiter reaches the thermal line (upper line) on the

TRAJ and return to auto guidance since energy is being dissipated at a high rate, and the high energy condition can become a low energy condition in a hurry if the high energy technique is continued. The pitch down is performed slowly (at $1.0^{\circ}/\text{sec}$) to avoid inducing a large drag error. Large drag errors should be avoided since they cause the roll to oscillate as guidance attempts to null drag and altitude errors. There may be a momentary radical attitude adjustment when the vehicle is given back to auto, as auto guidance aggressively nulls these drag and altitude errors. Performing the pitch down slowly gives the roll command time to compensate for the reduced alpha. Mach 6 was selected as the final point to return to auto guidance to ensure the orbiter is at the desired angle of attack by transition to TAEM. It is important to decrease the angle of attack before transition to TAEM, since TAEM guidance assumes flight on the front side of the L/D curve.

One off-nominal situation that can arise for the highest energy conditions is a roll reversal. Holding a left roll bleeds off energy and brings the DELAZ toward the nose, but for the highest energy cases which launch after the middle of the launch window, holding the left roll for an extended time will eventually move DELAZ to the right. For cases that remain high energy until close to $V=6K$, the crew should monitor DELAZ and not let it get excessively far to the right. Analysis was not done to determine what amount of DELAZ would be termed, "excessively far to the right," however, a DELAZ of 10.5° is probably a good rule of thumb for initiating a roll reversal.

The PLT's primary job during this time frame is to help the CDR recognize when the orbiter bug reaches the thermal line on the Entry TRAJ. The other tasks for the PLT include entry systems configuration items included in the next section.

After the High Energy Gander procedure is completed, and the vehicle is returned to auto guidance, the crew should go to the Entry Maneuvers Cue Card to monitor entry and perform the required procedures. The Entry FPH contains a more complete discussion of entry navigation and the Entry Maneuvers Cue Card.

4.6.2.6 Entry Systems Configuration

V = 19K HYD MPS/TVC ISOL VLV (three) - CL
(hold 5 sec) tb - CL

V = 15K G50 √ RWY, TACAN, S/B, ALTM
(PASS/BFS)

V = 10K * If RCS < 57 % either side: *

* G51 AFT RCS INH, ITEM 13 EXEC *

V = 10K √SPDBK → 81%
Go to ENTRY MANEUVERS (Cue Card)

4.6.2.6.1 Cue

V = 19,000 fps for isolation valves

V = 15,000 fps for runway set-up

V = 10,000 fps and RCS Quantity for RCS dump inhibit

V = 10,000 fps for speedbrake position check

4.6.2.6.2 Displays

AMI

SPEC 50 Horizontal Sit Display

RCS/OMS PRPLT QTY

SPI

4.6.2.6.3 Crew Action

R4 HYD MPS/TVC ISOL VLV (three) - CL
(hold 5 sec) tb - CL

G50 √ITEM 3 or ITEM 3 EXEC for primary runway
√ITEM 4 or ITEM 4 EXEC for secondary runway
ITEM 5 EXEC for secondary TACAN
√ITEM 39 EXEC for nominal, shortfield or ELS speedbrake
ITEM 9 + XX.XX EXEC to enter altimeter setting

O3 √RCS PRPLT QTY
If < checklist value either side:
G51 ITEM 13 EXEC

F7 √Speedbrake % → 81%

4.6.2.6.4 Discussion

While the CDR is monitoring the trajectory and flying the vehicle, the PLT monitors the trajectory and also performs the nominal TAL PLT V= 19K, 15K, and 10K steps. See section 4.5.1.12 and 4.5.1.13 for more information. The additional step at V =10K, check speedbrake to 81% is included before the crew is sent to the entry maneuvers card since the speedbrake check occurs right at the V=10K point in the entry maneuvers cue card.

4.7 RTLS PROCEDURES

Procedures discussed in this section are used in the event of a RTLS. STS-114 is used as an illustrative example (figs. 4.7-1 and 4.7-2).

PILE	RTLS CDR																					
	Abort initiated: After 2:30 (2 eng) At 3:40 (3 eng)																					
	ABORT RTLS * No joy: * * OPS 601 PRO *																					
	√GUIDANCE STATUS on RTLS TRAJ Expect PPA when GUID % to go = 0	WINDS <table border="1" style="border-collapse: collapse; width: 100%;"> <tr><td>50K</td><td style="text-align: center;">/</td></tr> <tr><td>38</td><td style="text-align: center;">/</td></tr> <tr><td>28</td><td style="text-align: center;">/</td></tr> <tr><td>20</td><td style="text-align: center;">/</td></tr> <tr><td>12</td><td style="text-align: center;">/</td></tr> <tr><td>7</td><td style="text-align: center;">/</td></tr> <tr><td>3</td><td style="text-align: center;">/</td></tr> <tr><td>1</td><td style="text-align: center;">/</td></tr> <tr><td>SURF</td><td style="text-align: center;">/</td></tr> <tr><td>SPDBK @ 3000 FT</td><td style="text-align: center;">/</td></tr> </table>	50K	/	38	/	28	/	20	/	12	/	7	/	3	/	1	/	SURF	/	SPDBK @ 3000 FT	/
50K	/																					
38	/																					
28	/																					
20	/																					
12	/																					
7	/																					
3	/																					
1	/																					
SURF	/																					
SPDBK @ 3000 FT	/																					
	* If GUID 'INHB': * * √UNCONVERGED GUID TABLE * * MAN PPA per PRPLT * * REMAINING * * After GUID CONVERGE: * * P,R/Y AUTO/AUTO THROTTLE *																					
	After PPA: √BFS ITEM 1 (*) [TRAJ] √Bugs, [HSI] √ , Pitchdn ($\beta = 0^\circ$, $\alpha = -2^\circ$)																					
	MECO ----- MECO																					
	√ET SEP (MECO + 16 sec) √MM602 ($\alpha > 10^\circ$ and SEP + 10 sec) √P,R/Y, SPDBK, BDY FLP – AUTO $\alpha = 50^\circ$ until ~1.8g, maintain 2.2g																					
	Adjust seat																					
	$\dot{H} > -320\uparrow$ [VERT SIT] √ α vs Mach V = 5 √RUD, AIL TRIM and g < 2 AIR DATA PROBE (two) – Deploy (√Heat)																					
	M = 3.2 √SPDBK → 65% M = 2.7 L HUD PWR – ON																					
	* If M < 2.5, P CSS for ADTA to G&C incorp *																					
	M = 2.0 Ensure ADTA to G&C else THETA limits M < 1.0 P,R/Y – CSS, √SPDBK CMD vs POS √NWS – 1 Lock Inertia Reels																					
	POST LANDING: ENT, <u>POST LDG</u>																					
	FB 2-12	ASC/114/FIN A																				

Figure 4.7-1: STS-114 RTLS CDR Card

RTLS PLT
HOOK

If CSS: MAN THROT
 Man MECO
 ✓ P_C = 104% (2 eng)/69% (3 eng)
 ✓ DUMP

UNCONVERGED GUIDANCE TABLE

ENG OUT	OUTBOUND INITIAL θ	PITCHAROUND at % (8°/sec)	FLYBACK INITIAL θ
Liftoff	60°	44%	64°
:30	56°	47%	63°
1:00	57°	47%	63°
:30	56°	48%	62°
2:00	49°	51%	61°
:30	42°	51%	52°
3:00	38°	52%	50°
:30	34°	53%	48°
4:00	Last RTLS	52%	46°

✓ P_C at PPA + 20 sec
 * If P_C = 104% (2 eng): *
 * G51 MAX THROT – ITEM 4 (*) *

Pitchdn: ✓ P_C → 67%

MECO ----- **MECO**

KEAS = 77 ✓ SPDBK → 81%
 ✓ ET DOORS – Closed and latched (MECO +1:30)
 ✓ ET SEP, SRB SEP – AUTO
 Adjust seat
 ✓ TACANS, INCORPORATE
 * If KSC TACAN Fail: *
 * TACAN Ch 073X (OMN), ITEM 5 EXEC *

G51 ✓ AIR DATA, INCORPORATE

MM603 HYD MPS/TVC ISOL VLV (three) – CL
 (hold 5 sec) ✓ tb – CL

H = 85K MLS (three) – ON
 If Rwy 33(15): MLS CH (three) – 6(8)
 I/O RESET

M = 2.7 R HUD PWR – ON
 M < 1.0 ✓ R FLT CNTLR PWR – ON

M = 0.7 ✓ LG EXTEND ISOL VLV – OP
 H = 10K ✓ BDY FLP – TRAIL
 LES Visors – Down

POST LANDING: ENT, POST LDG

FB 2-13
ASC/114/FIN 1

Figure 4.7-2: STS-114 RTLS PLT Card

4.7.1 Abort Initiation

Abort initiated:

after 2:30 (2 eng)

at 3:40 (3 eng)

ABORT RTLS

* No joy: *

* OPS 601 PRO *

4.7.1.1 Cue

MCC Call or No Comm Mode Boundaries

4.7.1.2 Displays

Event Timer

CRT

4.7.1.3 Crew Action

F6 Abort Mode - RTLS
Abort Mode pb - push

or

CRT OPS 601 PRO

4.7.1.4 Discussion

RTLS is selected by placing the abort rotary switch in the RTLS position and depressing the abort pb. As per Flight Rules, RTLS is selected no earlier than 2:30 MET upon completion of alpha limiting. RTLS selection time is discussed in detail in section 2.6.1 of this document. In the event of an abort rotary switch malfunction, RTLS may also be selected via the OPS 601 PRO CRT entry.

4.7.2 Fuel Dissipation Attitude and Throttling

If CSS: MAN THROT

MAN MECO

$\sqrt{P_c} = 104\%$ (2 eng)/69% (3 eng)

UNCONVERGED GUIDANCE TABLE

ENG OUT	OUTBOUND INITIAL Θ	PITCHAROUND at % (8°/sec)	FLYBACK INITIAL Θ
Liftoff	60°	44%	64°
:30	56°	47%	63°
1:00	57°	47%	63°
:30	56°	48%	62°
2:00	49°	51%	61°
:30	42°	51%	52°
3:00	38°	52%	50°
:30	34°	53%	48°
4:00	Last RTLS	52%	46°

4.7.2.1 Cue

RTLS Abort, MM 601 initiation

CSS for Manual throttle/manual MECO actions

4.7.2.2 Displays

PITCH, ROLL/YAW Auto/CSS pbs

SPD BK/THROT Auto/Man pb

RTLS TRAJ

RTLS TRAJ 2 (BFS)

MPS PRESS P_c gauges

ADI

4.7.2.3 Crew action

Monitor unless takeover required

Monitor PCs

F7 MPS PRESS P_c - 104% (two engine)
69% (three engine)

If CSS, Depress SBTC button

Match *commanded* throttle level

Release SBTC button

$\sqrt{\text{SPD BK/THROT - MAN}}$

Throttle to desired setting

At C/O mark,

ME SHUTDN pbs (three) - push

4.7.2.4 Discussion

Once an RTLS abort is initiated, auto guidance pitches the vehicle to an I-loaded fuel dissipation attitude (in pitch) which is held constant with respect to the inertial reference frame until the start of pitcharound. These values are listed in the unconverged guidance table on the RTLS PLT page of the Ascent Checklist. This card lists the fuel dissipation attitude and ET propellant remaining at pitcharound versus engine out time as a backup in case guidance is unconverged. For RTLS aborts selected after the I-loaded value VLATE, the vehicle does not assume a fuel dissipation attitude but pitches around immediately.

For the two engine RTLS case, guidance throttles the remaining two engines to the abort throttle setting, or 104%, upon RTLS selection. For three engine RTLS aborts, guidance throttles the three engines down to 69%. This provides rough equivalence to the two engine case in total thrust (approximately 208% total). The throttles remain at the appropriate throttle setting from abort initialization until the pitcharound maneuver is completed.

The unconverged guidance table includes estimates for pitch attitude and propellant remaining at powered pitcharound. It should not be flown manually unless guidance is unconverged because the data is generic, and guidance uses a more accurate calculation as the pitcharound cue. Crews typically watch the propellant remaining closely and wait until about 3 to 5 percent after the expected pitcharound value to take CSS and pitcharound. When guidance is converged, this should not be necessary. It is also important to note that this table is designed for the two engine RTLS case. The three engine RTLS case is similar in total thrust profile to a late engine failure RTLS (312 percent total thrust up to the latest select time followed by 208% total thrust during the fuel dissipation phase). For this reason, the crew should expect pitcharound data for the three engine case to match the Last RTLS engine out data on the table.

If the CDR has selected CSS, the PLT selects manual throttles and performs a manual throttle down and MECO. To select manual throttles, the button on the SBTC is depressed and held until the commanded throttle level is matched. At this time the button is released and the PLT's MAN SPD BK/THROT light should illuminate.

4.7.3 Guidance Convergence and Powered Pitcharound

√GUIDANCE STATUS on RTLS TRAJ

Expect PPA when GUID % to go = 0

- * If GUID 'INHB': *
- * √UNCONVERGED GUID TABLE *
- * MAN PPA per PRPLT *
- * REMAINING *
- * After GUID CONVERGE: *
- * P, R/Y AUTO/AUTO THROTTLE *

After PPA: √BFS ITEM 1 (*)

4.7.3.1 Cue

Convergence:

ADI Error Needles
GUID Countdown Parameter

PPA:

ET propellant remaining
Time from MCC
Pitch rate = -10°/sec
GUID Countdown Parameter

4.7.3.2 Displays

RTLS TRAJ
BFS RTLS TRAJ 2
ADI
Clock

4.7.3.3. Crew Action

Monitor
Note predicted pitcharound time from MCC

4.7.3.4 Discussion

Guidance initiates the RTLS PPA based in part on a comparison of the predicted final mass at PPD to an I-loaded mass target (MBOD1 or MBOD2). When these numbers converge and when the thrust direction check and guidance convergence criteria are met, the pitcharound maneuver is initiated. During fuel dissipation, guidance computes the ratio of actual to expected mass in terms of percent remaining until PPA and displays it on the RTLS TRAJ display. PPA coincides with PPA percent = 0.

Pitcharound is essentially an inplane maneuver done at a pitch rate of approximately 10°/sec which orients the orbiter/ET configuration in a heads up attitude, pointing back toward the launch site (retrograde). Once the pitcharound is completed, flyback guidance is initiated to null the downrange velocity and add sufficient uprange velocity for the orbiter to glide to the RTLS runway.

For late RTLS aborts (selected after the I-loaded value VLATE) the vehicle does not assume a fuel dissipation attitude but rather pitches around immediately. RTLS pitcharound is usually delayed in order to burn off excess propellant until the MPS propellant remaining is sufficient to achieve the required RTLS MECO targets. Coarse weight control is achieved by selection of the time to begin the constant rate pitcharound. MPS throttling during flyback is used for fine weight control.

If guidance is not converged, the CDR takes CSS and pitches around at the manual propellant remaining percentage from the unconverged guidance table on the RTLS PLT page. Note that this data is generic, while the PPA computation reflects actual performance. Also note that when flying manually, it is much better to pitch around slightly early than slightly late because a nominal RTLS MECO state may not be reached as a result of a late pitcharound. A slower pitch rate of $8^{\circ}/\text{sec}$ is used when performing the pitcharound manually since the pitch rate pointer pegs at $10^{\circ}/\text{sec}$. Three to five cycles of unconverged guidance may immediately follow the PPA maneuver as the thrust turning rate equations stabilize and convergence checks are met after the dynamic maneuver.

After PPA, the CDR checks to see that the BFS has moded to flyback via ITEM 1 on the BFS RTLS TRAJ 2 display.

4.7.4 OMS Dump

√DUMP

4.7.4.1 Cue

RTLS abort, MM 601 initiation

4.7.4.2 Displays

OMS PRESS Pc gauge
RCS/OMS PRPLT QTY

4.7.4.3 Crew Action

Monitor

 √OMS dump
F7 OMS PRESS Pc
O3 RCS/OMS PRPLT QTY

4.7.4.4 Discussion

After checking the throttle levels, the PLT verifies that the OMS dump is proceeding nominally. OMS propellant is dumped at the initiation of MM 601 to improve performance, to reduce landing weight, to meet tank landing weight constraints, and to control the c.g. Depending on the flight, the OMS RCS interconnect may be enabled or inhibited prior to lift-off. If the interconnect is inhibited, OMS propellant is dumped through the two OMS engines. If the interconnect is enabled, the dump begins through the two OMS engines. After a 3 second interconnect sequence, the OMS propellant begins dumping through the 24 ARCS jets (20 null jets and 4 +X jets) as well. The dump is set to a predetermined I-loaded time duration but terminates automatically at MECO prep (fine countdown), MECO confirmed, or the timer, whichever comes first. This duration is fixed regardless of the abort initiation time.

The orbiter has a relatively narrow range of acceptable longitudinal and lateral c.g. locations. Failure to burn the planned amount of OMS propellants can result in reduced static margin and pitch stability problems, lateral stability problems, or a combination of both.

4.7.5 Flyback Attitude and Throttles

CDR:

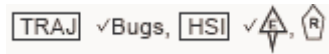

PLT:

$\sqrt{P_c}$ at PPA + 20 sec

* If $P_c = 104\%$ (2 eng): *

* G51 MAX THROT - ITEM 4 *

4.7.5.1 Cue

PPA + 20 seconds

4.7.5.2 Displays

RTLS TRAJ

RTLS TRAJ 2 (BFS)

MPS PRESS P_c gauges

AMI

HSI

SPEC 51 Override

4.7.5.3 Crew Action

Monitor trajectory

Monitor P_c s

F7 MPS PRESS P_c - $\sqrt{\sim 100\%}$ (two engine)
 $\sqrt{\sim 69\%}$ (three engine)

If $P_c = 104\%$ (2 eng),

G51 ITEM 4 EXEC

4.7.5.4 Discussion

The CDR verifies the trajectory using the predictor bugs on the RTLS TRAJ display. The orange Earth relative velocity (V_{REL}) bearing pointer and the green runway^[AFPH4.7-1] bearing pointer (waypoint 1 is the HAC tangency point) are checked on the Horizontal Situation Indicator (HSI) to ensure they are converged by MECO.

Once the pitcharound is completed, the engines throttle to 100% for a two SSME RTLS and 69% for a three SSME RTLS. These values are initial settings only, and the throttles may vary (3 to 5 percent) during the flyback phase to ensure less than 2% ET propellant remaining at MECO. Too much propellant remaining can result in the Orbiter recontacting the ET after separation, due to fuel slosh effects, while insufficient propellant will result in MECO short of the R-V line. MPS throttling is used during the flyback phase, in conjunction with flyback thrust attitude control, for fine weight control. If it appears that the vehicle will have too much propellant at MECO, the operating engines throttle down, and a higher thrust attitude preserves the vertical thrust component at the expense of the horizontal component. The increased flyback time compensates for the reduced propellant flow with the net result that more fuel is dissipated during flyback. The converse is true if it appears that the vehicle will be short of propellant. If guidance is

commanding for full throttle (104%) and it is at least 20 seconds after pitcharound, the crew enables K_MAX_SECONDARY (109%) via SPEC 51 (ITEM 4 EXEC).

If a three engine RTLS is being flown, the engines throttle down to resemble the two engine case. Thus, prior to pitcharound, the three engines throttle to 69%. The trajectory and timeline are similar in both cases. It is important to note that if manual throttle or CSS is selected during or after pitcharound, a return to AUTO does not regain throttling for weight control. The throttle setting remains at the last commanded manual setting.

4.7.6 Powered Pitchdown

CDR:

Pitchdn ($\beta = 0^\circ$, $\alpha = -2^\circ$)

PLT:

Pitchdn: $\sqrt{Pc} \rightarrow 67\%$

4.7.6.1 Cue

Range (Delta Range bug on RTLS TRAJ or RTLS TRAJ 2 reaches PD mark)

Time

Pitchdown maneuver

4.7.6.2 Displays

RTLS TRAJ

RTLS TRAJ 2 (BFS)

ADI

AMI

HSI

4.7.6.3 Crew Action

Monitor

AMI, $\sqrt{\text{Powered Pitchdown to } \alpha = -2^\circ, \beta = 0^\circ}$ (CDR)

HSI

F7 $\sqrt{\text{MPS PRESS } Pc} \rightarrow 67\%$ (PLT)

4.7.6.4 Discussion

This maneuver starts approximately 20 seconds prior to MECO. At this point PPD targeting is terminated and guidance begins active MECO targeting with the R-V-gamma line I-loads (3). This maneuver takes the mated vehicle from a relatively high angle of attack to the required separation attitude ($\alpha = -2^\circ$, pitch rate = $-0.25^\circ/\text{sec}$). MECO occurs when the desired cutoff velocity has been achieved based on the MECO R-V line. Auto guidance stabilizes the vehicle at least 5 seconds prior to MECO. At the start of PPD, the SSMEs are throttled back to minimum throttle level (usually 67%).

PPD is an especially critical maneuver if flying in CSS. For three engine RTLS cases, pitchdown must be started earlier. In this case, the PD3 mark is used as the pitchdown cue. At MECO, the yaw must be zeroed and the alpha stabilized at -2° . To zero yaw, the CDR must yaw to the orange HSI Vrel bearing pointer until the beta is nulled. The HSI contains a digital beta read out that the crew can monitor, including the direction to fly to null the error_[AFPH4.7-2]. The CDR then rolls to center the needles. Alpha deviations, significant MECO yaw, or delayed ET sep may result in loss of control. If CSS has been selected, manual throttles are also selected and the engines throttled to the PPD throttle level. MECO must then be performed manually when the Delta Range bug reaches the CO mark (RTLS TRAJ display).

4.7.7 MECO

-----MECO-----MECO-----

4.7.7.1 Cue

Delta range (DR) bug reaches CO tick
Sensed deceleration
Engine Pc gauges fall to zero
MAIN ENGINE STATUS lts - red

4.7.7.2 Displays

RTLS TRAJ
RTLS TRAJ 2 (BFS)
AMI (ACCEL)

4.7.7.3 Crew actions

Monitor if Man MECO not required

If Man MECO required,

TRAJ Delta Range bug @C/O mark,
C3 ME SHUTDN pbs (three) - push
If command path failure or data path failure and no comm with MCC,
R2 Affected MPS ENG PWR (two) - OFF (at $\alpha = -1$)

4.7.7.4 Discussion

Active targeting for MECO begins at PPD. Guidance targets for PPD utilize gamma, altitude, mass, and the PPD R-V line. After PPD, guidance targets to the I-loaded MECO R-V-gamma line. Throughout Powered RTLS, guidance continues to fly in the same inertial plane defined at lift-off. A target altitude is selected, consistent with velocity, to keep dynamic pressure within limits. Guidance commands MECO based on either guidance targeting or low-level sensors, whichever comes first. Nominally guidance commands shutdown based on the targeting criteria described above. However, if the ARM flag in the SSME OPS sequence has been set, the GPCs check the ET low-level sensors. If these sensors read dry, then a shutdown timer is initiated. The current value of this timer is 0 seconds.

If in manual throttle, the main engine shutdown pbs should be used. If a command path failure exists, then the appropriate ENGINE POWER ac switches (two per engine on panel R2) should be placed in OFF when alpha equals -1° , per the MPS cue card, MPS CMD/HYD/ELEC procedure. If a data path failure exists and there is no communication with MCC, treat the data path failure as a command path failure. This is because a data path failure masks a command path failure and because an engine with a command path failure must be shut down before the MECO command to avoid uncontained engine damage. It should be noted that an MPS dump cannot be accomplished for any engine which has been shut down by the ENGINE POWER switches on panel R2. If data path

failure or power switch shutdown occurs on more than one engine, the crew sets MECO confirmed by depressing all three SSME shutdown push buttons on panel C3 to start the ET sep sequence.

Since guidance attempts to fly to the R-V-gamma line at MECO, the post-MECO energy state may be high or low if the engines are not shut down on time, thus producing an off-nominal energy state in relationship to the landing site. The vehicle will execute an S-turn if required to null out additional energy.

4.7.8 ET Separation

√ ET SEP (MECO + 16 sec) [AFPH4.7-3]

4.7.8.1 Cue

MAIN ENGINE STATUS lights - out

Time (15.6 seconds after MECO command)

4.7.8.2 Displays

MAIN ENGINE STATUS lts

RTLS TRAJ 2 (BFS)

ADI

SPI

AMI

4.7.8.3 Crew Action

Monitor the auto sep sequence and subsequent -Z translation

√Attitude and pitch rate

AMI $\alpha = -2^\circ$, range: $+2^\circ$ to -89°

(Note: Within this range, guidance does not generate a SEP INH. However, the vehicle will probably go out of control if separation is done at angles of attack below -8° to -10°)

ADI Pitch rate = $< +.25^\circ/\text{sec}$

√ET sep and -Z translation

F7 √MAIN ENGINE STATUS lights - out

(Note: If SEP INH, auto seq will perform separation in 6 seconds.)

√-Z burn

SPI √aerosurface activation at 77 KEAS

4.7.8.4 Discussion

Nominal ET sep occurs 18.7 seconds after MECO command. The separation sequence begins at MECO and is accomplished in the AUTO mode without crew intervention. If there is a reason for delay of ET sep, placing the mode switch in the MAN position delays separation until returned to AUTO or the ET SEP pb is pushed. In the MAN mode, ET sep does not occur unless the SEP pb is depressed, initiating a fast sep.

The RTLS ET Separation inhibit constraints were converted from K-loads to I-loads in OI-26. Removal of the SRB and RTLS ET separation inhibits were recommended during the RTLS heavyweight certification process. The SRB sep inhibits were “no-opted” beginning with STS-73 per PRCBD S052891. Since the RTLS ET sep inhibits were K-loads, the decision was made to wait until OI-26 to convert these K-loads to I-loads, and then redefine the inhibit limits. Beginning with STS-84, the RTLS ET separation inhibit I-loads were changed to “no-opt” all but the pitch rate and angle of attack limits (see table 4.7.8.4-I below). If either the pitch rate or angle of attack separation constraints are

violated, the auto sequence is inhibited for up to 6 seconds. The sequence constantly checks to see if out of limits conditions have been satisfied. If so, the sequence continues. If not, after a 6 second delay, the constraints are ignored and the ET separates without crew intervention at MECO plus 13.2 seconds. At ET sep, the red main engine status lights extinguish.

Table 4.7.8.4-I: RTLS ET Separation Inhibit I-loads

Constraint	Old Limits	Current Limits
Pitch Rate	-5.0°/s to +0.25°/s	-20.0°/sec to +0.25°/s
Roll Rate	-5.0°/s to +5.0°/s	-20.0°/s to +20.0°/s
Yaw Rate	-0.5°/s to +0.5°/s	-20.0°/s to +20.0°/s
Angle of Attack	-89.0° to -2.0°	-89.0° to -1.5°
Sideslip	-2.0° to +2.0°	-20.0° to +20.0°

[AFPH4.7-4]

Immediately following the ET sep, the vehicle starts a -Z translation maneuver. This maneuver is initiated by firing 10 RCS jets (6 ARCS and 4 FRCS) burning in the downward direction. A commanded 2°/sec pitch rate is overlaid on top of this continuous commanded burn, resulting in a -Z translation for 5 seconds and a controlled pitchup at 2°/sec. This -Z translation is done to prevent recontact with the ET and prepare for the alpha recovery phase of GRTLS. If required the crew can manually perform this maneuver using the THC and RHC. At 77 KEAS, the aerosurfaces are activated.

4.7.9 Alpha Recovery Phase

√MM602 ($\alpha > 10^\circ$ and SEP + 10 sec)

√P,R/Y, SPDBK, BDY FLP - AUTO

4.7.9.1 Cue

Attitude rates

End of -Z translation (10 seconds and $\alpha > 10^\circ$)

CRT display changes - VERT SIT 1 appears

4.7.9.2 Displays

ADI

AMI

VERT SIT 1

SPI

Engine manifold pressure

4.7.9.3 Crew action

Monitor. If VERT SIT 1 does not appear at the end of the -Z translation burn, the crew performs an OPS 602 PRO.

CRT √MM602

ADI √Pitch rate = $2^\circ/\text{sec}$ to $\alpha = 50^\circ$

SPI √elevon and body flap activation

4.7.9.4 Discussion

The transition to MM 602 occurs at the end of the -Z translation burn (10 seconds from ET sep, $\alpha > 10^\circ$). After entry into MM 602, the CDR verifies that pitch, roll, and yaw, speedbrake, and body flap are in AUTO. Upon transition to MM602, the Alpha Recovery phase begins where the pitch up at $2^\circ/\text{sec}$ continues until $\alpha = 50^\circ$. During this phase, guidance brings the orbiter attitude from the low angle of attack required for ET sep to a high alpha (50°) and a wings level attitude in preparation for atmospheric flight. This attitude is maintained as the N_z increases to within 0.35g of the constant normal acceleration value (≈ 2 to 2.2g) used for the N_z hold phase. The value of the angle of attack influences the subsequent aerodynamic loads experienced by the orbiter, the minimum alpha reached during the N_z hold phase, and the orbiter range potential. There is no energy management performed during this phase.

A Forward RCS (FRCS) propellant dump may be performed on a mission specific basis depending upon premission planned orbiter weight and X c.g. The FRCS propellant dump begins post-ETSEP at a QBAR of 20 psf, which is ~ 45 sec after ET structural release. FRCS dumps are performed post ETSEP maneuver so that orbiter -Z translation capability from the ET is guaranteed. The GRTLS FRCS dump currently lasts for an I-loaded duration of 0 or 10 sec. Work is in progress to extend the duration to as much as 90 sec, but a longer FRCS dump causes the elevons to move up to higher positions than are currently certified for RTLS. The FRCS propellant is dumped through the 4 yaw jets in

the nose of the orbiter (2 on each side) such that the net result is a null burn. If one or both yaw jets fail on one side of the nose during the dump, then either or both opposing yaw jets on the opposite side of the orbiter are inhibited from dumping to ensure a null burn. The FRCS dump flow rate per jet is ≈ 3.05 lb/sec, so for a nominal 4 jet dump the flow rate is ≈ 12.2 lb/sec.

An Aft RCS (ARCS) propellant dump may also be performed on a mission specific basis depending upon premission planned orbiter weight and X c.g. The ARCS propellant dump begins post-ETSEP at MM602 + 20 sec, which is ≈ 30 sec after ET structural release. The ARCS dump is performed post ETSEP maneuver so that orbiter -Z translation capability from the ET is guaranteed. The GRTLs ARCS dump currently lasts for an I-loaded duration of 0, 88, or 185 sec. The ARCS propellant is dumped through the 4 +X jets in the rear of the orbiter such that the net result is a propulsive burn (forward thrust). If one or both +X jets fail on one side during the dump, then either or both opposing +X jets on the opposite side are inhibited from dumping to ensure symmetrical forward thrust. The ARCS dump flow rate per jet is ≈ 3.11 lb/sec, so for a nominal 4 jet dump the flow rate is ≈ 12.44 lb/sec.

A Main Propellant System (MPS) propellant dump is performed every mission independent of premission planned orbiter weight and X c.g. Failure to dump MPS propellant results in an X c.g. position further aft than desired, reducing static margin and pitch stability. The MPS propellant dump consists of dumping ≈ 304 lbs of LH₂ and $\approx 3,870$ lbs LO₂. LH₂ is dumped through the LH₂ 1.5 inch dump line and the LH₂ 8 inch fill/drain line, both of which are on the port side of the fuselage. The fuselage vent doors should be closed during the LH₂ dump, so they are closed automatically at the transition to MM602. The LH₂ dump through the 1.5 inch line actually begins at MECO + 10 sec (≈ 4 sec prior to ETSEP), while the LH₂ dump through the 8 inch line begins at MM602 (most of the LH₂ is dumped during MM602). LH₂ dumping is aided by Helium pressure and may be considered complete when a noticeable drop is observed on the engine manifold pressure gauges (normally by the beginning of the Nz Hold phase), although the LH₂ fill/drain lines remain open until $V_{REL} = 3800$ fps.

A small amount of LO₂ is dumped through the operational SSME MOVs, starting at MM602. However, most of the 3,870 lbs of LO₂ is dumped through the LO₂ 8 inch fill/drain line on the starboard side of the orbiter, starting at MM602 + an I-loaded time of either 0 or 66 sec. The intent of the 66 sec delay in starting the LO₂ 8 inch dump is to keep the X c.g. from moving forward of the 1079 inch RTLS limit which exists for angle of attack (α) $> 30^\circ$. During the LO₂ 8 inch dump, X c.g. moves forward ≈ 4 inches. Since the RTLS X c.g. limit changes from 1079 to 1076.7 inches as α drops below 30° during the Nz Hold phase, forward X c.g. missions are able to remain within the certified envelope by delaying the LO₂ 8 inch dump until after α is below 30° . LO₂ dumps are normally completed ≈ 10 sec after the Nz Hold begins if the dump starts at MM602 + 0 sec. For LO₂ dumps which start at MM602 + 66 sec (near the beginning of the Alpha Transition phase), completion usually occurs ≈ 20 sec after the Alpha Transition phase

begins. However, just as LH₂, the LO₂ fill/drain lines also remain open until $V_{REL} = 3800$ fps.

4.7.10 Flight Control Configuration

KEAS = 77 $\sqrt{\text{SPDBK}} \rightarrow 81\%$

4.7.10.1 Cue

KEAS = 54 Roll jets inactive

KEAS = 77 SPBK opens to 81%
Pitch jets inactive

KEAS = 121 RCS COMMAND Light Reconfiguration

4.7.10.2 Displays

AMI

SPI

VERT SIT 1 display

AMI (EAS)

RCS COMMAND lights

GNC SYS SUMM 1 display

4.7.10.3 Crew Action

Crew awareness for pitch and roll jet deactivation

SPI $\sqrt{\text{SPEEDBRAKE \%}} \rightarrow 81\%$

Monitor RCS COMMAND lights

ROLL lts - 3 or 4 yaw jets *commanded* on

PITCH lts - elevon rate saturation

4.7.10.4 Discussion

Attitude control after the -Z burn is accomplished by both RCS thrusters and aerodynamic surfaces until the onset of dynamic pressure. The RCS roll thrusters are deactivated at QBAR of 10 psf and the pitch thrusters are deactivated at QBAR of 20 psf (~77 KEAS). The aft yaw jets, which are used as the primary mode for lateral control during low dynamic pressure, remain available to assist the ailerons and rudder for lateral control until Mach = 1.

The GRTLS FCS automatically schedules the elevons and controls the BDYFLP to null the elevon trim command. Pitch is provided by the elevons and RCS jets. At QBAR of 20 psf (77 KEAS), the speedbrake should move to 81% (98.6° relative to the hingeline) in order to enhance lateral stability by allowing the elevons to be trimmed down (into the airstream).

Since the RTLS is a relatively low speed abort, heating is not as big a constraint as it is in AOA and nominal entry cases. For this reason, one generic GRTLS elevon trim schedule is sufficient. The correct elevon schedule should be selected automatically during an RTLS, so a SPEC 51 ITEM entry should not be necessary.

At QBAR = 50 psf, the roll and pitch RCS activity lights are reconfigured by the software to indicate the FCS workload to the crew. Left and right sides of the roll light illuminate simultaneously if three or four yaw jets are commanded on by the FCS. The lights indicate commands from the FCS to the jet select logic, not actual jet firings. And, since the minimum on-time for an RCS jet is 80 milliseconds, the commands to the light have been lengthened to allow the crew time to identify which light has failed. Both halves of the pitch light illuminate if priority rate limiting (PRL) issues a flag for elevon rate saturation, i.e., either the left or right elevons are driving at 20°/sec or greater.

4.7.11 ET Door Closure and ET/SRB Switch Configuration

- √ET DOORS - Closed and latched (MECO + 1:30)
- √ET SEP, SRB SEP - AUTO
- Adjust seat

4.7.11.1 Cue

MM 602 transition, ET Umbilical Door talkbacks

4.7.11.2 Displays

VERT SIT 1

4.7.11.3 Crew action

R2	CTRLINE LATCH tb - STO (ET DOORS closing)	
*	If not STO:	*
*	ET UMB DR MODE - GPC/MAN	*
*	CTRLINE LATCH - STOW (tb - STO)	*
*	L,R DR (two) - CLOSE (tb - CL)	*
*	LAT (two) - LATCH (tb - LAT)	*

4.7.11.4 Discussion

For an RTLS, the ET umbilical doors closure sequence is initiated automatically as soon as the ET sep flag is set. The first step in this sequence is to stow the centerline latches (CL). After 6 seconds, the CL latches will have released the doors even if only one motor is driving (the latches will be completely stowed if both motors are driving). Therefore, six seconds after sending the latch stow command, commands are sent to start closing the ET doors. The rest of the sequence allows for single motor operation of the doors (48 seconds) and uplock latches (12 seconds). The auto sequence takes 66 seconds to close the doors and should terminate at approximately TMECO + 1:20.

The transition to MM 602 occurs 10 seconds after ET sep, and by this time the centerline latch talkback should be indicating STO, giving a good indication to the crew that the auto sequence is working properly. If the talkback does not show STO within 2 seconds of MM602, then the auto sequence may not be working properly, and the crew should manually close the doors using the ET umbilical door closure cue card.

If the ET umbilical doors are not closed, the aerodynamic characteristics of the orbiter could be adversely affected, with the possibility of the doors ripping loose and damaging portions of the vehicle.

The PLT confirms that the ET SEP and SRB SEP pbs are in AUTO to ensure that WOW and WONG will be set correctly on touchdown.

4.7.12 TACAN Management

√TACANS, INCORPORATE

* If KSC TACAN Fail: *

* TACAN Ch 73X (OMN), ITEM 5 EXEC * [AFPH4.7-5]

4.7.12.1 Cue

MM 602 transition

4.7.12.2 Displays

VERT SIT 1

SPEC 50 Horizontal Situation Display

HSI

4.7.12.3 Crew action

√MCC

G50 ITEM 19 EXEC

If no comm,

refer to No Comm TACAN MGMT matrix in the Entry Checklist, pg 4-15.

4.7.12.4 Discussion

Before lift-off, the HORIZ SIT display is configured as it is for nominal entry. At the transition to MM 602, the orbiter is within range of the TACAN stations. Therefore, as soon as possible after the transition, the crew calls up SPEC 50 (HORIZ SIT) and evaluates the TACAN data. TACAN data may also be evaluated by selecting TACAN as the HSI SELECT SOURCE. Since the MCC can evaluate TACAN data compared to radar tracking and the crew can only evaluate compared to the navigation state, the crew should check with the MCC before taking action. In a no comm situation, the crew will incorporate TACAN data as appropriate based on their onboard evaluation. Page 4-15 of the Entry Checklist (MS only page), contains the NO COMM TACAN MGMT matrix.

If the KSC primary TACAN (Titusville, TTY59Y) is failed, the secondary TACAN (Ormond Beach, OMN73) is selected via ITEM 5 EXEC on SPEC 50. In the extremely unlikely event that neither the Titusville nor Ormond Beach TACAN is available, the Guidance and Procedures Officer (GPO) will uplink the Patrick TACAN (COF97) over one of the unavailable TACANs in the onboard landing site table and the the crew can access this TACAN by reselecting the landing site and the primary or secondary TACAN as necessary.[AFPH4.7-6]

4.7.13 NZ Hold Phase

$\alpha = 50^\circ$ until $\sim 1.8g$, maintain $2.2g$
Adjust seat

4.7.13.1 Cue

Nz approaches Nz desired minus $0.35g$ ($2.2 - .35 = 1.85g$)
 α decreasing to maintain target NZ

4.7.13.2 Displays

VERT SIT 1 (NZ displayed double bright)
SPEC 50 Horizontal Situation Display
G-meter
AMI (ACCEL)
ADI

4.7.13.3 Crew action

Monitor
Nz = $1.8g$ Nz Hold Phase
Nz constant at $2.2g$

4.7.13.4 Discussion

If alpha does not start a gradual decrease from 50° as Nz exceeds $1.8g$, an Nz overshoot will occur. Excessive g loading could cause structural damage or failure and could also dissipate enough energy, if sustained too long, to impact RTLS range capability.

As the orbiter descends into the atmosphere, QBAR increases with increasing density. This causes Nz to increase. When Nz actual is within $0.35g$ of Nz desired, the alpha decreases gradually as Nz actual builds to the target Nz (flight dependent). Alpha then gradually decreases to maintain the target Nz. All ranging techniques, including S-turns, are inhibited during this phase. The ADI pitch error needle displays Nz error during this phase, and AMI ACCEL displays Nz in MM 602.

4.7.14 Alpha Transition Phase

$\dot{H} > -320\uparrow$ VERT SIT $\sqrt{\alpha}$ vs Mach
 $V = 5$ $\sqrt{\text{RUD, AIL TRIM}}$
 and $g < 2$ AIR DATA PROBE (two) – Deploy ($\sqrt{\text{Heat}}$)

4.7.14.1 Cue

$\dot{H} > -320$ fps and $\alpha > \alpha$ reference
 Velocity of 5,000 fps and load factor < 2 g for probe deployment

4.7.14.2 Displays

VERT SIT 1
 AVVI
 AMI
 ADI

4.7.14.3 Crew Action

Monitor

VERT SIT	$\sqrt{\alpha}$ profile, trims
G50	$\sqrt{\text{Orbiter approaching HAC tangency}}$
C3	ADTA PROBE L,R - DEPLOY/HEAT

4.7.14.4 Discussion

The alpha transition phase is initiated and the Nz hold phase terminated when $\dot{H} > -320$ fps and $\alpha > \alpha$ reference. During this phase, an angle of attack command is generated as a linear function of Mach number, which can be monitored on the VERT SIT 1 Mach-alpha profile. A roll maneuver is performed if required to either null any heading errors to the HAC tangency point, or to dissipate excess energy by turning away from the HAC (S-turn). Assuming the MECO targets were achieved, the vehicle should already be heading to the HAC tangency point such that little roll is required. The ADI pitch error needle displays alpha error for this phase.

Below Mach 5, it is important to monitor the rudder and aileron trim to ensure there is no “force fight”. If aileron trim is greater than 1° and rudder and aileron trim are in the same direction (both L or both R), manual intervention is required. The roll panel trim should be deflected in the opposite direction as the displayed trim direction, until aileron trim is less than 1° . The ADTA probes are deployed at Mach 5. In addition to $V_{rel} \leq 5K$, g should be < 2 prior to deploying the Air Data probes. This is a physical constraint on the Air Data probe doors. It takes approximately 15 seconds to deploy if dual motors are available. If one probe motor has failed, it takes approximately 30 seconds to deploy the affected probe. Although more likely on an ECAL profile, it is still possible on an RTLS intact abort to have $g > 2$ at $V = 5K$ if it falls at the end of the Nz Hold phase of GRTLS guidance. The steps are ordered so that the Rudder/Aileron check is aligned with $V = 5K$. The “and $g < 2$ ”

constraint is then indented under $V = 5K$ and only applies to the probe deploy, not the monitoring of rudder/aileron trim_[AFPH4.7-7].

4.7.15 TAEM Interface

CDR:		PLT:	
M = 3.2	√SPDBK → 65%	MM603	G51 √AIR DATA, INCORPORATE HYD MPS /TVC ISOL VLV (three) - CL (hold 5 sec) √tb - CL
		H = 85K	MLS (three) - ON If Rwy 33(15): MLS CH (three) - 6 (8) I/O RESET

4.7.15.1 Cue

Mach = 3.2 for MM603 transition

H = 85K for MLS power on

4.7.15.2 Displays

AMI

VERT SIT 1

ADI

SPEC 51 Override

4.7.15.3 Crew action

Monitor

√MM603

* If no transition GNC, OPS 603 PRO*

4.7.15.4 Discussion

Air data may be incorporated once the probes are deployed and after Mach 3.5. However, the data will not be processed until Mach 2.5 unless it is being forced. Since the MCC can evaluate the ADTA altitude using radar tracking, the MCC should be consulted prior to incorporating ADTA to navigation. Since little information is downlisted in OPS 6 to evaluate from a control standpoint, incorporation of ADTA to G&C is a crew call.

The MPS/TVC ISOL valves must be closed by the crew before the low altitude/high maneuvering regions of TAEM to prevent PRL. Another constraint on these valves is that they must remain open during the MPS dump, which means they cannot be closed until after $V_{REL} = 3800$ fps. Since the MLS LRUs are powered off prelaunch to conserve electrical power, they are powered on at 85,000 ft, followed by an I/O RESET EXEC.

At Mach = 3.2, the Alpha Transition phase ends and guidance starts the nominal terminal area energy management (TAEM) phases. The software modes from MM 602 to MM 603, and the orbiter symbol on VERT SIT 1 switches from Mach-alpha profile to range-altitude lines. The ADI pitch error needle starts displaying Nz error at TAEM interface. At TAEM interface, guidance does one of two things. If the vehicle was in an S-turn at the MM 603 TRANS, the TAEM S-turn phase is initiated and the S-turn continued until the E/W is below the S-turn termination reference, at which time the TAEM acquisition

phase begins. If the vehicle was not S-turning at the MM 603 TRANS, the TAEM acquisition phase is initiated and the E/W is tested to determine if an S-turn is required. If an S-turn is required, the TAEM S-turn phase is initiated. If no S-turn is required, guidance stays in the TAEM acquisition phase.

The GRTLS TAEM guidance phases (S-turn, acquisition, heading alignment, and prefinal) are identical to the nominal entry TAEM guidance except:

- (a) The energy per unit weight, altitude, and dynamic pressure references are extended to higher speeds to include all possible conditions existing when the trajectory is stabilized following the load relief maneuver.
- (b) To provide greater energy control, the bank angle limit during S-turn is increased from 30° to 45°.
- (c) Nz Command is also limited by angle of attack in MM603.

At Mach 3.2, the speedbrake begins to close. It should reach 65% by Mach 2.5 and remain there until Mach .95. At Mach .95, the speedbrake modulates to control energy over weight. Below about 15,000 ft altitude, the speedbrake command is computed based on energy over weight and dynamic pressure. The energy over weight terms are ramped out and the dynamic pressure terms ramped into the calculation until about 10,000 ft where the speedbrake is only controlling dynamic pressure prior to Approach and Land transition. During Approach and Land, the speedbrake controls airspeed on the outer glideslope and is retracted at 3K and adjusted at 500 ft to hit the targeted touchdown distance.

4.7.16 TAEM and Post Landing Procedures

CDR:

M = 2.7

L HUD PWR - ON

[AFPH4.7-8]

M = 2.0

Ensure ADTA to G&C else THETA limits

M = 0.9

P, R/Y - CSS, $\sqrt{\text{SPDBK CMD vs POS}}$ $\sqrt{\text{NWS - 1}}$

Lock Inertia Reels

M = 0.7

H = 10K

PLT:

R HUD PWR

- ON

* If M < 2.5, P CSS for ADTA to G&C incorp*

 $\sqrt{\text{R FLT CNTLR PWR - ON}}$

Lock Inertia Reels

 $\sqrt{\text{LG EXTEND ISOL VLV - OP}}$ $\sqrt{\text{BDY FLP - TRAIL}}$

LES Visors - Down

POST LANDING: ENT, POST LDGPOST LANDING: ENT, POST LDG**4.7.16.1 Cue**

Mach

Altitude

4.7.16.2 Displays

SPEC 50 Horizontal Situation Display

SPI

VERT SIT

4.7.16.3 Crew Action

Perform switch config

Monitor aerosurfaces

Fly vehicle once subsonic

4.7.16.4

Most of the procedures are very similar, if not identical, to the nominal entry events. The landing gear (LG) EXTEND ISOL valve must be open to allow hydraulic system 1 pressure to the LG deploy system. Nominally, the valve is opened automatically at $V_{REL} = 800$ fps. The crew must verify that the valve is open prior to gear deployment to ensure a nominal hydraulic deploy of the gear.

The post-landing procedures for RTLS are the same as for nominal EOM except that the hydraulic load test is not done.

4.8 CONTINGENCY ABORT

The contingency abort cue card arranges the procedures based on an engine out or event timeline. The two engine and three engine out procedures are divided into procedural blocks and monitoring blocks. Procedural blocks are on top with the monitoring blocks below. Procedural blocks contain critical actions that the crew must perform, while monitoring blocks are mostly automated procedures that the crew should monitor. The contingency abort cue cards also contain procedures for the stuck minimum throttle cases and the entry portion of a CA.

During ascent, the TRAJ display depicts which CA region the vehicle is currently passing through. A region indicator exists for both two and three engine out scenarios.

STS-114 is used as an illustrative example of the current contingency abort cue cards as shown in figures 4.8.1-1 and 4.8.2-1. The contingency entry cue card is shown in the same figure as the ascent contingency abort cue card for simplicity, in the ascent checklist the contingency entry cue card is on a separate page. [AFPH4.8-1]

4.8.1 Contingency Abort Cue Card

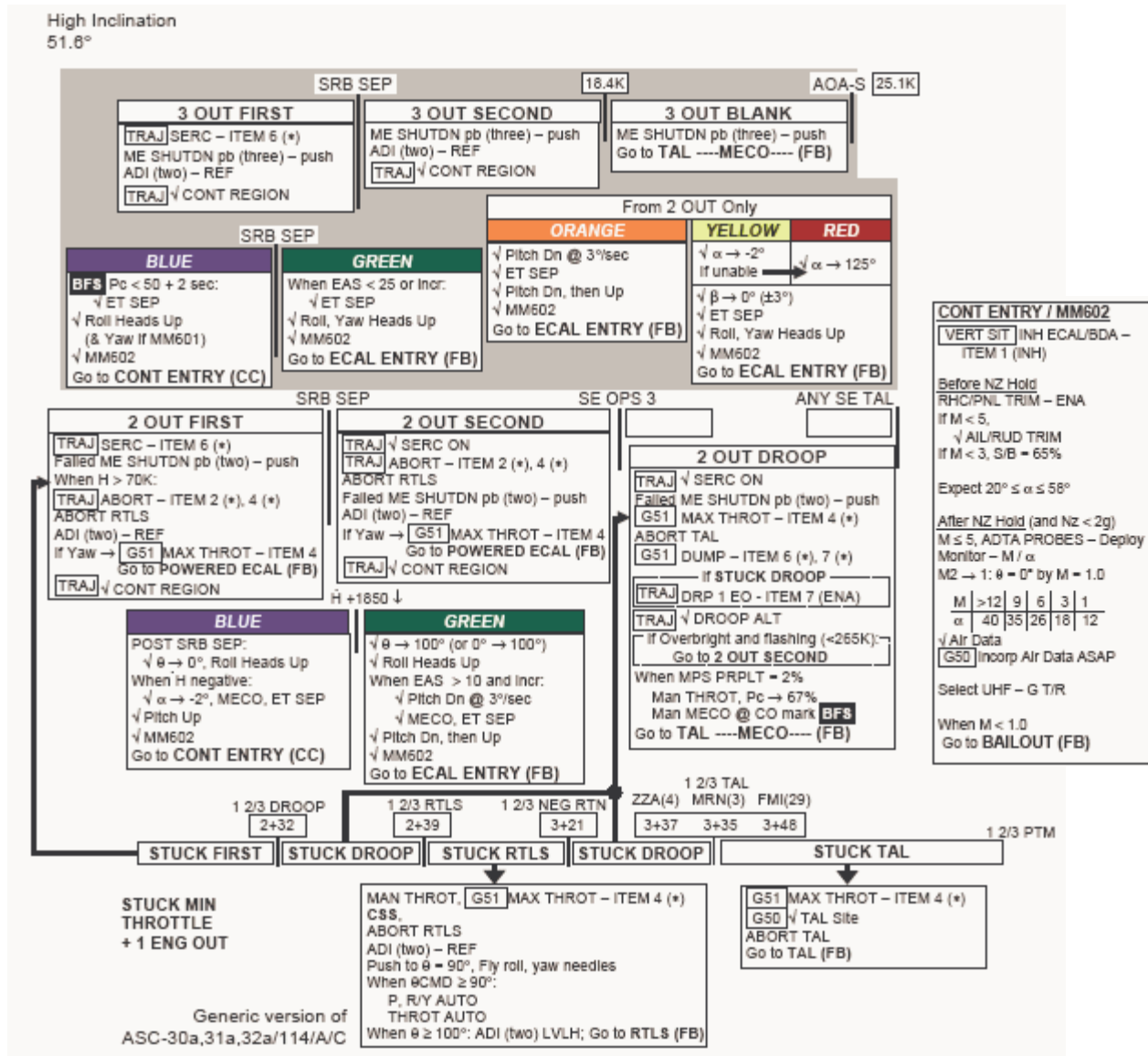

Figure 4.8.1-1 STS-114 Contingency Abort Cue Card

4.8.1.1 Two Engines Out

The two engine out portion of the contingency abort cue card is broken into three procedural blocks and two monitoring blocks. The two engine out procedural blocks are designed to get the crew to safe the vehicle (ensure SERC is on) as soon as two engines are believed failed without committing to a CA.

Single engine roll control (SERC) is required for any two engine out scenario to maintain vehicle control. Enabling SERC is a time critical action after the second engine fails and is now automated in second stage. However, because of its criticality, it is the first step in the two engine out procedure blocks. It should be turned on (or verified on) any time a second engine failure is suspected.

The GPCs will turn SERC on automatically during SRB tailoff when two engine failures are recognized in first stage. SERC will be turned on automatically in second stage if two engine failures are recognized by the GPCs or if sensed acceleration falls below a threshold in MM103. The crew can enable SERC via an ITEM 6 EXEC on the PASS TRAJ display anytime in MM102, 103 or 601. Executing a single engine auto contingency abort via ITEM 2,4 entry will also enable SERC (as discussed in detail below). However, SERC will not be turned on until SRB tailoff if enabled in MM102. Once enabled by the crew or based on a drop in sensed acceleration, SERC can be turned off by the crew via an ITEM 6 EXEC. However, if the GPCs enabled SERC by recognizing two engines failed, then SERC cannot be turned off using the ITEM 6. The PASS TRAJ display will show an asterisk next to the ITEM 6 whenever a crew action has enabled SERC (ITEM 6 or 2,4). The SERC ON will be displayed whenever the ascent DAP is using SERC. Once SERC is invoked, any manual pitch or yaw maneuvers should be limited to 4°/sec.

The auto CA is initiated by executing ITEMS 2 (Arm) and 4 (Start) on the PASS TRAJ display. Once ITEM 2 on the PASS TRAJ display is executed, the software is locked into the displayed abort region. However, the vehicles dynamics are constantly changing. If a significant delay transpires between executing the ITEM 2 and ITEM 4, the vehicle may actually transition to another abort region but the maneuver to be flown will have been frozen in the previous region. To avoid this dilemma, the crew should execute ITEMS 2 and 4 in close succession. To avoid confusion or possible sequencing problems, the crew should declare RTLS (Rotary, pb) immediately after executing the CA ITEM entries on the TRAJ display.

The first stage CA procedure is used anytime a second SSME fails while in first stage. The second stage CA procedure is used anytime a second SSME fails while in second stage, until the single engine OPS 3 109% boundary is reached. Both of these procedures result in a crew bailout unless within range of Bermuda or an ECAL. After the single engine OPS 3 109% boundary is reached but before the single engine TAL 104% boundary is reached, the crew should use the droop CA procedure. This procedure attempts to make a TAL site or downrange ELS and is often successful except for early in the region where a bailout may be necessary. After the single engine TAL 104% boundary is reached, the crew utilizes the TAL cue card for the intact abort.

After the crew completes the necessary steps to initiate the first or second stage CA, they should check which auto CA procedure is being executed by guidance (BLUE or GREEN or POWERED ECAL or POWERED BDA (Bermuda)). BLUE or GREEN will be displayed overbright on the PASS TRAJ display. If the crew sees a yaw out of plane, that indicates the contingency abort yaw steering is occurring and cues the crew to go to the POWERED ECAL page in the ascent flipbook. For low or mid-inclination flights the crew will be directed to POWERED BDA. POWERED ECAL and POWERED BDA are the same procedure, the only thing changing is the landing site (east coast site versus Bermuda). ECAL procedures will be discussed in Section 4.8.3. The BLUE or GREEN automated procedures can be monitored by the crew until they reach MM 602.

Once MM 602 is achieved, the crew should execute the appropriate CA entry procedures. Either the Contingency Entry procedures or the ECAL (or BDA) Entry procedures are used. Contingency Entry procedures fly a wings level attitude and bailout while the ECAL Entry procedures utilize pitch and bank commands to fly towards an emergency landing site in hopes of achieving a safe landing. These two entry procedures are applicable for all two and three engine out CAs.

The BFS software does not support any multiple engine out conditions nor any CAs. During a CA, the BFS CRT may display a big X, or the BFS software may not follow the PASS to a major mode or may skip major modes.

4.8.1.1.1 Two Engine Out First Stage

28.5° and 39° Inclination Versions:

2 OUT FIRST

TRAJ SERC ON - ITEM 6 (*)
 Failed ME SHUTDN pb(two) - push
 When H > 70K:
 TRAJ ABORT - ITEM 2 (*), 4 (*)
 ABORT RTLS
 ADI (two) - REF
 TRAJ √CONT REGION

51.6° & 57° Inclination Versions:

2 OUT FIRST

TRAJ SERC ON - ITEM 6 (*)
 Failed ME SHUTDN pb(two) - push
 When H > 70K:
 TRAJ ABORT - ITEM 2 (*), 4 (*)
 ABORT RTLS
 ADI (two) - REF
 If Yaw→ G51 MAX THROT - ITEM 4
 Go to **POWERED ECAL (FB)**
 TRAJ √CONT REGION

4.8.1.1.1.1 Cue

Two Engines failed in first stage

4.8.1.1.1.2 Displays

PASS XXXXXX TRAJ
 ADI
 SPEC 51 OVERRIDE

4.8.1.1.1.3 Crew Action

TRAJ ITEM 6 EXEC
 C3 Failed MAIN ENGINE SHUT DOWN pbs - push
 AVVI When H > 70K:
 TRAJ ITEM 2 EXEC
 ITEM 4 EXEC
 F6 ABORT MODE - RTLS
 ABORT pb - push
 F6,F8 ADI ATTITUDE (two) - REF
 If Yaw G51 ITEM 4
 TRAJ √2 E/O Color Region

4.8.1.1.1.4 Discussion

The first stage CA procedure should be executed anytime a second SSME is failed while in first stage.

Since SERC is needed during SRB tailoff for first stage two engine out scenarios, the crew should immediately execute ITEM 6 on the TRAJ display (SERC) when two engines are assumed failed. The flight software does not initiate SERC until SRB tailoff, even if the crew selects it earlier. ITEM 6 is capable of toggling SERC on and off and using it allows the crew to maintain control of the vehicle without immediately committing to a

CA. After the crew initiates SERC, they should confirm (or have the MCC confirm) that two engines have failed.

Initiating SERC with two engines running does not cause control problems. It does, however, take control of the roll channel from the two SSMEs and give it to the roll jets, which results in reduced roll authority. (Pitch and yaw channels remain under SSME control.) For this reason, if the crew confirms two engines are running and gimbaling normally, SERC should be toggled back off.

Once the crew confirms the failure of two SSMEs, they should push the two failed engine pbs. If any of the failed SSMEs has a data path failure or if one SSME fails and then the second SSME fails with the main engine limits inhibited, this step notifies the GPCs that two engines have failed. The GPCs initiate autoloft and the safing of the failed engines. Initiating autoloft is a high priority action in first stage. Autoloft guidance lofts the vehicle during first stage ascent to minimize peak QBAR and the QBAR at separation. If this step is delayed, the result is a flatter trajectory and a higher ET sep QBAR.

ITEM 2 and ITEM 4 on the TRAJ display initiate the auto CA software which automatically starts the OMS dump. In order to avoid collapsing the OMS engine bells, the abort is not declared until 70,000 ft. The abort rotary switch is rotated to RTLS and the abort pb depressed. Declaring RTLS transitions the software to OPS 6, which is better designed for executing CAs. In a TAL scenario, a pre-MECO TAL to RTLS downmode is legal when an auto CA is declared. To avoid confusion or possible problems with event sequencing, the crew should declare the RTLS immediately after the CA ITEM entries.

The reference (REF) position of the attitude director indicator (ADI) makes the ADI an inertial, three axis ball based on the launch pad coordinate system. This is done to ensure a discontinuity does not occur at 90° pitch and allows visibility in the yaw axis. If a yaw out of plane is observed then the contingency yaw steering is taking place and the crew is cued that the POWERED ECAL is being flown. Note a check for yaw is not included in the due east and mid-inclination checklists since the I-loaded velocity to begin yaw steering for these inclinations is greater than the maximum first stage velocity. Should the I-loads be lowered to begin yaw steering at earlier velocities, these check yaw steps would be added back in. As part of the POWERED ECAL procedures the crew should invoke maximum throttles (SPEC 51 ITEM 4) to reduce trajectory droop and increase altitude for better ET SEP conditions. The max throttle step is added at this point in the procedure to expedite getting to max throttles to help improve trajectory conditions as much as possible. The crew would then turn to the POWERED ECAL procedures in the checklist_[AFPH4.8-2]. The (FB) following the POWERED ECAL callout indicates that the procedure is located in the Ascent Flipbook pages.

If no yaw, the crew should check the TRAJ display to confirm whether the two engine out BLUE or GREEN procedure is going to be performed by the auto contingency logic. The crew should then refer to the proper two engine out monitor procedure. Usually the

BLUE maneuver is selected by the software in first stage. However, if a significant delay occurs (as for failures near staging), altitude rate can fall quickly enough to switch to a GREEN maneuver. Similarly, guidance may select the BLUE region for two engines out, early in second stage. These are the correct maneuvers for the situation and the crew should not be alarmed if these conditions occur.

4.8.1.1.2 Two Engine Out Second Stage

28.5° and 39° Inclination Version:

2 OUT SECOND

TRAJ √SERC ON
 TRAJ ABORT - ITEM 2 (*), 4 (*)
 ABORT RTLS
 Failed ME SHUTDN pb (two) - push
 ADI (two) - REF
 If Yaw→ G51 MAX THROT - ITEM 4
 Go to **POWERED BDA (FB)**
 TRAJ √CONT REGION

51.6° Inclination Version:

2 OUT SECOND

TRAJ √SERC ON
 TRAJ ABORT - ITEM 2 (*), 4 (*)
 ABORT RTLS
 Failed ME SHUTDN pb (two) - push
 ADI (two) - REF
 If Yaw→ G51 MAX THROT - ITEM 4
 Go to **POWERED ECAL (FB)**
 TRAJ √CONT REGION

57° Inclination Version:

2 OUT SECOND

TRAJ √SERC ON
 If simo (4+15) - (4+45),
 delay 45 s
 TRAJ ABORT - ITEM 2 (*), 4 (*)
 ABORT RTLS
 Failed ME SHUTDN pb (two) - push
 ADI (two) - REF
 If Yaw→ G51 MAX THROT - ITEM 4
 Go to **POWERED ECAL (FB)**
 TRAJ √CONT REGION

[AFPH4.8-3]

4.8.1.1.2.1 Cue

Two engines out in second stage prior to SE OPS 3 109% boundary

4.8.1.1.2.2 Displays

PASS XXXXXX TRAJ
 ADI
 SPEC 51 OVERRIDE

4.8.1.1.2.3 Crew Action

TRAJ √SERC ON
 ITEM 2 EXEC

	ITEM 4 EXEC
F6	ABORT MODE - RTLS
	ABORT pb - push
C3	Failed MAIN ENGINE SHUT DOWN pbs - push
F6,F8	ADI ATTITUDE (two) - REF
If Yaw	<input type="checkbox"/> G51 ITEM 4
<input type="checkbox"/> TRAJ	$\sqrt{2}$ E/O Color Region

4.8.1.1.2.4 Discussion

The second stage contingency abort procedure is used anytime a second SSME is believed failed while in second stage, up until the single engine OPS 3 109% boundary is achieved.

SERC is needed for all second stage two engine out scenarios. The crew should immediately check that SERC has been enabled when two engines fail. Guidance automatically invokes SERC in MM103 when sensed acceleration drops below a threshold value. The threshold is equivalent to about 10% below two engines at 65% thrust, equal to 117%. SERC will not automatically be invoked unless a prior engine failure or a data path failure has occurred. SERC can be toggled on and off by the crew via ITEM 6 on the PASS TRAJ display. However, once the GPCs are informed of the second engine failure either through the SSME pbs or nominal GPC sensing, the toggle function is disabled and SERC remains on. This ensures that SERC cannot be accidentally turned off once a second engine failure is confirmed. Once SERC is invoked, any manual pitch or yaw maneuvers should be limited to 4°/sec. Manually initiating SERC with two engines running does not cause control problems. It does, however, take control of the roll channel away from the two SSMEs and give it to the roll jets, resulting in reduced roll authority. (Pitch and yaw channels remain under SSME control). For this reason, if the crew confirms two engines are running and gimbaling normally, SERC should be toggled back off.

Once SERC is confirmed, the crew can execute ITEM 2 and ITEM 4 on the TRAJ display. These steps initiate the auto CA software and start the contingency OMS dump. Once ITEM 2 on the PASS TRAJ display is executed, the software is locked into the displayed abort region. However, the vehicles dynamics are constantly changing. If a significant delay transpires between executing the ITEM 2 and ITEM 4, the vehicle may actually transition to another abort region but the maneuver to be flown will have been frozen in the previous region. To avoid this dilemma, the crew should execute ITEMS 2 and 4 in close succession.

For 57° inclination ECAL aborts, the trajectory may sometimes encroach upon the ECAL Range Safety destruct line due to the yaw maneuver toward the coast. This scenario is most likely to occur when steering into the Cape Hatteras region (“Hatteras Gate”) while attempting a landing at Oceana or Cherry Point and is particular to the powered flight phase of the abort. In the past, the only operational workaround was to manually yaw back in-plane if a Range Safety violation occurred. However, with the automation of the

powered flight portion of ECAL aborts, crews receive very little training for this manual maneuver. It was later determined that simply delaying abort initiation in the window of concern ($\approx 4:15$ to $\approx 4:45$ MET) should eliminate Range Safety violations. Therefore, a step was added to the Second Stage procedure to delay the ITEM 2 EXEC, ITEM 4 EXEC by 45 seconds for two engines failed simultaneously between METs of 4:15 and 4:45. In this case, “simultaneously” doesn’t necessarily refer to two engines out at exactly the same time but it means that the engine failures occurred so close together that a TAL abort was not declared after the first engine failure (declaring TAL yaws the vehicle away from the coast enough to alleviate the Range Safety concerns). The 45 second delay reduces the amount of time the vehicle is actually yawed toward the coast and thus prevents violating the ECAL destruct line. The 45 second delay is acceptable at this point in the trajectory since the altitude is high enough. From a runway landing capability standpoint, the delay did not significantly impact ranging capability for the cases evaluated since the amount of powered flight yaw steering required close to the mainland is actually less than what would be obtained without the delay. In the unlikely event that there is still a Range Safety violation even with the delay, a call would be made for the crew to manually take out the yaw steering. However, once manual steering is initiated, the rest of the powered flight procedures must also be performed manually since the automatic sequencing was interrupted.

Declaring RTLS transitions the software to OPS 6, which is better designed for executing CAs. In a TAL scenario, a pre-MECO TAL to RTLS downmode is legal when an auto CA has been declared. To avoid confusion or possible problems with event sequencing, the crew should declare the RTLS immediately after the CA ITEM entries.

Once the crew has determined which engines have failed, they should push the two failed engine PBIs. If any of the failed SSMEs has a data path failure or if one SSME fails and then the second SSME fails with the main engine limits inhibited, this action notifies the GPCs to begin a safing of the failed engines.

The REF position of the ADI makes the ADI an inertial, three axis ball based on the launch pad coordinate system. This is done to ensure a discontinuity does not occur at 90° pitch, and allows visibility in the yaw axis. If a yaw out of plane is observed then the contingency yaw steering is taking place and the crew is cued that the POWERED ECAL or Bermuda logic is being flown. As part of the POWERED ECAL or Bermuda procedures the crew should invoke maximum throttles (SPEC 51 ITEM 4) to reduce trajectory droop and increase altitude for better ET SEP conditions. The max throttle step is added at this point in the procedure to expedite getting to max throttles to help improve trajectory conditions as much as possible. The crew would then turn to the POWERED ECAL or Bermuda procedures in the checklist_[AFPH4.8-4]. The (FB) following the POWERED ECAL (Bermuda) callout indicates that the procedure is located in the Ascent Flipbook pages.

If no yaw, the crew should check the TRAJ display to confirm whether the two engine out BLUE or GREEN procedure is going to be performed by the auto contingency logic. Early in second stage a BLUE maneuver is still performed but once the trajectory levels off (altitude rate less than 1330 fps) the GREEN maneuver is commanded. The crew should then refer to the proper two engine out monitoring procedure.

4.8.1.1.3 Two Engine Out BLUE Monitor

BLUE
POST SRB SEP: $\sqrt{\theta_{REF}} \rightarrow 0^\circ$, Roll Heads Up When \dot{H} negative: $\sqrt{\alpha} \rightarrow -2^\circ$, MECO, ET SEP $\sqrt{\text{Pitch Up}}$ $\sqrt{\text{MM602}}$ Go to CONT ENTRY (CC)

4.8.1.1.3.1 Cue

CONT 2 E/O BLUE on PASS TRAJ

4.8.1.1.3.2 Displays

PASS XXXXXX TRAJ

4.8.1.1.3.3 Crew Action

Monitor

4.8.1.1.3.4 Discussion

If two SSMEs fail between lift-off and before altitude rate has dropped below 1850 fps (approximately $V_{REL} = 7000$ fps), the vehicle is automatically pitched to a theta of 0° and rolled heads up after SRB sep to direct the thrust on the remaining good SSME along the local horizontal axis. This maneuver increases horizontal velocity while maintaining current apogee altitude which reduces the entry flightpath angle and the severity of the pullout. This technique of placing the thrust vector along the local horizontal axis is also used for early one engine out and one stuck at minimum throttle scenarios. This region can also be entered if the altitude rate is below 1850 fps and above 1330 fps while the inertial velocity is below 4500 fps_[AFPH4.8-5].

When altitude rate goes through zero, the flightpath angle is zero and alpha is approximately 10° . These parameters are optimum to begin the ET sep maneuver for this region since the flightpath angle is shallow at the start of the pullout.

The crew should see a pitchdown at this time to an alpha of -2° . MECO should then occur and is indicated by three red main engine status lights. Six seconds later, the status lights should extinguish indicating ET sep has occurred. At an angle of attack of -2° , ET recontact probability is minimized.

Typical ET sep conditions for this region are QBAR of 0.4 psf, alpha between -2° and -4° , and altitude between 238,000 and 268,000 ft. Although this altitude is below

the droop altitude, droop is not a factor at these low Mach numbers because ET heating is a function of Mach.

At MECO confirmed, three engine out auto guidance takes over from powered contingency logic. The maneuver to entry attitude is a pitch up to the alpha recovery angle which is a function of velocity and ranges between 20° and 58°. Major Mode 602 transition occurs when the attitude and rate constraints are satisfied or when EAS exceeds 77 knots (see table 2.7.3-II for transition criteria). Following MM602, the crew is directed to the Contingency Abort Entry Cue Card where they will perform contingency entry procedures and end up going to the Bailout procedures. Contingency Entry procedures are discussed in Section 4.8.1.5_[AFPH4.8-6]. The (CC) following the CONT ENTRY callout indicates the procedure is located on this cue card.

4.8.1.1.4 Two Engine Out GREEN Monitor

28.5° and 39° Inclination Missions

GREEN
√ $\theta \rightarrow 100^\circ$ (or $0^\circ \rightarrow 100^\circ$)
√Roll Hds Up
When EAS > 10 and incr:
√Pitch Dn at 3°/sec
√MECO, ET SEP
√Pitch Dn, then Up
√MM602
Go to BDA ENTRY (FB)

51.6° and 57° Inclination Missions

GREEN
√ $\theta \rightarrow 100^\circ$ (or $0^\circ \rightarrow 100^\circ$)
√Roll Hds Up
When EAS > 10 and incr:
√Pitch Dn at 3°/sec
√MECO, ET SEP
√Pitch Dn, then Up
√MM602
Go to ECAL ENTRY (FB)

4.8.1.1.4.1 Cue

CONT 2 E/O GREEN on PASS TRAJ

4.8.1.1.4.2 Displays

PASS XXXXXX TRAJ

4.8.1.1.4.3 Crew Action

Monitor

4.8.1.1.4.4 Discussion

If two SSMEs fail after the altitude rate has dropped to less than 1850 fps while the inertial velocity is greater than 4500 fps and the auto CA logic is initiated, the vehicle is maneuvered to a pitch attitude of about 100° [AFPH4.8-7] and rolled heads up. This stand on the tail maneuver is used to reduce the sink rate of the vehicle, which reduces the subsequent pullout Nz. This maneuver may not be performed purely in the pitch and roll axis by the auto system. If some yaw and roll are present when the maneuver begins, a combination of pitch, roll, and yaw may occur to achieve this attitude. In extreme cases of roll angle (caused by delay in getting SERC on), this maneuver may appear as pure yaw (quickest way to get there). This maneuver can also be initiated if two SSME's fail after the altitude rate has dropped below 1330 fps while the inertial velocity is below 4500 fps and the auto CA logic is invoked [AFPH4.8-8].

A small region exists where guidance begins the GREEN contingency maneuver by placing the thrust along the local horizontal (theta about 0°). Once the vehicle has gained some velocity, guidance then pitches to a theta of 100° . This combination of the BLUE and GREEN maneuvers is called a premode 2 or "combined" maneuver and may occur when two engines are lost early in second stage. The combined maneuver increases the

horizontal velocity and reduces the sink rate of the vehicle to improve the entry pullout. This combined maneuver can be initiated if two SSME's fail after the altitude rate has dropped below 1330 fps, but is still above 800 fps, while the inertial velocity is below 4500 fps and the auto CA logic is invoked.

When the equivalent airspeed builds to approximately 10 kt, the vehicle automatically pitches down at $3^\circ/\text{sec}$ _[AFPH4.8-9], commands MECO, and performs ET sep. If the pitchdown was initiated at a lower airspeed, the pullout starts at a higher altitude and results in a higher QBAR and pullout Nz. If the pitch maneuver was delayed until a higher airspeed, ET recontact could occur. Pitch rates greater than $6^\circ/\text{sec}$ may result in loss of control.

Typical ET sep conditions in this region are QBAR between 0.2 and 0.4 psf, alpha approximately 75° , and altitude between 287,000 and 302,000 ft.

At MECO confirmed, three engine out auto guidance takes over from powered contingency logic. The OI-25 monitoring step “√Pitch Dn, then Up” reflects the fact that the vehicle will continue to pitch down after ET sep until the -Z translation is complete. Once the -Z translation is complete, the RCS jets are available for rotational control and a pitch up to the entry angle of attack occurs. This step is consistent with 3 E/O ORANGE, since 3 E/O ORANGE region will take over from any two engine out high rate sep. Even though the alpha recovery angle is actually a function of velocity and ranges between 20° and 58° , the velocity will be high enough in this region that the alpha recovery angle will be 58° .

Major Mode 602 transition occurs when the attitude and rate constraints are satisfied or when EAS exceeds 77 knots (see table 2.7.3-II for transition criteria). Following MM602, the crew is directed to the ECAL (51.6° and 57° inclination missions) or BDA (28.5° and 39° inclination missions) ENTRY procedures page where they can select an ECAL site (or Bermuda) and fly towards that. Even though landing capability will not be achievable, the steering towards land will improve search and rescue efforts. The (FB) following the ECAL/BDA ENTRY callout indicates that the procedure is located in the Ascent Flipbook pages.

4.8.1.1.5 Two Engine Out Droop [AFPH4.8-10]

2 OUT DROOP	
TRAJ	√ SERC ON
Failed	ME SHUTDN pb (two) – push
G51	MAX THROT – ITEM 4 (*)
ABORT TAL	
G51	DUMP – ITEM 6 (*), 7 (*)
--- If STUCK DROOP ---	
TRAJ	DRP 1 EO - ITEM 7 (ENA)
TRAJ	√ DROOP ALT
--- If Overbright and flashing (<265K) ---	
Go to 2 OUT SECOND	
When MPS PRPLT = 2%	
Man THROT, Pc → 67%	
Man MECO @ CO mark BFS	
Go to TAL ----MECO---- (FB)	

4.8.1.1.5.1 Cue

Two engines failed past the SE OPS 3 109% boundary but prior to SE TAL 104%

4.8.1.1.5.2 Displays

PASS XXXXXX TRAJ
 SPEC 50 HORIZONTAL SIT
 SPEC 51 OVERRIDE

4.8.1.1.5.3 Crew Action

TRAJ	√SERC ON
C3	Failed MAIN ENGINE SHUT DOWN pbs - push
G51	ITEM 4 EXEC
F6	ABORT MODE - TAL
	ABORT pb - push (if not already TAL)
G51	ITEM 6 EXEC
	ITEM 7 EXEC
	If STUCK DROOP
TRAJ	ITEM 7 EXEC
TRAJ	√DROOP ALT
	If overbright and flashing (< 265K):
	Go to 2 OUT SECOND
	When PRPLT = 2%:
	MAN THROT, Pc → 67%
	BFS TRAJ At C/O Mark:
C3	MAIN ENGINE SHUTDOWN pbs (three) - push

4.8.1.1.5.4 Discussion

Once the single engine OPS 3 109% boundary is reached, the crew can use the droop contingency abort procedure if two engines fail. TAL droop control logic was added to shuttle flight software in OI-22. This logic predicts the minimum or “droop” altitude the vehicle would reach if significant loss of performance occurred. If the predicted altitude falls below a predetermined limit, the droop logic retargets the trajectory and computes new pitch commands to actively avoid violating the minimum droop altitude. The droop altitude limit is 265,000 ft and is constrained by ET heating.

The predicted droop altitude is displayed to the crew at all times in MM103, via the PASS TRAJ display. In the hypothetical mode, prior to droop logic engage, a single engine at the current thrust level and maximum thrust elevation are assumed. The software executes a complex set of checks to determine if droop logic engage is required, i.e., if the PEG pitch commands need to be overridden.

First, the droop predictor subtask uses Newton Raphson iteration techniques to determine the time to reach 265,000 ft. This subtask also outputs a discrete indicator, if a solution was found, and the range to landing site resulting from that solution. If the time to go to reach 265,000 ft is less than a minimum acceptable time and if the range solution does not indicate a high performance condition, the PEG pitch commands are changed.

Next, the steering parameters subtask increases the thrust attitude as required to maintain vehicle altitude at or above 265,000 ft. Note that droop logic only alters the pitch attitude, while PEG maintains yaw steering control. If the droop logic detects that the transition from second stage 2 E/O BLUE to GREEN has not yet occurred, i.e. stand on the tail maneuver required, the maximum thrust attitude is commanded. Then, once the droop altitude can be reached, the minimum acceptable thrust attitude is again commanded. The guidance unconverged (S_UNCONV) flag is turned off to ensure the ADI needles are unstowed.

Throughout this process, the droop logic determines if pitch control can be returned to PEG. The PEG solution must not be elevation limited, must be converged, and the commanded pitch attitude must be less than the droop solution. If for some reason, 265,000 ft is actually reached or if droop control logic cannot produce a solution, control is returned to PEG. If the predicted droop altitude is less than 265,000 ft when the droop logic is engaged, the DROOP procedure calls for a downmode to CA 2 E/O GREEN which results in an OPS 6 Contingency Abort.

If TAL is declared while droop control is active, the droop logic switches PEG to low energy TAL MECO targets to maximize anticipated low energy stretch performance. This switch reduces target altitude from 360,000 ft to 330,000 ft, increases target flight path angle from slightly negative to slightly positive, and reduces target crossrange from approximately 450 nm to 375 nm for low inclination and to 400 nm for mid and high inclinations.

The single engine droop procedure does not ensure the vehicle will make a runway but only that the minimum droop altitude will not be violated. The crew should be prepared to use low energy guidance during entry to increase the range capability and their chances of making a runway.

SERC is invoked automatically whenever GPC recognition of two SSMEs out occurs. SERC is also automatically invoked in second stage if an SSME or data path failure has occurred and acceleration drops below a threshold level. The crew may manually toggle SERC on and off by executing ITEM 6 on the PASS TRAJ display. However, once the GPCs are informed of the second engine failure either through the SSME pbs or nominal GPC sensing, the toggle function is disabled and SERC remains on. This ensures that SERC cannot be accidentally turned off once a second engine failure is confirmed. Once SERC is invoked, any manual pitch or yaw maneuvers should be limited to 4°/sec. Initiating SERC with two engines running does not cause control problems. It does, however, take control of the roll channel away from the two SSMEs and give it to the roll jets, which results in reduced roll authority. (Pitch and yaw channels remain under SSME control.)

Once the crew has determined which engines have failed, they should push the two failed engine pbs. If any of the failed SSMEs has a data path failure or if one SSME fails and then the second SSME fails with the main engine limits inhibited, this command notifies the GPCs to begin a safing of the failed engines.

Maximum throttle (109%) is set via ITEM 4 EXEC on the Override display and is needed to improve the thrust to weight ratio.

When the TAL abort is declared, the TAL yaw steering is initiated. The sooner the yaw steering begins the sooner the crossrange can be reduced. This generally helps performance.

The OMS dump is initiated via ITEMS 6 and 7 on the Override display. The objective of the OMS dump is to move the X c.g. forward, to decrease the weight of the vehicle to improve performance, and to satisfy the OMS tank landing constraints, if a landing is to be made.

Following the start of the OMS dump the “If STUCK DROOP” starred block appears. For OI-30, droop logic is initially inhibited for only 1 EO (CR 92668C – Prevent Erroneous Droop Guidance Engagement). This was designed into the droop logic since for some high performance missions first TAL capability occurred in first stage. However, if the engine failed in first stage, droop would erroneously engaged (it wasn't really required). The associated changes to the pitch commands to protect for altitude would kill off downrange performance and the capability to make the site disappeared. Because of this, the OI-30 logic was designed to only automatically engage for a loss of 2 main engines. For 1 engine out and another stuck in the bucket the crew is directed to the 2

OUT DROOP procedure, and doing the ITEM 7 on the TRAJ display enables the droop logic for these situations. For normal 2 engine out cases the ITEM 7 is not required.

A step that was deleted from the 2 OUT DROOP procedure that used to appear (after the STUCK DROOP check) was the selection of the low crossrange TAL site on SPEC 50. Prior to OI-22, manually flown low energy procedures in short range - high crossrange trajectories (hot wings region) were thermally unacceptable. For this reason reduced crossrange targets were developed. OI-22 automated the manually flown low energy procedures and eliminated the thermal concerns, though the call out for low crossrange was left in the checklist for contingency cases. (ie use Low XR Ben Guerir to pull Lajes into the capability footprint). Reduction of the nominal crossrange targets for all TAL sites later made this crew action unnecessary.

Current OI-30 Low Energy logic (CR 92671A Variable Low Alpha for Low Energy) protects for thermal concerns for these 2 OUT DROOP cases; therefore the low crossrange step was removed. Also, Le Tube (Istres, France) is being added as an intact TAL site, but has no low crossrange targets associated with it. Confusion could occur if the crew is asked to select the low crossrange site for Le Tube_[AFP4.8-12]. For information, a low crossrange TAL site is a TAL site that is duplicated in the landing site table but has a lower pre-MECO crossrange target. A nominal TAL site has a ~ 450 nm pre-MECO crossrange while a low crossrange TAL site targets for 375 nm on low inclination missions or 400 nm on mid and high inclination missions. The lower pre-MECO crossrange was used when a large MECO underspeed was predicted to try to make up for the reduced energy and reduced crossrange capability (thermal capability) during entry.

The droop altitude should be monitored on the TRAJ display. If predicted (or actual) droop altitude falls below the 265,000 ft limit, a downmode is required. Once in the 2 OUT SECOND block, the critical steps are to Abort 2 E/O Contingency (ITEMs 2,4), Abort RTLS to enable the RTLS ET SEP DAP, take the ADI's to REF and check the contingency region. Most downmodes to 2 OUT SECOND from 2 OUT DROOP should result in a yaw out of plane to indicate the POWERED ECAL or POWERED BDA procedure is occurring and directs the crew to those procedures in the Ascent flipbook..

Prior to incorporation of the TAL Droop CR, the altitude and altitude rate were monitored to determine if a downmode to the 2 OUT SECOND procedures was required. A rule of thumb check was performed at 300,000 ft. If altitude rate was -600 fps and increasing negatively when passing below 300,000 ft, the minimum droop altitude constraint would probably be violated. At this point, there was approximately 60 seconds until the minimum droop altitude of 265,000 ft. However, with the incorporation of the TAL Droop CR, the predicted droop altitude on the PASS TRAJ display is used to determine whether a downmode is required. A downmode to the 2 OUT SECOND procedure is required if the predicted droop altitude is less than 265K and flashing overbright on the PASS TRAJ display.

To preclude a low propellant level main engine shutdown from 109%, manual throttling must be performed to 67% when 2% of the propellant is remaining. The crew then shuts down the main engines with the pbs when the bug on the BFS TRAJ display reaches the cutoff mark. Note that low level depletion is expected prior to the bug reaching the cutoff mark but the manual shutdown steps are included to prevent an overspeed in the event that a low level depletion cutoff does not occur.

Post-MECO, the crew should use the TAL procedures, starting below the MECO line to perform the entry.

4.8.1.2 One Engine Stuck at Minimum Throttle and One Engine Out

The one engine stuck at minimum throttle plus one engine out procedures are broken into four different procedures. The STUCK FIRST procedure is performed any time one engine out and one stuck minimum throttle exist from lift-off until about 2 minutes 30 seconds MET (mission specific). The STUCK RTLS procedure is a manually performed PPA followed by an auto RTLS completion. This procedure has the crew manually throttle the remaining good engine to 109%, perform a manual PPA, and then complete the procedure as an intact RTLS. The STUCK DROOP procedure is the very similar to the 2 OUT DROOP described above and is performed until a TAL boundary is achieved. It should be noted that for most 51.6 inclination missions, there is overlap of the STUCK RTLS and STUCK TAL boundaries. In these instances no STUCK DROOP procedure is required and therefore is not on the CA cue card. Also, in some instances the STUCK DROOP can appear earlier than the STUCK RTLS region. As shown in Figure 4.8.1-1, the STS-114 data shows that a STUCK DROOP region appears on both the left and right sides of the STUCK RTLS region. The stuck TAL 109% procedure is similar to an intact TAL. The STUCK TAL window ends when the 1 2/3 Press to MECO boundary is achieved.

With an engine stuck in the bucket, the mode boundaries on the NO COMM mode boundary card are no longer valid. Instead, the times on the contingency abort cue card serve as the NO COMM mode boundaries. All the boundary times for the CA stuck throttle procedures are mission specific numbers based on an engine throttle stuck at the minimum level (flight specific, usually 72%). These boundary times differ if the engine throttle is stuck at a higher value. In this case a ground call informs the crew of the proper stuck throttle procedure.

The STUCK FIRST and STUCK DROOP procedures are able to use the same procedures as the 2 OUT FIRST and 2 OUT DROOP regions described in the two engine out procedures section (sections 4.8.1.1.1 and 4.8.1.1.5) with minor differences noted in the following sections.

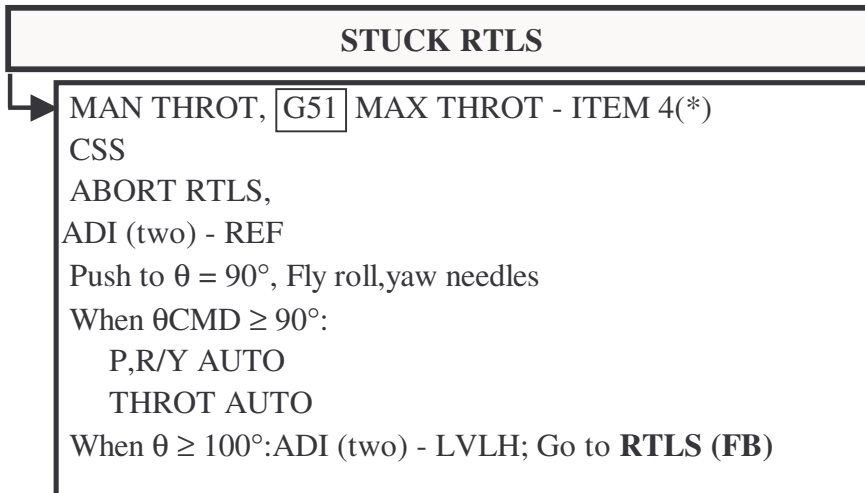
4.8.1.2.2 Stuck RTLS_[AFPH4.8-14]

4.8.1.2.2.1 Cue

One engine stuck in the bucket and another engine failure in the Stuck RTLS region

4.8.1.2.2.2 Displays

PASS XXXXXX TRAJ

4.8.1.2.2.3 Crew Action

MAN THROT

G51	ITEM 4 EXEC
F2	PITCH, ROLL/YAW CSS pbs - push
F6	ABORT MODE - RTLS ABORT pb - push
F6,F8	ADI ATTITUDE (two) - REF
ADI	Push to $\theta = 90^\circ$, fly roll and yaw error needles When pitch error needle moves from top of scale to center:
	F2 PITCH, ROLL/YAW pbs - AUTO
	F4 SPD BK/THROT pb - push
	When $\theta \geq 100^\circ$:
	F6,F8 ADI ATTITUDE (two) - LVLH

4.8.1.2.2.4 Discussion

All the boundary times for the stuck minimum throttle procedures are mission specific numbers based on an engine throttle stuck at the minimum level (usually 72%). For some missions, preflight analysis of an engine stuck at minimum throttle shows no window of opportunity for the stuck RTLS procedure. However, some stuck RTLS opportunity may exist if the engine throttle is stuck at a higher value. In this case a ground call informs the crew of the proper stuck throttle procedure.

The window of opportunity for manual RTLS completion assumes throttle up to 109% (manual throttle) within 15 seconds of the engine failure. CSS is required to interrupt the unusable auto guidance and prepare for the manual maneuver.

RTLS is selected using the abort rotary and the abort button. Aborting RTLS provides RTLS trajectory displays and OPS 6 software needed after the manual maneuver for RTLS completion. ADI - REF will preclude a roll singularity from causing disorientation when the pitch attitude is increased in the manual maneuver.

Pitching to a theta of 90° minimizes the sink rate from the engine failure and allows the vehicle to approach the RTLS reference trajectory. To prevent large beta, which is only a concern if a subsequent engine failure occurs, the roll and yaw ADI error needles are flown. When theta command becomes greater than 90° (pitch error needle moving from the top to bottom of the scale), auto RTLS guidance has achieved a solution for PPA and control can be returned to auto. When the vehicle is pitched past the 90° singularity point, the ADI is returned to LVLH. At this point the crew can go to the RTLS procedure.

4.8.1.2.3 Stuck Droop

See section 4.8.1.1.5 for the Droop procedure.

4.8.1.2.3.1 Cue

One engine stuck in the bucket and another engine failure in the Stuck Droop region

4.8.1.2.3.2 Displays

PASS XXXXXX TRAJ
 SPEC 50 HORIZONTAL SIT
 SPEC 51 OVERRIDE

4.8.1.2.3.3 Crew Action

G51	ITEM 4 EXEC
F6	ABORT MODE - TAL
	ABORT pb - push (if not already TAL)
G51	ITEM 6 EXEC
	ITEM 7 EXEC
	If STUCK DROOP
TRAJ	ITEM 7 EXEC
TRAJ	√DROOP ALT
	If overbright and flashing (< 265K):
	Go to 2 OUT SECOND
	When PRPLT = 2%:
	MAN THROT, Pc → 67%
BFS TRAJ	At C/O Mark:

4.8.1.2.3.4 Discussion

When executing droop procedures, the crew should be aware of two differences between the stuck droop and two engines out droop procedures. First, since two engines are running, SERC is not needed. Secondly, pushing the one failed engine pb is necessary only when a data path failure has occurred on that engine. That is why the arrow leading the crew to the 2 OUT DROOP procedure from STUCK DROOP points at the third line in the procedure.

4.8.1.2.4 Stuck TAL_[AFPH4.8-15]

G51	MAX THROT - ITEM 4 (*)
G50	√TAL Site
	ABORT TAL
	Go to TAL (FB)

4.8.1.2.4.1 *Cue*

One engine stuck in the bucket and another engine failure in the STUCK TAL region

4.8.1.2.4.2 *Displays*

SPEC 50 HORIZONTAL SIT
SPEC 51 OVERRIDE

4.8.1.2.4.3 *Crew Action*

G51	ITEM 4 EXEC
G50	Select low crossrange site or redesignate if required
F6	ABORT MODE - TAL
	ABORT pb - push (if not already TAL)

4.8.1.2.4.4 *Discussion*

If this step is executed within 15 seconds of failure, the vehicle can achieve TAL without having to go through the droop procedure. The crew should check (and select if necessary) the correct TAL site for the abort based on the MET boundaries. Note that if the engine is stuck at a throttle level other than the minimum, the MCC will make a “1 and 2/3 TAL” call to the crew. TAL is selected using the Abort rotary switch and the abort button. The crew can then go to the TAL procedure.

4.8.1.3 Three Engine Out Contingency Abort (OI-25 3 E/O Auto Guidance)

CR 90705, approved for OI-25, automated the manual contingency abort procedures for three engines out any time during powered flight. The three engines out auto contingency logic is more than a simple automation of the pre-OI-25 manual procedures, since it is applicable for both simultaneous and sequential engine failures. It provides for the computation of the current three engine out abort region, automatic declaration of an RTLS if in MM103, selection of the appropriate mated coast maneuver, ET sep and -Z translation, initiation of an interconnected OMS dump if required, a multi-axis maneuver to the entry attitude, and transition to MM602 at the completion of the maneuver. See section 2.7.2 for a discussion of the three engine out auto contingency logic and explanation of terms used in this section.

With the automation of the three engine out manual procedures, the contingency abort cue cards were modified to include a procedures block and monitoring blocks, similar to the two engine out procedures. The three engine out portion of the Contingency Abort cue card is broken into three procedural blocks and five monitoring blocks. The CA three engine out procedural blocks are 3 OUT FIRST, 3 OUT SECOND, and 3 OUT BLANK. The names are self-explanatory in that three engines out in 1st stage sends the crew to the 3 OUT FIRST block, three engines out in 2nd stage sends the crew to the 3 OUT SECOND block, or three engines out after the 3 engine out color region is blanked sends the crew to the 3 OUT BLANK block. All of these assume the vehicle is on a non-RTLS trajectory. These blocks in turn direct the crew to the appropriate monitoring blocks^[AFP4.8-16]. . The general philosophy for all OI-25 three engine out monitoring steps is to provide the crew a way to follow along with three engine out guidance so that they know when to perform the entry steps which do require crew action. Failure of the three engine out logic, requiring the crew to separate from the tank and maneuver to attitude manually, was not considered during the development of the OI-25 CA cue cards.

4.8.1.3.1 Three Engine Out First Block [AFPH4.8-17]

3 OUT FIRST	
TRAJ	SERC - ITEM 6 (*)
	ME SHUTDN pb (three) - push ADI (two) - REF
TRAJ	√CONT REGION

4.8.1.3.1.1 Cue

Three engines failed prior to SRB SEP.

4.8.1.3.1.2 Displays

PASS XXXXXX TRAJ
ADI

4.8.1.3.1.3 Crew Action

TRAJ ITEM 6
C3 MAIN ENGINE SHUT DOWN pbs (three) - pushF6,F8 ADI
ATTITUDE (two) - REF
TRAJ √3 E/O Color Region

4.8.1.3.1.4 Discussion

For three engines out in first stage, autoloft guidance steers the vehicle until tailoff. During tailoff SERC is normally automatically turned on. SERC improves vehicle control during tailoff and decreases the probability of recontacting the stack. Flight Software DR #109671 identified scenarios where SERC would not be automatically invoked for three engines out in first stage. A workaround identified in the DR was to enable SERC manually using TRAJ ITEM 6 EXEC_[AFPH4.8-18]. The next step of this three engine out contingency abort procedure is to depress all three main engine shutdown pushbuttons to set MECO confirmed. The MECO confirmed flag must be set before the three engine out auto contingency logic can be automatically executed when the color region is visible on the PASS TRAJ display. The three engine out color region will be displayed double bright and the ADI error needles will unstow if previously stowed indicating that the three engine out logic has been invoked.

Selecting the reference (REF) coordinate system makes the ADI an inertial, three axis ball based on the launch pad coordinate system. This is done so that maneuvers observed on the ADI more closely resemble the out of the window view.

The crew next checks the TRAJ display for the contingency abort color region. In first stage the only color region available will be BLUE and the crew will press on to those procedures. [AFPH4.8-19]

4.8.1.3.2 Three Engine Out Second Block [AFPH4.8-20]

3 OUT SECOND
ME SHUTDN pb (three) - push ADI (two) - REF TRAJ $\sqrt{3}$ CONT REGION

4.8.1.3.2.1 *Cue*

Three engines failed between SRB SEP and prior to blanking of the 3 E/O color region.

4.8.1.3.2.2 *Displays*

PASS XXXXXX TRAJ
ADI

4.8.1.3.2.3 *Crew Action*

C3 MAIN ENGINE SHUT DOWN pbs (three) - push
F6,F8 ADI ATTITUDE (two) - REF
TRAJ $\sqrt{3}$ E/O Color Region

4.8.1.3.2.4 *Discussion*

The first step of this three engine out contingency abort procedure is to depress all three main engine shutdown pushbuttons to set MECO confirmed. The MECO confirmed flag must be set before the three engine out auto contingency logic can be automatically executed when the color region is visible on the PASS TRAJ display. The three engine out color region will be displayed double bright and the ADI error needles will unstow if previously stowed indicating that the three engine out logic has been invoked.

Selecting the reference (REF) coordinate system makes the ADI an inertial, three axis ball based on the launch pad coordinate system. This is done so that maneuvers observed on the ADI more closely resemble the out of the window view.

The crew next checks the TRAJ display for the contingency abort color region and monitors the steps in that procedure box. Note all the steps are just monitoring steps and will eventually send the crew to the ECAL or BDA ENTRY procedures where it may or may not be possible to reach a landing site depending on when the 3 engines failed.

4.8.1.3.3 Three Engine Out BLANK

3 OUT BLANK
ME SHUTDN pb (three) - push Go to TAL ----- MECO ----- (FB)

4.8.1.3.3.1 Cue

Three engines failed between the blanking of the 3 E/O color region to the AOA-shallow MECO velocity.

4.8.1.3.3.2 Displays

PASS XXXXXX TRAJ
AMI

4.8.1.3.3.3 Crew Action

C3 MAIN ENGINE SHUT DOWN pbs (three) - push
TRAJ √3 E/O Color Blanking
 AMI √MECO Velocity

4.8.1.3.3.4 Discussion

The blanking of the 3 EO color region indicates the 3 EO Auto contingency guidance is unnecessary and the nominal guidance will be used. For three engines failed in second stage after an inertial velocity of 22K fps, the region index is set to zero and the color region blanked on the PASS TRAJ since the 3 engine out auto contingency logic is not required. When inertial velocity is between 22K and 14K fps, this logic may or may not be required depending on the predicted apogee conditions. An OPS 3 TAL completion will be performed rather than an OPS 6 fast separation, if the loads during the OPS 3 entry pullout are predicted to be below 3.5g. This prediction is made by comparing the predicted apogee altitude with a 3.5g apogee altitude versus velocity profile. If the predicted apogee altitude is below this profile, then OPS 3 entry pullout loads will be less than 3.5g and a fast separation is not required. The region index is set to zero and the 3 engine out color region blanked on the PASS TRAJ. If the predicted apogee altitude is above the 3.5g altitude versus velocity profile or inertial velocity is less than 14K fps, then an OPS 6 fast separation is required.

The first step of the 3 OUT BLANK procedure is to depress all three main engine shutdown pushbuttons to set MECO confirmed. The MECO confirmed flag must be set before the three engine out auto contingency logic can be automatically executed.

Following the steps to ensure MECO confirmed, the crew is directed to the TAL pages where they will start at the steps below the MECO line.

4.8.1.3.4 Three Engine Out BLUE

BLUE	
BFS	Pc<50 + 2 sec:
	√ET SEP
	√Roll Heads Up (& Yaw if MM601)
	√MM602
	Go to CONT ENTRY (CC)

[AFPH4.8-21]

4.8.1.3.4.1 Cue

Three engines failed in first stage

4.8.1.3.4.2 Displays

PASS XXXXXX TRAJ
 BFS XXXXXX TRAJ 1
 AMI
 ADI

4.8.1.3.4.3 Crew Action

Monitor

4.8.1.3.4.4 Discussion

Once the SRB PCs drop below 25 psia or a backup timer expires, separation from the stack (SRBs and ET) is commanded, followed by a 5 second -Z translation. The cue for separation in the checklist is the appearance of the “PC<50” message on the BFS TRAJ plus two seconds. This nomenclature is used since the actual SRB chamber pressures are not available on any onboard display and it takes approximately two seconds for the PCs to drop from 50 psia to 25 psia. The BFS TRAJ, instead of the PASS TRAJ, must be checked for the “PC<50” message, since the PASS SRB sep sequencer, which determines when this message should be displayed, terminates at MECO confirmed. To emphasize the use of the BFS TRAJ, the word “BFS” is shown in reverse image on the cue card. Separation will occur on the backup timer if a SRB PC transducer failure prevents the 25 psia criteria from being met.

The maneuver to entry attitude normally occurs in MM601 since there is better auto maneuver capability in MM601 than MM602. The maneuver to entry attitude is a roll to heads up about the stability axis and pitch as required to reach the alpha recovery angle which varies between 20° and 58° as a function of velocity. Major Mode 602 transition occurs when the attitude and rate constraints are satisfied or when EAS exceeds 77 knots (see table 2.7.3-II for transition criteria) .

Three engines failed early in first stage (before ≈1:00 MET) will result in the MM602 transition occurring immediately after the -Z because of excessive EAS. In MM602, the ADI always displays the vehicle's attitude in LVLH and roll and yaw rates with respect to the stability axis. Since the roll to heads up maneuver is a roll about the stability axis, this maneuver appears as a pure roll on the ADI in MM602. However, if the maneuver is performed in MM601 (later engine failures) and the ADI is in REF per the procedure, the maneuver will appear as a roll and yaw maneuver since the REF ball displays body attitude and body rates. Therefore, the “(& Yaw if MM601)” portion of the procedure was added after “√Roll Hds Up”, so crews would not be alarmed by the yaw maneuver displayed on the ADI in MM601.

Early versions of the 3 E/O BLUE monitoring block included a step after the roll to heads up to check the entry angle of attack. This step was omitted to be consistent with the general philosophy that the purpose of the OI-25 three engine out monitoring blocks is to provide the crew a way to follow along with three engine out guidance so that they know when to perform the entry steps which do require crew action. Failure of the three engine out logic, requiring the crew to separate from the tank and maneuver to attitude manually, was not considered during the development of the OI-25 CA cue cards. Removing the check alpha step also simplified the monitoring block since the entry angle of attack can vary between 20° and 58° depending on the vehicle's velocity. Furthermore, the entry side of the CA cue card tells the crew to expect 58° of alpha for Mach numbers greater than 3.5. Following MM602 transition the crew is directed to the CONT ENTRY procedures where they will proceed downrange and bailout.

A step to check the OMS dump appeared at the top of early versions of the 3 E/O BLUE monitoring block but was later removed for several reasons. The original purpose of this check was to provide the crew with feedback that three engine out guidance was active. However, the 3 E/O color region displayed double bright on the PASS TRAJ will provide this feedback. Also, if the dump doesn't occur, manual OMS dump start is not desired since the dump probably didn't occur because the engines failed too close to separation. Furthermore, none of the other three engine out or two engine out monitoring blocks included an OMS dump check. For simplicity and consistency, check OMS dump was removed from the 3 E/O BLUE steps.

4.8.1.3.5 Three Engine Out GREEN

28.5° and 39° Inclination Version

GREEN
When EAS<25 or incr: √ET SEP √Roll, Yaw Heads Up √MM602 Go to BDA ENTRY (FB)

51.6° and 57° Inclination Version

GREEN
When EAS<25 or incr: √ET SEP √Roll, Yaw Heads Up √MM602 Go to ECAL ENTRY (FB)

[AFPH4.8-22]

4.8.1.3.5.1 Cue

Three engines failed in the GREEN region

4.8.1.3.5.2 Displays

PASS XXXXXX TRAJ

AMI

ADI

4.8.1.3.5.3 Crew Action

Monitor

4.8.1.3.5.4 Discussion

For three engines out in the GREEN region, an attitude independent separation is commanded. Depending on the dynamic pressure and altitude rate, a fast separation (5 seconds) or nominal RTLS separation sequence (16 seconds) will be performed, followed by an 8 second -Z translation. If ET separation has not been commanded by an EAS of 77 knots and EAS is increasing, an immediate separation (referred to as emergency separation) will be commanded, followed by a five second -Z translation. This scenario has only been encountered in the YELLOW and RED regions in simulator testing but is available in the logic for all regions but 3 E/O BLUE.

The maneuver to entry attitude is a roll to heads up about the stability axis and pitch as required to reach the alpha recovery angle of 58° . The stability axis roll maneuver appears as roll and yaw on the ADI since the REF ball displays body attitude and body rates. It was unnecessary to differentiate between how the maneuver would appear on the ADI for MM601 and 602 as was done in the 3 E/O BLUE monitoring block, since it is unlikely that transition to MM602 will occur before the stability axis roll maneuver to entry attitude is complete. Even though the alpha recovery angle is actually a function of velocity and ranges between 20° and 58° , the velocity will be high enough in this region that the alpha recovery angle will be 58° . However, a check of alpha 58° is not included in the 3 E/O GREEN monitoring block for the reasons discussed in the 3 E/O BLUE rationale.

Major Mode 602 transition occurs when the attitude and rate constraints are satisfied or when EAS exceeds 77 knots (see table 2.7.3-II for transition criteria) . It is unlikely that transition to MM602 will occur based on EAS in the 3 E/O GREEN region since the vehicle is coasting toward apogee. See section 2.7.2.3 for additional information.

For 51.6° inclination missions, a runway landing may be possible for MECO velocities above about 12.6K for Inplane launches. 57° inclination missions will have capabilities at even lower MECO velocities. Due East missions really have no Bermuda capability for 3 engines out, but 39° inclination missions do have capability for a Bermuda landing. Whether or not capability exists to make a landing the crew will be directed to the ECAL or BDA ENTRY procedures where they will dial in an appropriate site and try to make the landing and if not successful will go to the BAILOUT procedures. This enables the vehicle to get closer to a land mass and improve search and rescue efforts.

4.8.1.3.6 Three Engine Out ORANGE

From 2 OUT Only
<p style="text-align: center;">ORANGE</p> <p>√Pitch Dn at 3°/sec √ET SEP √Pitch Dn, then Up √MM602 Go to ECAL ENTRY (FB)</p>

4.8.1.3.6.1 Cue

Three engines failed in the ORANGE region

4.8.1.3.6.2 Displays

PASS XXXXXX TRAJ

AMI

ADI

HSI

4.8.1.3.6.3 Crew Action

Monitor

4.8.1.3.6.4 Discussion

The ORANGE region will not typically appear on the PASS TRAJ display for “uphill” cases unless specific trajectory conditions occur when the two engine out auto contingency logic is invoked or the vehicle is rolled heads up on a TAL droop. The “From 2 OUT Only” block indicates that the color regions can be traversed in either order, i.e. GREEN then ORANGE then YELLOW or GREEN then YELLOW then ORANGE.

If three engines are out in this region, a rate separation will be commanded as long as beta is not too large. If beta is greater than 8°, there is insufficient time to zero beta, pitch down, and separate before dynamic pressure builds to an unsafe level. In this case, the 3 E/O region will change to GREEN and an attitude independent separation will be commanded. An ORANGE to GREEN region change occurs immediately upon setting MECO confirmed if β is large enough to force this region trip. For this reason the old procedure of “If CDI pegged: √CONT REGION” was unnecessary and removed from the procedure_[AFPH4.8-23]. If a rate sep is commanded, a pitchdown at 3_[AFPH4.8-24]°/sec will be performed, followed by ET separation and an eight second -Z translation maneuver. If ET separation has not been commanded by an EAS of 77 knots and EAS is increasing, an

immediate separation (emergency sep) will be commanded followed by a five second -Z translation. This scenario has only been encountered in the YELLOW and RED regions in simulator testing but is available in the logic for all regions but 3 E/O BLUE.

The maneuver to entry attitude is almost a pure pitch maneuver since the vehicle is already heads up (alpha must be positive to be in the 3 E/O ORANGE region). The monitoring step “√Pitch Dn, then Up” reflects the fact that the vehicle will continue to pitch down after ET sep until the -Z translation is complete. Once the -Z translation is complete, the RCS jets are available for rotational control and a pitch up to the entry angle of attack occurs. Even though the alpha recovery angle is actually a function of velocity and ranges between 20° and 58°, the velocity will be high enough in this region that the alpha recovery angle will be 58°. However, a check of alpha 58° is not included in the 3 E/O ORANGE monitoring block for the reasons discussed in the 3 E/O BLUE rationale.

Major Mode 602 transition occurs when the attitude and rate constraints are satisfied or when EAS exceeds 77 knots (see table 2.7.3-II for transition criteria) . See section 2.7.2.4 for additional information. Once in MM602 the crew is directed to the ECAL ENTRY procedures for high inclinations or BDA ENTRY for lower inclinations where they will dial in a landing site and fly towards that site in hopes of making a landing, if no landing capability exists the crew will be directed to the BAILOUT procedures.

4.8.1.3.7 Three Engine Out YELLOW and RED_[AFPH4.8-25]

From 2 OUT Only	
YELLOW	RED
$\sqrt{\alpha} \rightarrow -2^\circ$	$\sqrt{\alpha} \rightarrow 125^\circ$
If unable \rightarrow 	
$\sqrt{\beta} \rightarrow 0^\circ (\pm 3^\circ)$	
$\sqrt{\text{ET SEP}}$	
$\sqrt{\text{Roll, Yaw Hds Up}}$	
$\sqrt{\text{MM602}}$	
Go to ECAL ENTRY (FB)	

4.8.1.3.7.1 Cue

Three engines failed in the YELLOW or downmode to RED region

4.8.1.3.7.2 Displays

PASS XXXXXX TRAJ

AMI

ADI

HSI

4.8.1.3.7.3 Crew Action

Monitor

4.8.1.3.7.4 Discussion

The YELLOW region will not typically appear on the PASS TRAJ display for “uphill” cases unless specific trajectory conditions occur when the two engine out auto contingency logic is invoked or on a TAL droop. The “FROM 2 E/O” arrow indicates that the color regions can be traversed in either order, i.e. GREEN then ORANGE then YELLOW or GREEN then YELLOW then ORANGE. The RED region will not appear on the TRAJ display unless a third engine failure occurs in the YELLOW region and the targeted alpha cannot be achieved as described in the next paragraph. This is the reason the YELLOW and RED monitoring blocks are combined. Even though this downmode is very unlikely, it is included on the CA side of the card for completeness and consistency with the RTLS side of the card.

For three engines out in the YELLOW region, separation at a small negative angle of attack is required due to the high dynamic pressure. Therefore, three engine out auto guidance commands the vehicle to an alpha near -2° (between $+1^\circ$ and -5°) and a beta near $0^\circ (\pm 3^\circ)$ for separation. If aerodynamic loads cause insufficient pitch authority to pitch down to the targeted angle of attack, the three engine out auto guidance will downmode to the RED region. In this case, the vehicle will be pitched toward 125° angle

of attack for separation. [AFPH4.8-26] Once the targeted angle of attack of either $-2^{\circ}\pm 3^{\circ}$ or $125^{\circ}\pm 20^{\circ}$ is reached, ET separation is commanded, followed by a 5 second -Z translation. If ET separation has not been commanded by an EAS of 77 knots and EAS is increasing, an immediate separation (emergency sep) will be commanded, followed by a five second -Z translation. This scenario has only been encountered in the YELLOW and RED regions in simulator testing but is available in the logic for all regions but 3 E/O BLUE.

The maneuver to entry attitude is a roll to heads up about the stability axis and pitch as required to reach the alpha recovery angle. The stability axis roll maneuver appears as roll and yaw on the ADI since the REF ball displays body attitude and body rates. It was unnecessary to differentiate between how the maneuver would appear on the ADI for MM601 and 602 as was done in the 3 E/O BLUE monitoring block, since it is unlikely that transition to MM602 will occur before the stability axis roll maneuver to entry attitude is complete. Even though the alpha recovery angle is actually a function of velocity and ranges between 20° and 58° , the velocity will be high enough in this region that the alpha recovery angle will be 58° . However, a check of alpha 58° is not included in the 3 E/O YELLOW/RED monitoring block for the reasons discussed in the 3 E/O BLUE rationale.

Major Mode 602 transition occurs when the attitude and rate constraints are satisfied or when EAS exceeds 77 knots (see table 2.7.3-II for transition criteria) . See section 2.7.2.5 and 2.7.2.6 for additional information. Once in MM602 the crew is directed to the ECAL ENTRY procedures for high inclinations or BDA ENTRY for lower inclinations where they will dial in a landing site and fly towards that site in hopes of making a landing, if no landing capability exists the crew will be directed to the BAILOUT procedures.

4.8.1.4 Contingency Entry Procedures

These contingency entry procedures are applicable to both the CA and RTLS contingency entry portion of the cue card. After leaving the left half of the cue card, the crew is directed to the contingency entry, described here, to ECAL ENTRY or BDA ENTRY procedures, or to RTLS or TAL procedures. If directed to BDA/ECAL ENTRY or RTLS or TAL, the crew proceeds to the Ascent Flip Book for completion. The contingency entry procedures described here take the vehicle to the proper conditions for bailout. See Figure 4.8.1-1.

4.8.1.4.1 Before NZ Hold Steps

VERT SIT INH ECAL/BDA - ITEM 1 (INH_[AFPH4.8-27])

Before NZ Hold

RHC/PNL TRIM - ENA

If $M < 5$,

$\sqrt{\text{AIL/RUD TRIM}}$

If $M < 3$, S/B = 65%

[AFPH4.8-28]

Expect $20^\circ \leq \alpha \leq 58^\circ$ [AFPH4.8-29]

4.8.1.4.1.1 Cue

MM602 transition and directed to "CONT ENTRY" by the CA Cue Card

4.8.1.4.1.2 Displays

SPI

AMI

VERT SIT 1

4.8.1.4.1.3 Crew Action

VERT SIT ITEM 1

F3, F4 L,R TRIM RHC/PNL - ENA

Mach < 5: **VERT SIT** $\sqrt{\text{AIL and RUD TRIM}}$

If AIL and RUD TRIM > 1° in the same direction:

C3 Deflect ROLL TRIM to zero AIL trim

C3 SBTC - set if required

4.8.1.4.1.4 Discussion

The first step of the procedure is to go to the VERT SIT display and disable ECAL logic via an ITEM 1. The ECAL logic is I-loaded to ON in the software for any contingency entries, since in most situations the crew will want to fly towards a landing site and land if the capability exists or if no capability exists to bailout closer to land and search and rescue forces. The ITEM 1 on the VERT SIT display alternately enables/disables the logic. For the cases that get directed to the CONT ENTRY cue card a landing site cannot be made and the ECAL logic may actually cause a pitch-up divergence during the initial pullout. This is due to the fact that these regions don't experience large G forces during the initial pullout. Because of this, less than usual alpha pitch down is required for the Nz Hold phase. When ECAL logic is on, if a large heading error to the site is present the logic calls for ~ .2g's higher Nz value to be held during the pullout. This allows the alpha ramp down required for Nz Hold to be even less and because these cases are generally low speed, early abort cases, the entry Mach numbers experienced are very low (< ~ M4). The low Mach numbers coupled with the high alpha leave the vehicle in a region where pitch-

up divergence is very possible. Inhibiting the ECAL logic allows the vehicle to pitch down more and stay clear of the pitch-up divergence region.

After ET sep, the rudder may move full out one direction or the other in response to residual beta on the vehicle. During the pullout, the rudder may still be in that position and the ailerons may begin a force fight to compensate. The crew monitors the VERT SIT for aileron/rudder force fights. If the ailerons trim more than 1° or more in the same direction as the rudder deflection, the crew should intervene to trim out the force fight using the roll panel trim switch (trim away from displayed direction). The trim switch must be enabled before the panel trim switches are active. Rudder/aileron force fights are only prevalent for entry Mach numbers less than five. Since the rudder and aileron trim may saturate very quickly after Major Mode 602 transition, these steps appear near the beginning of the procedure. If the trim switches are not properly positioned, the crew may not be able to alleviate the saturated trim before vehicle control is lost.

Setting the speedbrake to 65% for low speed contingency aborts is crucial to maintain longitudinal stability. If the pullout is begun above Mach 3, sufficient longitudinal control is available without the speedbrake (leave it in AUTO). The crew should check the Mach number upon entry into MM 602 to see if below Mach 3. Setting the speedbrake to 65% in this case is time critical and must be complete before entering Nz hold to avoid mechanical failure.

The body flap is left in AUTO since CR 90711 Auto Body Flap, incorporated in OI-26, eliminated the need for a manual body flap schedule. Prior to this Flight Software delivery, a mission specific manual body flap schedule (body flap position versus Mach) was included and used to set the body flap prior to NZ Hold. The Mach was read upon entering MM 602 to determine the correct setting. SES testing has shown cases where the body flap setting is critical for control and/or structural integrity. The manual schedule was designed for optimizing both elevon and body flap loads during the pullout. Settings of body flap position more than 5° off of the scheduled setting have shown loss of control in the SES. Therefore, CR 90711 was incorporated to automatically balance the loads between the elevons and the bodyflap.

The alpha recovery angle is a function of Mach number and ranges between 20° and 58° below Mach 3.5. Above Mach 3.5, it is simply set to 58°. The alpha recovery angle is computed to minimize Nz and QBAR structural concerns during pullout.

The maximum negative altitude rate achieved after ET sep is a good indicator of how severe the CA entry will be, and is used to calculate the target Nz that is required for pullout. The target Nz can be estimated as:

$$Nz \text{ target} = -\text{Alt Rate max}/1000 + 0.6$$

4.8.1.4.2 After NZ Hold Steps

After NZ Hold (and NZ < 2g)

M ≤ 5, ADTA PROBES - Deploy [AFPH4.8-30]

Monitor - M/α

M2 → 1: θ = 0° by M = 1.0 [AFPH4.8-31]

M	> 12	9	6	3	1
α	40	35	26	18	12

√Air Data

G50 Incorp Air Data ASAP

Select UHF-G T/R

When M < 1:

Go to **BAILOUT (FB)**

4.8.1.4.2.1 Cue

NZ less than 2g (post-pullout)

4.8.1.4.2.2 Displays

AMI

VERT SIT 1

SPEC 50 HORIZONTAL SIT

4.8.1.4.2.3 Crew Action

F4 BODY FLAP - set if required

AMI Mach ≤ 5:

C3 AIR DATA PROBE (two) - DEPLOY

Monitor Mach - Alpha

Before Mach 2:

G50 ITEM 28 EXEC

4.8.1.4.2.4 Discussion

When the sink rate has reduced to -320 fps, the orbiter has achieved pullout and transitions to flying a wings level angle of attack (alpha) schedule based on the velocity relative to the Mach number.

As in a nominal entry, the air data probes should be deployed once below Mach 5. However, a CA entry may have a high g, high QBAR pullout below Mach 5. To avoid mechanical failure of the ADTA probes, the crew should wait until the pullout is complete before deploying the probes. Pullout is considered complete when the Nz loads are less than two.

The crew should check the Mach/alpha profile on the contingency entry cue card for the remaining portion of the entry flight phase. The trends of EAS and θ should be checked between Mach 2 to 1 since alpha control thru the transonic region is critical. Because CA guidance is not using air data for closed loop trajectory control, it is considered riskier to ignore transonic alpha control in favor of air data incorporation. The trends check is a reminder to prevent a loss of control by manually lowering the nose during the alpha transition phase of some CA post pullout profiles (if necessary).

Air Data should be incorporated to G&C as soon as possible. Since air data will not be processed above 105K ft, this reference was deleted from this step. Air Data should be incorporated as soon as possible to provide more accurate alpha, Mach, and altitude information to GN&C.

Selecting UHF-G (guard) T/R allows the crew to transmit and receive on the emergency (guard) frequency which is monitored by FAA and military facilities.

When Mach is less than 1 the crew goes to the BAILOUT cue card in preparation for bailout and ditching the vehicle.

4.8.2 RTLS Contingency Abort Cue Card

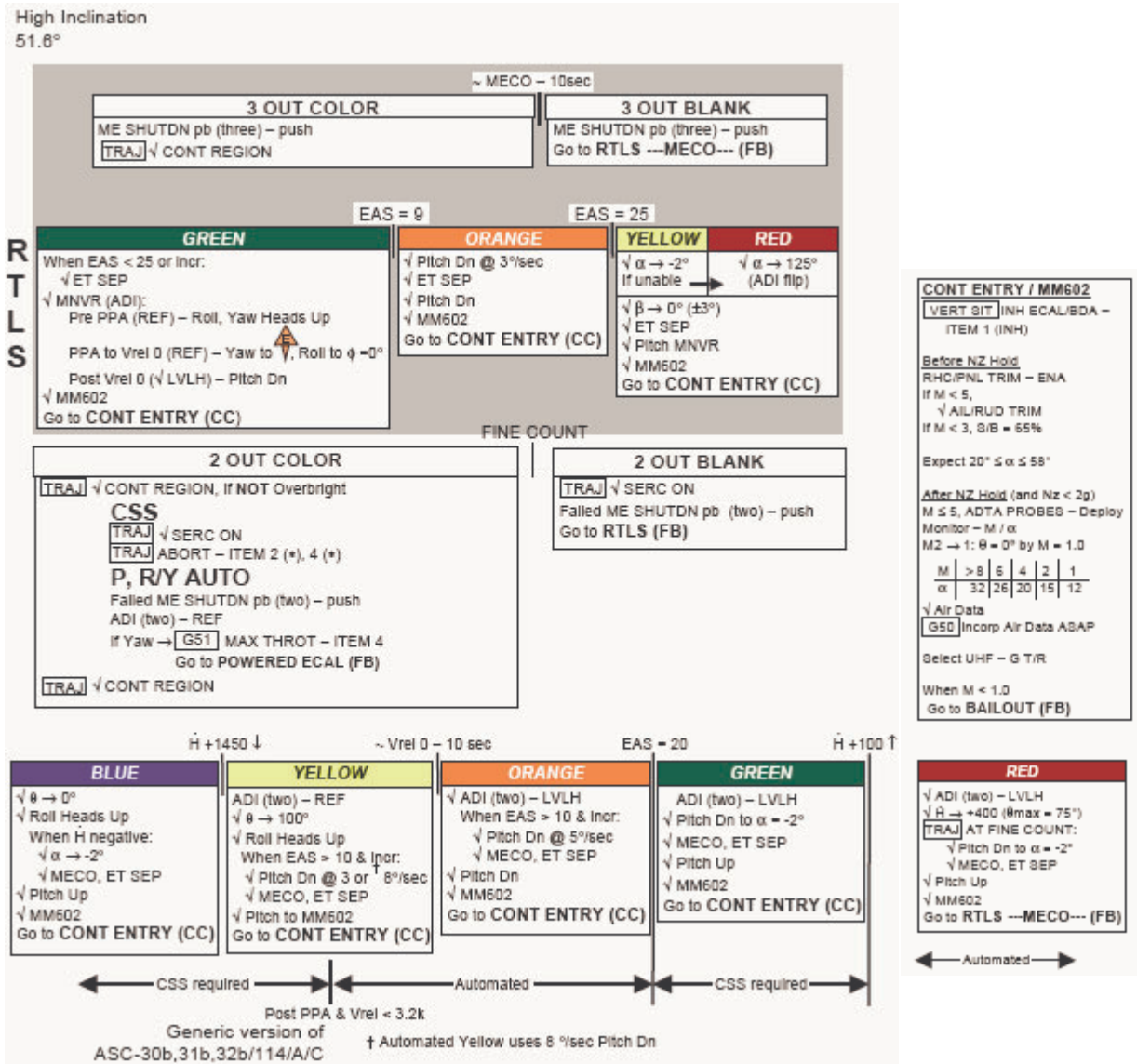

Figure 4.8.2-1: STS-114 RTLS Contingency Abort Cue Card

4.8.2.1 Two Engine Out RTLS

These procedures are designed for the case where a second engine fails during an RTLS abort. The RTLS may have been entered for systems failures or for an earlier single engine failure. Once a second engine fails during an RTLS abort, the crew performs the procedures on the RTLS side of the contingency abort cue card. These procedures are divided into blocks based on the same logic used on the front (non-RTLS) side of the cue card: The first block contains critical action tasks for the crew, and the blocks below contain monitoring information for the automated abort maneuver.

The critical action procedures for two engines out during RTLS is defined in the 2 OUT COLOR box of the RTLS contingency abort cue card^[AFPH4.8-32]. These critical procedures are used all the way through the RTLS timeline until late in the trajectory when fine count is achieved. At fine count, which occurs just prior to powered pitchdown and MECO, guidance goes open loop to preclude over controlling near the MECO target. Once past fine count, the RTLS in progress can be completed in spite of the second engine failure, and the automated CA is not required. The 2 OUT color region will blank to indicate this. The cue card directs the crew back to the regular RTLS procedures in the flipbook upon reaching fine count.

4.8.2.1.1 Two Engine Out RTLS Procedures (2 OUT COLOR_[AFPH4.8-33])

2 OUT COLOR	
TRAJ	√ CONT REGION, If NOT Overbright
	CSS
	TRAJ √SERC ON
	TRAJ ABORT - ITEM 2 (*), 4 (*)
	P,R/Y AUTO
	Failed ME SHUTDN pb (two) - push
	ADI (two) - REF
	If Yaw → G51 MAX THROT - ITEM 4
	Go to POWERED ECAL (FB)
TRAJ	√CONT REGION

4.8.2.1.1.1 Cue

Two engines failed during an RTLS prior to 2 OUT BLANK

4.8.2.1.1.2 Displays

PASS XXXXXX TRAJ

ADI

SPEC 51

4.8.2.1.1.3 Crew Action

TRAJ √ if 2 E/O color region NOT Overbright

F2 PITCH, ROLL/YAW pbs - CSS

TRAJ √SERC ON

ITEM 2 EXEC

ITEM 4 EXEC

F2 PITCH, ROLL/YAW pbs - AUTO

C3 Failed MAIN ENGINE SHUT DOWN pbs - push

F6,F8 ADI ATTITUDE (two) - REF

If Yaw **G51** ITEM 4

Go to POWERED ECAL procedures

TRAJ √2 E/O color region

4.8.2.1.1.4 Discussion

From the time an RTLS is declared through the beginning of fine count, the crew performs the critical actions described below to manually invoke the 2 out automated CA logic. There are three areas where the logic is invoked automatically though. In the 2 OUT YELLOW region when two engines are confirmed failed, powered pitch around (PPA) has occurred, and the horizontal component of downrange relative velocity has dropped

below ~3,200 fps the logic is automatically invoked. In the 2 OUT ORANGE region when two engines are confirmed failed the logic is automatically invoked and finally when two engines are confirmed failed in the 2 OUT RED region the logic is automatically invoked. The auto CA logic is automatically invoked in these regions because success of the maneuver is time critical, so having automatic recognition and initiation of the abort eliminates crew/ground reaction time and increases the chances of completing the RTLS abort. The YELLOW and ORANGE regions were automated in the OI-30 flight software build with CR92504G Alleviate ET Recontact for RTLS 2 EO Yellow and Orange Regions. This CR will be discussed more in the subsequent sections, but the main objective of the CR was to automatically initiate the auto CA logic and optimize the maneuvers in the 2 out region around VREL 0 so that more favorable ET sep conditions could be achieved, since ET recontact in these regions was highly likely. In the regions which are not initiated automatically, the logic is invoked with the crew performing the ITEM 2, ITEM 4 on the TRAJ display. The bottom of the RTLS CA cue card aids the crew in recognition of the Auto versus Manual regions.

Once a second engine is assumed failed on the RTLS trajectory the crew immediately checks the contingency region on the TRAJ display. If the region is Overbright, this signifies that the 2 out auto CA logic is active. The crew will also see the ITEM 2 and 4 asterisks appear on the TRAJ display. If this is the case, the crew can skip the indented steps of 2 OUT COLOR and proceed to the 2 out region's monitor block. If the region is NOT Overbright the crew will perform the indented steps. The crew should immediately take CSS, this action places the vehicle in an attitude hold to avoid any auto maneuvering that may cause control problems. This provides a greater chance of success in maintaining control while performing the subsequent steps in the procedure. The CSS step is bolded and a larger font is used to emphasize criticality of the step. [AFPH4.8-34]

In reality this step is only critical in regions where the shuttle is performing dynamic maneuvers to follow RTLS guidance. Since taking CSS is critical in these few regions and since it does not hinder performance or abort execution in the rest of the RTLS profile, this action is always the first step. It avoids the complexity of having separate procedures for each segment of the RTLS profile.

SERC is needed for all RTLS two engine out scenarios. Guidance automatically invokes SERC if two engines out are confirmed by the GPCs. SERC is also invoked automatically if an engine or data path failure has occurred and sensed acceleration falls below a threshold value. SERC ensures control of the vehicle during the critical time period just after the second engine failure when the crew is still trying to confirm the failure. SERC does not commit the crew to the CA but it does allow more time for analyzing the situation, especially if the second engine failed behind a data path failure or with engine limits inhibited. Initiating SERC with two engines running does not cause control problems. It does, however, take control of the roll channel from the two SSMEs, which results in reduced roll authority. (Pitch and yaw channels remains under SSME control.) For this reason, if the crew subsequently confirms two engines are running and gimbaling normally, SERC should be toggled off.

Once the failure of two main engines is confirmed, the crew can immediately execute ITEMS 2 and 4 on the TRAJ display, which commits the crew to the CA. The automated CA logic can be invoked by the crew, or in the case of a second engine failure confirmed by the GPC's in RTLS 2 OUT YELLOW (when post-PPA and horizontal downrange relative velocity < ~3200 fps), ORANGE, or RED the logic is initiated automatically. The crew will see the ITEM 2 and 4 asterisks appear on the TRAJ display and the color region go Overbright when the logic is invoked.

Because CSS was taken in the first step, auto cannot initiate maneuvering for the abort until the crew performs this step. This action is a time critical step and any delay in returning control to AUTO decreases the chances of a successful CA maneuver. For example, in the two engine out GREEN region, delays of greater than approximately 15 seconds from the time of failure to return of control to AUTO after invoking the abort frequently results in failure to safely separate from the external tank. Therefore, the crew should immediately return to AUTO after declaring the auto CA. This is the reason the step is bolded and in a larger font. If, while executing the two engine out COLOR procedures, the crew notices that the auto CA has been invoked automatically, they should return control to AUTO immediately and monitor the rest of the maneuvers.

Once the crew has determined which engines have failed, they should push the two failed main engine pbs. If any of the failed SSMEs has a data path failure or if one SSME fails and then the second SSME fails with the main engine limits inhibited, this command notifies the GPCs to begin safing of the failed engines.

The reference (REF) position of the attitude director indicator (ADI) makes the ADI an inertial, three axis ball based on the launch pad coordinate system. This is done to ensure a discontinuity does not occur at 90° pitch and allows visibility in the yaw axis. If a yaw out of plane is observed then the contingency yaw steering is taking place and the crew is cued that the POWERED ECAL logic is being flown. As part of the POWERED ECAL procedures the crew should invoke maximum throttles to reduce trajectory droop and increase altitude for better ET SEP conditions. The crew would then turn to the POWERED ECAL procedures in the checklist_[AFPH4.8-35]. It should be noted that for low and mid-inclination missions the I-loaded velocity to begin yaw steering is set higher than any velocity achieved during the RTLS abort and so this check for yaw, setting max throttles, and going to POWERED BDA is omitted from the checklist for these cases_[AFPH4.8-36].

If no yaw, the TRAJ display shows which color coded procedure the auto contingency logic will fly. Once the appropriate abort maneuver is confirmed, the crew proceeds to the corresponding color block on the cue card to monitor the automated maneuver.

During CA development it was discovered that Naval Air Stations Cherry Point and Oceana are available while on an RTLS for high inclination missions. If yaw steering is enabled and the vehicle is within altitude rate limits to yaw steer, the crew should notice

the vehicle starting to yaw and should go to the POWERED ECAL procedure in the Ascent Flip Book. On an RTLS abort, ECAL is only available during fuel dissipation before PPA. BDA is not available from RTLS on low inclination missions due to excessive crossrange. Reference the BDA/ECAL procedures, section 4.8.3, for more information.

4.8.2.1.2 Two Engine Out RTLS BLUE

BLUE
$\sqrt{\theta} \rightarrow 0^\circ$ $\sqrt{\text{Roll Heads Up}}$ When H negative: $\sqrt{\alpha} \rightarrow -2^\circ$ $\sqrt{\text{MECO, ET SEP}}$ $\sqrt{\text{Pitch Up}}$ $\sqrt{\text{MM602}}$ Go to CONT ENTRY (CC)

4.8.2.1.2.1 Cue

Two engine failures in the RTLS 2 E/O BLUE region

4.8.2.1.2.2 Displays

PASS XXXXXX TRAJ

ADI

AVVI

AMI

4.8.2.1.2.3 Crew Action

Monitor

4.8.2.1.2.4 Discussion

The automated BLUE procedure occurs early in the trajectory until altitude rate decreases through 1450 fps, where it transitions to YELLOW. Typical ET sep conditions for the BLUE region are QBAR between 1.5 and 6 psf, alpha between -1.8 and -4.8 and altitude between 200,000 and 235,000 ft. Typical pullout conditions are QBAR between 350 and 550 psf and Nz between 2.4 and 2.9g.

[AFPH4.8-37]

In this region of the trajectory, the vehicle must pitch down to the horizon to gain as much horizontal velocity out of the remaining thrust as possible. This reduces the flightpath angle and the severity of the pullout. The crew should observe a smooth pitchdown to the horizon in an inverted attitude. A roll to a heads up attitude is performed to prepare for ET sep and the subsequent pullout.

When altitude rate goes through zero, the flightpath angle is zero and the alpha is approximately 10° . These parameters are optimum to begin the ET sep maneuver for this

region since the flightpath angle will be shallow at the start of the pullout. The crew should see a pitchdown at this time to an alpha of -2° which is used for the ET sep. At that angle of attack ET recontact probability is minimized.

Upon reaching alpha -2° , the remaining engine should cut off almost immediately. Main engine cutoff is indicated by three red engine status lights. Six seconds later, the status lights should extinguish indicating ET sep has occurred. The -Z translation occurs automatically.

At MECO confirmed, three engine out auto guidance takes over from powered contingency logic. The maneuver to entry attitude is a pitch up to the alpha recovery angle which is a function of velocity and ranges between 20° and 58° . Major Mode 602 transition occurs when the attitude and rate constraints are satisfied or when EAS exceeds 77 knots (see table 2.7.3-II for transition criteria). Upon confirmation of the transition to 602 the crew should go to the contingency entry (CONT ENTRY) portion of the cue card.

4.8.2.1.3 Two Engine Out RTLS YELLOW

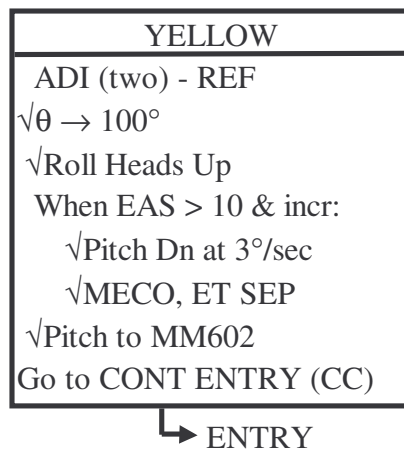

4.8.2.1.3.1 Cue

Two engine failures in the RTLS 2 E/O YELLOW region

4.8.2.1.3.2 Displays

PASS XXXXXX TRAJ

ADI

AMI

4.8.2.1.3.3 Crew Action

Monitor

4.8.2.1.3.4 Discussion

The YELLOW maneuver is performed for second engine failure cases that occur after altitude rate decreases to less than 1450 fps (approximately 3 + 40 MET) and out to a point after PPA when the horizontal component of downrange velocity is less than 350 fps (approximately 10 seconds prior to $V_{REL} = 0$). Note that in a portion of this window the 2 out automated CA logic is automatically invoked while in the other portion the logic has to be invoked with the ITEM 2, ITEM 4 steps on the TRAJ display. The first part of this window, from altitude rate less than 1450 fps until post-PPA and the horizontal component of downrange relative velocity still greater than ~3200 fps, will require the crew invoke the logic via the item entries. This involves the crew working the indented steps in the 2 OUT COLOR block before proceeding to the YELLOW monitor block. In the second part of the window, post-PPA and the horizontal component of the downrange relative velocity less than ~3200 fps, the logic will be automatically invoked for a second recognized engine failure in this region. Here the crew can proceed from the 2 OUT COLOR block to the YELLOW monitor block without working the indented steps in 2 OUT COLOR.

Typical ET sep conditions for this region are QBAR between .8 and 1.7 psf, alpha between 83° and 139°, and altitude between 240,000 and 188,000 ft. Typical pullout conditions are QBAR between 473 and 790 psf and Nz between 2.5 and 2.8g. Although these altitudes are below the minimum droop altitude, ET heating is not a concern due to the low Mach numbers of this abort.

The CDR and PLT place their ADI attitude switches in REF to avoid the 90° pitch attitude roll singularity and to permit them to monitor yaw. Note that the ADI - REF step is only necessary for the automated (last) portion of the window. In the first part of the window where the crew must perform the indented steps and invoke the 2 out auto CA logic with the item entries, the crew is already performing the ADI -REF step there. However, for the last part of the window (2 out auto CA logic automatically invoked), the indented steps are skipped and the ADI will still be in LVLH when the YELLOW monitor block is entered.

During this phase of the RTLS trajectory, the vehicle is no longer gaining altitude rapidly so a second engine failure induces high sink rates. To minimize the severity of the pullout, the vehicle uses its remaining thrust to minimize the developing sink rate by pitching to a theta of 100°. The crew should see 100° on the ADI, which provides a vertical thrust angle. This maneuver may not be performed purely in the pitch axis by the auto system. If some yaw and roll are present when the maneuver begins, a combination of pitch, roll, and yaw may occur to achieve this pitch attitude. In extreme cases of roll angle (caused by delay in getting SERC on), this maneuver may appear as pure yaw (quickest way to get there).

The roll to heads up is performed to prepare for ET sep and the subsequent pullout. The vehicle maneuvers heads up with respect to the velocity vector, which is still pointed down range in this region. Even though the vehicle was heads up after PPA because it was flying downrange (backwards), a roll is still required to orient the belly of the vehicle into the relative wind. Whether the failure occurs before or after PPA in the YELLOW region, the pullout and entry phase of the abort are flown in the downrange direction.

The optimum time to begin the ET sep maneuver is at 10 KEAS. If the pitch maneuver is initiated at a lower KEAS, the pullout starts at a higher altitude, resulting in higher QBAR and pullout Nz. If the maneuver is delayed to a higher KEAS, ET recontact could result. Pitch at separation will be about 85°. The pitchdown is performed at 3_[AFPH4.8-38]°/sec if in the first part of the window (logic initiated via item entry), while pitch rates of up to 8°/sec are used in the second part of the window (logic initiated automatically) In the second part of the window as the relative velocity is approaching 0 fps, the loss of a second engine causes the altitude rate to start dropping very quickly and the KEAS will build quickly, thus it is more important to get to a good sep attitude faster. Therefore the faster pitch rate is used. Some more on the OI-30 CR 92504G Alleviate ET Recontact for RTLS 2 EO Yellow and Orange Regions follows_[AFPH4.8-39].

The CR was written to help ET recontact issues near Vrel 0, these ET recontact issues cause the 2 engine out regions around VREL 0 to be defined as black zones (non-survivable). Extremely steep flight path angles (up to 80° below the horizon), high angles of attack, and rapidly building dynamic pressure saturate the ability of the Orbiter to safely maneuver away from the ET. At high alphas the ET blocks the oncoming airflow, casting an aerodynamic shadow on the Orbiter that prevents the Orbiter from producing lift. The RCS is unable to produce the thrust necessary to move away from the ET, which is experiencing full aerodynamic drag. The recontact could cause loss of vehicle and crew, depending on the damage experienced.

The maneuvers in the CR are aimed at reducing ET sep alpha, at the cost of an increasing dynamic pressure - since entry loads were not maxed out and slight increases would be acceptable if the recontact issues could be eliminated. Reducing alpha helps to eliminate the shadowing affect and allows the Orbiter to regain the lift necessary to move away from the ET. The automatic initiation of the 2 out auto CA logic eliminates the delay experienced while waiting for the crew to recognize the engine out and manually initiate the logic (~15 seconds). Higher pitch rates are used to help reduce alpha more quickly. The mated coast phase is extended also, this allows for more of a reduction in alpha prior to ET sep. Another item that helps the ET recontact concern includes firing the +X jets and OMS to maintain a +X acceleration during mated coast, this helps to reduce slosh dynamics of the ET and thus helps increase clearance margins. Finally, the -Z burn is extended to help improve clearance from the ET prior to pitching the vehicle up to the entry angle of attack.

Upon reaching the desired pitch rate, MECO is commanded, indicated by the three main engine status lights red. Separation is indicated by the lights extinguishing. For the non-automated portion of the window this should be six seconds after MECO. In the automated portion of the window near VREL 0 the separation will take longer, in some cases up to 16-18 seconds after MECO. At MECO confirmed, three engine out auto guidance takes over from powered contingency logic. The maneuver to entry attitude is a continuation of the pitch down to the alpha recovery angle which is a function of velocity and ranges between 20° and 58° . In some cases, the vehicle pitches down enough during the -Z translation maneuver that a pitch up to the entry attitude is required once the -Z is complete. Since the maneuver is sometimes a pitch down and other times a pitch down, then up, the step was written as “√Pitch to MM602”. Major Mode 602 transition occurs when the attitude and rate constraints are satisfied or when EAS exceeds 77 knots (see table 2.7.3-II for transition criteria). The crew should proceed to the entry portion of the RTLS contingency cue card at this point.

4.8.2.1.4 Two Engine Out RTLS ORANGE

ORANGE
✓ ADI (two) - LVLH When EAS > 10 & incr: ✓ Pitch Dn at 5°/sec ✓ MECO, ET SEP ✓ Pitch Dn ✓ MM602 Go to CONT ENTRY (CC)

4.8.2.1.4.1 Cue

Two engine failures in the RTLS 2 E/O ORANGE region

4.8.2.1.4.2 Displays

PASS XXXXXX TRAJ

ADI

AMI

4.8.2.1.4.3 Crew Action

Monitor

4.8.2.1.4.4 Discussion

This maneuver is flown for cases where the second engine fails during the RTLS profile between 10 seconds prior to $V_{REL} = 0$ and 20 KEAS. The 10 seconds prior to $V_{REL} = 0$ is just an approximation. The actual moding cue used in the software is a downrange velocity of less than 350 fps. Typical ET sep conditions for this region are QBAR between 0.5 and 2 psf, alpha between 105° and 37°, and altitude between 206,000 and 185,000 ft. Typical pullout conditions are QBAR between 536 and 335 psf and N_z between 2.9 and 2.4g. This region was also automated with CR 92504G Alleviate ET Recontact for RTLS 2EO Yellow and Orange Regions. See the previous section for a description of this CR. The indented steps in the 2 OUT COLOR region do not have to be performed by the crew in this region and the 2 out auto CA logic is automatically invoked, eliminating ~15 seconds worth of delay in initiating the logic.

After V_{REL} zero, the nose of the vehicle is in the direction of the velocity vector. Since virtually no yawing is performed after V_{REL} zero, the desired ADI reference frame is LVLH. This ensures that the heads up orientation is correctly depicted. Only a check of LVLH is required. The crew should already be in LVLH; however, if for some reason the indented steps on the 2 OUT COLOR block were worked the ADI's would be in REF. The check just ensures a good configuration. [AFPH4.8-40].

The ET sep maneuver is initiated when EAS is greater than 10 knots and increasing. This airspeed was derived empirically as a compromise between altitude, Nz, QBAR, and ET recontact constraints. At lower airspeeds the pullout is more severe, and at higher airspeeds ET recontact is more likely.

The orbiter performs a fast sep maneuver to get off the external tank. It uses this pitch rate to establish the separation. Simulations have shown that rates greater than $6^\circ/\text{sec}$ may result in loss of control. When the vehicle has achieved the separation pitch rate of $5_{[AFPH4.8-41]}^\circ/\text{sec}$, MECO should be commanded immediately and is confirmed by three red main engine status lights. The lights extinguish when the tank has separated. With the OI-30 updates to automate and optimize this region for better ET sep clearance margins the time between MECO and ET sep can vary, but is generally somewhere in the 10 - 16 second range. The extended mated coast allows for a reduced alpha at ET sep, this eliminates some of the ET shadowing that prevents good separation dynamics. See section 4.8.2.1.3 for a discussion on OI-30 CR 92504G Alleviate ET Recontact For RTLS 2EO Yellow and Orange Regions. Following ET sep a -Z translation maneuver also occurs automatically.

At MECO confirmed, three engine out auto guidance takes over from powered contingency logic. The maneuver to entry attitude is a continuation of the pitch down to the alpha recovery angle which is a function of velocity and ranges between 20° and 58° . In a few cases, a small amount of pitch up may be observed prior to Major Mode 602 transition. Since most cases will only pitch down, the monitoring step was left as “√Pitch Dn” instead of “√Pitch Dn, Then Up”. Major Mode 602 transition occurs when the attitude and rate constraints are satisfied or when EAS exceeds 77 knots (see table 2.7.3-II for transition criteria). At this point the crew should proceed to the entry procedures section on the cue card.

A manual MPS dump was performed prior to OI-23 to provide a 20 second LH_2 dump in MM602 and to prevent the LO_2 dump. The LO_2 dump was not done to avoid a possibly combustible mixture in the aft compartment. The first reason for the manual MPS dump was eliminated when the LH_2 dump in MM602 was automated in OI-23. Analysis of the simultaneous LH_2 and LO_2 dump revealed minimal ingestion into the aft compartment and minimal risk of an explosion. Therefore, the manual MPS dump step was removed from the RTLS 2 E/O ORANGE, 2 E/O GREEN, 3 E/O YELLOW, 3 E/O ORANGE, and 3 E/O GREEN procedures in OI-23.

4.8.2.1.5 Two Engine Out RTLS GREEN

GREEN
ADI (two) - LVLH
√Pitch Dn to $\alpha = -2^\circ$
√MECO, ET SEP
√Pitch Up
√MM602
Go to CONT ENTRY (CC)

4.8.2.1.5.1 Cue

Two engine failures in the RTLS 2 E/O GREEN region

4.8.2.1.5.2 Displays

PASS XXXXXX TRAJ

ADI

AMI

4.8.2.1.5.3 Crew Action

Monitor

4.8.2.1.5.4 Discussion

During an RTLS when EAS increases through 20 kt during flyback, the abort software modes to the GREEN region. This maneuver is flown for two engines out in a narrow region between EAS = 20 knots and altitude rate of +100 fps. As described earlier, this is the region where aerodynamic forces start to build, creating greater roll coupling effects if CSS is not taken while the steps to begin the abort are performed.

In this region the nose of the vehicle is in the direction of the velocity vector. Since virtually no yawing is performed after V_{REL} zero during flyback, the ADI is taken to LVLH so that the heads up orientation is correctly depicted. Remember the ADI's were taken to REF in the 2 OUT COLOR block prior to entering the GREEN block_[AFPH4.8-42].

Returning control to AUTO in this region is also very time critical. Delays of greater than approximately 15 seconds from the time of failure to return of control to AUTO after invoking the abort frequently result in failure to safely separate from the ET. The loss of the second engine causes a rapidly increasing sink rate which in turn results in excessive QBAR at ET sep if the ET sep pitchdown maneuver is delayed. The vehicle does not begin this maneuver until control is returned to AUTO. A fast sep is commanded when alpha reaches -2° . The vehicle needs to be at a negative angle of attack at separation in this region to avoid recontact due to the increasing QBAR.

Because the aerodynamic forces are starting to build rapidly in this region, the vehicle has marginal pitch authority with one engine. The crew should be alert for excessive maneuvering time to alpha -2° during this maneuver. The auto software does not command fast sep until alpha reaches exactly -2° , regardless of the QBAR value or its rate of buildup. If a side engine is running, the vehicle has a hard time achieving the $3_{[AFPH4.8-43]}^\circ/\text{sec}$ pitchdown but easily captures -2° alpha. If a center engine is running, the vehicle easily establishes the pitchdown rate but overshoots or has difficulty stabilizing on -2° alpha. In either case the crew should monitor QBAR and initiate a manual fast sep if QBAR is building past 20 KEAS with alpha still oscillating. Some negative alpha is highly desirable. If the crew has to manually separate, they may also need to take CSS, execute a 6 second -Z translation and then pull alpha within 5° of the alpha recovery angle to get a MM 602 transition.

As in the other regions, MECO is indicated by the three red main engine status lights, and ET sep occurs 6 seconds later, when the status lights extinguish. At MECO confirmed, three engine out auto guidance takes over from powered contingency logic. The maneuver to entry attitude is a pitch up to the alpha recovery angle which is a function of velocity and ranges between 20° and 58° . Major Mode 602 transition occurs when the attitude and rate constraints are satisfied or when EAS exceeds 77 knots (see table 2.7.3-II for transition criteria). At this point the crew should proceed to the entry portion of the cue card.

Typical ET sep conditions for this region are QBAR from 8.5 to 12 psf, alpha between 1.5° and -10° , and altitude between 158,000 and 177,000 ft.

A manual MPS dump was performed prior to OI-23 to provide a 20 second LH_2 dump in MM602 and to prevent the LO_2 dump. The LO_2 dump was not done to avoid a possibly combustible mixture in the aft compartment. The first reason for the manual MPS dump was eliminated when the LH_2 dump in MM602 was automated in OI-23. Analysis of the simultaneous LH_2 and LO_2 dump revealed minimal ingestion into the aft compartment and minimal risk of an explosion. Therefore, the manual MPS dump step was removed from the RTLS 2 E/O ORANGE, 2 E/O GREEN, 3 E/O YELLOW, 3 E/O ORANGE, and 3 E/O GREEN procedures in OI-23.

4.8.2.1.6 Two Engine Out RTLS RED

RED
√ ADI (two) - LVLH √ H → +400 ($\theta_{max} = 75^\circ$) TRAJ AT FINE COUNT: √ Pitch Dn to $\alpha = -2^\circ$ √ MECO, ET SEP √ Pitch Up √ MM602 Go to RTLS ---MECO--- (FB)

4.8.2.1.6.1 Cue

Two engine failures in the RTLS 2 E/O RED region

4.8.2.1.6.2 Displays

PASS XXXXXX TRAJ
 ADI
 AVVI
 AMI

4.8.2.1.6.3 Crew Action

Monitor

4.8.2.1.6.4 Discussion

The RED procedure is executed when the RTLS can be completed on one engine, which is when altitude rate = +100 fps. The upper boundary for the RED region is at fine count for MECO, which is indicated by a flashing “F” in the upper right corner of the TRAJ display.

While in the RTLS RED region, if a second engine failure is confirmed by the GPCs, the auto CA software automatically invokes the RED procedure. However, if the second engine out confirmation is delayed due to engine limits inhibited or a data path failure, crew action is required to initiate the abort. Prior to OI-30 the RED region had a procedure block of its own (2 OUT RED) since it was the only region prior to fine count that was initiated automatically. However, with the OI-30 CR 92504G Alleviate Recontact for RTLS 2EO Yellow and Orange Regions, RED is no longer the only region that automatically invokes the auto CA logic. To accommodate procedures for all three automated regions the RED procedural block was combined back into 2 OUT COLOR procedural block. If the RED is overbright on the TRAJ following the second engine failure, the crew skips the indented steps in the 2 OUT COLOR block and proceeds to the RED monitor block. If however, the confirmation of the second engine failure is delayed due to engine limits inhibited or a data path failure, the RED on the TRAJ will not be

Overbright and the crew will work the indented steps of 2 OUT COLOR to manually initiate the auto CA logic, then proceed to the RED monitor block. [AFPH4.8-44]. Be aware that for cases where an unconfirmed second engine failure occurs early enough in the RED region, delays in manually initiating the CA may result in the software moding back to the RTLS GREEN region if altitude rate drops below 100 fps.

[AFPH4.8-45]

Typical ET sep conditions for this region are QBAR between 5 and 10 psf, alpha between -2.4° and -5.1° , and altitude between 201,000 and 222,000 ft.

Since virtually no yawing is performed in this region, the desired ADI reference frame is LVLH. This ensures that the heads up orientation is correctly depicted. Only a check of LVLH is required. The crew should already be in LVLH; however, if for some reason the indented steps on the 2 OUT COLOR block were worked the ADI's could be in REF. The check just ensures a good configuration.

To achieve the R-V target line, some horizontal thrust vector component is required. For this reason, the pitch attitude may not exceed 75° . Additionally, SES testing has demonstrated that control problems may develop above that pitch attitude. Typically the pitch attitude is 60° prior to the second engine failure.

If the second engine fails at an altitude rate of 400 fps, pitch has to be reduced to hold altitude rate at +400 fps. This maneuvering results in theta of 30° prior to MECO. If the pitch attitude is allowed to stay high prior to the pitchdown, a propellant depletion MECO occurs before alpha reaches -2° . Control is then lost because the RCS jets are unable to arrest the pitch rate. On the other hand, if altitude rate is too low, e.g., 300 fps prior to pitchdown, the shuttle is lower in the atmosphere, QBAR is excessive, and control is lost during ET sep. Therefore the 400 fps target is essential for control through the ET sep maneuver.

Upon reaching fine count the vehicle begins to maneuver to an angle of attack of -2° for safe ET sep. This cue was established to provide the control system time to get to -2° alpha before MECO occurs.

As in the other abort regions, the MECO is commanded immediately upon reaching -2° alpha and is indicated by three red main engine status lights. The ET sep occurs 6 seconds later and is confirmed by the engine status lights going out. The maneuver to entry attitude is a pitch up to the alpha recovery angle which is a function of velocity and ranges between 20° and 58° . In most 2 E/O RED cases, the 3 E/O color region will be blanked before MECO is commanded and three engine out auto guidance will not take over from powered contingency. In this case, Major Mode 602 transition occurs as soon as the vehicle pitches above 10° and 10 seconds have elapsed since ET separation. However, if a large underspeed from the RTLS MECO R-V line occurs (3 E/O color region not blanked), three engine out auto guidance *will* take over from powered contingency logic at MECO confirmed. Major Mode 602 transition occurs when the attitude and rate

constraints are satisfied or when EAS exceeds 77 knots (see table 2.7.3-II for transition criteria). The crew should proceed to the RTLS procedures in the Ascent Flip Book. Since this procedure ends in an RTLS completion, the CA entry portion of the cue card does not apply.

4.8.2.1.7 Two Engine Out BLANK

[AFPH4.8-46]

2 OUT BLANK
TRAJ √ SERC ON Failed ME SHUTDN pb (two) - push Go to RTLS (FB)

4.8.2.1.7.1 Cue

Two engine failures after Fine Count and before MECO.

4.8.2.1.7.2 Displays

PASS XXXXXX TRAJ
ADI
AVVI
AMI

4.8.2.1.7.3 Crew Action

Monitor
C3 Failed MAIN ENGINE SHUT DOWN pbs - push

4.8.2.1.7.4 Discussion

The BLANK procedure is executed when a second engine fails after fine count and before MECO. Once past fine count, the RTLS in progress can be completed in spite of the second engine failure, and the automated CA is not required.

SERC is needed for all RTLS two engine out scenarios. Guidance automatically invokes SERC if two engines out are confirmed by the GPCs. SERC is also invoked automatically if an engine or data path failure has occurred and sensed acceleration falls below a threshold value. SERC ensures control of the vehicle during the critical time period just after the second engine failure when the crew is still trying to confirm the failure. SERC does not commit the crew to the CA but it does allow more time for analyzing the situation, especially if the second engine failed behind a data path failure or with engine limits inhibited. Initiating SERC with two engines running does not cause control problems. It does, however, take control of the roll channel from the two SSMEs, which results in reduced roll authority. (Pitch and yaw channels remains under SSME control.) For this reason, if the crew subsequently confirms two engines are running and gimbaling normally, SERC should be toggled off.

Once the crew has determined which engines have failed, they should push the two failed main engine pbs. If any of the failed SSMEs has a data path failure or if one SSME fails

and then the second SSME fails with the main engine limits inhibited, this command notifies the GPCs to begin safing of the failed engines.

The cue card then directs the crew to the RTLS pages in the checklist.

4.8.2.2 Three Engine Out RTLS Contingency Abort (OI-25 3 E/O Auto Guidance)

CR 90705, approved for OI-25, automated the manual contingency abort procedures for three engines out any time during powered flight. The three engines out auto contingency logic is more than a simple automation of the pre OI-25 manual procedures, since it is applicable for both simultaneous and sequential engine failures. It provides for the computation of the current 3 E/O abort region, automatic declaration of an RTLS if in MM103, selection of the appropriate mated coast maneuver, ET sep and -Z translation, initiation of an interconnected OMS dump if required, a multi-axis maneuver to the entry attitude, and transition to MM602 at the completion of the maneuver. See section 2.7.2 for a discussion of the three engine out auto contingency logic and explanation of terms used in this section.

With the automation of the three engine out manual procedures, the contingency abort cue cards were modified to include procedures and monitoring blocks, similar to the two engine out procedures. The three engine out portion of the RTLS Contingency Abort cue card is broken into two procedural blocks and four monitoring blocks. The primary RTLS CA three engine out procedural block (3 OUT COLOR) is entered any time three engines fail on an RTLS before the three engine out color region is blanked on the PASS TRAJ. This block directs the crew to the appropriate monitoring block. Past the three engine out color blanking at ~ MECO - 10 sec the crew enters the 3 OUT BLANK procedural block which refers the crew to the intact RTLS post-MECO procedure^[AFPH4.8-47]. The general philosophy for all OI-25 three engine out monitoring steps is to provide the crew a way to follow along with three engine out guidance so that they know when to perform the entry steps which do require crew action. Failure of the three engine out logic, requiring the crew to separate from the tank and maneuver to attitude manually, was not considered during the development of the OI-25 CA cue cards.

The RTLS three engine out procedure and monitoring blocks are similar to the non-RTLS contingency three engine out blocks. The major difference is that the 3 E/O BLUE region does not appear since a RTLS abort will not be performed in first stage. For an intact RTLS, the GREEN, YELLOW, and ORANGE regions will be displayed on the PASS TRAJ as the different three engine out regions are traversed. The RTLS side of the card is not used until a two or three engine RTLS abort is declared.

4.8.2.2.1 Three Engine Out Color Procedure Block^[AFPH4.8-48]

3 OUT COLOR
ME SHUTDN pb (three) - push
TRAJ $\sqrt{}$ CONT REGION

4.8.2.2.1.1 *Cue*

Three engines failed prior to the 3 E/O color region blanking on an RTLS

4.8.2.2.1.2 *Displays*

PASS XXXXXX TRAJ

4.8.2.2.1.3 *Crew Action*

C3 MAIN ENGINE SHUT DOWN pbs (three) - push

TRAJ $\sqrt{}$ 3 E/O Color Region

4.8.2.2.1.4 *Discussion*

The first step of any three engine out contingency abort procedure is to depress all three main engine shutdown pushbuttons to set MECO confirmed. The MECO confirmed flag must be set before the three engine out auto contingency logic can be automatically executed when the color region is visible on the PASS TRAJ display. The 3 E/O color region will be displayed double bright and the ADI error needles will unstow if previously stowed indicating that the three engine out logic has been invoked.

Switching the ADI to REF is not included in this block since this action is only performed in the GREEN region prior to V_{REL} zero. Selecting the reference (REF) coordinate system makes the ADI an inertial, three axis ball based on the launch pad coordinate system. However, post- V_{REL} zero, the maneuver to attitude is primarily a pitch maneuver so that the three axis ball is not required. Furthermore, after PPA, the ADI in REF will display roll at 180° even when the vehicle is heads up.

4.8.2.2.2 Three Engine Out GREEN

GREEN
When EAS<25 or incr: $\sqrt{\text{ET SEP}}$ $\sqrt{\text{MNVR (ADI):}}$ Pre PPA (REF) - Roll, Yaw Heads Up PPA to Vrel0 (REF) - Yaw to  , Roll to $\phi = 0^\circ$ Post Vrel0 ($\sqrt{\text{LVLH}}$) - Pitch Dn $\sqrt{\text{MM602}}$ Go to CONT ENTRY (CC)

4.8.2.2.2.1 Cue

Three engines failed in the GREEN region on an RTLS

4.8.2.2.2.2 Displays

PASS XXXXXX TRAJ

AMI

ADIHSI

4.8.2.2.2.3 Crew Action

Monitor

4.8.2.2.2.4 Discussion

For three engines out in the GREEN region, an attitude independent separation is commanded. Depending on the dynamic pressure and altitude rate, a fast separation (5 seconds) or nominal RTLS separation sequence (14 seconds) will be performed, followed by a 8 second -Z translation. Note that if ET separation has not been commanded by an EAS of 77 knots and EAS is increasing, an immediate separation (emergency sep) will be commanded, followed by a five second -Z translation. This scenario has only been encountered in the YELLOW and RED regions in simulator testing but is available in the logic for all regions but 3 E/O BLUE.

The maneuver to entry attitude depends on when the engine failures occur. For three engines failed prior to powered pitcharound, the vehicle is initially in a heads down attitude flying downrange (fuel dissipation phase). If MECO confirmed is set prior to powered pitcharound, the maneuver to entry attitude is almost a pure roll maneuver to heads up. Some yaw may be observed depending on when the abort is declared. After powered pitcharound and prior to V_{REL} zero, the vehicle is oriented heads up but still flying downrange. Therefore, the maneuver to entry attitude is a roll and yaw maneuver to orient the nose of the vehicle downrange. The closer to V_{REL} zero the engines fail, the more yaw used to maneuver the vehicle. In fact, just prior to V_{REL} zero, the maneuver is almost a pure yaw around. “Yaw, Roll” is included in the step rather than “Roll, Yaw” to

emphasize the significant amount of yaw that may be observed during the maneuver. The symbol  represents a depiction of the relative velocity bearing pointer on the HSI (relative velocity vector). The vehicle should be maneuvered back to the velocity vector using this cockpit cue. Note that prior to this maneuver, the ADI in REF will display roll at about 180° even though after powered pitch around the vehicle is heads up. A roll angle of 180° is displayed since the ADI in REF displays a roll/pitch/yaw sequence. If the ADI were in LVLH, it would show roll at 0° but the yaw attitude would not be visible. Therefore, the ADI is taken to REF until V_{REL} zero so that the roll/yaw maneuver is visible which best matches the view out of the window. After V_{REL} zero, the nose of the vehicle is already in the direction of the velocity vector, so the maneuver is simply a pitch down to the alpha recovery angle. Since virtually no yawing is performed after V_{REL} zero, the ADI is left in LVLH so that the heads up orientation is correctly depicted. The alpha recovery angle is a function of velocity which ranges between 20° and 58°. However, a check of alpha 58° is not included in the 3 E/O RTLS GREEN monitoring block for the reasons discussed in the 3 E/O CONT BLUE rationale

Major Mode 602 transition occurs when the attitude and rate constraints are satisfied or when EAS exceeds 77 knots (see table 2.7.3-II for transition criteria). See section 2.7.2.3 for additional information.

4.8.2.2.3 Three Engine Out ORANGE

ORANGE
√Pitch Dn at 3°/sec
√ET SEP
√Pitch Dn
√MM602
Go to CONT ENTRY (CC)

4.8.2.2.3.1 Cue

Three engines failed in the ORANGE region on an RTLS

4.8.2.2.3.2 Displays

PASS XXXXXX TRAJ
AMI
ADI
HSI

4.8.2.2.3.3 Crew Action

Monitor

4.8.2.2.3.4 Discussion

On an RTLS, the ORANGE region will appear on the PASS TRAJ display when EAS exceeds about 9 knots (QBAR of 2 psf), which occurs just after V_{REL} zero. If three engines are out in this region, a rate separation will be commanded as long as beta is not too large. If beta is greater than 8° , there is insufficient time to zero beta, pitch down, and separate before dynamic pressure builds to an unsafe level. In this case, the 3 E/O region will change to GREEN and an attitude independent separation will be commanded. An ORANGE to GREEN region change occurs immediately upon setting MECO confirmed if β is large enough to force this region trip. For this reason the old procedure of “If CDI pegged: √CONT REGION” was unnecessary and removed from the procedure_[AFPH4.8-49]. If a rate sep is commanded, a pitchdown at 3°/sec _[AFPH4.8-50] will be performed, followed by ET separation and a 8 second -Z translation maneuver. If ET separation has not been commanded by an EAS of 77 knots and EAS is increasing, an immediate separation (emergency sep) will be commanded followed by a five second -Z translation. This scenario has only been encountered in the YELLOW and RED regions in simulator testing but is available in the logic for all regions but 3 E/O BLUE.

The maneuver to entry attitude is almost a pure pitch maneuver since the vehicle is already heads up (alpha must be positive to be in the 3 E/O ORANGE region). Therefore, the ADI attitude switch is left in LVLH. Unlike, the 3 E/O CONT ORANGE, the 3 E/O RTLS

ORANGE pitch to entry attitude is a pitch down, rather than pitch down then up, since the alpha recovery angle is lower for the RTLS case. The alpha recovery angle is lower since it is a function of velocity and the RTLS ORANGE region occurs just after VREL zero. A check of alpha is not included in the 3 E/O RTLS ORANGE monitoring block for the reasons discussed in the 3 E/O BLUE rationale.

Major Mode 602 transition occurs when the attitude and rate constraints are satisfied or when EAS exceeds 77 knots (see table 2.7.3-II for transition criteria).

See section 2.7.2.4 for additional information.

4.8.2.2.4 Three Engine Out YELLOW and RED_[AFPH4.8-51]

YELLOW	RED
$\sqrt{\alpha} \rightarrow -2^\circ$	$\sqrt{\alpha} \rightarrow > 125^\circ$
If unable	→ (ADI flip)
$\sqrt{\beta} \rightarrow 0^\circ (\pm 3^\circ)$	
$\sqrt{\text{ET SEP}}$	
$\sqrt{\text{Pitch MNVR}}$	
$\sqrt{\text{MM602}}$	
Go to CONT ENTRY (CC)	

4.8.2.2.4.1 Cue

Three engines failed in the YELLOW or RED region

4.8.2.2.4.2 Displays

PASS XXXXXX TRAJ

AMI

ADI

HSI

4.8.2.2.4.3 Crew Action

Monitor

4.8.2.2.4.4 Discussion

The YELLOW region is encountered on an RTLS when EAS exceeds about 25 knots. For three engines out in the YELLOW region, separation at a small negative angle of attack is required due to the high dynamic pressure. Therefore, 3 E/O auto guidance commands the vehicle to an alpha near -2° (between $+1^\circ$ and -5°), beta near $0^\circ (\pm 3^\circ)$ attitude for separation. If there is insufficient pitch authority to pitch down to the targeted angle of attack due to aerodynamic loads, the 3 E/O auto guidance will downmode to the RED region. In this case, the vehicle will be pitched up to a 125° angle of attack for separation. Even though this maneuver to ET sep attitude is almost all pitch, false roll oscillations (referred to as ADI flip) will be observed on the LVLH ADI as the vehicle is pitched through the LVLH attitude singularity on the ADI. Once the targeted angle of attack of either $-2^\circ \pm 3^\circ$ or $125^\circ \pm 20^\circ$ is reached, ET separation is commanded followed by a 5 second -Z translation. If ET separation has not been commanded by an EAS of 77 knots and EAS is increasing, an immediate separation (emergency sep) will be commanded, followed by a five second -Z translation. This scenario has only been encountered in the YELLOW and RED regions in simulator testing but is available in the logic for all regions but 3 E/O BLUE.

Since the vehicle is already heads up, the maneuver to entry attitude is a pitch maneuver to the alpha recovery angle which is a function of velocity and ranges between 20° and 58° .

This maneuver may either be a pitch down for an $\alpha = 125^\circ$ sep or a pitch up for an $\alpha = -2^\circ$ sep. A check of entry alpha is not included in the 3 E/O RTLS YELLOW/RED monitoring block for the reasons discussed in the 3 E/O CONT BLUE rationale.

Major Mode 602 transition occurs when the attitude and rate constraints are satisfied or when EAS exceeds 77 knots (see table 2.7.3-II for transition criteria).

See sections 2.7.2.5 and 2.7.2.6 for additional information.

4.8.2.3 RTLS Contingency Entry Procedures

These contingency entry procedures are applicable to both the CA and RTLS contingency entry portion of the cue card. After leaving the left half of the cue card, the crew is directed to the RTLS contingency entry, to BDA/ECAL procedures, or to RTLS or TAL procedures. If directed to BDA/ECAL or RTLS or TAL, the crew proceeds to the Ascent Flip Book for completion. The RTLS contingency entry procedures are the same as the non-RTLS contingency entry procedures except that the Alpha/Mach schedule differs. See section 4.8.1.5 for a description of the contingency entry procedures.

4.8.3 BDA/ECAL Procedures [AFPH4.8-52]

Without BDA/ECAL, the only option available to the crew for two engine out failures prior to the single engine OPS 3 boundary is an in-plane CA and subsequent bailout. BDA/ECAL gives the crew the option to execute a contingency flight procedure which could possibly result in a landing. Flights with inclinations higher than 40° use ECAL, while lower inclinations use Bermuda. The BDA and ECAL procedures are identical. The procedures can be slightly different for mid inclination missions since high energy Bermuda procedures are available and the latter portion of the Bermuda window may not result in yaw steering (see section 4.8.3.2_[AFPH4.8-53]). However, the previous mid-inclination mission, STS-107, did not utilize this capability and therefore had similar procedures to the due east and high inclination missions.

In order to attempt a BDA or ECAL abort, the software must be satisfied on two conditions: The crew has enabled auto yaw steering via ITEM 5, prior to declaring the CA, and the auto CA is declared within the I-loaded velocity limits of the BDA or ECAL region. Once a CA is declared, the yaw steering option cannot be changed. Manual yaw steering is the only option. Yaw steering is open loop, i.e. there is no R-V target line being attempted, just a reduction in crossrange to the site. The decision to enable or inhibit yaw steering is made pre-mission based on inclination. Currently, yaw steering is enabled prior to launch for all inclinations, all missions.

Low inclination missions on a TAL abort to Ben Guerir or Moron can attempt a landing in Bermuda if a second engine fails between approximately 9,400 fps and the Single Engine OPS 3 109% boundary. The TAL trajectory to Banjul is too far south and insufficient yaw steering capability exists on one engine to take out the crossrange to Bermuda. However, even though the landing will not be achieved, yaw steering towards Bermuda will be performed in order to get as close as possible to land to improve search and rescue efforts. It should be noted that Banjul is no longer carried as a TAL site by the Shuttle Program; however, should another TAL site along or near the 28.5° inclination be chosen sometime in the future the same lack of Bermuda landing capability would be expected. High inclination missions can attempt a landing at an east coast abort site if a second engine fails between approximately 4,500 fps and 23,000 fps. This will enable yaw steering to be performed anytime in second stage to try and improve landing capability, as well as get closer to land for bailout and subsequent search and rescue efforts. ECAL boundaries are approximate and depend on ascent performance and the time of the first engine failure.

The Bermuda or ECAL procedure begins the same as a second stage CA. However, once the crew is at the point of taking the ADI to REF and seeing a yaw out of plane, they would enable max throttles and jump to the POWERED BDA or POWERED ECAL procedures in the Ascent flipbook..

Figures 4.8.3-1, 4.8.3-2, and 4.8.3-3 illustrate the Bermuda or ECAL Powered Flight and Entry procedures. Note the only difference on the POWERED ECAL and POWERED BDA cards due to the inclination differences will be the landing sites and capability boundaries shown on the table at the bottom of the page. Also note that the POWERED ECAL card represents a 51.6° inclination mission, the card for a 57° inclination mission will appear similar to the 51.6° deg ,

some landing sites may be different and capability boundaries should be larger. The POWERED BDA card represents a 39° inclination mission, a due east mission will appear similar to the 39° inclination mission but the boundaries to Bermuda will shift a bit. The Entry ECAL procedures are the same for all inclinations, with the exception of Bermuda being called out specifically as the site to select for due east and 39° inclination missions.

PILE

POWERED ECAL

G51 ✓ MAX THROT - ITEM 4 (*)
 ✓ ADI (two) - REF
 ✓ $\theta \rightarrow 60^\circ$, Yaw $\rightarrow 45^\circ$
 ✓ Roll to Heads Up
G50 Select SITE and TACAN
 When EAS > 4 and incr:
 ✓ Yaw to ΔE
 ✓ Pitch down at 3°/sec
 ✓ MECO, ET SEP

ET SEP + 8s: CSS, pull to $\alpha = 58^\circ$ at 4°/sec, AUTO
 ✓ MM602 (BFS, OPS 602 PRO)
 Go to ECAL ENTRY
2 E/O ECAL (51.6°)

Velocity (VI)			Location	Site	RWY	TACANS
IP - 2:30 *5.3-6.8	In Plane *5.3-6.7	IP + 2:30 *5.3-6.6 6.6-7.3	Wilmington	6	ILM 06	ILM 117
*6.8-8.6	*6.7-6.9 6.9-8.0 *8.0-8.4 RTLS	6.7-8.1 RTLS	Cherry Point	7	NKT 32L	EWN 83 (D)
*8.6-9.7	*8.4-8.7 8.7-9.3	8.0-9.7	Oceana NAS	8	NTU 32R	NFE 19Y
*9.7-10.5	9.1-9.9 *9.9-10.2	8.7-10.1	Wallops	9	WAL 28	SBY 49
	*10.2-10.4	9.5-11.2	Atlantic City	11	ACY 31	CYN 81
10.8-11.1	10.4-12.3	10.1-12.5	Gabreski	15	FOK 06	HTO 83
*10.5-10.8 10.8-13.1	10.6-13.4	10.3-13.4	Otis ANGB	16	FMH 32	BOS 74
12.3-12.6	11.3-13.1	11.3-13.8	Pease Int'l	17	PSM 34	ENE 118

*Probable bailout region (D) - DME only
3 E/O ECAL (51.6°)

MM 602 Velocity (Vrel)			Location	Site	RWY	TACANS
IP - 2:30 *5.3-6.6	In Plane *5.3-6.6	IP + 2:30 *5.3-6.7	Wilmington	6	ILM 06	ILM 117
*6.6-6.9	*6.6-6.7	*6.7-7.3 7.3-8.0 *8.0-8.6	Cherry Point	7	NKT 32L	EWN 83 (D)
*8.9-10.2	*8.7-10.0	*8.6-9.7	Oceana NAS	8	NTU 32R	NFE 19Y
*10.2-10.9	*10.0-10.7	*9.7-10.6	Wallops	9	WAL 28	SBY 49
	*10.7-11.0	*10.6-11.0	Atlantic City	11	ACY 31	CYN 81
*10.9-11.9 11.9-13.9	*11.0-11.6 11.6-14.4	*11.0-11.2 11.2-14.7	Otis ANGB	16	FMH 32	BOS 74
	11.8-12.3	11.2-13.0	Gabreski	15	FOK 06	HTO 83
	12.8 13.8	12.0-14.2	Pease Int'l	17	PSM 34	ENE 118
13.5-17.2	13.3-17.4	13.1-17.2	Halifax Int'l	18	YHZ 24	UAW 38
15.2-18.0	15.0-18.0	14.9-18.0	Stephenville	19	YJT 09	YJT 78
15.4-18.0	15.3-18.0	15.3-18.0	St. Johns Int'l	20	YYT 29	UYT 23
15.5-18.0	15.4-18.0	15.2-18.0	Gander Int'l	21	YQX 22	YQX 74
		17.3-17.6	Goose Bay	22	YYR 26	UYR 40

*Probable bailout region (D) - DME only

FB 2-20
ASC/114/SIM -

Figure 4.8.3-1: Powered ECAL Procedures

PILE

POWERED BERMUDA

G51 ✓MAX THROT – ITEM 4 (*)

✓ADI (two) – REF
 ✓ $\theta \rightarrow 60^\circ$, Yaw $\rightarrow 45^\circ$
 ✓Roll to Heads Up

G50 Select Bermuda (BDA–Site 6)

When EAS > 4 and incr:

✓Yaw to course pointer
 ✓Pitch down at $3^\circ/\text{sec}$
 ✓MECO, ET SEP

ET SEP + 8s: CSS, pull to $\alpha = 58^\circ$ at $4^\circ/\text{sec}$, AUTO

✓MM602 (BFS, OPS 602 PRO)

Go to BERMUDA ENTRY

2 EO BERMUDA

VELOCITY (Vi)	SITE	LOCATION	RWY	TACANS
9.2–11.2	6	BERMUDA	BDA 30 BDA 12	BDA 86 (DME) BDA 86 (DME)

3 EO BERMUDA

MM602 VEL (Vrel)	SITE	LOCATION	RWY	TACANS
10.6–13.5	6	BERMUDA	BDA 30 BDA 12	BDA 86 (DME) BDA 86 (DME)

FB 2–18
ASC/107/FIN A,3

Figure 4.8.3-2 Powered BERMUDA Procedures

HOOK

ECAL ENTRY

If 3 OUT ECAL or 2 OUT SECOND GREEN:
[G50] Select SITE and TACAN
BFS, OPS 602 PRO

[VERT SIT] √ECAL/BDA (ITEM 1) – ENA

Before NZ Hold:
RHC/PNL TRIM – ENA
If M < 5, √AIL/RUD TRIM
Expect 20° ≤ α ≤ 58°

BFS, [G50] √SITE and TACAN

Nz Hold:
 Expect prebank = 20° if TGT Nz < ~3.3g and ΔAZ > 20°
 At H = -600 ↑ expect initial bank 2xΔAZ (70° max)
 If E/W ≥ STN, expect bank = 70° until ΔAZ increased to 15-30°
 past site, then 2xΔAz

[G50] √TACANS, INCORPORATE

M < 5, and g < 2: AIR DATA PROBE (two) – Deploy (√Heat)

[G50] INCORPORATE Air Data ASAP

- * SPDBK, SHORT FIELD (ITEM 39) if RWY < 11K feet *

M = 3.2: √OPS 603

Select UHF-G T/R

NO COMM ECAL LNDG CRITERIA
@H = 70K, √Range:

- * If Range < 28 nm or Range > 54 nm: *
- * P, R/Y CSS *
- * Bank (≤ 30°) to HDG 120° *
- * Go to **BAILOUT** *

[G50] √SPDBK (ITEM 39) per ECAL LANDING Table

ECAL LANDING:

Runway Length + Ovrn	Spdbk	MGTD	Distance
≥ 11,000'	NOM	205	2500
≥ 8500 to < 11,000'	SHORT	205	1500
< 8500'	ELS	195	1000

MAIN GEAR TD: EARLY CHUTE, DEROTATE, √SPDBK – 100%
NOSE GEAR TD: BRAKE – as reqd

- * If 5K' remaining and V > 140 KGS – MAX BRAKING *
- * (smooth application, not < 2 sec) *

Go to RTLS (enter POST-MECO M = 2.7 step) or BAILOUT

FB 2-21 ASC/114/FIN A

Figure 4.8.3-3: ECAL/BDA Entry Procedures

4.8.3.1 POWERED ECAL (BERMUDA) Procedures (28.5, 39, 51.6, 57° Inclinations)

G51 √ MAX THROT ITEM 4 (*)

√ADI (two) - REF

√θREF → 60°, Yaw → 45°

√Roll to Heads Up

G50 Select TARGET and TACAN

4.8.3.1.1 Cue

Directed to POWERED ECAL (or BDA) procedures from 2 OUT FIRST, 2 OUT SECOND, or RTLS 2 OUT COLOR, or by MCC.

4.8.3.1.2 Displays

SPEC 51 OVERRIDE

SPEC 50 HORIZONTAL SIT

ADI

4.8.3.1.3 Crew Action

Check engine PC for max throttles

Monitor Maneuver

G50 ITEM 41+XX EXEC where XX from table or MCC

4.8.3.1.4 Discussion

Maximum throttle is set via ITEM 4 EXEC on the Override display on the CA cue card and is checked on the Powered ECAL/BDA card. Max throttles are needed to improve the thrust to weight ratio.

The REF coordinate system of the ADI makes the ADI an inertial, three axis ball based on the launch pad coordinate system. This is done to ensure a discontinuity does not occur at 90° pitch and allows visibility in the yaw axis.

The ADI should already be in REF for BDA/ECAL aborts coming from both the CA and RTLS CA side of the CA cue card.

Once the crew initiates the CA, the vehicle pitches to 60° to increase the vertical thrust and reduce the sink rate and yaws 45° to reduce the crossrange. Yaw can be either right or left, depending on the inclination. After the completion of the pitch and yaw maneuvers, the crew should see the “6” on the ADI-REF ball. At this time the vehicle rolls heads up^[AFPH4.8-54]

While the vehicle is maneuvering, the crew should be selecting the landing site targets and TACAN station. An abort to Bermuda would use the BDA landing site, for example, while an ECAL would use the landing site based on the engine out times. All the necessary information is included in the table on the BDA or ECAL card.

For 57° inclination ECAL aborts, the trajectory can sometimes encroach upon the range safety destruct line when yaw steering towards the coast. A 45 second contingency abort initiation delay was added to the 57° inclination CA card as discussed in section 4.8.1.1.2.4 to avoid the range safety destruct line. However, if the MCC still sees a range safety violation occurring, a call will be made for the crew to manually take out the yaw steering early. Since this requires CSS, the automated software maneuver is interrupted and all the steps discussed in the next section, from yawing to the course pointer through MM602 transition, may have to be performed manually by the crew.

The checklist does not amplify the following details about the steps that may need to be performed manually in the destruct line avoidance case. The crew should be alert to take action if auto is not completing the maneuver. After yawing to the course pointer the beta also needs to be flown to zero. To zero beta, yaw to place the course pointer under the upper lubber line (tail of pointer under lubber line if between PPA and $V_{REL} = 0$ on an RTLS), then roll to wings level (either roll = 0° or roll = 180°, as appropriate). The CDI should then be very close to centered. This technique is good for all attitudes and phases of powered flight, both uphill/TAL and RTLS. When the RHC is released, beta may increase some but should still remain small. Allow the flight control trim integrator to trim the vehicle by minimizing RHC inputs as much as possible. With a side engine out, or a single side engine running, expect a trim condition of about 2° of beta into the dead side engine, and up to 5° of roll away from the dead side engine. Pitch down after 10 KEAS but in time to reach separation before 25 KEAS. Manually MECO by hitting the ET SEP pushbutton (ET SEP - MAN, ET SEP pb push). Following the MECO/Fast SEP, control can be returned to AUTO and the 3 EO Contingency Abort logic will take over and command ET SEP and maneuver the vehicle for the proper attitude to transition to MM602.

4.8.3.2 Powered Flight No Yaw Procedures (39° Inclination Only)

For informational purposes only, this procedure was not carried on the last 39° Inclination Flight^[AFPH4.8-55].

G51 √ MAX THROT ITEM 4 (*)
 √ ADI (two) - REF
 √ θREF → 60°, Yaw → 45°

* If no yaw: *

* **G50** Select TARGET and TACAN *

* √ θREF = 100°, Roll Heads UP *

* When EAS > 10 and incr: *

* √ Pitch down at 4°/sec *

* √ MECO, ET SEP *

* √ Pitch down at 4°/sec *

* √ MM602 (√ BFS) *

* Go to BERMUDA CONT ENTRY *

4.8.3.2.1 Cue

2nd Engine Out after VI = 11.2K (no yaw observed on ADI) but prior to SE OPS 3

4.8.3.2.2 Displays

ADI
 SPEC 50 HORIZONTAL SIT
 AMI

4.8.3.2.3 Crew Action

G51 ITEM 4 EXEC
 ADI √ θREF = 100°, roll to heads up
 AMI When EAS > 10 and increasing:
 ADI √ Pitch down at 4°/sec
 F7 √ MAIN ENGINE STATUS lights - red then off
 PASS CRT √ MM602
 BFS CRT OPS 602 PRO if reqd
 Go to BERMUDA ENTRY Cue Card

4.8.3.2.4 Discussion

For 39° inclination flights, a gap exists between last Bermuda capability and droop (SE OPS 3 boundary). This gap varies in duration, depending on the time of the first engine failure. To reduce the size of this gap, the contingency abort yaw steer window was modified so yaw steer toward Bermuda would not be performed for a second engine failure just prior the droop boundary. This decreases the energy to Bermuda and extends the upper Bermuda boundary.

If the crew gets to the “ $\sqrt{\theta}$ REF \rightarrow 60°, Yaw \rightarrow 45°” step and sees no yaw maneuver, then the “If no yaw:” steps in the starred block as shown above will be executed. This situation will only occur if the two engine out contingency abort, executed in the SECOND STAGE block of the contingency abort cue card, was executed past the end of the I-loaded Bermuda yaw steer window (VI = 11.2K fps).

Just as in the yaw steer Bermuda procedures, the Bermuda landing site is selected on SPEC 50 to allow the Automated Entry ECAL logic to fly to the correct site post-MECO.. Since contingency powered flight guidance is open loop in this case, this step is not required in powered flight. However, it is performed here while the crew workload is relatively low, and allows the crew to focus on other items post-MECO. Also, note that the correct site does need to be selected prior to the first entry roll maneuver, which can occur fairly soon after MECO (within ~45 seconds in some cases, depending on entry pullout). So it is best to get the site selected at a convenient time pre-MECO.

Since the vehicle did not yaw, the software will execute a normal two engine out GREEN abort. The only difference between the no yaw steps and the two engine out GREEN procedure is the $\sqrt{\text{BFS}}$ step. A TAL abort is usually declared prior to the second engine failure that causes the Bermuda abort. Then, while executing the SECOND STAGE contingency block, the crew aborts RTLS. However, this transition from TAL to RTLS is illegal in the BFS. So the BFS stays in MM103 when the PASS is taken to MM601. In this case, the PASS will mode to MM602 after MECO, while the BFS will mode to MM104. Once the PASS is in MM602, the BFS should be checked in MM602. If it isn't there, the crew must PRO the BFS to MM602 manually so that it may track the PASS again.

After executing the two engine out GREEN contingency abort, instead of going to the contingency entry procedure, the crew now goes to the Bermuda entry procedures. They execute the Bermuda entry procedures as if they were on a standard Bermuda abort and attempt to make the runway. A successful landing is not guaranteed in this case but even if a bailout results, the orbiter should be much closer to Bermuda than if the vehicle had flown straight ahead during entry and not attempted a landing.

4.8.3.3 MECO and ET Separation Steps

When EAS > 4 & incr:

√Yaw to  [AFPH4.8-56]

√Pitch Dn at 3°/sec

√MECO, ET SEP

ET SEP + 8s: **CSS, pull to $\alpha = 58^\circ$ at 4°/sec, AUTO**

√MM602 (BFS, OPS 602 PRO)

Go to ECAL ENTRY

[AFPH4.8-57]

4.8.3.3.1 Cue

EAS > 4 and increasing

4.8.3.3.2 Displays

ADI

AMI

HSI

4.8.3.3.3 Crew Action

AMI When EAS > 4 and increasing:

HSI √Relative Velocity bearing pointer () → lubber line

ADI √Pitch down at 3°/sec

F7 √MAIN ENGINE STATUS lights - red then off

CRT √MM602

BFS CRT OPS 602 PRO

Go to BERMUDA (ECAL) ENTRY

4.8.3.3.4 Discussion

The shuttle continues to descend during powered flight because of the low thrust to weight ratio. As altitude decreases and density increases, the airspeed begins to build. ET sep should be initiated before 25 KEAS to avoid ET recontact. Since it takes time to zero the yaw and initiate PPD, the software starts the maneuver at 4 KEAS.

When the airspeed increases to 4 KEAS, the crew should monitor the vehicle yawing back until the lubber line on the horizontal situation indicator (HSI) is over the relative velocity course pointer.

PPD should not be initiated until the shuttle is wings level with a small sideslip. Sideslip can be monitored on the HSI course pointer. Once the sideslip is less than 5°, the vehicle starts a pitchdown at 3°/sec, commands MECO, and performs ET sep.

At MECO confirmed, three engine out auto guidance takes over from powered contingency logic and performs ET Sep and an 8 second -Z translation. A step to manually pitch up to the alpha recovery angle of 58° was added in response to a SAIL test case which experienced loss of control. The test case had the first engine fail near the opening of the TAL window, resulting in maximum TAL lofting. A second SSME failed a few minutes later near the maximum altitude resulting in a steep negative flight path angle. The SAIL results were more severe than the same cases ran in the SES since the SAIL had the aero models configured incorrectly. However, even in the SES with the correct aero model implementation, the dynamic pressure reached ~ 950 psf for this test case. Selecting CSS and manually pitching up reduced the dynamic pressure to about ~ 650 psf in the SES. Therefore, this manual pitchup will remain in the checklist until I-load changes can be made to reduce the severity of the pullout.

Major Mode 602 transition occurs when the attitude and rate constraints are satisfied or when EAS exceeds 77 knots (see table 2.7.3-II for transition criteria).

If the ECAL procedures are entered from an RTLS (small window for 51.6° and 57° intact RTLS aborts), the three engine out color region may blank before two engine out powered contingency commands MECO. This occurs when the ECAL site is selected during powered flight and a runway landing is possible since the color region is blanked based on range to go. If the color region is blanked at MECO, three engine out auto guidance will not take over from powered contingency. In this case, Major Mode 602 transition occurs as soon as the vehicle pitches above 10° and 10 seconds have elapsed since ET separation.

If a TAL abort was declared prior to the second engine failure, the BFS will not follow the PASS when the RTLS abort is declared. A downmode from TAL to RTLS in MM103 is not allowed unless the contingency abort arm and start ITEM entries are performed (PASS TRAJ ITEM 2 EXEC, ITEM 4EXEC). Since the BFS does not have contingency abort logic, it does not recognize the RTLS abort and must be manually transitioned to MM602.

4.8.3.4 ECAL (BERMUDA) ENTRY Procedures (Before NZ Hold_[AFPH4.8-58])

If 3 OUT ECAL or 2 OUT SECOND GREEN:

G50 Select SITE and TACAN
BFS, OPS 602 PRO

VERT SIT √ ECAL/BDA (ITEM 1) - ENA

Before NZ Hold:

RHC/PNL TRIM - ENA
If M < 5, √AIL/RUD TRIM
 Expect $20^\circ \leq \alpha \leq 58^\circ$

BFS, **G50** √ SITE and TACAN _[AFPH4.8-59]

4.8.3.4.1 Cue

MM602 transition and directed to "ECAL (BERMUDA) ENTRY" by the POWERED ECAL (BERMUDA) Card or the CA Cue Card

4.8.3.4.2 Displays

SPEC 50
 AMI
 VERT SIT 1

4.8.3.4.3 Crew Action

If 3 E/O or 2 E/O to ECAL Site:

G50 ITEM 41+XX EXEC
 ITEM 4 EXEC if secondary runway

VERT SIT √ ITEM 1 (ENA)
 F3, F4 L,R TRIM RHC/PNL - ENA
 Mach < 5: **VERT SIT** √AIL and RUD TRIM

If AIL and RUD TRIM > 1° in the same direction:
 C3 Deflect ROLL TRIM to zero AIL trim

AMI √ $20^\circ \leq \alpha \leq 58^\circ$

4.8.3.4.4 Discussion

The ECAL or BERMUDA ENTRY procedures can be entered from the 3 EO blocks on the CA Cue Card, the 2 EO GREEN Block on the CA Cue Card, or the POWERED ECAL or POWERED BERMUDA procedures. If entered from the 3 EO or 2 EO SECOND GREEN blocks on the CA Cue Card the crew must select a Target and Tacan via SPEC 50 Item 41 + XX. Whereas, if coming from the POWERED ECAL or BERMUDA page this step is already taken care of during powered flight.

PASS Major Mode 602 transition occurs when the attitude and rate constraints are satisfied or when EAS exceeds 77 knots (see table 2.7.3-II for transition criteria). Since

the BFS does not have Contingency Abort Logic, it does not recognize the RTLS abort and must be taken manually to MM602 with keyboard OPS 602 PRO.

With OI-28, ITEM 1 (centered at the bottom of the MM602 TRAJ) will enable/disable the Automated Entry ECAL Logic. This item entry is initialized enabled (ENA) and will require no action. Execution of the Item 1 is only legal in MM602 when the contingency abort flag is ON.

The crew should enable the trim switches in preparation for aileron/rudder force fights. During the ET sep maneuver, the rudder may move full out one direction or the other in response to residual beta on the vehicle. During Nz hold the rudder may still be in that position, and the ailerons may begin a force fight to compensate. If the ailerons trim 1° or more in the same direction as the rudder deflection, the crew should intervene to trim out the force fight using the roll panel trim switch. The trim switch must be enabled before the panel trim switches are active. Failure to stop an aileron rudder force fight can result in loss of control.

. In order to manage loads during the initial pullout the vehicle is pitched to an alpha recovery angle which maximizes lift and drag. This angle is dependent on velocity and can range from 20° to 58° . This ramp down is required for flight control constraints at low Mach numbers. The maximum of 58° is used since the alpha tape on the AMI used to only show a maximum of 60° , however; with OI-30 the MEDS alpha tape now displays - 180° to 180° . Also, beyond 60° alpha, the total vertical force that the shuttle can generate begins to decrease, so alpha recovery would be less effective.

Once PASS is in a good configuration for the NZ Hold phase the crew can check to verify a good Target and Tacan is in the BFS.

4.8.3.5 ECAL (BERMUDA) ENTRY Procedures (NZ Hold to TAEM)

Nz Hold:

Expect prebank = 20° if TGT Nz < ~3.3g and $\Delta AZ > 20^\circ$

At Hdot = -600 \uparrow expect initial bank $2x\Delta AZ$ (70° max)

If E/W \geq STN, expect bank = 70° until ΔAZ increased to 15 -30° past site, then $2x\Delta AZ$

G50 \sqrt TACANS, INCORPORATE

M < 5 and g < 2: AIR DATA PROBE (two) - Deploy (\sqrt Heat)

G50 INCORPORATE Air Data ASAP

4.8.3.5.1 Cues

TGT NZ < ~3.3g and $\Delta AZ > 20^\circ$ for prebank maneuver

Altitude rate -600 fps and increasing (less negative) for nominal roll maneuver

High EOW for high energy roll conditions

NZ < 2g and Alpha < 20° for probe deploy

4.8.3.5.2 Displays

ADI

AVVI

HSI

VERT SIT 1

SPEC 50 HORIZONTAL SIT

4.8.3.5.3 Crew Action

Monitor ECAL guidance for reasonableness, banking towards site, alpha modulation for EOW

G50 \sqrt TACAN RESIDs and RATIO
ITEM 19 EXEC to incorporate

AMI Mach \leq 5, NZ < 2g, Alpha < 20°:
C3 AIR DATA PROBE (two) - DEPLOY

G50 \sqrt ADTA RESIDs and RATIO
ITEM 25 EXEC, ITEM 28 EXEC to incorporate

4.8.3.5.4 Discussion

With the automation of the entry ECAL logic in OI-28 flight software, manual flying techniques are no longer required and the guidance is only monitored for reasonableness. If Target Nz allows room in the 3.5 g limit and heading error is high, automated ECAL logic rolls in early (or pre-banks) as much as 20° to better control heading error. The

actual Target Nz is biased up by $\sim .2g$, this allows a higher angle of attack to be maintained during the Nz Hold Phase thereby negating the lost lift due to the 20° prebank. The increase in g's is accepted since the 3.5 g limit is not being exceeded and it prevents an increase in dynamic pressure due to the roll. (Actual Target Nz must be less than 3.1 g, so the biased Target Nz is less than 3.3 g.)

Automated ECAL logic will start the nominal turn toward the SPEC 50 loaded site during Nz Hold and just prior to completion of the first pull-out at H-dot = -600 and increasing. This turn is accomplished prior to the top of the phugoid in order to reduce the severity of the second pull-out. Also, this value was chosen as the earliest point toward the end of the first pullout where banking can begin without causing significant increases in the loads on the vehicle, or creating controllability problems. The ECAL Automation logic actually banks $2.2 \times \Delta AZ$, the procedures simplify and state $2 \times \Delta AZ$.

The best single on-board cue for determining current ECAL energy state is the energy over weight bug (E/W Bug). If the E/W Bug shows high energy S-turn (STN) expect a 70° bank toward the site. This 70° degree bank will be held until the site moves to a point $15^\circ - 30^\circ$ to the opposite side of the nose. The 30° value is ramped down to 15° as GRTLS TAEM is approached since excessive heading error at the lower Mach numbers can often lead to low energy situations. At this point, bank will reverse and return to the normal $2.2 \times \Delta AZ$ value. If the E/W Bug decreases below the ECAL S-turn Termination line (EST) prior to reaching a delta azimuth $15^\circ - 30^\circ$ past the site, guidance will also return to its normal $2.2 \times \Delta AZ$ banking technique. During the 2nd and subsequent phugoids the roll commands are limited to protect g's and dynamic pressure, so it is common to see a smaller roll command than the 70° high energy roll command or the normal $2.2 \times \Delta AZ$ roll command.

Tacans Residuals and Ratios are evaluated on the Horizontal Sit Display (SPEC 50). When acceptable conditions exist the TACANs should be taken to AUTO with an ITEM 19. With no MLS, PAPI's, or Ballbars at the Emergency Landing Site (ELS) the crew should be aware that GPS may be available for incorporation if required. Ceiling/visibility, day/night, and unfamiliarity with the airport are factors in determining if GPS should be taken to NAV, provided GPS is working properly. SPEC 50 Item 42 will take GPS to AUTO (for NAV).

As in a nominal entry, the air data probes should be deployed once below Mach 5. However, a CA entry may have a high g, high QBAR pullout below Mach 5. To avoid mechanical failure of the ADTA probes, the crew should wait until the pullout is complete before deploying the probes. Pullout is considered complete when Nz loads are less than two. The crew should also avoid deploying the probes with an $\alpha > 20^\circ$. Deploying above the calibration limit of 20° can result in large residuals and possible dilemma. If a dilemma is observed, deselect/reselect an ADTA once below the 20° limit to clear the dilemma.

Air Data should be incorporated as soon as possible to provide more accurate alpha, Mach, and altitude information to Guidance, Navigation, and Control (GN&C). The compressed timeline for these ECAL aborts makes it important to incorporate air data as soon as possible since several other actions are required at lower altitudes for these contingency procedures.

4.8.3.6 Roll Maneuver and Post-NZ Hold Actions for Pre-OI-28 Flight Software

* *INFORMATION FOR HISTORICAL PURPOSES ONLY - PRE-AUTOMATED ENTRY ECAL* *

At $\dot{H} = -600$: CSS R/Y,
Bank $2 \times \Delta AZ$ (70° max)

√E/W bug on Vert Sit:

If $\geq 1/2$ scale, suspect high energy

If $\leq 1/3$ scale, suspect nominal to low energy

Confirm energy with \dot{H} , range ΔAZ , & E/W bug trends

- | | |
|---|-----------------------------------|
| * High Energy | * Low Energy * |
| * Bank 70° toward site (-500 to -900 max $-\dot{H}$) | * When $\Delta AZ < 10^\circ$: * |
| * When E/W bug drops or 30° ΔAZ past site: | * CSS pitch * |
| * Reverse/shallow bank to $2 \times \Delta AZ$ | * Fly $\alpha = 31^\circ$ or LO * |
| * Put primary bearing pointer on nose | * |

Maintain NZ < 2.5g after first pullout

When nominal energy and phugoiding complete:

Fly Href

Reverse bank at 17.5° ΔAZ

Keep E/W bug ~1/2 scale

G50 √TACANS, INCORPORATE

At NZ < 2g: $M \leq 5$, ADTA PROBES - Deploy

Maintain NZ < 2.5g after first pullout

4.8.3.6.1 Cue

Altitude rate -600 fps and increasing (less negative) for roll maneuver
NZ < 2g for probe deploy

4.8.3.6.2 Displays

ADI

AVVI

HSI

VERT SIT 1

SPEC 50 HORIZONTAL SIT

G-Meter

4.8.3.6.3 Crew Action

AVVI	At Hdot = -600 fps and increasing: HSI, ADI Bank $2 \times \Delta AZ$ (limit to 70°)
VERT SIT	$\sqrt{E/W}$ bug, \dot{H} , range, DAZ, and observe E/W bug trend
VERT SIT, HSI, AMI	If high energy: Bank 70° toward primary bearing pointer Reverse bank to $2 \times \Delta AZ$ when either: E/W bug comes off top of scale or when ΔAZ is 30° past site and increasing. If low energy and low ΔAZ , PITCH CSS, fly $\alpha = 31^\circ$ or αLO if $< 31^\circ$
G50 , ADI	Reduce bank if required to maintain $NZ < 2.5g$
G50	\sqrt{TACAN} RESIDs and RATIO ITEM 19 EXEC to incorporate
AMI	$NZ < 2g$ and $Mach \leq 5$: C3 AIR DATA PROBE (two) - DEPLOY

4.8.3.6.4 Discussion

Performing ECAL/BDA requires special entry procedures, which is the reason for the dedicated page in the Ascent Flip Book. Prior to Nz hold, this CA is not unlike those that end in bailout. However, at the end of Nz hold, the crew must manually fly to take out crossrange in order to make the site. The most critical step is to begin banking toward the site immediately upon reaching $\dot{H} = -600$ fps. This value was chosen as the earliest point toward the end of the pullout where banking can begin without causing any significant increases in the loads on the vehicle, leading to controllability problems. During the banking maneuver, the pitch axis is left in AUTO to enhance control margins. Attempting the banking maneuver in pitch CSS has resulted in loss of control in some simulations. Further, the bank is limited to 70° to keep altitude rate under control. If more bank is used, altitude rate increases (negatively) to unacceptably high levels (approaching -1000 fps) and Nz spikes above 2.5g. Bank angle is also flown in order to be at twice the delta azimuth (DELAZ) angle because this has been shown to provide the optimum balance for maintaining L/D for ranging while converging crossrange.

The best onboard cue to determine whether high energy procedures are required is the E/W bug on the VERT SIT display. The bug will appear on the display as altitude rate increases through -320 fps, where GRTLs TAEM guidance modes from the Nz hold to alpha transition phase. This is shortly after the CDR has initiated the CSS roll maneuver to a bank angle of $2 \times \Delta AZ$. If the E/W bug is at the top of the scale when first checked, or moves to the top of the scale subsequently during entry, the high energy procedures should be flown.

The high energy procedures call for a bank of 70° to expedite the turn and minimize the amount of positive altitude rate following the pullout. CAUTION: Nz loading must be

monitored closely. If altitude rate is large (-600 fps or more) and N_z is approaching 2g, bank should be decreased to maintain less than 2.5g. The bank is maintained, turning past the site if required, in an S-turn type maneuver. Bank is reversed (if not banked toward site) when the E/W bug starts down from the top of the scale, or when $30^\circ \Delta AZ$ is reached, whichever comes first. At this point, bank should be maintained at $2 \times \Delta AZ$ until the primary bearing pointer is under the lubber line (heading to Bermuda or ECAL site).

In many cases, as azimuth starts to come under control, the orbiter is in a low energy situation (check entry alpha cue card). So as soon as the azimuth is $<10^\circ$, fly stretch alpha (31° or LO on entry alpha cue card) using pitch CSS. As a guide for evaluating the ranging situation, the altitude in thousands of feet should exceed the range in nautical miles to go. If this ratio is not equal to or greater than one, the runway is likely out of reach unless a strong tailwind is present. This rule of thumb is best used only after the phugoid has fully damped. The crew should evaluate ranging early enough to make a bailout decision if the range to the runway is excessive.

A phugoid caused by the pullout sometimes leads to a second pullout that requires bank angle be reduced to less than twice DELAZ to stay below 2.5g. The bank can be returned to the twice the DELAZ value (70° maximum) when the second pullout is complete and the load factor begins to decrease again. Therefore, bank angle should be continuously assessed on entry and reduced as necessary to stay below 2.5g and at or below twice DELAZ.

As in a nominal entry, the air data probes should be deployed once below Mach 5. However, a CA entry may have a high g, high QBAR pullout below Mach 5. To avoid mechanical failure of the ADTA probes, the crew should wait until the pullout is complete before deploying the probes. Pullout is considered complete when N_z loads are less than two.

4.8.3.7 ECAL (BERMUDA) ENTRY Procedures (TAEM)

M = 3.2: ✓OPS 603

Select UHF-G T/R

NO COMM ECAL LNDG CRITERIA
 @H = 70K, ✓Range:

- * If Range < 28 nm or Range > 54 nm: *
- * P, R/Y CSS *
- * Bank (≤ 30°) to HDG 120° *
- * Go to BAILOUT *

G50 ✓SPDBK (ITEM 39) per ECAL LANDING Table

ECAL LANDING:

Runway Length + Ovrn	Spdbk	MGTD	Distance
≥ 11,000'	NOM	205	2500
≥ 8500 to < 11,000'	SHORT	205	1500
< 8500'	ELS	195	1000

MAIN GEAR TD: EARLY CHUTE, DEROTATE, ✓SPDBK - 100%
 NOSE GEAR TD: BRAKE - as reqd

- * If 5K' remaining and V > 140 KGS - MAX BRAKING *
- * (smooth application, not < 2 sec) *

Go to RTLS (enter POST-MECO M = 2.7 step) or BAILOUT

FB 2-21 ASC/114/FIN 3

4.8.3.7.1 Cue

Mach = 3.2

4.8.3.7.2 Displays

HSI
 ADI
 AMI
 SPEC 50 HORIZONTAL SIT

4.8.3.7.3 Crew Action

AMI When M = 3.2:
 CRT ✓ OPS 603

O6 UHF-G T/R

AVVI @H = 70K (ECAL only - N/A for BDA)
 HSI ✓Range
 If Range < 28 or Range > 54:
 F2 ROLL/YAW CSS pb - push
 HSI, ADI Bank to HDG 120° (maintain bank ≤30°)

Go to BAILOUT

G50 √ ITEM 39 EXEC per ECAL Landing Table (nominal, shortfield, or ELS speedbrake)

4.8.3.7.4 Discussion

During Automated Entry ECAL operations, an auto-pro to OPS 603 and GRTLS/TAEM logic will be achieved at Mach 3.2. Previous Entry ECAL procedures required the manual PRO to 603. The Contingency Abort and ECAL flags are automatically turned off at Mach 3.2 and nominal GRTLS/TAEM (MM603) operations are resumed. Selecting UHF-G (guard) T/R allows the crew to transmit and receive on the emergency (guard) frequency which is monitored by FAA and military facilities.

As a guide for evaluating the ranging situation, the altitude in thousands of feet should exceed the range in nautical miles to go. If this ratio is not equal to or greater than one, the runway is likely to be out of reach unless a strong tailwind is present. This rule of thumb is best used only after the phugoid has fully damped. The ECAL landing criteria were developed to provide the crew some concrete method of determining whether an ECAL runway is achievable, or if BAILOUT is required. The criteria were developed in shuttle simulators to maximize the probability of making a runway while minimizing potential loss of civilian life and property. The check, performed at an altitude of 70,000 ft, assures that shuttle energy is sufficient to prevent crashing short of the runway. If the criteria are not met, the crew banks away from populated areas and commences BAILOUT. A heading of 120° provides the quickest route away from the coast for all ECAL sites. Maintaining bank less than 30° prevents excessive altitude rate buildup during the high speed turn. These criteria aren't included for 28.5° and 39° inclination missions since Bermuda is small enough that an early bailout decision at 70K ft is not required to allow sufficient time to move the Orbiter impact point away from populated areas if a runway landing is not possible.

For ECAL landings it is possible to encounter runways of very short lengths. The minimum acceptable runway length is currently set at 7,500 ft. For the heavy weight ECAL landings the nominal speedbrake option can be used for runways $\geq 11,000$ ft in length. This allows touchdown at 205 kts EAS/2500 ft touchdown distance and assures stopping on the runway for runways greater than 11,000 ft. For runways between 8,500ft and 11,000 ft the shortfield speedbrake option can be used. This allows touchdown at 205 kts EAS/1500 ft touchdown distance and assures stopping on the runway for runways $\geq 8,500$ ft. If the runway is $< 8,500$ ft the ELS speedbrake option is used. This allows touchdown at 195 kts EAS/1000 ft touchdown distance and should assure stopping on the runway for runways $< 8,500$ ft and $\geq 7,500$ ft. The ELS speedbrake option is an option that utilizes extra speedbrake command below 3,000 ft in order to kill off energy and targets for a shorter than normal touchdown distance. The technique was a manual procedure in the OI-28 and OI-29 timeframe; however, the OI-30 flight software was

updated to automate this technique with CR 92551B Shortfield Landing Speedbrake Upgrade. The nominal/shortfield/ELS options for speedbrake can be obtained by simply cycling through the Horizontal Sit display's ITEM 39, Guidance is initialized to nominal speedbrake, one ITEM 39 will select shortfield, another ITEM 39 will select ELS, an another ITEM 39 will get back to the nominal speedbrake option. As mentioned above the ELS option uses additional speedbrake below 3,000 ft to kill off additional energy. This is generally close to the nominal speedbrake command + ~ 30 . The speedbrake is also adjusted at 500 ft to account for the real-time environment (winds). Targeting just 1000 ft down the runway allows the vehicle to get on the ground earlier and at a slower velocity, the sooner the vehicle is on the ground the sooner the chute, speedbrake full open, and brakes can help to stop the vehicle. The ECAL Landing table defines the speedbrake option to use as well as the steps post-landing for the chute, derotation, checking the speedbrake to full open, and the braking. Early chute is used for all ECAL/ELS scenarios. Braking should be as required (after nose gear touchdown), with the starred block for max braking being indicated for cases where the velocity is greater than 140 KGS with 5,000 ft remaining. This should always be the case when using the ELS speedbrake option.

If the crew is not going to the BAILOUT cue card they are directed to the RTLS Post-MECO M = 2.7 steps.

4.9 POWERED CSS PROCEDURES

The POWERED CSS Card is used by the crew for instances where the PASS and BFS Guidance are bad or suspect, but the Navigation is good. Manual techniques are used to fly the Orbiter to safe MECO conditions. Figure 4.9-1 shows the POWERED CSS Card for Uphill/TAL cases and Figure 4.9-2 shows the POWERED CSS Card for RTLS cases.. [AFPH4.9-1].

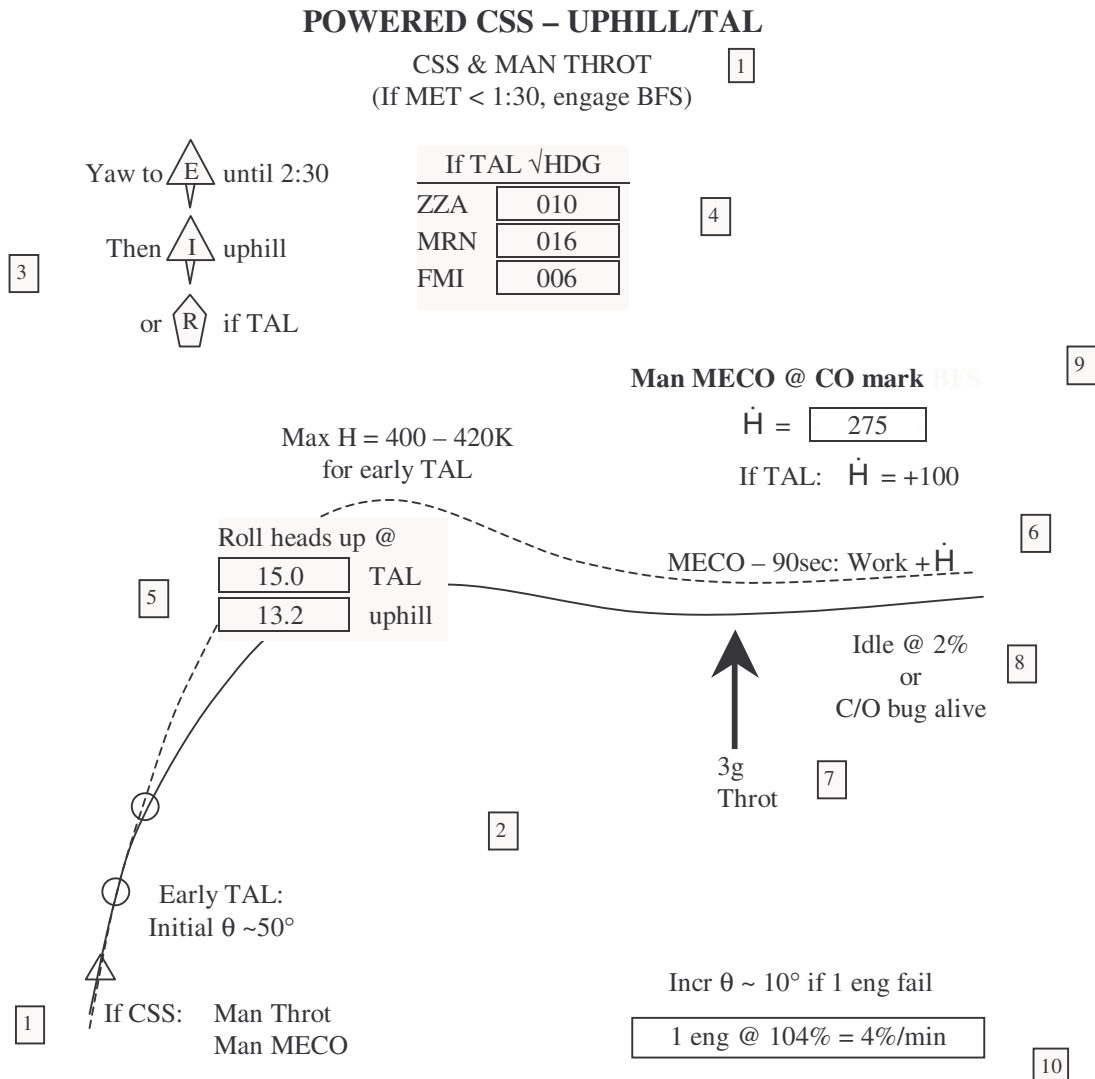

Figure 4.9-1 STS-114 POWERED CSS - UPHILL/TAL Card

POWERED CSS – RTLS
CSS & MAN THROT
 (IF MET < 1:30, ENGAGE BFS)

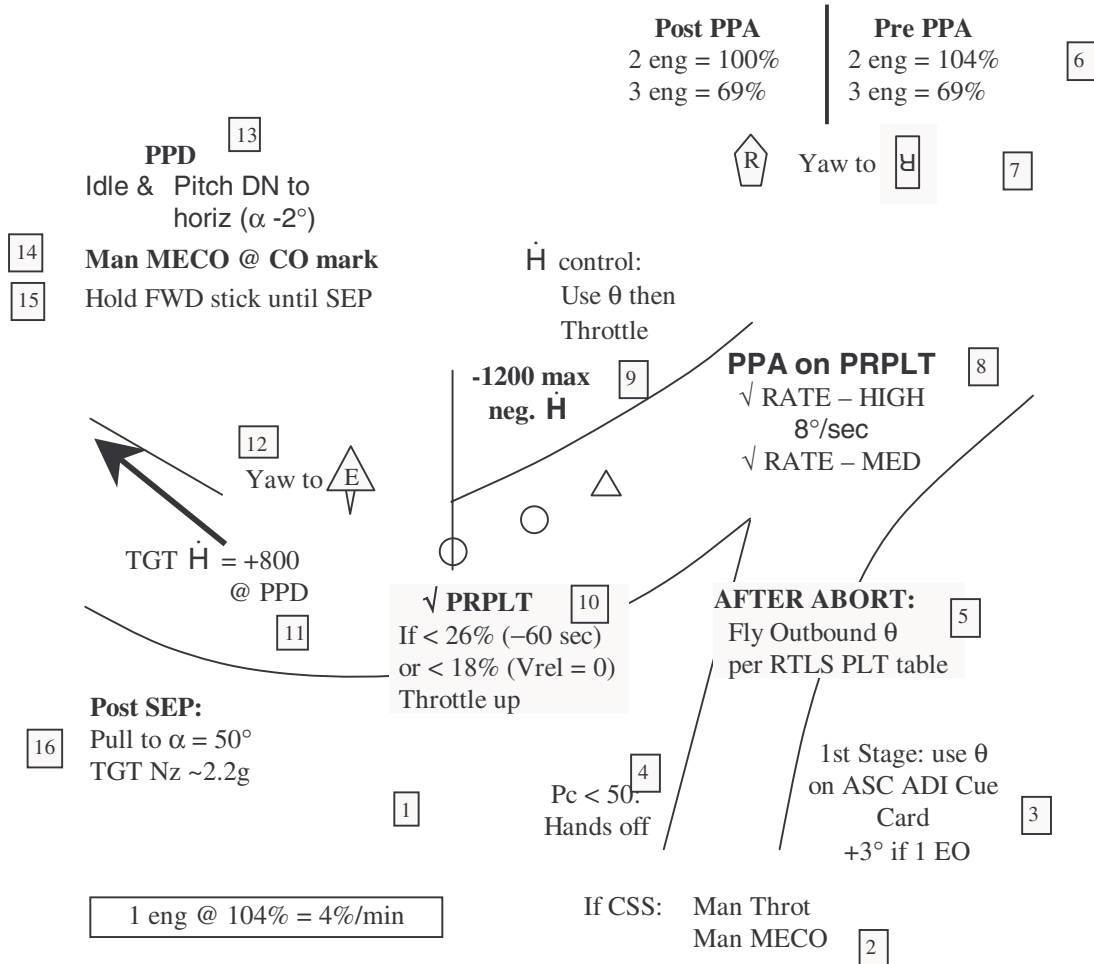

Figure 4.9-2 STS-114 POWERED CSS - RTLS Card

This page was created for the Ascent Checklist beginning with STS-90. The page exists in the CDR and PLT Ascent Flipbooks and MS Ascent Checklist. The page provides procedural and technique reminders for CSS flight should automatic guidance fail prior to MECO. Because of the unlikely probability of an automatic guidance failure during ascent, minimal training is dedicated to the development of proficient CSS flight. The absence of proficient flying skills mandates that cues for CSS flight be published; otherwise, unsafe errors will occur while attempting to fly rarely practiced procedures from memory. To emphasize further, the likelihood of a guidance failure is extremely remote; therefore, the reminders on this page will suffice in absence of extensive training towards full proficiency.

This page provides minimum reminders to fly the vehicle to safe MECO conditions allowing for either orbital insertion or in the case of an abort, a landing on an AOA, TAL, or RTLS runway. The procedures on this page do not fly to MECO conditions allowing mission success, only a safe MECO state is achieved. For most flights (especially ground-up rendezvous missions), manual flight will not achieve MECO conditions accurate enough to accomplish the mission objectives because of limited trajectory management information in the cockpit.

As shown in figure 4.9-1, this page contains information to manually fly ascent and abort trajectories to MECO using navigation derived information only. Guidance derived information is not used because it cannot be trusted in a situation where guidance is declared no-go. The page is used to fly normal, ATO, and TAL trajectories. The page that follows in the Ascent Checklist (and shown in Figure 4.9-2) is used to fly RTLS trajectories. A detailed discussion of each step on these pages is provided below.

UPHILL/TAL

1. The procedure begins at this step as a reminder that manual throttles and manual MECO are required for CSS flight. Subsequently, the user can skip to the appropriate steps in the procedure once manual throttles are established.
2. The central plot is a profile diagram depicting an altitude/velocity relationship representing the trajectory display in the cockpit. The central plot provides pitch instructions to fly the plot on the cockpit trajectory display using the triangle and predictor circles. The dashed line depicts instructions for a TAL trajectory with an engine failure at the two engine TAL boundary to produce a lofted trajectory. The loft provides a fuel efficient trajectory to MECO thereby preventing a low level cut-off. The “Early TAL - Initial $\theta \sim 50^\circ$ ” nomenclature next to the dashed line provides a cue to expect this theta for an engine out at the 2 engine TAL boundary. It is important to remember that the TAL dashed line and associated nomenclature assumes an SSME failure at the two engine TAL boundary. The loft magnitude decreases with later engine failures, eventually to the point where little loft is required. For later SSME failures, only enough loft is required to intercept the TAL trajectory line on the cockpit trajectory display. The “Incr $\theta \sim 10^\circ$...” nomenclature applies to all uphill, ATO, and TAL trajectories as a reminder to adjust pitch attitude to counter gravity in the event of an SSME failure. Later engine failures require less pitch adjustment as centrifugal force becomes the dominant force over gravity.
3. The HSI pointer pictorials provide yaw instruction to fly the proper orbit plane (Iy). The correct orbit plane is achieved by yawing to the applicable pointer as directed in the pictorials.
4. This area provides HSI compass card heading information for TAL aborts. These headings are used to cross-check the runway bearing pointer heading once a TAL has been declared. The compass card headings are flown instead of the primary bearing pointer if it is not close (within a few degrees) to the published headings.

5. The inertial velocity of the heads-up roll maneuver is published to provide instruction of when to perform this maneuver while flying CSS. A 180°, heads-down roll attitude is flown prior to the heads-up roll velocity cue. Two different velocities are published, one for TAL aborts and the other is used for all other uphill trajectories including ATO.
6. \dot{H} control becomes primary over altitude or attitude control as the time for manual MECO approaches. A positive \dot{H} is required at MECO to prevent atmospheric entry or TAL entries that are too steep. Once within 1:30 of MECO, the work \dot{H} cue is used along with the \dot{H} information to fly a pitch attitude that achieves the published \dot{H} when MECO is commanded manually. Since onboard TMECO may not be good if guidance is corrupted the time to MECO can be calculated from the amount of propellant remaining, knowing that 1 engine uses 4% propellant per minute. The nominal \dot{H} number is identical to the \dot{H} specified at the bottom of the Ascent ADI Cue Card.
7. Reminder to perform 3g throttling since throttles are in manual mode.
8. Either MPS propellant of 2% or movement of the cutoff bug (whichever occurs first) is used as cues for the timing of the manual throttle down to minimum throttle for NPSP protection at MECO.
9. Instruction to manually perform MECO using the cutoff bug on the trajectory display. The best uphill technique is to depress the SSME shutdown pushbuttons when the inverted triangle representing the cutoff bug is one triangle base width from the cutoff tic mark. This will accurately establish the pre-flight planned MECO V_i . Care should be taken to avoid any overspeed. Overspeeds of only 50-100 fps can result in the ET impacting land masses. Slight underspeeds are preferable to any overspeed. No cutoff bug lead is required for TAL aborts.
10. The propellant flow information for one engine at 104% power allows insight of the time to propellant depletion by comparing the number of running SSMEs to the total propellant shown on the ascent trajectory displays. Knowing the available burn time allows planning for \dot{H} control close to propellant depletion (or manual MECO) such that a negative \dot{H} can be avoided when the SSMEs shutdown.

RTLS

1. The central plot is a profile diagram depicting an altitude/velocity relationship representing the RTLS trajectory display in the cockpit. The central plot provides pitch instructions to fly the plot on the cockpit trajectory display using the triangle and predictor circles.
2. The procedure begins at this step as a reminder that manual throttles and manual MECO are required for CSS flight. Subsequently, the user can skip to the appropriate steps in the procedure once manual throttles are established.

3. The Ascent ADI Cue Card provides the only useful cockpit pitch information in the last 30 seconds of first stage because of insufficient cues on the ascent trajectory 1 display. Reminders to use the Ascent ADI Cue Card and increase the pitch attitude by 3° are provided to begin lofting the trajectory for the ensuing RTLS maneuver and to counter the performance robbing effects of gravity.
4. $PC < 50$ is the cue that SRB separation is imminent. "Hands off" means place the RHC in detent to prevent SRB re-contact during the separation sequence.
5. This is a reference to the Unconverged Guidance Table in the dedicated RTLS procedures of the Ascent Checklist once RTLS has been declared. The table provides the proper fuel dissipation and initial flyback pitch attitudes to fly. For first stage engine failures, little time exists between SRB separation and RTLS abort selection (~20 seconds); therefore, no pitch attitude instruction is provided, meaning that the attitude at staging will be sufficient. If necessary, a slight pitch correction can be made prior to RTLS abort declaration.
6. Pre- and Post- PPA SSME power level instructions are provided for two and three engine configurations.
7. Pre- and Post- PPA HSI pointer pictorials provide yaw instruction to fly directly from or to KSC. The correct direction is achieved by yawing to either the head or tail of the runway bearing pointer as directed in the pictorial, depending on whether or not PPA has occurred.
8. The nomenclature "PPA on PRPLT" is another reference to the Unconverged Guidance Table for instruction to pitch around on the propellant cue listed therein. Steps are provided to position the ADI rate switch to hi in order to fly the $8^\circ/\text{sec}$ rate for PPA, then back to medium once PPA is completed.
9. \dot{H} is controlled during flyback by first adjusting the pitch attitude before throttle to keep the \dot{H} from becoming more negative than -1200 fps. The idea is to avoid unnecessary throttle changes for three reasons: 1) A change from steady state conditions provides more opportunity for an engine failure, 2) The piloting task just prior to PPD becomes increasingly difficult if higher throttle settings are used, and 3) Abnormal power settings increase the difficulty of establishing MECO conditions allowing proper entry guidance moding. The -1200 maximum negative \dot{H} is a balance between the maximum safe value and the most fuel efficient profile. Only the later RTLS aborts will approach -1200 fps as needed in order to prevent wasting propellant and throttling up unnecessary. The \dot{H} will not approach -1200 for earlier aborts and is not a factor for consideration. Negative 1200 can be applied to earlier aborts, if for some reason due to CSS techniques, it were to approach this value (which it is not likely to do). Therefore, it is a valid number to cross-check against the cockpit RTLS trajectory display as long as all predictors stay above the bottom trajectory line. A pitch and/or throttle increase is warranted if either the \dot{H} value or the lower trajectory line is violated.

10. This is a propellant management cue indicating the minimum propellant required to fly to the MECO range-velocity target. A throttle up is required if the propellant is less than 26% when the 60 second predictor crosses the Vrel0 line or 18% when the orbiter bug crosses the same line one minute later. This provides two opportunities to ensure enough propellant remains to complete the RTLS maneuver to MECO conditions allowing a landing at KSC. These values apply to both two and three engine RTLS profiles. Fuel efficiency increases with increased power settings because of decreased time to manual MECO and decreased pitch attitudes to thrust toward the target rather than thrust in radial direction.
11. The arrow next to the “TGT $\dot{H}=+800$ @ PPD” indicates that the predictors should be aimed where the low \bar{q} bracket intersects the edge of the trajectory display. This will establish an \dot{H} close to the target of +800 at PPD. Achieving this \dot{H} will establish MECO conditions which prevent steep RTLS entries. Besides a possible overstress, steep trajectories cause improper GRTLS guidance moding which could prevent a return to automatic guidance. After a manual powered trajectory, it would be nice to be able to return the vehicle to automatic guidance and control.
12. Instruction to null sideslip (yaw to the relative velocity bearing pointer) is provided when the orbiter bug enters the \bar{q} brackets on the left-hand side of the trajectory display.
13. When the cutoff bug reaches the appropriate PPD tic on the RTLS trajectory display, steps specify to reduce power to minimum and pitch down to the ADI horizon. To prevent overcontrolling, the ADI is used to achieve $\alpha -2$ instead of either the alpha tape or ADI rates. A gross maneuver toward $\alpha -2$ is performed using the ADI, then the alpha tape should be used to fine tune the attitude for -2° just prior to manual MECO.
14. Instruction to manually perform MECO using the cutoff bug on the trajectory display, no lead is required.
15. Reminder to keep forward stick pressure from MECO until ET separation because the flight path angle is constantly decreasing immediately following MECO. Without forward stick, the alpha would become more positive than the targeted -2° for ET separation.
16. Instructions to pull to an $\alpha=50^\circ$ post ET separation in order to initiate MM602 and hopefully be able to return to automatic guidance since the algorithms for entry are entirely different than powered flight. A target Nz is specified for NZ hold to allow the MCC more time (if needed) for verification of guidance health prior to returning to automatic GNC.

The page does not specify entry procedures because guidance is assumed to be go as soon as entry guidance is initiated. It should not be inferred from this page that ascent guidance is more likely to fail than entry guidance. This page assumes full communications coverage with the MCC. This page is designed for the following single failure situations:

- The remote possibility of a guidance failure most likely caused by an erroneous day of launch uplink.
- A single SSME failure necessitating the use of rarely used abort guidance algorithms. It is prudent to design for the failure of abort algorithms since these algorithms do not possess the same amount of actual flight experience as normal guidance. It could be argued this is a dual failure situation; however, only one failure is required to cause a latent design flaw to manifest itself only under actual flight conditions.

Single engine flight operations are not shown on this page because they involve a second failure wherein contingency abort guidance (different algorithm) would be required for a large percentage of the ensuing trajectories.

SECTION 5

BACKUP FLIGHT SYSTEM

5.1 OVERVIEW

The BFS is a unique set of software that is loaded into GPC 5. It provides OPS 1, 3, and 6 capability plus some systems management (SM) functions, all in one resident set. It supports nominal ascent as well as ATO, AOA, RTLS, and TAL aborts. It can be engaged anytime after lift-off. However, BFS engage is an irreversible step until in orbit or back on the ground.

The BFS flight software provides navigation, guidance, flight control, fault detection, displays and controls, SM, and sequencing. It uses the same algorithms and guidance laws as the PASS to deliver the same performance, but with reduced capability. The BFS performs some functions in the pre-engaged state that the PASS does not. These functions include S-band antenna management, flash evaporator/ammonia boiler activation/deactivation, APU fuel quantity gauging, hydraulic water boiler quantity gauging, main engine helium pressure gauging, fuel cell total and current power calculations, and cabin delta pressure/delta time (dP/dT) calculations. If the BFS is not operating properly, the S-band antenna management and flash evaporator activation must be performed manually for ascent.

The BFS commands over the payload buses, and “listens” to the other PASS buses pre-engage. Upon engage, it takes over all buses. It is dependent on the PASS, pre-engage, for initialization data. Data is received by listening to the PASS buses (display keyboard (DK) listen). Post-engage, it is totally independent of the PASS. Pre-engage, the BFS stops listening to the PASS buses (goes standalone) for most OPS transitions (OPS 1 to 6 included) and some multiple PASS failures. The BFS state vector degrades quickly while in standalone mode as the state is propagated using the last known ΔV from the IMUs. It degrades very rapidly during powered flight (10 seconds), more slowly in gliding flight (45 seconds), and much more slowly during orbit coast. A standalone condition is indicated by the illumination of the backup flight control (BFC) light on the eyebrow panel and a CRT message. If an I/O RESET EXEC does not fix the problem within the time limits above, the BFS is declared No Go.

The BFS is engaged by depressing the pb on top of either RHC. The criteria for engaging BFS are listed in the Flight Rules and on the data processing and software (DPS) cue cards, but in general require the loss of PASS capability to maintain vehicle control. Upon BFS engage large Xs cover the PASS CRTs and the BFC light illuminates.

The BFS CRT display assignment is controlled by the BFC/CRT switch on panel C3. It is normally placed in the 3+1 position before lift-off. BFS then has CRT 3 pre-engage and picks up CRT 1 when engaged. The BFS can also be assigned to CRTs via the keyboard general purpose computer (GPC)/CRT pb.

The following BFS CRT displays are available during ascent:

XXXXXX TRAJ1	GNC SYS SUMM 1
XXXXXX TRAJ2	GNC SYS SUMM 2
RTLS TRAJ2	SM SYS SUMM 1
VERT SIT 1	SM SYS SUMM 2
VERT SIT 2	THERMAL
HSD	FAULT
XXXX MNVR XXXX	MEMORY
OVERRIDE	

The prelaunch checklist calls for the PASS/BFS one shot data transfer before the planned T - 20 minute hold. During this transfer the BFS receives IMU calibration and any first stage launch polynomials which have been uplinked to the PASS. Then, after the PASS is moded to OPS 1 at T - 20 minutes, the BFS is moded to OPS 1. SPEC 50 display is then checked to verify that the BFS is configured correctly for a possible RTLS abort. BFS SYS SUMM displays are used to monitor prelaunch systems on CRT 3. During flight, the crew monitors the BFS TRAJ displays on CRT 3 for trajectory information and guidance status. Note that the PASS TRAJ is better suited for monitoring an RTLS and the BFS is relied upon to provide uphill trajectory status. BFS TMECO should agree with PASS, and altitude errors should be near zero. The crew often uses the BFS SYS SUMM displays for systems malfunction troubleshooting since these contain more information than is available on the PASS SYS SUMM display. During OMS burns, the BFS OMS MNVR EXEC displays are monitored to ensure the BFS targets and guidance solutions agree with PASS.

During all OPS, the crew communicates with the BFS either directly through the keyboard, or via DK listen. The BFS DK listens to the following PASS inputs:

HSD: ITEMS 3 through 9, 40, 41
 MNVR: ITEMS 1 through 4, 6-26, 28-33, 35, EXEC
 OPS 104, 105, 106, 302, 303, 304, 305, 601, 602 PRO
 GPC/CRT 5X EXEC
 OVERRIDE: ITEMS 1-24

The Flight Rules call for BFS engage for the following situations:

- a. Loss of a redundant set: During ascent or entry a redundant set failure is defined as all PASS GPCs QUIT or HALT, or the redundant set to all simplex, meaning that each GPC no longer incorporates response data from any other GPC.
- b. Loss of the PASS capability to control the vehicle due to GPC/multiplexer/demultiplexer (MDM)/line replaceable unit (LRU) failures.
- c. Loss of control due to divergent trajectory: After 1:30 MET, CSS may be attempted before BFS engage.

- d. Post-tower clear roll maneuver not initiated as scheduled.

5.2 PASS/BFS DIFFERENCES

Many operational differences exist between PASS and BFS. Most of these differences are the result of one of the following seven functional differences between the two systems. The operational differences are discussed in more detail in sections 5.2.1 through 5.2.21.

- a. Guidance - the BFS is not required to support manual guidance (CSS) during powered flight or auto guidance (AUTO) during entry.
- b. Manual throttling - the BFS is not required to support manual throttling.
- c. Contingency aborts - the BFS is not required to support CAs (i.e. multiple SSME failures). Therefore, there is no SERC in the BFS.
- d. Pre-engage mode - the BFS must run pre-engage in parallel with PASS and, although not in control of the vehicle, must replicate the PASS commands in such a fashion as to enable the BFS to take over control of the vehicle at any time and ensure safe operation of the shuttle. This pre-engage mode of operation results in some unique BFS software requirements that are not applicable to the PASS.
- e. Operating system - the BFS backup operating system (BOS) is different from the PASS flight control operating system (FCOS). This results in some detailed requirements differences but does not result in functional differences.
- f. Computer memory load - the BFS has only one computer memory load and does not support OPS 2. Unique OPS 1, OPS 3, and OPS 6 requirements are merged into one common set of software.
- g. Global Positioning System (GPS) - the BFS has the capability to incorporate GPS data into the BFS onboard navigation state. However, operationally, the BFS is only used for GPS data collection and evaluation except for a contingency situation in which no TACAN data is available. The PASS also has the ability to incorporate GPS into the onboard navigation state; however this option is not available in PASS while in OPS 1 or OPS 601.

5.2.1 SSME Throttle Setting

During the pre-MECO major modes (102, 103, and 601), guidance calculations, such as mass, thrust, and acceleration, are a function of the SSME throttle setting. The PASS uses commanded throttle setting for these calculations whereas the BFS does not. Instead, the BFS estimates a throttle setting by performing a MIDVAL select on the three SSME PCs. This ensures that the pre-engaged BFS has an accurate throttle setting (as opposed to commanding its own) and protects against a single point failure of one of the Pc sensors. If the BFS is engaged, it continues to use measured throttle setting for mass estimation, but switches to commanded throttle setting

for all other calculations. That is post-engage the BFS uses the same scheme as the PASS. Note that for multiple engine failures (combinations of engines out, data path fail, or command path fail) the pre-engage BFS displays an erroneous TMECO and thrust factor. Upon engage, however, these parameters are calculated using the PASS (commanded throttle) scheme.

5.2.2 MPS Guidance Cutoff Task

This task executes at a rate of $3\frac{1}{8}$ Hz in the PFS and $6\frac{1}{4}$ Hz in the BFS during ascent second stage (MM 103). During powered RTLS (MM 601), it executes at $6\frac{1}{4}$ Hz for both the PASS and BFS.

During powered RTLS this task requires flight path angle, as an input, from the UPP principle function. In the PASS, flight path angle is only updated at a rate of 2.08 Hz. In the BFS, it is updated at 6.25 Hz. As a result, the PASS has unique guidance requirements to estimate flight path angle in between UPP updates.

The original design of this task did not require flight path angle as an input. Hence, there was no requirement for UPP to update this variable at 6.25 Hz. When the design of the MPS guidance cutoff task changed making flight path angle a required input, it was decided not to change the processing requirements of UPP, but rather to add code to guidance to estimate this variable locally in between UPP updates.

5.2.3 G-limiting

If the crew (manually) or the PASS (automatically) throttles the SSMEs erroneously during g-limiting, the BFS throttles up as required to maintain 3g, upon engage. This maximizes performance for BFS engage cases. A lower throttle setting during g-limiting results in excess fuel consumption.

When the BFS is not engaged, the g-limiting algorithm is active, but the “proportional + integral” acceleration filter is bypassed. If the acceleration filter were active when not engaged, the integral error term could become saturated if a manual throttle down were commanded by the crew.

5.2.4 Powered Explicit Guidance

The BFS uses 12 precise/predict integration steps to predict the final state in PEG, while the PFS uses 10 steps. The reason for this is to provide CPU load balancing and to minimize the BFS core. The final state prediction in PEG is performed in four minor cycles in the BFS. On each of the four minor cycles three integration steps are performed; hence, the 12 steps.

The PASS has logic that causes the error needles to be stowed if guidance is unconverged for several consecutive guidance cycles during second stage ascent and RTLS. The BFS does not have comparable logic. The reason that the PASS has this logic is to tell the crew that PEG is experiencing convergence problems. If PEG remains unconverged for any significant length of time, it may be necessary for the crew to engage manual guidance. Since the BFS does not support manual guidance, there is no point in telling the crew that PEG is experiencing convergence problems.

The criterion for outputting steering commands (EPS_TGO) when the BFS is not engaged is double the value of what is used when it is engaged. The reason for this difference is that, if the BFS is not controlling the vehicle, its guidance solution, while it is good, may be diverging somewhat and might not pass the standard criterion for issuing steering commands. So this criterion is relaxed when the BFS is not engaged to ensure that the BFS attitude errors are being cyclically updated for “reasonable” guidance solutions.

5.2.5 Range to Landing Site Task

In MM 303, the PASS executes this task only once (upon entry into the MM), while the BFS executes this task cyclically at a rate of 1/8 Hz. The original requirement was to execute this task cyclically for both the PASS and BFS. However, on early PASS software releases (pre-STS-1), the PASS was exhibiting cycle wrap problems with this task. As a result, the PASS requirements were changed such that this task is now executed only once at the start of MM 303.

5.2.6 Maneuver Execute Display Interface Processing (DIP)

For multiple inputs to the MNVR EXEC display via a single ITEM entry, the PASS accepts all data until a bad entry is made (i.e. improper format). It then rejects the bad entry and all subsequent good entries. The BFS rejects all entries of a multiple ITEM entry if a bad input is encountered.

If cyclic guidance becomes unconverged such that guidance outputs cannot be fully displayed on the CRT (e.g. $\Delta VTOT$), the BFS blanks the CRT ITEM, while the PASS truncates the leftmost digits.

If guidance does not converge during the execution of a LOAD solution, the BFS does not initiate cyclic guidance, while the PASS initiates cyclic guidance.

5.2.7 Restart

The BFS has restart capability, while the PASS does not. The primary purpose for restart capability is to allow the BFS to recover from momentary GPC errors due to divide-by-zero interrupts, power transients due to lightning, cycle wrap, etc. The PASS does not require this protection because of its redundant GPC set and also because of the existence of the BFS. If the BFS performs a restart it will be considered suspect and should only be engaged as a last resort.

5.2.8 I-loads

In the PASS, I-load values are assigned directly to the program variables and their values may be changed to satisfy mission requirements. For example, the MECO constraint I-load variable, RDMAG, is initially I-loaded to the nominal second stage value. If an RTLS abort is selected, this variable is reset internally by guidance to the required RTLS value.

The BFS, on the other hand, adheres to a philosophy that I-load variables should retain their original value and never be changed internally by the flight software. As a result, all I-loads are buffered in the BFS. When guidance is first activated, the local program variables are set to their

buffered values. The local program variables may be changed to satisfy mission requirements, but the set of I-load buffer variables is never changed.

5.2.9 RTLS Manual Turnaround

The PASS has logic to monitor for manual turnaround by the crew. When a manual turnaround is sensed, the PASS automatically modes to the flyback phase. The BFS does not have comparable logic. Instead, the BFS modes to flyback (pre-engage, only) after a manual turnaround when either the PASS's flyback discrete is received over the transfer data bus or (pre-engage and post-engage) when the crew issues a flyback moding command to the BFS via an RTLS TRAJ display ITEM entry.

If the crew commands the BFS to mode to flyback when not engaged, the BFS inhibits throttling for mass control if either PEG is unconverged or if the difference between the predicted and desired final masses, MF and MBO, respectively, is larger than a specified I-load value (currently, 800 slugs). Under these conditions, the BFS commanded throttle is frozen at the current PEG desired value (K).

5.2.10 Transfer Data

When the BFS is not engaged, it receives the following transfer data from the PASS:

- (1) Engine-out velocity (V_ME_OUT)
- (2) RTLS flyback discrete (S_RTLS_FB)
- (3) AOA excess velocity (DV_EXCESS)

The engine out velocity is required to ensure that the BFS selects the same target set in the event of an AOA or ATO abort. The RTLS flyback discrete is required to ensure that the PASS and BFS mode to the flyback phase at the same time. This is primarily for early, manual turnarounds. The AOA excess velocity ensures that the BFS selects the same AOA target set as the PASS, in the event that the PASS downmodes due to a negative excess velocity ($DV_EXCESS < 0$).

5.2.11 AOA/ATO Targeting

For variable-IY targeted missions, the BFS cyclically updates the desired plane (IY), when it is not engaged and an AOA or ATO has been declared. If the BFS is engaged when the abort is declared, the IY is calculated only once.

This change was made for Western Test Range (WTR) launches which required a significant amount of yaw steering. Typically, the PASS and BFS do not compute the variable-IY at the same time such that the state vectors used to compute the plane are different. If the IY is not recomputed each guidance cycle, the yaw error needle diverges and eventually can become "pegged".

5.2.12 Contingency Abort/Single Engine Roll Control

Since the BFS is not required to support multiple engine failures, Single Engine Roll Control (SERC) is not supported by the BFS. During a CA, the BFS CRT may get a big X, or the BFS software may not follow the PASS to a major mode or may skip major modes.

5.2.13 MPS Dump

Presently there is no manual MPS dump stop capability in the BFS. However, the dump may be initiated manually.

5.2.14 CRTs

There are only two CRTs available unless a third is assigned via keyboard input. The BFS can drive all four CRTs simultaneously, if desired, while the PASS can only drive three.

5.2.15 Dedicated Flight Instruments

The ADI and the HSI are the only dedicated displays supported in powered flight. There is no altitude or velocity data displayed during powered flight in the BFS since the AMI and AVVI are not driven.

5.2.16 Entry Guidance and Navigation

No autoland guidance available since there is no AUTO flight control capability during entry. Guidance stops at preflare (2000 ft). Bodyflap retracts at 10k (when in AUTO). Since autoland guidance is not available, there is no requirement for the Microwave Landing System (MLS). Therefore, MLS is not supported in the BFS.

5.2.17 SRB and ET Separation

The BFS does not do the 50 psi reasonableness test for SRB separation. Fast sep is available in MM 102 only. There is no manual -Z capability.

5.2.18 Caution and Warning (C&W)

Only half supported by BFS.

5.2.19 AUTO/CSS and TRANS DAP

There is no CSS capability during powered flight and no AUTO flight control capability during glided flight. There is no AUTO DAP maneuver capability or pulse mode.

5.2.20 Redundancy Management (RM)

Limited fault detection and isolation capability. Generally different RM schemes.

5.2.21 Switches

Many switches are not supported by the BFS:

Panel C3

ORB DAP pb

Panel F8

AIR DATA sw
 ADI ATT sw
 ADI ERROR sw
 ATT REF pb (ADI)
 HSI SEL MODE sw
 HSI SEL SOURCE TACAN/NAV/MLS sw
 HSI SEL SOURCE 1/2/3 sw
 RADAR ALTM 1/2 sw

Panel F6

ADI ERROR sw
 ADI RATE sw
 HSI SEL MODE sw
 HSI SEL SOURCE 1/2/3 sw
 RADAR ALTM 1/2 sw

Panel L1

H₂O PUMP LOOP 1 GPC/OFF/ON sw
 H₂O PUMP LOOP 2 GPC/OFF/ON sw

Panel R2

Backup LH₂ VLV sw
 He ISOLATION A sw
 HE ISOLATION B sw
 HYD CIRC PUMP sw

Panel O7

AFT LEFT RCS He PRESS sw
 AFT RIGHT RCS He PRESS sw
 AFT LEFT RCS MANIFOLD ISOLATION sw
 (No corresponding PASS GPC support)
 AFT RIGHT RCS MANIFOLD ISOLATION sw
 (No corresponding PASS GPC support)
 MASTER CROSSFEED sw
 LEFT, RIGHT CROSSFEED sw

Panel O8

FWD RCS He PRESS sw
 FWD RCS MANIFOLD ISOLATION sw
 (No corresponding PASS GPC support)
 OMS KIT TANK ISOLATION sw
 LEFT OMS TANK ISOLATION sw
 RIGHT OMS TANK ISOLATION sw

Panel R12

FUEL CELL GPC PURGE SEQ START sw

MISCELLANEOUS

Right RHC TRIM sw

ACRONYMS

α	angle of attack
A/G	air to ground
ACLS	augmented contingency landing site
ADI	attitude direction indicator
ADS	air data sensor
ADTA	air data transducer assembly
AESP	ascent/entry systems procedure
AFB	air force base
ALT	alternate
AMI	alpha/Mach indicator
AOA	abort once around
AOS	acquisition of signal
APU	auxiliary power unit
ARCS	aft reaction control system
ARD	abort region determinator
ASAP	as soon as possible
ASC	ascent
ASC PKT	Ascent Pocket (Checklist)
ASP	astronaut support personnel
ATO	abort to orbit
AUTO	automatic
AVVI	altitude/vertical velocity indicator
BDA	Bermuda
BDYFLP	body flap
BEN	Ben Guerir
BF	body flap
BFC	backup flight control
BFS	backup flight system
BITE	built-in test equipment
BOS	backup operating system
BRK	brake
BYD	Banjul, the Gambia
C&W	caution and warning
c.g.	center of gravity
C/L	checklist
CA	contingency abort
CDI	course deviation indicator
CDR	commander
CMD	command
CMDSOP	Command Subsystem Operating Program
CO	cutoff

comm	communications
CR	change request
CRT	cathode ray tube
CRYO	cryogenics
CSS	control stick steering
DAP	digital autopilot
DEL	deorbit, entry, and landing
DELAZ	delta azimuth
DEL PAD	DEL preliminary advisory data
DI	direct insertion
DIP	display interface processing
DK	display keyboard
DOF	degree of freedom
DOLILU	day of launch I-load uplink
dP/dT	delta pressure/delta time
DPS	data processing and software
DR	delta range
DVTOT	total delta velocity
E/W	energy-to-weight ratio
EAS	equivalent airspeed
ECAL	eastern coast abort landing
ECLSS	environmental control and life support system
EDW	Edwards Air Force Base
EI	entry interface
ELS	emergency landing site
EO	engine out
EOM	end of mission
ER	Eastern Range
ET	external tank
FA	flight aft
FCOS	flight control operating system
FCS	flight control system
FD	fuel dissipation
FDI	fault detection and identification
FDO	flight dynamics officer
FES	flash evaporator system
FPH	Flight Procedures Handbook
FPR	flight performance reserve
fps	feet per second
FRCS	forward reaction control system
Fu	fuel
FWD	forward

γ_1	inertial flightpath angle
GG	gas generator
GLS	ground launch sequencer
GMBL	gimbal
GMT	Greenwich mean time
GN&C	Guidance, Navigation, and Control
GN ₂	gaseous nitrogen
GNC	guidance navigation computer
GPC	general purpose computer
GPO	guidance and procedures officer
GPS	Global Positioning System
GRTLS	glide return to launch site
H	altitude rate
HA	apogee altitude
HAC	heading alignment circle
HP	perigee altitude
HPOT	high-pressure oxidizer turbo pump
HSD	horizontal situation display
HSI	horizontal situation indicator
HUD	head-up display
I-TGT	I-load target set
ID	identification
IMU	inertial measurement unit
INH	inhibit
INIT	initiation
INRTL	inertial
I _{sp}	specific impulse
IY	inertial plane
KEAS	knots equivalent airspeed
KSC	Kennedy Space Center
KYBD	keyboard
LCC	launch control center
LG	landing gear
LH ₂	liquid hydrogen
LOC	loss of control
LOS	loss of signal
LOX	liquid oxygen
LPS	launch processing system
LRU	line replaceable unit
LVIY	local vertical inertial yaw

LVLH	local vertical/local horizontal
MA	master alarm
MAN	manual
MC	mated coast
MCC	Mission Control Center
MDM	multiplexer/demultiplexer
ME	main engine
MECO	main engine cutoff
MET	mission elapsed time
MLS	microwave landing system
MM	major mode
MMU	mass memory unit
MNVR	maneuver
MOC	mission operations computer
MPS	main propulsion system
MRN	Moron, Spain
MSC	master sequence controller
NA	not applicable
NAS	naval air station
NAV	navigation
NAVAIDS	navigation aids
nm	nautical mile
NOM	nominal
NOR	Northrup Strip
NOTAMS	Notice to Airmen
NPSP	net positive suction pressure
NR	negative return
Nz	normal load factor
Ny	lateral load factor
OMS	orbital maneuvering system
OPS	operations sequence
OTC	orbiter test conductor
OX	oxygen
PA	product assurance
PAD	preliminary advisory data
PASS	primary avionics software system
pb	pushbutton
PBI	pushbutton indicator
Pc	chamber pressure
PD	pitchdown
PEG	powered explicit guidance

PFS	primary flight system
PIC	pyro initiator controller
PLS	primary landing site
PLT	pilot
PNL	panel
PPA	powered pitcharound
PPD	powered pitchdown
PRI	primary
PRL	priority rate limiting
PRTL5	powered return to launch site
psf	pounds per square foot
PTI	programmed test input
QBAR	dynamic pressure
R-V	range-velocity
RCS	reaction control system
REF	reference
REI	range at entry interface
RELMAT	relative matrix
RGA	rate gyro assembly
RHC	rotational hand controller
RM	redundancy management
RPL	rated power level
RS	redundant set
R5LS	redundant set launch sequencer
R55	range safety system
RTLS	return to launch site
RWY	runway
SBTC	speedbrake thrust controller
SE	single engine, southeast
SEC	secondary
SEP	separation
SEQ	sequencer
SERC	single engine roll control
SES	Shuttle Engineering Simulator
SI	standard insertion
SM	systems management
5ORT	simulation and optimization of rocket trajectories
SPD	speed
SPEC	specialist function
SPI	surface position indicator
SRB	solid rocket booster
SRM	solid rocket motor

SSME	space shuttle main engine
SSP	Space Shuttle Program
SSPO	Space Shuttle Program Office
STG	stage
STO	stow
STS	Space Transportation System
SVDS	space vehicle dynamics simulation
sw	switch
SW	southwest
T	time
TACAN	tactical air navigation
TAEM	terminal area energy management
TAL	transoceanic abort landing
TDDP	trajectory design data package
TFF	time to free fall
TGO	time to go
THC	translational hand controller
THROT	throttle
TIG	time of ignition
TK	tank
TMECO	time of main engine cutoff
TTA	time to apogee
TTC	time to circularize
TTG	time to go
TTP	time to perigee
TV	thrust vector
TVC	thrust vector control
Θ T	target parameter
UPP	user parameter processing
V_{GO}	velocity remaining to the target
V_{HOR}	horizontal velocity
V_I	inertial velocity
V_{REL}	relative velocity
V_{VER}	vertical velocity
WONG	weight on nose gear
WOW	weight on wheels
WSB	water spray boiler
WT	weight
WTR	Western Test Range

CHANGE CONTROL

The following process assumes a basic knowledge of Microsoft Word for Windows. If you are not familiar with this application, you may submit redlines to the Book Manager on a paper copy with rationale attached.

1. Electronically copy the pages or sections of interest from the MOD World shared server in the /Divisions/DM/Private/Dm43/Fph/Asc_fph/ directory into a new Microsoft Word document. Open the newly saved document. Note the following file structure:

Toc.doc	Title, acknowledgments, signature, Table of Contents
Sec1.doc	Introduction
Sec2.doc	Ascent Flight Phase Description
Sec3.doc	Ascent Crew Monitoring and Control Devices
Sec41.doc	Crew Operations Overview
Sec42.doc	Prelaunch Procedures
Sec43.doc	Nominal/ATO Ascent
Sec44.doc	AOA Procedures
Sec45.doc	TAL Procedures
Sec46.doc	High Energy TAL and High Energy Gander Procedures
Sec47.doc	RTLS Procedures
Sec48.doc	Contingency Abort
Sec49.doc	Powered CSS Procedures
Sec5.doc	Backup Flight System
Acronym.doc	Acronyms
change.doc	Change Control
Distrib.doc	Distribution List

2. Select “Track Changes” from the Tools menu and check the “Track Changes While Editing” box. Then select “Accept All” and “OK” so that your copy contains no revision marks until you enter your changes.

Note: If “Accept All” is not available (i.e. “grayed out”) then there were no previous revisions. Simply check the “Mark Revisions While Editing” box and select “OK”.

3. Select “Options” from the Tools menu and select the “User Info” tab. Enter your name and initials.
4. Enter your changes. After each technical change, select “Annotation” from the Insert menu. A window for annotations will appear. Next to the annotation (your initials followed by a number), enter the rationale for the change. Include 482 or Flight Software CR numbers, etc. as appropriate. Spelling corrections and other editorial changes do not require an annotation.
5. Insert this revised Word document into an E-mail addressed to the Book Manager (See page iii for the current Book Manager and e-mail address).

6. The Book Manager will then review the change and incorporate it as appropriate into the electronic version contained in the Asc_fph/Working Changes directory. The annotations will also be incorporated with the appropriate numbering scheme to serve as an electronic record of the change requests.
7. The Book Manager will then forward significant changes incorporated into the working version to subject matter experts for review. This step may be an iterative process until the subject matter expert, change initiator, and Book Manager agree to the change. Once the subject matter expert provides concurrence, the Book Manager will include the subject matter expert's name and discipline/organization in the annotation for the change reviewed.

Note: Prior to using information contained in the Working Changes directory, users should review the comments (select "Comments" from the View menu) or contact the Book Manager to verify that the changes of interest have been reviewed by the subject matter expert.

8. On a periodic basis, depending on the number and content of changes, a PCN or Rev will be submitted to the Ascent/Descent Dynamics Branch Chief for approval. Approval will be recorded in the electronic version by entering "Original Signed by <Branch Chief's name>" on the Branch Chief signature line of the PCN or Rev. The new version will be moved into the Asc_fph directory and then published to EDP. The previous version will be archived. The annotations included in each version provide the record of the change requests and the subject matter expert review.

CHANGE LOG

Microsoft Word Annotations (similar to endnotes) are used in the Ascent/Aborts Flight Procedures Handbook (FPH) electronic change control process to document the change requester, reviewer (if applicable), and reason for change. An annotation, in the form of [AFPHX.X-#], will appear in the vicinity of each technical change in the body of the document. When viewing a section of the Ascent/Aborts FPH using Microsoft Word, the change information is available by selecting “Annotations” from the “View” menu. This method serves as the electronic change log. When using a paper copy of this FPH, the following pages can be used for change information and serve as the paper copy of the change log for Revision F of the Ascent/Aborts FPH dated March 2005.

JSC-10559 Distribution
03/02/2005

NASA/JSC

CB/Chief
DA8/Chief
DA83/MOD Library (2)
DF22/DPS Library
DF24/Lead
DF6/Chief
DF7/Chief
DF82/Lead
DM4/Chief
DM43/Lead (6)
DT/Library
DT34/Library (2)
EG/Library
BT53/STI Center (3)

USA

USH-482L/Entry Console POC (2)
USH-482L/ADFD Library
USH-485L/ONAV Library
USH-636X/SAIL Library (10)

Boeing

HS3-10/D. Huntsman

Total: 39