

Space Flight Operations Contract

Guidance and Control Insertion/Orbit/Deorbit Workbook

G&C I/O/D 21002

May 14, 2004

Contract NAS9-20000

Copyright © 2004 by United Space Alliance, LLC. These materials are sponsored by the National Aeronautics and Space Administration under Contract NAS9-20000. The U.S. Government retains a paid-up, nonexclusive, irrevocable worldwide license in such materials to reproduce, prepare derivative works, distribute copies to the public, and to perform publicly and display publicly, by or on behalf of the U.S. Government. All other rights are reserved by the copyright owner.



**Guidance and Control
Insertion/Orbit/Deorbit Workbook**

G&C I/O/D 21002

Prepared by

Original approval obtained

Peter W. Pruyn
USA/Control/Propulsion Section

Approved by

Original approval obtained

Michael R. Sterling, Manager
USA/Control/Propulsion Section

REVISION LOG

Rev. letter	Change no.	Description	Date
Basic		Supersedes TD315. Added Insertion/Orbit/Deorbit to document title. Updates to entire document.	05/14/2004

LIST OF EFFECTIVE PAGES

The current status of all pages in this document is as shown below:

<u>Page No.</u>	<u>Change No.</u>
Preface	Basic
i – vi	Basic
1-1 – 1-4	Basic
2-1 – 2-7	Basic
3-1 – 3-13	Basic
4-1 – 4-17	Basic
5-1 – 5-23	Basic
6-1 – 6-10	Basic
7-1 – 7-17	Basic
8-1 – 8-7	Basic
9-1 – 9-15	Basic
A-1 – A-5	Basic
B-1 – B-2	Basic
C-1 – C-17	Basic
D-1	Basic

PREFACE

The content of this document was provided by the Control/Propulsion Department, Space Flight Training Division, Mission Operations Directorate (MOD), Lyndon B. Johnson Space Center (JSC), National Aeronautics and Space Administration (NASA). Technical documentation support was provided by Integrated Documentation Services (IDS), Hernandez Engineering, Inc. Any questions concerning this workbook or any recommendations should be directed to the book manager.

This material is for training purposes only and should not be used as a source of operational data. All numerical data, displays, and checklist references are intended as examples. To determine any prerequisites before using this document, consult the applicable Certification Plan. For shuttle manuals, consult the appropriate flight controller's certification guide (Blue Book), or the Crew Training Catalog. For Space Station manuals, consult the appropriate Space Station Certification Guide or Training Administration Management System (TAMS). The applicable training package should be studied before attending any classroom session or lesson for which this is a prerequisite.

If this workbook is being read as part of a formal syllabus, the reader should complete the training materials evaluation form at the end of the document. The eval form does not need to be signed.

CONTENTS

Section	Page
1.0 FLIGHT PROFILE INTRODUCTION.....	1-1
1.1 ORBIT INSERTION.....	1-1
1.2 ON ORBIT.....	1-2
1.3 DEORBIT.....	1-2
1.4 THE ROLE OF GUIDANCE, NAVIGATION, AND FLIGHT CONTROL.....	1-3
2.0 GUIDANCE, NAVIGATION, AND CONTROL OVERVIEW	2-1
2.1 OBJECTIVES.....	2-1
2.2 NAVIGATION.....	2-2
2.3 STATE VECTORS	2-3
2.3.1 Vector Selection.....	2-4
2.3.2 State Vector Updates.....	2-5
2.3.3 BFS – State Vectors.....	2-5
2.4 ATTITUDE PROCESSOR.....	2-5
2.5 QUESTIONS.....	2-7
3.0 PURPOSE OF GUIDANCE	3-1
3.1 OBJECTIVES.....	3-1
3.2 GUIDANCE	3-1
3.2.1 Insertion/Deorbit Guidance	3-1
3.2.2 PEG 4 vs. PEG 7 Guidance	3-2
3.3 PEG 4 CALCULATIONS.....	3-2
3.3.1 Orbit Guidance.....	3-3
3.4 FLIGHT CONTROL.....	3-4
3.4.1 Thrust Vector Control Digital Autopilot.....	3-7
3.4.2 Reaction Control System Digital Autopilot.....	3-9
3.4.3 TVC and RCS DAP Control Modes.....	3-11
3.4.4 BFS – DAP.....	3-11
3.5 QUESTIONS.....	3-13
4.0 DISPLAYS AND CONTROLS.....	4-1
4.1 OBJECTIVES.....	4-1
4.2 MANEUVER EXECUTE DISPLAY.....	4-1
4.2.1 Engine Configuration (Items 1 to 4).....	4-2
4.2.2 TV Roll (Item 5).....	4-3
4.2.3 Trim Load (Items 6 to 8).....	4-3
4.2.4 Weight (Item 9).....	4-5
4.2.5 TIG (Items 10 to 13).....	4-5
4.2.6 PEG 4 Targets (Items 14 to 18).....	4-5
4.2.7 PEG 7 Targets (Items 19 to 21).....	4-8
4.2.8 Load (Item 22).....	4-9

Section	Page
4.2.9 Timer (Item 23)	4-9
4.2.10 Burn Attitude and Maneuver (Items 24 to 27)	4-10
4.2.11 REI	4-11
4.2.12 TTA/TTP/TTC/TFF	4-12
4.2.13 OMS Gimbal Selection (Items 28 to 33).....	4-12
4.2.14 Gimbal Check (Item 34)	4-12
4.2.15 Flashing EXEC.....	4-13
4.2.16 Burn Data	4-13
4.2.17 Abort TGT (Item 35).....	4-14
4.2.18 Forward RCS Dump (Items 36 to 38).....	4-14
4.2.19 Surface Drive (Items 39 and 40)	4-14
4.2.20 BFS – MNVR EXEC.....	4-15
4.3 QUESTIONS.....	4-17
5.0 UNIVERSAL POINTING DISPLAY	5-1
5.1 OBJECTIVES.....	5-1
5.1.1 MNVR (Items 5 to 7 and 18)	5-2
5.1.2 TRK (Items 8 to 17 and 19).....	5-2
5.1.3 Body Vectors.....	5-3
5.1.4 Determining the Body Vector	5-5
5.1.5 Omicron	5-6
5.1.6 Targets.....	5-9
5.1.7 ROT (Items 14 to 16 and 20)	5-12
5.1.8 CNCL (Item 21).....	5-13
5.1.9 CUR MNVR COMPL	5-13
5.1.10 Start Time (Items 1 to 4)	5-14
5.1.11 MON Axis (Item 22)	5-14
5.1.12 Total/DAP Errors (Items 23 and 24).....	5-15
5.1.13 Maneuver Monitor	5-17
5.1.14 Reboost (Items 25 to 29).....	5-17
5.1.15 BFS - Universal Pointing	5-17
5.2 QUESTIONS.....	5-19
6.0 DAP CONFIGURATION DISPLAY	6-1
6.1 OBJECTIVES.....	6-1
6.1.1 A, B, and EDIT (Items 1, 2, 3, 4, and 5)	6-2
6.1.2 Alternate Mode.....	6-2
6.1.3 Rotation Discrete Rate (PRI: Items 10, 30, 50; VERN: Items 23, 43, 63)	6-3
6.1.4 Attitude Deadband (PRI: Items 11, 31, 51; VERN: Items 24, 44, 64)	6-3
6.1.5 Rate Deadband (PRI: Items 12, 32, 52; ALT: Items 18, 38, 58; VERN: Items 25, 45, 65)	6-3
6.1.6 Rotation Pulse Rate (PRI: Items 13, 33, 53; VERN: Items 26, 46, 66)	6-4

Section	Page	
6.1.7	Rotation Compensation (PRI: Items 14, 34, 54; VERN: Items 27, 47, 67).....	6-4
6.1.8	Jet Option (PRI: Items 15, 35, 55 and 16, 36, 56; ALT: Items 19, 39, 59).....	6-5
6.1.9	Translation Pulse (NORM: Items 17, 37, 57)	6-5
6.1.10	Number of Jets (ALT: Items 20, 40, 60).....	6-5
6.1.11	On Time (ALT: Items 21, 41, 61).....	6-6
6.1.12	Delay (ALT: Items 22, 42, 62).....	6-6
6.1.13	Control Acceleration (Items 28, 48, 68).....	6-6
6.1.14	Notch Filter Enable (Item 6).....	6-7
6.1.15	X Rotation Enable (Item 7).....	6-7
6.1.16	Reboost (Items 8 and 9).....	6-7
6.1.17	BFS - DAP Configuration	6-7
6.2	QUESTIONS.....	6-9
7.0	DAP PUSHBUTTON INDICATORS.....	7-1
7.1	OBJECTIVES.....	7-1
7.1.1	DAP Select.....	7-3
7.1.2	Automatic Control	7-3
7.1.3	Inertial Control.....	7-4
7.1.4	Local Vertical/Local Horizontal Control	7-4
7.1.5	Free Drift.....	7-4
7.1.6	Low Z Translation.....	7-4
7.1.7	High Z Translation.....	7-4
7.1.8	Normal Translation.....	7-6
7.1.9	Pulse Translation	7-6
7.1.10	Primary Jet Selection	7-6
7.1.11	Alternate Jet Selection	7-8
7.1.12	Vernier Jet Selection Logic	7-9
7.1.13	Discrete Rate	7-9
7.1.14	Pulse Rotation.....	7-9
7.1.15	Effect of Vernier Jet Failures.....	7-9
7.1.16	Effect of Inertial Measurement Unit Failures	7-10
7.1.17	BFS - pbi's.....	7-11
7.2	ATTITUDE DIRECTION INDICATOR	7-11
7.2.1	Attitude.....	7-12
7.2.2	Rate	7-14
7.2.3	Errors	7-14
7.3	BFS - ADI.....	7-14
7.4	RCS ACTIVITY LIGHTS	7-15
7.5	QUESTIONS.....	7-17

Section	Page
8.0 FLIGHT CONTROL MODES.....	8-1
8.1 OBJECTIVES.....	8-1
8.2 TVC MODES.....	8-1
8.2.1 Automatic TVC - Two Engines.....	8-2
8.2.2 Automatic TVC - One Engine.....	8-3
8.2.3 Manual TVC - Two Engines.....	8-3
8.2.4 Manual TVC - One Engine.....	8-4
8.3 RCS CONTROL MODES.....	8-5
8.3.1 Hand Controller Interface.....	8-5
8.4 BFS - CONTROLLERS.....	8-6
8.5 QUESTIONS.....	8-7
9.0 INSERTION, ON-ORBIT, DEORBIT PROCEDURES.....	9-1
9.1 OBJECTIVES.....	9-1
9.2 EXTERNAL TANK SEPARATION.....	9-1
9.2.1 -Z Translation Maneuver.....	9-2
9.2.2 Alpha-Beta Maneuver.....	9-4
9.3 OMS-1 BURN.....	9-5
9.3.1 Target Setup.....	9-6
9.3.2 Maneuver to Burn Attitude.....	9-6
9.3.3 Preburn Checks and Actions.....	9-7
9.3.4 Monitoring the Burn.....	9-8
9.3.5 Engine Failures.....	9-8
9.3.6 Trim Residuals.....	9-9
9.4 POST-OMS-1 BURN.....	9-9
9.5 OMS-2 BURN.....	9-10
9.6 ON-ORBIT OMS BURNS.....	9-10
9.7 RENDEZVOUS BURNS.....	9-11
9.8 RCS BURNS.....	9-13
9.9 DEORBIT BURN.....	9-14
9.10 QUESTIONS.....	9-15
 Appendix	
A ACRONYMS AND ABBREVIATIONS.....	A-1
B SUGGESTED REFERENCE DOCUMENTS.....	B-1
C ANSWERS TO TEST QUESTIONS.....	C-1
D TRAINING MATERIALS EVALUATION.....	D-1

TABLES

Table	Page
1-1 GN&C types by flight phase.....	1-4
3-1 Active DAPs.....	3-7
7-1 DAP pbi availability matrix	7-3
7-2 Primary RCS jet select logic	7-8
8-1 Available TVC modes	8-2
8-2 RHC deflection and pbi submode control for TRANS and ORBIT DAPS.....	8-6
9-1 ET SEP event timeline.....	9-3
9-2 Alpha-Beta maneuver – First 6.7 seconds of mated coast	9-4
9-3 Alpha-Beta maneuver – Post ET SEP	9-4
9-4 TRANS DAP deadband and maneuver rates	9-13

FIGURES

Figure

1-1 Nominal ascent profile	1-1
1-2 Typical mission profile	1-2
2-1 Guidance, navigation, and flight control software interfaces.....	2-2
2-2 Functions of the ATT PROC.....	2-6
3-1 On-orbit guidance displays	3-5
3-2 Flight control process	3-6
3-3 Commanded turning rate.....	3-8
3-4 RCS orbit DAP.....	3-9
3-5 Phase plane.....	3-10
4-1 MNVR EXEC display	4-1
4-2 Parallel engine burn and burning through the c.g.	4-4
4-3 The relationship between C_1 , C_2 , V_{vert} , and V_{horiz} shown with a typical velocity vector at EI resulting from a deorbit burn.....	4-6
4-4 PEG 4 target parameters.....	4-7
4-5 TGT PEG 7 field	4-9
4-6 REI and TXX fields	4-11
4-7 Item 35	4-14

Figure	Page
5-1 UNIV PTG display	5-1
5-2 Items 8 to 17.....	5-3
5-3 Determining the body vector - step 1.....	5-5
5-4 Determining the body vector - step 2.....	5-5
5-5 Determining the body vector - step 3.....	5-5
5-6 Determining the omicron angle – step 1.....	5-6
5-7 Determining the omicron angle – steps 2 and 3.....	5-7
5-8 Determining the omicron angle – step 4.....	5-7
5-9 Omicron, angle between two planes (A and B).....	5-8
5-10 LVLH and inertial attitude holds.....	5-9
5-11 Orbiting vehicle (Target ID = 1).....	5-9
5-12 Earth center (Target ID = 2).....	5-10
5-13 Earth surface (Target ID = 3).....	5-11
5-14 Sun center (Target ID = 4).....	5-12
5-15 “Barbecue” rotation about the +X axis.....	5-13
5-16 Item 22.....	5-15
5-17 Total vs. DAP errors.....	5-16
5-18 CUR and REQD vehicle attitudes.....	5-17
6-1 DAP CONFIG display.....	6-1
6-2 Deadbanding or limit cycling.....	6-4
7-1 Orbit and TRANS DAP pbi’s.....	7-2
7-2 Z translations.....	7-5
7-3 RCS jet location and thruster ID.....	7-7
7-4 Vernier jet failure pbi reconfiguration.....	7-10
7-5 Inertial measurement unit fail pbi reconfiguration.....	7-11
7-6 MEDS attitude direction indicator.....	7-12
7-7 Panel F6 – MEDS ADI.....	7-13
7-8 RCS activity lights, Panel F6.....	7-15
8-1 OMS TVC.....	8-4
9-1 OMS MNVR EXEC display.....	9-5
9-2 Two-engine burn vs. one-engine burn.....	9-9
9-3 POSIGRADE burn.....	9-11
9-4 RETROGRADE burn.....	9-11
9-5 OUT-OF-PLANE burn.....	9-12
9-6 RADIAL burn.....	9-12

1.0 FLIGHT PROFILE INTRODUCTION

1.1 ORBIT INSERTION

The main sources of energy to put the space shuttle vehicle into orbit are the Solid Rocket Boosters (SRBs) and the Space Shuttle Main Engines (SSMEs). The SRBs burn out and are jettisoned about 2 minutes into the flight, resulting in an Atlantic Ocean splashdown off the coast of Florida (Figure 1-1).

At this point, there are two options available to the planners of the flight: (a) direct orbital insertion using main engines, or (b) insertion with an Orbital Maneuvering System (OMS) burn (OMS 1). On STS-1 through STS 41-B, Main Engine Cutoff (MECO) occurred before the shuttle reached orbit. For these flights, insertion was done with the OMS engines. This helped to ensure that there was no danger of the External Tank (ET) coming down in a populated area. STS 41-C was the first direct insertion flight. The trajectory was modified and the SSMEs burned longer, thereby getting the vehicle into a higher orbit and eliminating the need for an OMS 1 burn.

Without a direct insertion ascent, the shuttle would follow the ET back to Earth. For these standard insertion ascents, the OMS 1 burn supplies the additional 200 to 300 ft/sec of velocity that is required to place the vehicle in a stable orbit.

Whether or not a direct insertion trajectory is followed, an OMS 2 burn is required to raise the Orbital Perigee (HP) to an acceptable value. This burn is done at apogee (when the orbiter is at its farthest point from the Earth), which occurs approximately 160° or 35 minutes from the insertion point. The amount of thrust required is dependent on the final orbital altitude desired.

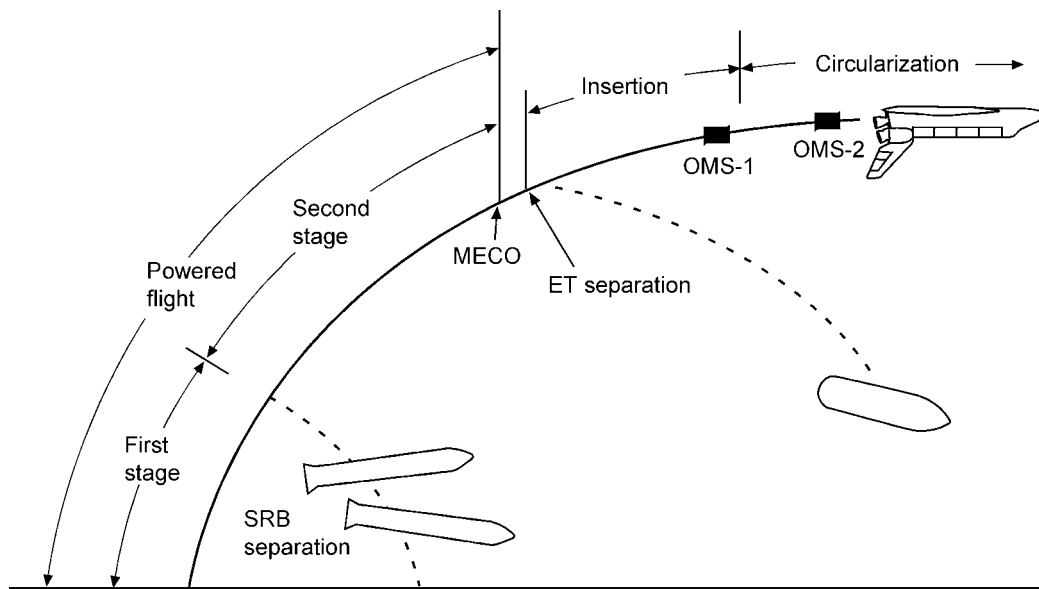

usa006501_001.cnv

Figure 1-1. Nominal ascent profile

1.2 ON ORBIT

Once the shuttle has achieved a stable orbit, the payload bay doors are opened, and the flight-specific operations begin (Figure 1-2). Depending on the mission objectives, it may be necessary to schedule OMS and/or Reaction Control System (RCS) translation burns as well as RCS attitude maneuvers. Satellite deployments, rendezvous operations, and Earth observation experiments often require orbital changes or adjustments.

1.3 DEORBIT

The purpose of a deorbit burn is to reduce the vehicle's orbital velocity, thereby decreasing its energy, which allows it to reenter the Earth's atmosphere. To control the entry, deorbit guidance targets the vehicle to a point where the range and velocity of the orbiter allow a safe landing at the desired site. The point at which the shuttle is targeted is called Entry Interface (EI). It is the height above the Earth where the atmosphere is considered to end and space begins. This point lies approximately 400,000 feet above sea level.

To decrease orbital velocity, the vehicle is turned around so that the OMS engines point in the direction of travel (thrusting opposite to the velocity vector) and fire until the desired result is achieved. After a deorbit burn of about 2.5 minutes, the vehicle is turned around again and placed in the best possible attitude for EI. After EI, the orbiter essentially becomes a glider, conserving energy or bleeding it off via banks, or roll reversals, until a safe landing can be made (Figure 1-2).

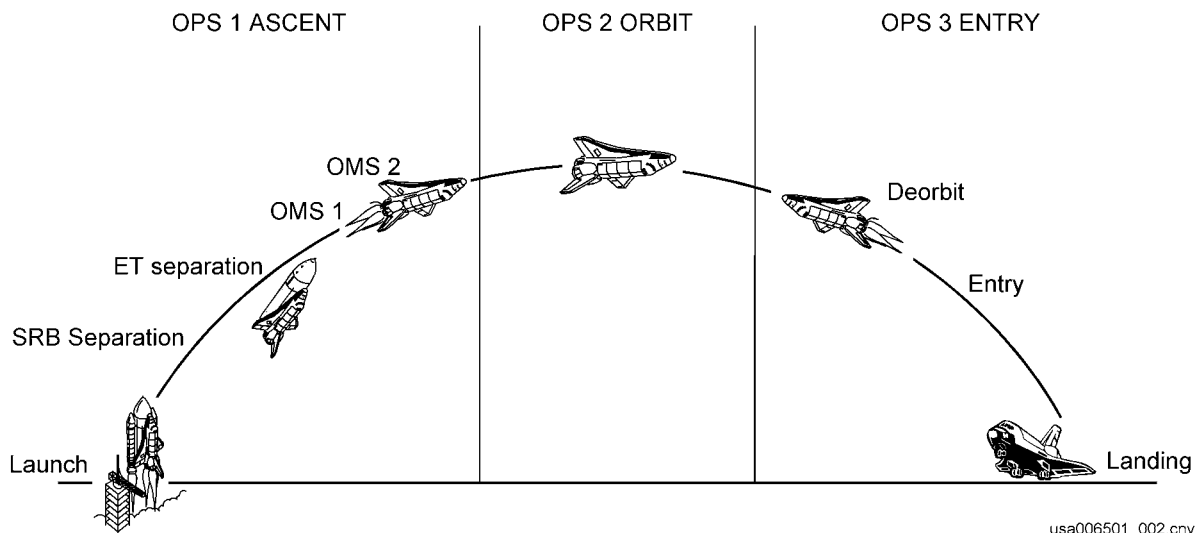

Figure 1-2. Typical mission profile

1.4 THE ROLE OF GUIDANCE, NAVIGATION, AND FLIGHT CONTROL

Simply stated, navigation equipment and software keep track of where the orbiter is located, guidance computes where it needs to be to satisfy mission requirements, and flight control gets it there.

Since the requirements and needs vary from one flight phase to another, Guidance, Navigation, and Control (GN&C) is different for different parts of the mission. For example, when on orbit, guidance target parameters related to the launch site are useless; whereas during ascent, they are essential. Similarly, the small Vernier (VERN) RCS jets are not needed while the main engines are thrusting since the effect would be insignificant. Without vernier jets on orbit, however, the pointing accuracy of the orbiter would not be sufficient to achieve many of the objectives that the payload users demand. To conserve badly needed computer space, software is written to conform to the specific needs of the mission timeline. Table 1-1 shows the types of GN&C for each flight phase.

Table 1-1. GN&C types by flight phase

Flight Phase	MM	Navigation	Guidance	Control
Ascent				
Precount	901	—	—	—
Terminal count	101	—	—	—
First stage (SRB ignition)	102	Asc. ¹ super-G (T-8s)	1st stage	Ascent DAP ²
Second stage (SRB separation)	103	Asc. super-G	PEG ³ 1	Asc. (until MECO)/ TRANS ⁴ DAP
Orbit Insertion				
OMS 1 ⁵ (-Z translation complete)	104	Asc. super-G	PEG 4, 7	TRANS DAP
OMS 2 ⁶	105	Asc. super-G	PEG 4, 7	TRANS DAP
Coast phase	106	Asc. super-G	—	TRANS DAP
Orbit				
Orbit coast	201	Orb super-G/RNDZ ⁷	UNIV PTG	Orbit DAP
Maneuver EXEC	202	Orb super-G/RNDZ	UNIV PTG/PEG 7	Orbit DAP
FCS ⁸ checkout	801	Orb super-G/RNDZ	UNIV PTG	Orbit DAP
Deorbit				
Predeorbit coast	301	Entry super-G	—	TRANS DAP
Deorbit EXEC	302	Entry super-G	PEG 4, 7	TRANS DAP
Preentry monitor	303	Entry super-G	—	TRANS DAP
Entry				
Entry monitor	304	Entry super-G	Entry	Aerojet DAP
TAEM ⁹ / Approach & Land	305	Preland super-G	TAEM (M = 2.5) / Approach & Land	Aerojet DAP
Aborts				
RTLS ¹⁰ second stage (RTLS abort)	601	RTLS super-G	PEG 5	Ascent DAP
Glided RTLS 1 (-Z translation complete)	602	RTLS super-G	PEG 5	GRTLS ¹¹ DAP
Glided RTLS 2 (TAEM interface) / Approach & Land	603	RTLS super-G	TAEM (M = 3.2) / Approach & Land	GRTLS DAP

¹ Asc – Ascent

² DAP – Digital Autopilot

³ PEG – Powered Explicit Guidance

⁴ TRANS – Transition

⁵ OMS 1 – First OMS burn (Not used nominally in a direct insertion ascent)

⁶ OMS 2 – Second OMS burn (or first OMS burn in a direct insertion ascent)

⁷ RNDZ – Rendezvous

⁸ FCS – Flight Control System

⁹ TAEM – Terminal Area Energy Management

¹⁰ RTLS – Return To Launch Site

¹¹ GRTLS – Glided portion of an RTLS

2.0 GUIDANCE, NAVIGATION, AND CONTROL OVERVIEW

2.1 OBJECTIVES

After completing this section, you should be able to

- a. Identify the purpose of navigation
- b. Define a state vector
- c. State when Inertial Measurement Unit (IMU) data is not incorporated for use in state vector propagation
- d. State what can be done to improve/update the onboard state vector
- e. Name the software that maintains the orbiter state vector
- f. Identify the components that compute the orbiter state vector and the algorithm that is used
- g. Identify the components and software modules that receive attitude-related data from the attitude processor

Figure 2-1 shows how guidance, navigation, and flight control software interfaces with the crew and with hardware devices. The left side shows the inputs, while the outputs are on the right side. The center section shows schematically how the various programs are tied together.

In this section, the diagram is examined from a software point of view. By knowing what information is being passed from one module to another and what sort of calculations are performed to process that information, you will acquire a better understanding of why the orbiter behaves as it does. Subsequent sections of this document cover crew displays, controls, and procedures, all of which hinge on this software.

A word of caution: The information presented in Figure 2-1 has been simplified to increase readability and maximize clarity. As a result, it is lacking some of the detail contained in other diagrams. If software modules or interface lines appear to be missing, it is because the author felt that such information is not essential to understand the subject matter and, in fact, may actually hinder you from learning the important parts. (See the reference guide in Appendix B for a list of documentation on this subject.)

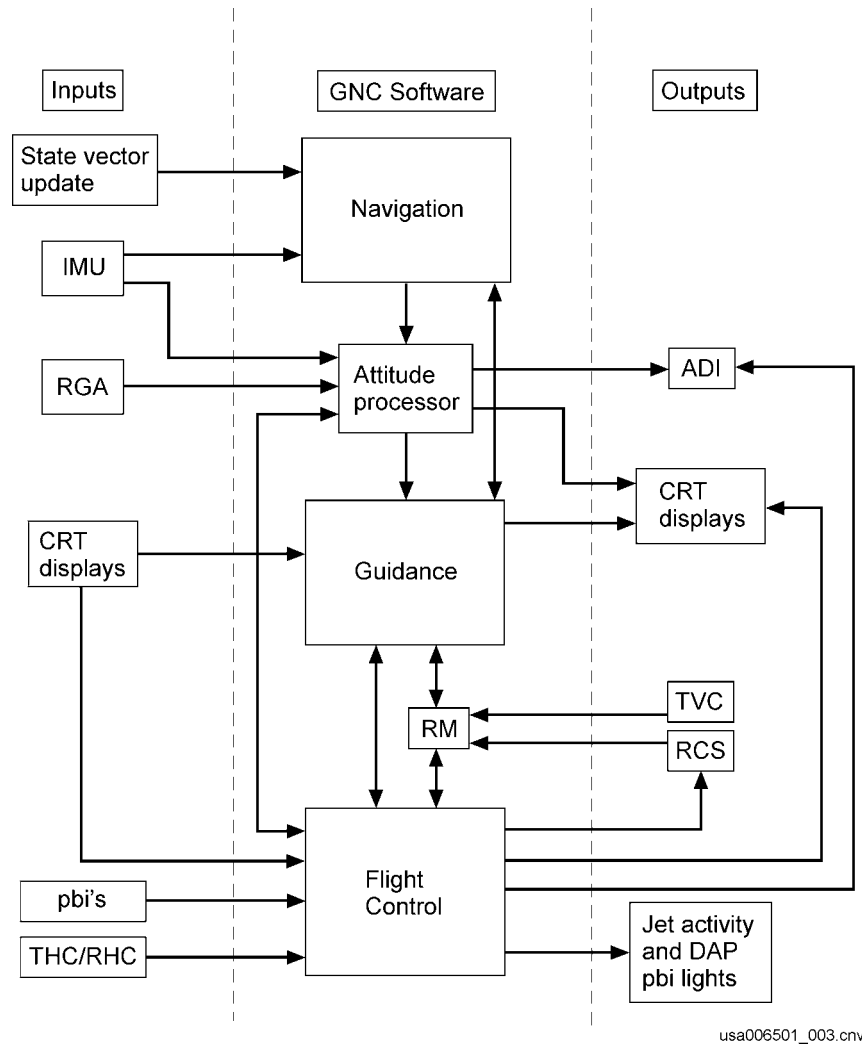

Figure 2-1. Guidance, navigation, and flight control software interfaces

2.2 NAVIGATION

To perform insertion, orbit, and deorbit maneuvers, there must be accurate data for the orbiter's location and velocity with respect to the Earth for use by guidance and control. This is the task of the shuttle navigation (nav) software.

The navigation software maintains an accurate estimate of the orbiter's Inertial (INRTL) position and velocity in the form of a seven-element "state vector." The seven elements include

$\left. \begin{array}{l} X \\ Y \\ Z \end{array} \right\}$ Position in Mean of 1950 (M50) coordinate system
 measured in feet from the center of the Earth

$\left. \begin{array}{l} V_x \\ V_y \\ V_z \end{array} \right\}$ Velocity in feet per second

$\left. \begin{array}{l} T \end{array} \right\}$ Time at which this vector is applicable in
 Greenwich mean time (GMT)

usa006501_052.cnv

(See the NAV 21001 workbook for more information about coordinate systems and state vectors.)

During accelerated flight, the IMUs supply the information to calculate this vector. The onboard vector may be updated or replaced by the ground with a vector based on data obtained from tracking devices. During entry, other onboard sensors are used. Since this training manual is concerned only with the flight phases of insertion, orbit, and deorbit, entry sensors are not discussed here.

When rendezvous navigation is active, the software also keeps track of a state vector for the target. Based on the assumption that the target state vector is accurate, nav can improve its estimate of the orbiter state vector relative to the target by incorporating data from one of the three external sensors designed for this purpose. These are the Rendezvous Radar (RR), Star Tracker (ST), and the Crew Optical Alignment Sight (COAS).

Once nav has computed a state vector, it is sent to guidance for use in calculating burn target solutions. The state vector also is used by various cockpit displays, where it is converted into forms that the crew finds useful for flying the vehicle.

2.3 STATE VECTORS

Because the vehicle's location changes with respect to the Earth as it orbits, the state vector is constantly changing, and nav is continually having to recompute it. This is done in the General Purpose Computers (GPCs) via an algorithm known as "super-g navigation."

The Super-g Algorithm performs the following functions:

- a. Given the state vector and gravitational acceleration from the last cycle, a new position vector is estimated using either modeled drag acceleration or IMU-sensed acceleration.
- b. The gravity at the new position is calculated.

- c. Using the change in gravity from the past to the current cycle, the position and velocity vectors are recomputed.

The modeled acceleration referred to above uses a simple gravity equation and IMU data when the IMU-sensed acceleration is above a certain threshold level. This happens only on ascent (powered flight) or during an OMS or RCS burn. Because the IMUs are actual measuring instruments, they not only sense ΔV 's due to legitimate accelerations, but those due to vehicle vibrations and other unwanted motions as well. (The software corrects for sensed ΔV 's due to rotations since it knows how far off the center of gravity (c.g.) the IMUs are located.) These noise outputs tend to degrade the state vector if not eliminated. For this reason, when the vehicle acceleration is below the required ΔV threshold, IMU data is not used and a more sophisticated gravity model, also incorporating drag effects, is used.

In Operational Sequence (OPS) 201 or 801 when some of the RCS burns may not produce enough acceleration for the IMUs to detect, the crew has the option to turn "Average G" (AVG G) on or off via an item entry (SPEC 33, Item 5). When it is turned on, IMU data is used when the magnitude of the sensed acceleration is enough to exceed the threshold level. When AVG G is turned off, IMU data is not incorporated.

In OPS 202, AVG G is automatically turned on so that sensed acceleration from an OMS burn is incorporated. The crew may not turn AVG G off in OPS 202, but the ΔV threshold test is active.

During dynamic flight phases, guidance and flight control need the state vector and attitude data often, especially for driving dedicated displays. Unfortunately, the nav software takes a long time (3.84 seconds) to compute a state vector. (The time required for a computation is called a "nav cycle.") To supply data more quickly, a software module called User Parameter Processing (UPP) is used to supply state vectors at a higher rate between nav cycles by using a simplified, but less accurate, propagation scheme. UPP updates its vectors with the regular nav-computed vector whenever one becomes available. The data from UPP is then made available to guidance, flight control, and crew displays.

2.3.1 Vector Selection

In Primary Avionics Software System (PASS) OPS 1, 2, 6, and 8, nav propagates one state vector based on data from all three IMUs as determined by the IMU Redundancy Management (RM) scheme. (See the RM Functional Subsystem Software Requirements (FSSR) or the IMU Training Manual for additional information.) In OPS 3, however, a separate state vector is propagated from each IMU. The vector that is used by nav is then created by taking the best components from each. As a result, the OPS 3 state vector, which is probably the most critical, has a lesser chance of being "polluted" by bad sensor data.

2.3.2 State Vector Updates

The flight controllers in the Mission Control Center (MCC) have the capability to monitor the onboard state vector as computed by nav. In addition, they can monitor tracking data from ground-based radar and other external sources. By comparing the two, they can see what sort of errors are accumulating. Errors in the onboard state vector are inherent in the propagation scheme and grow with time, following a fairly predictable pattern. MCC evaluates these errors and may uplink a correction factor called a “delta state update” (if in powered flight) or a new state vector (if in coasting flight) into the system. The crew can perform delta state updates in OPS 1, 3, or 6, using the Horizontal Situation (HORIZ SIT) display (SPEC 50) or new state vector updates in OPS 2 or 8 with the GPC MEMORY display.

2.3.3 BFS – State Vectors

When the Backup Flight System (BFS) is not engaged, it is very important that it keep a current state vector propagating in case it is needed. Unlike the PASS, the BFS uses only one state vector during all mission phases in which it is active (there is no OPS 2 in BFS). A PASS to BFS state vector transfer may be performed to ensure that the BFS state vector is kept up to date on all the various corrections that are applied to the PASS. This transfer capability is available in OPS 1, 3, and 6 via SPEC 50 (HORIZ SIT). It is also possible to uplink a new or delta state vector update directly to the BFS.

2.4 ATTITUDE PROCESSOR

The Attitude Processor (ATT PROC) derives attitude-related data for use by guidance, flight control, and crew displays, as well as by the Attitude Direction Indicator (ADI) as shown at the bottom and on the right side of Figure 2-2). Using data from a software-selected IMU, it computes the vehicle roll, pitch, and yaw attitude in an inertial coordinate system. For Local Vertical, Local Horizontal (LVLH) attitude processing, the vehicle state vector must also be taken into account.

During ascent and entry, when it becomes necessary to compute the attitude more frequently than the IMUs can provide data, Rate Gyro Assembly (RGA) data is used to propagate the attitude between the IMU attitude measurements. This means that the vehicle attitude is updated approximately 12 times per second during ascent and insertion and about 6 times per second on entry, as opposed to only once per second on orbit when the RGAs are turned off.

The other task of the ATT PROC is to process the vehicle roll, pitch, and yaw rates from SRB and orbiter rate gyros. In OPS 2 and 8, these rates are derived in the on-orbit DAP from successive attitude measurements, while in OPS 1 and 3, the rates are derived from RGA measurements. Such information is used by various software modules as well as for driving the ADI rate needles.

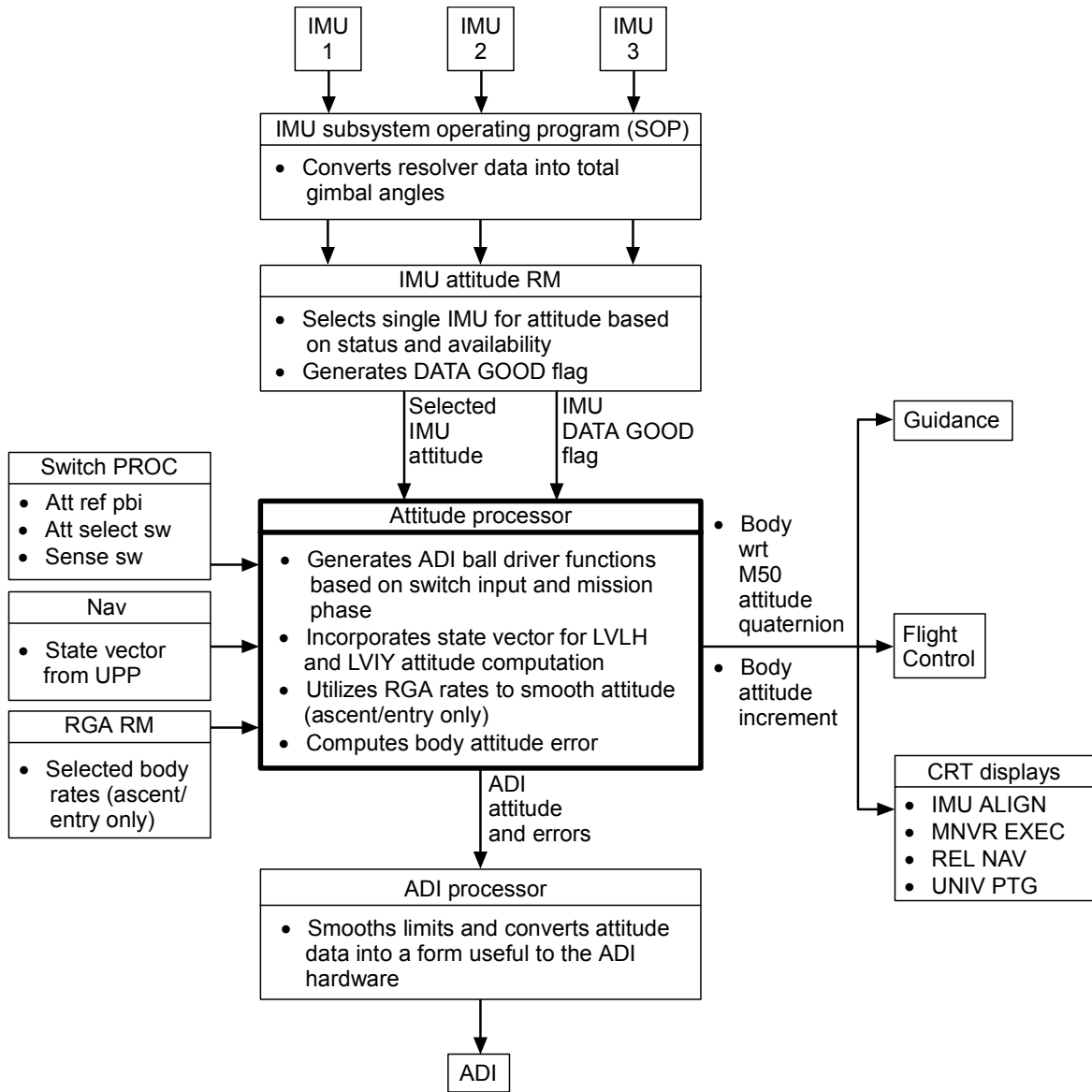

usa006501_004.cnv

Figure 2-2. Functions of the ATT PROC

2.5 QUESTIONS

1. The purpose of nav is (choose one)
 - (a) To maneuver the orbiter to the required position in space
 - (b) To determine where the orbiter must be to satisfy target requests
 - (c) To keep track of where the orbiter is located
2. A state vector is defined as an accurate estimate of the orbiter inertial _____ and _____.
3. The _____ software maintains the orbiter state vector.
4. The _____ compute the orbiter state vector using an algorithm known as _____.
5. When is IMU data not incorporated for use in state vector propagation?
6. What can be done to improve/update the onboard state vector?
7. Which components or software modules receive attitude-related data from the attitude processor?
 - (a) IMU
 - (b) ADI processor
 - (c) Guidance
 - (d) CRT displays
 - (e) Flight control

3.0 PURPOSE OF GUIDANCE

3.1 OBJECTIVES

After completing this section, you should be able to

- a. Describe the differences between Powered Explicit Guidance (PEG) 4 and PEG 7 burns
- b. State when the Transition (TRANS) Digital Autopilot (DAP) is active
- c. State when the Thrust Vector Control (TVC) DAP is active
- d. State the purpose of the phase plane

3.2 GUIDANCE

As previously mentioned, the function of navigation software is to answer the question, "Where am I?" Guidance's purpose is to determine where we want to be and how best to get there. Using the following information, guidance calculates how long and in what direction engines must burn to achieve the desired result.

- a. State vector from nav
- b. Vehicle attitude from ATT PROC
- c. Crew target information inputs to the Maneuver (MNVR) display (covered in detail later in this manual)
- d. Control effector inputs (OMS gimbals and RCS jets for the insertion, orbit, and deorbit flight phases)

Guidance also supplies the attitude error information to flight control, CRT displays, and to the ADI error needles during insertion and deorbit.

Although most burns and attitude maneuvers are "guided" (that is, employ software which utilizes knowledge of where the vehicle is with respect to where the crew wants it to be), there are times when the crew may want to perform simple burns or maneuvers without guidance. During the flight phases of insertion, orbit, and deorbit, such burns can be done only manually with RCS jets, using the Translation Hand Controller (THC) for translations or the Rotation Hand Controller (RHC) for rotations. OMS burns are always guided.

3.2.1 Insertion/Deorbit Guidance

Insertion and deorbit guidance is based on two mutually exclusive schemes. The next few paragraphs cover these two schemes in detail, when they are used, and the how and why of their operation.

3.2.2 PEG 4 vs. PEG 7 Guidance

When the guidance schemes for the shuttle were developed, two basic programs were produced for use on the insertion, orbit, and deorbit flight phases. These are called PEG routines 4 and 7 (other PEG numbers are used in different flight phases).

PEG 4 guidance, also called Linear Terminal Velocity Constraint (LTVC) guidance, achieves a specified relationship between the horizontal and vertical velocity components at a certain position in orbit. This guidance scheme can accept OMS engine failures, once they are recognized as such, and make appropriate compensations so that the original targets of the burn are still met.

PEG 7 guidance (also called external ΔV) is an “open loop” system. This means that there is no target position vs. current position feedback, since guidance is trying to achieve a desired delta velocity in the X, Y, and Z LVLH reference frame. The OMS engines fire until the original delta V requirements are met or the engines are shut down due to failures. As a result, anything but a nominal burn (that is, engine failure, gimbal problems, steering dispersions, and so forth) could lengthen the burn time such that the net effective delta V will have been imparted further downrange than intended, thereby causing the target to be missed.

Since PEG 4 guidance is “closed loop” and relates the orbiter position to the Earth, it is well suited for orbital insertion and deorbit. Once in space, however, the orbiter's relationship to the Earth becomes less critical, while the success of rendezvous operations depends on achieving certain positive or negative velocities with respect to other orbiting objects. Apogee or perigee adjustments can be made simply by adding or subtracting velocity from the current orbital velocities. For these reasons, PEG 7 guidance, an “open loop” scheme, is used on orbit. In fact, PEG 4 is not available in OPS 2.

As will be discussed in Section 3.3.1, Orbit Guidance, Lambert guidance also provides a pseudo “closed loop” solution during the rendezvous phase of flight.

3.3 PEG 4 CALCULATIONS

The following steps show the calculations that guidance goes through to converge on a burn solution. In an effort to keep this clear and simple, the steps have been translated from equations into words. If you wish to see a more rigorous approach to this subject, read Section 4.5.5 of the On-Orbit/Deorbit Guidance FSSR entitled “Powered Explicit Guidance Task (PEG TSK).”

1. The TARGET STATE is calculated based on CRT inputs of altitude (HT), down-range angle (θT), C1, and C2. (Parameter definitions are given in the MNVR display section of this manual.)
2. The CURRENT STATE comes from nav software.

3. The Time of Ignition (TIG) state (or position of the orbiter when the burn begins) is extrapolated from the CURRENT STATE and TIG.
4. To get a starting point, guidance begins with the PREDICTED C/O (Cutoff) STATE equal to the TIG STATE. (This is clearly impossible since it implies that the burn takes no time at all.)
5. The REQUIRED C/O VELOCITY that will satisfy the targets is computed next. The C/O state is not the same as the target state because the vehicle should stop burning some time before the target is reached and coast the rest of the way.
6. $V_{MISS} = \text{REQUIRED C/O VELOCITY} - \text{PREDICTED C/O VELOCITY}$. (These velocities are part of the state vectors calculated in steps 4 and 5.)
7. Velocity to Go (VGO) = $V_{MISS} + VGO$ from the previous cycle. (Initially $VGO = \text{zero}$.)
8. Burn time (TGO) is calculated from VGO using the basic rocket equation.
9. The predicted C/O state is now recomputed based on the addition of the following three vectors:
 - (a) Current state
 - (b) Theoretical burn state
 - (c) Gravity effects
10. Steps 5 through 9 are repeated until MISS is less than 1 percent the value of VGO . At this point, guidance is converged, and the target solution is displayed. If a solution is not reached after six iterations (this should take only a few seconds), the Burn Attitude (BURN ATT), Target Apogee (TGT HA), and Target Perigee (TGT HP) are not displayed, while total change in velocity ($\Delta VTOT$), TGO , and VGO show the last computed value before guidance stopped iterating. If this happens, recheck the targets because something is probably wrong with them.

3.3.1 Orbit Guidance

On-orbit guidance can be divided into three basic types. (Refer to Figure 3-1 for the displays that are used to execute on-orbit guidance.)

First, the MNVR EXEC display in OPS 202 can be used to execute external ΔV (PEG 7) burns just as they are done for insertion or deorbit.

Second, the MNVR EXEC can also be used for executing rendezvous maneuvers, which come in two varieties.

Third, there exists universal pointing software, available in Major Mode (MM) 201 and active until overridden in MM 202 or MM 801. This software provides the capability to set up and execute a wide variety of RCS attitude maneuvers and tracking options.

For on-orbit maneuvers, there is a guidance scheme that is used exclusively for rendezvous and Proximity Operations (PROX OPS). This capability is enabled via the ORBIT TGT display (SPEC 34) but executed on the ORBIT MNVR EXEC display (OPS 202). Once the onboard computations are made, using target state and time information, the result is a PEG 7 target (ΔV_X , ΔV_Y , and ΔV_Z) on the MNVR display. This PEG 7 target can then be executed just as any other PEG 7 burn.

The burn ΔV 's can be derived by two methods. The Lambert method compares the M50 state vector of the orbiter with the M50 state vector of the target and is normally used for rendezvous operations. The Clohessy-Wiltshire (C&W) equations, on the other hand, are considered a simplified version of Lambert targeting. In the C&W scheme, the relative state of the orbiter with respect to a target-centered coordinate system is used to derive the required ΔV 's. Of the two methods, Lambert is the more complex, accurate, and time-consuming method. (It usually takes between 30 seconds and 2 minutes for a solution to be reached.)

Universal pointing guidance uses the UNIV PTG display available only in OPS 201 to set up and initiate automatic RCS maneuvers. With this display, the crew can execute inertial attitude maneuvers, track specified targets with a selected axis of the vehicle, rotate the orbiter in any orientation, and perform automated reboost for the International Space Station. All these options are covered later in this manual.

3.4 FLIGHT CONTROL

The role of flight control is to assimilate maneuver requests from guidance or from crew inputs and convert them into signals which cause the orbiter's gimbals, aerosurfaces, or RCS jets to respond in the manner appropriate to the flight phase conditions (Figure 3-2).

During insertion, on-orbit, and deorbit, the OMS gimbals and RCS jets are the only active "effectors." In addition to sending commands to these effectors, flight control also smoothes the output signals and limits them so that guidance does not issue commands that may exceed structural limitations.

```

1051/ / OMS-2 MNVR EXEC 1 000/00:18:13
OMS BOTH 1* 000/00:19:29
L 2
R 3
RCS SEL 4
5 TV ROLL --0
TRIM LOAD --0
6 P H0.4
7 LY F5.7
8 RY H5.7
9 WT 255000
10 TIG --0/00:32:42.0
TGT PEG 4
14 C1 0.0000
15 C2 [10.0000
16 HT 111.000
17 OT 315.001
18 PRPLT [1.000
TGT PEG 7
19 ΔVX H1.136.0
20 ΔVY FL-0.1
21 ΔVZ FL-4.2
LOAD 22/TIMER 23

BURN ATT
24 R 232
25 P 045
26 Y 008
MNVR 27* AUTO
TTG 03:51
REI
TTA 19:44
GMBL
L R
P +0.4 +0.4
Y -5.8 +5.8

PRI 28* 29*
SEC 30 31
OFF 32 33
GMBL CK 34

ΔVTOT 136.0
TGO 1:28
VGO X - 86.54
Y - 26.05
Z +101.65

HA HP
TGT 120 +105
CUR 120 + 31

35 ABORT TGT 0

FWD RCS
ARM 36
DUMP 37
OFF 38*
SURF DRIVE
ON 39
OFF 40*

ITEM 27 EXEC

```

usa006501_155r1.tif

```

2021/034/ ORBIT TGT 1 003/22: 38: 38
000/00: 01: 00
MNVR TIG ΔVX ΔVY ΔXZ ΔVT
XX X X/XX:XX:XX ±XXX.X ±XX.X ±XX.X ±XXX.X
PRED MATCH XXXXXXXX
CONTROLS
T2 TO T1 25
LOAD 26
COMPUTE T1 27X
COMPUTE T1 28X

INPUTS
1 TGT NO XX
2 T1 TIG X/XX:XX:XX
6 EL [±]XXX.XX
7 ΔX/DNRNG [±]XXX.XX
8 ΔY [±]XXX.XX
9 ΔZ/ΔH [±]XXX.XX
10 ΔX [±]XXX.XX
11 ΔY [±]XXX.XX
12 ΔZ [±]XXX.XX
13 T2 TIG X/XX:XX:XX
17 ΔT [±]XXX.XX
18 ΔX [±]XXX.XX
19 ΔY [±]XXX.XX
20 ΔZ [±]XXX.XX
21 BASE TIME X/XX:XX:XX

ORBITER STATE
XXX/XX:XX:XX
X ±XXXX.XXX
Y ±XXXX.XXX
Z ±XXXX.XXX
VX ±XX.XXXXXX
VY ±XX.XXXXXX
VZ ±XX.XXXXXX
(XX)

```

00650112. CRT; 1

```

2011/ / UNIV PTG XX X 000/HH: MM: SS
CUR MNVR COMPL XX: XX: XX 000/HH: MM: SS
1 START TIME XXX/XX: XX: XX
CUR FUT CUR FUT
MNVR OPTION START MNVR 18 X X RBST 25
5 R XXX.XX TRK 19 X X CNCL 26
6 P XXX.XX ROT 20 X X DURATION 27
7 Y XXX.XX CNCL 21 0: 00: 00.00

TRK/ROT OPTIONS ATT MON
8 TGT ID XXX 22 MON AXIS X XX
ERR TOT 23X
ERR DAP 24X

9 RA XXX.XXX
10 DEC [±]XXX.XXX
11 LAT [±]XXX.XXX
12 LON [±]XXX.XXX
13 ALT [±]XXX.XXX

CUR ROLL PITCH YAW
CUR XXX.XX XXX.XX XXX.XX
REQD XXX.XX XXX.XX XXX.XX
ERR ±XXX.XX ±XXX.XX ±XXX.XX
RATE ±XX.XXX ±XX.XXX ±XX.XXX

14 BODY VECT X
15 P XXX.XX
16 Y XXX.XX
17 OM XXX.XX

(XX)

```

00650107. CRT; 2

Figure 3-1. On-orbit guidance displays

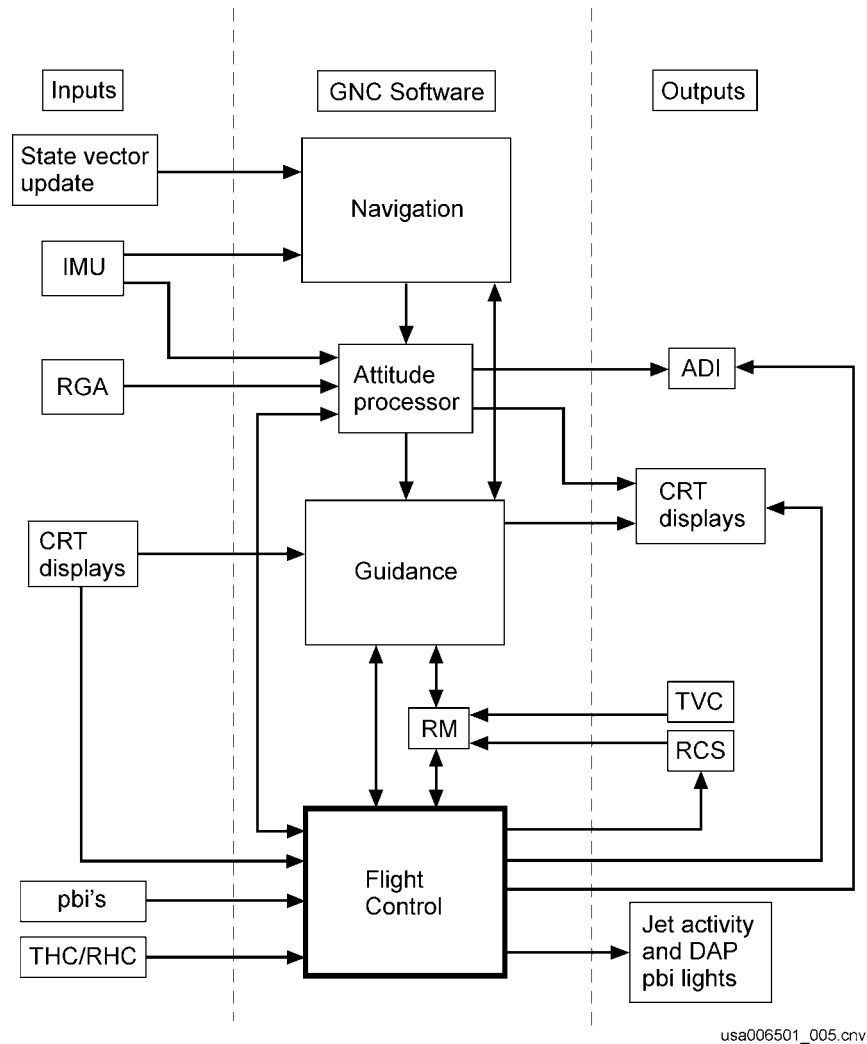

Figure 3-2. Flight control process

The DAP is the heart of the flight control software. It is composed of several software modules which interpret maneuver requests, compare the requests to what the vehicle is actually doing, and generate commands for the appropriate effectors as needed to satisfy the requests. There are different DAPs for different flight phases (five in all) and various modes and submodes of operation within each.

During insertion and deorbit, the TRANS DAP is running. It takes over from the ascent DAP in OPS 103 when the ZERO THRUST flag is set in the software. (The conditions that set this flag can be found in the Sequencing FSSR.) This means that the TRANS DAP is in effect for ET Separation (SEP) and the automatic -Z translation maneuver that follows. The TRANS DAP continues to run through MMs 104, 105, and 106 and resumes again for deorbit (MMs 301, 302, and 303). The ORBIT DAP is active only in MMs 201, 202, and 801. (See Table 3-1.) The other three DAPs (Ascent, Aerojet, and the Glided portion of a Return To Launch Site (GRTLS)) are not used in insertion, on-orbit, or deorbit and are not covered in this manual.

Table 3-1. Active DAPs

MM	Active DAP
102	Ascent
103 (pre-MECO)	Ascent
103 (post-MECO)	Transition
104	Transition
105	Transition
106	Transition
201	Orbit
202	Orbit
801	Orbit
301	Transition
302	Transition
303	Transition
304	Aerojet
305	Aerojet
601	Ascent
602	GRTLS
603	GRTLS

3.4.1 Thrust Vector Control Digital Autopilot

Both TRANS and Orbit DAPs are always in one of two modes, RCS or TVC. These are referred to as the RCS mode or RCS DAP and the TVC mode or TVC DAP. Usually, they are in the RCS mode, which means that the only effectors in use are the RCS jets. For the DAP to be in the TVC mode, the following conditions must be met:

- a. An ON command is being sent to one or both of the OMS engines.
- b. In Orbit DAP only, the IMU DATA GOOD flag must be set to ON (good). That is, there is at least one good IMU from which attitude data can be derived.

The following conditions are necessary for an engine ON command to be generated:

- a. The engines (L, R, or both) must be selected on the MNVR EXEC display in OPS 104, 105, 202, or 302.
- b. The Execute (EXEC) key must be pressed after the word EXEC flashes on the MNVR display.
- c. The designated TIG must have been reached.

When these conditions are satisfied, the burn commences and the TVC mode is in effect until cutoff occurs; the OMS ENG switches are turned off; the IMU DATA GOOD flag is set “bad”; or the crew transitions to the next major mode.

The TVC DAP is a “rate command system.” Every second, guidance calculates a desired direction for delta V needed to achieve the target condition. The IMUs measure the delta V sensed since the last guidance cycle. The cross product of these two vectors, multiplied by a constant (K), is the angular rotation rate vector for turning delta V achieved into delta V desired. Another way to put this, the commanded turning rate is proportional to the sine of the angle between the two vectors – achieved and desired delta V (Figure 3-3).

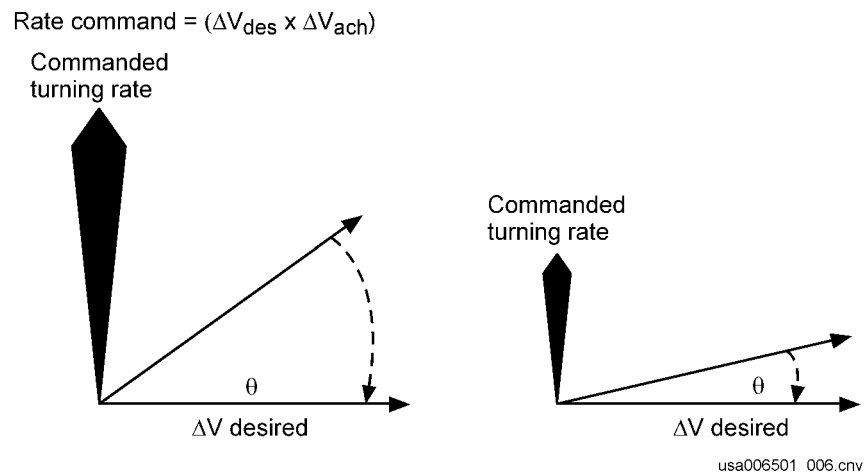

Figure 3-3. Commanded turning rate

When delta V desired and delta V achieved are in the same direction, the sine of the angle between them is zero and the commanded turning rate is zero. To produce a turning rate of zero, the gimbals must be pointed to provide a net thrust through the c.g.

When the TVC mode is active, RCS jets may be required to perform in either of two ways. First, if only one engine is being used, vehicle roll cannot be controlled by any combination of gimbal pitch and yaw. RCS jets are utilized, therefore, to control any roll commands that are generated. Second, whether there are two engines selected or only one, RCS jets may perform a “wraparound” function. This means that if the control authority of the gimbals is not adequate to keep the rate or attitude deadbands within the specified TVC limits, RCS jets fire as needed to correct the errors. This might occur if there was degradation in the OMS gimbal that prevents it from slewing properly or if the vehicle is significantly out of burn attitude for a PEG 4 burn when the OMS engines begin to fire.

3.4.2 Reaction Control System Digital Autopilot

The RCS DAP works to hold attitude or to accomplish an attitude maneuver through an error correction method. Figure 3-4 shows how it accomplishes the task of generating appropriate signals to send to the effectors.

The state estimator takes IMU data from the ATT PROC, filters it, and sends it to a module called RCS Errors.

In the RCS Errors module, attitude commands coming from the RHC or from the Universal Pointing software (which runs the display by the same name) are compared with the actual attitude as computed by the state estimator. The result is an attitude error and a rate error that are passed to the phase plane module.

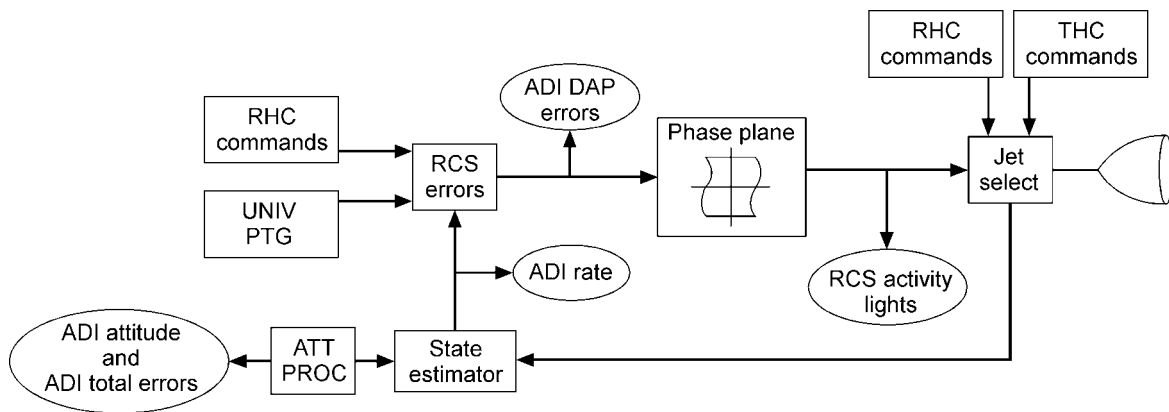

usa006501_007.cnv

Figure 3-4. RCS orbit DAP

A phase plane may be visualized as a graph plotting shuttle rate errors against attitude errors for one axis, with a “box” drawn around the center (Figure 3-5). There is a separate phase plane for each of the vehicle rotation axes (roll, pitch, and yaw). The box (the sides are actually parabolic) is used to determine when, if, and in what direction rates must be generated to null the errors.

Limits are defined by the crew with attitude and rate deadbands. If the shuttle is within the specified deadband limits, the rate and attitude errors are represented by a point plotted inside the box. If the point travels outside the box, jets fire to drive it back inside the box, thereby reducing the errors and achieving the maneuver request. In an attitude hold situation, the error plot actually cycles around the zero error point with jets turning off and on again each time the limits of the box are exceeded. This is known as “limit cycling.” The rate of limit cycling is dependent on the deadband size and the jet selection specified by the crew.

The manual acceleration and PULSE DAP modes, the so-called “free drift” modes, as well as the translation submodes, bypass RCS errors and phase plane and go to the jet select module. The bypass results because the free drift modes are not closed loop

and cannot be used for attitude holds. With one of these modes selected, jets are fired only when directly commanded by a crew hand controller input (THC or RHC).

The next part of the DAP is the jet select module. The phase plane generates positive or negative rate commands on an axis-by-axis basis and jet select determines which jet(s) to fire (Figure 3-5). The rate commands also are generated from crew hand controller inputs (THC or RHC). Jet select then commands the selected jet(s) to fire and informs the state estimator of the jet fire commands so that the RCS errors may be generated again.

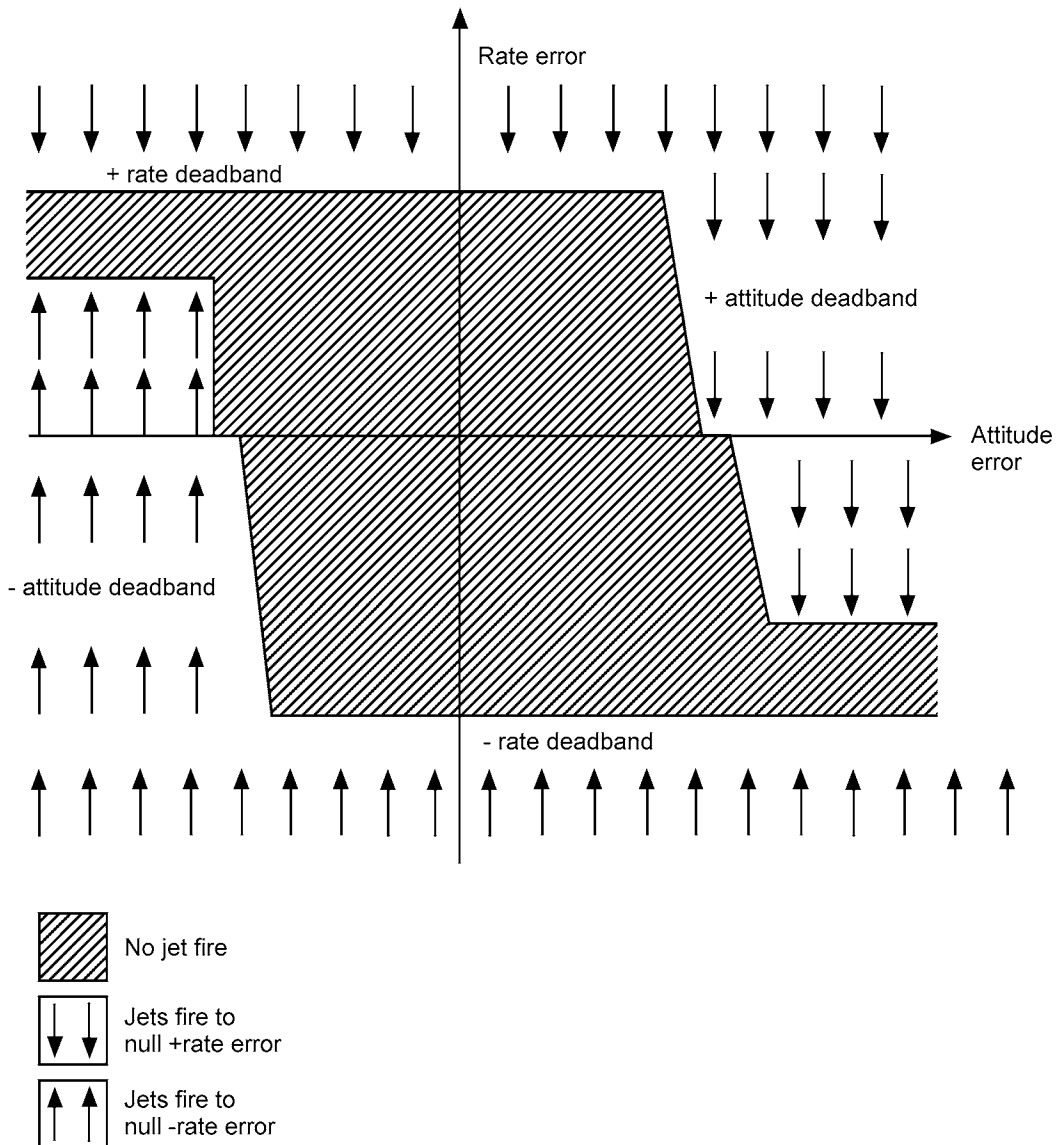

usa006501_008.cnv

Figure 3-5. Phase plane

3.4.3 TVC and RCS DAP Control Modes

Both RCS and TVC DAPs can be operated in several different control modes. Which mode is active depends on the configuration of the DAP Pushbutton Indicators (pbi's), the position of the hand controllers, and, in the case of TVC, how many engines are being used. There are enough variables involved that this subject will be covered in a separate section of this manual.

3.4.4 BFS – DAP

Since BFS does not have an OPS 2, it does not have an Orbit DAP. As a result, VERN jets are not available. BFS is completely manual, so AUTO maneuvers and the LVLH and FREE modes are not supported. (This topic will be covered in the section on DAP pbi's.) By selecting INRTL with all three rotational axes in DISC RATE, BFS can maintain an inertial attitude hold. There are also several differences in the way that jet RM works in the BFS. (The RCS training manual contains more on this subject.)

This page intentionally left blank.

3.5 QUESTIONS

1. Briefly describe the differences between PEG 4 and PEG 7 burns.
2. When is the TRANS DAP active?
3. Under what circumstances is the TVC DAP mode active?
4. What is the purpose of the phase plane?

4.0 DISPLAYS AND CONTROLS

4.1 OBJECTIVES

After completing this section, you should be able to

- Identify PEG 4 target parameters
- Identify items computed by guidance
- Identify burn attitude and maneuver parameters
- Identify burn data

4.2 MANEUVER EXECUTE DISPLAY

This section identifies the uses of the Maneuver Execute (MNVR EXEC) display (Figure 4-1).

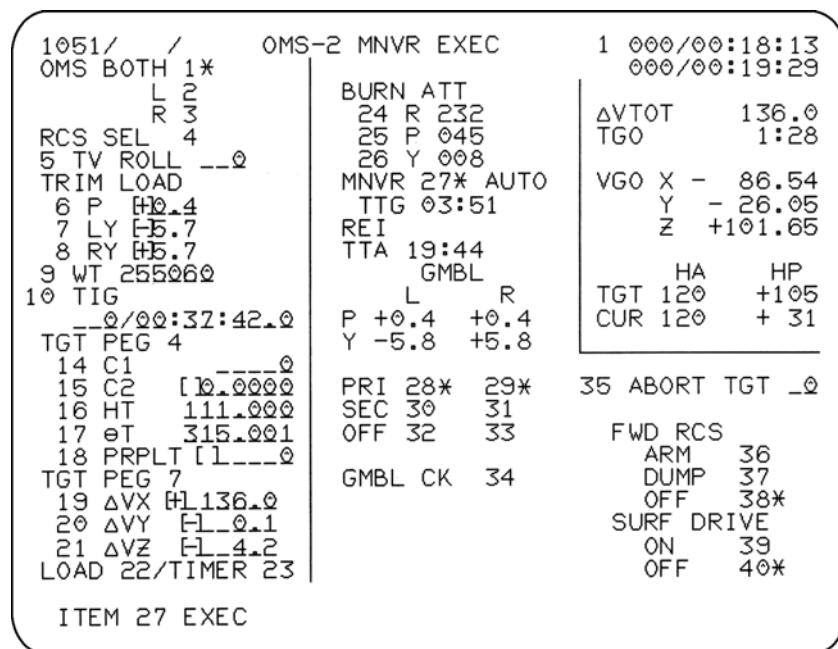

Figure 4-1. MNVR EXEC display

Availability: Guidance, Navigation, and Control (GNC) MMs 104, 105, 106, 202, 301, 302, and 303

Purpose: To provide a means by which OMS and RCS translation and (sometimes) attitude maneuvers can be set up, executed, and monitored

Uses: OMS 1, OMS 2, on-orbit, and deorbit burns

The title of the display changes depending on the MM for which it is being used.

MM	Title
104	OMS 1 MNVR EXEC
105	OMS 2 MNVR EXEC
106	OMS 2 MNVR COAST
202	ORBIT MNVR EXEC
301	DEORB MNVR COAST
302	DEORB MNVR EXEC
303	DEORB MNVR COAST

If an Abort To Orbit (ATO) or an Abort Once Around (AOA) has been declared via either the abort select rotary switch and pushbutton or through an abort target item entry, the following display titles appear:

MM	Title
104	ATO 1 MNVR EXEC
104	AOA 1 MNVR EXEC
105	ATO 2 MNVR EXEC
105	AOA MNVR TRANS
106	ATO 2 MNVR COAST

Notice that the display titles end in either EXEC, COAST, or TRANS. While any of these displays can be used to load burn targets, only the EXEC displays can be used to actually perform a burn.

Aside from the titles, all these displays look exactly the same. There are some subtle differences, however, in the way they behave.

4.2.1 Engine Configuration (Items 1 to 4)

The four mutually exclusive engine configurations to choose from are (1) both OMS, (2) left only, (3) right only, and (4) RCS SEL. Burns using any one of the three OMS engine configurations must be targeted and enabled using this display. RCS burns, on the other hand, can be performed without automatic guidance if the crew so desires. Once an OMS burn is targeted and enabled, the crew has the option to fly it manually using the RHC or to let automatic flight control fly it. On the other hand, RCS burns have no automatic flight control and thus happen only when a crewmember begins commanding with a THC deflection (except for the special case of the auto ET SEP - Z translation maneuver). A +X RCS burn fires four aft-firing jets if done while in TRANS DAP or only two jets while in Orbit DAP.

If an OMS engine fails, a down arrow appears in the display field next to the failed engine. This arrow is driven by a low engine chamber pressure ($P_c < 80$ percent) and a decrease in vehicle acceleration in the PASS. With BFS engaged, the down arrow is driven ONLY by the P_c check. When a comm fault is present, an "M" (for missing data) appears in the display field. Malfunctions are considered in greater depth later in this manual.

Note that if one or both engines should fail during the burn, and downmoding to a single engine or RCS is necessary, do not select a different engine, because you will have to reload the targets and re-execute the burn. By turning off the appropriate OMS ENG switch, guidance is informed of the engine failure and downmodes to a single-engine configuration.

4.2.2 TV Roll (Item 5)

The only two numbers that are needed to specify the relative orientation of the thrust vector are pitch and yaw. Viewed another way, the vehicle could roll about the body thrust direction (not the body roll axis) without affecting the burn. When an initial calculation of the burn attitude is made prior to an OMS burn, a roll orientation must be specified. This is the purpose of Item 5, TV (Thrust Vector) ROLL. Once this has been done, the pitch and yaw of the initial burn attitude can be determined. TV ROLL is defined such that a value of 0° means heads up (or away from the Earth). Both insertion and deorbit burns are performed using a value of 180° (heads down). A heads down orientation allows the crew to use the earth as a visual reference.

Changes to Item 5 are legal only in OPS 2; therefore, it must be set up as desired for deorbit before leaving OPS 2, since the last value is carried across the OPS transition.

Limits: 0° to 359°

4.2.3 Trim Load (Items 6 to 8)

The trim load tells the DAP and guidance what the initial position of the OMS gimbals should be at TIG. Guidance uses trim data to calculate the burn attitude. The item entries are broken up into Pitch (P) for both engines, Right Yaw (RY) and Left Yaw (LY). The two commonly used two-engine burn configurations are "parallel" or "through the c.g." (Figure 4-2).

- To burn with the engine thrust vectors parallel to each other, the trim values to enter are: $P = +0.4^\circ$, $RY = +5.7^\circ$, and $LY = -5.7^\circ$.
- To point the engine thrust vectors through the c.g., the trim values are approximately: $P = +0.4^\circ$, $RY = -5.2^\circ$, $LY = +5.2^\circ$ (note the sign reversal).
- For example, for a right-engine-only burn, the values are $P = +0.4^\circ$ and $RY = -5.2^\circ$. Since the left engine is not being used, its trim value does not matter.

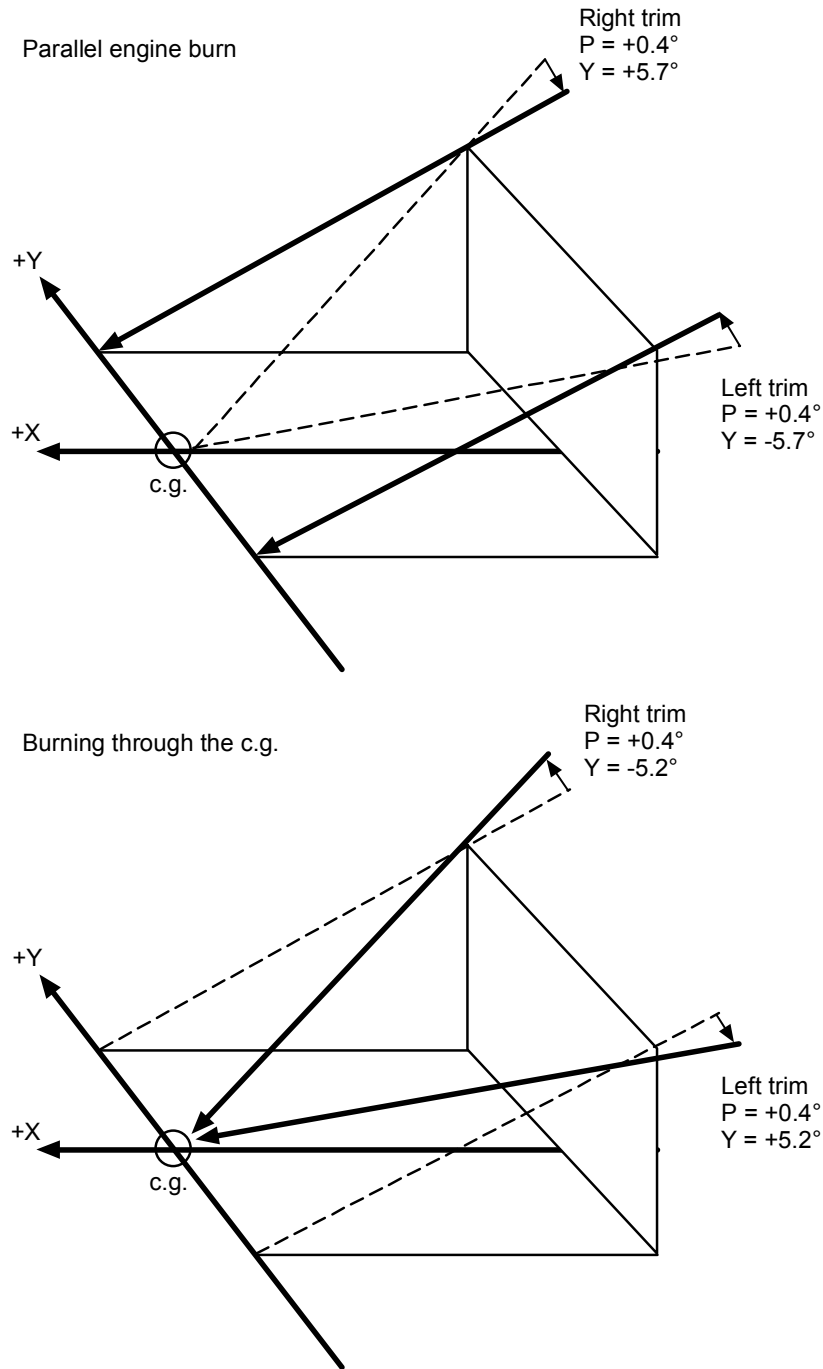

usa006501_009.cnv

Figure 4-2. Parallel engine burn and burning through the c.g.

The Flight Data File (FDF) or MCC supplies the exact trim values to use. If trim values for a PEG 4 burn are off a little, the burn is only less efficient. This is because PEG 4 burns correct for transients caused by initial gimbal mistrim. (The DAP commands the gimbals as necessary to put the net thrust vector through the vehicle c.g.) For PEG 7 burns, however, mistrim can result in a target miss since the DAP only burns out

the ΔV 's. In general, for both PEG 4 and PEG 7 burns, the shorter the burn, the more critical it is that the trim values be correct.

When this display is first called up, the values of trim read whatever the gimbal position was at the end of the last burn. After a new value is entered, the gimbals do not move to the new position until guidance becomes active, which is 15 seconds before the burn begins. If the difference between the gimbal trim values and actual position is less than 0.4° , the gimbals are not repositioned at TIG -15 seconds.

Limits: -9.9° to $+9.9^\circ$

4.2.4 Weight (Item 9)

This item entry tells the DAP what the vehicle weight is at the beginning of the burn. As the burn progresses, guidance computes how much propellant is being used and updates the display accordingly. Each time the display is called up, the weight is the value computed at the end of the previous burn.

Limits: 100,000 to 999,999 pounds

4.2.5 TIG (Items 10 to 13)

The TIG is displayed in days:hours:minutes:seconds Mission Elapsed Time (MET) with Item 10 referring to the days, 11 to the hours, 12 to the minutes, and 13 to the seconds. The TIG entered for the burn is constrained to be within 5 minutes in the past or 12 hours in the future.

Limits: 0 to 365 days, 0 to 23 hrs

0 to 59 min., 0 to 59.9 sec

4.2.6 PEG 4 Targets (Items 14 to 18)

As previously mentioned, PEG 4 is a closed loop guidance scheme which targets for a specified set of horizontal and vertical velocity components at a certain point in the vehicle's orbit. This scheme is the one nominally used for both the insertion and deorbit burns but is not available for use in OPS 2. A breakdown of the individual target parameters follows.

4.2.6.1 C_1 and C_2

These two parameters establish the relationship between the horizontal and vertical velocities by acting as coefficients in the equation:

$$V_{\text{vert}} = C_2 \cdot V_{\text{horiz}} + C_1$$

(Note the $Y = mX + b$ format, which is the equation of a straight line.)

This is a straight line relating horizontal and vertical velocities. In this case, C_2 is the slope of the line, while C_1 is the Y-intercept as shown in Figure 4-3.

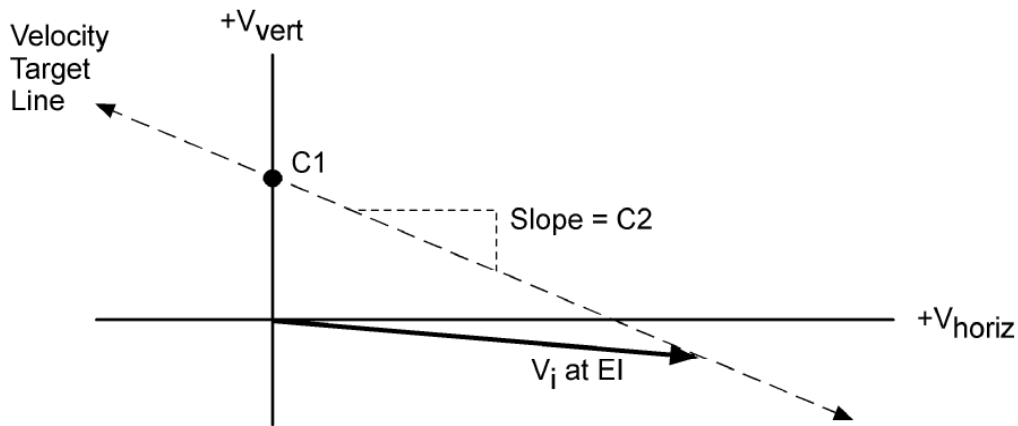

usa006501_010.cnv

Note: V_i at EI has a large V_{horiz} component and a slightly negative V_{vert} component

Figure 4-3. The relationship between C_1 , C_2 , V_{vert} , and V_{horiz} shown with a typical velocity vector at EI resulting from a deorbit burn

For the OMS 1 or OMS 2 burn, the target point is always an apogee or perigee point, which implies that the vertical velocity is zero. C_1 and C_2 should therefore be zero. For a deorbit burn, the vertical velocity must be a negative number at EI, which is the target point. As it turns out, for deorbit maneuvers, C_1 would be a large positive number, and C_2 would be a dimensionless number between 0 and -1. For example, a typical deorbit from a 150 n. mi. orbit might have $C_1 = 15,434$ and $C_2 = -0.6200$.

Figure 4-4 illustrates sample targets from STS-30.

Limits: $C_1 = 0$ to 99999 ft/sec

$C_2 = -9.9999$ to $+9.9999$

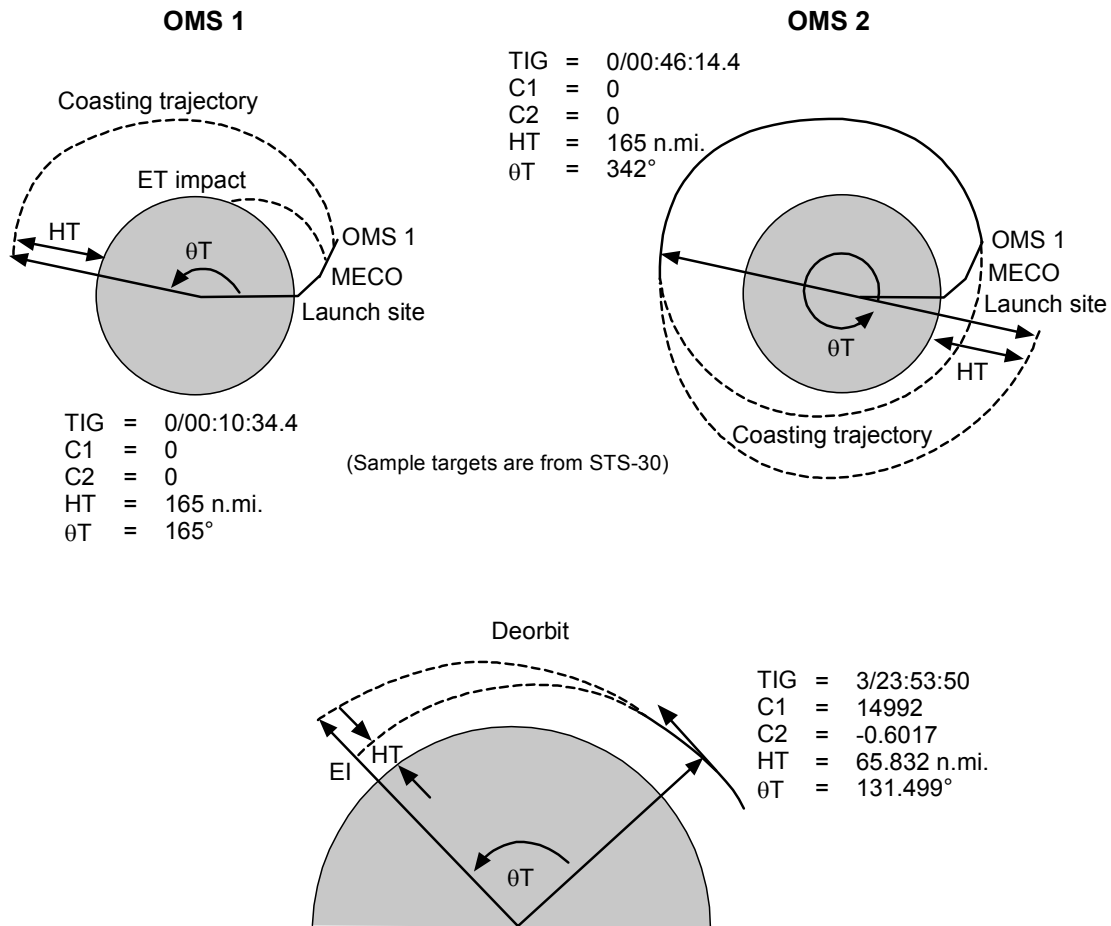

usa006501_011.cnv

Figure 4-4. PEG 4 target parameters

4.2.6.2 HT

This parameter specifies the Height of the Target Point (HT) above the surface of the Earth in nautical miles. The value of HT varies widely from flight to flight depending on mission objectives. To establish a circular 150 n. mi. orbit, for instance, HT would equal 150 for both the OMS 1 and OMS 2 targets. For deorbit maneuvers, this target point would be EI, which is at an altitude of 400,000 feet or HT = 65.8 n. mi.

Limits: 0 to 999.999 n. mi.

4.2.6.3 θT

Theta T (θT) has different definitions in OPS 1 and OPS 3. In OPS 1, θT is the angle from the launch site to the target point. See Figure 4-4 for clarification. By way of example, for STS-30, the OMS-1 θT was 165° for an HT of 165 n. mi. This becomes the orbit apogee. To raise perigee to circularize the orbit, the OMS 2 burn must be performed about 180° around the Earth from where OMS 1 was done. Since θT is still measured from the launch pad, for OMS 2, one would expect the value to be approximately $165^\circ + 180^\circ$, or 345° . The actual OMS-2 θT was 342° for STS-30.

In OPS 3, θT is defined as the angle from TIG to EI. It is roughly correlated with the orbital altitude before the burn: the higher the orbit, the greater the θT angle. For example, on STS-50, when HA was 156 n. mi., the deorbit θT had a value of 128° .

Limits: 0° to 540°

4.2.6.4 PRPLT

Item 18 works only in OPS 3. It specifies the minimum amount of OMS Propellant (PRPLT) in pounds mass to be expended during an OMS burn.

In some deorbit burns, it is desirable to burn excess propellant for c.g. control and weight reduction. In this case, the orbiter executes the burn in an attitude that directs some of the thrust in an out-of-plane direction. Such an action consumes propellant while having almost no effect on the trajectory. When the absolute value of PRPLT is less than or equal to the amount required to complete the burn, the most efficient solution is calculated and the actual value entered for PRPLT is essentially ignored.

The PRPLT quantity can be entered as a positive or negative number or zero, which determines whether the out-of-plane component is toward the positive (north) or negative (south) angular momentum vector. If a zero is entered, there is no out-of-plane component and thus no propellant wasting. This item is unique in that it can be executed at any time without necessitating a reload (during the burn, only a zero can be entered on the display).

Limits: -99,999 to +99,999 pounds

4.2.7 PEG 7 Targets (Items 19 to 21)

A PEG 7 burn attempts to achieve a specified change in velocity with respect to the LVLH reference frame at TIG. When an item entry to a PEG 7 target is made, any values in PEG 4 are blanked and vice versa (Figure 4-5).

To target for such a burn, enter a delta V in each of the three LVLH axes: X, Y, and Z. Guidance computes an appropriate burn attitude that satisfies the request. In the LVLH reference frame, +X is approximately along the velocity vector (in the same direction the orbiter is traveling), +Y is out of plane toward the negative angular momentum vector (or southern pole of the orbit), and +Z is radially inward toward the Earth. The origin of the LVLH frame is at the vehicle's center of mass.

Whenever Lambert targeting is used for rendezvous burns, the word LAMBERT appears in the normally blank field to the right of the PEG 7 target data. If C&W equations are used for orbit targeting, that same field reads EXT ΔV . EXT ΔV also appears anytime MCC uplinks, or the crew enters, an external delta V target set into the display.

Limits: X = -9999.9 to +9999.9 ft/sec

Y and Z = -999.9 to +999.9 ft/sec

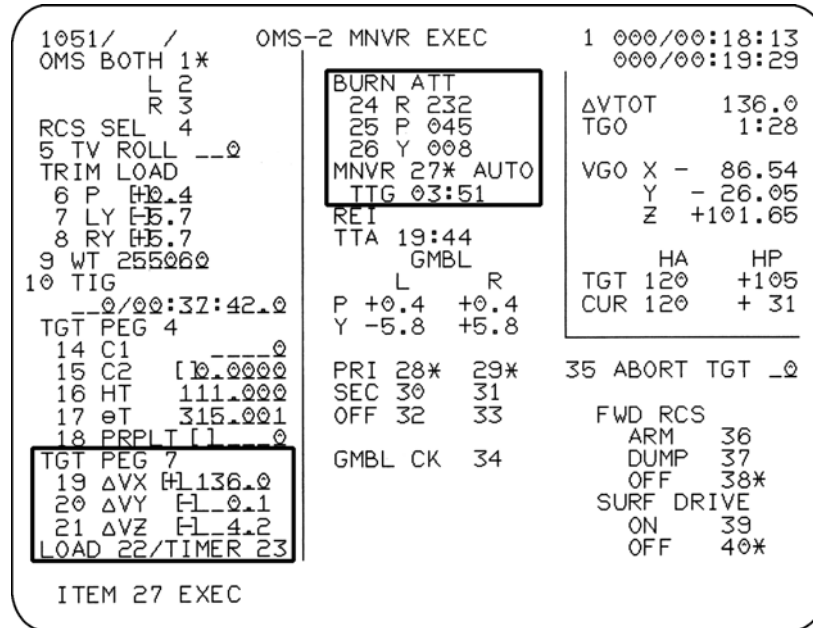

Figure 4-5. TGT PEG 7 field

4.2.8 Load (Item 22)

Once Items 14 to 17 or 19 to 21 have been set up and checked to the satisfaction of the crew, Item 22 should be executed to load the data so that guidance may initiate its calculations. When a MNVR display is first called up or an Item 1 through 21 is changed (except PRPLT), LOAD begins to flash, indicating that Item 22 must be executed to inform guidance of the update. The only exception to this occurs in MM 104, where the LOAD is performed automatically for the crew since the workload is very heavy prior to the OMS 1 burn.

Note: Any time the word LOAD is capitalized in this manual, reference is being made to Item 22 EXEC.

4.2.9 Timer (Item 23)

Item 23 starts a timer under MET in the upper right-hand corner of the display that counts down to the burn. Any attempt to start the timer before the targets are loaded results in an ILLEGAL ENTRY message. The timer is started automatically in MM 104.

4.2.10 Burn Attitude and Maneuver (Items 24 to 27)

Whenever a target set is LOAded, guidance computes and displays a burn attitude in Inertial roll, pitch, and yaw coordinates. The crew must maneuver to the attitude either manually or automatically and ensure that the orbiter is pointed the right direction at burn ignition.

Note: If the burn attitude computed by guidance is near a singularity of yaw = 90 or 270, the display will blank the roll and pitch under items 24 and 25.

To perform an auto maneuver, execute Item 27 (MNVR) with the DAP control mode in AUTO. An asterisk appears and the maneuver begins. When the attitude is reached, the asterisk disappears if you are in Orbit DAP but remains if in TRANS DAP; therefore, the attitude should be checked by reading the ADI. The crew also has the option to maneuver to burn attitude manually. In TRANS DAP, the ADI error needles are referenced to the burn attitude as soon as the targets are loaded, regardless of whether or not an Item 27 was performed. In Orbit DAP, for an OPS 202 burn attitude maneuver, however, an Item 27 must be executed to make use of the ADI error needles.

In TRANS DAP, when there is a maneuver to burn attitude in progress or the burn attitude is being held, there is an asterisk next to Item 27. If a new target set or different trim values are loaded, then the burn attitude changes, the current vehicle attitude is held inertially, and the asterisk goes away. The crew must then reexecute Item 27 to maneuver to and hold the new burn attitude. If in orbit DAP and manual mode, when Item 27 is executed, the error needles register the proper errors for flying manually to the burn attitude. If AUTO is selected subsequent to this, however, the automatic maneuver begins without a re-execution of the Item 27, as you would have to do in TRANS DAP.

To the right of the MNVR 27 field is displayed the current DAP status. This field will show either AUTO, INRTL, LVLH, or FREE based on the current DAP setting. If an ITEM 27 is executed without being in AUTO, this DAP status field will be displayed as overbright. This serves as a reminder to the crew that the maneuver will not begin automatically unless the DAP is put in AUTO. Once back in AUTO, in OPS 2 the previous ITEM 27 will then take effect. In OPS 1 & 3, an additional ITEM 27 is required to initiate the maneuver.

Below the MNVR 27, the time to go to complete the maneuver is displayed in minutes and seconds. This is shown as "TTG mm:ss" and is displayed whenever a maneuver is in progress, otherwise it is blank. The time to go field will also blank once the maneuver is complete. If the maneuver cannot be completed by TIG-30 seconds, the TTG is displayed as overbright. This serves to prompt the crew to consider either delaying TIG or speeding up the maneuver, for example by flying manually or selecting a faster DAP rotational rate.

Note that these DAP status and TTG features are available in PASS only.

In either Orbit or TRANS DAP, if Item 27 is not executed at any time prior to TIG and the control mode is in AUTO, the steering from guidance begins as soon as ignition occurs. Since this happens concurrently with OMS ignition, there is much OMS thrust and RCS propellant wasted until the correct attitude is reached. If an Item 27 is executed before guidance computes a solution (in other words, when the burn attitude is blank), the orbiter maneuvers to a default M50 attitude of roll = 0°, pitch = 0°, yaw = 0°.

In OPS 3 only, the guidance-computed burn attitude may be overridden at any time by entering the desired roll, pitch, and yaw for Items 24 to 26. To regain the burn attitude, a LOAD must be performed again. Attempting to enter data into the burn attitude items in OPS 1 or 2 results in an ILLEGAL ENTRY message.

Limits: R and P = 0° to 359°

Y = 0° to 90° and 270° to 359°

4.2.11 REI

The field to the right of the Range from Entry Interface (REI) shows orbiter range from EI (400,000 feet) to the chosen landing site in nautical miles (Figure 4-6). This only works in OPS 3 and does not appear until the burn targets are loaded.

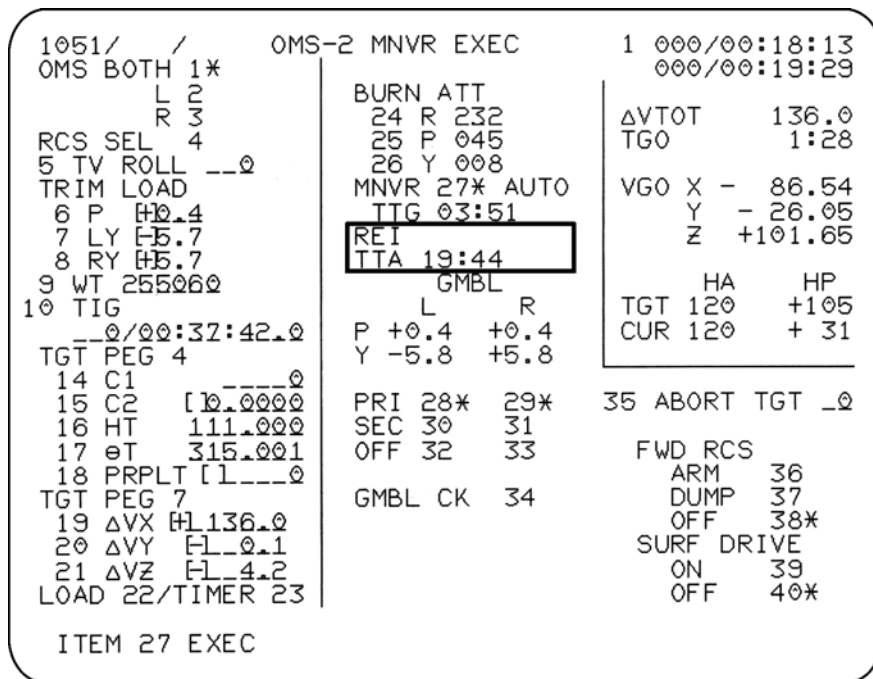

Figure 4-6. REI and TXX fields

4.2.12 TTA/TTP/TTC/TFF

This display field (see Figure 4-6) can show four different times, depending on the mission phase and where the vehicle is in orbit:

- a. Time To Apogee (TTA) OPS 1 and 2
- b. Time To Perigee (TTP) OPS 1 and 2
- c. Time To Circularize (TTC) OPS 1 and 2
- d. Time To Free Fall (TFF)* OPS 3

*This is more commonly known as Time to EI.

In OPS 1 and 2, if the vehicle is in a circular orbit (i.e., the difference between apogee and perigee is less than 5 n. mi.), TTC is displayed and the time field is blanked. Otherwise, the time of the closer of TTA or TTP can be read.

4.2.13 OMS Gimbal Selection (Items 28 to 33)

One pitch and one yaw actuator are used to control the gimbals on each engine. The crew has the option to drive these actuators with either the primary or secondary motor systems, but both pitch and yaw actuators must be driven by the same system. In other words, you cannot have the pitch actuator driven by the primary motor while the yaw is being driven by the secondary.

Items 32 and 33 (OFF) disable both drive systems, but they are usually left in either primary or secondary, even if only one engine is being used for the burn. The three choices (PRI, SEC, and OFF) are mutually exclusive.

Just above the gimbal select portion of the display is a readout that gives the current gimbal position angles in degrees as detected by either the primary or secondary actuator position sensors (whichever system is selected).

4.2.14 Gimbal Check (Item 34)

This item initiates an automatic gimbal drive check for whichever motor system is selected. This check simply sends commands to the actuators (just as flight control would during the burn) and causes them to move up and down (pitch) and side to side (yaw) to their software limited positions. These positions are (\pm) 5.89° in pitch and (\pm) 6.44° in yaw.

Usually, procedures have the crew select secondary gimbals for both sides, perform the drive check, select the primary gimbals, and repeat the check. The reason secondaries are done first is so that, barring any failures, the primary gimbals are selected for use in the burn after the last part of the check. After a gimbal check is run, the engines return to the position they had previous to the start of the check. Note that the GMBL CK item

entry is not locked out during the burn. If one is executed while a burn is in progress, control problems could ensue.

TVC fault detection checks to see whether the gimbal position commanded is within 2° of the position transducer. If they are off by 2° for 3.84 seconds, the gimbal is declared failed and a down arrow (\downarrow) appears next to the position readout. A gimbal moving at a rate below hardware specifications will be declared failed with a gimbal check. When there is a comm fault that prevents the position sensor feedback from returning to the GPCs, the actuator position data is replaced by an M (for missing data) and TVC fault detection is terminated for that system.

4.2.15 Flashing EXEC

Directly under the countdown timer is a four-character dynamic field that flashes EXEC starting at 15 seconds before TIG for the loaded burn. The crew must then press the EXEC button on the keyboard to enable the OMS burn ignition. EXEC on the display then disappears and the burn begins on time.

If EXEC is pressed after the scheduled TIG, the burn begins immediately. Remember that burns can be performed only in the MNVR EXEC MMs (104, 105, 202, and 302). If a transition to a non-EXEC mode is made while the burn is enabled or in progress, the burn is canceled or terminated.

4.2.16 Burn Data

The upper right section of the display contains information useful to monitoring the progress of a burn (Figure 4-7). When a target set is loaded, guidance computes and then displays $\Delta VTOT$, TGO, VGO X, VGO Y, VGO Z, TGT HA, and TGT HP. Current Height of Apogee (HA) and Height of Perigee (HP) are displayed at all times. When PEG 4 targets are LOADED in OPS 1 or 3, the equivalent PEG 7 targets (LVLH ΔVX , ΔVY , and ΔVZ) will also be computed and displayed under items 19, 20, and 21.

- a. $\Delta VTOT$ - The total change in velocity needed to satisfy the target requirements, given in feet per second.
- b. TGO - The expected remaining burn time in minutes:seconds and counts down as the burn progresses. If TGO starts counting up or counting down more slowly than real time, the orbiter is getting farther from the specified targets because it is out of the proper attitude or there is a problem with the engines or gimbals.
- c. VGO X, VGO Y, VGO Z - The X, Y, Z components of $\Delta VTOT$ which are listed in feet per second in the body axis coordinate system (+X is out the nose, +Y is in the direction of the right wing, and +Z is down toward the bottom of the orbiter).
- d. TGT HA, HP - Displayed in nautical miles above the surface of a spherical Earth, target apogee and perigee give orbital parameters predicted for the end of the burn.

4.2.17 Abort TGT (Item 35)

Item 35 permits entry of a pre-mission Initial-Loaded (I-Loaded) PEG 4 target set for OMS 1 or OMS 2 with a single keystroke. It is used primarily for calling up ATO and AOA targets (Figure 4-7).

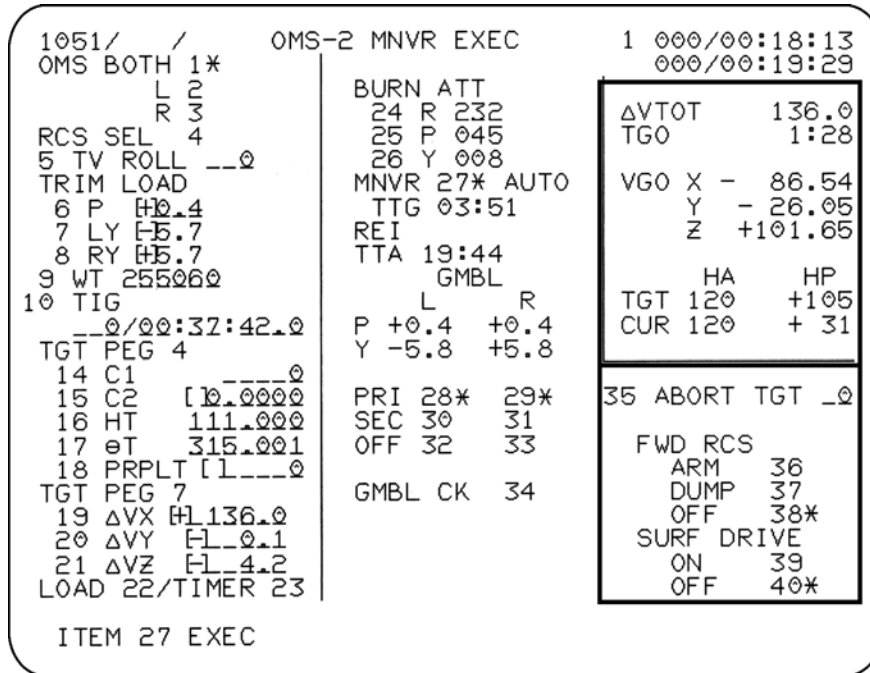

Figure 4-7. Item 35

4.2.18 Forward RCS Dump (Items 36 to 38)

With these display items, the crew can execute and terminate a dump of forward RCS propellant through four simultaneously fired jets. Both the ARM and DUMP items must be executed to initiate the dump, which is generally used to shift the X c.g. further aft for entry. This option is available only in OPS 3, and any major mode transitions cause the dump to stop.

4.2.19 Surface Drive (Items 39 and 40)

Execution of the surface drive test initiates simultaneous motion of all aerosurfaces to thermally condition the hydraulic fluids. This option is available only in OPS 3.

4.2.20 BFS – MNVR EXEC

This display is available in BFS MMs 104 to 106 and 301 to 303. It works just like the PASS display with the following exceptions:

- a. BFS continues to update TFF and REI in MM 303, while in PASS the values become static at this point.
- b. BFS freezes the comm-faulted (M) data; PASS blanks it.
- c. BFS does not support the AUTO MNVR (Item 27).
- d. GMBL CK (Item 34) is illegal before engaging the BFS but legal afterward. If Item 34 is inadvertently performed on the BFS display pre-engage, then the check begins as soon as BFS is engaged.
- e. TV ROLL (Item 5) is not supported by BFS, but the I-Loaded or uplinked value of the ROLL ANGLE is displayed in OPS 1 and 3.
- f. BFS monitors only engine Pc to determine whether an engine has failed. PASS uses engine Pc and vehicle acceleration to detect engine failures.
- g. BFS does not display a down arrow (↓) on the MNVR display when the OMS ENG switch is placed OFF during the burn. PASS displays a (↓) and fault message. BFS does not annunciate OMS failures pre-engage.
- h. The BFS OMS TRIM values change as the attitude changes. PASS values remain constant until the end of the burn.

This page intentionally left blank.

4.3 QUESTIONS

- Match the following PEG 4 target parameters for an OMS 1 burn with the appropriate labels:

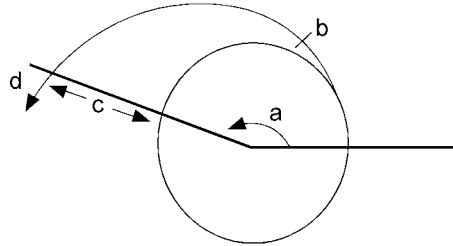

- _____ HT
- _____ θ T
- _____ TIG
- _____ C1/C2

usa006501_012.cnv

- On the figure below, circle the items computed by guidance which appear when a PEG 4 target set is LOADED in OPS 302.
- What is the purpose of the TRIM LOAD item entries?
- True or False. When any item on the left-hand portion of the MNVR EXEC display is altered, a reload is required for guidance to compute a new burn solution.
- What would you expect to see happen when an "Item 34 EXEC" is performed?

```

1051/ / OMS-2 MNVR EXEC 1 000/00:18:13
OMS BOTH 1* 000/00:19:29
  L 2
  R 3
RCS SEL 4
5 TV ROLL --0
TRIM LOAD
 6 P H10.4
 7 LY F5.7
 8 RY H5.7
 9 WT 255000
10 TIG
  --0/00:32:42.0
TGT PEG 4
 14 C1 -----0
 15 C2 [10.0000
 16 HT 111.000
 17  $\theta$ T 315.001
 18 PRPLT [1----0
TGT PEG 7
 19  $\Delta$ VX H1136.0
 20  $\Delta$ VY F1-0.1
 21  $\Delta$ VZ F1-4.2
LOAD 22/TIMER 23

BURN ATT
 24 R 232
 25 P 045
 26 Y 008
MNVR 27* AUTO
TTG 03:51
REI
TTA 19:44
  GMBL
  L R
P +0.4 +0.4
Y -5.8 +5.8

PRI 28* 29*
SEC 30 31
OFF 32 33

GMBL CK 34

35 ABORT TGT _0

 $\Delta$ VTOT 136.0
TGO 1:28
VGO X - 86.54
Y - 26.05
Z +101.65

HA HP
TGT 120 +105
CUR 120 + 31

FWD RCS
ARM 36
DUMP 37
OFF 38*
SURF DRIVE
ON 39
OFF 40*

ITEM 27 EXEC

```

usa006501_155r1.tif

5.0 UNIVERSAL POINTING DISPLAY

5.1 OBJECTIVES

After completing this section, you should be able to

- a. State the four maneuver options
- b. Identify pitch and yaw angles of a body vector
- c. State the keystrokes required to
 1. Change from three to two-axis tracking when performing a track option
 2. Maneuver to a specified inertial position
 3. Establish an LVLH hold
 4. Establish a Passive Thermal Control (PTC) barbecue rotation
- d. Identify the orbiter's position as related to a specified target

This section identifies the uses of the Universal Pointing (UNIV PTG) display (Figure 5-1).

```

2011/ / UNIV PTG XX X 000/HH# MM# SS
CUR MNVR COMPL XX# XX# XX 000/HH# MM# SS
1 START TIME XXX/XX# XX# XX
MNVN OPTION START MNVR 18 X X CUR FUT CUR FUT
5 R XXX.XX TRK 19 X X RBST 25
6 P XXX.XX ROT 20 X X CNCL 26
7 Y XXX.XX CNCL 21 DURATION 27
_Q# 00# 00# 00
TRK/ROT OPTIONS ATT MON
8 TGT ID XXX 22 MON AXIS X XX
ERR TOT 23X
ERR DAP 24X
9 RA XXX.XXX CUR XXX.XX ROLL PITCH YAW
10 DEC XXX.XXX REOD XXX.XX XXX.XX XXX.XX
11 LAT XXX.XXX ERR ±XXX.XX ±XXX.XX ±XXX.XX
12 LON XXX.XXX RATE ±XX.XXX ±XX.XXX ±XX.XXX
13 ALT XXXXX.X
14 BODY VECT X
15 P XXX.XX
16 Y XXX.XX
17 OM XXX.XX
( XX)

```

00650107.CRT# 2

Figure 5-1. UNIV PTG display

Availability: GNC major mode 201

Purpose: To provide a means by which a variety of on-orbit RCS attitude maneuvers can be set up, executed, and monitored

Uses: Almost all on-orbit RCS attitude maneuvers

Universal pointing includes the following features:

- a. Capability to perform both inertial and LVLH maneuvers and attitude holds
- b. Ability to point any specified axis of the orbiter at the center of the Earth, a target on the Earth's surface, the Sun, a star, or another orbiting vehicle
- c. Ability to automatically rotate the orbiter about a specified vehicle axis
- d. Option to set up a maneuver to start immediately or in the future

In addition to the various maneuver/track options available, universal pointing provides attitude monitoring information such as DAP errors, total errors, and predicted maneuver completion time.

The UNIV PTG display allows the crew to access any of four mutually exclusive MNVR options: Maneuver (MNVR), Track (TRK), Rotation (ROT), or Cancel (CNCL). Before any of these options are selected, there are several display items associated with the UNIV PTG display that must be specified if the desired result is to be achieved.

For any of these maneuvers to occur automatically, the AUTO DAP pbi on panel C3 (or A6) must be selected. Otherwise, the crew has to manually fly to the desired attitude. If AUTO is selected at any time subsequent to the selection of a MNVR option, the vehicle begins to move to the targeted attitude immediately. The exceptions to this are if an INRTL, LVLH, or FREE pbi was selected previous to the selection of AUTO; an Item 27 is performed on the OPS 202 MNVR EXEC display; or the maneuver start time is still in the future.

5.1.1 MNVR (Items 5 to 7 and 18)

The MNVR option is very similar to that used in the MNVR display for maneuvering to burn attitude. The crew enters the desired Inertial roll, pitch, and yaw attitudes into Items 5, 6, and 7, respectively, then types "ITEM 18 EXEC." Assuming the START TIME (which is discussed shortly) is not in the future, an asterisk appears next to Item 18 under the column marked CUR (for current) and the maneuver begins. Once there, the attitude is held inertially.

Limits: R and P = 0° to 359.99°

Y = 0° to 90° and 270° to 359.99°

5.1.2 TRK (Items 8 to 17 and 19)

The TRK option (Figure 5-2) points the orbiter body vector specified by Items 14 to 17 at the target specified by Items 8 to 13. The options for selecting body vectors and targets are discussed next.

```

2011/ / UNIV PTG XX X 000/HH: MM: SS
CUR MNVR COMPL XX: XX: XX 000/HH: MM: SS
1 START TIME XXX/XX: XX: XX

MNVR OPTION START MNVR 18 X X RBST 25
5 R XXX.XX TRK 19 X X CNCL 26
6 P XXX.XX ROT 20 X X DURATION 27
7 Y XXX.XX CNCL 21 _0: 00: 00.00

TRK/ROT OPTIONS
8 TGT ID XXX

9 RA XXX.XXX
10 DEC [ ]XX.XXX
11 LAT [ ]XX.XXX
12 LON [ ]XXX.XXX
13 ALT [ ]XXXXX.X

14 BODY VECT X

15 P XXX.XX
16 Y XXX.XX
17 OM XXX.XX

ATT MON
22 MON AXIS X XX
ERR TOT 23X
ERR DAP 24X

ROLL PITCH YAW
CUR XXX.XX XXX.XX XXX.XX
REQD XXX.XX XXX.XX XXX.XX
ERR ±XXX.XX ±XXX.XX ±XXX.XX
RATE ±XX.XXX ±XX.XXX ±XX.XXX

( XX )

```

00650109. CRT# 1

Figure 5-2. Items 8 to 17

5.1.3 Body Vectors

The body vector (also called pointing vector or body pointing vector) is an orbiter-relative vector that is pointed at a target. Entering a pitch (Item 15) and yaw (Item 16) on the UNIV PTG display specifies the axis of the orbiter to point at the target. The body vector specification axis is based on the orbiter body axis coordinate system. In this system, when the body vector has a pitch of 0° and yaw of 0°, the pointing vector is aiming out the nose of the orbiter.

The values entered for pitch and yaw specify the angle to which the pointer must be pitched and then yawed from the (0, 0) position to achieve the desired vector. For example, when P = 90° and Y = 0°, the body vector is aiming out the payload bay (or along the -Z body axis).

Omicron (Item 17) specification is not required in the definition of a body vector and will be discussed at length by itself. The body vector specification process is a “pitch, yaw Euler sequence.” This means that you have to pitch first, then rotate in a plane perpendicular to the new pitch axis in a positive direction (using the right-hand rule) to the yaw angle.

Another way of looking at this is to take a vector pointed through the nose of the vehicle (+X axis), execute the required pitch angle, then imagine that this vector is still the +X axis and that the rest of the coordinate system followed it. Now rotate in a positive direction about the new +Z axis to the required yaw angle (Figure 5-3). A yaw of 90° points the body vector in the direction of the right wing (+Y axis) independent of the specified pitch. Similarly, when yaw = 270°, the body vector lies along the left wing (-Y axis). In general, when the yaw angle lies between 0° and 90°, the body vector points in the starboard (right) direction. When the value of yaw is anywhere in the 270 to 359.99 range, the body vector points in the port (left) direction.

The UNIV PTG display is set up with some commonly used body vectors already established. To select the +X, -X, or -Z axis as the body vector, enter a 1, 2, or 3, respectively, for Item 14, and the appropriate pitch and yaw coordinates appear next to Items 15 and 16. If a 4 is entered as the body vector, the -Y Star Tracker (ST) axis is selected. Specifying body vector 5 (selectable) causes the values of pitch and yaw to flash, reminding the crew to enter the desired set of P and Y coordinates. When values are entered into Items 15 and 16 or an Item 19 EXEC is performed to start the track, the flashing ceases. Pitch and yaw can be loaded only when there is a 5 for Item 14; otherwise, an ILLEGAL ENTRY message results. The DAP book cue card contains a reference Table which lists all the preset body vector and target options available.

Limits: P = 0° to 359.99°

Y = 0° to 90° and 270° to 359.99°

5.1.4 Determining the Body Vector

1. Start with a body vector of pitch = 0° , yaw = 0° , which is pointing along the +X axis of the vehicle (Figure 5-3).

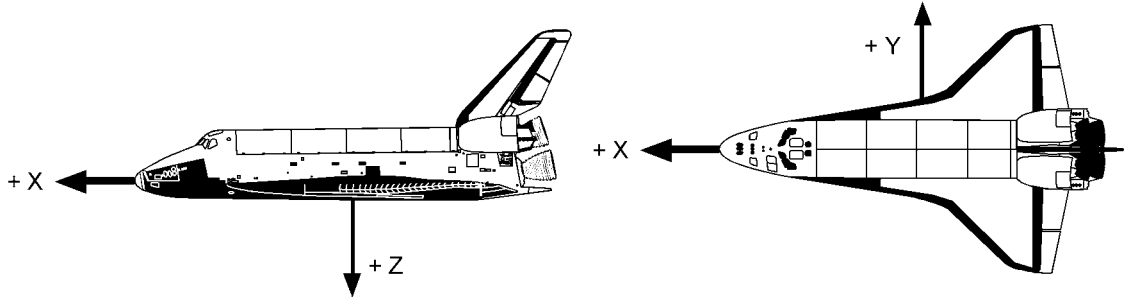

usa006501_014.cnv

Figure 5-3. Determining the body vector - step 1

2. Pitch the body vector up (in a positive direction about the +Y axis) to the desired pitch angle. In Figure 5-4, $P = 120^\circ$.

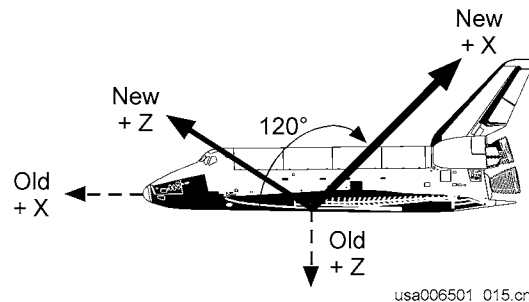

usa006501_015.cnv

Figure 5-4. Determining the body vector - step 2

3. Rotate the body vector to the desired yaw angle in the new X-Y plane (in a positive direction about the new +Z axis). In Figure 5-5, $Y = 45^\circ$.

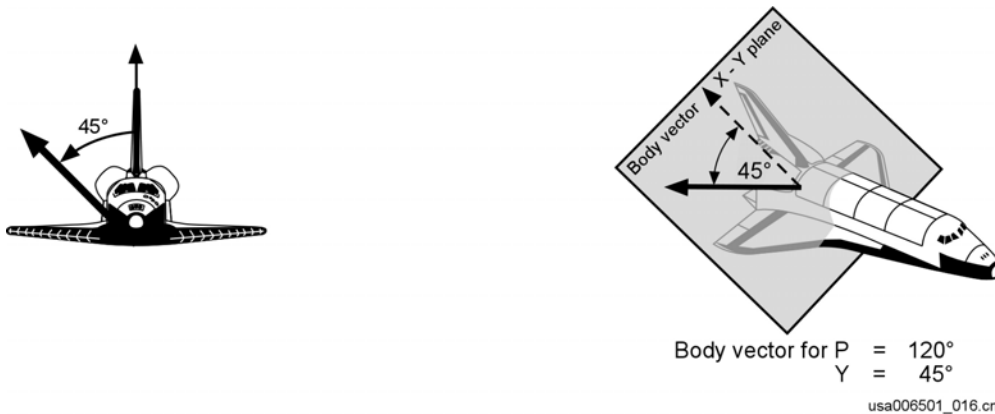

usa006501_016.cnv

Figure 5-5. Determining the body vector - step 3

5.1.5 Omicron

Omicron is the angle of rotation about the Body Vector (BV). If the center of Earth is the target selection, an omicron angle of 0° means that the right wing of the orbiter (+Y axis) is pointed toward the negative angular momentum vector (-H) of the orbit. (This would be toward the south for a due east launch.)

This is a simplified definition and applies only to the case where the center of Earth is the target, but will be adequate for most cases likely to be encountered.

The procedure for visualizing the orbiter's orientation with respect to the Earth is fairly simple.

1. Determine the orientation of the body vector with respect to the orbiter. As a sample case, consider the body vector defined as the -Z axis of the orbiter (BV = 3 or BV = 5 with P = 90, Y = 0). (See Figure 5-6.)

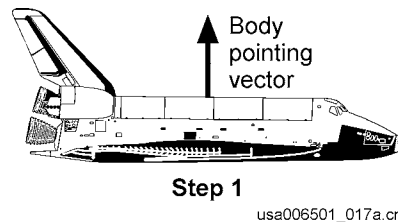
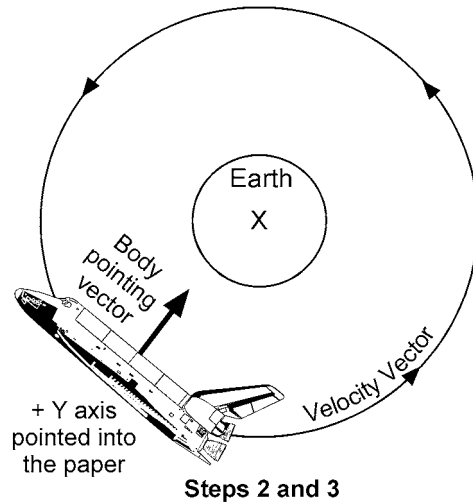

Figure 5-6. Determining the omicron angle – step 1

2. Orient the vehicle so that this vector is aiming at the target (target selection is discussed next). For this example, assume that the target is the center of the Earth.
3. Rotate the vehicle such that the +Y axis (right wing) is pointing toward the negative angular momentum vector of the orbit. The negative angular momentum vector can be found by using the right-hand rule. When you point the fingers of your right hand along the velocity vector (the direction the orbiter is traveling around the Earth) your thumb should be aimed in the direction of the positive angular momentum vector. The negative of this is 180° in the opposite direction. The omicron angle is 0° when the orbiter is oriented as just described. See Figure 5-7.



usa006501_018.cnv

Figure 5-7. Determining the omicron angle – steps 2 and 3

4. Now rotate the orbiter in a positive direction (using the right-hand rule) about the body vector until the required omicron angle is reached. A required omicron angle of 270° is depicted in Figure 5-8.

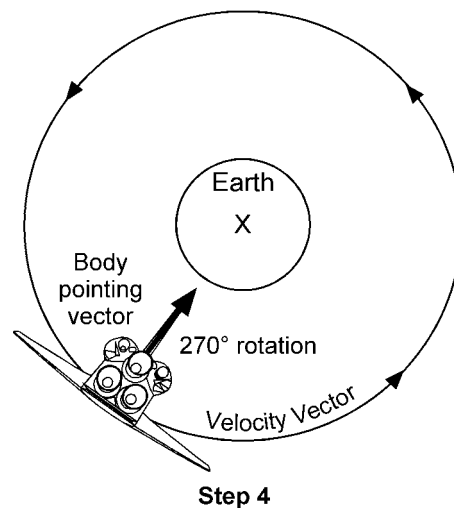

usa006501_019.cnv

Figure 5-8. Determining the omicron angle – step 4

The selection of an omicron angle is optional. If it is determined that mission objectives and/or constraints can be accomplished with two-axis tracking, omicron may be blanked. This may save some propellant when maneuvering to attitude.

To blank omicron, a TARGET ID (Item 8) must be selected whether it is a new value or the old one again. Any change made to the body vector or target options requires the re-execution of the start option (TRK, MNVR, or ROT) for the change to take effect.

A more rigorous definition of omicron is the angle between two planes, A and B, where plane A is defined by the body vector and negative angular momentum vector and plane B is defined by the body vector and the orbiter +Y axis (Figure 5-9).

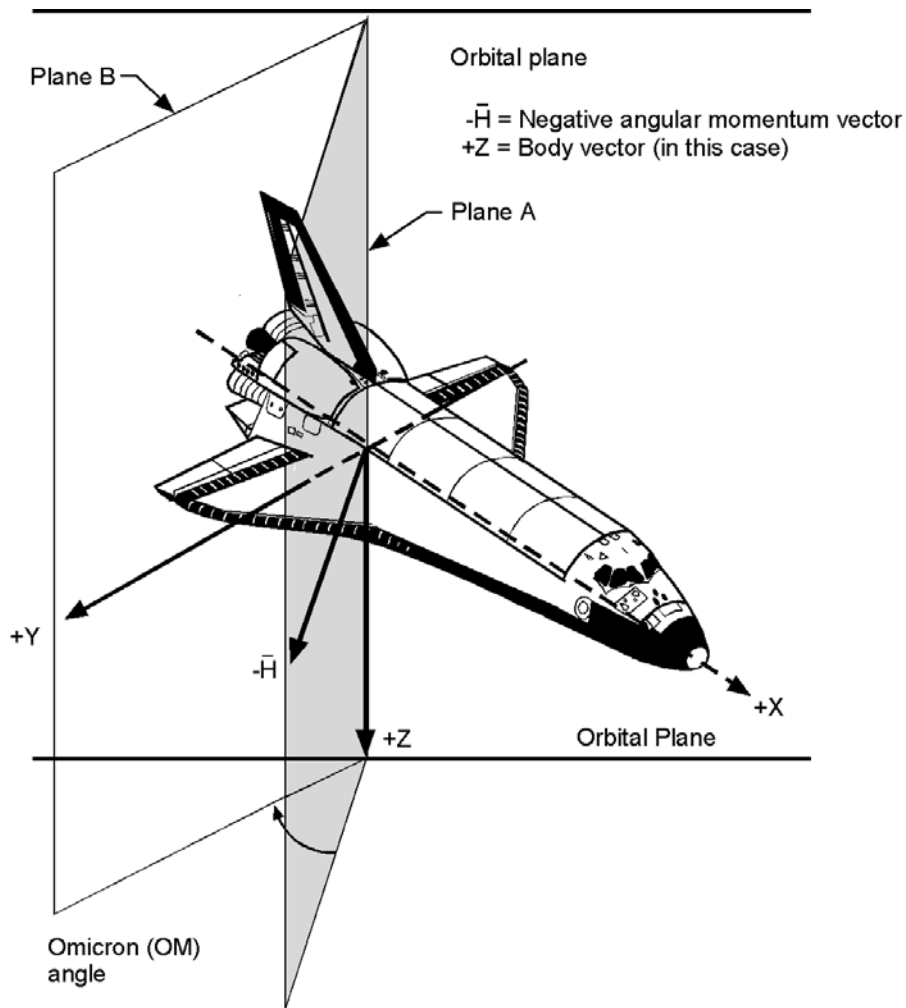

usa006501_020.cnv

Plane A – Formed by the negative orbital angular momentum vector (always perpendicular to the orbit plane) and the body vector.

Plane B – Formed by the +Y axis of the orbiter and the body vector. The body vector forms the “hinge line” between the two planes.

Figure 5-9. Omicron, angle between two planes (A and B)

Two special cases to note are

- When the body vector is the $\pm Y$ axis, substitute $-Z$ for the omicron reference axis.
- When the target vector is coincident with the negative or positive angular momentum vector ($\pm \vec{H}$), a vector from the center of the Earth through the descending node of the current orbit can be substituted for $-\vec{H}$.

5.1.6 Targets

Items 8 to 13 are used to specify the target that the body vector points to when TRK is initiated.

Before defining each target ID, we will define two kinds of attitude holds: LVLH and Inertial. An LVLH attitude hold means that the vehicle attitude is maintained with respect to the Earth. An Inertial hold means that the vehicle attitude is maintained with respect to the stars (See Figure 5-10).

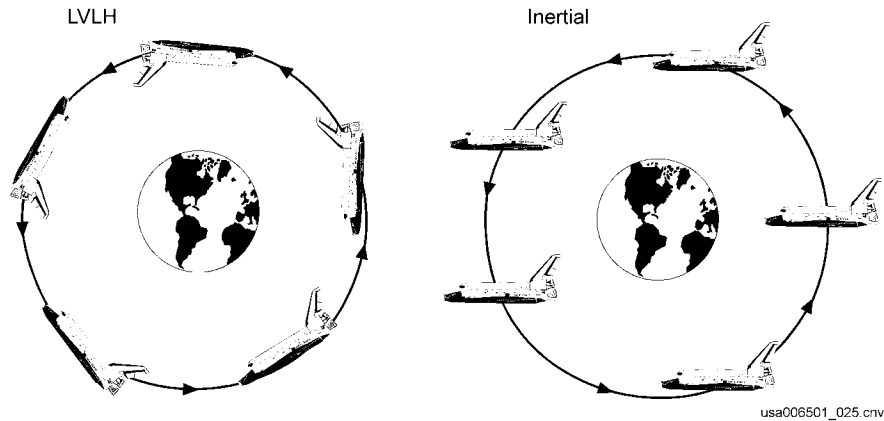

Figure 5-10. LVLH and inertial attitude holds

5.1.6.1 Orbiting Vehicle (Target ID = 1)

This option causes the orbiter to maneuver to establish and maintain line-of-sight tracking between the body vector selected and another orbiting vehicle (payload, satellite, and so forth) (Figure 5-11). To accomplish this maneuver, the software compares the orbiter state vector with that of a target.

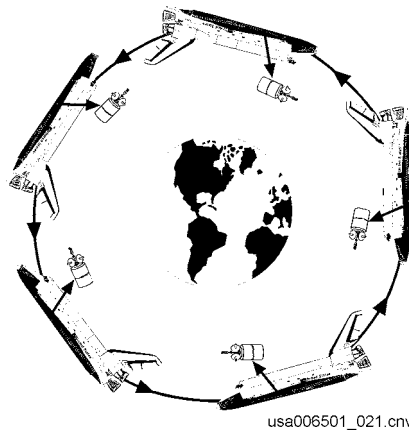

Figure 5-11. Orbiting vehicle (Target ID = 1)

5.1.6.2 Earth Center (Target ID = 2)

The most commonly used target is the center of the Earth. Once the attitude that aims a body vector at the center of the Earth is reached, it continues to be tracked, thus resulting in an LVLH attitude hold (shown in Figure 5-12).

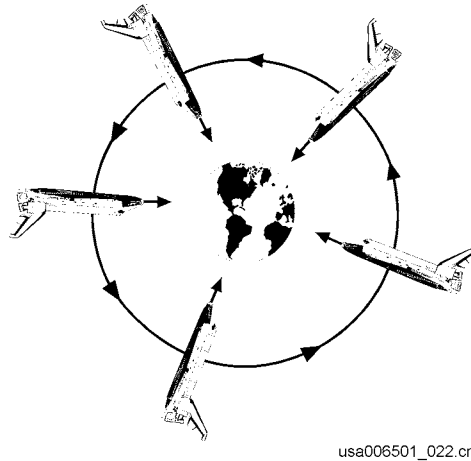

Figure 5-12. Earth center (Target ID = 2)

5.1.6.3 Earth Surface (Target ID = 3)

To perform Earth surface target tracking, the crew must specify the Latitude (LAT), Longitude (LON) and Altitude (ALT) of the point to be tracked. When executed, the orbiter aims the selected body vector at the surface of the Earth, whether the specified location is above the horizon or not. If the target point is such that the orbiter must pass directly over it, the rotation rate increases a great deal and may exceed the maneuver rate (discrete rate) to maintain tracking.

This option may also be used to track points that are actually further away from Earth than the orbiter is (i.e., a satellite in a geosynchronous orbit) (Figure 5-13). The altitude is measured as a height above the surface of the Earth in nautical miles.

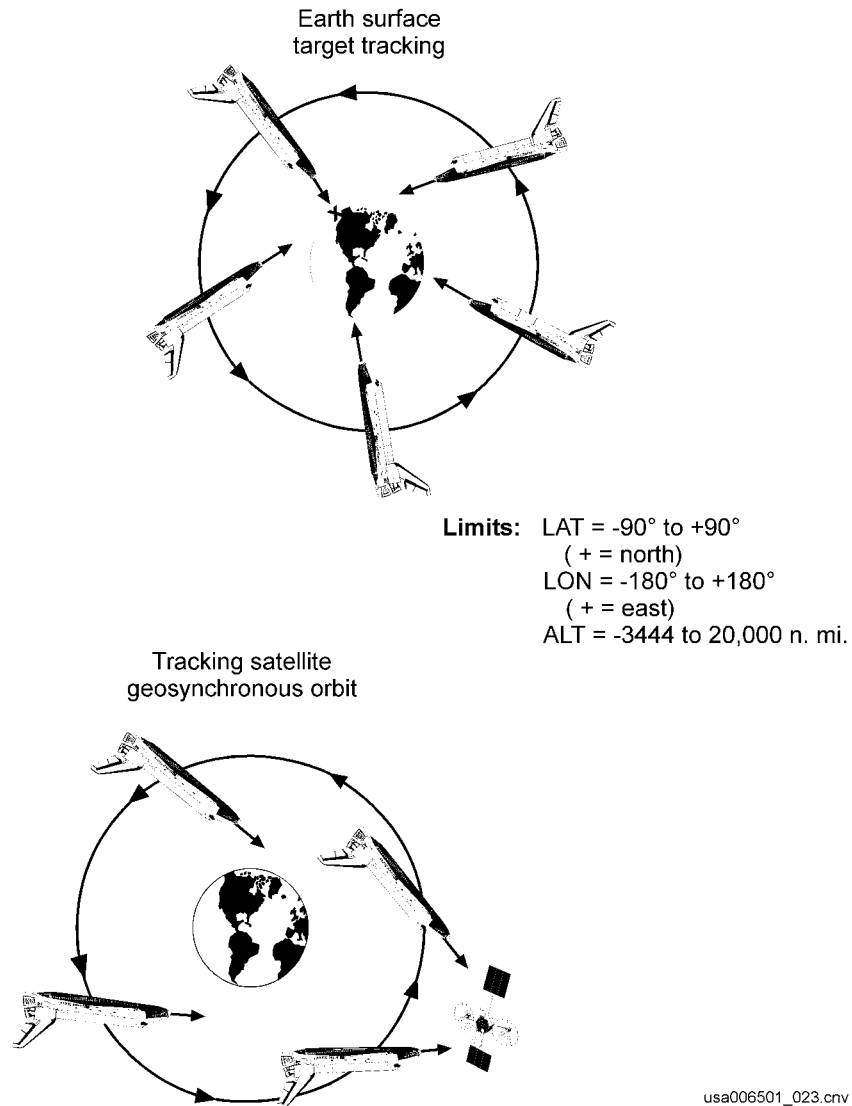

Figure 5-13. Earth surface (Target ID = 3)

5.1.6.4 Sun Center (Target ID = 4)

This option points the specified body vector of the orbiter at the center of the Sun. The Sun is so far away that this is basically an inertial attitude hold, useful for thermal conditioning or for maintaining hot or cold attitudes (Figure 5-14). The Right Ascension (RA) and Declination (DEC) display the position of the Sun as computed at the time of entering the Target ID.

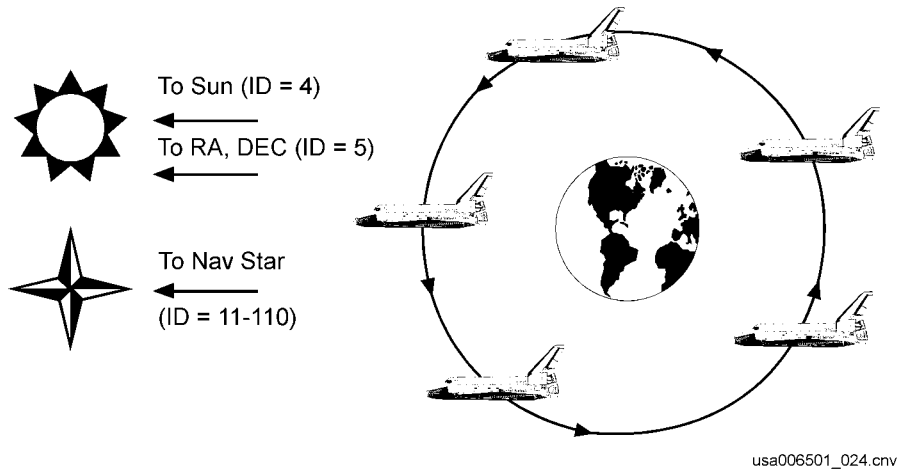

Figure 5-14. Sun center (Target ID = 4)

5.1.6.5 Celestial Object (Target ID = 5)

This option allows the crew to point the body vector of the vehicle at any celestial target. When a 5 is entered as the target ID, the previous values of RA (Item 9) and DEC (Item 10) begin to flash, reminding the crew to enter the desired RA and DEC.

Limits: RA = 0° to 359.99°

DEC = -90° to +90°

5.1.6.6 Navigation Stars (Target ID = 11-110)

Another way to select a celestial target is to enter the navigation star ID into Item 8. The RA and DEC for the particular star appear, and when the track option is executed, the maneuver begins. Once the target star is reached, the orbiter continues to follow it, thus performing an inertial attitude hold.

5.1.7 ROT (Items 14 to 16 and 20)

Item 20 EXEC initiates a positive vehicle rotation about the selected body vector. To see this, point your right thumb in the direction of the body vector and note which way your fingers tend to curl. That is the direction the vehicle rotates (this is another form of the “right-hand rule”). The rate of rotation is the discrete (DISC) rate specified on the DAP Configuration (DAP CONFIG) display (SPEC 20). Since the UNIV PTG display does not allow a track option and a rotation at the same time, the orientation of the body vector must be established before rotation is begun. The body vector is held inertially.

Since omicron defines the orbiter orientation about the body vector, this is what changes as the vehicle rotates. Therefore, it is senseless to specify an omicron once the vehicle has achieved the attitude desired for the initiation of the rotation. If an omicron is entered, it is ignored once the rotation begins.

The rotation option is mostly used for thermal conditioning. For example, a maneuver is made such that the Sun lies somewhere in the Y-Z plane of the orbiter and then a rotation is initiated about the X-axis. Known as the barbecue mode, the entire vehicle receives equal amounts of sunshine (Figure 5-15).

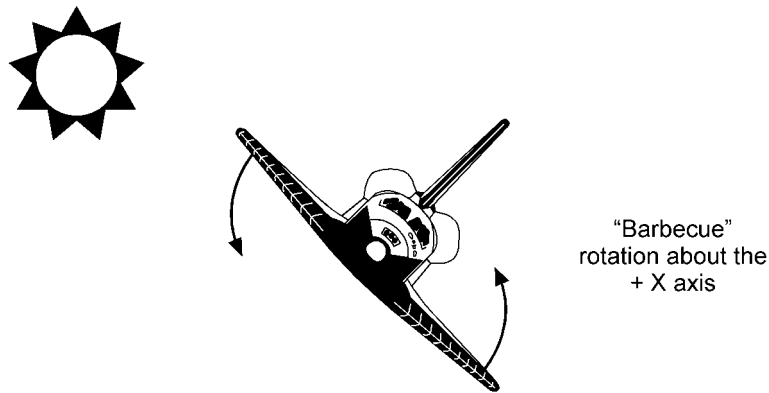

usa006501_026.crv

Figure 5-15. "Barbecue" rotation about the +X axis

5.1.8 CNCL (Item 21)

Selection of the Cancel (CNCL) option terminates all maneuver processing and initiates an Inertial hold about the current attitude at the time the Item was executed. If a manual maneuver to another attitude is performed and the DAP is returned to AUTO, the new attitude is held inertially.

When CNCL is executed, the errors on the UNIV PTG display are referenced to the current attitude at the time the Item 21 EXEC entry was made. When the DAP is moded to INRTL, LVLH, or FREE and then back to AUTO, the errors are still referenced to the CNCL attitude even though the orbiter is no longer trying to return there. It holds position about the new attitude when the return to AUTO is made.

Similar to the other maneuver options, upon return to OPS 201 from OPS 202, whatever option was being processed by UNIV PTG is resumed. A transition to OPS 801 and back has no effect on whatever UNIV PTG option is being processed, but since the UNIV PTG display is not available in OPS 8, the option cannot be changed until returning to OPS 201. If these are undesirable conditions, CNCL should be selected before leaving OPS 201. Unlike the other options, CNCL cannot be set up to occur at a future time. When CNCL is selected, there is no asterisk in the CUR column on the UNIV PTG display.

5.1.9 CUR MNVR COMPL

The Current (CUR) Maneuver Completion time in the upper left corner of the display gives the time in hours, minutes, and seconds MET when the maneuver currently in

progress will be complete. As the maneuver progresses, the time updates slightly to reflect more accurate estimates made by the software. The completion time also responds to changes in the discrete rate, switching between primary and vernier jets, or between DAP A and B (when the DISC RATES of these two DAPs are different).

5.1.10 Start Time (Items 1 to 4)

The maneuver start time can be set to an MET in the past, present, or future. To set up a future maneuver, load in the target information as desired, enter the start time, and execute the appropriate maneuver option. An asterisk appears in the Future (FUT) column and remains there until the start time becomes present. At that time, the asterisk appears in the CUR column and the maneuver starts. A future maneuver can be set up in OPS 201 then transfer to OPS 202 or OPS 801 and still begin on time. As with other UNIV PTG maneuvers, the DAP must be in the AUTO mode for the maneuver to start. If the DAP is in a manual mode (INRTL, LVLH, or FREE) 30 seconds or less before the future time becomes present, a SEL AUTO (select automatic) message is generated. This message can appear in OPS 201, 202, and 801.

5.1.11 MON Axis (Item 22)

Unless specified otherwise, all inertial attitudes, errors, and vehicle rates are given or discussed with respect to the +X direction (the commander and pilot's point of view). The sense switch on panel A6 associated with the aft RHC, THC, ADI, and DAP pbi's allows the crew to choose between a -X or -Z referenced system. The sense switch has the effect of making aft controller inputs match the views out of the aft or overhead windows in the same way that forward controller inputs match the view out of the forward windows. For example, pulling the RHC toward you in the aft station with -X sense selected results in a vehicle pitch down (tail pitch up), while the same hand controller motion performed in the forward station causes the orbiter to pitch up (tail pitch down). The -Z sense works in a similar manner, relating hand controller movements to views experienced through the overhead windows (see the Controllers training manual for more on this subject).

Located in the lower right corner of the UNIV PTG display is information useful in monitoring maneuvers. It would be useful for the crew to be able to select whether this information is presented to the viewer in either the +X or -X sense (the -Z sense option does not exist). To change senses, Item 22 can be set equal to 1 for +X or 2 for -X (Figure 5-16). To the right of MON AXIS, a +X or -X then appears, and the appropriate attitude and sign convention changes take place on the display as shown. Changes to the MON AXIS Item affect only the information located in the lower right portion of the UNIV PTG display. The Item has NO EFFECT on any other attitude inputs on this display, the ADIs, DAP pbi's, or hand controllers.

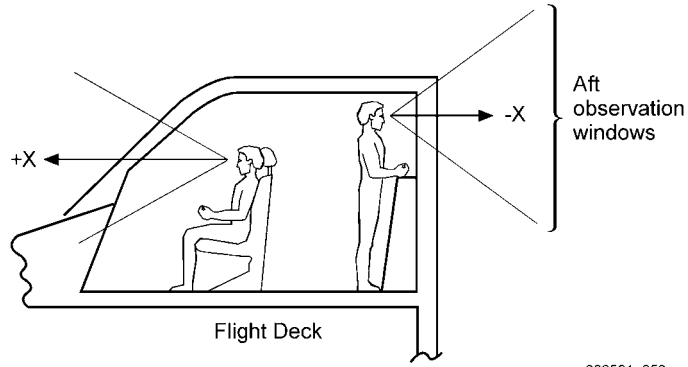

usa006501_053.cnv

+X sense

```

2011/ / UNIV PTG XX X 000/HH:MM:SS
CUR MNVR COMPL XX:XX:XX 000/HH:MM:SS
1 START TIME XXX/XX:XX:XX

MNVR OPTION START MNVR 18 X X RBST 25
5 R XXX.XX TRK 19 X X CNCL 26
6 P XXX.XX ROT 20 X X DURATION 27
7 Y XXX.XX CNCL 21 _0:00:00.00

TRK/ROT OPTIONS
8 TGT ID XXX
ATT MON
22 MON AXIS 1 +X
ERR TOT 23X
ERR DAP 24X

9 RA XXX.XXX
10 DEC @XX.XXX
11 LAT @XX.XXX
12 LON @XXX.XXX
13 ALT @XXXXX.X
CUR ROLL PITCH YAW
REQD 240.24 327.00 325.41
ERR + 0.58 + 0.88 - 0.64
RATE - 0.004 - 0.082 + 0.001

14 BODY VECT X
15 P XXX.XX
16 Y XXX.XX
17 OM XXX.XX
(XX)

```

00650108, CRT: 1

-X sense

```

2011/ / UNIV PTG XX X 000/HH:MM:SS
CUR MNVR COMPL XX:XX:XX 000/HH:MM:SS
1 START TIME XXX/XX:XX:XX

MNVR OPTION START MNVR 18 X X RBST 25
5 R XXX.XX TRK 19 X X CNCL 26
6 P XXX.XX ROT 20 X X DURATION 27
7 Y XXX.XX CNCL 21 _0:00:00.00

TRK/ROT OPTIONS
8 TGT ID XXX
ATT MON
22 MON AXIS 2 -X
ERR TOT 23X
ERR DAP 24X

9 RA XXX.XXX
10 DEC @XX.XXX
11 LAT @XX.XXX
12 LON @XXX.XXX
13 ALT @XXXXX.X
CUR ROLL PITCH YAW
REQD 300.21 146.06 36.04
ERR - 0.49 - 0.55 - 0.58
RATE + 0.004 + 0.082 + 0.001

14 BODY VECT X
15 P XXX.XX
16 Y XXX.XX
17 OM XXX.XX
(XX)

```

00650110, CRT: 1

Figure 5-16. Item 22

5.1.12 Total/DAP Errors (Items 23 and 24)

Items 23 and 24 give the crew the option to select total errors or DAP errors, respectively. This selection affects the error information as displayed on UNIV PTG and on the ADI error needles. DAP and TOT error Items on the display are mutually exclusive.

Most of the time, the crew deals with total attitude errors. Total attitude error refers to the difference between where the vehicle is currently located (current attitude) and where the vehicle should be located (required attitude). These errors are described in the orbiter body axis reference frame to provide “fly to” cues in aiding manual attitude maneuvers. In other words, these errors indicate the direction and magnitude of RHC inputs required to get to the desired attitude. The values displayed represent a rotation about a single, optimized axis. Generally speaking, one cannot simply perform an axis-by-axis subtraction between the current and required M50 attitudes to determine these errors as that would only define the absolute differences between the two attitudes and not the correct body rotations to get there.

DAP errors, on the other hand, are referenced to the center of the DAP phase plane. This means that DAP errors are an angular representation of the difference between where the vehicle is located in the phase plane and the null or zero error center of the phase plane. The distinction between total and DAP errors is most readily apparent when completing an attitude maneuver. While the total error would show the complete angle difference necessary to perform the maneuver, DAP errors would track along with the phase plane toward the new attitude. The errors gradually grow when the maneuver is executed until an attitude deadband is reached in any axis. At this point, jets fire and errors should decrease again. This continues until the desired attitude change is complete. While holding attitude, DAP and TOT errors should be practically the same (Figure 5-17).

The drawings at the right depict a typical AUTO maneuver sequence from the time of initiation to completion. The “X” represents the required attitude as specified on the UNIV PTG display. The “O” depicts the current vehicle attitude and rate error. The “phase plane” defines the DAP deadbands.

While the maneuver is in progress, the DAP continually computes where the orbiter is, based on initial attitude and the specified maneuver rate. This defines where the origin of the phase plane is at any given time.

There is a phase plane for each vehicle axis (R, P, and Y), but only one is shown here.

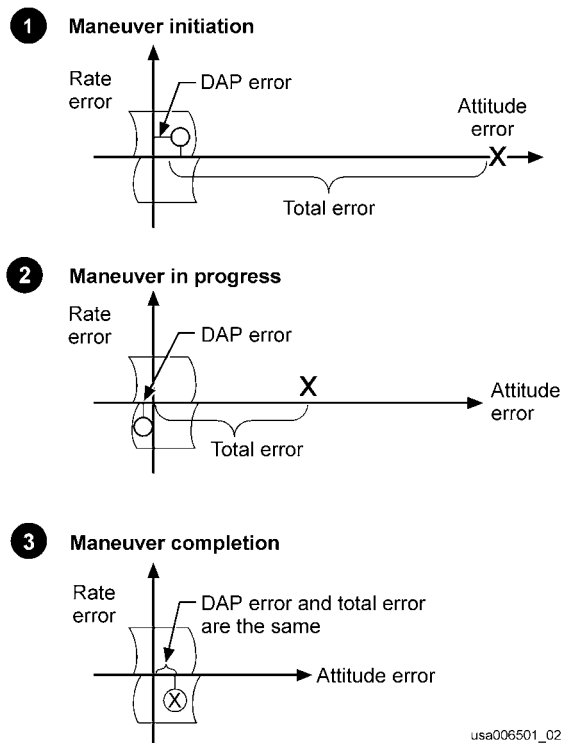

usa006501_028.cnv

Figure 5-17. Total vs. DAP errors

5.1.13 Maneuver Monitor

A noninteractive readout of the CUR and Required (REQD) vehicle attitudes in the inertial coordinate system is in the lower right corner of the display (Figure 5-18). Below these are the attitude Errors (ERR) given in either TOTAL or DAP errors, as specified earlier, and the vehicle rates expressed in degrees per second.

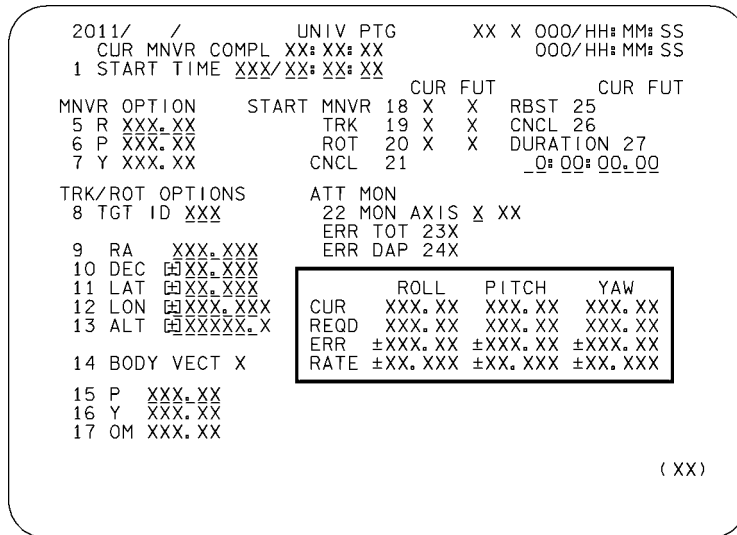

00650111.CRT: 1

Figure 5-18. CUR and REQD vehicle attitudes

5.1.14 Reboost (Items 25 to 29)

Items 25, 26, and 27 to 29 provide the orbiter with automatic reboost capability for the International Space Station.

Items 27 to 29 specify the duration of the reboost in hours, minutes, and seconds. Item 25, RBST, will initiate the reboost sequence at the time specified in Items 1 to 4 for the duration specified in Items 27 to 29. An asterisk (*) will appear next to Item 25 under CUR or FUT to indicate the status of the reboost request. When the reboost is in progress, an asterisk appears under CUR and the duration will decrement to reflect the time remaining.

Item 26 cancels the current reboost, causes the CUR or FUT asterisk to blank, and resets the duration time to zero.

Other parameters that further define reboost are included on SPEC 20, which will be discussed in the next chapter.

5.1.15 BFS - Universal Pointing

There is no UNIV PTG display in the BFS since there is no OPS 2 in the BFS.

This page intentionally left blank.

5.2 QUESTIONS

1. What are the four maneuver options?
2. What pitch and yaw need to be entered to specify the +Y axis of the vehicle as the body vector?

Pitch = _____
Yaw = _____

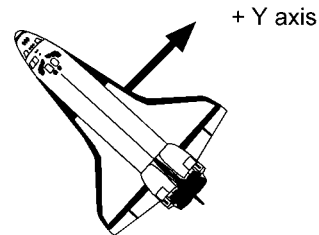

usa006501_029.cnv

3. What pitch and yaw angles best describe the body vector depicted in the drawing?

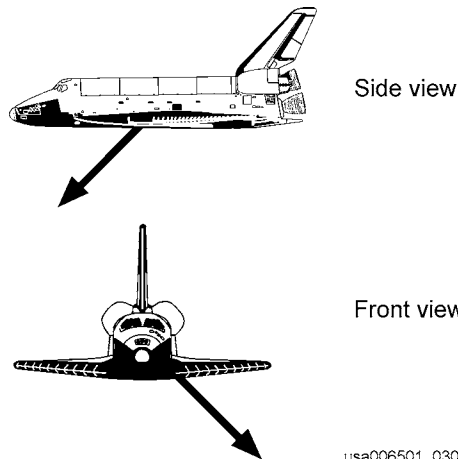

usa006501_030.cnv

- (a) $P = 330^\circ$ $Y = 300^\circ$
- (b) $P = 330^\circ$ $Y = 60^\circ$
- (c) $P = 30^\circ$ $Y = 300^\circ$
- (d) $P = 30^\circ$ $Y = 60^\circ$
- (e) None of the above

4. When performing a TRK option, omicron can be unspecified to save propellant. What keystroke(s) would be necessary to change this maneuver from three- to two-axis tracking?

```

2011/ / UNIV PTG 1 000/03:04:49
CUR MNVR COMPL 03:15:42 000/00:00:00
1 START TIME 000/00:00:00
MNVR OPTION START MNVR 18 CUR FUT CUR FUT
5 R 248.00 TRK 19 * RBST 25
6 P 338.00 RDT 20 CNCL 26
7 Y 352.00 CNCL 21 DURATION 27
           0:00:00.00

TRK/ROT OPTIONS ATT MON
8 TGT ID 2 22 MON AXIS 1 +X
ERR TOT 23*
ERR DAP 24

9 RA 0.000
10 DEC +0.000
11 LAT +0.000
12 LON +0.000
13 ALT +0.0

14 BODY VECT 3 CUR ROLL PITCH YAW
REQU 107.54 262.22 27.39
ERR -92.78 +88.14 -28.84
RATE -0.107 +0.089 -0.041

15 P 90.00
16 Y 0.00
17 DM 90.00

```

usa006501_154.tif

5. Using the UNIV PTG display and the excerpt from the DAP book given below, list the keystrokes necessary to perform the following operations (assume the DAP AUTO pbi is selected and the start time is in the past).

```

2011/ / UNIV PTG XX X 000/HH: MM: SS
CUR MNVR COMPL XX: XX: XX 000/HH: MM: SS
1 START TIME XXX/XX: XX: XX
CUR FUT CUR FUT
MNVR OPTION START MNVR 18 X X RBST 25
5 R XXX.XX TRK 19 X X CNCL 26
6 P XXX.XX ROT 20 X X DURATION 27
7 Y XXX.XX CNCL 21 _0: 00: 00.00
TRK/ROT OPTIONS ATT MON
8 TGT ID XXX 22 MON AXIS X XX
ERR TOT 23X
ERR DAP 24X
9 RA XXX.XXX
10 DEC XX.XXX
11 LAT XX.XXX
12 LON XX.XXX
13 ALT XXXXX.X
CUR ROLL PITCH YAW
REOD XXX.XX XXX.XX XXX.XX
ERR ±XXX.XX ±XXX.XX ±XXX.XX
RATE ±XX.XXX ±XX.XXX ±XX.XXX
14 BODY VECT X
15 P XXX.XX
16 Y XXX.XX
17 OM XXX.XX
( XX)

```

00650107. CRT, 2

UNIV PTG	
TGTID	= 1 Orbiting Vehicle
	= 2 Earth ctr
	= 3 Earth tgt
	Input LAT (± 90)
	LON (± 180. + = East)
	ALT (-3444.0 to 20000.0 nm)
	= 4 Sun ctr
	= 5 Celestial tgt
	Input RA (0-359.99)
	DEC (± 90)
	= 11-110 Nav Stars
BODY VECT	= 1 +X°
	= 2 -X°
	= 3 -Z°
	= 4 -Y Star Tracker
	= 5 Optional
	Input P (0-359.99)
	Y (270-359.99.0-90)
Input OM	= OM (0-359.99)
MON AXIS	= 1 +X
	= 2 -X

usa006501_036.cnv

- (a) Maneuver to an inertial position of R = 10°, P = 103°, Y = 42°.

- (b) Establish an LVLH attitude hold with the payload bay pointed toward the Earth and the nose of the orbiter pointed in the direction of the velocity vector, as shown (that is, -ZLV, +XVV).

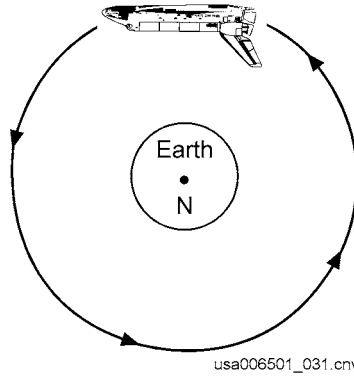

- (c) Set up a PTC "barbecue" rotation. To achieve proper thermal conditioning, the vehicle must be oriented with the X-axis, perpendicular to the direction of the Sun, as shown.

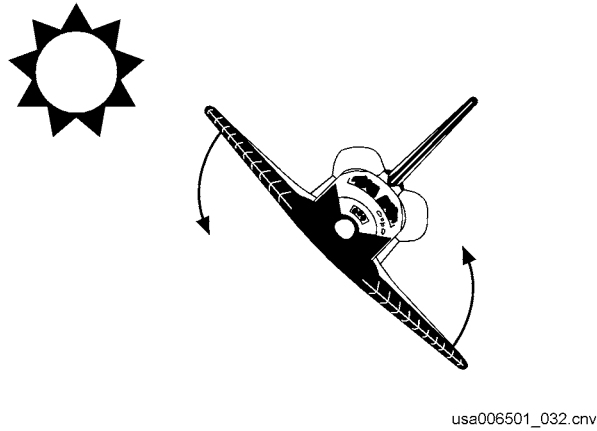

6. Fill in the blank boxes to complete the following Table. Assume that the velocity vector is to the left and that the center of the Earth is the target, as shown.

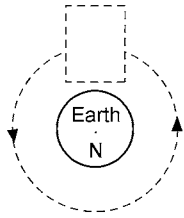

OMICRON MPV	OMICRON			
	1 0°	2 90°	3 180°	4 270°
+X P=0, Y=0				
-X P=180, Y=0				
+Z P=270, Y=0				
-Z P=90, Y=0				
+Y P=0, Y=90				
-Y P=0, Y=270				

usa006501_033.crv

6.0 DAP CONFIGURATION DISPLAY

6.1 OBJECTIVES

After completing this section, you should be able to

- State the function of ROT RATE and PULSE
- State the function of COMP, CNTL ACC, and JET OPT
- Identify the rate and attitude dead bands for PRI, ALT, and VERN
- Identify the ALT parameters

This section identifies the uses of the DAP CONFIG display (Figure 6-1).

XXXX/020/		DAP CONFIG		XX X DDD/HH# MM# SS DDD/HH# MM# SS	
PRI	1 XXXXXXXX	2 XXXXXXXX	PRI	DAP EDIT	
ROT RATE	10 X.XXXXX	30 X.XXXXX	50 X.XXXXX	3 DAP AXX	
ATT DB	11 XX.XX	31 XX.XX	51 XX.XX	4 DAP BXX	
RATE DB	12 X.XX	32 X.XX	52 X.XX	5 XXXX	
ROT PLS	13 X.XXX	33 X.XXX	53 X.XXX		
COMP	14 .XXX	34 .XXX	54 .XXX		
P OPTION	15 XXXX	35 XXXX	55 XXXX		
Y OPTION	16 XXXX	36 XXXX	56 XXXX	NOTCH FLTR	
TRAN PLS	17 X.XXX	37 X.XXX	57 X.XXX	ENA 6X	
ALT			ALT		
RATE DB	18 X.XXX	38 X.XXX	58 X.XXX	XJETS ROT	
JET OPT	19 XXXX	39 XXXX	59 XXXX	ENA 7X	
# JETS	20 X	40 X	60 X		
ON TIME	21 X.XX	41 X.XX	61 X.XX	REBOOST	
DELAY	22 XX.XX	42 XX.XX	62 XX.XX	8 CFG X	
VERN			VERN	9 INTVL	
ROT RATE	23 X.XXXX	43 X.XXXX	63 X.XXXX	XXX.XX	
ATT DB	24 XX.XXX	44 XX.XXX	64 XX.XXX		
RATE DB	25 .XXX	45 .XXX	65 .XXX		
ROT PLS	26 X.XXX	46 X.XXX	66 X.XXX		
COMP	27 .XXX	47 .XXX	67 .XXX		
CNTL ACC	28 X	48 X	68 X		

00650103.CRT# 1
usa006501_cnv.

Figure 6-1. DAP CONFIG display

Availability: GNC MMs 201 and 202

Purpose: To provide a means by which certain DAP parameters and jet configurations can be modified by the crew to satisfy the varying needs of the on-orbit timeline

Uses: On-orbit RCS rotation and translation maneuvers are affected by the parameters on this SPEC

DAP CONFIG includes the following features:

- a. Capability to specify vehicle automatic maneuver rates appropriate to the amount of propellant and time available for use
- b. Capability to specify desired pointing accuracy
- c. Option to enable nose only or tail only jets for pitch and/or yaw maneuvers

The DAP CONFIG display can be called up by entering SPEC 20 PRO on the crew keyboard in MM 201 or MM 202. The values entered on this display affect only the ORBIT DAP. Even though the display is not accessible in OPS 801, the values entered will be governing vehicle responses. For the TRANS DAP, the DAP CONFIG display is not available, so critical parameters such as maneuver rates and dead-bands are I-Loaded and cannot be changed by the crew.

6.1.1 A, B, and EDIT (Items 1, 2, 3, 4, and 5)

The DAP CONFIG display is divided into three sections labeled DAP A, DAP B, and DAP EDIT.

The DAP A column displays parameters for the currently loaded A DAP. The DAP B column displays parameters for the currently loaded B DAP. Fifteen A DAPs and fifteen B DAPs are available. Each can be loaded with an Item 1 or 2 plus an integer from 1 to 15. The A and B DAP parameters can be edited with Items 10 to 28 and Items 30 to 48, respectively. However, such changes are not saved permanently in GPC memory.

The DAP EDIT column allows one to make permanent changes to any DAP table. To edit a specific DAP, the crew will execute either Item 3 or 4 plus the DAP number, 1 to 15. The given DAP parameters will then appear in Items 50 to 68 where they may be modified. When finished editing, Item 5, LOAD, will permanently load these changes into GPC memory. If the edited DAP happens to be a currently loaded DAP, any changes will immediately appear in the respective active DAP column after the Item 5 is executed.

Functionally, the A and B DAPs are equivalent. In practice, however, one is usually set up for tighter, more accurate control, while the other is usually set up with looser constraints. Which set of parameters is active depends on which pushbutton, A or B, is selected on panel C3 or panel A6 DAP pbi matrix.

6.1.2 Alternate Mode

ALT DAP, the alternate mode of the orbit RCS DAP, was designed to combine the jet selection logic of the vernier jets (discussed later in this manual) with the redundancy of the primary jets, since there are 38 primary jets and only 6 vernier jets. In many cases, the ALT mode is capable of reducing loads on the RMS/payload to near vernier levels. Items 18 to 22, 38 to 42, and 58 to 62 specify the ALT parameters and can apply only when the ALT pbi is selected.

6.1.3 Rotation Discrete Rate (PRI: Items 10, 30, 50; VERN: Items 23, 43, 63)

ROT RATE is the rotation rate that the orbiter builds up to and maintains when one of the following operations is performed:

- a. Automatic MNVR, TRK, or ROT options from UNIV PTG
- b. Automatic preburn maneuver from the OPS 202, ORBIT MNVR EXEC display
- c. Manual maneuver when the DISC RATE pbi is selected in the axis that is being commanded with the RHC

Different values can be entered for NORM and VERN. NORM applies to primary RCS jets (PRI or ALT pbi selected) and VERN applies to vernier RCS jets (VERN pbi selected).

Limits: PRI and ALT = 0.05 to 2.0 deg/sec

VERN = 0.002 to 1.0 deg/sec

6.1.4 Attitude Deadband (PRI: Items 11, 31, 51; VERN: Items 24, 44, 64)

When performing an attitude hold, ATT DB specifies how much drift (+ or -) will be tolerated in any axis before jets are fired to correct the error. Changing the deadbands on DAP CONFIG alters the shape and size of the DAP phase plane. In a maneuver, the software calculates what the vehicle attitude should be. If the DAP-required attitude deviates from the current attitude by more than one deadband value, jets fire to make the required corrections, thereby forcing the vehicle back toward the correct attitude.

Limits: PRI and ALT = 0.1° to 40.0°

VERN = 0.01° to 40.0°

6.1.5 Rate Deadband (PRI: Items 12, 32, 52; ALT: Items 18, 38, 58; VERN: Items 25, 45, 65)

Rate deadbands basically work the same as attitude deadbands except that they govern allowable maneuver rate deviations (Figure 6-2). If the orbiter is maintaining an inertial attitude hold, the desired maneuver rate is 0 deg/sec. If the vehicle acquires a rate greater (+ or -) than the deadband value, jets fire to null it. When an attitude maneuver is requested, the required vehicle rates increase from 0 deg/sec to the DISC RATE. The vehicle does not maneuver, however, unless the resulting rate error (difference between the commanded DISC RATE and the current orbiter rate) is greater than the rate dead band or until the increasing attitude error exceeds the attitude dead band.

Limits: PRI = 0.1 to 5.0 deg/sec

ALT = 0.05 to 5.0 deg/sec

VERN = 0.01 to 0.5 deg/sec

The “O” plots the current vehicle attitude and rate errors with respect to the phase plane. If this point is inside the limits imposed by the deadbands, the DAP does not command jets to fire. Once the orbiter exceeds a deadband, jets are commanded to fire in an effort to null the rate error, thereby correcting the attitude error. Once the orbiter is back within the deadbands, the jets stop firing. While the vehicle is holding attitude, it cycles around within the phase plane, alternately hitting the positive and negative deadbands as shown. This process is called deadbanding or limit cycling.

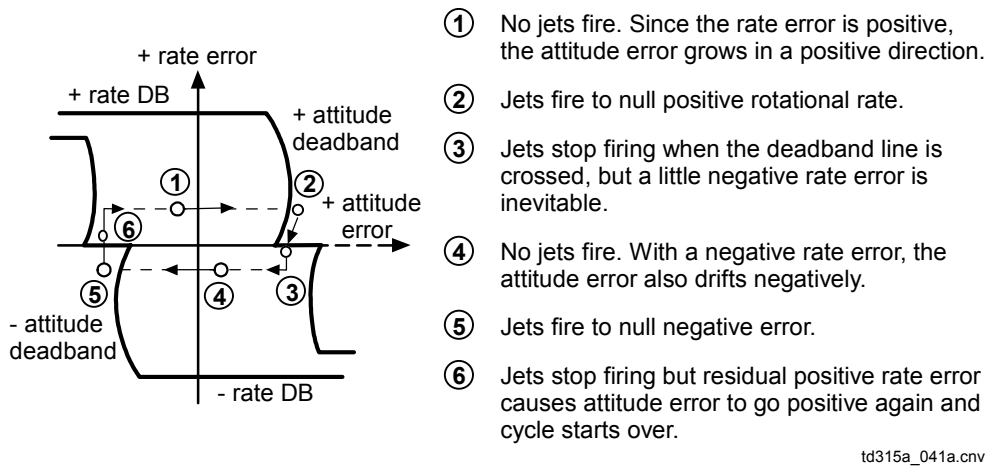

Figure 6-2. Deadbanding or limit cycling

6.1.6 Rotation Pulse Rate (PRI: Items 13, 33, 53; VERN: Items 26, 46, 66)

Rotation Pulse (ROT PLS) rate is analogous to the translation pulse rate. It specifies the change in rotation rate achieved by the single burst of jet firings when the RHC is taken out of detent in an axis for which the rotation PULSE pbi is selected. The units for the rotation PULSE are degrees per second, and the resulting vehicle rate is a product of the pulse size and the number of pulses commanded.

Limits: PRI and ALT = 0.0014 to 1.0 deg/sec

VERN = 0.001 to 0.5 deg/sec

6.1.7 Rotation Compensation (PRI: Items 14, 34, 54; VERN: Items 27, 47, 67)

Most RCS jets, especially the VERNs, produce vehicle rates in more than one axis. When commanding a pure yaw with the VERNs, for example, some degree of pitch and roll occurs, since the forward side-firing jets are canted slightly downward. Known as cross-coupling, it has no impact in most cases. The Compensation (COMP) value entered determines how much cross-coupling (in degrees per second) is tolerated before jets are fired to counteract the undesired motion.

To turn off the cross-coupling compensation (in other words, if pure, single-axis maneuvers are not a requirement) enter a value of zero for COMP. Entering a small

value means a great deal of compensation, while a greater number indicates less compensation.

Limits: PRI and ALT = 0.0 to 0.999 deg/sec

VERN = 0.0 to 0.999 deg/sec

6.1.8 Jet Option (PRI: Items 15, 35, 55 and 16, 36, 56; ALT: Items 19, 39, 59)

The jet option applies only to primary jets (PRI or ALT pbi selected) and allows the crew to choose which jets are allowed to fire: nose only, tail only, or all jets.

P OPTION and Y OPTION, Items 15, 35, 55 and 16, 36, 56, cycle through the three control modes for PRI jets: ALL, NOSE, or TAIL. JET OPT ALT, Items 19, 39, and 59 selects either ALL or TAIL for ALT DAP. NOSE is not available for ALT DAP.

If the VERN pbi is selected, the jet options have no effect. Nor does the jet option affect orbiter translation maneuvers. If the LOW Z pbi is selected, the jet option is overridden to maintain attitude control.

Options: P OPTION and Y OPTION: ALL, NOSE, TAIL

JET OPT ALT: ALL, TAIL

6.1.9 Translation Pulse (NORM: Items 17, 37, 57)

TRAN PLS, Items 17, 37 and 57, specifies the change in velocity achieved in feet per second for a single THC pulse. This rate results only when the translational PULSE pbi has been selected in the axis being commanded with the THC. Each time the THC is moved out of detent (the neutral or "hands-off" position of the hand controller), one burst of jet firings for the duration necessary to achieve the velocity requested is issued. To command another pulse, the THC must be returned to detent and then deflected again. The pulses are cumulative, so a crewmember can produce any multiple of the translational pulse rate simply by issuing the proper number of hand controller movements.

Limits: 0.001 to 5.0 ft/sec

6.1.10 Number of Jets (ALT: Items 20, 40, 60)

"# JETS" is used to specify the maximum number of primary jets that can fire simultaneously in ALT DAP. The crew can enter 1, 2, or 3 for number of jets and limit the number of jet firings.

Limits: ALT = 1, 2, or 3 (integers only)

6.1.11 On Time (ALT: Items 21, 41, 61)

The On Time specifies the maximum duration of ALT DAP jet firings, that is, how long the jets are ON. With a small value entered for On Time, the jets fire for short durations.

Limits: ALT = 0.08 to 9.99 sec

6.1.12 Delay (ALT: Items 22, 42, 62)

The delay is the minimum time delay between ALT DAP jet firings. With a large value for delay, the jet firings are spaced far apart. Thus, with number of jets = 1, on time = 0.08 sec, and delay = 99 sec, ALT fires one jet for 0.08 sec (or 80 msec) and does not fire another jet for at least 99 sec. This is an example of how ALT may reduce the structural loads on the RMS/payload as compared to primary jet firings (with PRI selected) and have more redundancy than the vernier jets.

Limits: ALT = 0.0 to 99.99 sec

6.1.13 Control Acceleration (Items 28, 48, 68)

To choose which VERN jets to fire (VERN pbi selected) or which primary jets to fire (ALT pbi selected) for any particular maneuver, the ORBIT DAP contains an I-Loaded table which lists the angular accelerations expected to result from the firing of each of the six vernier jets or from the firing of a primary jet from each of the primary jet groups. (Jet groups are discussed later in this manual.)

If a payload is attached to the extended Remote Manipulator System (RMS), the vehicle mass properties are drastically different from those of the stowed RMS condition. For this reason, the CNTL ACC option allows the crew to call up a different table of I-loads that is better suited to the current payload configuration. To call up one of these alternate tables, enter a number from 0 to 9 for CNTL ACC. Since there is no way to see what is actually happening to the jet select logic in the DAP onboard, the crew must rely on the Flight Data File (FDF) references for which value to choose. For example, for STS-49 the DAP book listed the following CNTL ACC configurations:

CNTL ACC

0 = Orbiter alone	3 = ASEM hover
1 = INTELSAT grapple	4 = ASEM SSF position 1
2 = INTELSAT hover	5 = ASEM SSF position 2

Limits: ALT and VERN = 0 (default orbiter configuration)

1 to 9 (alternate orbiter/payload configurations, integers only)

6.1.14 Notch Filter Enable (Item 6)

During rotation, the vehicle structure flexes some amount. If such flexing is interpreted by the DAP as rotation that should be dampened, jets will fire unnecessarily wasting propellant. To prevent this, the DAP has filters that attenuate motion detected at certain frequencies. When vehicle mass properties change, such as during payload operations, different filters need to be used. The DAP therefore selects an appropriate notch filter automatically based on the item entry made for CNTL ACC.

Item 6 allows the crew to manually inhibit the use of the current notch filter.

Display: An asterisk appears when enabled

6.1.15 X Rotation Enable (Item 7)

Normally pitch rotation is induced with up and/or down firing jets. When the orbiter is docked with the International Space Station, however, its center of gravity is far above the payload bay. As a result, pitch rotation of the entire stack must be accomplished with +/- X jet firings. In ALT DAP, this feature can be enabled with Item 7.

Display: ALT, an asterisk appears when enabled

6.1.16 Reboost (Items 8 and 9)

The REBOOST item entries control the automatic reboost function for the International Space Station. CFG, Item 8, allows the crew to select one of four pre-loaded jet-firing configurations. INTVL, Item 9, allows entry of a reference time between successive reboost firings in seconds.

Limits: CFG = 1 to 4 (integers only)

INTVL = 0.08 to 999.99 sec

6.1.17 BFS - DAP Configuration

There is no DAP CONFIG display in the BFS since SPEC 20 is only available in OPS 2, and there is no OPS 2 in the BFS. The BFS maneuver rates and deadbands are the same as those used in the TRANS DAP.

This page intentionally left blank.

6.2 QUESTIONS

1. In what units is TRANS PULSE measured?
2. In the display given, what would the PRI jet AUTO maneuver rate be with the DAP B pbi selected?

2011/020/		DAP CONFIG		1 000/02:18:22 000/00:00:00	
PRI	1 DAP A01	2 DAP B	PRI	DAP EDIT	
ROT RATE	10 0.2000	30 0.5000	50	3 DAP A	
ATT DB	11 5.00	31 3.00	51	4 DAP B	
RATE DB	12 0.20	32 0.20	52	5 LOAD	
ROT PLS	13 0.10	33 0.04	53		
COMP	14 .000	34 .000	54		
P OPTION	15 ALL	35 NOSE	55		
Y OPTION	16 ALL	36 NOSE	56		
TRAN PLS	17 0.10	37 0.10	57	NOTCH FLTR	
ALT			ALT	ENA 6	
RATE DB	18 0.200	38 0.100	58	XJETS ROT	
JET OPT	19 ALL	39 TAIL	59	ENA 7	
# JETS	20 2	40 2	60		
ON TIME	21 0.08	41 0.08	61	REBOOST	
DELAY	22 0.00	42 0.00	62	8 CFG 0	
VERN			VERN	9 INTVL	
ROT RATE	23 0.2000	43 0.0200	63	0.00	
ATT DB	24 1.000	44 1.000	64		
RATE DB	25 .020	45 .020	65		
ROT PLS	26 0.010	46 0.002	66		
COMP	27 .000	47 .000	67		
CNTL ACC	28 0	48 0	68		

usa006501_153.cnv

3. What does CNTL ACC do?
4. What happens if a +X RCS TRANS is commanded on DAP B (note the values of Items 35 and 36)?

2011/020/		DAP CONFIG		1 000/02:18:22 000/00:00:00	
PRI	1 DAP A01	2 DAP B	PRI	DAP EDIT	
ROT RATE	10 0.2000	30 0.5000	50	3 DAP A	
ATT DB	11 5.00	31 3.00	51	4 DAP B	
RATE DB	12 0.20	32 0.20	52	5 LOAD	
ROT PLS	13 0.10	33 0.04	53		
COMP	14 .000	34 .000	54		
P OPTION	15 ALL	35 NOSE	55		
Y OPTION	16 ALL	36 NOSE	56		
TRAN PLS	17 0.10	37 0.10	57	NOTCH FLTR	
ALT			ALT	ENA 6	
RATE DB	18 0.200	38 0.100	58	XJETS ROT	
JET OPT	19 ALL	39 TAIL	59	ENA 7	
# JETS	20 2	40 2	60		
ON TIME	21 0.08	41 0.08	61	REBOOST	
DELAY	22 0.00	42 0.00	62	8 CFG 0	
VERN			VERN	9 INTVL	
ROT RATE	23 0.2000	43 0.0200	63	0.00	
ATT DB	24 1.000	44 1.000	64		
RATE DB	25 .020	45 .020	65		
ROT PLS	26 0.010	46 0.002	66		
COMP	27 .000	47 .000	67		
CNTL ACC	28 0	48 0	68		

usa006501_153.cnv

7.0 DAP PUSHBUTTON INDICATORS

7.1 OBJECTIVES

After completing this section, you should be able to

- a. Identify the pbi's that are active
 1. In TRANS DAP
 2. With the BFS engaged
 3. On orbit, in OPS 3, when the IMU DATA GOOD flag is set to "bad"
- b. State the function of each DAP pbi
- c. State the effects on the pbi mode configuration for vernier and IMU failures
- d. State the information that the ADI provides

Figure 7-1 shows the 24 pbi's associated with the ORBIT and TRANS DAPs (23 pbi's are functional, and 1 is a spare). These pbi's are located on panel C3 (between the commander and the pilot) in the forward station and on panel A6 in the aft station. Assuming no electrical, computer bus (Multiplexer/Demultiplexer (MDM)), or hardware failures have occurred affecting the operation of the pbi's, inputs made to one panel are reflected in the configuration of the other panel. All the pbi's are active in the ORBIT DAP; only a subset of the pbi's work in the TRANS DAP, when the BFS is engaged, or when a condition referred to as IMU FAIL is present (see Table 7-1). None work during ascent or entry.

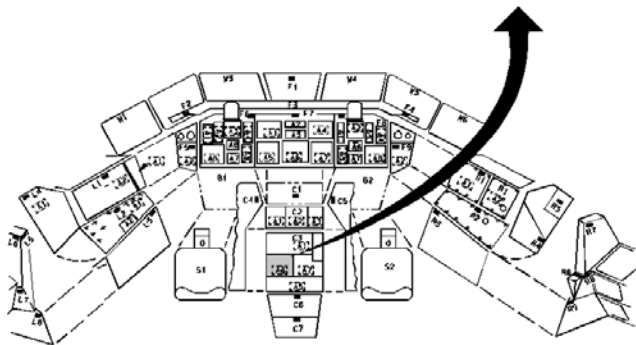
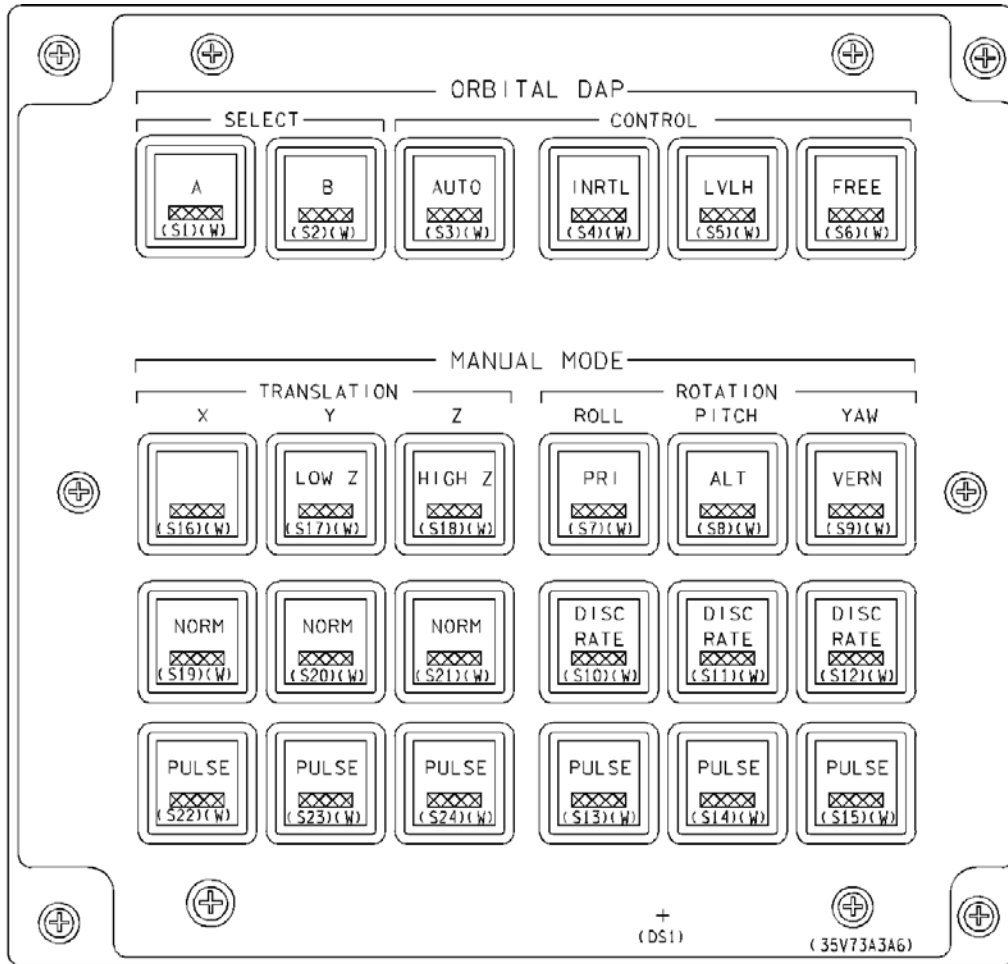

Forward Station

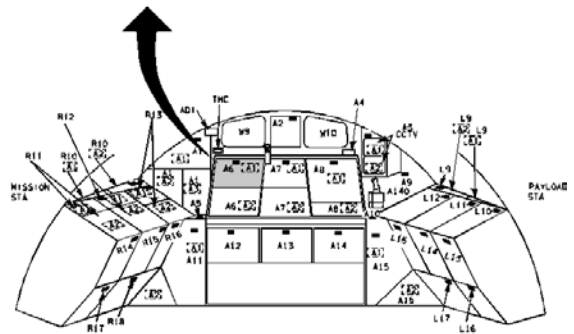

Aft Station

usa006501_038.cnv

Figure 7-1. Orbit and TRANS DAP pbi's

Table 7-1. DAP pbi availability matrix

pbi	TRANS DAP	ORBIT DAP	ORBIT DAP IMU fail	BFS engage
Select:				
A		X	X	
B		X	X	
Control:				
AUTO	X	X		
INRTL	X	X		X [†]
LVLH		X		
FREE		X	X	
RCS jets:				
PRI	X [†]	X	X	X [†]
ALT		X	X	
VERN		X	X	
Manual Trans (X, Y, Z):				
NORM	X [†]	X	X	X [†]
PULSE		X	X	
HIGH Z		X	X	
LOW Z		X	X	
Manual Rot (R, P, Y):				
DISC RATE	X	X		X*
PULSE	X	X	X	X*

[†] This mode is in effect but the pbi is not lit

* When BFS is engaged, the choice of DISC RATE or PULSE is the same for all three axes. For example, if the roll axis is switched to DISC RATE from PULSE, pitch and yaw also go to DISC RATE

7.1.1 DAP Select

The A and B pbi's select the set of parameters from the DAP CONFIG display that will be active. This lets the crew switch quickly from one set of DAP parameters to another. For example, on orbit, A DAP is frequently set up with slower maneuver rates and larger deadbands in PRI, making it more propellant conservative than B DAP.

7.1.2 Automatic Control

The selection of AUTO initiates an inertial attitude hold at the time the pbi is pressed in the TRANS DAP or if the CNCL option on the UNIV PTG display is selected in the ORBIT DAP. If a MNVR, TRK, or ROT option is currently selected, it begins or resumes

when AUTO is selected. The DISC RATE and PULSE pbi's located below the ROTATION label have no effect with AUTO selected. RHC use causes the DAP to downmode to INRTL, but THC use does not.

7.1.3 Inertial Control

Deflecting the RHC out of detent or pressing the INRTL pbi downmodes the DAP to a manual state. With the INRTL pbi selected, the DISC RATE and PULSE pbi's determine the kind of control that the RHC provides. If DISC RATE is selected, an inertial attitude hold is maintained. If maneuvering with the RHC and DISC RATE is selected, the inertial attitude when the RHC was released is maintained. If PULSE is selected, the orbiter is in free drift for the associated axis.

7.1.4 Local Vertical/Local Horizontal Control

The LVLH pbi's function is similar to the INRTL. With LVLH and DISC RATE selected, an LVLH attitude hold is maintained, and with PULSE selected, the orbiter is in free drift in that axis.

7.1.5 Free Drift

The FREE pbi puts the orbiter in free drift, which is no attitude hold. With FREE selected, the three rotation modes are in PULSE, and the crew cannot select DISC RATE. The two other pbi configurations of free drift, as previously mentioned, are INRTL/PULSE (ROT) and LVLH/PULSE (ROT). Of the three methods of free drift, the FREE pbi is the most convenient since it can be quickly selected, however it is available for ORBIT DAP only. During TRANS DAP, free drift is INRTL/PULSE.

7.1.6 Low Z Translation

The LOW Z pbi inhibits all up-firing jets from firing to prevent jet plumes from damaging payloads or Extravehicular Activity (EVA) crewmembers. If a +Z translation is required, +X and -X jets are commanded to fire since they have a small +Z thrust component (Figure 7-2). The -Z translations use the same six downfiring jets whether HIGH, LOW, or NORM Z is selected. The LOW Z pbi can be toggled on or off, is mutually exclusive with HIGH Z, and can be used regardless of the selection in the other translation axes.

7.1.7 High Z Translation

When the HIGH Z pbi is selected and a +Z translation is commanded with the THC, all nine upfiring jets fire for as long as the THC is held out of detent. This mode can be used for emergency braking or escape from a payload. The -Z translations use the same six downfiring jets whether HIGH, LOW, or NORM Z is selected.

Norm + Z

3 upfiring jets

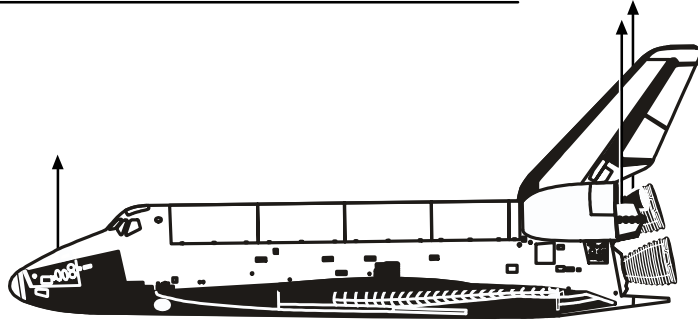

High + Z

9 upfiring jets

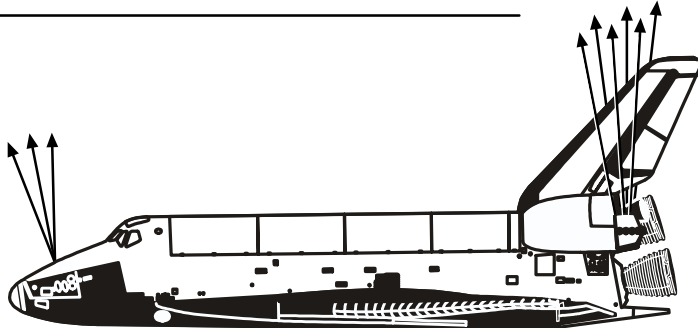

Low + Z

0 upfiring jets
(2 fwd. 2 aft)

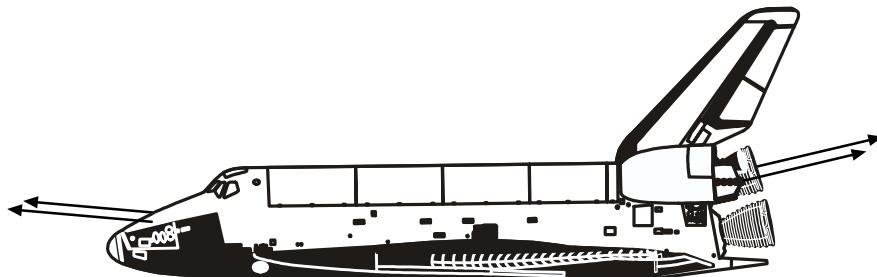

- Z translation

(independent of NORM, HIGH, or LOW Z selection)

6 downfiring jets

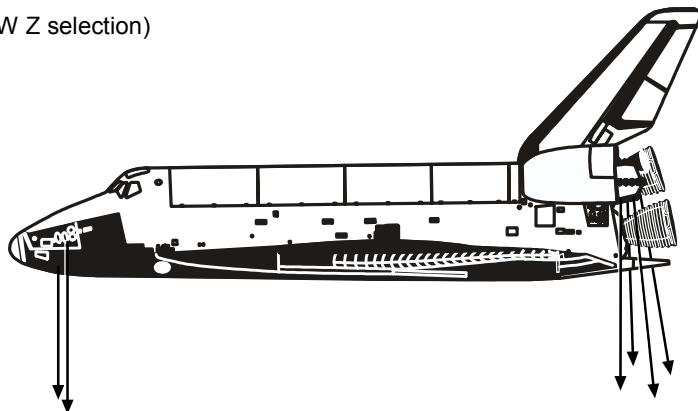

usa006501_042a.cnv

Figure 7-2. Z translations

7.1.8 Normal Translation

This mode provides continuous jet firings as long as the THC is held out of detent. The NORM mode is used for most RCS translation burns.

7.1.9 Pulse Translation

This mode provides a burst of jet fire each time the THC is deflected out of detent. The duration of jet firing is a function of the pulse size specified on the DAP CONFIG display.

7.1.10 Primary Jet Selection

The PRI pbi selects the primary RCS jet selection logic. For a given command (automatic or manual), the jet selection first references a look-up table to tell how many jets are needed from each jet group. A jet group is a group of jets located on the same pod (forward, left, or right) that point in the same direction, as shown in Figure 7-3. There are several tables, and they take into account factors such as jet failures, propellant feed constraints, and whether or not the jets are being fed OMS propellant through an interconnect. Then, the jet priority table is referenced for the actual selections. Pre-mission, each jet is assigned a rank within its jet group. Under normal conditions, only the jets with the highest priority are commanded to fire. If a jet fails and becomes deselected, it is removed from the table. Since jet RM keeps the DAP informed as to which jets have failed, only those jets that are still available on the priority table are commanded to fire. See the example in Table 7-2.

Thruster ID Code Format

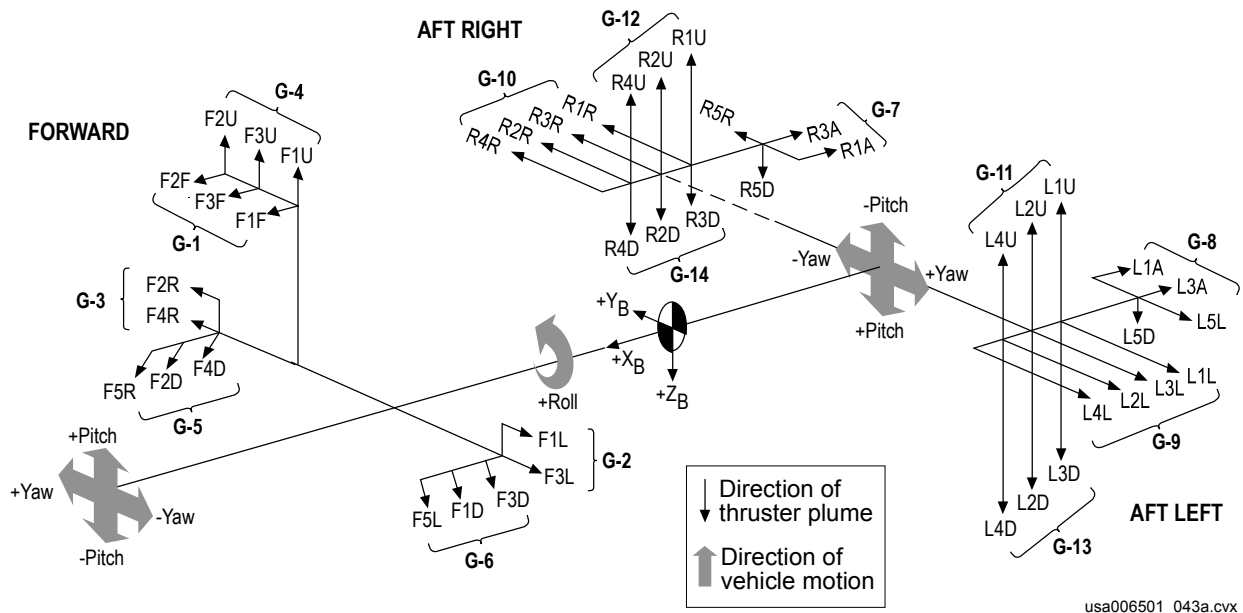
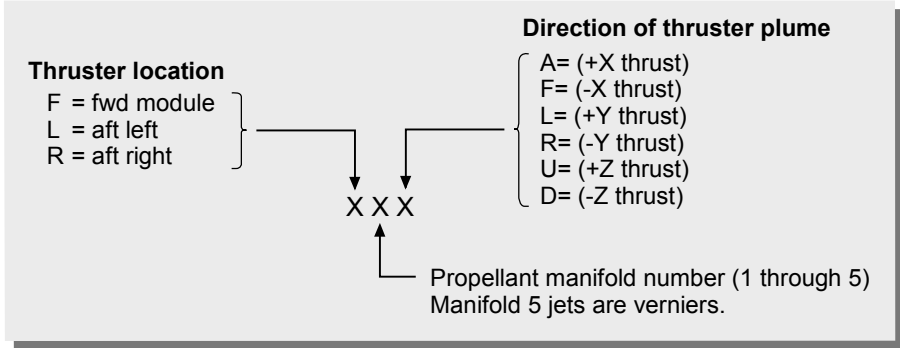

Figure 7-3. RCS jet location and thruster ID

Table 7-2. Primary RCS jet select logic

Step 1: Find the appropriate look-up table. This excerpt assumes a pure + yaw maneuver with both nose and tail jets active (HI ROT). This table excerpt is from the OI-30 Orbit DAP FSSR, p.194.

Table 4.2.2.2.1-2. Y Translation and/or Yaw Rotation Jet Groups

Commands	Failure locations by group	Number of jets used by group			
		G-2	G-3	G-9	G-10
+ YAW HI ROT	NONE	1	0	0	1
	2	1	0	0	1
	10	1	0	0	1
	2	0	0	0	1
	2	1	0	0	1
	10	1	0	0	1

Step 2: Use the jet priority table to choose the appropriate jets to fire. This table can be found in the FSSR as well, although it is not quite in the same form as the table presented here. The circled jets are the ones that are commanded to fire if no failures are present.

Jet priority table

Group #	1	2	3	4	5	6	7	8	9	10	11	12	13	14
Priority 1	F1F	F3L	F4R	F3U	F4D	F3D	R3A	L3A	L1L	R3R	L1U	R1U	L3D	R3D
2	F2F	F1L	F2R	F1U	F2D	F1D	R1A	L1A	L3L	R1R	L4U	R4U	L2D	R2D
3	F3F			F2U					L4L	R2R	L2U	R2U	L4D	R4D
4									L2L	R4R				

usa006501_044a.cnv

7.1.11 Alternate Jet Selection

The ALT pbi selects the alternate jet selection logic for the primary jets. It selects up to three jets (depending on the # JETS specified on the DAP CONFIG display) whose rotational velocity increment is closest to what would be required to satisfy crew or guidance maneuver requests. For each of 11 jet groups, the DAP refers to a table that specifies the angular rate expected in each rotation axis as a result of a jet firing from each jet group.

With this, the alternate jet selection logic chooses the best jet group for the commanded maneuver in one of two ways. The first method selects jets that minimize the difference between the angular rate of the jet compared with the desired rotation. The second method uses a dot-product to maximize the thrust component in the desired direction. A 2nd or 3rd jet may also be fired as long as they contribute at least a certain percentage of the thrust in the same direction. Current I-loads (STS-114) utilize the minimum angle method.

7.1.12 Vernier Jet Selection Logic

The VERN pbi selects the vernier jet selection logic that is nearly identical to ALT. Instead of selecting from primary jet groups (as ALT does), VERN selects from the six vernier jets. One, two, or three vernier jets are chosen whose rotational velocity increment is closest to the required maneuver the same way that ALT jet selection chose jet groups.

7.1.13 Discrete Rate

If the DISC RATE pbi is selected and the RHC is used, jets fire as needed to build up to and maintain the maneuver rate specified on the DAP CONFIG display. When the RHC is returned to detent, the current vehicle inertial attitude is held if INRTL is selected, and the LVLH attitude is held if LVLH is selected.

7.1.14 Pulse Rotation

In PULSE, each RHC command produces a single burst of jet firings for the length of time necessary to achieve the rotation rate specified on the DAP CONFIG display. A subsequent PULSE does not occur until the RHC is first returned to detent, then commanded again. While the RHC is in detent, the orbiter is in free drift.

7.1.15 Effect of Vernier Jet Failures

In some cases, vernier jet failures affect the DAP pbi configuration. If a vernier jet fails or is deselected on SPEC 23 while in VERN, the DAP will automatically downmode to free drift (FREE/PULSE (ROT)). If PRI or ALT is selected, nothing happens unless a return to VERN is made, at which time the DAP downmodes to free drift. The DAP RECONFIG error message is generated when a vernier jet has been deselected (either manually or automatically). This message is generated when the failure occurs, regardless of whether PRI, ALT, or VERN is selected.

The automatic downmode to free drift happens only when VERN is selected. Unboxed pbi's below are not affected (Figure 7-4).

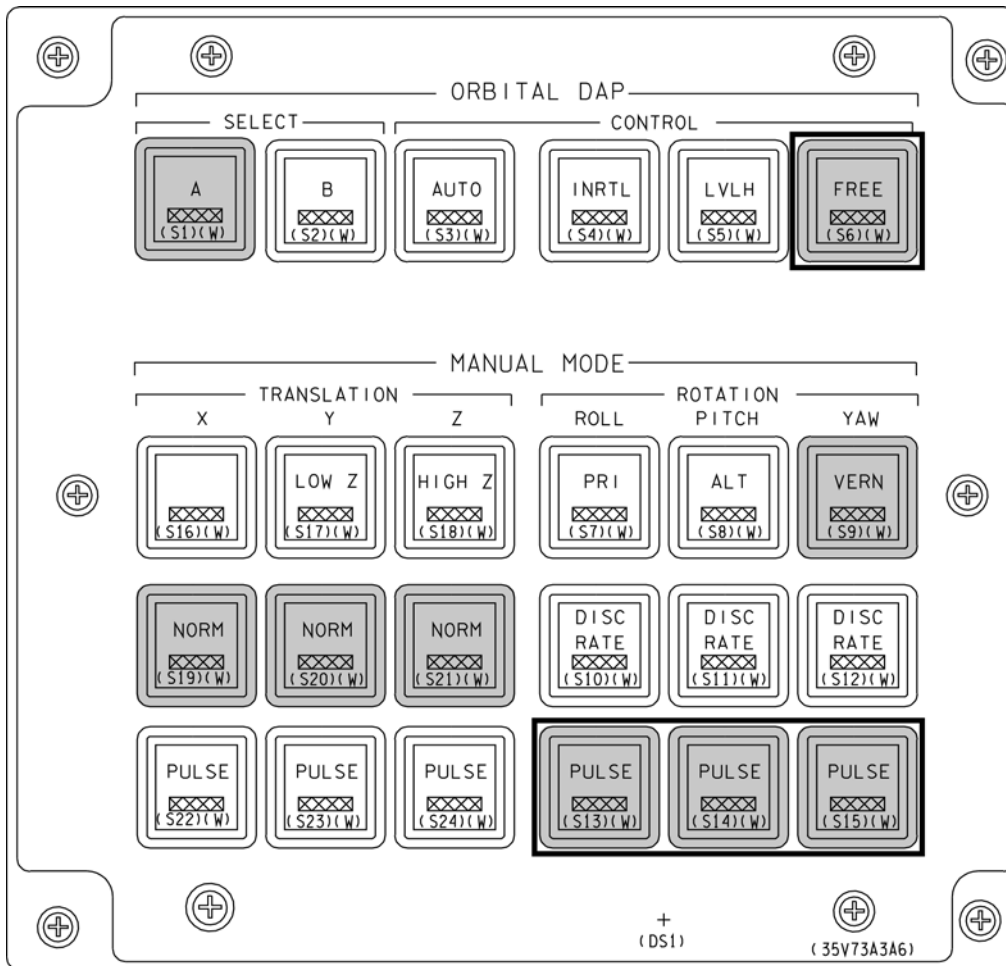

usa006501_039.cnv

Figure 7-4. Vernier jet failure pbi reconfiguration

7.1.16 Effect of Inertial Measurement Unit Failures

Within the OPS 2 IMU software operating program, there is a flag called DATA GOOD. The program looks at data coming from all three IMUs and determines whether the collective output is valid or not.

The DATA GOOD flag will be set to “bad” under the following conditions:

- a. All three IMUs have failed or are deselected
- b. Two IMUs are available and a dilemma exists between them in attitude
- c. Only one IMU is being used and it experiences a Built-In Test Equipment (BITE) failure

Since automatic flight control cannot work without feedback, all modes that use a phase plane become inoperative when the DATA GOOD flag is set to “bad.” The pbi matrix reflects this fact by reconfiguring to free drift (FREE/PULSE (ROT)). In addition, the

AUTO, INRTL, LVLH, and DISC RATE pbi's become inoperative. The manual translation mode pbi's go to PULSE in all three axes, but can be changed by the crew. The unboxed pbi's (that is, A, B and PRI/ALT/VERN) retain their configuration previous to the IMU fail condition (Figure 7-5).

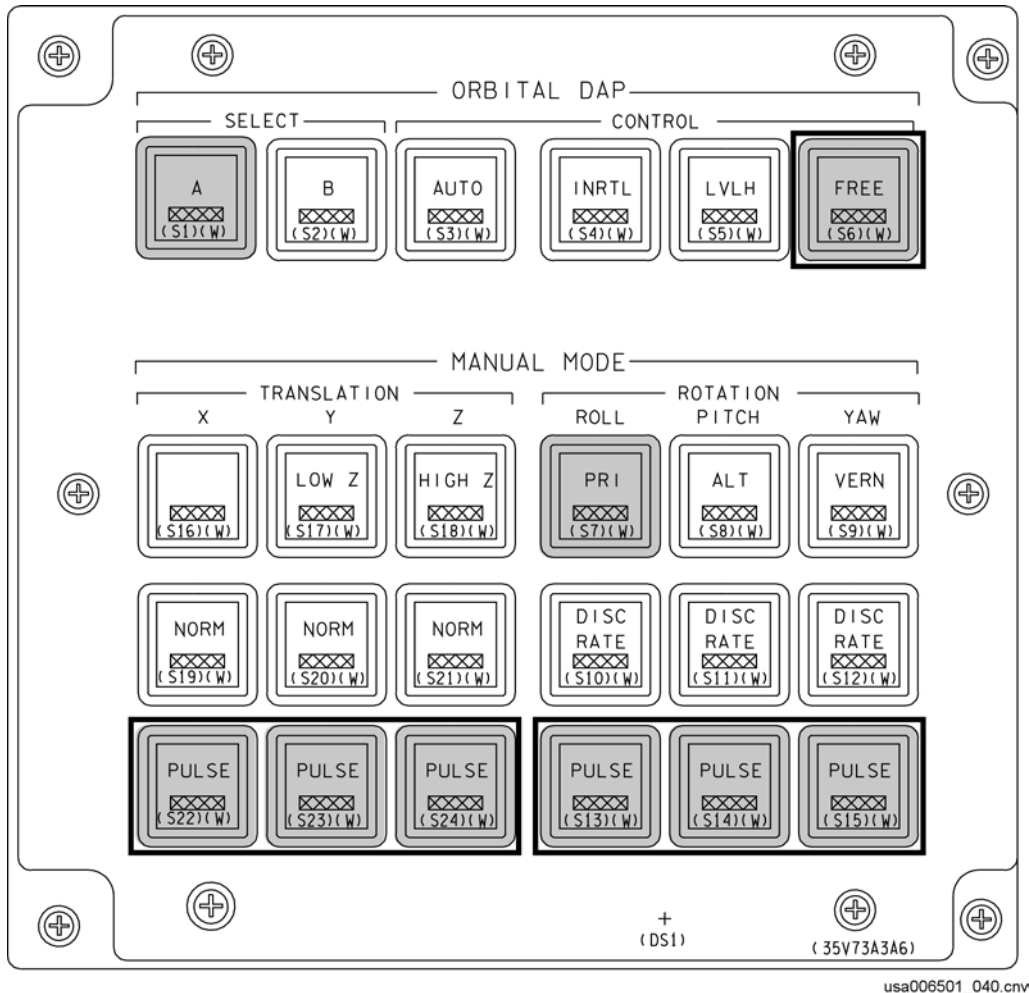

Figure 7-5. Inertial measurement unit fail pbi reconfiguration

7.1.17 BFS - pbi's

With BFS engaged, only the rotation PULSE and DISC RATE pbi's function, and these are not selectable on an axis-by-axis basis (when one is pressed, pbi's for all three axes are selected and illuminated). There is also no AUTO maneuver capability in either the RCS or TVC DAP modes.

7.2 ATTITUDE DIRECTION INDICATOR

Three identical ADIs are onboard the vehicle (Figure 7-6). Two are located in the forward flight station (panels F6 and F8) for viewing during ascent, orbit, and entry. The third is located in the aft station (panel A1) and is operative only in OPS 2 and 8.

The ADIs provide attitude information to the crew as well as attitude rate and attitude errors from the position of the pointers and needles (Figure 7-6). Each ADI also has a set of switches for the crew to select the mode or scale of the readout.

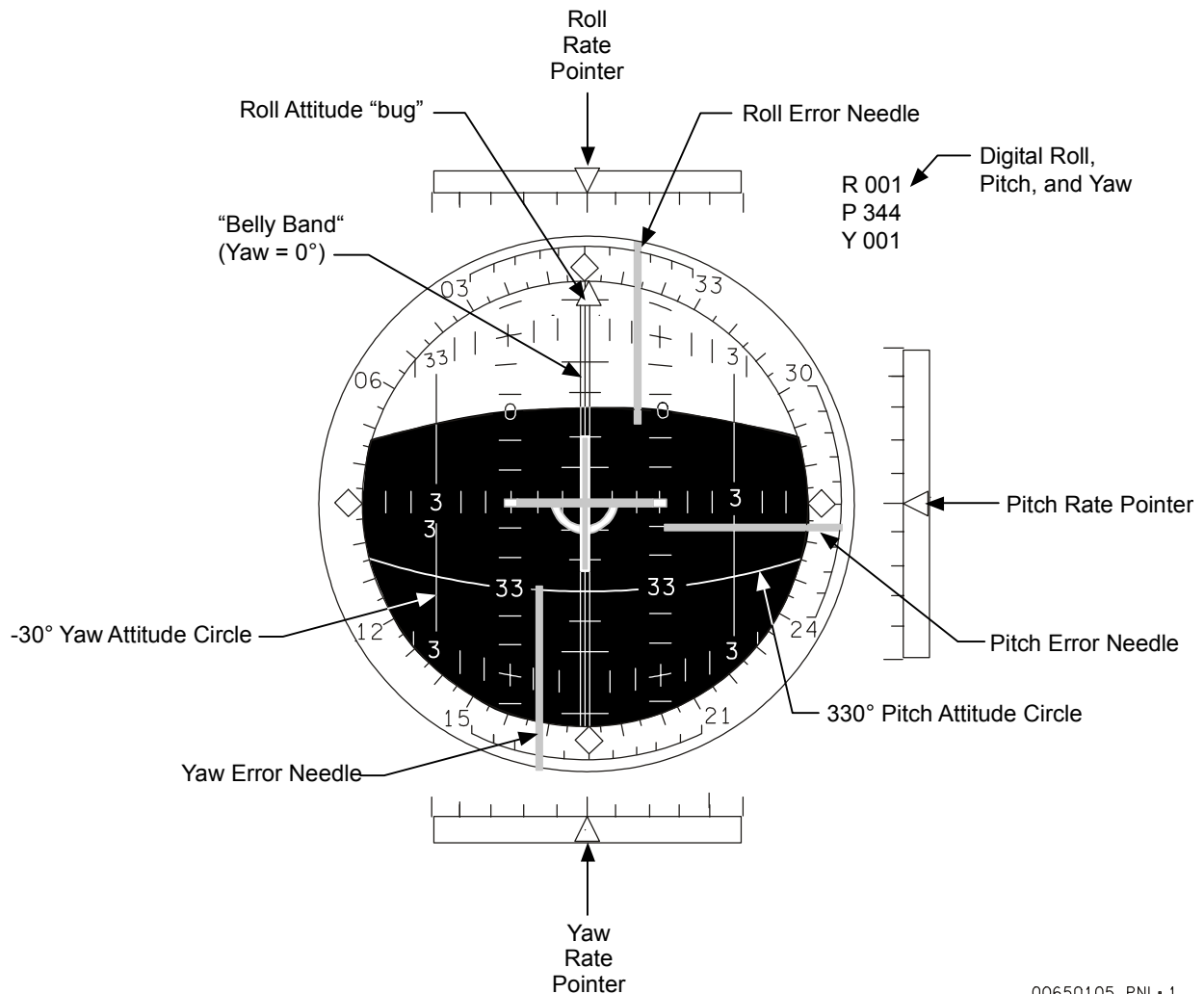

00650105, PNL# 1
usa006501.cnv

Figure 7-6. MEDS attitude direction indicator

7.2.1 Attitude

Each ADI has an ATTITUDE SELECT switch that determines the frame of reference for that particular instrument (Figure 7-7). The choices are INRTL, LVLH, and Reference (REF). The two forward switches are active during the ascent, orbit, and transition flight phases but have no effect (are overridden by software) during entry (MMs 304, 305), during the latter part of a return to launch site (RTLS) (MMs 602, 603), or when the BFS is engaged. The aft switch, like the aft ADI, works only on orbit.

CDR2

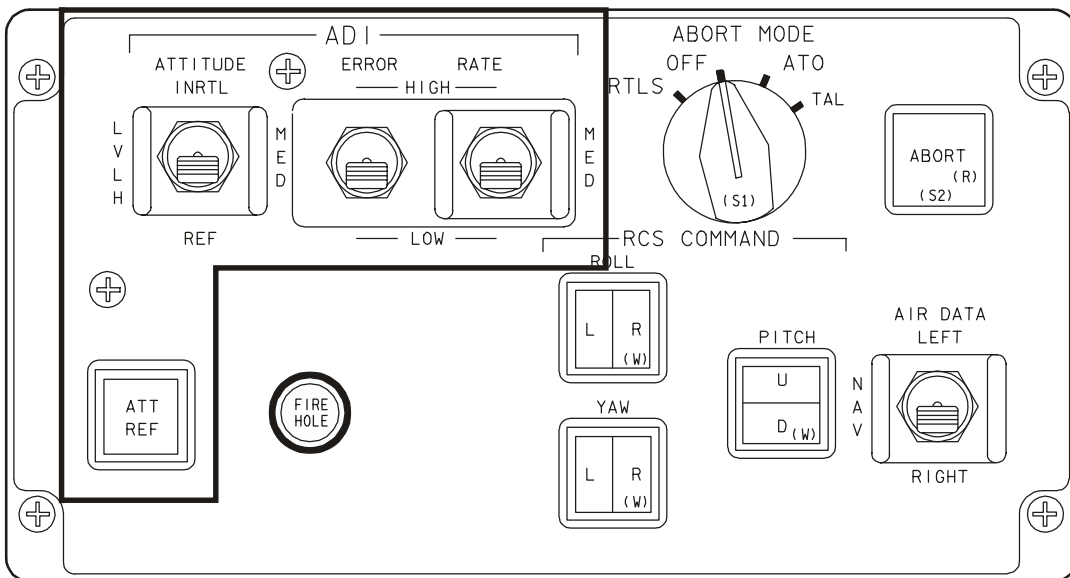
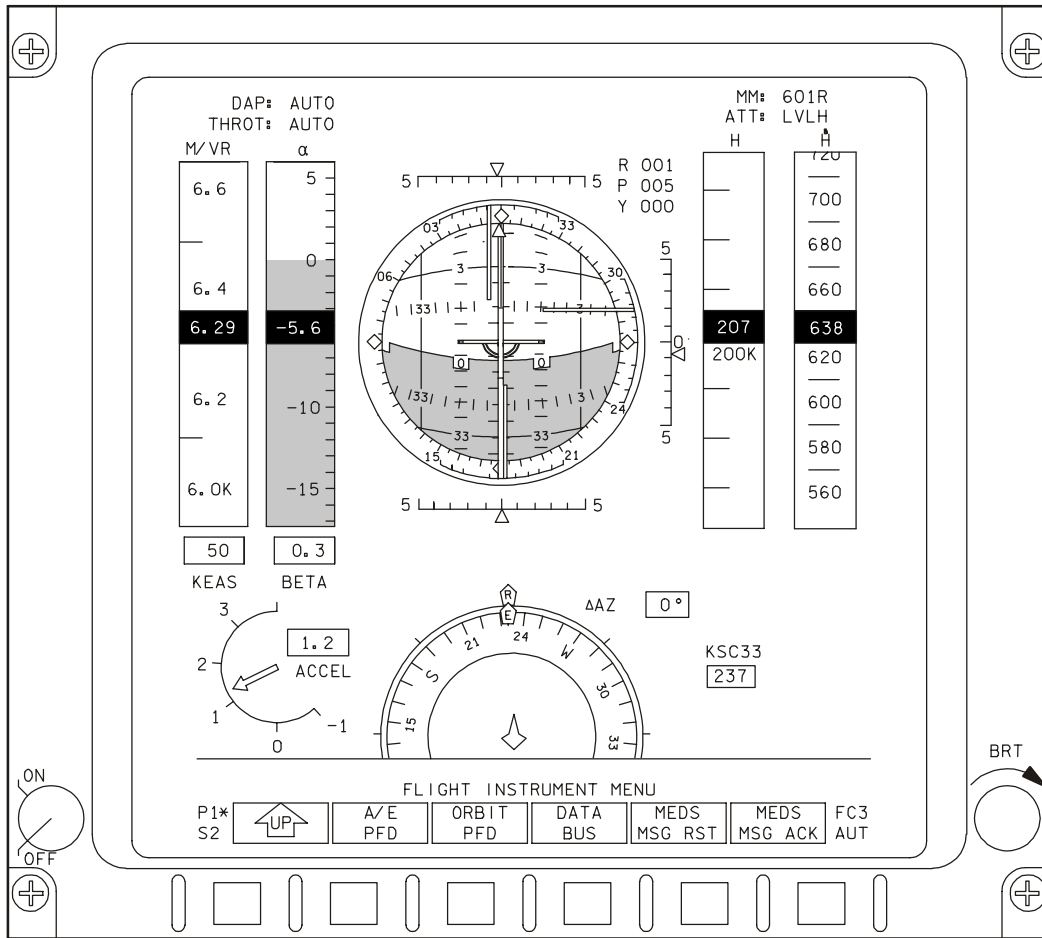

00650106. PNL 2

Figure 7-7. Panel F6 – MEDS ADI

The position selected depends on the task the crew is required to perform.

- a. The INRTL position allows the crew to view the orbiter's attitude with respect to the M50 Earth-centered Inertial reference frame that is useful in locating stars.
- b. The LVLH position shows the orbiter's attitude with respect to the LVLH reference frame, allowing the crew to see the orbiter's position with respect to the Earth.
- c. REF shows the orbiter's attitude with respect to the starball inertial reference frame if the ATT REF pbi has not been previously depressed. If it has been depressed, the REF position shows the orbiter's attitude with respect to the (0, 0, 0) attitude when the ATT REF pbi was last depressed. This is useful when flying back to a previous attitude or when monitoring an OMS burn for attitude excursions.

7.2.2 Rate

Each ADI has a set of three pointers that provide a readout of the vehicle body rotational rates. Roll, pitch, and yaw rates are displayed on the top, right, and bottom pointers, respectively. The center mark on the scale next to the pointer shows zero rates, while the rest of the marks indicate positive or negative rates. There is a three-position (HIGH, MED, and LOW) rate scale switch that determines the magnitude of full-scale deflection. ADI rate readings are independent of the attitude reference selected.

7.2.3 Errors

Three needles on each ADI display vehicle attitude errors (Figure 7-6). Similar to the rate pointer indicators, each error needle has a background scale with marks for the crew to read the magnitude of the attitude error. These errors are displayed with respect to the body axis coordinate system and thus are independent of which reference frame is selected for ADI attitude display.

The attitude error needles are “fly to.” This means that to null attitude error, the RHC should be moved in the same direction that the needle is being deflected. For example, if the pitch error needle points down, the crew must pitch down to null the pitch attitude error.

7.3 BFS - ADI

In the BFS only the left attitude switch (panel F6) works, allowing a selection of REF, LVLH, or INRTL for **both** forward station ADIs Only the left ATT REF pbi works in the BFS. The rate and error scale switches are also defaulted to MED.

7.4 RCS ACTIVITY LIGHTS

The RCS activity lights are located on panel F6 and are used during transition and on-orbit flight phases to indicate RCS jet commands by axis and direction (Figure 7-8). (During entry, OPS 304 or 603, the lights take on slightly different meanings. See the RCS Training Manual for more details.)

It should be emphasized that the activity lights are displaying jet commands only. This is not necessarily an indication of actual jet firings.

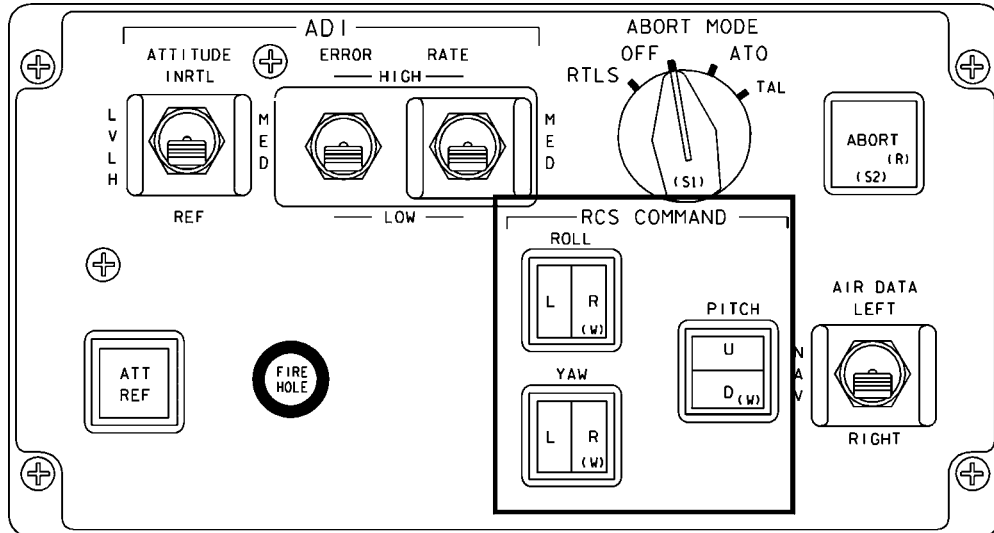

00650106, PNL 1a
usa006501_cnv.

Figure 7-8. RCS activity lights, Panel F6

This page intentionally left blank.

7.5 QUESTIONS

1. Name the active pbi's for the following situations:
 - (a) In TRANS DAP
 - (b) With BFS engaged
 - (c) On orbit, in OPS 2, when the IMU DATA GOOD flag is set to "bad"

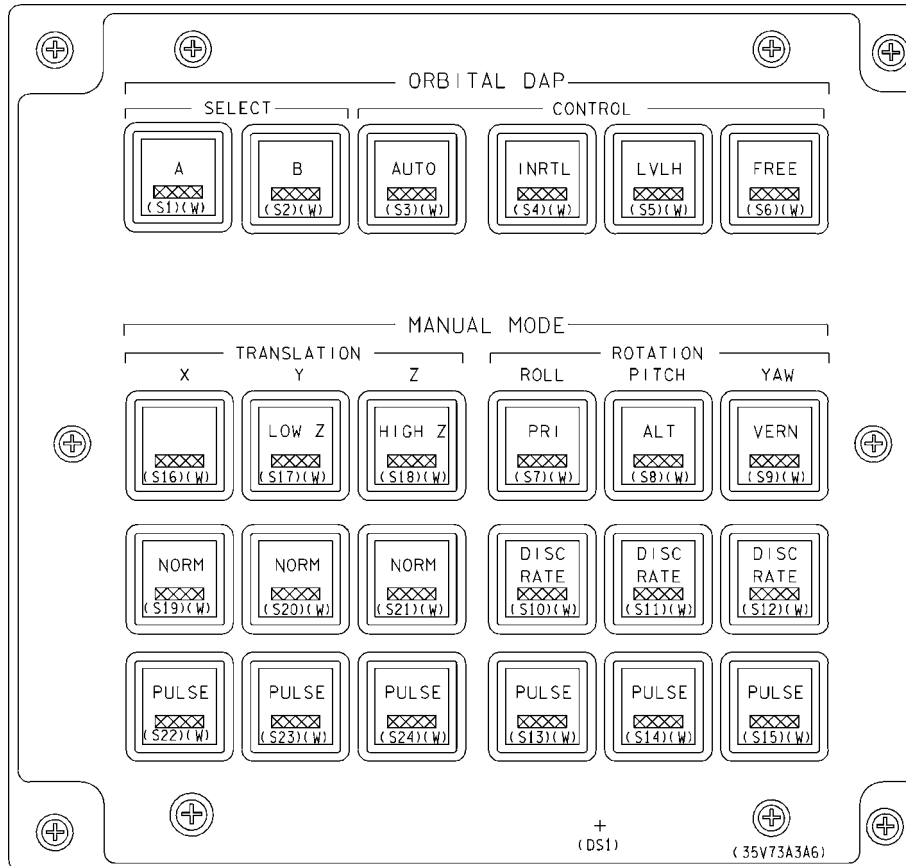

usa006501_044.cnv

2. What does the message DAP RECONFIG mean?
3. What happens to the pbi mode configuration if jet R5R should fail off? What if R5D fails instead?
4. What information does the ADI provide?
5. True or False. The RCS activity lights illuminate only if jets actually fire. Explain your answer.

8.0 FLIGHT CONTROL MODES

8.1 OBJECTIVES

After completing this section, you should be able to

- a. Define RCS wraparound
- b. List the TVC DAP deadbands
- c. Describe the results of taking the RHC out of detent

The TRANS and ORBIT DAPs are always in one of two modes, RCS or TVC. Within each of these modes, the crew could be in AUTO or a manual mode with any of a number of submodes selected. This section summarizes each of the available modes and submodes, detailing how they are entered and what sort of flight control can be expected.

8.2 TVC MODES

For the DAP to be in the TVC mode, the following conditions must be met:

- a. An ON command is being sent to one or both of the OMS engines.
- b. In ORBIT DAP only, the IMU DATA GOOD flag must be set to ON (“good”). That is, there is at least one good IMU from which attitude data can be derived.

For an engine ON command to be generated:

- a. The engines (L, R, or BOTH) must be selected on the MNVR EXEC display in OPS 104, 105, 202, or 302.
- b. The EXEC key must be pressed after the word “EXEC” flashes on the MNVR display.
- c. The designated TIG must have been reached.

When these conditions are satisfied, the burn commences and the TVC mode is in effect until either cutoff occurs, the OMS ENG(s) switch is turned OFF, the IMU DATA GOOD flag is set “bad,” or the crew transitions to the next MM.

Table 8-1 summarizes all the TVC modes available.

Table 8-1. Available TVC modes

C O N D I T I O N	TVC mode	Automatic			Manual					
	Number of engines	2	1		2		1			
	RHC deflection	In detent	In detent	In detent	Within softstop	Beyond softstop	Within softstop		Beyond softstop	
	Axis	All	Roll	Pitch Yaw	All	All	Roll	Pitch Yaw	Roll	Pitch Yaw
R E S U L T	OMS	Guid rate cmds	None	Guid rate cmds	Prop rate cmds	Max rate cmds	None	Prop rate cmds	None	Max rate cmds
	RCS	Wraparound			Wrap-around	Accel	Disc rate	Wrap-around	Accel	

8.2.1 Automatic TVC - Two Engines

This is the mode that is usually used for OMS burns. It is selected by pressing the AUTO pbi on panel C3 and leaving the RHC in detent. In this mode, flight control sends commands to the TVC system that cause the gimbals to move appropriately. Because it is a rate command system, guidance tells TVC how fast and in what direction to turn the orbiter.

Under normal conditions, OMS TVC provides adequate body axis control of the orbiter. Because of the sluggish response and limited torque of the TVC system, however, the RCS provides control when the TVC cannot. Such RCS control is known as “wraparound.” A typical situation under AUTO TVC where RCS wraparound control becomes active is following an OMS engine failure or a gimbal hard-over, when OMS TVC cannot counteract the initial torque caused by the failure, and the induced turning rate exceeds the wraparound limit. Since, to conserve propellant, it is desirable that the RCS not fire unless absolutely necessary, the TVC DAP RCS wraparound deadbands are chosen to lie outside the attitude and rate errors normally experienced during OMS burns.

Deadbands: Deadbands are same for Orbit or TRANS DAP TVC modes.

Attitude		Rate
R	= 5°	2.05 deg/sec (all three axes)
P and Y	= 10°	

Only the AUTO/INRTL pbi's on panel C3 are used directly during an OMS burn.

- a. If the VERN pbi is selected prior to the start of an automatic OMS burn, the PRI pbi lights up and primary jets are still used for wraparound.
- b. During the burn, the LVLH and VERN pbi's are extinguished and nonfunctional.
- c. During the burn the crew can select DAP A or B, translation and rotation DISC or PULSE, and LOW Z or HIGH Z. The light will reflect those changes; however, changes to the DAP panel do not take effect until after the burn is terminated.

If the THC is taken out of detent while flight control is in the TVC mode, nothing happens if in ORBIT DAP, but an RCS translation occurs if in TRANS DAP. The DAP remains in AUTO so that attitude control can be maintained.

8.2.2 Automatic TVC - One Engine

For a single-engine OMS burn with the AUTO pbi selected, pitch and yaw control are the same as in the two-engine case. Roll control, on the other hand, is maintained by RCS jets since one engine cannot maintain it.

8.2.3 Manual TVC - Two Engines

The manual TVC mode is selected by pressing the INRTL pbi or by taking one of the RHCs out of detent. It can be activated at any time before or during the burn. As long as the requirements for entering the TVC DAP are met, the engines fire and shut off automatically when TGO = 0. Once the INRTL mode has been engaged, the only way to return to automatic flight control is to press the AUTO pbi with the RHCs in detent.

The INRTL mode behaves just like it does in AUTO except that the crew, instead of guidance, must supply the rate commands to the TVC system. In the manual mode, turning rate commands are generated by proportional RHC deflections. The resultant vehicle rate corresponds in size and direction to the degree of RHC deflection. The greater the RHC deflection, the greater the turning rate commanded to flight control. When the RHC is returned to detent (a turning rate of zero), the gimbals must first null any previously induced rate and then point back through the c.g. to maintain a zero rate.

With the RHC inside the softstop, the RCS jets are available for "wraparound" to achieve the commanded rate, just as in the AUTO TVC mode. If the RHC is deflected past the softstop, however, the gimbals produce a maximum turning rate of 2 deg/sec and the RCS jets fire continuously (ACCEL mode). Figure 8-1 illustrates OMS TVC.

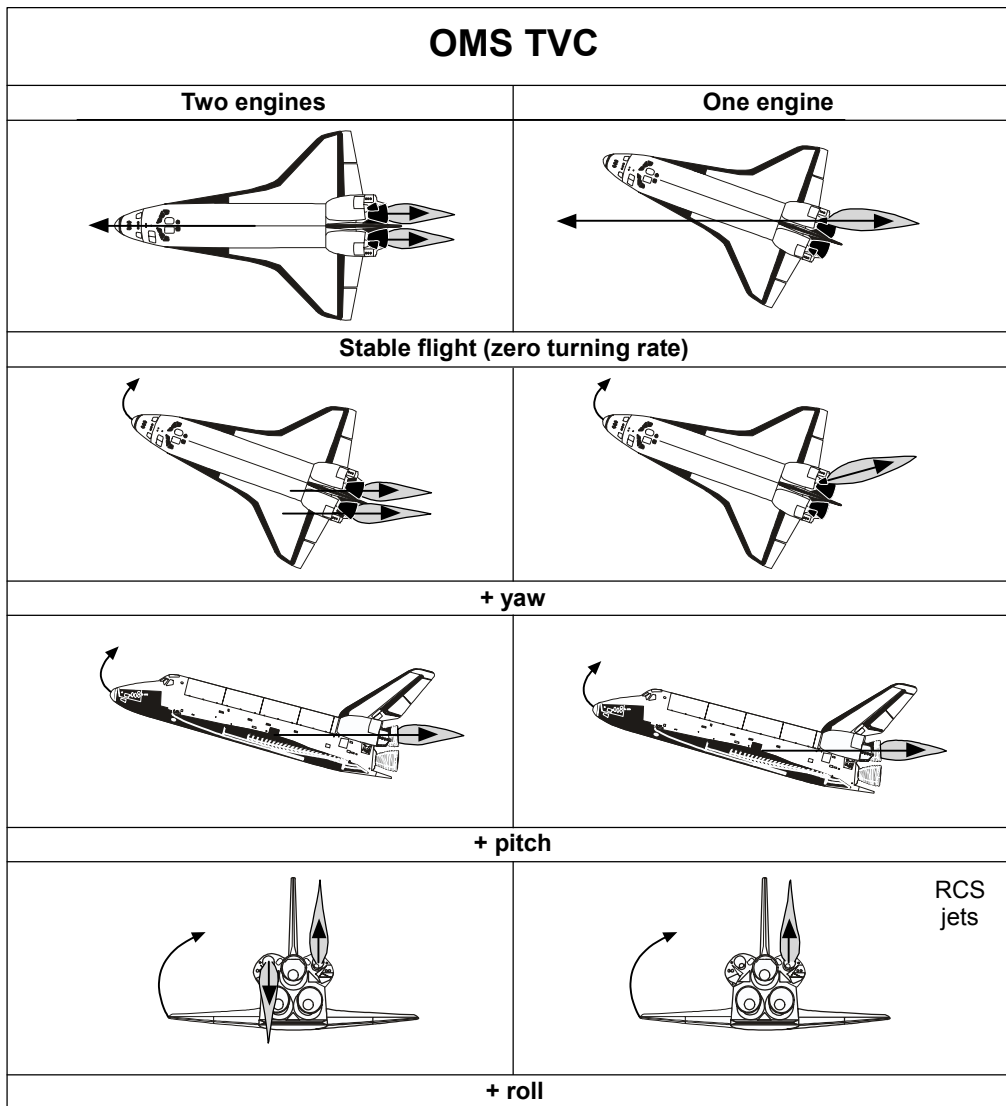

usa006501_045a.cnv

Figure 8-1. OMS TVC

8.2.4 Manual TVC - One Engine

When flight control recognizes an engine failure, it downmodes to the single engine mode in which roll control is maintained by RCS jets, just as in the AUTO TVC single-engine case previously described. For an engine failure to be “recognized,” flight control monitors the position of the OMS ENGINE switch on panel C3. When the switch output reads OFF (whether the crew placed it there, or some combination of commfaults, switch hardware problems, or power failures faulted it there) flight control downmodes to the single-engine control mode.

The pitch and yaw axes perform exactly as in the two-engine manual case, with proportional rate commands and RCS wraparound. Independent of rotation pbi selection, the roll axis behaves as if it is in discrete rate. If DISC RATE was not selected, the pbi illumination does not change, but DISC RATE is in effect. For both

ORBIT and TRANS DAPs, the DISC RATE during TVC operations is the same as the DISC RATE used for RCS operations.

In addition, the RHC position influences the type of roll control just as it does for RCS operations. When the RHC softstop is exceeded in roll, the jets fire continuously, and as the controller is taken back within softstop, no jets fire. Attitude hold with the TVC roll deadband of 5° is resumed when the RHC is returned to detent.

8.3 RCS CONTROL MODES

When the DAP is not in the TVC mode, it is in the RCS control mode. The four mutually exclusive RCS rotation submodes available in the ORBIT DAP are AUTO, INRTL, LVLH, or FREE. Since the LVLH and FREE modes are not available in the TRANS DAP, the choice is AUTO or INRTL. Within each of these modes are submodes which depend on conditions such as the DAP pbi configuration and RHC state. Manual RCS translation modes are independent of any of the listed RCS rotation modes. All the RCS control modes and submodes have been discussed in the DAP pbi section of this manual.

8.3.1 Hand Controller Interface

The position of the RHC affects the kind of attitude control that is effective with various pbi selections. The three basic zones of operation for the RHC are as follows:

- a. Detent - Hands-off position, no command outputs. To exceed the detent region, the RHC must be deflected 0.25°.
- b. Within softstop - Normal operating range.
- c. Past softstop - When the RHC is moved more than 20° in pitch and roll or more than 10° in yaw, there is a point where it becomes harder to cause any more deflection. The hardware limits are reached at 24° in pitch and roll or 14° in yaw.

Table 8-2 shows the control for any combination of RHC deflection and pbi submode for the TRANS and ORBIT DAPS. Note that the ACCEL mode (continuous jet fire for the duration of the RHC deflection) is available AT ALL TIMES by taking the RHC past the softstop. Once the RHC has been deflected beyond the softstop and then back between the softstop and detent with either DISC RATE or PULSE selected, the orbiter is in free drift until the RHC is returned to detent again. (Once back in detent with DISC RATE selected, attitude hold is initiated.) With PULSE selected, the orbiter is in free drift when back in detent.

The THC has no softstop. Use of the THC does not change the DAP control mode to INRTL as use of the RHC does.

Table 8-2. RHC deflection and pbi submode control for TRANS and ORBIT DAPS

RHC position \ PBI submode	Discrete rate		Pulse	
	Detent	Attitude hold	New attitude hold	Free drift
Detent to softstop	Disc rate	Free drift	Pulse	Free drift
Softstop to hardstop	Accel	Accel	Accel	Accel

usa006501_046a.cnv

8.4 BFS - CONTROLLERS

Only the forward station hand controllers work when BFS is engaged. See the Controllers training manual for more information on this subject.

8.5 QUESTIONS

1. What is meant by RCS wraparound? What else are RCS jets used for when the TVC DAP mode is active?
2. What are the TVC DAP deadbands?

Attitude: R = _____ deg

P = _____ deg

Y = _____ deg

Rate: R = _____ deg/sec

P = _____ deg/sec

Y = _____ deg/sec

3. Answer the following questions based on the pbi configuration shown (shaded pbi's are active):

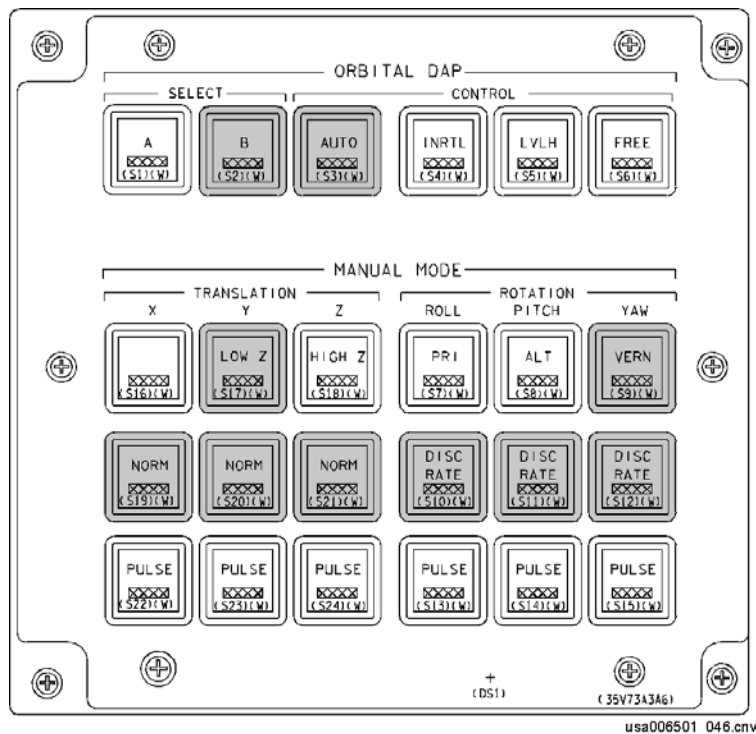

- (a) If the RHC is taken out of detent, what happens? Describe the control mode that results.
- (b) What would be the result of taking the THC out of detent in the +Z axis?

9.0 INSERTION, ON-ORBIT, DEORBIT PROCEDURES

9.1 OBJECTIVES

After completing this section, you should be able to

- a. Identify which parameters on the MNVR EXEC display should be monitored during a burn
- b. Explain why the crew should turn the OMS ENG switch to OFF if an engine failure occurs during a burn
- c. Describe the results of taking the THC out of detent before the ET SEP automatic -Z translation is complete
- d. State when the OMS gimbals move to their trim positions

Having previously discussed GN&C software and crew interfaces, this section will cover the insertion, on-orbit, and deorbit procedures as well as associated malfunctions.

9.2 EXTERNAL TANK SEPARATION

When main engine cutoff has occurred and the ZERO THRUST flag is set, the TRANS DAP takes control from the ASCENT DAP and the ET SEP sequence begins. The crew verifies MECO CONFIRM when the DAP pbi's on panel C3 initialize to the TRANS DAP configuration: the AUTO and three DISC RATE lights come on for the first time.

Under normal circumstances, about 20 seconds after MECO, the explosive bolts that hold the ET onto the vehicle fire to separate the ET from the orbiter. The AUTO ET SEP sequence checks pitch, roll, and yaw rates and the feedline disconnect valve status before firing the explosive bolts. If any rate exceeds 0.7 deg/sec or a valve failure is detected, ET SEP is inhibited and a crew alert is generated. The condition which caused the inhibit must be corrected or manually overridden before the sequence continues. For excessive vehicle rates, the crew must null them manually using the RHC or wait for the TRANS DAP to null them.

In the case of an RTLS abort, the following parameters are checked (instead of 0.7 deg/sec) to determine whether ET SEP should be executed:

(STS-114 I-Loads)

-20°/sec	≤	pitch rate	≤	+0.25°/sec
-20°/sec	≤	roll rate	≤	+20°/sec
-20°/sec	≤	yaw rate	≤	+20°/sec
-89°	≤	α	≤	-1.5°
-20°	≤	β	≤	+20°

If these parameters are outside the specified limits, ET SEP will be delayed up to 6 seconds to allow the parameters to come back within tolerances. After 6 seconds, the separation will occur regardless of the parameter values. ET SEP cannot be delayed longer because on an RTLS the orbiter is quickly entering the atmosphere.

9.2.1 -Z Translation Maneuver

Immediately following separation, an inertial attitude hold is established and an automatic RCS SEP maneuver occurs (Table 9-1). The purpose of this burn is to ensure orbiter clearance from the ET. Attitude control is inhibited during the first 2.96 seconds of this translation to ensure that attitude control jet activity does not interfere with ET/orbiter separation. Following this period, the DAP will maintain the orbiter inertial attitude throughout the translation. On a nominal mission, when a ΔV_z of -4 ft/sec is detected by the IMUs, the SEP burn stops, and the GPCs automatically Proceed (PRO) to MM 104. During the actual SEP burn, a special jet select logic table is in effect which causes 10 downfiring (-Z) jets to fire when the command is given (4 forward, 6 aft).

For an RTLS abort, the criteria for setting the ET SEP COMPLETE flag (and initiating an automatic PRO into MM 602) are an elapsed time of > 10 seconds from ET SEP and $\alpha > 10^\circ$. If a Transoceanic Abort Landing (TAL) is declared, the vehicle must achieve a ΔV_z of 11 ft/sec before the automatic PRO to MM 104 will occur.

If the crew takes the THC out of detent during the automatic translation maneuver (burn time is usually about 5 seconds), the automatic -Z translation maneuver is canceled. The crew must achieve the required -Z translation rate manually or the automatic transition to MM 104 will not occur.

Note that manual override of the -Z ET SEP maneuver is not available in the BFS.

Table 9-1. ET SEP event timeline

Event (Times are approximate for a nominal mission)	Results
8:30 MECO COMMAND <u>Set conditions:</u> guidance commanded or three Pc < 30 percent or two Pc < 30 percent with one data path failure or manual shutdown or prop depletion	<u>Results:</u> • Illuminates red ME status lights
8:31 MECO CONFIRM <u>Set conditions:</u> three Pc < 30 percent or two Pc < 30 percent with one data path failure or manual shutdown or OPS 104 PRO	<u>Results:</u> • Initiates ET SEP sequence
8:36 ZERO THRUST <u>Set conditions:</u> 3.75 sec after MECO CONFIRM	<u>Results:</u> • Initiates TRANS DAP • Holds last commanded attitude (DB = 10°)
8:50 ET SEPARATION <u>Set conditions:</u> ET SEP sw AUTO, MECO CONFIRM, feedline disconnect valves closed, and att rates < 0.7 deg/sec or ET SEP manual + pbi pressed	<u>Results:</u> • Extinguished ME status lights
8:55 -Z TRANSLATION <u>Set conditions:</u> Automatic part of ET SEP sequence	<u>Results:</u> • Fires 10 down jets • Free drift first 2.96 sec • Attitude hold (DB = 3.0°)
9:00 MM 104 TRANSITION <u>Set conditions:</u> -4 ft/sec ΔV_z achieved in AUTO or manually or MM 104 PRO	<u>Results:</u> • Attitude hold (DB = 3.5°)

9.2.2 Alpha-Beta Maneuver

Just before and after ET SEP, TRANS DAP targets alpha and beta within I-loaded limits with what is known as the Alpha-Beta Maneuver. For nominal trajectories, the Alpha-Beta maneuver is active only during mated coast. For TAL trajectories, the maneuver is also active in MM104, post-ET SEP. The purpose of the maneuver is to (1) ensure vehicle control in the event of unusual rates during ET SEP (roll-off), and (2) decrease the risk of ET recontact by avoiding delay of the MM304 transition which would also delay the TAL OPS 3 OMS dump.

The specific targets and rates of this maneuver are shown in the tables below.

Table 9-2. Alpha-Beta maneuver – First 6.7 seconds of mated coast

Note: Timer prevents ET-SEP Inhibit

	TAL	Nom/ATO/AOA
α (deg)	20.0	-2.0
β (deg)	0.0	0.0
Rate (deg/sec)	1.5	0.8

Table 9-3. Alpha-Beta maneuver – Post ET SEP

	TAL	Nom/ATO/AOA
α (deg)	28.0	N/A
β (deg)	0.0	
Rate (deg/sec)	5.0	

Note that for a TAL, while TRANS DAP targets these attitudes, it may not actually achieve them. As a result, for the sake of crew monitoring, the FDF TAL procedures specify:

$$\sqrt{\text{Rates}} < .5^\circ/\text{sec}; \theta > 15^\circ, Y = 0 \pm 30^\circ$$

The automated alpha-beta maneuver is a PASS only maneuver. If the BFS is engaged, this maneuver must be performed manually.

9.3 OMS-1 BURN

The purpose of the OMS-1 burn for a standard insertion ascent is to raise apogee after the main engines cut off to achieve a stable orbit. During a direct insertion ascent, the OMS-1 burn can also be used to make up for performance problems that may have occurred on ascent. The crew procedures for performing an OMS-1 burn can be divided into the following five steps:

1. Set up targets
2. Maneuver to burn attitude
3. Perform preburn checks/actions
4. Monitor the burn
5. Trim residuals

Each of these steps is examined in more detail in the following discussion. The OMS MNVR EXEC display (Figure 9-1) is included here for reference.

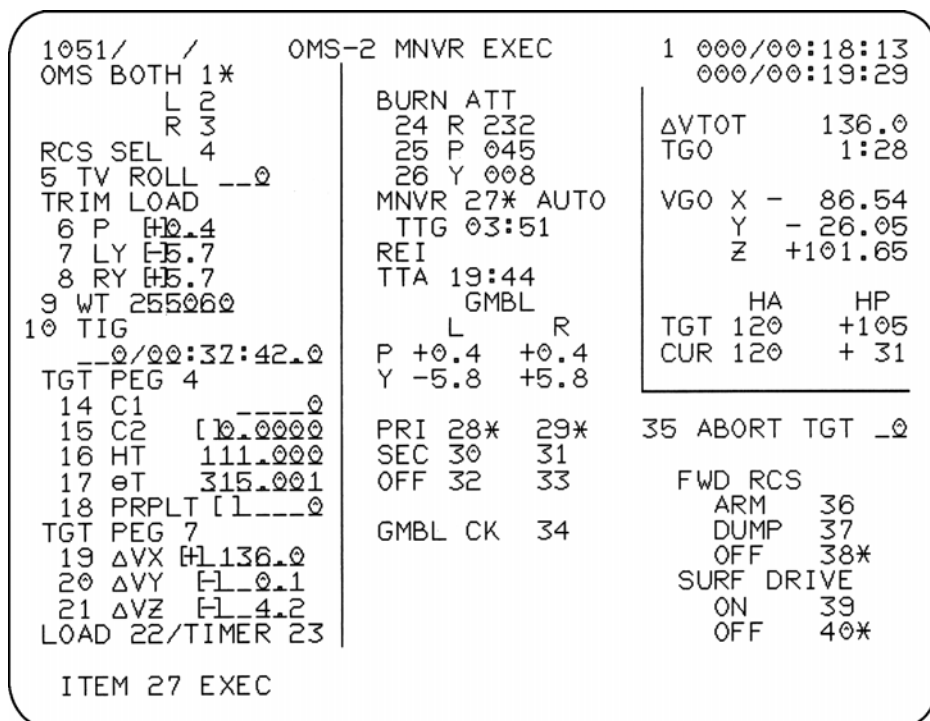

usa006501_155r1.tif

Figure 9-1. OMS MNVR EXEC display

9.3.1 Target Setup

Before an OMS burn can be performed, the crew must ensure that the proper targets are entered on the MNVR display. The individual parameters and software processing have already been discussed.

At MECO, MCC makes a recommendation to the crew based on the ascent performance. If no problems exist, the crew actions are minimal. The nominal targets appear automatically when the MM 104 MNVR display first appears. To verify the targets, the crew can compare TIG, HT, Θ T, and approximate ΔV with the values listed in the OMS TARGETS section of the Ascent Checklist. A comparison between the PASS and BFS target solutions is also made at this time. These targets are loaded and the countdown timer starts automatically for OMS 1.

The three primary reasons for an ascent abort are

- a. A main engine failure causing an underspeed at MECO
- b. A failure in the OMS, causing a loss of post-MECO ΔV capability
- c. A failure of a support system, making it necessary to land early

If one of these situations should occur, an alternate set of OMS-1 targets is required. There are several ways in which the proper targets can be entered. To call up the corresponding targets that are loaded automatically, turn the abort rotary switch to ATO and push the abort pbi (pre-MECO) or use ITEM 35 on the MNVR display (ABORT TGT) with the appropriate target set number. The crew can also enter the targets manually and load them with an ITEM 22 EXEC.

9.3.2 Maneuver to Burn Attitude

Once the targets are loaded, the burn attitude appears on the MNVR display. The crew must maneuver to this attitude either manually or automatically. Since TRANS DAP causes the ADI error needles to be referenced to the burn attitude as soon as the targets are LOADED, a manual maneuver can be performed with the RHC by commanding the appropriate rotations until the errors are eliminated.

To perform an automatic maneuver, the crew must first select the AUTO DAP pbi and then perform an ITEM 27 EXEC on the MNVR display. An asterisk appears and the vehicle begins moving at a rate of 0.5 deg/sec (the I-Loaded TRANS DAP auto maneuver rate) toward the burn attitude. Once there, the asterisk remains next to the Item 27, and the attitude is held within the nominal 3.5° TRANS DAP deadband. If the INRTL pbi is selected or the RHC is taken out of detent at any time before burn attitude is achieved, the automatic maneuver ceases. However, the ADI error needles are still referenced to the burn attitude.

To verify that the burn attitude has been achieved in TRANS DAP, the crew can compare the ADI inertial attitude with the burn attitude on the top center of the MNVR

display or check that the error needles are within the deadband. If the orbiter attitude differs slightly from the desired burn attitude at ignition, OMS TVC is usually able to complete the burn successfully. There may be a large startup transient, however, and more propellant is burned than necessary. Therefore, it is desirable that the burn attitude be correct to within (\pm) 5°.

9.3.3 Preburn Checks and Actions

Prior to the burn, valve configuration and system pressures and temperatures should be checked to ensure that everything is in working order. The items of primary interest include verifying that the burn attitude has been achieved, ensuring that the OMS gimbals move to their trim positions, placing the DAP pbi's in AUTO with the rotational mode in DISC RATE (all three axes), and checking that the OMS engine switches are in ARM/PRESS for the engines to fire. For the OMS-1 burn, the gimbals move from their stow position to the I-Loaded trim position when MM 104 is entered. For all subsequent OMS burns, the gimbals move to their trim values at TIG - 15 seconds. If BFS is engaged, the gimbals move when the LOAD item entry is made.

The insertion, on-orbit, or deorbit burns can be done with the TVC DAP in either the AUTO or INRTL flight control mode or with the +X RCS jets manually. The OMS-1 burn is usually performed in AUTO. If the crew wants to take over manually, the rotation control should be in DISC RATE so that the vehicle attitude is held between crew inputs. This is the reason for the AUTO/DISC RATE that the checklists refer to.

Another action taken at this time is to turn the flight controller power ON so that the RHC and THC are active if a downmode to manual is necessary.

The ADI setting is crew preference. For the maneuver to burn attitude, being in INRTL is the preferred mode since the burn attitude is given in inertial coordinates. For the burn itself, however, if the ADI is in LVLH, the burn attitude is near the "belly band" of the ADI. When the burn attitude is achieved and if the REF position on the ADI is selected, when the ATT REF pbi is pressed the ADI is reset to (0, 0, 0). This is the easiest attitude to monitor, as deviations caused by engine or gimbal failures would be readily apparent. It is suggested that the error needles be placed in HI (10° full scale deflection) and that the rate pointers use the MED position (5 deg/sec full scale).

Assuming that the targets were loaded properly, guidance has converged on a burn solution, and that you are in one of the MNVR EXEC MMs (OPS 104, 105, 202 or 302), the word EXEC will flash in the upper right-hand corner of the MNVR display at TIG -15 seconds. The EXEC key must then be pressed to initiate the OMS burn sequence and allow ignition at the scheduled TIG. If the EXEC keystroke is done after the planned TIG, ignition occurs immediately. For ascent and deorbit burns, make sure the EXEC keystroke is to a PASS computer since the BFS cannot initiate the OMS burn sequence if it is not engaged.

9.3.4 Monitoring the Burn

During the burn, the crew must verify that the engines are firing and that guidance remains converged. For each engine in use, the crew should see the following indications:

- a. The OMS Pc gauge should read approximately 104 percent (MEDS).
- b. The Engine Valves (ENG VLV) should read about 100 percent, corresponding to fully OPEN (BFS - GNC SYS SUMM 2).
- c. Helium pressure should decrease slowly as the propellant is expended (BFS - GNC SYS SUMM 2 or MEDS).
- d. Engine inlet pressures should drop to about 200 psi (OX) and 220 psi (FU) (BFS - GNC SYS SUMM 2).
- e. The $\Delta VTOT$ should be decreasing at a rate of about 2 ft/sec per second for a two-engine burn or about 1 ft/sec per second for a single-engine burn (MNVR EXEC display). TGO should count down steadily.
- f. Check the ADI for stability of attitude. The attitude deadbands during the burn are

Attitude	Rate
R = 5° P and Y = 10°	2.05 deg/sec (all three axes)

- g. Fifteen seconds after ignition, the OMS quantity gauge should begin to function and provide valid quantity data (panel O3).

9.3.5 Engine Failures

If a burn is set up for two engines and one fails during the burn or at TIG, the attitude processor detects the undesired rate and flight control moves the good engine to point the thrust through the c.g., thereby halting the turning rate (this whole process takes about 4 seconds) (Figure 9-2). As with all TVC modes, RCS jets “wraparound” for pitch and yaw control.

The turning rate is stopped when the thrust direction of the good engine is pointed through the c.g., but the orbiter is yawed with respect to the burn attitude. If the ADI was set to the REF position with an attitude of (0, 0, 0) before the burn started, this would show up as a yaw bias of approximately 12°. Since the error needles are still referenced to the last guidance-commanded attitude, these would register an error. If the DAP is left in AUTO, the error would remain, but would not be nulled since the ADI is referenced to the initial two-engine burn attitude.

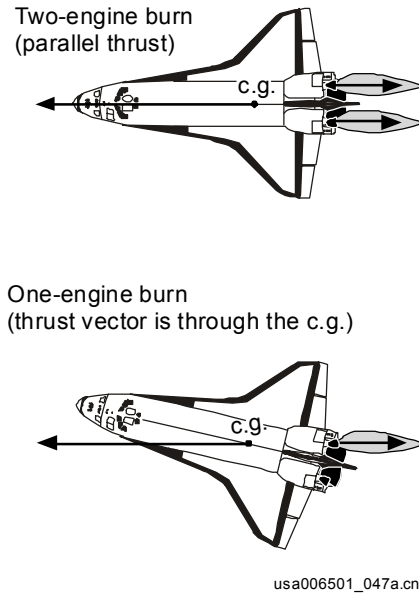

Figure 9-2. Two-engine burn vs. one-engine burn

To notify guidance and flight control of the failed engine and eliminate the errors displayed on the ADI needles, the crew must turn the affected OMS ENG switch to OFF. If there is a comm fault or other problem that prevents the GPCs from reading the switch position, TGO continues counting down at half speed and the burn is less efficient. See the OMS training manual for more on this subject.

9.3.6 Trim Residuals

OMS guidance and flight control normally achieve the desired ΔV in all axes to within several tenths of a foot per second. Off-nominal situations such as flight control problems or premature engine cutoff may leave the orbiter with a substantial ΔV still to be burned to achieve the desired target condition.

The specific required ΔV in each axis is shown in the upper right-hand box of the MNVR display as VGO X, VGO Y, and VGO Z. Some burns have more critical target conditions than others. OMS 1, OMS 2, deorbit, and rendezvous burns require the crew to take out residual velocities to less than 2 ft/sec (even less in some cases). The crew does this with the RCS. The sign of VGO tells the crew which way to deflect the THC. For example, if VGO Z = +3, push the THC in the +Z direction (that is, down) and watch the VGO Z value approach zero. The VGO is best taken out with a series of short firings of about 1 second each, watching the results of each firing on the VGO values.

9.4 POST-OMS-1 BURN

Between the OMS-1 and OMS-2 burns, the TRANS DAP is active since the GPCs are still in OPS 1. This means that the nominal I-Loaded deadbands of 3.5° for attitude and 0.5 deg/sec for rate are in effect. Also at this time, the AUTO maneuver/DISC RATE is 0.5 deg/sec and the PULSE rate is 0.08 seconds (the minimum jet on-time).

Nominally, the flight controller power would be turned OFF to prevent unintentional jet firings, and the DAP would be left in AUTO, holding the OMS 1 burn attitude during this period of time. As soon as the OMS-2 burn targets have been loaded and a burn attitude is computed by guidance and displayed, the crew should enter an ITEM 27 EXEC on the MNVR display to initiate a maneuver to the OMS 2 burn attitude.

9.5 OMS-2 BURN

The OMS-2 burn is done at the apogee of the elliptical orbit previously established by the OMS-1 burn (standard insertion) or by the main engines (direct insertion). It raises the perigee altitude and is usually done to create a circular orbit. OMS 2 normally occurs about 30 minutes after OMS 1, so the crew procedures in preparation for OMS 2 are not as hurried as they are for OMS 1. The procedures are similar for the two burns, but there are a few additional actions for OMS 2.

OMS 2 is done in MM 105, and the transition must be done manually. The software selects an appropriate target, but it must be verified and changed, if necessary, to reflect any new decisions if an ATO or AOA is in progress. The target must be loaded by executing Item 22 on the MNVR display to obtain a guidance solution.

The procedures for the OMS-2 burn appear on the OMS 2/ORBIT OMS BURN cue card. The OMS engine switches, which were placed in the OFF position at the end of OMS 1, must be put back to ARM/PRESS before OMS 2.

After each burn, the engine bells retain their last position. The TRIM LOAD data are static during a burn, but the postburn gimbal angles are displayed in the TRIM LOAD items when the MNVR display is next called up. The gimbals do not move to the new TRIM LOAD angles until guidance becomes active 15 seconds before the burn starts. The crew confirms this via the gimbal angle readouts on the display before enabling the burn with the EXEC keystroke.

9.6 ON-ORBIT OMS BURNS

OMS burns are required during orbit operations on some missions to raise or lower the orbital altitude; for example, as part of a rendezvous maneuver or to move away from a payload following deployment. The procedures for these burns are very similar to the procedures for OMS 2 and are provided in the Orbit Operations Checklist and on the OMS 2/ORBIT OMS BURN cue card.

Normal orbit operations are carried out with the GPCs in MM 201. To do an OMS burn, the crew must transition to MM 202 for the ORBIT MNVR EXEC display. For orbit OMS burns, there are no stored targets as there are for ascent. The target parameters would either be in a checklist or be provided by MCC. Orbit burns are done using PEG 7 targets. PEG 4 target item entries result in an ILLEGAL ENTRY message in OPS 2.

Orbit OMS burns are generally very short and are often done with only one OMS engine. The procedures for a single-engine OMS burn are similar to those for a two-engine burn with only a few differences. The appropriate single engine should be

selected on the MNVR display (Item 2 for left or Item 3 for right). The gimbal trim load should also be changed to the appropriate single-engine values that are listed on the burn cue card. All the MNVR display changes should be made before loading the targets.

9.7 RENDEZVOUS BURNS

Following insertion, a vehicle's orbit is essentially fixed, although such effects as venting and atmospheric drag can cause orbital perturbations. OMS or RCS burns can be used to correct or modify the orbit, as required, for mission operations. The direction and magnitude of the thrust, as well as when it is applied, determine the resultant orbit shape.

All burns can be thought of as a combination of the following four basic types of thrusting:

1. POSIGRADE burn: Increases the speed at the point of application and raises every point of the orbit except the thrust point (Figure 9-3).

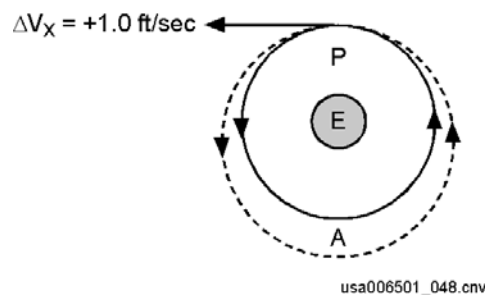

Figure 9-3. POSIGRADE burn

2. RETROGRADE burn: Decreases the speed at the point of application and lowers every point of the orbit except the thrust point (Figure 9-4).

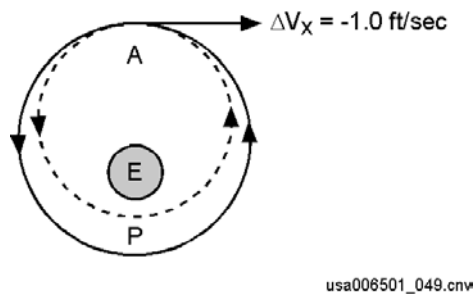

Figure 9-4. RETROGRADE burn

3. OUT-OF-PLANE burn: Alters the inclination of the orbital plane (Figure 9-5).



Figure 9-5. OUT-OF-PLANE burn

4. RADIAL burn: Moves the perigee and apogee points within the orbital plane (Figure 9-6).

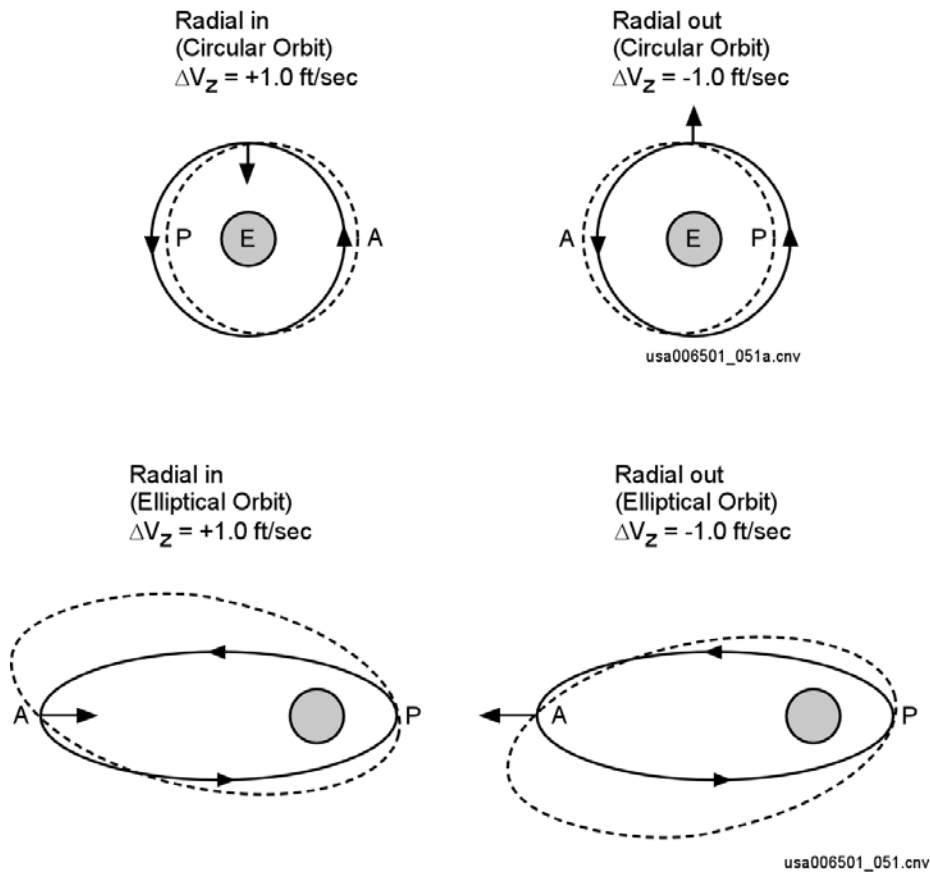

Figure 9-6. RADIAL burn

See the RNDZ Concepts CBT for more on this subject.

9.8 RCS BURNS

RCS jets also can be used for guided burns, either PEG 4 or PEG 7. Generally, this option is used only if no OMS engines are available or the desired ΔV is small (less than about 6 ft/sec).

If an RCS burn is planned, the crew should inform guidance and flight control with an ITEM 4 EXEC (RCS SEL) along with entry of the other target parameters on the MNVR EXEC display. The flashing EXEC appears, just as with an OMS burn, at TIG - 15 seconds. However, when TIG arrives, an automatic burn does not occur. The crew must deflect the THC to begin the burn.

If the burn is progressing nominally, the VGOs, $\Delta VTOT$, and TGO should be counting down as the crew holds the THC in for the required period of time. If the burn is not proceeding and the jets are operational, the DAP pbi's may not be configured properly. In ORBIT DAP, make sure that the translation mode is set to NORM for at least the axis that is being commanded (this problem cannot occur in TRANS DAP since there is no choice about the translation mode). Also, make sure that the flight controller power is turned ON.

Since the RCS DAP is active for a guided RCS burn, and assuming you have provided for an attitude hold by selecting either AUTO or INRTL/DISC RATE, the deadbands in effect are those normally expected to be present. That is, performing this burn in OPS 202 means the deadbands specified on the DAP CONFIG display would be in control. If this RCS burn is done in OPS 1 or 3, the I-Loaded values for a +X RCS burn (namely 3.0° for the attitude and 0.5 deg/sec for the rate deadbands) would be in control (Table 9-4).

Table 9-4. TRANS DAP deadband and maneuver rates

I-loads (subject to change) Auto/DISC RATE = 0.5 deg/sec		
Mission phase	Att DB	Rate DB
Mated coast	10.0°	0.5 deg/sec
ET SEP	3.0°	0.5 deg/sec
Nominal (coast)	3.5°	0.5 deg/sec
+ X RCS	3.0°	0.5 deg/sec
TVC roll	5.0°	2.05 deg/sec
TVC pitch, yaw	10.0°	2.05 deg/sec
The TRANS DAP PULSE rate is the minimum jet on-time, which is 0.08 sec.		

If an RCS completion burn is desired as the result of an OMS engine failure some time after TIG, the crew must first get out of the TVC DAP. This can usually be done by ensuring that both OMS ENG switches are turned OFF. This informs guidance and flight control of the problem and causes a down mode to the RCS DAP. If the OMS

ENG switch is broken, due to either a hardware problem or some combination of MDM failures, another way to exit the TVC mode is by performing an OPS transition to another MM. Once this is done, you may return to the burn OPS (assuming it is a legal transition), and the RCS DAP remains in effect.

9.9 DEORBIT BURN

The final use of the OMS during a mission is to accomplish the deorbit maneuver in which the OMS engines fire in the opposite direction to the velocity vector, thus decreasing the orbital velocity and lowering the perigee into the atmosphere.

Procedures for the deorbit burn are covered in the Deorbit Prep Checklist, the Entry Checklist, and on the Deorbit Burn cue card. The deorbit targets are loaded in MM 301, and the burn is performed in MM 302. A deorbit target appears automatically on the MNVR display. Changes are made to this target with information from the burn Preliminary Advisory Data (PAD) provided by MCC.

Following the deorbit burn, the GPCs are taken to MM 303. At the transition, the OMS engines gimbal to the stowed position, protecting the engine nozzles from the airflow during entry. The crew should verify that the OMS engines are in the stowed position, which is a pitch angle of $+5.9^\circ$, a left yaw angle of $+6.4^\circ$, and a right yaw angle of -6.4° . At that point, the gimbal drivers can be turned off by Items 32 and 33 on the MNVR display.

This concludes the main text of the workbook, please review the appendices for supplemental information.

If this workbook has been completed as part of a formal training syllabus, the reader is reminded to complete and submit the evaluation form at the end of this document.

9.10 QUESTIONS

1. Which parameters on the MNVR EXEC display should be monitored during a burn? How can you verify that the burn is proceeding as expected?

```

1051/ / OMS-2 MNVR EXEC 1 000/00:18:13
OMS BOTH 1* 000/00:19:29
  L 2
  R 3
RCS SEL 4
5 TV ROLL ---0
TRIM LOAD
6 P H10.4
7 LY L-5.7
8 RY H5.7
9 WT 255060
10 TIG
  0/00:32:42.0
TGT PEG 4
14 C1 -----0
15 C2 [10.0000
16 HT 111.000
17 0T 315.001
18 PRPLT [1-----0
TGT PEG 7
19 ΔVX H1136.0
20 ΔVY L-0.1
21 ΔVZ L-4.2
LOAD 22/TIMER 23

BURN ATT
24 R 232
25 P 045
26 Y 008
MNVR 27* AUTO
TTG 03:51
REI
TTA 19:44
  GMBL
  L R
P +0.4 +0.4
Y -5.8 +5.8

PRI 28* 29*
SEC 30 31
OFF 32 33

GMBL CK 34

ΔVTOT 136.0
TGO 1:28
VGO X - 86.54
  Y - 26.05
  Z +101.65

  HA HP
TGT 120 +105
CUR 120 + 31

35 ABORT TGT _0

FWD RCS
ARM 36
DUMP 37
OFF 38*
SURF DRIVE
ON 39
OFF 40*

ITEM 27 EXEC

```

usa006501_155r1.tif

2. Why should the crew turn the affected OMS ENG switch to OFF if an engine failure occurs during the burn?
3. What happens if the THC is taken out of detent before the ET SEP automatic -Z translation burn is complete? What must the crew do in this case?
4. When do the OMS gimbals move to their trim positions?
5. True or False. Explain the false answers.
- (a) _____ The OMS 2 burn is performed in MM 106.
- (b) _____ The typical purpose of the OMS 2 burn is to raise the perigee of the orbit.
- (c) _____ The four major classes of OMS burns include POSIGRADE, RETROGRADE, RADIAL, and OUT-OF-PLANE

APPENDIX A
ACRONYMS AND ABBREVIATIONS

ACCEL	Acceleration
ADI	Attitude Direction Indicator
ALT	Altitude
	Alternate
AOA	Abort Once Around
ASC	Ascent
ASEM	Assembly of Station by EVA Methods
ATO	Abort To Orbit
ATT	Attitude
ATT PROC	Attitude Processor
AVG G	Average G
BFS	Backup Flight System
BITE	Built-In Test Equipment
BURN ATT	Burn Attitude
BV	Body Vector
C&W	Clohessey-Wiltshire
c.g.	center of gravity
C/O	Cutoff
CNCL	Cancel Option
CNTL	Control
COAS	Crew Optical Alignment Sight
COMM	Communication
COMP	Compensation
COMPL	Completion
CPDS	Computer Program Development Specification
CRT	Cathode Ray Tube
CUR	Current
DAP	Digital Autopilot
DAP CONFIG	DAP Configuration Display
DB	Deadband
DEC	Declination
deg/sec	degrees per second
DISC	Discrete
EI	Entry Interface
ENT	Entry
ERR	Error
ET	External Tank
ET SEP	External Tank Separation

EXEC	Execute
EXT ΔV	External Velocity Increment
FCS	Flight Control System
FDF	Flight Data File
FREE	Free Drift
FSSR	Functional Subsystem Software Requirements
ft/sec	feet per second
FUT	Future
G&C	Guidance and Control
GMT	Greenwich Mean Time
GN&C, GNC	Guidance, Navigation, and Control
GPC	General Purpose Computer
GRTLS	Glided Portion of a Return To Launch Site
HA	Height of Apogee
HORIZ SIT	Horizontal Situation display
HP	Height of Perigee Orbital Perigee
HT	Altitude Height
I-load	Initialization Load
ID	Identification
IMU	Inertial Measurement Unit
INRTL	Inertial
INTELSAT	International Telecommunications Satellite Organization
JSC	Johnson Space Center
LAT	Latitude
LON	Longitude
LTVC	Linear Terminal Velocity Constraint
LVIY	Local Vertical IY Unit Vector
LVLH	Local Vertical, Local Horizontal
LY	Left Engine Yaw
M50	Mean of 1950
MCC	Mission Control Center
MDM	Multiplexer/Demultiplexer
ME	Main Engine
MECO	Main Engine Cutoff
MET	Mission Elapsed Time
MIN	Minute
MLS	Microwave Landing System
MM	Major Mode

MNVR	Maneuver
MNVR EXEC	Maneuver Execute
MOD	Mission Operations Directorate
MON	Monitor
n. mi.	nautical miles
NASA	National Aeronautics and Space Administration
Nav	Navigation
OM	Omicron
OMS	Orbital Maneuvering System
OMS 1	First OMS Burn (not used nominally in a direct insertion ascent)
OMS 2	Second OMS Burn (or first OMS burn in a direct insertion ascent)
OPS	Operational Sequence
ORB	Orbit
P	Pitch
PAD	Preliminary Advisory Data
PASS	Primary Avionics Software System
pbi	pushbutton indicator
PC	Chamber Pressure
PEG	Powered Explicit Guidance
PEG 4	Powered Explicit Guidance (Type 4)
PEG 7	Powered Explicit Guidance (Type 7)
PEG TSK	PEG Task
PRCS	Primary Reaction Control System
PRD	Program Requirements Document
PRI	Primary Jets
PRO	Proceed
PROC	Processor
PROX OPS	Proximity Operations
PRPLT	Propellant
PTC	Passive Thermal Control
R	Roll
RA	Right Ascension
RCS	Reaction Control System
REF	Reference
REI	Range from Entry Interface
REL NAV	Relative Navigation Display
REQD	Required
RGA	Rate Gyro Assembly
RHC	Rotation Hand Controller
RM	Redundancy Management
RMS	Remote Manipulator System
RNDZ	Rendezvous
ROT	Rotation

RR	Rendezvous Radar
RTLS	Return To Launch Site
RY	Right Engine Yaw
SEC	Secondary
SEL AUTO	Select Automatic
SEP	Separation
SOP	Subsystem Operating Program
SPEC	Specialist Function
	Specification
SRB	Solid Rocket Booster
SSME	Space Shuttle Main Engine
ST	Star Tracker
STS-	space shuttle flight designation
sw	switch
SYS	System
TAEM	Terminal Area Energy Management
TAL	Transoceanic Abort Landing
TFF	Time to Free Fall
TGO	Time to Go, time left in OMS burn
TGT	Target
TGT HA	Target Apogee
TGT HP	Target Perigee
THC	Translation Hand Controller
TIG	Time of Ignition
TRANS	Transition
	Translation
TRANS DAP	Transition DAP
TRK	Track
	Tracking Option
TTA	Time To Apogee
TTC	Time To Circularize
TTP	Time To Perigee
TV	Thrust Vector
TVC	Thrust Vector Control
UNIV PTG	Universal Pointing Display
UPP	User Parameter Processing
VERN	Vernier Jets
VGO	Velocity To Go
VGO X	Velocity To Go in X Body Axis Direction
VGO Y	Velocity To Go in Y Body Axis Direction
VGO Z	Velocity To Go in Z Body Axis Direction
VRCS	Vernier RCS Jets

Y	Yaw
ΔV	velocity increment
ΔV_{TOT}	total ΔV required
θT	theta T, downrange angle

APPENDIX B

SUGGESTED REFERENCE DOCUMENTS

- a. Other training manuals cover space shuttle systems as well as guidance, navigation, and flight control subjects. Some of the pertinent ones include
 - 1. GNC Hardware/Software Overview
 - 2. GNC Overview
 - 3. Inertial Measurement Unit
 - 4. Orbital Maneuvering System
 - 5. Reaction Control System
 - 6. Rendezvous/Prox Ops
 - 7. Sensors - Rate Gyros and Accelerometers
- b. There are Flight Procedures Handbooks that provide detailed explanations of crew procedures for all phases of flight. Two handbooks that are especially relevant are
 - 1. Ascent/Aborts (JSC 10559)
 - 2. OMS/RCS On Orbit (JSC 10588)
- c. The procedures described in this book are specified in the following FDF items:
 - 1. Ascent Checklist
 - 2. Orbit OPS Checklist
 - 3. Entry Checklist
 - 4. Cue Cards
 - 5. DPS Dictionary
- d. The Flight Rules outline preplanned decisions for failure situations.
- e. The Functional Subsystem Software Requirements (FSSR) document provides detailed descriptions of what the primary flight software is intended to do. It is divided into separate books on various segments of the software. The following are relevant to guidance and control:
 - 1. Displays and Controls (STS 83-0020)
 - 2. Trans DAP Flight Control (STS 83-0008V2)

3. Orbit Flight Control (STS-0009)
 4. On Orbit/Deorbit Guidance (STS 83-0003)
 5. Sequencing (STS 83-0026)
- f. The BFS Program Requirements Document (PRD) serves the same purpose as the FSSR for the BFS software.
- g. Other useful documents include the following:
1. PASS Users Guide
 2. Software Program Notes
 3. Computer Program Development Specification (CPDS) (SS-P-0002-510)

APPENDIX C ANSWERS TO TEST QUESTIONS

Appendix C contains answers to the test questions that appear at the end of the sections.

C.1 SECTION 1

There are no test questions for Section 1.

C.2 SECTION 2

1. (c) The purpose of nav is to keep track of where the orbiter is located.

Ref.: Section 2.2, Navigation, page 2-2

2. A state vector is defined as an accurate estimate of the orbiter inertial position and velocity.

Ref.: Section 2.2, Navigation, page 2-2

3. The navigation software maintains the orbiter state vector.

Ref.: Section 2.2, Navigation, page 2-2

4. The General Purpose Computers (GPCs) compute the orbiter state vector using an algorithm known as super-g nav.

Ref.: Section 2.3, State Vectors, page 2-3

5. IMU data is not incorporated for use in state vector propagation when the sensed accelerations are below certain threshold levels. Nor is the data used in OPS 201 or 801 when AVERAGE G (SPEC 33 Item 5) is turned off.

Ref.: Section 2.3, State Vectors, page 2-4

6. To improve/update the onboard state vector

(a) MCC can send delta or new state vector uplinks.

(b) The crew can perform delta state updates via the HORIZ SIT (SPEC 50) display or new state vector updates via GPC read/write.

(c) The BFS state vector can be updated from the PASS via a PASS/BFS state vector transfer or directly with new or delta state updates.

Ref.: Section 2.3.2, State Vector Updates, page 2-5

7. (b), (c), (d), and (e) The ADI processor, guidance, CRT displays, and flight control receive attitude-related data from the attitude processor.

Ref.: Section 2.4, Attitude Processor, page 2-5

C.3 SECTION 3

1. The differences between PEG 4 and PEG 7 burns are as follows:

PEG 4 – Closed loop guidance scheme which targets achieving a specified relationship between the horizontal and vertical velocity components of the vehicle at a certain position in the orbit. PEG 4 is not available in OPS 2.

PEG 7 – Open loop guidance scheme that aims to achieve a desired ΔV_x , ΔV_y , and ΔV_z in the LVLH reference frame.

Ref.: Section 3.2.2, PEG 4 vs. PEG 7 Guidance, page 3-2

2. The TRANS DAP is active after the ZERO THRUST flag is set in MM 103 through MM 106 and in MM 301 through MM 303.

Ref.: Section 3.4, Flight Control, page 3-4

3. The TVC DAP is active whenever the following two conditions are met:

- (a) An ON command is being sent to one or both of the OMS engines.

- (b) The IMU DATA GOOD flag is set to ON (good) in orbit DAP only. That is, there is at least one good IMU from which attitude data can be derived.

For an engine ON command to be generated:

- (1) The engines (L, R, or both) must be selected on the MNVR EXEC display in OPS 104, 105, 202, or 302.

- (2) The EXEC key must be pressed after the word EXEC flashes on the MNVR display.

- (3) The designated TIG must have been reached.

Ref.: Section 3.4.1, Thrust Vector Control Digital Autopilot, page 3-7

4. The purpose of the phase plane is to determine when, if, and in what direction rates must be generated to null any attitude or rate errors that exceed the limitations imposed by the deadbands.

Ref.: Section 3.4.2, Reaction Control System Digital Autopilot, page 3-9

C.4 SECTION 4

1. In the diagram, the PEG 4 target parameters for an OMS 1 burn are identified as:

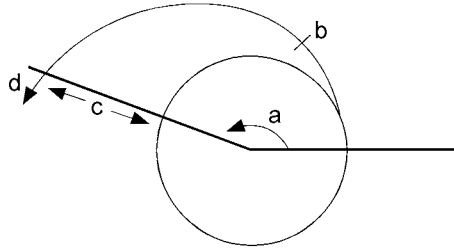

- c HT
- a θ T
- b TIG
- d C1/C2

usa006501_013.cnv

Ref.: Section 4.2.6, PEG 4 Targets (Items 14 to18), page 4-5

2. The boxed items are computed by guidance and should appear when a PEG 4 target set is LOAded in OPS 302.

```

1051/ / OMS-2 MNVR EXEC 1 000/00:18:13
OMS BOTH 1* 000/00:19:29
  L 2
  R 3
RCS SEL 4
5 TV ROLL --0
TRIM LOAD --0
6 P H10.4
7 LY F5.7
8 RY H5.7
9 WT 255060
10 TIG
  0/00:32:42.0
TGT PEG 4
14 C1 [ ] 0
15 C2 [ ] 0.0000
16 HT 111.0000
17  $\theta$ T 315.001
18 PRPLT [ ] 0
TGT PEG 7
19  $\Delta$ VX H1136.0
20  $\Delta$ VY F1-0.1
21  $\Delta$ VZ F1-4.2
LOAD 22/TIMER 23

BURN ATT
24 R 232
25 P 045
26 Y 008
MNVR 27* AUTO
TTG 03:51
REF
TTA 19:44
  GMBL
  L R
P +0.4 +0.4
Y -5.8 +5.8
PRI 28* 29*
SEC 30 31
OFF 32 33
GMBL CK 34

35 ABORT TGT _0
FWD RCS
ARM 36
DUMP 37
OFF 38*
SURF DRIVE
ON 39
OFF 40*
  
```

usa006501_155d1.tif

Ref.: Section 4.2.10, Burn Attitude and Maneuver (Items 24 to 27), page 4-10;
Section 4.2.17, Burn Data, page 4-13

- The purpose of the TRIM LOAD item entries is to tell the DAP what the initial position of the OMS engine gimbals should be at TIG so that guidance can calculate the correct burn attitude. This minimizes the chances of incurring a startup transient that would result if the engines were started with the gimbals out of position.

Ref.: Section 4.2.3, Trim Load (Items 6 to 8), page 4-3

- False. For all parameters **except PRPLT**, when an item on the left-hand portion of the MNVR EXEC display is altered, a reload is required for guidance to compute a new burn solution.

In OPS 3, if the PRPLT item is changed, guidance uses the new value to determine how much wasting out-of-plane is required to consume the excess quantity.

Ref.: Section 4.2.6, PEG 4 Targets (Items 14 to 18), page 4-5

- When an "Item 34 EXEC" is performed, an automatic gimbal drive check is initiated for the selected drive system (primary in this case). Assuming no failures when a GMBL CK is executed, the gimbals move to $(\pm) 5.89^\circ$ for pitch, $(\pm) 6.44^\circ$ for yaw, and then return to the initial portion before the check.

```

1051/ / OMS-2 MNVR EXEC 1 000/00:18:13
OMS BOTH 1* 000/00:19:29
  L 2
  R 3
RCS SEL 4
5 TV ROLL ___0
TRIM LOAD
6 P H0.4
7 LY L-5.7
8 RY H5.7
9 WT 255060
10 TIG
  ___0/00:32:42.0
TGT PEG 4
14 C1 _____0
15 C2 [ 0.0000
16 HT 111.000
17 0T 315.001
18 PRPLT [L___0
TGT PEG 7
19 ΔVX H1136.0
20 ΔVY L-0.1
21 ΔVZ L-4.2
LOAD 22/TIMER 23

BURN ATT
24 R 232
25 P 045
26 Y 008
MNVR 27* AUTO
TTG 03:51
REI
TTA 19:44
GMBL
  L R
P +0.4 +0.4
Y -5.8 +5.8
PRI 28* 29*
SEC 30 31
OFF 32 33
GMBL CK 34

ΔVTOT 136.0
TGO 1:28
VGO X - 86.54
Y - 26.05
Z +101.65

HA HP
TGT 120 +105
CUR 120 + 31

35 ABORT TGT _0

FWD RCS
ARM 36
DUMP 37
OFF 38*
SURF DRIVE
ON 39
OFF 40*

ITEM 27 EXEC

```

usa006501_155r1.tif

Ref.: Section 4.2.14, Gimbal Check (Item 34), page 4-12

C.5 SECTION 5

1. The four maneuver options are

MNVR	Identifies the inertial attitude maneuver
TRK	Aims and holds pointing vector at target of choice
ROT	Rotates vehicle about body vector
CNCL	Cancels all other options

Ref.: Section 5.1.1, MNVR, page 5-2; Section 5.1.2, TRK, page 5-2;
Section 5.1.7, ROT, page 5-12; Section 5.1.8, CNCL, page 5-13

2. The pitch and yaw that need to be entered to specify the +Y axis of the vehicle as the body vector are

Pitch = Anything (usually 0°)
Yaw = 90°

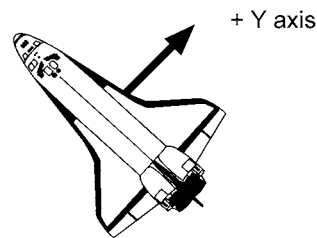

usa006501_034.cnv

Ref.: Section 5.1.3, Body Vectors, page 5-3

3. (a) The pitch and yaw angles that best describe the body vector depicted in the drawing are $P = 330^\circ$, $Y = 300^\circ$.

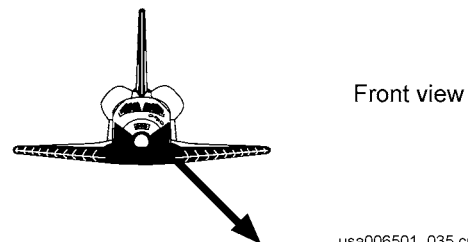
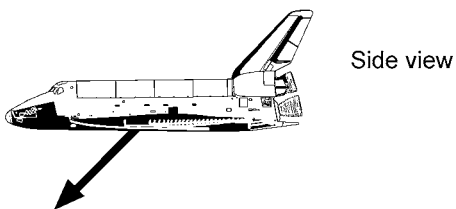

usa006501_035.cnv

Ref.: Section 5.1.3, Body Vectors, page 5-3

4. When performing a TRK option, omicron can be unspecified to save propellant. The keystrokes necessary to change this maneuver from three- to two-axis tracking are:

ITEM 8 + 2 EXEC

ITEM 19 EXEC

When a new Item 8 is entered (or the same value is reentered), OMICRON will blank. The TRK option must be re-executed for this display change to take effect.

Ref.: Section 5.1.5, Omicron, page 5-6

5. Assuming the DAP AUTO pbi is selected and the start time is in the past, the keystrokes necessary to perform the following operations are:

UNIV PTG		
TGTID	= 1	Orbiting Vehicle
	= 2	Earth ctr
	= 3	Earth tgt
		Input LAT (± 90)
		LON (± 180 , + = East)
		ALT (-3444.0 to 20000.0 nm)
	= 4	Sun ctr
	= 5	Celestial tgt
		Input RA (0-359.99)
		DEC (± 90)
	= 11-110	Nav Stars
BODY VECT	= 1	+X°
	= 2	-X°
	= 3	-Z°
	= 4	-Y Star Tracker
	= 5	Optional
		Input P (0-359.99)
		Y (270-359.99, 0-90)
Input OM	=	OM (0-359.99)
MON AXIS	= 1	+X
	= 2	-X

usa006501_036.cnv

- (a) Maneuver to an inertial position of $R = 10^\circ$, $P = 103^\circ$, $Y = 42^\circ$.

ITEM 5 + 10 + 103 + 42 EXEC

ITEM 18 EXEC

Ref.: Section 5.1.1, MNVR, page 5-2

- (b) Establish an LVLH attitude hold with the payload bay pointed toward the Earth and the nose of the orbiter pointed in the direction of the velocity vector, as shown (that is, -ZLV, +XVV):

ITEM 8 + 2 EXEC

ITEM 14 + 3 EXEC

ITEM 17 + 180 EXEC

ITEM 19 EXEC

Ref.: Sections 5.1.2 – 5.1.6.2, pages 5-2 – 5-10

- (c) Set up a PTC “barbecue” rotation. To achieve proper thermal conditioning, the vehicle must be oriented with the X-axis perpendicular to the direction of the Sun, as shown.

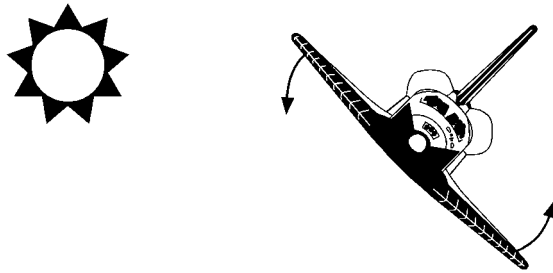

usa006501_037.cnv

First, get the X-axis of the vehicle perpendicular to the direction of the Sun. This can be done by pointing the Z (or Y) axis at the Sun.

ITEM 8 + 4 EXEC
ITEM 14 + 3 EXEC
(or ITEM 14 + 5 + 90 + 0 EXEC)
ITEM 19 EXEC

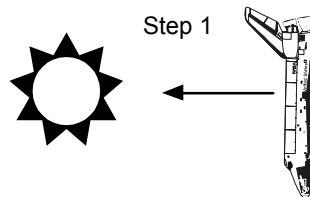

usa006501_038a.cnv

When this attitude maneuver is complete, initiate a rotation about the + X axis.

ITEM 14 + 1 EXEC
ITEM 20 EXEC

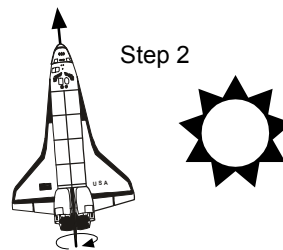

usa006501_039a.cnv

Ref.: Section 5.1.7, ROT, page 5-12

6. Assuming that the velocity vector is to the left and that the center of the Earth is the target, the table is filled in as shown.

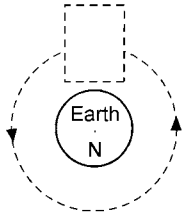

OMICRON \ MPV	OMICRON			
	1 0°	2 90°	3 180°	4 270°
+X P=0, Y=0				
-X P=180, Y=0				
+Z P=270, Y=0		 REAR		 FRONT
-Z P=90, Y=0		 FRONT		 REAR
+Y P=0, Y=90		 REAR		 FRONT
-Y P=0, Y=270		 FRONT		 REAR

usa006501_040a.cnv

Ref.: Section 5.1.5 Omicron, page 5-6

C.6 SECTION 6

1. The translation PULSE is measured in feet per second.

Ref.: Section 6.1.9, Translation Pulse, page 6-5

2. In the following display, the DAP B, PRI (or ALT), DISC RATE (which is what is used for AUTO MNVRs) is 0.5 deg/sec.

Ref.: Section 6.1.3, Rotation Discrete Rate, page 6-3

2011/020/		DAP CONFIG		1 000/02:18:22	
					000/00:00:00
PRI	1 DAP A01	2 DAP B		PRI	DAP EDIT
ROT RATE	10 0.2000	30 0.5000		50	3 DAP A
ATT DB	11 5.00	31 3.00		51	4 DAP B
RATE DB	12 0.20	32 0.20		52	5 LOAD
ROT PLS	13 0.10	33 0.04		53	
COMP	14 .000	34 .000		54	
P OPTION	15 ALL	35 NOSE		55	
Y OPTION	16 ALL	36 NOSE		56	
TRAN PLS	17 0.10	37 0.10		57	NOTCH FLTR
					ENA 6
	ALT			ALT	
RATE DB	18 0.200	38 0.100		58	XJETS ROT
JET OPT	19 ALL	39 TAIL		59	ENA 7
# JETS	20 2	40 2		60	
DN TIME	21 0.08	41 0.08		61	REBOOST
DELAY	22 0.00	42 0.00		62	8 CFG 0
	VERN			VERN	9 INTVL
ROT RATE	23 0.2000	43 0.0200		63	0.00
ATT DB	24 1.000	44 1.000		64	
RATE DB	25 .020	45 .020		65	
ROT PLS	26 0.010	46 0.002		66	
COMP	27 .000	47 .000		67	
CNTL ACC	28 0	48 0		68	

usa006501_153.cnv

3. CNTL ACCEL provides the crew with the capability to call up an alternate table of I-Loaded vehicle acceleration responses to vernier jet fire commands (VERN selected) or to primary jet fire commands (ALT selected). The purpose is to alert the DAP to vehicle mass property changes due to varying RMS/payload configurations, thereby making maneuvers more efficient.

Ref.: Section 6.1.13, Control Acceleration, page 6-6

4. If a +X RCS TRANS is commanded on DAP B with NOSE entered in Items 35 and 36, the translation maneuver occurs. Having “nose only” selected for pitch and yaw has no effect on translation maneuvers (that is, the aft-firing jets are used regardless).

Ref.: Section 6.1.8, Jet Option, page 6-5

```

2011/020/          DAP CONFIG          1 000/02:18:22
                                000/00:00:00
PRI 1 DAP A01      2 DAP B          PRI  DAP EDIT
ROT RATE 10 0.2000 30 0.5000 50      3 DAP A
ATT DB   11  5.00 31  3.00 51      4 DAP B
RATE DB  12  0.20 32  0.20 52      5 LOAD
ROT PLS  13  0.10 33  0.04 53
COMP    14  .000 34  .000 54
P OPTION 15 ALL   35 NOSE 55
Y OPTION 16 ALL   36 NOSE 56
TRAN PLS 17  0.10 37  0.10 57
      ALT
RATE DB  18  0.200 38  0.100 58
JET OPT  19 ALL   39 TAIL 59
# JETS   20     2  40     2  60
DN TIME  21  0.08 41  0.08 61
DELAY   22  0.00 42  0.00 62
      VERN
ROT RATE 23 0.2000 43 0.0200 63
ATT DB   24 1.000  44 1.000  64
RATE DB  25 .020   45 .020   65
ROT PLS  26 0.010 46 0.002  66
COMP    27 .000   47 .000   67
CNTL ACC 28  0    48  0      68
                                NOTCH FLTR
                                ENA 6
                                XJETS ROT
                                ENA 7
                                REBOOST
                                8 CFG 0
                                9 INTVL
                                0.00
                                -----

```

usa006501_153.cnv

5. The rate and attitude deadbands for PRI, ALT, and VERN with the DAP B pbi selected are as follows:

Option	Rate deadband	Attitude deadband
PRI	0.2 deg/sec	3.0°
ALT	0.1 deg/sec	3.0°
VERN	0.02 deg/sec	1.0°

Ref.: Section 6.1.4, Attitude Deadband, page 6-3;
Section 6.1.5, Rate Deadband, page 6-3

C.7 SECTION 7

1. The active pbi's for the following situations are:
 - (a) In TRANS DAP - AUTO/INRTL, rotation DISC RATE (all three axes), rotation PULSE (all three axes) are active. None of the translation pbi's illuminate, but all three axes behave as if they are in NORM.
 - (b) With BFS engaged - Only the INRTL, rotation DISC RATE, and rotation PULSE pbi's are active, and these are tied such that all three axes (R, P, and Y) are in the same mode.
 - (c) On orbit, in OPS 2, when the IMU DATA GOOD flag is set to "bad" - A/B, FREE, PRI/ALT/VERN, rotation PULSE (all three axes), and all the translation pbi's are active.

Ref.: Table 7-1, DAP pbi availability matrix, page 7-3

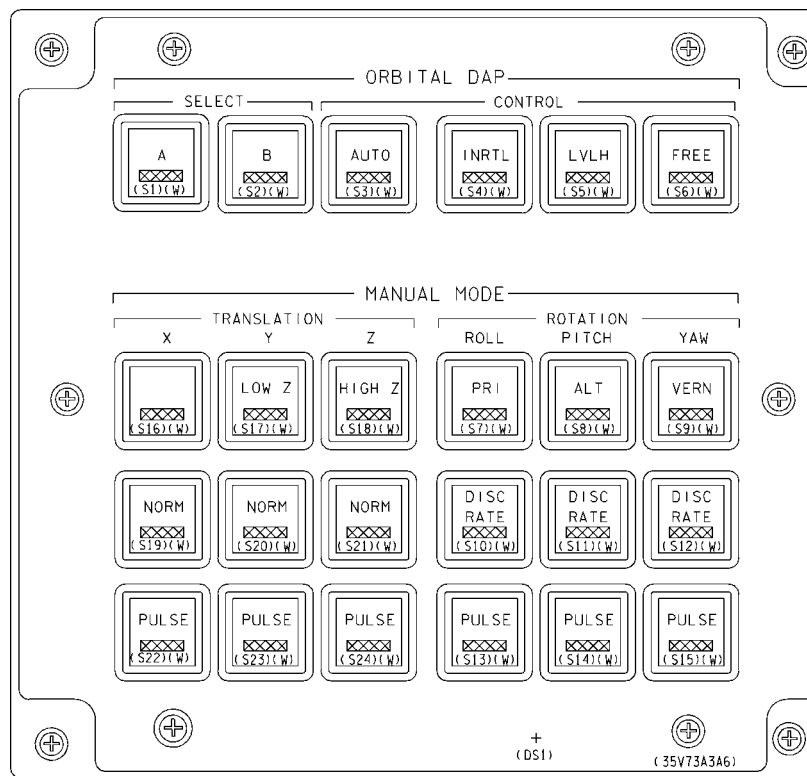

usa006501_045.crv

2. The message DAP RECONFIG means a vernier jet has been deselected either automatically or manually. This can happen whether or not vernier jets are actually being used at the time.

Ref.: Section 7.1.15, Effect of Vernier Jet Failures, page 7-9

3. If R5R or R5D fails with VERN selected, the pbi's immediately downmode to free drift (FREE, with all three rotational pbi's in PULSE). If PRI or ALT is selected when either jet is deselected, nothing happens until the VERN pbi is pressed, at which time the DAP downmodes to free drift.

Ref.: Section 7.1.15, Effect of Vernier Jet Failures, page 7-9

4. The ADI provides the following information:

- INRTL attitude - Roll, pitch, and yaw
- LVLH attitude - Roll, pitch, and yaw
- R, P, and Y with respect to a selected reference frame (REF)
- R, P, and Y attitude errors
- R, P, and Y rates

Ref.: Section 7.2, Attitude Direction Indicator, page 7-12

5. False. The RCS activity lights display jet commands only, not actual firings.

Ref.: Section 7.4, RCS Activity Lights, page 7-14

C.8 SECTION 8

1. RCS wraparound control means that the RCS jets fire automatically if the TVC authority cannot keep the vehicle attitude and rates within the TVC DAP deadbands.

RCS jets also are used in the single-engine burn case to provide orbiter roll control. In the TRANS DAP, RCS jets also can be used while the TVC DAP is active.

Ref.: Section 8.2.1, Automatic TVC -Two Engines, page 8-2

2. The TVC DAP deadbands are as follows:

Attitude: R = 5°

P = 10°

Y = 10°

Rate: R = 2.05 deg/sec

P = 2.05 deg/sec

Y = 2.05 deg/sec

Ref.: Section 8.2.1, Automatic TVC - Two Engines, page 8-2

3. The following answers are based on the pbi configuration shown:

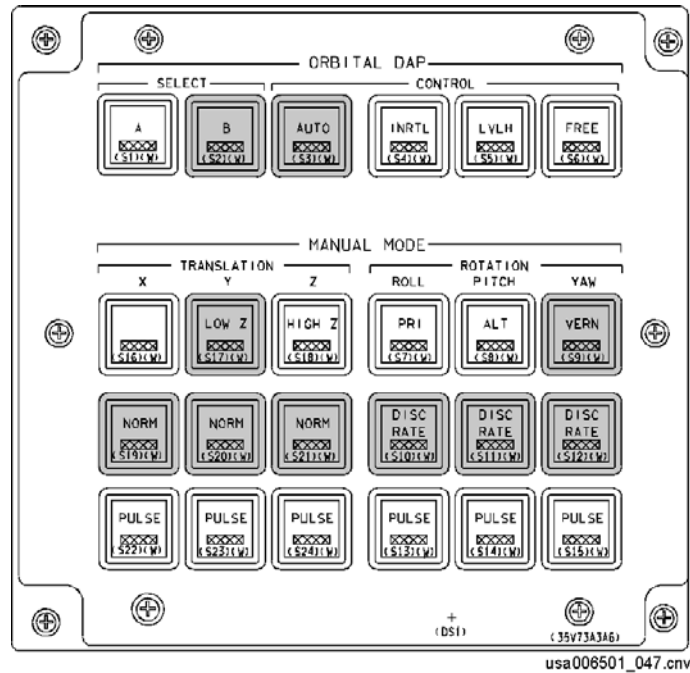

(a) If the RHC is taken out of detent, the INRTL pbi lights up, the AUTO pbi goes out, and the VERN jets fire to buildup to and maintain the DISC RATE specified on DAP CONFIG (SPEC 20). If the softstop is exceeded, the control mode ACCEL results.

Ref.: Section 8.3.1, Hand Controller Interface, page 8-5

(b) If the THC is taken out of detent in the +Z axis, the DAP upmodes to PRI to perform the translation. Since LOW Z is selected, the +Z translation is performed firing the +X and -X jets simultaneously.

Ref.: Section 8.3.1, Hand Controller Interface, page 8-5

C.9 SECTION 9

1. The parameters on the MNVR EXEC display that should be monitored during a burn are $\Delta VTOT$ and TGO.

```

1051/ / OMS-2 MNVR EXEC 1 000/00:18:13
OMS BOTH 1* 000/00:19:29
  L 2
  R 3
RCS SEL 4
5 TV ROLL --0
TRIM LOAD
6 P H-4
7 LY F-5.7
8 RY H5.7
9 WT 255000
10 TIG
  0/00:32:42.0
TGT PEG 4
14 C1
15 C2 [10.0000
16 HT 111.000
17 0T 315.001
18 PRPLT [1---0
TGT PEG 7
19  $\Delta VX$  H1136.0
20  $\Delta VY$  F1-0.1
21  $\Delta VZ$  F1-4.2
LOAD 22/TIMER 23

ITEM 27 EXEC

BURN ATT
24 R 232
25 P 045
26 Y 008
MNVR 27* AUTO
TTG 03:51
REI
TTA 19:44
  GMBL
    L R
P +0.4 +0.4
Y -5.8 +5.8

PRI 28* 29*
SEC 30 31
OFF 32 33
GMBL CK 34

 $\Delta VTOT$  136.0
TGO 1:28
VGO X - 86.54
  Y - 26.05
  Z +101.65

HA HP
TGT 120 +105
CUR 120 + 31

35 ABORT TGT _0

FWD RCS
ARM 36
DUMP 37
OFF 38*
SURF DRIVE
ON 39
OFF 40*

```

usa006501_155r1.tif

If the parameters are not counting down, or appear to be counting down too slowly, there maybe a problem with the burn. $\Delta VTOT$ should be decreasing at a rate of approximately 2 ft/sec per second for a two-engine burn, or at 1 ft/sec per second for a single-engine burn.

Ref.: Section 9.3.4, Monitoring the Burn, page 9-8

2. The crew turns the affected OMS ENG switch to the OFF position to alert guidance that the engine has failed. Guidance is then and only then able to account for the failure by recomputing TGO and repositioning the ADI error needles to reflect the fact that the vehicle is now yawed slightly toward the side with the good engine.

Ref.: Section 9.3.5, Engine Failures, page 9-8

3. If the THC is taken out of detent before or during the automatic -Z translation maneuver, the automatic mode is canceled and the crew has to complete the maneuver manually using the THC. If this is not done and a ΔV of 4 ft/sec is not achieved, the GPCs do not automatically transition to MM 104. A manual OPS transition would be required in such a case.

Ref.: Section 9.2.1, -Z Translation Maneuver, page 9-2

4. The OMS gimbals start moving to their designated trim positions before a burn when guidance becomes active at TIG -15 seconds. One exception is the OMS 1 burn for which the engines gimbal at the transition to MM 104.

Ref.: Section 9.3.3, Preburn Checks and Actions, page 9-7

5. (a) False. The OMS 2 burn is normally performed in MM 105.

Ref.: Section 9.5, OMS-2 Burn, page 9-10

- (b) True. The purpose of the OMS 2 burn is to raise the perigee altitude of the orbit.

Ref.: Section 9.5, OMS 2 Burn, page 9-10

- (c) True. The four major classes of OMS burns include POSIGRADE, RETROGRADE, RADIAL, and OUT-OF-PLANE.

Ref.: Section 9.7, Rendezvous Burns, page 9-11

APPENDIX D TRAINING MATERIALS EVALUATION

Please answer the following questions regarding the lesson that you have just completed. Your feedback allows us to produce more effective training materials. When completed, mail to Manager, DT34.

TITLE/LESSON CODE: Guidance & Control Insertion/Orbit/Deorbit Workbook 21002

SIZE OF AUDIENCE/CLASS:

1. How well did this lesson meet its purpose?

For each statement below, mark one box on the scale:

- a. *The lesson objectives are clearly stated.*
- b. *The lesson objectives are clearly defined.*
- c. *The lesson effectively teaches skills and information.*
- d. *The lesson meets its purpose and objectives.*

Strongly
Disagree

<input type="checkbox"/>	<input type="checkbox"/>	<input type="checkbox"/>	<input type="checkbox"/>	<input type="checkbox"/>	<input type="checkbox"/>
<input type="checkbox"/>	<input type="checkbox"/>	<input type="checkbox"/>	<input type="checkbox"/>	<input type="checkbox"/>	<input type="checkbox"/>
<input type="checkbox"/>	<input type="checkbox"/>	<input type="checkbox"/>	<input type="checkbox"/>	<input type="checkbox"/>	<input type="checkbox"/>
<input type="checkbox"/>	<input type="checkbox"/>	<input type="checkbox"/>	<input type="checkbox"/>	<input type="checkbox"/>	<input type="checkbox"/>

Strongly
Agree

2. How satisfying is the content of this lesson?

For each statement below, mark one box on the scale:

- a. *The information is structured in a logical flow.*
- b. *The content is clear.*
- c. *The content is complete.*
- d. *The level of detail is correct for this information.*
- e. *The amount of information is effective.*
- f. *The graphics contribute to my understanding.*

Strongly
Disagree

<input type="checkbox"/>	<input type="checkbox"/>	<input type="checkbox"/>	<input type="checkbox"/>	<input type="checkbox"/>	<input type="checkbox"/>
<input type="checkbox"/>	<input type="checkbox"/>	<input type="checkbox"/>	<input type="checkbox"/>	<input type="checkbox"/>	<input type="checkbox"/>
<input type="checkbox"/>	<input type="checkbox"/>	<input type="checkbox"/>	<input type="checkbox"/>	<input type="checkbox"/>	<input type="checkbox"/>
<input type="checkbox"/>	<input type="checkbox"/>	<input type="checkbox"/>	<input type="checkbox"/>	<input type="checkbox"/>	<input type="checkbox"/>
<input type="checkbox"/>	<input type="checkbox"/>	<input type="checkbox"/>	<input type="checkbox"/>	<input type="checkbox"/>	<input type="checkbox"/>
<input type="checkbox"/>	<input type="checkbox"/>	<input type="checkbox"/>	<input type="checkbox"/>	<input type="checkbox"/>	<input type="checkbox"/>

Strongly
Agree

3. How appealing was the presentation of this lesson?

For each statement below, mark one box on the scale:

- a. *The overall presentation is appealing.*
- b. *The visuals chosen are appropriate for the lesson.*
- c. *The visuals make the information more interesting.*
- d. *The graphics are legibly reproduced.*
- e. *The audio/visual or print quality is good.*

Strongly
Disagree

<input type="checkbox"/>	<input type="checkbox"/>	<input type="checkbox"/>	<input type="checkbox"/>	<input type="checkbox"/>	<input type="checkbox"/>
<input type="checkbox"/>	<input type="checkbox"/>	<input type="checkbox"/>	<input type="checkbox"/>	<input type="checkbox"/>	<input type="checkbox"/>
<input type="checkbox"/>	<input type="checkbox"/>	<input type="checkbox"/>	<input type="checkbox"/>	<input type="checkbox"/>	<input type="checkbox"/>
<input type="checkbox"/>	<input type="checkbox"/>	<input type="checkbox"/>	<input type="checkbox"/>	<input type="checkbox"/>	<input type="checkbox"/>
<input type="checkbox"/>	<input type="checkbox"/>	<input type="checkbox"/>	<input type="checkbox"/>	<input type="checkbox"/>	<input type="checkbox"/>

Strongly
Agree

4. How valuable is this information?

For each statement below, mark one box on the scale:

- a. *The lesson teaches skills and information I need.*
- b. *The lesson meets my expectations.*
- c. *This information is useful for later reference.*
- d. *I would recommend this lesson to others.*

Strongly
Disagree

<input type="checkbox"/>	<input type="checkbox"/>	<input type="checkbox"/>	<input type="checkbox"/>	<input type="checkbox"/>	<input type="checkbox"/>
<input type="checkbox"/>	<input type="checkbox"/>	<input type="checkbox"/>	<input type="checkbox"/>	<input type="checkbox"/>	<input type="checkbox"/>
<input type="checkbox"/>	<input type="checkbox"/>	<input type="checkbox"/>	<input type="checkbox"/>	<input type="checkbox"/>	<input type="checkbox"/>
<input type="checkbox"/>	<input type="checkbox"/>	<input type="checkbox"/>	<input type="checkbox"/>	<input type="checkbox"/>	<input type="checkbox"/>

Strongly
Agree

**PLEASE WRITE YOUR COMMENTS/QUESTIONS ON THE BACK OF THIS FORM.
EXPLAIN ANY NEGATIVE ANSWERS IN SPECIFIC TERMS
THANK YOU IN ADVANCE FOR YOUR ASSISTANCE!**

TITLE: Guidance and Control, Insertion/Orbit/Deorbit Workbook
G&C I/O/D 21002

NASA-JSC

*DA83 MOD Library (30)
*DT34 Library
*DT34 Pruyn, Peter

USA-HOUSTON

*USH-121G SFOC Technical Library

*Hard copy distribution.

Submit distribution changes to *Peter Pruyn/USH-493X/281/244-7354*. Most documents are available electronically via USA Intranet Web (usa1.unitedspacealliance.com), Space Flight Operations Contract (SFOC), SFOC Electronic Library System (SELS).