

Deorbit Prep

**Mission Operations Directorate
Operations Division**

**Generic, Rev H
July 5, 1996**

NOTE
For STS-79 and subsequent flights

REPRINT
Generic, Rev H, reprinted July 1, 1997
Includes updates thru PCN-2, dated
June 20, 1997

National Aeronautics and
Space Administration

Lyndon B. Johnson Space Center
Houston, Texas



United Space Alliance



CONTENTS

NOMINAL DEORBIT PREP PROCEDURES	1-1	
DEORBIT PREP BACKOUT PROCEDURES	2-1	
ENTRY SWITCH LIST/VERIFICATION	3-1	
BFS DEORBIT PREP NOTES	4-1	
CONTINGENCY DELTAS TO NOMINAL DEORBIT PREP	5-1	
PLBD CONTINGENCY EVA TIMELINE	6-1	
HARDWARE CONTINGENCY EVA TIMELINE	7-1	

NOMINAL DEORBIT PREP PROCEDURES

NOMINAL DEORBIT PREP

NOMINAL DEORBIT PREP OVERVIEW OF CONFIGURATION MANAGEMENT

		OPS 1 ASC C/L					OPS 2 ON-ORBIT					OPS 2 DEORBIT PREP TIG -03:28					OPS 3 DEORBIT PREP TIG -02:20					SEAT INGRESS TIG -01:00					EI-5	V = 15K		
DPS																														
GPC OPS		1	2	3	4	5	1	2	3	4	5	1	2	3	4	5	1	2	3	4	5	1	2	3	4	5				
POWER OUTPUT MODE		G1	G1	G1	G1	BFS	G2	G2	G2F	SM	BFS	G2	G2	G2F	SM	BFS	G3	G3	G3	G3	BFS	G3	G3	G3	G3	BFS				
GPC		ON	ON	ON	ON	ON	ON	ON	ON	ON	ON	ON	ON	ON	ON	ON	ON	ON	ON	ON	ON	ON	ON	ON	ON	ON				
OPS		N	N	N	N	B	N	N	N	T	N	N	N	N	T	N	N	N	N	N	B	N	N	N	N	B				
MODE		R	R	R	R	R	R	R	H	R	H	R	R	H	R	S	R	R	R	R	R	R	R	R	R	R				
CONFIG GPC		1	2	3	4	0	2	2	4	(5)	0	2	2	4	(5)	0	3	3	4	0	0	3	3	4	0	0				
STR		1	1				1	2	0	0	0	1	2	0	0	0	1	2	3	4	0	1	2	3	4	0				
PL		1/2	1				0	0	4			0	0	4			1	4				1	4							
CRT		1	1				1	2	0	0	0	1	2	0	0	0	1	2	3	0	0	1	2	3	0	0				
L		1	1				0	0	4			0	0	4			0	0	0			0	0	0						
MM		1	1				1	2	4			1	2	4			1	2				1	2							
MDM		ALL ON					ALL ON					ALL ON					ALL ON													
D & C		AD/DDU CRT/DEU INSTR	L,R 1,2,3 L,R		L,A 1,2,4-ON NONE	L,R	L,R	L,R	L,R	L,R	L,R	L,R	L,R	L,R	L,R	L,R	L,R	L,R	L,R	L,R	L,R	L,R	L,R	L,R	L,R	L,R	L,R	L,R	L,R	L,R
ECLS		AV BAY FAN CABIN FAN IMU FAN WATER LP FREON LP RADIATOR	1-B,2-A,3-B A B		1-OFF, 2-ON 1-B,2-B Stow	1-GPC,2-ON	1-OFF,2-ON																							
FCS / SENSORS		FCS ASA ACCEL RGA ADTA IMU RA TACAN UHF MLS	AUTO ALL ON ALL ON ALL ON ALL ON ALL ON ALL ON ALL ON ALL OFF		OFF OFF OFF OFF OFF OFF OFF OFF OFF	ALL ON ALL ON ALL ON ALL ON ALL ON ALL ON ALL ON ALL ON	ALL ON ALL ON ALL ON ALL ON ALL ON ALL ON ALL ON ALL ON	ALL ON ALL ON ALL ON ALL ON ALL ON ALL ON ALL ON ALL ON	ALL ON ALL ON ALL ON ALL ON ALL ON ALL ON ALL ON ALL ON	ALL ON ALL ON ALL ON ALL ON ALL ON ALL ON ALL ON ALL ON	ALL ON ALL ON ALL ON ALL ON ALL ON ALL ON ALL ON ALL ON	ALL ON ALL ON ALL ON ALL ON ALL ON ALL ON ALL ON ALL ON	ALL ON ALL ON ALL ON ALL ON ALL ON ALL ON ALL ON ALL ON	ALL ON ALL ON ALL ON ALL ON ALL ON ALL ON ALL ON ALL ON	ALL ON ALL ON ALL ON ALL ON ALL ON ALL ON ALL ON ALL ON	ALL ON ALL ON ALL ON ALL ON ALL ON ALL ON ALL ON ALL ON	ALL ON ALL ON ALL ON ALL ON ALL ON ALL ON ALL ON ALL ON	ALL ON ALL ON ALL ON ALL ON ALL ON ALL ON ALL ON ALL ON	ALL ON ALL ON ALL ON ALL ON ALL ON ALL ON ALL ON ALL ON	ALL ON ALL ON ALL ON ALL ON ALL ON ALL ON ALL ON ALL ON	ALL ON ALL ON ALL ON ALL ON ALL ON ALL ON ALL ON ALL ON	ALL ON ALL ON ALL ON ALL ON ALL ON ALL ON ALL ON ALL ON	ALL ON ALL ON ALL ON ALL ON ALL ON ALL ON ALL ON ALL ON	ALL ON ALL ON ALL ON ALL ON ALL ON ALL ON ALL ON ALL ON	ALL ON ALL ON ALL ON ALL ON ALL ON ALL ON ALL ON ALL ON	ALL ON ALL ON ALL ON ALL ON ALL ON ALL ON ALL ON ALL ON	ALL ON ALL ON ALL ON ALL ON ALL ON ALL ON ALL ON ALL ON	ALL ON ALL ON ALL ON ALL ON ALL ON ALL ON ALL ON ALL ON	ALL ON ALL ON ALL ON ALL ON ALL ON ALL ON ALL ON ALL ON	ALL ON ALL ON ALL ON ALL ON ALL ON ALL ON ALL ON ALL ON
RJDA		RJDA RJDF VERNIER	ALL ON ALL ON OFF		ON																									

NOMINAL DEORBIT PREP SUMMARY TIMELINE

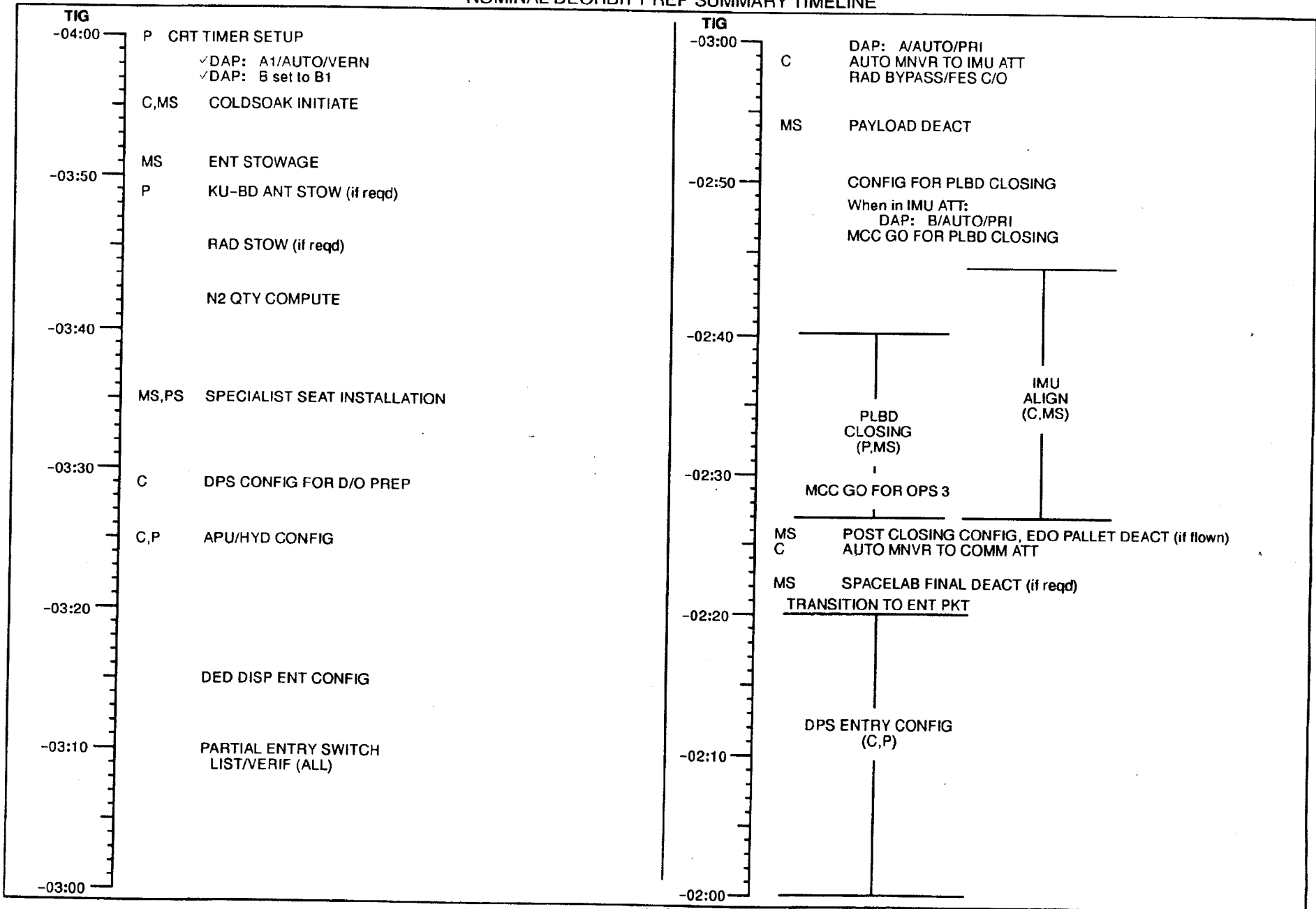

NOMINAL DEORBIT PREP SUMMARY TIMELINE

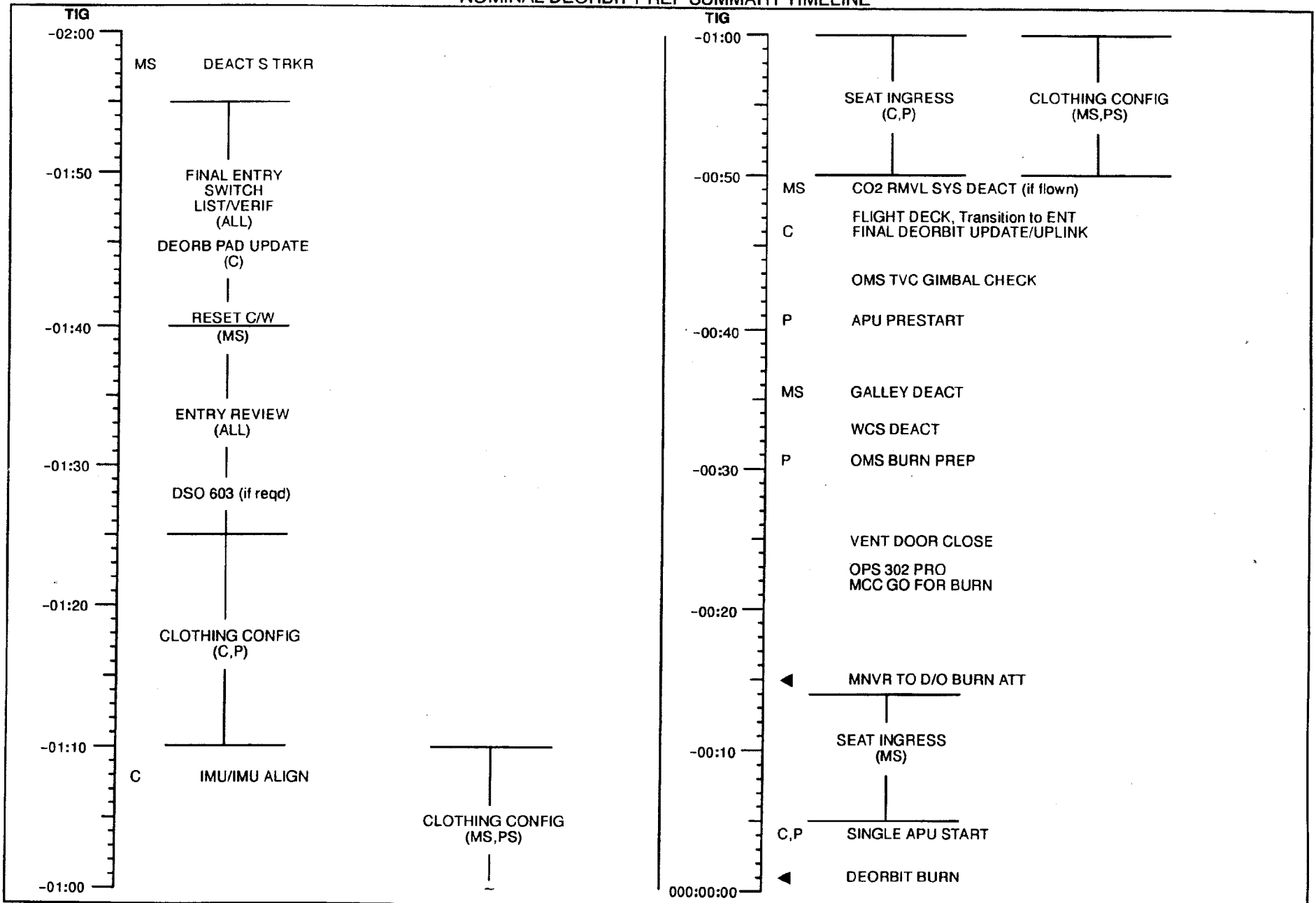

NOMINAL DEORBIT PREP

- * If TIME to TIG < 4 hr and > 2 hr 40 min: *
- * 1. ACCOMPLISH IMMEDIATELY: *
- * MNVR (TRK) BIASED -XSI (if not already in TAIL SUN) *
- * CRTX TGT ID +4 (blanks OM) *
- * BODY VECT +5 *
- * P +184 *
- * ✓OM (blank) *
- * Initiate TRK *
- * 2. Back out of PRIORITY PWRDN, as reqd (ORB PKT, PRIOR PWRDN) *
- * 3. If previous FC PURGE was not accomplished within last 6 hr: *
- * accomplish FC PURGE (ORB OPS, EPS) during D/O Prep prior to DPS ENTRY CONFIG *
- * 4. MS accomplish CABIN CONFIG/STOW (FLIGHT PLAN) during D/O Prep timeframe *
- * 5. Begin Deorbit Prep timeline immediately and perform procedures as rapidly as possible *

VERIFY THAT FOLLOWING ACTIVITIES HAVE BEEN ACCOMPLISHED:

FCS CHECKOUT (ORB OPS, GNC)

RCS HOT FIRE TEST (ORB OPS, BCS)

CABIN CONFIG/STOW (FLIGHT PLAN)

MNVR (TRK) BIASED -XSI (FLIGHT PLAN, DETAILED TIMELINE)

FC PURGE (ORB OPS, EPS)

OPS 2 DAP CONFIG

Back out of PRIORITY PWRDN, as reqd (ORB PKT, PRIOR PWRDN)

OPS 2 DAP CONFIG (GNC 20)				
PRI	A1		B1	
ROT RATE	10	0.20	30	0.50
ATT DB	11	5.00	31	3.00
RATE DB	12	0.20	32	0.20
ROT PLS	13	0.10	33	0.04
COMP	14	0.00	34	0.00
P OPTION	15	ALL	35	ALL
Y OPTION	16	ALL	36	ALL
TRAN PLS	17	0.10	37	0.10
ALT				
RATE DB	18	0.20	38	0.20
JET OPT	19	ALL	39	ALL
# JETS	20	2	40	2
ON TIME	21	0.08	41	0.08
DELAY	22	0.00	42	0.00
VERN				
ROT RATE	23	0.20	43	0.20
ATT DB	24	1.00	44	1.00
RATE DB	25	0.02	45	0.02
ROT PLS	26	0.01	46	.002
COMP	27	0.00	47	0.00
CNTL ACC	28	0	48	0

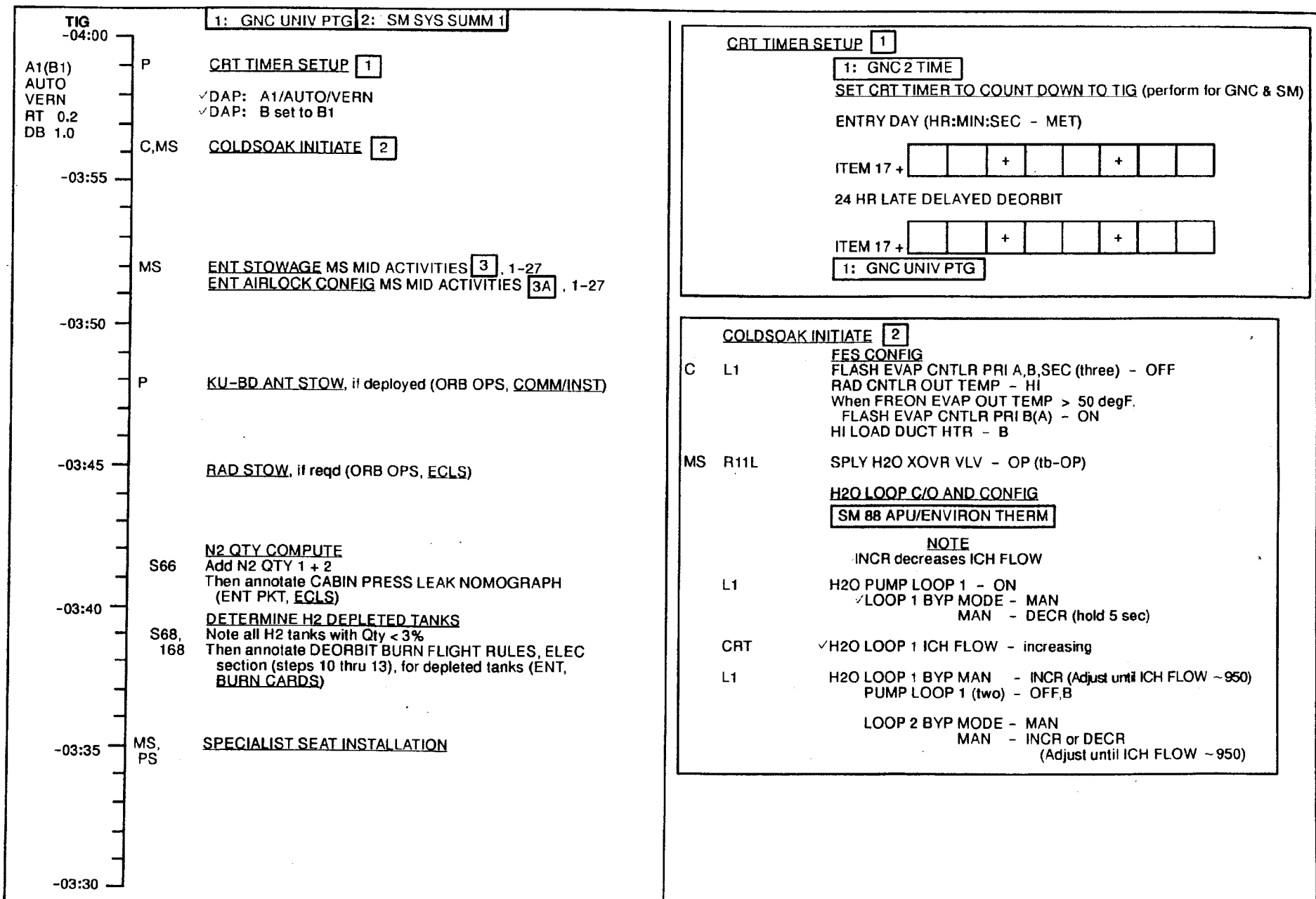

1: GNC 0 GPC MEMORY 2: BFS, GNC 0 BFS MEMORY

TIG

-03:30
A1(B1)
AUTO
VERN
RT 0.2
DB 1.0

C

DPS CONFIG FOR D/O PREP 4

-03:25

C,P

APU/HYD CONFIG 5

UPLINK
UPDATE
DEORBIT IMU
STAR PADS
if reqd
(ORB OPS FS,
PTG)

-03:20

UPLINK
(if reqd)
PASS SV

-03:15

DED DISP ENT CONFIG 6

NOTE

✓ MCC for unaccounted for switch
or cb configuration discrepancies

-03:10

C
P
MS

PARTIAL ENT SWITCH LIST/VERIF (FWD), 3-4 thru 3-6
PARTIAL ENT SWITCH LIST/VERIF (FWD), 3-7 & 3-8
PARTIAL ENT SWITCH LIST/VERIF (AFT), 3-9
PARTIAL ENT SWITCH LIST/VERIF (MID), 3-10 thru 3-12

-03:05

-03:00

DPS CONFIG FOR D/O PREP 4

NOTE

Do not perform any keyboard item entries
or switch throws 10 sec before and after
moding PASS GPCs to RUN or making
OPS transition requests

P/I Locker **ACTIVATE GPC 2** (if in HALT)
Remove and stow GPC Mode Switch Guard

O6 ✓ GPC MODE 2 - HALT (tb-bp)
✓ OUTPUT 2 - NORM
✓ PWR 2 - ON
MODE 2 - STBY (tb-RUN), RUN

TRANSITION GPCs 1 & 2 TO OPS 2
(if GPC 2 just activated)

1: GNC 0 GPC MEMORY

CONFIG - ITEM 1 +2 EXEC
Modify MC 2 per table →

CONFIG GPC	2
STR 1	1
2	2
3	1
4	2
PL 1/2	0
CRT 1	1
2	2
3	0
4	2
L 1	0
2	0
MM 1	1
2	2

1: GNC 22 S TRK/COAS CNTL

S TRK -Y,-Z: STAR TRK - ITEM 3,4 EXEC

1: GNC 21 IMU ALIGN

RESUME

O6 **ENSURE BFS GPC CAN DRIVE A CRT**
✓ GPC PWR 5 - ON
MODE 5 - STBY (tb-RUN)

C3 BFC CRT DISP - ON
SEL - 2+3

2: BFS, GNC BFS MEMORY or SM THERMAL

C3 BFC CRT DISP - OFF
SEL - 3+1

TIG

-03:00
A1(B1)
AUTO
PRI
RT 0.2
DB 5.0

NOTE

See DEORBIT IMU STAR PADS (ORB OPS FS, PTG)

C AUTO MNVR TO IMU ATT (Omit if BFS)

DAP: A/AUTO/PRI
Initiate MNVR

BAD BYPASS/FES C/Q (ORB OPS, ECLS)

-02:55

UPLINK
UPDATE
COMM
ATT

MS PAYLOAD DEACT if reqd (PL OPS, DEORB PREP)

CONFIG FOR PLBD CLOSING MS AFT ACTIVITIES 7, 1-25

When in IMU ATT:
DAP: B/AUTO/PRI

-02:50

B1(A1)
AUTO/PRI
RT 0.5
DB 3.0

MCC: GO/NO-GO FOR PLBD CLOSING

-02:45

C,MS IMU ALIGNMENT (Omit if BFS) 8

-02:40

P,MS PLBD CLOSING 9, 1-21 and 1-22

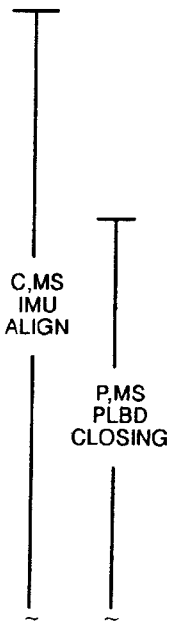

-02:35

-02:30

DPS ENTRY CONFIG 12

* If IMU or RHC dilemma, do not proceed with OPS 3 transition *

- ✓ Att mnvr complete
- ✓ RGA, AA, ASA, IMU (all) - ON

NOTE

Do not perform any keyboard item entries or switch throws 10 sec before and after moding PASS GPCs to RUN or making OPS transition requests

- C2
CRTX
1. **CRT CONFIG**
CRT 3 PWR - ON
GPC/CRT 2/3 EXEC
- O6
2. **VERIFY GPC CONFIG**
✓ GPC MODE 3 - HALT (tb-bp)
✓ PWR 3 - ON
✓ OUTPUT 1,2 - NORM (tb-gray)
 ✓ 3,5 - NORM (tb-bp)
 ✓ 4 - TERM (tb-bp)
✓ MODE 1,2,4 - RUN (tb-RUN)
 3 - STBY (tb-RUN)
 ✓ 5 - STBY (tb-RUN)
- 3. **SM CHECKPOINT/UL CNTL ENA**
1: SM 60 SM TABLE MAINT
2: SM 1 DPS UTILITY
CRT2
CRT1
MMU ASSIGN 2 SM - ITEM 4 EXEC
CKPT INITIATE - ITEM 18 EXEC
✓ Update of CKPT TIME and STATUS GOOD indicated
CRT2
CRT1
MMU ASSIGN 1 SM - ITEM 3 EXEC
CKPT INITIATE - ITEM 18 EXEC
✓ Update of CKPT TIME and STATUS GOOD indicated
CRT2
CKPT RETRV ENA - ITEM 12 EXEC (*)
UL CNTL ENA - ITEM 36 EXEC
- 4. **LOAD ENTRY TFL/RECONFIG UPLK**
Perform LOAD PDI DECOM FORMAT and LOAD PCMMU FORMAT for entry config (ORB OPS FS, COMM/INST)
- C2
Set event timer to count down to TIG
- 5. **TRANSITION GPC 1 & 2 TO GNC OPS 3**
1: GNC 0 GPC MEMORY
CONFIG - ITEM 1 +3 EXEC

Modify MC 3 per table
GNC, OPS 301 PRO

1: GNC DEORB MNVR COAST

- C3
6. **TRANSITION BFS GPC TO GNC OPS 3**
BFC CRT DISP - ON
✓ SEL = 3+1

3: BFS, GNC BFS MEMORY

- O6
CRT3
GPC OUTPUT 5 - B/U (tb-bp)
✓ TFL ENA - ITEM 29 (*)
BFS, GNC OPS 301 PRO

3: BFS, GNC DEORB MNVR COAST

- 7. **TRANSITION GPC 1,2,3,4 TO GNC OPS 3**
SM, OPS 000 PRO

X: SM GPC MEMORY

- O6
GPC OUTPUT 4 - NORM (tb-gray)
MODE 3,5 (two) - RUN (tb-RUN)

If no comm, sel best antenna
✓ CONFIG - ITEM 1 +3 EXEC

Modify MC 3 per table
GNC OPS 301 PRO

1: GNC DEORB MNVR COAST

- CRT3
BFS, GNC OPS 000 PRO
- C3
BFS, GNC OPS 301 PRO
BFC CRT DISP - OFF (GPC 3 driving CRT3)
- ON

- * If any IMU failed or not aligned: *
- * 3: BFS, GNC 51 OVERRIDE *
- * Aff IMU - desel *

- 8. **MNVR BACK TO COMM ATT**

- 9. **LOAD IN TGTs**

1: GNC DEORB MNVR COAST

- ✓ MCC for TGT and SV UPLINK
LOAD - ITEM 22 EXEC
TIMER - ITEM 23 EXEC

- 10. **VERIFY MC 9 TABLE (GNC) FOR POST LANDING**

2: GNC 0 GPC MEMORY

- CONFIG - ITEM 1 +9 EXEC
Modify MC 9 per table
CONFIG - ITEM 1 +3 EXEC

CONFIG GPC	3	12000
STR	1	1
	2	2
	3	1
	4	2
PL	1/2	0
CRT	1	1
	2	2
	3	2
	4	0
L	1	0
	2	0
MM	1	1
	2	2

CONFIG GPC	3	12340
STR	1	1
	2	2
	3	3
	4	4
PL	1/2	1
CRT	1	1
	2	2
	3	3
	4	0
L	1	0
	2	0
MM	1	1
	2	2

CONFIG GPC	9	12340
STR	1	1
	2	2
	3	3
	4	4
PL	1/2	1
CRT	1	1
	2	2
	3	3
	4	0
L	1	1
	2	2
MM	1	1
	2	2

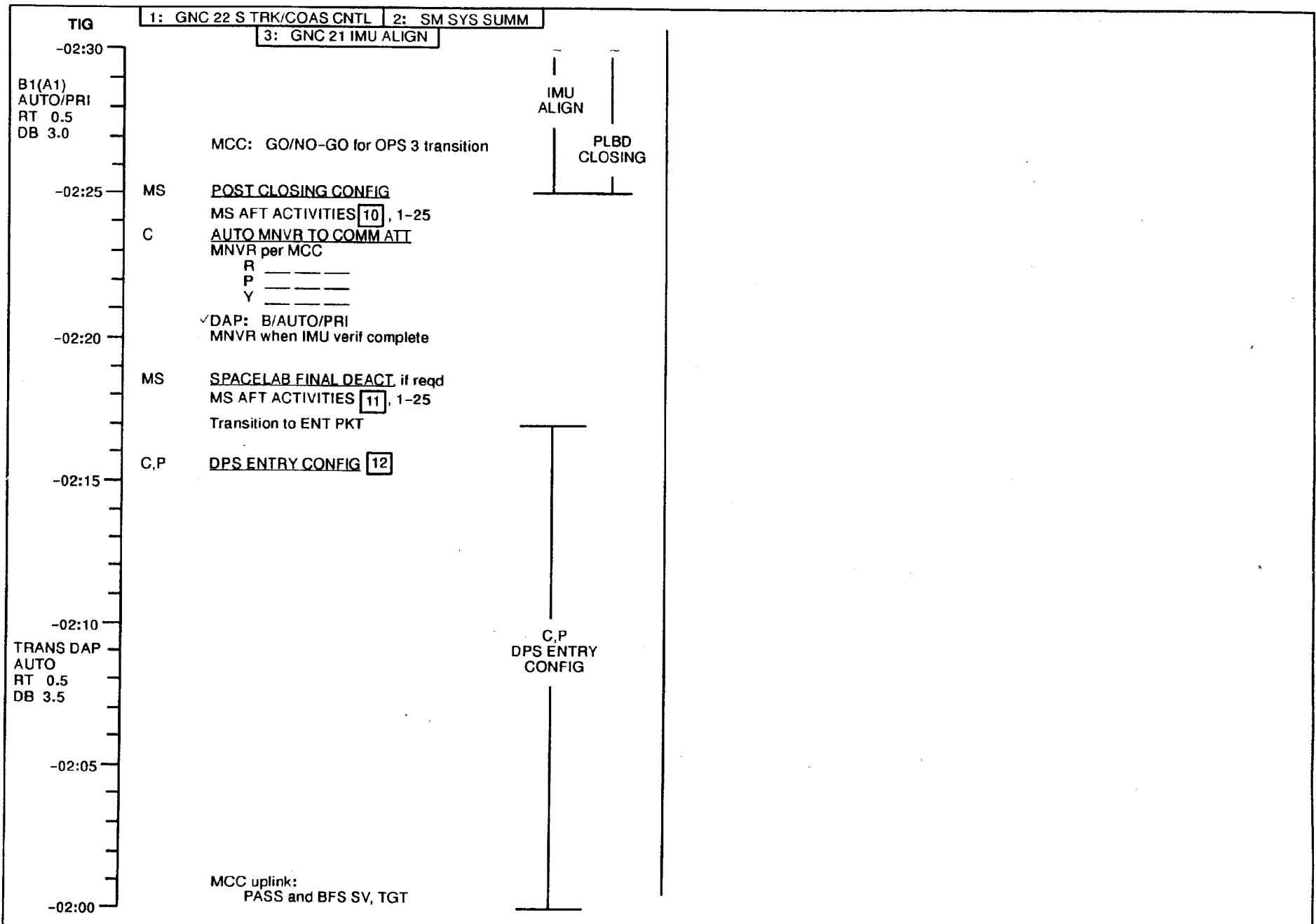

DEORB PAD UPDATE 17

MCC Update:

OMS PRPLT PAD, DEL PAD (ENT, PRPLT/DEL PADS)
& DEORBIT MNVR PAD (ENT, MNVR PADS)

* If MCC cannot provide DEORB TGT, use PGSC *

LANDING SITE UPDATE

1: GNC 50 HORIZ SIT

SEL SITE see DEL PAD (ENT, PRPLT/DEL PADS)

CHECK TGTs

1: GNC DEORB MNVR COAST

- ✓ PASS and BFS TGT per DEORBIT MNVR PAD
(ENT, MNVR PADS)
- ✓ PASS and BFS solution per DEORBIT MNVR PAD
(ENT, MNVR PADS):
BURN ATT, HA HP
ΔVTOT
TGO

TIG

1: GNC UNIV PTG 2: SM SYS SUMM 1

-03:00
 A1(B1)
 AUTO
 PRI
 RT 0.2
 DB 5.0

-02:55
 UPLINK
 UPDATE
 COMM
 ATT

-02:50
 B1(A1)
 AUTO/PRI
 RT 0.5
 DB 3.0

-02:45

-02:40

-02:35

-02:30

NOTE
 See DEORBIT IMU STAR PADS (ORB OPS FS, PTG)

C AUTO MNVR TO IMU ATT (Omit if BFS)

 DAP: A/AUTO/PRI
 Initiate MNVR

RAD BYPASS/FES C/Q (ORB OPS, ECLS)

MS PAYLOAD DEACT, if reqd (PL OPS, DEORB PREP)

CONFIG FOR PLBD CLOSING MS AFT ACTIVITIES 7, 1-25

 When in IMU ATT:
 DAP: B/AUTO/PRI

 MCC: GO/NO-GO FOR PLBD CLOSING

C,MS IMU ALIGNMENT (Omit if BFS) 8

P,MS PLBD CLOSING 9, 1-21 and 1-22

C,MS
IMU
ALIGN

P,MS
PLBD
CLOSING

SLP

DPS ENTRY CONFIG 12

* If IMU or RHC dilemma, do not proceed with OPS 3 transition *

- ✓ All mnvr complete
- ✓ RGA, AA, ASA, IMU (all) - ON

NOTE

Do not perform any keyboard item entries or switch throws 10 sec before and after moding PASS GPCs to RUN or making OPS transition requests

1. CRT CONFIG
C2 CRTX CRT 3 PWR - ON
GPC/CRT 2/3 EXEC
2. VERIFY GPC CONFIG
O6 ✓ GPC MODE 3 - HALT (tb-bp)
✓ PWR 3 - ON
✓ OUTPUT 1,2 - NORM (tb-gray)
✓ 3,5 - NORM (tb-bp)
✓ 4 - TERM (tb-bp)
✓ MODE 1,2,4 - RUN (tb-RUN)
3 - STBY (tb-RUN)
✓ 5 - STBY (tb-RUN)
3. SM CHECKPOINT/UL CNTL ENA
1: SM 60 SM TABLE MAINT
2: SM 1 DPS UTILITY
CRT2 MMU ASSIGN 2 SM - ITEM 4 EXEC
CRT1 CKPT INITIATE - ITEM 18 EXEC
✓ Update of CKPT TIME and STATUS GOOD indicated
CRT2 MMU ASSIGN 1 SM - ITEM 3 EXEC
CRT1 CKPT INITIATE - ITEM 18 EXEC
✓ Update of CKPT TIME and STATUS GOOD indicated
CRT2 CKPT RETRV ENA - ITEM 12 EXEC (*)
UL CNTL ENA - ITEM 36 EXEC
4. LOAD ENTRY TFL/RECONFIG UPLK
Perform LOAD PDI DECOM FORMAT and LOAD PCMMU FORMAT for entry config (ORB OPS FS, QCOMM/INST)
- C2 Set event timer to countdown to TIG
5. TRANSITION GPC 1 & 2 TO GNC OPS 3
1: GNC 0 GPC MEMORY
CONFIG - ITEM 1 +3 EXEC

Modify MC 3 per table
GNC, OPS 301 PRO

1: GNC DEORB MNVR COAST

- C3 6. TRANSITION BFS GPC TO GNC OPS 3
BFC CRT DISP - ON
✓ SEL = 3+1

3: BFS, GNC BFS MEMORY

- O6 CRT3 GPC OUTPUT 5 - B/U (tb-bp)
✓ TFL ENA - ITEM 29 (*)
BFS, GNC OPS 301 PRO

3: BFS, GNC DEORB MNVR COAST

7. TRANSITION GPC 1,2,3,4 TO GNC OPS 3
SM, OPS 000 PRO

X: SM GPC MEMORY

- O6 GPC OUTPUT 4 - NORM (tb-gray)
MODE 3,5 (two) - RUN (tb-RUN)

If no comm, sel best antenna

✓ CONFIG - ITEM 1 +3 EXEC

Modify MC 3 per table

GNC OPS 301 PRO

1: GNC DEORB MNVR COAST

- CRT3 BFS, GNC OPS 000 PRO
C3 BFS, GNC OPS 301 PRO
BFC CRT DISP - OFF (GPC 3 driving CRT3)
- ON

* If any IMU failed or not aligned: *

* 3: BFS, GNC 51 OVERRIDE *

* Aff IMU - desel *

8. MNVR BACK TO COMM ATT

9. LOAD IN TGTs

1: GNC DEORB MNVR COAST

✓ MCC for TGT and SV UPLINK

LOAD - ITEM 22 EXEC

TIMER - ITEM 23 EXEC

10. VERIFY MC 9 TABLE (GNC) FOR POST LANDING

2: GNC 0 GPC MEMORY

CONFIG - ITEM 1 +9 EXEC

Modify MC 9 per table

CONFIG - ITEM 1 +3 EXEC

CONFIG GPC	3
STR 1	1
2	2
3	1
4	2
PL 1/2	0
CRT 1	1
2	2
3	2
4	0
L 1	0
2	0
MM 1	1
2	2

CONFIG GPC	3
STR 1	1
2	2
3	3
4	4
PL 1/2	1
CRT 1	1
2	2
3	3
4	0
L 1	0
2	0
MM 1	1
2	2

CONFIG GPC	9
STR 1	1
2	2
3	3
4	4
PL 1/2	1
CRT 1	1
2	2
3	3
4	0
L 1	1
2	2
MM 1	1
2	2

SLP

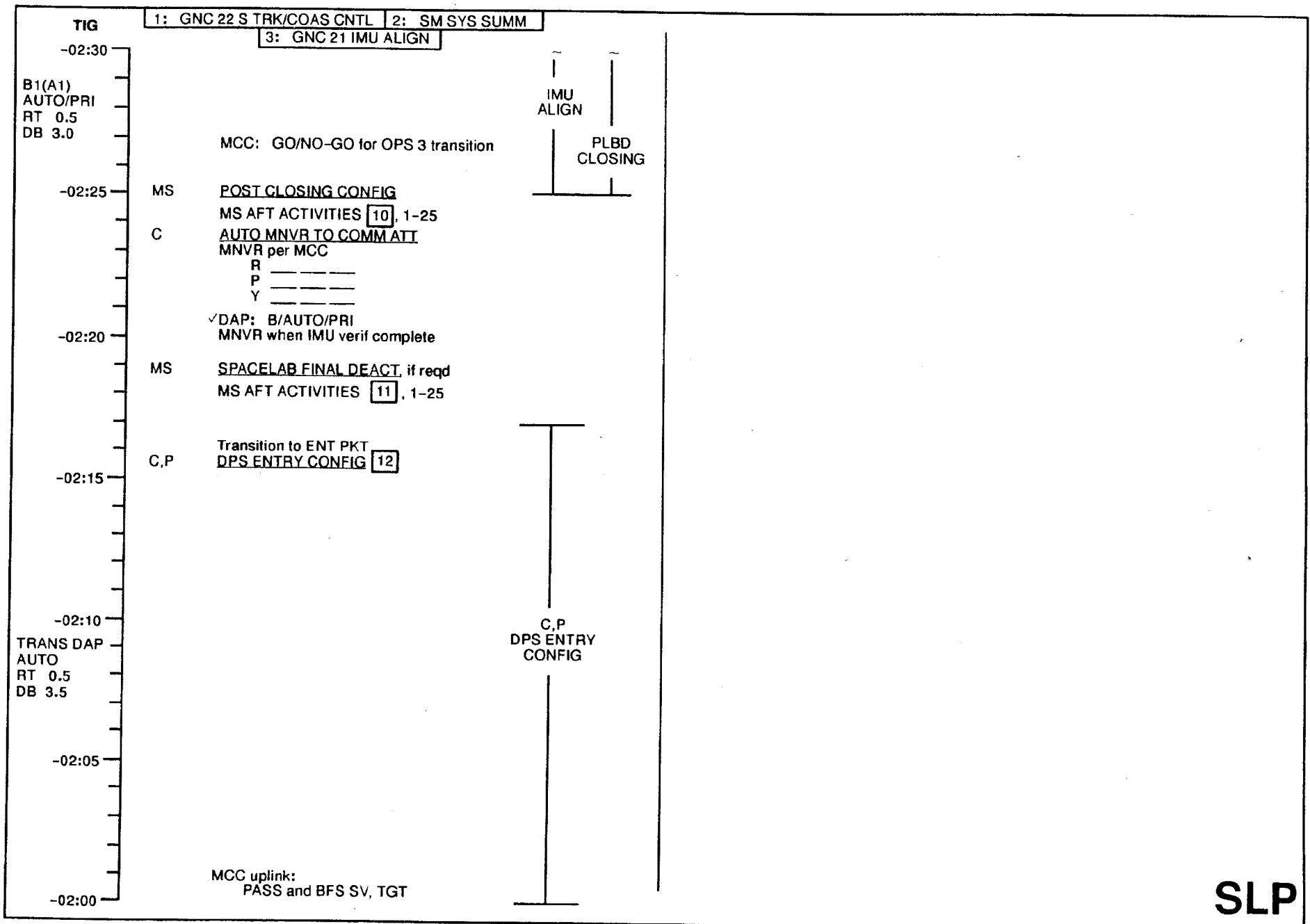

SLP

DEORB PAD UPDATE **17**

MCC update:

OMS PRPLT PAD, DEL PAD (ENT, PRPLT/DEL PADS)
& DEORBIT MNVR PAD (ENT, MNVR PADS)

* If MCC cannot provide DEORB TGT, use PGSC *

LANDING SITE UPDATE

1: GNC 50 HORIZ SIT

SEL SITE see DEL PAD (ENT, PRPLT/DEL PADS)

CHECK TGTs

1: GNC DEORB MNVR COAST

- ✓ PASS and BFS TGT per DEORBIT MNVR PAD
(ENT, MNVR PADS)
- ✓ PASS and BFS solution per DEORBIT MNVR PAD
(ENT, MNVR PADS):
BURN ATT, HA HP
 Δ VTOT
TGO

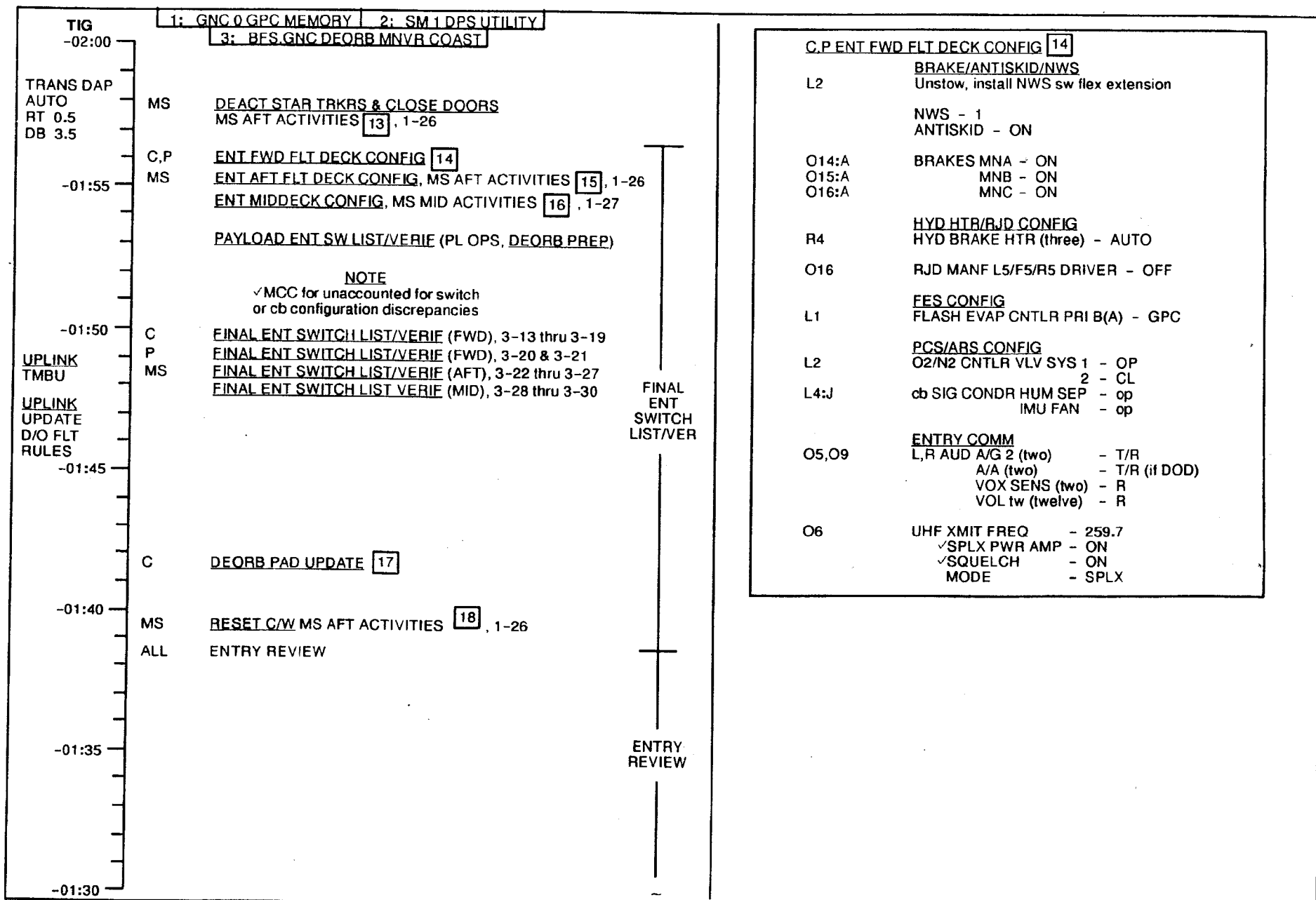

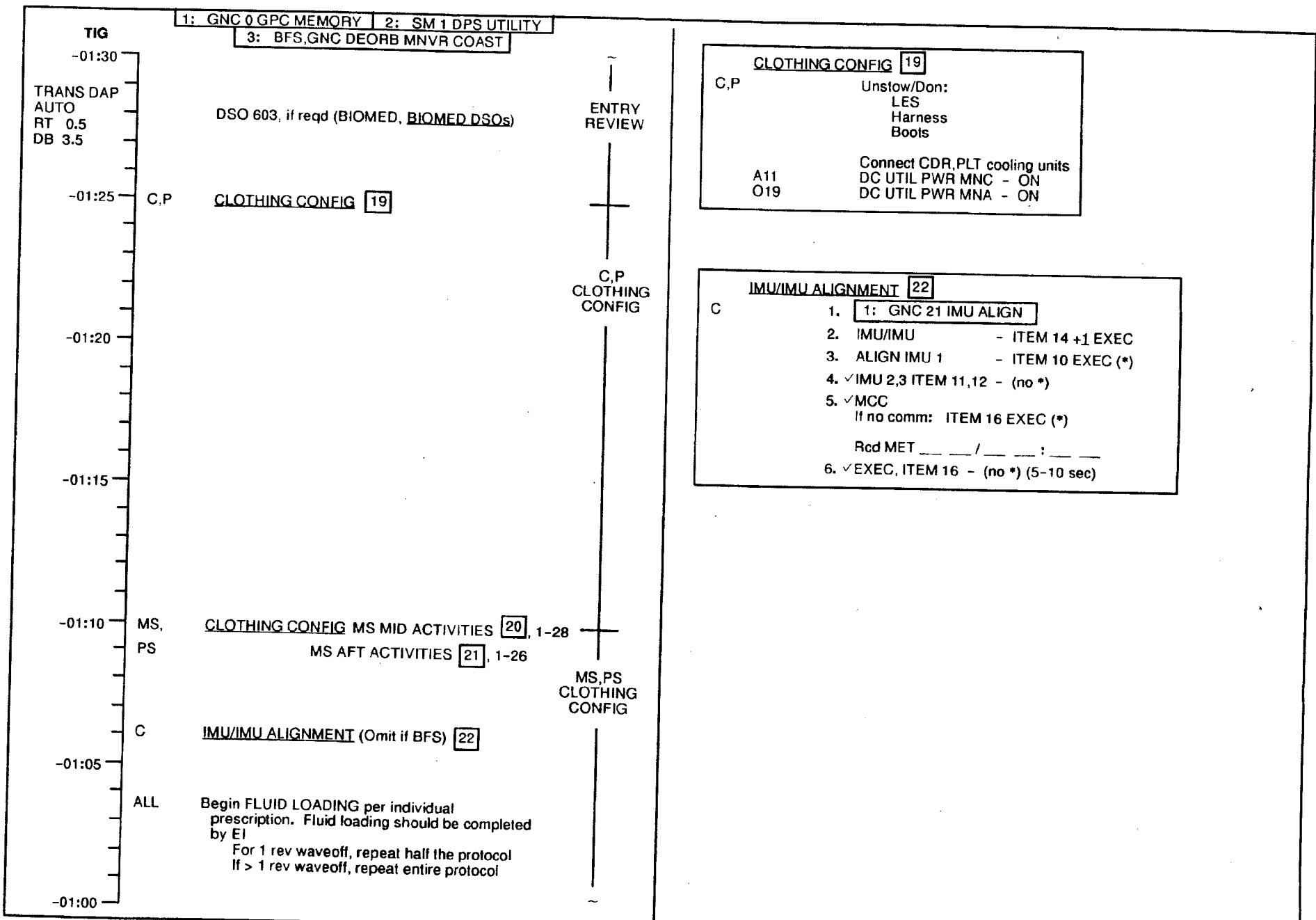

TIG		1: GNC DEORB MNVR COAST	2: GNC DEORB MNVR COAST
-01:00		3: BFS.GNC DEORB MNVR COAST	
TRANS DAP	C,P	SEAT INGRESS	
AUTO	C,P	HUD SETUP [23]	
RT 0.5	C,P	Adjust Seat	
DB 3.5		Exercise Brake Pedals	
			MS,PS CLOTHING CONFIG
-00:55	C	C6	LEH O2 vlv (four) - OP
	C,P		LES PRESS INTEGRITY CHECK
	MS		WIRELESS STOW MS AFT ACTIVITIES [24], 1-26
-00:50	MS		CO2 RMVL SYS DEACT, if flown, MS MID ACTIVITIES [25], 1-28
	C,P		Stow all unnecessary FDF articles FLIGHT DECK, Go to ENT, DEORBIT BURN
-00:45			
-00:40			
-00:35	MS		GALLEY DEACT MS MID ACTIVITIES [26], 1-28
	MS		WCS DEACT MS MID ACTIVITIES [27], 1-28
			NOTE WCS must be deactivated prior to EI
-00:30			

HUD SETUP [23]
 Remove, stow HUD Covers (two)
 Ensure Cloth Cover does not obscure light sensor

AUTO PLBD CLOSING

DETAILED PLBD CLOSING PROCEDURES 9

CAUTION
Verify no obstructions when closing and latching PLBD
(Ku ANT, RMS, RAD, etc)

- * If no motion determined visually or 'OP/CL' *
- * not blank within 10 sec after cmd, *
- * PL BAY DR - STOP *
- * ✓MCC *
- * If door motion stops and not 'RDY' or 'CL', *
- * PL BAY DR - STOP *
- * ✓MCC *

- R13L * If SM GPC fails during this operation: *
- * PL BAY DR SYS 1,2 (two) - DSBL *
- * Perform PASS SM GPC FAIL (ORB PKT, DPS) *

CRT4 SM, OPS X02 PRO or BFS, SM 63 PL BAY DOORS
4: SM PL BAY DOORS

- R13L ✓PL BAY DR - STOP
 CRT4 ✓PBD SW - STOP
 ✓MAN SEL (ten) - (no *)
 ✓PBD SW BYPASS - (no *)
 AC POWER ON - ITEM 1 EXEC (*)
 AUTO MODE SEL - ITEM 3 EXEC (*)

- R13L PL BAY DR SYS 1,2 (two) - ENA
 CRT4 ✓OP/CL STATUS (ten) - OP

NOTE
Note any single mtr operations (continue ops)
(single mtr times = 2x listed dual mtr times)

- * If PORT(STBD) DOOR not 'CL' within 6 sec of 'RDY' then: *
- * PL BAY DR - STOP *
- * ✓PLBD BLKHD LAT GO/NO-GO DIAGRAM, 1-22 *
- * If NO-GO: Go to MAL, MECH SSR-2 (CONTINGENCY) *
- * PLBD CLOSURE *
- * If GO: PL BAY DR - CL *

- R13L PL BAY DR - CL
 CRT4 ✓PORT DOOR - blank,RDY,CL (~63 sec)
 ✓FWD,AFT LATCHES - blank,CL (~30 sec)
 ✓STBD DOOR - blank

When STBD DOOR as close as possible to PORT DOOR before contacting it:

- R13L PL BAY DR - STOP
 Determine C/L Latch clearance on C/L NO-GO DIAGRAM, 1-22

- * If NO-GO for PLBD CLOSE and no waveoff capability, *
- * perform MAL, MECH SSR-3 (SIMULTANEOUS PLBD CL) *
- * If waveoff OK, contact MCC *

PL BAY DR - CL

- * If '(S63) PLBD CONFIG' msg occurs at this time and *
- * PORT DOOR and LATCHES are 'CL' and CENTER *
- * LATCHES are 'OP' then: *
- * PL BAY DR - STOP *
- * Deselect AUTO MODE - ITEM 3 EXEC (no *) *
- * AC POWER ON - ITEM 1 EXEC (*) *
- * CLOSE STBD FWD,AFT LATCHES, & DOOR *
- * in MANUAL Mode, 1-23 *
- * Continue using AUTO Mode *

- CRT4 ✓STBD DOOR - CL (~63 sec)
 ✓FWD,AFT LATCHES - blank,CL (~30 sec)
 ✓CENTER LATCHES 1-4, 13-16 (two) - blank,CL (~20 sec)
 ✓5-8, 9-12 (two) - blank,CL (20 sec)

- R13L PL BAY DR - STOP
 SYS 1,2 (two) - DSBL

- CRT4 ✓OP/CL STATUS (ten) - CL
 AC POWER OFF - ITEM 2 EXEC (*)

- R11L GPC/CRT 04 EXEC
 CRT4 PWR - OFF

**PLBD BULKHEAD LATCH GO/NO-GO DIAGRAM
(REVERSE FOR STBD DOOR)**

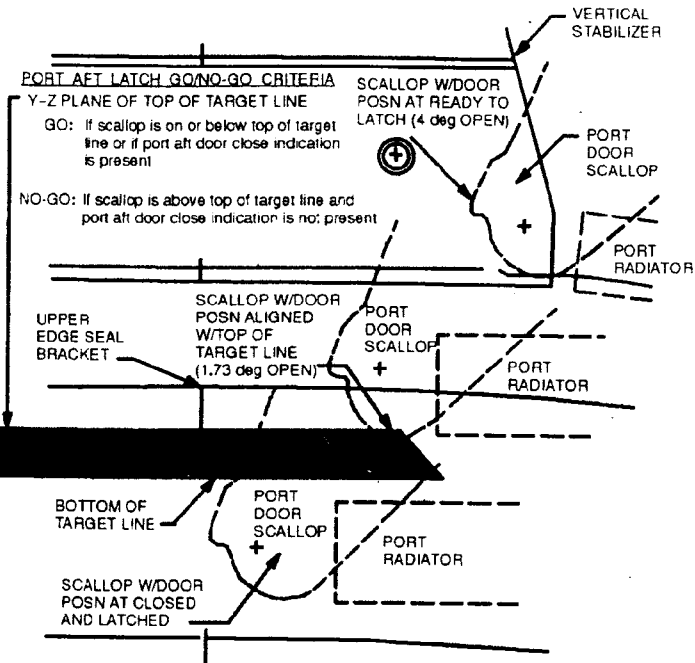

AUTO PLBD CLOSING

FUNCTION	PLBD CONTROL								PLBD DISPLAY PL MDM								
	Ref: MA73C:C&D for MCA (cb)																
	MTR 1				MTR 2				C	C	O	O	C	R	R	R	O
	AC/MCA	CNTL	MDM	SYS	AC/MCA	CNTL	MDM	SYS	A	B	A	B	A	B	C		
LATCH 5-8	1/MID3	AB3/AB2	PL1	2	3/MID2	CA3/CA1	PL2	1	1	2	1	2					
9-12	1/MID1	AB3/AB1	PL1	1	3/MID4	CA3/CA2	PL2	2	1	2	1	2					
1-4	1/MID3	AB3/AB2	PL1	2	3/MID2	CA3/CA1	PL2	1	1	2	1	2					
13-16	3/MID4	CA3/CA2	PL2	2	2/MID2	BC3/BC1	PL1	1	2	1	2	1					
S FWD	1/MID1	AB3/AB1	PL1	1	2/MID4	BC3/BC2	PL2	2	1	2	1	2					
S AFT	3/MID4	CA3/CA2	PL2	2	2/MID2	BC3/BC1	PL1	1	2	1	2	1					
S DOOR	1/MID1	AB3/AB1	PL1	1	2/MID4	BC3/BC2	PL2	2					1	1	2	2	1
P FWD	1/MID1	AB3/AB1	PL1	1	2/MID4	BC3/BC2	PL2	2	1	2	1	2					
P AFT	1/MID3	AB3/AB2	PL1	2	3/MID2	CA3/CA1	PL2	1	1	2	1	2					
P DOOR	3/MID4	CA3/CA2	PL2	2	2/MID2	BC3/BC1	PL1	1					2	1	1	2	2
													1	1	1	2	1

**ENTRY DAY NO-GO DIAGRAM
C/L LATCH EXTENDED GUIDE ROLLER TRAJECTORY**

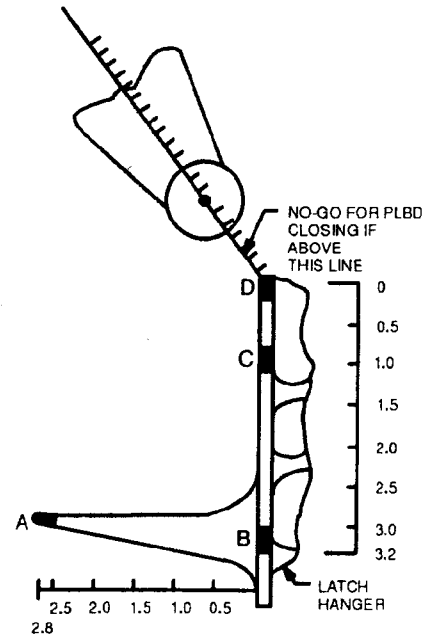

MANUAL PLBD CLOSING

DETAILED PLBD CLOSING PROCEDURES

CAUTION

Verify no obstructions when closing and latching PLBD
(Ku ANT, RMS, RAD, etc)

- * If no motion determined visually or 'OP/CL' *
- * not blank within 10 sec after cmd. *
- * PL BAY DR - STOP *
- * ✓MCC *
- * If door motion stops and not 'RDY' or 'CL', *
- * PL BAY DR - STOP *
- * ✓MCC *
- * If latch not 'CL' in single mtr time, *
- * PL BAY DR - STOP *
- * ✓MCC *
- * If SM GPC fails during this operation: *
- * PL BAY DR SYS 1,2 (two) - DSBL *
- * Perform PASS SM GPC FAIL (ORB PKT, DPS) *

R13L

CRT4

SM, OPS X02 PRO or BFS, SM 63 PL BAY DOORS
4: SM PL BAY DOORS

R13L
CRT4

- ✓ PL BAY DR - STOP
- ✓ PBD SW - STOP
- ✓ MAN SEL (ten) - (no *)
- ✓ PBD SW BYPASS - (no *)
- AC POWER ON - ITEM 1 EXEC (*)

R13L
CRT4

- PL BAY DR SYS 1,2 (two) - ENA
- ✓ OP/CL STATUS (ten) - OP

NOTE

Note any single mtr operations (continue ops)
(single mtr times = 2x listed dual mtr times)

- * If PORT(STBD) DOOR not 'CL' within 6 sec of 'RDY' then: *
- * PL BAY DR - STOP *
- * ✓ PLBD BLKHD LAT GO/NO-GO DIAGRAM, 1-24 *
- * If NO-GO: Go to MAL, MECH, SSR-2 (CONTINGENCY *
- * PLBD CLOSURE) *
- * If GO: Go to CLOSE PORT(STBD) FWD,AFT LATCHES, & *
- * DOOR *

CLOSE PORT DOOR

CRT4
R13L

Select PORT DOOR
PL BAY DR - CL

CRT4
R13L

- ✓ PORT DOOR - blank,RDY,CL (~63 sec)
- PL BAY DOOR - STOP

CLOSE PORT FWD,AFT LATCHES & DOOR

CRT4
R13L
CRT4

Select PORT FWD,AFT LATCHES
PL BAY DR - CL
✓ PORT DOOR - CL
 ✓ FWD,AFT LATCHES - blank,CL (~30 sec)

R13L
CRT4

PL BAY DR - STOP
Deselect PORT FWD,AFT LATCHES, & DOOR

CLOSE STBD DOOR

R13L
CRT4

Select STBD DOOR
PL BAY DR - CL
✓ STBD DOOR - blank

When STBD DOOR as close as possible to PORT DOOR
before contacting it:

R13L

PL BAY DR - STOP
Determine C/L Latch clearance on C/L NO-GO DIAGRAM, 1-24

- * If NO-GO for PLBD CLOSE and no waveoff capability, *
- * perform MAL, MECH SSR-3 (SIMULTANEOUS PLBD CL) *
- * If waveoff OK, contact MCC *

CRT4
R13L

PL BAY DR - CL
✓ STBD DOOR - RDY,CL (~63 sec)
PL BAY DR - STOP

CLOSE STBD FWD,AFT LATCHES & DOOR

CRT4
R13L
CRT4

Select STBD FWD,AFT LATCHES
PL BAY DR - CL
✓ STBD DR - CL
 ✓ FWD,AFT LATCHES - blank,CL (~30 sec)

R13L
CRT4

PL BAY DR - STOP
Deselect STBD FWD,AFT LATCHES & DOOR

CLOSE C/L LATCHES

CRT4
R13L
CRT4
R13L
CRT4

Select CENTER LATCHES 1-4 & 13-16
PL BAY DR - CL
✓ CENTER LATCHES 1-4, 13-16 (two) - blank,CL (~20 sec)
PL BAY DR - STOP
Deselect CENTER LATCHES 1-4 & 13-16
Select CENTER LATCHES 5-8 & 9-12

R13L
CRT4
R13L

PL BAY DR - CL
✓ CENTER LATCHES 5-8, 9-12 (two) - blank,CL (~20 sec)
PL BAY DR - STOP

CRT4

SYS 1,2 (two) - DSBL
Deselect CENTER LATCHES 5-8 & 9-12
✓ OP/CL STATUS (ten) - CL
AC POWER OFF - ITEM 2 EXEC (*)

R11L

GPC/CRT 04 EXEC
CRT4 PWR - OFF

PLBD BULKHEAD LATCH GO/NO-GO DIAGRAM
(REVERSE FOR STBD DOOR)

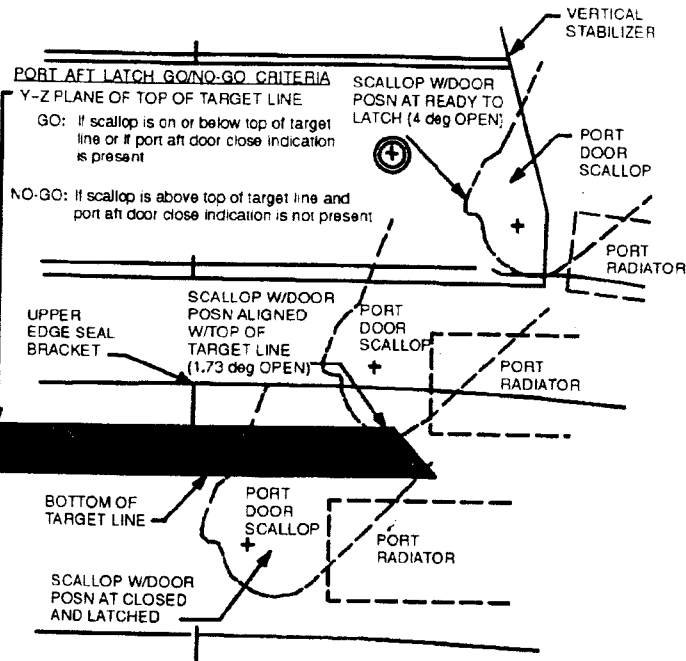

MANUAL PLBD CLOSING

FUNCTION	PLBD CONTROL								PLBD DISPLAY PL MDM								
	Ref: MA73C:C&D for MCA (cb)																
	MTR 1				MTR 2				C	C	O	O	C	R	R	R	O
	AC/MCA	CNTL	MDM	SYS	AC/MCA	CNTL	MDM	SYS	A	B	A	B	A	B	C		
LATCH																	
5-8	1/MID3	AB3/AB2	PL1	2	3/MID2	CA3/CA1	PL2	1	1	2	1	2					
9-12	1/MID1	AB3/AB1	PL1	1	3/MID4	CA3/CA2	PL2	2	1	2	1	2					
1-4	1/MID3	AB3/AB2	PL1	2	3/MID2	CA3/CA1	PL2	1	1	2	1	2					
13-16	3/MID4	CA3/CA2	PL2	2	2/MID2	BC3/BC1	PL1	1	2	1	2	1					
S FWD	1/MID1	AB3/AB1	PL1	1	2/MID4	BC3/BC2	PL2	2	1	2	1	2					
S AFT	3/MID4	CA3/CA2	PL2	2	2/MID2	BC3/BC1	PL1	1	2	1	2	1					
S DOOR	1/MID1	AB3/AB1	PL1	1	2/MID4	BC3/BC2	PL2	2					1	1	2	2	1
P FWD	1/MID1	AB3/AB1	PL1	1	2/MID4	BC3/BC2	PL2	2	1	2	1	2					
P AFT	1/MID3	AB3/AB2	PL1	2	3/MID2	CA3/CA1	PL2	1	1	2	1	2					
P DOOR	3/MID4	CA3/CA2	PL2	2	2/MID2	BC3/BC1	PL1	1					2	1	1	2	2
													1	1	1	2	1

ENTRY DAY NO-GO DIAGRAM
C/L LATCH EXTENDED GUIDE ROLLER TRAJECTORY

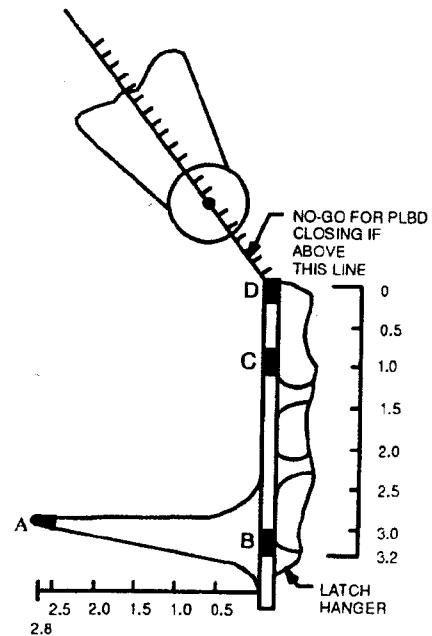

MS AFT FLIGHT DECK ACTIVITIES

NOTE
WAIT FOR GO FROM CDR OR PLT BEFORE STARTING ANY ACTIVITY ON THIS PAGE

TIME (TIG-)	MS AFT DECK ACTIONS
3:35	SPECIALIST SEAT INSTALLATION
3:10	PARTIAL ENT SWITCH LIST/VERIF, 3-9
2:55	PAYLOAD DEACT, if reqd (PL OPS, DEORB PREP)
2:51	CONFIG FOR PLBD CLOSING 7
2:40	CLOSE PLBD 9 , 1-21 and 1-22
2:25	POST CLOSING CONFIG 10
2:20	SPACELAB FINAL DEACT, if reqd 11
1:56	DEACT STAR TRKRS & CLOSE DOORS 13
	ENT AFT FLT DECK CONFIG 15
1:55	PAYLOAD ENT SWITCH LIST/VERIF (PL OPS, DEORB PREP)
1:50	FINAL ENT SWITCH LIST VERIF, 3-22 thru 3-27
1:41	RESET C/W 18
1:40	ENTRY REVIEW
1:28	DSO 603, if reqd (BIOMED, BIOMED DSOs)
1:10	CLOTHING CONFIG 21
1:00	Begin FLUID LOADING per individual prescription. Fluid loading should be completed by EI For 1 rev waveoff, repeat half the protocol If > 1 rev waveoff, repeat entire protocol
0:52	WIRELESS STOW 24

SPACELAB FINAL DEACT **11**

NOTE

Reqd only for Spacelab Module flights, if module will be unpowered for entry. Accomplish only after PLBDs are closed

SM 224 S/L COOLING LOOPS

	ECS MASTER OFF - ITEM 7 +1 EXEC
	Expect '225 AV FAN DP' and '224 H2O PUMP DP' msgs
R7	SS INV - OFF (It off)
	SS AC/DC PWR - OFF (It off)
R1	PRI PL MNC - OFF (It-off)
	PL AUX - OFF
	Expect '220 SOV P/C' and '224 H2O PUMP P' msgs
	If OARE flown:
L12L	OARE PWR - OFF
R1	PL CAB - OFF
R7	Remove fuse and stow
R1	PL CAB - MNA
L12L	OARE PWR - ON
	If OARE not flown:
R1	PL CAB - OFF

CONFIG FOR PLBD CLOSING **7**

	CONFIG RMS (if RMS onboard)
	✓ Elbow Camr in aligned position
	• Pan 90 deg from X-axis
	• Tilt per DECAL
A8L	RMS PWR - OFF (SM ALERT, BCE BYP MCIU)
	PORT RMS HTR (two) - OFF
	SET UP LIGHTS
R11L	CRT4 PWR - ON
A6U	✓ ANNUN BUS SEL - MNC

NOTE

Minimum operating time for PLB Floodlights: 25 min
~3 min to full bright

A7U	PL BAY FLOOD AFT STBD - <input type="checkbox"/>
	PORT - <input type="checkbox"/>
	MID STBD - <input type="checkbox"/>
	PORT - <input type="checkbox"/>
	FWD STBD - <input type="checkbox"/>
	PORT - <input type="checkbox"/>
	BHD - <input type="checkbox"/>

Record MET ____/____:____:____

- * If PLB floodlight not ON to full bright within 5 min: *
- * (All) PL BAY FLOOD - OFF *

TV/VTR ACT

Activate TV/VTR per Cue Card

POST CLOSING CONFIG **10**

NOTE

PLB Floodlights must be off for minimum of 10 min UNBLOCKED, 16 min BLOCKED prior to reuse

A7U	After floodlights ON > 25 min: PL BAY FLOOD (all) - OFF
	Stow Flt Deck Camrs & Accessories
	Deact TV/VTR per Cue Card
	FOOT LOOP CONFIG
	Tape foot loops in egress routes
	EDO PALLET DEACT, if flown (ORB OPS, EPS)

(Cont next page)

Back of MS AFT FLIGHT DECK ACTIVITIES

DEACT STAR TRKRS & CLOSE DOORS 13

- O6 STAR TRKR PWR (two) - OFF
- O14:E,
O15:E cb STAR TRKR -Z,-Y (two) - op
- O6 STAR TRKR DR CNTL SYS (two) - CL
 ✓ POS tb (two) - bp (start timer)
 When both tb - cl (~8-24 sec) or either tb - bp > 24 sec:
 STAR TRKR DR CNTL SYS (two) - OFF
- * If tb - bp > 8 sec, notify MCC *

RESET C/W (Contact CDR for additional parameters) 18

NOTE
 Expect 'MPS' light and master alarm.
 'MPS' light will extinguish at OPS 303 PRO

R13U		
PARAMETER NAME	C/W CH	ENA/INH
MPS He REG P C	39	ENA
	49	ENA
	59	ENA
MANF P LO2 LH2	69	INH
	79	INH
HYD P 1	99	ENA
	109	ENA
	119	ENA

CLOTHING CONFIG 21

- Unstow, don:
 LES
 Harness
 Boots
- O19 Connect MS1 suit fan
 DC UTIL PWR MNA - ON
- A15 Connect MS2 suit fan
 DC UTIL PWR MNC - ON

WIRELESS STOW 24

- Disconnect, stow Wireless comm (if reqd)
 ✓ Aft deck lts as reqd

ENTRY AFT FLT DECK CONFIG 15

- A7L **DSP (OV104)**
 SYS PWR SYS1, SYS2 (two) - OFF (hold 5 sec, tb-OFF)
 cb SYS PWR CNTL (two) - op
 DOCK LT MNA, B (four) - op
 MN A, B, C LOG (six) - op
- MADS (OV103, OV105)**
 MADS STRAIN GAGE - PCM ENA
- A6L **MADS (OV104)**
 MADS STRAIN GAGE - PCM ENA
- A7L **MADS/OEX (OV102)**
 OEX EQUIP - ON
- HYD HTR**
 A12 HYD HTR (eight) - OFF
- ENTRY COMM**
 A1L S-BD PM MODE - STDN LO
 NSP CODING (two) - OFF
- S-BAND PAYLOAD**
 S-BD PL CH SEL INTRG 1,2 tw (six) - 910,910
 PWR SYS - OFF
 SEL - PSP
 ANT POLAR - L CIRC
 PSP CMD OUTPUT - PL UMB
- A1R AUD CTR VOICE RCD SEL CH1 - ICOM A
 CH2 - ICOM B
- A13 OS AUD SPKR PWR - OFF (OV103, OV104, OV105)
 PWR - OFF (OV102)
- R14:C cb MNB KU ANT HTR - op
- R14:F ✓ cb ESS 1BC LDG GEAR ARM/DN RESET - op
- NOTE**
 Review or mark cb location for ease of
 finding during post landing procedures
- R10 MS AUD A/G 2 - T/R
 A/A - T/R
 VOX SENS - R
 VOL tw (five) - R
 XMIT/ICOM MODE - R
- L9 PS AUD PWR - AUD TONE
 A/G 1 - T/R
 A/A - T/R
 ICOM (two) - T/R
 VOX SENS - R
 XMIT/ICOM MODE - R
 VOL tw (five) - R
- ICOM RECORDER OPS, if reqd (ORB OPS, COMM/INST)

MS AFT FLIGHT DECK ACTIVITIES

NOTE
WAIT FOR GO FROM CDR OR PLT BEFORE STARTING ANY ACTIVITY ON THIS PAGE

TIME (TIG-)	MS AFT DECK ACTIONS
3:35	<u>SPECIALIST SEAT INSTALLATION</u>
3:10	<u>PARTIAL ENT SWITCH LIST/VERIF, 3-9</u>
2:58	<u>PAYLOAD DEACT, if reqd (PL OPS, DEORB PREP)</u>
2:51	<u>CONFIG FOR PLBD CLOSING</u> [7]
2:40	<u>CLOSE PLBD</u> [9], 1-21 and 1-22
2:25	<u>POST CLOSING CONFIG</u> [10]
2:20	<u>SPACELAB FINAL DEACT, if reqd</u> [11]
1:56	<u>DEACT STAR TRKRS & CLOSE DOORS</u> [13] <u>ENT AFT FLT DECK CONFIG</u> [15]
1:55	<u>PAYLOAD ENT SWITCH LIST/VERIE (PL OPS, DEORB PREP)</u>
1:50	<u>FINAL ENT SWITCH LIST VERIE, 3-22 thru 3-27</u>
1:41	<u>RESET C/W</u> [18]
1:40	<u>ENTRY REVIEW</u>
1:28	<u>DSO 603, if reqd (BIOMED, BIOMED DSOs)</u>
1:10	<u>CLOTHING CONFIG</u> [21]
1:00	Begin <u>FLUID LOADING</u> per individual prescription. Fluid loading should be completed by EI For 1 rev waveoff, repeat half the protocol If > 1 rev waveoff, repeat entire protocol
0:52	<u>WIRELESS STOW</u> [24]

<u>SPACELAB FINAL DEACT</u> [11]	
NOTE Reqd for SL Pallet flights to ensure proper thermal environment. Accomplish only after PLBDs are closed and before DPS ENTRY CONFIG	
<u>SM 224 S/L COOLING LOOPS</u>	
R7	<u>FREON LOOP PUMP 1,2 (two) OFF - ITEM 5 EXEC (*)</u> Expect '224 FRN PUMP P' msg SS INV - OFF (lt off) SS AC/DC PWR - OFF (lt off)
L12U	<u>FMDM 1,2 (two) - OFF (lb-bp)</u>
L12L	cb FMDM - op PRI PL MNC - OFF (lb-off) ✓ PL AUX - OFF CAB - OFF

<u>CONFIG FOR PLBD CLOSING</u> [7]																						
<u>CONFIG RMS</u> (if RMS onboard) ✓ Elbow Camr in aligned position • Pan 90 deg from X-axis • Tilt per DECAL																						
A8L	<u>RMS PWR - OFF (SM ALERT, BCE BYP MCIU)</u> <u>PORT RMS HTR (two) - OFF</u>																					
<u>SET UP LIGHTS</u>																						
R11L	<u>CRT4 PWR - ON</u>																					
A6U	✓ <u>ANNUN BUS SEL - MNC</u>																					
NOTE Minimum operating time for PLB Floodlights: 25 min - 3 min to full bright																						
A7U	<table style="width: 100%; border: none;"> <tr> <td style="width: 60%;">PL BAY FLOOD AFT STBD -</td> <td style="width: 5%; text-align: center;">-</td> <td style="width: 35%;"><input type="checkbox"/></td> </tr> <tr> <td>PORT -</td> <td style="text-align: center;">-</td> <td><input type="checkbox"/></td> </tr> <tr> <td>MID STBD -</td> <td style="text-align: center;">-</td> <td><input type="checkbox"/></td> </tr> <tr> <td>PORT -</td> <td style="text-align: center;">-</td> <td><input type="checkbox"/></td> </tr> <tr> <td>FWD STBD -</td> <td style="text-align: center;">-</td> <td><input type="checkbox"/></td> </tr> <tr> <td>PORT -</td> <td style="text-align: center;">-</td> <td><input type="checkbox"/></td> </tr> <tr> <td>BHD -</td> <td style="text-align: center;">-</td> <td><input type="checkbox"/></td> </tr> </table>	PL BAY FLOOD AFT STBD -	-	<input type="checkbox"/>	PORT -	-	<input type="checkbox"/>	MID STBD -	-	<input type="checkbox"/>	PORT -	-	<input type="checkbox"/>	FWD STBD -	-	<input type="checkbox"/>	PORT -	-	<input type="checkbox"/>	BHD -	-	<input type="checkbox"/>
PL BAY FLOOD AFT STBD -	-	<input type="checkbox"/>																				
PORT -	-	<input type="checkbox"/>																				
MID STBD -	-	<input type="checkbox"/>																				
PORT -	-	<input type="checkbox"/>																				
FWD STBD -	-	<input type="checkbox"/>																				
PORT -	-	<input type="checkbox"/>																				
BHD -	-	<input type="checkbox"/>																				
Record MET ____/____/____ : ____:____																						
* If PLB floodlight not ON to full bright within 5 min:* * (Aft) PL BAY FLOOD - OFF *																						
<u>TV/VTR ACT</u> Activate TV/VTR per Cue Card																						

<u>POST CLOSING CONFIG</u> [10]	
NOTE PLB Floodlights must be off for minimum of 10 min UNBLOCKED, 16 min BLOCKED prior to reuse	
A7U	After floodlights ON > 25 min: <u>PL BAY FLOOD (all) - OFF</u> Stow Flt Deck Camrs & Accessories Deact TV/VTR per Cue Card <u>FOOT LOOP CONFIG</u> Tape foot loops in egress routes <u>EDO PALLET DEACT, if flown (ORB OPS, EPS)</u>

SLP

(Cont next page)

Back of MS AFT FLIGHT DECK ACTIVITIES

DEACT STAR TRKRS & CLOSE DOORS 13

O6 STAR TRKR PWR (two) - OFF

O14:E,
O15:E cb STAR TRKR -Z,-Y (two) - op

O6 STAR TRKR DR CNTL SYS (two) - CL
 ✓ POS tb (two) - bp (start timer)
 When both tb - cl (~8-24 sec) or either tb - bp > 24 sec:
 STAR TRKR DR CNTL SYS (two) - OFF

If tb - bp > 8 sec, notify MCC

RESET C/W (Contact CDR for additional parameters) 18

NOTE

Expect 'MPS' light and master alarm.
 'MPS' light will extinguish at OPS 303 PRO

R13U		
PARAMETER NAME	C/W CH	ENA/ INH
MPS He REG P C	39	ENA
	49	ENA
	59	ENA
MANF P LO2 LH2	69	INH
	79	INH
HYD P 1	99	ENA
	109	ENA
	119	ENA

CLOTHING CONFIG 21

Unstow, don:
 LES
 Harness
 Boots

O19 Connect MS1 suit fan
 DC UTIL PWR MNA - ON

A15 Connect MS2 suit fan
 DC UTIL PWR MNC - ON

WIRELESS STOW 24

Disconnect, stow Wireless comm (if reqd)
 ✓ Aft deck lts as reqd

ENTRY AFT FLT DECK CONFIG 15

A7L MADS (OV103,OV105)
 MADS STRAIN GAGE - PCM ENA

A6L MADS (OV104)
 MADS STRAIN GAGE - PCM ENA

A7L MADS/OEX (OV102)
 OEX EQUIP - ON

A12 HYD HTR
 HYD HTR (eight) - OFF

A1L ENTRY COMM
 S-BD PM MODE - STDN LO
 NSP CODING (two) - OFF
 S-BAND PAYLOAD
 S-BD PL CH SEL INTRG 1,2 tw (six) - 910,910
 PWR SYS - OFF
 SEL - PSP
 ANT POLAR - L CIRC
 PSP CMD OUTPUT - PL UMB

A1R AUD CTR VOICE RCD SEL CH1 - ICOM A
 CH2 - ICOM B

A13 OS AUD SPKR PWR - OFF (OV103,OV104,OV105)
 PWR - OFF (OV102)

R14:C cb MNB KU ANT HTR - op
 R14:F ✓cb ESS 1BC LDG GEAR ARM/DN RESET - op

NOTE
 Review or mark cb location for ease of
 finding during post landing procedures

R10 MS AUD A/G 2 - T/R
 A/A - T/R
 VOX SENS - R
 VOL tw (five) - R
 XMIT/ICOM MODE - R

L9 PS AUD PWR - AUD TONE
 A/G 1 - T/R
 A/A - T/R
 ICOM (two) - T/R
 VOX SENS - R
 XMIT/ICOM MODE - R
 VOL tw (five) - R

ICOM RECORDER OPS, if reqd (ORB OPS, COMM/INST)

SLP

MS MIDDECK ACTIVITIES

NOTE
WAIT FOR GO FROM CDR OR PLT BEFORE STARTING ANY ACTIVITY ON THIS PAGE

TIME (TIG-)	MS MIDDECK ACTIONS
3:50	ENTRY STOWAGE 3
3:50	ENT AIRLOCK CONFIG 3A
3:35	SPECIALIST SEAT INSTALLATION
3:10	PARTIAL ENT SWITCH LIST/VERIF, 3-10 thru 3-12
1:55	ENT MIDDECK CONFIG 16
1:50	FINAL ENT SWITCH LIST/VERIF, 3-28 thru 3-30
1:40	ENTRY REVIEW
1:28	DSO 603, if reqd (BIOMED, BIOMED DSOs)
1:10	CLOTHING CONFIG 20
1:00	Begin FLUID LOADING per individual prescription. Fluid loading should be completed by EI For 1 rev waveoff, repeat half the protocol If > 1 rev waveoff, repeat entire protocol
0:50	CO2 RMVL SYS DEACT, if flown 25
0:35	GALLEY DEACT 26
0:33	WCS DEACT 27

ENTRY MIDDECK CONFIG 16	
MO42F	ENTRY COMM MIDDECK SPKR AUD A/G 2 - T/R A/A - T/R VOX SENS - R VOL tw (five) - R XMIT/ICOM MODE - R
ML85E	TIPS DEACTIVATION (ORB OPS, COMM/INST), steps 2 & 3
MO10W	MIDDECK PCS 14.7 CAB REG INLET vlv (two) - CL H2O TK N2 REG INLET vlv (two) - OP O2 REG INLET vlv (two) - CL
MO32M	LEH O2 vlv (two) - R
MO69M	LEH O2 8 vlv - CL Remove and stow O2 Bleed Orifice LEH O2 8 vlv - R
MO69M	LEH O2 7 vlv - R
MA73C:F	RMS PNL LITS (if RMS onboard) cb RMS PRI ϕ A - op B/U ϕ A - op

ENTRY STOWAGE 3
PERSONAL HYGIENE SYS STOWAGE Slow: Personal Hygiene Kits Hose
AIRLOCK CLOSEOUT Tether soft goods to EVA tether point or A/L Stowage Bag. Gray Tape to floor Airlock ENT SW VERIF, 3-3
POLE SETUP Reinstall Stbd Pip Pin Reinstall large Port Pin: Retract and hold Locking Pin (Ring) Reinstall large Pin Release Locking Pin (Ring) Slide forward Safing Latch ✓ Pole Straps secure
PDF STOWAGE Stow FLIGHT PLAN
CABIN CONFIG Slow: Backup PGSC Middeck Camrs, Accessories FWD/AFT Shades, Filters Exercise Equipment Quick Don Masks ✓ Retention net is in ASC/ENT config
EGRESS ROUTE CONFIG Tape foot loops in egress routes

ENT AIRLOCK CONFIG 3A	
ENT	If Mir docking mission: 1. Complete ODS SYSTEM STOW FOR ENTRY (MSJOC, GEN NON-JOINT), continue:
INNER HATCH	If internal airlock flown: 2. Close hatch per decal 3. Equal vlv (two) - NORM, install caps >>
MO13Q	If Booster Fan flown: 4. ARLK FAN A(B) - OFF 5. Remove, stow flex duct from booster fan outlet and external airlock duct inlet 6. Remove, stow flex duct from booster fan inlet and cabin middeck floor air fitting

(Cont next page)

Back of MS MIDDECK ACTIVITIES

- | | |
|---|---|
| MA73C:G | 7. Unstow, install booster fan inlet and outlet caps |
| | 8. cb AC1,2 ARLK TNL FAN A,B (six) - op |
| | 9. Go to step 11 |
| | 10. Remove, stow flex duct from cabin middeck floor air fitting |
| | 11. Unstow, reinstall diffuser cap on cabin middeck floor air fitting |
| MO13Q
MIDDECK
FLR
INNER
HATCH | 12. ✓ARLK H2O S/O vlv - OP (tb-op) |
| | 13. ✓EMU O2 ISOL vlv - CL |
| | 14. Close hatch per decal |
| | 15. Equal vlvs (two) - NORM, install caps |

CLOTHING CONFIG 20

Unstow, don:
LES
Harness
Boots

NOTE

Refer to flight specific utility
outlet plug-in plan if reqd

- | | |
|--------------------------------|---|
| MO52J
PDB J4(2,3)
OUTLET | Connect suit fans
DC UTIL PWR MNA - ON |
| MO30F | DC UTIL PWR MNC - as reqd |

GALLEY DEACT 26

- | | |
|---------|----------------------------------|
| GALLEY | OVEN/RHS - OFF |
| | H2O HTRS (two) - OFF |
| | ✓OVEN FAN - OFF |
| | ✓REHYD STA lever - cl (push in) |
| | ✓OVEN DOOR LATCH - latched |
| MA73C:G | cb AC3 GALLEY FAN (three) - op |
| ML86B:A | cb MNC SPLY H2O GALLEY SPLY - op |
| :B | cb MNA GALLEY OVEN - op |
| | cb MNB GALLEY H2O HTR - op |

CO2 RMVL SYS DEACT 25

- | | |
|-------|--------------------------------------|
| MO51F | CNTRLR 2(1) MODE - STBY (hold 3 sec) |
| | Wait 6 sec |
| | ✓CNTRLR 2(1) OPER II - off |
| | ✓FAIL II - on |
| | MNC(A) - OFF |
| | ✓CNTRLR 2(1) FAIL II - off |
| | AC 3(1) - OFF (hold 3 sec) |
| | AC 3(1) cbs (three) - op |
| | COM INSTR - OFF |

Remove and replace LiOH canister in position A with one
fresh LiOH canister

WCS DEACT 27

- | | |
|------------------|--|
| WCS
(EDO WCS) | ✓VAC VLV - CL |
| | Stow:
WCS Trash Can
Mirror
Privacy Curtain |
| | Foot/toe restraints - up, latched |
| EDO WCS | If EDO WCS:
Secure urinal hose with Velcro strap
URINAL SEL - OFF
WCS PWR SEL (two) - OFF 1, OFF 2
Commode lid lock - lock
✓COMPACTOR - stowed
COMPACTOR CLEANING LATCH PIN - disengaged
LOCK PINS (three) - tighten (snug) |
| | Stow thigh restraints |
| | Close and latch door |
| ML31C | VAC VENT ISOL VLV BUS SEL - MNB
CNTL - CL (tb-CL)
NOZ HTR - OFF |
| | ✓Middeck lts as reqd |

DEORBIT PREP BACKOUT PROCEDURES

DEORBIT PREP BACKOUT SUMMARY TIMELINES

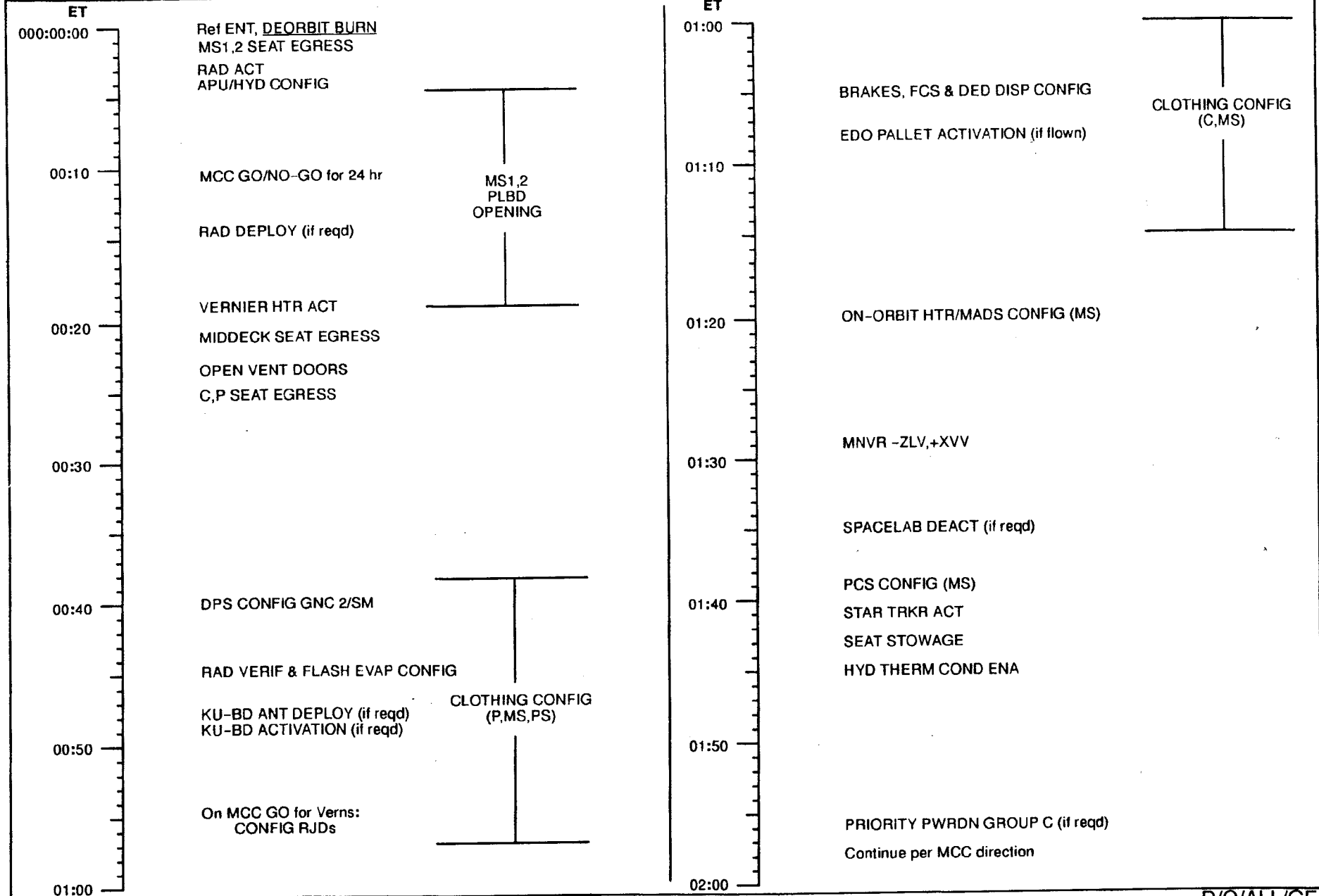

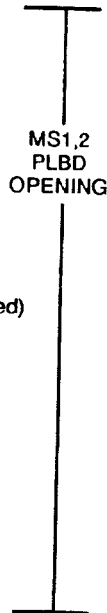
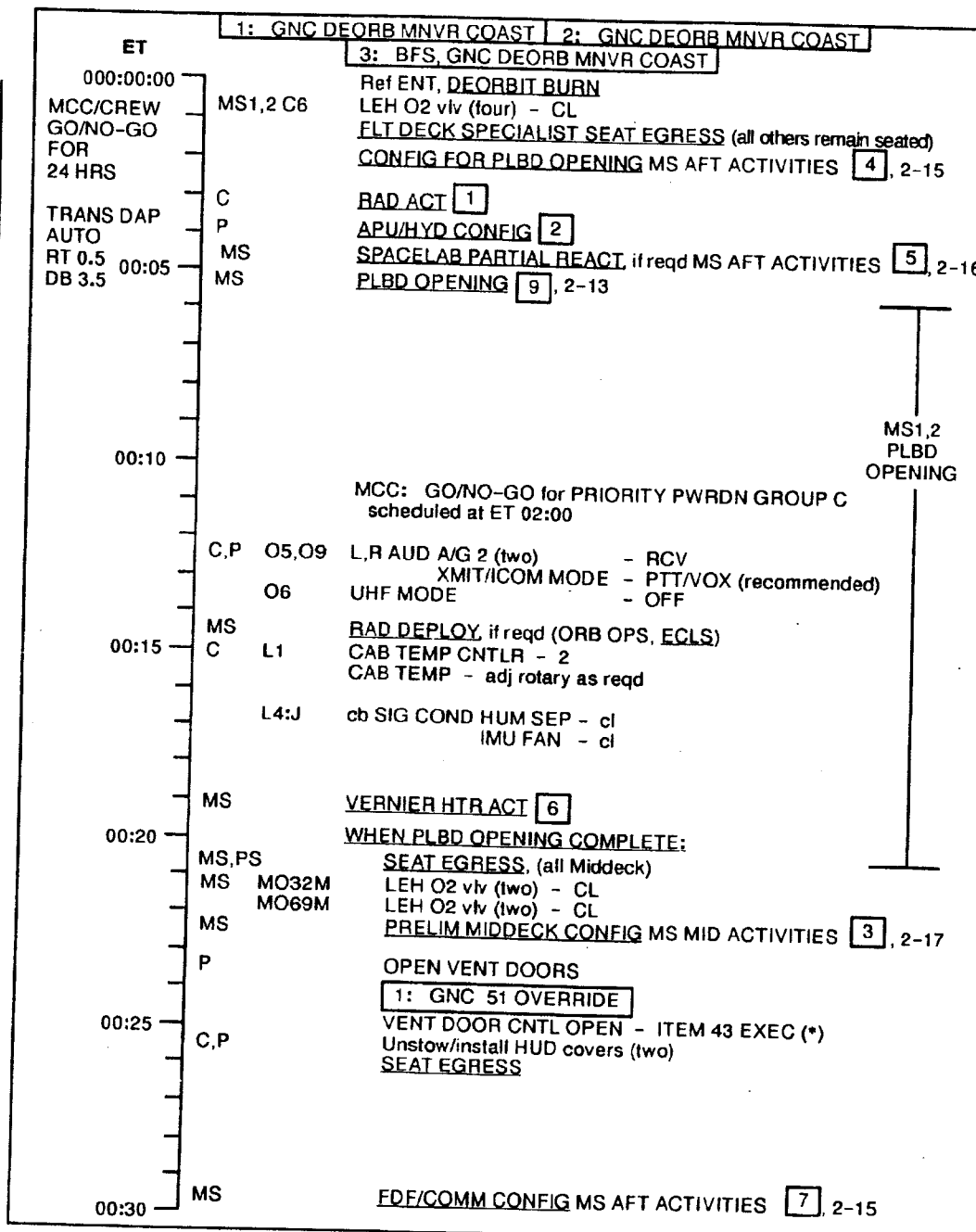

RAD ACT 1

C L1 ✓ RAD CNTLR OUT TEMP - NORM
BYP VLV MODE (two) - AUTO
CNTLR LOOP (two) - AUTO A(B)
After ~90 sec,
RAD BYP VLV (two) - RAD

- * If tb(s) remain in BYP or return to BYP: *
- * Use alternate RAD CNTLR *
- * Do not drive BYP VLV(s) manually *
- * If tb(s) bp: *
- * Do not select alternate RAD CNTLR *
- * Do not drive BYP VLV(s) manually *
- * If EVAP OUT T low or H2O ICH OUT T low: *
- * RAD BYP VLV MODE (two) - MAN *
- * MAN SEL (two) - BYP *
- * (after ~3 sec tb-BYP) *

APU/HYD CONFIG 2

DEACTIVATE APUs (APU SHUTDOWN Cue Card)

P R2 BLR N2 SPLY (three) - OFF
HYD MN PUMP PRESS (three) - NORM

VERNIER HTR ACT 6

P A14 RCS/OMS HTR FWD RCS JET 5 - AUTO
AFT RCS JET 5 - AUTO

NOTE
Delay use of verniers until MCC GO in GNC OPS 2

CLOTHING CONFIG 10

Doff/Stow:
Harness, Boots, LES, UCD (if not used)

Doff/Stow in Wet Trash (if used):
UCD (clamp)
Emesis Bag (unstow new Bag)

DPS CONFIG TO GNC2/SM 12

NOTE

Do not perform any keyboard item entries or switch throws 10 sec before **and** after moding PASS GPCs to RUN or making ops transition requests

1. TRANSITION TO GNC OPS 201

GNC 0 GPC MEMORY

✓ CONFIG - ITEM 1 +2 EXEC

Config for single G2 GPC ops unless directed otherwise by MCC:

Modify MC 2 per table

BFC CRT DISP - OFF

GNC, OPS 201 PRO

GNC UNIV PTG

DAP: B/AUTO/PRI

GNC 1 DPS UTILITY

✓ CKPT RETRV ENA - ITEM 12 EXEC (*)

BFC CRT DISP - ON

BFS, MSG RESET (✓BFC lt off)

BFS, GPC/CRT 04 EXEC

If single G2 GPC ops:

MAJ FUNC - PL

GPC/CRT 2X EXEC

X: PL GPC MEMORY

CONFIG ITEM 45 +2 EXEC

GPC ITEM 46 +2 EXEC

STORE ITEM 47 EXEC

Store complete when MC = 02 (~ 16 sec)

GPC MODE 2 - STBY (tb-bp)

- HALT (tb-bp)

- STBY (tb-RUN)

- HALT (tb-bp)

C3

C3

C2

CRT

CRTX

O6

		DUAL G2	SINGLE G2
CONFIG GPC		2	2
		12000	10000
STR	1	1	1
	2	2	1
	3	1	1
	4	2	1
PL	1/2	0	0
CRT	1	1	1
	2	2	1
	3	0	0
	4	2	1
L	1	0	0
	2	0	0
MM	1	1	1
	2	2	1

C3
CRTX

2. FREEZE DRY GPC 3

BFC CRT DISP - OFF

MAJ FUNC - PL

GPC/CRT 3X EXEC

X: PL GPC MEMORY

CONFIG - ITEM 45 +2 EXEC

GPC - ITEM 46 +3 EXEC

STORE - ITEM 47 EXEC

Store complete when MC = 02 (~ 16 sec)

GPC MODE 3 - STBY (tb-bp)

HALT (tb-bp)

STBY (tb-RUN)

HALT (tb-bp)

~~X:~~

O6

CRTY

CRTX

C3

CRT3

C3

O6

P/I Locker

C2

3. TRANSITION GPC 4 TO SM OPS 201(401)

✓ MAJ FUNC - PL

GPC/CRT 4X EXEC

X: PL GPC MEMORY

CONFIG - ITEM 1 +4 EXEC

✓ MC 4(5) per table

SM, OPS 201(401) PRO

X: SM ANTENNA

DAP: B/AUTO/PRI

SM 1 DPS UTILITY

UL CNTL AUTO - ITEM 35 EXEC

CONFIG GPC		4(5) 00040
STR	1	0
	2	0
	3	0
	4	0
PL	1/2	4
CRT	1	4
	2	4
	3	0
	4	4
L	1	4
	2	0
MM	1	4
	2	4

4. RECONFIG GPCs

BFC CRT DISP - ON

BFS, GNC OPS 000 PRO

3: BFS, GNC GPC MEMORY

BFC CRT DISP - OFF

✓ All CRTs deassigned from BFS

GPC MODE 5 - STBY (tb-RUN)

(releases payload buses 1,2)

then HALT (tb-bp)

OUTPUT 4 - TERM (tb-bp)

5 - NORM (tb-bp)

Unstow and install GPC Mode Switch Guard

5. RECONFIG CRTs

GPC/CRT 03 EXEC

04 EXEC

44 EXEC

CRT3 PWR - OFF

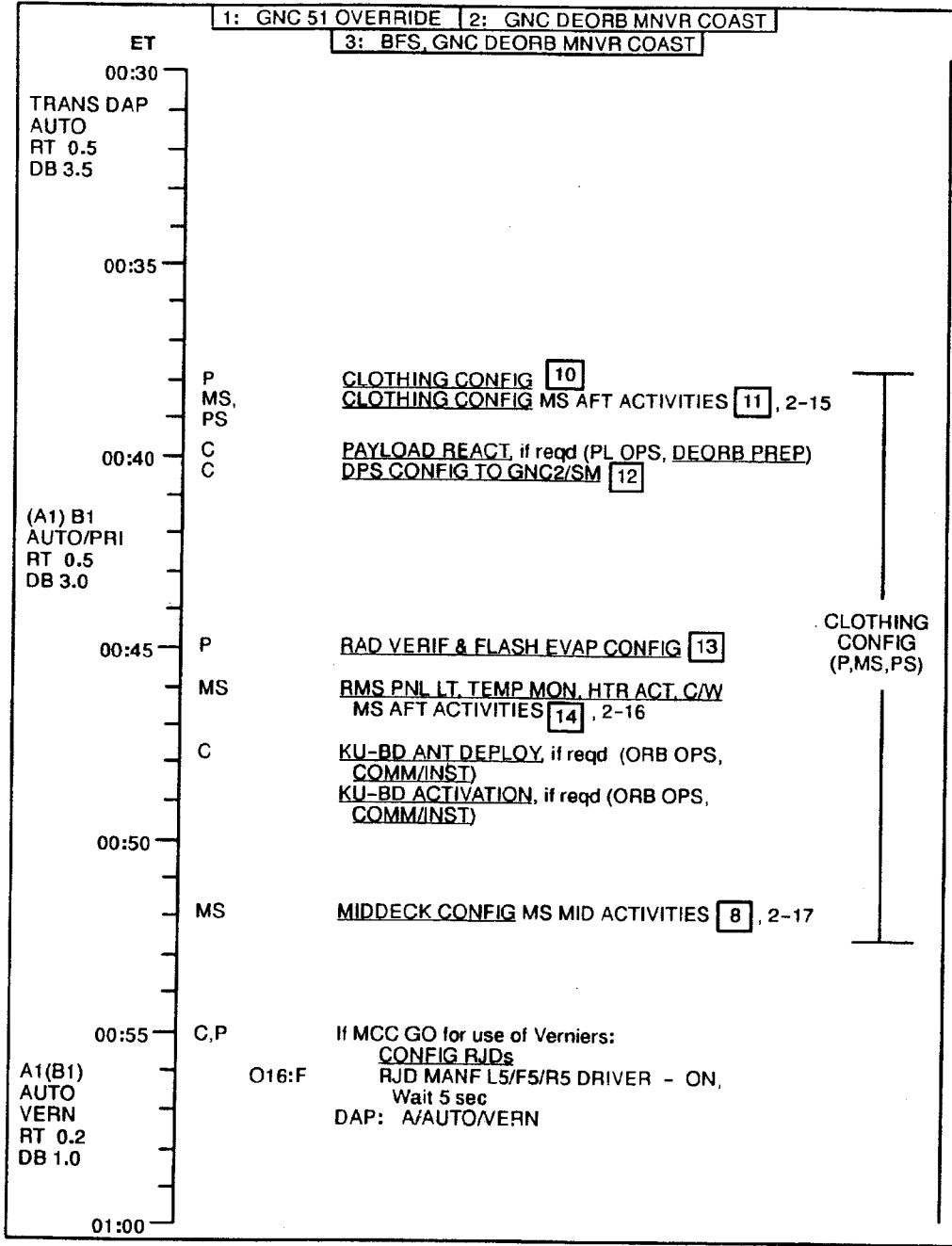

- 6. TFL/DFL FOR ON-ORBIT OPS
 MCC for TFL/DFL config
 Perform LOAD PCMMU FORMAT (ORB OPS FS, COMM/INST) and LOAD PDI DECOM FORMAT (ORB OPS FS, COMM/INST)
- 7. ERROR LOG RESET
 After MCC GO:
 SM 0 GPC MEMORY
 ERR LOG RESET - ITEM 48 EXEC
 GNC 0 GPC MEMORY
 ERR LOG RESET - ITEM 48 EXEC
 SM SYS SUMM 1

- RAD VERIF & FLASH EVAP CONFIG 13**
- 2: SM 88 APU/ENVIRON THERM
 - L1 RAD BYP VLV 1b (two) - RAD FLOW
 When FREON LOOP RAD OUT T < 60 degF:
 HI LOAD EVAP - OFF
 FLASH EVAP CNTLR PRI B(A) - OFF
 - L1 SPLY H2O TKC INLET - OP (1b-OP)
 OUTLET - OP (1b-OP)
 - R11L
 - 2: SM SYS SUMM 1

ET	1: GNC DEORB MNVR COAST	2: GNC DEORB MNVR COAST	3: BFS, GNC DEORB MNVR COAST
000:00:00	MS1,2 C6	Ref ENT, DEORBIT BURN LEH O2 vlv (four) - CL FLT DECK SPECIALIST SEAT EGRESS (all others remain seated) CONFIG FOR PLBD OPENING MS AFT ACTIVITIES	
	C	RAD ACT 1 4, 2-15	
	P	APU/HYD CONFIG 2	
	MS	PLBD OPENING 9, 2-13	
00:05			
00:10			
		MCC: GO/NO-GO for PRIORITY PWRDN GROUP C scheduled at ET 02:00	
	C,P	O5,O9 L,R AUD A/G 2 (two) - RCV XMIT/COM MODE - PTT/VOX (recommended)	
		O6 UHF MODE - OFF	
00:15	MS	RAD DEPLOY, if reqd (ORB OPS, ECLS)	
	C	L1 CAB TEMP CNTLR - 2 CAB TEMP - adj rotary as reqd	
		L4:J cb SIG COND HUM SEP - cl IMU FAN - cl	
	MS	VERNIER HTR ACT 6	
00:20		WHEN PLBD OPENING COMPLETE:	
	MS,PS	SEAT EGRESS, (all Middeck)	
	MS	MO32M LEH O2 vlv (two) - CL	
	MS	MO69M LEH O2 vlv (two) - CL	
	P	PRELIM MIDDECK CONFIG MS MID ACTIVITIES 3, 2-17	
		OPEN VENT DOORS	
		1: GNC 51 OVERRIDE	
00:25	C,P	VENT DOOR CNTL OPEN - ITEM 43 EXEC (*) Unstow/install HUD covers (two) SEAT EGRESS	
	MS	SPACELAB PARTIAL REACT, if reqd MS AFT ACTIVITIES 5, 2-16	
00:30	MS	FDF/COMM CONFIG MS AFT ACTIVITIES 7, 2-15	

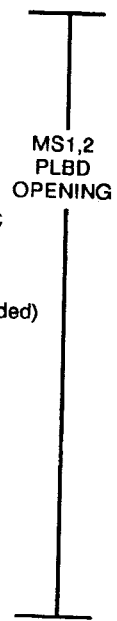

RAD ACT 1

C L1 ✓ RAD CNTLR OUT TEMP - NORM
BYP VLV MODE (two) - AUTO
CNTLR LOOP (two) - AUTO A(B)
After ~90 sec,
RAD BYP VLV (two) - RAD

- * If (b)s remain in BYP or return to BYP: *
- * Use alternate RAD CNTLR *
- * Do not drive BYP VLV(s) manually *
- * If (b)s bp: *
- * Do not select alternate RAD CNTLR *
- * Do not drive BYP VLV(s) manually *
- * If EVAP OUT T low or H2O ICH OUT T low: *
- * RAD BYP VLV MODE (two) - MAN *
- * MAN SEL (two) - BYP *
- * (after ~3 sec (b)-BYP) *

APU/HYD CONFIG 2

P R2 DEACTIVATE APUs (APU SHUTDOWN Cue Card)
BLR N2 SPLY (three) - OFF
HYD MN PUMP PRESS (three) - NORM

VERNIER HTR ACT 6

P A14 RCS/OMS HTR FWD RCS JET 5 - AUTO
AFT RCS JET 5 - AUTO

NOTE
Delay use of verniers until MCC GO in GNC OPS 2

SLP

CLOTHING CONFIG 10

Do/ff/Stow:
Harness, Boots, LES, UCD (if not used)

Do/ff/Stow in Wet Trash (if used):
UCD (clamp)
Emesis Bag (unstow new Bag)

DPS CONFIG TO GNC2/SM 12

NOTE

Do not perform any keyboard item entries or switch throws 10 sec before and after moding PASS GPCs to RUN or making ops transition requests

1. TRANSITION TO GNC OPS 201

GNC 0 GPC MEMORY

✓ CONFIG - ITEM 1 +2 EXEC

Config for single G2 GPC ops unless directed otherwise by MCC:

Modify MC 2 per table

BFC CRT DISP - OFF

GNC, OPS 201 PRO

GNC UNIV PTG

DAP: B/AUTO/PRI

GNC 1 DPS UTILITY

✓ CKPT RETRV ENA - ITEM 12 EXEC (*)

BFC CRT DISP - ON

BFS, MSG RESET (✓BFC lt off)

BFS, GPC/CRT 04 EXEC

If single G2 GPC ops:

MAJ FUNC - PL

GPC/CRT 2X EXEC

X: PL GPC MEMORY

CONFIG ITEM 45 +2 EXEC

GPC ITEM 46 +2 EXEC

STORE ITEM 47 EXEC

Store complete when MC = 02 (~ 16 sec)

GPC MODE 2 - STBY (tb-bp)

- HALT (tb-bp)

- STBY (tb-RUN)

- HALT (tb-bp)

		DUAL G2	SINGLE G2
CONFIG GPC		2	2
		12000	10000
STR	1	1	1
	2	2	1
	3	1	1
	4	2	1
PL	1/2	0	0
CRT	1	1	1
	2	2	1
	3	0	0
	4	2	1
L	1	0	0
	2	0	0
MM	1	1	1
	2	2	1

C3

C3

C2

CRT

CRTX

O6

C3
CRTX

O6

CRTY

CRTX

C3

CRT3

C3

O6

P/I Locker

C2

2. FREEZE DRY GPC 3

BFC CRT DISP - OFF

MAJ FUNC - PL

GPC/CRT 3X EXEC

X: PL GPC MEMORY

CONFIG - ITEM 45 +2 EXEC

GPC - ITEM 46 +3 EXEC

STORE - ITEM 47 EXEC

Store complete when MC = 02 (~ 16 sec)

GPC MODE 3 - STBY (tb-bp)

HALT (tb-bp)

STBY (tb-RUN)

HALT (tb-bp)

~~X:~~

3. TRANSITION GPC 4 TO SM OPS 201(401)

✓ MAJ FUNC - PL

GPC/CRT 4X EXEC

X: PL GPC MEMORY

CONFIG - ITEM 1 +4 EXEC

MC 4(5) per table

SM, OPS 201(401) PRO

X: SM ANTENNA

DAP: B/AUTO/PRI

SM 1 DPS UTILITY

UL CNTL AUTO - ITEM 35 EXEC

4. RECONFIG GPCs

BFC CRT DISP - ON

BFS, GNC OPS 000 PRO

3: BFS, GNC GPC MEMORY

BFC CRT DISP - OFF

✓ All CRTs deassigned from BFS

GPC MODE 5 - STBY (tb-RUN)

(releases payload buses 1,2)

then HALT (tb-bp)

OUTPUT 4 - TERM (tb-bp)

5 - NORM (tb-bp)

Unstow and install GPC Mode Switch Guard

5. RECONFIG CRTs

GPC/CRT 03 EXEC

04 EXEC

44 EXEC

CRT3 PWR - OFF

CONFIG GPC	4(5) 00040
STR	1 0
	2 0
	3 0
	4 0
PL	1/2 4
CRT	1 4
	2 4
	3 0
	4 4
L	1 4
	2 0
MM	1 4
	2 4

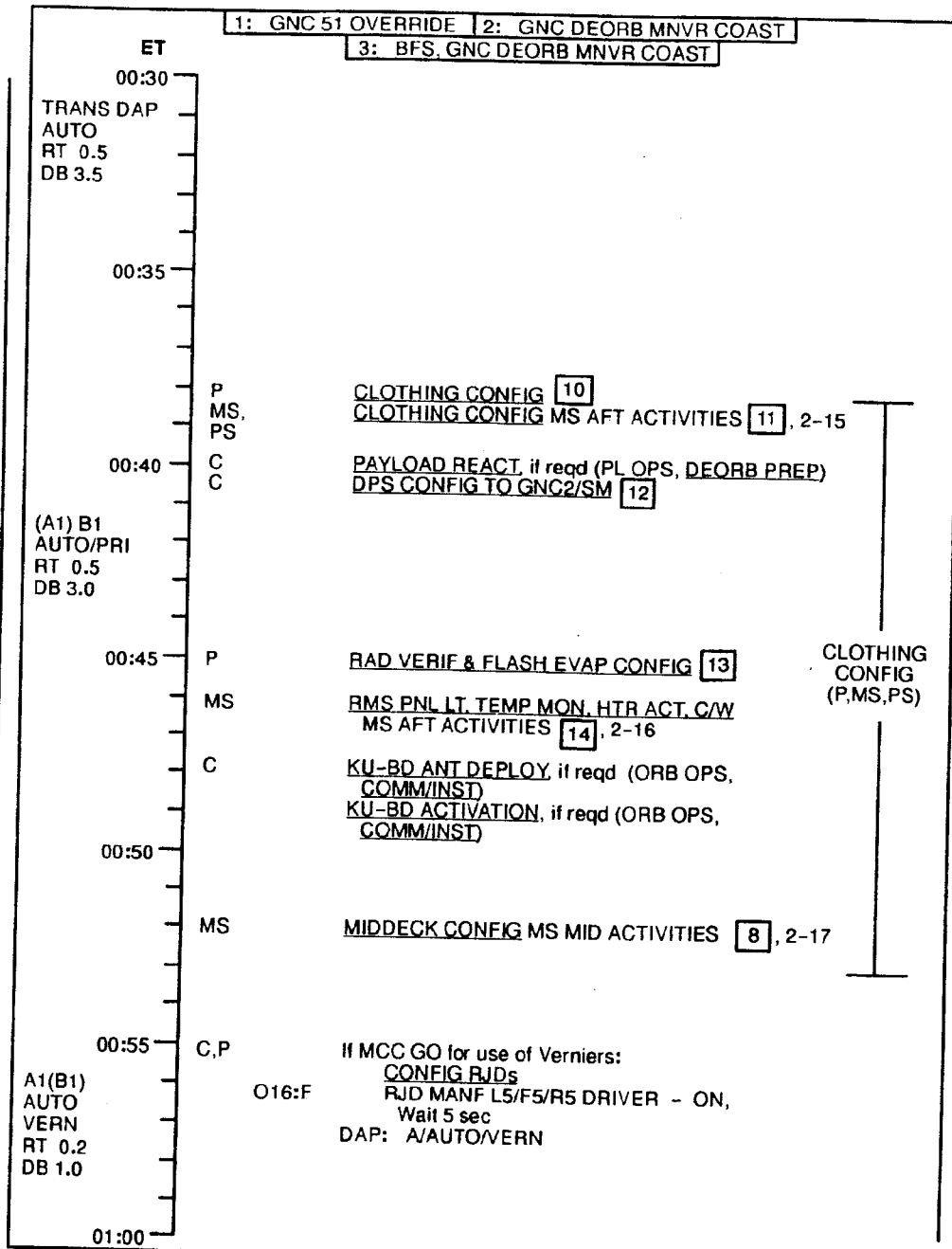

6. TFL/DFL FOR ON-ORBIT OPS
 ✓ MCC for TFL/DFL config
 Perform LOAD PCMMU FORMAT (ORB OPS FS, COMM/INST) and LOAD PDI DECOM FORMAT (ORB OPS FS, COMM/INST)
7. ERROR LOG RESET
 After MCC GO:
 - SM 0 GPC MEMORY
 - ERR LOG RESET - ITEM 48 EXEC
 - GNC 0 GPC MEMORY
 - ERR LOG RESET - ITEM 48 EXEC
 - SM SYS SUMM 1

- RAD VERIF & FLASH EVAP CONFIG **13**
- 2: SM 88 APU/ENVIRON THERM
 - L1 ✓ RAD BYP VLV tb (two) - RAD FLOW
 - CRT2 When FREON LOOP RAD OUT T < 60 degF:
 - L1 HI LOAD EVAP - OFF
 - R11L FLASH EVAP CNTLR PRI B(A) - OFF
 - SPLY H2O TKC INLET - OP (tb-OP)
 - OUTLET - OP (tb-OP)
 - 2: SM SYS SUMM 1

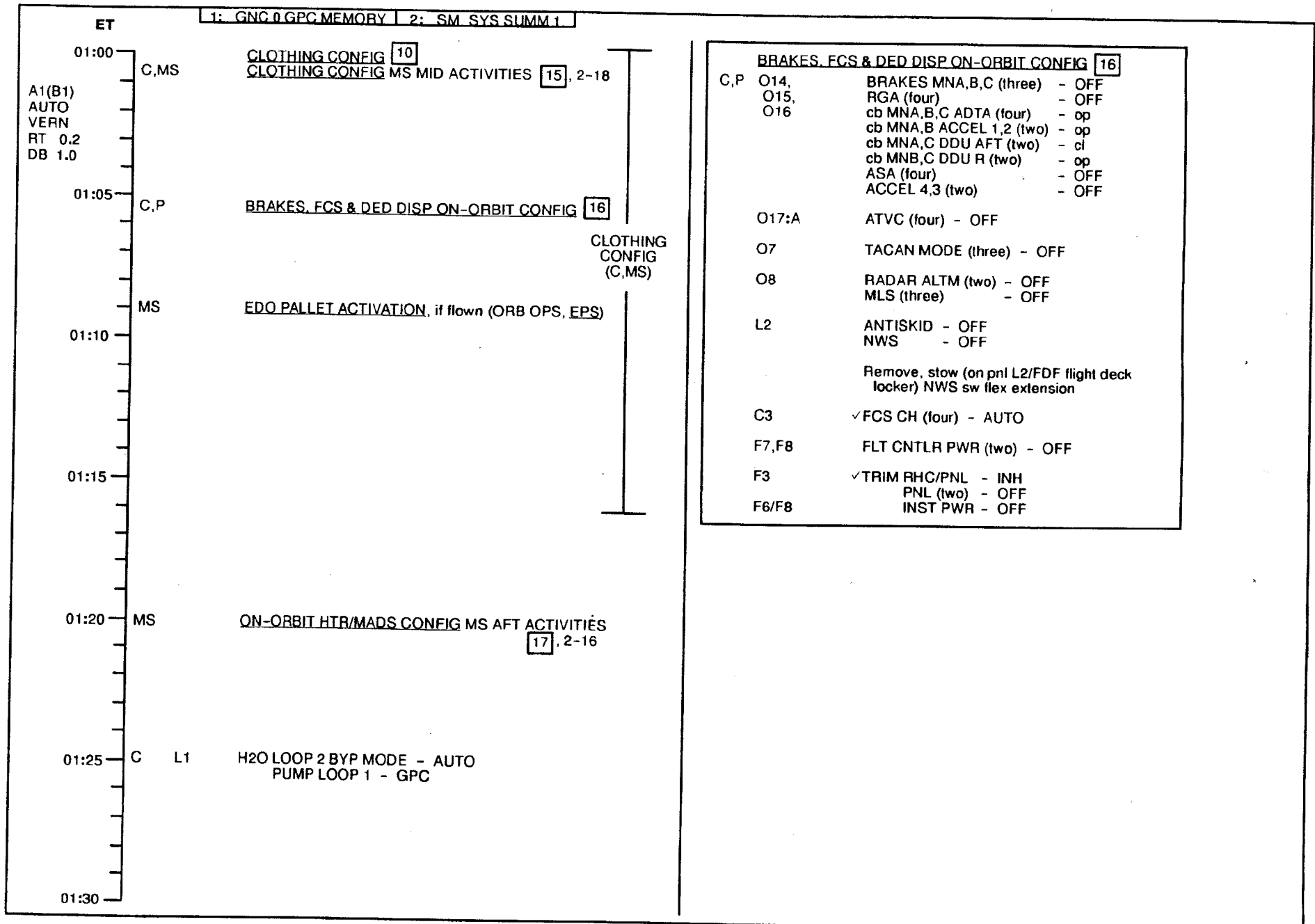

ET		1: GNC 0 GPC MEMORY	2: SM SYS SUMM
01:30	C	<u>AUTO MNVR -ZLV -XVV</u> ✓ TGT ID +2 BODY VECT +3 OM +0 DAP: A/AUTO/VERN Initiate TRK	
01:35	MS	<u>SPACELAB DEACT</u> if reqd MS AFT ACTIVITIES 18 , 2-16	
01:40	C,MS P	<u>ON-ORBIT PCS CONFIG</u> MS MID ACTIVITIES 19 2-18 <u>STAR TRKR ACT</u> 20	
01:45	MS,PS P A12 R2	<u>SPECIALIST SEAT REMOVAL/STOWAGE</u> <u>HYD THERM COND ENA</u> If BUS TIE for PRI PL, HYD CIRC PUMP PWR 3 - MNA HYD CIRC PUMP (three) - GPC	
01:50	MS	<u>EXTERNAL AIRLOCK SETUP FOR INGRESS</u> 21 , 2-18 (if flown)	
01:55			
02:00		On MCC call: PRIORITY PWRDN GROUP C, if reqd (ORB PKT, PRIORITY PWRDN) Continue per MCC direction	

<u>ON-ORBIT PCS 2(1) CONFIG</u> 19	
C L2	✓ O2 XOVR SYS (two) - OP O2/N2 CNTLR VLV SYS 1(2) - CL 2(1) - AUTO
O1	O2/N2 FLOW sel - SYS 2(1) O2
C7	✓ LEH O2 SPLY vlv (two) - OP Expect possible 'S66 CAB O2(N2) FLO 2(1)' msg
MS MO10W	14.7 CAB REG INLET SYS 2(1) vlv - OP H2O TK N2 REG INLET SYS 1(2) vlv - CL O2 REG INLET SYS 2(1) vlv - OP
MO69M	✓ LEH O2 8 vlv - CL Insert O2 Bleed Orifice Assembly into LEH O2 8 QD LEH O2 8 vlv - OP

<u>STAR TRKR ACT</u> 20	
O14:E, O15:E	cb STAR TRKR -Z,-Y (two) - cl
O6	STAR TRKR PWR (two) - ON
C2	GNC I/O RESET
O6	STAR TRKR DR CNTL SYS (two) - OP ✓ POS tb (two) - bp (start timer) When both tb - OP (~8-24 sec) or either tb - bp > 24 sec: STAR TRKR DR CNTL SYS (two) - OFF
X: GNC 22 S TRK/COAS CNTL	
S TRK -Y,-Z: STAR TRK - ITEM 3,4 (*)	
X: GNC 21 IMU ALIGN	
RESUME	
* If tb - bp > 8 sec, notify MCC *	

ET

1: GNC 0 GPC MEMORY 2: SM SYS SUMM

01:30 C AUTO MNVR -ZLV, -XVV
 ✓TGT ID +2
 BODY VECT +3
 OM +0
 DAP: A/AUTO/VERN
 Initiate TRK

A1(B1)
 AUTO
 VERN
 RT 0.2
 DB 1.0

01:35 If SL Pallet, **18** not reqd

01:40 C,MS ON-ORBIT PCS CONFIG MS MID ACTIVITIES **19**
 P STAR TRKR ACT **20**

MS,PS SPECIALIST SEAT REMOVAL/STOWAGE

01:45 P HYD THERM COND ENA
 If BUS TIE for PRI PL,
 A12 HYD CIRC PUMP PWR 3 - MNA
 R2 HYD CIRC PUMP (three) - GPC

01:50 MS EXTERNAL AIRLOCK SETUP FOR INGRESS **21**, 2-18 (if
 flown)

01:55

02:00 On MCC call:
 PRIORITY PWRDN GROUP C, if reqd (ORB
 PKT, PRIORITY PWRDN)
 Continue per MCC direction

ON-ORBIT PCS 2(1) CONFIG **19**

C L2 ✓O2 XOVR SYS (two) - OP
 O2/N2 CNTLR VLV SYS 1(2) - CL
 2(1) - AUTO

O1 O2/N2 FLOW sel - SYS 2(1) O2

C7 ✓LEH O2 SPLY vlv (two) - OP
 Expect possible 'S66 CAB O2(N2) FLO 2(1)' msg

MS MO10W 14.7 CAB REG INLET SYS 2(1) vlv - OP
 H2O TK N2 REG INLET SYS 1(2) vlv - CL
 O2 REG INLET SYS 2(1) vlv - OP

MO69M ✓LEH O2 8 vlv - CL
 Insert O2 Bleed Orifice Assembly into LEH O2 8 QD
 LEH O2 8 vlv - OP

STAR TRKR ACT **20**

O14:E, cb STAR TRKR -Z,-Y (two) - cl
 O15:E

O6 STAR TRKR PWR (two) - ON

C2 GNC I/O RESET

O6 STAR TRKR DR CNTL SYS (two) - OP
 ✓POS tb (two) - bp (start timer)
 When both tb - OP (~8-24 sec)
 or either tb - bp > 24 sec:
 STAR TRKR DR CNTL SYS (two) - OFF

X: GNC 22 S TRK/COAS CNTL

S TRK -Y,-Z: STAR TRK - ITEM 3,4 (*)

X: GNC 21 IMU ALIGN

RESUME

* If tb - bp > 8 sec, notify MCC *

PLBD OPENING

DETAILED PLBD OPENING PROCEDURES 9

- * When opening and unlatching PLBD: *
- * If no motion determined visually or 'OP/CL' *
- * not blank within 10 sec after cmd, *
- * PL BAY DR - STOP, ✓MCC *
- * If door motion stops and not 'OP', *
- * PL BAY DR - STOP, ✓MCC *
- * MANUAL MODE *
- * If latch not 'OP' in single mtr time, ✓MCC *

NOTE

Note any single mtr operations (continue ops) (single mtr times = 2x listed dual mtr times).

If one mtr in each of two separate latch gangs fails, contact MCC for mission length determination

AUTO PLBD OPENING PROCEDURE

- R13L * If BFS GPC fails during this operation: *
- O6 * PL BAY DR SYS 1,2 (two) - DSBL *
- * MDM PL 1,2 (two) - OFF *
- * GPC MODE 5 - STBY,HALT *
- * MDM PL 1,2 (two) - ON *
- * Proceed with DPS CONFIG TO GNC2/SM 12, then* *
- * continue in AUTO *
- R13L * If SM GPC fails during this operation: *
- * PL BAY DR SYS 1,2 (two) - DSBL *
- * Perform PASS SM GPC FAIL (ORB PKT, DPS) *
- P CRT4 SM, OPS X02 PRO or BFS, SM 63 PL BAY DOORS
- 4: SM PL BAY DOORS
- R13L ✓PL BAY DR - STOP
- CRT4 ✓PBD SW - STOP
- ✓MAN SEL (ten) - (no *)
- ✓PBD SW BYPASS - (no *)
- AC POWER ON - ITEM 1 EXEC (*)
- R13L PL BAY DR SYS 1,2 (two) - ENA
- CRT4 ✓OP/CL STATUS (ten) - CL
- ✓AOS
- OPEN C/L LATCHES 5-8,9-12 (MANUAL MODE)
- R13L Select CENTER LATCHES 5-8
- CRT4 PL BAY DR - OP
- ✓CENTER LATCHES 5-8 - blank, OP (~20 sec)
- R13L PL BAY DR - STOP
- CRT4 Deselect CENTER LATCHES 5-8
- Select CENTER LATCHES 9-12
- R13L PL BAY DR - OP

- CRT4 ✓CENTER LATCHES 9-12 - blank, OP (~20 sec)
- R13L PL BAY DR - STOP
- CRT4 Deselect CENTER LATCHES 9-12

OPEN REMAINING LATCHES/DOORS (AUTO MODE)

- AUTO MODE SEL - ITEM 3 EXEC (*)
- R13L PL BAY DR - OP
- CRT4 ✓CENTER LATCHES 1-4,13-16 (two) - blank, OP (~20 sec)
- ✓STBD FWD,AFT LATCHES (two) - blank, OP (~30 sec)
- ✓DOOR - RDY, blank, OP (~63 sec)
- ✓PORT FWD,AFT LATCHES (two) - blank, OP (~30 sec)
- ✓DOOR - RDY, blank, OP (~63 sec)
- R13L PL BAY DR - STOP
- SYS 1,2 (two) - DSBL
- CRT4 AC POWER OFF - ITEM 2 EXEC (*)
- SM OPS X01 PRO (if PASS SM)

4: SM ANTENNA

- A7U After floodlights ON > 25 min:
- PL BAY FLOOD (all) - OFF

MANUAL PLBD OPENING PROCEDURE

- R13L * If BFS GPC fails during this operation: *
- O6 * PL BAY DR SYS 1,2 (two) - DSBL *
- * MDM PL 1,2 (two) - OFF *
- * GPC MODE 5 - STBY,HALT *
- * MDM PL 1,2 (two) - ON *
- * Proceed with DPS CONFIG TO GNC2/SM 12, then* *
- * then continue in MANUAL *
- * If SM GPC fails during this operation: *
- R13L * PL BAY DR SYS 1,2 (two) - DSBL *
- * Perform PASS SM GPC FAIL (ORB PKT, DPS) *
- P CRT4 SM, OPS X02 PRO or BFS, SM 63 PL BAY DOORS
- 4: SM PL BAY DOORS
- R13L ✓PL BAY DR - STOP
- CRT4 ✓PBD SW - STOP
- ✓MAN SEL (ten) - (no *)
- ✓PBD SW BYPASS - (no *)
- AC POWER ON - ITEM 1 EXEC (*)
- R13L PL BAY DR SYS 1,2 (two) - ENA
- CRT4 ✓OP/CL STATUS (ten) - CL
- ✓AOS
- OPEN C/L LATCHES
- CRT4 Select CENTER LATCHES 5-8
- R13L PL BAY DR - OP
- CRT4 ✓CENTER LATCHES 5-8 - blank, OP (~20 sec)

PLBD OPENING

R13L PL BAY DR - STOP
 CRT4 Deselect CENTER LATCHES 5-8
 Select CENTER LATCHES 9-12

R13L PL BAY DR - OP
 CRT4 ✓ CENTER LATCHES 9-12 - blank, OP (~20 sec)
 R13L PL BAY DR - STOP
 CRT4 Deselect CENTER LATCHES 9-12
 Select CENTER LATCHES 1-4,13-16

R13L PL BAY DR - OP
 CRT4 ✓ CENTER LATCHES 1-4,13-16 (two) - blank, OP (~20 sec)
 R13L PL BAY DR - STOP
 CRT4 Deselect CENTER LATCHES 1-4,13-16

OPEN STBD FWD, AFT LATCHES & DOOR
 CRT4 Select STBD FWD, AFT LATCHES
 R13L PL BAY DR - OP
 CRT4 ✓ STBD FWD, AFT LATCHES (two) - blank, OP (~30 sec)
 R13L PL BAY DR - STOP
 CRT4 Deselect STBD FWD, AFT LATCHES
 Select STBD DOOR

R13L PL BAY DR - OP
 CRT4 ✓ STBD DOOR - RDY, blank, OP (~63 sec)
 R13L PL BAY DR - STOP
 CRT4 Deselect STBD DOOR

OPEN PORT FWD, AFT LATCHES & DOOR
 CRT4 Select PORT FWD, AFT LATCHES
 R13L PL BAY DR - OP
 CRT4 ✓ PORT FWD, AFT LATCHES (two) - blank, OP (~30 sec)
 R13L PL BAY DR - STOP
 CRT4 Deselect PORT FWD, AFT LATCHES
 Select PORT DOOR

R13L PL BAY DR - OP
 CRT4 ✓ PORT DOOR - RDY, blank, OP (~63 sec)
 R13L PL BAY DR - STOP
 CRT4 SYS 1,2 (two) - DSBL
 Deselect PORT DOOR
 AC POWER OFF - ITEM 2 EXEC (*)
 SM OPS X01 PRO (if PASS SM)

4: SM ANTENNA
 After floodlights ON > 25 min:
 A7U PL BAY FLOOD (all) - OFF

FUNCTION	PLBD CONTROL								PLBD DISPLAY PL MDM										
	Ref: MA73C:C&D for MCA cbs																		
	MTR 1				MTR 2				C	C	O	O	C	R	R	R	O		
	AC/ MCA	CNTL	MDM	SYS	AC/ MCA	CNTL	MDM	SYS	A	B	A	B	A	B	C				
LATCH																			
5-8	1/MID3	AB3/AB2	PL1	2	3/MID2	CA3/CA1	PL2	1	1	2	1	2							
9-12	1/MID1	AB3/AB1	PL1	1	3/MID4	CA3/CA2	PL2	2	1	2	1	2							
1-4	1/MID3	AB3/AB2	PL1	2	3/MID2	CA3/CA1	PL2	1	1	2	1	2							
13-16	3/MID4	CA3/CA2	PL2	2	2/MID2	BC3/BC1	PL1	1	2	1	2	1							
S FWD	1/MID1	AB3/AB1	PL1	1	2/MID4	BC3/BC2	PL2	2	1	2	1	2							
S AFT	3/MID4	CA3/CA2	PL2	2	2/MID2	BC3/BC1	PL1	1	2	1	2	1							
S DOOR	1/MID1	AB3/AB1	PL1	1	2/MID4	BC3/BC2	PL2	2							1	1	2	2	1
P FWD	1/MID1	AB3/AB1	PL1	1	2/MID4	BC3/BC2	PL2	2							2	1	2	2	2
P AFT	1/MID3	AB3/AB2	PL1	2	3/MID2	CA3/CA1	PL2	1	1	2	1	2							
P DOOR	3/MID4	CA3/CA2	PL2	2	2/MID2	BC3/BC1	PL1	1											
															2	1	1	2	2
															1	1	1	2	1

MS AFT DECK BACKOUT ACTIVITIES

NOTE
WAIT FOR GO FROM CDR OR PLT BEFORE STARTING ANY ACTIVITY ON THIS PAGE

TIME (ET)	MS AFT ACTIONS
00:07	C6 LEH O2 vlv (four) - CL
00:08	<u>SPECIALIST SEAT EGRESS</u>
00:12	<u>CONFIG FOR PLBD OPENING</u> 4
00:15	<u>SPACELAB PARTIAL REACT</u> , if reqd 5
00:18	<u>FDF/COMM CONFIG</u> 7
00:30	<u>CLOTHING CONFIG</u> 11
00:40	<u>PAYLOAD REACT</u> , if reqd (PL OPS, DEORB PREP)
00:47	<u>RMS PNL LT. TEMP MON. HTR ACT. C/W</u> 14
01:20	<u>ON-ORBIT HTR/MADS CONFIG</u> 17
01:36	<u>SPACELAB DEACT</u> , if reqd 18
01:45	<u>SPECIALIST SEAT REMOVAL/STOWAGE</u>

CONFIG FOR PLBD OPENING 4

R11L CRT4 PWR - ON
GPC/CRT 54 EXEC
4: BFS, SM 63 PL BAY DOORS

A6U SET UP LIGHTS
ANNUN BUS SEL - MNC

NOTE

Minimum operating time for PLB Floodlights: 25 min. Lights must be off for minimum of 10 min UNBLOCKED, 16 min BLOCKED prior to reuse. ~3 min to full bright

A7U PL BAY FLOOD AFT STBD -

PORT -

MID STBD -

PORT -

FWD STBD -

PORT -

BHD -

Record MET ___/___:___:___

* If PLB Floodlight not ON to full bright within 5 min: *
* (Aff) PL BAY FLOOD - OFF *

FDF/COMM CONFIG 7

COMM CONFIG

Unstow: Headsets, Handheld Mics and/or Wireless Comm if flown

If WCCS, perform STD WCCS CONFIG (ORB OPS, COMM/INST) or see WCCS Cue Card

If flight deck Handheld Mic/speaker operation:

R10	MS AUD PWR	- AUD/TONE
	A/G 1	- T/R, tw-2
	A/G 2	- RCV, tw-2
	A/A	- RCV, tw-2
	ICOM A	- T/R, tw-2
	ICOM B	- RCV, tw-2
	XMIT/ICOM MODE	- PTT/PTT

A13	OS AUD SPKR	- SPKR
	MSTR SPKR VOL	- 8

A11	MS COMM CCU PWR	- OFF
	Connect Handheld Mic to CCU	
	MS COMM CCU PWR	- ON

R6,L5	CCU PWR	- OFF
-------	---------	-------

A1L	S-BD PM MODE	- TDRS DATA
	NSP CODING (two)	- ON

TIPS ACTIVATION (ORB OPS, COMM/INST), steps 1 & 3

ICOM RECORDER OPS, if reqd (ORB OPS, COMM/INST)

FDF CONFIG

Stow:

ENT
ENT PKT
Entry cue cards

Unstow (if reqd):
Deploy Orbit Cue Cards

CLOTHING CONFIG 11

Do/ff/stow:

Harness, Boots, LES, UCD (if not used)

Do/ff, stow in Wet Trash (if used):

UCD (clamp)
Emesis Bag (unstow new bag)

(Cont next page)

MS AFT DECK BACKOUT ACTIVITIES

NOTE
WAIT FOR GO FROM CDR OR PLT BEFORE STARTING ANY ACTIVITY ON THIS PAGE

TIME (ET)	MS AFT ACTIONS
00:07	C6 LEH O2 vlv (four) - CL
00:08	SPECIALIST SEAT EGRESS
00:12	CONFIG FOR PLBD OPENING 4
00:18	FDF/COMM CONFIG 7
00:30	CLOTHING CONFIG 11
00:47	RMS PNL LT. TEMP MON. HTR ACT. C/W 14
00:51	SPACELAB PARTIAL REACT. if reqd 5
00:54	PAYLOAD REACT. if reqd (PL OPS, DEORB PREP)
01:20	ON-ORBIT HTR/MADS CONFIG 17
01:45	SPECIALIST SEAT REMOVAL/STOWAGE

<u>FDF/COMM CONFIG</u> 7	
<u>COMM CONFIG</u>	
Unstow: Headsets, Handheld Mics and/or Wireless Comm if flown	
If WCCS perform <u>STD WCCS CONFIG</u> (ORB OPS, <u>COMM/INST</u>) or see WCCS Cue Card	
If flight deck Handheld Mic/speaker operation:	
R10	MS AUD PWR - AUD/TONE
	A/G 1 - T/R, tw-2
	A/G 2 - RCV, tw-2
	A/A - RCV, tw-2
	ICOM A - T/R, tw-2
	ICOM B - RCV, tw-2
	XMIT/ICOM MODE - PTT/PTT
A13	OS AUD SPKR - SPKR
	MSTR SPKR VOL - 8
A11	MS COMM CCU PWR - OFF
	Connect Handheld Mic to CCU
	MS COMM CCU PWR - ON
R6,L5	CCU PWR - OFF
A1L	S-BD PM MODE - TDRS DATA
	NSP CODING (two) - ON
<u>TIPS ACTIVATION</u> (ORB OPS, <u>COMM/INST</u>), steps 1 & 3	
<u>ICOM RECORDER OPS</u> , if reqd (ORB OPS, <u>COMM/INST</u>)	
<u>FDF CONFIG</u>	
Stow:	
	ENT
	ENT PKT
	Entry cue cards
Unstow (if reqd):	
	Deploy Orbit Cue Cards

<u>CLOTHING CONFIG</u> 11	
Doff/stow:	
	Harness, Boots, LES, UCD (if not used)
Doff, stow in Wet Trash (if used):	
	UCD (clamp)
	Emesis Bag (unstow new bag)

<u>CONFIG FOR PLBD OPENING</u> 4	
R11L	CRT4 PWR - ON GPC/CRT 54 EXEC 4: BFS, SM 63 PL BAY DOORS
A6U	<u>SET UP LIGHTS</u> ANNUN BUS SEL - MNC
NOTE Minimum operating time for PLB Floodlights: 25 min. Lights must be off for minimum of 10 min UNBLOCKED, 16 min BLOCKED prior to reuse. ~3 min to full bright	
A7U	PL BAY FLOOD AFT STBD - <input type="checkbox"/>
	PORT - <input type="checkbox"/>
	MID STBD - <input type="checkbox"/>
	PORT - <input type="checkbox"/>
	FWD STBD - <input type="checkbox"/>
	PORT - <input type="checkbox"/>
	BHD - <input type="checkbox"/>
Record MET ____/____:____:____	
* If PLB Floodlight not ON to full bright within 5 min :*	
* (All) PL BAY FLOOD - OFF *	

SLP

(Cont next page)

Back of MS AFT DECK BACKOUT ACTIVITIES

RMS PNL LTS. TEMP MON. HTR ACT. C/W 14

MA73C:F RMS PNL LTS. TEMP MON. HTR ACT (if RMS onboard)
 A8L cb RMS PRI Φ A - cl
 RMS PWR - PRI (MA tone)

SM 94 PDRS CONTROL (MA, GPC DATA It on)

A8U
 A8L
 C/W

I/O ON - ITEM 5 EXEC (*)
 SAFING - CANCEL (tb-bp), (✓GPC DATA It off)
 PORT RMS HTR A - AUTO

R13U		
PARAMETER NAME	C/W CH	ENA/INH
MPS He REG P C	39	INH
L	49	INH
R	59	INH
HYD P 1	99	INH
2	109	INH
3	119	INH

SPACELAB PARTIAL REACT 5

NOTE

Reqd for SL Pallet flights to ensure proper thermal environment. Accomplish after DPS Config to GNC2/SM

- R1 PL CAB - MNA
- PL AUX - ON
- F9 DC VOLT/AMP sel - VOLTS MNC
- ✓DC VOLT ind > 28 and < 32 VDC
- R1 PL PRI MNC - ON (tb-on)
- L12L cb FMDM - cl
- L12U FMDM 1,2 (two) - ON (tb-UP)
- CRT SM I/O RESET
- R7 SS INV - ON (It on)
- EPDS VOLTS/AMPS sel - VOLTS SS
- ✓SS AC Φ A, Φ B, Φ C ind > 110 and < 122 VAC
- SS AC/DC PWR - ON (It on)
- SM 224 S/L COOLING LOOPS**
- SL FREON PUMP 1 ON - ITEM 4 EXEC (*)
- ✓FREON FLOW > 1500
- ✓ Δ P STATUS - 'blank'

ON-ORBIT HTR/MADS CONFIG 17

- R2 BLR PWR (three) - OFF
- R4 HYD BRAKE HTR (three) - OFF
- L1 ✓HI LOAD EVAP - OFF
- DUCT HTR - OFF
- A12 HYD HTR RUD SPD BK B - AUTO
- ✓A - OFF
- BDY FLP B - AUTO
- ✓A - OFF
- ELEV B - AUTO
- ✓A - OFF
- AFT FUS B - AUTO
- ✓A - OFF
- A14 RCS/OMS HTR FWD RCS - B AUTO
- ✓L POD - A OFF
- L POD - B AUTO
- ✓R POD - A OFF
- R POD - B AUTO
- OMS CRSFD LINES - A OFF
- ✓OMS CRSFD LINES - B AUTO
- R14:C cb KU ANT HTR - cl
- MADS CONFIG (OV103,OV105)**
- A7L ✓MADS STRAIN GAGE - PCM ENA
- MADS CONFIG (OV104)**
- A6L ✓MADS STRAIN GAGE - PCM ENA
- A7L

MADS/OEX (OV102)
- OEX EQUIP - OFF

MS MIDDECK BACKOUT ACTIVITIES

NOTE
WAIT FOR GO FROM CDR OR PLT BEFORE STARTING ANY ACTIVITY ON THIS PAGE

TIME (ET)	MS MIDDECK ACTIONS
00:08	SPECIALIST SEAT EGRESS
00:10	MO32M LEH O2 vlv (two) - CL MO69M LEH O2 vlv (two) - CL
00:11	PRELIM MIDDECK CONFIG 3
00:22	MIDDECK CONFIG 8
00:40	PAYLOAD REACT. if reqd (PL OPS, DEORB PREP) If SL Pallet perform at 00:50
00:50	CLOTHING CONFIG 15
01:40	ON-ORBIT PCS 2(1) CONFIG 19
01:45	SPECIALIST SEAT REMOVAL/STOWAGE
01:50	EXTERNAL AIRLOCK SETUP FOR INGRESS 21 if flown

PRELIM MIDDECK CONFIG 3	
INSTALL FILTERS Unstow, Install: Side Hatch UV Filter and Locking Device Pyro Box Safing Pin	
COMM CONFIG Unstow: Headsets, Handheld Mics and/or Wireless Comm if flown (see WCCS Cue Card)	
If WCCS perform STD WCCS CONFIG (ORB OPS, COMM/INST) or see WCCS Cue Card	
MO42F	If middeck Handheld Mic/speaker operation: MIDDECK SPKR AUD A/G 1 - T/R, tw-2 A/G 2 - RCV, tw-2 A/A - RCV, tw-2 ICOM A - T/R, tw-2 ICOM B - RCV, tw-2 XMIT/ICOM MODE - PTT/PTT MSTR SPKR VOL - 8
MO39M	MIDDECK COMM CCU PWR - OFF Connect Handheld Mic to CCU MIDDECK COMM CCU PWR - ON
ML31C	HTR CONFIG VAC VENT ISOL VLV BUS SEL - MNA NOZ HTR - ON ISOL VLV CNTL - OP (tb-OP)
	* If VAC VENT ISOL VLV CNTL tb - CL or bp: *
	* VAC VENT ISOL VLV BUS SEL - MNB *
	* CNTL - OP (tb-OP) *
	* If VAC VENT ISOL VLV CNTL tb still CL or bp: *
	* ✓ MCC for further actions *

MIDDECK CONFIG 8	
GALLEY ACTIVATION	
ML86B:A	cb MNC SPLY H2O GALLEY SPLY - cl
:B	cb MNA GALLEY OVEN - cl
	cb MNB GALLEY H2O HTR - cl
R11L:G	✓ SPLY H2O GALLEY SPLY VLV - OP (tb-OP)
GALLEY	H2O HTRS (two) - ON OVEN/RHS - ON
MA73C:G	cb AC3 GALLEY FAN (three) - cl Unstow, install Personal Hygiene Hose
WCS ACTIVATION	
WCS (EDO WCS)	VAC VLV - OP
If EDO WCS:	
	✓ CANISTER - LOCK
	Commode lid lock - use
	URINAL SEL - SEP1
	WCS PWR SEL (two) - AUTO 1, OFF 2
	✓ FAN PWR - AUTO
	✓ URN DIV VLV - FAN SEP 1
	Open commode lid
	✓ Commode airflow
	✓ Fecal Bag installed
	Close commode lid
	Unstrap urinal hose Velcro strap
	Unstow urinal hose
	✓ Urinal airflow
	✓ URINAL READY lt - on (5-15 sec)
	Stow urinal hose
	COMPACTOR LOCK PINS (three) - loosen (use 1/4-in Hex Wrench, if reqd)
	✓ COMPACTOR ARM LOCK PIN - raised
	COMPACTOR CLEANING LATCH PIN - engaged
	Install Fecal Bag and Lid Dispensers
If WCS:	
	MODE - WCS/EMU, ✓ Airflow, MODE - OFF
Unstow, install:	
	WCS Trash Can
	Mirror
	Urine Collection Cue Card
Foot/Toe Restraint - down, locked	

(Cont next page)

Back of MS MIDDECK BACKOUT ACTIVITIES

MO51F

CO2 RMVL SYS ACT (if flown)
 ✓ MCC prior to CO2 RMVL system activation
 cb AC3 (three) - cl
 AC3 - ON (hold 3 sec)
 MNC - ON
 CNTRL 2 MODE - OPER (hold 3 sec)
 Wait 6 sec
 CNTLR 2 OPER II - on
 COM INSTR - ON

If PRIORITY PWRDN GROUP C not reqd:
PGSC ACTIVATION
 (backup PGSC) PGSC ACTIVATION (ORB OPS, PGSC)

POLE STOWAGE
 Remove large Port Pin:
 Slide back Safing Latch
 Retract and hold Locking Pin (Ring)
 Remove large Pin
 Release Locking Pin (Ring)
 Remove STBD Pip Pin
 Stow Pole

MO13Q

18. Unstow aft flex duct from tunnel extension
 19. Remove, unstow booster fan outlet cap
 20. Connect flex duct to booster fan outlet
 21. Go to step 24
 22. Unstow flex duct from tunnel extension
 23. Connect flex duct to cabin middeck floor air fitting
 24. Remove, stow external airlock duct inlet cap
 25. Connect free end of flex duct to external airlock duct inlet
 If Booster Fan flown:
 26. ARLK FAN A(B) - ON
 27. ✓ Airflow at top of external airlock halo and/or at free end of external airlock flex duct
 If Spacehab flown:
 28. Perform SPACEHAB INGRESS AFTER WAVEOFF (SH OPS, ON-ORBIT)

CLOTHING CONFIG 15

DoFF/stow:
 Harness, Boots, LES, UCD (if not used)

DoFF, stow in Wet Trash (if used):
 UCD (clamp)
 Emesis Bag (unstow new bag)

EXTERNAL AIRLOCK SETUP FOR INGRESS 21

If Mir docking mission:

A7L(A6L) 1. SYS PWR SYS 1, SYS 2 (two) - ON (hold 5 sec) (tb-ON)
 INNER 2. LTS AIRLK - ON (as reqd)
 HATCH 3. Open hatch per decal

4. Remove, stow diffuser cap on cabin middeck floor air fitting (mark stowage location will be reused)

MA73C:G If Booster Fan flown:
 5. cb AC1,2 ARLK TNL FAN A,B (six) - cl
 6. Remove, stow booster fan muffler inlet cap
 7. Unstow fwd flex duct
 8. Attach one end to booster fan muffler inlet
 9. Attach free end to cabin middeck floor air fitting

TLN ADAPT If tunnel adapter flown:
 (AFT) 10. Disconnect tunnel adapter flex duct from PL ISOL vlv, remove cap, stow
 11. Reconnect flex duct to PL ISOL vlv
 12. PL ISOL vlv - OP

TLN ADAPT If tunnel adapter hatch flown:
 (HATCH) 13. Equal vlv cap (two) - remove, stow
 14. Open hatch per decal

A7L(A6L) If Mir docking mission:
 15. AIRLK/TNL FAN A(B) - ON
 16. Go to step 27
 17. Go to step 26

ON-ORBIT PCS 2(1) CONFIG 19

C	L2	✓ O2 XOVR SYS (two) - OP O2/N2 CNTLR VLV SYS 1(2) - CL 2(1) - AUTO
	O1	O2/N2 FLOW sel - SYS 2(1) O2
	C7	✓ LEH O2 SPLY vlv (two) - OP Expect possible 'S66 CAB O2(N2) FLO 2(1)' msg
MS	MO10W	14.7 CAB REG INLET SYS 2(1) vlv - OP H2O TK N2 REG INLET SYS 1(2) vlv - CL O2 REG INLET SYS 2(1) vlv - OP
	MO69M	✓ LEH O2 8 vlv - CL Insert O2 Bleed Orifice Assembly into LEH O2 8 QD LEH O2 8 vlv - OP

AIRLOCK ENTRY SWITCH LIST/VERIFICATION (TIG-3:50)

AIRLOCK

AW18A	3-3
AW18D	3-3
AW18H	3-3
AW82B	3-3

PARTIAL ENTRY SWITCH LIST/VERIFICATION (TIG-3:10)

LEFT SEAT

F3	3-4
F7	3-4
L,R HUD	3-4
F2	3-5
O7	3-5
O13	3-5
L side OVHD flood ..	3-5
F1	3-6
F6	3-6
L5	3-6

RIGHT SEAT

O8	3-7
R side OVHD flood ..	3-7
F4	3-7
F8	3-7
R2	3-8
R6	3-8
O17	3-8

AFT





O19	3-9
C5	3-9
C7	3-9
A11	3-9

MIDDECK-FWD

MO58F	3-10
MO39M	3-10
MO52J	3-10
MO30F	3-10
MD44F	3-10
MD24K	3-10
ML86B	3-11

MIDDECK-AFT

MO13Q	3-12
ML18F	3-12
ML26C	3-12
ML31C	3-12

<u>LEGEND</u>	
 up	R - as reqd
 center	● - cb close
 down	○ - cb open
 - indicates switch/display not checked during ENTRY SWITCH LIST/VERIFICATION	

<u>CIRCUIT BREAKER SNAP RING COLOR CODES</u>	
<u>COLOR</u>	<u>CONFIGURATION</u>
Red	Open at all times
Green	Open on orbit only
Yellow	Open ascent, close per procedure
Orange	Open orbit through entry
Blank (no ring)	Always closed or as reqd

**ENT SWITCH
LIST/VERIF**

FINAL ENTRY SWITCH LIST/VERIFICATION (TIG-1:50)

LEFT SEAT

L4
L1
L2
C2
C3
O1
O5
O6
O14
O15

RIGHT SEAT

O16
O9
R1
R4

AFT







3-13 R7
3-14 R10
3-15 R11U,L
3-16 R13L
3-16 R14
3-17 A1L,R
3-17 A7U,L
3-18 A12
3-19 A13
3-19 L9
A15

MIDDECK-FWD

3-20
3-20 MO42F
3-21 MO32M
3-21 MO69M
MO51F

MIDDECK-AFT

3-22 MA73C
3-22 MO10W
3-22 WCS
3-23 EDO WCS
3-23
3-24
3-25
3-25
3-25
3-26
3-27

<u>LEGEND</u>	
	up
	center
	down
	- indicates switch/display not checked during ENTRY SWITCH LIST/VERIFICATION
R - as reqd	
	- cb close
	- cb open

<u>CIRCUIT BREAKER SNAP RING COLOR CODES</u>	
<u>COLOR</u>	<u>CONFIGURATION</u>
Red	Open at all times
Green	Open on orbit only
Yellow	Open ascent, close per procedure
Orange	Open orbit through entry
Blank (no ring)	Always closed or as reqd

AIRLOCK ENTRY SWITCH LIST/VERIFICATION (TIG-3:50)

AIRLOCK

AW18A	3-3
AW18D	3-3
AW18H	3-3
AW82B	3-3

PARTIAL ENTRY SWITCH LIST/VERIFICATION (TIG-3:10)

LEFT SEAT

F3	3-4
F7	3-4
L,R HUD	3-4
F2	3-5
O7	3-5
O13	3-5
L side OVHD flood ..	3-5
F1	3-6
F6	3-6
L5	3-6

RIGHT SEAT

O8	3-7
R side OVHD flood ..	3-7
F4	3-7
F8	3-7
R2	3-8
R6	3-8
O17	3-8

AFT

O19	3-9
C5	3-9
C7	3-9
A11	3-9

MIDDECK-FWD

MO58F	3-10
MO39M	3-10
MO52J	3-10
MO30F	3-10
MD44F	3-10
MD24K	3-10
ML86B	3-11

MIDDECK-AFT

MO13Q	3-12
ML18F	3-12
ML26C	3-12
ML31C	3-12

<u>LEGEND</u>	
▼ up	R - as reqd
◆ center	● - cb close
▲ down	○ - cb open
■	- indicates switch/display not checked during ENTRY SWITCH LIST/VERIFICATION

<u>CIRCUIT BREAKER SNAP RING COLOR CODES</u>	
<u>COLOR</u>	<u>CONFIGURATION</u>
Red	Open at all times
Green	Open on orbit only
Yellow	Open ascent, close per procedure
Orange	Open orbit through entry
Blank (no ring)	Always closed or as reqd

ENT SWITCH LIST/VERIF

FINAL ENTRY SWITCH LIST/VERIFICATION (TIG-1:50)

LEFT SEAT

L4
L1
L2
C2
C3
O1
O5
O6
O14
O15

RIGHT SEAT

O16
O9
R1
R4

AFT

3-13 R7
3-14 R10
3-15 R11U,L
3-16 R13L
3-16 R14
3-17 A1L,R
3-17 A7U
3-18 A12
3-19 A13
3-19 L9
A6L,A7L
A8U
A15

MIDDECK-FWD

3-21 MO42F
MO32M
MO69M
MO51F
3-28
3-28
3-28
3-28

MIDDECK-AFT

3-22 MA73C
3-22 MO10W
3-22 WCS
3-23 EDO WCS
3-23
3-24
C3-25
C3-25
C3-25
C3-26
C3-26a
C3-26b
3-27

<u>LEGEND</u>	
▼	up
◆	center
▲	down
■	- indicates switch/display not checked during ENTRY SWITCH LIST/VERIFICATION
R	- as reqd
●	- cb close
○	- cb open

<u>CIRCUIT BREAKER SNAP RING COLOR CODES</u>	
<u>COLOR</u>	<u>CONFIGURATION</u>
Red	Open at all times
Green	Open on orbit only
Yellow	Open ascent, close per procedure
Orange	Open orbit through entry
Blank (no ring)	Always closed or as reqd

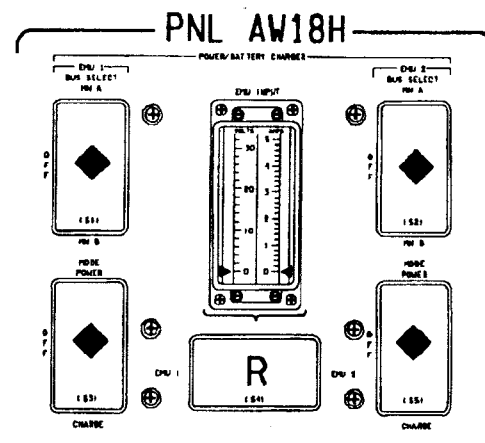
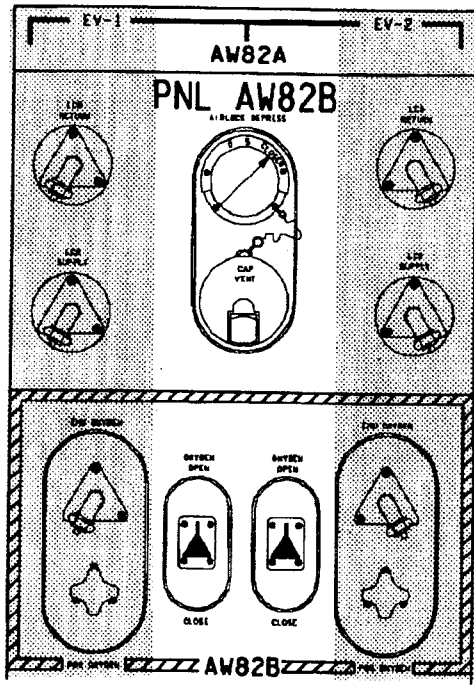
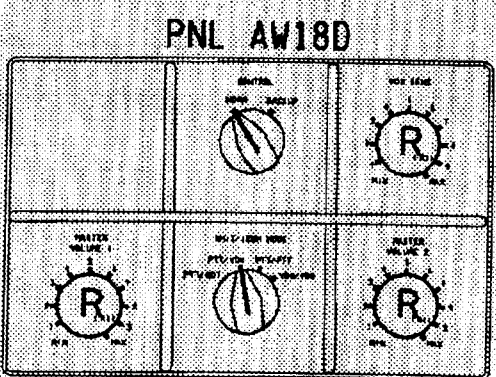
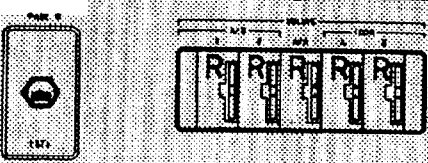
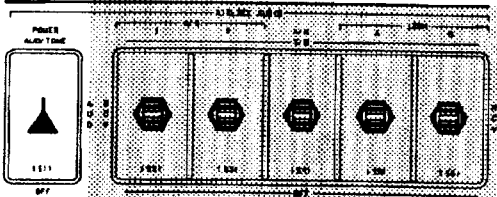
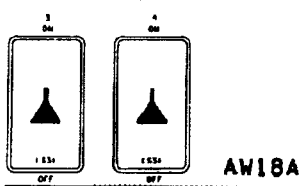
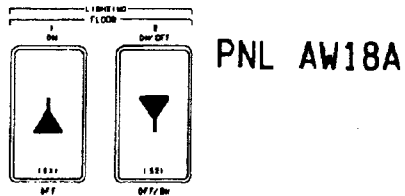

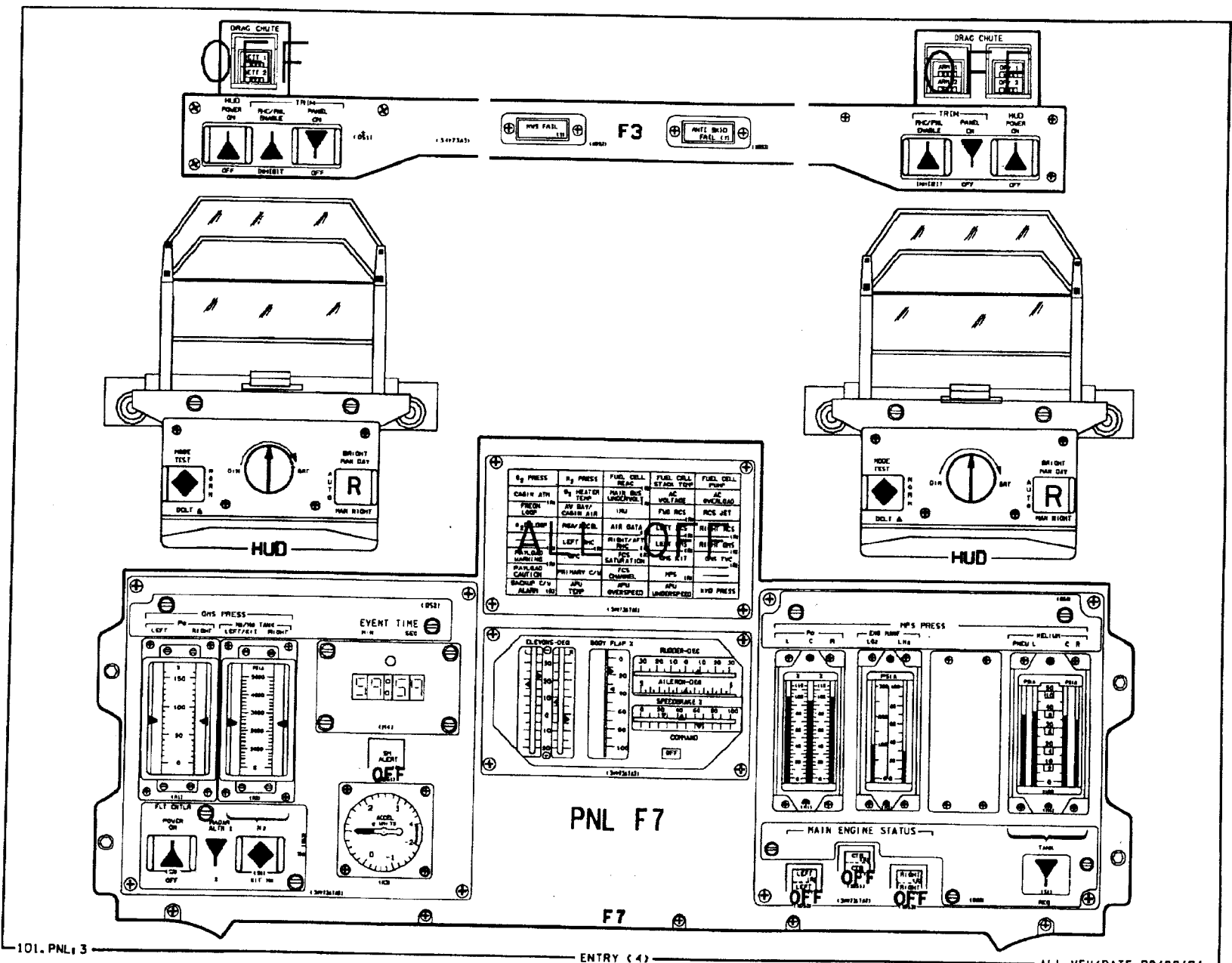

101. PNL 3

ENTRY (4)

ALL VEH/DATE 09/29/94

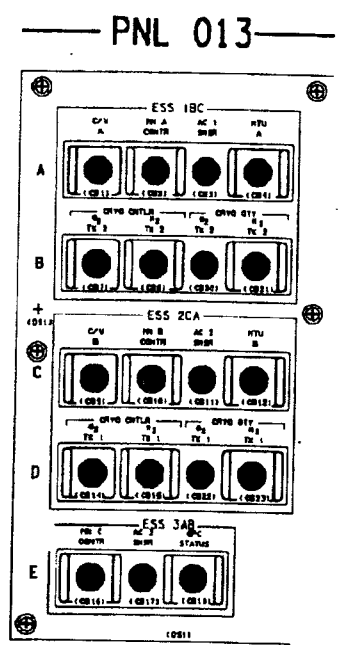
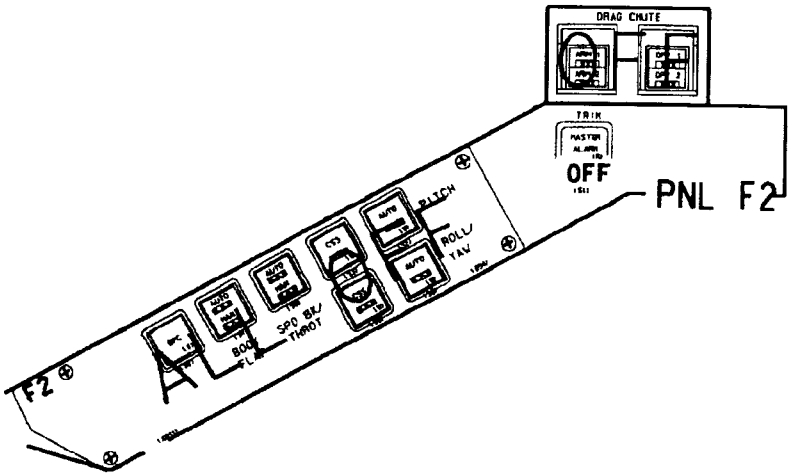

L side OVHD flood - R (MID)

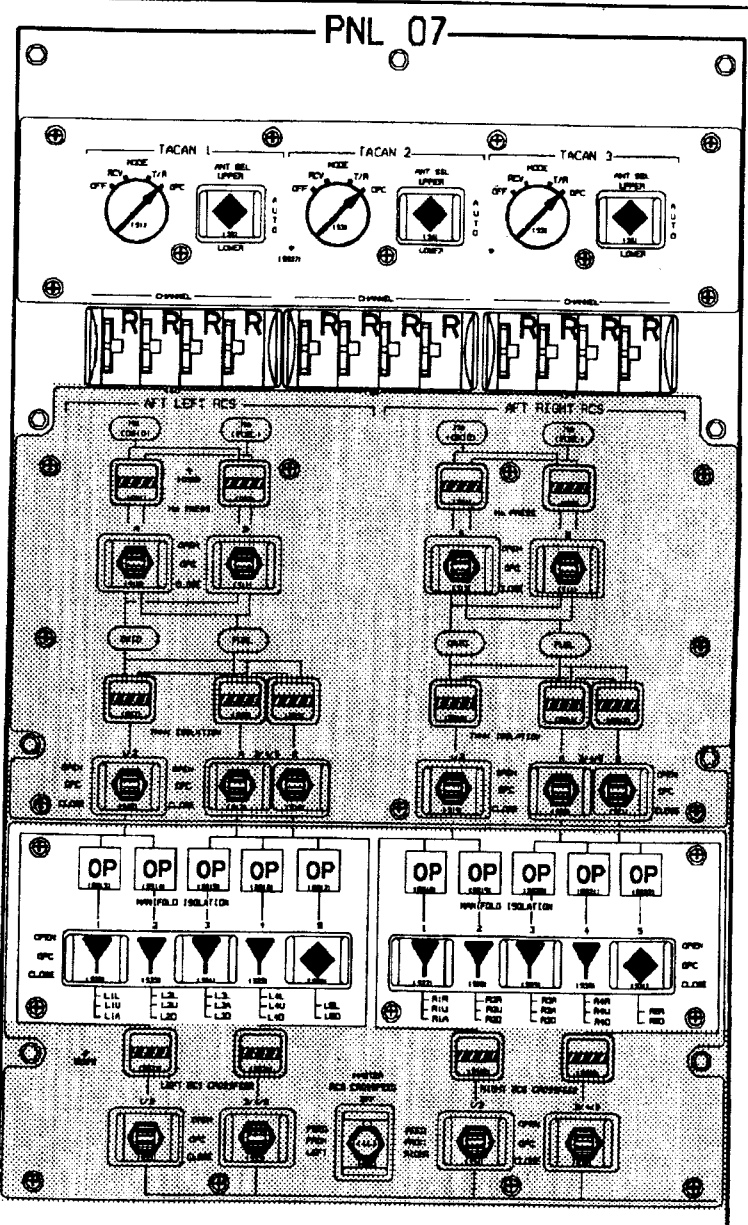

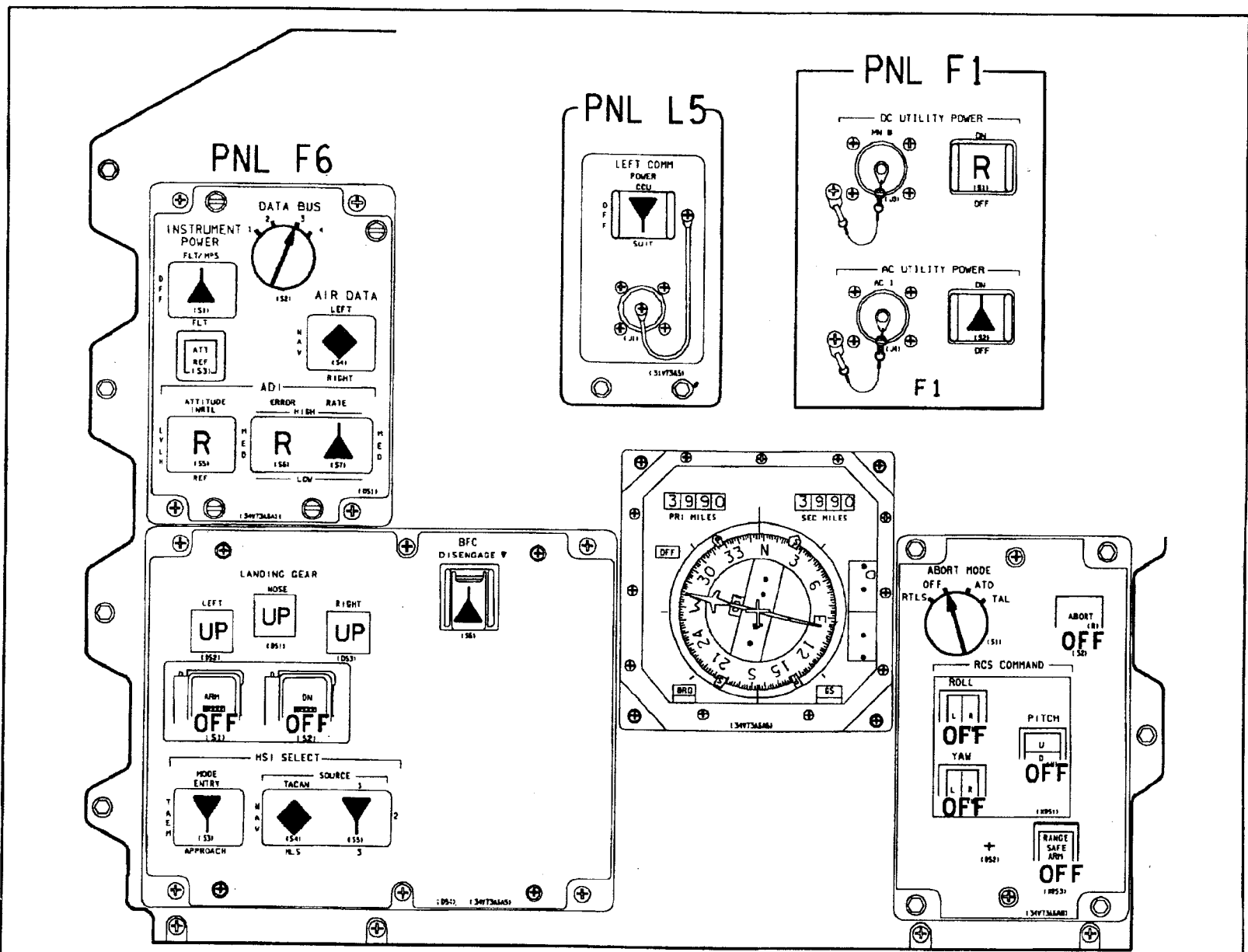

139. PNL 1

ENTRY (6)

ALL VEH/DATE 09/29/94

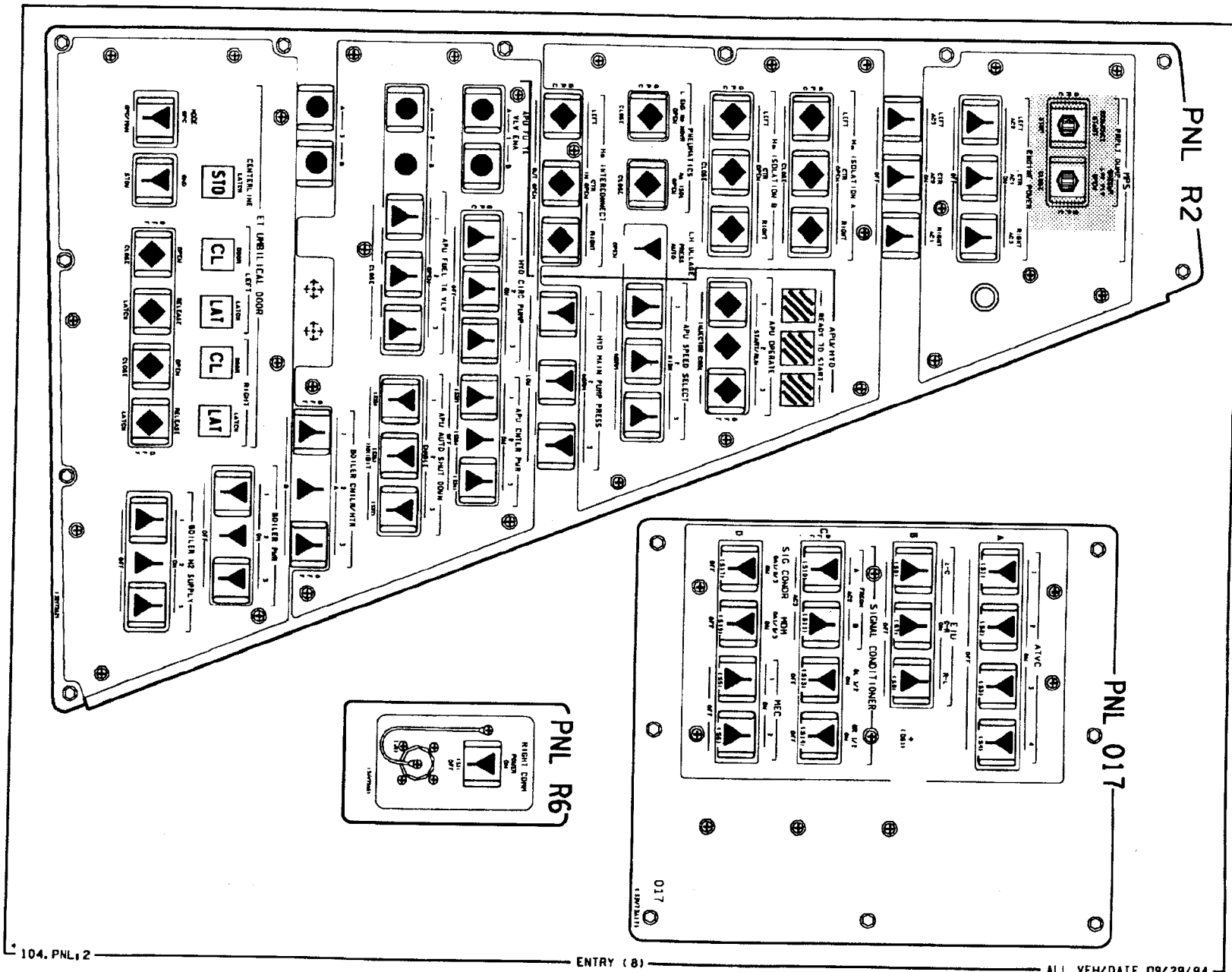

104. PNL 2

ENTRY (8)

ALL VER/DATE 09/29/94

OV102

PNL 019

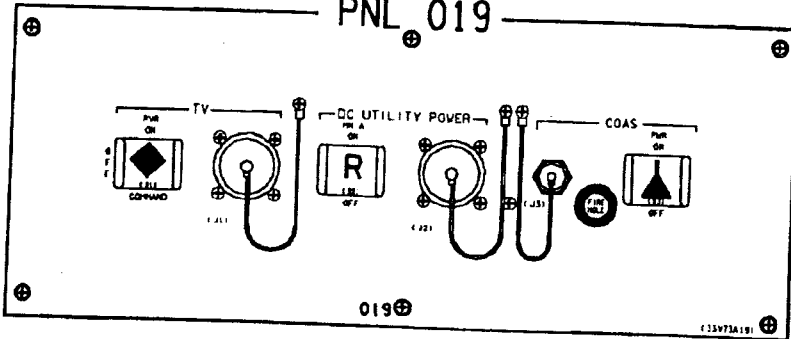

PNL C5

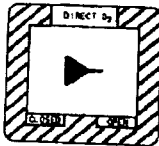

PNL C7

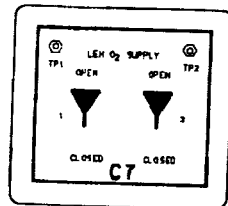

PNL A11
A11

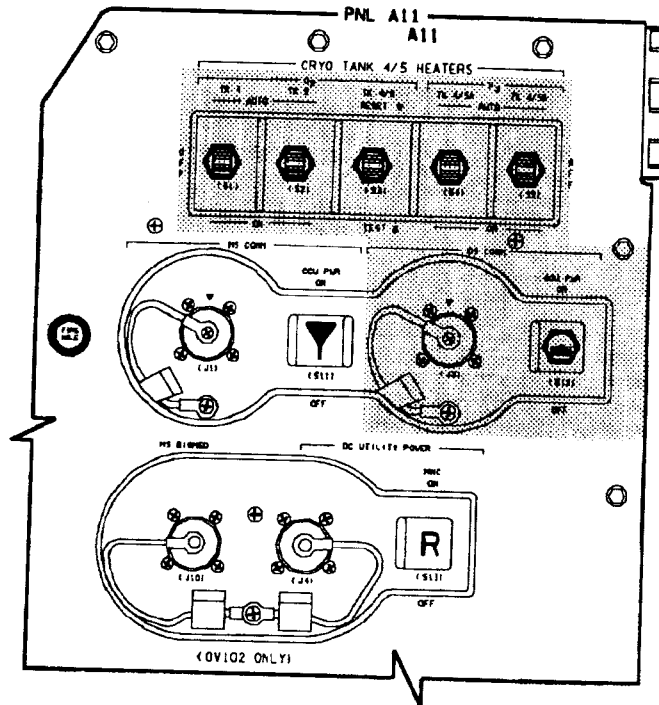

OV102

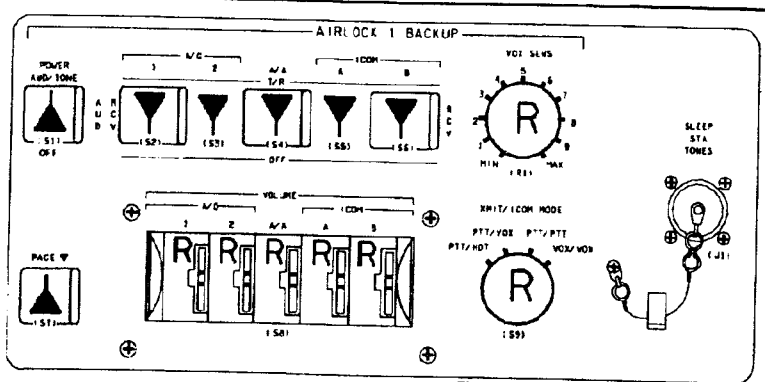

PNL M058F

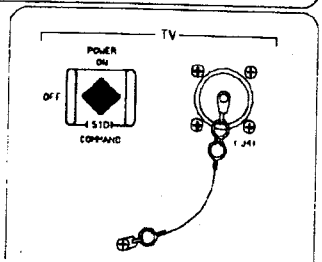

PNL M052J

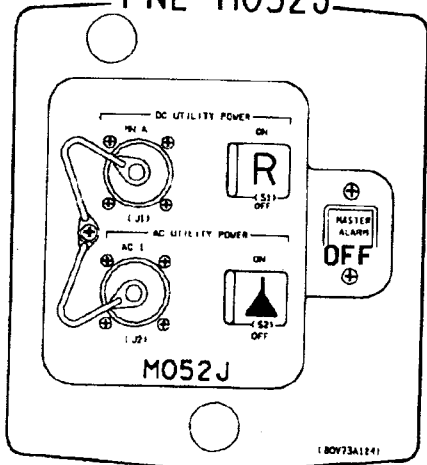

PNL M039M

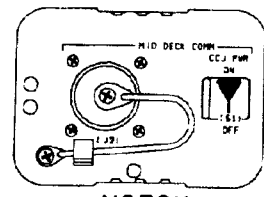

M039M

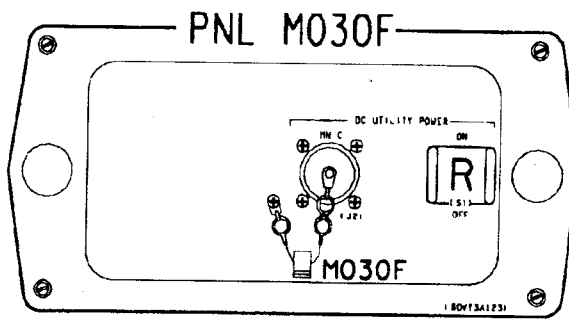

PNL MD24K

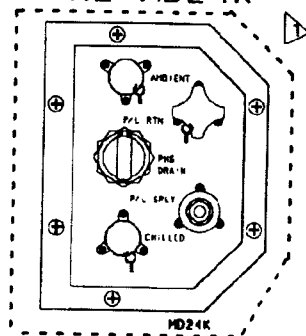

NOTE: Not visible if MAR flown

PNL MD44F

CAB TEMP CNTL ACT LINKAGE - SECONDARY ACTUATOR

OV102

PNL ML86B

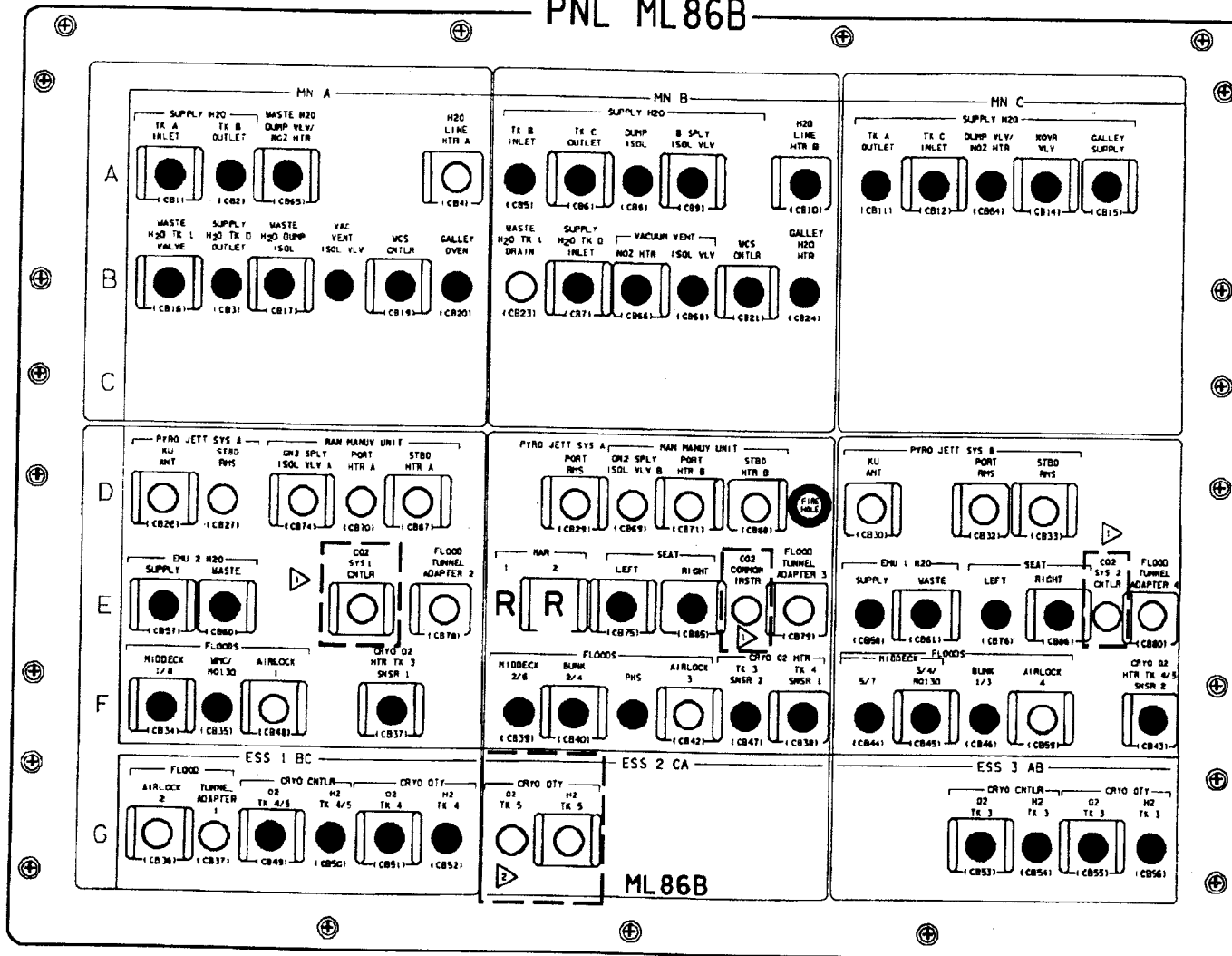

NOTES: ▷ CLOSED IF CO2 RMVL SYS FLOW
▷ CLOSED IF TK 5 FLOWN

138. PNL, 1

ENTRY (A11)

OV102/DATE 09/29/94

A3-11

D/O/2/GEN H,2

OV102

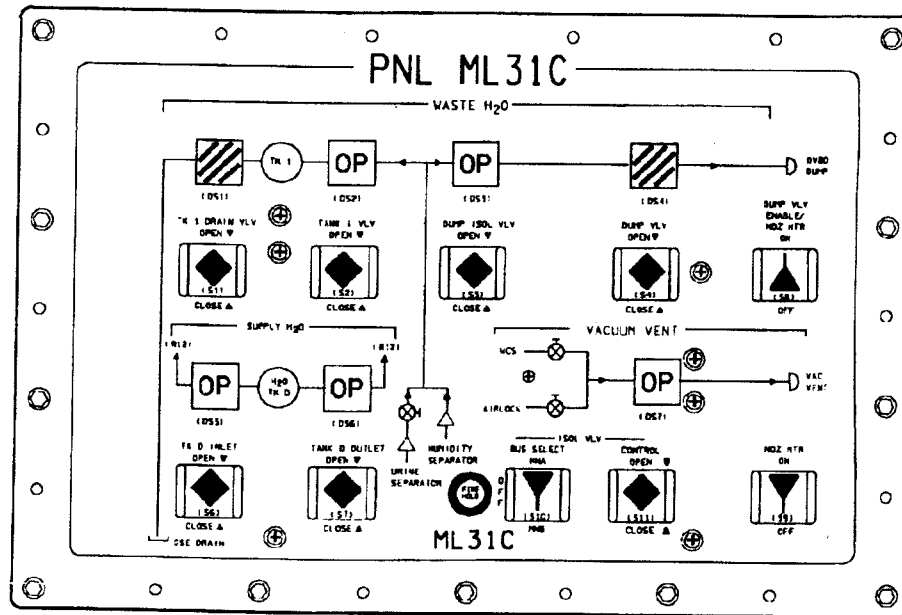
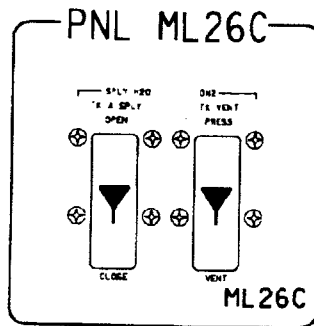
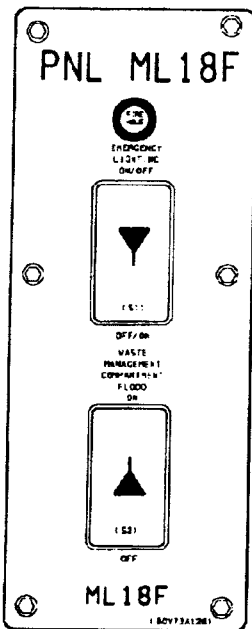
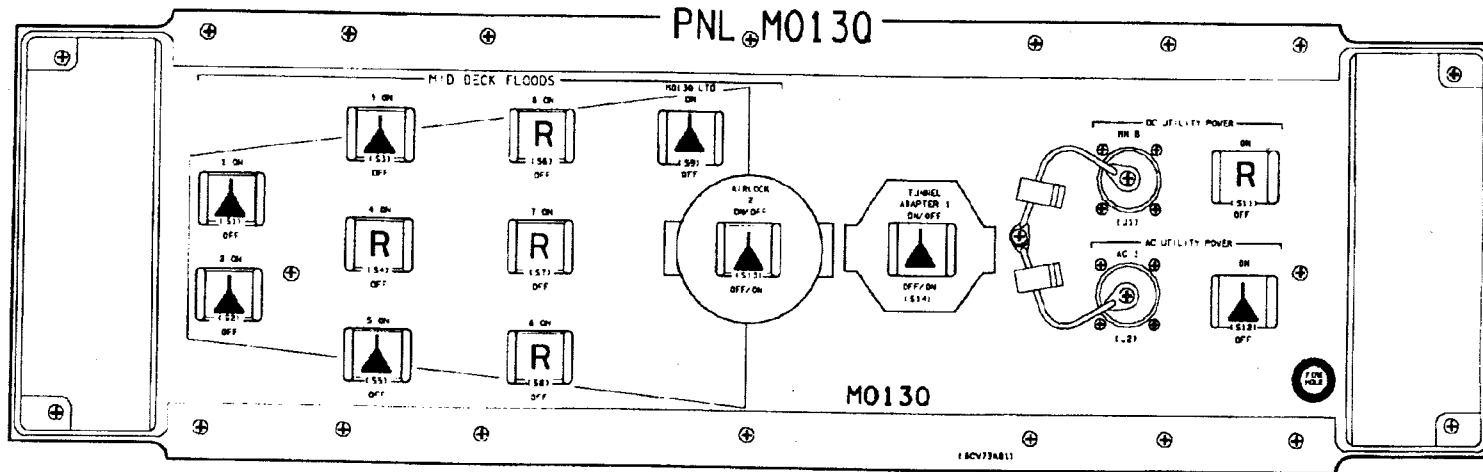

111. PNL 1

ENTRY (A12)
A3-12

ALL VEH/DATE 05/11/94

D/O/2/GEN H,2

OV105

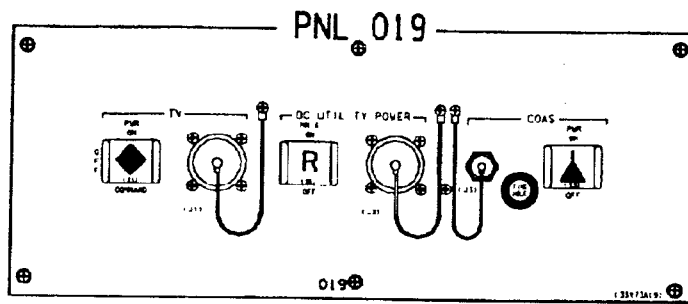

PNL C5



PNL C7

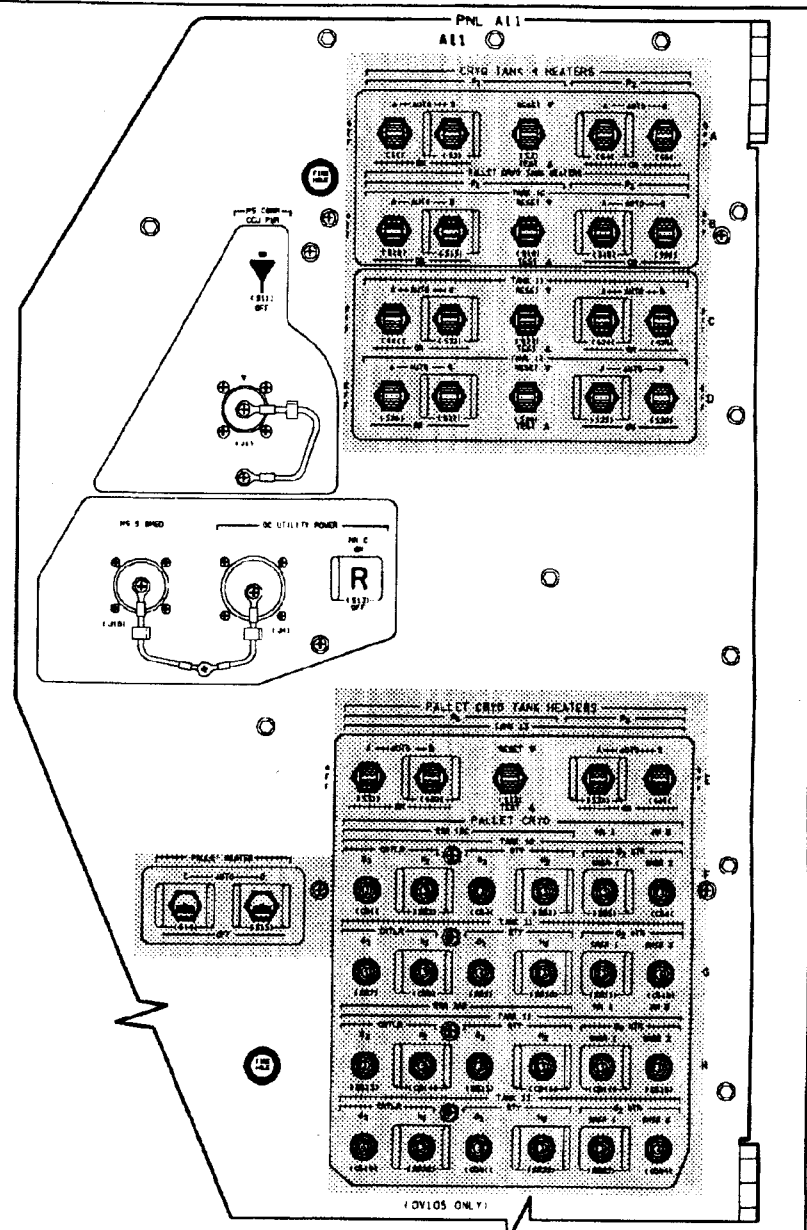
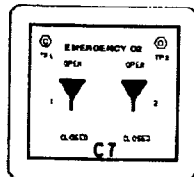

OV105

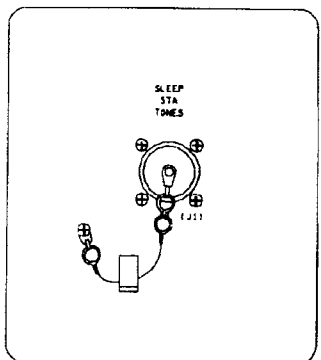

PNL M058F

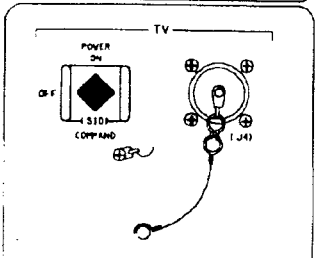

PNL M052J

—PNL M039M—

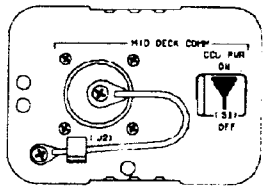

M039M

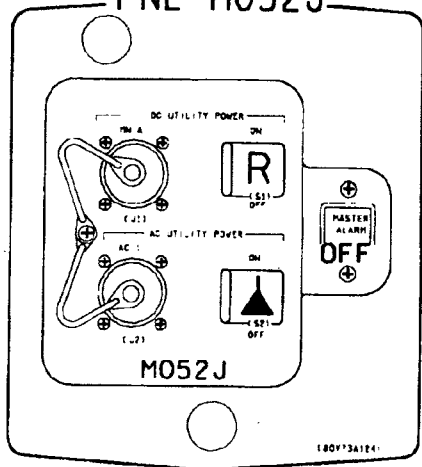

M052J

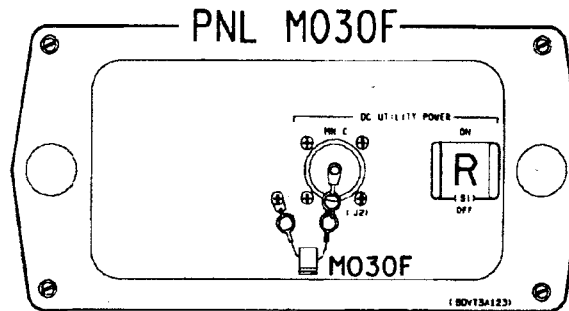

PNL M030F

PNL MD24K

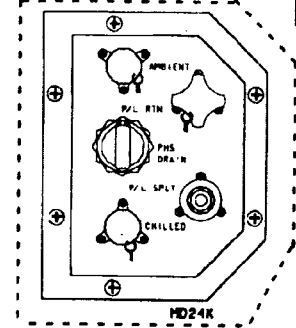

NOTE: ▸ Not visible if MAR flow

PNL MD44F

CAB TEMP CNTL ACT LINKAGE - SECONDARY ACTUATOR

OV103/OV104/OV105

PNL ML86B

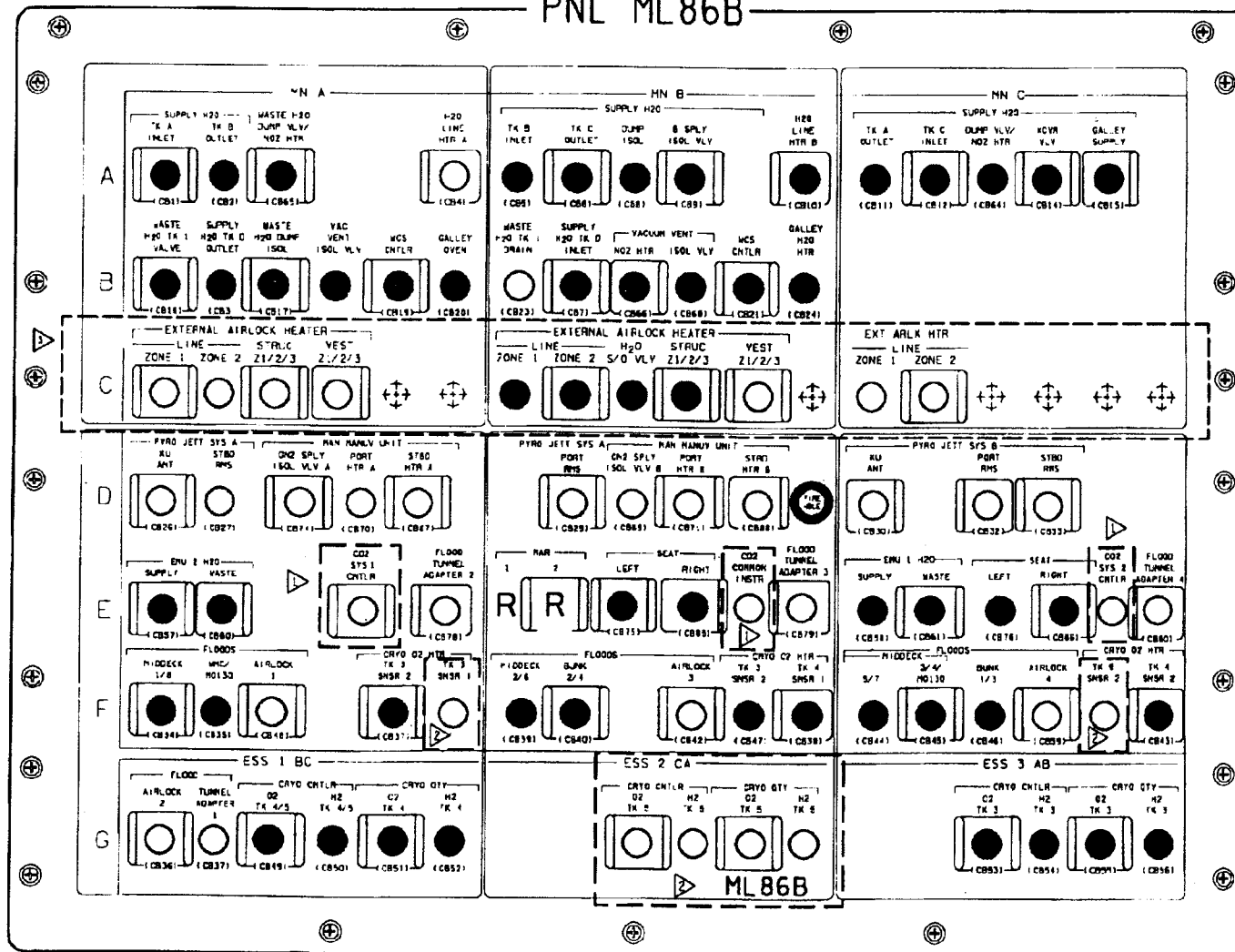

NOTES: ▷ CLOSED IF CO2 RMVL SYS FLOWN ▷ OV103,OV105 ONLY
 ▷ CLOSED IF TK 5 FLOWN

OV103/OV104/OV105

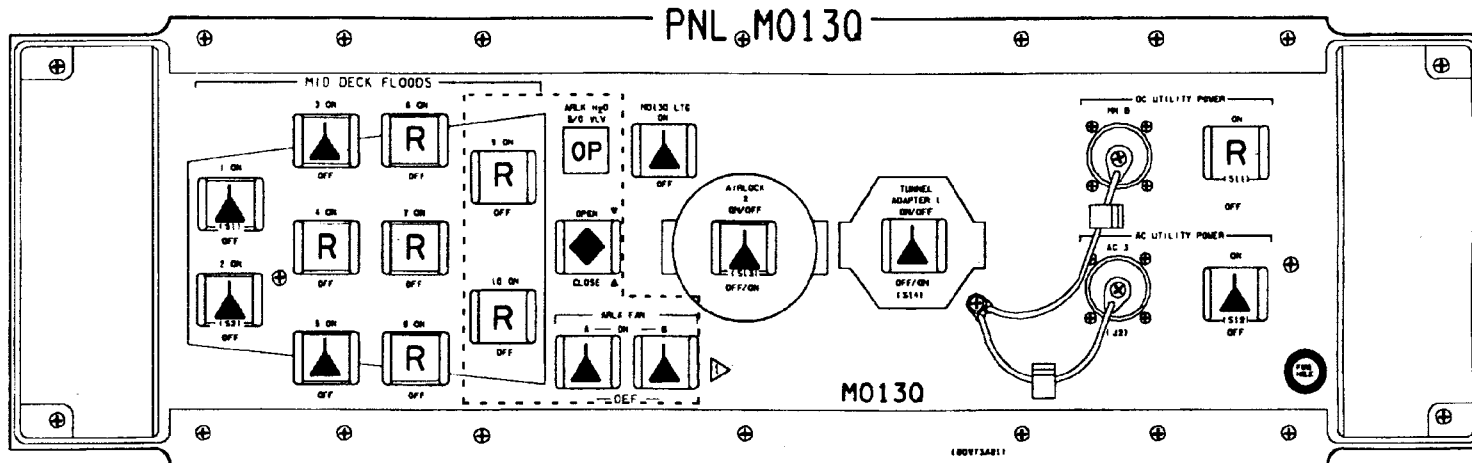

NOTES: ▷ OV-103/105 ONLY

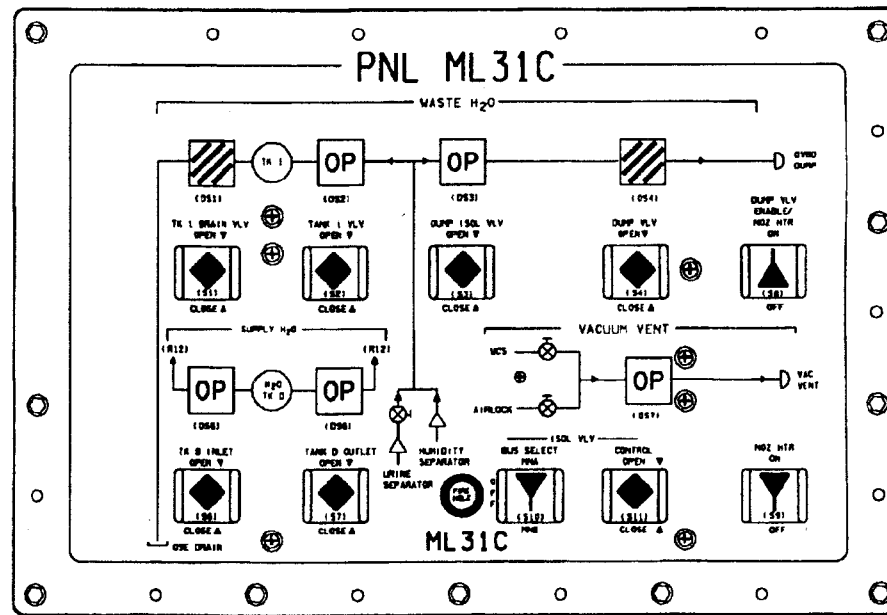
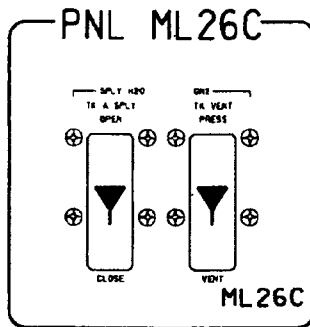
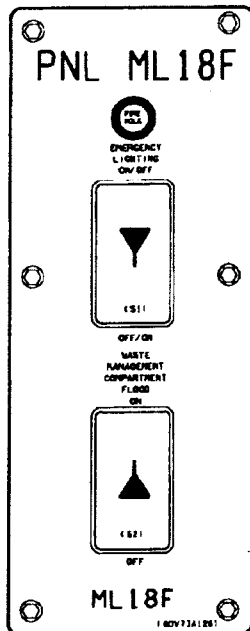

111. PNL 3

ENTRY (B12)

ALL VEH/DATE 12/03/96

OV103/OV104

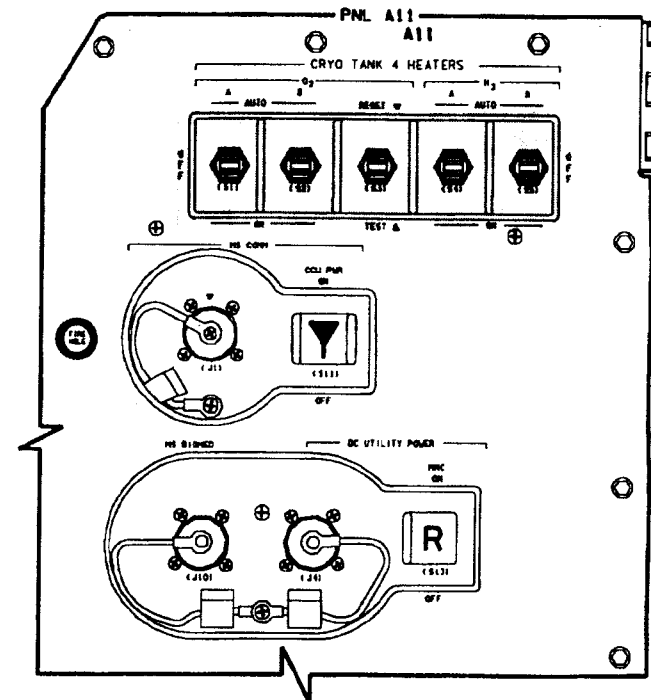
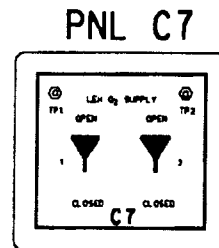
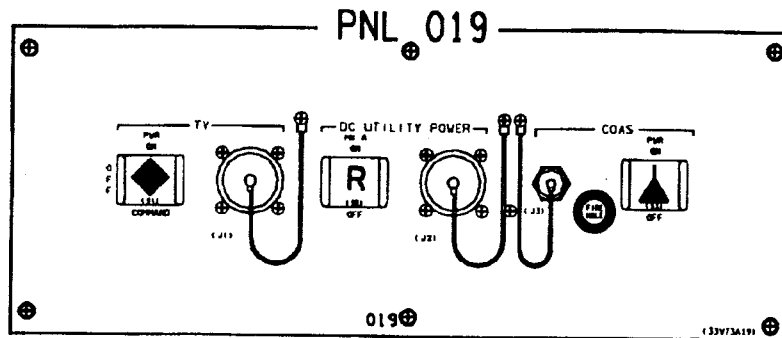

109. PNL 3

ENTRY (C9)

OV103/OV104/DATE 09/29/94

C3-9

D/O/3,4/GEN H

OV103/OV104

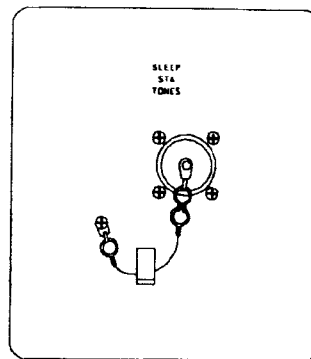

PNL M058F

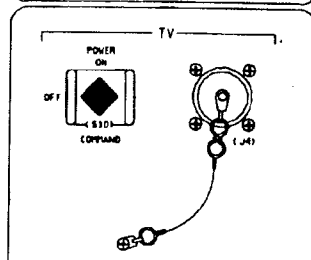

PNL M052J

—PNL M039M—

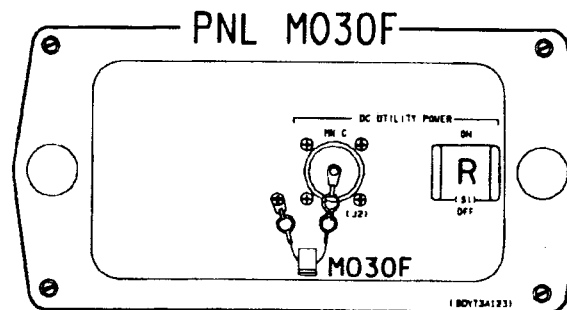
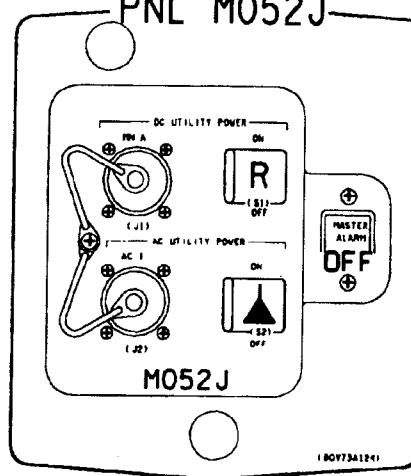
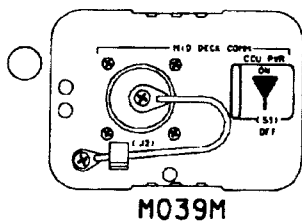

PNL MD24K

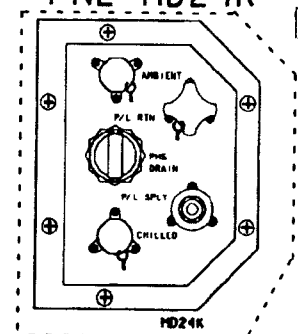

NOTE: Not visible if MAR flown

—PNL MD44F—

CAB TEMP CNTL ACT LINKAGE - SECONDARY ACTUATOR

PNL L4

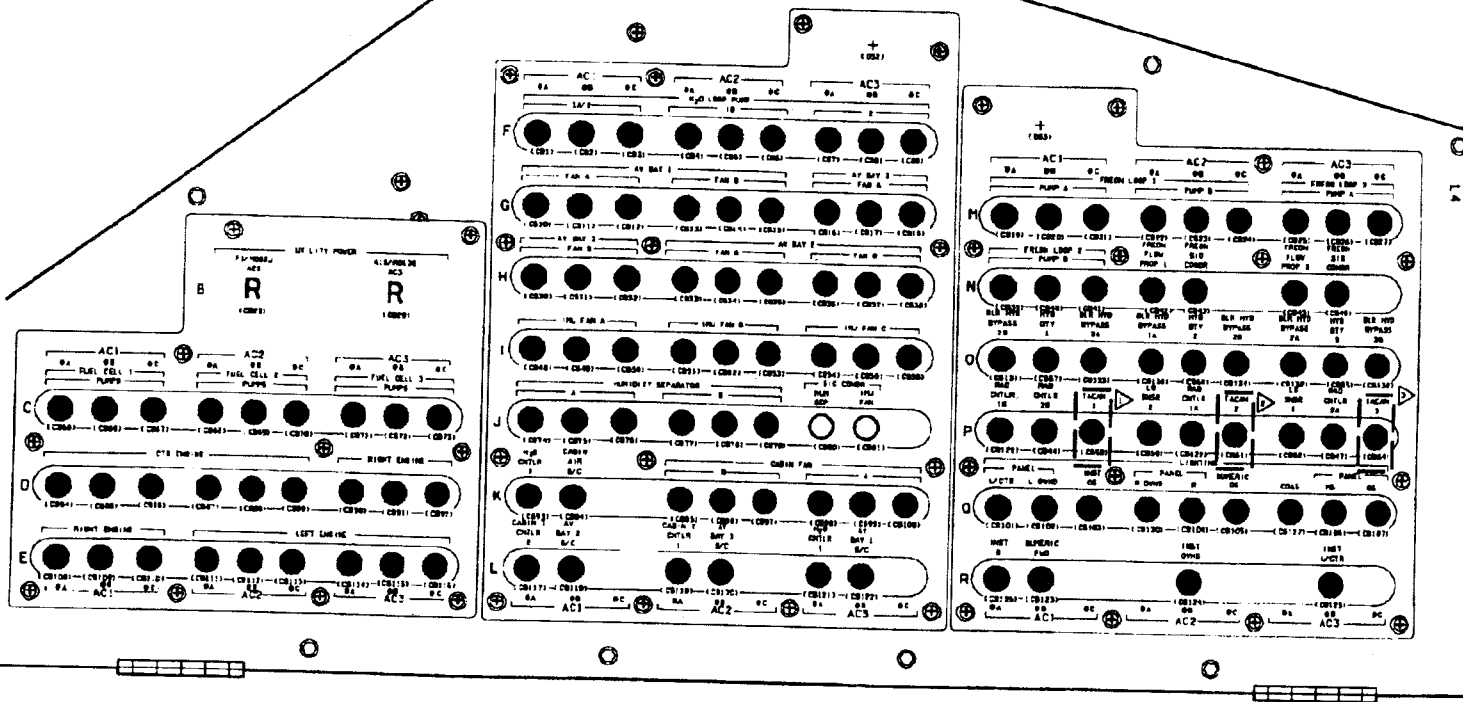

- NOTES:
- ▷ CB OPEN FOR OV102/OV104
 - ▷ CB OPEN FOR OV105
 - ▷ CB OPEN FOR OV103/OV104/OV105

112. PNL 5

ENTRY (13)

ALL VEH/DATE 06/01/86

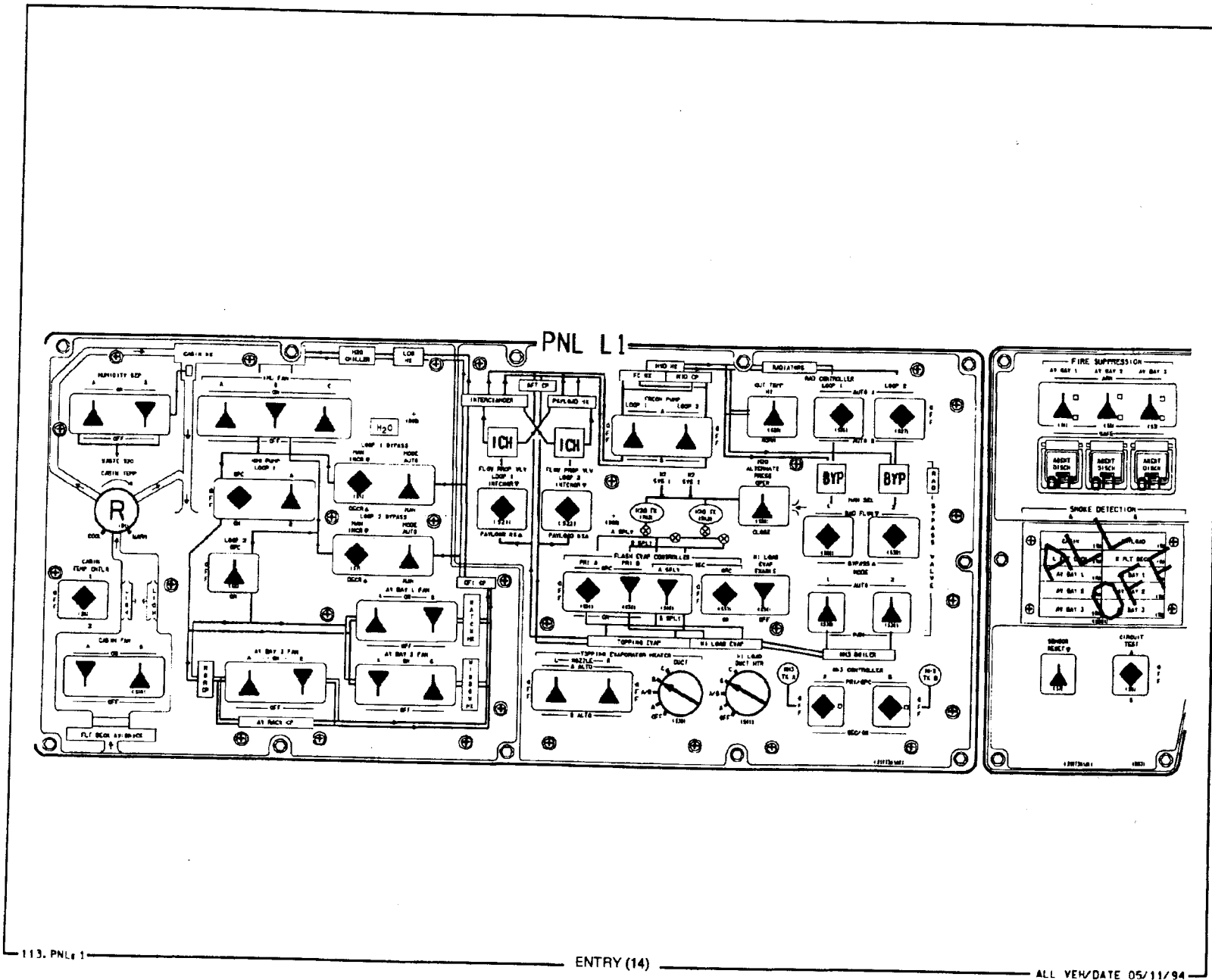

PNL C2/C3

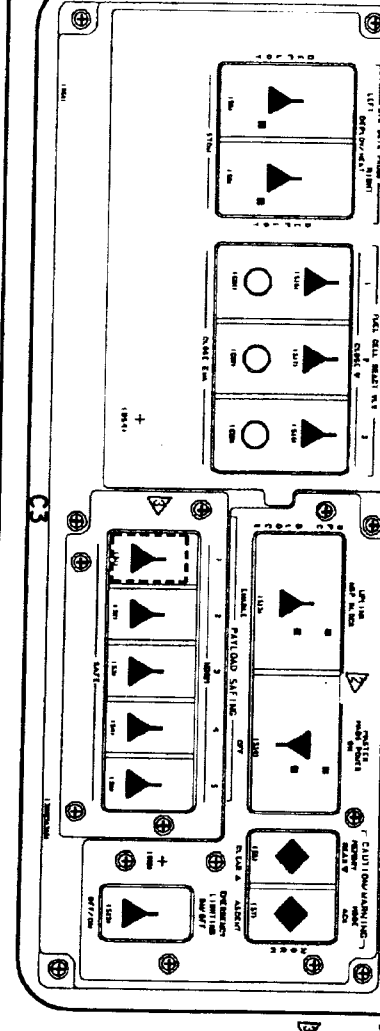
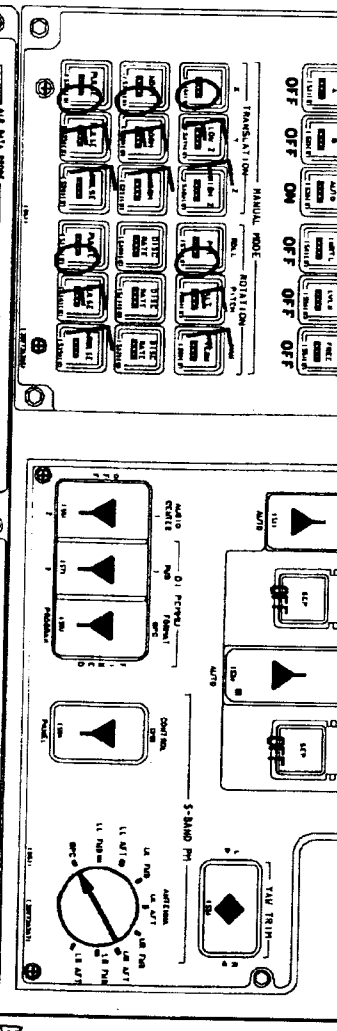
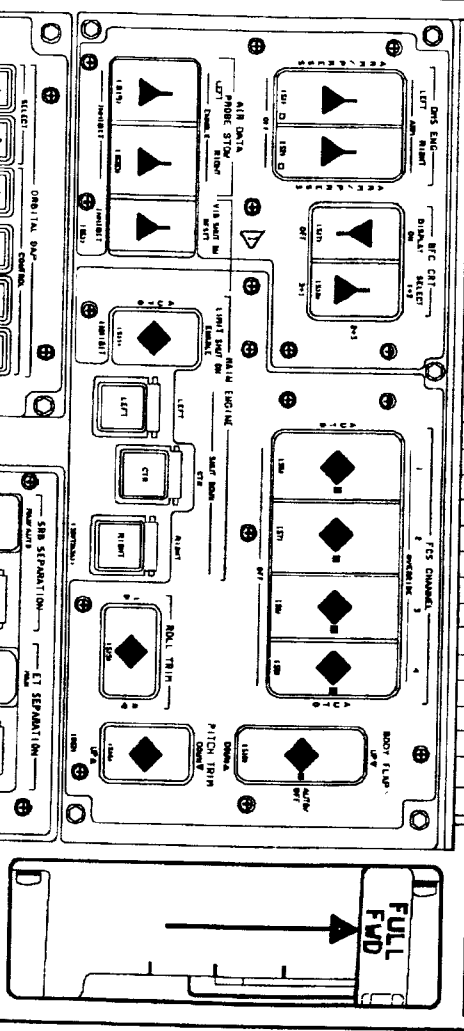
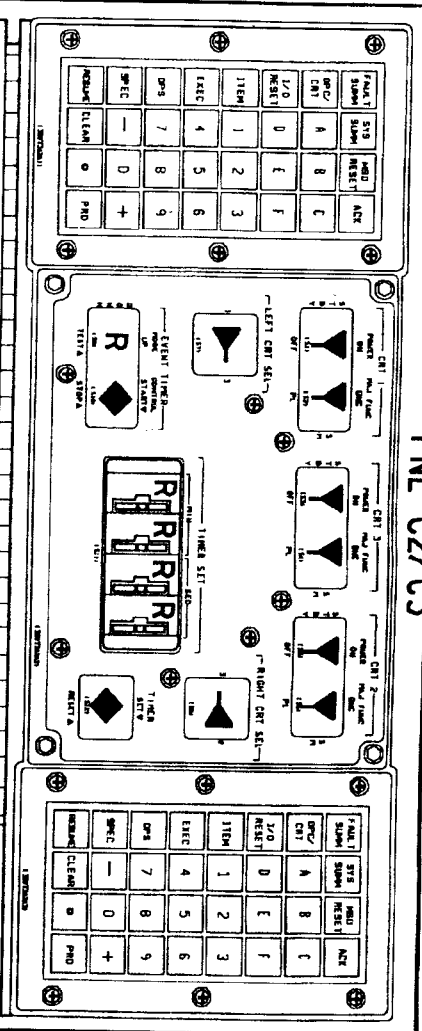

▷ ON OV102 ONLY

▷ MASTER OEX POWER ON OV102 ONLY
 ▷ POSSIBLE CONFIGURATION

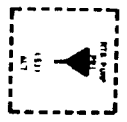

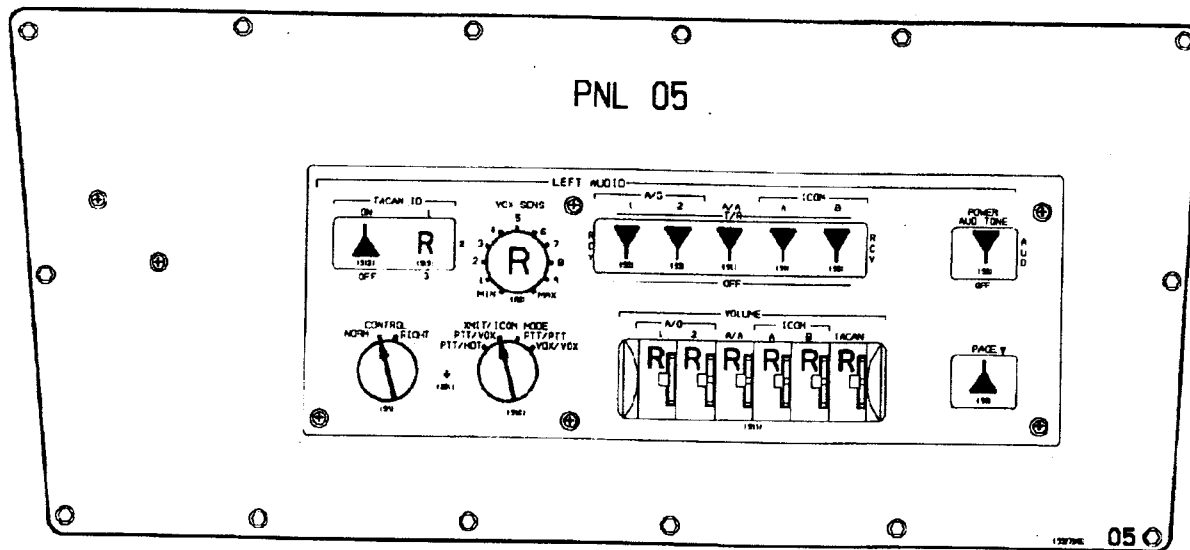
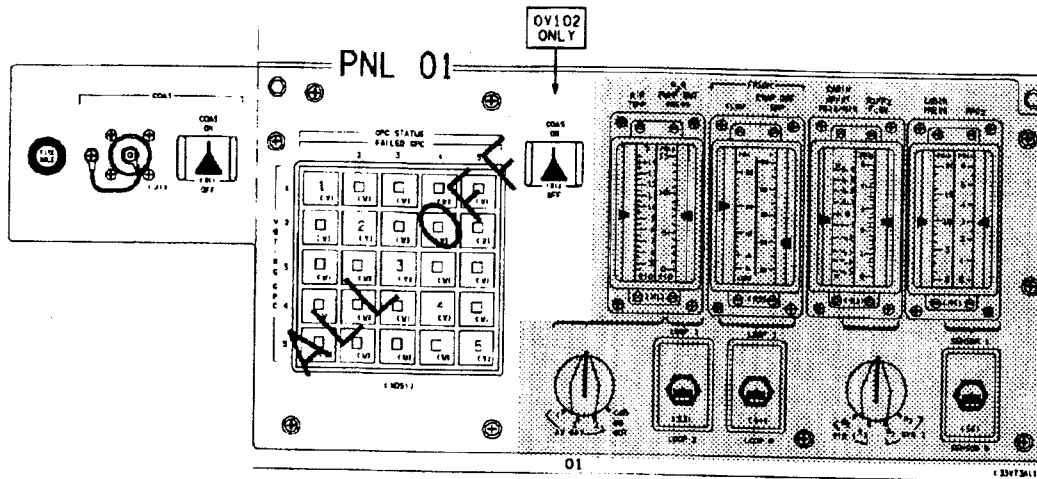

116. PNL 1

ENTRY (17)

ALL VEH/DATE 09/29/94

PNL 06

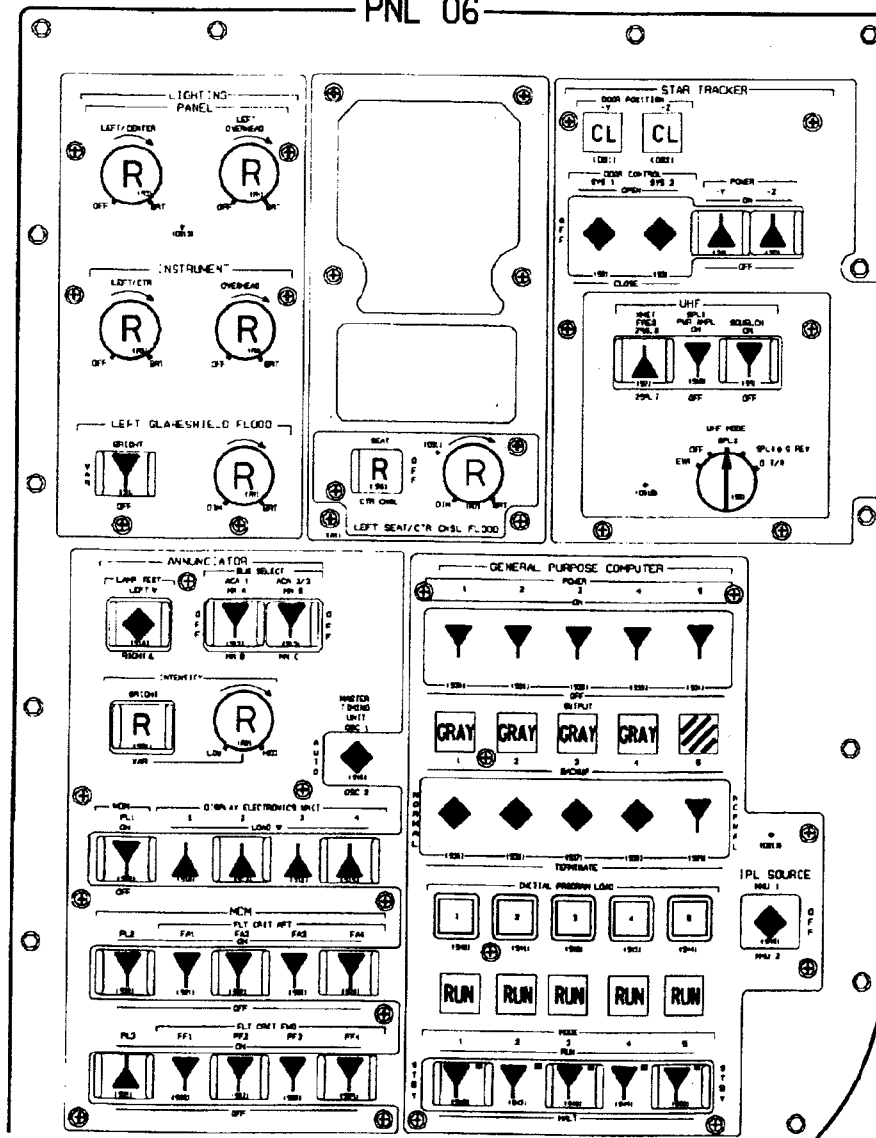

OV102

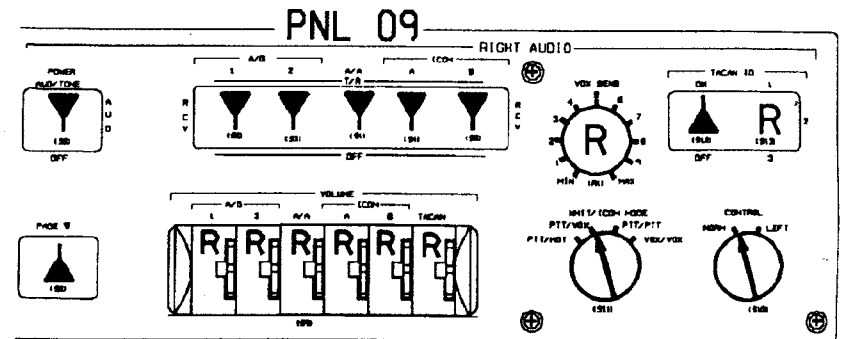
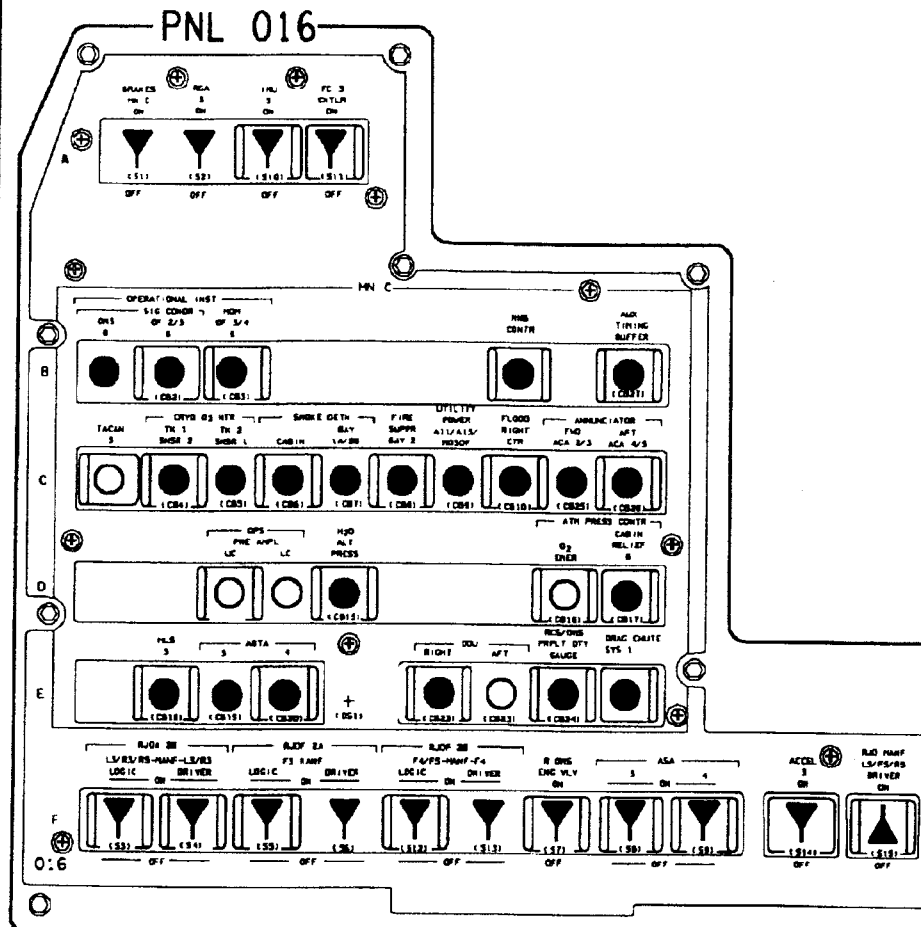

OV103/OV104/OV105

NOTES: ▷ CB CLOSED FOR OV105

▷ CB CLOSED FOR OV104

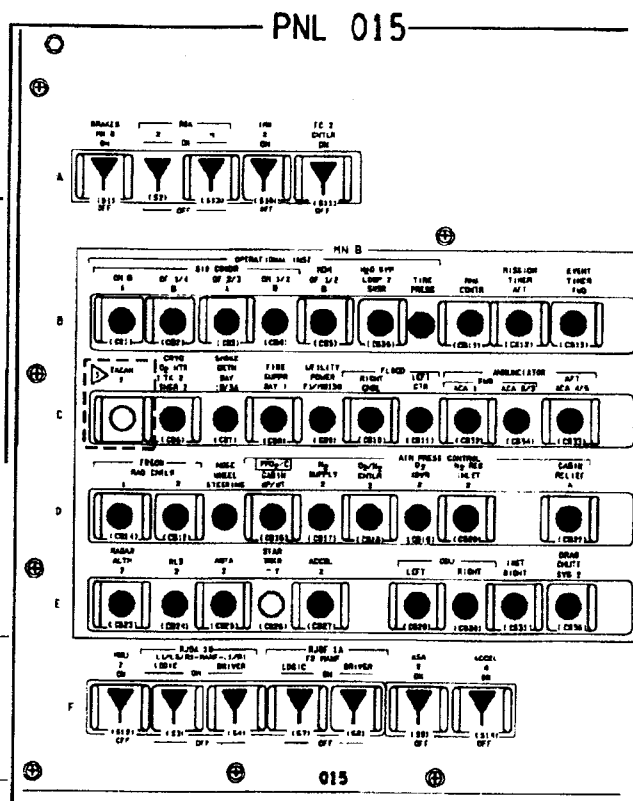
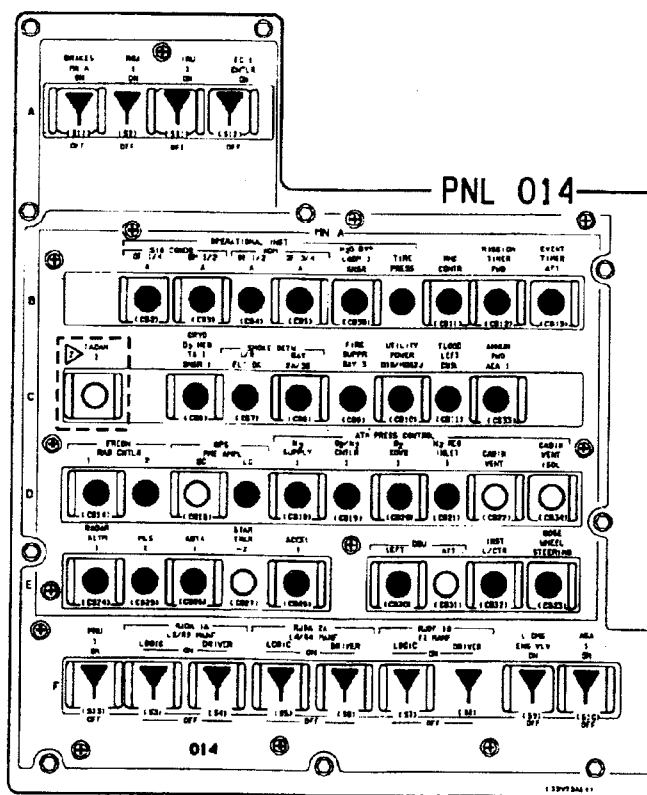

OV103/OV104/OV105

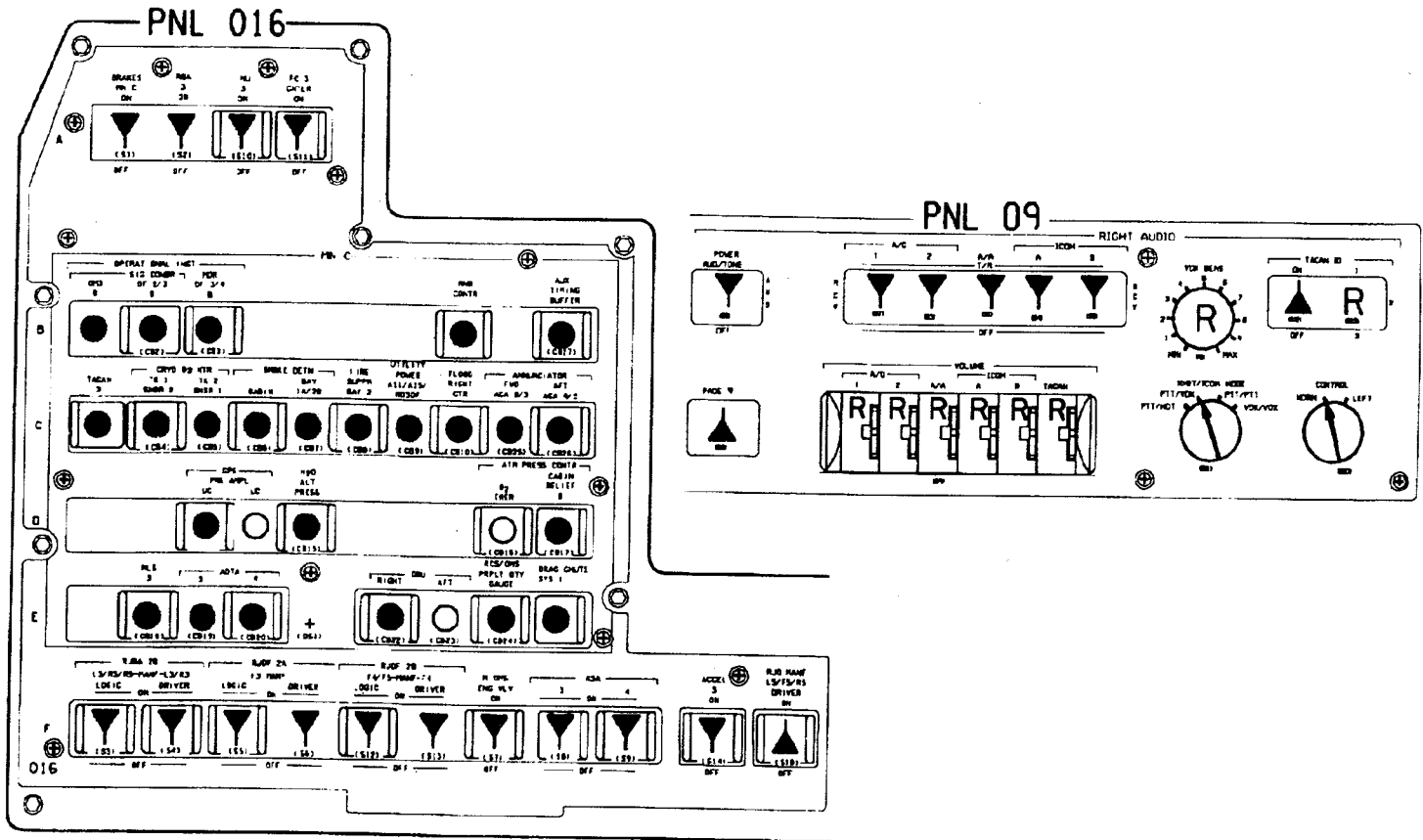

121. PNL 4

ENTRY (B20)

OV103/OV104/OV105/DATE 06/01/96

B3-20

D/O/3+/GEN H

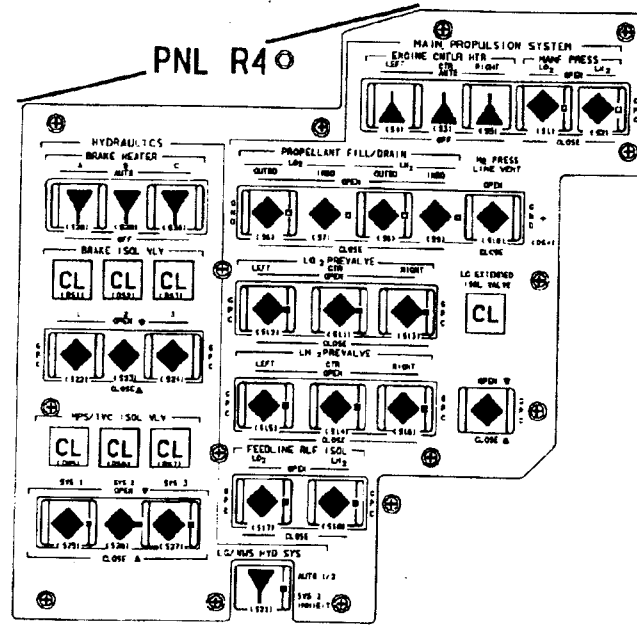
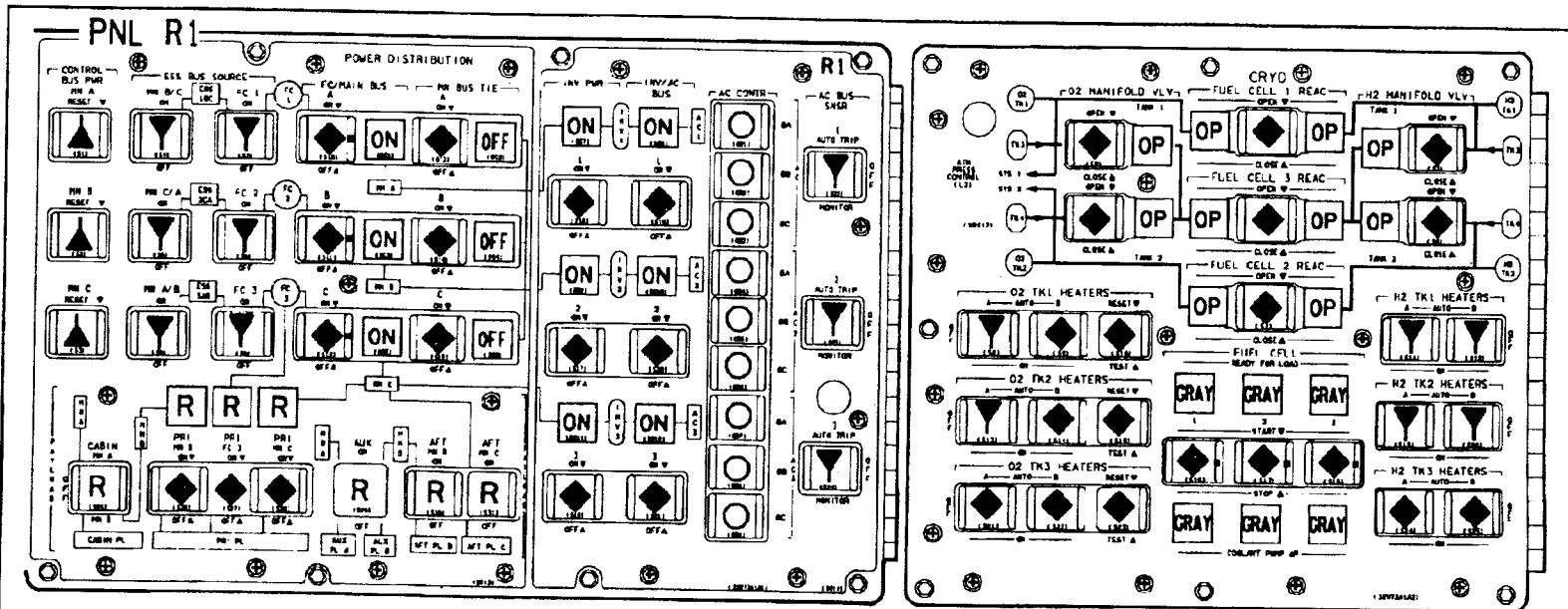

122. PNL R1

ENTRY (21)

ALL VEH/DATE 09/29/94

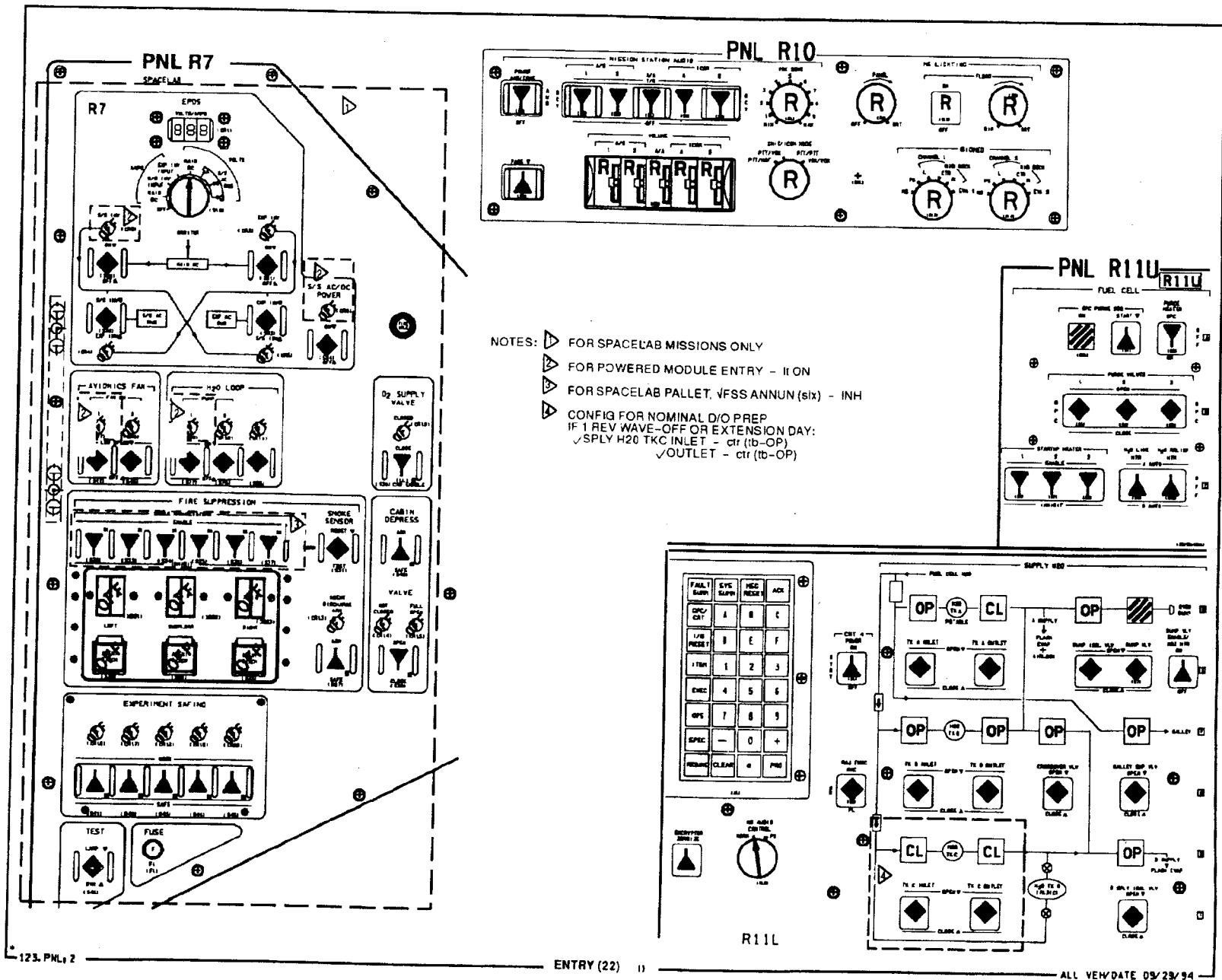

OV102/OV105

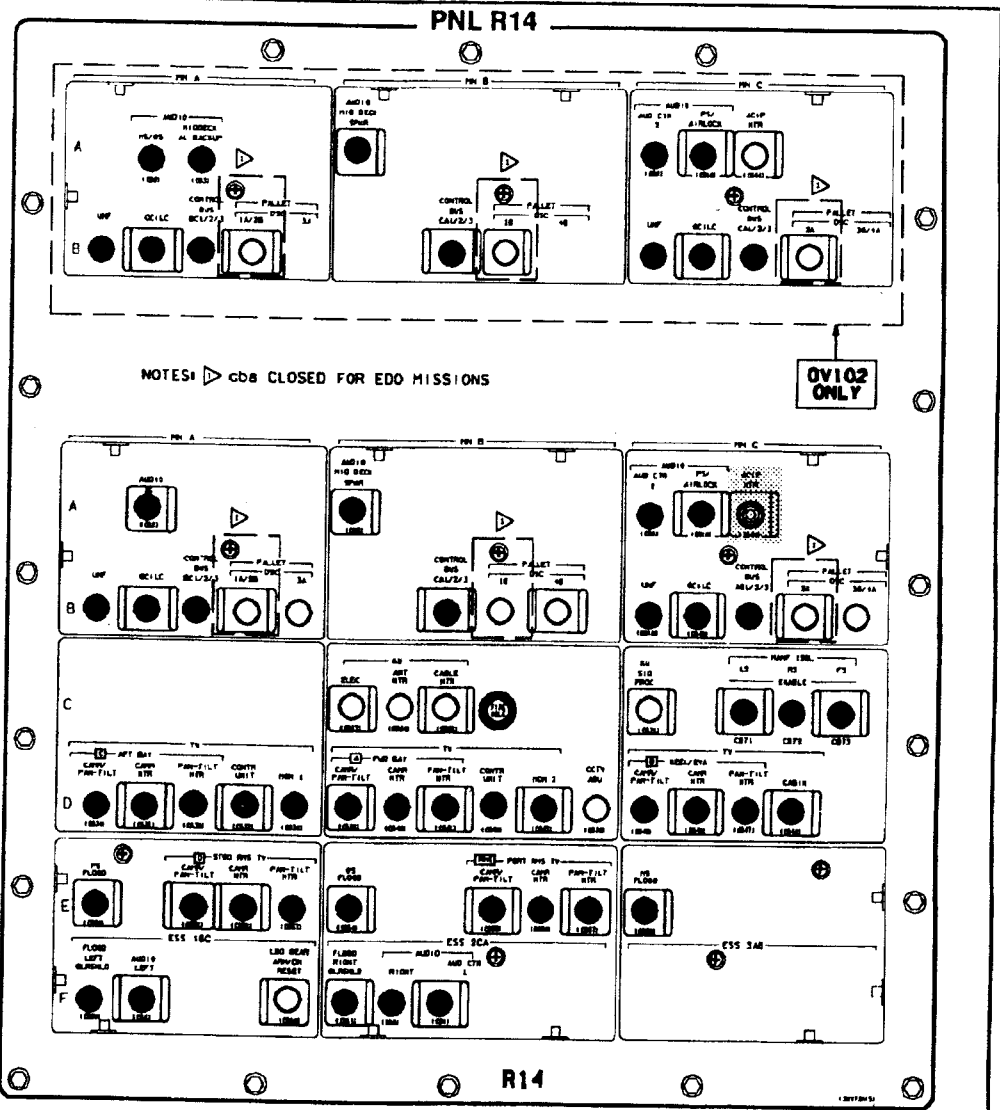
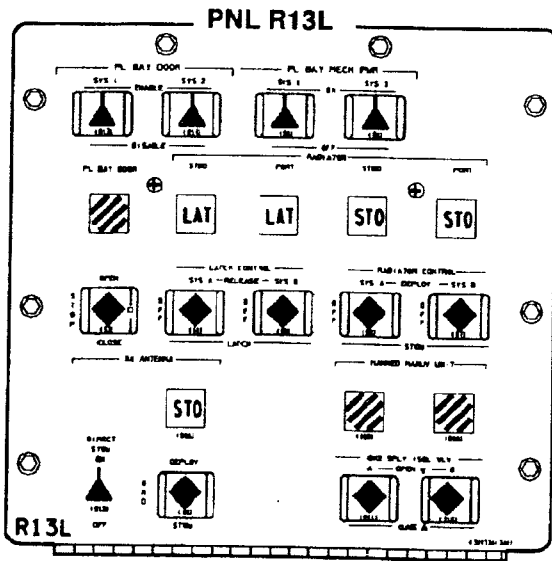

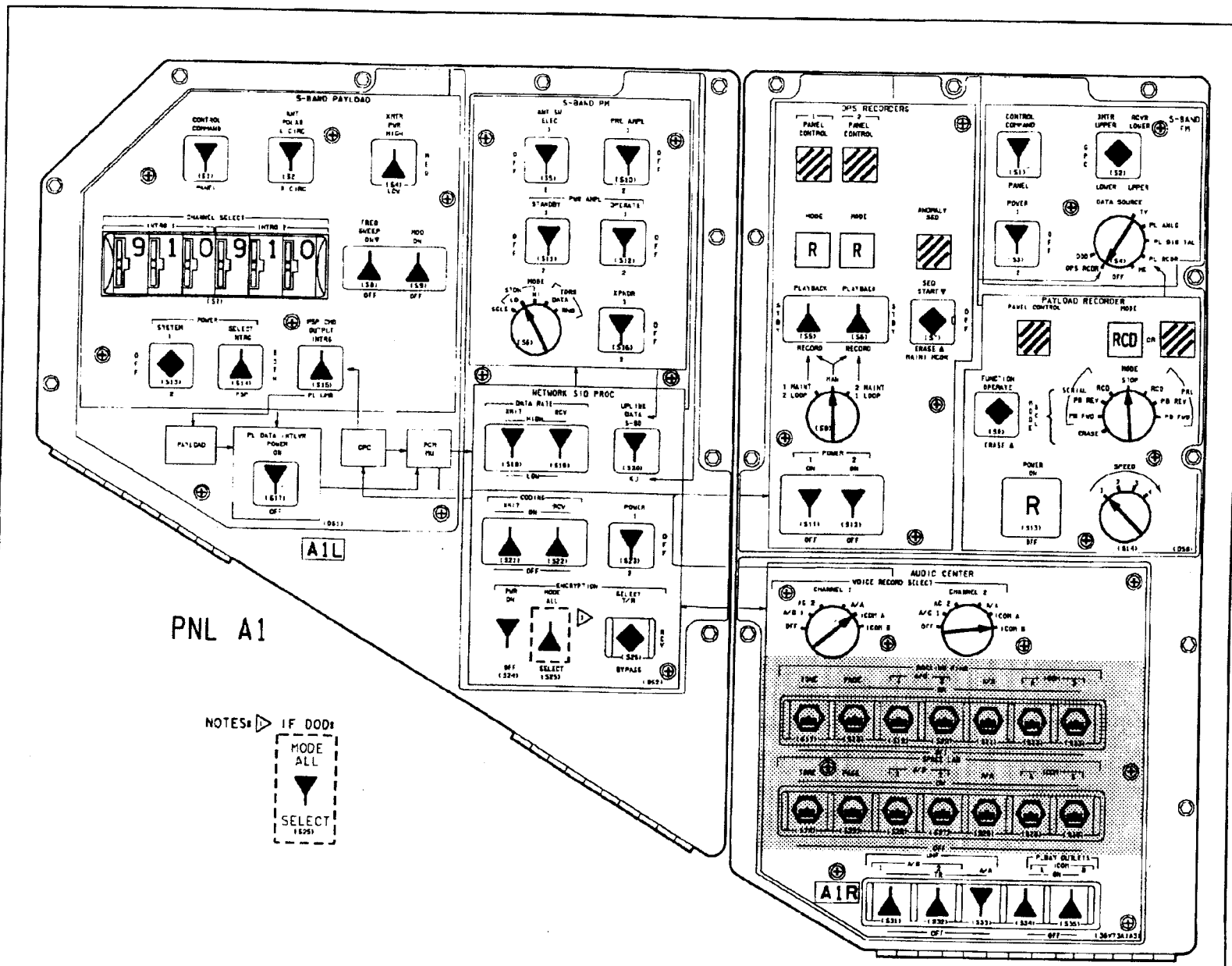

PNL A1

NOTES: IF DODs
 MODE ALL
 SELECT 1.525

125. PNL # 4

ENTRY (A24)

ALL VEH/DATE 06/01/96

A3-24

D/O/ALL/GEN H

0V102

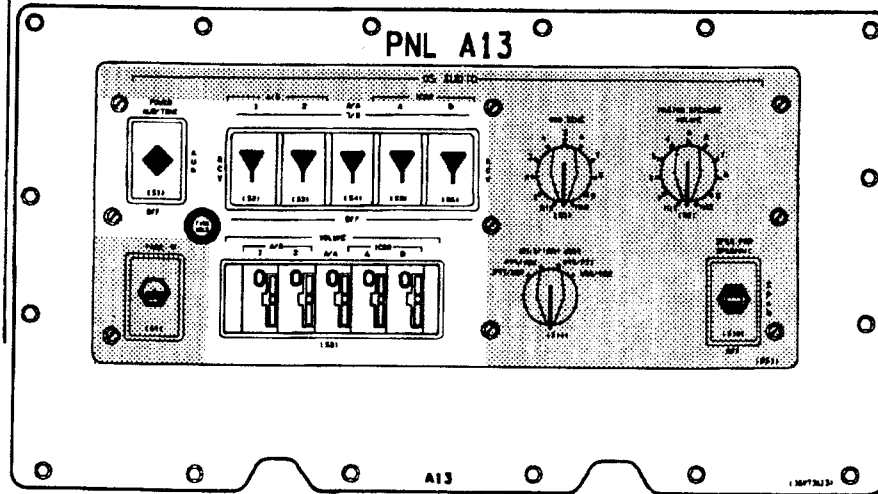
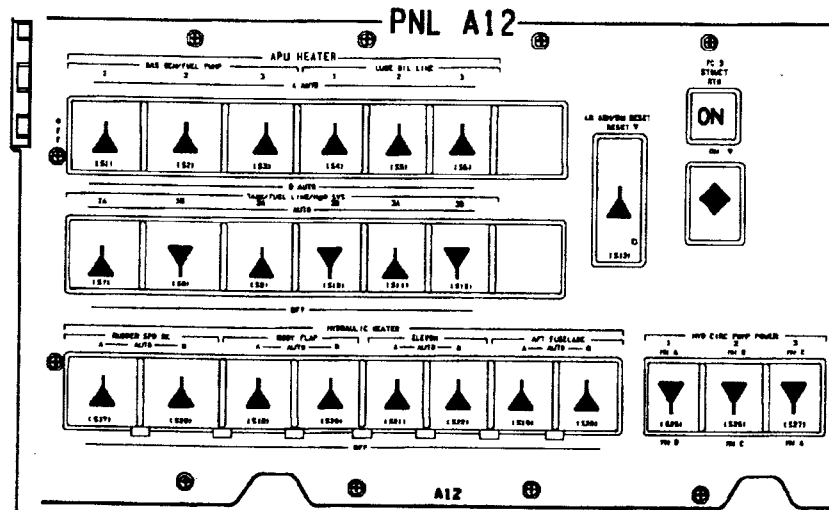
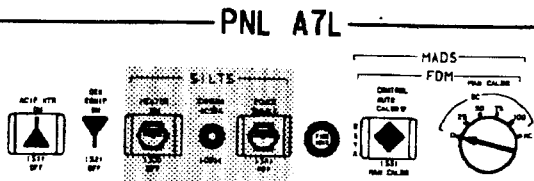
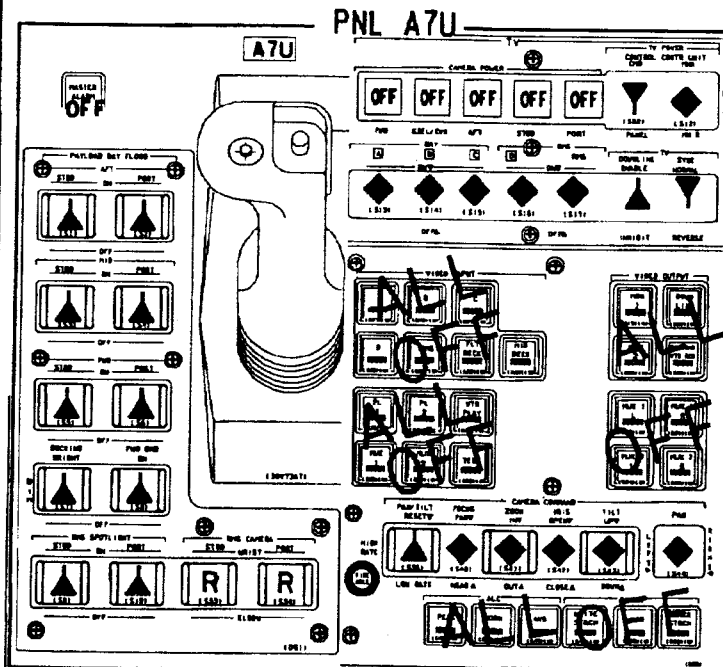

130, PNL: 2

ENTRY (A25)

0V102/DATE 09/29/94

PNL L9

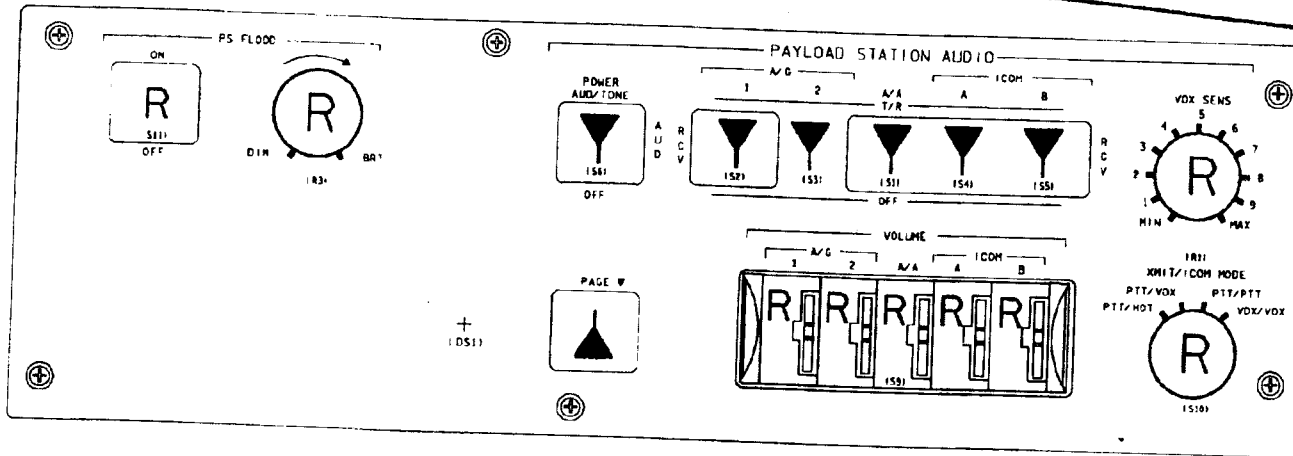

L9

(31V73A9A2)

131. PNL, 1

ENTRY (A26)

ALL VEH/DATE 09/29/94

A3-26

D/O/ALL/GEN H

OV103/OV104

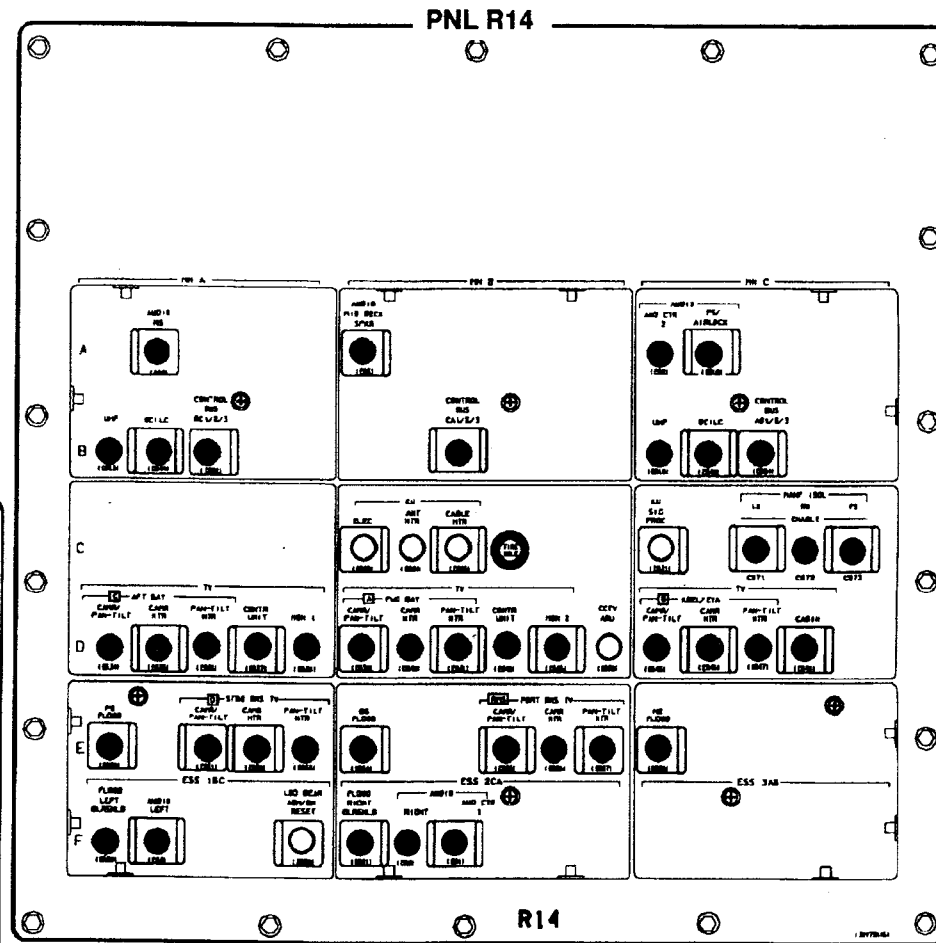
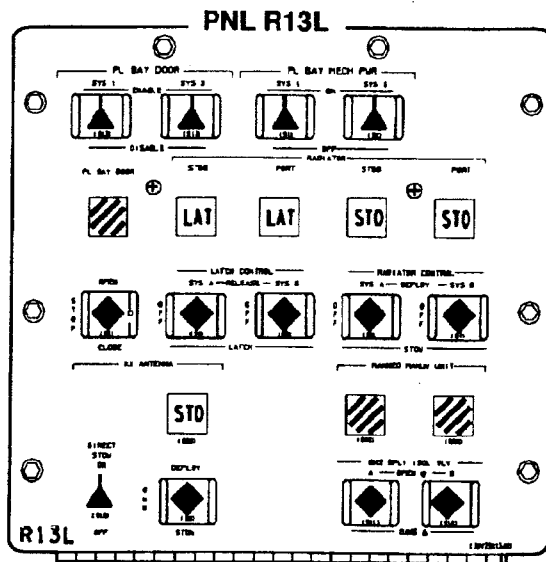

124.PNL:1

ENTRY (B23)

OV103/OV104/DATE 09/29/94

B3-23

D/O/3,4/GEN H

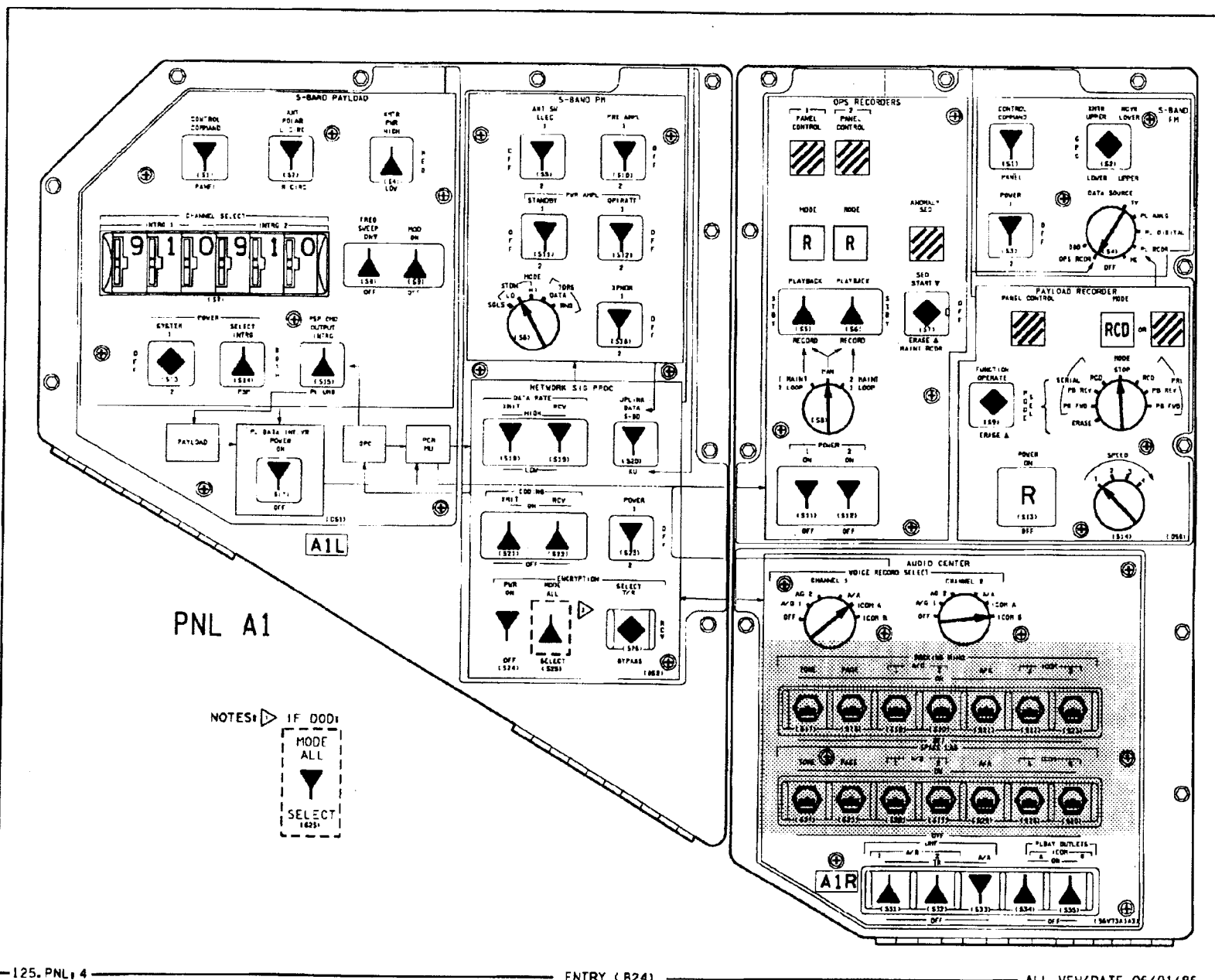

125. PNL 4

ENTRY (B24)

ALL VEH/DATE 06/01/96

OV103//OV104/OV105

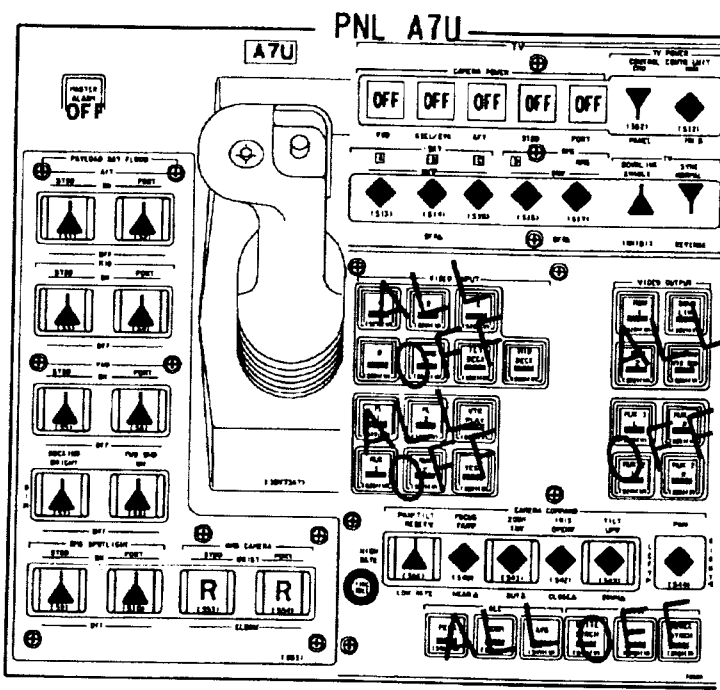

NOTE: PNL A6L FOR OV104 ONLY

PNL A7L (A6L)

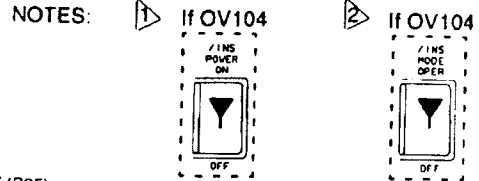
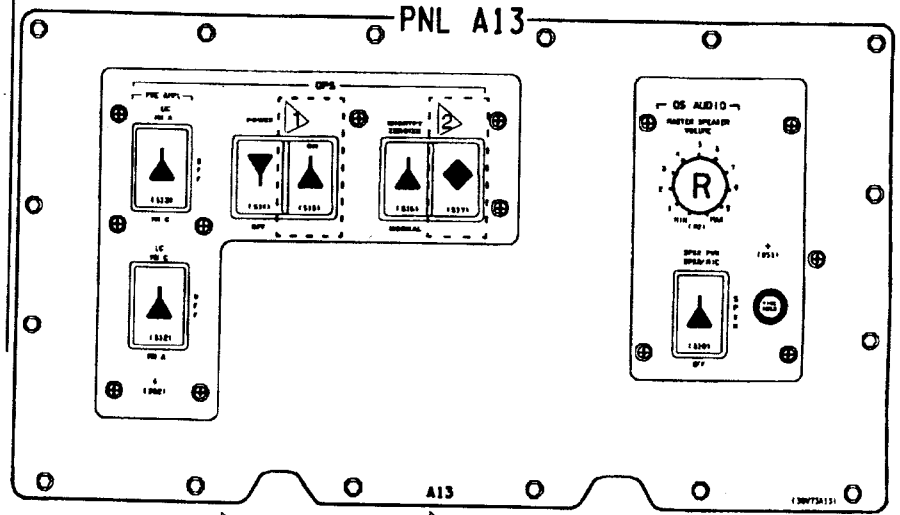
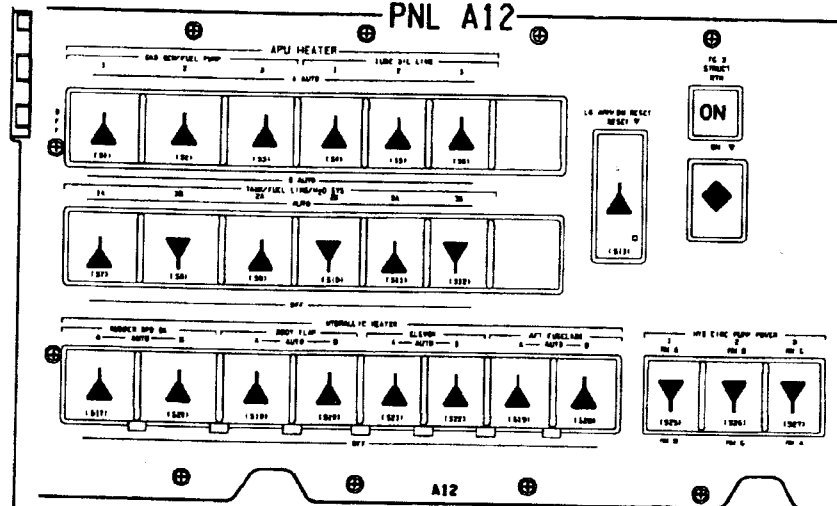
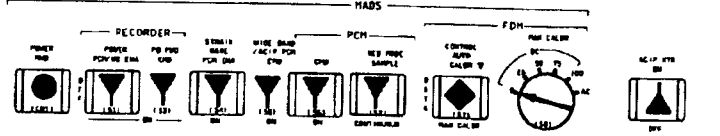

PNL L9

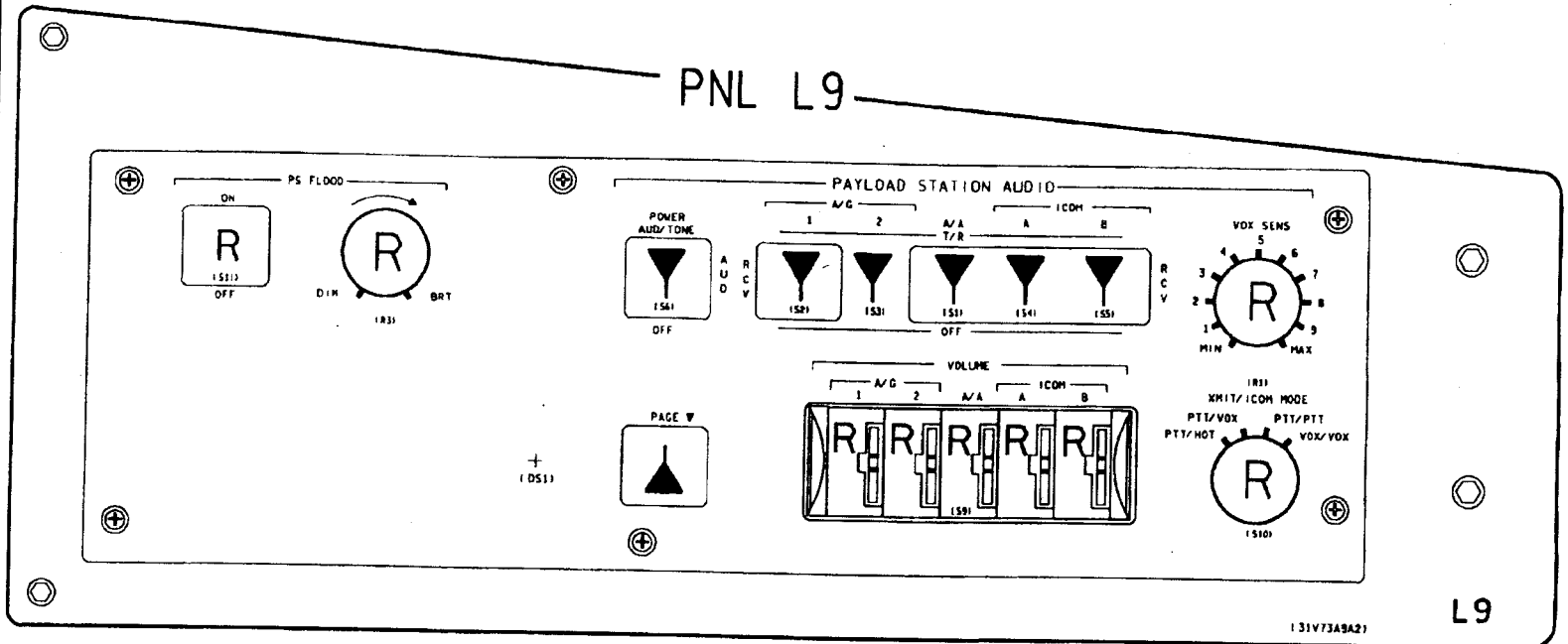

131. PNL# 1

ENTRY (B26)
B3-26

ALL VEH/DATE 09/29/94

D/O/ALL/GEN H

PNL L9

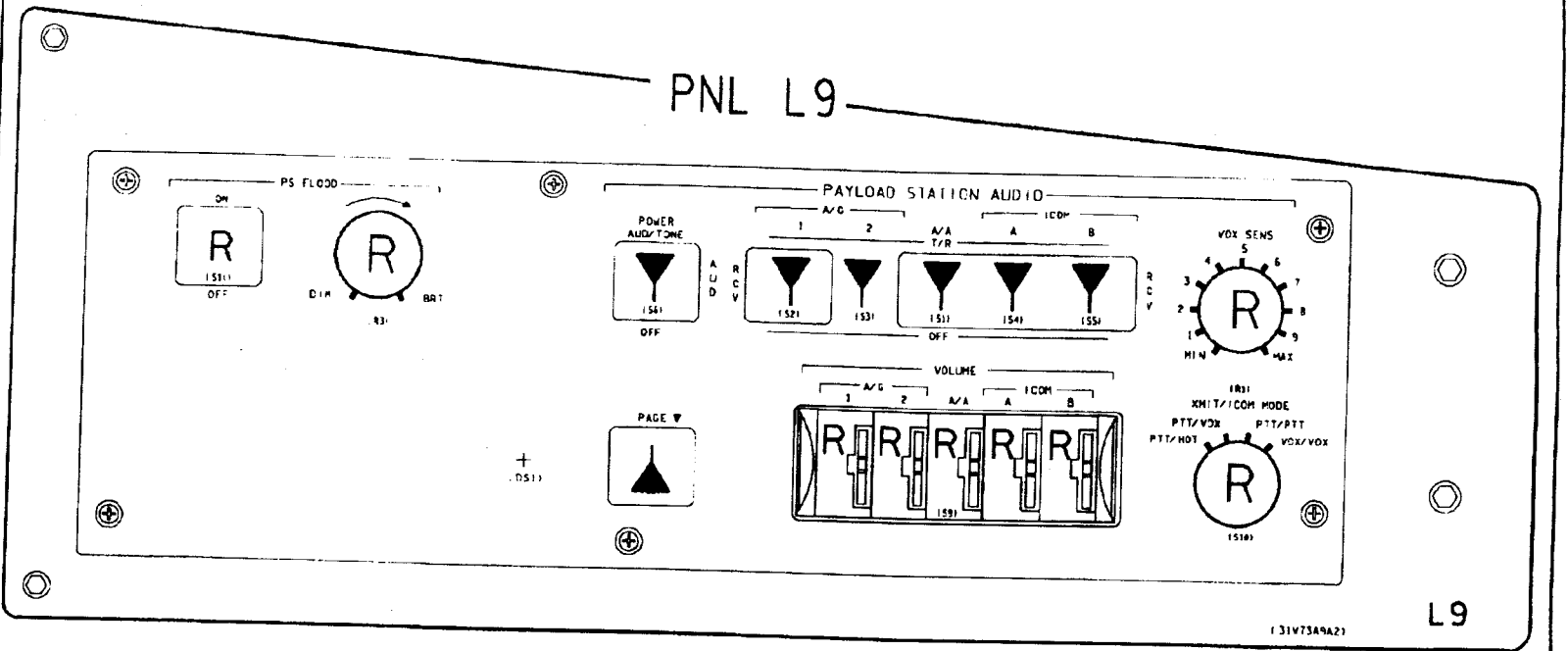

131. PNL, 1

ENTRY (C26)
C3-26

ALL VEH/DATE 09/29/94

ODS

D/O/ODS/GEN H

OV104

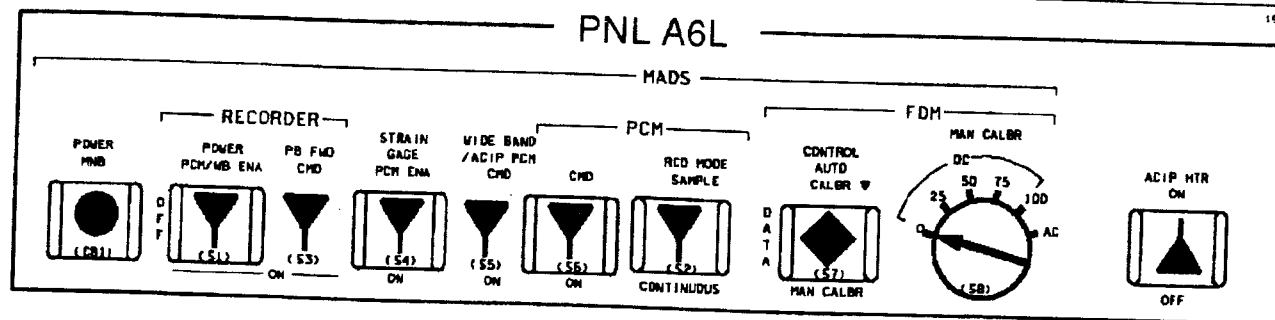
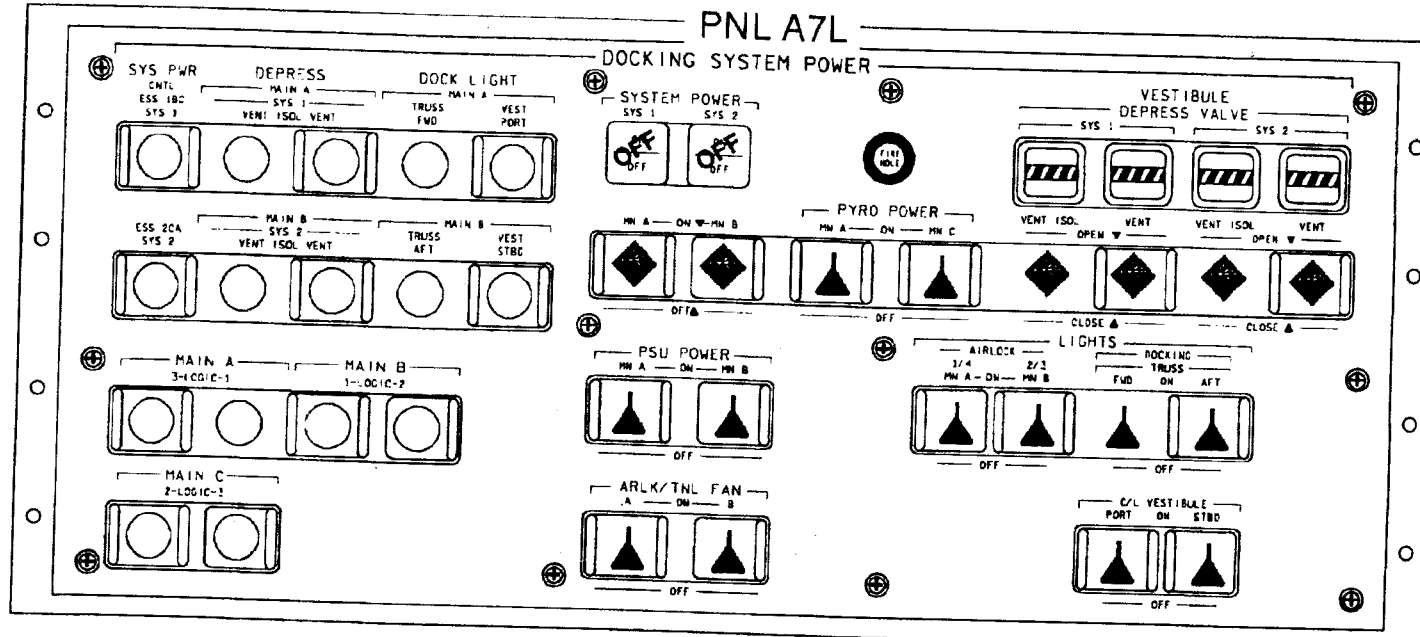

*.PNL:1

ENTRY (C-26a)

C3-26a

OV104/DATE 05/25/95

ODS

D/O/ODS/GEN H

OV104

CONTROL PANEL POWER

A ON OFF B ON OFF C ON OFF

HEATERS/DCU POWER

H1 ON OFF H2/DCU ON OFF H3/DCU ON OFF

APDS POWER

ADS ON OFF BDS ON OFF CDS ON OFF

STATUS

POWER	ON	INITIAL	CONTACT
APDS PROTECT	CIRCUIT OFF	CAPTURE	CAPTURE
RING	ALIGNED	RING	FORWARD POSITION
RING	INITIAL POSITION	RELEASE	TO HOOK
FIXERS	OFF	INTERP	SEALED
HOOKS 1	OPEN	HOOKS 1	CLOSED
HOOKS 2	OPEN	HOOKS 2	CLOSED
LATCHES	CLOSED	LATCHES	OPEN
UNDOCK	COMPLET	RING	FINAL POSITION

PYROS

Ap ON OFF Bp ON OFF Cp ON OFF

Ap OFF Cp



PYRO PROTECT OFF

PYRO COMMANDS

PYRO CIRC PROT OFF PYRO CIRC PROT ON

ACT HOOKS FIRING PAS HOOKS FIRING

APDS CONTROL COMMANDS

OPEN HOOKS OPEN LATCHES

UNDOCKING

ADS OFF BDS CDS

LAMP TEST

PNL A8U

APDS CONTROL COMMANDS

POWER ON POWER OFF RING OUT RING IN

APDS CIRC PROT OFF CLOSE HOOKS CLOSE LATCHES FIXER OFF

APDS CONTROL PANEL

ODS

*.PNL:1

ENTRY (C-26b)

OV104/DATE 05/25/95

C3-26b

D/O/ODS/GEN H

OV102/OV105

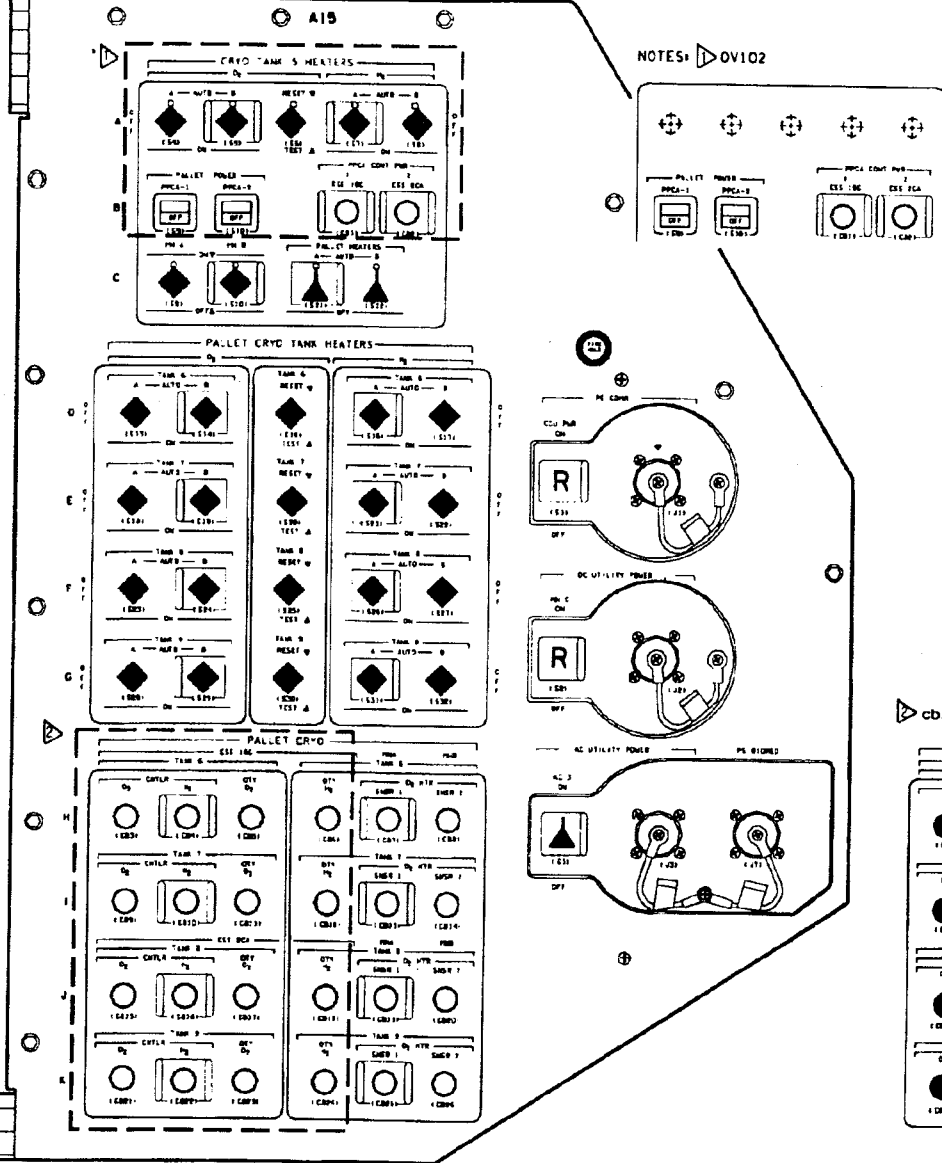

OV103/OV104
PNL A15

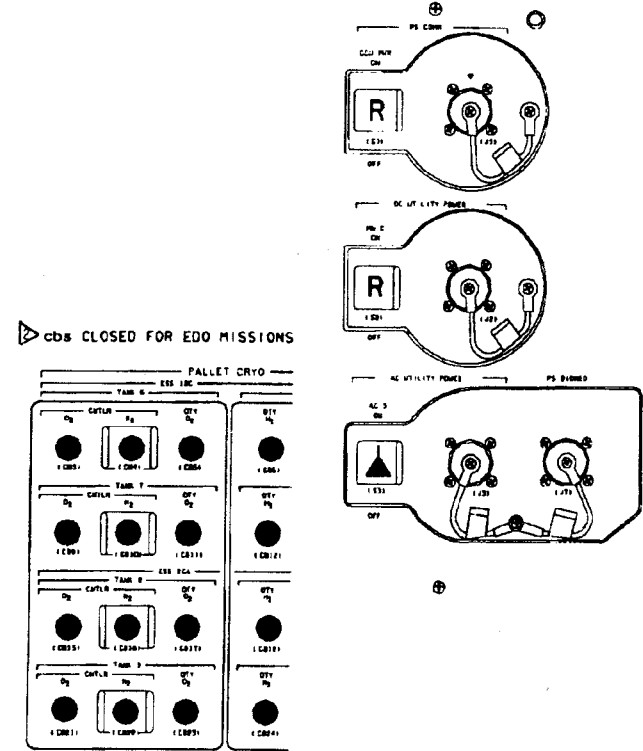

132. PNL 2

ENTRY (27)

ALL VEH/DATE 09/29/94

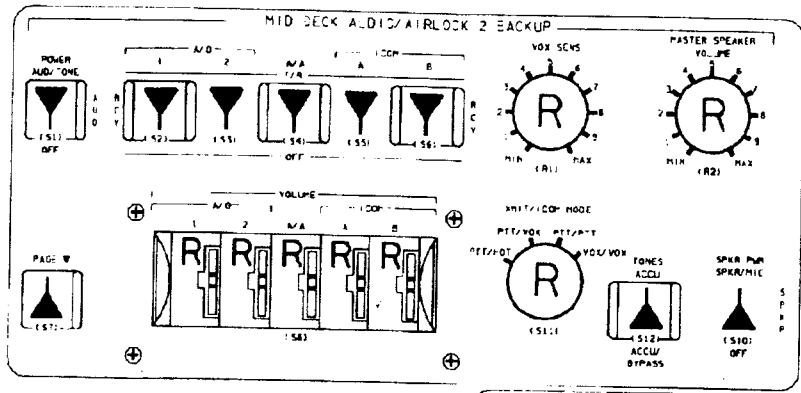

PNL M042F

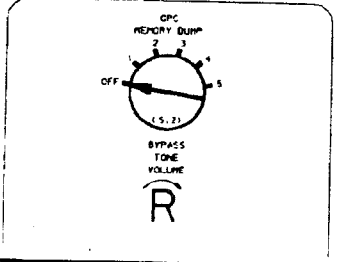

OV102

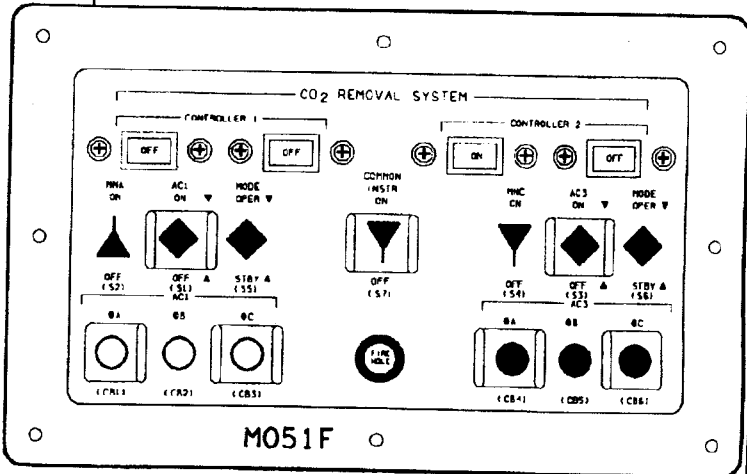

M051F

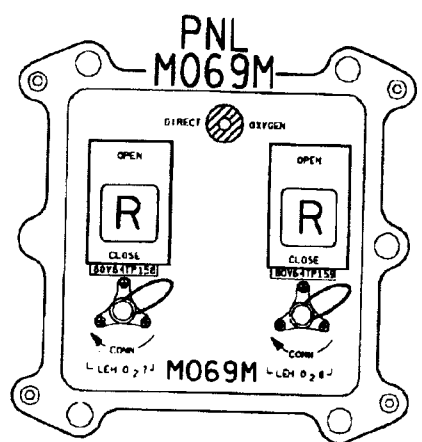
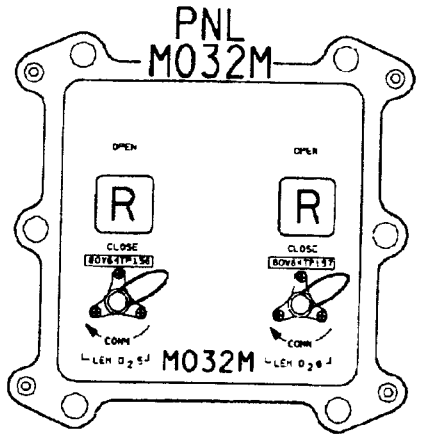

133. PNL 1

ENTRY (28)

ALL VEH/DATE 09/29/94

OV102/OV103/OV105

PNL MA73C

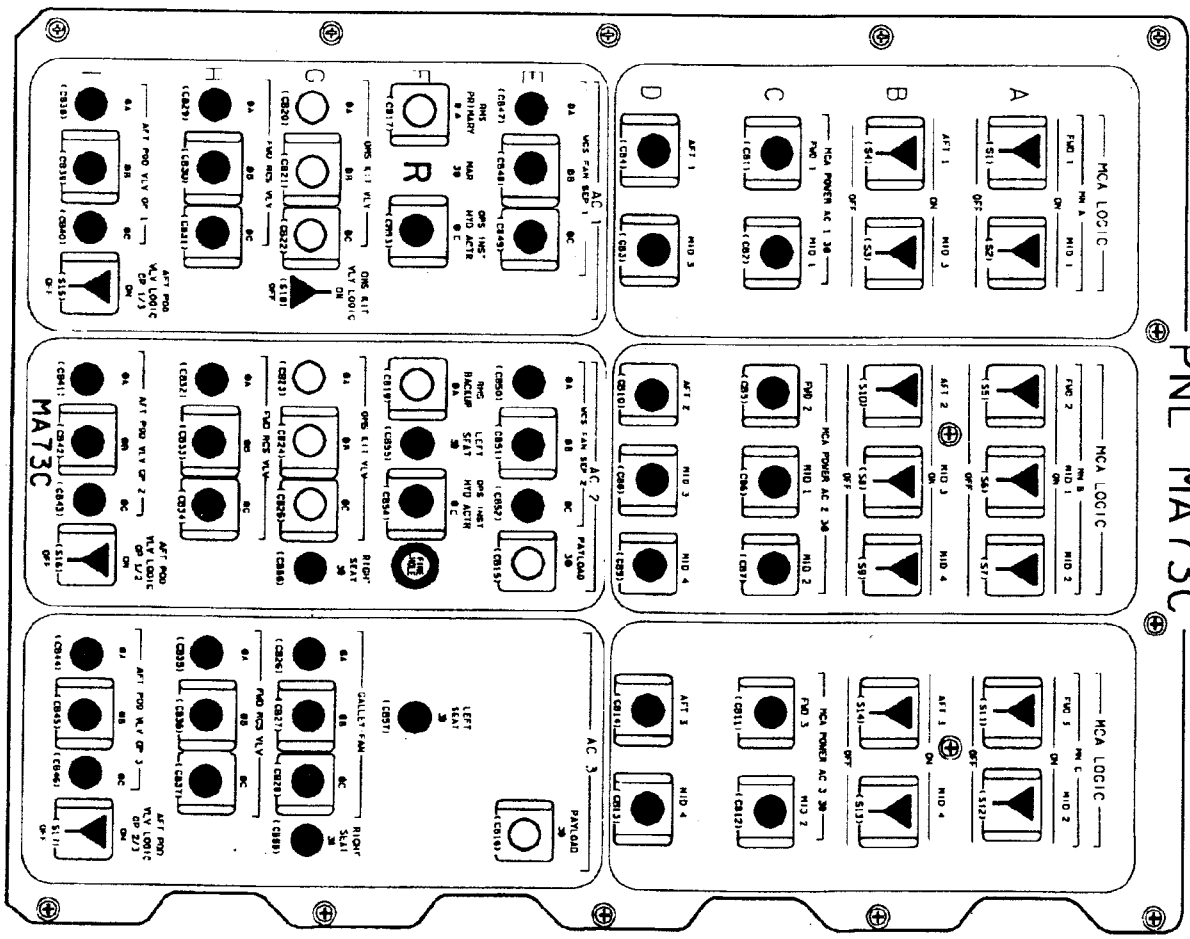

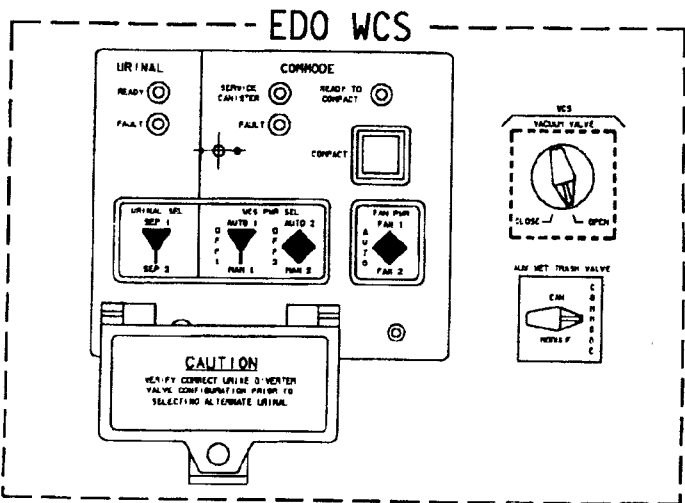
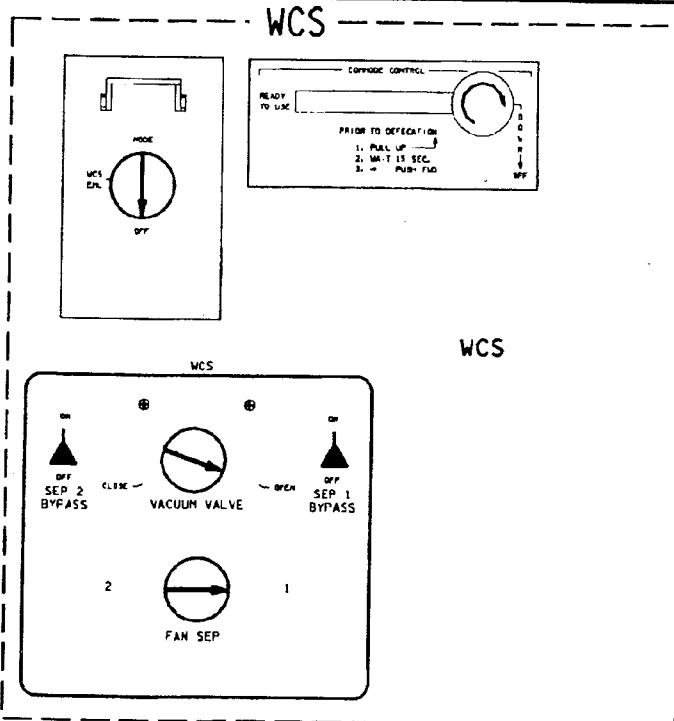
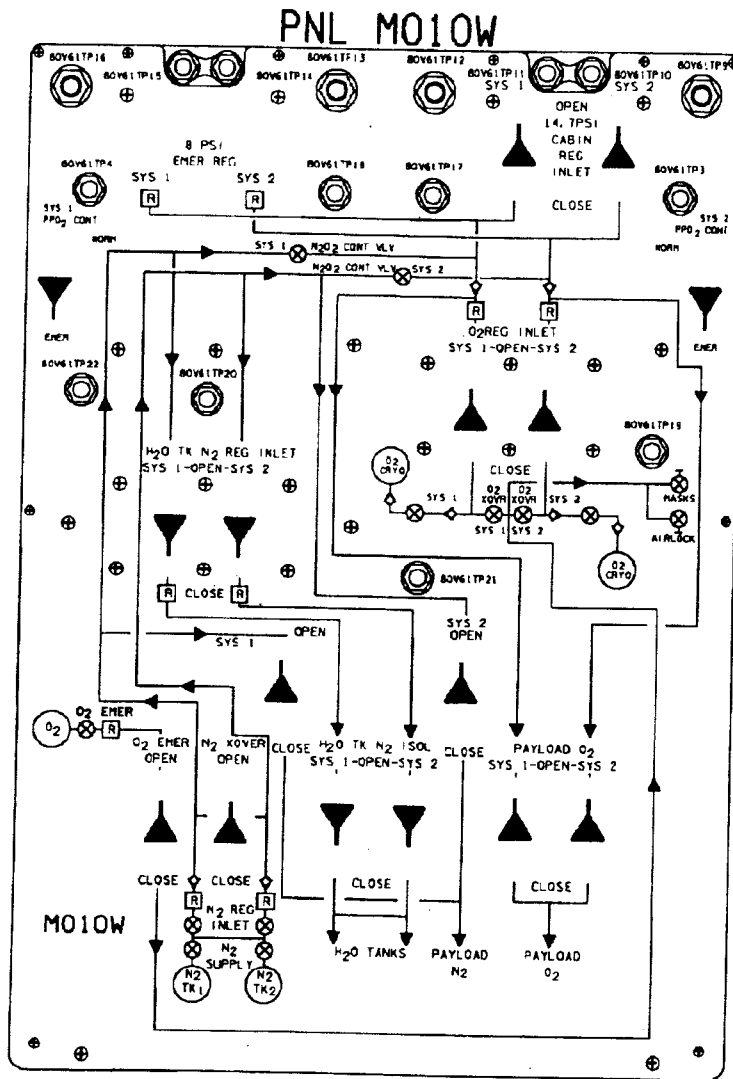

135.PNL;1 *

ENTRY (A30)
A3-30

ALL VEH/DATE 09/29/94

D/O/ALL/GEN H,2

PNL MA73C

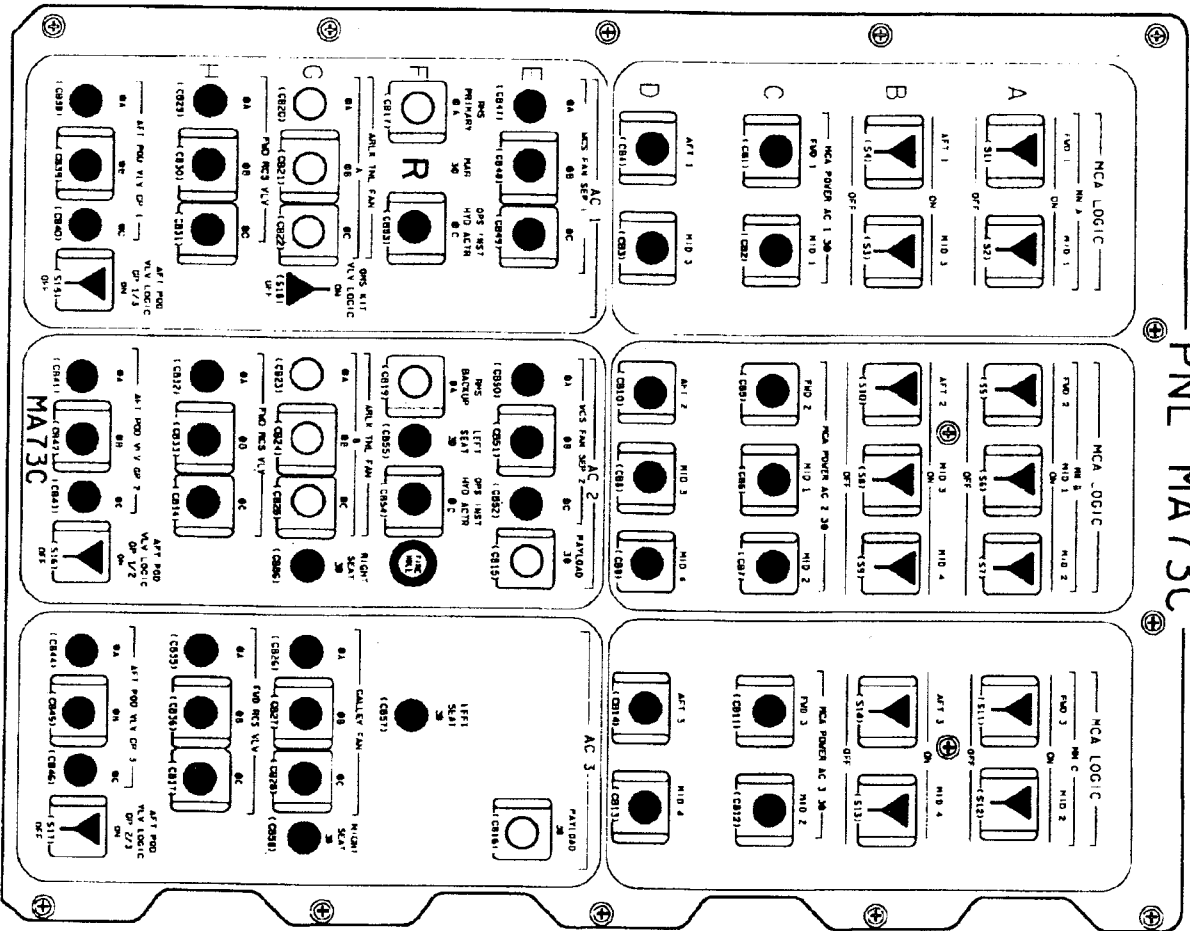

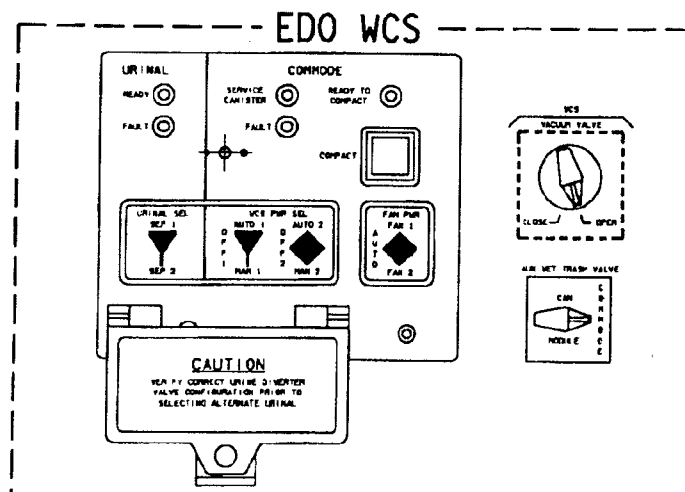
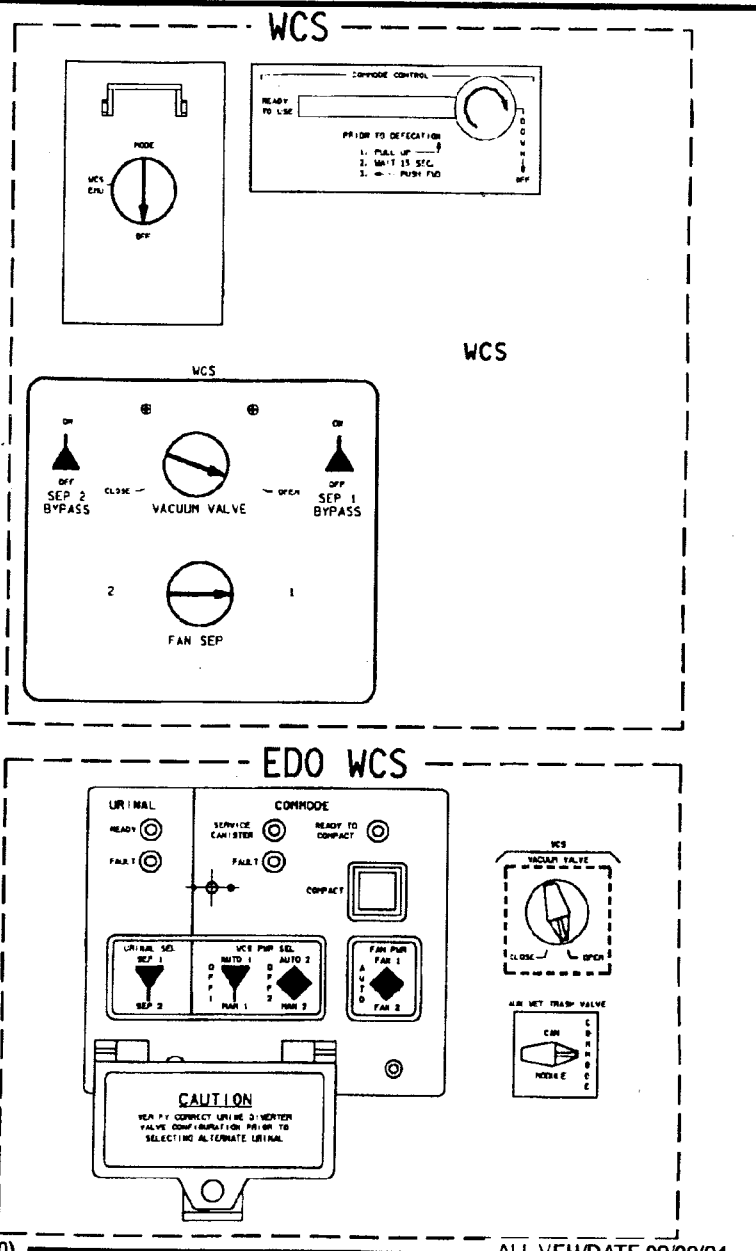
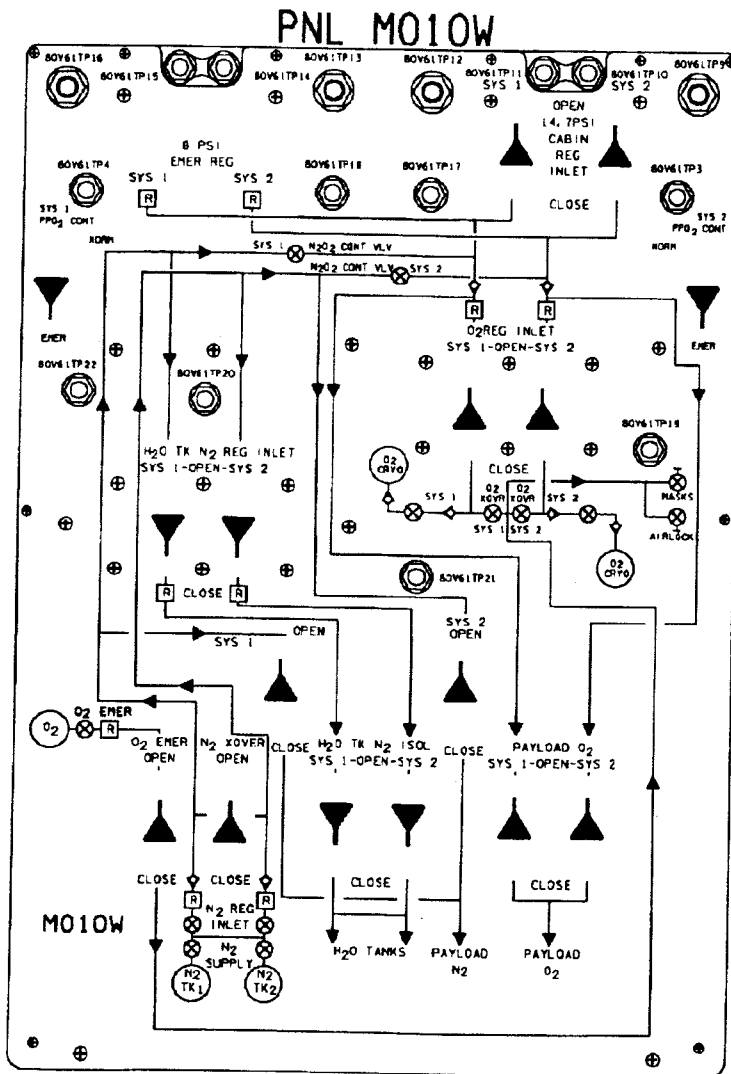

135.PNL;1 *

ENTRY (B30)

ALL VEH/DATE 09/29/94

B3-30

D/O/ALL/GEN H,2

BFS DEORBIT PREP NOTES

**BFS DEORBIT
PREP NOTES**

BFS DEORBIT PREP NOTES

- 1) BFS cannot support COAS Cal or an IMU Align
- 2) No AUTO DAP or AUTO TVC is available with BFS.
After OPS 304 Transition, CSS must be used
- 3) BFS does not support MSN TIMER updates
- 4) BFS supports manual RCS to RCS Xfeed only
- 5) BFS follows PASS port moding via BFS I/O RESET
- 6) BFS does not support the following switches:

NOTE

Boldface indicates items affected during Entry (MM 304)

LEFT SEAT

- C L1 H2O PUMP LOOP 1 (GPC pos only)
- F6 **ADI ERR
RATE
HSI SEL MODE
SOURCE 1, 2, 3**
- F7 **RDR ALTM**
- C, P C3 DAP pb (six)
MAN MODE TRANSLATION pb (eight)
jet option PRI,ALT,VERN pb
- O7 **MSTR RCS XFEED**
AFT L,R RCS TK ISOL (six) (GPC pos only)
XFEED (four) (GPC pos only)

RIGHT SEAT

- P F8 **AIR DATA (slaved to CDRs)
ADI ERR
RATE
ATT (slaved to CDRs)
ATT REF pb
HSI SEL MODE
SOURCE TACAN, MLS, NAV
(slaved to CDRs)
RDR ALTM**
- F3 **R TRIM RHC/PNL**
- R2 HYD CIRC PUMP (three) (GPC pos only)
- AFT
- MS R12U FC PURGE VLV (three) (GPC pos only)*
HTR (GPC pos only)*
GPC PURGE SEQ

*FC PURGE valve and heater functions can be ground-commanded through BFS when switches are in GPC position. Therefore, place these switches in GPC for entry

CONTINGENCY DELTAS TO NOMINAL DEORBIT PREP

**CONTINGENCY
DELTAS**

CONTINGENCY DELTAS TO NOMINAL DEORBIT PREP

NOTE

Perform NOMINAL DEORBIT PREP procedure with
CONTINGENCY DELTAS for specific case

LOSS OF 2 CAB FANS	5-3
LOSS OF AV BAY AIR COOLING	5-4
8 PSI DEORBIT PREP	5-6
AV BAY FIRE	5-8

LOSS OF 2 CAB FANS Assumes LOSS OF 2 CAB FANS (ORB PKT, PWRDN) accomplished

1. Minimize use of CRTs, FLT CNTLR PWR, INST PWR, DDU's to reduce cabin heat load and to save for use during entry
2. Minimize lighting
3. Wipe off any visible moisture with towels
4. Use CRT 4 when possible. Use one CRT as required. Use two CRTs for IMU ALIGN, two CRTs for DPS ENTRY CONFIG. Save two CRTs for entry
5. In DED DISP ENT CONFIG, do not power DDU's, INST PWR unless required. Minimize use
6. Replace SPACELAB FINAL DEACT with:
R1 PL PRI MNC, FC3, MNB (three) - OFF (tb-OFF)
AUX - OFF
CAB - OFF
AFT MNB, MNC (two) - OFF
7. In DPS ENTRY CONFIG, skip SM CKPT except UL CNTL ENA - ITEM 36 EXEC. Skip MC9 RECONFIG
8. In CLOTHING CONFIG, prepare LESs for donning. Don QDM if cabin temp > 90 deg and discomfort occurs. If cabin temp > 95 deg and no evaporative cooling, don LES, activate O2, and close visor. Inflate anti-G Suit as needed for circulatory support
9. ENTRY SWITCH LIST/VER will not reflect powerdown items
10. FLUID LOADING: Continue drinking 8 oz container of water every 15 min with salt tablets every other 8 oz container through entry
11. Maintain tail Sun attitude/leave window shades installed until TIG-15 minutes

For ENTRY C/L deltas, go to LOSS OF 2 CAB FANS (ENT PKT, PWRDN)

LOSS OF AV BAY AIR COOLING Assumes MAL, DPS, GPC FRP-7 accomplished

1. For Av Bay 1 or 2 loss, skip all of DPS CONFIG FOR D/O PREP except ENSURE BFS CAN DRIVE A CRT
If Av Bay 3 loss, perform all of DPS CONFIG FOR D/O PREP
2. In APU/HYD CONFIG:
 If AV BAY 1 or 2 air cooling lost:
 | FCS CH (four) - ORIDE
 If AV BAY 3 air cooling lost:
 ✓FCS CH 1,2,3 (three) - AUTO
 4 - OFF
3. In DED DISP ENT CONFIG, delay activation of affected TACANS, MLS, AA, ADTAs (EQUIP COOLING MATRIX, ORB PKT, ECLS); deactivate if already activated
4. During DPS ENTRY CONFIG
 - a. If loss of AV BAY 3, do not activate GPC 3
 - b. In all cases, substitute appropriate NBAT in following activities:
 TRANSITION GPC 1 & 2 TO GNC OPS 3 TRANSITION GPC 1,2,3,4 TO GNC OPS 3

CONFIG GPC	LOSS OF		
	BAY 1	BAY 2	BAY 3
	3 02000	3 10000	3 12000
STR 1	2	1	1
2	2	1	2
3	2	1	1
4	2	1	2
PL 1/2	0	0	0
CRT 1	2	1	1
2	2	1	2
3	2	1	2
4	0	0	0
L 1	0	0	0
2	0	0	0
MM 1	2	1	1
2	2	1	2

CONFIG GPC	LOSS OF		
	BAY 1	BAY 2	BAY 3
	3 02300	3 10040	3 12040
STR 1	3	1	1
2	2	4	2
3	3	1	4
4	2	4	2
PL 1/2	2	1	1
CRT 1	2	1	1
2	3	4	2
3	2	1	4
4	0	0	0
L 1	0	0	0
2	0	0	0
MM 1	2	1	1
2	3	4	2

LOSS OF AV BAY AIR COOLING (Cont)

4. Cont

RECONFIG MC 9 TABLE (GNC 9) FOR POST LANDING →

CONFIG GPC	LOSS OF		
	BAY 1	BAY 2	BAY 3
	9 02300	9 10040	9 12040
STR 1	3	1	1
2	2	4	2
3	3	1	4
4	2	4	2
PL 1/2	2	1	1
CRT 1	2	1	1
2	3	4	2
3	0	0	4
4	3	4	0
L 1	0	0	1
2	0	0	2
MM 1	2	1	1
2	3	4	2

5. In C.P ENT FWD FLT DECK CONFIG:

O14:A
O15:A
O16:A

If AV BAY 1 air cooling lost:

- ✓BRAKES MNA - OFF
- MNB - ON
- ✓MNC - OFF

If AV BAY 2 air cooling lost:

O14:A
O15:A
O16:A

- BRAKES MNA - ON
- ✓MNB - OFF
- MNC - ON

6. ENT SWITCH LIST/VERIF will not reflect powerdown items

7. Incorporate following pen and inks to ENT

MNVR Cue Cards:

EI: Power up affected air cooled equipment
except affected TACAN (EQUIP COOLING
MATRIX, ENT PKT, ECLS)

V = 10K: If unaffected TACAN failed,
(O7) Affected TACAN MODE - GPC

8. If just prior to OPS 302 TRANSITION, affected GPCs have
been in HALT for ≥ 3.5 hr, add to RS as follows:

- a. Modify MC3 per table →
- b. MODE affected GPCs to RUN
- c. BFC CRT DISP - OFF
OPS 301 PRO
BFC CRT DISP - ON
BFS GNC I/O RESET
- d. FCS CH (four) - AUTO

CONFIG GPC	LOSS OF		
	BAY 1	BAY 2	BAY 3
	3 12340	3 12045	3 12340
STR 1	1	1	1
2	2	2	2
3	3	4	4
4	4	5	3
PL 1/2	2	1	1
CRT 1	2	1	1
2	1	2	2
3	3	4	4
4	0	0	0
L 1	0	0	0
2	0	0	0
MM 1	2	1	1
2	3	4	2

9. Update GPC/FCS CHANNEL CONFIGURATION Cue Card

8 PSI DEORBIT PREP Assumes LOSS OF CABIN PRESS (ORB PKT, PWRDN) accomplished

If TIG < 4 hr: Begin NOMINAL DEORBIT PREP timeline 1-7 immediately and perform procedures as rapidly as possible with all following CONTINGENCY DELTAS except steps 6 and 10

If TIG > 4 hr: Perform steps 1, 2, and 3;

At TIG-4 hr, perform NOMINAL DEORBIT PREP with all remaining CONTINGENCY DELTAS

1. Back out of PRIORITY PWRDN, as reqd (ORB PKT, PRIOR PWRDN)
2. If previous FC PURGE was not accomplished within last 6 hr: Accomplish FC PURGE (ORB OPS, EPS) any time prior to DPS ENTRY CONFIG
3. MS accomplish CABIN CONFIG/STOW (FLIGHT PLAN) as time permits
4. Leave shades in until SEAT INGRESS
5. Minimize CRT use until TIG-20
6. Do not perform DPS CONFIG FOR D/O PREP
7. Replace RAD BYPASS/FES C/O with following:
 - R11L SPLY H2O XOVR VLV - OP (tb-OP)
 - TKC INLET - OP (tb-OP)
 - OUTLET - OP (tb-OP)
 - L1 FLASH EVAP CNTLR PRI A - OFF
 - B - ON
 - ✓HI LOAD DUCT HTR - B
 - EVAP - ENA
 - RAD BYP VLV MODE (two) - MAN
 - MAN SEL (two) - BYP (tb-BYP ~3 sec)
 - RAD CNTLR LOOP (two) - OFF
 - After 2.5 min:
 - O1 ✓FREON EVAP OUT TEMP ind: 39 ± 1 degF
 - L1 ✓FLOW PROP VLV LOOP 1,2 (two) tb - ICH
 - RAD CNTLR OUT TEMP - NORM
8. In DED DISP ENT CONFIG, delay activation of ADTAs, TACANs, MLS, RAs, DDUs, and INST PWR
9. Replace SPACELAB FINAL DEACT with:
 - R1 PL PRI MNC,FC3,MNB (three) - OFF (tb-OFF)
 - AUX - OFF
 - CAB - OFF
 - AFT MNB,MNC (two) - OFF
10. Immediately prior to DPS ENTRY CONFIG, activate GPCs 1 & 5; then proceed with nominal DPS ENTRY CONFIG
11. ENTRY SWITCH LIST/VER will not reflect powered down items

Cont next page

8 PSI DEORBIT PREP (Cont)

IN ENT C/L

1. At TIG-15, activate DDU's and INST PWR
2. At EI-5, activate ADTAs
3. At V = 15K, activate TACANs, MLS, RAs

Cont next page

5-7

D/O/ALL/GEN H

AV BAY FIRE Assumes AV BAY FIRE (ORB PKT, PWRDN) and MAL, ECLS SSR-12, AV BAY FIRE RECOVERY/RECONFIG accomplished

1. For Av Bay 1 or 2 loss, skip all of DPS CONFIG FOR D/O PREP except ENSURE BFS CAN DRIVE A CRT
If Av Bay 3 loss, perform all of DPS CONFIG FOR D/O PREP
2. In APU/HYD CONFIG:
If AV BAY 1 or 2 air cooling lost:
| FCS CH (four) - ORIDE
If AV BAY 3 air cooling lost:
| ✓FCS CH 1,2,3 (three) - AUTO
| 4 - OFF
3. During DED DISP ENT CONFIG, power up only 3 ADTAs, 3 AAs, 2 MLSs, and 2 TACANs

Cont next page

AV BAY FIRE (Cont)

4. During DPS ENTRY CONFIG

- a. If loss of Av Bay 3, do not pwrap GPC 3
- b. During SM CHECKPOINT, skip MMU 1 (if Av Bay 1) or MMU 2 (if Av Bay 2)
- c. Using column for affected Av Bay, substitute appropriate NBAT in following activities

TRANSITION GPC 1 & 2 TO OPS 3

CONFIG GPC	LOSS OF		
	BAY 1	BAY 2	BAY 3
	3 02000	3 10000	3 12000
STR 1	2	1	1
2	2	1	2
3	2	1	1
4	2	1	2
PL 1/2	0	0	0
CRT 1	2	1	1
2	2	1	2
3	2	1	2
4	0	0	0
L 1	0	0	0
2	0	0	0
MM 1	2	1	1
2	2	1	2

TRANSITION GPC 1,2,3,4 TO OPS 3

CONFIG GPC	LOSS OF		
	BAY 1	BAY 2	BAY 3
	3 02300	3 10040	3 12040
STR 1	3	1	1
2	2	4	2
3	3	1	4
4	2	4	2
PL 1/2	2	1	1
CRT 1	2	1	1
2	3	4	2
3	2	1	4
4	0	0	0
L 1	0	0	0
2	0	0	0
MM 1	2	1	1
2	3	4	2

RECONFIG MC 9 TABLE (GNC 9)
FOR POST LANDING

CONFIG GPC	LOSS OF		
	BAY 1	BAY 2	BAY 3
	9 02300	9 10040	9 12040
STR 1	3	1	1
2	2	4	2
3	3	1	4
4	2	4	2
PL 1/2	2	1	1
CRT 1	2	1	1
2	3	4	2
3	0	0	4
4	3	4	0
L 1	0	0	1
2	0	0	2
MM 1	2	1	1
2	3	4	2

5. ENT SWITCH LIST/VERIF pictorials will not reflect powerdown items

PLBD CONTINGENCY EVA TIMELINE

FLIGHT: PLBD EVA 102 EDITION: FROM D/O PREP TO EOM+1 PUB. DATE: 5/96

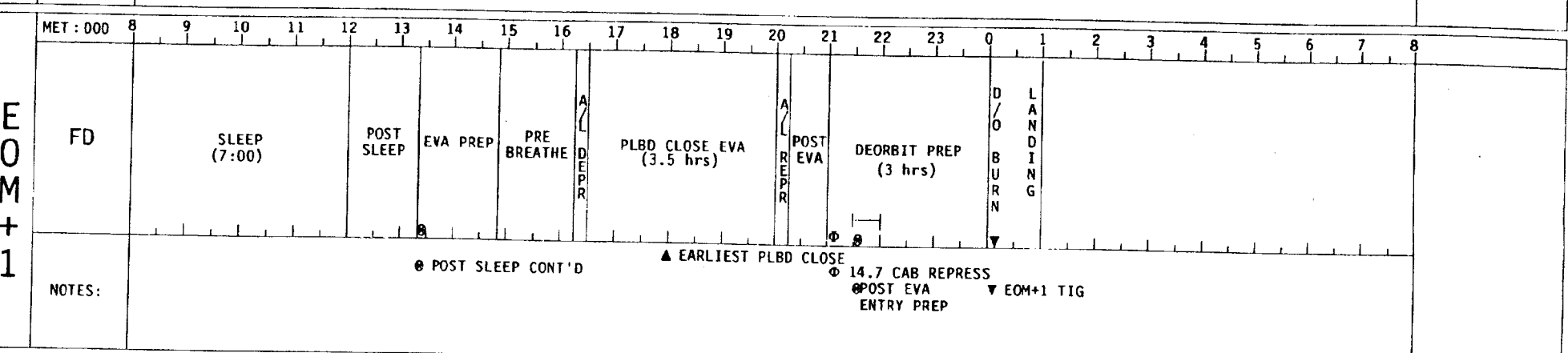
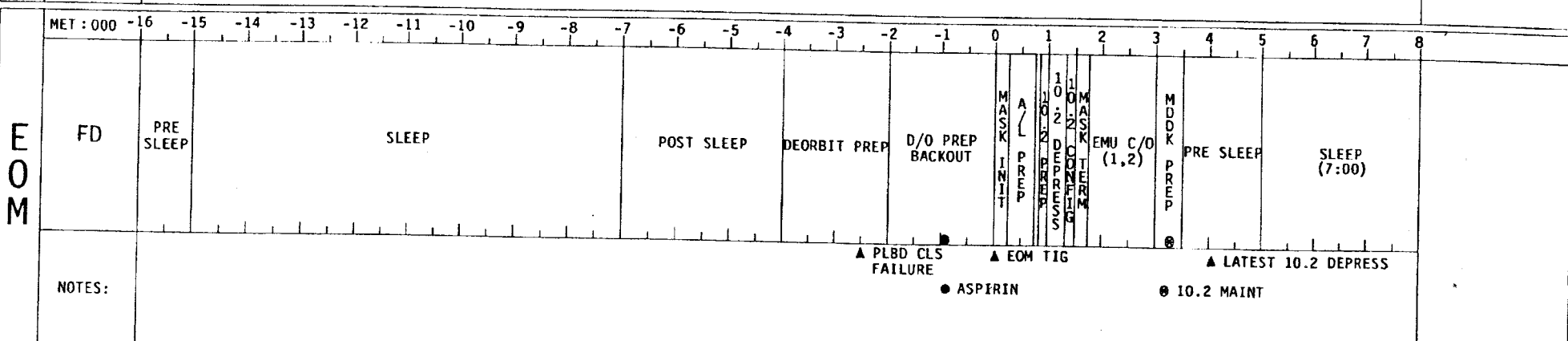
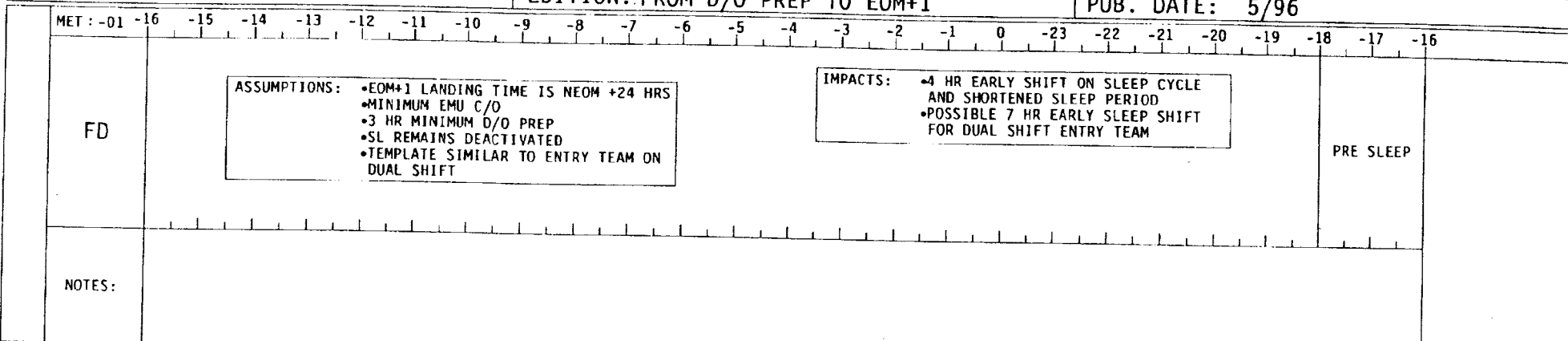

PLBD CONTINGENCY EVA NOTES

1. This timeline is an overview template that covers a payload bay door contingency EVA with a 10.2 cabin depress. The scenario starts from a closure failure 1.5 hr into the deorbit prep followed by a D/O PREP BACKOUT and Cabin depress activities. The EVA and landing will occur on the EOM + 1 day.
2. The timeline assumes that a two-crewmember 3.5 hr EVA to repair the problem is immediately followed by an entry to the prime landing site.
3. Specific procedure block callouts for the EV and IV crewmembers during the EVA will be coordinated realtime.
4. RCS hot fire testing, FCS C/O, and CABIN STOW are assumed to be previously accomplished.
5. The timeline utilizes minimum activity durations for POST/PRE SLEEPS, EMU C/O, and DEORBIT PREP.
6. The crew will be required to perform A/L PREP during the Mask Pre-Breathe prior to cabin depress.
7. Due to the necessity of performing the EVA on the same day as landing, the crew is required to start their sleep period 3.5 hr earlier than the previous day.
8. This template can be adapted for Dual Shift timelines by scheduling the Non-Entry team's sleep with the Entry team's sleep in order to modify the timeline to single shift operations.
9. The MET scale on this timeline is actually a PET scale counting down to nominal deorbit TIG.

HARDWARE CONTINGENCY EVA TIMELINE

7-1

D/O/ALL/GEN H

HARDWARE
EVA

HARDWARE EVA

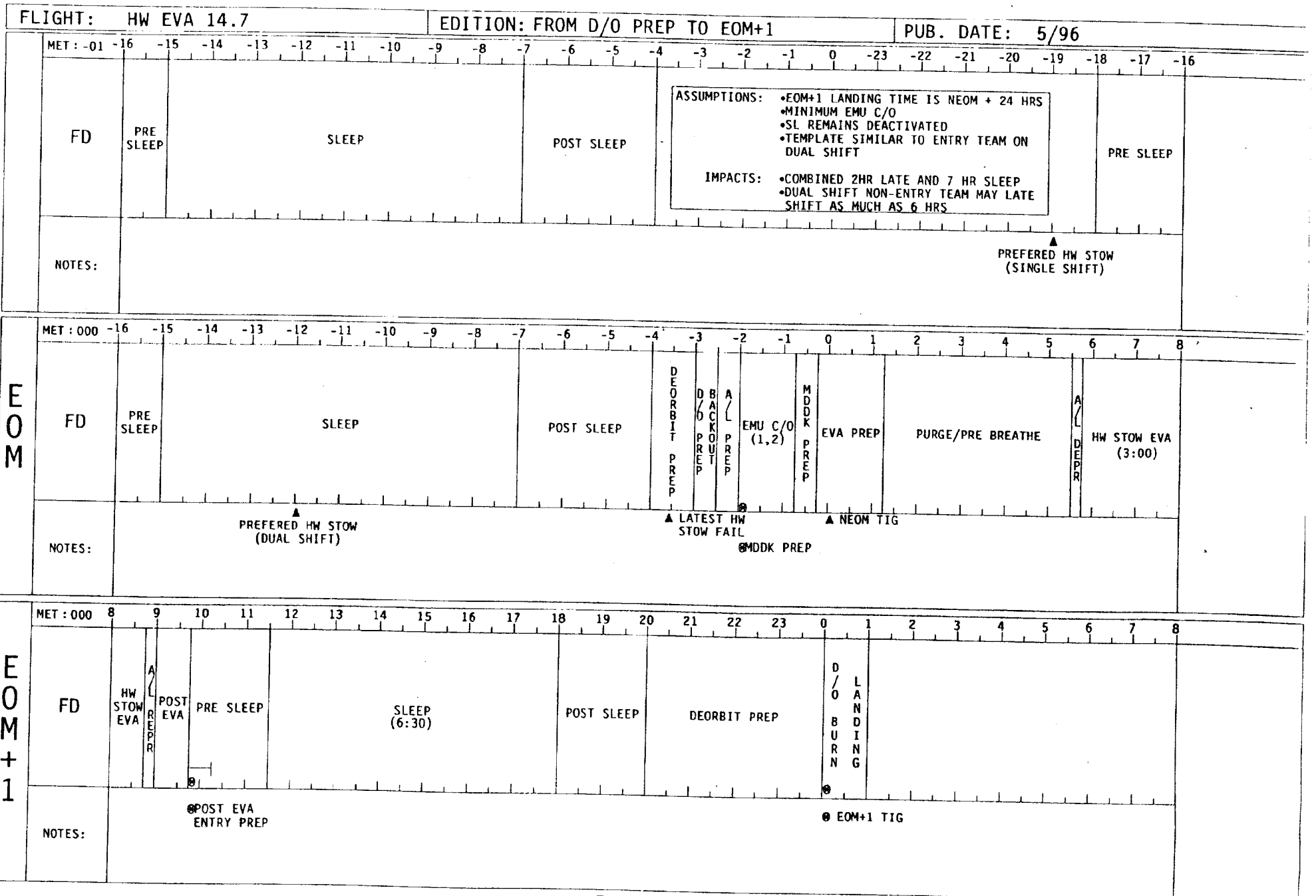

HARDWARE CONTINGENCY EVA NOTES

1. This timeline is an overview template that covers KU antenna, RMS, and RAD stow contingency EVAs with a "no cabin depress" scenario starting from a stow failure as late as 30 min into the deorbit prep. The Pre-Breathe and EVA will be performed after D/O BACKOUT is complete and a landing will occur on the EOM + 1 day.
2. The timeline assumes a two-crewmember 3 hr EVA to repair the problem.
3. Specific procedure block callouts for the EV and IV crewmembers during the EVA will be coordinated realtime.
4. RCS hot fire testing, FCS C/O, and CABIN STOW are assumed to be previously accomplished.
5. The timeline utilizes minimum activity durations for EMU C/O, and PRE/POST SLEEP.
6. Due to the necessity of the timeline, the crew is required to shorten their sleep to 7 hr and shift the sleep late by 2 hr.
7. This template can be adapted for Dual Shift by scheduling the Non-Entry team's sleep with the Entry team's sleep in order to modify the timeline to single shift operations.
8. The MET scale on this timeline is actually a PET scale counting down to nominal deorbit TIG.