

Deorbit Prep

**Mission Operations Directorate
Operations Division**

**Generic, Rev L
March 15, 2001**

NOTE
For STS-100 and subsequent flights

National Aeronautics and
Space Administration

Lyndon B. Johnson Space Center
Houston, Texas

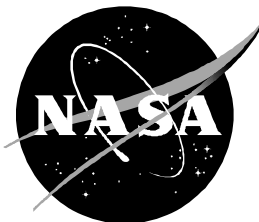

United Space Alliance

Verify this is the correct version for the pending operation (training, simulation or flight).
Electronic copies of FDF books are available. URL: <http://fltproc.jsc.nasa.gov/dfd>

DEORBIT PREP	GENERIC REV L (Mar 15, 2001)
---------------------	-------------------------------------

PCN-7 (Feb 11, 2002) Sheet 1 of 1

List of Implemented Change Requests (482s):

D/O-735 MULTI-1589A
 MULTI-1591

NOTE
 For STS-109 and subsequent flights

Incorporate the following:

1. Replace iii thru viii
2. Replace (MEDS) A1-25 and (MEDS) A1-26, (NOM) B1-25 and (NOM) B1-26
3. Replace (OV102) A3-3 thru (OV102) A3-8, (OV102) A3-11 and (OV102) A3-12, (OV102) A3-15 and (OV102) A3-16, (OV102) A3-19 and (OV102) A3-20, (OV102) A3-23 and (OV102) A3-24

Prepared by: _____
Book Manager

Approved by: _____
Manager, Shuttle Procedures Management (USA)

Accepted by: _____
FDF Subsystem Manager (NASA)

Encl: 24 pages

File this PCN immediately behind the front cover as a permanent record

MISSION OPERATIONS DIRECTORATE

DEORBIT PREP

GENERIC, REVISION L

March 15, 2001

PREPARED BY:

Michael Feierstein
Book Manager

APPROVED BY:

Deborah J. Jackson
Manager, Shuttle Procedures Management (USA)

ACCEPTED BY:

John W. Bearley
FDF Subsystem Manager (NASA)

This document is under the configuration control of the Crew Procedures Control Board (CPCB). All proposed changes must be submitted on JSC Form 482 to DO3/FDF Manager.

Additional distribution of this book for official use must be requested in writing to DO3/FDF Manager. The request must include justification and requester's name, organization, position, and phone number. Contractor requests are made through the NASA or DOD organization supported. Deletions, reduction in quantity, or change of address may be submitted to DO3/FDF Management Office, 281-244-1184.

Incorporates the following:		
482#:	D/O-682	D/O-712
	D/O-687A(P)	D/O-715
	D/O-692	D/O-716
	D/O-707	D/O-718

(P) – Previously implemented in an earlier publication

AREAS OF TECHNICAL RESPONSIBILITY

Book Manager

DO3/M. Feierstein

281-483-1861

DEORBIT PREP

LIST OF EFFECTIVE PAGES

GENERIC	09/16/87
REV L	03/15/01
PCN-1	04/26/01
PCN-2	05/31/01
PCN-3	08/20/01
PCN-4	10/22/01
PCN-5	11/01/01
PCN-6	12/21/01
PCN-7	02/11/02

Sign Off	*	ALL/GEN L
ii	*	ALL/GEN L
iii	*	ALL/GEN L,7
iv	*	ALL/GEN L,7
v	*	ALL/GEN L,7
vi	*	ALL/GEN L,7
vii	*	ALL/GEN L,7
viii	*	ALL/GEN L
ix		ALL/GEN L
x		ALL/GEN L
(MEDS) A1-1		ALL/GEN L
(MEDS) A1-2		ALL/GEN L
(MEDS) A1-3		MEDS/GEN L
(MEDS) A1-4		ALL/GEN L
(MEDS) A1-5		ALL/GEN L
(MEDS) A1-6		ALL/GEN L
(MEDS) A1-7		ALL/GEN L
(MEDS) A1-8		MEDS/GEN L
(MEDS) A1-9		MEDS/GEN L,3
(MEDS) A1-10		ALL/GEN L
(MEDS) A1-11		ALL/GEN L,3
(MEDS) A1-12		MEDS/GEN L
(MEDS) A1-13		ALL/GEN L,3
(MEDS) A1-14		ALL/GEN L
(MEDS) A1-15		ALL/GEN L,4
(MEDS) A1-16		ALL/GEN L
(MEDS) A1-17		ALL/GEN L
(MEDS) A1-18		ALL/GEN L
(MEDS) A1-19		ALL/GEN L
(MEDS) A1-20		ALL/GEN L
(MEDS) A1-21		MEDS/GEN L
(MEDS) A1-22		ALL/GEN L
(MEDS) A1-23		MEDS/GEN L
(MEDS) A1-24		ALL/GEN L
(MEDS) A1-25	†	MEDS/GEN L,3
(MEDS) A1-26	†	MEDS/GEN L,7
(MEDS) A1-27	†	ALL/GEN L,3
(MEDS) A1-28	†	ALL/GEN L
(NOM) B1-1		ALL/GEN L
(NOM) B1-2		ALL/GEN L
(NOM) B1-3		NOM/GEN L
(NOM) B1-4		ALL/GEN L
(NOM) B1-5		ALL/GEN L

* - Omit from flight book

† - Extra copies of appropriate pages flown in back of MS2's book only

(NOM) B1-6	ALL/GEN L
(NOM) B1-7	ALL/GEN L
(NOM) B1-8	NOM/GEN L
(NOM) B1-9	NOM/GEN L,3
(NOM) B1-10	ALL/GEN L
(NOM) B1-11	ALL/GEN L,3
(NOM) B1-12	NOM/GEN L
(NOM) B1-13	ALL/GEN L,3
(NOM) B1-14	ALL/GEN L
(NOM) B1-15	ALL/GEN L,4
(NOM) B1-16	ALL/GEN L
(NOM) B1-17	ALL/GEN L
(NOM) B1-18	ALL/GEN L
(NOM) B1-19	ALL/GEN L
(NOM) B1-20	ALL/GEN L
(NOM) B1-21	NOM/GEN L
(NOM) B1-22	ALL/GEN L
(NOM) B1-23	NOM/GEN L
(NOM) B1-24	ALL/GEN L
(NOM) B1-25 †	NOM/GEN L,3
(NOM) B1-26 †	NOM/GEN L,7
(NOM) B1-27 †	ALL/GEN L,3
(NOM) B1-28 †	ALL/GEN L
(MEDS) A2-1	ALL/GEN L
(MEDS) A2-2	ALL/GEN L
(MEDS) A2-3	ALL/GEN L
(MEDS) A2-4	ALL/GEN L
(MEDS) A2-5	MEDS/GEN L
(MEDS) A2-6	MEDS/GEN L
(MEDS) A2-7	MEDS/GEN L,4
(MEDS) A2-8	ALL/GEN L
(MEDS) A2-9	MEDS/GEN L
(MEDS) A2-10	ALL/GEN L
(MEDS) A2-11	ALL/GEN L,1
(MEDS) A2-12	ALL/GEN L
(MEDS) A2-13	ALL/GEN L,4
(MEDS) A2-14	ALL/GEN L
(MEDS) A2-15 †	ALL/GEN L,3
(MEDS) A2-16 †	ALL/GEN L
(MEDS) A2-17 †	ALL/GEN L,3
(MEDS) A2-18 †	ALL/GEN L,2
(NOM) B2-1	ALL/GEN L
(NOM) B2-2	ALL/GEN L
(NOM) B2-3	ALL/GEN L
(NOM) B2-4	ALL/GEN L
(NOM) B2-5	NOM/GEN L
(NOM) B2-6	NOM/GEN L
(NOM) B2-7	NOM/GEN L,4
(NOM) B2-8	ALL/GEN L
(NOM) B2-9	NOM/GEN L
(NOM) B2-10	ALL/GEN L
(NOM) B2-11	ALL/GEN L,3
(NOM) B2-12	ALL/GEN L
(NOM) B2-13	ALL/GEN L,4
(NOM) B2-14	ALL/GEN L
(NOM) B2-15 †	ALL/GEN L,3
(NOM) B2-16 †	ALL/GEN L
(NOM) B2-17 †	ALL/GEN L,3

† – Extra copies of appropriate pages flown in back of MS2's book only

(NOM) B2-18	† ALL/GEN L,2
3-1	ALL/GEN L
3-2	ALL/GEN L,1
(OV102) A3-3	ALL/GEN L
(OV102) A3-4	2/GEN L,7
(OV102) A3-5	ALL/GEN L
(OV102) A3-6	2/GEN L,7
(OV102) A3-7	2/GEN L,7
(OV102) A3-8	ALL/GEN L
(OV102) A3-9	2/GEN L
(OV102) A3-10	2/GEN L
(OV102) A3-11	2/GEN L,7
(OV102) A3-12	2/GEN L,7
(OV102) A3-13	2/GEN L,6
(OV102) A3-14	ALL/GEN L
(OV102) A3-15	2/GEN L,3
(OV102) A3-16	2/GEN L,7
(OV102) A3-17	2/GEN L
(OV102) A3-18	2/GEN L,1
(OV102) A3-19	2/GEN L,7
(OV102) A3-20	2/GEN L,6
(OV102) A3-21	ALL/GEN L
(OV102) A3-22	2/GEN L
(OV102) A3-23	2/GEN L,7
(OV102) A3-24	ALL/GEN L,1
(OV102) A3-25	2/GEN L,6
(OV102) A3-26	ALL/GEN L
(OV102) A3-27	2/GEN L,1
(OV102) A3-28	2/GEN L,1
(OV102) A3-29	2/GEN L,1
(OV102) A3-30	ALL/GEN L,1
(OV103) B3-3	ALL/GEN L
(OV103) B3-4	3/GEN L
(OV103) B3-5	ALL/GEN L
(OV103) B3-6	3/GEN L
(OV103) B3-7	3/GEN L
(OV103) B3-8	ALL/GEN L
(OV103) B3-9	3/GEN L
(OV103) B3-10	3/GEN L
(OV103) B3-11	3/GEN L,3
(OV103) B3-12	3/GEN L
(OV103) B3-13	3/GEN L
(OV103) B3-14	ALL/GEN L
(OV103) B3-15	3/GEN L,5
(OV103) B3-16	3/GEN L
(OV103) B3-17	3/GEN L
(OV103) B3-18	3/GEN L
(OV103) B3-19	3/GEN L
(OV103) B3-20	3/GEN L
(OV103) B3-21	ALL/GEN L
(OV103) B3-22	ALL/GEN L
(OV103) B3-23	3/GEN L
(OV103) B3-24	ALL/GEN L,1
(OV103) B3-25	3/GEN L,6
(OV103) B3-26	ALL/GEN L,1
(OV103) B3-27	3/GEN L,1
(OV103) B3-28	3/GEN L,1
(OV103) B3-29	3/GEN L,1
(OV103) B3-30	3/GEN L,1

† – Extra copies of appropriate pages flown in back of MS2's book only

(OV103) B3-31	3/GEN L,1
(OV103) B3-32	ALL/GEN L,1
(OV104) C3-3	ALL/GEN L
(OV104) C3-4	4/GEN L
(OV104) C3-5	ALL/GEN L
(OV104) C3-6	4/GEN L
(OV104) C3-7	4/GEN L
(OV104) C3-8	ALL/GEN L
(OV104) C3-9	4/GEN L
(OV104) C3-10	4/GEN L
(OV104) C3-11	4/GEN L,3
(OV104) C3-12	4/GEN L
(OV104) C3-13	4/GEN L
(OV104) C3-14	ALL/GEN L
(OV104) C3-15	4/GEN L,5
(OV104) C3-16	4/GEN L
(OV104) C3-17	4/GEN L
(OV104) C3-18	4/GEN L
(OV104) C3-19	4/GEN L
(OV104) C3-20	4/GEN L
(OV104) C3-21	ALL/GEN L
(OV104) C3-22	4/GEN L
(OV104) C3-23	4/GEN L
(OV104) C3-24	ALL/GEN L,1
(OV104) C3-25	4/GEN L,2
(OV104) C3-26	ALL/GEN L,1
(OV104) C3-27	4/GEN L,1
(OV104) C3-28	4/GEN L,1
(OV104) C3-29	4/GEN L,1
(OV104) C3-30	ALL/GEN L,1
(OV104) C3-31	4/GEN L,1
(OV104) C3-32	ALL/GEN L,1
(OV105) D3-3	ALL/GEN L
(OV105) D3-4	5/GEN L
(OV105) D3-5	ALL/GEN L
(OV105) D3-6	5/GEN L
(OV105) D3-7	5/GEN L
(OV105) D3-8	ALL/GEN L
(OV105) D3-9	5/GEN L
(OV105) D3-10	5/GEN L
(OV105) D3-11	5/GEN L,3
(OV105) D3-12	5/GEN L
(OV105) D3-13	5/GEN L
(OV105) D3-14	ALL/GEN L
(OV105) D3-15	5/GEN L,5
(OV105) D3-16	5/GEN L
(OV105) D3-17	5/GEN L
(OV105) D3-18	5/GEN L
(OV105) D3-19	5/GEN L
(OV105) D3-20	5/GEN L
(OV105) D3-21	ALL/GEN L
(OV105) D3-22	5/GEN L
(OV105) D3-23	5/GEN L,2
(OV105) D3-24	ALL/GEN L,1
(OV105) D3-25	5/GEN L,6
(OV105) D3-26	5/GEN L,1
(OV105) D3-27	5/GEN L,1
(OV105) D3-28	5/GEN L,1

(OV105) D3-29	5/GEN L,1
(OV105) D3-30	5/GEN L,1
(OV105) D3-31	5/GEN L,1
(OV105) D3-32	ALL/GEN L,1
4-1	ALL/GEN L
4-2	ALL/GEN L
5-1	ALL/GEN L
5-2	ALL/GEN L
(MEDS) A5-3	MEDS/GEN L
(MEDS) A5-4	MEDS/GEN L
(MEDS) A5-5	ALL/GEN L
(MEDS) A5-6	MEDS/GEN L,1
(MEDS) A5-7	MEDS/GEN L
(MEDS) A5-8	MEDS/GEN L
(MEDS) A5-9	ALL/GEN L
(MEDS) A5-10	ALL/GEN L
(NOM) B5-3	NOM/GEN L
(NOM) B5-4	NOM/GEN L
(NOM) B5-5	ALL/GEN L
(NOM) B5-6	NOM/GEN L,1
(NOM) B5-7	NOM/GEN L
(NOM) B5-8	NOM/GEN L
(NOM) B5-9	ALL/GEN L
(NOM) B5-10	ALL/GEN L
6-1	ALL/GEN L
6-2	ALL/GEN L
6-3	ALL/GEN L
6-4	ALL/GEN L
7-1	ALL/GEN L
7-2	ALL/GEN L
7-3	ALL/GEN L
7-4	ALL/GEN L

This Page Intentionally Blank

CONTENTS

PAGE

NOMINAL DEORBIT PREP PROCEDURES	1-1
DEORBIT PREP BACKOUT PROCEDURES	2-1
ENTRY SWITCH LIST/VERIFICATION	3-1
BFS DEORBIT PREP NOTES	4-1
CONTINGENCY DELTAS TO NOMINAL DEORBIT PREP	5-1
PLBD CONTINGENCY EVA TIMELINE	6-1
HARDWARE CONTINGENCY EVA TIMELINE	7-1

This Page Intentionally Blank

NOMINAL DEORBIT PREP PROCEDURES

(MEDS) A1-1

D/O/ALL/GEN L

**NOMINAL
DEORBIT PREP**

This Page Intentionally Blank

NOMINAL DEORBIT PREP SUMMARY TIMELINE

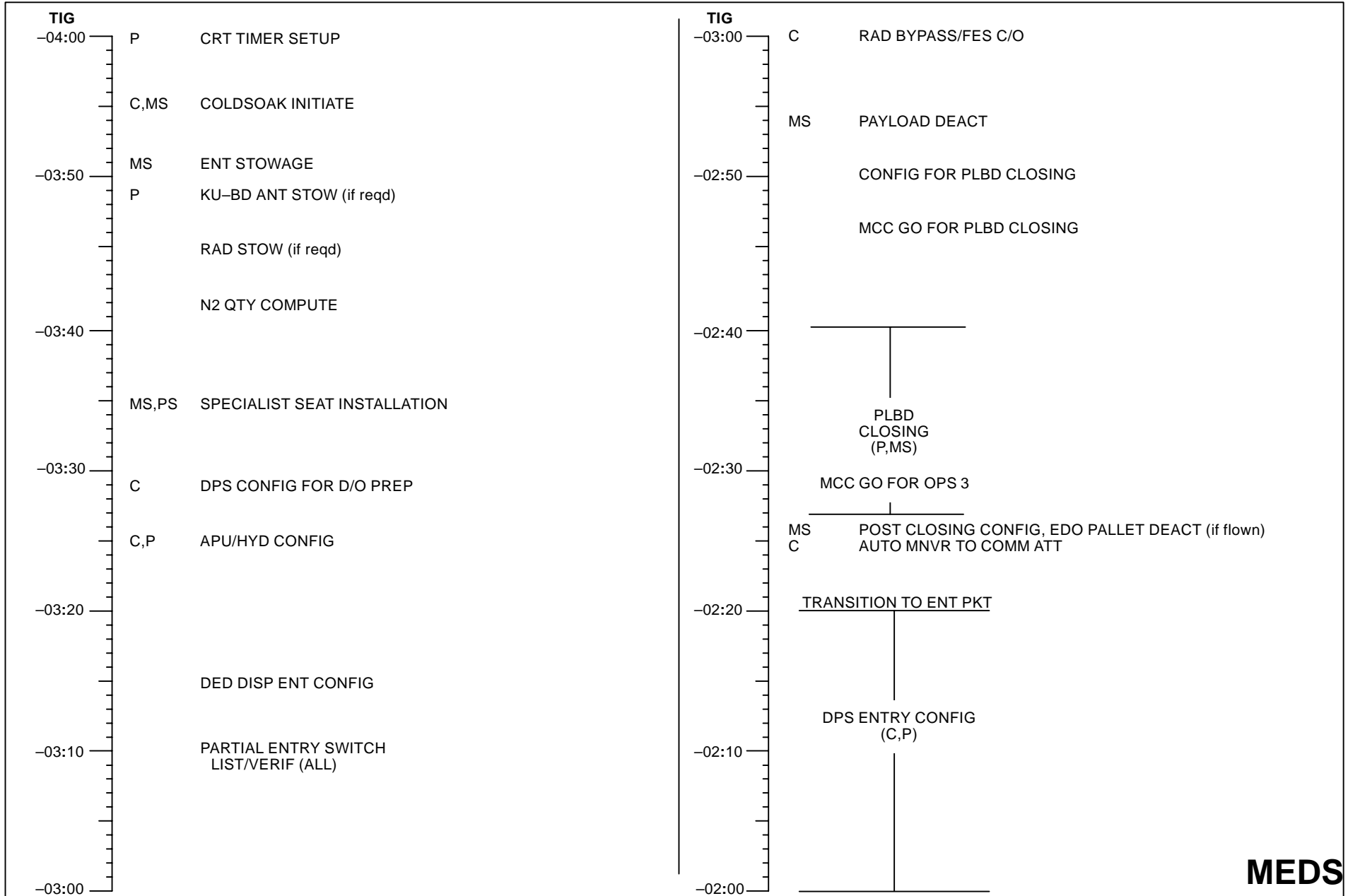

NOMINAL DEORBIT PREP SUMMARY TIMELINE

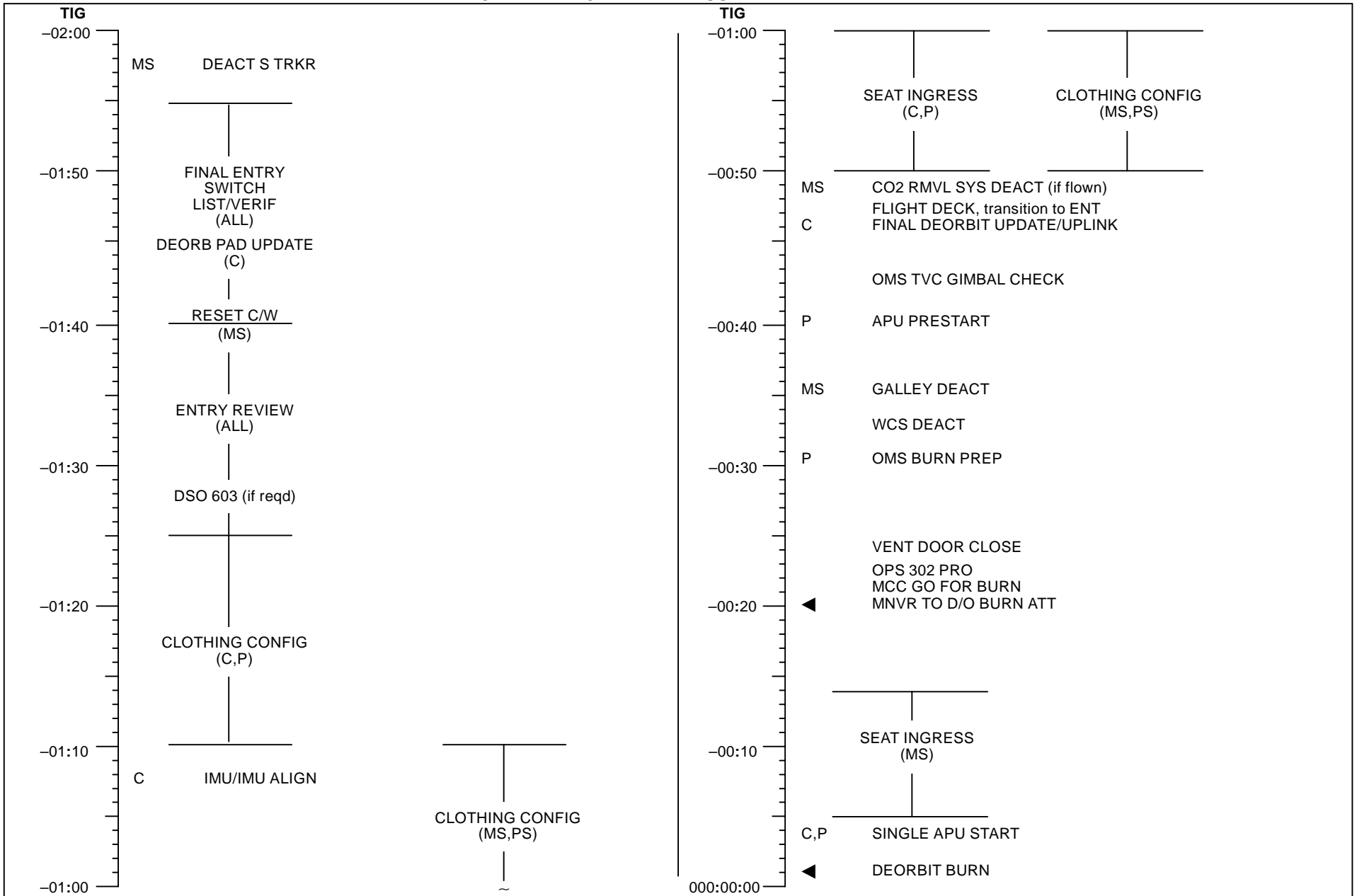

(MEDS) A1-5

D/O/ALL/GEN L

NOMINAL DEORBIT PREP

* If TIME to TIG <4 hr and >2 hr 40 min:

*

* 1. ACCOMPLISH IMMEDIATELY:

*

* MNVR (TRK) BIASED -XSI (if not already in TAIL SUN)

*

* CRTX TGT ID +4 (blanks OM)

*

BODY VECT +5

*

P +184

*

✓OM (blank)

*

Initiate TRK

*

* 2. Back out of PRIORITY PWRDN, as reqd (ORB PKT, PRIOR PWRDN)

*

* 3. If previous FC PURGE was not accomplished within last 6 hr:

*

Accomplish FC PURGE (ORB OPS, EPS) during D/O Prep prior to DPS ENTRY
CONFIG

*

* 4. MS accomplish CABIN CONFIG/STOW (FLIGHT PLAN) during D/O Prep timeframe

*

* 5. Begin Deorbit Prep timeline immediately and perform procedures as rapidly as possible

VERIFY THAT FOLLOWING ACTIVITIES HAVE BEEN ACCOMPLISHED:

FCS CHECKOUT (ORB OPS, GNC)

RCS HOT FIRE TEST (ORB OPS, RCS)

CABIN CONFIG/STOW (FLIGHT PLAN)

IMU ALIGN – S TRK (ORB OPS, GNC)

MNVR (TRK) BIASED -XSI (FLIGHT PLAN, DETAILED TIMELINE)

FC PURGE (ORB OPS, EPS)

Back out of PRIORITY PWRDN, as reqd (ORB PKT, PRIOR PWRDN)

(MEDS) A1-6

D/O/ALL/GEN L

1: GNC UNIV PTG		2: SM SYS SUMM 1	
TIG			
-04:00	P	CRT TIMER SETUP	1
A5(B1) AUTO VERN RT 0.2 DB 1.0	C,MS	COLDSOAK INITIATE	2
-03:55		Verify in ATT: DAP: A5/AUTO/VERN(ALT) If no FWD RCS: ✓A6/AUTO/ALT ✓DAP: B set to B1	
	MS	ENT STOWAGE	3, 1-27
		ENT AIRLOCK CONFIG	3A, 1-28
-03:50	P	KU-BD ANT STOW, if deployed (ORB OPS, COMM/INST)	
-03:45		RAD STOW, if reqd (ORB OPS, ECLS)	
	S66	N2 QTY COMPUTE Add N2 QTY 1 + 2 Then annotate CABIN PRESS LEAK NOMOGRAPH (ENT PKT, ECLS)	
-03:40	S68, 168	DETERMINE H2 DEPLETED TANKS Note all H2 tanks with Qty <3% Then annotate DEORBIT BURN FLIGHT RULES, ELEC section (steps 9 thru 12) for depleted tanks (ENT, BURN CARDS)	
-03:35	MS, PS	SPECIALIST SEAT INSTALLATION	
-03:30			

CRT TIMER SETUP 1

1: GNC 2 TIME

SET CRT TIMER TO COUNT DOWN TO TIG (perform for GNC & SM)

ENTRY DAY (HR:MIN:SEC - MET)

ITEM 17 + + +

24 HR LATE DELAYED DEORBIT

ITEM 17 + + +

1: GNC UNIV PTG

COLDSOAK INITIATE 2

FES CONFIG

C L1 FLASH EVAP CNTLR PRI A,B,SEC (three) - OFF
RAD CNTLR OUT TEMP - HI
When FREON EVAP OUT TEMP > 50 degF,
FLASH EVAP CNTLR PRI B(A) - ON
HI LOAD DUCT HTR - B

MS R11L ✓SPLY H2O XOVR VLV - OP (tb-OP)

H2O LOOP C/O AND CONFIG

SM 88 APU/ENVIRON THERM

NOTE
INCR decreases ICH FLOW

L1 H2O LOOP 2 BYP MODE - MAN
MAN - INCR or DECR
(Adjust until ICH FLOW ~950 ± 50)

L1

If first Deorbit Prep:
H2O PUMP LOOP 1 - ON
✓LOOP 1 BYP MODE - MAN
MAN - DECR (hold 5 sec)

CRT ✓H2O LOOP 1 ICH FLOW - increasing

L1 H2O LOOP 1 BYP MAN - INCR (Adjust until ICH FLOW ~950 ± 50)
H2O PUMP LOOP 1 (two) - OFF,B

TIG
 -03:30
 A5(B1)
 AUTO
 VERN
 RT 0.2
 DB 1.0

1: GNC 0 GPC MEMORY 2: BFS, GNC 0 BFS MEMORY

C If single G2: DPS CONFIG FOR D/O PREP 4a
ENSURE BFS GPC CAN COMMAND AN IDP 4b

-03:25 C,P APU/HYD CONFIG 5, 1-8

-03:20 UPLINK
 (if reqd)
 PASS SV

-03:15 DED DISP ENT CONFIG 6, 1-8

NOTE
 ✓MCC for unaccounted-for switch
 or cb config discrepancies

-03:10 C
 P
 MS
PARTIAL ENT SWITCH LIST/VERIF (FWD), 3-4 thru 3-6
PARTIAL ENT SWITCH LIST/VERIF (FWD), 3-7 & 3-8
PARTIAL ENT SWITCH LIST/VERIF (AFT), 3-9
PARTIAL ENT SWITCH LIST/VERIF (MID), 3-10 thru 3-12

-03:05

-03:00

DPS CONFIG FOR D/O PREP 4a

NOTE
 Do not perform any keyboard item entries
 or switch throws 10 sec before and after
 moding PASS GPCs to RUN or making
 OPS transition requests

P/I Locker ACTIVATE GPC 2 (if in HALT)
 Remove and stow GPC Mode Switch Guard

O6 ✓GPC MODE 2 - HALT (tb-bp)
 ✓OUTPUT 2 - NORM
 ✓PWR 2 - ON
 MODE 2 - STBY (tb-RUN), RUN

TRANSITION GPCs 1 & 2 TO OPS 2
 (if GPC 2 just activated)

1: GNC 0 GPC MEMORY
 CONFIG - ITEM 1 +2 EXEC
 Modify MC 2 per table →
 GNC, OPS 201 PRO

CONFIG GPC	2	12000
STR 1	1	
2	2	
3	1	
4	2	
PL 1/2	0	
CRT 1	1	
2	2	
3	0	
4	2	
L 1	0	
2	0	
MM 1	1	
2	2	

1: GNC 22 S TRK/COAS CNTL
 S TRK -Y,-Z: STAR TRK - ITEM 3,4 EXEC

1: GNC 21 IMU ALIGN
 RESUME

ENSURE BFS GPC CAN COMMAND AN IDP 4b

O6 ✓GPC PWR 5 - ON
 MODE 5 - STBY (tb-RUN)

C3 BFC CRT DISP - ON
 SEL - 2+3

2: BFS, GNC BFS MEMORY or SM THERMAL

C3 BFC CRT DISP - OFF
 SEL - 3+1

MEDS

Block deleted

(MEDS) A1-10

MEDS
D/O/ALL/GEN L

1: GNC UNIV PTG

2: SM SYS SUMM 1

TIG

-03:00

A5(B1)
AUTO
ALT
RT 0.2
DB 5.0

DAP: A/AUTO/ALT

-02:55

RAD BYPASS/FES C/O (ORB OPS, ECLS)

MS

PAYLOAD DEACT, if reqd (PL OPS, DEORB PREP
or SODF: ASSY OPS, ACTIVATION AND
CHECKOUT; DEORBIT PREP)

-02:50

CONFIG FOR PLBD CLOSING [7], 1-25

MCC: GO/NO-GO FOR PLBD CLOSING

-02:45

UPLINK
UPDATE
COMM
ATT

-02:40

P,MS

DETAILED PLBD CLOSING PROCEDURES [9], 1-21

-02:35

P,MS
PLBD
CLOSING

-02:30

MEDS

DPS ENTRY CONFIG 12

* If IMU or RHC dilemma, do not proceed with OPS 3 transition *

- ✓ Att mnvr complete
- ✓ RGA,AA,ASA,IMU (all) – ON

NOTE

Do not perform any keyboard item entries or switch throws 10 sec before and after moding PASS GPCs to RUN or making OPS transition requests

1. **MEDS CONFIG**
 C2 IDP/CRT 3 PWR – ON
 CRTX GPC/CRT 2/3 EXEC
 F6,F7,F8 ✓ All forward MDUs ON and selected to primary port
2. **VERIFY GPC CONFIG**
 O6 ✓ GPC MODE 3 – HALT (tb-bp)
 ✓ PWR 3 – ON
 ✓ OUTPUT 1,2 – NORM (tb-gray)
 ✓ 3,5 – NORM (tb-bp)
 ✓ 4 – TERM (tb-bp)
 ✓ MODE 1,2,4 – RUN (tb-RUN)
 3 – STBY (tb-RUN)
 ✓ 5 – STBY (tb-RUN)
3. **SM CHECKPOINT/UL CNTL ENA**
 1: SM 60 SM TABLE MAINT
 2: SM 1 DPS UTILITY
 CRT2 MMU ASSIGN 2 SM – ITEM 4 EXEC
 CRT1 CKPT INITIATE – ITEM 18 EXEC
 ✓ Update of CKPT TIME and STATUS GOOD indicated
 CRT2 MMU ASSIGN 1 SM – ITEM 3 EXEC
 CRT1 CKPT INITIATE – ITEM 18 EXEC
 ✓ Update of CKPT TIME and STATUS GOOD indicated
 CRT2 CKPT RETRV ENA – ITEM 12 EXEC (*)
 UL CNTL ENA – ITEM 36 EXEC
4. **LOAD ENTRY TFL/RECONFIG UPLK**
 Perform LOAD PDI DECOM FORMAT and LOAD PCMMU FORMAT for entry config (ORB OPS FS, COMM/INST)
5. **TRANSITION GPC 1&2 TO GNC OPS 3**
 C2 Set event timer to count down to TIG
 1: GNC 0 GPC MEMORY
 CONFIG – ITEM 1 +3 EXEC

(MEDS) A1-12

6. **TRANSITION BFS GPC TO GNC OPS 3**
 C3 BFC CRT DISP – ON
 ✓ SEL = 3+1
 3: BFS, GNC BFS MEMORY
 O6 GPC OUTPUT 5 – B/U (tb-bp)
 CRT3 ✓ TFL ENA – ITEM 29 (*)
 BFS, GNC OPS 301 PRO
 3: BFS, GNC DEORB MNVR COAST
7. **TRANSITION GPC 1,2,3,4 TO GNC OPS 3**
 O6 SM, OPS 000 PRO
 X: SM GPC MEMORY
 GPC OUTPUT 4 – NORM (tb-gray)
 MODE 3,5 (two) – RUN (tb-RUN)
 If no comm, sel best antenna
 ✓ CONFIG – ITEM 1 +3 EXEC
 Modify MC 3 per table
 GNC OPS 301 PRO
 1: GNC DEORB MNVR COAST
 CRT3 BFS, GNC OPS 000 PRO
 C3 BFS, GNC OPS 301 PRO
 BFC CRT DISP – OFF (GPC 3 commanding IDP 3)
 – ON
 * If any IMU failed or not aligned: *
 * 3: BFS, GNC 51 OVERRIDE *
 * Aff IMU – desel *
8. **MNVR BACK TO COMM ATT**
9. **LOAD IN TGTs**
 1: GNC DEORB MNVR COAST
 ✓ MCC for TGT and SV UPLINK
 LOAD – ITEM 22 EXEC
 TIMER – ITEM 23 EXEC
10. **VERIFY MC 9 TABLE (GNC) FOR POST LANDING**
 2: GNC 0 GPC MEMORY
 CONFIG – ITEM 1 +9 EXEC
 Modify MC 9 per table
 CONFIG – ITEM 1 +3 EXEC

CONFIG GPC	3	12000
------------	---	-------

STR	1	1
	2	2
	3	1
	4	2
PL	1/2	0

CRT	1	1
	2	2
	3	2
	4	0

L	1	0
	2	0
MM	1	1
	2	2

CONFIG GPC	3	12340
------------	---	-------

STR	1	1
	2	2
	3	3
	4	4
PL	1/2	1

CRT	1	1
	2	2
	3	3
	4	0
L	1	0
	2	0

MM	1	1
	2	2

CONFIG GPC	9	12340
------------	---	-------

STR	1	1
	2	2
	3	3
	4	4
PL	1/2	1

CRT	1	1
	2	2
	3	3
	4	0
L	1	1
	2	2

MM	1	1
	2	2

MEDS

D/O/MEDS/GEN L

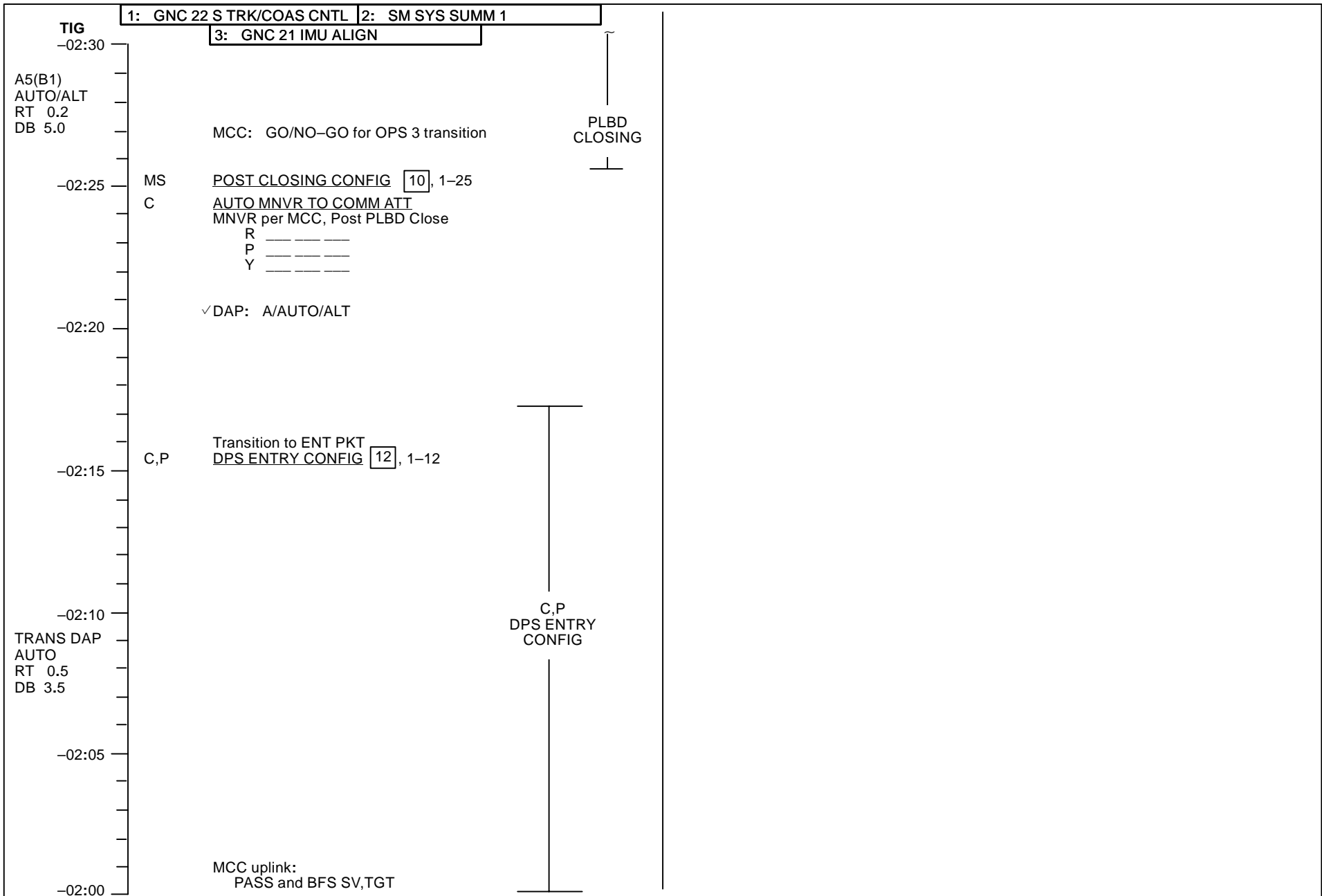

DEORB PAD UPDATE 17

MCC update:

OMS PRPLT PAD, DEL PAD (ENT, PRPLT/DEL PADS)
and DEORBIT MNVR PAD (ENT, MNVR PADS)

* If MCC cannot provide DEORB TGT, use PGSC *

LANDING SITE UPDATE

1: GNC 50 HORIZ SIT

SEL SITE see DEL PAD (ENT, PRPLT/DEL PADS)

CHECK TGTs

1: GNC DEORB MNVR COAST

- ✓ PASS and BFS TGT per DEORBIT MNVR PAD
(ENT, MNVR PADS)
- ✓ PASS and BFS solution per DEORBIT MNVR PAD
(ENT, MNVR PADS)
BURN ATT, HA HP
 Δ VTOT
TGO

		1: GNC 0 GPC MEMORY	2: SM 1 DPS UTILITY		
TIG		3: BFS,GNC DEORB MNVR COAST			
-02:00					
TRANS DAP					
AUTO					
RT 0.5	MS	<u>DEACT STAR TRKRS & CLOSE DOORS</u> 13, 1-26			
DB 3.5					
	C,P	<u>ENT FWD FLT DECK CONFIG</u> 14			
-01:55					
	MS	<u>ENT AFT FLT DECK CONFIG</u> , 15, 1-26			
		<u>ENT MIDDECK CONFIG</u> , 16, 1-27			
		<u>PAYLOAD ENT SW LIST/VERIF (PL OPS, DEORB PREP or SODF: ASSY OPS, ACTIVATION AND CHECKOUT; DEORBIT PREP)</u>			
		<u>NOTE</u>			
		✓MCC for unaccounted—for switch or cb config discrepancies			
-01:50					
	C	<u>FINAL ENT SWITCH LIST/VERIF (FWD)</u> , 3-13 thru 3-19			
	P	<u>FINAL ENT SWITCH LIST/VERIF (FWD)</u> , 3-20 and 3-21			
UPLINK					
TMBU	MS	<u>FINAL ENT SWITCH LIST/VERIF (AFT)</u> , 3-22 thru 3-29		FINAL	
UPLINK		<u>FINAL ENT SWITCH LIST VERIF (MID)</u> , 3-30 thru 3-32		ENT	
UPDATE					
D/O FLT					
RULES					
-01:45					
	C	<u>DEORB PAD UPDATE</u> 17, 1-14			
-01:40					
	MS	<u>RESET C/W</u> 18, 1-26			
	ALL	ENTRY REVIEW			
-01:35					
-01:30					
				ENTRY	
				REVIEW	

		ENT FWD FLT DECK CONFIG	14
C,P		<u>BRAKE/ANTISKID/NWS</u>	
L2		Unstow,install NWS sw flex extension	
		NWS - 1	
		ANTISKID - ON	
O14:A		BRAKES MNA - ON	
O15:A		MNB - ON	
O16:A		MNC - ON	
R4		<u>HYD HTR/RJD CONFIG</u>	
		HYD BRAKE HTR (three) - AUTO	
O16		RJD MANF L5/F5/R5 DRIVER - OFF	
L1		<u>FES/RAD CONFIG</u>	
L2		FLASH EVAP CNTLR PRI B(A) - GPC	
		FREON ISOL MODE - OFF	
L2		<u>PCS/ARS CONFIG</u>	
		O2/N2 CNTLR VLV SYS 1 - OP	
		2 - CL	
L4:J		cb SIG CONDR HUM SEP - op	
		IMU FAN - op	
O5,09		<u>ENTRY COMM</u>	
		L,R AUD A/G 2 (two) - T/R	
		A/A (two) - T/R (if DOD)	
		VOX SENS (two) - R	
		VOL tw (twelve) - R	
O6		UHF SPLX/EVA XMIT FREQ - 259.7/414.2	
		✓PWR AMP - ON	
		✓SPLX SQUELCH - ON	
		MODE - SPLX	

This Page Intentionally Blank

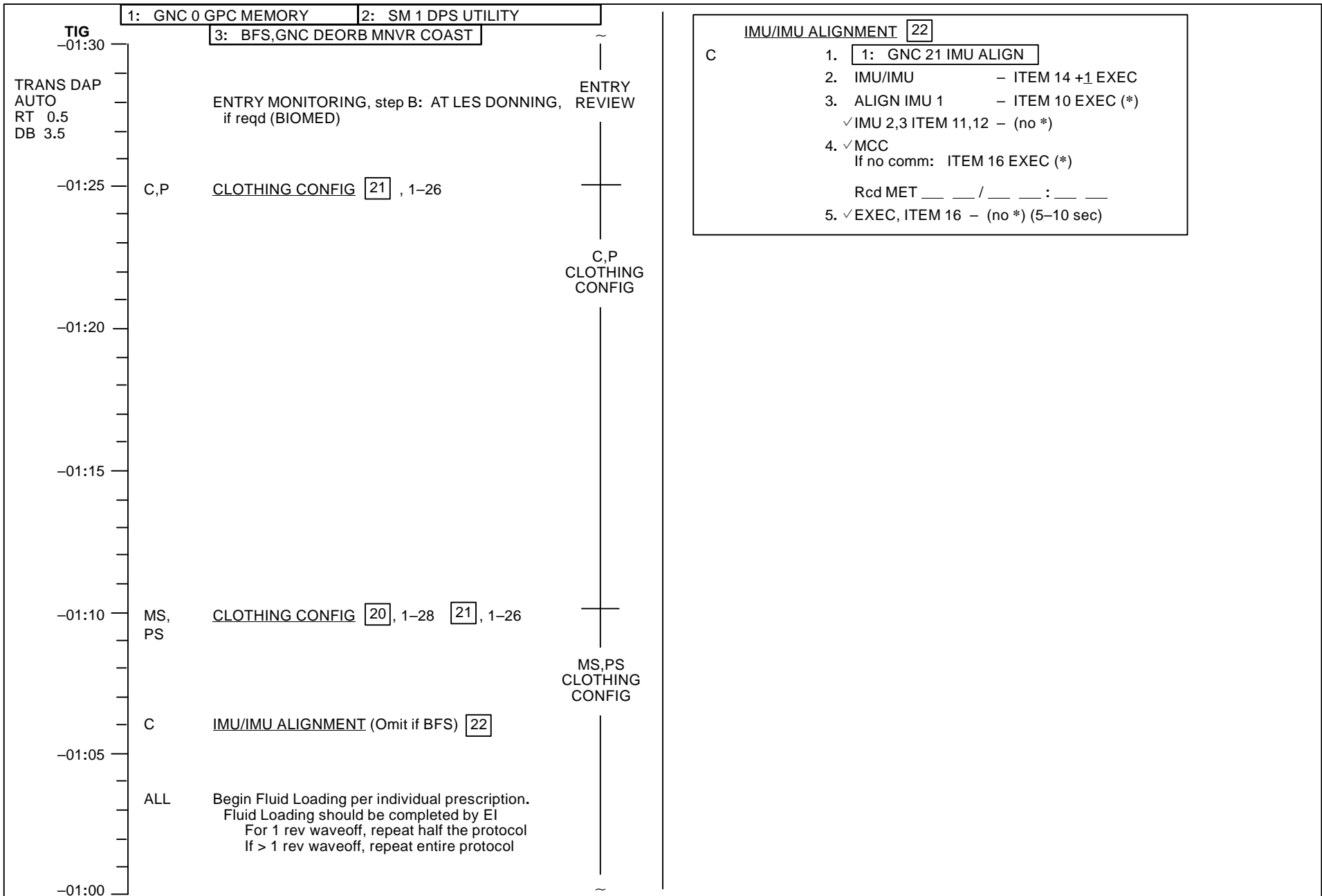

This Page Intentionally Blank

TIG		1: GNC DEORB MNVR COAST	2: GNC DEORB MNVR COAST	
-01:00				
TRANS DAP	C,P	<u>SEAT INGRESS</u>		MS,PS CLOTHING CONFIG
AUTO	C,P	<u>HUD SETUP</u> [23]		
RT 0.5	C,P	Adjust seat Exercise brake pedals		
DB 3.5				
-00:55	C	C6	<u>LEH O2 vlv (four) - OP</u>	
	C,P		<u>LES PRESS INTEGRITY CHECK</u>	
	MS		<u>AFD AUD SPKR CONFIG</u> [28], 1-25	
	MS		<u>WIRELESS STOW</u> [24]	
	MS		<u>MD AUD SPKR CONFIG</u> [29], 1-28	
-00:50	MS		<u>CO2 RMVL SYS DEACT</u> , if flown [25], 1-28	
	C,P		Stow all unnecessary FDF articles <u>FLIGHT DECK</u> , go to ENT, <u>DEORBIT BURN</u>	
-00:45				
-00:40				
-00:35	MS		<u>GALLEY DEACT</u> [26], 1-27	
	MS		<u>WCS DEACT MS</u> [27], 1-28	
			<u>NOTE</u> WCS must be deactivated prior to EI	
-00:30				

HUD SETUP [23]
Remove, stow HUD Covers (two)
Ensure Cloth Cover does not obscure light sensor

WIRELESS STOW [24]
Disconnect, stow Wireless Comm (if reqd)
✓ Aft deck lts as reqd

This Page Intentionally Blank

AUTO PLBD CLOSING

DETAILED PLBD CLOSING PROCEDURES 9

CAUTION
Verify no obstructions when closing and latching PLBD
(Ku ANT,RMS,RAD,etc)

- R13L
- * If no motion determined visually or 'OP/CL' *
 - * not blank within 10 sec after cmd, *
 - * PL BAY DR – STOP *
 - * Perform MAL, MECH, 9.1a *
 - * If Latch not 'CL' in single-motor time, *
 - * PL BAY DR – STOP *
 - * Perform MAL, MECH, 9.1e *
 - * If door motion stops and not 'RDY' or 'CL', *
 - * PL BAY DR – STOP *
 - * Perform MAL, MECH, 9.1g *

 - * If SM GPC fails during this operation: *
 - * PL BAY DR SYS 1,2 (two) – DSBL *
 - * DR – STOP *
 - * Perform PASS SM GPC FAIL (ORB PKT, DPS) *

 - * If BFS AUTO sequence has been interrupted by reversing *
 - * Latch/door drive direction, or if MANUAL mode has been *
 - * used at any time during the mission, use MANUAL mode *
 - * for all subsequent BFS PLBD ops *

NOTE

Note any single-motor operations (continue ops)
(single-motor times = 2x listed dual-motor times)

CONFIGURE FOR AUTO MODE

- CRT4
1. SM, OPS X02 PRO or BFS, SM 63 PL BAY DOORS
- 4: SM PL BAY DOORS
- R13L
- ✓ PL BAY DR – STOP
 - ✓ PBD SW – STOP
 - ✓ MAN SEL (ten) – (no *)
 - ✓ PBD SW BYPASS – (no *)
2. AC POWER ON – ITEM 1 EXEC (*)
 3. AUTO MODE SEL – ITEM 3 EXEC (*)

- R13L
4. PL BAY DR SYS 1,2 (two) – ENA
- CRT4
- ✓ OP/CL STATUS (ten) – OP

CLOSE PLBDs USING AUTO MODE

- * If PORT (STBD) DOOR not 'CL' within 6 sec of 'RDY': *
- * PL BAY DR – STOP *
- * ✓ PLBD BULKHEAD LATCH GO/NO-GO DIAGRAM, *
- * 1-22 *
- * If NO-GO: Go to MAL, MECH SSR-2 (CONTINGENCY *
- * PLBD CLOSURE) *
- * If GO: PL BAY DR – CL *
- * Continue in procedure *

- R13L
5. PL BAY DR – CL
- CRT4
- ✓ PORT DOOR – blank,RDY,CL (~63 sec)
 - ✓ FWD,AFT LATCHES – blank,CL (~30 sec)
 - ✓ STBD DOOR – blank

6. When STBD DOOR as close as possible to PORT DOOR before contact, perform PLBD fit check:

- R13L
- PL BAY DR – STOP
 - Determine C/L Latch clearance on ENTRY DAY NO-GO
 - DIAGRAM C/L LATCH EXTENDED GUIDE ROLLER
 - TRAJECTORY, 1-22

- * If NO-GO for PLBD CLOSE and no waveoff capability, *
- * perform MAL, MECH SSR-3 (SIMULTANEOUS PLBD CL) *
- * If waveoff OK, ✓ MCC *

7. PL BAY DR – CL

- CRT4
- ✓ STBD DOOR – CL (~63 sec)
 - ✓ FWD,AFT LATCHES (two) – blank,CL (~30 sec)
 - ✓ CENTER LATCHES 1-4,13-16 (two) – blank,CL (~20 sec)
 - ✓ 5-8, 9-12 (two) – blank,CL (~20 sec)

- R13L
8. PL BAY DR – STOP

POST-PLBD CLOSING CLEANUP

- CRT4
9. PL BAY DR SYS 1,2 (two) – DSBL
 - ✓ OP/CL STATUS (ten) – CL
10. AC POWER OFF – ITEM 2 EXEC (*)
 11. GPC/CRT 54 EXEC

MEDS

**PLBD BULKHEAD LATCH GO/NO-GO DIAGRAM
(REVERSE FOR STBD DOOR)**

AUTO PLBD CLOSING

FUNCTION	PLBD CONTROL								PLBD DISPLAY PL MDM								
	Ref: MA73C:C&D for MCA (cb)																
	MTR 1				MTR 2				C C O O C R R R O		A B A B		A B C				
	AC/MCA	CNTL	MDM	SYS	AC/MCA	CNTL	MDM	SYS	A	B	A	B	A	B	C		
LATCH																	
5-8	1/MID3	AB3/AB2	PL1	2	3/MID2	CA3/CA1	PL2	1	1	2	1	2					
9-12	1/MID1	AB3/AB1	PL1	1	3/MID4	CA3/CA2	PL2	2	1	2	1	2					
1-4	1/MID3	AB3/AB2	PL1	2	3/MID2	CA3/CA1	PL2	1	1	2	1	2					
13-16	3/MID4	CA3/CA2	PL2	2	2/MID2	BC3/BC1	PL1	1	2	1	2	1					
S FWD	1/MID1	AB3/AB1	PL1	1	2/MID4	BC3/BC2	PL2	2	1	2	1	2					
S AFT	3/MID4	CA3/CA2	PL2	2	2/MID2	BC3/BC1	PL1	1	2	1	2	1					
S DOOR	1/MID1	AB3/AB1	PL1	1	2/MID4	BC3/BC2	PL2	2					1	1	2	2	1
													2	1	2	2	2
P FWD	1/MID1	AB3/AB1	PL1	1	2/MID4	BC3/BC2	PL2	2	1	2	1	2					
P AFT	1/MID3	AB3/AB2	PL1	2	3/MID2	CA3/CA1	PL2	1	1	2	1	2					
P DOOR	3/MID4	CA3/CA2	PL2	2	2/MID2	BC3/BC1	PL1	1					2	1	1	2	2
													1	1	1	2	1

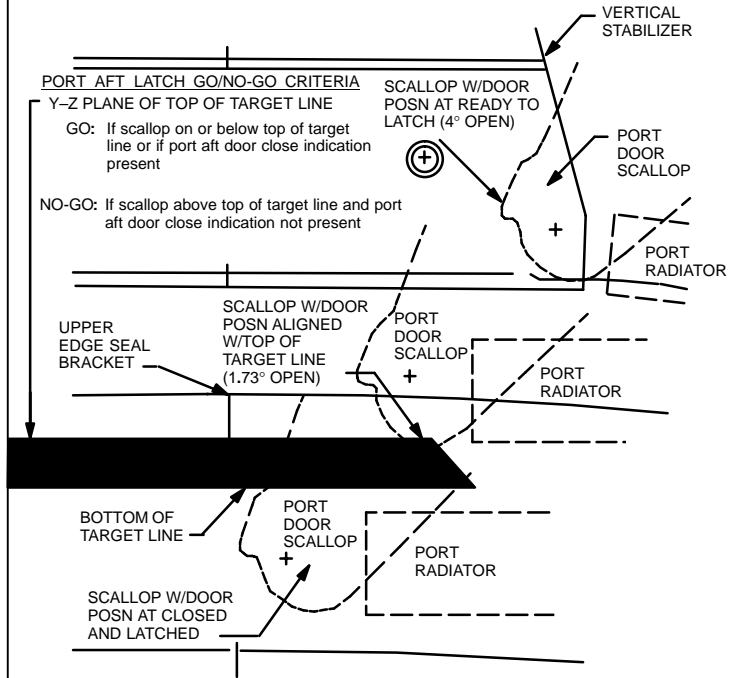

**ENTRY DAY NO-GO DIAGRAM
C/L LATCH EXTENDED GUIDE ROLLER TRAJECTORY**

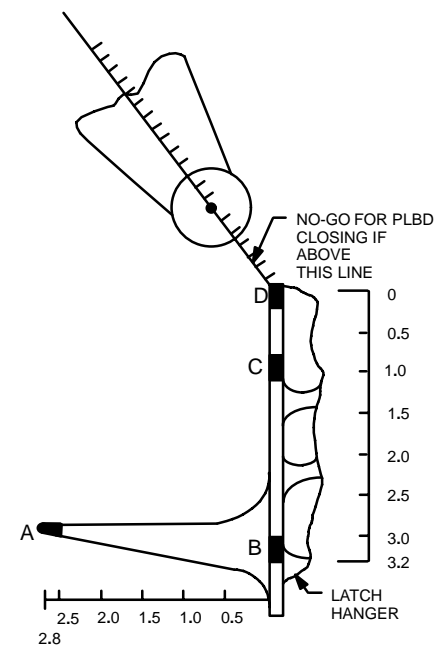

MEDS

MANUAL PLBD CLOSING

DETAILED PLBD CLOSING PROCEDURES

CAUTION

Verify no obstructions when closing and latching PLBD (Ku ANT,RMS,RAD,etc)

- R13L
- * If no motion determined visually or 'OP/CL' *
 - * not blank within 10 sec after cmd, *
 - * PL BAY DR – STOP *
 - * Perform MAL, MECH, 9.1a *
 - * If Latch not 'CL' in single–motor time, *
 - * PL BAY DR – STOP *
 - * Perform MAL, MECH, 9.1e *
 - * If door motion stops and not 'RDY' or 'CL', *
 - * PL BAY DR – STOP *
 - * Perform MAL, MECH, 9.1g *
- R13L
- * If SM GPC fails during this operation: *
 - * PL BAY DR SYS 1,2 (two) – DSBL *
 - * PL BAY DR – STOP *
 - * Perform PASS SM GPC FAIL (ORB PKT, DPS) *
- * If BFS AUTO sequence has been interrupted by reversing *
 - * Latch/door drive direction, or if MANUAL has been used *
 - * at any time during the mission, use MANUAL mode for all *
 - * subsequent BFS PLBD ops *

NOTE

Note any single–motor operations (continue ops)
(single–motor times = 2x listed dual–motor times)

CONFIGURE FOR MANUAL MODE

- CRT4
1. SM, OPS X02 PRO or BFS, SM 63 PL BAY DOORS
4: SM PL BAY DOORS
- R13L
- ✓ PL BAY DR – STOP
- CRT4
- ✓ PBD SW – STOP
 - ✓ MAN SEL (ten) – (no *)
 - ✓ PBD SW BYPASS – (no *)
2. AC POWER ON – ITEM 1 EXEC (*)
 - ✓ AUTO MODE SEL – (no *)
- R13L
3. PL BAY DR SYS 1,2 (two) – ENA
- CRT4
- ✓ OP/CL STATUS (ten) – OP
- CLOSE PORT DOOR, FWD & AFT LATCHES
- R13L
- * If PORT(STBD) DOOR not 'CL' within 6 sec of 'RDY': *
 - * PL BAY DR – STOP *
 - * ✓ PLBD BULKHEAD LATCH GO/NO–GO DIAGRAM, 1–24 *
 - * If NO–GO: Go to MAL, MECH, SSR–2 (CONTINGENCY *
 - * PLBD CLOSURE) *
 - * If GO: Continue in procedure *
- CRT4
4. Select PORT DOOR – ITEM 13 EXEC (*)
- R13L
5. PL BAY DR – CL

- CRT4
- ✓ PORT DOOR – blank, RDY, CL (~63 sec)
- R13L
6. PL BAY DOOR – STOP
- CRT4
7. Select PORT FWD, AFT LATCHES – ITEM 11,12 EXEC (*)
- R13L
8. PL BAY DR – CL
- CRT4
- ✓ PORT DOOR – CL
 - ✓ FWD, AFT LATCHES (two) – blank, CL (~30 sec)
- R13L
9. PL BAY DR – STOP
- CRT4
10. Deselect PORT FWD, AFT LATCHES, & DOOR – ITEM 11,12,13 EXEC (no *)
- CLOSE STBD DOOR, FWD & AFT LATCHES
- R13L
11. Select STBD DOOR – ITEM 10 EXEC (*)
- CRT4
12. PL BAY DR – CL
 - ✓ STBD DOOR – blank
13. When STBD DOOR as close as possible to PORT DOOR before contact, perform fit check:
- R13L
- PL BAY DR – STOP
 - Determine C/L Latch clearance on ENTRY DAY NO–GO DIAGRAM C/L LATCH EXTENDED GUIDE ROLLER TRAJECTORY, 1–24
 - * If NO–GO for PLBD CLOSE and no waveoff capability, *
 - * perform MAL, MECH SSR–3 (SIMULTANEOUS PLBD CL) *
 - * If waveoff OK, ✓ MCC *
14. PL BAY DR – CL
- CRT4
- ✓ STBD DOOR – RDY, CL (~63 sec)
- R13L
15. PL BAY DR – STOP
- CRT4
16. Select STBD FWD, AFT LATCHES – ITEM 8,9 EXEC (*)
- R13L
17. PL BAY DR – CL
- CRT4
- ✓ STBD DR – CL
 - ✓ FWD, AFT LATCHES (two) – blank, CL (~30 sec)
- R13L
18. PL BAY DR – STOP
- CRT4
19. Deselect STBD FWD, AFT LATCHES & DOOR – ITEM 8,9,10 EXEC (no *)
- CLOSE C/L LATCHES
- CRT4
20. Select CENTER LATCHES 1–4,13–16 – ITEM 6,7 EXEC (*)
- R13L
21. PL BAY DR – CL
- CRT4
- ✓ CENTER LATCHES 1–4,13–16 (two) – blank, CL (~20 sec)
- R13L
22. PL BAY DR – STOP
- CRT4
23. Deselect CENTER LATCHES 1–4,13–16 – ITEM 6,7 EXEC (no *)
- R13L
24. Select CENTER LATCHES 5–8,9–12 – ITEM 4,5 EXEC (*)
- R13L
25. PL BAY DR – CL
- CRT4
- ✓ CENTER LATCHES 5–8,9–12 (two) – blank, CL (~20 sec)
- R13L
26. PL BAY DR – STOP
- CRT4
27. Deselect CENTER LATCHES 5–8,9–12 – ITEM 4,5 EXEC (no *)
- POST–PLBD CLOSING CLEANUP
- R13L
28. PL BAY DR SYS 1,2(two) – DSBL
- ✓ OP/CL STATUS (ten) – CL
- R13L
29. AC POWER OFF – ITEM 2 EXEC (*)
- CRT4
30. GPC/CRT 54 EXEC

MEDS

**PLBD BULKHEAD LATCH GO/NO-GO DIAGRAM
(REVERSE FOR STBD DOOR)**

MANUAL PLBD CLOSING

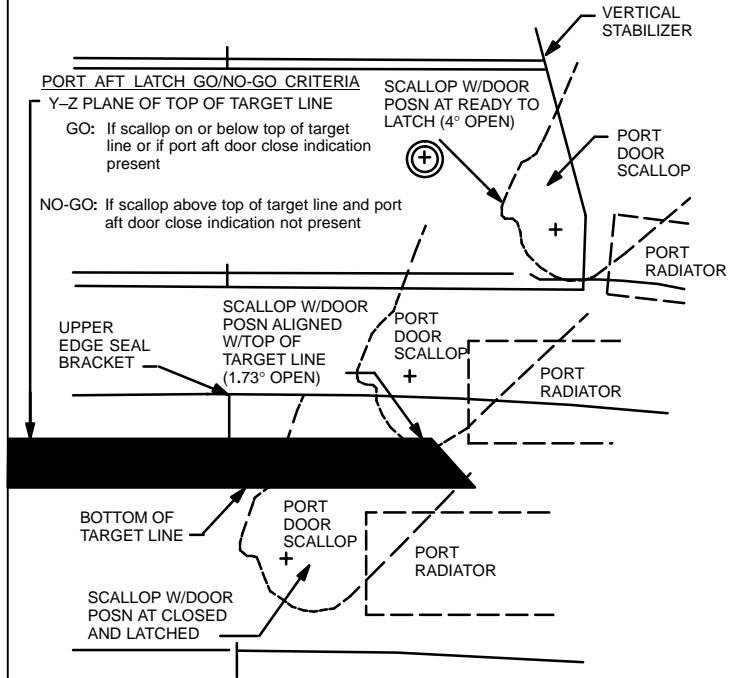

FUNCTION	PLBD CONTROL								PLBD DISPLAY PL MDM						
	Ref: MA73C:C&D for MCA (cb)														
	MTR 1				MTR 2				C C O O		C R R R		O		
	AC/MCA	CNTL	MDM	SYS	AC/MCA	CNTL	MDM	SYS	A	B	A	B	A	B	C
LATCH															
5-8	1/MID3	AB3/AB2	PL1	2	3/MID2	CA3/CA1	PL2	1	1	2	1	2			
9-12	1/MID1	AB3/AB1	PL1	1	3/MID4	CA3/CA2	PL2	2	1	2	1	2			
1-4	1/MID3	AB3/AB2	PL1	2	3/MID2	CA3/CA1	PL2	1	1	2	1	2			
13-16	3/MID4	CA3/CA2	PL2	2	2/MID2	BC3/BC1	PL1	1	2	1	2	1			
S FWD	1/MID1	AB3/AB1	PL1	1	2/MID4	BC3/BC2	PL2	2	1	2	1	2			
S AFT	3/MID4	CA3/CA2	PL2	2	2/MID2	BC3/BC1	PL1	1	2	1	2	1			
S DOOR	1/MID1	AB3/AB1	PL1	1	2/MID4	BC3/BC2	PL2	2					1	1	2 2 1
P FWD	1/MID1	AB3/AB1	PL1	1	2/MID4	BC3/BC2	PL2	2	1	2	1	2	2	1	2 2 2
P AFT	1/MID3	AB3/AB2	PL1	2	3/MID2	CA3/CA1	PL2	1	1	2	1	2			
P DOOR	3/MID4	CA3/CA2	PL2	2	2/MID2	BC3/BC1	PL1	1					2	1	1 2 2
													1	1	1 2 1

**ENTRY DAY NO-GO DIAGRAM
C/L LATCH EXTENDED GUIDE ROLLER TRAJECTORY**

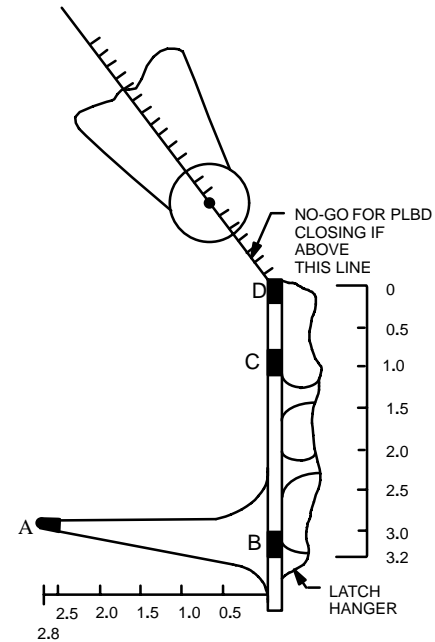

MEDS

MS AFT FLIGHT DECK ACTIVITIES

NOTE
WAIT FOR GO FROM CDR OR PLT BEFORE STARTING ANY ACTIVITY ON THIS PAGE

TIME (TIG-)	MS AFT DECK ACTIONS
3:35	<u>SPECIALIST SEAT INSTALLATION</u>
3:10	<u>PARTIAL ENT SWITCH LIST/VERIF (AFT)</u>
2:55	<u>PAYLOAD DEACT</u> , if reqd (PL OPS, <u>DEORB PREP</u> or <u>SODF: ASSY OPS, ACTIVATION AND CHECKOUT; DEORBIT PREP</u>)
2:51	<u>CONFIG FOR PLBD CLOSING</u> 7
2:40	<u>DETAILED PLBD CLOSING PROCEDURES</u> 9 , 1-21
2:25	<u>POST CLOSING CONFIG</u> 10
1:56	<u>DEACT STAR TRKRS & CLOSE DOORS</u> 13 , 1-26 <u>ENT AFT FLT DECK CONFIG</u> 15 , 1-26
1:55	<u>PAYLOAD ENT SW LIST/VERIF</u> (PL OPS, <u>DEORB PREP</u> or <u>SODF: ASSY OPS, ACTIVATION AND CHECKOUT; DEORBIT PREP</u>)
1:50	<u>FINAL ENT SWITCH LIST VERIF (AFT)</u> , 3-22 thru 3-33
1:41	<u>RESET C/W</u> 18 , 1-26
1:40	<u>ENTRY REVIEW</u>
1:28	DSO 603, if reqd (BIOMED, <u>BIOMED DSOs</u>)
1:10	<u>CLOTHING CONFIG</u> 21 , 1-26
1:00	Begin Fluid Loading per individual prescription. Fluid Loading should be completed by EI For 1 rev waveoff, repeat half the protocol If > 1 rev waveoff, repeat entire protocol
0:53	<u>AFD AUD SPKR CONFIG</u> 28
0:52	<u>WIRELESS STOW</u> 24 , 1-19

Block 11 deleted

<u>AFD AUD SPKR CONFIG</u> 28	
	Verify CDR, PLT on headsets
A13	OS AUD SPKR PWR – OFF PWR – OFF (OV102)
	Stow Handheld Mic Connect Lightweight Headsets

<u>CONFIG FOR PLBD CLOSING</u> 7	
	<u>CONFIG RMS</u> (if RMS onboard) ✓ Elbow Camr in aligned position <ul style="list-style-type: none"> ● Pan 90° from X-axis ● Tilt per decal
A8L	RMS PWR – OFF (SM ALERT, BCE BYP MCIU) PORT RMS HTR (two) – OFF
	<u>SET UP LIGHTS</u>
R11L	IDP/CRT4 PWR – ON
MDU	✓ CRT4 PWR – ON
A6U	✓ ANNUN BUS SEL – MNC
	<u>NOTE</u>
	Minimum operating time for PLB Floodlights: 25 min ~3 min to full bright
A7U	PL BAY FLOOD AFT STBD – <input style="width: 40px; height: 15px;" type="text"/> PORT – <input style="width: 40px; height: 15px;" type="text"/> MID STBD – <input style="width: 40px; height: 15px;" type="text"/> PORT – <input style="width: 40px; height: 15px;" type="text"/> FWD STBD – <input style="width: 40px; height: 15px;" type="text"/> PORT – <input style="width: 40px; height: 15px;" type="text"/> BHD – <input style="width: 40px; height: 15px;" type="text"/>
	Record MET ____/____ : ____ : ____
	* If PLB floodlight not ON to full bright within 5 min: * * (Aff) PL BAY FLOOD – OFF *
	<u>TV ACT</u> Perform ACTIVATION (Cue Card, <u>TV</u>)

<u>POST CLOSING CONFIG</u> 10	
	<u>NOTE</u>
	PLB Floodlights must be off for minimum of 10 min UNBLOCKED, 16 min BLOCKED prior to reuse
A7U	After floodlights ON > 25 min: PL BAY FLOOD (all) – OFF Stow Flt Deck Camrs, Accessories Perform DEACTIVATION (Cue Card, <u>TV</u>)
	<u>FOOT LOOP CONFIG</u> Tape Foot Loops in egress routes <u>EDO PALLET DEACT</u> , if flown (ORB OPS, <u>EPS</u>)

MEDS

Back of MS AFT FLIGHT DECK ACTIVITIES

DEACT STAR TRKRS & CLOSE DOORS 13

- O6 STAR TRKR PWR (two) – OFF
- O14:E, cb STAR TRKR –Z,–Y (two) – op
O15:E
- O6 STAR TRKR DR CNTL SYS (two) – CL (start timer)
 √ POS tb (two) – bp
 When both tb – cl (~8–24 sec) or either tb – bp > 24 sec:
 STAR TRKR DR CNTL SYS (two) – OFF
- * If tb – bp > 8 sec, notify MCC *

RESET C/W (Contact CDR for additional parameters) 18

NOTE
Expect 'MPS' light and master alarm.
'MPS' light will extinguish at OPS 303 PRO

R13U		
PARAMETER NAME	C/W CH	ENA/ INH
MPS He REG P C	39	ENA
L	49	ENA
R	59	ENA
MANF P LO2	69	INH
LH2	79	INH
HYD P 1	99	ENA
2	109	ENA
3	119	ENA

CLOTHING CONFIG 21

- Unstow,don:
 ACES
 Harness
 Boots
- Remove radiation dosimeter from inflight garments and insert in ACES
- Connect flight deck cooling units per PWR/DATA/VIDEO:
 ASCENT/ENTRY CONFIG (REF FS, UTIL PWR)
- A11,A15, DC UTIL PWR MNA(B,C) – ON as reqd
F1,O19 Cooling units – Hose Jumper Plug installed
Pre–chill cooling units 10 min prior to seat ingress

ENT AFT FLT DECK CONFIG 15

- A6L DSP (OV103,OV104,OV105)
 SYS PWR MNA,MNB (two) – OFF (hold 5 sec)
 √ SYS1,SYS2 tb (two) – OFF
 cb ESS 1BC SYS PWR CNTL SYS1 – op
 2CA SYS PWR CNTL SYS2 – op
 MNA,B DOCK LIGHT (four) – op
 MN A,B,C LOG (six) – op
- A12 HYD HTR
 HYD HTR (eight) – OFF
- A1L ENTRY COMM
 S–BD PM MODE – STDN LO
 NSP CODING (two) – OFF
- S–BAND PAYLOAD
 S–BD PL CH SEL INTRG 1,2 tw (six) – 910,910
 PWR SYS – OFF
 SEL – PSP
 ANT POLAR – L CIRC
 PSP CMD OUTPUT – PL UMB
- A1R AUD CTR VOICE RCD SEL CH1 – ICOM A
 CH2 – ICOM B
- A7 If WVS installed:
 √ WIRELESS VIDEO PWR – OFF
 WIRELESS VIDEO HTR – OFF
- R14:C cb MNB KU ANT HTR – op
 UHF EVA (two) – op
- :F √ cb ESS 1BC LDG GEAR ARM/DN RESET – op

NOTE
Review or mark cb location for ease of finding during post landing procedures

- VPU √ VPU POWER – OFF
R10 MS AUD A/G 2 – T/R
 A/A – T/R
 VOX SENS – R
 VOL tw (five) – R
 XMIT/ICOM MODE – R
- L9 PS AUD PWR – AUD TONE
 A/G 1 – T/R
 A/A – T/R
 ICOM (two) – T/R
 VOX SENS – R
 XMIT/ICOM MODE – R
 VOL tw (five) – R
- ICOM RECORDER OPS, if reqd (ORB OPS, COMM/INST)

MEDS

MS MIDDECK ACTIVITIES

NOTE

WAIT FOR GO FROM CDR OR PLT BEFORE STARTING ANY ACTIVITY ON THIS PAGE

TIME (TIG-)	MS MIDDECK ACTIONS
3:50	<u>ENT STOWAGE</u> [3]
3:50	<u>ENT AIRLOCK CONFIG</u> [3A], 1-28
3:35	<u>SPECIALIST SEAT INSTALLATION</u>
3:10	<u>PARTIAL ENT SWITCH LIST/VERIF (MID)</u> , 3-10 thru 3-12
1:55	<u>ENT MIDDECK CONFIG</u> [16]
1:50	<u>FINAL ENT SWITCH LIST/VERIF (MID)</u> , 3-28 thru 3-30 (OV102), 3-30 thru 3-32 (OV103, OV104, OV105)
1:40	<u>ENTRY REVIEW</u>
1:28	DSO 603, if reqd (BIOMED, BIOMED DSOs)
1:10	<u>CLOTHING CONFIG</u> [20], 1-28
1:00	Begin Fluid Loading per individual prescription. Fluid Loading should be completed by EI For 1 rev waveoff, repeat half the protocol If > 1 rev waveoff, repeat entire protocol
0:51	<u>MD AUD SPKR CONFIG</u> [29], 1-28
0:50	<u>CO2 RMVL SYS DEACT</u> , if flown [25], 1-28
0:35	<u>GALLEY DEACT</u> [26]
0:33	<u>WCS DEACT</u> [27], 1-28

<u>ENT MIDDECK CONFIG</u> [16]	
	<u>ENTRY COMM</u>
MO42F	MIDDECK SPKR AUD A/G 2 - T/R A/A - T/R VOX SENS - R VOL tw (five) - R XMIT/ICOM MODE - R
	<u>MIDDECK PCS</u>
MO10W	14.7 CAB REG INLET vlv (two) - CL H2O TK N2 REG INLET vlv (two) - OP O2 REG INLET vlv (two) - CL
MO32M	LEH O2 vlv (two) - R
MO69M	LEH O2 8 vlv - CL Remove, stow O2 Bleed Orifice LEH O2 8 vlv - R
MO69M	7 vlv - R
	<u>RMS PNL LTS</u> (if RMS onboard)
MA73C:F	cb RMS PRI ΦA - op B/U ΦA - op

<u>ENT STOWAGE</u> [3]	
	<u>PERSONAL HYGIENE SYS STOWAGE</u>
	Stow: Personal Hygiene Kits Hose
	<u>AIRLOCK CLOSEOUT</u>
	Tether soft goods to EVA tether point or A/L Stowage Bag. Gray Tape to floor Airlock ENT SW VERIF, 3-3
	<u>POLE SETUP</u>
	Reinstall Stbd Pip Pin Reinstall large Port Pin: Retract and hold Locking Pin (Ring) Reinstall large Pin Release Locking Pin (Ring) Slide forward Safing Latch
	✓ Pole Straps secure
	<u>FDI STOWAGE</u>
	Stow FLIGHT PLAN
	<u>CABIN CONFIG</u>
	Stow: Backup PGSC Middeck Camrs, Accessories FWD/AFT Shades, Filters Exercise Equipment Quick Don Masks
	✓ Retention net is in ASC/ENT config
	<u>EGRESS ROUTE CONFIG</u>
	Tape Foot Loops in egress routes
	<u>NOTE</u>
	Chemlights are middeck carry-on items Activate green chemlights after TIG Do not activate orange chemlights (slide ops only)
	Install green chemlights (8 ea) near egress hdw and egress routes Install orange chemlights (2 ea) above side hatch

<u>GALLEY DEACT</u> [26]	
GALLEY	OVEN/RHS - OFF H2O HTRS (two) - OFF ✓ OVEN FAN - OFF ✓ REHYD STA lever - cl (push in) ✓ OVEN DOOR LATCH - latched
MA73C:G	cb AC3 GALLEY FAN (three) - op
ML86B:A	MNC SPLY H2O GALLEY SPLY - op
:B	MNA GALLEY OVEN - op MNB GALLEY H2O HTR - op

(Cont next page)

(MEDS) A1-27

D/O/ALL/GEN L,3

Back of MS MIDDECK ACTIVITIES

ENT AIRLOCK CONFIG 3A

- If Internal Airlock flown:
- 1. Rotate, stow vent duct
 - 2. Close hatch per decal
 - 3. Equal vlv (two) – NORM, install caps >>
- If Booster Fan flown:
- 4. ARLK FAN A(B) – OFF
 - 5. Remove, stow flex duct from booster fan muffler inlet and cabin middeck floor air fitting
 - 6. cb AC1,2 ARLK TNL FAN A,B (six) – op
 - 7. Go to step 9
 - 8. Remove, stow flex duct from cabin middeck floor air fitting
 - 9. Unstow, install diffuser cap on middeck floor air fitting
 - 10. LTG FLOOD 1(3,4) – OFF
 - 11. Close hatch per decal
 - 12. Equal vlv (two) – NORM, install caps
 - 13. ✓ EMU O2 ISOL vlv – CL
 - 14. AIRLK 2 – OFF/ON
 - 15. ✓ ARLK H2O S/O vlv – OP (tb-op)
- If TNL ADAPT FLOWN:
- 16. cb MNA FLOOD TNL ADAPT 2 – op
 - cb MNB FLOOD TNL ADAPT 3 – op
 - cb MNC FLOOD TNL ADAPT 4 – op
- :F 17. cb MNA FLOODS AIRLK 1 – op
- MIDDECK 9 – op
 - cb MNB FLOODS MIDDECK 10 – op
 - AIRLK 3 – op
 - cb MNC FLOODS AIRLK 4 – op
- :G 18. cb ESS 1BC FLOOD AIRLK 2 – op
- If TNL ADAPT FLOWN:
- 19. cb ESS 1BC FLOOD TNL ADAPT 1 – op

CLOTHING CONFIG 20

- Unstow, don:
- ACES
 - Harness
 - Boots
- Remove radiation dosimeter from inflight garments and insert in ACES; if waveoff, remove radiation dosimeter from ACES and insert in inflight garments
- NOTE**
- Refer to flight specific utility outlet plug-in plan if reqd
- Connect middeck cooling units per PWR/DATA/VIDEO:
ASCENT/ENTRY CONFIG (REF FS, UTIL PWR)
- MO13Q, DC UTIL PWR MNA(B,C) – ON as reqd
MO30F, Cooling units – Hose Jumper Plug installed
MO52J, Pre-chill cooling units 10 min prior to seat ingress
PDB J2(3,4)
ML85E (MUP)

CO2 RMVL SYS DEACT 25

- MO51F CNTLR 2(1) MODE – STBY (hold 3 sec)
Wait 6 sec
- ✓ CNTLR 2(1) OPER It – off
 - ✓ FAIL It – on
 - MNC(A) – OFF
 - ✓ CNTLR 2(1) FAIL It – off
 - AC 3(1) – OFF (hold 3 sec)
 - AC 3(1) cbs (three) – op
 - COM INSTR – OFF
- Remove and replace LiOH Canister in position A with one fresh LiOH Canister

WCS DEACT 27

- WCS VAC VLV – CL
(EDO WCS) ✓ MODE – AUTO
FAN SEP SEL sw – OFF
Unstow hose from cradle, attach hose to WCS housing via Velcro straps
- Stow:
- WCS Trash Can
 - Mirror
 - Privacy Curtain
- Foot/toe restraints – up, latched
- If EDO WCS:
- Secure urinal hose with Velcro strap
 - URINAL SEL – OFF
 - WCS PWR SEL (two) – OFF 1, OFF 2
 - Commode lid lock – lock
 - ✓ COMPACTOR – stowed
 - COMPACTOR CLEANING LATCH PIN – disengaged
 - LOCK PINS (three) – tighten (snug)
- Stow thigh restraints
- Close and latch door
- ML31C VAC VENT ISOL VLV BUS SEL – MNB
CNTL – CL (tb-CL)
NOZ HTR – OFF
- ✓ Middeck Its as reqd

MD AUD SPKR CONFIG 29

- MO42F MIDDECK AUD SPKR PWR – OFF (OV103,4,5)
AUD/ARLK 2 BU SPKR PWR – OFF (OV102)
- Stow Handheld Mic
Connect Lightweight Headsets

NOMINAL DEORBIT PREP PROCEDURES

(NOM) B1-1

D/O/ALL/GEN L

**NOMINAL
DEORBIT PREP**

This Page Intentionally Blank

NOMINAL DEORBIT PREP OVERVIEW OF CONFIGURATION MANAGEMENT

DPS		OPS 1 ASC C/L					OPS 2 ON-ORBIT					OPS 2 DEORBIT PREP TIG -03:28					OPS 3 DEORBIT PREP TIG -02:20					SEAT INGRESS TIG -01:00					EI-5	V = 15K	
GPC OPS		1 G1	2 G1	3 G1	4 G1	5 BFS	1 G2	2 G2	3 G2F	4 SM	5 BFS	1 G2	2 G2	3 G2F	4 SM	5 BFS	1 G3	2 G3	3 G3	4 G3	5 BFS	1 G3	2 G3	3 G3	4 G3	5 BFS			
POWER OUTPUT MODE		ON N R	ON N R	ON N R	ON N R	ON B R	ON N R	ON N H	ON N H	ON T R	ON N H	ON N R	ON N H	ON N R	ON T R	ON N S	ON N R	ON N R	ON N R	ON N R	ON B R	ON N R	ON N R	ON N R	ON N R	ON B R			ON N R
CONFIG GPC		1 1 2 3 4 0					2 1 2 0 0 0		4 (5) 0 0 0 4 0		2 1 2 0 0 0		4 (5) 0 0 0 4 0		3 1 2 3 4 0		3 1 2 3 4 0												
STR	1 2 3 4 PL 1/2	1 2 3 4 1					1 2 1 2 0		0 0 0 4 4		1 2 1 2 0		0 0 0 4 4		1 2 3 4 1		1 2 3 4 1												
CRT	1 2 3 4	1 2 3 0					1 2 0 2		4 4 0 4		1 2 0 2		4 4 0 4		1 2 3 0		1 2 3 0												
L	1 2	1 2					0 0		4 0		0 0		4 0		0 0		0 0												
MM	1 2	1 2					1 2		4 4		1 2		4 4		1 2		1 2												
MDM		ALL ON					ALL ON					ALL ON					ALL ON												
D & C	ADI/DDU CRT/DEU INSTR	L,R 1,2,3 L,R	L,A 1,2,4-ON NONE					L,R L,R					1,2,3-ON																
E C L S	AV BAY FAN CABIN FAN IMU FAN WATER LP FREON LP RADIATOR	1-B,2-A,3-B A B 1-OFF, 2-ON 1-B,2-B Stow	1-GPC,2-ON					1-OFF,2-ON																					
F C S S / N N A V A R I D S	FCS ASA ACCEL RGA ADTA IMU RA TACAN UHF MLS	AUTO ALL ON ALL ON ALL ON ALL ON ALL ON ALL ON ALL ON ON ALL OFF	OFF ALL ON ALL ON ALL ON ALL ON OFF ALL ON ALL ON ALL ON					ALL ON ALL ON ALL ON ALL ON ALL ON ALL ON ALL ON																					
R J D	RJDA RJDF VERNIER	ALL ON ALL ON OFF	ON																										

NOM

NOMINAL DEORBIT PREP SUMMARY TIMELINE

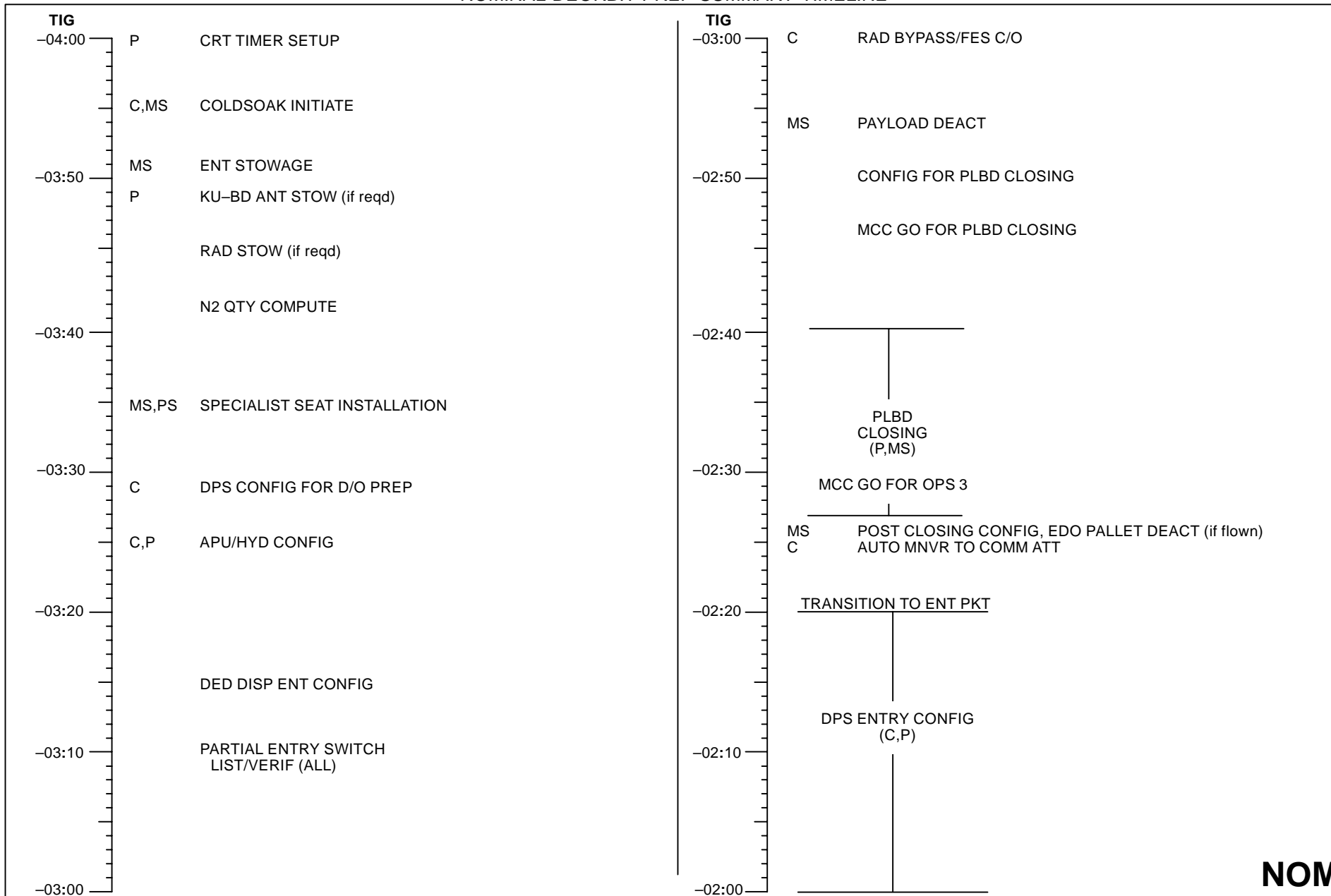

(NOM) B1-4

NOM

D/O/ALL/GEN L

NOMINAL DEORBIT PREP SUMMARY TIMELINE

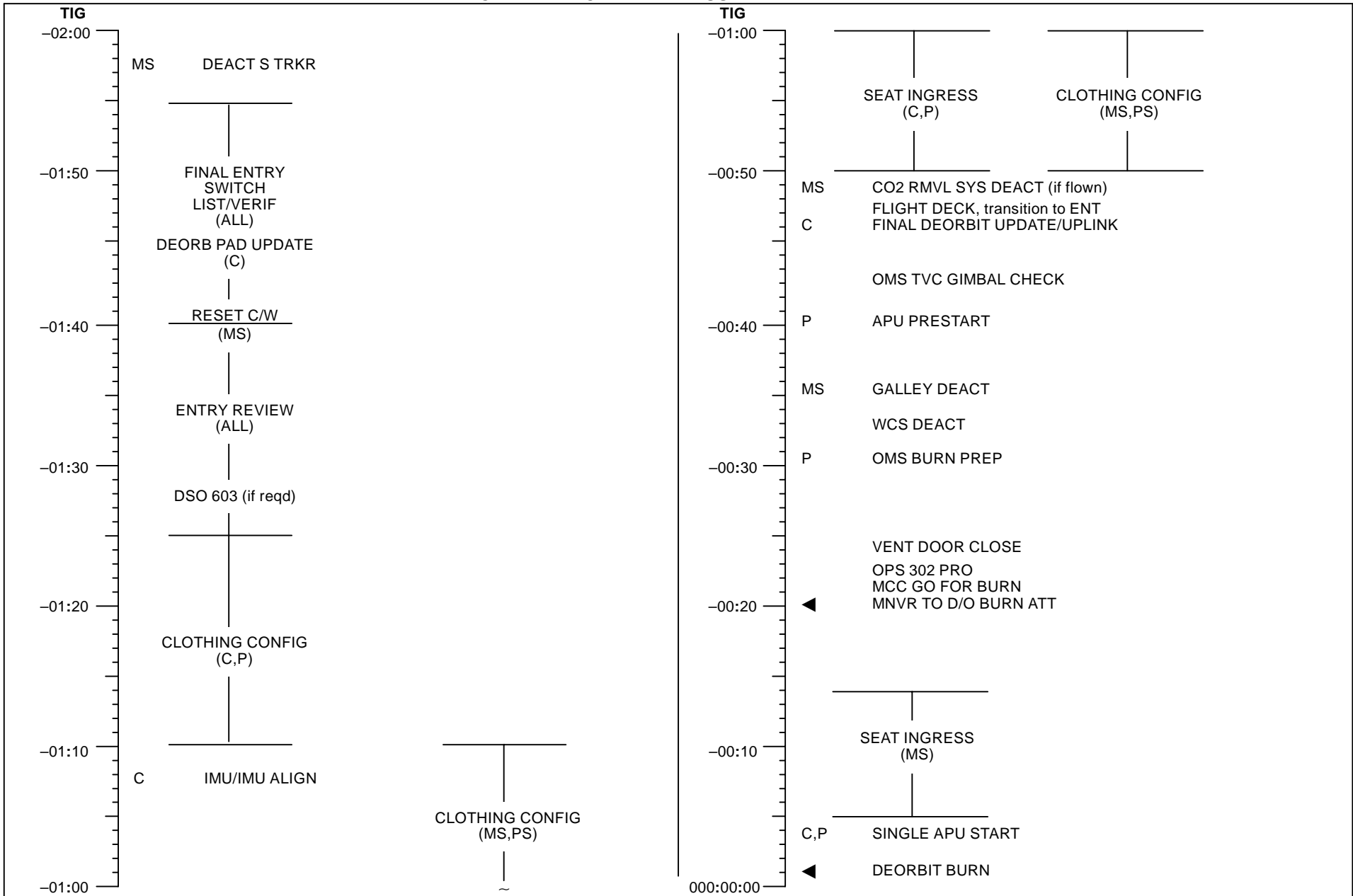

(NOM) B1-5

D/O/ALL/GEN L

NOMINAL DEORBIT PREP

* If TIME to TIG <4 hr and >2 hr 40 min:

* 1. ACCOMPLISH IMMEDIATELY:

* MNVR (TRK) BIASED -XSI (if not already in TAIL SUN)

CRTX	TGT ID	+4 (blanks OM)
	BODY VECT	+5
	P	+184
	✓OM	(blank)
	Initiate TRK	

* 2. Back out of PRIORITY PWRDN, as reqd (ORB PKT, PRIOR PWRDN)

* 3. If previous FC PURGE was not accomplished within last 6 hr:
Accomplish FC PURGE (ORB OPS, EPS) during D/O Prep prior to DPS ENTRY
CONFIG

* 4. MS accomplish CABIN CONFIG/STOW (FLIGHT PLAN) during D/O Prep timeframe

* 5. Begin Deorbit Prep timeline immediately and perform procedures as rapidly as possible

VERIFY THAT FOLLOWING ACTIVITIES HAVE BEEN ACCOMPLISHED:

FCS CHECKOUT (ORB OPS, GNC)

RCS HOT FIRE TEST (ORB OPS, RCS)

CABIN CONFIG/STOW (FLIGHT PLAN)

IMU ALIGN – S TRK (ORB OPS, GNC)

MNVR (TRK) BIASED -XSI (FLIGHT PLAN, DETAILED TIMELINE)

FC PURGE (ORB OPS, EPS)

Back out of PRIORITY PWRDN, as reqd (ORB PKT, PRIOR PWRDN)

(NOM) B1-6

D/O/ALL/GEN L

1: GNC UNIV PTG		2: SM SYS SUMM 1	
TIG -04:00 A5(B1) AUTO VERN RT 0.2 DB 1.0 -03:55 -03:50 -03:45 -03:40 -03:35 -03:30	P	<u>CRT TIMER SETUP</u>	1
	C,MS	<u>COLDSOAK INITIATE</u>	2
		Verify in ATT: DAP: A5/AUTO/VERN(ALT) If no FWD RCS: ✓A6/AUTO/ALT ✓DAP: B set to B1	
	MS	<u>ENT STOWAGE</u>	3, 1-27
		<u>ENT AIRLOCK CONFIG</u>	3A, 1-28
	P	<u>KU-BD ANT STOW</u> , if deployed (ORB OPS, <u>COMM/INST</u>)	
		<u>RAD STOW</u> , if reqd (ORB OPS, <u>ECLS</u>)	
	S66	<u>N2 QTY COMPUTE</u> Add N2 QTY 1 + 2 Then annotate CABIN PRESS LEAK NOMOGRAPH (ENT PKT, <u>ECLS</u>)	
	S68, 168	<u>DETERMINE H2 DEPLETED TANKS</u> Note all H2 tanks with Qty < 3% Then annotate DEORBIT BURN FLIGHT RULES, ELEC section (steps 9 thru 12) for depleted tanks (ENT, <u>BURN CARDS</u>)	
	MS, PS	<u>SPECIALIST SEAT INSTALLATION</u>	

CRT TIMER SETUP 1

1: GNC 2 TIME

SET CRT TIMER TO COUNT DOWN TO TIG (perform for GNC & SM)

ENTRY DAY (HR:MIN:SEC - MET)

ITEM 17 + + +

24 HR LATE DELAYED DEORBIT

ITEM 17 + + +

1: GNC UNIV PTG

COLDSOAK INITIATE 2

FES CONFIG

C L1 FLASH EVAP CNTLR PRI A,B,SEC (three) - OFF
RAD CNTLR OUT TEMP - HI
 When FREON EVAP OUT TEMP > 50 degF,
FLASH EVAP CNTLR PRI B(A) - ON
HI LOAD DUCT HTR - B

MS R11L ✓ SPLY H2O XOVR VLV - OP (tb-OP)

H2O LOOP C/O AND CONFIG

SM 88 APU/ENVIRON THERM

NOTE
 INCR decreases ICH FLOW

L1 H2O LOOP 2 BYP MODE - MAN
H2O LOOP 2 BYP MAN - INCR or DECR (adjust until ICH FLOW
 -950 ± 50)

If first Deorbit Prep:
H2O PUMP LOOP 1 - ON
 ✓ LOOP 1 BYP MODE - MAN
 MAN - DECR (hold 5 sec)

CRT ✓ H2O LOOP 1 ICH FLOW - increasing

L1 H2O LOOP 1 BYP MAN - INCR (Adjust until ICH FLOW -950 ± 50)
H2O PUMP LOOP 1 (two) - OFF,B

APU/HYD CONFIG 5

APU STEAM VENT HTR ACT

R2 ✓BLR CNTLR/HTR (three) – B
 PWR (three) – ON

NOTE

HTR reqd to be on 2 hr prior to APU act

R2 HYD CIRC PUMP TERM
 HYD CIRC PUMP (three) – OFF

C3 SSME HYD REPRESS PREP
O17 ✓FCS CH (four) – AUTO
 ATVC (four) – ON

DED DISP ENT CONFIG 6

O14, RGA (four) – ON
O15, cb MNA,B,C ADTA (four) – cl
O16 MNA,B ACCEL 1, 2 (two) – cl
 MNA,C DDU AFT (two) – op
 MNB,C DDU R (two) – cl
 ASA (four) – ON
 ACCEL 4,3 (two) – ON

O7 TACAN MODE (three) – GPC
 ANT SEL (three) – AUTO

O8 RADAR ALTM (two) – ON
 MLS (three) – ON
 CH tw (three) – See DEL PAD (ENT, PRPLT/DEL PADS)

F6/F8 INST PWR – FLT (F6)
 – ON (F8)

F3 TRIM PNL (two) – ON
F6/F8 HSI: ✓Off flag – not visible

ADI: ✓Error needles & rate pointers – visible

TIG
-03:30

A5(B1)
AUTO
VERN
RT 0.2
DB 1.0

-03:25

-03:20

UPLINK
(if reqd)
PASS SV

-03:15

-03:10

-03:05

-03:00

1: GNC 0 GPC MEMORY 2: BFS, GNC 0 BFS MEMORY

C If single G2: DPS CONFIG FOR D/O PREP [4a]
ENSURE BFS GPC CAN COMMAND A CRT [4b]

C,P APU/HYD CONFIG [5], 1-8

DED DISP ENT CONFIG [6], 1-8

NOTE
 ✓MCC for unaccounted-for switch
 or cb config discrepancies

C
P
MS PARTIAL ENT SWITCH LIST/VERIF (FWD), 3-4 thru 3-6
PARTIAL ENT SWITCH LIST/VERIF (FWD), 3-7 & 3-8
PARTIAL ENT SWITCH LIST/VERIF (AFT), 3-9
PARTIAL ENT SWITCH LIST/VERIF (MID), 3-10 thru 3-12

DPS CONFIG FOR D/O PREP [4a]

NOTE
 Do not perform any keyboard item entries
 or switch throws 10 sec before and after
 moding PASS GPCs to RUN or making
 OPS transition requests

P/I Locker ACTIVATE GPC 2 (if in HALT)
 Remove and stow GPC Mode Switch Guard

O6 ✓GPC MODE 2 - HALT (tb-bp)
 ✓OUTPUT 2 - NORM
 ✓PWR 2 - ON
 MODE 2 - STBY (tb-RUN),RUN

TRANSITION GPCs 1 & 2 TO OPS 2
 (if GPC 2 just activated)

[1: GNC 0 GPC MEMORY]
 CONFIG - ITEM 1 +2 EXEC
 Modify MC 2 per table →
 GNC, OPS 201 PRO

CONFIG GPC	2	12000
STR 1	1	1
2	2	2
3	1	1
4	2	2
PL 1/2	0	0
CRT 1	1	1
2	2	2
3	0	0
4	2	2
L 1	0	0
2	0	0
MM 1	1	1
2	2	2

[1: GNC 22 S TRK/COAS CNTL]
 S TRK -Y,-Z: STAR TRK - ITEM 3,4 EXEC

[1: GNC 21 IMU ALIGN]
 RESUME

ENSURE BFS GPC CAN COMMAND A CRT [4b]

O6 ✓GPC PWR 5 - ON
 MODE 5 - STBY (tb-RUN)

C3 BFC CRT DISP - ON
 SEL - 2+3

[2: BFS, GNC BFS MEMORY or SM THERMAL]

C3 BFC CRT DISP - OFF
 SEL - 3+1

NOM

Block deleted

(NOM) B1-10

NOM
D/O/ALL/GEN L

TIG

-03:00

A5(B1)
 AUTO
 ALT
 RT 0.2
 DB 5.0

DAP: A/AUTO/ALT

-02:55

RAD BYPASS/FES C/O (ORB OPS, ECLS)

MS

PAYLOAD DEACT, if reqd (PL OPS, DEORB PREP
or SODF: ASSY OPS, ACTIVATION AND
CHECKOUT; DEORBIT PREP)
CONFIG FOR PLBD CLOSING [7], 1-25

-02:50

MCC: GO/NO-GO FOR PLBD CLOSING

-02:45

UPLINK
 UPDATE
 COMM
 ATT

-02:40

P,MS

DETAILED PLBD CLOSING PROCEDURES [9], 1-21

-02:35

P,MS
 PLBD
 CLOSING

-02:30

DPS ENTRY CONFIG 12

* If IMU or RHC dilemma, do not proceed with OPS 3 transition *

- ✓ Att mnvr complete
- ✓ RGA,AA,ASA,IMU (all) – ON

NOTE

Do not perform any keyboard item entries or switch throws 10 sec before and after moding PASS GPCs to RUN or making OPS transition requests

1. CRT CONFIG
 C2 CRTX CRT3
 CRT 3 PWR – ON
 GPC/CRT 2/3 EXEC
2. VERIFY GPC CONFIG
 O6
 ✓ GPC MODE 3 – HALT (tb-bp)
 ✓ PWR 3 – ON
 ✓ OUTPUT 1,2 – NORM (tb-gray)
 ✓ 3,5 – NORM (tb-bp)
 ✓ 4 – TERM (tb-bp)
 ✓ MODE 1,2,4 – RUN (tb-RUN)
 3 – STBY (tb-RUN)
 ✓ 5 – STBY (tb-RUN)
3. SM CHECKPOINT/UL CNTL ENA
1: SM 60 SM TABLE MAINT
2: SM 1 DPS UTILITY
 CRT2 MMU ASSIGN 2 SM – ITEM 4 EXEC
 CRT1 CKPT INITIATE – ITEM 18 EXEC
 ✓ Update of CKPT TIME and STATUS GOOD indicated
 CRT2 MMU ASSIGN 1 SM – ITEM 3 EXEC
 CRT1 CKPT INITIATE – ITEM 18 EXEC
 ✓ Update of CKPT TIME and STATUS GOOD indicated
 CRT2 CKPT RETRV ENA – ITEM 12 EXEC (*)
 UL CNTL ENA – ITEM 36 EXEC
4. LOAD ENTRY TFL/RECONFIG UPLK
 Perform LOAD PDI DECOM FORMAT and LOAD PCMMU FORMAT for entry config (ORB OPS FS, COMM/INST)
 C2 Set event timer to count down to TIG
5. TRANSITION GPC 1&2 TO GNC OPS 3
1: GNC 0 GPC MEMORY
 CONFIG – ITEM 1 +3 EXEC

6. TRANSITION BFS GPC TO GNC OPS 3
 C3 BFC CRT DISP – ON
 ✓ SEL = 3+1
3: BFS, GNC BFS MEMORY
 O6 GPC OUTPUT 5 – B/U (tb-bp)
 CRT3 ✓ TFL ENA – ITEM 29 (*)
 BFS, GNC OPS 301 PRO
3: BFS, GNC DEORB MNVR COAST
7. TRANSITION GPC 1,2,3,4 TO GNC OPS 3
 O6 SM, OPS 000 PRO
X: SM GPC MEMORY
 GPC OUTPUT 4 – NORM (tb-gray)
 MODE 3,5 (two) – RUN (tb-RUN)
 If no comm, sel best antenna
 ✓ CONFIG – ITEM 1 +3 EXEC
 Modify MC 3 per table →
 GNC OPS 301 PRO
1: GNC DEORB MNVR COAST
 CRT3 BFS, GNC OPS 000 PRO
 BFS, GNC OPS 301 PRO
 C3 BFC CRT DISP – OFF (GPC 3 driving CRT3)
 – ON
 * If any IMU failed or not aligned: *
 * 3: BFS, GNC 51 OVERRIDE *
 * Aff IMU – desel *
8. MNVR BACK TO COMM ATT
9. LOAD IN TGTs
1: GNC DEORB MNVR COAST
 ✓ MCC for TGT and SV UPLINK
 LOAD – ITEM 22 EXEC
 TIMER – ITEM 23 EXEC
10. VERIFY MC 9 TABLE (GNC) FOR POST LANDING
2: GNC 0 GPC MEMORY
 CONFIG – ITEM 1 +9 EXEC
 Modify MC 9 per table →
 CONFIG – ITEM 1 +3 EXEC

CONFIG GPC	3	12000
STR	1	1
	2	2
	3	1
	4	2
PL	1/2	0
CRT	1	1
	2	2
	3	2
	4	0
L	1	0
	2	0
MM	1	1
	2	2
CONFIG GPC	3	12340
STR	1	1
	2	2
	3	3
	4	4
PL	1/2	1
CRT	1	1
	2	2
	3	3
	4	0
L	1	0
	2	0
MM	1	1
	2	2
CONFIG GPC	9	12340
STR	1	1
	2	2
	3	3
	4	4
PL	1/2	1
CRT	1	1
	2	2
	3	3
	4	0
L	1	1
	2	2
MM	1	1
	2	2

NOM

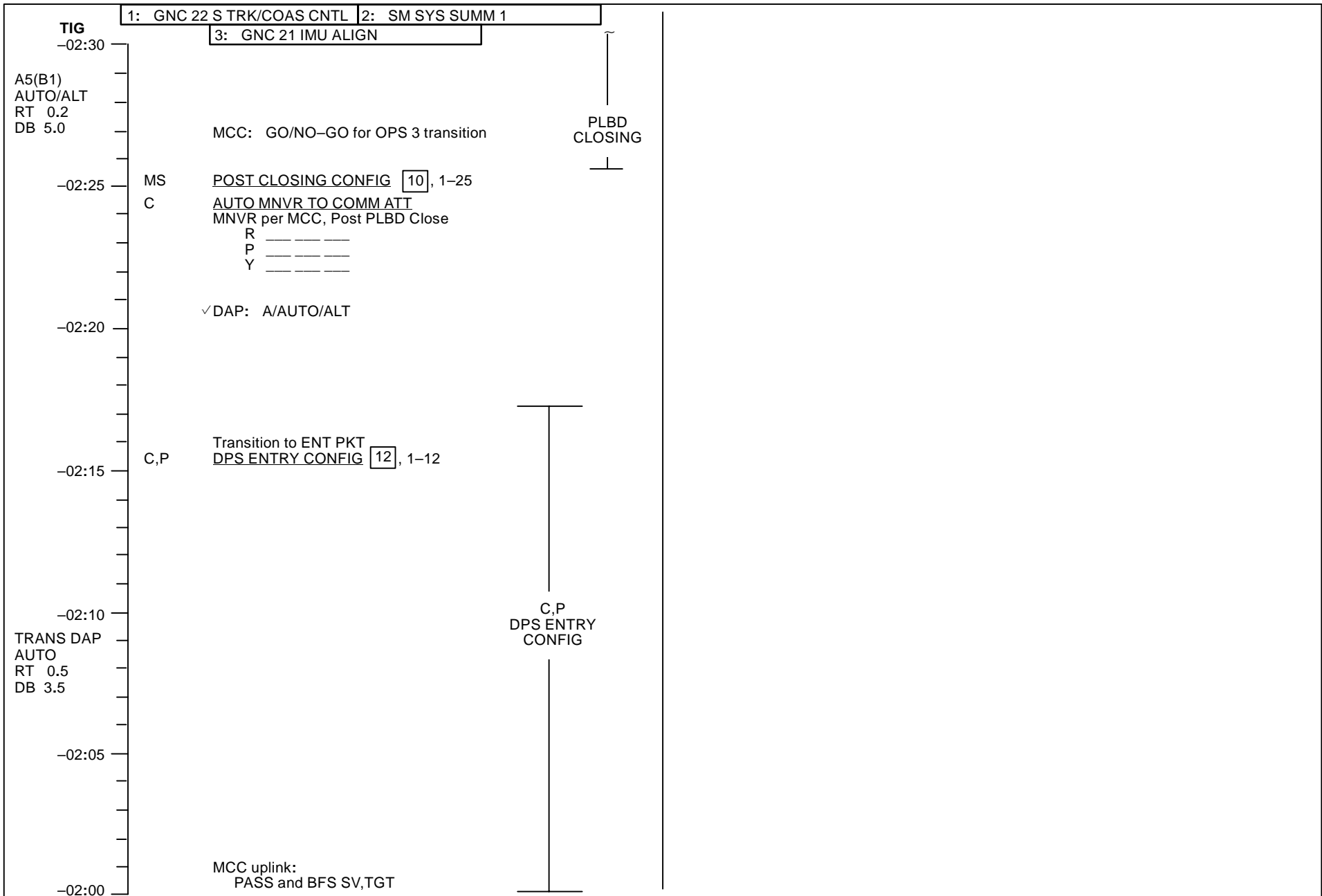

DEORB PAD UPDATE 17

MCC update:

OMS PRPLT PAD, DEL PAD (ENT, PRPLT/DEL PADS)
and DEORBIT MNVR PAD (ENT, MNVR PADS)

* If MCC cannot provide DEORB TGT, use PGSC *

LANDING SITE UPDATE

1: GNC 50 HORIZ SIT

SEL SITE see DEL PAD (ENT, PRPLT/DEL PADS)

CHECK TGTs

1: GNC DEORB MNVR COAST

- ✓ PASS and BFS TGT per DEORBIT MNVR PAD
(ENT, MNVR PADS)
- ✓ PASS and BFS solution per DEORBIT MNVR PAD
(ENT, MNVR PADS):
BURN ATT, HA HP
 Δ VTOT
TGO

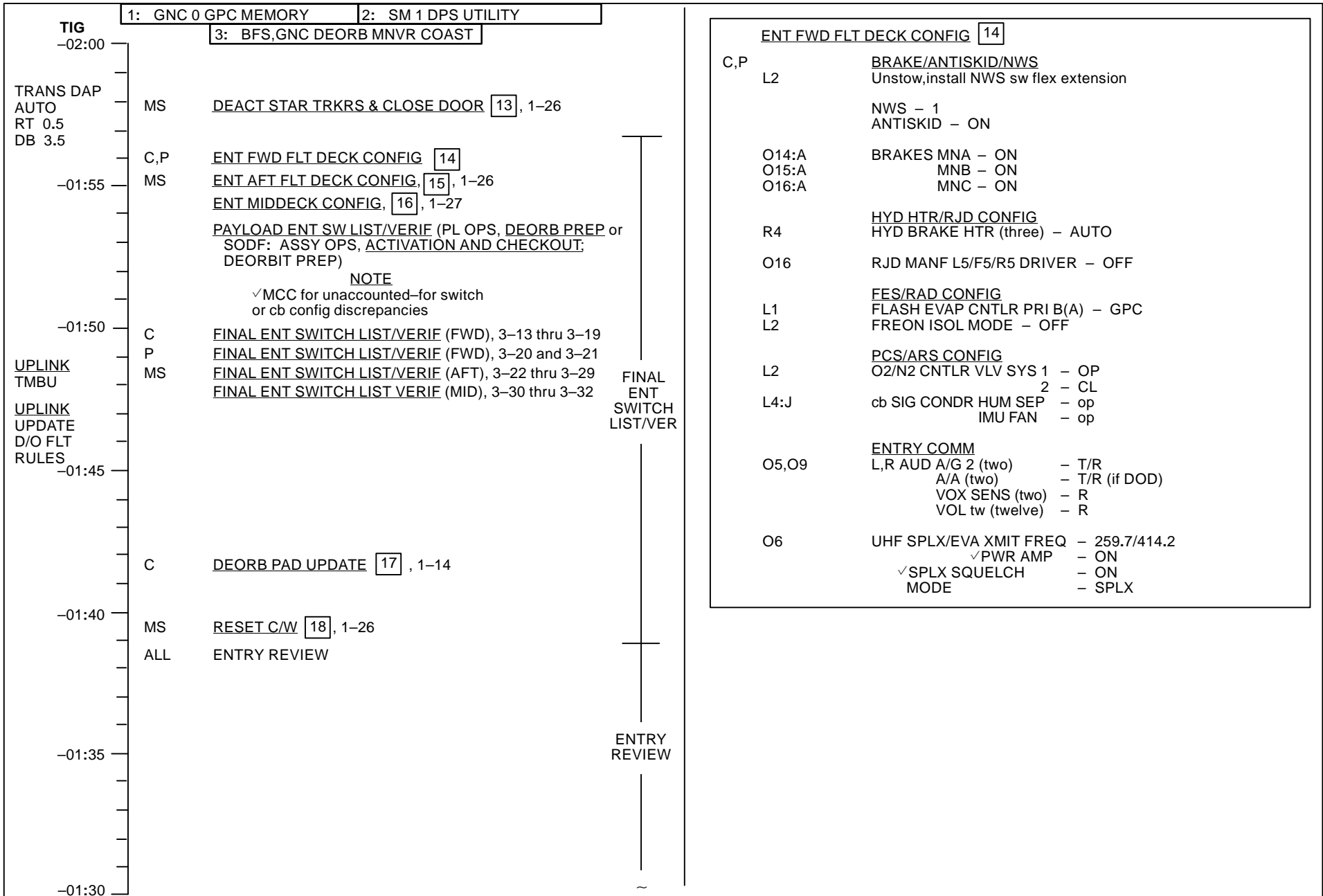

1: GNC 0 GPC MEMORY 2: SM 1 DPS UTILITY
 3: BFS, GNC DEORB MNVR COAST

ENT FWD FLT DECK CONFIG 14

C,P **BRAKE/ANTISKID/NWS**
 L2 Unstow, install NWS sw flex extension

NWS - 1
 ANTISKID - ON

O14:A BRAKES MNA - ON
 O15:A MNB - ON
 O16:A MNC - ON

R4 **HYD HTR/RJD CONFIG**
 HYD BRAKE HTR (three) - AUTO

O16 RJD MANF L5/F5/R5 DRIVER - OFF

L1 **FES/RAD CONFIG**
 L2 FLASH EVAP CNTLR PRI B(A) - GPC
 FREON ISOL MODE - OFF

L2 **PCS/ARS CONFIG**
 O2/N2 CNTLR VLV SYS 1 - OP
 2 - CL
 L4:J cb SIG CONDR HUM SEP - op
 IMU FAN - op

O5,O9 **ENTRY COMM**
 L,R AUD A/G 2 (two) - T/R
 A/A (two) - T/R (if DOD)
 VOX SENS (two) - R
 VOL tw (twelve) - R

O6 UHF SPLX/EVA XMIT FREQ - 259.7/414.2
 ✓PWR AMP - ON
 ✓SPLX SQUELCH - ON
 MODE - SPLX

(NOM) B1-15

D/O/ALL/GEN L,4

This Page Intentionally Blank

(NOM) B1-16

D/O/ALL/GEN L

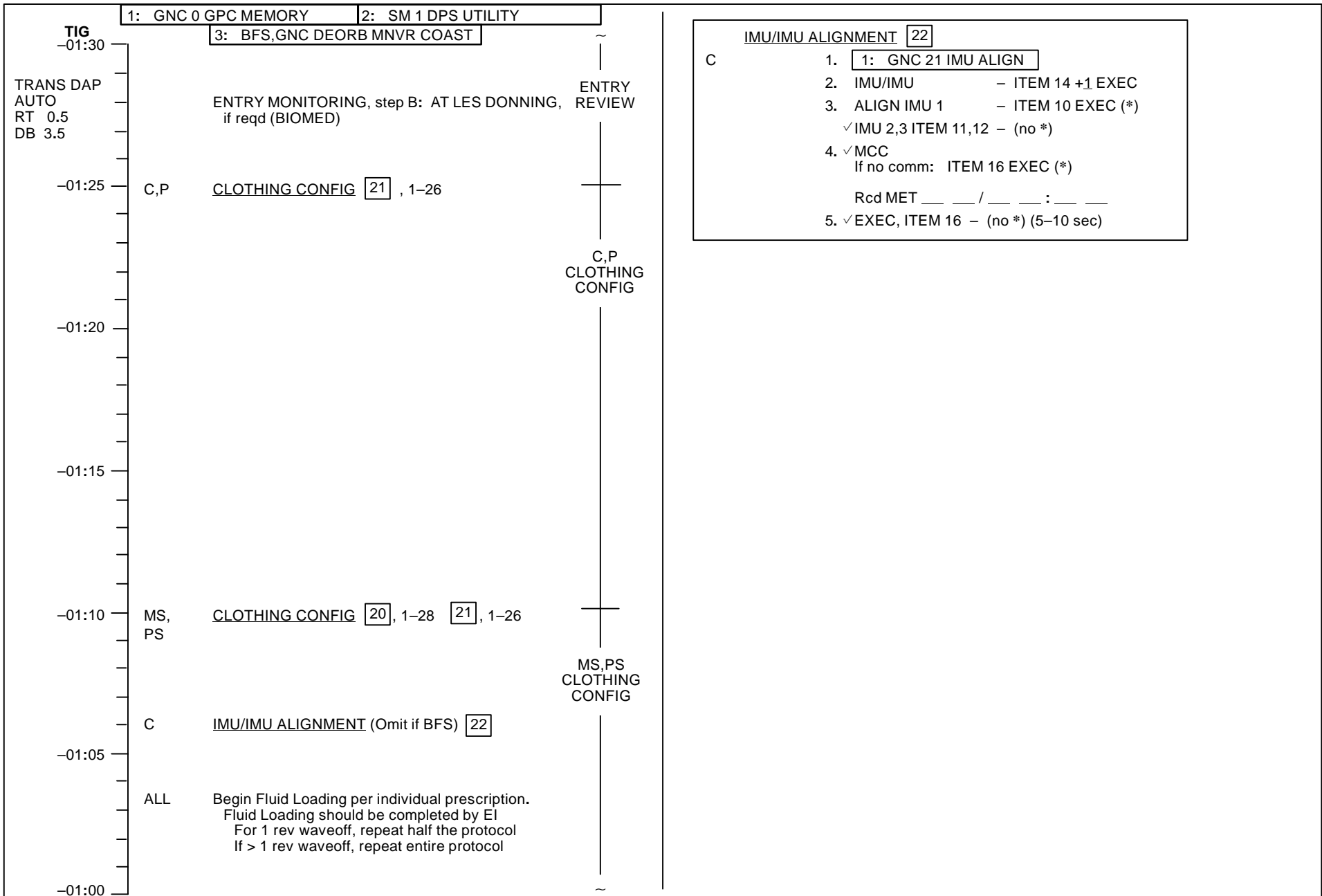

This Page Intentionally Blank

(NOM) B1-18

D/O/ALL/GEN L

TIG		1: GNC DEORB MNVR COAST	2: GNC DEORB MNVR COAST	
-01:00				
TRANS DAP	C,P	SEAT INGRESS		MS,PS CLOTHING CONFIG
AUTO	C,P	HUD SETUP [23]		
RT 0.5	C,P	Adjust seat Exercise brake pedals		
DB 3.5				
-00:55	C	C6	LEH O2 vlv (four) – OP	
	C,P		LES PRESS INTEGRITY CHECK	
	MS		AFD AUD SPKR CONFIG [28], 1-25	
	MS		WIRELESS STOW [24]	
	MS		MD AUD SPKR CONFIG [29], 1-28	
-00:50	MS		CO2 RMVL SYS DEACT, if flown [25], 1-28	
	C,P		Stow all unnecessary FDF articles FLIGHT DECK, go to ENT, DEORBIT BURN	
-00:45				
-00:40				
-00:35	MS		GALLEY DEACT [26], 1-27	
	MS		WCS DEACT MS [27], 1-28	
			NOTE WCS must be deactivated prior to EI	
-00:30				

HUD SETUP [23]
Remove, stow HUD Covers (two)
Ensure Cloth Cover does not obscure light sensor

WIRELESS STOW [24]
Disconnect, stow Wireless Comm (if reqd)
✓ Aft deck lts as reqd

This Page Intentionally Blank

(NOM) B1-20

D/O/ALL/GEN L

AUTO PLBD CLOSING

DETAILED PLBD CLOSING PROCEDURES 9

CAUTION

Verify no obstructions when closing and latching PLBD
(Ku ANT,RMS,RAD,etc)

- R13L
- * If no motion determined visually or 'OP/CL' *
 - * not blank within 10 sec after cmd, *
 - * PL BAY DR – STOP *
 - * Perform MAL, MECH, 9.1a *
 - * If Latch not 'CL' in single-motor time, *
 - * PL BAY DR – STOP *
 - * Perform MAL, MECH, 9.1e *
 - * If door motion stops and not 'RDY' or 'CL', *
 - * PL BAY DR – STOP *
 - * Perform MAL, MECH, 9.1g *
 - * If SM GPC fails during this operation: *
 - * PL BAY DR SYS 1,2 (two) – DSBL *
 - * PL BAY DR – STOP *
 - * Perform PASS SM GPC FAIL (ORB PKT, DPS) *
 - * If BFS AUTO sequence has been interrupted by reversing *
 - * latch/door drive direction, or if MANUAL mode has been *
 - * used at any time during the mission, use MANUAL mode *
 - * for all subsequent BFS PLBD ops *

NOTE

Note any single-motor operations (continue ops)
(single-motor times = 2x listed dual-motor times)

CONFIGURE FOR AUTO MODE

- CRT4
1. SM, OPS X02 PRO or BFS, SM 63 PL BAY DOORS
 - 4: SM PL BAY DOORS
- R13L
- ✓ PL BAY DR – STOP
 - ✓ PBD SW – STOP
 - ✓ MAN SEL (ten) – (no *)
 - ✓ PBD SW BYPASS – (no *)
2. AC POWER ON – ITEM 1 EXEC (*)
 3. AUTO MODE SEL – ITEM 3 EXEC (*)

- R13L
4. PL BAY DR SYS 1,2 (two) – ENA
- CRT4
- ✓ OP/CL STATUS (ten) – OP

CLOSE PLBDs USING AUTO MODE

- * If PORT(STBD) DOOR not 'CL' within 6 sec of 'RDY': *
 - * PL BAY DR – STOP *
 - * ✓ PLBD BULKHEAD LATCH GO/NO-GO DIAGRAM, *
 - * 1-22 *
 - * If NO-GO: Go to MAL, MECH SSR-2 (CONTINGENCY *
 - * PLBD CLOSURE) *
 - * If GO: PL BAY DR – CL *
 - * Continue in procedure *
- R13L
5. PL BAY DR – CL
- CRT4
- ✓ PORT DOOR – blank,RDY,CL (~63 sec)
 - ✓ FWD,AFT LATCHES – blank,CL (~30 sec)
 - ✓ STBD DOOR – blank
6. When STBD DOOR as close as possible to PORT DOOR before contact, perform PLBD fit check:
- R13L
- PL BAY DR – STOP
 - Determine C/L Latch clearance on ENTRY DAY NO-GO DIAGRAM C/L LATCH EXTENDED GUIDE ROLLER TRAJECTORY, 1-22
 - * If NO-GO for PLBD CLOSE and no waveoff capability, *
 - * perform MAL, MECH SSR-3 (SIMULTANEOUS PLBD CL) *
 - * If waveoff OK, ✓ MCC *
7. PL BAY DR – CL
- CRT4
- ✓ STBD DOOR – CL (~63 sec)
 - ✓ FWD,AFT LATCHES (two) – blank,CL (~30 sec)
 - ✓ CENTER LATCHES 1-4,13-16 (two) – blank,CL (~20 sec)
 - ✓ 5-8,9-12 (two) – blank,CL (~20 sec)
- R13L
8. PL BAY DR – STOP
- ### POST-PLBD CLOSING CLEANUP
- CRT4
9. PL BAY DR SYS 1,2 (two) – DSBL
 - ✓ OP/CL STATUS (ten) – CL
 10. AC POWER OFF – ITEM 2 EXEC (*)
 11. GPC/CRT 04 EXEC
 12. CRT4 PWR – OFF

NOM

**PLBD BULKHEAD LATCH GO/NO-GO DIAGRAM
(REVERSE FOR STBD DOOR)**

AUTO PLBD CLOSING

FUNCTION	PLBD CONTROL								PLBD DISPLAY PL MDM											
	Ref: MA73C:C&D for MCA (cb)																			
	MTR 1				MTR 2				C		O		C		R		R		O	
	AC/MCA	CNTL	MDM	SYS	AC/MCA	CNTL	MDM	SYS	A	B	A	B	A	B	C					
LATCH																				
5-8	1/MID3	AB3/AB2	PL1	2	3/MID2	CA3/CA1	PL2	1	1	2	1	2								
9-12	1/MID1	AB3/AB1	PL1	1	3/MID4	CA3/CA2	PL2	2	1	2	1	2								
1-4	1/MID3	AB3/AB2	PL1	2	3/MID2	CA3/CA1	PL2	1	1	2	1	2								
13-16	3/MID4	CA3/CA2	PL2	2	2/MID2	BC3/BC1	PL1	1	2	1	2	1								
S FWD	1/MID1	AB3/AB1	PL1	1	2/MID4	BC3/BC2	PL2	2	1	2	1	2								
S AFT	3/MID4	CA3/CA2	PL2	2	2/MID2	BC3/BC1	PL1	1	2	1	2	1								
S DOOR	1/MID1	AB3/AB1	PL1	1	2/MID4	BC3/BC2	PL2	2					1	1	2	2	1			
													2	1	2	2	2			
P FWD	1/MID1	AB3/AB1	PL1	1	2/MID4	BC3/BC2	PL2	2	1	2	1	2								
P AFT	1/MID3	AB3/AB2	PL1	2	3/MID2	CA3/CA1	PL2	1	1	2	1	2								
P DOOR	3/MID4	CA3/CA2	PL2	2	2/MID2	BC3/BC1	PL1	1					2	1	1	2	2			
													1	1	1	2	1			

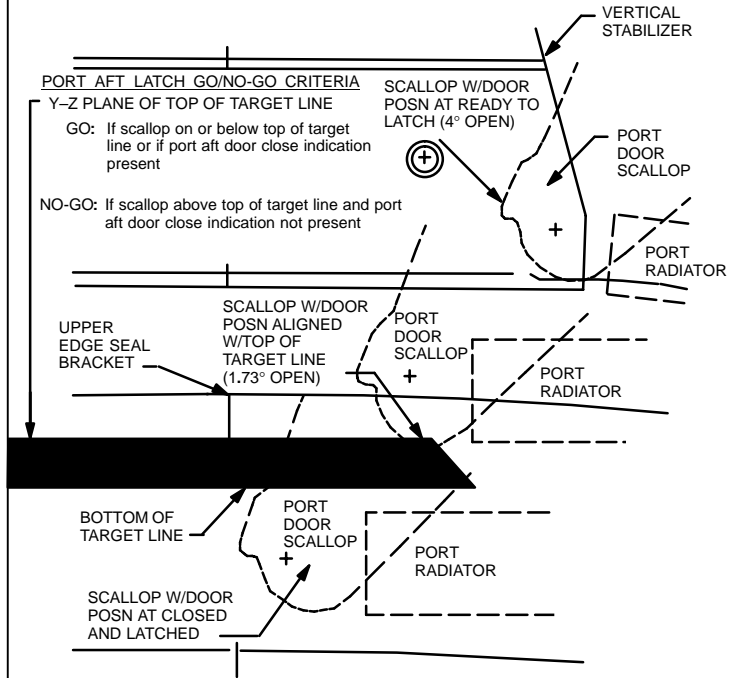

**ENTRY DAY NO-GO DIAGRAM
C/L LATCH EXTENDED GUIDE ROLLER TRAJECTORY**

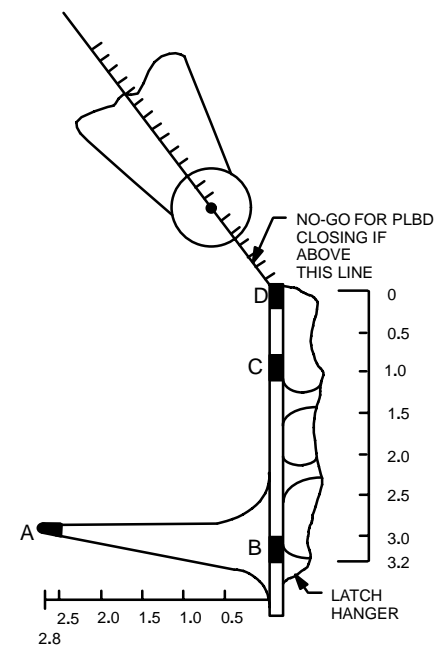

NOM

MANUAL PLBD CLOSING

DETAILED PLBD CLOSING PROCEDURES

CAUTION

Verify no obstructions when closing and latching PLBD (Ku ANT,RMS,RAD,etc)

- R13L
- * If no motion determined visually or 'OP/CL' *
 - * not blank within 10 sec after cmd, *
 - * PL BAY DR – STOP *
 - * Perform MAL, MECH, 9.1a *
 - * If Latch not 'CL' in single–motor time, *
 - * PL BAY DR – STOP *
 - * Perform MAL, MECH, 9.1e *
 - * If door motion stops and not 'RDY' or 'CL', *
 - * PL BAY DR – STOP *
 - * Perform MAL, MECH, 9.1g *

 - * If SM GPC fails during this operation: *
 - * PL BAY DR SYS 1,2 (two) – DSBL *
 - * PL BAY DR – STOP *
 - * Perform PASS SM GPC FAIL (ORB PKT, DPS) *

 - * If BFS AUTO sequence has been interrupted by reversing *
 - * Latch/door drive direction, or if MANUAL has been used *
 - * at any time during the mission, use MANUAL mode for all *
 - * subsequent BFS PLBD ops *

NOTE

Note any single–motor operations (continue ops)
(single–motor times = 2x listed dual–motor times)

CONFIGURE FOR MANUAL MODE

- CRT4 1. SM, OPS X02 PRO or BFS, SM 63 PL BAY DOORS
- R13L 4: SM PL BAY DOORS
- CRT4
- ✓ PL BAY DR – STOP
 - ✓ PBD SW – STOP
 - ✓ MAN SEL (ten) – (no *)
 - ✓ PBD SW BYPASS – (no *)
- R13L 2. AC POWER ON – ITEM 1 EXEC (*)
- CRT4 ✓ AUTO MODE SEL – (no *)
- R13L 3. PL BAY DR SYS 1,2 (two) – ENA
- CRT4 ✓ OP/CL STATUS (ten) – OP
- CLOSE PORT DOOR, FWD & AFT LATCHES
- R13L
- * If PORT (STBD) DOOR not 'CL' within 6 sec of 'RDY': *
 - * PL BAY DR – STOP *
 - * ✓ PLBD BULKHEAD LATCH GO/NO–GO DIAGRAM, 1–24 *
 - * If NO–GO: Go to MAL, MECH, SSR–2 (CONTINGENCY *
 - * PLBD CLOSURE) *
 - * If GO: Continue in procedure *
- CRT4 4. Select PORT DOOR – ITEM 13 EXEC (*)
- R13L 5. PL BAY DR – CL

- CRT4 ✓ PORT DOOR – blank, RDY, CL (~63 sec)
- R13L 6. PL BAY DOOR – STOP
- CRT4 7. Select PORT FWD, AFT LATCHES – ITEM 11,12 EXEC (*)
- R13L 8. PL BAY DR – CL
- CRT4 ✓ PORT DOOR – CL
- ✓ FWD, AFT LATCHES (two) – blank, CL (~30 sec)
- R13L 9. PL BAY DR – STOP
- CRT4 10. Deselect PORT FWD, AFT LATCHES, & DOOR – ITEM 11,12,13 EXEC (no *)
- CLOSE STBD DOOR, FWD & AFT LATCHES
- R13L 11. Select STBD DOOR – ITEM 10 EXEC (*)
- CRT4 12. PL BAY DR – CL
- ✓ STBD DOOR – blank
13. When STBD DOOR as close as possible to PORT DOOR before contact, perform fit check:
- R13L PL BAY DR – STOP
- Determine C/L Latch clearance on ENTRY DAY NO–GO DIAGRAM C/L LATCH EXTENDED GUIDE ROLLER TRAJECTORY, 1–24
- * If NO–GO for PLBD CLOSE and no waveoff capability, *
 - * perform MAL, MECH SSR–3 (SIMULTANEOUS PLBD CL) *
 - * If waveoff OK, ✓ MCC *
14. PL BAY DR – CL
- CRT4 ✓ STBD DOOR – RDY, CL (~63 sec)
- R13L 15. PL BAY DR – STOP
- CRT4 16. Select STBD FWD, AFT LATCHES – ITEM 8,9 EXEC (*)
- R13L 17. PL BAY DR – CL
- CRT4 ✓ STBD DR – CL
- ✓ FWD, AFT LATCHES (two) – blank, CL (~30 sec)
- R13L 18. PL BAY DR – STOP
- CRT4 19. Deselect STBD FWD, AFT LATCHES & DOOR – ITEM 8,9,10 EXEC (no *)
- CLOSE C/L LATCHES
- CRT4 20. Select CENTER LATCHES 1–4,13–16 – ITEM 6,7 EXEC (*)
- R13L 21. PL BAY DR – CL
- CRT4 ✓ CENTER LATCHES 1–4,13–16 (two) – blank, CL (~20 sec)
- R13L 22. PL BAY DR – STOP
- CRT4 23. Deselect CENTER LATCHES 1–4,13–16 – ITEM 6,7 EXEC (no *)
- R13L 24. Select CENTER LATCHES 5–8,9–12 – ITEM 4,5 EXEC (*)
- CRT4 25. PL BAY DR – CL
- ✓ CENTER LATCHES 5–8,9–12 (two) – blank, CL (~20 sec)
- R13L 26. PL BAY DR – STOP
- CRT4 27. Deselect CENTER LATCHES 5–8,9–12 – ITEM 4,5 EXEC (no *)
- POST–PLBD CLOSING CLEANUP
- R13L 28. PL BAY DR SYS 1,2(TWO) – DSBL
- CRT4 ✓ OP/CL STATUS (ten) – CL
29. AC POWER OFF – ITEM 2 EXEC (*)
30. GPC/CRT 04 EXEC
- R11 31. CRT PWR 4 – OFF

NOM

**PLBD BULKHEAD LATCH GO/NO-GO DIAGRAM
(REVERSE FOR STBD DOOR)**

MANUAL PLBD CLOSING

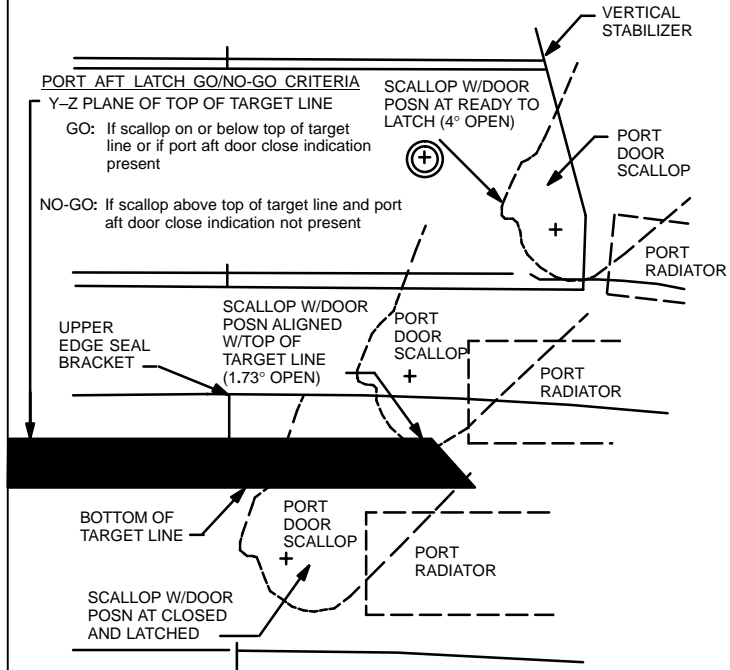

FUNCTION	PLBD CONTROL								PLBD DISPLAY PL MDM						
	Ref: MA73C:C&D for MCA (cb)														
	MTR 1				MTR 2				C C O O C R R R O						
	AC/MCA	CNTL	MDM	SYS	AC/MCA	CNTL	MDM	SYS	A	B	A	B	A	B	C
LATCH															
5-8	1/MID3	AB3/AB2	PL1	2	3/MID2	CA3/CA1	PL2	1	1	2	1	2			
9-12	1/MID1	AB3/AB1	PL1	1	3/MID4	CA3/CA2	PL2	2	1	2	1	2			
1-4	1/MID3	AB3/AB2	PL1	2	3/MID2	CA3/CA1	PL2	1	1	2	1	2			
13-16	3/MID4	CA3/CA2	PL2	2	2/MID2	BC3/BC1	PL1	1	2	1	2	1			
S FWD	1/MID1	AB3/AB1	PL1	1	2/MID4	BC3/BC2	PL2	2	1	2	1	2			
S AFT	3/MID4	CA3/CA2	PL2	2	2/MID2	BC3/BC1	PL1	1	2	1	2	1			
S DOOR	1/MID1	AB3/AB1	PL1	1	2/MID4	BC3/BC2	PL2	2					1	1	2
													2	1	2
P FWD	1/MID1	AB3/AB1	PL1	1	2/MID4	BC3/BC2	PL2	2	1	2	1	2			
P AFT	1/MID3	AB3/AB2	PL1	2	3/MID2	CA3/CA1	PL2	1	1	2	1	2			
P DOOR	3/MID4	CA3/CA2	PL2	2	2/MID2	BC3/BC1	PL1	1					2	1	1
													1	1	1

**ENTRY DAY NO-GO DIAGRAM
C/L LATCH EXTENDED GUIDE ROLLER TRAJECTORY**

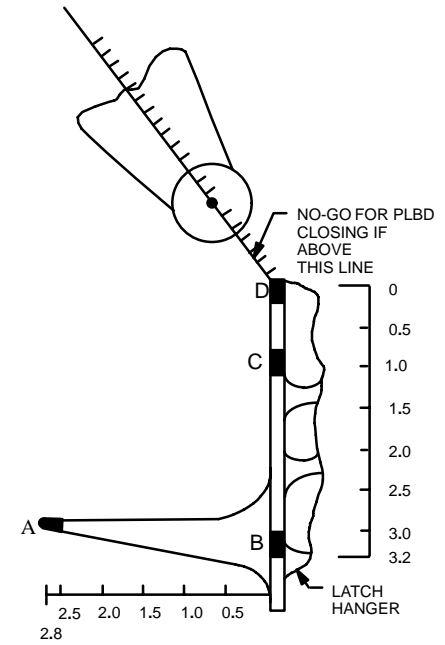

NOM

MS AFT FLIGHT DECK ACTIVITIES

NOTE
WAIT FOR GO FROM CDR OR PLT BEFORE STARTING ANY ACTIVITY ON THIS PAGE

TIME (TIG-)	MS AFT DECK ACTIONS
3:35	<u>SPECIALIST SEAT INSTALLATION</u>
3:10	<u>PARTIAL ENT SWITCH LIST/VERIF (AFT)</u>
2:55	<u>PAYLOAD DEACT</u> , if reqd (PL OPS, <u>DEORB PREP</u> or <u>SODF: ASSY OPS, ACTIVATION AND CHECKOUT; DEORBIT PREP</u>)
2:51	<u>CONFIG FOR PLBD CLOSING</u> [7]
2:40	<u>PLBD CLOSING</u> [9], 1-21
2:25	<u>POST CLOSING CONFIG</u> [10]
1:56	<u>DEACT STAR TRKRS & CLOSE DOORS</u> [13], 1-26 <u>ENT AFT FLT DECK CONFIG</u> [15], 1-26
1:55	<u>PAYLOAD ENT SW LIST/VERIF (PL OPS, DEORB PREP or SODF: ASSY OPS, ACTIVATION AND CHECKOUT; DEORBIT PREP)</u>
1:50	<u>FINAL ENT SWITCH LIST VERIF (AFT)</u> , 3-22 thru 3-33
1:41	<u>RESET C/W</u> [18], 1-26
1:40	<u>ENTRY REVIEW</u>
1:28	DSO 603, if reqd (BIOMED, <u>BIOMED DSOs</u>)
1:10	<u>CLOTHING CONFIG</u> [21], 1-26
1:00	Begin Fluid Loading per individual prescription. Fluid Loading should be completed by EI For 1 rev waveoff, repeat half the protocol If > 1 rev waveoff, repeat entire protocol
0:53	<u>AFD AUD SPKR CONFIG</u> [28]
0:52	<u>WIRELESS STOW</u> [24], 1-19

Block [11] deleted

<u>AFD AUD SPKR CONFIG</u> [28]	
	Verify CDR,PLT on headsets
A13	OS AUD SPKR PWR - OFF PWR - OFF (OV102)
	Stow Handheld Mic Connect Lightweight Headsets

<u>CONFIG FOR PLBD CLOSING</u> [7]	
	<u>CONFIG RMS</u> (if RMS onboard) ✓ Elbow Camr in aligned position <ul style="list-style-type: none"> ● Pan 90° from X-axis ● Tilt per decal
A8L	RMS PWR - OFF (SM ALERT, BCE BYP MCIU) PORT RMS HTR (two) - OFF
R11L	<u>SET UP LIGHTS</u> CRT4 PWR - ON
A6U	✓ ANNUN BUS SEL - MNC
<u>NOTE</u> Minimum operating time for PLB Floodlights: 25 min ~3 min to full bright	
A7U	PL BAY FLOOD AFT STBD - <input type="checkbox"/> PORT - <input type="checkbox"/> MID STBD - <input type="checkbox"/> PORT - <input type="checkbox"/> FWD STBD - <input type="checkbox"/> PORT - <input type="checkbox"/> BHD - <input type="checkbox"/>
	Record MET ___/___:___:___
	* If PLB floodlight not ON to full bright within 5 min: * * (Aff) PL BAY FLOOD - OFF *
	<u>TV ACT</u> Perform ACTIVATION (Cue Card, <u>TV</u>)

<u>POST CLOSING CONFIG</u> [10]	
<u>NOTE</u> PLB Floodlights must be off for minimum of 10 min UNBLOCKED, 16 min BLOCKED prior to reuse	
A7U	After floodlights ON > 25 min: PL BAY FLOOD (all) - OFF Stow Flt Deck Camrs, Accessories Perform DEACTIVATION (Cue Card, <u>TV</u>) <u>FOOT LOOP CONFIG</u> Tape Foot Loops in egress routes <u>EDO PALLET DEACT</u> , if flown (ORB OPS, <u>EPS</u>)

(Cont next page)
(NOM) B1-25

NOM

D/O/NOM/GEN L,3

Back of MS AFT FLIGHT DECK ACTIVITIES

DEACT STAR TRKRS & CLOSE DOORS 13

- O6 STAR TRKR PWR (two) – OFF
- O14:E, cb STAR TRKR –Z,–Y (two) – op
O15:E
- O6 STAR TRKR DR CNTL SYS (two) – CL (start timer)
 √ POS tb (two) – bp
 When both tb – cl (~8–24 sec) or either tb – bp > 24 sec:
 STAR TRKR DR CNTL SYS (two) – OFF
- * If tb – bp > 8 sec, notify MCC *

RESET C/W (Contact CDR for additional parameters) 18

NOTE
Expect 'MPS' light and master alarm.
'MPS' light will extinguish at OPS 303 PRO

R13U		
PARAMETER NAME	C/W CH	ENA/ INH
MPS He REG P C	39	ENA
L	49	ENA
R	59	ENA
MANF P LO2	69	INH
LH2	79	INH
HYD P 1	99	ENA
2	109	ENA
3	119	ENA

CLOTHING CONFIG 21

- Unstow,don:
 ACES
 Harness
 Boots
- Remove radiation dosimeter from inflight garments and insert in ACES
- Connect flight deck cooling units per REF, UTIL PWR,
POWER: ENTRY CONFIGURATION
- A11,A15, DC UTIL PWR MNA(B,C) – ON as reqd
F1,O19 Cooling units – Hose Jumper Plug installed
Pre–chill cooling units 10 min prior to seat egress

ENT AFT FLT DECK CONFIG 15

- A6L DSP (OV103,OV104,OV105)
 SYS PWR MNA,MNB (two) – OFF (hold 5 sec)
 √ SYS1,SYS2 tb (two) – OFF
 cb ESS 1BC SYS PWR CNTL SYS1 – op
 2CA SYS PWR CNTL SYS2 – op
 MNA,B DOCK LIGHT (four) – op
 MN A,B,C LOG (six) – op
- A12 HYD HTR
 HYD HTR (eight) – OFF
- A1L ENTRY COMM
 S–BD PM MODE – STDN LO
 NSP CODING (two) – OFF
- S–BAND PAYLOAD
 S–BD PL CH SEL INTRG 1,2 tw (six) – 910,910
 PWR SYS – OFF
 SEL – PSP
 ANT POLAR – L CIRC
 PSP CMD OUTPUT – PL UMB
- A1R AUD CTR VOICE RCD SEL CH1 – ICOM A
 CH2 – ICOM B
- A7 If WVS installed:
 √ WIRELESS VIDEO PWR – OFF
 HTR – OFF
- R14:C cb MNB KU ANT HTR – op
 UHF EVA (two) – op
- :F √ cb ESS 1BC LDG GEAR ARM/DN RESET – op

NOTE
Review or mark cb location for ease of finding during post landing procedures

- VPU √ VPU POWER – OFF
- R10 MS AUD A/G 2 – T/R
 A/A – T/R
 VOX SENS – R
 VOL tw (five) – R
 XMIT/ICOM MODE – R
- L9 PS AUD PWR – AUD TONE
 A/G 1 – T/R
 A/A – T/R
 ICOM (two) – T/R
 VOX SENS – R
 XMIT/ICOM MODE – R
 VOL tw (five) – R

ICOM RECORDER OPS, if reqd (ORB OPS, COMM/INST)

NOM

MS MIDDECK ACTIVITIES

NOTE

WAIT FOR GO FROM CDR OR PLT BEFORE STARTING ANY ACTIVITY ON THIS PAGE

TIME (TIG-)	MS MIDDECK ACTIONS
3:50	<u>ENT STOWAGE</u> [3]
3:50	<u>ENT AIRLOCK CONFIG</u> [3A], 1-28
3:35	<u>SPECIALIST SEAT INSTALLATION</u>
3:10	<u>PARTIAL ENT SWITCH LIST/VERIF (MID)</u> , 3-10 thru 3-12
1:55	<u>ENT MIDDECK CONFIG</u> [16]
1:50	<u>FINAL ENT SWITCH LIST/VERIF (MID)</u> , 3-28 thru 3-30 (OV102), 3-30 thru 3-32 (OV103, OV104, OV105)
1:40	<u>ENTRY REVIEW</u>
1:28	DSO 603, if reqd (BIOMED, <u>BIOMED DSOs</u>)
1:10	<u>CLOTHING CONFIG</u> [20], 1-28
1:00	Begin Fluid Loading per individual prescription. Fluid Loading should be completed by EI For 1 rev waveoff, repeat half the protocol If > 1 rev waveoff, repeat entire protocol
0:51	<u>MD AUD SPKR CONFIG</u> [29], 1-28
0:50	<u>CO2 RMVL SYS DEACT</u> , if flown [25], 1-28
0:35	<u>GALLEY DEACT</u> [26]
0:33	<u>WCS DEACT</u> [27], 1-28

<u>ENT MIDDECK CONFIG</u> [16]	
<u>ENTRY COMM</u>	
MO42F	MIDDECK SPKR AUD A/G 2 - T/R
	A/A - T/R
	VOX SENS - R
	VOL tw (five) - R
	XMIT/ICOM MODE - R
<u>MIDDECK PCS</u>	
MO10W	14.7 CAB REG INLET vlv (two) - CL
	H2O TK N2 REG INLET vlv (two) - OP
	O2 REG INLET vlv (two) - CL
MO32M	LEH O2 vlv (two) - R
MO69M	LEH O2 8 vlv - CL
	Remove, stow O2 Bleed Orifice
	LEH O2 8 vlv - R
MO69M	7 vlv - R
<u>RMS PNL LTS</u> (if RMS onboard)	
MA73C:F	cb RMS PRI ΦA - op
	B/U ΦA - op

<u>ENT STOWAGE</u> [3]	
<u>PERSONAL HYGIENE SYS STOWAGE</u>	
Stow:	
	Personal Hygiene Kits
	Hose
<u>AIRLOCK CLOSEOUT</u>	
Tether soft goods to EVA tether point or A/L Stowage Bag. Gray	
	Tape to floor
	Airlock ENT SW VERIF, 3-3
<u>POLE SETUP</u>	
	Reinstall Stbd Pip Pin
	Reinstall large Port Pin:
	Retract and hold Locking Pin (Ring)
	Reinstall large Pin
	Release Locking Pin (Ring)
	Slide forward Safing Latch
	✓ Pole Straps secure
<u>FDF STOWAGE</u>	
	Stow FLIGHT PLAN
<u>CABIN CONFIG</u>	
Stow:	
	Backup PGSC
	Middeck Camrs, Accessories
	FWD/AFT Shades, Filters
	Exercise Equipment
	Quick Don Masks
	✓ Retention net is in ASC/ENT config
<u>EGRESS ROUTE CONFIG</u>	
	Tape Foot Loops in egress routes
<u>NOTE</u>	
	Chemlights are middeck carry-on items
	Activate green chemlights after TIG
	Do not activate orange chemlights (slide ops only)
	Install green chemlights (8 ea) near egress hdw and egress routes
	Install orange chemlights (2 ea) above side hatch

<u>GALLEY DEACT</u> [26]	
GALLEY	OVEN/RHS - OFF
	H2O HTRS (two) - OFF
	✓ OVEN FAN - OFF
	✓ REHYD STA lever - cl (push in)
	✓ OVEN DOOR LATCH - latched
MA73C:G	cb AC3 GALLEY FAN (three) - op
ML86B:A	MNC SPLY H2O GALLEY SPLY - op
	:B MNA GALLEY OVEN - op
	MNB GALLEY H2O HTR - op

(Cont next page)

(NOM) B1-27

D/O/ALL/GEN L,3

Back of MS MIDDECK ACTIVITIES

ENT AIRLOCK CONFIG 3A

- If Internal Airlock flow:
- 1. Rotate, stow vent duct
 - 2. Close hatch per decal
 - 3. Equal vlv (two) – NORM, install caps >>
- If Booster Fan flow:
- 4. ARLK FAN A(B) – OFF
 - 5. Remove, stow flex duct from booster fan muffler inlet and cabin middeck floor air fitting
 - 6. cb AC1,2 ARLK TNL FAN A,B (six) – op
 - 7. Go to step 9
 - 8. Remove, stow flex duct from cabin middeck floor air fitting
 - 9. Unstow, install diffuser cap on middeck floor air fitting
 - 10. LTG FLOOD 1(3,4) – OFF
 - 11. Close hatch per decal
 - 12. Equal vlv (two) – NORM, install caps
 - 13. ✓ EMU O2 ISOL vlv – CL
 - 14. AIRLK 2 – OFF/ON
 - 15. ✓ ARLK H2O S/O vlv – OP (tb-op)
- If TNL ADAPT FLOWN:
- 16. cb MNA FLOOD TNL ADAPT 2 – op
 - cb MNB FLOOD TNL ADAPT 3 – op
 - cb MNC FLOOD TNL ADAPT 4 – op
- :F 17. cb MNA FLOODS AIRLK 1 – op
- MIDDECK 9 – op
 - cb MNB FLOODS MIDDECK 10 – op
 - AIRLK 3 – op
 - cb MNC FLOODS AIRLK 4 – op
- :G 18. cb ESS 1BC FLOOD AIRLK 2 – op
- If TNL ADAPT FLOWN:
- 19. cb ESS 1BC FLOOD TNL ADAPT 1 – op

CLOTHING CONFIG 20

Unstow, don:
ACES
Harness
Boots

Remove radiation dosimeter from inflight garments and insert in ACES; if waveoff, remove radiation dosimeter from ACES and insert in inflight garments

NOTE

Refer to flight specific utility outlet plug-in plan if reqd

Connect middeck cooling units per PWR/DATA/VIDEO:
ASCENT/ENTRY CONFIG (REF FS, UTIL PWR)

- MO13Q, DC UTIL PWR MNA(B,C) – ON as reqd
- MO30F, Cooling units – Hose Jumper Plug installed
- MO52J, Pre-chill cooling units 10 min prior to seat ingress
- PDB J2(3,4)
- ML85E (MUP)

CO2 RMVL SYS DEACT 25

- MO51F CNTLR 2(1) MODE – STBY (hold 3 sec)
Wait 6 sec
- ✓ CNTLR 2(1) OPER It – off
 - ✓ FAIL It – on
 - MNC(A) – OFF
 - ✓ CNTLR 2(1) FAIL It – off
 - AC 3(1) – OFF (hold 3 sec)
 - AC 3(1) cbs (three) – op
 - COM INSTR – OFF
- Remove and replace LiOH Canister in position A with one fresh LiOH Canister

WCS DEACT 27

- WCS VAC VLV – CL
- (EDO WCS) ✓ MODE – AUTO
- FAN SEP SEL sw – OFF
- Unstow hose from cradle, attach hose to WCS housing via Velcro straps
- Stow:
- WCS Trash Can
 - Mirror
 - Privacy Curtain
- Foot/toe restraints – up, latched
- If EDO WCS:
- Secure urinal hose with Velcro strap
 - URINAL SEL – OFF
 - WCS PWR SEL (two) – OFF 1, OFF 2
 - Commode lid lock – lock
 - ✓ COMPACTOR – stowed
 - COMPACTOR CLEANING LATCH PIN – disengaged
 - LOCK PINS (three) – tighten (snug)
- Stow thigh restraints
- Close and latch door
- ML31C VAC VENT ISOL VLV BUS SEL – MNB
- CNTL – CL (tb-CL)
 - NOZ HTR – OFF
- ✓ Middeck lts as reqd

MD AUD SPKR CONFIG 29

- MO42F MIDDECK AUD SPKR PWR – OFF (OV103,4,5)
- AUD/ARLK 2 BU SPKR PWR – OFF (OV102)
 - Stow Handheld Mic
 - Connect Lightweight Headsets

DEORBIT PREP BACKOUT PROCEDURES

(MEDS) A2-1

D/O/ALL/GEN L

DEORBIT PREP
BACKOUT

**DEORBIT PREP
BACKOUT**

This Page Intentionally Blank

DEORBIT PREP BACKOUT SUMMARY TIMELINES

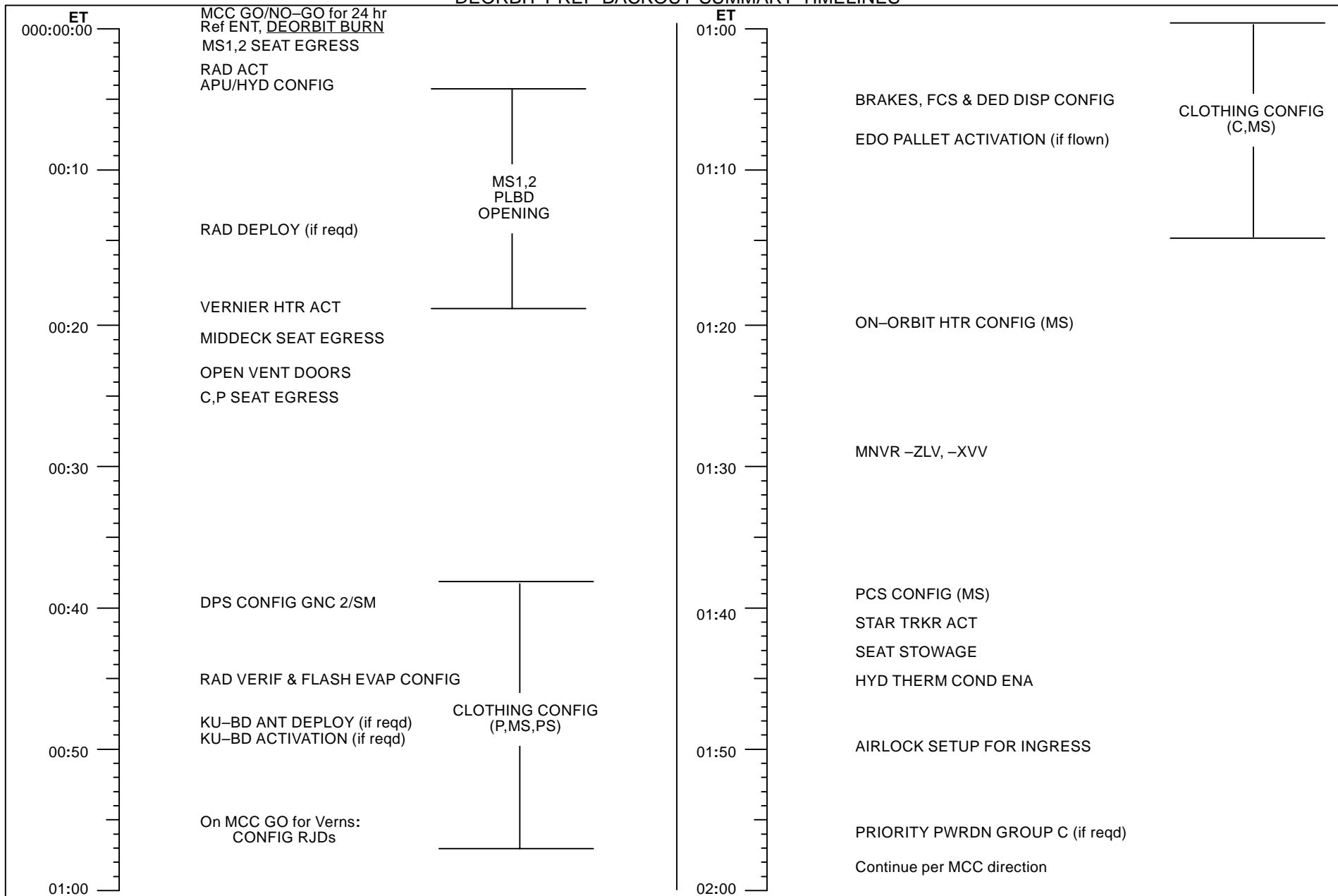

This Page Intentionally Blank

ET	1: GNC DEORB MNVR COAST	2: GNC DEORB MNVR COAST
000:00:00		
MCC/CREW GO/NO-GO FOR 24 HR	MS1,2 C6	3: BFS, GNC DEORB MNVR COAST Ref ENT, DEORBIT BURN LEH O2 vlv (four) - CL FLT DECK SPECIALIST SEAT EGRESS (all others remain seated) CONFIG FOR PLBD OPENING [1], 2-15
TRANS DAP AUTO RT 0.5 DB 3.5	C	RAD ACT [2]
	P	APU/HYD CONFIG [3]
	MS	PLBD OPENING [5], 2-13
00:10		MS1,2 PLBD OPENING
		MCC: GO/NO-GO for PRIORITY PWRDN GROUP C scheduled at ET 02:00
	C,P	O5,O9 L,R AUD A/G 2 (two) - RCV XMIT/ICOM MODE - PTT/VOX (recommended)
		O6 UHF MODE - OFF
00:15	MS	RAD DEPLOY, if reqd (ORB OPS, ECLS)
	C	L1 CAB TEMP CNTLR - 2 TEMP - adj rotary as reqd
		L4:J cb SIG COND HUM SEP - cl IMU FAN - cl
00:20	MS	VERNIER HTR ACT [6]
		WHEN PLBD OPENING COMPLETE:
	MS,PS	SEAT EGRESS (all middeck)
	MS	MO32M LEH O2 vlv (two) - CL
		MO69M - CL
	MS	PRELIM MIDDECK CONFIG [7], 2-17
00:25	P	OPEN VENT DOORS 1: GNC 51 OVERRIDE
	C,P	VENT DOOR CNTL OPEN - ITEM 43 EXEC (*) Unstow/install HUD covers (two) SEAT EGRESS
00:30	MS	FDF/COMM CONFIG MS AFT ACTIVITIES [8], 2-15

	RAD ACT [2]
C	L1 ✓RAD CNTLR OUT TEMP - NORM BYP VLV MODE (two) - AUTO CNTLR LOOP (two) - AUTO A(B) After ~90 sec, ✓RAD BYP VLV tb (two) - RAD * If tb(s) remain in BYP or return to BYP: * * Use alternate RAD CNTLR * * Do not drive BYP VLV(s) manually * * If tb(s) bp: * * Do not select alternate RAD CNTLR * * Do not drive BYP VLV(s) manually * * If EVAP OUT T low or H2O ICH OUT T low: * * RAD BYP VLV MODE (two) - MAN * * MAN SEL (two) - BYP * * (after ~3 sec tb-BYP) *

	APU/HYD CONFIG [3]
P	R2 APU SHUTDOWN (EPCL, APU/HYD) BLR N2 SPLY (three) - OFF HYD MN PUMP PRESS (three) - NORM

	VERNIER HTR ACT [6]
P	A14 RCS/OMS HTR FWD RCS JET 5 - AUTO AFT RCS JET 5 - AUTO NOTE Delay use of verniers until MCC GO in GNC OPS 2

MEDS

CLOTHING CONFIG 9

Doff/Stow:
Harness,Boots,ACES,UCD (if not used)

Remove radiation dosimeter from ACES and insert in inflight garments

Doff/Stow in Wet Trash (if used):
UCD (clamp)
Emesis Bag (unstow new Bag)

DPS CONFIG TO GNC2/SM 11

NOTE

Do not perform any keyboard item entries or switch throws 10 sec before and after moding PASS GPCs to RUN or making ops transition requests

1. TRANSITION TO GNC OPS 201

GNC 0 GPC MEMORY

✓ CONFIG – ITEM 1 +2 EXEC

Config for single G2 GPC ops unless directed otherwise by MCC:

Modify MC 2 per table →

BFC CRT DISP – OFF
GNC, OPS 201 PRO

GNC UNIV PTG

DAP: B/AUTO/PRI

GNC 1 DPS UTILITY

✓ CKPT RETRV ENA – ITEM 12 EXEC (*)

BFC CRT DISP – ON

BFS, MSG RESET (✓BFC It off)

BFS, GPC/CRT 04 EXEC

If single G2 GPC ops:

MAJ FUNC – PL

GPC/CRT 2X EXEC

X: PL GPC MEMORY

CONFIG ITEM 45 +2 EXEC

GPC ITEM 46 +2 EXEC

STORE ITEM 47 EXEC

Store complete when MC = 02 (~16 sec)

GPC MODE 2 – STBY (tb-bp)
– HALT (tb-bp)
– STBY (tb-RUN)
– HALT (tb-bp)

		DUAL G2	SINGLE G2
CONFIG GPC		2 12000	2 10000
STR	1	1	1
	2	2	1
	3	1	1
	4	2	1
PL	1/2	0	0
CRT	1	1	1
	2	2	1
	3	0	0
	4	2	1
L	1	0	0
	2	0	0
MM	1	1	1
	2	2	1

C3

C3

C2

CRT

CRTX

O6

C3
CRTX

2. **FREEZE DRY GPC 3**
BFC CRT DISP – OFF
MAJ FUNC – PL
GPC/CRT 3X EXEC

X: PL GPC MEMORY

CONFIG – ITEM 45 +2 EXEC
GPC – ITEM 46 +3 EXEC
STORE – ITEM 47 EXEC
Store complete when MC = 02 (~16 sec)

O6

✓ All IDPs deassigned from FD GPC
GPC MODE 3 – STBY (tb-bp)
– HALT (tb-bp)
– STBY (tb-RUN)
– HALT (tb-bp)

CRTY

3. **TRANSITION GPC 4 TO SM OPS 201(401)**
MAJ FUNC – SM
GPC/CRT 4X EXEC

X: SM GPC MEMORY

CONFIG – ITEM 1 +4 EXEC

CRTX

✓ MC 4(5) per table →

SM, OPS 201(401) PRO

X: SM ANTENNA

DAP: B/AUTO/PRI

SM 1 DPS UTILITY

UL CNTL AUTO – ITEM 35 EXEC

C3
CRT3

4. **RECONFIG GPCs**
BFC CRT DISP – ON
BFS, GNC OPS 000 PRO

3: BFS, GNC GPC MEMORY

C3

BFC CRT DISP – OFF

O6

✓ All IDPs deassigned from BFS
GPC MODE 5 – STBY (tb-RUN)
(releases payload buses 1,2)
then HALT (tb-bp)
OUTPUT 4 – TERM (tb-bp)
5 – NORM (tb-bp)

P/I Locker

Unstow and install GPC Mode Switch Guard

C2

5. **MEDS RECONFIG**
GPC/CRT 03 EXEC
44 EXEC

IDP/CRT3 PWR – OFF

CONFIG GPC		4(5) 00040
STR	1	0
	2	0
	3	0
	4	0
PL	1/2	4
CRT	1	4
	2	4
	3	0
	4	4
L	1	4
	2	0
MM	1	4
	2	4

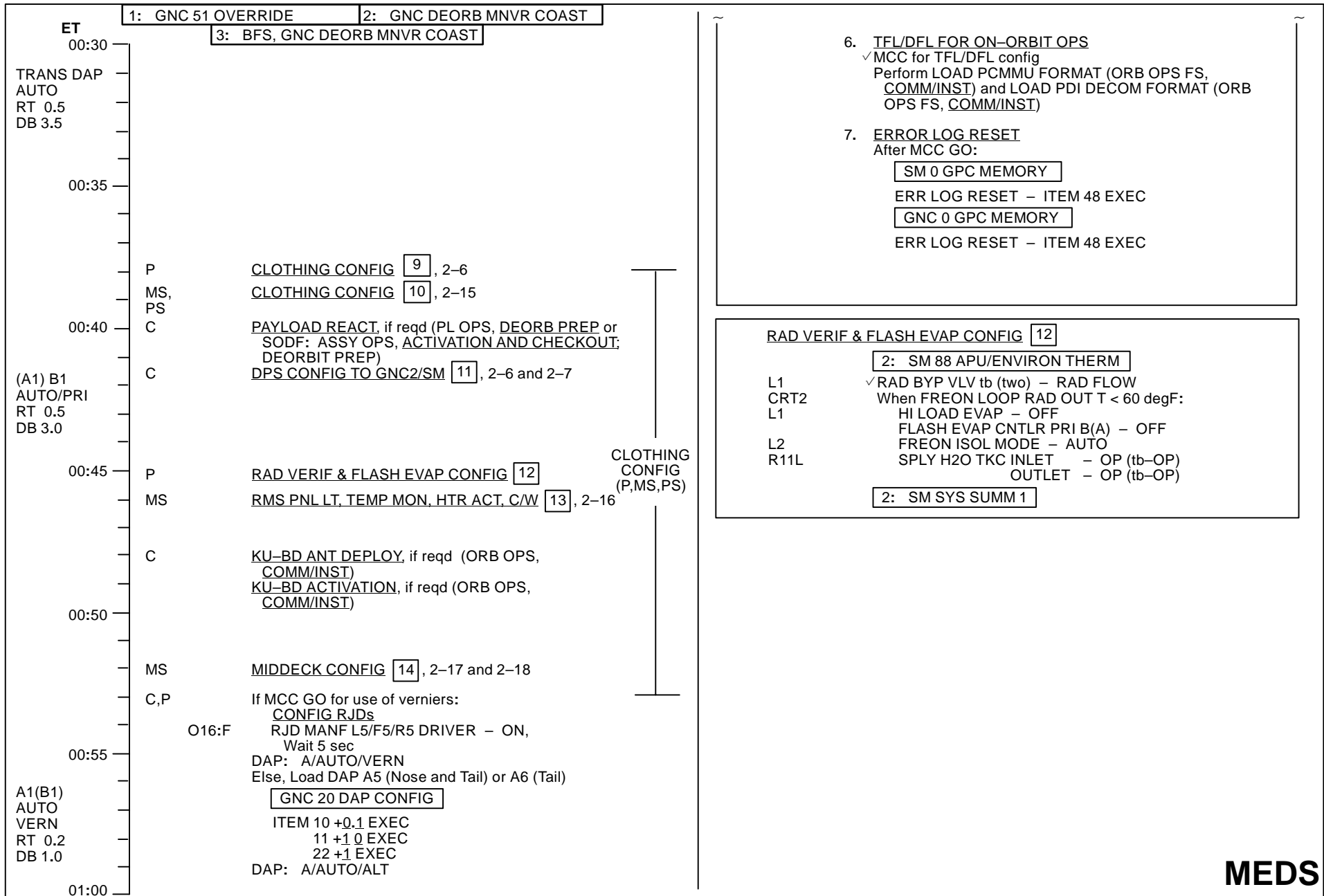

This Page Intentionally Blank

(MEDS) A2-8

MEDS
D/O/ALL/GEN L

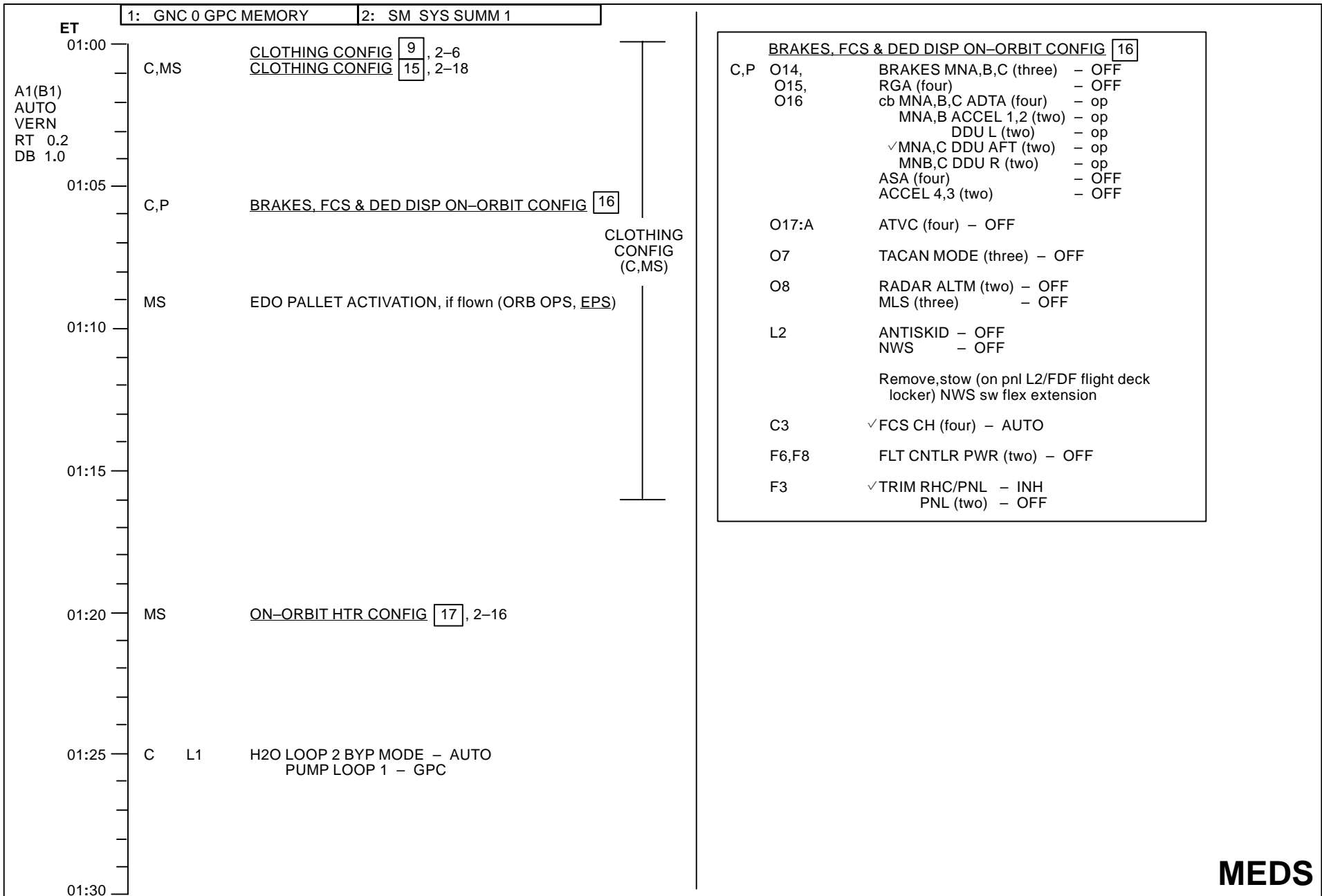

This Page Intentionally Blank

(MEDS) A2-10

MEDS
D/O/ALL/GEN L

		1: GNC 0 GPC MEMORY	2: SM SYS SUMM
ET			
01:30	C	<u>AUTO MNVR -ZLV, -XVV</u> ✓ TGT ID +2 BODY VECT +3 OM +0 DAP: A/AUTO/VERN Initiate TRK	
A1(B1) AUTO VERN RT 0.2 DB 1.0			
01:35			
01:40	C,MS P	<u>ON-ORBIT PCS2(1) CONFIG</u> [19], 2-18 <u>STAR TRKR ACT</u> [20]	
	MS,PS	<u>SPECIALIST SEAT REMOVAL/STOWAGE</u>	
01:45	P R2	<u>HYD THERM COND ENA</u> <u>HYD CIRC PUMP (three) - GPC</u>	
01:50	MS	<u>AIRLOCK SETUP FOR INGRESS</u> [21], 2-18	
01:55			
02:00		On MCC call: PRIORITY PWRDN GROUP C, if reqd (ORB PKT, PRIORITY PWRDN) Continue per MCC direction	

STAR TRKR ACT [20]
O14:E, cb STAR TRKR -Z,-Y (two) - cl
O15:E

O6 STAR TRKR PWR (two) - ON

C2 GNC I/O RESET

O6 STAR TRKR DR CNTL SYS (two) - OP (start timer)
 ✓ POS tb (two) - bp
When both tb - OP (~8-24 sec)
or either tb - bp > 24 sec:
 STAR TRKR DR CNTL SYS (two) - OFF

[X: GNC 22 S TRK/COAS CNTL]
S TRK -Y,-Z: STAR TRK - ITEM 3,4 (*)
[X: GNC 21 IMU ALIGN]
RESUME

* If tb - bp > 8 sec, notify MCC *

This Page Intentionally Blank

PLBD OPENING

DETAILED PLBD OPENING PROCEDURES 5

- R13L * If no motion determined visually or 'OP/CL' *
 * not blank within 10 sec after cmd: *
 * PL BAY DR – STOP, perform MAL, MECH, 9.1a *
 * If Latch not 'OP' in single-motor time: *
 * PL BAY DR – STOP, perform MAL, MECH, 9.1d *
 * If door motion stops and not 'OP': *
 * PL BAY DR – STOP, perform MAL, MECH, 9.1f *
- O6 * If BFS GPC fails during operation: *
 * PL BAY DR SYS 1,2 (two) – DSBL *
 * PL BAY DR – STOP *
 * MDM PL1,2 (two) – OFF *
 * GPC MODE 5 – STBY, HALT *
 * MDM PL 1,2 (two) – ON *
 * Proceed with DPS CONFIG TO GNC2/SM 11, then *
 * continue in MANUAL PLBD OPENING PROCEDURE, *
 * as reqd *
- R13L * If SM GPC fails during this operation: *
 * PL BAY DR SYS 1,2 (two) DSBL *
 * PL BAY DR – STOP *
 * Perform PASS SM GPC FAIL (ORB PKT, DPS) *
- * If BFS AUTO sequence has been interrupted by reversing *
 * latch/door drive direction, or if MANUAL has been used at *
 * any time during the mission, use MANUAL mode for all *
 * subsequent BFS PLBD ops *

NOTE

Note any single-motor ops (continue ops)
 (single-motor times = 2x listed dual-motor times)

AUTO PLBD OPENING PROCEDURE

- MS CRTX 1. SM, OPS X02 PRO or BFS, SM 63 PL BAY DOORS
4: SM PL BAY DOORS
- R13L CRTX
 R13L CRTX
 R13L CRTX
 R13L CRTX
1. PL BAY DR – STOP
 ✓ PBD SW – STOP
 ✓ MAN SEL (ten) – (no *)
 ✓ PBD SW BYPASS – (no *)
 2. AC POWER ON – ITEM 1 EXEC (*)
 ✓ AUTO MODE SEL – (no *)
 3. PL BAY DR SYS 1,2 (two) – ENA
 ✓ OP/CL STATUS (ten) – CL
 ✓ AOS
- OPEN C/L LATCHES 5-8 (MANUAL MODE)
 4. Select CENTER LATCHES 5-8 – ITEM 4 EXEC (*)
 5. PL BAY DR – OP
 ✓ CENTER LATCHES 5-8 – blank, OP (~20 sec)
 6. PL BAY DR – STOP

OPEN REMAINING LATCHES/DOORS (AUTO MODE)

- R13L CRTX 7. AUTO MODE SEL – ITEM 3 EXEC (*)
 8. PL BAY DR – OP
 ✓ CENTER LATCHES 9-12 – blank, OP (~20 sec)
 ✓ CENTER LATCHES 1-4,13-16 (two) – blank, OP (~20 sec)
 ✓ STBD FWD,AFT LATCHES (two) – blank, OP (~30 sec)
 ✓ DOOR – RDY, blank, OP (~63 sec)
 ✓ PORT FWD,AFT LATCHES (two) – blank, OP (~30 sec)
 ✓ DOOR – RDY, blank, OP (~63 sec)
- R13L 9. PL BAY DR – STOP
- CRTX 10. POST-PLBD OPENING CLEANUP
 PL BAY DR SYS 1,2 (two) – DSBL
 ✓ OP/CL STATUS (ten) – OP
11. AC POWER OFF – ITEM 2 EXEC (*)
 12. SM, OPS X01 PRO (if PASS SM)
4: SM ANTENNA
- A7U 13. After floodlights ON > 25 min:
 PL BAY FLOOD (all) – OFF

MANUAL PLBD OPENING PROCEDURE

- MS CRTX 1. SM, OPS X02 PRO or BFS, SM 63 PL BAY DOORS
4: SM PL BAY DOORS
- R13L CRTX
 R13L CRTX
1. PL BAY DR – STOP
 ✓ PBD SW – STOP
 ✓ MAN SEL (ten) – (no *)
 ✓ PBD SW BYPASS – (no *)
 2. AC POWER ON – ITEM 1 EXEC (*)
 ✓ AUTO MODE SEL – (no *)
 R13L CRTX 3. PL BAY DR SYS 1,2 (two) – ENA
 ✓ OP/CL STATUS (ten) – CL
 ✓ AOS
- OPEN C/L LATCHES
 4. Select CENTER LATCHES 5-8 – ITEM 4 EXEC (*)
 5. PL BAY DR – OP
 ✓ CENTER LATCHES 5-8 – blank, OP (~20 sec)
 R13L CRTX 6. PL BAY DR – STOP
 R13L CRTX 7. Deselect CENTER LATCHES 5-8 – ITEM 4 EXEC (no *)
 8. Select CENTER LATCHES 9-12 – ITEM 5 EXEC (*)
 9. PL BAY DR – OP
 ✓ CENTER LATCHES 9-12 – blank, OP (~20 sec)
 R13L CRTX 10. PL BAY DR – STOP
 11. Deselect CENTER LATCHES 9-12 – ITEM 5 EXEC (no *)
 12. Select CENTER LATCHES 1-4,13-16 – ITEM 6,7 EXEC (*)
 R13L CRTX 13. PL BAY DR – OP
 CENTER LATCHES 1-4,13-16 (two) – blank, OP (~20 sec)
 R13L CRTX 14. PL BAY DR – STOP
 R13L CRTX 15. Deselect CENTER LATCHES 1-4,13-16 – ITEM 6,7 EXEC (no *)

PLBD OPENING

- OPEN STBD FWD, AFT LATCHES & DOOR**
- R13L 16. Select STBD FWD, AFT LATCHES – ITEM 8,9 EXEC (*)
 - CRTX 17. PL BAY DR OP
 - ✓ STBD FWD, AFT LATCHES (two) – blank, OP (~30 sec)
 - R13L 18. PL BAY DR – STOP
 - CRTX 19. Deselect STBD FWD, AFT LATCHES – ITEM 8,9 EXEC (*)
 - 20. Select STBD DOOR – ITEM 10 EXEC (*)
 - R13L 21. PL BAY DR – OP
 - CRTX 21. ✓ STBD DOOR – RDY, blank, OP (~63 sec)
 - R13L 22. PL BAY DR – STOP
 - CRTX 23. Deselect STBD DOOR – ITEM 10 EXEC (*)
- OPEN PORT FWD, AFT LATCHES & DOOR**
- R13L 24. Select PORT FWD, AFT LATCHES – ITEM 11,12 EXEC (*)
 - CRTX 25. PL BAY DR – OP
 - ✓ PORT FWD, AFT LATCHES (two) – blank, OP (~30 sec)
 - R13L 26. PL BAY DR – STOP
 - CRTX 27. Deselect PORT FWD, AFT LATCHES – ITEM 11,12 EXEC (no *)
 - 28. Select PORT DOOR – ITEM 13 EXEC (*)
 - R13L 29. PL BAY DR – OP
 - CRTX 29. ✓ PORT DOOR – RDY, blank, OP (~63 sec)
 - R13L 30. PL BAY DR – STOP
 - CRTX 31. Deselect PORT DOOR – ITEM 13 EXEC (no *)

- POST-PLBD OPENING CLEANUP**
- R13L 32. PL BAY DR SYS 1,2 (two) – DSBL
 - CRTX ✓ OP/CL STATUS (ten) – OP
 - 33. AC POWER OFF – ITEM 2 EXEC (*)
 - 34. SM, OPS X01 PRO (if PASS SM)
 - 4: SM ANTENNA
 - A7U 35. After floodlights ON > 25 min:
PL BAY FLOOD (all) – OFF

FUNCTION	PLBD CONTROL								PLBD DISPLAY PL MDM								
	Ref: MA73C:C&D for MCA cbs																
	MTR 1				MTR 2				C C O O		C R R R		O				
	AC/MCA	CNTL	MDM	SYS	AC/MCA	CNTL	MDM	SYS	A	B	A	B	A	B	C		
LATCH																	
5-8	1/MID3	AB3/AB2	PL1	2	3/MID2	CA3/CA1	PL2	1	1	2	1	2					
9-12	1/MID1	AB3/AB1	PL1	1	3/MID4	CA3/CA2	PL2	2	1	2	1	2					
1-4	1/MID3	AB3/AB2	PL1	2	3/MID2	CA3/CA1	PL2	1	1	2	1	2					
13-16	3/MID4	CA3/CA2	PL2	2	2/MID2	BC3/BC1	PL1	1	2	1	2	1					
S FWD	1/MID1	AB3/AB1	PL1	1	2/MID4	BC3/BC2	PL2	2	1	2	1	2					
S AFT	3/MID4	CA3/CA2	PL2	2	2/MID2	BC3/BC1	PL1	1	2	1	2	1					
S DOOR	1/MID1	AB3/AB1	PL1	1	2/MID4	BC3/BC2	PL2	2					1	1	2	2	1
													2	1	2	2	
P FWD	1/MID1	AB3/AB1	PL1	1	2/MID4	BC3/BC2	PL2	2	1	2	1	2					
P AFT	1/MID3	AB3/AB2	PL1	2	3/MID2	CA3/CA1	PL2	1	1	2	1	2					
P DOOR	3/MID4	CA3/CA2	PL2	2	2/MID2	BC3/BC1	PL1	1					2	1	1	2	2
													1	1	1	2	1

MS AFT DECK BACKOUT ACTIVITIES

NOTE

WAIT FOR GO FROM CDR OR PLT BEFORE STARTING ANY ACTIVITY ON THIS PAGE

TIME (ET)	MS AFT ACTIONS
00:01	C6 LEH O2 vlv (four) – CL
00:02	CONFIG FOR PLBD OPENING 1
00:20	SPECIALIST SEAT EGRESS
00:30	FDF/COMM CONFIG 8
00:38	CLOTHING CONFIG 10
00:40	PAYLOAD REACT, if reqd (PL OPS, DEORB PREP or SODF: ASSY OPS, ACTIVATION AND CHECKOUT; DEORBIT PREP)
00:47	RMS PNL LT, TEMP MON, HTR ACT, C/W 13 , 2–6
01:20	ON-ORBIT HTR CONFIG 17 , 2–16
01:42	SPECIALIST SEAT REMOVAL/STOWAGE

	FDF/COMM CONFIG 8
	COMM CONFIG
	Unstow: Headsets, Handheld Mics and/or Wireless Comm if flown
	If WCCS, perform STD WCCS CONFIG (ORB OPS, COMM/INST) or see WCCS COMM PLAN (Cue Card)
	If flight deck Handheld Mic/speaker operation:
R10	MS AUD PWR – AUD/TONE
	A/G 1 – T/R, tw–2
	A/G 2 – RCV, tw–2
	A/A – RCV, tw–2
	ICOM A – T/R, tw–2
	ICOM B – RCV, tw–2
	XMIT/ICOM MODE – PTT/PTT
A13	OS AUD SPKR PWR – SPKR/MIC
	MSTR SPKR VOL – 8
	PWR – AUD/TONE (OV102)
A11	MS COMM CCU PWR – OFF
	Connect Handheld Mic to CCU
	MS COMM CCU PWR – ON
R6,L5	CCU PWR – OFF
A1L	S–BD PM MODE – TDRS DATA
	NSP CODING (two) – ON
	OCA SETUP (ORB OPS, PGSC) A/G 2 MODE
	OCA S–BAND MODEM (MFX) ACTIVATION (ORB OPS, PGSC)
	COLOR PRINTER UNSTOW AND ASSEMBLE (ORB OPS, PGSC)
	ICOM RECORDER OPS, if reqd (ORB OPS, COMM/INST)
	FDF CONFIG
	Stow:
	ENT
	ENT PKT
	ENT Cue Cards
	Unstow (if reqd):
	Deploy Orbit Cue Cards

	CONFIG FOR PLBD OPENING 1
	4 : BFS, SM 63 PL BAY DOORS
A6U	SET UP LIGHTS ANNUN BUS SEL – MNC
	NOTE
	Minimum operating time for PLB Floodlights: 25 min. Lights must be off for minimum of 10 min UNBLOCKED, 16 min BLOCKED prior to reuse. ~3 min to full bright
A7U	PL BAY FLOOD AFT STBD – <input type="checkbox"/>
	PORT – <input type="checkbox"/>
	MID STBD – <input type="checkbox"/>
	PORT – <input type="checkbox"/>
	FWD STBD – <input type="checkbox"/>
	PORT – <input type="checkbox"/>
	BHD – <input type="checkbox"/>
	Record MET ____/____:____:____
	* If PLB Floodlight not ON to full bright within 5 min: *
	* (Aff) PL BAY FLOOD – OFF *

	CLOTHING CONFIG 10
	Doff/stow:
	Harness, Boots, ACES, UCD (if not used)
	Remove radiation dosimeter from ACES and insert in inflight garments
	Doff, stow in Wet Trash (if used):
	UCD (clamp)
	Emesis Bag (unstow new bag)

(Cont next page)

Back of MS AFT DECK BACKOUT ACTIVITIES

RMS PNL LTS, TEMP MON, HTR ACT, C/W 13

MA73C:F RMS PNL LTS, TEMP MON, HTR ACT (if RMS onboard)
 A8L cb RMS PRI ΦA – cl
 RMS PWR – PRI (MA tone)

SM 94 PDRS CONTROL (MA, GPC DATA It on)

A8U I/O ON – ITEM 5 EXEC (*)
 A8L SAFING – CANCEL (tb–bp) (✓GPC DATA It off)
 C/W PORT RMS HTR A – AUTO

R13U		
PARAMETER NAME	C/W CH	ENA/INH
MPS He REG P C	39	INH
L	49	INH
R	59	INH
HYD P 1	99	INH
2	109	INH
3	119	INH

ON-ORBIT HTR CONFIG 17

R2 BLR PWR (three) – OFF

R4 HYD BRAKE HTR (three) – OFF

L1 ✓HI LOAD EVAP – OFF
 DUCT HTR – OFF

If WVS installed:
 WIRELESS VIDEO HTR – ON

A7

A12 HYD HTR RUD SPD BK B – AUTO
 ✓A – OFF
 BDY FLP B – AUTO
 ✓A – OFF
 ELEV B – AUTO
 ✓A – OFF
 AFT FUS B – AUTO
 ✓A – OFF

A14 RCS/OMS HTR FWD RCS – B AUTO
 ✓L POD – A OFF
 L POD – B AUTO
 ✓R POD – A OFF
 R POD – B AUTO
 OMS CRSFD LINES – A OFF
 ✓OMS CRSFD LINES – B AUTO

R14:C cb KU ANT HTR – cl

Block 4 deleted

Block 18 deleted

MS MIDDECK BACKOUT ACTIVITIES

NOTE

WAIT FOR GO FROM CDR OR PLT BEFORE STARTING ANY ACTIVITY ON THIS PAGE

TIME (ET)	MS MIDDECK ACTIONS
00:20	<u>SPECIALIST SEAT EGRESS</u>
00:21	MO32M LEH O2 vlv (two) – CL MO69M LEH O2 vlv (two) – CL
00:22	<u>PRELIM MIDDECK CONFIG</u> 7
00:40	<u>PAYLOAD REACT</u> , if reqd (PL OPS, DEORB PREP or SODF: ASSY OPS, <u>ACTIVATION AND CHECKOUT</u> ; DEORBIT PREP)
00:52	<u>MIDDECK CONFIG</u> 14
01:00	<u>CLOTHING CONFIG</u> 15 , 2–18
01:40	<u>ON-ORBIT PCS 2(1) CONFIG</u> 19 , 2–18
01:42	<u>SPECIALIST SEAT REMOVAL/STOWAGE</u>
01:50	<u>AIRLOCK SETUP FOR INGRESS</u> 21 , 2–18

<u>PRELIM MIDDECK CONFIG</u> 7	
<u>INSTALL FILTERS</u> Unstow,install: Side Hatch UV Filter and Locking Device Pyro Box Safing Pin	
<u>COMM CONFIG</u> Unstow: Headsets, Handheld Mics and/or Wireless Comm if flown (see <u>WCCS COMM PLAN</u> (Cue Card))	
If WCCS perform STD WCCS CONFIG (ORB OPS, <u>COMM/INST</u>) or see <u>WCCS COMM PLAN</u> (Cue Card)	
If middeck Handheld Mic/speaker operation:	
MO42F	MIDDECK SPKR AUD A/G 1 – T/R, tw–2 A/G 2 – RCV, tw–2 A/A – RCV, tw–2 ICOM A – T/R, tw–2 ICOM B – RCV, tw–2 XMIT/ICOM MODE – PTT/PTT MSTR SPKR VOL – 8
MO39M	MIDDECK COMM CCU PWR – OFF Connect Handheld Mic to CCU MIDDECK COMM CCU PWR – ON
<u>HTR CONFIG</u>	
ML31C	VAC VENT ISOL VLV BUS SEL – MNA NOZ HTR – ON ISOL VLV CNTL – OP (tb–OP)
* If VAC VENT ISOL VLV CNTL tb – CL or bp: *	
* VAC VENT ISOL VLV BUS SEL – MNB *	
* CNTL – OP (tb–OP) *	
* If VAC VENT ISOL VLV CNTL tb still CL or bp: *	
* ✓ MCC for further actions *	

MIDDECK CONFIG 14

<u>GALLEY ACTIVATION</u>	
ML86B:A	cb MNC SPLY H2O GALLEY SPLY – cl
:B	cb MNA GALLEY OVEN – cl
	cb MNB GALLEY H2O HTR – cl
R11L:G	✓ SPLY H2O GALLEY SPLY VLV – OP (tb–OP)
GALLEY	H2O HTRS (two) – ON OVEN/RHS – ON
MA73C:G	cb AC3 GALLEY FAN (three) – cl Unstow,install Personal Hygiene Hose
<u>WCS ACTIVATION</u>	
WCS (EDO WCS)	VAC VLV – OP

If EDO WCS:

- ✓ CANISTER – LOCK
- Commode lid lock – use
- URINAL SEL – SEP 1
- WCS PWR SEL (two) – AUTO 1, OFF 2
- ✓ FAN PWR – AUTO
- ✓ URN DIV VLV – FAN SEP 1
- Open commode lid
- ✓ Commode airflow
- ✓ Fecal Bag installed
- Close commode lid
- Unstrap urinal hose Velcro strap
- Unstow urinal hose
- ✓ Urinal airflow
- ✓ URINAL READY It – on (5–15 sec)
- Stow urinal hose
- COMPACTOR LOCK PINS (three) – loosen
(use 1/4–in Hex Wrench, if reqd)
- ✓ COMPACTOR ARM LOCK PIN – raised
- COMPACTOR CLEANING LATCH PIN – engaged
- Install Fecal Bag and Lid Dispensers

If WCS:

- Unstow Urinal Hose from Velcro strap, install hose in cradle
- ✓ MODE – AUTO
- ✓ CRADLE – AUTO
- FAN SEP SEL sw – 1
- Unstow hose from cradle (✓ airflow)
- ✓ WCS ON It – ON
- Stow hose in cradle
- ✓ WCS ON It – OFF

Unstow,install:

- WCS Trash Can
- Mirror
- Urine Collection Cue Card
- Foot/Toe Restraint – down,locked

(Cont next page)

(MEDS) A2–17

D/O/ALL/GEN L,3

Back of MS MIDDECK BACKOUT ACTIVITIES

MO51F CO2 RMVL SYS ACT (if flown)
 ✓ MCC prior to CO2 RMVL system activation
 cb AC3 (three) - cl
 AC3 - ON (hold 3 sec)
 MNC - ON
 CNTRL 2 MODE - OPER (hold 3 sec)
 Wait 6 sec
 CNTLR 2 OPER It - on
 COM INSTR - ON

If PRIORITY PWRDN GROUP C not reqd:
PGSC ACTIVATION
 (backup PGSC) PGSC ACTIVATION (ORB OPS, PGSC)

POLE STOWAGE
 Remove large Port Pin:
 Slide back Safing Latch
 Retract and hold Locking Pin (Ring)
 Remove large Pin
 Release Locking Pin (Ring)
 Remove Stbd Pip Pin
 Stow Pole

FLOODLIGHT CONFIG
 If TNL ADAPT FLOWN:
 ML86B:E cb MNA FLOOD TNL ADAPT 2 - cl
 cb MNB FLOOD TNL ADAPT 3 - cl
 cb MNC FLOOD TNL ADAPT 4 - cl
 ML86B:F cb MNA FLOODS AIRLK 1 - cl
 MIDDECK 9 - cl
 cb MNB FLOODS MIDDECK 10 - cl
 AIRLK 3 - cl
 ML86B:G cb MNC FLOODS AIRLK 4 - cl
 cb ESS 1BC FLOOD AIRLK 2 - cl
 If TNL ADAPT FLOWN:
 cb ESS 1BC FLOOD TNL ADAPT 1 - cl

CLOTHING CONFIG 15

Do off/stow:
 Harness, Boots, ACES, UCD (if not used)

Remove radiation dosimeter from ACES and insert in
 inflight garments

Do off, stow in Wet Trash (if used):
 UCD (clamp)
 Emesis Bag (unstow new bag)

ON-ORBIT PCS 2(1) CONFIG 19

C	L2	✓ O2 XOVR SYS (two) - OP O2/N2 CNTLR VLV SYS 1(2) - CL 2(1) - AUTO
	O1	O2/N2 FLOW sel - SYS 2(1) O2
	C7	✓ LEH O2 SPLY vlv (two) - OP Expect possible 'S66 CAB O2(N2) FLO 2(1)' msg
MS	MO10W	14.7 CAB REG INLET SYS 2(1) vlv - OP H2O TK N2 REG INLET SYS 1(2) vlv - CL O2 REG INLET SYS 2(1) vlv - OP
	MO69M	✓ LEH O2 8 vlv - CL Insert O2 Bleed Orifice Assembly into LEH O2 8 QD LEH O2 8 vlv - OP

AIRLOCK SETUP FOR INGRESS 21

INNER HATCH	1. Equal vlv caps (two) - remove, stow 2. ✓ Equal vlv (two) - NORM 3. Open hatch per decal
AW18A MO13Q	4. LTG FLOOD 1(3,4) - ON (as reqd) 5. AIRLOCK 2 - ON/OFF
	If internal airlock: 6. Rotate vent duct into airlock >>
MO13Q MIDDECK FLR	7. ✓ ARLK H2O S/O vlv - OP (tb-op) 8. ✓ EMU O2 ISOL vlv - CL 9. Remove, stow diffuser cap on middeck floor air fitting (mark stowage location; will be reused)
	If Booster Fan flown: 10. cb AC1,2 ARLK TNL FAN A,B (six) - cl 11. Unstow, install flex duct from booster fan muffler inlet to cabin middeck floor air fitting
MA73C:G MO13Q	12. ARLK FAN A(B) - ON 13. ✓ Airflow at top of external airlock halo If Spacehab flown: 14. Perform SPACEHAB INGRESS AFTER WAVEOFF (SH OPS, <u>ON-ORBIT</u>) >> If Spacehab not flown >> 15. Unstow flex duct from tunnel extension; install between middeck floor air fitting and airlock duct inlet

DEORBIT PREP BACKOUT PROCEDURES

(NOM) B2-1

D/O/ALL/GEN L

**DEORBIT PREP
BACKOUT**

This Page Intentionally Blank

DEORBIT PREP BACKOUT SUMMARY TIMELINES

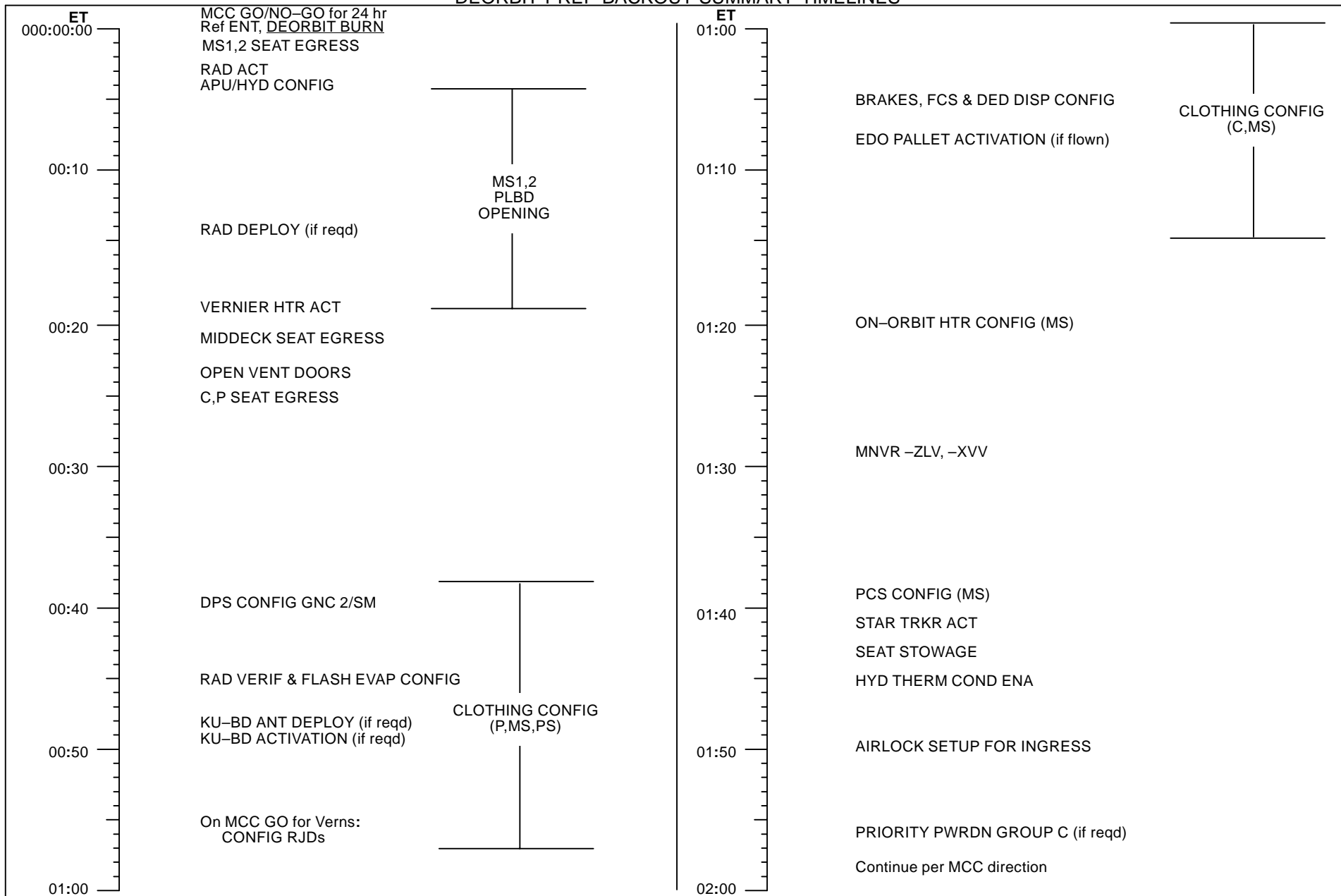

This Page Intentionally Blank

(NOM) B2-4

D/O/ALL/GEN L

ET	1: GNC DEORB MNVR COAST	2: GNC DEORB MNVR COAST
000:00:00		
MCC/CREW GO/NO-GO FOR 24 HR	MS1,2 C6	Ref ENT, DEORBIT BURN LEH O2 vlv (four) - CL FLT DECK SPECIALIST SEAT EGRESS (all others remain seated) CONFIG FOR PLBD OPENING [1], 2-15
TRANS DAP AUTO RT 0.5 00:05 DB 3.5	C	RAD ACT [2]
	P	APU/HYD CONFIG [3]
	MS	PLBD OPENING [5], 2-13
		MS1,2 PLBD OPENING
00:10		MCC: GO/NO-GO for PRIORITY PWRDN GROUP C scheduled at ET 02:00
	C,P O5,O9	L,R AUD A/G 2 (two) - RCV XMIT/ICOM MODE - PTT/VOX (recommended)
	O6	UHF MODE - OFF
00:15	MS	RAD DEPLOY, if reqd (ORB OPS, ECLS)
	C L1	CAB TEMP CNTLR - 2 CAB TEMP - adj rotary as reqd
	L4:J	cb SIG COND HUM SEP - cl IMU FAN - cl
	MS	VERNIER HTR ACT [6]
00:20		WHEN PLBD OPENING COMPLETE:
	MS,PS	SEAT EGRESS (all middeck)
	MS MO32M	LEH O2 vlv (two) - CL
	MO69M	LEH O2 vlv (two) - CL
	MS	PRELIM MIDDECK CONFIG [7], 2-17
	P	OPEN VENT DOORS
00:25		[1: GNC 51 OVERRIDE]
	C,P	VENT DOOR CNTL OPEN - ITEM 43 EXEC (*) Unstow/install HUD covers (two) SEAT EGRESS
00:30	MS	FDF/COMM CONFIG [8], 2-15

	RAD ACT [2]
C L1	<ul style="list-style-type: none"> ✓ RAD CNTLR OUT TEMP - NORM BYP VLV MODE (two) - AUTO CNTLR LOOP (two) - AUTO A(B) After ~90 sec, ✓ RAD BYP VLV tb (two) - RAD
	<ul style="list-style-type: none"> * If tb(s) remain in BYP or return to BYP: * * Use alternate RAD CNTLR * * Do not drive BYP VLV(s) manually * * If tb(s) bp: * * Do not select alternate RAD CNTLR * * Do not drive BYP VLV(s) manually * * If EVAP OUT T low or H2O ICH OUT T low: * * RAD BYP VLV MODE (two) - MAN * * MAN SEL (two) - BYP * * (after ~3 sec tb-BYP) *

	APU/HYD CONFIG [3]
P R2	APU SHUTDOWN (EPCL, APU/HYD)
	BLR N2 SPLY (three) - OFF
	HYD MN PUMP PRESS (three) - NORM

	VERNIER HTR ACT [6]
P A14	RCS/OMS HTR FWD RCS JET 5 - AUTO
	AFT RCS JET 5 - AUTO
	NOTE
	Delay use of verniers until MCC GO in GNC OPS 2

NOM

CLOTHING CONFIG 9

Doff/Stow:
 Harness,Boots,ACES,UCD (if not used)
 Remove radiation dosimeter from ACES and insert in
 inflight garments
 Doff/Stow in Wet Trash (if used):
 UCD (clamp)
 Emesis Bag (unstow new Bag)

DPS CONFIG TO GNC2/SM 11

NOTE

Do not perform any keyboard item entries
 or switch throws 10 sec before and after
 moding PASS GPCs to RUN or making
 ops transition requests

1. TRANSITION TO GNC OPS 201

GNC 0 GPC MEMORY

✓ CONFIG – ITEM 1 +2 EXEC

Config for single G2 GPC ops unless
 directed otherwise by MCC:

Modify MC 2 per table

BFC CRT DISP – OFF
 GNC, OPS 201 PRO

GNC UNIV PTG

DAP: B/AUTO/PRI

GNC 1 DPS UTILITY

✓ CKPT RETRV ENA – ITEM 12 EXEC (*)

BFC CRT DISP – ON
 BFS, MSG RESET (✓BFC It off)
 BFS, GPC/CRT 04 EXEC

If single G2 GPC ops:

MAJ FUNC – PL

GPC/CRT 2X EXEC

X: PL GPC MEMORY

CONFIG ITEM 45 +2 EXEC

GPC ITEM 46 +2 EXEC

STORE ITEM 47 EXEC

Store complete when MC = 02 (~16 sec)

GPC MODE 2 – STBY (tb-bp)
 – HALT (tb-bp)
 – STBY (tb-RUN)
 – HALT (tb-bp)

	DUAL G2	SINGLE G2
--	------------	--------------

CONFIG GPC	2 12000	2 10000
STR 1	1	1
2	2	1
3	1	1
4	2	1
PL 1/2	0	0
CRT 1	1	1
2	2	1
3	0	0
4	2	1
L 1	0	0
2	0	0
MM 1	1	1
2	2	1

C3

C3
 C2
 CRT

CRTX

O6

C3
 CRTX

2. **FREEZE DRY GPC 3**
 BFC CRT DISP – OFF
 MAJ FUNC – PL
 GPC/CRT 3X EXEC
X: PL GPC MEMORY

CONFIG – ITEM 45 +2 EXEC
 GPC – ITEM 46 +3 EXEC
 STORE – ITEM 47 EXEC
 Store complete when MC = 02 (~16 sec)
 GPC MODE 3 – STBY (tb-bp)
 – HALT (tb-bp)
 – STBY (tb-RUN)
 – HALT (tb-bp)

O6

✓ All CRTs deassigned from FD GPC

CRTY

3. **TRANSITION GPC 4 TO SM OPS 201(401)**
 MAJ FUNC – SM
 GPC/CRT 4X EXEC
X: PL GPC MEMORY

CONFIG – ITEM 1 +4 EXEC

✓ MC 4(5) per table

SM, OPS 201(401) PRO

X: SM ANTENNA

DAP: B/AUTO/PRI

SM 1 DPS UTILITY

UL CNTL AUTO – ITEM 35 EXEC

CRTX

C3
 CRT3

4. **RECONFIG GPCs**
 BFC CRT DISP – ON
 BFS, GNC OPS 000 PRO
3: BFS, GNC GPC MEMORY

C3

O6

BFC CRT DISP – OFF
 ✓ All CRTs deassigned from BFS
 GPC MODE 5 – STBY (tb-RUN)
 (releases payload buses 1,2)
 then HALT (tb-bp)
 OUTPUT 4 – TERM (tb-bp)
 5 – NORM (tb-bp)

P/I Locker

Unstow and install GPC Mode Switch Guard

C2

5. **RECONFIG CRTs**
 GPC/CRT 03 EXEC
 04 EXEC
 44 EXEC

CRT3 PWR – OFF

CONFIG GPC	4(5) 00040
STR 1	0
2	0
3	0
4	0
PL 1/2	4
CRT 1	4
2	4
3	0
4	4
L 1	4
2	0
MM 1	4
2	4

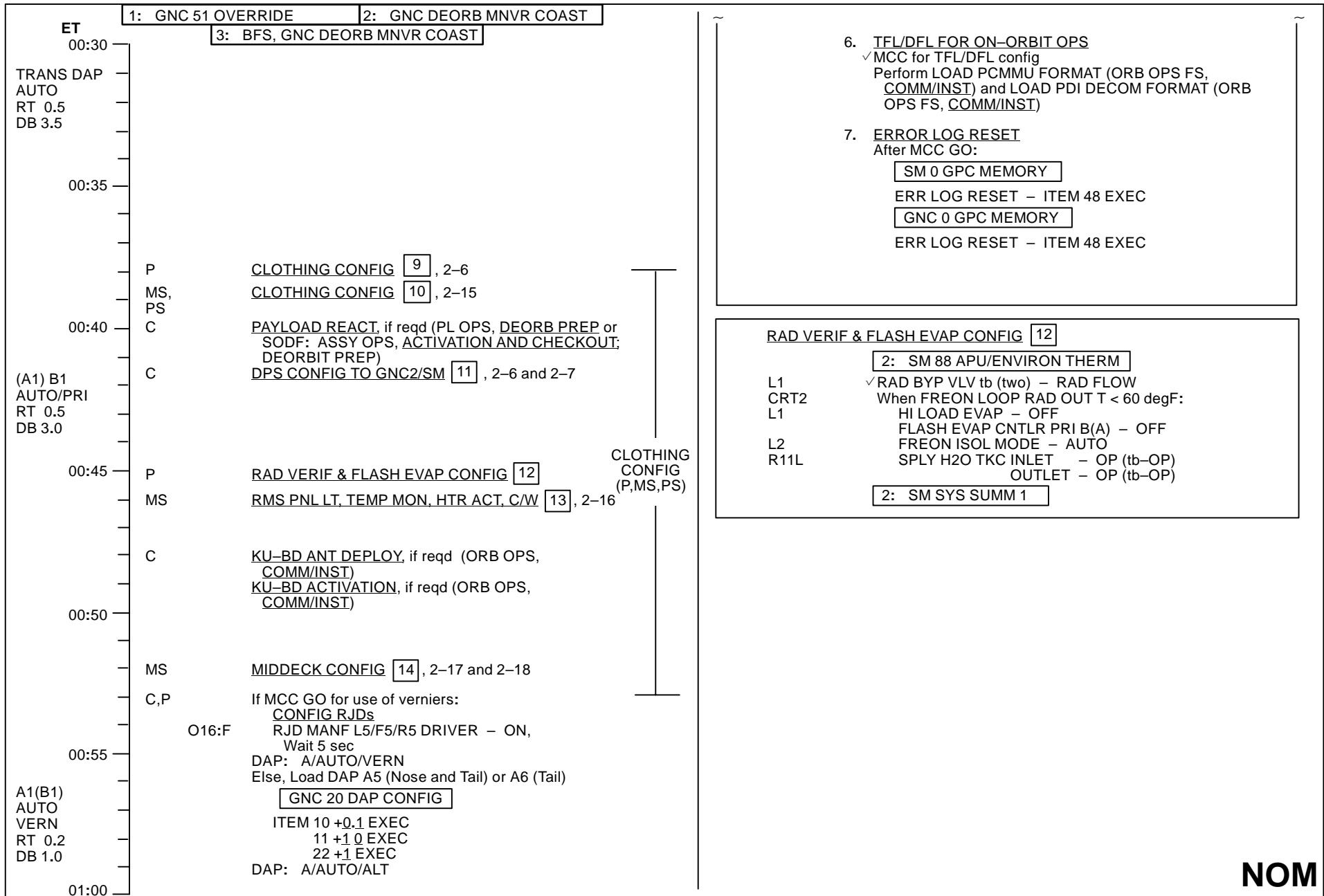

This Page Intentionally Blank

(NOM) B2-8

NOM
D/O/ALL/GEN L

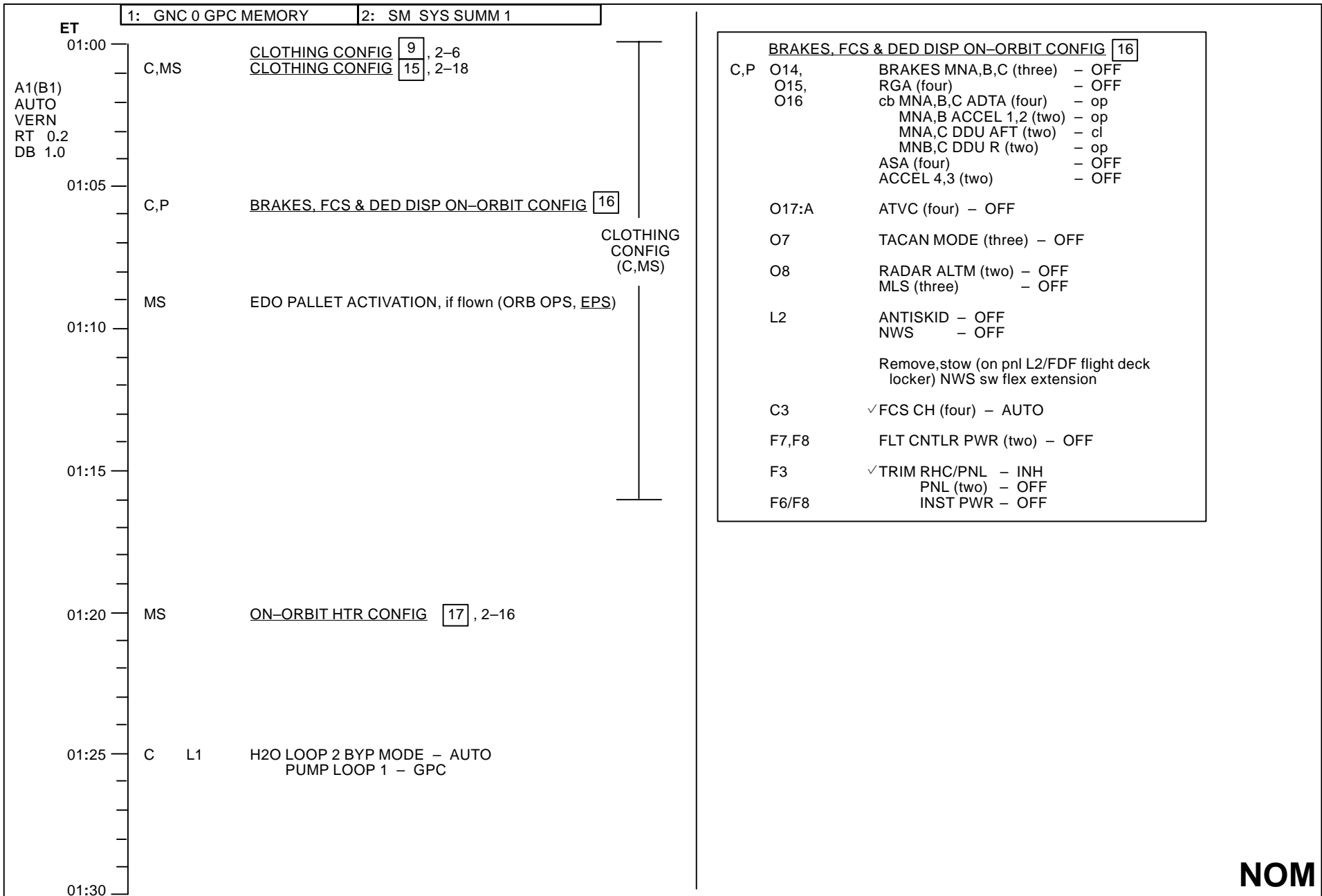

This Page Intentionally Blank

(NOM) B2-10

NOM
D/O/ALL/GEN L

		1: GNC 0 GPC MEMORY	2: SM SYS SUMM
ET			
01:30	C	<u>AUTO MNVR -ZLV, -XVV</u> ✓ TGT ID +2 BODY VECT +3 OM +0 DAP: A/AUTO/VERN Initiate TRK	
A1(B1) AUTO VERN RT 0.2 DB 1.0			
01:35			
01:40	C,MS P	<u>ON-ORBIT PCS2(1) CONFIG</u> [19], 2-18 <u>STAR TRKR ACT</u> [20]	
	MS,PS	<u>SPECIALIST SEAT REMOVAL/STOWAGE</u>	
01:45	P R2	<u>HYD THERM COND ENA</u> HYD CIRC PUMP (three) - GPC	
01:50	MS	<u>AIRLOCK SETUP FOR INGRESS</u> [21], 2-18	
01:55			
02:00		On MCC call: PRIORITY PWRDN GROUP C, if reqd (ORB PKT, PRIORITY PWRDN) Continue per MCC direction	

STAR TRKR ACT [20]
O14:E, cb STAR TRKR -Z,-Y (two) - cl
O15:E

O6 STAR TRKR PWR (two) - ON

C2 GNC I/O RESET

O6 STAR TRKR DR CNTL SYS (two) - OP (start timer)
 ✓ POS tb (two) - bp
When both tb - OP (~8-24 sec)
or either tb - bp > 24 sec:
 STAR TRKR DR CNTL SYS (two) - OFF

[X: GNC 22 S TRK/COAS CNTL]
S TRK -Y,-Z: STAR TRK - ITEM 3,4 (*)
[X: GNC 21 IMU ALIGN]
RESUME

* If tb - bp > 8 sec, notify MCC *

This Page Intentionally Blank

(NOM) B2-12

D/O/ALL/GEN L

PLBD OPENING

DETAILED PLBD OPENING PROCEDURES 5

- * If no motion determined visually or 'OP/CL' *
- * not blank within 10 sec after cmd, *
- R13L * PL BAY DR – STOP, perform MAL, MECH, 9.1a *
- * If Latch not 'OP' in single-motor time, *
- * PL BAY DR – STOP, perform MAL, MECH, 9.1d *
- * If door motion stops and not 'OP', *
- * PL BAY DR – STOP, perform MAL, MECH, 9.1f *

- * If BFS GPC fails during operation: *
- * PL BAY DR SYS 1,2 (two) – DSBL *
- * PL BAY DR – STOP *
- * MDM PL1,2 (two) – OFF *
- O6 * GPC MODE 5 – STBY, HALT *
- * MDM PL 1,2 (two) – ON *
- * Proceed with DPS CONFIG TO GNC2/SM 11, then *
- * continue in MANUAL PLBD OPENING PROCEDURE, *
- * as reqd *

- * If SM GPC fails during this operation: *
- * PL BAY DR SYS 1,2 (two) DSBL *
- R13L * PL BAY DR – STOP *
- * Perform PASS SM GPC FAIL (ORB PKT, DPS) *

- * If BFS AUTO sequence has been interrupted by reversing *
- * latch/door drive direction, or if MANUAL has been used at *
- * any time during the mission, use MANUAL mode for all *
- * subsequent BFS PLBD ops *

NOTE

Note any single-motor ops (continue ops)
(single-motor times = 2x listed dual-motor times)

AUTO PLBD OPENING PROCEDURE

- | | | |
|---|------|---|
| MS | CRTX | 1. SM, OPS X02 PRO or BFS, SM 63 PL BAY DOORS
4: SM PL BAY DOORS |
| R13L | CRTX | <ul style="list-style-type: none"> ✓ PL BAY DR – STOP ✓ PBD SW – STOP ✓ MAN SEL (ten) – (no *) ✓ PBD SW BYPASS – (no *) |
| R13L | CRTX | 2. AC POWER ON – ITEM 1 EXEC (*)
✓ AUTO MODE SEL – (no *) |
| R13L | CRTX | 3. PL BAY DR SYS 1,2 (two) – ENA
✓ OP/CL STATUS (ten) – CL
✓ AOS |
| <p style="margin: 0;"><u>OPEN C/L LATCHES 5-8 (MANUAL MODE)</u></p> | | |
| R13L | CRTX | 4. Select CENTER LATCHES 5-8 – ITEM 4 EXEC (*) |
| R13L | CRTX | 5. PL BAY DR – OP
✓ CENTER LATCHES 5-8 – blank, OP (~20 sec) |
| R13L | CRTX | 6. PL BAY DR – STOP |

OPEN REMAINING LATCHES/DOORS (AUTO MODE)

- | | | |
|--|------|--|
| R13L | CRTX | 7. AUTO MODE SEL – ITEM 3 EXEC (*) |
| R13L | CRTX | 8. PL BAY DR – OP
✓ CENTER LATCHES 9-12 – blank, OP (~20 sec)
✓ CENTER LATCHES 1-4,13-16 (two) – blank, OP (~20 sec)
✓ STBD FWD,AFT LATCHES (two) – blank, OP (~30 sec)
✓ DOOR – RDY, blank, OP (~63 sec)
✓ PORT FWD,AFT LATCHES (two) – blank, OP (~30 sec)
✓ DOOR – RDY, blank, OP (~63 sec) |
| R13L | CRTX | 9. PL BAY DR – STOP |
| <p style="margin: 0;"><u>POST-PLBD OPENING CLEANUP</u></p> | | |
| R13L | CRTX | 10. PL BAY DR SYS 1,2 (two) – DSBL
✓ OP/CL STATUS (ten) – OP |
| R13L | CRTX | 11. AC POWER OFF – ITEM 2 EXEC (*) |
| R13L | CRTX | 12. SM, OPS X01 PRO (if PASS SM)
4: SM ANTENNA |
| A7U | CRTX | 13. After floodlights ON > 25 min:
PL BAY FLOOD (all) – OFF |

MANUAL PLBD OPENING PROCEDURE

- | | | |
|---|------|---|
| MS | CRTX | 1. SM, OPS X02 PRO or BFS, SM 63 PL BAY DOORS
4: SM PL BAY DOORS |
| R13L | CRTX | <ul style="list-style-type: none"> ✓ PL BAY DR – STOP ✓ PBD SW – STOP ✓ MAN SEL (ten) – (no *) ✓ PBD SW BYPASS – (no *) |
| R13L | CRTX | 2. AC POWER ON – ITEM 1 EXEC (*)
✓ AUTO MODE SEL – (no *) |
| R13L | CRTX | 3. PL BAY DR SYS 1,2 (two) – ENA
✓ OP/CL STATUS (ten) – CL
✓ AOS |
| <p style="margin: 0;"><u>OPEN C/L LATCHES</u></p> | | |
| R13L | CRTX | 4. Select CENTER LATCHES 5-8 – ITEM 4 EXEC (*) |
| R13L | CRTX | 5. PL BAY DR – OP
✓ CENTER LATCHES 5-8 – blank, OP (~20 sec) |
| R13L | CRTX | 6. PL BAY DR – STOP |
| R13L | CRTX | 7. Deselect CENTER LATCHES 5-8 – ITEM 4 EXEC (no *) |
| R13L | CRTX | 8. Select CENTER LATCHES 9-12 – ITEM 5 EXEC (*) |
| R13L | CRTX | 9. PL BAY DR – OP
✓ CENTER LATCHES 9-12 – blank, OP (~20 sec) |
| R13L | CRTX | 10. PL BAY DR – STOP |
| R13L | CRTX | 11. Deselect CENTER LATCHES 9-12 – ITEM 5 EXEC (no *) |
| R13L | CRTX | 12. Select CENTER LATCHES 1-4,13-16 – ITEM 6,7 EXEC (*) |
| R13L | CRTX | 13. PL BAY DR – OP
CENTER LATCHES 1-4,13-16 (two) – blank, OP (~20 sec) |
| R13L | CRTX | 14. PL BAY DR – STOP |
| R13L | CRTX | 15. Deselect CENTER LATCHES 1-4,13-16 – ITEM 6,7 EXEC (no *) |

PLBD OPENING

- OPEN STBD FWD,AFT LATCHES & DOOR**
- R13L 16. Select STBD FWD,AFT LATCHES – ITEM 8,9 EXEC (*)
 - CRTX 17. PL BAY DR – OP
 - R13L 18. PL BAY DR – STOP
 - CRTX 19. Deselect STBD FWD,AFT LATCHES – ITEM 8,9 EXEC (*)
 - R13L 20. Select STBD DOOR – ITEM 10 EXEC (*)
 - CRTX 21. PL BAY DR – OP
 - R13L 22. PL BAY DR – STOP
 - CRTX 23. Deselect STBD DOOR – ITEM 10 EXEC (*)
- OPEN PORT FWD,AFT LATCHES & DOOR**
- R13L 24. Select PORT FWD,AFT LATCHES – ITEM 11,12 EXEC (*)
 - CRTX 25. PL BAY DR – OP
 - R13L 26. PL BAY DR – STOP
 - CRTX 27. Deselect PORT FWD,AFT LATCHES – ITEM 11,12 EXEC (no *)
 - R13L 28. Select PORT DOOR – ITEM 13 EXEC (*)
 - CRTX 29. PL BAY DR – OP
 - R13L 30. PL BAY DR – STOP
 - CRTX 31. Deselect PORT DOOR – ITEM 13 EXEC (no *)

- POST-PLBD OPENING CLEANUP**
- R13L 32. PL BAY DR SYS 1,2 (two) – DSBL
 - CRTX 33. OP/CL STATUS (ten) – OP
 - A7U 34. AC POWER OFF – ITEM 2 EXEC (*)
 - 35. SM, OPS X01 PRO (if PASS SM)
 - 4: SM ANTENNA
 - 35. After floodlights ON > 25 min:
PL BAY FLOOD (all) – OFF

FUNCTION	PLBD CONTROL								PLBD DISPLAY PL MDM								
	Ref: MA73C:C&D for MCA cbs																
	MTR 1				MTR 2				C C O O		C R R R		O				
	AC/MCA	CNTL	MDM	SYS	AC/MCA	CNTL	MDM	SYS	A	B	A	B	A	B	C		
LATCH																	
5-8	1/MID3	AB3/AB2	PL1	2	3/MID2	CA3/CA1	PL2	1	1	2	1	2					
9-12	1/MID1	AB3/AB1	PL1	1	3/MID4	CA3/CA2	PL2	2	1	2	1	2					
1-4	1/MID3	AB3/AB2	PL1	2	3/MID2	CA3/CA1	PL2	1	1	2	1	2					
13-16	3/MID4	CA3/CA2	PL2	2	2/MID2	BC3/BC1	PL1	1	2	1	2	1					
S FWD	1/MID1	AB3/AB1	PL1	1	2/MID4	BC3/BC2	PL2	2	1	2	1	2					
S AFT	3/MID4	CA3/CA2	PL2	2	2/MID2	BC3/BC1	PL1	1	2	1	2	1					
S DOOR	1/MID1	AB3/AB1	PL1	1	2/MID4	BC3/BC2	PL2	2					1	1	2	2	1
P FWD	1/MID1	AB3/AB1	PL1	1	2/MID4	BC3/BC2	PL2	2	1	2	1	2					
P AFT	1/MID3	AB3/AB2	PL1	2	3/MID2	CA3/CA1	PL2	1	1	2	1	2					
P DOOR	3/MID4	CA3/CA2	PL2	2	2/MID2	BC3/BC1	PL1	1					2	1	1	2	2
													1	1	1	2	1

MS AFT DECK BACKOUT ACTIVITIES

NOTE

WAIT FOR GO FROM CDR OR PLT BEFORE STARTING ANY ACTIVITY ON THIS PAGE

TIME (ET)	MS AFT ACTIONS
00:01	C6 LEH O2 vlv (four) – CL
00:02	<u>CONFIG FOR PLBD OPENING</u> 1
00:20	<u>SPECIALIST SEAT EGRESS</u>
00:30	<u>FDF/COMM CONFIG</u> 8
00:38	<u>CLOTHING CONFIG</u> 10
00:40	<u>PAYLOAD REACT</u> , if reqd (PL OPS, <u>DEORB PREP</u> or <u>SODF: ASSY OPS, ACTIVATION AND CHECKOUT; DEORBIT PREP</u>)
00:47	<u>RMS PNL LT, TEMP MON, HTR ACT, C/W</u> 13 , 2–16
01:20	<u>ON-ORBIT HTR CONFIG</u> 17 , 2–16
01:42	<u>SPECIALIST SEAT REMOVAL/STOWAGE</u>

<u>CONFIG FOR PLBD OPENING</u> 1	
R11L	CRT4 PWR – ON GPC/CRT 54 EXEC 4 : BFS, SM 63 PL BAY DOORS
A6U	<u>SET UP LIGHTS</u> ANNUN BUS SEL – MNC
	<u>NOTE</u>
	Minimum operating time for PLB Floodlights: 25 min. Lights must be off for minimum of 10 min UNBLOCKED, 16 min BLOCKED prior to reuse. ~3 min to full bright
A7U	PL BAY FLOOD AFT STBD – <input type="checkbox"/>
	PORT – <input type="checkbox"/>
	MID STBD – <input type="checkbox"/>
	PORT – <input type="checkbox"/>
	FWD STBD – <input type="checkbox"/>
	PORT – <input type="checkbox"/>
	BHD – <input type="checkbox"/>
	Record MET ____/____:____:____
	* If PLB Floodlight not ON to full bright within 5 min: * * (Aff) PL BAY FLOOD – OFF *

	<u>FDF/COMM CONFIG</u> 8
	<u>COMM CONFIG</u>
	Unstow: Headsets, Handheld Mics and/or Wireless Comm if flown
	If WCCS, perform STD WCCS CONFIG (ORB OPS, <u>COMM/INST</u>) or see <u>WCCS COMM PLAN</u> (Cue Card)
	If flight deck Handheld Mic/speaker operation:
R10	MS AUD PWR – AUD/TONE
	A/G 1 – T/R, tw–2
	A/G 2 – RCV, tw–2
	A/A – RCV, tw–2
	ICOM A – T/R, tw–2
	ICOM B – RCV, tw–2
	XMIT/ICOM MODE – PTT/PTT
A13	OS AUD SPKR PWR – SPKR/MIC
	MSTR SPKR VOL – 8
	PWR – AUD/TONE (OV102)
A11	MS COMM CCU PWR – OFF
	Connect Handheld Mic to CCU
	MS COMM CCU PWR – ON
R6,L5	CCU PWR – OFF
A1L	S–BD PM MODE – TDRS DATA
	NSP CODING (two) – ON
	OCA SETUP (ORB OPS, <u>PGSC</u>) A/G 2 MODE
	OCA S–BAND MODEM (MFX) ACTIVATION (ORB OPS, <u>PGSC</u>)
	COLOR PRINTER UNSTOW AND ASSEMBLE (ORB OPS, <u>PGSC</u>)
	ICOM RECORDER OPS, if reqd (ORB OPS, <u>COMM/INST</u>)
	<u>FDF CONFIG</u>
	Stow:
	ENT
	ENT PKT
	ENT Cue Cards
	Unstow (if reqd):
	Deploy Orbit Cue Cards

	<u>CLOTHING CONFIG</u> 10
	Doff/stow:
	Harness, Boots, ACES, UCD (if not used)
	Remove radiation dosimeter from ACES and insert in inflight garments
	Doff, stow in Wet Trash (if used):
	UCD (clamp)
	Emesis Bag (unstow new bag)

(Cont next page)

(NOM) B2–15

D/O/ALL/GEN L,3

Back of MS AFT DECK BACKOUT ACTIVITIES

RMS PNL LTS, TEMP MON, HTR ACT, C/W 13

MA73C:F RMS PNL LTS, TEMP MON, HTR ACT (if RMS onboard)
 A8L cb RMS PRI ΦA - cl
 RMS PWR - PRI (MA tone)

SM 94 PDRS CONTROL (MA, GPC DATA It on)

A8U I/O ON - ITEM 5 EXEC (*)
 A8L SAFING - CANCEL (tb-bp) (✓GPC DATA It off)
 C/W PORT RMS HTR A - AUTO

R13U		
PARAMETER NAME	C/W CH	ENA/INH
MPS He REG P C	39	INH
L	49	INH
R	59	INH
HYD P 1	99	INH
2	109	INH
3	119	INH

ON-ORBIT HTR CONFIG 17

R2 BLR PWR (three) - OFF

R4 HYD BRAKE HTR (three) - OFF

L1 ✓HI LOAD EVAP - OFF
 DUCT HTR - OFF

If WVS installed:
 A7 WIRELESS VIDEO HTR - ON

A12 HYD HTR RUD SPD BK B - AUTO
 ✓A - OFF
 BDY FLP B - AUTO
 ✓A - OFF
 ELEV B - AUTO
 ✓A - OFF
 AFT FUS B - AUTO
 ✓A - OFF

A14 RCS/OMS HTR FWD RCS - B AUTO
 ✓L POD - A OFF
 L POD - B AUTO
 ✓R POD - A OFF
 R POD - B AUTO
 OMS CRSFD LINES - A OFF
 ✓OMS CRSFD LINES - B AUTO

R14:C cb KU ANT HTR - cl

Block 4 deleted

Block 18 deleted

MS MIDDECK BACKOUT ACTIVITIES

NOTE

WAIT FOR GO FROM CDR OR PLT BEFORE STARTING ANY ACTIVITY ON THIS PAGE

TIME (ET)	MS MIDDECK ACTIONS
00:20	<u>SPECIALIST SEAT EGRESS</u>
00:21	MO32M LEH O2 vlv (two) - CL MO69M LEH O2 vlv (two) - CL
00:22	<u>PRELIM MIDDECK CONFIG</u> 7
00:40	<u>PAYLOAD REACT</u> , if reqd (PL OPS, <u>DEORB PREP</u> or <u>SODF: ASSY OPS, ACTIVATION AND CHECKOUT; DEORBIT PREP</u>)
00:52	<u>MIDDECK CONFIG</u> 14
01:00	<u>CLOTHING CONFIG</u> 15 , 2-18
01:40	<u>ON-ORBIT PCS 2(1) CONFIG</u> 19 , 2-18
01:42	<u>SPECIALIST SEAT REMOVAL/STOWAGE</u>
01:50	<u>AIRLOCK SETUP FOR INGRESS</u> 21 , 2-18

<u>PRELIM MIDDECK CONFIG</u> 7	
<u>INSTALL FILTERS</u> Unstow,install: Side Hatch UV Filter and Locking Device Pyro Box Safing Pin	
<u>COMM CONFIG</u> Unstow: Headsets, Handheld Mics and/or Wireless Comm if flown (see <u>WCCS COMM PLAN</u> (Cue Card))	
If WCCS perform STD WCCS CONFIG (ORB OPS, <u>COMM/INST</u>) or see <u>WCCS COMM PLAN</u> (Cue Card)	
If middeck Handheld Mic/speaker operation:	
MO42F	MIDDECK SPKR AUD A/G 1 - T/R, tw-2 A/G 2 - RCV, tw-2 A/A - RCV, tw-2 ICOM A - T/R, tw-2 ICOM B - RCV, tw-2 XMIT/ICOM MODE - PTT/PTT MSTR SPKR VOL - 8
MO39M	MIDDECK COMM CCU PWR - OFF Connect Handheld Mic to CCU MIDDECK COMM CCU PWR - ON
<u>HTR CONFIG</u>	
ML31C	VAC VENT ISOL VLV BUS SEL - MNA NOZ HTR - ON ISOL VLV CNTL - OP (tb-OP)
	* If VAC VENT ISOL VLV CNTL tb - CL or bp: *
	* VAC VENT ISOL VLV BUS SEL - MNB *
	* CNTL - OP (tb-OP) *
	* If VAC VENT ISOL VLV CNTL tb still CL or bp: *
	* ✓ MCC for further actions *

MIDDECK CONFIG 14

GALLEY ACTIVATION

ML86B:A cb MNC SPLY H2O GALLEY SPLY - cl
:B cb MNA GALLEY OVEN - cl
cb MNB GALLEY H2O HTR - cl
R11L:G ✓ SPLY H2O GALLEY SPLY VLV - OP (tb-OP)

GALLEY H2O HTRS (two) - ON
OVEN/RHS - ON

MA73C:G cb AC3 GALLEY FAN (three) - cl
Unstow,install Personal Hygiene Hose

WCS ACTIVATION
WCS VAC VLV - OP
(EDO WCS)

If EDO WCS:

- ✓ CANISTER - LOCK
Commode lid lock - use
- URINAL SEL - SEP 1
- WCS PWR SEL (two) - AUTO 1, OFF 2
- ✓ FAN PWR - AUTO
- ✓ URN DIV VLV - FAN SEP 1
Open commode lid
- ✓ Commode airflow
- ✓ Fecal Bag installed
Close commode lid
Unstrap urinal hose Velcro strap
Unstow urinal hose
- ✓ Urinal airflow
- ✓ URINAL READY It - on (5-15 sec)
Stow urinal hose
- COMPACTOR LOCK PINS (three) - loosen
(use 1/4-in Hex Wrench, if reqd)
- ✓ COMPACTOR ARM LOCK PIN - raised
COMPACTOR CLEANING LATCH PIN - engaged
Install Fecal Bag and Lid Dispensers

If WCS:

- Unstow Urinal Hose from Velcro strap, install hose in cradle
- ✓ MODE - AUTO
- ✓ CRADLE - AUTO
FAN SEP SEL sw - 1
Unstow hose from cradle (✓ airflow)
- ✓ WCS ON It - ON
Stow hose in cradle
- ✓ WCS ON It - OFF

Unstow,install:

- WCS Trash Can
- Mirror
- Urine Collection Cue Card
- Foot/Toe Restraint - down, locked

(Cont next page)

(NOM) B2-17

D/O/ALL/GEN L,3

Back of MS MIDDECK BACKOUT ACTIVITIES

MO51F CO2 RMVL SYS ACT (if flown)
 ✓ MCC prior to CO2 RMVL system activation
 cb AC3 (three) - cl
 AC3 - ON (hold 3 sec)
 MNC - ON
 CNTRL 2 MODE - OPER (hold 3 sec)
 Wait 6 sec
 CNTLR 2 OPER It - on
 COM INSTR - ON

If PRIORITY PWRDN GROUP C not reqd:
PGSC ACTIVATION
 (backup PGSC) PGSC ACTIVATION (ORB OPS, PGSC)

POLE STOWAGE
 Remove large Port Pin:
 Slide back Safing Latch
 Retract and hold Locking Pin (Ring)
 Remove large Pin
 Release Locking Pin (Ring)
 Remove Stbd Pip Pin
 Stow Pole

FLOODLIGHT CONFIG
 If TNL ADAPT FLOWN:
 ML86B:E cb MNA FLOOD TNL ADAPT 2 - cl
 cb MNB FLOOD TNL ADAPT 3 - cl
 cb MNC FLOOD TNL ADAPT 4 - cl
 ML86B:F cb MNA FLOODS AIRLK 1 - cl
 MIDDECK 9 - cl
 cb MNB FLOODS MIDDECK 10 - cl
 AIRLK 3 - cl
 cb MNC FLOODS AIRLK 4 - cl
 ML86B:G cb ESS 1BC FLOOD AIRLK 2 - cl
 If TNL ADAPT FLOWN:
 cb ESS 1BC FLOOD TNL ADAPT 1 - cl

CLOTHING CONFIG 15

Do off/stow:
 Harness, Boots, ACES, UCD (if not used)

Remove radiation dosimeter from ACES and insert in
 inflight garments

Do off, stow in Wet Trash (if used):
 UCD (clamp)
 Emesis Bag (unstow new bag)

ON-ORBIT PCS 2(1) CONFIG 19

C L2 ✓ O2 XOVR SYS (two) - OP
 O2/N2 CNTLR VLV SYS 1(2) - CL
 2(1) - AUTO

O1 O2/N2 FLOW sel - SYS 2(1) O2

C7 ✓ LEH O2 SPLY vlv (two) - OP
 Expect possible 'S66 CAB O2(N2) FLO 2(1)' msg

MS MO10W 14.7 CAB REG INLET SYS 2(1) vlv - OP
 H2O TK N2 REG INLET SYS 1(2) vlv - CL
 O2 REG INLET SYS 2(1) vlv - OP

MO69M ✓ LEH O2 8 vlv - CL
 Insert O2 Bleed Orifice Assembly into LEH O2 8 QD
 LEH O2 8 vlv - OP

AIRLOCK SETUP FOR INGRESS 21

INNER HATCH 1. Equal vlv caps (two) - remove, stow
 2. ✓ Equal vlv (two) - NORM
 3. Open hatch per decal

AW18A 4. LTG FLOOD 1(3,4) - ON (as reqd)
 MO13Q 5. AIRLOCK 2 - ON/OFF

If internal airlock:
 6. Rotate vent duct into airlock >>

MO13Q 7. ✓ ARLK H2O S/O vlv - OP (tb-op)
 MIDDECK FLR 8. ✓ EMU O2 ISOL vlv - CL
 9. Remove, stow diffuser cap on middeck floor air fitting (mark
 stowage location; will be reused)

If Booster Fan flown:
 MA73C:G 10. cb AC1,2 ARLK TNL FAN A,B (six) - cl
 11. Unstow, install flex duct from booster fan muffler inlet to
 cabin middeck floor air fitting

MO13Q 12. ARLK FAN A(B) - ON
 13. ✓ Airflow at top of external airlock halo

If Spacehab flown:
 14. Perform SPACEHAB INGRESS AFTER WAVEOFF
 (SH OPS, ON-ORBIT) >>

If Spacehab not flown >>
 15. Unstow flex duct from tunnel extension; install between
 middeck floor air fitting and airlock duct inlet

AIRLOCK ENTRY SWITCH LIST/VERIFICATION (TIG-3:50)

AIRLOCK

AW18A	3-3
AW18D	3-3
AW18H	3-3
AW82B	3-3

PARTIAL ENTRY SWITCH LIST/VERIFICATION (TIG-3:10)

LEFT SEAT

F3	3-4
F7	3-4
L,R HUD	3-4
F2	3-5
O7	3-5
O13	3-5
L side OVHD flood ..	3-5
F1	3-6
F6	3-6
L5	3-6

RIGHT SEAT

O8	3-7
R side OVHD flood ..	3-7
F4	3-7
F8	3-7
R2	3-8
R6	3-8
O17	3-8









AFT

O19	3-9
C5	3-9
C7	3-9
A11	3-9
MIDDECK-FWD	
MO58F	3-10
MO39M	3-10
MO52J	3-10
MO30F	3-10
MD44F	3-10
MD24K	3-10
A/L HATCH	3-10
MO63P (OV104)	3-10
ML86B	3-11

MIDDECK-AFT

MO13Q	3-12
ML18F	3-12
ML26C	3-12
ML31C	3-12

LEGEND

 - left	 - right
 - up	R - as reqd
 - center	 - cb close
 - down	 - cb open
 - indicates switch/display not checked during ENT SWITCH LIST/VERIFICATION. Switch/display pictorials are generic representations and are not intended to depict actual switch positions. ✓MCC if additional clarification reqd	

CIRCUIT BREAKER SNAP RING COLOR CODES

<u>COLOR</u>	<u>CONFIGURATION</u>
Red	Open at all times
Green	Open on orbit only
Yellow	Open ascent, close per procedure
Orange	Open orbit through entry
Blank (no ring)	Always closed or as reqd

**ENT SWITCH
LIST/VERIF**

FINAL ENTRY SWITCH LIST/VERIFICATION (TIG-1:50)

LEFT SEAT

L4
L1
L2
C2/C3
O1
O5
O6
O14
O15

AFT

3-13 R10
3-14 R11U,L
3-15 R13L
3-16 R14
3-17 A1L,R
3-17 A7U,L
3-18 A12
3-19 A13
(OV102,103,105)
L9
A6L
(OV103,104,105)
3-20 A7L
3-20 (OV103,104,105)
3-21 A15 (OV102)
3-21 A15
(OV103,104,105)

MIDDECK-AFT

3-22 MA73C (OV102) 3-29
3-22 MA73C
(OV103,104,105) .. 3-31
3-23 MO10W (OV102) ... 3-30
3-24 MO10W
(OV103,104,105) .. 3-32
3-25 WCS (OV102) 3-30
WCS
(OV103,104,105) .. 3-32
3-26 EDO WCS
(OV102) 3-30
3-27 EDO WCS
(OV103,104,105) .. 3-32
3-28
3-27
3-29









RIGHT SEAT

O16
O9
R1
R4

MIDDECK-FWD

MO42F (OV102) 3-28
MO42F
(OV103,104,105) .. 3-30
MO32M 3-30
MO69M 3-30
MO51F (OV102) 3-28
MO51F
(OV104,105) 3-30

LEGEND

	- left		- right
	- up	R	- as reqd
	- center		- cb close
	- down		- cb open
	- indicates switch/display not checked during ENT SWITCH LIST/VERIFICATION. Switch/display pictorials are generic representations and are not intended to depict actual switch positions. ✓MCC if additional clarification reqd		

**CIRCUIT BREAKER SNAP RING
COLOR CODES**

<u>COLOR</u>	<u>CONFIGURATION</u>
Red	Open at all times
Green	Open on orbit only
Yellow	Open ascent, close per procedure
Orange	Open orbit through entry
Blank (no ring)	Always closed or as reqd

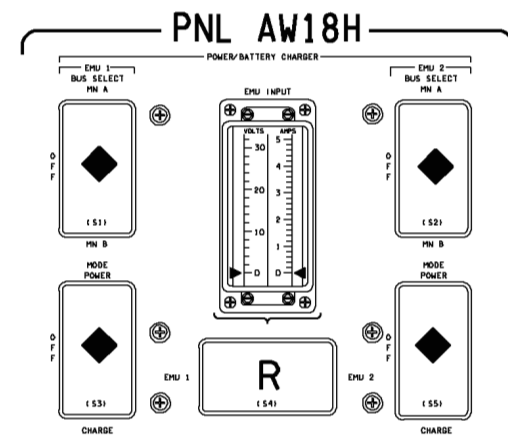
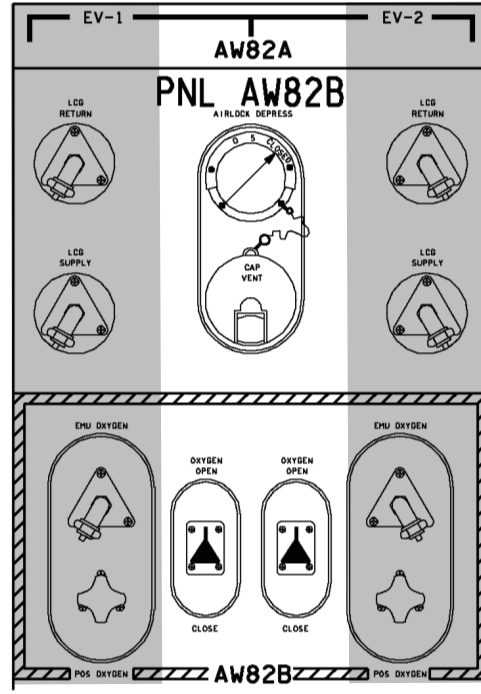
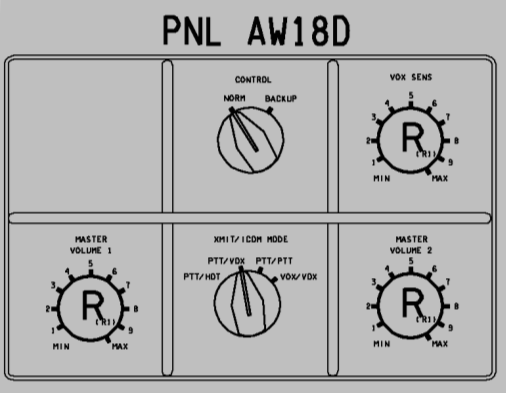
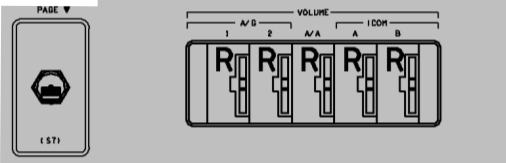
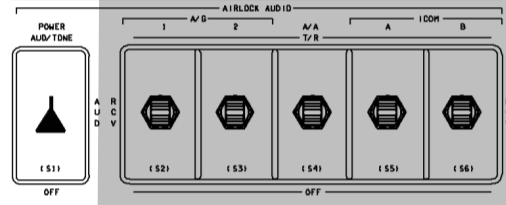
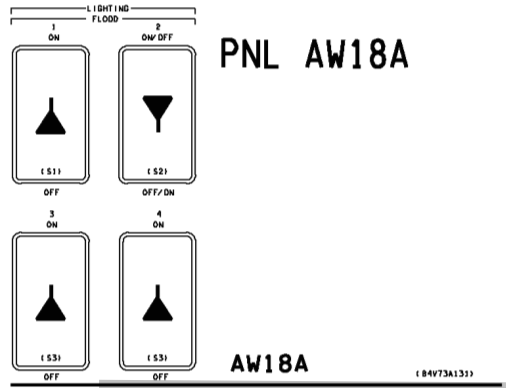

OV102

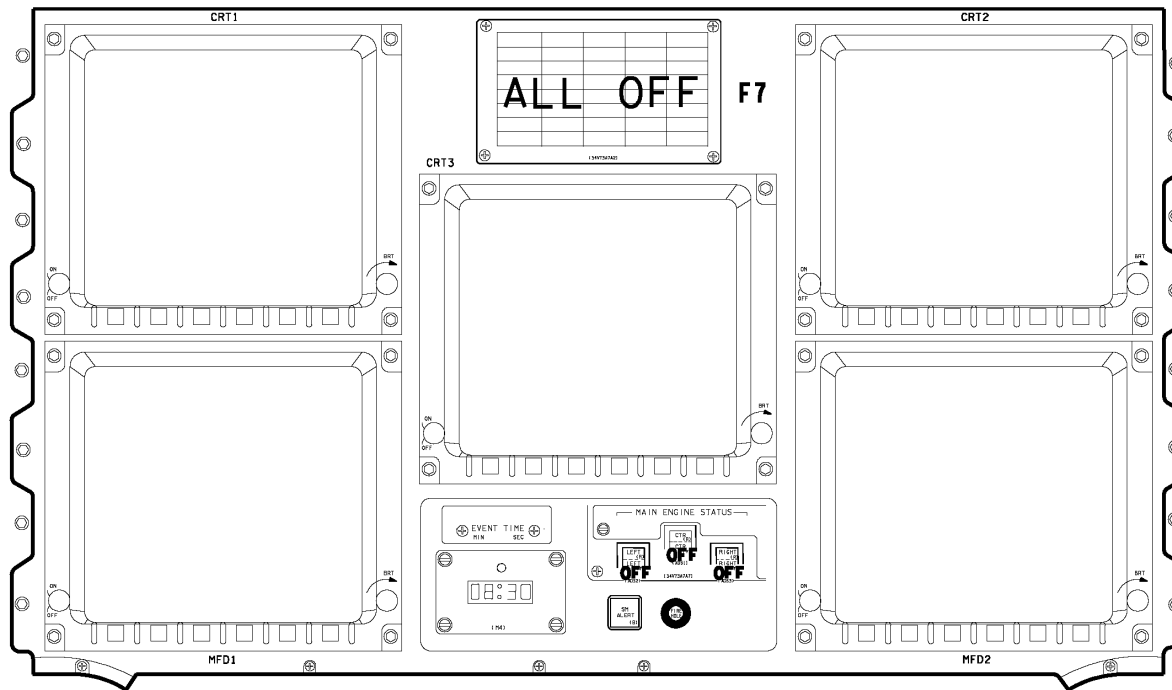
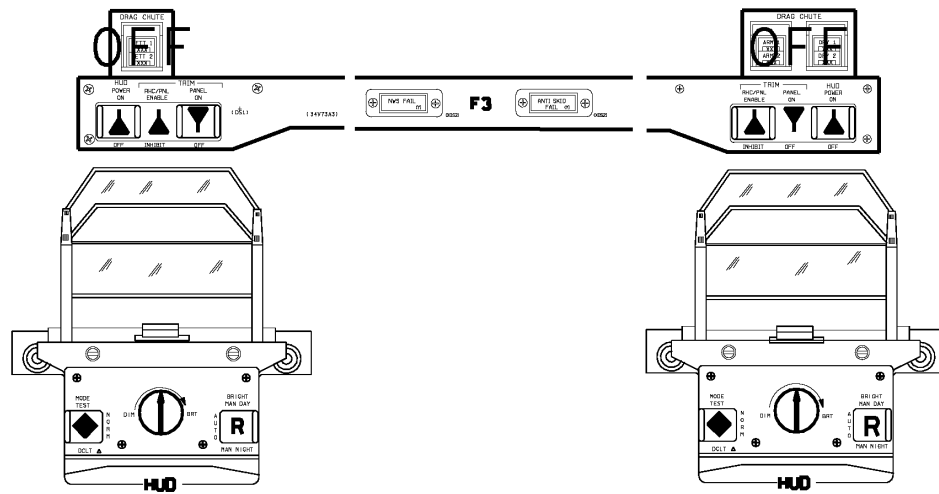

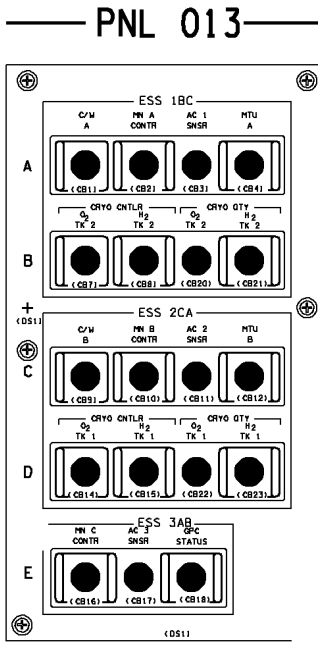
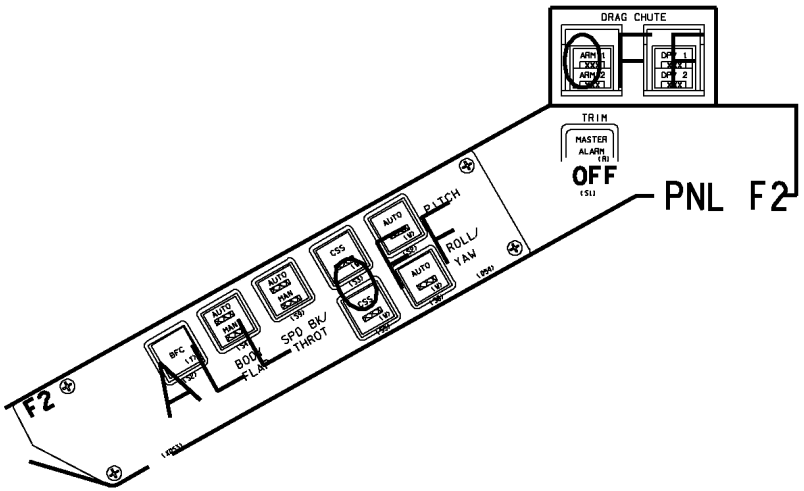

L side OVHD flood - R (MID)

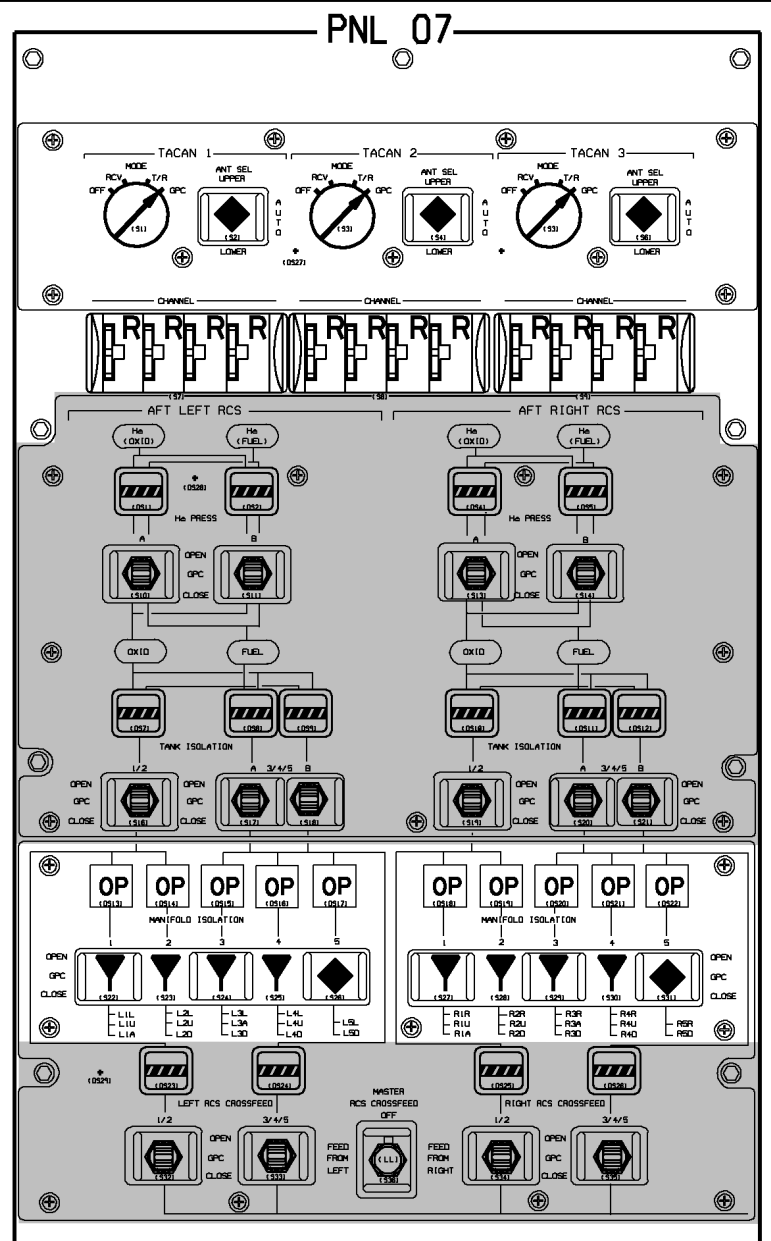

OV102

OV102

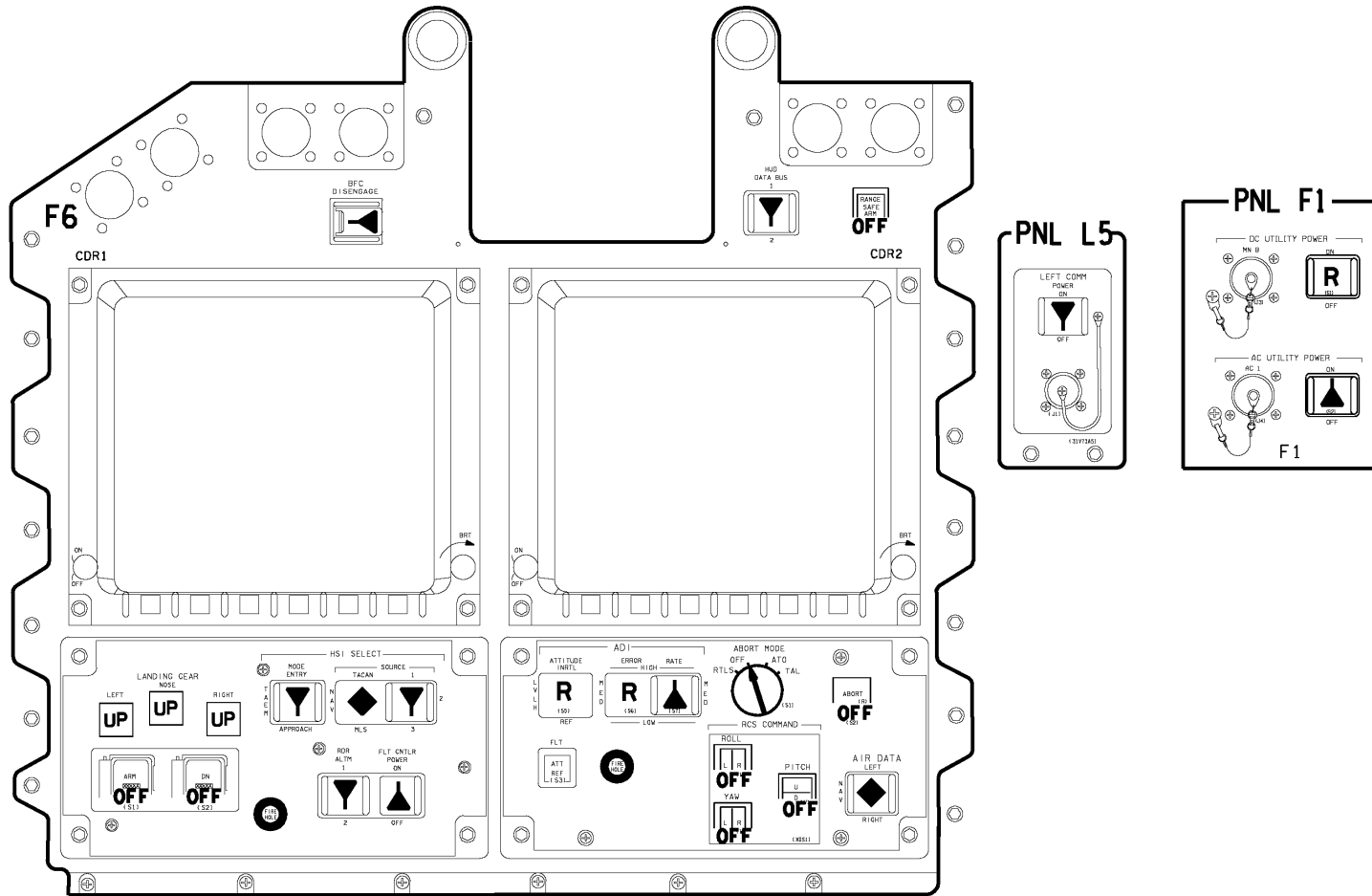

OV102

OV102

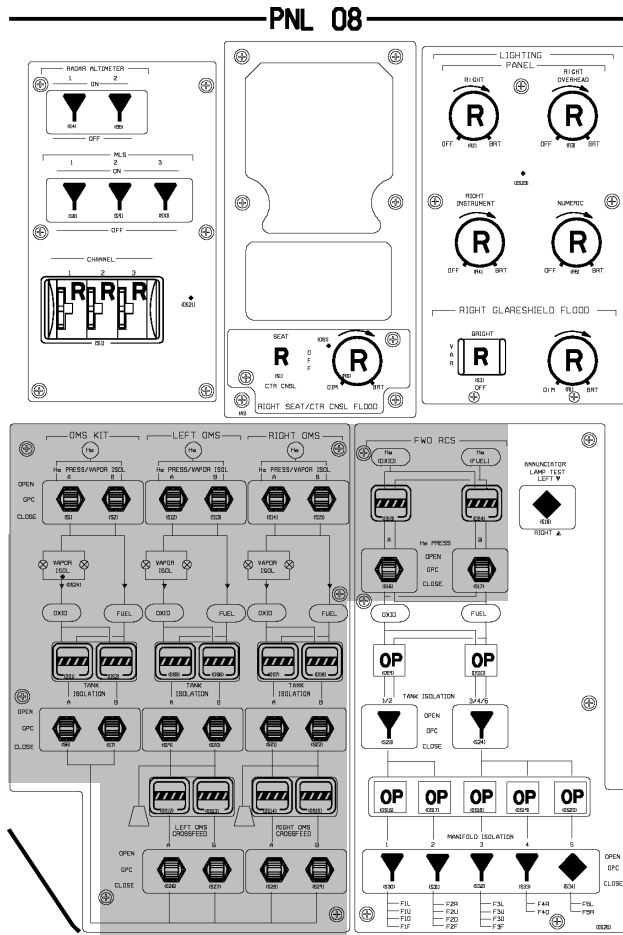

R side OVHD flood - R (MID)

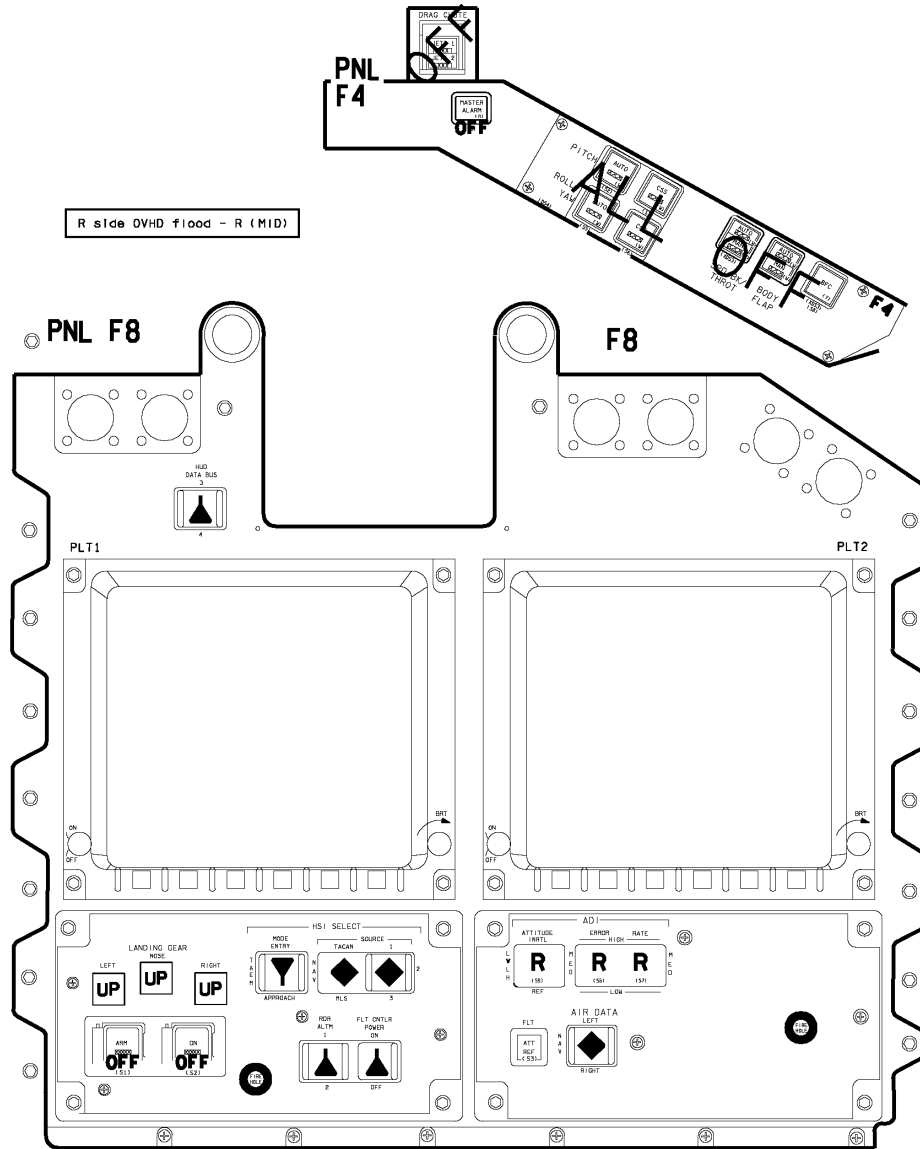

OV102

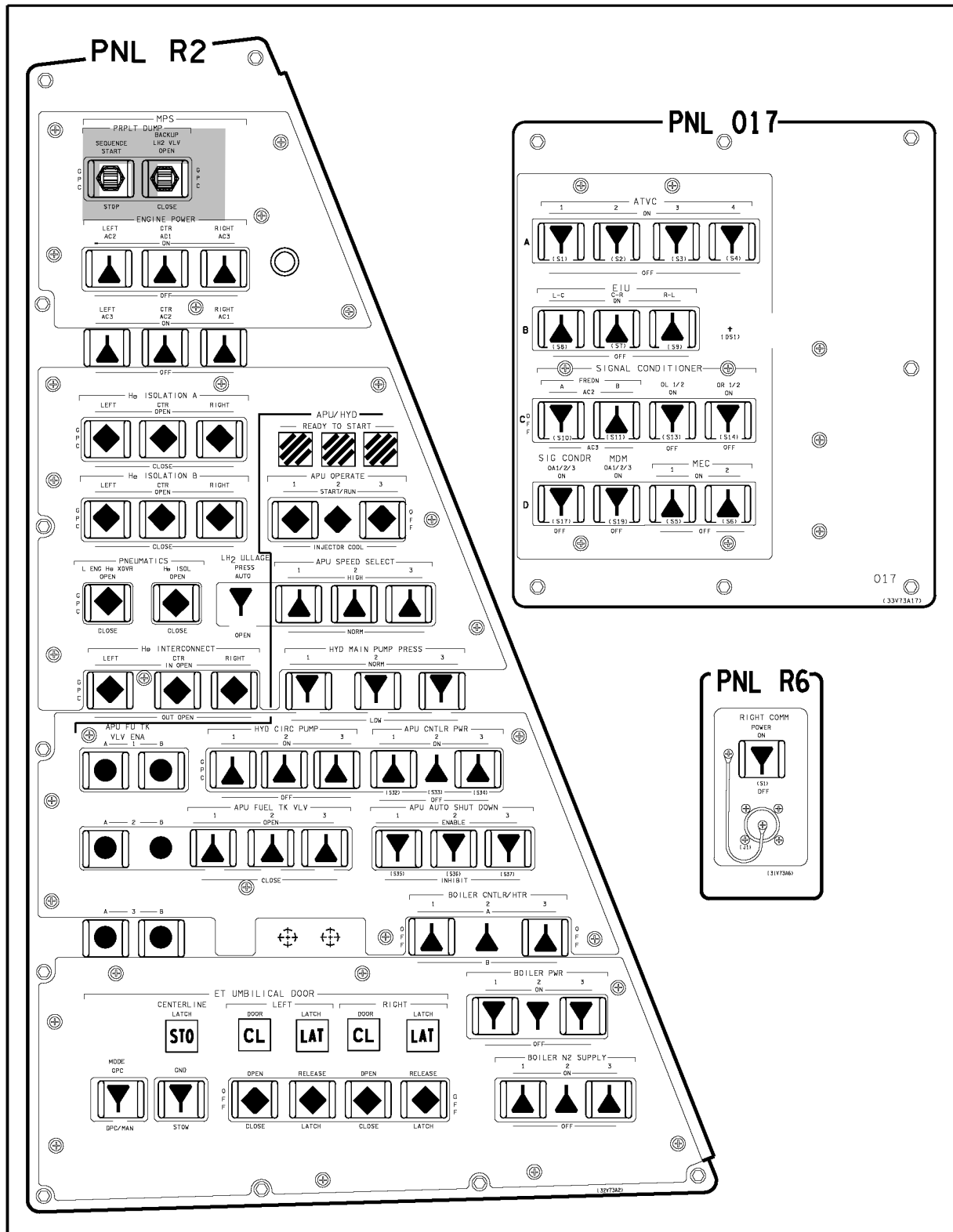

ALL VEH/DATE 09/29/94
104. PNL 3

OV102

(OV102) A3-8

D/O/ALL/GEN L

OV102

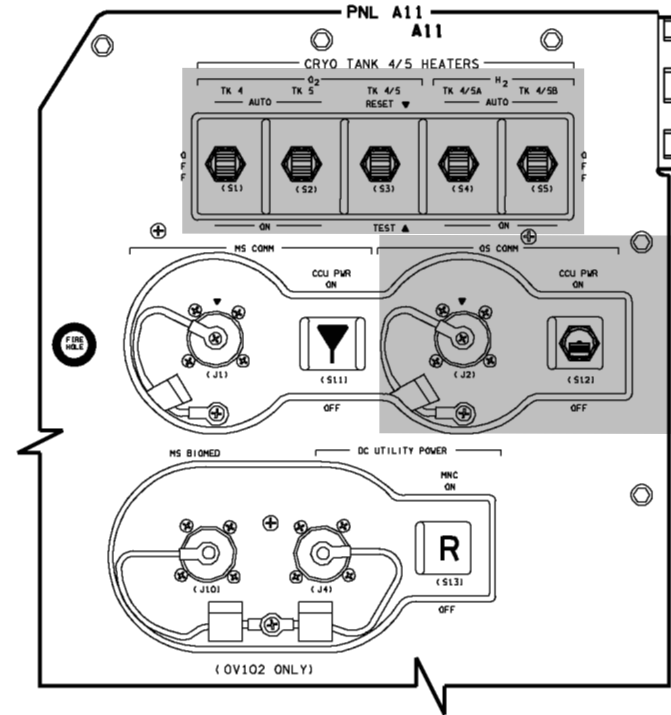
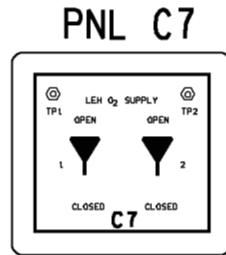
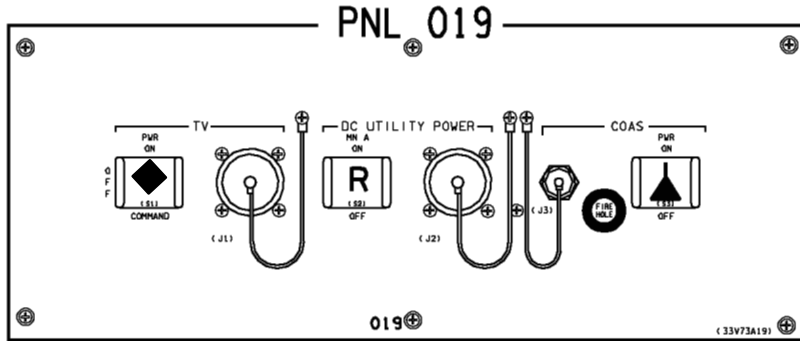

OV102

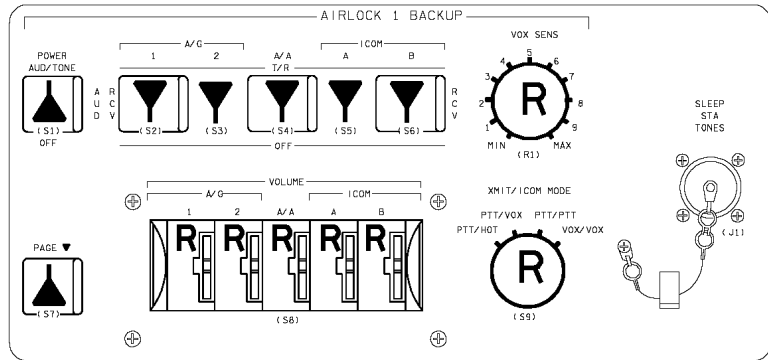

PNL M058F

AIRLOCK HATCH

ACTUATOR HANDLE - LATCHED
 LOCK LEVER - LOCKED
 EQUALIZATION VLV (TWO) - NORM
 -CAPS INSTALLED

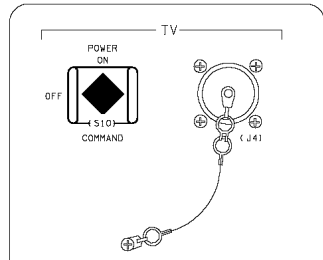

PNL M052J

PNL M039M

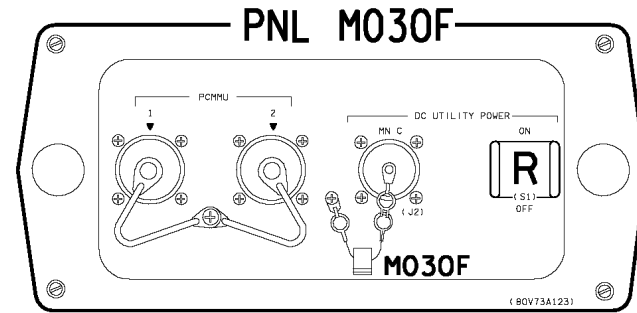
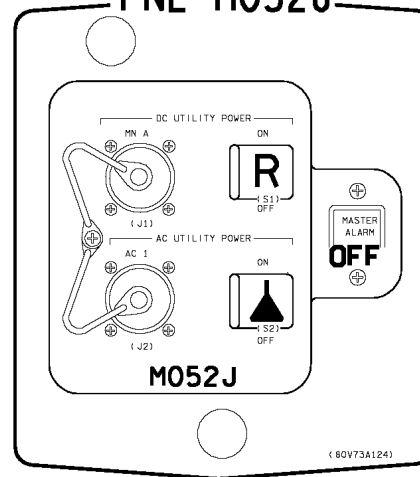
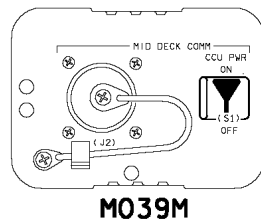

PNL MD24K

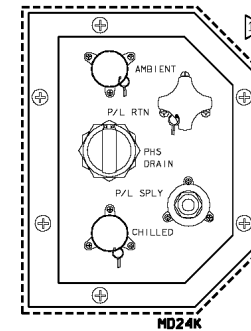

NOTE: NOT VISIBLE IF MAR FLOWN

PNL MD44F

CAB TEMP CNTL ACT LINKAGE - SECONDARY ACTUATOR

OV102

PNL ML86B

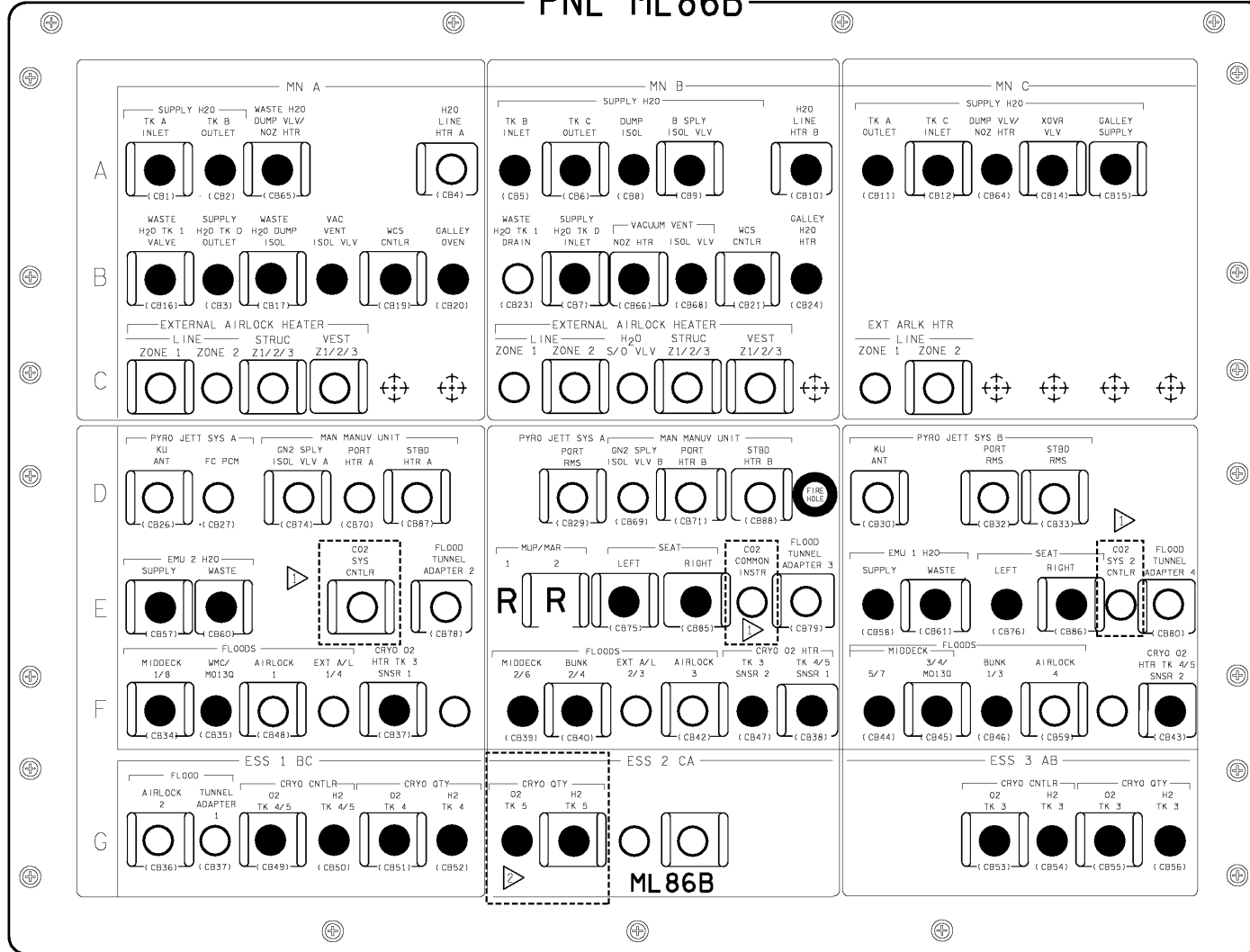

NOTES: ▷ CLOSED IF CO2 RMVL SYS FLOWN
▷ OPEN IF TK 5 NOT FLOWN

OV102

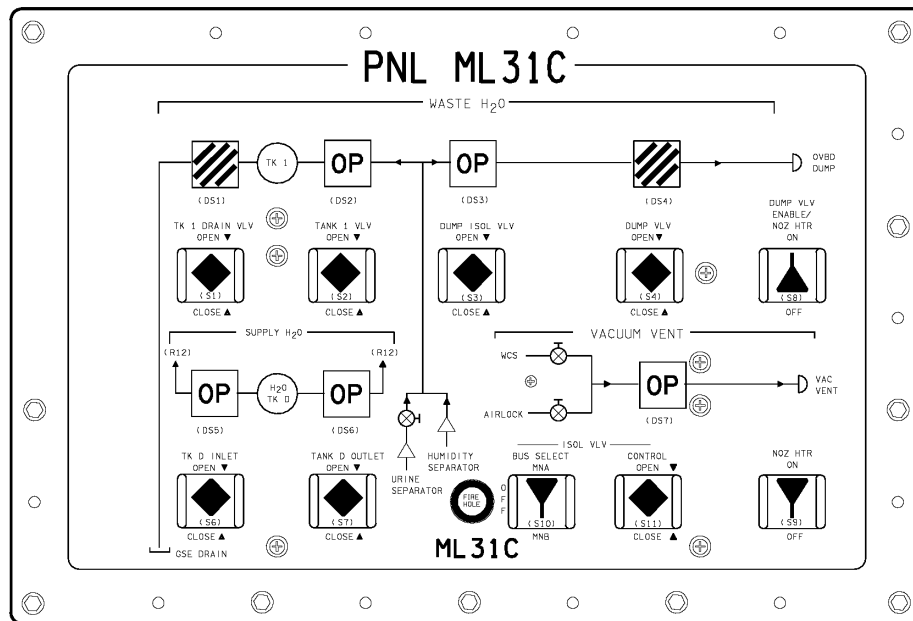
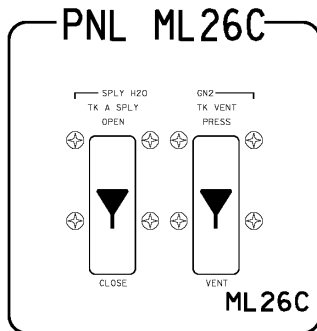
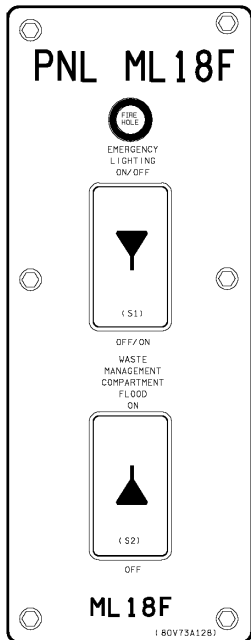
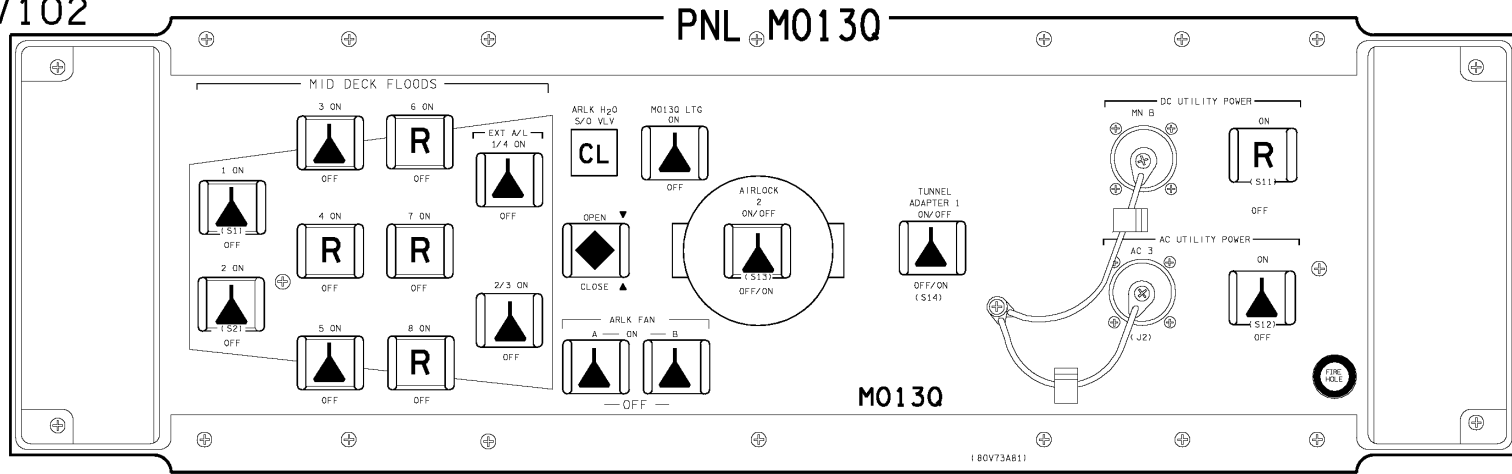

OV102

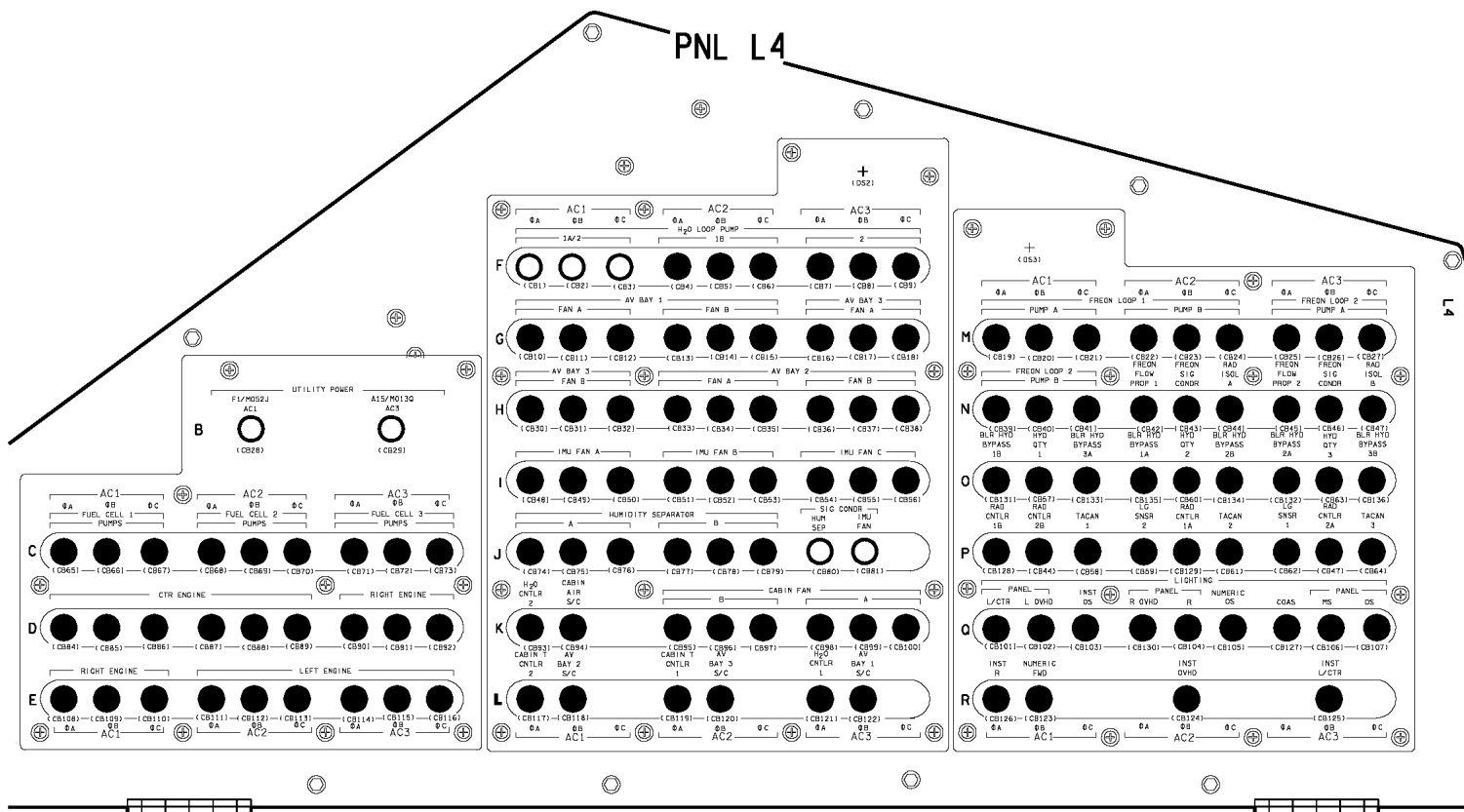

OV102

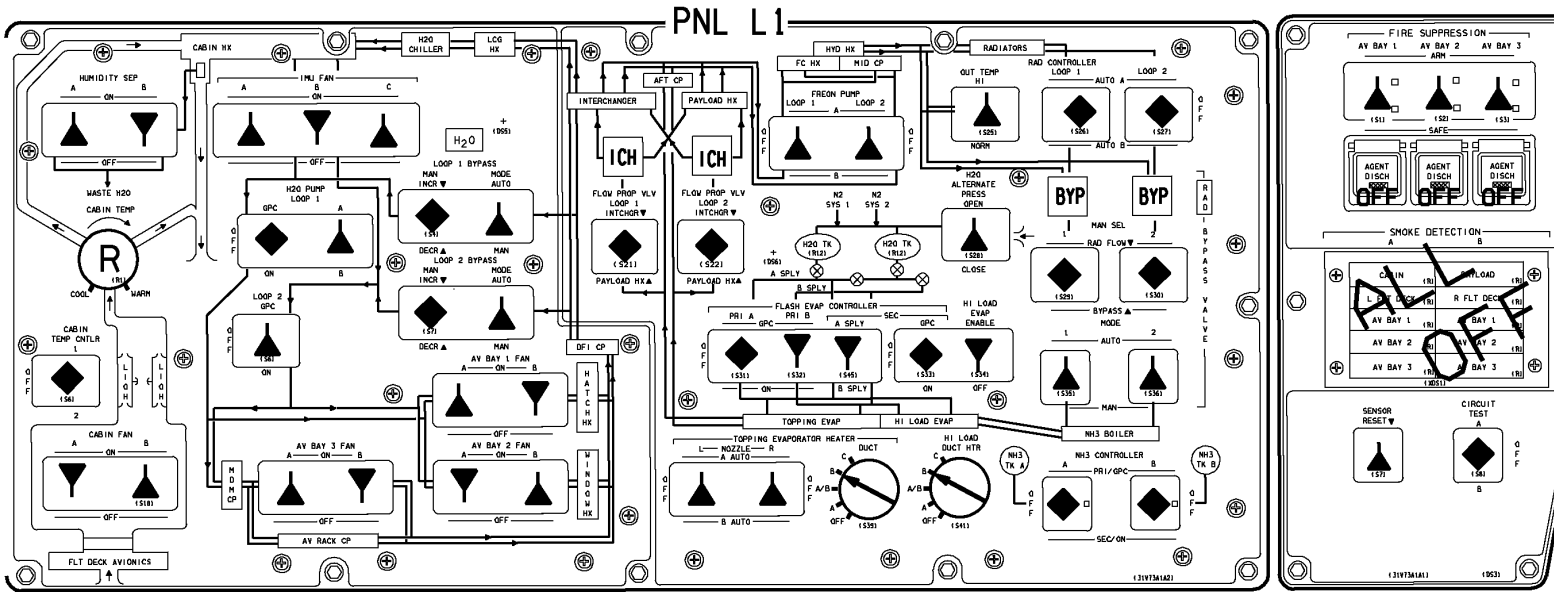

OV102

PNL L2

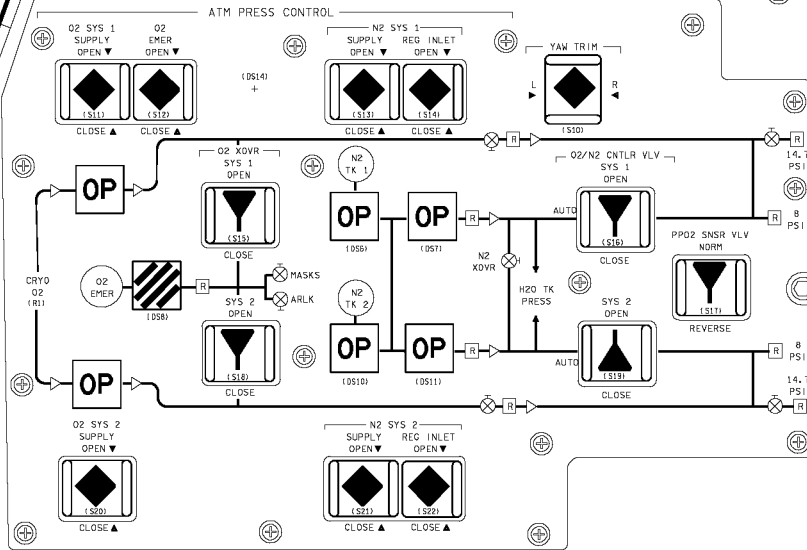
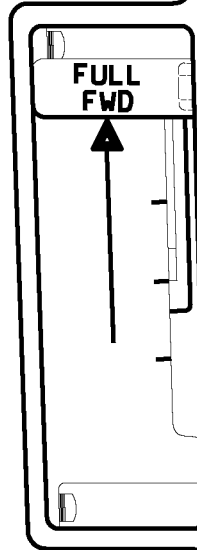
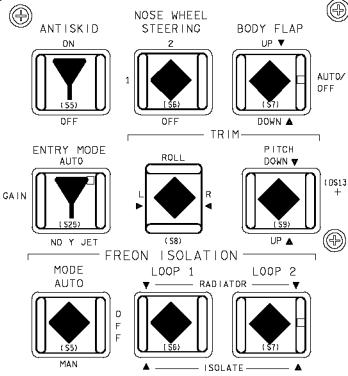
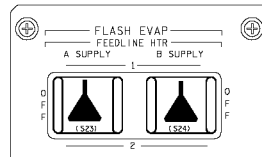
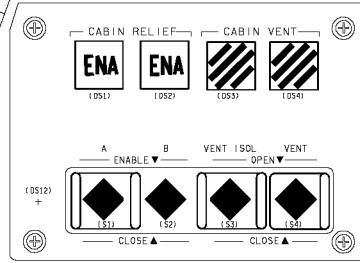

OV102/DATE 07/05/01

48015A315_108, PNL, 1

OV102

(OV102) A3-15

D/O/2/GEN L,3

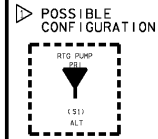
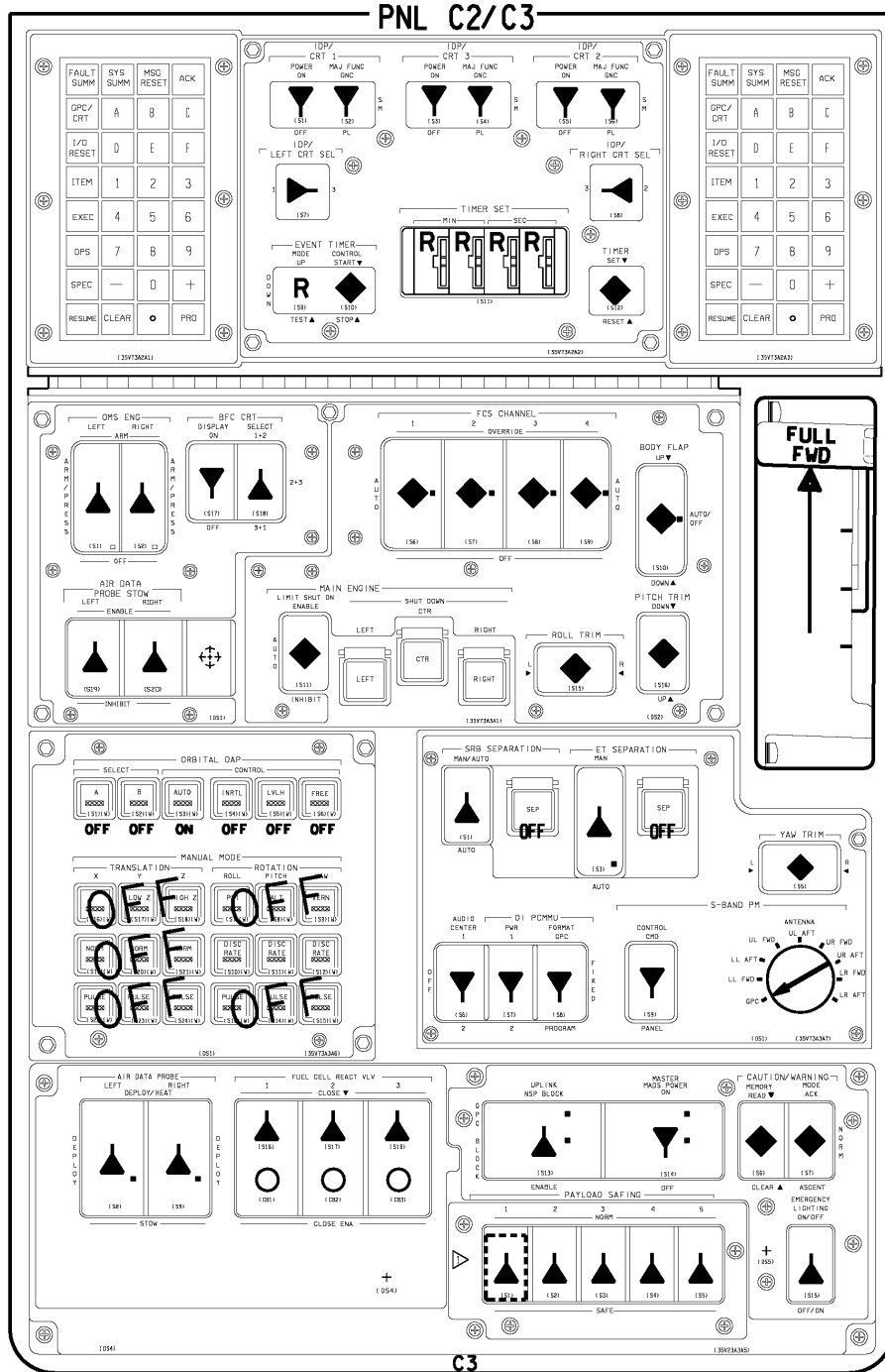

OV102

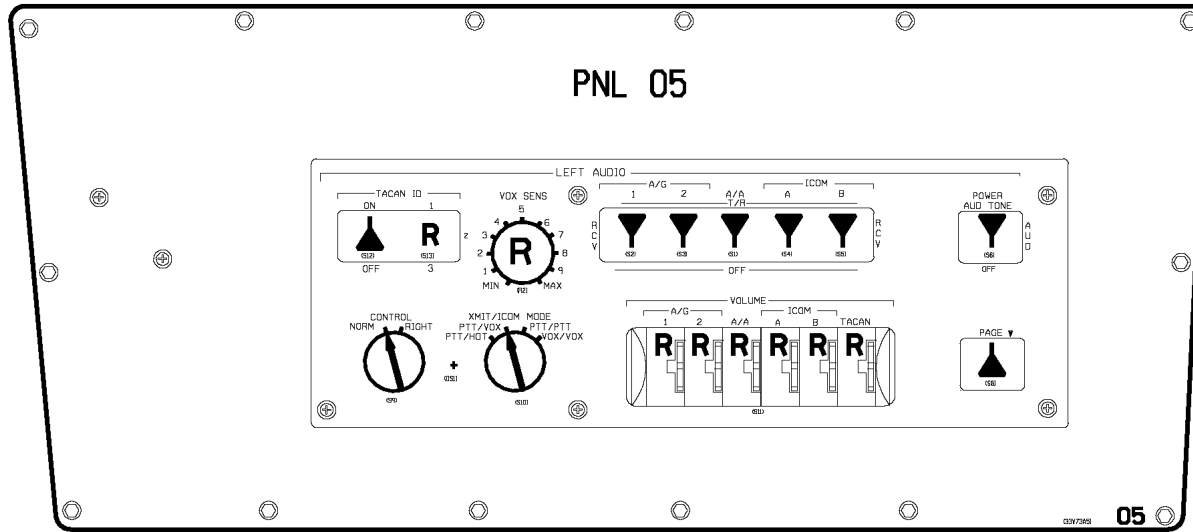
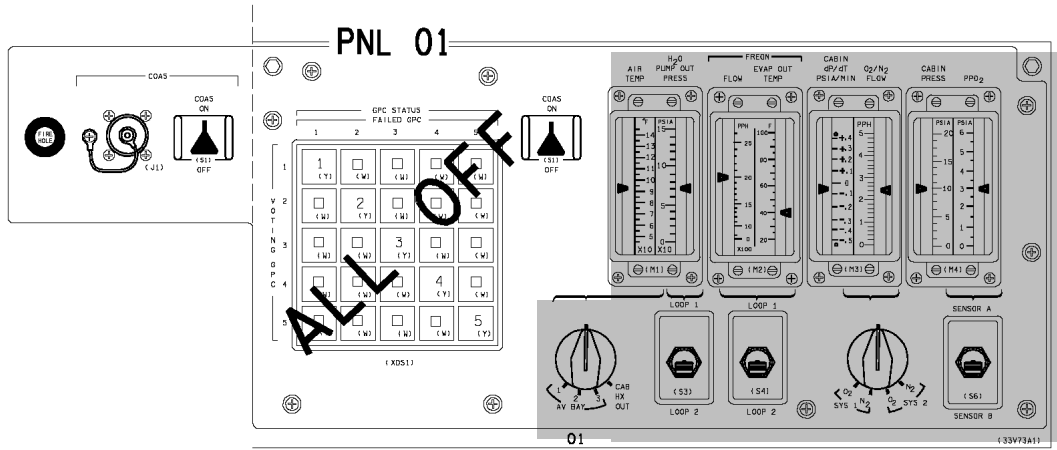

OV102

PNL 06

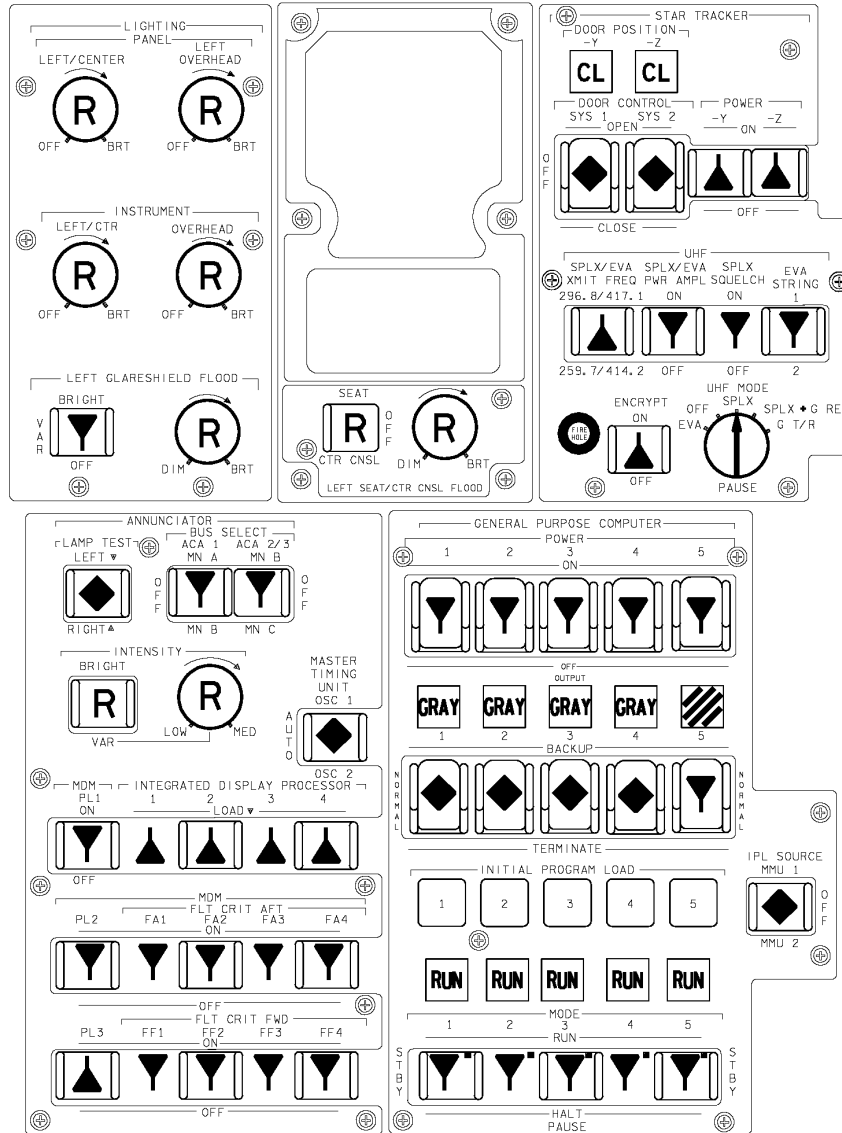

OV102

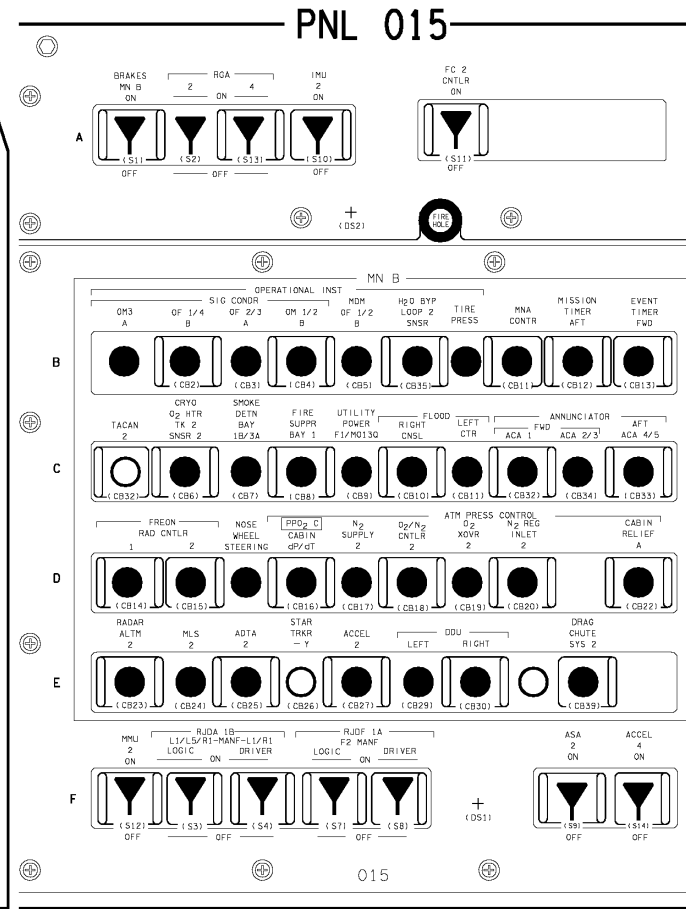
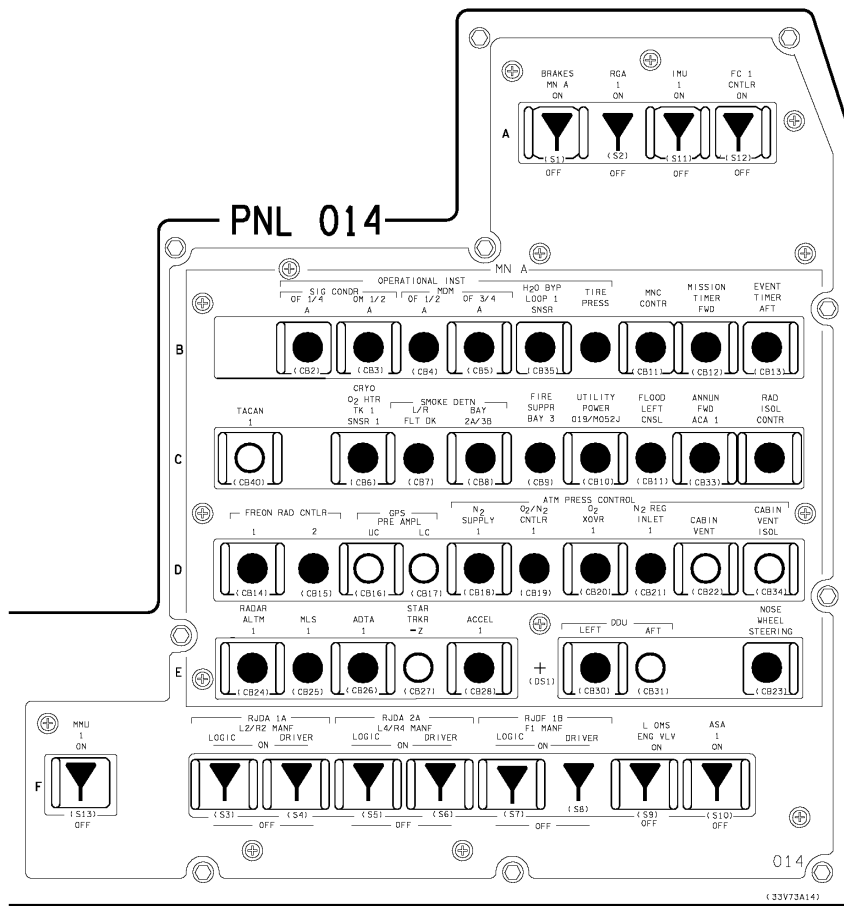

OV102

OV102

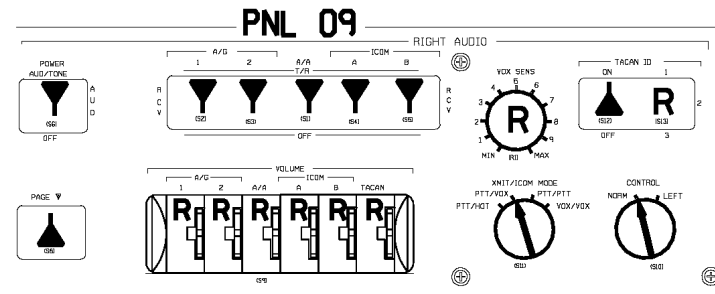
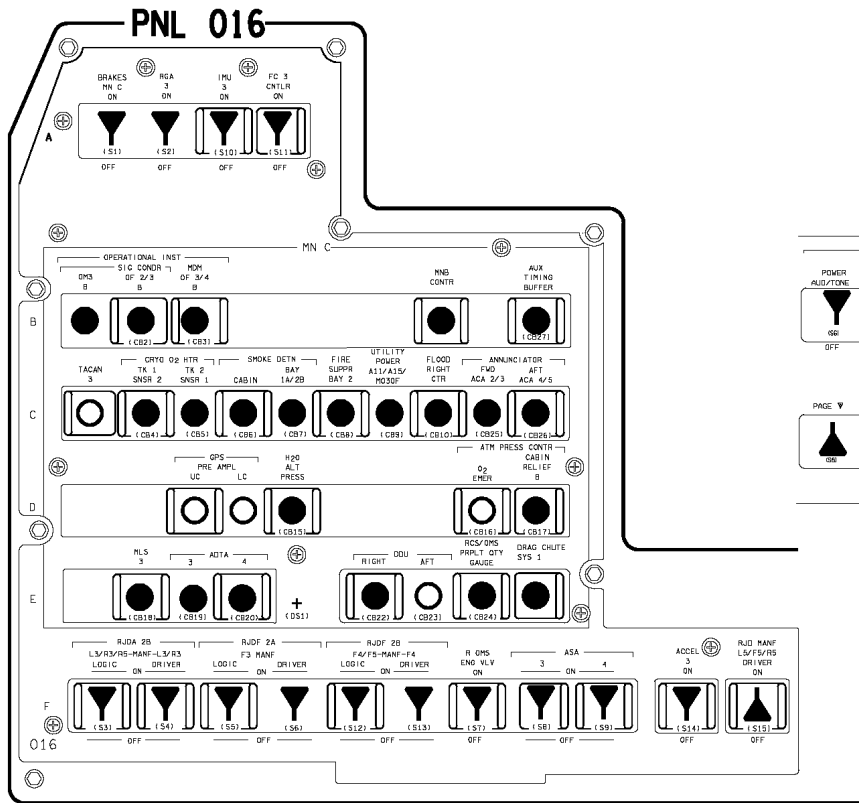

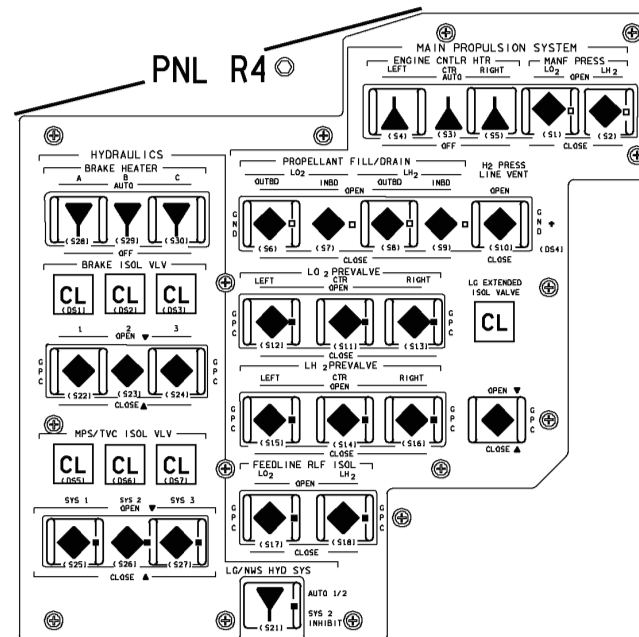
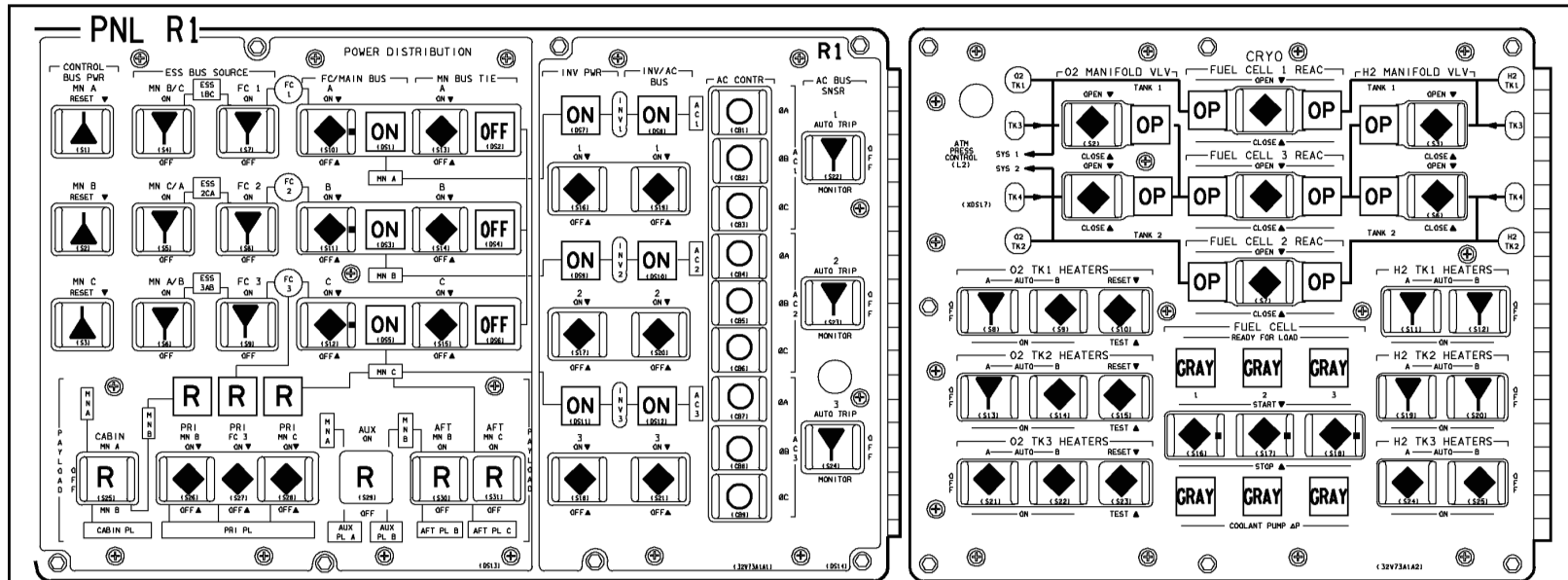

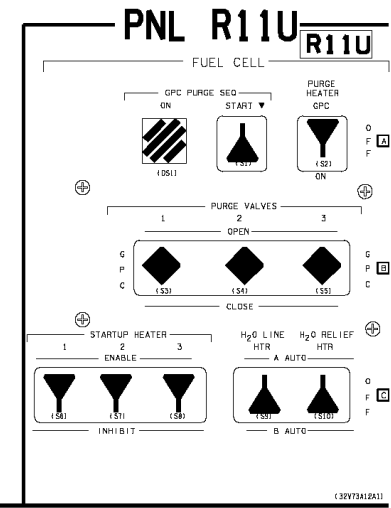
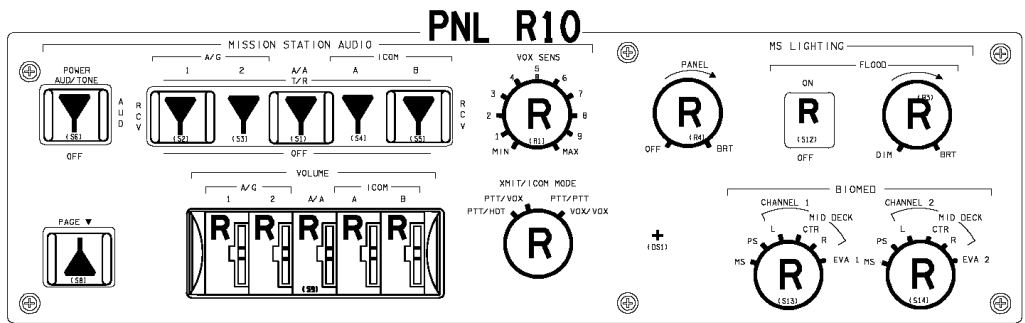

NOTES: ▷ CONFIG FOR NOMINAL D/O PREP
 IF 1 REV WAVE-OFF OR EXTENSION DAY:
 ✓ SPLY H₂O TKC INLET - CTR (+b-OP)
 ✓ OUTLET - CTR (+b-OP)

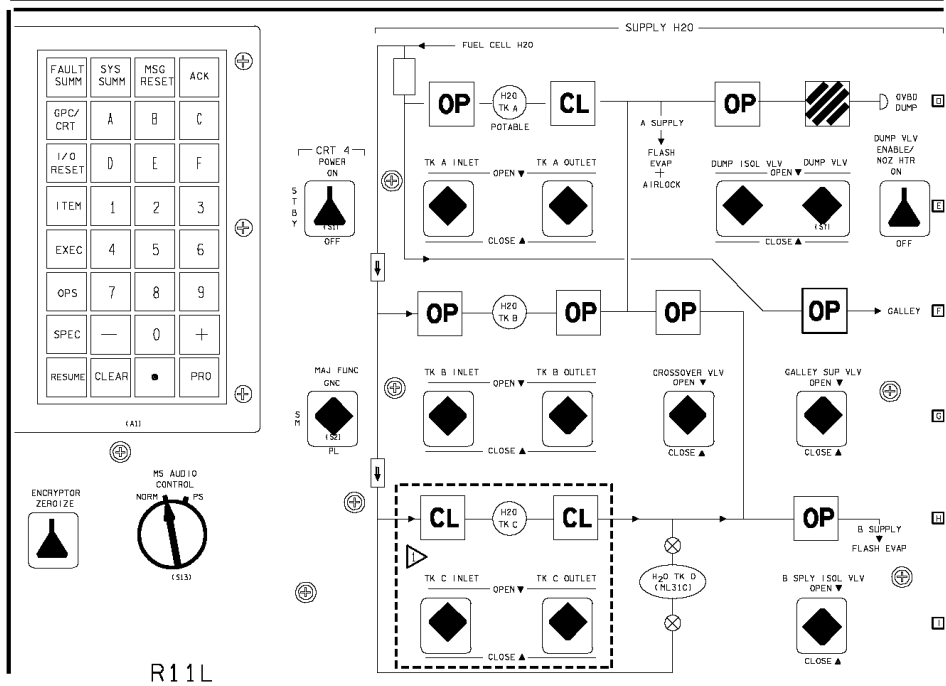

OV102

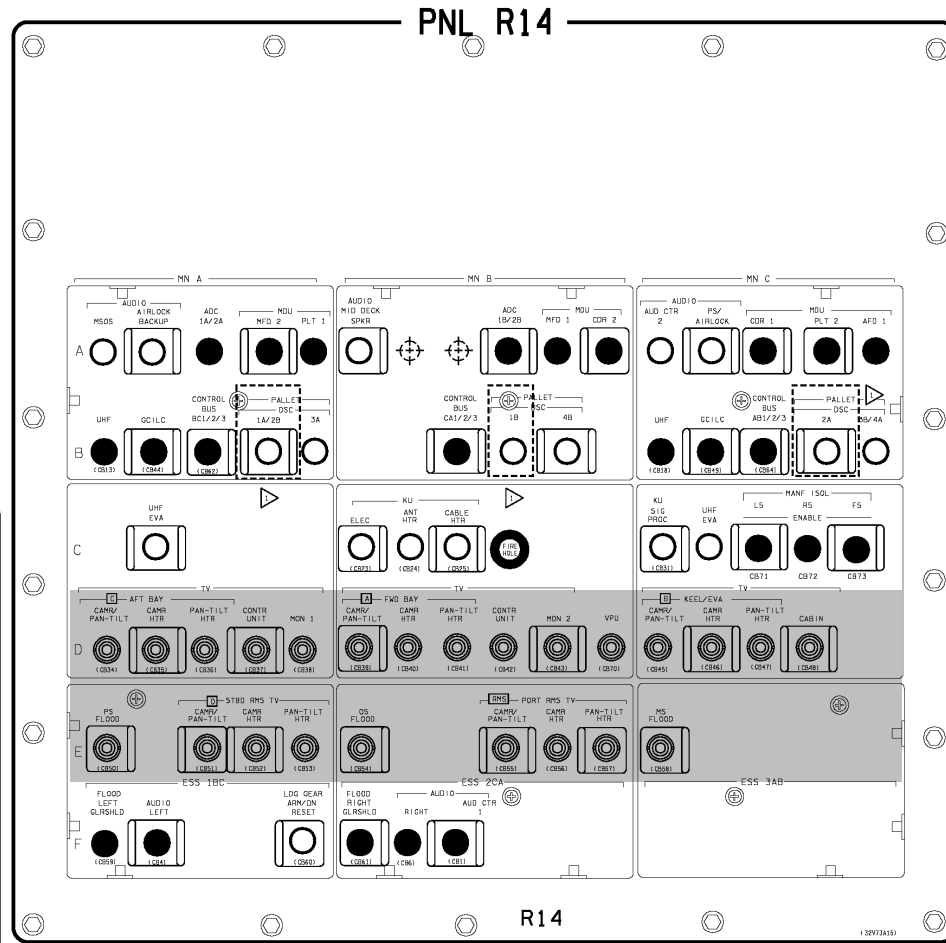
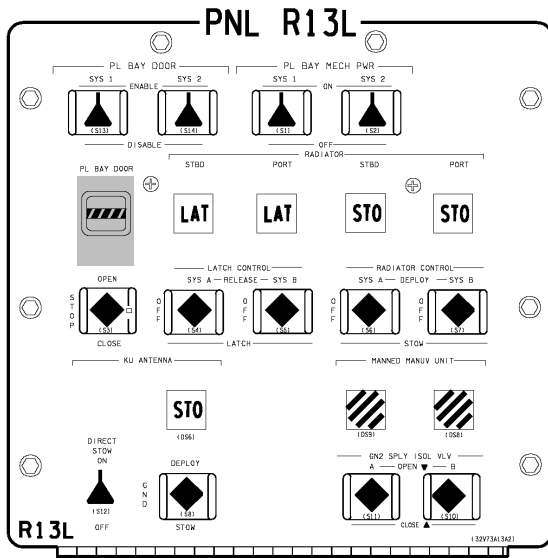

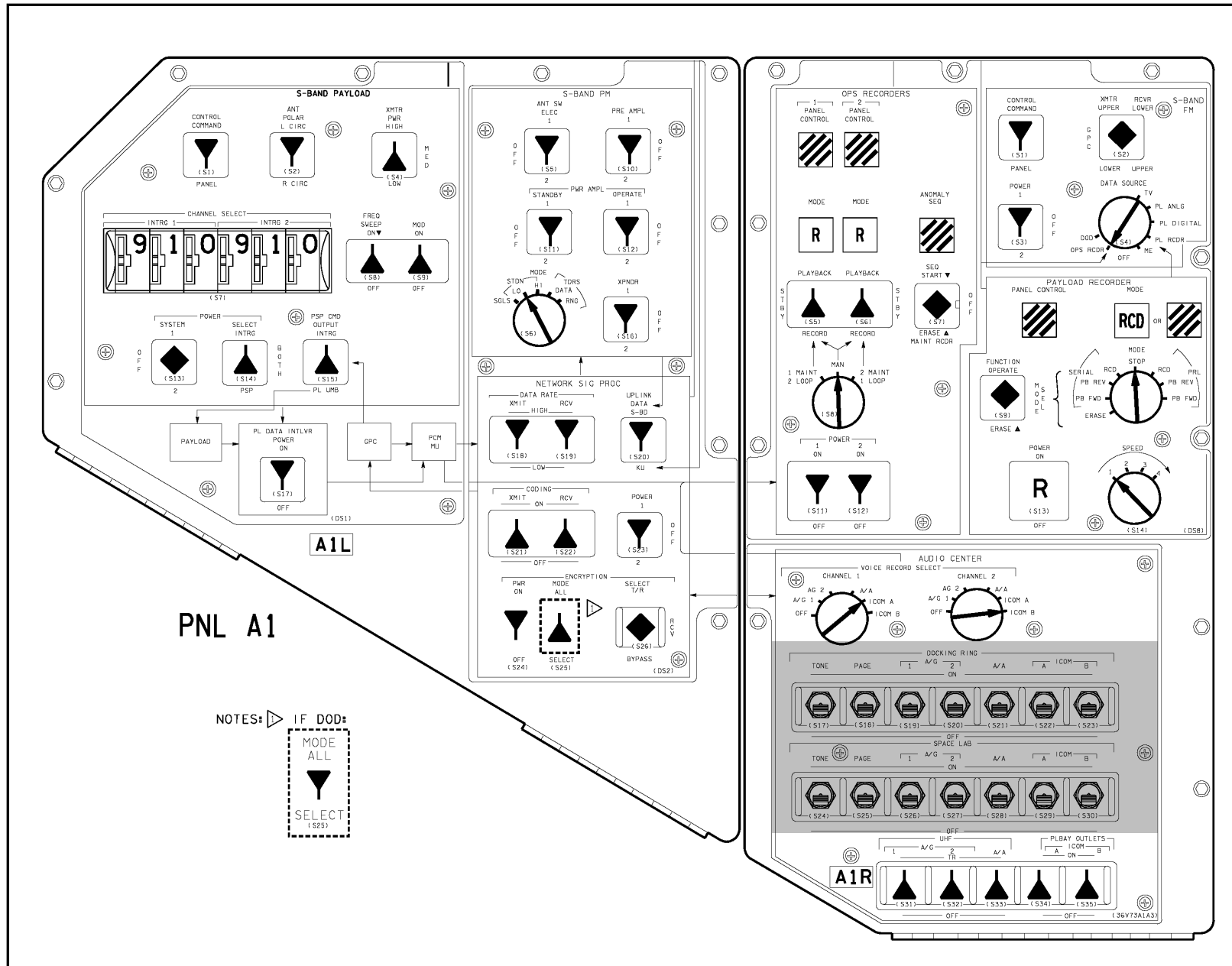

PNL A1

NOTES: IF DOD:
 MODE ALL
 SELECT (S29)

OV102

OV102

PNL A7U

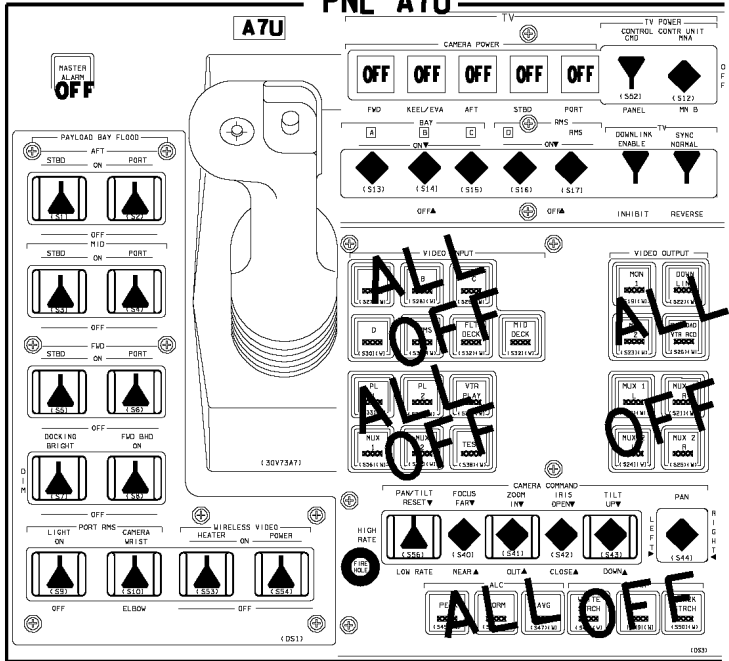

PNL A7L

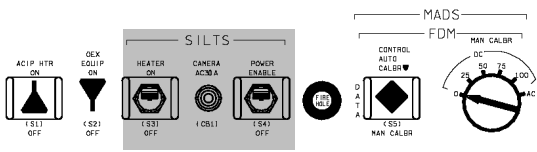

PNL A12

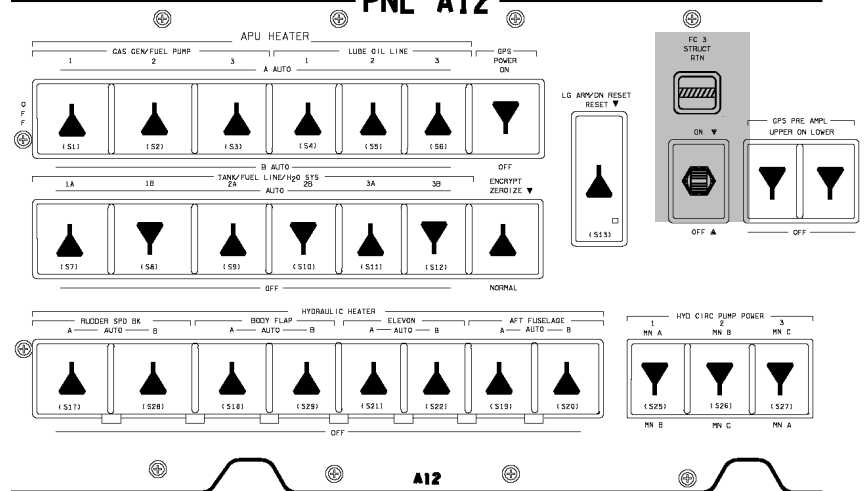

PNL A13

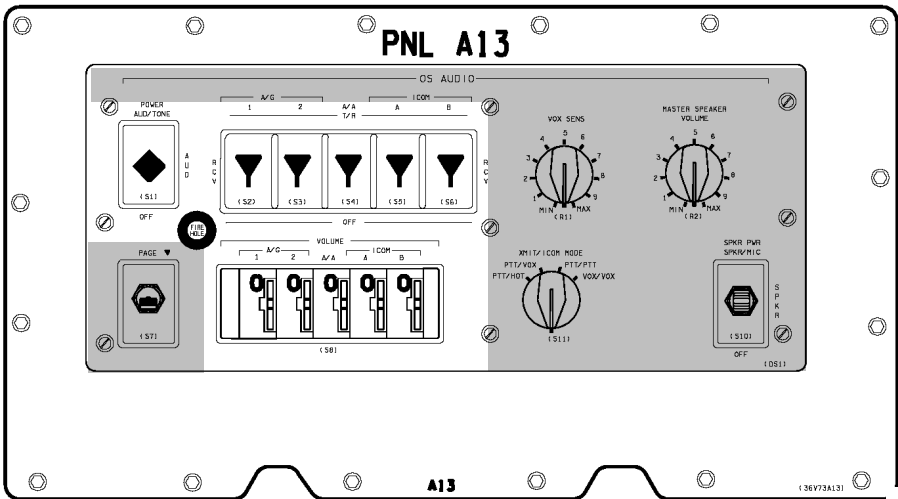

PNL L9

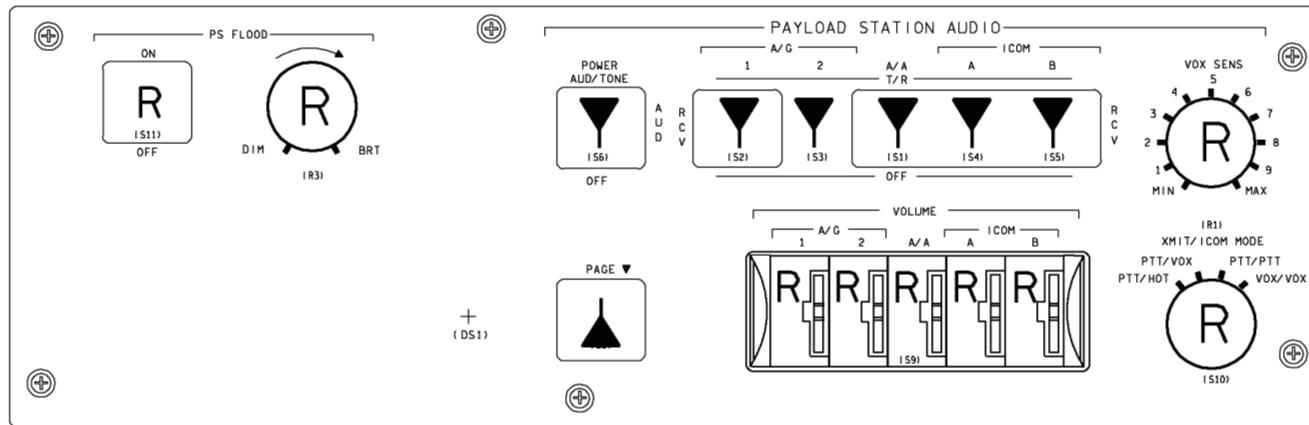

(31V73A9A2)

L9

OV102

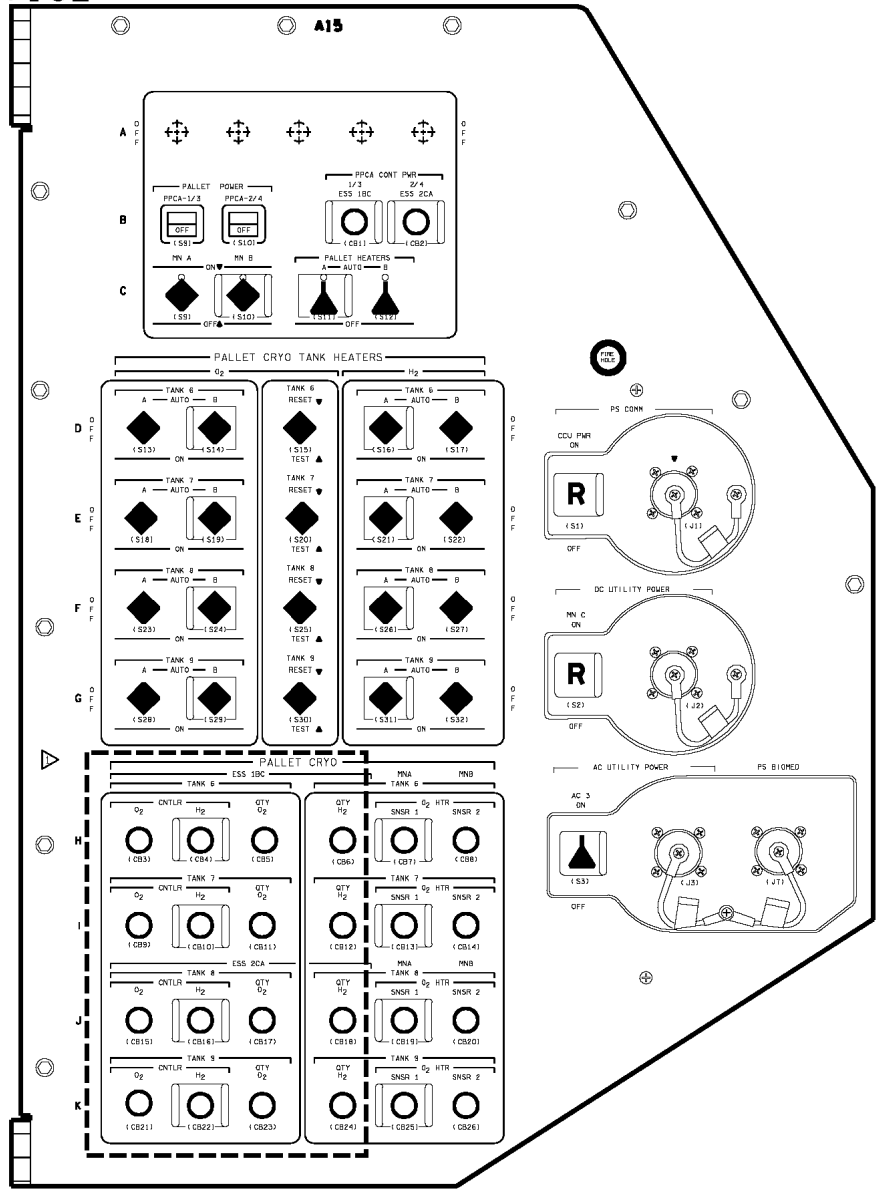

▶ cbs CLOSED FOR EDO MISSIONS

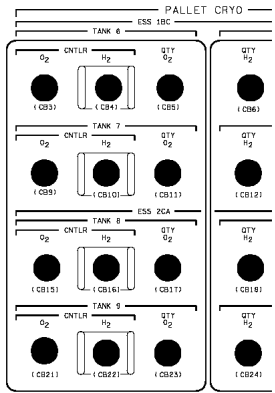

OV102

OV102

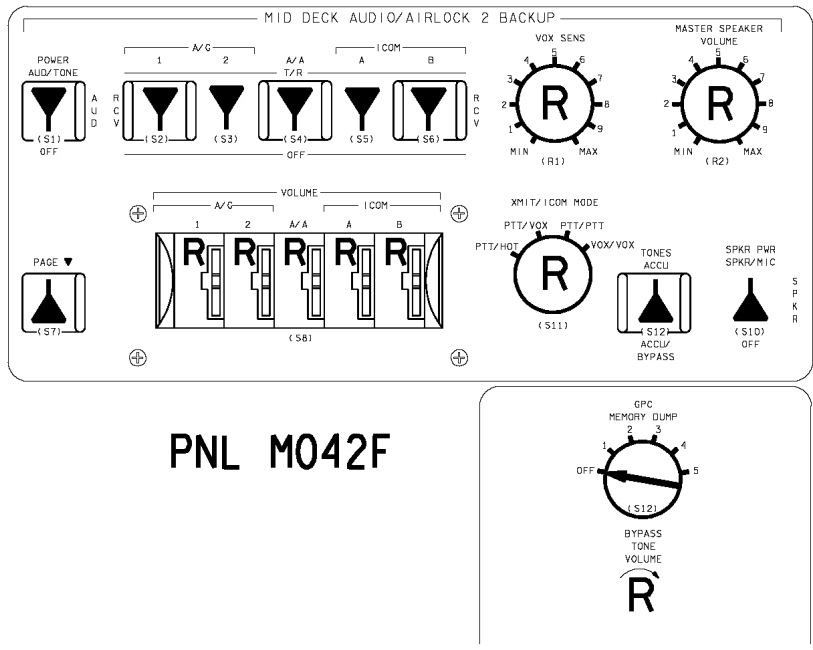

PNL M042F

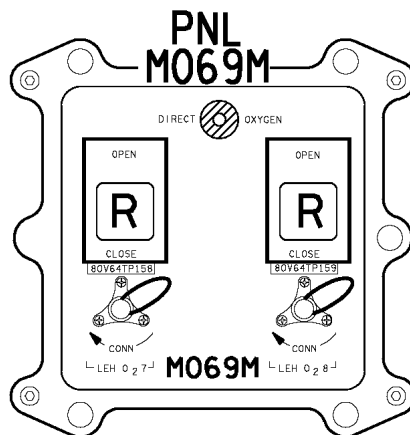
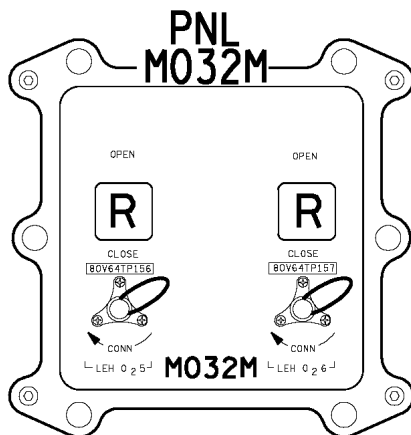
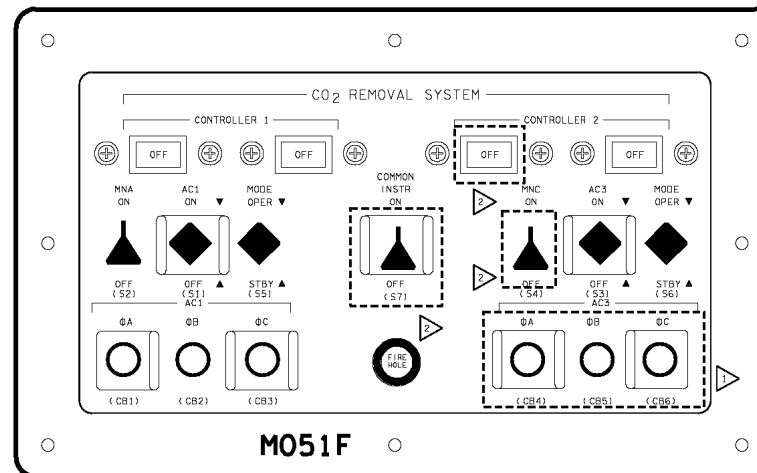

NOTES: ▷ CLOSED IF CO2 RMVL SYS FLOWN
▷ ON IF CO2 RMVL SYS FLOWN

OV102

PNL MA73C

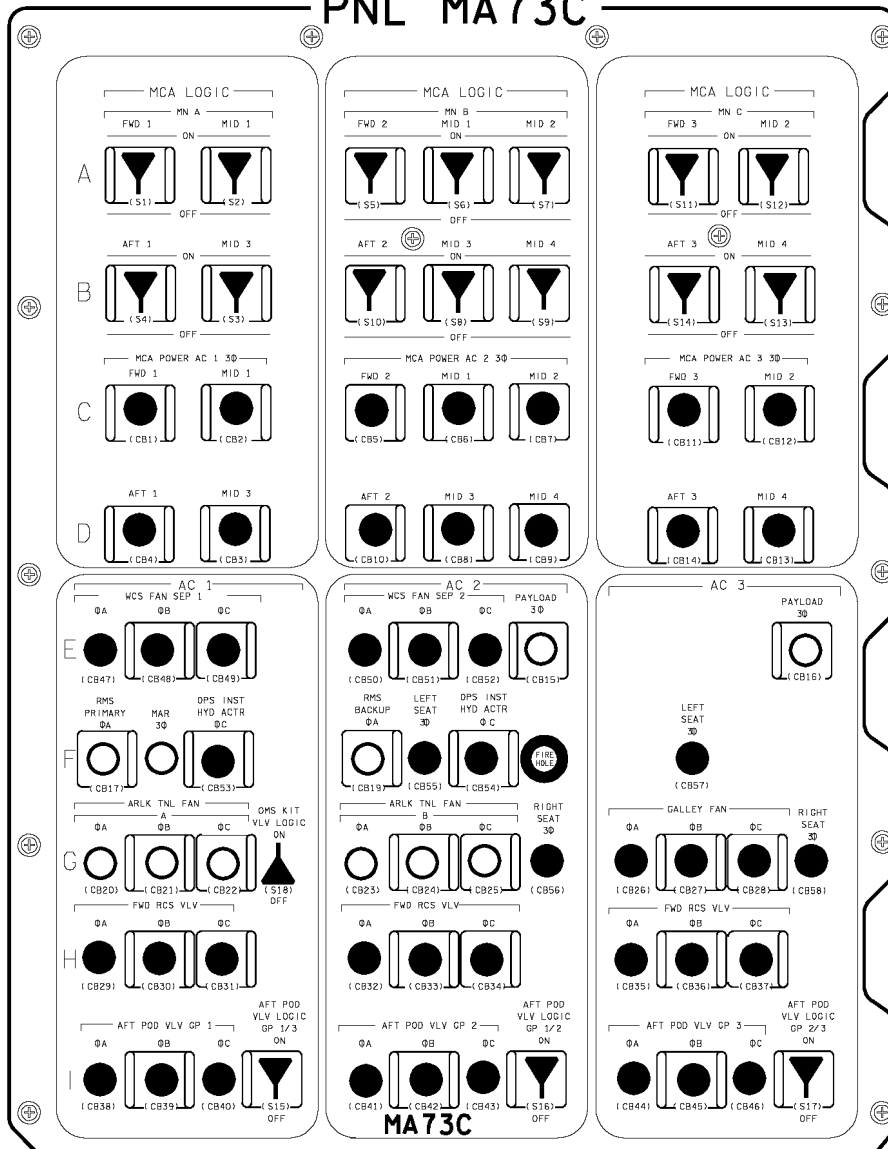

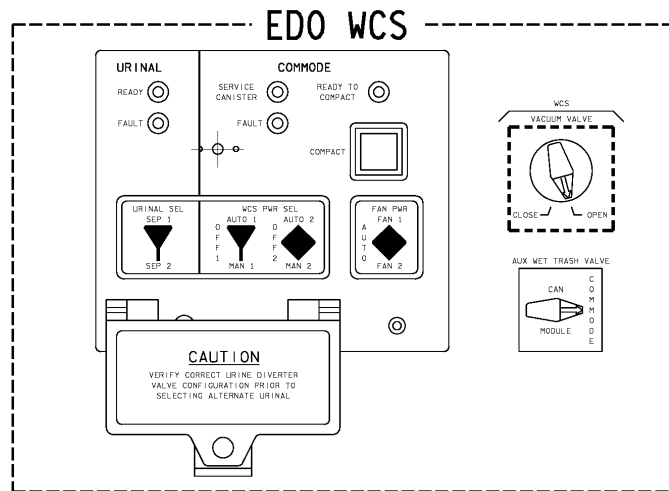
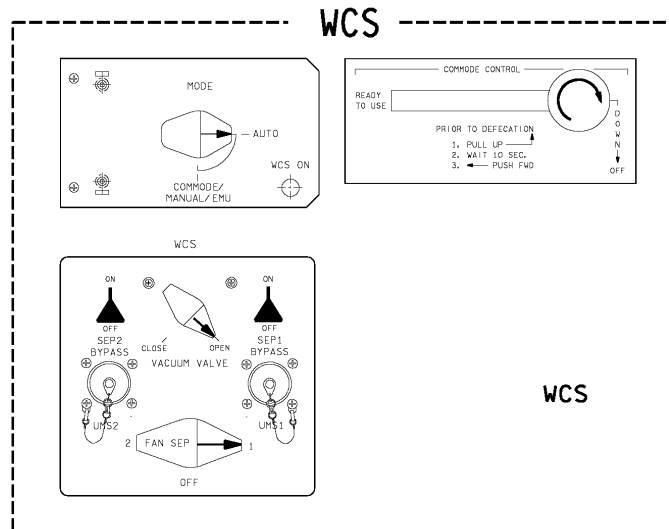
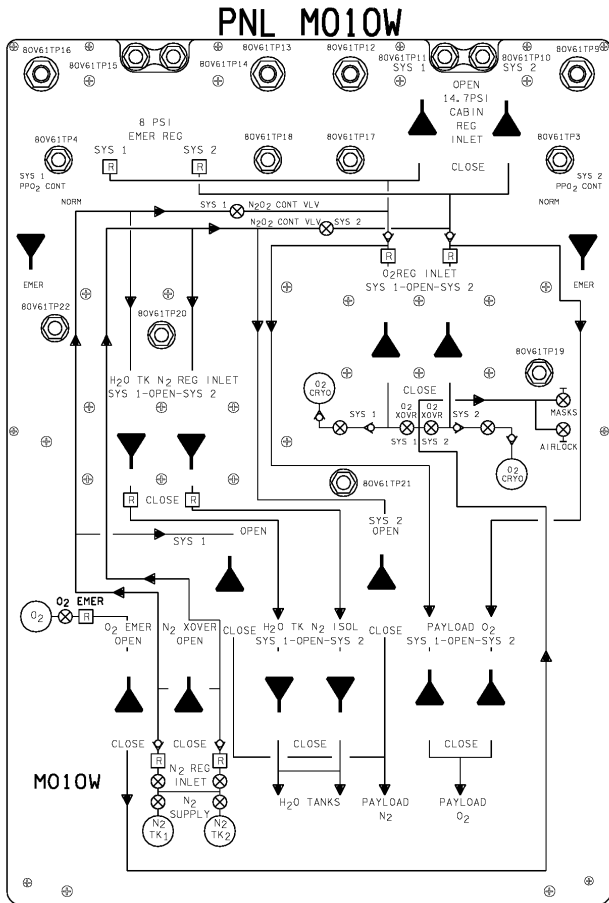

LIGHTING FLOOD

1 ON (S1) 2 ON/OFF (S2)

PNL AW18A

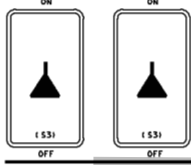

AW18A

(84V73A133)

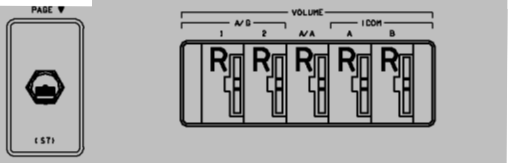
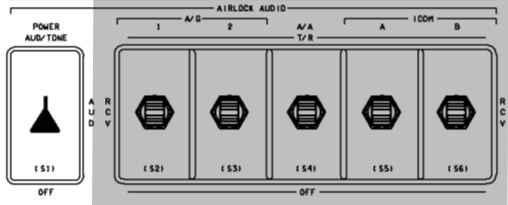

PNL AW18D

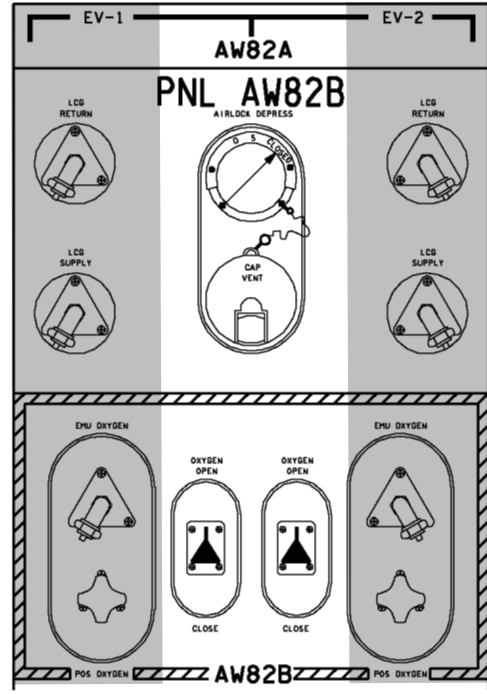
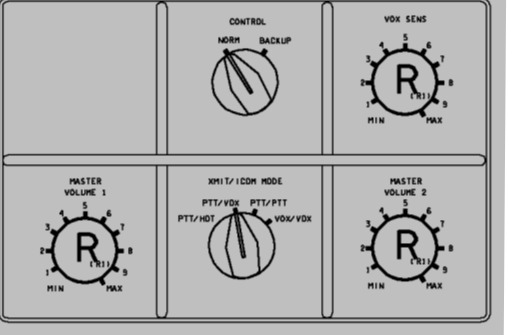

PNL AW18H

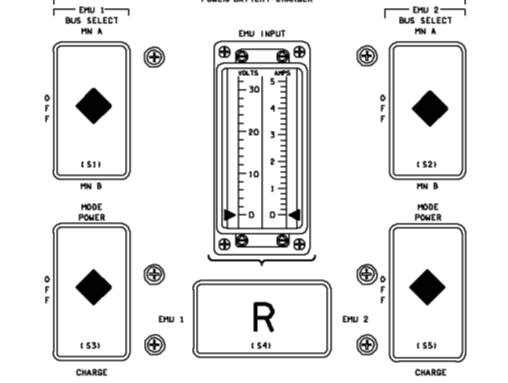

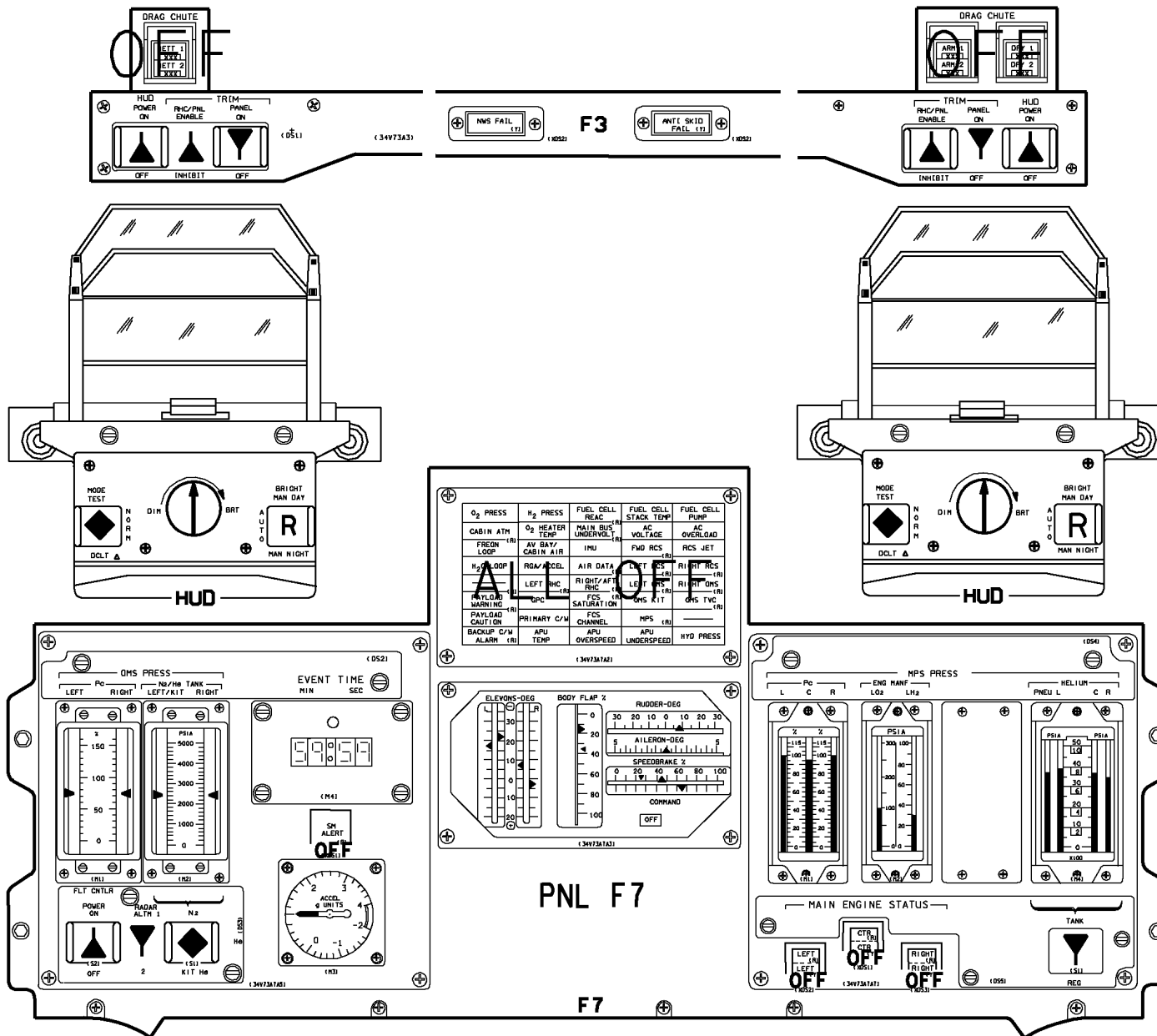

101. PNL 3

ALL VEH/DATE 09/29/94

(OV103) B3-4

OV103

D/O/3/GEN L

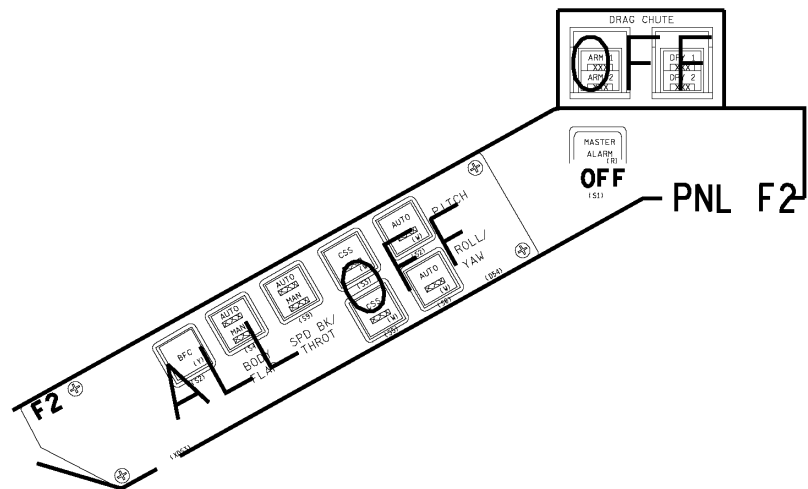

PNL 013

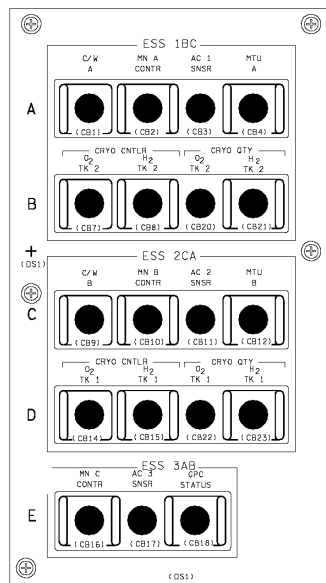

L side OVHD flood - R (MID)

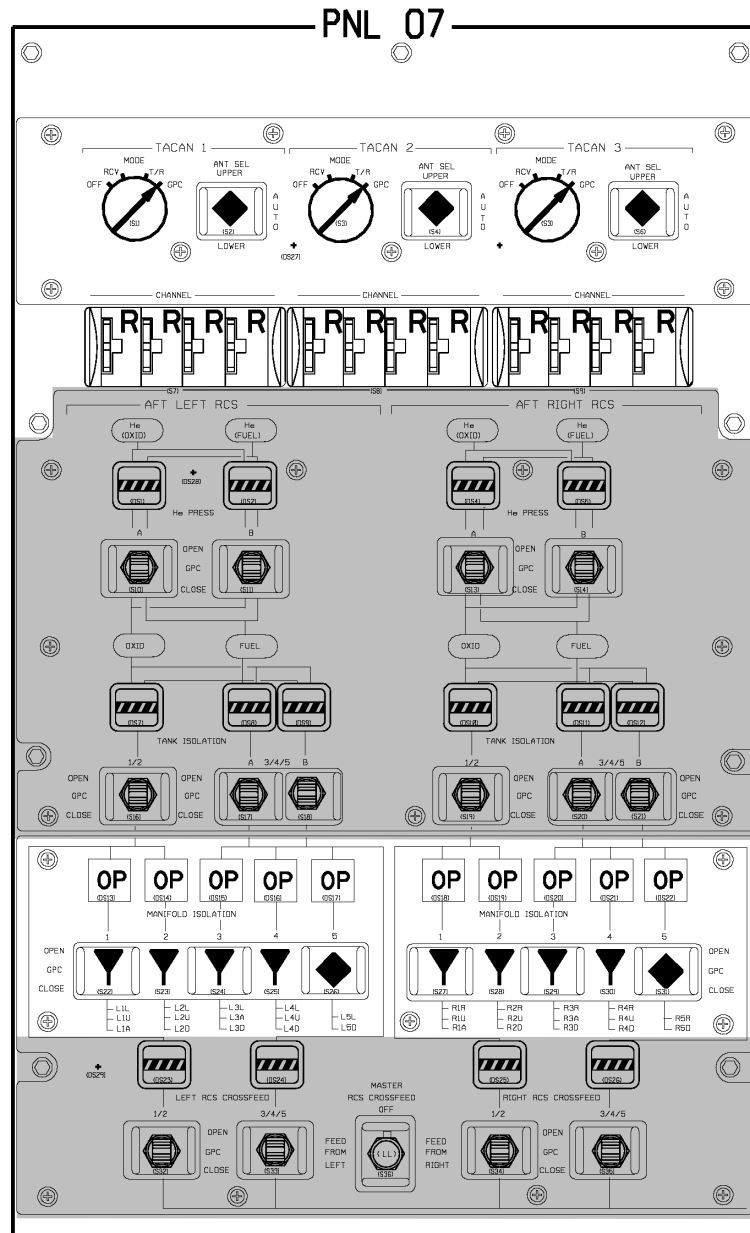

OV103

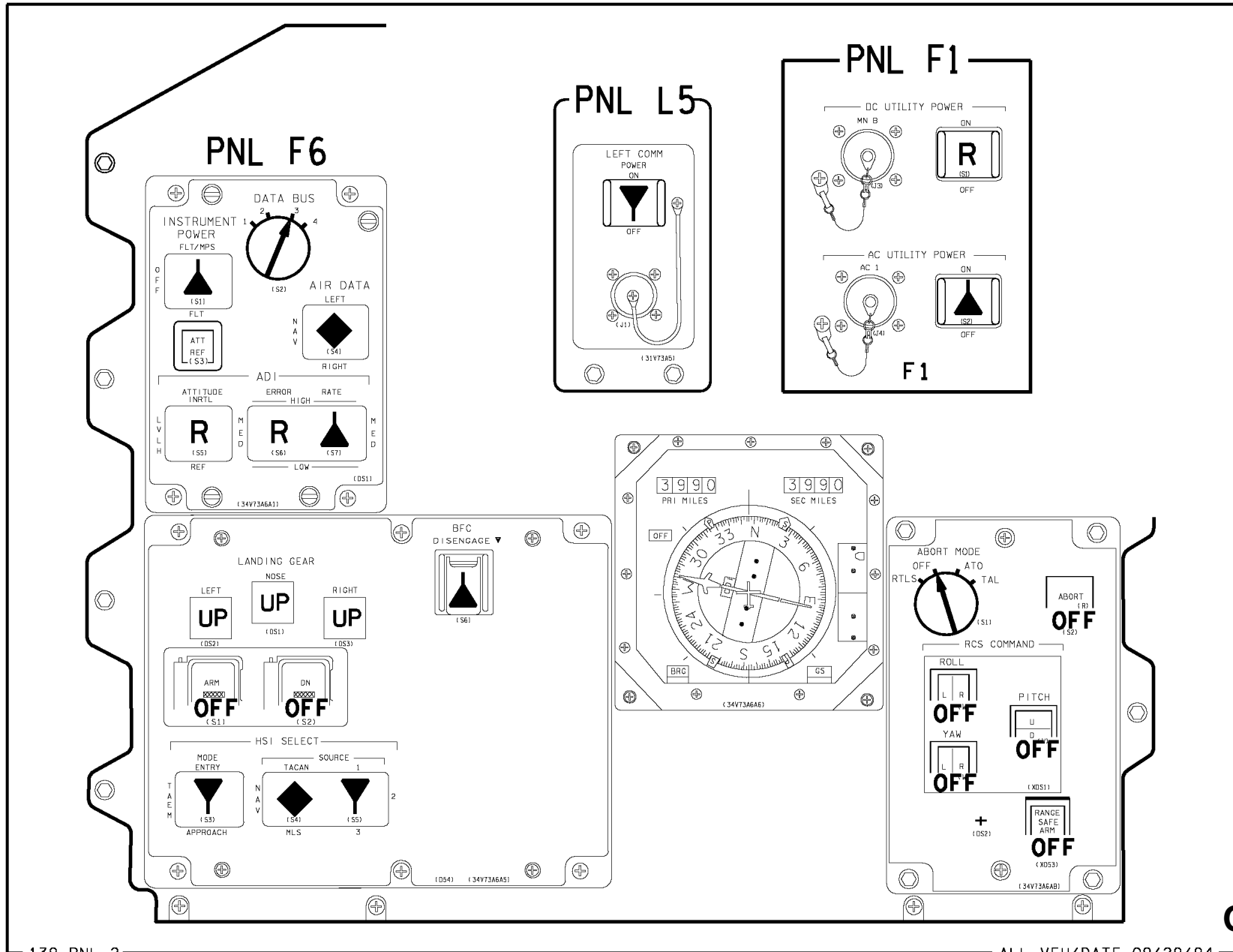

139. PNL 2

(OV103) B3-6

ALL VEH/DATE 09/29/94

OV103

D/O/3/GEN L

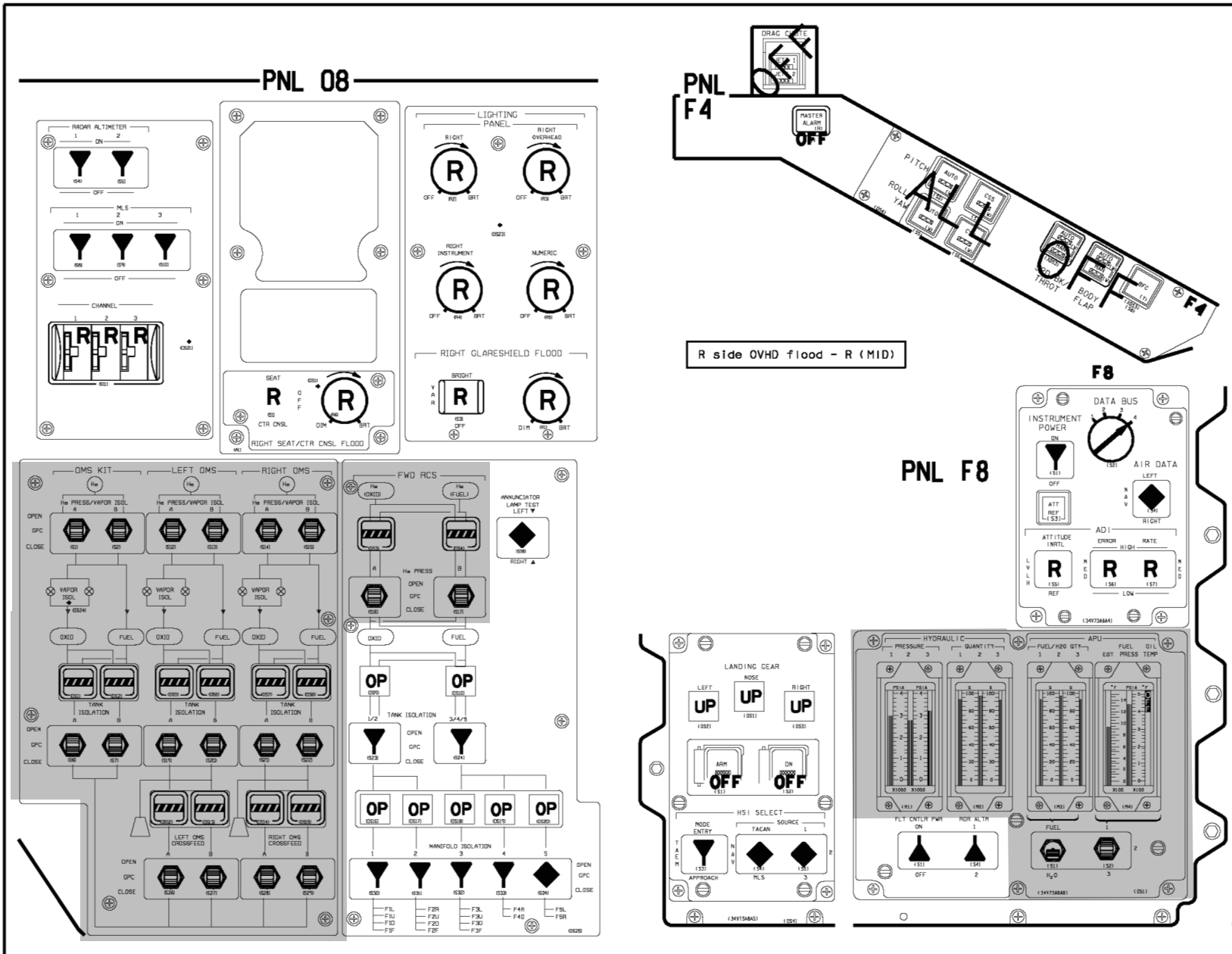

103. PNL 3

ALL VEH/DATE 09/29/94

(OV103) B3-7

OV103

D/O/3/GEN L

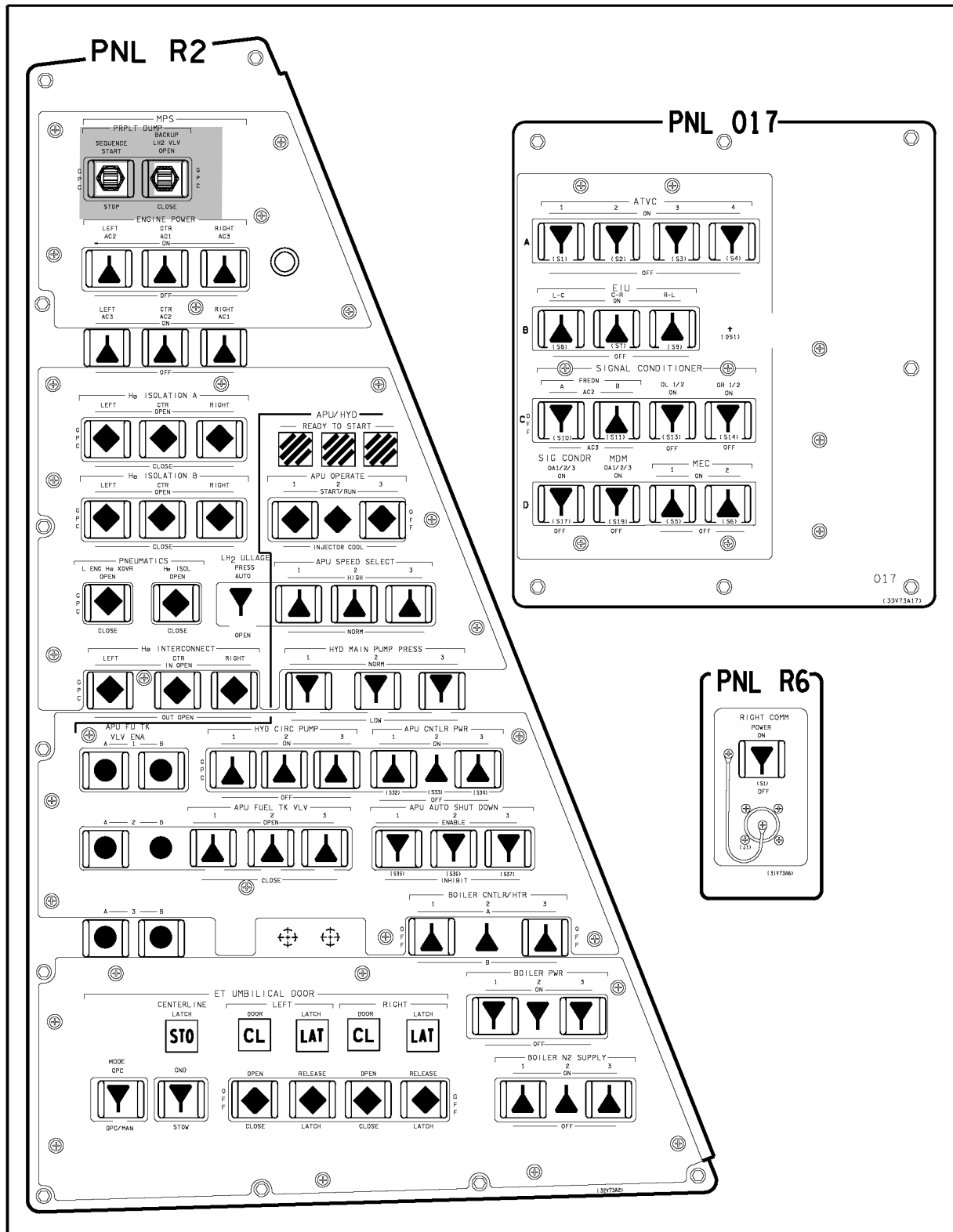

OV103

(OV103) B3-8

D/O/ALL/GEN L

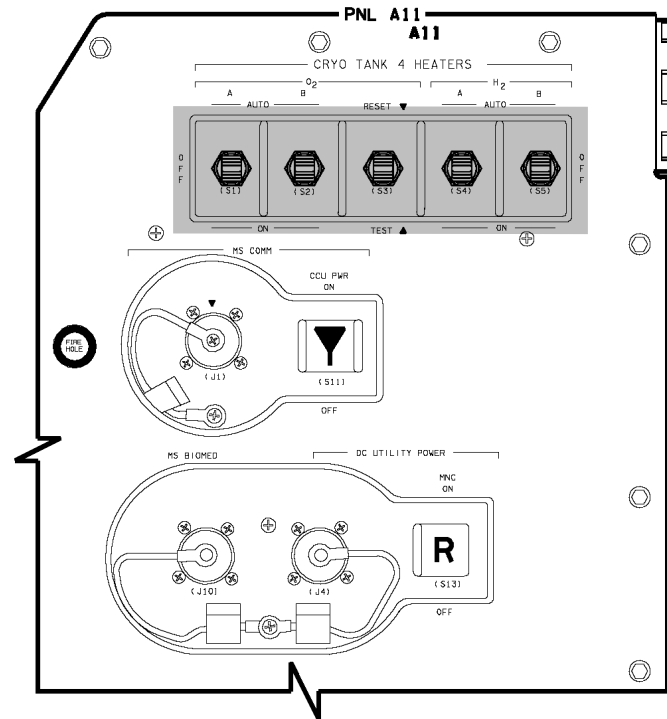
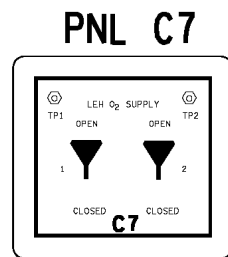
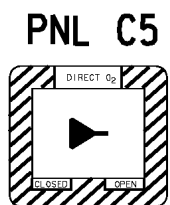
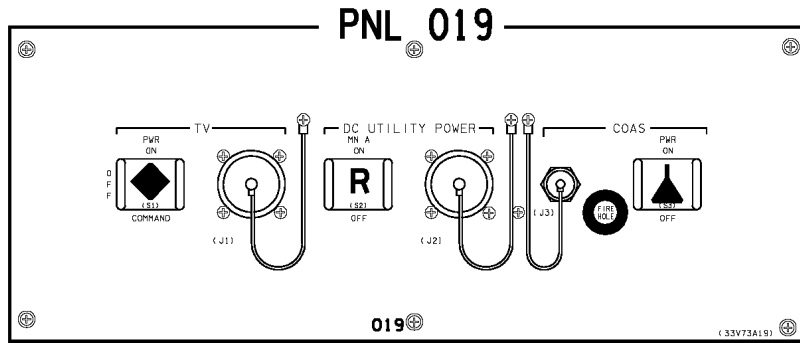

OV103

AIRLOCK HATCH

ACTUATOR HANDLE - LATCHED
 LOCK LEVER - LOCKED
 EQUALIZATION VLV (TWO) - NORM
 -CAPS INSTALLED

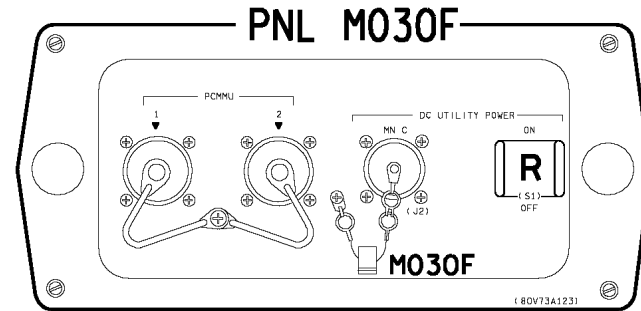
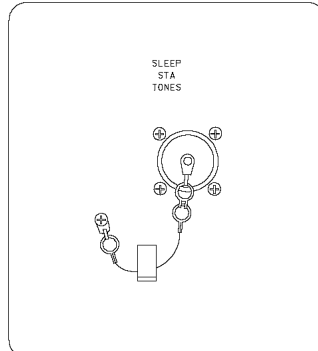

PNL M058F

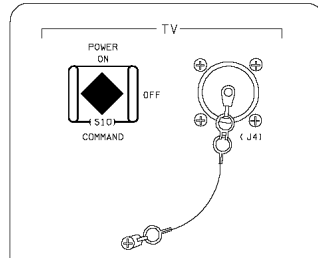

PNL MD24K

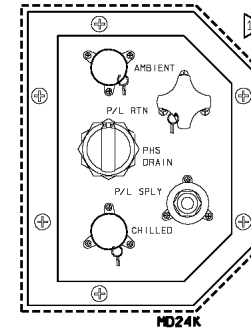

NOTE: NOT VISIBLE IF MAR FLOWN

PNL M039M

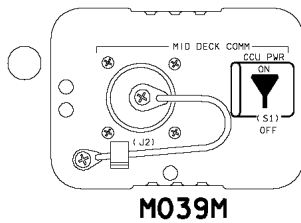

PNL M052J

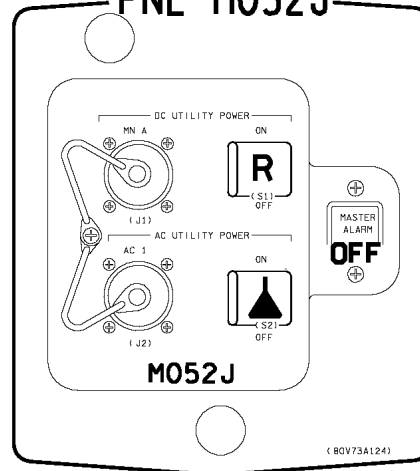

PNL MD44F

CAB TEMP CNTL ACT LINKAGE - SECONDARY ACTUATOR

OV103

PNL ML86B

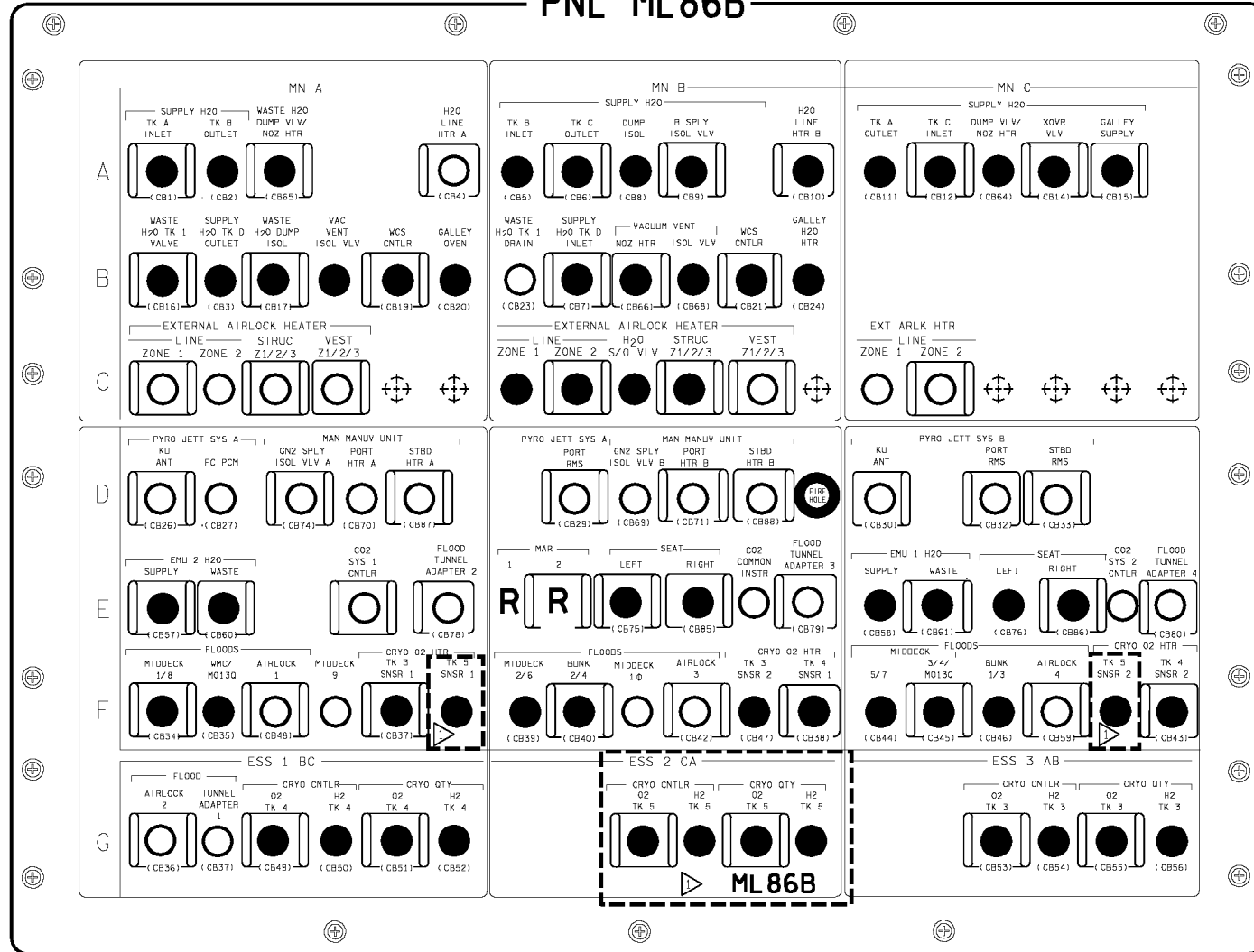

NOTES: ▷ OPEN IF TK 5 NOT FLOWN

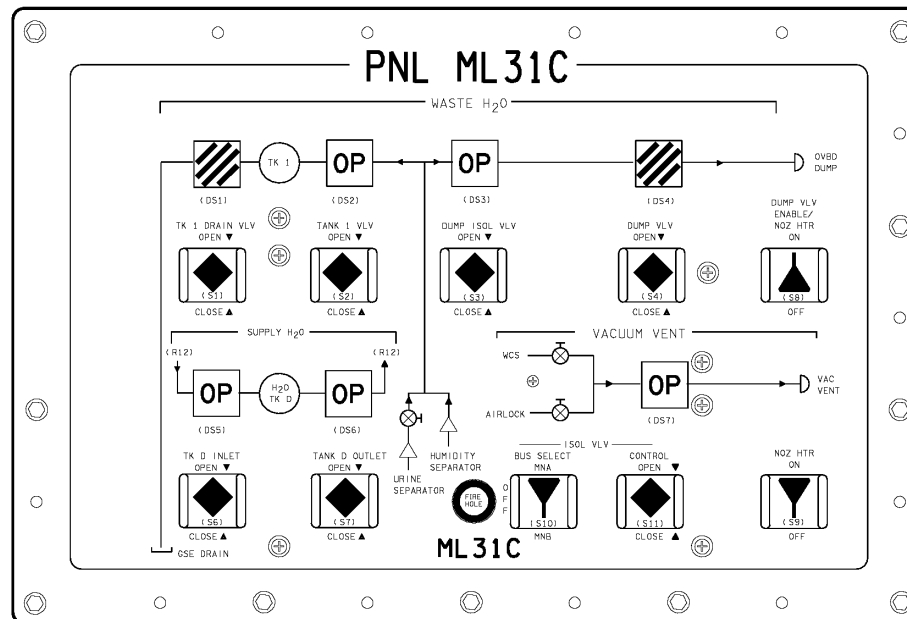
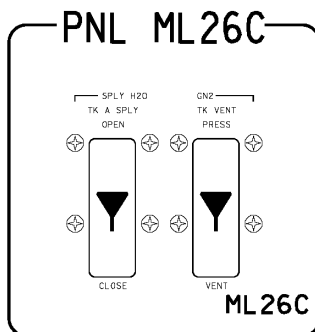
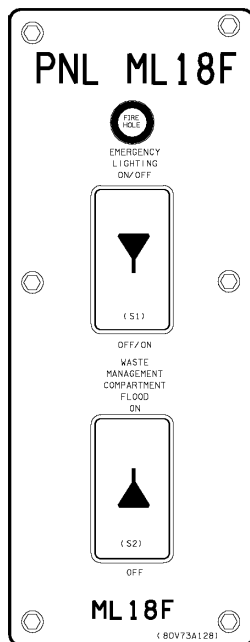
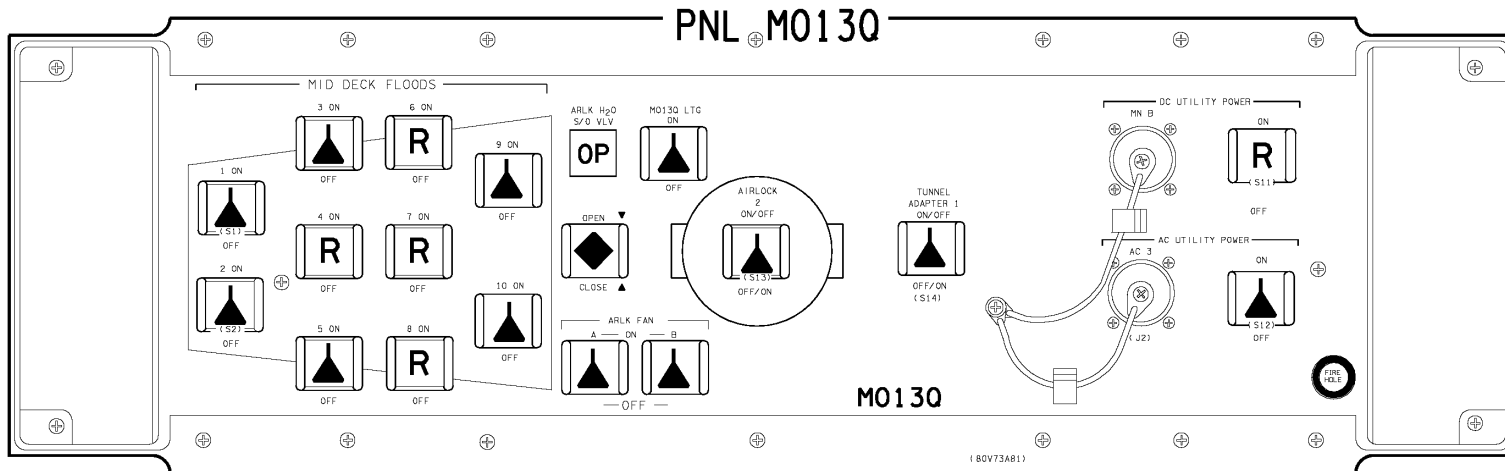

OV103

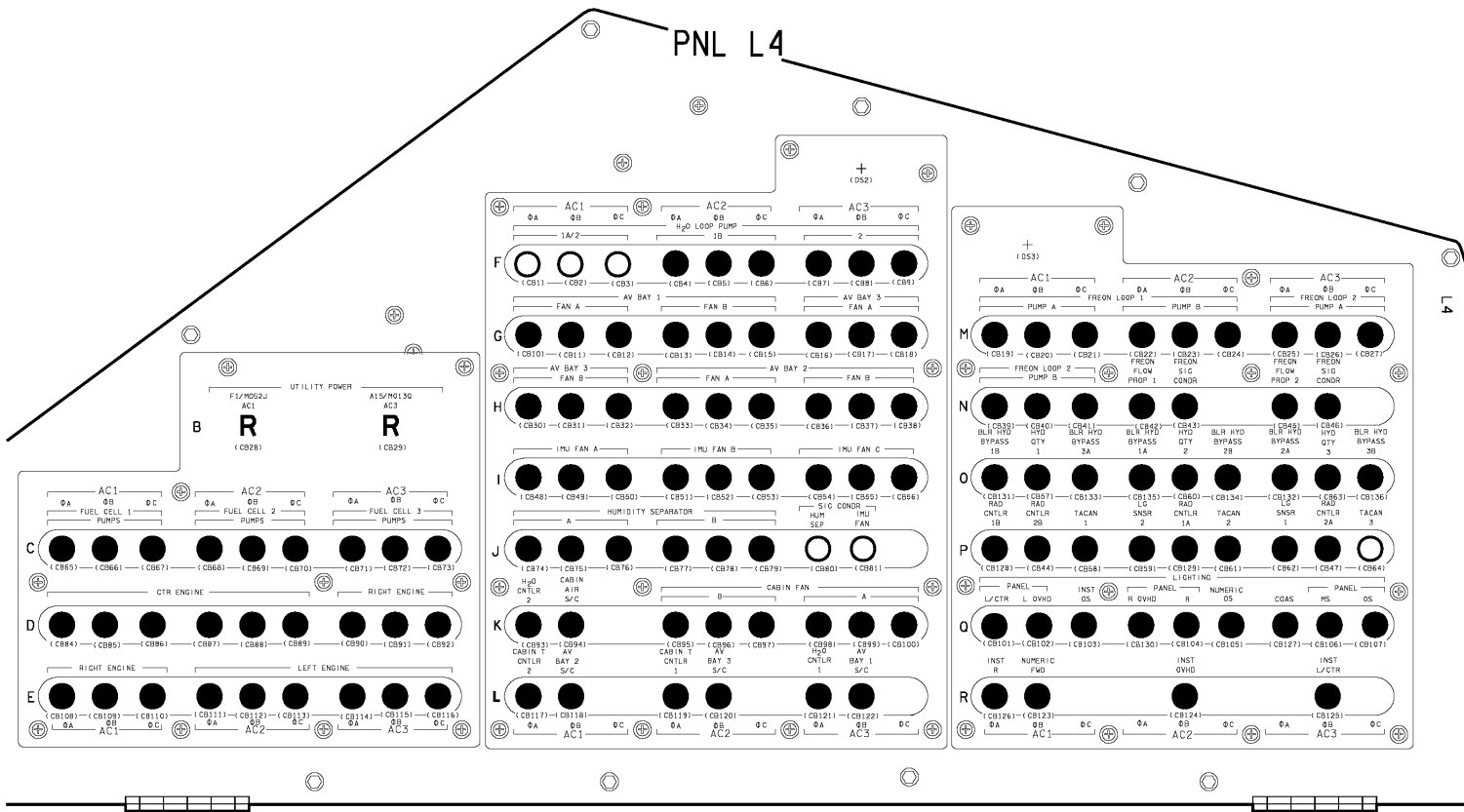

OV103

D/O/3/GEN L

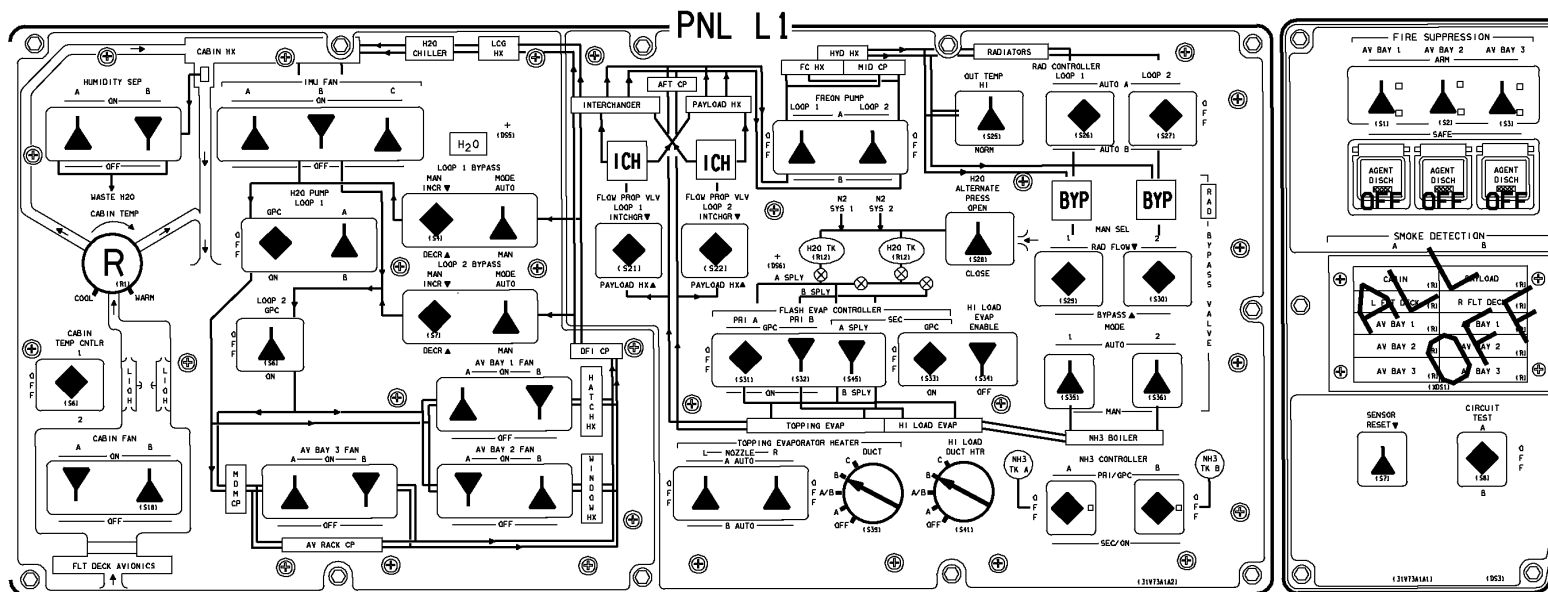

OV103

OV103

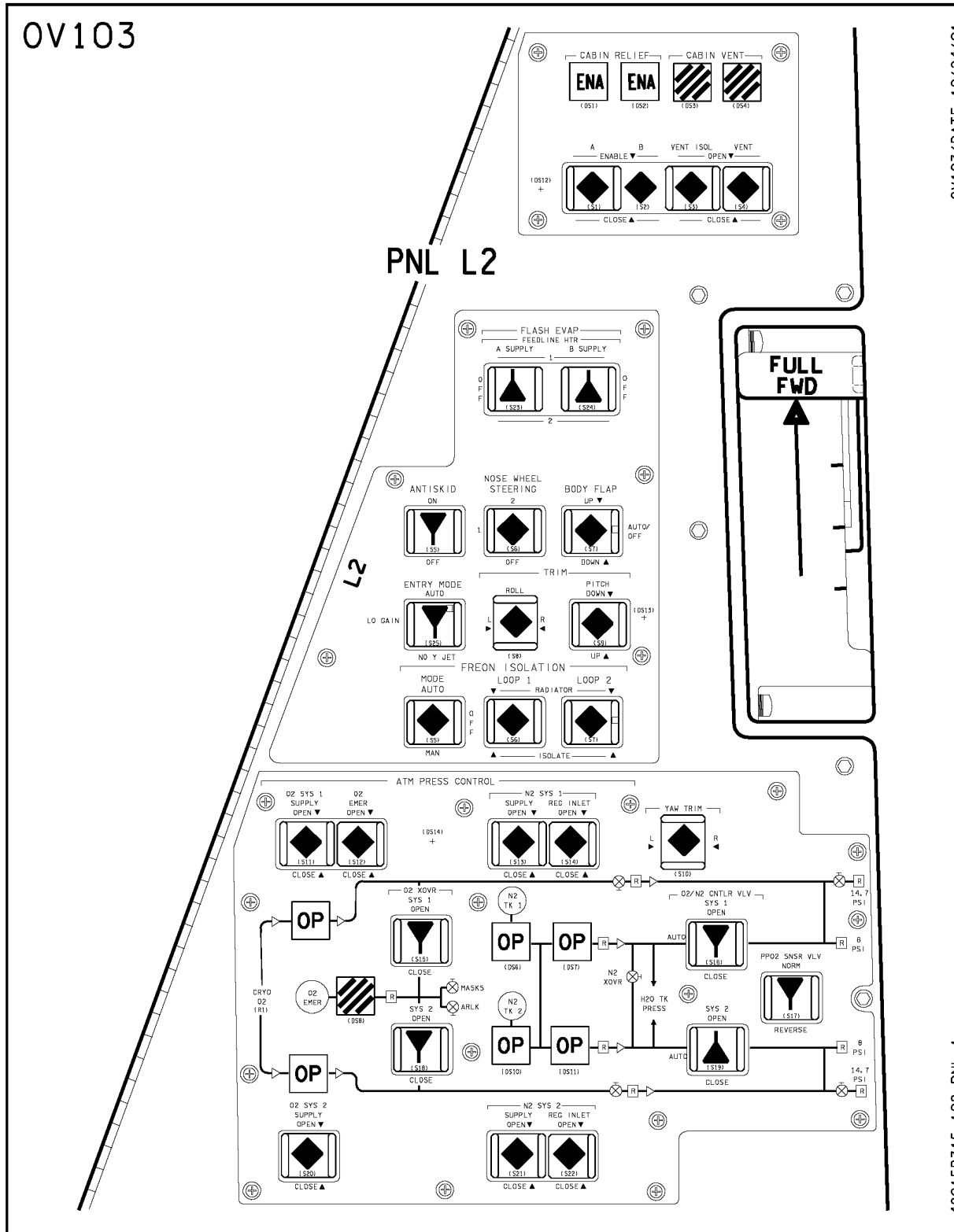

OV103/DATE 10/24/01

48015B315_108, PNL L2

OV103

(OV103) B3-15

D/O/3/GEN L,5

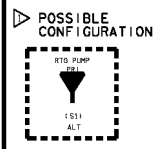
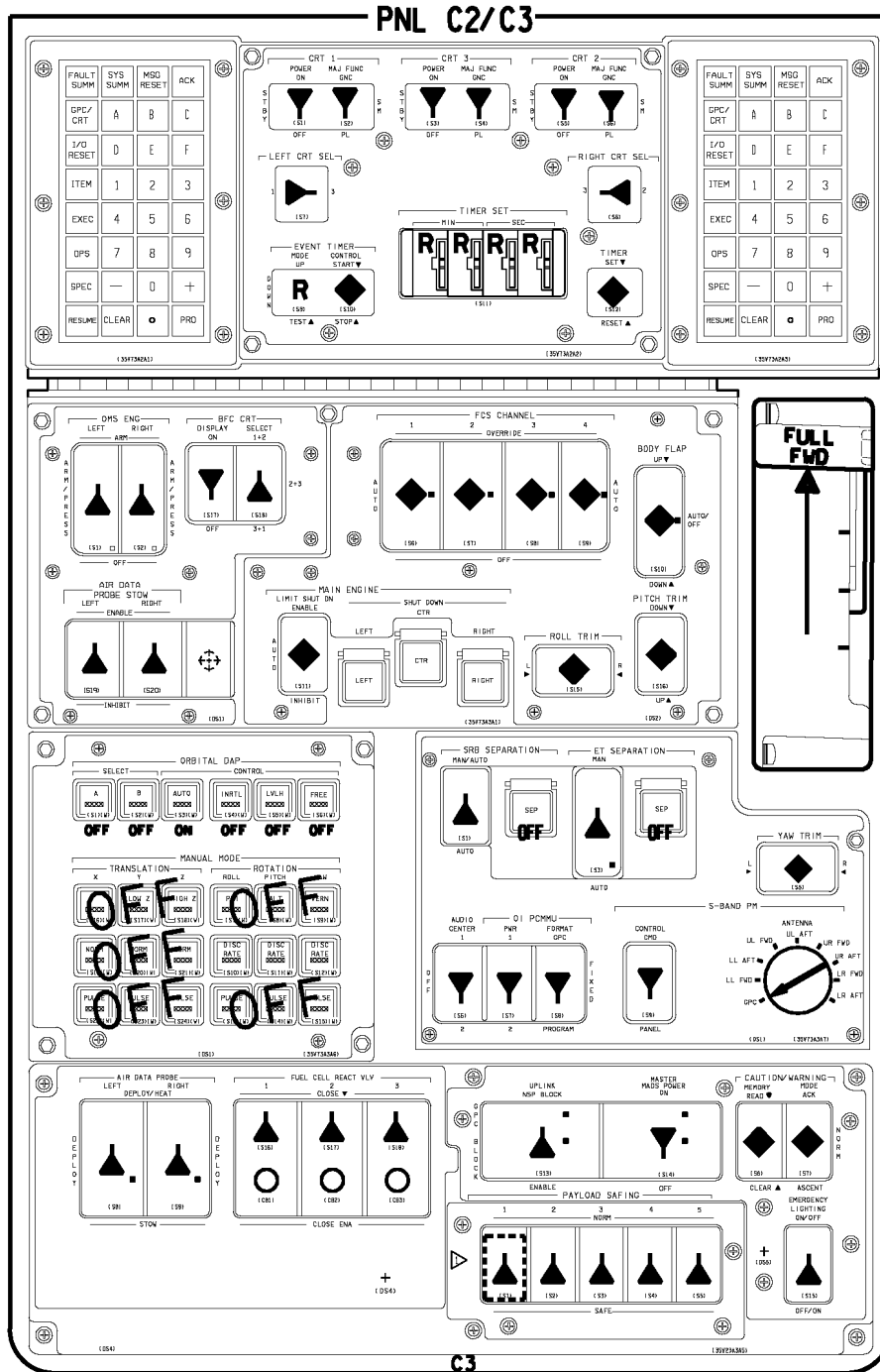

OV103

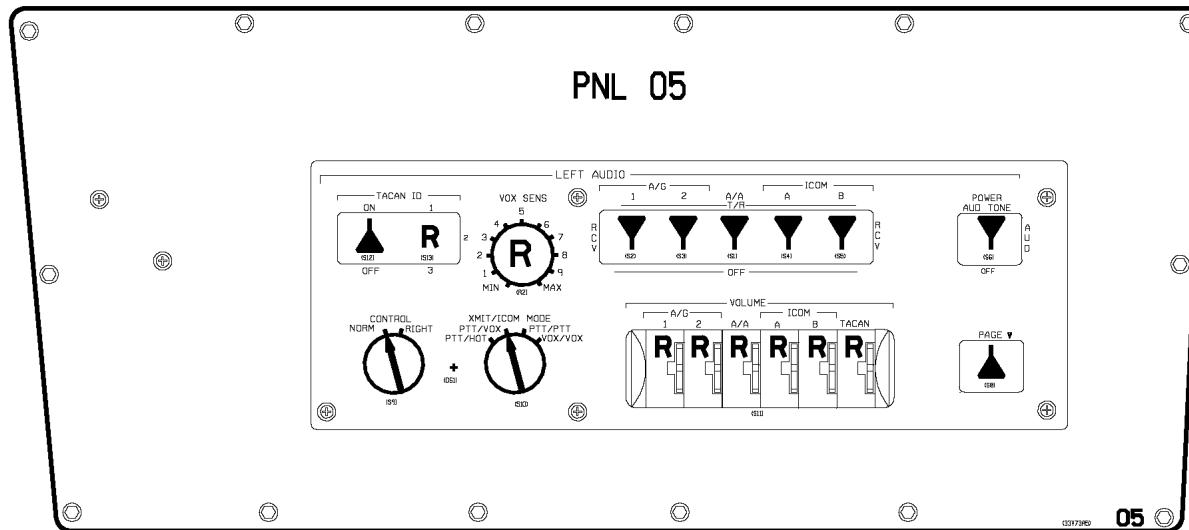
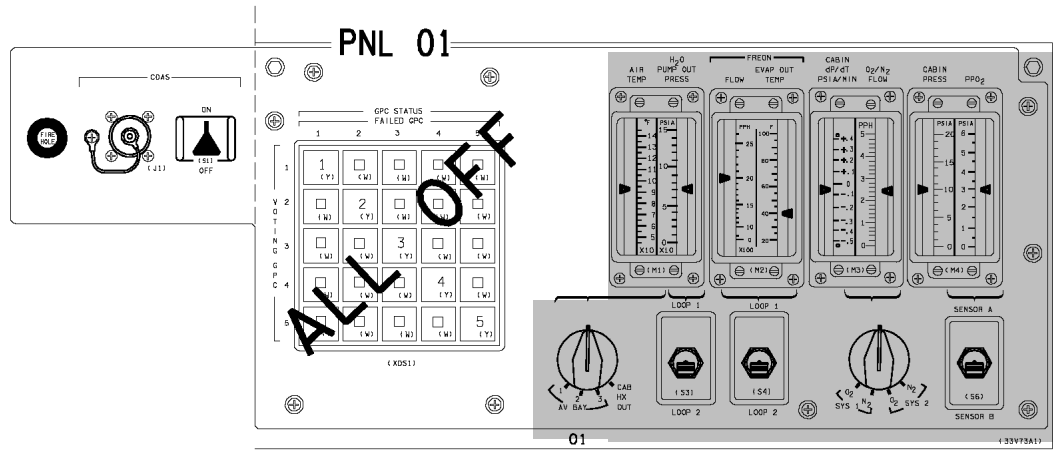

OV103

PNL 06

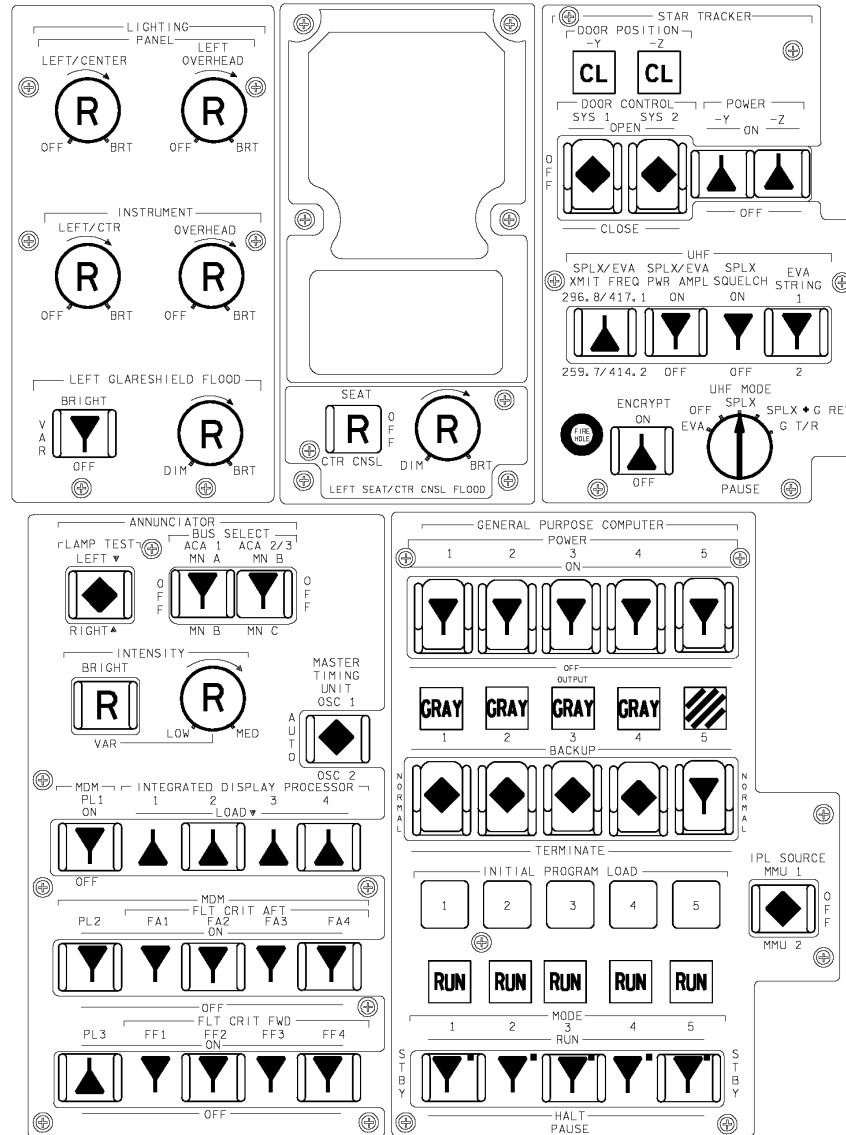

OV103

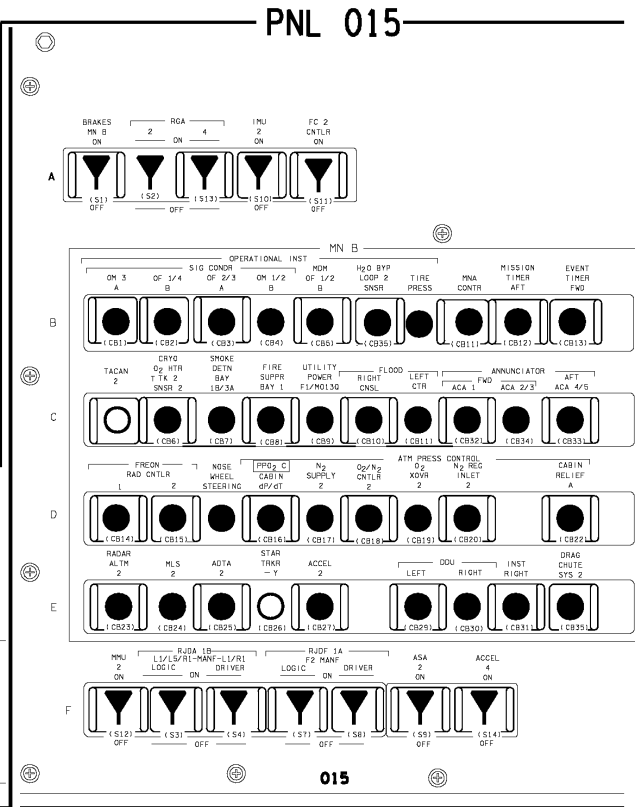
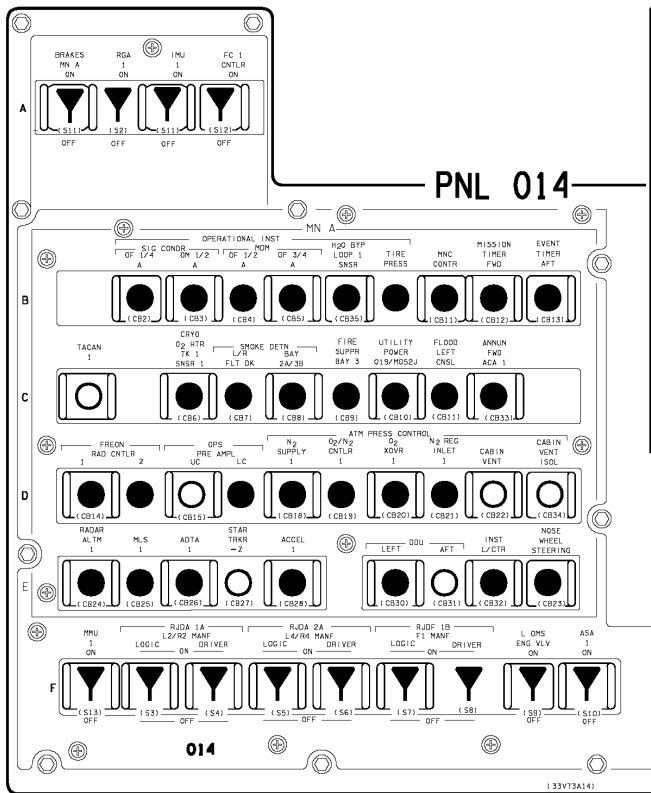

OV103

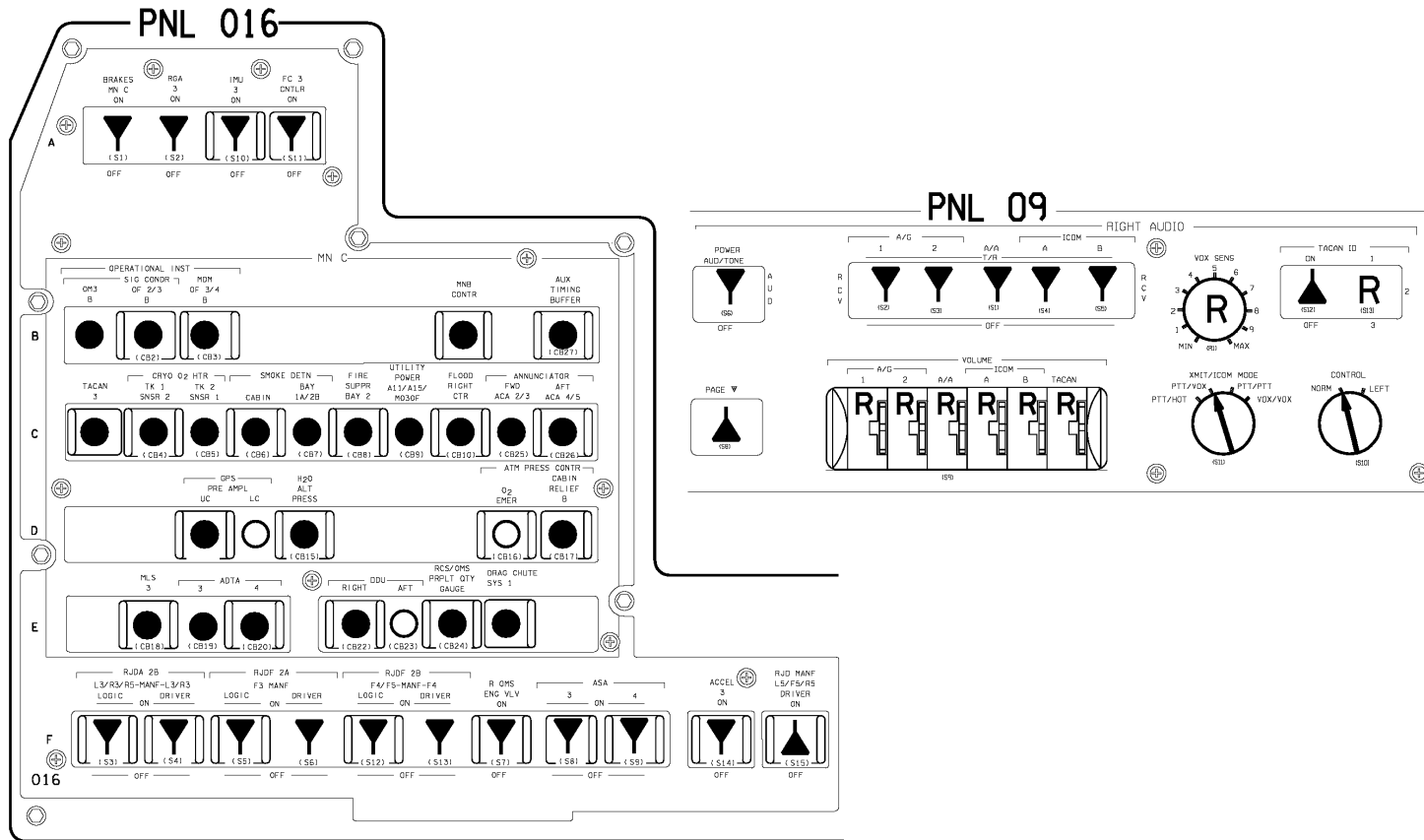

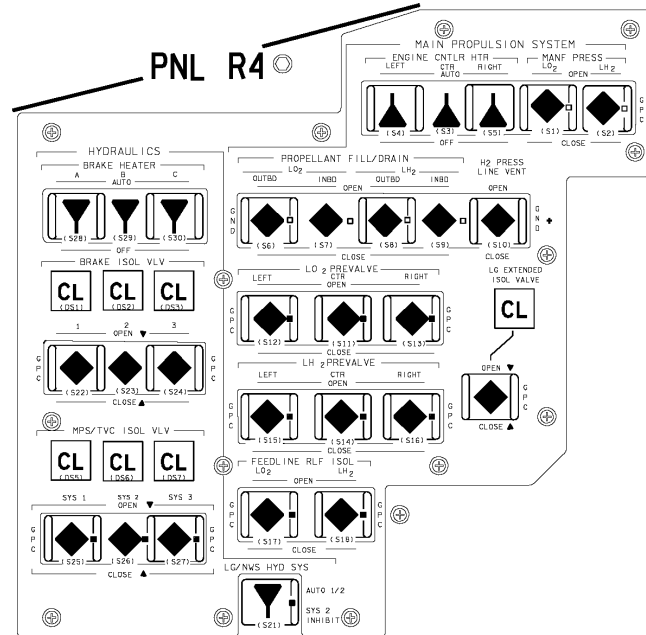
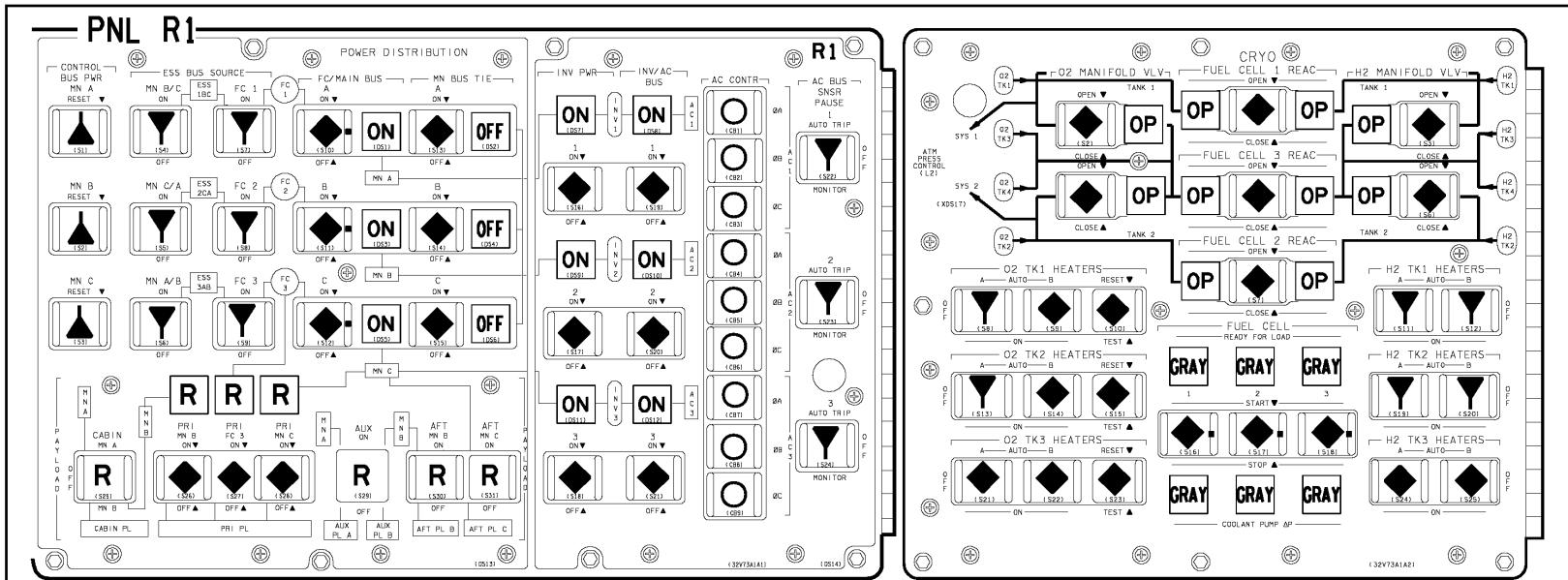

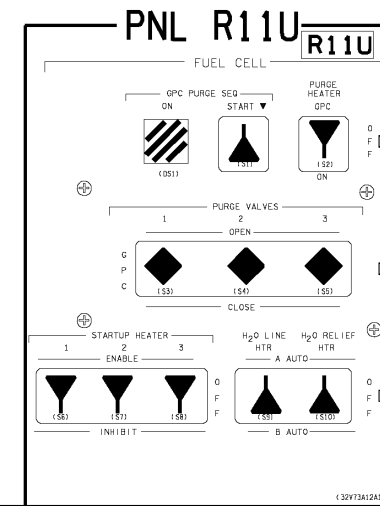
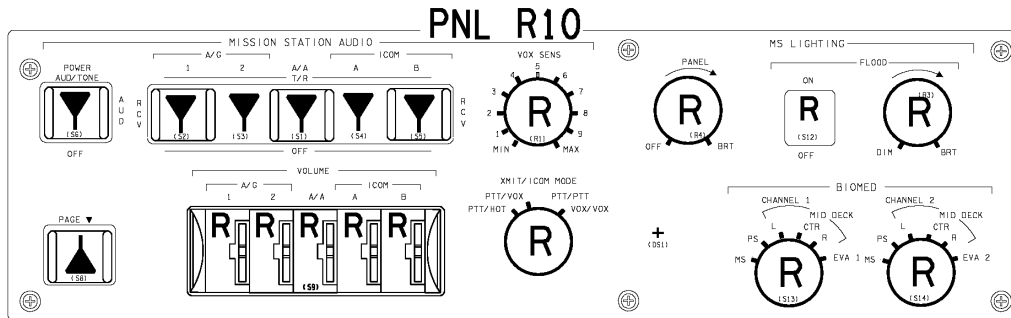

NOTES: ▷ CONFIG FOR NOMINAL D/O PREP
 IF 1 REV WAVE-OFF OR EXTENSION DAY:
 ✓ SPLY H₂O TKC INLET - CTR (+b-OP)
 ✓ OUTLET - CTR (+b-OP)

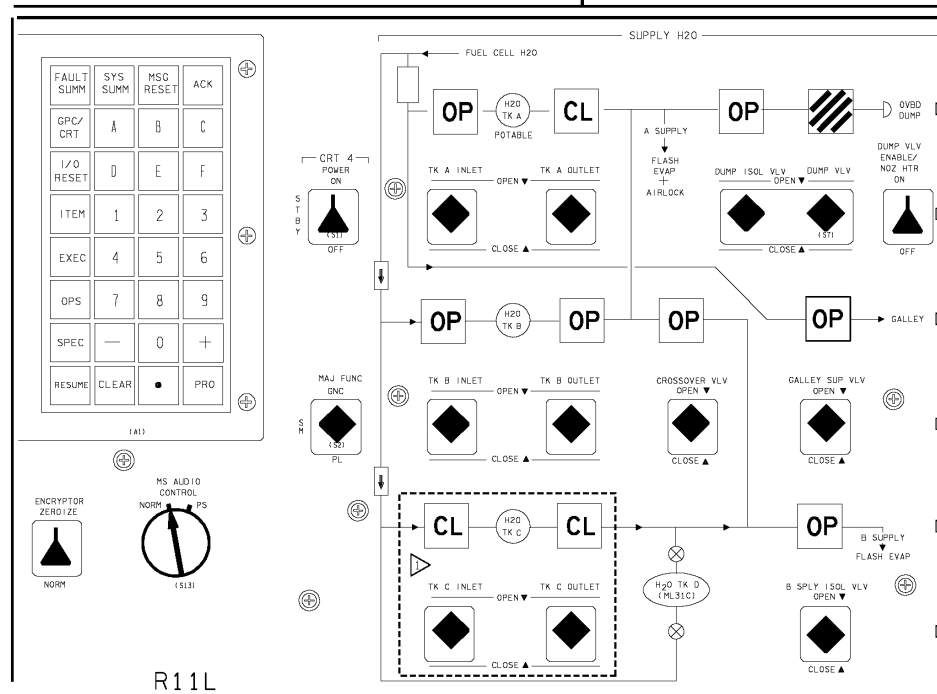

OV103

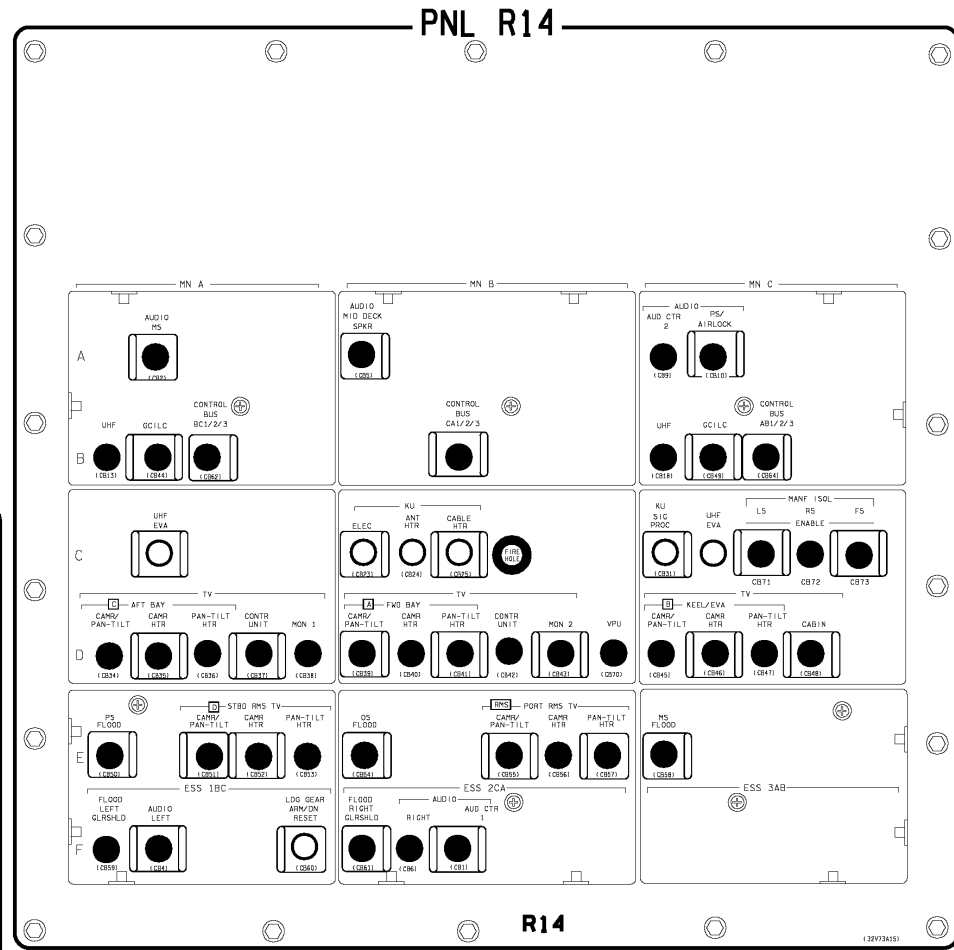
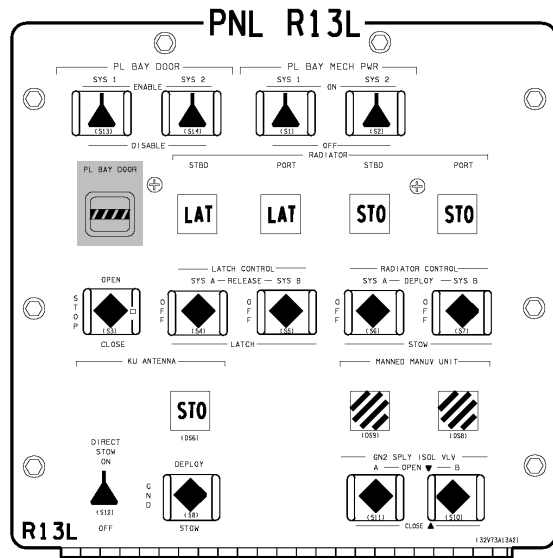

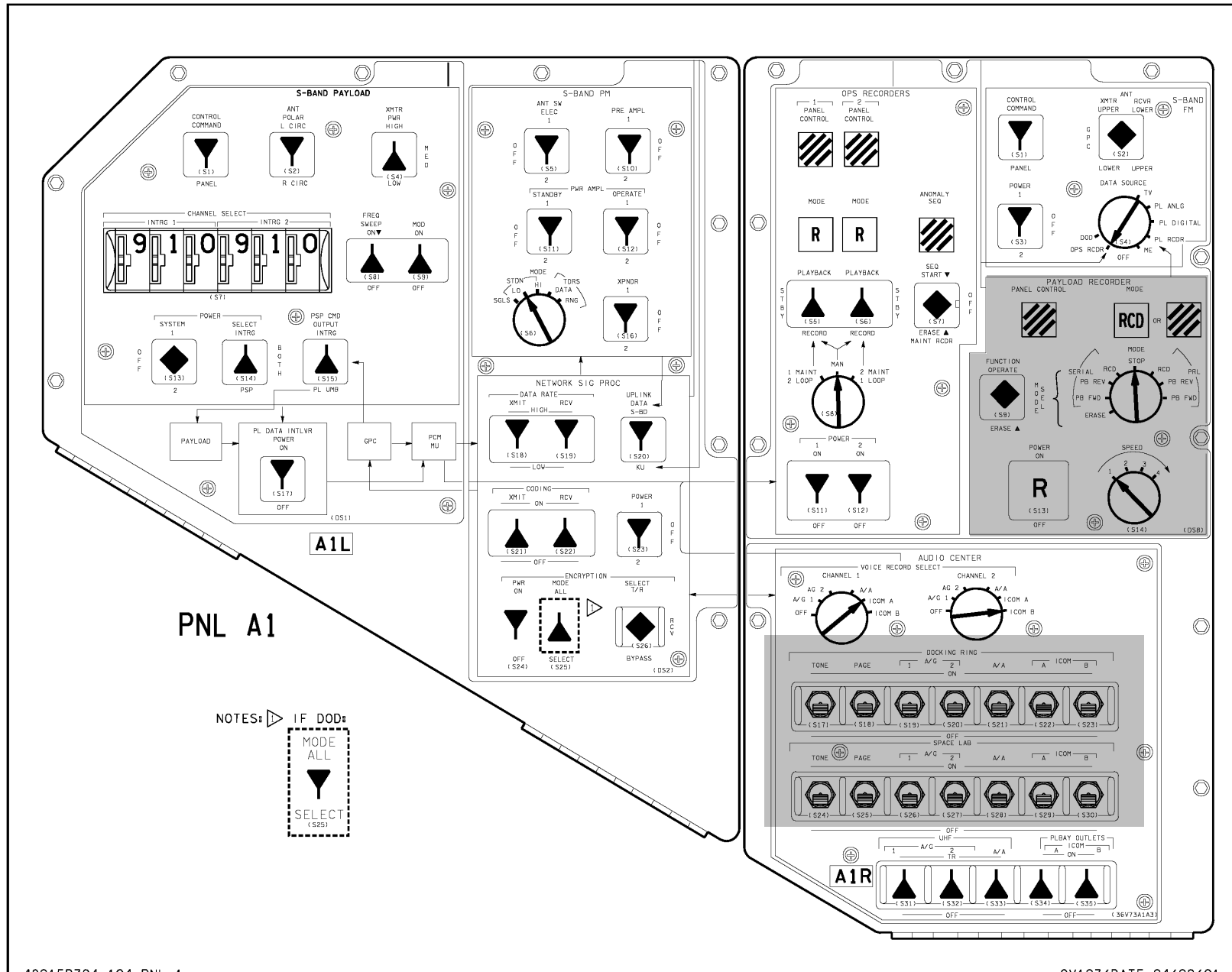

PNL A1

NOTES: IF DOD:
MODE ALL
SELECT (S2B)

OV103

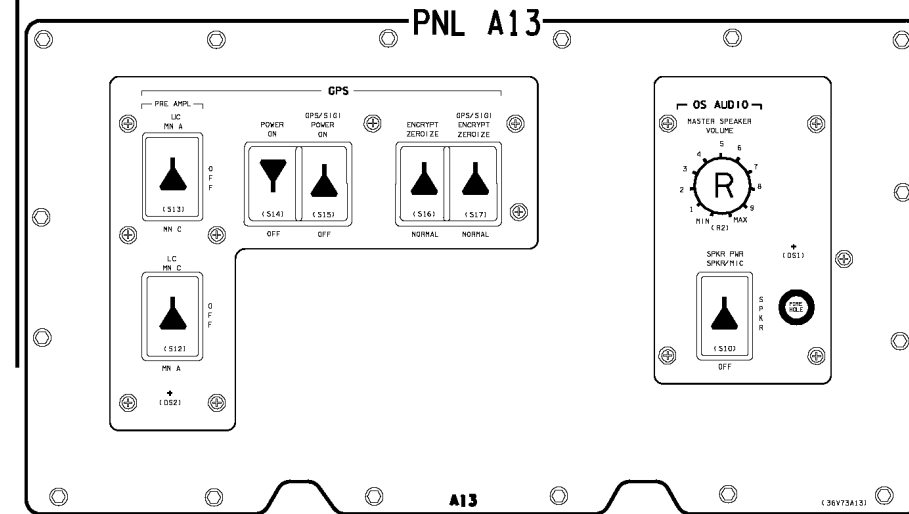
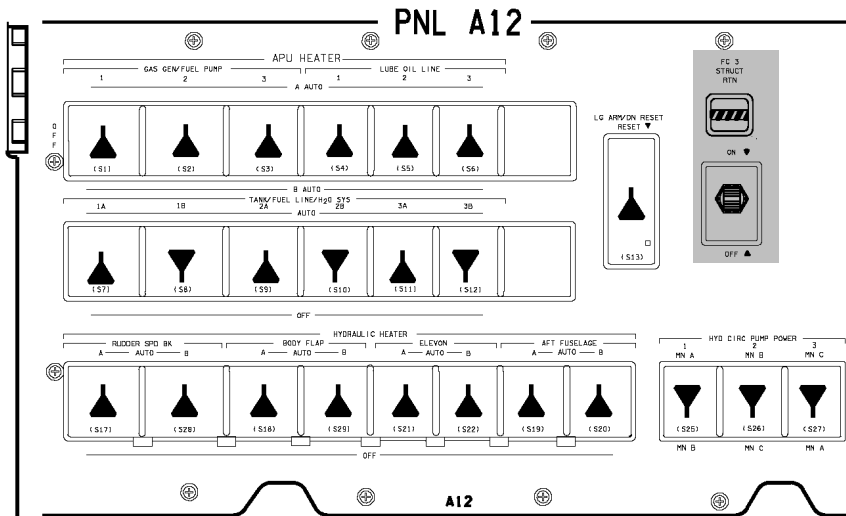
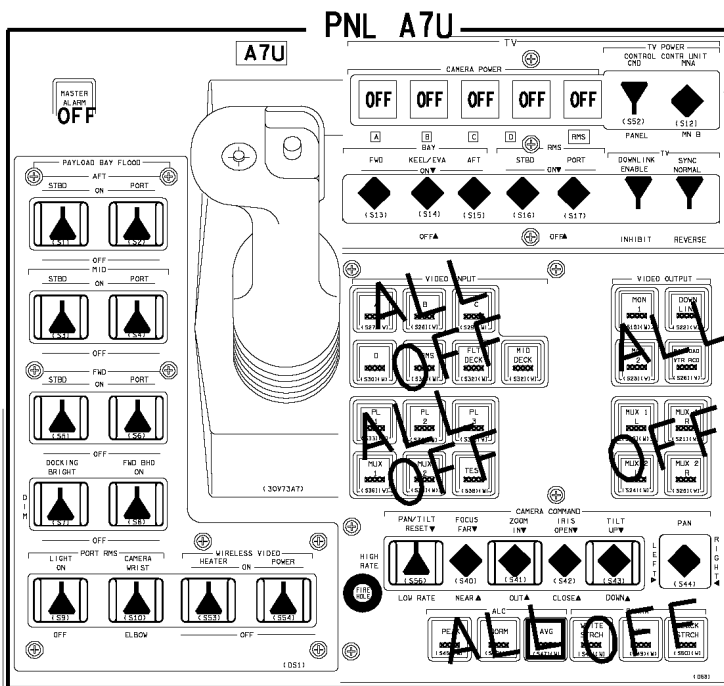

OV103

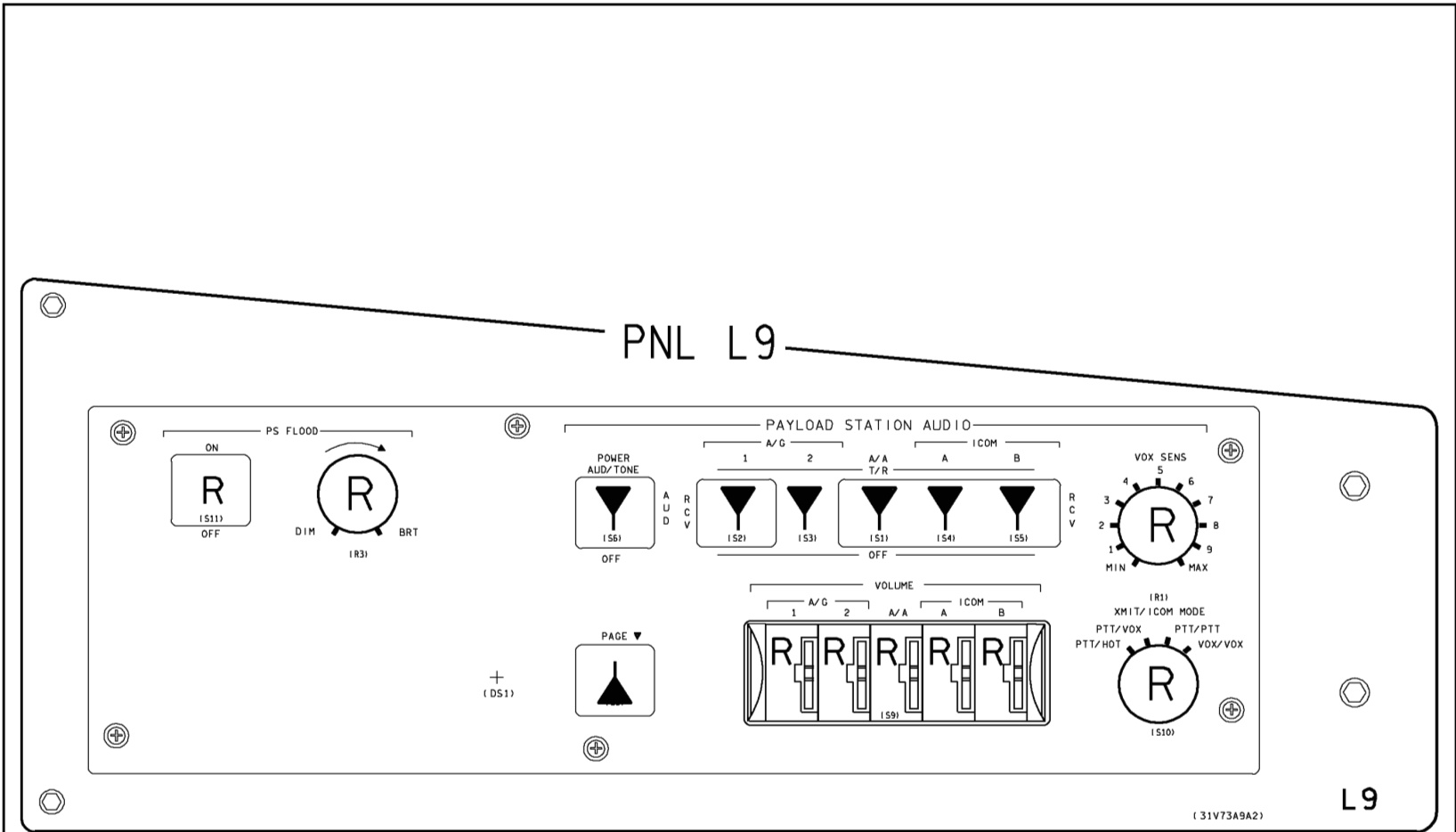

131. PNL# 1

ALL VEH/DATE 09/29/94

OV103 |

(OV103) B3-26

D/O/ALL/GEN L,1

OV103

PNL A6L

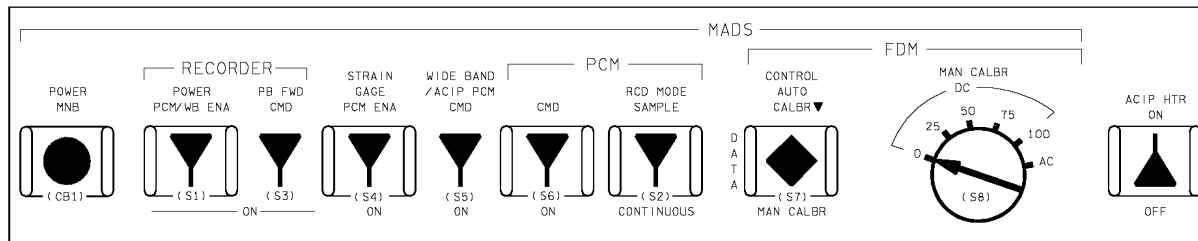
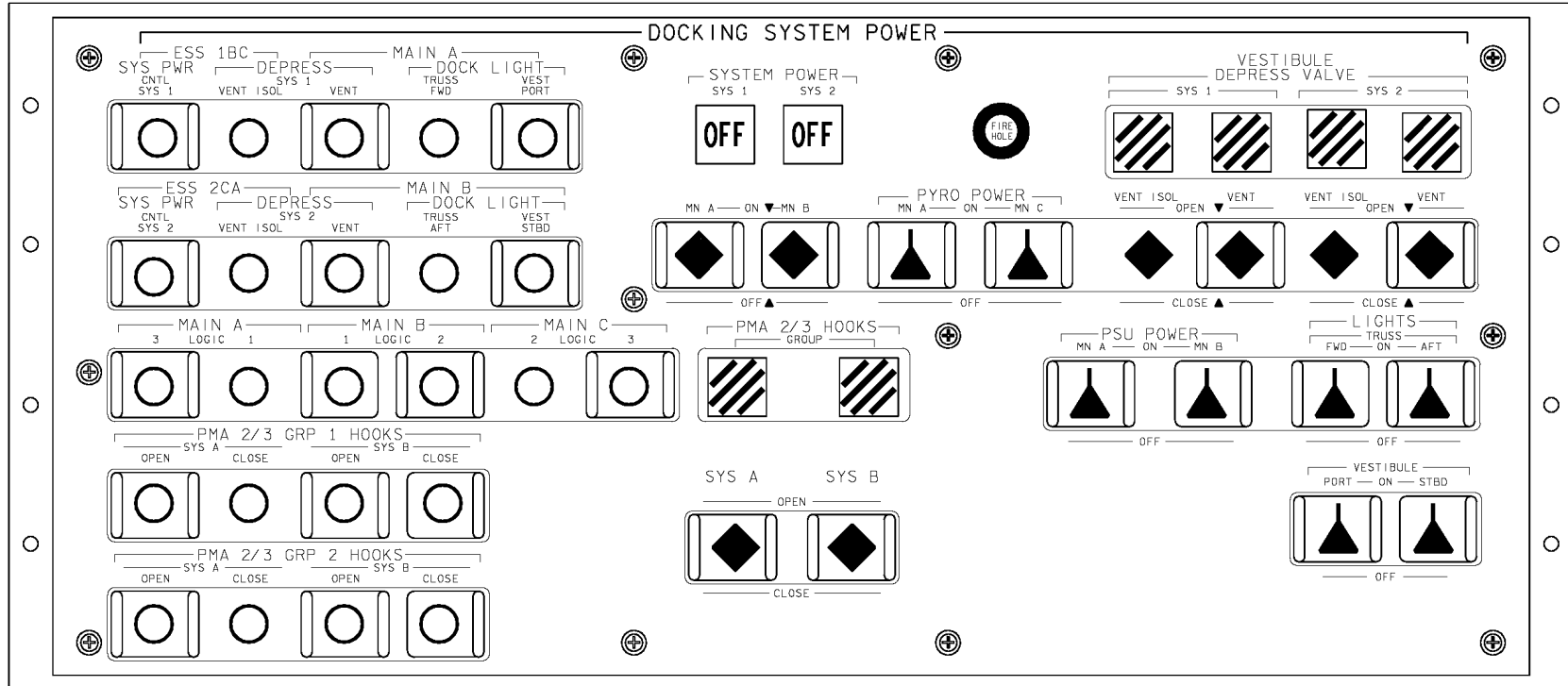

48015B331_104. PNL, 1

OV103/DATE 04/10/01

(OV103) B3-27

OV103 |
D/O/3/GEN L,1

OV103

CONTROL PANEL POWER

A ON OFF B ON OFF C ON OFF

HEATERS/DCU POWER

H1 ON OFF H2/DCU ON OFF H3/DCU ON OFF

APDS POWER

A_{DS} ON OFF B_{DS} ON OFF C_{DS} ON OFF

A_{DS} OFF B_{DS} OFF C_{DS} OFF

LAMP TEST

STATUS

POWER	ON	INITIAL	CONTACT
APDS PROTECT	CIRCUIT OFF	CAPTURE	CAPTURE
RING	ALIGNED	RING	FORWARD POSITION
RING	INITIAL POSITION	TO HOOK	
FIXERS	DEF	INTER	SEALED
HOOKS 1	OPEN	HOOKS 1	CLOSED
HOOKS 2	OPEN	HOOKS 2	CLOSED
LATCHES	CLOSED	LATCHES	OPEN
UNDOCK	COMPLET	RING	FINAL POSITION

ALL OFF

PYROS

A_p ON OFF B_p ON OFF C_p ON OFF

A_p OFF C_p OFF



PYRO LIGHT OFF

PYRO COMMANDS

PYRO CIRC PROT OFF PYRO CIRC PROT ON

ACT HOOKS FIRING PAS HOOKS FIRING

APDS CONTROL COMMANDS

OPEN HOOKS OPEN LATCHES

UNDOCKING

PNL A7L

APDS CONTROL PANEL

APDS CONTROL COMMANDS

POWER ON	POWER OFF	RING OUT	RING IN
APDS CIRC PROT OFF	CLOSE HOOKS	CLOSE LATCHES	FIXER OFF

OV103

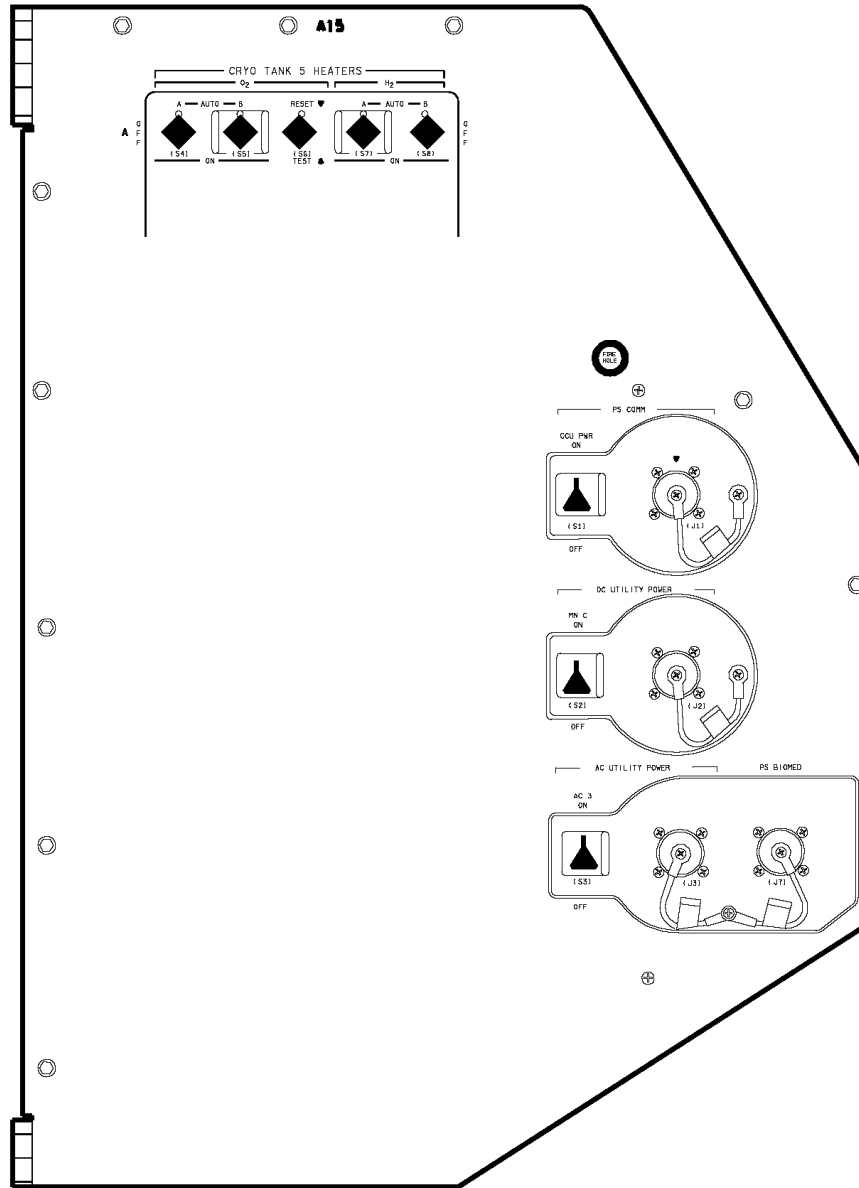

OV103

OV103

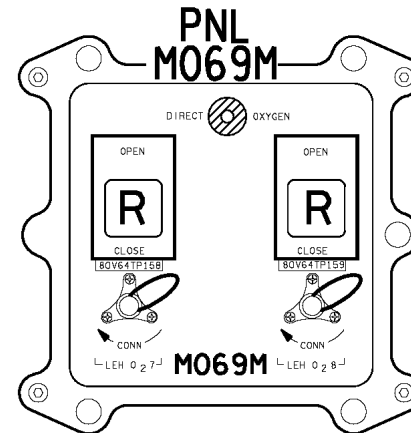
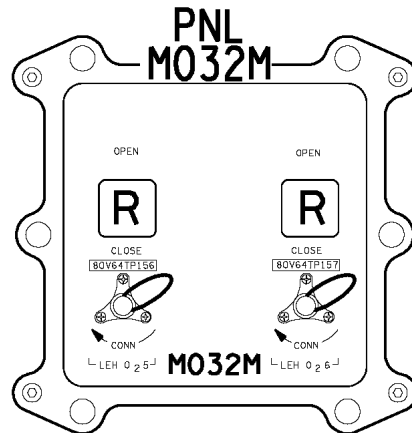
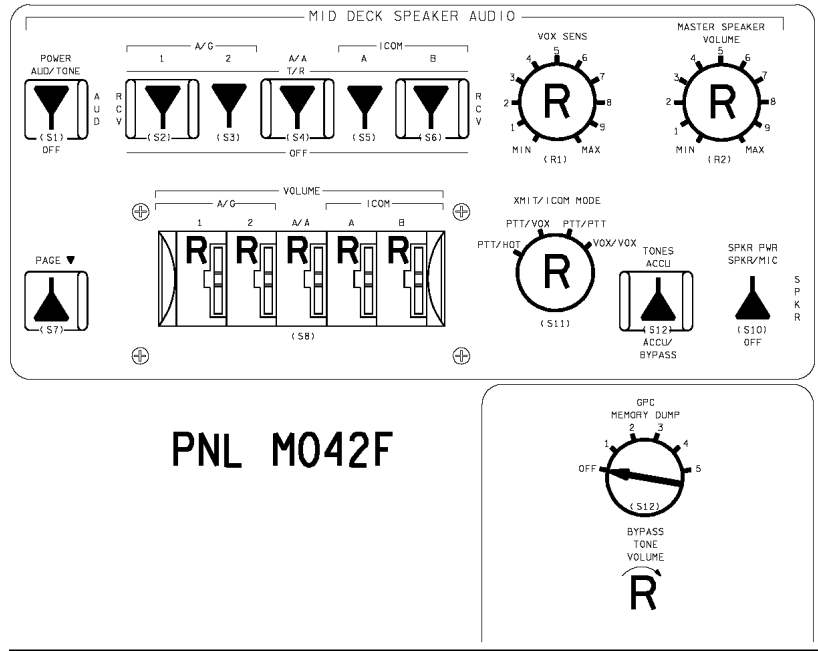

OV103

PNL MA73C

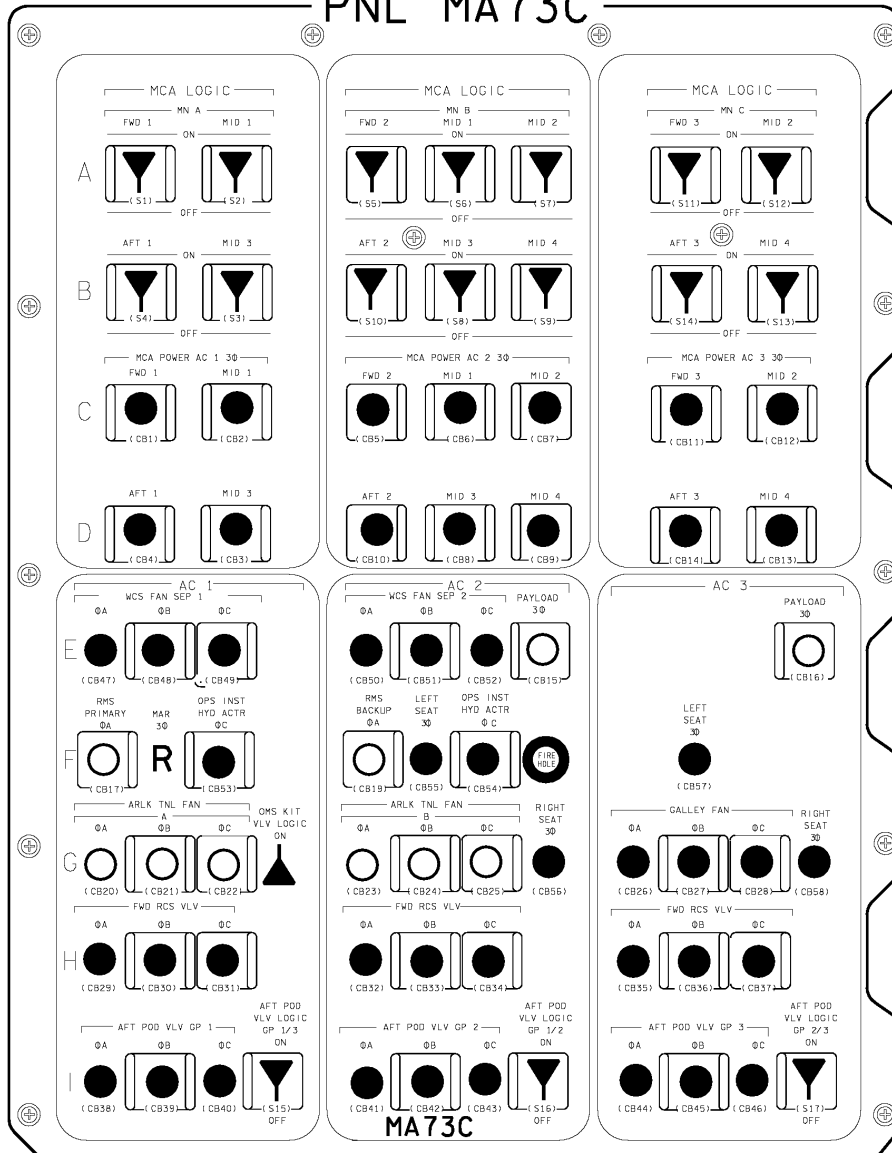

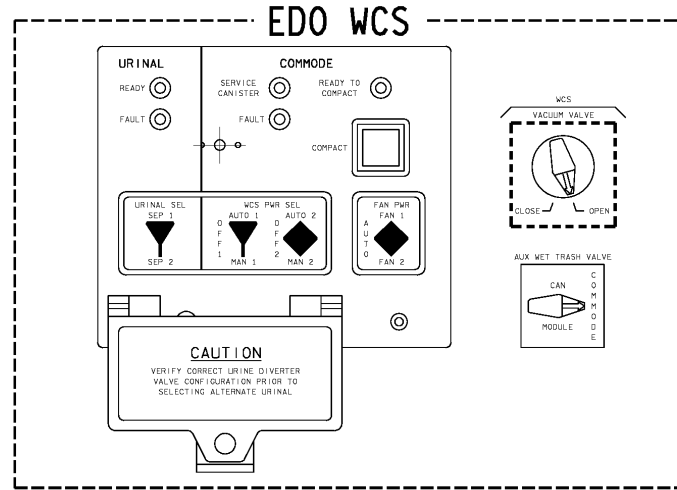
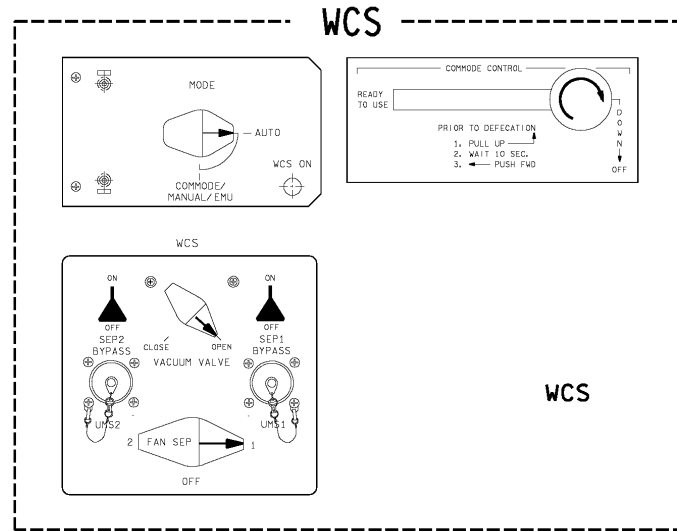
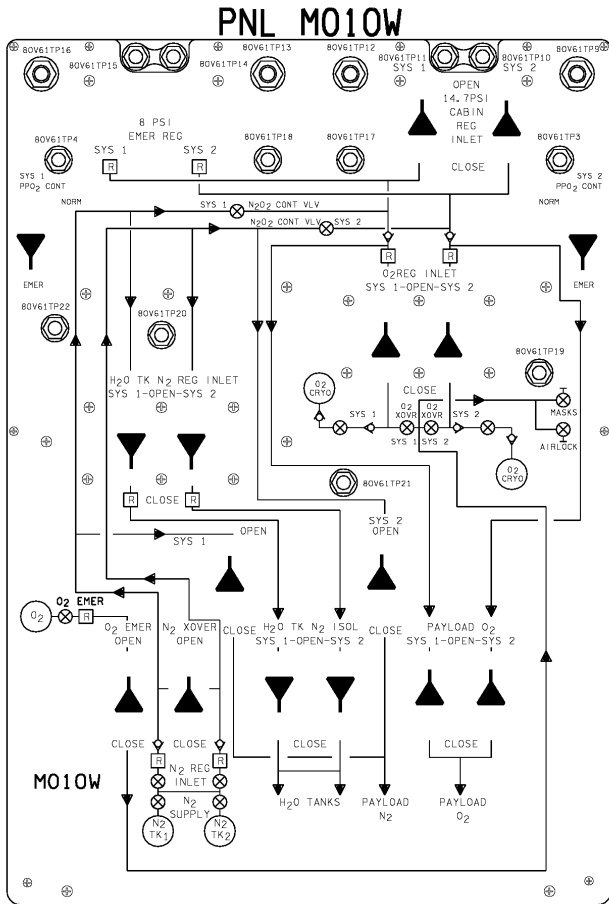

LIGHTING FLOOD

1 ON (S1) 2 ON/OFF (S2)

PNL AW18A

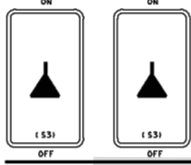
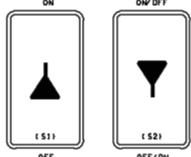

AW18A

(84V73A133)

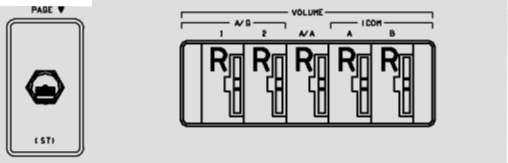
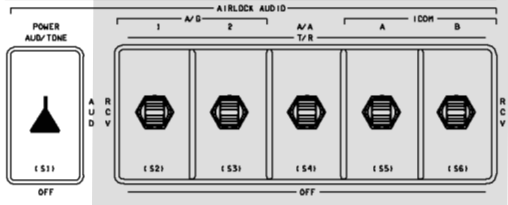

PNL AW18D

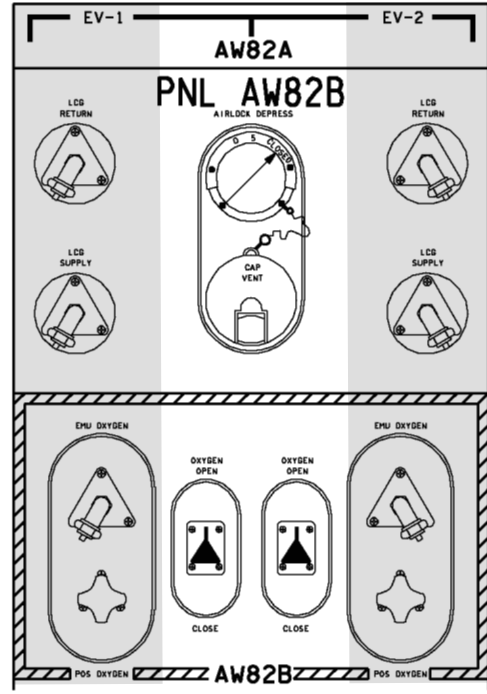
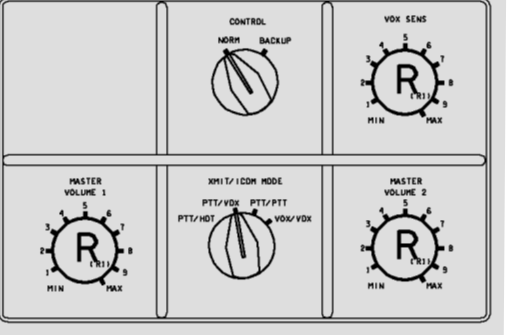

PNL AW18H

POWER/BATTERY CHARGER

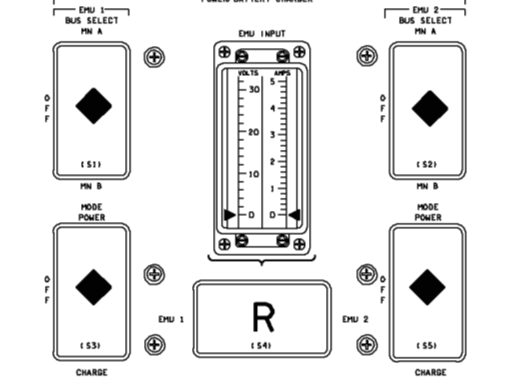

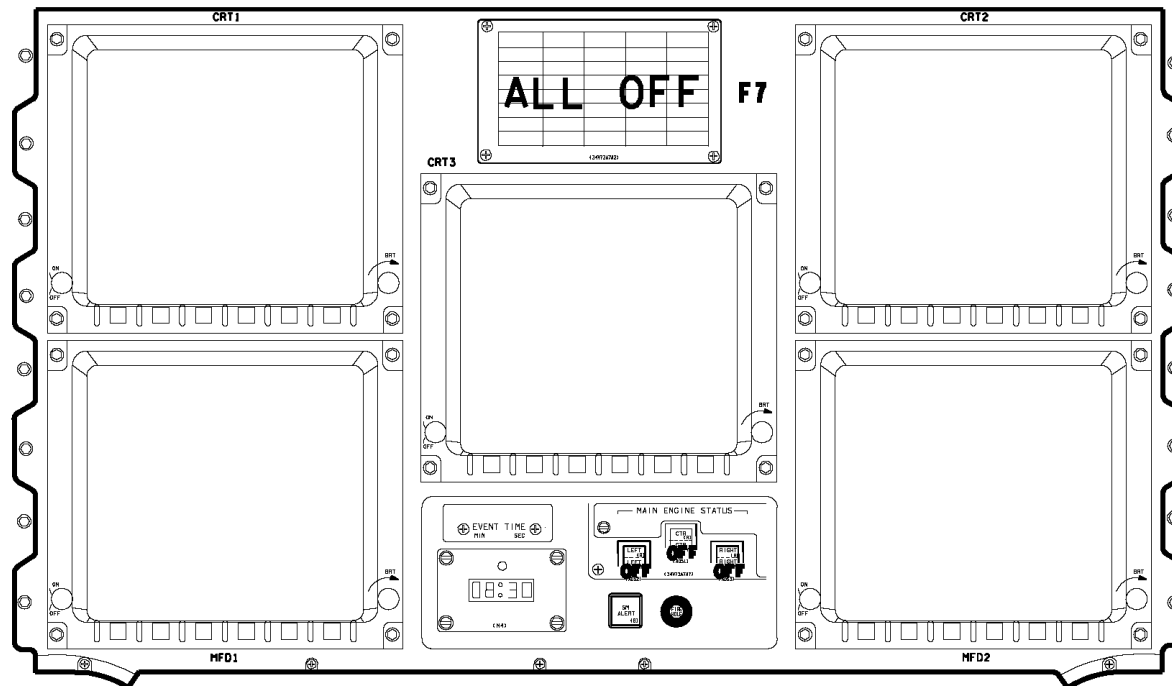
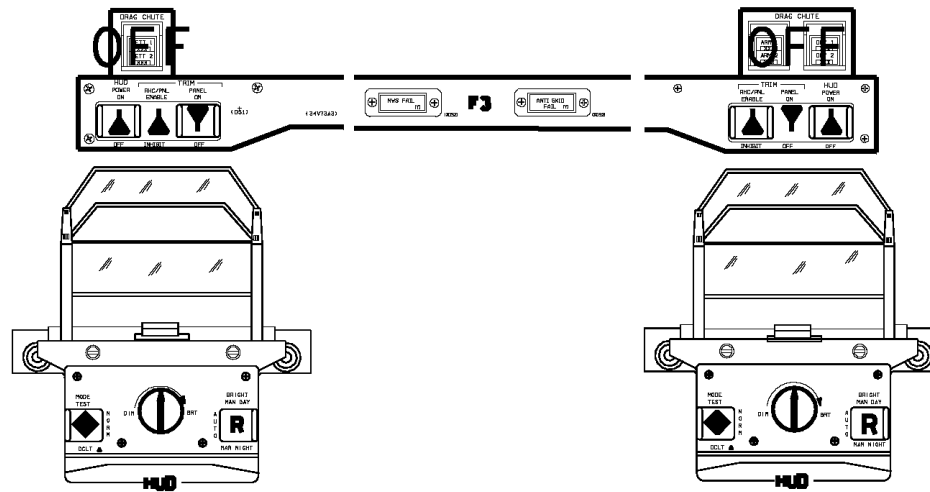

PNL F7

OV104

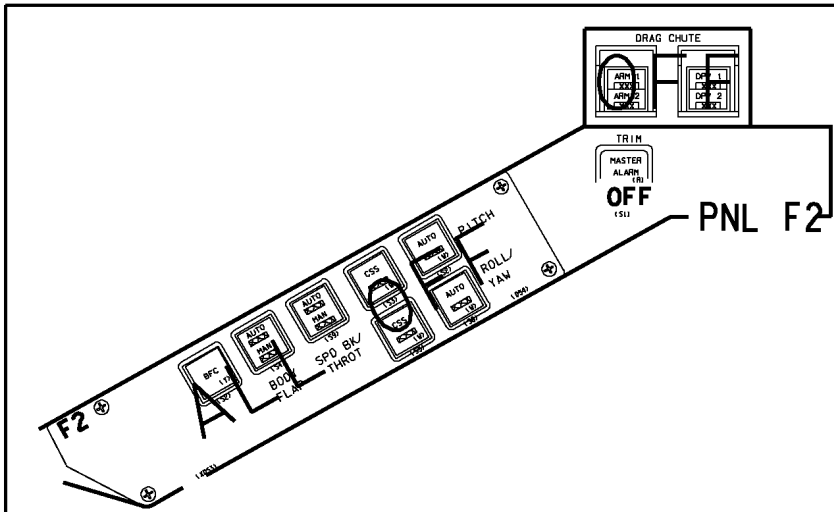

PNL F2

PNL 013

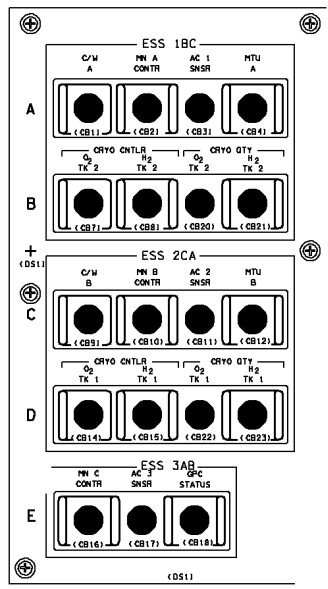

L side OVHD flood - R (MID)

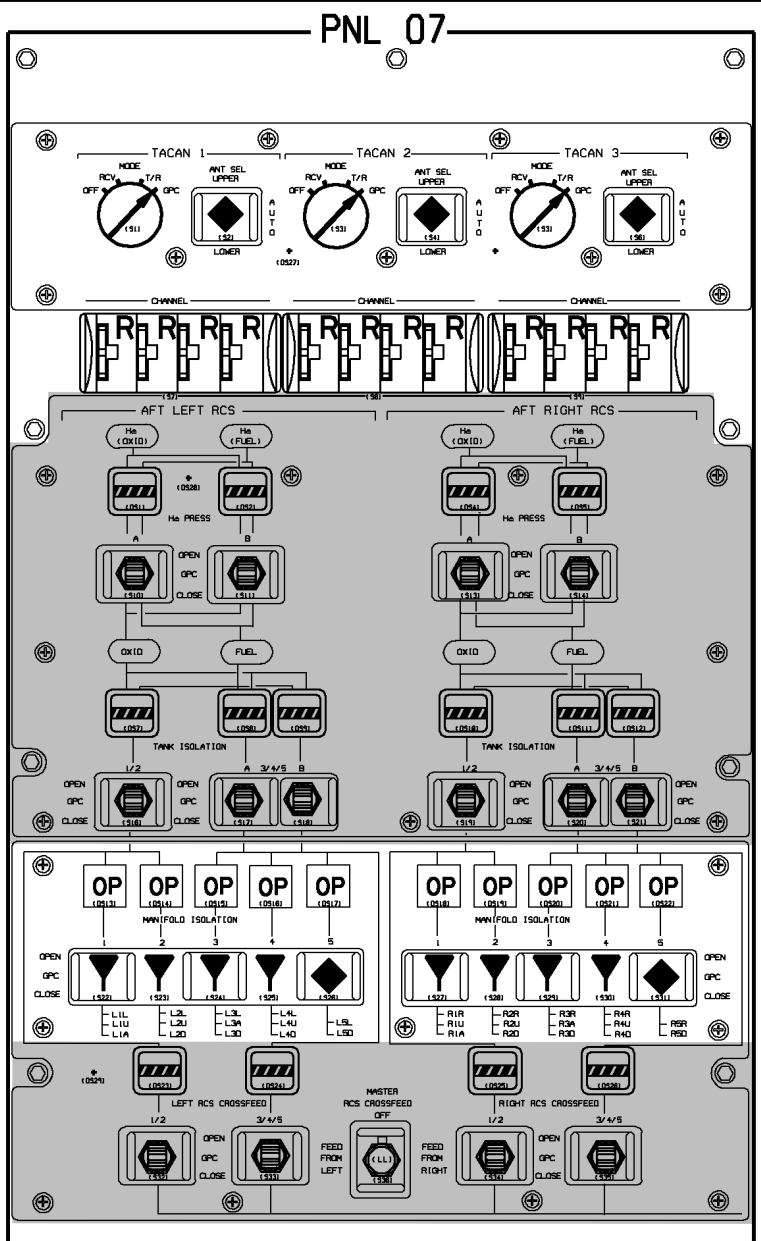

PNL 07

OV104

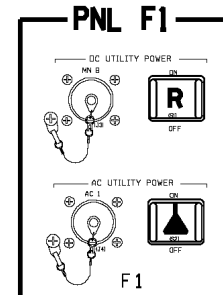
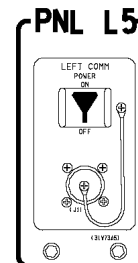
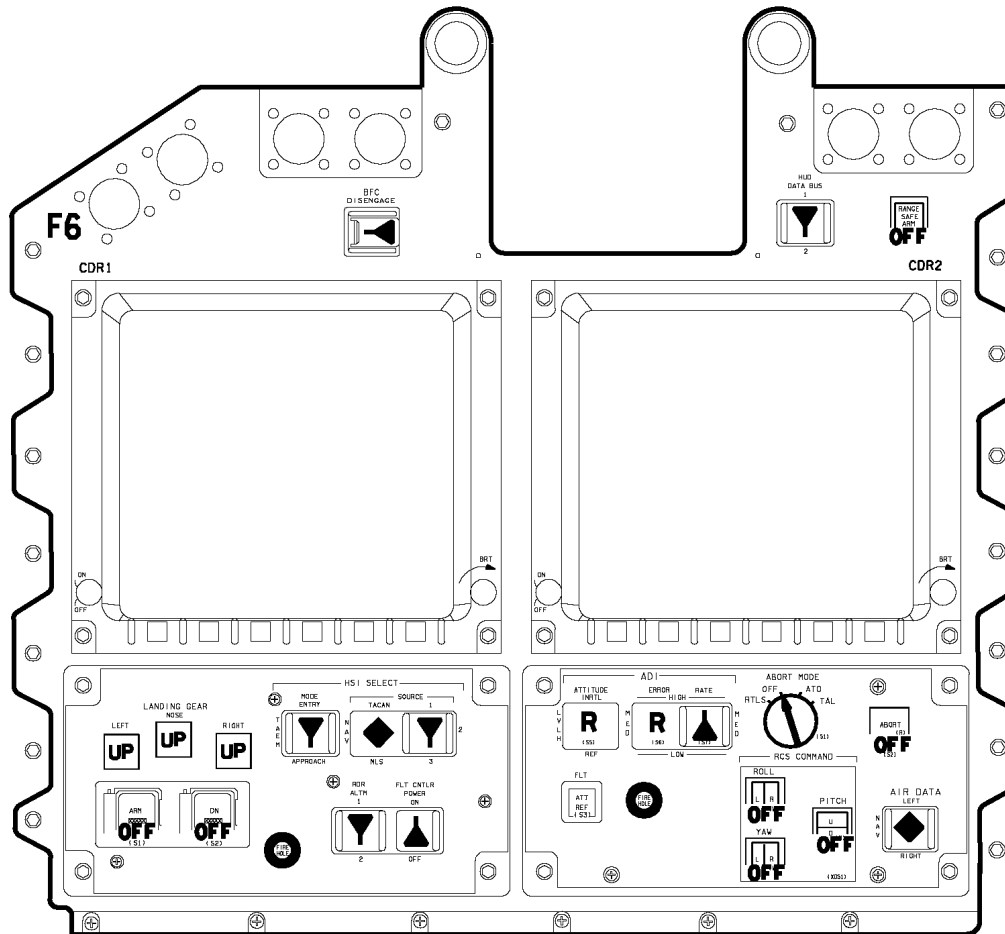

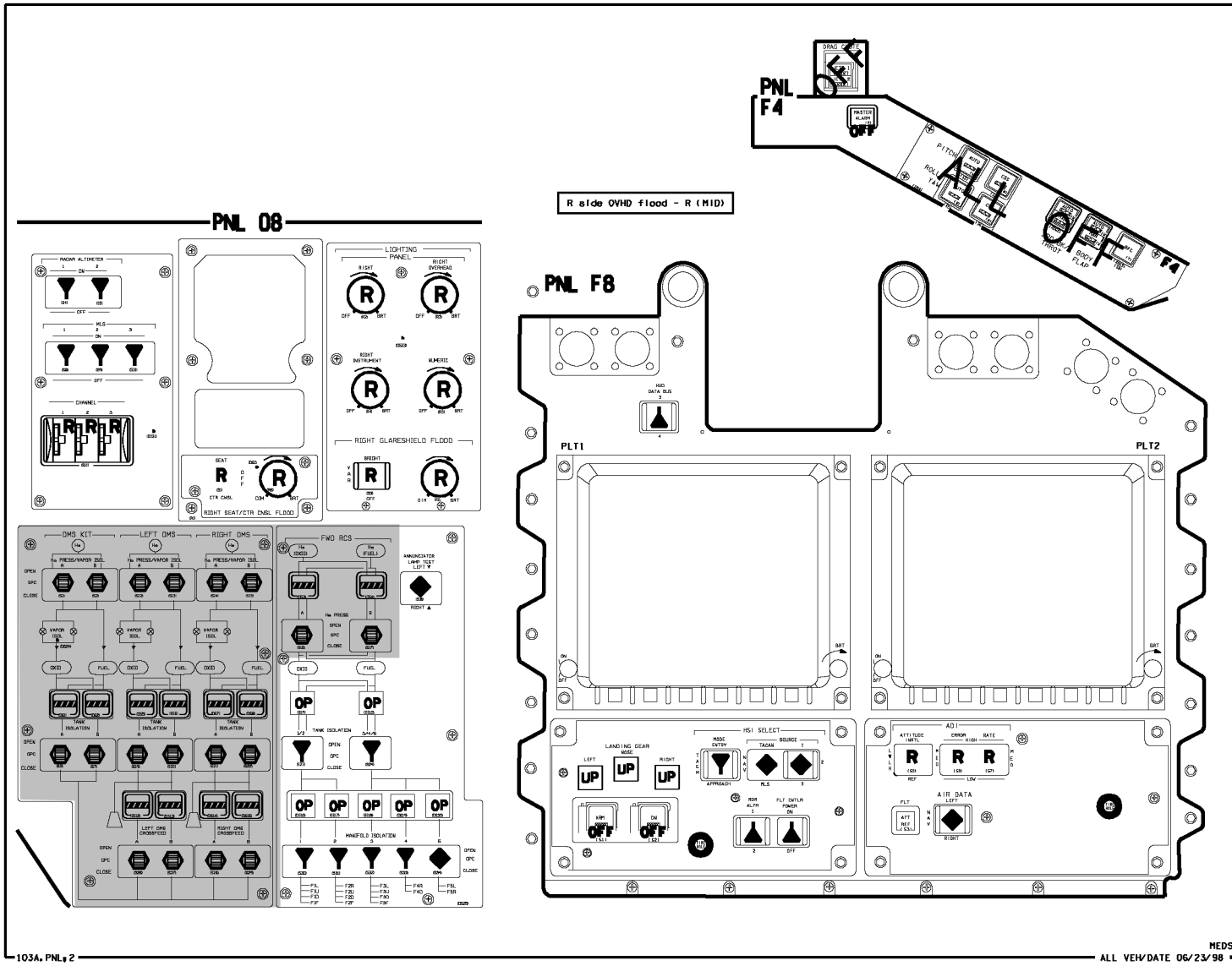

(OV104) C3-7

OV104

D/O/4/GEN L

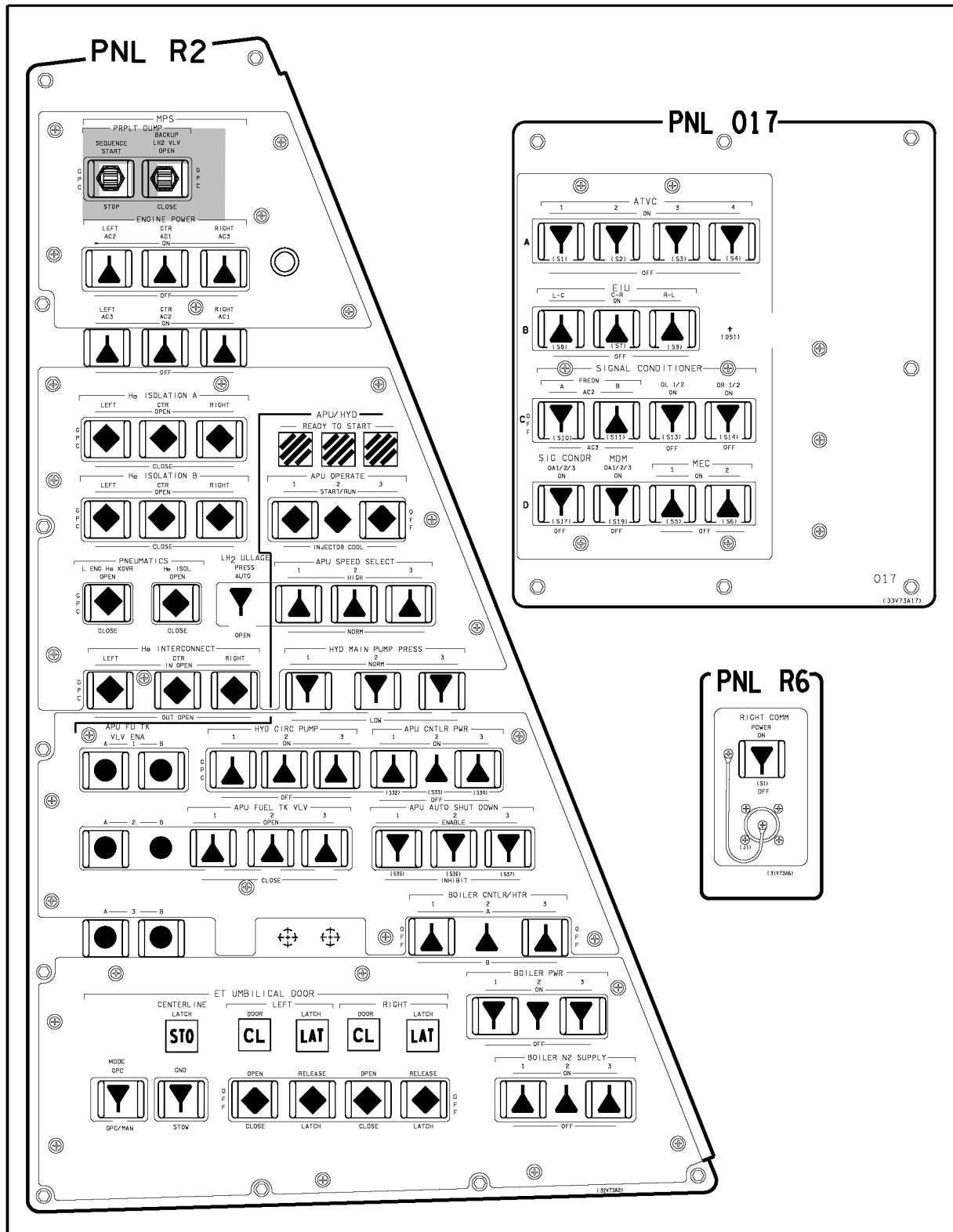

OV104

(OV104) C3-8

D/O/ALL/GEN L

OV104

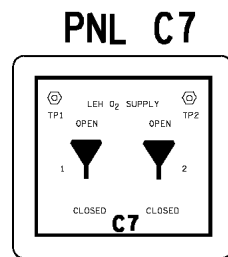
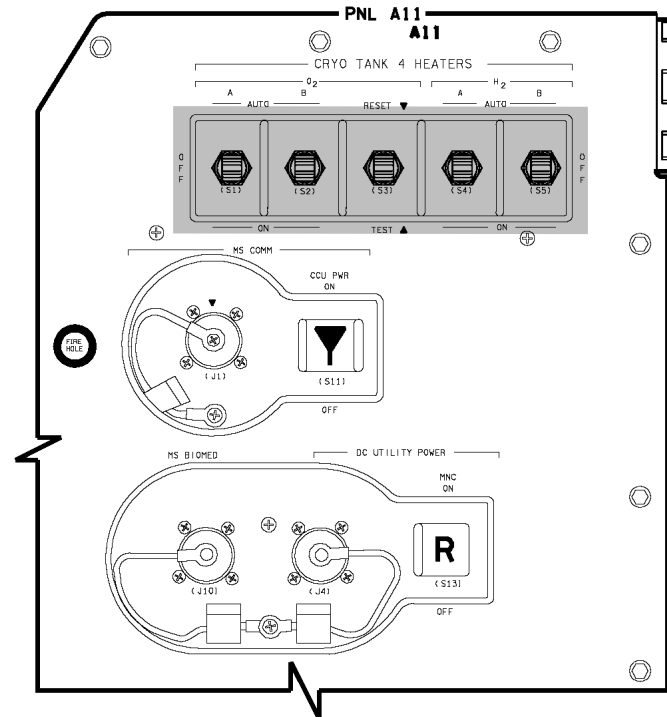
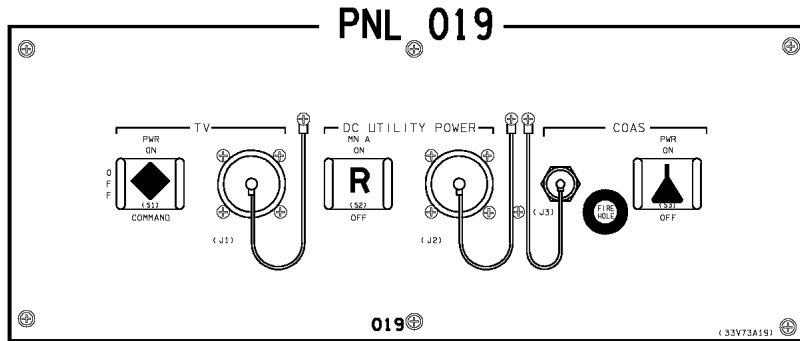

AIRLOCK HATCH
 ACTUATOR HANDLE - LATCHED
 LOCK LEVER - LOCKED
 EQUALIZATION VLV (TWO) - NORM
 -CAPS INSTALLED

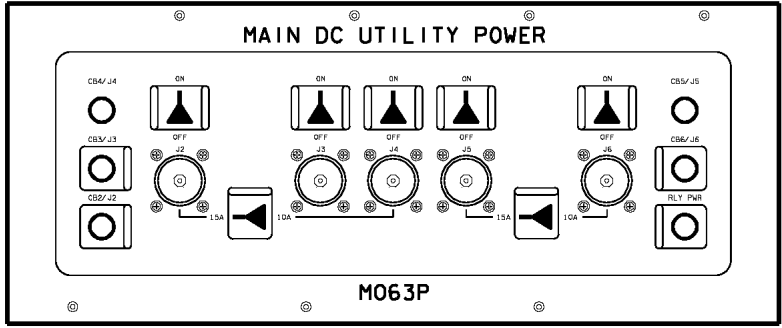

PNL M058F

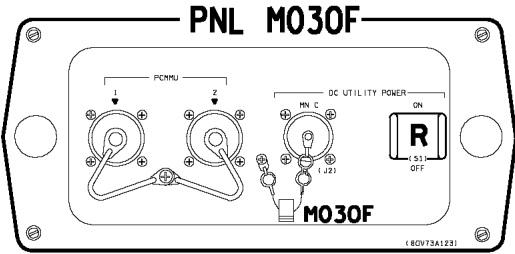
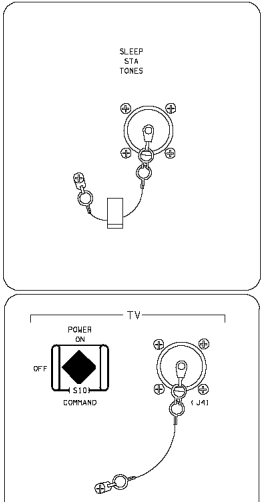

- PNL M039M -

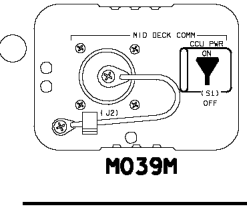

PNL M052J

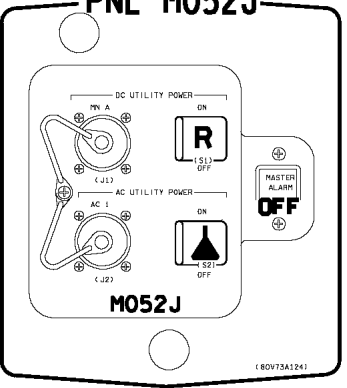

PNL MD24K

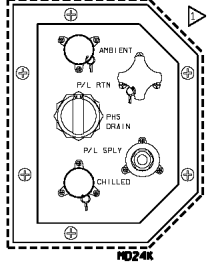

NOTE: NOT VISIBLE IF MAR FLOWN

PNL MD44F

CAB TEMP CNTL ACT LINKAGE - SECONDARY ACTUATOR

OV104

PNL ML86B

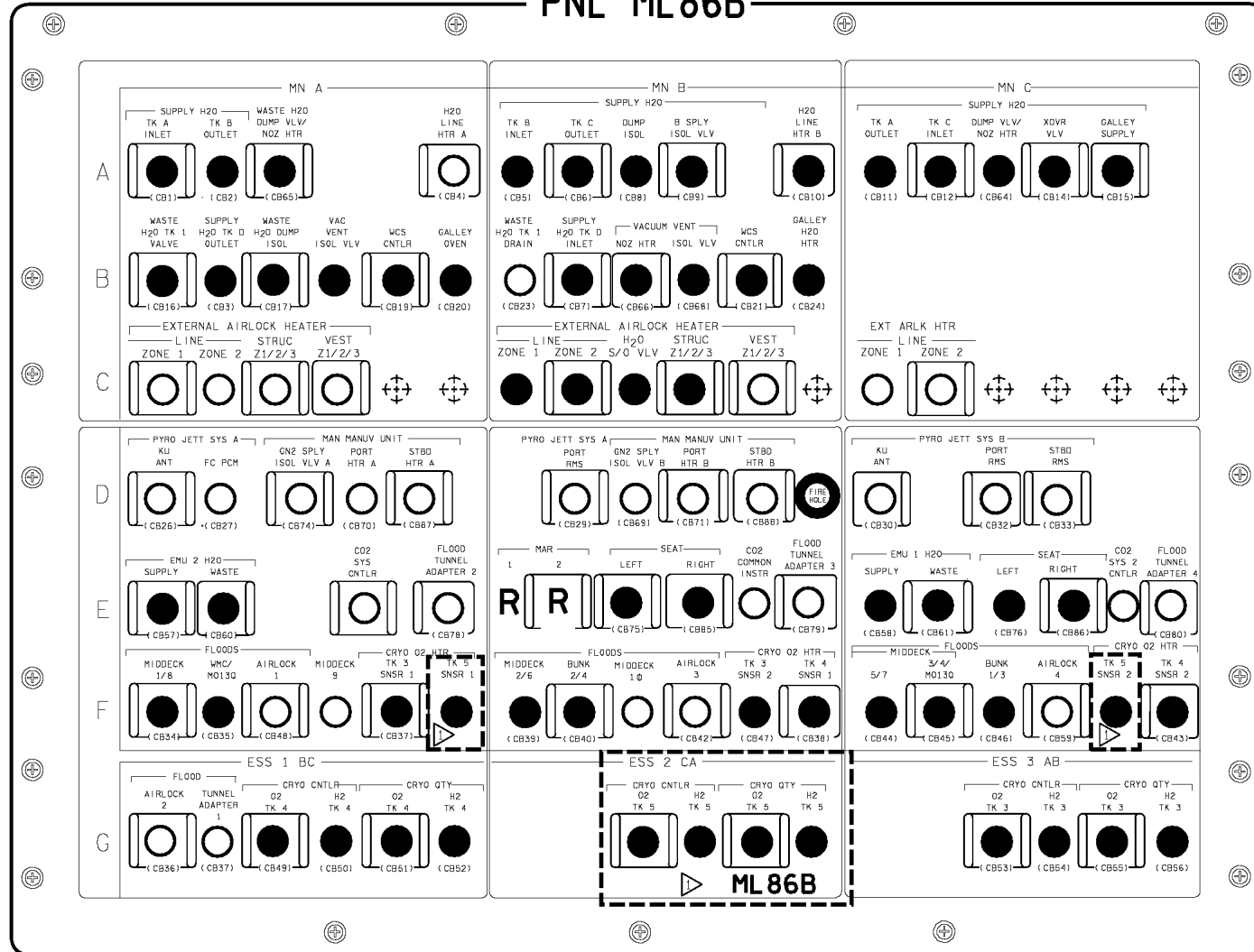

NOTES: ▷ OPEN IF TK 5 NOT FLOWN

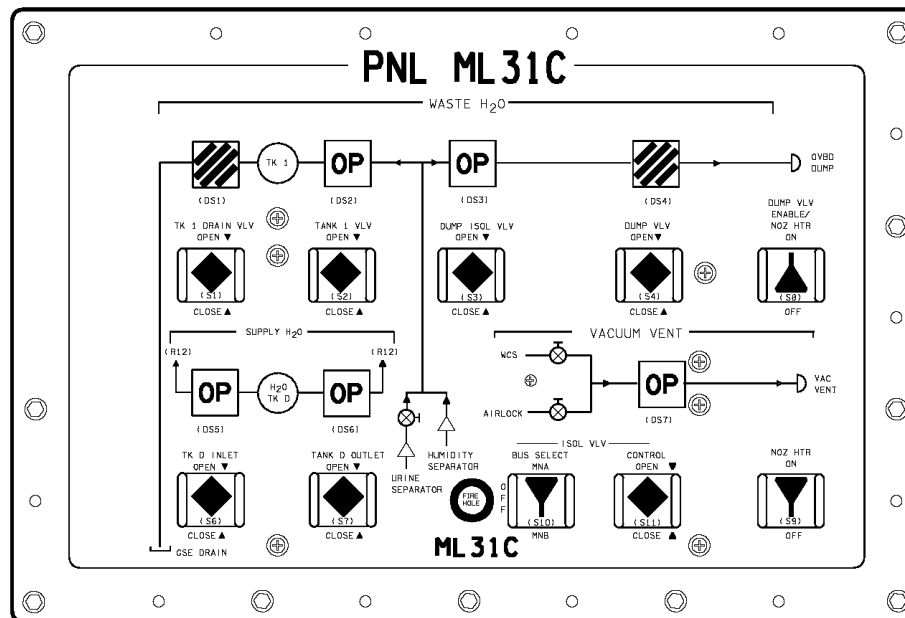
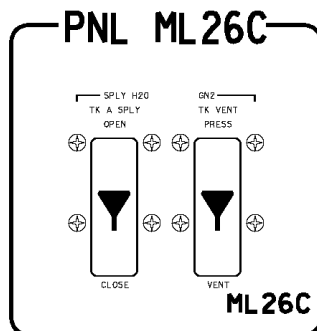
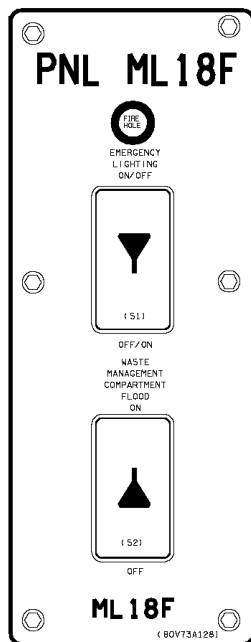
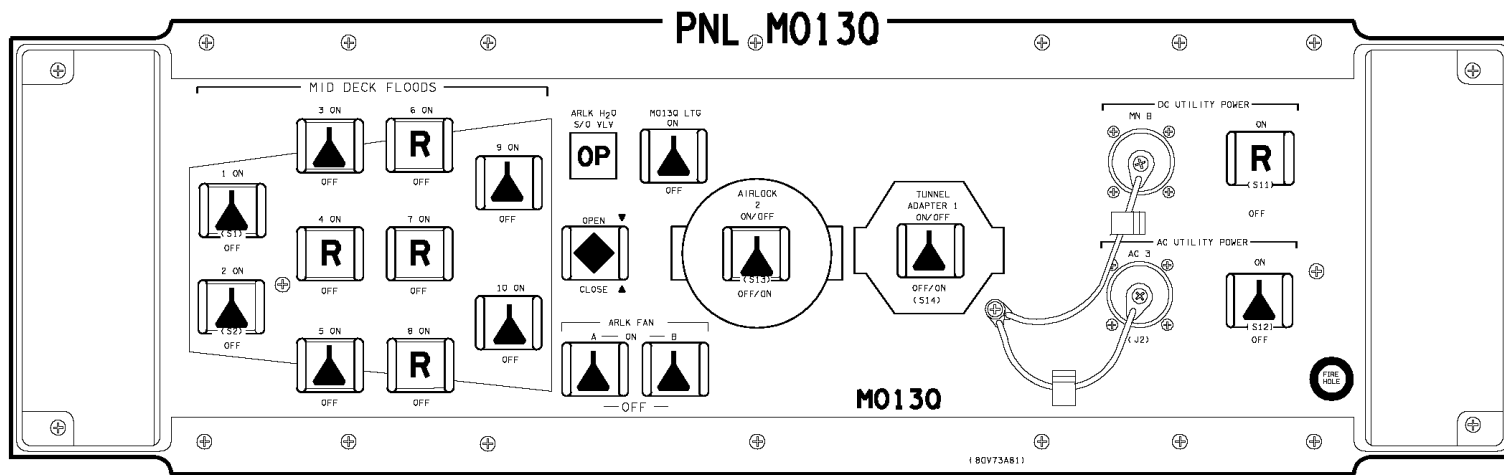

48015B312.PNL;1

(OV104) C3-12

OV103, OV104, OV105

OV104
D/O/4/GEN L

OV104

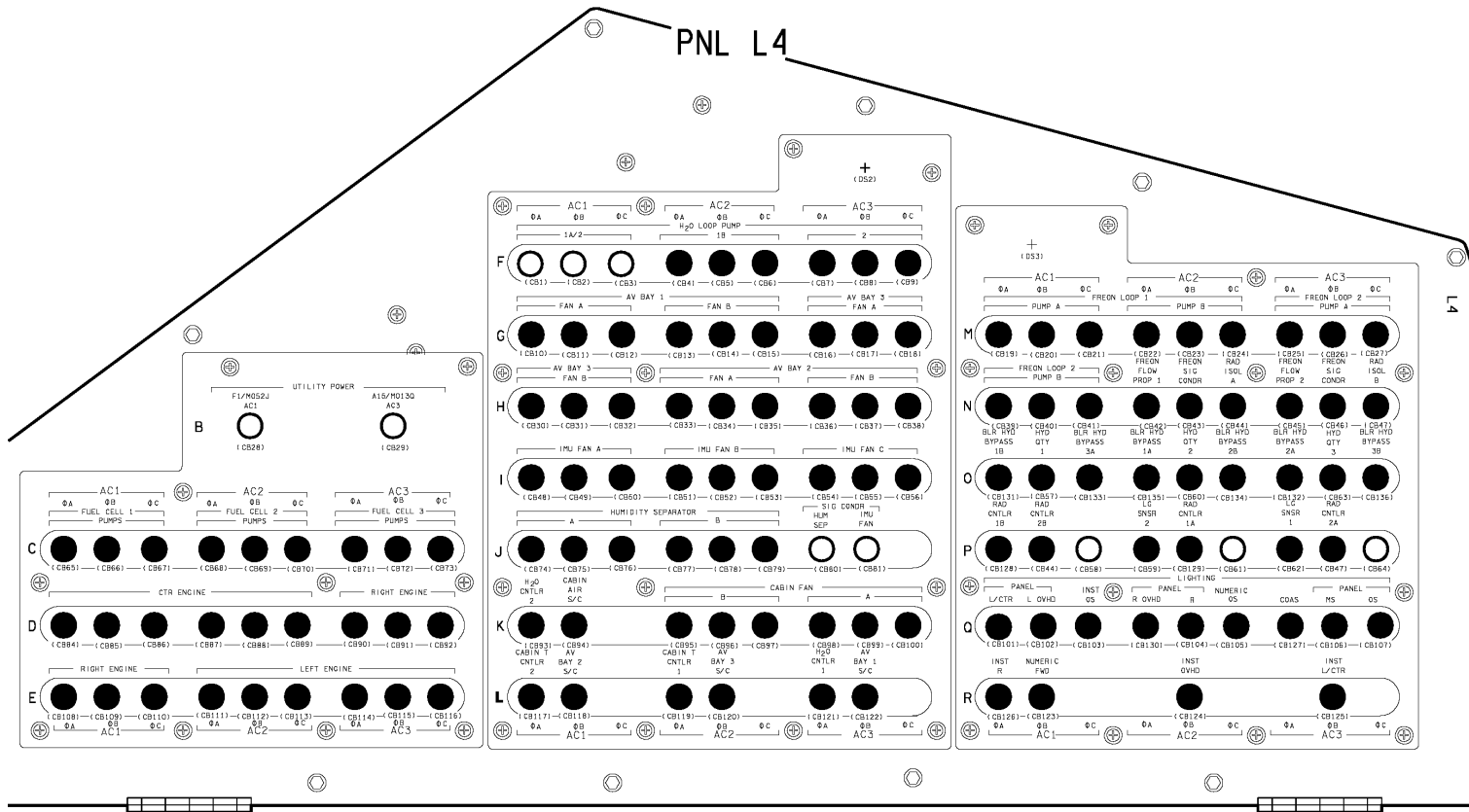

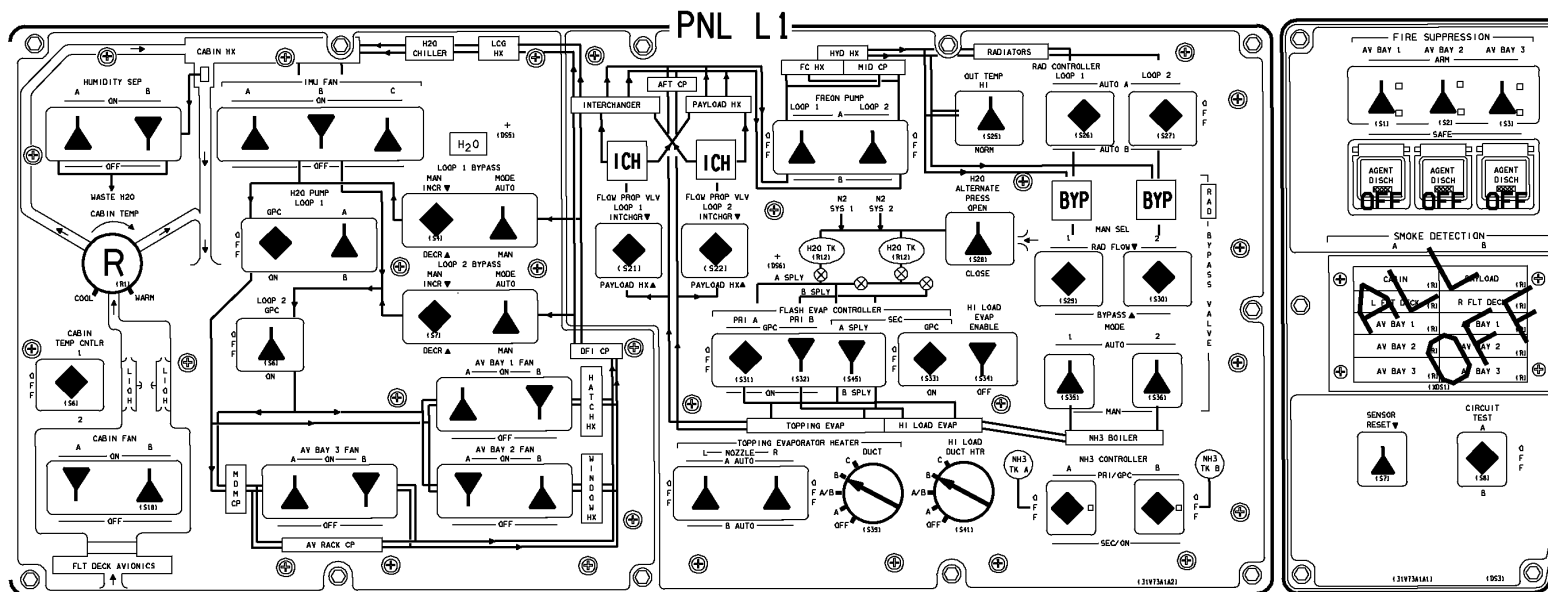

OV104

OV104

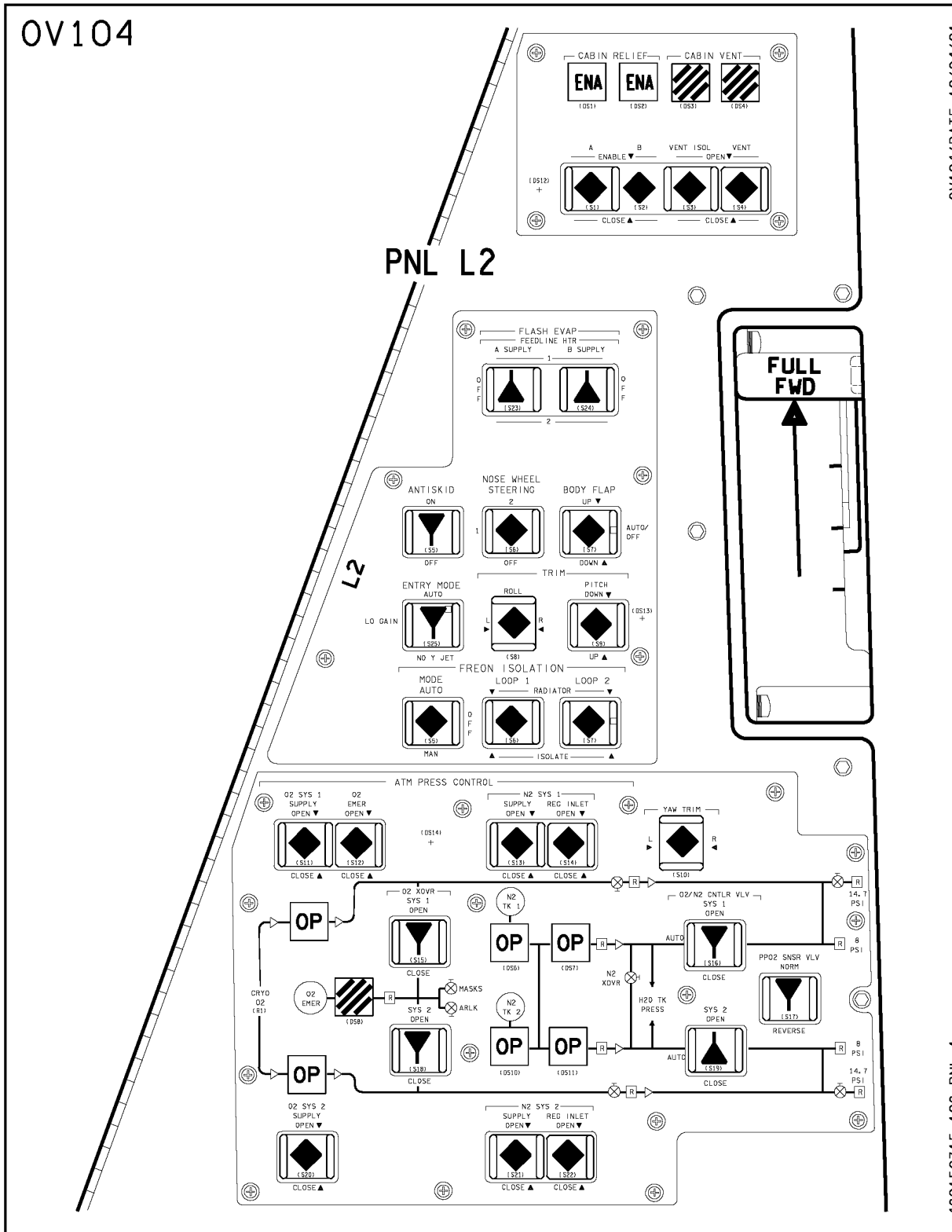

OV104/DATE 10/24/01

48015C315_108, PNL 1

OV104

(OV104) C3-15

D/O/4/GEN L,5

PNL C2/C3

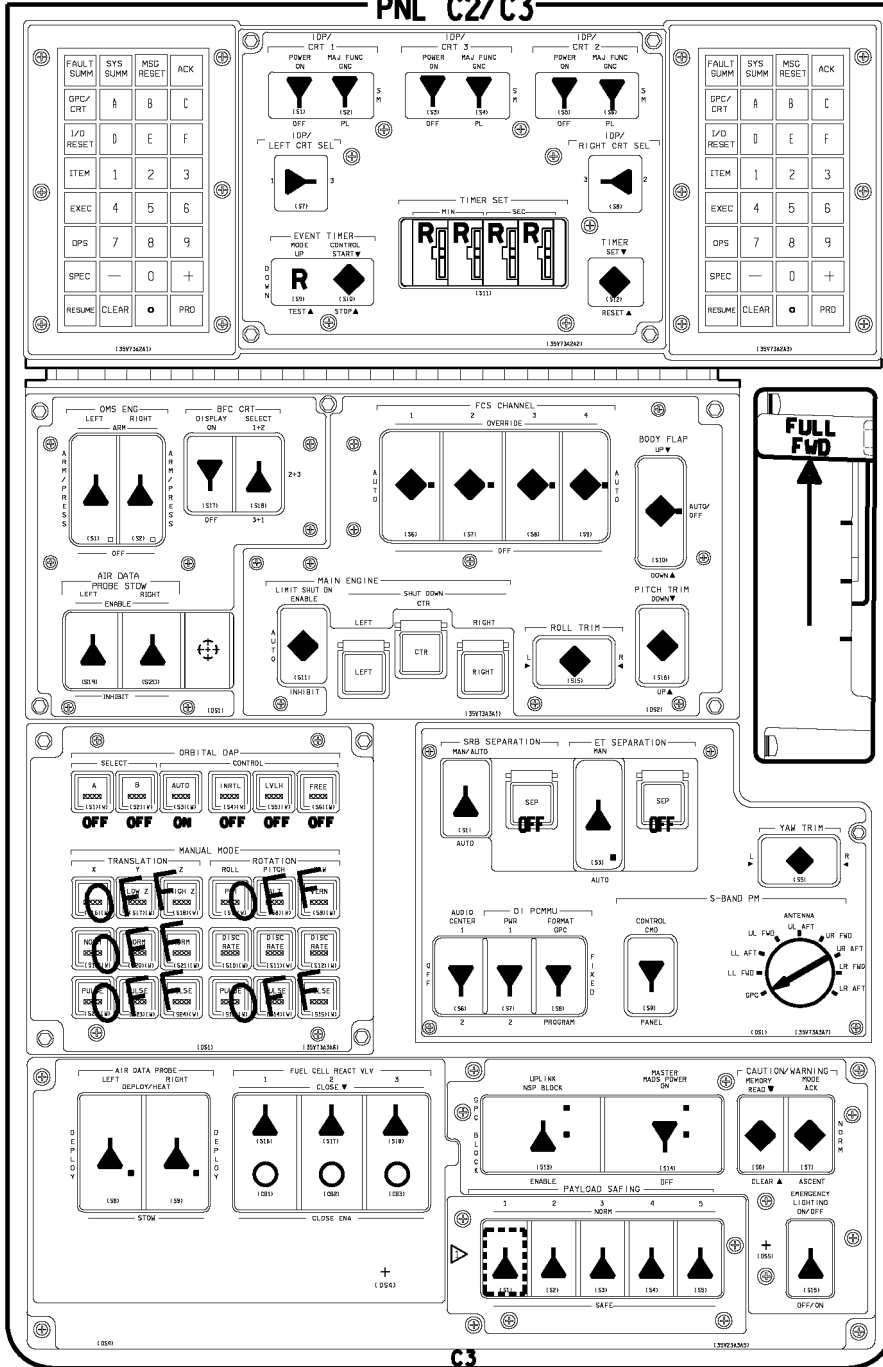

POSSIBLE CONFIGURATION

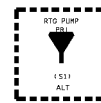

OV104

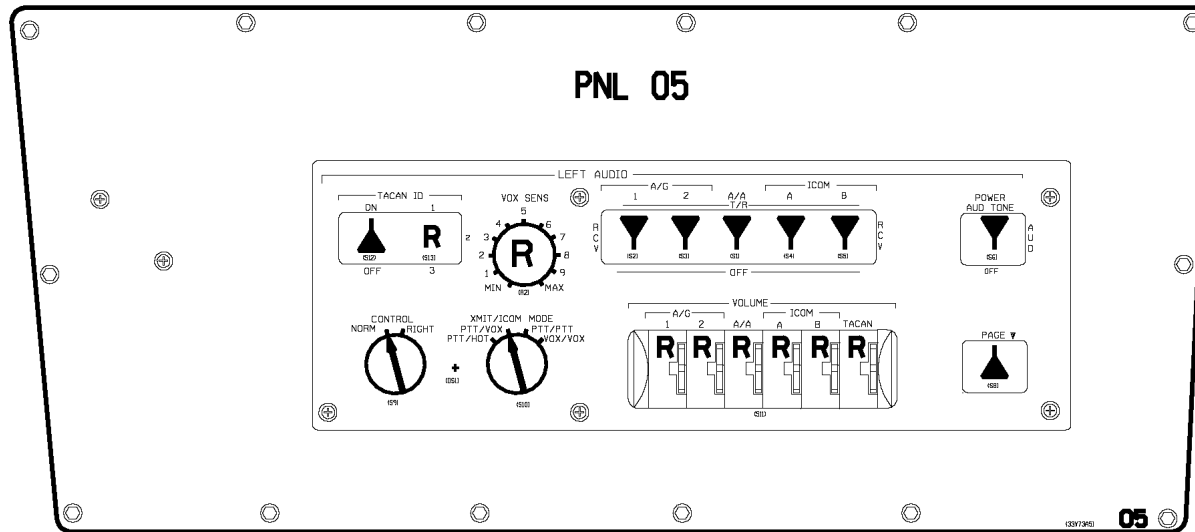
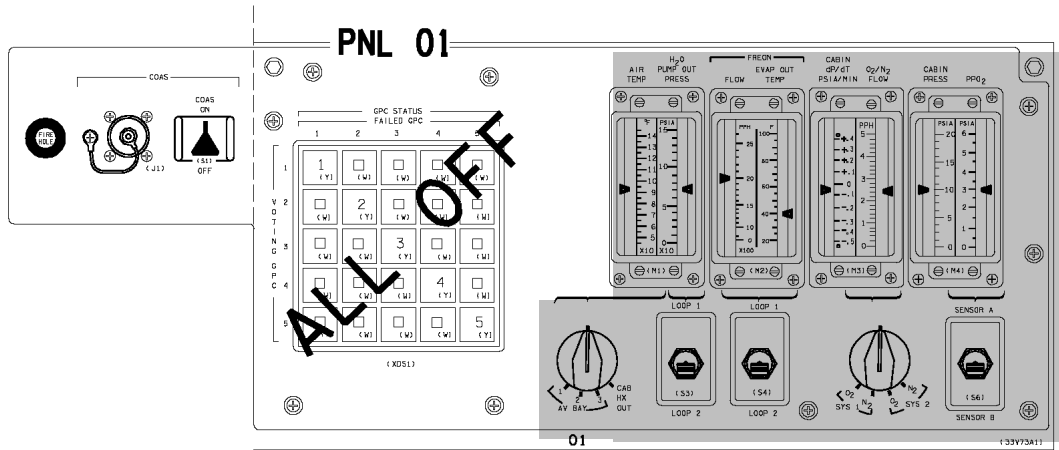

OV104

PNL 06

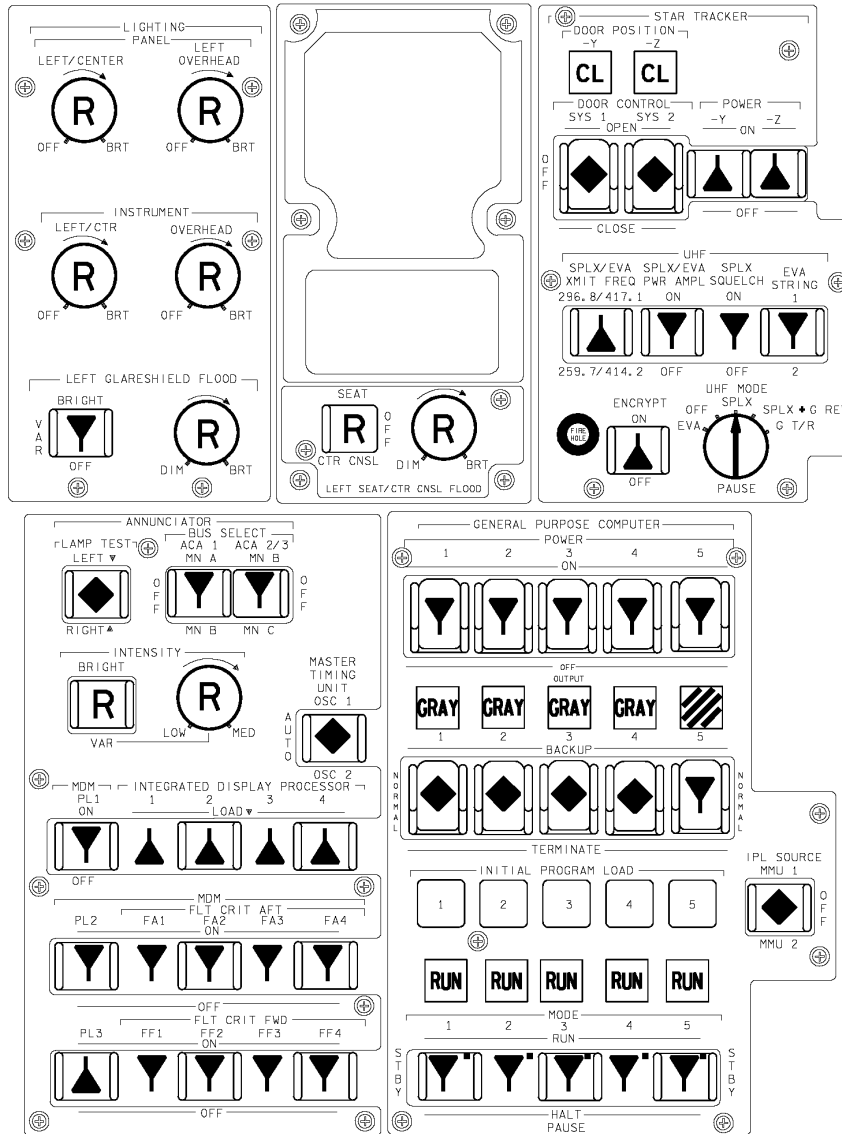

MEDS

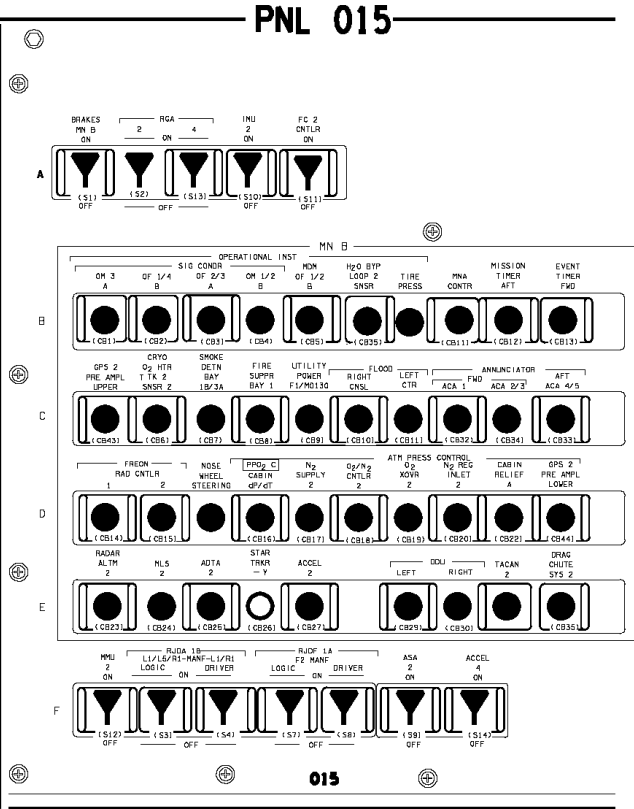
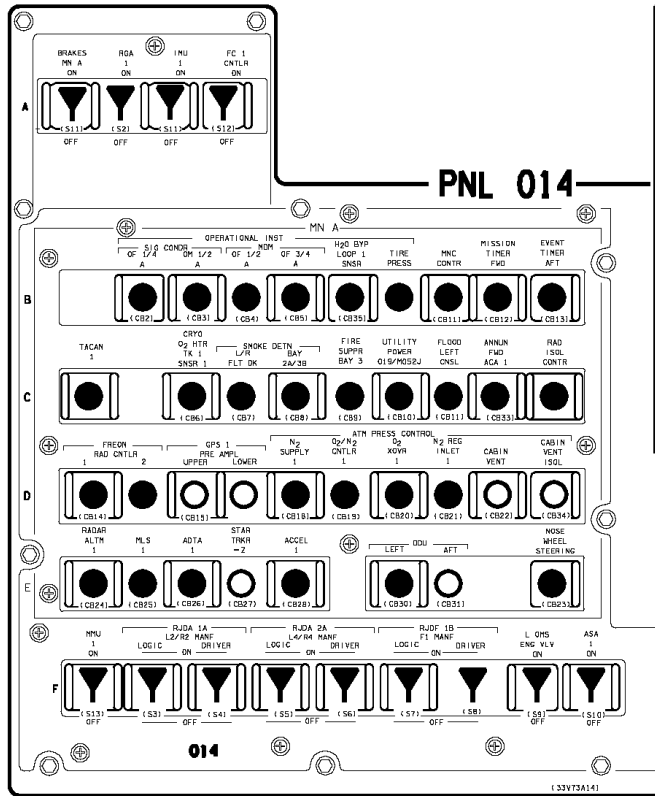

OV104

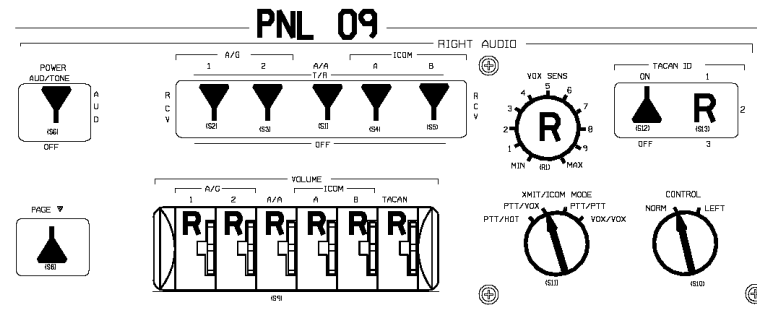
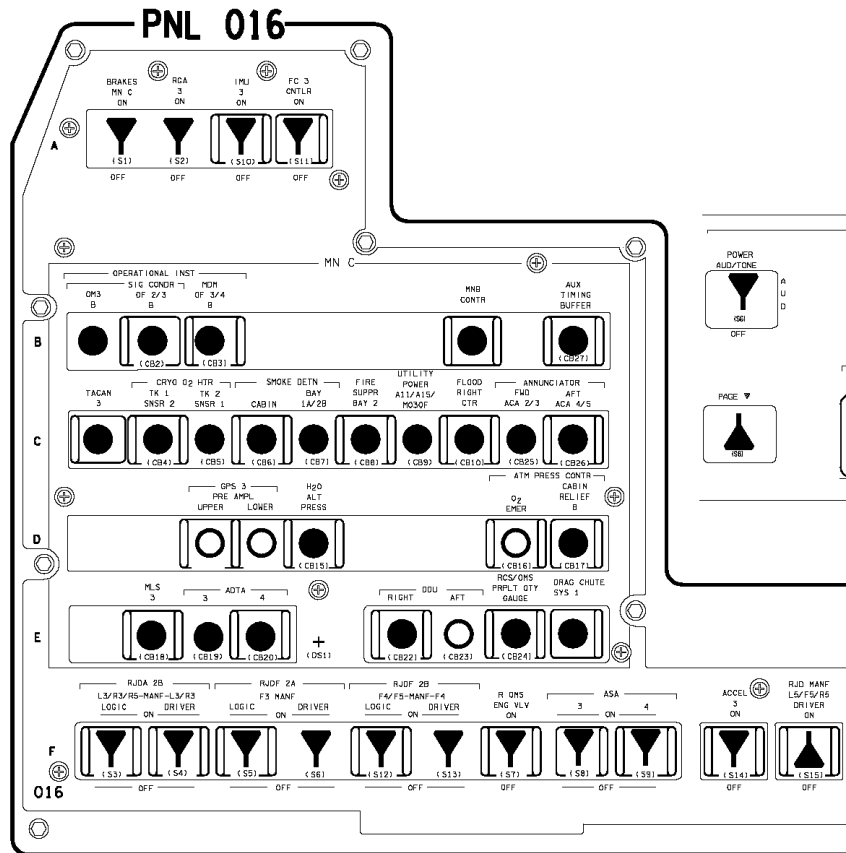

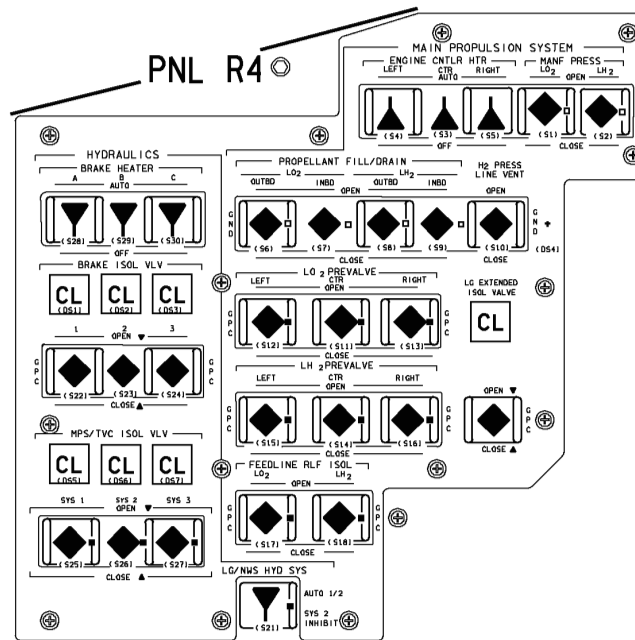
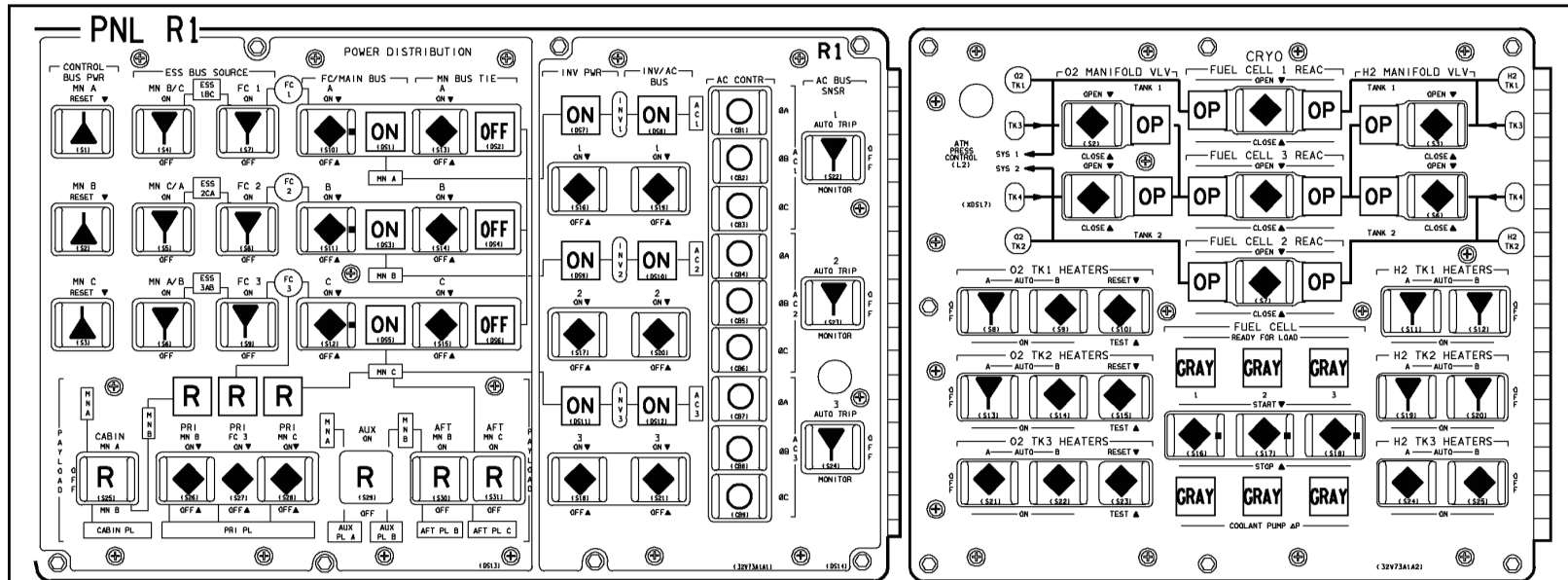

122. PNL 1

ALL VEH/DATE 09/29/94

(OV104) C3-21

OV104

D/O/ALL/GEN L

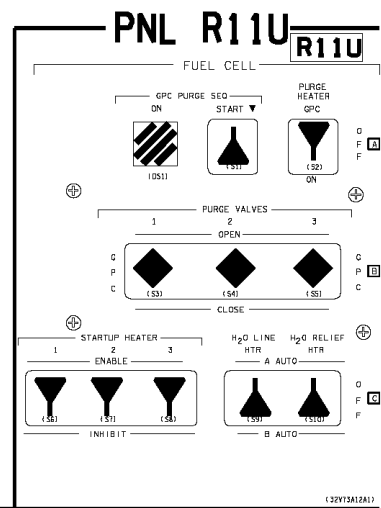
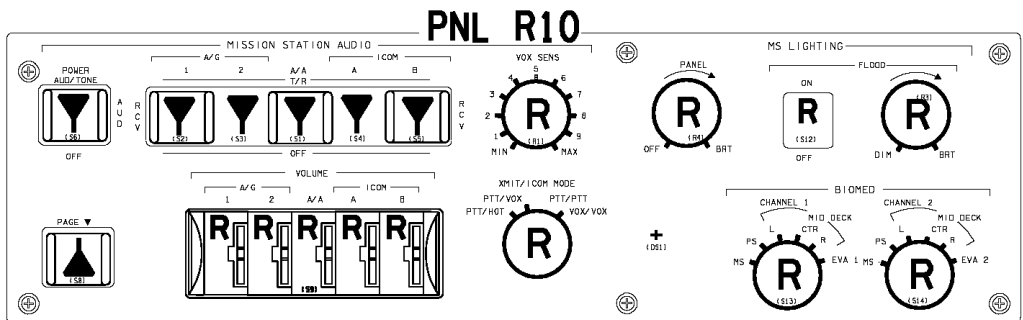

NOTES: ▽ CONFIG FOR NOMINAL D/O PREP
 IF 1 REV WAVE-OFF OR EXTENSION DAY:
 ✓/SPLY H2O TKC INLET - CTR (+b-OP)
 ✓/OUTLET - CTR (+b-OP)

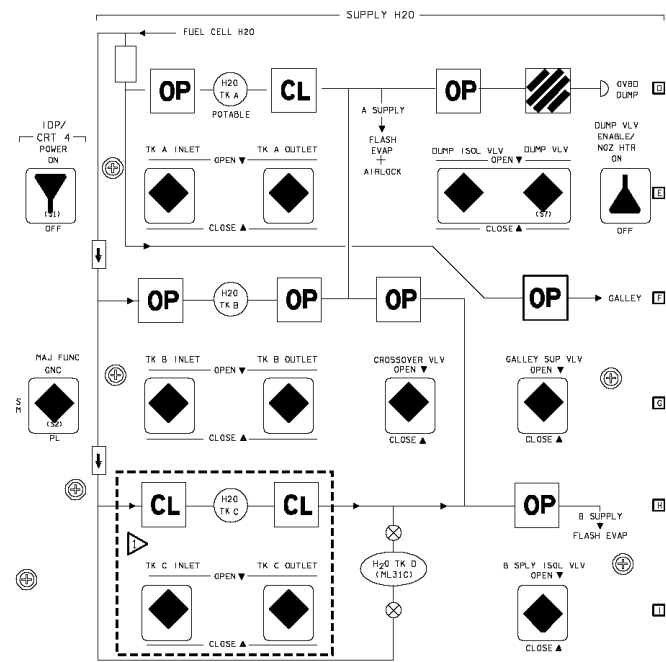
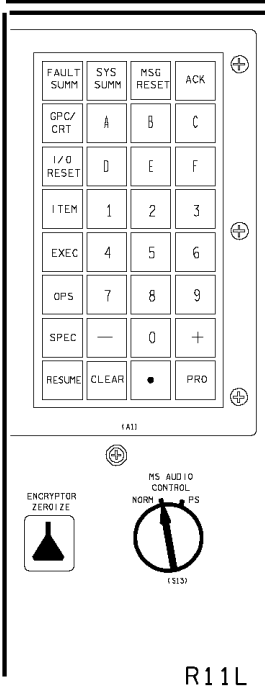

OV104

OV104

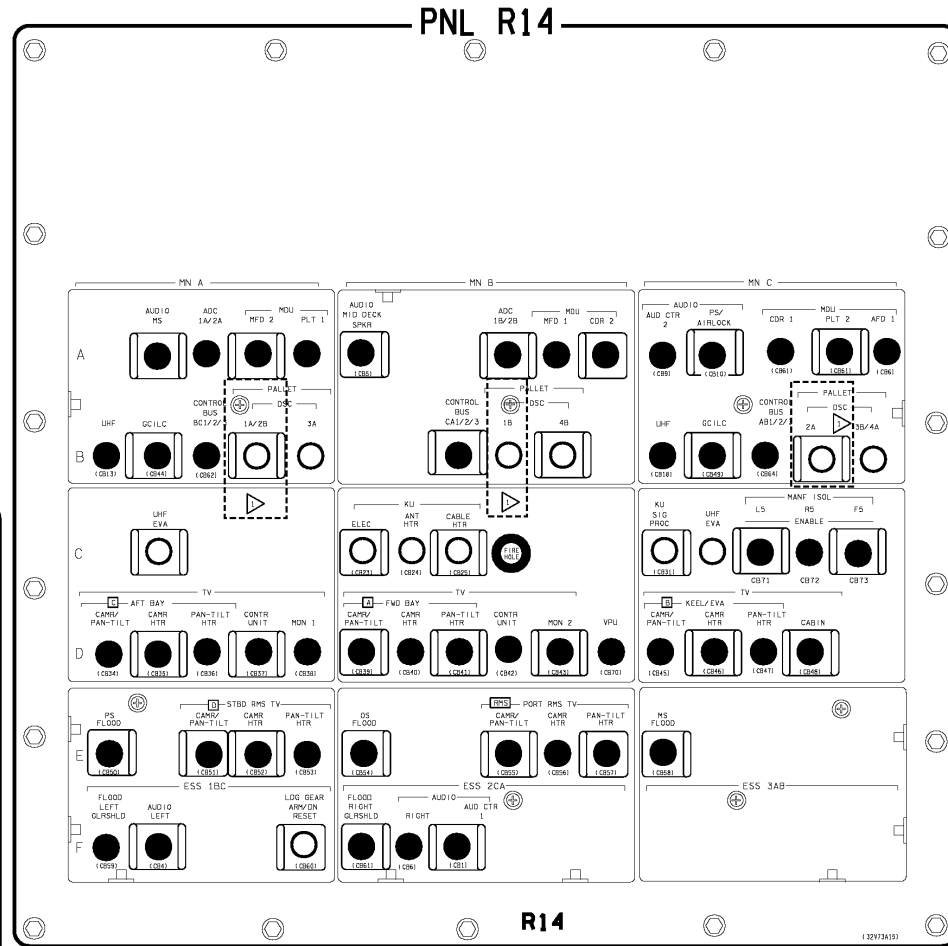
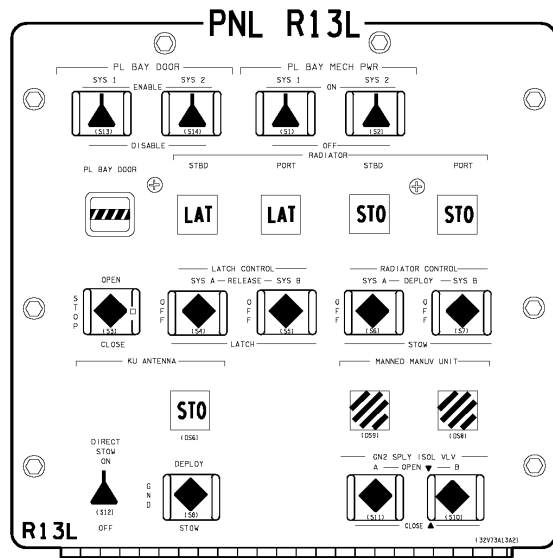

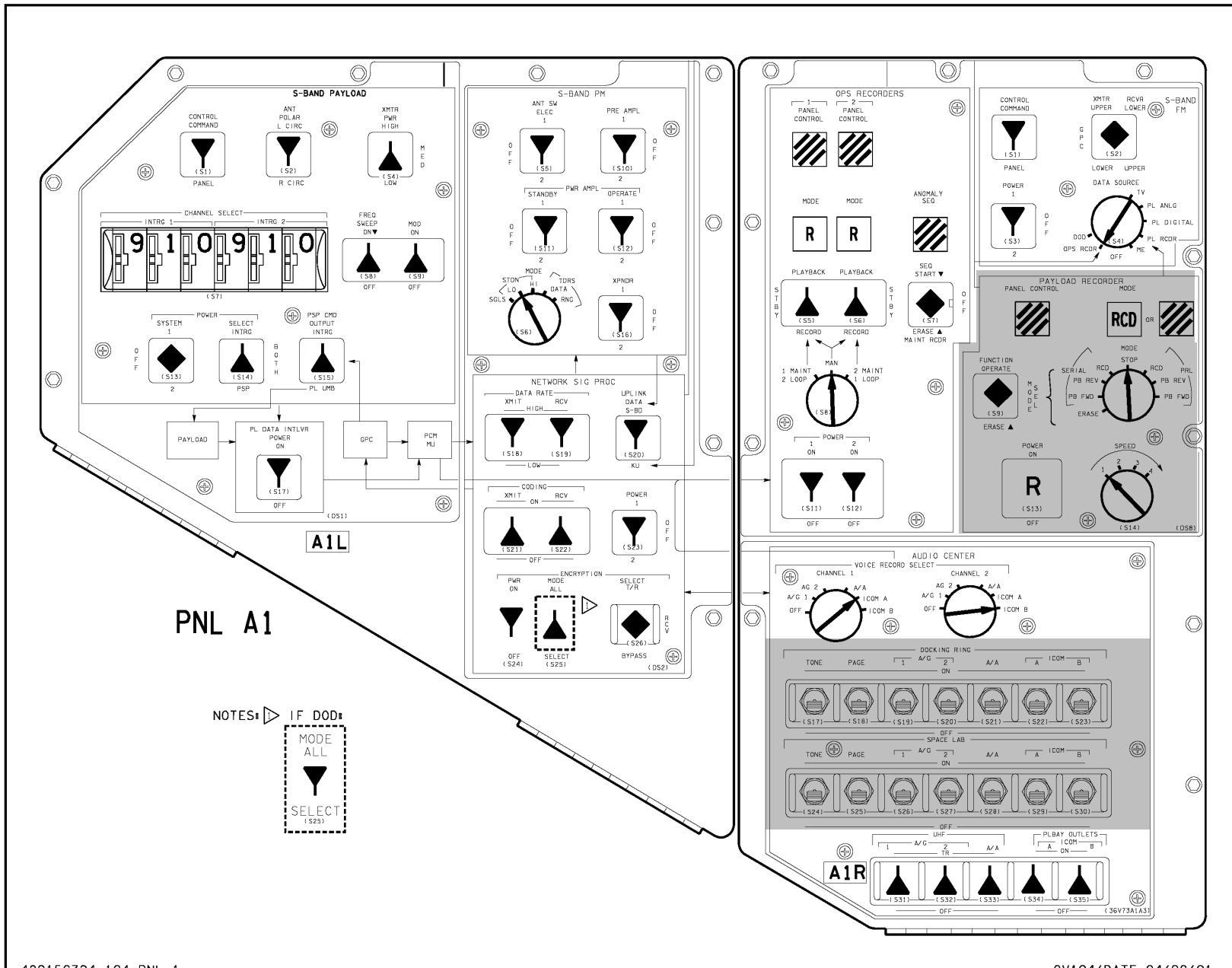

PNL A1

NOTES: IF DOD:
 MODE ALL
 SELECT (S23)

OV104

PNL A7U

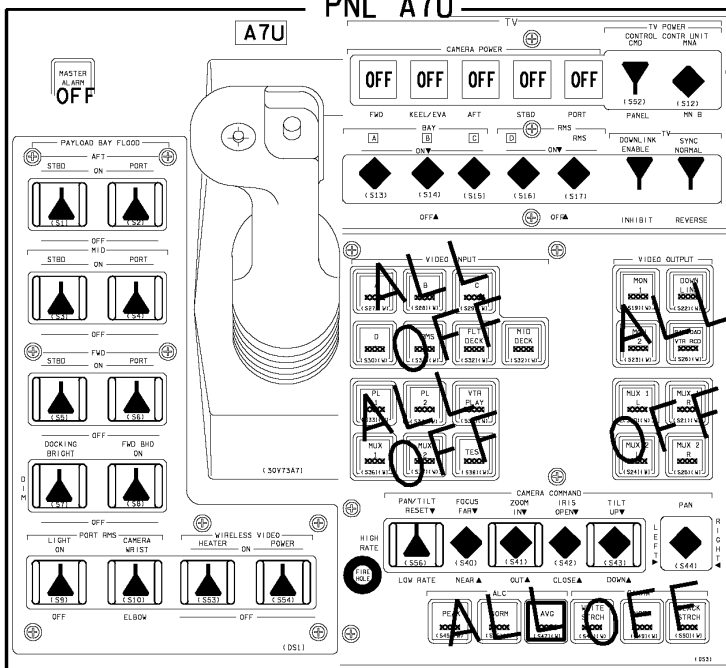

PNL A12

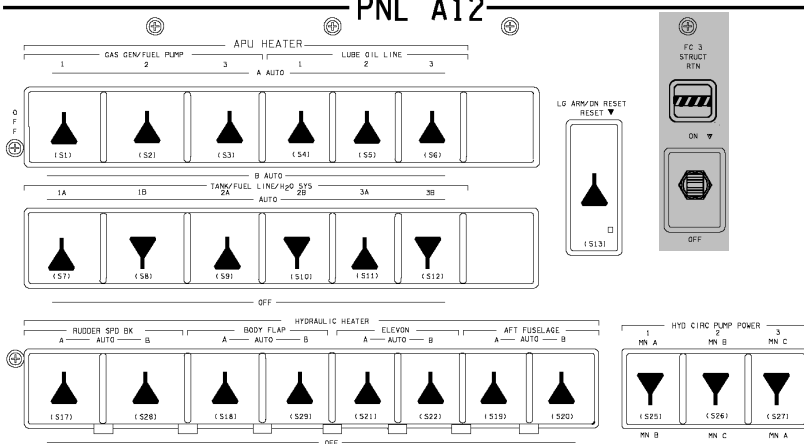

OV104

PNL L9

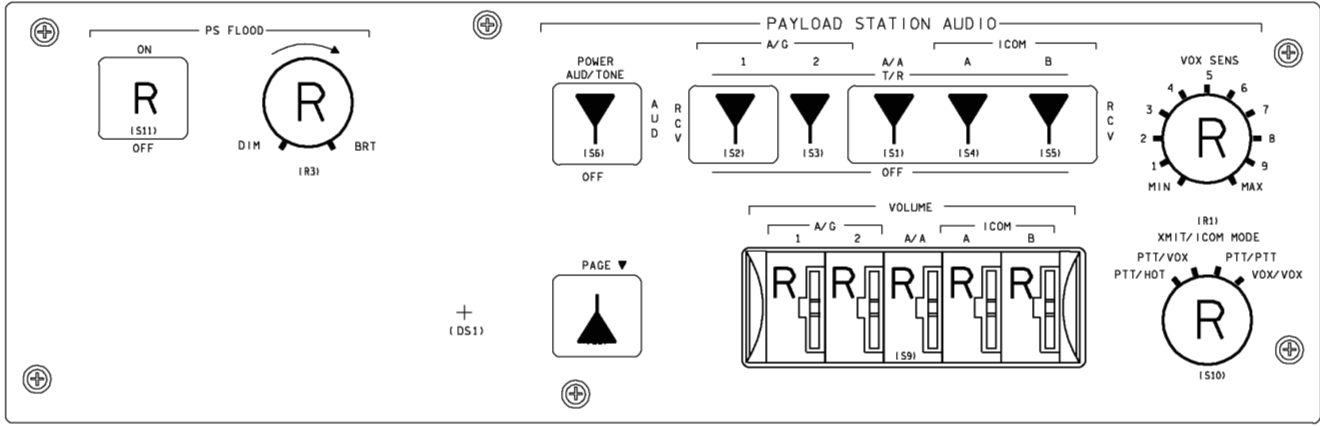

L9

(31V73A9A2)

OV104 |

OV104

PNL A6L

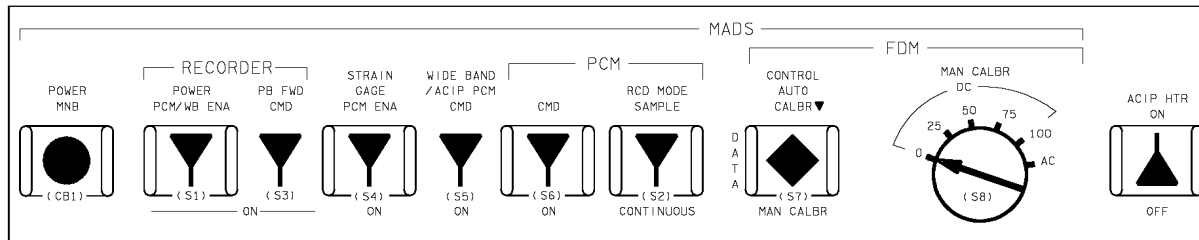
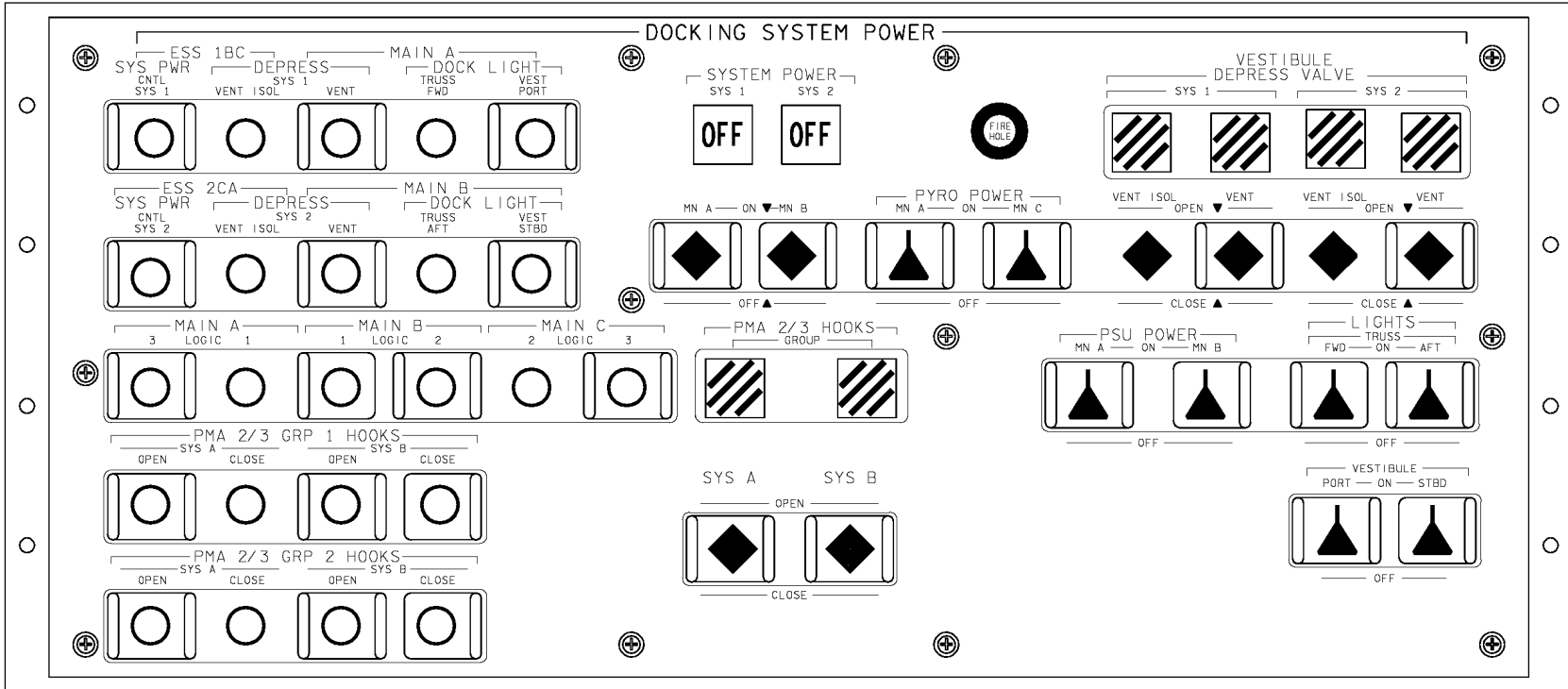

48015C331_104. PNL 1

OV104/DATE 04/10/01

OV104 I

(OV104) C3-27

D/O/4/GEN L,1

OV104

CONTROL PANEL POWER

A ON OFF B ON OFF C ON OFF

HEATERS/DCU POWER

H1 ON OFF H2/DCU ON OFF H3/DCU ON OFF

APDS POWER

A_{Ds} ON OFF B_{Ds} ON OFF C_{Ds} ON OFF

STATUS

POWER	ON	INITIAL	CONTACT
APDS PROTECT	CIRCUIT OFF	CAPTURE	CAPTURE
RING	ALIGNED	RING	FORWARD POSITION
RING	INITIAL POSITION	TO HOOK	
FIXERS	OFF	INTER	SEALED
HOOKS 1	OPEN	HOOKS 1	CLOSED
HOOKS 2	OPEN	HOOKS 2	CLOSED
LATCHES	CLOSED	LATCHES	OPEN
UNDOCK	COMPLET	RING	FINAL POSITION

PYROS

A_p ON OFF B_p ON OFF C_p ON OFF

A_p OFF C_p



PYRO LIGHT OFF

PYRO COMMANDS

PYRO CIRC PROT OFF PYRO CIRC PROT ON

ACT HOOKS FIRING PAS HOOKS FIRING

APDS CONTROL COMMANDS

OPEN HOOKS OPEN LATCHES

UNDOCKING

A_{Ds} OFF B_{Ds} C_{Ds}

LAMP TEST

PNL A7L

APDS CONTROL COMMANDS

POWER ON	POWER OFF	RING OUT	RING IN
----------	-----------	----------	---------

APDS CIRC PROT OFF	CLOSE HOOKS	CLOSE LATCHES	FIXER OFF
--------------------	-------------	---------------	-----------

APDS CONTROL PANEL

OV104 |

OV104

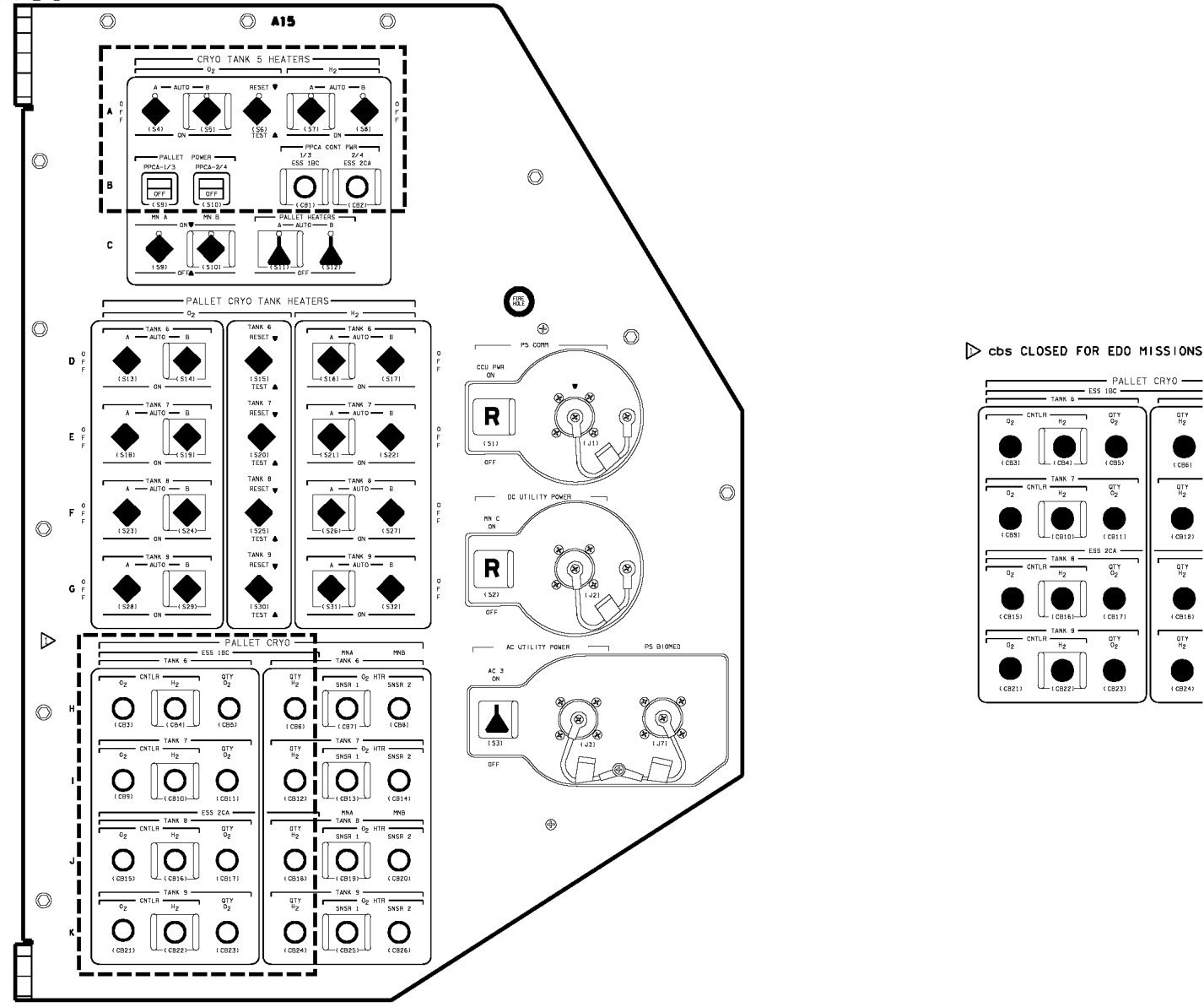

▶ cbs CLOSED FOR EDO MISSIONS

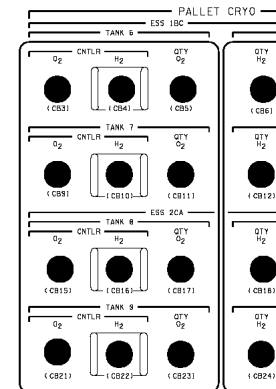

OV104

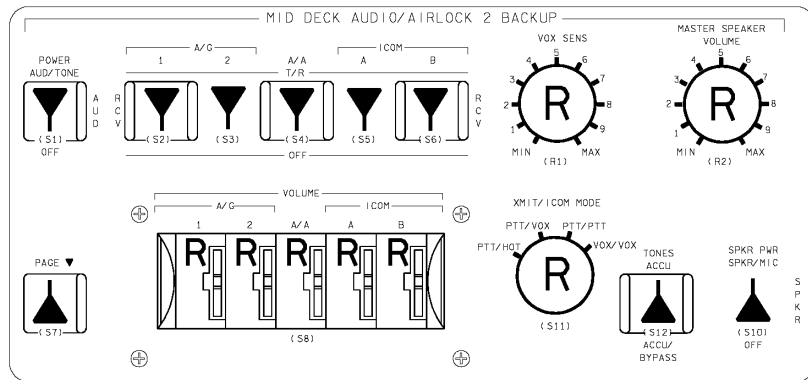

PNL M042F

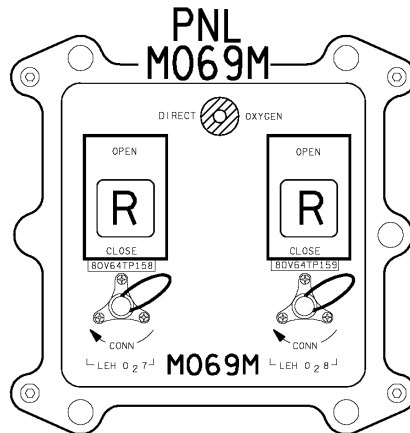
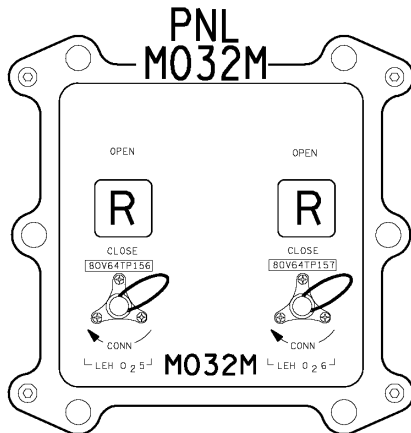
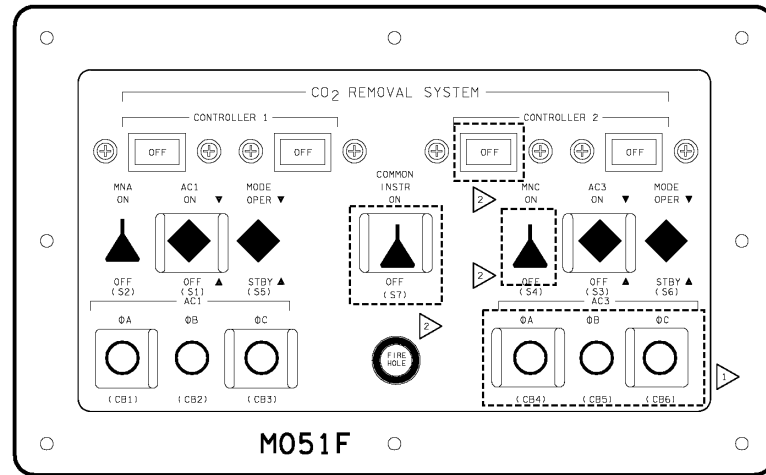
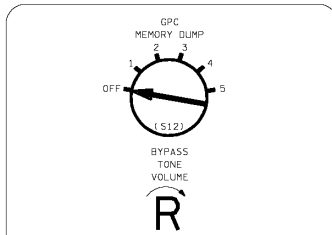

NOTES: ▷ CLOSED IF CO2 RMVL SYS FLOWN
▷ ON IF CO2 RMVL SYS FLOWN

OV104

PNL MA73C

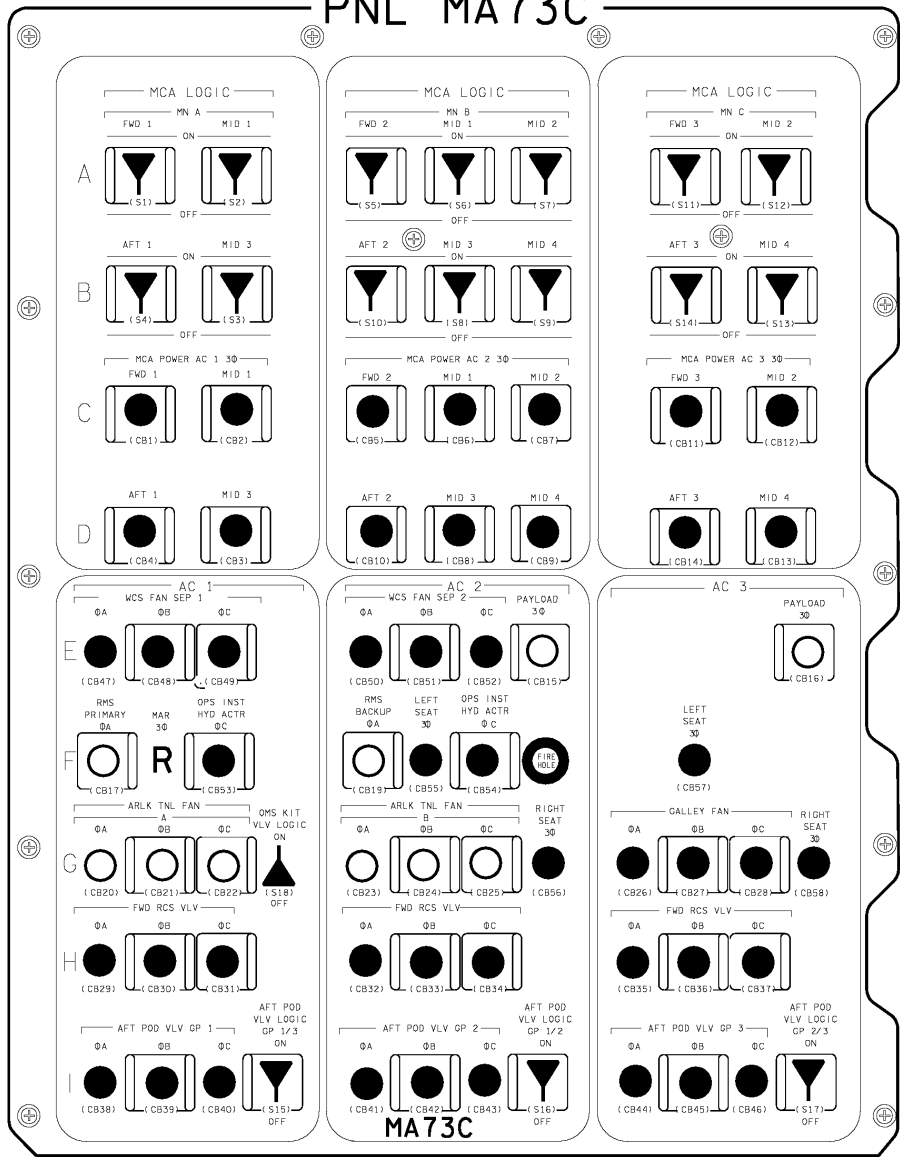

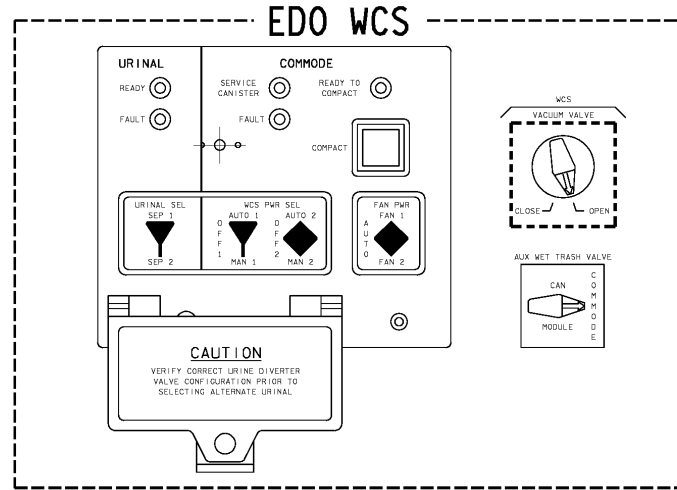
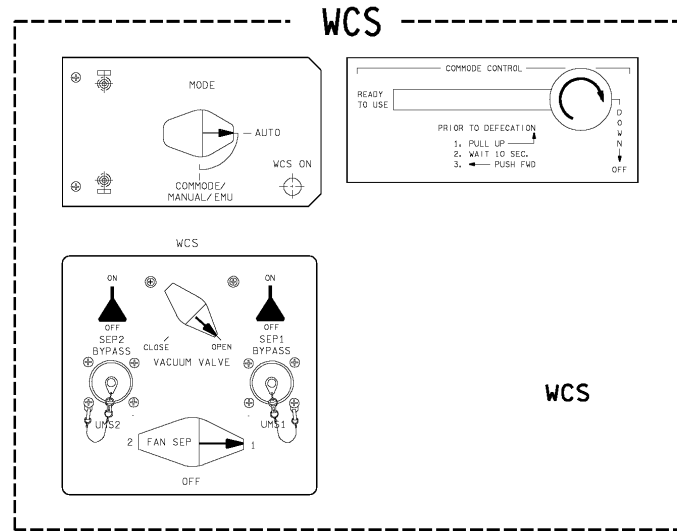
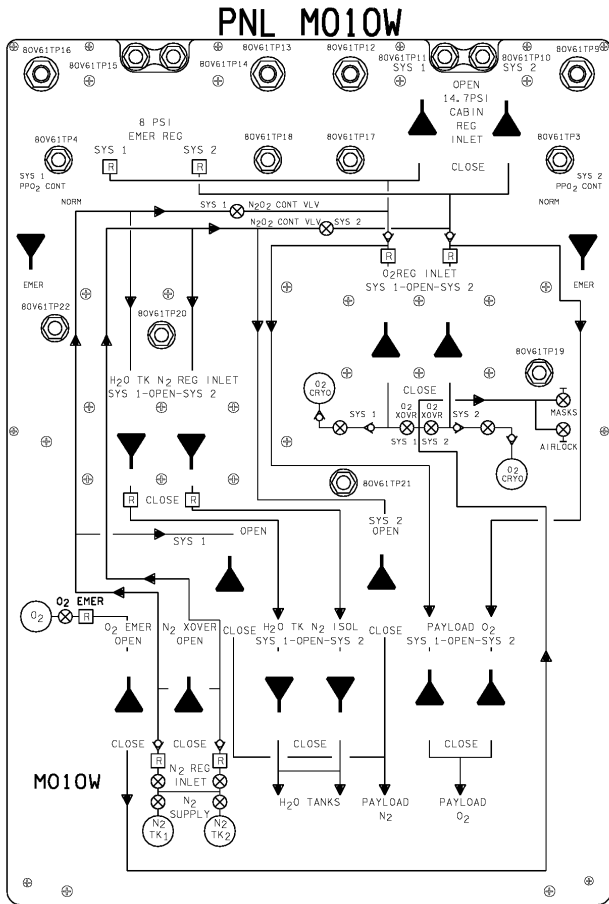

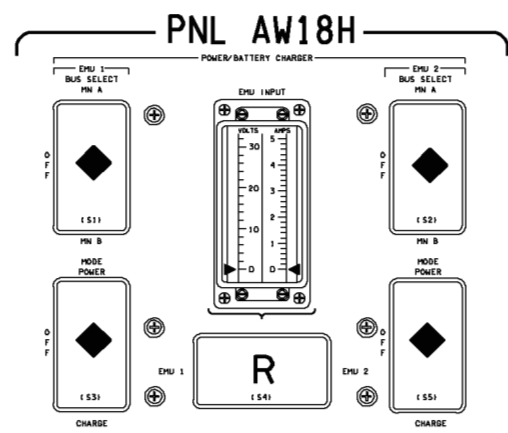
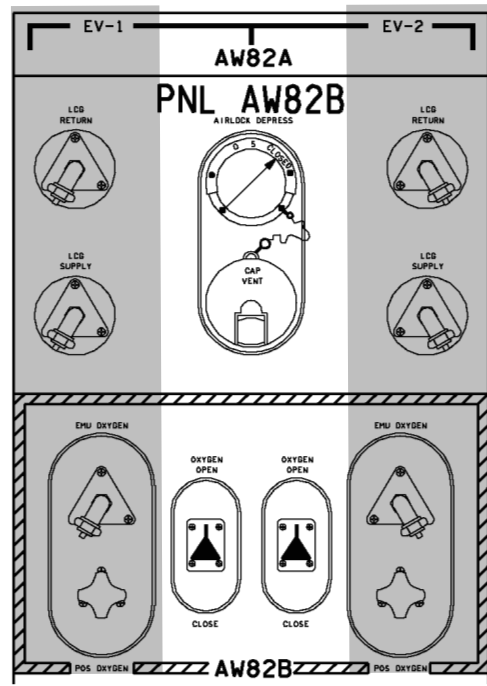
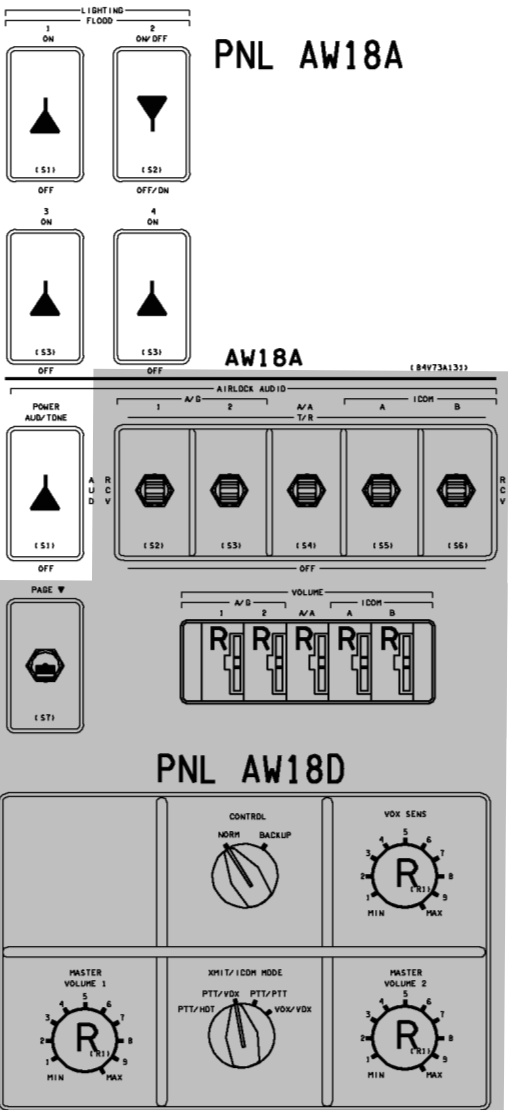

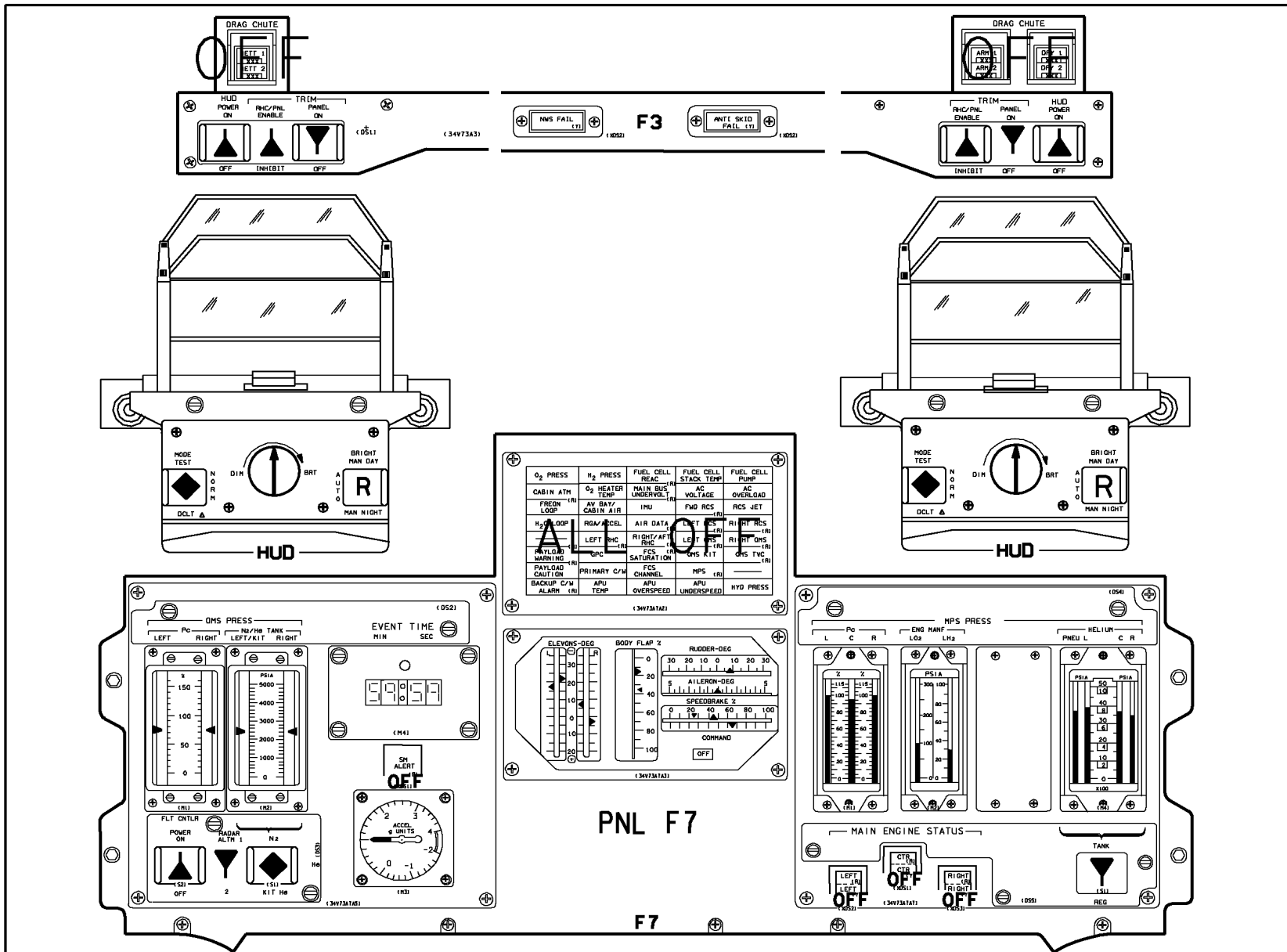

101. PNL 3

ALL VEH/DATE 09/29/94

(OV105) D3-4

OV105

D/O/5/GEN L

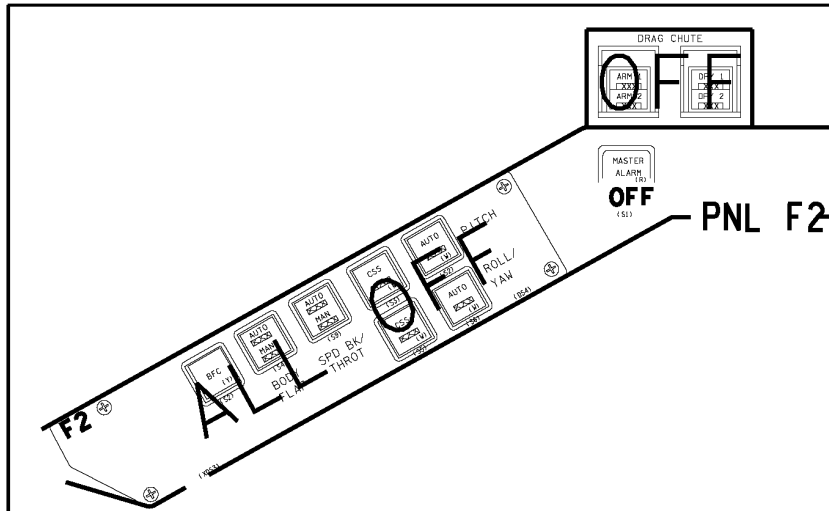

PNL 013

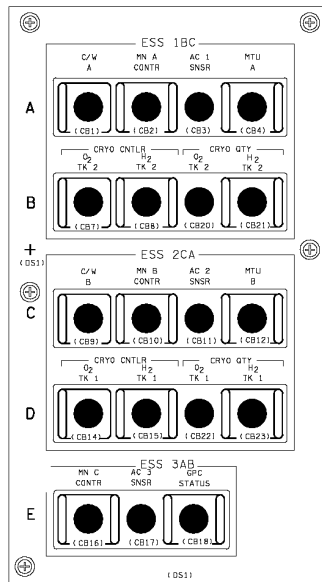

L side OVHD flood - R (MID)

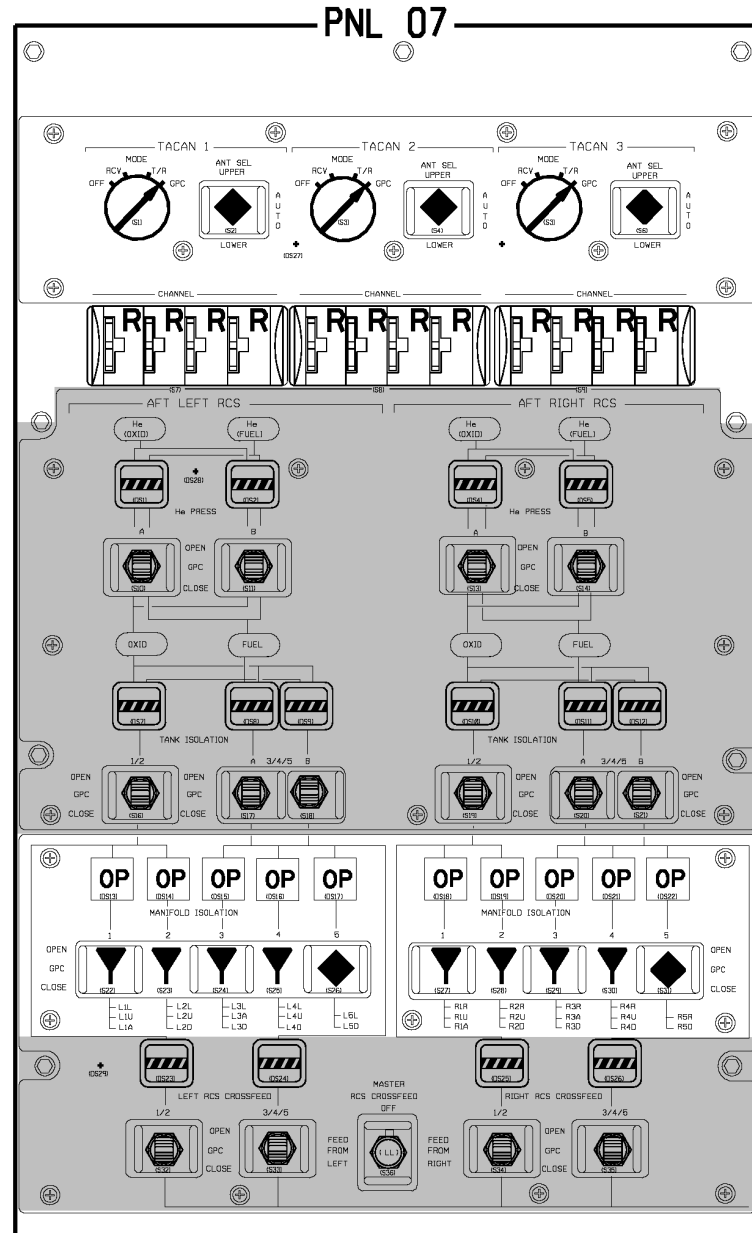

OV105

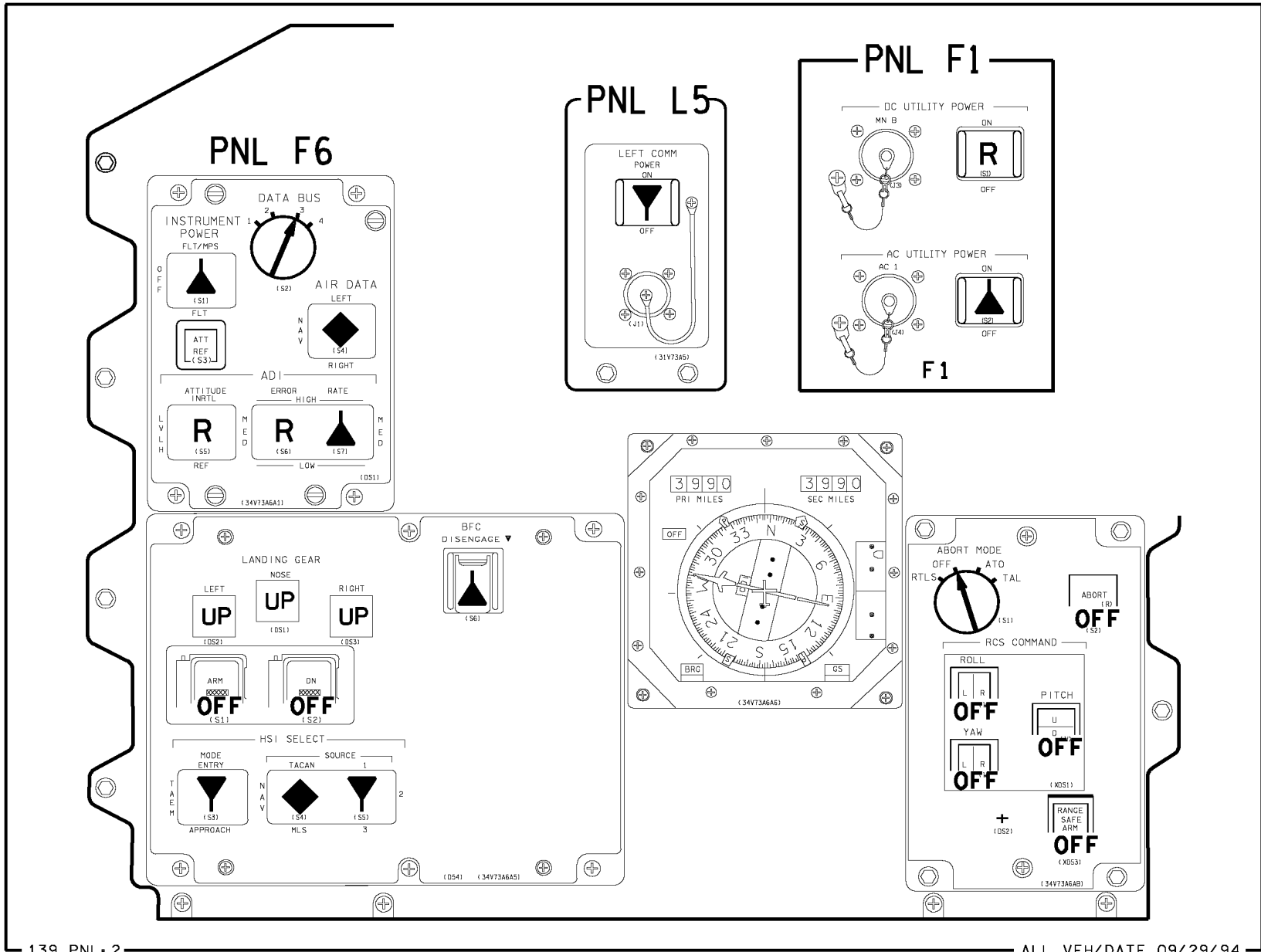

139. PNLs 2

ALL VEH/DATE 09/29/94

OV105

(OV105) D3-6

D/O/5/GEN L

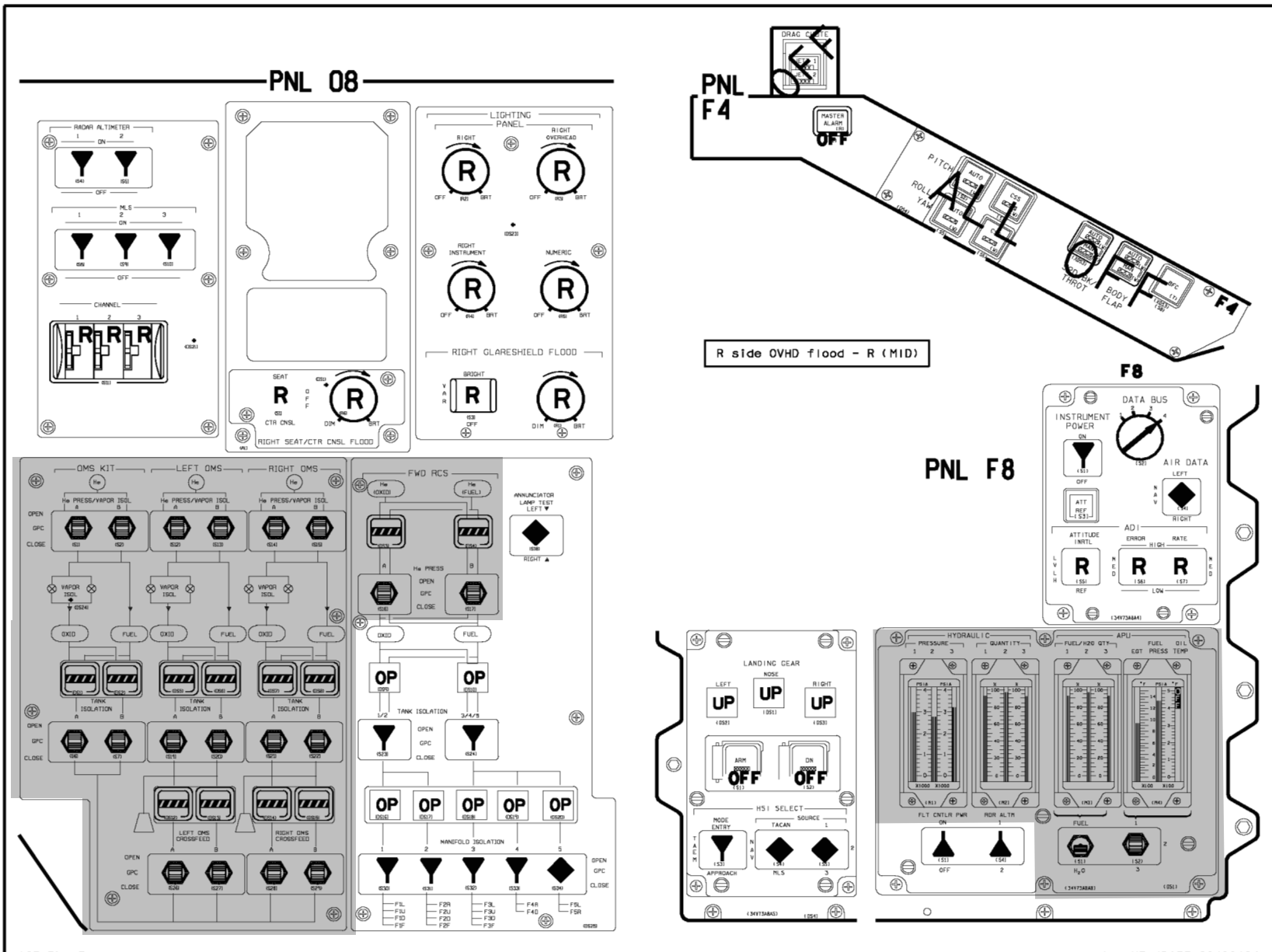

103. PNL 3

ALL VEH/DATE 09/29/94

(OV105) D3-7

OV105

D/O/5/GEN L

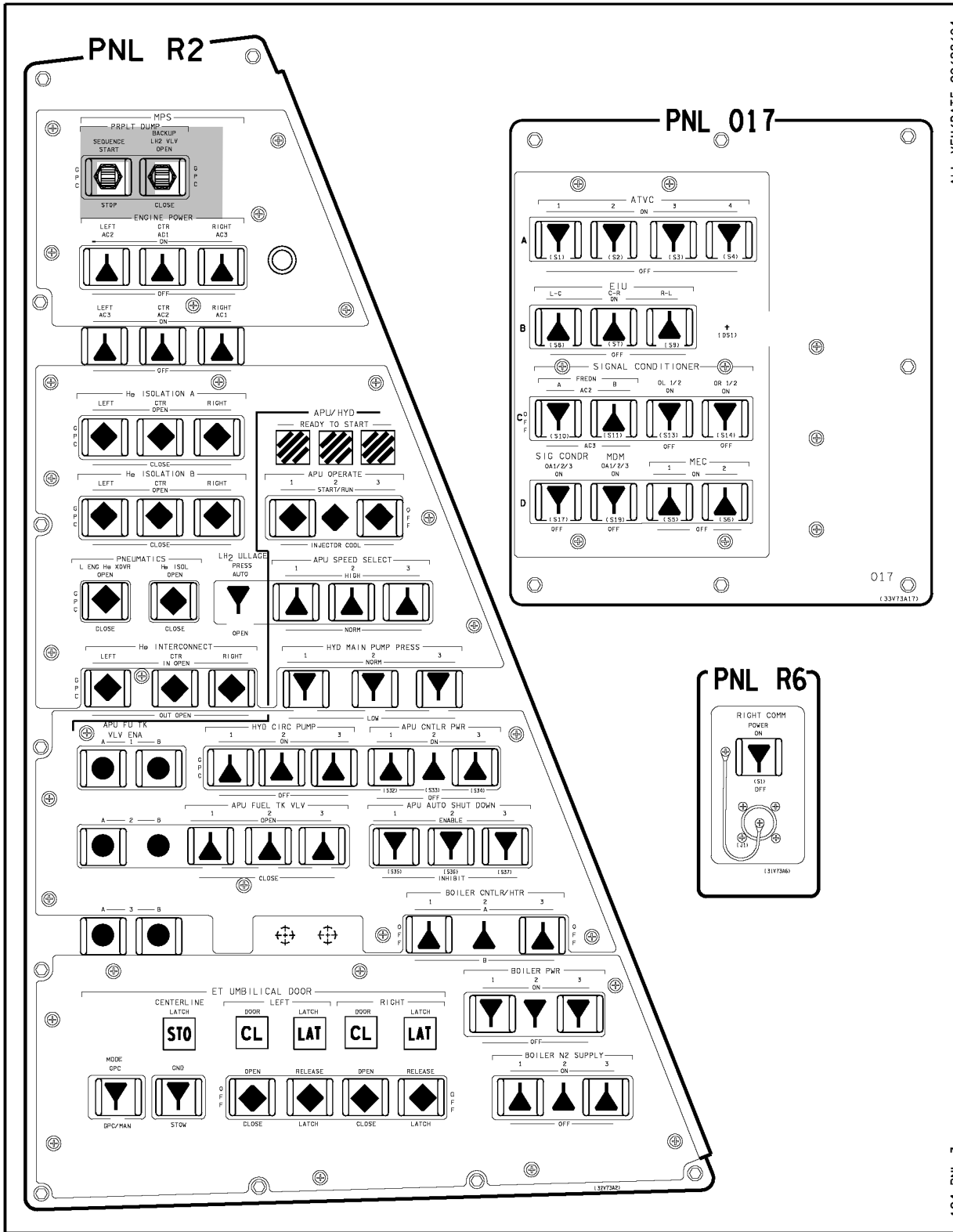

ALL VEH/DATE 09/29/94
104. PNL 3

OV105

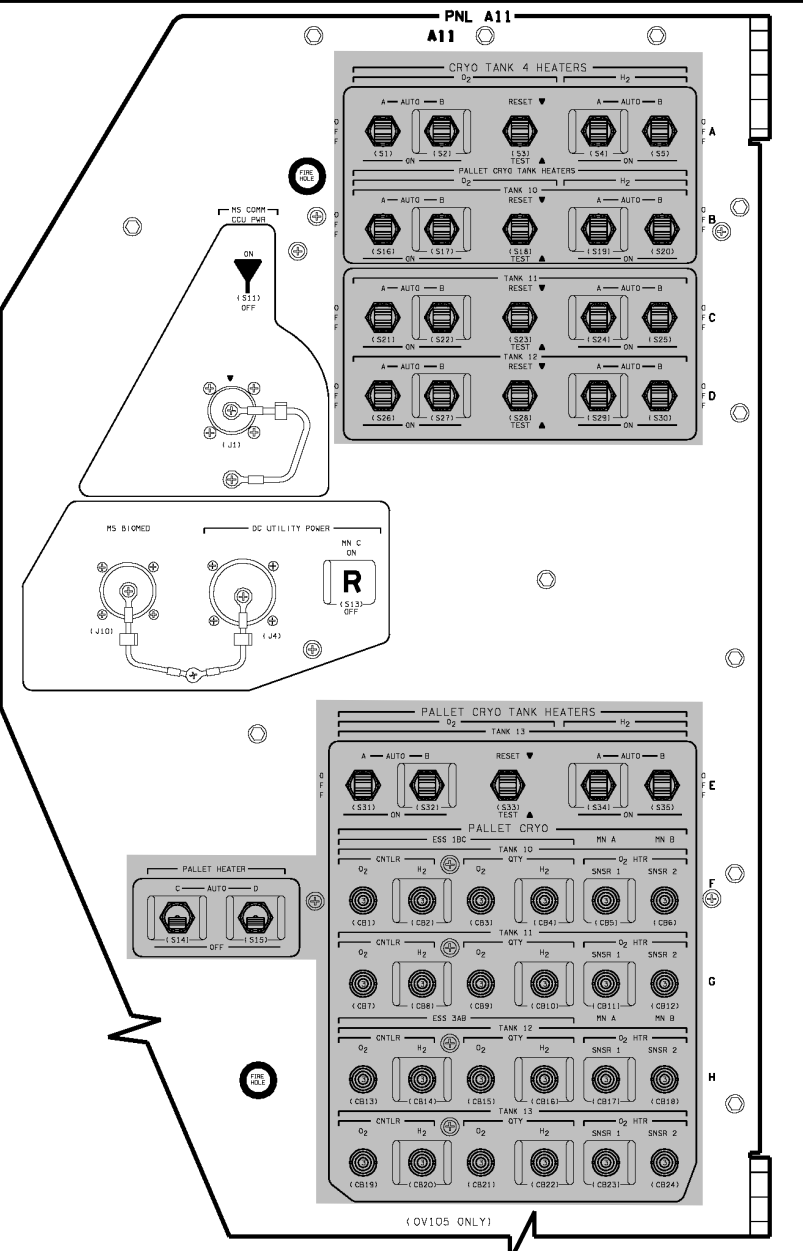
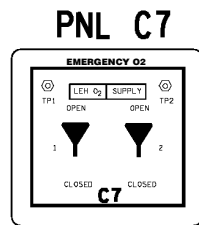
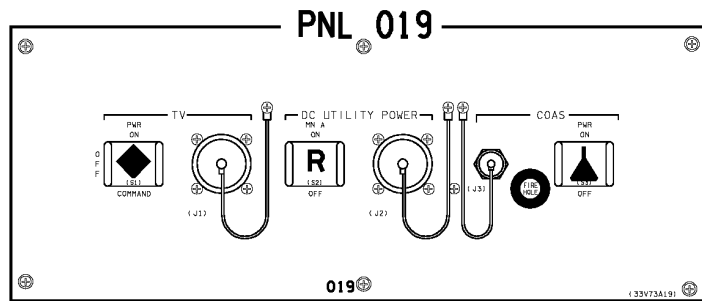

OV105

AIRLOCK HATCH
 ACTUATOR HANDLE - LATCHED
 LOCK LEVER - LOCKED
 EQUALIZATION VLV (TWO) - NORM
 -CAPS INSTALLED

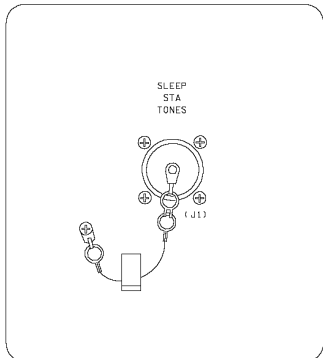

PNL M058F

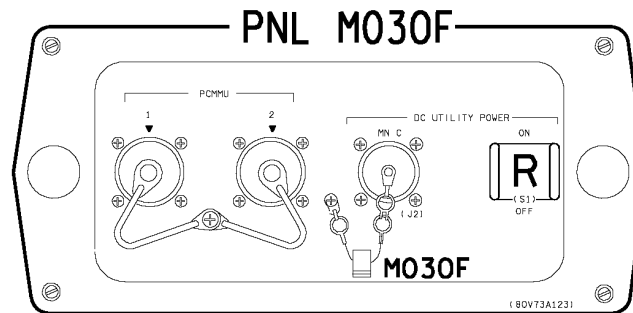
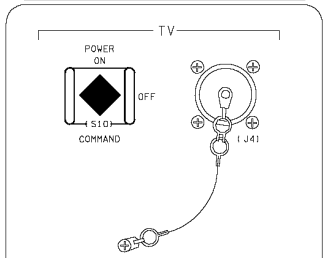

PNL M052J

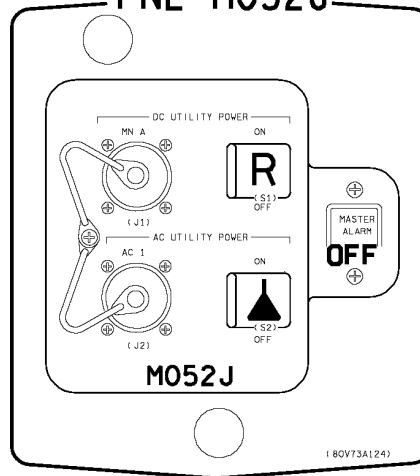

PNL M039M

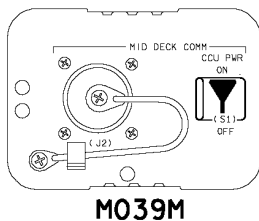

PNL MD24K

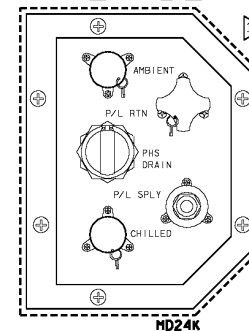

NOTE: NOT VISIBLE IF MAR FLOWN

PNL MD44F

CAB TEMP CNTL ACT LINKAGE - SECONDARY ACTUATOR

OV105

PNL ML86B

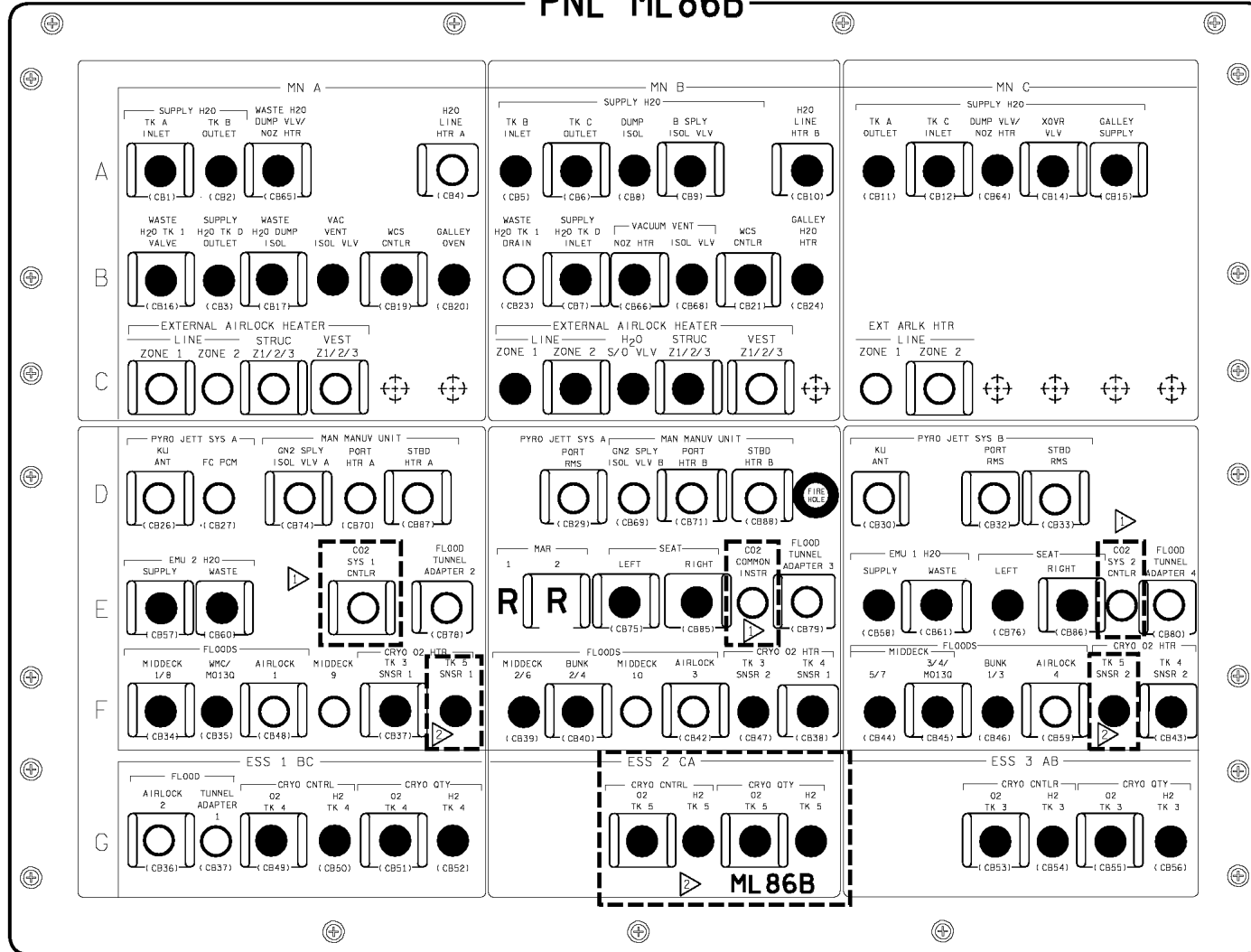

NOTES: ▷ CLOSED IF CO2 RMVL SYS FLOWN

▷ OPEN IF TK 5 NOT FLOWN

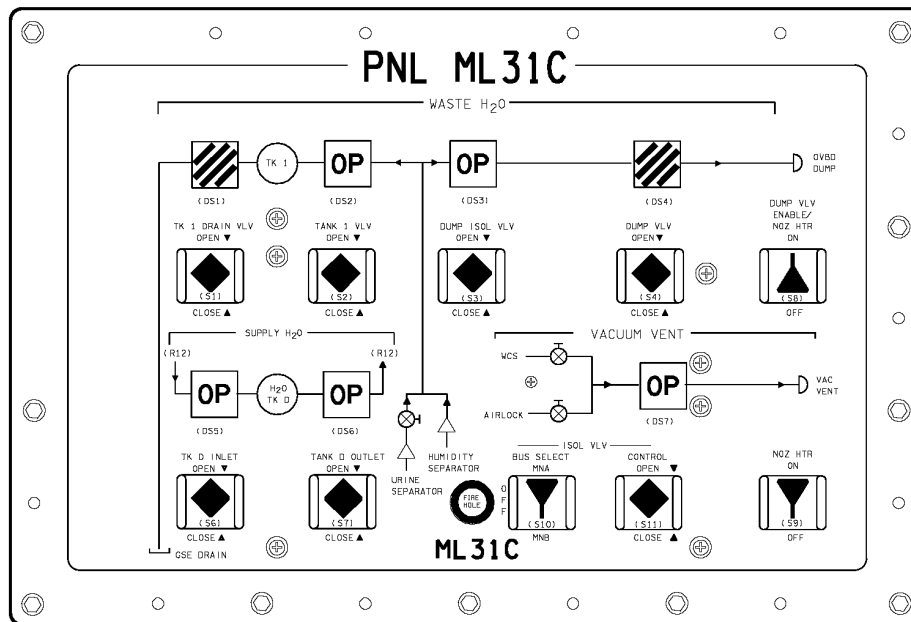
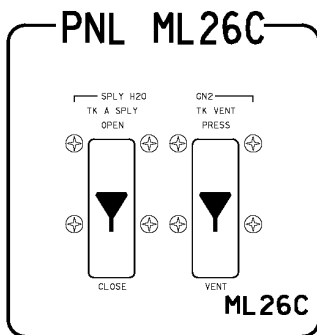
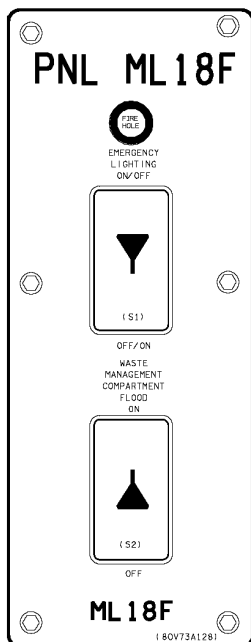
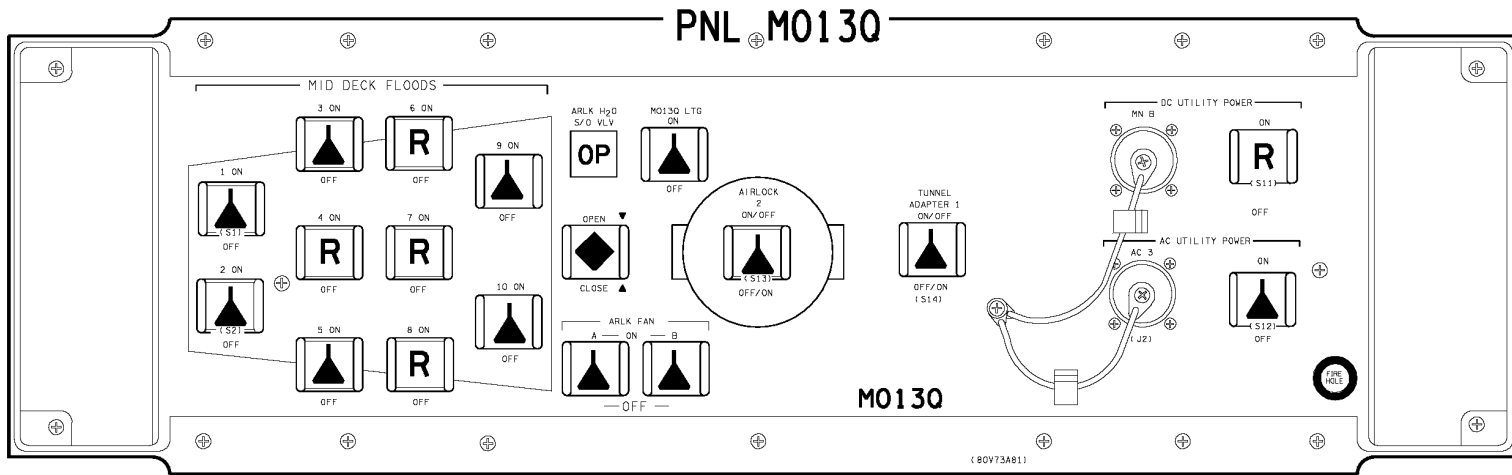

OV105

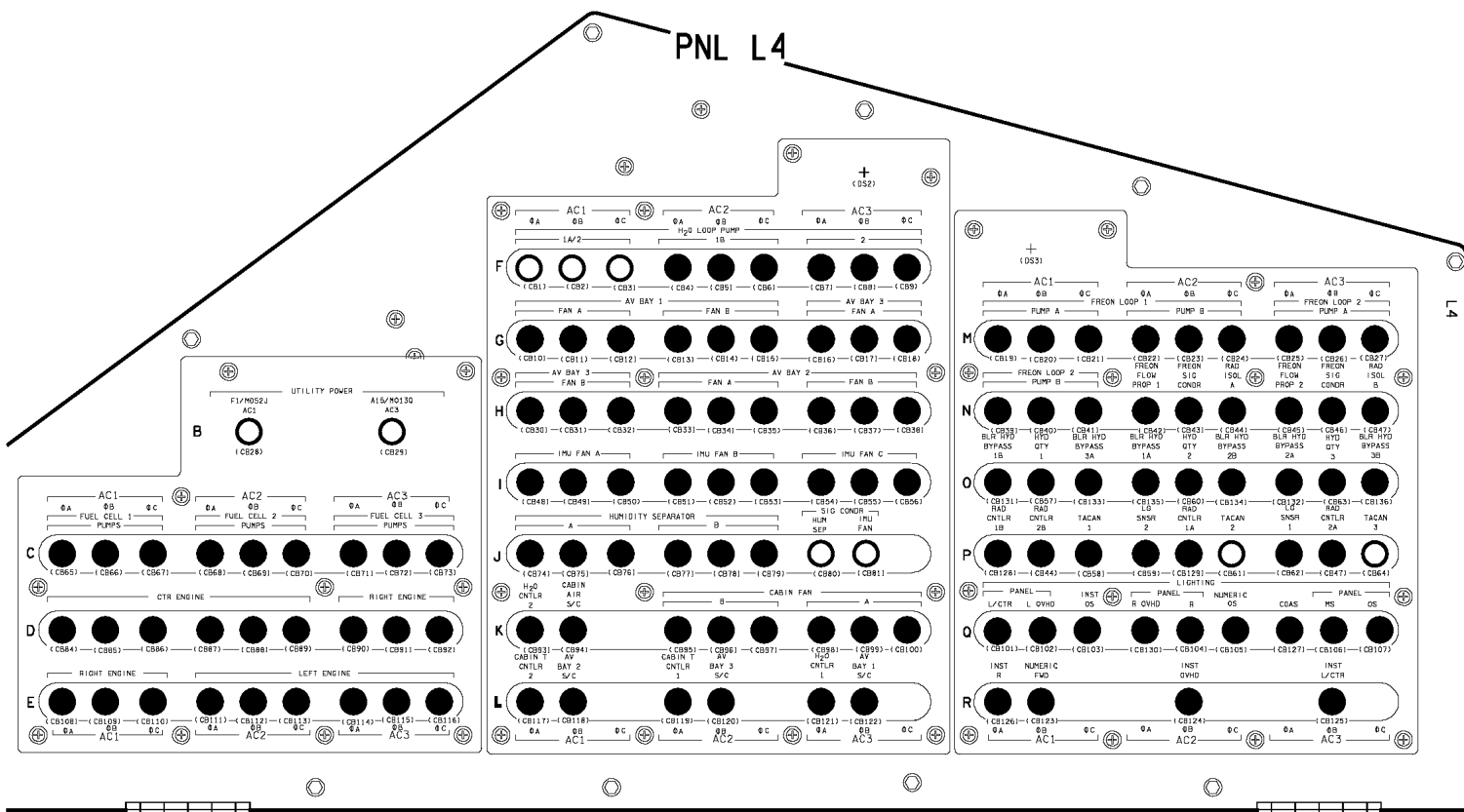

PNL L4

L4

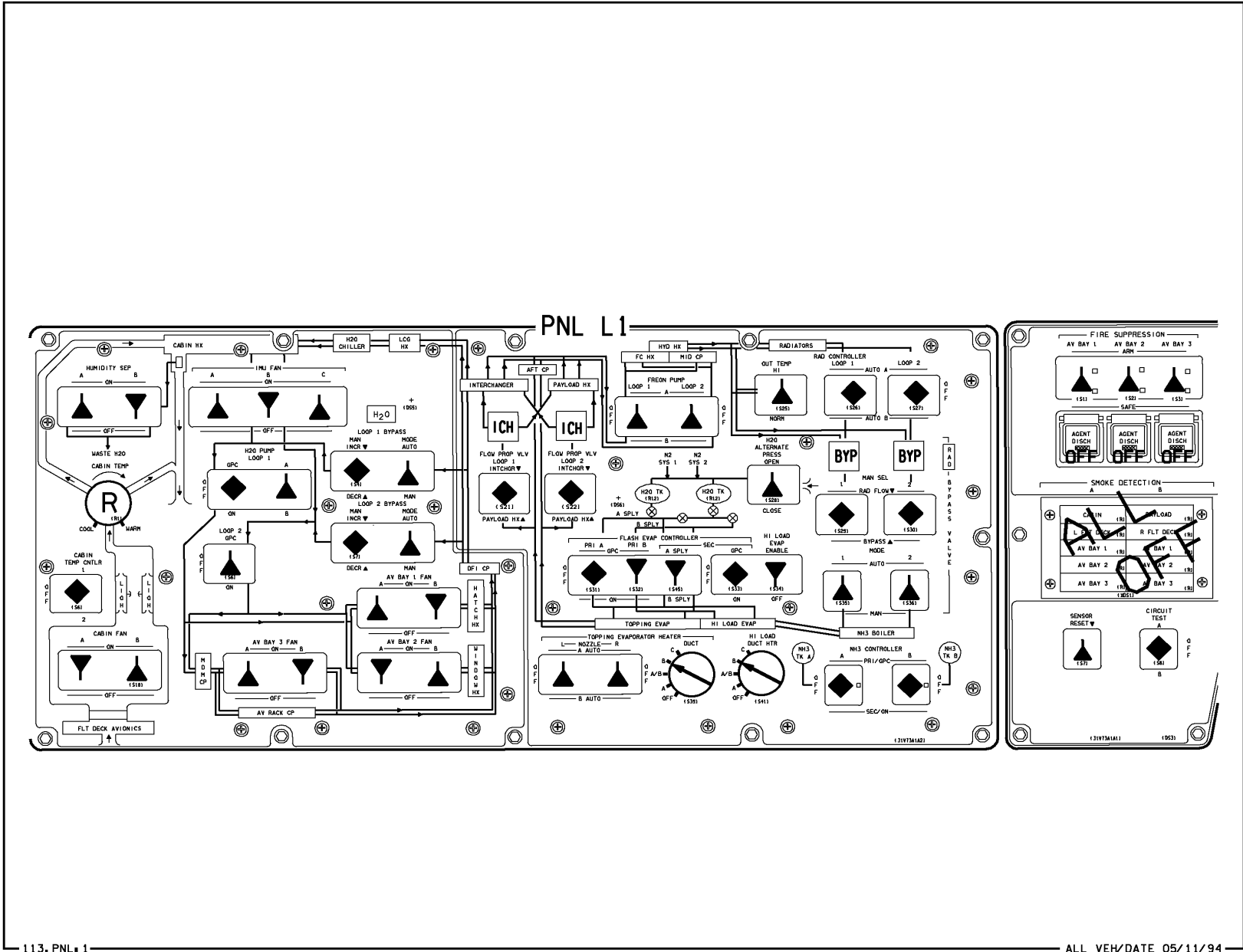

113. PNL L1

ALL VEH/DATE 05/11/94

OV105

(OV105) D3-14

D/O/ALL/GEN L

OV105

PNL L2

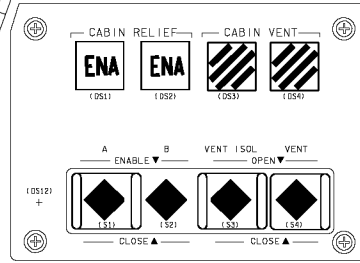

L2

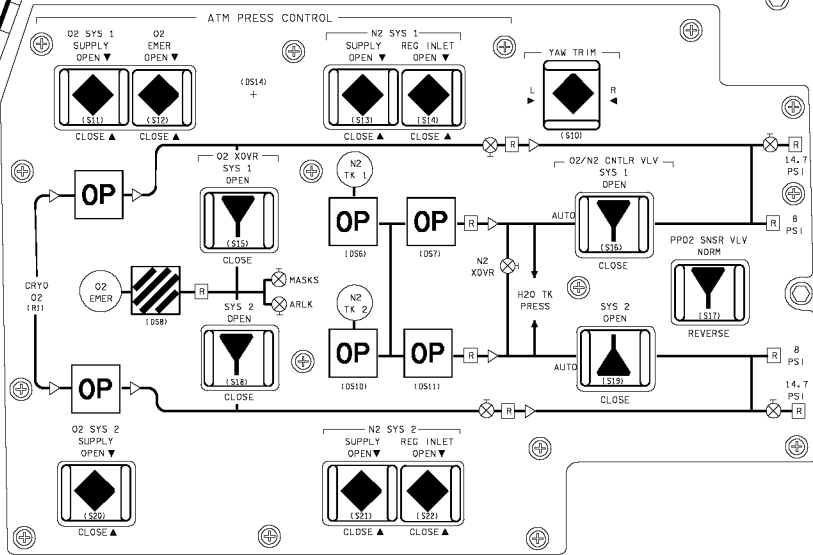
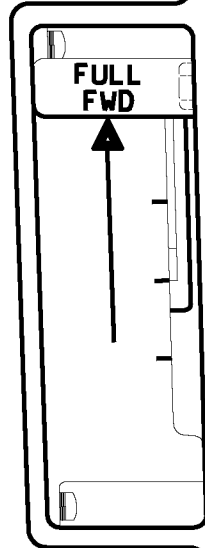
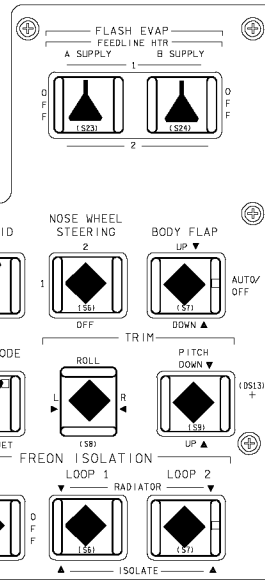

OV105/DATE 10/24/01
48015D315_108_PNL L2

OV105

(OV105) D3-15

D/O/5/GEN L,5

PNL C2/C3

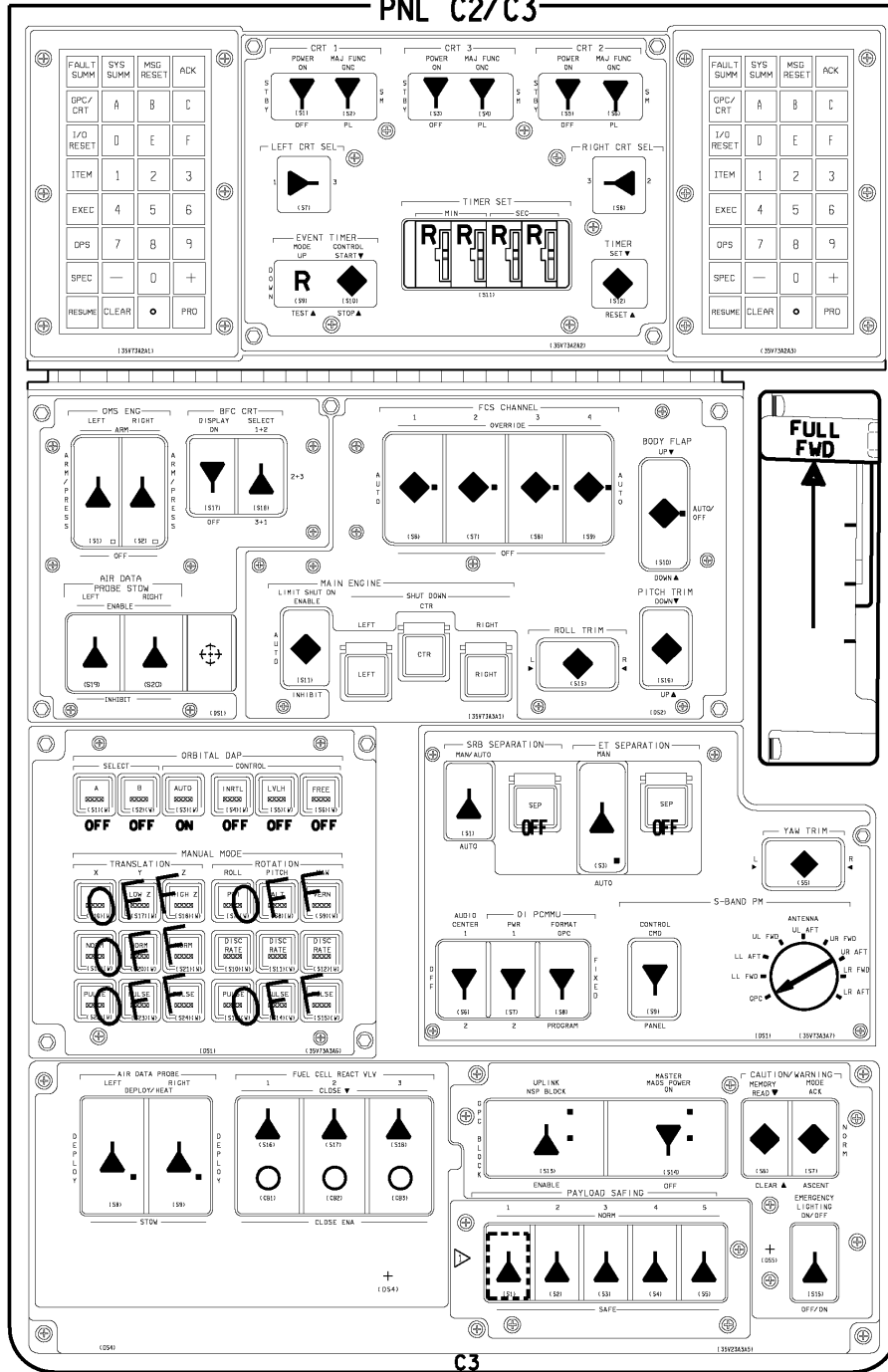

OV105/DATE 03/02/01

48015D316-100, PNL, 1

C3

OV105

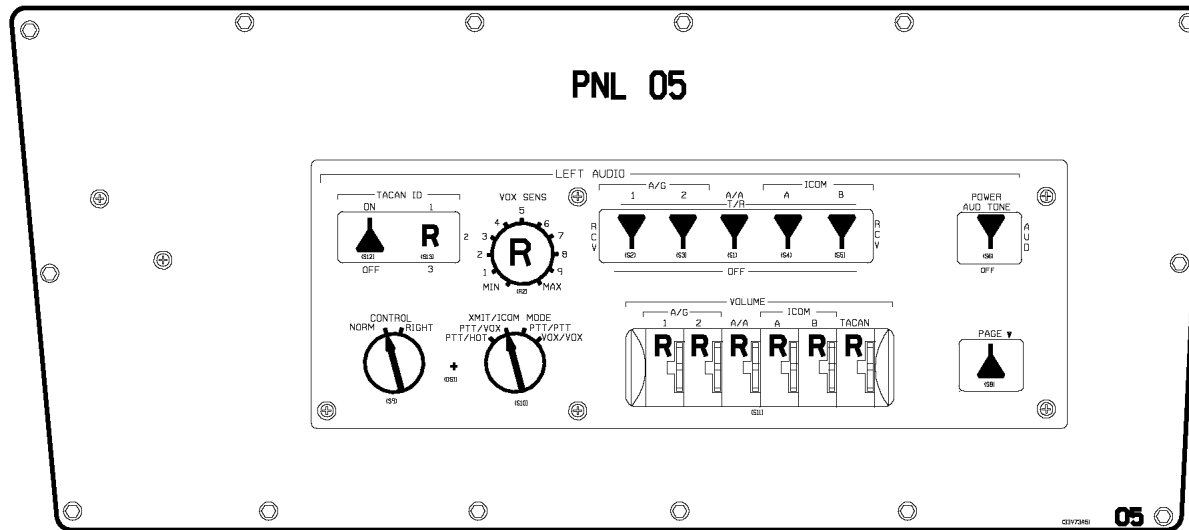
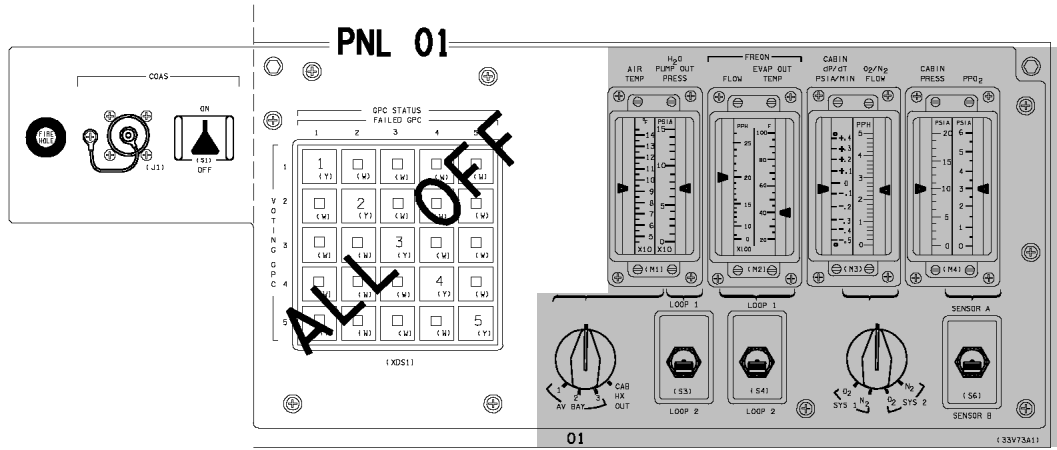

OV105

OV105

PNL 06

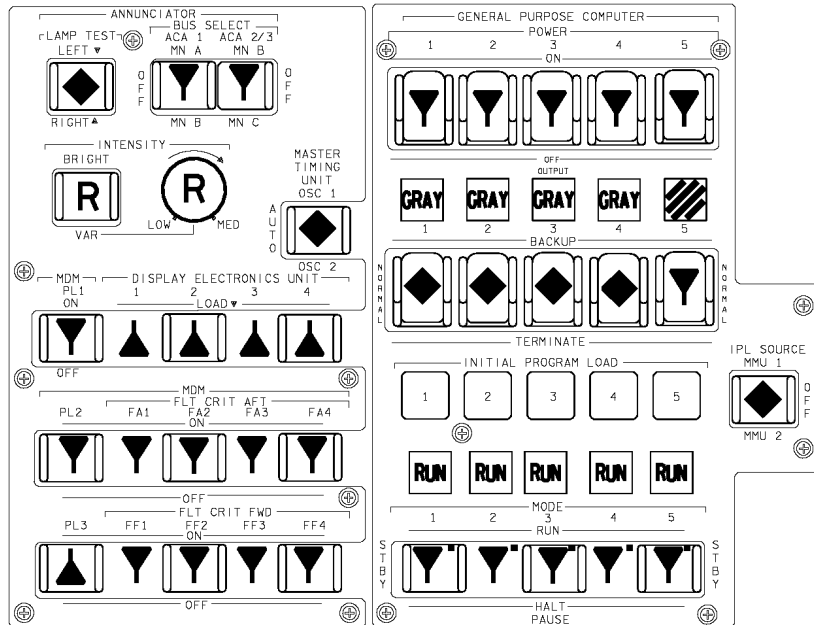
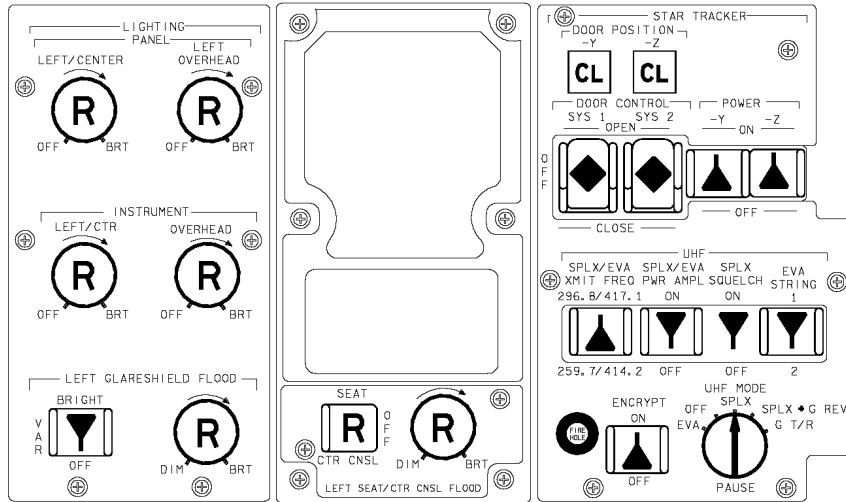

OV105

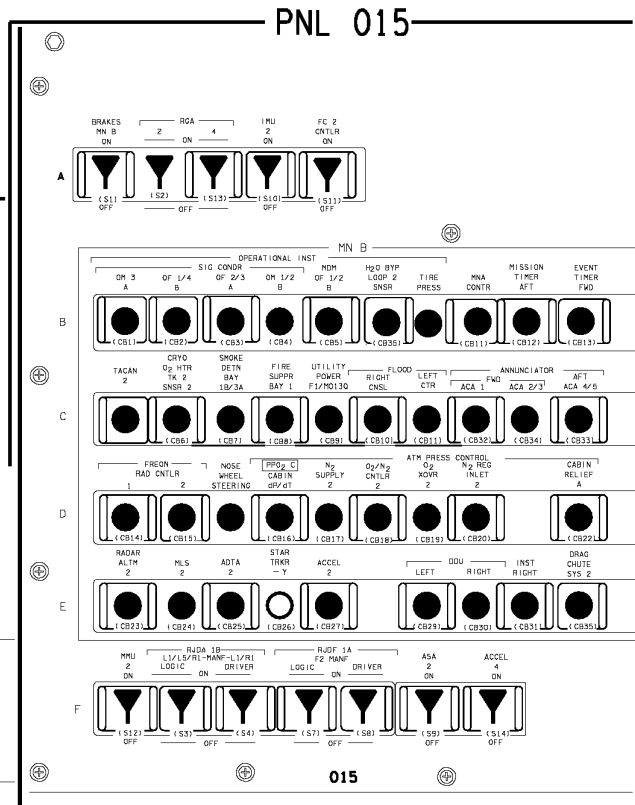
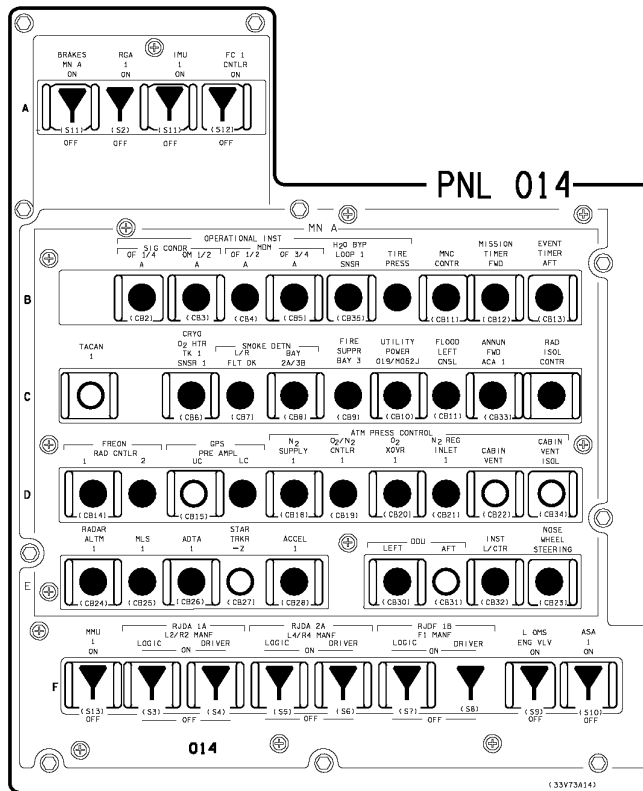

OV105

D/O/5/GEN L

OV105

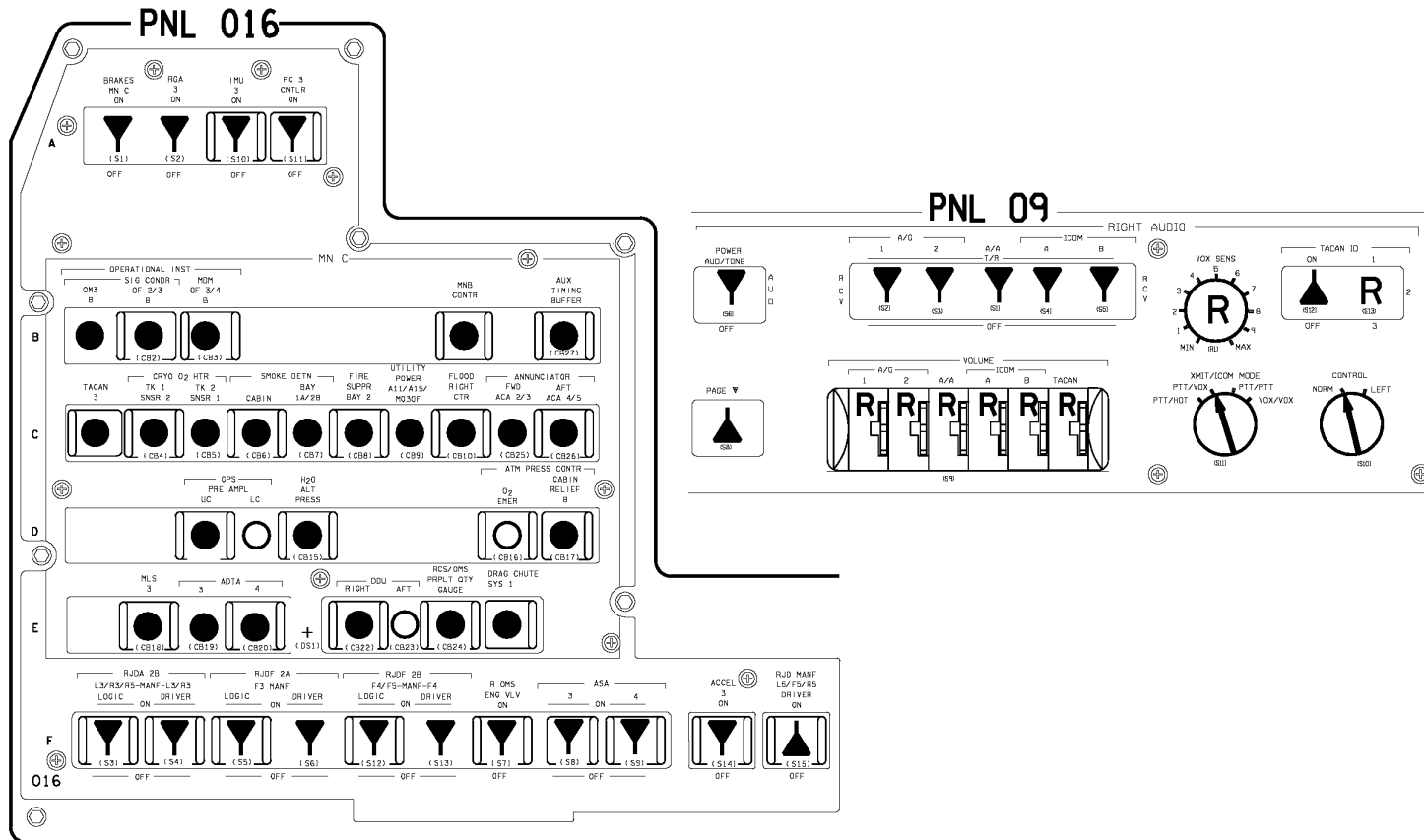

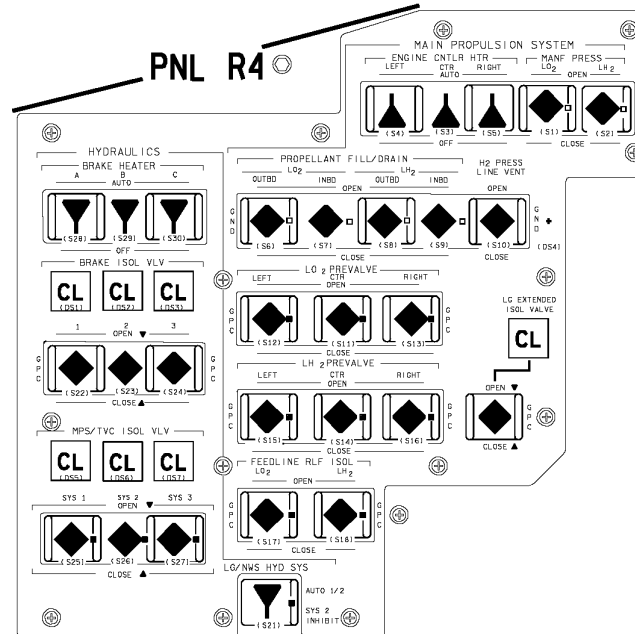
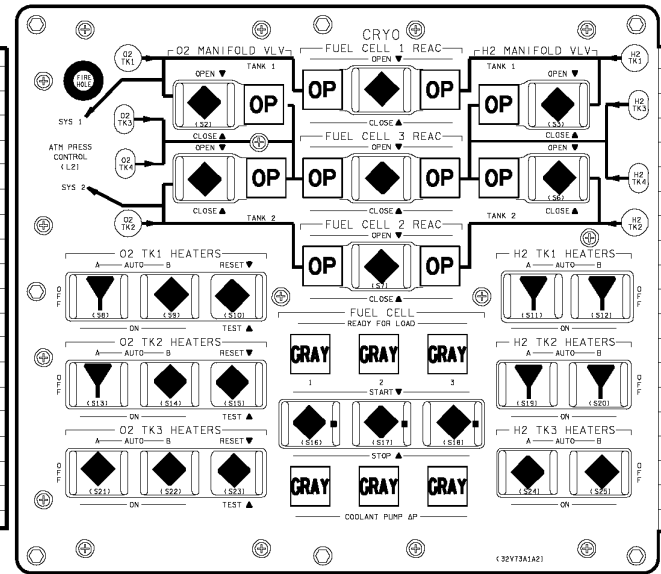
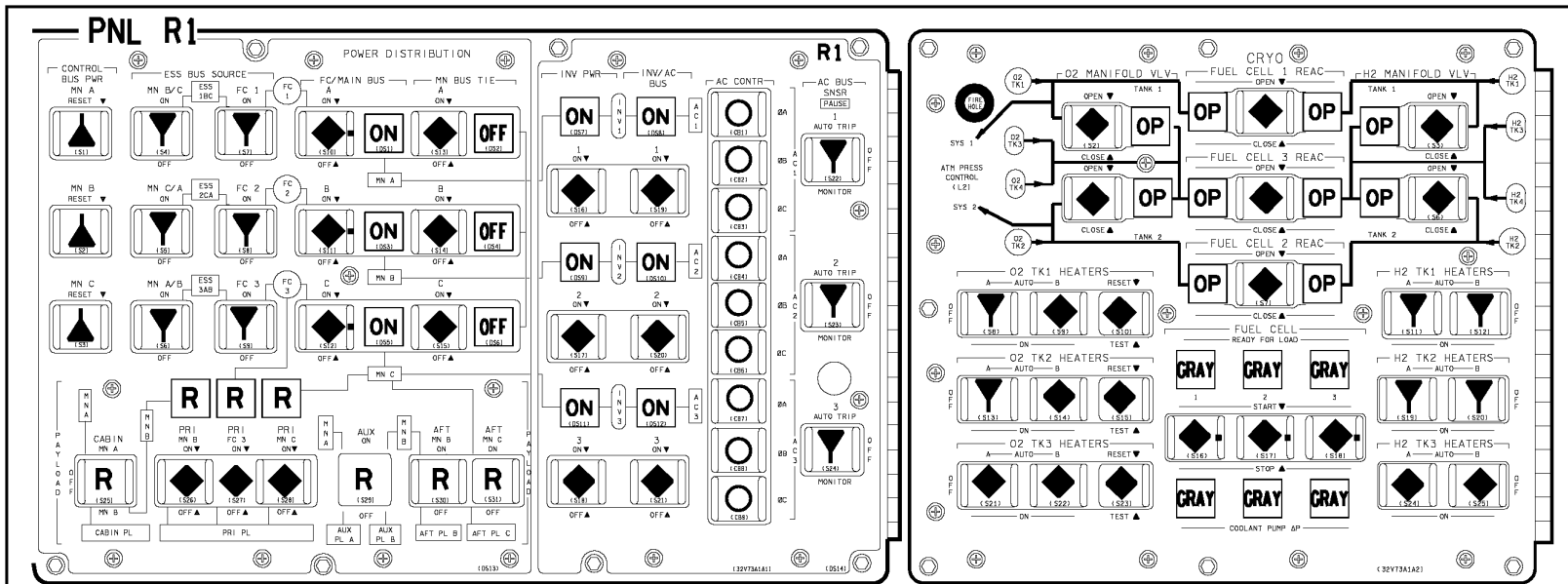

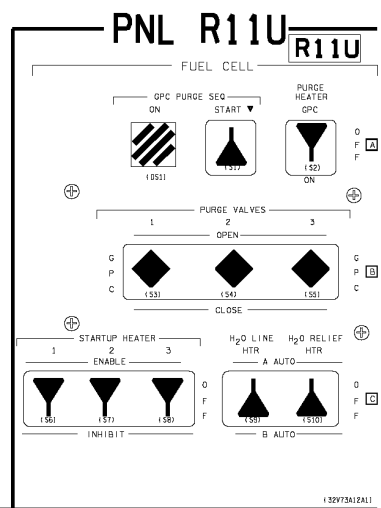
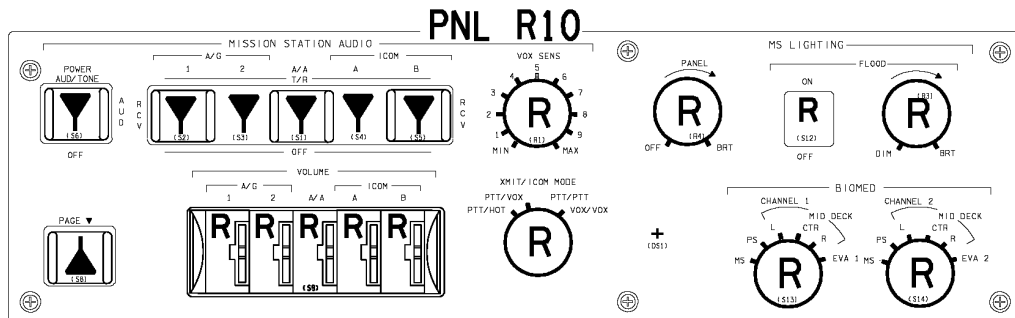

NOTES: ▷ CONFIG FOR NOMINAL D/O PREP
 IF 1 REV WAVE-OFF OR EXTENSION DAY:
 ✓/SPLY H2O TKC INLET - CTR (tb-OP)
 ✓/OUTLET - CTR (tb-OP)

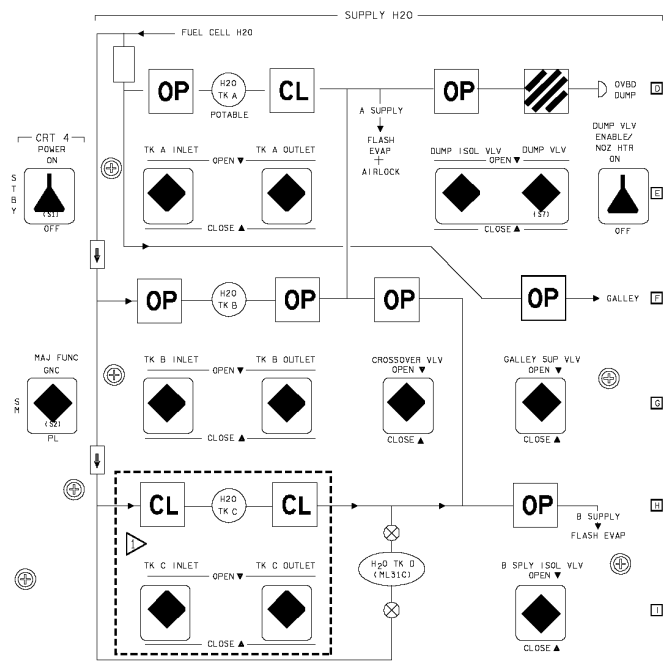
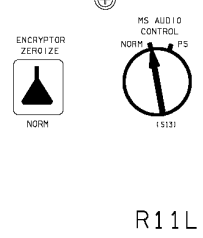
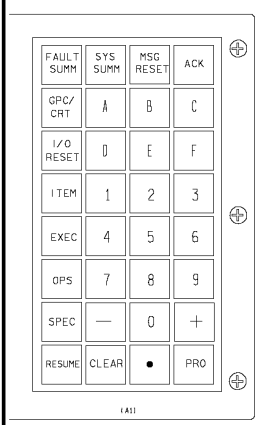

OV105

OV105

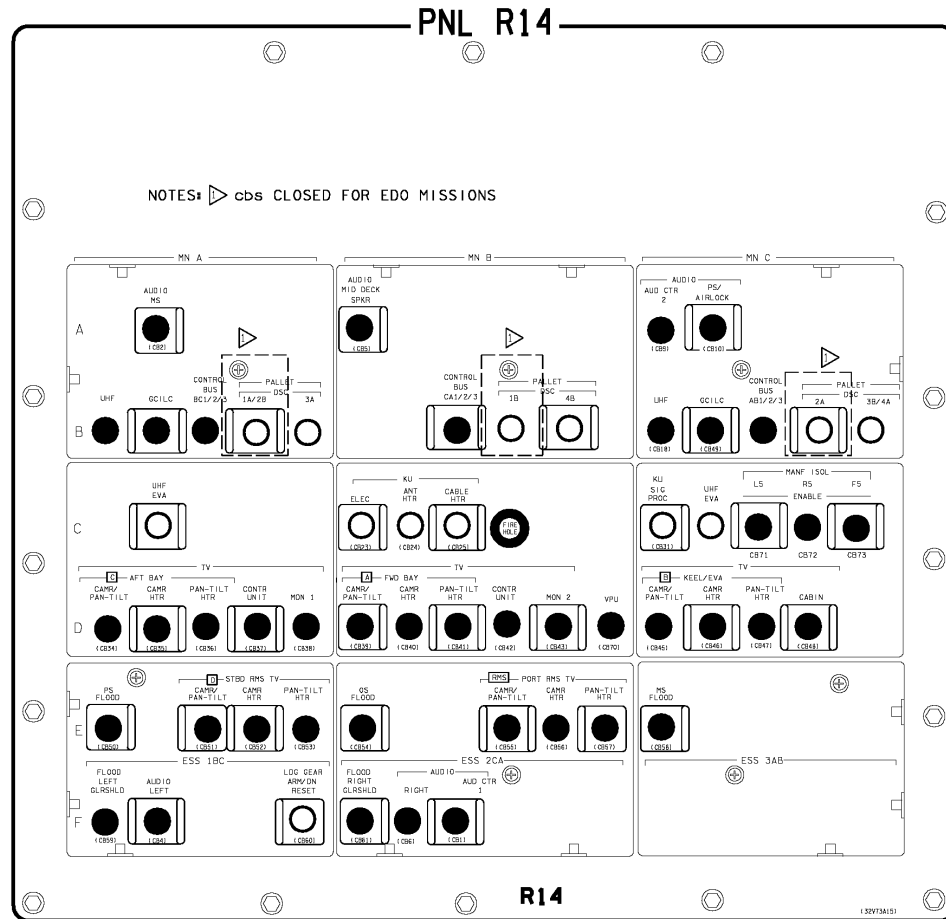
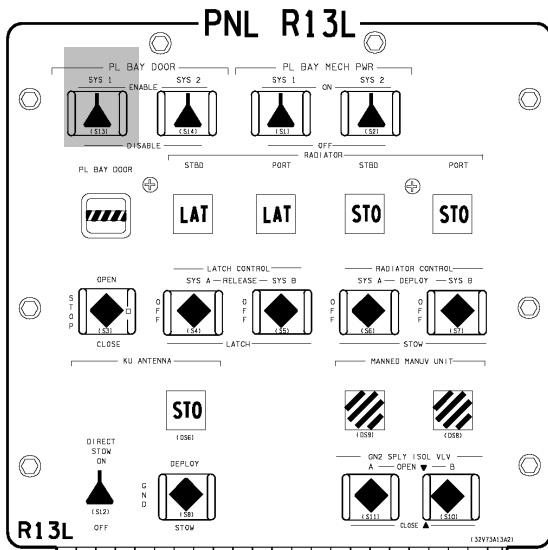

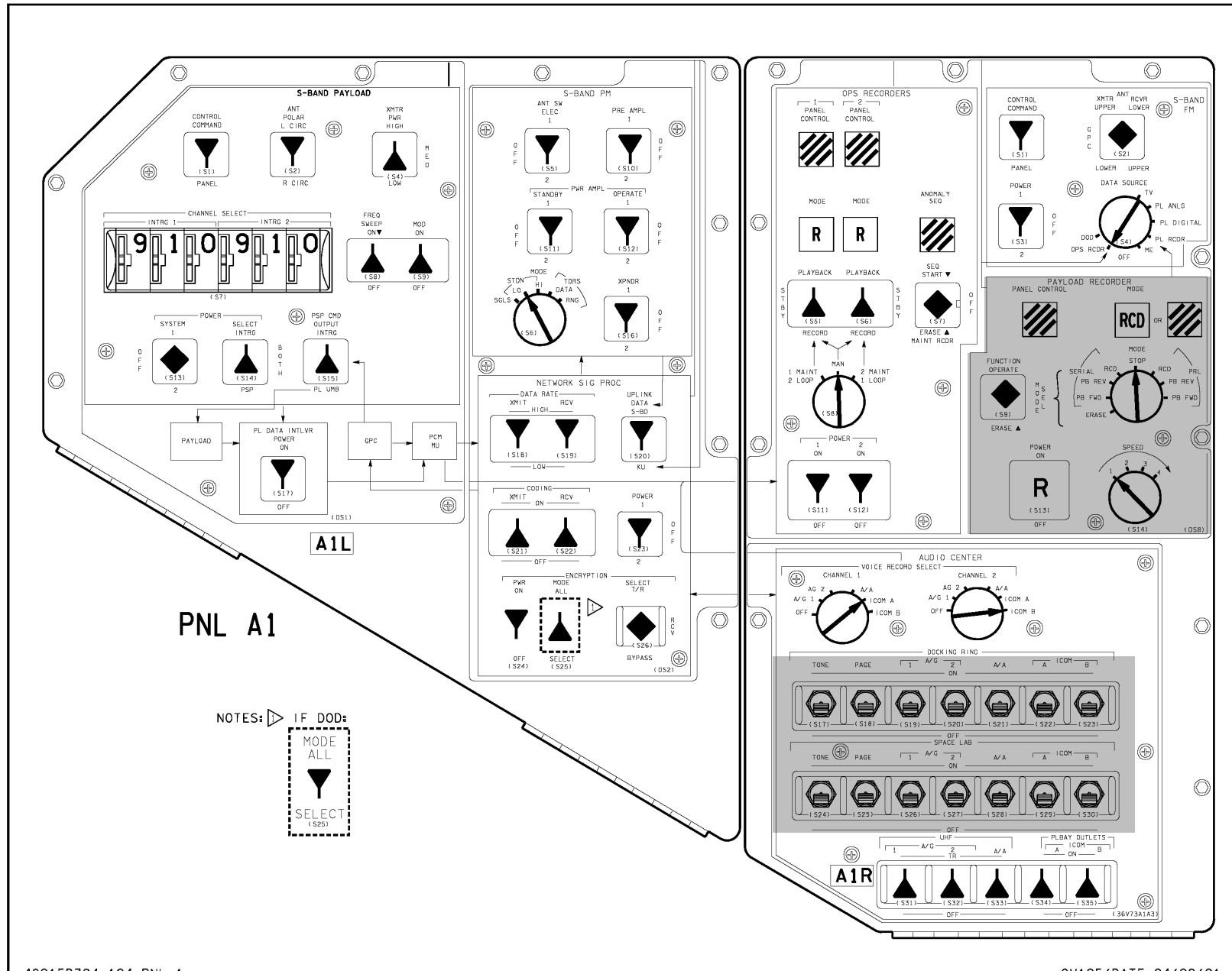

PNL A1

NOTES: IF DOD:
 MODE ALL
 SELECT (S25)

OV105

OV105

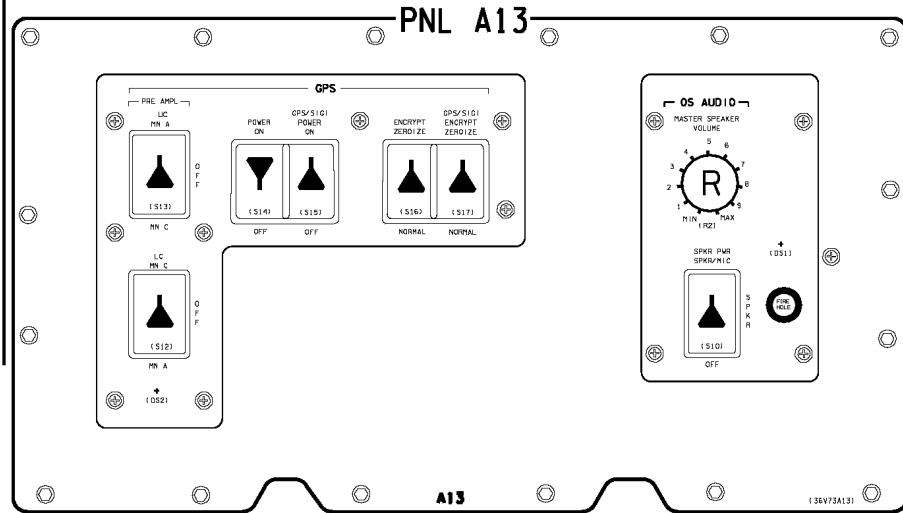
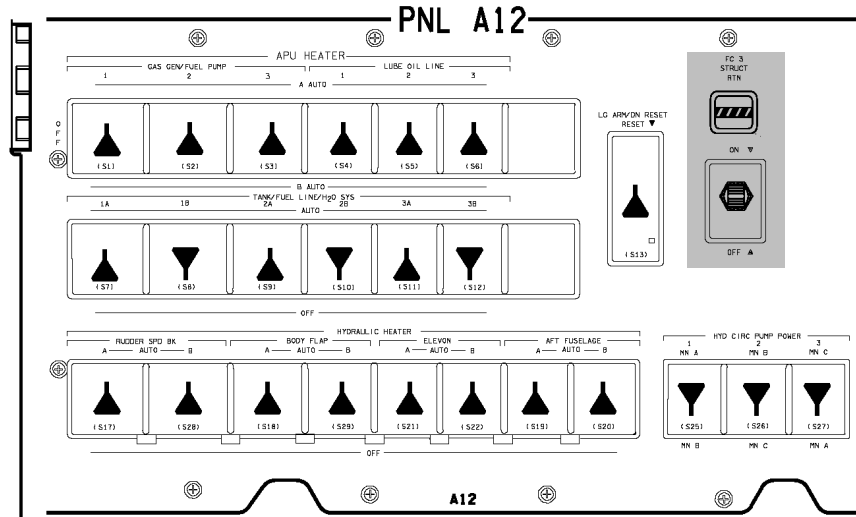
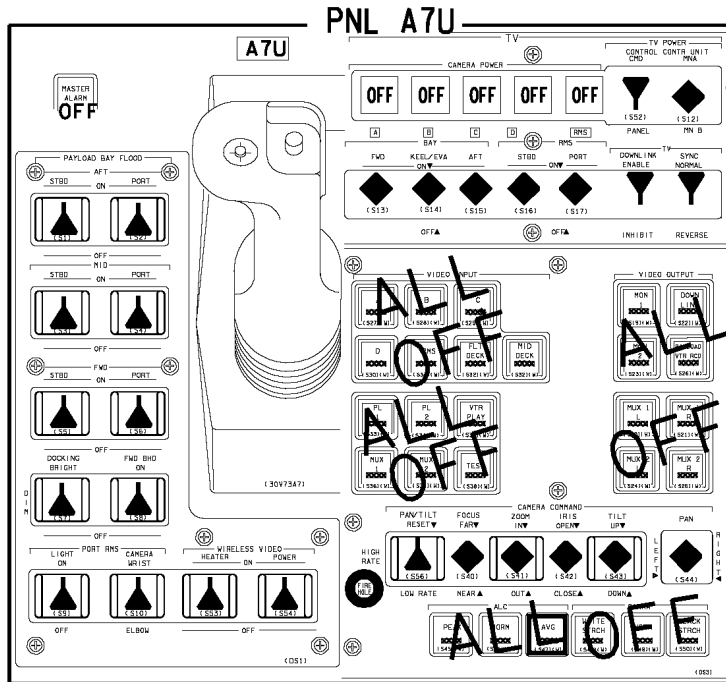

PNL L9

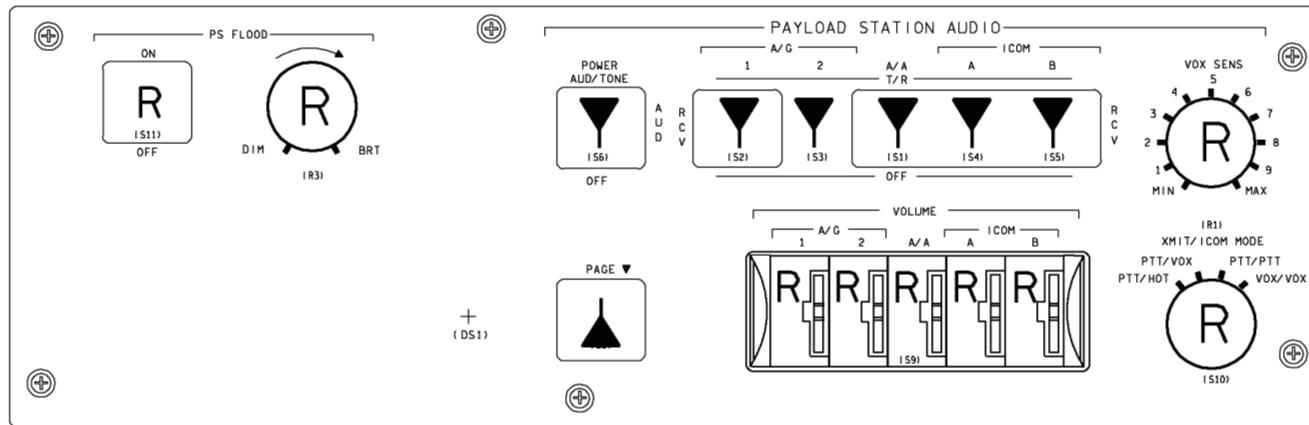

(31V73A9A2)

L9

OV105

PNL A6L

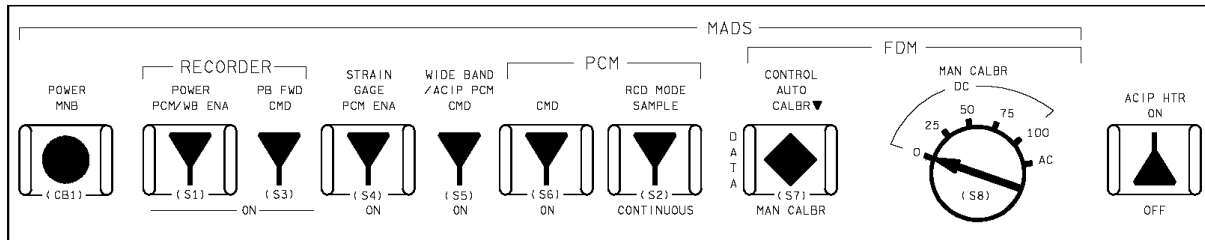
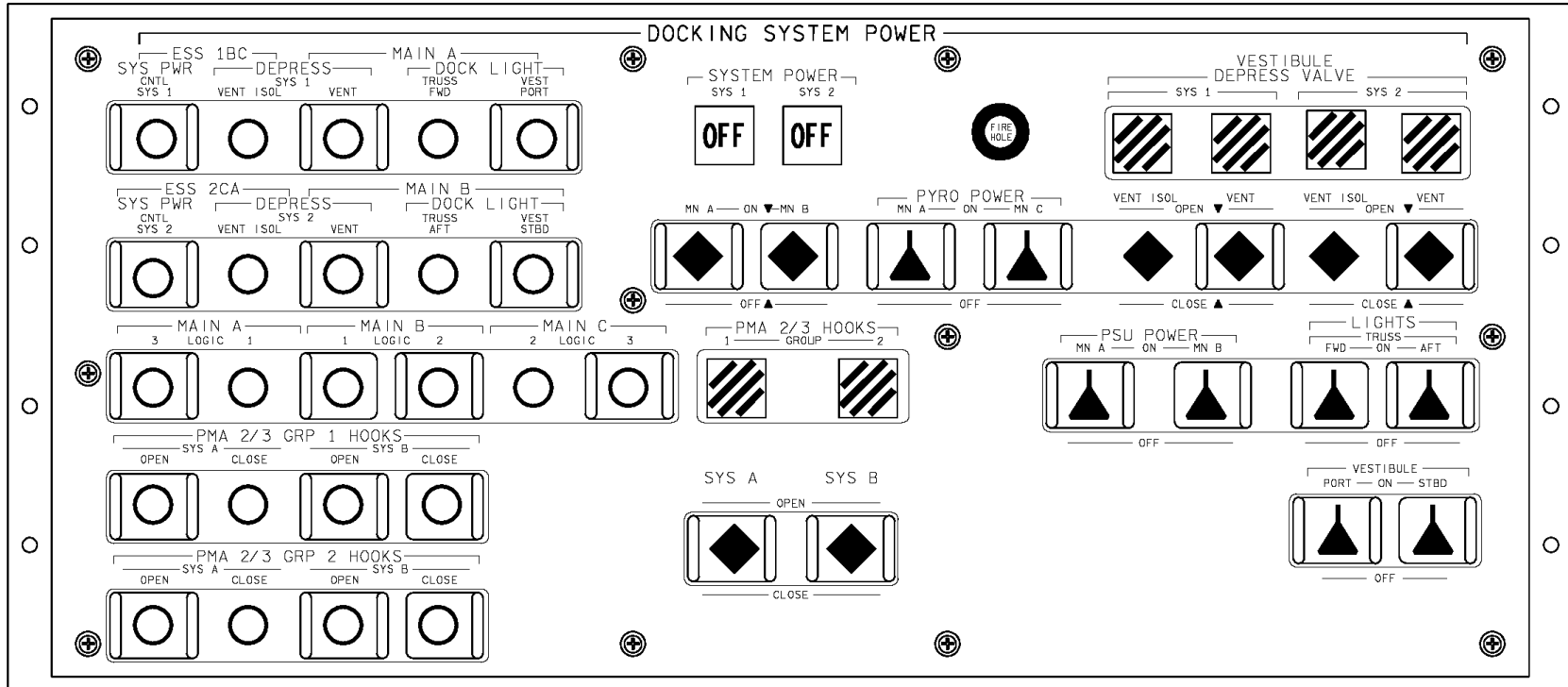

48015D331_104. PNL 1

OV105/DATE 04/10/01

(OV105) D3-27

OV105 |
D/O/5/GEN L,1

OV105

CONTROL PANEL POWER

A ON OFF B ON OFF C ON OFF

HEATERS/DCU POWER

H1 ON OFF H2/DCU ON OFF H3/DCU ON OFF

APDS POWER

A_{DS} ON OFF B_{DS} ON OFF C_{DS} ON OFF

STATUS

POWER	ON	INITIAL	CONTACT
APDS PROTECT	CIRCUIT OFF	CAPTURE	CAPTURE
RING	ALIGNED	RING	FORWARD POSITION
RING	INITIAL POSITION	TO HOOK	
FIXERS	OFF	INTE	SEALED
HOOKS 1	OPEN	HOOKS 1	CLOSED
HOOKS 2	OPEN	HOOKS 2	CLOSED
LATCHES	CLOSED	LATCHES	OPEN
UNDOCK	COMPLET	RING	FINAL POSITION

PYROS

A_p ON OFF B_p ON OFF C_p ON OFF

FIRE HOLE

Ap OFF Cp OFF

PYRO COMMANDS

PYRO CIRC PYRO CIRC
PROT OFF PROT ON

ACT HOOKS PAS HOOKS
FIRING FIRING

APDS CONTROL COMMANDS

OPEN OPEN
HOOKS LATCHES
UNDOCKING

A_{DS} OFF B_{DS} OFF C_{DS} OFF

LAMP TEST

PNL A7L

APDS CONTROL COMMANDS

POWER ON	POWER OFF	RING OUT	RING IN
----------	-----------	----------	---------

APDS CIRC PROT OFF	CLOSE HOOKS	CLOSE LATCHES	FIXER OFF
--------------------	-------------	---------------	-----------

APDS CONTROL PANEL

OV105

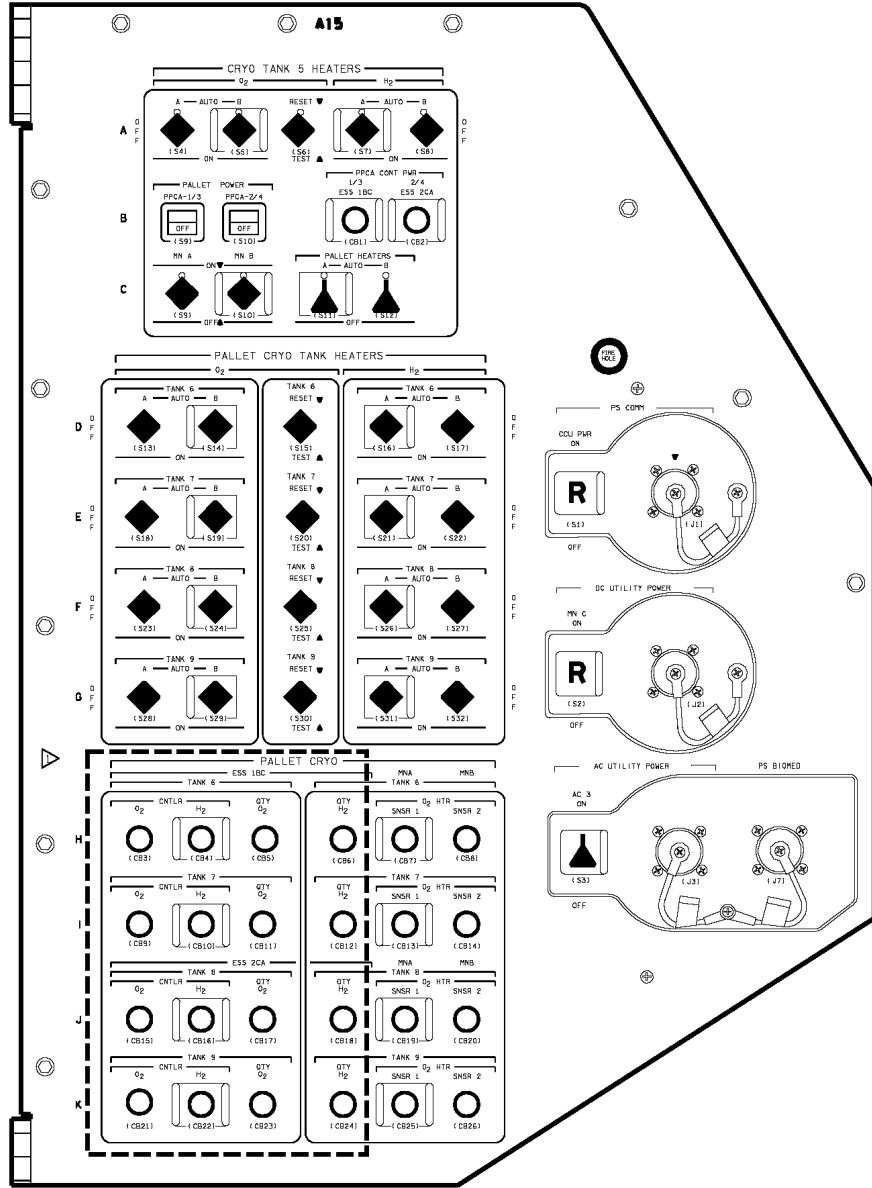

▷ cbs CLOSED FOR EDO MISSIONS

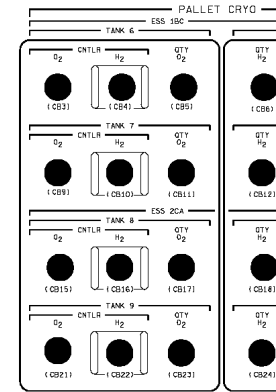

OV105

OV105

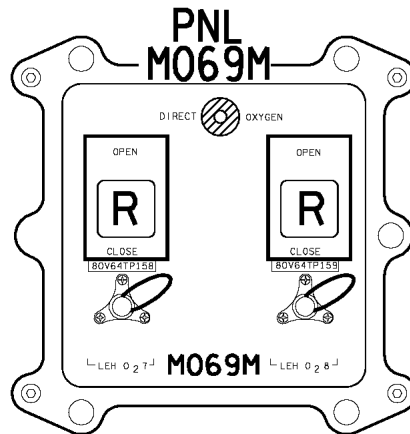
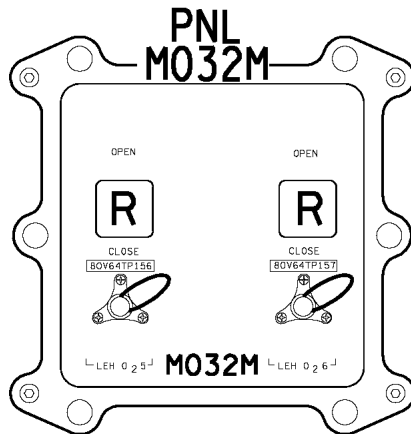
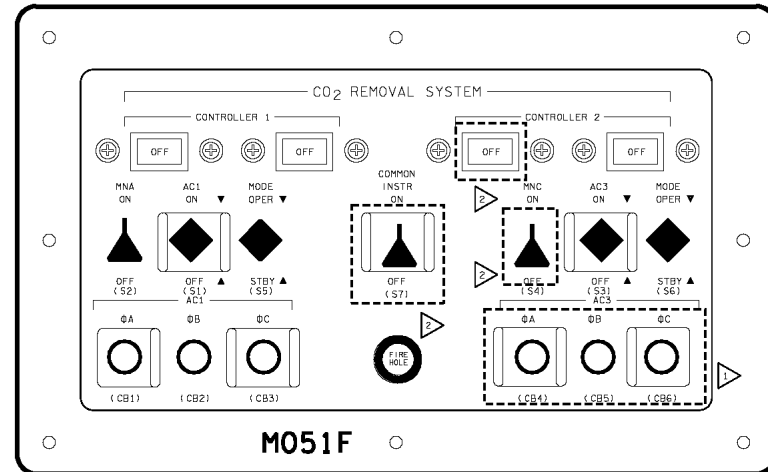
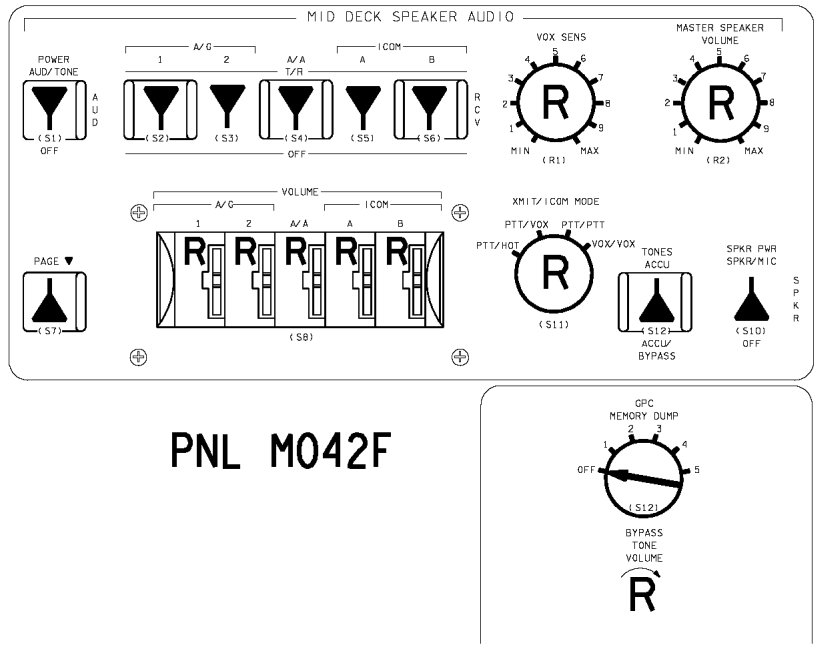

NOTES: ▷ CLOSED IF CO2 RMVL SYS FLOWN
▷ ON IF CO2 RMVL SYS FLOWN

OV105

PNL MA73C

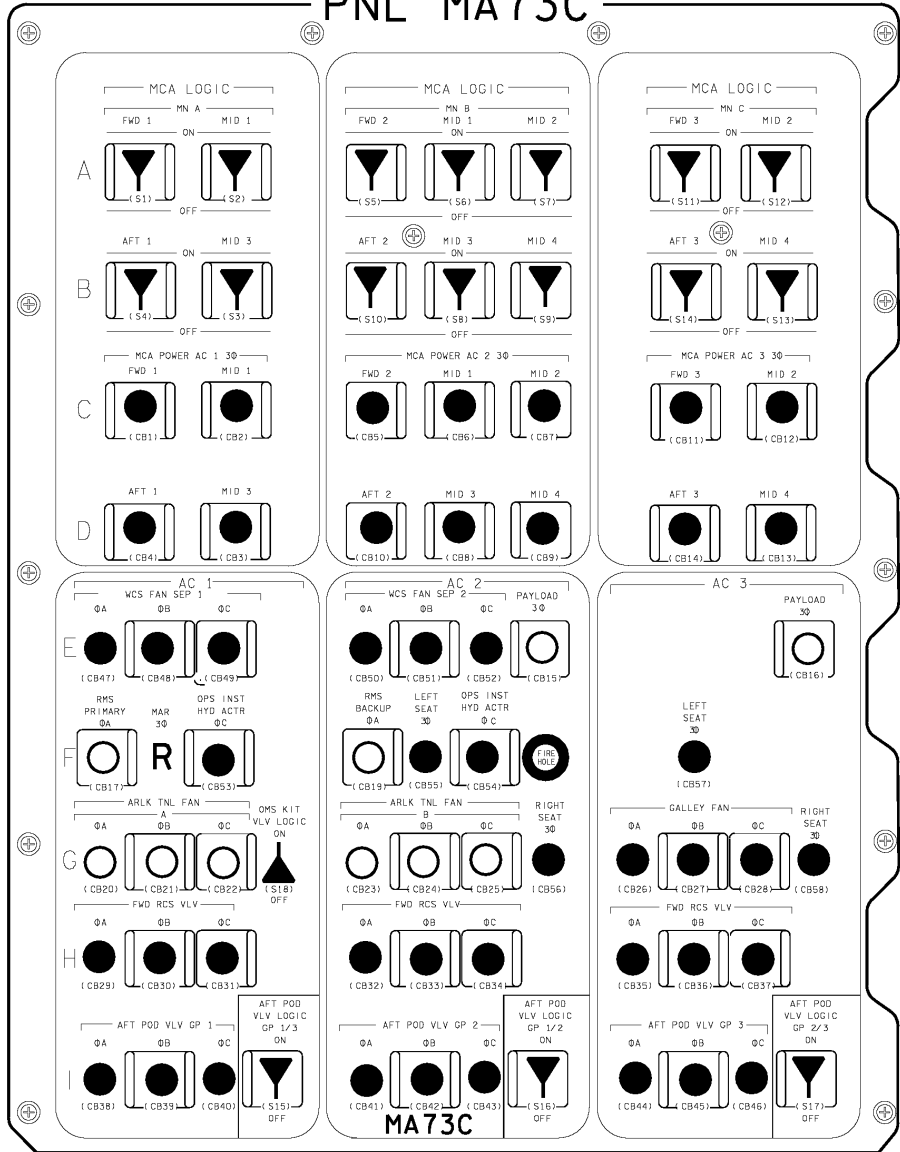

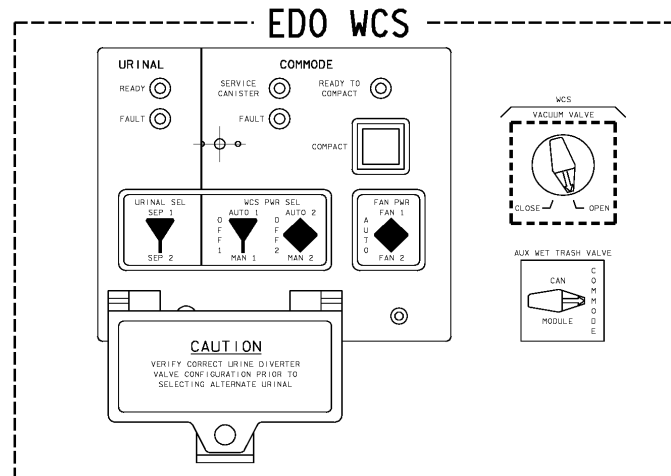
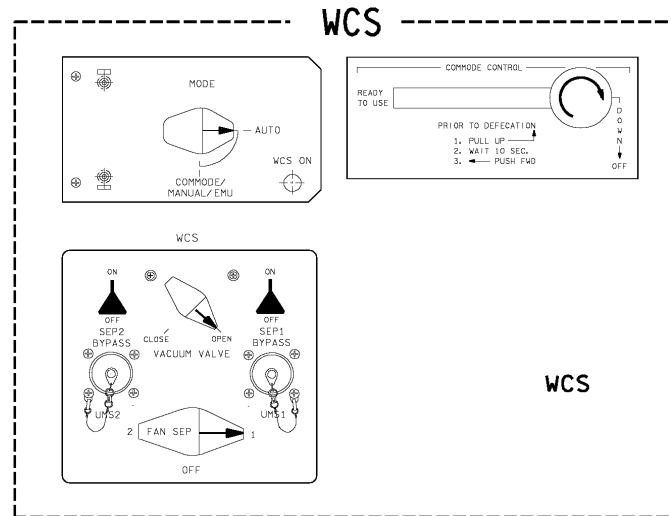
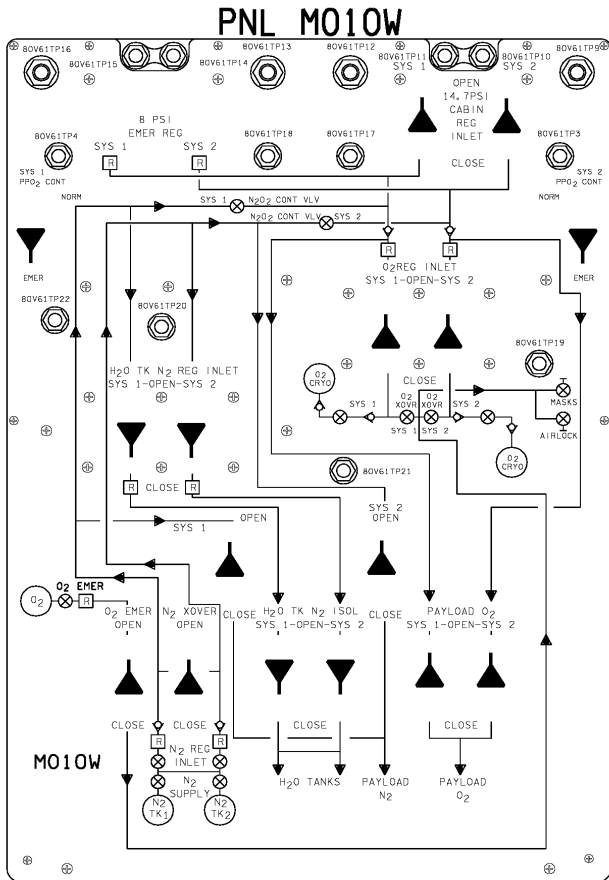

BFS DEORBIT PREP NOTES

**BFS DEORBIT
PREP NOTES**

BFS DEORBIT PREP NOTES

- 1) BFS cannot support COAS Cal or an IMU Align
- 2) No AUTO DAP or AUTO TVC is available with BFS.
After OPS 304 Transition, CSS must be used
- 3) BFS does not support MSN TIMER updates
- 4) BFS supports manual RCS to RCS Xfeed only
- 5) BFS follows PASS port moding via BFS I/O RESET
- 6) BFS does not support the following switches:

NOTE

Boldface indicates items affected during Entry (MM 304)

LEFT SEAT

- | | | |
|------|----|--|
| C | L1 | H2O PUMP LOOP 1 (GPC pos only) |
| | F6 | ADI ERR
RATE
HSI SEL MODE
SOURCE 1, 2, 3
RDR ALTM |
| C, P | C3 | DAP pb (six)
MAN MODE TRANSLATION pb (eight)
jet option PRI,ALT,VERN pb |
| | O7 | MSTR RCS XFEED
AFT L,R RCS TK ISOL (six) (GPC pos only)
XFEED (four) (GPC pos only) |

RIGHT SEAT

- | | | |
|----|------------|---|
| P | F8 | AIR DATA (slaved to CDRs)
ADI ERR
RATE
ATT (slaved to CDRs)
ATT REF pb
HSI SEL MODE
SOURCE TACAN, MLS, NAV
(slaved to CDRs)
RDR ALTM |
| | F3 | R TRIM RHC/PNL |
| | R2 | HYD CIRC PUMP (three) (GPC pos only) |
| | <u>AFT</u> | |
| MS | R12U | FC PURGE VLV (three) (GPC pos only)*
HTR (GPC pos only)*
GPC PURGE SEQ |

*FC PURGE valve and heater functions can be ground-commanded through BFS when switches are in GPC position. Therefore, place these switches in GPC for entry

CONTINGENCY DELTAS TO NOMINAL DEORBIT PREP

**CONTINGENCY
DELTAS**

CONTINGENCY DELTAS TO NOMINAL DEORBIT PREP

NOTE

Perform NOMINAL DEORBIT PREP procedure with
CONTINGENCY DELTAS for specific case

LOSS OF 2 CAB FANS	5-3
LOSS OF AV BAY AIR COOLING	5-4
8 PSI DEORBIT PREP	5-6
AV BAY FIRE	5-8

LOSS OF 2 CAB FANS

Assumes LOSS OF 2 CAB FANS (ORB PKT, PWRDN) accomplished

1. Minimize use of IDPs,MDUs,FLT CNTLR PWR,DDUs to reduce cabin heat load and to save for use during entry
2. Minimize lighting
3. Wipe off any visible moisture with towels
4. Use IDP/CRT 4 when possible. Use one IDP/CRT with two MDUs as reqd. Use two IDP/CRTs with two MDUs for DPS ENTRY CONFIG. Save two forward IDP/CRTs with four MDUs that interface with those IDPs for entry
5. In DED DISP ENT CONFIG, do not power DDUs unless reqd. Minimize use
6. In DPS ENTRY CONFIG, skip SM CKPT except UL CNTL ENA – ITEM 36 EXEC. Skip MC9 RECONFIG
7. In CLOTHING CONFIG, prepare LESs for donning. Don QDM if cabin temp > 90 degF and discomfort occurs. If cabin temp > 95 degF and no evaporative cooling, don LES, activate O2, and close visor. Inflate Anti-G Suit as needed for circulatory support
8. ENTRY SWITCH LIST/VER will not reflect pwrn items
9. FLUID LOADING: Continue drinking 8 oz container of water every 15 min with salt tablets every other 8 oz container through entry
10. Maintain tail Sun attitude/leave window shades installed until TIG–15 min

For ENTRY C/L deltas, go to LOSS OF 2 CAB FANS (ENT PKT, PWRDN)

LOSS OF AV BAY AIR COOLING

Assumes MAL, DPS, GPC FRP-7 accomplished

1. For Av Bay 1 or 2 loss, skip DPS CONFIG FOR D/O PREP 4a, but perform ENSURE BFS GPC CAN COMMAND AN IDP 4b
 If Av Bay 3 loss, perform both DPS CONFIG FOR D/O PREP 4a and ENSURE BFS GPC CAN COMMAND AN IDP 4b
2. In APU/HYD CONFIG:
 If AV BAY 1 or 2 air cooling lost:
 | FCS CH (four) – ORIDE
 If AV BAY 3 air cooling lost:
 ✓FCS CH 1,2,3 (three) – AUTO
 4 – OFF
3. In DED DISP ENT CONFIG, delay activation of affected TACANs,MLSs,AAs,ADTAs (EQUIP COOLING MATRIX, ORB PKT, ECLS); deactivate if already activated
4. During DPS ENTRY CONFIG
 - a. If loss of AV BAY 3, do not activate GPC 3
 - b. In all cases, substitute appropriate NBAT in following activities:

TRANSITION GPC 1 & 2 TO GNC OPS 3

TRANSITION GPC 1,2,3,4 TO GNC OPS 3

CONFIG GPC	LOSS OF		
	BAY 1	BAY 2	BAY 3
	3 02000	3 10000	3 12000
STR 1	2	1	1
2	2	1	2
3	2	1	1
4	2	1	2
PL 1/2	0	0	0
CRT 1	2	1	1
2	2	1	2
3	2	1	2
4	0	0	0
L 1	0	0	0
2	0	0	0
MM 1	2	1	1
2	2	1	2

CONFIG GPC	LOSS OF		
	BAY 1	BAY 2	BAY 3
	3 02300	3 10040	3 12040
STR 1	3	1	1
2	2	4	2
3	3	1	4
4	2	4	2
PL 1/2	2	1	1
CRT 1	2	1	1
2	3	4	2
3	2	1	4
4	0	0	0
L 1	0	0	0
2	0	0	0
MM 1	2	1	1
2	3	4	2

Cont next page
(MEDS) A5-4

LOSS OF AV BAY AIR COOLING (Cont)

RECONFIG MC 9 TABLE (GNC 9) FOR POST LANDING →

5. In C.P ENT FWD FLT DECK CONFIG:

O14:A If AV BAY 1 air cooling lost:
 O15:A ✓BRAKES MNA – OFF
 O16:A MNB – ON
 ✓MNC – OFF

O14:A If AV BAY 2 air cooling lost:
 O15:A BRAKES MNA – ON
 O16:A ✓MNB – OFF
 MNC – ON

6. ENT SWITCH LIST/VERIF will not reflect powerdown items

7. Incorporate following pen and inks to ENT

MNVR Cue Cards:

EI: Power up affected air-cooled equipment
 except affected TACAN (EQUIP COOLING
 MATRIX, ENT PKT, ECLS)

V = 10K: If unaffected TACAN failed,
 Affected TACAN MODE – GPC

O7

8. If just prior to OPS 302 TRANSITION, affected GPCs have
 been in HALT for ≥ 3.5 hr, add to RS as follows:

- Modify MC3 per table →
- MODE affected GPCs to RUN
- BFC CRT DISP – OFF
 OPS 301 PRO
 BFC CRT DISP – ON
 BFS GNC I/O RESET
- FCS CH (four) – AUTO

9. Update GPC/FCS CHANNEL CONFIGURATION (Cue Card)

CONFIG	LOSS OF		
	BAY 1	BAY 2	BAY 3
GPC	9 02300	9 10040	9 12040
STR	1 3 2 2 3 3 4 2	1 1 4 4 1 1 4 4	1 1 2 2 4 4 2 1
PL	1/2 2	1 1	1 1
CRT	1 2 2 3 3 0 4 3	1 1 4 4 0 0 4 4	1 1 2 2 4 4 0 0
L	1 0 2 0	0 0 0 0	1 1 2 2
MM	1 2 2 3	1 1 4 4	1 1 2 2

CONFIG	LOSS OF		
	BAY 1	BAY 2	BAY 3
GPC	3 12340	3 12045	3 12340
STR	1 1 2 2 3 3 4 4	1 1 2 2 4 4 5 5	1 1 2 2 4 4 3 3
PL	1/2 2	1 1	1 1
CRT	1 2 2 1 3 3 4 0	1 1 2 2 4 4 0 0	1 1 2 2 4 4 0 0
L	1 0 2 0	0 0 0 0	0 0 0 0
MM	1 2 2 3	1 1 4 4	1 1 2 2

8 PSI DEORBIT PREP

Assumes LOSS OF CABIN PRESS (ORB PKT, PWRDN) accomplished

If TIG < 4 hr: Begin NOMINAL DEORBIT PREP timeline 1–8 immediately and perform procedures as rapidly as possible with all following CONTINGENCY DELTAS except steps 7 and 10

If TIG > 4 hr: Perform steps 1, 2, 3, and 4;

At TIG–4 hr, perform NOMINAL DEORBIT PREP with all remaining CONTINGENCY DELTAS

1. Back out of PRIORITY PWRDN, as reqd (ORB PKT, PRIOR PWRDN)
2. If previous FC PURGE was not accomplished within last 6 hr: Accomplish FC PURGE (ORB OPS, EPS) anytime prior to DPS ENTRY CONFIG
3. MS accomplish CABIN CONFIG/STOW (FLIGHT PLAN) as time permits
4. Perform IMU ALIGN–S TRK (ORB OPS, GNC)
✓MCC for align attitudes or use STAR PAIRS PAD (ORB OPS FS, PTG)
5. Leave shades in until SEAT INGRESS
6. Minimize IDP/MDU use until TIG–20
7. Do not perform either DPS CONFIG FOR D/O PREP 4a or ENSURE BFS GPC CAN COMMAND AN IDP 4b
8. Replace RAD BYPASS/FES C/O with following:
 - ML86B:A ✓cb MNC SPLY H2O XOVR VLV – cl
 - R11L SPLY H2O XOVR VLV – OP (tb–OP)
 - TKC INLET – OP (tb–OP)
 - OUTLET – OP (tb–OP)
 - L1 FLASH EVAP CNTLR PRI A – OFF
 - B – ON
 - ✓HI LOAD DUCT HTR – B
 - EVAP – ENA
 - RAD BYP VLV MODE (two) – MAN
 - MAN SEL (two) – BYP (tb–BYP ~3 sec)
 - RAD CNTLR LOOP (two) – OFF
 - After 2.5 min:
 - O1 ✓FREON EVAP OUT TEMP ind: 39 ± 1 degF
 - L1 ✓FLOW PROP VLV LOOP 1,2 tb (two) – ICH
 - RAD CNTLR OUT TEMP – NORM

Cont next page
(MEDS) A5–6

MEDS

D/O/MEDS/GEN L,1

8 PSI DEORBIT PREP (Cont)

9. In DED DISP ENT CONFIG, delay activation of ADTAs, TACANs, MLS, RAs, and DDU
10. Immediately prior to DPS ENTRY CONFIG, activate GPCs 1,5; then proceed with nominal DPS ENTRY CONFIG
11. ENTRY SWITCH LIST/VER will not reflect powered down items

IN ENT C/L

12. At TIG-15, activate DDU
13. At EI-5, activate ADTAs
14. At V = 15K, activate TACANs,MLSs,RAs

AV BAY FIRE

Assumes AV BAY FIRE (ORB PKT, PWRDN) and MAL, ECLS SSR-12, AV BAY FIRE RECOVERY/RECONFIG accomplished

1. For Av Bay 1 or 2 loss, skip DPS CONFIG FOR D/O PREP 4a, but perform ENSURE BFS GPC CAN COMMAND AN IDP 4b
If Av Bay 3 loss, perform both DPS CONFIG FOR D/O PREP 4a and ENSURE BFS GPC CAN COMMAND AN IDP 4b
2. In APU/HYD CONFIG:
If AV BAY 1 or 2 air cooling lost:
| FCS CH (four) – ORIDE
If AV BAY 3 air cooling lost:
✓ FCS CH 1,2,3 (three) – AUTO
4 – OFF
3. During DED DISP ENT CONFIG, power up only three ADTAs, three AAs, two MLSs, and two TACANs

AV BAY FIRE (Cont)

4. During DPS ENTRY CONFIG

- a. If loss of Av Bay 3, do not pwrap GPC 3
- b. During SM CHECKPOINT, skip MMU 1 (if Av Bay 1) or MMU 2 (if Av Bay 2)
- c. Using column for affected Av Bay, substitute appropriate NBAT in following activities

TRANSITION GPC 1 & 2 TO OPS 3

CONFIG GPC	LOSS OF		
	BAY 1	BAY 2	BAY 3
	3 02000	3 10000	3 12000
STR 1	2	1	1
2	2	1	2
3	2	1	1
4	2	1	2
PL 1/2	0	0	0
CRT 1	2	1	1
2	2	1	2
3	2	1	2
4	0	0	0
L 1	0	0	0
2	0	0	0
MM 1	2	1	1
2	2	1	2

TRANSITION GPC 1,2,3,4 TO OPS 3

CONFIG GPC	LOSS OF		
	BAY 1	BAY 2	BAY 3
	3 02300	3 10040	3 12040
STR 1	3	1	1
2	2	4	2
3	3	1	4
4	2	4	2
PL 1/2	2	1	1
CRT 1	2	1	1
2	3	4	2
3	2	1	4
4	0	0	0
L 1	0	0	0
2	0	0	0
MM 1	2	1	1
2	3	4	2

RECONFIG MC 9 TABLE (GNC 9)
FOR POST LANDING

CONFIG GPC	LOSS OF		
	BAY 1	BAY 2	BAY 3
	9 02300	9 10040	9 12040
STR 1	3	1	1
2	2	4	2
3	3	1	4
4	2	4	2
PL 1/2	2	1	1
CRT 1	2	1	1
2	3	4	2
3	0	0	4
4	3	4	0
L 1	0	0	1
2	0	0	2
MM 1	2	1	1
2	3	4	2

5. ENT SWITCH LIST/VERIF pictorials will not reflect pwrnd items

This Page Intentionally Blank

LOSS OF 2 CAB FANS

Assumes LOSS OF 2 CAB FANS (ORB PKT, PWRDN) accomplished

1. Minimize use of CRTs,FLT CNTLR PWR,INST PWR,DDUs to reduce cabin heat load and to save for use during entry
2. Minimize lighting
3. Wipe off any visible moisture with towels
4. Use CRT 4 when possible. Use one CRT as reqd. Use two CRTs for DPS ENTRY CONFIG. Save two CRTs for entry
5. In DED DISP ENT CONFIG, do not power DDUs, INST PWR unless reqd. Minimize use
6. In DPS ENTRY CONFIG, skip SM CKPT except UL CNTL ENA – ITEM 36 EXEC. Skip MC9 RECONFIG
7. In CLOTHING CONFIG, prepare LESs for donning. Don QDM if cabin temp > 90 degF and discomfort occurs. If cabin temp > 95 degF and no evaporative cooling, don LES, activate O2, and close visor. Inflate Anti-G Suit as needed for circulatory support
8. ENTRY SWITCH LIST/VER will not reflect powerdown items
9. FLUID LOADING: Continue drinking 8 oz container of water every 15 min with salt tablets every other 8 oz container through entry
10. Maintain tail Sun attitude/leave window shades installed until TIG–15 min

For ENTRY C/L deltas, go to LOSS OF 2 CAB FANS (ENT PKT, PWRDN)

LOSS OF AV BAY AIR COOLING

Assumes MAL, DPS, GPC FRP-7 accomplished

1. For Av Bay 1 or 2 loss, skip DPS CONFIG FOR D/O PREP 4a, but perform ENSURE BFS GPC CAN COMMAND A CRT 4b
 If Av Bay 3 loss, perform both DPS CONFIG FOR D/O PREP 4a and ENSURE BFS GPC CAN COMMAND A CRT 4b
2. In APU/HYD CONFIG:
 If AV BAY 1 or 2 air cooling lost:
 | FCS CH (four) – ORIDE
 If AV BAY 3 air cooling lost:
 ✓FCS CH 1,2,3 (three) – AUTO
 4 – OFF
3. In DED DISP ENT CONFIG, delay activation of affected TACANs,MLSs,AAAs,ADTAs (EQUIP COOLING MATRIX, ORB PKT, ECLS); deactivate if already activated
4. During DPS ENTRY CONFIG
 - a. If loss of AV BAY 3, do not activate GPC 3
 - b. In all cases, substitute appropriate NBAT in following activities:

TRANSITION GPC 1 & 2 TO GNC OPS 3

TRANSITION GPC 1,2,3,4 TO GNC OPS 3

		LOSS OF		
		BAY 1	BAY 2	BAY 3
CONFIG GPC		3 02000	3 10000	3 12000
STR	1	2	1	1
	2	2	1	2
	3	2	1	1
	4	2	1	2
PL	1/2	0	0	0
CRT	1	2	1	1
	2	2	1	2
	3	2	1	2
	4	0	0	0
L	1	0	0	0
	2	0	0	0
MM	1	2	1	1
	2	2	1	2

		LOSS OF		
		BAY 1	BAY 2	BAY 3
CONFIG GPC		3 02300	3 10040	3 12040
STR	1	3	1	1
	2	2	4	2
	3	3	1	4
	4	2	4	2
PL	1/2	2	1	1
CRT	1	2	1	1
	2	3	4	2
	3	2	1	4
	4	0	0	0
L	1	0	0	0
	2	0	0	0
MM	1	2	1	1
	2	3	4	2

Cont next page
(NOM) B5-4

LOSS OF AV BAY AIR COOLING (Cont)

RECONFIG MC 9 TABLE (GNC 9) FOR POST LANDING →

5. In C.P ENT FWD FLT DECK CONFIG:

O14:A If AV BAY 1 air cooling lost:
 O15:A ✓BRAKES MNA – OFF
 O16:A MNB – ON
 ✓MNC – OFF

O14:A If AV BAY 2 air cooling lost:
 O15:A BRAKES MNA – ON
 O16:A ✓MNB – OFF
 MNC – ON

6. ENT SWITCH LIST/VERIF will not reflect powerdown items

7. Incorporate following pen and inks to ENT

MNVR Cue Cards:

EI: Power up affected air-cooled equipment
 except affected TACAN (EQUIP COOLING
 MATRIX, ENT PKT, ECLS)

V = 10K: If unaffected TACAN failed,
 Affected TACAN MODE – GPC

O7

8. If just prior to OPS 302 TRANSITION, affected GPCs have
 been in HALT for ≥ 3.5 hr, add to RS as follows:

- a. Modify MC3 per table →
- b. MODE affected GPCs to RUN
- c. BFC CRT DISP – OFF
 OPS 301 PRO
 BFC CRT DISP – ON
 BFS GNC I/O RESET
- d. FCS CH (four) – AUTO

9. Update GPC/FCS CHANNEL CONFIGURATION (Cue Card)

CONFIG	LOSS OF		
	BAY 1	BAY 2	BAY 3
GPC	9 02300	9 10040	9 12040
STR	1 3 2 2 3 3 4 2	1 1 4 4 1 1 4 4	1 1 2 2 4 4 2 2
PL	1/2 2	1 1	1 1
CRT	1 2 2 3 3 0 4 3	1 1 4 4 0 0 4 4	1 1 2 2 4 4 0 0
L	1 0 2 0	0 0 0 0	1 1 2 2
MM	1 2 2 3	1 1 4 4	1 1 2 2

CONFIG	LOSS OF		
	BAY 1	BAY 2	BAY 3
GPC	3 12340	3 12045	3 12340
STR	1 1 2 2 3 3 4 4	1 1 2 2 4 4 5 5	1 1 2 2 4 4 3 3
PL	1/2 2	1 1	1 1
CRT	1 2 2 1 3 3 4 0	1 1 2 2 4 4 0 0	1 1 2 2 4 4 0 0
L	1 0 2 0	0 0 0 0	0 0 0 0
MM	1 2 2 3	1 1 4 4	1 1 2 2

8 PSI DEORBIT PREP

Assumes LOSS OF CABIN PRESS (ORB PKT, PWRDN) accomplished

If TIG < 4 hr: Begin NOMINAL DEORBIT PREP timeline 1–8 immediately and perform procedures as rapidly as possible with all following CONTINGENCY DELTAS except steps 7 and 10

If TIG > 4 hr: Perform steps 1, 2, 3, and 4;

At TIG–4 hr, perform NOMINAL DEORBIT PREP with all remaining CONTINGENCY DELTAS

1. Back out of PRIORITY PWRDN, as reqd (ORB PKT, PRIOR PWRDN)
2. If previous FC PURGE was not accomplished within last 6 hr: Accomplish FC PURGE (ORB OPS, EPS) anytime prior to DPS ENTRY CONFIG
3. MS accomplish CABIN CONFIG/STOW (FLIGHT PLAN) as time permits
4. Perform IMU ALIGN–S TRK (ORB OPS, GNC)
✓MCC for align attitudes or use STAR PAIRS PAD (ORB OPS FS, PTG)
5. Leave shades in until SEAT INGRESS
6. Minimize CRT use until TIG–20
7. Do not perform either DPS CONFIG FOR D/O PREP 4a or ENSURE BFS GPC CAN COMMAND A CRT 4b
8. Replace RAD BYPASS/FES C/O with following:
 - ML86B:A ✓cb MNC SPLY H2O XOVR VLV – cl
 - R11L SPLY H2O XOVR VLV – OP (tb–OP)
 - TKC INLET – OP (tb–OP)
 - OUTLET – OP (tb–OP)
 - L1 FLASH EVAP CNTLR PRI A – OFF
 - B – ON
 - ✓HI LOAD DUCT HTR – B
 - EVAP – ENA
 - RAD BYP VLV MODE (two) – MAN
 - MAN SEL (two) – BYP (tb–BYP ~3 sec)
 - RAD CNTLR LOOP (two) – OFF
 - After 2.5 min:
 - O1 ✓FREON EVAP OUT TEMP ind: 39 ± 1 degF
 - L1 ✓FLOW PROP VLV LOOP 1,2 tb (two) – ICH
 - RAD CNTLR OUT TEMP – NORM

Cont next page
(NOM) B5–6

NOM
D/O/NOM/GEN L,1

8 PSI DEORBIT PREP (Cont)

9. In DED DISP ENT CONFIG, delay activation of ADTAs, TACANs, MLS, RAs, DDUUs, and INST PWR
10. Immediately prior to DPS ENTRY CONFIG, activate GPCs 1,5; then proceed with nominal DPS ENTRY CONFIG
11. ENTRY SWITCH LIST/VER will not reflect powered down items

IN ENT C/L

12. At TIG-15, activate DDUUs and INST PWR
13. At EI-5, activate ADTAs
14. At V = 15K, activate TACANs,MLSs,RAs

AV BAY FIRE

Assumes AV BAY FIRE (ORB PKT, PWRDN) and MAL, ECLS SSR-12, AV BAY FIRE RECOVERY/RECONFIG accomplished

1. For Av Bay 1 or 2 loss, skip DPS CONFIG FOR D/O PREP 4a, but perform ENSURE BFS GPC CAN COMMAND A CRT 4b
If Av Bay 3 loss, perform both DPS CONFIG FOR D/O PREP 4a and ENSURE BFS GPC CAN COMMAND A CRT 4b
2. In APU/HYD CONFIG:
If AV BAY 1 or 2 air cooling lost:
| FCS CH (four) – ORIDE
If AV BAY 3 air cooling lost:
✓ FCS CH 1,2,3 (three) – AUTO
4 – OFF
3. During DED DISP ENT CONFIG, power up only three ADTAs, three AAs, two MLSs, and two TACANs

AV BAY FIRE (Cont)

4. During DPS ENTRY CONFIG

- a. If loss of Av Bay 3, do not pwrap GPC 3
- b. During SM CHECKPOINT, skip MMU 1 (if Av Bay 1) or MMU 2 (if Av Bay 2)
- c. Using column for affected Av Bay, substitute appropriate NBAT in following activities

TRANSITION GPC 1 & 2 TO OPS 3

CONFIG GPC	LOSS OF		
	BAY 1	BAY 2	BAY 3
	3 02000	3 10000	3 12000
STR 1	2	1	1
2	2	1	2
3	2	1	1
4	2	1	2
PL 1/2	0	0	0
CRT 1	2	1	1
2	2	1	2
3	2	1	2
4	0	0	0
L 1	0	0	0
2	0	0	0
MM 1	2	1	1
2	2	1	2

TRANSITION GPC 1,2,3,4 TO OPS 3

CONFIG GPC	LOSS OF		
	BAY 1	BAY 2	BAY 3
	3 02300	3 10040	3 12040
STR 1	3	1	1
2	2	4	2
3	3	1	4
4	2	4	2
PL 1/2	2	1	1
CRT 1	2	1	1
2	3	4	2
3	2	1	4
4	0	0	0
L 1	0	0	0
2	0	0	0
MM 1	2	1	1
2	3	4	2

RECONFIG MC 9 TABLE (GNC 9)
FOR POST LANDING

CONFIG GPC	LOSS OF		
	BAY 1	BAY 2	BAY 3
	9 02300	9 10040	9 12040
STR 1	3	1	1
2	2	4	2
3	3	1	4
4	2	4	2
PL 1/2	2	1	1
CRT 1	2	1	1
2	3	4	2
3	0	0	4
4	3	4	0
L 1	0	0	1
2	0	0	2
MM 1	2	1	1
2	3	4	2

5. ENT SWITCH LIST/VERIF pictorials will not reflect powerdown items

This Page Intentionally Blank

(NOM) B5-10

D/O/ALL/GEN L

PLBD CONTINGENCY EVA TIMELINE

FLIGHT: PLBD EVA 102 EDITION: FROM D/O PREP TO EOM+1 PUB. DATE: 5/96

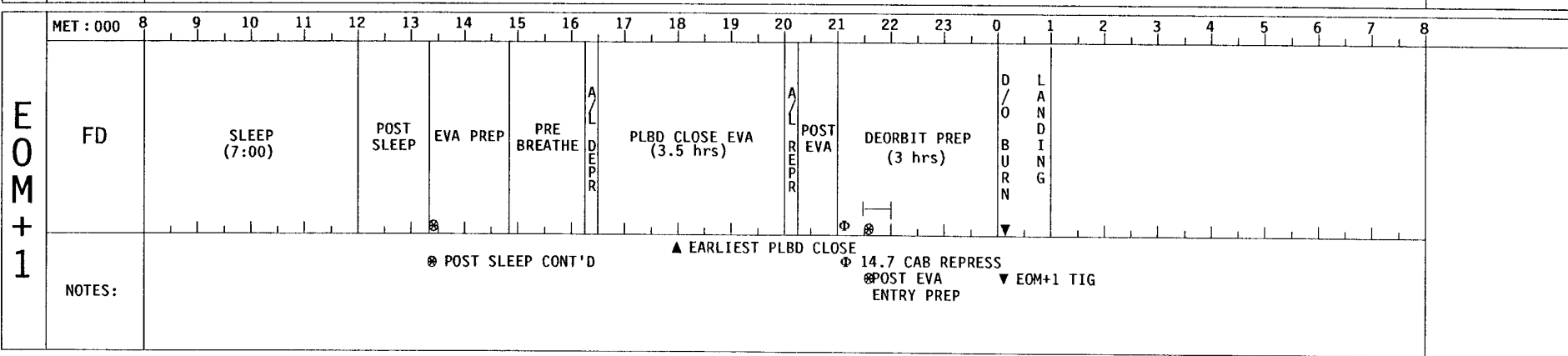
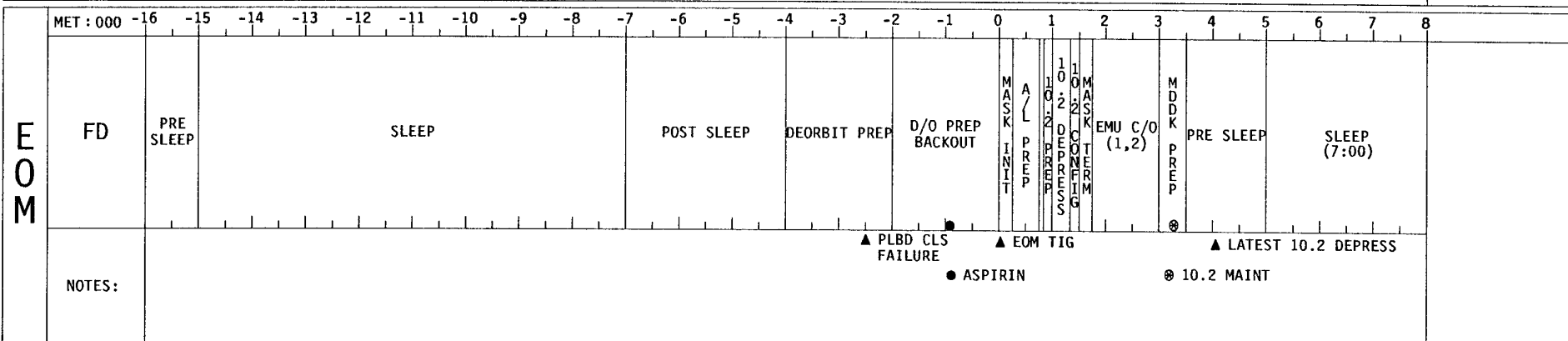
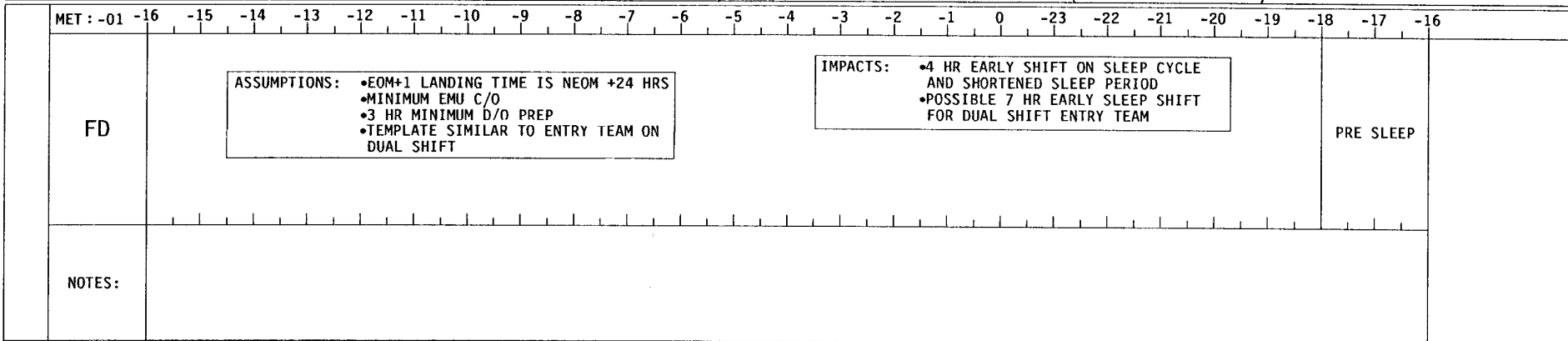

PLBD CONTINGENCY EVA NOTES

1. This timeline is an overview template that covers a payload bay door contingency EVA with a 10.2 cabin depress. The scenario starts from a closure failure 1.5 hr into the deorbit prep followed by a D/O PREP BACKOUT and cabin depress activities. The EVA and landing will occur on the EOM + 1 day
2. The timeline assumes that a two-crewmember 3.5 hr EVA to repair the problem is immediately followed by an entry to the prime landing site
3. Specific procedure block callouts for the EV and IV crewmembers during the EVA will be coordinated in real time
4. RCS hot fire testing, FCS C/O, and CABIN STOW are assumed to be previously accomplished
5. The timeline utilizes minimum activity durations for POST/PRE SLEEPS, EMU C/O, and DEORBIT PREP
6. The crew will be reqd to perform A/L PREP during Mask Pre-Breathe prior to cabin depress
7. Due to necessity of performing the EVA on the same day as landing, the crew is reqd to start their sleep period 3.5 hr earlier than the previous day
8. This template can be adapted for dual-shift timelines by scheduling Non-Entry team sleep with Entry team sleep in order to modify the timeline to single-shift operations
9. The MET scale on this timeline is actually a PET scale counting down to nominal deorbit TIG

This Page Intentionally Blank

HARDWARE CONTINGENCY EVA TIMELINE

7-1

D/O/ALL/GEN L

**HARDWARE
EVA**

HARDWARE EVA

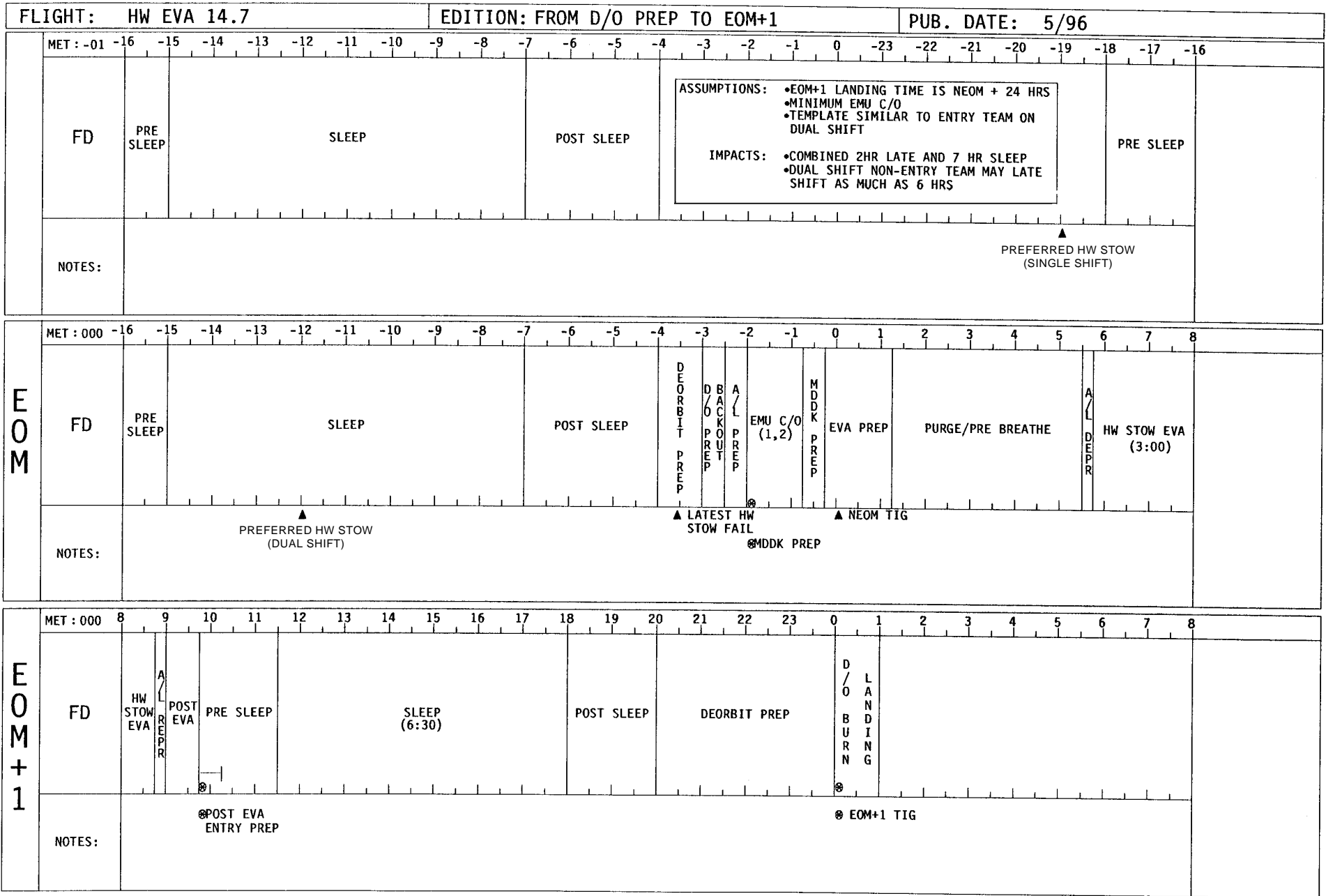

HARDWARE CONTINGENCY EVA NOTES

1. This timeline is an overview template that covers KU antenna, RMS, and RAD stow contingency EVAs with a “no cabin depress” scenario starting from a stow failure as late as 30 min into deorbit prep. The Pre-Breathe and EVA will be performed after D/O BACKOUT is complete and a landing will occur on the EOM + 1 day
2. The timeline assumes a two-crewmember 3 hr EVA to repair the problem
3. Specific procedure block callouts for the EV and IV crewmembers during the EVA will be coordinated in real time
4. RCS hot fire testing, FCS C/O, and CABIN STOW are assumed to be previously accomplished
5. The timeline utilizes minimum activity durations for EMU C/O and PRE/POST SLEEP
6. Due to the necessity of the timeline, the crew is reqd to shorten their sleep to 7 hr and shift the sleep late by 2 hr
7. This template can be adapted for dual-shift timelines by scheduling Non-Entry team sleep with Entry team sleep in order to modify the timeline to single-shift operations
8. The MET scale on this timeline is actually a PET scale counting down to nominal deorbit TIG

This Page Intentionally Blank

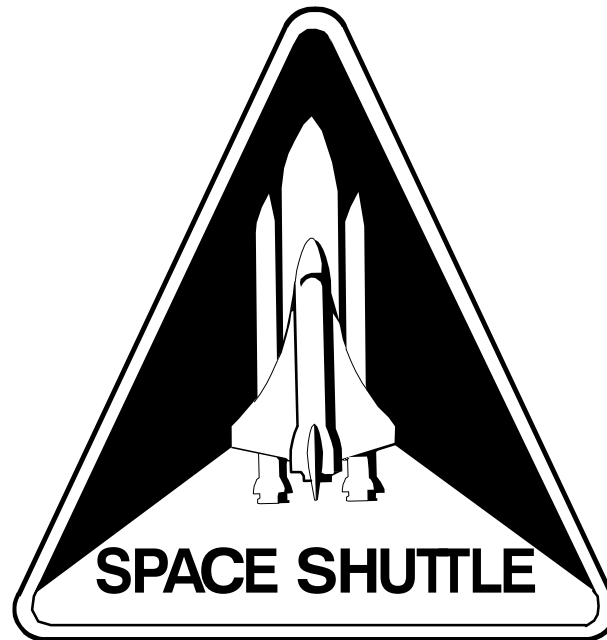

DEORBIT PREP

**STS
ALL**