

EVA Checklist

STS-116 Flight Supplement

**Mission Operations Directorate
EVA, Robotics, and Crew Systems
Operations Division**

**Final
November 15, 2006**

NOTE

This supplement is to be integrated into the generic edition to provide a complete document for the specific flight. Some pages in the generic edition may be replaced with supplemental pages identified as 'TEMP'. These generic pages, if any, must be retained for use on future flights.

National Aeronautics and
Space Administration

Lyndon B. Johnson Space Center
Houston, Texas



MISSION OPERATIONS DIRECTORATE

**EVA CHECKLIST
STS-116 FLIGHT SUPPLEMENT**

FINAL
November 15, 2006

PREPARED BY:

Christy M. Hansen
Book Manager

APPROVED BY:

Tricia K. Mack
Lead, EVA Systems Group

Randall S. McDaniel
Lead, EVA Task Group

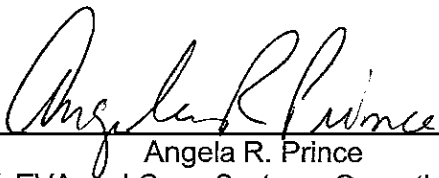
Angela R. Prince
Chief, EVA and Crew Systems Operations Branch

This document is under the configuration control of the Crew Procedures Control Board (CPCB). All proposed changes must be submitted via FDF Workflow Crew Procedure Change Request (CR) to DO3/FDF Manager.

Additional distribution of this book, for official use only, may be requested in writing to DO3/PMO Administrator. The request must include justification and requester's name, organization, position, and phone number. Contractor requests are made through the NASA or DOD organization supported. Deletions, reduction in quantity, or change of address may be submitted to DO3/FDF Management Office, 281-244-1184.

Incorporates the following:		
482#:	EVA-1721	EVA-1732
	EVA-1725	EVA-1733
	EVA-1726	EVA-1734
	EVA-1727	EVA-1737
	EVA-1728	EVA-1738
	EVA-1729	EVA-1739
	EVA-1730	EVA-1740
	EVA-1731	EVA-1741

AREAS OF TECHNICAL RESPONSIBILITY

Book Manager

DX32/C. Hansen

281-483-7522

EVA CHECKLIST
STS-116 FLIGHT SUPPLEMENT

LIST OF EFFECTIVE PAGES

FINAL 11/15/06

Sign Off	* 116/FIN	FS 2-16.....	116/FIN
FS ii.....	* 116/FIN	FS 2-17.....	116/FIN
iii.....	* generic	FS 2-18.....	116/FIN
iv.....	* generic	FS 2-19.....	116/FIN
FS v.....	* 116/FIN	FS 2-20.....	116/FIN
FS vi.....	* 116/FIN	FS 2-21.....	116/FIN
FS vii.....	* 116/FIN	FS 2-22.....	116/FIN
FS viii.....	* 116/FIN	FS 2-23.....	116/FIN
FS ix.....	* 116/FIN	FS 2-24.....	116/FIN
FS x.....	* 116/FIN	3-1.....	generic
FS xi.....	* 116/FIN	3-2.....	generic
FS xii.....	* 116/FIN	3-3.....	generic
FS xiii.....	116/FIN	3-4.....	generic
FS xiv.....	116/FIN	3-5.....	generic
FS xv.....	116/FIN	3-6.....	generic
FS xvi.....	116/FIN	3-7.....	generic
FS xvii.....	116/FIN	3-8.....	generic
FS xviii.....	116/FIN	3-9.....	generic
FS xix.....	116/FIN	3-10.....	generic
FS xx.....	116/FIN	CC 3-10.....	generic
FS xxi.....	116/FIN	CC 3-11.....	generic
FS xxii.....	116/FIN	3-12.....	generic
1-1.....	generic	4-1.....	generic
1-2.....	generic	4-2.....	generic
1-3.....	generic	4-3.....	generic
1-4.....	generic	4-4.....	generic
1-5.....	generic	4-5.....	generic
1-6.....	generic	4-6.....	generic
1-7.....	generic	4-7.....	generic
1-8.....	generic	4-8.....	generic
1-9.....	generic	4-9.....	generic
1-10.....	generic	4-10.....	generic
TEMP FS 2-1.....	116/FIN	4-11.....	generic
TEMP FS 2-2.....	ALL/FIN	4-12.....	generic
2-3.....	generic	5-1.....	generic
2-4.....	generic	5-2.....	generic
TEMP FS 2-5.....	116/FIN	5-3.....	generic
TEMP FS 2-6.....	ALL/FIN	5-4.....	generic
FS 2-7.....	116/FIN	B6-1.....	generic
FS 2-8.....	116/FIN	CC B6-2.....	generic
FS 2-9.....	116/FIN	6-3.....	generic
FS 2-10.....	116/FIN	CC 6-4.....	generic
FS 2-11.....	116/FIN	FS 7-1.....	116/FIN
FS 2-12.....	116/FIN	FS 7-2.....	116/FIN
FS 2-13.....	116/FIN	FS 7-3.....	116/FIN
FS 2-14.....	116/FIN	FS 7-4.....	116/FIN
FS 2-15.....	116/FIN	FS 7-5.....	116/FIN
		FS 7-6.....	116/FIN

* – Omit from flight book

FS 7-7	116/FIN	FS 7-60.....	116/FIN
FS 7-8	116/FIN	FS 7-61.....	116/FIN
FS 7-9	116/FIN	FS 7-62.....	116/FIN
FS 7-10	116/FIN	FS 7-63.....	116/FIN
FS 7-11	116/FIN	FS 7-64.....	116/FIN
FS 7-12	116/FIN	FS 7-65.....	116/FIN
FS 7-13	116/FIN	FS 7-66.....	116/FIN
FS 7-14	116/FIN	FS 7-67.....	116/FIN
FS 7-15	116/FIN	FS 7-68.....	116/FIN
FS 7-16	116/FIN	FS 7-69.....	116/FIN
FS 7-17	116/FIN	FS 7-70.....	116/FIN
FS 7-18	116/FIN	FS 7-71.....	116/FIN
FS 7-19	116/FIN	FS 7-72.....	116/FIN
FS 7-20	116/FIN	FS 7-73.....	116/FIN
FS 7-21	116/FIN	FS 7-74.....	116/FIN
FS 7-22	116/FIN	FS 7-75.....	116/FIN
FS 7-23	116/FIN	FS 7-76.....	116/FIN
FS 7-24	116/FIN	FS 7-77.....	116/FIN
FS 7-25	116/FIN	FS 7-78.....	116/FIN
FS 7-26	116/FIN	FS 7-79.....	116/FIN
FS 7-27	116/FIN	FS 7-80.....	116/FIN
FS 7-28	116/FIN	FS 7-81.....	116/FIN
FS 7-29	116/FIN	FS 7-82.....	116/FIN
FS 7-30	116/FIN	FS 7-83.....	116/FIN
FS 7-31	116/FIN	FS 7-84.....	116/FIN
FS 7-32	116/FIN	FS 7-85.....	116/FIN
FS 7-33	116/FIN	FS 7-86.....	116/FIN
FS 7-34	116/FIN	FS 7-87.....	116/FIN
FS 7-35	116/FIN	FS 7-88.....	116/FIN
FS 7-36	116/FIN	FS 7-89.....	116/FIN
FS 7-37	116/FIN	FS 7-90.....	116/FIN
FS 7-38	116/FIN	FS 7-91.....	116/FIN
FS 7-39	116/FIN	FS 7-92.....	116/FIN
FS 7-40	116/FIN	FS 7-93.....	116/FIN
FS 7-41	116/FIN	FS 7-94.....	116/FIN
FS 7-42	116/FIN	FS 7-95.....	116/FIN
FS 7-43	116/FIN	FS 7-96.....	116/FIN
FS 7-44	116/FIN	TEMP FS 8-1	116/FIN
FS 7-45	116/FIN	TEMP FS 8-2.....	116/FIN
FS 7-46	116/FIN	8-3	generic
FS 7-47	116/FIN	8-4	generic
FS 7-48	116/FIN	8-5	generic
FS 7-49	116/FIN	8-6	generic
FS 7-50	116/FIN	FS 8-7.....	116/FIN
FS 7-51	116/FIN	FS 8-8.....	116/FIN
FS 7-52	116/FIN	FS 8-9.....	116/FIN
FS 7-53	116/FIN	FS 8-10.....	116/FIN
FS 7-54	116/FIN	FS 8-11.....	116/FIN
FS 7-55	116/FIN	FS 8-12.....	116/FIN
FS 7-56	116/FIN	FS 8-13.....	116/FIN
FS 7-57	116/FIN	FS 8-14.....	116/FIN
FS 7-58	116/FIN	FS 8-15.....	116/FIN
FS 7-59	116/FIN	FS 8-16.....	116/FIN

FS 8-17	116/FIN	12-10	generic
FS 8-18	116/FIN	12-11	generic
FS 8-19	116/FIN	12-12	generic
FS 8-20	116/FIN	12-13	generic
FS 8-21	116/FIN	12-14	generic
FS 8-22	116/FIN	12-15	generic
FS 8-23	116/FIN	12-16	generic
FS 8-24	116/FIN	12-17	generic
FS 8-25	116/FIN	12-18	generic
FS 8-26	116/FIN	12-19	generic
FS 8-27	116/FIN	12-20	generic
FS 8-28	116/FIN	12-21	generic
FS 8-29	116/FIN	12-22	generic
FS 8-30	116/FIN	12-23	generic
FS 8-31	116/FIN	12-24	generic
FS 8-32	116/FIN	12-25	generic
9-1	generic	12-26	generic
9-2	generic	FS 12-27	116/FIN
9-3	generic	FS 12-28	116/FIN
9-4	generic	FS 12-29	116/FIN
9-5	generic	FS 12-30	116/FIN
9-6	generic	FS 12-31	116/FIN
TEMP FS 10-1	116/FIN	FS 12-32	116/FIN
TEMP FS 10-2	ALL/FIN	FS 13-1	116/FIN
10-3	generic	FS 13-2	116/FIN
10-4	generic	14-1	generic
10-5	generic	14-2	generic
10-6	generic	14-3	generic
10-7	generic	14-4	generic
10-8	generic	14-5	generic
10-9	generic	14-6	generic
10-10	generic	14-7	generic
10-11	generic	14-8	generic
10-12	generic	14-9	generic
FS CC 10-13	116/FIN	14-10	generic
FS CC 10-14	116/FIN	14-11	generic
FS 10-15	116/FIN	14-12	generic
FS 10-16	116/FIN	14-13	generic
11-1	generic	14-14	generic
11-2	generic	14-15	generic
11-3	generic	14-16	generic
11-4	generic	14-17	generic
12-i	generic	14-18	generic
12-ii	generic	14-19	generic
TEMP FS 12-1	116/FIN	14-20	generic
TEMP FS 12-2	ALL/FIN	14-21	generic
12-3	generic	14-22	generic
12-4	generic	15-1	generic
12-5	generic	15-2	generic
12-6	generic	15-3	generic
12-7	generic	15-4	generic
12-8	generic	15-5	generic
12-9	generic	15-6	generic

15-7	generic	FS 16-44	116/FIN
15-8	generic	FS 16-45	116/FIN
15-9	generic	FS 16-46	116/FIN
15-10	generic	FS 16-47	116/FIN
15-11	generic	FS 16-48	116/FIN
15-12	generic	FS 16-49	116/FIN
15-13	generic	FS 16-50	116/FIN
15-14	generic	FS 16-51	116/FIN
16-i	generic	FS 16-52	116/FIN
16-ii	generic	FS 16-53	116/FIN
TEMP FS 16-1	116/FIN	FS 16-54	116/FIN
TEMP FS 16-2	ALL/FIN	FS 16-55	116/FIN
FS 16-3	116/FIN	FS 16-56	116/FIN
FS 16-4	116/FIN	FS 16-57	116/FIN
FS 16-5	116/FIN	FS 16-58	116/FIN
FS 16-6	116/FIN	FS 16-59	116/FIN
FS 16-7	116/FIN	FS 16-60	116/FIN
FS 16-8	116/FIN	FS 16-61	116/FIN
FS 16-9	116/FIN	FS 16-62	116/FIN
FS 16-10	116/FIN	FS 16-63	116/FIN
FS 16-11	116/FIN	FS 16-64	116/FIN
FS 16-12	116/FIN	FS 16-65	116/FIN
FS 16-13	116/FIN	FS 16-66	116/FIN
FS 16-14	116/FIN	FS 16-67	116/FIN
FS 16-15	116/FIN	FS 16-68	116/FIN
FS 16-16	116/FIN	FS 16-69	116/FIN
FS 16-17	116/FIN	FS 16-70	116/FIN
FS 16-18	116/FIN	FS 16-71	116/FIN
FS 16-19	116/FIN	FS 16-72	116/FIN
FS 16-20	116/FIN	FS 16-73	116/FIN
FS 16-21	116/FIN	FS 16-74	116/FIN
FS 16-22	116/FIN	FS 16-75	116/FIN
FS 16-23	116/FIN	FS 16-76	116/FIN
FS 16-24	116/FIN	FS 16-77	116/FIN
FS 16-25	116/FIN	FS 16-78	116/FIN
FS 16-26	116/FIN	FS 16-79	116/FIN
FS 16-27	116/FIN	FS 16-80	116/FIN
FS 16-28	116/FIN	FS 16-81	116/FIN
FS 16-29	116/FIN	FS 16-82	116/FIN
FS 16-30	116/FIN	FS 16-83	116/FIN
FS 16-31	116/FIN	FS 16-84	116/FIN
FS 16-32	116/FIN	FS 16-85	116/FIN
FS 16-33	116/FIN	FS 16-86	116/FIN
FS 16-34	116/FIN	FS 16-87	116/FIN
FS 16-35	116/FIN	FS 16-88	116/FIN
FS 16-36	116/FIN	FS 16-89	116/FIN
FS 16-37	116/FIN	FS 16-90	116/FIN
FS 16-38	116/FIN	FS 16-91	116/FIN
FS 16-39	116/FIN	FS 16-92	116/FIN
FS 16-40	116/FIN	FS 16-93	116/FIN
FS 16-41	116/FIN	FS 16-94	116/FIN
FS 16-42	116/FIN	FS 16-95	116/FIN
FS 16-43	116/FIN	FS 16-96	116/FIN

FS 16-97	116/FIN	FS 16-150.....	116/FIN
FS 16-98	116/FIN	FS 16-151.....	116/FIN
FS 16-99	116/FIN	FS 16-152.....	116/FIN
FS 16-100	116/FIN	FS 16-153.....	116/FIN
FS 16-101	116/FIN	FS 16-154.....	116/FIN
FS 16-102	116/FIN	FS 16-155.....	116/FIN
FS 16-103	116/FIN	FS 16-156.....	116/FIN
FS 16-104	116/FIN	FS 16-157.....	116/FIN
FS 16-105	116/FIN	FS 16-158.....	116/FIN
FS 16-106	116/FIN	FS 16-159.....	116/FIN
FS 16-107	116/FIN	FS 16-160.....	116/FIN
FS 16-108	116/FIN	FS 16-161.....	116/FIN
FS 16-109	116/FIN	FS 16-162.....	116/FIN
FS 16-110	116/FIN	FS 16-163.....	116/FIN
FS 16-111	116/FIN	FS 16-164.....	116/FIN
FS 16-112	116/FIN	FS 16-165.....	116/FIN
FS 16-113	116/FIN	FS 16-166.....	116/FIN
FS 16-114	116/FIN	FS 16-167.....	116/FIN
FS 16-115	116/FIN	FS 16-168.....	116/FIN
FS 16-116	116/FIN	17-1	generic
FS 16-117	116/FIN	17-2	generic
FS 16-118	116/FIN	FS 18-1.....	116/FIN
FS 16-119	116/FIN	FS 18-2.....	116/FIN
FS 16-120	116/FIN	FS 18-3.....	116/FIN
FS 16-121	116/FIN	FS 18-4.....	116/FIN
FS 16-122	116/FIN	FS 18-5.....	116/FIN
FS 16-123	116/FIN	FS 18-6.....	116/FIN
FS 16-124	116/FIN	FS 18-7.....	116/FIN
FS 16-125	116/FIN	FS 18-8.....	116/FIN
FS 16-126	116/FIN	FS 18-9.....	116/FIN
FS 16-127	116/FIN	FS 18-10.....	116/FIN
FS 16-128	116/FIN	FS 18-11.....	116/FIN
FS 16-129	116/FIN	FS 18-12.....	116/FIN
FS 16-130	116/FIN	FS 18-13.....	116/FIN
FS 16-131	116/FIN	FS 18-14.....	116/FIN
FS 16-132	116/FIN	FS 18-15.....	116/FIN
FS 16-133	116/FIN	FS 18-16.....	116/FIN
FS 16-134	116/FIN	FS 18-17.....	116/FIN
FS 16-135	116/FIN	FS 18-18.....	116/FIN
FS 16-136	116/FIN	FS 18-19.....	116/FIN
FS 16-137	116/FIN	FS 18-20.....	116/FIN
FS 16-138	116/FIN	FS 18-21.....	116/FIN
FS 16-139	116/FIN	FS 18-22.....	116/FIN
FS 16-140	116/FIN	FS 18-23.....	116/FIN
FS 16-141	116/FIN	FS 18-24.....	116/FIN
FS 16-142	116/FIN	FS 18-25.....	116/FIN
FS 16-143	116/FIN	FS 18-26.....	116/FIN
FS 16-144	116/FIN	FS 18-27.....	116/FIN
FS 16-145	116/FIN	FS 18-28.....	116/FIN
FS 16-146	116/FIN	FS 18-29.....	116/FIN
FS 16-147	116/FIN	FS 18-30.....	116/FIN
FS 16-148	116/FIN	FS 18-31.....	116/FIN
FS 16-149	116/FIN	FS 18-32.....	116/FIN

FS 18-33	116/FIN	FS 18-86	116/FIN
FS 18-34	116/FIN	FS 18-87	116/FIN
FS 18-35	116/FIN	FS 18-88	116/FIN
FS 18-36	116/FIN	FS 18-89	116/FIN
FS 18-37	116/FIN	FS 18-90	116/FIN
FS 18-38	116/FIN	FS 18-91	116/FIN
FS 18-39	116/FIN	FS 18-92	116/FIN
FS 18-40	116/FIN	FS 18-93	116/FIN
FS 18-41	116/FIN	FS 18-94	116/FIN
FS 18-42	116/FIN	FS 18-95	116/FIN
FS 18-43	116/FIN	FS 18-96	116/FIN
FS 18-44	116/FIN	FS 18-97	116/FIN
FS 18-45	116/FIN	FS 18-98	116/FIN
FS 18-46	116/FIN	FS 18-99	116/FIN
FS 18-47	116/FIN	FS 18-100	116/FIN
FS 18-48	116/FIN	FS 18-101	116/FIN
FS 18-49	116/FIN	FS 18-102	116/FIN
FS 18-50	116/FIN	FS 18-103	116/FIN
FS 18-51	116/FIN	FS 18-104	116/FIN
FS 18-52	116/FIN	FS 18-105	116/FIN
FS 18-53	116/FIN	FS 18-106	116/FIN
FS 18-54	116/FIN	FS 18-107	116/FIN
FS 18-55	116/FIN	FS 18-108	116/FIN
FS 18-56	116/FIN	FS 18-109	116/FIN
FS 18-57	116/FIN	FS 18-110	116/FIN
FS 18-58	116/FIN	FS 18-111	116/FIN
FS 18-59	116/FIN	FS 18-112	116/FIN
FS 18-60	116/FIN	FS 18-113	116/FIN
FS 18-61	116/FIN	FS 18-114	116/FIN
FS 18-62	116/FIN	FS 18-115	116/FIN
FS 18-63	116/FIN	FS 18-116	116/FIN
FS 18-64	116/FIN	FS 18-117	116/FIN
FS 18-65	116/FIN	FS 18-118	116/FIN
FS 18-66	116/FIN	FS 18-119	116/FIN
FS 18-67	116/FIN	FS 18-120	116/FIN
FS 18-68	116/FIN	FS 18-121	116/FIN
FS 18-69	116/FIN	FS 18-122	116/FIN
FS 18-70	116/FIN	FS 18-123	116/FIN
FS 18-71	116/FIN	FS 18-124	116/FIN
FS 18-72	116/FIN	FS 18-125	116/FIN
FS 18-73	116/FIN	FS 18-126	116/FIN
FS 18-74	116/FIN	FS 18-127	116/FIN
FS 18-75	116/FIN	FS 18-128	116/FIN
FS 18-76	116/FIN	FS 18-129	116/FIN
FS 18-77	116/FIN	FS 18-130	116/FIN
FS 18-78	116/FIN	FS 18-131	116/FIN
FS 18-79	116/FIN	FS 18-132	116/FIN
FS 18-80	116/FIN	FS 18-133	116/FIN
FS 18-81	116/FIN	FS 18-134	116/FIN
FS 18-82	116/FIN	FS 18-135	116/FIN
FS 18-83	116/FIN	FS 18-136	116/FIN
FS 18-84	116/FIN	FS 18-137	116/FIN
FS 18-85	116/FIN	FS 18-138	116/FIN

FS 18-139	116/FIN
FS 18-140	116/FIN
FS 18-141	116/FIN
FS 18-142	116/FIN
FS 18-143	116/FIN
FS 18-144	116/FIN
FS 18-145	116/FIN
FS 18-146	116/FIN
FS 18-147	116/FIN
FS 18-148	116/FIN
FS 18-149	116/FIN
FS 18-150	116/FIN
FS 18-151	116/FIN
FS 18-152	116/FIN
19-i	generic
19-ii	generic
19-1	generic
19-2	generic
19-3	generic
19-4	generic
19-5	generic
19-6	generic
19-7	generic
19-8	generic
19-9	generic
19-10	generic
19-11	generic
19-12	generic
20-1	generic*
20-2	generic*

* – Omit from flight book

EVA CUE CARDS

<u>Title</u>	<u>Ref. Page</u>	<u>Card No.</u>
SAFER CHECKOUT RESULTS (Front).....	CC 3-10	generic
SAFER STATUS TROUBLESHOOTING (Back)	CC 3-11	generic
DEPRESS/REPRESS (TNL) (Front).....	CC B6-2	generic
FAILED LEAK CHECK (Back of DEPRESS/REPRESS)	CC 6-4	generic
STS-116 LOGISTICS CUE CARD	FS CC 10-13	EVA-4a/116/O/A
(Back).....	FS CC 10-14	EVA-4b/116/O/A

CONTENTS

PAGE

10.2 PSI CABIN	1-1
MASK PREBREATHE INITIATE	1-2
PREP FOR 10.2 PSI CABIN	1-3
CABIN DEPRESS TO 10.2 PSI.....	1-4
10.2 PSIA DEPRESS CHART	1-5
10.2 PSI CABIN CONFIG.....	1-6
MASK PREBREATHE TERMINATE	1-6
10.2 PSI MAINTENANCE.....	1-7
CABIN REPRESS TO 14.7 PSI.....	1-8
14.7 PSI CABIN CONFIG.....	1-9
AIRLOCK CONFIG.....	2-1
AIRLOCK PREP	TEMP FS 2-2
EMU SWAP	2-3
BOOSTER FAN DEACTIVATION/REMOVAL.....	2-4
BOOSTER FAN INSTALLATION/ACTIVATION.....	2-4
EMU REMOVAL	2-4
EMU INSTALLATION	2-4
EMU CHECKOUT PREP.....	TEMP FS 2-5
LTA RESTRAINT STRAP REMOVAL	TEMP FS 2-6
LTA RESTRAINT STRAP INSTALLATION	TEMP FS 2-6
EMU AND EVA TRANSFER PREP.....	FS 2-7
EMU AND EVA TOOL TRANSFER AND RECONFIGURATION.....	FS 2-14
POST EVA RECONFIGURATION AND TRANSFER	FS 2-19
CHECKOUTS.....	3-1
EMU CHECKOUT	3-2
EMU POWERUP AND COMM CHECK.....	3-2
PRIMARY REGULATOR/FAN/PUMP CHECK.....	3-4
SOP CHECK.....	3-5
BATTERY CHARGE CHECK INIT.....	3-6
BATTERY CHARGE CHECK TERM	3-6
EMU SWAP DURING CHECKOUT	3-7
POST EMU C/O RECONFIG	3-7
SAFER CHECKOUT	3-8
SELF TEST SEQUENCE	3-9
SAFER CHECKOUT RESULTS.....	CC 3-10
SAFER STATUS TROUBLESHOOTING	CC 3-11
REBA POWERED HARDWARE CHECKOUT	3-12
EVA PREP	4-1
MIDDECK PREP	4-2
EVA PREP.....	4-3
PREP FOR DONNING.....	4-3
EMU DONNING	4-5
EMU CHECK	4-7
EMU PURGE.....	4-7
EMU PREBREATHE	4-8
SAFER DONNING	4-8
EVA COMM CONFIG	4-10
EVA COMM DECONFIG	4-10
APPROVED NON-EMU HARDWARE MATRIX.....	4-11

EMU STATUS	5-1	
EMU STATUS	5-2	
DEPRESS/REPRESS	B6-1	
DEPRESS/REPRESS (TNL)	CC B6-2	
FAILED LEAK CHECK	6-3	
FAILED LEAK CHECK (5 PSI)	CC 6-4	
FAILED LEAK CHECK (14.7/10.2 PSI)	CC 6-4	
TIMELINES	FS 7-1	I
EVA 1		
EVA 1 NOTES, CAUTIONS, & WARNINGS	FS 7-3	
EVA 1 BRIEFING CARD	FS 7-5	
EVA 1 INHIBIT PAD	FS 7-6	
EVA 1 SUMMARY TIMELINE	FS 7-7	
EVA 1 TOOL CONFIG	FS 7-8	
EGRESS	FS 7-9	
P5 LAUNCH LOCK REMOVAL	FS 7-10	
P5 TO P4 ATTACHMENT	FS 7-14	
PVRGF TRANSFER TO KEEL	FS 7-20	
P5 TO P4 UTILITIY CONNECTIONS (GET AHEAD)	FS 7-24	
CLA OPEN (GET AHEAD)	FS 7-26	
P5 PORT LAUNCH LOCK REMOVAL (GET AHEAD)	FS 7-28	
CP3 CAMERA R&R	FS 7-31	
CLEANUP	FS 7-35	
INGRESS	FS 7-36	
EVA 2		
EVA 2 NOTES, CAUTIONS, & WARNINGS	FS 7-37	
EVA 2 BRIEFING CARD	FS 7-39	
EVA 2 INHIBIT PAD	FS 7-40	
EVA 2 SUMMARY TIMELINE	FS 7-41	
EVA 2 TOOL CONFIG	FS 7-42	
EGRESS	FS 7-43	
CHANNEL 2/3 POWER RECONFIGURATION	FS 7-44	
CETA CART 2 RELOCATION	FS 7-49	
CETA CART 1 RELOCATION	FS 7-52	
SSRMS FMS MLI INSTALLATION	FS 7-56	
Z1-006 PATCH PANEL 2 RECONFIGURATION	FS 7-58	
STBD AND PORT QD BAG INSTALLATION	FS 7-60	
VTE AND PM JUMPER BAG INSTALLATION	FS 7-61	
CLEANUP	FS 7-62	
INGRESS	FS 7-63	
EVA 3		
EVA 3 NOTES, CAUTIONS, & WARNINGS	FS 7-64	
EVA 3 BRIEFING CARD	FS 7-68	
EVA 3 INHIBIT PAD	FS 7-69	
EVA 3 SUMMARY TIMELINE	FS 7-70	
EVA 3 TOOL CONFIG	FS 7-71	
EGRESS	FS 7-72	
CHANNEL 1/4 POWER RECONFIGURATION	FS 7-73	
SMDP TRANSFER	FS 7-79	
Z1-005 PATCH PANEL 1 RECONFIGURATION	FS 7-86	
RUSSIAN POWER RECONFIGURATION	FS 7-88	
AGB TRANSFER TO FHRC	FS 7-91	
CLEANUP	FS 7-94	
INGRESS	FS 7-95	

TOOLS AND STOWAGE	TEMP FS	8-1
PGT CHECKOUT		8-3
760XD PGSC-PGT CONNECTION.....		8-4
PROGRAM PGT SETTINGS.....		8-4
DOWNLOAD/ERASE EVENT LOG.....		8-5
PGT CONTINGENCIES		8-6
APFR MANAGEMENT – STS-116 (12A.1)	FS	8-7
SAFETY TETHER CONFIGURATION	FS	8-8
PORT LIGHTWEIGHT TOOL STOWAGE ASSEMBLY	FS	8-9
TOOLBOX STOWAGE.....	FS	8-10
TOOLBOX PANEL AND SLOT LABELS.....	FS	8-11
Z1 TOOLBOX INTERNAL LAYOUT	FS	8-12
AIRLOCK TOOLBOX INTERNAL LAYOUT	FS	8-13
STBD QD BAG PACK	FS	8-14
PORT QD BAG PACK.....	FS	8-15
VTE BAG AND PUMP MODULE JUMPER BAG PACK	FS	8-16
EMU EQUIPMENT SORTED BY ITEM.....	FS	8-17
EMU EQUIPMENT SORTED BY LOCATION	FS	8-19
SHUTTLE EVA TOOLS SORTED BY TOOL NAME.....	FS	8-21
SHUTTLE EVA TOOLS SORTED BY LOCATION.....	FS	8-26
POST EVA		9-1
POST EVA.....		9-2
SUIT DOFFING.....		9-2
SAFER DOFFING.....		9-2
EMU WATER RECHARGE.....		9-3
SAFER STOW		9-3
SUIT DRYING/SEAL WIPE		9-4
OXYGEN RECHARGE VERIFICATION		9-4
WATER FILL VERIFICATION.....		9-4
EMU POWERDOWN/OVERNIGHT STOW.....		9-5
EMU MAINT/RECHARGE.....		10-1
WATER RECHARGE	TEMP FS	10-2
EMU POWERUP	TEMP FS	10-2
WATER FILL.....	TEMP FS	10-2
WATER FILL VERIFICATION.....	TEMP FS	10-2
EMU LiOH CHANGEOUT		10-4
MIDDECK EMU BATTERY RECHARGE/LiOH REPLACEMENT		10-5
INITIATE		10-5
TERMINATE		10-6
IN-SUIT EMU BATTERY RECHARGE/CHARGE VERIFICATION		10-7
INITIATE		10-7
TERMINATE		10-7
EMU POWERDOWN.....		10-7
HELMET LIGHT/PGT BATTERY RECHARGE		10-8
INITIATE		10-8
TERMINATE		10-9
REBA BATTERY INSTALLATION.....		10-9
EMU BATTERY REMOVAL/INSTALL		10-10
HELMET LIGHT BULB CHANGEOUT		10-11
REBA BATTERY RECHARGE		10-12
INITIATE		10-12
TERMINATE		10-12
STS-116 LOGISTICS CUE CARD	FS CC	10-13
EMU BATTERY RECHARGE.....	FS	10-15

POST EVA ENTRY PREP	11-1
POST EVA ENTRY PREP	11-2
SAFER ENTRY STOW	11-2
POST ISS EVA ENTRY PREP	11-3
SAFER ENTRY STOW	11-3
<u>OFF-NOMINAL PROCEDURES</u>	12-i
EMU CONTINGENCY PROCS	12-1
DISPLAY LOSS DURING POWER TRANSFER (WARM RESTART) .. TEMP FS	12-2
VACUUM H2O RECHARGE (MANNED)	TEMP FS 12-2
LIOH REPLACEMENT (MANNED)	12-3
BATTERY REPLACEMENT (MANNED)	12-4
WATER DUMP	12-6
SCU SWAP (UNMANNED)	12-7
SCU SWAP (MANNED)	12-7
EMU COLD RESTART (MANNED)	12-7
12.1 STS EVA DECONTAMINATION	12-8
CONTAMINATION TEST	12-15
SAFER BATTERY CHANGEOUT	12-18
BENDS TREATMENT ADAPTER (BTA) INSTALLATION (IN-SUIT)	12-19
BTA PREP	12-19
BTA TREATMENT	12-19
BENDS TREATMENT ADAPTER (BTA) INSTALLATION (POST	
SUIT DOFFING)	12-21
BTA PREP	12-21
BTA TREATMENT	12-21
EMU RESIZE	12-24
STS-116 NOMINAL EMU SIZING MATRIX	FS 12-27
EMU CONTINGENCY RESIZE MATRIX	FS 12-28
PRE EVA 3 EMU RESIZE	FS 12-29
TPS REPAIR	FS 13-1
ORBITER CONTINGENCY EVA	14-1
PAYLOAD BAY EVA NOMENCLATURE	14-2
RMS/PRLA CONTINGENCY EVA	14-3
96 BOLT PRE-EVA TOOL CONFIG	14-13
96 BOLT EVA TIMELINE	14-14
CAPTURE LATCH MANUAL RELEASE (ODS/PMA)	14-19
96 BOLT EVA LAYOUT	14-21
PLBD LATCH TOOL PLACEMENT WITH DUAL LATCH GANG FAILURES	14-22
EVA CUFF CHECKLIST (CIL)	15-1
NORMAL EVA STATUS	15-2
DCM CONFIGURATION	15-2
EMU MALFUNCTION INDEX	15-2
DECOMPRESSION SICKNESS (DCS)	15-3
DECOMPRESSION SICKNESS (DCS) (CONT)	15-3
ABORT EVA	15-3
TERMINATE EVA	15-3
SUIT P EMERG	15-4
SOP O2 ON	15-4
BATT AMPS HIGH	15-4
BATT V DECAY OR BATT VDC LOW	15-4
SUIT P LOW	15-5
SUIT P HIGH	15-5

SOP P LOW	15-5
O2 USE HIGH	15-5
SUBLM PRESS	15-6
H2O GP LOW	15-6
RESRV H2O ON	15-6
H2O WP HIGH	15-6
NO VENT FLOW	15-7
CO2 HIGH OR MONITOR CO2	15-7
CO2 SNSR BAD	15-7
COMM FAILURE	15-7
AIR FLOW CONTAMINATION	15-8
LOSS OF COOLING	15-8
RLF V FAIL	15-8
MISC MSGS 1	15-8
MISC MSGS (CONT)/TIME LF	15-9
AIRLOCK LATCH DISCONNECT	15-9
AIRLOCK INGRESS	15-9

FOLLOWING PAGES NOT IN EV CUFF

RADIATOR ACTUATOR DISCONNECT	15-9
PLBD DRIVE CUT	15-10
DOOR DRIVE RESTRAINT	15-10
DOOR DRIVE DISCONNECT	15-10
WINCH OPERATIONS	15-10
WINCH OPERATIONS (CONT)	15-11
3-PT TOOL INSTALLATION	15-11
CL LATCH TOOL	15-11
RMS JOINT ALIGN	15-11
MPM STOW/DEPLOY	15-12
RMS TIEDOWN	15-12
RMS FLIGHT RELEASABLE GRAPPLE FIXTURE RELEASE	15-12
PRLA OPEN/CLOSE	15-12
PRLA OPEN/CLOSE (CONT)	15-13
KU ANTENNA STOW	15-13
KU ANTENNA STOW (CONT)	15-13
AIRLOCK EGRESS	15-13

FLIGHT SPECIFIC REFERENCE 16-i

UNSCHEDULED/CONTINGENCY EVA TASKS	TEMP FS 16-1
12A.1 WORKAROUNDS CRIBSHEET	FS 16-3
EVA 1 CONTINGENCIES	
MANUAL EATCS N2 VENTING	FS 16-15
SOFT CAPTURE MANUAL OVERRIDE	FS 16-21
MRTAS PRIMARY BOLT CONTINGENCIES	FS 16-23
MRTAS CONTINGENCY BOLT INSTALL	FS 16-25
SOLAR ARRAY	
MANUAL OVERRIDE TO RETRACT MAST	FS 16-28
MANUAL OVERRIDE TO LATCH/UNLATCH (TENSION) 4B SABB	FS 16-31
SOLAR ARRAY JETTISON	FS 16-34
EVA 2 CONTINGENCIES	
CHANNEL 2/3 CONNECTOR BACKOUT	FS 16-40
MBSU REMOVE AND REPLACE – 2A2B (EVA 2)	FS 16-43
MBSU REMOVE AND REPLACE – 3A3B (EVA 2)	FS 16-51
DDCU REMOVE AND REPLACE – CH 2/3 (EVA 2)	FS 16-59
BCDU BACKOUT – CH 2/3 (EVA 2)	FS 16-67
P1 PUMP MODULE R&R SUMMARY TIMELINE	FS 16-70

EVA 3 CONTINGENCIES	
CHANNEL 1/4 CONNECTOR BACKOUT	FS 16-96
MBSU REMOVE AND REPLACE – 1A1B (EVA 3)	FS 16-100
MBSU REMOVE AND REPLACE – 4A4B (EVA 3)	FS 16-108
DDCU REMOVE AND REPLACE – CH 1/4 (EVA 3)	FS 16-117
BCDU BACKOUT – CH 1/4 (EVA 3)	FS 16-126
S1 PUMP MODULE R&R SUMMARY TIMELINE	FS 16-130
MISCELLANEOUS	
SSRMS JOINT DRIVE	FS 16-154
MSS EXTENSION CABLE INSTALL	FS 16-156
PUMP MODULE MANUAL VENTING	FS 16-159
FAILED PUMP MODULE RETURN TO ICC	FS 16-163
GENERIC EVA REFERENCE	17-1
FLIGHT SPECIFIC EVA REFERENCE	FS 18-1
12A.1 OVERVIEW	
12A.1 ISS OVERVIEW	FS 18-5
PAYLOAD BAY OVERVIEW	FS 18-6
MT/CETA CART LOCATIONS PER EVA	FS 18-7
12A.1 TRUSS WORKSITES	FS 18-8
12A.1 ICC OVERVIEW	FS 18-9
ICC WIF AND HANDRAIL LAYOUT – TOP	FS 18-10
ICC WIF AND HANDRAIL LAYOUT – BOTTOM	FS 18-11
ICC – FAILED PUMP MODULE RETURN CONFIG	FS 18-12
ESP2 HANDRAILS AND WIFs – ZENITH	FS 18-13
ESP2 HANDRAILS AND WIFs – NADIR	FS 18-14
EVA 1 OVERVIEW	
P5 SAFETY TETHER SWAP OVERVIEW	FS 18-15
P5 PRE-INSTALL POSITION	FS 18-16
RTAS CORNER 2 CLEARANCES	FS 18-17
RTAS CORNER 2 CLOSEUP VIEW OF CLEARANCES – SSU & P5	FS 18-18
RTAS CORNERS 1&2 AND FINAL TORQUING	FS 18-19
RTAS CORNERS 3&4 AND FINAL TORQUING	FS 18-20
PVRGF OVERVIEW	FS 18-21
PVRGF REMOVAL WORKSITE – P5 WIF 11	FS 18-22
PVRGF STOWED ON KEEL	FS 18-23
CP3 OVERVIEW AND TRANSLATION PATH	FS 18-24
EVA 2 OVERVIEW	
S0 WORKSITES – EVA 2	FS 18-25
SAFETY TETHER SWAP LOCATION FOR P1 BAY 16 DDCU	FS 18-26
Z1 PP WORKSITES – EVA 2	FS 18-27
CETA CART RELOCATION – INITIAL POSN & SAFETY TETHER SWAP	FS 18-28
CETA CART RELOCATION	FS 18-29
CETA CART RELOCATION – FINAL POSN	FS 18-30
SSRMS FMS MLI INSTALL	FS 18-31
EVA 3 OVERVIEW	
S0 WORKSITES – EVA 3	FS 18-32
S1 BAY 15 DDCU WORKSITE AND TRANSLATION	FS 18-33
TRANSLATION PATH TO FACE 3 ACCESS FLAP FOR LAB 4A DDCU SECONDARY PWR	FS 18-34
S0 PORT WEDGE FACE DDCU TRANSLATION PATH AND WORKSITE	FS 18-35
Z1 PP WORKSITES – EVA 3	FS 18-36
APFR INGRESS LOCATION FOR SMDP TRANSFER	FS 18-37
TRANSLATION PATH AND SAFETY TETHER SWAP TO PLB	FS 18-38

Z1-NODE 1 UMBILICALS WORKSITE OVERVIEW	FS 18-39
H-JUMPER WORKSITE	FS 18-40
P5/PVRGF	
P5 ISOMETRIC VIEW	FS 18-41
P5 HANDRAILS AND WIFs (PORT/FWD VIEW)	FS 18-42
P5 HANDRAILS AND WIFs (ZENITH/STBD VIEW).....	FS 18-43
P5 HANDRAILS AND WIFs (NADIR/STBD VIEW).....	FS 18-44
P5 HANDRAILS AND WIFs (FWD/PORT VIEW)	FS 18-45
P5 MRTAS – ACTIVE	FS 18-46
P5 EWIS LAYOUT	FS 18-47
RTAS HOUSING DIMENSIONS.....	FS 18-49
P4 MRTAS – PASSIVE.....	FS 18-50
P5 TO P4 MRTAS PRIMARY BOLT ENGAGED.....	FS 18-51
GAP CHECK TOOL	FS 18-52
P5-P4 CONNECTOR PANEL	FS 18-53
P5 CAPTURE LATCH ASSEMBLY (CLA).....	FS 18-54
ETVCG	
ETVCG – ASSEMBLED.....	FS 18-55
ETVCG MOUNTED ON STANCHION.....	FS 18-56
U.S. CONNECTIONS	
S0 FORWARD AVIONICS PANEL WORKSITE.....	FS 18-57
S0 WORKSITES – PANELS 163 AND 165, MBSU RECONFIG.....	FS 18-58
S0 – PANELS 163 AND 165.....	FS 18-59
S0 CH 1/4 AND 2/3 JUMPERS.....	FS 18-60
MBSU BYPASS JUMPER RECONFIG – CH 1/4	FS 18-61
MBSU BYPASS JUMPER RECONFIG – CH 2/3	FS 18-62
CID PHOTO	FS 18-63
S0/N1 PWR CABLE WORKSITE OVERVIEW	FS 18-64
S0 PANEL A166 WORKSITE	FS 18-65
DDCU COLDPLATE CONNECTOR BOX – GENERIC	FS 18-66
S0 AFT TRAY	FS 18-67
Z1-LAB-S0 CONNECTIONS (PRE-12A.1 CONFIG)	FS 18-68
Z1-LAB-S0 CONNECTIONS (POST-12A.1 CONFIG).....	FS 18-69
RAT’S NEST QD OVERVIEW	FS 18-70
RAT’S NEST CONNECTIONS – CHANNEL 2/3	FS 18-71
RAT’S NEST CONNECTIONS – CHANNEL 1/4	FS 18-72
PATCH PANELS 1 AND 2 – SPDA	FS 18-74
PATCH PANELS 5 AND 6 – DDCU.....	FS 18-75
P1 BAY 16 DDCU THERMAL COVER.....	FS 18-77
S1 DDCU THERMAL COVER	FS 18-78
CETA CART	
CETA CART – TOP VIEW	FS 18-79
CETA SWINGARM AND WIF MARKINGS.....	FS 18-80
CETA CART COUPLERS.....	FS 18-81
CETA CART WHEEL BOGIES	FS 18-82
SSRMS FMS MLI	
SSRMS FMS LOCATION	FS 18-83
SSRMS FMS MLI	FS 18-84
LATCHING END EFFECTOR (LEE).....	FS 18-85
SMDP	
SMDP BUNDLE OVERVIEW.....	FS 18-86
SMDP TDK – LAUNCH CONFIG FOR BUNDLES 2 AND 3	FS 18-87
SMDP TDK – LANDING CONFIG FOR BUNDLES 2 AND 3	FS 18-88
SMDP TDK – LANDING CONFIG FOR BUNDLE 4	FS 18-89
TDK LANDING CONFIG – SIDE VIEW	FS 18-90

TDK BOLT OVERVIEW WITH LABELS	FS 18-91
TDK BOLTS – NOMINAL AND CONTINGENCY	FS 18-92
SMDP ADAPTER	FS 18-93
CHRISTMAS TREE	FS 18-94
CHRISTMAS TREE STOWAGE ON PMA3.....	FS 18-95
RUSSIAN PWR RECONFIG	
S0/NODE 1 SWINGARM.....	FS 18-96
Z1-NODE CONNECTIONS – PRE 12A.1.....	FS 18-97
Z1-NODE 1 CONNECTIONS – POST 12A.1	FS 18-98
FGB/PMA1 H-JUMPER 2/3 CONFIG	FS 18-99
FGB/PMA1 CONFIG POST H-JUMPER REMOVAL.....	FS 18-100
ADJUSTABLE GRAPPLE BAR	FS 18-101
FHRC.....	FS 18-102
CONTINGENCIES	
P1 PUMP MODULE WORKSITE OVERVIEW	FS 18-103
P1 PM INSTALLED IN TRUSS.....	FS 18-104
S1 PUMP MODULE WORKSITE OVERVIEW	FS 18-105
PUMP MODULE AND FSE OVERVIEW	FS 18-106
LAPA AND REAR CONTINGENCY PINS	FS 18-107
PUMP MODULE WITH FIXED GRAPPLE BAR AND MLI	FS 18-108
FLUID QD BAIL LEVERS	FS 18-109
QD CAP TOOLS.....	FS 18-110
1.5-IN FLUID QD SPOOL POSITIONING DEVICE	FS 18-111
FLUID QD RELEASE TOOLS	FS 18-112
0.5-IN FLUID QD SPOOL POSITIONING DEVICE	FS 18-113
0.5-IN SPD BOOTIE EXTENSION	FS 18-113
QD VENT TOOLS.....	FS 18-114
VENT TOOL EXTENDER BAG	FS 18-115
VTE AND VTE BAG DETAILS.....	FS 18-116
PUMP MODULE NH3 JUMPER	FS 18-117
STATUS INDICATORS (MBSU, DDCU, BCDU)	FS 18-118
FAILED MBSU LOCATIONS	FS 18-119
CETA CART LOCATION FOR MBSU R&R.....	FS 18-120
SPARE MBSU STOWED ON CETA GRID E WITH PORT TFR	
SWINGARM DEPLOYED	FS 18-121
MBSU ORU	FS 18-122
MBSU AND COLDPLATE.....	FS 18-123
DDCU LOCATIONS.....	FS 18-124
DC-TO-DC CONVERTER UNIT – EXTERNAL	FS 18-125
SPARE DDCU S0-4B WORKSITE (S0 PORT WEDGE FACE) (EVA 3)....	FS 18-126
FAILED DDCU S1-4B WORKSITE (S1 BAY 15) (EVA 3)	FS 18-127
FAILED DDCU S0-1A WORKSITE (S0 BAY 01) (EVA 3)	FS 18-128
SPARE DDCU S0-3B WORKSITE (S0 BAY 04) (EVA 2).....	FS 18-129
FAILED DDCU S0-2B WORKSITE (S0 BAY 02) (EVA 2)	FS 18-130
FAILED DDCU P1-3A WORKSITE (P1 BAY 16) (EVA 2)	FS 18-131
P6 OVERVIEW FOR STBD BCDUs.....	FS 18-132
P4 2A BCDU WORKSITE OVERVIEW	FS 18-133
P4 4A BCDU WORKSITE OVERVIEW	FS 18-134
BCDU.....	FS 18-135
P6 2B STBD IEA (UPPER/NON-KEEL SIDE) ORU LABELS.....	FS 18-136
P6 4B PORT IEA (LOWER/KEEL SIDE) ORU LABELS.....	FS 18-137
P4 4A FWD IEA (UPPER/NON-KEEL SIDE) ORU LABELS	FS 18-138
P4 2A AFT IEA (LOWER/KEEL SIDE) ORU LABELS.....	FS 18-139
4B MANUAL RETRACT – P6 WIF 37.....	FS 18-140
SOLAR ARRAY LATCH/TENSION OVERRIDE – LEFT BLANKET BOX ...	FS 18-141

SOLAR ARRAY JETTISON OVERVIEW.....	FS 18-142
MAST CANISTER MDA.....	FS 18-143
SABB MDA	FS 18-144
SOLAR ARRAY BLANKET BOX (SABB)	FS 18-145
FRAM/FSE/ORU ASSEMBLY	FS 18-146
ACTIVE FRAM SOFT CAPTURE MECHANISM	FS 18-147
FRAM CONTINGENCY BOLTS – SAPA.....	FS 18-148
P5 SOFT CAPTURE ASSY MANUAL OVERRIDE	FS 18-149
SMDP ADAPTER FAILED MAGNETIC SOCKET	FS 18-151
<u>EVA EMERGENCY</u>	19-i
EMERGENCY PROCEDURES.....	19-1
EMERGENCY AIRLOCK REPRESS	19-3
EMERGENCY AIRLOCK REPRESS.....	19-4
POST EMERGENCY AIRLOCK REPRESS	19-4
SAFER RESCUE.....	19-5
SAFER RESCUE	19-6
DAP/EVA RESCUE/RETRIEVE	19-7
EVA ORBITER CONFIG.....	19-7
EVA RESCUE/RETRIEVE.....	19-9
19.1 DCS TREATMENT	19-10
 CUE CARD CONFIGURATION	 20-1

This Page Intentionally Blank

AIRLOCK CONFIG

AIRLOCK PREP TEMP FS 2-2
EMU SWAP 2-3
BOOSTER FAN DEACTIVATION/REMOVAL 2-4
BOOSTER FAN INSTALLATION/ACTIVATION 2-4
EMU REMOVAL 2-4
EMU INSTALLATION 2-4
EMU CHECKOUT PREP TEMP FS 2-5
LTA RESTRAINT STRAP REMOVAL TEMP FS 2-6
LTA RESTRAINT STRAP INSTALLATION TEMP FS 2-6
EMU AND EVA TRANSFER PREP FS 2-7
EMU AND EVA TOOL TRANSFER AND RECONFIGURATION FS 2-14
POST EVA RECONFIGURATION AND TRANSFER..... FS 2-19

AIRLOCK
CONFIG

AIRLOCK PREP (50 min)

	Retrieve or unstow following equipment:
MF28G	3/8-in breaker bar, 4-in ext w/3/8-in drive
IFM Tool Kit	1/2-in socket w/3/8-in drive
Vol H	EMU Equipment Bag – attach to middeck wall
	Helmet Lights
	EVA Bag
	Contamination Detection Kit (location flight specific)
FDF Locker	Cuff Checklists (2) – stow in EMU Equipment Bag
	<u>DEPRESS/REPRESS</u> Cue Card

- AW18A
1. ✓ Inner hatch Equal vlv (two) – OFF
 2. LTG FLOOD (four) – ON
 3. Remove from airlock, as reqd:
 - Airlock Stowage Bag
 - Airlock Floor Pallet using 3/8-in breaker bar, 4-in ext w/3/8-in drive, and 1/2-in socket w/3/8-in drive
 4. Stow Vol H Bags in Vol H
 5. Transfer to airlock:
 - EVA Bag – install on airlock wall
 - DEPRESS/REPRESS Cue Card
 - Helmet Lights
 - Contamination Detection Kit – install on airlock wall
 6. Install IVA foot restraint, as reqd
 7. Unbuckle SCU straps, Velcro SCU to wall
 8. Install EMU lights on helmets (EMU 1, EMU 2)
 9. Disconnect helmets from Airlock EMUs, temp stow
 10. Remove comm caps from LTA Restraint Bags and connect to electrical harnesses
 11. Install helmets (not reqd if proceeding directly to EMU Checkout)
 12. Remove LTA Restraint Bags
 13. Disconnect waist rings; remove and stow any equipment stowed in HUT/LTA
 14. Stow LTA Restraint Bags on AAPs
 15. ✓ Thermal cover clear of waist ring
 16. Waist ring – engage posn
 17. Connect LTA to HUT, lock
 18. Remove 20-g Crash Bag from middeck EMU, as reqd

AIRLOCK
CONFIG

EMU CHECKOUT PREP (30 min)

I

- AW18A
1. LTG FLOOD (four) – ON
 1. Remove Airlock Stowage Bag from airlock (as reqd)
 3. Unbuckle SCU straps, Velcro SCU to wall
 4. Disconnect helmets from airlock EMUs, temp stow
 5. ✓DIDB restraint bags installed
 6. Remove comm caps, s/n 1166 (Cr) and s/n 1203 (Fg) from LTA restraint bag kangaroo pouches and connect to electrical harnesses (Cr backup comm cap s/n 1165 will get stowed in Cr ECOK)
 7. Remove LTA restraint bags
 8. Disconnect waist rings; remove ECOKs, LCVGs, DIDBs, and arm ring protective cover (Fg only) stowed in HUT/LTA
 9. Stow DIDBs, Cr backup comm cap, and arm ring protective cover in ECOKs (LCVGs will be used for EMU Checkout)
 10. Retrieve EMU SYS TRANSFER BAG #2 from Curbeam ECOK, temp stow ECOKs
- Vol H INBD11. Unstow:
- EMU Servicing Kit (s/n 5002) – (yellow tagged for transfer to ISS)
 - From EMU Equipment Bag:
 - 2 SCOFs (s/n 1009, 1010) – will be used for EMU Checkout, then xfer
 - 2 Cooling Loop Jumpers (s/n 044, 046)
12. Stow Vol H Bag in Vol H
 13. Stow EMU Servicing Kit (s/n 5002) in EMU SYS TRANSFER BAG #2
 14. Stow 2 Cooling Loop Jumpers in EMU SYS TRANSFER BAG #2
 15. Stow LTA restraint bags on AAPs
 16. ✓Thermal cover clear of waist ring
 17. Waist ring – engage posn
 18. Connect LTA to HUT, lock
 19. Temp stow EMU SYS TRANSFER BAG #2 (used later for EMU and EVA Transfer Prep)

LTA RESTRAINT STRAP REMOVAL (15 min)

NOTE

May be performed on EMU 1 and 2 simultaneously.
Perform steps as reqd for current EMU config

1. As reqd, remove comm cap from LTA Restraint Bag; temp stow
2. Remove EMU from AAP
3. Disconnect all restraint attachments from SAFER mount brackets (two)
4. Loosen cinch strap mechanism, remove SAFER mount brackets
5. Remove strap from PLSS
6. Stow strap in LTA Restraint Bag Pouch with D-rings (three) connected
7. Engage EMU in AAP
8. Stow LTA Restraint Bag/strap

LTA RESTRAINT STRAP INSTALLATION (15 min)

NOTE

May be performed on EMU 1 and 2 simultaneously. Perform steps as reqd for current EMU config. Procedure written to install in Launch/Landing config shown below

1. Unstow LTA Restraint Bag/strap
2. Remove EMU from AAP
3. Install SAFER mount brackets (two)
4. Install elastic band of strap around SOP
5. Tighten cinch strap mechanism
6. Attach strap French hooks (two) to SAFER mount brackets
7. Engage EMU in AAP
8. Stow LTA, suit arms inside LTA Restraint Bag
9. Connect upper spring hooks (two) over suit shoulders to upper AAP attachment rings (two)
10. Connect lower spring hooks (two) around suit arms to SAFER mount brackets (two)
11. Tighten all LTA bag straps with bag as high as possible on EMU

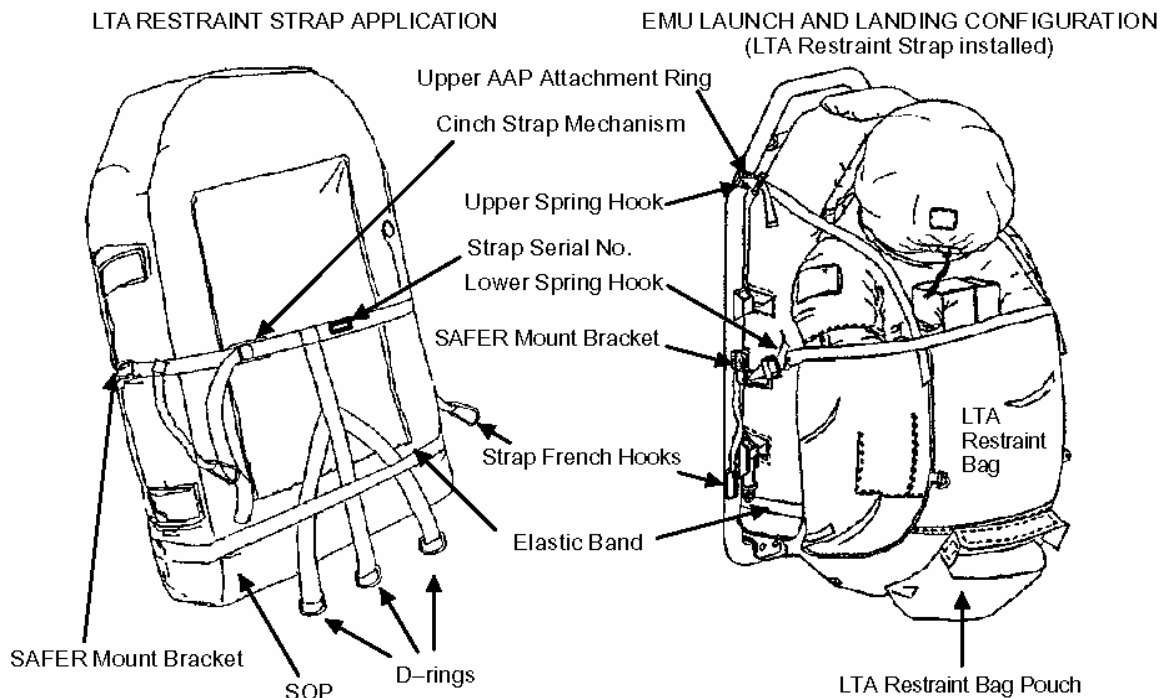

NOTE

French hooks should be attached to SAFER mount brackets for launch and landing

EMU AND EVA TRANSFER PREP (90 min)

I

- BOTH EMUs
1. Retrieve EMU SYS TRANSFER BAG #1 and #2 (#2 was temp stowed earlier, #1 is in Cr ECOK)
 2. √PWR – SCU
 3. √DCM PURGE vlv – op (up)
 4. √O2 ACT – OFF
 5. √WATER – OFF, switch guard installed
 6. √Helmet sun visors down, cover installed
 7. Configure/verify items stowed in the table below

<p><u>EMU 3003 (XL) (Cr)</u></p> <ul style="list-style-type: none"> <input type="checkbox"/> Helmet (Cr) S/N 1061 <ul style="list-style-type: none"> <input type="checkbox"/> Valsalva <input type="checkbox"/> Helmet cover <input type="checkbox"/> LTA (Cr) (attached) <input type="checkbox"/> EV1 (Cr) gloves S/N 6238 <input type="checkbox"/> Wrist Mirrors (2) 	<p><u>EMU 3018 (M) (Fg)</u></p> <ul style="list-style-type: none"> <input type="checkbox"/> Helmet (Fg) S/N 1063 <ul style="list-style-type: none"> <input type="checkbox"/> Fresnel Lens <input type="checkbox"/> Valsalva <input type="checkbox"/> Helmet cover <input type="checkbox"/> LTA (Fg) (attached) <input type="checkbox"/> EV2 (Fg) gloves S/N 6197 <input type="checkbox"/> Wrist Mirrors (2)
<p><u>EMU Crew Options Kit (Cr)</u></p> <ul style="list-style-type: none"> <input type="checkbox"/> ECOK Mesh Bag (EV Crew Options Kit) (Cr) <ul style="list-style-type: none"> <input type="checkbox"/> LCVG <input type="checkbox"/> Cr EVA #1 Ziplock Bag <ul style="list-style-type: none"> <input type="checkbox"/> MAG <input type="checkbox"/> Ziplock bag <input type="checkbox"/> TCU (top) <input type="checkbox"/> TCU (bottom) <input type="checkbox"/> Wristlets <input type="checkbox"/> Comfort gloves <input type="checkbox"/> Thermax Sock Liners <input type="checkbox"/> Cr EVA #2 Bag (same as Cr EVA #1) <input type="checkbox"/> Cr EVA #3 Bag (same as Cr EVA #1) <input type="checkbox"/> Cr Contingency Bag <ul style="list-style-type: none"> <input type="checkbox"/> 8 MAGs <input type="checkbox"/> 8 Ziplock bags <input type="checkbox"/> EV Crew ID stripes <input type="checkbox"/> EV Crew ID tags <input type="checkbox"/> Mission patch and flag <input type="checkbox"/> 3 DIDBs <input type="checkbox"/> Backup CCA (comm cap) S/N 1165 	<p><u>EMU Crew Options Kit (Fg)</u></p> <ul style="list-style-type: none"> <input type="checkbox"/> ECOK Mesh Bag (EV Crew Options Kit) (Fg) <ul style="list-style-type: none"> <input type="checkbox"/> LCVG <input type="checkbox"/> Fg EVA #1 Ziplock Bag <ul style="list-style-type: none"> <input type="checkbox"/> MAG <input type="checkbox"/> Ziplock bag <input type="checkbox"/> TCU (top) <input type="checkbox"/> TCU (bottom) <input type="checkbox"/> Wristlets <input type="checkbox"/> Comfort gloves <input type="checkbox"/> Tube Socks <input type="checkbox"/> Croakie <input type="checkbox"/> Moleskin <input type="checkbox"/> Fg EVA #2 Bag (same as Fg EVA #1) <input type="checkbox"/> Fg Contingency Bag <ul style="list-style-type: none"> <input type="checkbox"/> 7 MAGs <input type="checkbox"/> 7 Ziplock bags <input type="checkbox"/> Fresnel Lens <input type="checkbox"/> Moleskin <input type="checkbox"/> EV Crew ID stripes <input type="checkbox"/> EV Crew ID tags <input type="checkbox"/> Mission patch and flag <input type="checkbox"/> 2 DIDBs <input type="checkbox"/> Arm sizing ring protective Cover <input type="checkbox"/> Spare Mesh Bag

8. Stow LTA, suit arms inside LTA Restraint Bag
9. Connect upper spring hooks (two) over suit shoulders to upper AAP attachment rings (two)
10. Connect lower spring hooks (two) around suit arms to SAFER mount brackets (two)
11. Tighten all LTA bag straps with bag as high as possible on EMU
12. Pack EMU SYS TRANSFER BAG #1 and #2 per table below:

EMU AND EVA TRANSFER PREP (90 min) (Cont)

<u>EMU Sys Transfer Bag #1 & #2</u>	<u>Bag #</u>
Vol H – Previously gathered	
<input type="checkbox"/> EMU Servicing Kit (S/N 5002, Yellow Transfer Tag)	2
<input type="checkbox"/> 2 SCOFs (S/N 1009, 1010)	2
<input type="checkbox"/> 2 Cooling Loop Jumpers (S/N 044, 046)	2
Drug Subpack (MF28H)	
<input type="checkbox"/> Aspirin	1
FDF/SODF Shared Locker (MF57H)	
<input type="checkbox"/> Ziplock bag labeled “EVA Procedures/Cue Cards”	1
Verify contents:	
<input type="checkbox"/> STS-116 LOGISTICS Cue Card (1 of 1)	
<input type="checkbox"/> STS EVA Checklist (2 of 3 – PLT and MS3)	
<input type="checkbox"/> ISS EVA Systems Checklists (2 of 3 – PLT and CDR copies)	
<input type="checkbox"/> Crewlock DEPRESS/REPRESS Cue Card (2 of 2)	
<input type="checkbox"/> EVA PREBREATHE Cue Card (1 of 2 – with STS 116 exercise prescriptions filled in)	
<input type="checkbox"/> Ziplock bag labeled “ISS EVA Cuff Checklists” (in MF57H or MF71G)	
<input type="checkbox"/> ISS EVA Cuff Checklist (3 of 3 – put Cr and Fg in bag 1, W in bag 2)	1&2
Crew Personal Notes	
<input type="checkbox"/> Crew personal list of items to be in airlock for campout	1
External Airlock Floor Bag	
<input type="checkbox"/> 2 LiOH Cartridges (CCC) (S/N 2018, 2019)	1
<input type="checkbox"/> SAFER Latch Guards (qty 2 pr)	1
<input type="checkbox"/> EV3 (W) Prime Gloves (S/N 6047)	2
<input type="checkbox"/> EV3 (W) B/U Gloves (S/N 6046)	2
<input type="checkbox"/> EV3 (W) EMU Boots (S/N 203)	2
<input type="checkbox"/> EV3 (W) EMU Crew Options Kit (ECOK)	N/A
Add:	
<input type="checkbox"/> DIDB	-
<input type="checkbox"/> EV3 (W) LCVG (S/N 3141)	-
<input type="checkbox"/> EV3 (W) CCA (comm cap) (S/N 1194)	-
Verify:	
<input type="checkbox"/> 2 spare in-flight stowage restraint bags	-
<input type="checkbox"/> W EVA #1 STS-116 Ziplock Bag	-
<input type="checkbox"/> 2 MAGs	-
<input type="checkbox"/> 2 Ziplock bags	-
<input type="checkbox"/> TCU (top)	-
<input type="checkbox"/> TCU (bottom)	-
<input type="checkbox"/> Wristlets	-
<input type="checkbox"/> 2 pair Comfort gloves	-
<input type="checkbox"/> Tube socks	-
<input type="checkbox"/> Moleskin	-
<input type="checkbox"/> STS-116 Mission Patch	-
<input type="checkbox"/> National Flag	-
<input type="checkbox"/> EV Crew ID stripes (EV2)	-
<input type="checkbox"/> EV Crew ID tags	-
<input type="checkbox"/> Crew personal items	-

EMU AND EVA TRANSFER PREP (90 min) (Cont)

<u>EMU Sys Transfer Bag #1 & #2</u> (Cont)	
Verify (Cont):	
<input type="checkbox"/> W EVA #1 Bag (same as W EVA #1 STS-116, but with Inc 14 mission patch instead of STS-116 mission patch, and EV1 crew ID stripes)	-
<input type="checkbox"/> W EVA #2 Bag (same as W EVA #1, but w/o mission patch or flag)	-
<input type="checkbox"/> W EVA #3 Bag (same as W EVA #2)	-
<input type="checkbox"/> W Contingency Bag	-
<input type="checkbox"/> 2 MAGs	-
<input type="checkbox"/> 2 Ziplock bags	-
<input type="checkbox"/> Moleskin	-
<input type="checkbox"/> Woodsman Socks	-
<input type="checkbox"/> Fresnel Lens	-
<input type="checkbox"/> Crew personal items	-
Locker MF43K	
<input type="checkbox"/> 1 BTA (S/N 1003)	2
WCS	
<input type="checkbox"/> Towels	1
Middeck Floor STBD 1 Bag	
<input type="checkbox"/> Contamination Detection Kit (s/n 1002)	1
<input type="checkbox"/> ISS CSA-O2 Resupply Kit	1

EMU AND EVA TRANSFER PREP (90 min) (Cont)

EVA 1 TOOLS AND HARDWARE

1. Retrieve the "EVA 2/3 Shuttle to ISS" Jettison Stowage Bag from AP01, temp stow (needed for EVA 2 and 3)
2. Retrieve the "EVA 1 Shuttle to ISS" Jettison Stowage bag from AP01
3. Using the table below, obtain EVA 1 Tools from each stowage location and stow in the "EVA 1 Shuttle to ISS" Jettison Stowage Bag:

EVA 1 TOOLS					
Location	Item Description	Qty.	Part No.	Serial No.	Comments
AP01 (5 MLE bag)	"EV1" Jettison Stowage Bag	□ 1	SEB13100134-304		
AP01 (5 MLE bag)	"EV2" Jettison Stowage Bag	□ 1	SEB13100134-304		
AP01 (5 MLE bag)	"Return to Shuttle 1, 2, 3" Jettison Stowage Bags	□ 3	SEB13100134-304		Needed for EVA hardware cleanup
AC01 (1.0 CTB)	Sm-sm RET	□ 9	SEG33106164-381	4057, 4070 4071, 4073 4075, 4170 4271, 4272 TBD (blue)	8 color coded yellow. Use for all 12A.1 EVAs 9th RET (blue) is being launched to replace 12A returned RET. It will go to tether staging area
AC01 (1.0 CTB)	Sm-sm RET w/PIP pin	□ 4	SEG33106164-383	4238, 4239 4240, 4241	Color coded yellow. Use for all EVAs
AC01 (1.0 CTB)	Lg-sm equip RET	□ 6	SEG33106164-385	4252, 4253 4254, 4255 4256, 4257	Color coded yellow. Use for all EVAs
AP07 (3.0 CTB)	Torque Wrench	□ 1	SEG33106948-301	1001	
AP07 (3.0 CTB)	Torque Wrench Bag	□ 1	SEG33110183-301	1001	
FC02 (1.0 CTB)	Velcro/Tape Caddy	□ 1	SED33104207-301	1019	Will relocate to the Staging Bag once on ISS. Needed for contingency only

4. Temp Stow "EVA 1 Shuttle to ISS" Jettison Stowage Bag
5. Reference OSO procedure for details of ETVCG and Light assembly per EVA 1 Hardware table below. Reference Transfer procedures for details on transfer to ISS

EVA 1 HARDWARE					
Location	Item Description	Qty.	Part No.	Serial No.	Comments
PF01	ETVCG Assembly PanTilt Unit (PTU) Color TV Camera (CTVC) TV Camera Interface Converter (TVCIC) Video Luminaire Assembly (VLA/light)	□ 1	10033194-501	N/A	Beamer and Christer assemble all but light on FD2 (b/c light won't fit through hatch) (gloves reqd). Assy actually happens after transfer prep Billyo and Joanie install light on FD3 post dock and safety brief once on ISS (gloves reqd) ACO transfer controls transfer of this item

EMU AND EVA TRANSFER PREP (90 min) (Cont)

EVA 2 TOOLS AND HARDWARE

1. Using the table below, perform the following steps to gather and temp stow EVA 2 tools:
 - a. Retrieve 5 MLE Bag from AP01
 - b. Retrieve 1.0 CTB from AC01, temp stow
 - c. Retrieve adjustable tethers (4) from FC02, stow in 1.0 CTB from AC01
 - d. Retrieve 1" NH3/N2 Vent Tool – F from Middeck Floor Stbd 1 Bag; stow in 1.0 CTB from AC01

EVA 2 TOOLS					
Spacehab	Item Description	Qty.	Part No.	Serial No.	Comments
AP01 (5 MLE bag)	Port QD Bag <ul style="list-style-type: none"> • 3/4" NH3/N2 Vent Tool – F • 1.5" NH3/N2 Vent Tool – F • 1/4" NH3/N2 Vent Tool – F • 1" NH3/N2 Vent Tool – M • 1" H20/N2 Vent Tool – F 	<input type="checkbox"/> 1	SEG33114667-301	1001	1 set of vent tools will fly in place inside port QD bag. Other set are stowed separately in foam in 5 MLE bag
		<input type="checkbox"/> 1	1F98597-1		
		<input type="checkbox"/> 1	1F98591-1		
		<input type="checkbox"/> 1	1F98592-1		
		<input type="checkbox"/> 1	1F98596-1	01	
<input type="checkbox"/> 1	1F98593-1	02			
AP01 (5 MLE bag)	1/4" NH3/N2 Vent Tool – F	<input type="checkbox"/> 1	1F98592-1	01, 02	Will go into stbd QD bag once on orbit QD tool bag pack occurs on FD5 by Christer and Beamer
AP01 (5 MLE bag)	3/4" NH3/N2 Vent Tool – F	<input type="checkbox"/> 1	1F98597-1	01, 02	Will go into stbd QD bag once on orbit
AP01 (5 MLE bag)	1.5" NH3/N2 Vent Tool – F	<input type="checkbox"/> 1	1F98591-1	01, 02	Will go into stbd QD bag once on orbit
AP01 (5 MLE bag)	Vent Tool Adapter	<input type="checkbox"/> 2	SEG33119079-301	1001, 1002	Both will go into port QD bag on FD5
AC01 (1.0 CTB)	1/4" Button Depress Tool (BDT)	<input type="checkbox"/> 1	SEG33114984-301	001	One will go into port QD bag on FD5. Other will stay inside ISS (separate transfer item)
AC01 (1.0 CTB)	3/4" Button Depress Tool (BDT)	<input type="checkbox"/> 1	SEG33114986-301	001	One will go into port QD bag on FD5. Other will stay inside ISS (separate transfer item)
AC01 (1.0 CTB)	3/4" Anti-Kickback Tool (AKT)	<input type="checkbox"/> 1	SEG33114983-301	1001	One will go into port QD bag on FD5. Other will stay inside ISS (separate transfer item)
AC01 (1.0 CTB)	Gap spanners	<input type="checkbox"/> 3	SEG33109930-301	1033,1036,1037	For QD tool bag external stowage (labeled, short, med, long-303)
		<input type="checkbox"/> 1	SEG33109930-303	1038	
FC02 (1.0 CTB)	Adjustable Tethers	<input type="checkbox"/> 4	SEG33106945-307	23, 24 25, 26	Needed for tools in port QD bag
Middeck Floor Stbd 1 Bag	1" NH3/N2 Vent Tool – F	<input type="checkbox"/> 1	1F98589-1		New item on manifest. Will be mated to VTE once on ISS

2. Retrieve the "EVA 2/3 Shuttle to ISS" Jettison Stowage Bag from temp stow location
3. Using the table below, obtain EVA 2 Hardware from each stowage location and stow in "EVA 2/3 Shuttle to ISS" Jettison Stowage Bag:

EVA 2 HARDWARE					
Spacehab	Item Description	Qty.	Part No.	Serial No.	Comments
FC07 (1.0 CTB)	S0 CH 2/3 EVA Power Cable	<input type="checkbox"/> 1	1F15343-1	NA	Our name: S0 CH 2/3 Jumper
FC07 (1.0 CTB)	S0/N1 EVA SM Pri Power Cable	<input type="checkbox"/> 1	1F15359-1		Our name: S0/N1 Pwr Cable
FP04 (0.5 CTB)	SSRMS FMS MLI Shrouds	<input type="checkbox"/> 2	51612-4031-351	202, 203	

4. Temp stow "EVA 2/3 Shuttle to ISS" Jettison Stowage Bag

EMU AND EVA TRANSFER PREP (90 min) (Cont)

5. Using the table below, retrieve the following EVA 2 GET-AHEAD HARDWARE from each stowage location:

EVA 2 GET-AHEAD HARDWARE					
Spacehab	Item Description	Qty.	Part No.	Serial No.	Comments
AS01 (5 MLE Bag)	Vent Tool Extension Bag (VTEB 01) Vent Tool Extender (VTE)	<input type="checkbox"/> 1	SEG33119100-301	1001	Get-ahead for EVA 2 to install on airlock Will pack this bag with vent tool and MUT EE on FD5 Only needed for PM R&R
		<input type="checkbox"/> 1	SEG33119090-301	1001	
AS01 (5 MLE Bag)	PM Jumper Bag (VTEB 02) PM Jumper	<input type="checkbox"/> 1	SEG33119100-301	1002	Install PM Jumper into PM Jumper bag Will pack this bag on FD5 Only needed for PM R&R
		<input type="checkbox"/> 1	1F15818-1		

6. Temp stow Vent Tool Extender Bag and PM Jumper Bag

EMU AND EVA TRANSFER PREP (90 min) (Cont)

EVA 3 HARDWARE

1. Using the table below, retrieve the S0 CH 1/4 Power Cable from its stowage location and stow in "EVA 2/3 Shuttle to ISS" Jettison Stowage Bag:
2. Refer to Transfer list for details regarding AGB transfer:

EVA 3 HARDWARE					
Spacehab	Item Description	Qty.	Part No.	Serial No.	Comments
FC07 (1.0 CTB)	S0 CH 1/4 EVA Power Cable	□ 1	1F15341-1	NA	Our name: S0 CH 1/4 Jumper
SF13	Adjustable Grapple Bar (AGB)	□ 1	1F82020-1	NA	<p>AGB is launched in the unlocked position</p> <p>Immediately after unpacking, set the AGB to the NTA setting and push the T-Handle to Lock (no white lines visible) This will keep it from sliding in and out and will make it the smallest setting for egress</p> <p>ACO Transfer controls transfer of AGB</p>

SUMMARY OF EVA HARDWARE AND BAGS:

1. "EVA 1 Shuttle to ISS" Jettison Stowage Bag
2. 5 MLE Bag
3. 1.0 CTB
4. Vent Tool Extender Bag
5. Pump Module Jumper Bag (labeled VTE Bag II)
6. "EVA 2/3 Shuttle to ISS" Jettison Stowage Bag

EMU AND EVA TOOL TRANSFER AND RECONFIGURATION (100 min)

I

PRE-EVA 1 TRANSFER

NOTE

This procedure assumes that transfer items were preconfigured per EMU AND EVA TRANSFER PREP

1. Transfer the following EVA equipment to ISS:

Item	Destination	Transfer Status
EVA 1 Hardware		
EMU 3003 (Cr)	E-Lk aft EDDA (Perform steps 3-9 below to install EMU in EDDA)	
EMU 3018 (Fg)	E-Lk fwd EDDA (Perform steps 3-9 below to install EMU in EDDA)	
ECOK (Cr)	E-Lk	
ECOK (Fg)	E-Lk	
EMU SYS TRANSFER BAG #1	E-Lk	
EMU SYS TRANSFER BAG #2	E-Lk	
EVA 1 Shuttle to ISS jettison stowage bag	E-Lk	
EVA 2/3 Hardware		
EVA 2/3 Shuttle to ISS jettison stowage bag	NODE	
5 MLE bag	NODE	
1.0 CTB	NODE	
Vent Tool Extender Bag	NODE	
PM Jumper Bag (VTE Bag II)	NODE	
EVA3 Hardware		
ECOK (W)	NODE	

2. Report transfer status to MCC

PRE-EVA 1 EMU RECONFIGURATION

LTA RESTRAINT REMOVAL

3. Remove LTA Restraint Bags
4. Disconnect all restraint attachments from SAFER mount brackets (two)
5. Loosen cinch strap mechanism, remove SAFER mount brackets
6. Remove strap from PLSS
7. Stow strap in LTA Restraint Bag Pouch with D-rings (three) connected
8. Engage EMU in EDDA
9. Stow LTA Restraint Bag/strap in ECOKs

EMU AND EVA TOOL TRANSFER AND RECONFIGURATION (100 min) (Cont)

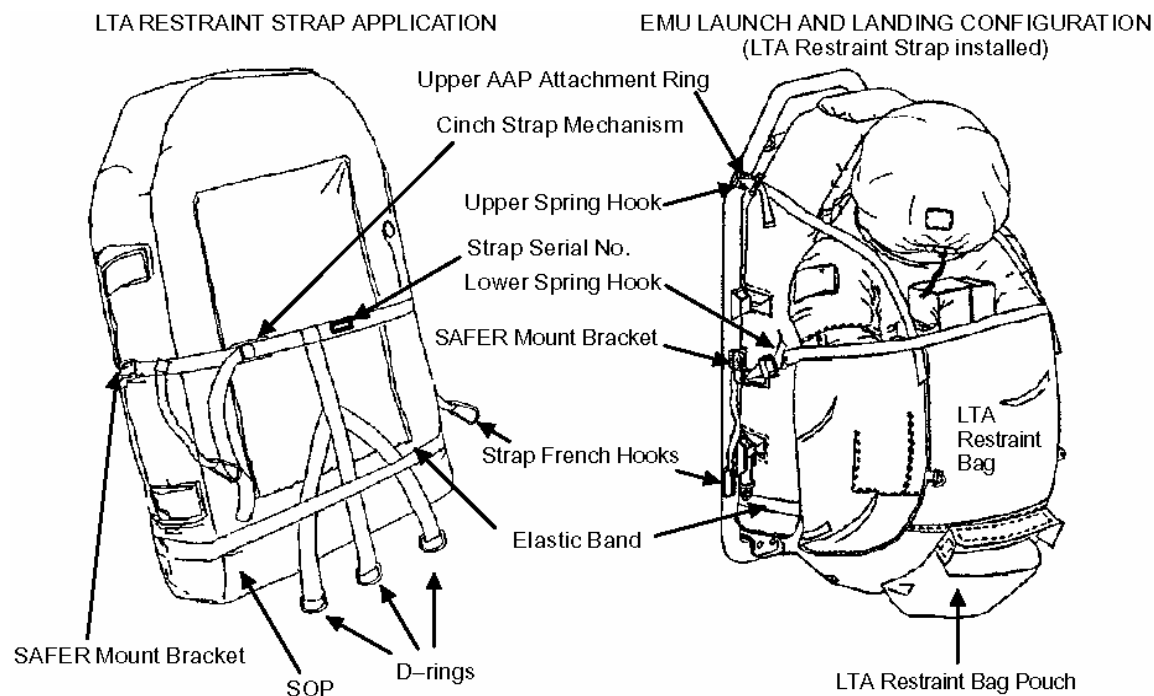

NOTE

French hooks should be attached to SAFER mount brackets for launch and landing

REBA INSTALLATION INTO EMUs 3003 and 3018

- BOTH
10. Unstow REBAs S/N 1003 and 1011 from EVA 1 mesh bag
 11. Rotate EDDA to access back of EMUs
 12. ✓Glove heater sw (two) – OFF
 13. Unzip TMG to access REBA pouch and power cable
 14. Remove REBA J1 connector fabric cover
 15. Install REBA 1003 on EMU 3003(Cr), and REBA 1011 on EMU 3018(Fg)
 16. Configure REBA pull tabs through slots in TMG
 17. ✓REBA sw – OFF, toward left arm of suit
 18. Connect EMU Power Harness (P1) to REBA (J1), gently perform pull test to verify connection
 19. Zip TMG closed
 20. Rotate EDDA closed

EMU TV (ERCA) INSTALLATION AND REBA HARDWARE CHECKOUT

21. Remove helmet lights (two) with EMU TVs (ERCA) from ISS EMU helmets
22. Verify EMU TV camera addresses and serial numbers below

	Address	Serial number
Curbeam – EV1	16	1010
Fuglesang – EV2	18	1007

- PLSS
23. Install helmet lights with EMU TVs (ERCA) on EV1 and EV2 helmets
 24. Verify EMU TV cables covered with helmet light TMG
 25. Unstow EMU TV power cable, disconnect from ground plug
 26. Mate EMU TV power cable to EMU TV
 27. ✓Lower arm power harness connected to upper arm power connectors
 28. ✓Glove heater sw (one per glove) – OFF
 29. Connect lower arm power harness to gloves

EMU AND EVA TOOL TRANSFER AND RECONFIGURATION (100 min) (Cont)

NOTE

To avoid excessive battery consumption and heat buildup, deactivate heaters once heat detected at fingertips

30. REBA sw (1 per EMU) – ON, pull tab toward right arm of suit
31. Glove heater sw (one per glove) – ON
When heat detected on all outside fingertips:
 32. Glove heater sw (one per glove) – OFF
33. EMU TV power pb – press, √Green LED illuminated
34. EMU TV power pb – press, √Green LED not illuminated
35. REBA sw (1 per EMU) – OFF, pull tab toward left arm of suit
36. Disconnect lower arm power harness from gloves
37. Stow lower arm and glove power harness connectors under TMG
38. Disconnect EMU TV power cable from EMU TV
- PLSS 39. Connect EMU TV power cable to ground plug

AIRLOCK SETUP

40. Install ISS EVA Cuff Checklists on EV1 and EV2 EMUs from EMU SYS TRANSFER BAG #1
41. Remove SODF, FDF, and Cue Cards from EMU SYS TRANSFER BAG #1, position as desired (make sure one DEPRESS/REPRESS Cue Card located in E-Lk, and one DEPRESS/REPRESS Cue Card in C-Lk)
42. Locate/position as desired:
 - EVA 1, EVA 2, EVA 3 mesh bags
 - EMU Equipment Bag
 - EMU Servicing Kit s/n 5005 (old kit on ISS, use for all STS 116 EVAs)
43. Remove LiOHs (S/N 2018, 2019) (two) from EMU SYS TRANSFER BAG #1 and stow in EVA 2 mesh bag
44. Swap Contamination Detection Kit (s/n 1002) from EMU SYS TRANSFER BAG #1 with Contamination Detection Kit (s/n 1001) in Crewlock IV Bag
45. Stow the following items from EMU SYS TRANSFER BAG #1 into EMU Equipment Bag:
 - Aspirin
 - SAFER Latch Guards (to be installed on SAFERs during EMU Prebreathe)
46. Unstow CSA-O2s from EMU SYS TRANSFER BAG #1 and position/temp stow in Equipment Lock

EQUIPMENT LOCK PREP

47. Waist ring ←|→ HUT (if items stowed in HUT for transfer)
48. Remove loose equipment from HUT
49. Waist ring →|← HUT
50. Stage crew preference items in EMU Equipment Bag as required
51. Helmet ←|→ HUT
52. Inspect comm cap MBEDs (two per comm cap) for damage
Replace MBEDs as required (EMU Servicing Kit s/n 5005 – old kit on ISS)
53. Remove DIDB restraint bag from HUT
54. Insert filled drink bag (from ECOK) into restraint bag.
Install restraint bag in HUT
55. √Fresnel lenses, valsalva devices installed as desired

EMU AND EVA TOOL TRANSFER AND RECONFIGURATION (100 min) (Cont)

CAUTION

In order to preclude release of ethanol, after use, antifog wipes and packaging must be sealed in containment bag and disposed of in wet trash

56. Apply antifog (EMU Servicing Kit s/n 5005 – old kit on ISS) to the following:
Helmet (not Fresnel lens)
EV Glasses
Thoroughly wipe off antifog
Seal used antifog wipes and packages in containment bag and dispose of in wet trash
57. Helmet →|← HUT
58. Unstow four helmet light batteries from EVA 1 mesh bag
Install Batteries in helmet lights per STS-116 LOGISTICS Cue Card
59. ✓Helmet light ops
60. Reposition EDDA for EMU donning as required
61. ✓PHA configuration (2 PHA bags) per figure 1 below

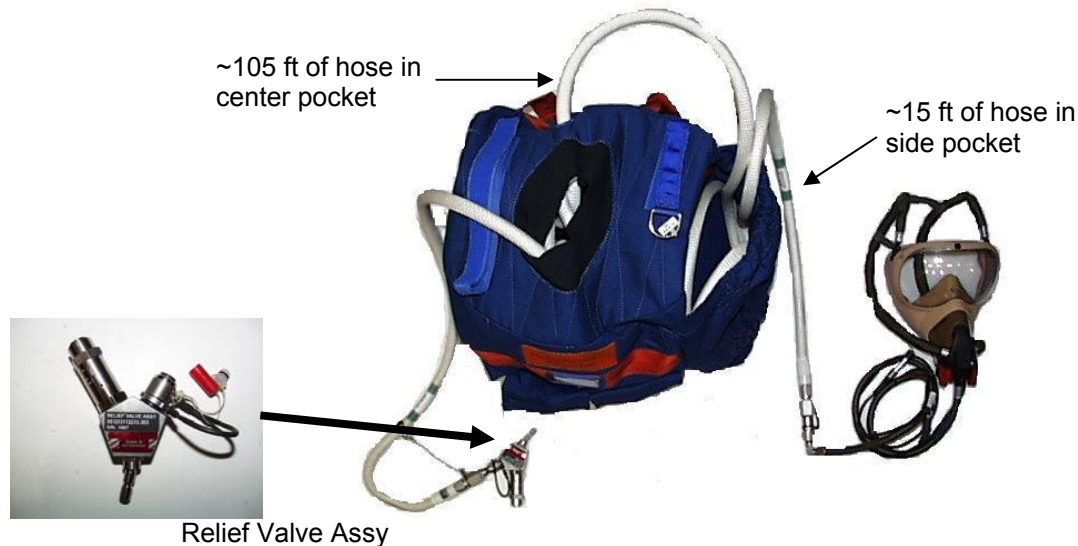

Figure 1.- Prebreathe Hose Assembly (PHA)

62. Visually inspect two PHAs, PHA Quick Don Masks for any damage
- BOTH 63. Stow Quick Don Masks and 15 ft of hose in large side pocket of PHA Bags
- A/L10A1 64. ✓Flexible Ventilation Duct attached to Conditioned Air Supply connection

VERIFYING EQUIPMENT IN AIRLOCK

65. Confirm the following equipment is located in the Airlock
 - PFE located in PFE locker
 - ✓Pressure gauge needle in green zone (800 to 900 psig)
 - PBA Quick Don Masks and bottles for every isolated crewmember (4 total for EVA 1)
 - ✓PBA Bottles →|← Quick Don Masks for each non-EVA crewmember in airlock
 - ✓Oxygen bottle pressure \geq 3000 psig for each bottle
 - Hardcopy of Emergency Book (from FGB location)
 - CSA-O2s (two for overnight campout)
 - ✓Good Battery power on both CSA-O2s
 - Inform MCC-H of CSA-O2 readings
 - MCC-H will verify accuracy
 - Two spare regenerated METOX canisters

EMU AND EVA TOOL TRANSFER AND RECONFIGURATION (100 min) (Cont)

All required EMU components:

- HUTS
- LTAs
- Gloves
- Helmets
- LCVGs (with biomed)
- Comm Caps
- ECOKs
- Crew preference items

- Dosimeter
- EMU Servicing Kit
- Flashlight
- Jeweler's Screwdriver (optional)
- Airlock Tool kit
- Earplugs
- Towel (EMU SYS TRANSFER BAG #1)
- Aspirin

WARNING

EV crewmembers should minimize application of hygiene and hydrocarbon-based products prior to EVA day to avoid introduction of irritants and combustibles into the EMU.

For acceptable items in EMU, refer to {5.110 APPROVED NON-EMU HARDWARE}, all (SODF: ISS EVA SYS: REFERENCE), as required

- Personal Hygiene Items
- Egg Timers
- Vacuum Manometer (optional, √MCC-M for VM number)

POST EVA RECONFIGURATION AND TRANSFER (135 min)

I

EMU RECONFIGURATION FOR TRANSFER

1. Unstow two used LiOH canisters s/n 2018 and s/n 2019 (the ones without caps) and EMU Batteries s/n 2057 and s/n 2058 from EMU SYS TRANSFER BAG #1
- PLSS 2. Unzip thermal cover for EMUs 3015 (Fg), 3003 (Cr), and 3018 (W).
Affix thermal cover to top of EMU with Velcro
3. Remove used Metox from EMUs 3003 and 3018, install caps and stow in mesh bag labeled Expended Metox in EVA Prep and Ops M-02 bag (s/n 1038)
4. Remove vent port plugs from EMU 3015, and install them in EMU 3018
- UIA 5. √sw PWR EV-1,2 (two) → OFF
- DCM 6. √sw POWER – SCU
- PLSS 7. Remove used EMU Batteries from EMU 3003 and 3018, stow in 0.5 CTB labeled EMU Batteries in M-02 bag (s/n 1038)
8. Install EMU Battery s/n 2057 in EMU 3003, and EMU Battery s/n 2058 in EMU 3015 (EMU 3018 (W) should have NO battery installed)
9. Engage latch
While holding LiOH canister with silver plate label facing self:
10. Install LiOH s/n 2018 in EMU 3003 and s/n 2019 in EMU 3015 (attach Velcro Strap)
Latch canister in place
- EMU 3003 11. √sw (pulltab) REBA – OFF
12. EMU Power Harness (P1) ←|→ REBA (J1)
13. Remove REBA from EMU
14. Install REBA J1 fabric cover
15. Stow REBA in M-02 bag (s/n 1038)
- PLSS 16. Close thermal cover zipper on EMUs 3003, 3015, and 3018
17. Remove helmet lights and EMU TV from EMU 3003, and install them on EMU 3008 (La)
18. Remove EVA Cuff Checklist from EMU 3003 and stow in EMU Equipment Bag
19. √No tools or tethers installed on EMU 3003 or EMU 3015
20. Remove LTA Restraint Straps and LTA Restraint Bags from Cr and Fg ECOKs
21. Remove CCAs (comm caps) from Cr and Fg ECOKs
22. On EMU 3003, remove helmet, disconnect CCA from electrical harness, connect helmet to HUT
23. Stow prime and backup Cr CCAs in Cr LTA Restraint Bag kangaroo pouch, and Fg CCA in Fg LTA Restraint Bag kangaroo pouch (can be performed after LTA Restraint Bag installation if desired)
24. Verify Cr and Fg ECOKs contain only the items listed in table 1

POST EVA RECONFIGURATION AND TRANSFER (135 min) (Cont)

TABLE 1.- CR AND FG ECOK CONTENTS

EMU Crew Options Kit (Cr)	EMU Crew Options Kit (Fg)
<ul style="list-style-type: none"> <input type="checkbox"/> ECOK Mesh Bag (EV Crew Options Kit) (Cr) <ul style="list-style-type: none"> <input type="checkbox"/> LCVG <input type="checkbox"/> Cr EVA #1 Ziplock Bag <ul style="list-style-type: none"> <input type="checkbox"/> TCU (top) <input type="checkbox"/> TCU (bottom) <input type="checkbox"/> Wristlets <input type="checkbox"/> Comfort gloves <input type="checkbox"/> Thermax Sock Liners <input type="checkbox"/> Cr EVA #2 Bag (same as Cr EVA #1) <input type="checkbox"/> Cr EVA #3 Bag (same as Cr EVA #1) <input type="checkbox"/> Cr Contingency Bag <ul style="list-style-type: none"> <input type="checkbox"/> 8 MAGs <input type="checkbox"/> 8 Ziplock bags <input type="checkbox"/> EV Crew ID stripes <input type="checkbox"/> EV Crew ID tags <input type="checkbox"/> Mission patch and flag 	<ul style="list-style-type: none"> <input type="checkbox"/> ECOK Mesh Bag (EV Crew Options Kit) (Fg) <ul style="list-style-type: none"> <input type="checkbox"/> LCVG <input type="checkbox"/> Fg EVA #1 Ziplock Bag <ul style="list-style-type: none"> <input type="checkbox"/> TCU (top) <input type="checkbox"/> TCU (bottom) <input type="checkbox"/> Wristlets <input type="checkbox"/> Comfort gloves <input type="checkbox"/> Tube Socks <input type="checkbox"/> Croakie <input type="checkbox"/> Moleskin <input type="checkbox"/> Fg EVA #2 Bag (same as Fg EVA #1) <input type="checkbox"/> Fg Contingency Bag <ul style="list-style-type: none"> <input type="checkbox"/> 7 MAGs <input type="checkbox"/> 7 Ziplock bags <input type="checkbox"/> Fresnel Lens <input type="checkbox"/> Moleskin <input type="checkbox"/> EV Crew ID stripes <input type="checkbox"/> EV Crew ID tags <input type="checkbox"/> Mission patch and flag <input type="checkbox"/> Spare Mesh Bag

25. On EMU 3003 and 3015, disconnect LTAs
26. Stow Cr ECOK in EMU 3003 and Fg ECOK in EMU 3015
27. Connect LTAs to HUTs, and verify final configuration of both EMUs per lists below:

EMU 3003 (XL) FINAL RETURN CONFIG	EMU 3015 (L) FINAL RETURN CONFIG
<ul style="list-style-type: none"> <input type="checkbox"/> EMU 3003 – XL <input type="checkbox"/> EMU Battery 2057 <input type="checkbox"/> LiOH s/n 2018 <input type="checkbox"/> LCVG (Cr) <input type="checkbox"/> Mesh Bag (ECOK) (Cr) <input type="checkbox"/> Gloves (Cr) <input type="checkbox"/> LTA (Cr) <input type="checkbox"/> Patches, Stripes, Flag (Cr) <input type="checkbox"/> Wrist Mirrors <input type="checkbox"/> Helmet (S/N 1061) <input type="checkbox"/> Helmet cover installed <input type="checkbox"/> O2 ACT → OFF <input type="checkbox"/> PWR → SCU <input type="checkbox"/> DCM Purge vlv → Op (up) <input type="checkbox"/> WATER → OFF <input type="checkbox"/> WATER Switch Guard installed <input type="checkbox"/> No Tethers/Tools <input type="checkbox"/> No Cuff Checklist <input type="checkbox"/> No EMU TV, Helmet Lights or REBA 	<ul style="list-style-type: none"> <input type="checkbox"/> EMU 3015 – L <input type="checkbox"/> EMU Battery 2058 <input type="checkbox"/> LiOH s/n 2019 <input type="checkbox"/> LCVG (Fg) <input type="checkbox"/> Mesh Bag (ECOK) (Fg) <input type="checkbox"/> Gloves (Fg) <input type="checkbox"/> LTA <input type="checkbox"/> Patches, Stripes, Flag (Fg, or none – no need to install) <input type="checkbox"/> Wrist Mirrors <input type="checkbox"/> Helmet (S/N 1063) <input type="checkbox"/> Helmet cover installed <input type="checkbox"/> O2 ACT → OFF <input type="checkbox"/> PWR → SCU <input type="checkbox"/> DCM Purge vlv → Op (up) <input type="checkbox"/> WATER → OFF <input type="checkbox"/> WATER Switch Guard installed <input type="checkbox"/> No Tethers/Tools <input type="checkbox"/> No Cuff Checklist <input type="checkbox"/> No EMU TV, Helmet Lights or REBA

POST EVA RECONFIGURATION AND TRANSFER (135 min) (Cont)

Perform following on EMU 3003 and EMU 3015 to install the LTA Restraint Bag, reference LTA RESTRAINT STRAP INSTALLATION for diagrams as needed:

NOTE

If EMU 3015 already has an LTA Restraint Strap and LTA Restraint Bag installed on it, you may use that one and leave Fg LTA Restraint Strap and LTA Restraint Bag on ISS in M-02 bag s/n 1038. Make sure Fg CCA is stowed in LTA Restraint Bag kangaroo pouch on EMU 3015. If leaving Fg LTA Restraint Strap and Bag on ISS, inform MCC for stowage update purposes

28. ✓ LTA Restraint Bag attached to LTA Restraint Strap D-rings (three)
29. Remove EMU from EDDA, as reqd
30. LTA Restraint Strap SAFER mount brackets (two) →|← SAFER striker plate on PLSS
31. Install elastic band of LTA Restraint Strap around SOP
32. Tighten cinch strap mechanism
33. Engage EMU in EDDA as required to restrain EMU (will be pulled off of EDDA for transfer at the end of this procedure)
34. Stow LTA and suit arms inside LTA Restraint Bag
35. Upper spring hooks (two) →|← SAFER mount brackets (two) such that strap runs over shoulder
36. Lower spring hooks (two) →|← SAFER mount brackets (two)
37. Tighten all LTA Restraint Bag Straps with Bag as high as possible on EMU
38. Remove EMUs from EDDA as required to leave ISS airlock in the following config: EMU 3008 (La) on aft EDDA and EMU 3018 (W) on forward EDDA
39. Install helmet covers and temp stow EMU 3003 and EMU 3015 in Node (will be transferred to shuttle middeck at the end of this procedure)

EMU SYS TRANSFER BAG RECONFIGURATION FOR TRANSFER

40. Swap or transfer the following hardware per table 2 below

TABLE 2.- EVA SYSTEMS TRANSFER ITEMS

ITEM #	ITEM	CURRENT LOCATION	DESTINATION	STATUS
1a	EMU Servicing Kit (s/n 5002, yellow transfer tag)	EMU SYS TRANSFER BAG #2	EVA Prep and Ops M-02 bag (s/n 1038)	
1b	EMU Servicing Kit (s/n 5005)	EVA Prep and Ops M-02 bag (s/n 1038)	EMU SYS TRANSFER BAG #2	
2a	2 SCOFs (s/n 1009, 1010)	EMU SYS TRANSFER BAG #2	ISS EMU Equipment Bag	
2b	2 SCOFs (s/n 1006, 1008)	ISS EMU Equipment Bag	EMU SYS TRANSFER BAG #2	
3a	2 Cooling Loop Jumpers (s/n 044, 046)	EMU SYS TRANSFER BAG #2	ISS EMU Equipment Bag	
3b	2 Cooling Loop Jumpers (s/n 014, 051)	ISS EMU Equipment Bag	EMU SYS TRANSFER BAG #2	

POST EVA RECONFIGURATION AND TRANSFER (135 min) (Cont)

TABLE 2.- EVA SYSTEMS TRANSFER ITEMS (Cont)

ITEM #	ITEM	CURRENT LOCATION	DESTINATION	STATUS
4	EMU Gloves W backup (s/n 6046)	EMU SYS TRANSFER BAG #2	EMU Soft Goods M-02 bag (s/n 1010)	
5a	Bends Treatment Adapter (s/n 1003)	EMU SYS TRANSFER BAG #2	EVA Prep and Ops M-02 bag (s/n 1038) – in outside pocket	
5b	Bends Treatment Adapter (s/n 1009)	EVA Prep and Ops M-02 bag (s/n 1038) – in outside pocket	EMU SYS TRANSFER BAG #2	

41. Configure/verify final contents of EMU Sys Transfer Bags per table 3 below. Report any additional or missing hardware to MCC

TABLE 3.- EMU SYS TRANSFER BAG FINAL CONFIGURATION

<u>EMU SYS TRANSFER BAG #1</u>	<u>EMU SYS TRANSFER BAG #2</u>
<input type="checkbox"/> Aspirin (if any left over after EVAs) <input type="checkbox"/> STS-116 Logistics Cue Card <input type="checkbox"/> 2 STS EVA Checklists (PLT and MS3 copies) <input type="checkbox"/> 2 LiOH Cartridges (CCC) (S/N 2024, 2025) <input type="checkbox"/> Towels (brought over from WCS) <input type="checkbox"/> Contamination Detection Kit (s/n 1001)	<input type="checkbox"/> EMU Servicing Kit (s/n 5005) <input type="checkbox"/> 2 ISS EVA Systems Checklists (CDR and PLT copies) <input type="checkbox"/> EVA PREBREATHE Cue Card (with STS 116 protocol pen and inks) <input type="checkbox"/> 1 BTA (s/n 1009) <input type="checkbox"/> 2 SCOFs (s/n 1006, 1008) <input type="checkbox"/> 2 Cooling Loop Jumpers (s/n 014, 051)

TRANSFER AND STOW

42. Transfer the items in table 4 to shuttle

TABLE 4.- TRANSFER TO STS

Item	Destination	Transfer Status
EMU 3003 (XL) with ECOK	Temp stow Middeck	
EMU 3015 (L) with ECOK	Temp stow Middeck	
EMU SYS TRANSFER BAG #1	Temp stow Middeck	
EMU SYS TRANSFER BAG #2	Temp stow Middeck	
"Return to Shuttle 1" Jettison Stowage Bag	Temp stow Middeck	
"Return to Shuttle 2" Jettison Stowage Bag	Temp stow Middeck	
"Return to Shuttle 3" Jettison Stowage Bag	Temp stow Middeck	
5 MLE bag (used for tool xfer)	Temp stow Middeck	
1.0 CTB (used for tool xfer)	Temp stow Middeck	

POST EVA RECONFIGURATION AND TRANSFER (135 min) (Cont)

43. Unpack and stow items from EMU Sys Transfer Bags per table 5 below; report status to MCC when complete:

TABLE 5.- EMU SYS TRANSFER BAG UNPACK AND STOW

Current Location	Item	Final Stowage Location	Status
EMU SYS TRANSFER BAG #1	Aspirin	Drug Subpack (MF28H)	
-	STS-116 Logistics Cue Card	FDF/SODF Locker (MF57H)	
-	STS EVA Checklists (2)	FDF/SODF Locker (MF57H)	
-	2 LiOH Cartridges (s/n 2024, 2025)	External Airlock Floor Bag	
-	Towels	Crew pref	
-	Contamination Detection Kit	Middeck Floor STBD 1 bag	
EMU SYS TRANSFER BAG #2	ISS EVA Systems Checklists (2)	FDF/SODF Locker (MF57H)	
-	EVA PREBREATHE Cue Card	FDF/SODF Locker (MF57H)	
-	BTA	MF43K	
-	EMU Servicing Kit	Volume H Inboard	
-	2 SCOFs	Volume H Inboard, inside EMU Equipment Bag	
-	2 Cooling Loop Jumpers	Volume H Inboard, inside EMU Equipment Bag	

This Page Intentionally Blank

TIMELINES

I

EVA 1

- EVA 1 NOTES, CAUTIONS, & WARNINGS FS 7-3
- EVA 1 BRIEFING CARD FS 7-5
- EVA 1 INHIBIT PAD FS 7-6
- EVA 1 SUMMARY TIMELINE FS 7-7
- EVA 1 TOOL CONFIG FS 7-8
- EGRESS FS 7-9
- P5 LAUNCH LOCK REMOVAL FS 7-10
- P5 TO P4 ATTACHMENT FS 7-14
- PVRGF TRANSFER TO KEEL FS 7-20
- P5 TO P4 UTILITIY CONNECTIONS (GET AHEAD) FS 7-24
- CLA OPEN (GET AHEAD) FS 7-26
- P5 PORT LAUNCH LOCK REMOVAL (GET AHEAD)..... FS 7-28
- CP3 CAMERA R&R FS 7-31
- CLEANUP FS 7-35
- INGRESS FS 7-36

EVA 2

- EVA 2 NOTES, CAUTIONS, & WARNINGS FS 7-37
- EVA 2 BRIEFING CARD FS 7-39
- EVA 2 INHIBIT PAD FS 7-40
- EVA 2 SUMMARY TIMELINE FS 7-41
- EVA 2 TOOL CONFIG FS 7-42
- EGRESS FS 7-43
- CHANNEL 2/3 POWER RECONFIGURATION FS 7-44
- CETA CART 2 RELOCATION FS 7-49
- CETA CART 1 RELOCATION FS 7-52
- SSRMS FMS MLI INSTALLATION FS 7-56
- Z1-006 PATCH PANEL 2 RECONFIGURATION FS 7-58
- STBD AND PORT QD BAG INSTALLATION..... FS 7-60
- VTE AND PM JUMPER BAG INSTALLATION FS 7-61
- CLEANUP FS 7-62
- INGRESS FS 7-63

EVA 3

- EVA 3 NOTES, CAUTIONS, & WARNINGS FS 7-64
- EVA 3 BRIEFING CARD FS 7-68
- EVA 3 INHIBIT PAD FS 7-69
- EVA 3 SUMMARY TIMELINE FS 7-70
- EVA 3 TOOL CONFIG FS 7-71
- EGRESS FS 7-72
- CHANNEL 1/4 POWER RECONFIGURATION FS 7-73
- SMDP TRANSFER..... FS 7-79
- Z1-005 PATCH PANEL 1 RECONFIGURATION FS 7-86
- RUSSIAN POWER RECONFIGURATION..... FS 7-88
- AGB TRANSFER TO FHRC FS 7-91
- CLEANUP FS 7-94
- INGRESS..... FS 7-95

TIMELINES

This Page Intentionally Blank

EVA 1 NOTES, CAUTIONS, & WARNINGS

NOTES

1. Bolt release: report torque and turns if different from published range
2. EVA connectors: after disconnection and prior to connection; verify pin and EMI band integrity; verify connector free of FOD
3. Inspect QDs for damage prior to mating (EETCS manual N2 venting)

CAUTION

ISS Constraints

- A. Avoid inadvertent contact with:
1. Grapple fixture shafts
 2. PIP pins
 3. Passive UMAs
 4. MBS VDU, MCU, CRPCMs & Cameras (taped radiative surfaces, silver Teflon)
 5. Deployed TUS cable
 6. SVS Targets with planned future use [S1, P1]
 7. EETCS/PV Radiator bellows and panels [P6, P4, S4, S6]
 8. SSRMS cameras
- B. Electrical cables:
1. Avoid bend radii < 10 times cable diameter
- C. Fluid line flex hoses & QDs:
1. Avoid bend radii < 2 in for hoses with a diameter < 1 in
 2. Avoid bend radii < 10 in for hoses with a diameter ≥ 1 in
 3. Additional care should be taken to not exceed bend radii when applying loads at the flexible hose to rigid tube stub interfaces
 4. Ensure fluid QD booties are fully closed prior to leaving worksite; wire tie if reqd

CAUTION (Cont)

ISS Constraints (Cont)

- D. For structural reasons:
1. Avoid vigorous body motions, quick grabs and kickoffs against tether restraints
 2. Avoid performing shaking motions (sinusoidal functions) more than four cycles
- E. Other:
1. ITT Cannon connector: do not turn collar from WHITE to BLACK without a mating half attached
 2. Lubricant from Ku-Band SGANT gimbals [Z1], CMGs [Z1], and RTAS Ground Strap fasteners [P6,P4,S4,S6] can contaminate EMU

EVA 1 NOTES, CAUTIONS, & WARNINGS (Cont)

WARNING**ISS Constraints**

- A. Avoid inadvertent contact with:
1. Grapple fixture targets and target pins
 2. SSU, ECU, beta gimbal platform, mast canister, SAW blanket boxes unless the beta gimbal is locked and the motor is turned off
 3. Stay inboard of SARJ when active
 4. Stay 5 ft from moving MT on face 1
- B. Pinch:
1. NZGL connector linkage. Use caution when mating/locking
 2. ITT Cannon Connector rotating housing
 3. EV side of IV hatch during hatch operation (also snag hazard) [A/L]
- C. QDs:
1. If QD is in FID when valve is opened (bail fwd), QD will leak and fluid line may whip
 2. Do not rotate if in mated/valve open config

WARNING (Cont)**ISS Constraints (Cont)**

- D. Sharp Edges:
1. Inner edges of WIF sockets
 2. Mating surfaces of EVA connectors. Avoid side loads during connector mating
 3. Back side of MMOD shield fasteners
 4. Nickel coated braided copper Ground Straps may contain frayed wires [P6, P4, S4, S6]
 5. Solar Array Blanket Box [P6, S6]
 6. Spring loaded captive EVA fasteners (e.g., 6B-boxes, BMRRM, RTAS ground strap bolt); the end of the spring may protrude
- E. Thermal:
1. EVA connectors with booties may become hot if left uncovered. Handling may need to be limited
 2. Turn off glove heaters when comfortable temp reached to prevent bladder damage. Do not pull fingers out of gloves when heaters are on
 3. Uncovered trunnion pins may be hot
 4. SSRMS/MBS operating cameras/lights may radiate large amounts of heat
 5. Do not touch EMU protective visor if temp has been < -134 for > 15 min
 6. Stay 1 ft away from PMAs and MMOD shields > 270 degF if EMU sun visor up
 7. Stay at least 1 ft away for no more than 15 min from PMAs and MMOD shields > 300 degF if EMU sun visor up
 8. Stay 0.5 ft away from PMA and MMOD shields > 325 degF

WARNING (Cont)**ISS Constraints (Cont)**

9. No EMU boot contact with foot restraint when temp < -120 degF or > 200 degF
 10. No EMU TMG contact of PMAs and MMOD shields when temp > 320 degF
- F. RF radiation exposure:
1. Stay 3.6 ft from S-Band (SASA) high gain Antenna when powered [S1,P1,P6]
 2. Stay 1.3 ft from S-Band (SASA) low gain Antenna when powered [S1,P1,P6]
 3. Stay 1 ft from UHF Antenna when powered [Lab, P1]

EVA 1 BRIEFING CARD

1. EVA Prep

- Get-up Plan – clothing and EMU equipment bag
- Prebreathe protocol review
- Equipment lock activities
- Suit donning plan
- Airlock depress review

2. Communications

- Overall setup: big loop, A/G2, S/G2, ICOM, Hardline, remind EV crew when mode swapping
- Use EV1(2) for DCM sw throws (all time in A/L)

3. EVA Procedure Review

- Order of tasks (summary timeline)
- Egress Plan
- Detailed Task Review
- Notes, Cautions, and Warnings
- Get ahead tasks
 - o P5-P4 Connections
 - o P5 CLA Cycle
 - o P5 Outboard LL Removal
- Ingress Plan
- Section 16 Contingencies

4. Robotics

- SRMS/SSRMS initial position, maneuvers, clearances
- Coordinate Frames
- SSRMS/SRMS/IV comm protocol review

5. Post EVA

- Coldsoak
- Airlock Repress review
- Suit doffing responsibilities
- Post EVA plan

6. Emergencies

- Emergency suit doff and power down during EVA prep and post EVA
- CUFF checklist
- Abort and Terminate review – scenarios/protocols
- Hand signals

IV CHECKLIST VERIFICATION ITEMS

- Day/Night Cycles and extended two-handed ops
 - o √Lights, heaters, visors, tools, tethers, gloves
- √Load Alleviating Strap on Safety Tethers not damaged
- √Safety Tether in good config
 - o Crew Report: “**Hook closed, slide locked, reel unlocked**”
- √Both SAFER valves down at egress
 - o Crew Report: “**Both handles down**”
- √APFR locking collar Black-on-Black and pull test
 - o Clocking, pitch, roll, yaw
- √PGT Green light on for bolt engage
 - o program, (C)CW, MTL setting
 - o PGT and sockets – pull test
 - o May get Lo Torque msg at bolt release
 - o Crew Report: “**Torqued out, XX turns (or green light)**”
- √Connectors for damage, bent pins, EMI band, FOD, cable bend radii
 - o Always receive GO from MCC prior to mating/demating electrical connections, review inhibits as reqd
 - o Crew Report: “ **Pins good, EMI band good, no FOD, bend radius OK**”
- Coordination between IV/EV/Robotics/Ground

EVA 1 INHIBIT PAD

Orbiter

All EVAs

TCS

- L12 1. √TCS POWER – OFF

Ku-Band Antenna

- MCC-H 1. √KU-BAND Mask – active
2. √KU-BAND EVA Protect Box – active

RCS

If EV crew < 27 ft from FRCS:

- IV 1. √DAP: VERN, FREE, LO Z (flt specific √ with GNC)
O14,15,16 2. √RJDF F1, F2, F3, F4 MANF DRIVER (four) – OFF
LOGIC (four) – OFF
- MCC-H 3. √Above RCS config
IV 4. √RCS F – ITEM 1 EXEC (*)
√JET DES F1U – ITEM 17 (*)
√F3U – ITEM 19 (*)
√F2U – ITEM 21 (*)

S-Band Antennas

NOTE

Possible loss of comm when forced LL FWD antenna

- IV If EV crew < 1.6 ft from S-Band antenna:
A1R 1. S-BAND FM ANT – XMIT LOWER/RCVR UPPER
2. √MCC, lower antenna selected
- If no comm, or on MCC call:
C3 3. S-BAND PM ANT – LL FWD
- When EVA crewmember at least 1.6 ft away from all S-Band upper antennas:
C3 4. S-BAND PM ANT – GPC

USOS

All EVAs

PCU

- MCC-H 1. √PCUs (two) operational in discharge mode and one of the following:
A. CCS PCU EVA Hazard Control enabled
B. No more than two arrays unshunted
C. No more than two arrays pointed < 90 degrees from velocity vector
- OR
2. One or no PCUs operational in discharge mode and one of the following:
A. No more than two arrays unshunted
B. No more than two arrays pointed < 90 degrees from velocity vector

Ground Radar

- MCC-H 1. √TOPO and FDO consoles, ground radar restrictions in place for EVA

Location Dependent Inhibits

SARJ

- MCC-H If EV crew working within 2 ft or outboard of SARJ:
1. √DLA (1) – LOCKED
2. All motor setpoints set to zero
3. All motors deselected
- OR
4. Both DLAs – LOCKED

RSOS

All EVAs

SM Antennas

- MCC-M 1. Global Timing Sys 1(400.1 MHz) [GTS] – Deactivate

EVA 1 SUMMARY TIMELINE

TIME	SSRMS	EV1 (FF)	EV2 (FF)
0:00		POST DEPRESS (00:05)	POST DEPRESS (00:05)
0:05		EGRESS (00:25)	EGRESS (00:25)
0:30	SSRMS: 2.101 P5 INSTALL AND UNGRAPPLE	P5 LAUNCH LOCK REMOVAL (01:00) <ul style="list-style-type: none"> • Corners 1 and 3 Setup • SSRMS GCA in to 20 cm (~8 in) • Launch Lock Removal from Corner 3 • Launch Lock Removal from Corner 1 	P5 LAUNCH LOCK REMOVAL (01:00) <ul style="list-style-type: none"> • Corner 2 Setup • SSRMS GCA in to 20 cm (~8 in) • Launch Lock Removal from Corner 2 • Launch Lock Removal/Setup from Corner 4
1:30	SSRMS: 2.101 P5 INSTALL AND UNGRAPPLE	P5 TO P4 ATTACHMENT (01:30) <ul style="list-style-type: none"> • SSRMS GCA in to Soft Capture • Bolt #1 Initial Torque (Fwd/Zenith) (Fixed) • Bolt #3 Initial and Final Torque (Aft/Zenith) (Float) • Ground Strap #3 Installation • P4 Soft Capture Pin 3 Removal • Bolt #1 Final Torque • Ground Strap #1 Installation • P4 Soft Capture Pin 1 Removal (Fwd/Zenith) 	P5 TO P4 ATTACHMENT (01:30) <ul style="list-style-type: none"> • SSRMS GCA in to Soft Capture • Bolt #2 Initial Torque (Fwd/Nadir) (Y-Slider) • Bolt #4 Initial and Final Torque (Aft/Nadir) (Float) • Ground Strap #4 Installation • P5 EWIS Connector Mate (at Corner 4) • Bolt #2 Final Torque • Ground Strap #2 Installation
3:00		PVRGF TRANSFER TO KEEL (01:00)	PVRGF TRANSFER TO KEEL (01:00)
4:00		CP3 CAMERA R&R (01:30) <ul style="list-style-type: none"> • CP3 Worksite Setup • Failed Camera Removal • Spare Camera Install 	CP3 CAMERA R&R (01:30) <ul style="list-style-type: none"> • Camera Retrieval From Airlock • Failed Camera Removal • Spare Camera Install
5:30		CLEANUP (00:20)	CLEANUP (00:20)
5:50		INGRESS (00:20)	INGRESS (00:20)
6:10		PRE REPRESS (00:05)	PRE REPRESS (00:05)
6:15			

Assumptions: Get ahead P5 tasks (P5/P4 Connections, CLA Cycling, P5 Port Launch Lock Removal) will be added if time permits. The EVA will be extended to a maximum 6:30 duration in order to accommodate the get-aheads

EVA 1 TOOL CONFIG

AIRLOCK

EMU 1

- MWS, right swing arm
- Digital camera (inner right swing arm)
- BRT (left)
- w/2 wire ties & sm-sm RET
- T-Bar
- ISS trash bag (inner left)
- Socket caddy (outer right)
- RAD (s/n:)
- 7/16 x 6-in ext
- 5/8 x 7.8-in ext
- Sm-sm RET (left D-ring)
- Adj tether (left D-ring)
- Sm-sm RET w/PIP pin (right D-ring)
- Adj tether (right D-ring)
- D-ring ext – left
- 85' safety tether
- Waist tether – right
- SAFER

EMU 2

- MWS, right swing arm
- Digital camera (inner right swing arm)
- BRT (left)
- w/3 wire ties & sm-sm RET
- T-Bar
- ISS trash bag (outer right)
- Wire ties (2) around T-Bar
- Socket caddy (inner left)
- RAD (s/n:)
- 7/16 x 6-in ext
- 5/8 x 7.8-in ext
- Sm-sm RET w/PIP pin (left D-ring)
- Adj tether (left D-ring)
- Sm-sm RET w/PIP pin (right D-ring)
- Adj tether (right D-ring)
- D-ring ext (2)
- 85' safety tether (left D-ring extender)
- Spare 55' safety tether to MWS (left D-ring ext)
- Waist tethers (2) (attach 1 to right D-ring extender)
- SAFER

Total sm-sm RETs used (w/o PIP pin): 6 Total sm-sm RETs (w/PIP Pin) used: 3 Total lg-sm RETs used: 1 Total adj tethers used: 5

AIRLOCK ENDCONE

- Staging Bag
- Fish Stringer #3
- Connector cleaner tool caddy
- Wire tie caddy (2)
- Pin straightener
- MWS Key strap
- Velcro/Tape caddy
- Spare PGT (s/n: _____); battery (s/n: _____)
- Pry Bar
- EVA Ratchet
- Probe
- IV Bag
- Contamination Detection Kit
- Hydrazine Detector (Gold Salt Coupon) (6)
- Color Chart (2)
- ISS Contamination Detection Sampler (2)
- Shuttle Contamination Detection Sampler (2)
- Nitrogen Dioxide Detector (Oxidizer Draeger Tube) (6)
- Ammonia Detector (NH3 Draeger Tube) (6)
- 2 towels with wire ties
- DCM plug (2) (SAFER hardmount)
- GP caddy (2)
- Thermal mittens (2 pr)
- Socket Caddy (hatch contingencies) w/sm-sm RET
- 1/2 X 8-in socket (IV hatch)
- 7/16 X 6-in socket (spare)

PRE-EVA 1 TOOL CONFIG

1. Configure/verify MWSs
2. Transfer RETs onto MWSs as listed
3. Relocate wire ties from staging bag onto MWS
4. Attach transferred Torque Wrench and MLI to fish stringer #2
5. Attach fish stringers #1& #2 to UIA tether point
6. Transfer Velcro/tape caddy to staging bag
7. Transfer remaining sm-sm RETs (3), sm-sm RET w/PIP Pin, and Lg-sm RETs (5) to tether staging area
8. Verify IV and Staging Bag contents per list
9. Put ETVCG in airlock and config as listed
10. Stow MWSs in "EV1" and "EV2" jettison stow bags as reqd (from "EVA 1 Shuttle to ISS" bag)
11. Prior to EVA, inspect the following:
 - RET cords for damage
 - BRT and MWS toggles: loose fittings/screws
 - Safety and waist tether load alleviating straps (no red band or damage)

AIRLOCK INTERNAL D-RING

- D-ring extender

UIA HANDRAILS:

- Fish Stringer #1 (laid across UIA HRs)
- Cannon Connector Tool (1 tool, no caddy)
- Torque Wrench (set to 57 ft-lb) (s/n: _____)
- (use both torque wrench and bag tether points)
- Spare safety tether (55')
- PGT (s/n: _____) w/RET; battery (s/n: _____)
- Fish Stringer #2 (laid across UIA HRs)
- Torque Wrench (set to 57 ft-lb) (s/n: _____)
- (use both torque wrench and bag tether points)
- PGT (s/n: _____) w/RET; battery (s/n: _____)

ZEN/PORT CREWLOCK HR (or UIA HR)

- Config ETVCG as follows (s/n#: _____)
 - Verify camera electrical cap is removed
 - Light pre-installed on camera & conn mated
 - Tedlar bag removed from light
 - Camera stowed in lg ORU bag w/round scoop installed, light hangs out of hinge on right side
 - ETVCG tethered inside bag (RET) via light tether point or scoop
 - 1 adj on bag HR (truss tether)
 - Round scoop attached to bag fitting (2nd)
 - Lg-sm RET for stowage inside A/L

POST EVA 1 TOOL CONFIG

1. Retrieve "Return to Shuttle 1" jett stow bag from "EVA 1 Shuttle to ISS" jett stow bag
2. Stow the following items in the "Return to Shuttle 1" jettison stowage bag
 - P5 launch locks (4-8) (from trash bags & stringer)
 - P4 EWIS cap
 - P5 soft capture assemblies (2)
3. Stow failed ETVCG TBD
4. Stow torque wrenches (2) in Staging Bag
5. Relocate PGT w/6-in socket from EV2's MWS to crewlock bag #2 (becomes spare PGT); stow socket on socket caddy
6. Relocate EV1's and EV2's socket caddy w/RAD and 5/8 x 7.8-in ext to Staging Bag

EGRESS (00:25)

IV	EV1 (FF)	EV2 (FF)
<p><u>NOTE</u> For safety tether swaps, expect to hear:</p> <ol style="list-style-type: none"> Hook closed Slide locked Reel unlocked <p>1. Start torque wrench thermal clock: _____ (3.5 hr)</p> <p>2. WVS Software: Select page – RF camera Sel ‘Advanced Controls’ S-Band Level (two) – Max (required after EV1 and EV2 egress airlock)</p>	<p>√Right waist tether to airlock internal D-ring extender, verify ST config √85’ safety tether attached to left D-ring extender, verify ST config</p> <ol style="list-style-type: none"> Thermal cover – open Egress airlock Inspect load alleviating straps on 55’ safety tethers (2) Attach long strap of 85’ safety tether to airlock fwd D-ring, verify ST config Release waist tether from internal D-ring extender Receive fish stringer’s #1 and #2 from EV2 <p>← □</p> <ol style="list-style-type: none"> Temp stow fish stringer #1 in between A/L port toolbox HR and stbd toolbox HR (stretched out) Temp stow fish stringer #2 in between A/L HR 0560 (fwd/stbd/nadir) and HR 0555 (nadir of stbd toolbox) Receive EV2’s 85’ safety tether, attach to airlock aft D-ring, verify ST config Remove 55’ safety tether from airlock fwd external D-ring, stow on fish stringer #1 <p>11. √EV2’s SAFER MAN ISOL vlv – OP (dn) and HCM (dn)</p> <ol style="list-style-type: none"> Relocate PGT (and RET) from fish stringer #1 to outer swingarm Retrieve fish stringer #1; attach to MWS Perform translation adaptation on S0 	<p>√Right waist tether to UIA panel fwd D-ring, verify ST config √85’ safety tether attached to left D-ring extender, verify ST config</p> <ol style="list-style-type: none"> Transfer fish stringers #1 and #2 to EV1 <p>2. Transfer long strap of 85’ safety tether to EV1</p> <ol style="list-style-type: none"> Release right waist tether from UIA panel D-ring Egress airlock <p>← □</p> <ol style="list-style-type: none"> Close thermal cover √EV1’s SAFER MAN ISOL vlv – OP (dn) and HCM (dn) Remove 55’ safety tether from airlock aft external D-ring, stow on fish stringer #2 Relocate PGT (and RET) from fish stringer #2 to outer swingarm Retrieve fish stringer #2, attach to MWS Perform translation adaptation on airlock spur

P5 LAUNCH LOCK REMOVAL (01:00)

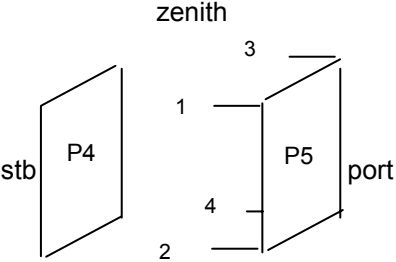
IV/SSRMS	EV1 (FF)	EV2 (FF)
 <p>P5 AND P4 CORNER DESIGNATION</p>	<p><u>CORNERS 1 AND 3 SETUP</u></p> <ol style="list-style-type: none"> 1. Translate to P1 HR 3602 (P1 Bay 14, Face 1) 2. Perform safety tether swap onto HR 3602 with 55' safety tether, verify ST config 3. Translate to P4 HR 5104 (zenith IEA) <p style="text-align: center;"><u>NOTE</u> EV1 translates zenith on P4</p> <ol style="list-style-type: none"> 4. Perform safety tether swap onto P4 HR 5104 with remaining 55' safety tether, verify ST config 5. Translate to P4 corner 1 (fwd/zenith); √P4 soft capture pin is set (pin is visible in alignment hole) 6. Translate to P4 corner 3 (aft/zenith); temp stow fish stringer #1 on HRs 5135 (5134 other side) 7. √P4 WIF 17 APFR settings: [5,RR,J,12] 8. √P4 soft capture pin is set (pin is visible in alignment hole) <p><u>SSRMS GCA IN TO 20 CM (~8 IN)</u></p> <ol style="list-style-type: none"> 1. Get in position for GCA at corner 3 (aft/zenith); aft of corner 3 looking forward 	<p><u>CORNER 2 SETUP</u></p> <ol style="list-style-type: none"> 1. Translate to P1 HR 3601 (P1 Bay 12, Face 1) 2. Perform safety tether swap onto HR 3601 with 55' safety tether, verify ST config 3. Translate to P4 HR 5133 (nadir IEA) <p style="text-align: center;"><u>NOTE</u> EV2 translates nadir on P4</p> <ol style="list-style-type: none"> 4. Perform safety tether swap onto P4 HR 5133 with remaining 55' safety tether, verify ST config 5. Translate to P4 corner 2 (fwd/nadir) 6. Temp stow fish stringer #2 on P4 HR 5154 & 5153 7. Assess need for fairlead around radiator, install as reqd 8. √P4 soft capture pin is set (pin is visible in alignment hole) <p><u>SSRMS GCA IN TO 20 CM (~8 IN)</u></p> <ol style="list-style-type: none"> 1. Get in position for GCA at corner 2 (fwd/nadir) (hold on to P4 HR 5149 by WIF 23) <div style="border: 1px solid black; padding: 5px; margin-top: 10px;"> <p style="text-align: center;"><u>WARNING</u></p> <p>SSU and RTAS housing – do not allow RTAS housing clearance with SSU to fall below 3.0 cm (1.2 inches)</p> <p>SSU and P5 HR</p> </div>
<p><u>CAUTION</u> Tight clearances between BGA and P5; monitor: RTAS housing and 4-bar linkage</p>		

P5 LAUNCH LOCK REMOVAL (01:00) (Cont)

IV/SSRMS	EV1 (FF)	EV2 (FF)
<p>1. 2.101 P5 Install and Ungrapple (SODF: RBT FS: P5 Install - EVA 1) steps 3-3.4</p> <div data-bbox="142 537 541 812" style="text-align: center;"> <p>P5 AND P4 CORNER DESIGNATION</p> </div> <p>2. SSRMS operator: when brakes on, give EV crew GO to begin launch lock removal</p> <p>3. Record number of turns to retract P5 primary bolt from launch lock</p> <p>LL #3 (EV1) _____ turns LL #2 (EV2) _____ turns</p>	<p>2. GCA SSRMS into launch lock removal position <u>LAUNCH LOCK REMOVAL FROM CORNER 3</u></p> <div data-bbox="789 443 1698 743" style="border: 1px solid black; padding: 5px; margin: 10px 0;"> <p style="text-align: center;">CAUTION</p> <p>Clearances between P4 and P5 are tight. Avoid contact with P5 and do not impart any loads into structure while removing launch locks</p> <p>Do not exceed 72 turns (PGT), 36 turns (bolt) when removing launch locks or primary bolt can come free of self feeding nut</p> <p>Hardware sensitive to crew loads. Do not apply a push or pull force on primary bolt. Damage to self-feeding nut may result</p> </div> <p>1. BRT to P4 HR 5136 (next to P4 WIF 17)</p> <div data-bbox="573 998 730 1036" style="text-align: center;"> </div> <p>2. PGT [B1, CCW2, 30.5]-RAD-7.8"-Ext-5/8: Retract P5 primary bolt from launch lock #3, 54 turns (PGT), 27 turns (bolt)</p> <div data-bbox="573 1156 730 1193" style="text-align: center;"> </div> <p>3. Remove launch lock #3, stow in trash bag</p> <p>4. $\sqrt{2}$-7 threads visible or bolt head recessed inside shear cylinder</p> <p>5. Remove RAD and 5/8" socket from PGT, temp stow on PIP pin in trash bag</p>	<p>2. GCA SSRMS into launch lock removal position <u>LAUNCH LOCK REMOVAL FROM CORNER 2</u></p> <p>1. Watch clearances between helmet and SSU</p> <p>2. BRT to P4 HR 5138</p> <p>3. PGT [B1, CCW2, 30.5]-RAD-7.8"-Ext-5/8: Retract P5 primary bolt from launch lock #2, 54 turns (PGT), 27 turns (bolt)</p> <div data-bbox="1251 1156 1409 1193" style="text-align: center;"> </div> <p>4. Remove launch lock #2, stow on fish stringer #2</p> <p>5. $\sqrt{2}$-7 threads visible or bolt head recessed inside shear cylinder</p> <p>6. Remove RAD and 5/8" socket from PGT, temp stow on PIP pin in trash bag</p>

P5 LAUNCH LOCK REMOVAL (01:00) (Cont)

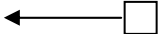
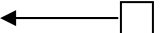
IV/SSRMS	EV1 (FF)	EV2 (FF)
<p>LL #1 (EV1) _____ turns</p> <p>LL #4 (EV2) _____ turns</p>	<p><u>LAUNCH LOCK REMOVAL FROM CORNER 1</u></p> <ol style="list-style-type: none"> 1. Translate to corner 1; BRT to P4 HR 5107 2. PGT [B1, CCW2, 30.5]-RAD-7.8"-Ext-5/8: Retract P5 primary bolt from launch lock #1, 54 turns (PGT), 27 turns (bolt)  <ol style="list-style-type: none"> 3. Remove launch lock #1, stow in trash bag 4. √2-7 threads visible or bolt head recessed inside shear cylinder 5. Remove RAD and 5/8" socket from PGT, temp stow on PIP pin in trash bag 6. Verify P5 alignment at corner 1 	<p><u>LAUNCH LOCK REMOVAL/SETUP FROM CORNER 4</u></p> <ol style="list-style-type: none"> 1. Translate to corner 4 (aft/nadir) 2. √P4 soft capture pin is set (pin is visible in alignment hole) 3. BRT to P4 HR 5137 4. PGT [B1, CCW2, 30.5]-RAD-7.8"-Ext-5/8: Retract P5 primary bolt from launch lock #4, 54 turns (PGT), 27 turns (bolt)  <ol style="list-style-type: none"> 5. Remove launch lock #4, stow on fish stringer #2 6. √2-7 threads visible or bolt head recessed inside shear cylinder 7. Remove RAD and 5/8" socket from PGT, temp stow on PIP pin in trash bag 8. √APFR settings for P4 WIF 20: [6,WW,A,10] 9. Verify P5 alignment at corner 4

P5 LAUNCH LOCK REMOVAL TASK DATA SHEET

Tools:

EV1	EV2
PGT	PGT
RAD	RAD
5/8 x 7.8-in ext	5/8 x 7.8-in ext

Foot Restraints (Optional Use)

Task	WIF	APFR Setting
P5 LL 3 Removal	(P4 WIF 17)	[5,RR,J,12]
P5 LL 4 Removal	(P4 WIF 20)	[6,WW,A,10]
	(P4 WIF 20)	OR [6,QQ,A,12]
P5 LL 1 Removal	(P4 WIF 18)	[8,OO,D,12]
P5 LL 2 Removal	(P4 WIF 19)	[6,PP,L,11]
	OR (P4 WIF 26)	OR [12,NN,B,12]

Alternate HRs to BRT:

Task	HR
P5 LL 3 Removal	P4 HR 5142 (port) (SSU)
P5 LL 4 Removal	P4 HR 5146 (nadir)
P5 LL 1 Removal	P4 HR 5139 (trunnion)
P5 LL 2 Removal	P4 HR 5150 (nadir)

EVA Fasteners:

Fastener Name	Label	Head Size	Qty	Release Torque (ft-lbs)	Failure Torque (ft-lbs)	Turns	RPM
Primary Bolt	1	5/8"	1	12.0 (thru RAD) 25.5 (no RAD)	610	27 (bolt)	30
Primary Bolt	2	5/8"	1	same	610	27 (bolt)	30
Primary Bolt	3	5/8"	1	same	610	27 (bolt)	30
Primary Bolt	4	5/8"	1	same	610	27 (bolt)	30

EVA Connectors: N/A

Notes:

- EV1 translates zenith on P4
- EV2 translates nadir on P4
- Primary bolt will come free of launch lock at ~ 38 turns (PGT), 19 turns (bolt) (KSC data)

Cautions:

- Tight clearances between BGA and P5; monitor: SSU and RTAS housing (for EV2, do not allow RTAS housing clearance with SSU to fall below 3.0 cm (1.2 inches), SSU and P5 handrail, RTAS housing and 4-bar linkage, PVRGF and Mast canister HR
- Clearances between P4 and P5 are tight. Avoid contact with P5 and do not impart any loads into structure while removing launch locks
- Do not exceed 72 turns (PGT), 36 turns (bolt) when removing launch locks or primary bolt can come free of self feeding nut
- Hardware sensitive to crew loads. Do not apply a push or pull force on primary bolt. Damage to self-feeding nut may result

Warnings:

- N/A

Timeline Considerations:

- P5 launch locks must be removed before P5 can be soft captured to P4
- Torque wrench exposure is limited to 3.5 hr to maintain correct calibration. Thermal clock starts when tool is removed from airlock

RTAS Guidelines:

- One crewmember can translate on P5 with any 2 diagonal corners in soft capture (TBR for two crewmembers)

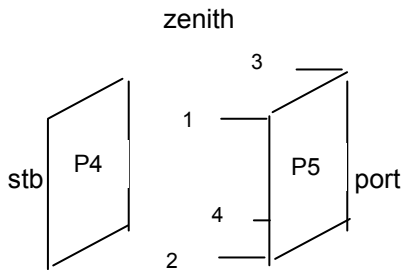

P5 TO P4 ATTACHMENT (01:30)

IV/SSRMS	EV1 (FF)	EV2 (FF)
<p>1. 2.101 P5 Install and Ungrapple (SODF: RBT FS: P5 Install - EVA 1) step 3.5</p>  <p>P5 AND P4 CORNER DESIGNATION</p>	<p><u>SSRMS GCA IN TO SOFT CAPTURE</u></p> <ol style="list-style-type: none"> 1. Translate to corner 3 (aft/zenith) 2. Get in position for GCA at corner 3 <p style="text-align: center;"><u>NOTE</u> Monitor zenith corners (3 and 1) during GCA</p> <ol style="list-style-type: none"> 3. Verify P5 alignment with SSRMS operator prior to GCA 4. GCA SSRMS into soft capture 5. ✓P4 soft capture pin has engaged P5 coarse alignment cone at corner 3 6. ✓P4 soft capture pin has engaged P5 coarse alignment cone at corner 1 (fwd/zenith) 	<p><u>SSRMS GCA IN TO SOFT CAPTURE</u></p> <ol style="list-style-type: none"> 1. Translate to corner 2 (fwd/nadir) <p style="text-align: center;"><u>NOTE</u> Monitor nadir corners (2 and 4) during GCA</p> <ol style="list-style-type: none"> 2. Verify P5 alignment with SSRMS operator prior to GCA 3. GCA SSRMS into soft capture 4. ✓P4 soft capture pin has engaged P5 coarse alignment cone at corner 2 5. ✓P4 soft capture pin has engaged P5 coarse alignment cone at corner 4 (aft/nadir)



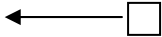
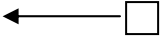

P5 TO P4 ATTACHMENT (01:30) (Cont)

IV/SSRMS	EV1 (FF)	EV2 (FF)
<div data-bbox="142 446 541 706" data-label="Diagram"> </div> <p data-bbox="216 753 478 808">P5 AND P4 CORNER DESIGNATION</p> <p data-bbox="142 846 541 932">2. 2.101 P5 Install & Ungrapple (SODF: RBT FS: P5 Install - EVA 1) step 4 (limp mode)</p> <p data-bbox="142 967 489 1023">3. Record initial torque and turns on RTAS bolts:</p> <p data-bbox="142 1060 520 1088">Bolt 1 (init) ____ turns ____ ft-lb</p> <p data-bbox="142 1091 520 1118">Bolt 2 (init) ____ turns ____ ft-lb</p> <p data-bbox="142 1122 520 1149">Bolt 3 (init) ____ turns ____ ft-lb</p>	<p data-bbox="562 326 1182 354"><u>BOLT #1 INITIAL TORQUE (FWD/ZENITH) (FIXED)</u></p> <p data-bbox="562 386 863 414">1. Translate to corner 1</p> <div data-bbox="1234 446 1308 474" data-label="Section-Header"> <p><u>NOTE</u></p> </div> <p data-bbox="909 479 1570 506">1. Primary bolts must be fastened in the following order:</p> <ul data-bbox="957 509 1608 634" style="list-style-type: none"> • Bolt 1 (fwd/zenith) • Bolt 2 (fwd/nadir) • Bolts 3 (aft/zenith) and 4 (aft/nadir) can be fastened in any order after bolts 1 and 2 <p data-bbox="909 667 1167 695">2. Gap check criteria:</p> <ul data-bbox="957 698 1596 756" style="list-style-type: none"> • For equip tether hook, tip of hook should not pass through or penetrate gap between RTAS housings <div data-bbox="583 841 741 873" data-label="Diagram"> </div> <p data-bbox="562 873 1150 932">2. PGT [B1, CW2, 30.5]-RAD-7.8"-Ext-5/8: Drive bolt #1, 54 turns (PGT), 27 turns (bolt)</p> <div data-bbox="583 964 741 997" data-label="Diagram"> </div> <p data-bbox="562 997 1230 1149">3. ✓Primary bolt shoulder seated (flush to large nut) 4. Perform gap check w/equipment hook; give EV2 GO for corner #2 (fwd/nadir) 5. Remove RAD and 5/8" socket from PGT, temp stow on PIP pin in trash bag</p> <p data-bbox="562 1190 1213 1250"><u>BOLT #3 INITIAL AND FINAL TORQUE (AFT/ZENITH) (FLOAT)</u></p> <p data-bbox="562 1287 1251 1380">1. Retrieve torque wrench from fish stringer #1, translate to corner 3 2. Ingress APFR in P4 WIF 17</p>	<p data-bbox="1276 326 1927 354"><u>BOLT #2 INITIAL TORQUE (FWD/NADIR) (Y-SLIDER)</u></p> <div data-bbox="1234 446 1308 474" data-label="Section-Header"> <p><u>NOTE</u></p> </div> <p data-bbox="1276 1060 1927 1120">1. PGT [B1, CW2, 30.5]-RAD-7.8"-Ext-5/8: On EV1 GO: Drive bolt #2, 54 turns (PGT), 27 turns (bolt)</p> <p data-bbox="1276 1125 1944 1282">2. ✓Primary bolt shoulder seated (flush to large nut) 3. Perform gap check w/equipment hook; give EV1 GO for corner #3 (aft/zenith) 4. Remove RAD and 5/8" socket from PGT, temp stow on PIP pin in trash bag</p>

P5 TO P4 ATTACHMENT (01:30) (Cont)

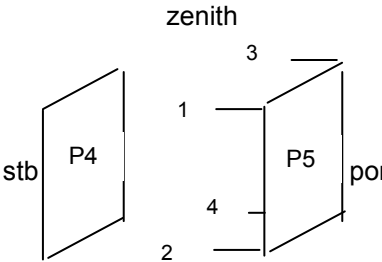
IV/SSRMS	EV1 (FF)	EV2 (FF)
<p>Bolt 4 (init) ____ turns ____ ft-lb</p> <p>4A. Verify initial torque complete on all 4 bolts prior to final torquing. Final bolt torquing may be completed in any order</p> <p>4B. Verify EV1 and EV2 are clear of SSRMS ungrapple envelope</p> <p>4C. 2.101 P5 Install and Ungrapple (SODF: RBT FS: P5 Install - EVA 1) step 5 (Give SSRMS operator GO to ungrapple)</p> <p>4D. Record turn count for final bolt torquing:</p> <p>Bolt 3 (final) ____ turn Bolt 4 (final) ____ turn</p>	<p>3. PGT [B1, CW2, 30.5]-RAD-7.8"-Ext-5/8: On EV2 GO: Drive bolt #3, 54 turns (PGT), 27 turns (bolt)</p> <p>4. ✓Primary bolt shoulder seated (flush to large nut)</p> <p>5. Stow RAD on socket caddy</p> <div style="text-align: center;">  </div> <p>6. Configure torque wrench w/7.8-Ext-5/8: ✓57 ft-lb; tighten primary bolt at corner 3 until torque wrench trips (~1/4 turn)</p> <p>7. Perform gap check w/equipment hook</p> <p>8. Remove 5/8-in socket from torque wrench, temp stow in trash bag (for translation)</p> <p><u>GROUND STRAP #3 INSTALLATION</u></p> <p>1. Reconfigure PGT with 6-in socket</p> <p>2. Egress APFR</p> <p>3. BRT to P4 HR 5136</p> <p>4. PGT [B3, CCW2, 30.5]-6"-Ext-7/16: Release ground strap from P4, 13 turns</p> <div style="text-align: center; border: 1px solid black; padding: 5px; margin: 10px 0;"> <p>CAUTION</p> <p>Ground straps are sensitive to cross threading. Begin installation manually for thread alignment and complete total turns and torque with PGT</p> </div> <p>5. PGT [B1, CW1, 30.5]-6"-Ext-7/16: Manually install ground strap to P5 ~1 turn; continue installing ground strap with PGT for total of ~ 9-12 turns (hard stop)</p>	<p><u>BOLT #4 INITIAL AND FINAL TORQUE (AFT/NADIR)</u></p> <p>1. Retrieve torque wrench from fish stringer #2, translate to corner 4</p> <p>2. Ingress APFR in P4 WIF 20</p> <p>3. PGT [B1, CW2, 30.5]-RAD-7.8 Ext-5/8: Drive bolt #4, 54 turns (PGT), 27 turns (bolt)</p> <p>4. ✓Primary bolt shoulder seated (flush to large nut)</p> <p>5. Stow RAD on socket caddy</p> <div style="text-align: center;">  </div> <p>5. Configure torque wrench w/7.8-Ext-5/8: ✓57 ft-lb; tighten primary bolt at corner 4 until torque wrench trips (~1/4 turn)</p> <p>6. Perform gap check w/equipment hook</p> <p>7. Remove 5/8-in socket from torque wrench, temp stow in trash bag (for translation)</p> <p><u>GROUND STRAP #4 INSTALLATION</u></p> <p>1. Reconfigure PGT with 6-in socket</p> <p>2. PGT [B3, CCW2, 30.5]-6"-Ext-7/16: Release ground strap from P4, 13 turns</p> <p>3. PGT [B1, CW1, 30.5]-6"-Ext-7/16: Manually install ground strap to P5 ~1 turn; continue installing ground strap with PGT for total of ~ 9-12 turns (hard stop)</p> <p>4.  corner 4 final config</p> <p>5. Egress APFR</p>

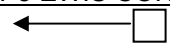
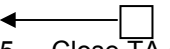
P5 TO P4 ATTACHMENT (01:30) (Cont)

IV/SSRMS	EV1 (FF)	EV2 (FF)
<p>5. √MCC EWIS inhibits in place: Open RPCM P42A-A, RPC8</p> <p>6. Give MCC GO for EWIS power up</p> <p>Bolt 2 (final) _____ turn Bolt 1 (final) _____ turn</p>  <p>P5 AND P4 CORNER DESIGNATION</p>	<p><u>P4 SOFT CAPTURE PIN 3 REMOVAL</u></p> <ol style="list-style-type: none"> 1. PGT [A6, CCW2, 30.5]-6"-Ext-7/16: Release soft capture pin fasteners (4), 13-17 turns 2. Remove soft capture pin assembly 3. Stow on fish stringer #1 on way to corner 1 4.  corner 3 final config <p><u>BOLT #1 FINAL TORQUE</u></p> <ol style="list-style-type: none"> 1. Relocate APFR from P4 WIF 17 to P4 WIF 18 (fwd/zenith); configure to [8,OO,D,12] 2. Ingress APFR 3. Reconfigure torque wrench w/5/8-in socket 4. Torque wrench w/7.8"-Ext-5/8: √57 ft-lb; tighten primary bolt until torque wrench trips (~1/4 turn) 5. Perform gap check w/equipment hook 6. Stow 7.8"-Ext-5/8" socket on socket caddy <p><u>GROUND STRAP #1 INSTALLATION</u></p> <ol style="list-style-type: none"> 1. Egress APFR 2. BRT to P4 HR 5107 3. PGT [B3, CCW2, 30.5]-6"-Ext-7/16: Release ground strap from P4, 13 turns 4. PGT [B1, CW1, 30.5]-6"-Ext-7/16: Manually install ground strap to P5 ~1 turn; continue installing ground strap with PGT for total of ~ 9-12 turns (hard stop) 	<p><u>P5 EWIS CONNECTOR MATE (at corner 4)</u></p>  <p style="text-align: center;"><u>NOTE</u></p> <p>Check connectors for FOD, bent pins, bend radius, and EMI band</p> <ol style="list-style-type: none"> 1. Position body at P4 EWIS cap (by alignment cone) 2. Demate cap from P4 J1, stow in trash bag 3. Release TA clamps (2) 4. Demate P5 P1 from P5 J1, mate to P4 J1  <ol style="list-style-type: none"> 5. Close TA clamps (2) 6. Install wire ties as reqd 7.  connector final config <p><u>BOLT #2 FINAL TORQUE</u></p> <ol style="list-style-type: none"> 1. Relocate APFR from P4 WIF 20 to P4 WIF 19 (fwd/nadir); configure to [6,PP,K,11] 2. Ingress APFR 3. Reconfigure torque wrench w/5/8-in socket 4. Torque wrench w/7.8"-Ext-5/8: √57 ft-lb; tighten primary bolt until torque wrench trips (~1/4 turn) 5. Perform gap check w/equipment hook 6. Stow 7.8"-Ext-5/8" socket on socket caddy <p><u>GROUND STRAP #2 INSTALLATION</u></p> <ol style="list-style-type: none"> 1. PGT [B3, CCW2, 30.5]-6"-Ext-7/16: Release ground strap from P4, 13 turns

P5 TO P4 ATTACHMENT (01:30) (Cont)

IV/SSRMS	EV1 (FF)	EV2 (FF)
	<p><u>P4 SOFT CAPTURE PIN 1 REMOVAL (FWD/ZENITH)</u></p> <ol style="list-style-type: none"> 1. PGT [A6, CCW2, 30.5]- 6"-Ext-7/16: Release soft capture pin fasteners (4), 13-17 turns 2. Remove soft capture pin assembly, temp stow 3. ☐ corner 1 final config 4. Stow torque wrench, soft capture pin assembly, and socket caddy on fish stringer #1 	<ol style="list-style-type: none"> 2. PGT [B1, CW1, 30.5]-6"-Ext-7/16: Manually install ground strap to P5 ~1 turn Continue installing ground strap with PGT for total of ~ 9-12 turns (hard stop) 3. Egress APFR 4. ☐ corner 2 final config 5. Temp stow torque wrench on fish stringer #2

P5 TO P4 ATTACHMENT TASK DATA SHEET

Tools:

EV1	EV2
PGT	PGT
RAD	RAD
5/8 x 7.8-in ext	5/8 x 7.8-in ext
7/16 x 6-in ext	7/16 x 6-in ext
Torque Wrench	Torque Wrench

Foot Restraints (Optional Use)

Task	WIF	APFR Setting
Bolt 1 Initial and Final Torque	P4 WIF 18	[8,OO,D,12]
Bolt 2 Initial and Final Torque	P4 WIF 19	[6,PP,K,11]
Bolt 2 Initial and Final Torque — alternate	(P4 WIF 26)	[3,PP,G,11]
Bolt 3 Initial and Final Torque	P4 WIF 17	[5,RR,J,12]
Bolt 4 Initial and Final Torque	P4 WIF 20	[6,WW,A,10]

EVA Fasteners:

Fastener Name	Label	Head Size	Qty	Release/Install Torque (ft-lbs)	Failure Torque (ft-lbs)	Turns	RP M
RTAS Primary Fastener	1,2,3,4	5/8"	4	Install: 25.5 (initial) 57.0 (final)	105.3 (insert shear out)	27 (bolt)	30
Ground Straps	none	7/16"	4	Release: 18.4 Install: 12.0	Release: 31.1 Install: 26.4	Release: 11-13 Install: 8-12	30
Soft Capture Pin Assembly	none	7/16"	4	Release: 8.3	12.0	13-17	30
Gap check tool bolts	none	7/16"	2	Release: 8.3	Release: 12.2	12-14	30

EVA Connectors:

Connector	From	To	Clamps	Size	Function
P5 EWIS	P5 P1 (W5426)	P4 J1 (W5425)	2	15	EWIS heater

RTAS Guideline:

- P5 can be translated on by one crewmember after 2 diagonal corners are in soft capture (TBR for 2 crewmembers). Thus, P5 is in a safe config to be used as an ingress aid for final torquing of RTAS bolts (already have achieved initial torque)

Notes:

- Primary bolts must be fastened in the following order; Bolt 1 (fwd/zenith), Bolt 2 (fwd/nadir), Bolts 3 (aft/zenith) and 4 (aft/nadir) can be fastened in any order AFTER bolts 1 & 2
- For contingency gap check measurement using gap check tool, retrieve gap check tool from Corner 1 (see MRTAS Primary Bolt Contingencies procedure in section 16, step 3C). Tip of tool should not penetrate gap between RTAS housings past second line
- Soft capture black indicator lines will NOT be visible when P4 soft capture pins have engaged P5 coarse alignment cones successfully
- All 4 corners must have initial torque prior to final bolt torquing on any bolt. Final torquing can happen in any order
- Tolerances for Coarse Align Cone Engagement (getting all 4 cones to go into the cups):
 - Lateral: +/- 2.0 inches, Roll: +/- 1.7 degrees, Wobble: +/- 3.1 degrees
- Tolerances for Soft Capture Engagement (pin dropping into slot):
 - Lateral: +/- 0.175 inches, Roll: +/- 0.15 degrees
- P4 HR 5138 serves as backup for EV2 ground strap 2 install

Cautions:

- Tight clearances between BGA and P5; monitor: SSU and RTAS housing (from pre-install to LL removal); SSU and P5 HR (from LL removal to soft capture); RTAS housing and 4-bar linkage (from LL removal to soft capture); PVRGF and mast canister HR
- Ground straps are sensitive to cross threading. Begin installation manually for thread alignment and complete total turns and torque with PGT
- Hardware sensitive to crew loads. Do not apply a push force on primary bolt. Damage to self-feeding nut may result

Timeline Considerations:

- The final torquing sequence and ground strap attach order in this procedure weighs socket swaps against APFR relocations as well as crew translations between corners
- Torque wrench exposure is limited to 3.5 hours to maintain correct calibration. Thermal clock starts when tool is removed from airlock
- The soft capture pin assembly at corner 1 is removed because of a future hardware interference between it and the outboard MT/CETA rail. The soft capture pin assembly at corner 3 is removed because EVA deployed wire harnesses W10 and W08 are eventually routed through this area between P4 and P5
- Initial torque must be achieved at all 4 corners prior to giving SSRMS operator GO to ungrapple (conservative approach and pending new data, ungrapple may occur after 4 corners have achieved soft capture)
- EWIS thermal clock: The EWIS thermal clock begins once P5 is soft captured to P4; connector must then be mated within 6 hours

PVRGF TRANSFER TO KEEL (01:00)

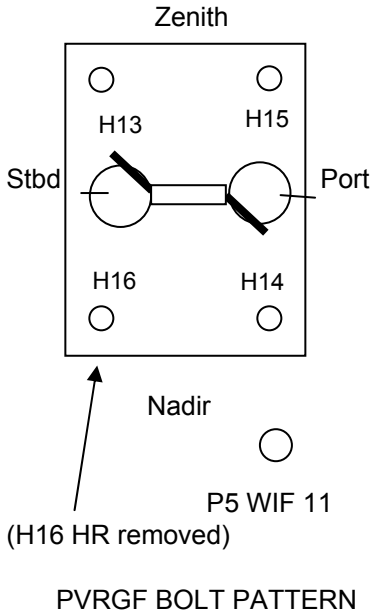
IV	EV1 (FF)	EV2 (FF)
 <p>H13 WASHER STOWED IN MLI</p>  <p>Zenith</p> <p>Stbd</p> <p>Port</p> <p>Nadir</p> <p>P5 WIF 11 (H16 HR removed)</p> <p>PVRGF BOLT PATTERN</p>	<p>NOTE EV1 remains zenith when translating to the PVRGF via zenith fwd edge of P4/P5</p> <div style="border: 1px solid black; padding: 5px; text-align: center;"> <p>CAUTION Avoid contact with PVRGF grapple pins and RMS targets</p> </div> <p><u>RELEASE FASTENER H15 (Zenith/Port)</u></p> <ol style="list-style-type: none"> 1. Translate to PVRGF fastener H15 (zenith/port); fair lead tether over APFR as reqd; BRT to HR 5203 2. PGT [B4, CCW2, 30.5]-6"-Ext-7/16: Release PVRGF fastener H15, 6-8 turns (do not go to hard stop at this torque) 3. Remove retaining washer, stow in TA clamp 	<p>NOTE EV2 remains nadir when translating to the PVRGF via nadir of 4A BGA</p> <p><u>RELOCATE APFR</u></p> <ol style="list-style-type: none"> 1. Relocate APFR from P4 WIF 19 (fwd/nadir) to P5 WIF 11 (nadir): configure APFR to [9,QQ,H,12] <p><u>RELEASE GROUND STRAP FASTENER (H14)</u></p> <ol style="list-style-type: none"> 1. Attach waist tether to APFR roll pedal 2. Ingress APFR in P5 WIF 11 3. PGT [B7, CCW2, 30.5]-6"-Ext-7/16: Release PVRGF ground strap fastener, G1 (at H14 corner), 11-13 turns 4. Secure end in PVRGF TA clamp <p><u>RELEASE FASTENER H14 (Nadir/Port)</u></p> <ol style="list-style-type: none"> 1. PGT [B4, CCW2, 30.5]-6"-Ext-7/16: Release PVRGF fastener H14, 6-8 turns (do not go to hard stop at this torque) 2. Remove retaining washer, stow in adjacent P5 TA clamp

PVRGF TRANSFER TO KEEL (01:00) (Cont)

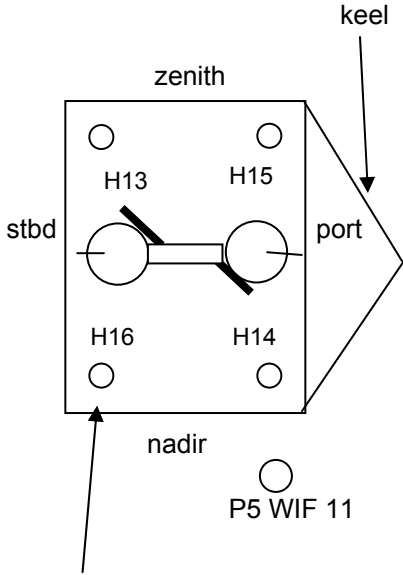
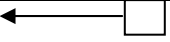
IV	EV1 (FF)	EV2 (FF)
<p>1A. Verify SSRMS is clear of PVRGF removal plane 1B. Do not release H13 fastener until EV2 is holding PVRGF</p>  <p>(H16 HR removed)</p> <p>PVRGF BOLT PATTERN</p>	 <p><u>RELEASE FASTENER H13 (Zenith/Stbd)</u></p> <ol style="list-style-type: none"> 1. Translate to PVRGF fastener H13 (zenith/stbd) 2. Reposition body so feet are zenith/stbd (on your left side) 3. BRT to HR 5202 4. PGT [B4, CCW2, 30.5]-6"-Ext-7/16: Release PVRGF fastener H13, 6-8 turns (do not go to hard stop at this torque) 5. Remove retaining washer, stow in adjacent P5 MLI flap 6. Monitor clearances between port PVRGF corners and P5 outboard RTAS housing 	<p><u>RELEASE FASTENER H16 (Nadir/Stbd)</u></p> <ol style="list-style-type: none"> 1. Reconfigure PGT w/RAD and 6-in socket 2. PGT [B1, CCW2, 30.5]-RAD-6"-Ext-7/16; Release PVRGF fastener H16 (nadir/stbd), 12-16 turns (PGT), 6-8 turns (bolt) (do not go to hard stop) 3. Remove retaining washer, stow in adjacent P5 MLI flap <div data-bbox="779 613 1816 824" style="border: 1px solid black; padding: 5px;"> <p style="text-align: center;"><u>CAUTION</u></p> <p>Be aware of tight clearances between:</p> <ul style="list-style-type: none"> • Nadir/stbd corner of PVRGF (fastener H16) with Mast Canister HR & BGA platform cables • Nadir/stbd PIP pin on PVRGF with Mast Canister HR & BGA platform cables • Port corners of PVRGF (H15 & H14) and outbd RTAS housings </div> <ol style="list-style-type: none"> 4. Deconfigure RAD with 6-in (for translation) 5. Roll APFR from H to G 6. Tether to PVRGF HR next to H14 with RET 7. Hold PVRGF HRs 8. Give EV1 GO to begin releasing bolt H13 <ol style="list-style-type: none"> 9. Lift PVRGF off posts due forward while pitching port corners H14 and H15 ~ 10 degrees away from P5 outboard RTAS housing 10. Remove PVRGF

PVRGF TRANSFER TO KEEL (01:00) (Cont)

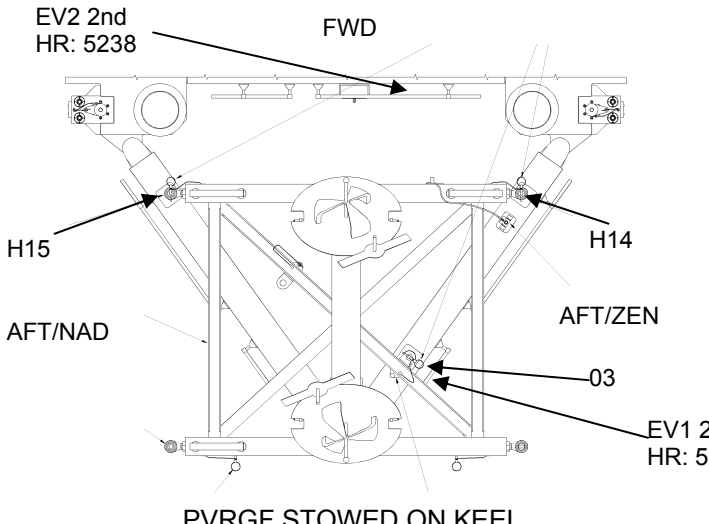
IV	EV1 (FF)	EV2 (FF)
<p>IV NOTE EV1 and EV2's 1st HRs are not shown in picture</p>	<p><u>PVRGF STOWAGE ON KEEL</u></p> <ol style="list-style-type: none"> 1. Translate to EV2 (go zenith, then aft to deconflict tethers) (zenith/fwd P5 HR 5241) 2. Assist EV2 with guiding PVRGF around corner 3. Translate to P5 HR 5240, attach BRT 4. Receive PVRGF from EV2, tether 5. Transfer PVRGF to EV2 6. Translate to P5 keel HR 5234 (zen/aft), attach BRT 7. Align PVRGF corner H14 with keel post H14 8. Slide spherical bearing onto keel post at corner H14 and along diagonal beam post #03 until fully seated 9. Install PIP pin at corner H14 10. Install PIP pin at diagonal beam #03 (on keel)  <p style="text-align: center;">PVRGF STOWED ON KEEL</p>	<p><u>PVRGF STOWAGE ON KEEL</u></p> <ol style="list-style-type: none"> 1. Guide PVRGF around corner 2. Transfer PVRGF to EV1 3. Egress APFR 4. Translate to P5 HR 5243 (nadir/port), attach BRT (feet nadir) 5. Receive PVRGF from EV1, tether 6. Align PVRGF corner H15 with keel post H15 7. Slide spherical bearing onto keel post at corner H15 until fully seated 8. Install PIP pin at corner H15 9. Release PVRGF ground strap from TA clamp 10. BRT to P5 HR 5238 11. PGT [A5, CW2, 30.5]-6"-Ext-7/16: Manually install ground strap fastener to keel fitting ~ 1 turn; Continue driving ground strap with PGT for total of 11-13 turns (hard stop)

PVRGF RELOCATION TO KEEL TASK DATA SHEET

Tools:

EV1	EV2
PGT	PGT
7/16 x 6-in ext	RAD
	5/8 x 7.8-in ext
	7/16 x 6-in ext

Foot Restraints (Optional Use)

Task	WIF	APFR Setting
PVRGF Removal	P5 WIF 11	[9,QQ,H,12]

EVA Fasteners:

Fastener Name	Label	Head Size	Qty	Torque (ft-lbs)	Failure Torque (ft-lbs)	Turns	RPM
PVRGF Fastener	H13 H14 H15 H16	7/16"	4	Release: 19.4 (do not go to hard stop at this torque) (12.0 w/RAD)	167.5 8.3 (failure torque at hard stop)	6-8	30
Ground Strap	GS 1	7/16"	1	Release: 25.5 Install: 7.0		Release: 11-13 Install on keel: 11-13	30

PVRGF Mass = ~228 lbs/103 kg

Notes:

- EV1 remains zenith when translating to the PVRGF via zenith fwd edge of P4/P5
- EV2 remains nadir when translating to the PVRGF via nadir of 4A BGA
- For PVRGF spherical bearings: H13 (fixed), H16 (slotted), H14 (float), H15 (float)

Cautions:

- Avoid contact with PVRGF grapple pins and SRMS targets
- Be aware of tight clearances between:
 - Nadir/stbd corner of PVRGF (fastener H16) with Mast Canister HR & BGA platform cables
 - Nadir/stbd PIP pin on PVRGF with Mast Canister HR & BGA platform cables
 - Port corners of PVRGF (H15 & H14) and outbd RTAS housings





Warnings:

- N/A

Timeline Considerations:

- PVRGF must be removed in order to rotate 4A BGA
- The H16 HR on the PVRGF was removed pre-flight (to reduce clearance concerns with BGA during removal)
- PVRGF bolts can be released in any order with the exception that EV2 must be holding the PVRGF prior to EV1 releasing the last bolt (H13)
- PVRGF bolts are captive and will reach a hard stop when released all the way. Bolts can be re-driven (CW) up to 17 turns after washer removal; this can provide an additional 0.85" of clearance for PVRGF removal

P5 TO P4 UTILITY CONNECTIONS (GET AHEAD) (00:45)

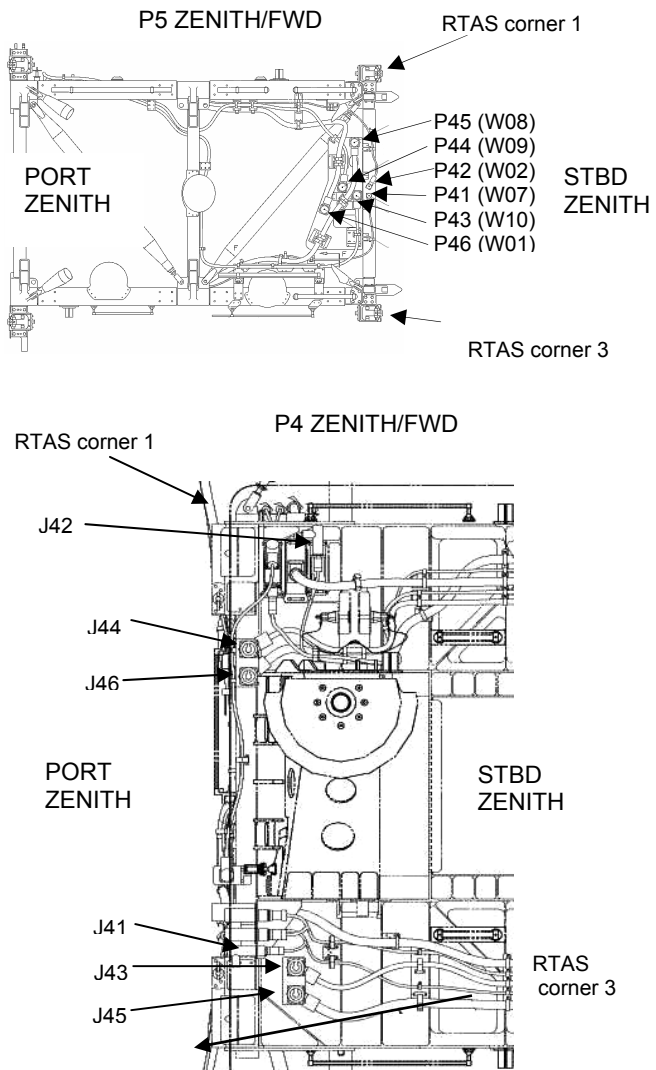
IV	EV1 (FF)	
<p>1. √MCC inhibits in place:</p> <p>A. RPCM P44A-B RPC1 open (cl-inh) (P44)</p> <p>B. RPCM P42A-B RPC1 open (cl-inh) (P43)</p> <p>C. Prim PMCU Auto Trans to Diag - Inh (P42)</p> <p>D. LB PMCU-2 on Chan B (P42)</p> <p>E. LB PMCU-4 on Chan B (P42)</p> <p>F. Auto Channel Switch Status for LB PMCU-2 and 4 - Inh</p> <p style="text-align: center;"><u>IV NOTE</u></p> <p>Connector order was originally decided at KSC OOC and was based on cable routing only.</p> <p>From a pwr inhibits standpoint, four of the six connectors can be mated in any order, however, P42 and P41 have mutually exclusive inhibits and thus can't be done at the same time</p> <p>2. Inform MCC GO to perform ASSY Ops: 1553 Checkout, step 4 (P41 inhibits)</p> <p>3. √MCC inhibits in place for P41: LB PMCU-2 on Chan A (P41) LB PMCU-4 on Chan A (P41)</p> <p>4. Inform MCC GO to perform ASSY Ops: 1553 Checkout, steps 6 and 7</p>	<p style="text-align: center;"><u>P5 TO P4 UTILITY CONNECTIONS</u></p> <p>← </p> <ol style="list-style-type: none"> Retrieve cannon connector tool from fish stringer #1 Translate to P5 zenith connector panel <p style="text-align: center;"><u>NOTE</u></p> <p>Check connectors for FOD, bent pins, bend radius and EMI band</p> <ol style="list-style-type: none"> Release TA clamps on P5 cables: <ul style="list-style-type: none"> <input type="checkbox"/> P42: (3) <input type="checkbox"/> P44: (2) – if needed, 2 more TA clamps to release <input type="checkbox"/> P46: (3) <input type="checkbox"/> P43: (4) <input type="checkbox"/> P45: (4) – if needed, 3 more TA clamps to release <input type="checkbox"/> P41: (1) Verify TA clamps closed Perform the following connector and cap swaps: <ul style="list-style-type: none"> <input type="checkbox"/> P5 P42 with P4 J42 cap <p>← </p> <ul style="list-style-type: none"> <input type="checkbox"/> P5 P44 with P4 J44 cap <input type="checkbox"/> P5 P45 with P4 J45 cap <input type="checkbox"/> P5 P43 with P4 J43 cap <input type="checkbox"/> P5 P46 with P4 J46 cap <p>← </p> <ul style="list-style-type: none"> <input type="checkbox"/> P5 P41 with P4 J41 cap <p>← </p> <ol style="list-style-type: none">  connector final config 	

P5 TO P4 UTILITY CONNECTIONS (GET AHEAD) TASK DATA SHEET

Tools:

EV1	EV2
Cannon Connector Tools	N/A

Foot Restraints (if BRT does not work):

Task	APFR Setting		
P5 to P4 Utility Connections (in order they must occur)	P5 WIF	Connector	APFR Setting
	04	P42 J42	[9,UU,K,12] [4,PP,C,11]
	04	P44 J44	[9,UU,K,12] [4,PP,C,11]
	03	P45 J45	[4,SS,D,1] [4,RR,B,1]
	03	P43 J43	[4,SS,D,1] [4,RR,B,1]
	04	P46 J46	[9,UU,K,12] [4,PP,C,11]
	03	P41 J41	[4,SS,D,1] [4,RR,B,1]

EVA Fasteners: N/A

EVA Connectors:

Connector	From	To	Clamps	Size	Function
W02-P42 (pin)	P5 J42	P4 J42	3	19	1553 Bus A (data)
W07-P41 (pin)	P5 J41	P4 J41	3	19	1553 Bus B (data)
W01-P46	P5 J46	P4 J46 (pin)	6	37	UPR Primary Power
W08-P45	P5 J45	P4 J45 (pin)	7	37	LPR Primary Power
W09-P44 (pin)	P5 J44	P4 J44	4	37	UPR MSC to UMA 1 (power)
W10-P43 (pin)	P5 J43	P4 J43	6	37	LPR MSC to UMA 2 (power)

Notes:

1. Check connectors for FOD, bent pins, bend radius, and EMI bands
2. Size 37 P4 caps (4) are dust caps. They are not keyed or labeled and can be mated to any size 37 P5 jack.
3. Size 19 P4 caps (2) are terminator caps. They are not uniquely keyed and are identical and interchangeable with each other. They are, however, only keyed for 1553 lines, and thus cannot be installed on other size 19 functional connector receptacles other than the intended P5 jacks and associated P4 BMRRM jacks. They are both labeled: P1-T (W28)
4. P4 terminator plugs should be installed onto P5 jacks to protect for P4 contingencies (BMRRM R&R, etc.). Only the J41 and J42 terminator caps are reqd for the BMRRM R&R.
5. For connector soft dock: white on white
6. For connector engage/lock: rotate 90 deg to white on black
7. W08-P45 excess cable line length does not meet required 11 inches; measured 7.75 inches
8. P5 cables were demated and mated at OOCT in the exact order as listed in the procedures to deconflict cable routing interferences
9. Connector inhibit rationale:
 - Step 1 in the IV column provides inhibits for P42, P44, and P43; P45 and P46 are primary power feeds, but they're open circuit on EVA 1 so no inhibits required.
 - Step 2 in the IV column provides inhibits for P41. It cannot be performed until after P42 is mated to J42. Also, it is listed a couple of steps before P41 to allow ODIN to inhibit it ahead of time

Cautions: N/A

Warnings: N/A

Timeline Considerations: N/A

CLA OPEN (GET AHEAD) (00:15)

IV		EV2 (FF)
		<p><u>P5 CLA OPEN</u></p> <div data-bbox="1356 391 1927 509" style="border: 1px solid black; padding: 5px; margin: 10px 0;"> <p style="text-align: center;"><u>CAUTION</u></p> <p>Avoid contact with PVRGF grapple pins and RMS target</p> </div> <ol style="list-style-type: none"> 1. Translate to P5 CLA (go zenith of PVRGF) 2. BRT to P5 HR 5239 3. PGT [A6, CCW3, 30.5]-6Ext-7/16: Open CLA, ~127 turns (hard stop) 4. PGT [A6, CW2, 30.5]-6Ext-7/16: Partially close CLA, ~1 turn 5.  final CLA config

CLA OPEN (GET AHEAD) TASK DATA SHEET

Tools:

EV1	EV2
N/A	PGT
	7/16 x 6-in ext

Foot Restraints: N/A

EVA Fasteners:

Fastener Name	Label	Head Size	Qty	Torque (ft-lbs)	Failure Torque (ft-lbs)	Turns	RPM
CLA Drive	CLA Drive	7/16"	1	8.3	14.6	127 (open)	60 (open)
						1 (close)	30 (close)

EVA Connectors: N/A

Notes:

1. N/A

Cautions:

1. Avoid contact with PVRGF grapple pins and RMS target

Warnings:

1. N/A

Timeline Considerations:

1. This task must be done prior to P6 install

P5 PORT LAUNCH LOCK REMOVAL (GET AHEAD) (00:30)

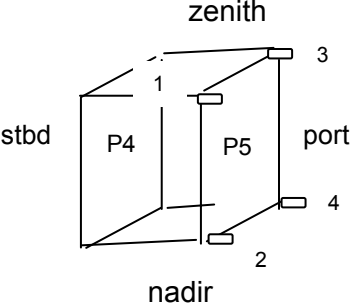
IV		EV2 (FF)
<p><u>IV NOTE</u> There is no reqd order for LL removal. The current order is based on crew preference</p>  <p>P5 AND P4 CORNER DESIGNATION</p>		<p><u>EV2 (FF)</u></p> <p><u>LAUNCH LOCK REMOVAL FROM CORNER 3</u></p> <div style="border: 1px solid black; padding: 5px; margin: 10px 0;"> <p style="text-align: center;"><u>CAUTION</u></p> <p>Do not exceed 36 turns (bolt) when removing launch locks or primary bolt can come free of self feeding nut</p> <p>Hardware sensitive to crew loads. Do not apply a push or pull force on primary bolt. Damage to self-feeding nut may result</p> </div> <ol style="list-style-type: none"> 1. Translate to corner 3 (aft/zenith) 2. BRT to P5 HR 5224 if reqd 3. PGT [B7, CCW2, 30.5]-7.8"-Ext-5/8: Retract P5 primary bolt from launch lock #3, 27 turns 4. Remove launch lock #3, stow in trash bag 5. $\sqrt{2}$-7 threads visible or bolt head recessed inside shear cylinder <p><u>LAUNCH LOCK REMOVAL FROM CORNER 1</u></p> <ol style="list-style-type: none"> 1. Translate to corner 1 (fwd/zenith) 2. BRT to P5 HR 5203 if reqd 3. PGT [B7, CCW2, 30.5]-7.8"-Ext-5/8: Retract P5 primary bolt from launch lock #1, 27 turns 4. Remove launch lock #1, stow in trash bag 5. $\sqrt{2}$-7 threads visible or bolt head recessed inside shear cylinder

P5 PORT LAUNCH LOCK REMOVAL (GET AHEAD) (00:30) (Cont)

IV		EV2 (FF)
		<p><u>LAUNCH LOCK REMOVAL FROM CORNER 4</u></p> <ol style="list-style-type: none"> 1. Translate to corner 4 (aft/nadir) 2. BRT to P5 HR 5225 if reqd 3. PGT [B7, CCW2, 30.5]-7.8"-Ext-5/8: Retract P5 primary bolt from launch lock #4, 27 turns 4. Remove launch lock #4, stow in trash bag 5. √2-7 threads visible or bolt head recessed inside shear cylinder <p><u>LAUNCH LOCK REMOVAL FROM CORNER 2</u></p> <ol style="list-style-type: none"> 1. Translate to corner 2 (fwd/nadir) 2. BRT to P5 HR 5226 if req'd 3. PGT [B1, CCW2, 30.5]-RAD-7.8"-Ext-5/8: Retract P5 primary bolt from launch lock #2, 54 turns (PGT), 27 turns (bolt) 4. Remove launch lock #2, stow in trash bag 5. √2-7 threads visible or bolt head recessed inside shear cylinder 6. Deconfigure RAD and 5/8" socket from PGT

P5 PORT LAUNCH LOCK REMOVAL (GET AHEAD) TASK DATA SHEET

Tools:

EV1	EV2
	PGT
	5/8 x 7.8-in
	RAD

Foot Restraints: N/A

HRs to BRT:

Task	HR
P5 LL 3 Removal	P4 5224
P5 LL 4 Removal	P4 5225
P5 LL 1 Removal	P4 5203
P5 LL 2 Removal	P4 5226

EVA Fasteners:

Fastener Name	Label	Head Size	Qty	Torque (ft-lbs)	Failure Torque (ft-lbs)	Turns	RPM
Primary Bolt	1	5/8"	1	12.0 (thru RAD) 25.5 (no RAD)	610	27 (bolt)	30
Primary Bolt	2	5/8"	1	same	610	27 (bolt)	30
Primary Bolt	3	5/8"	1	same	610	27 (bolt)	30
Primary Bolt	4	5/8"	1	same	610	27 (bolt)	30

Notes:

- 6 LLs will fit in a small trash bag, but very tight
- KSC fitcheck of PGT w/7.8" socket to P5 outboard RTAS bolts on 3/8/06:
 - Corner 1: PGT with 7.8" socket can fit on bolt from a clearance standpoint, but gets very close to EWIS TAA. Can opt to use RAD here but does not look to be required
 - Corner 2: PGT with 7.8" socket has hard interference with antenna; must use RAD at this corner
 - Corners 3 and 4: no hard interferences with EWIS hardware

Cautions:

- Do not exceed 36 turns (bolt) when removing launch locks or primary bolt can come free of self feeding nut
- Hardware sensitive to crew loads. Do not apply a push or pull force on primary bolt. Damage to self-feeding nut may result

Warnings: N/A

Timeline Considerations:

- P5 launch locks must be removed prior to P6 install

CP3 CAMERA R&R (01:30)

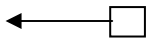
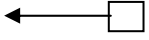
IV	EV1 (FF)	EV2 (FF)
<p>1A. Verify w/MCC that CP3 is in park position (-180 deg pan and -90 deg tilt)</p> <p>1B. Give MCC GO to put camera inhibits in place: RPCM S1-1A-A RPC 1 open RPCM S1-1A-A RPC 15 open RPCM S1-2B-A RPC 2 open RPCM S1-2B-A RPC 16 open</p> <p>2. Start camera thermal clock: PET: _____</p>	<p><u>CP3 WORKSITE SETUP</u></p> <p>1. Translate to P4 WIF 18 (fwd/zenith) </p> <p>2. Retrieve APFR from WIF 18, attach to BRT</p> <p>3. Relocate connector tool to fish stringer #1</p> <p>4. Retrieve fish stringer #1, stow on MWS</p> <p>5. Translate to P4 HR 5104, perform safety tether swap onto 55' safety tether, verify ST config</p> <p>6. Translate to CETA cart #2 (stbd most)</p> <p>7. Relocate APFR from BRT to CETA cart WIF 03 (zen/stbd swingarm), configure to: [12,PP,F,6]</p> <p>8. Translate to P1 HR 3602, perform safety tether swap onto airlock safety tether, verify ST config</p> <p>9. Temp stow fish stringer #1 near airlock spur on S0 HRs 3414 and 3415</p> <p>10. Verify spare safety tethers (2) on fish stringer #1</p> <p>11. Translate to CP3 (S1 bay 15, face 6 nadir)</p> <p>12. ✓S1 nadir SVS targets are clear of ETVCG cables</p>	<p><u>CAMERA RETRIEVAL FROM AIRLOCK</u></p> <p>1. Retrieve APFR from P5 WIF 11</p> <p>2. Retrieve fish stringer #2 from P4 HRs 5154 & 5153</p> <p>3. Translate to P4 HR 5133, perform safety tether swap onto 55' safety tether, verify ST config</p> <p>4. Translate to P1 HR 3601, perform safety tether swap onto airlock safety tether, verify ST config</p> <p>5. Translate to airlock</p> <p>6. Stow APFR in airlock toolbox 1 (stbd): [9,MM,F,12]</p> <p>7. Stow fish stringer #2 on A/L HRs 0560 and 0555 (stbd/nadir/fwd)</p> <p>8. Relocate spare 55' safety tethers (2), socket caddy (with RAD, 5/8", and 6-in sockets), and PGT (w/RET) to fish stringer #2</p> <p>9. Open airlock thermal cover</p> <p>10. Retrieve spare camera from airlock, attach to BRT</p> <p></p> <p>11. Close thermal cover</p> <div data-bbox="982 1019 1562 1140" style="border: 1px solid black; padding: 5px; text-align: center;"> <p><u>CAUTION</u> Avoid contact with S1 SVS targets, RBVM fluid lines and QDs</p> </div> <p>12. Translate to CP3 (S1 bay 15, face 6 - nadir)</p> <p>13. Temp stow large ORU bag on S1 HR 3215 (use 2 adj tethers) - nadir tray HR</p>

CP3 CAMERA R&R (01:30) (Cont)

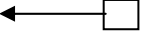
IV	EV1 (FF)	EV2 (FF)
<p>3. √MCC Camera inhibits in place</p>	<div data-bbox="1026 342 1522 461" style="border: 1px solid black; padding: 5px; margin-bottom: 10px;"> <p style="text-align: center;">CAUTION Avoid contact with light (Z-93 paint) and camera (silver Teflon)</p> </div>  <p><u>FAILED CAMERA REMOVAL</u></p> <ol style="list-style-type: none"> 1. Take camera pan/tilt lever to LOCKED (may have to assist with positioning camera to stowed posn) 2. Tether to failed ETVCG light 3. PGT [A7, CCW2, 30.5]-6Ext-7/16: Release outer bolts (2) ~ 12 turns 4. PGT [A7, CCW2, 30.5]-6Ext-7/16: Release center jacking bolt ~ 30 turns 5. Receive round scoop from EV2, attach to failed camera fitting 6. Attach BRT to failed camera 7. Remove failed camera (soft dock wedges) and position behind back <p><u>SPARE CAMERA INSTALL</u></p> <ol style="list-style-type: none"> 1. Verify blind mate connector on stanchion mount is clear of FOD 2. Receive spare camera from EV2 3. Install camera (soft dock wedges) 4. Remove round scoop from camera fitting, transfer to EV2 5. PGT [A7, CW2, 30.5]-6Ext-7/16: Drive center jacking bolt ~ 24-30 turns (hard stop) 	<p><u>FAILED CAMERA REMOVAL</u></p> <ol style="list-style-type: none"> 1. Transfer spare round scoop to EV1 2. Assist EV1 as req'd <p><u>SPARE CAMERA INSTALL</u></p> <ol style="list-style-type: none"> 1. Remove spare camera from ORU bag, transfer to EV1, assist EV1 as req'd

CP3 CAMERA R&R (01:30) (Cont)

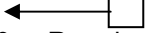
IV	EV1 (FF)	EV2 (FF)
<p>4. Inform MCC camera installed and RPCs for survival heater power can be closed: (RPCM S12B-A RPCs 2 and 16)</p>	<p>6. PGT [A7, CW2, 30.5]-6Ext-7/16: Drive outer bolts (2) ~ 6-12 turns (hard stop)</p> <p>7. Unlock camera pan/tilt unit (90 deg lever)</p> <p>8.  ETVCG final config</p> <p>9.  Re-orient body prior to translating away from new ETVCG</p>	<p>2. Retrieve ORU bag from truss, attach to BRT</p>

CP3 CAMERA R&R TASK DATA SHEET

Tools:

EV1	EV2
PGT	PGT
6-in ext x 7/16	6-in ext x 7/16
	Lg ORU bag with spare camera <ul style="list-style-type: none"> 1 rd scoop on spare camera fitting 1 rd scoop on bag fitting

Foot Restraints:

Task	WIF	APFR Setting
Failed Camera Removal and Spare Camera Install	(S1 WIF 32)	[12,GG,C,12]

EVA Fasteners:

Fastener Name	Label	Head Size	Qty	Torque (ft-lbs)	Failure Torque (ft-lbs)	Turns	RPM
Outer bolts	N/A	7/16"	2	9.2 (release)	14.8 (release) (shank failure)	6-12 (release)	30
				9.2 (install)	13.2 (install) (insert thread shear)	6-12 (install)	
Center jacking bolt	N/A	7/16"	1	9.2 (release)	14.8 (release) (shank failure)	24-30 (release)	30
				9.2 (install)	13.2 (install) (insert thread shear)	24-30 (install)	

Notes:

- The camera bolts have no hard stop. They free spin when released
- There is no anti-rotation device on the camera bolts
- Camera soft dock force is ~ 10 lbs
- An equipment hook will not fit around the camera tether point; the light tether point must be used
- Pan/tilt unit lock lever requires a push to turn the lever 90 degrees to go from lock to unlock, and from unlock back to lock. Both the unlock and lock positions sit in detents
- If the pan/tilt lock lever becomes unlocked, the pan/tilt joints can begin to move and back-drive the motor. This is undesirable and can damage the hardware
- The pan/tilt lock lever can only be locked if the pan/tilt mechanism is in the home position (camera lens facing TVCIC bolt box)

Cautions:

- Avoid contact with S1 SVS targets, RBVM fluid lines and QDs
- Avoid contact with light (Z-93 paint) and camera (silver Teflon)

Warnings:

- N/A

Timeline Considerations:

- The spare ETVCG has a thermal clock of 2 hours once it leaves the A/L (no ORU bag). Clock is longer when inside bag

CLEANUP (00:20)

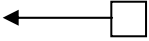
IV	EV1 (FF)	EV2 (FF)
<p>1. Give MCC GO to begin MT translation to WS 3 when EV1 and EV2 are at airlock</p>	<p>1. Translate to S0 HRs 3414 and 3415, temp stow PGT on fish stringer #1 2. Retrieve fish stringer #1 3. Translate to airlock </p> <p>4. Perform tool inventory</p> <p><u>POST EVA TOOL CONFIG</u></p> <ul style="list-style-type: none"> <input type="checkbox"/> Sm-sm RETs (3): _____ <input type="checkbox"/> Adj tethers (2): _____ <input type="checkbox"/> Wire Ties (2): _____ <input type="checkbox"/> Trash bag: _____ <ul style="list-style-type: none"> <input type="checkbox"/> P5 launch locks (2) <input type="checkbox"/> BRT <input type="checkbox"/> Camera: _____ <input type="checkbox"/> Waist tether: _____ <input type="checkbox"/> Fish Stringer #1: _____ <ul style="list-style-type: none"> <input type="checkbox"/> soft capture pin assys (2) <input type="checkbox"/> torque wrench <input type="checkbox"/> spare safety tether (2) <input type="checkbox"/> socket caddy, RAD, 5/8" socket <input type="checkbox"/> PGT w/6-in socket and RET: _____ <input type="checkbox"/> Cannon connector tool <input type="checkbox"/> Failed camera <input type="checkbox"/> Round scoop 	<p>1. Translate to airlock 2. Perform tool inventory</p> <p><u>POST EVA TOOL CONFIG</u></p> <ul style="list-style-type: none"> <input type="checkbox"/> Sm-sm RETs (4): _____ (1 from lg ORU bag) <input type="checkbox"/> Adj tethers (3): _____ (1 from lg ORU bag) <input type="checkbox"/> Wire Ties (4): _____ <input type="checkbox"/> Trash bag: _____ <ul style="list-style-type: none"> <input type="checkbox"/> P5 outboard launch locks (0-4) <input type="checkbox"/> P4 EWIS connector cap <input type="checkbox"/> BRT <input type="checkbox"/> Camera: _____ <input type="checkbox"/> Waist tether (2): _____ <input type="checkbox"/> Fish Stringer #2: _____ <ul style="list-style-type: none"> <input type="checkbox"/> torque wrench <input type="checkbox"/> spare safety tether (2) <input type="checkbox"/> P5 LLs (2) <input type="checkbox"/> socket caddy with RAD, 5/8" and 6-in socket <input type="checkbox"/> PGT with RET <input type="checkbox"/> Lg ORU Bag <ul style="list-style-type: none"> <input type="checkbox"/> Round scoop

INGRESS (00:20)

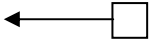
IV	EV1 (FF)	EV2 (FF)
<p>1. Perform WVS PWRDN (PHOTO/TV, <u>WVS CUE CARD</u>)</p>	<ol style="list-style-type: none"> 1. Receive EV2 safety tether; stow on airlock aft D-ring, √reel unlocked 2. Transfer fish stringers #1 and #2 to EV2 3. Transfer failed camera to EV2 4. Connect right waist tether to D-ring extender on airlock internal D-ring, verify ST config 5. Disconnect from airlock safety tether, stow on airlock fwd D-ring, √reel unlocked 6. Ingress airlock 7. Retrieve SCU, remove DCM cover 8. Connect SCU to DCM, √locked 9. DCM: water – OFF 10. Hatch thermal cover – close, attach Velcro strap <div data-bbox="940 1036 1579 1133" style="border: 1px solid black; text-align: center; padding: 5px; margin: 10px auto; width: fit-content;"> <p>CAUTION Do not close hatch until EMU water – OFF for 2 min</p> </div> <ol style="list-style-type: none"> 11. Verify hardware clear of hatch 12. Outer hatch – close and lock 13. Go to PRE REPRESS 	<div style="text-align: center; margin-bottom: 10px;">  </div> <ol style="list-style-type: none"> 1. Stow ORU bag inside airlock 2. Ingress airlock 3. Connect right waist tether to UIA panel fwd D-ring, verify ST config 4. Disconnect from airlock safety tether, hand to EV1 5. Receive fish stringers #1 and #2 from EV1, temp stow 6. Receive failed camera from EV1, stow in port/zenith side of crewlock 7. Retrieve SCU, remove DCM cover 8. Connect SCU to DCM, √locked 9. DCM: water – OFF <p>10. Go to PRE REPRESS</p>

EVA 2 NOTES, CAUTIONS, & WARNINGS

NOTES

1. Bolt release: report torque and turns if different from published range
2. EVA connectors: after disconnection and prior to connection; verify pin and EMI band integrity; verify connector free of FOD

CAUTION

ISS Constraints

- A. Avoid inadvertent contact with:
1. Grapple fixture shafts
 2. PIP pins
 3. CETA Lights (Z-93 paint) [Lab, S1, Node 1]
 4. Passive UMAs
 5. MBS VDU, MCU, CRPCMs & Cameras (taped radiative surfaces, silver Teflon)
 6. Deployed TUS cable
 7. S0 aft face Radiator
 8. GPS Antennas (S13 paint) [S0]
 9. SVS Targets with planned future use [S1, P1]
 10. UHF Antennas [Lab, P1]
 11. ETCS Radiators [S1, P1]
 12. SASA RF Group [Z1, S1, P6]
 13. Heat pipe radiators [Z1]
 14. PCU cathode and HCA ports [Z1]
 15. Ku-Band Antenna (SGANT) dish [Z1]
 16. CMG cover/shells [Z1]
 17. SSRMS cameras
- B. Electrical cables:
1. Avoid bend radii < 10 times cable diameter

CAUTION (Cont)

ISS Constraints (Cont)

- C. For structural reasons:
1. Avoid vigorous body motions, quick grabs and kickoffs against tether restraints
 2. Avoid performing shaking motions (sinusoidal functions) more than four cycles
 3. Avoid kicking S1/P1 radiator beam
If any of these occur, wait 2-5 min to allow structural response to dissipate
- D. Other:
1. WIS Antennas: do not use as handholds [Node 1, P6, Z1]
 2. Lubricant from Ku-Band SGANT gimbals [Z1], CMGs [Z1], and RTAS Ground Strap fasteners [P6,P4,S4,S6] can contaminate EMU

EVA 2 NOTES, CAUTIONS, & WARNINGS (Cont)

WARNING**ISS Constraints**

- A. Avoid inadvertent contact with:
1. Grapple fixture targets and target pins
 2. Stay inboard of SARJ when active
 3. Stay 2 ft from S1/P1 radiator beam rotational envelope when beam is free to rotate
 4. Stay 5 ft from moving MT on face 1
- B. Pinch:
1. NZGL connector linkage. Use caution when mating/locking
 2. EV side of IV hatch during hatch operation (also snag hazard) [A/L]
- C. RF radiation exposure:
1. Stay 3.6 ft from S-Band (SASA) high gain Antenna when powered [S1,P1,P6]
 2. Stay 1.3 ft from S-Band (SASA) low gain Antenna when powered [S1,P1,P6]
 3. Stay 1 ft from UHF Antenna when powered [Lab, P1]

WARNING (Cont)**ISS Constraints** (Cont)

- D. Sharp Edges:
1. Inner edges of WIF sockets
 2. Mating surfaces of EVA connectors. Avoid side loads during connector mating
 3. Back side of MMOD shield fasteners
 4. Spring loaded captive EVA fasteners (e.g., 6B-boxes, BMRRM, RTAS ground strap bolt); the end of the spring may protrude
 5. Ku-Band upper handrail by the Ku boom launch restraint [Z1]

WARNING (Cont)**ISS Constraints** (Cont)

- E. Thermal:
1. EVA connectors with booties may become hot if left uncovered. Handling may need to be limited
 2. Turn off glove heaters when comfortable temp reached to prevent bladder damage. Do not pull fingers out of gloves when heaters are on
 3. Uncovered trunnion pins may be hot
 4. SSRMS/MBS operating cameras/lights may radiate large amounts of heat
 5. Stay 1 ft away from PMAs and MMOD shields > 270 degF if EMU sun visor up
 6. Stay at least 1 ft away for no more than 15 min from PMAs and MMOD shields > 300 degF if EMU sun visor up
 7. Stay 0.5 ft away from PMA and MMOD shields > 325 degF
 8. Do not touch EMU protective visor if temp has been < -134 for >15 min
 9. No EMU TMG contact of PMAs and MMOD shields when temp > 320 degF
 10. No EMU boot contact with foot restraint when temp < -120 degF or > 200 degF

EVA 2 BRIEFING CARD

1. EVA Prep

- Get-up Plan – clothing and EMU equipment bag
- Prebreathe protocol review
- Equipment lock activities
- Suit donning plan
- Airlock depress review

2. Communications

- Overall setup: big loop, A/G2, S/G2, ICOM, Hardline, remind EV crew when mode swapping
- Use EV1(2) for DCM sw throws (all time in A/L)

3. EVA Procedure Review

- Order of tasks (summary timeline)
- Egress Plan
- Detailed Task Review
- Notes, Cautions, and Warnings
- Get ahead tasks
 - QD Bag install
 - PM Jumper install
 - VTE bag install
- Ingress Plan
- Section 16 Contingencies

4. Robotics

- SRMS/SSRMS initial position, maneuvers, clearances
- Coordinate Frames
- SSRMS/SRMS/IV comm protocol review

5. Post EVA

- Coldsoak
- Airlock Repress review
- Suit doffing responsibilities
- Post EVA plan

6. Emergencies

- Emergency suit doff and power down during EVA prep
- CUFF checklist
- Abort and Terminate review – scenarios/protocols
- Hand signals

IV CHECKLIST VERIFICATION ITEMS

- Day/Night Cycles and extended two-handed ops
 - √Lights, heaters, visors, tools, tethers, gloves
- √Load Alleviating Strap on Safety Tethers not damaged
- √Safety Tether in good config
 - Crew Report: **“Hook closed, slide locked, reel unlocked”**
- √Both SAFER valves down at egress
 - Crew Report: **“Both handles down”**
- √APFR locking collar Black-on-Black and pull test
 - Clocking, pitch, roll, yaw
- √PGT Green light on for bolt engage
 - program, (C)CW, MTL setting
 - PGT and sockets – pull test
 - May get Lo Torque msg at bolt release
 - Crew Report: **“Torqued out, XX turns (or green light)”**
- √Connectors for damage, bent pins, EMI band, FOD, cable bend radii
 - Always receive GO from MCC prior to mating/demating electrical connections, review inhibits as reqd
 - Crew Report: **“Pins good, EMI band good, no FOD, bend radius OK”**
- Coordination between IV/EV/Robotics/Ground

EVA 2 INHIBIT PAD

Orbiter

All EVAs	
TCS L12	1. √TCS POWER – OFF
Ku-Band Antenna	
MCC-H	1. √KU-BAND Mask – active 2. √KU-BAND EVA Protect Box – active
RCS	
	If EV crew < 27 ft from FRCS:
IV O14,15,16	1. √DAP: VERN, FREE, LO Z (flt specific √ with GNC) 2. √RJDF F1, F2, F3, F4 MANF DRIVER (four) – OFF LOGIC (four) – OFF
MCC-H	3. √Above RCS config
IV	4. √RCS F – ITEM 1 EXEC (*) √JET DES F1U – ITEM 17 (*) √F3U – ITEM 19 (*) √F2U – ITEM 21 (*)
S-Band Antennas	
	<u>NOTE</u> Possible loss of comm when forced LL FWD antenna
IV A1R	If EV crew < 1.6 ft from S-Band antenna: 1. S-BAND FM ANT – XMIT LOWER/RCVR UPPER 2. √MCC, lower antenna selected
	If no comm, or on MCC call:
C3	3. S-BAND PM ANT – LL FWD
	When EVA crewmember at least 1.6 ft away from all S-Band upper antennas:
C3	4. S-BAND PM ANT – GPC

USOS

All EVAs	
PCU	
MCC-H	1. √PCUs (two) operational in discharge mode and one of the following: A. CCS PCU EVA Hazard Control enabled B. No more than two arrays unshunted C. No more than two arrays pointed < 90 degrees from velocity vector
	OR
	2. One or no PCUs operational in discharge mode and one of the following: A. No more than two arrays unshunted B. No more than two arrays pointed < 90 degrees from velocity vector
Ground Radar	
MCC-H	1. √TOPO and FDO consoles, ground radar restrictions in place for EVA

RSOS

All EVAs	
SM Antennas	
MCC-M	1. Global Timing Sys 1(400.1 MHz) [GTS] – Deactivate

EVA 2 SUMMARY TIMELINE

TIME	SSRMS	EV1 (FF)	EV2 (SSRMS/FF)
0:00		POST DEPRESS (00:05)	POST DEPRESS (00:05)
0:05		EGRESS (00:25)	EGRESS (00:25)
0:30		CHANNEL 2/3 POWER RECONFIGURATION (1:30) <ul style="list-style-type: none"> • S0 Fwd Stbd Avionics Reconfiguration (Panel A148) • Lab 2A DDCU Secondary Power Disconnect from S0 (Panel A165) • S0/N1 Pwr Cable Install (S0 Panel A166) • S0-2B DDCU Reconfiguration (Panel A70) • MBSU Bypass Jumper (2/3) Reconfiguration (CID 7 Removal) • P1-3A DDCU Reconfiguration (Panel A9) • P1-3A DDCU Thermal Cover Removal 	CHANNEL 2/3 POWER RECONFIGURATION (01:00) <ul style="list-style-type: none"> • CIDS 3, 4, and 5 Removal/S0 Tray Connections • Z1-003 Patch Panel 5 Reconfiguration (DDCU HP 3B)
			CETA CART 2 RELOCATION (01:55) <ul style="list-style-type: none"> • CETA 2 Prep • Tip LEE FMS MLI Install
2:00	SSRMS: 4.101 STBD CETA CART 2 RELOCATION	CETA CART 2 RELOCATION (01:25) <ul style="list-style-type: none"> • CETA 2 Prep • CETA 2 Removal from S1 Bay 11 • CETA 2 Install on S0 Bay 3 	<ul style="list-style-type: none"> • CETA 2 Removal from S1 Bay 11 • CETA 2 Install on S0 Bay 3
3:25	SSRMS: 4.102 STBD CETA CART 1 RELOCATION	CETA CART 1 RELOCATION (01:10) <ul style="list-style-type: none"> • CETA 1 Removal from S1 Bay 9 • CETA 1 Install on S0 Bay 1 	CETA CART 1 RELOCATION (01:20) <ul style="list-style-type: none"> • CETA 1 Removal from S1 Bay 9 • CETA 1 Install on S0 Bay 1 • SSRMS and CETA Cart Cleanup
4:35		SSRMS FMS MLI INSTALL (00:20) <ul style="list-style-type: none"> • Base LEE FMS MLI Install 	STBD AND PORT QD BAG INSTALLATION (00:20) VTE AND PM JUMPER BAG INSTALLATION (00:10)
4:55		Z1-006 PATCH PANEL 2 RECONFIG (00:20) (SPDA Z1-3B) <ul style="list-style-type: none"> • Assist with QD Bag Installation 	
5:15		CLEANUP (00:20)	CLEANUP (00:20)
5:35		INGRESS (00:20)	INGRESS (00:20)
5:55		PRE REPRESS (00:05)	PRE REPRESS (00:05)
6:00			

EVA 2 TOOL CONFIG

AIRLOCK

EMU 1

- MWS, right swing arm
- Digital camera (right swing arm)
- BRT (left)
 - w/3 wire ties
 - w/Sm-sm RET
- T-Bar
 - ISS trash bag (inner left)
 - Sm-sm RET (left D-ring)
 - Adj tether (2) (left D-ring)
 - Sm-sm RET w/PIP pin (right D-ring)
 - Adj tether (right D-ring)
- D-ring ext – left
- Waist tether – right
- SAFER

EMU 2

- MWS, right swing arm
- Digital camera (inner right swing arm)
- BRT (left)
 - w/2 wire ties
 - w/Sm-sm RET
- T-Bar
 - Wire ties (2) around T-Bar
 - ISS trash bag (inner left)
 - WIF adapter with adj tether
 - Sm-sm RET (right D-ring)
 - Adj tether (left D-ring)
 - Sm-sm RET w/PIP pin (left D-ring)
 - Adj tether (right D-ring)
 - Fish Stringer #2 (empty)
 - Spare 55' safety tether (for egress)
- D-ring ext – left
- D-ring ext – right
 - Waist tether (gives extra reach/egress)
- Waist Tether – left
- SAFER

Total sm-sm RETs used: 7 Total sm-sm RETs used (w/PIP pin): 2 Total adj tethers used: 6 Total lg-sm RETs used: 5

AIRLOCK ENDCONE

Staging Bag

- Fish Stringer #3
- Connector cleaner tool caddy
- Wire tie caddy (2)
- Pin straightener
- MWS Key strap
- Velcro/Tape caddy
- Torque Wrench (2)
- Pry bar
- EVA Ratchet
- Socket caddies(2) with RAD (2) & 5/8 x 7.8-in ext (2)
- Spare PGT (s/n: _____); (battery (s/n: N/A)
- Probe

IV Bag

- Contamination Detection Kit
- Hydrazine Detector (Gold Salt Coupon) (6)
- Color Chart (2)
- ISS Contamination Detection Sampler (2)
- Shuttle Contamination Detection Sampler (2)
- Nitrogen Dioxide Detector (Oxidizer Draeger Tube) (6)
- Ammonia Detector (NH3 Draeger Tube) (6)
- 2 towels with wire ties
- DCM plug (2) (SAFER hardmount)
- GP caddy (2)
 - Thermal mittens (2 pr)
- Socket Caddy (hatch contingencies) w/sm-sm RET
 - 1/2 X 8-in socket (IV hatch)
 - 7/16 X 6-in socket (spare)

PRE EVA 2 TOOL CONFIG

1. Verify EVA 2 Tools and Hardware in equipment lock
2. Transfer WIF adapter from INC 14 packed "Tools for EVA 2 and EVA 3" bag to EV2 MWS
3. Config MWSs
4. Verify Crewlock Bags 1 and 2, QD Bags, PM Jumper Bag, VTE Bag, and UIA tether point as listed
5. Verify IV and Staging Bag contents per list
6. Stow MWSs in "EV1" and "EV2" bags as reqd
7. Prior to EVA, inspect the following:
 - RET cords for damage
 - BRT and MWS toggles: loose fittings/screws
 - Safety and waist tether load alleviating straps (no red band or damage)
 - Inspect ballstack (debris sleeve in tact)

AIRLOCK INTERNAL D-RING

- D-ring extender

UIA HANDRAILS

- Crewlock Bag #1 (for contingency) w/lg-sm RET
 - Square scoop (MBSU or DDCU R&R)
 - Ballstack (MBSU R&R, S1 DDCU R&R)
 - Spare 55' safety tethers (2) (for P4 BCDU cont)
 - MUT EEs (2) (SASA cont temp stow)
- Crewlock Bag #2 (for contingency) w/lg-sm RET
 - CETA cart PIP pin (wheel bogie R&R)
 - Socket caddy with 6-in socket and 2-in sockets (2)
 - Spare PGT (prime) (s/n: _____); batt s/n: _____
 - Spare WIF adapter
- Stbd QD Bag w/lg-sm RET and sm-sm RET
 - Gap spanners (2), -303 (upper left), -301 (upper rt) (hook to hook)
 - Port QD Bag w/lg-sm RET and sm-sm RET
 - Gap spanners (2), -301 (upper left), -301 (upper rt) (hook to hook)
 - Pump Module Jumper Bag (VTEB 02) & Vent Tool
 - Extension Bag (VTEB 01) (strapped together via integral bag hooks)
 - Lg-sm RET
- Fish Stringer #1
 - PGT (s/n: _____) w/6-in socket, sm-sm RET; batt s/n: _____
 - Spare 55' safety tether (for P1 Bay 16)
 - FMS MLI (2)
 - S0 CH 2/3 Power Cable (jumper) (tether to both caps)
 - S0/N1 Pwr Cable (tape removed from J342A connector; there is no cap)



POST EVA 2 TOOL STOW

1. Retrieve "Return to Shuttle 2" jett stow bag from "EVA 1 Shuttle to ISS" jett stow bag
2. Stow the following items in the "Return to Shuttle 2" Jettison Stowage Bag:
 - CIDs 3,4, 5, and 7
 - P1 DDCU Thermal Cover
 - S0 Channel 2/3 Jumper Caps (2)
 - Panel A166 DF cap
3. Relocate RAD from staging bag to socket caddy in crewlock bag #2
4. Transfer PGT in staging bag to fish stringer #2; transfer 2-in socket from socket caddy in crewlock bag #2 to PGT on fish stringer #2

EGRESS (00:25)

IV	EV1 (FF)	EV2 (FF)
<p><u>NOTE</u> For safety tether swaps, expect to hear:</p> <ol style="list-style-type: none"> 1. Hook closed 2. Slide locked 3. Reel unlocked <ol style="list-style-type: none"> 1. WVS Software: Select page – RF camera Sel ‘Advanced Controls’ S-Band Level (two) – Max (required after EV1 and EV2 egress airlock) 	<p>√Right waist tether to UIA panel fwd D-ring, verify ST config</p> <ol style="list-style-type: none"> 1. Transfer fish stringer #1 to EV2 2. Receive fwd airlock safety tether from EV2, attach to left D-ring extender, verify ST config 3. Release right waist tether from UIA panel D-ring 4. Egress airlock 5. Close thermal cover 6. √EV2’s SAFER MAN ISOL vlv – OP (dn) and HCM (dn) 7. Attach fish stringer #1 to MWS 	<p>√Right waist tether to airlock internal D-ring extender, verify ST config</p> <ol style="list-style-type: none"> 1. Thermal cover – open 2. Egress airlock 3. Inspect load alleviating straps on 85’ safety tethers (2) 4. Retrieve airlock safety tether from aft external D-ring, attach to left D-ring extender, verify ST config 5. Release waist tether from internal D-ring extender 6. Receive fish stringer #1 from EV1, temp stow in between port and stbd airlock toolbox HRs 7. Transfer fwd airlock safety tether to EV1 8. Temp stow spare safety tether and WIF adapter (1 adj) on airlock HR 0512 (equip lock) (don’t need until CETA) 9. √EV1’s SAFER MAN ISOL vlv – OP (dn) and HCM (dn)

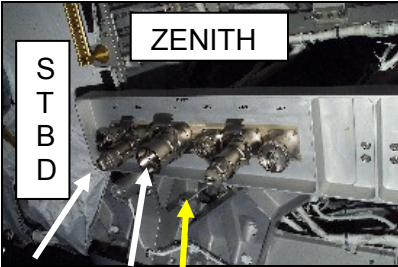
CHANNEL 2/3 POWER RECONFIGURATION (01:30)

IV	EV1 (FF)	EV2 (FF)
<p>1. Verify w/MCC: Power Reconfig Inhibit Check (SODF: ASSY OPS: EPS CH 2/3 Powerdown for EVA 2, steps 6 and 7 complete (DCSU 2B RBI 6 open) (DCSU 2A RBI 6 open)</p>  <p>J238 J230</p> <p>S0 FWD/STBD CONNECTOR PANEL (PANEL A148) HR 3463</p>  <p>J338A P338 P338A J338 S0 PANEL A165 WITH S0 JUMPER INSTALLED</p>	<p style="text-align: center;">← □</p> <p style="text-align: center;"><u>NOTE</u> √Connectors for damage, FOD, bent pins, cable bend radii, and EMI band</p> <p><u>S0 FWD STBD AVIONICS RECONFIGURATION</u> (Panel A148)</p> <ol style="list-style-type: none"> 1. Translate to S0 Bay 03, Face 1; temp stow fish stringer #1 on S0 HR 3414 2. Translate to stbd S0 connector panel on Bay 01, Face 6 3. BRT to S0 HR 3443 4. Remove DF cap from S0 J230 5. Demate P230 (W9002) from S0 J238; mate to S0 J230 6. Install DF cap on S0 J238 7. □ connector closeout <p><u>LAB 2A DDCU SECONDARY PWR DISCONNECT FROM S0</u> (Panel A165)</p> <ol style="list-style-type: none"> 1. Retrieve S0 CH 2/3 jumper from fish stringer #1, attach to MWS 2. Translate to S0 Bay 01, face 1 3. Access <i>zenith</i> worksite through face 1 (looking port) 4. BRT to S0 HR 3465 5. Open P338 (W4144) clamp 6. Release cap from S0 CH 2/3 jumper J338A, temp stow 7. Demate S0 P338 (W4144) from J338, mate to S0 CH 2/3 jumper J338A 8. Release cap from S0 jumper P338A, temp stow 9. Mate S0 CH 2/3 jumper P338A to S0 J338 10. Restrain S0 cable or jumper using TA clamp or wire tie to HR 3463, close TA clamp 11. □ connector closeout 12. Egress truss 	<p style="text-align: center;">← □</p> <p><u>CIDS 3, 4, AND 5 REMOVAL/S0 TRAY CONNECTIONS</u></p> <div style="border: 1px solid black; padding: 5px; margin: 10px 0;"> <p style="text-align: center;"><u>WARNING</u></p> <p style="text-align: center;">Wire ties on CIDs may break and cause sharp edges and debris</p> </div> <div style="border: 1px solid black; padding: 5px; margin: 10px 0;"> <p style="text-align: center;"><u>CAUTION</u></p> <p style="text-align: center;">Avoid contact with SASA antennas and S0 radiator</p> </div> <ol style="list-style-type: none"> 1. Translate to stbd Lab/Z1 tray (go aft of airlock) 2. Open TA clamps and remove wire ties as reqd 3. BRT to HR 6007 4. Demate S0 P240 (W4034) from Z1 CID 5 J440; temp stow 5. Demate CID 5 P240 from Z1 tray J440 6. Mate S0 P240 to Z1 tray J440 7. Remove CID 5 from Z1 tray, stow on fish stringer #2 8. Demate Z1 P316 (W24C) from CID 3 J216; mate to Z1 J216 (tray), restrain in TA clamps 9. Demate Z1 P315 (W24B) from CID 4 J215; mate to Z1 J215 (tray), restrain in TA clamps 10. Demate CID 3 P316 from Lab J216, stow on fish stringer 11. Demate CID 4 P315 from Lab J215, stow on fish stringer 12. Release necessary TA clamps on port S0 tray, remove cables, close clamps (panel A199) 13. BRT to Lab HR 0213 14. Demate S0 P215 (W4014) from S0 J474; mate to Lab J215

CHANNEL 2/3 POWER RECONFIGURATION (01:30) (Cont)

IV	EV1 (FF)	EV2 (FF)
<div data-bbox="96 386 491 678"> <p>DF Cap J342 P342</p> </div> <p data-bbox="191 727 390 756">S0 PANEL A166</p> <div data-bbox="96 818 491 1110"> <p>P2/J2 J1</p> <p>zenit</p> <p>Fwd</p> </div> <p data-bbox="128 1143 443 1172">Z1 PP 5 (ZENITH PANEL)</p>	<p data-bbox="510 354 865 383"><u>S0/N1 PWR CABLE INSTALL</u></p> <p data-bbox="510 386 709 415">(S0 Panel A166)</p> <ol data-bbox="510 448 1230 1000" style="list-style-type: none"> 1. Translate to fish stringer #1, stow caps (2) 2. Retrieve S0/N1 Pwr Cable from S0 HR 3414 3. Translate to S0 Bay 02, access through face 1 4. Access panel A166 in S0 Bay 02 (face 2 tri-truss, stbd) 5. BRT to HR 3502 6. Retrieve EMU scissors (right side) 7. Cut lacing cord connecting bails of P342 and DF cap J342 (outboard), stow scissors in trash bag 8. Release TA clamp as reqd 9. Take S0 P342 (stbd) to soft dock posn 10. Demate DF cap J342 from S0 P342 (port), temp stow on RET 11. Release S0/N1 Pwr Cable cable tie #1 (captive) 12. Mate S0/N1 Pwr Cable J342A to S0 P342 (no cap) 13. Take S0 P342 to hard dock 14. Pass cable bundle through face 3 bulkhead cutout, temp stow bundle with wire tie onto HR 3499 15. connector closeout <p data-bbox="510 1065 936 1094"><u>S0-2B DDCU RECONFIGURATION</u></p> <p data-bbox="510 1114 653 1143">(Panel A70)</p> <ol data-bbox="510 1175 1230 1419" style="list-style-type: none"> 1. Access coldplate connector panel on face 1 (still Bay 02) 2. Remove connector cap from J7 on DDCU coldplate connector box; temp stow (lanyarded to panel) 3. If required, release P574 from TA clamp 4. Demate S0 P574 (W4144) from DDCU CP J8; mate to J7 5. Install connector cap on J8 6. Close TA clamp if reqd 7. connector closeout 	<ol data-bbox="1276 324 1906 506" style="list-style-type: none"> 15. Demate S0 P216 (W4012) from S0 J475; mate to Lab J216 16. Demate S0 P242 (W4186) from S0 J478; mate to Z1 J442 17. Temp stow fish stringer #2 on dog house HR 18. connector closeout <p data-bbox="1276 578 1839 636"><u>Z1-003 PATCH PANEL 5 RECONFIGURATION</u> (DDCU HP 3B)</p> <div data-bbox="1352 652 1780 773" style="border: 1px solid black; padding: 5px; text-align: center;"> <p><u>CAUTION</u></p> <p>Avoid contact with Z1 DDCU heat pipes and SASA antennas</p> </div> <ol data-bbox="1276 883 1944 1175" style="list-style-type: none"> 1. Translate to Z1 stbd face, zenith panel 2. Fold back thermal shroud (STD SHRD Z1/02/04-03), release Velcro straps from HRs 6005 and 6024 3. Demate Z1 P2 (W21) from Z1 J2, temp stow 4. Remove connector cap from Z1 J1, mate to Z1 J2 5. Mate Z1 P2 (W21) to Z1 J1 6. connector closeout 7. Reinstall thermal shroud 8. Retrieve fish stringer #2 from dog house HR

CHANNEL 2/3 POWER RECONFIGURATION (01:30) (Cont)

IV	EV1 (FF)	EV2 (FF)
	<p><u>MBSU BYPASS JUMPER (2/3) RECONFIGURATION</u> (CID 7 Removal)</p> <ol style="list-style-type: none"> 1. Translate to S0 Bay 04 <div style="border: 1px solid black; padding: 5px; margin: 10px 0; text-align: center;"> <p>WARNING Wire ties on CIDs may break and cause sharp edges and debris</p> </div> <ol style="list-style-type: none"> 2. Access MBSU nadir reconfig worksite through face 1 3. Attach MWS EE to HR 3536 as reqd (panel A260) 4. Remove connector cap from J488; temp stow 5. Demate S0 P488 from CID 7 J487; mate to S0 J488 6. Demate CID 7 P488 from S0 J487, attach to MWS 7. Release old wire tie from CID 7, stow in trash bag 8. If needed, remove P487 (W4032) from TA clamp; close clamp 9. Demate S0 P487 from S0 J490 (panel A303); mate to S0 J487 (panel A260) 10. Install connector cap on J490 11.  connector closeout 12. Translate to fish stringer #1: <ul style="list-style-type: none"> <input type="checkbox"/> Retrieve spare safety tether and attach to MWS <input type="checkbox"/> Stow CID 7 and J342 DF cap <input type="checkbox"/> Retrieve PGT w/RET from fish stringer <p><u>P1-3A DDCU RECONFIGURATION</u> (Panel A9)</p> <ol style="list-style-type: none"> 1. Translate to P1 HR 3602 (P1 Bay 14, Face 1) 2. Perform safety tether swap onto HR 3602 with 55' safety tether, verify ST config 	

CHANNEL 2/3 POWER RECONFIGURATION (01:30) (Cont)

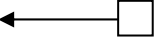
IV	EV1 (FF)	EV2 (FF)
<p>2. When EV1's and EV2's connections complete, give MCC GO for power up</p>	<ol style="list-style-type: none"> 3. Translate to P1 Bay 16, enter face 1 4. Remove connector cap from J7 on DDCU coldplate connector box, temp stow (lanyarded to panel) 5. If required, release P169 from TA clamp 6. Demate P1 P169 (W5113) from J8; mate to J7 7. Install connector cap on J8 8.  connector closeout <div style="text-align: center;">  </div> <p><u>P1-3A DDCU THERMAL COVER REMOVAL</u></p> <ol style="list-style-type: none"> 1. Attach MWS EE to HR 3680 (zenith rail for ground release) 2. PGT [A1, CCW2, 30.5]-6"-Ext-7/16: Release DDCU thermal cover grounding strap fastener (zenith), 10-16 turns 3. Release Velcro straps (3) 4. Using handhold, pull thermal cover away from DDCU until straps are free 5. Tend cover using existing straps and 1 adjustable tether; temp stow on MWS 	

CHANNEL 2/3 POWER RECONFIGURATION TASK DATA SHEET

Tools:

EV1	EV2
PGT w/6-in	

EVA Fasteners:

Fastener Name	Label	Head Size	Qty	Release Torque (ft-lbs)	Failure Torque (ft-lbs)	Turns	RPM
P1 DDCU thermal cover ground strap		7/16	1	3.8	4.7 (shank failure)	9-10	30

EVA Connectors:

Connector	From	To	Clamps	Size	Function
S0 P230 (W9002)	S0 J238	S0 J230		25	Primary Power MBSU 2 to DDCU LA2A
S0 P338 (W4144)	S0 J338	S0 CH 2/3 Pwr Cable J338a		37	Disconnect DDCU LA2A Power to Truss
S0 CH 2/3 Pwr cable P338a		S0 J338			
S0 P574 (W4144)	J8	J7		33	DDCU S02B 2ndary Power to Core Bus
S0 P240 (W4034)	CID 5 J440	Z1 tray J440		33	2B Primary Power to MBSU 2
CID 5 P240	Z1 J440 (tray)			33	CID 5 Removal (2B Primary Power)
Z1 P316 (W24C)	CID 3 J216	Z1 J216 (tray)		25	Dcnct DDCU LA2B from Z1 IDA
Z1 P315 (W24B)	CID 4 J215	Z1 J215 (tray)		25	Dcnct DDCU LA3B from Z1 IDA
CID 3 P316	Lab J216			25	CID 3 Removal
CID 4 P315	Lab J215			25	CID 4 Removal
S0 P215 (W4014)	S0 J474	Lab J215		25	Primary Power MBSU 3 to DDCU LA3B
S0 P216 (W4012)	S0 J475	Lab J216		25	Primary Power MBSU 2 to DDCU LA2B
S0 P242 (W4186)	S0 J478	Z1 J442		33	2ndary Power DDCU S03B to SPDA Z13B
S0 P488	CID 7 J487	S0 J488		37	Primary Power DCSU 2A to MBSU 2
CID 7 P488	S0 J487				CID 7 Removal
S0 P487	S0 J490	S0 J487			Primary Power DCSU 2B to MBSU 2
P1 P169 (W5113)	J8	J7		33	DDCU P13A 2ndary Power to Utility Bus
Z1 P2 (W21)	Z1 J2	Z1 J1		25	Primary Power MBSU 3 to DDCU Z13B

Notes:

1. √connectors for damage, FOD, bent pins, and cable bend radii, and EMI band
2. It is possible for the DDCU thermal cover to get caught on coldplate legs during removal

Cautions:

1. Avoid contact with SASA antennas and S0 Radiator
2. Avoid contact with Z1 DDCU Heatpipes

Warnings:

1. Wire ties may break and cause sharp edges and debris

Timeline Considerations:

1. At least one CETA cart must be relocated port of the MT to support failed MBSU or DDCU R&Rs
2. CH 2/3 Connections can be completed in any order

CETA CART 2 RELOCATION (01:25)

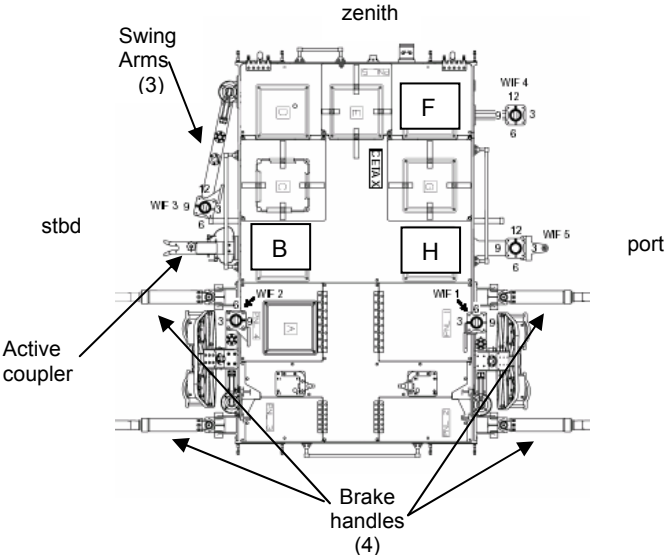
IV/SSRMS	EV1 (FF)	EV2 (SSRMS)
<p>1. 4.101 Stbd CETA Cart 2 Relocation (SODF: ROBO: EVA 2)</p> <p>2. Give SSRMS operator GO to take BRAKES→ON</p>	<p><u>CETA 2 PREP</u></p> <ol style="list-style-type: none"> 1. Translate to P1 HR 3602, perform safety tether swap onto airlock safety tether, verify ST config 2. Translate to S0 HR 3493 (S0 Bay 00), stow DDCU thermal cover w/adj tether, spare safety tether, and PGT w/RET on fish stringer #1 3. Relocate fish stringer #1 to S0 HR 3444 (S0 Face 6) (clear of CETA cart relocation) 	<p><u>CETA 2 PREP</u></p> <ol style="list-style-type: none"> 1. Translate to airlock, temp stow fish stringer #2 on airlock HR 0543 (equipment lock, nadir) 2. Retrieve the following items and stow on MWS: <ul style="list-style-type: none"> □ spare safety tether □ WIF adapter w/adj tether 3. Translate to fish stringer #1 on S0 HR 3414, retrieve FMS MLI 4. Translate to CETA 2 (~ S1 Bay 11) 5. Prep CETA 2 for transfer <ul style="list-style-type: none"> □ ✓ Brake handles (4) straight and collars locked □ ✓ Swingarms stowed (3) □ Take CETA 1 coupler to UNLOCK □ Translate CETA 2 stbd ~ 2 ft, align with SSRMS □ Engage CETA 2 parking brake (left handle) □ Take CETA 1 coupler to CAPTURE <p><u>TIP LEE FMS MLI INSTALL</u></p> <ol style="list-style-type: none"> 1. GCA SSRMS for FMS install <div style="border: 1px solid black; padding: 5px; margin: 10px 0;"> <p style="text-align: center;">CAUTION</p> <ol style="list-style-type: none"> 1. Avoid no touch areas on tip LEE 2. Do not fold or crease FMS MLI </div> <ol style="list-style-type: none"> 2. Translate onto tip LEE 3. Attach waist tether onto LEE HR 4. Release CLA ground strap Velcro flaps (2) 5. Attach FMS MLI grounding flaps to CLA grounding points (Velcro) 6. Re-install CLA Velcro flaps onto FMS MLI grounding flaps, and press to ensure good grounding path 7. Unroll FMS MLI around LEE FMS

CETA CART 2 RELOCATION (01:25) (Cont)

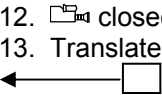
IV/SSRMS	EV1 (FF)	EV2 (SSRMS)
<p>3. Give SSRMS operator GO to take BRAKES→OFF</p>	<p style="text-align: center;"><u>NOTE</u> Ensure safety tethers are clear of CETA cart during safety tether swap and CETA cart relocation</p> <p><u>CETA 2 REMOVAL FROM S1 BAY 11</u></p> <ol style="list-style-type: none"> 1. Translate to port side of CETA 2 2. GCA EV2 as reqd for ingress 3. Check EV2 boots engaged in APFR heel clips 	<ol style="list-style-type: none"> 8. Tighten and secure inner Velcro strap until diamonds are aligned** 9. Attach single flap end of MLI in between double flap end and attach Velcro 10. Verify that grounding flaps are still secure and re-press to ensure proper grounding path** 11. Ensure all Velcro flaps are closed (flap 1 and flap 2)** 12.  closeout of shroud install 13. Translate onto CETA cart <p style="text-align: center;"><u>NOTE</u> Ensure safety tethers are clear of CETA cart during safety tether swap and CETA cart relocation</p> <p><u>CETA 2 REMOVAL FROM S1 BAY 11</u></p> <ol style="list-style-type: none"> 1. GCA SSRMS for APFR install 2. Install WIF adapter on SSRMS; tether point on WIF adapter points toward end effector 3. Relocate APFR from CETA 2 WIF 03 to SSRMS; √settings: [12,PP,F,6] 4. Perform safety tether swap onto SSRMS w/spare safety tether, verify ST config; temp stow airlock safety tether on S1 HR 3246 (face 6 stbd of CETA 2) 5. GCA SSRMS for ingress 6. Install local waist tether onto APFR 7. Ingress SSRMS using grid H (head nadir, facing cart) 8. SSRMS mnvr to CETA 2 removal position 9. Tether to CETA 2 with RET 10. Verify that brake handles (4) are in stowed posn (up) 11. Hold CETA 2 at grids B and H (heads nadir)
<p>CAUTION Do not impart loads into CETA cart with less than 3 of 4 wheel bogies engaged</p>		

CETA CART 2 RELOCATION (01:25) (Cont)

IV/SSRMS	EV1 (FF)	EV2 (SSRMS)
<p>4. IV monitor clearances between CETA 2 and Orbiter nose cap through flight deck windows</p>	<p>4. Release CETA 2 brakes (tap pedal twice) 5. Release CETA 2 wheel bogies (4); give EV2 GO to remove CETA 2 from rails 6. Assist EV2/M1 with clearances as reqd; verify CETA 2 is clear of structure prior to EV2 re-positioning cart in hands</p> <p><u>CETA 2 INSTALL ON S0 BAY 3</u></p>  <p>1. Translate to port side of MT and CETA 2 install location 2. Monitor EV2 and CETA 2 cart clearances with:</p> <ul style="list-style-type: none"> • P6 fwd radiator • Orbiter nose cap <p style="text-align: center;"><u>NOTE</u> Ensure safety tethers are clear of structure during CETA cart install</p> <p>3. At SSRMS port install posn, GCA EV2 and CETA cart for initial alignment with rails 4. Guide CETA cart onto nadir rail 5. Install wheel bogies (4)</p> <div style="border: 1px solid black; padding: 5px; text-align: center;"> <p><u>CAUTION</u> CETA to MT max coupling rate is 0.5 ft/sec</p> </div> <p>6. √CETA 2 coupler in CAPTURE 7. Couple CETA 2 to MT; take CETA 2 coupler to LOCK</p>	<p>12. Give EV1 GO to release wheel bogies</p> <p>13. Remove CETA 2 from MT rails; lift CETA cart from rails due forward until wheel bogies clear rail 14. At SSRMS clearance posn, reposition CETA 2 such that right hand is on CETA 2 zenith HR and left hand is on grid F</p> <p><u>CETA 2 INSTALL ON S0 BAY 3</u></p> <p>1. Mnvtr to port side of MT</p> <p>2. Install CETA 2 on MT rail (~S0 Bay 01) due aft</p> <p>3. Release tether</p>

CETA CART 1 RELOCATION (01:10)

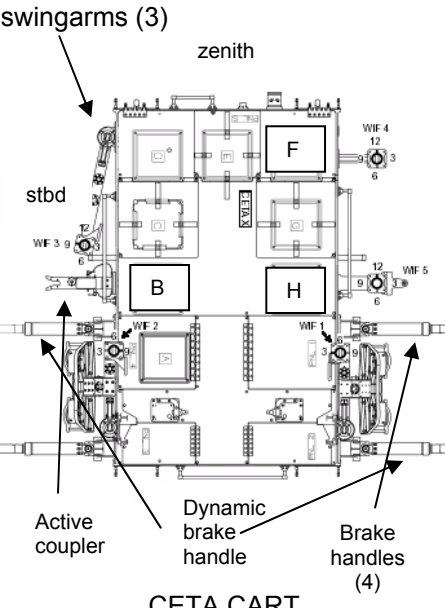
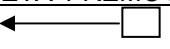
IV/SSRMS	EV1 (FF)	EV2 (SSRMS)
<p>1A. √MCC: Status of MBSU pwr up prior to SSRMS mnvr to stbd side of MT for CETA 1 relocation (easier arm trans to ESP2 to pick up spare MBSU from port side of MT)</p> <p>1B. 4.102 Stbd CETA Cart 1 Relocation (SODF:ROBO: EVA 2)</p>  <p>The diagram shows a top-down view of the CETA CART. It is a rectangular structure with four bogies. Grids B, H, and F are marked on the cart. Labels include 'swingarms (3)' pointing to the top-left, 'zenith' at the top center, 'stbd' on the left side, and 'WIF 4', 'WIF 3', 'WIF 2', 'WIF 5' at various points. At the bottom, 'Active coupler', 'Dynamic brake handle', and 'Brake handles (4)' are labeled. The cart is shown on a set of rails.</p>	<p><u>CETA 1 REMOVAL FROM S1 BAY 9</u></p> <ol style="list-style-type: none"> Translate to CETA 1 (S1 Bay 9) Prep CETA 1 for transfer <ul style="list-style-type: none"> □ √Brake handles (4) stowed (up), straight, and collars locked □ √Swingarms stowed (3) □ Take MT coupler to UNLOCK □ Translate CETA 1 stbd ~ Bay 11 (align with SSRMS) □ Engage CETA 1 parking brake (left handle) □ Take MT coupler to CAPTURE <p style="text-align: center;"><u>NOTE</u> Ensure safety tethers are clear of CETA cart during CETA cart relocation</p> <div style="border: 1px solid black; padding: 5px; text-align: center; margin: 10px auto; width: fit-content;"> <p><u>CAUTION</u> Do not impart loads into CETA cart with less than 3 of 4 wheel bogies engaged</p> </div> <ol style="list-style-type: none"> Release CETA 1 brakes (tap pedal twice) Release CETA 1 wheel bogies (4); give EV2 GO to release CETA 1 from rails Assist EV2/M1 with clearances as reqd; verify CETA 1 is clear of structure prior to EV2 re-positioning cart in hands 	<p><u>CETA 1 REMOVAL FROM S1 BAY 9</u></p>  <ol style="list-style-type: none"> SSRMS mnvr to CETA 1 removal position <ol style="list-style-type: none"> GCA SSRMS to CETA 1 removal posn Tether to CETA 1 with RET Hold CETA 1 at grids B and H (heads down) <ol style="list-style-type: none"> Give EV1 GO to release wheel bogies Remove CETA 1 from MT rails; lift CETA 1 from rails due forward until wheel bogies clear rail At SSRMS clearance posn, reposition CETA 1 such that right hand is on CETA 1 zenith HR and left hand is on grid F

CETA CART 1 RELOCATION (01:10) (Cont)

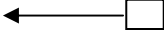
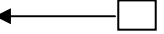
IV/SSRMS	EV1 (FF)	EV2 (SSRMS)
<p>2. IV monitor clearances between CETA cart and Orbiter nose cap through flight deck windows</p> <p>3. Give SSRMS operator GO to take BRAKES→ON (EV1 can translate on base LEE)</p>	<p><u>CETA 1 INSTALL ON S0 BAY 1</u></p> <ol style="list-style-type: none"> 1. Tether to EV2's airlock safety tether, retrieve from S1 HR 3246, attach to MWS (to move down to S0) 2. Temp stow EV2's safety tether on CETA 2 nadir HR 3. Translate to port side of MT/CETA 2 and CETA 1 install location 4. Monitor EV2 and CETA 1 cart clearances with: <ul style="list-style-type: none"> • P6 fwd radiator • Orbiter nose cap <p style="text-align: center;"><u>NOTE</u> Ensure safety tethers are clear of structure during CETA cart install</p> <ol style="list-style-type: none"> 5. GCA EV2 and CETA cart for initial alignment with rails 6. Guide CETA cart onto nadir rail 7. Install wheel bogies (4) 8. Engage CETA parking brake (left handle) 	<p><u>CETA 1 INSTALL ON S0 BAY 1</u></p>  <ol style="list-style-type: none"> 1. Mvnr to port side of MT/CETA 2 <ol style="list-style-type: none"> 2. Install CETA 1 on MT rail (~S0 Bay 01) due aft 3. Release tether <p><u>SSRMS AND CETA CART CLEANUP</u></p> <ol style="list-style-type: none"> 1. Egress SSRMS (using CETA 1) 2. GCA SSRMS to APFR cleanup and safety tether swap positions (same posn)  <ol style="list-style-type: none"> 3. Remove APFR, temp stow in CETA 1 WIF 04 4. Remove WIF adapter, stow on MWS 5. Perform safety tether swap onto airlock safety tether, verify ST config, retrieve spare from SSRMS 6. ✓CETA 1 coupler in CAPTURE

CETA CART 1 RELOCATION (01:10) (Cont)

IV/SSRMS	EV1 (FF)	EV2 (SSRMS)
		<div data-bbox="1360 347 1953 435" style="border: 1px solid black; padding: 5px; text-align: center;"> <p><u>CAUTION</u> CETA to CETA max coupling rate is 1 inch/sec</p> </div> <ol style="list-style-type: none"> 7. Release CETA cart brakes (tap petal twice) 8. Couple CETA 1 to CETA 2; take CETA 1 coupler to LOCK 9. Retrieve fish stringer #1 from S0 HR 3444 10. Retrieve APFR from CETA WIF, attach to BRT 11. Translate to airlock 12. Transfer WIF adapter (w/adj tether) and spare safety tether to fish stringer #2 13. Stow APFR in ESP2 WIF 8; configure to: [3,PP,F,12]

CETA CART RELOCATION TASK DATA SHEET

Tools: N/A

Foot Restraints

Task	WIF	APFR Setting
CETA Cart Removal/Install	SSRMS	12,PP,F,6

EVA Fasteners: N/A

EVA Connectors: N/A

CETA cart Mass = ~ 560 lb (with launch bolts)/254 kg

Notes:

1. Ensure safety tethers are clear of CETA cart during safety tether swap, CETA cart relocation, and CETA cart install
2. 3 of 4 wheel bogies are required to be installed prior to untethering (from a safety, fault-tolerance standpoint)
3. SSRMS brakes must be on before EV2 translates onto tip LEE for FMS MLI install

Cautions:

1. Do not impart loads into CETA cart with less than 3 of 4 wheel bogies engaged
2. CETA to MT max coupling rate is 0.5 ft/sec
3. CETA to CETA max coupling rate is 1 inch/sec

Warnings: N/A

Timeline Considerations:

1. Both CETA carts must be relocated to port side of the MT in order to checkout MT worksite 2
2. If both carts are not on the port side of the MT, the MT will not reach worksite 2 because of the S1 MT stop and the S1 Bay 15 DDCU thermal cover
3. The MT can reach worksite 2 with no interferences even if the S1 Bay 15 DDCU thermal cover is still installed as long as both CETA carts have been relocated to the port side of the MT
4. At least one CETA cart is reqd to be on the port side of the MT to support real-time failed MBSU or DDCU R&Rs during EVAs 2 and 3

SSRMS FMS MLI INSTALLATION (00:20)

IV/SSRMS	EV1 (FF)	EV2 (FF)
<p>1. Receive GO from EV2 that all SSRMS motion has stopped and brakes are ON prior to translating on base LEE</p>	<p><u>BASE LEE FMS MLI INSTALL</u></p> <div data-bbox="590 399 1058 488" style="border: 1px solid black; padding: 5px; margin: 10px auto; width: fit-content;"> <p style="text-align: center;"><u>CAUTION</u> Avoid no touch areas on base LEE</p> </div> <ol style="list-style-type: none"> 1. Retrieve FMS MLI from fish stringer #1 (S0 HR 3444) 2. Translate to MBS PDGF #3 (zenith/port) <div data-bbox="604 643 1047 732" style="border: 1px solid black; padding: 5px; margin: 10px auto; width: fit-content;"> <p style="text-align: center;"><u>CAUTION</u> Do not fold or crease the FMS MLI</p> </div> <ol style="list-style-type: none"> 3. Translate onto base LEE 4. Attach MWS EE to LEE HR 5. Release CLA ground strap Velcro flaps (2) (zenith) 6. Attach FMS MLI grounding flaps to CLA grounding points (Velcro) 7. Re-install CLA Velcro flaps onto FMS MLI grounding flaps, and press to ensure good grounding path 8. Unroll FMS MLI around LEE FMS 9. Tighten and secure inner Velcro strap until diamonds are aligned** 10. Attach single flap end of MLI in between double flap end and attach Velcro 11. Verify that grounding flaps are still secure and re-press to ensure proper grounding path** 12. Ensure all Velcro flaps are closed (flap 1 and flap 2) ** 13.  closeout of shroud install 14. When clear of base LEE joints, give SSRMS operator GO to move SSRMS to stow posn 15. Retrieve fish stringer #1, stow on MWS 	

SSRMS FMS MLI INSTALLATION TASK DATA SHEET

Tools: N/A

Foot Restraints: N/A

EVA Fasteners: N/A

EVA Connectors:N/A

Notes:

1. ** CSA requests verbal confirmation that these steps are completed
2. An APFR installed in A/L Toolbox WIF 2 interferes with airlock ops

Cautions:

1. CETA to CETA max coupling rate is 1 inch/sec
2. Do not fold or crease the FMS MLI
3. Avoid no touch areas for base and tip LEE:

For Base LEE (EV1), avoid contact with:

1. MCAS latches (zenith)
2. POA curvic coupling
3. POA stowage bracket curvic coupling
4. PDGF grapple pins and targets
5. Base LEE CLA and POA CLA lens
6. Silver Teflon surfaces:
 - a. MBS Camera
 - b. POA camera
 - c. Base LEE CLA
 - d. Base LEE electronics units (2)

For Tip LEE (EV2), avoid contact with:

1. Tip LEE curvic coupling and latch openings
2. Tip LEE CLA lens and silver Teflon coating
3. Tip LEE electronics units (silver Teflon coating)

Warnings: N/A

Timeline Considerations: N/A

Z1-006 PATCH PANEL 2 RECONFIGURATION (00:20)

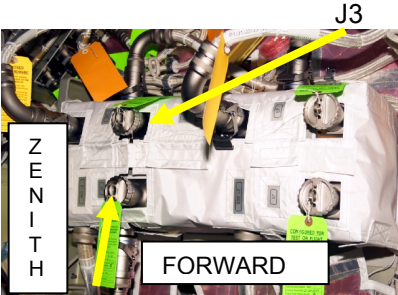
IV	EV1 (FF)	
<p>1. Verify w/MCC: Z1 PP 2 inhibits in place: (SODF: ASSY OPS: Z1 CPP X2 (SPDA Z1-3B) Reconfig, steps 3 and 4 complete) (RPCM 2B-B RPC 1 open) (DDCU S03B Conv Off) Verify 2B array >15 degrees to wake</p> <p>Z1-006 PP 2</p>  <p>J1</p> <p>2. Inform MCC connections complete</p>	<p><u>Z1-006 PATCH PANEL 2 RECONFIGURATION</u> (SPDA Z1-3B) (zenith panel)</p> <ol style="list-style-type: none"> Translate to airlock, temp stow fish stringer #1 on toolboxes <p style="text-align: center;"><u>NOTE</u> Check connectors for FOD, bent pins, bend radius, and EMI bands</p> <p style="text-align: center;">← □</p> <ol style="list-style-type: none"> Translate to Z1 port face; attach poorman's fairlead above Z1 MBM at P6 HR 5308 Translate to zenith patch panel <div style="border: 1px solid black; padding: 5px; text-align: center;"> <p><u>CAUTION</u> Avoid contact with PCU grates and S0 radiator (silver Teflon coating)</p> </div> <p style="text-align: center;"><u>NOTE</u> J3 label is missing on patch panel 2</p> <ol style="list-style-type: none"> BRT to HR 6011 Remove connector cap from J1; temp stow Demate Z1 P1 (W05) from Z1 J3; mate to Z1 J1 Install connector cap on J3 □ connector closeout <p style="text-align: center;">← □</p>	

Z1-006 PATCH PANEL 2 RECONFIGURATION TASK DATA SHEET

Tools: N/A

Foot Restraints: N/A

EVA Fasteners: N/A

EVA Connectors:

Connector	From	To	Clamps	Size	Function
Z1 P1 (W05)	Z1 J3	Z1 J1		25	secondary Power DDCU S03B to SPDA Z13B

Notes:

1. Check connectors for FOD, bent pins, bend radius, and EMI bands
2. J3 label is missing on patch panel 2

Cautions:

1. Avoid contact with PCU grates and S0 Radiator (silver Teflon coating)

Warnings: N/A

Timeline Considerations:

1. This task must be completed separate from the main ISS powerdown due to shorter thermal clocks for KU-Band hardware

STBD AND PORT QD BAG INSTALLATION (00:20)

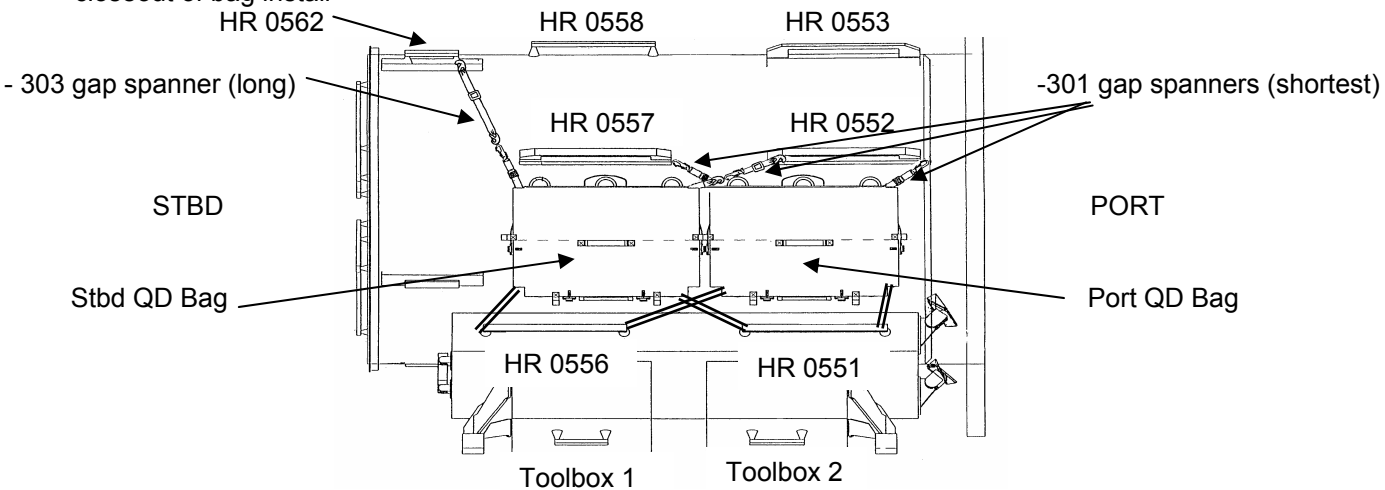
IV	EV1/EV2				
	<ol style="list-style-type: none"> 1. Translate to airlock 2. Retrieve stbd QD bag w/integral gap spanners from airlock (shepherd it out of airlock) 3. Translate to zenith crewlock 4. Attach stbd QD bag with integral gap spanners per the table below 5. Repeat steps 1 through 4 for port QD bag installation (thermal cover can remain open for ~ 30 min per flight rule) <table border="1" data-bbox="499 505 1974 787"> <thead> <tr> <th data-bbox="499 505 1243 537">STBD QD BAG</th> <th data-bbox="1243 505 1974 537">PORT QD BAG</th> </tr> </thead> <tbody> <tr> <td data-bbox="499 537 1243 787"> <ul style="list-style-type: none"> <input type="checkbox"/> Orient QD bag with HR facing forward toward toolboxes <input type="checkbox"/> Lower left French hook to airlock HR 0556 stbd standoff and back onto strap <input type="checkbox"/> Lower right French hook to airlock HR 0551 stbd standoff and back onto strap <input type="checkbox"/> Upper left 303 gap spanner to airlock HR 0562 stbd standoff <input type="checkbox"/> Upper right 301 gap spanner to airlock HR 0552 stbd standoff </td> <td data-bbox="1243 537 1974 787"> <ul style="list-style-type: none"> <input type="checkbox"/> Orient QD bag with HR facing forward toward toolboxes <input type="checkbox"/> Lower left French hook to airlock HR 0556 port standoff and back onto strap <input type="checkbox"/> Lower right French hook to airlock HR 0551 port standoff and back onto strap <input type="checkbox"/> Upper left 301 gap spanner to airlock HR 0557 port standoff <input type="checkbox"/> Upper right 301 gap spanner to airlock HR 0552 port standoff </td> </tr> </tbody> </table> <ol style="list-style-type: none"> 6. Cinch straps, verify both bags are secure 7.  closeout of bag install  <p style="text-align: center;">QD BAGS INSTALLED ON ZENITH CREWLOCK</p>	STBD QD BAG	PORT QD BAG	<ul style="list-style-type: none"> <input type="checkbox"/> Orient QD bag with HR facing forward toward toolboxes <input type="checkbox"/> Lower left French hook to airlock HR 0556 stbd standoff and back onto strap <input type="checkbox"/> Lower right French hook to airlock HR 0551 stbd standoff and back onto strap <input type="checkbox"/> Upper left 303 gap spanner to airlock HR 0562 stbd standoff <input type="checkbox"/> Upper right 301 gap spanner to airlock HR 0552 stbd standoff 	<ul style="list-style-type: none"> <input type="checkbox"/> Orient QD bag with HR facing forward toward toolboxes <input type="checkbox"/> Lower left French hook to airlock HR 0556 port standoff and back onto strap <input type="checkbox"/> Lower right French hook to airlock HR 0551 port standoff and back onto strap <input type="checkbox"/> Upper left 301 gap spanner to airlock HR 0557 port standoff <input type="checkbox"/> Upper right 301 gap spanner to airlock HR 0552 port standoff
STBD QD BAG	PORT QD BAG				
<ul style="list-style-type: none"> <input type="checkbox"/> Orient QD bag with HR facing forward toward toolboxes <input type="checkbox"/> Lower left French hook to airlock HR 0556 stbd standoff and back onto strap <input type="checkbox"/> Lower right French hook to airlock HR 0551 stbd standoff and back onto strap <input type="checkbox"/> Upper left 303 gap spanner to airlock HR 0562 stbd standoff <input type="checkbox"/> Upper right 301 gap spanner to airlock HR 0552 stbd standoff 	<ul style="list-style-type: none"> <input type="checkbox"/> Orient QD bag with HR facing forward toward toolboxes <input type="checkbox"/> Lower left French hook to airlock HR 0556 port standoff and back onto strap <input type="checkbox"/> Lower right French hook to airlock HR 0551 port standoff and back onto strap <input type="checkbox"/> Upper left 301 gap spanner to airlock HR 0557 port standoff <input type="checkbox"/> Upper right 301 gap spanner to airlock HR 0552 port standoff 				

VTE AND PM JUMPER BAG INSTALLATION (00:10)

IV	EV1/EV2				
	<ol style="list-style-type: none"> 1. Translate to airlock 2. Retrieve VTE Bag and PM Jumper Bag 3. Translate to zenith/aft crewlock 4. Attach VTE Bag and PM Jumper Bag per the table below: <table border="1" data-bbox="487 474 1990 678"> <thead> <tr> <th data-bbox="487 474 1218 506">VTE BAG (STBD)</th> <th data-bbox="1218 474 1990 506">PM JUMPER (VTE BAG II) (PORT)</th> </tr> </thead> <tbody> <tr> <td data-bbox="487 506 1218 678"> <ul style="list-style-type: none"> <input type="checkbox"/> Orient VTE bag with opening forward toward QD bags <input type="checkbox"/> Lower left hook to HR 557 stbd standoff <input type="checkbox"/> Lower right hook to HR 552 stbd standoff <input type="checkbox"/> Upper left hook to HR 558 stbd standoff <input type="checkbox"/> Upper right hook to HR 553 stbd standoff </td> <td data-bbox="1218 506 1990 678"> <ul style="list-style-type: none"> <input type="checkbox"/> Orient PM Jumper bag with opening forward toward QD bags <input type="checkbox"/> Lower left hook to HR 557 port standoff <input type="checkbox"/> Lower right hook to HR 552 port standoff <input type="checkbox"/> Upper left hook to HR 553 stbd standoff <input type="checkbox"/> Upper right hook to HR 553 port standoff </td> </tr> </tbody> </table> <div data-bbox="724 717 1717 1263" style="text-align: center;"> <p>VTE BAG AND PM JUMPER BAGS INSTALLED ON CREWLOCK</p> </div> <ol style="list-style-type: none"> 5. Cinch straps, verify both bags are secure 6. <input type="checkbox"/> closeout of bag install 	VTE BAG (STBD)	PM JUMPER (VTE BAG II) (PORT)	<ul style="list-style-type: none"> <input type="checkbox"/> Orient VTE bag with opening forward toward QD bags <input type="checkbox"/> Lower left hook to HR 557 stbd standoff <input type="checkbox"/> Lower right hook to HR 552 stbd standoff <input type="checkbox"/> Upper left hook to HR 558 stbd standoff <input type="checkbox"/> Upper right hook to HR 553 stbd standoff 	<ul style="list-style-type: none"> <input type="checkbox"/> Orient PM Jumper bag with opening forward toward QD bags <input type="checkbox"/> Lower left hook to HR 557 port standoff <input type="checkbox"/> Lower right hook to HR 552 port standoff <input type="checkbox"/> Upper left hook to HR 553 stbd standoff <input type="checkbox"/> Upper right hook to HR 553 port standoff
VTE BAG (STBD)	PM JUMPER (VTE BAG II) (PORT)				
<ul style="list-style-type: none"> <input type="checkbox"/> Orient VTE bag with opening forward toward QD bags <input type="checkbox"/> Lower left hook to HR 557 stbd standoff <input type="checkbox"/> Lower right hook to HR 552 stbd standoff <input type="checkbox"/> Upper left hook to HR 558 stbd standoff <input type="checkbox"/> Upper right hook to HR 553 stbd standoff 	<ul style="list-style-type: none"> <input type="checkbox"/> Orient PM Jumper bag with opening forward toward QD bags <input type="checkbox"/> Lower left hook to HR 557 port standoff <input type="checkbox"/> Lower right hook to HR 552 port standoff <input type="checkbox"/> Upper left hook to HR 553 stbd standoff <input type="checkbox"/> Upper right hook to HR 553 port standoff 				

CLEANUP (00:20)

IV	EV1 (FF)	EV2 (FF)
<p style="text-align: center;"><u>NOTE</u> Someone will have two extra sm-sm RETs from the QD Bag</p>	<ol style="list-style-type: none"> 1. Translate to airlock 2. Perform tool inventory <p><u>POST EVA TOOL CONFIG</u></p> <p>MWS</p> <ul style="list-style-type: none"> <input type="checkbox"/> Sm-sm RETs (2) _____ <input type="checkbox"/> Adj Tether (2) _____ <input type="checkbox"/> Trash Bag _____ <input type="checkbox"/> Camera _____ <input type="checkbox"/> Waist Tether _____ <p>BRT</p> <ul style="list-style-type: none"> <input type="checkbox"/> Sm-sm RET _____ <input type="checkbox"/> Wire Ties (2) _____ <p>Fish Stringer #1: _____</p> <ul style="list-style-type: none"> <input type="checkbox"/> PGT w/6-in socket w/RET _____ <input type="checkbox"/> P1 DDCU Thermal Cover, w/adj _____ <input type="checkbox"/> S0 CH 2/3 jumper caps (2) _____ <input type="checkbox"/> spare safety tether _____ <input type="checkbox"/> CID 7 _____ <input type="checkbox"/> spare safety tether _____ <input type="checkbox"/> WIF adapter w/adj tether _____ <input type="checkbox"/> Panel A166 DF cap _____ 	<ol style="list-style-type: none"> 1. Translate to airlock 2. Perform tool inventory <p><u>POST EVA TOOL CONFIG</u></p> <p>MWS</p> <ul style="list-style-type: none"> <input type="checkbox"/> Sm-sm RETs (2) _____ <input type="checkbox"/> Adj Tethers (2) _____ <input type="checkbox"/> Trash Bag _____ <input type="checkbox"/> Camera _____ <input type="checkbox"/> Waist Tethers (2) _____ <input type="checkbox"/> Wire Ties (2) _____ <p>BRT</p> <ul style="list-style-type: none"> <input type="checkbox"/> Sm-sm RET _____ <input type="checkbox"/> Wire Ties (2) _____ <p>Fish Stringer #2: _____</p> <ul style="list-style-type: none"> <input type="checkbox"/> CIDs 3, 4, and 5 _____

INGRESS (00:20)

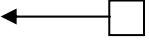
IV	EV1 (FF)	EV2 (FF)
<p>1. Perform WVS PWRDN (PHOTO/TV, <u>WVS CUE CARD</u>)</p>	 <ol style="list-style-type: none"> 1. Ingress airlock 2. Connect right waist tether UIA panel fwd D-ring, verify ST config 3. Disconnect from airlock safety tether, hand to EV2 4. Receive fish stringers (2) from EV2 5. Retrieve SCU, remove DCM cover 6. Connect SCU to DCM, √locked 7. DCM: water – OFF 8. Go to PRE REPRESS 	<ol style="list-style-type: none"> 1. Receive EV1 safety tether; stow on airlock fwd D-ring, √reel unlocked 2. Transfer fish stringers (2) to EV1 3. Connect left waist tether to D-ring extender on airlock internal D-ring, verify ST config 4. Disconnect from airlock safety tether, stow on airlock aft D-ring, √reel unlocked 5. Ingress airlock 6. Retrieve SCU, remove DCM cover 7. Connect SCU to DCM, √locked 8. DCM: water – OFF 9. Hatch thermal cover – close; attach Velcro strap 10. Verify hardware clear of hatch 11. Outer hatch – close and lock 12. Go to PRE REPRESS

CAUTION
Do not close hatch until EMU water – OFF for 2 min

EVA 3 NOTES, CAUTIONS, & WARNINGS

NOTES

1. Bolt release: report torque and turns if different from published range
2. EVA connectors: after disconnection and prior to connection; verify pin and EMI band integrity; verify connector free of FOD

CAUTION

ISS Constraints

- A. Avoid inadvertent contact with:
1. Grapple fixture shafts
 2. PIP pins
 3. MDM sunshade [PMA 1]
 4. EVA Crane [PMA 1]
 5. TCS Reflectors [PMA 2, PMA 3]
 6. APAS hardware [PMA 2, PMA 3]
 7. CETA Lights (Z-93 paint) [Lab, S1, Node 1]
 8. Passive UMAs
 9. MBS VDU, MCU, CRPCMs & Cameras (taped radiative surfaces, silver Teflon)
 10. Deployed TUS cable
 11. S0 aft face Radiator
 12. GPS Antennas (S13 paint) [S0]
 13. SVS Targets with planned future use [S1, P1]
 14. UHF Antennas [Lab, P1]
 15. ETCS Radiators [S1, P1]
 16. SASA RF Group [Z1, S1, P6]
 17. Heat pipe radiators [Z1]
 18. PCU cathode and HCA ports [Z1]
 19. Ku-Band Antenna (SGANT) dish [Z1]
 20. CMG cover/shells [Z1]
 21. SSRMS cameras
- B. Electrical cables:
1. Avoid bend radii < 10 times cable diameter

CAUTION (Cont)

ISS Constraints (Cont)

- C. For structural reasons:
1. Avoid vigorous body motions, quick grabs and kickoffs against tether restraints
 2. Avoid performing shaking motions (sinusoidal functions) more than four cycles
 3. Avoid kicking S1/P1 radiator beam
If any of these occur, wait 2-5 min to allow structural response to dissipate
- D. Other:
1. WIS Antennas: do not use as handholds [Node 1, P6, Z1]
 2. Lubricant from Ku-Band SGANT gimbals [Z1], CMGs [Z1], and RTAS Ground Strap fasteners [P6,P4,S4,S6] can contaminate EMU

EVA 3 NOTES, CAUTIONS, & WARNINGS (Cont)

CAUTION (Cont)

Shuttle Constraints

E. Avoid contact with:

1. OBSS and SRMS Composite Sections and Cable Harnesses
2. LCS/IDC (silver Teflon) and LDRI (silver Teflon) and ITVC (gold foil) [OBSS]
3. WVS Antenna [ODS]
4. Payload Bay wire harnesses, cables and connectors
5. LDRI diffuser [OBSS]
6. OBSS saddle contacts (when OBSS unberthed) [OBSS]
7. OBSS LDRI, LSC, and IDC camera lenses; scratches degrade sensor performance
8. Monkey fur [PLB]
9. Cameras: metallic surfaces [PLB]
10. Ku-Band Antenna black dish and gold thermal blankets [PLB]

EVA 3 NOTES, CAUTIONS, & WARNINGS (Cont)

WARNING

ISS Constraints

- A. Avoid inadvertent contact with:
1. Grapple fixture targets and target pins
 2. Lab window shutter during operation
 3. Stay inboard of SARJ when active
 4. Stay 2 ft from S1/P1 radiator beam rotational envelope when beam is free to rotate
 5. Stay 5 ft from moving MT on face 1
- B. Pinch:
1. NZGL connector linkage. Use caution when mating/locking
 2. EV side of IV hatch during hatch operation (also snag hazard) [A/L]
- C. RF radiation exposure:
1. Stay 3.6 ft from S-Band (SASA) high gain Antenna when powered [S1,P1,P6]
 2. Stay 1.3 ft from S-Band (SASA) low gain Antenna when powered [S1,P1,P6]
 3. Stay 1 ft from UHF Antenna when powered [Lab, P1]

WARNING (Cont)

ISS Constraints (Cont)

- D. Sharp Edges:
1. Inner edges of WIF sockets
 2. Mating surfaces of EVA connectors. Avoid side loads during connector mating
 3. Back side of MMOD shield fasteners
 4. Spring loaded captive EVA fasteners (e.g., 6B-boxes, BMRRM) ; the end of the spring may protrude
 5. PMA umbilical launch restraints- exposed bolt threads
 6. Ku-Band upper handrail by the Ku boom launch restraint [Z1]

WARNING (Cont)

ISS Constraints (Cont)

- E. Thermal:
1. EVA connectors with booties may become hot if left uncovered. Handling may need to be limited
 2. PMA handrails may be hot. Handling may need to be limited
 3. Turn off glove heaters when comfortable temp reached to prevent bladder damage. Do not pull fingers out of gloves when heaters are on
 4. Uncovered trunnion pins may be hot
 5. SSRMS/MBS operating cameras/lights may radiate large amounts of heat
 6. Stay 1 ft away from PMAs and MMOD shields > 270 degF if EMU sun visor up
 7. Stay at least 1 ft away for no more than 15 min from PMAs and MMOD shields > 300 degF if EMU sun visor up
 8. Stay 0.5 ft away from PMA and MMOD shields > 325 degF
 9. Do not touch EMU protective visor if temp has been < -134 for > 15 min
 10. No EMU TMG contact of PMAs & MMOD shields when temp > 320 degF
 11. No EMU boot contact with foot restraint when temp < -120 degF or > 200 degF

EVA 3 NOTES, CAUTIONS, & WARNINGS (Cont)

WARNING (Cont)

Shuttle Constraints

H. Arcing/Molten Debris:

1. Stay \geq 2 ft from exposed EFGF connector when OBSS berthed, powered, and EFGF not grappled [PLB]
2. Stay \geq 2 ft from Stbd Fwd MPM contacts [PLB]

I. Pinch:

1. PRLA operation [PLB]

J. RF radiation exposure:

1. Stay 3.28 ft from S-Band Antenna when powered
2. Stay 1 ft from top and side of UHF PLB Antenna radome surface when in high powered mode [ODS truss]
3. Stay 0.33 ft from top and side of UHF PLB Antenna radome surface when in low powered mode [ODS truss]
4. Remain below the level of the PLB door mold line for first 20 in aft of fwd bulkhead when S-Band Antenna powered [PLB]
5. Remain on the inboard side of the Stbd slidewire (sill handrails if slidewire not installed) for first 20 ft aft of fwd bulkhead when Ku-Band Antenna powered [PLB]

WARNING (Cont)

Shuttle Constraints (Cont)

K. Sharp Edges:

1. PRLA grounding wipers [PLB]
2. LDRI baffles. They also pose an entrapment hazard [OBSS]

L. Thermal:

1. Illuminated PLB lights, do not touch
2. OBSS grapple fixture shafts/cams may be hot. Limit handling if required

M. Thruster Contamination:

1. Stay out of the immediate vicinity of leaking jet or APU
2. Stay 27 ft from PRCS when powered
3. Stay 3 ft from VRCS when powered
4. Stay 3 ft from APU when operating

N. Other:

1. Do not look at the LDRI diffuser

EVA 3 BRIEFING CARD

1. EVA Prep
 - Get-up Plan – clothing and EMU equipment bag
 - Prebreathe protocol review
 - Equipment lock activities
 - Suit donning plan
 - Airlock depress review
2. Communications
 - Overall setup: big loop, A/G2, S/G2, ICOM, Hardline, remind EV crew when mode swapping
 - Use EV1(2) for DCM sw throws (all time in A/L)
3. EVA Procedure Review
 - Order of tasks (summary timeline)
 - Egress Plan
 - Detailed Task Review
 - Notes, Cautions, and Warnings
 - Ingress Plan
 - Section 16 Contingencies
4. Robotics
 - SRMS/SSRMS initial position, maneuvers, clearances
 - Coordinate Frames
 - SSRMS/SRMS/IV comm protocol review
5. Post EVA
 - Coldsoak
 - Airlock Repress review
 - Suit doffing responsibilities
 - Post EVA plan

6. Emergencies
 - Emergency suit doff and power down during EVA prep
 - CUFF checklist
 - Abort and Terminate review – scenarios/protocols
 - Hand signals

IV CHECKLIST VERIFICATION ITEMS

- Day/Night Cycles and extended two-handed ops
 - √Lights, heaters, visors, tools, tethers, gloves
- √Load Alleviating Strap on Safety Tethers not damaged
- √Safety Tether in good config
 - Crew Report: “**Hook closed, slide locked, reel unlocked**”
- √Both SAFER valves down at egress
 - Crew Report: “**Both handles down**”
- √APFR locking collar Black-on-Black and pull test
 - Clocking, pitch, roll, yaw
- √PGT Green light on for bolt engage
 - program, (C)CW, MTL setting
 - PGT and sockets – pull test
 - May get Lo Torque msg at bolt release
 - Crew Report: “**Torqued out, XX turns (or green light)**”
- √Connectors for damage, bent pins, EMI band, FOD, cable bend radii
 - Always receive GO from MCC prior to mating/demating electrical connections, review inhibits as reqd
 - Crew Report: “**Pins good, EMI band good, no FOD, bend radius OK**”
- Coordination between IV/EV/Robotics/Ground

EVA 3 INHIBIT PAD

Orbiter

All EVAs	
TCS L12	1. √TCS POWER – OFF
Ku-Band Antenna	
MCC-H	1. √KU-BAND Mask – active 2. √KU-BAND EVA Protect Box – active
RCS	
	If EV crew < 27 ft from FRCS:
IV O14,15,16	1. √DAP: VERN, FREE, LO Z (flt specific √ with GNC) 2. √RJDF F1, F2, F3, F4 MANF DRIVER (four) – OFF LOGIC (four) – OFF
MCC-H	3. √Above RCS config
IV	4. √RCS F – ITEM 1 EXEC (*) √JET DES F1U – ITEM 17 (*) √F3U – ITEM 19 (*) √F2U – ITEM 21 (*)
S-Band Antennas	
	<u>NOTE</u> Possible loss of comm when forced LL FWD antenna
IV A1R	If EV crew < 1.6 ft from S-Band antenna: 1. S-BAND FM ANT – XMIT LOWER/RCVR UPPER 2. √MCC, lower antenna selected
C3	If no comm, or on MCC call: 3. S-BAND PM ANT – LL FWD
C3	When EVA crewmember at least 1.6 ft away from all S-Band upper antennas: 4. S-BAND PM ANT – GPC

USOS

All EVAs	
PCU	
MCC-H	1. √PCUs (two) operational in discharge mode and one of the following: A. CCS PCU EVA Hazard Control enabled B. No more than two arrays unshunted C. No more than two arrays pointed < 90 degrees from velocity vector
	OR
	2. One or no PCUs operational in discharge mode and one of the following: A. No more than two arrays unshunted B. No more than two arrays pointed < 90 degrees from velocity vector
Ground Radar	
MCC-H	1. √TOPO and FDO consoles, ground radar restrictions in place for EVA
Location Dependent Inhibits	
LAB Window	
IV	If EV crew less than 10 ft/3.5 m from window or in window FOV close window shutter
RSOS	
All EVAs	
SM Antennas	
MCC-M	1. Global Timing Sys 1(400.1 MHz) [GTS] – Deactivate

EVA 3 SUMMARY TIMELINE

TIME	SRMS	EV1 (FF)	EV2 (FF/SRMS)
00:00		POST DEPRESS (00:05)	POST DEPRESS (00:05)
00:05		EGRESS (00:25)	EGRESS (00:25)
00:30		CHANNEL 1/4 POWER RECONFIGURATION (01:30) <ul style="list-style-type: none"> • S0 Fwd Stbd Avionics Reconfiguration (Panel A148) • S1-4B DDCU Reconfiguration • S1-4B DDCU Thermal Cover Removal • S0-1A DDCU Reconfiguration (A27) • Lab 4A DDCU Secondary Power Disconnect from S0 (Panel A163) • S0/N1 Pwr Cable Routing (S0 Routing) • S0-4B Port Wedge Face DDCU Thermal Cover Removal • MBSU Bypass Jumper (1/4) Reconfiguration 	CHANNEL 1/4 POWER RECONFIGURATION (01:00) <ul style="list-style-type: none"> • CIDs 1 and 2 Removal/S0 Tray Connections (Panel A199) • Z1-003 Patch Panel 6 Reconfiguration (DDCU HP4B)
02:00	SRMS: SMDP Assembly SRMS: SMDP Stow SRMS: APFR Egress/Removal	SMDP TRANSFER (02:00) <ul style="list-style-type: none"> • Setup • TDK #4 Stow • TDK #3 Stow • TDK #2 Stow • SMDP Stow on PMA3 	SMDP TRANSFER (02:40) <ul style="list-style-type: none"> • SRMS Setup • SMDP Adapter Prep • Bundle #4 Retrieval and Stow • Bundle #3 Retrieval and Stow • Bundle #2 Retrieval and Stow • SMDP Stow on PMA3 • SRMS Cleanup
04:00		Z1-005 PATCH PANEL 1 RECONFIG (00:10) (SPDA Z1-4B)	
04:10		RUSSIAN POWER RECONFIG (00:30) <ul style="list-style-type: none"> • Z1 to Node 1 Connections • S0 to Node 1 Connections 	RUSSIAN POWER RECONFIG (00:30) <ul style="list-style-type: none"> • H-jumper Removal (Channel 2/3) – Stbd
04:40		AGB TRANSFER TO FHRC (00:45)	AGB TRANSFER TO FHRC (00:45)
05:25		CLEANUP (00:20) <ul style="list-style-type: none"> • Get-ahead 	CLEANUP (00:20) <ul style="list-style-type: none"> • Get-ahead
05:45		INGRESS (00:20)	INGRESS (00:20)
06:05		PRE REPRESS (00:05)	PRE REPRESS (00:05)
06:10			

EVA 3 TOOL CONFIG

AIRLOCK

EMU 1

- MWS, right swing arm
- Digital Camera (inner rt swingarm)- 28 mm
- BRT (left) w/4 wire ties
- w/sm-sm RET
- T-Bar
- ISS trash bag (inner left)
- Sm-sm RET (left D-ring)
- Adj tether (left D-ring) (2)
- Sm-sm RET w/PIP pin (right D-ring)
- Adj tether (right D-ring)
- D-ring ext – left
- Waist tether – right
- SAFER

EMU 2

- MWS, right swing arm
- Digital Camera (inner rt swing arm)- 28 mm
- BRT (left)
- w/1 short wire tie and 2 long wire ties
- w/Sm-sm RET
- T-Bar
- ISS trash bag (inner left)
- Wire ties (2) around T-Bar
- Lg-sm RET (SMDP adapter) (right D-ring)
- Adj tether (left D-ring)
- Adj tether (right D-ring)
- Sm-sm RET w/PIP pin (left D-ring)
- D-ring ext – left
- D-ring ext – right
- Waist tether – right D-ring ext
- SAFER

Total sm-sm RETs used: 4 Total sm-sm RETs w/PIP Pin used: 3 Total adj tethers used: 9 Total lg-sm RETs used: 3

AIRLOCK ENDCONE

- Staging Bag
- Fish Stringer #3
- Connector cleaner tool caddy
- Wire tie caddy (2)
- Pin straightener
- MWS Key strap
- Velcro/Tape caddy
- Torque Wrench (2)
- Socket Caddy (2) w/RAD (1) and 5/8 x 7.8-in ext (2)
- Pry Bar RAD s/n: _____
- EVA Ratchet
- Probe
- IV Bag
- Contamination Detection Kit
- Hydrazine Detector (Gold Salt Coupon) (6)
- Color Chart (2)
- ISS Contamination Detection Sampler (2)
- Shuttle Contamination Detection Sampler (2)
- Nitrogen Dioxide Detector (Oxidizer Draeger Tube) (6)
- Ammonia Detector (NH3 Draeger Tube) (6)
- 2 towels with wire ties
- DCM plug (2) (SAFER hardmount)
- GP caddy (2)
- Thermal mittens (2 pr)
- Socket Caddy (hatch contingencies) w/sm-sm RET
- 1/2 X 8-in socket (IV hatch)
- 7/16 X 6-in socket (spare)

PRE EVA 3 TOOL CONFIG

1. Verify EVA 3 Hardware in equipment lock
2. Transfer PAD from INC "EVA2-3 tools" bag to FS#2
3. Config MWSs (see INC packed "Tools for EVA2-3" bag for long wire ties)
4. Verify crewlock bags 1 & 2 and UIA tether point as listed (see INC packed "Tools for EVA2-3" bag)
5. Verify IV and Staging Bag contents per list
6. Stow MWSs in "EV1" and "EV2" bags as reqd
7. Prior to EVA, inspect the following:
 - RET cords for damage
 - BRT and MWS toggles: loose fittings/screws
 - Safety and waist tether load alleviating straps (no red band or damage)

AIRLOCK INTERNAL D-RING

- D-Ring Extender

UIA HANDRAILS

- AGB, 2 adj tethers (stay in A/L for EVA)
- Crewlock Bag #1 (for contingency) w/lg-sm RET
- Square scoop (MBSU or DDCU R&R)
- Ballstack (MBSU R&R)
- Spare 55' safety tethers (2) (for BCDU cont)
- MUT EEs (2) (S1 Bay 15 DDCU or SASA cont temp stow)
- Crewlock Bag #2 (for contingency) w/lg-sm RET
- CETA cart PIP pin (wheel bogie R&R)
- Socket caddy with 6-in, RAD s/n: _____ (AGB cont) and 2-inch socket
- Russian adj tethers (2) (SMDP contingencies)
- Russian fixed-length tether (SMDP contingencies)
- Spare PGT (s/n: _____); batt s/n: _____
- Spare WIF adapter

- Fish stringer # 1
- Spare 55' safety tether
- S0 Channel 1/4 Pwr Cable (jumper) (tether to both caps)
- PGT w/6-in ext (s/n: _____), RET; batt s/n: _____
- Fish stringer # 2
- PGT w/2-in ext (s/n: _____), RET w/PIP pin & adj; batt s/n: _____
- Spare 55' safety tether
- PAD w/WIF adapter, adj tether





POST EVA 3 TOOL STOW

1. Retrieve "Return to Shuttle 3" jett stow bag from "EVA 1 Shuttle to ISS" jett stow bag
2. Stow the following items in the "Return to Shuttle 3" Jettison Stowage Bag:
 - "EV1" and "EV2" jettison stowage bags
 - "EVA 1 Shuttle to ISS" jettison stowage bag
 - "EVA 2/3 Shuttle to ISS" jettison stowage bag
 - CIDs 1 and 2
 - S1 DDCU Thermal Cover
 - S0 Channel 1/4 Pwr Jumper Caps (2)
 - S0 port wedge face DDCU Thermal Cover
 - CH 2/3 H-Jumper
 - SMDP adapter magnetic latch covers (3)

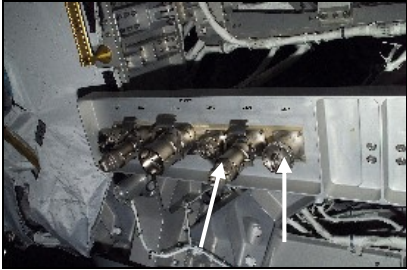
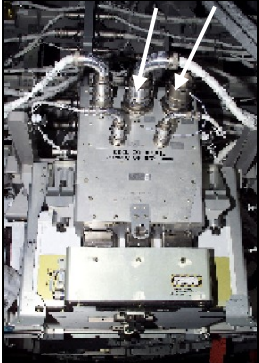
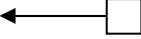

EGRESS (00:25)

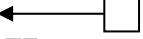
IV	EV1 (FF)	EV2 (FF)
<p><u>NOTE</u> For safety tether swaps, expect to hear:</p> <ol style="list-style-type: none"> 1. Hook closed 2. Slide locked 3. Reel unlocked <ol style="list-style-type: none"> 1. WVS Software: Select page – RF camera Sel 'Advanced Controls' S-Band Level (two) – Max (required after EV1 and EV2 egress airlock) 	<p>√Right waist tether to airlock internal D-ring extender, verify ST config</p> <ol style="list-style-type: none"> 1. Thermal cover – open 2. Egress airlock 3. Inspect load alleviating straps on 85' safety tethers (2) 4. Retrieve airlock safety tether from fwd external D-ring, attach to left D-ring extender, verify ST config 5. Release waist tether from internal D-ring extender 6. Receive fish stringer #1 and #2 from EV2 7. Temp stow fish stringer #1 in between A/L port toolbox HR and stbd toolbox HR (stretched out) 8. Temp stow fish stringer #2 in between A/L HR 0560 (fwd/stbd/nadir) and HR 0555 (nadir of stbd toolbox) 9. Transfer aft airlock safety tether to EV2 10. Transfer PGT w/RET from fish stringer #1 to right swingarm 11. Transfer spare safety tether from fish stringer #1 to airlock toolbox #1 (stbd) HR 12. Attach fish stringer #1 to MWS <ol style="list-style-type: none"> 13. √EV2's SAFER MAN ISOL vlv – OP (dn) and HCM (dn) 	<p>√Right waist tether to UIA panel fwd D-ring, verify ST config</p> <ol style="list-style-type: none"> 1. Transfer fish stringer #1 and #2 to EV1 2. Receive airlock safety tether from EV1, attach to left D-ring extender, verify ST config 3. Release right waist tether from UIA panel D-ring 4. Egress airlock ←  5. Close thermal cover 6. √EV1's SAFER MAN ISOL vlv – OP (dn) and HCM (dn) 7. Temp stow spare safety tether, PAD with WIF adapter (1 adj), and PGT (1 RET, 1 adj) on airlock HR 0555 (don't need until SMDPs) 8. Retrieve fish stringer #2 9. Perform translation adaptation on equipment lock

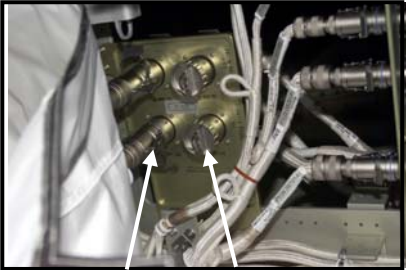

CHANNEL 1/4 POWER RECONFIGURATION (01:30)

IV	EV1 (FF)	EV2 (FF)
<p>1. Verify w/MCC: Power Reconfig Inhibit Check (SODF: ASSY OPS:EPS CH 1/4) Powerdown for EVA 3, steps 6 and 7) complete (DCSU 4B RBI 6 open) (DCSU 4A RBI 6 open)</p>  <p>J226 J237 S0 FWD/STBD CONNECTOR PANEL (PANEL A148)</p>  <p>J8 J7 DDCU COLDPLATE CONNECTOR BOX</p>	<div style="text-align: center;">  </div> <p style="text-align: center;">NOTE √Connectors for damage, FOD, bent pins, cable bend radius, and EMI bands</p> <p><u>S0 FWD STBD AVIONICS RECONFIGURATION</u> (Panel A148)</p> <ol style="list-style-type: none"> 1. Translate to S0 Bay 03, Face 1; temp stow fish stringer #1 on CETA 2 (stbd most) square grid 2. Translate to stbd S0 connector panel on Bay 01, Face 6 3. BRT to HR 3443 4. Remove DF cap from J226 5. Demate S0 P226 (W9003) from S0 J237; mate to S0 J226 6. Install DF cap on S0 J237 7.  connector closeout <p><u>S1-4B DDCU RECONFIGURATION (S1 BAY 15)</u></p> <ol style="list-style-type: none"> 1. Translate to S1 Bay 15 2. Attach MWS EE to S1 HR 3200 (nadir HR) 3. Remove connector cap from J7 on DDCU coldplate connector box (panel A9); temp stow (lanyarded to panel) 4. If required, release P169 from TA clamp 5. Demate S1 P169 (W5113) from DDCU CP J8; mate to J7 6. Install cap on J8 7.  connector closeout 	<div style="text-align: center;">  </div> <p style="text-align: center;">NOTE √Connectors for damage, FOD, bent pins, cable bend radius, and EMI bands</p> <p><u>CIDS 1 AND 2 REMOVAL/S0 TRAY CONNECTIONS</u> (panel A199)</p> <div style="border: 1px solid black; padding: 5px; margin: 10px 0;"> <p style="text-align: center;">WARNING</p> <p style="text-align: center;">Wire ties may break and cause sharp edges and debris</p> </div> <div style="border: 1px solid black; padding: 5px; margin: 10px 0;"> <p style="text-align: center;">CAUTION</p> <p style="text-align: center;">Avoid contact with SASA antennas and S0 Radiator</p> </div> <ol style="list-style-type: none"> 1. Translate to port Lab/Z1 tray (go aft of airlock); fairlead above Z1 MBM at P6 HR 5308 2. Open TA clamps and remove wire ties as reqd 3. Demate S0 P232 from S0 J460; mate to Z1 J432 4. BRT to Lab HR 0211 5. Demate Z1 P301 (W26B) from CID 1 J201; mate to Z1 J201 (tray) 6. Demate Z1 P302 (W26C) from CID 2 J202; mate to Z1 J202 (tray) 7. Demate CID 1 P301 from Lab J201; temp stow on fish stringer #2 8. Demate CID 2 P302 from Lab J202; temp stow on fish stringer #2 9. Release necessary TA clamps on port S0 tray, remove cables, close clamps (panel A199) 10. Demate S0 P201 from S0 J462; mate to Lab J201 11. Demate S0 P202 from S0 J463; mate to Lab J202 12. Close TA clamps as reqd 13.  connector closeout



CHANNEL 1/4 POWER RECONFIGURATION (01:30) (Cont)

IV	EV1 (FF)	EV2 (FF)
<p style="text-align: center;">Zenith</p>  <p style="text-align: center;">P2/J4 J3</p> <p style="text-align: center;">Z1 PP 6 (NADIR PANEL)</p>	<p><u>S1-4B DDCU THERMAL COVER REMOVAL</u></p> <ol style="list-style-type: none"> 1. Attach MWS EE to S1 HR 3200 (nadir HR) 2. PGT [A1, CCW2, 30.5]-6"-Ext-7/16: Release DDCU thermal cover grounding strap fastener, 10-15 turns 3. Release Velcro straps (3) 4. Pull thermal cover away from DDCU until straps are free 5. Tend cover using integral straps and adj tether; tether to MWS <p><u>S0-1A DDCU RECONFIGURATION</u> (panel A27)</p> <ol style="list-style-type: none"> 1. Translate to CETA 2, temp stow S1 DDCU thermal cover w/adj tether and PGT w/RET on fish stringer #1 2. Translate to port-most CETA cart (CETA 1) 3. Rotate CETA 1 coupler to UNLOCK, slide CETA port until clear of S0 Bay 01 4. Engage parking brake (left handle) 5. Rotate CETA 1 coupler to CAPTURE 6. Translate to S0 Bay 01, access through face 1 7. Remove connector cap from J7 on DDCU coldplate connector box, temp stow (lanyarded to panel) 8. If required, release P157 from TA clamp 9. Demate S0 P157 (W4145) from J8, temp stow 10. Install connector cap on J8 11. Mate S0 P157 to S0 J7 12.  connector closeout 13. Release CETA parking brake (tap pedal twice) <div style="border: 1px solid black; padding: 5px; text-align: center;"> <p>CAUTION CETA to CETA max coupling rate is 1 inch/sec</p> </div> <ol style="list-style-type: none"> 14. Couple CETA 1 to CETA 2, take CETA 1 coupler to LOCK 15. Relocate S0 CH 1/4 Jumper from fish stringer #1 to MWS 	<p><u>Z1-003 PATCH PANEL 6 RECONFIGURATION</u> (DDCU HP 4B)</p> <ol style="list-style-type: none"> 1. Translate to Z1 patch panel 6 (stbd face, nadir panel) 2. Temp stow fish stringer #2 on doghouse HR (or airlock HR 0521) <div style="border: 1px solid black; padding: 10px; text-align: center;"> <p>CAUTION Avoid contact with Z1 DDCU Heatpipes and SASA antennas</p> </div> <ol style="list-style-type: none"> 3. Fold back thermal shroud (STD SHRD Z1/02/04-03), release Velcro straps from Z1 HRs 6005 and 6024 4. Demate Z1 P2 (W23) from Z1 J4; temp stow 5. Remove connector cap from Z1 J3, mate to Z1 J4 6. Mate Z1 P2 (W23) to Z1 J3 7.  connector closeout 8. Reinstall thermal shroud 9. Retrieve fish stringer #2 from doghouse HR

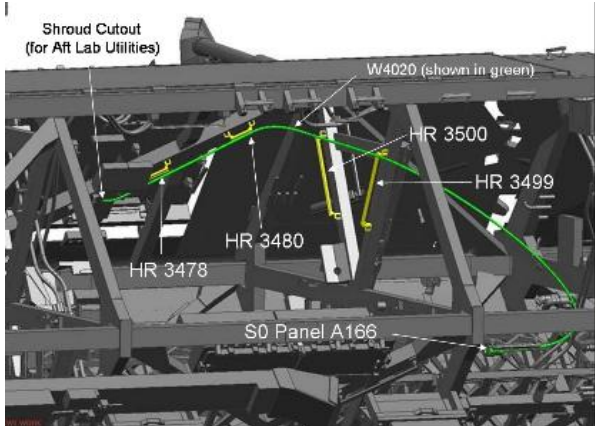
CHANNEL 1/4 POWER RECONFIGURATION (01:30) (Cont)

IV	EV1 (FF)	EV2 (FF)
 <p>P333/J333 PANEL A163</p>	<p><u>LAB 4A DDCU SECONDARY POWER DISCONNECT FROM S0 (Panel A163) (look port)</u></p> <div style="border: 1px solid black; padding: 5px; text-align: center;"> <p>CAUTION Avoid contact with GPS antennas and S0 Radiator</p> </div> <ol style="list-style-type: none"> 1. Translate to S0 Bay 00, access through face 03 door 2. Open MLI door 3. Ingress truss (feet first) 4. BRT to HR 3500 5. If reqd, release S0 P333 (W4145) TA clamp 6. Release cap from S0 CH 1/4 jumper J333A, temp stow 7. Demate S0 P333 (W4145) from S0 J333; mate to S0 CH 1/4 jumper J333A 8. Deconflict routing with S0/N1 Pwr cable 9. Release cap from S0 CH 1/4 jumper P333A, temp stow 10. Mate S0 CH 1/4 jumper P333A to S0 J333 11. Restrain S0 cable or jumper using TA clamp or wire tie to HR 3499, close TA clamp 12.  connector closeout <p><u>S0/N1 PWR CABLE ROUTING (S0 ROUTING)</u></p> <ol style="list-style-type: none"> 1. Translate to S0/N1 Pwr Cable on port bulkhead (still bay 00) 2. Release cable ties as reqd 3. Route S0/N1 Pwr Cable toward aft S0 tray and wire tie cable to S0 internal HRs: <ul style="list-style-type: none"> <input type="checkbox"/> 3500 <input type="checkbox"/> 3480 <input type="checkbox"/> 3478 4. Open S0 Face 5 MLI shroud as reqd (Velcros) 5. Pass S0/N1 Pwr Cable through shroud opening onto S0 tray 6. Close MLI shroud as reqd 	 <p style="text-align: center;">S0/N1 PWR CABLE ROUTING</p>

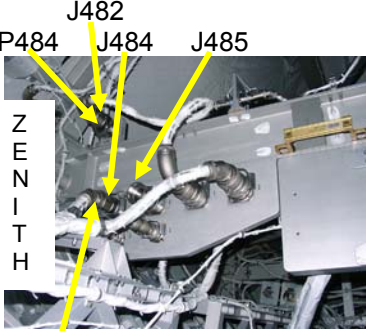
CHANNEL 1/4 POWER RECONFIGURATION (01:30) (Cont)

IV	EV1 (FF)	EV2 (FF)
 <p>Z E N I T H</p> <p>P484 J482 J484 J485</p> <p>P485</p> <p>MBSU BYPASS JUMPER PANEL</p> <p>2. When EV1's and EV2's connections complete, give MCC GO for power up</p>	<p>7. Egress truss 8. Close Face 3 door</p> <p><u>S0-4B PORT WEDGE FACE DDCU THERMAL COVER REMOVAL</u></p> <p>1. Translate to S0 port wedge face</p> <div style="border: 1px solid black; padding: 5px; width: fit-content; margin: 10px auto;"> <p style="text-align: center;">CAUTION</p> <p style="text-align: center;">Avoid contact with TERA stanchion grapple fixture and target</p> </div> <p>2. Attach MWS EE to S0 HR 3541 3. Release cover strap and remove cover 4. Translate to S0 HR 3519, wrap cover with adj tether and stow on MWS 5. Translate to CETA 2, temp stow S0 DDCU thermal cover w/adj tether and S0 jumper caps (2) on fish stringer #1</p> <p><u>MBSU BYPASS JUMPER (1/4) RECONFIGURATION (zenith panel)</u></p> <p>1. Translate to S0 Bay 04 2. Access MBSU zenith reconfig worksite through face 1 3. BRT to S0 HR 3533 as reqd (Panel A200) 4. Remove connector cap from S0 J485; temp stow 5. Demate S0 P485 from S0 J484 (A302); mate to S0 J485 (Panel A200) 6. If needed, remove P484 (W4033) from TA clamp; close clamp 7. Demate S0 P484 from S0 J482; mate to S0 J484 (A200) 8. Install connector cap on J482 (A302) 9.  connector closeout</p> <p style="text-align: center;">← </p> <p>10. Retrieve fish stringer #1 from CETA 2, stow on MWS</p>	

CHANNEL 1/4 POWER RECONFIGURATION TASK DATA SHEET

Tools:

EV1	EV2
PGT w/6-in	

EVA Fasteners:

Fastener Name	Label	Head Size	Qty	Release Torque (ft-lbs)	Failure Torque (ft-lbs)	Turns	RPM
S1 DDCU thermal cover ground strap		7/16	1	3.8	4.7 (shank failure)	10-15	30

Connector	From	To	Clamps	Size	Function
S0 P230 (W4035)	Z1 CID 6 J430	Z1 tray J430		33	4B Primary Power to MBSU 4
Z1 P301 (W26B)	CID 1 J201	Z1 J201 (tray)		25	Disconnects DDCU LA1A from Z1 IDA
Z1 P302 (W26C)	CID 2 J202	Z1 J202 (tray)		25	Disconnects DDCU LA1B from Z1 IDA
CID 1 P301	Lab J201			25	CID 1 Removal (4B Primary Power)
CID 2 P302	Lab J202			25	CID 2 Removal (4B Primary Power)
S0 P201	S0 J462	Lab J201		25	Primary Power MBSU 1 to DDCU LA1A
S0 P202	S0 J463	Lab J202		25	Primary Power MBSU 1 to DDCU LA1B

Notes:

1. √connectors for damage, FOD, bent pins, and cable bend radii, and EMI bands
2. It is possible for the DDCU thermal cover to get caught on coldplate legs during removal

Cautions:

1. Avoid contact with SASA antennas and S0 Radiator
2. Avoid contact with GPS antennas
3. Avoid contact with Z1 DDCU Heatpipes
4. Avoid contact with TERA stanchion grapple fixture and target
5. CETA to CETA max coupling rate is 1 inch/sec

Warnings:

1. Wire ties may break and cause sharp edges and debris

Timeline Considerations:

1. 1/4 Connections can be completed in any order
2. CIDs 6 and 8 were removed on 12A

CHANNEL 1/4 POWER RECONFIGURATION TASK DATA SHEET (Cont)

Connector	From	To	Clamps	Size	Function
S0 P232	S0 J460	Z1 J432		33	Secon Power DDCU S04B to SPDA Z14B
S1 P169 (W5113)	J8	J7		33	DDCU S14B 2ndary Power to Utility Bus
S0 P157 (W4145)	J8	J7		33	DDCU S01A 2ndary Power to Core Bus
S0 P333 (W4145)	S0 J333	S0 CH 1/4 pwr cable J333a		37	Disconnect DDCU LA4A Power to Truss
S0 CH 1/4 Pwr Cable P333a		S0 J333		37	
S0 P485	S0 J484	S0 J485		37	Primary Power DCSU 4A to MBSU 4
S0 P484	S0 J482	S0 J484		37	Primary Power DCSU 4B to MBSU 4
S0 P226 (W9003)	S0 J237 Cap has bail	S0 J226		25	MBSU 4 power to DDCU LA4A

SMDP TRANSFER (02:00)

IV/SRMS	EV1 (FF)	EV2 (SRMS)
<p>1. (PDRS: EVA 3, APFR Install/ Ingress)</p> <p>2. SRMS mnvr to ICC pallet (PDRS: EVA 3, SMDP Assembly, step 1)</p>	<p><u>SETUP</u></p> <ol style="list-style-type: none"> 1. Translate to airlock 2. Temp stow fish stringer #1 in between A/L port toolbox HR and stbd toolbox HR (stretched out) 3. Retrieve spare safety tether from toolbox HR and stow on MWS 4. Retrieve PGT w/RET and stow on MWS 5. Translate to ICC via the following path to ensure safety tether is clear of SRMS trajectory: <ul style="list-style-type: none"> ❑ Translate to Lab nadir/stbd HRs ❑ Translate along Lab HRs to ODS aft HRs ❑ Install poorman's fairlead under ODS light ❑ Translate to port ODS truss HR and perform safety tether swap onto spare safety tether, verify ST config ❑ Translate along Orbiter port sill to ICC 6. Translate to bundle #4 (aft/stbd) 	<p><u>SRMS SETUP</u></p> <ol style="list-style-type: none"> 1. Translate to airlock 2. Temp stow fish stringer #2 in between A/L HR 0560 (fwd/stbd/nadir) and HR 0555 (nadir of stbd toolbox) 3. Retrieve the following tools from airlock HR 0555 and stow on MWS: <ul style="list-style-type: none"> ❑ PAD with WIF adapter (w/adj tether) ❑ PGT with 2-in socket (w/RET and adj tether) ❑ Spare safety tether (55') 4. Retrieve APFR from airlock toolbox 1 WIF (stbd), stow on BRT 5. Translate to Lab HR 0245 (nadir/aft/port) 6. If reqd, temp stow APFR in Lab WIF 05 or 04 7. GCA as reqd for PAD and APFR install 8. Verify PAD J-hook unlocked prior to opening jaws 9. Install PAD w/WIF adapter onto SRMS, PFR socket toward end effector 10. Lock PAD J-hook 11. Perform safety tether swap onto SRMS black D-ring, verify ST config 12. Install APFR onto PAD, configure to: [12,PP,F,6] 13. GCA as reqd for APFR ingress 14. Install local waist tether onto APFR 15. Ingress APFR <p><u>SMDP ADAPTER PREP</u></p> <ol style="list-style-type: none"> 1. SRMS mnvr to SMDP adapter 2. Remove magnetic latch covers (3), stow in trash bag 3. Check magnetic latches (3) for FOD 4. Retrieve EMU scissors from right pocket 5. Cut fishing line on magnetic latches (3) 6. Stow EMU scissors in trash bag

SMDP TRANSFER (02:00) (Cont)

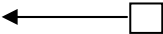
IV/SRMS	EV1 (FF)	EV2 (SRMS)												
<p>3. √MCC: successful power up of channel 1/4 connections prior to releasing any TDK bolts</p> <table border="1" data-bbox="111 678 441 906"> <thead> <tr> <th></th> <th>B1</th> <th>B2</th> </tr> </thead> <tbody> <tr> <td>Tie Rod I</td> <td></td> <td></td> </tr> <tr> <td>Tie Rod II</td> <td></td> <td></td> </tr> <tr> <td>Tie Rod III</td> <td></td> <td></td> </tr> </tbody> </table> <p>TDK #4 BOLT STATUS</p>		B1	B2	Tie Rod I			Tie Rod II			Tie Rod III			<p>TDK #4 STOW</p> <ol style="list-style-type: none"> Flip TDK tie rod #1 (fwd-most) turnbuckle lever 90°; release tie rod from stbd (opens toward port sill) Flip TDK tie rod #2 turnbuckle lever 90°; release tie rod <p style="text-align: center;"><u>NOTE</u> There is not a soft dock to hold the SMDP bundle in place once the tie rods are released</p> <ol style="list-style-type: none"> Flip TDK tie rod #3 turnbuckle lever 90°; release tie rod 	<ol style="list-style-type: none"> Rotate lock lever open; cycle magnetic latches (3) from OPEN to CLOSE to OPEN <p><u>BUNDLE #4 RETRIEVAL AND STOW</u></p>  <ol style="list-style-type: none"> GCA to bundle #4 (aft/stbd) as reqd to access fixator Handles Tether to bundle #4 Rotate fixator handles A1 and A2 (6 total) to OPEN (hard stop) PGT [A5, CCW1, 30.5]-2"-Ext-7/16: Release B1 and B2 bolts (6 total) 2 turns max <div style="border: 1px solid black; padding: 5px; margin: 10px 0;"> <p style="text-align: center;"><u>CAUTION</u></p> <p style="text-align: center;">The SMDP tie rods do not withstand 125 lb kick-loads in the open config</p> </div> <div style="border: 3px double black; padding: 5px; margin: 10px 0;"> <p style="text-align: center;"><u>WARNING</u></p> <ol style="list-style-type: none"> The TDK tie rods and hold down beams are potential pinch point hazards at hinges Avoid contact with buckles on SMDP bundle orange straps. They have sharp edges </div>
	B1	B2												
Tie Rod I														
Tie Rod II														
Tie Rod III														

SMDP TRANSFER (02:00) (Cont)

IV/SRMS	EV1 (FF)	EV2 (SRMS)																								
<table border="1" data-bbox="119 448 449 675"> <thead> <tr> <th></th> <th>B1</th> <th>B2</th> </tr> </thead> <tbody> <tr> <td>Tie Rod I</td> <td></td> <td></td> </tr> <tr> <td>Tie Rod II</td> <td></td> <td></td> </tr> <tr> <td>Tie Rod III</td> <td></td> <td></td> </tr> </tbody> </table> <p data-bbox="136 711 420 735">TDK #3 BOLT STATUS</p> <table border="1" data-bbox="119 1023 449 1250"> <thead> <tr> <th></th> <th>B1</th> <th>B2</th> </tr> </thead> <tbody> <tr> <td>Tie Rod I</td> <td></td> <td></td> </tr> <tr> <td>Tie Rod II</td> <td></td> <td></td> </tr> <tr> <td>Tie Rod III</td> <td></td> <td></td> </tr> </tbody> </table> <p data-bbox="136 1286 420 1310">TDK #2 BOLT STATUS</p>		B1	B2	Tie Rod I			Tie Rod II			Tie Rod III				B1	B2	Tie Rod I			Tie Rod II			Tie Rod III			<p data-bbox="508 360 1096 513">4. Config TDK for landing:</p> <ul data-bbox="560 393 1096 513" style="list-style-type: none"> <input type="checkbox"/> stow short tie rods (3), pull test <input type="checkbox"/> stow long tie rods (3), pull test <input type="checkbox"/> flip turnbuckle levers on short rods (3) 90° <input type="checkbox"/> configure wire ties for landing (tension) <p data-bbox="508 776 688 800"><u>TDK #3 STOW</u></p> <ol data-bbox="508 841 1260 966" style="list-style-type: none"> 1. Flip TDK tie rod #1 (fwd-most) turnbuckle lever 90°; release tie rod from stbd (opens toward port sill) 2. Flip TDK tie rod #2 turnbuckle lever 90°; release tie rod 3. Flip TDK tie rod #3 turnbuckle lever 90°; release tie rod <p data-bbox="508 1002 1165 1154">4. Config TDK for landing:</p> <ul data-bbox="560 1034 1165 1154" style="list-style-type: none"> <input type="checkbox"/> stow long tie rods (3), attach short rods to sides <input type="checkbox"/> do pull test to ensure rods are latched <input type="checkbox"/> flip turnbuckle levers (3) 90° <input type="checkbox"/> configure wire ties for landing (tension) 	<ol data-bbox="1295 328 1995 513" style="list-style-type: none"> 5. Retrieve bundle #4 from TDK 6. GCA SRMS to SMDP adapter 7. Install bundle #4 onto adapter magnetic socket #4, uneven end up; jiggle until magnetic socket turns 8. Verify magnetic socket fully to CLOSE (no distinct hard stop); rotate lock lever to locked position <p data-bbox="1295 552 1747 576"><u>BUNDLE #3 RETRIEVAL AND STOW</u></p> <ol data-bbox="1295 617 1948 802" style="list-style-type: none"> 1. GCA SRMS to bundle #3 (fwd/center) 2. Tether to bundle #3 3. Rotate fixator handles A1 and A2 (6 total) to OPEN (hard stop) 4. PGT [A5, CCW1, 30.5]-2"-Ext-7/16: Release B1 and B2 bolts (6 total) 2 turns max <ol data-bbox="1295 971 1995 1156" style="list-style-type: none"> 5. Retrieve bundle #3 from TDK 6. GCA SRMS to SMDP adapter 7. Install bundle #3 onto adapter magnetic socket #3, uneven end up; jiggle until magnetic socket turns 8. Verify magnetic socket fully to CLOSE (no distinct hard stop); rotate lock lever to locked position <p data-bbox="1295 1195 1747 1219"><u>BUNDLE #2 RETRIEVAL AND STOW</u></p> <ol data-bbox="1295 1260 2028 1416" style="list-style-type: none"> 1. GCA SRMS to bundle #2 (fwd/port) 2. Tether to bundle #2 3. Rotate fixator handles A1 and A2 (6) to OPEN (hard stop) 4. PGT [A5, CCW1, 30.5]-2"-Ext-7/16: Release B1 and B2 bolts (6 total) 2 turns max
	B1	B2																								
Tie Rod I																										
Tie Rod II																										
Tie Rod III																										
	B1	B2																								
Tie Rod I																										
Tie Rod II																										
Tie Rod III																										

SMDP TRANSFER (02:00) (Cont)

IV/SRMS	EV1 (FF)	EV2 (SRMS)
	<p><u>TDK #2 STOW</u></p> <ol style="list-style-type: none"> 1. Flip TDK tie rod #1 (fwd-most) turnbuckle lever 90°; release tie rod from stbd (opens toward port sill) 2. Flip TDK tie rod #2 turnbuckle lever 90°; release tie rod 3. Flip TDK tie rod #3 turnbuckle lever 90°; release tie rod 4. Config TDK for landing: <ul style="list-style-type: none"> <input type="checkbox"/> stow long tie rods (3), attach short rods to sides <input type="checkbox"/> do pull test to ensure rods are latched <input type="checkbox"/> flip turnbuckle levers (3) 90° <input type="checkbox"/> configure wire ties for landing (tension) <p><u>SMDP STOW ON PMA3</u></p> <ol style="list-style-type: none"> 1. Translate to stbd side of SMDP adapter (Christmas tree) <p style="text-align: center;"><u>NOTE</u> There is not a soft dock in between the SMDP adapter and the ICC</p>	<ol style="list-style-type: none"> 5. Retrieve bundle #2 from TDK <p style="text-align: center;"><u>NOTE</u> Be aware of tight clearances between the OBSS and bundle #2 during installation onto the SMDP adapter</p> <ol style="list-style-type: none"> 6. GCA SRMS to SMDP adapter 7. Install bundle #2 onto adapter magnetic socket #2, uneven end up; jiggle until magnetic socket turns 8. Verify magnetic socket fully to CLOSE (no distinct hard stop); rotate lock lever to locked position <p><u>SMDP STOW ON PMA3</u></p> <ol style="list-style-type: none"> 1. GCA SRMS to fwd of SMDP adapter (Christmas tree) 2. Tether to Christmas tree (lg-sm RET to fit adapter HR) 3. Hold Christmas tree HRs

SMDP TRANSFER (02:00) (Cont)

IV/SRMS	EV1 (FF)	EV2 (SRMS)
<p>4. SRMS mnvr to PMA3 (PDRS: EVA 3, SMDP Stow)</p>	<p>2. Release Christmas tree from ICC:</p> <ul style="list-style-type: none"> <input type="checkbox"/> Flip lock lever up (to unlock it) <input type="checkbox"/> Pull out on handle and rotate to OPEN <p>3. Translate to port ODS HR; perform safety tether swap onto airlock safety tether, verify ST config, retrieve spare safety tether</p> <p>4. Translate to airlock via Lab stbd sill</p> <p>5. Transfer spare safety tether and PGT w/6-in socket to fish stringer #1</p> <div style="border: 1px solid black; padding: 5px; margin: 10px auto; width: fit-content;"> <p style="text-align: center;">CAUTION Avoid contact with S0 Radiator</p> </div> <p>6. Translate to PMA3 aft grapple fixture via Rat's Nest; fairlead above Z1 MBM at P6 HR 5308</p> <p>7. Assist EV2 with clearances as reqd</p> <p style="text-align: center;"><u>NOTE</u> Monitor clearances between Christmas tree and Node 1</p> <p>8. GCA EV2/SRMS until Christmas tree is fully seated in Strela Adapter, assist with install as reqd</p> <p>9. Pull out on handle and rotate to CLOSE</p> <p>10. Flip lock lever down (to lock it)</p>	<p>4. Release Christmas tree from ICC</p> <p>5. SRMS mnvr to aft grapple fixture on PMA 3 (pre-stow posn)</p> <p>6. At SRMS pre-stow posn, verify Christmas tree is oriented such that:</p> <ul style="list-style-type: none"> <input type="checkbox"/> Corner of Bundles #4 (smallest) and #2 are closest to Node 1 <input type="checkbox"/> Right hand is holding right vertical HR <input type="checkbox"/> Left hand is holding left vertical HR or circular HR <p>7. Install Christmas tree onto Strela adapter</p> <p>8. Release tether from Christmas tree</p> <p>9.  Christmas Tree closeout</p>

SMDP TRANSFER (02:00) (Cont)

IV/SRMS	EV1 (FF)	EV2 (SRMS)
<p>5. SRMS mnvr Lab for SRMS cleanup (PDRS: EVA 3, APFR Egress/Removal, steps 1 and 2)</p>		<p><u>SRMS CLEANUP</u></p> <ol style="list-style-type: none"> 1. SRMS mnvr to Lab HR 0245 (nadir/aft/port) 2. Egress SRMS 3. GCA as reqd to remove APFR and PAD 4. Remove APFR from WIF adapter, stow on BRT 5. Remove PAD and WIF adapter from SRMS, attach to MWS 6. GCA as reqd to perform safety tether swap 7. Perform safety tether swap onto airlock safety tether, verify ST config, attach spare tether to MWS 8. Translate to airlock 9. Stow APFR in airlock toolbox 1 (stbd) WIF; configure to: [9,MM,F,12] 10. Stow PAD with WIF adapter (with adj) and spare safety tether on fish stringer #2

SMDP TRANSFER TASK DATA SHEET

Tools:

EV1	EV2
PGT with 6-in x 7/16	PGT with 2-in x 7/16
	PAD with WIF Adapter, APFR
	EMU Scissors

Foot Restraints

Task	WIF	APFR Setting
SMDP Transfer	SRMS	12,PP,F,6

EVA Fasteners:

Fastener Name	Label	Head Size	Qty	Release Torque (ft-lbs)	Failure Torque (ft-lbs)	Turns	RPM
A1 (fixator handle and override bolt)	A1	7/16"	9	0.38	N/A	~1/4 (90 ⁰)	PGT-ratchet
A2 (fixator handle and override bolt)	A2	7/16"	9	0.38	N/A	~1/4 (90 ⁰)	PGT-ratchet
B1 (nominal)	B1	7/16"	9	4.34	7.2 (bolt tooth breakage)	2 max	10
B2 (nominal)	B2	7/16"	9	4.34	7.2 (bolt tooth breakage)	2 max	10
Open 1 (cont)	Open 1	7/16"	9	0.38	N/A	~ 1/9 (40 ⁰)	PGT-ratchet
Open 2 (cont)	Open 2	7/16"	9	3.26	N/A	~ 1/2 (170 ⁰)	PGT-ratchet
Cont bolts to release SMDP adapter and NHP plate from ICC	No label	7/16"	4	25.3	50.6 (bolt fracture along thread)		

Notes:

1. There is not a soft dock to hold the SMDP bundles in place once the tie rods are released
2. Be aware of tight clearances between the OBSS and bundle #2 during installation onto the SMDP adapter
3. There is not a soft dock in between the SMDP adapter and the ICC
4. Monitor clearances between Christmas tree and Node 1
5. For the B1 and B2 primary bolts, release the bolt a maximum of two turns. Do not go to the hard stop. If more than two turns is exceeded, the protruding bolt could potentially hinder correct stowage of the TDK hold down beam onto the frame for TDK's 2 and 3

Cautions:

1. The SMDP tie rods do not withstand 125 lb kick-loads in the open config (can only withstand 22 lbs)
2. Avoid contact with S0 Radiator

Warnings:

1. The TDK tie rods and hold down beams are potential pinch point hazards at hinges
2. Avoid contact with buckles on SMDP bundle orange straps. They have sharp edges

Timeline Considerations:

1. Once any bolts are untorqued, TDK is not certified for landing. SMDP adapter magnetic latches can be cycled and TDK fixator handles can be opened prior to CH 1/4 power up
2. Wire Ties are reqd for TDK landing loads
3. SMDP bundles can be released from ICC and attached to SMDP adapter in any order
4. TDK primary bolts and tie rods can be released in any order
5. Bundles are required to be installed at specific, labeled sockets on SMDP adapter to accommodate clearances on PMA 3

SMDP Mass:

Bundle #2: 48 kg (106 lbs)
 Bundle #3: 56 kg (123 lbs)
 Bundle #4: 45 kg (99 lbs)
 SMDP Adapter: 24 kg (53 lbs)
 Christmas Tree: 173 kg (380 lbs)

Z1-005 PATCH PANEL 1 RECONFIGURATION (00:10)

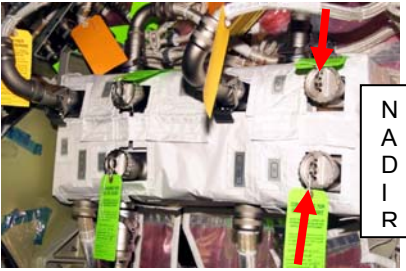
IV	EV1 (FF)	
<p>1. Verify w/MCC: Z1 PP 1 inhibits in place: (SODF: ASSY OPS: Z1 CPP X1 (SPDA Z14B) Reconfig, steps 3 and 4) complete (DDCU S04B Conv – off) Verify 2B array > 15 deg to wake</p>  <p>J3</p> <p>J1 Z1-005 PP 1</p> <p>2. Notify MCC Z1-005 PP 1 connections complete</p>	<p>← □</p> <ol style="list-style-type: none"> 1. Translate to Z1 port face 2. Translate to nadir patch panel <p style="text-align: center;"><u>NOTE</u> √Connectors for damage, FOD, bent pins, and cable bend radii, and EMI band</p> <div style="border: 1px solid black; padding: 5px; text-align: center;"> <p><u>CAUTION</u> Avoid contact with PCU grates and S0 radiator</p> </div> <ol style="list-style-type: none"> 3. BRT to HR Z1 6011 as reqd 4. Remove connector cap from J1; temp stow 5. Demate Z1 P1 (W10) from Z1 J3; mate to Z1 J1 6. Install connector cap on J3 7. □ connector closeout <p>← □</p>	

Z1-005 PATCH PANEL 1 RECONFIGURATION TASK DATA SHEET

Tools: N/A

Notes:

1. √Connectors for damage, FOD, bent pins, and cable bend radii, and EMI band

EVA Fasteners: N/A

Cautions:

1. Avoid contact with PCU grates and S0 radiator

Warnings: N/A







EVA Connections:

Connector	From	To	Clamps	Size	Function
Z1 P1 (W10)	Z1 J3	Z1 J1	3	25	Secondary Pwr DDCU S04B to SPDA Z14B

Timeline Considerations:

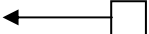
1. Z1 Patch Panel 1 Reconfig must be performed as a separate power down from 1/4 Reconfig. This is due to the short thermal clock for the KU-Band antenna

RUSSIAN POWER RECONFIGURATION (00:30)

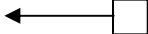
IV	EV1 (FF)	EV2 (FF)
<p>1. Verify w/MCC: Russian Reconfig inhibits in place: (SODF: ASSY OPS: Z1 CPP X1 (SPDA Z14B) Reconfig, step 5) complete (RPCM Z13B A RPC 01 Op) (RPCM Z13B A RPC 03 Op) (MBSU 3 RBI 05 Op) J650 J651</p>  <p>Z1 NADIR/STBD (shows launch config)</p> <p>H-Jumper wire tied to FGB HR</p>  <p>H-JUMPER W/BOOTIES</p>	<div style="text-align: center;">  <p>NOTE</p> <p>√Connectors for damage, FOD, bent pins, and cable bend radii, and EMI band</p> <div style="border: 1px solid black; padding: 5px; margin: 10px auto; width: 80%;"> <p style="text-align: center;">CAUTION</p> <p style="text-align: center;">Avoid contact with S0 radiator and SASA antennas</p> </div> <p><u>Z1 TO NODE 1 CONNECTIONS</u></p> <ol style="list-style-type: none"> 1. Translate to Node 1 stbd/zenith, release fairlead above Z1 MBM to P6 HR 5308 2. Open TA clamps as reqd 3. Demate Z1 P151 (W32C) from Node 1 J651 4. Restrain connector on MWS 5. Translate to Z1 stbd/nadir face 6. BRT or MWS EE to A/L HR 0522 7. Inspect and mate: Z1 P151 to Z1 J651 (outboard) 8. Close TA clamps as reqd 9.  connector closeout <p><u>S0 TO NODE 1 CONNECTIONS</u></p> <ol style="list-style-type: none"> 1. Translate to stbd S0 swingarm 2. Release TA clamps as reqd 3. Demate S0 P651 (W4014) from S0 J872; mate to Node 1 J651 4.  connector closeout 5. Translate to S0/N1 Pwr cable bundle on S0 tray 6. Wire tie S0/N1 Pwr cable to S0 tray fwd/stbd HR 7.  connector closeout </div>	<div style="text-align: center;">  <p><u>H-JUMPER REMOVAL (CHANNEL 2/3) – STBD</u></p> <p>NOTE</p> <p>√Connectors for damage, FOD, bent pins, and cable bend radii, and EMI band</p> <div style="border: 3px double black; padding: 10px; margin: 10px auto; width: 90%;"> <p style="text-align: center;">WARNING</p> <p style="text-align: center;">Wire ties may break and cause sharp edges and debris</p> </div> <div style="border: 1px solid black; padding: 10px; margin: 10px auto; width: 80%;"> <p style="text-align: center;">CAUTION</p> <p style="text-align: center;">Avoid contact with MDM sunshade</p> </div> <ol style="list-style-type: none"> 1. Translate to zenith PMA1/FGB – stbd (via aft of A/L) 2. BRT or MWS end effector to FGB HR 1035 (stbd of SVS) 3. Remove thermal booties from PMA1-P20, PMA1-P21, and H-jumper 4. Take PMA1 connector bails on panel A9 to soft dock posn: <ul style="list-style-type: none"> <input type="checkbox"/> PMA1 – P20 <input type="checkbox"/> PMA1 – P21 5. Remove wire tie from H-jumper, stow on MWS 6. Remove H-Jumper by demating the following connectors (4): <ul style="list-style-type: none"> <input type="checkbox"/> Jumper J20a from FGB P20 <input type="checkbox"/> Jumper J21a from FGB P21 <input type="checkbox"/> Jumper P20a from PMA1 J20 <input type="checkbox"/> Jumper P21a from PMA1 J21 7. Stow H-Jumper on MWS 8. Inspect and mate: </div>

RUSSIAN POWER RECONFIGURATION (00:30) (Cont)

IV	EV1 (FF)	EV2 (FF)
<p>2. Inform MCC when EV1 and EV2 Russian connections complete</p>	<p>← <input type="checkbox"/></p>	<ul style="list-style-type: none"> <input type="checkbox"/> FGB P20 to PMA1 J20 <input type="checkbox"/> FGB P21 to PMA1 J21 <p>9. Take PMA1 connectors to hard dock:</p> <ul style="list-style-type: none"> <input type="checkbox"/> PMA1 P20 to J20 <input type="checkbox"/> PMA1 P21 to J21 <p>10. <input type="checkbox"/> connector closeout</p> <p>11. Re-install thermal booties</p> <p>← <input type="checkbox"/></p>

RUSSIAN POWER RECONFIGURATION TASK DATA SHEET

Tools: N/A

EVA Fasteners: N/A

EVA Connections:

Connector	From	To	Clamps	Size	Function
Z1 P151 (W32C)	Node 1 J651	Z1 J651	4	25	Dcnet SM Power from Z1 SPDA
S0 P651 (W4014)	S0 J872	Node 1 J651		25	Cnct SM Power to MBSU 3
PMA1 P20	Softdock			25	
PMA1 P21	Softdock			25	
Jumper J20a	FGB P20			25	H-Jumper Removal (PMA 1B SEC PWR)
Jumper J21a	FGB P21			25	H-Jumper Removal (PMA 1D PRI PWR)
Jumper P20a	PMA 1 J20			25	H-Jumper Removal (PMA 1B SEC PWR)
Jumper P21a	PMA1 J21			25	H-Jumper Removal (PMA 1D PRI PWR)
FGB P20		PMA1 J20		25	FGB ARCU power from Z1 SPDA
FGB P21		PMA1 J21		25	SM CHT power from MBSU 3
PMA1 P20		J20		25	FGB ARCU power from Z1 SPDA
PMA1 P21		J21		25	SM CHT power from MBSU 3
S0/N1 Pwr Cable P651A		Node 1 J651 (stage)		25	Not performed on 12A.1

Notes:

- √Connectors for damage, FOD, bent pins, and cable bend radii, and EMI band
- H-Jumper Note:
 - J20a is a pin; P20 is a socket
 - P20a is a socket; J20 is a pin
 - J21a is a pin; P21 is a socket
 - P21a is a socket; J21 is a pin

Cautions:

- Avoid contact with S0 radiator and SASA antennas
- Avoid contact with MDM sunshade

Warnings:

- Wire ties may break and cause sharp edges and debris

Timeline Considerations:

- Russian Reconfig must be performed as a separate power down from 1/4 Reconfig
- The CH 1/4 H-Jumper will only be removed if the "S0/N1 SM Pri Pwr EVA Cable" gets plugged into the Node during EVA 3 (not the current plan)
- Per FOR, the Z1 P150 and S0 P650 connections will not be performed; this is based on the fact that the CH 1/4 H-jumper is still installed (the 4B tasks are deleted here)

AGB TRANSFER TO FHRC (00:45)

IV	EV1 (FF)	EV2 (FF)
	<p><u>RETRIEVE AGB FROM AIRLOCK</u></p> <ol style="list-style-type: none"> 1. Translate to airlock 2. Ingress airlock <div data-bbox="961 493 1619 586" style="border: 1px solid black; padding: 5px; margin: 10px auto; width: fit-content;"> <p style="text-align: center;"><u>CAUTION</u> Avoid contact with AGB target pin and grapple shaft</p> </div> <ol style="list-style-type: none"> 3. Retrieve AGB using the following steps: <ul style="list-style-type: none"> ❑ Release adjustable tethers (2) from AGB ❑ Maintain constant visual on grapple shaft and target pin ❑ Holding AGB, egress airlock feet first 4. Attach AGB to BRT <p><u>AGB INSTALL ONTO FHRC</u></p> <ol style="list-style-type: none"> 1. Translate to stbd side of FHRC on ESP2 (fwd/nadir/center) 2. Orient AGB such that T-handle is zenith 3. Pull T-handle out to unlock (see 2 white lines) 4. Extend AGB out to position wider than FHRC 5. Slide single pin end into stbd receptacle until aligned with FHRC position indicator line 6. Push T-handle in to lock (no lines visible) 	<p><u>RETRIEVE AGB FROM AIRLOCK</u></p> <ol style="list-style-type: none"> 1. Translate to airlock 2. Stow H-jumper on fish stringer #2 <ol style="list-style-type: none"> 3. Assist EV1 as reqd 4. Close airlock thermal cover <p><u>AGB INSTALL ONTO FHRC</u></p> <ol style="list-style-type: none"> 1. Translate to port side of FHRC on ESP2 (fwd/nadir/center) 2. Release AGB attach flaps (3) (velcro holds them open) 3. Install AGB 2-pin side into port receptacles on FHRC (soft dock), react EV1 loads

AGB TRANSFER TO FHRC (00:45) (Cont)

IV	EV1 (FF)	EV2 (FF)
	<ol style="list-style-type: none">7. Release tether8. Receive PGT from EV29. PGT [A2, CW2, 30.5]-2"-Ext-7/16: Drive AGB bolt, 2-4 turns (hard stop) (preps it for grapple)10. Take digital stills of AGB from various angles, specifically the RMS target pin	<ol style="list-style-type: none">4. Transfer PGT to EV1 (stay tethered) 5. Take digital stills of AGB from various angles, specifically the RMS target pin

AGB TRANSFER TO FHRC TASK DATA SHEET

Tools:

EV1	EV2
	PGT with 2-in x 7/16

Foot Restraints: N/A

EVA Fasteners:

Fastener Name	Label	Head Size	Qty	Install Torque (ft-lbs)	Failure Torque (ft-lbs)	Turns	RPM
Center Drive Pin	4	7/16"	1	3.8	5.7 (overload fwd leg pin & retainer)	~2-4	30 CW

AGB Mass: 34 kg (75 lbs)

Notes:

- The AGB is tethered inside the A/L using 2 adj tethers:
 - AGB grapple pin shall be low-profile and not block IV hatch (determine best config on-orbit)
 - Single pin side is tethered from AGB tether point to TBD zenith HR and back onto AGB tether point
 - Double pin side is tethered from AGB HR to UIA HR
- A RAD with 2-inch socket may be needed to access AGB bolt because of tight clearances with UTA on ESP2

Cautions:

- Avoid contact with AGB target pin and grapple shaft

Warnings: N/A

Other: The flight AGB retracted length (NTA setting) is: ~38.4"
The NBL AGB retracted length (NTA setting) -s: ~37.3"

CLEANUP (00:20)

IV	EV1 (FF)	EV2 (FF)
	<p>1. Translate to airlock 2. Perform tool inventory</p> <p><u>POST EVA TOOL CONFIG</u></p> <ul style="list-style-type: none"> <input type="checkbox"/> Sm-sm RETs (3): _____ <input type="checkbox"/> Adj tether: _____ <input type="checkbox"/> Wire Ties (0): _____ (used for S0/N1 pwr cable) <input type="checkbox"/> Trash bag: _____ <ul style="list-style-type: none"> <input type="checkbox"/> (may have a broken wire tie) <input type="checkbox"/> Camera: _____ <input type="checkbox"/> BRT <input type="checkbox"/> Waist tether: _____ <input type="checkbox"/> Fish Stringer #1: _____ <ul style="list-style-type: none"> <input type="checkbox"/> PGT w/6-in socket w/RET <input type="checkbox"/> S1 DDCU Thermal Cover w/adj <input type="checkbox"/> S0 DDCU Thermal Cover w/adj <input type="checkbox"/> S0 CH 1/4 jumper caps (2) <input type="checkbox"/> 55' safety tether <input type="checkbox"/> 85' safety tether (still wearing) <p><u>GET-AHEAD</u></p> <p>1. Relocate APFR from A/L WIF 1 to CETA 2 WIF 1 (on port TFR), configure to: [1,NN,E,1]</p>	<p>1. Translate to airlock 2. Transfer PGT w/2-in (w/RET & adj) to fish stringer 2 3. Perform tool inventory</p> <p><u>POST EVA TOOL CONFIG</u></p> <ul style="list-style-type: none"> <input type="checkbox"/> Sm-sm RETs (2): _____ <input type="checkbox"/> Lg-sm RET: _____ <input type="checkbox"/> Adj tethers (3): _____ <input type="checkbox"/> Short Wire Ties (3): _____ Long Wire Ties (2)___ <input type="checkbox"/> Trash bag: _____ <ul style="list-style-type: none"> <input type="checkbox"/> (may have broken wire ties) <input type="checkbox"/> Strela Adapter latch covers (3) <input type="checkbox"/> Camera: _____ <input type="checkbox"/> BRT <input type="checkbox"/> Waist tether: _____ <input type="checkbox"/> Fish Stringer #2: _____ <ul style="list-style-type: none"> <input type="checkbox"/> 55' safety tether <input type="checkbox"/> CIDs 1 and 2 <input type="checkbox"/> PAD w/WIF adapter <input type="checkbox"/> 85' safety tether (still wearing) <input type="checkbox"/> PGT w/2-in socket (w/RET and adj) <input type="checkbox"/> H-Jumper (CH 2-3) <p><u>GET-AHEAD</u></p> <p>1. Relocate APFR from ESP2 WIF 8 to CETA 2 WIF 2 (on stbd TFR), configure to: [3,TT,F,12]</p>

INGRESS (00:20)

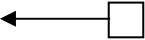
IV	EV1 (FF)	EV2 (FF)
<p>1. Perform WVS PWRDN (PHOTO/TV, <u>WVS CUE CARD</u>)</p>	<ol style="list-style-type: none"> 1. Disconnect EV2's 85' safety tether from airlock external aft D-ring, transfer to EV2 2. Transfer fish stringer's #1 and #2 to EV2 3. Connect right waist tether to D-ring extender on airlock internal D-ring, verify ST config 4. Disconnect 85' safety tether from airlock external fwd D-ring, stow on MWS 5. Ingress airlock 6. Retrieve SCU, remove DCM cover 7. Connect SCU to DCM, √locked 8. DCM: water – OFF 9. Hatch thermal cover – close; attach Velcro strap <div data-bbox="982 951 1623 1036" style="border: 1px solid black; text-align: center; padding: 5px; margin: 10px auto; width: fit-content;"> <p><u>CAUTION</u> Do not close hatch until EMU water – OFF for 2 min</p> </div> <ol style="list-style-type: none"> 10. Verify hardware clear of hatch 11. Outer hatch – close and lock 12. Go to PRE REPRESS 	<div style="text-align: center; margin-bottom: 10px;">  </div> <ol style="list-style-type: none"> 1. Ingress airlock 2. Connect right waist tether UIA panel fwd D-ring, verify ST config 3. Receive 85' safety tether from EV1, stow in airlock 4. Receive fish stringer's #1 and #2 from EV1, temp stow 5. Retrieve SCU, remove DCM cover 6. Connect SCU to DCM, √locked 7. DCM: water – OFF <ol style="list-style-type: none"> 8. Go to PRE REPRESS

This Page Intentionally Blank

TOOLS AND STOWAGE

PGT CHECKOUT	8-3
760XD PGSC-PGT CONNECTION	8-4
PROGRAM PGT SETTINGS	8-4
DOWNLOAD/ERASE EVENT LOG	8-5
PGT CONTINGENCIES.....	8-6
APFR MANAGEMENT – STS-116 (12A.1).....	FS 8-7
SAFETY TETHER CONFIGURATION	FS 8-8
PORT LIGHTWEIGHT TOOL STOWAGE ASSEMBLY.....	FS 8-9
TOOLBOX STOWAGE	FS 8-10
TOOLBOX PANEL AND SLOT LABELS	FS 8-11
Z1 TOOLBOX INTERNAL LAYOUT	FS 8-12
AIRLOCK TOOLBOX INTERNAL LAYOUT.....	FS 8-13
STBD QD BAG PACK.....	FS 8-14
PORT QD BAG PACK	FS 8-15
VTE BAG AND PUMP MODULE JUMPER BAG PACK.....	FS 8-16
EMU EQUIPMENT SORTED BY ITEM	FS 8-17
EMU EQUIPMENT SORTED BY LOCATION	FS 8-19
SHUTTLE EVA TOOLS SORTED BY TOOL NAME	FS 8-21
SHUTTLE EVA TOOLS SORTED BY LOCATION	FS 8-26

This Page Intentionally Blank

APFR MANAGEMENT – STS-116 (12A.1)

APFR DESIGNATOR	APFR 1 (8A Pitch knob problem)	APFR 2	APFR 3 S/N 1005 no pitch knob prob 9A-inc12 Ingress aid	APFR 4 TS, old ORU tether (heat shield)	APFR 5 TS, old ORU tether (heat shield)	APFR 6 (heat shield)	APFR 7 S/N 1008	IAPFR 1	IAPFR 2	CRANE (ballstack, old ORU tether)	TS	ORU stanchion/T ERA (headless)
EVA 1	P4 WIF 17 [5,RR,J,12]	P4 WIF 20 [6,WW,A,10]	Z1 WIF 11 [2,TT,H,11]	Node WIF 5 [6,PP,B,12]	PMA1 WIF 2 [12,KK,F,6] TS pointed along node 1, zen/stbd dir	PMA1 WIF 4 [4,PP,A,6]	S0 WIF 07 [5,NN,L,12]	Z1 WIF 1 [12,PP,F,12]	Z1 WIF 3 [6,PP,F,12]	PMA1 WIF 5	S0 port wedge face	S0 port wedge face
Final Torquing (RTAS corner 3)	P4 WIF 17 [5,RR,J,12]											
Final Torquing (RTAS corner 4)		P4 WIF 20 [6,WW,A,10]										
Final Torquing (RTAS corner 1)	P4 WIF 18 [8,OO,D,12]											
Final Torquing (RTAS corner 2)		P4 WIF 19 [6,PP,L,11]										
PVRGF Transfer to SSRMS		P5 WIF 11 [9,QQ,H,12]										
Get-ahead: EVA 2 (CETA Cart) EVA 3 (SMDP)	CETA 2 WIF 03 [12,PP,F,6]	Airlock Toolbox 1 WIF [9,MM,F,12]										
EVA 2	CETA 2 WIF 03 [12,PP,F,6]	Airlock Toolbox 1 [9,MM,F,12]	Z1 WIF 11 [2,TT,H,11]	Node WIF 5 [6,PP,B,12]	PMA1 WIF 2 [12,KK,F,6]	PMA1 WIF 4 [4,PP,A,6]	S0 WIF 07 [5,NN,L,12]	Z1 WIF 1 [12,PP,F,12]	Z1 WIF 3 [6,PP,F,12]	PMA1 WIF 5	S0 port wedge face	S0 port wedge face
CETA Cart Relocation	SSRMS WIF [12,PP,F,6]											
Cleanup	ESP 2 WIF 8 [3,PP,F,12]											
EVA 3	ESP 2 WIF 8 [3,PP,F,12]	Airlock Toolbox 1 WIF [9,MM,F,12]	Z1 WIF 11 [2,TT,H,11]	Node WIF 5 [6,PP,B,12]	PMA1 WIF 2 [12,KK,F,6]	PMA1 WIF 4 [4,PP,A,6]	S0 WIF 07 [5,NN,L,12]	Z1 WIF 1 [12,PP,F,12]	Z1 WIF 3 [6,PP,F,12]	PMA1 WIF 5	S0 port wedge face	S0 port wedge face
PAD Setup		SRMS [12,PP,F,6]										
PAD Cleanup		Airlock Toolbox 1 [9,MM,F,12]										
Post-EVA 3	ESP 2 WIF 8 [3,PP,F,12]	Airlock Toolbox 1 [9,MM,F,12]	Z1 WIF 11 [2,TT,H,11]	Node WIF 5 [6,PP,B,12]	PMA1 WIF 2 [12,KK,F,6]	PMA1 WIF 4 [4,PP,A,6]	S0 WIF 07 [5,NN,L,12]	Z1 WIF 1 [12,PP,F,12]	Z1 WIF 3 [6,PP,F,12]	PMA1 WIF 5	S0 port wedge face	S0 port wedge face

SAFETY TETHER CONFIGURATION – 116

I

	#60 or #70 SN 1008 or 1020 Lg-sm Locking hooks	#60 or #70 SN 1008 or 1020 Lg-sm Locking hooks	#59 SN 1007 Sm-sm Locking hooks	#72 SN 1022 Lg-sm Locking hooks	#73 SN 1023 (or 1015) Locking hooks	#71 SN 1021 Lg-sm Locking hooks	#66 SN 1016 Sm-sm Locking hooks	#22 SN 1002 85-ft Tether Sm-sm Locking hooks	#26 SN 1006 85-ft Tether Lg-sm Locking hooks	#25 SN 1005 85-ft	#28 SN 1008 85-ft
Pre EVA1	S0 HH 3529	S0 HH 3530	INSIDE A/L Interior	INSIDE A/L Interior	INSIDE A/L Interior	A/L Ext D- ring and A/L HH 0506	A/L Ext D- ring and A/L HH 0506	INSIDE A/L Interior	INSIDE A/L Interior	Shuttle Middeck	Shuttle Middeck
Post EVA 1			INSIDE A/L Interior	INSIDE A/L Interior	INSIDE A/L Interior	INSIDE A/L Interior	INSIDE A/L Interior	A/L Ext D- ring and A/L HH 0506	A/L Ext D- ring and A/L HH 0506		
Post EVA 2			INSIDE A/L Interior	INSIDE A/L Interior	INSIDE A/L Interior	INSIDE A/L Interior	INSIDE A/L Interior	A/L Ext D- ring and A/L HH 0506	A/L Ext D- ring and A/L HH 0506		
Post EVA 3	S0 HH 3529	S0 HH 3530	INSIDE A/L Interio	INSIDE A/L Interior	INSIDE A/L Interior	INSIDE A/L Interior	INSIDE A/L Interior	INSIDE A/L Interior	INSIDE A/L Interior	Shuttle Middeck	Shuttle Middeck

PORT LIGHTWEIGHT TOOL STORAGE ASSEMBLY

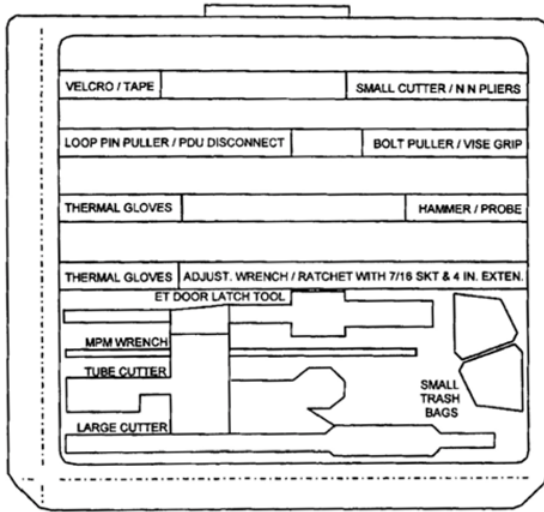
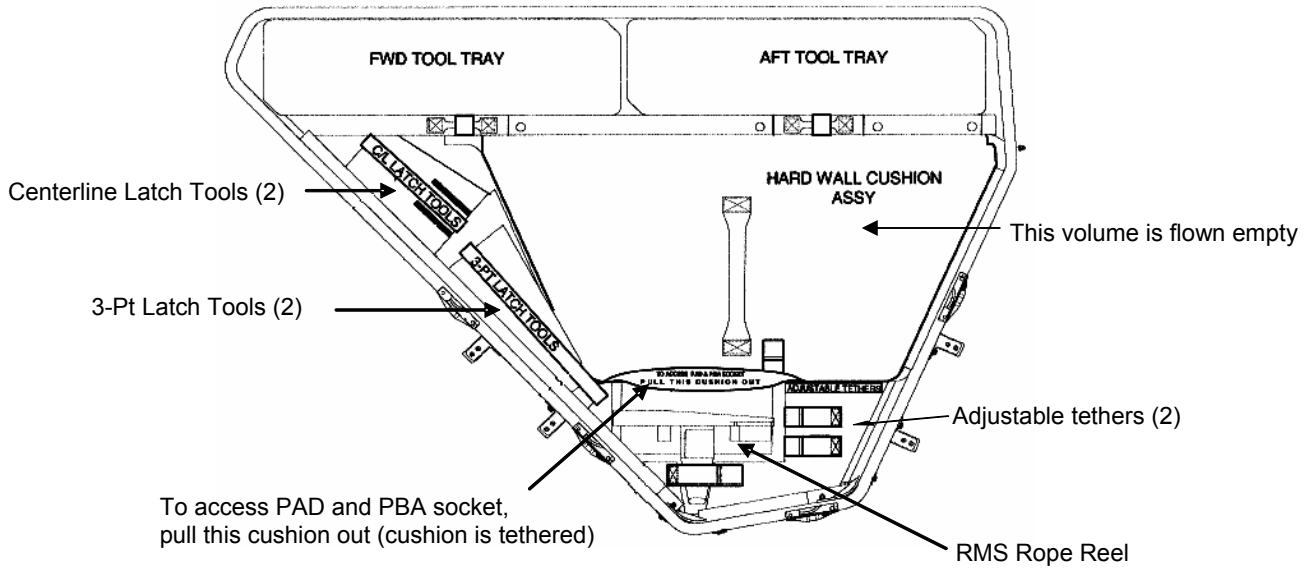

Forward Tray layout and Labels

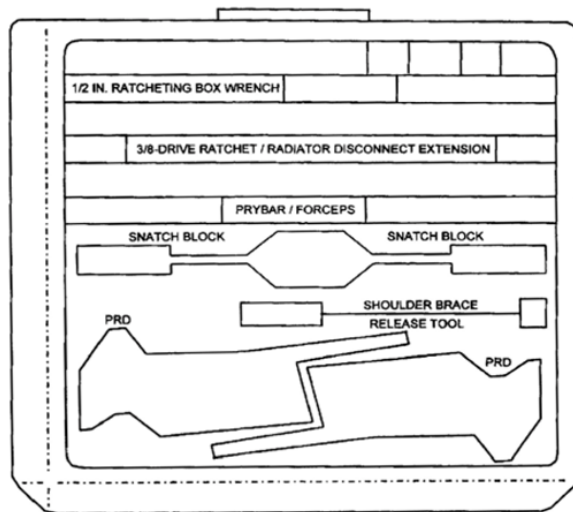

Aft Tray Layout and Labels



TOOLBOX STOWAGE

I

	Z1 PORT TOOLBOX	Z1 STBD TOOLBOX	A/L TOOLBOX 1 (STBD)	A/L TOOLBOX 2 (PORT)
SLOT # 1	SQUARE TM BOARD SQ TORQUE MULTIPLIER 7/16" FLUSH SQ SOCKET 7/16" PROUD SQ SOCKET 7/16" RECESSED SQ SOCKET	SQUARE TM BOARD SQ TORQUE MULTIPLIER 7/16" FLUSH SQ SOCKET 7/16" PROUD SQ SOCKET 7/16" RECESSED SQ SOCKET	HAMMER BOARD HAMMER	CABLE CUTTER BOARD COMPOUND CUTTERS (SM) SCISSORS
SLOT # 2		QD BAIL TOOL BOARD BMRRM LATCH TOOL QD BAIL DRIVE TOOL (1")	PLIERS BOARD NEEDLE NOSE PLIERS	
SLOT # 3	RATCHET BOARD 3/8" DRIVE RATCHET 7/16" X 12" WOBBLE SOCKET 7/16" X 2" RIGID SOCKET	RATCHET BOARD 3/8" DRIVE RATCHET 7/16" X 6" WOBBLE SOCKET		
SLOT # 4				
SLOT # 5	ROUND TM BOARD RND TORQUE MULTIPLIER 5/8" PROUD RND SOCKET 7/16" FLUSH RND SOCKET 7/16" PROUD RND SOCKET	ROUND TM BOARD 7/16" FLUSH RND SOCKET 7/16" PROUD RND SOCKET	ADJ WRENCH BOARD FORCEPS WRENCH, ADJ	T-HANDLE TOOL BOARD 1-3" T-TOOLS 2-8" T-TOOLS
SLOT # 6	TRASH BAG BOARD LARGE TRASH BAG SMALL TRASH BAG	TRASH BAG BOARD	HYDRAZINE BRUSH BOARD HYDRAZINE BRUSH	
SLOT # 7	SOCKET BOARD 5/32" BALL END ALLEN DR 1/2" X 8" WOBBLE SOCKET 5/16" X 7" RIGID SOCKET	SOCKET BOARD 5/32" BALL END ALLEN DR 1/2" X 8" WOBBLE SOCKET 5/16" X 7" RIGID SOCKET	PRD (Toolboard) PRD	PRD (Toolboard) PRD
PANEL # 8	CHEATER BAR PANEL ADJ EQUIP TETHER	CHEATER BAR PANEL CHEATER BAR ADJ EQUIP TETHER	TOOL CADDY PANEL CADDY, ISS (BUNGEE)	
PANEL # 9	18" SOCKET PANEL 7/16" X 18" WOBBLE SOCKET	18" SOCKET PANEL	BOLT PULLER PANEL BOLT PULLER MECHANICAL FINGER	LARGE CUTTER PANEL GP CUTTER (LARGE)
EXTERNAL	1 SQUARE SCOOP 1 ROUND SCOOP D-HANDLE	2 SQUARE SCOOPs D-HANDLE		

TOOLBOX PANEL AND SLOT LABELS

NOTE

- A/L Toolbox: Slider feature located in center slot only (#3)
- CETA Toolbox: Slider feature located in all slots

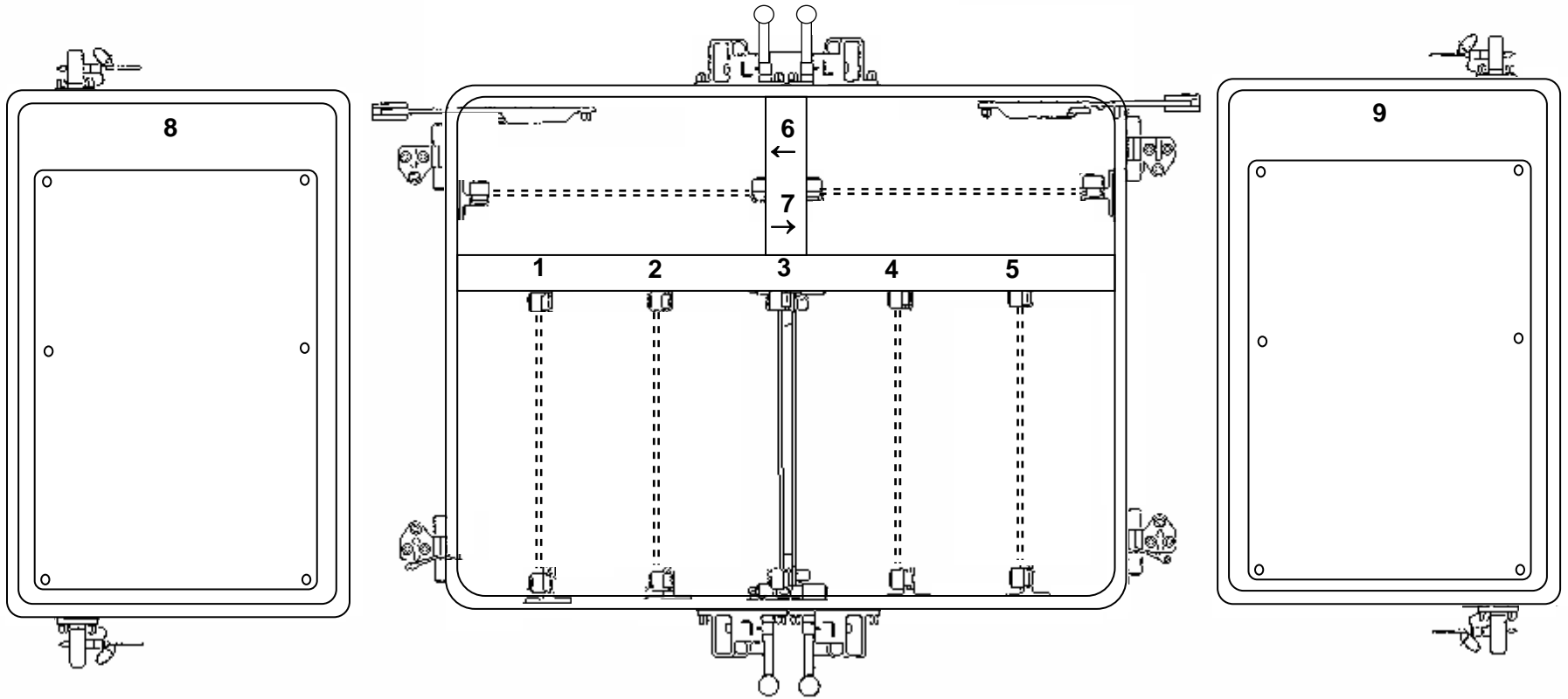

Z1 TOOLBOX INTERNAL LAYOUT

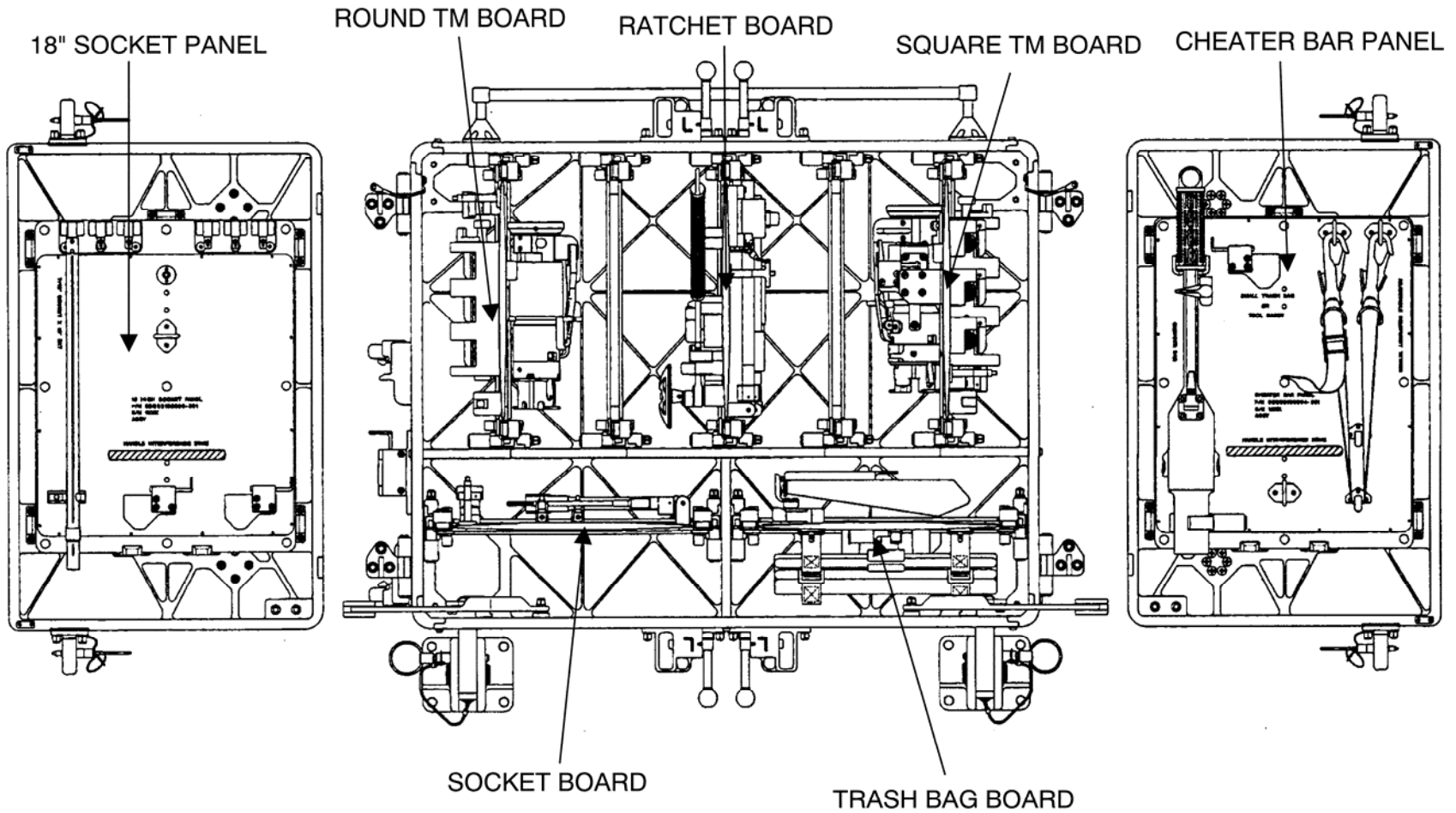

DOORS SHOWN REMOVED AND ROTATED 180° FROM CLOSED POSITION FOR CLARITY.

AIRLOCK TOOLBOX INTERNAL LAYOUT

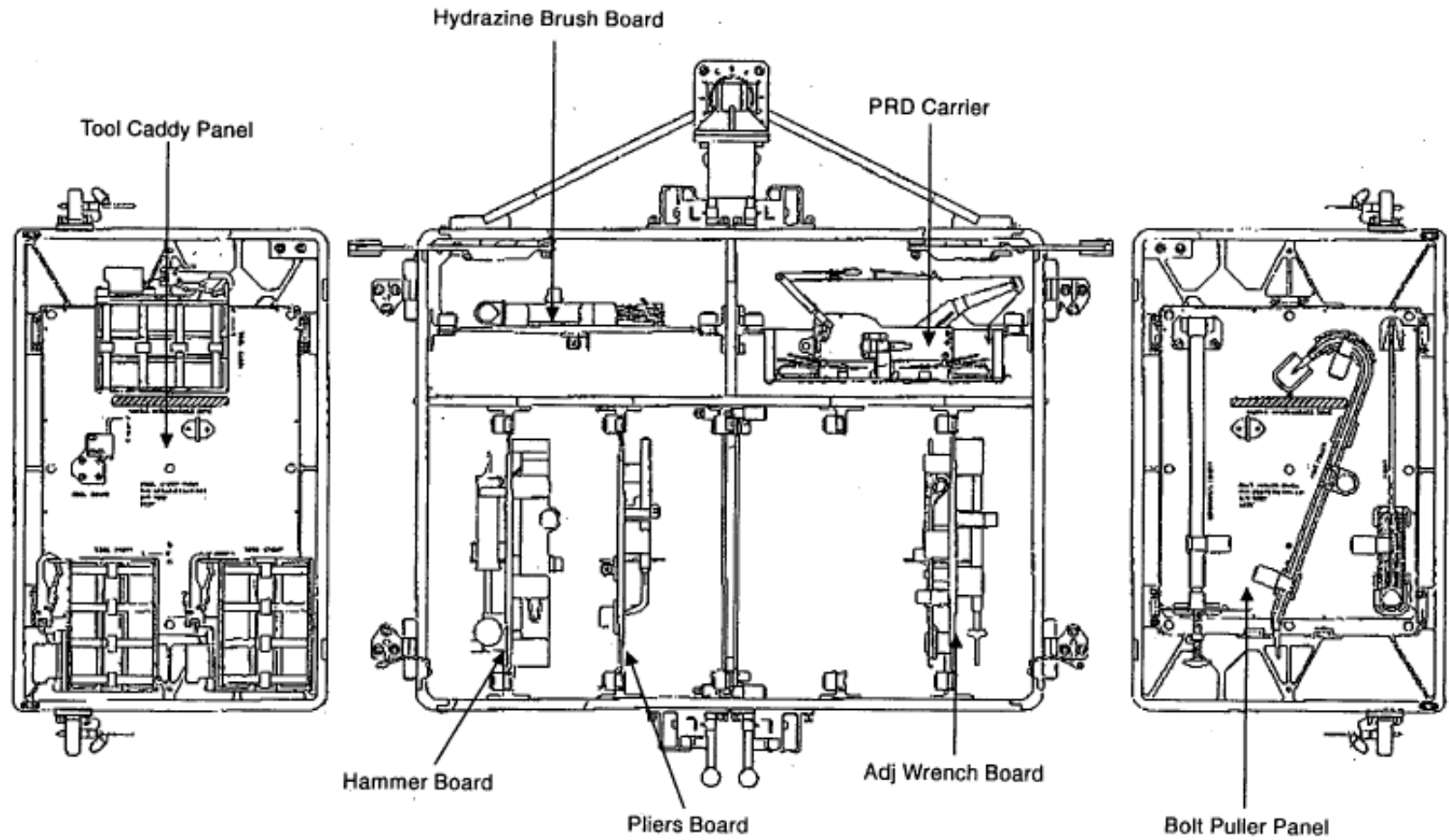

STBD QD BAG PACK

NOTE

QD tools in rows 1 through 10 that are grayed out have been pre-packed by ISS crew

1. Retrieve INC 14 pre-packed "STBD QD BAG" from temp stow area
2. Retrieve "5 MLE bag" from temp stow area
3. Remove Port QD Bag from 5 MLE bag, temp stow (leave all foam in 5 MLE bag)
4. Pack "STBD QD BAG" using vent tools (3) in rows 11-13 from "5 MLE Bag" per table below
5. Add gap spanners to Port and Stbd QD bags per EVA 2 tool config
6. Perform photo closeout of internal stowage of Stbd QD Bag when complete

STBD QD BAG (SEG33114667-301)			
#	TOOL	PART#	LOCATION IN BAG
1.	1/4" cap tool	GD2043725	<input type="checkbox"/> 1/4" cap tool (pocket)
2.	1/2" cap tool	GD2043730	<input type="checkbox"/> 1/2" cap tool (pocket)
3.	1" cap tool	GD2043325	<input type="checkbox"/> 1" cap tool (pocket)
4.	3/4" & 1' QD Bail Drive lever	SDG33113838-703	<input type="checkbox"/> 3/4" & 1' QD Bail Drive Lever pouch on lid
5.	1.5" QD Bail Drive Lever	SDG33113837-701	<input type="checkbox"/> 1.5" QD bail Drive Lever pouch on lid
6.	1.5" QRT & FID Gauge	SEG33114617-701	<input type="checkbox"/> 1.5" QRT & FID Gauge (pocket)
7.	3/4" & 1" QRT & FID Gauge	SEG33114616-701	<input type="checkbox"/> 3/4" & 1" QRT & FID Gauge (pocket)
8.	1" H2O/N2 Vent Tool – F	1F98593-1	<input type="checkbox"/> 1" H2O/N2 Vent Tool – F (pocket)
9.	1" NH3/N2 Vent Tool – F	1F98589-1	<input type="checkbox"/> 1" NH3/N2 Vent Tool – F (pocket)
10.	1" NH3/N2 Vent Tool – M	1F98596-1	<input type="checkbox"/> 1" NH3/N2 Vent Tool – M (pocket)
11.	1.5" NH3/N2 Vent Tool – F	1F9859-1	<input type="checkbox"/> 1.5" NH3/N2 Vent Tool – F (pocket)
12.	3/4" NH3/N2 Vent Tool – F	1F98597-1	<input type="checkbox"/> 3/4" NH3/N2 Vent Tool – F (pocket)
13.	1/4" NH3/N2 Vent Tool – F	1F98592-1	<input type="checkbox"/> 1/4" NH3/N2 Vent Tool – F (pocket)

- Ensure cap tools (3) are friction fitted
- Close all QRT tool flaps (2)
- Close all vent tool flaps (6)

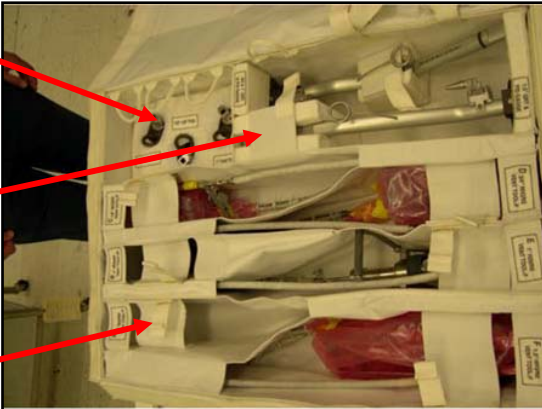

- Close bail drive lever flaps (2)
- Internal bag straps (2) should be stowed in pouches

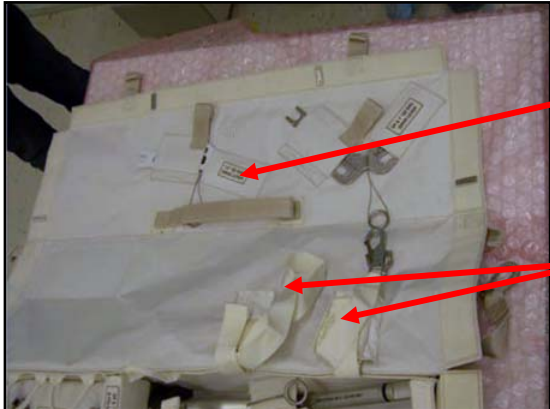

PORT QD BAG PACK

NOTE

QD vent tools in rows 3 thru 7 that are grayed out launch in place inside Port QD Bag

1. Retrieve "PORT QD BAG" from 5 MLE Bag, re-attach insert velcro to bag wall velcro, temp stow bag (leave all foam in 5 MLE bag)
2. Retrieve 1.0 CTB, temp stow
3. Retrieve adjustable tethers (4) and gap spanners (4) from 1.0 CTB, temp stow
4. Retrieve "PORT QD BAG and VTE BAG" that INC 14 crew pre-packed from temp stow area
5. Retrieve remaining QD tools from 5 MLE Bag and "PORT QD Bag and VTE Bag" and pack into port QD bag per table below:
6. Add gap spanners to Port and Stbd QD bags per EVA 2 tool config
7. Perform photo closeout of internal stowage of Port QD Bag when complete

PORT QD BAG (SEG33114667-301/1001)			
#	TOOL	PART #	LOCATION IN BAG
1.	1/4" cap tool	GD2043725	<input type="checkbox"/> 1/4" cap tool (pocket)
2.	1/2" cap tool	GD2043730	<input type="checkbox"/> 1/2" cap tool (pocket)
3.	1.5" NH3/N2 Vent Tool – F	1F9859-1	<input type="checkbox"/> 1.5" NH3/N2 Vent Tool – F (pocket)
4.	1" H20/N2 Vent Tool – F	1F98593-1	<input type="checkbox"/> 1" H20/N2 Vent Tool – F (pocket)
5.	3/4" NH3/N2 Vent Tool – F	1F98597-1	<input type="checkbox"/> 3/4" NH3/N2 Vent Tool – F (pocket)
6.	1" NH3/N2 Vent Tool – M	1F98596-1	<input type="checkbox"/> 1" NH3/N2 Vent Tool – M (pocket)
7.	1/4" NH3/N2 Vent Tool – F	1F98592-1	<input type="checkbox"/> 1/4" NH3/N2 Vent Tool – F (pocket)
8.	Vent Tool Adapters (2)	SEG33119079-301	<input type="checkbox"/> One VTA goes in the 3/4" & 1" QRT & FID Gauge pouch; the other goes in the 1.5" QRT & FID Gauge pouch <input type="checkbox"/> Each VTA must be tethered inside the bag using 1 adj tether for each <input type="checkbox"/> See picture B
9.	1/4" BDT	SEG33114984-301	<input type="checkbox"/> Stowed on top of 1/4" Vent Tool <input type="checkbox"/> Must be tethered to inside of bag using 1 adj <input type="checkbox"/> See picture A
10.	3/4" BDT	SEG33114986-301	<input type="checkbox"/> Stowed on top of 1/4" Vent Tool, tethers to bag internal loops using BDT integral tether <input type="checkbox"/> See picture A
11.	3/4" AKT	SEG33114983-301	<input type="checkbox"/> Stowed with vent tool adapters in QRT & FID pouches <input type="checkbox"/> Must be tethered to inside of bag using 1 adj <input type="checkbox"/> See picture A

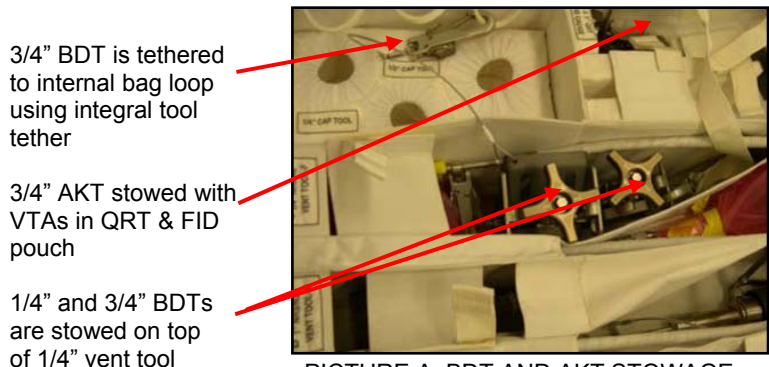

PICTURE A: BDT AND AKT STOWAGE

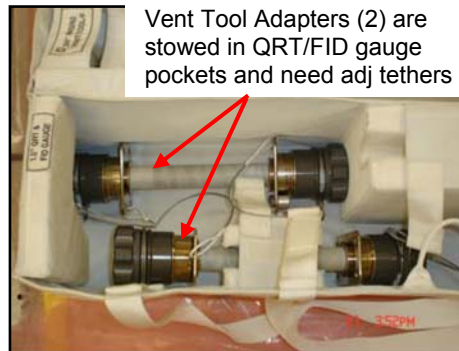

PICTURE B: VENT TOOL ADAPTER STOWAGE

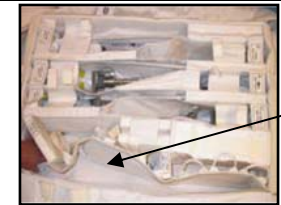

Port QD Bag launch config with insert peeled back

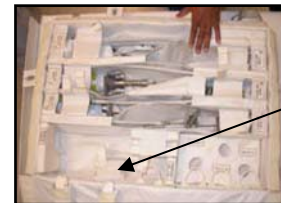

Port QD Bag with insert re-attached to bag wall

VTE BAG AND PUMP MODULE JUMPER BAG PACK

I

1. Retrieve "VTE BAG" (VTEB 01) from temp stow area
2. Retrieve "Pump Module Jumper Bag" (VTEB 02) from temp stow area
3. Retrieve the 1-in NH3/N2 Vent Tool – F (1F98589-1) from the 1.0 CTB
4. Retrieve MUT EE from INC 14 pre-packed "PORT QD BAG & VTE BAG"
5. Perform photo closeout of internal stowage of both bags when complete

VTE BAG PACK

1. Remove VTE from VTE Bag
2. Perform visual check that 1-in vent tool nozzle will protrude past VTE internal seals:
 - ❑ Hold vent tool nozzle against VTE external alignment groove (vent tool hook should contact VTE connector)
 - ❑ ✓Nozzle tip is past thin black alignment line
3. Install 1-in vent tool nozzle into VTE connector via the following steps:
 - ❑ Rotate lock lever to unlock (hard stop detent – very loose)
 - ❑ Depress lever to hard stop (2-10 lb)
 - ❑ Insert vent tool nozzle into connector tube (vent tool hook will contact front of connector, go to hard stop)
 - ❑ Release lever and rotate lock
4. Install MUT EE onto VTE nozzle 90 degree bracket ECOM fitting
5. Install 1-in vent tool and VTE inside VTE bag, install internal Velcro straps and tethers
6. Close bag lid



VTE Seal Check



Vent Tool Nozzle Install onto VTE



Vent tool & VTE Installed in VTE Bag

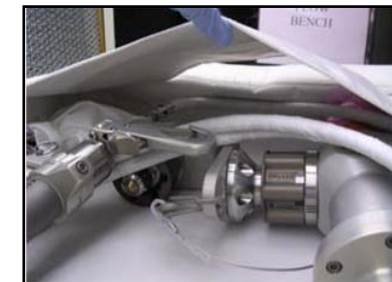

Vent tool & VTE Installed in VTE Bag – pouch view

PM JUMPER BAG PACK

1. Open Pump Module Jumper bag lid
2. Verify Pump Module Jumper tethered inside bag using integral hooks
3. Close bag lid

EMU EQUIPMENT SORTED BY ITEM

I

ITEM	LOCATION	QTY	S/N
3/8 Drive Ratchet w/7/16 Socket	EVA Airlock Accessory Bag (Shuttle) 1014	1	108
Arm Sizing Ring Protective Pouch (0.5")	EMU 3018 (Fg/W)	1	
Bends Treatment Adapter (BTA)	MF43K	1	1003
Boots (pr) – (W)	EXT A/L Floor Bag	1	203
BSC Contingency Tool	EMU Equip Bag Assy	1	5015
Comfort Gloves – custom (pr)	ECOK (Fg)	2	
Comfort Gloves – Spectra (-04) (pr)	ECOK (W)	4	
Comfort Gloves – Spectra (-08) (pr)	ECOK (W)	4	
Comfort Gloves – Spectra (pr)	ECOK (Cr)	3	
Comm Cap Assy (CCA) – (Cr prime & b/u)	EMU 3003 (Cr)	2	1166 (pr) 1165(b/u)
Comm Cap Assy (CCA) – (Fg prime)	EMU 3018 (Fg/W)	1	1203
Comm Cap Assy (CCA) – (W prime)	EXT A/L Floor Bag	1	1194
Contaminant Control Cartridge (CCC), EMU LiOH	EMU 3003 (Cr)	1	2024
	EMU 3018 (Fg/W)	1	2025
	EXT A/L Floor Bag	2	2018 2019
	MD CEIL (PORT 1)	6	2014 2016 2020 2021 2022 2023
Contamination Detection Kit (CDK)	MD FLOOR (STBD 1)	1	1002
Crewlock DEPRESS/REPRESS Cue Card	MF57H	2	
Crewlock DEPRESS/REPRESS Without IV Cue Card	MF57H	1	
Croakie (MOD)	ECOK (Fg)	2	
Disposable In-Suit Drink Bags (DIDB)	EXT A/L Floor Bag	1	
	EMU 3003 (Cr)	3	
	EMU 3018 (Fg/W)	2	
	MD CEIL (STBD 2)	6	
	MF57C	6	
Disposable In-Suit Drink Bags (DIDB) Restraint Bag	EMU 3003 (Cr)	1	
	EMU 3018 (Fg/W)	1	
EMU – 3003	Ext A/L Starboard	1	3003
EMU – 3018	Ext A/L Port	1	3018
EMU 3-Micron Filter	EXT A/L Floor Bag	3	1026
			1027
			1028
EMU Battery (ICB)	EMU 3003 (Cr)	1	2057
	EMU 3018 (Fg/W)	1	2058
	EXT A/L Floor Bag	1	2061
EMU Battery (ICB) Charger	EXT A/L Floor Bag	1	1001
EMU Equip Bag Crew Specific Compartment	Volume H, OTBD	2	1033
			1038
EMU Equip Bag Trash Bag	EMU Equip Bag Assy	1	1036
EMU Equip Bag Trash Liner	EMU Equip Bag Assy	5	
EMU Equipment Bag Assy	Volume H, INBD	1	1031
EMU Helmet/EVVA	EMU 3003 (Cr)	1	1061
	EMU 3018 (Fg/W)	1	1063
EMU Mirror Assy	EMU 3003 (Cr)	2	1009 1013
	EMU 3018 (Fg/W)	2	5011 5028
EMU Servicing Kit	Volume H, INBD	1	5002
EMU Water Processing Kit	MD FLOOR (STBD 1)	1	
EVA Adjustable Wrench	EVA Airlock Accessory Bag (Shuttle) 1015	1	116
EVA Airlock Accessory Bag (Shuttle)	Volume H, OTBD	1	1014
EVA Crew Options Kit (ECOK) – (Cr)	EMU 3003 (Cr)	1	
EVA Crew Options Kit (ECOK) – (Fg)	EMU 3018 (Fg/W)	1	
EVA Crew Options Kit (ECOK) – (W)	EXT A/L Floor Bag	1	

EMU EQUIPMENT SORTED BY ITEM (Cont)

ITEM	LOCATION	QTY	S/N
EVA Cuff Checklist – ISS (or located in MF71G)	MF57H	3	
EVA Cuff Checklist – STS	MF57H	3	
EVA PREBREATHE Cue Card	MF57H	2	
Fresnel Lens (-005)	ECOK (W)	1	
Fresnel Lens (-015)	ECOK (Fg)	1	
Gloves (pr) – (Cr & Fg b/u)	MD CEIL (STBD 1)	2	6207 6209
Gloves (pr) – (Cr prime)	EMU 3003 (Cr)	1	6238
Gloves (pr) – (Fg prime)	EMU 3018 (Fg/W)	1	6197
Gloves (pr) – (W prime & b/u)	EXT A/L Floor Bag	2	6047 6046
Helmet Light (EHIP)	Volume H, INBD	1	
	Volume H, OTBD	1	
Helmet Light (EHIP) Battery Pack	Volume H, INBD	2	
	Volume H, OTBD	2	
ISS CSA-O2 Resupply Kit	MD FLOOR (STBD 1)	1	
ISS EVA Systems Checklist	MF57H	3	
LCVG (Cr b/u & Fg b/u)	MD CEIL (STBD 1)	2	3204 3137
LCVG w/Biomed Hdwr – (Cr prime)	EMU 3003 (Cr)	1	3132
LCVG w/Biomed Hdwr – (Fg prime)	EMU 3018 (Fg/W)	1	3196
LCVG w/Biomed Hdwr – (W prime)	EXT A/L Floor Bag	1	3141
Leg Sizing Ring Protective Pouch (1.5")	EXT A/L Floor Bag	1	
Lower Arm – (Sw)	Spacehab	2	213 214
			2041
Lower Torso Assembly (LTA)	EMU 3003 (Cr)	1	2041
	EMU 3018 (Fg/W)	1	2057
LTA Donning Handle (pr)	EMU Equip Bag Assy	1	131 134
LTA Restraint Bag	EMU 3003 (Cr)	1	1012
	EMU 3018 (Fg/W)	1	1013
Maximum Absorption Garment (MAG)	ECOK (Cr)	11	
	ECOK (Fg)	9	
	ECOK (W)	10	
Moleskin	ECOK (Fg)	24	
MWC Flight Cover Jumper (Cooling Loop Jumper)	EMU Equip Bag Assy	2	046 044
PGT/EHIP Y-Power Charger Cable	EXT A/L Floor Bag	1	1024
SAFER (includes 1 pair of latch guards)	Spacehab	1	1006
SAFER Hand Controller Mount (DCM Plug)	EXT A/L Floor Bag	1	00006
SAFER Latch Guard, Port	EXT A/L Floor Bag	2	
	SAFER 1006	1	
SAFER Latch Guard, Starboard	EXT A/L Floor Bag	2	
	SAFER 1007	1	
Scissors	EMU Equip Bag Assy	1	
Scissors with tether	EMU 3003 (Cr)	1	
	EMU 3018 (Fg/W)	1	
Sock Liners, Thermax (pr)	ECOK (Cr)	3	
Socks, Thermal Woodsman (pr)	ECOK (W)	1	
Socks, Tube (pr)	ECOK (Fg)	2	
	ECOK (W)	4	
SOP Checkout Fixture (SCOF)	EMU Equip Bag Assy	2	1009 1010
STS EVA Checklist	MF57H	3	
STS-116 LOGISTICS Cue Card	MF57H	1	
Thermal Comfort Undergarment (TCU-top & bottom)	ECOK (Cr)	3	
	ECOK (Fg)	2	
	ECOK (W)	4	
Wristlets (pr)	ECOK (Cr)	3	
	ECOK (Fg)	2	
	ECOK (W)	4	

EMU EQUIPMENT SORTED BY LOCATION

I

LOCATION	ITEM	QTY	S/N	
ECOK (Cr)	Comfort Gloves – Spectra (pr)	3		
	Maximum Absorption Garment (MAG)	11		
	Sock Liners, Thermax (pr)	3		
	Thermal Comfort Undergarment (TCU-top & bottom)	3		
	Wristlets (pr)	3		
ECOK (Fg)	Comfort Gloves – custom (pr)	2		
	Croakie (MOD)	2		
	Fresnel Lens (-015)	1		
	Maximum Absorption Garment (MAG)	9		
	Moleskin	24		
	Socks, Tube (pr)	2		
	Thermal Comfort Undergarment (TCU-top & bottom)	2		
	Wristlets (pr)	2		
ECOK (W)	Comfort Gloves – Spectra (-04) (pr)	4		
	Comfort Gloves – Spectra (-08) (pr)	4		
	Fresnel Lens (-005)	1		
	Maximum Absorption Garment (MAG)	10		
	Socks, Thermal Woodsman (pr)	1		
	Socks, Tube (pr)	4		
	Thermal Comfort Undergarment (TCU-top & bottom)	4		
	Wristlets (pr)	4		
EMU 3003 (Cr)	Comm Cap Assy (CCA) – (Cr prime & b/u)	2	1166 (pr) 1165(b/u)	
	Contaminant Control Cartridge (CCC), EMU LiOH	1	2024	
	Disposable In-Suit Drink Bags (DIDB)	3		
	Disposable In-Suit Drink Bags (DIDB) Restraint Bag	1		
	EMU Battery (ICB)	1	2057	
	EMU Helmet/EVVA	1	1061	
	EMU Mirror Assy	2	1009 1013	
	EVA Crew Options Kit (ECOK) – (Cr)	1		
	Gloves (pr) – (Cr prime)	1	6238	
	LCVG w/ Biomed Hdwr – (Cr prime)	1	3132	
	Lower Torso Assembly (LTA)	1	2041	
	LTA Restraint Bag	1	1012	
	Scissors with tether	1		
	EMU 3018 (Fg/W)	Arm Sizing Ring Protective Pouch (0.5")	1	
		Comm Cap Assy (CCA) – (Fg prime)	1	1203
Contaminant Control Cartridge (CCC), EMU LiOH		1	2025	
Disposable In-Suit Drink Bags (DIDB)		2		
Disposable In-Suit Drink Bags (DIDB) Restraint Bag		1		
EMU Battery (ICB)		1	2058	
EMU Helmet/EVVA		1	1063	
EMU Mirror Assy		2	5011 5028	
EVA Crew Options Kit (ECOK) – (Fg)		1		
Gloves (pr) – (Fg prime)		1	6197	
LCVG w/ Biomed Hdwr – (Fg prime)		1	3196	
Lower Torso Assembly (LTA)		1	2057	
LTA Restraint Bag		1	1013	
Scissors with tether		1		
EMU Equip Bag Assy		BSC Contingency Tool	1	5015
	EMU Equip Bag Trash Bag	1	1036	
	EMU Equip Bag Trash Liner	5		
	LTA Donning Handle (pr)	1	131 134	
	MWC Flight Cover Jumper (Cooling Loop Jumper)	2	046 044	
	Scissors	1		
	SOP Checkout Fixture (SCOF)	2	1009 1010	

EMU EQUIPMENT SORTED BY LOCATION (Cont)

LOCATION	ITEM	QTY	S/N
Ext A/L Port	EMU – 3018	1	3018
Ext A/L Starboard	EMU – 3003	1	3003
EXT A/L Floor Bag	Boots (pr) – (W)	1	203
	Comm Cap Assy (CCA) – (W prime)	1	1194
	EMU 3-Micron Filter	3	1026 1027 1028
	EMU Battery (ICB)	1	2061
	EMU Battery (ICB) Charger	1	1001
	EVA Crew Options Kit (ECOK) – (W)	1	
	Contaminant Control Cartridge (CCC), EMU LiOH	2	2018 2019
	Disposable In-Suit Drink Bag (DIDB)	1	
	Gloves (pr) – (W prime & b/u)	2	6047 6046
	LCVG w/ Biomed Hdwr – (W prime)	1	3141
	Leg Sizing Ring Protective Pouch (1.5")	1	
	PGT/EHIP Y-Power Charger Cable	1	1024
	SAFER Hand Controller Mount (DCM Plug)	1	00006
	SAFER Latch Guard, Port	2	
	SAFER Latch Guard, Starboard	2	
MD CEIL (PORT 1)	Contaminant Control Cartridge (CCC), EMU LiOH	6	2014 2016 2020 2021 2022 2023
MD CEIL (STBD 1)	Gloves (pr) – (Cr & Fg b/u)	2	6207 6209
	LCVG (Cr b/u & Fg b/u)	2	3204 3137
MD CEIL (STBD 2)	Disposable In-Suit Drink Bags (DIDB)	6	
MD FLOOR (STBD 1)	Contamination Detection Kit (CDK)	1	1002
	EMU Water Processing Kit	1	
	ISS CSA-O2 Resupply Kit	1	
MF43K	Bends Treatment Adapter (BTA)	1	1003
MF57C	Disposable In-Suit Drink Bags (DIDB)	6	
MF57H	Crewlock DEPRESS/REPRESS Cue Card	2	
	Crewlock DEPRESS/REPRESS Without IV Cue Card	1	
	EVA Cuff Checklist – ISS (or located in MF71G)	3	
	EVA Cuff Checklist – STS	3	
	EVA PREBREATHE Cue Card	2	
	ISS EVA Systems Checklist	3	
	STS EVA Checklist	3	
	STS-116 LOGISTICS Cue Card	1	
MF71G	EVA Cuff Checklist – ISS (or located in MF57H)	3	
EVA Airlock Accessory Bag (Shuttle) 1014	3/8 Drive Ratchet w/7/16 Socket	1	108
	EVA Adjustable Wrench	1	116
SAFER 1006	SAFER Latch Guard, Port	1	
	SAFER Latch Guard, Starboard	1	
Spacehab	Lower Arm – (Sw)	2	213 214
	SAFER (includes 1 pair of latch guards)	1	1006
Volume H, INBD	EMU Equipment Bag Assy	1	1031
	EMU Servicing Kit	1	5002
	Helmet Light (EHIP)	1	
	Helmet Light (EHIP) Battery Pack	2	
Volume H, OTBD	EMU Equip Bag Crew Specific Compartment	2	1033 1038
	EVA Airlock Accessory Bag (Shuttle)	1	1014
	Helmet Light (EHIP)	1	
	Helmet Light (EHIP) Battery Pack	2	

SHUTTLE EVA TOOLS SORTED BY TOOL NAME

1

ITEM	COMMENT	UP	DN	LOCATION
3 Point Latch Tool	sn 1003, 1007	2	2	PLB TSA port
35 mm Camera Mounting Bracket	sn 1003,1008	2	0	SHAB SF21 (3.0 CTB)
5/32 in short Ball End Allen Driver	TPS RCC plug sn 1012	1	1	MDK Bag, Ceil Stbd 1, "G"
Adjustable Grapple Bar Assembly		1	0	SHAB SF13
Adjustable Thermal Mitten (in caddy)	sn 007	2	2	PLB TSA port, fwd tray
Adjustable Thermal Mitten (in caddy)	sn 018	2	2	PLB TSA port, fwd tray
Bag, 3 Point Latch Tool Stowage	sn HG3-366	1	1	PLB TSA port
Bag, Centerline Latch Tool	sn HF9-046A	1	1	PLB TSA port
Bag, CIPAA Containment	sn 1001	1	1	MDK MF28E/G
Bag, Crack Repair				
❑ Outer Bag Assy, Crack Repair Bag				
❑ Crack Repair Bag Assy				
❑ ETS Module, Crack Repair Bag				
❑ Inner Bag Assy, Crack Repair Bag	sn (all parts, 1004)	1	1	MDK Bag, Ceil Stbd 2, "H"
Bag, EVA Accessory (EVA Airlock Access Bag)	sn 1014	1	1	MDK Vol H, OBD
Bag, EVA Trash	sn 1005	1	1	PLB TSA port, fwd tray
Bag, Jettison Stowage – EVA 2/3 Shuttle to ISS		1	2	SHAB AP01 (5 MLE Bag)
Bag, Jettison Stowage – EVA 1 Shuttle to ISS		1		SHAB AP01 (5 MLE Bag)
Bag, Jettison Stowage – EV1		1	1	SHAB AP01 (5 MLE Bag)
Bag, Jettison Stowage – EV2		1	1	SHAB AP01 (5 MLE Bag)
Bag, Jettison Stowage – Return to Shuttle 1, 2, 3		3	3	SHAB AP01 (5 MLE Bag)
Bag, Port QD	sn 1001 (Port written above label by crew)	1	0	SHAB AP01 (5 MLE Bag)
Bag, Pump Module Jumper (VTEB 02)	sn 1002	1	0	SHAB AS01 (5 MLE Bag)
Bag, Torque Wrench	sn 1001	1	0	SHAB AP07 (3.0 CTB)
Bag, EVA Large Trash	TPS sn 1009	1	1	MDK Bag, ceil port 1, "E"
Bag, Vent Tool Extension	sn 1001	1	1	SHAB AS01 (5 MLE Bag)
Body Restraint Tether (BRT)	sn TBD001	1	1	MDK Bag, Ceil Port 1, "E"
Bolt Puller	sn 102	1	1	PLB TSA port, fwd tray
Bolt Puller/Vise Grip Pliers Tool Caddy	sn 102	1	1	PLB TSA port, fwd tray
Brush Assembly, 1 inch (Sylgard)	TPS	9	9	MDK Bag, Ceil Stbd 1, "G"; in Gel Brush Kit
Brush Assembly, 1 inch (Sylgard)	TPS	4	4	MDK Bag, Ceil Stbd 1, "G"; in 1/2 Gel Br Kt
Brush Assembly, 3 inch (Sylgard)	TPS	9	9	MDK Bag, Ceil Stbd 1, "G"; in Gel Brush Kit
Brush Assembly, 3 inch (Sylgard)	TPS	4	4	MDK Bag, Ceil Stbd 1, "G"; in 1/2 Gel Br Kt
Brush Assembly, Pencil Tip (Sylgard)	TPS	3	3	MDK Bag, Ceil Stbd 1, "G"; in Gel Brush Kit
Brush Assembly, Pencil Tip (Sylgard)	TPS	3	3	MDK Bag, Ceil Stbd 1, "G"; in 1/2 Gel Br Kt
Brush Handle Assembly	TPS	1	1	MDK Bag, Ceil Port 1, "E"; Part of EWAK
Brush Handle Assembly	TPS	1	1	MDK Bag, Ceil Port 1, "E"; Part of EWAK
Brush Handle Assembly	TPS	1	1	MDK Bag, Ceil Stbd 1, "G"; in Gel Brush Kit

SHUTTLE EVA TOOLS SORTED BY TOOL NAME (Cont)

ITEM	COMMENT	UP	DN	LOCATION
Brush Handle Assembly	TPS	1	1	MDK Bag, Ceil Stbd 1, "G"; in 1/2 Gel Br Kt
Caddy, 1/2 in. Box Ratchet Tool	sn 108	1	1	PLB TSA port, aft tray
Caddy, Compund Cutter/Needle Nose Pliers Tool	sn 108	1	1	PLB TSA port, fwd tray
Caddy, Emittance Wash Applicator	TPS sn 1002	1	1	MDK Bag, Ceil Port 1, "E";
Caddy, Emittance Wash Applicator	TPS sn 1003	1	1	MDK Bag, Ceil Port 1, "E";
Caddy, EVA Adjustable Wrench/4 in Ratchet Ext. Tool	sn 102	1	1	PLB TSA port, fwd tray
Caddy, General Purpose Tool (GP Tool Caddy)	sn 1002 (for Adjustable Thermal Mittens sn007)	1	1	PLT TSA port, fwd tray
Caddy, General Purpose Tool (GP Tool Caddy)	sn 1013 (for Adjustable Thermal Mittens sn018)	1	1	PLT TSA port, fwd tray
Caddy, General Purpose Tool (GP tool caddy)	Sn 1003	1	1	MDK Vol H, OBD
Caddy, Hammer/Chisel Long Probe Tool	sn 107	1	1	PLB TSA port, fwd tray
Caddy, MWS Tool Stowage (Broom clip caddy)	TPS sn 1002	1	1	MDK Bag, ceil port 1, "E"
Caddy, PDU Disc/Loop Pin Puller Tool	sn 104	1	1	PLB TSA port, fwd tray
Caddy, Prybar/EVA Forceps Tool	sn 106	1	1	PLB TSA port, aft tray
Caddy, Radiator Extension/Drive Ratchet Tool	sn 107	1	1	PLB TSA port, aft tray
Caddy, Tool	sn 1017,1022,1023, 1076, 5009,5041,5042,	7	7	PLB TSA port
Caddy, Velcro/Tape	sn 1010; 1019	2	1	PLB TSA port, fwd tray; SHAB FC02 (1.0 CTB) - EVA replaces
Chisel-Long Probe	sn 107	1	1	PLB TSA port, fwd tray
CIPAA Sack Assy (TRAD Sack)	No serial #s	2	2	MDK MF28E/G
Compound Cutter (Small Cutter)	sn 1009	1	1	PLB TSA port, fwd tray
Contamination Detection Kit	sn 1002	1	1	MDK Bag, Floor Stbd 1, "C"
Cover Assembly, Flap (1)	sn N/A1,N/A2	2	0	SHAB FP04 (0.5 CTB)
Cover Assembly, Flap (1/2)	sn N/A1,N/A2	2	0	SHAB FP04 (0.5 CTB)
Cover Assembly, Flap (3/4)	sn N/A1,N/A2	2	0	SHAB FP04 (0.5 CTB)
Crack Repair Gun Cartridge (Manual)	TBD	2	2	MDK MA9D
Crack Repair Gun, Manual (w/thermal cover)	TPS sn 1008,1009	2	2	MDK Bag, Ceil Stbd 1, "G"
Crack Repair Palette Assy	TPS sn 1003, 1006	2	2	MDK Bag, Ceil Stbd 1, "G"
Emittance Wash Applicator	TPS sn XXXX in kit X	1	1	MDK Bag, Ceil Port 1, "E"; Part of EWAK
Emittance Wash Applicator	TPS sn XXXX in kit X	1	1	MDK Bag, Ceil Port 1, "E"; Part of EWAK
ET Umbilical Door Tool	sn 1004	1	1	PLB TSA port, fwd tray
ETVCG Assembly	sn N/A1	1	0	SHAB PF01
EVA Wipe	TPS sn 1001-1005	6 5	6 5	MDK Bag, Ceil Port 1, "E"; Part of EWA Kits MDK Bag, Ceil Stbd 1, "G"
Flow Shut Off Valve Assy	TPS sn 1010,1009	2	2	MDK Bag, Ceil Stbd 1, "G"
Fluid Leak Indicator (FLI)	sn 1003,1004	2	0	SHAB AS01 (5 MLE Bag)
Foam Brush Head Assy, 1 inch	TPS sn XXXX	1	1	MDK Bag, Ceil Port 1, "E"; Part of EWAK

SHUTTLE EVA TOOLS SORTED BY TOOL NAME (Cont)

ITEM	COMMENT	UP	DN	LOCATION
Foam Brush Head Assy, 1 inch	TPS sn XXXX	1	1	MDK Bag, Ceil Port 1, "E"; Part of EWAK
Foam Brush Head Assy, 1 inch	TPS sn XXXX-XXXX	5	5	MDK Bag, Ceil Stbd 1, "G"; in 1/2 Gel Br Kt
Foam Brush Head Assy, 3 inch	TPS sn XXXX-XXXX	5	5	MDK Bag, Ceil Stbd 1, "G"; in 1/2 Gel Br Kt
Forceps	sn 106	1	1	PLB TSA port, aft tray
Gap Spanner (orbit installed, 18-21")	No serial #s	3	0	SHAB AC01 (1.0 CTB) (labeled "short," "short," "medium")
Gap Spanner (orbit installed, 21-30")	No serial #s	1	0	SHAB AC01 (1.0 CTB) (labeled "long-303")
Gel Brush Kit (1/2 gel, 1/2 foam)	TPS sn 1005	1	1	MDK Bag, Ceil Stbd 1, "G"
Gel Brush Kit (Full Gel)	TPS sn 1001	1	1	MDK Bag, Ceil Stbd 1, "G"
General Purpose Cutter	sn 1010	1	1	PLB TSA port, fwd tray
Hammer	sn 103	1	1	PLB TSA port, fwd tray
Loop Pin Extractor Puller	sn 107	1	1	PLB TSA port, fwd tray
Modular Mini-Workstation Key Strap Assembly	sn 1006	1	1	MDK Bag, Ext A/L Floor
Modular MWS Baseplate Assy	sn 1001,1003	2	2	MDK Bag, Ext A/L Floor; w/ gimbal assy
Modular MWS Gimbal Assy	sn 1006,1029	2	2	MDK Bag, Ext A/L Floor; w/baseplates
Modular MWS LH Swingarm Assy	sn 1011,1012,1013	3	0	SHAB SF21 (3.0 CTB)
Modular MWS RH Swingarm Assy	sn 1002	1	0	SHAB SF21 (3.0 CTB); MDK Bag, Ceil Port 1, "E"
Modular MWS Retracting End Effector ❑ Reel housing ❑ Hook	sn 1005,1013	1	0	SHAB SF21 (3.0 CTB)
MPM Ratchet Wrench	sn 1005	1	1	PLB TSA port, fwd tray
Needle Nose Pliers	sn 1003	1	1	PLB TSA port, fwd tray
Payload Retention Device (PRD)	sn 1006, 1016	2	2	PLB TSA port, aft tray
PB Articulating Socket	sn 1010	1	1	PLB TSA port
PDU Disconnect Tool	sn 104	1	1	PLB TSA port, fwd tray
PFR	sn 4001	1	1	PLB Bkhd Fwd
PFR Attachment Device (PAD, unpainted)	sn 1008	1	1	PLB TSA port
Pistol Grip Tool (ISS Power Tool)	sn 1004, 1005,1008 (# 1, #5, #8)	3	0	SHAB FC02 (1), PF25 (2)
PGT Program Cable RS422	sn 1003,1004	2	0	SHAB TBD
Pry Bar	sn 106	1	1	PLB TSA port, aft tray
Pump Module Jumper	sn 01	1	0	SHAB AS01 (5 MLE Bag); in VTE Bag sn 1002
Punch Tool Assy, EVA	sn 1004	1	1	MDK Bag, Ceil Stbd 1, "G"
QD Anti-Kickback Tool (ATK) Assy, 0.75"	sn 1001,1002	2	0	SHAB AC01 (1.0 CTB)
QD Button Depress Tool, 0.25"	sn 1001, 1002	2	0	SHAB AC01 (1.0 CTB), SHAB FP08 (1.0 CTB)
QD Button Depress Tool, 0.75"	sn 1002,1003	2	0	SHAB AC01 (1.0 CTB)
QD Trainer Assembly (housing with male QDs)	sn 1001	1	0	SHAB FP08 (1.0 CTB)
QD Trainer (3/4" female QD)	sn 1001	1	0	SHAB FP08 (1.0 CTB)
QD Trainer (1.5" female QD)	sn 1002	1	0	SHAB FP08 (1.0 CTB)
RCC CRM Scraper, 2" stiff (in ziplock bag)	TPS sn 1004-1007	4	4	MDK Bag, Ceil Stbd 1, "G"

SHUTTLE EVA TOOLS SORTED BY TOOL NAME (Cont)

ITEM	COMMENT	UP	DN	LOCATION
RCC CRM Scraper, 5" wide (in ziplock bag)	TPS sn 1016,1017	2	2	MDK Bag, Ceil Stbd 1, "G"
RMS Shoulder Brace Release Hand Tool	sn 301	1	1	PLB TSA port, aft tray
Ruler and Protuberance Gauge	sn 1001	1	1	MDK Bag, Ceil Stbd 1, "G"
S0 Channel 1/4 Power Cable	sn N/A1	1	0	SHAB FC07 (1.0 CTB)
S0 Channel 2/3 Power Cable	sn N/A1	1	0	SHAB FC07 (1.0 CTB)
S0/N1 EVA SM PRI PWR Cable	sn TBD001	1	0	SHAB FC07 (1.0 CTB)
SPD, 1.0"	sn 1022-1025	4	0	SHAB FP08 (1.0 CTB)
SPD, 1.0" (QD Trainer Assembly)	sn 1003	1	0	SHAB FP08 (1.0 CTB)
SPD, 1.5" (QD Trainer Assembly)	sn 1004	1	0	SHAB FP08 (1.0 CTB)
Seal Assy – Fluid Line Anchor Patch 0.25 in OD (0.25 in Flap)	sn N/A1,N/A2	2	0	SHAB FP04 (0.5 CTB)
Seal Assy – Fluid Line Anchor Patch 0.375 in OD (0.375 in Flap)	sn N/A1,N/A2	2	0	SHAB FP04 (0.5 CTB)
Seal Assy – Fluid Line Anchor Patch 1.5 in OD (1.5 in Flap)	sn N/A1,N/A2	2	0	SHAB FP04 (0.5 CTB)
Snatch Block	sn 1013, 1014	2	2	PLB TSA port, aft tray
Socket Extension 6" w/7/16" Wobble	sn 1001	1	0	SHAB TBD
SSRMS FMS MLI Shrouds	sn 202,203	2	0	SHAB FP04 (0.5 CTB)
Tether, Adjustable Equipment (Eq-Eq w/slide lock)	TBD 012-015; TBD 023-026; sn 1019,1038, 1067,1068	10	6	Ext A/L Floor Bag (qty 2); MDK Bag, Ceil Port 1, "E" (qty 4); SHAB FC02 (1.0 CTB) (qty 4 - for QD bag)
Tether, Adjustable Equipment (Sm-Sm)	sn 1027, 1028	2	2	PLB TSA port, aft tray
Tether, Adjustable Fuse (Eq hooks w/slide lock)	sn TBD008	1	1	MDK Bag, Ceil Port 1, "E"
Tether Extension	sn 1001	1	1	MDK Bag, Ceil Port 1, "E"
Tether, Retractable Equipment (Eq-Eq w/slide lock) (-381)	Yellow tethers (8) sn 4057,4070,4071, 4073,4075, 4170,4271, 4272; Blue tether (1) sn 4272; Late Inspection Black Tethers (7) sn TBD; ISS Black tethers (3) sn 4062, 4063, 4073	19	7	SHAB AC01 (1.0 CTB) (qty 8); SHAB AC01 (1.0 CTB) (qty 1); MDK Bag, Ceil Port 1, "E" (qty 7); External A/L Floor Bag (qty 3)
Tether, Retractable Equipment (Eq-Eq/pip w/slide lock) (-383)	Yellow tethers sn 4238-4241	4	0	SHAB AC01 (1.0 CTB)
Tether, Retractable Equipment (Lg-Eq w/slide lock) (-385)	Yellow tethers sn 4252-4257	6	0	SHAB AC01 (1.0 CTB)
Tether, 85' Safety (-307)	sn 1005 (25),1007 (27) (Lg-sm)	1	1	MDK Bag, Ceil Stbd 2, "H"
Tether, Waist (w/slide lock)	sn 1033,1035,1048, 1058 (moved off EMUs)	4	4	MDK Bag, Ext A/L Floor
Thermal Sensor, EVA (w/ goose neck probe)	TPS sn 1002	1	1	MDK Bag, Ceil Stbd 1, "G"
Tile Repair Ablator Assembly (TRAD)	sn 1001	1	1	MDK MF28E/G
Torque Wrench	sn 1001	1	0	SHAB AP07 (3.0 CTB)
Tube Cutter	sn 1006	1	1	PLB TSA port, fwd tray
Vent Tool Adapter	N/A	2	0	SHAB AP01 (5 MLE Bag)
Vent Tool Assy, 1/4" NH3/N2 - F	N/A	2	0	SHAB AP01 (5 MLE Bag)
Vent Tool Assy, 3/4" NH3/N2 - F	N/A	2	0	SHAB AP01 (5 MLE Bag)

SHUTTLE EVA TOOLS SORTED BY TOOL NAME (Cont)

ITEM	COMMENT	UP	DN	LOCATION
Vent Tool Assy, 1.5" NH3/N2 - F	N/A	2	0	SHAB AP01 (5 MLE Bag)
Vent Tool Assy, 1" NH3/N2 - F	N/A	1		Middeck Floor Stbd 1 Bag (5 MLE Bag)
Vent Tool H2O-N2, 1" - F	N/A	1	0	SHAB AP01 (5 MLE Bag)
Vent Tool, 1" N2-M	N/A	1	0	SHAB AP01 (5 MLE Bag)
Vent Tool Extender	sn 1001	1	0	SHAB AS01 (5 MLE Bag); in VTE Bag sn 1001
Vise Grip Pliers	sn 102	1	1	PLB TSA port, fwd tray
Winch and Mount Assy, Aft (w/4 ball pip pin)	sn 1004	1	1	PLB Blkhd Aft
Winch and Mount Assy, Fwd (w/4 ball pip pin)	sn 5006	1	1	PLB Blkhd Fwd
Winch Hook Adapter (RMS Rope Reel)	sn 1003	1	1	PLB TSA port
Wire Tie, Long (32")	N/A102-108,N/A110-125,N/A127	24	0	SHAB TBD
Wire Tie, Short (16")	N/A12,13,16,18,148,199,200,201,202-217	24	0	SHAB TBD
Wrench, 1/2 in. box end	sn 103	1	1	PLB TSA port, aft tray
Wrench, Adjustable	sn 116; 103	2	2	MDK Vol H, OBD; PLB TSA port, fwd tray
Wrench, EVA Ratchet (palm wheel)	sn 1013	1	1	SHAB TBD
Wrench, 3/8" Ratchet with 2-in 7/16" pinned socket	sn 108	1	1	MDK Vol H, OBD
Wrench, Ratchet 4 in Extension, 7/16 in socket	sn 102	1	1	PLB TSA port, fwd tray
Wrench, Ratchet Radiator Extension, 3/8"	sn 107	1	1	PLB TSA port, aft tray

SHUTTLE EVA TOOLS SORTED BY LOCATION

I

NOTE: pp = pre-positioned for,  = stowed as a kit

ITEM	COMMENT	UP	DN	LOCATION
Tether, Retractable Equipment (Eq-Eq w/slide lock)	sn 4062, 4063, 4073 (black RETs)	3	0	A/L External Floor Bag
Modular Mini-Workstation Key Strap Assembly	sn 1006	1	1	MDK Bag, Ext A/L Floor
Modular MWS Baseplate Assy	sn 1001, 1003	2	2	MDK Bag, Ext A/L Floor; w/ gimbal assy
Modular MWS Gimbal Assy	sn 1006, 1029	2	2	MDK Bag, Ext A/L Floor; w/baseplates
Tether, Adjustable Equipment (Eq-Eq w/slide lock)	sn 1019,1038	2	2	MDK Bag, Ext A/L Floor
Tether, Waist (w/slide lock) sn 1033,1035,1048, 1058	removed from EMU	4	4	MDK Bag, Ext A/L Floor
Bag, EVA Large Trash	TPS sn 1001	1	1	MDK Bag, Ceil Port 1, "E"
Caddy, MWS Tool Stowage (Broom clip caddy)	TPS sn 1002	1	1	MDK Bag, Ceil Port 1, "E"
Emittance Wash Applicator Caddy	TPS sn 1002,1003	2	2	MDK Bag, Ceil Port 1, "E"
1 in. Foam Brush Assy		2	2	
Brush Handle Assembly		2	2	
Emittance Wash Applicator		2	2	
EVA Wipes (3)		2	2	
Modular MWS RH Swingarm Assy	1037,1039 (transfer)	2	2	MDK Bag, Ceil Port 1, "E"
Tether, Adjustable Equipment (Eq-Eq w/slide lock)	sn TBD012-015	4	4	MDK Bag, Ceil Port 1, "E"
Tether, Adjustable Fuse (Eq hooks w/slide lock)	sn TBD008	1	1	MDK Bag, Ceil Port 1, "E"
Tether, Body Restraint (BRT)	sn TBD001	1	1	MDK Bag, Ceil Port 1, "E"
Tether Extension	sn 1001	1	1	MDK Bag, Ceil Port 1, "E"
Tether, Retractable Equipment (Eq-Eq w/slide lock)	Late Inspection (-381) sn TBD	7	7	MDK Bag, Ceil Port 1, "E"
5/32 in short Ball End Allen Driver	TPS RCC plug sn 1012 (none on ISS)	1	1	MDK Bag, Ceil Stbd 1, "G"
Crack Repair Gun, Manual (w/thermal cover)	TPS sn 1008, 1009	2	2	MDK Bag, Ceil Stbd 1, "G"
Crack Repair Palette Assy	TPS sn 1003, 1006	2	2	MDK Bag, Ceil Stbd 1, "G"
Thermal Sensor, EVA (w/goose neck probe)	TPS sn 1002	1	1	MDK Bag, Ceil Stbd 1, "G"
EVA Wipe	TPS sn 1001-1005	5	5	MDK Bag, Ceil Stbd 1, "G"

SHUTTLE EVA TOOLS SORTED BY LOCATION (Cont)

NOTE: pp = pre-positioned for,  = stowed as a kit

ITEM	COMMENT	UP	DN	LOCATION
Flow Shut Off Valve Assy	TPS sn 1010,1009	2	2	MDK Bag, Ceil Stbd 1, "G"
Gel Brush Kit (1/2 gel, 1/2 foam)	TPS sn 1005	1	1	MDK Bag, Ceil Stbd 1, "G"
1 in. Foam Brush Assy (5)				
1 in. Silicone Gel Brush (4) (Sylgard br)				
3 in Silicone Gel Brush (4) (Sylgard br)				
Foam Brush Head Assy, 3" (5)				
Pencil Tip Gel Brush (3) (Sylgard br)				
Brush Handle Assembly				
Gel Brush Kit (Full Gel)	TPS sn 1001	1	1	MDK Bag, Ceil Stbd 1, "G"
1 in. Silicone Gel Brush (9) (Sylgard br)				
3 in Silicone Gel Brush (9) (Sylgard br)				
Pencil Tip Gel Brush (3) (Sylgard br)				
Brush Handle Assembly				
RCC CRM Scraper, 2" stiff (in ziplock bag)	TPS sn 1004-1007	4	4	MDK Bag, Ceil Stbd 1, "G"
RCC CRM Scraper, 5" wide (in ziplock bag)	TPS sn 1016,1017	2	2	MDK Bag, Ceil Stbd 1, "G"
Ruler and Protuberance Gauge	sn 1001	1	1	MDK Bag, Ceil Stbd 1, "G"
Punch Tool Assy, EVA	TPS sn 1004	1	1	MDK Bag, Ceil Stbd 1, "G"
Bag, Crack Repair	TPS sn 1004	1	1	MDK Bag, Ceil Stbd 2, "H"
<input type="checkbox"/> Outer Bag Assy, Crack Repair Bag				
<input type="checkbox"/> Crack Repair Bag Assy				
<input type="checkbox"/> ETS Module, Crack Repair Bag				
<input type="checkbox"/> Inner Bag Assy, Crack Repair Bag				
Tether, 85' Safety (-307)	sn 1005,1007 (Lg-sm)	2	2	MDK Bag, Ceil Stbd 2, "H"
Vent Tool Assy, 1" NH3/N2 – F	N/A	1	0	MDK Bag, Floor Stbd 1
Crack Repair Gun Cartridge (Manual)	sn N/A1,N/A2	2	2	MDK MA9D
Bag, CIPAA Containment	sn 1001	1	1	MDK MF28E/G
CIPAA Sack Assy (TRAD Sack)	No serial #s	2	2	MDK MF28E/G
Tile Repair Ablator Assembly (TRAD)	sn 1001	1	1	MDK MF28E/G

SHUTTLE EVA TOOLS SORTED BY LOCATION (Cont)

NOTE: pp = pre-positioned for, = stowed as a kit

ITEM	COMMENT	UP	DN	LOCATION
Volume H Container Assy, Inboard		1	1	MDK Vol H
EHIP Light	sn 1008			
EHIP Battery Pack Assy (2 up, 2 dn)	sn 1001, 1002			
Volume H Container Assy, Outboard		1	1	MDK Vol H
Bag, EVA Accessory	sn 1014			
Wrench, Adjustable	sn 116			
Ratchet w/7/16 in. socket (pinned)	sn 108			
EHIP Light	sn 1003			
EHIP Battery Pack Assy (2 up, 2 dn)	sn 1003, 1005			
Caddy, General Purpose Tool (GP tool Caddy)	sn 1003			
Winch and Mount Assy, Aft (w/4 ball pip pin)	sn 1004	1	1	PLB Blkhd Aft
PFR	sn 4001	1	1	PLB Blkhd Fwd
Winch and Mount Assy, Fwd (w/4 ball pip pin)	sn 5006	1	1	PLB Blkhd Fwd
3 Point Latch Tool Stowage Bag	sn HG3-366	1	1	PLB TSA port
3 Point Latch Tools (2)	sn 1003, 1007			
Caddy, Tool	sn 1017,1022,1023, 1076, 5009,5041,5042	7	7	PLB TSA port
Centerline Latch Tool Bag	sn HF9-046A	1	1	PLB TSA port
Centerline Latch Tools (2)	Sn 1009, 1010			
PB Articulating Socket	sn 1010	1	1	PLB TSA port
PFR Attachment Device (PAD, unpainted)	sn 1008	1	1	PLB TSA port
Winch Hook Adapter (RMS Rope Reel)	sn 1003	1	1	PLB TSA port
1/2 in. Box Ratchet Tool Caddy	sn 108	1	1	PLB TSA port, aft tray
1/2 in. Box Socket Wrench	sn 103			
Payload Retention Device (PRD)	sn 1006, 1016	2	2	PLB TSA port, aft tray
Prybar/EVA Forceps Tool Caddy	sn 106	1	1	PLB TSA port, aft tray
Forceps	sn 106			
Pry Bar	sn 106			

SHUTTLE EVA TOOLS SORTED BY LOCATION (Cont)

NOTE: pp = pre-positioned for, = stowed as a kit

ITEM	COMMENT	UP	DN	LOCATION
Radiator Extension/Drive Ratchet Tool Caddy Radiator Extension Ratchet	sn 107 sn 107 sn 105	1	1	PLB TSA port, aft tray
RMS Shoulder Brace Release Hand Tool	sn 301	1	1	PLB TSA port, aft tray
Snatch Block	sn 1013, 1014	2	2	PLB TSA port, aft tray
Tether, Adjustable Equipment (Sm-Sm)	sn 1027, 1028	2	2	PLB TSA port, aft tray
Bag, EVA Trash	sn 1005	2	2	PLB TSA port, fwd tray
Bolt Puller/Vise Grip Pliers Tool Caddy Bolt Puller Vise Grip Pliers	sn 102 sn 102 sn 102	1	1	PLB TSA port, fwd tray
Caddy, Velcro/Tape	sn 1010	1	1	PLB TSA port, fwd tray
Compound Cutter/Needle Nose Pliers Tool Caddy Compound Cutter (Small Cutter) Needle Nose Pliers	sn 108 sn 1009 sn 1003	1	1	PLB TSA port, fwd tray
ET Umbilical Door Tool	sn 1004	1	1	PLB TSA port, fwd tray
EVA Adjustable Wrench/4 in Ratchet Ext. Tool caddy Ratchet, 4 in Extension, 7/16 in socket EVA Adjustable Wrench	sn 102 sn 102 sn 103	1	1	PLB TSA port, fwd tray
General Purpose Cutter	sn 1010	1	1	PLB TSA port, fwd tray
General Purpose Tool Caddy (GP tool caddy) Adjustable Thermal Mitten (2)	sn 1002,1013 sn 007,018	2	2	PLB TSA port, fwd tray
Hammer/Chisel Long Probe Tool Caddy Chisel-Long Probe Hammer	sn 107 sn 107 sn 103	1	1	PLB TSA port, fwd tray
MPM Ratchet Wrench	sn 1005	1	1	PLB TSA port, fwd tray
PDU Disc/Loop Pin Puller Tool Caddy Loop Pin Extractor Puller PDU Disconnect Tool	sn 104 sn 107 sn 104	1	1	PLB TSA port, fwd tray

SHUTTLE EVA TOOLS SORTED BY LOCATION (Cont)

NOTE: pp = pre-positioned for,  = stowed as a kit

ITEM	COMMENT	UP	DN	LOCATION
Tube Cutter	sn 1006	1	1	PLB TSA port, fwd tray
Gap Spanner (orbit installed, 18-21")	No serial #s	3	0	SHAB AC01 (1.0 CTB) (labeled "short," "short," "medium") (for QD bags)
Gap Spanner (orbit installed, 21-30")	No serial #s	1	0	SHAB AC01 (1.0 CTB) (labeled "long-303") (for QD bags)
QD Anti-Kickback Tool (AKT) Assy, 0.75"	sn 1001,1002	2	0	SHAB AC01 (1.0 CTB)
QD Button Depress Tool, 0.25"	sn 1001	1	0	SHAB AC01 (1.0 CTB)
QD Button Depress Tool, 0.75"	sn 1002,1003	2	0	SHAB AC01 (1.0 CTB)
Tether, Retractable Equipment (Eq-Eq w/slide lock)	Yellow tethers (-381) sn 4057,4070,4071, 4073,4075,4170, 4271, 4272	8	0	SHAB AC01 (1.0 CTB)
Tether, Retractable Equipment (Eq-Eq w/slide lock)	Blue tethers (-381) sn 4272	1	0	SHAB AC01 (1.0 CTB)
Tether, Retractable Equipment (Eq-Eq/pip w/slide lock)	Yellow tethers (-383) sn 4238-4241	4	0	SHAB AC01 (1.0 CTB)
Tether, Retractable Equipment (Lg-Eq w/slide lock)	Yellow tethers(-385) sn 4252-4257	6	0	SHAB AC01 (1.0 CTB)
Vent Tool Adapter	sn 1001,1002	2	0	SHAB AP01 (5 MLE Bag)
Bag, Jettison Stowage	sn N/A5,N/A6	2	2	SHAB AP01 (5 MLE Bag)
Bag, Jettison Stowage – EV1		1	1	SHAB AP01 (5 MLE Bag)
Bag, Jettison Stowage – EV2		1	1	SHAB AP01 (5 MLE Bag)
Bag, Jettison Stowage – Return to Shuttle 1, 2, 3		3	3	SHAB AP01 (5 MLE Bag)
Bag, Port QD	sn 1001 (Port written above label by crew)	1	0	SHAB AP01 (5 MLE Bag)
Vent Tool Assy, 1/4" NH3/N2 – F	N/A	2	0	SHAB AP01 (5 MLE Bag)
Vent Tool Assy, 3/4" NH3/N2 – F	N/A	2	0	SHAB AP01 (5 MLE Bag)
Vent Tool Assy, 1.5" NH3/N2 – F	N/A	2	0	SHAB AP01 (5 MLE Bag)

SHUTTLE EVA TOOLS SORTED BY LOCATION (Cont)

NOTE: pp = pre-positioned for,  = stowed as a kit

ITEM	COMMENT	UP	DN	LOCATION
Vent Tool H2O-N2, 1" – F	N/A	1	0	SHAB AP01 (5 MLE Bag)
Vent Tool, 1" N2-M	N/A	1	0	SHAB AP01 (5 MLE Bag)
Bag, Torque Wrench	sn 1001	1	0	SHAB AP07 (3.0 CTB) (EVA add)
Torque Wrench	sn 1001	1	0	SHAB AP07 (3.0 CTB) (EVA add)
Bag, Pump Module Jumper (VTEB 02)	sn 1002	1	0	SHAB AS01 (5 MLE Bag)
Bag, Vent Tool Extension	sn 1001	1	1	SHAB AS01 (5 MLE Bag)
Fluid Leak Indicator (FLI)	sn 1003,1004	2	0	SHAB AS01 (5 MLE Bag) (transfer only)
Pump Module Jumper	sn 01	1	0	SHAB AS01 (5 MLE Bag); in VTE Bag sn 1002
Vent Tool Extender	sn 1001	1	0	SHAB AS01 (5 MLE Bag); in VTE Bag sn 1001
Caddy, Velcro/Tape	sn 1019	1	0	SHAB FC02 (1.0 CTB) (EVA replace)
Pistol Grip Tool (ISS Power Tool)	sn 1004	1	0	SHAB FC02 (1.0 CTB) (transfer only)
Tether, Adjustable Equipment (Eq-Eq w/slide lock)	sn 1067, 1068, 1019, 1038	4	0	SHAB FC02 (1.0 CTB)
S0 Channel 1/4 Power Cable	sn N/A1	1	0	SHAB FC07 (1.0 CTB)
S0 Channel 2/3 Power Cable	sn N/A1	1	0	SHAB FC07 (1.0 CTB)
S0/N1 EVA SM PRI PWR Cable	sn TBD001	1	0	SHAB FC07 (1.0 CTB)
Cover Assembly, Flap (1)	sn N/A1,N/A2	2	0	SHAB FP04 (0.5 CTB)
Cover Assembly, Flap (1/2)	sn N/A1,N/A2	2	0	SHAB FP04 (0.5 CTB)
Cover Assembly, Flap (3/4)	sn N/A1,N/A2	2	0	SHAB FP04 (0.5 CTB)
Seal Assy – Fluid Line Anchor Patch 0.25 in OD (0.25 in Flap)	sn N/A1,N/A2	2	0	SHAB FP04 (0.5 CTB)
Seal Assy – Fluid Line Anchor Patch 0.375 in OD (0.375 in Flap)	sn N/A1,N/A2	2	0	SHAB FP04 (0.5 CTB)
Seal Assy – Fluid Line Anchor Patch 1.5 in OD (1.5 in Flap)	sn N/A1,N/A2	2	0	SHAB FP04 (0.5 CTB)
SSRMS FMS MLI Shrouds	sn 202,203	2	0	SHAB FP04 (0.5 CTB)
SPD, 1.0"	sn 1022-1025	4	0	SHAB FP08 (1.0 CTB)
SPD, 1.5" (QD Trainer Assembly)	sn 1004	1	0	SHAB FP08 (1.0 CTB)

SHUTTLE EVA TOOLS SORTED BY LOCATION (Cont)

NOTE: pp = pre-positioned for,  = stowed as a kit

ITEM	COMMENT	UP	DN	LOCATION
SPD, 1.0" (QD Trainer Assembly)	sn 1003	1	0	SHAB FP08 (1.0 CTB)
QD Trainer Assembly (housing with 3 male QDs)	sn 1001	1	0	SHAB FP08 (1.0 CTB)
QD Trainer (3/4" female QD)	sn 1001	1	0	SHAB FP08 (1.0 CTB)
QD Trainer (1.5" female QD)	sn 1002	1	0	SHAB FP08 (1.0 CTB)
QD Button Depress Tool, 0.25"	sn 1002	1	0	SHAB FP08 (1.0 CTB)
ETVCG Assembly	sn N/A1	1	0	SHAB PF01
Pistol Grip Tool (ISS Power Tool)	sn 1005,1008	2	0	SHAB PF25 (1.0 CTB) (transfer only)
Adjustable Grapple Bar Assembly		1	0	SHAB SF13
35mm Camera Mounting Bracket	sn 1003,1008	2	0	SHAB SF21 (3.0 CTB) (transfer only)
Modular MWS LH Swingarm Assy	sn 1011,1012,1013	3	0	SHAB SF21 (3.0 CTB) (transfer only)
Modular MWS RH Swingarm Assy	sn 1002	1	0	SHAB SF21 (3.0 CTB) (transfer only)
Modular MWS Retracting End Effector <input type="checkbox"/> Reel housing <input type="checkbox"/> Hook	sn 1005,1013	1	0	SHAB SF21 (3.0 CTB) (transfer only)
PGT Program Cable RS422	sn 1003,1004	2	0	SHAB TBD
Wrench, EVA Ratchet	sn 1013	1	0	SHAB TBD (transfer only)
Socket Extension, 6" w/7/16" Wobble	sn 1001	1	0	SHAB TBD (transfer only)
Wire Tie, Long (32")	N/A102-108,N/A110-125,N/A127	24	0	SHAB TBD (transfer only)
Wire Tie, Short (16")	N/A202-217	16	0	SHAB TBD (transfer only)
Wire Tie, Short (16")	N/A12,13,16,18,148,199,200, 201	8	0	SHAB TBD (transfer only)

EMU MAINT/RECHARGE

WATER RECHARGE.....	TEMP FS 10-2
EMU POWERUP.....	TEMP FS 10-2
WATER FILL.....	TEMP FS 10-2
WATER FILL VERIFICATION.....	TEMP FS 10-2
EMU LiOH CHANGEOUT.....	10-4
MIDDECK EMU BATTERY RECHARGE/LiOH REPLACEMENT.....	10-5
INITIATE.....	10-5
TERMINATE.....	10-6
IN-SUIT EMU BATTERY RECHARGE/CHARGE VERIFICATION.....	10-7
INITIATE.....	10-7
TERMINATE.....	10-7
EMU POWERDOWN.....	10-7
HELMET LIGHT/PGT BATTERY RECHARGE.....	10-8
INITIATE.....	10-8
TERMINATE.....	10-9
REBA BATTERY INSTALLATION.....	10-9
EMU BATTERY REMOVAL/INSTALL.....	10-10
HELMET LIGHT BULB CHANGEOUT.....	10-11
REBA BATTERY RECHARGE.....	10-12
INITIATE.....	10-12
TERMINATE.....	10-12
STS-116 LOGISTICS CUE CARD.....	FS CC 10-13
EMU BATTERY RECHARGE.....	FS 10-15

WATER RECHARGE

IF EMU NOT ALREADY POWERED UP:

EMU POWERUP

- BOTH DCM 1. Retrieve, position SCUs; remove DCM covers
 2. Connect SCUs to DCM, √locked
 3. PWR – BATT

CAUTION

EMU must be on BATT pwr when
 airlock pwr supply is turned on

- AW18H 4. PWR/BATT CHGR EMU 1,2 MODE (two) – PWR
 BUS SEL (two) – MNA(MNB)
 MD(flr) 5. √EMU O2 ISOL VLV – OP
 AW82B 6. EV1,2 O2 vlv (two) – OP
 DCM 7. PWR – SCU

WATER FILL

- MO13Q 8. √ARLK H2O S/O VLV – OPEN (tb-OP)
 R11L 9. √SPLY H2O TKA OUTLET – CL (tb-CL)

SM 60 TABLE MAINT

- CRT 10. Use TKB quantity:
 PARAM ID – ITEM 1 +0 6 2 0 4 2 0 EXEC
 11. Log value before recharge

Recharge #	H2O TKB %
1	
2	
3	
4	
5	

- AW82D 12. √EMU 1,2 H2O WASTE tb (two) – CL
 SPLY (two) – OP (tb-OP)
 13. √H2O TKB quantity decreasing

NOTE

Full charge requires ~15 min

WATER FILL VERIFICATION

- DCM 14. √STATUS: H2O WP 8-15 psi and stable for ~30 sec (indicates charging complete)

SM 60 TABLE MAINT

- CRT 15. Use TKB quantity:
 PARAM ID – ITEM 1 +0 6 2 0 4 2 0 EXEC
 16. Log value after recharge

Recharge #	H2O TKB %
1	
2	
3	
4	
5	

EMU MAINT/
 RECHARGE

Cont next page

TEMP FS 10-2

TOP

HOOK
VELCRO

STS-116 LOGISTICS CUE CARD

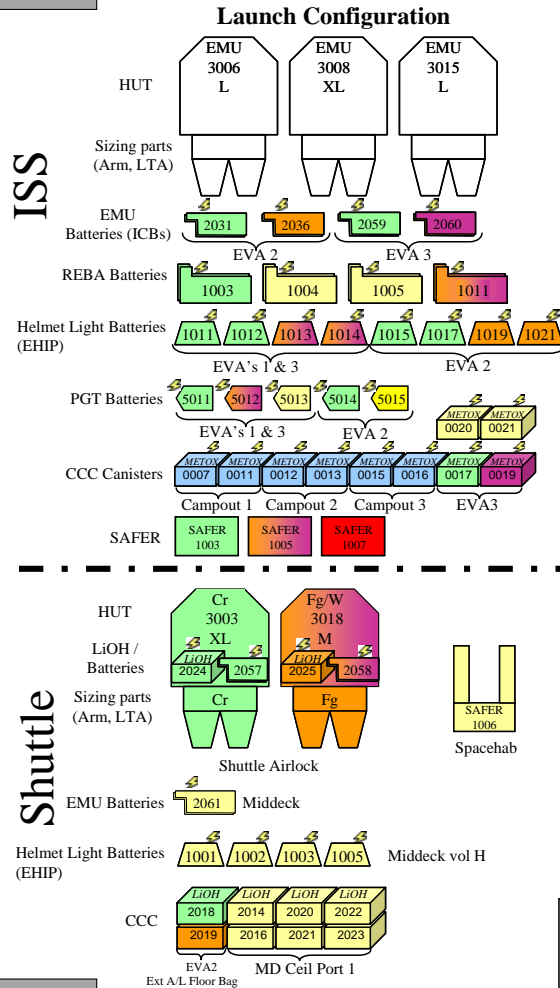

HOOK
VELCRO

POST EVA 1 Battery

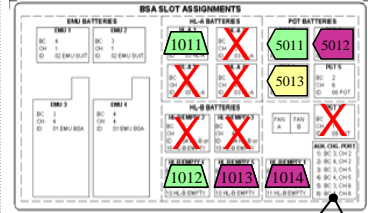

POST EVA 2 Battery

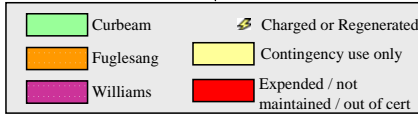
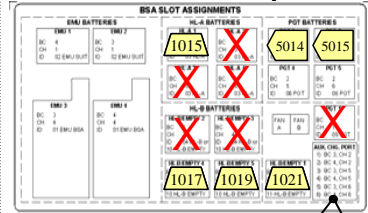

Landing Configuration

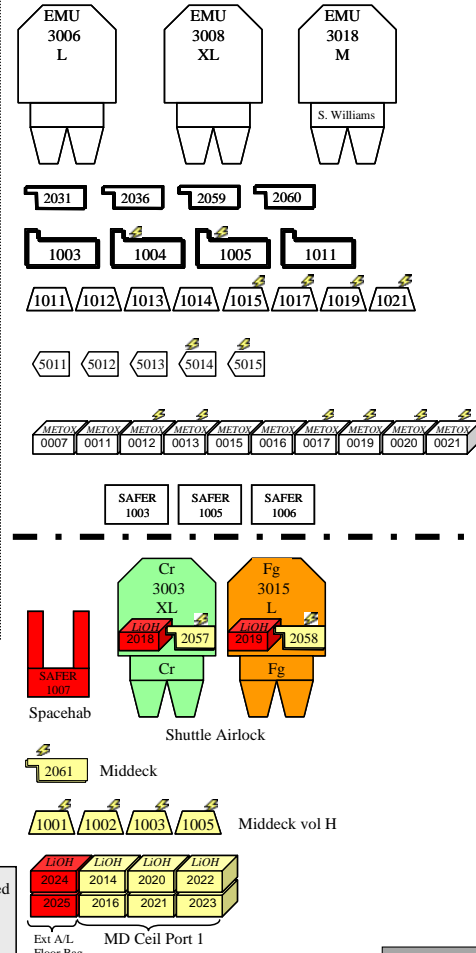

HOOK
VELCRO

HOOK
VELCRO

(reduced copy)

EVA-4a/116/O/A

TOP
BACK OF 'STS-116 LOGISTICS CUE CARD'

HOOK
VELCRO

STS-116 LOGISTICS CUE CARD

HOOK
VELCRO

AIRLOCK
Operations

EVA	METOX For 10.2 Ops (S/Ns) (B/Cs)	PWR (EMU Water Bag) (S/N) <i>Floor Bins</i>	IRU EMU Fill Quantity; Post EVA (lb)	CWC (for EMU water dump) (S/N)
1	0007/0011+ 7802J/7792J	1013^		1026
2	0012/ 0013+ 7812J/7794J (Regen)	1013^ / 1018 ^		1026
3	0015/0016+++ 7686J/7796J	1018^		1026

Location Key
* EMU
^ Floor Bins
" ISS Airlock
+ EVA 1 bag
++ EVA 2 bag
+++EVA 3 bag

**EV1 - Cr
EMU 3003**



EVA	LiOH (S/N) (B/C)	METOX (S/N) (B/C)	EMU BATTERY	REBA (S/N)	Helmet Light Battery (S/N)	ERCA (Address) (S/N)	SAFER (S/N)	PGT (S/N)	PGT Spare (S/N)
1	2024* EMUD08J	N/A	2057* (recharge)	1003+ (recharge)	1011/1012+ (recharge)	16" 1010	1003"	5011+ (recharge)	5013+ (recharge)
2	2018+ EMUD97J	N/A	2031+ (recharge)	1003* (recharge)	1015/1017+ (recharge)	16" 1010	1003"	5014+ (recharge)	5015+ (recharge)
3	N/A	0017+++ 7811J (Regen)	2059+++	1003*	1011/1012 +++	16" 1010	1003"	5011+++	5013+++

**EV2 - Fg / W
EMU 3018**



EVA	LiOH (S/N) (B/C)	METOX (S/N) (B/C)	EMU BATTERY	REBA (S/N)	Helmet Light Battery (S/N)	ERCA (Address) (S/N)	SAFER (S/N)	PGT (S/N)
1	2025* EMUF09J	N/A	2058* (recharge)	1011+ (recharge)	1013/1014+ (recharge)	18" 1007	1005"	5012+ (recharge)
2	2019+ EMUF27J	N/A	2036+ (recharge)	1011* (recharge)	1019/1021+ (recharge)	18" 1007	1005"	
3	N/A	0019+++ 7807J (Regen)	2060+++	1011*	1013/1014+++	18" 1007	1005"	5012+++

HOOK
VELCRO

EVA-4b/116/O/A

HOOK
VELCRO

(reduced copy)

EMU BATTERY RECHARGE

I

INITIATE (20 min)

- | | |
|---------|---|
| | 1. Unstow middeck battery charger from External Airlock Floor Bag |
| ML85E | 2. √DC UTIL PWR – OFF on J23 utility outlet |
| (MUP) | 3. Affix batteries to charger using Velcro straps on charger |
| | 4. Connect charger cables to batteries |
| | 5. Stow batteries/charger for charge |
| | 6. Connect charger power cable to MUP J23 utility outlet |
| | 7. √CB5 closed for J23 utility outlet |
| | 8. DC UTIL PWR (S5) – ON |
| Charger | 9. √ON LEDs (red) – ON |
| | √READY LEDs (green) – ON (for 10 sec at startup) |
| | √READY LEDs (green) – blinking |

NOTE

EMU batteries may experience a false charge completion due to passivation within the battery. The passivation is removed with repeated attempts (two to three times) at charging the battery

After 15 min charging, verify charging is continuing:

- | | | |
|---------|--|---|
| Charger | 10. √ON LEDs (red) – ON | |
| | √READY LEDs (green) – blinking | |
| | * If ON LED (red) is OFF and READY LED (green) is ON | * |
| | * (non-blinking): | * |
| | * 1. DC UTIL PWR – OFF (3 sec) | * |
| | * 2. DC UTIL PWR – ON | * |
| | * 3. √ON LEDs (red) – ON | * |
| Charger | * √READY LEDs (green) – ON 10 sec at startup | * |
| | * √READY LEDs (green) – blinking | * |
| | * 4. Report anomaly to MCC | * |

NOTE

The absence of any active LEDs represents an over-current or overvoltage condition that has caused the charger to shut down, or the charger has not been properly powered from the DC Utility Outlet. All protective conditions are resettable by taking the DC UTILITY POWER to OFF.

During the charge, the red ON LED will be illuminated and the green READY LED will continue to blink, giving positive indication that the charger is still charging

EMU BATTERY RECHARGE (Cont)

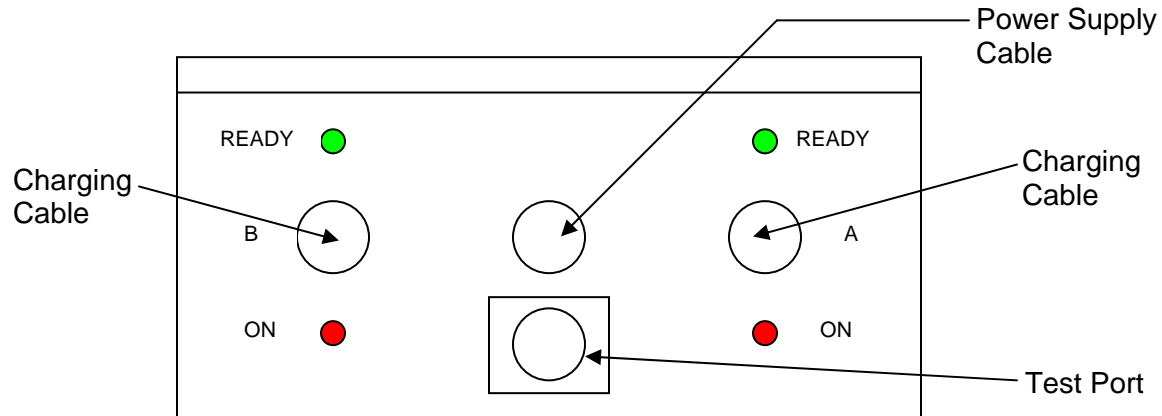

TERMINATE (10 min)

NOTE

When a nominal charge is complete, the red ON LED will extinguish and the green READY LED will illuminate without blinking. The red ON LED will be illuminated only when the positive current flow into the battery is greater than 0.6A

- | | |
|----------------|---|
| Charger | 11. When charge complete: |
| | √ON LEDs (red) – OFF |
| | √READY LEDs (green) – ON |
| ML85E
(MUP) | DC UTIL PWR (S5) – OFF |
| | Disconnect cables from batteries |
| | 12. Disconnect charger power cable from utility outlet |
| | 13. Stow charger back in External Airlock Floor Bag |
| | 14. Take EMU batteries back to ISS, stow in EMU SYS TRANSFER BAG #1
(these batteries will be installed in the EMUs during POST EVA RECONFIGURATION AND TRANSFER) |

EMU CONTINGENCY PROCS

DISPLAY LOSS DURING POWER TRANSFER (WARM RESTART).....	TEMP FS	12-2
VACUUM H2O RECHARGE (MANNED).....	TEMP FS	12-2
LiOH REPLACEMENT (MANNED).....		12-3
BATTERY REPLACEMENT (MANNED)		12-4
WATER DUMP		12-6
SCU SWAP (UNMANNED).....		12-7
SCU SWAP (MANNED).....		12-7
EMU COLD RESTART (MANNED)		12-7
12.1 STS EVA DECONTAMINATION.....		12-8
CONTAMINATION TEST.....		12-15
SAFER BATTERY CHANGEOUT		12-18
BENDS TREATMENT ADAPTER (BTA) INSTALLATION (IN-SUIT)		12-19
BTA PREP		12-19
BTA TREATMENT		12-19
BENDS TREATMENT ADAPTER (BTA) INSTALLATION (POST SUIT DOFFING).....		12-21
BTA PREP		12-21
BTA TREATMENT		12-21
EMU RESIZE		12-24
STS-116 NOMINAL EMU SIZING MATRIX.....	FS	12-27
EMU CONTINGENCY RESIZE MATRIX.....	FS	12-28
PRE EVA 3 EMU RESIZE	FS	12-29

EMU CONT
PROCS

DISPLAY LOSS DURING POWER TRANSFER (WARM RESTART)

- DCM If PWR – BATT and SCU connected:
AW18H 1. √PWR/BATT CHGR EMU 1(2) BUS SEL – OFF
DCM If PWR – SCU:
2. PWR – BATT
AW18H 3. PWR/BATT CHGR EMU 1(2) BUS SEL – OFF

WARNING

Fan will be off from steps 4 to 9 during which time CO2 buildup is a concern

NOTE

Affected EMU will be without comm after step 6. Steps 6 and 7 should be read together before step 6 is performed

- DCM 4. FAN – OFF (expect **FAN SW OFF** msg, DISP – PRO)
IV 5. Inform affected EV crewmember of impending comm loss
DCM 6. PWR – SCU (7 sec)
7. PWR – BATT
When power restart complete:
8. √Display – **O2 POS XX**, expect **FAN SW OFF** msg, DISP – PRO
9. As reqd, FAN – ON
If display blank or locked up:
10. Contact MCC
If SCU power desired:
11. √SCU connected to DCM
AW18H 12. PWR/BATT CHGR EMU 1(2) MODE – PWR
BUS SEL – MNA(MNB)
13. √EMU INPUT 1(2) Volts = 18.0 – 20.0
DCM 14. PWR – SCU
DCM 15. √Display – **O2 POS XX**

VACUUM H2O RECHARGE (MANNED)

WARNING

Procedure should be used only if performing a contingency EVA

- EV 1. Perform AIRLOCK INGRESS, Cuff C/L, 30 (Close hatch, partially engage latches)
2. √Helmet purge vlv – cl, locked
DCM 3. √PURGE vlv – cl (dn)
4. √WATER – OFF
IV MO13Q 5. √ARLK H2O S/O VLV – OPEN (tb-OP)
MD(flr) 6. √EMU O2 ISOL VLV – OP
ML86B:C 7. √cb MNC EXT ARLK HTR LINE ZN 1,2 (two) – op
AW82B 8. √EV-1(EV-2) O2 vlv – OP
EV AW18H 9. PWR/BATT CHGR EMU 1(2) BUS SEL – MNA(MNB)
DCM 10. PWR – SCU (fwd), WARN TONE
IV R11L If SPLY H2O XOVR VLV closed (tb-CL or bp) (water transfer config):
11. SPLY H2O TKA OUTLET – CL (tb-CL)
If SPLY H2O XOVR VLV open (tb-OP) (nominal config):
L1 12. √RAD CNTLR OUT TEMP – NORM
13. √FLASH EVAP CNTLR PRI A,B (two) – OFF
ML31C 14. SPLY H2O TKD OUTLET – CL (tb-CL)
R11L 15. SPLY H2O TKB OUTLET – CL (tb-CL)
√TKA OUTLET – CL (tb-CL)
TKC INLET – CL (tb-CL)
TKC OUTLET – OP (tb-OP)

STS-116 NOMINAL EMU SIZING MATRIX

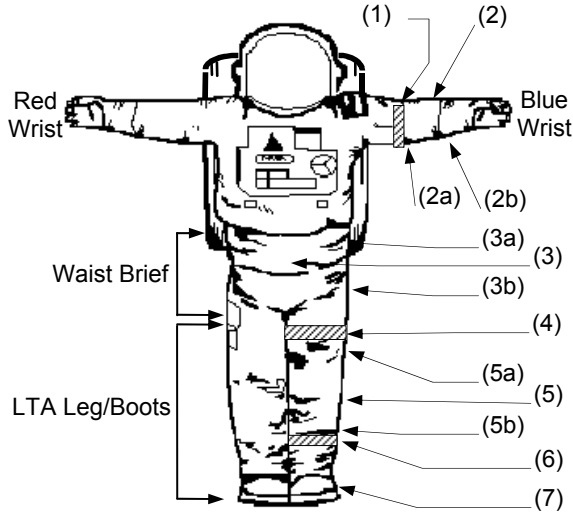

NOTE

Note any changes made in-flight to EMU size; record in EVA C/L

EMU	Helmet	HUT Size/ SEMU #	(1) Arm Sizing Ring	(2a) Arm Cam	(2) Lower Arm	(2b) Wrist Cam	PhaseVI Glove
Curbeam	1061	XL / 3003	0.5 inch (s/n 140/141)	Short	04 (s/n 335/336)	Long	6CR (s/n 6238)
Fuglesang up	1063	M / 3018	0.5 inch (s/n 167/168)	Long	03 (s/n 217/218)	Long	6FG (s/n 6197)
Fuglesang down	1063	L / 3015	None	Short	03 (s/n 241/242)	Long	6FG (s/n 6197)
Williams	1071	M / 3018	None	Short	03 (s/n 217/218)	Long	6WS (s/n 6047)

LTA	(3a) Brief Upper Cam	(3) Waist Brief	(3b) Brief Lower Cam	(4) Thigh Sizing Ring	(5a) Leg Upper Cam	(5) Leg Segment	(5b) Leg Lower Cam	(6) Leg Sizing Ring	(7) Boot/Insert
Curbeam	Long	02 (s/n 2041)	Long	None	Short	03 (s/n 191/192)	Long	None	02 / None (s/n 220)
Fuglesang - up	Long	01 (s/n 2057)	Long	None	Short	03 (s/n 185/186)	Long	1.0-inch (s/n 117/118)	02 / None (s/n 215)
Fuglesang - dn	Long	01 (s/n 2074)	Long	None	Short	03 (s/n 173/174)	Long	1.0-inch (s/n 119/120)	02 / None (s/n 212)
Williams	Short	01 (s/n 2053)	Short	None	Short	02 (s/n 153/154)	Long	None	01 / 03 (s/n 203)

Crew Options: Size (Serial #)	CCA / CCEM	MAG	TCU top / bottom	Comfort Gloves / Wristlets	LCVG / AVD / LVD / BLVD	OBS	Boot Liner / Sock	Comments
Curbeam	05 / 323 (s/n 1166/1050)	711	XL / M	XL, Thick [-14] / Yes	05 / 14 / 08 / 07 (s/n 3132)	pr:122 b/u:117	Thermax Liners [L] Thermal Slipper (07) 1/4" Heel Pads on sides only	fresnel lens: none
Fuglesang	03 / 327 (s/n 1203/1070)	711	M / M	Flat Pattern [MM] / Yes	05 / 13 / 07 / 05 (s/n 3196)	pr:106 b/u:103	Tube sock Thermal Slipper (07) 1/4" Heel Pads on sides only	fresnel lens: 3.5 diopter (-015) modified croakie [M]
Williams	01 / 323 (s/n 1194/1036)	709	S / M	M, Thin [-04] S, Thick [-08] / Yes	02 / 13 / 05 / 03 (s/n 3141)	pr:121	Tube sock	Fresnel lens: none

EMU CONTINGENCY RESIZE MATRIX

I

LOSS OF:	EV1 Curbeam (Cr)	EV2 (Fuglesang)	EV3 (Williams)
CCA	(05/323 - 1166/1050) 1. Use Cr b/u CCA (05/323 --1165/1046)	(03/327 - 1203/1070) 1. Use Ta CCA (03/327 -1177/1060)	(01/323 - 1194/1036) TBD
LCVG	(05 - 3132) 1. Use Cr b/u LCVG (05 - 3204) 2. Transfer: biomed & dosimeter	(05 - 3196) 1. Use Fg b/u LCVG (05 - 3137) 2. Transfer: biomed & dosimeter	(02 - 3141) TBD
HUT/PLSS	(XL - EMU 3003) 1. Use La HUT 3008 (XL) 2. Install Cr arm sizing ring, lower arms, & gloves 3. Use Cr CCA 4. Use Cr Helmet 5. Use Cr LTA	(M - EMU 3018) 1. Use Rei HUT 3015 (L) 2. Remove EMU 3015 arm sizing rings (138/139) 3. Reinstall EMU 3015 lower arms (03 - 241/242) 4. Verify cams: S/L 5. Install Fg gloves 6. Use Fg CCA 7. Use Fg Helmet 8. Use Fg LTA	(M - EMU 3018) 1. Use ISS HUT 3006 (L) 2. Use Sw lower arm segments (02 -- 213/214) 3. Set arm segment cams: S/S 4. Install W gloves (6WS -- 6047) 5. Use W CCA 6. Use W Helmet 7. Use W LTA
Arm Sizing Ring (1)	(0.5" - 140/141) 1. Use EMU 3015 arm sizing ring (0.5" - 138/139)	(0.5" - 167/168) 1. Use EMU 3015 arm sizing ring (0.5" - 138/139)	N/A
Lower Arm Segment (2) & cams (2a/2b)	(04, S/L - 335/336) 1. Use EMU 3006 lower arm segments (04 - 225/226) 2. Verify cams: S/L	(03, L/L - 217/218) 1. Use EMU 3015 lower arm segments (03 - 241/242) 2. Set cams: L/L	(03, S/L - 217/218) 1. Use EMU 3015 lower arm segments (03 - 241/242) 2. Verify cams: S/L
Gloves	(6CR - 6238) 1. Use Cr b/u gloves (6CR - 6207)	(6FG - 6197) 1. Use Fg b/u gloves (6FG - 6209) 2. Set arm segment upper cams: S	(6WS - 6047) 1. Use W b/u gloves (6WS -- 6046)
Waist Brief (3) & cams (3a/3b)	(02, L/L - 2041) 1. Use EMU 3006 waist brief (02 - 2056) 2. Set cams: L/L 3. Install Cr leg segments (03) & Cr boots (02)	(01, L/L - 2057) 1. Use EMU 3015 LTA (waist brief: 01 - 2074) 2. Verify waist brief cams: L/L 3. Verify leg cams: S/L	(01, S/S - 2053) 1. Use Fg waist brief (01 - 2057) 2. Set cams: S/S 3. Install W leg segments (02 - 153/154) & W boots (01 - 203)
Leg Segment (5) & cams (5a/5b)	(03, S/L - 191/192) 1. Use EMU 3015 leg segments (03 - 173/174) 2. Verify cams: S/L	(03, S/L - 185/186) 1. Use EMU 3015 LTA (waist brief: 01 - 2074) 2. Verify waist brief cams: L/L 3. Verify leg cams: S/L	(02, S/L - 153/154) TBD
Leg Sizing Ring (6)	N/A	(1.0" - 117/118) 1. Use EMU 3015 LTA (waist brief: 01 - 2074) 2. Verify waist brief cams: L/L 3. Verify leg cams: S/L	N/A
Boot/BSI (7)	(02/none - 220) 1. Use EMU 3015 boot (02/none - 212) 2. Verify no BSI or toe cap installed in boot	(02/none - 215) 1. Use EMU 3015 LTA (waist brief: 01 - 2074) 2. Verify waist brief cams: L/L 3. Verify leg cams: S/L	(01/03 - 203) 1. Use spare ISS boot (prepack - Pi) (01/none -222) 2. Remove BSI's and toe caps from boots (W) (203) 3. Install BSI's (03) and toe caps into spare ISS boot (222)

PRE EVA 3 EMU RESIZE

I

OBJECTIVE

This procedure will reconfigure **EMU 3018 for S. Williams** per Figure 1 and complete final reconfiguration of **EMU 3015 for C. Fuglesang (return contingency EMU)** per Figure 2.

NOTE

1. Reference {1.550 EMU RESIZE} (SODF: ISS EVA SYS: EMU MAINTENANCE) for component changeout steps.
2. Reference {5.115 EMU BARCODE LOCATION REFERENCE} (SODF: ISS EVA SYS: REFERENCE) for barcode and EMU serial number locations. The CCA (comm cap) serial number is located on a tag above the left earphone.
3. EMU may be installed in EDDAs as needed to perform resize.
4. Place covers on all EMU softgoods components prior to stowage. (Covers located in A/L1D0, bag labeled EMU COVERS VARIOUS SIZES).

CAUTION

1. Remove rings and other jewelry before exposing EMU bladder.
2. All seals are clean and free of debris before making connections

1. Retrieve W waist brief (01 – Waist 021) from A/L1O1, M-02 bag (1010) labeled “EMU Soft Goods”.
2. Retrieve W leg segments (02 – s/n 153/154) from “EMU Soft Goods” M-02 bag (s/n 1010), may already be attached to W waist brief.
3. Install W leg segments (02 – s/n 153/154) onto W waist brief (01 – Waist 021), if not already installed.
4. Configure W leg segments cams and W waist brief cams per Figure 1.
5. Remove Fg LTA (waist brief: 01 – Waist 007) from EMU 3018.
6. Install LTA BSC cover from W LTA (waist brief: 01 – Waist 021) onto Fg LTA (waist brief: 01 – Waist 007).
7. Stow Fg LTA in “EMU Soft Goods” M-02 bag (s/n 1010). May need to disassemble LTA to fit in bag (if so, cover components per Note 4 above).
8. Install W LTA (waist brief: 01 – Waist 021) onto EMU 3018.
9. Install W boots (01/BSI – s/n 203) from EMU SYS TRANSFER BAG #2 onto EMU 3018.
10. Remove Fg gloves (6FG – s/n 6197) from EMU 3018.

PRE EVA 3 EMU RESIZE (Cont)

11. Install Fg gloves (6FG – s/n 6197) onto EMU 3015, stow arm covers from EMU 3015 in “EMU Covers (Various sizes)” 1.0 CTB s/n 1163 (located A/L1D0).
12. Disconnect lower arm power cable from upper arm power harness (both arms) on EMU 3018.
13. Remove Fg arm sizing rings (0.5” – s/n 167/168) from EMU 3018, then re-install lower arms.
14. Connect Fg arm sizing ring (0.5” – s/n 167) to sizing ring (0.5” – s/n 168).
15. Stow sizing rings (0.5” – s/n 167/168) in sizing ring protective pouch from Fg ECOK, then stow in “EMU Soft Goods” M-02 bag (s/n 1010).
16. Adjust arm segments upper cams (2 per arm) to short position on EMU 3018, see Figure 1.
17. Connect lower arm power cable to upper arm power harness (both arms) on EMU 3018.
18. Install W gloves (6WS – s/n 6047) from EMU SYS TRANSFER BAG #2 onto EMU 3018.
19. Remove W helmet (s/n 1071) from EMU 3015.
20. Remove Fg helmet (s/n 1063) from EMU 3018.
21. Install Fg helmet (s/n 1063) onto EMU 3015.
22. Disconnect Fg CCA (s/n 1203) from EMU 3018 electrical harness.
23. Stow Fg CCA (s/n 1203) in Fg ECOK.
24. Connect W CCA (s/n 1194) from EMU SYS TRANSFER BAG #2 to EMU 3018 electrical harness, stow comm cap in arm of EMU.
25. Install W helmet (s/n 1071) onto EMU 3018.
26. Verify wrist mirrors on both EMU 3018 & EMU 3015.
27. Remove ISS Cuff Checklist containing Fg notes from EMU 3018, stow in EMU Equipment Bag (stays on ISS).
28. Install ISS Cuff Checklist containing W notes from EMU SYS TRANSFER BAG #2 onto EMU 3018.
29. Remove helmet lights and EMU TV from Fg helmet and install on W helmet.
30. Remove Fg STS 116 patch and Swedish flag from EMU 3018, stow in ECOK or install on EMU 3015.
31. Install W STS 116 patch and US flag (from ECOK EVA #1 STS-116 bag) on EMU 3018.
32. Verify final configuration per Figures 1 and 2 below.

PRE EVA 3 EMU RESIZE (Cont)

- NOTE**
1. All labels show serial numbers on top and barcodes in parentheses.
 2. **BLACK** font indicates hardware already installed on EMU 3018.
 3. **GREEN** font indicates hardware stowed on ISS.
 4. **BLUE** font indicates hardware delivered on STS-116/12A.1.
 5. **RED** font indicates adjustments to hardware.

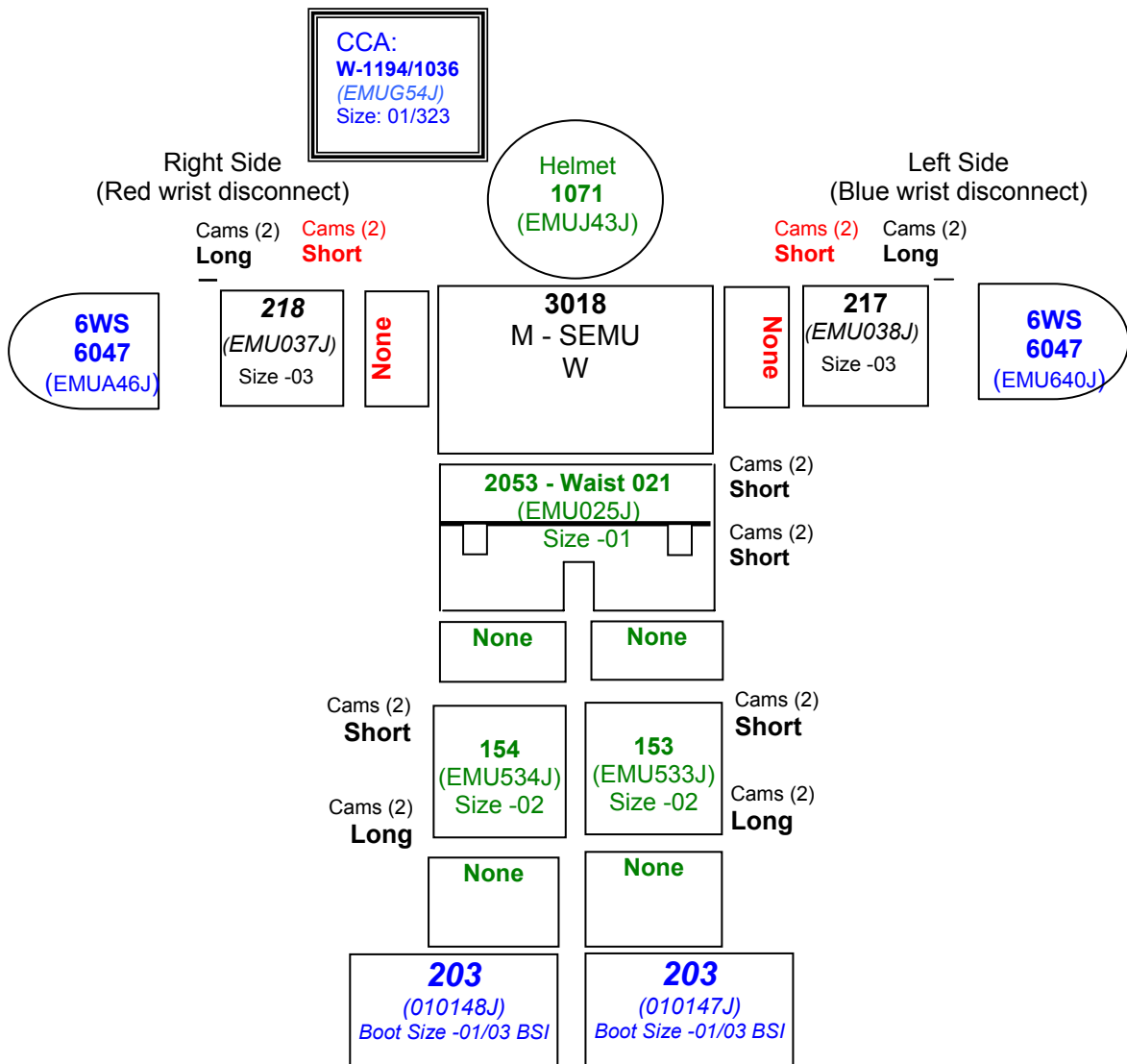

FIGURE 1 - FINAL EMU 3018 (W) CONFIG (viewed from front)

PRE EVA 3 EMU RESIZE (Cont)

- NOTE**
1. All labels show serial numbers on top and barcodes in parentheses.
 2. **BLACK** font indicates hardware already installed on EMU 3015.
 3. **BLUE** font indicates hardware delivered on **STS-116/12A.1**.

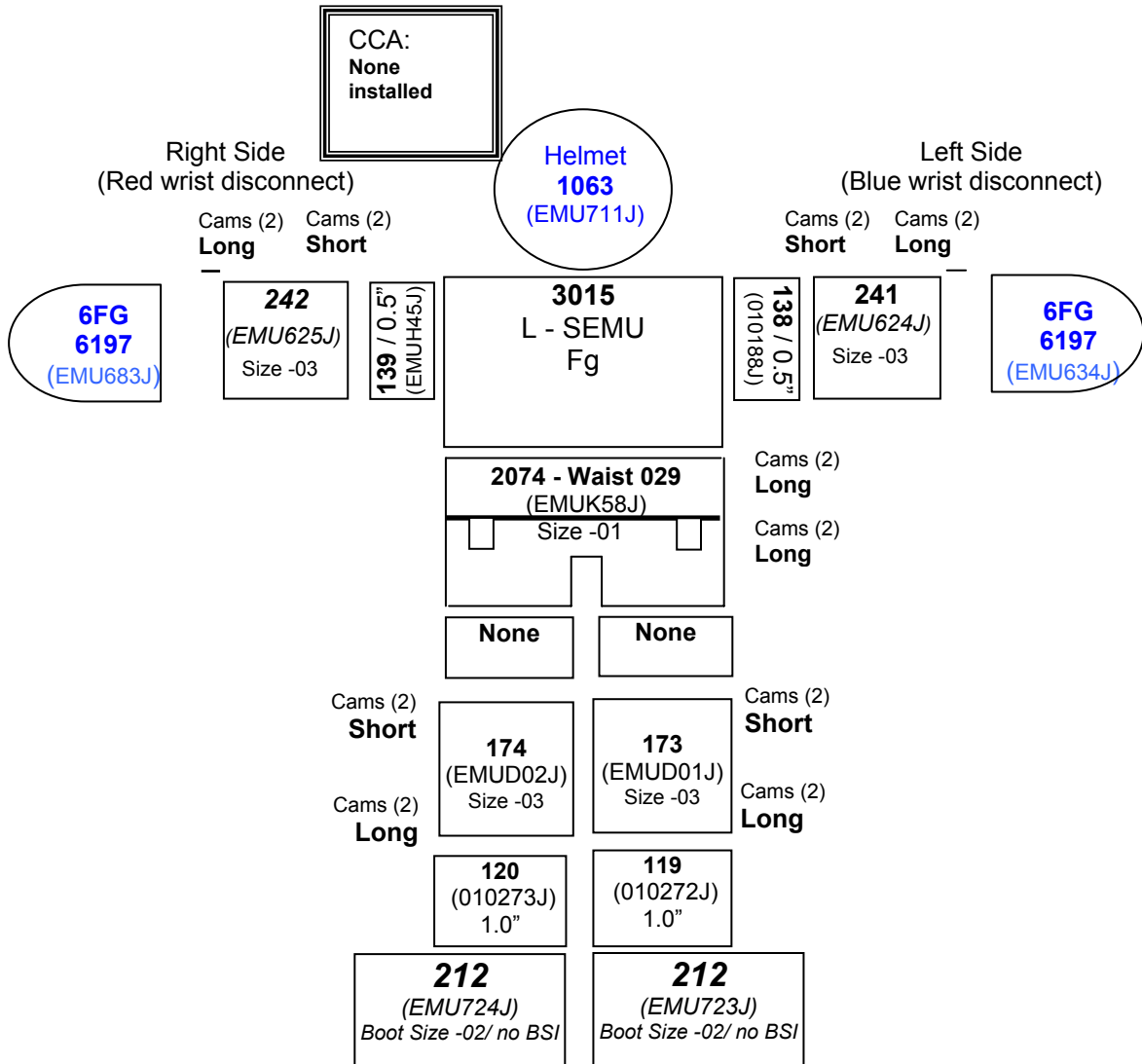

FIGURE 2 - FINAL EMU 3015 (Fg) CONFIG (viewed from front)

TPS REPAIR

The TPS Repair procedures listed below are not published in the hardcopy EVA Flight Supplement. These procedures will be uplinked realtime if they are required.

A PDF and a WORD version of the procedures can be found at:
<http://mod.jsc.nasa.gov/do3/FDF/FDFBooks/Status%20Sheets/index.html>.

Select the "As Flown" Status sheet for STS-116 and the link to the procedures can be found with the link to the EVA FS. The procedures can also be found on the FDF Books CD provided to the FAO console

BOOM TPS INSPECTION	
BOOM POINT INSPECTION SUMMARY TIMELINE	FS 13-3
BOOM POINT INSPECTION TOOL CONFIG.....	FS 13-4
BOOM POINT INSPECTION	FS 13-5
BOOM WLE MAPPING SUMMARY TIMELINE	FS 13-15
BOOM WLE MAPPING TOOL CONFIG	FS 13-17
BOOM WLE MAPPING	FS 13-18
EVA WLE MAPPING INSPECTION.....	FS 13-24
SAFER TPS INSPECTION	
SAFER TPS INSPECTION SUMMARY TIMELINE	FS 13-29
SAFER TPS INSPECTION TOOL CONFIG.....	FS 13-30
SAFER TPS INSPECTION	FS 13-31
BOOM CONTINGENCY	
BOOM FRGF SHAFT RELEASE	FS 13-37
BOOM FRGF SHAFT INSTALLATION	FS 13-38
BOOM EFGF SHAFT RELEASE	FS 13-40
BOOM MPM STOW/DEPLOY.....	FS 13-42
BOOM ASSISTED LATCHING	FS 13-43
TILE REPAIR	
EMU PREP FOR TPS REPAIR.....	FS 13-44
POST TPS REPAIR DOFFING	FS 13-45
EWA MATERIAL MIXING	FS 13-46
EWA REF DATA	FS 13-47
EWA TILE REPAIR – DOCKED/ORM SUMMARY TIMELINE	FS 13-48
EWA TILE REPAIR – DOCKED/ORM TOOL CONFIG.....	FS 13-49
EWA TILE REPAIR – DOCKED/ORM	FS 13-50
SSRMS GAP FILLER REMOVAL SUMMARY TIMELINE	FS 13-58
BOOM GAP FILLER REMOVAL SUMMARY TIMELINE	FS 13-59
GAP FILLER REMOVAL	FS 13-60
RCC REPAIR	
RCC CRACK REPAIR BAG ASSEMBLY.....	FS 13-65
TEMP SENSOR DISASSEMBLY POST-EVA.....	FS 13-68
RCC CRACK REPAIR BAG DISASSEMBLY POST-EVA	FS 13-69
TEMPERATURE PROBE ASSEMBLY	FS 13-71
CRM APPLICATOR ASSEMBLY	FS 13-71
CRM APPLICATOR NOZZLE INSTALLATION (DAY OF EVA).....	FS 13-72
NOTES, CAUTIONS, WARNINGS	
EVA TPS INSPECTION/REPAIR INHIBIT PAD.....	FS 13-73
ORM WARNINGS AND NOTES	FS 13-76
TPS REPAIR CAUTIONS AND WARNINGS	FS 13-77
TPS REPAIR NOTES.....	FS 13-78
BOOM OPERATIONAL WARNINGS	FS 13-79
BOOM OPERATIONAL NOTES	FS 13-80

TPS REF DATA	
PREFERRED EMU POSITIONING FOR TPS REPAIR.....	FS 13-81
EVA TPS REACH AND ACCESS	FS 13-82
POINT INSPECTION REACH AND ACCESS WHILE DOCKED.....	FS 13-83
WLE MAPPING INSPECTION WHILE DOCKED	FS 13-85
TILE LAYUP.....	FS 13-86
85-FOOT SAFETY TETHER.....	FS 13-87
PFR ATTACHMENT DEVICE (PAD)	FS 13-88
WIF EXTENDER	FS 13-89
EVA DIGITAL CAMERA.....	FS 13-90
EVA IR CAMERA	FS 13-92
OVERLAY TILE REPAIR SYSTEM (OTRS)	FS 13-94
OTRS MARKING TEMPLATE AND INSULATION BAGS	FS 13-95
AUGER HOUSING.....	FS 13-96
OTRS RELEASED CONFIGURATION	FS 13-97
ORU BAG INSERT FOR OTRS	FS 13-98
BOOM REF DATA	
RTF BOOM OVERVIEW.....	FS 13-99
BOOM TRANSITIONS WITH MLI	FS 13-100
BOOM BASE END AND MODIFIED EFGF	FS 13-101
BOOM BASE END EFGF ADAPTER PLATE	FS 13-102
EVA-ASSISTED EFGF CONNECTOR DEMATE	FS 13-103
BOOM BASE END SADDLE AND MPM.....	FS 13-104
BOOM MID SECTION AND MODIFIED FRGF.....	FS 13-105
BOOM MID SECTION FRGF ADAPTER PLATE.....	FS 13-106
BOOM TIP END AND SENSORS	FS 13-107
BOOM SENSOR DETAILS	FS 13-109
SENSOR PACKAGE 1 (SP1): LDRI/ITVC	FS 13-111
SENSOR PACKAGE 2 (SP2): LCS.....	FS 13-113
POSSIBLE PRD ROUTING FOR EVA ASSISTED LATCHING	
OF BOOM IN MPMS.....	FS 13-115
BOOM CONTINGENCIES	FS 13-116
GRAPPLE SHAFTS	FS 13-117
PDGF GRAPPLE SHAFT COVER.....	FS 13-118
BOOM FRGF FSE.....	FS 13-119

UNSCHEDULED/CONTINGENCY EVA TASKS

UNSCH/CONT
EVA TASKS

12A.1 WORKAROUNDS CRIBSHEET	FS 16-3
EVA 1 CONTINGENCIES	
MANUAL EATCS N2 VENTING	FS 16-15
SOFT CAPTURE MANUAL OVERRIDE	FS 16-21
MRTAS PRIMARY BOLT CONTINGENCIES	FS 16-23
MRTAS CONTINGENCY BOLT INSTALL	FS 16-25
SOLAR ARRAY	
MANUAL OVERRIDE TO RETRACT MAST	FS 16-28
MANUAL OVERRIDE TO LATCH/UNLATCH (TENSION) 4B SABB	FS 16-31
SOLAR ARRAY JETTISON	FS 16-34
EVA 2 CONTINGENCIES	
CHANNEL 2/3 CONNECTOR BACKOUT	FS 16-40
MBSU REMOVE AND REPLACE – 2A2B (EVA 2)	FS 16-43
MBSU REMOVE AND REPLACE – 3A3B (EVA 2)	FS 16-51
DDCU REMOVE AND REPLACE – CH 2/3 (EVA 2)	FS 16-59
BCDU BACKOUT – CH 2/3 (EVA 2)	FS 16-67
P1 PUMP MODULE R&R SUMMARY TIMELINE	FS 16-70
EVA 3 CONTINGENCIES	
CHANNEL 1/4 CONNECTOR BACKOUT	FS 16-96
MBSU REMOVE AND REPLACE – 1A1B (EVA 3)	FS 16-100
MBSU REMOVE AND REPLACE – 4A4B (EVA 3)	FS 16-108
DDCU REMOVE AND REPLACE – CH 1/4 (EVA 3)	FS 16-117
BCDU BACKOUT – CH 1/4 (EVA 3)	FS 16-126
S1 PUMP MODULE R&R SUMMARY TIMELINE	FS 16-130
MISCELLANEOUS	
SSRMS JOINT DRIVE	FS 16-154
MSS EXTENSION CABLE INSTALL	FS 16-156
PUMP MODULE MANUAL VENTING	FS 16-159
FAILED PUMP MODULE RETURN TO ICC	FS 16-163

This Page Intentionally Blank

12A.1 WORKAROUNDS CRIBSHEET

GENERIC

NZGL CONNECTOR

A. Connector fails to demate	<ol style="list-style-type: none"> 1. Verify bail fully thrown and undamaged 2. Inspect connector/bail for FOD 3. Check alignment/side loads 4. Wiggle/jiggle connector, pull on connector back shell away from cap/jack for additional leverage 5. Attach 2 hooks from adjustable tether to connector bail, use adjustable strap to pull bail into demated position (this works better after bail/linkage has passed over-center feature) 6. Check for harness interference 7. Increase force on bail
B. Connector fails to soft dock	<ol style="list-style-type: none"> 1. Verify bail fully aft 2. Verify plug half shell is aligned with jack half shell, avoid rolling/rocking plug onto jack (this could possibly unseat soft dock springs; it is also possible for keying feature to prevent soft dock). Once half shells are aligned, connector should snap into soft dock position with little force
C. Connector fails to mate	<ol style="list-style-type: none"> 1. Detach from soft dock and inspect the following: <ol style="list-style-type: none"> a. Pins b. FOD c. EMI band d. bend radius e. bail linkages/rivets f. soft dock springs g. O-ring seal on non-active side or main joint gasket inside receptacle h. connector keying features 2. Cycle bail while disconnected, push on connector back shell toward cap/jack for additional leverage 3. Verify half-shells are fully seated on both sides
D. Connector pin bent (16,20,22 gauge)	<ol style="list-style-type: none"> 1. Rotate connector to bail up position, describe pin condition. If possible, obtain WVS view or interface 2. On MCC GO, retrieve pin straightener (A/L staging bag) or needle nose pliers (stbd A/L toolbox, slot 2); attempt pin repair (this is based on pin size and MCC will verify actual pin size prior to retrieving tool)
E. Connector FOD	<p>On MCC GO, obtain connector cleaner tool from A/L staging bag; use entire cartridge prior to re-entry to the airlock</p> <p style="text-align: center;"><u>NOTE</u></p> <p>One N2 cartridge is already captured onto the CCT (the other is lanyarded inside caddy). In order to puncture cartridge, it must be threaded into CCT until indicator line passes out of sight under the collar of the CCT</p>
F. Connector EMI band bent	<p>On MCC GO, obtain needle nose pliers (stbd A/L toolbox, slot 2) or forceps to remove band</p>
G. Connector bail linkage failure	<p>On MCC GO, re-attempt connector mate with broken bail. Vice grips may be used for additional leverage or hand on backshell (hand on back shell is easiest once linkage/bail has passed over-center feature)</p>
H. Connector soft dock spring bent	<p>On MCC GO, obtain needle nose pliers (stbd A/L toolbox, slot 2); attempt to remove bent spring</p>

12A.1 WORKAROUNDS CRIBSHEET (Cont)

I. Connector O-ring or Main Joint Gasket seal loose (used as a moisture seal in 1G only, not needed on orbit)	<ol style="list-style-type: none"> 1. Remove seal with tether hook 2. If no joy, on MCC GO, obtain needle nose pliers (stbd A/L toolbox, slot 2) to remove seal
J. Twist cap will not release	<ol style="list-style-type: none"> 1. On MCC GO, increase force 2. On MCC GO, attach equipment hook to cap tether point and use strap of adj tether to assist with cap release

TA Clamp

TA clamp fails to release	Use tether hook to open clamp (do not use as a prying mechanism)
---------------------------	--

TSA

A. Latch fails to open	Release 7/16" EVA bolt on latch bracket, rotate bracket clear of latch tongue
B. Latch fails to close	Close remaining latches (3 of 4 required for landing)

APFR

A. APFR fails to install in WIF	<ol style="list-style-type: none"> 1. Verify APFR collar in install position 2. Check for FOD in WIF or structural interference 3. Attempt APFR install in alternate position. If no joy (APFR failure), use another APFR
B. Joint fails to actuate	<ol style="list-style-type: none"> 1. Verify no load is applied to joint 2. Increase force applied to free joint
C. EMU boot becomes stuck in bootplate	PGT[B1, CCW2, 30.5]-6"-ext-7/16" : Release EVA bolts on heel plate, 5 turns

SAFETY TETHER

A. 55' safety tether fails to retract/tend	<ol style="list-style-type: none"> 1. Verify reel is unlocked 2. Verify tether reel opening is clear of FOD 3. Pull out small amount of cable, allow reel to retract while holding cable slightly tensioned
B. 85' safety tether fails to retract/tend	<ol style="list-style-type: none"> 1. Verify reel is unlocked 2. Verify tether reel opening and cable guide is clear of FOD (ensure nothing is blocking cable from retracting) 3. Pull out small amount of cable, allow reel to retract while holding cable slightly tensioned
C. Safety tether red stripe showing (any length)	Safety tether cannot be used. Replace with spare safety tether from Crewlock Bag #1

PAD

A. For PAD install, release knob fails to rotate to close	<ol style="list-style-type: none"> 1. Verify knob unlocked and in release position 2. Stow PAD in A/L, retrieve backup PAD from port TSA
B. For PAD remove, release knob fails to rotate to open	<ol style="list-style-type: none"> 1. Verify knob unlocked and in release position 2. Attempt to rotate release knob using 7/16" Ratchet on knob's 7/16" hex stud 3. To remove PAD from SRMS, PGT[A6, CCW2, 30.5]-6-in ext: Release contingency release bar by rotating 7/16" captive release bolts (2) ccw, 5 turns

12A.1 WORKAROUNDS CRIBSHEET (Cont)

TORQUE MULTIPLIER

A. Torque Multiplier fails to release from fitting	<ol style="list-style-type: none"> 1. Verify anti-backlash feature in neutral; if not: PGT[RCW, MTL 30.5]: Apply cw torque and push anti-backlash button to neutral posn 2. PGT[A5, 2.5 ft-lb, CCW2, 30.5]-5/32" allen driver: Release torque multiplier contingency release band pin 20 turns (do not exceed 28 turns) 3. When contingency band springs open, remove TM
--	---

SCOOPS

A. Scoop will not release from fitting	PGT[A2, CCW2, 30.5] -5/32" allen driver: Remove screws (not captive), 5 turns each
--	---

FLIGHT SPECIFIC – NOMINAL TASKS

EVA 1

P5/P4

A. P5 launch lock will not release because primary bolt torques out	<ol style="list-style-type: none"> 1. Check worksite for FOD 2. Retrieve EVA Ratchet Wrench from Staging Bag in A/L, install 7.8" x 5/8" socket on ratchet 3. Attempt to break torque (ccw) on launch lock 4. Use PGT with RAD to continue driving bolt through running torque to nominal turn count <p style="text-align: center;"><u>NOTE</u></p> <p>Boeing has given the GO to use B7 from a truss hardware standpoint, but we are limited to a setting of B1 with the RAD</p>
B. P5 launch lock will not release from P5 when PIP pin is pulled	<ol style="list-style-type: none"> 1. Verify PGT turn count. Is primary bolt free of launch lock threads? 2. If no joy, drive primary bolt additional turns, not to exceed 36
C. P5 launch lock PIP pin will not release	<ol style="list-style-type: none"> 1. Check worksite for FOD or damage to PIP pin 2. Increase removal force and try again 3. Retrieve needle nose pliers or vice grips and re-attempt
D. P5-P4 Soft Capture not achieved at any of the 4 corners	<ol style="list-style-type: none"> 1. SSRMS re-attempts per flight rules 2. EVA perform SOFT CAPTURE MANUAL OVERRIDE from section 16
E. For any of the following P5 Primary Bolt contingencies: <ol style="list-style-type: none"> a. Does not achieve full torque b. Bolt shoulder has a gap (is not seated against nut) c. Gap check at corner's 1 and 2 does not pass 	EVA perform MRTAS PRIMARY BOLT CONTINGENCIES from section 16
F. P5 gap check tool (inboard) will not release from corner 1	<ol style="list-style-type: none"> 1. Check worksite for FOD 2. If bolt did not turn, increase PGT setting to B7, drive one turn only, then return to original PGT setting 3. Retrieve gap check tool from outboard corner 1
G. P4 ground strap will not release from P4 launch position	<ol style="list-style-type: none"> 1. Check worksite for FOD 2. Increase PGT setting to B5 3. If bolt did not turn, increase PGT setting to B7, drive one turn only, then return to B5
H. P4 ground strap cross threads during install onto P5 lug	Ensure EV crew begins installation manually, back-off thread engagement and re-attempt

12A.1 WORKAROUNDS CRIBSHEET (Cont)

I. P4 ground strap will not seat properly onto P5 lug (ground strap is not flush to surface or PGT stalls)	<ol style="list-style-type: none"> 1. Check ground strap alignment 2. Increase PGT torque setting to B4
J. P4 soft capture pin bolts will not release	<ol style="list-style-type: none"> 1. Check worksite for FOD 2. If bolt did not turn, increase PGT setting to B7, drive 1 turn only, then return to original PGT setting
K. Primary bolt free spins and does not advance into P4 nut (PGT does not "see" torque) (possible broken self-feeding nut)	If bolt free spins, push P5 bolt axially toward P4 while driving PGT until bolt threads begin to engage P4 nut (under load)

PVRGF

A. PVRGF bolts (H13, H14, and H15) won't release	<ol style="list-style-type: none"> 1. Check worksite for FOD 2. Increase PGT torque setting to B7, re-attempt 3. If no joy: <ul style="list-style-type: none"> • PGT – off • Ratchet ccw, (MTL: 30.5) • Attempt to break torque
B. PVRGF bolt H16 won't release (RAD used at this corner)	<ol style="list-style-type: none"> 1. Check worksite for FOD 2. Retrieve the following tools: <ul style="list-style-type: none"> □ EVA Ratchet Wrench from Staging Bag in A/L, install 6-inch socket on Ratchet □ Cheater Bar from Z1 port toolbox, panel 8 3. Using Ratchet Wrench, attempt to break torque (ccw) on launch lock (keep downward pressure on wobble socket while breaking torque). If no joy, install cheater bar on Ratchet Wrench and re-attempt to break torque 4. Use PGT with RAD to continue driving bolt through running torque to nominal turn count
C. PVRGF ground strap bolt won't release (corner H14)	<ol style="list-style-type: none"> 1. Check worksite for FOD 2. Use PGT in ratchet mode: <ul style="list-style-type: none"> • PGT – off • Ratchet ccw, (MTL: 30.5) • Attempt to break torque
D. Corner H16 (nadir/stbd) on PVRGF is interfering with 4A BGA during removal	<ol style="list-style-type: none"> 1. Drive H16 bolt CW up to 17 turns with PGT setting of A5 toward structure to provide an additional 0.85" of clearance at that corner for removal, re-attempt PVRGF removal 2. Remove PIP pin from PVRGF at H16 corner (lanyarded), re-attempt removal
E. PVRGF ground strap bolt will not install onto P5 Keel lug (cross thread problem)	<ol style="list-style-type: none"> 1. Check worksite for FOD 2. Back-off thread engagement and re-attempt installation manually
F. PVRGF ground strap will not seat properly onto P5 keel lug (ground strap is not flush to surface or PGT stalls)	<ol style="list-style-type: none"> 1. Check worksite for FOD 2. Release bolt at B7, re-align and attempt installation at nominal installation PGT setting

ETVCG

A. Failed ETVCG is not oriented correctly for removal (should be in park position) or will not pan to park position (camera lens should point zenith and directly toward TVCIC structure (bolt housing))	<ol style="list-style-type: none"> 1. Contact MCC 2. Manually align (pan/tilt lock lever will not lock unless camera is in home position)
B. Failed ETVCG pan/tilt lever won't rotate	<ol style="list-style-type: none"> 1. Check worksite for FOD 2. Increase force, re-attempt 3. Contact MCC
C. Failed ETVCG outer bolt does not release	<ol style="list-style-type: none"> 1. Check worksite for FOD 2. Increase PGT setting to B7 for ONE turn only. Reset PGT to A7 for full run-out of bolt

12A.1 WORKAROUNDS CRIBSHEET (Cont)

D. Failed ETVCG center jacking bolt does not release	<ol style="list-style-type: none"> 1. Check worksite for FOD 2. Check outer bolts to make sure they are fully backed out 3. Increase PGT torque setting to B7 for ONE turn only. Reset PGT to A7 for full run-out of bolt
E. Spare ETVCG center jacking bolt does not engage	Remove camera, inspect rail and bolt interface from damage, attempt re-installation, ensure outer bolts are retracted
F. Spare ETVCG center jacking bolt does not reach minimum turn count (24 turns)	Increase PGT torque setting to B1; re-attempt
G. Spare ETVCG outer bolt does not engage	<ol style="list-style-type: none"> 1. Check worksite for FOD 2. Engage opposite outer bolt, re-attempt driving failed bolt 3. Increase PGT torque setting to B1, re-attempt 4. Contact MCC

EVA 2

P1 DDCU THERMAL COVER GROUND STRAP



A. Ground bolt fails to release	If bolt did not turn, increase PGT setting to B7, drive one turn only, then return to original PGT setting
B. If bolt still fails to release at new setting	<ol style="list-style-type: none"> 1. Using EMU scissors, cut ground strap close to bolt -OR- 2. On MCC GO, shear bolt

Z1-003 PATCH PANEL 5 RECONFIGURATION

A. Cannot reach connectors on Z1 stbd patch panel due to SASA interference	<ol style="list-style-type: none"> 1. Contact MCC for SASA removal and temp stow: <ol style="list-style-type: none"> a. Retrieve ballstack and MUT EEs (2) from crewlock bag #1 b. Reconfig Z1-01 IAPFR settings to: [3,RR,F,12], ingress IAPFR c. PGT [B7 25.5 ft-lb, CCW3 60 RPM, 30.5]-6"-ext-7/16: Release SASA stanchion storage bolts (2) ~ 9 turns; If no joy with B7: PGT[RCCW, MTL 30.5]-6 ext 7/16: Re-attempt fastener release d. Release SASA from soft dock (if difficult, wiggle/jiggle SASA from soft dock) e. Temp stow SASA via MUT-ballstack-MUT to adjacent Z1 HR <p>If SASA heater cable length prevents SASA removal and temp stow:</p> <ol style="list-style-type: none"> 1. Contact MCC to put Z1 SASA inhibits in place: RPCM Z14B B RPC1 – OPEN, CLOSE CMD INH 2. Demate EAS W200A-P33 from SASA J3 (starts thermal clock) 3. Re-attempt temp stow
--	---

12A.1 WORKAROUNDS CRIBSHEET (Cont)

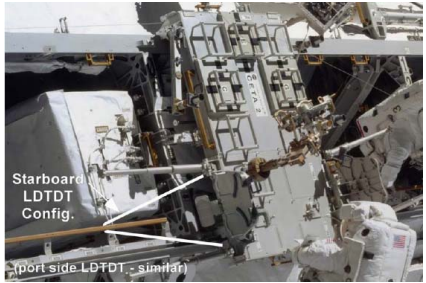
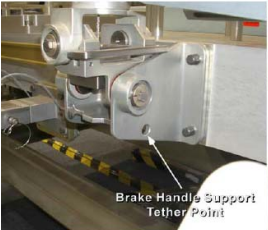
CETA CART

A. Wheel bogie fails to release from truss	Perform CETA Cart Wheel Bogie R&R procedure from section 16; there is no spare bogie on orbit, so remove the failed one from the cart, relocate the cart onto the truss, and then re-install the same wheel bogie
B. Wheel bogie fails to install onto truss	There are no spares on-orbit; it is acceptable to perform the following actions with an unsecured or missing wheel bogie: <ul style="list-style-type: none"> <input type="checkbox"/> Manual EVA translation of CETA cart <input type="checkbox"/> CETA cart coupling to MT <input type="checkbox"/> MT translation with CETA cart coupled to MT
C. Parking brake fails to engage/disengage	<ol style="list-style-type: none"> 1. Retry using other side 2. Contact MCC
D. Dynamic brake fails to engage	<ol style="list-style-type: none"> 1. Limit translation rates for manual stopping or use parking brake as dynamic brake 2. Try other side
<p>E. CETA active coupler fails to capture and lock (CETA cart safing)</p>   	<ol style="list-style-type: none"> 1. Translate CETA cart to TBD location on truss (not over truss segment joint) 2. Pull parking brake (left handle) 3. Retrieve two long duration tie-down tethers (LDTDT) from P6 Aux bag (fwd face of P6) 4. Route one LDTDT on stbd side of CETA cart per the following details: <ul style="list-style-type: none"> <input type="checkbox"/> Attach one hook to zenith brake handle support tether point <input type="checkbox"/> Loop tether strap around CETA rail HR standoff and back toward nadir brake handle support tether point <input type="checkbox"/> Attach second hook to nadir brake handle support tether point <input type="checkbox"/> Lightly cinch straps, snap buckle over <input type="checkbox"/> Close MLI flap over buckle and any excess strap length 5. Repeat sequence for port side of CETA cart
F. Coupler knob fails to lock	The CETA cart coupler cannot be left in the CAPTURE position and allowed to translate with the MT. In the event the coupler fails to LOCK: Perform steps 1 through 5 in section E above
G. Coupler knob fails to unlock	Remove coupler: remove wire ties (2) and PIP pins to release active coupler or single EVA bolt to release passive coupler
H. Swing arm fails to rotate	Do not force swing arm into position; use alternate swing arm/WIF
I. Swing arm fails to lock	Wire tie in stowed position

12A.1 WORKAROUNDS CRIBSHEET (Cont)

EVA 3

S1 DDCU THERMAL COVER GROUND STRAP

A. Ground bolt fails to release	If bolt did not turn, increase PGT setting to B7, drive one turn only, then return to original PGT setting
B. If bolt still fails to release at new setting	1. Using EMU scissors, cut ground strap close to bolt -OR- 2. On MCC GO, shear bolt

Z1-003 PATCH PANEL 6 RECONFIGURATION

A. Cannot reach connectors on Z1 stbd patch panel due to SASA interference	<ol style="list-style-type: none"> 1. Contact MCC for SASA removal and temp stow: <ol style="list-style-type: none"> a. Retrieve ballstack and MUT EEs (2) from crewlock bag #1 b. Reconfig Z1-01 IAPFR settings to: [3,RR,F,12], ingress IAPFR c. PGT [B7 25.5 ft-lb, CCW3 60 RPM, 30.5]-6"-ext-7/16: Release SASA stanchion storage bolts (2) ~ 9 turns; If no joy with B7: PGT[RCCW, MTL 30.5]-6 ext 7/16: Re-attempt fastener release d. Release SASA from soft dock (if difficult, wiggle/jiggle SASA from soft dock) e. Temp stow SASA via MUT-ballstack-MUT to adjacent Z1 HR <p>If SASA heater cable length prevents SASA removal and temp stow:</p> <ol style="list-style-type: none"> 1. Contact MCC to put Z1 SASA inhibits in place: RPCM Z14B B RPC1 – OPEN, CLOSE CMD INH 2. Demate EAS W200A-P33 from SASA J3 (starts thermal clock) 3. Re-attempt temp stow
--	---

SMDP

A. Fixator handle fails to rotate by hand	<ol style="list-style-type: none"> 1. PGT – off 2. If A1: <ol style="list-style-type: none"> a. Ratchet cw (MTL: 30.5) b. Release fixator handle override bolt A1 3. If A2: <ol style="list-style-type: none"> a. Ratchet ccw (MTL: 30.5) b. Release fixator handle override bolt A2
B. Crew cannot access contingency A1 or A2 bolts because adjacent tie rod is still installed and blocks PGT access to bolts	Release adjacent tie rod that is still installed via nominal procedure, re-attempt release of A1/A2 bolts
C. B1/B2 bolt fails to release	<ol style="list-style-type: none"> 1. If it's first bolt on tie rod attempted, <ol style="list-style-type: none"> a. Release other bolt b. Attempt to release tie rod from failed bolt side (~15 kg force) c. If no joy, attempt to release tie rod from successful bolt side (~15 kg force) d. Go to row D 2. If it's second bolt on tie rod attempted, <ol style="list-style-type: none"> a. Attempt to release tie rod from failed bolt side (~15 kg force) b. If no joy, attempt to release tie rod from successful bolt side (~15 kg force) c. Go to row D

12A.1 WORKAROUNDS CRIBSHEET (Cont)

<p>D. B1/B2 bolt fails to release and cannot release tie rod using procedure in C</p>	<ol style="list-style-type: none"> 1. Cut fishing line at hinge contingency override bolt (2 places) (either side of hold down beam) 2. Rotate "Open 1" fixator handle 40° (drops in detent); if handle does not rotate, take PGT to ratchet cw or ccw as needed (MTL: 30.5) 3. Tether to ring 4. PGT – off; ratchet cw or ccw as needed (MTL: 30.5): Rotate "Open 2" 180° in direction of arrow (drops in detent) 5. Release tie rod 6. Pull pin out, stow in trash bag
<p>E. SMDP Adapter handle unable to move from launch position</p>	<p>Perform the following steps to release SMDP adapter contingency bolts (4) and tie down to Lab nadir HRs:</p> <ol style="list-style-type: none"> 1. PGT [B7, CCW2, 30.5] 6"-ext-7/16: Release EVA contingency override bolts, (4) 16 turns (bolts are lanyarded) (no soft dock once bolts are released) (if access is poor with 6-in socket, use RAD with 2-in, MCC to re-calculate torque setting) 2. EV2 remove SMDP adapter from ICC (will have ICC NHP plate attached to it with hex probe) 3. Perform steps 7 through 10 in row F

12A.1 WORKAROUNDS CRIBSHEET (Cont)

- F. SMDP Adapter handle jams in intermediate position upon releasing SMDP Adapter from ICC

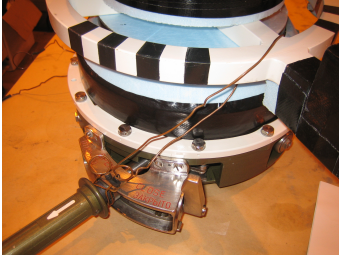

WIRE TIE CONFIG FOR HANDLE



WIRE TIE CONFIG FOR HANDLE

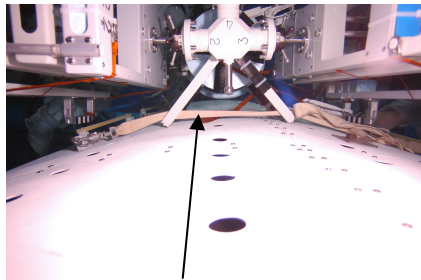

TIE DOWN CONFIG ON LAB
(first tether)

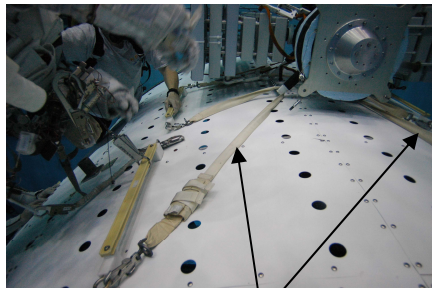

TIE DOWN CONFIG ON LAB
(second and third tethers)

Perform the following steps to secure the SMDP adapter handle toward the Closed position:

1. EV1 retrieve long wire tie from EV2
2. Wrap one end of wire tie around SMDP adapter handle, then around the HR support structure and back onto handle
3. Wrap both ends of wire tie around handle twice
4. Wrap remaining loops around each other 3 times

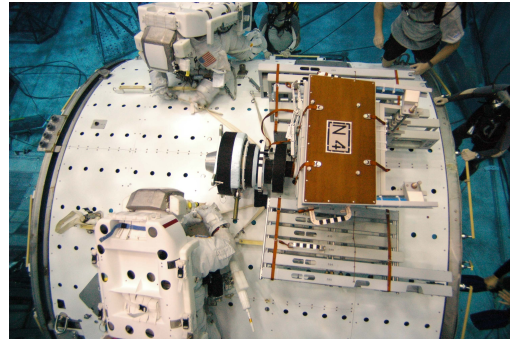

SMDP ADAPTER TIE DOWN OVERVIEW

Perform the following steps to release SMDP adapter contingency bolts (4) and tie down to Lab nadir HRs.

NOTE: Tiedown is not a certified method:

5. **PGT [B7, CCW2, 30.5] 6"-ext-7/16:** Release EVA contingency override bolts, (4) 16 turns (bolts are lanyarded) (no soft dock once bolts are released) (if access is poor with 6-in socket, use RAD with 2-in, re-calculate torque setting)
6. EV2 remove SMDP adapter from ICC (will have ICC NHP plate attached to it with hex probe)
7. SRMS mnvr to contingency tie-down location (Lab nadir/aft/port) near APFR setup/cleanup wkst)
8. EV1 retrieve 3 long duration tie-down tethers from P6 Aux Bag (located on P6 forward face); translate to tie-down worksite on Lab aft/nadir
9. Using 3 long duration tie-down tethers, strap SMDP adapter to Lab HRs using SMDP adapter vertical HRs, cinch down. See photos above and on left:
10. Stow excess strap inside buckle and install MLI over buckle

12A.1 WORKAROUNDS CRIBSHEET (Cont)

<p>G. Magnetic socket fails to lock</p> 	<p>Perform the following steps to secure SMDP bundle to a magnetic socket that fails to lock:</p> <ol style="list-style-type: none"> 1. Retrieve Russian adjustable and fixed length tether from crewlock bag #2 (airlock) 2. Attach 1st hook of fixed-length tether to SMDP bundle HR 3. Attach 2nd hook of fixed-length tether to 1st hook of fixed-length tether (see adjacent photo) 4. Attach 1st hook of adj tether to 2nd hook of fixed-length tether (3 hooks in a row) 5. Route 2nd hook of adj tether through SMDP adapter HRs to SMDP bundle HR on opposite side of adapter, cinch tether
<p>H. SMDP Adapter handle jams in intermediate position while attaching it to Strela adapter on PMA3</p>	<p>Perform the following steps to remove SMDP adapter, Strela adapter, and PMA3 grapple fixture shaft from PMA3 and stow on Lab HRs:</p> <ol style="list-style-type: none"> 1. Retrieve the following tools: <ul style="list-style-type: none"> o Russian long wire tie from EV2 o Velcro/Tape caddy from Staging Bag o 8" x 1/2" rigid socket from Z1 port toolbox, slot 7 (stow socket in trash bag) o Long duration tie down tethers (3) from P6 aux bag (P6 fwd) 2. Attach wire tie to SMDP adapter handle and support structure per steps 1 through 4 in row E 3. PGT [A6 (8.3), CCW2, 30.5]-8"-ext-1/2: Rotate unmarked release rod 9 turns to hard stop (remain tethered to SMDP adapter) 4. PGT[A6 (8.3), CW2, 30.5]-8"-ext-1/2: Rotate white release rod cw 8 turns to hard stop 5. Remove SMDP adapter, Strela adapter, and PMA3 grapple shaft from PMA3 grapple fixture 6. Install kapton tape strip over grapple shaft to prevent slug from coming loose 7. Perform steps 7-10 in row F

AGB

<p>A. T-handle fails to unlock to allow AGB to extend</p>	<ol style="list-style-type: none"> 1. Check interface for FOD or damage 2. Increase force and re-attempt, contact MCC if no joy
<p>B. T-Handle pin does not drop into AGB alignment hole during installation onto FHRC</p>	<ol style="list-style-type: none"> 1. Slide AGB single pin side in and out a few centimeters while simultaneously tapping the T-handle into position 2. Contact MCC
<p>C. AGB center drive pin does not install</p>	<ol style="list-style-type: none"> 1. Check for FOD 2. If bolt did not turn, increase PGT setting to B7, drive one turn only, then return to original PGT setting 3. If no joy, AGB is in good config for on orbit loads and can be left as is, but cannot be grappled to by RMS

12A.1 WORKAROUNDS CRIBSHEET (Cont)

FLIGHT SPECIFIC – CONTINGENCY TASKS

GENERIC EPS ORUS (MBSU, DDCU, BCDU)

A. Box binds during H2 fastener install	<ol style="list-style-type: none"> 1. PGT: [B1, CCW2, 30.5]-6ext-7/16: Drive H2 fastener ccw same # of turns that bolt was driven in 2. PGT: [B1, CW2, 30.5]-6ext-7/16: Drive H2 fastener cw TBD turns while simultaneously putting light pressure on H1 side of box. This helps keep box level to preclude box canting and bolt binding
B. H2 status indicator slot does not properly align with UNLOCK silver mark	<ol style="list-style-type: none"> 1. Verify that indicator slot is to the left or right of UNLOCK silver mark by a distance no greater than width of black stripe: <ol style="list-style-type: none"> a. If yes, proceed with R&R b. If no, contact MCC. Status indicators are not reliable, rely on torque and turns
C. H2 status indicator slot does not properly align with LOCK silver mark	<ol style="list-style-type: none"> 1. Verify that indicator slot is to the left or right of LOCK silver mark by a distance no greater than width of black stripe: <ol style="list-style-type: none"> a. If yes, proceed with R&R b. If no, contact MCC. Status indicators are not reliable, rely on torque and turns
D. H1 status indicator slot does not properly align with UNLOCK silver mark	<ol style="list-style-type: none"> 1. Verify that indicator slot is to the left or right of UNLOCK silver mark by a distance no greater than width of black stripe: <ol style="list-style-type: none"> a. If yes, proceed with R&R b. If no, contact MCC. Status indicators are not reliable, rely on torque and turns
E. H1 status indicator slot does not properly align with LOCK silver mark	<ol style="list-style-type: none"> 1. Verify that indicator slot is to the left of LOCK silver mark by a distance no greater than width of black stripe: <ol style="list-style-type: none"> a. If yes, proceed with R&R b. If no, contact MCC. Status indicators are not reliable, rely on torque and turns

PUMP MODULE

A. FGB to PM attach bolt fails to release	<ol style="list-style-type: none"> 1. PGT – off 2. Ratchet ccw (MTL: 30.5), re-attempt fastener release
B. FGB fails to install onto PM	<ol style="list-style-type: none"> 1. Verify no MLI interference; re-attempt 2. Release bolts an additional 5 turns as required to increase clearance in between FGB and PM
C. FGB to PM attach bolt fails to engage	<ol style="list-style-type: none"> 1. PGT: B7, CCW2, 30.5: Back bolt out 5 turns, inspect for FOD; re-attempt engagement (A7, CW2, 30.5) 2. If no joy, back out problematic bolt, back out remaining 3 bolts 10 turns, engage bolts in cross pattern 3 turns at a time
D. PM Integrated Assy fails to install on ICC passive FRAM	<ol style="list-style-type: none"> 1. Check alignment pins/cones free of FOD; re-attempt installation 2. Notify MCC
E. Ball plunger soft dock feature at GP3 location on FGB is stuck, precluding installation onto PM	<ol style="list-style-type: none"> 1. Apply more force when attempting to slide FGB baseplate past bolts 2. Attempt to depress/unstick plunger using EVA hook, or bolt puller from TSA

12A.1 WORKAROUNDS CRIBSHEET (Cont)

FRAM

A. Primary FRAM bolt fails to release	Contact MCC
B. Primary FRAM bolt fails to engage	<ol style="list-style-type: none"> 1. Verify active FRAM fully seated on passive FRAM, check for FOD, back out primary FRAM bolt (A7, CCW2, 30.5) fully; re-attempt engagement (A7, CW2, 30.5) 2. Engage contingency locking pins (4) <ol style="list-style-type: none"> a. FRAM FWD Cont Pins (SAPA and LAPA): PGT: TBD, TBD turns (see equation) b. FRAM AFT Cont Pins (SAPA/MBSU) (see equation) c. FRAM AFT Cont Pins (LAPA/PM) (see equation) <div style="border: 1px solid black; padding: 5px; margin-top: 10px;"> <p><u>FWD CONT PINS:</u></p> <ul style="list-style-type: none"> ➤ Turns = $14.11 - (1.25 \times \text{Primary bolt turns})$ <p><u>AFT CONT PINS (SAPA):</u></p> <ul style="list-style-type: none"> ➤ The rear cont pin can be installed if the primary turn count is 6.5 turns or less ➤ With greater than 6.5 turn on the primary bolt, the cont pin is not needed, and in some cases where most turns have been engaged by the primary bolt, cannot be installed <p><u>AFT CONT PINS (LAPA):</u></p> <ul style="list-style-type: none"> ➤ Turns = $16.858 - (1.25 \times \text{Primary bolt turns})$ </div>

MANUAL EATCS N2 VENTING

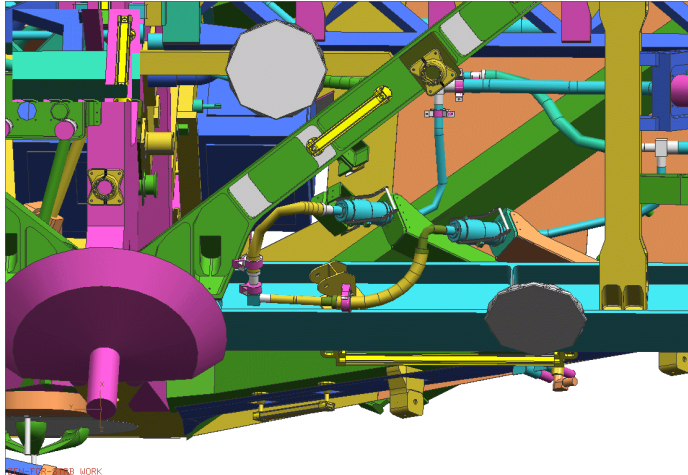
IV	EV1 (FF)	
<p>1. √MCC, GO for manual venting</p>	<p>← <input type="checkbox"/></p> <p><u>S0 PORT EATCS VENT INITIATE (~ 20 min at wkst)</u></p> <ol style="list-style-type: none"> 1. Translate to S0 Bay 04 Face 6 2. Open thermal shrouds to access port shunt jumper 3. Release jumper TA clamps (3) (TBD) 4. BRT to HR 3539 <div style="border: 1px solid black; padding: 5px; margin: 10px 0;"> <p style="text-align: center;">CAUTION</p> <p>When operating QDs, assess sideloads and flexhose alignment prior to mating/demating and valve opening/closing</p> </div> <ol style="list-style-type: none"> 5. Perform the following steps to close valve and demate S0 QD-F212 from S0-A508-M5: <ol style="list-style-type: none"> a. Remove thermal booty b. Push bail toward open posn (toward male half) w/great force (unsticks male sleeve seals) c. Remove SPD, temp stow d. Align flexhose/QDs to remove sideloads e. Depress detent button f. Close valve (pull bail aft) g. √Detent button up h. √Fwd white band visible i. Rotate locking collar to LOCKED j. Demate QD, temp stow (adjustable?) 6. Demate cap from 1.0" female vent tool 7. Perform the following steps to mate 1.0" vent tool to S0-A508-M5: <ol style="list-style-type: none"> a. Inspect QDs for debris or damage b. √Detent button up c. √Release ring retracted (fwd white band not visible) d. Mate vent tool e. √Fwd white band visible (snapback, pull and gap√) 	 <p style="text-align: center;">PORT SHUNT JUMPER WKST</p>

MANUAL EATCS N2 VENTING (Cont)

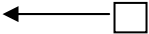
IV	EV1 (FF)	
<p>2. IV: Record GMT start time for venting: _____</p> <p>3A. ✓MCC, GO to terminate venting</p> <p>3B. IV: Record GMT end time for venting: _____</p>	<p>8. Attach 1.0" female vent tool nozzle to HR 3543</p>  <p>9. Perform the following steps to open valve on vent tool:</p> <ol style="list-style-type: none"> a. Align flexhose/QDs to remove sideloads b. Depress detent button c. Open valve (push bail fwd) d. ✓Aft white band visible and detent button up <p><u>S0 PORT EATCS VENT TERMINATE (~ 20 min at wkst)</u></p>  <ol style="list-style-type: none"> 1. Perform the following steps to close vent tool valve: <ol style="list-style-type: none"> a. Verify aft white band is visible b. Align flexhose/QDs to remove sideloads c. Depress detent button d. Close valve (pull bail aft) e. ✓Detent button up f. ✓Fwd white band visible 2. Perform the following steps to demate vent tool from S0-A508-M5: <ol style="list-style-type: none"> a. Assess sideload potential b. Demate vent tool, temp stow 3. Perform the following steps to mate and open valve on S0 QD-F212 to S0-A508-M5: <ol style="list-style-type: none"> a. Inspect QDs for debris or damage b. ✓Detent button up c. ✓Release ring retracted (fwd white band not visible) d. Mate QD e. ✓Fwd white band visible (snapback, pull and gap✓) f. Rotate locking collar to unlock g. Depress detent button h. Open valve (push bail fwd) i. ✓Aft white band visible and detent button up 	

MANUAL EATCS N2 VENTING (Cont)

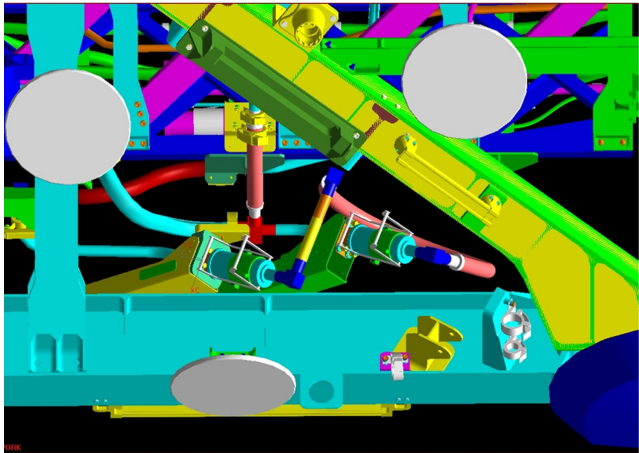
IV	EV1 (FF)	
<p>1. √MCC, GO for manual venting</p>	<p>j. Install 1" SPD</p> <ul style="list-style-type: none"> - push down on latch tabs - √4 capture points – collar boss (2), bail boss (2), 2 line indicators - pull test <p>√Button depressed by moving bail aft, then fwd</p> <p>k. Install thermal booty</p> <p>4. Close S0 thermal shrouds</p> <p>← <input type="checkbox"/></p> <p><u>S0 STBD EATCS VENT INITIATE (~ 20 min at wkst)</u></p> <ol style="list-style-type: none"> 1. Translate to S0 Bay 03 Face 6 2. Open thermal shrouds to access stbd shunt jumper <div style="border: 1px solid black; padding: 5px; margin: 10px 0;"> <p style="text-align: center;">CAUTION</p> <p>When operating QDs, assess sideloads and flexhose alignment prior to mating/demating and valve opening/closing</p> </div> <ol style="list-style-type: none"> 4. Perform the following steps to close valve and demate S0 QD-F211 from S0-A505-M4: <ol style="list-style-type: none"> a. Remove thermal booty b. Push bail toward open posn (toward male half) w/great force (unsticks male sleeve seals) c. Remove SPD, temp stow d. Align flexhose/QDs to remove sideloads e. Depress detent button f. Close valve (pull bail aft) g. √Detent button up h. √Fwd white band visible i. Rotate locking collar to LOCKED 	 <p style="text-align: center;">STBD SHUNT JUMPER WKST</p>

MANUAL EATCS N2 VENTING (Cont)

IV	EV1 (FF)	
<p>2. IV: Record GMT start time for venting: _____</p> <p>3A. ✓MCC, GO to terminate venting</p> <p>3B. IV: Record GMT end time for venting: _____</p>	<p>j. Demate QD, temp stow on S0 HR 3438</p> <p>5. Demate cap from 1.0" female vent tool</p> <p>6. Perform the following steps to mate 1.0" vent tool to S0-A505-M4:</p> <ul style="list-style-type: none"> a. Inspect QDs for debris or damage b. ✓Detent button up c. ✓Release ring retracted (fwd white band not visible) d. Mate vent tool e. ✓Fwd white band visible (snapback, pull and gap✓) <p>7. Attach 1.0" female vent tool nozzle to HR TBD</p> <p style="text-align: center;">← □</p> <p>8. Perform the following steps to open valve on vent tool:</p> <ul style="list-style-type: none"> a. Align flexhose/QDs to remove sideloads b. Depress detent button c. Open valve (push bail fwd) d. ✓Aft white band visible and detent button up <p><u>S0 STBD EATCS VENT TERMINATE (~ 20 min at wkst)</u></p> <p style="text-align: center;">← □</p> <p>1. Perform the following steps to close vent tool valve:</p> <ul style="list-style-type: none"> a. Verify aft white band is visible b. Align flexhose/QDs to remove sideloads c. Depress detent button d. Close valve (pull bail aft) e. ✓Detent button up f. ✓Fwd white band visible <p>2. Perform the following steps to demate vent tool from S0-A505-M4:</p> <ul style="list-style-type: none"> a. Assess sideload potential b. Demate vent tool, temp stow <p>3. Perform the following steps to mate and open valve on S0 QD-F211 to S0-A505-M4:</p> <ul style="list-style-type: none"> a. Inspect QDs for debris or damage 	

MANUAL EATCS N2 VENTING (Cont)

IV	EV1 (FF)	
	<ul style="list-style-type: none"> b. ✓ Detent button up c. ✓ Release ring retracted (fwd white band not visible) d. Mate QD e. ✓ Fwd white band visible (snapback, pull and gap✓) f. Rotate locking collar to unlock g. Depress detent button h. Open valve (push bail fwd) i. ✓ Aft white band visible and detent button up j. Install 1" SPD <ul style="list-style-type: none"> – push down on latch tabs – ✓ 4 capture points – collar boss (2), bail boss (2), 2 line indicators – pull test ✓ Button depressed by moving bail aft, then fwd k. Install thermal booty 4. Close S0 thermal shrouds 	

MANUAL EATCS N2 VENTING TASK DATA SHEET

Tools:

EV1 (FF)	EV2 (FF)
1.0" vent tool	
(1.0" cap tool)	
(1.0" bail lever tool)	
(1.0" QRT/FID gauge)	

EVA Fasteners: N/A

EVA Connectors: N/A

Foot Restraints: N/A

Notes:

1. The shunt jumper has 2 female QDs and is attached to two male QDs on the truss. For manual N2 venting, any of the 2 male QDs can be used, so EV can demate either and of the jumper

Cautions:

1. When operating QDs, assess sideloads and flexhose alignment prior to mating/demating and valve opening/closing

Warnings: N/A

Assumptions:

1. SPDs are already installed on shunt jumpers
2. Venting can be performed from either of the 2 males
3. QD tools must be pre-staged in the crewlock prior to EVA 1 in order to support manual venting. This failure would be known prior to EVA 1:
 - Crewlock bag (for QD tools)
 - 1.0" NH3/N2 Female Vent Tool
 - 1.0" cap tool (contingency only)
 - 1.0" bail lever tool (contingency only)
 - 1.0" QRT/FID gauge (contingency only)

SOFT CAPTURE MANUAL OVERRIDE

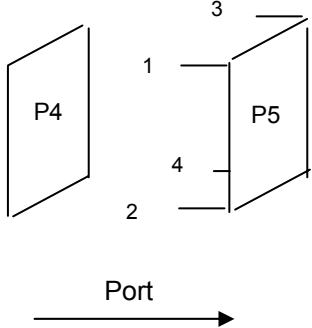
IV/SSRMS	EV1 (FF)	EV2 (FF)
<p>1. ROBO: √SSRMS in limp mode</p> <p><u>ISS Fwd View</u></p>  <p><u>APFR INFO</u></p> <p>For corner 4 (P4 WIF 20): √settings: [6,WW,A,10]</p> <p>For corner 2 (P4 WIF 19), relocate APFR from WIF 20 to WIF19: reconfigure to: [6,PP,K,11]</p> <p>For corner 3 (P4 WIF 17), √settings: [5,RR,J,12]</p> <p>For corner 1 (P4 WIF 18), relocate APFR from WIF 17 to WIF 18; reconfigure to: [8,OO,D,12]</p>	<p style="text-align: center;">← <input type="checkbox"/></p> <p style="text-align: center;"><u>NOTE</u> Depending on which corner fails soft capture, one crewmember will be prime for APFR ops, and the other will assist with PRD routing as necessary</p> <ol style="list-style-type: none"> 1. If necessary, temp stow tools 2. Translate to failed corner 3. Install APFR, configure settings per <u>APFR INFO</u> in IV column 4. Ingress APFR 5. Using P5 HRs, manually attempt to pull P5 into soft capture; √P4 soft capture pin has engaged P5 coarse alignment cone <ol style="list-style-type: none"> 6. Pull out ~ 6 inches of excess strap (~ length of PRD) and ratchet strap a minimum of 14 strokes to ensure strap won't slip under tension 7. Ratchet PRD to achieve proper preload 8. √P4 soft capture pin has engaged P5 coarse alignment cone 9. Egress APFR 	<ol style="list-style-type: none"> 1. If no joy with soft capture pin set, translate to A/L Toolbox 1 (stbd), retrieve PRD from slot 7 2. Translate to failed corner at P5 3. Route PRD between P5 and P4 <ul style="list-style-type: none"> ❑ Hold PRD housing flush against structure adjacent to P5 HR ❑ Route retractable strap around P5 trunnion strut and back around P4 soft capture assy housing ❑ Hook straps together and remove excess slack ❑ Ensure strap is flush to structure and not twisted ❑ Ensure strap is not routed over HRs 4. Remove PRD

SOFT CAPTURE MANUAL OVERRIDE TASK DATA SHEET

Tools: Backup tool shown in ()

EV1	EV2
PRD	
APFR	

Foot Restraints

Task	WIF	APFR Setting
Corner 1 PRD routing	P4 WIF 18	[8,OO,D,12]
Corner 2 PRD routing	P4 WIF 19	[6,PP,K,11]
Corner 3 PRD routing	P4 WIF 17	[5,RR,J,12]
Corner 4 PRD routing	P4 WIF 20	[6,WW,A,10]

EVA Fasteners: NA

Notes:

1. Depending on which corner fails soft capture, one crewmember will be prime for APFR ops, and the other will assist with PRD routing as necessary

Cautions:

1. P5 can be translated on with any 2 diagonal corners in soft capture

Warnings:

1. NA

MRTAS PRIMARY BOLT CONTINGENCIES

IV	EV1/EV2 (FF)
<p>A. Record Torque: _____</p> <p><u>PRD ROUTING</u></p> <ol style="list-style-type: none"> Route PRD between P5 and P4 <ul style="list-style-type: none"> Hold PRD housing flush against structure adjacent to P5 HR Route retractable strap around P5 trunnion strut and back around P4 soft capture assy housing Hook straps together and remove excess slack Ensure strap is flush to structure and not twisted Ensure strap is not routed over HRs Ingress APFR if reqd Pull out ~ 6 inches of excess strap (~ length of PRD) and ratchet strap a minimum of 14 strokes to ensure strap won't slip under tension Ratchet PRD to achieve proper preload <p>B. Record torque: _____</p>	<p>Failure of a primary bolt is defined as not meeting any 1 of the following 3 criteria:</p> <ol style="list-style-type: none"> Full torque achieved Bolt shoulder has no gap Equipment hook gap check is good (applies to corner's 1 and 2 only) <ol style="list-style-type: none"> PGT [B1, CCW2, 30.5]-RAD-7.8"-Ext-5/8: Loosen primary bolt same # of turns that bolt was driven (allowable torque for RAD) <ul style="list-style-type: none"> If bolt galling has occurred, and primary bolt will not loosen, go to step 3b PGT [B1, CW2, 30.5]- RAD-7.8"-Ext-5/8: Drive primary bolt 54 turns (PGT), 27 turns (bolt) <ul style="list-style-type: none"> ← <input type="checkbox"/> Check cases a-d to determine next steps: <ol style="list-style-type: none"> If all primary bolt criteria passes, proceed to next MRTAS corner If bolt galling has occurred and the primary bolt cannot be used, go to MRTAS CONTINGENCY BOLT INSTALL procedure If gap check fails, retrieve gap check tool from corner 1: <ul style="list-style-type: none"> PGT [A6, CCW2, 30.5]-6"-Ext-7/16: Release gap check tool bolts (2), 12-14 turns Perform gap check. Report to MCC gap check tool depth If gap check passes and remaining criteria passes, proceed to next MRTAS corner If gap check fails, go to step 4 If any other primary bolt criteria fails, go to step 4 Retrieve PRD from A/L Toolbox 1 (stbd) slot 7; Install PRD and apply preload – reference IV column, <u>PRD ROUTING</u> Verify gap: <ol style="list-style-type: none"> If gap check passes, go to step 6 If gap check fails, report to MCC gap check tool depth <ul style="list-style-type: none"> If MCC is satisfied with gap check, go to step 6 If gap check fails again, verify PRD routing and re-apply preload <ul style="list-style-type: none"> If gap check passes, go to step 6 If gap check fails again, contact MCC PGT [B1, CCW2, 30.5]-RAD-7.8"-Ext-5/8: Loosen primary bolt same # of turns that bolt was driven PGT [B1, CW2, 30.5]- RAD-7.8"-Ext-5/8: Drive primary bolt 54 turns (PGT), 27 turns (bolt) <ul style="list-style-type: none"> ← <input type="checkbox"/> If all criteria are met, proceed to next RTAS corner If any criteria fail, go to MRTAS CONTINGENCY BOLT INSTALL procedure

MRTAS PRIMARY BOLT CONTINGENCIES TASK DATA SHEET

Tools:

EV1	EV2
PGT	PGT
RAD	RAD
7.8-in ext x 5/8	7.8-in ext x 5/8
Torque Wrench	Torque Wrench

Foot Restraints:

Task	WIF	APFR Setting
Bolt 1 PRD routing	P4 WIF 18	[8,OO,D,12]
Bolt 2 PRD routing	P4 WIF 19	[6,PP,K,11]
Bolt 3 PRD routing	P4 WIF 17	[5,RR,J,12]
Bolt 4 PRD routing	P4 WIF 20	[6,WW,A,10]

EVA Fasteners:

Fastener Name	Label	Head Size	Qty	Release Torque (ft-lbs)	Failure Torque (ft-lbs)	Turns	RPM
RTAS Primary Fastener	1,2,3,4	5/8"	4	12.0 (w/RAD)	105.3	27 (bolt)	30
Gap check tool bolts	none	7/16"	2	8.3	12.2	12-14	30

Notes:

- Primary bolt engagement criteria is the following:
 - Full torque achieved
 - Bolt shoulder has no gap
 - Equipment hook gap check is good. If gap check using equip hook fails, retrieve gap check tool from corner 1 to perform more accurate gap check

Cautions:

- Primary bolts must be fastened in the following order; Bolt 1 (fwd/zenith), Bolt 2 (fwd/nadir), Bolts 3 (aft/zenith) and 4 (aft/nadir) can be fastened in any order AFTER bolts 1 and 2. This also applies in the event of any primary bolt contingencies. Each corner must be secured in the required order regardless of whether a primary bolt or contingency bolt is used
- Hardware sensitive to crew loads. Do not apply a push force on primary bolt. Damage to self-feeding nut may result

Warnings:

- N/A

Other:

- If primary bolt fails at corner 3 or 4 (whichever is driven first), attempt primary bolt at next corner (3 or 4) prior to installing contingency bolt at failed corner. If the second bolt drives successfully, the contingency bolt may be installed at the failed corner without installing a PRD

MRTAS CONTINGENCY BOLT INSTALL

IV	EV1/EV2 (FF)
<p><u>APFR INFO</u> For corner 4 (P4 WIF 20): √settings: [6,WW,A,10] For corner 2 (P4 WIF 19), relocate APFR from WIF 20 to WIF19: reconfigure to: [6,PP,K,11] For corner 3 (P4 WIF 17), √settings: [5,RR,J,12] For corner 1 (P4 WIF 18), relocate APFR from WIF 17 to WIF 18; reconfigure to: [8,OO,D,12]</p> <p>1. Record which contingency sleeve used: _____</p> <p><u>PRD ROUTING</u></p> <p>1. Route PRD between P5 and P4</p> <ul style="list-style-type: none"> <input type="checkbox"/> Hold PRD housing flush against structure adjacent to P5 HR <input type="checkbox"/> Route retractable strap around P5 trunnion strut and back around P4 soft capture assy housing <input type="checkbox"/> Hook straps together and remove excess slack <input type="checkbox"/> Ensure strap is flush to structure and not twisted <input type="checkbox"/> Ensure strap is not routed over HRs <p>2. Ingress APFR if reqd</p>	<p style="text-align: center;"><u>NOTE</u> If a primary bolt contingency required the use of a PRD at the failed corner, steps 1 through 3 are not required for the contingency bolt procedure</p> <p>1. If reqd, install APFR for PRD ops at failed corner, configure settings per <u>APFR INFO</u> in IV column 2. Retrieve PRD from A/L Toolbox 1 (stbd) slot 7; install PRD and apply preload – reference IV column, <u>PRD ROUTING</u></p> <p style="text-align: center;"><u>NOTE</u> Gap Check Criteria:</p> <ul style="list-style-type: none"> • For equip tether hook, tip of hook should not pass through or penetrate gap between RTAS housings • For gap check tool, tip of tool should not penetrate gap between RTAS housings past second line <p>3. Perform gap check using equip tether hook 4. Verify contingency nuts centered and aligned within anti-rotation slots ➤ If not centered, adjust by jiggling w/gloved hand 5. PGT [B2, CCW1, 30.5]-6"-Ext-7/16: Loosen spacer locking device bolt, ~ 1 turn 6. Tighten spacer sleeve by hand until snug, ~ 10 turns (CW)</p> <p style="text-align: center;">← <input type="checkbox"/></p> <p>7. Verify sleeve aligned w/in nut by attempting to jiggle back side of nut ➤ If spacer does not seat in nut, back out and re-attempt 8. PGT [A6, CCW2, 30.5]-6"-Ext-7/16: Release gap check tool bolts (2) from corner 1, 12-14 turns (possibly done) 9. Install gap check tool around contingency spacer sleeve (friction fit)</p> <p style="text-align: center;"><u>NOTE</u> Contingency Bolt Engagement Criteria:</p> <ul style="list-style-type: none"> <input type="checkbox"/> Full torque achieved <input type="checkbox"/> Minimum turn count (after bolt drops out of launch threads) <input type="checkbox"/> Gap check is good <p>10. PGT [B1, CW2, 30.5]-6"-Ext-7/16: ➤ Drive contingency bolt 7-9 turns to clear launch threads ➤ Push bolt ~ .5-in to contact nut (no turns reqd) ➤ Drive contingency bolt 9-11 turns to fully engage nut</p>

MRTAS CONTINGENCY BOLT INSTALL (Cont)

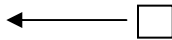
IV	EV1/EV2 (FF)
<p>3. Pull out ~ 6 inches of excess strap (~ length of PRD) and ratchet strap a minimum of 14 strokes to ensure strap won't slip under Tension</p> <p>4. Ratchet PRD to achieve proper preload</p> <p>5. Record torque and turns: Torque: _____ Turns: _____</p>	<div style="text-align: center;">  </div> <p>11. Perform gap check using equip tether hook</p> <p>12. Check cases A and B to determine next steps:</p> <ol style="list-style-type: none"> If all contingency bolt criteria pass, go to step 13 If any contingency bolt criteria fail, go to next contingency bolt, and pick up at step 6 <p>13. PGT [A5, CCW2, 30.5]-6"-Ext-7/16: Release nut locking plate bolt, 12-14 turns</p> <p>14. Remove nut locking plate (lanyarded), wire tie to adjacent structure</p> <p>15. Remove gap check tool from spacer sleeve, attach to MWS</p> <p>16. PGT [B2, CW1, 30.5]-6"-Ext-7/16: Tighten contingency spacer locking device bolt, ~ 1 turn (do not exceed 1 turn)</p> <p>17. Remove PRD, temp stow</p> <p style="text-align: center;"><u>NOTE</u> After all 4 RTAS corners have initial torque, perform final torquing on contingency bolt</p> <p>18. Configure torque wrench w/7.8-Ext-5/8: set to 52 ft-lb; tighten contingency bolt until torque wrench trips (~1/4 turn)</p>

MRTAS CONTINGENCY BOLT INSTALL TASK DATA SHEET

Tools: Backup tool shown in ()

EV1	EV2
PGT	PGT
RAD	RAD
7.8-in ext x 5/8	7.8-in ext x 5/8
Torque Wrench	Torque Wrench

Foot Restraints:

Task	WIF	APFR Setting
Bolt 1 PRD routing	P4 WIF 18	[8,OO,D,12]
Bolt 2 PRD routing	P4 WIF 19	[6,PP,K,11]
Bolt 3 PRD routing	P4 WIF 17	[5,RR,J,12]
Bolt 4 PRD routing	P4 WIF 20	[6,WW,A,10]

EVA Fasteners:

Fastener Name	Label	Head Size	Qty	Release Torque (ft-lbs)	Failure Torque (ft-lbs)	Turns	RPM
RTAS Cont Bolts	1,2,3,4	5/8"	4	Install: 52.0		7-9 (launch threads) 9-11 (P4 nut)	30
Cont Spacer Sleeve Locking Device Bolt	none	7/16"	1	Release: 16.0 Install: 16.0	31.1	.5-1	30
Gap check tool bolts	none	7/16"	2	Release: 8.3	12.2	12-14	30
Cont Nut Locking Plate Bolts	none	7/16"	2	Release: 7.0	12.2	12-14	30

Notes:

- Contingency bolt engagement criteria is the following:
 - Full torque achieved
 - Minimum turn count (after bolt drops out of launch threads)
 - Equipment hook gap check is good (this applies to corner's 1 and 2 only). If gap check using equip hook fails, retrieve gap check tool from corner 1 to perform more accurate gap check

Cautions:

- Primary bolts must be fastened in the following order; Bolt 1 (fwd/zenith), Bolt 2 (fwd/nadir), Bolts 3 (aft/zenith) and 4 (aft/nadir) can be fastened in any order AFTER bolts 1 and 2. This also applies in the event of any primary bolt contingencies. Each corner must be secured in the required order regardless of whether a primary bolt or contingency bolt is used
- Hardware sensitive to crew loads. Do not apply a push force on primary bolt. Damage to self-feeding nut may result

Warnings:

- N/A

SOLAR ARRAY

MANUAL OVERRIDE TO RETRACT MAST (~ 02:30)

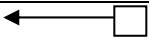
IV	EV1 (FF)	EV2 (FF)
<p>1A. √MCC inhibits in place: (SODF:EPS:MALFUNCTION: PRIMARY POWER, FAILURE TO RETRACT MAST REMOTELY)</p> <p>1B. Verify mast canister MDA facing nadir and BGA latched; 4B BGA = 180.000 (+/- 0.5) Motor State – OFF Latch 1 Pin Status – Latched</p> <p>1C. √MCC free drift or CMG control prior to mast retraction</p>		
	<p style="text-align: center;"><u>MANUAL OVERRIDE TO RETRACT MAST</u></p> <ol style="list-style-type: none"> 1. Translate to P6 4B (port) mast canister HRs (nadir) via P6 stbd/aft edge 2. BRT to mast canister HR 3. Ratchet-2"-Ext-7/16: Rotate Manual Override Actuator Shaft on left side of MDA 180 deg to disengage MDA, Indicator – MANUAL <p style="text-align: center;"><u>NOTE</u></p> <p>Expect ~ 1300 turns per PGT battery. A spare battery will be required for a manual retract of an array that fails at a position that is more than half deployed.</p> <p>Prior to removing PGT from MDA backup fastener, engage ratchet w/2-in socket onto bolt on side of MDA and rotate 180 deg to AUTOMATIC</p>	<p style="text-align: center;"><u>MANUAL OVERRIDE TO RETRACT MAST</u></p> <ol style="list-style-type: none"> 1. Assist EV1 as reqd

MANUAL OVERRIDE TO RETRACT MAST (~ 02:30) (Cont)

IV	EV1 (FF)	EV2 (FF)
<p>2. IV: check limit switch indication that array has fully retracted; give EV go to re-engage MDA clutch</p>	<p>4. PGT [A7, CW3, 10.5]-2"-Ext-7/16: Drive MDA backup fastener 2460 turns (for full retract) (hard stop) ← <input type="checkbox"/></p> <p>5. Perform the following steps to re-engage MDA clutch:</p> <ul style="list-style-type: none"> ❑ Keep the PGT with 2-in socket installed on the backup drive fastener ❑ Install the ratchet with 2-in socket onto the Manual Override Actuator Bolt ❑ Rotate Manual Override Actuator Shaft 180 deg to disengage MDA, indicator – AUTOMATIC <p>6. Remove PGT and ratchet, stow on MWS</p> <p>7. Translate to airlock</p>	<p>2. Translate to airlock</p>

MANUAL OVERRIDE TO RETRACT MAST TASK DATA SHEET

Tools: Backup tool shown in ()

EV1 (FF)	EV2 (FF)
Ratchet with 2-in	
PGT with 2-in	
Spare PGT battery	
(APFR)	(MCHD) – Located in Mast Canister Bag on aft/stbd Node

EVA Fasteners:

Name	Label	Head Size	Qty	Install Torque (ft-lb)	Release Torque (ft-lb)	Failure Torque (ft-lb)	Turns	RPM
Backup drive fastener (MDA fastener)		7/16	1		9	13.3	Up to 2461	60
Mast Canister manual Override Actuator Bolt		7/16	2 per	2.5	NA	50	.5	10
MCDH Fasteners		7/16	4	10	NA	TBD	Zip	10

EVA Connectors:

Harness	From	To	Clamps (#)	Conn Size	Function
NA					

Foot Restraints: Backup tool shown in ()

Task	WIF	APFR Setting
(4B solar array manual retract) (keel side)	P6-37	[12,FF,F,12]

Notes:

1. The Mast Canister Handling Device (MCHD) is located in the Mast Canister Bag on the aft/stbd Node. It is available for the crew to use in the event they must do a complete manual retraction and want to reduce overall PGT operations
2. Depending on crew comfort, either an APFR can be used for the manual retract, or they can directly BRT to the Mast Canister HRs
3. The right side mast canister manual override actuator shaft bolt can be used but a PGT with 6-in socket must be used and the bolt is accessed from under the adjacent HR
4. Rationale for leaving the PGT installed on the MDA bolt while taking the override actuator bolt back to AUTO: Sunnyvale is concerned that once the PGT is removed, the Solar array will tend to backdrive and re-extend the mast off of the hard stop (and thus move the blankets out of the latching capture envelope). The PGT serves to keep the array itself from backdriving, and sort of acts like a locking mechanism for the bolt

Cautions:

1. Avoid contact with blanket box latches and mechanisms on underside of blanket box

Warnings:

1. Sharp edge/pinch point entrapment hazard: avoid contact with outboard underside of SABB due to exposed reels, guide wire, and tension mechanisms
2. Avoid contact with blanket box latches during manual override operation

Timeline Considerations:

1. Retrieving the MCHD from the mast canister bag will add time to the EVA. Perform the following steps to unfold and install the MCHD:
 - a. Deploy MCHD PGT swingarm and appendages
 - b. Install MCHD onto mast canister, install zip nuts (4)
 - c. **PGT [A7 9.2, CW2, 10.5]-2"-Ext-7/16:** Secure MCHD fasteners (4) to hardstop
 - d. Place PGT in MCHD swingarm when reqd

Assumptions:

1. 85' safety tether will reach P6 4B
2. Crew will BRT for task, but APFR position is available if reqd

MANUAL OVERRIDE TO LATCH/UNLATCH (TENSION) 4B SABB

IV	EV1 (FF)	EV2 (FF)
<p>1A. √MCC Inhibits in place: Perform {TBD SAW XX FAILURE TO LATCH (TENSION) SABB REMOTELY} (SODF: EPS: MALFUNCTION: PRI PWR)</p> <p>1B. Verify affected SABB positioned over IEA and BGA latched: Verify: Left SABB: Actual angle, deg = 270.000 (+/- 0.5) OR Right SABB: Actual angle, deg = 90.000 (+/- 0.5) Motor State – OFF Latch 1 Pin Status – Latched</p> <p>1C. √MCC free drift or CMG control prior to mast retraction</p>	<div style="text-align: center;">  </div> <div style="border: 1px solid black; padding: 5px; margin: 10px auto; width: 80%;"> <p style="text-align: center;"><u>CAUTION</u></p> <p>Moving equipment. Avoid contact with blanket box latches during manual override operation</p> </div> <div style="border: 1px solid black; padding: 5px; margin: 10px auto; width: 80%;"> <p>Equipment damage. Avoid contact with blanket box latches and mechanisms on underside of blanket box</p> </div> <div style="border: 3px double black; padding: 5px; margin: 10px auto; width: 80%;"> <p style="text-align: center;"><u>WARNING</u></p> <p>Sharp edge/pinch point/entrapment hazard. Avoid contact with underside of SABB due to exposed reels, guide-wire, and tension mechanisms</p> </div> <ol style="list-style-type: none"> 1. Translate to P6 4B (port) mast canister HRs (nadir) via P6 stbd/aft edge 2. BRT to mast canister HR 3. Release PIP pin from backup position lever 4. Move override lever to MANUAL position (hard) 5. Insert PIP pin into lock lever position <div style="border: 1px solid black; padding: 5px; margin: 10px auto; width: 80%;"> <p style="text-align: center;"><u>CAUTION</u></p> <p>Moving equipment. Avoid contact with blanket box latches during manual override operation</p> </div> <ol style="list-style-type: none"> 6. PGT [A6, CW2, 10.5]-2"-Ext-7/16: (or 6-in socket) Push to engage MDA drive fastener (3-10 lb); drive fastener 48 +/- 1 turns until visual indication of latch position or hard stop (can see on inbd most latch) 	<ol style="list-style-type: none"> 1. Assist EV1 as reqd

MANUAL OVERRIDE TO LATCH/UNLATCH (TENSION) 4B SABB (Cont)

IV	EV1 (FF)	EV2 (FF)
	<p>(Latches along blanket box are visible and will move to engaged posn)</p> <ol style="list-style-type: none">7. Release PIP pin from override positioning lever8. Move override lever to AUTOMATIC posn9. Insert PIP pin into lock lever posn10. PGT [RCCW, 10.5]-2"-Ext-7/16: (or 6-in socket) Push to engage MDA drive fastener (3-10 lb); drive fastener 1/4 turn to engage clutch pins (may "feel" pins drop in)	

MANUAL OVERRIDE TO LATCH (TENSION) 4B SABB TASK DATA SHEET

Tools: Backup tool shown in ()

EV1 (FF)	EV2 (FF)
PGT w/6-in or 2-in socket	PGT w/6-in or 2-in socket
(APFR)	

EVA Fasteners:

Name	Label	Head Size	Qty	Install Torque (ft-lb)	Release Torque (ft-lb)	Failure Torque (ft-lb)	Turns	RPM
Backup drive fastener		7/16	1		9		48 +/- 1 turns	10

EVA Connectors: NA

Foot Restraints:

Task	WIF	APFR Setting
4B solar array latch override	P6-37 (near P6 IEA keel)	Left SABB: [12,FF,F,9] Right SABB: [12,FF,F,3] (Ingress aid required for ingress)

Notes:

- Hi-tension = latch = cw
Low-tension = unlatch = ccw
- The 1/4 turn at the end of the override will always be in the opposite direction as the initial turning
- SABB location designator: The right and left SABBs are defined by standing with one's back toward the mast canister on the solar array active side (the side where the blanket boxes are initially together for launch, opposite the SSU) with one's head outboard toward the array. The left SABB is then on one's left side and the right SABB is on one's right side
- PIP pin not reqd to lock MDA override lever into MANUAL posn
- The additional 1/4 turn at the end of the manual latching is required in order to re-align the pins with the slots on the gear mechanisms. Once the 1/4 turn is made, the spring-loaded mechanism will push the slots on the torque shaft gear onto the pins on the motor gear
- BRT to the mast canister HR will be the nominal plan for latching override; APFR use is a backup

Cautions:

- Equipment damage. Avoid contact with blanket box latches and mechanisms on underside of blanket box

Warnings:

- Sharp edge/pinch point/entrapment hazard. Avoid contact with underside of SABB due to exposed reels, guide-wire, and tension mechanisms

Assumptions:

- 85' safety tether will reach P6 4B
- Crew will BRT for task, but APFR position is available if reqd

SOLAR ARRAY JETTISON

IV	EV1 (FF)	EV2 (FF)
<p>1A. √MCC SSU inhibits in place: Configure SSU inhibits: Perform {TBD SSU TBD SAFING FOR REMOVAL} (SODF: EPS: CORRECTIVE: PR PWR)</p> <p>1B. Mnvr ISS for SAW jettison</p> <p>1C. Posn and safe SAW for SSU Removal. Perform {2.106 PVM CONFIG BGA P6 4B TO SAFE LOCK MODE} (SODF: EPS: NOMINAL: PRI PWR), using the following: BGA 4B Cmded Angle = 270 BGA 4B Latch Select = 1</p>	<div style="border: 1px solid black; padding: 5px; margin-bottom: 10px;"> <p style="text-align: center;"><u>WARNING</u></p> <p>Electrical shock hazard: Voltage hazard exists at the connectors of the SSU; SSU must be safed prior to removal and must only be removed during orbit eclipse</p> <p>Protrusion hazard: SSU alignment post protrudes beyond the mast canister. Maintain clearances between structure and self during SSU removal</p> <p>Electric shock hazard: SSU Shunt Plug installation and SSU removal must occur during eclipse. Crew must wait the specified time period while voltage drops to safe levels before proceeding. EV crew will need to move away from exposed electrical receptacles during day pass</p> <p>Collision hazard: Solar array motion should be prevented by locking the BGA. This avoids a collision hazard with the EV crew if the EV crew is within 24 inches of the array rotational envelope</p> </div> <p><u>TOOL RETRIEVAL AND SETUP</u></p> <ol style="list-style-type: none"> 1. Translate to Z1 stbd toolbox 2. Open right door 3. Retrieve square TM w/7/16 recessed socket from slot 1, stow on MWS (release slider lock only) 4. Close door – both latches reqd if not coming back 5. Retrieve square scoop from lid 6. <u>If required</u>, translate to Z1 forward face and demate Cannon connector cap from Z1 J259 or J260, stow 7. Retrieve APFR from <u>TBD</u>, attach to BRT 8. Translate to P6 WIF 33 (aft/port/zenith trunnion) via P6 stbd/aft edge 9. Install APFR into WIF 33, configure to: [4,PP,G,9] 	<p><u>TOOL RETRIEVAL AND SETUP</u></p> <ol style="list-style-type: none"> 1. Translate to Mast Canister/Aux bag (PMA1 stbd by Node bag) 2. Retrieve mast canister handling device (MCDH); attach to BRT 3. Translate to <u>TBD WIF</u>, retrieve APFR, attach to BRT <p style="text-align: center;"><u>NOTE</u></p> <p>It may be difficult to translate with both the APFR and the mast canister handling device. Two trips up to P6 may be required to get both tools to the worksite</p> <ol style="list-style-type: none"> 4. Translate to P6 WIF 33 (aft/port/zenith trunnion) via P6 stbd/aft edge 5. Temp stow APFR, MCDH, and SSU cover 6. Translate to port BMRRM

SOLAR ARRAY JETTISON (Cont)

IV	EV1 (FF)	EV2 (FF)
<p>4A. Posn and safe SAW for ECU Removal. Perform {2.106 PVM CONFIG BGA P6 4B TO SAFE LOCK MODE} (SODF: EPS: NOMINAL: PRI PWR), using the following: BGA 4B Cmded Angle = 180 BGA 4B Latch Select = 1</p> <p>4B. When BGA latched, give EV crew GO to ingress ECU worksite</p> <p>5. √MCC ECU and BMRRM cable demate inhibits in place: PCS: Remove ECU Power PVM: EPS: BGA 4B</p>	<p>7. PGT [A7, CCW2, 30.5]-sq TM w/7/16" REC: Release fastener, 5 turns (PGT), 1 turn (bolt)</p> <p>8. Remove TM, install square scoop on SSU</p> <p>9. PGT [A7, CCW2, 10.5]-6"-Ext-7/16: Release fastener, 10 turns √Status indicator – UNLOCK</p> <p>10. Remove SSU, transfer to EV2</p> <p>11. Egress APFR and report when clear of worksite (BGA rotation plane)</p> <div data-bbox="974 659 1619 789" style="border: 2px solid black; padding: 5px; text-align: center;"> <p>WARNING Moving equipment hazard. Avoid contact with mast canister/beta gimbal during rotation of SAW</p> </div> <p>← <input type="checkbox"/></p> <p><u>ECU REMOVAL</u> (if reqd)</p> <p>1. Relocate APFR to P6 WIF 37 (port IEA by keel), Configure to: [8,00,A,3]</p> <p>2. Ingress APFR</p> <p>← <input type="checkbox"/></p>	<p>4. Receive SSU, install cover or temp stow in ORU bag</p> <p>5. Translate away from BGA rotation plane and report when clear of worksite</p> <p>← <input type="checkbox"/></p> <p><u>BMRRM FASTENER/CONNECTOR RELEASE</u></p> <p>1. Translate to 4B BMRRM</p> <p>← <input type="checkbox"/></p>

SOLAR ARRAY JETTISON (Cont)

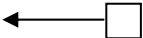
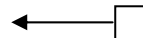
IV	EV1 (FF)	EV2 (FF)
<p>BGA 4B sel RPCM XX A RPC 02 RPCM XX A RPC 02 Cmd RPC Position – Open (Verify - Op) (Expect Caution Message: BGA 4B Loss of Comm)</p> <p>6. √MCC GO for SAW Jettison</p>	<ol style="list-style-type: none"> 3. PGT [A7, CCW2, 10.5]-sq TM w/7/16" REC: Release fastener, 1 turn 4. Remove TM, install square scoop on ECU 5. PGT [A7, CCW2, 10.5]-6"-Ext-7/16: Release fastener, 10 +/- 2 turns √Status indicator – UNLOCK 6. Remove ECU, transfer to EV2 <p><u>P6 4B SAW JETTISON PREP</u></p>  <ol style="list-style-type: none"> 1. Egress APFR 2. Reconfigure APFR to: [12,FF,F,12] (still WIF 37) 3. Ingress APFR 4. Receive MCHD from EV2 5. Deploy MCHD appendages 6. Install MCHD on mast canister (4 zip nuts) 7. PGT [A7, CW2, 10.5]-6"-Ext-7/16: Fasten MCHD corner attach fasteners (4) to hard stop 8. Hold MCHD HRs, give EV2 GO to release vice clamp fastener 	<ol style="list-style-type: none"> 2. Remove BMRRM thermal shroud (peels back) 3. BRT to BGA housing HR 4. PGT [A5, CCW2, 10.5]-6"-Ext-7/16: Release BMRRM center fastener 10 +/- 2 turns 5. On MCC GO, disconnect the following connectors from the BMRRM: <ul style="list-style-type: none"> □ Demate connector from J3 □ Demate connector from J2 6. Receive ECU from EV1, temp stow <p><u>P6 4B SAW JETTISON PREP</u></p>  <ol style="list-style-type: none"> 1. Install APFR into P6 WIF 33, configure to: [4,PP,H,9] 2. Transfer MCHD to EV1 3. Ingress APFR 4. On EV1 GO: PGT [A5, CCW2, 10.5]-6"-Ext-7/16: Release platform vice clamp fastener, 19 turns (hard stop)

SOLAR ARRAY JETTISON (Cont)

IV	EV1 (FF)	EV2 (FF)
	<p><u>P6 4B SAW JETTISON</u></p> <ol style="list-style-type: none"> Using MCDH, move canister away from beta gimbal at a velocity less than 1 ft/min. Move mast canister 2 feet from beta gimbal separation plane. Correct wing attitude as reqd to achieve stability *** <u>TBD release plan</u>*** 	<p><u>P6 4B SAW JETTISON</u></p> <ol style="list-style-type: none"> Assist EV1 to separate mast canister from beta gimbal and control SAW using handholds on BGA housing and BGA platform. Call out separation distance until 2 ft separation achieved Release BGA platform handholds, egress and move clear of predicted SAW separation direction *** <u>TBD release plan</u>***

SOLAR ARRAY JETTISON TASK DATA SHEET

Tools:

EV1 (FF)	EV2 (FF)
APFR	APFR
PGT with 6" socket	MCHD (TBD)
Square scoops (2)	SSU cover or large ORU bag (SSU)
Square TM with 7/16" REC socket	Med ORU bag (ECU)
SSU shunt plug adapter and plugs (2)	
Cannon connector tool	
Cannon connector cap (size 37)	

EVA Fasteners:

Name	Label	Head Size	Qty	Install Torque (ft-lb)	Release Torque (ft-lb)	Failure Torque (ft-lb)	Turns	RPM
SSU Fastener	NA	7/16	1	NA	45	TBD	11+/-2	
ECU Fastener	NA	7/16	1	NA	35	50	11+/-2	
BMRRM Center Fastener	NA	7/16	1	NA	7.5	TBD	10+/-2	
MCHD Fasteners	NA	7/16	4	2.5-3.3	2.5-3.3	TBD	zip	
Vice Clamp	NA	7/16	1	NA	7.5	TBD	19+/-2	

EVA Connectors:

Harness	From	To	Clamps (#)	Conn Size	Function
W05 P23 J3		BMRRM P3		25	ECU feed; SSU control pwr; 1553B
W06 P22 J2		BMRRM P2		25	ECU cross feed
		BMRRM P1		37	Primary Power

Foot Restraints:

Task	WIF	APFR Setting
4B SSU access	P6-33	[4,PP,G,9]
4B ECU access	P6-37	[8,OO,A,3]
4B BMRRM access	P6-33	[4,PP,H,9]
4B Jettison	P6-37	[12,FF,F,12]
4B Vice Clamp Release	P6-33	[4,PP,H,9]

SAW Mass: ~ 2500 lbs (1133.9 kg)

Notes:

1. If SSU Removal is done from P6 WIF 33 at a BGA of 270, an ingress will be needed for ingress
2. If SSU remains installed, the MCHD should be used (better reach and HR options); if SSU is removed, the MCHD may not be needed
3. Caps are not needed for BMRRM J2 and J3 since they are not hot

Warnings:

1. Electrical shock hazard: remove SSU only during orbit eclipse
2. Protrusion hazard: SSU alignment post protrudes beyond the mast canister. Maintain clearances between structure and self during SSU removal
3. Moving equipment hazard. Avoid contact with mast canister/beta gimbal during rotation of SAW

Timeline Considerations:

1. The SAW jettison timeline PET can be reduced by not removing the SSU and ECU
2. The SSU Removal does not necessarily have to be removed at a BGA of 270; it could possibly be done at 180 and FF; this would eliminate an entire BGA rotation prior to jettison

Assumptions:





1. EV1 gets square scoops (2) from inside ISS (scoops needed for SSU and ECU removal if performed)
2. EV2 gets square TM from stbd Z1 toolbox
3. 85' safety tethers will reach P6 worksite
4. EV2 has SSU cover from inside ISS (or lg ORU bag)
5. SSU shunting plug remains installed and gets jettisoned along with SAW
6. If no size 37 Cannon connector cap inside, EV crew will need to retrieve one from Z1 during EVA

Prior to EVA, complete the following setup steps:

1. Retrieve SSU shunt plug adapter and SSU shunt plugs (2) from TBD
2. Remove SSU shunt plug adapter caps (2, J5A and J6A) from adapter, and mate SSU shunt plugs (2, J5A and J6A) to adapter jacks (plugs can go to either adapter jacks)
3. Remove caps (2) from adapter ground service equipment jacks
4. Stow SSU shunt plug adapter with plugs and Cannon connector tool in crewlock bag

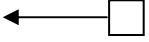
EVA 2 CONTINGENCY

CHANNEL 2/3 CONNECTOR BACKOUT (01:00)

IV	EV1 (FF)	EV2 (FF)
<p>1. Verify w/MCC inhibits in place: Power Reconfig Inhibit Check (SODF: ASSY OPS: EPS CH 2/3 Powerdown for EVA 2, steps 6 and 7 complete (DCSU 2B RBI 6 open) (DCSU 2A RBI 6 open)</p>	<div style="text-align: center;">  </div> <p style="text-align: center;"><u>NOTE</u> √Connectors for damage, EMI band, FOD, bent pins, and cable bend radii</p> <p><u>P1-3A DDCU RECONFIGURATION</u> (Panel A9)</p> <ol style="list-style-type: none"> 1. Translate to P1 HR 3602 (P1 Bay 14, Face 1) 2. Perform safety tether swap onto HR 3602 with 55' safety tether, verify ST config 3. Translate to P1 Bay 16, enter face 1 4. Remove connector cap from J8 on DDCU coldplate connector box (cap is lanyarded to panel) 5. Demate P1 P169 (W5113) from J7; mate to J8 6. Install connector cap on J7 7.  connector closeout <p><u>MBSU BYPASS JUMPER (2/3) RECONFIGURATION</u> (CID 7 Removal)</p> <ol style="list-style-type: none"> 1. Translate to P1 HR 3602 (P1 Bay 14, Face 1) 2. Perform safety tether swap onto airlock safety tether, retrieve spare, verify ST config 3. Translate to S0 Bay 04 4. Access MBSU nadir reconfig worksite thru face 1 5. Attach MWS EE to HR 3536 6. Remove connector cap from J490; temp stow 7. Demate S0 P487 from S0 J487; mate to S0 J490 8. Demate S0 P488 from S0 J488, mate to S0 J487 9. Install connector cap on J488 10.  connector closeout 	<p><u>CIDS 3, 4, AND 5 REMOVAL/S0 TRAY CONNECTIONS</u></p> <ol style="list-style-type: none"> 1. Translate to stbd Z1-S0 tray area <p style="text-align: center;"><u>NOTE</u> Avoid contact with S0 radiator</p> <ol style="list-style-type: none"> 2. Demate S0 P215 (W4014) from Lab J215; mate to S0 J474 3. Demate S0 P216 (W4012) from Lab J216; mate to S0 J475 4. Demate S0 P242 (W4186) from Z1 J442; mate to S0 J478 5. Demate Z1 P316 (W24C) from Z1 J216 (tray), mate to Lab J216 (CID removed) 6. Demate Z1 P315 (W24B) from Z1 J215 (tray), mate to Lab J215 (CID removed) 7.  connector closeout

CHANNEL 2/3 CONNECTOR BACKOUT (01:00) (Cont)

IV	EV1 (FF)	EV2 (FF)
	<p style="text-align: center;"><u>NOTE</u> Z1-006 PP 2 Reconfig will not be backed out since the nominal reconfig will be skipped in the event of either an MBSU or DDCU R&R. The steps are listed for info only</p> <p><u>Z1-006 PATCH PANEL 2 RECONFIGURATION</u> (SPDA Z1-3B) (zenith panel)</p> <ol style="list-style-type: none">1. Translate to Z1 port face; fairlead above Z1, MBM P6 HR 5308 <div style="border: 1px solid black; padding: 5px; margin: 10px auto; width: fit-content;"><p style="text-align: center;"><u>CAUTION</u> Avoid contact with PCUs and S0 Radiator</p></div> <p style="text-align: center;"><u>NOTE</u> J3 label is missing off of patch panel 2</p> <ol style="list-style-type: none">2. Remove connector cap from J3; temp stow3. Demate Z1 P1 (W05) from Z1 J1; mate to Z1 J34. Install connector cap on J15.  connector closeout	

MBSU REMOVE AND REPLACE – 2A2B (EVA 2) (03:30)

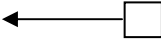
IV/SSRMS	EV1 (FF)	EV2 (SSRMS)
<p>1. Verify w/MCC ESP2 inhibits in place: RPCM N1RS2-B RPC10 – open and close INHIBITED RPCM S04B F RPC 12 – open and close INHIBITED</p>	<div style="text-align: center;">  </div> <p><u>CETA CART PREP</u></p> <ol style="list-style-type: none"> 1. Transfer PGT w/6-in to EV2 2. Translate to port-most CETA cart (S0 Bay 03) 3. Deploy port brake handles on CETA cart (down) 4. Take CETA coupler to UNLOCK 5. MnvR CETA cart port ~ 5 feet 6. Deploy stbd brake handles on CETA cart (down) 7. √CETA brakes by pulling parking brake (left handle) 8. Take CETA coupler to CAPTURE 9. Release CETA brakes (tap pedal twice) 10. Translate CETA to S0 Bay 00 (by hand): <ul style="list-style-type: none"> • Stop when stbd TFR is port of CETA marker 7650 11. Engage parking brake – left handle 12. Rotate port TFR swing arm to 15 <p><u>TOOL RETRIEVAL</u></p> <ol style="list-style-type: none"> 1. Translate to airlock 2. Retrieve crewlock bag #1, BRT 3. Retrieve spare PGT and 6-in socket from crewlock bag #2 4. Translate to Z1 stbd toolbox 5. Retrieve 2 sq scoops from toolbox lid: <ul style="list-style-type: none"> □ Stow 1 sq scoop on MWS □ Stow 1 sq scoop in crewlock bag #1 (may have to relocate D-Handle to get sq scoop) 6. Open right door 7. Retrieve sq TM w/7/16 recessed socket from slot 1, stow on MWS (release slider lock only) 8. Close door – both latches reqd if not coming back 	<p><u>SPARE MBSU RETRIEVAL FROM ESP2</u></p> <ol style="list-style-type: none"> 1. Receive PGT w/6-in from EV1, stow on swingarm 2. Stow 6-in socket in trash bag 3. SSRMS mnvr to ESP2 for MBSU retrieval (~ 30 min)

MBSU REMOVE AND REPLACE – 2A2B (EVA 2) (03:30) (Cont)

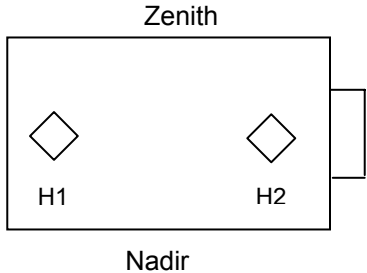
IV/SSRMS	EV1 (FF)	EV2 (SSRMS)
<div style="text-align: center;">  <p>MBSU ORIENTATION ON CETA CART GRID E</p> </div>	<p><u>SPARE MBSU RETRIEVAL FROM ESP2</u></p> <ol style="list-style-type: none"> 1. Translate to ESP2, temp stow crewlock bag #1 on CETA spur 2. Attach BRT to ESP2 HR 8003 (aft face, stbd side) 3. Engage FRAM soft capture lever (slides down) 4. PGT [A4, CCW2, 10.5]-6"-Ext-7/16: Release primary FRAM bolt 11 turns (hard stop) 5. Using vertical HRs on FRAM, remove MBSU from ESP2 (magnetic soft dock to overcome) 6. Transfer MBSU to EV2 7. Retrieve crewlock bag #1 from CETA spur, BRT <p><u>TEMP STOW SPARE MBSU ON CETA CART</u></p> <ol style="list-style-type: none"> 1. Translate to port CETA cart on S0 Bay 00 2. Temp stow crewlock bag #1 on port side of CETA cart, S0 HR 3494 3. Retrieve ballstack from crewlock bag #1, install on port TFR swingarm ECOM fitting 4. Position body to see grid E 5. Assist EV2 with clearances 6. PGT [A4, CW2, 10.5]-6"- Ext-7/16: Drive primary FRAM bolt 11 turns (hard stop) 7. Retrieve sq scoop from crewlock bag #1, transfer to EV2 	<ol style="list-style-type: none"> 4. Receive MBSU from EV1 (body is parallel to stbd side of ESP2 with head aft and face port) <p><u>TEMP STOW SPARE MBSU ON CETA CART</u></p> <ol style="list-style-type: none"> 1. SSRMS mnvr to port CETA cart on S0 Bay 00 2. Rotate MBSU until FRAM primary bolt faces ISS zenith 3. Install MBSU/FRAM onto grid E (zenith center) (rock FRAM square grid into place) 4. Receive sq scoop from EV1, stow on MWS

MBSU REMOVE AND REPLACE – 2A2B (EVA 2) (03:30) (Cont)

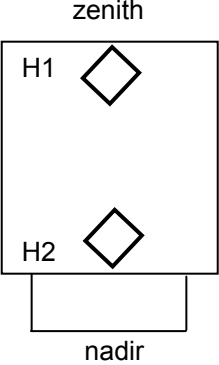
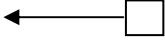
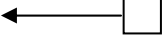
IV/SSRMS	EV1 (FF)	EV2 (SSRMS)
<p>2. Verify w/MCC S0 inhibits in place: DCSU P4 2A RBI 6 Op (CI Inh) DCSU P6 2B RBI 6 Op (CI Inh) MBSU 3 RBI 7 Op (CI Inh) MBSU 1 RBI 6 Op (CI Inh) MBSU 1 RBI 14 Op (CI Inh)</p> <p>3. Record failed MBSU serial #: _____</p> <div style="text-align: center;">  <p>MBSU ORIENTATION ON FACE 6</p> </div>	<div style="text-align: center;">  </div> <p><u>MBSU REMOVAL FROM S0 FACE 6 (2A2B)</u></p> <ol style="list-style-type: none"> Translate to failed MBSU (port nadir) <div style="text-align: center;">  </div> <ol style="list-style-type: none"> Install square TM onto H1 fitting, √anti-backlash neutral Get in posn to assist EV2 	<p><u>MBSU REMOVAL FROM S0 FACE 6 (2A2B)</u></p> <ol style="list-style-type: none"> SSRMS mnvr to failed MBSU wkst (port nadir) <div style="border: 1px solid black; padding: 5px; margin: 10px 0;"> <p style="text-align: center;"><u>CAUTION</u></p> <p>H1 bolt must always be released first or damage to ORU and underlying structure will occur</p> </div> <ol style="list-style-type: none"> PGT [B2, CCW2, 30.5]-sq TM: Release acme screw H1, 5 turns (PGT), 1 turn (bolt) Remove sq TM from H1, install onto H2 √Anti-backlash neutral Install sq scoop onto H1, handle points zenith PGT [B1, CCW2, 30.5]-6"-Ext-7/16: (use EV1's PGT) Release H1 acme screw ~ 8 turns √Status indicator – UNLOCK PGT [B2, CCW2, 30.5]-sq TM: Break torque on H2, 5 turns (PGT), 1 turn (bolt) Remove sq TM from H2, stow on MWS Install sq scoop onto H2, handle points zenith PGT [B1, CCW2, 30.5]-6"-Ext-7/16: (use EV1's PGT) Release H2 acme screw ~ 18 turns √Status indicator – UNLOCK <p style="text-align: center;"><u>NOTE</u></p> <p>Removing MBSU from coldplate causes H1 status indicator to move from UNLOCK to LOCK</p>

MBSU REMOVE AND REPLACE – 2A2B (EVA 2) (03:30) (Cont)

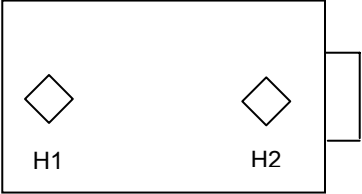
IV/SSRMS	EV1 (FF)	EV2 (SSRMS)
<p style="text-align: center;">Zenith</p> <div style="display: flex; align-items: center; justify-content: center;"> <div style="writing-mode: vertical-rl; transform: rotate(180deg); margin-right: 5px;">S T B D</div>  </div> <p style="text-align: center;">Nadir</p> <p style="text-align: center;">MBSU ORIENTATION ON CETA CART GRID E</p> <p>4. Record spare MBSU serial #: _____</p>	<p>4. Assist EV2 w/clearances 5. Translate to port side of CETA cart 6. Assist EV2</p> <p><u>SPARE MBSU REMOVAL FROM FRAM</u></p> <p>1. Release MBSU thermal cover:</p> <ul style="list-style-type: none"> <input type="checkbox"/> Release velcro tabs on front, side, and back corners of ORU base <input type="checkbox"/> Release integral strap from underside of fwd flap <input type="checkbox"/> Fold or roll cover toward back of MBSU, attach strap to Velcro mating swatch on back side of MLI (can also attach strap to adjacent structure) <input type="checkbox"/> Using side straps from front of MLI, secure rest of MLI as reqd <p style="text-align: center;">← <input type="checkbox"/></p> <p>2. Remove 3rd sq scoop from crewlock bag #1, transfer to EV2</p>	<p style="text-align: center;"><u>NOTE</u> Primary stanchion (H2) has ~ 15-20 lb soft dock force to overcome during MBSU removal from FSE</p> <div style="border: 1px solid black; padding: 5px; text-align: center;"> <p><u>WARNING</u> Fins on bottom of MBSU and coldplate are no-touch</p> </div> <p>10. Remove MBSU from coldplate 11. ✓Status indicator on H1 in LOCK 12. SSRMS mnvr to port side of CETA cart 13. Attach MBSU to ballstack 14. Remove free sq scoop from MBSU, stow on MWS</p> <p><u>SPARE MBSU REMOVAL FROM FRAM</u></p> <p>1. SSRMS mnvr to spare MBSU (head nadir)</p> <div style="border: 1px solid black; padding: 5px; text-align: center;"> <p><u>CAUTION</u> H1 bolt must always be released first or damage to ORU and underlying structure will occur</p> </div> <p>2. Install sq TM onto H1 fitting, ✓anti-backlash neutral 3. PGT [B2, CCW2, 30.5]-sq TM: Release acme screw H1, 5 turns (PGT), 1 turn (bolt) 4. Remove sq TM from H1, install onto H2 ✓Anti-backlash neutral 5. Receive sq scoop from EV1, install onto H1 fitting</p>

MBSU REMOVE AND REPLACE – 2A2B (EVA 2) (03:30) (Cont)

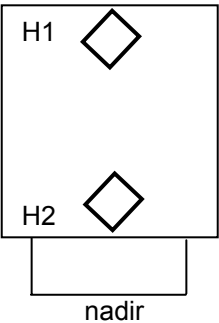
IV/SSRMS	EV1 (FF)	EV2 (SSRMS)
<div style="text-align: center;"> <p>zenith</p>  <p>nadir</p> <p>MBSU ORIENTATION ON FACE 6</p> </div>	<p>3. Assist EV2 w/clearances</p> <p><u>SPARE MBSU INSTALLATION ONTO S0</u></p> <ol style="list-style-type: none"> When EV1 clear of CETA cart, articulate ball stack and failed MBSU stbd over CETA cart (clears EV2's trajectory toward MBSU install onto nadir/port coldplate) Translate to port nadir MBSU coldplate 	<ol style="list-style-type: none"> PGT [B1, CCW2, 30.5]-6"-Ext-7/16: (use EV1's PGT) Release H1 acme screw ~ 8 turns √Status indicator – UNLOCK PGT [B2, CCW2, 30.5]-sq TM: Break torque on H2, 5 turns (PGT), 1 turn (bolt) Remove sq TM from H2, stow on MWS or handoff to EV1 Install sq scoop onto H2 PGT [B1, CCW2, 30.5]-6"-Ext-7/16: (use EV1's PGT) Release H2 acme screw ~ 18 turns √Status indicator – UNLOCK <p style="text-align: center;"><u>NOTE</u></p> <p>Removing MBSU from coldplate causes H1 status indicator to move from UNLOCK to LOCK.</p> <p>Primary stanchion (H2) has ~ 15-20 lb soft dock force to overcome during MBSU removal from FSE</p> <div style="border: 2px solid black; padding: 5px; text-align: center; margin: 10px auto; width: fit-content;"> <p><u>WARNING</u> Fins on bottom of MBSU are no-touch</p> </div> <ol style="list-style-type: none"> Remove MBSU from FRAM √Status indicator on H1 in LOCK <p><u>SPARE MBSU INSTALLATION ONTO S0</u></p> <ol style="list-style-type: none"> SRMS mnvr to S0 wkst (port nadir MBSU) (heads nadir) Orient MBSU such that blind-mate connectors and H2 fitting are nadir

MBSU REMOVE AND REPLACE – 2A2B (EVA 2) (03:30) (Cont)

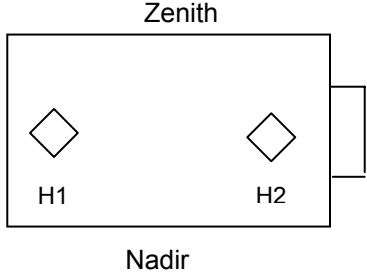
IV/SSRMS	EV1 (FF)	EV2 (SSRMS)
<div style="text-align: center;">  <p>MBSU ORIENTATION ON CETA CART GRID E</p> </div>	<ol style="list-style-type: none"> 4. Receive sq scoop from EV2, stow on MWS (or in crewlock bag #1) 5. Receive sq scoop from EV2, stow on MWS (or in crewlock bag #1) 6. Install MBSU thermal cover 7. Relocate EV2's airlock safety tether from stbd of MT to port of MT (EV2 egress posn) <p><u>CETA CART CLEANUP</u></p> <ol style="list-style-type: none"> 1. If necessary, stow CETA cart swingarms 2. Release brake pedal (tap pedal twice) 3. Translate CETA cart to S0 Bay 01 4. Stow stbd brake handles (up) <div style="border: 1px solid black; padding: 5px; text-align: center; margin: 10px 0;"> <p>CAUTION CETA to MT max coupling rate is .5 ft/sec</p> </div> <ol style="list-style-type: none"> 5. Couple CETA to MT 6. Take CETA coupler to LOCK 7. Stow port brake handles (UP) 8. Retrieve crewlock bag #1 9. Translate to airlock 	<ol style="list-style-type: none"> 5. Install failed MBSU onto FRAM (ball detent soft dock on primary bolt and stanchion) 6. ✓Status indicator on H1 is in UNLOCK 7. PGT [B2, CW2, 30.5]-6"-Ext-7/16: (use EV1's PGT) Drive H2 jack screw ~ 18 turns ✓Status indicator – LOCK 8. Remove square scoop from H2, transfer to EV1 9. Remove square scoop from H1, transfer to EV1 10. PGT [B2, CW2, 30.5]-6"-Ext-7/16: (use EV1's PGT) Drive H1 acme screw ~ 8 turns ✓Status indicator – LOCK <p><u>SSRMS CLEANUP</u></p> <ol style="list-style-type: none"> 1. SSRMS mnvr to egress posn (port of MT) 2. Egress SSRMS 3. Remove APFR from SSRMS 4. Remove WIF adapter from SSRMS, stow on MWS 5. Perform safety tether swap onto airlock safety tether, verify ST config; retrieve spare from SSRMS 6. Translate to airlock, stow APFR in Toolbox WIF 1

MBSU REMOVE AND REPLACE – 2A2B (EVA 2) TASK DATA SHEET

Tools:

EV1	EV2
PGT w-6-in	PGT
Crewlock bag #1	
Sq TM w/7/16 recessed socket	
Ballstack	
3 sq scoops	

EVA Fasteners:

Fastener Name/Label	Head Size	Qty	Release Torque (ft-lbs)	Install Torque	Failure Torque (ft-lbs)	Turns	RPM
H1	7/16	1	BREAK TORQUE	4.8 (bolt)	190.3 (bolt) (removal)	1	30
			60.0 (bolt) 12.0 (pgt) RUNNING TORQUE (very little, just picked 12.0)		22.8 (bolt) (install)		
H2	7/16	1	BREAK TORQUE	4.8 (bolt)	188.4 (bolt) (removal)	1	30
			60.0 (bolt) 12.0 (pgt) RUNNING TORQUE (very little, just picked 12.0)		27.8 (bolt) (install)		

Foot Restraints:

Task	WIF	Swingarm Setting	P/Y Fitting	APFR Setting
MBSU R&R	SSRMS			[12,PP,F,6]

Notes:

- H1 is secondary bolt, H2 is primary bolt
- Removing MBSU from coldplate causes H1 status indicator to move from UNLOCK to LOCK
- CETA to MT max coupling rate is .5 ft/sec
- There is no hard stop when releasing H1 and H2 bolts; upon release, they will free spin

Cautions:

- Fins on bottom of MBSU and coldplate are no touch
- Primary stanchion (H2) has ~ 15-20 lb soft dock force to overcome during MBSU removal and installation from/to FSE and coldplate
- H1 bolt must always be released first or damage to ORU and underlying structure will occur
- H2 bolt (jack screw) must always be installed first or damage to ORU and underlying structure will occur
- Minimize force applied to H1 microfixture. It is not rated to withstand excessive loads

ORU Weight with FRAM = ~ 500 lbs

Timeline Considerations:

- Decision to perform R&R is based on limiting consumables

EVA Connectors: N/A

Assumptions:

- Failure discovered during 1st CETA cart move, finish 1st CETA cart move prior to starting MBSU task (need 1 cart port to support R&R)
- EV1 uses 85' safety tethers from airlock D-ring, EV2 on SSRMS tether
- MT @ WS 3, SSRMS is already setup because of CETA Relocate task
- TM not reqd for on-orbit loads
- Failed MBSU left on CETA cart at end of EVA (CETA is coupled to MT)
- Due to long SSRMS times, EV1 will do all setup tasks
- EV1 gives EV2 his PGT (to free his swingarm) and retrieves spare PGT from airlock

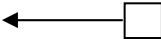

MBSU REMOVE AND REPLACE – 3A3B (EVA 2) (03:30)

IV/SSRMS	EV1 (FF)	EV2 (SSRMS)
<p>1. Verify w/MCC ESP2 inhibits in place: RPCM N1RS2-B RPC10 – OPEN AND CLOSE INHIBITED RPCM S04B F RPC 12 – OPEN AND CLOSE INHIBITED</p>	<div style="text-align: center;">  </div> <p><u>CETA CART PREP</u></p> <ol style="list-style-type: none"> 1. Transfer PGT w/6-in to EV2 2. Translate to port-most CETA cart (S0 Bay 03) 3. Deploy port brake handles on CETA cart (down) 4. Take CETA coupler to UNLOCK 5. MnvR CETA cart port ~ 5 feet 6. Deploy stbd brake handles on CETA 1 (down) 7. ✓CETA brakes by pulling parking brake (left handle) 8. Take CETA coupler to CAPTURE 9. Release CETA brakes (tap pedal twice) 10. Translate CETA to S0 Bay 00 (by hand): <ul style="list-style-type: none"> • Stop when stbd TFR is port of CETA marker 7650 11. Engage parking brake – left handle 12. Rotate port TFR swing arm to 15 <p><u>TOOL RETRIEVAL</u></p> <ol style="list-style-type: none"> 1. Translate to airlock 2. Retrieve crewlock bag #1, BRT 3. Retrieve spare PGT and 6-in socket from crewlock bag #2, stow on swingarm 4. Translate to Z1 stbd toolbox 5. Retrieve 2 sq scoops from toolbox lid: <ul style="list-style-type: none"> ☐ Stow 1 sq scoop on MWS ☐ Stow 1 sq scoop in crewlock bag #1 (may have to relocate D-Handle to get sq scoop) 6. Open right door 7. Retrieve sq TM w/7/16 recessed socket from slot 1, stow on MWS (release slider lock only) 8. Close door – both latches reqd if not coming back 	<p><u>SPARE MBSU RETRIEVAL FROM ESP2</u></p> <ol style="list-style-type: none"> 1. Receive PGT w/6-in from EV1, stow on swingarm 2. Stow 6-in socket in trash bag 3. SSRMS mnvr to ESP2 for MBSU retrieval (~ 30 min)

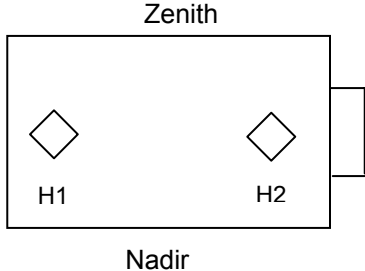
MBSU REMOVE AND REPLACE – 3A3B (EVA 2) (03:30) (Cont)

IV/SSRMS	EV1 (FF)	EV2 (SSRMS)
<div style="text-align: center;">  <p>MBSU ORIENTATION ON CETA CART GRID E</p> </div>	<p><u>SPARE MBSU RETRIEVAL FROM ESP2</u></p> <ol style="list-style-type: none"> 1. Translate to ESP2, temp stow crewlock bag #1 on CETA spur 2. Attach BRT to ESP2 HR 8003 (aft face, stbd side) 3. Engage FRAM soft capture lever (slides down) 4. PGT [A4, CCW2, 10.5]-6"-Ext-7/16: Release primary FRAM bolt 11 turns (hard stop) 5. Using vertical HRs on FRAM, remove MBSU from ESP2 (magnetic soft dock to overcome) 6. Transfer MBSU to EV2 7. Retrieve crewlock bag #1 from CETA spur, BRT <p><u>TEMP STOW SPARE MBSU ON CETA CART</u></p> <ol style="list-style-type: none"> 1. Translate to port CETA cart on S0 Bay 00 2. Temp stow crewlock bag #1 on port side of CETA cart, S0 HR 3494 3. Retrieve ballstack from crewlock bag #1, install on port TFR swingarm ECOM fitting 4. Position body to see grid E 5. Assist EV2 with clearances 6. PGT [A4, CW2, 10.5]-6" - Ext-7/16: Drive primary FRAM bolt 11 turns (hard stop) 7. Retrieve sq scoop from crewlock bag #1, transfer to EV2 	<ol style="list-style-type: none"> 4. Receive MBSU from EV1 (body is parallel to stbd side of ESP2 with head aft and face port) <p><u>TEMP STOW SPARE MBSU ON CETA CART</u></p> <ol style="list-style-type: none"> 1. SSRMS mnvr to port CETA cart on S0 Bay 00 2. Rotate MBSU until FRAM primary bolt faces ISS zenith 3. Install MBSU/FRAM onto grid E (zenith center) (rock FRAM square grid into place) 4. Receive sq scoop from EV1, stow on MWS

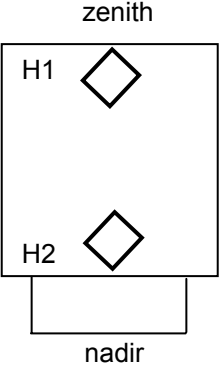
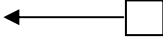
MBSU REMOVE AND REPLACE – 3A3B (EVA 2) (03:30) (Cont)

IV/SSRMS	EV1 (FF)	EV2 (SSRMS)
<p>2. Verify w/MCC S0 inhibits in place: MBSU 2 RBI 7 Op (CI Inh) MBSU 2 RBI 6 Op (CI Inh) MBSU 4 RBI 14 Op (CI Inh)</p> <p>3. Record failed MBSU serial #: _____</p> <div style="text-align: center;">  <p>MBSU ORIENTATION ON FACE 6</p> </div>	<div style="text-align: center;">  </div> <p><u>MBSU REMOVAL FROM S0 FACE 6 (3A3B)</u></p> <ol style="list-style-type: none"> 1. Translate to failed MBSU (stbd nadir) <div style="text-align: center;">  </div> <ol style="list-style-type: none"> 2. Install square TM onto H1 fitting, √anti-backlash neutral 3. Attach BRT to stbd Lab/S0 strut, head nadir 	<p><u>MBSU REMOVAL FROM S0 FACE 6 (3A3B)</u></p> <ol style="list-style-type: none"> 1. SSRMS mnvr to failed MBSU wkst (stbd nadir) <div style="border: 1px solid black; padding: 5px; margin: 10px 0;"> <p style="text-align: center;">CAUTION</p> <p>H1 bolt must always be released first or damage to ORU and underlying structure will occur</p> </div> <ol style="list-style-type: none"> 2. PGT [B2, CCW2, 30.5]-sq TM: Release acme screw H1, 5 turns (PGT), 1 turn (bolt) 3. Remove sq TM from H1, install onto H2 √Anti-backlash neutral 4. Install sq scoop onto H1, handle points zenith 5. PGT [B1, CCW2, 30.5]-6"-Ext-7/16: (use EV1's PGT) Release H1 acme screw ~ 8 turns √Status indicator – UNLOCK 6. PGT [B2, CCW2, 30.5]-sq TM: Break torque on H2, 5 turns (PGT), 1 turn (bolt) 7. Remove sq TM from H2, stow on MWS 8. Install sq scoop onto H2, handle points zenith 9. PGT [B1, CCW2, 30.5]-6"-Ext-7/16: (use EV1's PGT) Release H2 acme screw ~ 18 turns √Status indicator – UNLOCK <p style="text-align: center;">NOTE</p> <p>Removing MBSU from coldplate causes H1 status indicator to move from UNLOCK to LOCK</p>

MBSU REMOVE AND REPLACE – 3A3B (EVA 2) (03:30) (Cont)

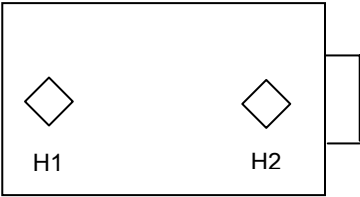
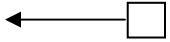
IV/SSRMS	EV1 (FF)	EV2 (SSRMS)
<p style="text-align: center;">Zenith</p> <div style="display: flex; align-items: center; justify-content: center;"> <div style="writing-mode: vertical-rl; transform: rotate(180deg); font-weight: bold; margin-right: 5px;">S T B D</div>  </div> <p style="text-align: center;">Nadir</p> <p style="text-align: center;">MBSU ORIENTATION ON CETA CART GRID E</p> <p>4. Record spare MBSU serial #: _____</p>	<p>4. Assist EV2 w/clearances 5. Translate to port side of CETA cart 6. Assist EV2</p> <p><u>SPARE MBSU REMOVAL FROM FRAM</u></p> <p>1. Release MBSU thermal cover:</p> <ul style="list-style-type: none"> <input type="checkbox"/> Release velcro tabs on front, side, and back corners of ORU base <input type="checkbox"/> Release integral strap from underside of fwd flap <input type="checkbox"/> Fold or roll cover toward back of MBSU, attach strap to Velcro mating swatch on back side of MLI (can also attach strap to adjacent structure) <input type="checkbox"/> Using side straps from front of MLI, secure rest of MLI as reqd <div style="display: flex; align-items: center;">  </div> <p>2. Remove 3rd sq scoop from crewlock bag #1, transfer to EV2</p>	<p style="text-align: center;"><u>NOTE</u> Primary stanchion (H2) has ~ 15-20 lb soft dock force to overcome during MBSU removal from FSE</p> <div style="border: 2px solid black; padding: 5px; margin: 10px auto; width: fit-content;"> <p style="text-align: center;"><u>WARNING</u> Fins on bottom of MBSU and coldplate are no-touch</p> </div> <p>10. Remove MBSU from coldplate 11. ✓Status indicator on H1 in LOCK 12. SSRMS mnvr to port side of CETA cart 13. Attach MBSU to ballstack 14. Remove free sq scoop from MBSU, stow on MWS</p> <p><u>SPARE MBSU REMOVAL FROM FRAM</u></p> <p>1. SSRMS mnvr to spare MBSU (head nadir)</p> <div style="border: 1px solid black; padding: 5px; margin: 10px auto; width: fit-content;"> <p style="text-align: center;"><u>CAUTION</u> H1 bolt must always be released first or damage to ORU and underlying structure will occur</p> </div> <p>2. Install sq TM onto H1 fitting, ✓anti-backlash neutral 3. PGT [B2, CCW2, 30.5]-sq TM: Release acme screw H1, 5 turns (PGT), 1 turn (bolt) 4. Remove sq TM from H1, install onto H2 ✓Anti-backlash neutral 5. Receive sq scoop from EV1, install onto H1 fitting</p>

MBSU REMOVE AND REPLACE – 3A3B (EVA 2) (03:30) (Cont)

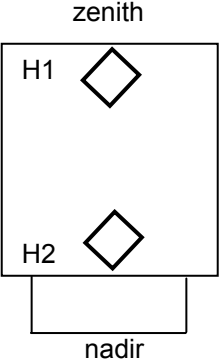
IV/SSRMS	EV1 (FF)	EV2 (SSRMS)
<div style="text-align: center;">  <p>MBSU ORIENTATION ON FACE 6</p> </div>	<p>3. Assist EV2 w/clearances</p> <p><u>SPARE MBSU INSTALLATION ONTO S0</u></p> <p>1. Translate to stbd nadir MBSU coldplate</p>	<p>6. PGT [B1, CCW2, 30.5]-6"-Ext-7/16: (use EV1's PGT) Release H1 acme screw ~ 8 turns √Status indicator – UNLOCK</p> <p>7. PGT [B2, CCW2, 30.5]-sq TM: Break torque on H2, 5 turns (PGT), 1 turn (bolt)</p> <p>8. Remove sq TM from H2, stow on MWS or handoff to EV1</p> <p>9. Install sq scoop onto H2</p> <p>10. PGT [B1, CCW2, 30.5]-6"-Ext-7/16: (use EV1's PGT) Release H2 acme screw ~ 18 turns √Status indicator – UNLOCK</p> <p style="text-align: center;"><u>NOTE</u></p> <p>Removing MBSU from coldplate causes H1 status indicator to move from UNLOCK to LOCK.</p> <p>Primary stanchion (H2) has ~ 15-20 lb soft dock force to overcome during MBSU removal from FSE</p> <div style="border: 2px solid black; padding: 5px; text-align: center; margin: 10px 0;"> <p><u>WARNING</u> Fins on bottom of MBSU are no-touch</p> </div> <p>11. Remove MBSU from FRAM 12. √Status indicator on H1 in LOCK</p> <p><u>SPARE MBSU INSTALLATION ONTO S0</u></p> <p>1. SSRMS mnvr to S0 wkst (stbd nadir MBSU) (head nadir) 2. Orient MBSU such that blind-mate connectors and H2 fitting are nadir</p>

MBSU REMOVE AND REPLACE – 3A3B (EVA 2) (03:30) (Cont)

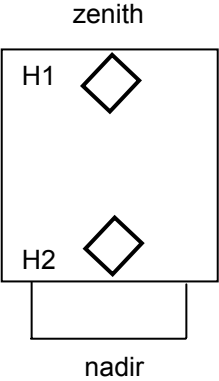
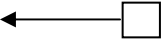
IV/SSRMS	EV1 (FF)	EV2 (SSRMS)
<div style="text-align: center;">  <p>MBSU ORIENTATION ON FACE 6</p> <p>5. Inform MCC MBSU Installed</p> </div>	<p>2. GCA EV2 as required</p> <p><u>INSTALLATION OF FAILED MBSU ONTO FRAM</u></p> <ol style="list-style-type: none"> 1. Translate to port TFR swingarm 2. Remove ballstack from port swingarm, stow in crewlock bag #1 3. Stow port swingarm (rotate to 0) 	<p style="text-align: center;"><u>NOTE</u> Primary stanchion has ~ 15-20 lb soft dock force to overcome during MBSU installation onto coldplate</p> <ol style="list-style-type: none"> 3. Install MBSU onto coldplate 4. √Status indicator on H1 is in UNLOCK <div style="border: 1px solid black; padding: 5px; margin: 10px 0;"> <p style="text-align: center;"><u>CAUTION</u> H2 bolt must always be installed first or damage to ORU and underlying structure will occur</p> </div> <ol style="list-style-type: none"> 5. PGT [A3, CW2, 30.5]-6"-Ext-7/16: (use EV1's PGT) Drive H2 jack screw ~ 18 turns √Status indicator – LOCK 6. PGT [A3, CW2, 30.5]-6"-Ext-7/16: (use EV1's PGT) Drive H1 acme screw ~ 8 turns √Status indicator – LOCK <div style="text-align: center; margin: 10px 0;">  </div> <ol style="list-style-type: none"> 7. Remove sq scoops from MBSU, stow on MWS <p><u>INSTALLATION OF FAILED MBSU ONTO FRAM</u></p> <ol style="list-style-type: none"> 1. SSRMS mnvr to failed MBSU on port TFR swingarm 2. Release MBSU from ballstack 3. Orient MBSU such that H2 fitting is port 4. SSRMS mnvr to FRAM <p style="text-align: center;"><u>NOTE</u> Primary stanchion has ~ 15-20 lb soft dock force to overcome during MBSU installation onto FRAM</p>

MBSU REMOVE AND REPLACE – 3A3B (EVA 2) (03:30) (Cont)

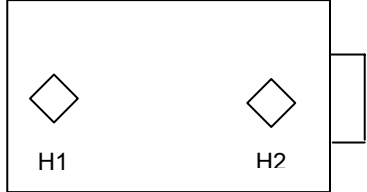
IV/SSRMS	EV1 (FF)	EV2 (SSRMS)
<div style="text-align: center;">  <p>MBSU ORIENTATION ON CETA CART GRID E</p> </div>	<ol style="list-style-type: none"> 4. Receive sq scoop from EV1, stow on MWS (or in crewlock bag #1) 5. Receive sq scoop from EV1, stow on MWS (or in crewlock bag #1) 6. Install MBSU thermal cover 7. Relocate EV2's airlock safety tether from stbd of MT to port of MT (EV2 egress posn) <p><u>CETA CART CLEANUP</u></p> <ol style="list-style-type: none"> 1. If necessary, stow CETA cart swingarms 2. Release brake pedal (tap pedal twice) 3. Translate CETA cart to S0 Bay 01 4. Stow stbd brake handles (up) <div style="border: 1px solid black; padding: 5px; text-align: center; margin: 10px auto; width: fit-content;"> <p>CAUTION CETA to MT max coupling rate is .5 ft/sec</p> </div> <ol style="list-style-type: none"> 5. Couple CETA to MT 6. Take CETA coupler to LOCK 7. Stow port brake handles (UP) 8. Retrieve crewlock bag #1 9. Translate to airlock 	<ol style="list-style-type: none"> 5. Install failed MBSU onto FRAM (ball detent soft dock on primary bolt and stanchion) 6. ✓Status indicator on H1 is in UNLOCK 7. PGT [B2, CW2, 30.5]-6"-Ext-7/16: (use EV1's PGT) Drive H2 jack screw ~ 18 turns ✓Status indicator – LOCK 8. Remove square scoop from H2, transfer to EV2 9. Remove square scoop from H1, transfer to EV2 10. PGT [B2, CW2, 30.5]-6"-Ext-7/16: (use EV1's PGT) Drive H1 acme screw ~ 8 turns ✓Status indicator – LOCK <p><u>SSRMS CLEANUP</u></p> <ol style="list-style-type: none"> 1. SSRMS mnvr to egress posn (port of MT) 2. Egress SSRMS 3. Remove APFR from SSRMS 4. Remove WIF adapter from SSRMS, stow on MWS 5. Perform safety tether swap onto airlock safety tether, verify ST config; retrieve spare from SSRMS 6. Translate to airlock

MBSU REMOVE AND REPLACE – 3A3B (EVA 2) (03:30)

Tools:

EV1	EV2
PGT w-6-in	PGT
Crewlock bag #1	
Sq TM w/7/16 recessed socket	
Ballstack	
3 sq scoops	

EVA Fasteners:

Fastener Name/Label	Head Size	Qty	Release Torque (ft-lbs)	Install Torque	Failure Torque (ft-lbs)	Turns	RPM
H1	7/16	1	BREAK TORQUE 60.0 (bolt) 12.0 (pgt)	4.8 (bolt)	190.3 (bolt) (removal)	1	30
			RUNNING TORQUE (very little, just picked 12.0)		22.8 (bolt) (install)	8	
H2	7/16	1	BREAK TORQUE 60.0 (bolt) 12.0 (pgt)	4.8 (bolt)	188.4 (bolt) (removal)	1	30
			RUNNING TORQUE (very little, just picked 12.0)		27.8 (bolt) (install)	18	

Foot Restraints:

Task	WIF	Swingarm Setting	P/Y Fitting	APFR Setting
MBSU R&R	SSRMS			[12,PP,F,6]

Notes:

- H1 is secondary bolt, H2 is primary bolt
- Removing MBSU from coldplate causes H1 status indicator to move from UNLOCK to LOCK
- CETA to MT max coupling rate is .5 ft/sec
- There is no hard stop when releasing H1 and H2 bolts; upon release, they will free spin

Cautions:

- Fins on bottom of MBSU and coldplate are no touch
- Primary stanchion (H2) has ~ 15-20 lb soft dock force to overcome during MBSU removal and installation from/to FSE and coldplate
- H2 bolt (jack screw) must always be released last or damage to ORU and underlying structure will occur
- H2 bolt (jack screw) must always be installed first or damage to ORU and underlying structure will occur
- Minimize force applied to H1 microfixture. It is not rated to withstand excessive loads

ORU Weight with FRAM = ~ 500 lbs

Timeline Considerations:

- Decision to perform R&R is based on limiting consumables

EVA Connectors: N/A

Assumptions:

- Failure discovered during 1st CETA cart move, finish 1st CETA cart move prior to starting MBSU task (need 1 cart port to support R&R)
- EV1 uses 85' safety tethers from airlock D-ring, EV2 on SSRMS tether
- MT @ WS 3, SSRMS is already setup because of CETA Relocate task
- TM not reqd for on-orbit loads
- Failed MBSU left on CETA cart at end of EVA (CETA is coupled to MT)
- Due to long SSRMS times, EV1 will do all setup tasks
- EV1 gives EV2 his PGT (to free his swingarm) and retrieves spare PGT from airlock

DDCU REMOVE AND REPLACE – CH 2/3 (EVA 2)

IV	EV1 (FF)	EV2 (FF)
<p>1. Verify w/MCC inhibits in place: MBSU 3 RBI 13 Op (CI Inh)</p>	<p><u>CETA CART PREP</u></p> <ol style="list-style-type: none"> Retrieve spare safety tether and PGT with 6-in socket from fish stringer #1 (if reqd) Receive APFR from EV2, install into CETA WIF 04 (zen/port) configure to: [12,FF,A,4]; P/Y fitting: P=GG, Y=12 Deploy port brake handles (down) Take CETA/MT coupler to UNLOCK (if necessary) Mnvr CETA port a few feet, deploy stbd brake handles Take CETA/MT coupler to CAPTURE √CETA brakes by pulling parking brake (left handle) Translate CETA 1 to S0 Bay 00 (by hand): <ul style="list-style-type: none"> □ Stop when stbd TFR is port of CETA marker 8040 (gets CETA cart to spare DDCU retrieval worksite) Engage parking brake – left handle <p>← □</p> <p><u>SPARE DDCU REMOVAL (DDCU S0-3B)</u> (S0 Bay 04)</p> <ol style="list-style-type: none"> Ingress APFR in WIF 04 Receive square TM from EV2 Receive square scoops (3) from EV2 	<p><u>SSRMS CLEANUP</u></p> <ol style="list-style-type: none"> SSRMS mnvr to EV2 egress position on port side of MT Egress SSRMS; perform safety tether swap onto airlock safety tether, verify ST config; retrieve spare from SSRMS Remove APFR, transfer to EV1 Remove WIF adapter, temp stow on MWS <p><u>TOOL RETRIEVAL</u></p> <ol style="list-style-type: none"> Translate to airlock Retrieve spare PGT (no socket) from crewlock bag #2, and retrieve crewlock bag #1, attach to BRT Translate to Z1 stbd toolbox Retrieve 2 square scoops from toolbox lid: <ul style="list-style-type: none"> □ Stow 1 square scoop on MWS □ Stow 1 square scoop in crewlock bag #1 Open right door Retrieve square TM w/7/16 recessed socket from slot 1, stow on MWS (release slider lock only) Close door – both latches reqd if not coming back <p><u>SPARE DDCU REMOVAL (DDCU S0-3B)</u> (S0 Bay 04)</p> <ol style="list-style-type: none"> Translate to S0 Bay 04 Temp stow crewlock bag #1 near EV1 (CETA HR) Transfer square TM w/7/16" recessed socket to EV1 Transfer square scoops (3) to EV1

DDCU REMOVE AND REPLACE – CH 2/3 (EVA 2) (Cont)

IV	EV1 (FF)	EV2 (FF)
<p>2. Record spare DDCU serial #: _____</p>	<div data-bbox="569 354 1173 485" style="border: 1px solid black; padding: 5px; margin-bottom: 10px;"> <p style="text-align: center;"><u>CAUTION</u></p> <p>H1 bolt must always be released first or damage to ORU and underlying structure will occur</p> </div> <div data-bbox="512 532 663 570" style="display: flex; align-items: center;"> ← <div style="border: 1px solid black; width: 15px; height: 15px; margin-right: 5px;"></div> </div> <ol style="list-style-type: none"> 4. Install TM onto H1 fitting, √anti-backlash neutral 5. PGT [B2, CCW2, 30.5]-sq TM: (use EV2 spare PGT) Break torque on H1, 5 turns (PGT), 1 turn (bolt) 6. Remove TM from H1, install onto H2 √Anti-backlash neutral 7. Install square scoop onto H1 fitting 8. PGT [B1, CCW2, 30.5]-6"-Ext-7/16: Release H1 acme screw ~ 8 turns √Status indicator – UNLOCK 9. PGT [B2, CCW2, 30.5]-sq TM: Break torque on H2, 5 turns (PGT), 1 turn (bolt) 10. Remove TM from H2, stow on MWS 11. Install square scoop on H2 fitting 12. PGT [B1, CCW2, 30.5]-6"-Ext-7/16: Release H2 jack screw ~ 18 turns √Status indicator – UNLOCK <p style="text-align: center;"><u>NOTE</u></p> <p>Removing DDCU from coldplate causes H1 status indicator to move from UNLOCK to LOCK.</p> <p>Primary stanchion (H2) has ~ 15-20 lb soft dock force to overcome during DDCU removal from FSE</p>	

DDCU REMOVE AND REPLACE – CH 2/3 (EVA 2) (Cont)

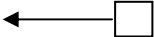
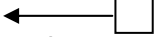
IV	EV1 (FF)	EV2 (FF)
<p>3. Verify w/MCC inhibits in place: MBSU 3 RBI 4 Op (CI Inh)</p> <p>4. Verify w/MCC inhibits in place: MBSU 2 RBI 12 Op (CI Inh)</p>	<div style="border: 2px solid black; padding: 5px; text-align: center; margin-bottom: 10px;"> <p>WARNING Fins on bottom of DDCU and coldplate are no-touch</p> </div> <p>13. Remove DDCU from coldplate 14. ✓Status indicator on H1 in LOCK 15. Attach spare DDCU to EV2's BRT 16. Egress APFR 17. Remove free scoop from spare DDCU, attach to MWS</p> <p><u>FAILED DDCU REMOVAL</u></p> <p>For DDCU P1-3A (P1 Bay 16): </p> <ol style="list-style-type: none"> 1. Ingress port TFR 2. Release CETA brakes (tap petal twice) 3. Translate to P1 HR 3602 (P1 Bay 14, Face 1), perform safety tether swap onto spare tether, verify ST config 4. At CETA marker 9760, engage parking brake – (left handle); cart is ~ 2 feet stbd of DDCU, proceed to step 5 <p>For DDCU S0-2B (S0 Bay 02): </p> <ol style="list-style-type: none"> 1. Ingress port TFR 2. Release CETA brakes (tap petal twice) 3. Translate to S0 Bay 00 4. At CETA marker 7980 on S0, engage parking brake – (left handle); cart is ~ 2 feet stbd of DDCU, proceed to step 5 	<p>5. Get in position to receive spare DDCU from EV1</p> <p>6. Attach spare DDCU to BRT</p> <p><u>FAILED DDCU REMOVAL</u></p> <p>For DDCU P1-3A (P1 Bay 16):</p> <ol style="list-style-type: none"> 1. Translate to P1 Bay 16, perform safety tether swap onto P1 HR 3601 as reqd, verify ST config; proceed to step 2 <p>For DDCU S0-2B (S0 Bay 02):</p> <ol style="list-style-type: none"> 1. Translate to S0 Bay 02; proceed to step 2

DDCU REMOVE AND REPLACE – CH 2/3 (EVA 2) (Cont)

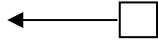
IV	EV1 (FF)	EV2 (FF)
<p>5. Record failed DDCU serial #: _____</p>	<p>5. Install square TM onto H1 fitting, $\sqrt{\text{anti-backlash neutral}}$</p>  <div data-bbox="571 396 1194 509" style="border: 1px solid black; padding: 5px; margin: 10px 0;"> <p style="text-align: center;"><u>CAUTION</u></p> <p>H1 bolt must always be released first or damage to ORU and underlying structure will occur</p> </div> <p>6. Ingress APFR in WIF 04</p> <p>7. PGT [B2, CCW2, 30.5]-sq TM: Break torque on H1, 5 turns (PGT), 1 turn (bolt)</p> <p>8. Remove square TM from H1, install onto H2 $\sqrt{\text{Anti-backlash neutral}}$</p> <p>9. Install sq scoop on H1</p> <p>10. PGT [B1, CCW2, 30.5]-6"-Ext-7/16: Release H1 acme screw ~ 8 turns $\sqrt{\text{Status indicator – UNLOCK}}$</p> <p>11. PGT [B2, CCW2, 30.5]-sq TM: Break torque on H2, 5 turns (PGT), 1 turn (bolt)</p> <p>12. Remove square TM from H2, stow on MWS</p> <p>13. Install square scoop on H2 fitting</p> <p>14. PGT [B1, CCW2, 30.5]-6"-Ext-7/16: Release H2 jack screw ~ 18 turns $\sqrt{\text{Status indicator – UNLOCK}}$</p> <p style="text-align: center;"><u>NOTE</u></p> <p>Removing DDCU from coldplate causes H1 status indicator to move from UNLOCK to LOCK.</p> <p>Primary stanchion (H2) has ~ 15-20 lb soft dock force to overcome during DDCU removal from FSE</p> <div data-bbox="579 1299 1234 1399" style="border: 3px double black; padding: 5px; margin: 10px 0;"> <p style="text-align: center;"><u>WARNING</u></p> <p>Fins on bottom of DDCU and coldplate are no-touch</p> </div>	

DDCU REMOVE AND REPLACE – CH 2/3 (EVA 2) (Cont)

IV	EV1 (FF)	EV2 (FF)
	<p>15. Remove DDCU from coldplate 16. ✓Status indicator on H1 in LOCK 17. Attach failed DDCU to BRT 18. Receive free square scoop from EV2</p> <p><u>SPARE DDCU INSTALL</u></p> <p>1. Install square scoop onto spare DDCU (on EV2's BRT) 2. Remove spare DDCU from EV2's BRT</p> <p style="text-align: center;"><u>NOTE</u> Primary stanchion has ~ 15-20 lb soft dock force to overcome during DDCU installation onto coldplate</p> <p>3. Install DDCU onto coldplate 4. ✓Status indicator on H1 is in UNLOCK</p> <div style="border: 1px solid black; padding: 5px; margin: 10px auto; width: fit-content;"> <p style="text-align: center;"><u>CAUTION</u> H2 bolt (jack screw) must always be installed first or damage to ORU and underlying structure will occur</p> </div> <p>5. PGT [A3, CW2, 30.5]-6"-Ext-7/16: Drive H2 jack screw ~ 18 turns ✓Status indicator – LOCK 6. PGT [A3, CW2, 30.5]-6"-Ext-7/16: Drive H1 acme screw ~ 8 turns ✓Status indicator – LOCK 7. Remove square scoops from DDCU, stow on MWS 8. Egress APFR</p>	<p>2. Assist EV1, remove free scoop 3. Transfer free square scoop to EV1</p> <p><u>SPARE DDCU INSTALL</u></p> <p>1. Assist EV1 2. Retrieve crewlock bag #1, BRT</p>

DDCU REMOVE AND REPLACE – CH 2/3 (EVA 2) (Cont)

IV	EV1 (FF)	EV2 (FF)
<p>6. Verify w/MCC inhibits in place: MBSU 3 RBI 13 Op (CI Inh)</p>	<p><u>FAILED DDCU INSTALL</u> (S0 Bay 04) (to protect coldplate)</p> <ol style="list-style-type: none"> 1. Release CETA 1 parking brake (tap pedal twice) 2. Translate CETA 1 to S0 Bay 00 (by hand): <ul style="list-style-type: none"> □ Stop when stbd TFR is port of CETA marker 8040 (gets CETA cart to spare DDCU retrieval worksite) 3. Engage parking brake – left handle <p>← <input type="checkbox"/></p> <ol style="list-style-type: none"> 4. Ingress APFR in WIF 04 <p style="text-align: center;"><u>NOTE</u> Primary stanchion has ~ 15-20 lb soft dock force to overcome during DDCU installation onto coldplate</p> <ol style="list-style-type: none"> 5. Install DDCU onto coldplate 6. ✓Status indicator on H1 is in UNLOCK <div style="border: 1px solid black; padding: 5px; margin: 10px auto; width: fit-content;"> <p style="text-align: center;"><u>CAUTION</u> H2 bolt (jack screw) must always be installed first or damage to ORU and underlying structure will occur</p> </div> <ol style="list-style-type: none"> 7. PGT [A3, CW2, 30.5]-6"-Ext-7/16: Drive H2 jack screw ~ 18 turns ✓Status indicator – LOCK 8. PGT [A3, CW2, 30.5]-6"-Ext-7/16: Drive H1 acme screw ~ 8 turns ✓Status indicator – LOCK 9. Remove square scoops from DDCU, stow on MWS 10. Egress APFR (APFR left on CETA cart) 	<p><u>FAILED DDCU INSTALL</u> (S0 Bay 04) (to protect coldplate)</p> <ol style="list-style-type: none"> 1. Translate to DDCU coldplate in S0 bay 04 2. Install square scoop onto failed DDCU (on EV1's BRT) 3. Assist EV1

DDCU REMOVE AND REPLACE – CH 2/3 (EVA 2) (Cont)

IV	EV1 (FF)	EV2 (FF)
	<p><u>CLEANUP</u></p> <ol style="list-style-type: none"> 1. Translate to airlock 2. Perform safety tether swap onto airlock safety tether if reqd, verify ST config, retrieve spare 3. Perform tool inventory 	<p><u>CETA CART CLEANUP</u></p> <ol style="list-style-type: none"> 1. If necessary, stow CETA cart swingarms 2. Stow all brake handles (up) 3. Release brake pedal (tap pedal twice) 4. Translate CETA cart to S0 Bay 01, perform safety tether swap onto airlock safety tether if reqd, verify ST config, retrieve spare <div style="border: 1px solid black; padding: 5px; margin: 10px auto; width: fit-content;"> <p style="text-align: center;">CAUTION CETA to CETA max coupling rate is 1 inch/sec</p> </div> <ol style="list-style-type: none"> 5. Couple CETA 2 to MT (or CETA 1 to CETA 2) 6. Take MT/CETA coupler to LOCK 7. Translate to airlock 8. Perform tool inventory

DDCU REMOVE AND REPLACE – CH 2/3 TASK DATA SHEET

Tools: Backup tool shown in ()

EV1	EV2
PGT w/6-in	PGT
APFR	Crewlock bag #1
	Square TM w/7/6" TM
	3 square scoops

Foot Restraints (Optional Use)

Task	WIF	APFR Setting	Comments
DDCU Remove and Replace (nominal)	CETA 1 WIF 04	12,FF,A,4 P=GG, Y=12	
DDCU S03B (S0 Bay 04)	(S0 WIF 45)	10,SS,F,12	
DDCU S02B (S0 Bay 02)	(S0 WIF 21) (S0 WIF 24)	9,OO,H,12 8,NN,F,12	Can't reach H1 Can't reach H2
DDCU P13A (P1 Bay 16)	(P3 WIF 06)	2,NN,F,12	Side mounted WIF, not great access to both bolts

EVA Fasteners:

Fastener Name/Label	Head Size	Qty	Release Torque (ft-lbs)	Install Torque	Failure Torque (ft-lbs)	Turns	RPM
H1	7/16	1	BREAK TORQUE	4.8 (bolt)	190.3 (bolt) (removal)	1	30
			60.0 (bolt) 12.0 (pgt)		22.8 (bolt) (install)		
H2	7/16	1	BREAK TORQUE	4.8 (bolt)	188.4 (bolt) (removal)	1	30
			60.0 (bolt) 12.0 (pgt)		27.8 (bolt) (install)		
			RUNNING TORQUE (very little, just picked 12.0)				

Notes:

1. There is no hard stop when releasing H1 and H2 bolts; upon release, they will free spin
2. Removing DDCU from coldplate causes H1 status indicator to move from UNLOCK to LOCK
3. Primary stanchion (H2) has a 15-20 lb soft dock

Cautions:

1. There is no hard stop when releasing H1 and H2 bolts; upon release, they will free spin
2. H2 bolt (jack screw) must always be installed first or damage to ORU and underlying structure will occur
3. Fins on bottom of DDCU and coldplate are no-touch
4. H1 bolt must always be released first or damage to ORU and underlying structure will occur
5. Minimize force applied to H1 microfixture. It is not rated to withstand excessive loads

Timeline Considerations:

1. Decision to perform R&R is based on limiting consumables

Assumptions:

1. Learn of failure ~ 20-30 min after CH 2/3 powerup
2. CETA cart is used as work platform for APFRs. There are back-up truss WIFs in the task data sheet, however CETA cart was chosen as the primary means for the R&R b/c the CETA cart WIFs give very good access to both H1 and H2 bolts at all worksites. The truss WIFs are not ideal, and often only provide good access to only 1 of the bolts. Also, when using the CETA cart, you only setup 1 APFR that can be used to both retrieve the spare and R&R the failed. Without the cart, you automatically have to setup up two APFR worksites (balance this with CETA cart setup and translation)
3. Spare DDCU is DDCU S0-3B (in S0 Bay 04). Skip Z1 PP if any of the 2/3 DDCU fails and you use the S03B DDCU as a spare (or it fails itself)
4. TM not used on spare DDCU for on-orbit loads
5. All tools retrieved from Z1 toolbox come inside after EVA
6. Failed DDCU is installed into spare site
7. MT @ WS 3 w/at least one CETA cart coupled to port side
8. If the S0-3B spare fails during pwr up, the R&R will be skipped, and so will the PP. That is why there is no option in the above procedures to R&R S0-3B. None of the other DDCUs can be used as the spare, so the R&R will occur on another day using the internal spare
9. EV2 has spare safety tether from CETA Relocate and EV1 can pick up his spare from fish stringer #1 (for the P1 bay 16 DDCU) or crewlock bag #1
10. EV2 retrieves spare PGT from airlock for more efficient PGT ops. This is not reqd, and EV1 can socket swap throughout the R&R, temp stowing the socket in his trash bag

BCDU BACKOUT – CH 2/3 (EVA 2)

IV	EV1 (FF)	EV2 (FF)
<p>1A. ✓Verify SARJ locked at 35 deg 1B. ✓MCC inhibits in place: BCDU 4A1</p> <ol style="list-style-type: none"> 1. DCSU 4A RBI 2 Op, CI Inh 2. BCDU 2A1 CP RBI Op <p>- OR -</p> <p>BCDU 4A2</p> <ol style="list-style-type: none"> 1. DCSU 4A RBI 3 Op, CI Inh 2. BCDU 2A2 CP RBI Op <p>- OR -</p> <p>BCDU 4A3</p> <ol style="list-style-type: none"> 1. DCSU 4A RBI 4 Op, CI Inh 2. BCDU 2A3 CP RBI Op <p>2. IV record serial # of failed box: _____</p>	<div style="text-align: center;">← <input type="checkbox"/></div> <p><u>FAILED P4 4A BCDU BACK-OUT</u></p> <ol style="list-style-type: none"> 1. Translate to airlock 2. Retrieve spare 55' safety tether from crewlock bag #1, stow on MWS 3. Translate to Z1 stbd toolbox 4. Open right door 5. Retrieve sq TM w/7/16 recessed socket from slot 1, stow on MWS 6. Close door – 1 latch reqd 7. Translate to fish stringer #1, retrieve second 55' safety tether and PGT w/6-in, stow on MWS 8. Translate to P1 HR 3602 (Bay 14); perform safety tether swap using 55' spare safety tether, verify ST config 9. Translate to P4 HR 5104 (zenith IEA) 10. Perform safety tether swap onto P4 HR 5104 with remaining 55' safety tether, verify ST config 11. Translate to failed BCDU on P4 (<u>P4 fwd.TBD BCDU</u>) <div style="text-align: center;">← <input type="checkbox"/></div> <div style="border: 1px solid black; padding: 5px; margin: 10px auto; width: fit-content;"> <p style="text-align: center;"><u>CAUTION</u> H1 bolt must always be released first or damage to ORU and underlying structure will occur</p> </div> <ol style="list-style-type: none"> 12. Install TM onto H1 fitting, ✓anti-backlash neutral 13. PGT [B2, CCW2, 30.5]-sq TM: Release acme screw H1, ~ 1 turn 14. Remove TM from H1, install onto H2 ✓Anti-backlash neutral 	<p><u>FAILED P4 4A BCDU BACK-OUT</u></p> <ol style="list-style-type: none"> 1. Finish current CETA cart task 2. GCA SSRMS for APFR egress 3. Assist EV1 as reqd

BCDU BACKOUT – CH 2/3 (EVA 2) (Cont)

IV	EV1 (FF)	EV2 (FF)
	<ol style="list-style-type: none"> 15. Reconfigure PGT with 6-in socket 16. PGT [B1, CCW2, 30.5]-6"-Ext-7/16: Release H1 acme screw ~ 8 turns √Status indicator – UNLOCK 17. Remove socket from PGT 18. PGT [B2, CCW2, 30.5]-sq TM: Break torque on H2, ~ 1 turn 19. Remove TM from H2, stow on MWS 20. Reconfigure PGT with 6-in socket 21. PGT [B1, CCW2, 30.5]-6"-Ext-7/16: Release H2 jack screw 5 turns 22. ☐ BCDU final config 23. Translate to airlock 	

BCDU BACKOUT – CH 2/3 (EVA 2) TASK DATA SHEET

Tools:

EV1 (FF)	EV2 (FF)
PGT w/6-in socket	
Square TM w/7/16 in Rec Socket	

EVA Fasteners:

Fastener Name/Label	Head Size	Qty	Release Torque (ft-lbs)	Install Torque	Failure Torque (ft-lbs)	Turns	RPM
H1	7/16	1	BREAK TORQUE	4.8 (bolt)	190.3 (bolt) (removal)	1	30
			60.0 (bolt) 12.0 (pgt)		22.8 (bolt) (install)		
			RUNNING TORQUE (very little, just picked 12.0)			8	
H2	7/16	1	BREAK TORQUE	4.8 (bolt)	188.4 (bolt) (removal)	1	30
			60.0 (bolt) 12.0 (pgt)		27.8 (bolt) (install)		
			RUNNING TORQUE (very little, just picked 12.0)			18	

EVA Connectors: NA

Harness	From	To	Clamps (#)	Conn Size	Function
NA					

Foot Restraints: NA

Notes:

- H1 is secondary bolt, H2 is primary bolt
- Removing BCDU from coldplate causes H1 status indicator to move from UNLOCK to LOCK
- The BCDU backout procedure does not actually remove the ORU from the truss, it just backs the H2 bolt out enough to demate the blind-mate connectors

Cautions:

- Fins on bottom of MBSU and coldplate are no touch
- Primary stanchion (H2) has ~ 15-20 lb soft dock force to overcome during MBSU removal and installation from/to FSE and coldplate
- H1 bolt must always be released first or damage to ORU and underlying structure will occur
- Minimize force applied to H1 microfixture. It is not rated to withstand excessive loads
- T-handle on connector cover poses a tether snag point. Connector cover could become loose debris if advertently snagged by EVA tether

Warnings:

- Hazard voltage exist at the connectors of the BCDU. BCDU must be safed before removal

ORU Mass: 234 lbs

Assumptions:

- This failure would happen on EVA 2 (CH 2/3), and protects for P4 4A BCDUs only (only channel carrying core loads)
- SARJ must be stopped and locked
- EV2 would be starting SSRMS setup and CETA cart relocate, so it would be easier for EV1 to break away from his task to support BCDU back-out. EV2 will complete current CETA cart task and then egress APFR to assist EV1 as reqd. EV2 needs EV1 for GCA assist and so cannot continue with CETA cart tasks until EV1 is back
- All bolts are driven FF
- EV is on 85' safety tether from airlock

P1 PUMP MODULE R&R SUMMARY TIMELINE

TIME	IV/SRMS/SSRMS	EV1 (FF)	EV2 (SSRMS)
00:00		POST DEPRESS (00:05)	POST DEPRESS (00:05)
00:05		EGRESS (00:20)	EGRESS (00:20)
00:25	SSRMS: PM R&R SRMS: PM R&R	FAILED PM REMOVAL FROM P1 (01:30) <ul style="list-style-type: none"> • Setup • PM Prep for FGB Install • PM QD Operations • PM Jumper N2 Vent and Install • PM Electrical Connections • Release PM Bolts • Temp Stow Failed PM on SRMS 	FAILED PM REMOVAL FROM P1 (01:30) <ul style="list-style-type: none"> • SSRMS Setup • FGB Removal from Spare PM • Break Torque on PM Bolts • PM Jumper N2 Vent and Install • FGB Install • Release PM Bolts • Temp Stow Failed PM on SRMS
01:55		SPARE PM RETRIEVAL FROM ESP2 (01:30) <ul style="list-style-type: none"> • Spare PM Electrical Connections 	SPARE PM RETRIEVAL FROM ESP2 (01:30) <ul style="list-style-type: none"> • Break Torque on PM Bolts • Release PM Bolts
03:25		SPARE PM INSTALL ON P1 (02:00) <ul style="list-style-type: none"> • P1 PM Install • PM Electrical Connections • PM Jumper NH3 Vent and Removal • P1 PM N2 vent • PM QD Operations • CETA Cart Cleanup 	SPARE PM INSTALL ON P1 (02:00) <ul style="list-style-type: none"> • P1 PM Install • PM Bolt Initial Torque • PM Jumper NH3 Vent and Removal • PM Bolt Final Torque
*** BREAKOUT POINT IF REQD ***			
05:25		FAILED PM INSTALL ONTO ESP2 (01:30) <ul style="list-style-type: none"> • Retrieve Failed PM from SRMS • Install Failed PM onto ESP2 • PM Electrical Connections • Cleanup 	FAILED PM INSTALL ONTO ESP2 (01:30) <ul style="list-style-type: none"> • Retrieve Failed PM from SRMS • Install Failed PM onto ESP2 • PM Bolt Initial Torque • PM Bolt Final Torque • SSRMS Cleanup
06:55		INGRESS (00:20)	INGRESS (00:20)
07:05		PRE REPRESS (00:05)	PRE REPRESS (00:05)
07:25			

P1 PUMP MODULE R&R TOOL CONFIG

AIRLOCK

EMU1

- MWS, right swing arm
- Camera (inner right swing arm)
- BRT (left)
 - w/3 wire ties and sm-sm RET
- T-Bar
 - ISS trash bag (inner left)
 - Sm-sm RET (left D-ring)
 - Adj tethers (2) (left D-ring)
 - Sm-sm RET w/PIP pin (right D-ring)
 - Adj tethers (2) (right D-ring)
- D-ring ext – left
- Waist tether – right
- SAFER

EMU2

- MWS, right swing arm
- Camera (inner right swing arm)
- BRT (left)
 - w/3 wire ties and sm-sm RET
- T-Bar
 - ISS trash bag (inner right)
 - Wire ties (2) around T-Bar
 - Socket caddy (inner left)
 - 5/8 x 7.8-in ext
 - Sm-sm RET w/PIP pin (left D-ring)
 - Adj tether (left D-ring)
 - Sm-sm RET w/PIP pin (right D-ring)
 - Adj tethers (2) (right D-ring)
 - Lg-sm RETs (2) (need for PM HRs)
- D-ring ext (2)
 - Spare 55' safety tether to MWS (left D-ring extender)
- Waist tethers (2)
- SAFER

AIRLOCK ENDCONE

- Staging Bag
- Fish Stringer #3
- Connector cleaner tool caddy
 - Wire tie caddy (2)
- Pin straightener
- MWS Key strap
- Velcro/Tape caddy
- Pry bar
- EVA Ratchet
- Socket caddy (inner right)
 - 5/8 x 7.8-in ext
- Spare 55' safety tethers (2)

- IV Bag
- Contamination Detection Kit
 - Hydrazine Detector (Gold Salt Coupon) (6)
 - Color Chart (2)
 - ISS Contamination Detection Sampler (2)
 - Shuttle Contamination Detection Sampler (2)
 - Nitrogen Dioxide Detector (Oxidizer Draeger Tube) (6)
 - Ammonia Detector (NH3 Draeger Tube) (6)
- 2 towels with wire ties
- DCM plug (2) (SAFER hardmount)
- GP caddy (2)
 - Thermal mittens (2 pr)
- Socket Caddy (hatch contingencies) w/sm-sm RET
 - 1/2 X 8-in socket (IV hatch)
 - 7/16 X 6-in socket (spare)

PRE EVA TOOL CONFIG

- 1. Prior to EVA, inspect the following:
 - RET cords for damage
 - BRT and MWS toggles: loose fittings/screws
 - Safety and waist tether load alleviating straps (no red band or damage)

AIRLOCK INTERNAL D-RING

- D-Ring Extender

UIA HANDRAILS:

- Fish Stringer #1 (laid across UIA HRs)
 - PGT with 7/16 x 6-in ext (s/n:_____) w/RET
- Torque Wrench (set to 37 ft-lbs) (need for PM Return)
 - Lg-sm RET
- Fish Stringer #2
 - PGT with 7/16 x 6-in ext (s/n:_____) w/RET
 - Round TM w/5/8 proud socket
- Crewlock bag #1 (empty) – for QD cont tools if needed
 - Lg-sm RET

EXTERNALLY STOWED QD TOOLS: (INFO ONLY)

- PM Jumper Bag
 - PM Jumper
- VTE Bag (only needed if EVA NH3 vent is reqd)
 - 1.0" vent tool mated to vent tool extender
 - MUT EE
- Stbd QD Bag (QD cont tools)
 - 1.5" QRT/FID gauge
 - 1.5" Bail drive lever
 - .5" cap tool

NOTE

Only need vent tool and VTE for specific failures where MCC cannot remotely vent PM NH3 through truss aft vent panel

EGRESS (00:25)

IV	EV1 (FF)	EV2 (FF)
<p><u>NOTE</u> For safety tether swaps, expect to hear:</p> <ol style="list-style-type: none"> 1. Hook closed 2. Slide locked 3. Reel unlocked <ol style="list-style-type: none"> 1. WVS Software: Select page – RF camera Sel 'Advanced Controls' S-Band Level (two) – Max (required after EV1 and EV2 egress airlock) 	<p>√Right waist tether to airlock internal D-ring extender, verify ST config</p> <ol style="list-style-type: none"> 1. Thermal cover – open 2. Egress airlock 3. Inspect load alleviating straps on 85' safety tethers (2) 4. Retrieve airlock safety tether from fwd external D-ring, attach to left D-ring extender, verify ST config 5. Release waist tether from internal D-ring extender 6. Receive fish stringer #1 and #2 from EV2 7. Temp stow fish stringer #1 in between A/L port toolbox HR and stbd toolbox HR (stretched out) 8. Temp stow fish stringer #2 in between A/L HR 0560 (fwd/stbd/nadir) and HR 0555 (nadir of stbd toolbox) 9. Transfer aft airlock safety tether to EV2 10. Transfer PGT from fish stringer #1 to right swingarm 11. Retrieve fish stringer #1 <ol style="list-style-type: none"> 12. √EV2's SAFER MAN ISOL vlv – OP (dn) and HCM (dn) 	<p>√Right waist tether to UIA panel fwd D-ring, verify ST config</p> <ol style="list-style-type: none"> 1. Transfer fish stringer #1 and #2 to EV1 2. Receive airlock safety tether from EV1, attach to left D-ring extender, verify ST config 3. Release right waist tether from UIA panel D-ring 4. Egress airlock ← <input type="checkbox"/> 5. Close thermal cover 6. √EV1's SAFER MAN ISOL vlv – OP (dn) and HCM (dn) 7. Transfer PGT from fish stringer #2 to right swingarm 8. Transfer Round TM from fish stringer #2 to MWS 9. Retrieve fish stringer #2

FAILED PUMP MODULE REMOVAL FROM P1

IV/SRMS/SSRMS	EV1 (FF)	EV2 (SSRMS)
<p>1. P1 PM R&R (SODF: RBT FS: APFR Install/APFR Ingress)</p> <div data-bbox="94 630 441 901" style="text-align: center;"> </div> <p>PM on ESP2 w/FGB</p> <p>2. IV Record PM serial #: _____</p> <p>3. P1 PM R&R (SODF: RBT FS: FGB Removal)</p> <p>4. √MCC GO to begin QD ops</p>	<p><u>WORKSITE SETUP</u></p> <ol style="list-style-type: none"> Translate to PM Jumper bag on crewlock Retrieve PM Jumper bag, attach to BRT Translate to CETA 1 (port) (S0 Bay 02) – MT @ WS 4 Stow fish stringer #1 and PM Jumper bag on CETA cart square grid Prep CETA 1 for transfer to port side of P1 PM <ul style="list-style-type: none"> □ √Brake handles (4) straight and collars locked □ Deploy CETA 1 port brake handles (down) □ √Swingarms stowed (3) □ Take CETA 1 coupler to UNLOCK □ Translate CETA port a few inches; engage parking brake (left handle) – to verify that brakes work □ Release CETA brakes (tap pedal twice) □ Translate CETA 1 to ~ P1 Bay 10 (stbd brake pedal between CETA marker 8850 and 8820) □ Engage CETA 1 parking brake (left handle) □ Take CETA 1 coupler to CAPTURE □ Rotate zenith swingarm clear of CETA cart stbd HR Open face 1 shroud (velcroes) (opens toward port) <p><u>PUMP MODULE PREP FOR FGB INSTALL</u></p> <ol style="list-style-type: none"> Read failed PM serial # to IV ← <input type="checkbox"/> Open MLI flap on integral PM cover (FGB bolts) PGT [B7, CCW2, 30.5]-6-Ext-7/16: Disengage FGB to Pump Module mounting bolts (4) 17-20 turns <div data-bbox="525 1193 1260 1315" style="border: 1px solid black; padding: 5px; text-align: center;"> <p><u>CAUTION</u></p> <p>Use extreme caution when manipulating F-171 (zen) and F-177 (nad) prior to P-Clamp release; minimize loads input into QD hard lines and QDs</p> </div> <p><u>PUMP MODULE QD OPERATIONS</u></p> <p>← <input type="checkbox"/></p>	<p><u>SSRMS SETUP</u></p> <ol style="list-style-type: none"> Retrieve APFR from A/L Toolbox #1 (stbd) Translate to ESP2 fwd/zenith GCA SSRMS for APFR setup Install WIF adapter (tether point facing same direction as LEE) into SSRMS Install APFR on WIF adapter: configure to: [12,PP,F,6] Perform safety tether swap onto SSRMS safety tether; temp stow airlock safety tether on VSSA FRAM HR (fwd) <p><u>FGB REMOVAL FROM SPARE PUMP MODULE</u></p> <div data-bbox="1344 787 1984 909" style="border: 1px solid black; padding: 5px; text-align: center;"> <p><u>CAUTION</u></p> <p>Minimize loads inputted into PM MLI handholds. It is possible that handholds may tear off when used</p> </div> <ol style="list-style-type: none"> Temp stow fish stringer #2 on ESP2 Release Velcro strap on fwd face of PM MLI Open forward flap on PM MLI tent, attach velcro flaps (2) GCA SSRMS for ingress Attach waist tether to APFR, ingress SSRMS (head zenith) <div data-bbox="1344 1144 1984 1266" style="border: 1px solid black; padding: 5px; text-align: center;"> <p><u>CAUTION</u></p> <p>Avoid contact with FGB grapple pin and RMS target</p> </div> <ol style="list-style-type: none"> Attach fish stringer #2 to PM fwd HRs (clear of FGB) SSRMS mnvr to FGB bolt release Tether to FGB PGT [B7, CCW2, 30.5]-6-Ext-7/16: Release FGB to Pump Module mounting bolts (4) 8-11

FAILED PUMP MODULE REMOVAL FROM P1 (Cont)

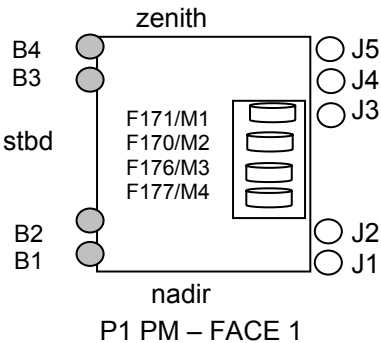
IV/SRMS/SSRMS	EV1 (FF)	EV2 (SSRMS)
<p>5. P1 PM R&R (SODF: RBT FS: FGB Install)</p>  <p style="text-align: center;">P1 PM – FACE 1</p>	<ol style="list-style-type: none"> 1. PGT [A7, CCW2, 30.5]-6-Ext-7/16: Release F171, F170, and F176 P-clamps, 12-14 turns 2. Release F171, F170, and F176 TA clamps from flexlines 3. Remove wire tie (1) from 1.5" SPDs, temp stow 4. Remove SPDs from QDs (4), stow on fish stringer #1 5. Check QD buttons installed (4) 6. Stow PGT on fish stringer #1 <div style="border: 1px solid black; padding: 5px; margin: 10px 0;"> <p style="text-align: center;">CAUTION</p> <p>When operating QDs, assess sideloads and flexhose alignment prior to mating/demating and valve opening/closing; perform necessary actions to counteract sideloads as reqd</p> <hr/> <p>While demating F-171 from M1, do not exceed 20 lb of force in the forward, zenith, and nadir direction</p> <hr/> <p>Once F-171 is demated from M1, do not use the QD to manipulate the line out of the way (use the hard line)</p> </div> <ol style="list-style-type: none"> 7. BRT to stbd HR on CETA cart 8. Perform the following steps to close valve and demate P1-F171/PM M1: (zenith-most) <ol style="list-style-type: none"> A. Take valve to full open (push fwd, button pops up) (unsticks male sleeve seals) B. Depress button and close valve (pull bail aft) C. Verify detent button up D. Verify fwd white line visible E. Demate P1-F171 from M1 (using release trigger) F. Restrain P1-F171 clear of PM using adj tether 9. Perform the following steps to close valve and demate P1-F170/PM M2: <ol style="list-style-type: none"> A. Take valve to full open (push fwd, button pops up) (unsticks male sleeve seals) B. Depress button and close valve (pull bail aft) C. Verify detent button up D. Verify fwd white line visible E. Demate P1-F170 from M2 (using release trigger) F. Restrain P1-F170 clear of PM using adj tethers 	<p>turns (any order)</p> <ol style="list-style-type: none"> 10. Remove FGB from Pump Module (soft dock) 11. Attach FGB to BRT 12. SSRMS mnvr to failed PM (P1 Face 1, Bay 08) (head zenith) <p><u>BREAK TORQUE ON PUMP MODULE BOLTS</u></p> <ol style="list-style-type: none"> 1. GCA SSRMS to Bolt 1 (nadir-most) 2. Perform the following steps to break torque on PM bolts 1, 2, 3, and 4: <ul style="list-style-type: none"> <input type="checkbox"/> Install round TM w/5/8" proud socket on PM Bolt <input type="checkbox"/> √Anti-backlash neutral <input type="checkbox"/> PGT [B6, CCW1, 30.5]-rd TM: Break torque on Bolt ~ 1 turn (of bolt) <input type="checkbox"/> GCA to next bolt as reqd 3. Remove TM from Bolt 4, stow on MWS 4. Reconfigure PGT with 6-inch socket (FGB ops)

FAILED PUMP MODULE REMOVAL FROM P1 (Cont)

IV/SRMS/SSRMS	EV1 (FF)	EV2 (SSRMS)
<div data-bbox="94 332 472 690" data-label="Diagram"> <p style="text-align: center;">zenith</p> <p>B4 B3</p> <p>stbd</p> <p>F171/M1 F170/M2 F176/M3 F177/M4</p> <p>B2 B1</p> <p style="text-align: center;">nadir</p> <p style="text-align: center;">P1 PM – Face 1</p> </div> <p data-bbox="94 738 493 836">6. Inform MCC 1.5" QDs (3) are demated (valve change) (00:08 min vent thru vent panel)</p> <p data-bbox="94 998 493 1136">7. √MCC GO to close valve on P1-F177 (.5" QD) and that IV venting of PM is complete</p>	<p data-bbox="514 292 1207 357">10. Perform the following steps to close valve and demate P1-F176/PM M3:</p> <ol data-bbox="619 365 1207 617" style="list-style-type: none"> A. Take valve to full open (push fwd, button pops up) (unsticks male sleeve seals) B. Depress button and close valve (pull bail aft) C. Verify detent button up D. Verify fwd white line visible E. Demate P1-F176 from M3 (using release trigger) F. Restrain P1-F176 clear of PM using adj tethers <div data-bbox="514 738 1228 990" data-label="Complex-Block"> <p style="text-align: center;">CAUTION</p> <p>During valve closure and demate, F-177 (nad) can only be handled from the fwd end of the QD to a point halfway between the QD and P-clamp</p> <p>Use extreme caution when manipulating F-177 (nad) in the fwd, zenith, and nadir directions <u>(during demate only)</u></p> </div> <p data-bbox="514 1031 1207 1096">11. PGT [A7, CCW2, 30.5]-6-Ext-7/16: Release F177 P-clamp, 12-14 turns</p> <p data-bbox="514 1104 1207 1169">12. Perform the following steps to close valve and demate P1-F177/PM M4:</p> <ol data-bbox="619 1177 1207 1388" style="list-style-type: none"> A. Take valve to full open (push fwd, button pops up) (unsticks male sleeve seals) B. Depress button and close valve (pull bail aft) C. Verify detent button up D. Verify fwd white line visible E. Rotate locking collar to lock 	

FAILED PUMP MODULE REMOVAL FROM P1 (Cont)

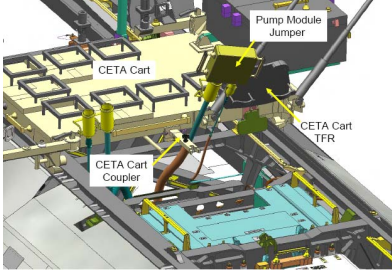
IV/SRMS/SSRMS	EV1 (FF)	EV2 (SSRMS)
 <p>PM JUMPER STOW CONFIG</p>	<p>F. Demate P1-F177 from M4 G. Restrain P1-F177 clear of PM using adj tethers</p> <p><u>PM JUMPER N2 VENT AND INSTALL</u></p> <ol style="list-style-type: none"> 1. Retrieve PM Jumper from PM Jumper bag 2. Transfer PM Jumper to EV2 3. Attach BRT to CETA cart stbd HR 4. Perform the following steps to mate P1-F176 to PM Jumper M3: <ol style="list-style-type: none"> A. Demate cap from PM Jumper M3 (lanyarded to box) B. Inspect male and female QDs for debris or damage C. ✓Button up D. ✓Release ring retracted (fwd white band not visible) E. Mate P1-F176 to PM jumper M3 F. ✓Fwd white band visible (snapback, pull and gap✓) 5. Perform the following steps to mate P1-F177 to PM Jumper M4: <ol style="list-style-type: none"> A. Demate cap from PM Jumper M4 (lanyarded to box) B. Inspect male and female QDs for debris or damage C. Verify detent button up D. ✓Release ring retracted (fwd white band not visible) E. Mate P1-F177 to PM Jumper M4 F. ✓Fwd white band visible (snapback, pull and gap✓) 6. Restrain PM jumper clear of PM removal space; mnvr jumper straight out of truss and stow on CETA cart using adjustables <div style="border: 1px solid black; padding: 5px; margin-top: 10px;"> <p style="text-align: center;"><u>CAUTION</u></p> <p>Minimize loads to F-177 (nad) when the line is mated/valve open to PM Jumper M4 and pressurized. The line must only be handled halfway in between the QD and P-clamp</p> </div>	<p><u>PM JUMPER N2 VENT AND INSTALL</u></p> <ol style="list-style-type: none"> 1. GCA SSRMS to assist EV1 with PM Jumper 2. Receive PM Jumper from EV1 3. Orient PM jumper such that male QDs face ISS port, M4 nadir 4. React QD loads as reqd

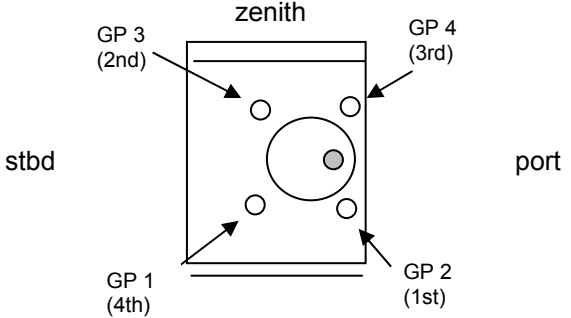

FAILED PUMP MODULE REMOVAL FROM P1 (Cont)

IV/SRMS/SSRMS	EV1 (FF)	EV2 (SSRMS)
<p>8A. Inform MCC that F44 valve is open (~ 1 min to vent N2)</p> <p>8B. When N2 venting complete, give MCC go to take NH3 Iso vent valve to close</p> <p>9. Record turns and torque for FGB to PM mounting bolts: GP2: _____ turns _____ ft-lb GP3: _____ turns _____ ft-lb GP4: _____ turns _____ ft-lb GP1: _____ turns _____ ft-lb</p> <p>10. √With MCC inhibits in place</p>	<p>7. Perform the following steps to open valve on P1-F177/PM Jumper M4: A. Depress detent button and open valve (push bail fwd) B. √Aft white band visible and detent button up</p> <p>← <input type="checkbox"/></p> <p>(if this does not happen prior to opening valve on M3, system NH3 would be dumped overboard thru vent panel)</p> <p>8. On MCC GO, perform the following steps to open valve on P1-F176/PM Jumper M3: A. Depress detent button and open valve (push bail fwd) B. √Aft white band visible and detent button up</p> <p>9. Assist EV1 with FGB install as reqd</p> <p><u>PUMP MODULE ELECTRICAL CONNECTIONS</u></p> <p style="text-align: center;"><u>NOTE</u></p> <p>← <input type="checkbox"/> Check connectors for damage, emi band, FOD, bent pins, and cable bend radii</p>	<p><u>FGB INSTALL</u></p>  <p style="text-align: center;">FGB ORIENTATION ON P1 PM</p> <ol style="list-style-type: none"> When EV1 complete with QD ops, GCA to FGB install Orient FGB such that RMS target is facing port Put one hand on PM nadir HR and one on FGB HR Soft dock FGB to P1 Pump Module <p>← <input type="checkbox"/></p> <div style="border: 1px solid black; padding: 5px; margin: 10px 0;"> <p style="text-align: center;">CAUTION</p> <p>GP2 (zen/stbd) must be the first bolt torqued during installation. Remaining bolts torqued in a star pattern</p> </div> <ol style="list-style-type: none"> PGT [A7, CW2, 30.5]-6-Ext-7/16: Engage PM to FGB mounting bolts (4) 8-11 turns; GP2, GP3, GP4, GP1 Stow 6-in socket on socket caddy Reconfig PGT with 5/8" socket

FAILED PUMP MODULE REMOVAL FROM P1 (Cont)

IV/SRMS/SSRMS	EV1 (FF)	EV2 (SSRMS)
<div data-bbox="94 332 472 690" data-label="Diagram"> <p>zenith</p> <p>B4 B3</p> <p>stbd</p> <p>B2 B1</p> <p>nadir</p> <p>P1 PM – FACE 1</p> <p>F171/M1 F170/M2 F176/M3 F177/M4</p> <p>J5 J4 J3 J2 J1</p> </div> <p>11. P1 PM R&R (SODF: RBT FS: PM Removal)</p> <p>12. P1 PM R&R (SODF: RBT FS: Mnv to handoff)</p> <p>13. P1 PM Handoff (PDRS, <u>Contingency Support</u>)</p>	<ol style="list-style-type: none"> Release TA clamps as reqd Demate the following connectors from the PM and restrain clear of PM using adjustable tethers: <ul style="list-style-type: none"> <input type="checkbox"/> P1 P525 from PM J5 (zenith) <input type="checkbox"/> P1 P524 from PM J4, temp stow <input type="checkbox"/> P1 P523 from PM J3, temp stow <input type="checkbox"/> P1 P522 from PM J2, temp stow <input type="checkbox"/> P1 P521 from PM J1, temp stow Inform EV2 electrical connections complete (give EV2 GO to release last bolt) <p><u>RELEASE PUMP MODULE BOLTS</u></p> <ol style="list-style-type: none"> Assist EV2 as required Monitor clearances between PM and truss as reqd <p>PM HANDOFF POSITION</p> <div data-bbox="625 922 1150 1286" data-label="Image"> </div>	<p><u>RELEASE PUMP MODULE BOLTS</u></p> <ol style="list-style-type: none"> PGT [B7, CCW2, 30.5]-7.8"-Ext-5/8: Release PM Bolts 4, 3, and 2, 14-17 turns (bolt pops out) Tether to PM On EV1's GO (electricals finished): PGT [B7, CCW2, 30.5]-7.8"-Ext-5/8: Release PM Bolt 1 14-17 turns (bolt pops out) Holding PM fwd HR and FGB HR, pull PM from truss in forward direction (<i>slides along rails</i>) At SSRMS clearance posn, orient the PM such that: <ul style="list-style-type: none"> <input type="checkbox"/> FGB is toward your head <input type="checkbox"/> You are holding the bottom HRs <p><u>TEMP STOW FAILED PUMP MODULE ON SRMS</u></p> <ol style="list-style-type: none"> SSRMS mnvr to PM temp stow position While holding PM steady, give SRMS operator GO to capture PM, release tether (leave RET on PM HR) <ul style="list-style-type: none"> <input type="checkbox"/> hold PM parallel to chest <input type="checkbox"/> SRMS will back away to a clearance posn (ISS nad/por)

SPARE PUMP MODULE RETRIEVAL FROM ESP2

IV/SSRMS	EV1 (FF)	EV2 (SSRMS)
<p>1. P1 PM R&R (SODF: RBT FS: Spare PM Retrieval)</p> <p>2A. Start PM thermal clock MET: _____</p> <p>2B. Record serial #: _____</p> <p>3. √MCC inhibits in place for electrical connections</p>	<p><u>SPARE PUMP MODULE ELECTRICAL CONNECTIONS</u></p> <p>1. Translate to ESP2, monitor clearances between EV2, LEE, and Lab</p> <div data-bbox="569 440 1234 561" style="border: 1px solid black; padding: 5px; margin: 10px 0;"> <p style="text-align: center;">CAUTION</p> <p style="text-align: center;">Minimize loads inputted into PM MLI handholds. It is possible that handholds may tear off when used</p> </div> <p>2. Fold back remaining flaps of MLI tent</p> <ul style="list-style-type: none"> • (front flap already folded back) • Release three 1/4 turn fasteners on stbd flap and fold up toward top of PM, attach velcro flaps (2) • Release three 1/4 fasteners on aft flap • Release MLI strap from top of PM (velcros) • Using strap, pull MLI tent away from PM in port direction, attach to S0/Lab aft struts <p style="text-align: center;">← </p> <p>3. Close FGB-PM mounting bolts thermal cover</p> <p>4. Read serial # to IV</p> <p>5. Remove 4 QD caps from M1, M2, M3, and M4</p> <p>6. Stow caps on fish stringer #2</p> <p>7. Release tape from PM fwd/stbd HR (3 pieces) and fwd/port HR (3 pieces), fold in half, stow in trash bag</p> <p style="text-align: center;">← </p> <p>8. Demate M/W J5 (P11) from PM J5, temp stow</p> <p>9. Demate M/W J4 (P10) from PM J4, temp stow</p>	<p><u>BREAK TORQUE ON PUMP MODULE BOLTS</u></p> <ol style="list-style-type: none"> 1. SSRMS mnvr to ESP2 2. Stow 5/8" socket onto socket caddy 3. GCA SSRMS to PM bolt release worksite (bolt 4) 4. Perform the following steps to break torque on PM bolts 4, 3, 2, and 1: <ul style="list-style-type: none"> □ Install round TM w/5/8" proud socket on PM Bolt □ √Anti-backlash neutral □ PGT [B6, CCW1, 30.5]-rd TM: Break torque on Bolt ~ 1 turn (of bolt) □ GCA to next bolt as reqd 5. Remove TM from Bolt 1, stow on MWS 6. Reconfigure PGT w/5/8-in socket <p><u>RELEASE PUMP MODULE BOLTS</u></p> <ol style="list-style-type: none"> 1. PGT [B7, CCW2, 30.5]-7.8"-Ext-5/8: Release PM Bolts 1, 2, and 3, 14-17 turns (bolts pop out)

SPARE PUMP MODULE RETRIEVAL FROM ESP2 (Cont)

IV/SSRMS	EV1 (FF)	EV2 (SSRMS)
	<ol style="list-style-type: none"> 10. Demate conn cap from from J3, stow on fish stringer #2 11. Demate conn cap from from J2, stow on fish stringer #2 12. Demate M/W J1 (P12) from PM J1, temp stow cable on ESP2 HR 8013 13. Remove fish stringer #2 from PM HRs, stow on VSSA FRAM HR 14. Give EV2 GO to release remaining bolt 15. Monitor clearances as reqd 	<ol style="list-style-type: none"> 2. Receive GO from EV1 to release last bolt 3. Tether to PM 4. PGT [B7, CCW2, 30.5]-7.8"-Ext-5/8: Release PM Bolt 4, 14-17 turns (bolt pops out) 5. Using PM forward HRs, remove PM from FRAM (slides fwd along LAPA guide rails), GCA SSRMS as reqd 6. At clearance position, rotate PM to hold bottom HRs (low-profile config is required for translation past UHF antenna and wrist cluster)

SPARE PUMP MODULE INSTALL ON P1

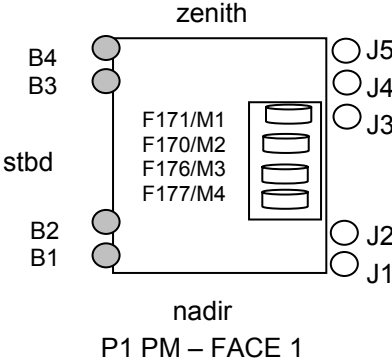
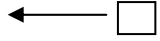
IV/SSRMS	EV1 (FF)	EV2 (SSRMS)
<p>1. P1 PM R&R (SODF: RBT FS: Spare PM Install)</p> <p>2. √MCC electrical inhibits in place</p>  <p>P1 PM – FACE 1</p>	<p><u>P1 PM INSTALL</u></p> <ol style="list-style-type: none"> 1. Translate to P1 Bay 08 2. GCA as required 3. Check with EV2 at least 1 bolt installed prior to beginning electrical ops (structural reasons) <p><u>PUMP MODULE ELECTRICAL CONNECTIONS</u></p>  <p><u>NOTE</u> Check connectors for damage, FOD, emi band, bent pins, and cable bend radii</p> <ol style="list-style-type: none"> 1. Mate P1 P521 to PM J1, close TA clamps as required 2. Mate P1 P522 to PM J2, close TA clamps as required 3. Mate P1 P523 to PM J3, close TA clamps as required 4. Mate P1 P524 to PM J4, close TA clamps as required 5. Mate P1 P525 to PM J5, close TA clamps as required 6. Inform MCC connectors mated <p><u>PM JUMPER NH3 VENT AND REMOVAL</u></p> <ol style="list-style-type: none"> 1. Attach BRT to CETA cart stbd HR 2. Perform the following steps to close valve on P1-F176/PM Jumper M3: <ol style="list-style-type: none"> A. Close valve (depress button, pull bail aft) B. Verify detent button up 	<p><u>PUMP MODULE INSTALLATION INTO TRUSS</u></p> <ol style="list-style-type: none"> 1. SSRMS mnvr to P1 Bay 08 (feet nadir) 2. At truss clearance posn, re-orient PM so that bolts point stbd 3. Install PM into truss, GCA SSRMS as reqd <p><u>PM BOLT INITIAL TORQUE</u></p> <ol style="list-style-type: none"> 1. GCA SSRMS to PM Bolt 1 (nadir) (reqd to do first) 2. PGT [B7, CW2, 30.5]-7.8"-Ext-5/8: Drive PM Bolts 1, 2, 3, and 4, 14-17 turns 3. Give EV1 GO to begin electricals 4. Release PM tether 5. Remove 5-8" socket from PGT, stow on caddy <p><u>PM JUMPER NH3 VENT AND REMOVAL</u></p> <ol style="list-style-type: none"> 1. GCA SSRMS to PM Jumper removal wkst 2. Hold PM Jumper to react loads (Jumper cannot be moved until vented due to loads constraints on M4 line when pressurized)

SPARE PUMP MODULE INSTALL ON P1 (Cont)

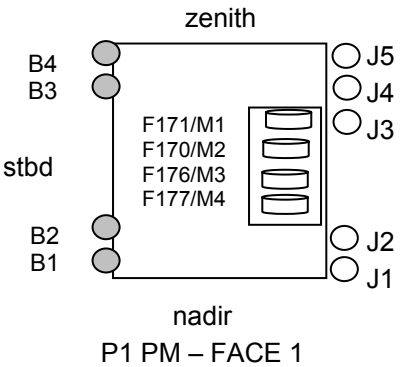
IV/SSRMS	EV1 (FF)	EV2 (SSRMS)
<p>3A. Give MCC GO for PM Jumper venting (~ 5 min)</p> <p>3B. Receive GO from MCC: PM Jumper NH3 venting complete; GO for PM Jumper removal</p>  <p style="text-align: center;">P1 PM – FACE 1</p>	<p>C. Verify fwd white line visible</p> <p>← <input type="checkbox"/></p> <ol style="list-style-type: none"> 3. Release PM Jumper from CETA cart 4. Transfer PM Jumper to EV2 5. Perform the following steps to close valve and demate P1 F177/PM Jumper M4: <ol style="list-style-type: none"> A. Close valve (depress button, pull bail aft) B. Verify detent button up C. Verify fwd white line visible D. Rotate locking collar to lock E. Demate P1-F177 from PM Jumper M4 6. Temp stow P1-F177 7. Perform the following step to demate P1-F176 from PM Jumper M3: <ol style="list-style-type: none"> A. Demate P1-F176 from PM Jumper M3 (using release trigger) <div style="border: 1px solid black; padding: 5px; margin: 10px 0;"> <p style="text-align: center;">CAUTION</p> <p>When mating P1-F176 to PM M3, do not open valve until all N2 has been vented from the PM. Otherwise, undesired mixing of NH3 and N2 will occur inside the PM</p> </div> <ol style="list-style-type: none"> 8. Perform the following steps to <u>mate</u> P1-F176 to PM M3: <ol style="list-style-type: none"> A. Inspect male and female QDs for debris or damage B. ✓Button up C. ✓Release ring retracted (fwd white band not visible) D. Mate P1-F176 to PM M3 E. ✓Fwd white band visible (snapback, pull and gap✓) 	<ol style="list-style-type: none"> 3. Receive PM Jumper from EV1, react loads as reqd 4. Temp stow PM Jumper

SPARE PUMP MODULE INSTALL ON P1 (Cont)

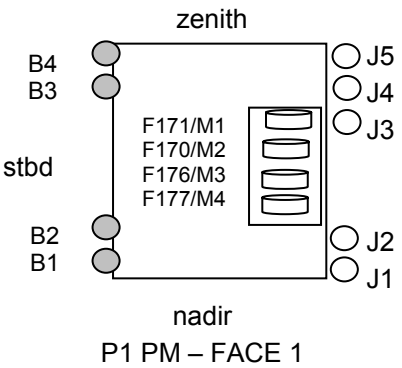
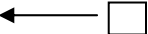
IV/SSRMS	EV1 (FF)	EV2 (SSRMS)
<p>4. Receive GO from MCC to mate/open valve on F177 (.5" QD) ~ 12 min (begin MCC venting of N2)</p>  <p>P1 PM – FACE 1</p>	<p><u>P1 PUMP MODULE N2 VENT</u></p>  <div style="border: 1px solid black; padding: 5px; margin: 10px 0;"> <p style="text-align: center;">CAUTION</p> <p>Use extreme caution when manipulating F-177 (nad) in the fwd, zenith, and nadir directions</p> <p>During mate and valve opening, F-177 (nad) can only be handled from the fwd end of the QD to a point halfway between the QD and P-clamp</p> </div> <ol style="list-style-type: none"> 1. Perform the following steps to mate and open valve on P1-F177/PM M4: <ol style="list-style-type: none"> A. Inspect male and female QDs for debris or damage B. Verify detent button up; ✓collar locked C. ✓Release ring retracted (fwd white band not visible) D. Mate P1-F177 to PM M4 E. ✓Fwd white band visible (snapback, pull and gap ✓) F. Rotate locking collar to unlock G. Depress detent button and open valve (push bail fwd) H. ✓Aft white band visible and detent button up 	<p><u>PM BOLT FINAL TORQUE</u></p> <ol style="list-style-type: none"> 1. Perform the following steps for final torquing of PM bolts 1, 2, 3, and 4: <ul style="list-style-type: none"> ❑ Install round TM w/5/8" proud socket on PM bolt ❑ ✓Anti-backlash neutral ❑ PGT [A4, CW1, 30.5]-rd TM: Drive PGT ~ 1 turn (of bolt), 5 turns (PGT) ❑ GCA to next bolt as reqd ❑ Remove TM from Bolt 4, stow on MWS

SPARE PUMP MODULE INSTALL ON P1 (Cont)

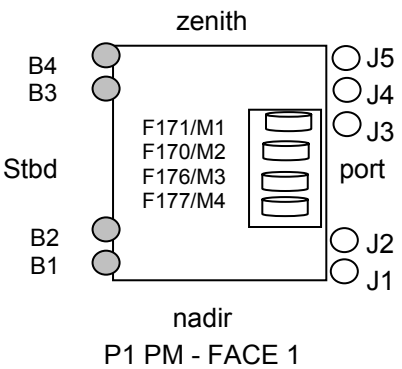
IV/SSRMS	EV1 (FF)	EV2 (SSRMS)
 <p>zenith</p> <p>B4 B3</p> <p>Stbd</p> <p>F171/M1 F170/M2 F176/M3 F177/M4</p> <p>port</p> <p>J5 J4 J3</p> <p>J2 J1</p> <p>nadir</p> <p>P1 PM - FACE 1</p> <p>6. Inform MCC when QD ops complete</p>	<p>A. Inspect male and female QDs for debris or damage</p> <p>B. ✓Button up</p> <p>C. ✓Release ring retracted (fwd white band not visible)</p> <p>D. Mate P1-F171 to PM M1</p> <p>E. ✓Fwd white band visible (snapback, pull and gap✓)</p> <p>F. Depress detent button and open valve (push bail fwd)</p> <p>G. ✓Aft white band visible and detent button up</p> <p>5. Retrieve fish stringer #1 from CETA cart</p> <p>6. Install 1.5" SPDs (3):</p> <ul style="list-style-type: none"> - Install aft part of SPD (black fwd) - Depress button and pull bail aft against SPD - Install fwd part of SPD (black to black) - Push bail against fwd SPD; ✓button down <p>7. Install wire tie on three 1.5" SPDs, attach to QD bail, fluid line, or surrounding structure</p> <p>8. Install .5" SPD:</p> <ul style="list-style-type: none"> - Pull bail aft ~ 1/4 inch (until aft white line hidden) - Install SPD (slider aft) - Push SPD slider forward - Secure bail in SPD slider; engage lock button <p>← <input type="checkbox"/></p> <p><u>CETA CART CLEANUP</u></p> <ol style="list-style-type: none"> 1. ✓CETA 1 coupler in CAPTURE 2. Release CETA 1 parking brake (tap pedal twice) 3. Slide CETA 1 toward CETA 2 <div style="border: 1px solid black; padding: 5px; text-align: center;"> <p><u>CAUTION</u> CETA to CETA max coupling rate is 1 inch/sec</p> </div> <ol style="list-style-type: none"> 4. Couple CETA 1 to CETA 2; take CETA 1 coupler to LOCK 5. Retrieve fish stringer #1 and PM Jumper bag 	

FAILED PUMP MODULE INSTALL ONTO ESP2

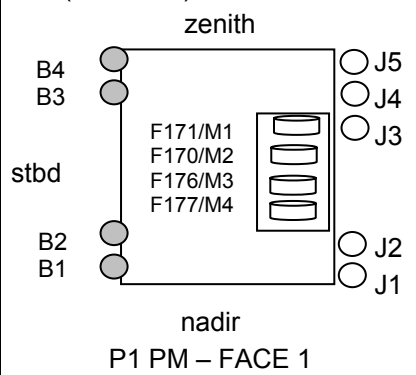
IV/SSRMS	EV1 (FF)	EV2 (SSRMS)
<p>1. P1 PM R&R (SODF: RBT FS: PM Retrieval)</p> <p>2. P1 PM Handoff (PDRS, <u>Contingency Support</u>)</p> <p>3. P1 PM R&R (SODF: RBT FS: Failed PM Install on ESP2)</p> <p>4. Start torque wrench thermal clock : _____ (3.5 hours)</p> <p style="text-align: center;">zenith</p>  <p style="text-align: center;">nadir</p> <p style="text-align: center;">P1 PM – FACE 1</p>	<p style="text-align: center;"><u>INSTALL FAILED PUMP MODULE ONTO ESP2</u></p> <p>1. Translate to airlock, temp stow fish stringer #1 and PM Jumper</p> <p>2. Retrieve torque wrench from inside airlock</p> <p>3. Translate to ESP2</p> <p>4. Monitor clearances between EV2, LEE, and Lab</p> <p>5. BRT to ESP2 HR 8012 (fwd)</p> <p>6. GCA as required</p> <p>7. Retrieve fish stringer #2 from VSSA FRAM HRs</p> <p>8. Retrieve M/W J4 and J5 connectors</p>	<p style="text-align: center;"><u>RETRIEVE FAILED PUMP MODULE FROM SRMS</u></p> <p>1. SSRMS mnvr to SRMS (clearance posn)</p> <p>2. GCA SSRMS to PM retrieval posn</p> <p>3. Grasp PM using bottom HRs (head nearest to FGB), use RET left on PM to tether</p> <p>4. Give SRMS operator GO for PM ungrapple</p> <p>5. Give SRMS operator GO to mnvr to clearance posn</p> <p style="text-align: center;"><u>INSTALL FAILED PUMP MODULE ONTO ESP2</u></p> <p>1. SSRMS mnvr to ESP2 failed PM install posn</p> <p>2. Reorient PM so FGB interface is fwd</p> <p>3. Install PM onto PM FSE, GCA SSRMS as reqd</p> <p style="text-align: center;"><u>PM BOLT INITIAL TORQUE</u></p> <p>1. GCA SSRMS to PM bolts</p> <p>2. PGT [B7, CW2, 30.5]-7.8"-Ext-5/8: Drive PM Bolt 1, 14-17 turns (reqd to do first)</p>

FAILED PUMP MODULE INSTALL ONTO ESP2 (Cont)

IV/SSRMS	EV1 (FF)	EV2 (SSRMS)
<p>5. √MCC electrical inhibits in place</p> <p>6. Give MCC GO to power up PM on ESP2 after EV1 and EV2 connections complete</p> <p>7. P1 PM R&R (SODF: RBT FS: APFR Egress)</p> <p>8. P1 PM R&R (SODF: RBT FS: APFR Removal)</p>	<p>9. Receive GO from EV2 to translate on PM</p> <p>10. Install fish stringer #2 on PM HRs</p> <p><u>PM ELECTRICAL CONNECTIONS</u></p> <p>← <input type="checkbox"/></p> <ol style="list-style-type: none"> Mate M/W J5 (P11) to PM J5 Mate M/W J4 (P10) to PM J4 Retrieve J3 cap from fish stringer #2, mate to J3 Retrieve J2 cap from fish stringer #2, mate to J2 Transfer torque wrench to EV2 Retrieve M/W J1 connector, mate M/W J1 (P12) to PM J1 Inform IV when connections complete <p>← <input type="checkbox"/></p> <p>8. Retrieve QD caps (4) from fish stringer</p> <p style="text-align: center;"><u>NOTE</u> QD cap lock tab may not fully engage. If tab does not fully engage after several attempts to seat, leave QD uncapped</p> <ol style="list-style-type: none"> Install QD caps onto M1, M2, M3, and M4 Retrieve fish stringer #2 from PM HRs Release MLI strap from S0/Lab struts and re-install MLI onto PM <ul style="list-style-type: none"> <input type="checkbox"/> Attach aft 1/4 turn fasteners (3) <input type="checkbox"/> Release stbd flap from top of MLI (2 straps) 	<ol style="list-style-type: none"> Give EV1 GO to translate on PM Drive PM Bolts 2, 3, and 4, 14-17 turns Remove 5/8" socket from PGT, temp stow Release PM tether <p><u>PM BOLT FINAL TORQUE</u></p> <ol style="list-style-type: none"> Receive torque wrench from EV1, verify set to 37 ft-lbs Install 5/8" socket onto wrench Tighten PM bolts (4) until torque wrench trips (any order) <p><u>SSRMS CLEANUP</u></p> <ol style="list-style-type: none"> SSRMS mnvr to ESP2 egress posn Egress SSRMS Perform safety tether swap onto airlock safety tether, verify ST config Relocate APFR from SSRMS to A/L Toolbox #1; reconfigure to: [9,MM,F,12] Remove WIF adapter, stow on MWS Translate to airlock Perform tool inventory Stow torque wrench on fish stringer #1

FAILED PUMP MODULE INSTALL ONTO ESP2 (Cont)

IV/SSRMS	EV1 (FF)	EV2 (SSRMS)
	<ul style="list-style-type: none"><input type="checkbox"/> Verify Velcro from Flap 3 is attached<input type="checkbox"/> Attach stbd 1/4 turn fasteners (2) <p>12. When EV2 complete w/bolts, reinstall MLI tent</p> <p>13. Ensure all Velcro flaps are covered, and fwd Velcro strap installed</p> <p><u>CLEANUP</u></p> <ol style="list-style-type: none">1. Translate to crewlock and stow PM Jumper bag2. Translate to airlock3. Perform tool inventory	

INGRESS

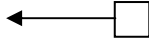
IV	EV1 (FF)	EV2 (FF)
<p>1. Perform WVS PWRDN (PHOTO/TV, <u>WVS CUE CARD</u>)</p>	<ol style="list-style-type: none"> 1. Receive EV2 safety tether; stow on airlock aft D-ring, √reel unlocked 2. Transfer fish stringers #1 and #2 to EV2 3. Connect right waist tether to D-ring extender on airlock internal D-ring, verify ST config 4. Disconnect from airlock safety tether, stow on airlock fwd D-ring, √reel unlocked 5. Ingress airlock 6. Retrieve SCU, remove DCM cover 7. Connect SCU to DCM, √locked 8. DCM: water – OFF 9. Hatch thermal cover – close, attach Velcro strap <div data-bbox="942 993 1593 1086" style="border: 1px solid black; text-align: center; padding: 5px; margin: 10px auto; width: fit-content;"> <p>CAUTION Do not close hatch until EMU water – OFF for 2 min</p> </div> <ol style="list-style-type: none"> 10. Verify hardware clear of hatch 11. Outer hatch – close and lock 12. Go to PRE REPRESS 	<div style="text-align: center; margin-bottom: 10px;">  </div> <ol style="list-style-type: none"> 1. Ingress airlock 2. Connect right waist tether to UIA panel fwd D-ring, verify ST config 3. Disconnect from airlock safety tether, hand to EV1 4. Receive fish stringers #1 and #2 from EV1 5. Retrieve SCU, remove DCM cover 6. Connect SCU to DCM, √locked 7. DCM: water – OFF <ol style="list-style-type: none"> 8. Go to PRE REPRESS

P1 PUMP MODULE R&R TASK DATA SHEET

Tools:

EV1	EV2
PGT w/6-in	PGT w/6-in
PM Jumper	Round TM w/58" proud socket
(1.5" vent tool)	Torque Wrench

Foot Restraints:

Task	WIF	APFR Setting
PM R&R	SSRMS	12, PP, F,6

EVA Fasteners:

Fastener Name	Label	Head Size	Qty	Release Torque (ft-lbs)	Failure Torque (ft-lbs)	Turns	RPM
FGB-PM mounting bolts	GP1, GP2, GP3, GP4	7/16"	4	Release: 25.5 Install: 9.2		Release: 17-20 Install: 8-11 (w/FGB inplace)	30
PM Attach Bolts (truss)	Bolt 1, 2, 3,4	5/8"	4	Release: 25 (w/TM) Install: 6.3 (w/TM)		Release: 14-17 Install: 14-17	30
PM Attach Bolts (FSE)	Bolt 1, 2, 3,4	5/8"	4	Release: 24 (w/TM) Install: 37 – torq wren		Release: 14-17 Install: 14-17	30
P-Clamp Bolts	NA	7/16"	4	Release: 9.2 Install: 7.0		Release: 12-14 Install: 12-14	30

EVA Connectors:

Connector	From	To	Clamps	Size	Function
P1 P525		PM J5	1		
P1 P524		PM J4	1		
P1 P523		PM J3	1		
P1 P522		PM J2	1		
P1 P521		PM J1	1		
ESP2 M/W J5 (P11)		PM J5			
ESP2 M/W J4 (P10)		PM J4			
ESP2 M/W J1 (P12)		PM J1			

Notes:

1. Check connectors for damage, emi band, FOD, bent pins, and cable bend radii
2. Original vent time of 00:25 for failed PM NH3 vent given by TCS community. New time of 00:08 minutes given by Boeing TCS

Cautions:

1. When operating QDs, assess sideloads and flexhose alignment prior to mating/demating and valve opening/closing
2. Avoid contact with FGB grapple pin and RMS target
3. Minimize loads inputted into PM MLI handholds. It is possible that handholds may tear off when used
4. GP2 must be the first bolt torqued during installation. Remaining bolts torqued in a star pattern
5. When operating QDs, assess sideloads and flexhose alignment prior to mating/demating and valve opening/closing
6. PM Installation bolts (for initial torque) must be installed in the following order: bolt 1 first, and then bolts 2-4 in any order (due to nut plate tolerances). There is no required order for bolt release, and no required order for torque multiplier operations (KSC)

Warnings:

1. N/A

Timeline Considerations:

1. The PM thermal clock begins when the PM MLI tent is removed on ESP2

Connector	From	To	Clamps	Size	Function
P1 F171	NA	PM M1	1 P, 1 TA	1.5"	Bypass outlet
P1 F170	NA	PM M2	1 P, 1 TA	1.5"	Radiator return
P1 F176	NA	PM M3	1 P, 1 TA	1.5"	Pump Outlet
P1 F177	NA	PM M4	1 P, 1 TA	.5"	Ammonia supply

P1 PUMP MODULE R&R TASK DATA SHEET

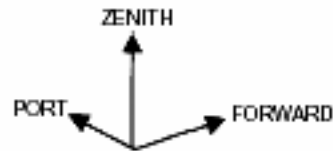
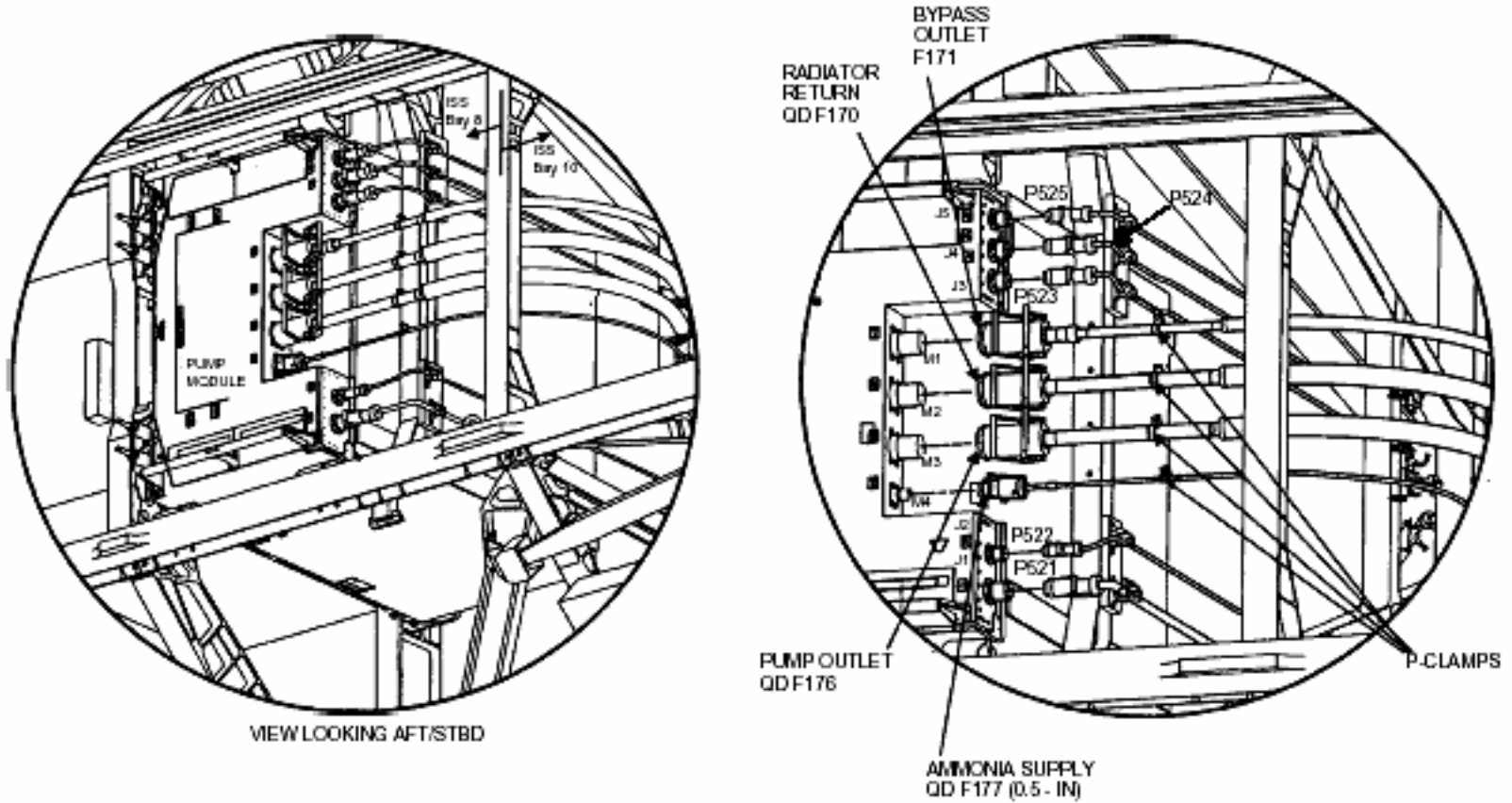

NOTES

Assumptions:

- MT @ WS 4; CETA carts coupled to port side of MT
- SSRMS on Lab PDGF
- SSRMS on MBS PDGF 3
- Temp stow failed PM on SRMS
- Keep crew separated from each other during failed PM venting ops to minimize contamination
- Plan to leave all cont tools in airlock
- Plan to remove 4 QD caps and 2 remaining electrical dust caps at ESP2 and leave them there for PM translation to S1
- EV1 FF/EV2 SSRMS
- EV1 on 85' safety tether
- Use second set of QD tools that are inside to save time during EVA (won't have to go to QD tool bag) – OR go to bag??? Have to get extender from outside anyway – or does 12A.1 launch?
- SSRMS translation times will be longer than S1 (from ESP2 to truss and back)
- Should not need to do a safety tether swap if on 85 footer
- For venting: the procedure is written assuming that IV can vent through the vent panel, and that no EVA venting of the NH3 from the failed PM is required. It also assumes we vent the PM jumper of Nitrogen using the vent panel and not the vent tool
- Need 2 crewmembers for all PM jumper operations, including N2 venting of jumper
- If EV crew vents N2 from spare PM on ESP2 (~12 min)
- The procedure is baselined to allow MCC to vent the N2 from the spare PM while it's in the truss. There is no additional EVA time needed for this. As soon as the PM gets installed into the truss, EV1 will mate and open valve on the .5: QD; no electricals are reqd for this since the valves are already configured to allow the N2 to vent through the ATA panel. No additional EVA time is needed

CETA CART WHEEL BOGIE R&R

Objective: Removal of a wheel bogie to allow relocation of the CETA cart in a failure case where a wheel bogie failed to pivot clear of the MT/CETA rail. Once the cart is relocated the wheel bogie is reinstalled

Wheel Bogie Removal

1. Retrieve CETA cart PIP pin (SEG 33108659-705) from crewlock bag #2
2. √Parking brake off
3. √CETA cart coupled to MT or restrained prior to bogie release
4. Insert PIP pin to restrain brake linkages
5. **PGT [A7, CCW2, 30.5]-6"-Ext-7/16:**
Disengage ORU bolts (4) ~8 turns (bolts pop out)
6. Remove wheel bogie

Wheel Bogie Installation

NOTE

Pip-pin installation ensures proper brake pad alignment. If brake pad misaligned, wheel bogie cannot be installed due to interference with MT rails.

If CETA cart is not on rails during bogie installation, wheel bogie can be installed such that brake mechanism is not connected

1. Install CETA cart on rails; engage other bogies
2. √CETA/MT Coupler set to capture, couple CETA cart to MT
3. Take coupler to locked
4. √Parking brake released
5. Install wheel bogie into tray guides
 - * If brake cable mechanical coupler interferes (wheel bogie *
* will not install fully): *
 - * Pull dynamic brake handle while reattempting install *
 - * *
 - * If no PIP pin used and bogie will not fully install: *
 - * Remove bogie, realign brake pad linkage and reattempt *
6. **PGT: [A7, CW2 30.5]-6"-Ext-7/16:**
Engage ORU bolts (4) ~8 turns
7. Remove PIP pin

CETA CART WHEEL BOGIE TASK DATA SHEET

EVA Fasteners:

Fastener Name	Label	Head Size	Qty	Install Torque (ft-lb)	Release Torque (ft-lb)	Failure Torque (ft-lb)	Turns	RPM
Wheel bogie ORU bolt	none	7/16	4	7-10	10		8	30 Max

WHEEL BOGIE R&R – REFERENCE

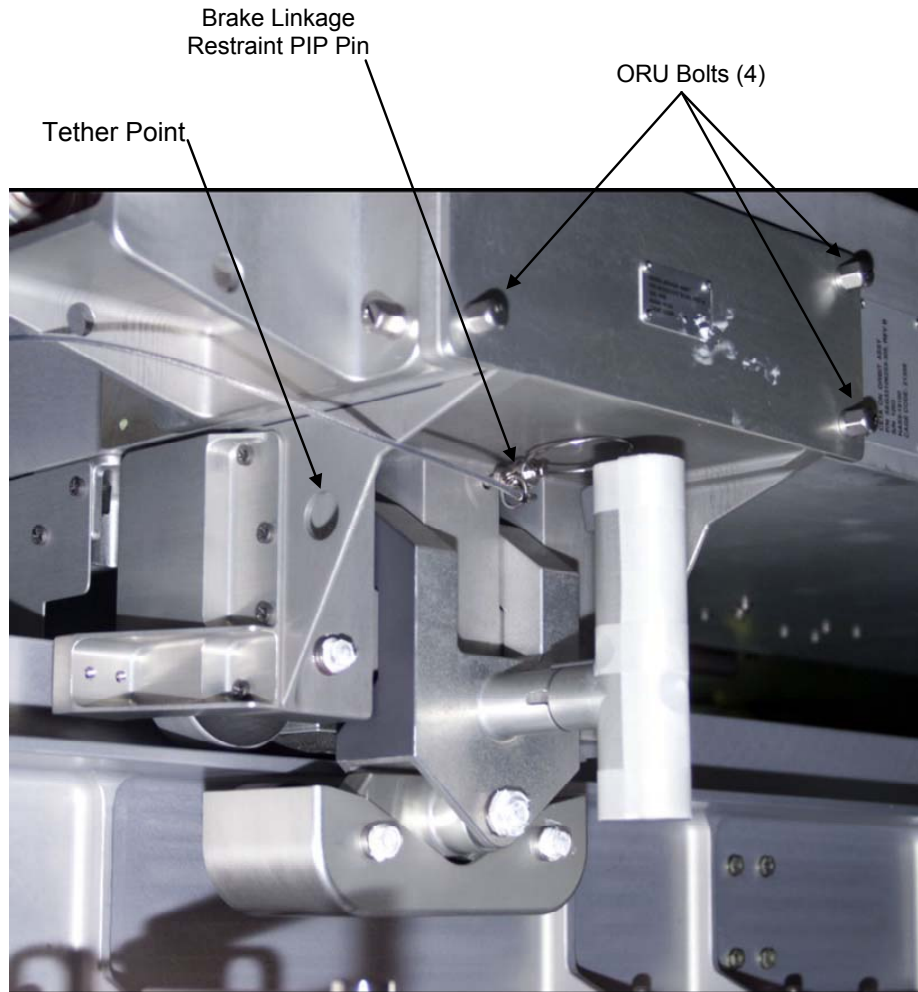

WHEEL BOGIE INSTALLED – OUTBOARD VIEW

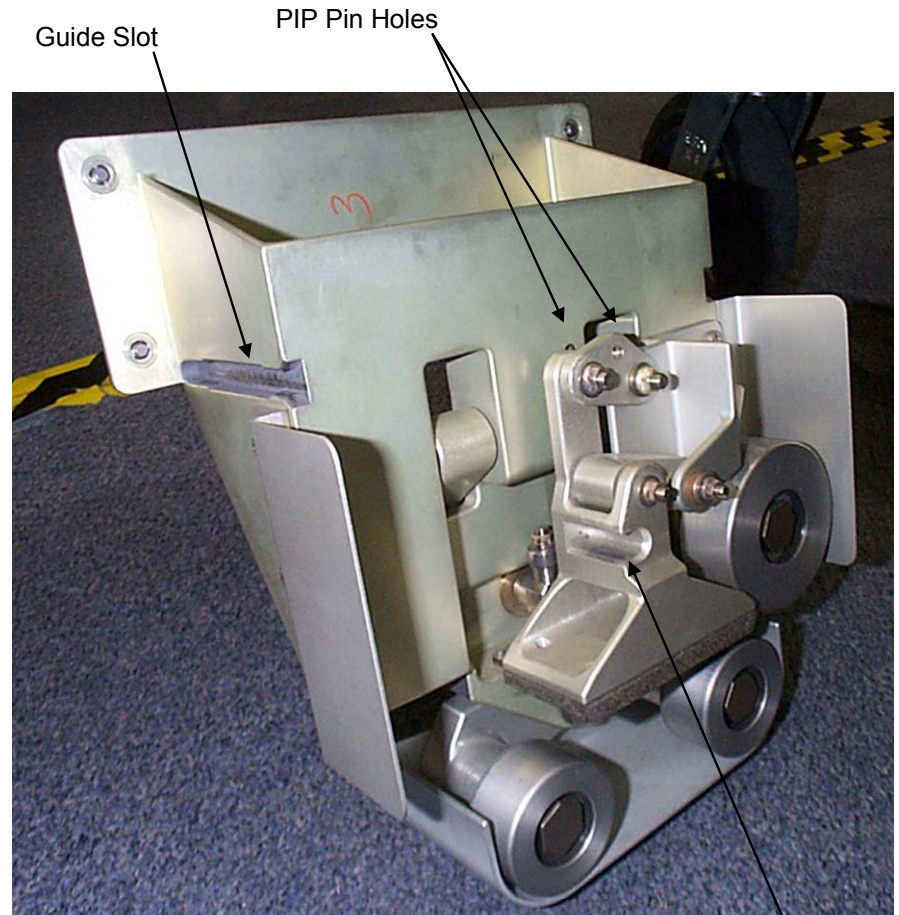

WHEEL BOGIE REMOVED – INBOARD VIEW

Brake Linkage Slot (Slot A)

WHEEL BOGIE R&R – REFERENCE (Cont)

WHEEL BOGIE REMOVED – OUTBOARD VIEW



Tray Guide

Brake Linkage Engagement
Tab (tab A)

WHEEL BOGIE PARTIALLY INSTALLED – INBOARD VIEW

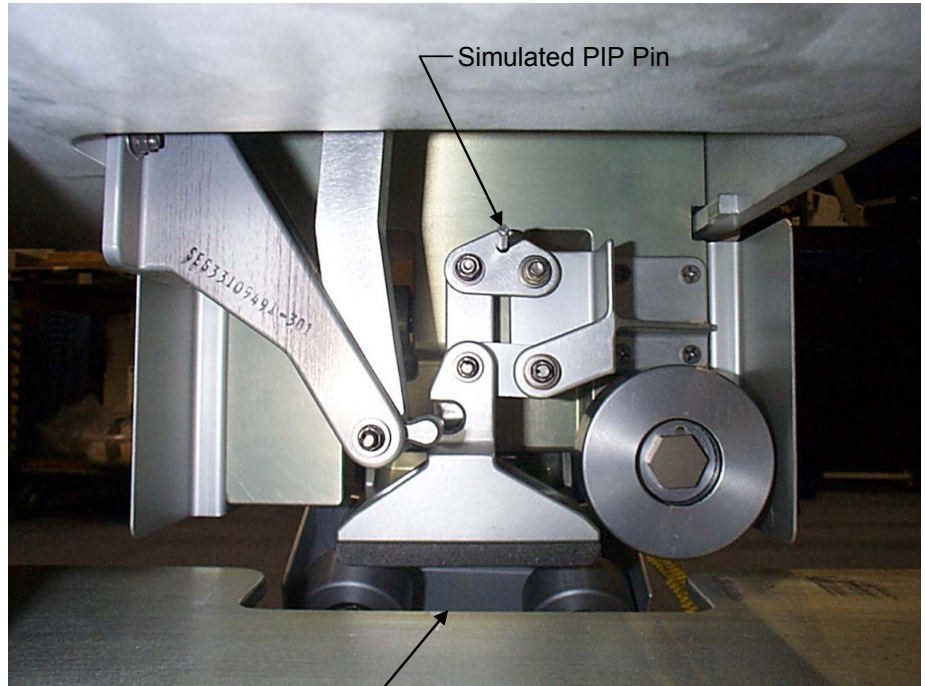



Simulated PIP Pin

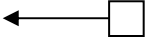

Cutout in rail not fight like

EVA 3 CONTINGENCY

CHANNEL 1/4 CONNECTOR BACKOUT (01:00)

IV	EV1 (FF)	EV2 (FF)
<p>1. Verify w/MCC inhibits in place: Power Reconfig Inhibit Check (SODF: ASSY OPS: EPS CH 1/4) Powerdown for EVA 3, steps 6 and 7) complete (DCSU 4B RBI 6 open) (DCSU 4A RBI 6 open)</p>	<div style="text-align: center;">  </div> <p style="text-align: center;"><u>NOTE</u> √Connectors for damage, FOD, EMI band, bent pins, and cable bend radii</p> <p><u>S1-4B DDCU RECONFIGURATION</u> (Panel A9)</p> <ol style="list-style-type: none"> 1. Translate to S1 Bay 15 2. Remove connector cap from J8 on DDCU coldplate connector box (cap is lanyarded to panel) 3. Demate S1 P169 (W5113) from J7; mate to J8 4. Install connector cap on J7 5.  connector closeout <p><u>MBSU BYPASS JUMPER (1/4) RECONFIGURATION</u></p> <ol style="list-style-type: none"> 1. Translate to S0 Bay 04 2. Access MBSU zenith reconfig worksite through face 1 3. Attach MWS EE to HR 3533 4. Remove connector cap from J482; temp stow 5. Demate S0 P484 from S0 J484, mate to S0 J482 6. Demate S0 P485 from S0 J485; mate to S0 J484 7. Install connector cap on J485 8.  connector closeout 	<p><u>CIDS 1 AND 2 REMOVAL/S0 TRAY CONNECTIONS</u></p> <ol style="list-style-type: none"> 1. Perform safety tether swap onto airlock safety tether as reqd, verify ST config <p style="text-align: center;"><u>NOTE</u> Avoid contact with S0 radiator</p> <ol style="list-style-type: none"> 2. Translate to port Z1-S0 tray area; fairlead above Z1 MBM, P6 HR 5308 3. Demate S0 P201 from Lab J201; mate to S0 J462 4. Demate S0 P202 from Lab J202; mate to S0 J463 5. Demate S0 P232 from Z1 J432; mate to S0 J460 6. Demate Z1 P301 (W26B) from Z1 J201 (tray), mate to Lab J201 (CID removed) 7. Demate Z1 P302 (W26C) from Z1 J202 (tray), mate to Lab J202 (CID removed)

CHANNEL 1/4 CONNECTOR BACKOUT (01:00) (Cont)

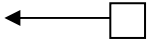
IV	EV1 (FF)	EV2 (FF)
<p>2. When all EV2's connections complete, notify MCC</p>	<p><u>LAB 4A DDCU SECONDARY POWER DISCONNECT FROM S0</u></p> <div data-bbox="564 383 1197 477" style="border: 1px solid black; padding: 5px; margin: 10px 0;"> <p style="text-align: center;"><u>CAUTION</u> Avoid contact with GPS antennas and S0 radiator</p> </div> <ol style="list-style-type: none"> 1. Translate to S0 Bay 00, access through face 3 2. Open MLI door 3. Attach fairlead to HR 3414, ingress truss 4. Demate S0 P333 from S0 CH 1/4 pwr cable J333A 5. Demate S0 CH 1/4 pwr cable P333A from S0 J333 6. Mate S0 P333 to S0 J333 7. Egress truss, remove fairlead 8. Close MLI door 9. Retrieve jumper, stow on MWS 10.  connector closeout <p><u>S0-1A DDCU RECONFIGURATION (Panel A27)</u></p> <ol style="list-style-type: none"> 1. Translate to CETA 2 2. Translate to port-most CETA cart (CETA 1) 3. Rotate CETA 1 coupler to UNLOCK, slide CETA port until clear of S0 Bay 01 4. Engage parking brake (left handle) 5. Rotate CETA 1 coupler to CAPTURE 6. Translate to S0 Bay 01 7. Access worksite through face 1 8. Remove connector cap from J8 on DDCU coldplate connector box (cap is lanyarded to panel) 9. Demate S0 P157 (W4145) from J7; mate to J8 10. Install connector cap on J7 11.  connector closeout 12. Release CETA parking brake (tap pedal twice) 	<p><u>Z1-003 PATCH PANEL 6 RECONFIGURATION (DDCU HP 4B) (nadir panel)</u></p> <ol style="list-style-type: none"> 1. Translate to Z1 PP6 (stbd face) <div data-bbox="1325 472 1803 591" style="border: 1px solid black; padding: 5px; margin: 10px 0;"> <p style="text-align: center;"><u>CAUTION</u> Avoid contact with Z1 heat pipes and SASA antennas</p> </div> <ol style="list-style-type: none"> 2. Fold back thermal shroud (STD SHRD Z1/02/04-03), release Velcro straps from HRs 6005 and 6024 3. Remove connector cap from J4 4. Demate Z1 P2 (W23) from Z1 J3; mate to Z1 J4 5. Install connector cap on J3 6.  connector closeout 7. Reinstall thermal shroud <div data-bbox="1283 867 1430 907" style="margin-top: 20px;">  </div>

CHANNEL 1/4 CONNECTOR BACKOUT (01:00) (Cont)

IV	EV1 (FF)	EV2 (FF)
<p>2. When all EV1's connections complete, notify MCC</p>	<p style="text-align: center;">CAUTION CETA to CETA max coupling rate is 1 inch/sec</p> <p>13. Couple CETA 1 to CETA 2, take CETA 1 coupler to LOCK</p> <p><u>S0 FWD STBD AVIONICS RECONFIGURATION</u> (Panel A148)</p> <ol style="list-style-type: none">1. Translate to stbd S0 connector panel (Bay 01, Face 6)2. BRT to HR 34433. Remove DF cap from S0 J2374. Demate P226 (W9003) from S0 J226; mate to S0 J2375. Install DF cap on S0 J226 <p style="text-align: center;">← </p> <p style="text-align: center;">NOTE Z1-005 PP 1 Reconfig will not be backed out since the nominal reconfig will be skipped in the event of either an MBSU or DDCU R&R. The steps are listed for info only</p> <p><u>Z1-005 PATCH PANEL 1 RECONFIGURATION</u> (SPDA Z1-4B) (nadir panel)</p> <ol style="list-style-type: none">1. Translate to Z1 port face; fairlead above Z1, MBM P6 HR 5308	

CHANNEL 1/4 CONNECTOR BACKOUT (01:00) (Cont)

IV	EV1 (FF)	EV2 (FF)
	<p style="text-align: center;"><u>CAUTION</u> Avoid contact with PCUs and S0 radiator</p> <p style="text-align: center;"><u>NOTE</u> J3 label is missing off of patch panel 2</p> <ol style="list-style-type: none">2. Remove connector cap from J3; temp stow3. Demate Z1 P1 (W10) from Z1 J1; mate to Z1 J34. Install connector cap on J1	

MBSU REMOVE AND REPLACE – 1A1B (EVA 3)

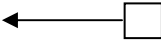
IV/SSRMS	EV1 (FF)	EV2 (SSRMS)
<p>1. Verify w/MCC ESP2 inhibits in place: RPCM N1RS2-B RPC10 – OPEN AND CLOSE INHIBITED RPCM S04B F RPC 12 – OPEN AND CLOSE INHIBITED</p>	 <p><u>CETA CART PREP</u></p> <ol style="list-style-type: none"> 1. Translate to port-most CETA cart (CETA 1)(S0 Bay 01) 2. Deploy port brake handles on CETA 1 (down) 3. Take CETA coupler to UNLOCK 4. MnvR CETA 1 port ~ 5 feet 5. Deploy stbd brake handles on CETA 1 (down) 6. ✓CETA 1 brakes by pulling parking brake (left handle) 7. Take CETA 1 coupler to CAPTURE 8. Release CETA 1 brakes (tap pedal twice) 9. Translate CETA 1 to S0 Bay 00 (by hand): <ul style="list-style-type: none"> • Stop when stbd TFR is port of CETA marker 7650 10. Engage parking brake – left handle 11. Rotate port TFR swing arm to 15 <p><u>TOOL RETRIEVAL</u></p> <ol style="list-style-type: none"> 1. Translate to airlock 2. Retrieve crewlock bag #1, BRT 3. Translate to Z1 stbd toolbox 4. Retrieve 2 sq scoops from toolbox lid: <ul style="list-style-type: none"> ☐ Stow 1 sq scoop on MWS ☐ Stow 1 sq scoop in crewlock bag #1 (may have to relocate D-Handle to get sq scoop) 5. Open right door 6. Retrieve sq TM w/7/16 recessed socket from slot 1, stow on MWS (release slider lock only) 7. Close door – both latches reqd if not coming back 	<p><u>SSRMS SETUP</u></p> <ol style="list-style-type: none"> 1. Translate to airlock 2. Retrieve spare safety tether, WIF adapter, and PGT w/RET from airlock HR 0560, stow on MWS 3. Retrieve APFR from airlock toolbox 1 WIF (if reqd), attach to BRT 4. Translate to ESP2 5. Install WIF adapter onto SSRMS, tether point oriented toward EE 6. Install APFR into WIF adapter: configure to: [12,PP,F,6] 7. Perform safety tether swap onto SSRMS, verify ST config; stow spare tether clear of MBSU removal envelope and ESP2 trajectory 8. Ingress SSRMS (head aft, face port)

MBSU REMOVE AND REPLACE – 1A1B (EVA 3) (Cont)

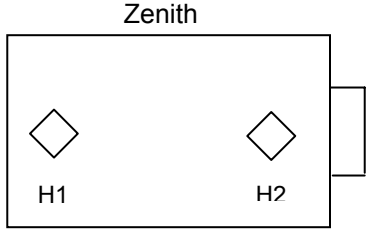
IV/SSRMS	EV1 (FF)	EV2 (SSRMS)
<div style="text-align: center;">  <p>MBSU ORIENTATION ON CETA CART GRID E</p> </div>	<p><u>SPARE MBSU RETRIEVAL FROM ESP2</u></p> <ol style="list-style-type: none"> 1. Translate to ESP2, temp stow crewlock bag #1 on CETA spur 2. Attach BRT to ESP2 HR 8003 (aft face, stbd side) 3. Engage FRAM soft capture lever (slides down) 4. PGT [A4, CCW2, 10.5]-6"-Ext-7/16: Release primary FRAM bolt 11 turns (hard stop) 5. Using vertical HRs on FRAM, remove MBSU from ESP2 (magnetic soft dock to overcome) 6. Transfer MBSU to EV2 7. GCA EV2 and SSRMS clear of ESP2 8. Retrieve EV2's airlock safety tether from ESP2, attach to MWS 9. Retrieve crewlock bag #1 from CETA spur, attach to BRT <p><u>TEMP STOW SPARE MBSU ON CETA CART</u></p> <ol style="list-style-type: none"> 1. Translate to CETA 1 on S0 Bay 00 2. Temp stow crewlock bag #1 on port side of CETA cart, S0 HR 3494 3. Temp stow EV2's airlock safety tether on port S0/Lab strut clear of SSRMS trajectory 4. Retrieve ballstack from crewlock bag #1, install on port TFR swingarm ECOM fitting 5. Position body to see grid E 6. Assist EV2 with clearances 7. PGT [A4, CW2, 10.5]-6"- Ext-7/16: Drive primary FRAM bolt 11 turns (hard stop) 8. Retrieve sq scoop from crewlock bag #1, transfer to EV2 	<p><u>SPARE MBSU RETRIEVAL FROM ESP2</u></p> <ol style="list-style-type: none"> 1. Receive MBSU from EV1 (body is parallel to stbd side of ESP2 with head aft and face port) <p><u>TEMP STOW SPARE MBSU ON CETA CART</u></p> <ol style="list-style-type: none"> 1. SSRMS mnvr to CETA 1 on S0 Bay 00 2. Rotate MBSU until FRAM primary bolt faces ISS zenith 3. Install MBSU/FRAM onto grid E (zenith center) (rock FRAM square grid into place) 4. Receive sq scoop from EV1, stow on MWS

MBSU REMOVE AND REPLACE – 1A1B (EVA 3) (Cont)

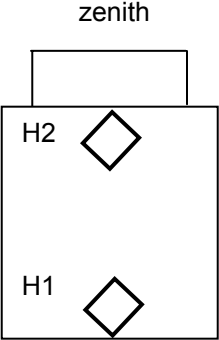
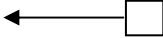
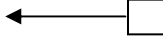
IV/SSRMS	EV1 (FF)	EV2 (SSRMS)
<p>2. Verify w/MCC S0 inhibits in place: MBSU 4 RBI 7 Op (CI Inh) MBSU 4 RBI 6 Op (CI Inh) MBSU 2 RBI 14 Op (CI Inh)</p> <p>3. Record failed MBSU serial #: _____</p> <div style="text-align: center;">  <p>MBSU ORIENTATION ON FACE 2</p> </div>	<div style="text-align: center;">  </div> <p><u>MBSU REMOVAL FROM S0 FACE 2 (1A1B)</u></p> <ol style="list-style-type: none"> Translate to failed MBSU (stbd zenith) <div style="text-align: center;">  </div> <ol style="list-style-type: none"> Install sq TM onto H1 fitting, √anti-backlash neutral Get in posn to assist EV2 	<p><u>MBSU REMOVAL FROM S0 FACE 2 (1A1B)</u></p> <ol style="list-style-type: none"> SSRMS mnvr to failed MBSU wkst (stbd zenith) <div style="border: 1px solid black; padding: 10px; margin: 10px 0;"> <p style="text-align: center;"><u>CAUTION</u></p> <p>H1 bolt must always be released first or damage to ORU and underlying structure will occur</p> </div> <ol style="list-style-type: none"> Temp stow 2-in socket on PIP pin in trash bag PGT [B2, CCW2, 30.5]-sq TM: Release acme screw H1, 5 turns (PGT), 1 turn (bolt) Remove sq TM from H1, install onto H2 √Anti-backlash neutral Install sq scoop onto H1, handle points zenith PGT [B1, CCW2, 30.5]-6"-Ext-7/16: (use EV1's PGT) Release H1 acme screw ~ 8 turns √Status indicator – UNLOCK PGT [B2, CCW2, 30.5]-sq TM: Break torque on H2, 5 turns (PGT), 1 turn (bolt) Remove sq TM from H2, stow on MWS Install sq scoop onto H2, handle points zenith PGT [B1, CCW2, 30.5]-6"-Ext-7/16: (use EV1's PGT) Release H2 acme screw ~ 18 turns √Status indicator – UNLOCK <p style="text-align: center;"><u>NOTE</u></p> <p>Removing MBSU from coldplate causes H1 status indicator to move from UNLOCK to LOCK</p>

MBSU REMOVE AND REPLACE – 1A1B (EVA 3) (Cont)

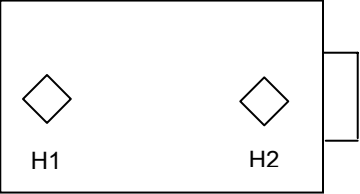
IV/SSRMS	EV1 (FF)	EV2 (SSRMS)
<p style="text-align: center;">Zenith</p> <div style="display: flex; align-items: center; justify-content: center;"> <div style="writing-mode: vertical-rl; transform: rotate(180deg); margin-right: 5px;">S T B D</div>  </div> <p style="text-align: center;">Nadir</p> <p>MBSU ORIENTATION ON CETA CART GRID E</p> <p>4. Record spare MBSU serial #: _____</p>	<p>4. Assist EV2 w/clearances</p> <p>5. Translate to port side of CETA cart</p> <p>6. Assist EV2</p> <p><u>SPARE MBSU REMOVAL FROM FRAM</u></p> <p>1. Release MBSU thermal cover:</p> <ul style="list-style-type: none"> <input type="checkbox"/> Release velcro tabs on front, side, and back corners of ORU base <input type="checkbox"/> Release integral strap from underside of fwd flap <input type="checkbox"/> Fold or roll cover toward back of MBSU, attach strap to Velcro mating swatch on back side of MLI (can also attach strap to adjacent structure) <input type="checkbox"/> Using side straps from front of MLI, secure rest MLI as reqd <div style="display: flex; align-items: center;"> <div style="width: 20px; height: 20px; border: 1px solid black; margin-right: 5px;"></div> <div style="font-size: 24px;">←</div> </div> <p>2. Remove 3rd sq scoop from crewlock bag #1, transfer to EV2</p>	<p style="text-align: center;"><u>NOTE</u></p> <p>Primary stanchion (H2) has ~ 15-20 lb soft dock force to overcome during MBSU removal from FSE</p> <div style="border: 2px solid black; padding: 5px; margin: 10px 0;"> <p style="text-align: center;"><u>WARNING</u></p> <p>Fins on bottom of MBSU and coldplate are no-touch</p> </div> <p>11. Remove MBSU from coldplate</p> <p>12. ✓Status indicator on H1 in LOCK</p> <p>13. SSRMS mnvr to port side of CETA cart</p> <p>14. Attach MBSU to ballstack</p> <p>15. Remove free sq scoop from MBSU, stow on MWS</p> <p><u>SPARE MBSU REMOVAL FROM FRAM</u></p> <p>1. SRMS mnvr to spare MBSU (head nadir)</p> <div style="border: 1px solid black; padding: 5px; margin: 10px 0;"> <p style="text-align: center;"><u>CAUTION</u></p> <p>H1 bolt must always be released first or damage to ORU and underlying structure will occur</p> </div> <p>2. Install sq TM onto H1 fitting, ✓anti-backlash neutral</p> <p>3. PGT [B2, CCW2, 30.5]-sq TM: Release acme screw H1, 5 turns (PGT), 1 turn (bolt)</p> <p>4. Remove sq TM from H1, install onto H2 ✓Anti-backlash neutral</p> <p>5. Receive sq scoop from EV1, install onto H1 fitting</p>

MBSU REMOVE AND REPLACE – 1A1B (EVA 3) (Cont)

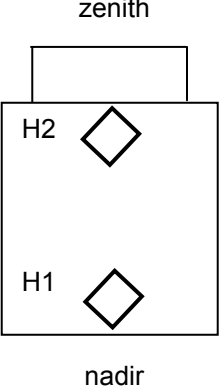
IV/SSRMS	EV1 (FF)	EV2 (SSRMS)
<div style="text-align: center;">  <p>MBSU ORIENTATION ON FACE 2</p> </div>	<p>3. Assist EV2 w/clearances</p> <p><u>SPARE MBSU INSTALLATION ONTO S0</u></p> <p>1. Translate to stbd zenith MBSU coldplate</p>	<p>6. PGT [B1, CCW2, 30.5]-6"-Ext-7/16: (use EV1's PGT) Release H1 acme screw ~ 8 turns √Status indicator – UNLOCK</p> <p>7. PGT [B2, CCW2, 30.5]-sq TM: Break torque on H2, 5 turns (PGT), 1 turn (bolt)</p> <p>8. Remove sq TM from H2, stow on MWS or handoff to EV1</p> <p>9. Install sq scoop onto H2</p> <p>10. PGT [B1, CCW2, 30.5]-6"-Ext-7/16: (use EV1's PGT) Release H2 acme screw ~ 18 turns √Status indicator – UNLOCK</p> <p style="text-align: center;"><u>NOTE</u></p> <p>Removing MBSU from coldplate causes H1 status indicator to move from UNLOCK to LOCK.</p> <p>Primary stanchion (H2) has ~ 15-20 lb soft dock force to overcome during MBSU removal from FSE</p> <div style="border: 2px solid black; padding: 5px; text-align: center; margin: 10px 0;"> <p>WARNING Fins on bottom of MBSU are no-touch</p> </div> <p>11. Remove MBSU from FRAM 12. √Status indicator on H1 in LOCK</p> <p><u>SPARE MBSU INSTALLATION ONTO S0</u></p> <p>1. SSRMS mnvr to S0 wkst (stbd zenith MBSU) 2. Orient MBSU such that blind-mate connectors and H2 fitting are zenith</p>

MBSU REMOVE AND REPLACE – 1A1B (EVA 3) (Cont)

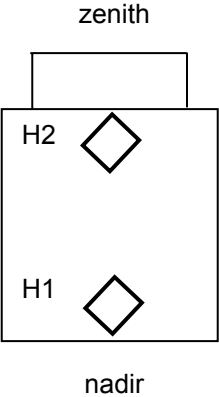
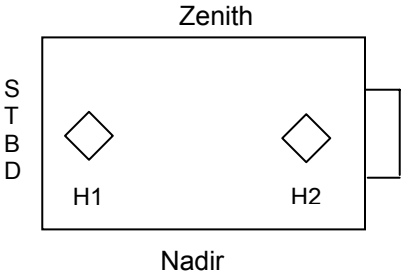
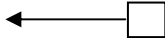
IV/SSRMS	EV1 (FF)	EV2 (SSRMS)
<div style="text-align: center;">  <p>MBSU ORIENTATION ON FACE 2</p> </div> <p>5. Inform MCC MBSU installed</p> <div style="text-align: center;">  <p>MBSU ORIENTATION ON CETA CART GRID E</p> </div>	<p>2. GCA EV2 as required</p> <p style="text-align: center;"><u>INSTALLATION OF FAILED MBSU ONTO FRAM</u></p> <ol style="list-style-type: none"> 1. Translate to port TFR swingarm 2. Remove ballstack from port swingarm, stow in crewlock bag #1 3. Stow port swingarm (rotate to 0) 	<p style="text-align: center;"><u>NOTE</u></p> <p>Primary stanchion has ~ 15-20 lb soft dock force to overcome during MBSU installation onto coldplate</p> <ol style="list-style-type: none"> 3. Install MBSU onto coldplate 4. ✓Status indicator on H1 is in UNLOCK <div style="border: 1px solid black; padding: 5px; margin: 10px 0;"> <p style="text-align: center;"><u>CAUTION</u></p> <p>H2 bolt must always be installed first or damage to ORU and underlying structure will occur</p> </div> <ol style="list-style-type: none"> 5. PGT [A3, CW2, 30.5]-6"-Ext-7/16: Drive H2 jack screw ~ 18 turns ✓Status indicator – LOCK 6. PGT [A3, CW2, 30.5]-6"-Ext-7/16: Drive H1 acme screw ~ 8 turns ✓Status indicator – LOCK <div style="text-align: center; margin: 10px 0;">  </div> <ol style="list-style-type: none"> 7. Remove sq scoops from MBSU, stow on MWS <p style="text-align: center;"><u>INSTALLATION OF FAILED MBSU ONTO FRAM</u></p> <ol style="list-style-type: none"> 1. SSRMS mnvr to failed MBSU on port TFR swingarm 2. Release MBSU from ballstack 3. Orient MBSU such that H2 fitting is port 4. SSRMS mnvr to FRAM <p style="text-align: center;"><u>NOTE</u></p> <p>Primary stanchion has ~ 15-20 lb soft dock force to overcome during MBSU installation onto FRAM</p>

MBSU REMOVE AND REPLACE – 1A1B (EVA 3) (Cont)

IV/SSRMS	EV1 (FF)	EV2 (SSRMS)
	<p>4. Receive sq scoop from EV1, stow on MWS (or in crewlock bag #1)</p> <p>5. Receive sq scoop from EV1, stow on MWS (or in crewlock bag #1)</p> <p>6. Install MBSU thermal cover</p> <p><u>CETA CART CLEANUP</u></p> <p>1. If necessary, stow CETA 1 swingarms</p> <p>2. Release brake pedal (tap pedal twice)</p> <p>3. Translate CETA 1 to S0 Bay 01</p> <p>4. Stow stbd brake handles (up)</p> <div style="border: 1px solid black; padding: 5px; margin: 10px auto; width: fit-content;"> <p style="text-align: center;">CAUTION CETA to CETA max coupling rate is 1 inch/sec</p> </div> <p>5. Couple CETA 1 to CETA 2</p> <p>6. Take CETA 1 coupler to LOCK</p> <p>7. Stow port brake handles (UP)</p> <p>8. Retrieve crewlock bag #1</p> <p>9. Translate to airlock</p>	<p>5. Install failed MBSU onto FRAM (ball detent soft dock on primary bolt and stanchion)</p> <p>6. ✓Status indicator on H1 is in UNLOCK</p> <p>7. PGT [B2, CW2, 30.5]-6"-Ext-7/16: Drive H2 jack screw ~ 18 turns ✓Status indicator – LOCK</p> <p>8. Remove square scoop from H2, transfer to EV2</p> <p>9. Remove square scoop from H1, transfer to EV2</p> <p>10. PGT [B2, CW2, 30.5]-6"-Ext-7/16: Drive H1 acme screw ~ 8 turns ✓Status indicator – LOCK</p> <p><u>SSRMS CLEANUP</u></p> <p>1. SSRMS mnvr to egress posn on S0 (port of MT)</p> <p>2. Egress SSRMS (on CETA cart)</p> <p>3. Remove APFR from SSRMS, attach to BRT</p> <p>4. Remove WIF adapter from SSRMS, stow on MWS</p> <p>5. Perform safety tether swap onto airlock safety tether, verify ST config; retrieve spare from SSRMS</p> <p>6. Translate to airlock</p> <p>7. Stow APFR in airlock toolbox 1 (stbd) WIF; configure to: [9,MM,F,12]</p>

MBSU REMOVE AND REPLACE – 1A1B (EVA 3) TASK DATA SHEET

Tools:

EV1	EV2
PGT w-6-in	PGT
Crewlock bag #1	APFR
Sq TM w/7/16 recessed socket	
Ballstack	
3 sq scoops	

EVA Fasteners:

Fastener Name/Label	Head Size	Qty	Release Torque (ft-lbs)	Install Torque	Failure Torque (ft-lbs)	Turns	RPM
H1	7/16	1	BREAK TORQUE	4.8 (bolt)	190.3 (bolt) (removal)	1	30
			60.0 (bolt) 12.0 (pgt)		22.8 (bolt) (install)		
H2	7/16	1	BREAK TORQUE	4.8 (bolt)	188.4 (bolt) (removal)	1	30
			60.0 (bolt) 12.0 (pgt)		27.8 (bolt) (install)		
			RUNNING TORQUE (very little, just picked 12.0)				

Foot Restraints:

Task	WIF	Swingarm Setting	P/Y Fitting	APFR Setting
MBSU R&R	SSRMS			[12,PP,F,6]

Notes:

- H1 is secondary bolt, H2 is primary bolt
- Removing MBSU from coldplate causes H1 status indicator to move from UNLOCK to LOCK
- CETA to CETA max coupling rate is 1 inch/sec
- There is no hard stop when releasing H1 and H2 bolts; upon release, they will free spin

Cautions:

- Fins on bottom of MBSU and coldplate are no touch
- Primary stanchion (H2) has ~ 15-20 lb soft dock force to overcome during MBSU removal and installation from/to FSE and coldplate
- H1 bolt must always be released first or damage to ORU and underlying structure will occur
- H2 bolt (jack screw) must always be installed first or damage to ORU and underlying structure will occur
- Minimize force applied to H1 microfixture. It is not rated to withstand excessive loads

Timeline Considerations:

- Decision to perform R&R is based on limiting consumables

ORU Weight with FRAM = ~ 500 lbs

EVA Connectors: N/A

Assumptions:

- Both CETA carts are port and MT is @ WS 3
- Using 85' safety tethers from airlock D-rings
- Failure discovered on way to SMDP task: EV1 on way to ICC, EV2 has not ingressed SRMS for SMDPs yet
- TM not reqd for on-orbit loads
- Failed MBSU left on CETA cart at end of EVA (CETA is coupled to MT)
- Due to long SSRMS times, EV1 will do all setup tasks
- EV2 gets spare PGT from airlock, has APFR on BRT
- EV1 already has a PGT

MBSU REMOVE AND REPLACE – 4A4B (EVA 3) (03:30)

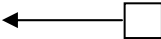
IV/SSRMS	EV1 (FF)	EV2 (SSRMS)
<p>1. Verify w/MCC ESP2 inhibits in place: RPCM N1RS2-B RPC10 – OPEN AND CLOSE INHIBITED RPCM S04B F RPC 12 – OPEN AND CLOSE INHIBITED</p>	 <p><u>CETA CART PREP</u></p> <ol style="list-style-type: none"> 1. Translate to port-most CETA cart (CETA 1)(S0 Bay 01) 2. Deploy port brake handles on CETA 1 (down) 3. Take CETA coupler to UNLOCK 4. MnvR CETA 1 port ~ 5 feet 5. Deploy stbd brake handles on CETA 1 (down) 6. ✓CETA 1 brakes by pulling parking brake (left handle) 7. Take CETA 1 coupler to CAPTURE 8. Release CETA 1 brakes (tap pedal twice) 9. Translate CETA 1 to S0 Bay 00 (by hand): <ul style="list-style-type: none"> • Stop when stbd TFR is port of CETA marker 7650 10. Engage parking brake – left handle 11. Rotate port TFR swing arm to 15 <p><u>TOOL RETRIEVAL</u></p> <ol style="list-style-type: none"> 1. Translate to airlock 2. Retrieve crewlock bag #1, BRT 3. Translate to Z1 stbd toolbox 4. Retrieve 2 sq scoops from toolbox lid: <ul style="list-style-type: none"> ☐ Stow 1 sq scoop on MWS ☐ Stow 1 sq scoop in crewlock bag #1 (may have to relocate D-Handle to get sq scoop) 5. Open right door 6. Retrieve sq TM w/7/16 recessed socket from slot 1, stow on MWS (release slider locks only) 7. Close door – both latches reqd if not coming back 	<p><u>SSRMS SETUP</u></p> <ol style="list-style-type: none"> 1. Translate to airlock 2. Retrieve spare safety tether, WIF adapter, and PGT w/RET from airlock HR 0560, stow on MWS 3. Retrieve APFR from airlock toolbox 1 WIF (if reqd), attach to BRT 4. Translate to ESP2 5. Install WIF adapter onto SSRMS, tether point oriented toward EE 6. Install APFR into WIF adapter: configure to: [12,PP,F,6] 7. Perform safety tether swap onto SSRMS, verify ST config; stow spare tether on ESP2 HR 8002 clear of MBSU removal envelope and ESP2 trajectory 8. Ingress SSRMS (head aft, face port)

MBSU REMOVE AND REPLACE – 4A4B (EVA 3) (03:30) (Cont)

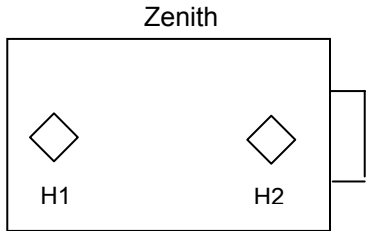
IV/SSRMS	EV1 (FF)	EV2 (SSRMS)
 <p style="text-align: center;">Zenith</p> <p style="text-align: center;">S T B D</p> <p style="text-align: center;">H1 H2</p> <p style="text-align: center;">Nadir</p> <p style="text-align: center;">MBSU ORIENTATION ON CETA CART GRID E</p>	<p><u>SPARE MBSU RETRIEVAL FROM ESP2</u></p> <ol style="list-style-type: none"> 1. Translate to ESP2, temp stow crewlock bag #1 on CETA spur 2. Attach BRT to ESP2 HR 8003 (aft face, stbd side) 3. Engage FRAM soft capture lever (slides down) 4. PGT [A4, CCW2, 10.5]-6"-Ext-7/16: Release primary FRAM bolt 11 turns (hard stop) 5. Using vertical HRs on FRAM, remove MBSU from ESP2 (magnetic soft dock to overcome) 6. Transfer MBSU to EV2 7. GCA EV2 and SSRMS clear of ESP2 8. Retrieve EV2's airlock safety tether from ESP2, attach to MWS 9. Retrieve crewlock bag #1 from CETA spur, attach to BRT <p><u>TEMP STOW SPARE MBSU ON CETA CART</u></p> <ol style="list-style-type: none"> 1. Translate to CETA 1 on S0 Bay 00 2. Temp stow crewlock bag #1 on port side of CETA cart, S0 HR 3494 3. Temp stow EV2's airlock safety tether on port S0/Lab strut clear of SSRMS trajectory 4. Retrieve ballstack from crewlock bag #1, install on port TFR swingarm ECOM fitting 5. Position body to see grid E 6. Assist EV2 with clearances 7. PGT [A4, CW2, 10.5]-6" - Ext-7/16: Drive primary FRAM bolt 11 turns (hard stop) 8. Retrieve sq scoop from crewlock bag #1, transfer to EV2 	<p><u>SPARE MBSU RETRIEVAL FROM ESP2</u></p> <ol style="list-style-type: none"> 1. Receive MBSU from EV1 (body is parallel to stbd side of ESP2 with head aft and face port) <p><u>TEMP STOW SPARE MBSU ON CETA CART</u></p> <ol style="list-style-type: none"> 1. SSRMS mnvr to CETA 1 on S0 Bay 00 2. Rotate MBSU until FRAM primary bolt faces ISS zenith 3. Install MBSU/FRAM onto grid E (zenith center) (rock FRAM square grid into place) 4. Receive sq scoop from EV1, stow on MWS

MBSU REMOVE AND REPLACE – 4A4B (EVA 3) (03:30) (Cont)

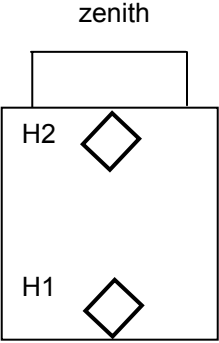
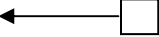
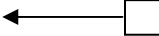
IV/SSRMS	EV1 (FF)	EV2 (SSRMS)
<p>2. Verify w/MCC S0 inhibits in place: DCSU P4 4A RBI 6 Op (CI Inh) DCSU P6 4B RBI 6 Op (CI Inh) MBSU 3 RBI 6 Op (CI Inh) MBSU 3 RBI 6 Op (CI Inh) MBSU 3 RBI 14 Op (CI Inh)</p> <p>3. Record failed MBSU serial #: _____</p> <div style="text-align: center;">  <p>MBSU ORIENTATION ON FACE 2</p> </div>	<div style="text-align: center;">  </div> <p><u>MBSU REMOVAL FROM S0 FACE 2 (4A4B)</u></p> <ol style="list-style-type: none"> Translate to failed MBSU (port zenith) <div style="text-align: center;">  </div> <ol style="list-style-type: none"> Install sq TM onto H1 fitting, √anti-backlash neutral Get in posn to assist EV2 	<p><u>MBSU REMOVAL FROM S0 FACE 2 (4A4B)</u></p> <ol style="list-style-type: none"> SSRMS mnvr to failed MBSU wkst (port zenith) <div style="border: 1px solid black; padding: 5px; margin: 10px 0;"> <p style="text-align: center;">CAUTION</p> <p>H1 bolt must always be released first or damage to ORU and underlying structure will occur</p> </div> <ol style="list-style-type: none"> Temp stow 2-in socket on PIP pin in trash bag PGT [B2, CCW2, 30.5]-sq TM: Release acme screw H1, 5 turns (PGT), 1 turn (bolt) Remove sq TM from H1, install onto H2 √Anti-backlash neutral Install sq scoop onto H1, handle points zenith PGT [B1, CCW2, 30.5]-6"-Ext-7/16: (use EV1's PGT) Release H1 acme screw ~ 8 turns √Status indicator – UNLOCK PGT [B2, CCW2, 30.5]-sq TM: Break torque on H2, 5 turns (PGT), 1 turn (bolt) Remove sq TM from H2, stow on MWS Install sq scoop onto H2, handle points zenith PGT [B1, CCW2, 30.5]-6"-Ext-7/16: (use EV1's PGT) Release H2 acme screw ~ 18 turns √Status indicator – UNLOCK

MBSU REMOVE AND REPLACE – 4A4B (EVA 3) (03:30) (Cont)

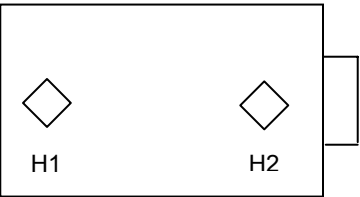
IV/SSRMS	EV1 (FF)	EV2 (SSRMS)
<p style="text-align: center;">Zenith</p> <div style="display: flex; align-items: center; justify-content: center;"> <div style="writing-mode: vertical-rl; transform: rotate(180deg); font-weight: bold; margin-right: 5px;">S T B D</div>  </div> <p style="text-align: center;">Nadir</p> <p style="text-align: center;">MBSU ORIENTATION ON CETA CART GRID E</p> <p>4. Record spare MBSU serial #: _____</p>	<p>4. Assist EV2 w/clearances 5. Translate to port side of CETA cart</p> <p>6. Assist EV2</p> <p><u>SPARE MBSU REMOVAL FROM FRAM</u></p> <p>1. Release MBSU thermal cover:</p> <ul style="list-style-type: none"> <input type="checkbox"/> Release velcro tabs on front, side, and back corners of ORU base <input type="checkbox"/> Release integral strap from underside of fwd flap <input type="checkbox"/> Fold or roll cover toward back of MBSU, attach strap to Velcro mating swatch on back side of MLI (can also attach strap to adjacent structure) <input type="checkbox"/> Using side straps from front of MLI, secure rest MLI as reqd <div style="display: flex; align-items: center;"> ← <div style="border: 1px solid black; width: 15px; height: 15px; margin-right: 5px;"></div> </div>	<p style="text-align: center;"><u>NOTE</u></p> <p>Removing MBSU from coldplate causes H1 status indicator to move from UNLOCK to LOCK.</p> <p>Primary stanchion (H2) has ~ 15-20 lb soft dock force to overcome during MBSU removal from FSE</p> <div style="border: 2px solid black; padding: 5px; margin: 10px 0; text-align: center;"> <p style="margin: 0;"><u>WARNING</u></p> <p style="margin: 0;">Fins on bottom of MBSU and coldplate are no-touch</p> </div> <p>11. Remove MBSU from coldplate 12. ✓ Status indicator on H1 in LOCK 13. SSRMS mnvr to port side of CETA cart 14. Attach MBSU to ballstack 15. Remove free sq scoop from MBSU, stow on MWS</p> <p><u>SPARE MBSU REMOVAL FROM FRAM</u></p> <p>1. SSRMS mnvr to spare MBSU (head nadir)</p> <div style="border: 1px solid black; padding: 5px; margin: 10px 0; text-align: center;"> <p style="margin: 0;"><u>CAUTION</u></p> <p style="margin: 0;">H1 bolt must always be released first or damage to ORU and underlying structure will occur</p> </div> <p>2. Install sq TM onto H1 fitting, ✓ anti-backlash neutral 3. PGT [B2, CCW2, 30.5]-sq TM: Release acme screw H1, 5 turns (PGT), 1 turn (bolt)</p>

MBSU REMOVE AND REPLACE – 4A4B (EVA 3) (03:30) (Cont)

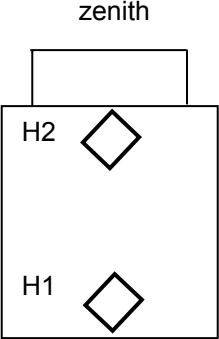
IV/SSRMS	EV1 (FF)	EV2 (SSRMS)
<p>zenith</p>  <p>nadir</p> <p>MBSU ORIENTATION ON FACE 2</p>	<p>2. Remove 3rd sq scoop from crewlock bag #1, transfer to EV2</p> <p>3. Assist EV2 w/clearances</p>	<p>4. Remove sq TM from H1, install onto H2 √Anti-backlash neutral</p> <p>5. Receive sq scoop from EV1, install onto H1 fitting</p> <p>6. PGT [B1, CCW2, 30.5]-6"-Ext-7/16: (use EV1's PGT) Release H1 acme screw ~ 8 turns √Status indicator – UNLOCK</p> <p>7. PGT [B2, CCW2, 30.5]-sq TM: Break torque on H2, 5 turns (PGT), 1 turn (bolt)</p> <p>8. Remove sqTM from H2, stow on MWS or handoff to EV1</p> <p>9. Install sq scoop onto H2</p> <p>10. PGT [B1, CCW2, 30.5]-6"-Ext-7/16: (use EV1's PGT) Release H2 acme screw ~ 18 turns √Status indicator – UNLOCK</p> <p style="text-align: center;"><u>NOTE</u> Removing MBSU from coldplate causes H1 status indicator to move from UNLOCK to LOCK.</p> <p>Primary stanchion (H2) has ~ 15-20 lb soft dock force to overcome during MBSU removal from FSE</p> <div style="border: 2px solid black; padding: 5px; margin: 10px auto; width: fit-content;"><p style="text-align: center;"><u>WARNING</u> Fins on bottom of MBSU are no-touch</p></div> <p>11. Remove MBSU from FRAM</p> <p>12. √Status indicator on H1 in LOCK</p>

MBSU REMOVE AND REPLACE – 4A4B (EVA 3) (03:30) (Cont)

IV/SSRMS	EV1 (FF)	EV2 (SSRMS)
<div data-bbox="184 568 401 966" style="text-align: center;"> <p>zenith</p> <p>nadir</p> </div> <p data-bbox="138 995 453 1052">MBSU ORIENTATION ON FACE 2</p> <p data-bbox="92 1214 478 1239">5. Inform MCC MBSU Installed</p>	<p data-bbox="543 293 1041 318"><u>SPARE MBSU INSTALLATION ONTO S0</u></p> <ol data-bbox="543 354 1066 657" style="list-style-type: none"> 1. Translate to port zenith MBSU coldplate 2. GCA EV2 as required <p data-bbox="543 1304 1129 1328"><u>INSTALLATION OF FAILED MBSU ONTO FRAM</u></p> <ol data-bbox="543 1365 972 1390" style="list-style-type: none"> 1. Translate to port TFR swingarm 	<p data-bbox="1272 293 1770 318"><u>SPARE MBSU INSTALLATION ONTO S0</u></p> <ol data-bbox="1272 354 1961 690" style="list-style-type: none"> 1. SRMS mnvr to S0 wkst (port zenith MBSU) 2. Orient MBSU such that blind-mate connectors and H2 fitting are zenith <p data-bbox="1602 508 1680 532" style="text-align: center;"><u>NOTE</u></p> <p data-bbox="1350 537 1948 594" style="text-align: center;">Primary stanchion has ~ 15-20 lb soft dock force to overcome during MBSU installation onto coldplate</p> <ol data-bbox="1272 630 1759 690" style="list-style-type: none"> 3. Install MBSU onto coldplate 4. ✓Status indicator on H1 is in UNLOCK <div data-bbox="1329 743 1936 867" style="border: 1px solid black; padding: 5px; text-align: center;"> <p data-bbox="1570 760 1694 784" style="text-align: center;"><u>CAUTION</u></p> <p data-bbox="1350 789 1913 846" style="text-align: center;">H2 bolt must always be installed first or damage to ORU and underlying structure will occur</p> </div> <ol data-bbox="1272 935 1734 1117" style="list-style-type: none"> 5. PGT [A3, CW2, 30.5]-6"-Ext-7/16: Drive H2 jack screw ~ 18 turns ✓Status indicator – LOCK 6. PGT [A3, CW2, 30.5]-6"-Ext-7/16: Drive H1 acme screw ~ 8 turns ✓Status indicator – LOCK <div data-bbox="1287 1206 1446 1247" style="text-align: center;"> </div> <ol data-bbox="1272 1247 1875 1271" style="list-style-type: none"> 7. Remove sq scoops from MBSU, stow on MWS <p data-bbox="1272 1304 1860 1328"><u>INSTALLATION OF FAILED MBSU ONTO FRAM</u></p> <ol data-bbox="1272 1365 1940 1422" style="list-style-type: none"> 1. SSRMS mnvr to failed MBSU on port TFR swingarm 2. Release MBSU from ballstack

MBSU REMOVE AND REPLACE – 4A4B (EVA 3) (03:30) (Cont)

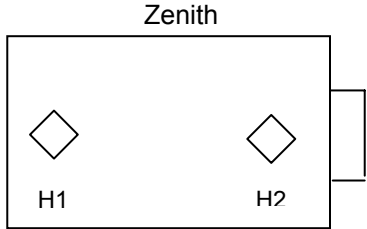
IV/SSRMS	EV1 (FF)	EV2 (SSRMS)
<div style="text-align: center;">  <p>MBSU ORIENTATION ON CETA CART GRID E</p> </div>	<ol style="list-style-type: none"> 2. Remove ballstack from port swingarm, stow in crewlock bag #1 3. Stow port swingarm (rotate to 0) <ol style="list-style-type: none"> 4. Receive sq scoop from EV1, stow on MWS (or in crewlock bag #1) 5. Receive sq scoop from EV1, stow on MWS (or in crewlock bag #1) 6. Install MBSU thermal cover <p><u>CETA CART CLEANUP</u></p> <ol style="list-style-type: none"> 1. If necessary, stow CETA 1 swingarms 2. Release brake pedal (tap pedal twice) 3. Translate CETA 1 to S0 Bay 01 4. Stow stbd brake handles (up) <div style="border: 1px solid black; padding: 5px; text-align: center; margin-top: 10px;"> <p>CAUTION CETA to CETA max coupling rate is 1 inch/sec</p> </div>	<ol style="list-style-type: none"> 3. Orient MBSU such that H2 fitting is port 4. SSRMS mnvr to FRAM <p style="text-align: center;"><u>NOTE</u> Primary stanchion has ~ 15-20 lb soft dock force to overcome during MBSU installation onto FRAM</p> <ol style="list-style-type: none"> 5. Install failed MBSU onto FRAM (ball detent soft dock on primary bolt and stanchion) 6. ✓Status indicator on H1 is in UNLOCK 7. PGT [B2, CW2, 30.5]-6"-Ext-7/16: Drive H2 jack screw ~ 18 turns ✓Status indicator – LOCK 8. Remove square scoop from H2, transfer to EV2 9. Remove square scoop from H1, transfer to EV2 10. PGT [B2, CW2, 30.5]-6"-Ext-7/16: Drive H1 acme screw ~ 8 turns ✓Status indicator – LOCK <p><u>SSRMS CLEANUP</u></p> <ol style="list-style-type: none"> 1. SSRMS mnvr to egress posn on S0 (port of MT) 2. Egress SSRMS (on CETA cart) 3. Remove APFR from SSRMS, attach to BRT 4. Remove WIF adapter from SSRMS, stow on MWS 5. Perform safety tether swap onto airlock safety tether, verify ST config; retrieve spare from SSRMS 6. Translate to airlock 7. Stow APFR in airlock toolbox 1 (stbd) WIF; configure to: [9,MM,F,12]

MBSU REMOVE AND REPLACE – 4A4B (EVA 3) (03:30) (Cont)

IV/SSRMS	EV1 (FF)	EV2 (SSRMS)
	<ol style="list-style-type: none"> 5. Couple CETA 1 to CETA 2 6. Take CETA 1 coupler to LOCK 7. Stow port brake handles (UP) 8. Retrieve crewlock bag #1 9. Translate to airlock 	

MBSU REMOVE AND REPLACE – 4A4B (EVA 3) TASK DATA SHEET

Tools:

EV1	EV2
PGT w-6-in	PGT
Crewlock bag #1	APFR
Sq TM w/7/16 recessed socket	
Ballstack	
3 sq scoops	

EVA Fasteners:

Fastener Name/Label	Head Size	Qty	Release Torque (ft-lbs)	Install Torque	Failure Torque (ft-lbs)	Turns	RPM
H1	7/16	1	BREAK TORQUE 60.0 (bolt) 12.0 (pgt)	4.8 (bolt)	190.3 (bolt) (removal)	1	30
			RUNNING TORQUE (very little, just picked 12.0)		22.8 (bolt) (install)	8	
H2	7/16	1	BREAK TORQUE 60.0 (bolt) 12.0 (pgt)	4.8 (bolt)	188.4 (bolt) (removal)	1	30
			RUNNING TORQUE (very little, just picked 12.0)		27.8 (bolt) (install)	18	

Foot Restraints:

Task	WIF	Swingarm Setting	P/Y Fitting	APFR Setting
MBSU R&R	SSRMS			[12,PP,F,6]

Notes:

- H1 is secondary bolt, H2 is primary bolt
- Removing MBSU from coldplate causes H1 status indicator to move from UNLOCK to LOCK
- CETA to CETA max coupling rate is 1 inch/sec
- There is no hard stop when releasing H1 and H2 bolts; upon release, they will free spin

Cautions:

- Fins on bottom of MBSU and coldplate are no touch
- Primary stanchion (H2) has ~ 15-20 lb soft dock force to overcome during MBSU removal and installation from/to FSE and coldplate
- H1 bolt must always be released first or damage to ORU and underlying structure will occur
- H2 bolt (jack screw) must always be installed first or damage to ORU and underlying structure will occur
- Minimize force applied to H1 microfixture. It is not rated to withstand excessive loads

ORU Weight with FRAM = ~ 500 lbs

Timeline Considerations:

- Decision to perform R&R is based on limiting consumables

EVA Connectors: N/A

Assumptions:

- Both CETA carts are port and MT is @ WS 3
- Using 85' safety tethers from airlock D-rings
- Failure discovered on way to SMDP task: EV1 on way to ICC, EV2 has not ingressed SRMS for SMDPs yet
- TM not reqd for on-orbit loads
- Failed MBSU left on CETA cart at end of EVA (CETA is coupled to MT)
- Due to long SSRMS times, EV1 will do all setup tasks
- EV2 gets spare PGT from airlock HR, has APFR on BRT
- EV1 already has a PGT



DDCU REMOVE AND REPLACE – CH 1/4 (EVA 3)

IV	EV1 (FF)	EV2 (FF)
<p>1. Verify w/MCC inhibits in place: MBSU 4 RBI 12 Op (CI Inh)</p> <p>2. Record spare DDCU serial #: _____</p>	<p><u>WORKSITE SETUP</u></p> <ol style="list-style-type: none"> Retrieve APFR from <u>TBD</u> Translate to S0 port wedge face Install APFR in S0 WIF 41; configure to: [7,QQ,E,1] <p>← <input type="checkbox"/></p> <p><u>SPARE DDCU REMOVAL (DDCU S0-4B)</u> (S0 port wedge face)</p> <ol style="list-style-type: none"> Ingress APFR in S0 WIF 41 <div style="border: 1px solid black; padding: 5px; margin: 10px auto; width: fit-content;"> <p style="text-align: center;"><u>CAUTION</u></p> <p>H2 bolt (jack screw) must always be released last or damage to ORU and underlying structure will occur</p> </div> <p>← <input type="checkbox"/></p> <ol style="list-style-type: none"> Receive sq TM from EV2, install onto H1 fitting, √Anti-backlash neutral PGT [B2, CCW2, 30.5]-sq TM: (stow 6-in socket in trash) Break torque on H1, 5 turns (PGT), 1 turn (bolt) Remove square TM from H1, install onto H2 √Anti-backlash neutral 	<p><u>TOOL RETRIEVAL</u></p> <ol style="list-style-type: none"> Translate to airlock Retrieve crewlock bag #1, BRT (use either spare PGT or temp stow your 6-in socket in trash) Translate to Z1 stbd toolbox Retrieve 2 square scoops from toolbox lid: <ul style="list-style-type: none"> □ Stow 1 square scoop on MWS □ Stow 1 square scoop in crewlock bag #1 Open right door Retrieve square TM w/7/16 recessed socket from slot 1, stow on MWS (release slider lock only) Close door – both latches reqd if not coming back <p><u>SPARE DDCU REMOVAL (DDCU S0-4B)</u> (S0 port wedge face)</p> <ol style="list-style-type: none"> Translate to S0 port wedge face (zenith HRs on S0 and P1 worked well in pool) Temp stow crewlock bag near EV1 (he'll pick up later) <p>3. Transfer square TM to EV1</p>

DDCU REMOVE AND REPLACE – CH 1/4 (EVA 3) (Cont)

IV	EV1 (FF)	EV2 (FF)
	<p>5. Receive square scoop from EV2, install onto H1 fitting</p> <p>6. PGT [B1, CCW2, 30.5]-6"-Ext-7/16: Release H1 acme screw ~ 8 turns √Status indicator – UNLOCK</p> <p>7. PGT [B2, CCW2, 30.5]-sq TM: Break torque on H2, 5 turns (PGT), 1 turn (bolt)</p> <p>8. Remove square TM from H2, stow on MWS</p> <p>9. Receive square scoop from EV2, install onto H2 fitting</p> <p>10. PGT [B1, CCW2, 30.5]-6"-Ext-7/16: Release H2 jack screw ~ 18 turns √Status indicator – UNLOCK</p> <p style="text-align: center;"><u>NOTE</u> Removing DDCU from coldplate causes H1 status indicator to move from UNLOCK to LOCK.</p> <p>Primary stanchion (H2) has ~ 15-20 lb soft dock force to overcome during DDCU removal from FSE</p> <div style="border: 1px solid black; padding: 5px; margin: 10px auto; width: fit-content;"> <p style="text-align: center;"><u>CAUTION</u> Minimize force applied to H1 microfixture. It is not rated to withstand excessive loads</p> </div> <div style="border: 3px double black; padding: 5px; margin: 10px auto; width: fit-content;"> <p style="text-align: center;"><u>WARNING</u> Fins on bottom of DDCU and coldplate are no-touch</p> </div> <p>11. Remove DDCU from coldplate 12. √Status indicator on H1 in LOCK 13. Attach failed DDCU to EV2's BRT 14. Remove free sq scoop from failed DDCU, stow on MWS 15. Egress APFR</p>	<p>4. Transfer square scoop to EV1</p> <p>5. Transfer square scoop to EV1</p> <p>6. Position BRT toward EV1</p>

DDCU REMOVE AND REPLACE – CH 1/4 (EVA 3) (Cont)

IV	EV1 (FF)	EV2 (FF)
<p>3. Verify w/MCC inhibits in place: MBSU 1 RBI 4 Op (CI Inh)</p> <p>4. Record failed DDCU serial #: _____</p>	<p>16. Retrieve crewlock bag, attach to BRT</p> <p><u>FAILED DDCU REMOVAL</u></p> <p>For DDCU S0-1A (S0 Bay 01):</p> <p>← </p> <ol style="list-style-type: none"> 1. Remove APFR from WIF 41, stow on BRT 2. Translate to S0 Bay 01 3. Install APFR into S0 WIF 21 (side-mounted WIF); configure to: [3,OO,G,12] 4. Ingress APFR <div style="border: 1px solid black; padding: 5px; margin: 10px auto; width: fit-content;"> <p style="text-align: center;"><u>CAUTION</u></p> <p style="text-align: center;">H1 bolt must always be released first or damage to ORU and underlying structure will occur</p> </div> <p>← </p> <ol style="list-style-type: none"> 5. Install square TM onto H1 fitting, √anti-backlash neutral 6. PGT [B2, CCW2, 30.5]-sq TM: Break torque on H1, 5 turns (PGT), 1 turn (bolt) 7. Remove square TM from H1, install onto H2 (may require EV2's help, access from APFR not ideal) √Anti-backlash neutral 8. Install square scoop on H1 9. PGT [B1, CCW2, 30.5]-6"-Ext-7/16: Release H1 acme screw ~ 8 turns √Status indicator – UNLOCK 10. PGT [B2, CCW2, 30.5]-sq TM: Break torque on H2, 5 turns (PGT), 1 turn (bolt) 11. Remove square TM from H2, stow on MWS 12. Receive square scoop from EV2, install onto H2 fitting 13. PGT [B1, CCW2, 30.5]-6"-Ext-7/16: 	<p><u>FAILED DDCU REMOVAL</u></p> <p>For DDCU S0-1A (S0 Bay 01):</p> <ol style="list-style-type: none"> 1. Translate to CETA carts (must be slid port of DDCU in bay 01 for access to DDCU removal worksite) 2. Take CETA 2 coupler to unlock (will move both carts together as one unit, so carts will stay coupled together) 3. Mnvr CETA carts port a few feet to clear S0 Bay 01 wkst 4. Take CETA 2 coupler to CAPTURE 5. Engage CETA 2 parking brake (left handle) <p>6. Transfer square scoop to EV1</p>

DDCU REMOVE AND REPLACE – CH 1/4 (EVA 3) (Cont)

IV	EV1 (FF)	EV2 (FF)
	<p>Release H2 jack screw ~ 18 turns ✓Status indicator – UNLOCK</p> <p style="text-align: center;"><u>NOTE</u> Removing DDCU from coldplate causes H1 status indicator to move from UNLOCK to LOCK.</p> <p>Primary stanchion (H2) has ~ 15-20 lb soft dock force to overcome during DDCU removal from FSE</p> <div style="border: 3px double black; padding: 5px; text-align: center;"> <p><u>WARNING</u> Fins on bottom of DDCU and coldplate are no-touch</p> </div> <p>14. Remove DDCU from coldplate 15. ✓Status indicator on H1 in LOCK 16. Attach failed DDCU to BRT 17. Receive free square scoop from EV2</p>	<p>7. Assist EV1, remove free scoop 8. Transfer free square scoop to EV1</p> <div style="border: 1px solid black; padding: 5px; text-align: center;"> <p><u>CAUTION</u> CETA to MT max coupling rate is 0.5 ft/sec</p> </div> <p>9. Couple CETA 2 (both carts) to MT 10. Take CETA 2 coupler to LOCK 11. Translate to airlock 12. Perform tool inventory</p>

DDCU REMOVE AND REPLACE – CH 1/4 (EVA 3) (Cont)

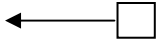
IV	EV1 (FF)	EV2 (FF)
<p>5. Verify w/MCC inhibits in place: MBSU 4 RBI 11 Op (CI Inh)</p>	<p>For DDCU S1-4B (S1 Bay 15):</p>  <ol style="list-style-type: none"> 1. Retrieve crewlock bag #1 (EV2 has spare DDCU) 2. Translate to S1 Bay 15 (APFR not needed for this DDCU, there are no adjacent WIFs to support) 3. Retrieve MUT EE and ballstack from crewlock bag #1 4. Attach MUT EE and ballstack to S1 Bay 15 zenith HR 3208 (for temp stow of failed DDCU) 5. Temp stow crewlock bag #1 on Bay 15 zenith HR 6. Retrieve sq scoop from crewlock bag #1, attach to MWS 7. Translate to face 6 (nadir) 8. Attach BRT to S1 Bay 15 nadir HR 3217 (very far reach) <div style="border: 1px solid black; padding: 5px; margin: 10px 0;"> <p style="text-align: center;">CAUTION</p> <p>H1 bolt must always be released first or damage to ORU and underlying structure will occur</p> </div> <ol style="list-style-type: none"> 9. Install square TM onto H1 fitting, √anti-backlash neutral 10. PGT [B2, CCW2, 30.5]-sq TM: Break torque on H1, 5 turns (PGT), 1 turn (bolt) 11. Remove square TM from H1, install onto H2 (may require EV2's help, access from APFR not ideal) √Anti-backlash neutral 12. Install square scoop on H1 13. PGT [B1, CCW2, 30.5]-6"-Ext-7/16: Release H1 acme screw ~ 8 turns √Status indicator – UNLOCK 14. PGT [B2, CCW2, 30.5]-sq TM: Break torque on H2, 5 turns (PGT), 1 turn (bolt) 15. Remove square TM from H2, stow on MWS 16. Install square scoop onto H2 fitting 17. PGT [B1, CCW2, 30.5]-6"-Ext-7/16: Release H2 jack screw ~ 18 turns √Status indicator – UNLOCK 	<p>For DDCU S1-4B (S1 Bay 15):</p> <ol style="list-style-type: none"> 1. Translate to S1 Bay 15, face 2 (zenith) 2. Assist EV1

DDCU REMOVE AND REPLACE – CH 1/4 (EVA 3) (Cont)

IV	EV1 (FF)	EV2 (FF)
	<p style="text-align: center;"><u>NOTE</u></p> <p>Removing DDCU from coldplate causes H1 status indicator to move from UNLOCK to LOCK.</p> <p>Primary stanchion (H2) has ~ 15-20 lb soft dock force to overcome during DDCU removal from FSE</p> <div style="border: 1px solid black; padding: 5px; margin: 10px auto; width: fit-content;"> <p style="text-align: center;"><u>WARNING</u></p> <p style="text-align: center;">Fins on bottom of DDCU and coldplate are no-touch</p> </div> <ol style="list-style-type: none"> 18. Remove DDCU from coldplate 19. ✓Status indicator on H1 in LOCK 20. Transfer DDCU to EV2 21. Translate to face 2 22. Receive DDCU from EV2 23. Temp stow DDCU on ballstack 24. Remove free square scoop from failed DDCU <p><u>SPARE DDCU INSTALL</u></p> <ol style="list-style-type: none"> 1. Install square scoop onto spare DDCU (EV2's BRT) 2. Remove spare DDCU from EV2's BRT <p style="text-align: center;"><u>NOTE</u></p> <p>Primary stanchion has ~ 15-20 lb soft dock force to overcome during DDCU installation onto coldplate</p> <ol style="list-style-type: none"> 3. Install DDCU onto coldplate 4. ✓Status indicator on H1 is in UNLOCK 	<ol style="list-style-type: none"> 3. Receive DDCU from EV1 4. Transfer DDCU to EV1 <p><u>SPARE DDCU INSTALL</u></p> <ol style="list-style-type: none"> 1. Assist EV1 2. Assist EV1 3. Retrieve MUT EE and ballstack (S1-4B DDCU only), stow in crewlock bag #1) 4. Retrieve crewlock bag #1

DDCU REMOVE AND REPLACE – CH 1/4 (EVA 3) (Cont)

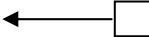
IV	EV1 (FF)	EV2 (FF)
<p>6. Verify w/MCC inhibits in place: MBSU 4 RBI 12 Op (CI Inh)</p>	<div style="border: 1px solid black; padding: 5px; margin-bottom: 10px;"> <p style="text-align: center;"><u>CAUTION</u></p> <p>H2 bolt (jack screw) must always be installed first or damage to ORU and underlying structure will occur</p> </div> <ol style="list-style-type: none"> 5. PGT [A3, CW2, 30.5]-6"-Ext-7/16: Drive H2 jack screw ~ 18 turns √Status indicator – LOCK 6. PGT [A3, CW2, 30.5]-6"-Ext-7/16: Drive H1 acme screw ~ 8 turns √Status indicator – LOCK 7. Remove square scoops from DDCU, stow on MWS 8. Egress APFR <p><u>FAILED DDCU INSTALL</u> (S0 port wedge face) (to protect coldplate)</p> <ol style="list-style-type: none"> 1. If DDCU failure was S0-1A, APFR must be relocated from S0 WIF 21 back to S0 WIF 41 <div style="margin-left: 20px;">  </div> <ol style="list-style-type: none"> 2. Translate to S0 port wedge face 3. If reqd, install APFR into S0 WIF 41, config to: [7,QQ,E,1] 4. Install square scoop onto failed DDCU (on EV2's BRT) 5. Ingress APFR in S0 WIF 41 6. Remove DDCU from EV2's BRT <p style="text-align: center;"><u>NOTE</u></p> <p style="text-align: center;">Primary stanchion has ~ 15-20 lb soft dock force to overcome during DDCU installation onto coldplate</p> <ol style="list-style-type: none"> 7. Install DDCU onto coldplate 8. √Status indicator on H1 is in UNLOCK 	<p><u>FAILED DDCU INSTALL</u> (S0 port wedge face) (to protect coldplate)</p> <ol style="list-style-type: none"> 1. Translate to S0 port wedge face 2. Orient DDCU toward EV1 3. Assist EV1

DDCU REMOVE AND REPLACE – CH 1/4 (EVA 3) (Cont)

IV	EV1 (FF)	EV2 (FF)
	<div data-bbox="571 329 1167 453" style="border: 1px solid black; padding: 5px; margin-bottom: 10px;"> <p style="text-align: center;"><u>CAUTION</u></p> <p>H2 bolt (jack screw) must always be installed first or damage to ORU and underlying structure will occur</p> </div> <ol style="list-style-type: none"> 9. PGT [A3, CW2, 30.5]-6"-Ext-7/16: Drive H2 jack screw ~ 18 turns √Status indicator – LOCK 10. PGT [A3, CW2, 30.5]-6"-Ext-7/16: Drive H1 acme screw ~ 8 turns √Status indicator – LOCK 11. Remove square scoops from DDCU, stow on MWS 12. Egress APFR (APFR left in S0 WIF 41) 13. Translate to airlock 14. Perform tool inventory 	<ol style="list-style-type: none"> 4. Translate to airlock 5. Perform tool inventory

DDCU REMOVE AND REPLACE – CH 1/4 (EVA 3) TASK DATA SHEET

Tools:

EV1	EV2
PGT w/6-in	PGT
APFR	Crewlock bag #1
	Square TM w/7/6" TM
	3 square scoops

Foot Restraints:

Task	WIF	APFR Setting
DDCU S0-4B (spare)	S0 WIF 41	7,QQ,E,1
DDCU S0-1A (S0 Bay 01)	S0 WIF 21 (side mounted) CETA cart WIF 4 (zen/port)	3,OO,G,12 TBD settings
DDCU S1-4B (S1 Bay 15)	No available WIFs or CETA cart	

EVA Fasteners:

Fastener Name/Label	Head Size	Qty	Release Torque (ft-lbs)	Install Torque	Failure Torque (ft-lbs)	Turns	RPM
H1	7/16	1	BREAK TORQUE 60.0 (bolt) 12.0 (pgt)	4.8 (bolt)	190.3 (bolt) (removal)	1	30
			RUNNING TORQUE (very little, just picked 12.0)		22.8 (bolt) (install)		
H2	7/16	1	BREAK TORQUE 60.0 (bolt) 12.0 (pgt)	4.8 (bolt)	188.4 (bolt) (removal)	1	30
			RUNNING TORQUE (very little, just picked 12.0)		27.8 (bolt) (install)		

Notes:

1. There is no hard stop when releasing H1 and H2 bolts; upon release, they will free spin
2. Removing DDCU from coldplate causes H1 status indicator to move from UNLOCK to LOCK
3. Primary stanchion (H2) has a 15-20 lb soft dock

Cautions:

1. There is no hard stop when releasing H1 and H2 bolts; upon release, they will free spin
2. H2 bolt (jack screw) must always be installed first or damage to ORU and underlying structure will occur
3. Fins on bottom of DDCU and coldplate are no-touch
4. H1 bolt must always be released first or damage to ORU and underlying structure will occur
5. Minimize force applied to H1 microfixture. It is not rated to withstand excessive loads

Timeline Considerations:

1. Decision to perform R&R is based on limiting consumables



Assumptions:

1. Learn of failure ~ 20-30 min after CH 1/4 powerup
2. Spare DDCU is DDCU S0-4B (on S0 port wedge face). Skip Z1 PP if any of the 1/4 DDCU fails and you use the S04B DDCU as a spare (or it fails itself)
3. TM not used on spare DDCU for on-orbit loads
4. All tools retrieved from Z1 toolbox come inside at end of EVA
5. Need to determine where APFR is coming from
6. MT @ WS 3 w/both CETA carts coupled to port side – nominal location for 1/4 powerup
 - If the S0-4B spare fails during pwr up, the R&R will be skipped, and so will the PP. That is why there is no option in the above procedures to R&R S0-4B. None of the other DDCUs can be used as the spare, so the R&R will occur on another day using the internal spare
7. For the 1/4 DDCU R&Rs, truss WIFs are used, with the exception of the S1 Bay 15 DDCU (no near-by WIFs). This decision was made because the CETA cart can only be used to support 1 of the 3 DDCU failures (S0-1A) for this channel, so it would be inefficient to both use a truss WIF and set up the cart
8. Neither crewmember has a socket caddy, so either EV1 or EV2 will have to temp stow their socket in the trash bag for TM ops (don't necessarily get spare PGT from crewlock bag (too many tools to manage)
9. Failed DDCU gets installed into spare worksite
10. Don't need spare safety tether to reach these DDCUs (the 85 footer from airlock works for all DDCUs)

BCDU BACKOUT – CH 1/4 (EVA 3)

IV	EV1 (FF)	EV2 (FF)
<p>1. √MCC inhibits in place: BCDU 2B1 1. DCSU 2B RBI 2 Op, CI Inh 2. BCDU 4B1 CP RBI Op - OR - BCDU 2B2 1. DCSU 2B RBI 3 Op, CI Inh 2. BCDU 4B2 CP RBI Op - OR - BCDU 2B3 1. DCSU 2B RBI 4 Op, CI Inh 2. BCDU 4B3 CP RBI Op</p> <p>2. IV record serial # of failed box: _____</p>	<p style="text-align: center;">← <input type="checkbox"/></p> <p><u>FAILED P6 2B BCDU BACK-OUT</u></p> <ol style="list-style-type: none"> 1. Translate to airlock 2. Translate to Z1 stbd toolbox 3. Open right door 4. Retrieve sq TM w/7/16 recessed socket from slot 1, stow on MWS 5. Close door – 1 latch reqd 6. Translate to fish stringer #1, retrieve PGT with 6-in, stow on MWS 7. Translate to P6 BCDU <u>TBD</u> on stbd face of P6 (via P6 stbd/aft P6 edge) <p style="text-align: center;">← <input type="checkbox"/></p> <div style="border: 1px solid black; padding: 5px; margin: 10px auto; width: fit-content;"> <p style="text-align: center;"><u>CAUTION</u> H1 bolt must always be released first or damage to ORU and underlying structure will occur</p> </div> <ol style="list-style-type: none"> 8. Install TM onto H1 fitting, √anti-backlash neutral 9. PGT [B2, CCW2, 30.5]-sq TM: Release acme screw H1, ~ 1 turn 10. Remove TM from H1, install onto H2 √Anti-backlash neutral 11. Reconfigure PGT with 6-in socket 12. PGT [B1, CCW2, 30.5]-6"-Ext-7/16: Release H1 acme screw ~ 8 turns √Status indicator – UNLOCK 13. Remove socket from PGT 14. PGT [B2, CCW2, 30.5]-sq TM: Break torque on H2, ~ 1 turn 	<p><u>FAILED P6 2B BCDU BACK-OUT</u></p> <ol style="list-style-type: none"> 1. Assist EV1 as reqd (continue with SMDPs unless EV1 needs assistance)

BCDU BACKOUT – CH 1/4 (EVA 3) (Cont)

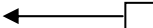
IV	EV1 (FF)	EV2 (FF)
<p>1A. ✓SARJ locked at 205 deg 1B. ✓MCC inhibits in place: BCDU 2A1 1. DCSU 2A RBI 2 Op, CI Inh 2. BCDU 4A1 CP RBI Op - OR - BCDU 2A2 1. DCSU 2A RBI 3 Op, CI Inh 2. BCDU 4A2 CP RBI Op - OR - BCDU 2A3 1. DCSU 2A RBI 4 Op, CI Inh 2. BCDU 4A3 CP RBI Op</p> <p>2. IV record serial # of failed box: _____</p>	<p>15. Remove TM from H2, stow on MWS 16. Reconfigure PGT with 6-in socket 17. PGT [B1, CCW2, 30.5]-6"-Ext-7/16: Release H2 jack screw 5 turns 18.  BCDU final config 19. Translate to airlock</p> <p><u>FAILED P4 2A BCDU BACK-OUT</u></p> <p></p> <p>1. Translate to airlock 2. Retrieve spare 55' safety tether from crewlock bag #1, stow on MWS 3. Translate to Z1 stbd toolbox 4. Open right door 5. Retrieve sq TM w/7/16 recessed socket from slot 1, stow on MWS 6. Close door – 1 latch reqd 7. Translate to fish stringer #1, retrieve second 55' safety tether and PGT w/6-in, stow on MWS 8. Translate to P1 HR 3602 (Bay 14); perform safety tether swap using 55' spare safety tether, verify ST Config 9. Translate to P4 HR 5104 (zenith IEA) 10. Perform safety tether swap onto P4 HR 5104 with remaining 55' safety tether, verify ST config 11. Translate to failed BCDU on P4 (P4 aft, <u>TBD BCDU</u>)</p> <p></p>	<p><u>FAILED P4 2A BCDU BACK-OUT</u></p> <p>1. Assist EV1 as reqd (continue with SMDPs unless EV1 needs assistance)</p>

BCDU BACKOUT – CH 1/4 (EVA 3) (Cont)

IV	EV1 (FF)	EV2 (FF)
	<div data-bbox="611 362 1213 488" style="border: 1px solid black; padding: 5px; margin-bottom: 10px;"> <p style="text-align: center;"><u>CAUTION</u></p> <p>H1 bolt must always be released first or damage to ORU and underlying structure will occur</p> </div> <ol style="list-style-type: none"> 12. Install TM onto H1 fitting, √anti-backlash neutral 13. PGT [B2, CCW2, 30.5]-sq TM: Release acme screw H1, ~ 1 turn 14. Remove TM from H1, install onto H2 √Anti-backlash neutral 15. Reconfigure PGT with 6-in socket 16. PGT [B1, CCW2, 30.5]-6"-Ext-7/16: Release H1 acme screw ~ 8 turns √Status indicator – UNLOCK 17. Remove socket from PGT 18. PGT [B2, CCW2, 30.5]-sq TM: Break torque on H2, ~ 1 turn 19. Remove TM from H2, stow on MWS 20. Reconfigure PGT with 6-in socket 21. PGT [B1, CCW2, 30.5]-6"-Ext-7/16: Release H2 jack screw 5 turns 22. ☐ BCDU final config 23. Translate to airlock 	

BCDU BACKOUT – CH 1/4 (EVA 3) TASK DATA SHEET

Tools:

EV1 (FF)	EV2 (FF)
PGT w/6-in socket	
Square TM w/7/16 in Rec Socket	

EVA Fasteners:

Fastener Name/Label	Head Size	Qty	Release Torque (ft-lbs)	Install Torque	Failure Torque (ft-lbs)	Turns	RPM
H1	7/16	1	BREAK TORQUE 60.0 (bolt) 12.0 (pgt)	4.8 (bolt)	190.3 (bolt) (removal)	1	30
			RUNNING TORQUE (very little, just picked 12.0)		22.8 (bolt) (install)		
H2	7/16	1	BREAK TORQUE 60.0 (bolt) 12.0 (pgt)	4.8 (bolt)	188.4 (bolt) (removal)	1	30
			RUNNING TORQUE (very little, just picked 12.0)		27.8 (bolt) (install)		

EVA Connectors: NA

Foot Restraints: NA

Notes:

- H1 is secondary bolt, H2 is primary bolt
- Removing BCDU from coldplate causes H1 status indicator to move from UNLOCK to LOCK
- The BCDU backout procedure does not actually remove the ORU from the truss, it just backs the H2 bolt out enough to demate the blind-mate connectors

Cautions:

- Fins on bottom of MBSU and coldplate are no touch
- Primary stanchion (H2) has ~ 15-20 lb soft dock force to overcome during MBSU removal and installation from/to FSE and coldplate
- H1 bolt must always be released first or damage to ORU and underlying structure will occur
- Minimize force applied to H1 microfixture. It is not rated to withstand excessive loads
- T-handle on connector cover poses a tether snag point. Connector cover could become loose debris if advertently snagged by EVA tether

Warnings:

- Hazard voltage exist at the connectors of the BCDU. BCDU must be safed before removal

ORU Mass: 234 lbs

Assumptions:

- This failure would happen on EVA 3 (CH 1/4); we would primarily protect for P6 2B (since it carries the primary core loads), but EPS may want us to protect for P4 2A (utility loads only)
- EV2 would be starting SRMS setup and SMDP transfer, so it would be easier for EV1 to break away from his task to support BCDU back-out. EV2 does not require EV1 for GCA assist until just prior to Christmas tree release from ICC
- Each EV is reqd to have 2 spare 55' safety tethers to reach all possible P4 BCDUs. The P6 BCDUs can be reached from the 85' airlock safety tether (no swaps reqd)
- All bolts are driven FF

S1 PUMP MODULE R&R SUMMARY TIMELINE

TIME	IV/SRMS/SSRMS	EV1 (FF)	EV2 (SSRMS)
00:00		POST DEPRESS (00:05)	POST DEPRESS (00:05)
00:05		EGRESS (00:20)	EGRESS (00:20)
00:25	SSRMS: PM R&R SRMS: PM R&R	FAILED PM REMOVAL FROM S1 (01:30) <ul style="list-style-type: none"> • Setup • PM Prep for FGB Install • PM QD Operations • PM Jumper N2 Vent and Install • PM Electrical Connections • Release PM Bolts • Temp Stow Failed PM on SRMS 	FAILED PM REMOVAL FROM S1 (01:30) <ul style="list-style-type: none"> • SSRMS Setup • FGB Removal from Spare PM • Break Torque on PM Bolts • PM Jumper N2 Vent and Install • FGB Install • Release PM Bolts • Temp Stow Failed PM on SRMS
01:55		SPARE PM RETRIEVAL FROM ESP2 (01:30) <ul style="list-style-type: none"> • Spare PM Electrical Connections 	SPARE PM RETRIEVAL FROM ESP2 (01:30) <ul style="list-style-type: none"> • Break Torque on PM Bolts • Release PM Bolts
03:25	SSRMS: PM R&R	SPARE PM INSTALL ON S1 (02:00) <ul style="list-style-type: none"> • S1 PM Install • PM Electrical Connections • PM Jumper NH3 Vent and Removal • S1 PM N2 vent • PM QD Operations • CETA Cart Cleanup 	SPARE PM INSTALL ON S1 (02:00) <ul style="list-style-type: none"> • S1 PM Install • PM Bolt Initial Torque • PM Jumper NH3 Vent and Removal • PM Bolt Final Torque
*** BREAKOUT POINT IF REQD ***			
05:25	SSRMS: PM R&R SRMS: PM R&R	FAILED PM INSTALL ONTO ESP2 (01:30) <ul style="list-style-type: none"> • Retrieve Failed PM from SRMS • Install Failed PM onto ESP2 • PM Electrical Connections • Cleanup 	FAILED PM INSTALL ONTO ESP2 (01:30) <ul style="list-style-type: none"> • Retrieve Failed PM from SRMS • Install Failed PM onto ESP2 • PM Bolt Initial Torque • PM Bolt Final Torque • SSRMS Cleanup
06:55		INGRESS (00:20)	INGRESS (00:20)
07:05		PRE REPRESS (00:05)	PRE REPRESS (00:05)
07:25			

TOOL CONFIG

AIRLOCK

- EMU1
- MWS, right swing arm
- Digital Camera (inner right swing arm)
- BRT (left)
 - w/3 wire ties and sm-sm RET
- T-Bar
 - ISS trash bag (inner left)
 - Sm-sm RET (left D-ring)
 - Adj tethers (2) (left D-ring)
 - Sm-sm RET w/PIP pin (right D-ring)
 - Adj tethers (2) (right D-ring)
- D-ring ext – left
- Waist tether – right
- SAFER

- EMU2
- MWS, right swing arm
- Digital Camera (inner right swing arm)
- BRT (left)
 - w/3 wire ties and sm-sm RET
- T-Bar
 - ISS trash bag (inner right)
 - Wire ties (2) around T-Bar
 - Socket caddy (inner left)
 - 5/8 x 7.8-in ext
 - Round TM w/5/8 proud socket (outer right)
 - Sm-sm RET w/PIP pin (left D-ring)
 - Adj tether (left D-ring)
 - Sm-sm RET w/PIP pin (right D-ring)
 - Adj tethers (2) (right D-ring)
 - Lg-sm RETs (2) (need for PM HRs)
- D-ring ext (2)
 - Spare 55' safety tether to MWS (left D-ring extender)
- Waist tethers (2)
- SAFER

AIRLOCK ENDCONE

- Staging Bag
- Fish Stringer #3
- Connector cleaner tool caddy
- Wire tie caddy (2)
- Pin straightener
- MWS Key strap
- Velcro/Tape caddy
- Pry bar
- EVA Ratchet
- Socket caddy (inner right)
 - 5/8 x 7.8-in ext
- Spare 55' safety tethers (2)

- IV Bag
- Contamination Detection Kit
 - Hydrazine Detector (Gold Salt Coupon) (6)
 - Color Chart (2)
 - ISS Contamination Detection Sampler (2)
 - Shuttle Contamination Detection Sampler (2)
 - Nitrogen Dioxide Detector (Oxidizer Draeger Tube) (6)
 - Ammonia Detector (NH3 Draeger Tube) (6)
- 2 towels with wire ties
- DCM plug (2) (SAFER hardmount)
- GP caddy (2)
- Thermal mittens (2 pr)
- Socket Caddy (hatch contingencies) w/sm-sm RET
 - 1/2 X 8-in socket (IV hatch)
 - 7/16 X 6-in socket (spare)

PRE EVA TOOL CONFIG

- 1. Prior to EVA, inspect the following:
 - RET cords for damage
 - BRT and MWS toggles: loose fittings/screws
 - Safety and waist tether load alleviating straps (no red band or damage)

AIRLOCK INTERNAL D-RING

- D-Ring Extender

UIA HANDRAILS:

- Fish Stringer #1 (laid across UIA HRs)
 - PGT with 7/16 x 6-in ext (s/n:_____) w/RET
- Torque Wrench (set to 37 ft-lbs) (need for PM Return)
 - Lg-sm RET
- Fish Stringer #2
 - PGT with 7/16 x 6-in ext (s/n:_____) w/RET
- Crewlock bag #1 (empty) – for QD cont tools if needed
 - Lg-sm RET

EXTERNALLY STOWED QD TOOLS: (INFO ONLY)

- PM Jumper Bag
 - PM Jumper
- VTE Bag (only needed if EVA NH3 vent is reqd)
 - 1.0" vent tool mated to vent tool extender
 - MUT EE
- Stbd QD Bag (QD cont tools)
 - 1.5" QRT/FID gauge
 - 1.5" Bail drive lever
 - .5" cap tool

NOTE

Only need vent tool and VTE for specific failures where MCC cannot remotely vent PM NH3 through truss aft vent panel

EGRESS (00:25)

IV	EV1 (FF)	EV2 (FF)
<p><u>NOTE</u> For safety tether swaps, expect to hear:</p> <ol style="list-style-type: none"> 1. Hook closed 2. Slide locked 3. Reel unlocked <ol style="list-style-type: none"> 1. WVS Software: Select page – RF camera Sel ‘Advanced Controls’ S-Band Level (two) – Max (required after EV1 and EV2 egress airlock) 	<p>√Right waist tether to airlock internal D-ring extender, verify ST config</p> <ol style="list-style-type: none"> 1. Thermal cover – open 2. Egress airlock 3. Inspect load alleviating straps on 85' safety tethers (2) 4. Retrieve airlock safety tether from fwd external D-ring, attach to left D-ring extender, verify ST config 5. Release waist tether from internal D-ring extender 6. Receive fish stringer #1 and #2 from EV2 7. Temp stow fish stringer #1 in between A/L port toolbox HR and stbd toolbox HR (stretched out) 8. Temp stow fish stringer #2 in between A/L HR 0560 (fwd/stbd/nadir) and HR 0555 (nadir of stbd toolbox) 9. Transfer aft airlock safety tether to EV2 10. Transfer PGT from fish stringer #1 to right swingarm 11. Retrieve fish stringer #1 <ol style="list-style-type: none"> 12. √EV2's SAFER MAN ISOL vlv – OP (dn) and HCM (dn) 	<p>√Right waist tether to UIA panel fwd D-ring, verify ST config</p> <ol style="list-style-type: none"> 1. Transfer fish stringer #1 and #2 to EV1 2. Receive airlock safety tether from EV1, attach to left D-ring extender, verify ST config 3. Release right waist tether from UIA panel D-ring 4. Egress airlock ← □ 5. Close thermal cover 6. √EV1's SAFER MAN ISOL vlv – OP (dn) and HCM (dn) 7. Transfer PGT from fish stringer #2 to right swingarm 8. Transfer Round TM from fish stringer #2 to MWS 9. Retrieve fish stringer #2

FAILED PUMP MODULE REMOVAL FROM S1

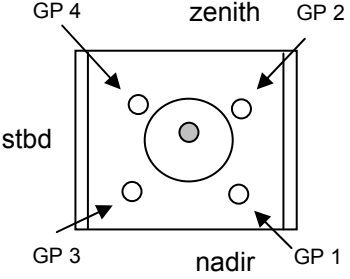
IV/SRMS/SSRMS	EV1 (FF)	EV2 (SSRMS)
<p>1. S1 PM R&R (SODF: RBT FS: APFR Install/APFR Ingress)</p>  <p>PM on ESP2 WITH FGB</p> <p>2. IV Record PM serial #: _____</p> <p>3. √MCC GO to begin QD ops</p>	<p><u>SETUP</u></p> <ol style="list-style-type: none"> Retrieve PM jumper bag from zenith crewlock, BRT Translate to CETA 1 (port-most), MT @ WS 2 Stow fish stringer #1 and PM Jumper bag on CETA 1 square grid Prep CETA 1 for transfer to port side of P1 PM: <ul style="list-style-type: none"> √Brake handles (4) straight and collars locked Deploy CETA 1 port brake handles (down) √Swingarms stowed (3) Take CETA 1 coupler to UNLOCK Translate CETA 1 port of S1 PM wkst (out of way) Engage CETA 1 parking brake (left handle) Take CETA 1 coupler to CAPTURE <p>(this gets CETA 1 out of the way so CETA 2 port HR can be used to BRT to for QD ops)</p> Prep CETA 2 for use: <ul style="list-style-type: none"> √Brake handles (4) straight and collars locked Take CETA 2 coupler to UNLOCK Move CETA 2 port a few inches, engage parking brake (left handle, and take coupler to CAPTURE) Open face 1 shroud (velcroes) (opens toward stbd) <p><u>PUMP MODULE PREP FOR FGB INSTALL</u></p> <ol style="list-style-type: none"> Read failed PM serial # to IV Open MLI flap on integral PM cover (FGB bolts) PGT [B7, CCW2, 30.5]-6-Ext-7/16: Disengage FGB to Pump Module mounting bolts (4) 17-20 turns <div style="border: 1px solid black; padding: 5px; margin: 10px 0;"> <p style="text-align: center;">CAUTION</p> <p>Use extreme caution when manipulating F-49 (zen) and F-44 (nad) prior to P-Clamp release; minimize loads input into QD hard lines and QDs</p> </div> <p><u>PUMP MODULE QD OPERATIONS</u></p> <ol style="list-style-type: none"> PGT [A7, CCW2, 30.5]-6-Ext-7/16: Release F44, F45, and F48 P-clamps, 12-14 turns (nadir) 	<p><u>SSRMS SETUP</u></p> <ol style="list-style-type: none"> Retrieve APFR from A/L Toolbox #1 (stbd) Translate to ESP2 fwd/zenith GCA SSRMS for APFR setup Install WIF adapter (tether point facing same direction as LEE) into SSRMS Install APFR on WIF adapter: configure to: [12,PP,F,6] Perform safety tether swap onto SSRMS safety tether; temp stow airlock safety tether on VSSA FRAM HR (fwd) <p><u>FGB REMOVAL FROM SPARE PUMP MODULE</u></p> <div style="border: 1px solid black; padding: 5px; margin: 10px 0;"> <p style="text-align: center;">CAUTION</p> <p>Minimize loads inputted into PM MLI handholds. It is possible that handholds may tear off when used</p> </div> <ol style="list-style-type: none"> Temp stow fish stringer #2 on ESP2 Release velcro strap on fwd face of PM MLI Open forward flap on PM MLI tent, attach velcro flaps (2) GCA SSRMS for ingress Attach waist tether to APFR, ingress SSRMS (head nadir) <div style="border: 1px solid black; padding: 5px; margin: 10px 0;"> <p style="text-align: center;">CAUTION</p> <p>Avoid contact with FGB grapple pin and RMS target</p> </div> <ol style="list-style-type: none"> Attach fish stringer #2 to PM fwd HRs (clear of FGB) SSRMS mnvr to FGB bolt release Tether to FGB PGT [B7, CCW2, 30.5]-6-Ext-7/16: Release FGB to Pump Module mounting bolts (4) 8-11 turns (any order) Remove FGB from Pump Module (soft dock) Attach FGB to BRT

FAILED PUMP MODULE REMOVAL FROM S1 (Cont)

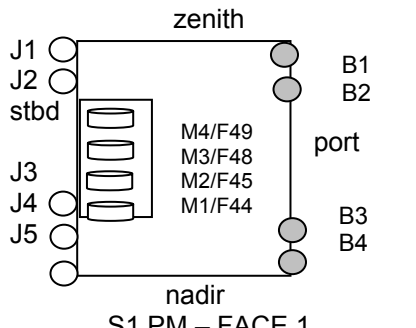
IV/SRMS/SSRMS	EV1 (FF)	EV2 (SSRMS)
<p>4. S1 PM R&R (SODF: RBT FS: FGB Removal)</p> <p>5. S1 PM R&R (SODF: RBT FS: FGB Install)</p>  <p>S1 PM – FACE 1</p>	<ol style="list-style-type: none"> 2. Release F44, F45, and F48 TA clamps from flexlines 3. Remove wire tie (1) from 1.5" SPDs, temp stow 4. Remove SPDs from QDs (4), stow on fish stringer #1 5. Check QD buttons installed (4) 6. Stow PGT on fish stringer #1 <div style="border: 1px solid black; padding: 5px; margin: 10px 0;"> <p style="text-align: center;">CAUTION</p> <p>When operating QDs, assess sideloads and flexhose alignment prior to mating/demating and valve opening/closing</p> <p>While demating F-44 from M1, do not exceed 20 lbs of force in the forward, zenith, and nadir direction</p> <p>Once F-44 is demated from M1, do not use the QD to manipulate the line out of the way (use the hard line)</p> </div> <ol style="list-style-type: none"> 7. BRT to port HR on CETA cart 8. Perform the following steps to close valve and demate S1-F44/PM M1: (nadir-most) <ol style="list-style-type: none"> A. Take valve to full open (push fwd, button pops up) (unsticks male sleeve seals) B. Depress button and close valve (pull bail aft) C. Verify detent button up D. Verify fwd white line visible E. Demate S1-F44 from M1 (using release trigger) F. Restrain S1-F44 clear of PM using adj tether 9. Perform the following steps to close valve and demate S1-F45/PM M2: <ol style="list-style-type: none"> A. Take valve to full open (push fwd, button pops up) (unsticks male sleeve seals) B. Depress button and close valve (pull bail aft) C. Verify detent button up D. Verify fwd white line visible E. Demate S1-F45 from M2 (using release trigger) F. Restrain S1-F45 clear of PM using adj tether 10. Perform the following steps to close valve and demate S1-F48/PM M3: <ol style="list-style-type: none"> A. Take valve to full open (push fwd, button pops up) (unsticks male sleeve seals) 	<p>12. SSRMS mnvr to failed PM (S1 Face 1, Bay 07) (head nadir)</p> <p><u>BREAK TORQUE ON PUMP MODULE BOLTS</u></p> <ol style="list-style-type: none"> 1. GCA SSRMS to Bolt 1 (zenith-most) 2. Perform the following steps to break torque on PM bolts 1, 2, 3, and 4: <ul style="list-style-type: none"> <input type="checkbox"/> Install round TM w/5/8" proud socket on PM Bolt <input type="checkbox"/> √Anti-backlash neutral <input type="checkbox"/> PGT [B6, CCW1, 30.5]-rd TM: Break torque on Bolt ~ 1 turn (of bolt) <input type="checkbox"/> GCA to next bolt as reqd 3. Remove TM from Bolt 4, stow on MWS 4. Reconfigure PGT with 6-inch socket (FGB ops)

FAILED PUMP MODULE REMOVAL FROM S1 (Cont)

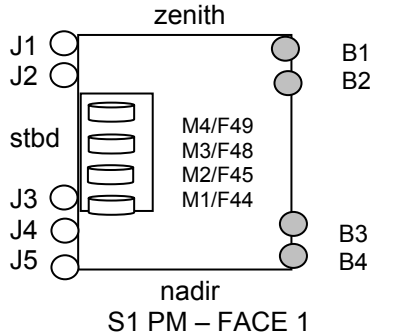
IV/SRMS/SSRMS	EV1 (FF)	EV2 (SSRMS)
<p>6. Inform MCC 1.5" QDs (3) are demated (valve change) (00:08 min vent thru vent panel)</p> <p>7. √MCC GO to close valve on S1-F49 (.5" QD) and that IV venting of PM is complete</p>  <p style="text-align: center;">S1 PM – FACE 1</p>	<p>B. Depress button and close valve (pull bail aft)</p> <p>C. Verify detent button up</p> <p>D. Verify fwd white line visible</p> <p>E. Demate S1-F48 from M3 (using release trigger)</p> <p>F. Restrain S1-F48 clear of PM using adj tether</p> <div style="border: 1px solid black; padding: 5px; margin: 10px 0;"> <p style="text-align: center;">CAUTION</p> <p>During valve closure and demate, F-49 (zen) can only be handled from the fwd end of the QD to a point halfway between the QD and P-clamp</p> <p>Use extreme caution when manipulating F-49 (zen) in the fwd, zenith, and nadir directions (during demate only)</p> </div> <p>11. PGT [A7, CCW2, 30.5]-6-Ext-7/16: Release F-49 P-clamp, 12-14 turns</p> <p>12. Perform the following steps to close valve and demate S1-F49/PM M4:</p> <p>A. Take valve to full open (push fwd, button pops up) (unsticks male sleeve seals)</p> <p>B. Depress button and close valve (pull bail aft)</p> <p>C. Verify detent button up</p> <p>D. Verify fwd white line visible</p> <p>E. Rotate locking collar to lock</p> <p>F. Demate S1-F49 from M4</p> <p>G. Restrain S1-F49 clear of PM using adj tethers</p>	

FAILED PUMP MODULE REMOVAL FROM S1 (Cont)

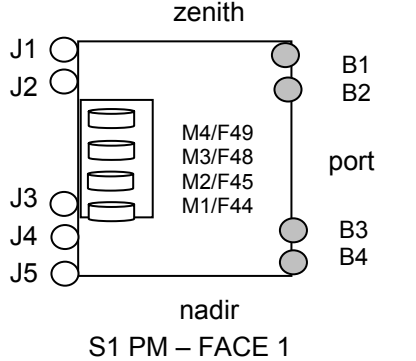
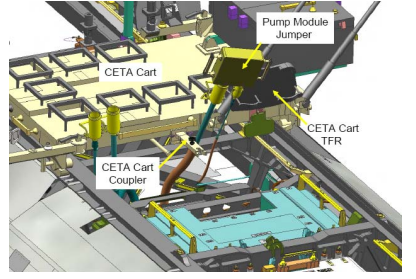
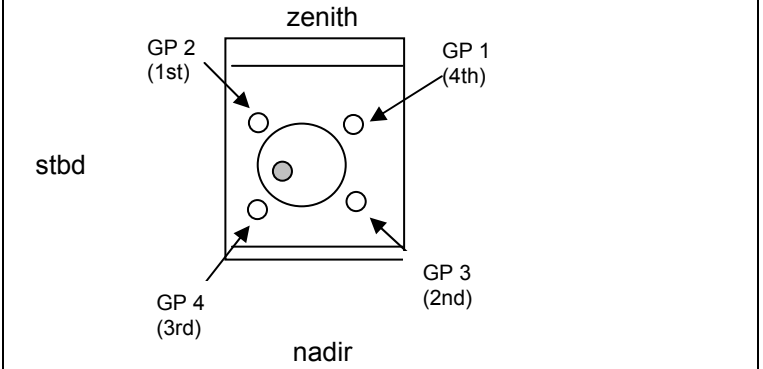
IV/SRMS/SSRMS	EV1 (FF)	EV2 (SSRMS)
<p data-bbox="86 548 499 906">  </p> <p data-bbox="86 950 499 1226">  </p> <p data-bbox="86 1242 499 1274">PM JUMPER STOW CONFIG</p> <p data-bbox="86 1323 499 1391">8A. Inform MCC that F44 valve is open (~ 1 minute to vent N2)</p>	<p data-bbox="499 292 1262 324"><u>PM JUMPER N2 VENT AND INSTALL</u></p> <ol data-bbox="499 357 1262 1391" style="list-style-type: none"> Retrieve PM Jumper from PM Jumper bag Transfer PM Jumper to EV2 Attach BRT to CETA cart port HR Perform the following steps to mate S1-F48 to PM Jumper M3: <ol data-bbox="609 535 1262 755" style="list-style-type: none"> Demate cap from PM Jumper M3 (lanyarded to box) Inspect male and female QDs for debris or damage √Button up √Release ring retracted (fwd white band not visible) Mate S1-F48 to PM jumper M3 √Fwd white band visible (snapback, pull and gap√) Perform the following steps to mate S1-F44 to PM Jumper M4: <ol data-bbox="609 836 1262 1055" style="list-style-type: none"> Demate cap from PM Jumper M4 (lanyarded to box) Inspect male and female QDs for debris or damage Verify detent button up √Release ring retracted (fwd white band not visible) Mate S1-F44 to PM Jumper M4 √Fwd white band visible (snapback, pull and gap√) Restrain PM jumper clear of PM removal space; mnvr jumper straight out of truss and stow on CETA cart using adjustables Perform the following steps to open valve on S1-F44/PM Jumper M4: <ol data-bbox="609 1242 1262 1315" style="list-style-type: none"> Depress detent button and open valve (push bail fwd) √Aft white band visible and detent button up <p data-bbox="499 1323 682 1356">← <input type="checkbox"/></p>	<p data-bbox="1262 292 2020 324"><u>PM JUMPER N2 VENT AND INSTALL</u></p> <ol data-bbox="1262 357 2020 576" style="list-style-type: none"> GCA SSRMS to assist EV1 with PM Jumper Receive PM Jumper from EV1 Orient PM jumper such that male QDs face ISS stbd, M4 zenith React QD loads as reqd <p data-bbox="1262 803 2020 1169">  </p> <p data-bbox="1262 1209 2020 1242">FGB TO PM BOLT LABELS</p>

FAILED PUMP MODULE REMOVAL FROM S1 (Cont)

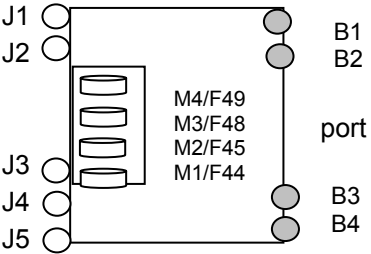
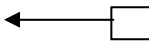
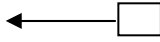
IV/SRMS/SSRMS	EV1 (FF)	EV2 (SSRMS)
<p>8B. MCC: When N2 venting complete, Thor to take NH3 Iso vent valve to close</p> <p>9. ✓With MCC inhibits in place for electrical connections</p> <p>10. Record turns and torque for FGB to PM mounting bolts: GP2: _____ turns _____ ft-lb GP3: _____ turns _____ ft-lb GP4: _____ turns _____ ft-lb GP1: _____ turns _____ ft-lb zenith</p>  <p style="text-align: center;">nadir S1 PM – FACE 1</p> <p>11. S1 PM R&R (SODF: RBT FS: PM Removal)</p>	<p>(if valve change does not happen prior to opening valve on M3, system NH3 would be dumped overboard thru vent panel)</p> <p>8. On MCC GO, perform the following steps to open valve on S1-F48/PM Jumper M3: A. Depress detent button and open valve (push bail fwd) B. ✓Aft white band visible and detent button up</p> <p>9. Assist EV2 with FGB install</p> <p><u>PUMP MODULE ELECTRICAL CONNECTIONS</u></p>  <p style="text-align: center;"><u>NOTE</u> Check connectors for damage, emi band, FOD, bent pins, and cable bend radii</p> <ol style="list-style-type: none"> Release TA clamps as reqd Demate the following connectors from the PM and restrain clear of PM using adjustable tethers: <ul style="list-style-type: none"> <input type="checkbox"/> S1 P525 from PM J5 (nadir most) <input type="checkbox"/> S1 P524 from PM J4 <input type="checkbox"/> S1 P523 from PM J3 <input type="checkbox"/> S1 P522 from PM J2 <input type="checkbox"/> S1 P521 from PM J1 Inform EV2 electrical connections complete (give GO to release last bolt) <p><u>RELEASE PUMP MODULE BOLTS</u></p> <ol style="list-style-type: none"> Assist EV2 as required Monitor clearances between PM and truss as reqd 	<p><u>FGB INSTALL</u></p> <ol style="list-style-type: none"> When EV1 complete with QD ops, GCA to FGB install Orient FGB such that RMS target is facing stbd Soft dock FGB to S1 Pump Module <div style="border: 1px solid black; padding: 5px; margin: 10px 0;"> <p style="text-align: center;"><u>CAUTION</u></p> <p>GP2 (zen/stbd) must be the first bolt torqued during installation. Remaining bolts torqued in a star pattern</p> </div>  <ol style="list-style-type: none"> PGT [A7, CW2, 30.5]-6-Ext-7/16: Engage PM to FGB mounting bolts (4) 8-11 turns; GP2, GP3, GP4, GP1 Stow 6-in socket on socket caddy Reconfig PGT with 5/8" socket <p><u>RELEASE PUMP MODULE BOLTS</u></p> <ol style="list-style-type: none"> PGT [B7, CCW2, 30.5]-7.8"-Ext-5/8: Release PM Bolt 1, 14-17 turns (bolt pops out) Tether to PM On EV1's Go (electricals finished): PGT [B7, CCW2, 30.5]-7.8"-Ext-5/8: Release PM Bolt 1, 14-17 turns (bolt pops out) Holding PM fwd HR and FGB HR, pull PM from truss in forward direction (slides along rails) GCA SSRMS operator as reqd to pull PM free of rails and truss

FAILED PUMP MODULE REMOVAL FROM S1 (Cont)

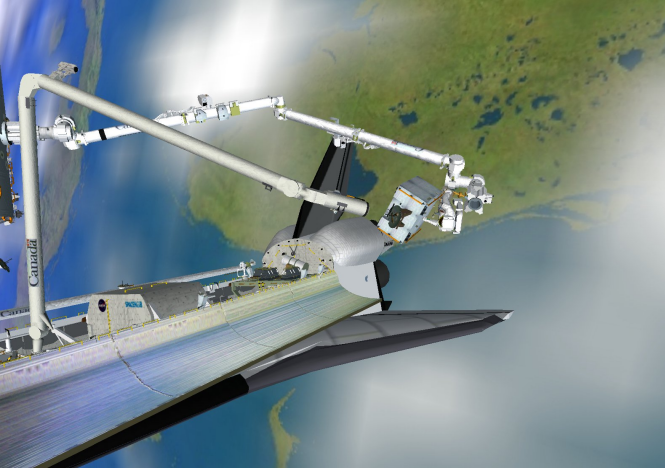
IV/SRMS/SSRMS	EV1 (FF)	EV2 (SSRMS)
<p>12. S1 PM R&R (SODF: RBT FS: Mnv to handoff)</p> <p>13. S1 PM Handoff (PDRS, Contingency Support)</p>	 <p>PM HANDOFF POSITION</p>	<p>6. At SSRMS clearance posn, orient the PM such that:</p> <ul style="list-style-type: none"> ❑ FGB is toward your head ❑ You are holding the bottom HRs <p><u>TEMP STOW FAILED PUMP MODULE ON SRMS</u></p> <ol style="list-style-type: none"> 1. SSRMS mnvr to PM handoff position 2. While holding PM steady, give SRMS operator GO to capture PM, release tether (leave RET on PM HR) <ul style="list-style-type: none"> ❑ hold PM parallel to chest ❑ SRMS will back away to a clearance posn (ISS nad/por)

SPARE PUMP MODULE RETRIEVAL FROM ESP2

IV/SSRMS	EV1 (FF)	EV2 (SSRMS)
<p>1. S1 PM R&R (SODF: RBT FS: Spare PM Retrieval)</p> <p>2A. Start PM thermal clock MET: _____</p> <p>2B. Record serial #: _____</p> <p>3. √MCC inhibits in place for electrical connections</p>	<p><u>SPARE PUMP MODULE ELECTRICAL CONNECTIONS</u></p> <p>1. Translate to ESP2, monitor clearances between EV2, LEE, and Lab</p> <div style="border: 1px solid black; padding: 5px; margin: 10px 0;"> <p style="text-align: center;">CAUTION</p> <p style="text-align: center;">Minimize loads inputted into PM MLI handholds. It is possible that handholds may tear off when used</p> </div> <p>2. Fold back remaining flaps of MLI tent</p> <ul style="list-style-type: none"> • (front flap already folded back) • Release three 1/4 turn fasteners on stbd flap and fold up toward top of PM, attach velcro flaps (2) • Release three 1/4 fasteners on aft flap • Release MLI strap from top of PM (velcroes) • Using strap, pull MLI tent away from PM in port direction, attach to S0/Lab aft struts <p style="text-align: center;">← <input type="checkbox"/></p> <p>3. Close FGB-PM mounting bolts thermal cover</p> <p>4. Read serial # to IV</p> <p>5. Remove 4 QD caps from M1, M2, M3, and M4</p> <p>6. Stow caps on fish stringer #2</p> <p>7. Release tape from PM fwd/stbd HR (3 pieces) and fwd/port HR (3 pieces), fold in half, stow in trash bag</p> <p style="text-align: center;">← <input type="checkbox"/></p> <p>8. Demate M/W J5 (P11) from PM J5, temp stow</p> <p>9. Demate M/W J4 (P10) from PM J4, temp stow</p>	<p><u>BREAK TORQUE ON PUMP MODULE BOLTS</u></p> <p>1. SSRMS mnvr to ESP2</p> <p>2. Stow 5/8" socket onto socket caddy</p> <p>3. GCA SSRMS to PM bolt release worksite (bolt 4)</p> <p>4. Perform the following steps to break torque on PM bolts 4, 3, 2, and 1:</p> <ul style="list-style-type: none"> □ Install round TM w/5/8" proud socket on PM Bolt □ √Anti-backlash neutral □ PGT [B6, CCW1, 30.5]-rd TM: Break torque on Bolt ~ 1 turn (of bolt) □ GCA to next bolt as reqd <p>5. Remove TM from Bolt 1, stow on MWS</p> <p>6. Reconfigure PGT w/5/8-in socket</p> <p><u>RELEASE PUMP MODULE BOLTS</u></p> <p>1. PGT [B7, CCW2, 30.5]-7.8"-Ext-5/8: Release PM Bolts 1, 2, and 3, 14-17 turns (bolts pop out)</p>

SPARE PUMP MODULE RETRIEVAL FROM ESP2 (Cont)

IV/SSRMS	EV1 (FF)	EV2 (SSRMS)
	<ol style="list-style-type: none"> 10. Demate conn cap from from J3, stow on fish stringer #2 11. Demate conn cap from from J2, stow on fish stringer #2 12. Demate M/W J1 (P12) from PM J1, temp stow cable on ESP2 HR 8013 13. Remove fish stringer #2 from PM HRs, stow on VSSA FRAM HR 14. Give EV2 GO to release remaining bolt 15. Monitor clearances as reqd 	<ol style="list-style-type: none"> 2. Receive GO from EV1 to release last bolt 3. Tether to PM 4. PGT [B7, CCW2, 30.5]-7.8"-Ext-5/8: Release PM Bolt 4, 14-17 turns (bolt pops out) 5. Using PM forward HRs, remove PM from FRAM (slides fwd along LAPA guide rails), GCA SSRMS as reqd (rotating does not help here)

SPARE PUMP MODULE INSTALL ON S1

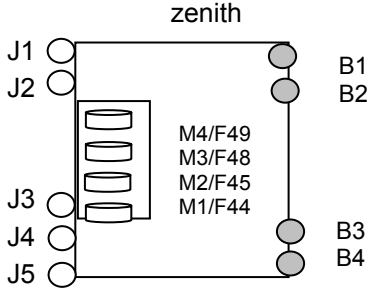
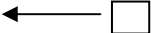
IV/SSRMS	EV1 (FF)	EV2 (SSRMS)
<p>1. S1 PM R&R (SODF: RBT FS: Spare PM Install)</p>  <p style="text-align: center;">S1 PM – FACE 1</p> <p>2. √MCC electrical inhibits in place</p>	<p><u>S1 PM INSTALL</u></p> <ol style="list-style-type: none"> 1. Translate to S1 Bay 07 2. GCA as required 3. Check with EV2 at least 1 bolt installed prior to beginning electrical ops (structural reasons) <p><u>PUMP MODULE ELECTRICAL CONNECTIONS</u></p>  <p style="text-align: center;"><u>NOTE</u> Check connectors for damage, FOD, emi band, bent pins, and cable bend radii</p> <ol style="list-style-type: none"> 1. Mate S1 P521 to PM J1, close TA clamps as required 2. Mate S1 P522 to PM J2, close TA clamps as required 3. Mate S1 P523 to PM J3, close TA clamps as required 4. Mate S1 P524 to PM J4, close TA clamps as required 5. Mate S1 P525 to PM J5, close TA clamps as required 6. Inform MCC connectors mated 	<p><u>S1 PM INSTALL</u></p> <ol style="list-style-type: none"> 1. SSRMS mnvr to S1 Bay 07 2. At truss clearance posn, re-orient PM such that bolts point port 3. Install PM into truss (slides along rails), GCA SSRMS as reqd <p><u>PM BOLT INITIAL TORQUE</u></p> <ol style="list-style-type: none"> 1. GCA SSRMS to PM Bolt 1 (zen, reqd to do first) 2. PGT [B7, CW2, 30.5]-7.8"-Ext-5/8: Drive PM Bolts 1, 2, 3, and 4, 14-17 turns 3. Give EV1 GO to begin electricals 4. Release PM tether 5. Remove 5-8" socket from PGT, stow on caddy

SPARE PUMP MODULE INSTALL ON S1 (Cont)

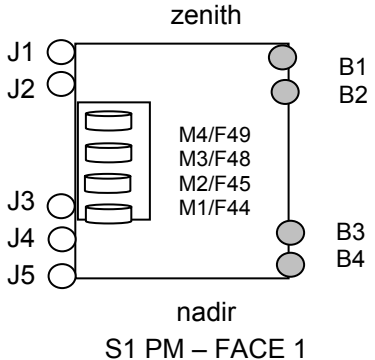
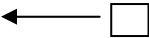
IV/SSRMS	EV1 (FF)	EV2 (SSRMS)
<p>3A. Give MCC GO for PM Jumper venting (~ 5 min)</p> <p>3B. Receive GO from MCC: PM Jumper NH3 venting complete; GO for PM Jumper removal</p>  <p style="text-align: center;">S1 PM – FACE 1</p>	<p><u>PM JUMPER NH3 VENT AND REMOVAL</u></p> <ol style="list-style-type: none"> 1. Attach BRT to CETA cart port HR 2. Perform the following steps to close valve on S1-F48/PM Jumper M3: <ol style="list-style-type: none"> A. Close valve (depress button, pull bail aft) B. Verify detent button up C. Verify fwd white line visible <div style="text-align: center;">  </div> <ol style="list-style-type: none"> 3. Release PM Jumper from CETA cart 4. Transfer PM Jumper to EV2 5. Perform the following steps to close valve and demate S1 F49/PM Jumper M4: <ol style="list-style-type: none"> A. Close valve (depress button, pull bail aft) B. Verify detent button up C. Verify fwd white line visible D. Rotate locking collar to lock E. Demate S1-F49 from PM Jumper M4 6. Temp stow S1-F49 7. Perform the following step to demate S1-F48 from PM Jumper M3: <ol style="list-style-type: none"> A. Demate S1-F48 from PM Jumper M3 (using release trigger) 	<p><u>PM JUMPER NH3 VENT AND REMOVAL</u></p> <ol style="list-style-type: none"> 1. GCA SSRMS to PM Jumper removal wkst 2. Hold PM Jumper to react loads (Jumper cannot be moved until vented due to loads constraints on M4 line when pressurized) <p>3. Receive PM Jumper from EV1, react loads as reqd</p> <p>4. Temp stow PM Jumper</p>

SPARE PUMP MODULE INSTALL ON S1 (Cont)

IV/SSRMS	EV1 (FF)	EV2 (SSRMS)
<div data-bbox="121 370 493 727" data-label="Diagram"> <p style="text-align: center;">S1 PM – FACE 1</p> </div> <p data-bbox="121 812 493 950">4. Receive GO from MCC to mate/open valve on F49 (.5" QD) ~ 12 min (begin MCC venting of N2)</p>	<div data-bbox="598 316 1192 487" data-label="Text" style="border: 1px solid black; padding: 5px;"> <p style="text-align: center;">CAUTION</p> <p>When mating S1-F48 to PM M3, do not open valve until all N2 has been vented from the PM. Otherwise, undesired mixing of NH3 and N2 will occur inside the PM</p> </div> <p data-bbox="541 511 1249 730">8. Perform the following steps to <u>mate</u> S1-F48 to PM M3:</p> <ol style="list-style-type: none"> A. Inspect male and female QDs for debris or damage B. ✓Button up C. ✓Release ring retracted (fwd white band not visible) D. Mate S1-F48 to PM M3 E. ✓Fwd white band visible (snapback, pull and gap✓) <p data-bbox="541 771 903 803"><u>S1 PUMP MODULE N2 VENT</u></p> <div data-bbox="556 812 714 852" data-label="Diagram"> </div> <div data-bbox="598 860 1213 1055" data-label="Text" style="border: 1px solid black; padding: 5px;"> <p style="text-align: center;">CAUTION</p> <p>Use extreme caution when manipulating F-49 (zen) in the fwd, zenith, and nadir directions</p> <p>During mate and valve opening, F-49 (zen) can only be handled from the fwd end of the QD to a point halfway between the QD and P-clamp</p> </div> <p data-bbox="541 1063 1270 1388">1. Perform the following steps to mate and open valve on S1-F49/PM M4:</p> <ol style="list-style-type: none"> A. Inspect male and female QDs for debris or damage B. Verify detent button up; ✓collar locked C. ✓Release ring retracted (fwd white band not visible) D. Mate S1-F49 to PM M4 E. ✓Fwd white band visible (snapback, pull and gap ✓) F. Rotate locking collar to unlock G. Depress detent button and open valve (push bail fwd) 	<p data-bbox="1302 771 1627 803"><u>PM BOLT FINAL TORQUE</u></p> <ol style="list-style-type: none"> 1. Perform the following steps for final torquing of PM bolts 1, 2, 3, and 4: <ul style="list-style-type: none"> ❑ Install round TM w/5/8" proud socket on PM bolt ❑ ✓Anti-backlash neutral ❑ PGT [A4, CW1, 30.5]-rd TM: Drive PGT ~ 1 turn (of bolt), 5 turns (PGT) ❑ GCA to next bolt as reqd 2. Remove TM from Bolt 4, stow on MWS

SPARE PUMP MODULE INSTALL ON S1 (Cont)

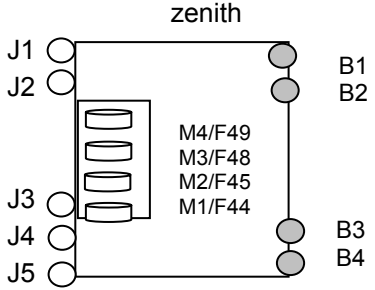
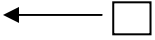
IV/SSRMS	EV1 (FF)	EV2 (SSRMS)
<p>5. √MCC GO to mate/open valve for F48, F44, and F45 (N2 venting complete)</p>  <p style="text-align: center;">nadir S1 PM – FACE 1</p>	<p>H. √Aft white band visible and detent button up</p> <p><u>PUMP MODULE QD OPERATIONS</u></p>  <div style="border: 1px solid black; padding: 5px; margin: 10px 0;"> <p style="text-align: center;"><u>CAUTION</u></p> <p>S1-F49/M4 P-Clamp must be installed prior to opening valve on S1-F48/M3 to preclude damage to S1-F49 QD</p> </div> <ol style="list-style-type: none"> 1. PGT [A7, CW2, 30.5]-6-Ext-7/16: Re-install S1-F49 P-Clamp, 12-14 turns 2. Perform the following steps to open valve on S1-F48/PM M3: <ol style="list-style-type: none"> A. Depress detent button and open valve (push bail fwd) B. √Aft white band visible and detent button up 3. Perform the following steps to mate and open valve on S1-F45/PM M2: <ol style="list-style-type: none"> A. Inspect male and female QDs for debris or damage B. √Button up C. √Release ring retracted (fwd white band not visible) D. Mate S1-F45 to PM M2 E. √Fwd white band visible (snapback, pull and gap√) F. Depress detent button and open valve (push bail fwd) G. √Aft white band visible and detent button up 	

SPARE PUMP MODULE INSTALL ON S1 (Cont)

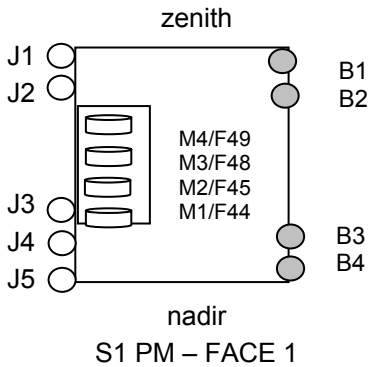
IV/SSRMS	EV1 (FF)	EV2 (SSRMS)
 <p style="text-align: center;">S1 PM – FACE 1</p>	<div style="border: 1px solid black; padding: 5px; margin-bottom: 10px;"> <p style="text-align: center;">CAUTION</p> <p>Do not use the QD on F-44 (nad) when re-orienting the line to the mate position (use the hard line)</p> <p>When mating F-44 to M1, do not exceed 20 lbs of force in the forward, zenith, and nadir direction</p> </div> <ol style="list-style-type: none"> 4. Perform the following steps to mate and open valve on S1-F44/PM M1: <ol style="list-style-type: none"> A. Inspect male and female QDs for debris or damage B. ✓Button up C. ✓Release ring retracted (fwd white band not visible) D. Mate S1-F44 to PM M1 E. ✓Fwd white band visible (snapback, pull and gap✓) F. Depress detent button and open valve (push bail fwd) G. ✓Aft white band visible and detent button up 5. Retrieve fish stringer #1 from CETA cart 6. Install 1.5" SPDs (3): <ul style="list-style-type: none"> – Install aft part of SPD (black fwd) – Depress button and pull bail aft against SPD – Install fwd part of SPD (black to black) – Push bail against fwd SPD; ✓button down 7. Install wire tie on three 1.5" SPDs, attach to QD bail, fluid line, or surrounding structure 8. Install .5" SPD: <ul style="list-style-type: none"> – Pull bail aft ~ 1/4 inch (until aft white line hidden) – Install SPD (slider aft) – Push SPD slider forward – Secure bail in SPD slider; engage lock button 	

SPARE PUMP MODULE INSTALL ON S1 (Cont)

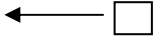
IV/SSRMS	EV1 (FF)	EV2 (SSRMS)
<p>6. Inform MCC when QD ops complete</p>	<div style="text-align: center;">  </div> <p><u>CETA CART CLEANUP</u></p> <ol style="list-style-type: none"> 1. √CETA 2 coupler in CAPTURE 2. Release CETA 2 parking brake (tap pedal twice) <div style="border: 1px solid black; padding: 5px; margin: 10px auto; width: fit-content;"> <p style="text-align: center;"><u>CAUTION</u> CETA to MT max coupling rate is 0.5 ft/sec</p> </div> <ol style="list-style-type: none"> 3. Couple CETA 2 to MT; take CETA 2 coupler to LOCK 4. √CETA 1 coupler in CAPTURE 5. Release CETA 1 parking brake (tap pedal twice) 6. Slide CETA 1 toward CETA 2 <div style="border: 1px solid black; padding: 5px; margin: 10px auto; width: fit-content;"> <p style="text-align: center;"><u>CAUTION</u> CETA to CETA max coupling rate is 1 inch/sec</p> </div> <ol style="list-style-type: none"> 7. Couple CETA 1 to CETA 2; take CETA 1 coupler to LOCK 8. Retrieve fish stringer #1 and PM Jumper bag 	

INSTALLATION OF FAILED PUMP MODULE ONTO ESP2

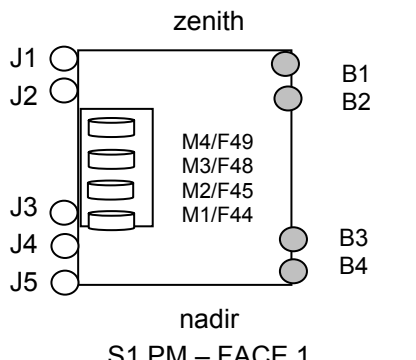
IV/SSRMS	EV1 (FF)	EV2 (SSRMS)
<p>1. S1 PM R&R (SODF: RBT FS: PM Retrieval)</p> <p>2. S1 PM Handoff (PDRS, <u>Contingency Support</u>)</p> <p>3. S1 PM R&R (SODF: RBT FS: Failed PM Install on ESP2)</p> <p>4. Start torque wrench thermal clock: _____ (3.5 hours)</p>  <p style="text-align: center;">S1 PM – FACE 1</p>	<p style="text-align: center;"><u>INSTALL FAILED PUMP MODULE ONTO ESP2</u></p> <p>1. Translate to airlock, temp stow fish stringer #1 and PM Jumper</p> <p>2. Retrieve torque wrench from inside airlock</p> <p style="text-align: center;">← <input type="checkbox"/></p> <p>3. Translate to ESP2</p> <p>4. Monitor clearances between EV2, LEE, and Lab</p> <p>5. BRT to ESP2 HR 8012 (fwd)</p> <p>6. GCA as required</p> <p>7. Retrieve fish stringer #2 from VSSA FRAM HRs</p> <p>8. Retrieve M/W J4 and J5 connectors</p> <p>9. Receive GO from EV2 to translate on PM</p>	<p style="text-align: center;"><u>RETRIEVE FAILED PUMP MODULE FROM SRMS</u></p> <p>1. SSRMS mnvr to SRMS (clearance posn)</p> <p>2. GCA SSRMS to PM retrieval posn</p> <p>3. Grasp PM using bottom HRs (head nearest to FGB), use RET left on PM to tether</p> <p>4. Give SRMS operator GO for PM ungrapple</p> <p>5. Give SRMS operator GO to mnvr to clearance posn</p> <p style="text-align: center;"><u>INSTALL FAILED PUMP MODULE ONTO ESP2</u></p> <p>1. SSRMS mnvr to ESP2 failed PM install posn</p> <p>2. Reorient PM so FGB interface is fwd</p> <p>3. Install PM onto PM FSE, GCA SSRMS as reqd</p> <p style="text-align: center;"><u>PM BOLT INITIAL TORQUE</u></p> <p>1. GCA SSRMS to PM bolts</p> <p>2. PGT [B7, CW2, 30.5]-7.8"-Ext-5/8: Drive PM Bolt 1, 14-17 turns (reqd to do first)</p> <p>3. Give EV1 GO to translate on PM</p>

INSTALLATION OF FAILED PUMP MODULE ONTO ESP2 (Cont)

IV/SSRMS	EV1 (FF)	EV2 (SSRMS)
<p>5. √MCC electrical inhibits in place</p> <p>6. Give MCC GO to power up PM on ESP2 after EV1 and EV2 connections complete</p> <p>7. S1 PM R&R (SODF: RBT FS: APFR Egress)</p> <p>8. S1 PM R&R (SODF: RBT FS: APFR Removal)</p>	<p>10. Install fish stringer #2 on PM HRs</p> <p><u>PM ELECTRICAL CONNECTIONS</u></p> <p>← <input type="checkbox"/></p> <ol style="list-style-type: none"> Mate M/W J5 (P11) to PM J5 Mate M/W J4 (P10) to PM J4 Retrieve J3 cap from fish stringer #2, mate to J3 Retrieve J2 cap from fish stringer #2, mate to J2 Transfer torque wrench to EV2 Retrieve M/W J1 connector, mate M/W J1 (P12) to PM J1 Inform IV when connections complete <p>← <input type="checkbox"/></p> <p>8. Retrieve QD caps (4) from fish stringer</p> <p style="text-align: center;"><u>NOTE</u> QD cap lock tab may not fully engage. If tab does not fully engage after several attempts to seat, leave QD uncapped</p> <ol style="list-style-type: none"> Install QD caps onto M1, M2, M3, and M4 Retrieve fish stringer #2 from PM HRs Release MLI strap from S0/Lab struts and re-install MLI onto PM <ul style="list-style-type: none"> <input type="checkbox"/> Attach aft 1/4 turn fasteners (3) 	<ol style="list-style-type: none"> Drive PM Bolts 2, 3, and 4, 14-17 turns Remove 5/8" socket from PGT, temp stow Release PM tether <p><u>PM BOLT FINAL TORQUE</u></p> <ol style="list-style-type: none"> Receive torque wrench from EV1, verify set to 37 ft-lbs Install 5/8" socket onto wrench Tighten PM bolts (4) until torque wrench trips (any order) <p><u>SSRMS CLEANUP</u></p> <ol style="list-style-type: none"> SSRMS mnvr to ESP2 egress posn Egress SSRMS Perform safety tether swap onto airlock safety tether, verify ST config Relocate APFR from SSRMS to A/L Toolbox #1; reconfigure to: [9,MM,F,12] Remove WIF adapter, stow on MWS Translate to airlock Perform tool inventory Stow torque wrench on fish stringer #1

INSTALLATION OF FAILED PUMP MODULE ONTO ESP2 (Cont)

IV/SSRMS	EV1 (FF)	EV2 (SSRMS)
	<ul style="list-style-type: none"><input type="checkbox"/> Release stbd flap from top of MLI (2 straps)<input type="checkbox"/> Verify Velcro from Flap 3 is attached<input type="checkbox"/> Attach stbd 1/4 turn fasteners (2) <p>12. When EV2 complete w/bolts, reinstall MLI tent</p> <p>13. Ensure all Velcro flaps are covered, and fwd Velcro strap installed</p> <p><u>CLEANUP</u></p> <ol style="list-style-type: none">1. Translate to crewlock and stow PM Jumper bag2. Translate to airlock3. Perform tool inventory	

INGRESS

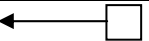
IV	EV1 (FF)	EV2 (FF)
<ol style="list-style-type: none"> 1. Perform WVS PWRDN (PHOTO/TV, <u>WVS CUE CARD</u>) 	<ol style="list-style-type: none"> 1. Receive EV2 safety tether; stow on airlock aft D-ring, √reel unlocked 2. Transfer fish stringers #1 and #2 to EV2 3. Connect right waist tether to D-ring extender on airlock internal D-ring, verify ST config 4. Disconnect from airlock safety tether, stow on airlock fwd D-ring, √reel unlocked 5. Ingress airlock 6. Retrieve SCU, remove DCM cover 7. Connect SCU to DCM, √locked 8. DCM: water – OFF 9. Hatch thermal cover – close, attach Velcro strap <div data-bbox="957 1003 1617 1097" style="border: 1px solid black; padding: 5px; text-align: center; margin: 10px auto; width: fit-content;"> <p>CAUTION Do not close hatch until EMU water – OFF for 2 min</p> </div> <ol style="list-style-type: none"> 10. Verify hardware clear of hatch 11. Outer hatch – close and lock 12. Go to PRE REPRESS 	<div style="text-align: center; margin-bottom: 10px;">  </div> <ol style="list-style-type: none"> 1. Ingress airlock 2. Connect right waist tether to UIA panel fwd D-ring, verify ST config 3. Disconnect from airlock safety tether, hand to EV1 4. Receive fish stringers #1 and #2 from EV1 5. Retrieve SCU, remove DCM cover 6. Connect SCU to DCM, √locked 7. DCM: water – OFF <ol style="list-style-type: none"> 8. Go to PRE REPRESS

S1 PUMP MODULE R&R TASK DATA SHEET

Tools:

EV1	EV2
PGT w/6-in	PGT w/6-in
PM Jumper	Round TM w/58" proud socket
(1.5" vent tool)	Torque Wrench

Foot Restraints:

Task	WIF	APFR Setting
PM R&R	SSRMS	12, PP, F,6

EVA Fasteners:

Fastener Name	Label	Head Size	Qty	Release/Install Torque (ft-lbs)	Failure Torque (ft-lbs)	Turns	RPM
FGB-PM mounting bolts	GP1, GP2, GP3, GP4	7/16"	4	Release: 25.5 Install: 9.2		Release: 17-20 Install: 8-11 (w/FGB inplace)	30
PM Attach Bolts (truss)	Bolt 1, 2, 3,4	5/8"	4	Release: 25 (w/TM) Install: 6.3 (w/TM)		Release: 14-17 Install: 14-17	30
PM Attach Bolts (FSE)	Bolt 1, 2, 3,4	5/8"	4	Release: 24 (w/TM) Install: 37 - torq wren		Release: 14-17 Install: 14-17	30
P-Clamp Bolts	NA	7/16"	4	Release: 9.2 Install: 7.0		Release: 12-14 Install: 12-14	30

EVA Connectors:

Connector	From	To	Clamps	Size	Function
S1 P521		PM J1	1		
S1 P522		PM J2	1		
S1 P523		PM J3	1		
S1 P524		PM J4	1		
S1 P525		PM J5	1		
ESP2 M/W J5 (P11)		PM J5			
ESP2 M/W J4 (P10)		PM J4			
ESP2 M/W J1 (P12)		PM J1			

Notes:

1. Check connectors for damage, emi band, FOD, bent pins, and cable bend radii
2. Original vent time of 00:25 for failed PM NH3 vent given by TCS community. New time of 00:08 minutes given by Boeing TCS

Cautions:

1. When operating QDs, assess sideloads and flexhose alignment prior to mating/demating and valve opening/closing
2. Avoid contact with FGB grapple pin and RMS target
3. Minimize loads inputted into PM MLI handholds. It is possible that handholds may tear off when used
4. GP2 must be the first bolt torqued during installation. Remaining bolts torqued in a star pattern
5. When operating QDs, assess sideloads and flexhose alignment prior to mating/demating and valve opening/closing
6. PM Installation bolts (for initial torque) must be installed in the following order: bolt 1 first, and then bolts 2-4 in any order (due to nut plate tolerances). There is no required order for bolt release, and no required order for torque multiplier operations (KSC)

Warnings:

1. N/A

Timeline Considerations:

1. The PM thermal clock begins when the PM MLI tent is removed on ESP2

Connector	From	To	Clamps	Size	Function
S1-F49	NA	M4	1 P, 1 TA	.5"	Connects the NH3 tank and NH3 supply to the inlet side of the PM (downstream of mixing valve) – venting QD
S1-F48	NA	M3	1 P, 1 TA	1.5"	Connects outlet of the PM to the EATCS system (iso valve)
S1-F45	NA	M2	1 P, 1 TA	1.5"	Connects radiator return NH3 to PM inlet
S1-F44	NA	M1	1 P, 1 TA	1.5"	Connects bypass return NH3 to PM inlet (doesn't go thru radiators)

S1 PUMP MODULE R&R TASK DATA SHEET (Cont)

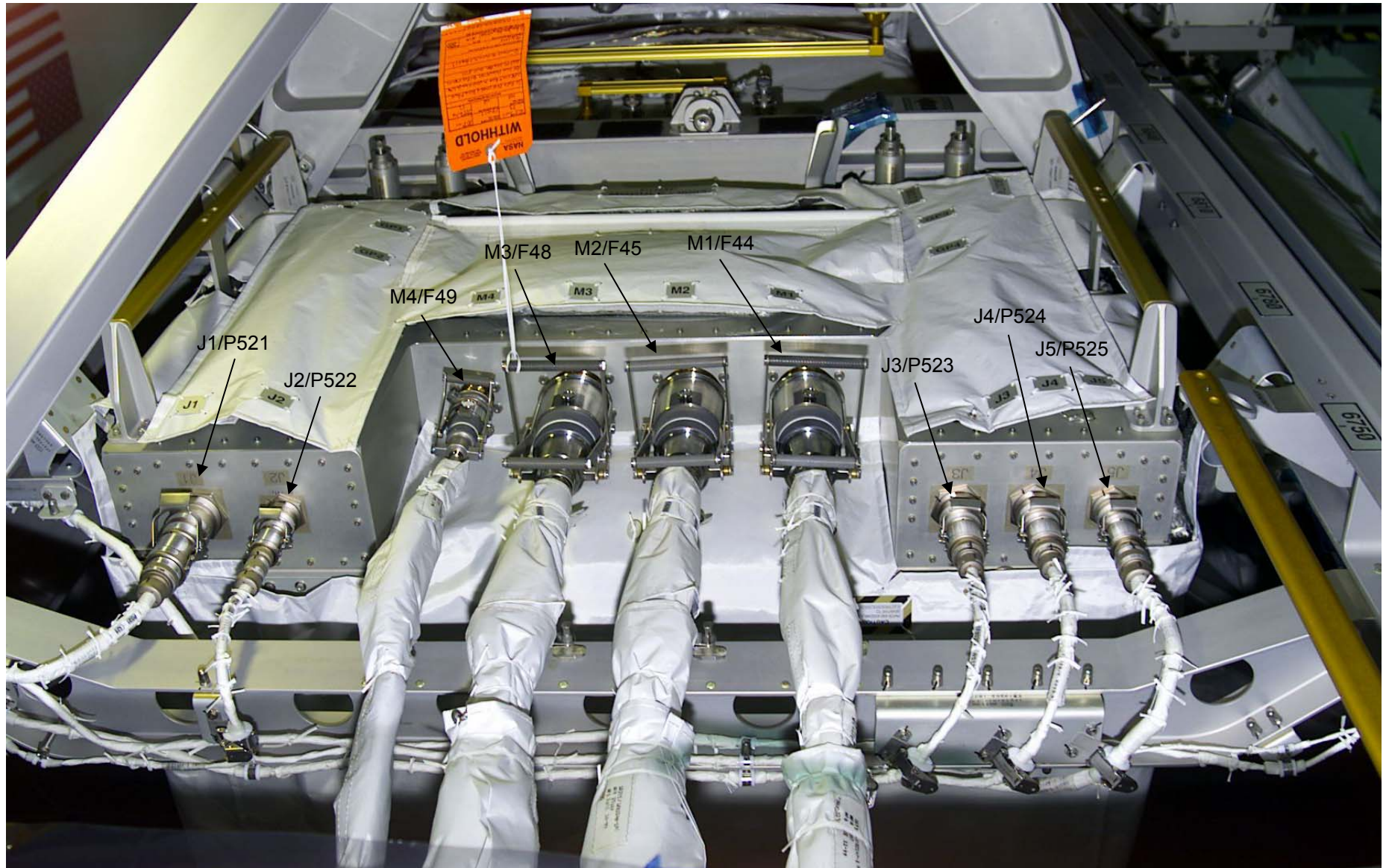

STBD

FS 16-152



EVA/116/FIN

NOTES

Assumptions:

- Start on 85' safety tethers at airlock
- MT @ WS 2; CETA carts coupled to port side of MT; CETA carts can be decoupled and moved as reqd to allow EV1 good access to QD lines
- SSRMS on MBS PDGF 3
- Temp stow failed PM on SRMS
Keep crew separated from each other during failed PM venting ops to minimize contamination
- Plan to leave all cont tools in airlock
- Plan to remove 4 QD caps and 2 remaining electrical dust caps at ESP2 and leave them there for PM translation to S1
- EV1 FF/EV2 SSRMS
- EV1 on 85' safety tether
- Assumed 1st QD bag is outside and all cont tools we will need are in it
- For venting: the procedure is written assuming that IV can vent through the vent panel, and that no EVA venting of the NH3 from the failed PM is required. It also assumes we vent the PM jumper of Nitrogen using the vent panel and not the vent tool
- Need 2 crewmembers for all PM jumper operations, including N2 venting of jumper
- If EV crew vents N2 from spare PM on ESP2 (~12 min)
- The procedure is baselined to allow MCC to vent the N2 from the spare PM while it's in the truss. There is no additional EVA time needed for this. As soon as the PM gets installed into the truss, EV1 will mate and open valve on the .5: QD; no electricals are reqd for this since the valves are already configured to allow the N2 to vent through the ATA panel. No additional EVA time is needed

SSRMS JOINT DRIVE

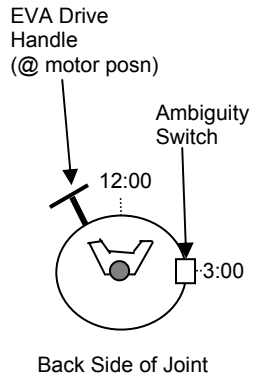
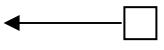
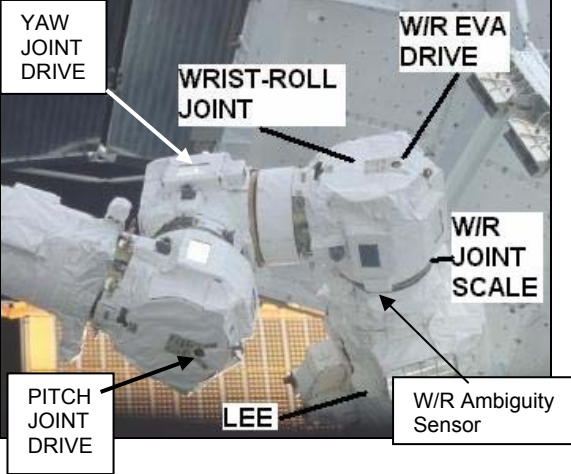
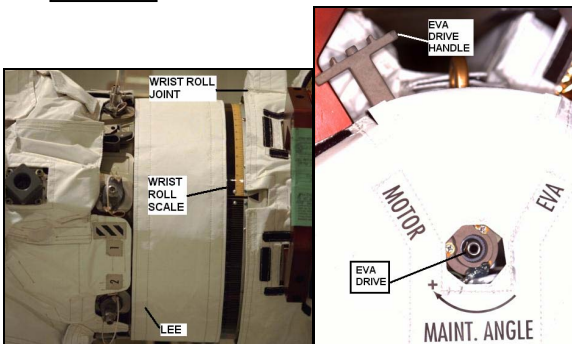
IV/RMS	EV1/EV2	REFERENCE
<p><u>IV NOTE</u></p> <p>Square scoop may be needed for body positioning at the worksite. If required, retrieve square scoop from crewlock bag #1 in airlock. Install square scoop on failed joint micro fitting; attach BRT for body stabilization</p> <p>1. IV: Record ambiguity sensor reading and joint angle: _____</p>  <p>Joint Scale and Black Triangle</p>  <p>Ambiguity Switch</p>  <p>EVA Drive Handle (@ motor posn)</p> <p>Ambiguity Switch</p> <p>12:00</p> <p>3:00</p> <p>Back Side of Joint</p>	<p><u>INITIAL POSITION VERIFICATION</u></p> <ol style="list-style-type: none"> 1. Translate to failed joint 2. Verify initial joint position using the following: <ul style="list-style-type: none"> ❑ Black triangle on fixed side of failed joint ❑ Ambiguity sensor (90 degrees CW from EVA drive, toward front side of joint)  <p><u>JOINT EVA DRIVE</u></p> <ol style="list-style-type: none"> 1. Depress button and move EVA Drive handle to EVA 2. PGT[A 2.5 ft-lb, CW2 or CCW2 (as required), MTL 1.5]-6ext-7/16: Drive EVA bolt in +/- direction _____ turns to desired position 3. Verify joint angle using scale and ambiguity sensor 4. If possible, verify joint angle with IV; if necessary, fine position joint using PGT in manual ratchet mode 5. Depress button and move EVA Drive handle to MOTOR 	<p><u>REFERENCE</u></p>  

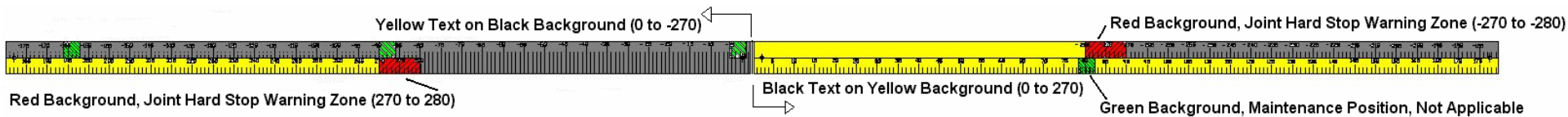

JOINT SCALE

SSRMS JOINT DRIVE TASK DATA SHEET

Tools:

EV1
PGT
7/16 (wobble) Socket-6 ext
BRT
Square Scoop

EVA Fasteners:

Fastener Name	Label	Head Size	Qty	Min Drive Torque (ft-lb)	Max Drive Torque (ft-lb)	Failure Torque (ft-lb)	RPM
EVA Drive	--	7/16	1				30

Foot Restraints: N/A

Other:

1. Gear ratio: 3.26 EVA Drive turns/1 degree of joint movement
2. CW input to the EVA drive will produce CCW motion of the joint
3. Starting from LEE, the order of joints is: roll, yaw, pitch
4. The signs of the logical (indicated on RWS) and physical (indicated on EVA scale) angles are reversed for the wrist roll joint (i.e. +73.2 logical = -73.2 physical)
5. Scale and Ambiguity Switch
 - Since the SSRMS joints can rotate more than 360 degrees, there is an ambiguity switch that tells the crewmember whether to use the positive or negative scale
 - The crew reads the scale using the black triangle on the fixed side of the joint. Located to the side of the black triangle (~ 90 degrees around the circumference of the joint) is the ambiguity switch. The switch has a pointer that indicates "+" or "-" to tell the crew which side of the scale to read. If the ambiguity switch points to "+" then the crew should read off the yellow scale (black text on yellow background). If the switch points to "-" then the crew should read off the black scale (yellow text on black background)
 - EVA Drive handle is on back side of joint (away from LEE), and scale triangle is across from it toward the LEE side

Cautions:

1. Avoid contact with ACU radiator surface – silver Teflon film (white in color)
2. CLA and CLPA radiator surface – silver Teflon film (white in color)
3. VDU radiator surface – silver Teflon film (white in color)
4. JEU radiator surface – Z93 paint

MSS EXTENSION CABLE INSTALL (00:45)

IV/SSRMS							EV1 (FF)		EV2 (FF)																																																																									
<p>√MCC Go for MT power cable demate</p> <p>* If no comm: Reference RPCM on Task *</p> <p>* Data Page: *</p> <p>S0 (P1): EPS: 'RPCM X' 1:</p> <p>RPCM X RPC 1</p> <p>Verify 'RPC Position' – Op</p> <p>√Close Cmd – Inh</p>							<p><u>NOTE</u></p> <p>MSS Extension Cable is coiled into 5 wire tied loops, each 7 feet long; wire ties are captive</p> <p>← </p>		<p><u>NOTE</u></p> <p>MSS Extension Cable is coiled into 5 wire tied loops, each 7 feet long; wire ties are captive</p>																																																																									
<table border="1"> <thead> <tr> <th>Worksite</th> <th>UMA Panel</th> <th>P Harness</th> <th>J Connector</th> <th>Location in Truss</th> <th>MBS Connection (RPCM)</th> </tr> </thead> <tbody> <tr> <td rowspan="2">2 (S1, Bay 13)</td> <td>A107</td> <td>P243</td> <td>J2</td> <td>Outside</td> <td>J35 (4B)</td> </tr> <tr> <td>A119</td> <td>P246</td> <td>J2</td> <td>Outside</td> <td>J37 (3A)</td> </tr> <tr> <td rowspan="2">3 (S1, Bay 5)</td> <td>A112</td> <td>P642</td> <td>J2</td> <td>Outside</td> <td>J35 (4B)</td> </tr> <tr> <td>A118</td> <td>P645</td> <td>J2</td> <td>Outside</td> <td>J37 (3A)</td> </tr> <tr> <td rowspan="2">4 (S0, Bay 1)</td> <td>A294</td> <td>P174</td> <td>J2</td> <td>Inside</td> <td>J35 (4B)</td> </tr> <tr> <td>A143</td> <td>P172</td> <td>J2</td> <td>Inside</td> <td>J37 (3A)</td> </tr> <tr> <td rowspan="2">5 (S0, Bay 4)</td> <td>A292</td> <td>P763</td> <td>J2</td> <td>Inside</td> <td>J35 (4B)</td> </tr> <tr> <td>A249</td> <td>P761</td> <td>J2</td> <td>Inside</td> <td>J37 (3A)</td> </tr> <tr> <td rowspan="2">6 (P1, Bay 6)</td> <td>A118</td> <td>P645</td> <td>J2</td> <td>Outside</td> <td>J35 (4B)</td> </tr> <tr> <td>A112</td> <td>P642</td> <td>J2</td> <td>Outside</td> <td>J37 (3A)</td> </tr> <tr> <td rowspan="2">7 (P1, Bay 14)</td> <td>A119</td> <td>P246</td> <td>J2</td> <td>Inside</td> <td>J35 (4B)</td> </tr> <tr> <td>A107</td> <td>P243</td> <td>J2</td> <td>Inside</td> <td>J37 (3A)</td> </tr> </tbody> </table>							Worksite	UMA Panel	P Harness	J Connector	Location in Truss	MBS Connection (RPCM)	2 (S1, Bay 13)	A107	P243	J2	Outside	J35 (4B)	A119	P246	J2	Outside	J37 (3A)	3 (S1, Bay 5)	A112	P642	J2	Outside	J35 (4B)	A118	P645	J2	Outside	J37 (3A)	4 (S0, Bay 1)	A294	P174	J2	Inside	J35 (4B)	A143	P172	J2	Inside	J37 (3A)	5 (S0, Bay 4)	A292	P763	J2	Inside	J35 (4B)	A249	P761	J2	Inside	J37 (3A)	6 (P1, Bay 6)	A118	P645	J2	Outside	J35 (4B)	A112	P642	J2	Outside	J37 (3A)	7 (P1, Bay 14)	A119	P246	J2	Inside	J35 (4B)	A107	P243	J2	Inside	J37 (3A)	<ol style="list-style-type: none"> Demate MT power cable connector <ul style="list-style-type: none"> <input type="checkbox"/> P35 from MBS J35 (4B) - OR - <input type="checkbox"/> P37 from MBS J37 (3A) Temp stow MT power cable connector P35 (P37) on JO13 or JO19 MT dummy connector Receive P2 connector from EV2 Inspect P2 and MBS J35 (J37) and mate Assist EV2 with cable routing and securing 		<ol style="list-style-type: none"> Retrieve MSS extension cable from bag Release wire ties from P2 end of extension cable bundle Remove protective cap from P2 Transfer P2 connector to EV1 Translate to passive UMA location closest to MT, releasing coils as reqd Remove protective cap from extension cable J2 Open shroud at UMA location (if required) Transfer MSS extension cable J2 to EV1 	
Worksite	UMA Panel	P Harness	J Connector	Location in Truss	MBS Connection (RPCM)																																																																													
2 (S1, Bay 13)	A107	P243	J2	Outside	J35 (4B)																																																																													
	A119	P246	J2	Outside	J37 (3A)																																																																													
3 (S1, Bay 5)	A112	P642	J2	Outside	J35 (4B)																																																																													
	A118	P645	J2	Outside	J37 (3A)																																																																													
4 (S0, Bay 1)	A294	P174	J2	Inside	J35 (4B)																																																																													
	A143	P172	J2	Inside	J37 (3A)																																																																													
5 (S0, Bay 4)	A292	P763	J2	Inside	J35 (4B)																																																																													
	A249	P761	J2	Inside	J37 (3A)																																																																													
6 (P1, Bay 6)	A118	P645	J2	Outside	J35 (4B)																																																																													
	A112	P642	J2	Outside	J37 (3A)																																																																													
7 (P1, Bay 14)	A119	P246	J2	Inside	J35 (4B)																																																																													
	A107	P243	J2	Inside	J37 (3A)																																																																													
							<p><u>NOTE</u></p> <p>Each cable is labeled both on the harness and opposite side of the feed-through bracket. Verify that the connector being demated has a P label versus a J label</p>																																																																											
							<p>Refer to Worksite UMA Location Chart for the following steps:</p>																																																																											
							<ol style="list-style-type: none"> Enter truss segment for access to UMA panel At UMA panel, demate P harness from J2 Inspect P harness and MSS extension cable J2; mate Secure extension cable at worksite using wire ties, as reqd 																																																																											

MSS EXTENSION CABLE INSTALL TASK DATA SHEET

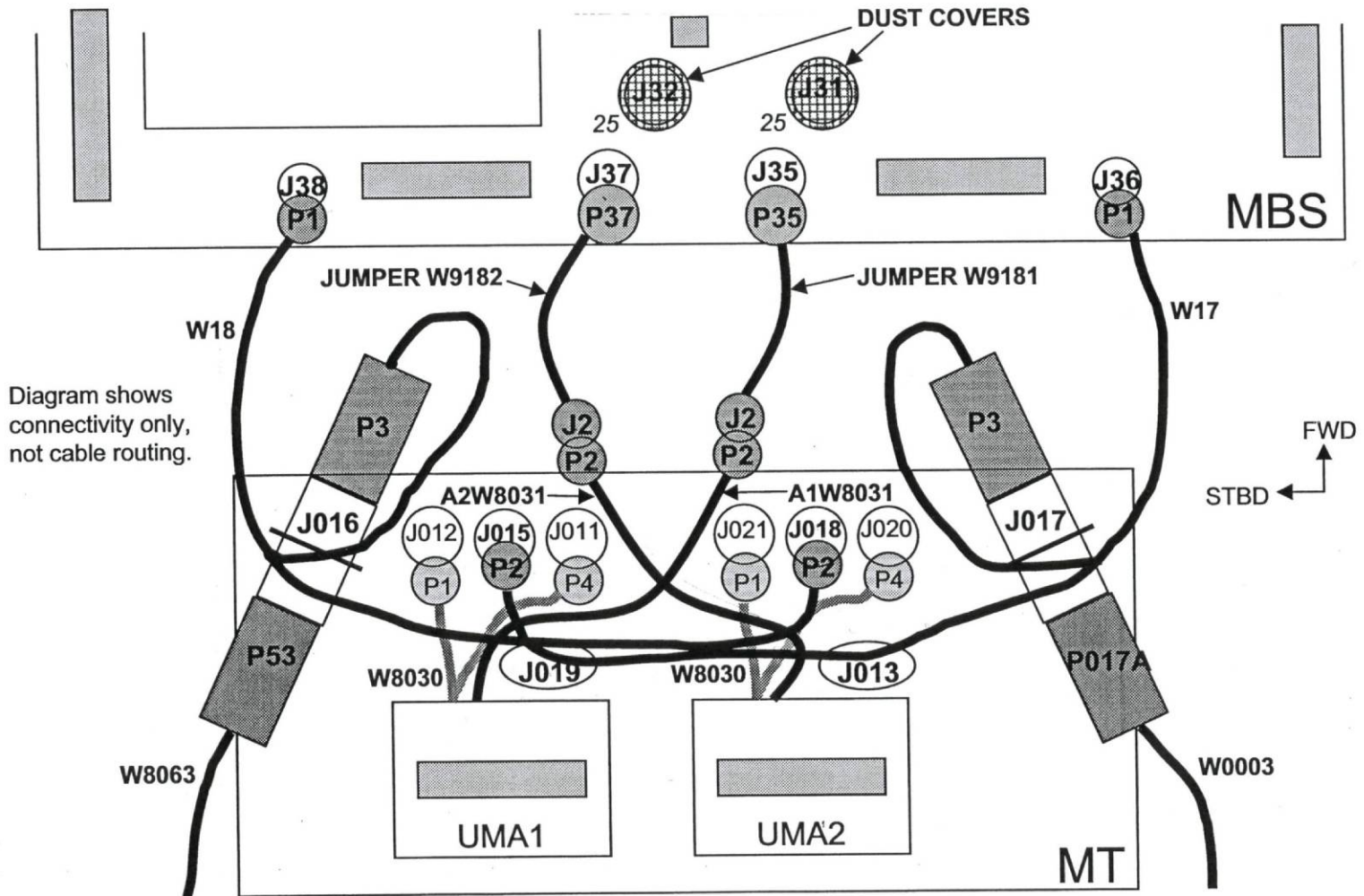

MSS EXTENSION CABLE INSTALL TASK DATA SHEET (Cont)

Tools:

EV1 (RMS)	EV2 (FF)
NA	Wire Tie Caddy

EVA Fasteners:

Fastener Name	Label	Head Size	Qty	Install Torque (ft-lb)	Release Torque (ft-lb)	Failure Torque (ft-lb)	Turns	RPM
None								

EVA Connectors:

From MBS	To MSS Ext. Cable	Truss Panel	Harness	From	To MSS Ext. Cable	Conn Size	Function
J35	P2	A107		P243	J2	33	RPCM S1-4B-E
		A112		P642		33	RPCM S1-4B-F
		A143	W4122	P172		33	RPCM S0 4B-A, Data
		A249	W4122	P761		33	RPCM S0 4B-B, Data
		A112	W5195	P642		33	RPCM P1 4B-F, Data
		A107	W5198	P243		33	RPCM P1 4B-E, Data
J37	P2	A119		P246	J2	33	RPCM S1-3A-E
		A118		P645		33	RPCM S1-3A-F
		A294	W4121	P174		33	RPCM S0 3A-A, Data
		A292	W4121	P763		33	RPCM S0 3A-B, Data
		A118	W5199	P645		33	RPCM P1 3A-F, Data
		A119	W5193	P246		33	RPCM P1 3A-E, Data

Foot Restraints:

Task	WIF	APFR Setting
None		

PUMP MODULE MANUAL VENTING

IV	EV1 (FF)	
	<p><u>QD TOOL RETRIEVAL</u></p> <ol style="list-style-type: none"> 1. Translate to stbd QD tool bag 2. Open lid 3. Remove 1.5" vent tool from bag, stow on MWS 4. Translate to VTE bag (aft) 5. Open VTE bag 6. Remove VTE and 1.0" vent tool from bag 7. Demate 1.0" vent tool from VTE 8. Perform visual check that 1.5" vent tool nozzle will protrude past VTE internal seals: <ul style="list-style-type: none"> <input type="checkbox"/> Hold vent tool nozzle against VTE external alignment groove (vent tool hook should contact VTE connector) <input type="checkbox"/> Nozzle tip is past thin black alignment line 9. Install 1.5" vent tool nozzle into VTE connector via the following steps: <ul style="list-style-type: none"> <input type="checkbox"/> Rotate lock lever to unlock (hard stop detent – very loose) <input type="checkbox"/> Depress lever to hard stop (2-10 lbs) <input type="checkbox"/> Insert vent tool nozzle into connector tube (vent tool hook will contact front of connector, go to hard stop) <input type="checkbox"/> Release lever and rotate lock 10. Install 1.5" vent tool and VTE inside VTE bag, install internal straps 11. Close VTE bag lid 12. Stow 1.0" vent tool in stbd QD bag 13. Retrieve VTE bag from crewlock, attach to BRT <p><u>VENT TOOL EXTENDER INSTALL</u></p> <ol style="list-style-type: none"> 1. Translate to <u>TBD</u> PM worksite 2. Temp stow VTE bag 3. Vent M4 flexline (<u>via TBD procedure</u>) prior to EV crew demate and handling (based on new QD load limits) 4. Remove 1.5" vent tool and VTE from VTE bag 5. Perform the following steps to mate 1.5" vent tool to PM M3: 	<p><u>Possible HRs for VTE nozzle attachment:</u></p> <p>S1 zenith: 3235, 3236 S1 nadir: 3273</p> <p>P1 zenith: TBD P1 nadir: TBD</p> <p><u>Assumptions</u></p> <ol style="list-style-type: none"> 1. The VTE bag and PM jumper bag were installed on the airlock during EVA 2. If they have not been, the tools will be brought outside with the crew prior to the EVA 2. The 1.0" female NH3 vent tool was installed onto the VTE inside ISS prior to EVA 2 for 2 reasons: <ul style="list-style-type: none"> <input type="checkbox"/> As a get-ahead for 10A nominal venting <input type="checkbox"/> To prevent the VTE internal seals (2) from rigidizing to a smaller diameter interface in cold conditions that would prevent successful mating of a vent tool nozzle to the VTE connector (by having one already installed, the nozzle keeps the seals in a more "open" position to readily accept another vent tool) 3. If manual venting is required, must decide best way to carry both VTE bag and PM Jumper bag to worksite

PUMP MODULE MANUAL VENTING (Cont)

IV	EV1 (FF)	
	<ol style="list-style-type: none">3. Tending VTE coil, translate to HR where MUT EE is attached; remove VTE nozzle from HR4. Translate to VTE Bag5. Stow VTE and 1.5" vent tool in VTE bag; black lines on VTE harness aid in alignment during re-coiling of cable, attach Velcro strap around coil <p><u>CLEANUP</u></p> <ol style="list-style-type: none">1. After PM R&R complete, translate to airlock2. Stow VTE bag on zenith crewlock	

PUMP MODULE MANUAL VENTING TASK DATA SHEET

ASSUMPTIONS

1. PM failed in such a way that MCC cannot vent NH3 through ATA vent panel; EVA must vent
2. VTE required when EVA vents NH3
3. Assumes zenith HRs for venting; could use nadir HRs
4. Could use any 1.5" QDs to vent
5. Assumes NH3 venting done at truss wkst, not ESP2

VENTING NOTE

Although manual venting can occur from any 1.5" male QD, plan on only venting the QD portion with respect to M3. The isolation valve connect to M3 is normally going to be the only valve that we will be closing on-orbit (for heat exchanger freeze protection) and is therefore the most likely valve to be failed closed. The PM is also useless with this valve closed. The rest of the PM can still be vented through M4 and the ATA vent panel

If M3 valve fails, only the QD portion needs to be manually vented (tube to valve). No plan to ever close M4, should stay open and so should never fail closed on our flight. The manual venting should take place after the PM jumper is (installed all QDs disconnected)

FAILED PUMP MODULE RETURN TO ICC

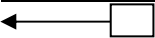
IV/SSRMS	EV1 (FF)	EV2 (SSRMS)
1. ROBO: TBD	<p><u>SETUP</u></p> <ol style="list-style-type: none"> Translate to ESP2 	<p><u>SSRMS SETUP</u></p> <ol style="list-style-type: none"> Retrieve APFR from <u>TBD</u>, attach to BRT Translate to ESP2 fwd/zenith GCA SSRMS for APFR setup Install WIF adapter (tether point facing same direction as LEE) into SSRMS Relocate APFR from <u>TBD</u> to SSRMS, configure to: [12,PP,F,6] Perform safety tether swap onto SSRMS safety tether; verify ST config Temp stow airlock safety tether on VSSA FRAM HR (fwd) Release velcro strap on PM fwd flap Open forward flap on PM MLI tent, attach velcro flaps (2) Install local waist tether onto APFR Ingress SSRMS (head zenith)
2. ROBO: TBD	<p><u>FGB REMOVAL AND TEMP STOW</u></p> <ol style="list-style-type: none"> Assist EV2 will PM MLI as reqd 	<p><u>FGB REMOVAL AND TEMP STOW</u></p> <ol style="list-style-type: none"> SSRMS mnvr to FGB bolt release position Tether to FGB PGT [B7, CCW2, 30.5]-6-Ext-7/16: Release FGB to Pump Module mounting bolts (4), ~ 8-11 turns (any order) Remove FGB from Pump Module, transfer to EV1
3. √MCC ESP2 inhibits in place	<p><u>FAILED PUMP MODULE REMOVAL FROM ESP2</u></p>  <ol style="list-style-type: none"> Receive FGB from EV2, temp stow on BRT. Ensure FGB is tucked behind body and clear of snags Translate aft on ESP2 until body is port of MBSU Access PM primary FRAM bolt with body in between MBSU and PM with head facing forward PGT [A4, CCW2, 10.5]-6Ext-7/16: Release primary FRAM bolt 11 turns (hard stop) 	<p><u>FAILED PUMP MODULE REMOVAL FROM ESP2</u></p> <ol style="list-style-type: none"> Tether to PM

FAILED PUMP MODULE RETURN TO ICC (Cont)

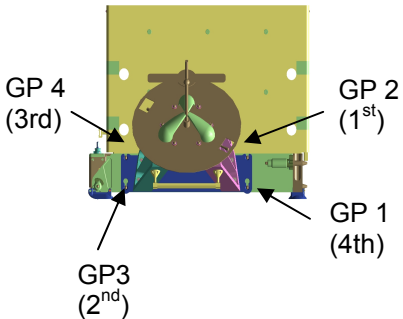
IV/SSRMS	EV1 (FF)	EV2 (SSRMS)
<p>4. ROBO: TBD</p> <p>5. Record turns and torque for ATA grapple bolts:</p> <p>GP2: _____ turns _____ ft-lb GP3: _____ turns _____ ft-lb GP4: _____ turns _____ ft-lb GP1: _____ turns _____ ft-lb</p>	<p style="text-align: center;"><u>NOTE</u> FRAM has magnetic soft dock: 5 ½ lb at forward 2 corners and 3 ½ lb at aft 2 corners</p> <p>4. Assist EV2 with PM removal and clearances</p> <p><u>FGB INSTALL ONTO ATA</u></p> <div style="border: 1px solid black; padding: 5px; margin: 10px auto; width: fit-content;"> <p style="text-align: center;"><u>CAUTION</u> Crew must be two feet from radiator beam when it's not locked</p> </div> <p>1. Translate to zenith S1 ATA (TBD) (S1 face 4, inboard) 2. PGT [B7 (18.4 ft-lb), CCW2, 30.5]-6Ext-7/16: Disengage S1 ATA grapple bolts (4) 20 turns 3. Soft dock FGB to ATA (RMS target closest to top of box)</p> <p style="text-align: center;"><u>NOTE</u> GP2 must be the first bolt torqued Remaining bolts are torqued in a star pattern</p> <p>4. PGT [A7 (9.2 ft-lb), CW2, 30.5]-6Ext-7/16: Engage S1 ATA grapple bolts (4), 10-11 turns in the following order: GP2, GP3, GP4, GP1 5. Perform WVS survey</p> <p><u>FAILED PUMP MODULE INSTALL ON ICC</u></p> <p>1. Retrieve APFR from <u>TBD</u>, attach to BRT 2. Translate to ICC via the following path to ensure safety tether is clear of SSRMS trajectory: <input type="checkbox"/> Translate along Lab stbd/zen HRs to stbd ODS truss</p>	<p>2. Remove Pump Module from passive FRAM</p> <p><u>FAILED PUMP MODULE INSTALL ON ICC</u></p> <p>1. SSRMS mnvr to ICC (EV2 on left side) 2. Orient PM such that primary FRAM bolt faces Orbiter port</p> <div style="text-align: center; margin: 20px 0;">  <p>The diagram shows a top-down view of the S1 ATA bolt pattern. It features a central circular component with four grapple points (GP1, GP2, GP3, GP4) arranged in a star pattern. GP2 is at the top, GP4 is on the left, GP3 is at the bottom, and GP1 is on the right. Arrows point from the labels to the corresponding grapple points.</p> </div> <p style="text-align: center;">S1 ATA BOLT PATTERN</p>

FAILED PUMP MODULE RETURN TO ICC (Cont)

IV/SSRMS	EV1 (FF)	EV2 (SSRMS)
<p>6. ROBO: TBD</p>	<ul style="list-style-type: none"> ❑ Install poorman's fairlead around stbd ODS truss HR and under ODS light ❑ Translate to port ODS truss HR and perform safety tether swap onto spare safety tether, verify ST config ❑ Translate along Orbiter port sill to ICC <ol style="list-style-type: none"> 3. Install fairlead at port/fwd corner of ICC on sill HR 4. Install APFR into ICC bottom/aft/port WIF, configure to: [12,PP,H,9] 5. Ingress APFR 6. Assist EV2 and SSRMS operator with clearances <p style="text-align: center;">NOTE Be aware of tight clearances between PM and ICC. It is difficult to monitor aft/stbd corner of PM with KYA</p> <ol style="list-style-type: none"> 7. Receive PM from EV2, bring close to body in port direction to provide clearance for EV2 8. Install PM onto passive FRAM 9. If reqd, egress APFR 10. PGT [A4, CW2, 10.5]-6"-Ext-7/16: Drive primary FRAM bolt 11 turns (hard stop) 11. Egress APFR 12. Remove APFR from ICC WIF, attach to BRT 13. Egress ICC <p><u>CLEANUP</u></p> <ol style="list-style-type: none"> 1. Translate to port ODS truss; perform safety tether swap onto airlock safety tether, verify ST config 2. Stow APFR in <u>TBD</u> WIF 3. Perform tool inventory 	<ol style="list-style-type: none"> 3. GCA SSRMS in toward bottom of ICC <ol style="list-style-type: none"> 4. Transfer PM to EV1 5. SSRMS mnvr to ICC dropoff position (fwd edge) 6. Egress SSRMS 7. Translate to bottom of ICC through stbd side, install local fairlead if reqd 8. Inform EV1 when clear of passive FRAM interface 9. GCA PM clearances with coarse alignment cones and KYA 10. Egress ICC, go aft of PM and egress KYA via port side (must tend safety tether around PM) <p><u>SSRMS CLEANUP</u></p> <ol style="list-style-type: none"> 1. Hold LEE HR 2. SSRMS mnvr to ESP2 3. GCA SSRMS for egress 4. Egress APFR

FAILED PUMP MODULE RETURN TO ICC (Cont)

IV/SSRMS	EV1 (FF)	EV2 (SSRMS)
	<p>4. Translate to airlock</p> <p><u>Assumptions/Questions:</u></p> <ul style="list-style-type: none"> • Need 2 APFRs for this, 1 for SSRMS, 1 for ICC • Need to determine where APFRs come from • Using SSRMS on Lab PDGF • FGB must be removed from PM and stowed somewhere • (S1 ATA?) (1 person comfortable with this?) • This task will be done with connector re-do on same EVA • Both crew begin EVA on 85' safety tethers 	<p>5. Perform safety tether swap onto airlock safety tether, verify ST config</p> <p>6. Retrieve spare safety tether from SSRMS</p> <p>7. Remove APFR, stow in <u>TBD</u> WIF</p> <p>8. Remove WIF adapter, stow on MWS</p> <p>9. Perform tool inventory</p> <p>10. Translate to airlock</p>

FAILED PUMP MODULE RETURN TO ICC TASK DATA SHEET

Tools:

EV1	EV2
<ul style="list-style-type: none"> • PGT with 7/16, 6-in • BRT • APFR 	<ul style="list-style-type: none"> • PGT with 7/16, 6-in • BRT • APFR • WIF adapter

EVA Fasteners:

Fastener Name	Head Size	Qty	Install Torque (ft-lb)	Release Torque (ft-lb)	Failure Torque (ft-lb)	Turns
FRAM Primary Bolt	7/16	1	6.3	6.3	21 (both)	11
ATA FGB GP bolt release	7/16	4	---	25.5	47.4	20 17 min
ATA FGB GP bolt install	7/16	4	9.2	---	16.1	10-11

Notes:

1. Do not touch SRMS target or grapple pin shaft on FGB
2. FRAM has magnetic soft dock: 5 ½ lb at forward 2 corners and 3 ½ lb at aft 2 corners
3. GP2 must be the first bolt torqued. Remaining bolts are torqued in a star pattern
4. FGB FSE bolts must be backed out at least 20 turns to remove the FGB. Running torque will decrease at ~18 turns when the locking “poly patch” ends. The bolts are fully backed out at 33 turns, but torque should not be applied at this point to avoid breaking the castellated nut captive feature
5. Be aware of tight clearances between PM and ICC. It is difficult to monitor aft/stbd corner of PM with KYA

Cautions:

1. Crew must be two feet from radiator beam when it's not locked

This Page Intentionally Blank

FLIGHT SPECIFIC EVA REFERENCE

12A.1 OVERVIEW	
12A.1 ISS OVERVIEW.....	FS 18-5
PAYLOAD BAY OVERVIEW.....	FS 18-6
MT/CETA CART LOCATIONS PER EVA	FS 18-7
12A.1 TRUSS WORKSITES	FS 18-8
12A.1 ICC OVERVIEW	FS 18-9
ICC WIF AND HANDRAIL LAYOUT – TOP	FS 18-10
ICC WIF AND HANDRAIL LAYOUT – BOTTOM.....	FS 18-11
ICC – FAILED PUMP MODULE RETURN CONFIG.....	FS 18-12
ESP2 HANDRAILS AND WIFs – ZENITH.....	FS 18-13
ESP2 HANDRAILS AND WIFs – NADIR	FS 18-14
EVA 1 OVERVIEW	
P5 SAFETY TETHER SWAP OVERVIEW.....	FS 18-15
P5 PRE-INSTALL POSITION.....	FS 18-16
RTAS CORNER 2 CLEARANCES.....	FS 18-17
RTAS CORNER 2 CLOSEUP VIEW OF CLEARANCES – SSU & P5	FS 18-18
RTAS CORNERS 1&2 AND FINAL TORQUING	FS 18-19
RTAS CORNERS 3&4 AND FINAL TORQUING	FS 18-20
PVRGF OVERVIEW.....	FS 18-21
PVRGF REMOVAL WORKSITE – P5 WIF 11	FS 18-22
PVRGF STOWED ON KEEL.....	FS 18-23
CP3 OVERVIEW AND TRANSLATION PATH.....	FS 18-24
EVA 2 OVERVIEW	
S0 WORKSITES – EVA 2	FS 18-25
SAFETY TETHER SWAP LOCATION FOR P1 BAY 16 DDCU	FS 18-26
Z1 PP WORKSITES – EVA 2.....	FS 18-27
CETA CART RELOCATION – INITIAL POSN & SAFETY TETHER SWAP	FS 18-28
CETA CART RELOCATION.....	FS 18-29
CETA CART RELOCATION – FINAL POSN	FS 18-30
SSRMS FMS MLI INSTALL	FS 18-31
EVA 3 OVERVIEW	
S0 WORKSITES – EVA 3	FS 18-32
S1 BAY 15 DDCU WORKSITE AND TRANSLATION	FS 18-33
TRANSLATION PATH TO FACE 3 ACCESS FLAP FOR LAB 4A DDCU SECONDARY PWR	FS 18-34
S0 PORT WEDGE FACE DDCU TRANSLATION PATH AND WORKSITE	FS 18-35
Z1 PP WORKSITES – EVA 3.....	FS 18-36
APFR INGRESS LOCATION FOR SMDP TRANSFER.....	FS 18-37
TRANSLATION PATH AND SAFETY TETHER SWAP TO PLB	FS 18-38
Z1-NODE 1 UMBILICALS WORKSITE OVERVIEW.....	FS 18-39
H-JUMPER WORKSITE.....	FS 18-40
P5/PVRGF	
P5 ISOMETRIC VIEW.....	FS 18-41
P5 HANDRAILS AND WIFs (PORT/FWD VIEW).....	FS 18-42
P5 HANDRAILS AND WIFs (ZENITH/STBD VIEW)	FS 18-43
P5 HANDRAILS AND WIFs (NADIR/STBD VIEW)	FS 18-44
P5 HANDRAILS AND WIFs (FWD/PORT VIEW).....	FS 18-45
P5 MRTAS – ACTIVE	FS 18-46
P5 EWIS LAYOUT	FS 18-47
RTAS HOUSING DIMENSIONS	FS 18-49
P4 MRTAS – PASSIVE	FS 18-50
P5 TO P4 MRTAS PRIMARY BOLT ENGAGED	FS 18-51
GAP CHECK TOOL	FS 18-52
P5-P4 CONNECTOR PANEL	FS 18-53
P5 CAPTURE LATCH ASSEMBLY (CLA)	FS 18-54

FLIGHT SPECIFIC
EVA REFERENCE

ETVCG	
ETVCG – ASSEMBLED	FS 18-55
ETVCG MOUNTED ON STANCHION	FS 18-56
U.S. CONNECTIONS	
S0 FORWARD AVIONICS PANEL WORKSITE	FS 18-57
S0 WORKSITES – PANELS 163 AND 165, MBSU RECONFIG	FS 18-58
S0 – PANELS 163 AND 165	FS 18-59
S0 CH 1/4 AND 2/3 JUMPERS	FS 18-60
MBSU BYPASS JUMPER RECONFIG – CH 1/4.....	FS 18-61
MBSU BYPASS JUMPER RECONFIG – CH 2/3.....	FS 18-62
CID PHOTO	FS 18-63
S0/N1 PWR CABLE WORKSITE OVERVIEW.....	FS 18-64
S0 PANEL A166 WORKSITE.....	FS 18-65
DDCU COLDPLATE CONNECTOR BOX – GENERIC	FS 18-66
S0 AFT TRAY	FS 18-67
Z1-LAB-S0 CONNECTIONS (PRE-12A.1 CONFIG).....	FS 18-68
Z1-LAB-S0 CONNECTIONS (POST-12A.1 CONFIG)	FS 18-69
RAT’S NEST QD OVERVIEW.....	FS 18-70
RAT’S NEST CONNECTIONS – CHANNEL 2/3.....	FS 18-71
RAT’S NEST CONNECTIONS – CHANNEL 1/4.....	FS 18-72
PATCH PANELS 1 AND 2 – SPDA.....	FS 18-74
PATCH PANELS 5 AND 6 – DDCU	FS 18-75
P1 BAY 16 DDCU THERMAL COVER	FS 18-77
S1 DDCU THERMAL COVER.....	FS 18-78
CETA CART	
CETA CART – TOP VIEW	FS 18-79
CETA SWINGARM AND WIF MARKINGS	FS 18-80
CETA CART COUPLERS	FS 18-81
CETA CART WHEEL BOGIES	FS 18-82
SSRMS FMS MLI	
SSRMS FMS LOCATION.....	FS 18-83
SSRMS FMS MLI.....	FS 18-84
LATCHING END EFFECTOR (LEE)	FS 18-85
SMDP	
SMDP BUNDLE OVERVIEW	FS 18-86
SMDP TDK – LAUNCH CONFIG FOR BUNDLES 2 AND 3.....	FS 18-87
SMDP TDK – LANDING CONFIG FOR BUNDLES 2 AND 3.....	FS 18-88
SMDP TDK – LANDING CONFIG FOR BUNDLE 4.....	FS 18-89
TDK LANDING CONFIG – SIDE VIEW.....	FS 18-90
TDK BOLT OVERVIEW WITH LABELS.....	FS 18-91
TDK BOLTS – NOMINAL AND CONTINGENCY	FS 18-92
SMDP ADAPTER.....	FS 18-93
CHRISTMAS TREE.....	FS 18-94
CHRISTMAS TREE STOWAGE ON PMA3	FS 18-95
RUSSIAN PWR RECONFIG	
S0/NODE 1 SWINGARM	FS 18-96
Z1-NODE CONNECTIONS – PRE 12A.1	FS 18-97
Z1-NODE 1 CONNECTIONS – POST 12A.1	FS 18-98
FGB/PMA1 H-JUMPER 2/3 CONFIG.....	FS 18-99
FGB/PMA1 CONFIG POST H-JUMPER REMOVAL	FS 18-100
ADJUSTABLE GRAPPLE BAR.....	FS 18-101
FHRC	FS 18-102
CONTINGENCIES	
P1 PUMP MODULE WORKSITE OVERVIEW.....	FS 18-103
P1 PM INSTALLED IN TRUSS	FS 18-104
S1 PUMP MODULE WORKSITE OVERVIEW.....	FS 18-105

PUMP MODULE AND FSE OVERVIEW.....	FS 18-106
LAPA AND REAR CONTINGENCY PINS.....	FS 18-107
PUMP MODULE WITH FIXED GRAPPLE BAR AND MLI.....	FS 18-108
FLUID QD BAIL LEVERS.....	FS 18-109
QD CAP TOOLS	FS 18-110
1.5-IN FLUID QD SPOOL POSITIONING DEVICE	FS 18-111
FLUID QD RELEASE TOOLS.....	FS 18-112
0.5-IN FLUID QD SPOOL POSITIONING DEVICE	FS 18-113
0.5-IN SPD BOOTIE EXTENSION.....	FS 18-113
QD VENT TOOLS	FS 18-114
VENT TOOL EXTENDER BAG.....	FS 18-115
VTE AND VTE BAG DETAILS	FS 18-116
PUMP MODULE NH3 JUMPER.....	FS 18-117
STATUS INDICATORS (MBSU, DDCU, BCDU).....	FS 18-118
FAILED MBSU LOCATIONS.....	FS 18-119
CETA CART LOCATION FOR MBSU R&R	FS 18-120
SPARE MBSU STOWED ON CETA GRID E WITH PORT TFR SWINGARM DEPLOYED.....	FS 18-121
MBSU ORU.....	FS 18-122
MBSU AND COLDPLATE	FS 18-123
DDCU LOCATIONS	FS 18-124
DC-TO-DC CONVERTER UNIT – EXTERNAL.....	FS 18-125
SPARE DDCU S0-4B WORKSITE (S0 PORT WEDGE FACE) (EVA 3).....	FS 18-126
FAILED DDCU S1-4B WORKSITE (S1 BAY 15) (EVA 3)	FS 18-127
FAILED DDCU S0-1A WORKSITE (S0 BAY 01) (EVA 3).....	FS 18-128
SPARE DDCU S0-3B WORKSITE (S0 BAY 04) (EVA 2).....	FS 18-129
FAILED DDCU S0-2B WORKSITE (S0 BAY 02) (EVA 2).....	FS 18-130
FAILED DDCU P1-3A WORKSITE (P1 BAY 16) (EVA 2).....	FS 18-131
P6 OVERVIEW FOR STBD BCDUs	FS 18-132
P4 2A BCDU WORKSITE OVERVIEW.....	FS 18-133
P4 4A BCDU WORKSITE OVERVIEW.....	FS 18-134
BCDU	FS 18-135
P6 2B STBD IEA (UPPER/NON-KEEL SIDE) ORU LABELS	FS 18-136
P6 4B PORT IEA (LOWER/KEEL SIDE) ORU LABELS	FS 18-137
P4 4A FWD IEA (UPPER/NON-KEEL SIDE) ORU LABELS	FS 18-138
P4 2A AFT IEA (LOWER/KEEL SIDE) ORU LABELS	FS 18-139
4B MANUAL RETRACT – P6 WIF 37	FS 18-140
SOLAR ARRAY LATCH/TENSION OVERRIDE – LEFT BLANKET BOX	FS 18-141
SOLAR ARRAY JETTISON OVERVIEW	FS 18-142
MAST CANISTER MDA	FS 18-143
SABB MDA.....	FS 18-144
SOLAR ARRAY BLANKET BOX (SABB).....	FS 18-145
FRAM/FSE/ORU ASSEMBLY	FS 18-146
ACTIVE FRAM SOFT CAPTURE MECHANISM	FS 18-147
FRAM CONTINGENCY BOLTS – SAPA	FS 18-148
P5 SOFT CAPTURE ASSY MANUAL OVERRIDE.....	FS 18-149
SMDP ADAPTER FAILED MAGNETIC SOCKET.....	FS 18-151

This Page Intentionally Blank

12A.1 ISS OVERVIEW

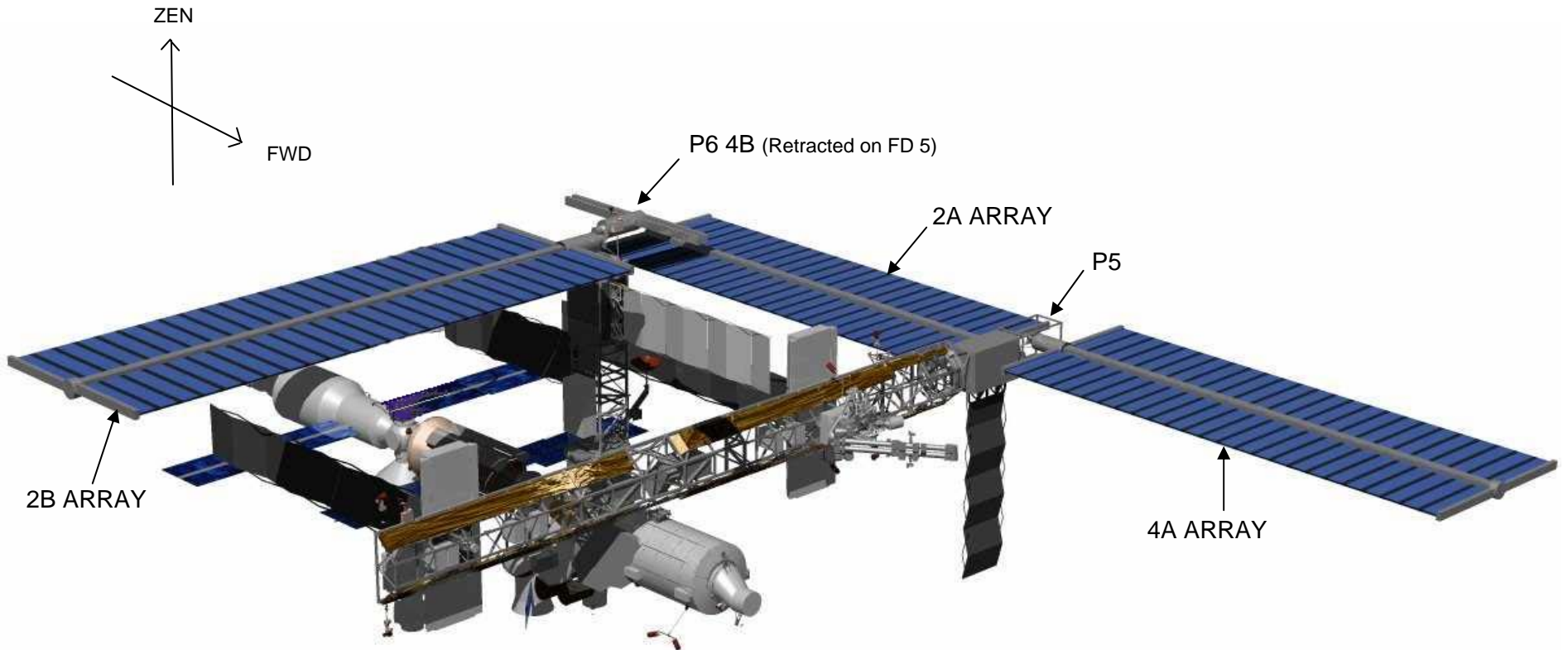

2B ARRAY

P6 4B (Retracted on FD 5)

2A ARRAY

P5

4A ARRAY

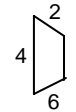

S1/P1 TRUSS FACES

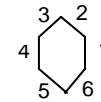

S0 TRUSS FACES

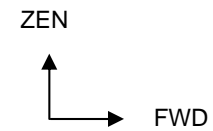

FS 18-5

EVA/116/FIN

12A.1 OVERVIEW

PAYLOAD BAY OVERVIEW

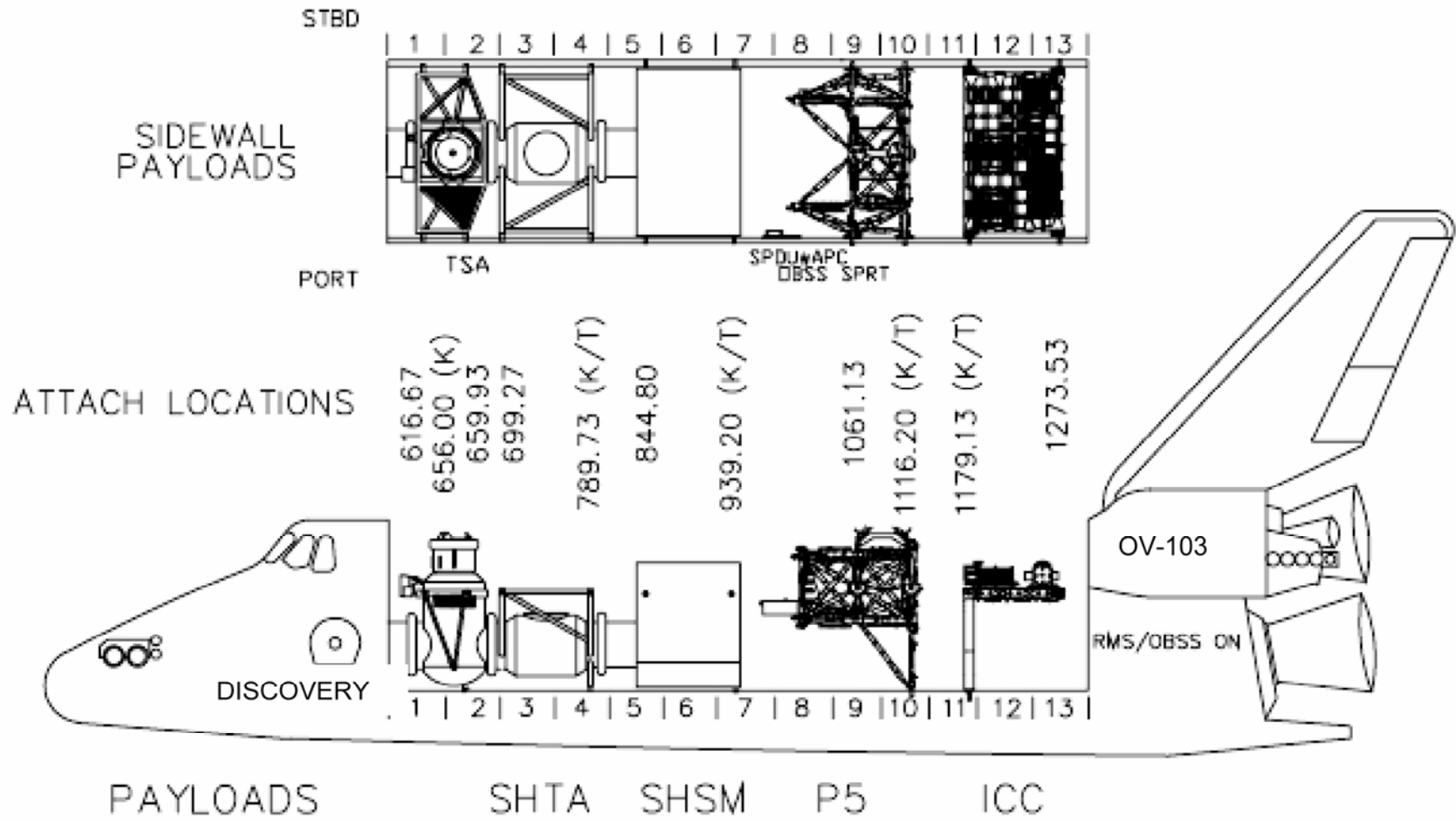

MT/CETA CART LOCATIONS PER EVA

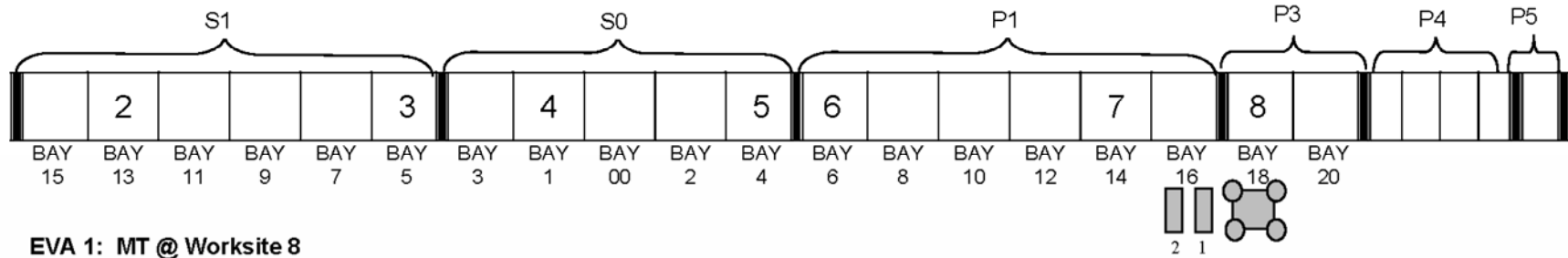

EVA 1: MT @ Worksite 8

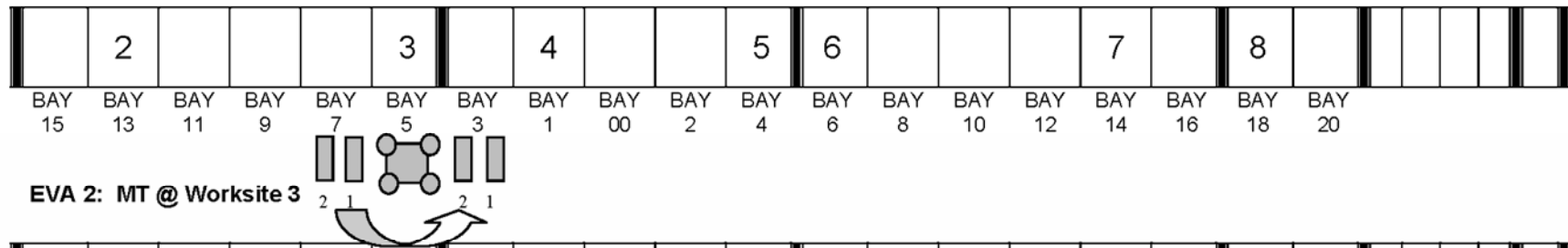

EVA 2: MT @ Worksite 3

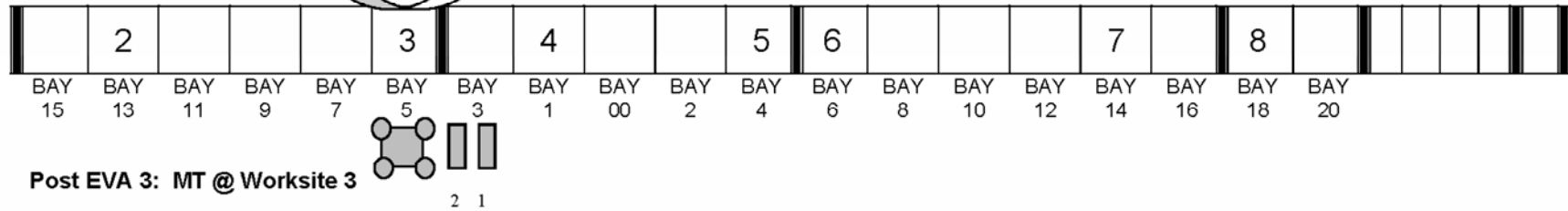

Post EVA 3: MT @ Worksite 3

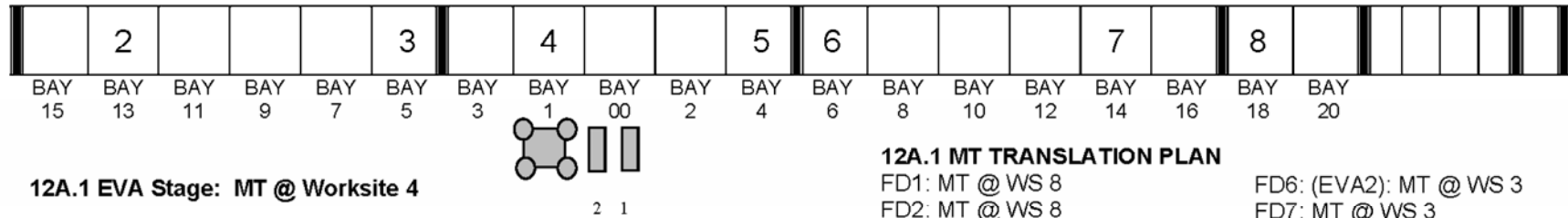

12A.1 EVA Stage: MT @ Worksite 4

12A.1 MT TRANSLATION PLAN

- FD1: MT @ WS 8
- FD2: MT @ WS 8
- FD3: MT @ WS 8
- FD4: (EVA1): MT @ WS 8 → WS 3
- FD5: (P6 4B Retract): MT @ WS 3
- FD6: (EVA2): MT @ WS 3
- FD7: MT @ WS 3
- FD8: (EVA3): MT @ WS 3
- FD9: MT @ WS 3 - WS 2 for C/O - WS 4

12A.1 TRUSS WORKSITES

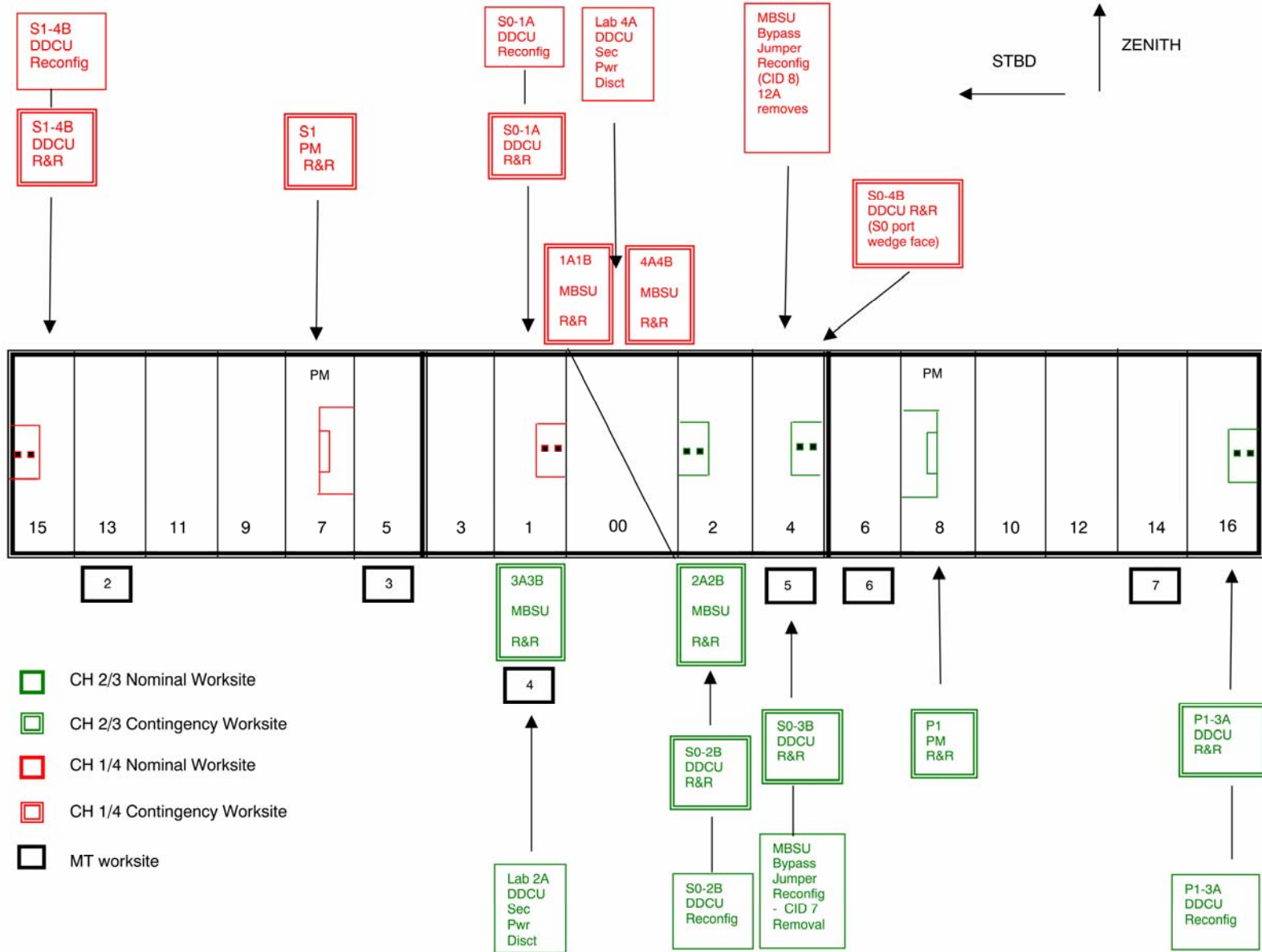

12A.1 ICC OVERVIEW

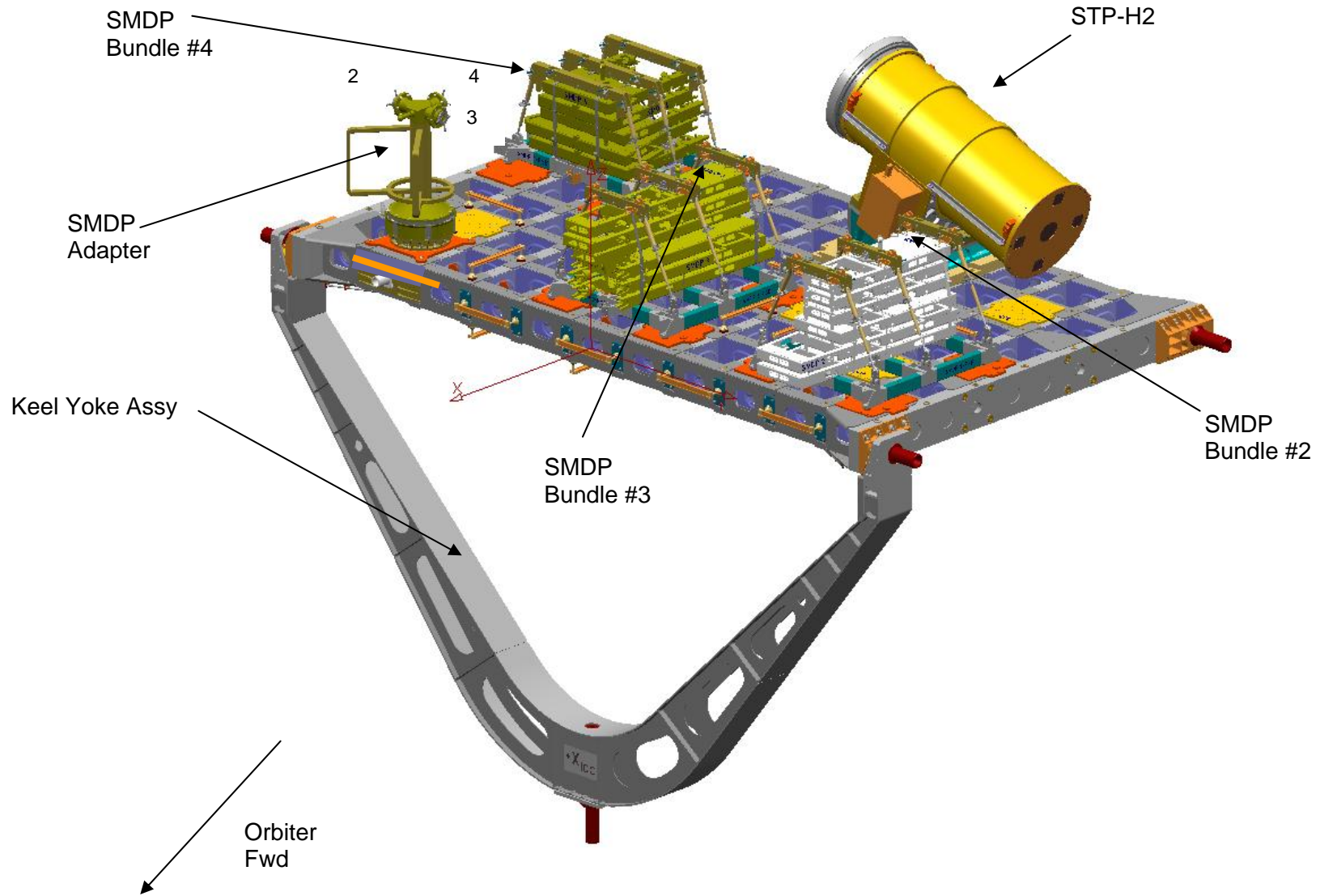

ICC WIF AND HANDRAIL LAYOUT – TOP

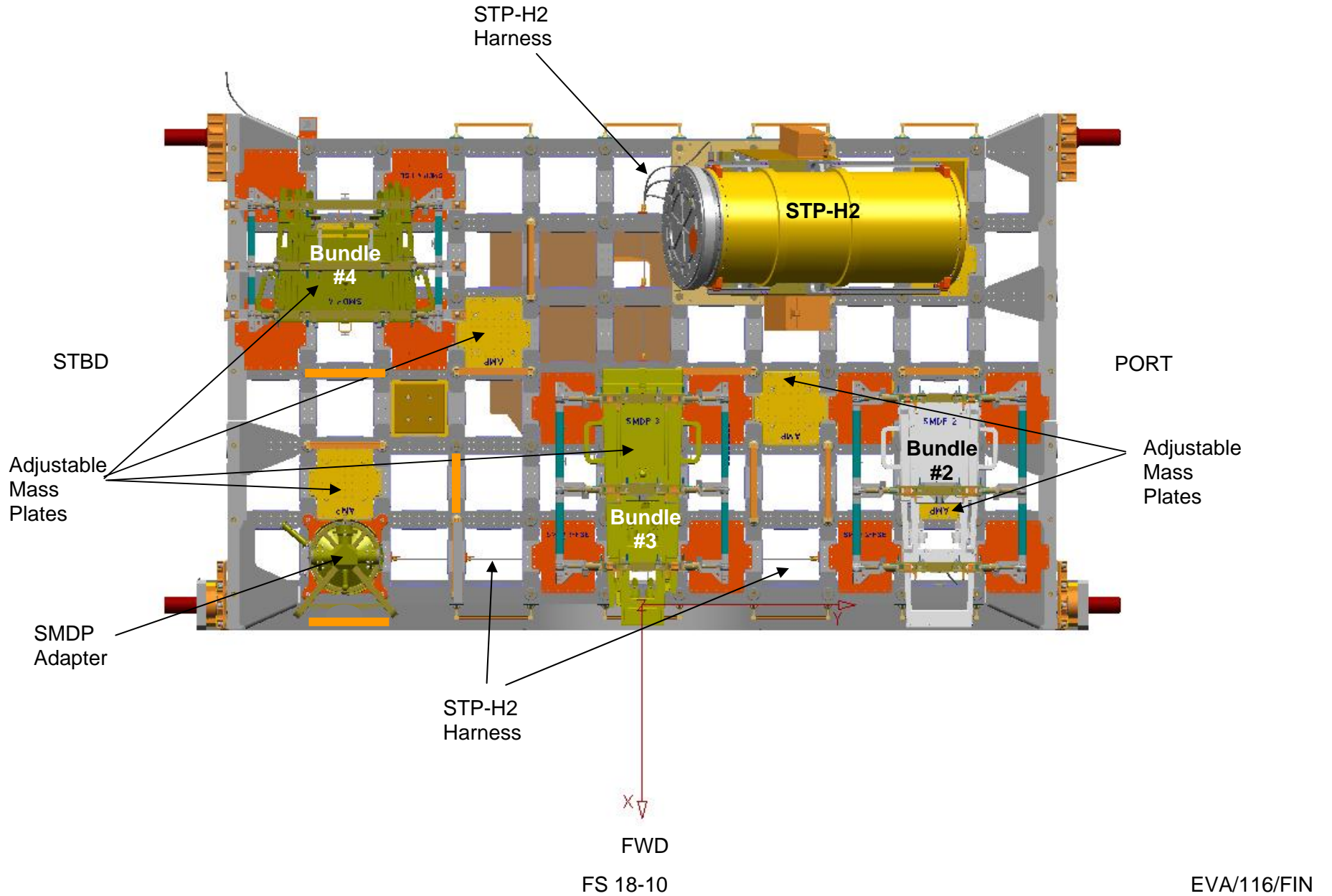

ICC WIF AND HANDRAIL LAYOUT – BOTTOM

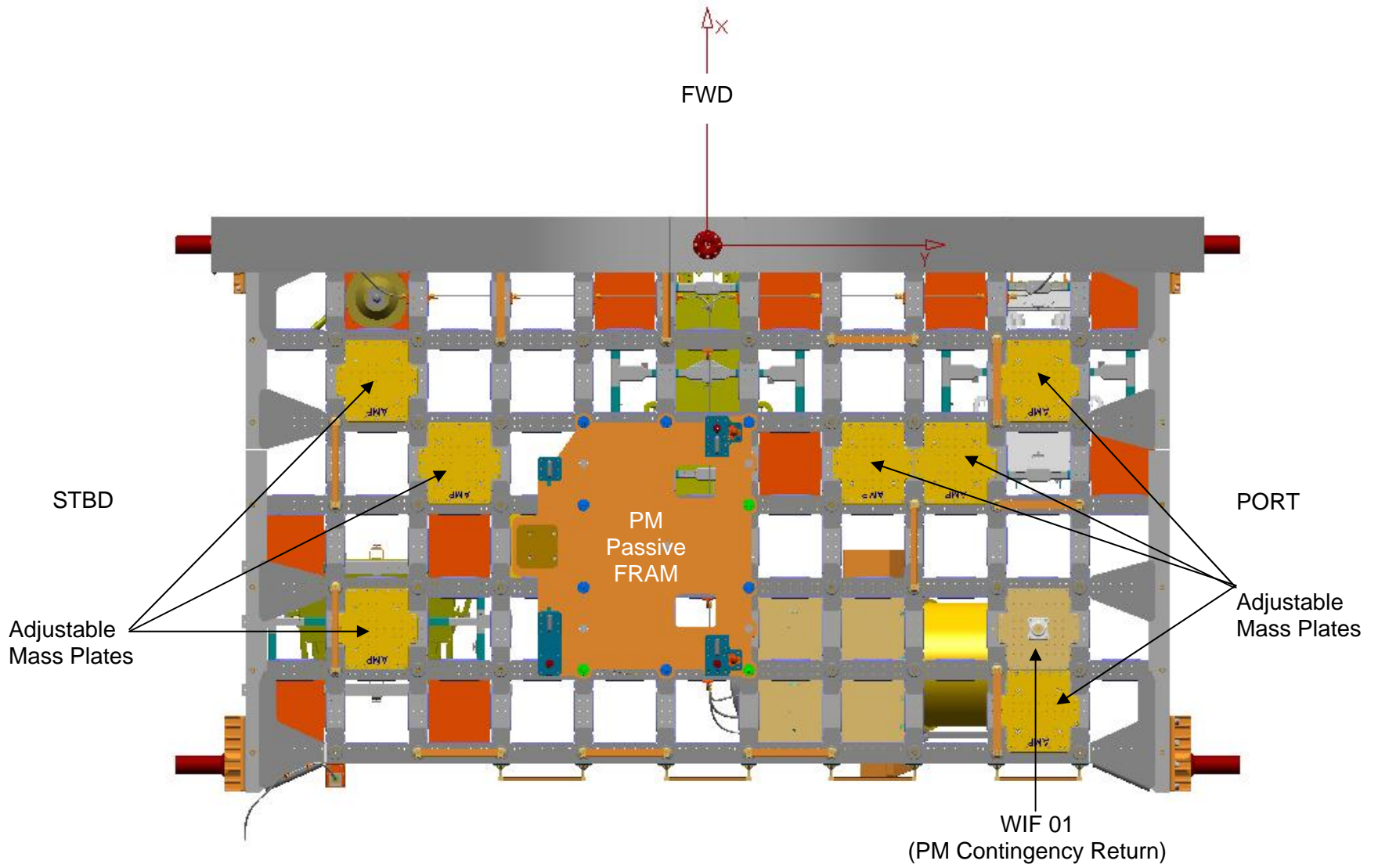

ICC – FAILED PUMP MODULE RETURN CONFIG

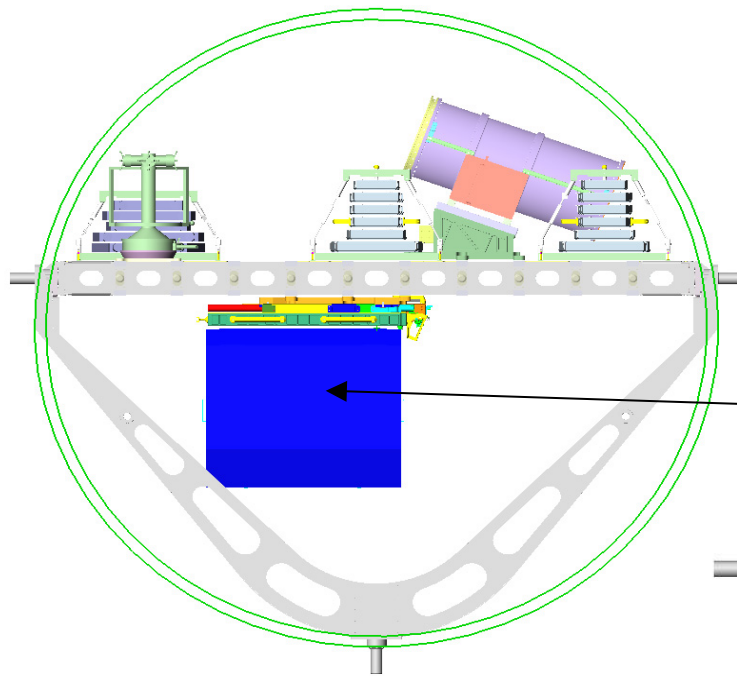

ICC FWD VIEW

PORT

Failed PM on Bottom of ICC

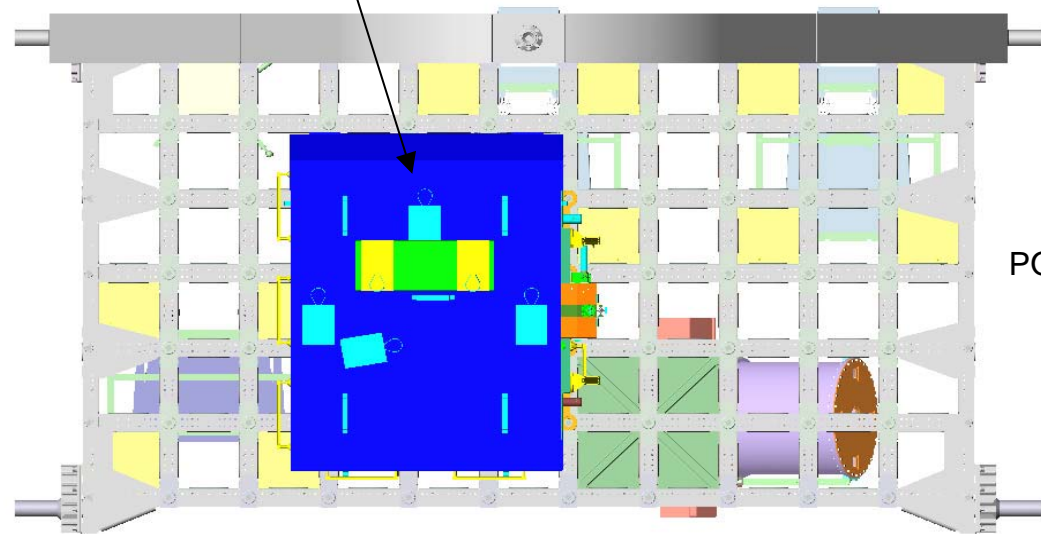

PORT

ICC BOTTOM VIEW

AIRLOCK

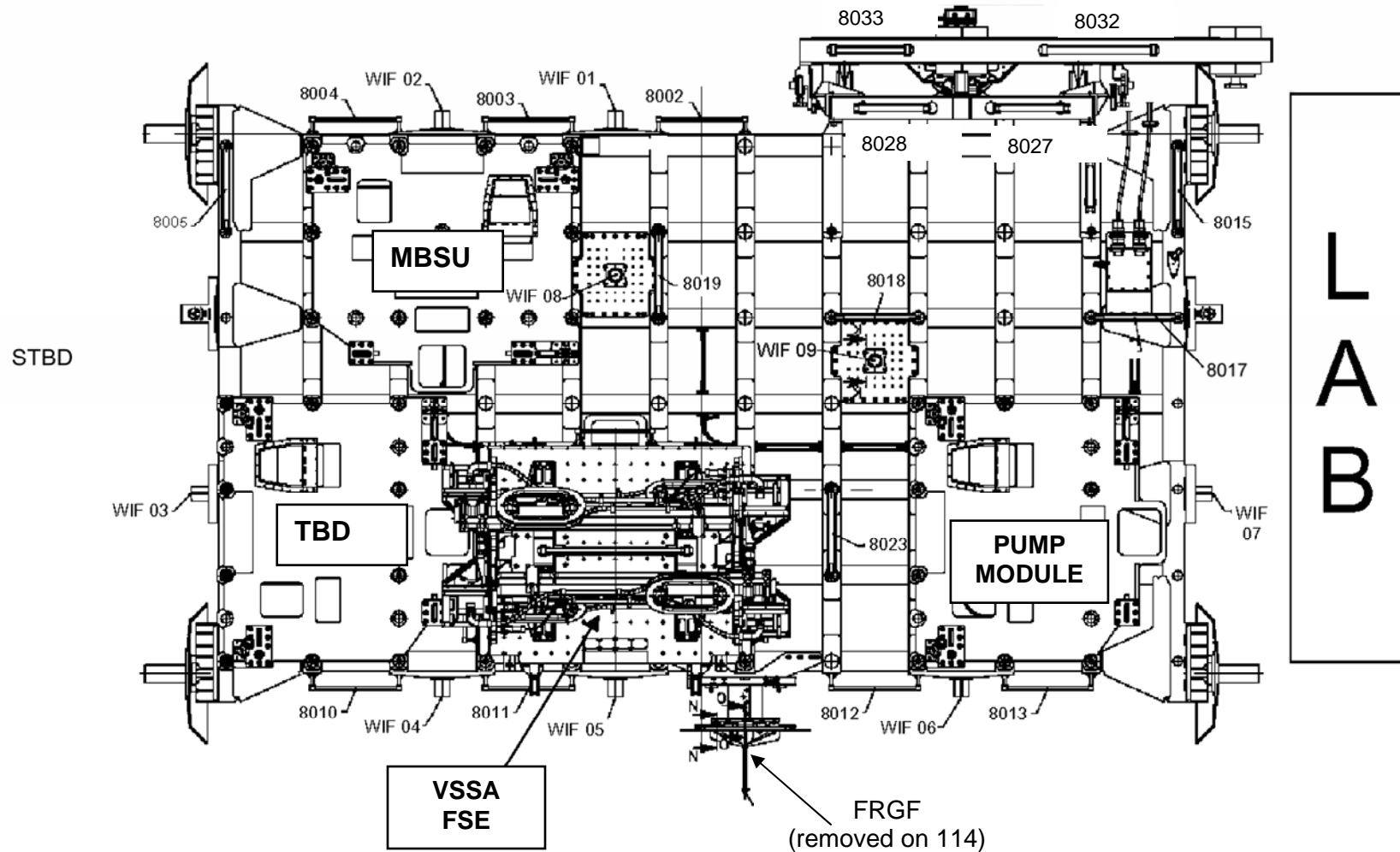

AIRLOCK

L
A
B

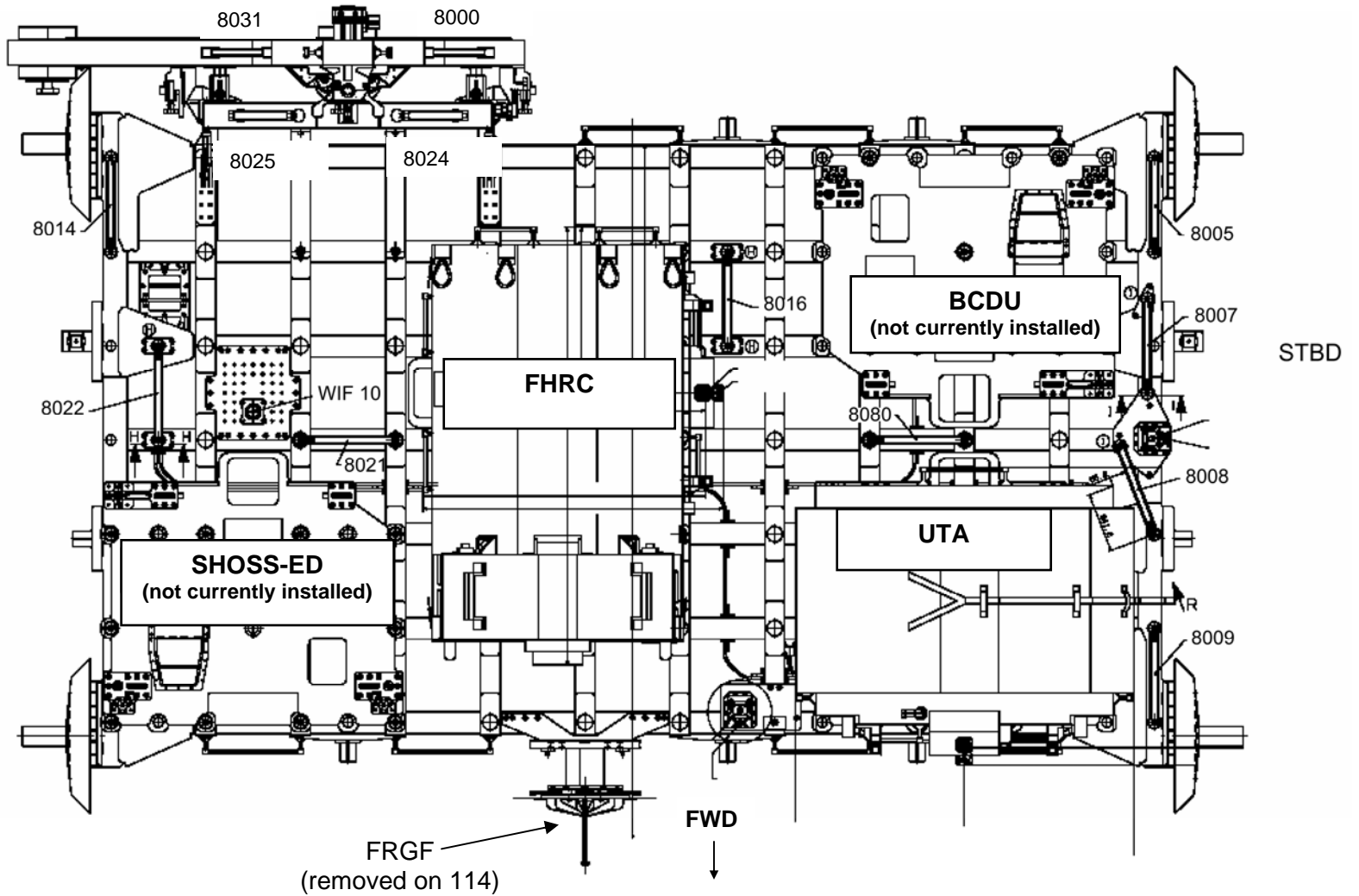

P5 SAFETY TETHER SWAP OVERVIEW

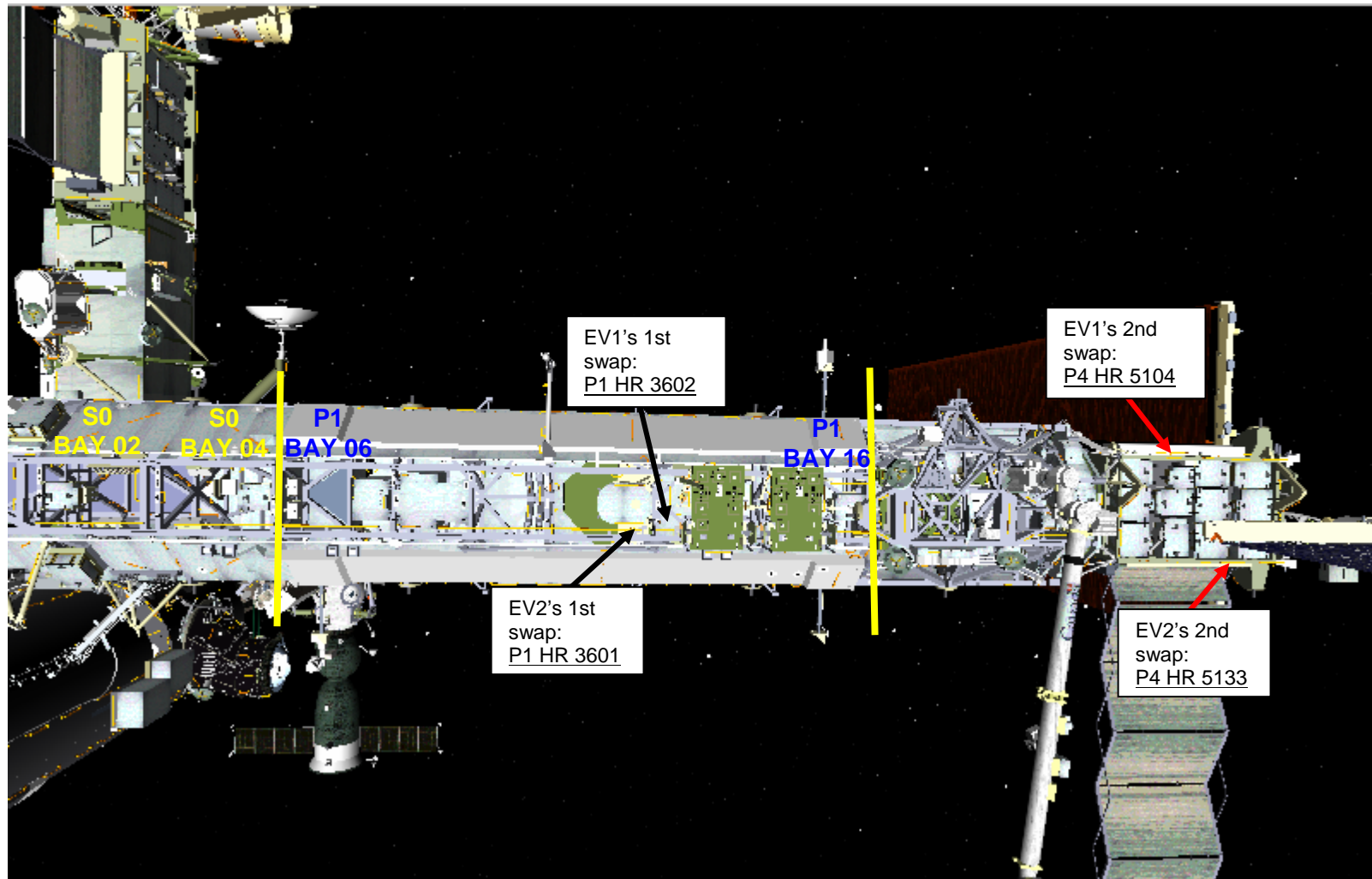

FS 18-15

EVA/116/FIN

EVA 1 OVERVIEW

P5 PRE-INSTALL POSITION

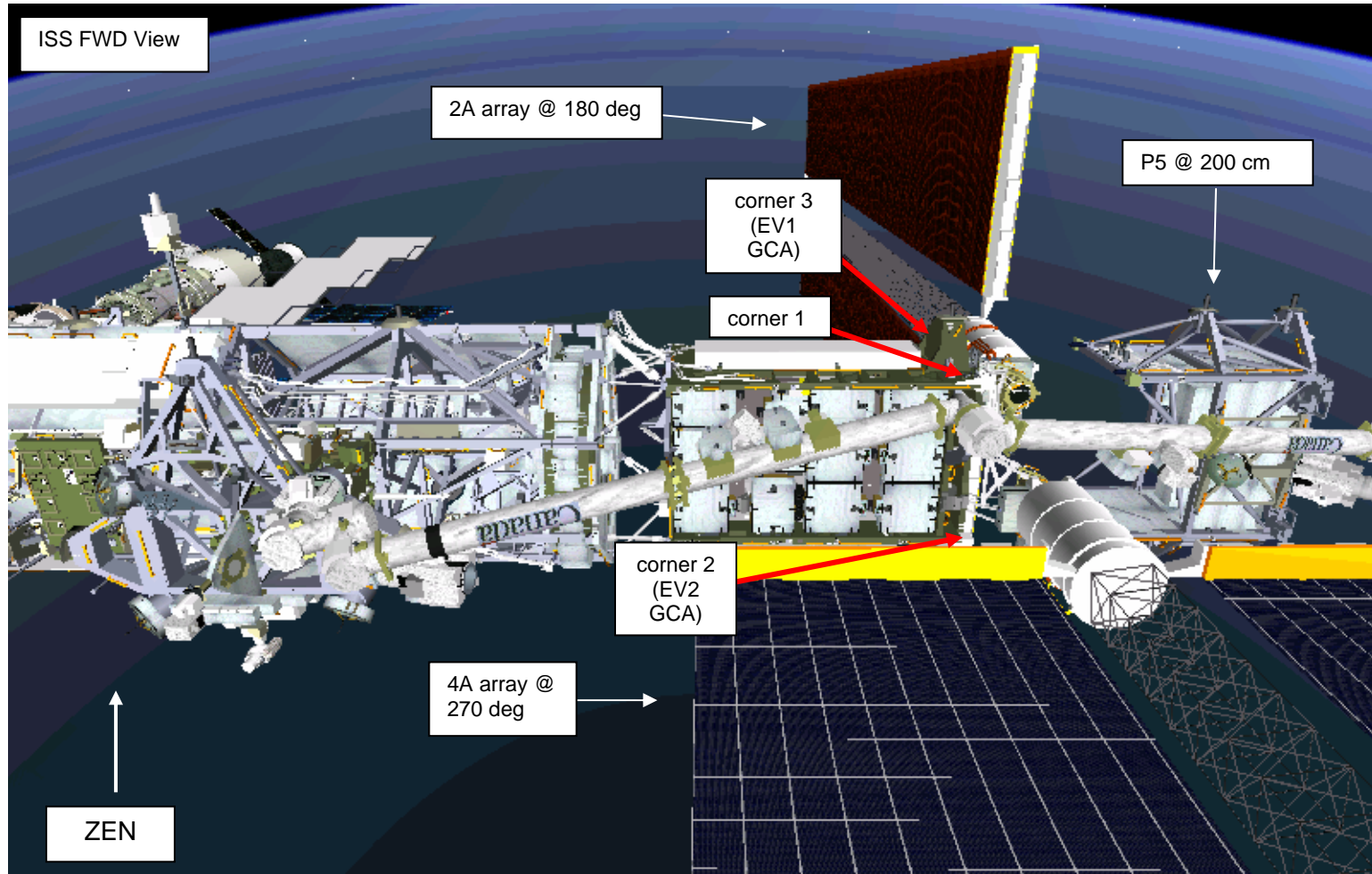

RTAS CORNER 2 CLEARANCES

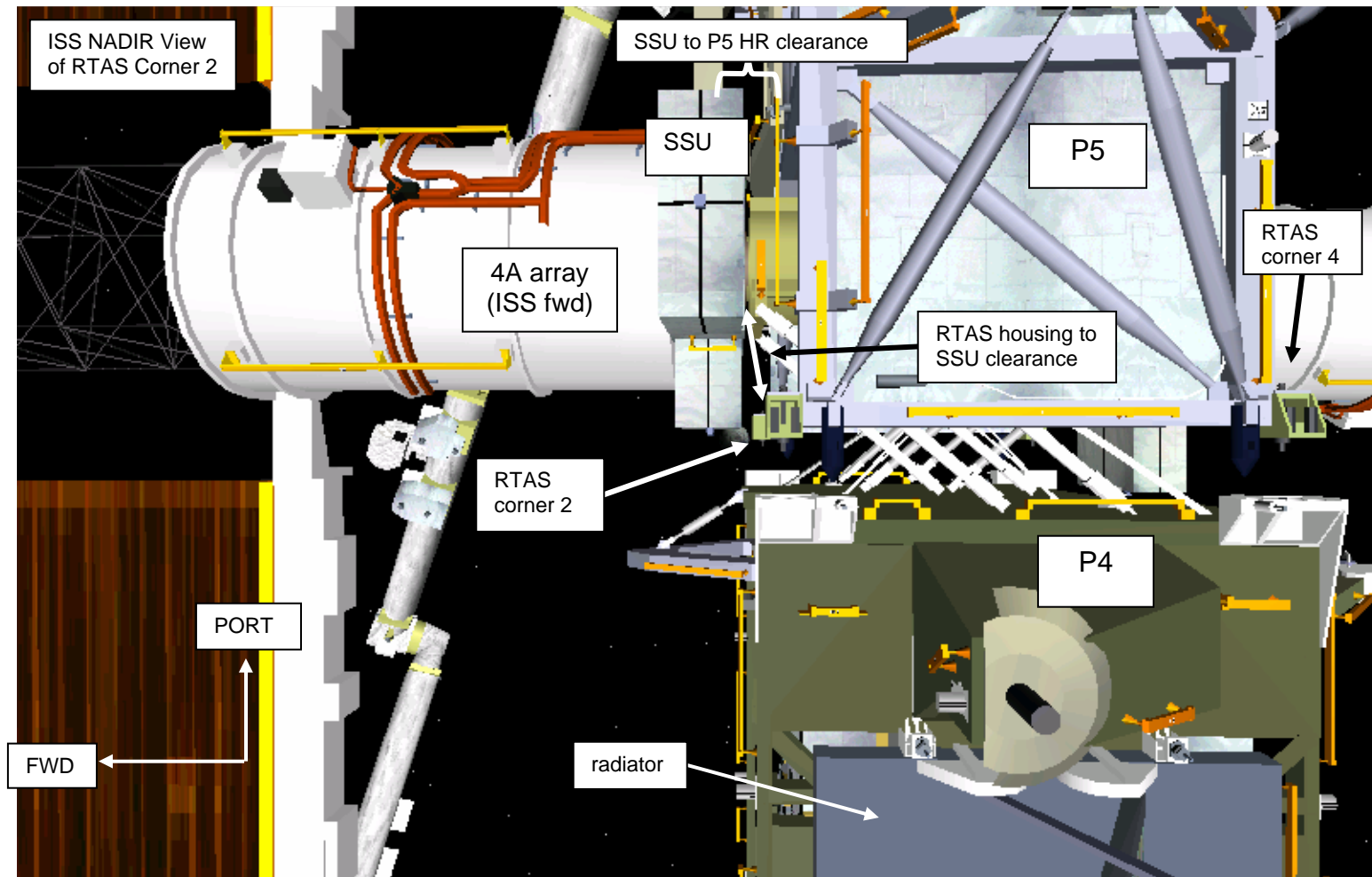

RTAS CORNER 2 CLOSEUP VIEW OF CLEARANCES – SSU & P5

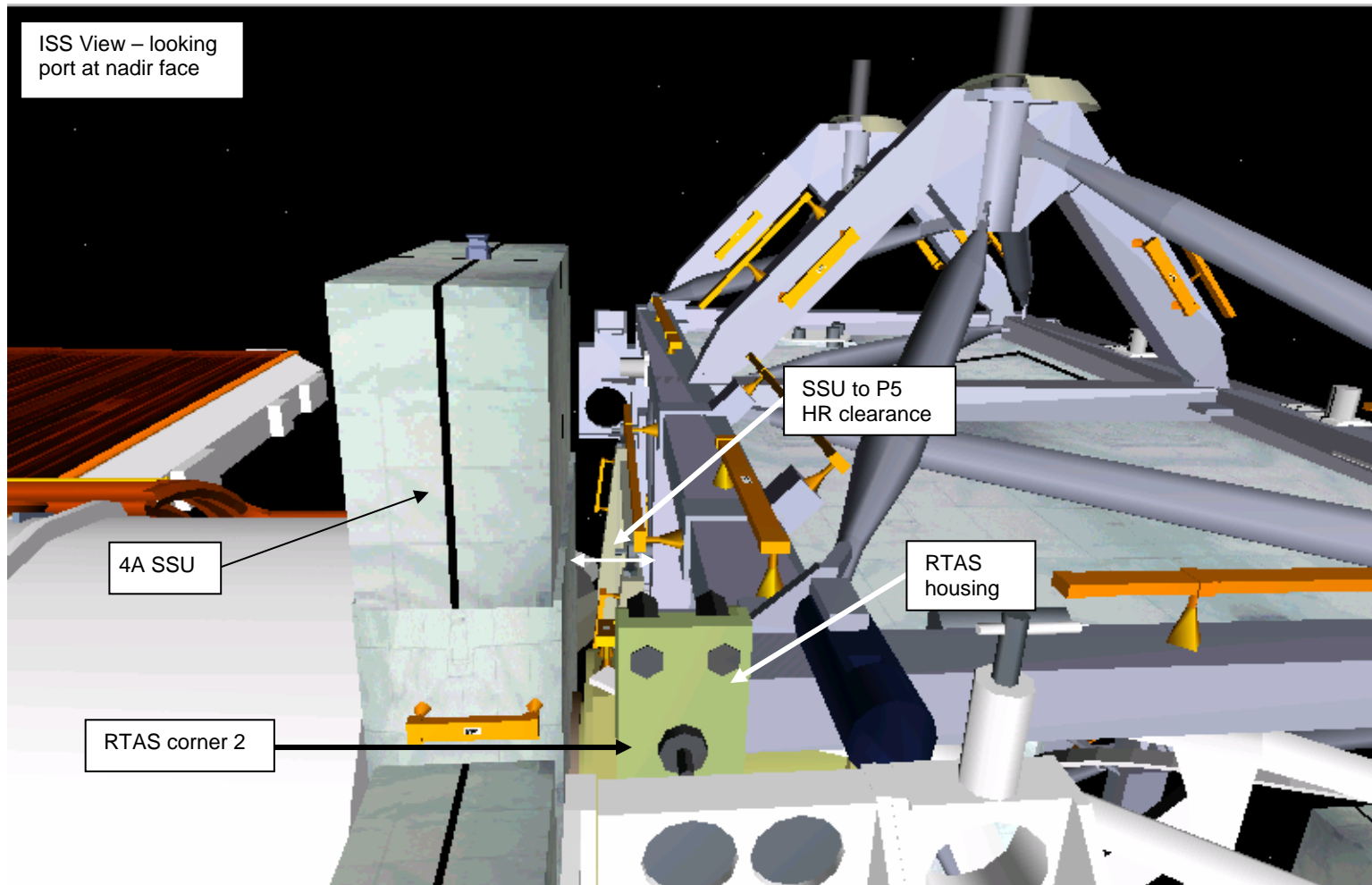

RTAS CORNERS 1&2 AND FINAL TORQUING

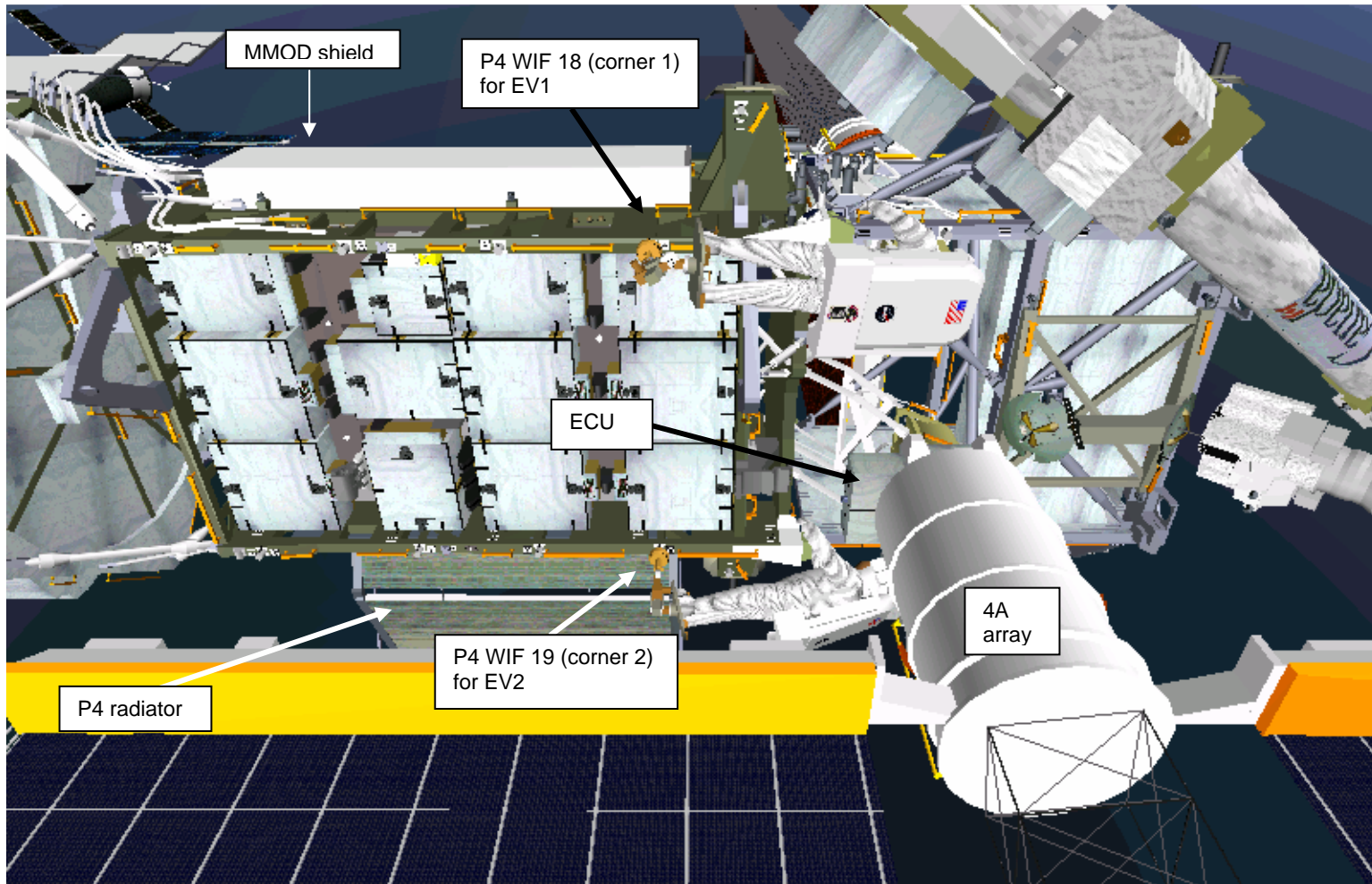

RTAS CORNERS 3&4 AND FINAL TORQUING

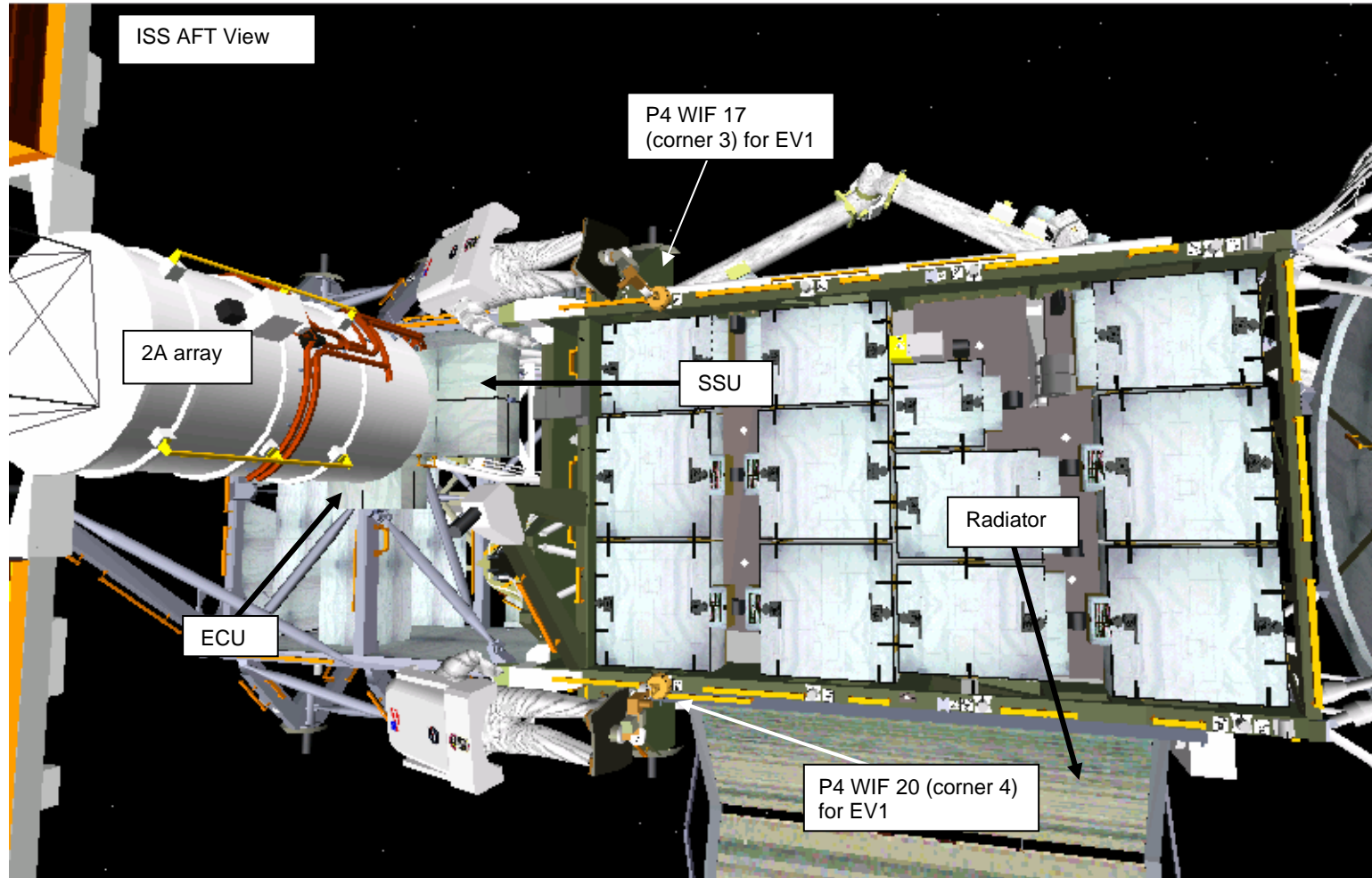

PVRGF OVERVIEW

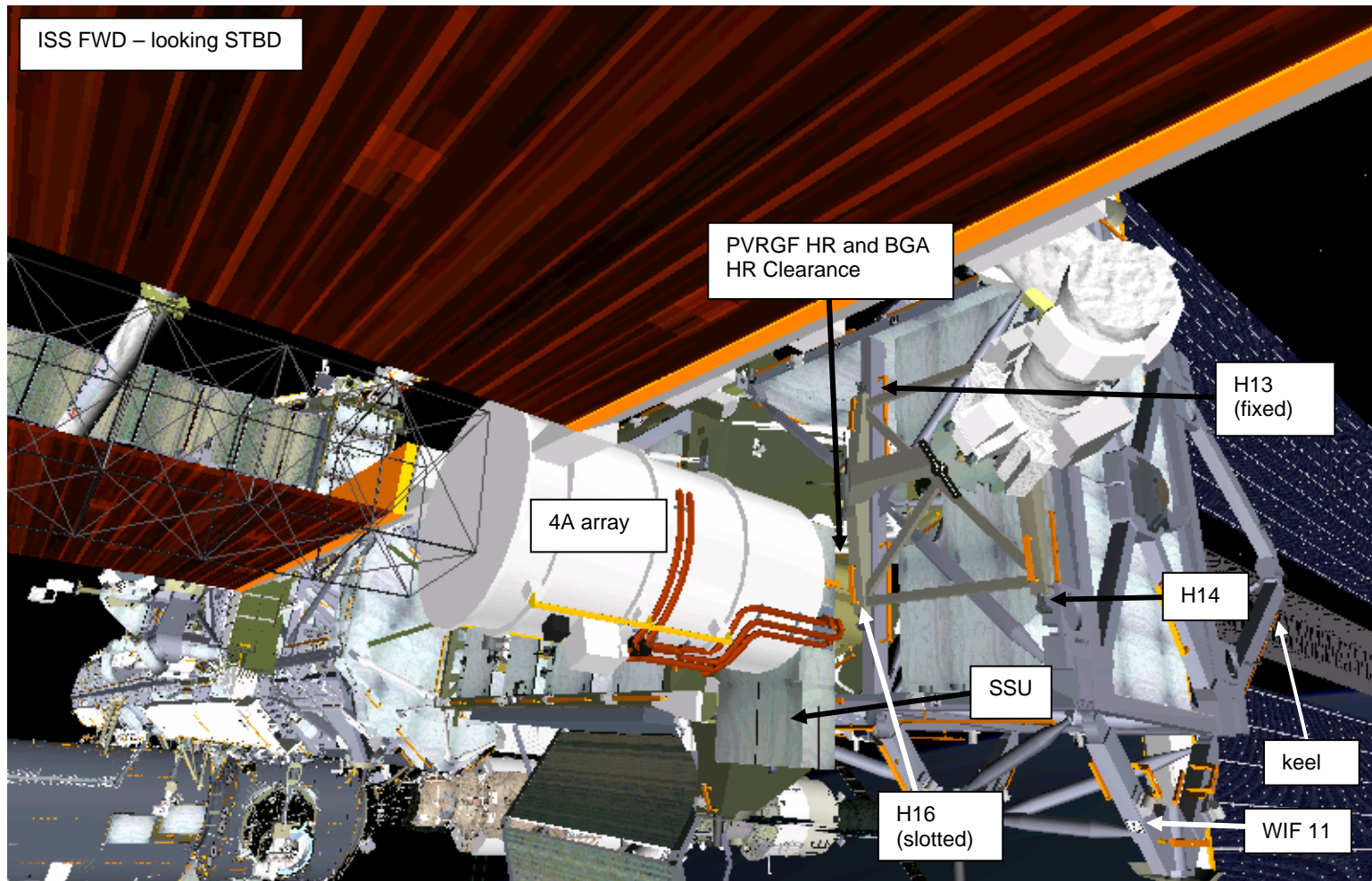

PVRGF REMOVAL WORKSITE – P5 WIF 11

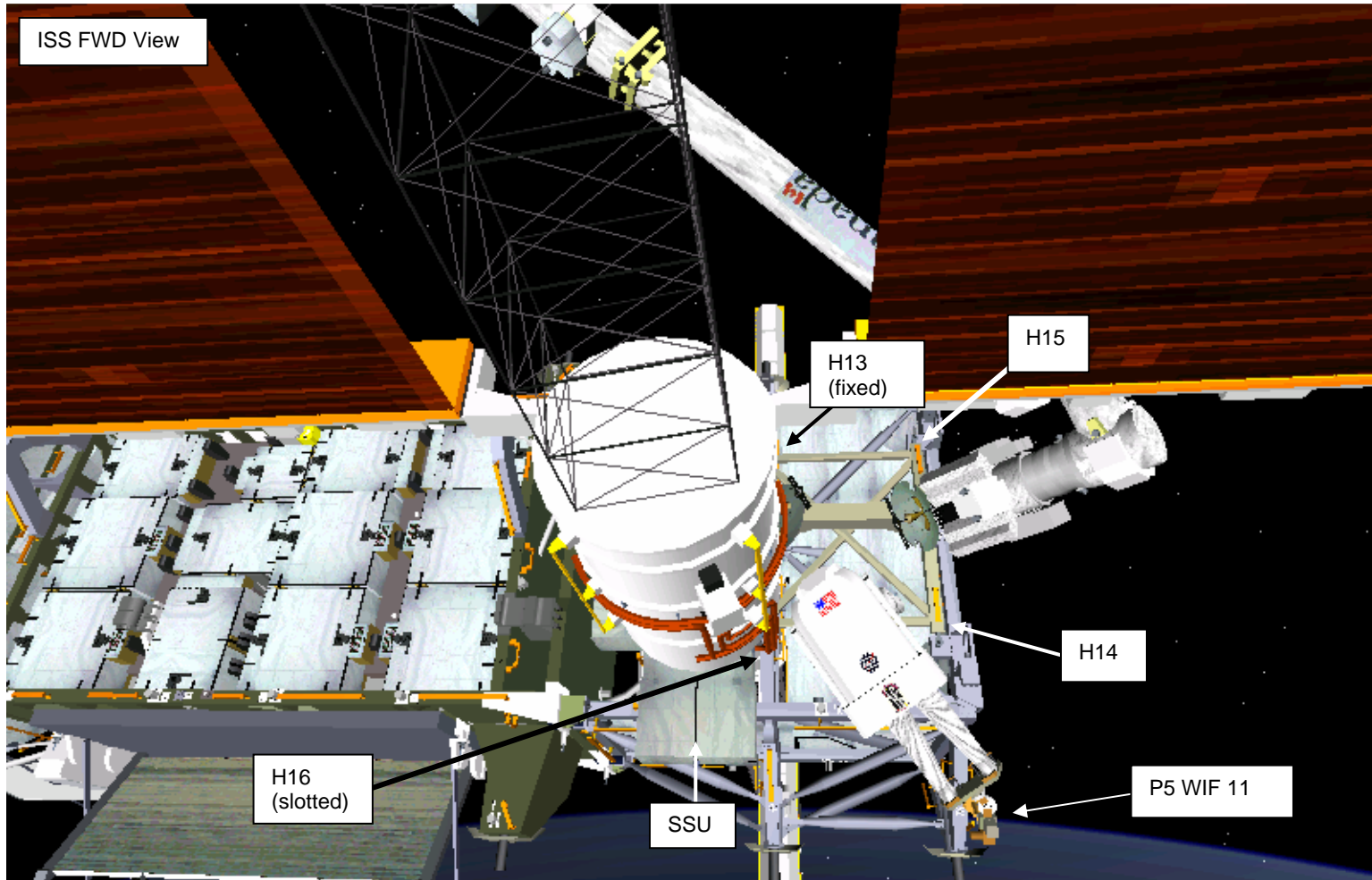

PVRGF STOWED ON KEEL

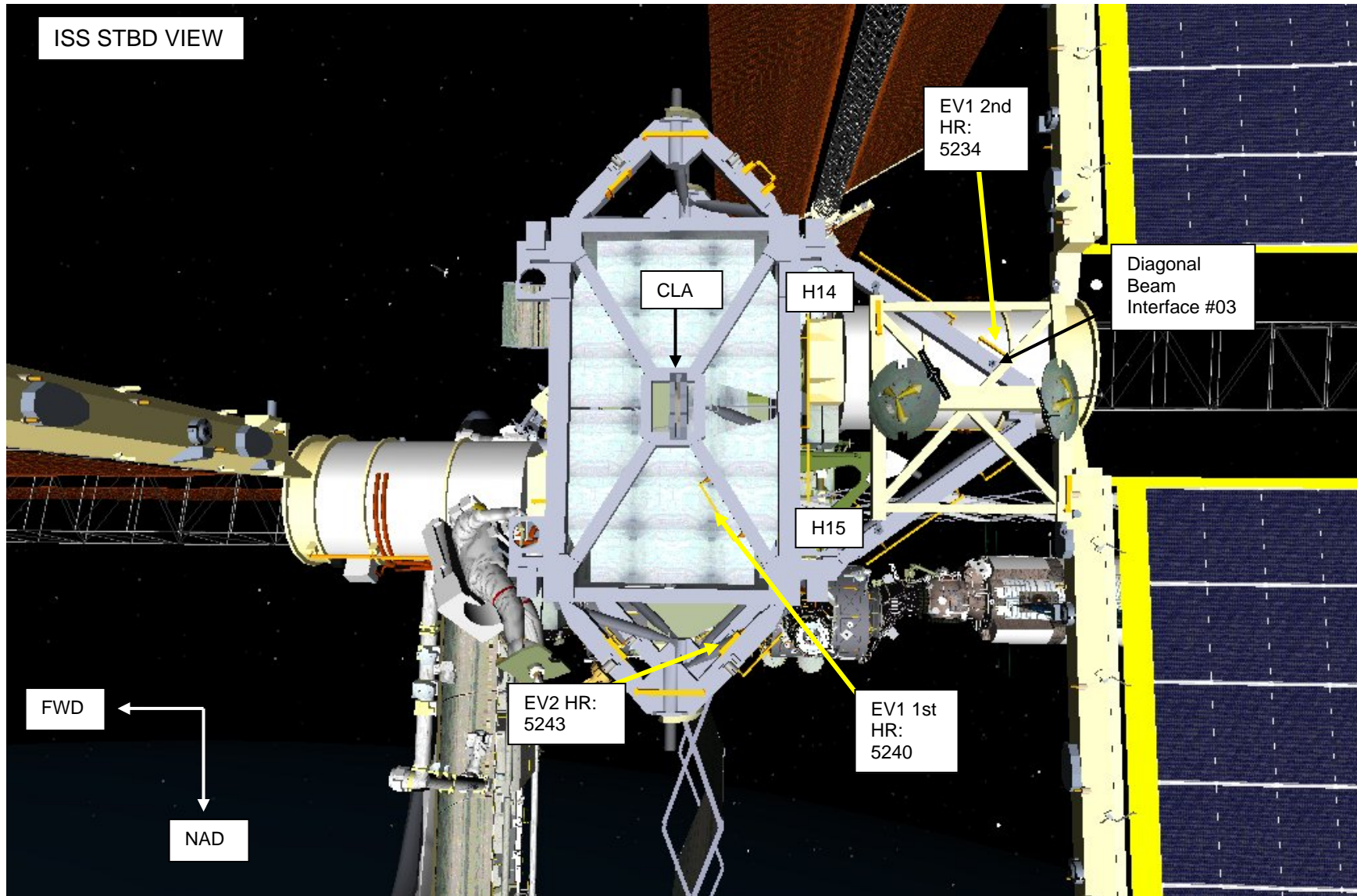

CP3 OVERVIEW AND TRANSLATION PATH

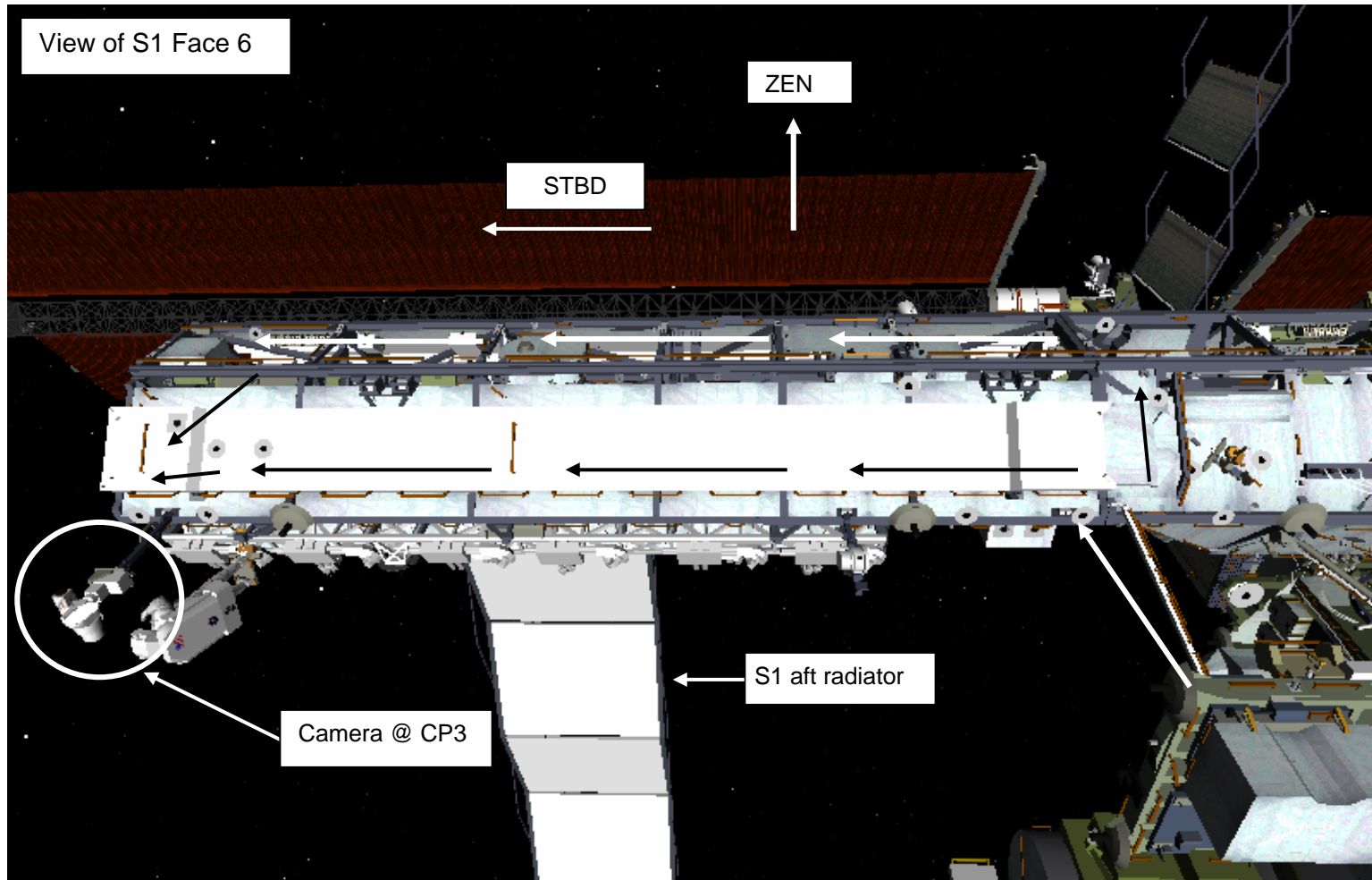

S0 WORKSITES – EVA 2

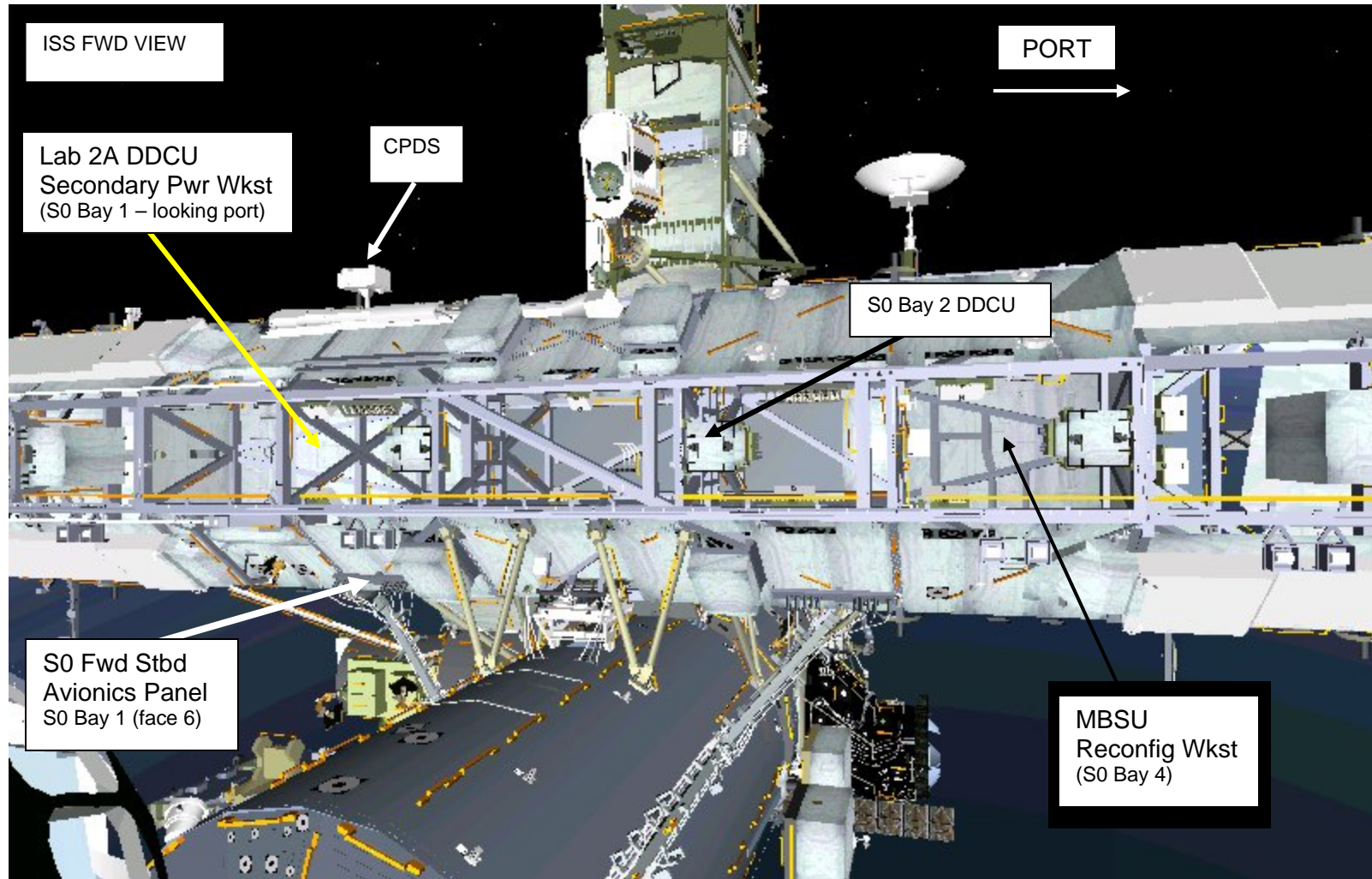

FS 18-25

EVA/116/FIN

**EVA 2
OVERVIEW**

SAFETY TETHER SWAP LOCATION FOR P1 BAY 16 DDCU

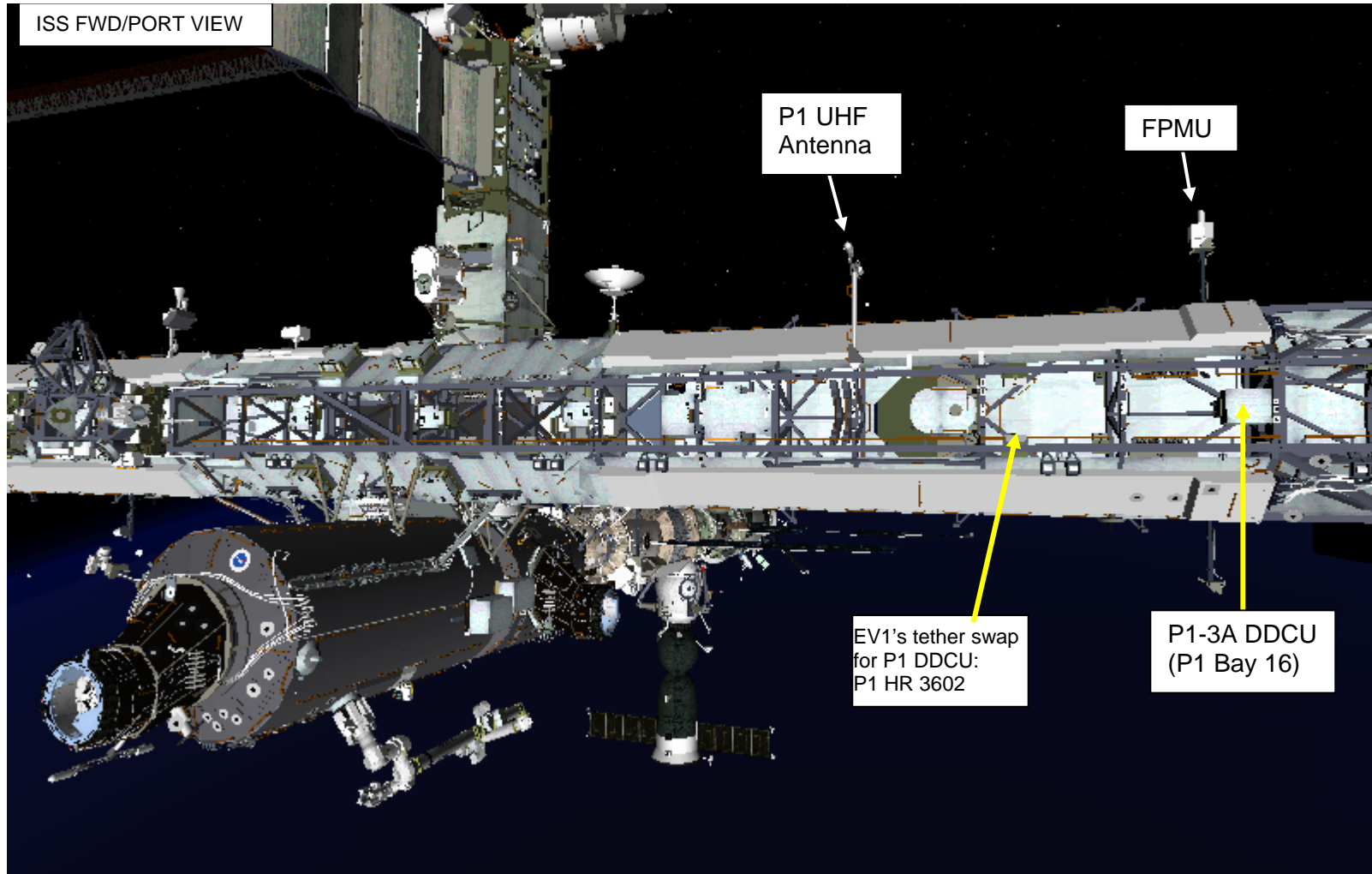

Z1 PP WORKSITES – EVA 2

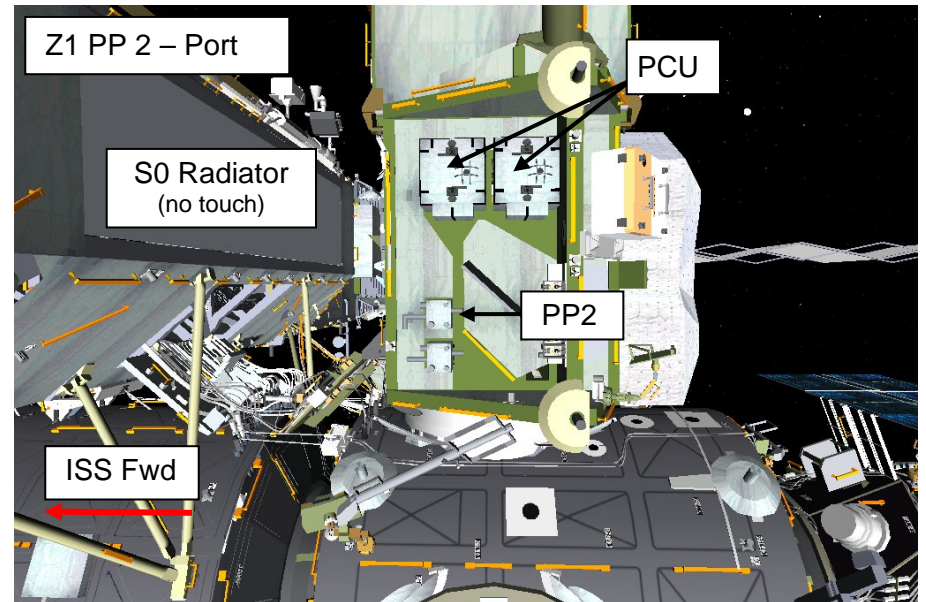
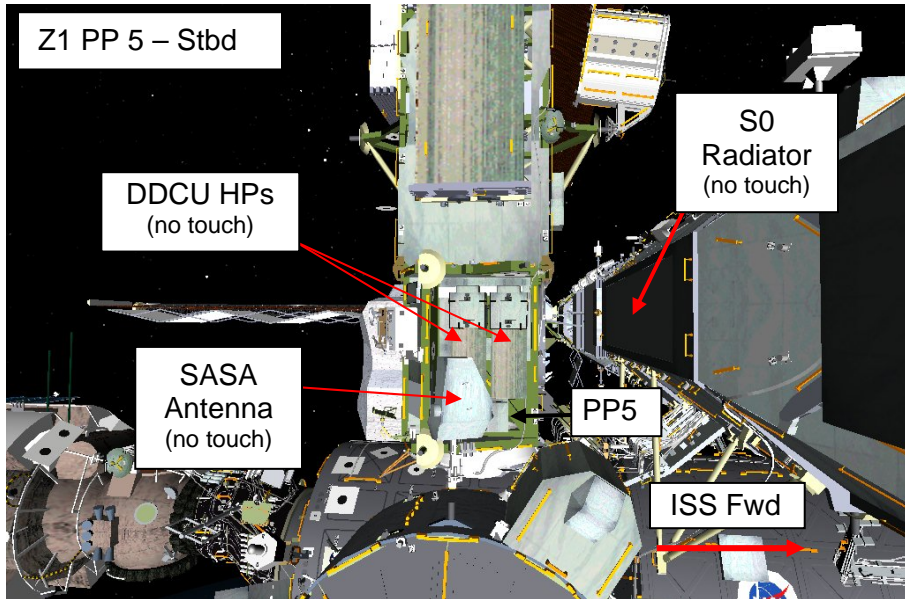

CETA CART RELOCATION – INITIAL POSN & SAFETY TETHER SWAP

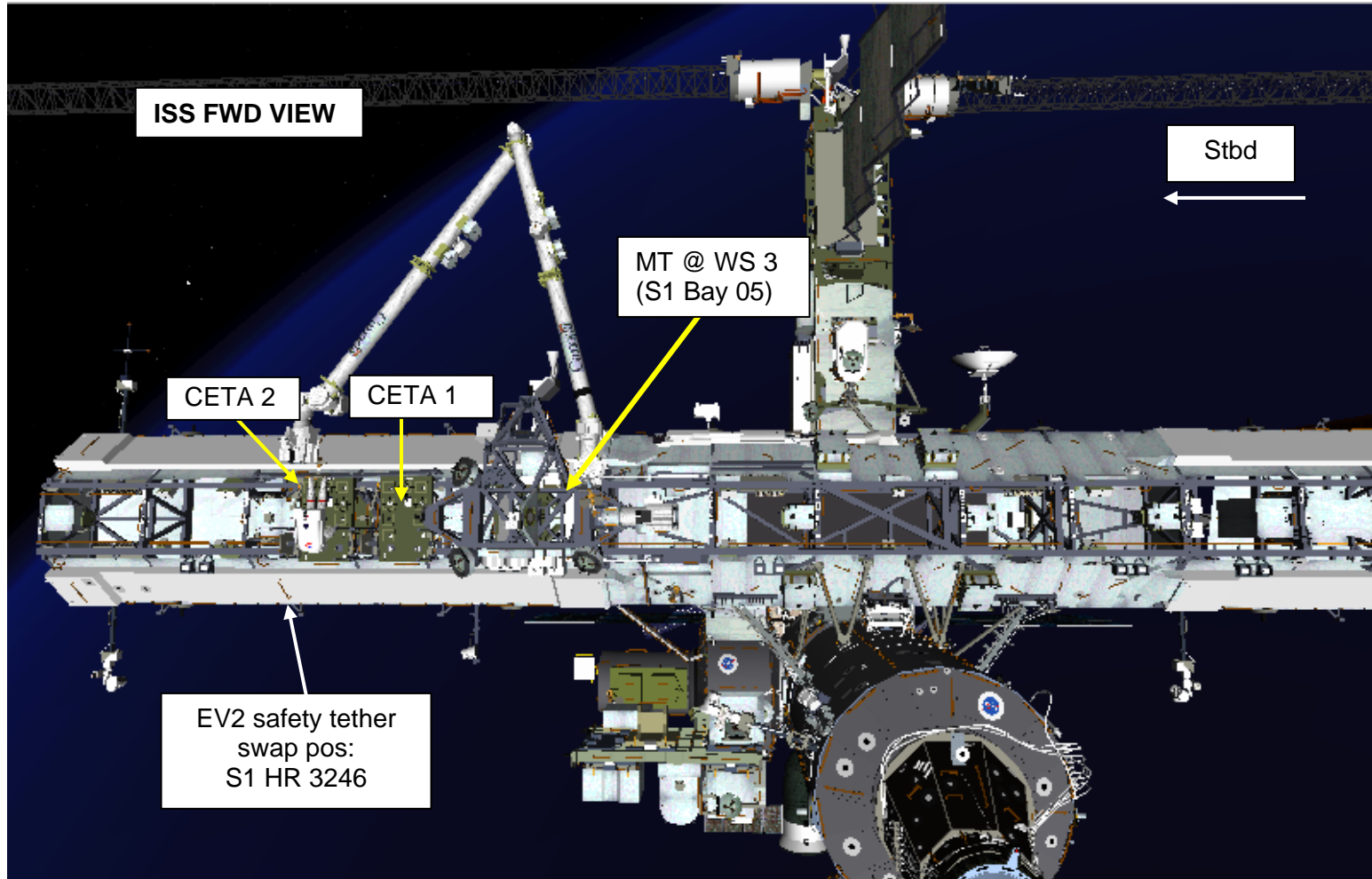

CETA CART RELOCATION

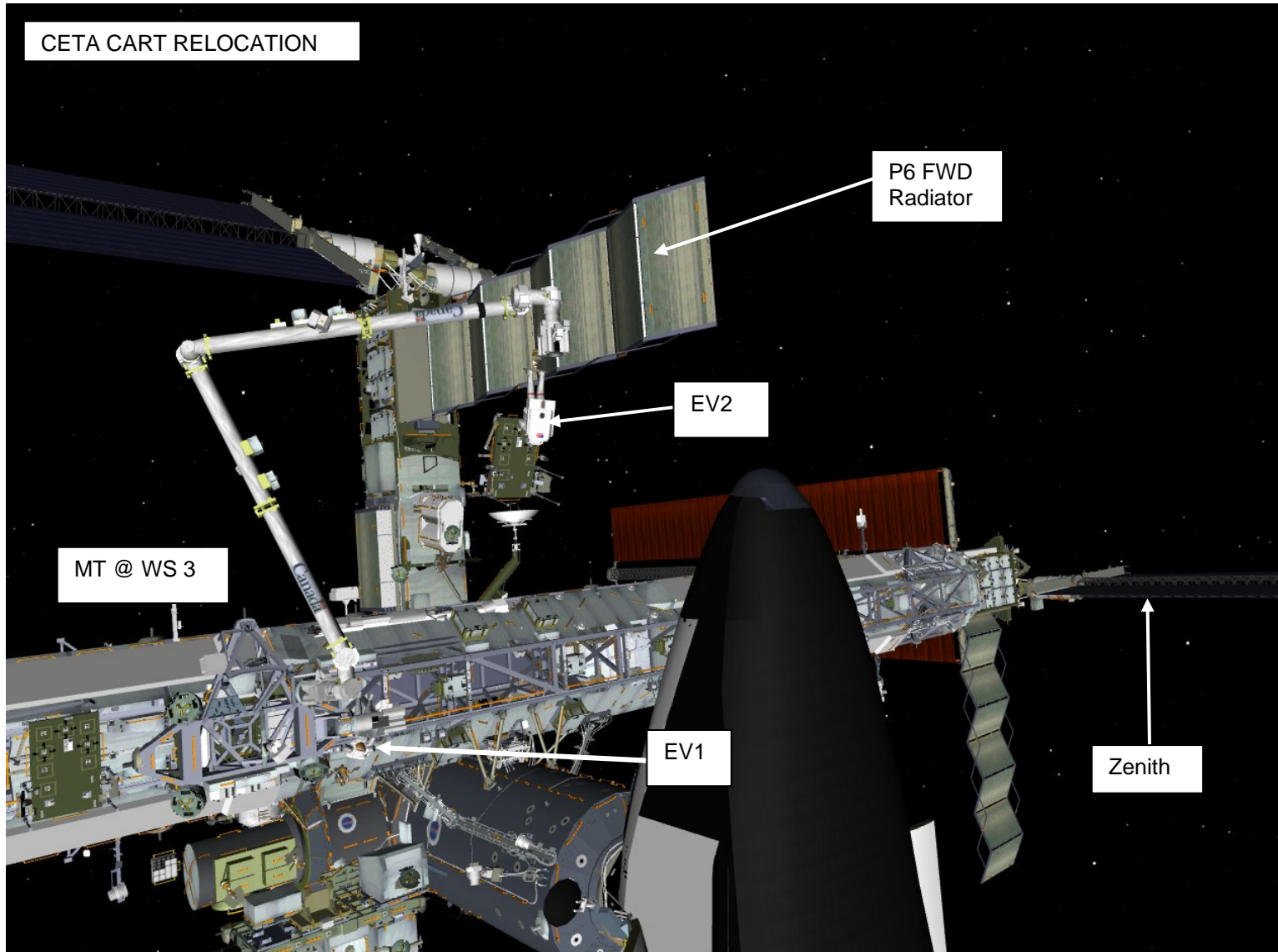

CETA CART RELOCATION – FINAL POSN

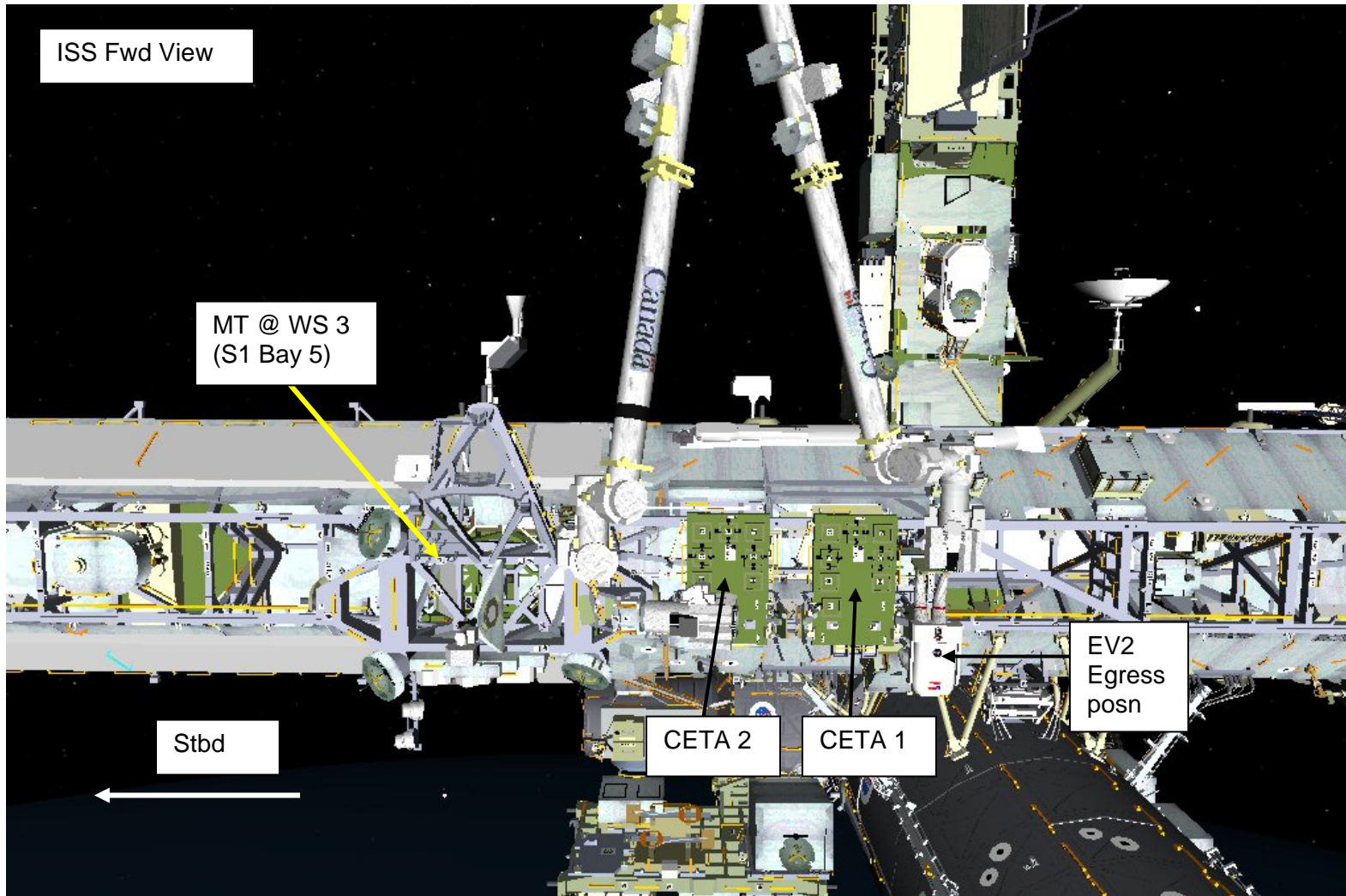

SSRMS FMS MLI INSTALL

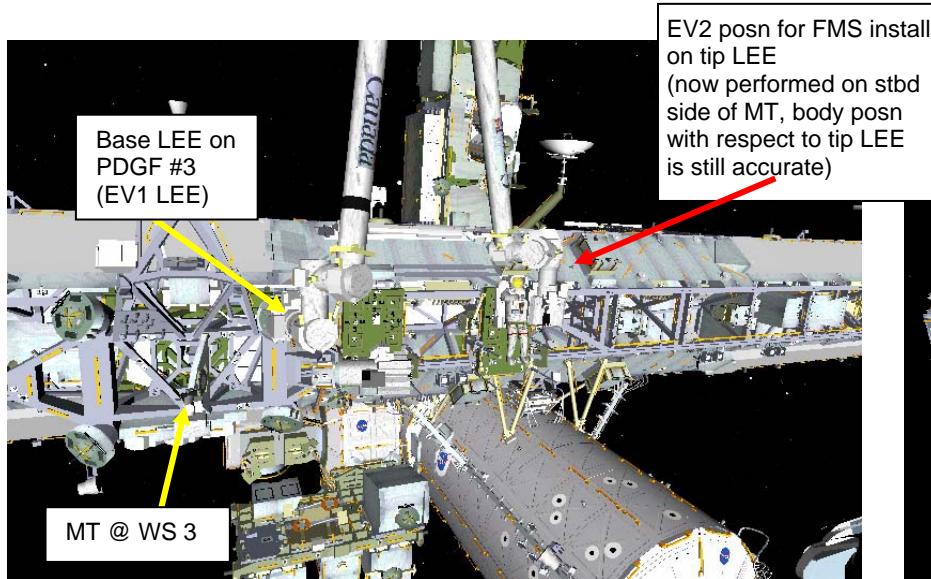

FMS INSTALL OVERVIEW

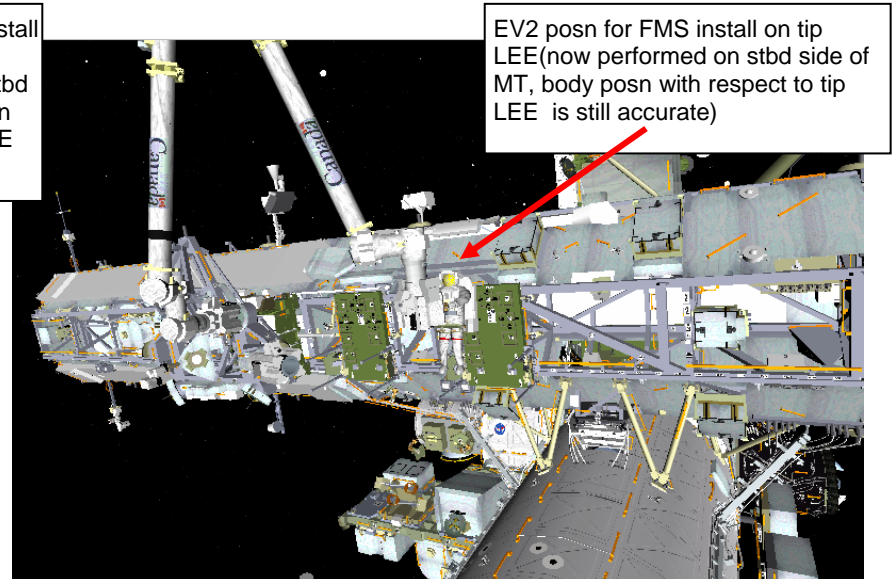

FMS INSTALL OVERVIEW, VIEW 2

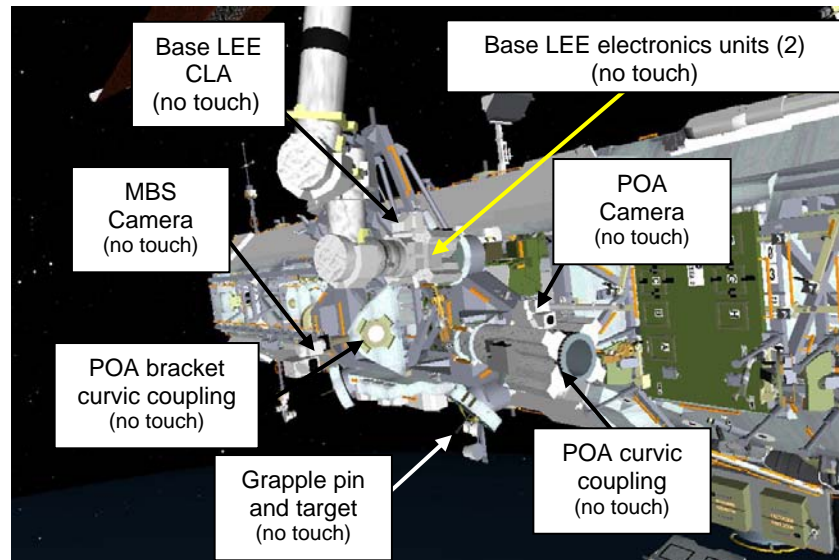

BASE LEE OVERVIEW

EVA 3
OVERVIEW

S0 WORKSITES – EVA 3

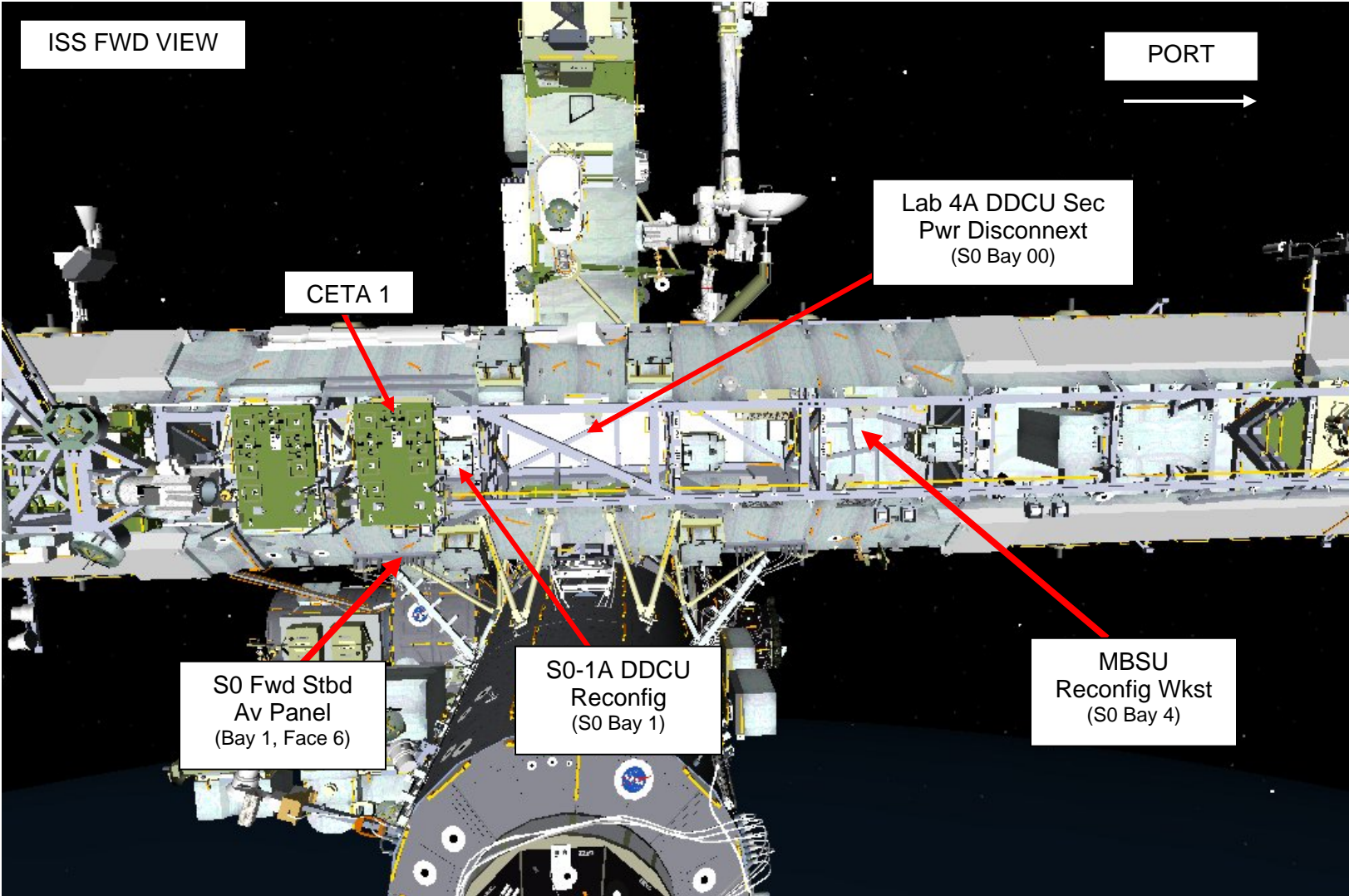

S1 BAY 15 DDCU WORKSITE AND TRANSLATION

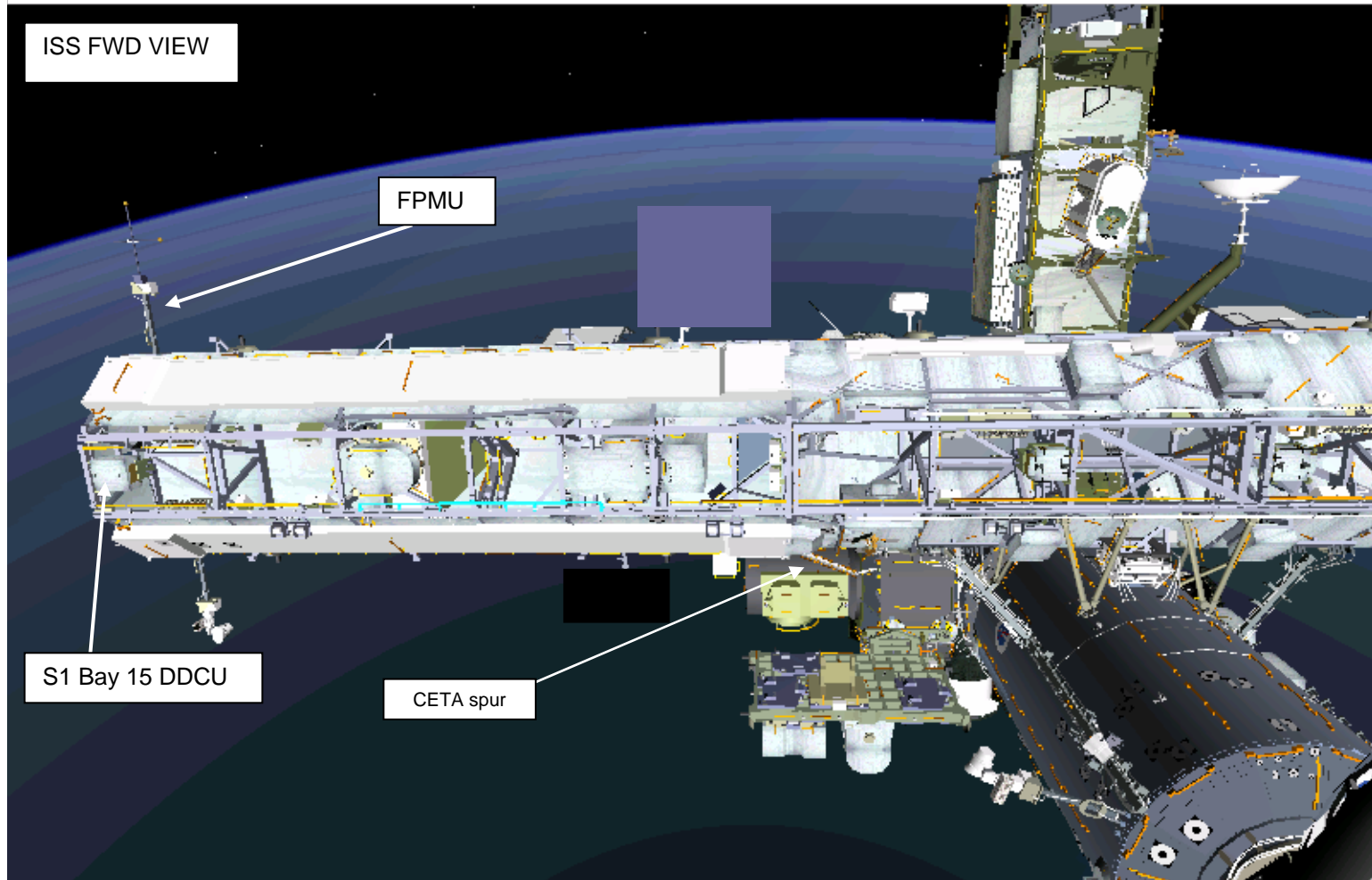

TRANSLATION PATH TO FACE 3 ACCESS FLAP FOR LAB 4A DDCU SECONDARY PWR

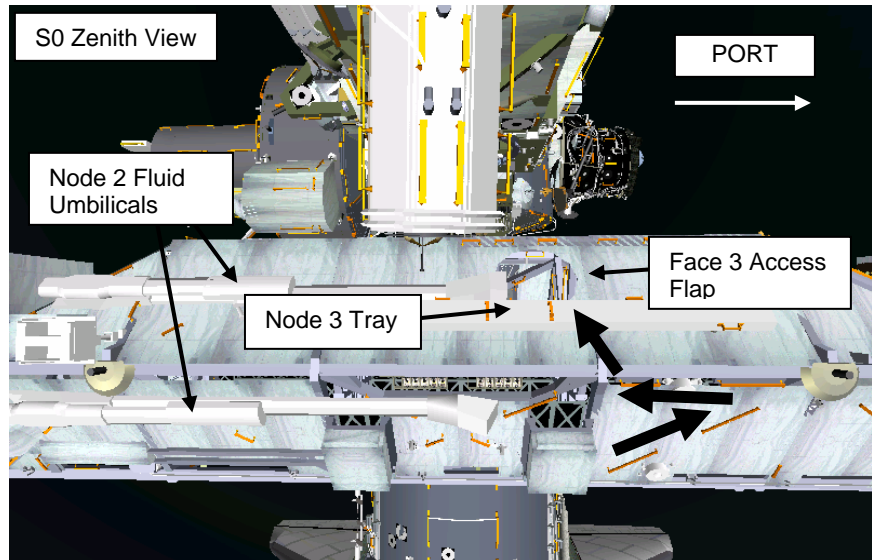
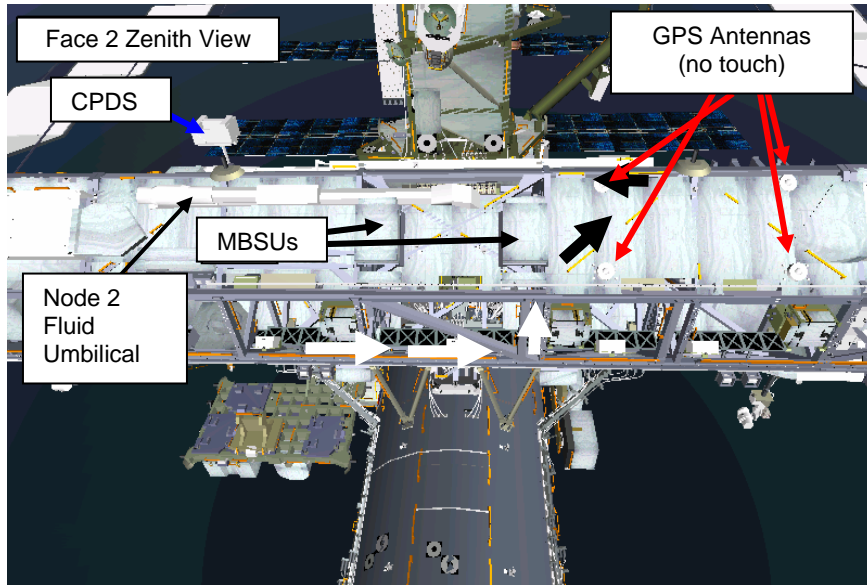

S0 PORT WEDGE FACE DDCU TRANSLATION PATH AND WORKSITE

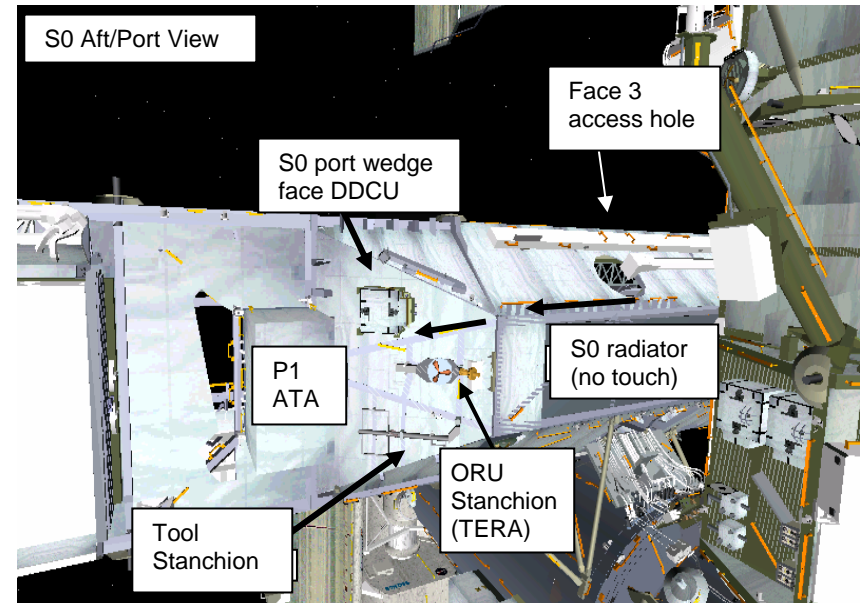
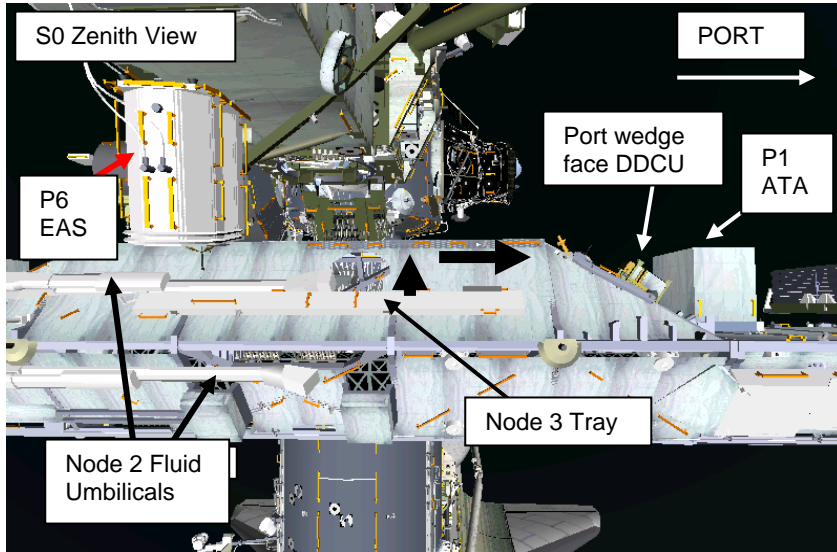

Z1 PP WORKSITES – EVA 3

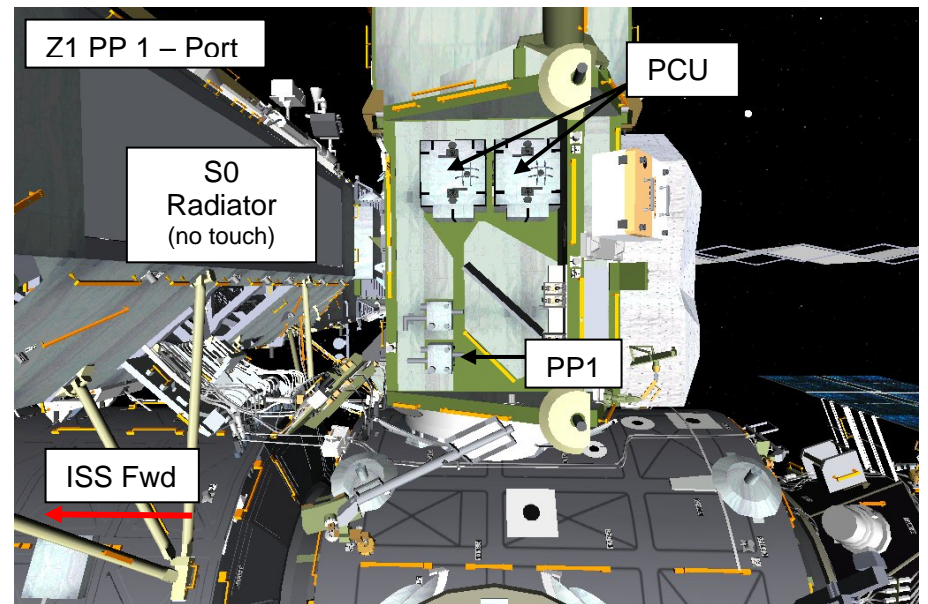
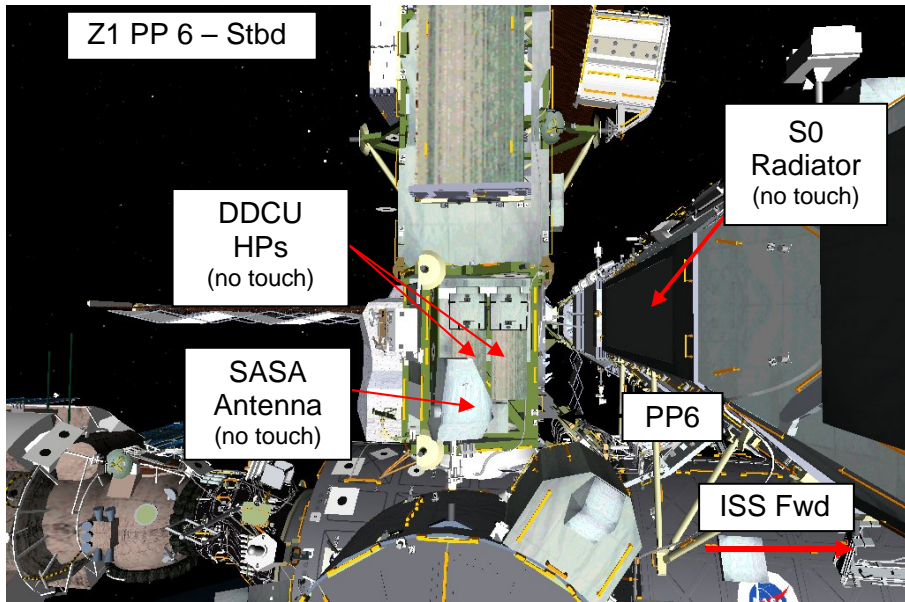

APFR INGRESS LOCATION FOR SMDP TRANSFER

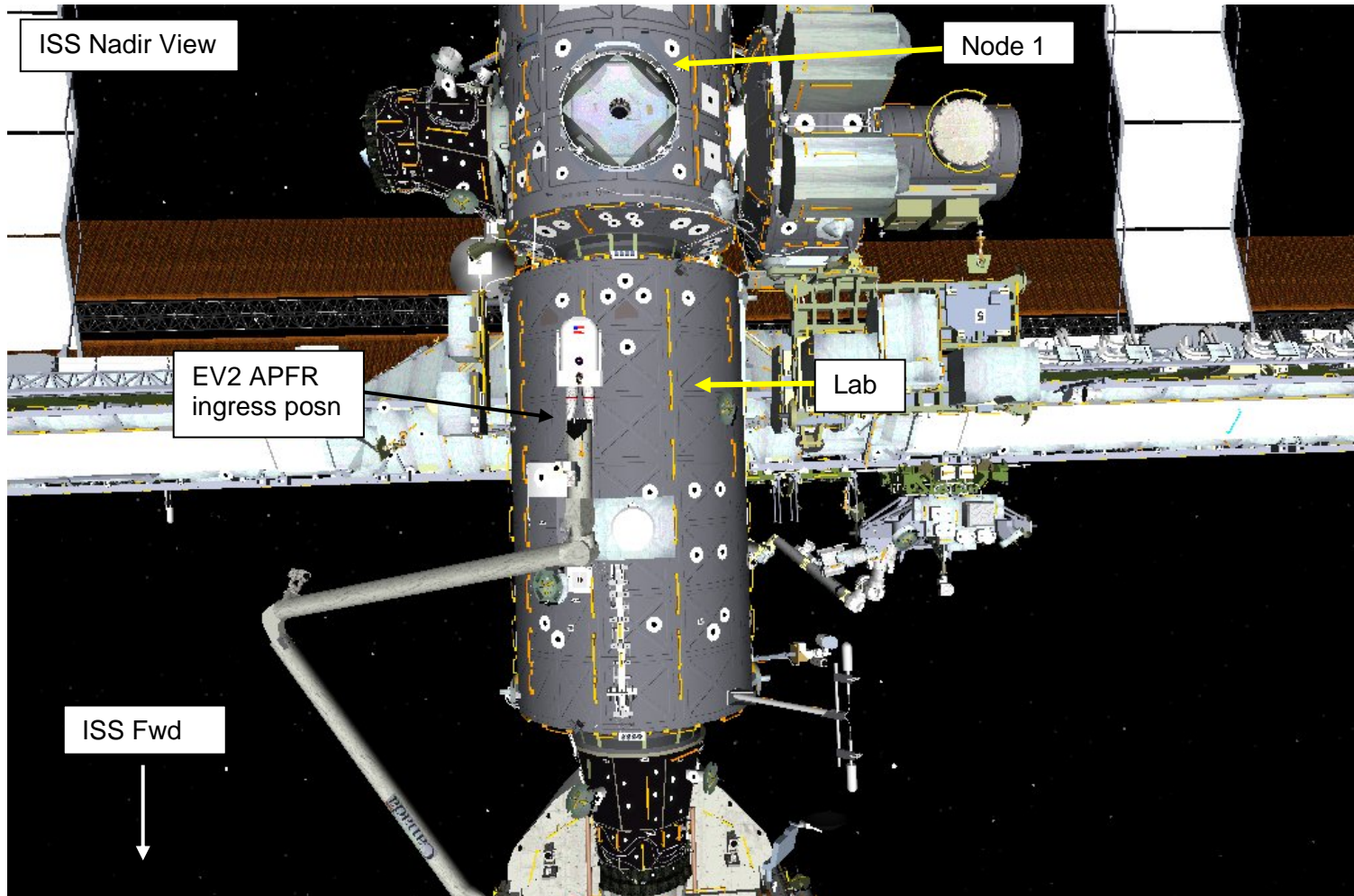

TRANSLATION PATH AND SAFETY TETHER SWAP TO PLB

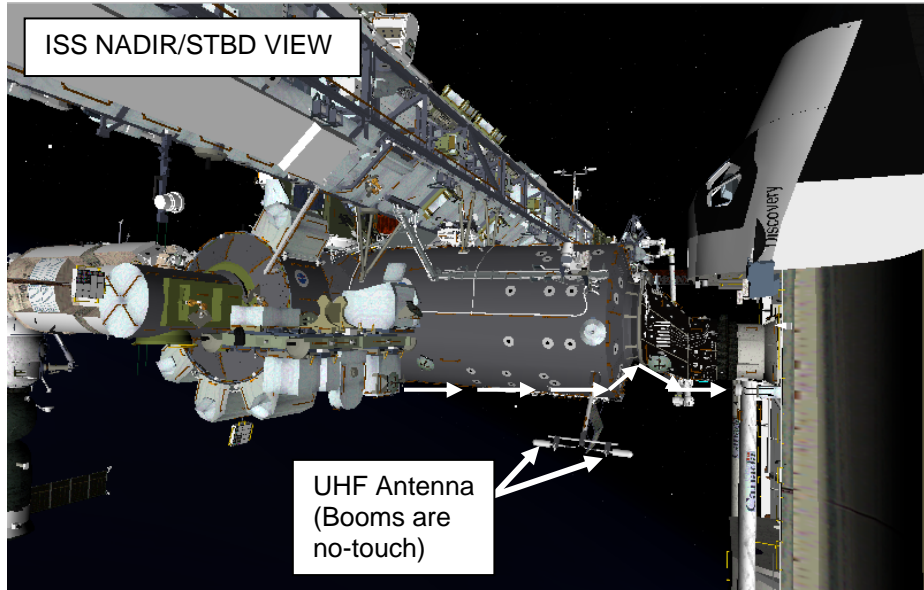

PATH FROM AIRLOCK TO ORBITER STBD SILL

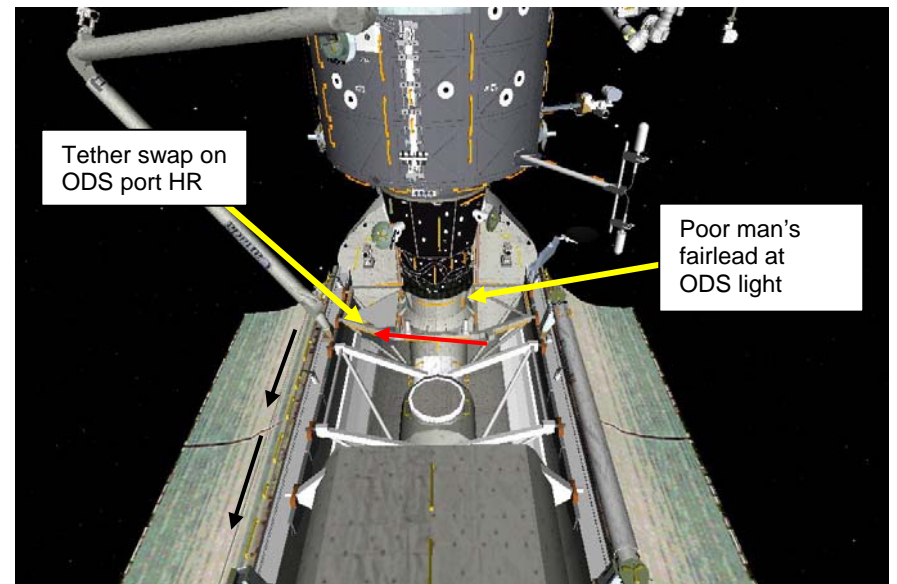

TETHER SWAP AT PORT ODS HR & TRANSLATION TO ICC

Z1-NODE 1 UMBILICALS WORKSITE OVERVIEW

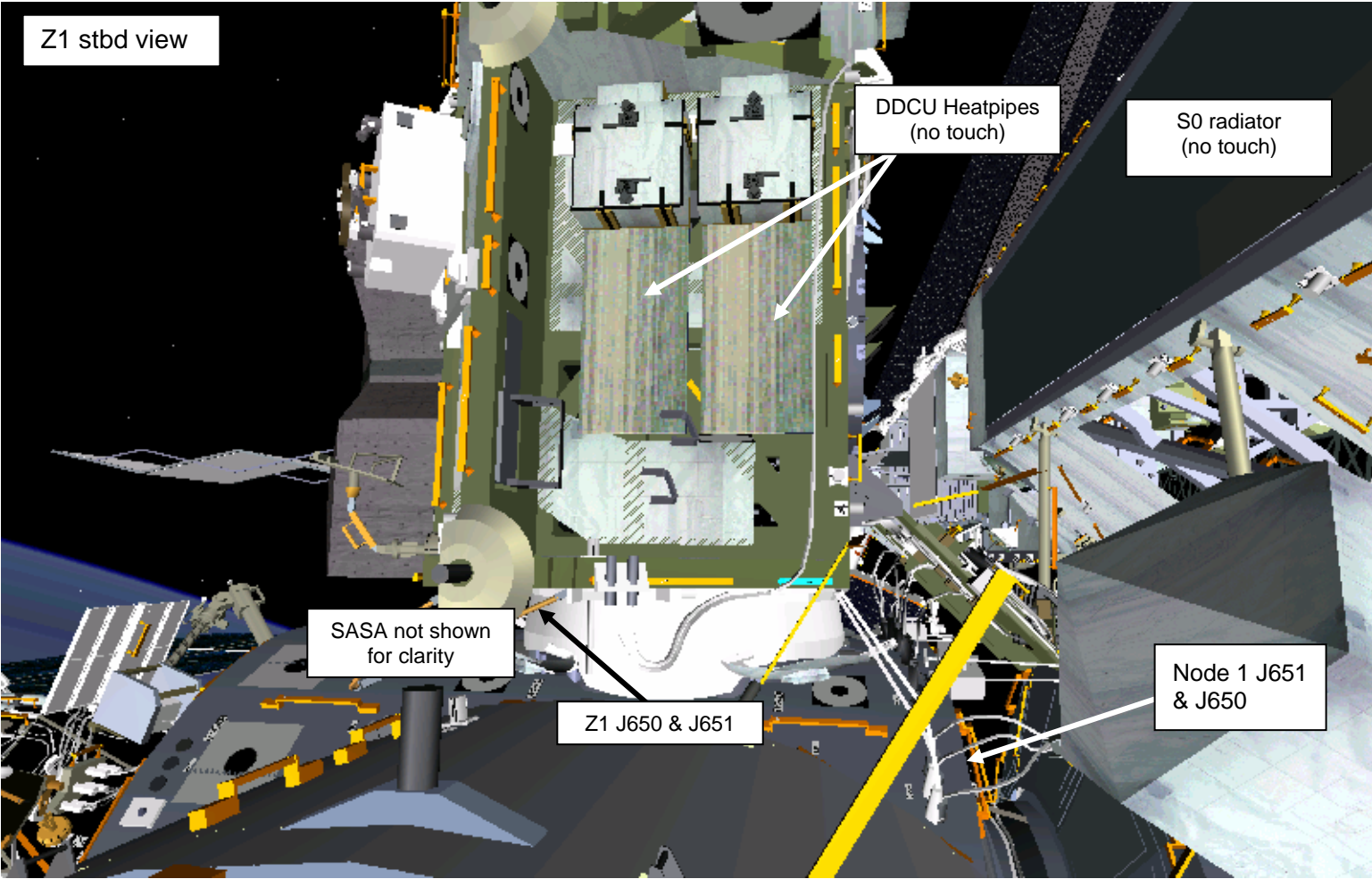

H-JUMPER WORKSITE

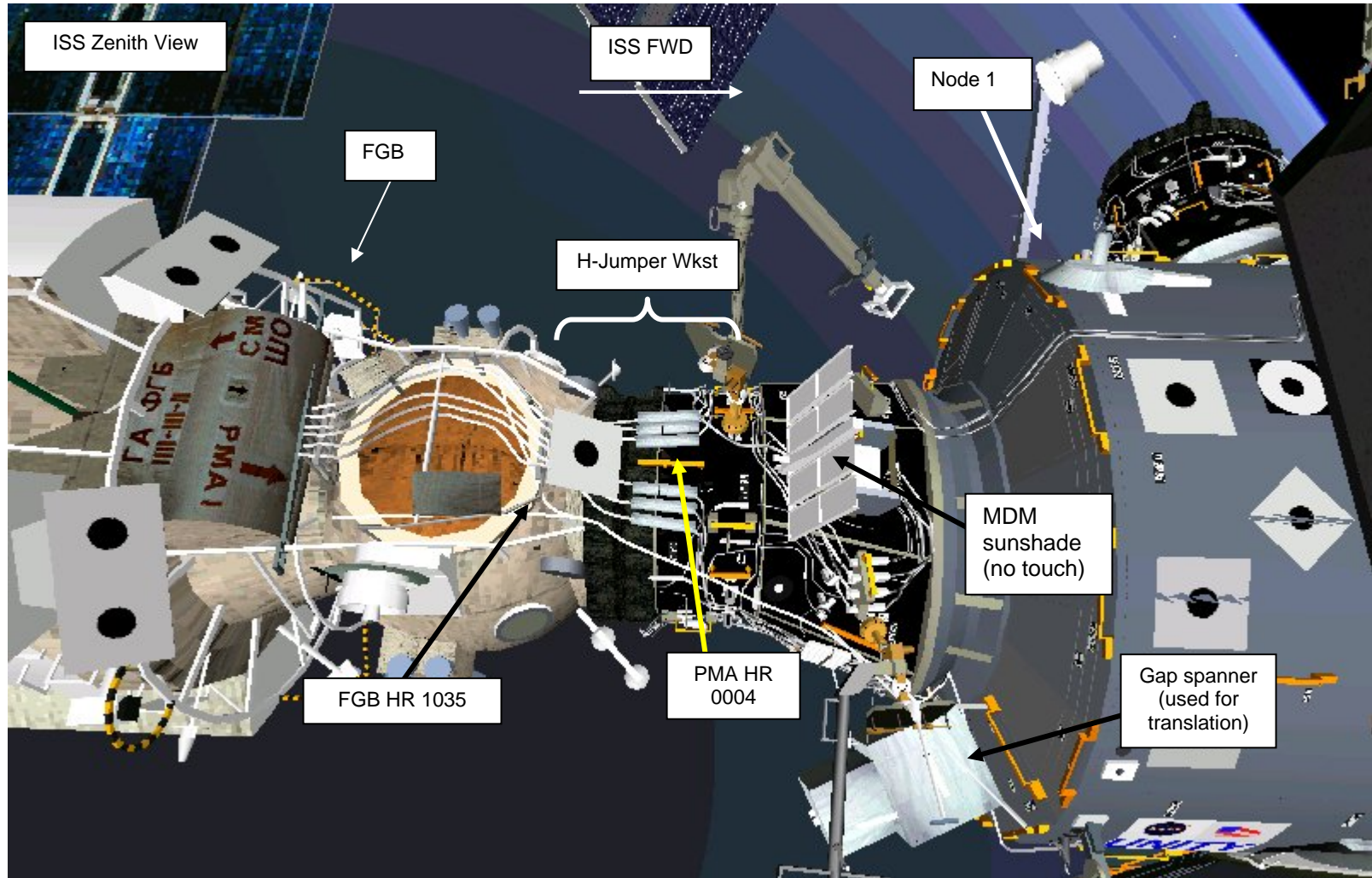

P5 ISOMETRIC VIEW

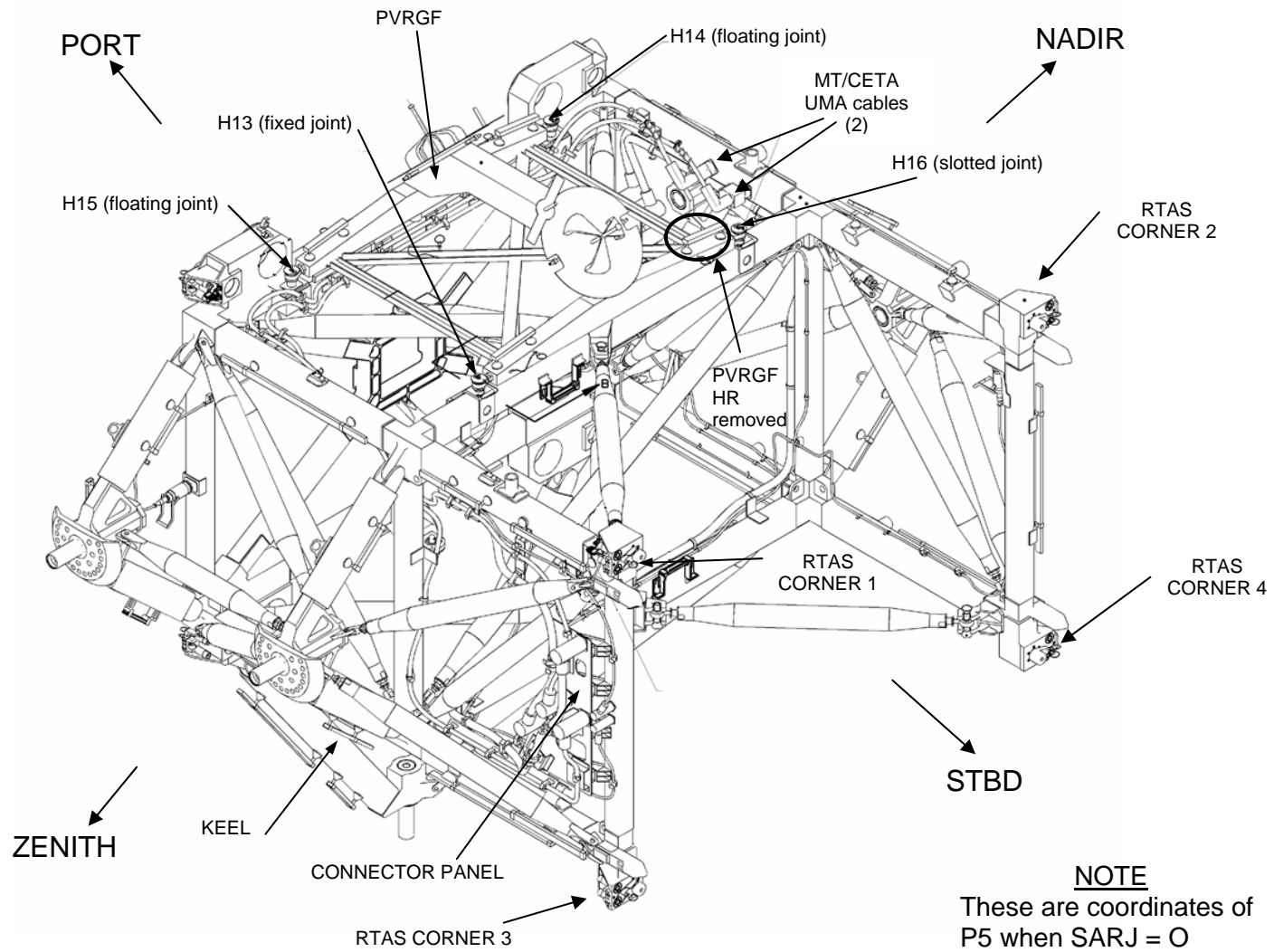

FS 18-41

EVA/116/FIN

P5/PVRGF

P5 HANDRAILS AND WIFs (PORT/FWD VIEW)

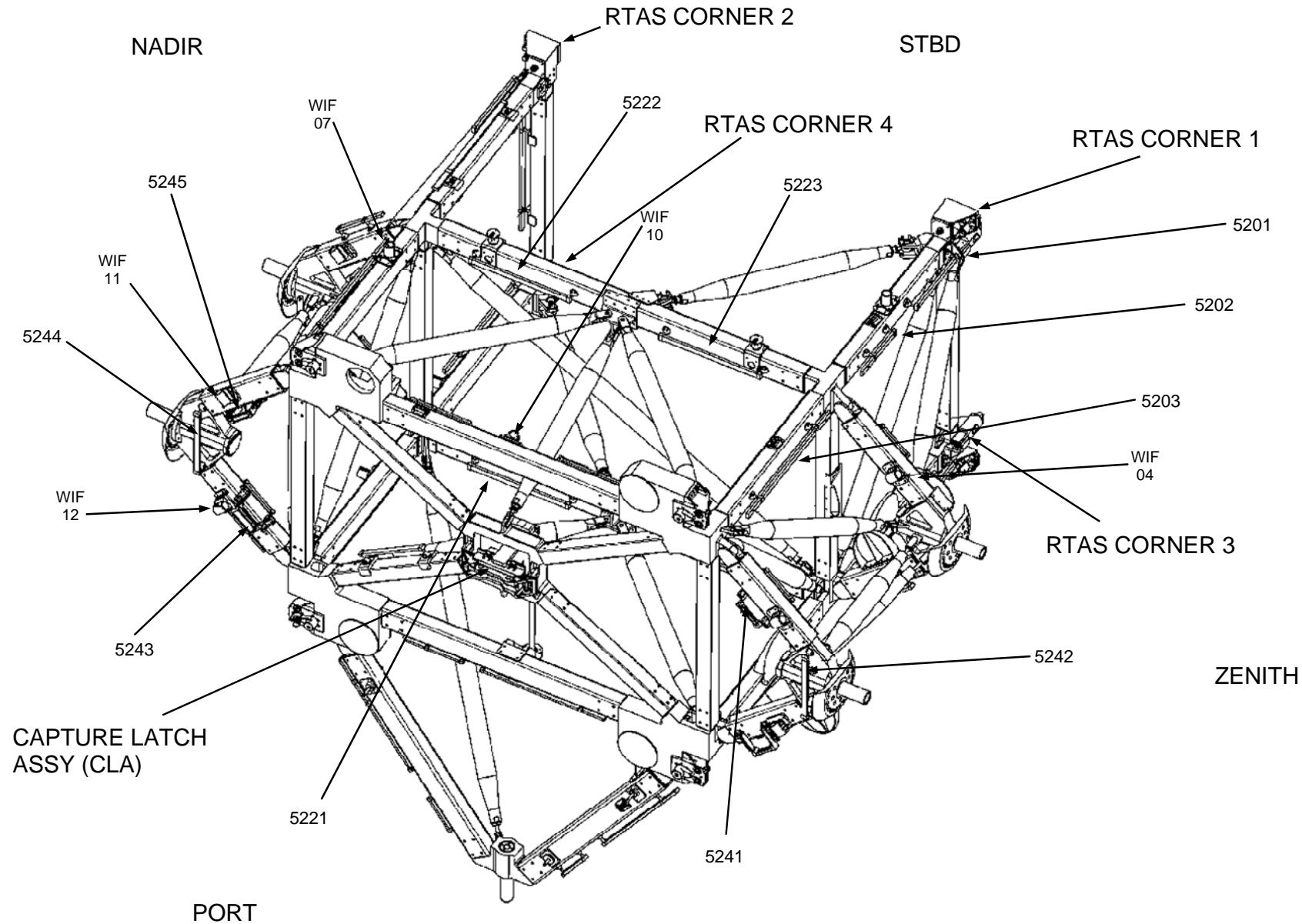

P5 HANDRAILS AND WIFs (ZENITH/STBD VIEW)

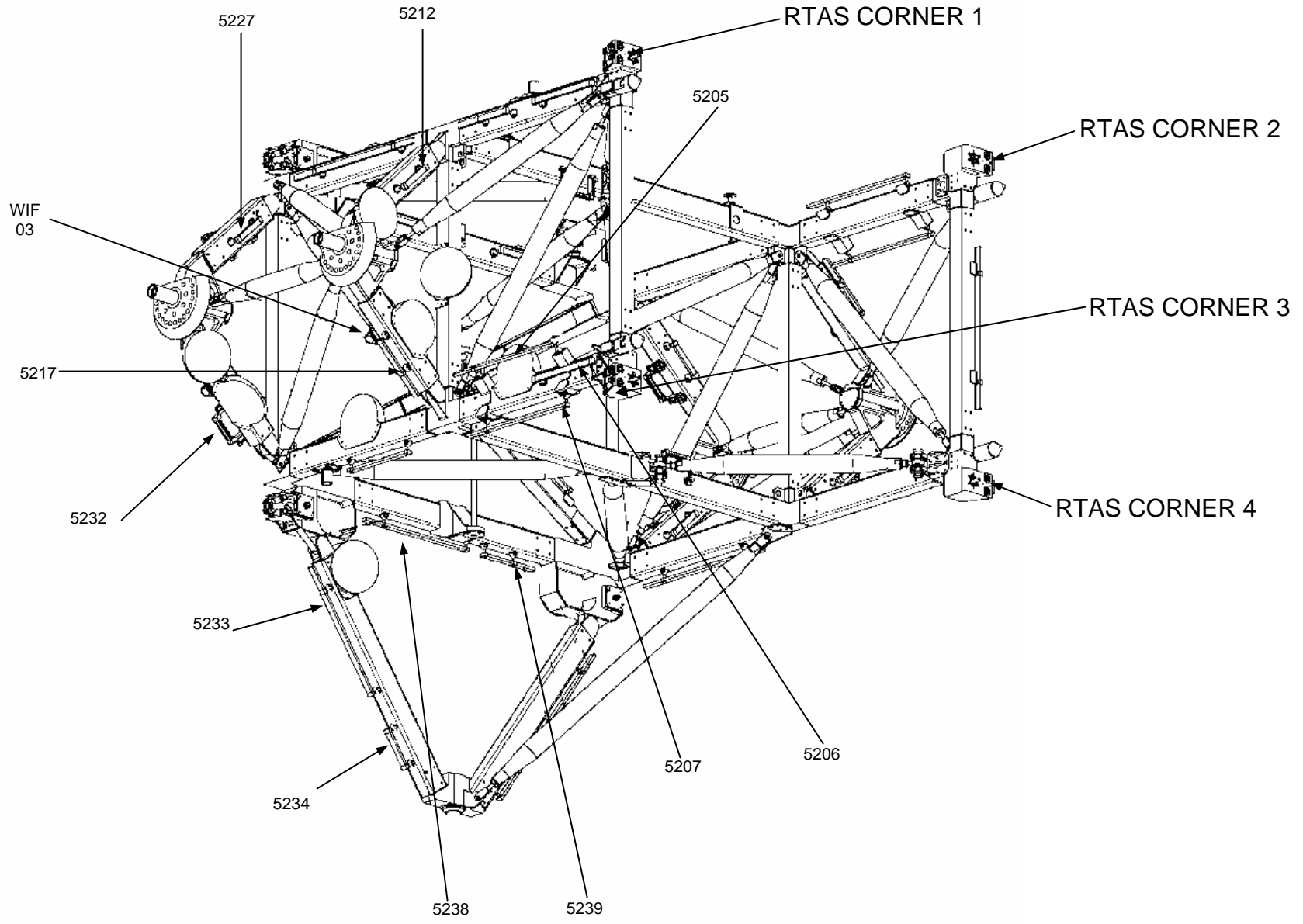

P5 HANDRAILS AND WIFs (FWD/PORT VIEW)

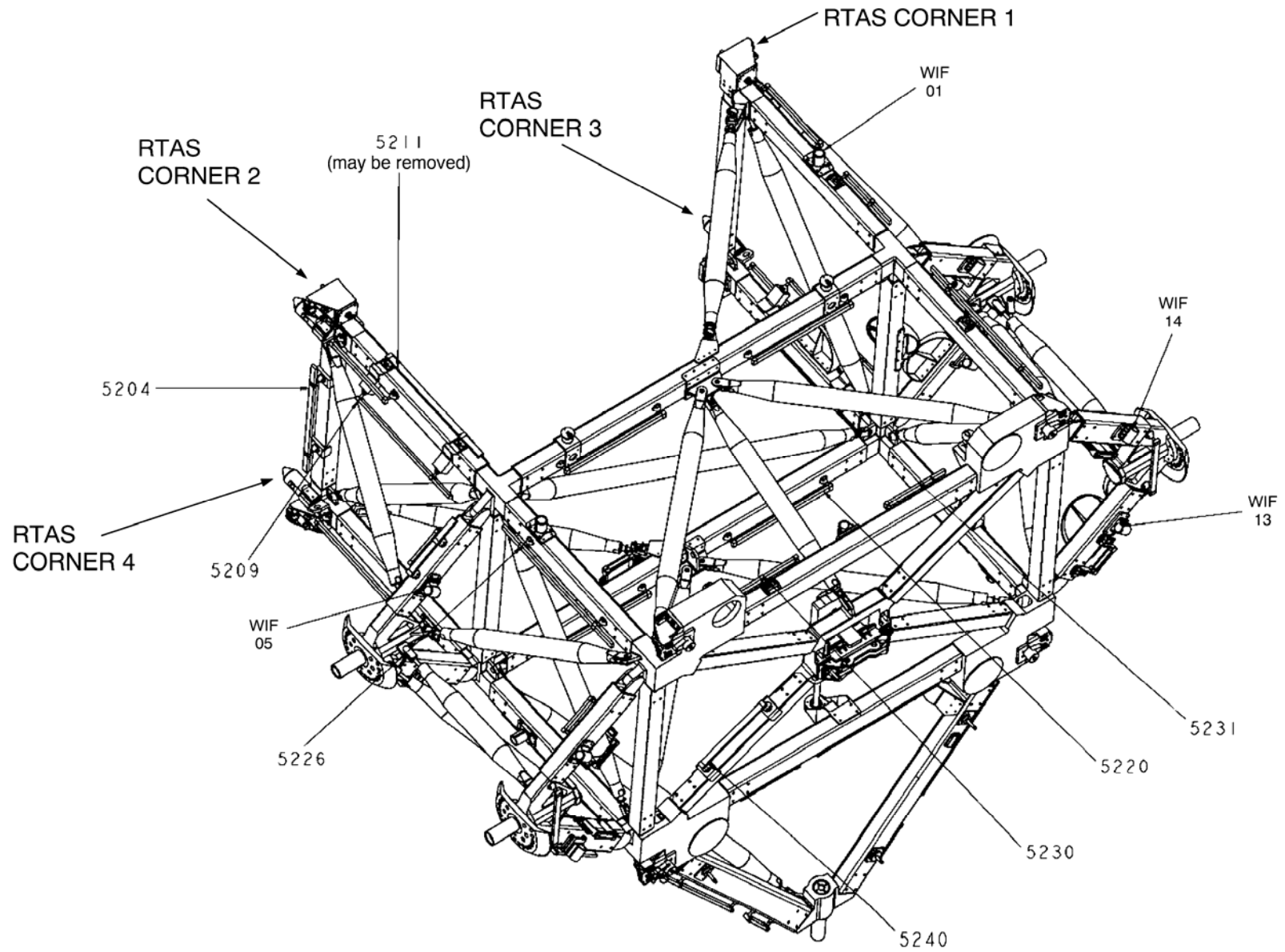

P5 MRTAS – ACTIVE

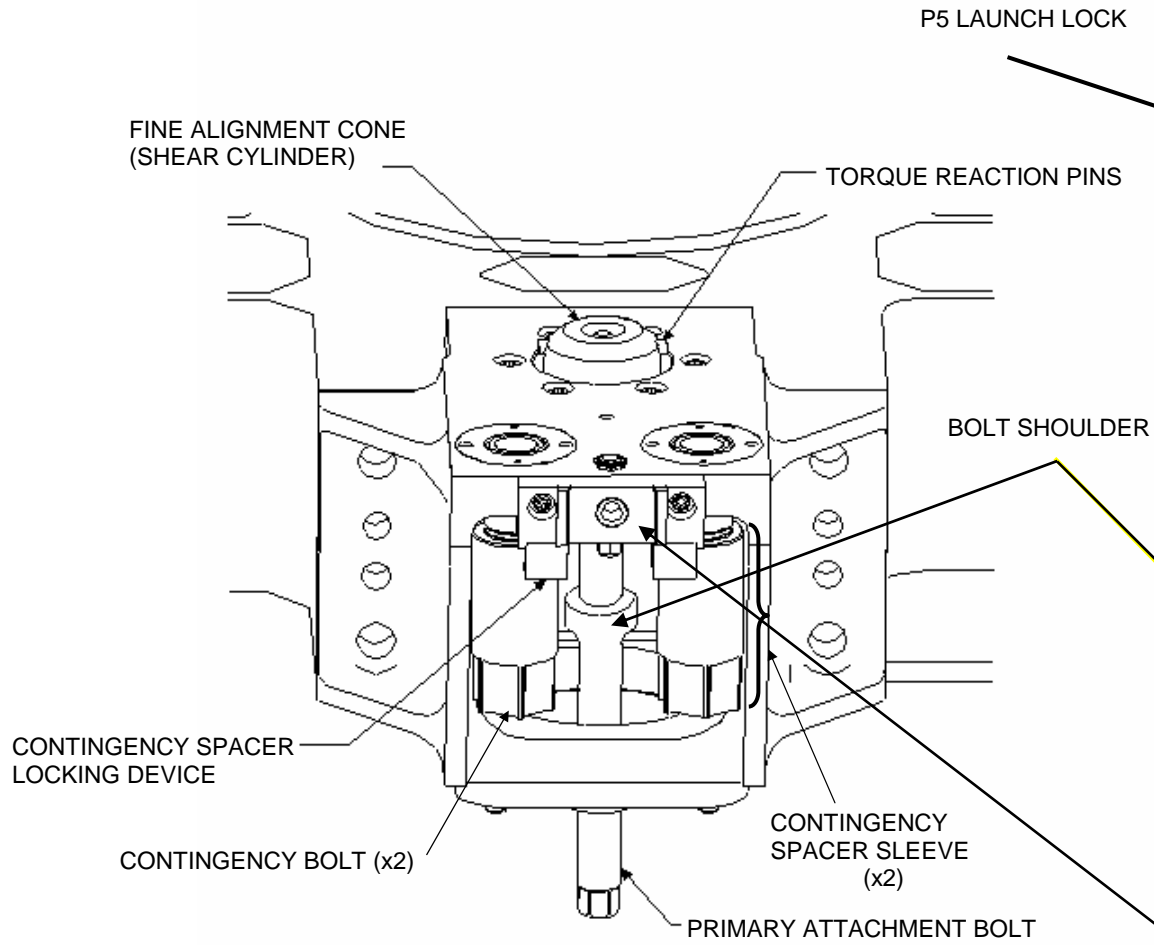

P5 LAUNCH LOCK

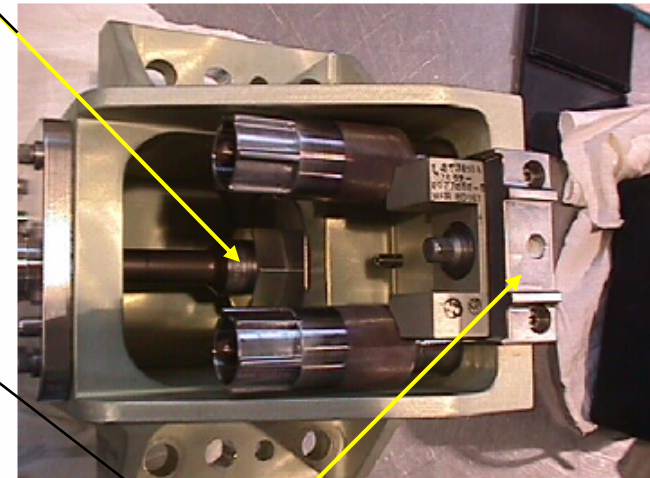
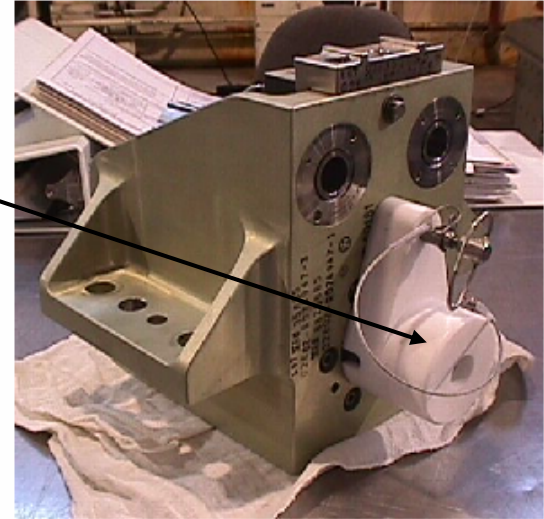

GROUND STRAP RECEPTACLE (GROUNDING LUG)

P5 EWIS LAYOUT

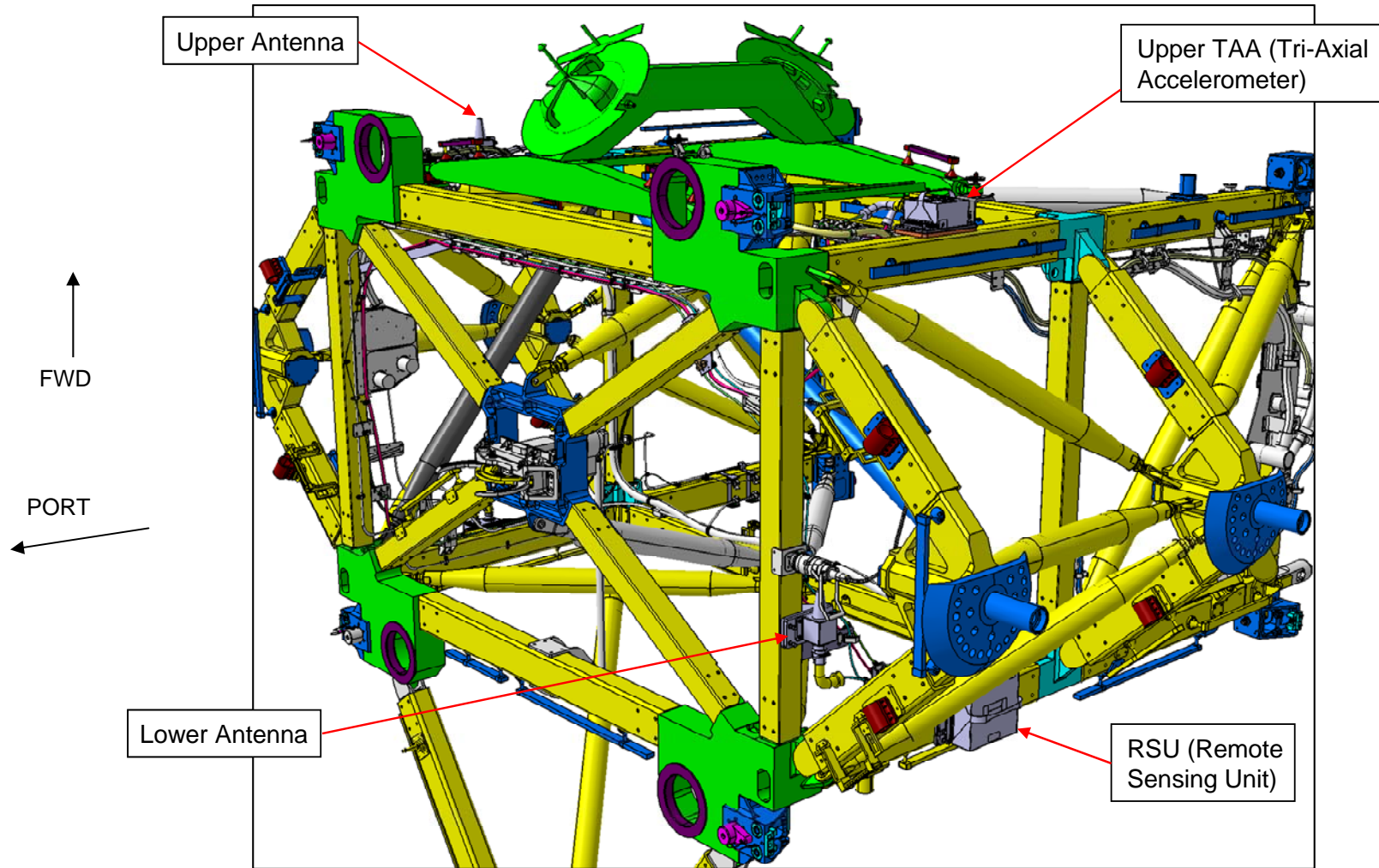

P5 EWIS LAYOUT (Cont)

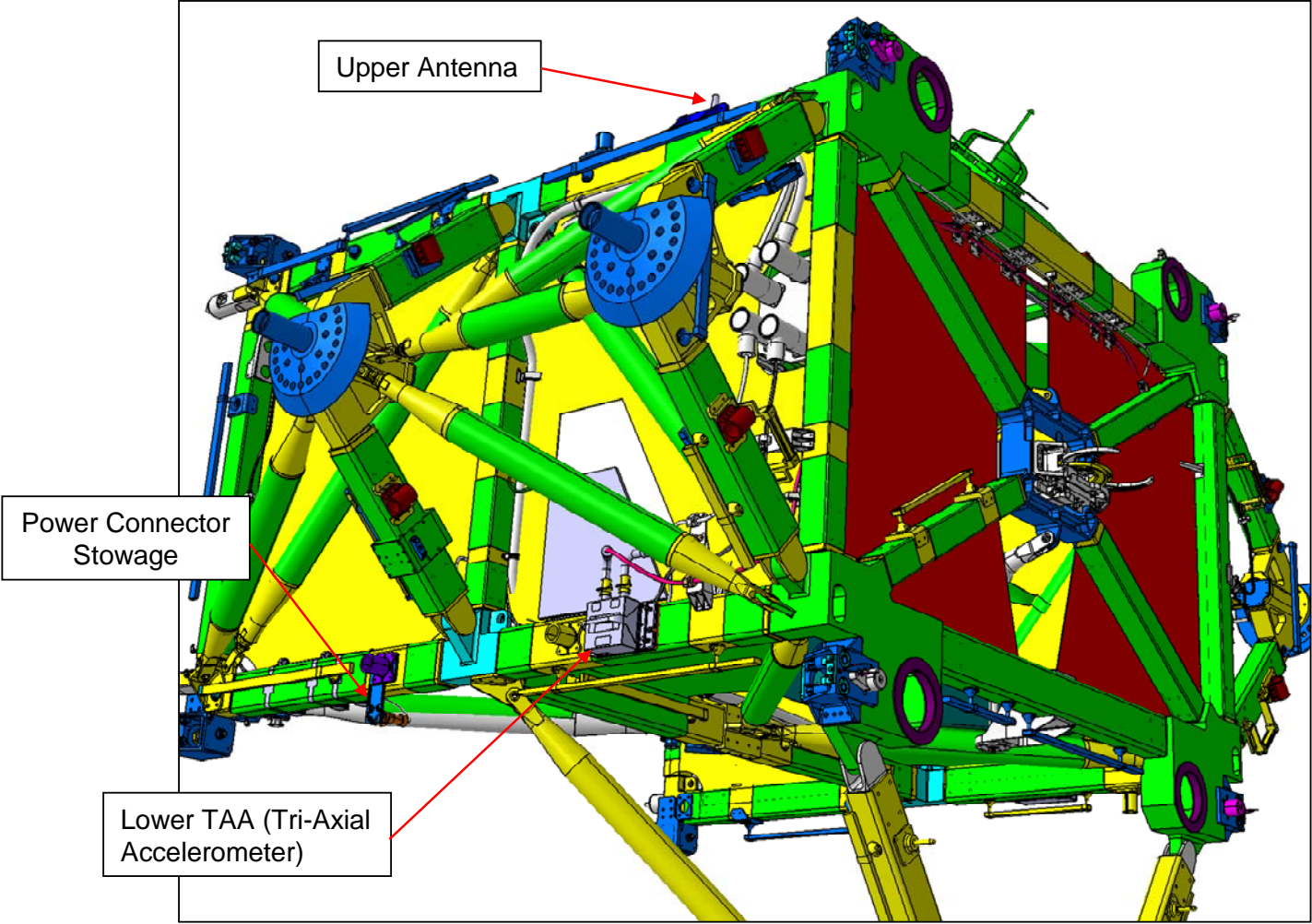

RTAS HOUSING DIMENSIONS

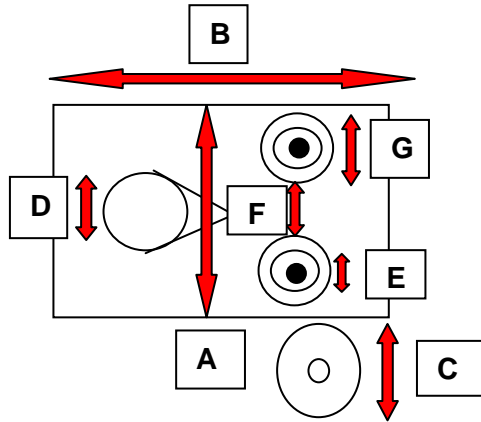

A	Height of RTAS Housing	14.1 cm
B	Width of RTAS Housing	21.5 cm
C	Diameter of Coarse Alignment Cone	9.2 cm
D	Diameter of Launch Lock	6.4 cm
E	Diameter of Cont Bolt Hole	3.0 cm
F	Distance between contingency bolt disks	2.9 cm
G	Diameter of contingency bolt disk	5.5 cm

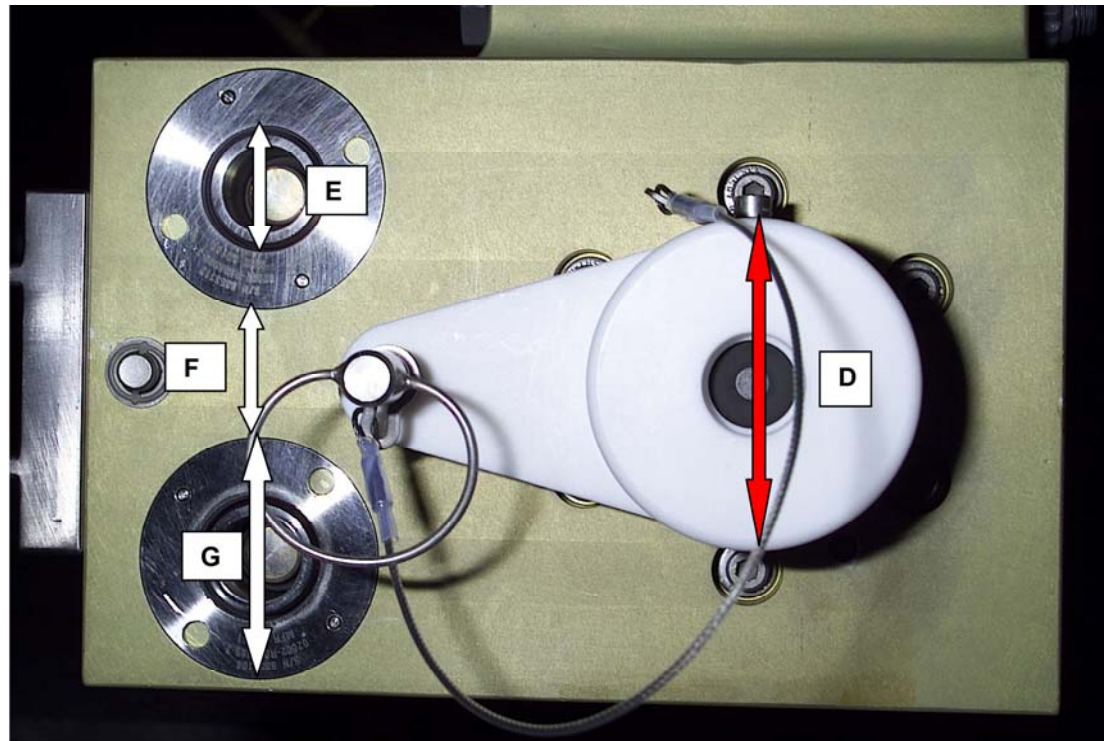

P4 MRTAS – PASSIVE

GROUND STRAP, STOWED POSITION

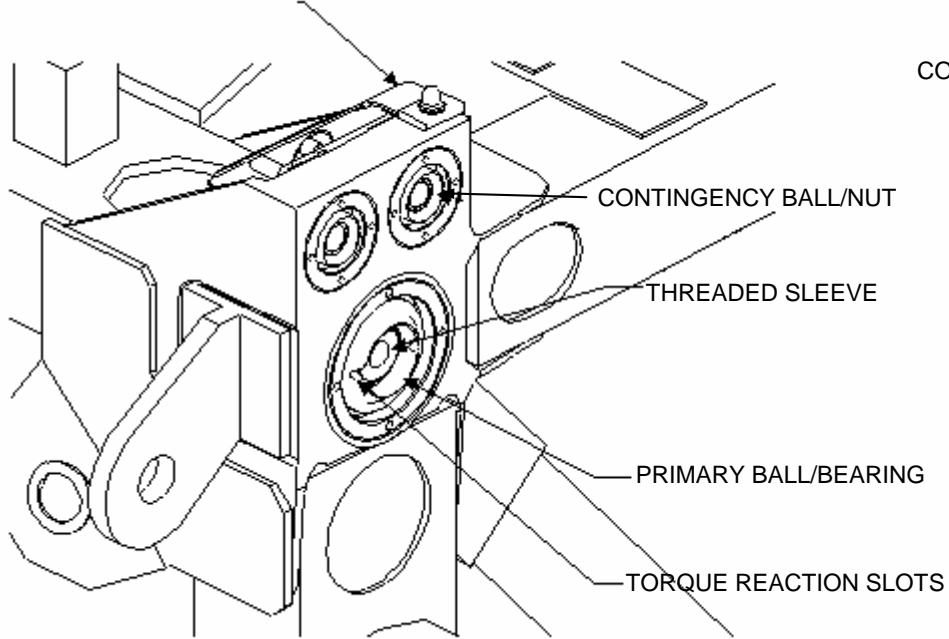

GROUND STRAP STOWAGE BOLT

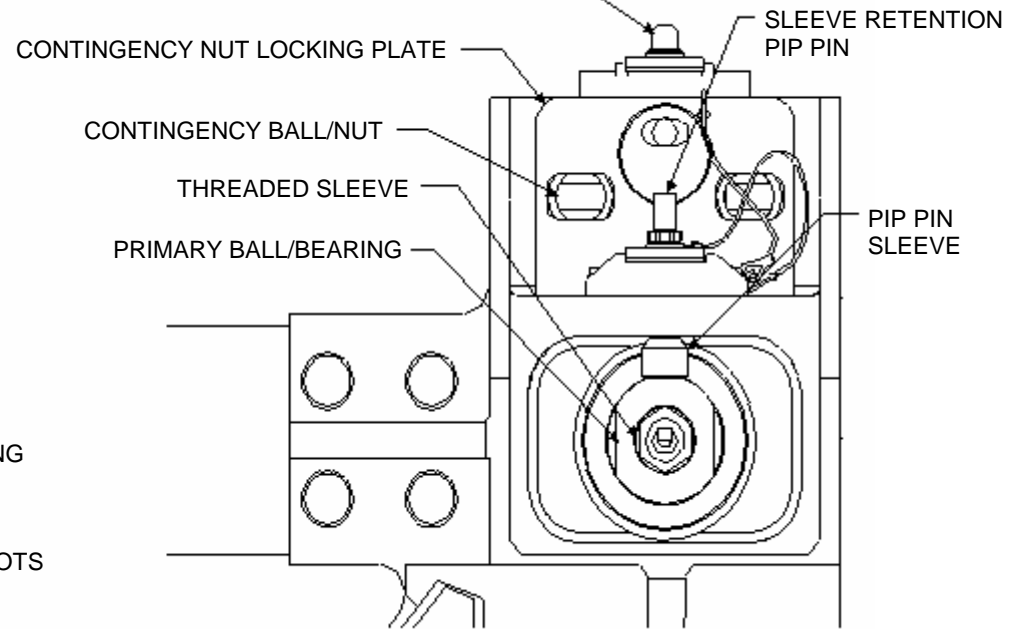

FS 18-50

EVA/116/FIN

GAP CHECK TOOL

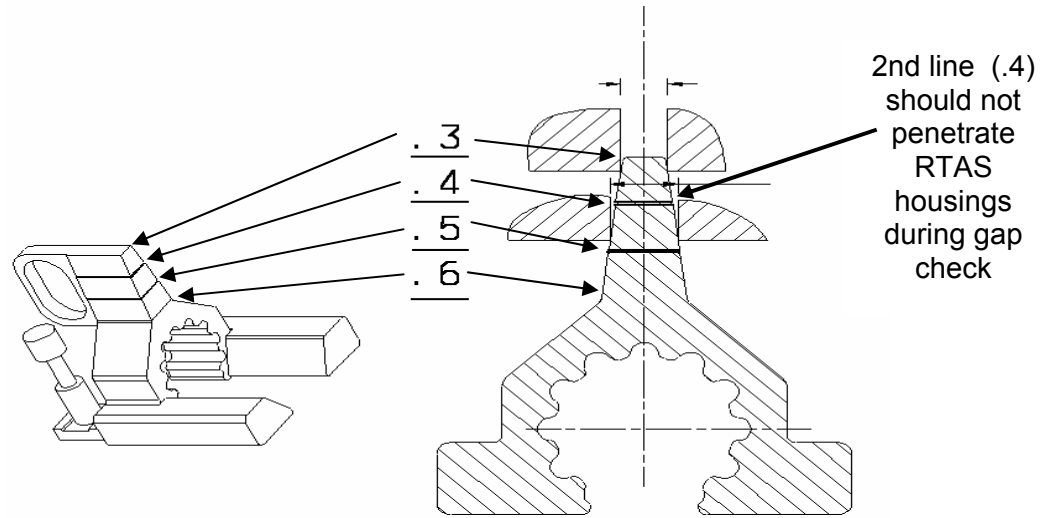
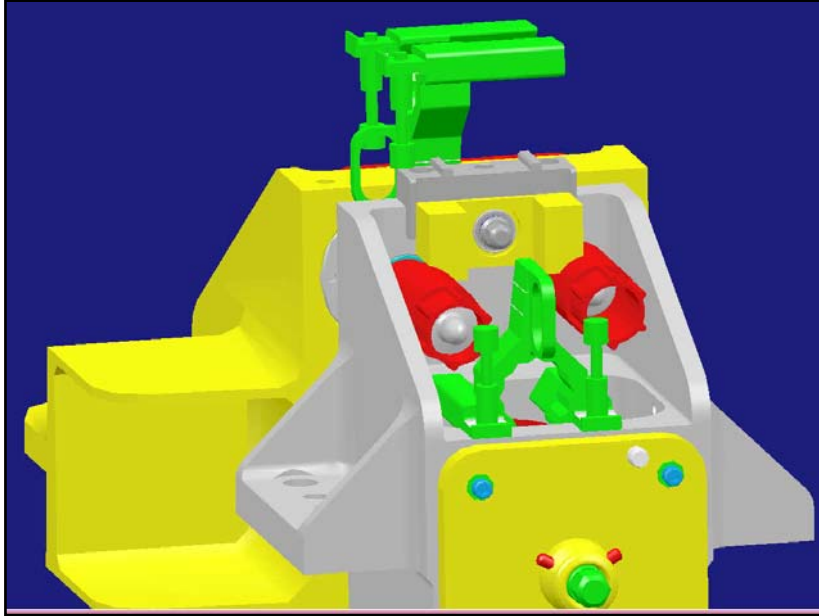

LAUNCH POSITION
(RTAS corner #1)



TOOL REMOVED

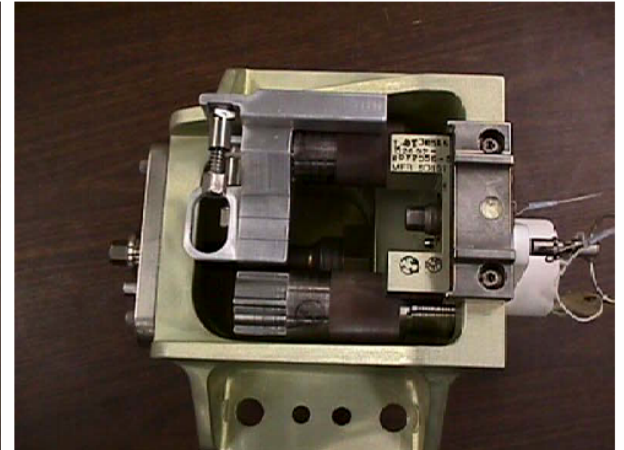

TOOL INSTALLED ON
RTAS CONTINGENCY SPACER SLEEVE

P5-P4 CONNECTOR PANEL

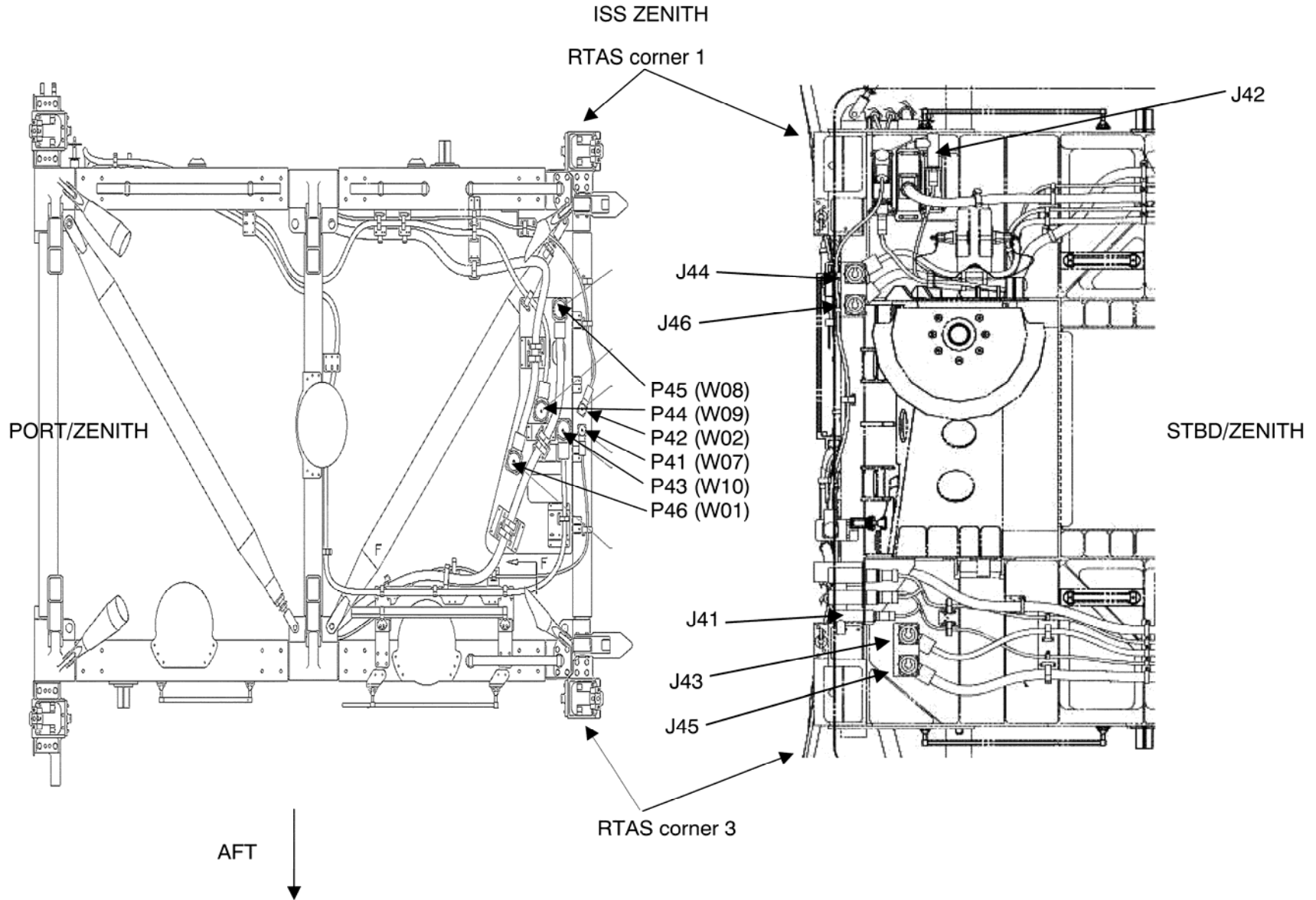

P5 CAPTURE LATCH ASSEMBLY (CLA)

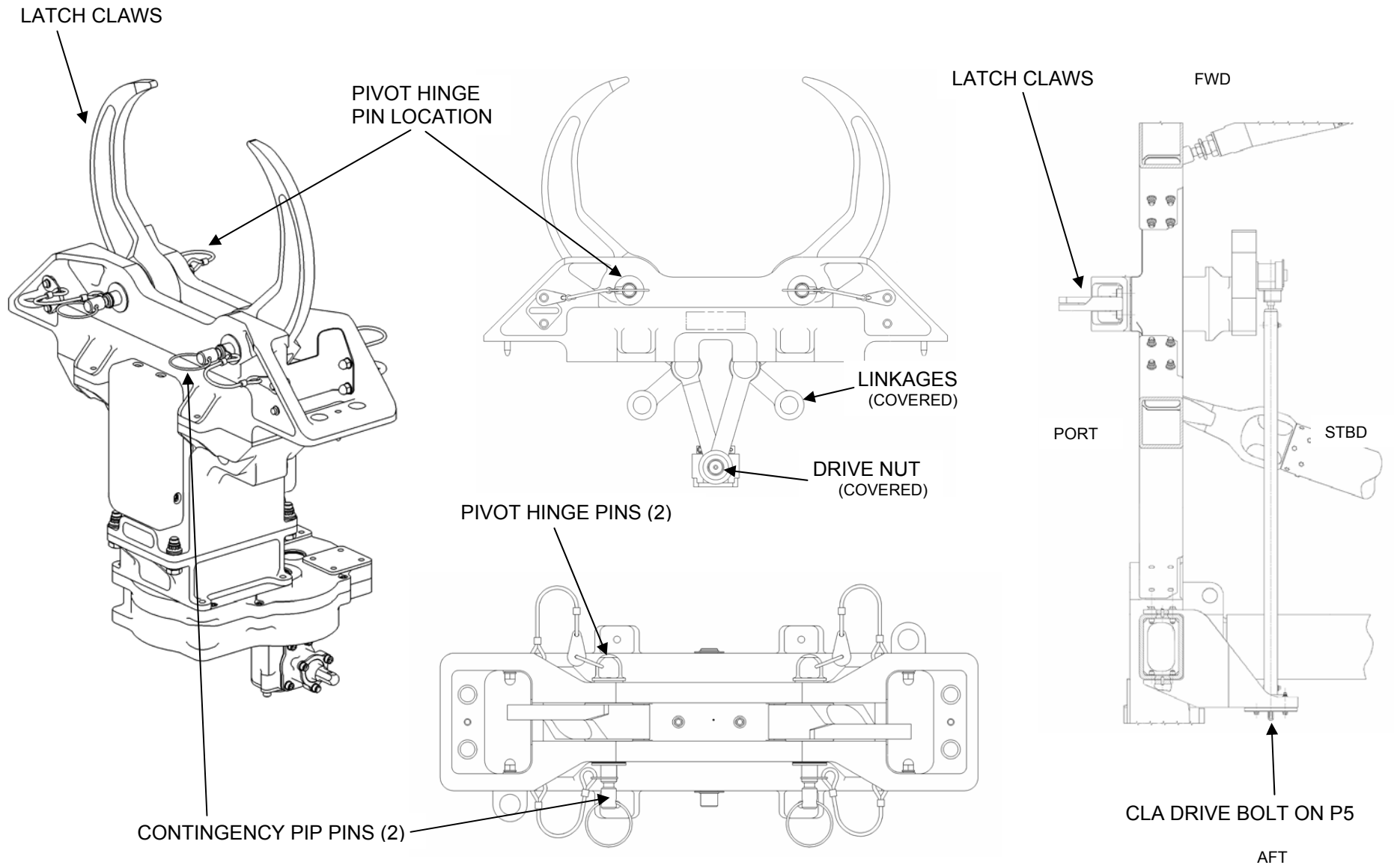

ETVCG – ASSEMBLED

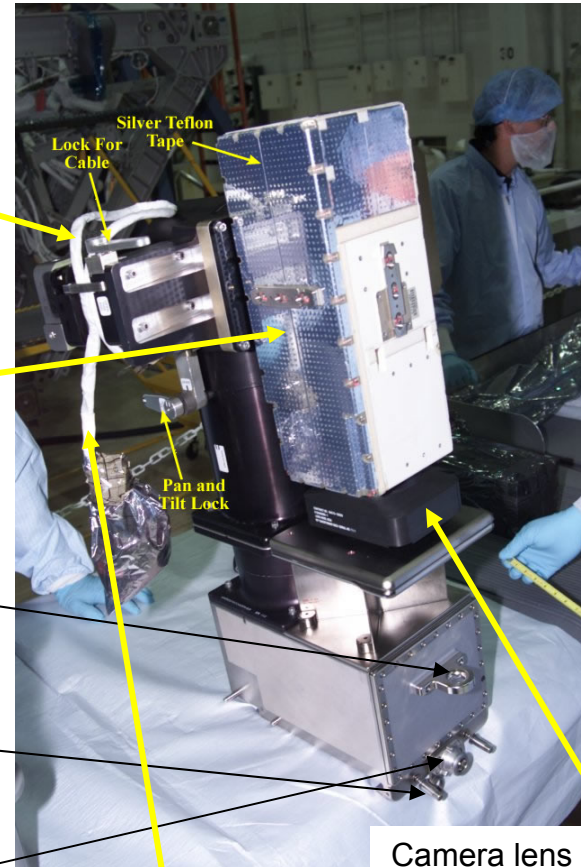
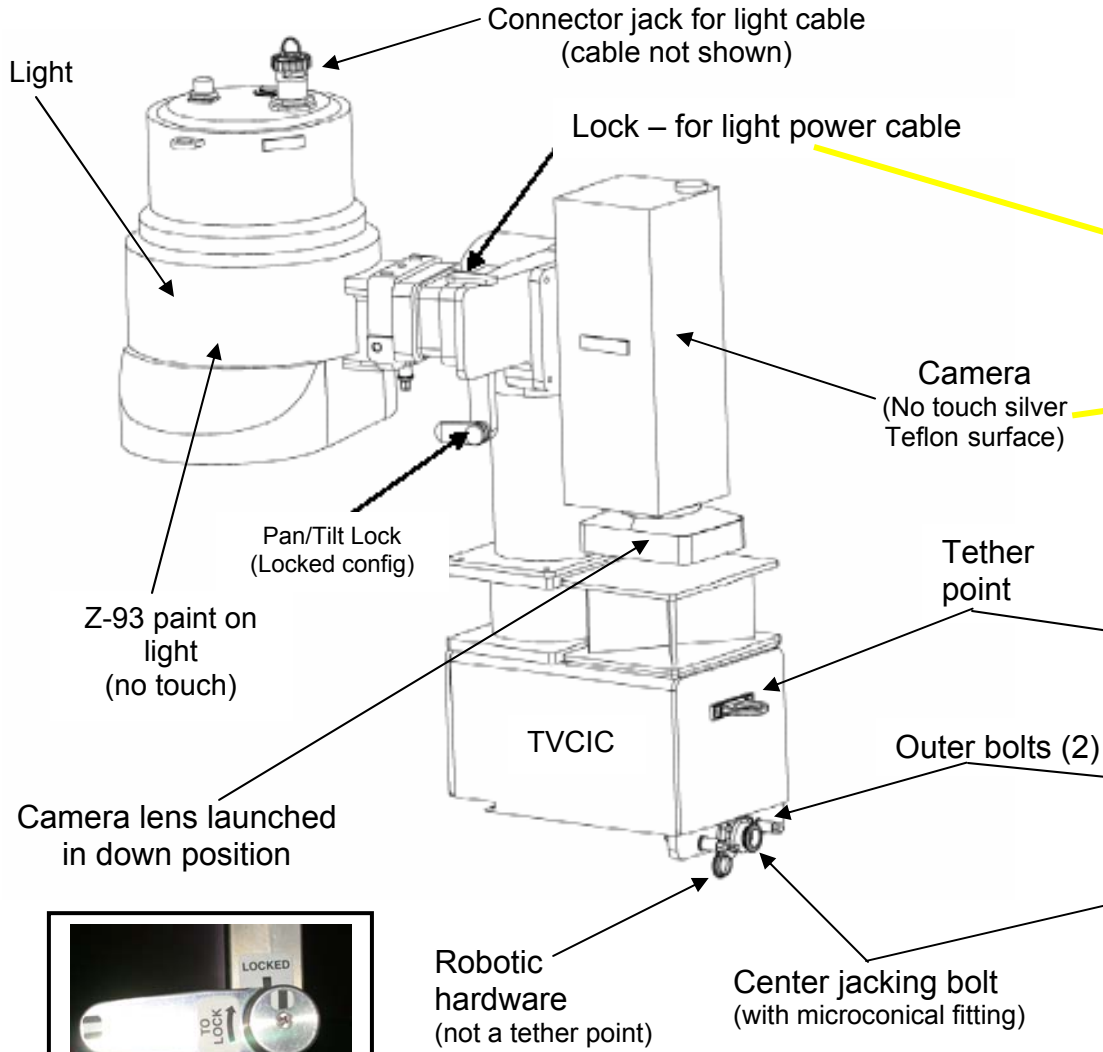

Camera lens launched in down position

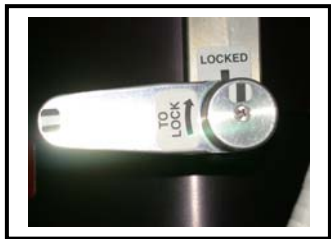

Pan/Tilt Lock in Locked Posn

Camera lens launched in down position

Cable for light

ETVCG

ETVCG MOUNTED ON STANCHION

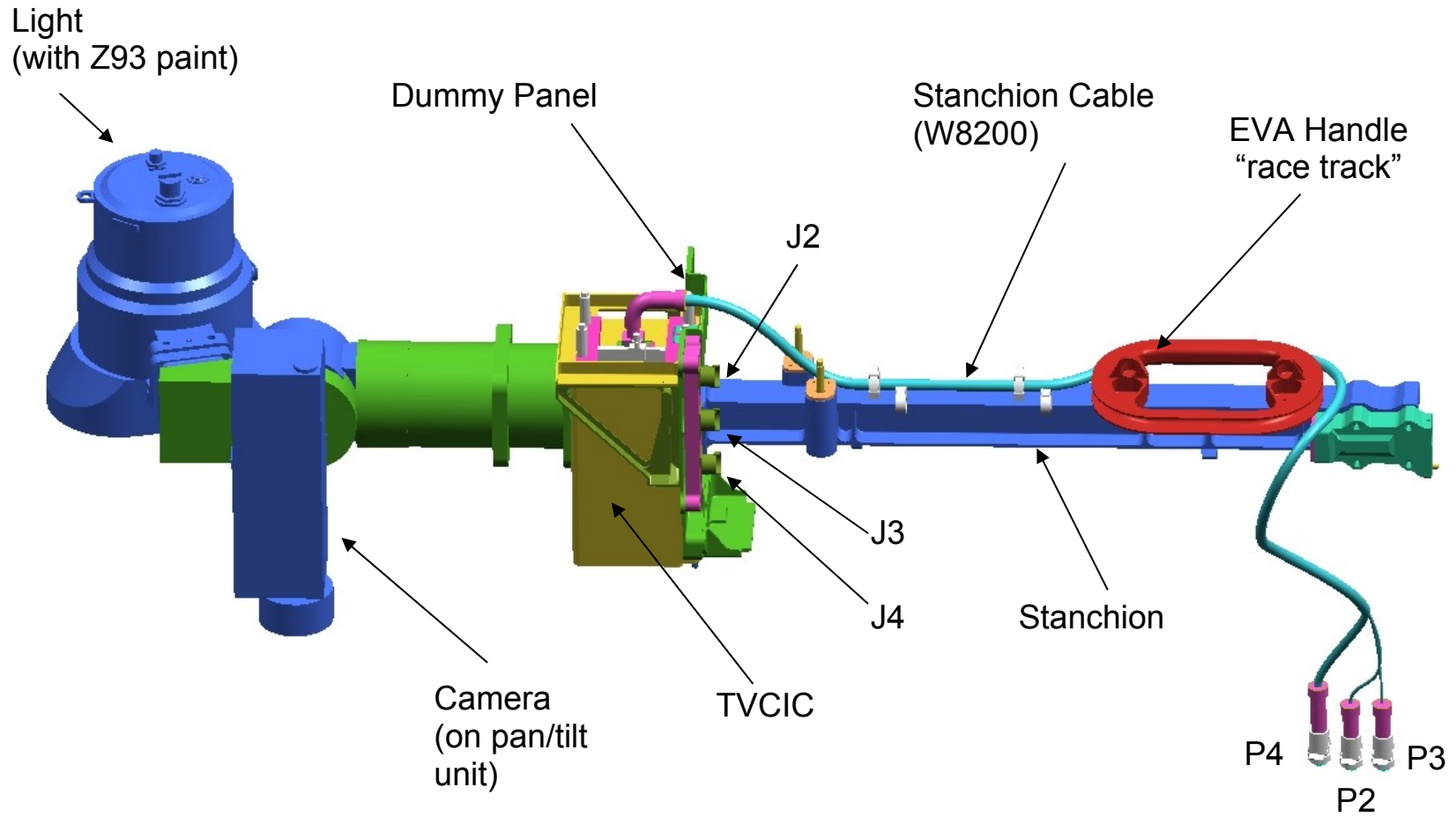

S0 FORWARD AVIONICS PANEL WORKSITE

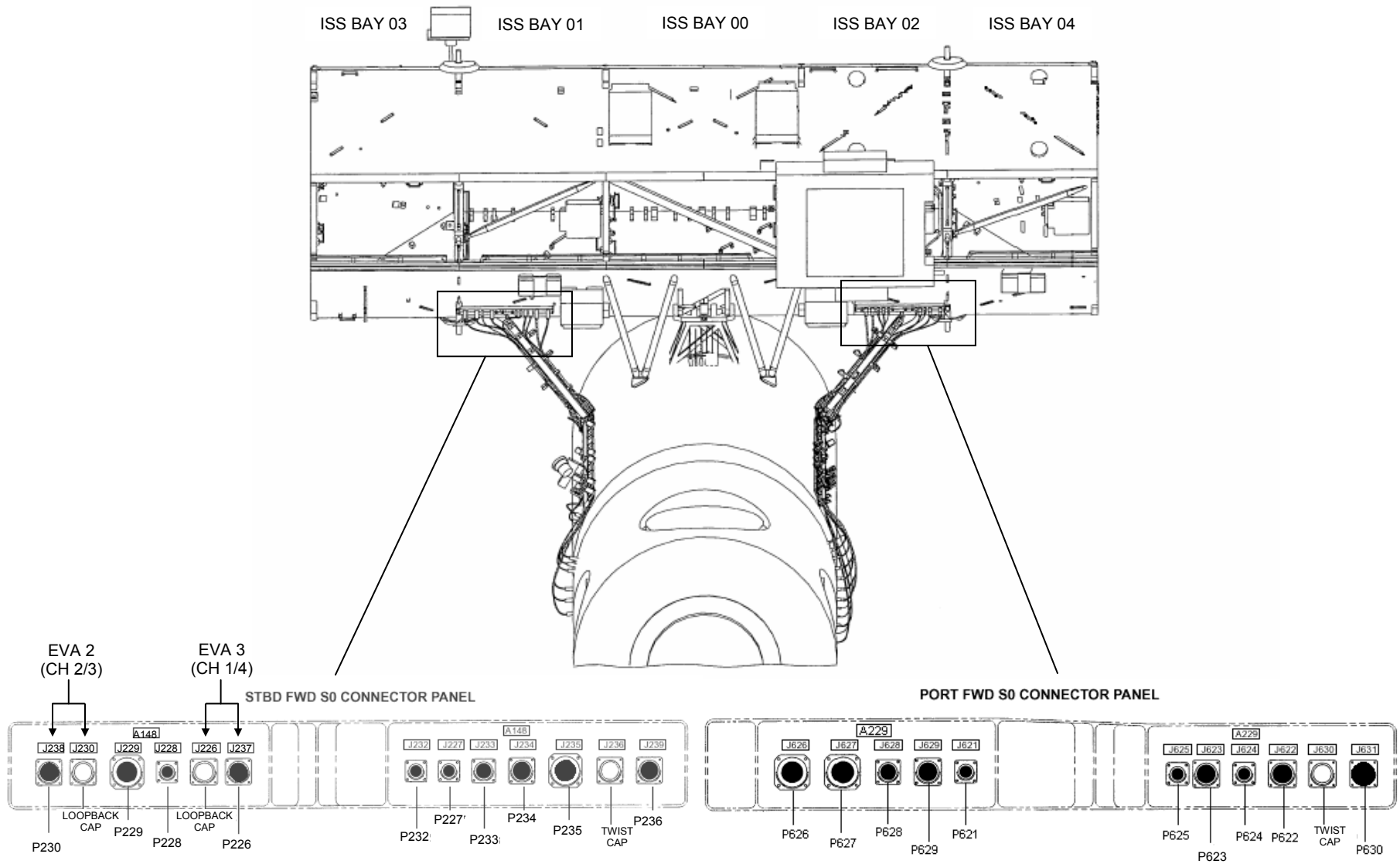

FS 18-57

EVA/116/FIN

S0 WORKSITES – PANELS 163 AND 165, MBSU RECONFIG

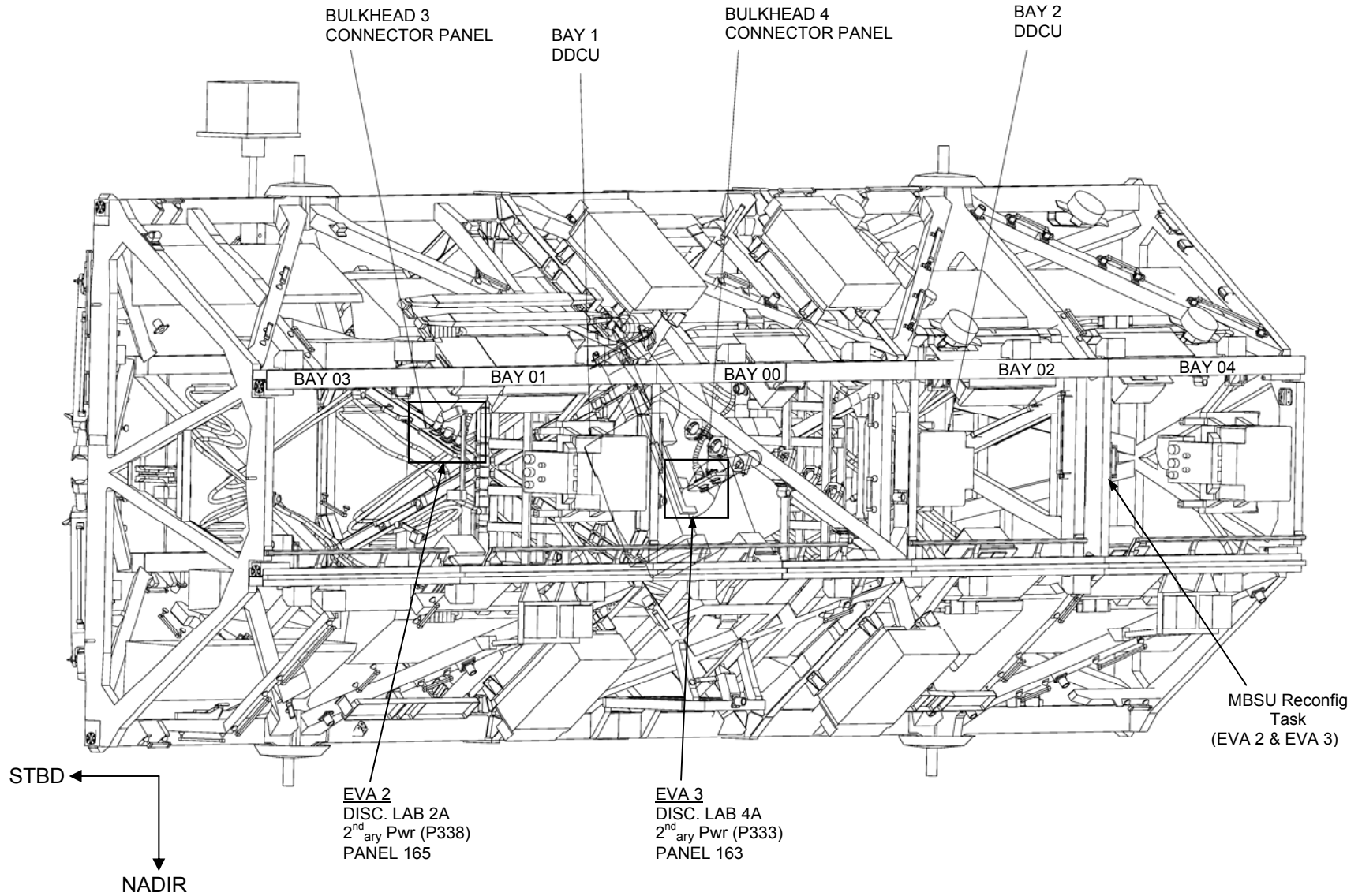

S0 – PANELS 163 AND 165

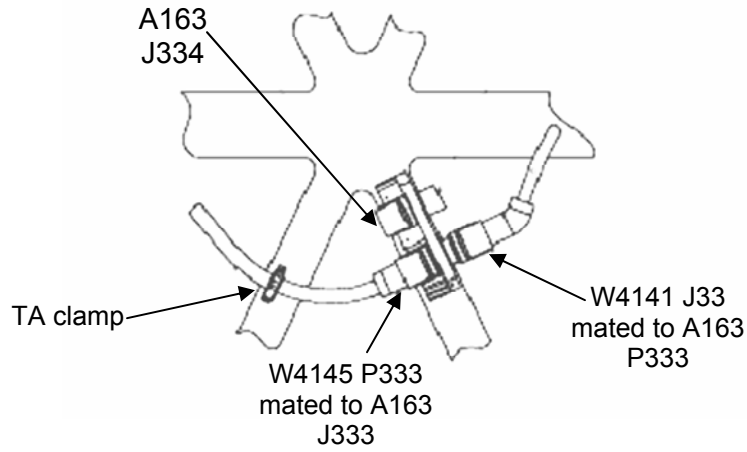

PANEL A163 (EVA 3)
PRE 12A.1

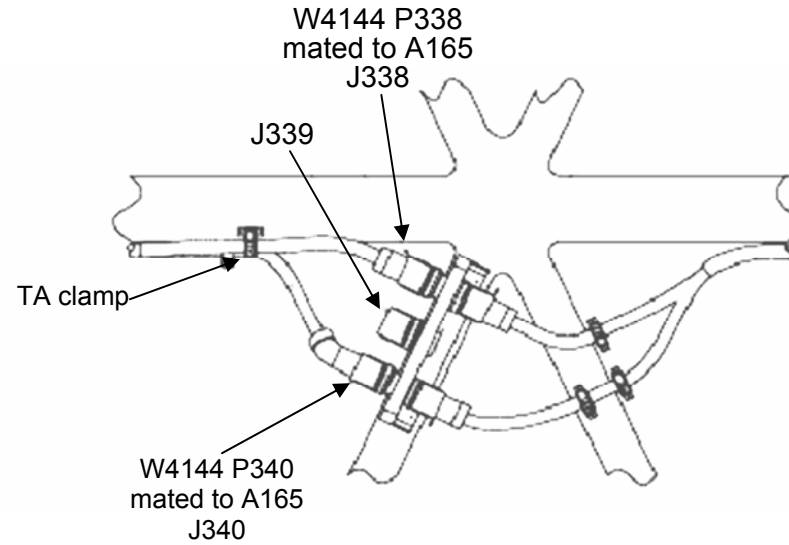

PANEL A165 (EVA 2)
PRE 12A.1

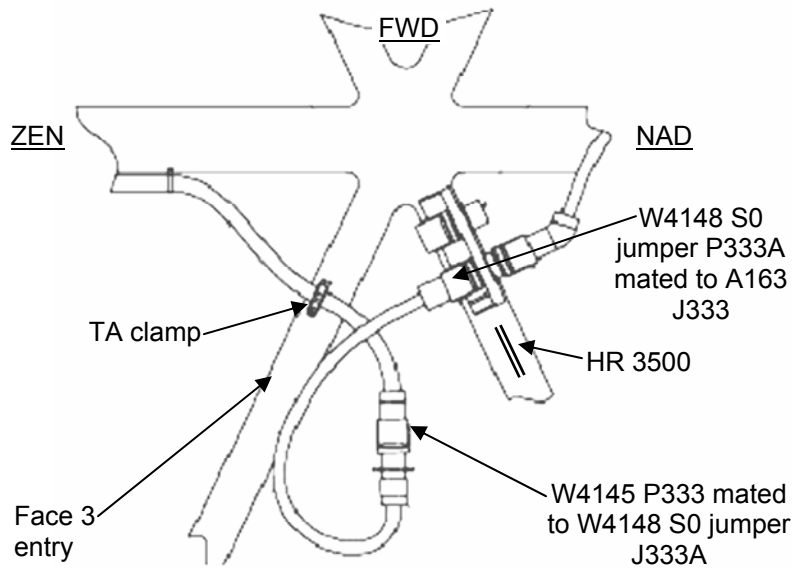

PANEL A163 (EVA 3)
POST 12A.1

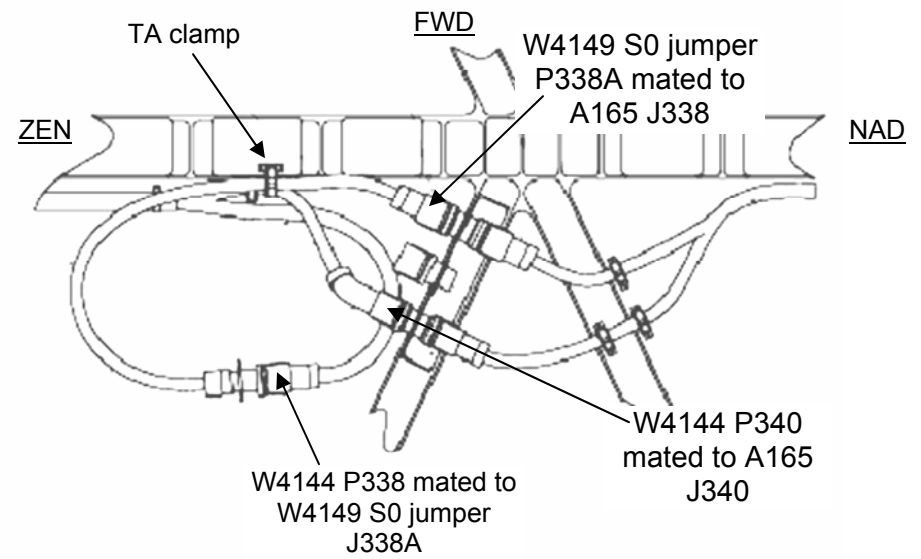

PANEL A165 (EVA 2)
POST 12A.1

S0 CH 1/4 AND 2/3 JUMPERS

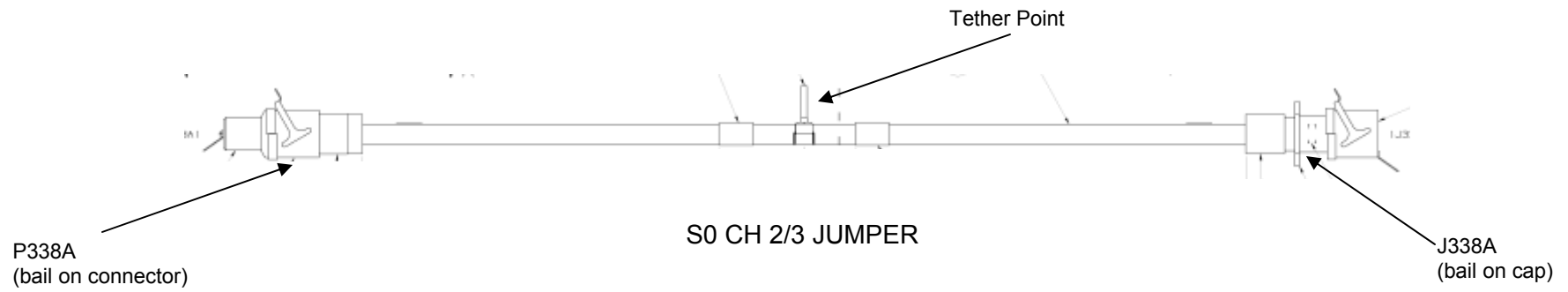
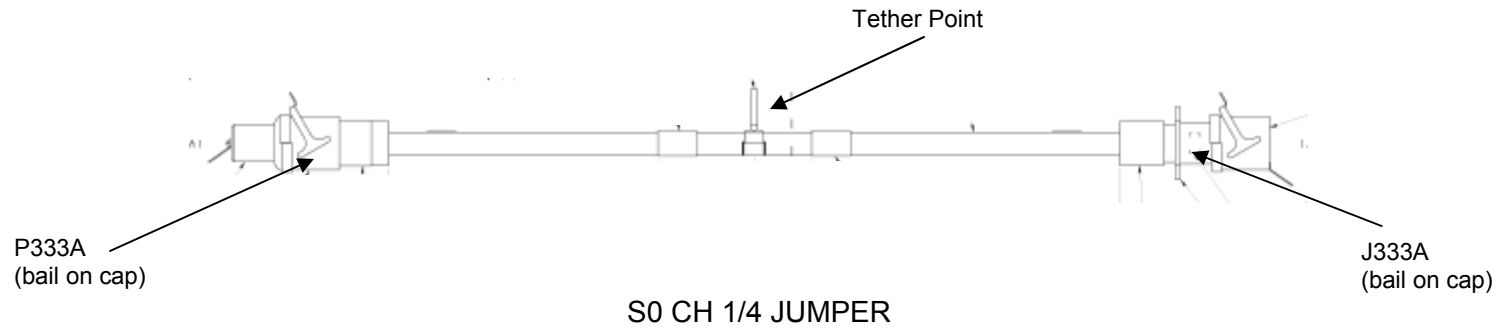

MBSU BYPASS JUMPER RECONFIG – CH 1/4

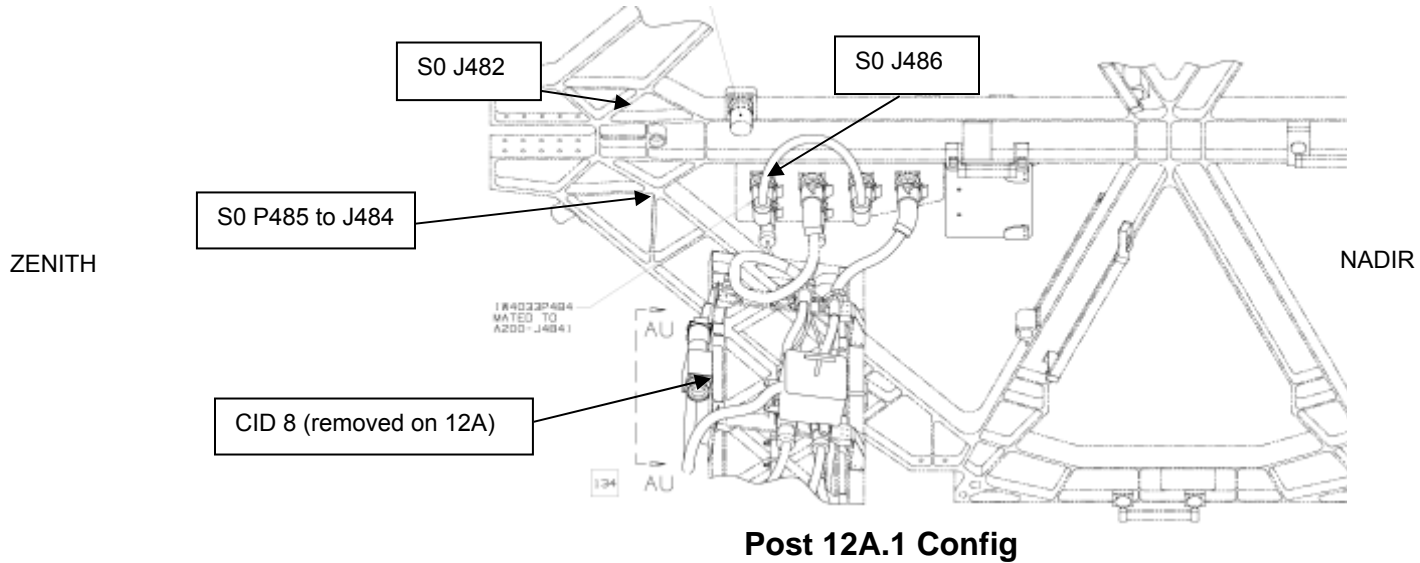
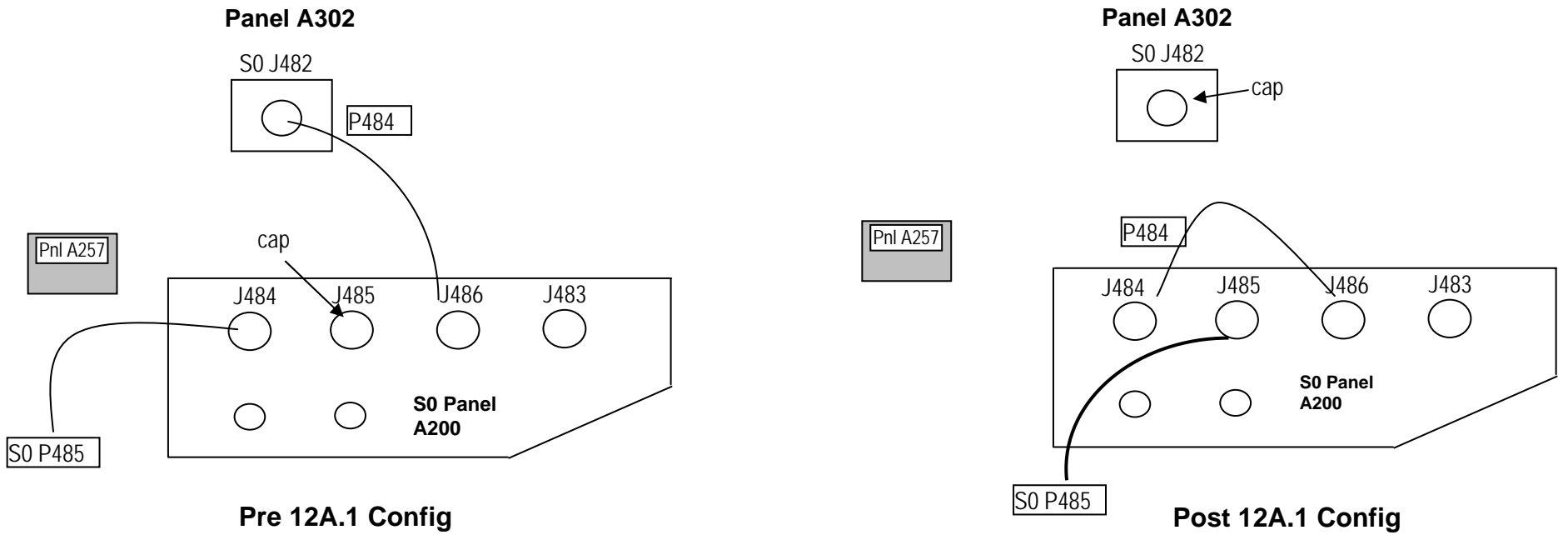

MBSU BYPASS JUMPER RECONFIG – CH 2/3

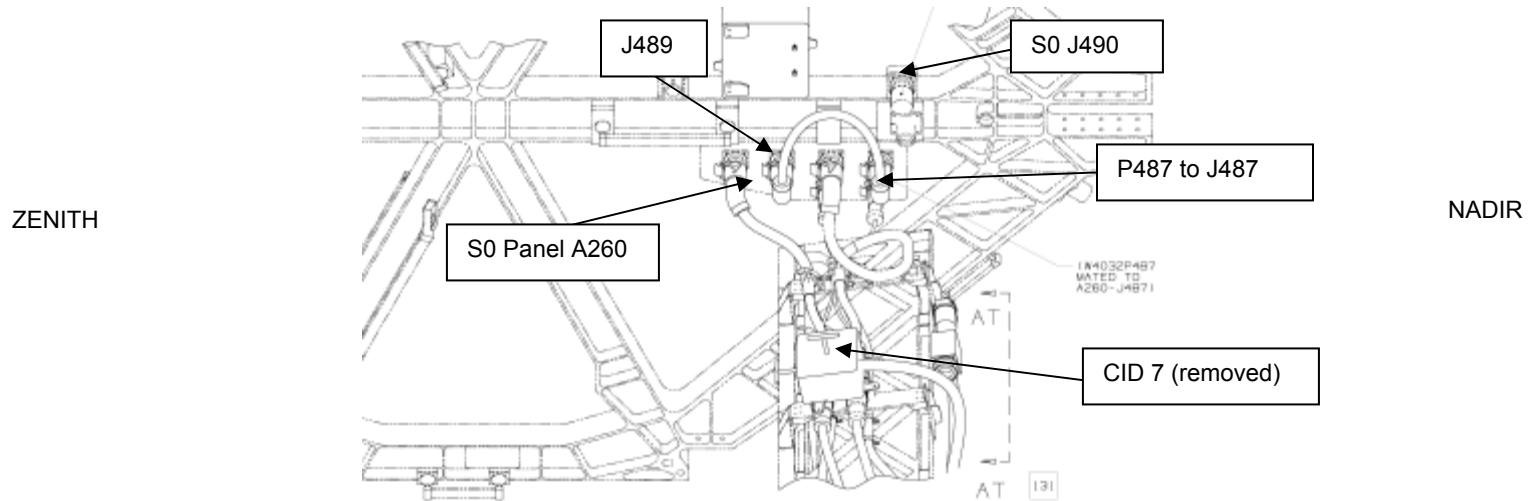
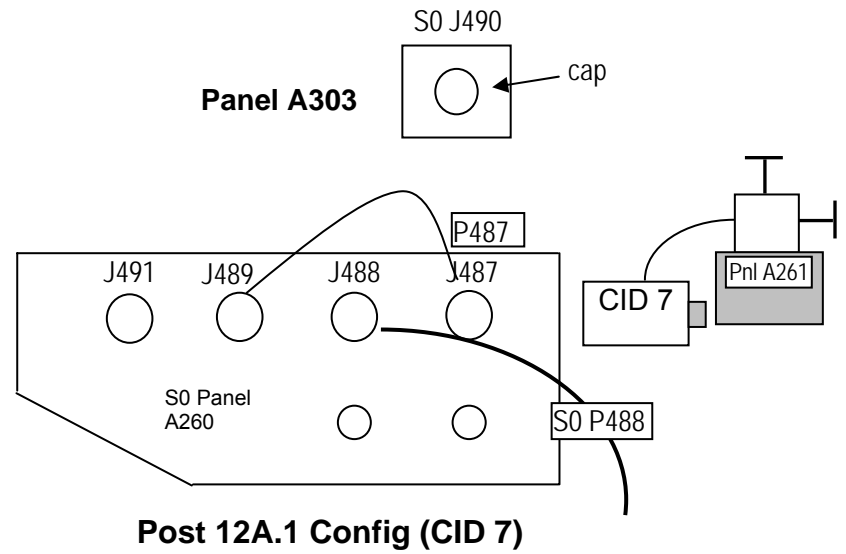
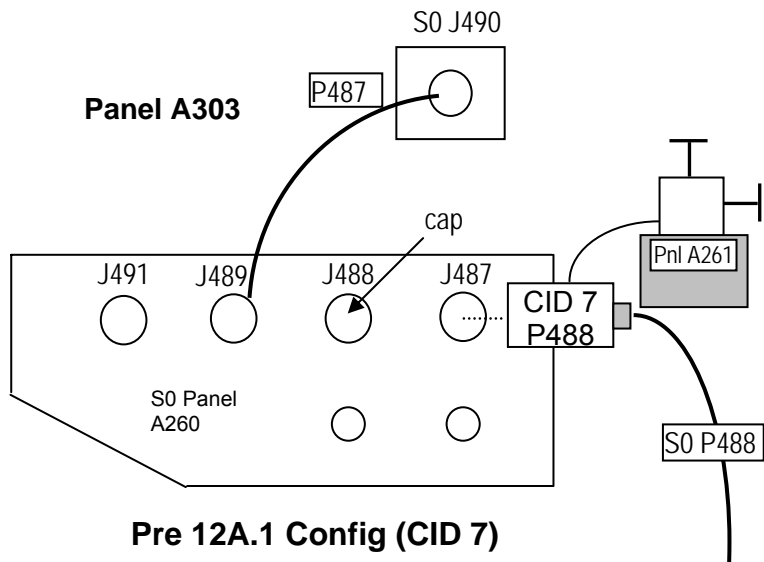

Post 12A.1 Config (CID 7)

CID PHOTO

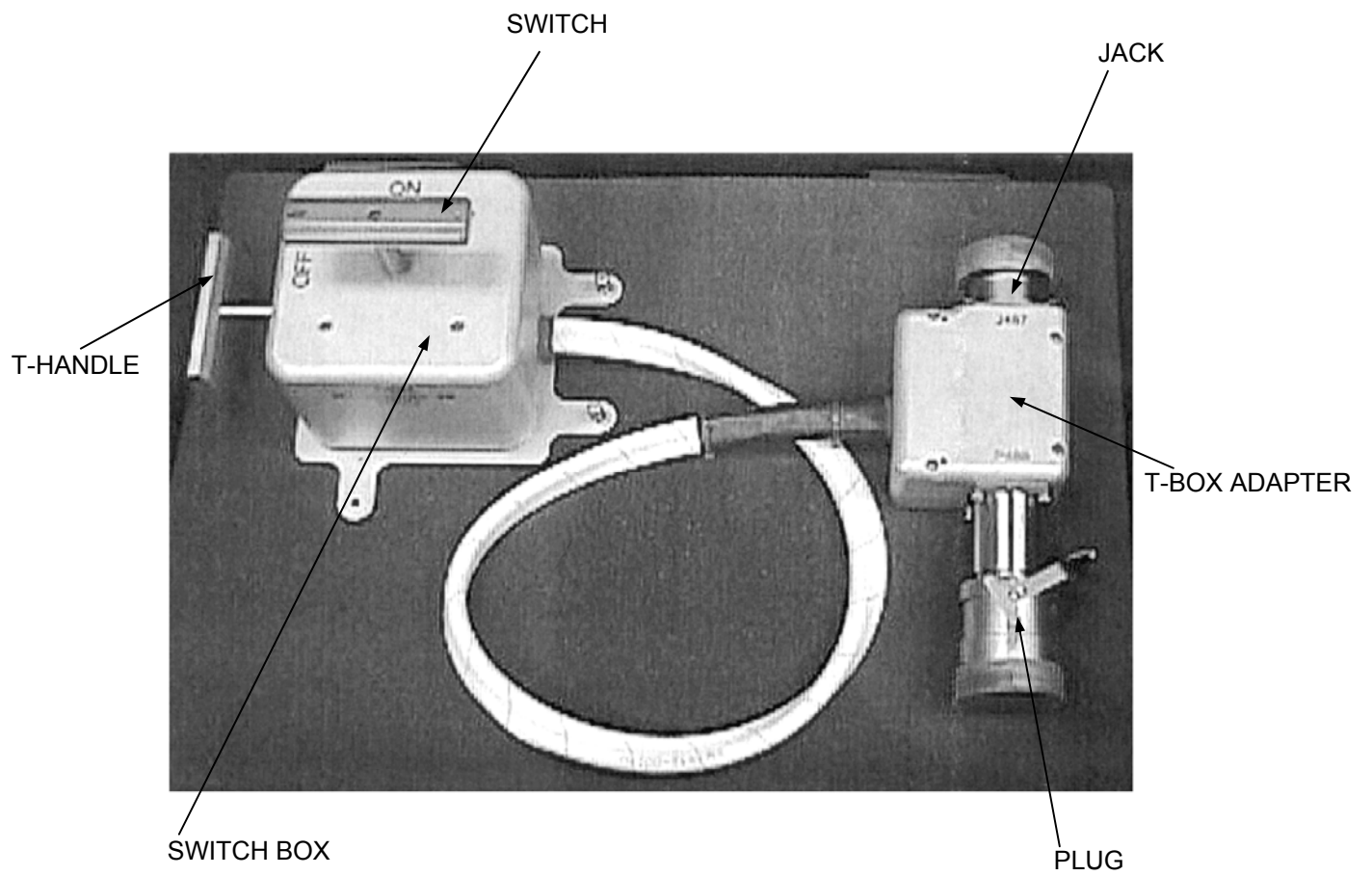

S0/N1 PWR CABLE WORKSITE OVERVIEW

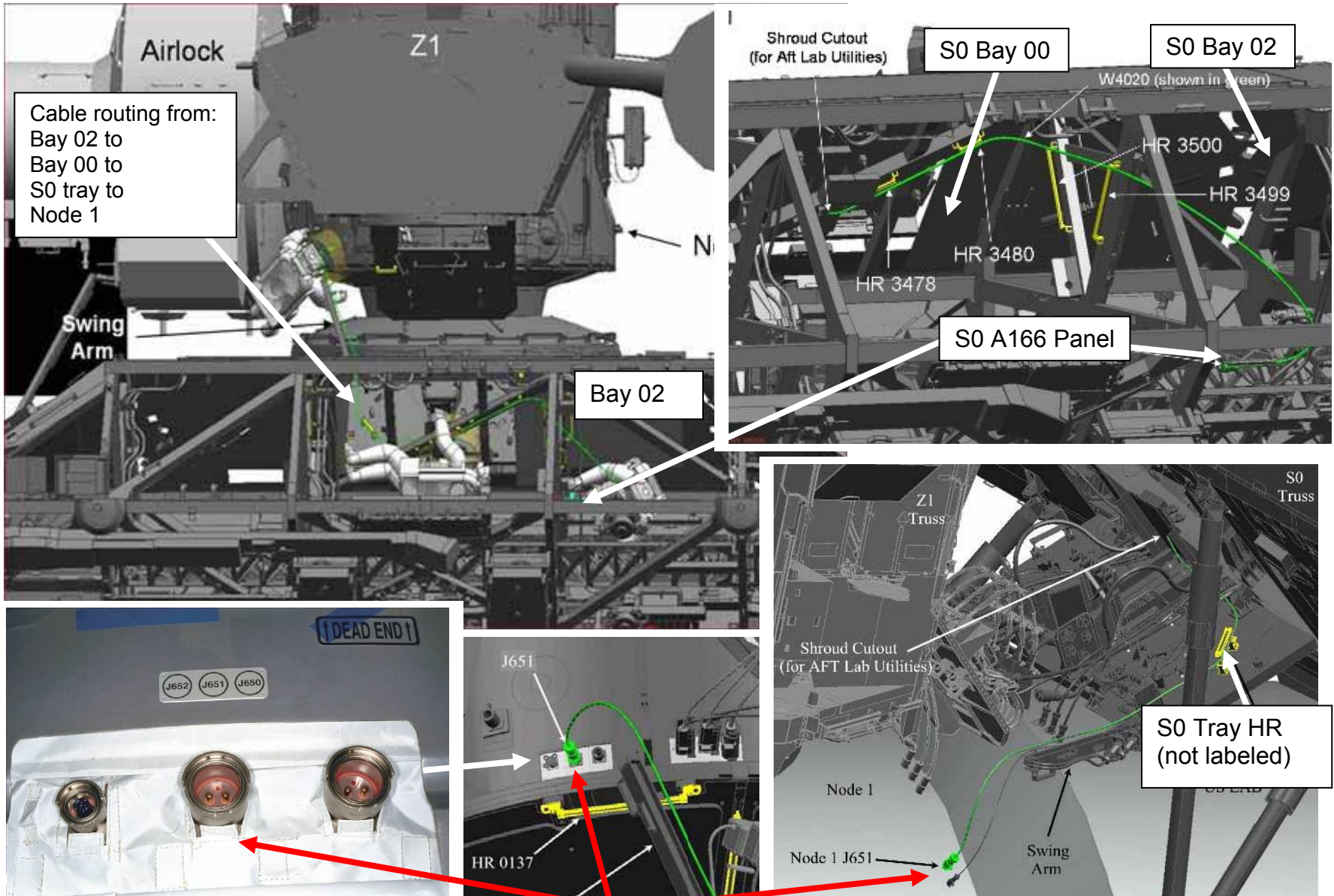

NODE 1 JACKS (don't plug cable into Node on 12A.1)

S0 PANEL A166 WORKSITE

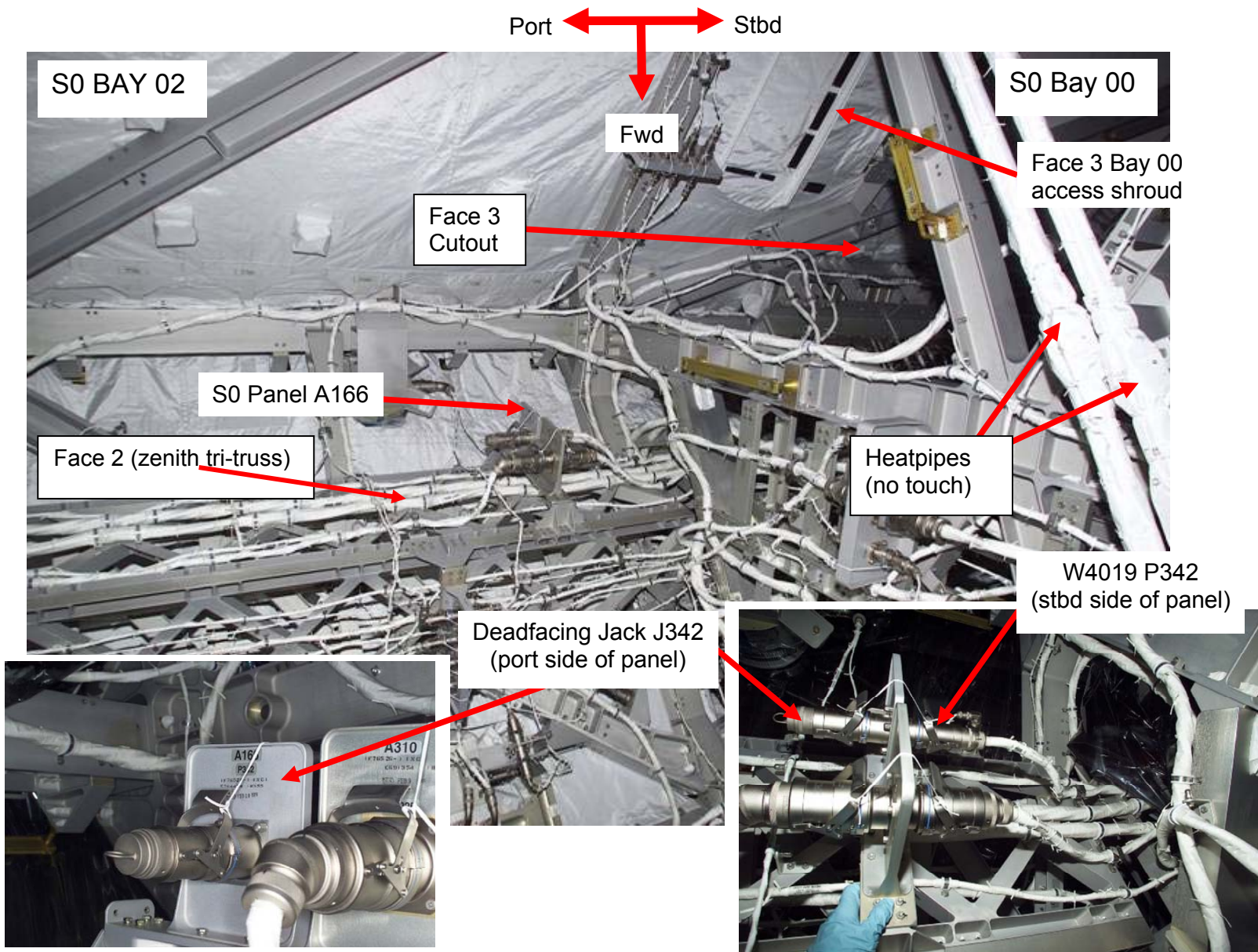

DDCU COLDPLATE CONNECTOR BOX – GENERIC

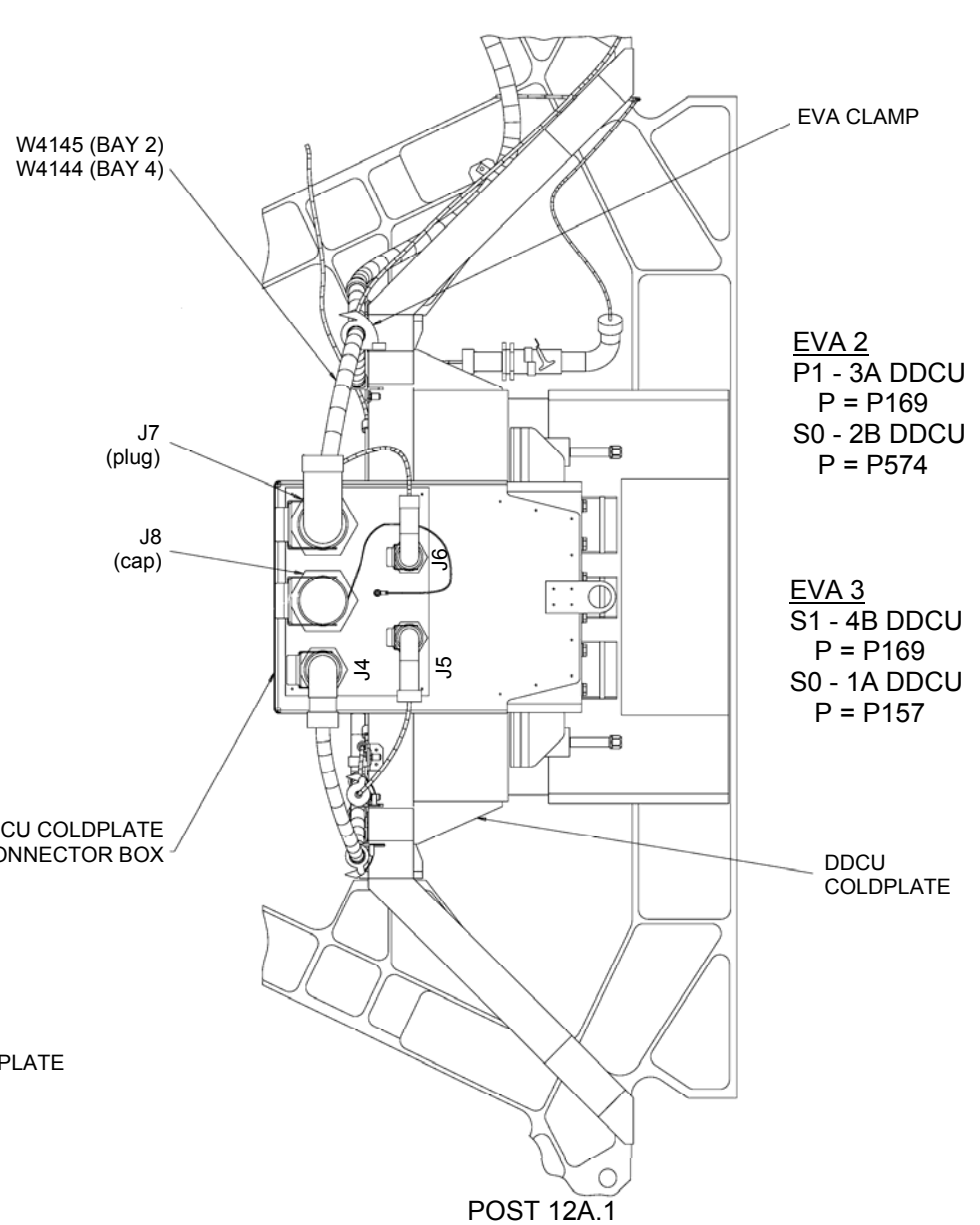
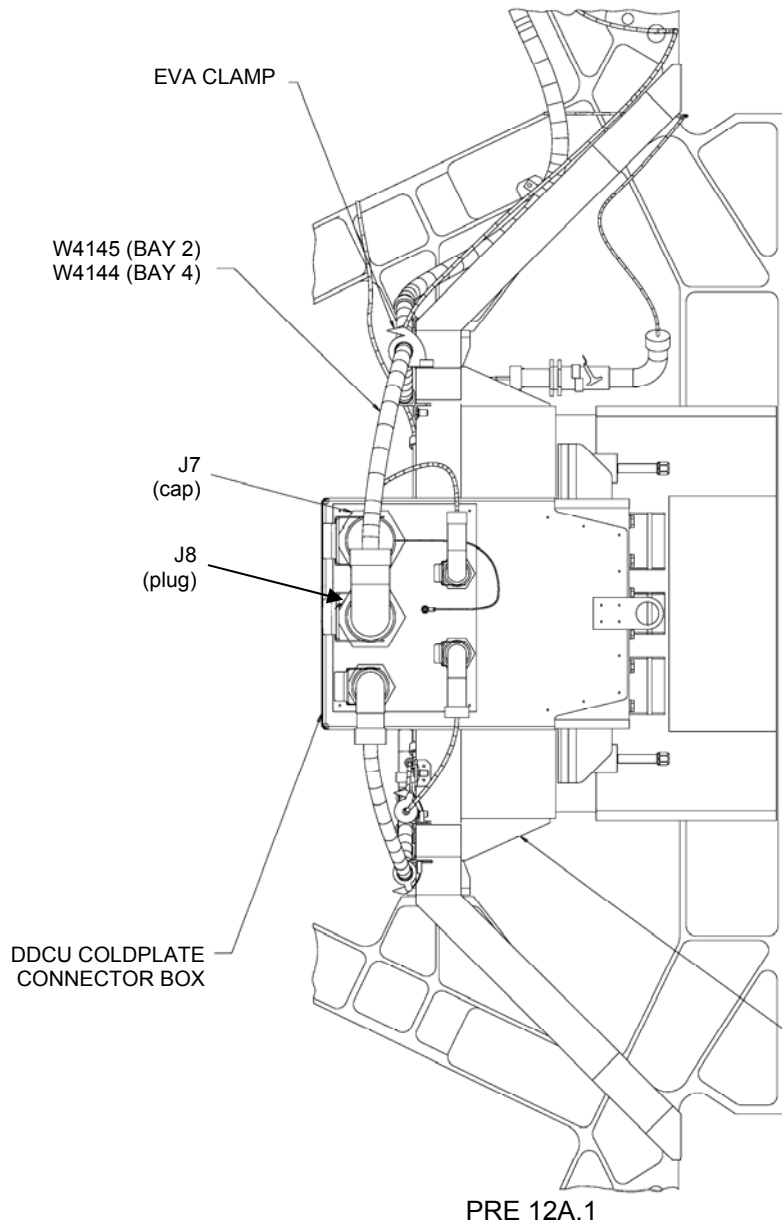

EVA 2
P1 - 3A DDCU
P = P169
S0 - 2B DDCU
P = P574

EVA 3
S1 - 4B DDCU
P = P169
S0 - 1A DDCU
P = P157

S0 AFT TRAY

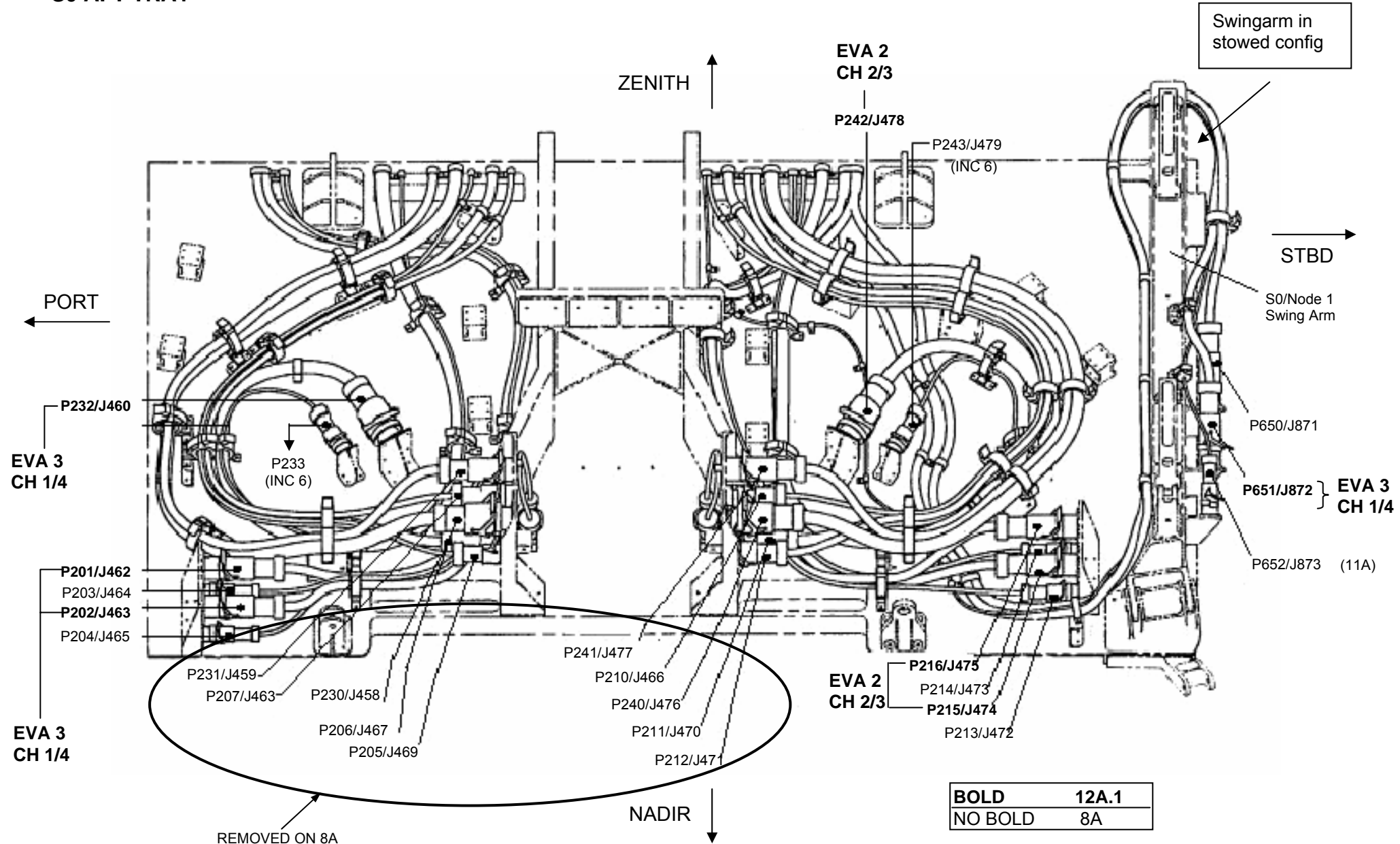

BOLD	12A.1
NO BOLD	8A

Z1-LAB-S0 CONNECTIONS (PRE-12A.1 CONFIG)

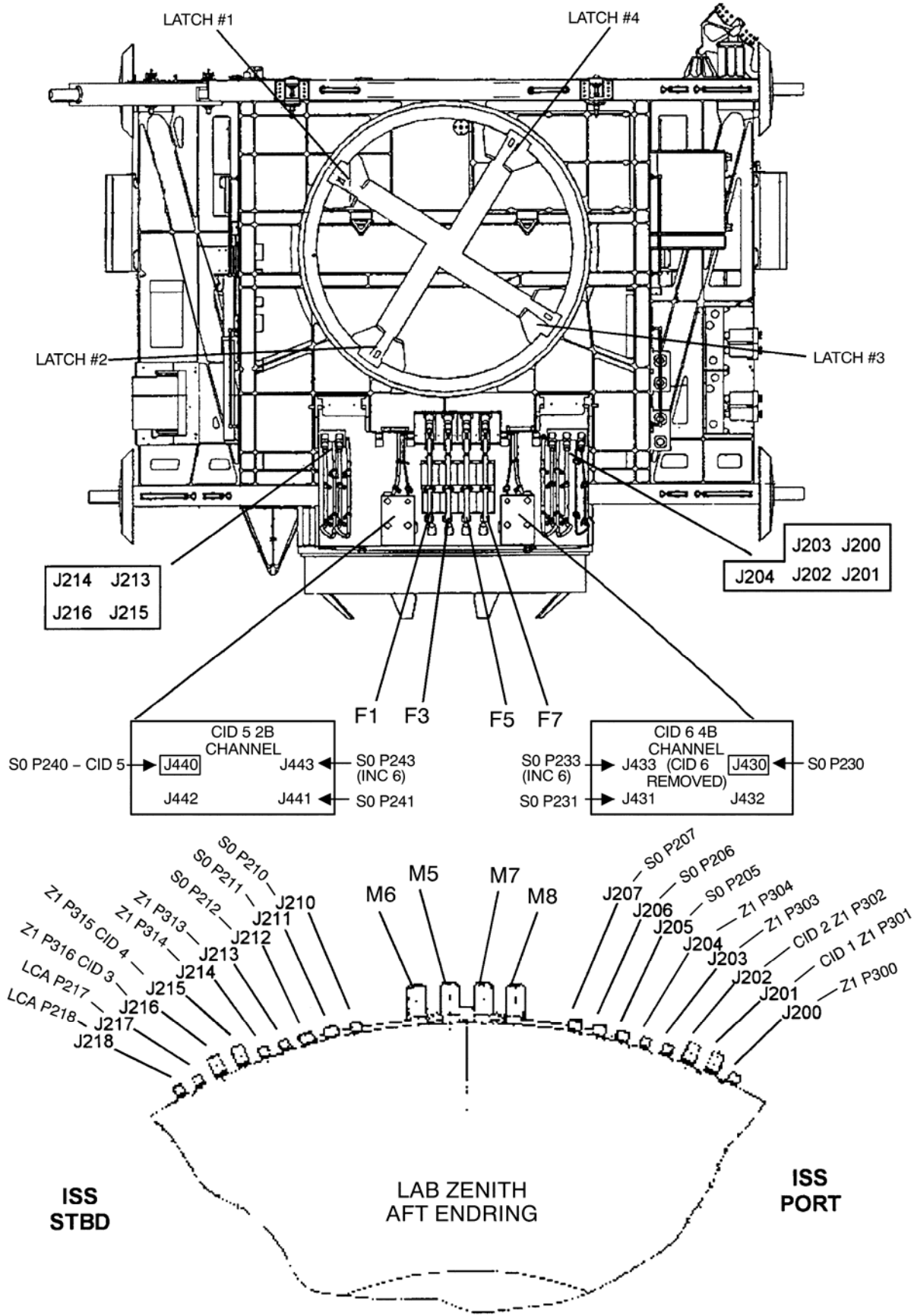

Z1-LAB-S0 CONNECTIONS (POST-12A.1 CONFIG)

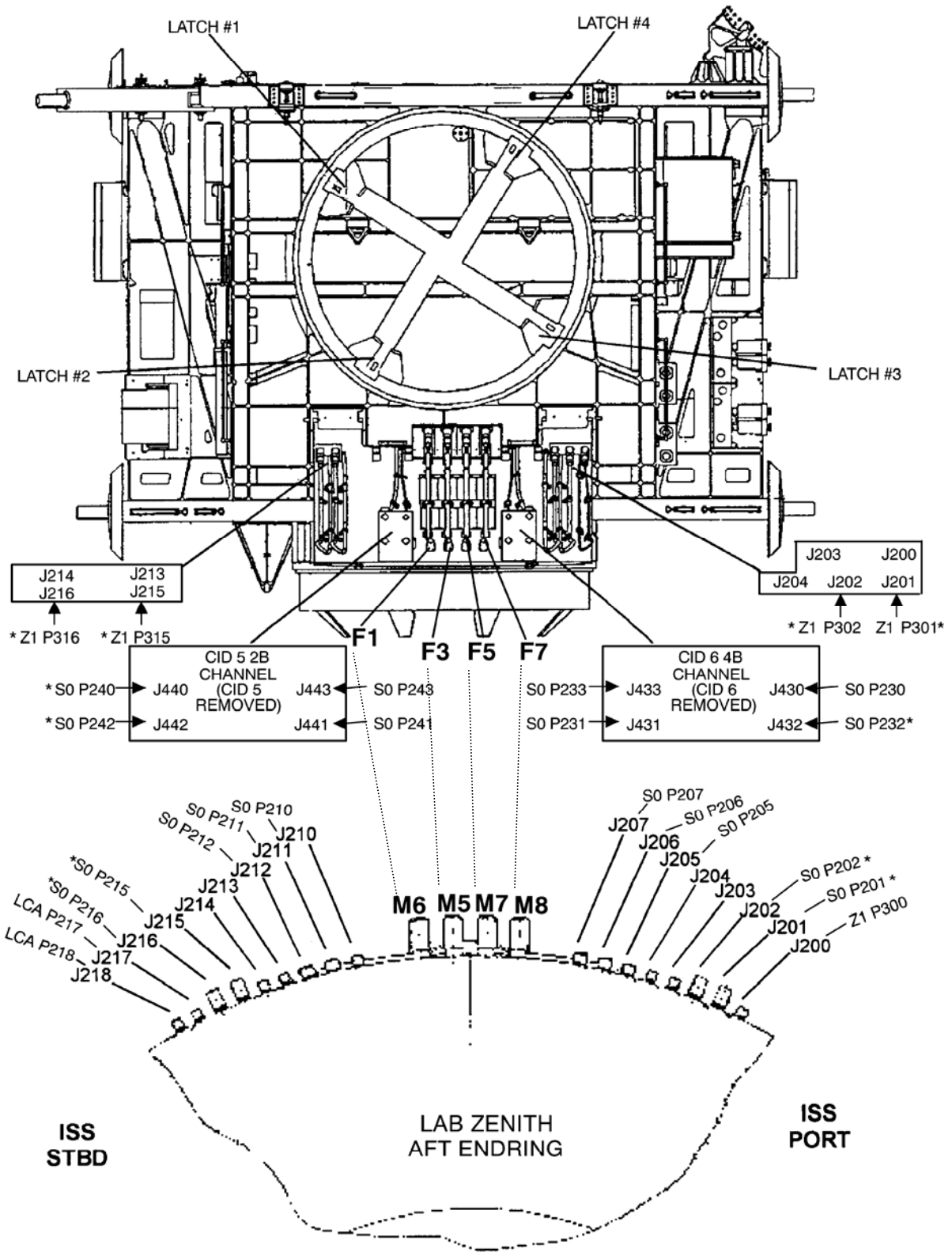

* = Connected on 12A.1

RAT'S NEST QD OVERVIEW

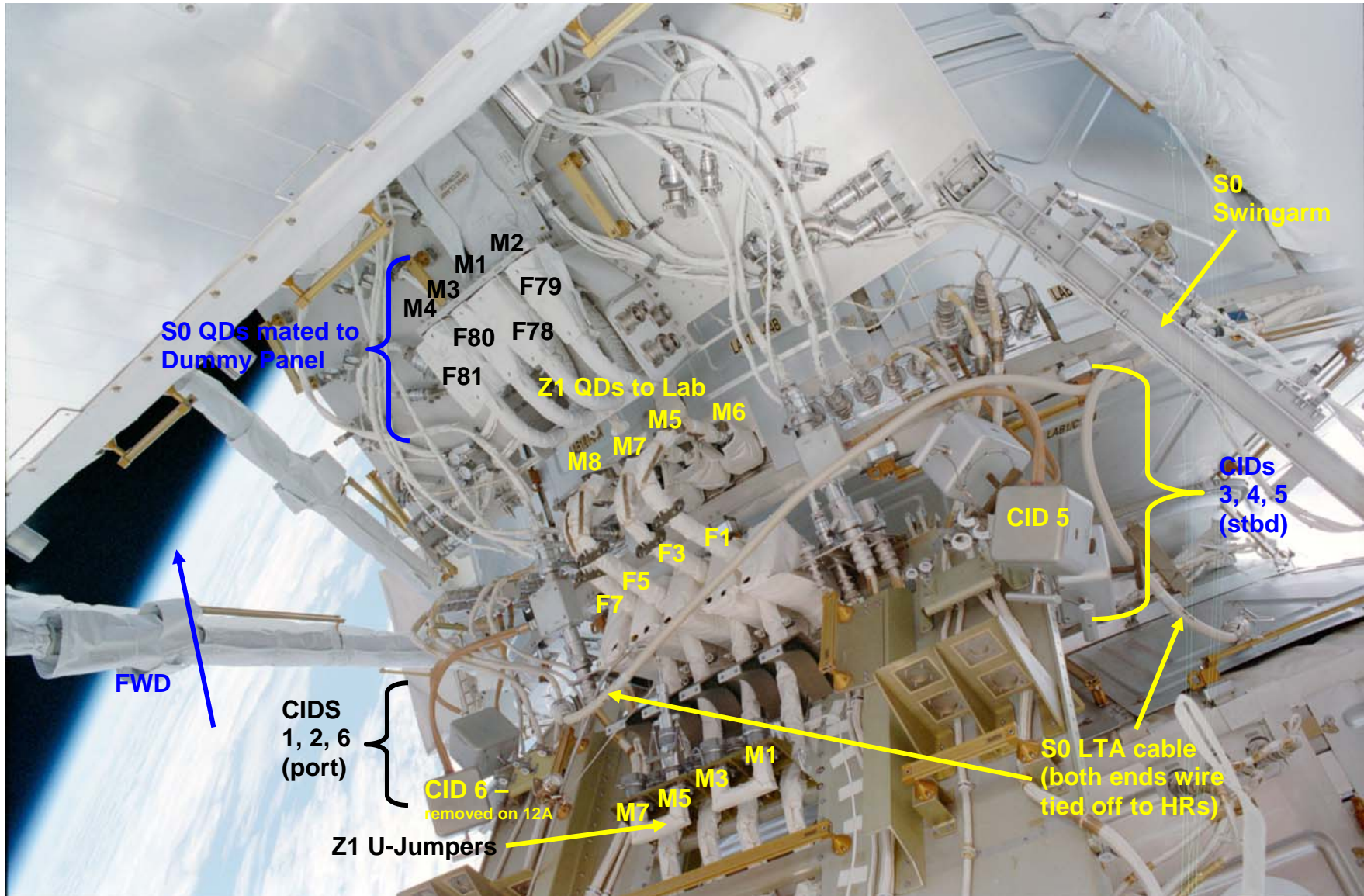

RAT'S NEST CONNECTIONS – CHANNEL 2/3

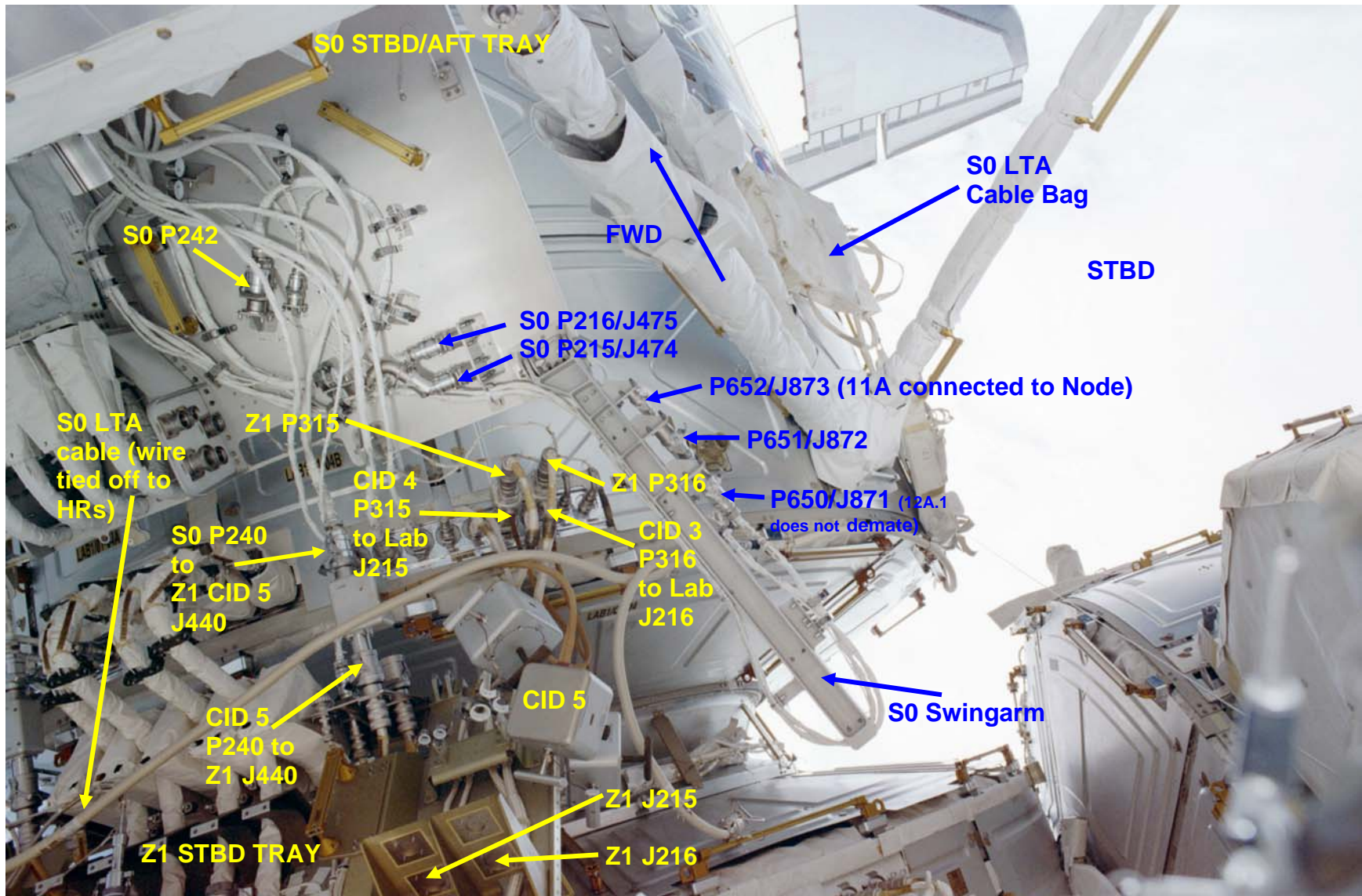

RAT'S NEST CONNECTIONS – CHANNEL 1/4

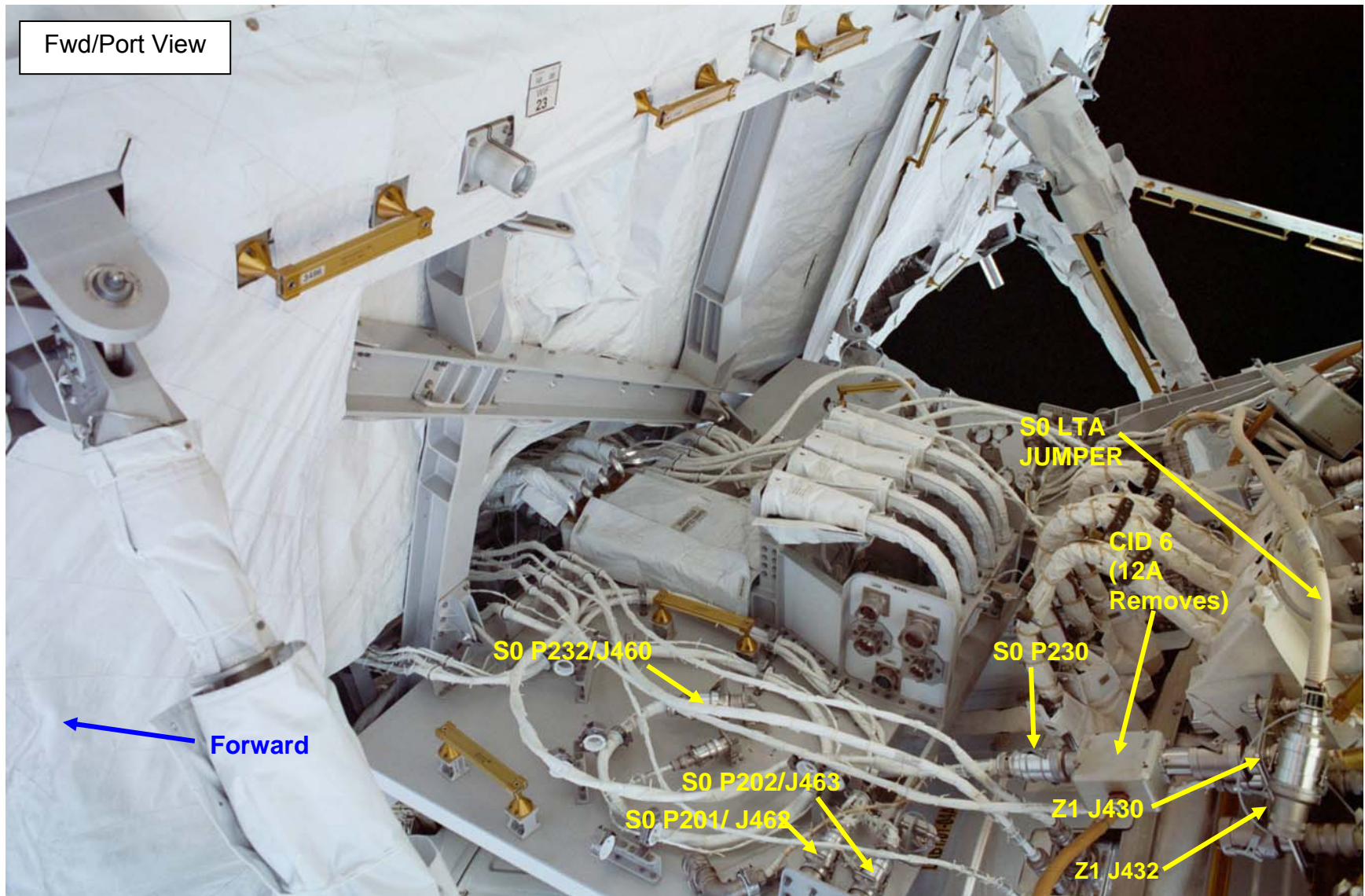

RAT'S NEST CONNECTIONS – CHANNEL 1/4 (Cont)

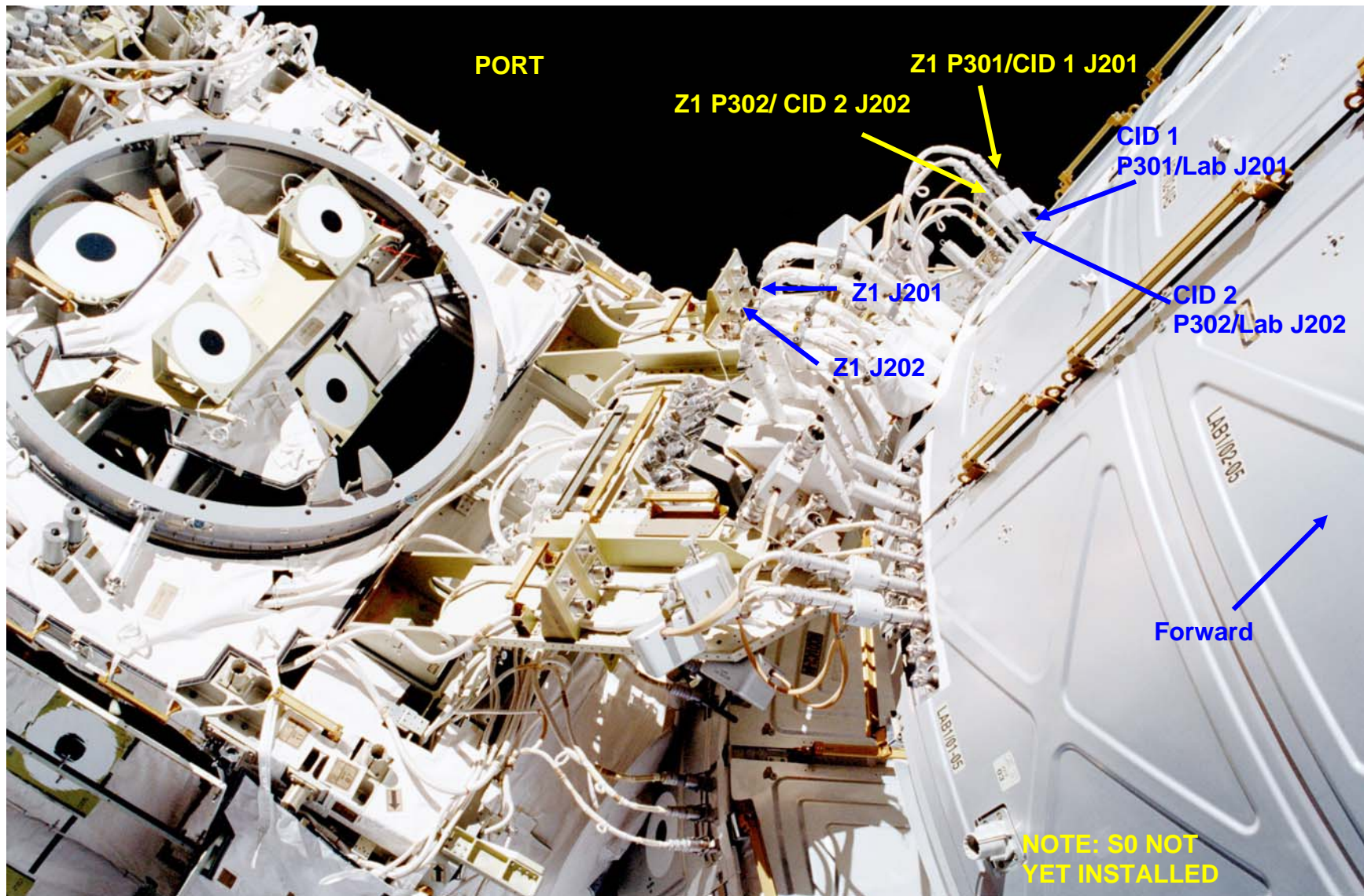

**PATCH PANELS 1 AND 2 – SPDA
(Z1 PORT)**

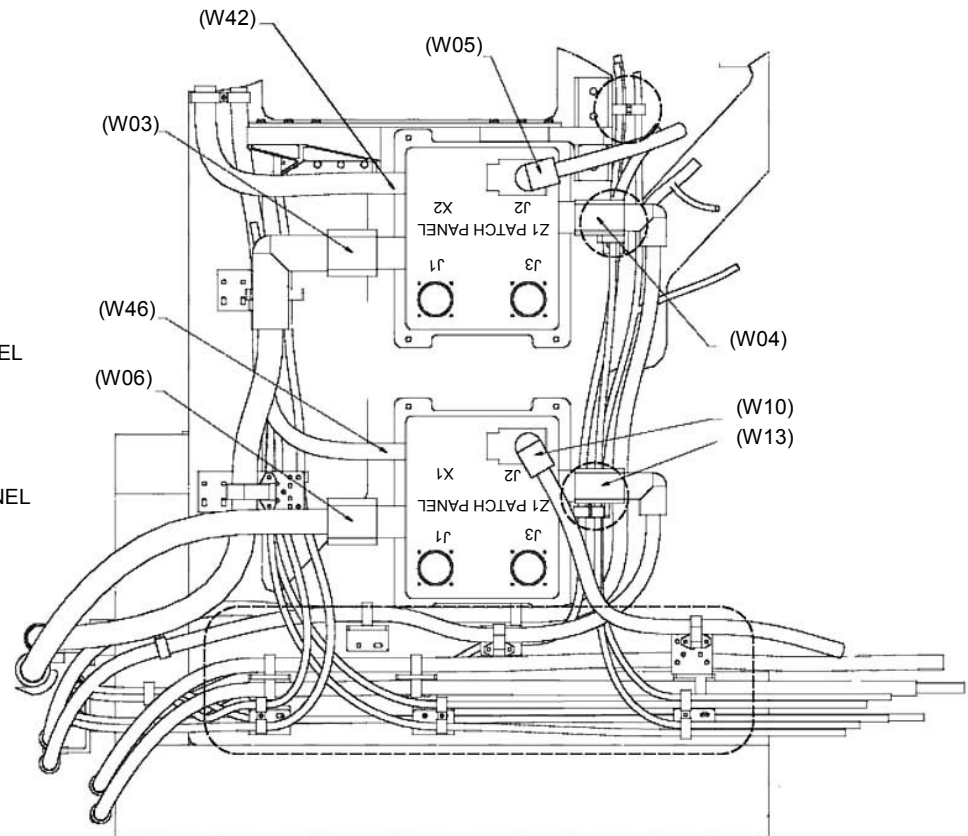
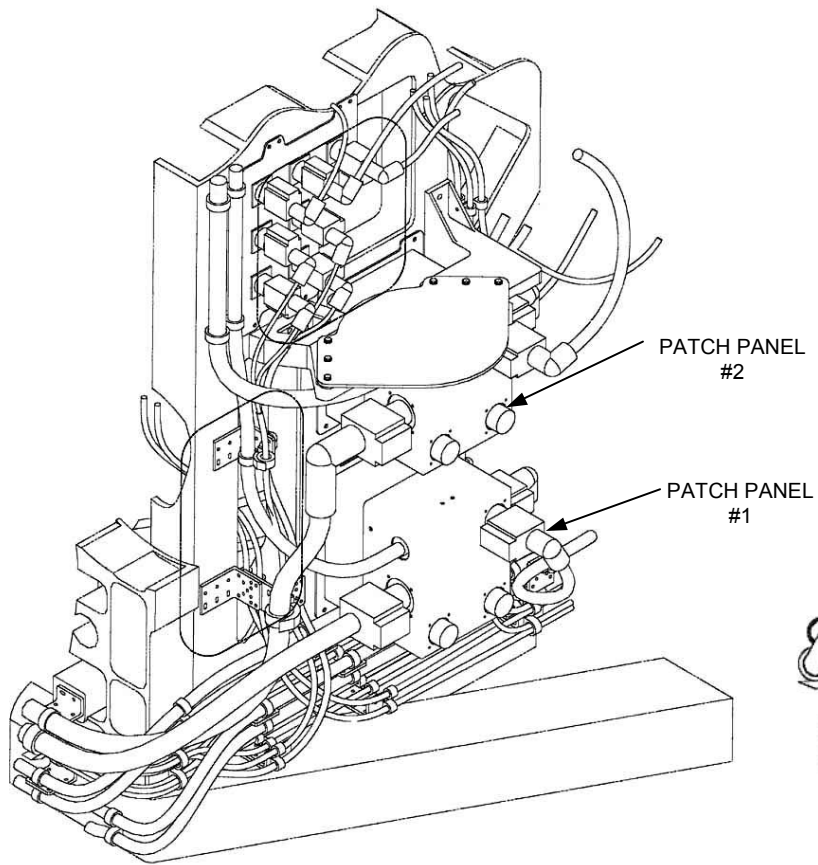

PATCH PANELS 5 AND 6 – DDCU
(Z1 STBD)

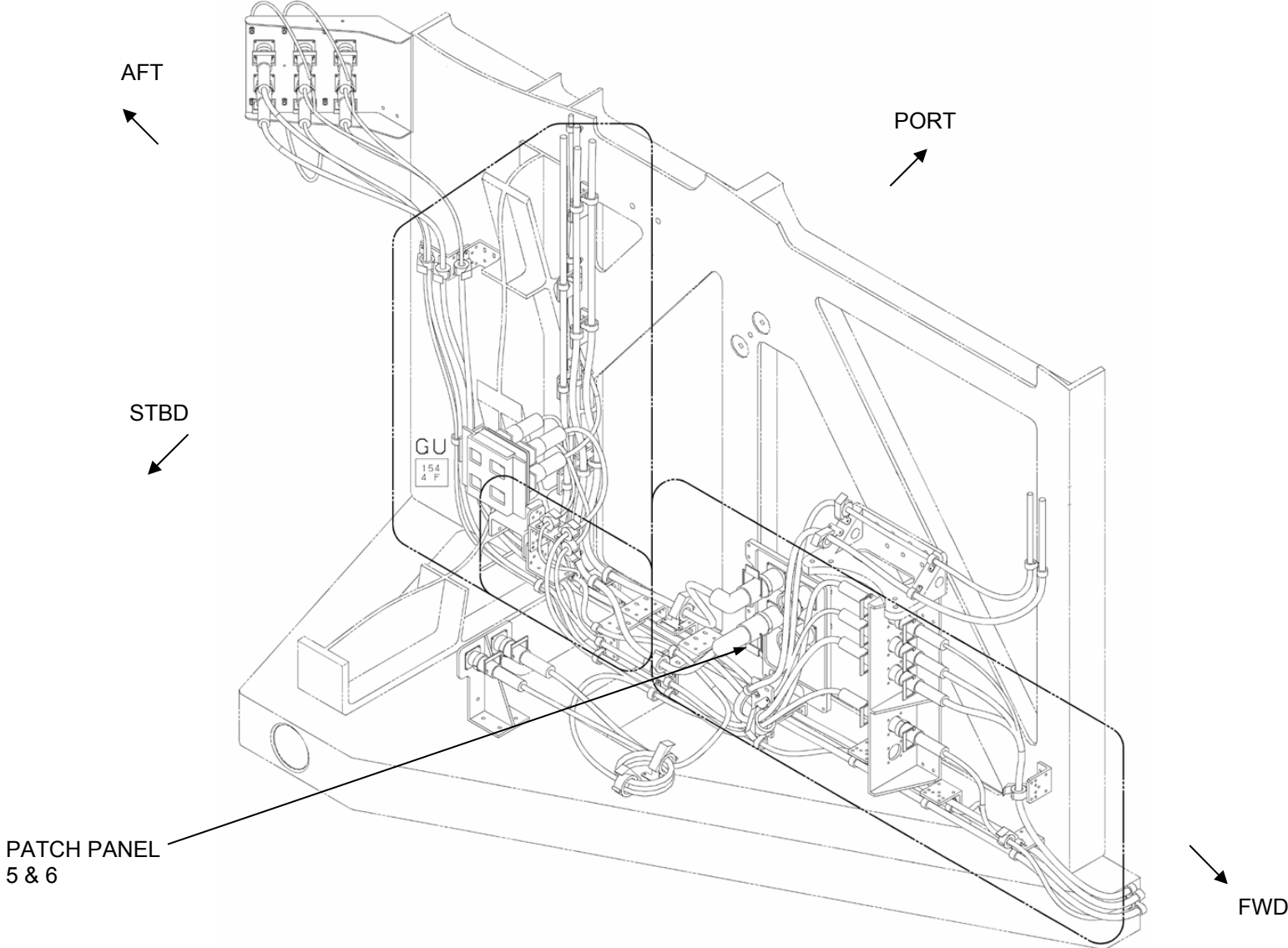

PATCH PANELS 5 AND 6 – DDCU (Cont)
(Z1 STBD)

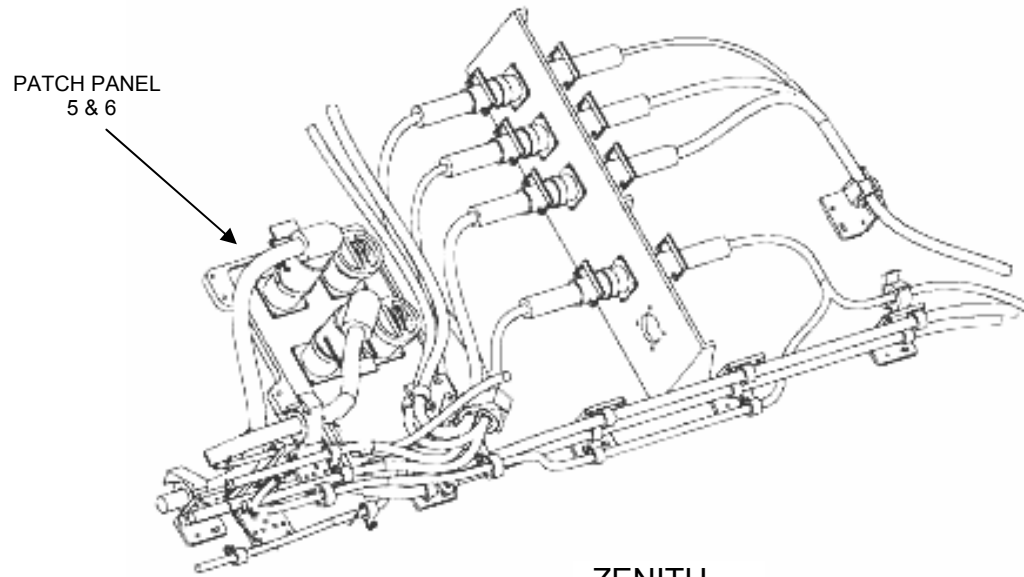

ZENITH

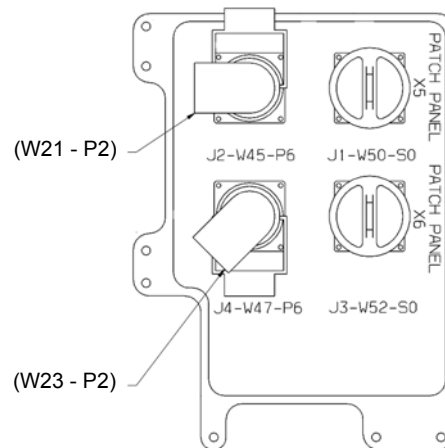

FS 18-76

EVA/116/FIN

P1 BAY 16 DDCU THERMAL COVER

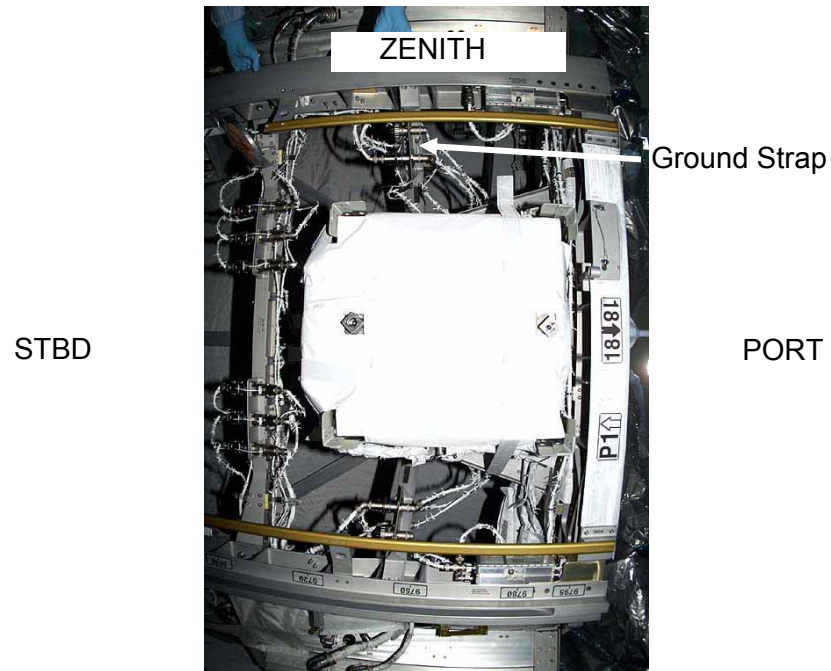
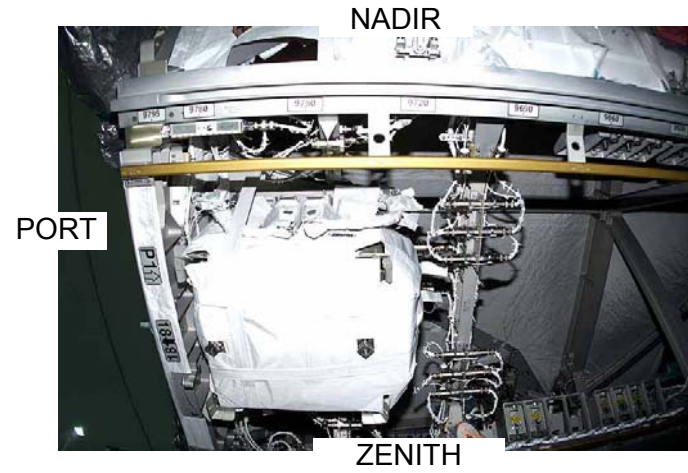
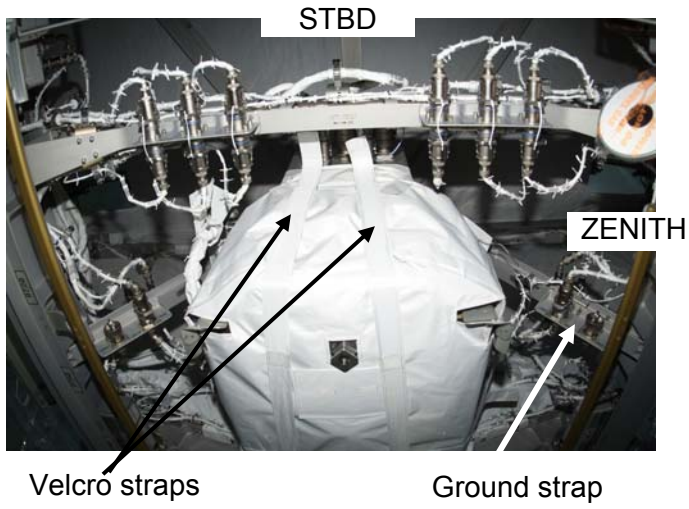

S1 DDCU THERMAL COVER

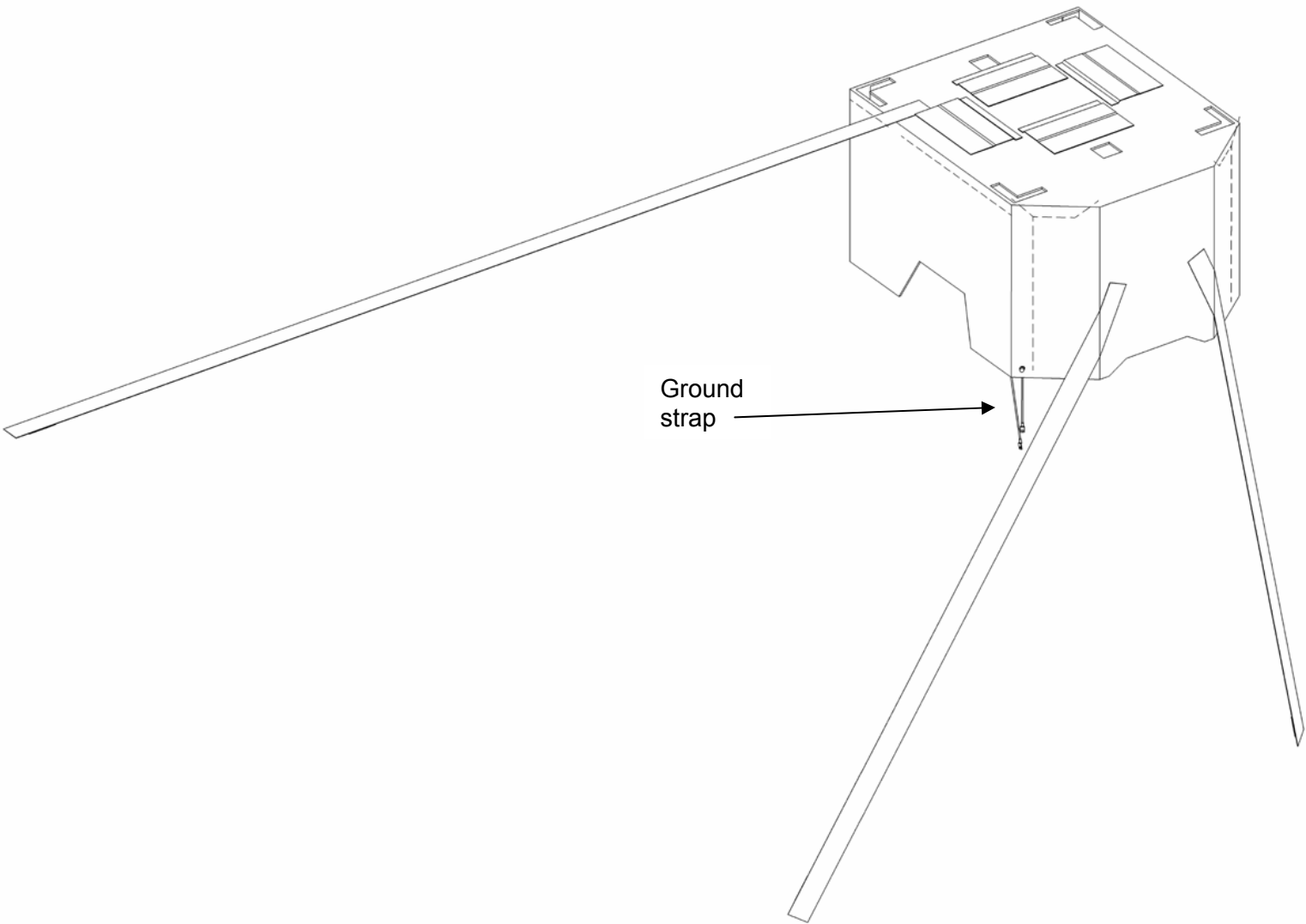

CETA CART – TOP VIEW

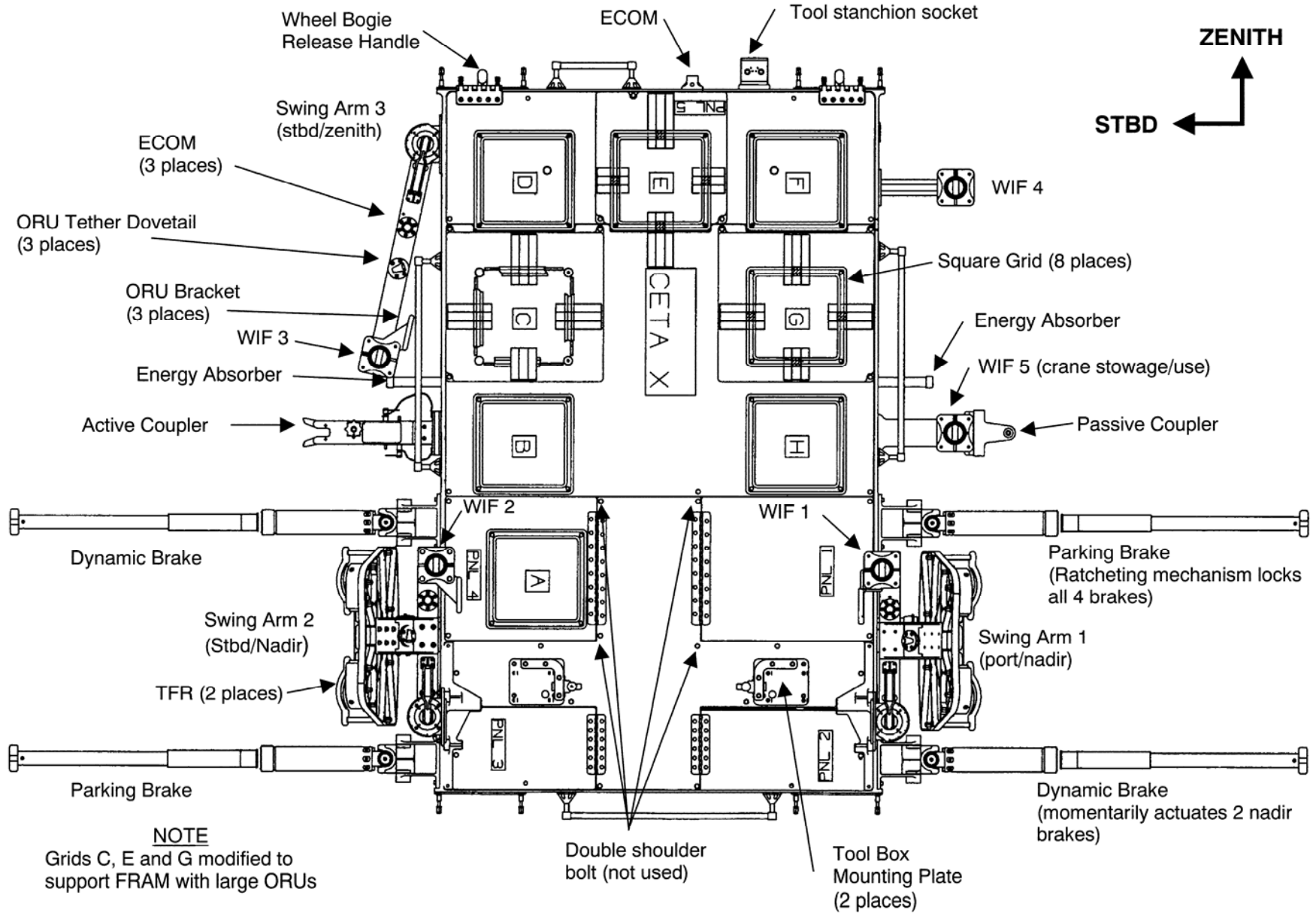

CETA SWINGARM AND WIF MARKINGS

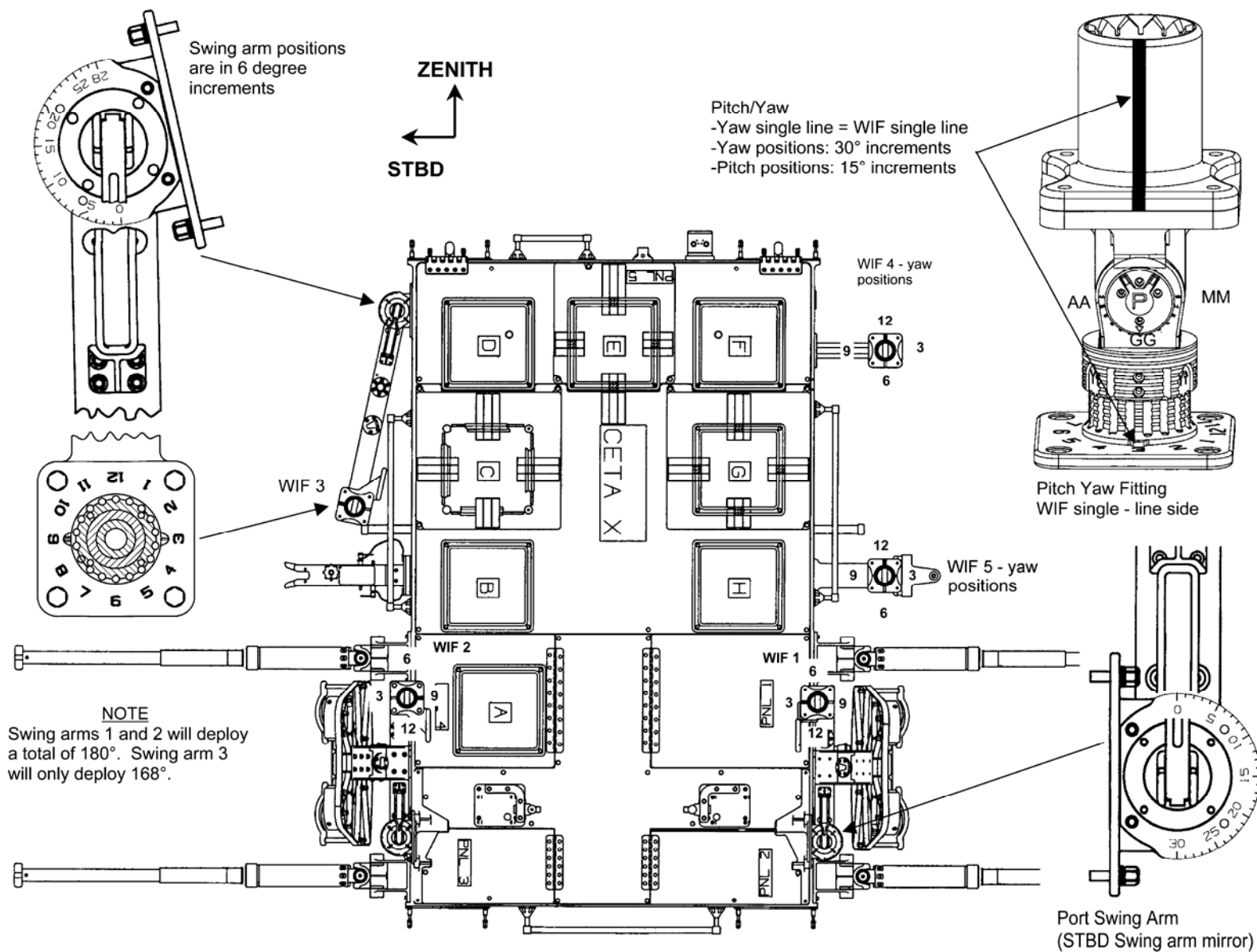

CETA CART COUPLERS

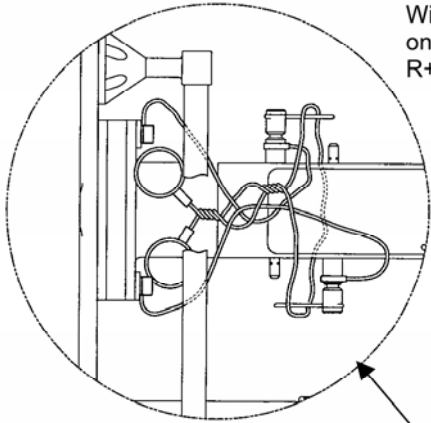

Wire ties required for launch only. Removed for coupler R+R

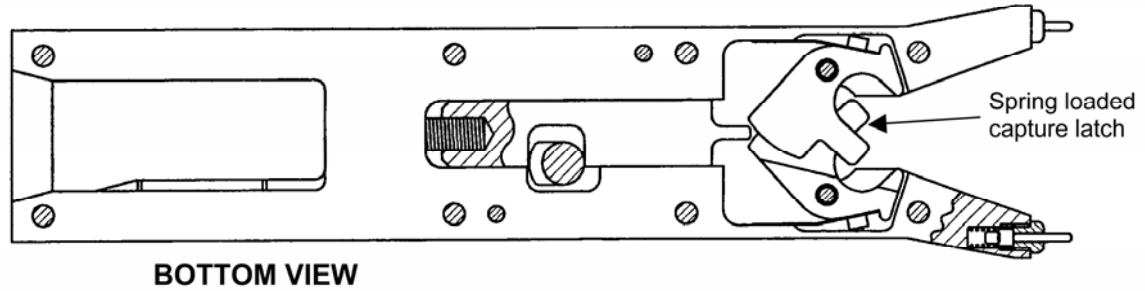

BOTTOM VIEW

Spring loaded capture latch

Compliance in indicated direction to allow for misalignment. Centering spring nominally constrains motion

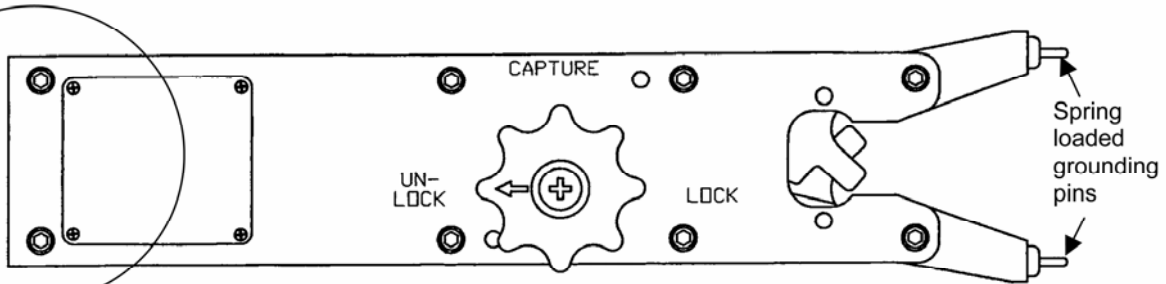

TOP VIEW

CAPTURE
UN-LOCK
LOCK

Spring loaded grounding pins

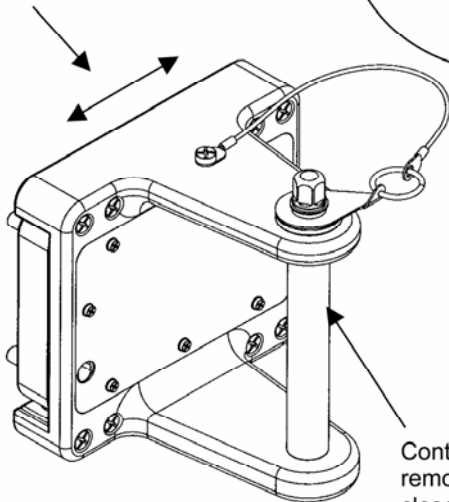

PASSIVE COUPLER

Contingency bolt removed if latch failed closed

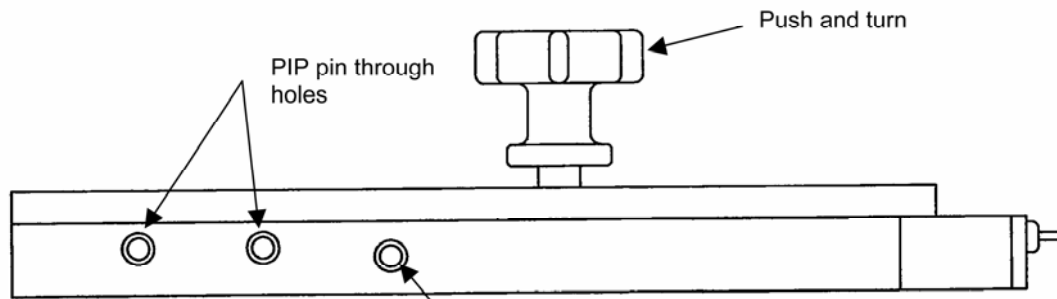

SIDE VIEW

PIP pin through holes

Push and turn

Threaded bolt hole not used

CETA CART WHEEL BOGIES

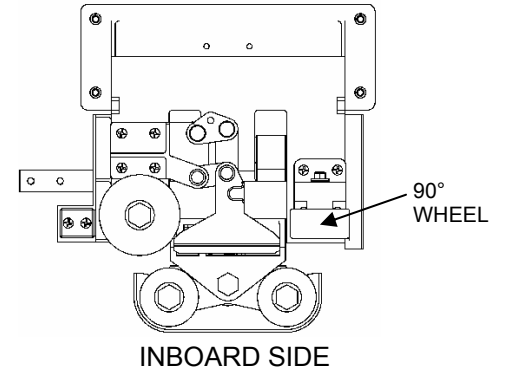
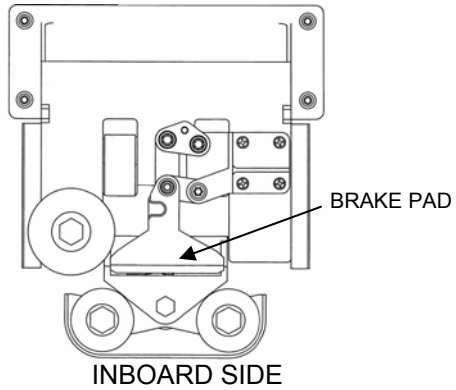
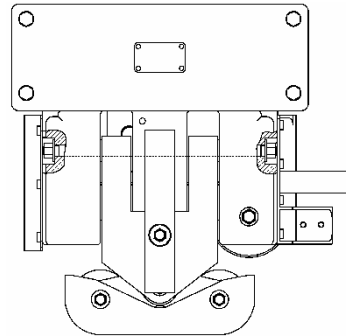
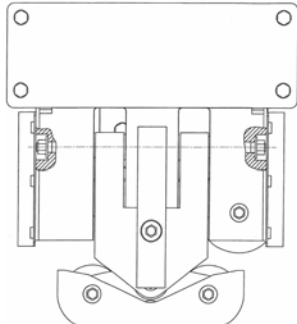
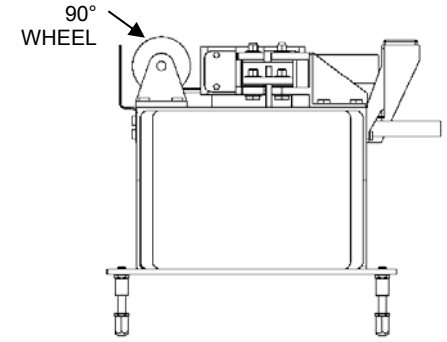
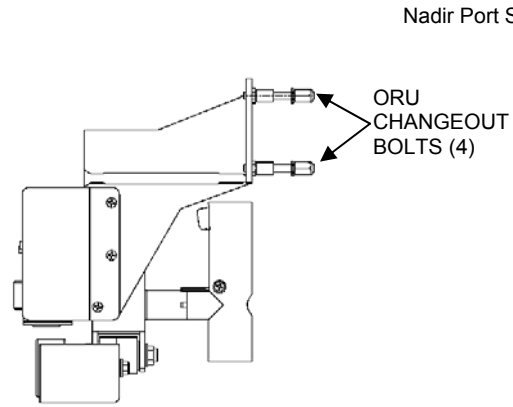
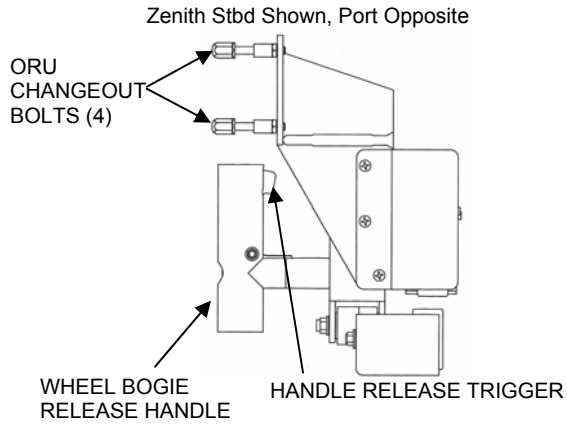

SSRMS FMS LOCATION

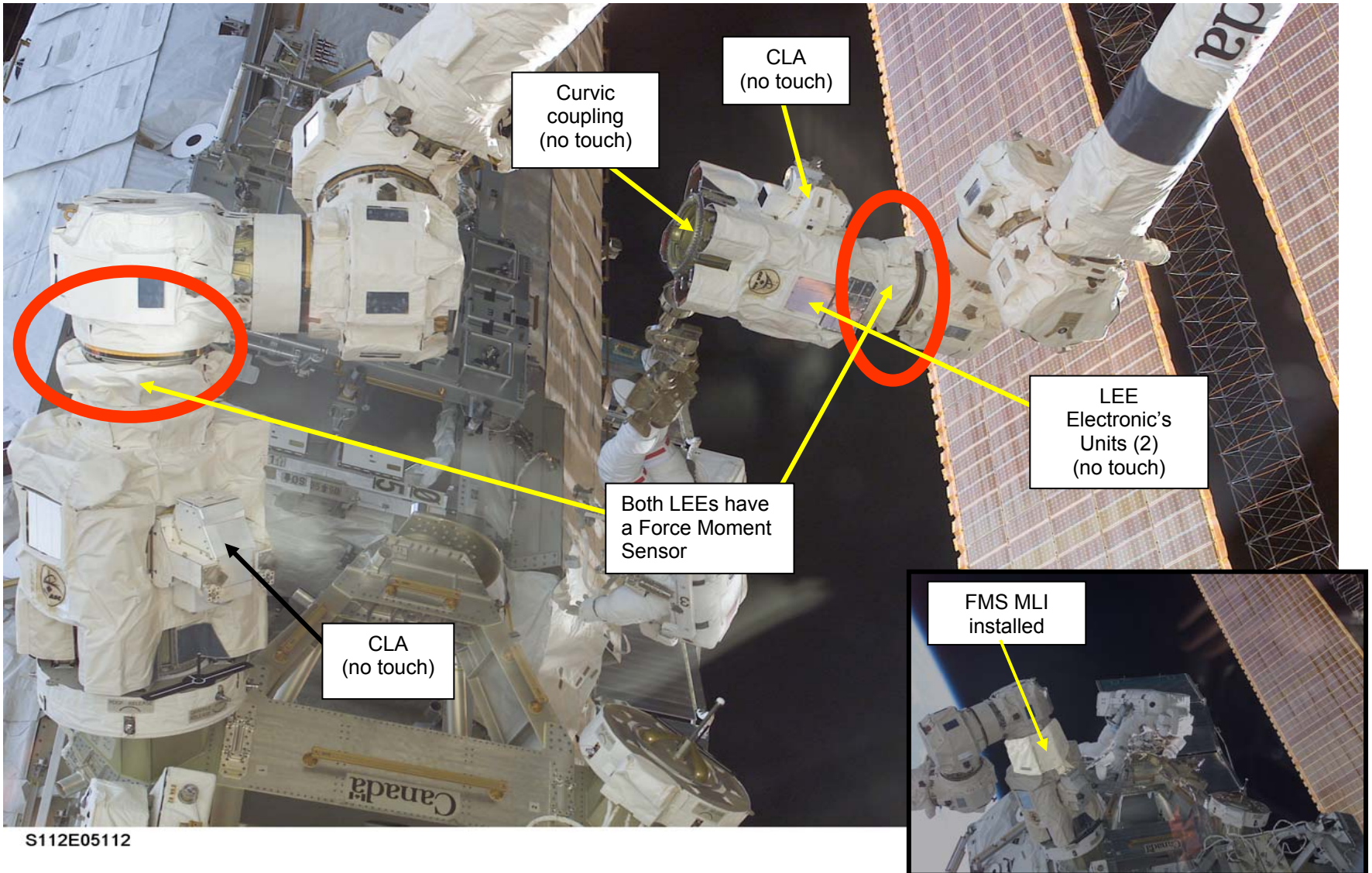

SSRMS FMS MLI

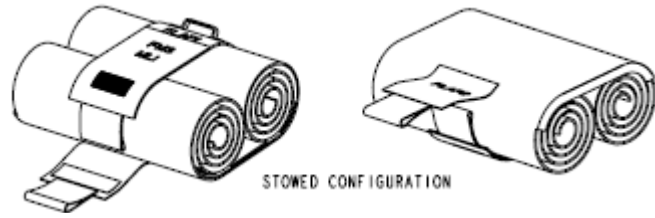

FMS MLI STOWED CONFIG

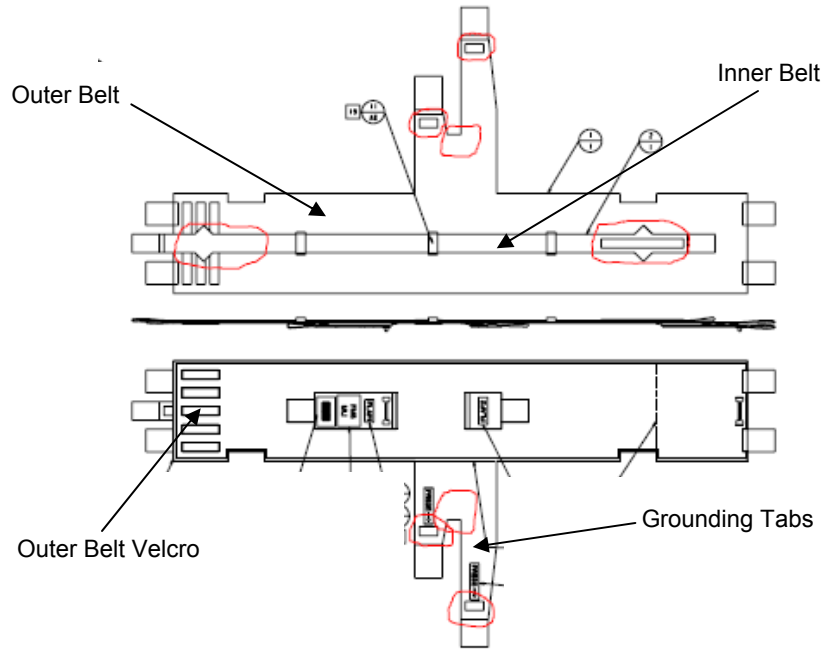

FMS MLI - UNROLLED

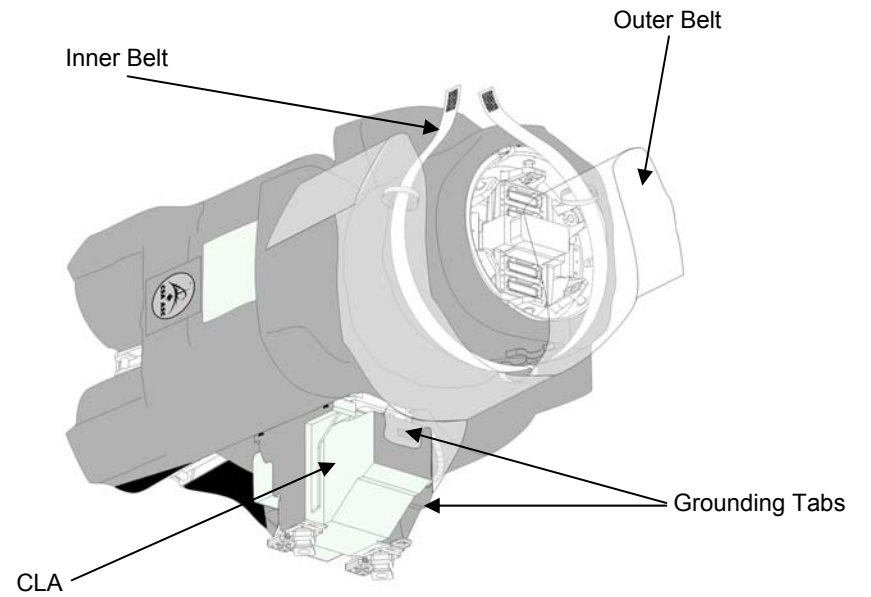
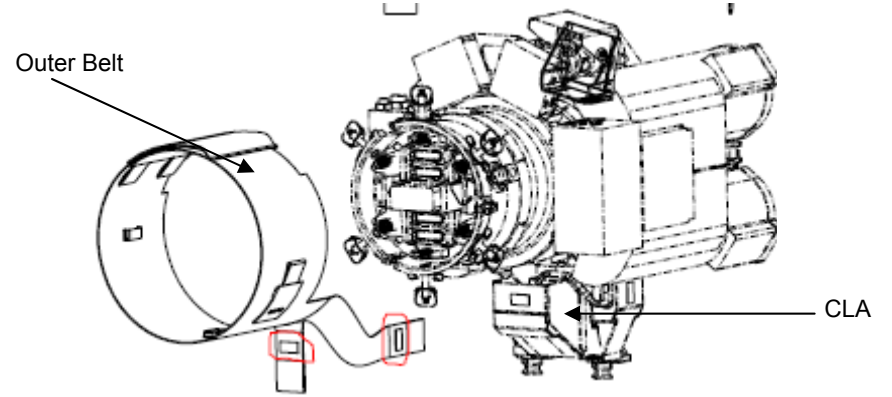

FMS MLI INSTALLATION

LATCHING END EFFECTOR (LEE)

PASSIVE WORKSITE INTERFACE (WIF) ADAPTER ASSY
(Dimensions shown in inches)

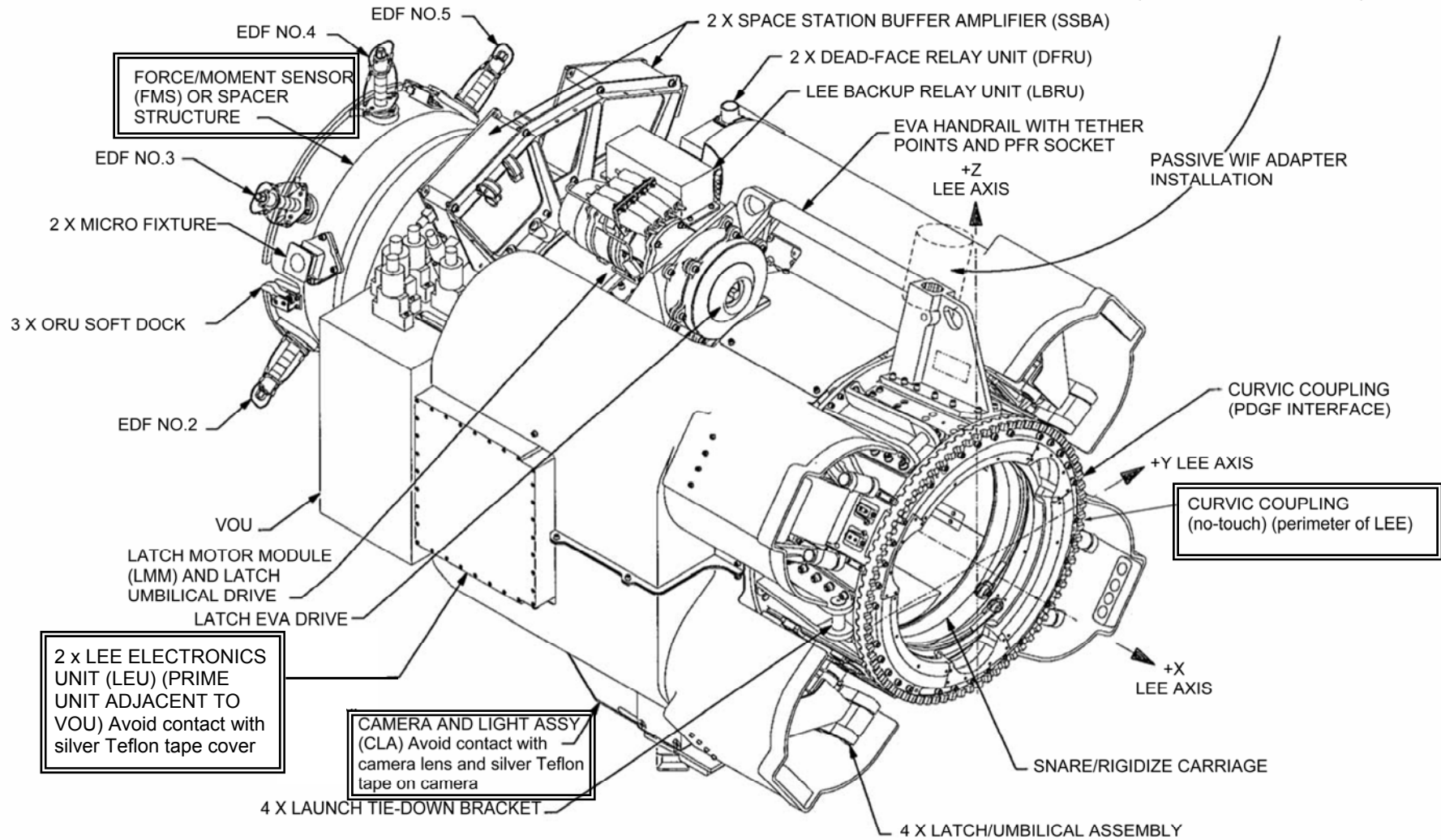

LATCHING END EFFECTOR (LEE) (2 places)
(Cables and thermal blankets not shown for clarity)

SMDP

SMDP BUNDLE OVERVIEW

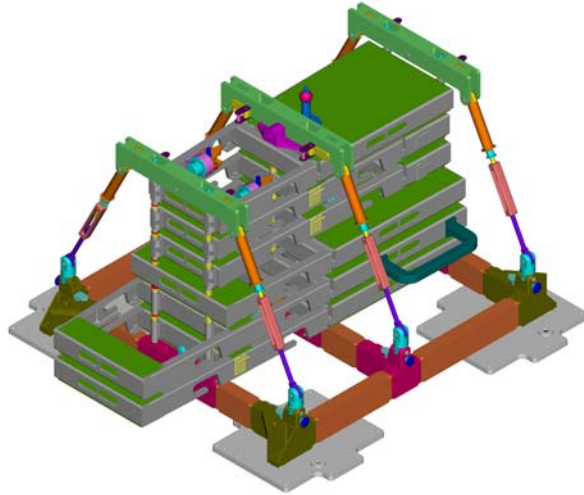

BUNDLE #2
(6 panels)

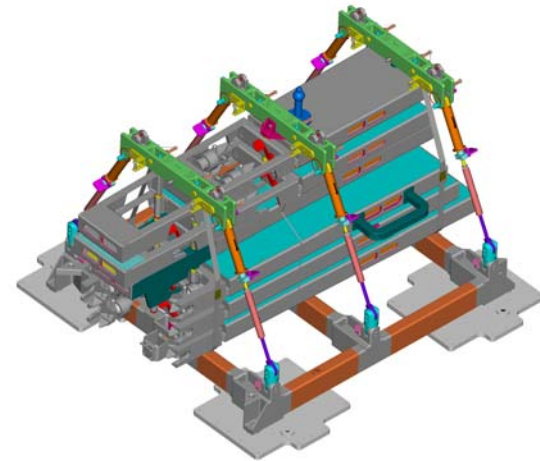

BUNDLE #3
(6 panels)

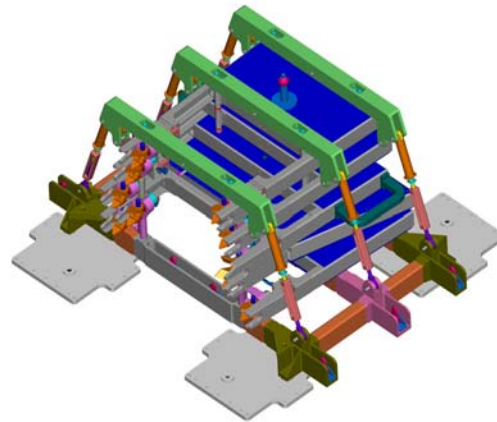

BUNDLE #4
(5 panels)

SMDP TDK – LAUNCH CONFIG FOR BUNDLES 2 AND 3

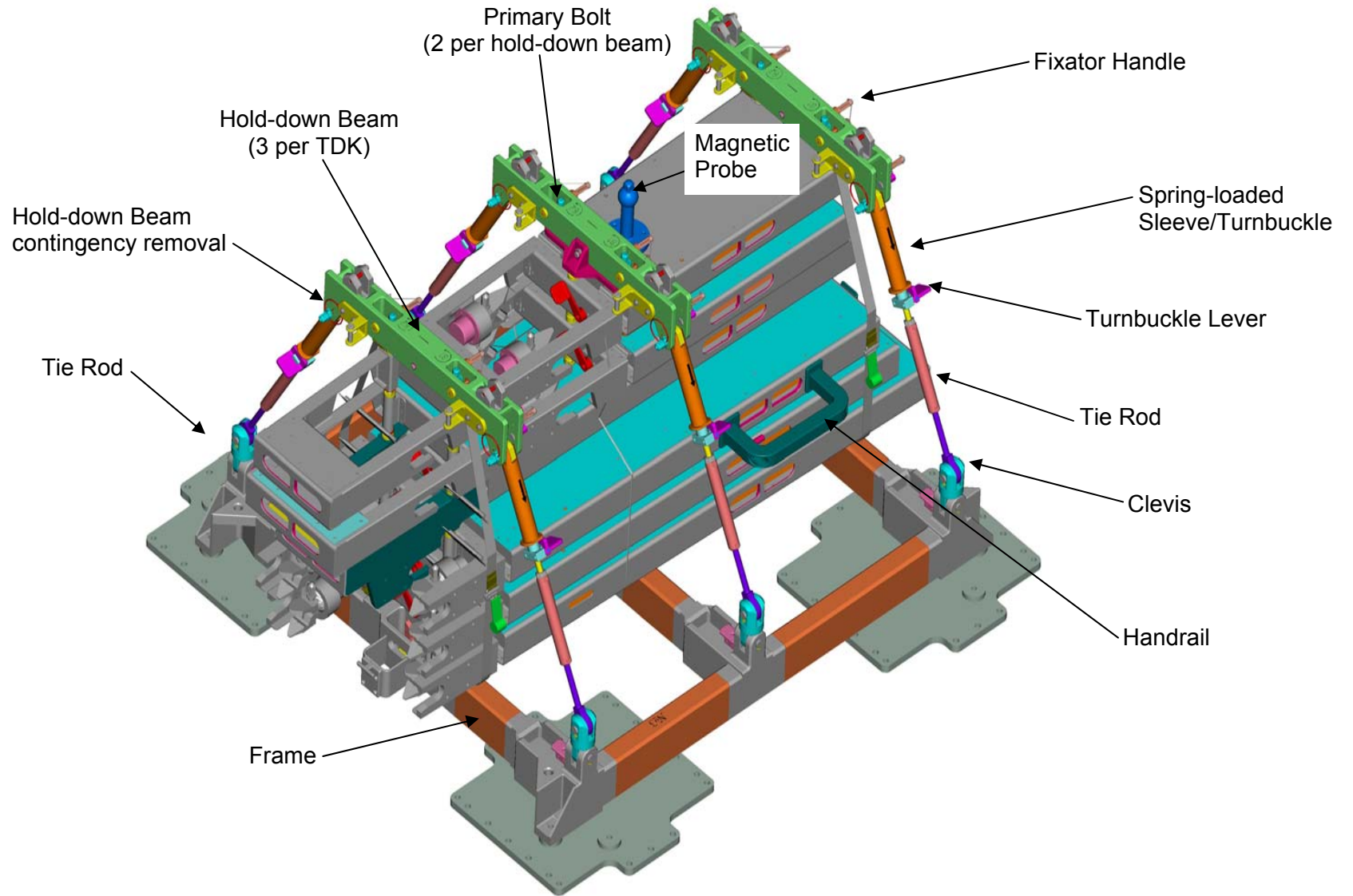

TDK WITH 6 PANELS

SMDP TDK – LANDING CONFIG FOR BUNDLES 2 AND 3

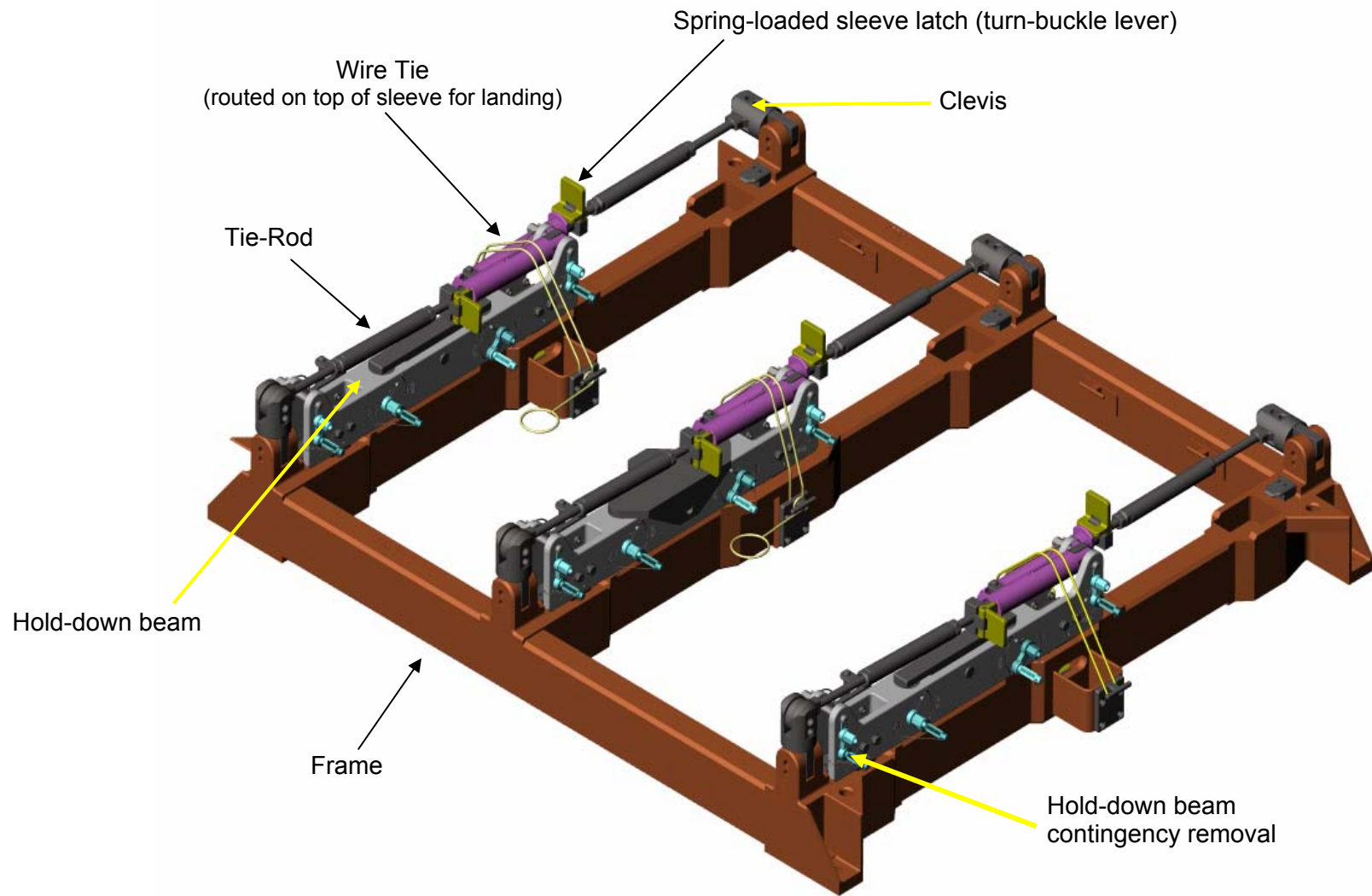

TDK LANDING CONFIG FOR BUNDLES 2 AND 3
(6 PANEL CONFIG)

SMDP TDK – LANDING CONFIG FOR BUNDLE 4

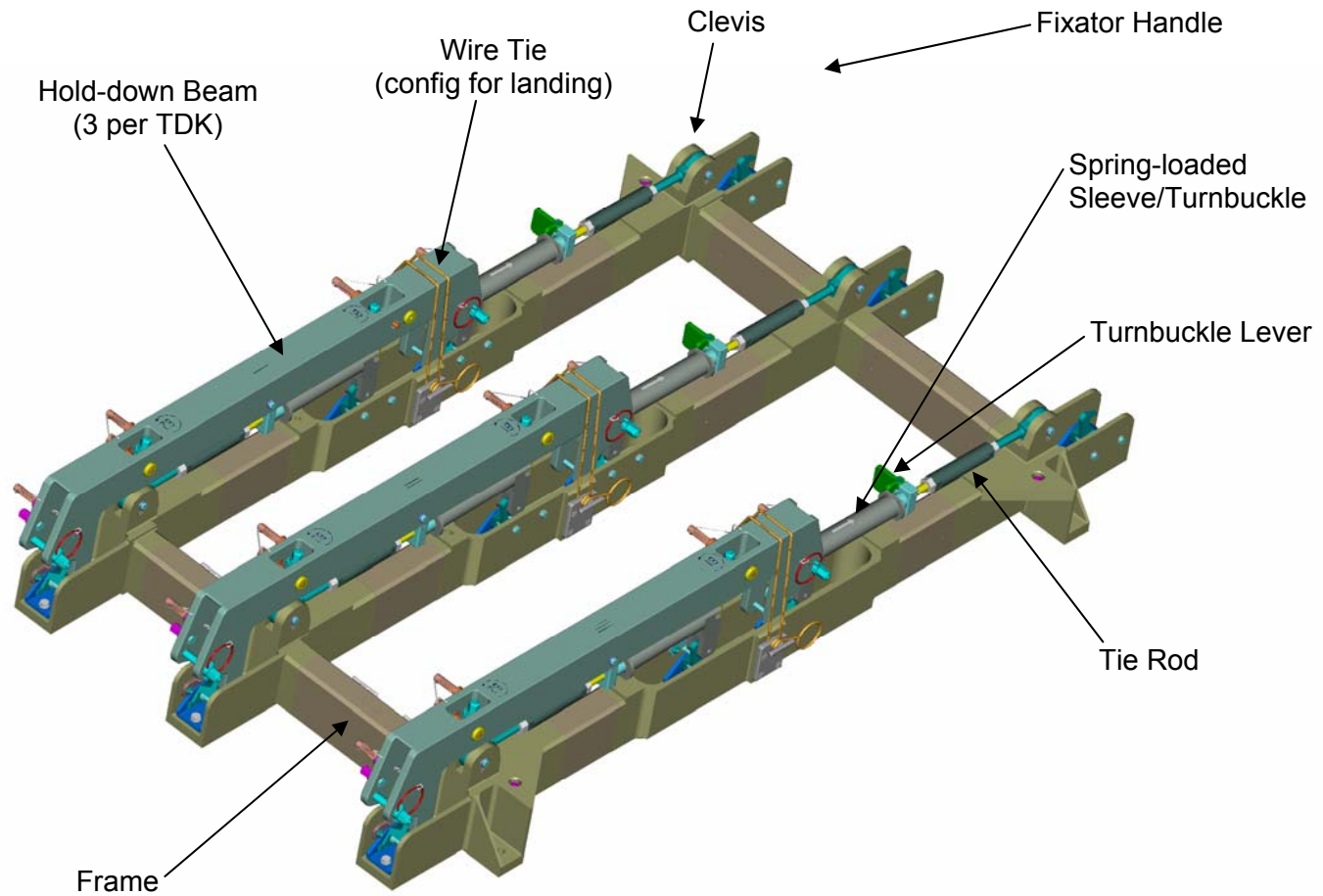

TDK WITH 6 PANELS

TDK LANDING CONFIG – SIDE VIEW

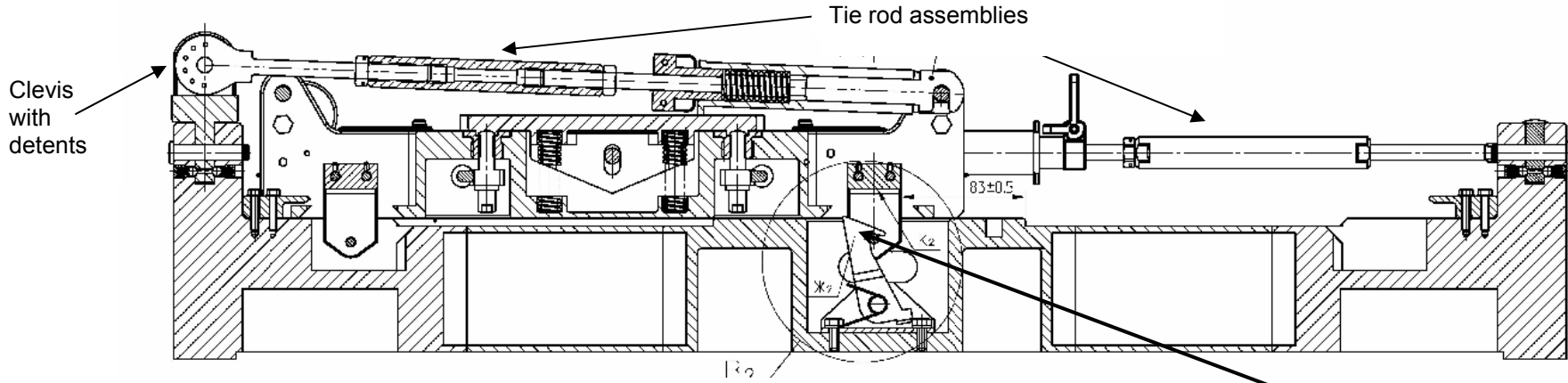

TDK LANDING CONFIG FOR 6 PANEL DESIGN

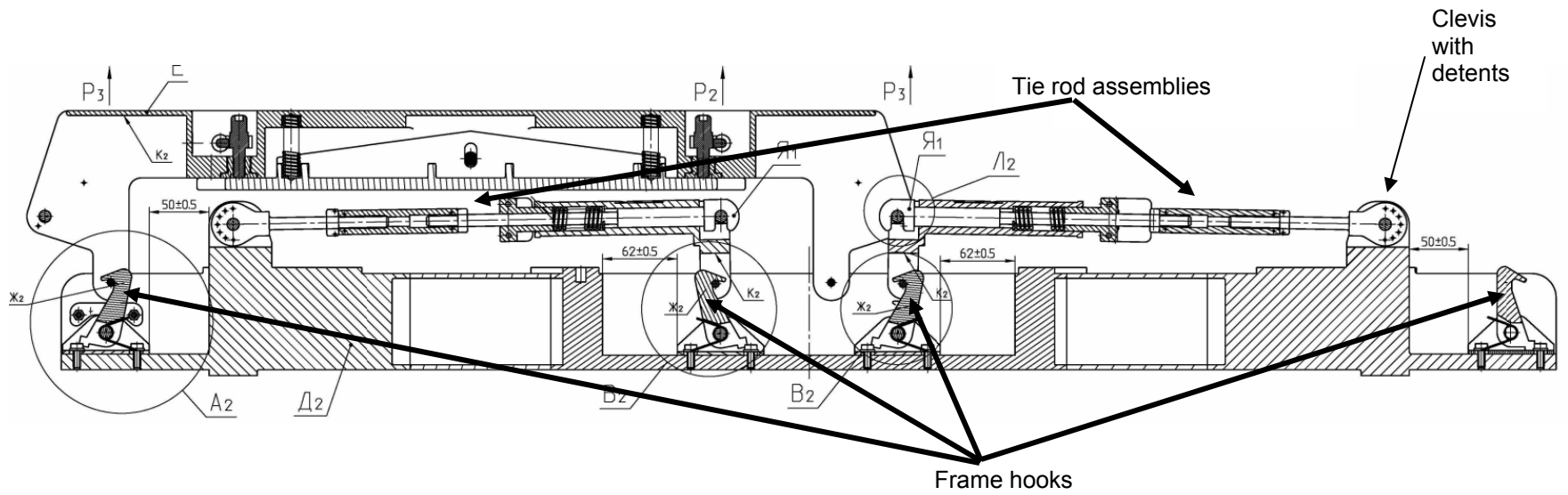

TDK LANDING CONFIG FOR 5 PANEL DESIGN

TDK BOLT OVERVIEW WITH LABELS

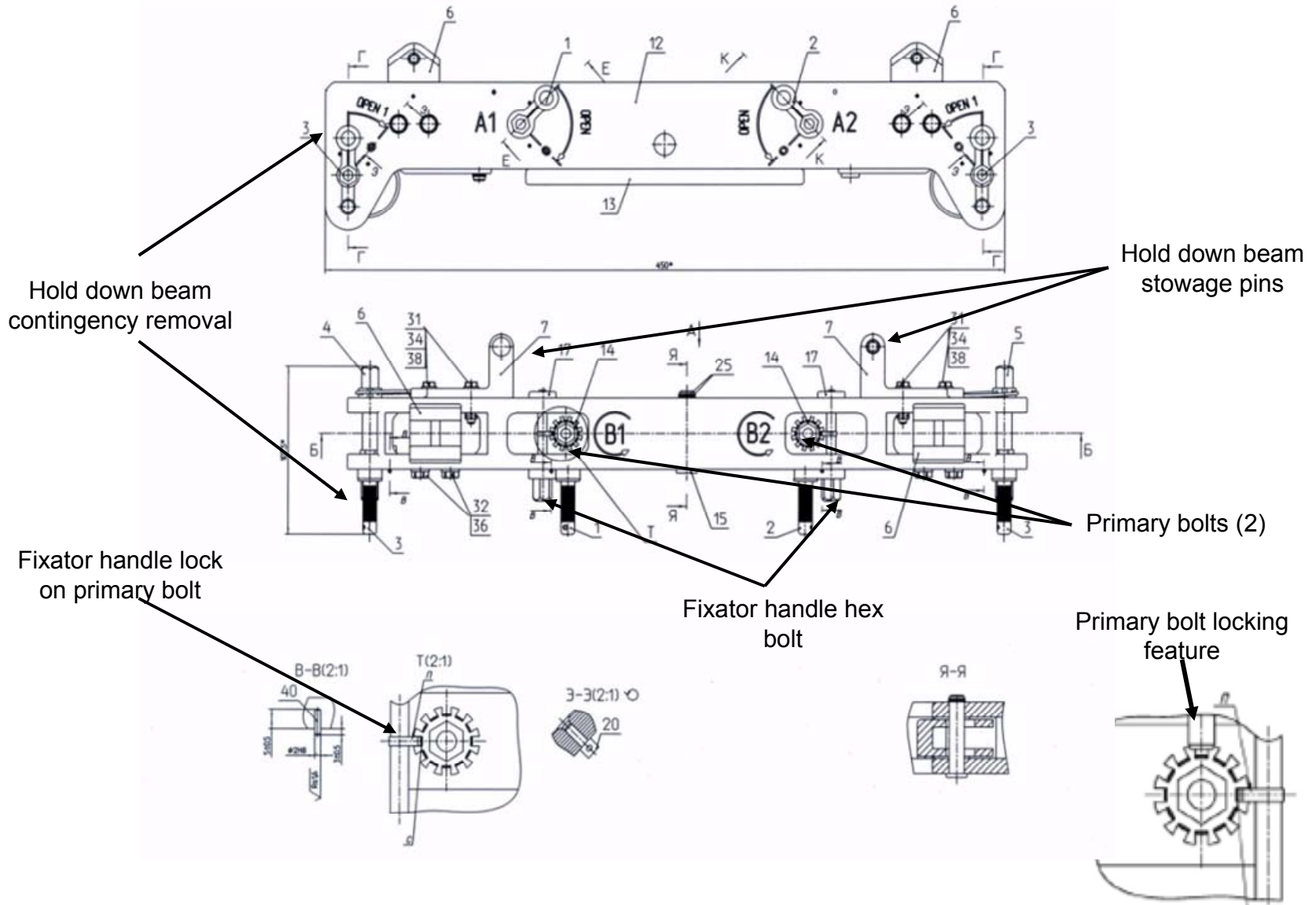

TDK BOLTS – NOMINAL AND CONTINGENCY

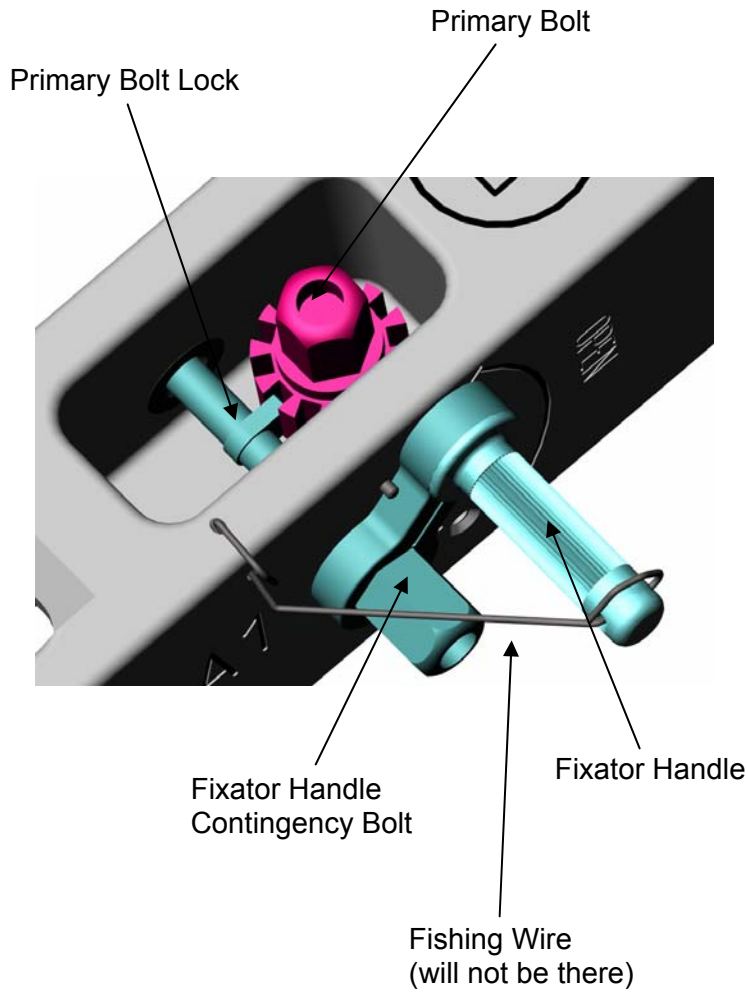

Nominal TDK Release Interface

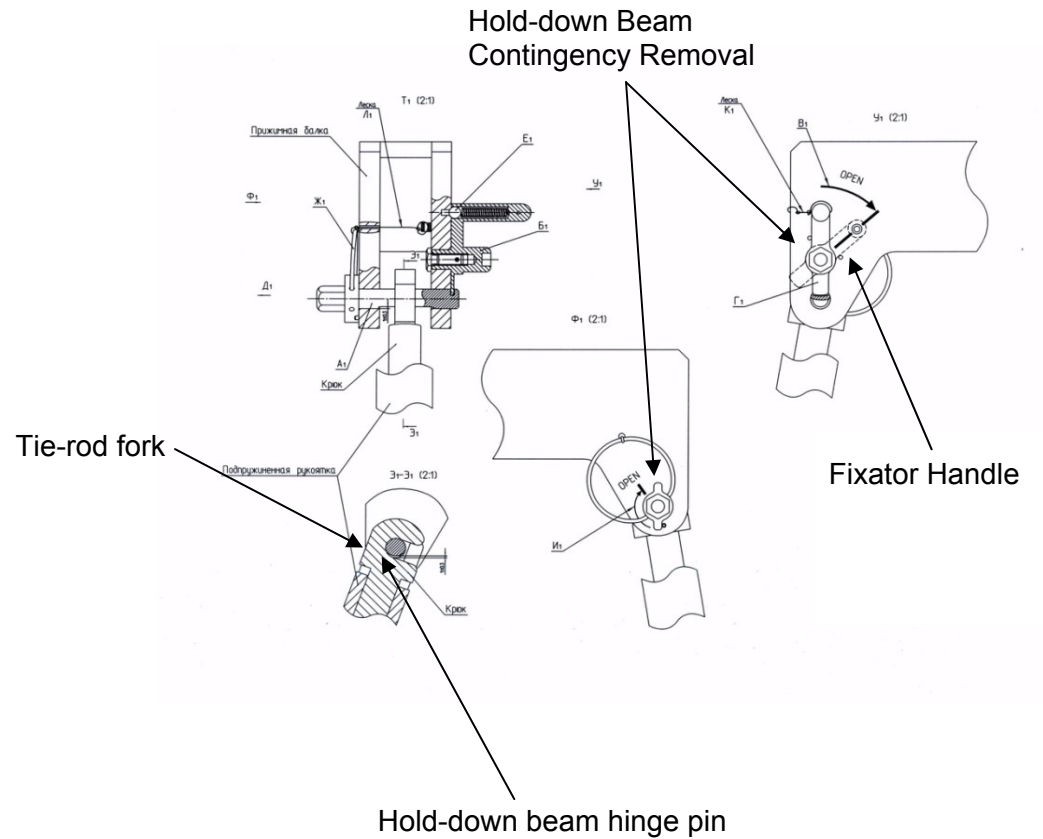

Hinge Pin Contingency Release

SMDP ADAPTER

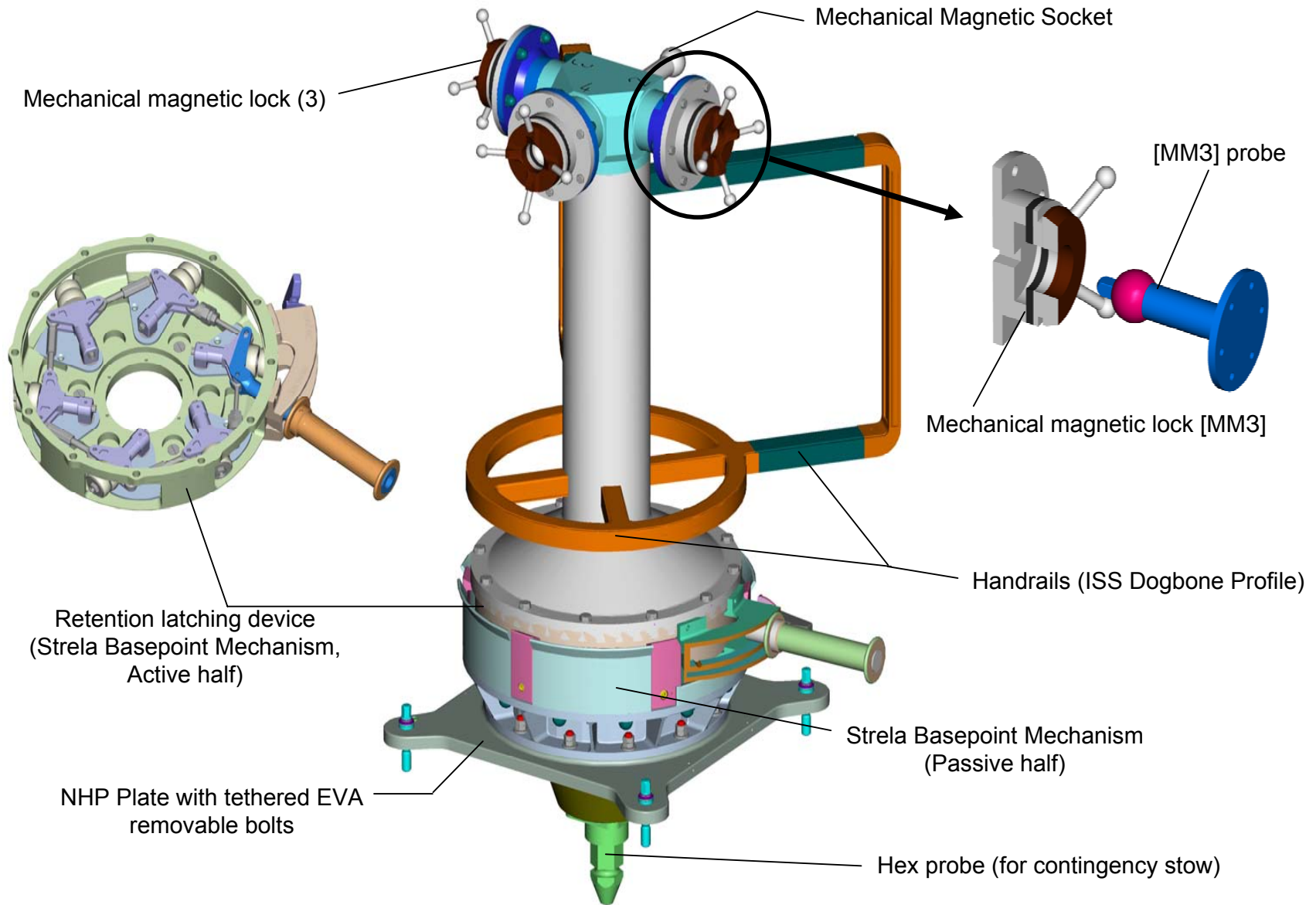

CHRISTMAS TREE

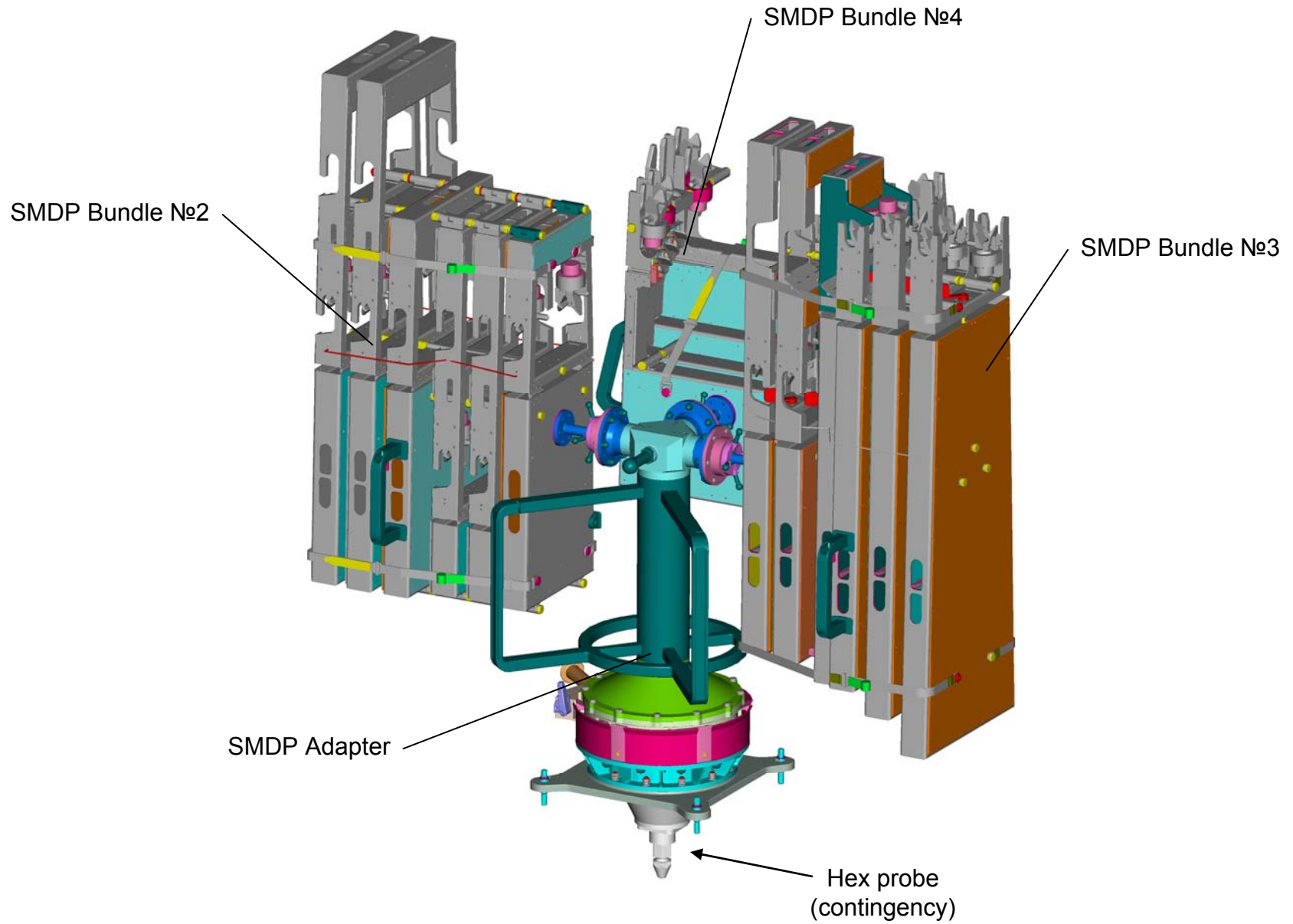

CHRISTMAS TREE STOWAGE ON PMA3

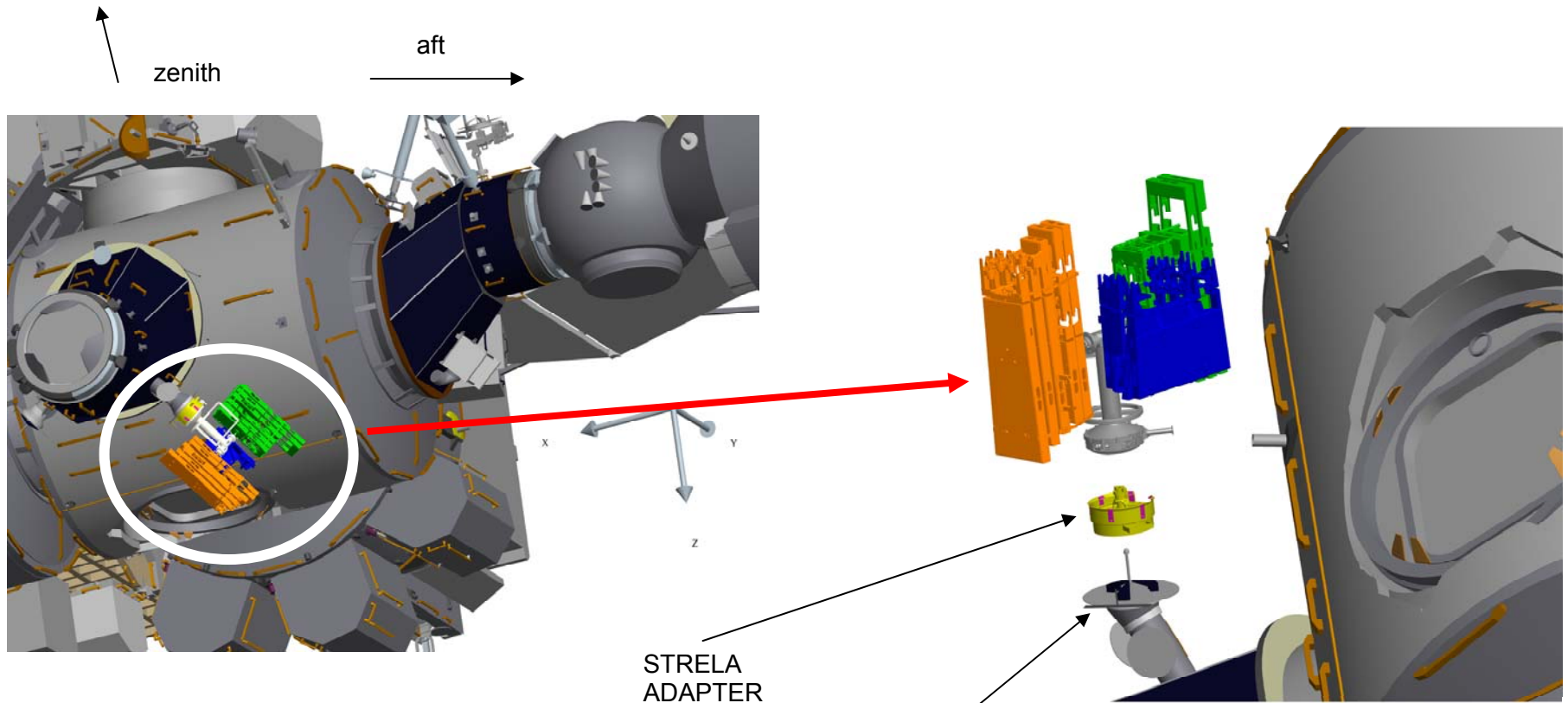

PORT VIEW OF NODE 1

RUSSIAN PWR RECONFIG

S0/NODE 1 SWINGARM

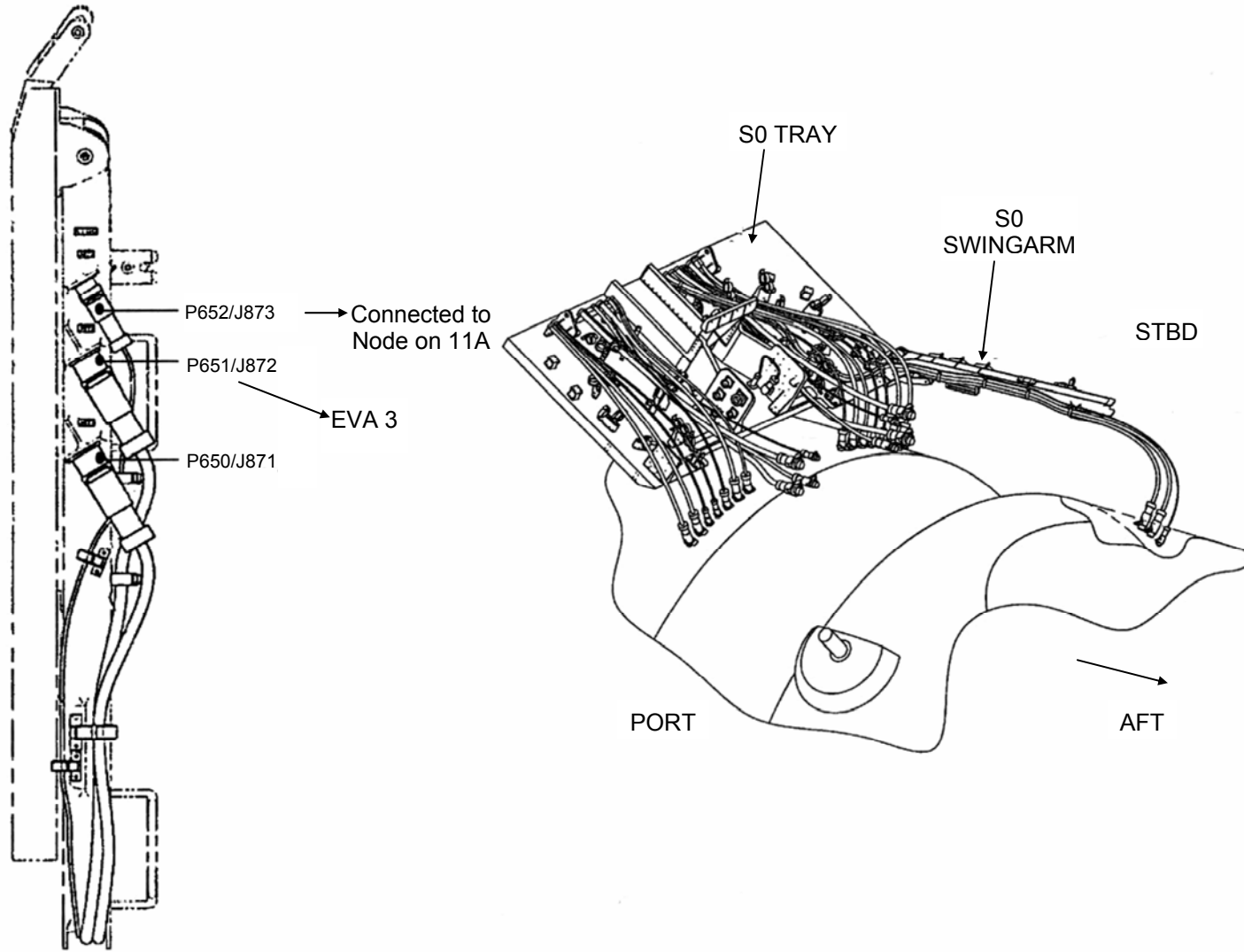

S0/NODE 1 SWINGARM DEPLOYED
(PRE 12A.1 CONFIG)

S0/NODE 1 SWINGARM DEPLOYED
(POST 12A.1 CONFIG)

Z1-NODE CONNECTIONS – PRE 12A.1

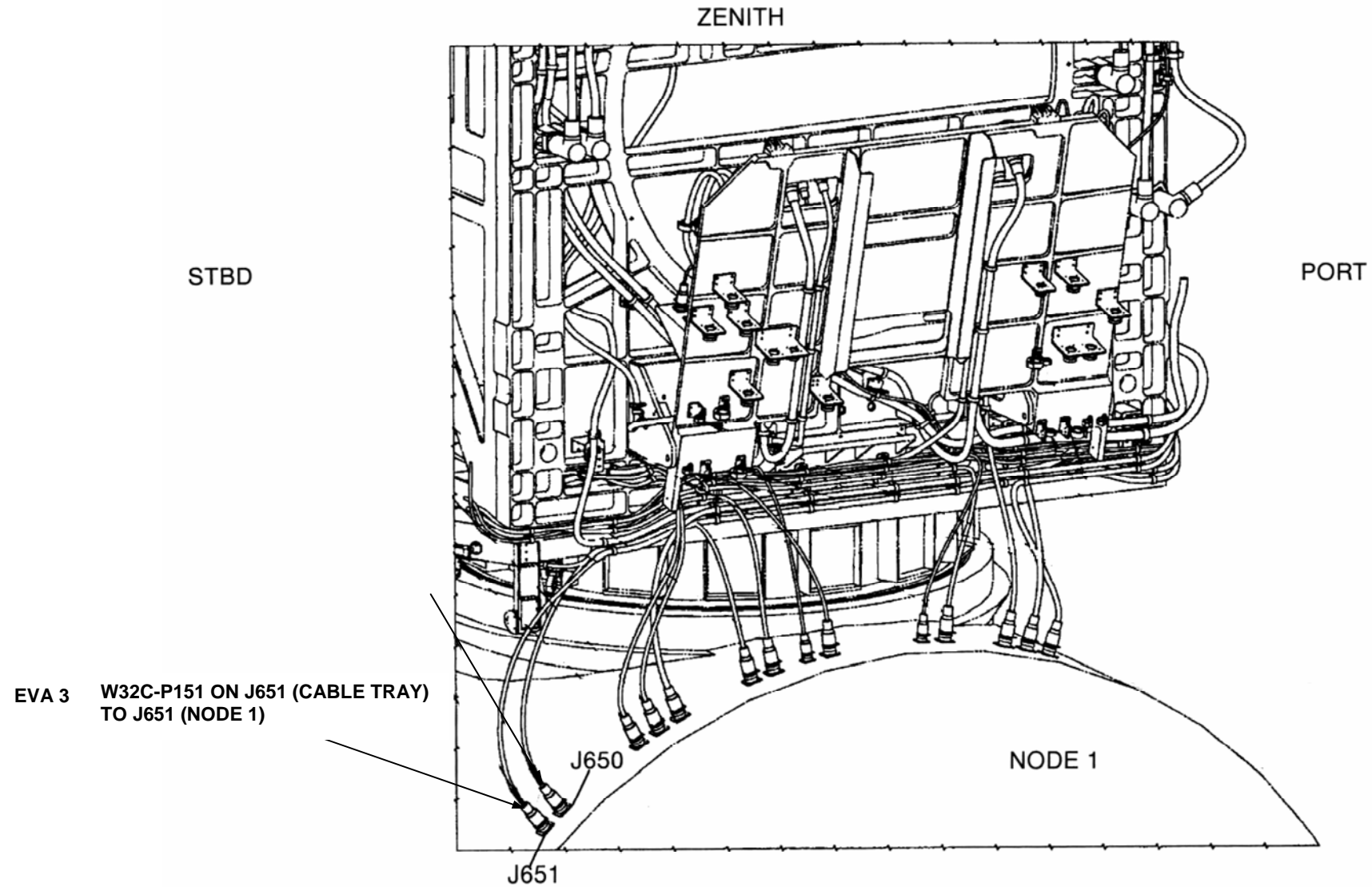

EVA 3 W32C-P151 ON J651 (CABLE TRAY TO J651 (NODE 1))

PRE 12A.1 CONFIG
(TRAY NOT DEPLOYED IN PICTURE)

Z1-NODE 1 CONNECTIONS – POST 12A.1

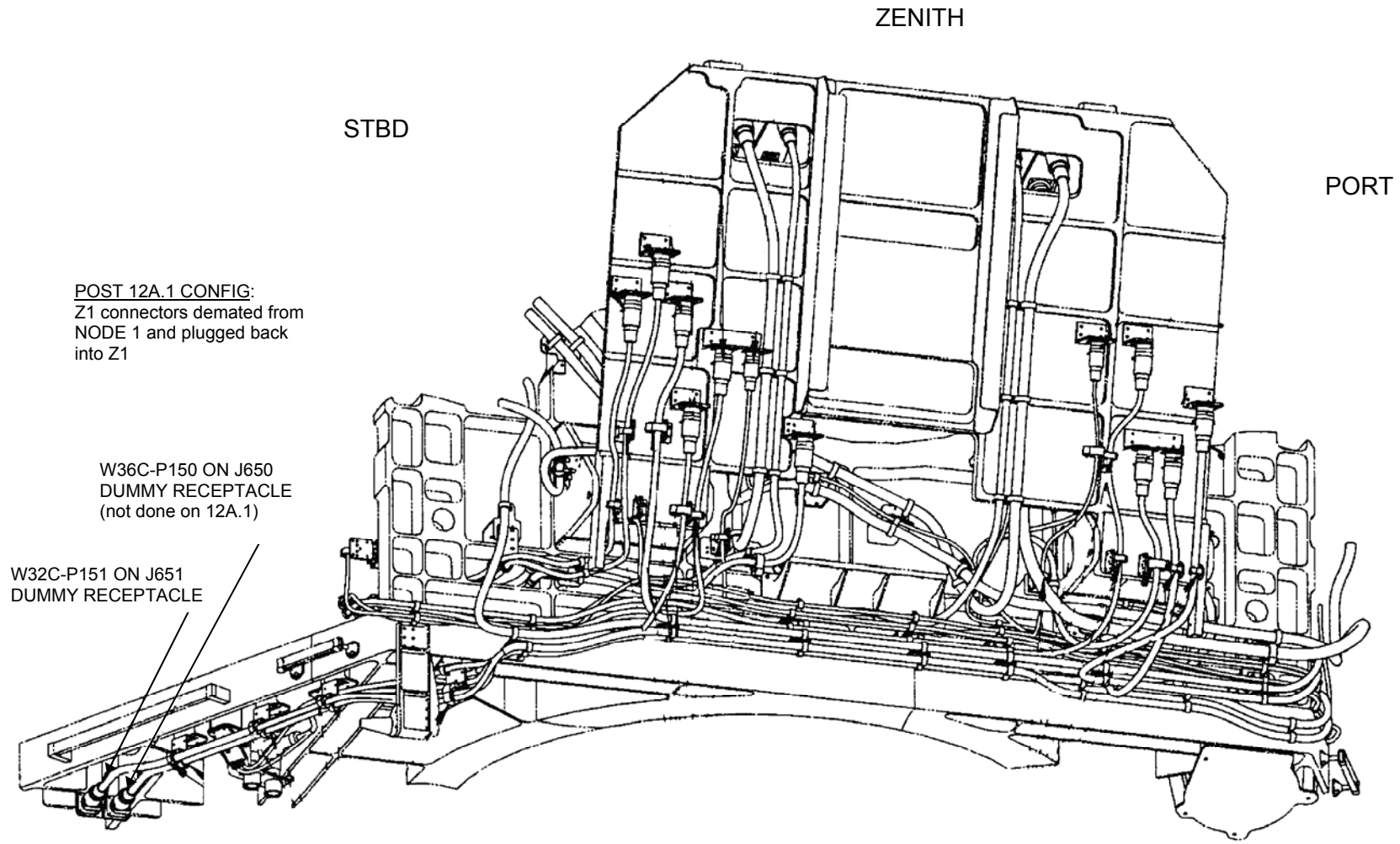

POST 12A.1 CONFIG:
Z1 connectors demated from
NODE 1 and plugged back
into Z1

W36C-P150 ON J650
DUMMY RECEPTACLE
(not done on 12A.1)

W32C-P151 ON J651
DUMMY RECEPTACLE

POST 12A.1 CONFIG
(TRAY NOT DEPLOYED IN PICTURE)

FGB/PMA1 H-JUMPER 2/3 CONFIG

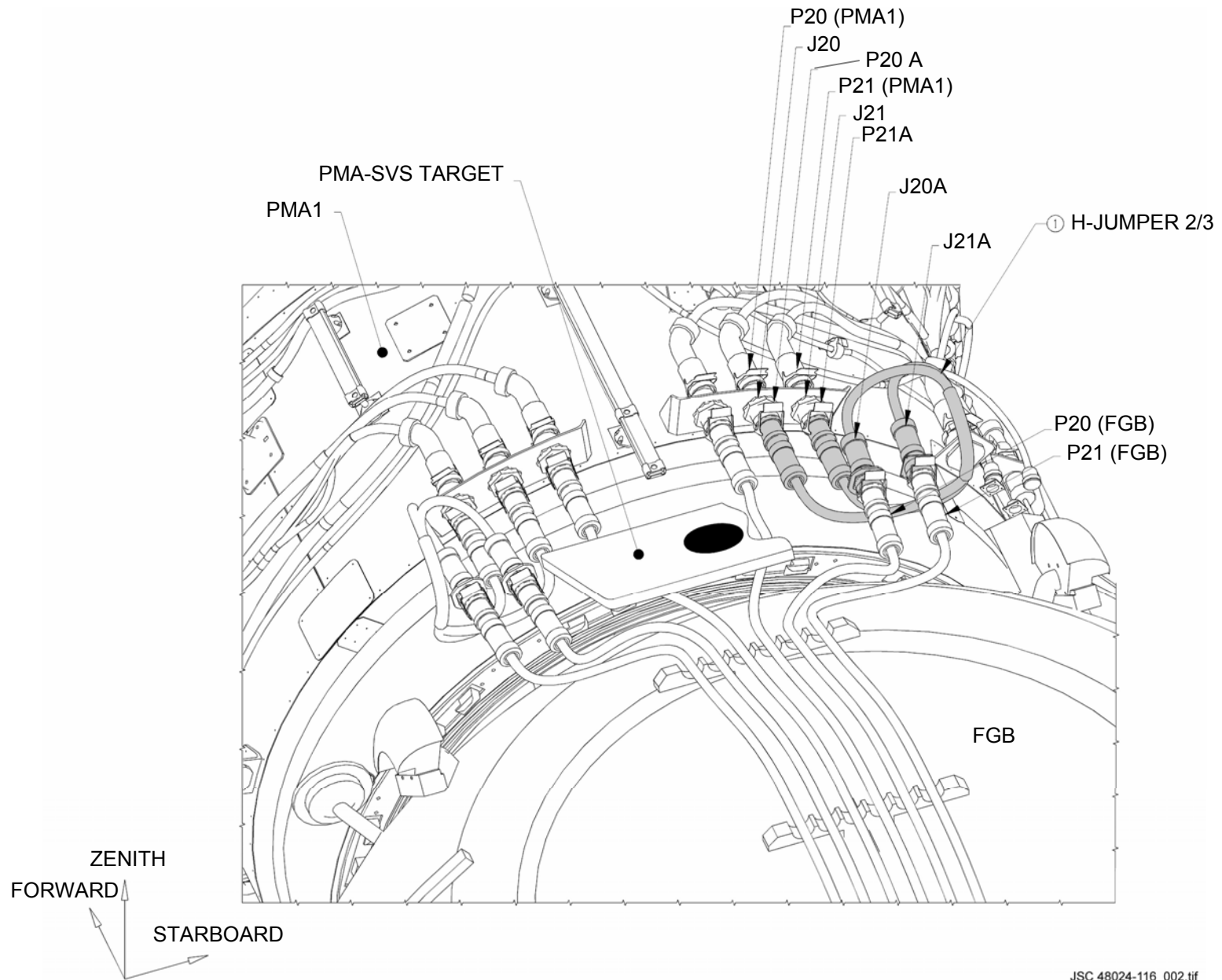

JSC 48024-116_002.tif

FGB/PMA1 CONFIG POST H-JUMPER REMOVAL

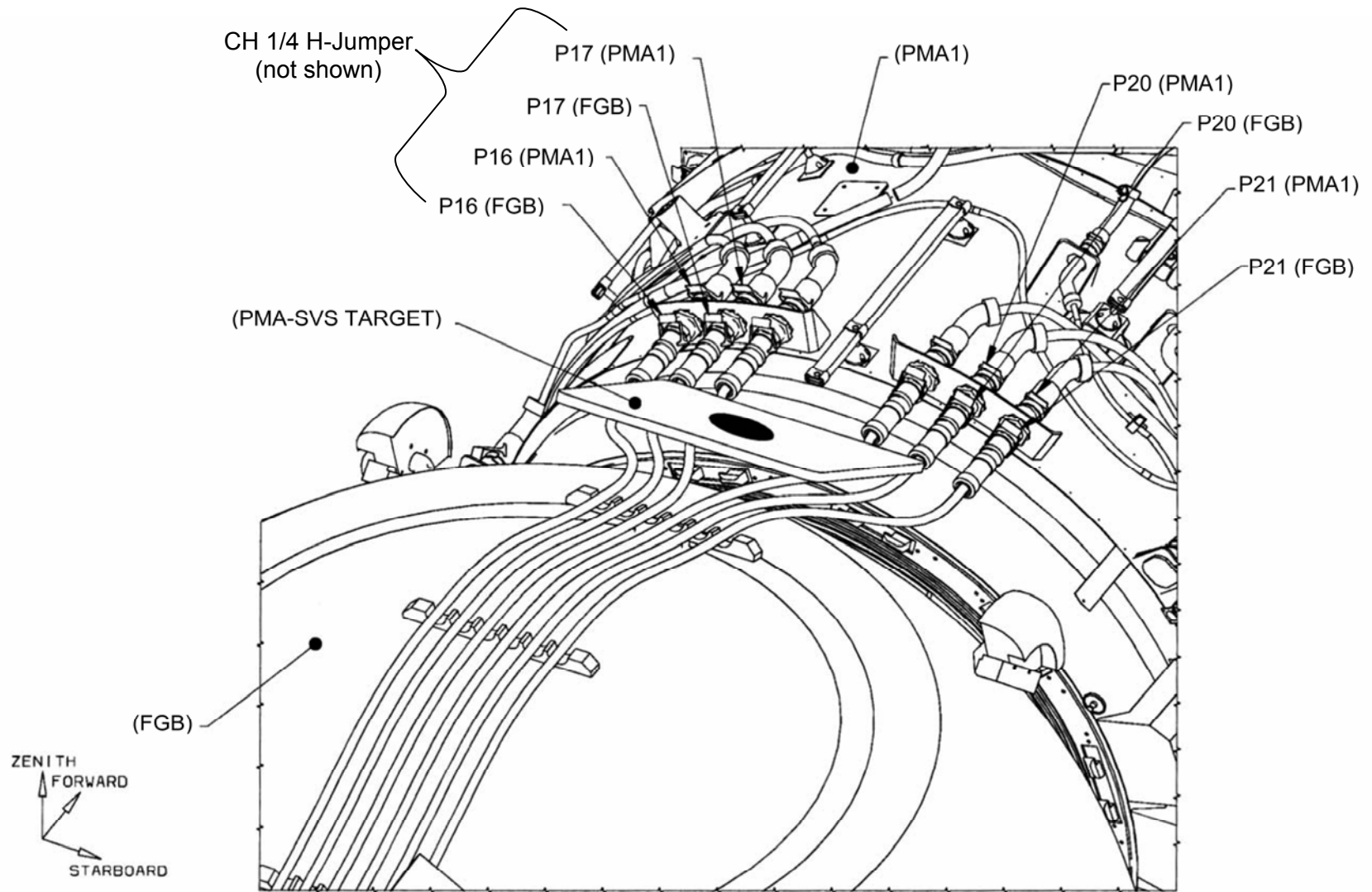

ADJUSTABLE GRAPPLE BAR

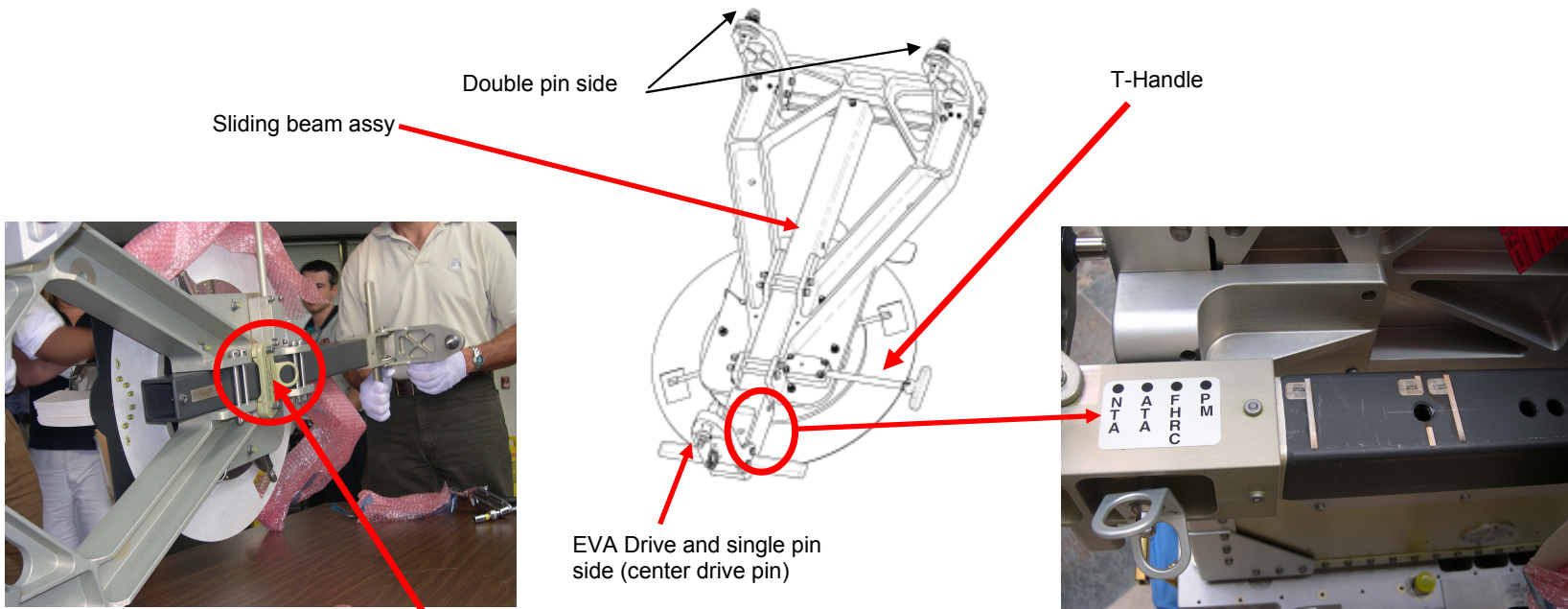

ORU INDICATOR LABEL

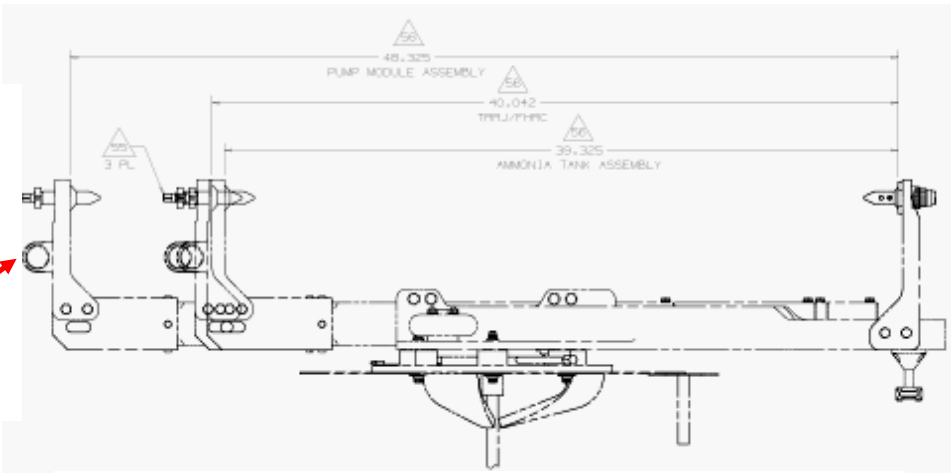
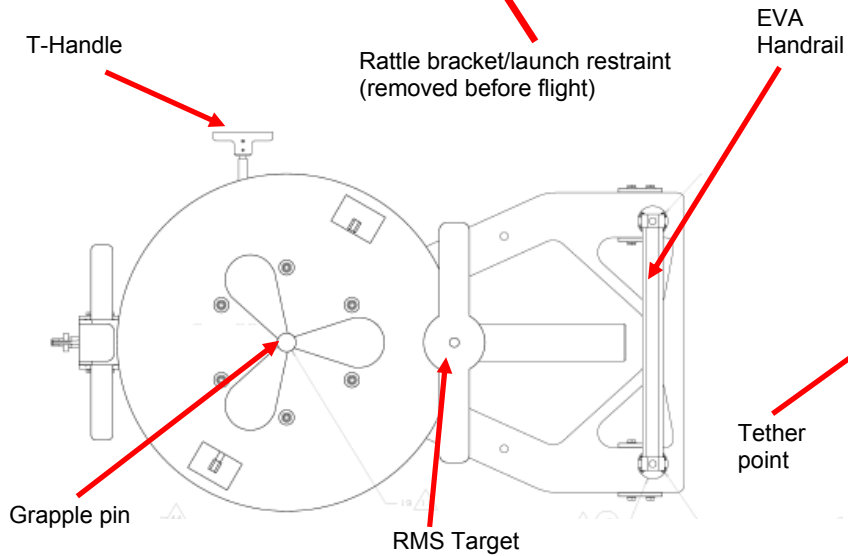

AGB EXTENDED FOR DIFFERENT ORUs

FHRC



VELCRO FLAPS FOR AGB ATTACH – CLOSED POSN

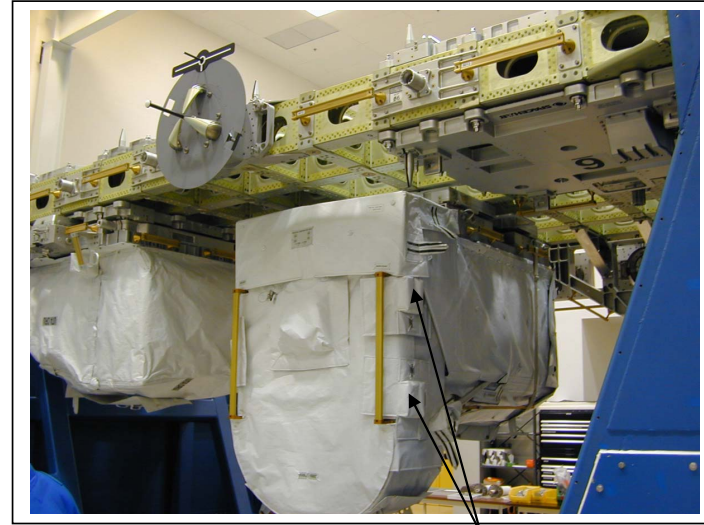

FHRC ON ESP2 (DOUBLE PIN SIDE)



AGB INSTALL ON FHRC – DOUBLE PIN SIDE
(MLI FLAPS ARE VELCROED OPEN)



AGB INSTALL ON FHRC – FRONT VIEW

P1 PUMP MODULE WORKSITE OVERVIEW

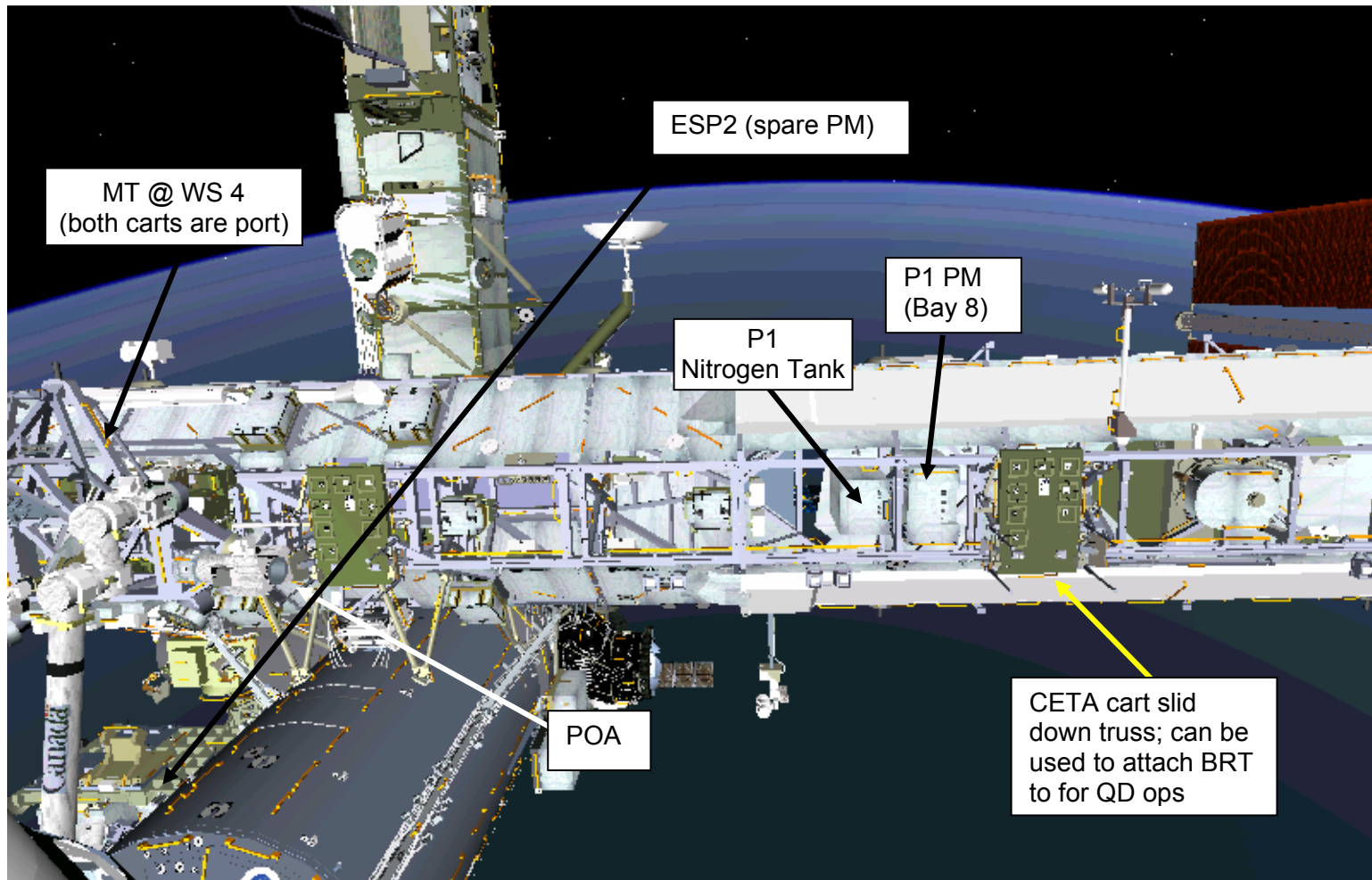

FS 18-103

EVA/116/FIN

CONTINGENCIES

CONTINGENCIES

P1 PM INSTALLED IN TRUSS

ZENITH

STBD

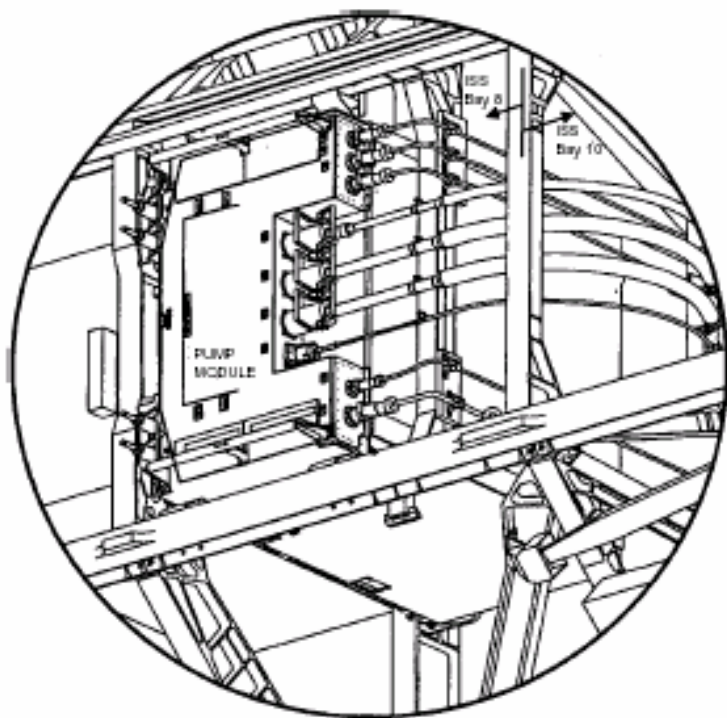

VIEW LOOKING AFT/STBD

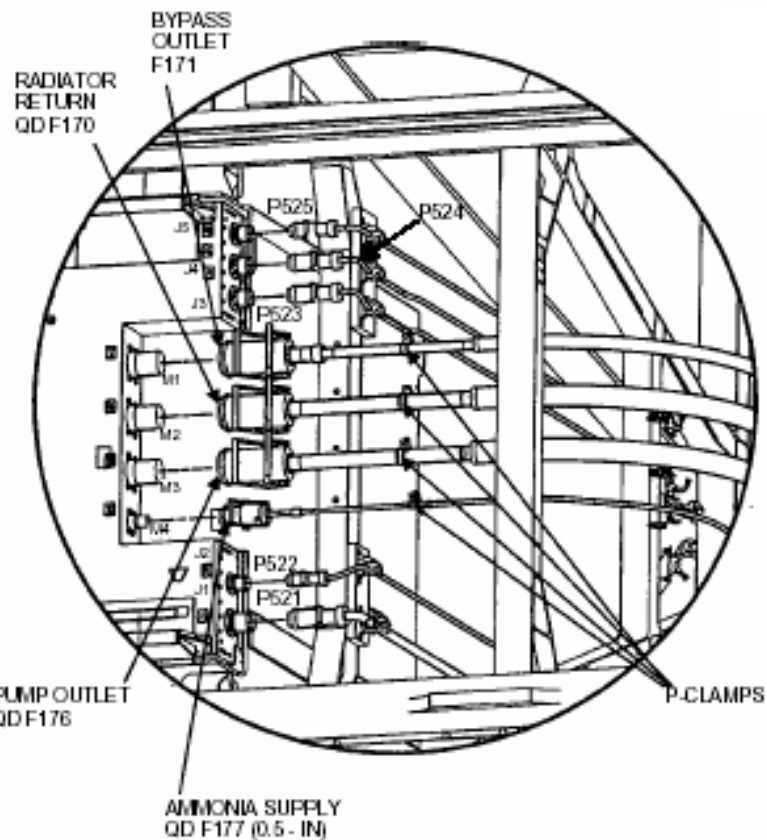

PORT

NADIR

S1 PUMP MODULE WORKSITE OVERVIEW

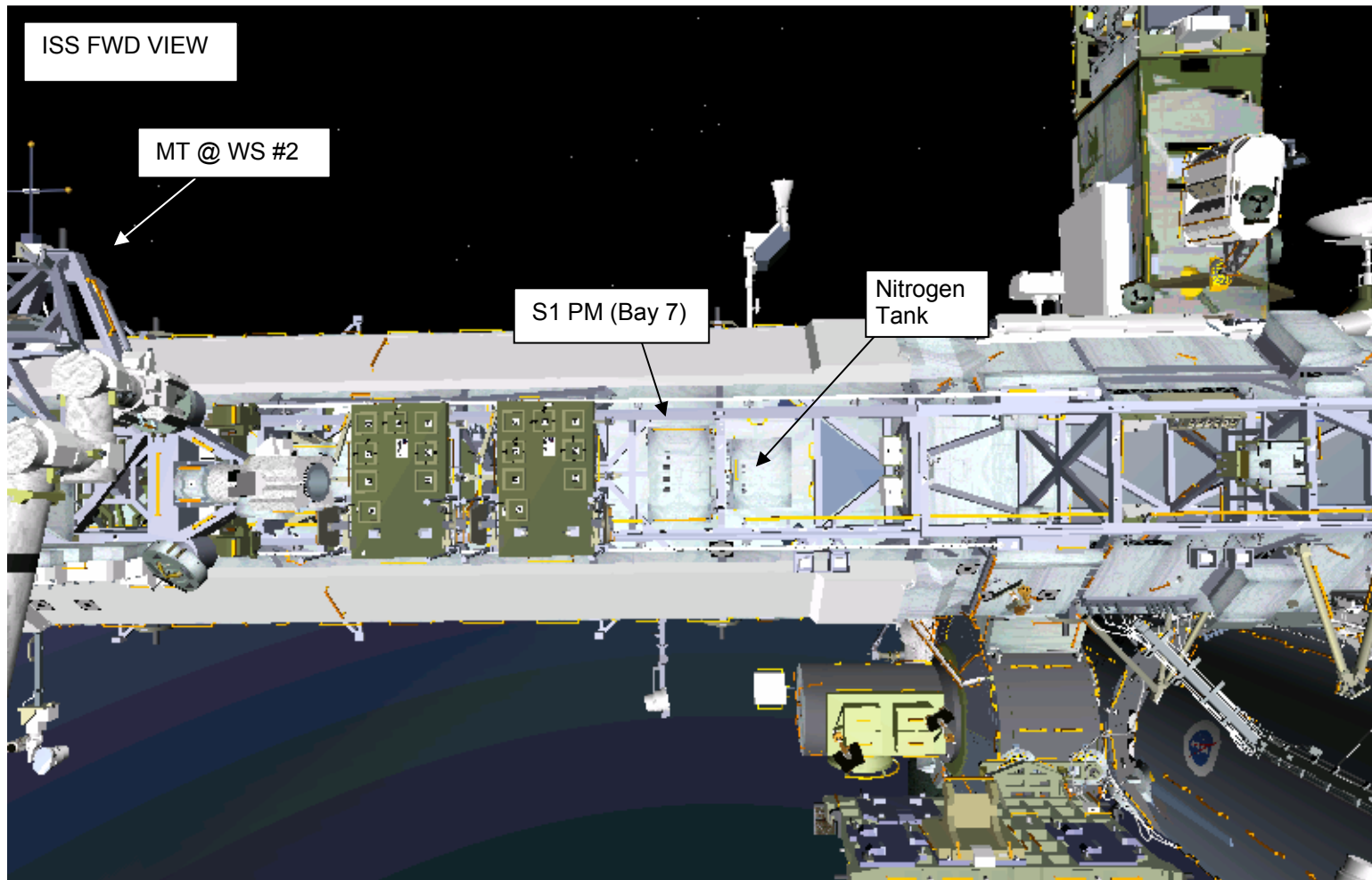

PUMP MODULE AND FSE OVERVIEW

PUMP MODULE ON LAPA
(FRAM + LARGE ADAPTER PLATE)

LAPA WITH FSE
(PM REMOVED)

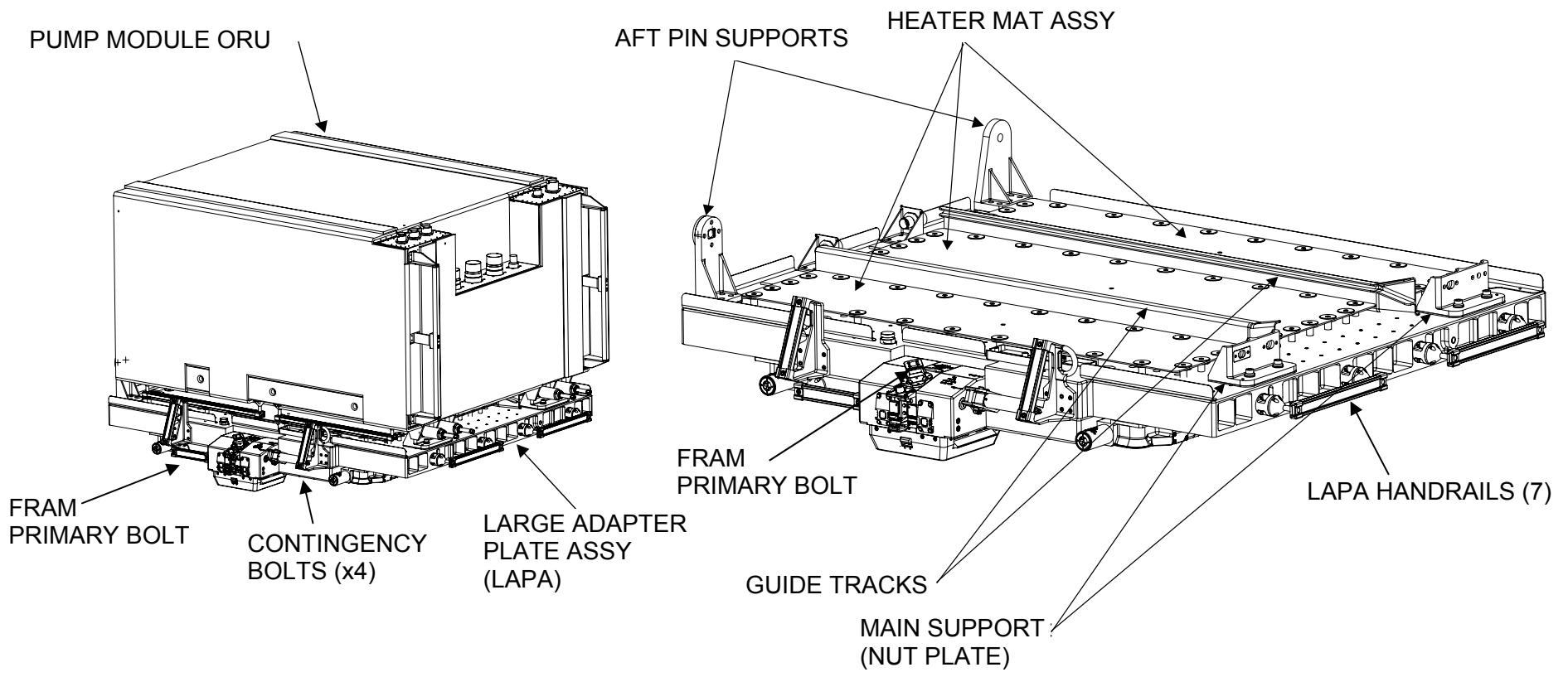

LAPA AND REAR CONTINGENCY PINS

LAPA SHOWING EXTENDED CONTINGENCY PINS

FRAM EXTENDED REAR CONTINGENCY PIN

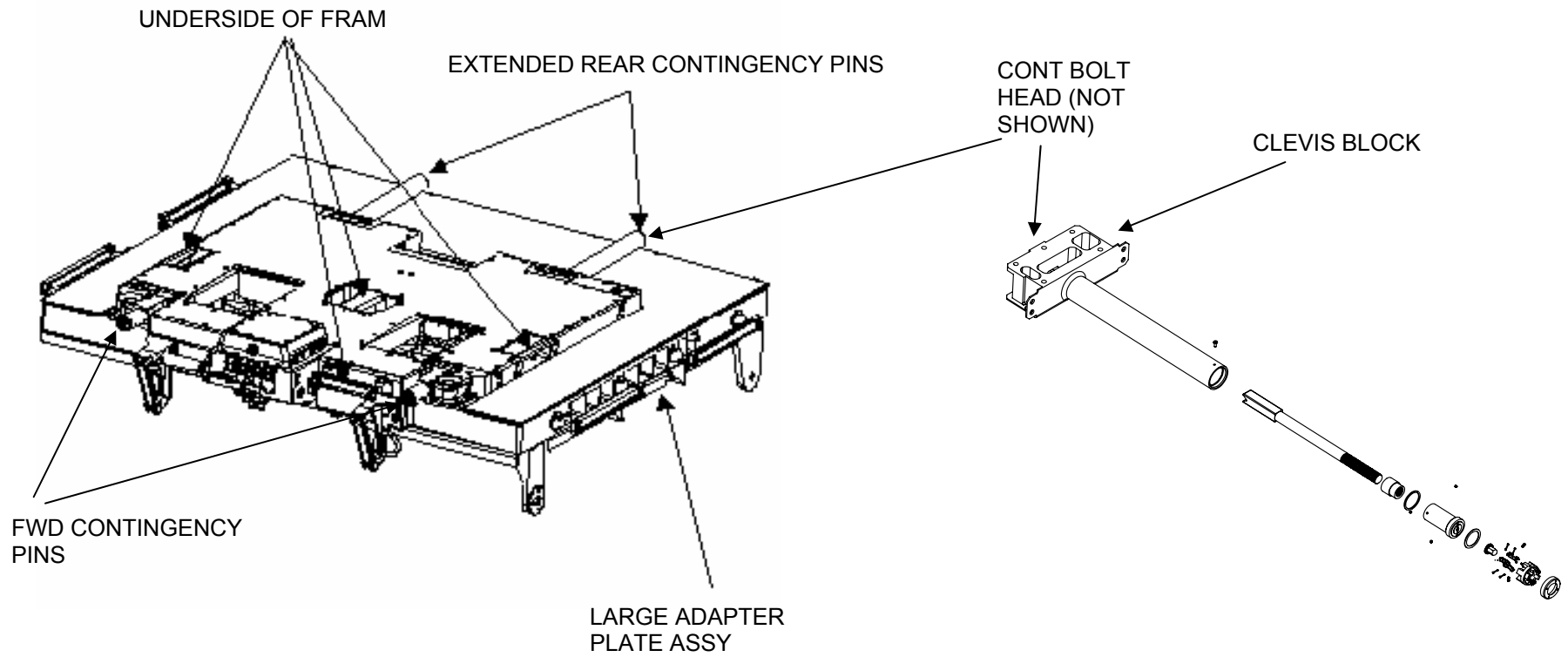

PUMP MODULE WITH FIXED GRAPPLE BAR AND MLI

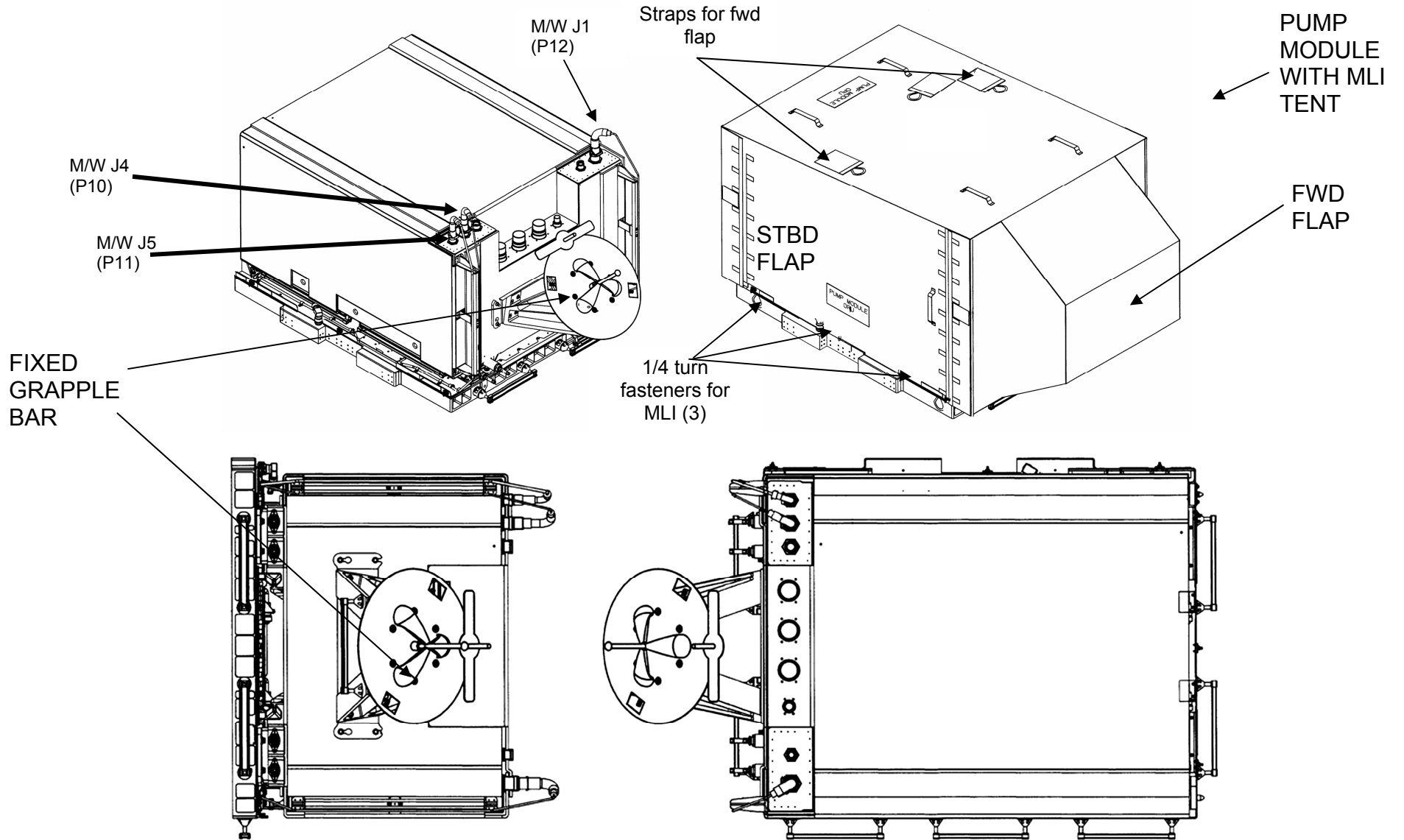

FLUID QD BAIL LEVERS

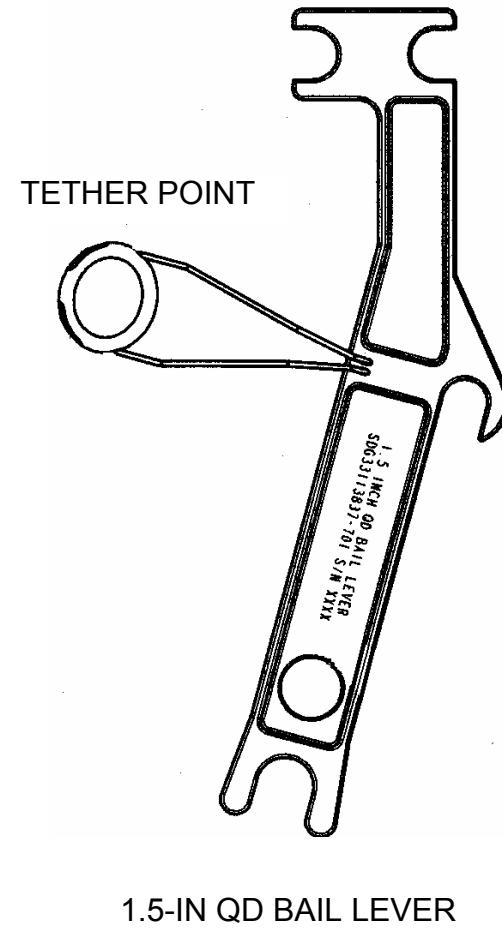
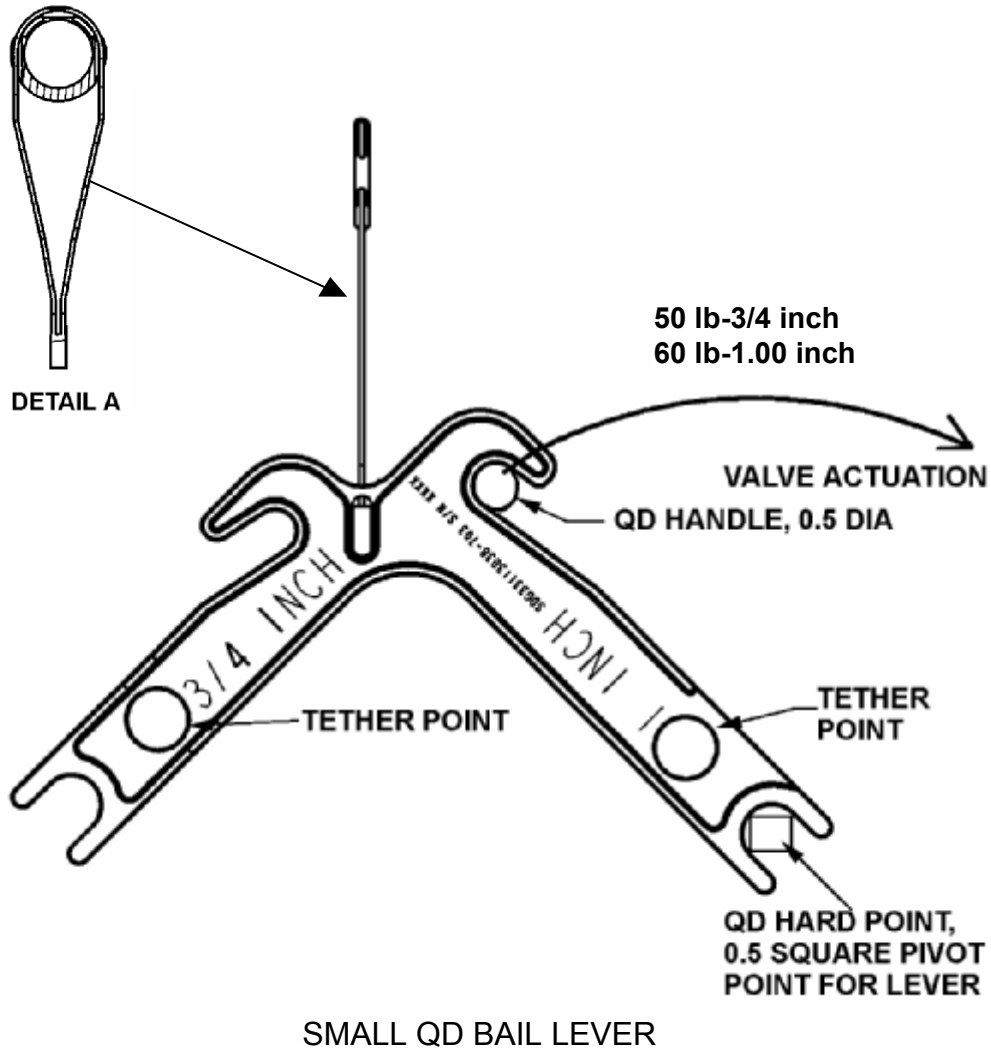

QD CAP TOOLS

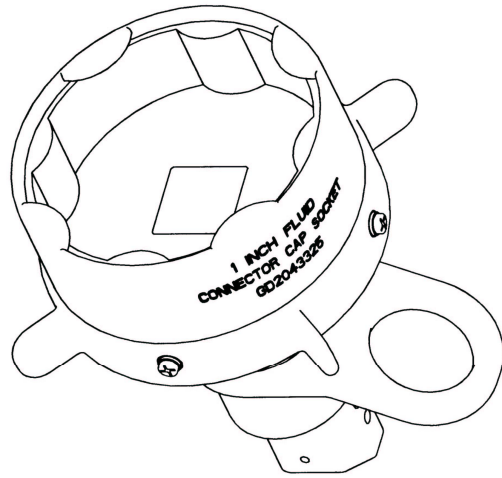

1 INCH CAP TOOL

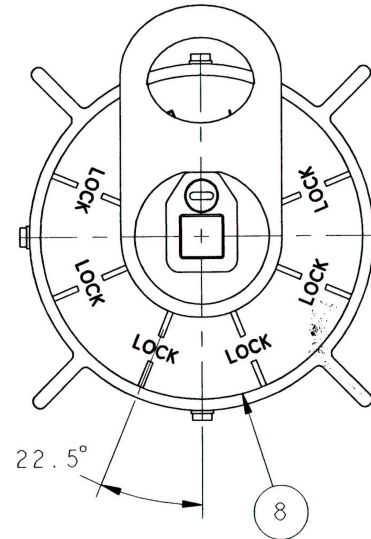

ORIENT AS SHOWN

CAP TOOL - PGT INTERFACE

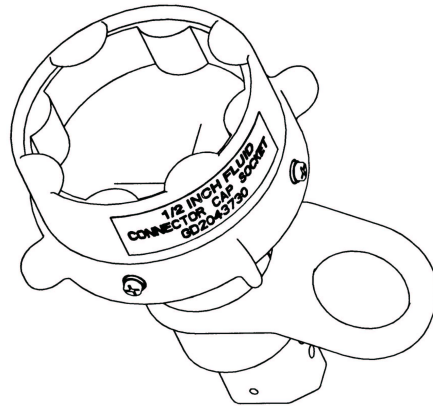

1/2 INCH CAP TOOL

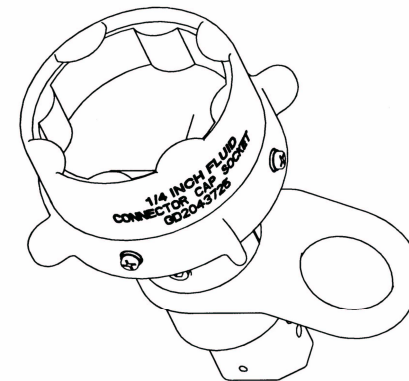

1/4 INCH CAP TOOL

1.5-IN FLUID QD SPOOL POSITIONING DEVICE

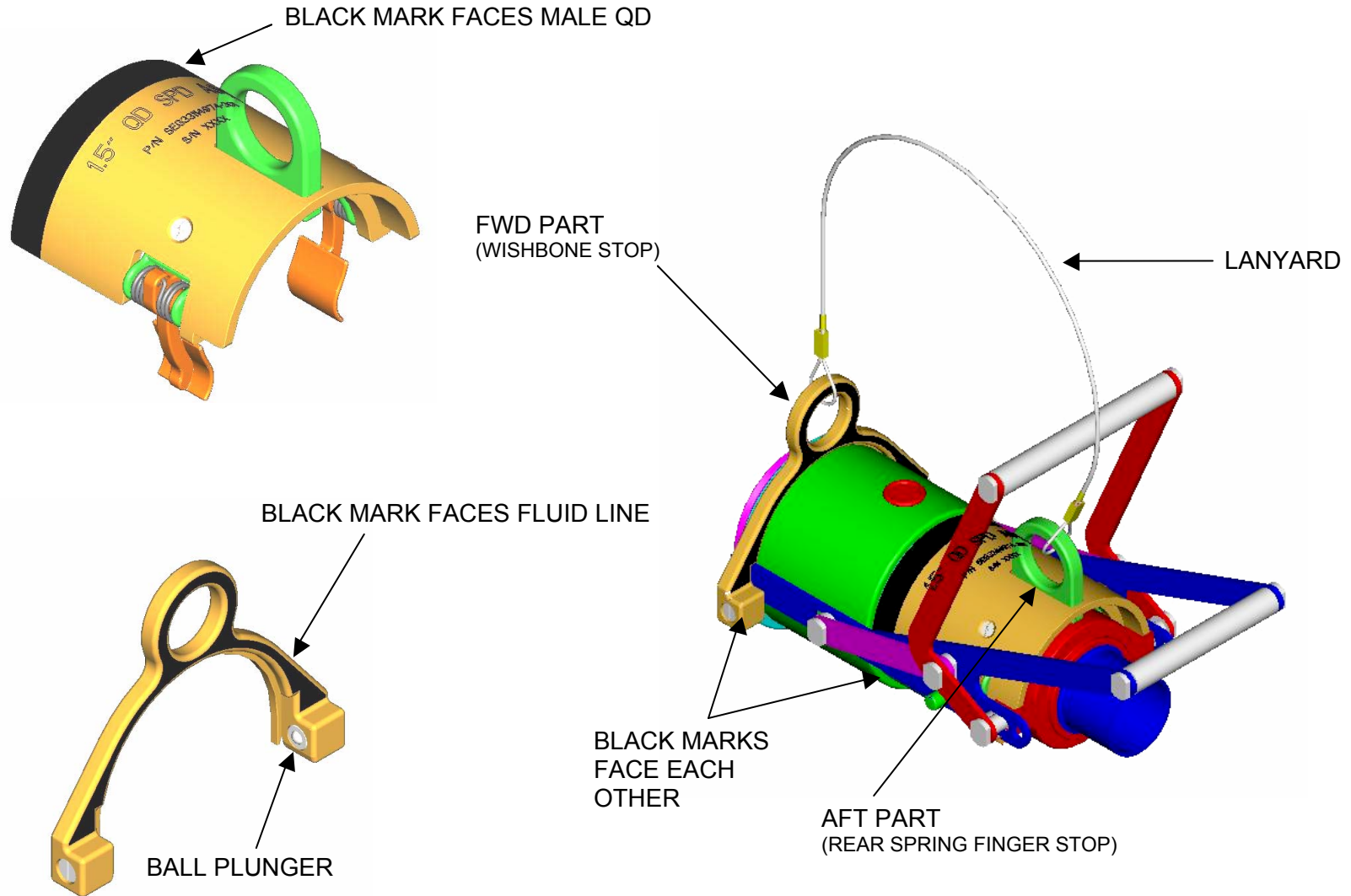

FLUID QD RELEASE TOOLS

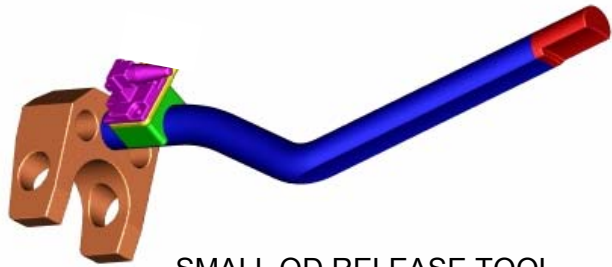

SMALL QD RELEASE TOOL
w/FID GAUGE



1.5-in QD RELEASE TOOL
w/FID GAUGE

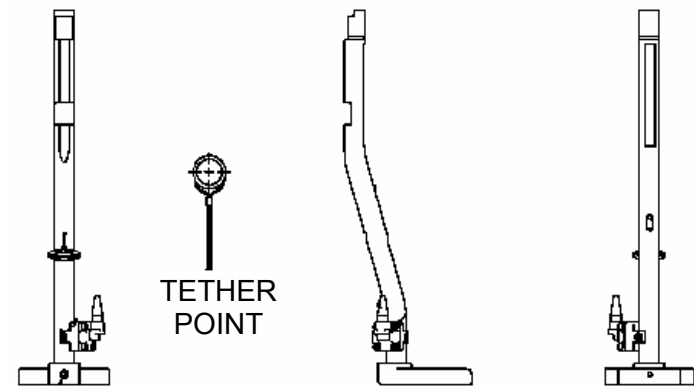
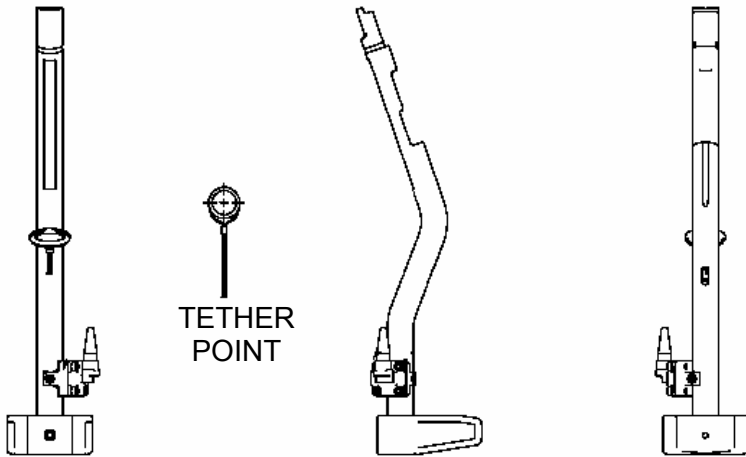

0.5-IN FLUID QD SPOOL POSITIONING DEVICE

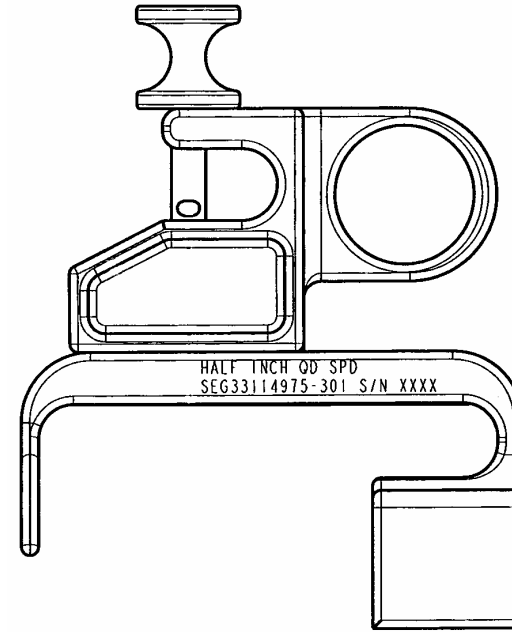
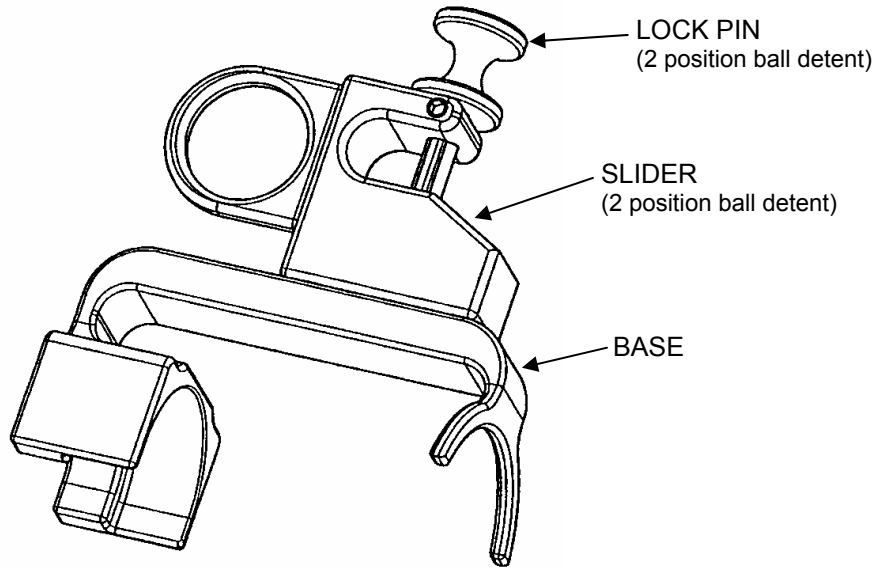

0.5-IN SPD BOOTIE EXTENSION

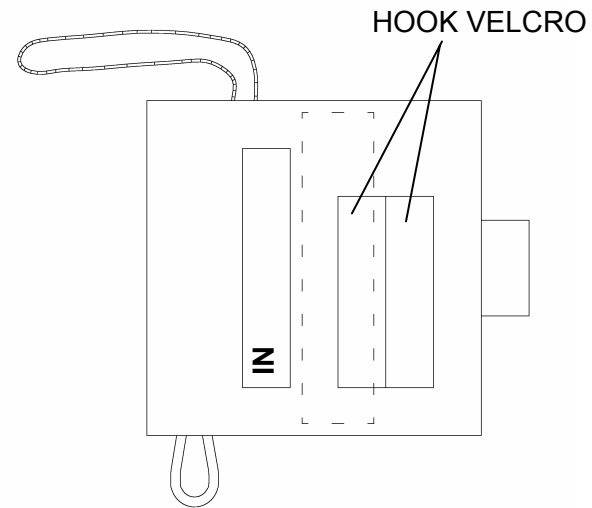
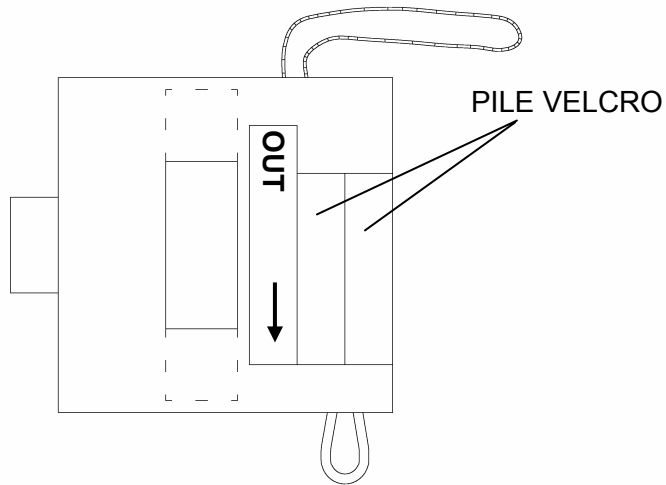

QD VENT TOOLS

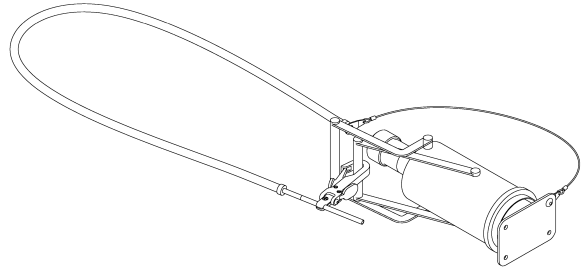

1.5" VENT TOOL

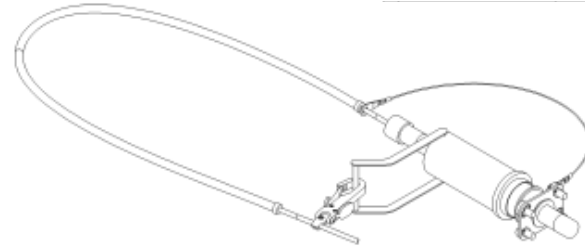

1.0" VENT TOOL

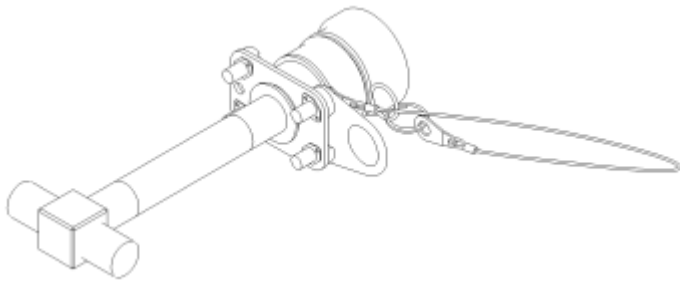

1.0" NH3/N2 VENT TOOL – M

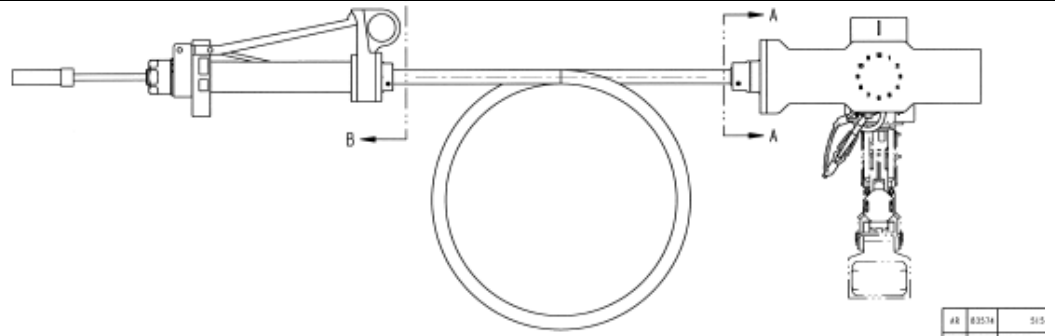

VENT TOOL EXTENDER

AR 83574 515

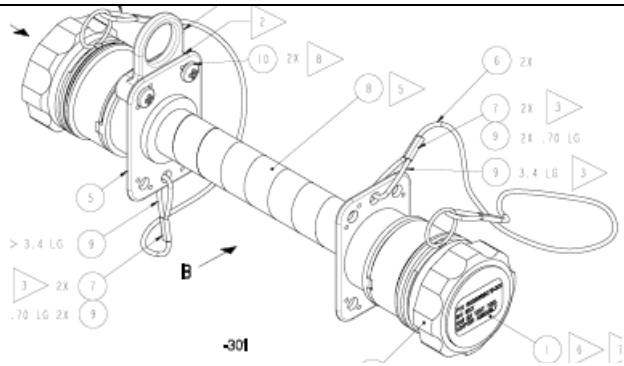

VENT TOOL ADAPTER

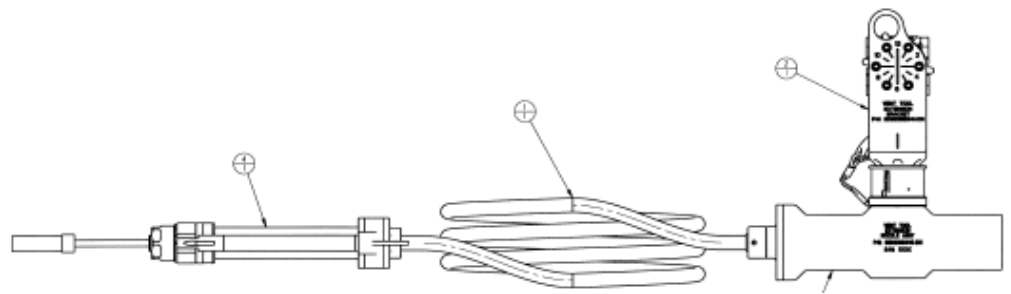

VENT TOOL EXTENDER

VENT TOOL EXTENDER BAG

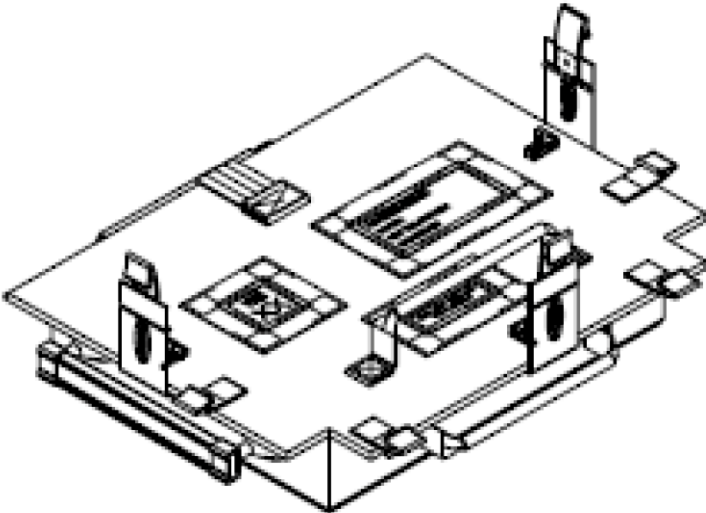
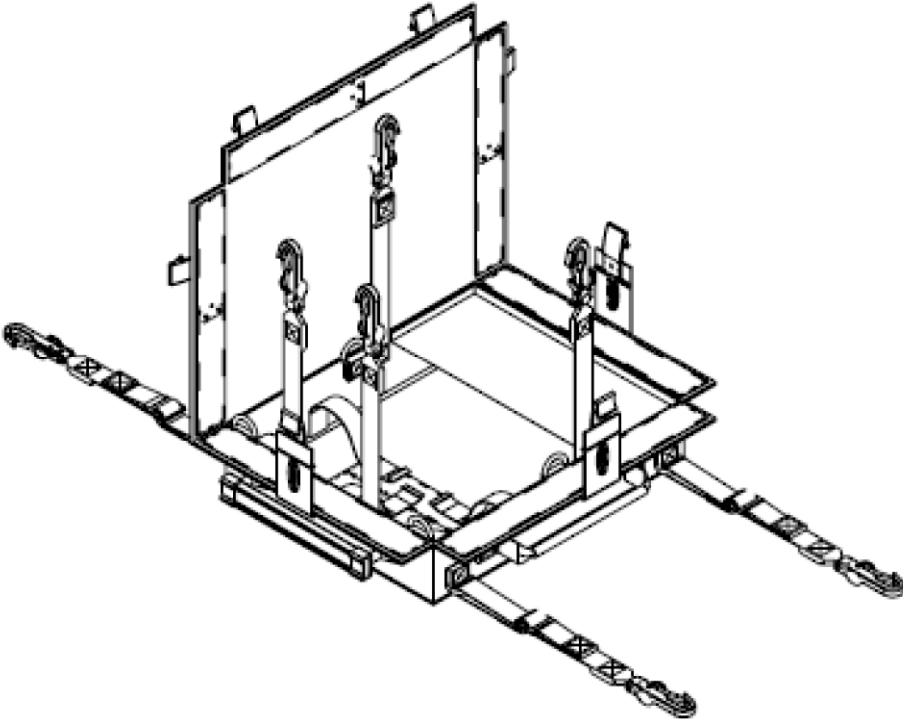

VTE AND VTE BAG DETAILS

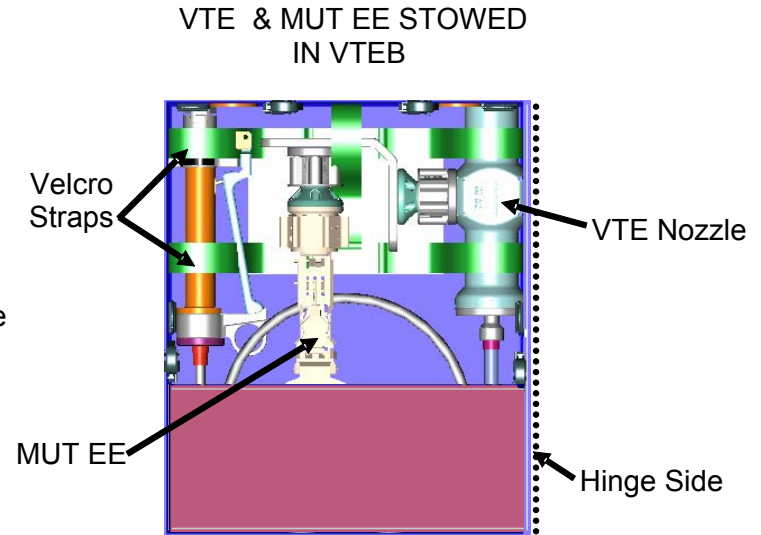
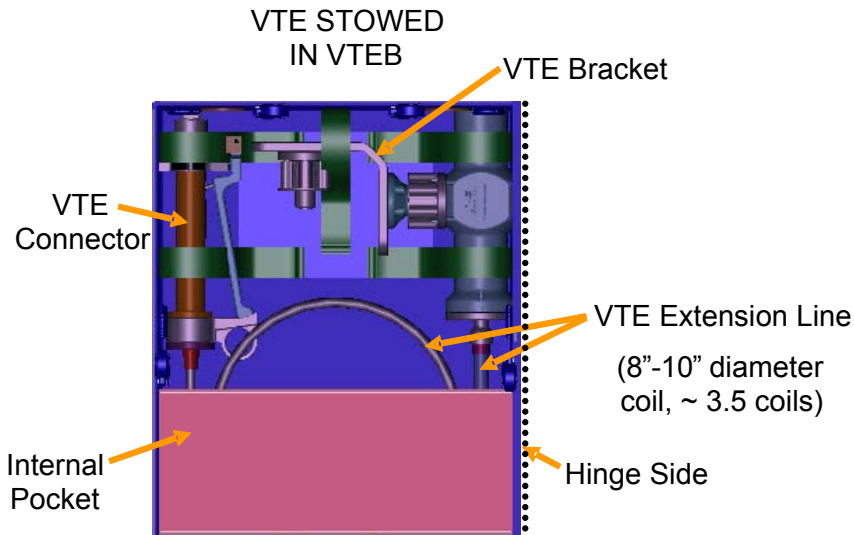
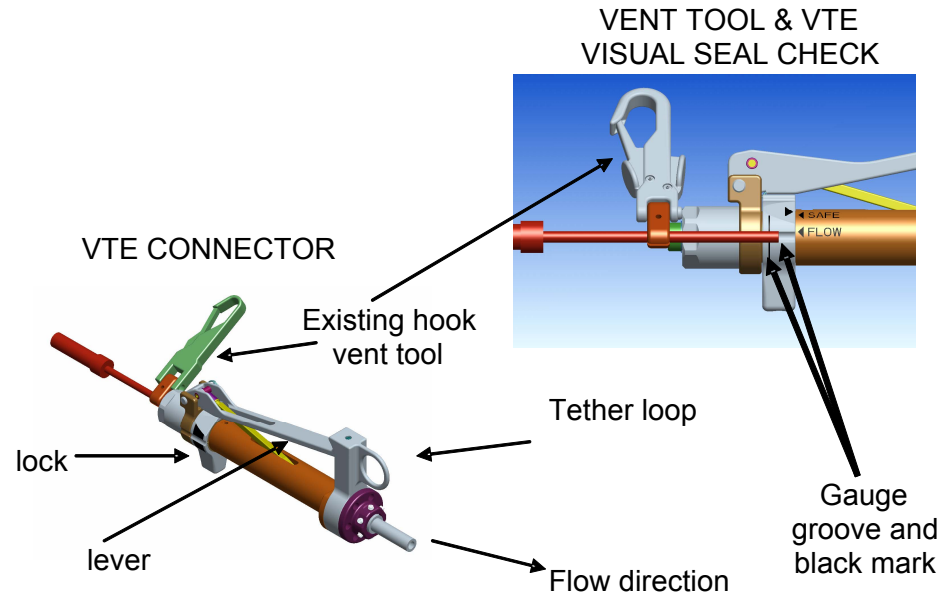
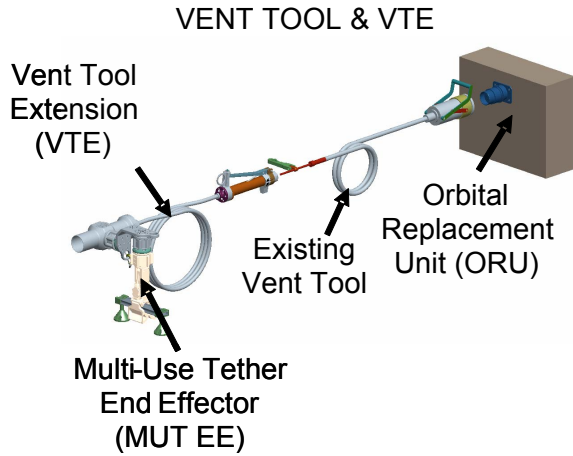

PUMP MODULE NH3 JUMPER

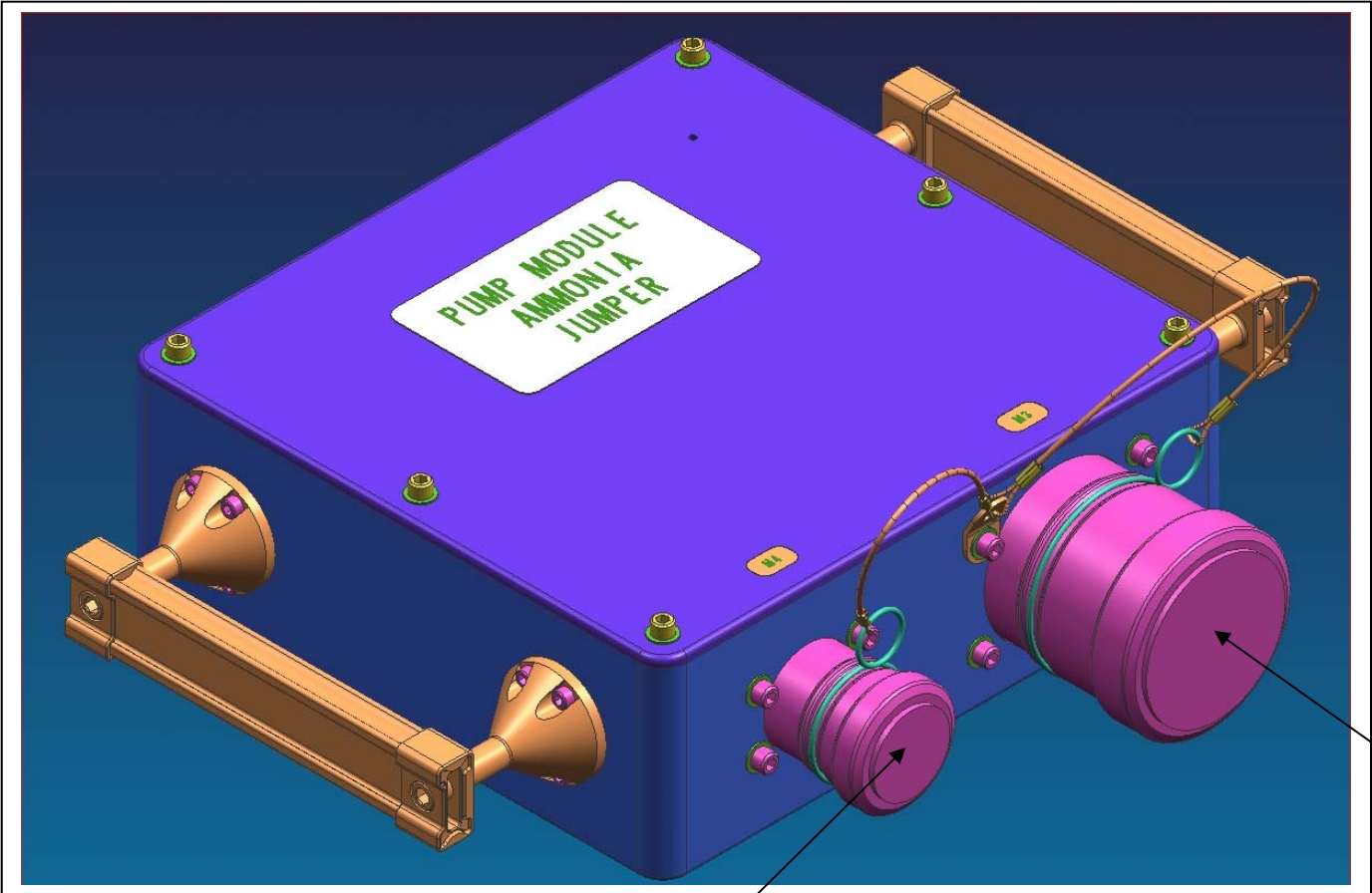

M4

M3

STATUS INDICATORS (MBSU, DDCU, BCDU)

H2 Status Indicator

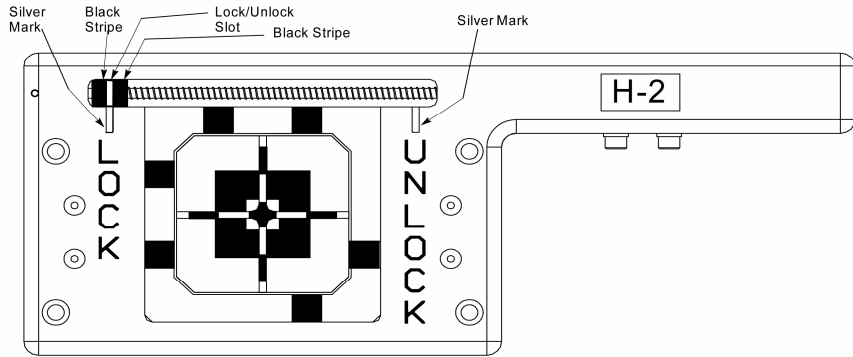

H1 Status Indicator

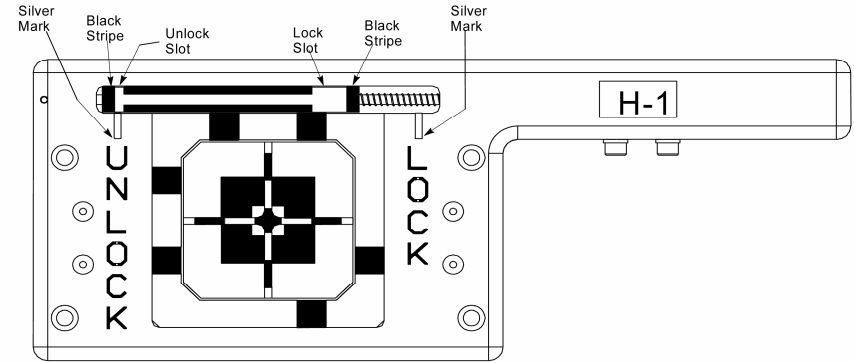

Positional Criteria

(Adhered to in accordance with torque and turns specified in LSAR procedure.)

Locked, Nominal: The lock/unlock slot should be centered in relation to the silver mark.

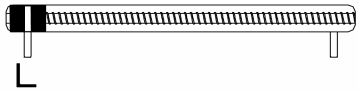

Unlocked, Nominal: The lock/unlock slot should be centered in relation to the silver mark.



Locked, Tolerance: The lock/unlock slot can be left or right of nominal by a distance no greater than the width of the black stripe.

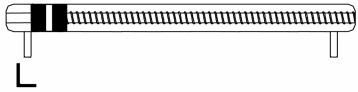

Unlocked, Tolerance: The lock/unlock slot can be left or right of nominal by a distance no greater than the width of the black stripe.

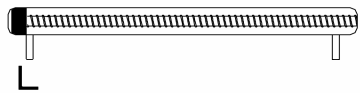
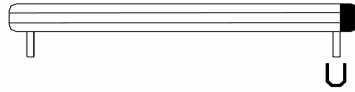

LOG-1010-01

Positional Criteria

(Adhered to in accordance with torque and turns specified in LSAR procedure.)

Unlocked, Nominal: The unlock slot should be centered in relation to the silver mark.



Locked, Nominal: The right edge of the lock slot should be flush with the right edge of the silver mark.



Unlocked, Tolerance: The unlock slot can be left or right of nominal by a distance no greater than the width of the black stripe.



Locked, Tolerance: The lock slot can be left of nominal by a distance no greater than the width of the black stripe.



LOG-1009-01

FAILED MBSU LOCATIONS

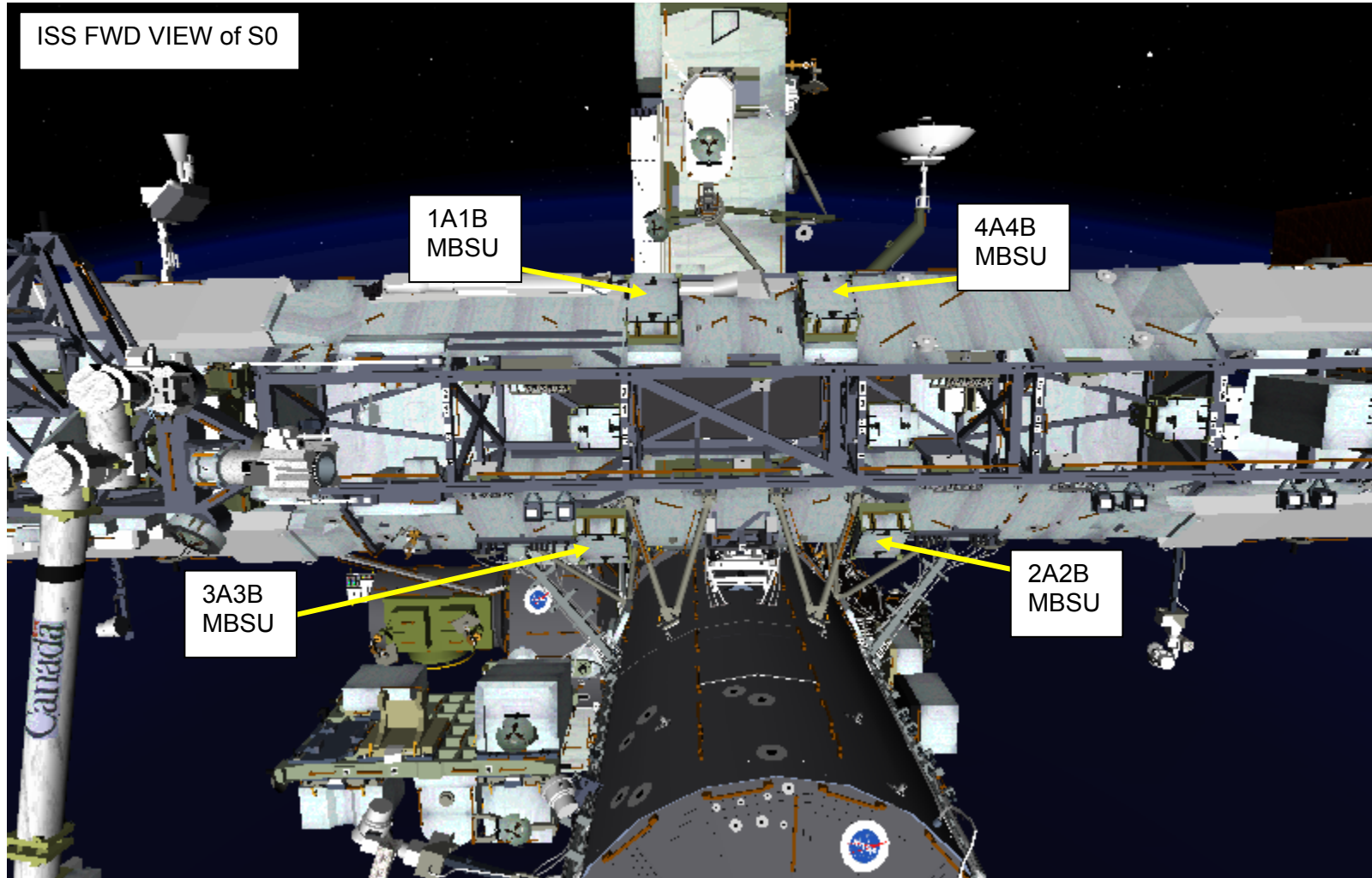

CETA CART LOCATION FOR MBSU R&R

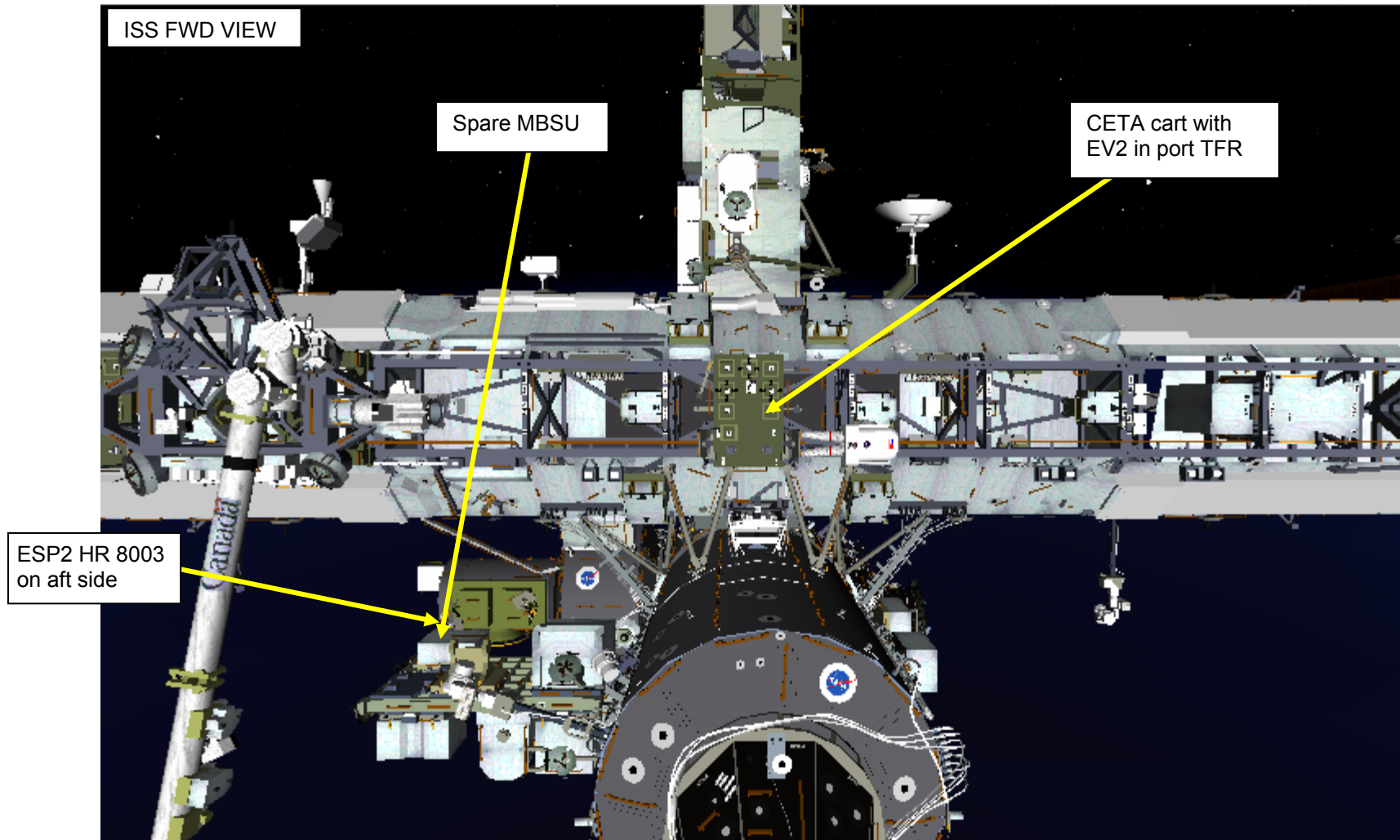

SPARE MBSU STOWED ON CETA GRID E WITH PORT TFR SWINGARM DEPLOYED

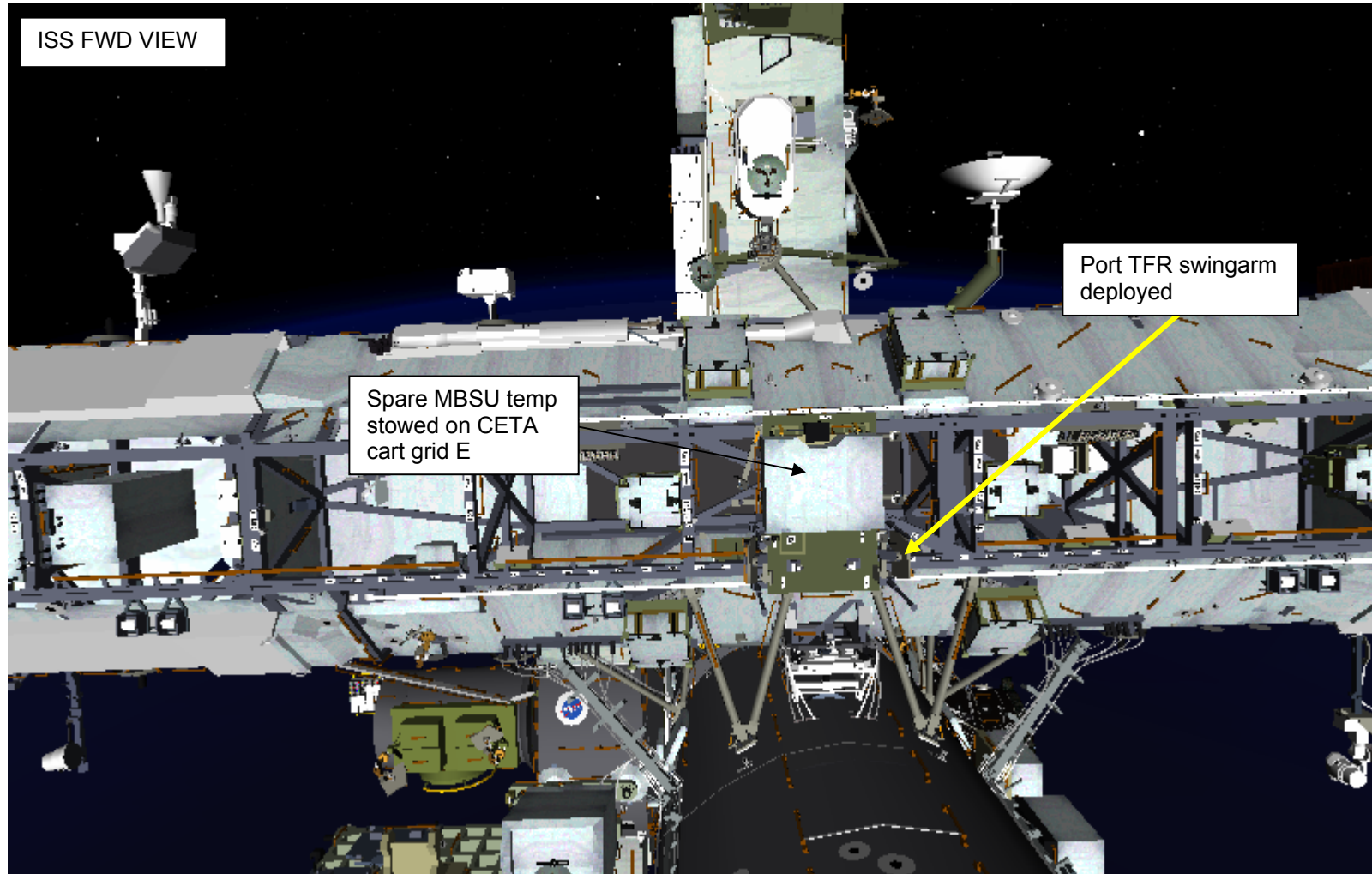

MBSU ORU

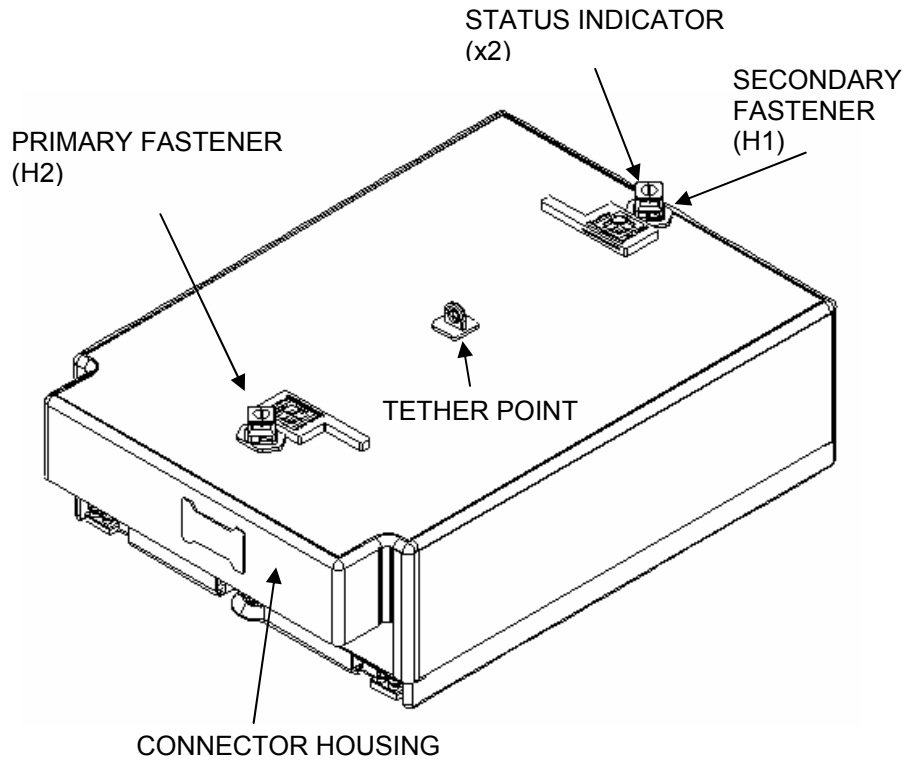

MBSU ORU

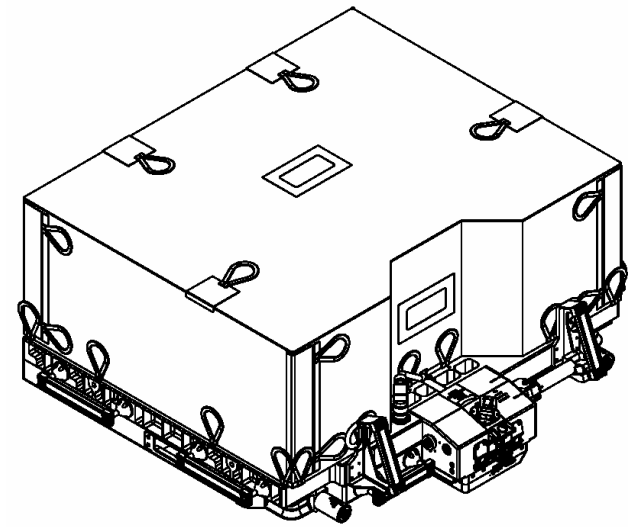

MBSU with Thermal Cover

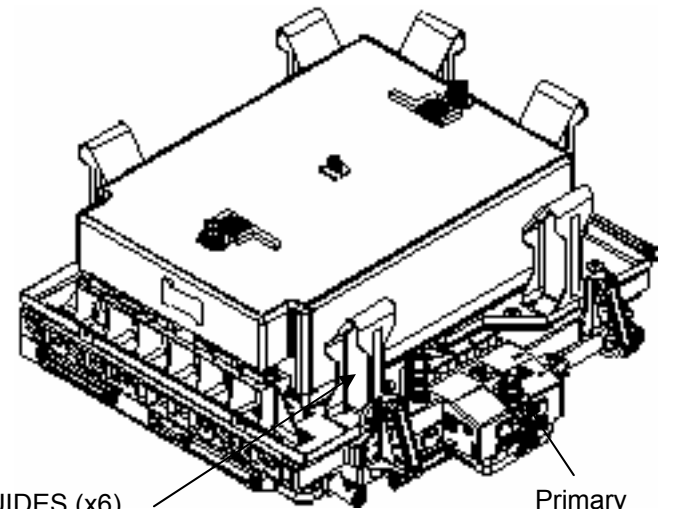

MBSU with FRAM

MBSU AND COLDPLATE

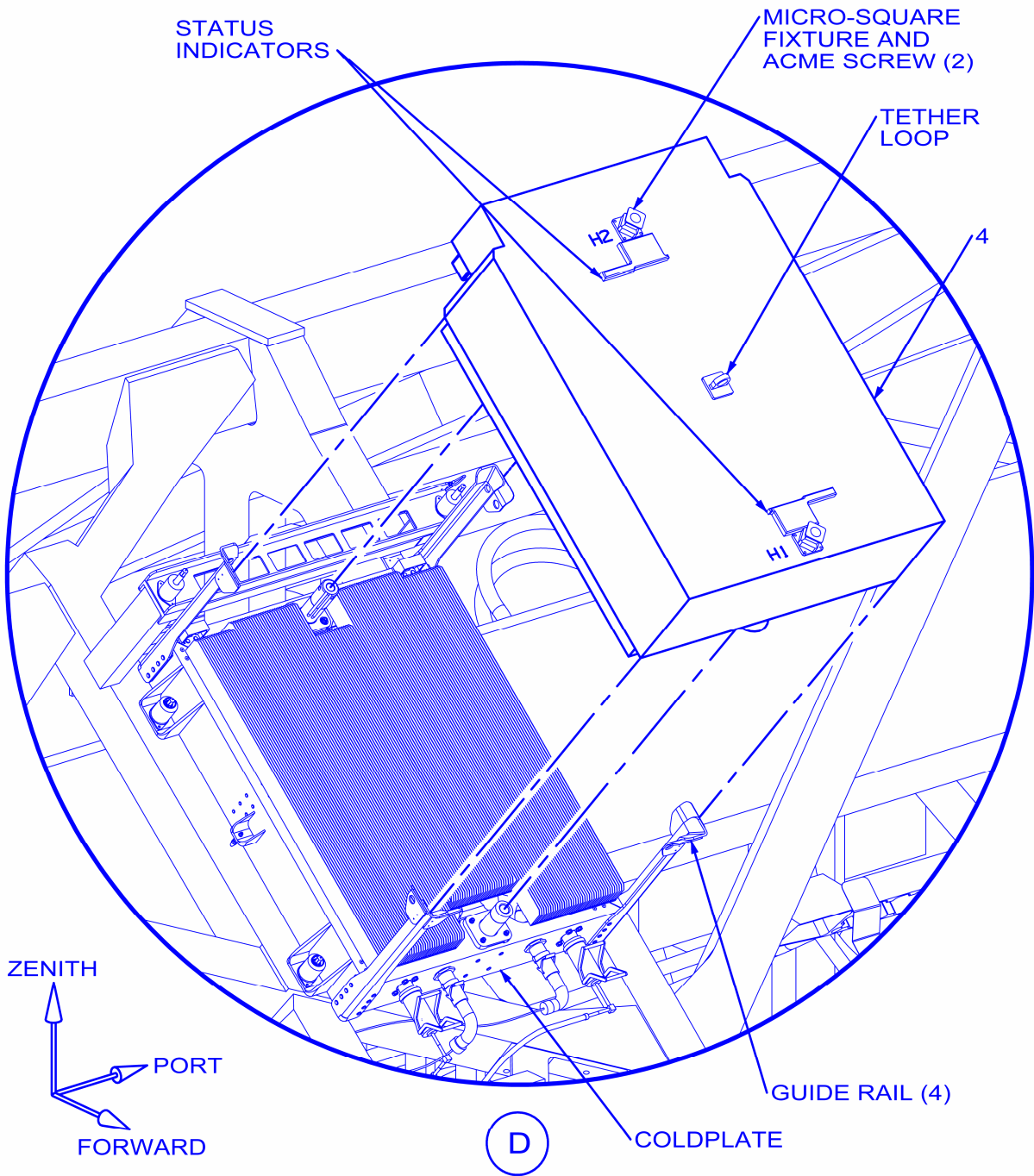

DDCU LOCATIONS

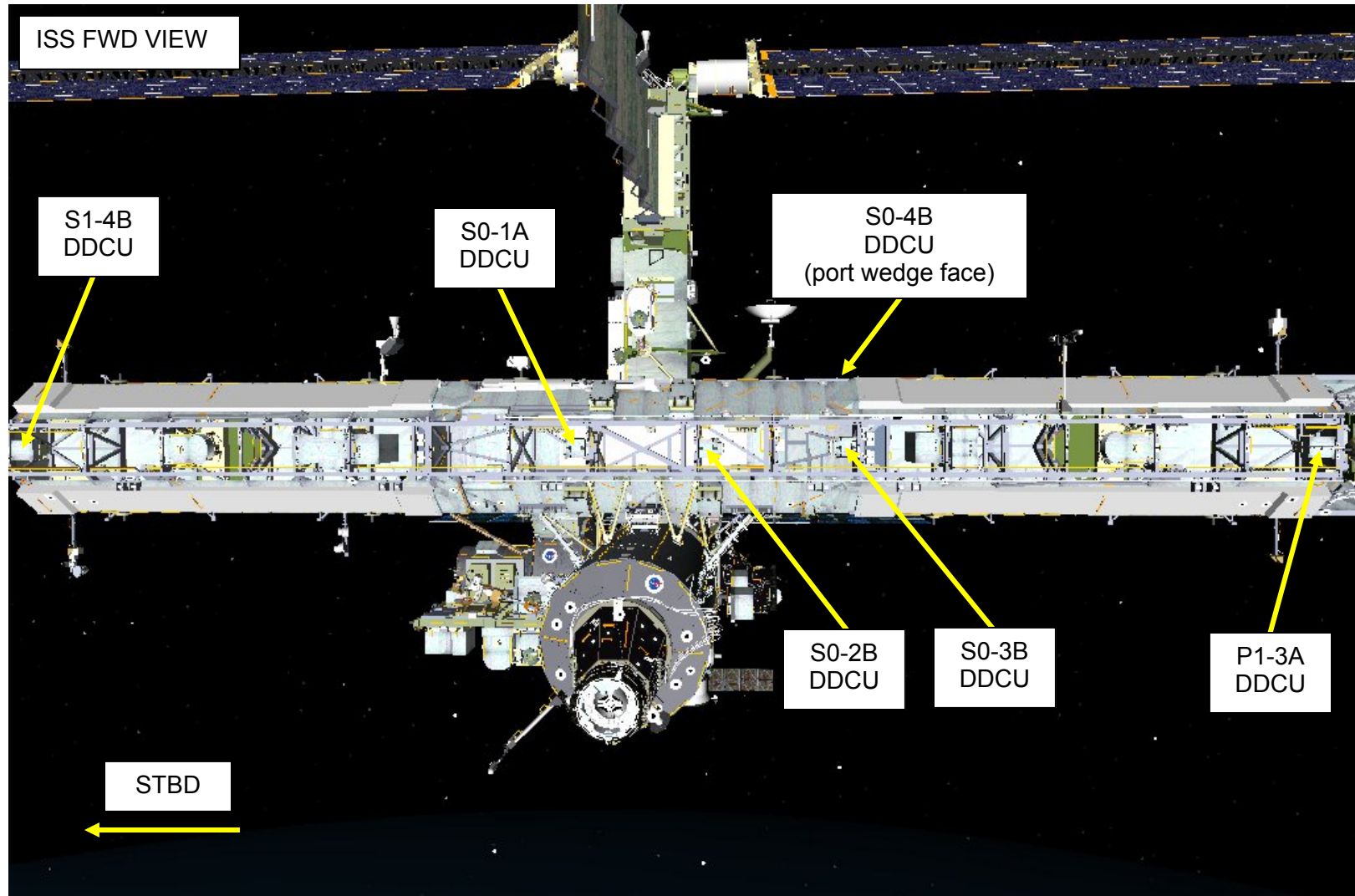

DC-TO-DC CONVERTER UNIT – EXTERNAL

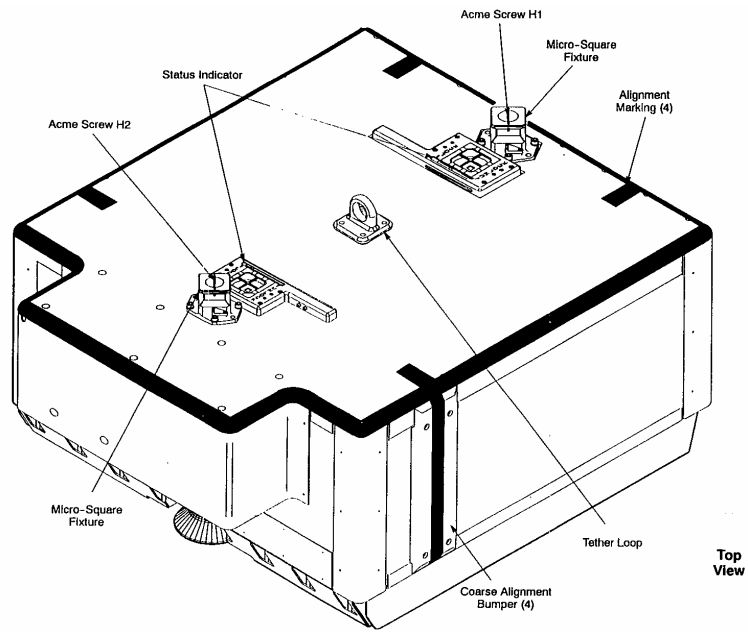

TOP VIEW

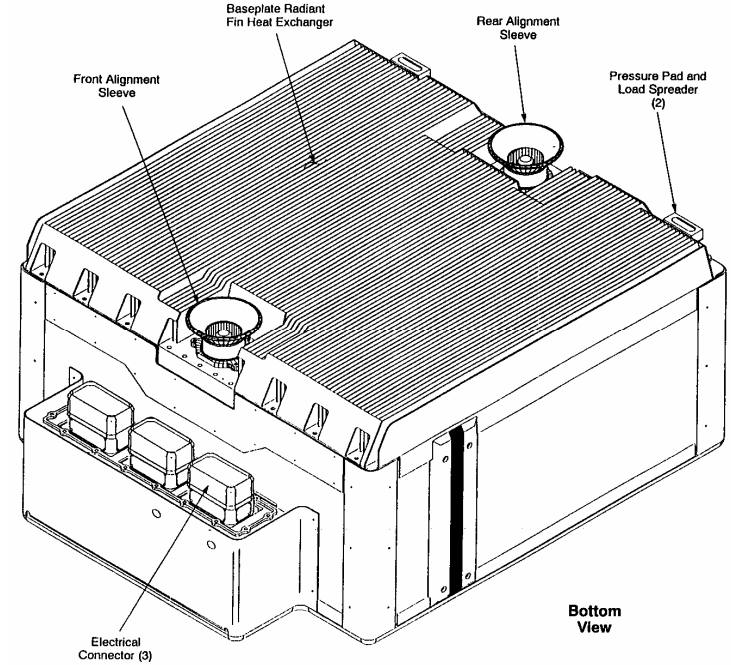

BOTTOM VIEW

SPARE DDCU S0-4B WORKSITE (S0 PORT WEDGE FACE) (EVA 3)

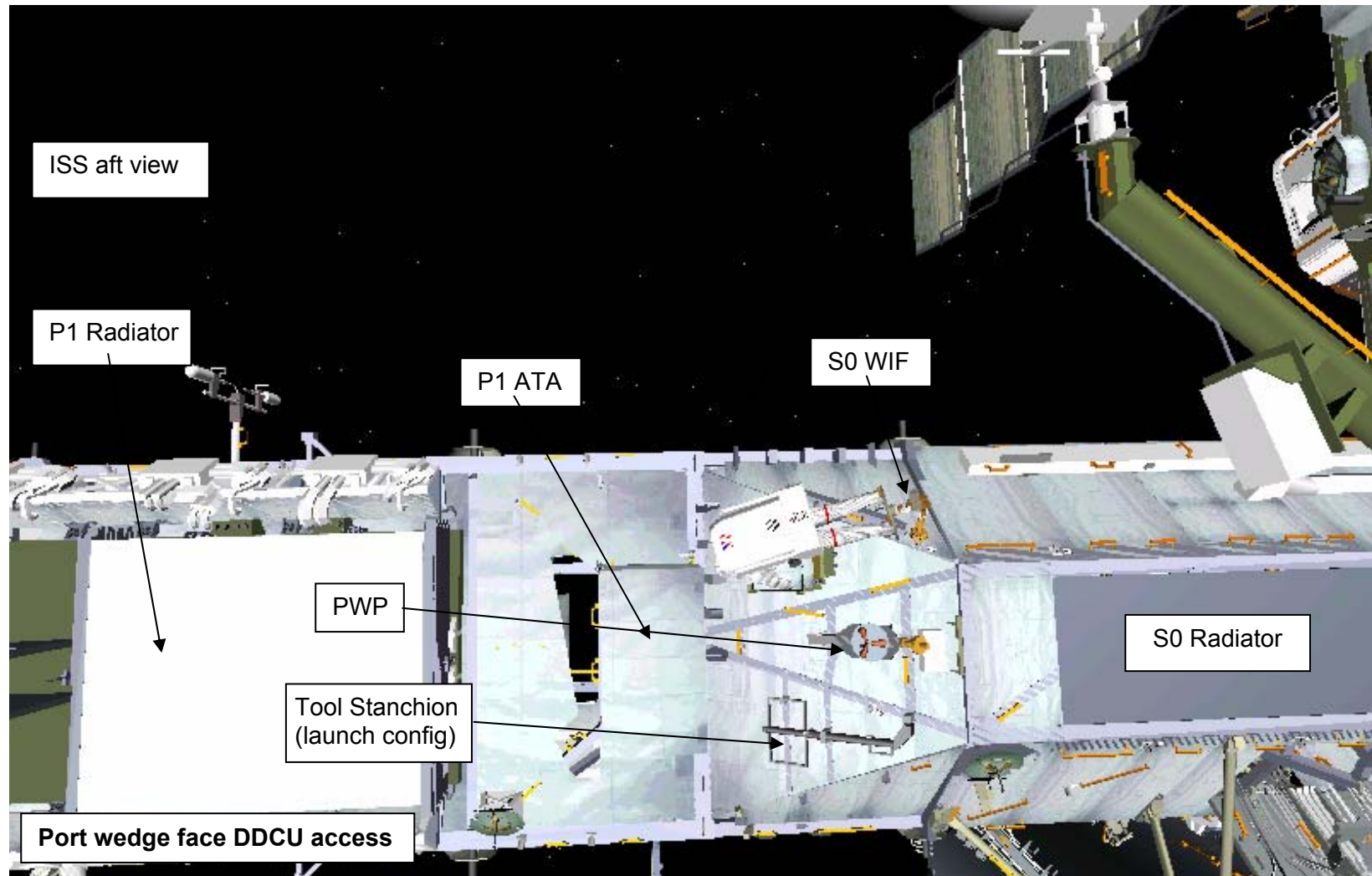

FAILED DDCU S1-4B WORKSITE (S1 BAY 15) (EVA 3)

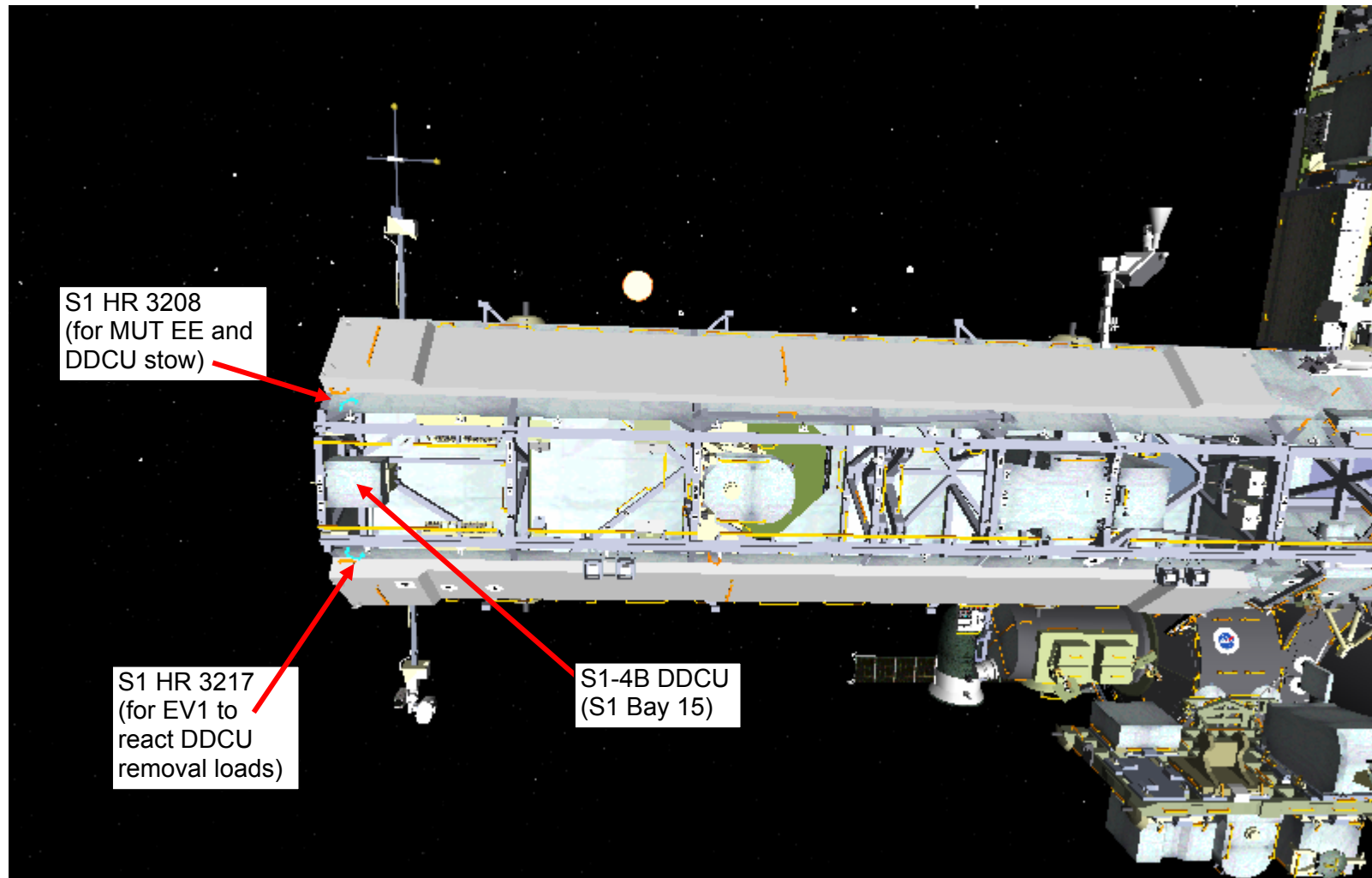

FAILED DDCU S0-1A WORKSITE (S0 BAY 01) (EVA 3)

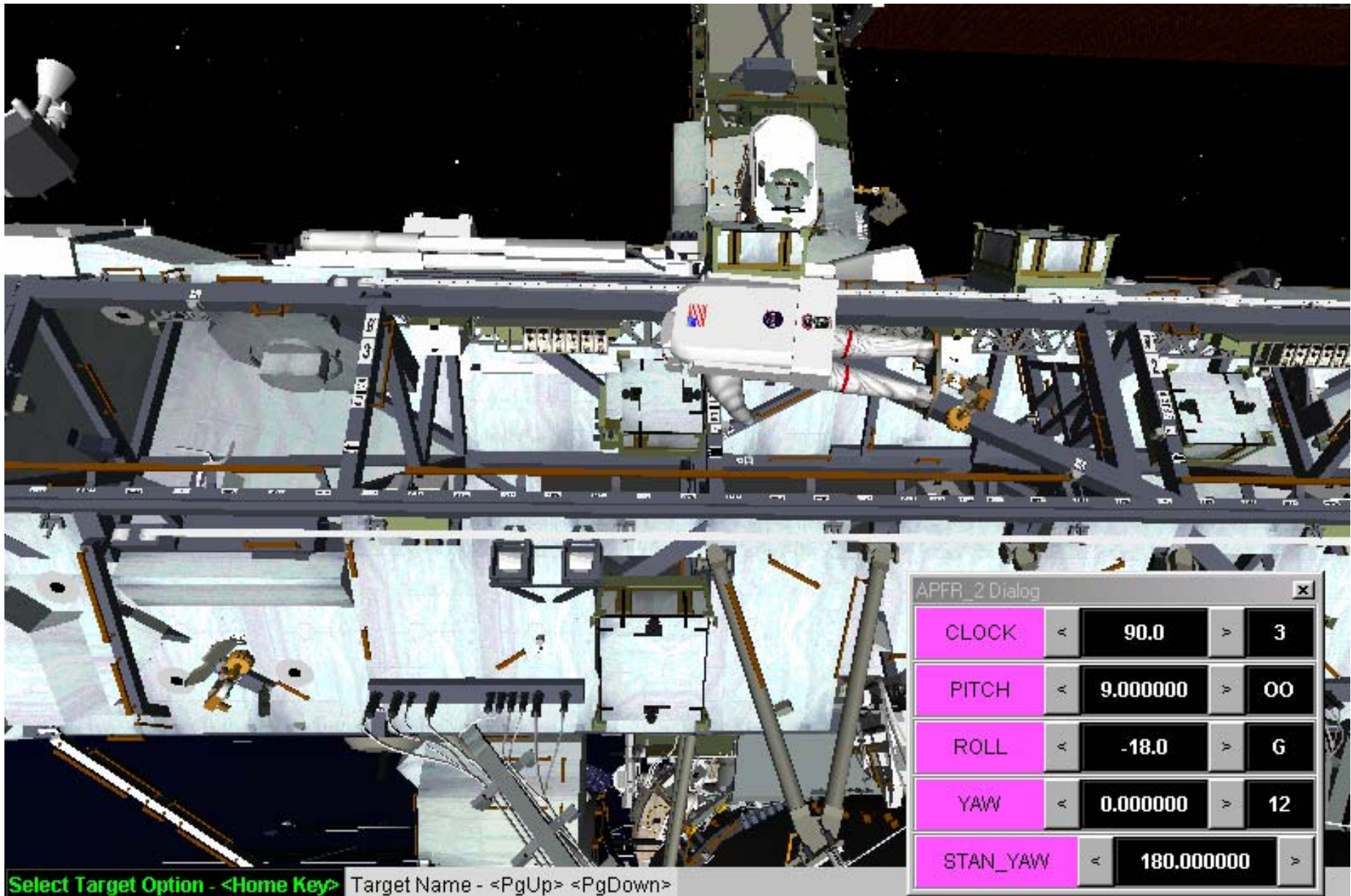

SPARE DDCU S0-3B WORKSITE (S0 BAY 04) (EVA 2)

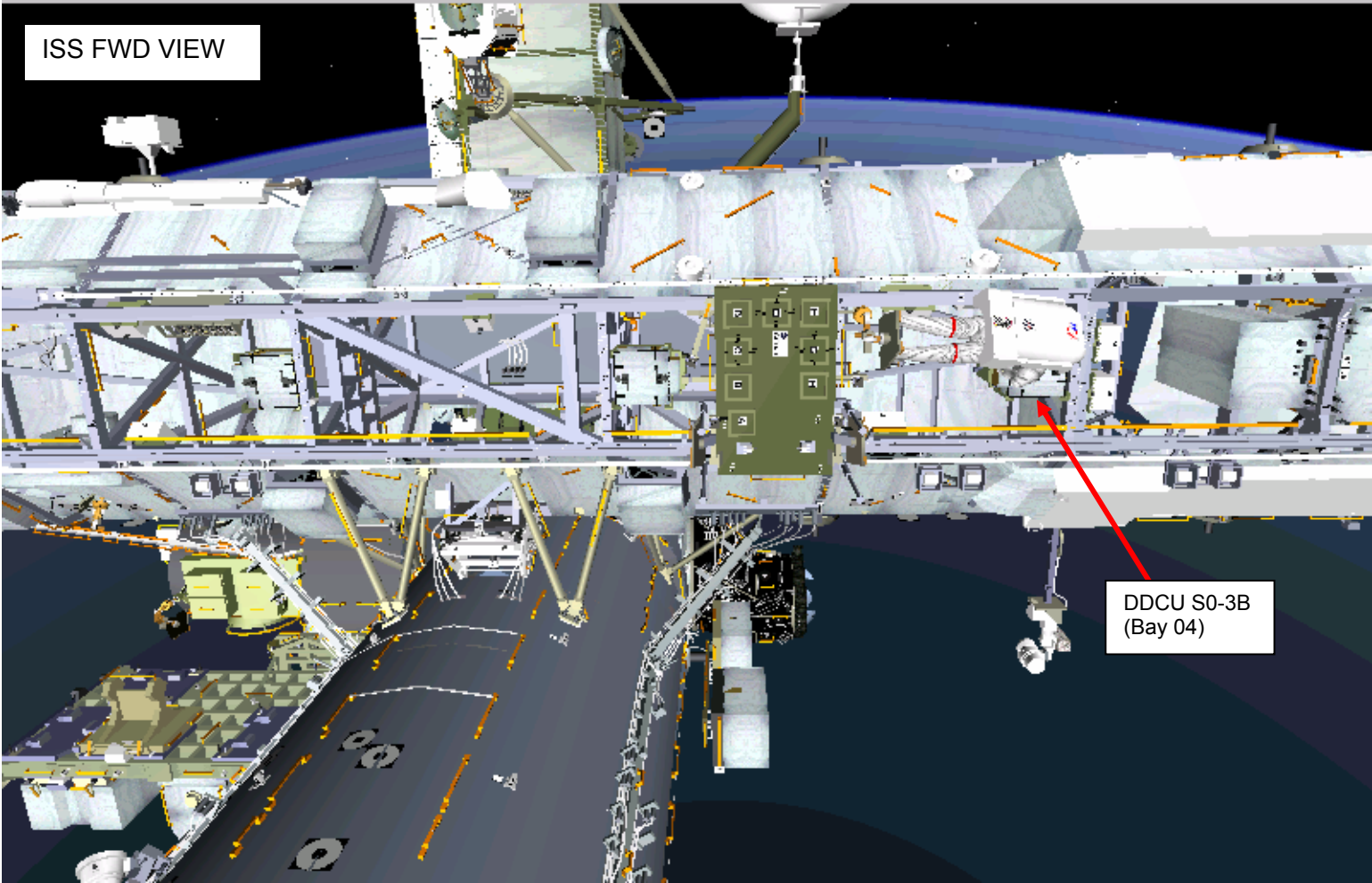

FAILED DDCU S0-2B WORKSITE (S0 BAY 02) (EVA 2)

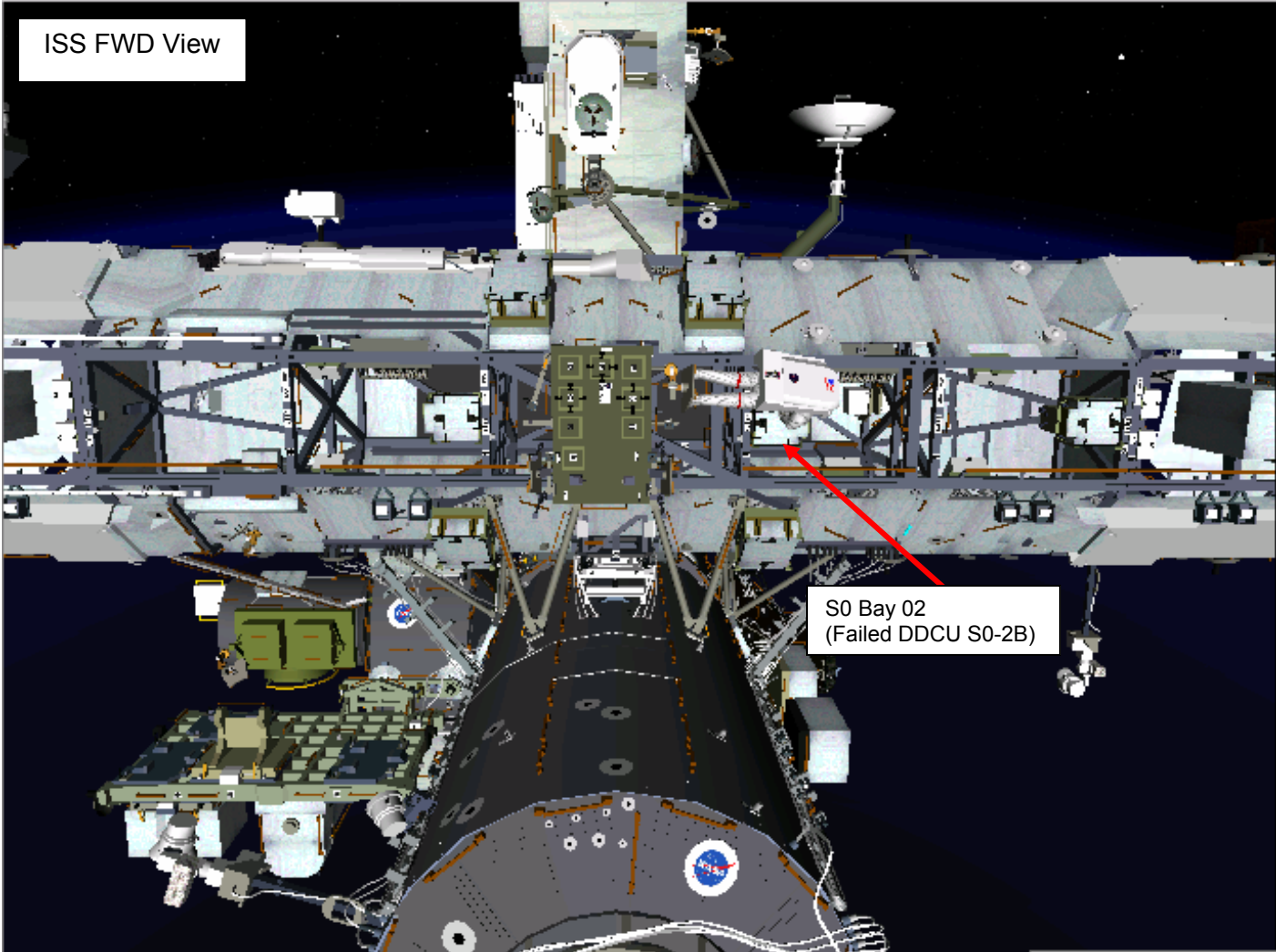

FAILED DDCU P1-3A WORKSITE (P1 BAY 16) (EVA 2)

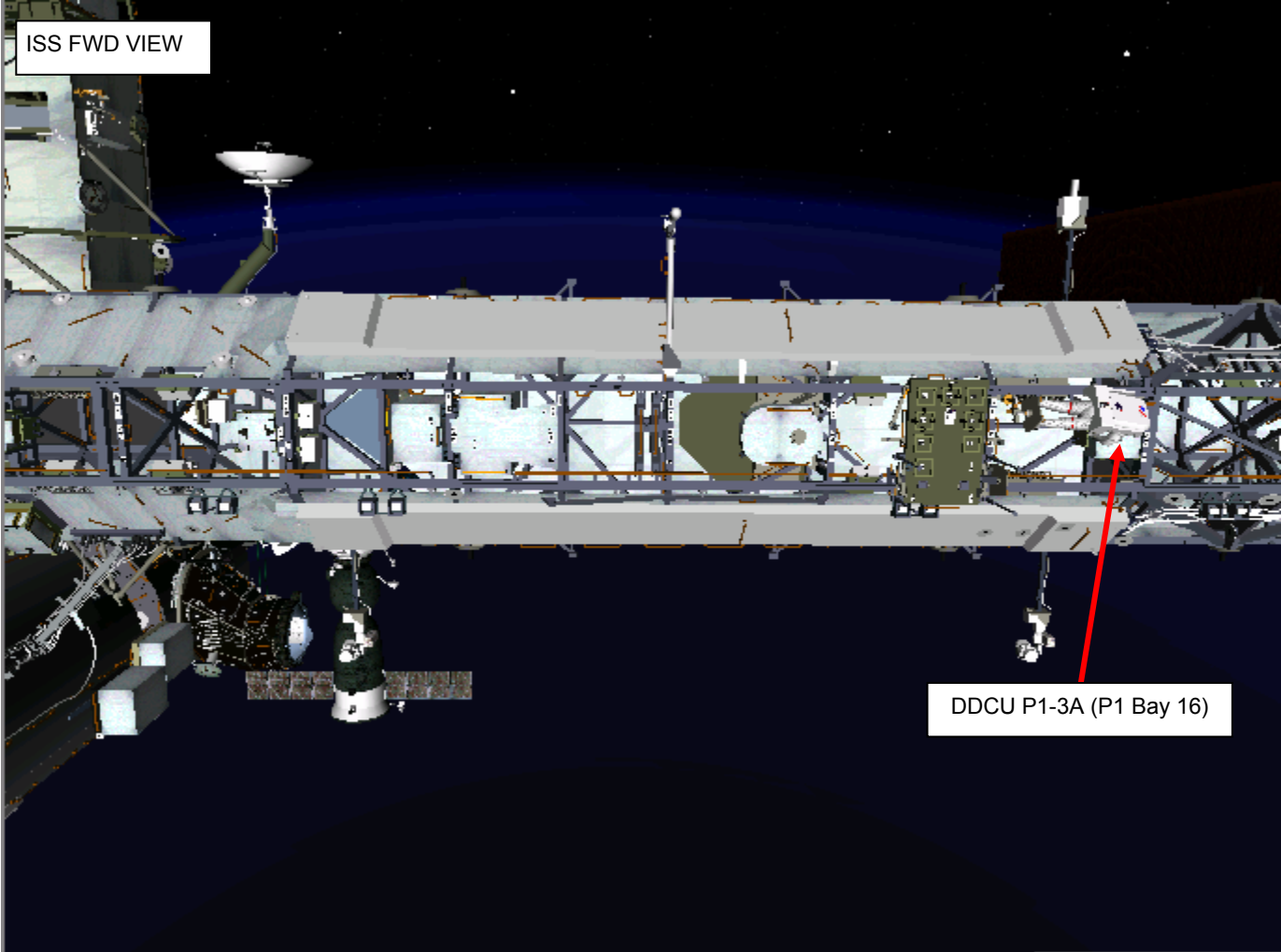

P6 OVERVIEW FOR STBD BCDUs

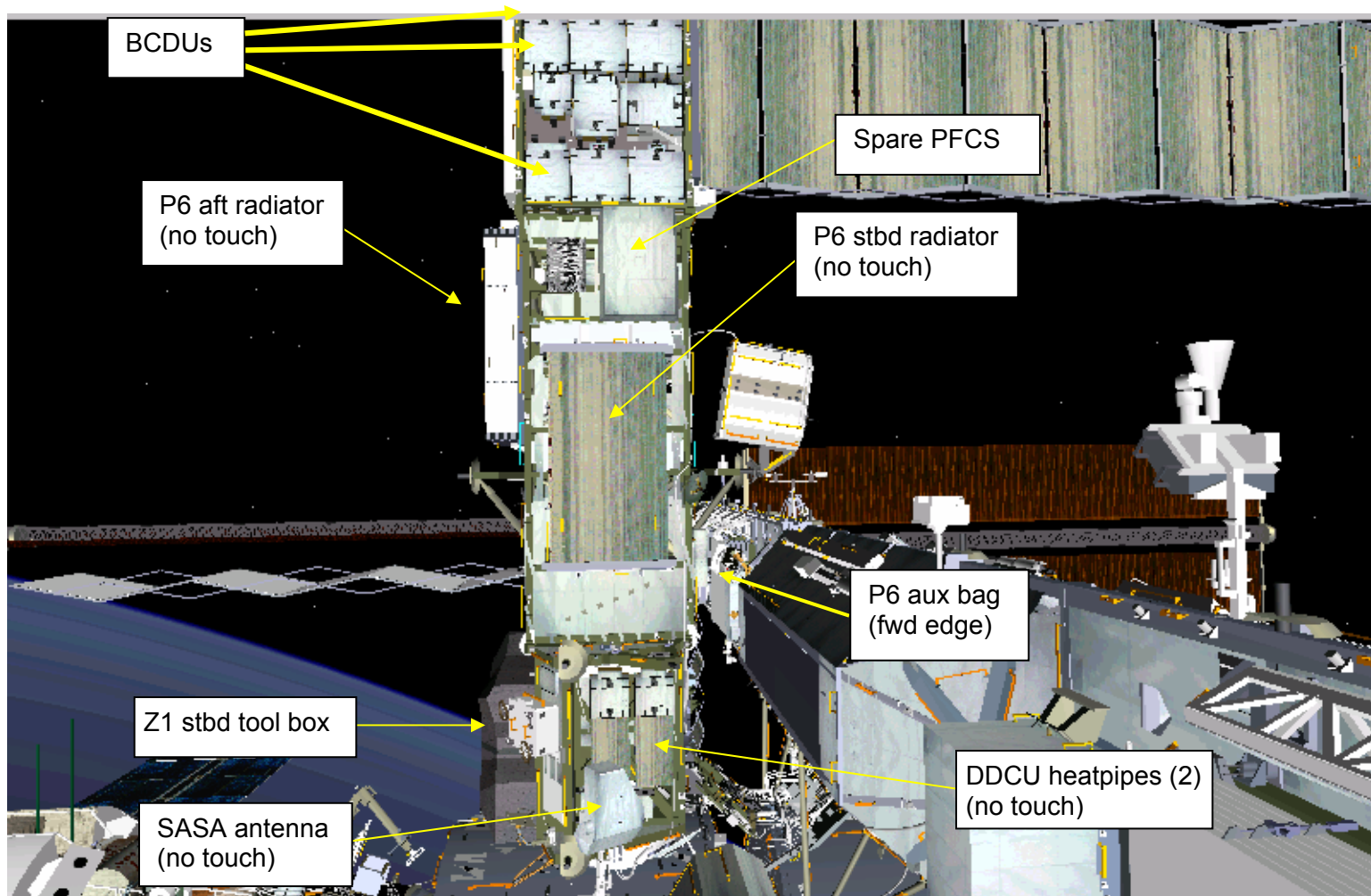

P4 2A BCDU WORKSITE OVERVIEW

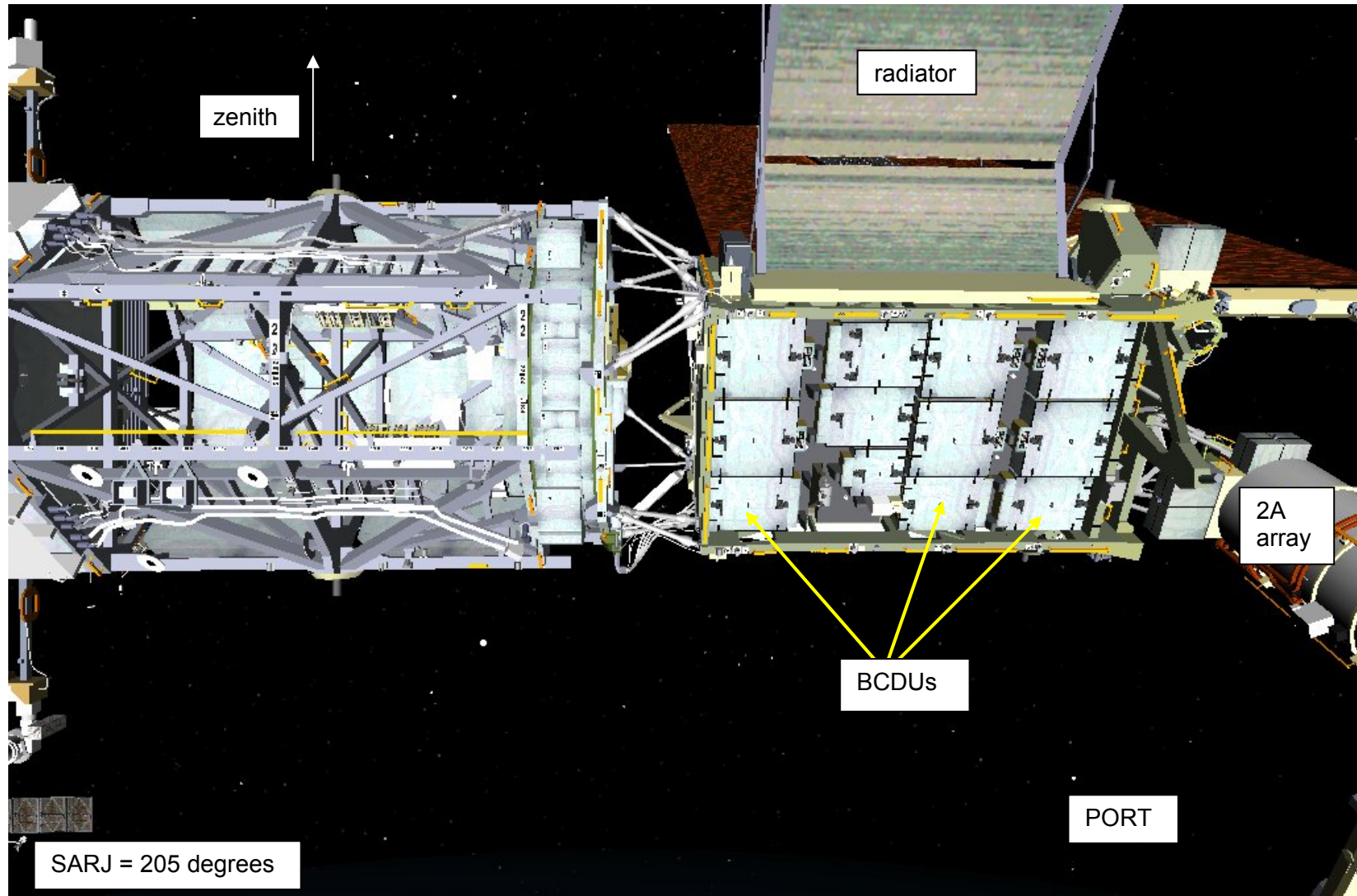

P4 4A BCDU WORKSITE OVERVIEW

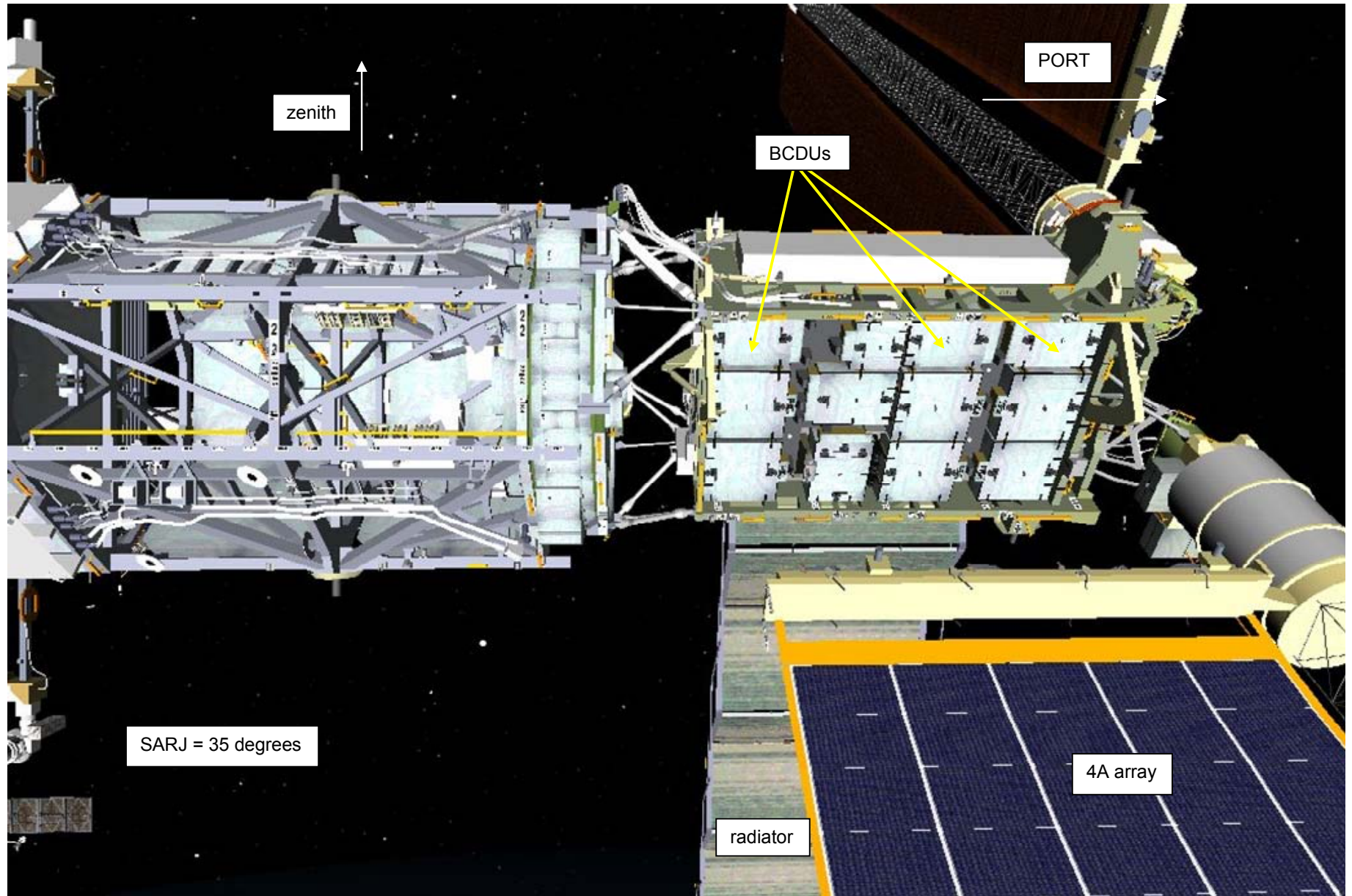

BCDU

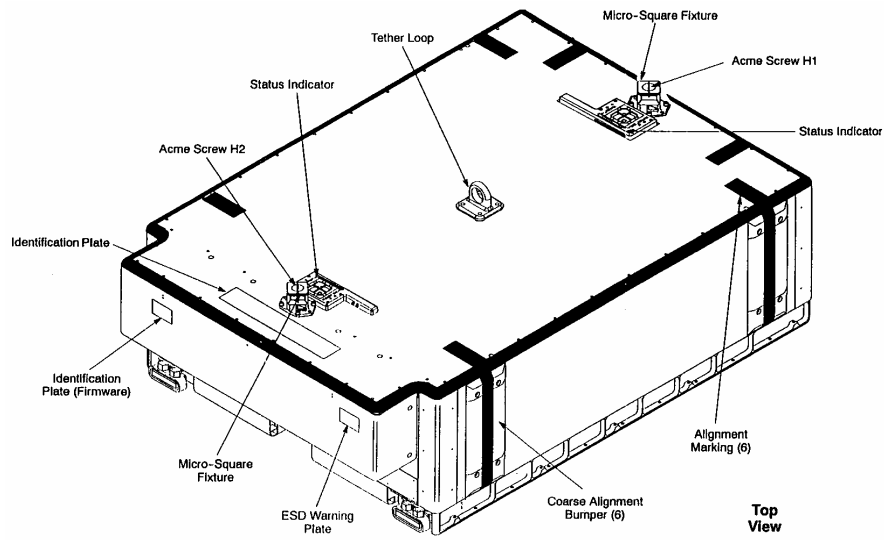

TOP VIEW

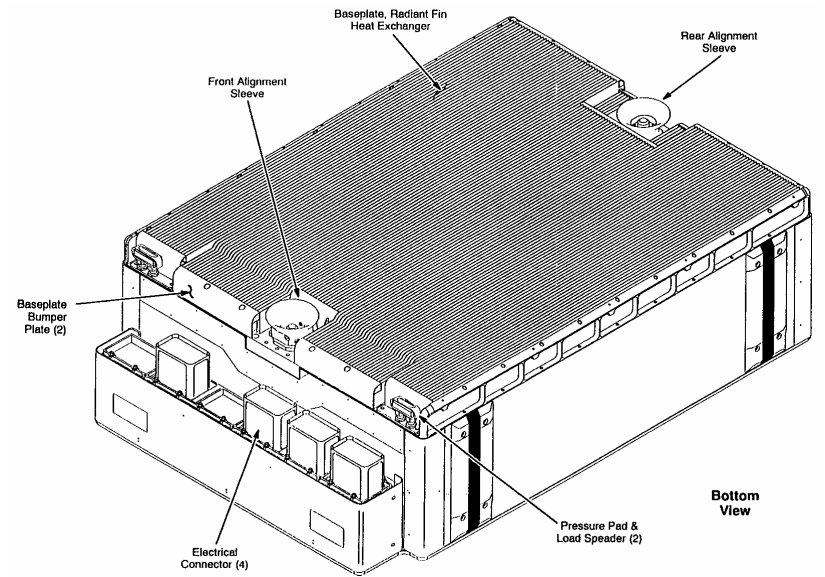

BOTTOM VIEW

P6 2B STBD IEA (UPPER/NON-KEEL SIDE) ORU LABELS

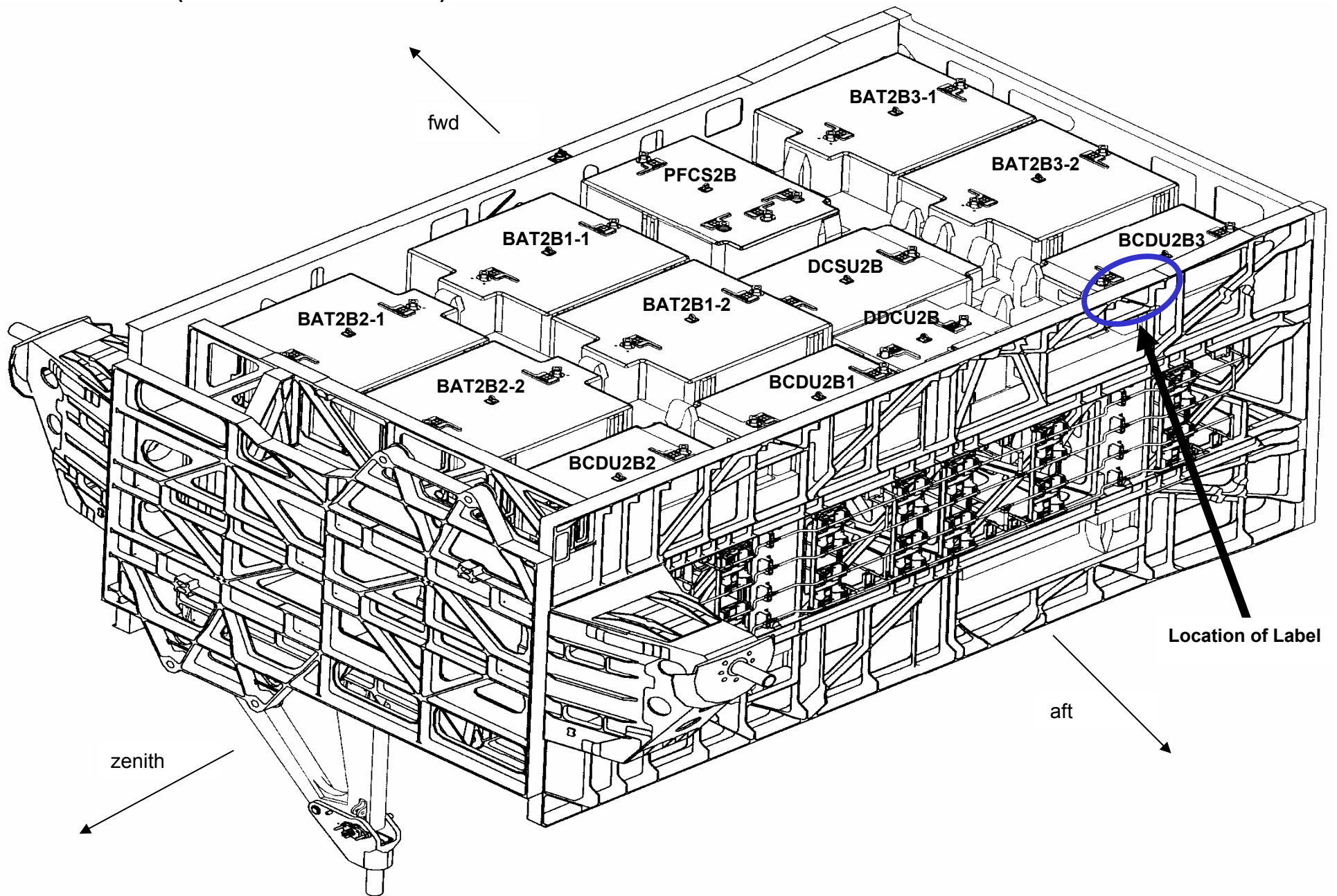

P6 4B PORT IEA (LOWER/KEEL SIDE) ORU LABELS

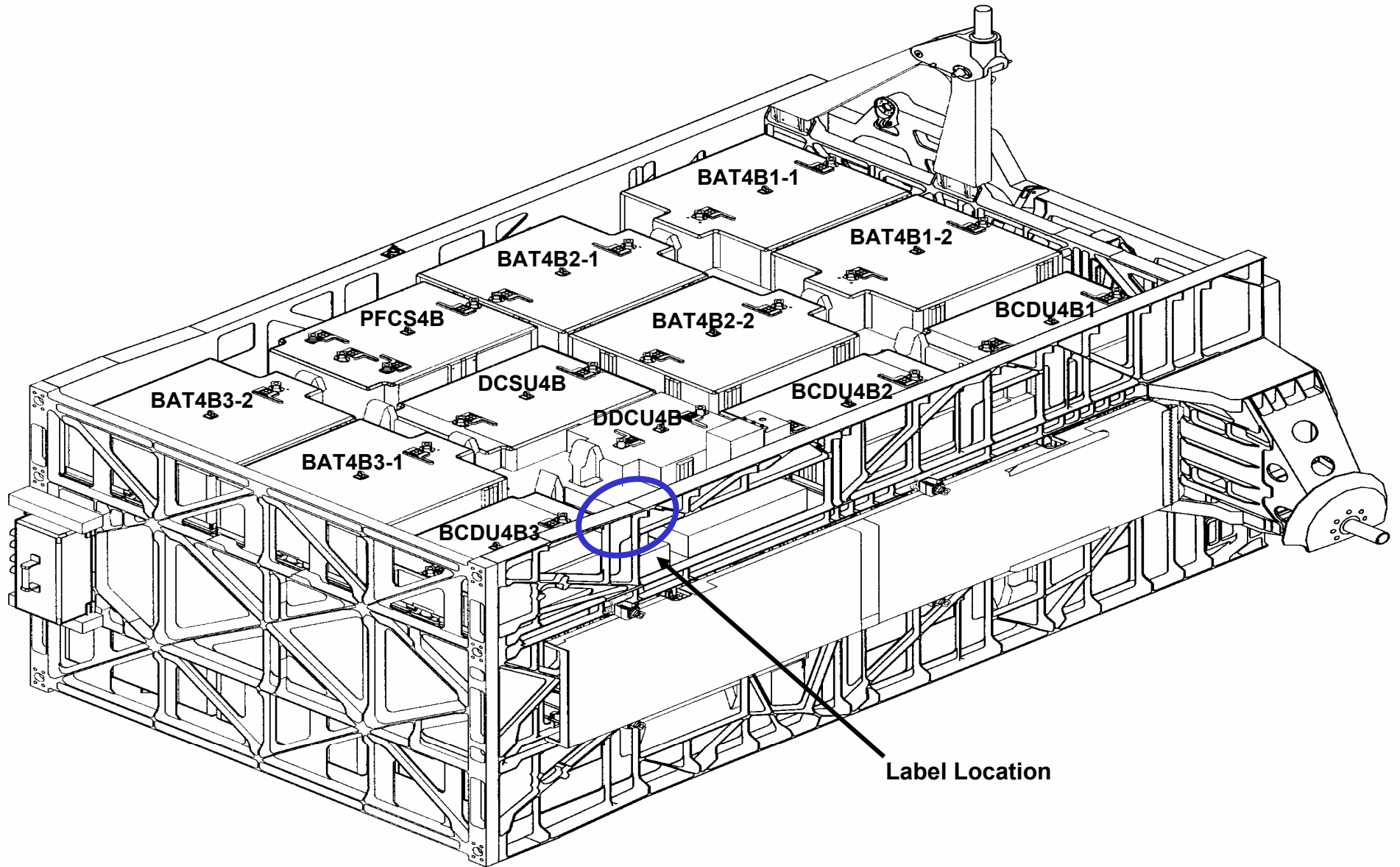

P4 4A FWD IEA (UPPER/NON-KEEL SIDE) ORU LABELS

(SARJ = 35 degrees)

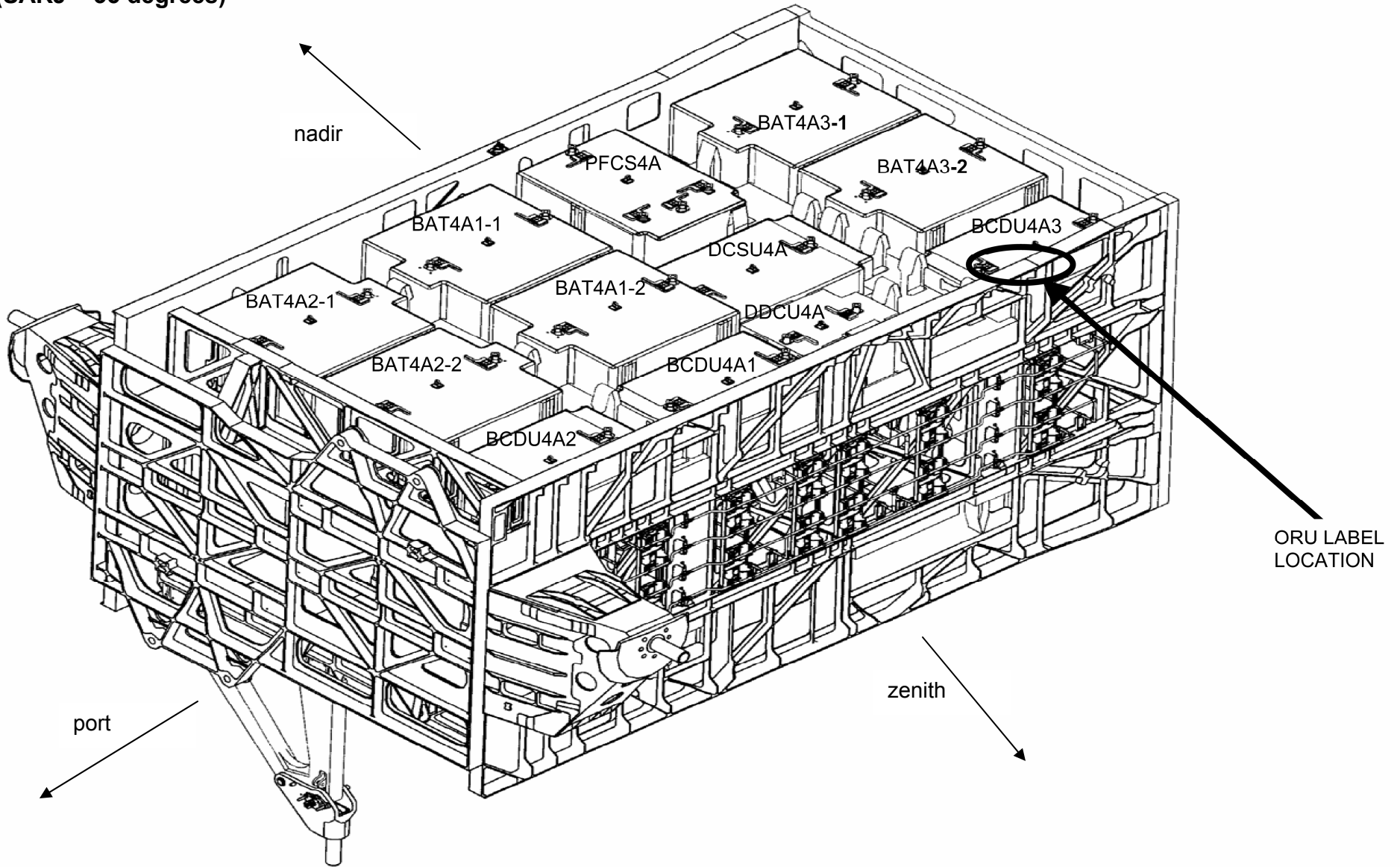

P4 2A AFT IEA (LOWER/KEEL SIDE) ORU LABELS

(SARJ = 205 degrees)

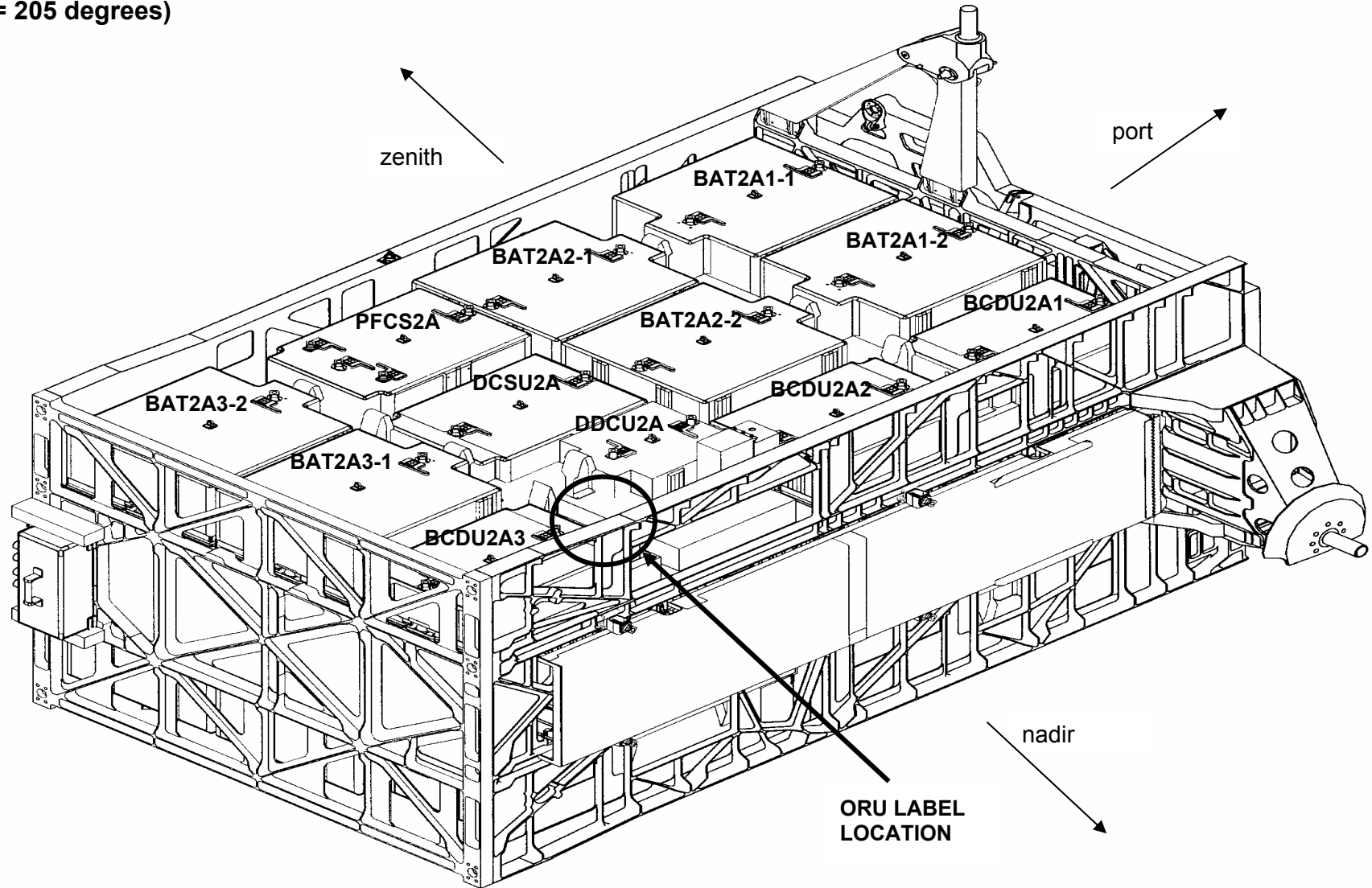

4B MANUAL RETRACT – P6 WIF 37

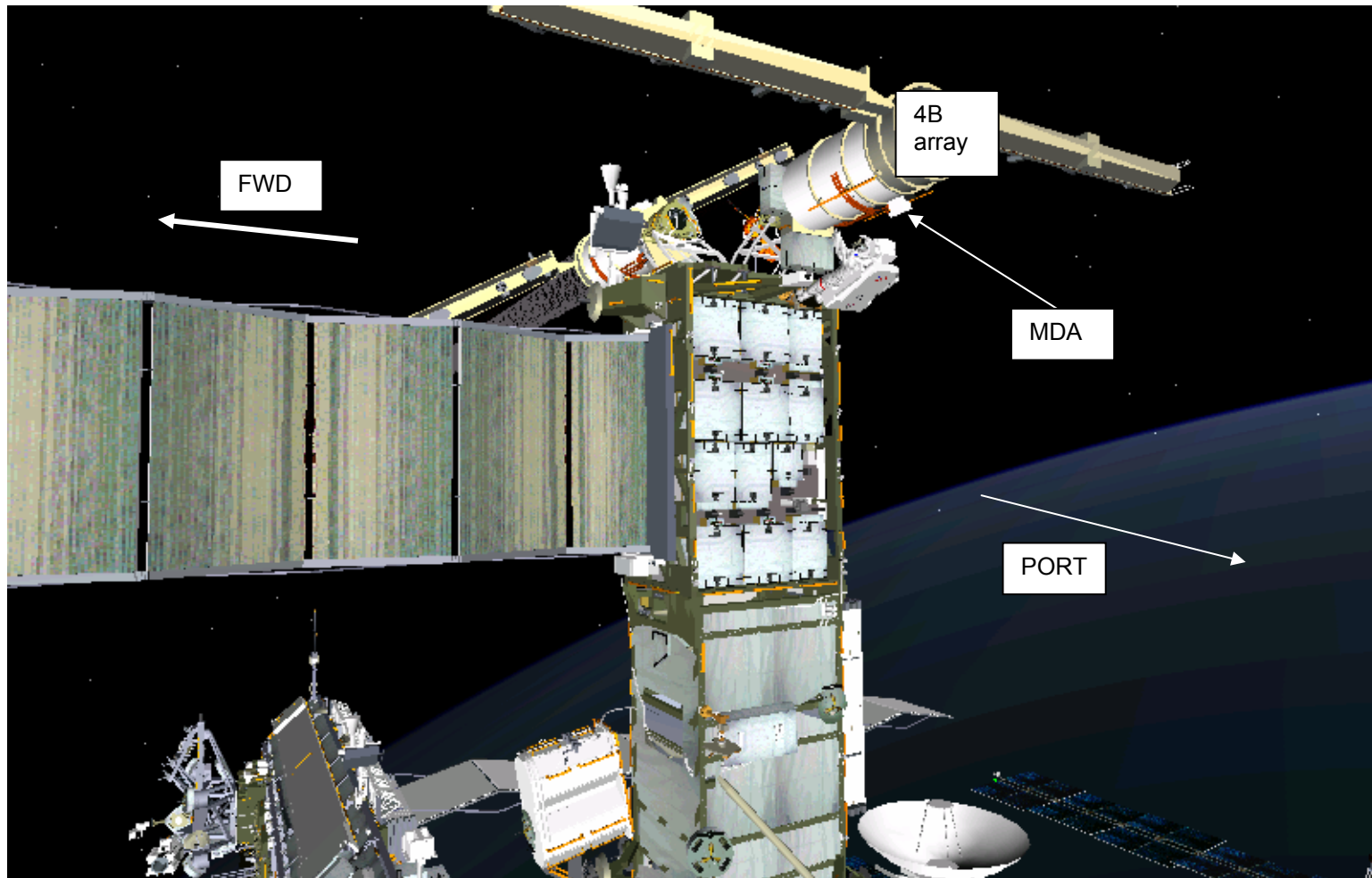

SOLAR ARRAY LATCH/TENSION OVERRIDE – LEFT BLANKET BOX

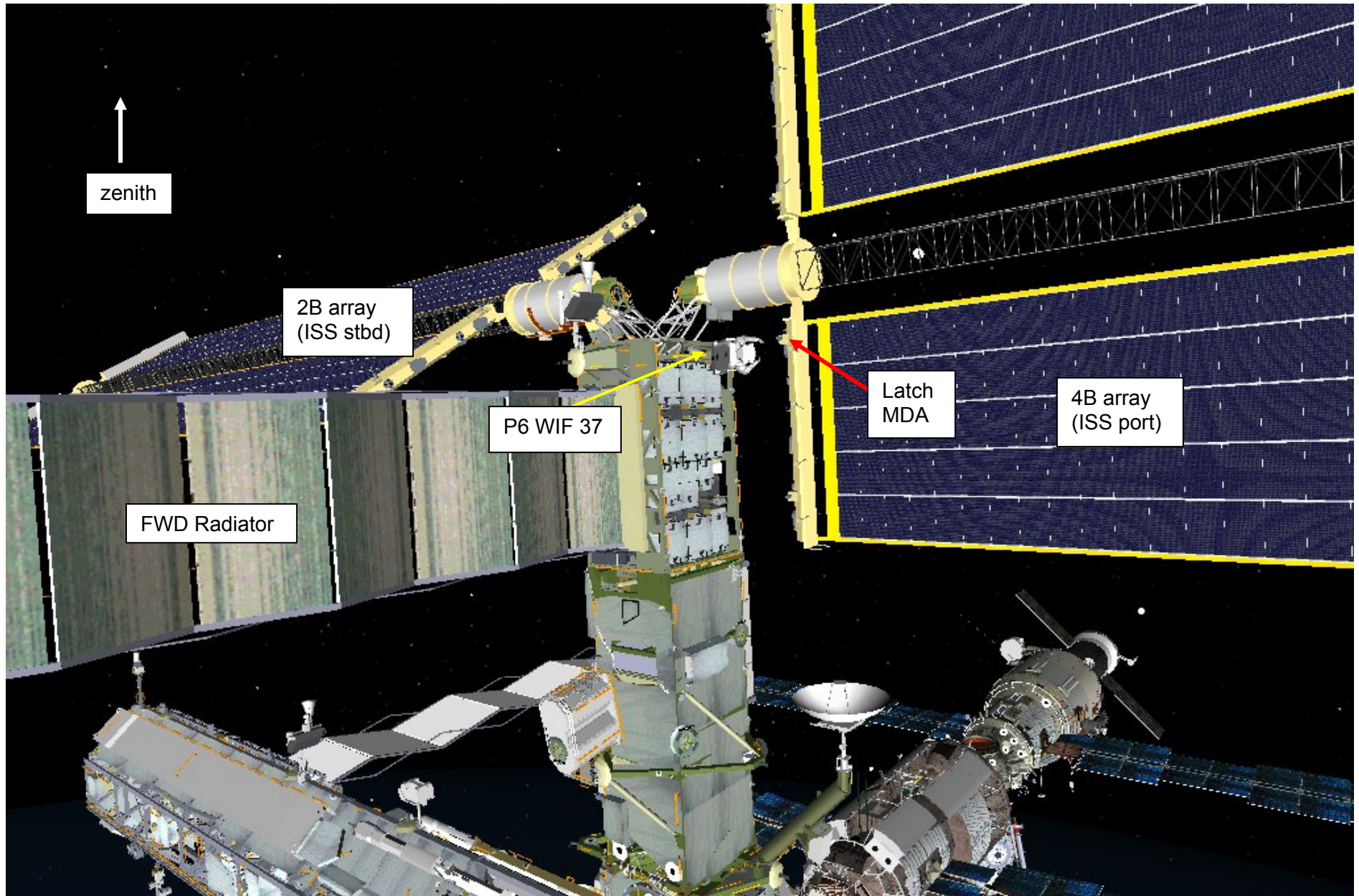

SOLAR ARRAY JETTISON OVERVIEW

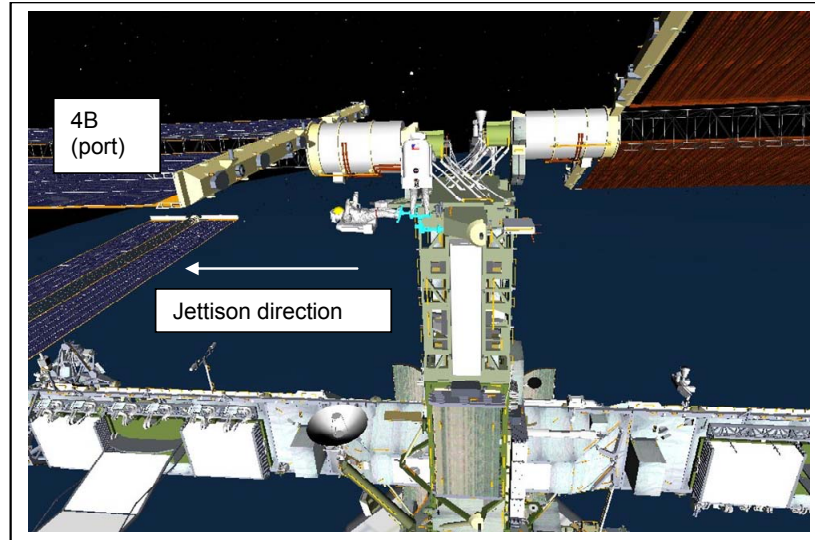

JETTISON POSITIONS FOR EV1 and EV2

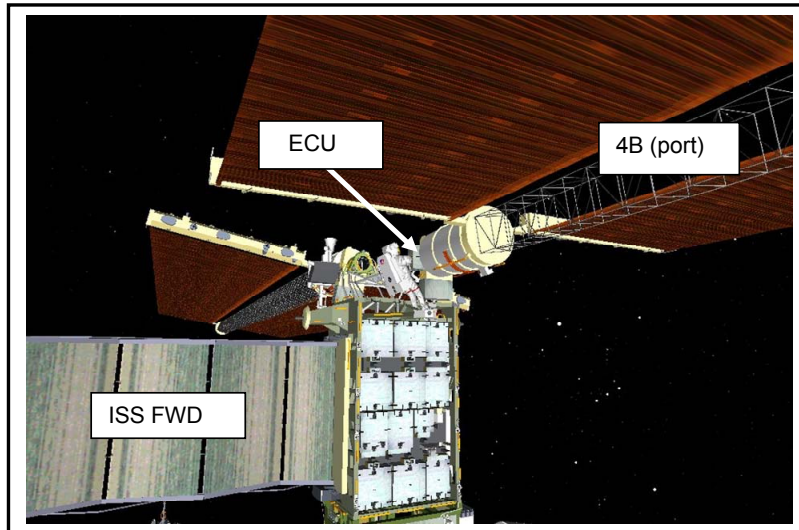

ECU REMOVAL POSITION

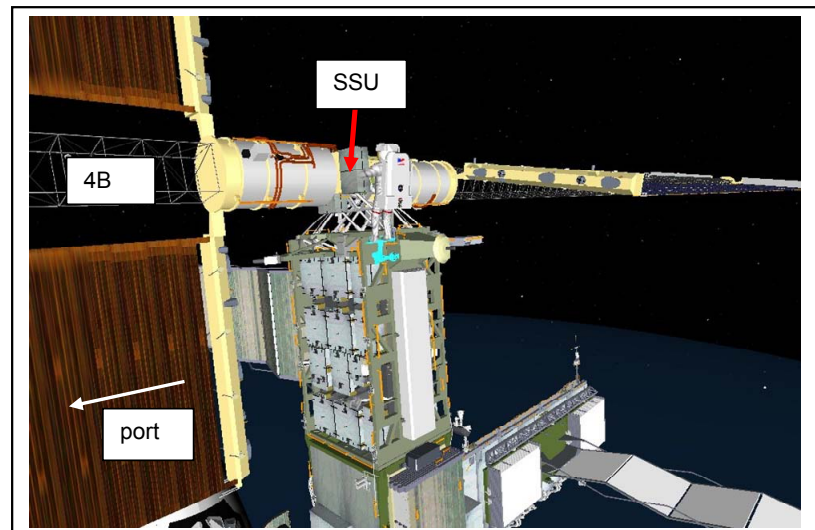

SSU REMOVAL POSITION

MAST CANISTER MDA

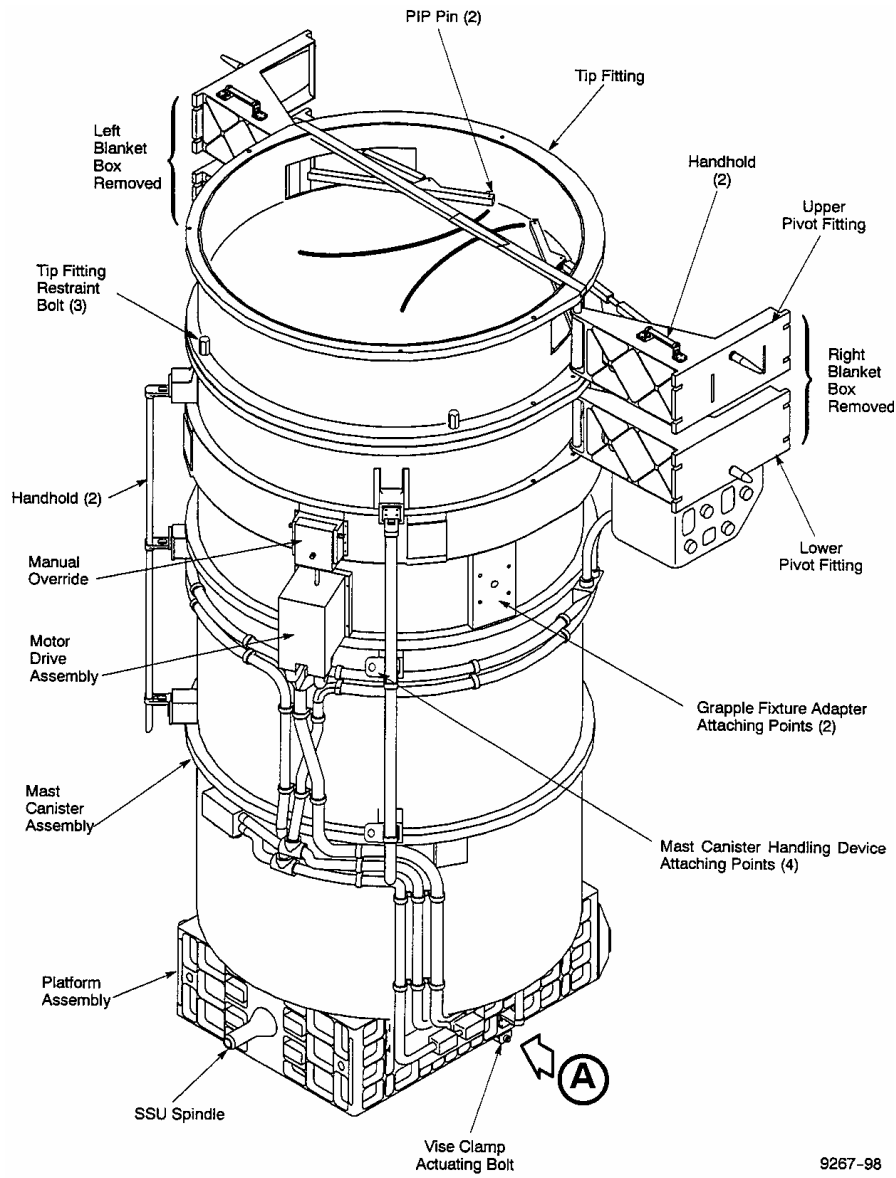

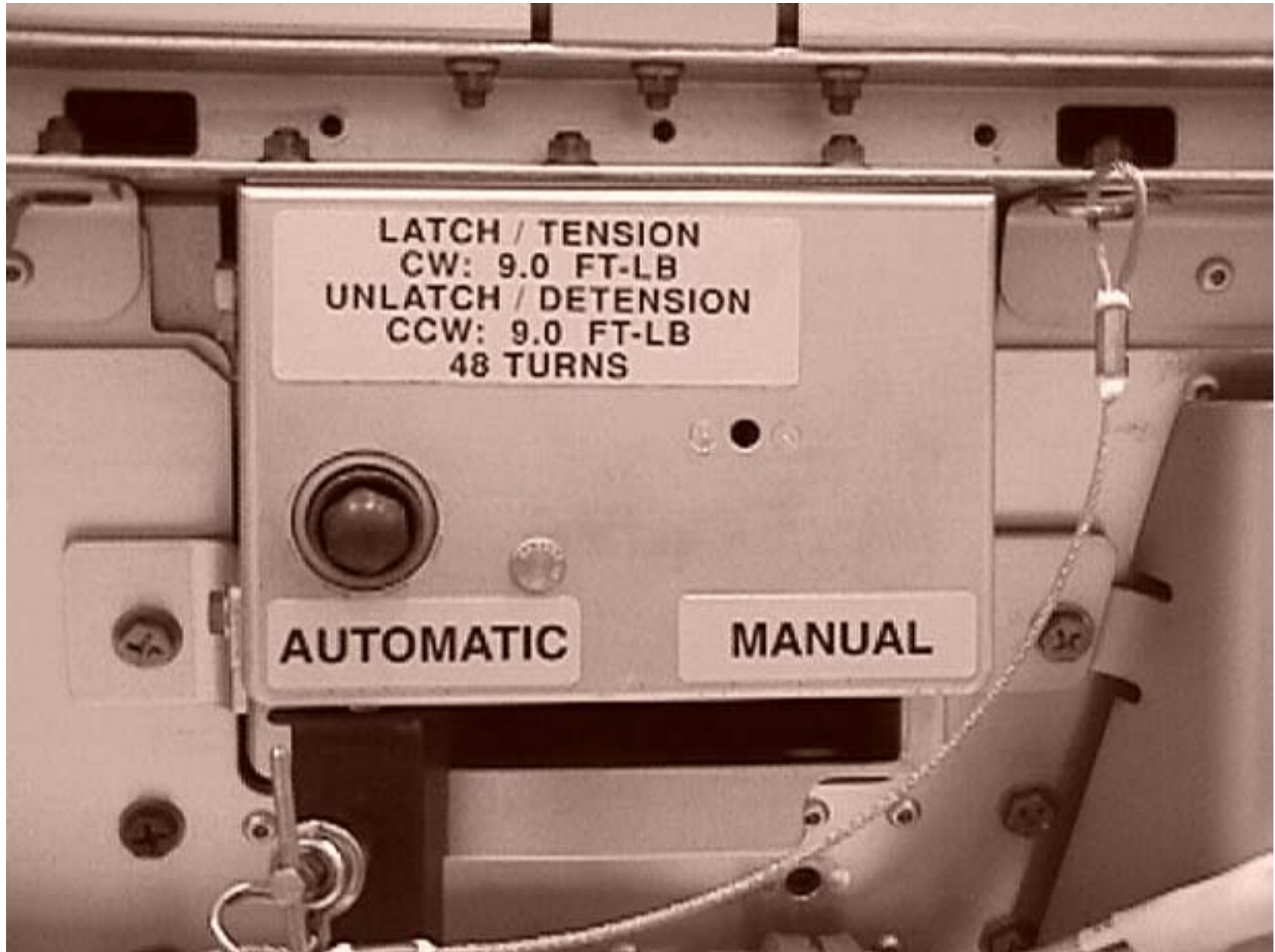

SOLAR ARRAY BLANKET BOX (SABB)

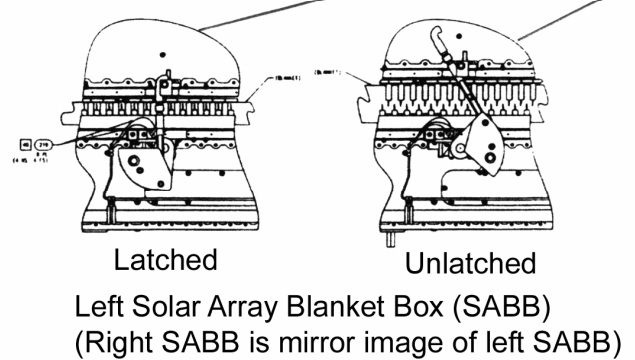
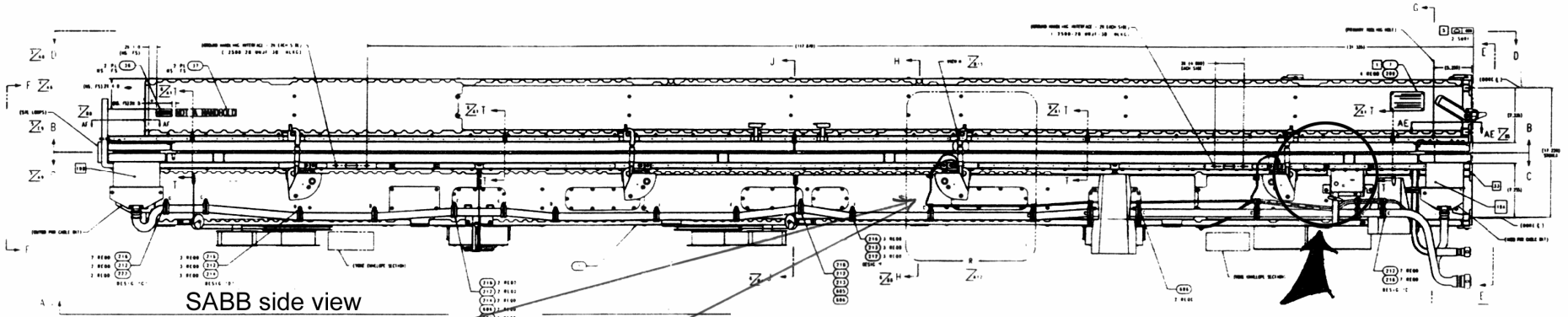
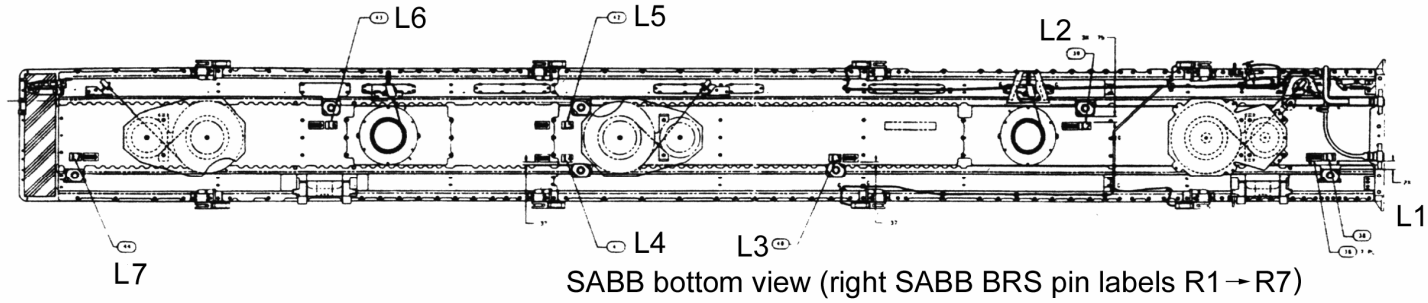

(See enlarged photo next page)

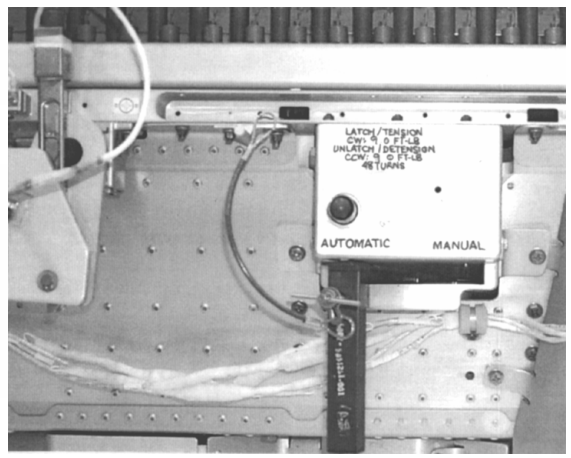

SABB MDA

FRAM/FSE/ORU ASSEMBLY

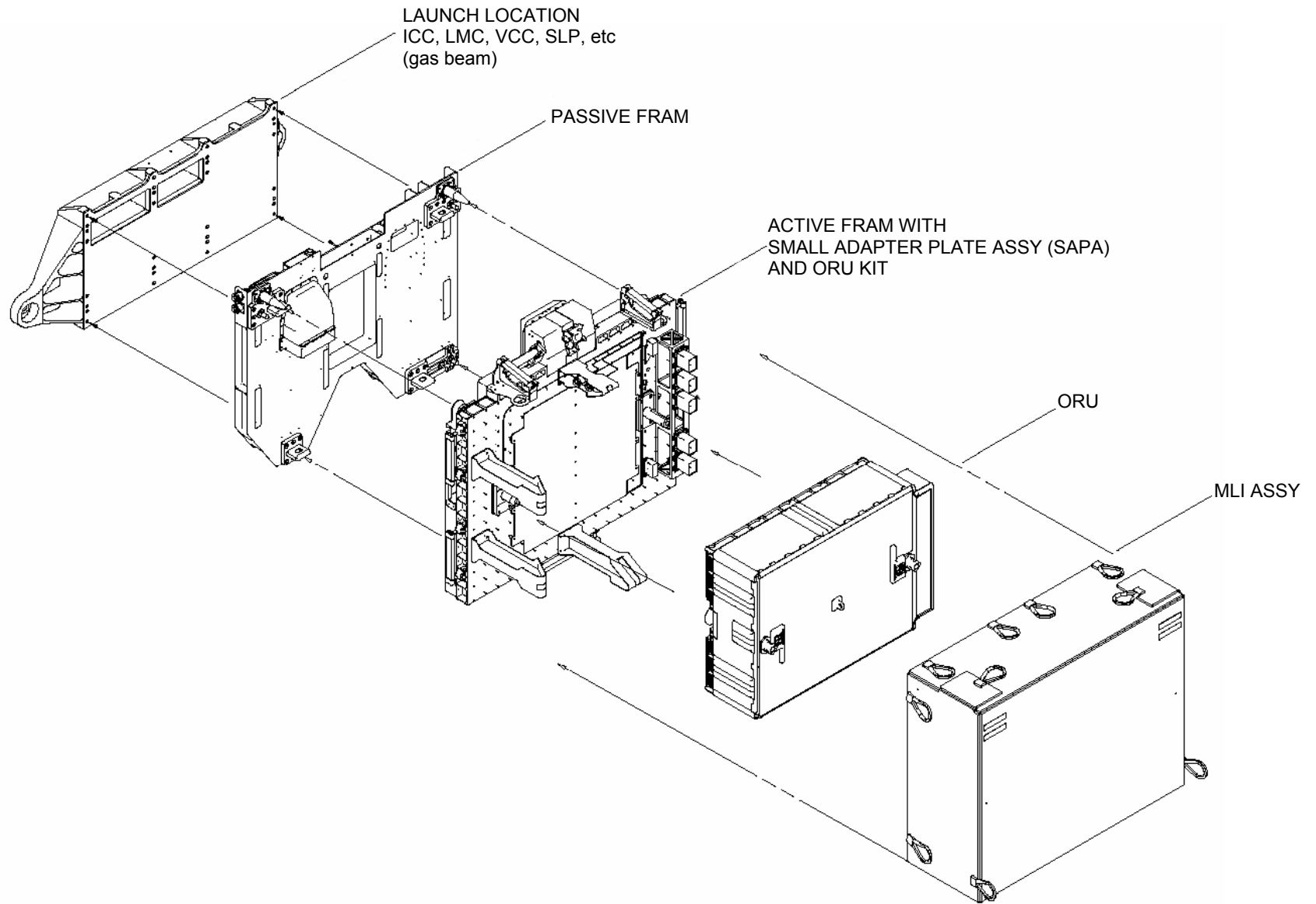

ACTIVE FRAM SOFT CAPTURE MECHANISM

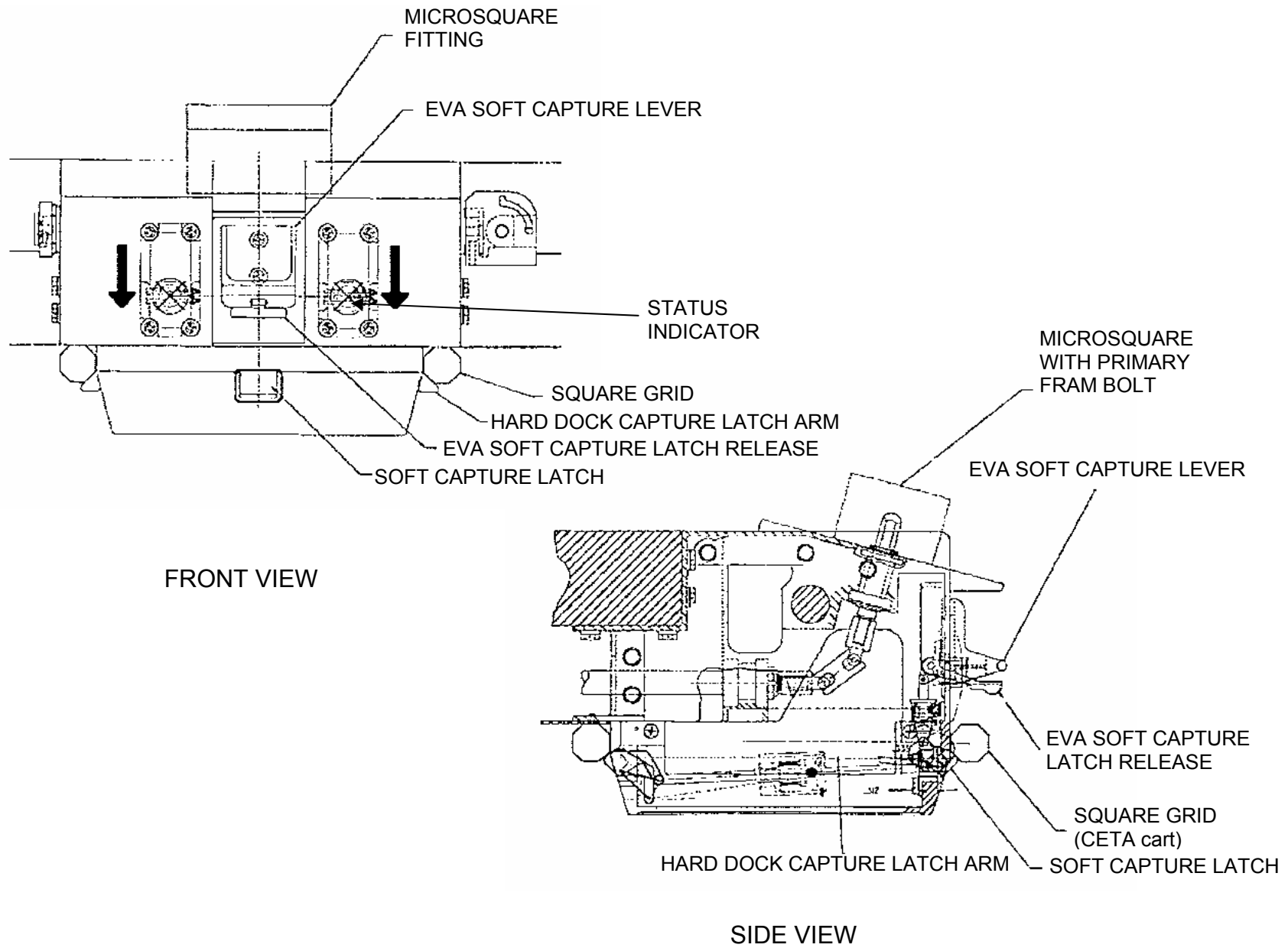

FRAM CONTINGENCY BOLTS – SAPA

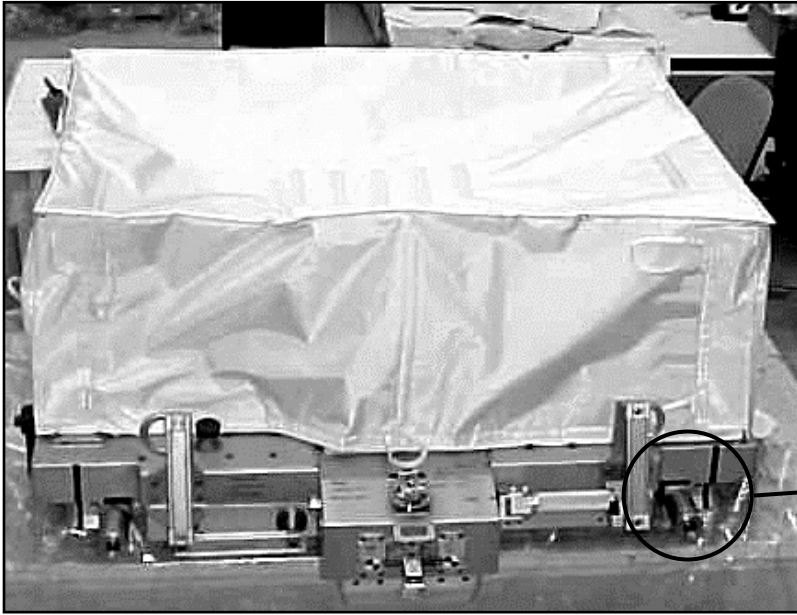

FWD CONTINGENCY BOLT (2)

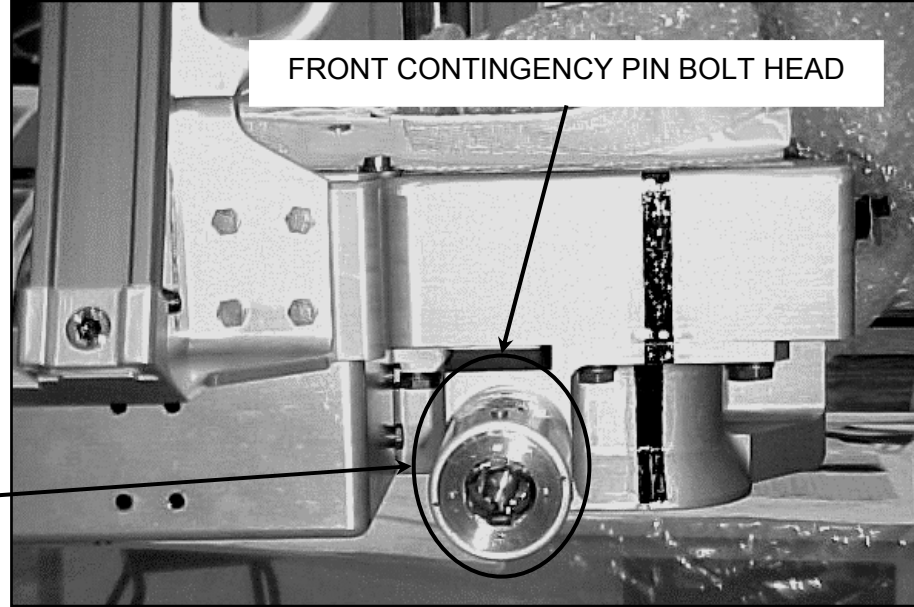

AFT CONTINGENCY BOLT (2)

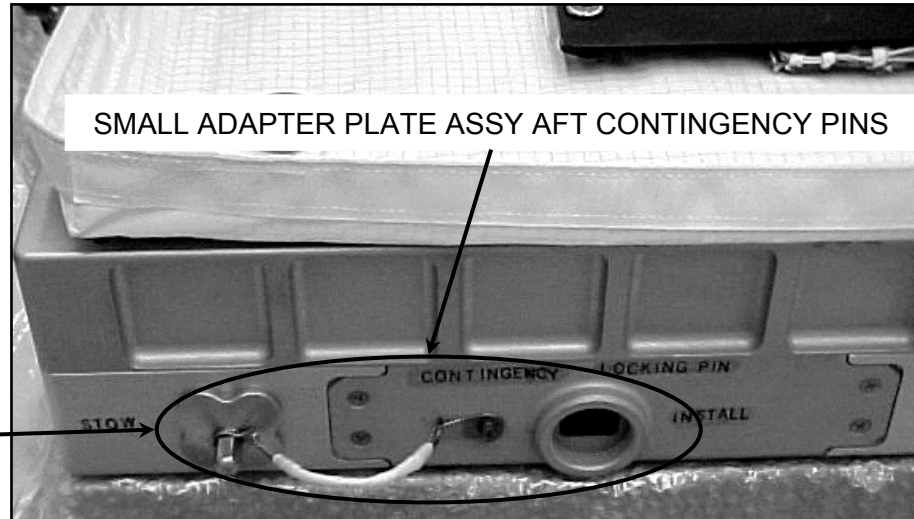

P5 SOFT CAPTURE ASSY MANUAL OVERRIDE

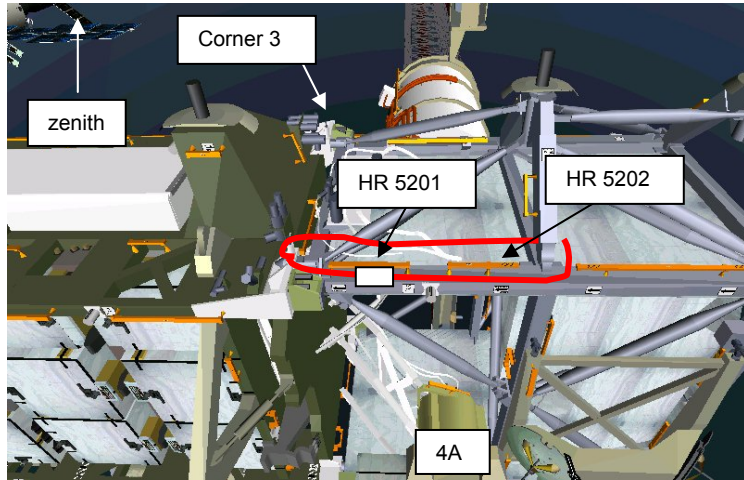

MRTAS CORNER 1

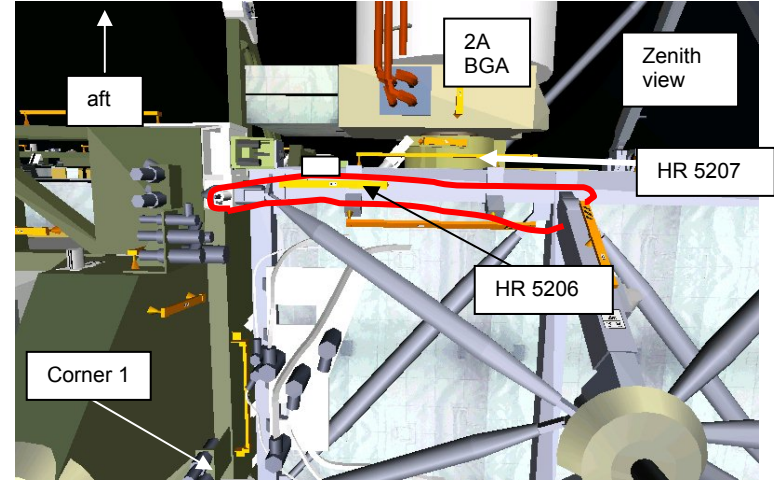

MRTAS CORNER 3

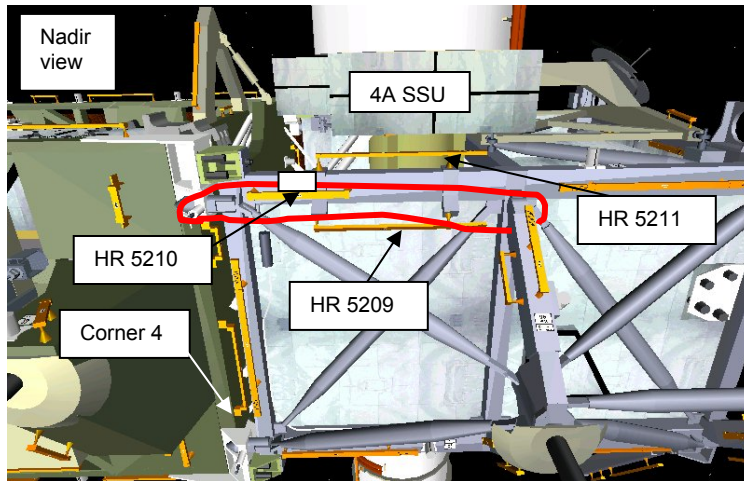

MRTAS CORNER 2

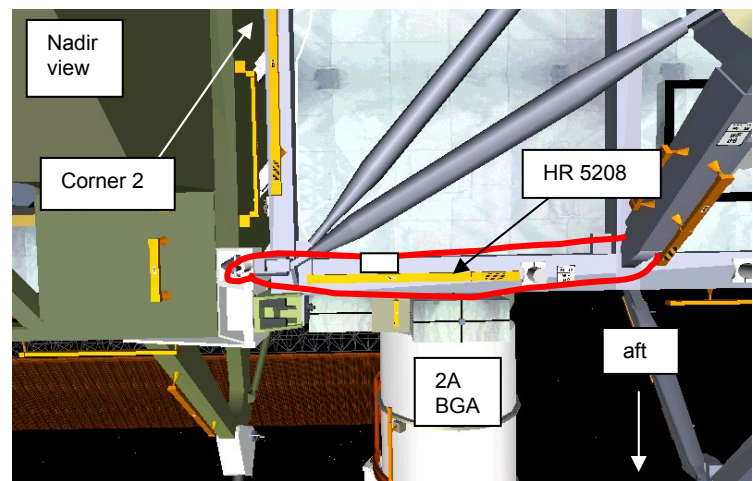

MRTAS CORNER 4

P5 SOFT CAPTURE ASSY MANUAL OVERRIDE (Cont)

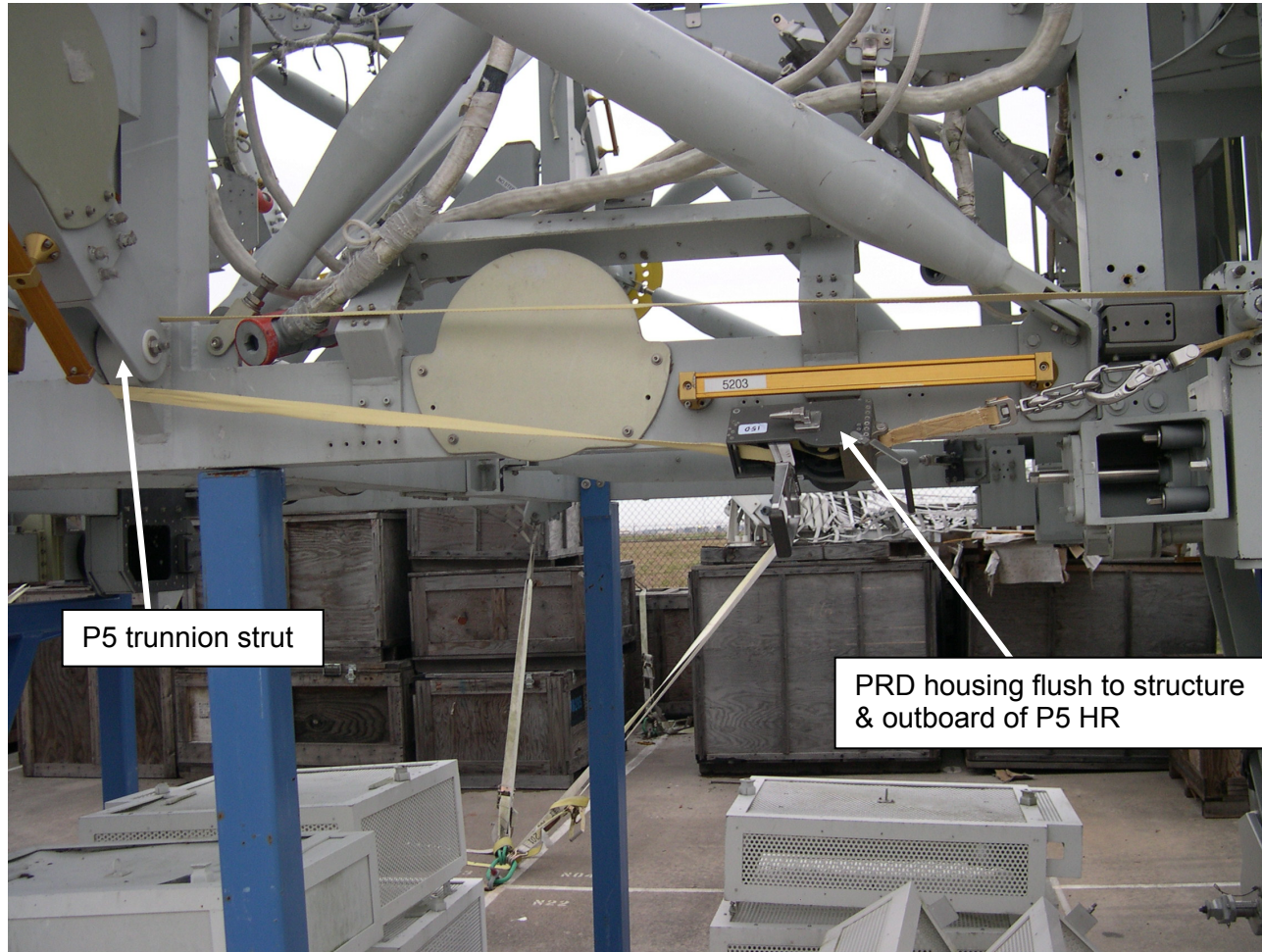

P5 trunnion strut

PRD housing flush to structure
& outboard of P5 HR

P4 soft capture
assy housing

SMDP ADAPTER FAILED MAGNETIC SOCKET

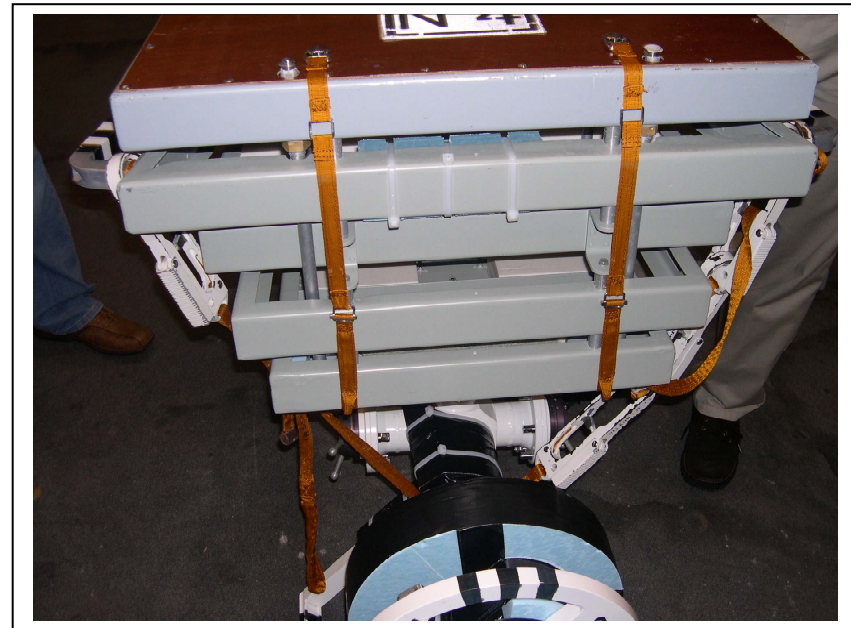
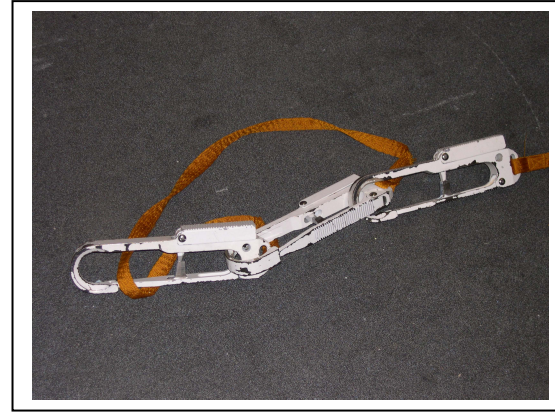

This Page Intentionally Blank



EVA CHECKLIST

STS
116