

EVA Checklist

STS-117 Flight Supplement

**Mission Operations Directorate
EVA, Robotics, and Crew Systems
Operations Division**

**Final
February 26, 2007**

NOTE

This supplement is to be integrated into the generic edition to provide a complete document for the specific flight. Some pages in the generic edition may be replaced with supplemental pages identified as 'TEMP'. These generic pages, if any, must be retained for use on future flights.

National Aeronautics and
Space Administration

Lyndon B. Johnson Space Center
Houston, Texas

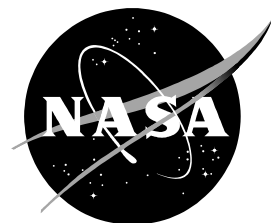

MISSION OPERATIONS DIRECTORATE

**EVA CHECKLIST
STS-117 FLIGHT SUPPLEMENT**

FINAL
February 26, 2007

PREPARED BY:

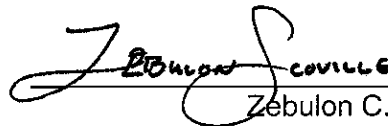

Zebulon C. Scoville
Book Manager

APPROVED BY:



Tricia K. Mack
Lead, EVA Systems Group

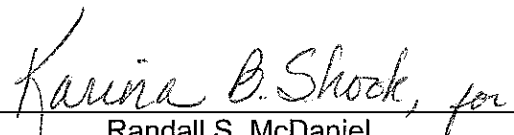

Randall S. McDaniel
Lead, EVA Task Group



Angela R. Prince
Chief, EVA and Crew Systems Operations Branch

This document is under the configuration control of the Crew Procedures Control Board (CPCB). All proposed changes must be submitted via FDF Workflow Crew Procedure Change Request (CR) to DO3/FDF Manager.

Additional distribution of this book, for official use only, may be requested in writing to DO3/PMO Administrator. The request must include justification and requester's name, organization, position, and phone number. Contractor requests are made through the NASA or DOD organization supported. Deletions, reduction in quantity, or change of address may be submitted to DO3/FDF Management Office, 281-244-1184.

Incorporates the following:				
482#:	EVA FS-0008	EVA FS-0017	EVA FS-0025	EVA FS-0033
	EVA FS-0009	EVA FS-0018	EVA FS-0026	EVA FS-0034
	EVA FS-0010	EVA FS-0019	EVA FS-0027	EVA FS-0035
	EVA FS-0011	EVA FS-0020	EVA FS-0028	EVA FS-0036
	EVA FS-0012	EVA FS-0021	EVA FS-0029	EVA FS-0037
	EVA FS-0013	EVA FS-0022	EVA FS-0030	EVA FS-0038
	EVA FS-0014	EVA FS-0023	EVA FS-0031A	EVA FS-0039
	EVA FS-0015	EVA FS-0024	EVA FS-0032	EVA FS-0040
	EVA FS-0016			

AREAS OF TECHNICAL RESPONSIBILITY

Book Manager

DX35/Z. Scoville

281-483-2701

EVA CHECKLIST
STS-117 FLIGHT SUPPLEMENT

LIST OF EFFECTIVE PAGES

	FINAL	02/26/07	
Sign Off	* 117/FIN	3-8	generic
FS ii	* 117/FIN	3-9	generic
iii	* generic	CC 3-10	generic
iv	* generic	CC 3-11	generic
FS v	* 117/FIN	3-12	generic
FS vi	* 117/FIN	4-1	generic
FS vii	* 117/FIN	4-2	generic
FS viii	* 117/FIN	4-3	generic
FS ix	117/FIN	4-4	generic
FS x	117/FIN	4-5	generic
FS xi	117/FIN	4-6	generic
FS xii	117/FIN	4-7	generic
FS xiii	117/FIN	4-8	generic
FS xiv	117/FIN	4-9	generic
FS xv	117/FIN	4-10	generic
FS xvi	117/FIN	4-11	generic
1-1	generic	4-12	generic
1-2	generic	5-1	generic
1-3	generic	5-2	generic
1-4	generic	5-3	generic
1-5	generic	5-4	generic
1-6	generic	A6-1	generic
1-7	generic	CC A6-2	generic
1-8	generic	6-3	generic
1-9	generic	CC 6-4	generic
1-10	generic	FS 7-1	117/FIN
TEMP FS 2-1	117/FIN	FS 7-2	117/FIN
TEMP FS 2-2	ALL/FIN	FS 7-3	117/FIN
2-3	generic	FS 7-4	117/FIN
2-4	generic	FS 7-5	117/FIN
TEMP FS 2-5	117/FIN	FS 7-6	117/FIN
TEMP FS 2-6	ALL/FIN	FS 7-7	117/FIN
FS 2-7	117/FIN	FS 7-8	117/FIN
FS 2-8	117/FIN	FS 7-9	117/FIN
FS 2-9	117/FIN	FS 7-10	117/FIN
FS 2-10	117/FIN	FS 7-11	117/FIN
FS 2-11	117/FIN	FS 7-12	117/FIN
FS 2-12	117/FIN	FS 7-13	117/FIN
FS 2-13	117/FIN	FS 7-14	117/FIN
FS 2-14	117/FIN	FS 7-15	117/FIN
FS 2-15	117/FIN	FS 7-16	117/FIN
FS 2-16	117/FIN	FS 7-17	117/FIN
FS CC 2-17	117/FIN	FS 7-18	117/FIN
FS CC 2-18	117/FIN	FS 7-19	117/FIN
3-1	generic	FS 7-20	117/FIN
3-2	generic	FS 7-21	117/FIN
3-3	generic	FS 7-22	117/FIN
3-4	generic	FS 7-23	117/FIN
3-5	generic	FS 7-24	117/FIN
3-6	generic	FS 7-25	117/FIN
3-7	generic	FS 7-26	117/FIN

* – Omit from flight book

FS 7-27	117/FIN	FS 7-81.....	117/FIN
FS 7-28	117/FIN	FS 7-82.....	117/FIN
FS 7-29	117/FIN	FS 7-83.....	117/FIN
FS 7-30	117/FIN	FS 7-84.....	117/FIN
FS 7-31	117/FIN	FS 7-85.....	117/FIN
FS 7-32	117/FIN	FS 7-86.....	117/FIN
FS 7-33	117/FIN	FS 7-87.....	117/FIN
FS 7-34	117/FIN	FS 7-88.....	117/FIN
FS CC 7-35.....	117/FIN	FS 7-89.....	117/FIN
FS CC 7-36.....	117/FIN	FS 7-90.....	117/FIN
FS 7-37	117/FIN	FS 7-91.....	117/FIN
FS 7-38	117/FIN	FS 7-92.....	117/FIN
FS 7-39	117/FIN	FS 7-93.....	117/FIN
FS 7-40	117/FIN	FS 7-94.....	117/FIN
FS 7-41	117/FIN	FS 7-95.....	117/FIN
FS 7-42	117/FIN	FS 7-96.....	117/FIN
FS 7-43	117/FIN	FS 7-97.....	117/FIN
FS 7-44	117/FIN	FS 7-98.....	117/FIN
FS 7-45	117/FIN	FS 7-99.....	117/FIN
FS 7-46	117/FIN	FS 7-100.....	117/FIN
FS 7-47	117/FIN	FS 7-101.....	117/FIN
FS 7-48	117/FIN	FS 7-102.....	117/FIN
FS 7-49	117/FIN	FS 7-103.....	117/FIN
FS 7-50	117/FIN	FS 7-104.....	117/FIN
FS 7-51	117/FIN	FS 7-105.....	117/FIN
FS 7-52	117/FIN	FS 7-106.....	117/FIN
FS 7-53	117/FIN	FS 7-107.....	117/FIN
FS 7-54	117/FIN	FS 7-108.....	117/FIN
FS 7-55	117/FIN	FS 7-109.....	117/FIN
FS 7-56	117/FIN	FS 7-110.....	117/FIN
FS 7-57	117/FIN	TEMP FS 8-1.....	117/FIN
FS 7-58	117/FIN	TEMP FS 8-2.....	117/FIN
FS 7-59	117/FIN	8-3	generic
FS 7-60	117/FIN	8-4	generic
FS 7-61	117/FIN	8-5	generic
FS 7-62	117/FIN	8-6	generic
FS 7-63	117/FIN	FS 8-7.....	117/FIN
FS 7-64	117/FIN	FS 8-8.....	117/FIN
FS 7-65	117/FIN	FS 8-9.....	117/FIN
FS 7-66	117/FIN	FS 8-10.....	117/FIN
FS 7-67	117/FIN	9-1	generic
FS 7-68	117/FIN	9-2	generic
FS 7-69	117/FIN	9-3	generic
FS 7-70	117/FIN	9-4	generic
FS 7-71	117/FIN	9-5	generic
FS 7-72	117/FIN	9-6	generic
FS 7-73	117/FIN	TEMP FS 10-1.....	117/FIN
FS 7-74	117/FIN	TEMP FS 10-2.....	ALL/FIN
FS 7-75	117/FIN	10-3	generic
FS 7-76	117/FIN	10-4	generic
FS 7-77	117/FIN	10-4a	generic
FS 7-78	117/FIN	10-4b	generic
FS 7-79	117/FIN	10-5	generic
FS 7-80	117/FIN	10-6	generic

10-7	generic	14-7	generic
10-8	generic	14-8	generic
10-9	generic	14-9	generic
10-10	generic	14-10	generic
10-11	generic	14-11	generic
10-12	generic	14-12	generic
FS CC 10-13	117/FIN	14-13	generic
FS CC 10-14	117/FIN	14-14	generic
FS 10-15	117/FIN	14-15	generic
FS 10-16	117/FIN	14-16	generic
11-1	generic	14-17	generic
11-2	generic	14-18	generic
11-3	generic	14-19	generic
11-4	generic	14-20	generic
12-i	generic	14-21	generic
12-ii	generic	14-22	generic
TEMP FS 12-1	117/FIN	15-1	generic
TEMP FS 12-2	ALL/FIN	15-2	generic
12-3	generic	15-3	generic
12-4	generic	15-4	generic
12-5	generic	15-5	generic
12-6	generic	15-6	generic
12-7	generic	15-7	generic
12-8	generic	15-8	generic
12-9	generic	15-9	generic
12-10	generic	15-10	generic
12-11	generic	15-11	generic
12-12	generic	15-12	generic
12-13	generic	15-13	generic
12-14	generic	15-14	generic
12-15	generic	16-i	generic
12-16	generic	16-ii	generic
12-17	generic	TEMP FS 16-1	117/FIN
12-18	generic	TEMP FS 16-2	117/FIN
12-19	generic	FS 16-3	117/FIN
12-20	generic	FS 16-4	117/FIN
12-21	generic	FS 16-5	117/FIN
12-22	generic	FS 16-6	117/FIN
12-23	generic	FS 16-7	117/FIN
12-24	generic	FS 16-8	117/FIN
12-25	generic	FS 16-9	117/FIN
12-26	generic	FS 16-10	117/FIN
FS 12-27	117/FIN	FS 16-11	117/FIN
FS 12-28	117/FIN	FS 16-12	117/FIN
FS 12-29	117/FIN	FS 16-13	117/FIN
FS 12-30	117/FIN	FS 16-14	117/FIN
FS 13-1	117/FIN	FS 16-15	117/FIN
FS 13-2	117/FIN	FS 16-16	117/FIN
14-1	generic	FS 16-17	117/FIN
14-2	generic	FS 16-18	117/FIN
14-3	generic	FS 16-19	117/FIN
14-4	generic	FS 16-20	117/FIN
14-5	generic	FS 16-21	117/FIN
14-6	generic	FS 16-22	117/FIN

FS 16-23	117/FIN	FS 16-77	117/FIN
FS 16-24	117/FIN	FS 16-78	117/FIN
FS 16-25	117/FIN	FS 16-79	117/FIN
FS 16-26	117/FIN	FS 16-80	117/FIN
FS 16-27	117/FIN	FS 16-81	117/FIN
FS 16-28	117/FIN	FS 16-82	117/FIN
FS 16-29	117/FIN	FS 16-83	117/FIN
FS 16-30	117/FIN	FS 16-84	117/FIN
FS 16-31	117/FIN	FS 16-85	117/FIN
FS 16-32	117/FIN	FS 16-86	117/FIN
FS 16-33	117/FIN	FS 16-87	117/FIN
FS 16-34	117/FIN	FS 16-88	117/FIN
FS 16-35	117/FIN	17-1	generic
FS 16-36	117/FIN	17-2	generic
FS 16-37	117/FIN	FS 18-1	117/FIN
FS 16-38	117/FIN	FS 18-2	117/FIN
FS 16-39	117/FIN	FS 18-3	117/FIN
FS 16-40	117/FIN	FS 18-4	117/FIN
FS 16-41	117/FIN	FS 18-5	117/FIN
FS 16-42	117/FIN	FS 18-6	117/FIN
FS 16-43	117/FIN	FS 18-7	117/FIN
FS 16-44	117/FIN	FS 18-8	117/FIN
FS 16-45	117/FIN	FS 18-9	117/FIN
FS 16-46	117/FIN	FS 18-10	117/FIN
FS 16-47	117/FIN	FS 18-11	117/FIN
FS 16-48	117/FIN	FS 18-12	117/FIN
FS 16-49	117/FIN	FS 18-13	117/FIN
FS 16-50	117/FIN	FS 18-14	117/FIN
FS 16-51	117/FIN	FS 18-15	117/FIN
FS 16-52	117/FIN	FS 18-16	117/FIN
FS 16-53	117/FIN	FS 18-17	117/FIN
FS 16-54	117/FIN	FS 18-18	117/FIN
FS 16-55	117/FIN	FS 18-19	117/FIN
FS 16-56	117/FIN	FS 18-20	117/FIN
FS 16-57	117/FIN	FS 18-21	117/FIN
FS 16-58	117/FIN	FS 18-22	117/FIN
FS 16-59	117/FIN	FS 18-23	117/FIN
FS 16-60	117/FIN	FS 18-24	117/FIN
FS 16-61	117/FIN	19-i	generic
FS 16-62	117/FIN	19-ii	generic
FS 16-63	117/FIN	19-1	generic
FS 16-64	117/FIN	19-2	generic
FS 16-65	117/FIN	19-3	generic
FS 16-66	117/FIN	19-4	generic
FS 16-67	117/FIN	19-5	generic
FS 16-68	117/FIN	19-6	generic
FS 16-69	117/FIN	19-7	generic
FS 16-70	117/FIN	19-8	generic
FS 16-71	117/FIN	19-9	generic
FS 16-72	117/FIN	19-10	generic
FS 16-73	117/FIN	19-11	generic
FS 16-74	117/FIN	19-12	generic
FS 16-75	117/FIN	20-1	* generic
FS 16-76	117/FIN	20-2	* generic

* – Omit from flight book

EVA CUE CARDS

<u>Title</u>	<u>Ref. Page</u>	<u>Card No.</u>
EMU SWAP CUE CARD (Front).....	FS CC 2-17	EVA-7a/117/O/A
LTA RESTRAINT STRAP CUE CARD (Back).....	FS CC 2-18	EVA-7b/117/O/A
SAFER CHECKOUT RESULTS (Front)	CC 3-10	generic
SAFER STATUS TROUBLESHOOTING (Back)	CC 3-11	generic
DEPRESS/REPRESS		
Nominal Configuration (Front).....	CC A6-2	generic
FAILED LEAK CHECK		
(Back of DEPRESS/REPRESS).....	CC 6-4	generic
SARJ PREP CUE CARD (Front)	FS CC 7-35	EVA-6a/117/O/B
(Back).....	FS CC 7-36	EVA-6b/117/O/B
STS-117 CONSUMABLES TRACKING		
CUE CARD.....	FS CC 10-13	EVA-5a/117/O/B
STS-117 BATTERY RECHARGE PLAN	FS CC 10-14	EVA-5b/117/O/B

This Page Intentionally Blank

CONTENTS

PAGE

10.2 PSI CABIN	1-1
MASK PREBREATHE INITIATE	1-2
PREP FOR 10.2 PSI CABIN	1-3
CABIN DEPRESS TO 10.2 PSI.....	1-4
10.2 PSIA DEPRESS CHART	1-5
10.2 PSI CABIN CONFIG	1-6
MASK PREBREATHE TERMINATE	1-6
10.2 PSI MAINTENANCE.....	1-7
CABIN REPRESS TO 14.7 PSI.....	1-8
14.7 PSI CABIN CONFIG.....	1-9
AIRLOCK CONFIG.....	TEMP FS 2-1
AIRLOCK PREP	TEMP FS 2-2
EMU SWAP.....	2-3
BOOSTER FAN DEACTIVATION/REMOVAL.....	2-4
BOOSTER FAN INSTALLATION/ACTIVATION.....	2-4
EMU REMOVAL	2-4
EMU INSTALLATION	2-4
EMU CHECKOUT PREP.....	TEMP FS 2-5
LTA RESTRAINT STRAP REMOVAL	TEMP FS 2-6
LTA RESTRAINT STRAP INSTALLATION	TEMP FS 2-6
EVA PREP FOR TRANSFER TO ISS.....	FS 2-7
POST-DOCKING EVA TRANSFER/RECONFIG	FS 2-10
FR/SW EMU RECONFIGURATION.....	FS 2-11
POST EVA RECONFIGURATION AND TRANSFER	FS 2-13
EMU SWAP CUE CARD	FS CC 2-17
LTA RESTRAINT STRAP CUE CARD.....	FS CC 2-18
CHECKOUTS.....	3-1
EMU CHECKOUT	3-2
EMU POWERUP AND COMM CHECK.....	3-2
PRIMARY REGULATOR/FAN/PUMP CHECK.....	3-4
SOP CHECK.....	3-5
BATTERY CHARGE CHECK INIT.....	3-6
BATTERY CHARGE CHECK TERM	3-6
EMU SWAP DURING CHECKOUT	3-7
POST EMU C/O RECONFIG.....	3-7
SAFER CHECKOUT	3-8
SELF TEST SEQUENCE	3-9
SAFER CHECKOUT RESULTS.....	CC 3-10
SAFER STATUS TROUBLESHOOTING	CC 3-11
REBA POWERED HARDWARE CHECKOUT	3-12
EVA PREP	4-1
MIDDECK PREP	4-2
EVA PREP.....	4-3
PREP FOR DONNING.....	4-3
EMU DONNING	4-5
EMU CHECK	4-7
EMU PURGE.....	4-7
EMU PREBREATHE	4-8
SAFER DONNING.....	4-8
EVA COMM CONFIG.....	4-10
EVA COMM DECONFIG	4-10
APPROVED NON-EMU HARDWARE MATRIX.....	4-11

EMU STATUS	5-1
EMU STATUS	5-2
DEPRESS/REPRESS	A6-1
DEPRESS/REPRESS (NOM A/L)	CC A6-2
FAILED LEAK CHECK	6-3
FAILED LEAK CHECK (5 PSI)	CC 6-4
FAILED LEAK CHECK (14.7/10.2 PSI)	CC 6-4
TIMELINES	FS 7-1
EVA 1	
EVA 1 SUMMARY TIMELINE	FS 7-3
PRE EVA 1 TOOL CONFIG	FS 7-4
EVA BRIEFING CARD (HC)	FS 7-5
EVA 1 INHIBIT PAD (HC)	FS 7-6
NOTES, CAUTIONS, AND WARNINGS (HC)	FS 7-7
EVA 1 EGRESS/SETUP	FS 7-9
S1-S3 UTILITY TRAY CONNECT	FS 7-10
SABB RESTRAINT RELEASE	FS 7-11
S4 IEA KEEL PIN ROTATE/TA CLAMP RELEASE/ S5 RTAS SOFTDOCK ROTATE	FS 7-12
PVR RADIATOR CINCHES/WINCHES	FS 7-13
SAW BETA GIMBAL RESTRAINT RELEASE	FS 7-14
FWD/AFT (1A/3A) SABB UNSTOW	FS 7-15
AJIS STRUT RIGIDIZATION	FS 7-16
SARJ DLA 2 DEPLOY	FS 7-17
SARJ LAUNCH LOCK REMOVAL	FS 7-18
EVA 1 CLEANUP/INGRESS	FS 7-19
POST EVA 1 TOOL CONFIG	FS 7-20
EVA 1 TASK DATA	FS 7-21
SARJ PREP CUE CARD	FS CC 7-35
EVA 2	
EVA 2 SUMMARY TIMELINE	FS 7-37
PRE EVA 2 TOOL CONFIG	FS 7-38
EVA BRIEFING CARD (HC)	FS 7-39
EVA 2 INHIBIT PAD (HC)	FS 7-40
NOTES, CAUTIONS, AND WARNINGS (HC)	FS 7-41
EVA 2 EGRESS/SETUP FOR SOLAR ARRAY	FS 7-43
2B SOLAR ARRAY RETRACT	FS 7-44
DEPLOY SARJ BRACES	FS 7-46
SARJ DLA 1 INSTALL	FS 7-47
SARJ LAUNCH LOCK/LAUNCH RESTRAINT REMOVAL	FS 7-48
MT/CETA PATH/S4 MMOD SHIELD BOLT RELEASE	FS 7-49
EVA 2 CLEANUP/INGRESS	FS 7-50
POST EVA 2 TOOL CONFIG	FS 7-51
EVA 2 TASK DATA	FS 7-52
EVA 3	
EVA 3 SUMMARY TIMELINE	FS 7-63
PRE EVA 3 TOOL CONFIG	FS 7-64
EVA 3 INHIBIT PAD (HC)	FS 7-65
NOTES, CAUTIONS, AND WARNINGS (HC)	FS 7-67
EVA 3 EGRESS/SETUP	FS 7-69
2B SOLAR ARRAY RETRACT	FS 7-70
S3 KEEL PIN/DRAW LINK STOW	FS 7-72
MT/CETA PATH/S4 MMOD SHIELD BOLT RELEASE	FS 7-73
H2O/H2 VENT VALVE CHANGEOUT	FS 7-75
LAB EWIS ANTENNA INSTALLATION	FS 7-76

NODE/SM LAN CABLE ROUTING.....	FS 7-77
SASA GIMBAL LOCKS	FS 7-78
GPS ANTENNA #4 REMOVAL.....	FS 7-79
CP7 ETVCG STANCHION INSTALLATION.....	FS 7-80
S3 LOWER OUTBOARD PAS DEPLOY	FS 7-81
EVA 3 CLEANUP/INGRESS.....	FS 7-83
POST EVA 3 TOOL CONFIG	FS 7-84
EVA 3 TASK DATA.....	FS 7-85
TOOLS AND STOWAGE	TEMP FS 8-1
PGT CHECKOUT	8-3
PGSC-PGT CONNECTION (A31P AND 760XD).....	8-4
PROGRAM PGT SETTINGS.....	8-5
DOWNLOAD/ERASE EVENT LOG.....	8-5
PGT CONTINGENCIES.....	8-6
TOOLBOX STOWAGE	FS 8-7
TOOLBOX PANEL AND SLOT LABELS.....	FS 8-8
Z1 TOOLBOX INTERNAL LAYOUT	FS 8-9
AIRLOCK TOOLBOX INTERNAL LAYOUT.....	FS 8-10
POST EVA	9-1
POST EVA.....	9-2
SUIT DOFFING.....	9-2
SAFER DOFFING.....	9-2
EMU WATER RECHARGE.....	9-3
SAFER STOW	9-4
SUIT DRYING/SEAL WIPE	9-4
OXYGEN RECHARGE VERIFICATION	9-4
WATER FILL VERIFICATION.....	9-4
EMU POWERDOWN/OVERNIGHT STOW.....	9-5
EMU MAINT/RECHARGE.....	TEMP FS 10-1
WATER RECHARGE	TEMP FS 10-2
EMU POWERUP	TEMP FS 10-2
WATER FILL.....	TEMP FS 10-2
WATER FILL VERIFICATION.....	TEMP FS 10-2
EMU LiOH CHANGEOUT	10-4
MIDDECK EMU BATTERY RECHARGE (STAND-ALONE).....	10-4a
MIDDECK EMU BATTERY RECHARGE/LiOH REPLACEMENT	10-5
INITIATE	10-5
TERMINATE	10-6
IN-SUIT EMU BATTERY RECHARGE/CHARGE VERIFICATION	10-7
INITIATE	10-7
TERMINATE	10-7
EMU POWERDOWN.....	10-7
HELMET LIGHT/PGT BATTERY RECHARGE	10-8
INITIATE	10-8
TERMINATE.....	10-9
REBA BATTERY INSTALLATION.....	10-9
EMU BATTERY REMOVAL/INSTALL.....	10-10
HELMET LIGHT BULB CHANGEOUT	10-11
REBA BATTERY RECHARGE	10-12
INITIATE	10-12
TERMINATE	10-12
STS-117 CONSUMABLES TRACKING CUE CARD	FS CC 10-13
STS-117 BATTERY RECHARGE PLAN	FS CC 10-14
STS-117 LOGISTICS OVERVIEW.....	FS 10-15

POST EVA ENTRY PREP	11-1
POST EVA ENTRY PREP	11-2
SAFER ENTRY STOW	11-2
POST ISS EVA ENTRY PREP	11-3
SAFER ENTRY STOW	11-3
<u>OFF-NOMINAL PROCEDURES</u>	12-i
EMU CONTINGENCY PROCS	TEMP FS 12-1
DISPLAY LOSS DURING POWER TRANSFER (WARM RESTART) ...	TEMP FS 12-2
VACUUM H2O RECHARGE (MANNED)	TEMP FS 12-2
LiOH REPLACEMENT (MANNED)	12-3
BATTERY REPLACEMENT (MANNED)	12-4
WATER DUMP	12-6
SCU SWAP (UNMANNED)	12-7
SCU SWAP (MANNED)	12-7
EMU COLD RESTART (MANNED)	12-7
12.1 STS EVA DECONTAMINATION	12-8
CONTAMINATION TEST	12-15
SAFER BATTERY CHANGEOUT	12-18
BENDS TREATMENT ADAPTER (BTA) INSTALLATION (IN-SUIT)	12-19
BTA PREP	12-19
BTA TREATMENT	12-19
BENDS TREATMENT ADAPTER (BTA) INSTALLATION (POST	
SUIT DOFFING)	12-21
BTA PREP	12-21
BTA TREATMENT	12-21
EMU RESIZE	12-24
STS-117 NOMINAL EMU SIZING	FS 12-27
STS-117/13A EMU CONTINGENCY RESIZE MATRIX	FS 12-29
 TPS REPAIR	 FS 13-1
 ORBITER CONTINGENCY EVA	 14-1
PAYLOAD BAY EVA NOMENCLATURE	14-2
RMS/PRLA CONTINGENCY EVA	14-3
96 BOLT PRE-EVA TOOL CONFIG	14-13
96 BOLT EVA TIMELINE	14-14
CAPTURE LATCH MANUAL RELEASE (ODS/PMA)	14-19
96 BOLT EVA LAYOUT	14-21
PLBD LATCH TOOL PLACEMENT WITH DUAL LATCH GANG FAILURES	14-22
 EVA CUFF CHECKLIST (CIL)	 15-1
NORMAL EVA STATUS	15-2
DCM CONFIGURATION	15-2
EMU MALFUNCTION INDEX	15-2
DECOMPRESSION SICKNESS (DCS)	15-3
DECOMPRESSION SICKNESS (DCS) (CONT)	15-3
ABORT EVA	15-3
TERMINATE EVA	15-3
SUIT P EMERG	15-4
SOP O2 ON	15-4
BATT AMPS HIGH	15-4
BATT V DECAY OR BATT VDC LOW	15-4
SUIT P LOW	15-5
SUIT P HIGH	15-5
SOP P LOW	15-5

O2 USE HIGH	15-5
SUBLM PRESS	15-6
H2O GP LOW	15-6
RESRV H2O ON	15-6
H2O WP HIGH	15-6
NO VENT FLOW	15-7
CO2 HIGH OR MONITOR CO2	15-7
CO2 SNSR BAD	15-7
COMM FAILURE	15-7
AIR FLOW CONTAMINATION	15-8
LOSS OF COOLING	15-8
RLF V FAIL	15-8
MISC MSGS 1	15-8
MISC MSGS (CONT)/TIME LF	15-9
AIRLOCK LATCH DISCONNECT	15-9
AIRLOCK INGRESS	15-9

FOLLOWING PAGES NOT IN EV CUFF

RADIATOR ACTUATOR DISCONNECT	15-9
PLBD DRIVE CUT	15-10
DOOR DRIVE RESTRAINT	15-10
DOOR DRIVE DISCONNECT	15-10
WINCH OPERATIONS	15-10
WINCH OPERATIONS (CONT)	15-11
3-PT TOOL INSTALLATION	15-11
CL LATCH TOOL	15-11
RMS JOINT ALIGN	15-11
MPM STOW/DEPLOY	15-12
RMS TIEDOWN	15-12
RMS FLIGHT RELEASABLE GRAPPLE FIXTURE RELEASE	15-12
PRLA OPEN/CLOSE	15-12
PRLA OPEN/CLOSE (CONT)	15-13
KU ANTENNA STOW	15-13
KU ANTENNA STOW (CONT)	15-13
AIRLOCK EGRESS	15-13

FLIGHT SPECIFIC REFERENCE 16-i

UNSCHEDULED/CONTINGENCY EVA TASKS	TEMP FS 16-1
13A WORKAROUNDS CRIBSHEET	TEMP FS 16-2
S1-S3 CAPTURE LATCH OVERRIDE	FS 16-13
S1-S3 MBA BOLT OVERRIDE	FS 16-19
S1-S3 SSAS CONTINGENCY BOLT INSTALL	FS 16-23
MANUAL OVERRIDE TO UNLATCH/LATCH (TENSION) SABB	FS 16-25
MANUAL RELEASE OF SABB RESTRAINT PINS	FS 16-27
MANUAL OVERRIDE TO EXTEND/RETRACT MAST	FS 16-30
SABB SPOOL RE-TENSION	FS 16-33
EVA ASSISTED DEPLOYMENT OF S4 SAW	FS 16-39
SSRMS JOINT DRIVE	FS 16-42
MANUAL SAW JETTISON	FS 16-47
BDCU BACKOUT	FS 16-53
REMOVE AND REPLACE DCSU	FS 16-56
REMOVE AND REPLACE PVCU LOWER	FS 16-61
MDM REMOVE AND REPLACE	FS 16-64
CANADIAN REMOTE POWER CONTROL MODULE (CRPCM) REMOVE/REPLACE	FS 16-68

MBSU REMOVE/REPLACE	FS 16-72
REMOVE AND REPLACE PFCS	FS 16-79
GENERIC EVA REFERENCE.....	17-1
FLIGHT SPECIFIC EVA REFERENCE.....	FS 18-1
TRUSS SSAS COMPONENTS AT READY-TO-LATCH (RTL) POSITION...	FS 18-3
BGA PRIMARY POWER CABLE CLAMPS	FS 18-4
RELEASE BETA GIMBAL LAUNCH RESTRAINTS	FS 18-5
FOUR BAR IN LOCKED POSITION	FS 18-6
SABB UNSTOW	FS 18-7
4-BAR STOWED AND DEPLOYED CONFIGURATIONS	FS 18-10
MAST CANISTER MDA	FS 18-11
SARJ DLA EVA BOLT CONFIG.....	FS 18-12
P4 UPPER ORU AND CABLE BOX NUMBERS.....	FS 18-13
P4 LOWER ORU AND CABLE BOX NUMBERS	FS 18-14
P6 UPPER ORU AND CABLE BOX NUMBERS.....	FS 18-15
P6 LOWER ORU AND CABLE BOX NUMBERS	FS 18-16
PRD USE FOR 4-BAR DEPLOY	FS 18-17
ESP-2 HANDRAILS AND WIFs – ZENITH.....	FS 18-18
ESP-2 HANDRAILS AND WIFs – NADIR	FS 18-19
CETA CART – TOP VIEW.....	FS 18-20
CETA SWINGARM AND WIF MARKINGS	FS 18-21
CETA CART COUPLERS	FS 18-22
STATUS INDICATORS (MBSU, DDCU, BCDU).....	FS 18-23
<u>EVA EMERGENCY</u>	19-i
EMERGENCY PROCEDURES.....	19-1
EMERGENCY AIRLOCK REPRESS	19-3
EMERGENCY AIRLOCK REPRESS.....	19-4
POST EMERGENCY AIRLOCK REPRESS	19-4
SAFER RESCUE.....	19-5
SAFER RESCUE	19-6
DAP/EVA RESCUE/RETRIEVE	19-7
EVA ORBITER CONFIG.....	19-7
EVA RESCUE/RETRIEVE.....	19-9
19.1 DCS TREATMENT	19-10
CUE CARD CONFIGURATION	20-1

AIRLOCK CONFIG

AIRLOCK PREP TEMP FS 2-2
EMU SWAP 2-3
BOOSTER FAN DEACTIVATION/REMOVAL 2-4
BOOSTER FAN INSTALLATION/ACTIVATION 2-4
EMU REMOVAL 2-4
EMU INSTALLATION 2-4
EMU CHECKOUT PREP TEMP FS 2-5
LTA RESTRAINT STRAP REMOVAL TEMP FS 2-6
LTA RESTRAINT STRAP INSTALLATION TEMP FS 2-6
EVA PREP FOR TRANSFER TO ISS FS 2-7
POST-DOCKING EVA TRANSFER/RECONFIG FS 2-10
FR/SW EMU RECONFIGURATION FS 2-11
POST EVA RECONFIGURATION AND TRANSFER FS 2-13
EMU SWAP CUE CARD FS CC 2-17
LTA RESTRAINT STRAP CUE CARD FS CC 2-18

AIRLOCK
CONFIG

AIRLOCK PREP (50 min)

MF28G	Retrieve or unstow following equipment:
IFM Tool Kit	3/8-in breaker bar, 4-in ext w/3/8-in drive
Vol H	1/2-in socket w/3/8-in drive
	EMU Equipment Bag – attach to middeck wall
	Helmet Lights
	EVA Bag
	Contamination Detection Kit (location flight specific)
FDF Locker	Cuff Checklists (2) – stow in EMU Equipment Bag
	<u>DEPRESS/REPRESS</u> Cue Card

- AW18A
1. ✓ Inner hatch Equal vlv (two) – OFF
 2. LTG FLOOD (four) – ON
 3. Remove from airlock, as reqd:
 - Airlock Stowage Bag
 - Airlock Floor Pallet using 3/8-in breaker bar, 4-in ext w/3/8-in drive, and 1/2-in socket w/3/8-in drive
 4. Stow Vol H Bags in Vol H
 5. Transfer to airlock:
 - EVA Bag – install on airlock wall
 - DEPRESS/REPRESS Cue Card
 - Helmet Lights
 - Contamination Detection Kit – install on airlock wall
 6. Install IVA foot restraint, as reqd
 7. Unbuckle SCU straps, Velcro SCU to wall
 8. Install EMU lights on helmets (EMU 1, EMU 2)
 9. Disconnect helmets from Airlock EMUs, temp stow
 10. Remove comm caps from LTA Restraint Bags and connect to electrical harnesses
 11. Install helmets (not reqd if proceeding directly to EMU Checkout)
 12. Remove LTA Restraint Bags
 13. Disconnect waist rings; remove and stow any equipment stowed in HUT/LTA
 14. Stow LTA Restraint Bags on AAPs
 15. ✓ Thermal cover clear of waist ring
 16. Waist ring – engage posn
 17. Connect LTA to HUT, lock
 18. Remove 20-g Crash Bag from middeck EMU, as reqd

EMU CHECKOUT PREP (30 min)

- AW18A 1. LTG FLOOD (four) – ON
2. Remove Airlock Stowage Bag from airlock (as reqd)
3. Unbuckle SCU straps, Velcro SCU to wall
4. Disconnect helmets from airlock EMUs, temp stow
5. ✓DIDB restraint bags installed
6. Remove comm caps, s/n 1189 (RY) and s/n 1197 (OL) from LTA restraint bag kangaroo pouches and connect to electrical harnesses (RY backup comm cap s/n 1185 will get stowed in RY ECOK)
7. Remove LTA restraint bags
8. Disconnect waist rings; remove ECOKs, LCVGs
9. Stow RY backup comm cap (s/n 1185) in RY ECOK (LCVGs will be used for EMU Checkout)
10. Retrieve mesh bag labeled “EVA SYSTEMS TRANSFER BAG” from RY ECOK; temp stow ECOKs
- Vol H 11. Unstow:
 - EMU Servicing Kit (s/n 5004) – (tagged for transfer to ISS)
 - EMU Equipment Bag
12. Stow EMU Servicing Kit (s/n 5004) and EMU Equipment Bag Crew Compartments in EVA SYSTEMS TRANSFER BAG
13. Stow LTA restraint bags on AAPs
14. ✓Thermal cover clear of waist ring
15. Waist ring – engage posn
16. Connect LTA to HUT, lock

LTA RESTRAINT STRAP REMOVAL (15 min)

NOTE

May be performed on EMU 1 and 2 simultaneously.
Perform steps as reqd for current EMU config

1. As reqd, remove comm cap from LTA Restraint Bag; temp stow
2. Remove EMU from AAP
3. Disconnect all restraint attachments from SAFER mount brackets (two)
4. Loosen cinch strap mechanism, remove SAFER mount brackets
5. Remove strap from PLSS
6. Stow strap in LTA Restraint Bag Pouch with D-rings (three) connected
7. Engage EMU in AAP
8. Stow LTA Restraint Bag/strap

LTA RESTRAINT STRAP INSTALLATION (15 min)

NOTE

May be performed on EMU 1 and 2 simultaneously. Perform steps as reqd for current EMU config. Procedure written to install in Launch/Landing config shown below

1. Unstow LTA Restraint Bag/strap
2. Remove EMU from AAP
3. Install SAFER mount brackets (two)
4. Install elastic band of strap around SOP
5. Tighten cinch strap mechanism
6. Attach strap French hooks (two) to SAFER mount brackets
7. Engage EMU in AAP
8. Stow LTA, suit arms inside LTA Restraint Bag
9. Connect upper spring hooks (two) over suit shoulders to upper AAP attachment rings (two)
10. Connect lower spring hooks (two) around suit arms to SAFER mount brackets (two)
11. Tighten all LTA bag straps with bag as high as possible on EMU

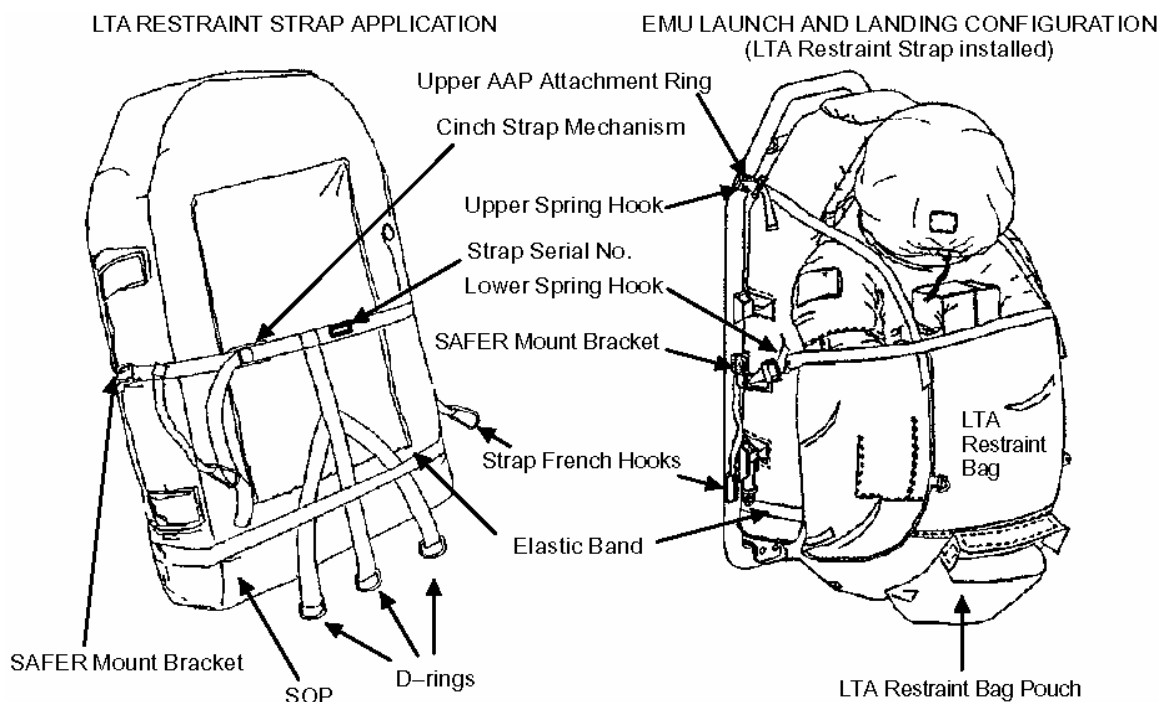

NOTE

French hooks should be attached to SAFER mount brackets for launch and landing

EVA PREP FOR TRANSFER TO ISS (90 min)

EMU PACK-UP (45 min)

- BOTH EMUs
DCM
1. √PWR – SCU
 2. √DCM PURGE vlv – op (up)
 3. √WATER – OFF, switch guard installed
 4. √O2 ACT – OFF
 5. √Helmet sun visors down, cover installed
 6. Retrieve EVA SYSTEMS TRANSFER BAG (was temp stowed earlier)
 7. Configure/verify items stowed in the table below

<p style="text-align: center;"><u>EMU 3010 (L)(RY)</u></p> <ul style="list-style-type: none"> <input type="checkbox"/> Helmet s/n 1072 (with cover) <ul style="list-style-type: none"> <input type="checkbox"/> Valsalva <input type="checkbox"/> Wrist Mirror (2) <input type="checkbox"/> CCA (s/n 1189) <input type="checkbox"/> RY1 Gloves (s/n 6073) <input type="checkbox"/> EMU Battery (s/n 2077) <input type="checkbox"/> LiOH Cartridge (s/n 2028) <input type="checkbox"/> LTA (RY) <input type="checkbox"/> LTA Restraint Strap and Bag 	<p style="text-align: center;"><u>EMU 3004 (L) (OL)</u></p> <ul style="list-style-type: none"> <input type="checkbox"/> Helmet s/n 1068 (with cover) <ul style="list-style-type: none"> <input type="checkbox"/> Valsalva <input type="checkbox"/> Wrist Mirror (2) <input type="checkbox"/> CCA (s/n 1197) <input type="checkbox"/> OL1 Gloves (s/n 6138) <input type="checkbox"/> EMU Battery (s/n 2038) <input type="checkbox"/> LiOH Cartridge (s/n 2030) <input type="checkbox"/> LTA (OL) <input type="checkbox"/> LTA Restraint Strap and Bag
<p style="text-align: center;"><u>EMU Crew Option Kit (RY)</u></p> <ul style="list-style-type: none"> <input type="checkbox"/> ECOK Mesh Bag <ul style="list-style-type: none"> <input type="checkbox"/> LCVG w/biomed (RY1) (s/n 3182) <input type="checkbox"/> RY EVA #1 Ziplock Bag <ul style="list-style-type: none"> <input type="checkbox"/> 2 MAGs <input type="checkbox"/> TCUs (top, bottom) <input type="checkbox"/> Thermal Socks <input type="checkbox"/> Sock Liners <input type="checkbox"/> Comfort Gloves <input type="checkbox"/> Wristlets <input type="checkbox"/> Glasses Retention Device <input type="checkbox"/> Croakie <input type="checkbox"/> 2 Ziplock Bags <input type="checkbox"/> Mole Skin <input type="checkbox"/> Mosite <input type="checkbox"/> RY EVA #3 Ziplock Bag (same as RY EVA #1 plus crew patch) <input type="checkbox"/> RY Contingency Ziplock Bag <ul style="list-style-type: none"> <input type="checkbox"/> 3 MAGs <input type="checkbox"/> Sock Liners <input type="checkbox"/> 2 Ziplock Bags <input type="checkbox"/> Moleskin <input type="checkbox"/> Mosite <input type="checkbox"/> Back-up CCA (comm cap) s/n 1185 	<p style="text-align: center;"><u>EMU Crew Option Kit (OL)</u></p> <ul style="list-style-type: none"> <input type="checkbox"/> ECOK Mesh Bag <ul style="list-style-type: none"> <input type="checkbox"/> LCVG w/biomed (OL1) (s/n 3206) <input type="checkbox"/> OL EVA #1 Ziplock Bag <ul style="list-style-type: none"> <input type="checkbox"/> 2 MAGs <input type="checkbox"/> TCUs (top, bottom) <input type="checkbox"/> Thermal Socks <input type="checkbox"/> Comfort Gloves <input type="checkbox"/> Wristlets <input type="checkbox"/> 2 Ziplock Bags <input type="checkbox"/> OL EVA #3 Ziplock Bag (same as OL EVA #1 plus crew patch) <input type="checkbox"/> OL Contingency Ziplock Bag <ul style="list-style-type: none"> <input type="checkbox"/> 3 MAGs <input type="checkbox"/> 2 Ziplock Bags <input type="checkbox"/> Spare mesh bag

EVA PREP FOR TRANSFER TO ISS (90 min) (Cont)

<u>EMU Crew Option Kit (FR)</u>	<u>EMU Crew Option Kit (SW)</u>
<input type="checkbox"/> ECOK Mesh Bag <input type="checkbox"/> FR EVA #2 Ziplock Bag <input type="checkbox"/> 2 MAGs <input type="checkbox"/> TCUs (top, bottom) <input type="checkbox"/> Comfort Gloves, Thick <input type="checkbox"/> Comfort Gloves, Thin <input type="checkbox"/> Wristlets <input type="checkbox"/> Sock Liners <input type="checkbox"/> Modified Croakie <input type="checkbox"/> 2 Ziplock Bags <input type="checkbox"/> Moleskin <input type="checkbox"/> Mosite <input type="checkbox"/> EV-3 Crew ID stripes <input type="checkbox"/> Mission patch and flag <input type="checkbox"/> FR EVA #4 Ziplock Bag (same as FR EVA #2, no stripes, no flag) <input type="checkbox"/> FR Spares Bag	<input type="checkbox"/> ECOK Mesh Bag <input type="checkbox"/> SW EVA #2 Ziplock Bag <input type="checkbox"/> 2 MAGs <input type="checkbox"/> TCUs (top, bottom) <input type="checkbox"/> Comfort Gloves, Thick <input type="checkbox"/> Comfort Gloves, Thin <input type="checkbox"/> Wristlets <input type="checkbox"/> Tube Socks <input type="checkbox"/> Glasses Retention Device <input type="checkbox"/> 2 Ziplock Bags <input type="checkbox"/> EV-4 Crew ID stripes <input type="checkbox"/> Mission patch and flag <input type="checkbox"/> SW EVA #4 Ziplock Bag (same as SW EVA #2, no stripes, no flag) <input type="checkbox"/> SW Spares Bag <input type="checkbox"/> Crew Prefs Bag

8. Stow LTA, suit arms inside LTA Restraint Bag
9. Connect upper spring hooks (two) over suit shoulders to upper AAP attachment rings (two)
10. Connect lower spring hooks (two) around suit arms to SAFER mount brackets (two)
11. Tighten all LTA bag straps with bag as high as possible on EMU
12. Gather items and pack EVA Systems Transfer Bag per table below

EVA SYSTEMS TRANSFER BAG
Vol H – Previously gathered <input type="checkbox"/> EMU Servicing Kit (S/N 5004, For Xfer to ISS) <input type="checkbox"/> EMU Equipment Bag Crew Compartments
External Airlock Floor Bag <input type="checkbox"/> 8 DIDBs <input type="checkbox"/> Small Shuttle Trash Bag (2) (s/n 1003, 1010) <input type="checkbox"/> 5/8 (rigid) Socket-7.8 ext (s/n 1009) <input type="checkbox"/> Spare 85-ft safety tether (s/n 1001)
Drug Subpack (MF28H) <input type="checkbox"/> Aspirin
Middeck Locker (MA16G) <input type="checkbox"/> CSA-O2 Monitor (2) (s/n 1056, 1059)
FDF/SODF Shared Locker (MF57K) <input type="checkbox"/> Ziplock bag labeled “EVA Procedures/Cue Cards” Verify contents: <input type="checkbox"/> STS-117 Consumables Tracking Cue Card (1 of 1) <input type="checkbox"/> STS-117 EMU Swap Cue Card (1 of 1) <input type="checkbox"/> STS EVA Checklist (1 of 3) <input type="checkbox"/> ISS EVA Systems Checklists (2 of 2) <input type="checkbox"/> Ziplock bag labeled “ISS EVA Cuff Checklists” <input type="checkbox"/> STS-117 ISS EVA Cuff Checklists (4 of 4)
Crew Personal Notes <input type="checkbox"/> Crew personal items to be in airlock for campout
WCS <input type="checkbox"/> Towels <input type="checkbox"/> Hygiene Items

EVA PREP FOR TRANSFER TO ISS (90 min) (Cont)

13. Verify contents of External Airlock Floor Bag per table below

EXTERNAL AIRLOCK FLOOR BAG
<input type="checkbox"/> 3 LiOH Cartridges (CCC) (s/n 2015, 2017, 2031)
<input type="checkbox"/> FR EMU Crew Options Kit (ECOK)
<input type="checkbox"/> FR1 LCVG w/biomed
<input type="checkbox"/> FR1 CCA (s/n 1065)
<input type="checkbox"/> FR1 prime gloves
<input type="checkbox"/> SW EMU Crew Options Kit (ECOK)
<input type="checkbox"/> SW1 LCVG w/biomed (s/n 3154)
<input type="checkbox"/> SW1 CCA (s/n 1023)
<input type="checkbox"/> SW1 prime gloves
<input type="checkbox"/> EMU Lower Arms – SW back-up (s/n 319/320)
<input type="checkbox"/> EMU Batteries (s/n 2039, 2040)
<input type="checkbox"/> Compound Cutters/Needle Nose Pliers Caddy (w/Kapton Tape) (s/n 101)
<input type="checkbox"/> Velcro/Tape Caddy (s/n 1007)
<input type="checkbox"/> Wire Tie Caddy (s/n 1001)
<input type="checkbox"/> Loop Pin Puller Caddy (w/Kapton Tape) (s/n 101)
<input type="checkbox"/> EVA Punch Tool (s/n 1001)
<input type="checkbox"/> SLR Torque Multiplier (s/n xxxx) – transfer here from MF710

14. Report to MCC-H when complete with EVA Prep for Transfer to ISS

POST-DOCKING EVA TRANSFER/RECONFIG (60 min)

NOTE

This procedure assumes that transfer items were reconfigured per EVA PREP FOR TRANSFER TO ISS procedure

EMU/TOOL TRANSFER TO ISS (15 min)

1. Transfer following EMU equipment to ISS per table:

Item	Destination	Transfer Status
STS-117 EVA Hardware		
EMU 3010 (RY)	E-Lk aft EDDA	
EMU 3004 (OL)	E-Lk fwd EDDA	
EVA Systems Transfer Bag	E-Lk	
External Airlock Floor Bag	E-Lk	

2. Report transfer status to MCC-H

CAUTION

Do NOT install METOX in the Airlock CO2 Removal Box at this point in the timeline

EVA Sys
Transfer Bag

3. Unstow the following items and position in E-Lk for Campout:

- STS-117 Consumables Tracking Cue Card
- STS-117 ISS EVA Checklist
- CSA-O2 Monitors (2)
- Crew Preference and Hygiene Items
- 2.0 CTB s/n 1060 (Regenerated Metox)

M02 Bag

E-Lk

4. Locate the EV1/3 and EV2/4 bags and verify each bag contains the items in the list below

EV1/3 Bag,
EV2/4 Bag

- Helmet Light Batteries (4)
- PGT Battery (1) – loose in bag or with PGTs
- REBA Battery (1)
- Old ISS EMU Servicing Kit (in bag or attached to E-Lk wall)

5. Perform EVA 1 Tool Config as time permits

FR/SW EMU RECONFIGURATION (40 min)

EMU 3018 RECONFIG FOR FORRESTER (15 min)

NOTE

Reconfig can be performed as late as FD5. Steps 1-14 and steps 15-28 can be performed in parallel

1. Install EMU (s/n 3018, M, FR) in EDDA, as reqd to assist with config
2. Attach FR1 gloves, lock
3. Install ISS EVA Cuff Checklist, √wrist mirrors installed
4. Install STS-117 mission patch, EV3 (broken) ID stripes, USA flag
5. Verify cam configurations per EMU NOMINAL SIZING (STS-117/13A) (EMU CONT PROCS)
6. Rotate EDDA open, as reqd
7. Unzip PLSS thermal cover and Velcro to top
8. Verify METOX canister installed per STS-117 CONSUMABLES TRACKING CUE CARD
9. Install EMU battery from External Airlock Floor Bag per STS-117 CONSUMABLES TRACKING CUE CARD
10. √REBA installed per STS-117 CONSUMABLES TRACKING CUE CARD
11. Verify REBA connected to power harness with pull test
12. √All latches locked, zip thermal cover closed
13. Install/replace valsalva (as reqd)
14. Reconfig ISS EMU Equipment Bag crew compartment (1 of 2) with items from FR ECOK:
 - Comfort Gloves
 - FR1 CCA
 - Wristlets

EMU 3006 RECONFIG FOR SWANSON (15 min)

15. Install EMU (s/n 3006, L, SW) in EDDA, as reqd to assist with config
16. Attach SW1 gloves, lock
17. Install ISS EVA Cuff Checklist, √wrist mirrors installed
18. Install STS-117 mission patch, EV4 (bp) ID stripes, USA flag
19. Verify cam configurations per EMU NOMINAL SIZING (STS-117/13A) (EMU CONT PROCS)
20. Rotate EDDA open, as reqd
21. Unzip PLSS thermal cover and Velcro to top
22. Verify METOX canister installed per STS-117 CONSUMABLES TRACKING CUE CARD
23. Install EMU battery from External Airlock Floor Bag per STS-117 CONSUMABLES TRACKING CUE CARD
24. √REBA installed per STS-117 CONSUMABLES TRACKING CUE CARD
25. Verify REBA connected to power harness with a pull test
26. √All latches locked, zip thermal cover closed
27. Install/replace valsalva (as reqd)
28. Reconfig ISS EMU Equipment Bag crew compartment (1 of 2) with items from SW ECOK:
 - Comfort Gloves
 - SW1 CCA
 - Wristlets

FR/SW EMU RECONFIGURATION (40 min) (Cont)

FR/SW HEATED GLOVE CHECKOUT (10 min)

NOTE

The heated glove checkout can be performed serially or in parallel for both EMU 3018 and 3006

- EMU 3018, 29. ✓REBA sw (1 per EMU) – OFF (toward left arm of suit)
- EMU 3006 30. ✓Upper arm connections mated
- 31. ✓Glove heater sw (one per glove) – OFF
- 32. Connect lower arm pwr harness to gloves

NOTE

To avoid excessive battery consumption and heat buildup, deactivate heaters once heat detected at fingertips

- 33. REBA sw (1 per EMU) – ON, pull tab toward right arm of suit
 - 34. Glove heater sw (one per glove) – ON
- When heat detected on all outside fingertips:
- 35. Glove heater sw (one per glove) – OFF
 - 36. REBA sw (1 per EMU) – OFF, pull tab toward left arm of suit
 - 37. Disconnect lower arm pwr harness from gloves
 - 38. Stow lower arm and glove pwr harness connectors under TMG
39. As comm permits, report completion of EMU reconfig to MCC-H

POST EVA RECONFIGURATION AND TRANSFER (120 min)

I

EMU RECONFIGURATION FOR TRANSFER

- Node 1. Unstow EMU batteries s/n 2031 and s/n 2036 from EMU Temp Stow Bag
- PLSS 2. Unzip thermal cover for EMUs 3010 (RY), 3004 (OL)
- 3. √Expended LiOH (s/n 2015, 2017) installed
- DCM 4. √sw POWER – SCU
- EMU 3010 5. Remove used EMU batteries (s/n 2077, 2038) from EMUs 3010 and 3004; stow
- EMU 3004 in 0.5 CTB labeled EMU Batteries in M-02 bag (s/n 1038)
- 6. Install EMU battery s/n 2031 in EMU 3010, and EMU battery s/n 2036 in EMU 3004
- 7. Engage latch
- 8. √sw (pulltab) REBA – OFF
- 9. Disconnect EMU Power Harness (P1) from REBA (J1)
- 10. Remove REBAs from EMUs 3010 and 3004
- 11. Install REBA J1 fabric cover
- 12. Stow REBAs in M-02 bag (s/n 1038)
- PLSS 13. Close thermal cover zipper on EMUs 3010 and 3004
- 14. Remove helmet lights and EMU TV from EMUs 3010 and 3004; temp stow
- 15. Remove Cuff Checklists, stow in EVA Systems Transfer Bag
- 16. √No tools or tethers installed on EMU 3010 or EMU 3004
- 17. Remove LTA Restraint Straps and Restraint Bags from RY and OL ECOKs
- 18. On EMUs 3010 and 3004, remove helmet, disconnect CCA from electrical harness, connect helmet to HUT, lock, install helmet cover
- 19. Remove CCA (comm cap) from RY ECOK
- Node 20. Retrieve OL back-up CCA (s/n 1177) EMU Temp Stow Bag
- 21. Stow prime and backup RY CCAs in RY LTA Restraint Bag kangaroo pouch, and prime and backup OL CCAs in OL LTA Restraint Bag kangaroo pouch (can be performed after LTA Restraint Bag installation if desired)
- 22. Verify RY and OL ECOKs contain, at most, items listed in Table 1 (some items may be in clothes hamper)

EMU Crew Options Kit (RY)	EMU Crew Options Kit (OL)
<input type="checkbox"/> ECOK Mesh Bag <ul style="list-style-type: none"> <input type="checkbox"/> LCVG w/biomed (RY1) (s/n 3182) <input type="checkbox"/> RY EVA #1 Ziplock Bag <ul style="list-style-type: none"> <input type="checkbox"/> Glasses Retention Device <input type="checkbox"/> 2 Ziplock Bags <input type="checkbox"/> RY EVA #3 Ziplock Bag (same as RY EVA #1) <input type="checkbox"/> RY Contingency Ziplock Bag <ul style="list-style-type: none"> <input type="checkbox"/> 3 MAGs <input type="checkbox"/> Sock Liners <input type="checkbox"/> 2 Ziplock Bags <input type="checkbox"/> Moleskin <input type="checkbox"/> Mosite <input type="checkbox"/> EV Crew ID tags 	<input type="checkbox"/> ECOK Mesh Bag <ul style="list-style-type: none"> <input type="checkbox"/> LCVG w/biomed (OL1) (s/n 3206) <input type="checkbox"/> OL EVA #1 Ziplock Bag <ul style="list-style-type: none"> <input type="checkbox"/> 2 Ziplock Bags <input type="checkbox"/> OL EVA #3 Ziplock Bag (same as OL EVA #1) <input type="checkbox"/> OL Contingency Ziplock Bag <ul style="list-style-type: none"> <input type="checkbox"/> 3 MAGs <input type="checkbox"/> 2 Ziplock Bags <input type="checkbox"/> EV Crew ID tags

Table 1. RY and OL ECOK Contents

- 23. On EMUs 3010 and 3004, disconnect LTAs
- 24. Stow RY ECOK in EMU 3010 and OL ECOK in EMU 3004

POST EVA RECONFIGURATION AND TRANSFER (120 min) (Cont)

25. Connect LTAs to HUTs, and verify final configuration of both EMUs per lists below:

EMU 3010 (L) FINAL RETURN CONFIG	EMU 3004 (L) FINAL RETURN CONFIG
<input type="checkbox"/> EMU 3010 – L <input type="checkbox"/> EMU Battery 2031 <input type="checkbox"/> LiOH s/n 2015 <input type="checkbox"/> Gloves (RY1) <input type="checkbox"/> Mesh Bag (ECOK) (RY) <input type="checkbox"/> LCVG (RY1) <input type="checkbox"/> LTA (RY) <input type="checkbox"/> Patches, Stripes, Flag <input type="checkbox"/> Wrist Mirrors (2) <input type="checkbox"/> Helmet (S/N 1072) <input type="checkbox"/> Helmet cover installed <input type="checkbox"/> O2 ACT – OFF <input type="checkbox"/> PWR – SCU <input type="checkbox"/> DCM Purge vlv – Op (up) <input type="checkbox"/> WATER – OFF <input type="checkbox"/> WATER Switch Guard installed <input type="checkbox"/> <u>No</u> Tethers/Tools <input type="checkbox"/> <u>No</u> EMU TV, Helmet Lights or REBA	<input type="checkbox"/> EMU 3004 – L <input type="checkbox"/> EMU Battery 2036 <input type="checkbox"/> LiOH s/n 2017 <input type="checkbox"/> Gloves (OL1) <input type="checkbox"/> Mesh Bag (ECOK) (OL) <input type="checkbox"/> LCVG (OL1) <input type="checkbox"/> LTA (OL) <input type="checkbox"/> Patches, Stripes, Flag <input type="checkbox"/> Wrist Mirrors (2) <input type="checkbox"/> Helmet (S/N 1068) <input type="checkbox"/> Helmet cover installed <input type="checkbox"/> O2 ACT – OFF <input type="checkbox"/> PWR – SCU <input type="checkbox"/> DCM Purge vlv – Op (up) <input type="checkbox"/> WATER – OFF <input type="checkbox"/> WATER Switch Guard installed <input type="checkbox"/> <u>No</u> Tethers/Tools <input type="checkbox"/> <u>No</u> EMU TV, Helmet Lights or REBA

26. Install LTA Restraint Strap and Restraint Bag on EMUs 3010 and EMU 3004. Reference LTA Restraint Strap Installation (LTA RESTRAINT STRAP CUE CARD) for diagrams as needed
27. Remove EMUs from EDDAs and temp stow EMU 3010 and EMU 3004 in Node (will be transferred to shuttle middeck at the end of this procedure)

FR AND SW EMU CONFIG FOR UNDOCK

EMU 3006,
EMU 3018

28. Install EMUs 3006 and 3018 in EDDAs as reqd
29. Remove following items from both EMU 3006 and 3018; stow in External Airlock Floor Bag for return to Shuttle:
- EMU Gloves
 - CCA (comm cap)
 - Mission Patch, Flag, EV Crew Identifier Stripes
30. Remove EVA Cuff Checklist from EMU 3006 and EMU 3018; stow in EVA Systems Transfer Bag
31. Remove boots from EMU 3018 (FR), then remove 0.5-in leg rings (s/n 118/119); re-attach boots, lock
32. Connect rings together, lock
33. Retrieve 0.5-in leg ring protective pouch from EMU Temp Stow Bag; stow rings inside, close pouch. Stow in Shuttle External Airlock Floor Bag

POST EVA RECONFIGURATION AND TRANSFER (120 min) (Cont)

EMU SYSTEMS TRANSFER BAG RECONFIGURATION FOR TRANSFER

34. Swap or transfer following hardware per Table 2 below:

ITEM #	ITEM	CURRENT LOCATION	DESTINATION	STATUS
1	1 pr EMU Lower Arms (s/n 319/320)	External A/L Floor Bag	EMU Soft Goods M-02 bag (s/n 1010)	
2a	EMU Servicing Kit (s/n 5004, Xfer to ISS)	EVA Systems Transfer Bag	EVA Prep and Ops M-02 bag (s/n 1038)	
2b	EMU Servicing Kit (s/n 5002)	E-Lk Wall or EVA Prep and Ops M-02 bag (s/n 1038)	EVA Systems Transfer Bag	
3a	Velcro/Tape Caddy (s/n 1007)	External A/L Floor Bag	Crewlock Staging Bag	
3b	Velcro/Tape Caddy (s/n 1019)	Crewlock Staging Bag	External Airlock Floor Bag	
4	5/8 (rigid) Socket – 7.8-in ext (s/n 1009)	Crewlock Bag #1	Leave in Crewlock Bag #1 for ISS unstow	
5	EVA Punch Tool (s/n 1001)	External A/L Floor Bag	Mesh Bag: IV Tools	
6	CSA-O2 (2) (s/n 1056, 1059)	E-Lk Wall	Leave on E-Lk Wall	

Table 2. EVA Systems Transfer Items

35. Configure/verify final contents of EVA Systems Transfer Bags per Table 3 below. Report any additional or missing hardware to MCC

EVA SYSTEMS TRANSFER BAG
<input type="checkbox"/> Aspirin (if any left over after EVAs)
<input type="checkbox"/> <u>STS-117 CONSUMABLES TRACKING CUE CARD</u>
<input type="checkbox"/> 1 STS-117 EVA Checklist
<input type="checkbox"/> 2 ISS EVA Systems Checklists (STS-117 copies)
<input type="checkbox"/> 4 STS-117 ISS Cuff Checklists
<input type="checkbox"/> 1 SYS-117 EMU Swap Cue Card
<input type="checkbox"/> STS EMU Equipment Bag Crew Compartments (2)
<input type="checkbox"/> EMU Servicing Kit (s/n 5002)
<input type="checkbox"/> Towels (brought over from WCS)

Table 3. EVA Systems Transfer Bag Final Configuration

POST EVA RECONFIGURATION AND TRANSFER (120 min) (Cont)

36. Configure/verify final contents of External Airlock Floor Bag per Table 4 below. Report any additional or missing hardware to MCC

EXTERNAL AIRLOCK FLOOR BAG	
<input type="checkbox"/>	3 LiOH Cartridges (CCC) (s/n 2028, 2030, 2031)
<input type="checkbox"/>	FR ECOK
<input type="checkbox"/>	FR1 LCVG w/biomed
<input type="checkbox"/>	FR1 CCA (s/n 1169)
<input type="checkbox"/>	FR1 prime gloves
<input type="checkbox"/>	SW ECOK
<input type="checkbox"/>	SW1 LCVG w/biomed (s/n 3154)
<input type="checkbox"/>	SW1 CCA (s/n 1168)
<input type="checkbox"/>	SW1 prime gloves
<input type="checkbox"/>	Small Shuttle Trash Bag (2) (s/n 1003, 1010)
<input type="checkbox"/>	SLR Torque Multiplier (s/n xxxx)
<input type="checkbox"/>	Compound Cutters/Needle Nose Pliers Caddy (w/Kapton Tape) (s/n 101)
<input type="checkbox"/>	Loop Pin Puller (w/Kapton Tape) and caddy (s/n 101)
<input type="checkbox"/>	Wire Tie Caddy (s/n 1001)
<input type="checkbox"/>	Spare 85 ft safety tether (s/n 1001)
<input type="checkbox"/>	EMU 0.5" leg sizing rings (sn 118/119) in protective pouch
<input type="checkbox"/>	EMU Batteries (s/n 2059, 2060) – Returning ISS batteries via Transfer List
<input type="checkbox"/>	Velcro/Tape caddy (s/n 1019) – Returning ISS caddy

Table 4. External Airlock Floor Bag Return Configuration

TRANSFER AND STOW

37. Transfer the items in Table 5 to Shuttle

Item	Destination	Transfer Status
EMU 3010 (L) with ECOK	Temp stow Middeck	
EMU 3004 (L) with ECOK	Temp stow Middeck	
EVA Systems Transfer Bag	Temp stow Middeck	
EVA Laundry Bag	Temp stow Middeck	
External Airlock Floor Bag	External Airlock	

Table 5. Transfer to Shuttle

EVA UNPACK AND STOW (15 min)

38. Unpack and stow items from EVA Systems Transfer Bag per Table 6 below; report status to MCC when complete:

Current Location	Item	Final Stowage Location	Status
EVA Systems Transfer Bag	Aspirin	Drug subpack (MF28H)	
–	STS-117 Consumables Tracking Cue Card	FDF/SODF Locker (MF57K)	
–	STS EVA Checklists (1)	FDF/SODF Locker (MF57K)	
–	ISS EVA Systems Checklists (2)	FDF/SODF Locker (MF57K)	
–	STS-117 EMU Swap Cue Card	FDF/SODF Locker (MF57K)	
–	4 STS-117 ISS Cuff Checklists	FDF/SODF Locker (MF57K)	
–	Towels (as required)	Crew pref	
–	EMU Servicing Kit (s/n 5002)	Volume H Inboard	
–	EMU Equipment Bag Crew Compartments	Volume H Outboard	
-	Empty Systems Transfer Bag	FR ECOK in Ext A/L Flr Bag	

Table 6. EVA Systems Transfer Bag Unpack and Stow

TOP

HOOK
VELCRO

EMU SWAP CUE CARD

Outgoing
EMUs

- √O2 ACT – OFF
- √WATER – OFF
- √PWR – SCU
- Remove EMUs from EDDAs
- Stow EMU Equipment Bag Crew Compartments in ECOKs
- Stow EMUs and ECOKs in Node, bundle as reqd

Incoming
EMUs

- Install EMUs in EDDAs
- Swap Helmet Lights/WVS assembly onto helmets
- Remove helmet, verify CCA connected to electrical harness
- Install/replace valsalva (as reqd)
- √Cuff checklist, wrist mirrors installed
- √O2 ACT – OFF
- √WATER – OFF
- √PWR – SCU
- Stow ECOKs in E-Lk
- Configure EMU Equipment Bag Crew Compartments as reqd

EVA-7a/117/O/A

TOP
Back of 'EMU SWAP CUE CARD'

HOOK
VELCRO

LTA RESTRAINT STRAP CUE CARD

Perform following on EMU 3010 and EMU 3004 to install LTA Restraint Strap and Stowage Bag. Reference LTA RESTRAINT STRAP INSTALLATION for diagrams as needed:

- LTA Restraint Bag attached to LTA Restraint Strap D-rings (three)
- Remove EMU from EDDA, as reqd
- Connect LTA Restraint Strap SAFER mount brackets (two) to SAFER striker plate on PLSS
- Install elastic band of LTA Restraint Strap around SOP
- Tighten cinch strap mechanism
- Engage EMU in EDDA as reqd to restrain EMU (will be pulled off of EDDA for transfer at end of procedure)
- Stow LTA and suit arms inside LTA Stowage Bag
- Connect upper spring hooks (two) to SAFER mount brackets (two) such that strap runs over shoulder
- Connect lower spring hooks (two) to SAFER mount brackets (two)
- Tighten all LTA Stowage Bag Straps with bag as high as possible on EMU

EVA-7b/117/O/A

TIMELINES

EVA 1

EVA 1 SUMMARY TIMELINE	FS 7-3
PRE EVA 1 TOOL CONFIG	FS 7-4
EVA BRIEFING CARD	FS 7-5
EVA 1 INHIBIT PAD	FS 7-6
NOTES, CAUTIONS, AND WARNINGS	FS 7-7
EVA 1 EGRESS/SETUP	FS 7-9
S1-S3 UTILITY TRAY CONNECT	FS 7-10
SABB RESTRAINT RELEASE	FS 7-11
S4 IEA KEEL PIN ROTATE/TA CLAMP RELEASE/ S5 RTAS SOFTDOCK ROTATE	FS 7-12
PVR RADIATOR CINCHES/WINCHES	FS 7-13
SAW BETA GIMBAL RESTRAINT RELEASE	FS 7-14
FWD/AFT (1A/3A) SABB UNSTOW	FS 7-15
AJIS STRUT RIGIDIZATION	FS 7-16
SARJ DLA 2 DEPLOY	FS 7-17
SARJ LAUNCH LOCK REMOVAL	FS 7-18
EVA 1 CLEANUP/INGRESS	FS 7-19
POST EVA 1 TOOL CONFIG	FS 7-20
EVA 1 TASK DATA	FS 7-21
SARJ PREP CUE CARD	FS CC 7-35

EVA 2

EVA 2 SUMMARY TIMELINE	FS 7-37
PRE EVA 2 TOOL CONFIG	FS 7-38
EVA BRIEFING CARD	FS 7-39
EVA 2 INHIBIT PAD	FS 7-40
NOTES, CAUTIONS, AND WARNINGS	FS 7-41
EVA 2 EGRESS/SETUP FOR SOLAR ARRAY	FS 7-43
2B SOLAR ARRAY RETRACT	FS 7-44
DEPLOY SARJ BRACES	FS 7-46
SARJ DLA 1 INSTALL	FS 7-47
SARJ LAUNCH LOCK/LAUNCH RESTRAINT REMOVAL	FS 7-48
MT/CETA PATH/S4 MMOD SHIELD BOLT RELEASE	FS 7-49
EVA 2 CLEANUP/INGRESS	FS 7-50
POST EVA 2 TOOL CONFIG	FS 7-51
EVA 2 TASK DATA	FS 7-52

EVA 3

EVA 3 SUMMARY TIMELINE	FS 7-63
PRE EVA 3 TOOL CONFIG	FS 7-64
EVA 3 INHIBIT PAD	FS 7-65
NOTES, CAUTIONS, AND WARNINGS	FS 7-67
EVA 3 EGRESS/SETUP	FS 7-69
2B SOLAR ARRAY RETRACT	FS 7-70
S3 KEEL PIN/DRAW LINK STOW	FS 7-72
MT/CETA PATH/S4 MMOD SHIELD BOLT RELEASE	FS 7-73
H2O/H2 VENT VALVE CHANGEOUT	FS 7-75
LAB EWIS ANTENNA INSTALLATION	FS 7-76
NODE/SM LAN CABLE ROUTING	FS 7-77
SASA GIMBAL LOCKS	FS 7-78
GPS ANTENNA #4 REMOVAL	FS 7-79
CP7 ETVCG STANCHION INSTALLATION	FS 7-80
S3 LOWER OUTBOARD PAS DEPLOY	FS 7-81
EVA 3 CLEANUP/INGRESS	FS 7-83
POST EVA 3 TOOL CONFIG	FS 7-84
EVA 3 TASK DATA	FS 7-85

TIMELINES

This Page Intentionally Blank

EVA 1 SUMMARY TIMELINE

TIME HR : MIN	IV	EV1 (RY)	EV2 (OL)	
00:00		POST DEPRESS (00:10) EGRESS/SETUP (00:15) • Relocate CETA APFR to S3-04	POST DEPRESS (00:10) EGRESS/SETUP (00:35) • Translation adaptation	00:00
	MCC: Verify Nadir Tray Utilities Inhibited; IV – Go to connect Nadir Tray	S1 – S3 NADIR UTILITY TRAY CONNECT (00:30)	• Relocate CETA APFR to S4-15	
01:00	IV: Notify MCC, Nadir Tray complete MCC: Perform Nadir Tray Utilities powerup	• Notify IV: Nadir Tray connected APFR RECONFIG, ORU BAG CONFIG, AND MDM SHROUD (00:35) • Relocate APFR from S3-04 to S3-01 • Config ORU Bag over AJIS interface • Keel Pin Nut Clamp Bolts • On IV GO: MDM shroud Removal and Jettison	AFT/FWD (3A/1A) SABB RESTRAINT RELEASE (02:00)	01:00
	MCC: Verify MDM activated; IV – GO to remove MCC: Verify Zenith Tray Utilities inhibited; IV – GO to connect Zenith Tray	S1 – S3 ZENITH UTILITY TRAY CONNECT (00:30)	• Relocate APFR from S4-15 to S4-13	
02:00	IV: Notify MCC, Zenith Tray complete MCC: Perform Zenith Tray Utilities powerup	• Notify IV: Zenith Tray connected APFR RECONFIG, KEEL PIN ROTATE (00:30) • Relocate APFR from S3-01 to S4-04 • Rotate IEA Keel Pin • Release TA Clamps	• Relocate APFR from S4-13 to S3-28 • Release TA Clamps	02:00
		1A/3A SAW BETA GIMBAL RESTRAINT RELEASE (00:40)	PVR RADIATOR CINCHES/WINCHES (00:30)	
03:00		FWD (1A) SABB UNSTOW (00:20)	AFT (3A) SABB UNSTOW (00:20)	03:00
	MCC: Verify 1A/3A SSU/ECU Activated; IV – Go to Remove/Jettison MCC: Verify DLA 2 commanding; IV – GO to Deploy DLA 2	• Engage TA clamps SARJ DLA 2 INSTALL (01:00) • On IV GO: Install DLA 2	• Engage TA clamps FWD/AFT (1A/3A) ECU/SSU MLI REMOVAL AND JETTISON (00:30) • On IV GO: Remove AFT (3A) SSU/ECU MLI • Remove FWD (1A) SSU/ECU MLI	
04:00			AJIS STRUT RIGIDIZATION (1-4) (00:40)	04:00
	IV: Notify MCC DLA 2 Installed MCC: Command DLA 2 Engage	• Notify IV: DLA 2 installed SARJ LAUNCH LOCKS (01:15) • On IV GO: Verify DLA 2 teeth engaged then install DLA 2 cover	SARJ LAUNCH LOCKS (01:00) • Assist EV1 with DLA 2 cover	05:00
05:00		• Observe PVR deploy		
	MCC: Verify PVR Ready for Deploy; IV – GO	CLEANUP/INGRESS (00:40)	CLEANUP/INGRESS (00:40)	06:00
06:00		PREREPRESS (00:05)	PREREPRESS (00:05)	

EVA 1

PRE EVA 1 TOOL CONFIG

EV1

<input type="checkbox"/>	MWS
<input type="checkbox"/>	BRT (L)
<input type="checkbox"/>	RET (eq-eq)
<input type="checkbox"/>	Swing Arm (R)
<input type="checkbox"/>	RET (eq-eq)
<input type="checkbox"/>	PGT [A1 2.5ft-lb, CAL, MTL 30.5] S/N _____
<input type="checkbox"/>	7/16 (wobble) Socket-6 ext
<input type="checkbox"/>	PGT Battery S/N _____
<input type="checkbox"/>	T-Bar
<input type="checkbox"/>	RET (eq-eq)(2)
<input type="checkbox"/>	RET (eq-eq) w/PIP pin (2)
<input type="checkbox"/>	Wire Ties (2)
<input type="checkbox"/>	Small Shuttle Trash Bag
<input type="checkbox"/>	Adj Equip Tether (2, R & L glove)
<input type="checkbox"/>	D-Ring Extender (2, R & L)
<input type="checkbox"/>	85 ft Safety Tether (L D-ring to MWS)
<input type="checkbox"/>	Waist Tether (2, L D-ring and R ext)
<input type="checkbox"/>	SAFER
<input type="checkbox"/>	WVS

EV2

<input type="checkbox"/>	MWS
<input type="checkbox"/>	BRT (L)
<input type="checkbox"/>	RET (eq-eq)
<input type="checkbox"/>	Swing Arm (R)
<input type="checkbox"/>	RET (eq-eq)
<input type="checkbox"/>	PGT [B7 25.5 ft-lb, CAL, MTL 30.5] S/N _____
<input type="checkbox"/>	PGT Battery S/N _____
<input type="checkbox"/>	T-Bar
<input type="checkbox"/>	RET (eq-eq) (2)
<input type="checkbox"/>	RET (eq-eq) w/PIP pin (2)
<input type="checkbox"/>	5/8 (rigid) Socket-7.8 ext
<input type="checkbox"/>	Wire Ties (2)
<input type="checkbox"/>	Small Shuttle Trash Bag
<input type="checkbox"/>	Adj Equip Tethers (2, R & L glove)
<input type="checkbox"/>	D-ring Extender (2, R & L)
<input type="checkbox"/>	85-ft Safety Tether (R D-ring to EV1 extender)
<input type="checkbox"/>	Waist Tether (2, L D-ring and R ext)
<input type="checkbox"/>	SAFER
<input type="checkbox"/>	WVS

AIRLOCK CONFIG

<input type="checkbox"/>	Staging Bag
<input type="checkbox"/>	Fuse Tether
<input type="checkbox"/>	PGT S/N _____
<input type="checkbox"/>	PGT Battery S/N _____
<input type="checkbox"/>	Wire Tie Caddy
<input type="checkbox"/>	RAD S/N _____
<input type="checkbox"/>	Connector Cleaner Tool Kit
<input type="checkbox"/>	Probe
<input type="checkbox"/>	Prybar
<input type="checkbox"/>	Connector Pin Straightener
<input type="checkbox"/>	Velcro/Tape Caddy
<input type="checkbox"/>	Fuse Tether
<input type="checkbox"/>	Locking Strut Aids (4)
<input type="checkbox"/>	GP Caddy (2)
<input type="checkbox"/>	SSAS Contingency Bolts (4 per caddy)
<input type="checkbox"/>	ISS Torque Wrench Bag
<input type="checkbox"/>	ISS Torque Wrench (preset to 34 ft-lb)
<input type="checkbox"/>	Spare 85-ft safety tether
<input type="checkbox"/>	IV Bag
<input type="checkbox"/>	Towels (2)
<input type="checkbox"/>	Contamination Detection Kit
<input type="checkbox"/>	GP Caddy (2)
<input type="checkbox"/>	Adjustable Thermal Mittens (2)
<input type="checkbox"/>	Socket Caddy (hatch cont) w/eq-eq RET
<input type="checkbox"/>	1/2 Socket-8 ext
<input type="checkbox"/>	7/16 (wobble) Socket-6 ext (spare)
<input type="checkbox"/>	DCM Plug (SAFER Hardmount) (2)
<input type="checkbox"/>	EVA Crewlock Bag
<input type="checkbox"/>	Vise Grips
<input type="checkbox"/>	RET (eq-eq) w/PIP pin
<input type="checkbox"/>	3/8-in IVA Tool Stack w/DPT Adapter
<input type="checkbox"/>	ISS Ratchet Wrench (palm wheel removed or taped)
<input type="checkbox"/>	5/8 (rigid) Socket-7.8 ext
<input type="checkbox"/>	Round Torque Multiplier
<input type="checkbox"/>	Rd TM Socket – 5/8 prd
<input type="checkbox"/>	Socket Caddy
<input type="checkbox"/>	7/16 (wobble) Socket-6 ext
<input type="checkbox"/>	7/16 (rigid) Socket-9 ext
<input type="checkbox"/>	7/16 (rigid) Socket-2 ext
<input type="checkbox"/>	RET (eq-Lg) (outside of bag)
<input type="checkbox"/>	Medium ORU Bag with SLRI 6
<input type="checkbox"/>	Fuse Tether (tethered to inside bottom of bag)
<input type="checkbox"/>	RET (eq-eq)
<input type="checkbox"/>	Large Trash Bag
<input type="checkbox"/>	Digital camera w/L bracket
<input type="checkbox"/>	Adj Equip Tether (eq-Lg) (2 outside bottom of bag)
<input type="checkbox"/>	RET (eq-lg) (outside of bag)

CETA 2

<input type="checkbox"/>	WIF 1 APFR [7,MM,E,1]
<input type="checkbox"/>	WIF 2 APFR [3,TT,F,12]

NOTE

Prior to use, perform the following hardware inspections:

1. RET cords for fraying
2. No red line visible on safety and waist tether load Alleviation straps
3. Check BRT/Ballstack for loose screws and play
4. Inspect STS trash bags for deformation/damage

 Shading indicates tools that came from STS

EVA BRIEFING CARD

EV1/3 _____ EV2/4 _____ IV1 _____ IV2 _____

EVA Prep start (GMT) ____ / ____ : ____
Depress to 10.2 _____ : _____
Start purge _____ : _____
PET 00:00 _____ : _____

EVA Prep

- Get-up plan – clothing and EMU equipment bag
- Exercise protocol review if required
- Equipment lock activities – IV responsibilities
- Suit donning plan – special requests
- SAFER, MWS, tools, CL positions and bag stowage
- Airlock depress review
- EV/IV comm protocol
- SRMS/SSRMS initial position

EV Crew Procedure Review

- Egress Plan
- Translations – tether swaps
- Order of tasks
- Ingress Plan

General Procedure Review

- Get ahead tasks
- Constraints – ground and flight
- Cautions and warnings review
- RMS operations – comm protocol/clearances
- Contingency procedures – crib sheet

Emergencies review

- Lost comm
- EMU malfunctions
- Lost tools
- Lost crewmember
- DCS

Post EVA

- Suit doffing responsibilities
- Post EVA plan

Lessons learned from previous EVAs and general motherhood

EVA 1 INHIBIT PAD

Orbiter

TCS

- L12 1. √TCS POWER – OFF

Ku-Band Antenna

- MCC-H 1. √KU-BAND Mask – active
2. √KU-BAND EVA Protect Box – active

RCS

If EV crew < 27 ft from FRCS:

- IV 1. √DAP: VERN, FREE, LO Z
O14,15,16 2. √RJDF F1, F2, F3, F4 MANF DRIVER (four) – OFF
LOGIC (four) – OFF
- MCC-H 3. √Above RCS config
IV 4. √RCS F – ITEM 1 EXEC (*)
√JET DES F1U – ITEM 17 (*)
F3U – ITEM 19 (*)
F2U – ITEM 21 (*)

Ground

Ground Radar

- MCC-H 1. √TOPO console, ground radar restrictions in place for EVA

USOS

PCU

- MCC-H 1. √PCUs (two) operational in discharge mode and one of the following:
A. CCS PCU EVA Hazard Control enabled
B. No more than two arrays unshunted
C. No more than two arrays pointed < 90 from velocity vector
- OR
2. One or no PCUs operational in discharge mode and one of the following:
A. No more than two arrays unshunted
B. No more than two arrays pointed < 90 from velocity vector

TRRJ DLA

- MCC-H 1. Starboard radiator TRRJ parked at 0 degrees

RSOS

SM Antennas

- MCC-M 1. Global Timing Sys 1(400.1 MHz) [GTS] – Deactivate
IV 2. ARISS (HAM radio) – Deactivate, or VHF (144-146 MHz) TX only

FGB Antennas

- IV 1. ARISS (HAM radio) – Deactivate, or VHF (144-146 MHz) TX only

NOTES, CAUTIONS, AND WARNINGS

NOTES

1. Bolt install: report torque and turns
2. Bolt release: report torque and turns if different from published range
3. EVA connectors: after disconnection and prior to connection; verify pin and EMI band integrity; verify connector free of FOD
4. Toolbox doors must be closed with one latch per door when EV crew not in immediate vicinity

CAUTION

Flight Specific

- A. Electrical Cables:
 1. Avoid bend radius < 10 times cable diameter
- B. Fiber optic cables:
 1. Avoid bend radius < 10 times cable diameter
 2. Avoid pulling on cable during mate/demate
- C. SABB Restraints:
 1. Unfasten jack bolt #6 last
- D. Prior to releasing SAW BGA Restraints:
 1. SABB Restraints Released (2 per wing)
 2. Primary Power cable TA clamps released (3 per wing)
 3. APFR relocated from SABB Restraint location
 4. IEA Keel Pin rotated prior to forward wing BGA Restraint release
- E. SABB Unstow:
 1. Deploy rate of SABB must not exceed 6 degrees/sec (15 sec for full deploy)
 2. Four-bar linkage must be deployed and locked and SABBs rotated into deploy position before Mast Canister Tip Fitting restraints can be disengaged
- F. SARJ Prep:
 1. During removal of inboard MLI cover fasteners:
 - a. Limit turn count to minimum required for fastener release
 - b. Minimize side loading bolt head
 - c. Maintain axial force on fastener to compress spring during rotation
 2. During re-installation of MLI covers, do not re-install swing bolts on MLI covers
 3. Avoid impacting the race ring with the DLA when the DLA is unconstrained
 4. DLA must be held against the outer side of the SARJ race ring during follower arm deploy to avoid interference with structure
- G. Radiators:
 1. Avoid contact with radiator bellows and thermal outer coating
- H. Translation Path/Tether routing
 1. Avoid contact with S1/P1 Radiator Beam
 2. During ingress route and fairlead safety tether forward of camera/light stanchions and trunnions

CAUTION (Cont)

ISS Generic Constraints

- I. Avoid inadvertent contact with:
 1. Grapple fixture shafts (dry lube)
 2. PIP pins
 3. EVA Crane [PMA 1]
 4. TCS Reflectors [PMA 2, PMA 3]
 5. APAS hardware [PMA 2, PMA 3]
 6. CETA Lights (Z-93 paint) [Lab, S1, Node 1]
 7. Deployed MISSEs
 8. Passive UMAs
 9. MBS VDU, MCU, CRPCMs and Cameras (tape radiative surface, silver Teflon)
 10. Deployed TUS cable
 11. S0 aft face radiator
 12. GPS Antennas (S13 paint) [S0]
 13. UHF Antennas [Lab, P1]
 14. ETCS Radiators [S1, P1]
 15. SASA RF Group [Z1, S1, P6]
 16. Heat pipe radiators [Z1]
 17. PCU cathode and HCA ports [Z1]
 18. Ku-Band Antenna (SGANT) dish [Z1]
 19. CMG cover/shells [Z1]
 20. SSRMS Cameras
 21. Lab window shutter
- J. For Structural Reasons:
 1. Avoid vigorous body motions, quick grabs and kickoffs against tether restraints
 2. Avoid performing shaking motions (sinusoidal functions) more than four cyclesIf any of these occur, wait 2-5 min to allow structural response to dissipate
- K. Other:
 1. ITT Cannon connector: On demated connectors, do not rotate collar or manipulate cable/connector using collar or connector tool
 2. WIS Antennas: do not use as handholds [Node 1, P6, Z1, P4, S4]
 3. Lubricant from Ku-Band SGANT gimbals [Z1], CMGs [Z1], and RTAS Ground Strap fasteners can contaminate EMU [P6, P4, S4]
 4. MLI handholds are not rated for crewmember translation loads
 5. CBM petal covers may not be used as handholds unless both launch restraint pins are engaged
 6. Do not close hatch until EMU water OFF for 2 min

NOTES, CAUTIONS, AND WARNINGS (Cont)

WARNING

Flight Specific

- A. Electrical connectors:
1. NZGL connector linkage. Use caution when mating/locking
 2. Power must be turned off to electrical connectors prior to mating/demating to preclude arcing/sparking
 3. Sharp edge – mating surfaces of EVA connectors. Avoid side loads during mating
- B. Release SABB restraints
1. Sharp edge – avoid contact with exposed threads on jack bolt #6 after clam shell released
 2. Sharp edge – blanket box skirt
- C. Release SAW beta gimbal restraints:
1. Entire area behind IEA bulkhead, beta gimbal/solar array wing must be clear prior to fastener disengagement
 2. Verify beta gimbal/solar array motion has stopped before exiting worksite
 3. Sharp edge – exposed threads on keel pin fastener
- D. Unstow SABB:
1. Pinch point – pivot fitting and lockout arm during SABB rotation
 2. Sharp edge – exposed bolts in rib cavities on mast canister
- E. SARJ Prep
1. Sharp edge – spring loaded captive EVA fasteners (SARJ MLI cover bolts); ends of springs may protrude

ISS Generic Constraints

- F. Avoid inadvertent contact with:
1. Grapple fixture targets and target pins
 2. SSU, ECU, beta gimbal platform, mast canister, SAW blanket boxes unless the beta gimbal is locked and the motor is turned off
 3. Stay 2 ft from S1/P1 radiator beam rotational envelope when beam is free to rotate
 4. Stay 5 ft from moving MT on face 1
 5. Stay inboard of SARJ when active
- G. Handrails
1. Handrails previously used for MISSE attachment may not be used as a safety tether point [A/L endcone 564 and 566, A/L Tank 2 nad/fwd and port/fwd, P6 5389]

WARNING (Cont)

ISS Generic Constraints (Cont)

- H. Pinch
1. ITT Cannon Connector rotating housing
 2. EV side of IV Hatch during Hatch operation (also snag hazard) [A/L]
 3. LAB window shutter and CBM petal cover linkages during operation
- I. RF radiation exposure
1. Stay 3 ft from S-Band (SASA) high gain antenna when powered [S1, P6]
 2. Stay 1.3 ft from S-Band (SASA) low gain antenna when powered [S1, P6]
 3. Stay 1 ft from UHF antenna when powered [Lab, P1, PLB]
- J. Sharp Edges:
1. Inner edges of WIF sockets
 2. Back side of MMOD shield fasteners
 3. PMA umbilical launch restraints – exposed threads
 4. Adjustable Fuse Tether buckles stowed in Node Bag
 5. Nickel coated braided copper ground straps may have frayed wires [P6, P4, S4]
 6. Z1 handrail 6061 by the Ku-Band boom launch restraint [Z1]
 7. Solar Array
 - a. SABB (skirts, swing bolts)
 - b. Solar cells
 - c. Springs along tension bar
 - d. Panel hinges
 - e. Guide cable burrs or frays
 - f. Mast Canister roller guides
 - g. Braided cables
 - h. Fastener exposed threads
 - i. Exposed bolts in rib cavities on mast canister
 8. Keep hands away from SSRMS LEE opening, and snares
 9. Exposed fasteners on back of Z1 U-jumper male QD panel, if nutplate cap missing
- K. Thermal:
1. EVA connectors with booties may become hot if left uncovered. Handling may need to be limited
 2. PMA handrails may be hot. Handling may need to be limited
 3. Turn off glove heaters when comfortable temp reached to prevent bladder damage. Do not pull fingers out of gloves when heaters are on

WARNING (Cont)

ISS Generic Constraints (Cont)

- K. Thermal (Cont)
4. Uncovered trunnion pins may be hot
 5. SSRMS/MBS operating Cameras and lights may radiate large amounts of heat
 6. Stay 1 ft away from PMAs and MMOD shields > 270 degF if EMU sun visor up
 7. Stay 1 ft away for no more than 15 min from PMAs and MMOD shields > 300 degF if EMU sun visor up
 8. Stay 0.5 ft away from PMA and MMOD shields > 325 degF
 9. Do not touch EMU protective visor if temp has been < -134 for > 15 min
 10. No EMU TMG contact of PMAs and MMOD shields when temp > 320 degF
 11. No EMU boot contact with foot restraint when temp < -120 degF or > 200 degF



EVA 1 EGRESS/SETUP (00:35)

IV	EV1	EV2
<p>Initial Condition: PLB Camera C pointed at Airlock</p> <p>1. WVS Software: Select page – RF camera Sel 'Advanced Controls' S-Band Level (two) – Max</p>	<p>Initial Condition: Waist Tether (L + R) D-ring to MWS EV2 85-ft tether to (L) extender EV1 85-ft tether on (R) D-ring to MWS</p> <p><u>EGRESS</u></p> <ol style="list-style-type: none"> 1. Open A/L thermal cover 2. Egress airlock 3. √SAFER man isol vlv – open (down) 4. √SAFER HCM – closed (down) 5. Receive/temp stow Crewlock Bag 6. Receive Medium ORU Bag from EV2; stow on BRT 7. Translate to S1 HR 3214 (stanchion/trunnion at 3282, 3234) 8. Attach EV1 85-ft safety tether to S1 HR 3214 9. Verify locking hooks – Locked 10. Attach EV2 85-ft safety tether to S1 HR 3221 11. Verify locking hooks – Locked 12. Give EV2 GO for translation <p><u>SETUP</u></p> <ol style="list-style-type: none"> 13. Translate to S3; temp stow ORU bag on S3 HR 3063 14. Configure/relocate APFR: CETA WIF 2 to S3-04 [6,TT,F,12] 	<p>Initial Condition: Waist Tether (L) to A/L D-ring, (R) to MWS, 85-ft tether on (R) D-ring to EV1 (L) extender</p> <p><u>EGRESS</u></p> <ol style="list-style-type: none"> 1. Transfer Crewlock Bag to EV1 (RET stays on bag) 2. Transfer Medium ORU Bag to EV1 (RET stays in A/L) 3. Egress airlock 4. √SAFER man isol vlv – open (down) 5. √SAFER HCM – closed (down) 6. Retrieve Crewlock Bag; stow on BRT 7. On EV1 GO, disconnect waist tether 8. Close A/L thermal cover <p><u>SETUP</u></p> <ol style="list-style-type: none"> 9. Translate to CETA cart 10. Stow Crewlock Bag on APFR 11. Configure/relocate APFR: CETA WIF 1 to S4-15 [9,MM,E,1] 12. Stow Crewlock Bag on S4 HR 2245 13. Retrieve Rd TM

SABB RESTRAINT RELEASE (02:00)

IV	EV2
	<p><u>RELEASE AFT INBOARD RESTRAINTS</u></p> <ol style="list-style-type: none">1. Ingress APFR: S4-15 [9,MM,E,1]2. PGT[B7] 25.5 ft-lb, CCW3 60 RPM, MTL 30.5]Rd TM-5/8 prd: √Anti-backlash Neutral: Break torque on Inboard SABB fasteners (2) ~5 turns3. PGT[B7] 25.5 ft-lb, CCW2 30 RPM, MTL 30.5]-7.8ext 5/8: Release Inboard SABB fasteners (2) ~12 turns4. Open clam shell; remove 7.8ext 5/8 from PGT5. Egress APFR and reconfigure: S4-15 [2,MM,E,12] <p><u>RELEASE AFT OUTBOARD RESTRAINTS</u></p> <div data-bbox="388 467 640 521" style="border: 1px solid black; padding: 2px; margin: 5px 0;"><p style="text-align: center;">CAUTION Unfasten jack bolt #6 last</p></div> <ol style="list-style-type: none">6. Connect RET to S4 HR 2229 and SABB Restraint7. Ingress APFR: S4-15 [2,MM,E,12]8. PGT[B7] 25.5 ft-lb, CCW3 60 RPM, MTL 30.5]Rd-TM-5/8 prd: √Anti-backlash Neutral: Break torque on Outboard SABB fasteners (6) ~5 turns9. PGT[B7] 25.5 ft-lb, CCW2 30 RPM, MTL 30.5]-7.8ext 5/8: Release Outboard SABB fasteners (6) ~12 turns10. Temp stow SABB Restraint11. Stow 7.8 ext-5/8 socket in trash bag12. Egress APFR13. Stow SABB Restraint on APFR14. Retrieve APFR15. Stow SABB Restraint on fuse tether16. Relocate APFR: S4-13 [9,NN,E,1] <p><u>RELEASE FORWARD INBOARD RESTRAINTS</u></p> <ol style="list-style-type: none">17. Ingress APFR: S4-13 [9,NN,E,1]18. PGT[B7] 25.5 ft-lb, CCW3 60 RPM, MTL 30.5]Rd TM-5/8 prd: √Anti-backlash Neutral: Break torque on Inboard SABB fasteners (2) ~5 turns19. PGT[B7] 25.5 ft-lb, CCW2 30 RPM, MTL 30.5]-7.8ext 5/8: Release Inboard SABB fasteners (2) ~12 turns20. Open clam shell; remove 7.8 ext 5/8 from PGT21. Egress APFR and reconfigure: S4-13 [2,NN,E,11] <p><u>RELEASE FORWARD OUTBOARD RESTRAINTS</u></p> <div data-bbox="388 1073 640 1127" style="border: 1px solid black; padding: 2px; margin: 5px 0;"><p style="text-align: center;">CAUTION Unfasten jack bolt #6 last</p></div> <ol style="list-style-type: none">22. Connect RET to S4 HR 2236 and SABB Restraint23. Ingress APFR: S4-13 [2,NN,E,11]24. PGT[B7] 25.5 ft-lb, CCW3 60 RPM, MTL 30.5]Rd-TM-5/8 prd: √Anti-backlash Neutral: Break torque on Outboard SABB fasteners (6) ~5 turns25. PGT[B7] 25.5 ft-lb, CCW2 30 RPM, MTL 30.5]-7.8ext 5/8: Release Outboard SABB fasteners (6) ~12 turns26. Temp stow SABB Restraint27. Stow 7.8 ext 5/8 socket in trash bag28. Egress APFR29. Stow SABB Restraint on fuse tether30. Relocate APFR S4-13 to S3-28 [2, PP, F, 12] (for DLA 1); Translation path: S4 zenith/aft, cross to S3 to relocate APFR, retrace to go back to S431. Transfer TM to Crewlock Bag; retrieve 7/16-in 6-in ext, stow 5/8 socket32. Coordinate with MCC/IV for GO to release TA clamps, Remove ECU/SSU covers or PVR cinches/winch

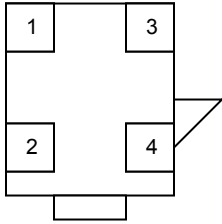
S4 IEA KEEL PIN ROTATE/TA CLAMP RELEASE/S5 RTAS SOFTDOCK ROTATE (00:30)

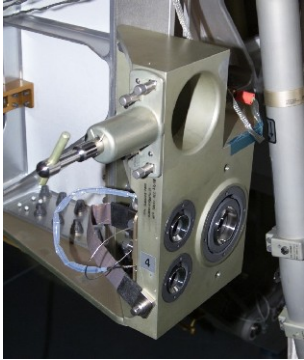
IV	EV1
<p data-bbox="233 886 317 911">ZENITH</p>  <p data-bbox="111 1016 155 1040">AFT</p> <p data-bbox="239 1268 310 1292">NADIR</p> <p data-bbox="92 1292 447 1341">S4 S5 RTAS Labeling – S4 Outboard Bulkhead (looking inboard)</p>	<p data-bbox="518 253 747 277"><u>ROTATE IEA KEEL PIN</u></p> <div data-bbox="602 305 1184 396" style="border: 3px double black; padding: 5px; text-align: center;"> <p data-bbox="837 318 947 339">WARNING</p> <p data-bbox="617 342 1161 388">Sharp edge. The Keel fastener has exposed bolt threads when removed from the Keel body</p> </div> <ol data-bbox="518 423 1556 643" style="list-style-type: none"> 1. If not already performed, relocate APFR from S3-01 to S4-04 [6,PP,L,1] (for DLA 2) 2. Translate to IEA Keel Pin 3. BRT to keel structure handrail 4. PGT[B7 25.5 ft-lb, CCW3 60 RPM, MTL 30.5]-6ext 7/16: Release fastener ~43 turns (push to engage) 5. Remove the keel fastener completely from keel body 6. Rotate keel pin until the hard dock detent capture 7. Verify alignment marks 8. Insert keel fastener into keel body 9. PGT[B7 25.5 ft-lb, CW3 60 RPM, MTL 30.5] -6ext 7/16: Engage fastener =10 turns  <p data-bbox="518 667 894 691"><u>POWER CABLE TA CLAMP RELEASE</u></p> <ol data-bbox="518 691 1087 740" style="list-style-type: none"> 10. Release aft wing Primary Power cable TA clamps (3) 11. Release fwd wing Primary Power cable TA clamps (3) <p data-bbox="518 764 852 789"><u>S5 RTAS SOFTDOCK ROTATION</u></p> <ol data-bbox="518 789 1436 911" style="list-style-type: none"> 12. Rotate S5 softdock mechanisms to capture position and inspect bolt interface for FOD  <ul style="list-style-type: none"> <input type="checkbox"/> #1 RTAS <input type="checkbox"/> #2 RTAS <input type="checkbox"/> #3 RTAS <input type="checkbox"/> #4 RTAS  <p data-bbox="791 1268 1268 1292">S4 S5 RTAS Soft Dock Pin (launch/release config)</p> <ol data-bbox="518 1317 1507 1341" style="list-style-type: none"> 13. If not previously performed, transfer SABB Restraints (2) to Medium ORU Bag; stow on fuse tether

SAW BETA GIMBAL RESTRAINT RELEASE (00:40)

IV

EV1

WARNING

Stored energy and collision hazard. EV crew must remain clear of IEA bulkhead, Beta Gimbal/Solar Array Wing during Beta Gimbal Restraint disengagement
Verify that Beta Gimbal/Solar Array motion has stopped before exiting worksite

CAUTION

The following must be complete prior to release of BGA Restraints:

1. SABB Restraints Released (2 per wing)
2. Primary Power cable TA clamps released (3 per wing)
3. APFR relocated from SABB Restraint location
4. IEA Keel Pin rotated prior to forward wing BGA Restraint release

RELEASE AFT WING (3A) BETA GIMBAL RESTRAINTS

1. Retrieve ratchet wrench with 7.8 ext 5/8 from Crewlock Bag
2. Remove PIP pins from BGA launch restraint assemblies (2)
3. Verify EV2 is clear of stored energy hazard
4. BRT to HR 2235
5. Ratchet wrench -7.8 ext 5/8: Release AFT Wing Beta Gimbal restraints (2) ~10 turns
6. Re-insert anti-rotation PIP pins (2) into BGA launch restraint assemblies
7. Verify 4-Bar linkages have been fully deployed and locked (minimum of 3 of 4 locks) 

RELEASE FWD WING (1A) BETA GIMBAL RESTRAINTS

8. Remove PIP pins from BGA launch restraint assemblies (2)
9. Verify EV2 is clear of stored energy hazard and SABB restraint/keel rotation complete
10. BRT to HR 2207
11. Ratchet wrench -7.8 ext 5/8: Release FWD Wing Beta Gimbal restraints (2) ~10 turns
12. Re-insert anti-rotation PIP pins (2) into BGA launch restraint assemblies
13. Verify 4-Bar linkages have been fully deployed and locked (minimum of 3 of 4 locks) 
14. Stow ratchet wrench in Crewlock Bag



FWD/AFT (1A/3A) SABB UNSTOW (00:20/SABB)

IV		EV1/EV2			
		<p style="text-align: center;"><u>WARNING</u> Pinch Point – Stay clear of pivot fitting and lockout arm during SABB rotation</p>			
		<p><u>UNSTOW FWD/AFT WING (1A/3A) SABBs</u></p> <ol style="list-style-type: none"> 1. Translate to top of Mast Canister 2. Remove PIP pin from Lockout arm 3. Rotate blanket box to deploy position (15 sec minimum) 4. Verify pivot arm is locked with locking sleeve over joint 5. Install PIP pin through the Lockout arm 6. Repeat steps 2-5 for other blanket box 7. PGT[A7 9.2 ft-lb, CCW2 30 RPM, MTL 30.5J-6ext 7/16: Release Mast Tip fasteners (3) ~14 turns 8. Verify Mast Tip fasteners are released 9. <input type="checkbox"/> 10. Re-engage TA clamps (3 per wing) 11. EV2 Retrieve Crewlock Bag; relocate to S3 HR 3049 (face 4) 			
	1A (fwd)	3A (aft)			
	Left BB	Right BB	Left BB	Right BB	
PIP Pin	<input type="checkbox"/>	<input type="checkbox"/>	<input type="checkbox"/>	<input type="checkbox"/>	
Lock sleeve	<input type="checkbox"/>	<input type="checkbox"/>	<input type="checkbox"/>	<input type="checkbox"/>	
Mast Tip 1		<input type="checkbox"/>		<input type="checkbox"/>	
Mast Tip 2		<input type="checkbox"/>		<input type="checkbox"/>	
Mast Tip 3		<input type="checkbox"/>		<input type="checkbox"/>	

AJIS STRUT RIGIDIZATION (00:10 PER STRUT – 00:40 TOTAL)

IV	EV1/EV2
	<ol style="list-style-type: none">1. Rigidize AJIS struts using the procedure below for each AJIS strut (no specific order required)<ul style="list-style-type: none"><input type="checkbox"/> AJIS strut fwd zenith (#3) (HR 3064)<input type="checkbox"/> AJIS strut aft zenith (#4) (HR 2203)<input type="checkbox"/> AJIS strut aft nadir (#1) (HR 2211)<input type="checkbox"/> AJIS strut fwd nadir (#2) (HR 2212) <p><u>RIGIDIZE STRUT</u></p> <ol style="list-style-type: none">2. Open thermal bootie3. Release Velcro strap4. Tether to Strut Launch Restraint5. Remove PIP pin6. Remove Hitch pin7. Remove and stow Strut Launch Restraint8. Verify anti-rotation tabs on cones and ground wire attach point are pointing “out” of cups and are visible9. Position fastener into mating bulkhead bracket10. PGT[B2 16.0 ft-lb, CW3 60 RPM, MTL 30.5]-6ext 7/16: Engage fastener ~39 turns to torque11. Re-install thermal bootie <input type="checkbox"/>12. Stow AJIS Launch Restraint in Large Trash Bag

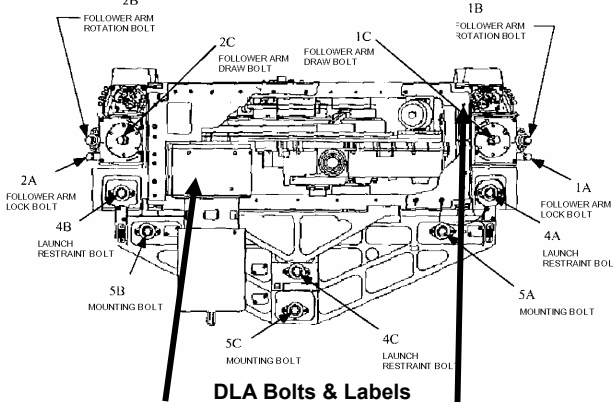
SARJ DLA 2 DEPLOY (01:00)

IV	EV1																			
<p>MCC-H 1. Verify step 4 complete (SODF: ASSY OPS: SARJ INITIAL ACTIVATION AND CHECKOUT)</p> <p>IV 2. Give EV1 GO for DLA Install</p>  <p>DLA Bolts & Labels</p>  <table border="1" data-bbox="94 1136 703 1242"> <thead> <tr> <th rowspan="2">DLA 2</th> <th colspan="2">Initial</th> <th colspan="2">Final</th> </tr> <tr> <th>Torque</th> <th>Turns</th> <th>Torque</th> <th>Turns</th> </tr> </thead> <tbody> <tr> <td>1C</td> <td></td> <td></td> <td></td> <td></td> </tr> <tr> <td>2C</td> <td></td> <td></td> <td></td> <td></td> </tr> </tbody> </table> <p>MCC-H 4. Verify step 8 (DLA2) complete (SODF: ASSY OPS: SARJ INITIAL ACTIVATION AND CHECKOUT)</p>	DLA 2	Initial		Final		Torque	Turns	Torque	Turns	1C					2C					<p>EV1</p> <p>☐ DLA 2: APFR S4-04 [6,PP,L,1]</p> <p><u>REMOVE DLA 2 MLI COVER</u></p> <ol style="list-style-type: none"> 1. Attach adj. tether to S3 HR 3060 and RET to face 5 HR 3058 2. PGT[A1 2.5 ft-lb, CCW3 60 RPM, MTL 30.5]-6ext 7/16: Release swing bolt cover fasteners (4) ~10-11 turns 3. Verify fasteners swing open 4. PGT[A6 8.3 ft-lb, CCW3 60 RPM, MTL 30.5]-6ext 7/16: Release inboard MLI cover fasteners (4) =9 turns (add single turns incrementally as required for release) 5. Ingress APFR 6. Remove MLI cover and temp stow 7. On IV GO, proceed with DLA Install <p><u>ROTATE DLA DRAW BOLTS (1C AND 2C)</u> (This decreases friction between pivot fork and follower bracket)</p> <ol style="list-style-type: none"> 8. PGT[A3 4.8 ft-lb, CW2 30 RPM, MTL 30.5]-6ext 7/16: Rotate draw bolt 1C =2 turns 9. PGT[A3 4.8 ft-lb, CCW2 30 RPM, MTL 30.5]-6ext 7/16: Rotate draw bolt 2C =2 turns <p><u>BACK OFF DLA LOCK BOLTS (1A AND 2A)</u> (releases lock preload on follower arm, lock tip bolt retracted from follower bracket)</p> <ol style="list-style-type: none"> 10. PGT[A6 8.3 ft-lb, CCW3 60 RPM, MTL 30.5]-6ext 7/16: Release lock bolts 1A and 2A fasteners (2) =6 turns <p><u>RELEASE 3 DLA LAUNCH RESRAINT BOLTS (4A, 4B, 4C)</u> (this allows the DLA frame to move relative to the launch bracket)</p> <ol style="list-style-type: none"> 11. PGT[B7 25.5 ft-lb, CCW2 30 RPM, MTL 30.5]-6ext 7/16: Release launch restraint bolts 4A, 4B, 4C ~8-10 turns – bolt pops up <p><u>REPOSITION DLA AND ROTATE FOLLOWER ARMS</u></p> <ol style="list-style-type: none"> 12. Reconfigure PGT[A3 4.8 ft-lb, CCW1 10 RPM, MTL 30.5]-6ext 7/16: Reposition DLA onto race ring (approx 3/8 inch outboard, 1.5 inches radially in) Rotate follower arm rotation bolt 1B ~5/8 turn to hardstop 13. Verify follower arm has rotated 90 deg 14. PGT[A3 4.8 ft-lb, CW2 30 RPM, MTL 30.5]-6ext 7/16: Rotate follower arm draw bolt 1C ~32 turns to torque 15. Verify follower bearings are in contact with race ring 16. PGT[A3 4.8 ft-lb, CW1 10 RPM, MTL 30.5]-6ext 7/16: Rotate follower arm rotation bolt 2B ~5/8 turn to hardstop 17. Verify follower arm has rotated 90 deg 18. PGT[A3 4.8 ft-lb, CCW2 30 RPM, MTL 30.5]-6ext 7/16: Rotate follower arm draw bolt 2C ~32 turns to torque 19. Verify follower bearings are in contact with race ring 20. PGT[B4 19.4 ft-lb, CCW2 30 RPM, MTL 30.5]-6ext 7/16: Final installation torque on follower arm draw bolt 2C ~4 turns to torque 21. PGT[B4 19.4 ft-lb, CW2 30 RPM, MTL 30.5]-6ext 7/16: Final installation torque on follower arm draw bolt 1C ~4 turns to torque <p><u>INSPECT DLA</u></p> <ol style="list-style-type: none"> 22. On MCC GO; verify DLA pinion gear teeth fully engaged to SARJ race ring teeth ☐ <p><u>REINSTALL DLA MLI COVER</u></p> <ol style="list-style-type: none"> 23. PGT[A1 2.5 ft-lb, CW2 30 RPM, MTL 30.5]-6ext 7/16: Engage inboard MLI cover fasteners (4) ~9 turns
DLA 2		Initial		Final																
	Torque	Turns	Torque	Turns																
1C																				
2C																				

SARJ LAUNCH LOCK REMOVAL (01:15)

IV	EV1	EV2														
	<p>A. Remove the following Launch Locks and swing bolts:</p> <ul style="list-style-type: none"> <input type="checkbox"/> Cover 4, Face 2, Launch Lock 10 <input type="checkbox"/> Cover 3, Face 1/2, swing bolt (1) <input type="checkbox"/> Cover 2, Face 1, Launch Lock 9 <input type="checkbox"/> Cover 1, Face 1, Launch Lock 8 <input type="checkbox"/> Cover 22, Face 1/6, swing bolt (1) <input type="checkbox"/> Cover 21, Face 6, Launch Lock 7 	<p>A. Remove the following Launch Locks:</p> <ul style="list-style-type: none"> <input type="checkbox"/> Cover 18, Face 5, Launch Lock 5, if APFR required: S3-30 [9,PP,G,12] <input type="checkbox"/> Cover 19, Face 6, Launch Lock 6, if APFR required: S3-30 [9,PP,F,12] <p>B. Release the following swing bolts (# per cover):</p> <table border="0"> <tr> <td><input type="checkbox"/> Cover 17 (2)</td> <td><input type="checkbox"/> Cover 10 (3)</td> </tr> <tr> <td><input type="checkbox"/> Cover 16 (2)</td> <td><input type="checkbox"/> Cover 9 (2)</td> </tr> <tr> <td><input type="checkbox"/> Cover 15 (3)</td> <td><input type="checkbox"/> Cover 8 (2)</td> </tr> <tr> <td><input type="checkbox"/> Cover 14 (1)</td> <td><input type="checkbox"/> Cover 7 (2)</td> </tr> <tr> <td><input type="checkbox"/> Cover 13 (3)</td> <td><input type="checkbox"/> Cover 6 (2)</td> </tr> <tr> <td><input type="checkbox"/> Cover 12 (3)</td> <td><input type="checkbox"/> Cover 5 (4)</td> </tr> <tr> <td><input type="checkbox"/> Cover 11 (1)</td> <td></td> </tr> </table>	<input type="checkbox"/> Cover 17 (2)	<input type="checkbox"/> Cover 10 (3)	<input type="checkbox"/> Cover 16 (2)	<input type="checkbox"/> Cover 9 (2)	<input type="checkbox"/> Cover 15 (3)	<input type="checkbox"/> Cover 8 (2)	<input type="checkbox"/> Cover 14 (1)	<input type="checkbox"/> Cover 7 (2)	<input type="checkbox"/> Cover 13 (3)	<input type="checkbox"/> Cover 6 (2)	<input type="checkbox"/> Cover 12 (3)	<input type="checkbox"/> Cover 5 (4)	<input type="checkbox"/> Cover 11 (1)	
<input type="checkbox"/> Cover 17 (2)	<input type="checkbox"/> Cover 10 (3)															
<input type="checkbox"/> Cover 16 (2)	<input type="checkbox"/> Cover 9 (2)															
<input type="checkbox"/> Cover 15 (3)	<input type="checkbox"/> Cover 8 (2)															
<input type="checkbox"/> Cover 14 (1)	<input type="checkbox"/> Cover 7 (2)															
<input type="checkbox"/> Cover 13 (3)	<input type="checkbox"/> Cover 6 (2)															
<input type="checkbox"/> Cover 12 (3)	<input type="checkbox"/> Cover 5 (4)															
<input type="checkbox"/> Cover 11 (1)																
<p><u>RELEASE SWING BOLTS</u></p> <ol style="list-style-type: none"> PGT[A1 2.5 ft-lb, CCW3 60 RPM, MTL 30.5]-6ext 7/16: Release swing bolts (1 to 4) ~10-11 turns Verify fasteners swing open <p><u>REMOVE SARJ LAUNCH LOCKS</u></p> <div style="border: 1px solid black; padding: 5px; margin: 10px 0;"> <p style="text-align: center;"><u>CAUTION</u></p> <p>The following precautions should be observed to prevent loss of inboard MLI cover fasteners during removal:</p> <ul style="list-style-type: none"> • Limit turn count to minimum required for fastener release • Minimize side loading bolt head • Maintain axial force on fastener to compress spring during rotation </div> <ol style="list-style-type: none"> PGT[A6 8.3 ft-lb, CCW3 60 RPM, MTL 30.5]-6ext 7/16: Release inboard MLI cover fasteners (4-6) =9 turns (add single turns incrementally as required for release) Remove MLI cover and temp stow PGT[B7 25.5 ft-lb, CCW3 60 RPM, MTL 30.5]-6ext 7/16: Release SARJ Launch Lock fasteners (4) ~13-15 turns Remove launch lock and stow Re-position MLI cover PGT[A1 2.5 ft-lb, CW2 30 RPM, MTL 30.5]-6ext 7/16: Engage inboard MLI cover fasteners (4-6) ~9 turns 																

EVA 1 CLEANUP/INGRESS (00:40)

IV	EV1	EV2
<p>1. Perform WVS PWRDN (PHOTO/TV, <u>WVS CUE CARD</u>)</p>	<p><u>CLEANUP</u></p> <ol style="list-style-type: none"> 1. If 4 or more Launch Locks removed, retrieve Med ORU Bag; stow on BRT 2. Retrieve digital camera 3. Perform tool inventory 4. Translate to Airlock <p><u>INGRESS</u></p> <ol style="list-style-type: none"> 5. Transfer Med ORU Bag to EV2 6. Attach Waist Tether (R) to A/L D-ring; verify locked 7. Stow Safety Tether on external A/L handrail (√reel unlocked) 8. Ingress A/L 9. Remove SCU from stowage pouch Remove DCM cover Connect SCU to DCM, check locked 10. Water – OFF 11. Close thermal cover, attach Velcro strap <div style="border: 1px solid black; padding: 5px; margin: 10px auto; width: fit-content;"> <p style="text-align: center;"><u>CAUTION</u> Do not close hatch until EMU water off for 2 min</p> </div> <ol style="list-style-type: none"> 12. Verify no hardware blocking hatch 13. EV Hatch Handle – Preclose 14. EV Hatch – close and lock 15. Go to PRE-REPRESS Cue Card 	<p><u>CLEANUP</u></p> <ol style="list-style-type: none"> 1. If not already performed, retrieve Crewlock Bag; stow on S3 HR 3049 2. Perform tool inventory 3. Translate to Airlock <p><u>INGRESS</u></p> <ol style="list-style-type: none"> 4. Open A/L Thermal Cover 5. Ingress A/L 6. Waist tether swap (end with R on UIA D-ring); verify locked 7. Stow Safety Tether on external Airlock handrail (√reel unlocked) 8. Receive Med ORU Bag; stow in Airlock 9. Remove SCU from stowage pouch Remove DCM cover Connect SCU to DCM, check locked 10. Water – OFF

POST EVA 1 TOOL CONFIG

EV 1

- MWS
- BRT (L)
- RET (eq-eq)
- Swing Arm (R)
- RET (eq-eq)
- PGT
- PGT Battery
- 7/16 (wobble) Socket-6 ext
- T-Bar
- RET (eq-eq) (2)
- RET (eq-eq) w/PIP pin (2)
- Wire Ties (2)
- Small Shuttle Trash Bag
- Adj Equip Tether (2, R & L glove)
- D-Ring Extender (2, R & L)
- Waist Tether (2, L D-ring and R extender)
- SAFER
- WVS

EV 2

- MWS
- BRT (L)
- Ret (eq-eq)
- Swing Arm (R)
- RET (eq-eq)
- PGT
- PGT Battery
- 7/16 (wobble) Socket-6 ext
- T-Bar
- RET (eq-eq)(2)
- RET (eq-eq) w/PIP pin (2)
- Wire Tie (2)
- Small Shuttle Trash Bag
- Adj Equip Tether (2, R & L glove)
- D-ring Extender (2, R & L)
- Waist Tether (2, R on D-ring & L on extender)
- SAFER
- WVS

AIRLOCK CONFIG

- Staging Bag
- Fuse Tether
- PGT
- PGT Battery
- Wire Tie Caddy
- RAD
- Connector Cleaner Tools Kit
- Probe
- Prybar
- Connector Pin Straightener
- Velcro/Tape Caddy
- Fuse Tether
- Locking Strut Aids (4)
- GP Caddy (2)
- SSAS Contingency Bolts (4 per caddy)
- ISS Torque Wrench Bag
- ISS Torque Wrench (preset to 34 ft-lb)
- Spare 85-ft safety tether

IV Bag

- Towels (2)
- Contamination Detection Kit
- GP Caddy (2)
- Adjustable Thermal Mittens (2)
- Socket Caddy (hatch cont) w/eq-eq RET
- 1/2 Socket-8 ext
- 7/16 (wobble) Socket-6 ext (spare)
- DCM Plug (SAFER Hardmount) (2)

Medium ORU Bag with SLRI 6

- Fuse Tether
- RET (eq-lg)
- SABB Restraints (2)**
- Large Trash Bag
- AJIS Launch Restraint Locks (4)**
- Digital camera
- SARJ Launch Locks (up to 6)**
- Adj Equip Tether (eq-lg) (2 outside bag)
- RET (eq-lg) (outside of bag)

S1 TRUSS

- Safety Tether – S1 – HR 3214 (cable tray) strung to airlock
- Safety Tether – S1 – HR 3221 (nadir edge) strung to airlock

S3 TRUSS

- APFR WIF S3-28 [2,PP,F,12]
- EVA Crewlock Bag – S3 – HR 3049
- Vise Grips
- Socket Caddy
- 5/8 (rigid) socket-7.8 ext
- 7/16 (rigid) Socket-2 ext
- 7/16 (rigid) Socket-9 ext
- RET (eq-eq) w/PIP pin
- 3/8-in IVA Tool Stack w/DPT Adapter
- ISS Ratchet Wrench
- 5/8 (rigid) socket-7.8 ext
- RET (eq-eq)
- Round Torque Multiplier
- Rd TM Socket – 5/8 prd
- RET (eq-lg) (outside of bag)

S4 TRUSS

- APFR WIF S4-04 [6,PP,L,1]

 Shading indicates trash items

EVA 1 TASK DATA

S1-S3 UTILITY TRAY CONNECT – TASK DATA

Estimated Task Duration:

	With RMS	Without RMS
One EV Crew	NA	0:30/utility tray + 0:35 commanding
Two EV Crew	NA	NA

Tools:

EV1	EV2
BRT	NA
APFR	

EVA Fasteners:

Fastener Name	Label	Head Size	Qty	Install Torque (ft-lb)	Release Torque (ft-lb)	Failure Torque (ft-lb)	Turns	RPM
NA								

EVA Connectors:

Harness – Connector	From: panel/ connector	To: panel/ connector	Clamps (#)	Conn Size	Function
W5002 (EO) – P11	A51/J31	A88/J11	1	37	Primary Power 3A
W5004 (EO) – P12	A51/J32	A88/J12	1	37	Primary Power 3B
W5104 (EO) – P13	A51/J33	A88/J13	1	25	Secondary Power 2B
W5102 (EO) – P14	A51/J34	A88/J14	1	33	Secondary Power 3A
W5210 (RF) – P15	A51/J1	A88/J15	1	25	Data/1553 B
W5402 (FO) – P16	A51/J36	A88/J16	1	15	High Rate Data Link (PAS-1/4)
W5304 (ML) – P17	A51/J37	A88/J17	1	25	INSTM (Strain Gage/ Accelerometer)
W5001 (EO) – P1	A50/J21	A89/J1	1	37	Primary Power 1A
W5003 (EO) – P2	A50/J22	A89/J2	1	37	Primary Power 1B
W5101 (EO) – P3	A50/J23	A89/J3	1	25	Secondary Power 1A
W5103 (EO) – P4	A50/J24	A89/J4	2	33	Secondary Power 4B
W5209 (RF) – P5	A50/J1	A89/J5	1	25	Data/1553 A
W5401 (FO) – P6	A50/J26	A89/J6	1	15	Video/Sync-3, High Rate Data Link (PAS-2/3)

Foot Restraints:

Task	WIF	APFR Setting
Mate S1 to S3 Nadir Tray Umbilicals	S3-04	[6,TT,F,12]
Mate S1 to S3 Fluid Line	S3-04	[6,TT,F,12]
Mate S1 to S3 Zenith Tray Umbilicals	S3-01	[6,TT,F,12]

Note:

1. Internal S1 TA clamps (3) were released during 9A
2. No shroud exists on the S3 side utility tray
3. P11/J11 and P12/J12 connector mating may require excessive cable manipulation due to excess cable length on W5001, W5002, W5003, and W5004. (Ref: S1 to S3 OOCT Crew squak)
4. Connectors can be mated in any order to optimize EVA sequence

Cautions:

1. Power should be restored as quickly as possible after the power umbilicals have been connected
2. Fiber optic cable harnesses P6 and P16 shall be firmly supported during installation to prevent damage due to excessive bending, kinking, tension, torsional loading or other excessive strain. Avoid bend radii of less than 10 times the diameter of the wire harness

Warnings:

1. Power must be turned off to connectors P1-P6 and P11-P17 while being mated/demated to preclude arcing/sparking

S1-S3 UTILITY TRAY CONNECT – TASK DATA (Cont)

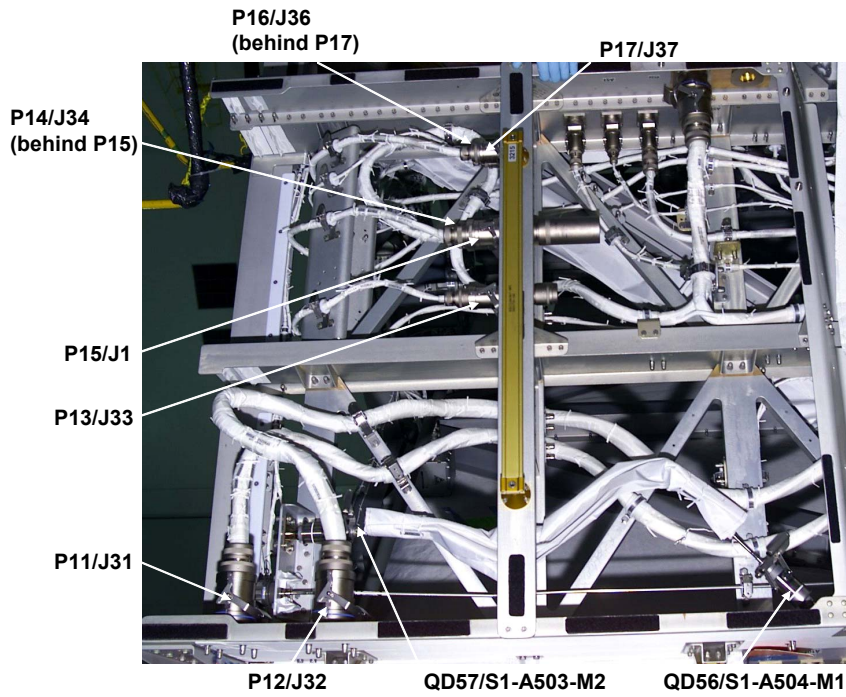

S1-S3 Nadir Tray Utilities (Face 6) – before mating to S3

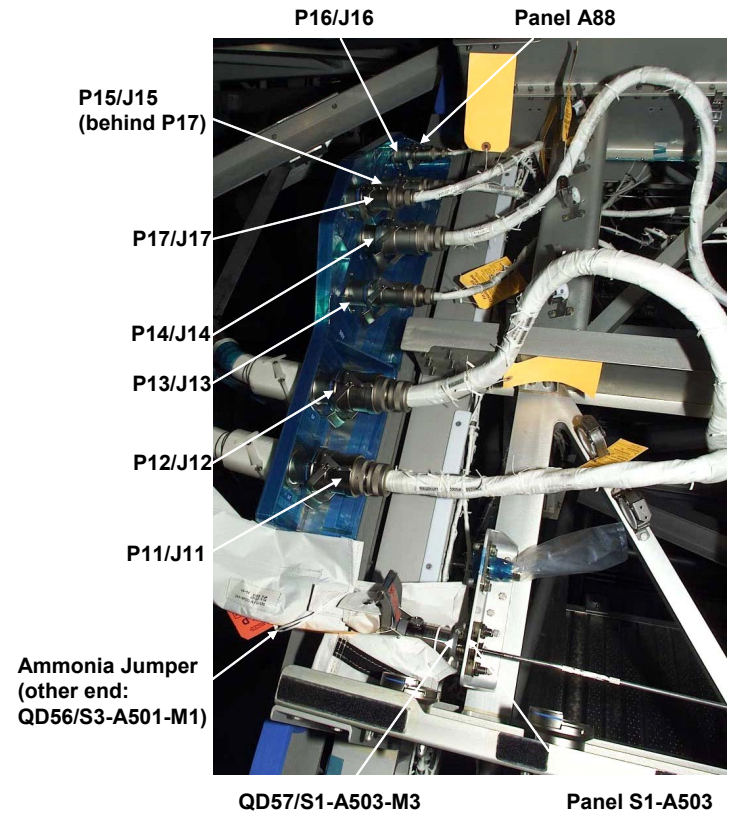

S1-S3 Nadir Tray Utilities (Face 6) – after mating to S3

S1-S3 UTILITY TRAY CONNECT – TASK DATA (Cont)

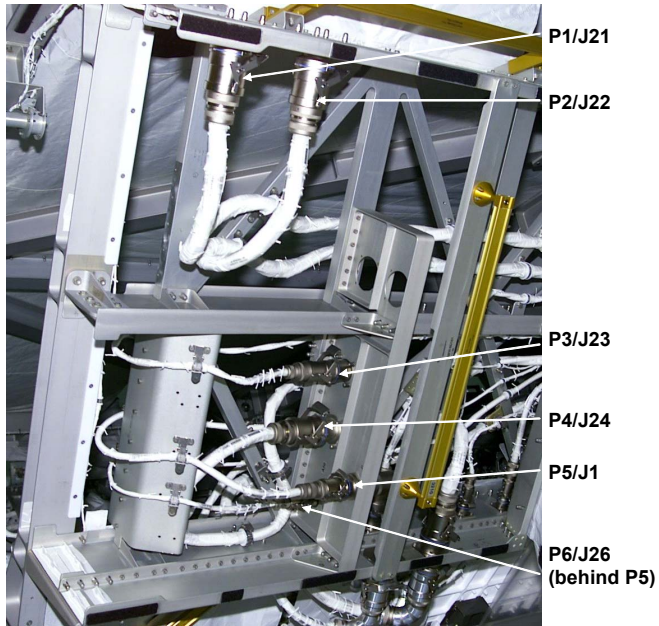

S1-S3 Zenith Tray Utilities (Face 2) – before mating to S3

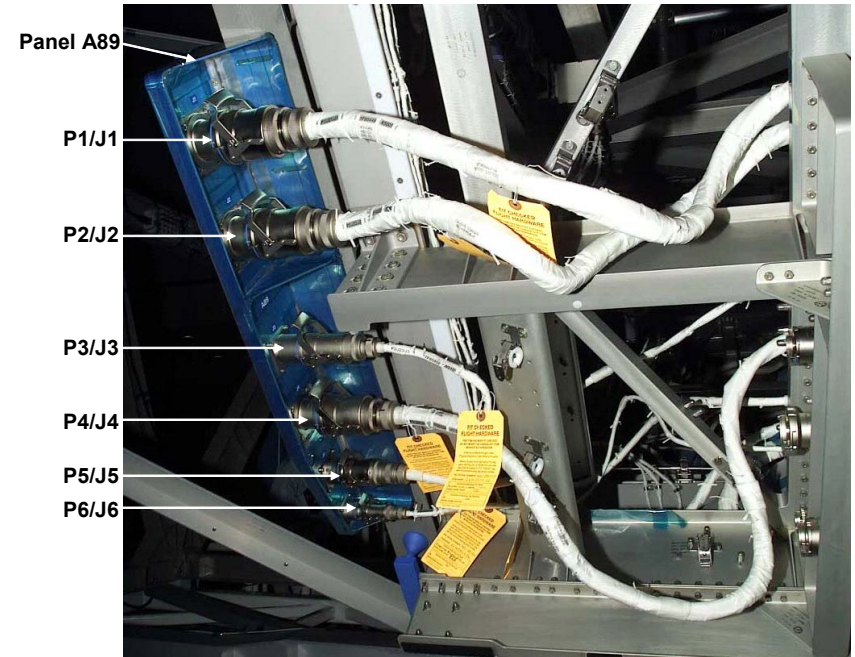

S1-S3 Zenith Tray Utilities (Face 2) – after mating to S3 (mockup)

P5/J1

SABB RESTRAINT RELEASE – TASK DATA

Estimated Task Duration:

	With RMS	Without RMS
One EV Crew	NA	02:00
Two EV Crew	NA	01:00

Tools:

EV1	EV2
NA	PGT
	Rd TM with 5/8
	5/8 (rigid) Socket-7.8 ext
	APFR

EVA Fasteners:

Fastener Name	Label	Head Size	Qty	Install Torque (ft-lb)	Release Torque (ft-lb)	Failure Torque (ft-lb)	Turns	RPM
Inboard SABB Launch Restraint	NA	5/8	2	98	119	389	13	30
Outboard SABB Launch Restraint	1-6	5/8	6	97	118	390	13	30

EVA Connectors:

Harness	From	To	Clamps (#)	Conn Size	Function
NA					

Foot Restraints:

Task	WIF	APFR Setting
Release aft inboard SABB Launch Restraint	S4-15	[9,MM,E,1]
Release aft outboard SABB Launch Restraint	S4-15	[2,MM,E,12]
Release forward inboard SABB Launch Restraint	S4-13	[9,NN,E,1]
Release forward outboard SABB Launch Restraint	S4-13	[2,NN,E,11]

Notes:

1. Reach to Outboard SABB restraint fasteners 5 and 6 may require partial egress of APFR

Cautions:

1. Unfasten Jack bolt #6 (nearest the tether point) last. Fasteners #1-5 can be released in any order

Warnings:

None

SABB RESTRAINT RELEASE – TASK DATA (Cont)

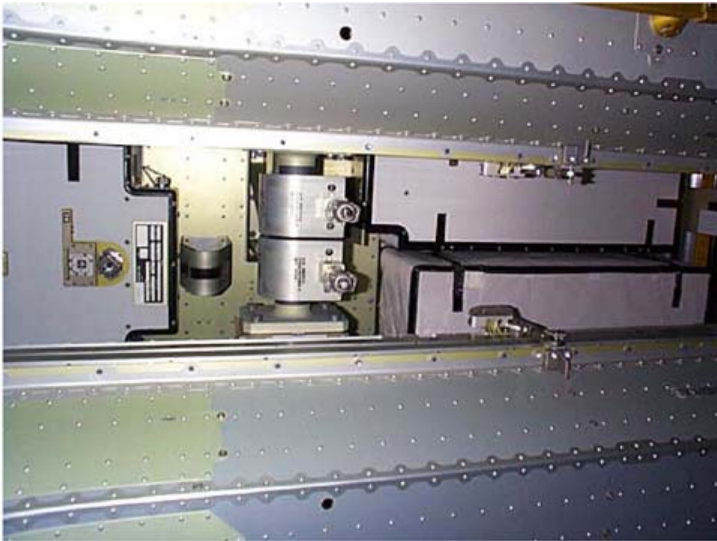

SABB Inboard Launch Restraint

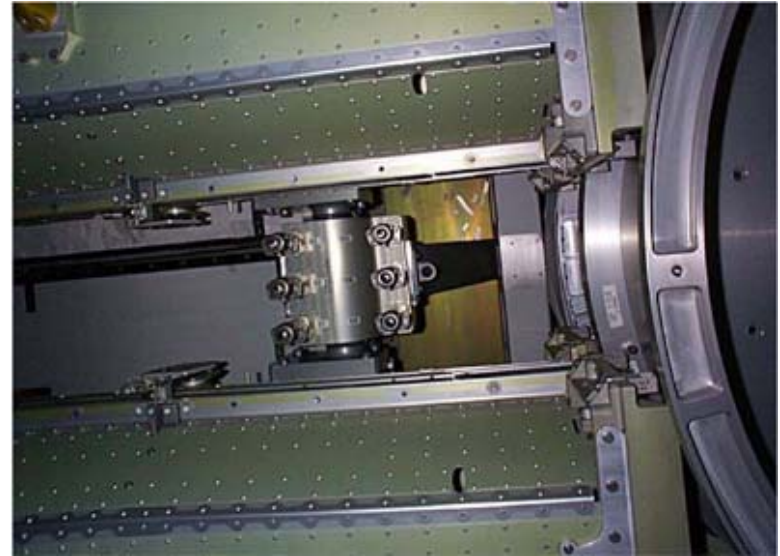

SABB Outboard Launch Restraint

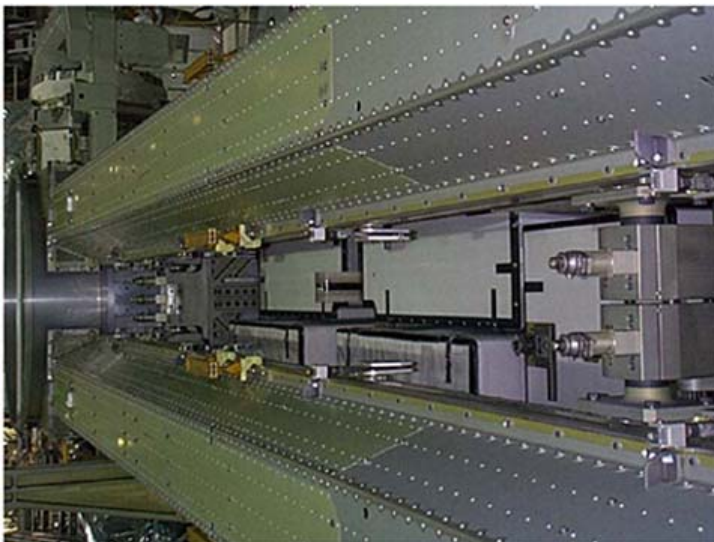

SABB Outboard and Inboard Restraints (left to right in view)

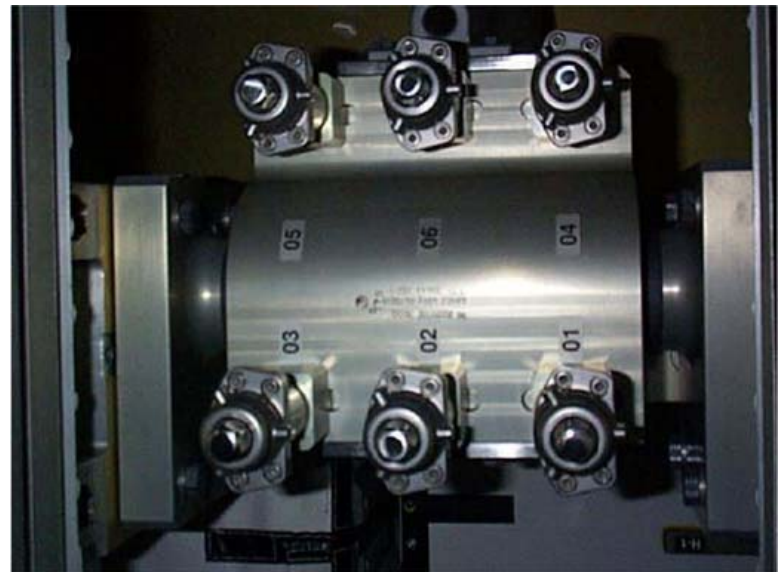

SABB Outboard Launch Restraint

S4 IEA KEEL PIN ROTATE – TASK DATA

Estimated Task Duration:

	With RMS	Without RMS
One EV Crew	NA	0:30
Two EV Crew	NA	N/A

Tools:

EV1	EV2
PGT (prime)	NA
7/16 wobble socket-6 ext	

EVA Fasteners:

Fastener Name	Label	Head Size	Qty	Install Torque (ft-lb)	Release Torque (ft-lb)	Failure Torque (ft-lb)	Turns	RPM
IEA Keel Pin Restraint Bolt	NA	7/16	1	4 gnd	38	168 removal 44 install	43	60

EVA Connectors:

Harness	From	To	Clamps (#)	Conn Size	Function
NA					

Foot Restraints:

Task	WIF	APFR Setting
Rotate IEA Keel Pin	S4-28	12,QQ,G,12 (3A 4-bar must be deployed)

Notes:

none

Cautions:

none

Warnings:

1. Sharp edge. The Keel fastener has exposed bolt threads when removed from the Keel body

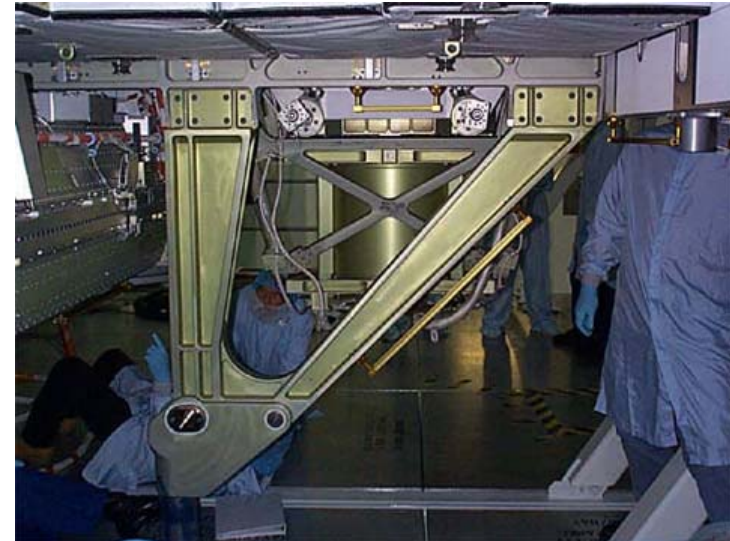

Beta Gimbal Restraints and IEA Keel Pin



Keel Pin Rotated

PVR RADIATOR CINCHES/WINCHES – TASK DATA

Estimated Task Duration:

	With RMS	Without RMS
One EV Crew	N/A	0:30
Two EV Crew	N/A	0:15

Tools:

EV2
PGT
BRT
7/16 wobble socket-6 ext

EVA Fasteners:

Fastener Name	Label	Head Size	Qty	Install Torque (ft-lb)	Release Torque (ft-lb)	Failure Torque (ft-lb)	Turns	RPM
Cinch	H11-H16	7/16	6	22.9	15.8	35.7	8-14	30
				(H11-H12)	(H11-H12)	(H11-H12)		
				33.8	24.6	39.7		
				(H13-H16)	(H13-H16)	(H13-H16)		

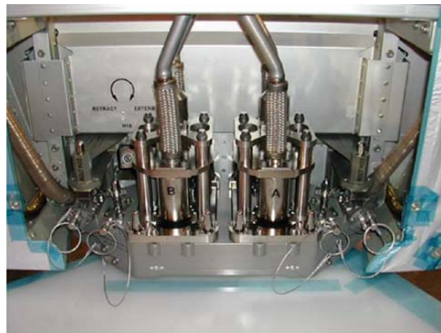

PVR FQDC

Notes:

- Incidental contact with silver radiator surface is acceptable
- Winch release is performed after cinches so that winch bar tension is relieved for PIP pin removal

Cautions:

None

Warnings:

- Moving hardware hazard. Radiators are free to move after winches released

Constraints:

- APFR ingress/egress cannot happen concurrently with radiator deploy

PVR EVA Interfaces

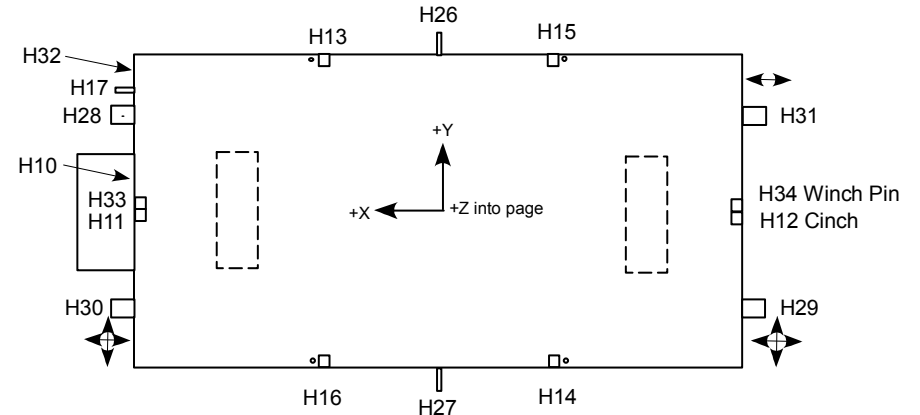

PVR

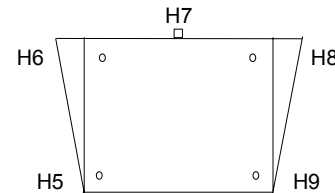

FQDC Shroud

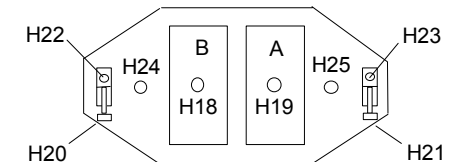

FQDC

H5,6,9,8 = FQDC Shroud Fasteners
 H7 = FQDC Shroud Alignment Pin
 H10 = Winch Drive
 H11 - H16 = Cinches
 H17 = Grounding Strap
 H18 - H19 = FQDC Drive bolts
 H20 - H21 = Carrier Slider bolts
 H22 - H23 = Carrier to PVR Attach
 H24 - H25 = Carrier to IEA Attach
 H26 - H27 = Center Bolts
 H28 - H31 = Corner Bolts
 H32 = Manual Deploy/Retract
 H33-H34 = Winch PIP pins

SAW BETA GIMBAL RESTRAINT RELEASE – TASK DATA

Estimated Task Duration:

	With RMS	Without RMS
One EV Crew	NA	0:40
Two EV Crew	NA	N/A

Tools:

EV1	EV2
Ratchet wrench	NA
5/8 (rigid) Socket-7.8 ext	
BRT	
Rd TM with 5/8 prd (backup)	
PGT (backup)	

EVA Fasteners:

Fastener Name	Label	Head Size	Qty	Install Torque (ft-lb)	Release Torque (ft-lb)	Failure Torque (ft-lb)	Turns	RPM
Beta Gimbal Launch Restraint Bolts	NA	5/8	2	60 gnd	60 @ 70F, 118 @200F	496	10-12	60

EVA Connectors:

Harness	From	To	Clamps (#)	Conn Size	Function
NA					

Foot Restraints:

Task	WIF	APFR Setting
Release Aft Beta Gimbal Restraints	S4-16	1,PP,L,12
Release Forward Wing Beta Gimbal Restraints	S4-14	12,PP,K,12

Notes:

- Do not release the third clamp from the BMRRM. This is a sliding clamp which the Primary power cable is intended to slide through

Cautions:

The following must be complete prior to release of BGA Restraints:

- SABB Restraints Released (2 per wing)
- Primary Power cable TA clamps released (3 per wing)
- APFR relocated from SABB Restraint location
- IEA Keel Pin rotated prior to forward wing BGA Restraint release

Warnings:

- Entire area behind the IEA bulkhead, Beta Gimbal/Solar Array wing, must be clear prior to fastener disengagement
- Verify that Beta Gimbal/Solar Array wing motion has stopped before exiting worksite

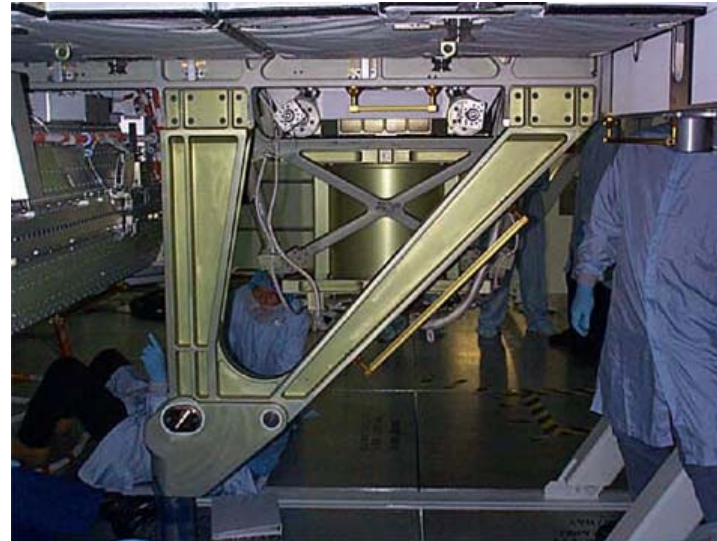

Beta Gimbal Restraints (Aft Wing)

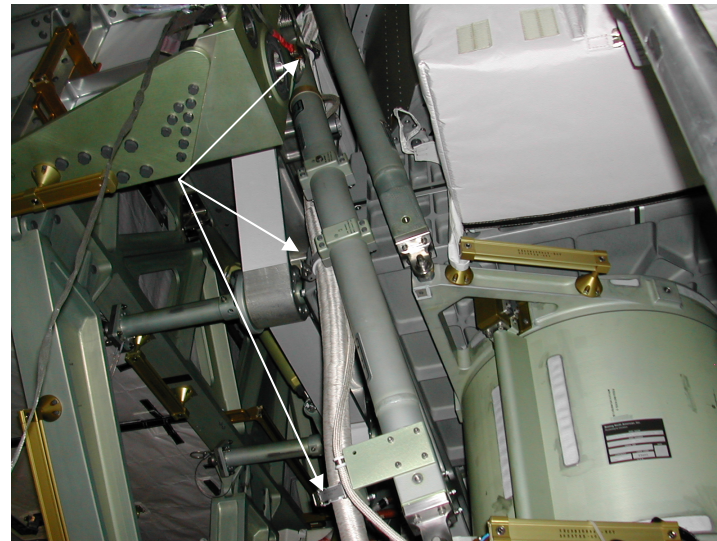

Primary Power Cable TA Clamps (Aft Wing)

FWD/AFT (1A/3A) SABB UNSTOW – TASK DATA

Estimated Task Duration:

	With RMS	Without RMS
One EV Crew	NA	0:45
Two EV Crew	NA	0:20

Tools:

EV1	EV2
PGT	
7/16 (wobble) Socket-6 ext	

EVA Fasteners:

Fastener Name	Label	Head Size	Qty	Install Torque (ft-lb)	Release Torque (ft-lb)	Failure Torque (ft-lb)	Turns	RPM
Mast Canister Tip Fitting	Yes	7/16	3	7	8	12.8	14	30

EVA Connectors:

Harness	From	To	Clamps (#)	Conn Size	Function
NA					

Foot Restraints:

Task	WIF	APFR Setting
NA		

Note:

1. Mast Tip Fasteners will pop-up when disengaged

Cautions:

1. Deploy SABB no faster than 6 degrees/second (15 seconds minimum for complete deployment)
2. 4-bar linkage must be deployed and SABBs rotated into the deployed position before Mast Canister Tip Fitting restraints can be disengaged

Warnings:

1. Pinch point hazard – Stay clear of pivot fitting and lockout arm during SABB rotation

AJIS STRUT RIGIDIZATION – TASK DATA

Estimated Task Duration:

	With RMS	Without RMS
One EV Crew	NA	0:40
Two EV Crew	NA	NA

Tools:

EV1	EV2
NA	PGT
	7/16 (wobble) Socket-6 ext
	Large Trash Bag

EVA Fasteners:

Fastener Name	Label	Head Size	Qty	Install Torque (ft-lb)	Release Torque (ft-lb)	Failure Torque (ft-lb)	Turns	RPM
AJIS Strut Fastener	Yes	7/16	4	7-22 on orbit	N/A	22.1	39	60

EVA Connectors:

Harness	From	To	Clamps (#)	Conn Size	Function
NA					

Foot Restraints:

Task	WIF	APFR Setting
AJIS Strut #1 worksite	S4-11	[9,QQ,F,12]
AJIS Strut #2 worksite	S4-03	[7,PP,G,12]
AJIS Strut #3 worksite	S4-02	[5,PP,E,12]
AJIS Strut #4 worksite	S4-10	[3,QQ,F,12]

Notes:

- Per 12A analysis, Struts 1 and 4 are predicted to not engage the cone fasteners if they are not installed prior to SARJ Launch Lock and Launch restraint removal due to structural deflection
- There are (4) AJIS on-orbit struts between S4 and S3. The struts may be rigidized in any order
- The strut numbers correspond to the label numbers located on the S4 bulkhead adjacent to the strut clevis

Cautions:

None

Warnings:

None

AJIS STRUT RIGIDIZATION – TASK DATA (Cont)

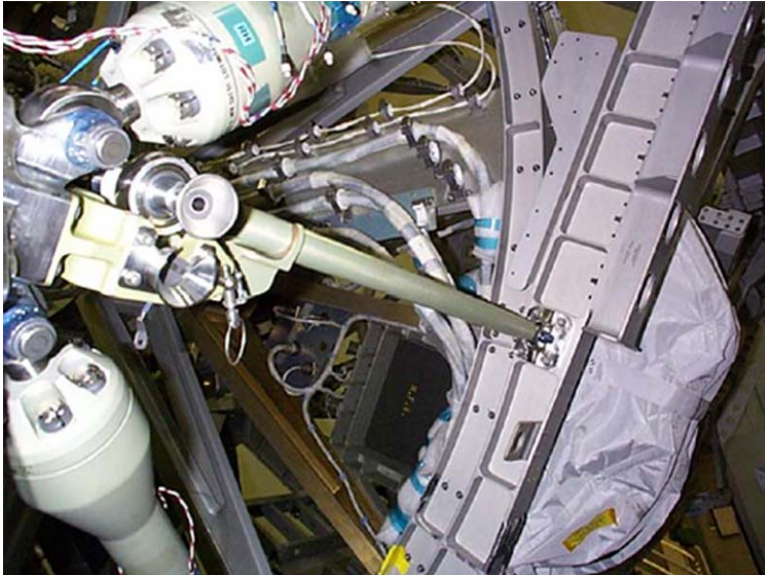

AJIS Strut with SARJ Bulkhead in Background (thermal bootie not shown)



AJIS Strut Cone Fastener (engaged, but not fastened)



AJIS Strut with Strut Launch Restraint (thermal bootie removed)

SARJ DLA INSTALL – TASK DATA

Estimated Task Duration:

	With RMS	Without RMS
One EV Crew	NA	1:00
Two EV Crew	NA	NA

Tools:

EV1	EV2
PGT	NA
6 Ext 7/16	
APFR	
RET	
Adj. Equipment Tether	

EVA Fasteners:

Fastener Name	Label	Head Size	Qty	Install Torque (ft-lb)	Release Torque (ft-lb)	Failure Torque (ft-lb)	Turns	RPM
MLI Cover Swing Bolts	NA	7/16	4 per cover	2.3-3.0	2.8	5.5	8-12	60
MLI Cover Inboard Fasteners	NA	7/16	4 per cover	3.1-3.6 gnd 0.8-3.8 on-orbit	3.4	13.7	7-9	60 rmv 30 inst
DLA 1A and 2A Lock bolts	Yes	7/16	2 per	3.3-6.3	6.7	42.2	6	30
DLA 1C and 2C Draw Bolts	Yes	7/16	2 per	4.8 initial 19.4 final	0.8	38.9	38	30
DLA 4A, 4B, and 4C Launch Restraint Bolts	Yes	7/16	3 per	24-26	25	50-A&B 75-C	10-A&B 8-C	30
DLA 1B and 2B Follower arm rotation Bolts	Yes	7/16	2 per	NA	NA	10.6	5/8	10

EVA Connectors:

Harness	From	To	Clamps (#)	Conn Size	Function
NA					

Foot Restraints:

Task	WIF	APFR Setting
Cover 5 DLA 1 Face 2	S3-28	[2,PP,F,12]
Cover 20 DLA 2 Face 6	S4-04	[6,PP,L,1]

Notes:

1. If any spring clamp assembly fails to snap completely out of the way, a gentle nudge may be required
2. The bolts nearest the tether loop must be released prior to tethering to the shroud to avoid interference between the tether hook and PGT
3. The outboard SARJ race ring side MLI cover bolts (spring clamp bolts) should be released prior to the inboard MLI cover bolts
4. Cabling on outboard side of SARJ may interfere with DLA cover re-installation. Cover should be installed outboard side first, then inboard side
5. To re-install the DLA cover, all bolts should be started before any are driven fully

Cautions:

1. During re-installation of MLI covers, do not re-install spring clamp assemblies on the outboard SARJ race ring side (outboard fasteners). This will preclude SARJ rotation
2. Any single failure of bolts/spring clamp assemblies will prevent SARJ activation
3. Avoid impacting the race ring with the DLA when the DLA is unconstrained
4. During follower arm rotation (90 deg turn) when the DLA is still unconstrained, interference with structure may occur. The DLA must be held against the outer side of the SARJ race ring for the follower arm to rotate fully – clearing obstruction

Warnings:

None

SARJ DLA INSTALL – TASK DATA (Cont)



SARJ Race Ring and DLA Pinion Gear (gold)

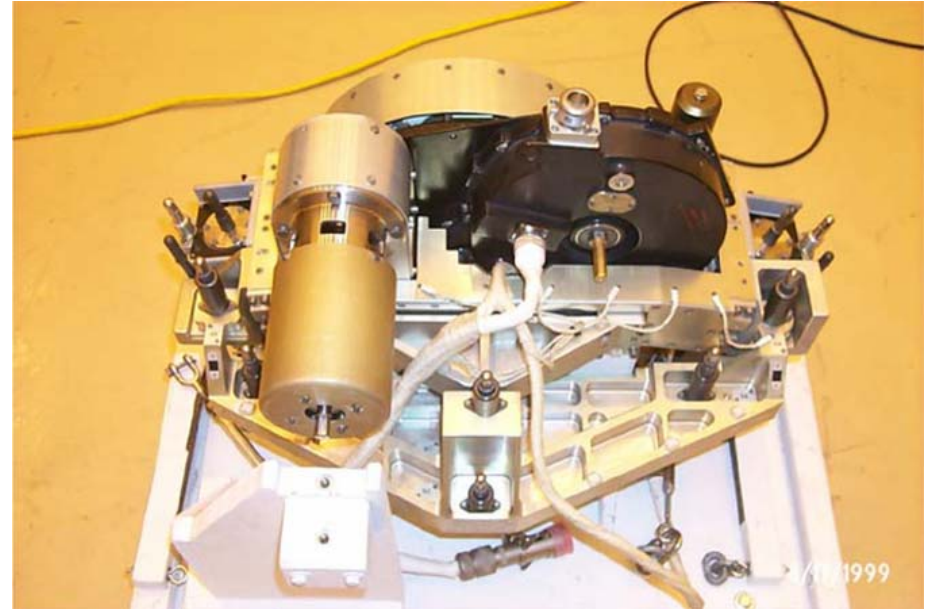

DLA

SARJ PREP CUE CARD

TOP

HOOK
VELCRO

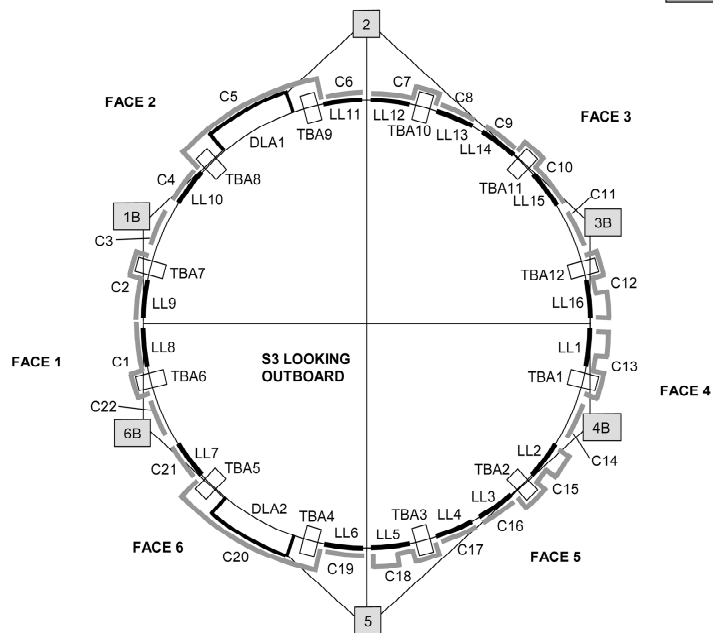

Cover # (# Inbd bolts/ # Outbd bolts)	Item under cover	Swing bolt released	Inboard cover bolt released	Item removed	Inbd cover bolts installed
1 (6/3)	LL 8				
2 (6/3)	LL 9				
3 (4/1)					
4 (4/2)	LL 10				
5 (4/4)	DLA 1				
6 (4/2)	LL 11				
7 (6/2)	LL 12				
8 (4/2)	LL 13				
9 (4/2)	LL 14				
10 (6/3)	LL 15				
11 (4/1)					
12 (6/3)	LL 16				
13 (6/3)	LL 1				
14 (4/1)					
15 (6/3)	LL 2				
16 (4/2)	LL 3				
17 (4/2)	LL 4				
18 (6/3)	LL 5				
19 (4/2)	LL 6				
20 (4/4)	DLA 2				
21 (4/2)	LL 7				
22 (4/1)					

LL = Launch Lock
DLA = Drive Lock Assembly

Launch Restraints	Torque Broken	Removed
Face 1-2 (1B)		
Face 2-3 (2)		
Face 3-4 (3B)		
Face 4-5 (4B)		
Face 5-6 (5)		
Face 6-1 (6B)		

Tether Point

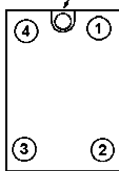

Launch Lock

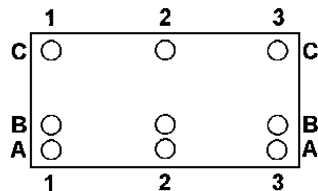

SARJ MLI Cover

Outboard

(reduced copy)

EVA-6a/117/O/B

TOP
Back of 'SARJ PREP CUE CARD'

HOOK
VELCRO

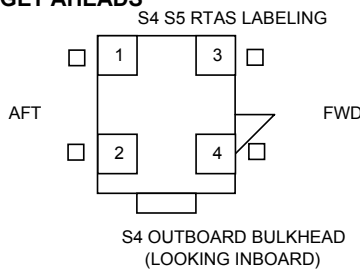
EVA 1 TASKS	EVA 2 TASKS	EVA 3 TASKS
<ul style="list-style-type: none"> <input type="checkbox"/> Nadir Utility Tray Connect <input type="checkbox"/> Zenith Utility Tray Connect <input type="checkbox"/> MDM Shroud removed <p>AFT WING DEPLOY Prior to BGA Release:</p> <ul style="list-style-type: none"> <input type="checkbox"/> Inb SABB Restraint release <input type="checkbox"/> Out SABB Restraint release <input type="checkbox"/> TA Clamp release (3) <input type="checkbox"/> APFR relocated <input type="checkbox"/> BGA Restraints released (2) <input type="checkbox"/> Blanket Boxes deployed <input type="checkbox"/> ECU Cover removed <input type="checkbox"/> SSU Cover removed <input type="checkbox"/> Aft wing TA clamps reclosed (3) <input type="checkbox"/> BGA pip pins reinserted <p>FWD WING DEPLOY Prior to BGA Release:</p> <ul style="list-style-type: none"> <input type="checkbox"/> Inb SABB Restraint release <input type="checkbox"/> Out SABB Restraint release <input type="checkbox"/> TA Clamp release (3) <input type="checkbox"/> APFR relocated <input type="checkbox"/> Keel Pin rotated <input type="checkbox"/> BGA Restraints released (2) <input type="checkbox"/> Blanket Boxes deployed <input type="checkbox"/> ECU Cover removed <input type="checkbox"/> SSU Cover removed <input type="checkbox"/> Fwd wing TA clamps reclosed <input type="checkbox"/> BGA PIP pins reinserted 	<p>PVR</p>  <p>AJIS</p> <ul style="list-style-type: none"> <input type="checkbox"/> AJIS STRUT AFT NADIR (#1) <input type="checkbox"/> AJIS STRUT FWD NADIR (#2) <input type="checkbox"/> AJIS STRUT FWD ZENITH (#3) <input type="checkbox"/> AJIS STRUT AFT ZENITH (#4) <p>SARJ PREP</p> <ul style="list-style-type: none"> <input type="checkbox"/> DLA 2 deployed <input type="checkbox"/> See opposite side launch locks, swing bolts <p>GET AHEADS</p>  <p>S4 S5 RTAS LABELING</p> <p>S4 OUTBOARD BULKHEAD (LOOKING INBOARD)</p> <p>SARJ PREP</p> <ul style="list-style-type: none"> <input type="checkbox"/> DLA 1 deployed <input type="checkbox"/> SARJ Brace Beam deployed face 2 <input type="checkbox"/> SARJ Brace Beam deployed face 3 <input type="checkbox"/> SARJ Brace Beam deployed face 5 <input type="checkbox"/> SARJ Brace Beam deployed face 6 <input type="checkbox"/> See opposite side launch locks, restraints, swing bolts <p>MT/CETA PATH PREP</p> <ul style="list-style-type: none"> <input type="checkbox"/> ETRS installed <input type="checkbox"/> Tether Shuttle Stop stowed <input type="checkbox"/> S3 SVS Target removed <p>GET AHEADS</p> <ul style="list-style-type: none"> <input type="checkbox"/> APFR to S4-19 <input type="checkbox"/> APFR to S3-05 (for drag link/keel pin) <input type="checkbox"/> MMOD Shield Bolts (4) released <p>CLEANUP</p> <ul style="list-style-type: none"> <input type="checkbox"/> All Medium ORU Bags inside airlock 	<ul style="list-style-type: none"> <input type="checkbox"/> Solar array 2B retracted <p>S3/S4</p> <ul style="list-style-type: none"> <input type="checkbox"/> S3 MT Stop pip pin pulled <input type="checkbox"/> Drag Link/Keel Pin stowed <input type="checkbox"/> S1 MT Stop stowed <p>CLEANUP</p> <ul style="list-style-type: none"> <input type="checkbox"/> Crewlock Bag inside <input type="checkbox"/> MMOD T-handle Tools <p>GET AHEADS</p> <ul style="list-style-type: none"> <input type="checkbox"/> H2 Vent installed <input type="checkbox"/> H2 Vent opened (post leak check) <input type="checkbox"/> EWIS installed <input type="checkbox"/> Node/SM LAN Cable installed <input type="checkbox"/> S1 to S3 Fluid Line installed <input type="checkbox"/> APFR to S4-18 <input type="checkbox"/> SASA Gimbal Bolts <input type="checkbox"/> Node HR 120 removed <input type="checkbox"/> GPS 4 removed <input type="checkbox"/> VSSA Stanchion installed <input type="checkbox"/> S3 LO PAS Deployed

EVA-6b/117/O/B

(reduced copy)

EVA 2 SUMMARY TIMELINE

TIME HR : MIN	IV	EV3 (FR)	EV4 (SW)	
00:00		POST DEPRESS (00:05) EGRESS/SETUP (00:40)	POST DEPRESS (00:05) EGRESS/SETUP (00:40)	00:00
01:00		2B RETRACT (00:45)	2B RETRACT (00:45)	01:00
	· Verify MCC GO for DLA 2 Install	SARJ BRACE DEPLOY (2) (00:30)	SARJ BRACE DEPLOY (2) (00:30)	
02:00		SARJ DLA INSTALL (01:00)	SARJ LAUNCH LOCK/LAUNCH RESTRAINT REMOVAL (03:30) · Remove Launch Locks (Covers 15, 8, 9, 10, 12, 13)	02:00
03:00	Perform DLA 2 engagement	SARJ LAUNCH LOCK/LAUNCH RESTRAINT REMOVAL (03:00) · Remove Launch Locks (Covers 17, 16, 6, 7)		03:00
04:00				04:00
05:00		· Remove Launch Restraints · MT/CETA Path clearing tasks as time permits	· Remove Launch Restraints · MT/CETA Path clearing tasks as time permits	05:00
06:00	Lock DLA	CLEANUP/INGRESS (00:30)	CLEANUP/INGRESS (00:30)	06:00
		PREREPRESS (00:05)	PREREPRESS (00:05)	

EVA 2

PRE EVA 2 TOOL CONFIG

- EV 3**
- MWS
 - BRT (L)
 - RET (eq-eq)
 - Swing Arm (R)
 - RET (eq-eq)
 - T-Bar
 - RET (eq-eq)
 - RET (eq-eq) w/PIP pin
 - Adj Equip Tether (2)
 - Wire Tie (2)
 - Small Shuttle Trash Bag
 - D-ring Extender (2, R & L D-ring)
 - Waist Tether (L D-ring)
 - SAFER
 - WVS

- EV 4**
- MWS
 - BRT (L)
 - RET (eq-eq)
 - Wire Tie
 - Swing Arm (R)
 - RET (eq-eq)
 - PGT [A2 3.8ft-lb, CAL, MTL 30.5] S/N _____
 - PGT Battery S/N _____
 - 7/16 (wobble) Socket-6 ext
 - T-Bar
 - RET (eq-eq)
 - RET (eq-eq) w/PIP Pin
 - Adj Equip Tether
 - Wire Tie (2)
 - Small Shuttle Trash Bag
 - D-ring Extender (2, R & L D-ring)
 - 85 ft Safety Tether**
 - Waist Tether (L D-ring)
 - SAFER
 - WVS

- AIRLOCK CONFIG**
- Staging Bag
 - Fuse Tether
 - PGT S/N _____
 - PGT Battery S/N _____
 - Wire Tie Caddy
 - RAD S/N _____
 - Connector Cleaner Tool Kit
 - Probe
 - Prybar
 - Connector Pin Straightener
 - Velcro/Tape Caddy
 - SLR Torque Multiplier**
 - IV Bag
 - Towels (2)
 - Contamination Detection Kit
 - GP Caddy (2)
 - Adjustable Thermal Mittens (2)
 - Socket Caddy (hatch cont) w/ eq-eq RET
 - 1/2 Socket-8 ext
 - 7/16 (wobble) Socket-6 ext (spare)
 - DCM Plug (SAFER Hardmount) (2)
 - Fuse Tether
 - PGT [A2 3.8ft-lb, CAL, MTL 30.5] S/N _____
 - PGT Battery S/N _____
 - 7/16 (wobble) Socket-6 ext
 - WIF Adapter w/PIP pin**
 - Cheater Bar (w/ Tape)**
 - 1.5" Bail Drive Lever (taped to Cheater Bar)**
 - Crewlock Bag
 - EVA Temporary Rail Stop (ETRS) S/N _____
 - RET (eq-eq)(2)
 - RET (eq-lg) (outside of bag)
 - Crewlock Bag (2B Tools)**
 - Digital Camera
 - Digital Camera L bracket
 - Compound Cutter/Needle Nose Pliers Caddy (w/ Tape)**
 - Loop Pin Puller Caddy (w/ Tape)**
 - TPS Scraper (w/ Kapton Tape)**
 - BRS Pin Contingency Tool (w/ Kapton Tape)**
 - RET (eq-lg) (outside of bag)
 - Medium ORU Bag with SLRI 10
 - RET (eq-eq) (2)
 - Adj Equip Tether
 - Large Trash Bag (empty)
 - Adj Equip Tethers (2 eq-lg) (outside of bag)
 - RET (eq-lg) (outside of bag)

- S1 TRUSS**
- Safety Tether – S1 - HR 3214 (cable tray) strung to airlock
 - Safety Tether– S1 - HR 3221 (nadir edge) strung to airlock

- S3 TRUSS**
- APFR WIF S3-28 [2,PP,F,12]
 - Crewlock EVA Bag – S3 - HR 3049
 - Vise Grips
 - Socket Caddy
 - 5/8 (rigid) Socket-7.8 ext
 - 7/16 (rigid) Socket-2 ext
 - 7/16 (rigid) Socket-9 ext
 - RET (eq-eq) w/PIP pin
 - 3/8-in IVA Tool Stack w/DPT Adapter
 - ISS ratchet wrench
 - 5/8 (rigid) Socket-7.8 ext
 - Round Torque Multiplier
 - Rd TM Socket – 5/8 prd
 - RET (eq-lg) (outside of bag)

- S4 TRUSS**
- APFR WIF S4-04 [6,PP,L,1]

- NOTE
- Prior to use, perform the following hardware inspections:
1. RET cords for fraying
 2. No red line visible on safety and waist tether load Alleviation straps
 3. Check BRT/Ballstack for loose screws and play
 4. Check Kapton Tape on solar array tools for damage
 5. Inspect STS trash bags for deformation/damage

Shading indicates tools coming from STS
Bold indicates tools required for Solar Array tasks

EVA BRIEFING CARD

EV1/3 _____ EV2/4 _____ IV1 _____ IV2 _____

EVA Prep start (GMT) ____ / ____ : ____
Depress to 10.2 _____ : _____
Start purge _____ : _____
PET 00:00 _____ : _____

EVA Prep

- Get-up plan – clothing and EMU equipment bag
- Exercise protocol review if required
- Equipment lock activities – IV responsibilities
- Suit donning plan – special requests
- SAFER, MWS, tools, CL positions and bag stowage
- Airlock depress review
- EV/IV comm protocol
- SRMS/SSRMS initial position

EV Crew Procedure Review

- Egress Plan
- Translations – tether swaps
- Order of tasks
- Ingress Plan

General Procedure Review

- Get ahead tasks
- Constraints – ground and flight
- Cautions and warnings review
- RMS operations – comm protocol/clearances
- Contingency procedures – crib sheet

Emergencies review

- Lost comm
- EMU malfunctions
- Lost tools
- Lost crewmember
- DCS

Post EVA

- Suit doffing responsibilities
- Post EVA plan

Lessons learned from previous EVAs and general motherhood

EVA 2 INHIBIT PAD

Orbiter

TCS
L12 1. √TCS POWER – OFF

Ku-Band Antenna
MCC-H 1. √KU-BAND Mask – active
2. √KU-BAND EVA Protect Box – active

RCS
If EV crew < 27 ft from FRCS:
IV 1. √DAP: VERN, FREE, LO Z
O14,15,16 2. √RJDF F1, F2, F3, F4 MANF DRIVER (four) – OFF
LOGIC (four) – OFF
MCC-H 3. √Above RCS config
IV 4. √RCS F – ITEM 1 EXEC (*)
√JET DES F1U – ITEM 17 (*)
F3U – ITEM 19 (*)
F2U – ITEM 21 (*)

Ground

Ground Radar
MCC-H 1. √TOPO console, ground radar restrictions in place for EVA

USOS

PCU
MCC-H 1. √PCUs (two) operational in discharge mode and one of the following:
A. CCS PCU EVA Hazard Control enabled
B. No more than two arrays unshunted
C. No more than two arrays pointed < 90 from velocity vector
OR
2. One or no PCUs operational in discharge mode and one of the following:
A. No more than two arrays unshunted
B. No more than two arrays pointed < 90 from velocity vector

TRRJ DLA
MCC-H 1. Starboard radiator TRRJ parked at 0 degrees

INHIBITS IF SOLAR ARRAY TASKS PERFORMED

S-BAND (SASA) Antennas
MCC-H 1. S1 SASA – Powered down
BGA 2. 2B BGA angle = 227.8125
3. 2B Motor State – OFF
4. Latch 2 Pin Status – Latched
5. 2B SSU - Shunted

RSOS

SM Antennas
MCC-M 1. Global Timing Sys 1(400.1 MHz) [GTS] – Deactivate
IV 2. ARISS (HAM radio) – Deactivate, or
VHF (144-146 MHz)TX only

FGB Antennas
IV 1. ARISS (HAM radio) – Deactivate, or
VHF (144-146 MHz)TX only

NOTES, CAUTIONS, AND WARNINGS

NOTES

1. Bolt install: report torque and turns
2. Bolt release: report torque and turns if different from published range
3. EVA connectors: after disconnection and prior to connection; verify pin and EMI band integrity; verify connector free of FOD
4. Toolbox doors must be closed with one latch per door when EV crew not in immediate vicinity

CAUTION

Flight Specific

- A. SARJ Prep:
1. During removal of inboard MLI cover fasteners:
 - a. Limit turn count to minimum required for fastener release
 - b. Minimize side loading bolt head
 - c. Maintain axial force on fastener to compress spring during rotation
 2. During re-installation of MLI covers, do not re-install swing bolts on MLI covers
 3. Avoid impacting the race ring with the DLA when the DLA is unconstrained
 4. DLA must be held against the outer side of the SARJ race ring during follower arm deploy to avoid interference with structure
- B. Translation Path/Tether routing
1. Avoid contact with S1/P1 Radiator Beam
 2. During ingress route and fairlead safety tether forward of camera/light stanchions and trunions
 3. During translation to 2B retract activities, fairlead safety tether along P6 to clear SSRMS path

ISS Generic Constraints

- C. Electrical Cables:
1. Avoid bend radius < 10 times cable diameter
- D. Fiber optic cables:
1. Avoid bend radius < 10 times cable diameter
 2. Avoid pulling on harness during mate/demate
- E. For Structural Reasons:
1. Avoid vigorous body motions, quick grabs and kickoffs against tether restraints
 2. Avoid performing shaking motions (sinusoidal functions) more than four cycles
- If any of these occur, wait 2-5 min to allow structural response to dissipate
- F. Other:
1. ITT Cannon connector: On demated connectors, do not rotate collar or manipulate cable/connector using collar or connector tool
 2. WIS Antennas: do not use as handholds [Node 1, P6, Z1, P4, S4]
 3. Lubricant from Ku-Band SGANT gimbals [Z1], CMGs [Z1], and RTAS Ground Strap fasteners can contaminate EMU [P6, P4, S4]
 4. MLI handholds are not rated for crewmember translation loads
 5. CBM petal covers may not be used as handholds unless both launch restraint pins are engaged
 6. Do not close hatch until EMU water OFF for 2 min

CAUTION (Cont)

ISS Generic Constraints

- G. Avoid inadvertent contact with:
1. Grapple fixture shafts (dry lube)
 2. PIP pins
 3. EVA Crane [PMA 1]
 4. TCS Reflectors [PMA 2, PMA 3]
 5. APAS hardware [PMA 2, PMA 3]
 6. CETA Lights (Z-93 paint) [Lab, S1, Node 1]
 7. Deployed MISSEs
 8. Passive UMAs
 9. MBS VDU, MCU, CRPCMs and Cameras (tape radiative surface, silver Teflon)
 10. Deployed TUS cable
 11. S0 aft face radiator
 12. GPS Antennas (S13 paint) [S0]
 13. UHF Antennas [Lab, P1]
 14. ETCS Radiators [S1, P1]
 15. EETCS/PV Radiator bellows and panels [P6, P4, S4, S6]
 16. SASA RF Group [Z1, S1, P6]
 17. Heat pipe radiators [Z1]
 18. PCU cathode and HCA ports [Z1]
 19. Ku-Band Antenna (SGANT) dish [Z1]
 20. CMG cover/shells [Z1]
 21. SSRMS Cameras
 22. Lab window shutter

NOTES, CAUTIONS, AND WARNINGS (Cont)

WARNING

Flight Specific

A. Solar Array

1. Sharp edges:
 - a. SABB (skirt, swing bolts)
 - b. Solar cells
 - c. Springs along tension bar
 - d. Panel hinges
 - e. Guide cable burrs or frays
 - f. Mast Canister roller guides
 - g. Braided cables
 - h. Fastener exposed threads
 - i. Exposed bolts in rib cavities on mast canister
 - j. Keep hands away from SSRMS LEE opening, and snares
2. RF radiation exposure:
 - a. Stay 3 ft from S-Band (SASA) high gain antenna when powered [S1, P6]
 - b. Stay 1.3 ft from S-Band (SASA) low gain antenna when powered [S1, P6]
3. Avoid inadvertent contact with:
 - a. SSU, ECU, beta gimbal platform, mast canister, SAW blanket boxes unless the beta gimbal is locked and the motor is turned off
4. Pinch:
 - a. Lower SABB exposed reels and pulleys (guide wire and tensioning mechanisms)
 - b. Solar array mast during retraction
5. Other:
 - a. EV crew will only contact energized surfaces with approved tools that have been insulated with Kapton tape to prevent molten metal and shock
 - b. Solar array to be manipulated will be shunted prior to EV crew entering worksite

B. SARJ Prep

1. Sharp edge - spring loaded captive EVA fasteners (SARJ MLI cover bolts); ends of springs may protrude

WARNING (Cont)

ISS Generic Constraints

C. Avoid inadvertent contact with:

1. Grapple fixture targets and target pins
3. Stay 2 ft from S1/P1 radiator beam rotational envelope when beam is free to rotate
4. Stay 5 ft from moving MT on face 1
5. Stay inboard of SARJ when active
6. Power must be turned off to electrical connectors prior to mating/demating to preclude arcing/sparking

D. Handrails

1. Handrails previously used for MISSE attachment may not be used as a safety tether point [A/L endcone 564 & 566, A/L Tank 2 nad/fwd & port/fwd, P6 5389]

E. Pinch

1. ITT Cannon Connector rotating housing
2. EV side of IV Hatch during Hatch operation (also snag hazard) [A/L]
3. LAB window shutter and CBM petal cover linkages during operation
4. NZGL connector linkage. Use caution when mating/locking

F. RF radiation exposure

1. Stay 1 ft from UHF antenna when powered [Lab, P1, PLB]

G. Sharp Edges:

1. Inner edges of WIF sockets
2. Back side of MMOD shield fasteners
3. PMA umbilical launch restraints – exposed threads
4. Adjustable Fuse Tether buckles stowed in Node Bag
5. Nickel coated braided copper ground straps may have frayed wires [P6, P4, S4]
6. Z1 handrail 6061 by the Ku-Band boom launch restraint [Z1]
7. Exposed fasteners on back of Z1 U-jumper male QD panel, if nutplate cap missing
8. Sharp edge – mating surfaces of EVA connectors. Avoid side loads during mating

WARNING (Cont)

ISS Generic Constraints (Cont)

H. Thermal:

1. EVA connectors with booties may become hot if left uncovered. Handling may need to be limited
2. PMA handrails may be hot. Handling may need to be limited
3. Turn off glove heaters when comfortable temp reached to prevent bladder damage. Do not pull fingers out of gloves when heaters are on
4. Uncovered trunnion pins may be hot
5. SSRMS/MBS operating Cameras and lights may radiate large amounts of heat
6. Stay 1 ft away from PMAs and MMOD shields > 270 degF if EMU sun visor up
Stay 1 ft away for no more than 15 min from PMAs and MMOD shields > 300 degF if EMU sun visor up
7. Stay 1 ft away for no more than 15 min from PMAs and MMOD shields > 325 degF
8. Stay 0.5 ft away from PMA and MMOD shields > 325 degF
9. Do not touch EMU protective visor if temp has been < -134 for > 15 min
10. No EMU TMG contact of PMAs and MMOD shields when temp > 320 degF
11. No EMU boot contact with foot restraint when temp < -120 degF or > 200 degF

EVA 2 EGRESS/SETUP FOR SOLAR ARRAY (00:40)

IV/SSRMS	EV3	EV4
<p>SSRMS at 2B SAW EVA Setup location</p> <p>1. WVS Software: Select page – RF camera Sel 'Advanced Controls' S-Band Level (two) – Max</p> <p>2. SSRMS translate to 2B array</p>	<p>Initial Condition: Waist Tether (L) to A/L D-ring</p> <p><u>EGRESS</u></p> <ol style="list-style-type: none"> 1. Open A/L thermal cover 2. Egress airlock 3. Attach airlock 55 ft Safety Tether to D-ring extender (L); verify Locked 4. √SAFER man isol vlv – open (down) 5. √SAFER HCM – closed (down) 6. Receive tools from EV4 7. Receive/temp stow Crewlock Bag 8. Connect EV4 safety tether to external airlock D-ring; verify locked 9. Retrieve airlock 55 ft safety tether; stow on MWS 10. Give EV4 GO for egress <p><u>SETUP</u></p> <ol style="list-style-type: none"> 11. Retrieve APFR from Z1-11; fairlead safety tether on Z1-6024 12. Translate to P6 HR 5327 13. GCA SSRMS for APFR install 14. Install WIF Adapter, tether point towards end effector 15. Install APFR in WIF adapter [12,PP,F,6] 16. Tether swap to SSRMS; verify locked 17. Stow airlock safety tether on P6-5327 18. Ingress APFR 19. Give SSRMS GO for translation to 2B array 	<p>Initial Condition: Waist Tether (L) to UIA D-ring, 85 ft safety tether to D-Ring Extender (R)</p> <p><u>EGRESS</u></p> <ol style="list-style-type: none"> 1. Transfer Cheater Bar and WIF Adapter to EV3 2. Transfer 2B Tools Crewlock Bag to EV3 3. Transfer safety tether (cable end) to EV3 4. On EV 3 GO, Egress A/L 5. √SAFER man isol vlv – open (down) 6. √SAFER HCM – closed (down) 7. Close A/L thermal cover 8. Retrieve Crewlock Bag <p><u>SETUP</u></p> <ol style="list-style-type: none"> 9. Translate to P6 HR 5307 via P6 aft/stbd (to avoid SASA KOZ); Fairlead safety tether at P6-5309 10. Temp stow Crewlock Bag and PGT on P6 HR 5307 11. Retrieve digital camera <div style="border: 1px solid black; padding: 5px; text-align: center;"> <p>WARNING SASA Keepout Zone 0.9 meters. Avoid translation forward of 2B four bar linkage</p> </div> <ol style="list-style-type: none"> 12. Translate to 2B mast canister

2B SOLAR ARRAY RETRACT (00:45)

IV/SSRMS	EV3	EV4
<p>1. SSRMS to APFR egress location</p>	<div data-bbox="667 228 1608 548" style="border: 1px solid black; padding: 5px; margin-bottom: 10px;"> <p style="text-align: center;">WARNING</p> <p>Sharp edge/pinch point/shock hazard: Avoid EMU contact with the following:</p> <ol style="list-style-type: none"> 1. Lower SABB exposed reels and pulleys (guide wire and tensioning mechanisms) 2. SABB skirt 3. Swing bolts 4. Springs on tension bar 5. Panel hinges 6. Guide wire frays 7. Braided cables 8. Fastener exposed threads 9. Exposed bolts in rib cavities on mast canister 10. Mast roller guides 11. FCC and Kapton part of solar array panels </div> <ol style="list-style-type: none"> 1. Verify glove gauntlets cover wrist disconnects 2. Determine SAW problem and perform corresponding <u>SAW WORKAROUND</u> 3. As body position allows inspect the following: <ul style="list-style-type: none"> • Y-guides (4 per SABB should not be visible) • Center and outboard guide wire not rubbing against power Cable near pulley • Foam pads in SABB base 4. Prior to retract, GCA SSRMS and EMU 3 ft away from array plane 5. Give IV GO for retract 6. Monitor array retract; call ABORT if problem seen 7. Repeat steps 1 thru 6 until EVA PET = 1:15 or on MCC GO <p><u>2B CLEANUP</u></p> <ol style="list-style-type: none"> 8. Give SSRMS GO for translation to APFR egress location 9. Egress APFR 10. Tether swap to airlock safety tether; verify locked 11. Relocate APFR from SSRMS to P6-11 [4,PP,F,6] 12. Retrieve WIF adapter 13. Translate to Airlock, retrieve fairlead 14. When EV4 waist tether locked, transfer EV4 safety tether to EV4 15. Transfer WIF Adapter and Cheater Bar to EV4 16. Receive PGT from EV4 17. Tether swap to S1 safety tether; verify locked 18. Stow both 55ft safety tethers on airlock external D-ring; verify hooks locked, reels unlocked 19. Receive Medium ORU Bag; stow on BRT 20. Transfer S1 safety tether to EV4 21. Receive/temp stow Crewlock Bag 	<ol style="list-style-type: none"> 1. Verify glove gauntlets cover wrist disconnects 2. Assist EV3 with clearance and tool management 3. If cheater bar available free grommets on inboard guide wire as able <ol style="list-style-type: none"> 4. Prior to retract, translate below Mast Canister separation plane 5. Give IV GO for retract 6. Monitor array retract; call ABORT if problem seen 7. Repeat steps 1 thru 6 until EVA PET = 1:15 or on MCC GO <p><u>2B CLEANUP</u></p> <ol style="list-style-type: none"> 8. Retrieve Crewlock Bag and PGT from P6 HR 5307 9. Translate to Airlock; retrieve fairlead 10. Ingress Airlock 11. Connect waist tether to UIA D-Ring; verify locked 12. Stow 2B Tools Crewlock Bag in Airlock <ol style="list-style-type: none"> 13. Stow spare 85 ft safety tether on fuse tether 14. Receive/stow WIF Adapter and Cheater Bar on fuse tether 15. Transfer PGT to EV3 16. Transfer digital camera to Crewlock Bag with ETRS <ol style="list-style-type: none"> 17. Transfer Medium ORU Bag to EV3 (RET stays in A/L) 18. Tether swap to S1 safety tether; verify locked 19. Transfer Crewlock Bag with ETRS, camera to EV3 (RET stays on bag) 20. Egress airlock 21. Close thermal cover 22. Retrieve Crewlock Bag

2B SOLAR ARRAY RETRACT (00:45) (Cont)

SAW WORKAROUND

Over-center Hinge Reset:

- A. GCA SSRMS to affected location on panel
- B. Use cheater bar to press metal panel hinge into normal configuration; avoid contact with guide wire

Uneven Panel Distribution (causes stuck grommets during retract):

- C. GCA SSRMS to lower blanket box near center guide wire on affected solar array
- D. Use TPS scraper or cheater bar to evenly distribute panel folds along array (fluff); avoid contact with guide wire; GCA SSRMS along center guide wire as required

Stuck Grommet:

NOTE

Provided a fray is not causing the grommet fault, panel fluffing near center guide wire will likely clear problems at all three guide wires

If guide wire fray NOT suspected:

- E. If backward folding panel still a potential, free specific grommet; do not fluff
- F. If backward folding panel not a concern, GCA SSRMS to affected panel near center guide wire
- G. Use TPS scraper or cheater bar to evenly distribute panel folds (fluff); avoid contact with guide wire
- H. If no joy; perform steps as is guide wire fray suspected

If guide wire fray is suspected:

- I. GCA SSRMS to affected grommet
- J. Use TPS scraper or cheater bar to free grommet; repeat as necessary for lower panel grommets as guide wire fray retracts

Guide Wire Slack Due to Reel/Pulley Jam:

CAUTION

Guide wire can jump out of pulley track, attempt cable manipulation from inside blanket box first. If guide wire must be handled from outside of blanket box, avoid pulling guide wire to side of pulley plane

- K. Verify all grommets on affected guide wire are loose
- L. GCA SSRMS to lower blanket box near affected guide wire
- M. Use needle nose pliers to pull cable out of reel; allow cable to retract

Out of Plane Panels:

- N. Perform steps for stuck grommet
- O. If no joy; GCA SSRMS to goal posts of affected blanket
- P. Use gloved hand to realign STE loops between goal posts; avoid contact with FCC



Y-Guide Reset

- Q. Verify SABB is unlatched (low tension)
- R. Use BRS Pin Tool on short skirt stiffener to lift tension bar; TPS scraper can be used assist with tension bar manipulation
- S: Lower tension bar on to Y-guide

DEPLOY SARJ BRACES (00:30)

IV	EV3	EV4
<p>Installation Data SARJ Brace 2: Torque _____ Turns _____</p> <p>Installation Data SARJ Brace 3: Torque _____ Turns _____</p> <p>Installation Data SARJ Brace 5: Torque _____ Turns _____</p> <p>Installation Data SARJ Brace 6: Torque _____ Turns _____</p>	<p><u>SETUP</u></p> <ol style="list-style-type: none"> Translate to S1 (stanchion/trunion at 3282, 3234); verify safety tether anchor hooks locked Temp stow Med ORU bag on S3 HR 3065 Translate to SARJ Brace (face 6) Execute <u>DEPLOY SARJ BRACE</u> steps <p><input type="checkbox"/> SARJ Brace Face 6 (HR 3061) <input type="checkbox"/> SARJ Brace Face 2 (HR 3052)</p>	<p><u>SETUP</u></p> <ol style="list-style-type: none"> Stow Crewlock Bag on S3 HR 3050; stage digital camera for use Stow Medium ORU Bag on Face 4 with adj tethers to S3 HR 3065, 3066, lid straps to S4 HRs 2209, 2210 Stage Large Trash Bag with Adj tether on S3 HR 3057 Stage RET nearby for temp stowing launch locks Translate to S3, SARJ Brace (face 3) Execute <u>DEPLOY SARJ BRACE</u> steps <p><input type="checkbox"/> SARJ Brace Face 3 (HR 3055) <input type="checkbox"/> SARJ Brace Face 5 (HR 3058)</p>
	<p><u>DEPLOY SARJ BRACE</u></p> <ol style="list-style-type: none"> PGT[B6 24.0 ft-lb, CCW2 30 RPM, MTL 30.5]-6ext 7/16: Release brace launch restraint fastener ~11 turns Rotate brace away from diagonal beam Re-insert launch restraint bolt into diagonal beam fitting ~1 turn Rotate brace and insert the double cone assembly into the SARJ bulkhead cup feature PGT[B2 16.0 ft-lb, CW3 60 RPM, MTL 30.5]-6ext 7/16: Engage brace cone fastener ~40 turns to torque 	

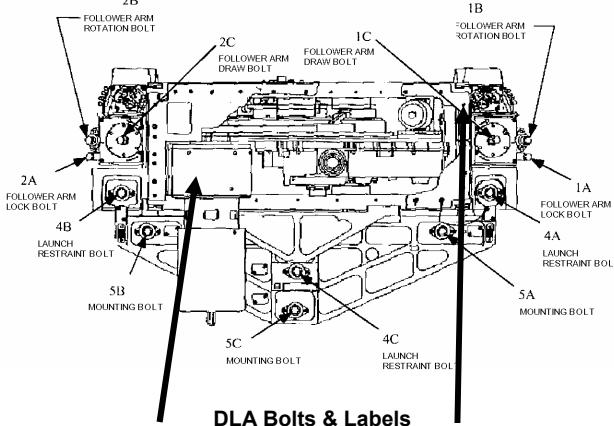
SARJ DLA 1 INSTALL (01:00 PER DLA)

IV	EV3																			
<p>MCC-H 1. Verify step 4 complete (SODF: ASSY OPS: SARJ INITIAL ACTIVATION AND CHECKOUT)</p> <p>IV 2. Give EV3 GO for DLA Install</p>  <p>DLA Bolts & Labels</p>  <table border="1" data-bbox="94 1161 703 1274"> <thead> <tr> <th rowspan="2">DLA 1</th> <th colspan="2">Initial</th> <th colspan="2">Final</th> </tr> <tr> <th>Torque</th> <th>Turns</th> <th>Torque</th> <th>Turns</th> </tr> </thead> <tbody> <tr> <td>1C</td> <td></td> <td></td> <td></td> <td></td> </tr> <tr> <td>2C</td> <td></td> <td></td> <td></td> <td></td> </tr> </tbody> </table> <p>3. Inform MCC, DLA Deploy Complete, GO for Engage</p> <p>MCC-H 4. Verify step 7 (DLA1)/step 8 (DLA2) complete (SODF: ASSY OPS: SARJ INITIAL ACTIVATION AND CHECKOUT)</p>	DLA 1	Initial		Final		Torque	Turns	Torque	Turns	1C					2C					<p>□ DLA 1: APFR S3-28 [2,PP,F,12]</p> <p>REMOVE DLA MLI COVER</p> <ol style="list-style-type: none"> 1. Attach adj. tether to S3 HR 3053, RET to hard tether point on side 2 of DLA cover and cover 8 tether point 2. If required, PGT[A1 2.5 ft-lb, CCW3 60 RPM, MTL 30.5]-6ext 7/16: Release swing bolt cover fasteners (4) ~10-11 turns 3. Verify fasteners swing open 4. PGT[A6 8.3 ft-lb, CCW3 60 RPM, MTL 30.5]-6ext 7/16: Release inboard MLI cover fasteners (4) =9 turns Add single turns incrementally as required for release; remove bolt 2A last, after ingressed APFR 5. Ingress APFR 6. Remove MLI cover and temp stow; attach adj. tether on S3 HR 3053 to tether point on side 1 of DLA cover 7. On IV GO, proceed with DLA Install <p>ROTATE DLA DRAW BOLTS (1C AND 2C) (This decreases friction between pivot fork and follower bracket)</p> <ol style="list-style-type: none"> 8. PGT[A3 4.8 ft-lb, CW2 30 RPM, MTL 30.5]-6ext 7/16: Rotate draw bolt 1C =2 turns 9. PGT[A3 4.8 ft-lb, CCW2 30 RPM, MTL 30.5]-6ext 7/16: Rotate draw bolt 2C =2 turns <p>BACK OFF DLA LOCK BOLTS (1A AND 2A) (Releases lock preload on follower arm, lock tip bolt retracted from follower bracket)</p> <ol style="list-style-type: none"> 10. PGT[A6 8.3 ft-lb, CCW3 60 RPM, MTL 30.5]-6ext 7/16: Release lock bolts 1A and 2A fasteners (2) =6 turns <p>RELEASE 3 DLA LAUNCH RESRAINT BOLTS (4A, 4B, 4C) (Allows the DLA frame to move relative to the launch bracket)</p> <ol style="list-style-type: none"> 11. PGT[B7 25.5 ft-lb, CCW2 30 RPM, MTL 30.5]-6ext 7/16: Release launch restraint bolts 4A, 4B, 4C ~8-10 turns- bolt pops up <p>REPOSITION DLA AND ROTATE FOLLOWER ARMS</p> <ol style="list-style-type: none"> 12. Reconfigure PGT[A3 4.8 ft-lb, CCW1 10 RPM, MTL 30.5]-6ext 7/16: Reposition DLA onto race ring (approx. 3/8 inch outboard, 1.5 inches radially in) Rotate follower arm rotation bolt 1B ~5/8 turn to hardstop 13. Verify follower arm has rotated 90 deg 14. PGT[A3 4.8 ft-lb, CW2 30 RPM, MTL 30.5]-6ext 7/16: Rotate follower arm draw bolt 1C ~32 turns to torque 15. Verify follower bearings are in contact with race ring 16. PGT[A3 4.8 ft-lb, CW1 10 RPM, MTL 30.5]-6ext 7/16: Rotate follower arm rotation bolt 2B ~5/8 turn to hardstop 17. Verify follower arm has rotated 90 deg 18. PGT[A3 4.8 ft-lb, CCW2 30 RPM, MTL 30.5]-6ext 7/16: Rotate follower arm draw bolt 2C ~32 turns to torque 19. Verify follower bearings are in contact with race ring 20. PGT[B4 19.4 ft-lb, CCW2 30 RPM, MTL 30.5]-6ext 7/16: Final installation torque on follower arm draw bolt 2C ~4 turns to torque 21. PGT[B4 19.4 ft-lb, CW2 30 RPM, MTL 30.5]-6ext 7/16: Final installation torque on follower arm draw bolt 1C ~4 turns to torque <p>INSPECT DLA</p> <ol style="list-style-type: none"> 22. On IV GO: verify DLA pinion gear teeth fully engaged to SARJ race ring teeth <p>REINSTALL DLA MLI COVER</p> <ol style="list-style-type: none"> 23. PGT[A1 2.5 ft-lb, CW2 30 RPM, MTL 30.5]-6ext 7/16: Engage inboard MLI cover fasteners (4) ~9 turns 24. Release cover bolts 1a, 1b on cover 6 prior to APFR egress
DLA 1		Initial		Final																
	Torque	Turns	Torque	Turns																
1C																				
2C																				

SARJ LAUNCH LOCK/LAUNCH RESTRAINT REMOVAL (03:30)

IV	EV3	EV4
<p>1. Prior to removal of last launch restraint/lock, verify DLA 1&2 in ENGAGE steps 7 & 8 complete (SODF: ASSY OPS: SARJ INITIAL ACTIVATION AND CHECKOUT)</p> <div data-bbox="184 691 558 792" style="border: 1px solid black; padding: 5px; margin: 10px 0;"> <p style="text-align: center;">WARNING Remain inboard of SARJ and limit motion until 1 DLA in LOCK</p> </div>	<p>A. The following covers are nominally completed on EVA 1 <input type="checkbox"/> Cover 1, 2, 3, 4, 11, 14, 18, 19, 20, 21, 22</p> <p>B. Remove the following Launch Locks: <input type="checkbox"/> Cover 17, Face 5, Launch Lock 4 (BRT - 3059) <input type="checkbox"/> Cover 16, Face 5, Launch Lock 3 (BRT -3058)</p> <p>C. Reconfigure and ingress APFR: S3-28 [2,QQ,D,11] <input type="checkbox"/> Cover 6, Face 2, Launch Lock 11 (BRT - 3053)</p> <p>D. Reconfigure and ingress APFR: S3-28 [2,QQ,C,9] <input type="checkbox"/> Cover 7, Face 3, Launch Lock 12 (BRT - 3054)</p> <p>E. Retrieve ratchet wrench and configure 7/16 (rigid) 9 ext</p> <p>F. Perform step 9 to break torque on Launch Restraints: 2, 1B, 6B, 5</p> <p>G. Transfer ratchet wrench to EV4 or stow in Crewlock Bag</p> <p>H. Remove the following Launch Restraints: <input type="checkbox"/> Launch Restraint 5 (BRT - 3068 - alternate 3060) <input type="checkbox"/> Launch Restraint 6B <input type="checkbox"/> Launch Restraint 1B <input type="checkbox"/> On IV GO: Launch Restraint 2 (stow in Crewlock Bag on HR 3050) (BRT - 3054)</p>	<p>A. Verify swing bolts released on covers 3, 11, 14, 22</p> <p>B. Remove the following Launch Locks: <input type="checkbox"/> Cover 15, Face 5, Launch Lock 2 (BRT - 3067) <input type="checkbox"/> Cover 9, Face 3, Launch Lock 14 (BRT - 3054) <input type="checkbox"/> Cover 8, Face 3, Launch Lock 13 (BRT - 3054) <input type="checkbox"/> Cover 10, Face 3, Launch Lock 15 (BRT - 3055) <input type="checkbox"/> Cover 12, Face 4, Launch Lock 16 (BRT - 3065) <input type="checkbox"/> Cover 13, Face 4, Launch Lock 1 (BRT - 3066)</p> <p>C. Retrieve ratchet wrench and configure 7/16 (rigid) 9 ext</p> <p>D. Perform step 9 to break torque on Launch Restraints: 4B, 3B</p> <p>E. Stow ratchet wrench in Crewlock Bag</p> <p>F. Remove the following Launch Restraints: <input type="checkbox"/> Launch Restraint 4B <input type="checkbox"/> Launch Restraint 3B</p> <p>G. Stow Large Trash Bag in Medium ORU Bag</p> <p>H. Perform Medium ORU Bag tool inventory</p> <p>I. If Get-Aheads to be performed, temp stow Medium ORU Bag on S3 HR 3049 (face 4); else stow on BRT</p>
<p>2. When Launch Restraint 2 removed: Inform MCC – all launch restraints removed</p> <p>3. Notify EV crew when DLA locked</p> <p>4. Perform tool inventory</p>	<p style="text-align: center;"><u>RELEASE SWING BOLTS</u></p> <p>1. PGT[A1 2.5 ft-lb, CCW3 60 RPM, MTL 30.5]-6ext 7/16: Release swing bolts (1 to 4) ~10-11 turns</p> <p>2. Verify fasteners swing open</p> <p style="text-align: center;"><u>REMOVE SARJ LAUNCH LOCKS</u></p> <div data-bbox="942 927 1745 1089" style="border: 1px solid black; padding: 5px; margin: 10px 0;"> <p style="text-align: center;">CAUTION</p> <p>The following precautions should be observed to prevent loss of inboard MLI cover fasteners during removal:</p> <ul style="list-style-type: none"> Limit turn count to minimum required for fastener release Minimize side loading bolt head Maintain axial force on fastener to compress spring during rotation </div> <p>3. PGT[A6 8.3 ft-lb, CCW3 60 RPM, MTL 30.5]-6ext 7/16: Release inboard MLI cover fasteners (4-6) =9 turns (add single turns incrementally as required for release)</p> <p>4. Remove MLI cover and temp stow</p> <p>5. PGT[B7 25.5 ft-lb, CCW3 60 RPM, MTL 30.5]-6ext 7/16: Release SARJ Launch Lock fasteners (4) ~13-15 turns</p> <p>6. Remove launch lock and stow</p> <p>7. Re-position MLI cover</p> <p>8. PGT[A1 2.5 ft-lb, CW2 30 RPM, MTL 30.5]-6ext 7/16: Engage inboard MLI cover fasteners (4-6) ~9 turns to torque</p> <p style="text-align: center;"><u>BREAK TORQUE AND REMOVE SARJ LAUNCH RESTRAINT</u></p> <p>9. Ratchet wrench: 7/16 (rigid) 9 ext: Break torque on retaining bolts (2) (55 ft-lb)</p> <p>10. PGT[B7 25.5 ft-lb, CCW3 60 RPM, MTL 30.5]-6 ext 7/16: Release retaining bolts (2) =9 turns</p> <p>11. PGT[B7 25.5 ft-lb, CCW2 30 RPM, MTL 30.5]- 6 ext 7/16: if launch restraint not loosened on “mushroom-shaped” fittings: Release jack bolt (1) up to 3 turns</p> <p>12. PGT[B7 25.5 ft-lb, CCW3 60 RPM, MTL 30.5]-6 ext 7/16: Release retaining bolts (2) ~9 turns</p> <p>13. Remove clamshell from “mushroom-shaped” fitting; stow clamshell in large trash bag</p>	

EVA 2 CLEANUP/INGRESS (00:30)

IV	EV3	EV4
<p>1. Perform WVS PWRDN (PHOTO/TV, <u>WVS CUE CARD</u>)</p>	<p><u>CLEANUP</u></p> <ol style="list-style-type: none"> 1. Retrieve Crewlock Bag from S3 HR 3050 2. If Keel Pin Nut Clamp Bolts tight, retrieve Crewlock Bag from S3 HR 3049 3. Perform tool inventory 4. Translate to Airlock <p><u>INGRESS</u></p> <ol style="list-style-type: none"> 5. Hand in Crewlock Bags 6. Stow EV4 safety tether on A/L circular handrail 7. Attach waist tether (L) to A/L D-ring; verify locked 8. Stow safety tether on A/L circular handrail <ol style="list-style-type: none"> 9. Ingress A/L 10. Remove SCU from stowage pouch Remove DCM cover Connect SCU to DCM, check locked 11. Water – OFF 12. Close thermal cover, attach Velcro strap <div style="border: 1px solid black; padding: 5px; text-align: center; margin: 10px 0;"> <p><u>CAUTION</u> Do not close hatch until EMU water off for 2 min</p> </div> <ol style="list-style-type: none"> 13. Verify no hardware blocking hatch 14. EV Hatch Handle – Preclose 15. EV Hatch – close and lock 16. Go to PRE-REPRESS Cue Card 	<p><u>CLEANUP</u></p> <ol style="list-style-type: none"> 1. Retrieve Face 4 Medium ORU Bag 2. Perform tool inventory 3. Translate to Airlock <p><u>INGRESS</u></p> <ol style="list-style-type: none"> 4. Open A/L thermal cover 5. Stow Medium ORU Bag in A/L 6. Ingress airlock 7. Attach waist tether (L) to UIA; verify locked 8. Retrieve Crewlock Bags from EV3 9. Release safety tether; hand to EV3 10. Remove SCU from stowage pouch Remove DCM cover Connect SCU to DCM, check locked 11. Water – OFF 12. Give EV3 GO for Ingress

POST EVA 2 TOOL CONFIG

EV 3

	MWS
	BRT (L)
	RET (eq-eq)
	SVS Target
	Swing Arm (R)
	RET (eq-eq)
	PGT
	PGT Battery
	7/16 (wobble) Socket-6 ext
	T-Bar
	RET (eq-eq)
	RET (eq-eq) w/PIP pin
	Adj Equip Tether (2)
	Wire Tie (2)
	Small Shuttle Trash Bag
	D-ring Extender (2, R & L D-ring)
	Waist Tether (L D-ring)
	SAFER
	WVS

EV 4

	MWS
	BRT (L)
	RET (eq-eq)
	Wire Tie
	Swing Arm (R)
	RET (eq-eq)
	PGT
	PGT Battery
	7/16 (wobble) Socket-6 ext
	T-Bar
	RET (eq-eq)
	RET (eq-eq) w/PIP Pin
	Wire Tie (2)
	Adj Equip Tether
	Small Shuttle Trash Bag
	D-ring Extender (2, R & L D-ring)
	Waist Tether (L D-ring)
	SAFER
	WVS

AIRLOCK CONFIG

	Staging Bag
	Fish Stringer
	PGT
	PGT Battery
	Wire Tie Caddy
	RAD
	Connector Cleaner Tool Kit
	Probe
	Prybar
	Connector Pin Straightener
	Velcro/Tape Caddy
	SLR Torque Multiplier
	IV Bag
	Towels (2)
	Contamination Detection Kit
	GP Caddy (2)
	Adjustable Thermal Mittens (2)
	Socket Caddy (hatch cont) w/ eq-eq RET
	1/2 Socket-8 ext
	7/16 (wobble) Socket-6 ext (spare)
	DCM Plug (SAFER Hardmount) (2)
	Fuse Tether
	85 ft Safety Tether
	WIF Adapter w/PIP pin
	Cheater Bar (w/ Tape)
	1.5" Bail Drive Lever (taped to Cheater Bar)
	Crewlock Bag
	Digital Camera
	Digital Camera L Bracket
	Launch Restraint
	RET (eq-eq)(2)
	RET (eq-lg) (lg hook to aft UIA HR)
	Medium ORU Bag with SLRI 10
	Launch Locks (10 total)
	RET (eq-eq) (2)
	Adj Equip Tether
	Large Trash Bag
	Launch Restraints (5)
	RET (eq-Lg)(outside of bag)
	Adj Equip Tethers (2 eq-lg) (outside of bag)
	Crewlock Bag (2B Tools)
	Cutters/Needle Nose Pliers Caddy (w/ Tape)
	Loop Pin Puller Caddy (w/ Tape)
	TPS Scraper (w/ Tape)
	BRS Pin Contingency Tool (w/ Tape)
	RET (eq-Lg)(outside of bag)

S1 TRUSS

	Safety Tether – S1-HR 3214 (cable tray) strung to airlock
	Safety Tether – S1-HR 3221 (nadir edge) strung to airlock

S3 TRUSS

	APFR WIF S3-05 [6,PP,L,10]
	Crewlock EVA Bag
	Vise Grips
	Socket Caddy
	5/8 (rigid) Socket-7.8 ext
	5/8 (rigid) Socket-7.8 ext
	7/16 (rigid) Socket-2 ext
	RET (eq-eq) w/PIP pin
	3/8-in IVA Tool Stack w/DPT Adapter
	ISS ratchet wrench
	7/16 (wobble) Socket-9 ext
	Round Torque Multiplier
	Rd TM Socket – 5/8 prd
	RET (eq-Lg)(outside of bag)

S4 TRUSS

	APFR S4-19 (6,TT,J,11) (13A.1 prep)
--	--

Shading indicates trash items

EVA 2 TASK DATA

DEPLOY SARJ BRACES – TASK DATA

Estimated Task Duration:

	With RMS	Without RMS
One EV Crew	NA	1:00
Two EV Crew	NA	0:30

Tools:

EV3	EV4
PGT	PGT
7/16 (wobble) Socket-6 ext	7/16 (wobble) Socket-6 ext

EVA Fasteners:

Fastener Name	Label	Head Size	Qty	Install Torque (ft-lb)	Release Torque (ft-lb)	Failure Torque (ft-lb)	Turns	RPM
Brace cone fastener	No	7/16	4	NA	NA	22.1	37-39	60
Brace launch restraint fastener	No	7/16	4	12.1-15 gnd	16.9	32.3	10-11 release ~1 install	30

EVA Connectors:

Harness	From	To	Clamps (#)	Conn Size	Function
NA					

Foot Restraints:

Task	WIF	APFR Setting
SARJ Brace Face 2, 3, 5, 6	NA	NA

Note:

- SARJ Braces lay longitudinally against the diagonal beam in a launch/stowed position ready for deployment. The SARJ brace is attached at one end to the diagonal beam with a rod and bearing allowing rotation and restrained at the opposite end. Brace restraint bolt is attached to diagonal beam via lanyard
- Deployment of SARJ Braces is required prior to mating S5 to S4

Cautions:

- 1 DLA must be in lock OR power must be off to RJMCs with both DLA pinion gears engaged to prevent freewheeling movement OR a minimum of one launch lock in place on the SARJ during this procedure

Warnings:

None

DEPLOY SARJ BRACES – TASK DATA (Cont)



SARJ Brace (Launch position)



SARJ Brace Cup Cone placed in on-orbit position



SARJ Brace Launch Restraint bolt (re-inserted into housing after brace release)

SARJ DLA INSTALL – TASK DATA

Estimated Task Duration:

	With RMS	Without RMS
One EV Crew	NA	1:00
Two EV Crew	NA	NA

Tools:

EV3	EV4
PGT	NA
6 Ext 7/16	
APFR	
RET	
Adj. Equipment Tether	

EVA Fasteners:

Fastener Name	Label	Head Size	Qty	Install Torque (ft-lb)	Release Torque (ft-lb)	Failure Torque (ft-lb)	Turns	RPM
MLI Cover Swing Bolts	NA	7/16	4 per cover	2.3-3.0	2.8	5.5	8-12	60
MLI Cover Inboard Fasteners	NA	7/16	4 per cover	3.1-3.6 gnd 0.8-3.8 on orbit	3.4	13.7	7-9	60 rmv 30 inst
DLA 1A and 2A Lock bolts	Yes	7/16	2 per	3.3 – 6.3	6.7	42.2	6	30
DLA 1C and 2C Draw Bolts	Yes	7/16	2 per	4.8 initial 19.4 final	0.8	38.9	38	30
DLA 4A, 4B, and 4C Launch Restraint Bolts	Yes	7/16	3 per	24-26	25	50 - A&B 75 - C	10-A&B 8-C	30
DLA 1B and 2B Follower arm rotation Bolts	Yes	7/16	2 per	NA	NA	10.6	5/8	10

EVA Connectors:

Harness	From	To	Clamps (#)	Conn Size	Function
NA					

Foot Restraints:

Task	WIF	APFR Setting
Cover 5 DLA 1 Face 2	S3-28	[2,PP,F,12]
Cover 20 DLA 2 Face 6	S4-04	[6,PP,L,1]

Notes:

1. If any spring clamp assembly fails to snap completely out of the way, a gentle nudge may be required
2. The bolts nearest the tether loop must be released prior to tethering to the shroud to avoid interference between the tether hook and PGT
3. The outboard SARJ race ring side MLI cover bolts (spring clamp bolts) should be released prior to the inboard MLI cover bolts
4. Cabling on the outboard side of the SARJ may interfere with DLA cover re-installation. The cover should be installed outboard side first, then inboard side
5. To re-install the DLA cover, all bolts should be started before any are driven fully

Cautions:

1. During re-installation of MLI covers, do not re-install spring clamp assemblies on the outboard SARJ race ring side (outboard fasteners). This will preclude SARJ rotation
2. Any single failure of bolts/spring clamp assemblies will prevent SARJ activation
3. Avoid impacting the race the ring with the DLA when the DLA is unconstrained
4. During follower arm rotation (90 deg turn) when the DLA is still unconstrained, interference with structure may occur. The DLA must be held against the outer side of the SARJ race ring for the follower arm to rotate fully – clearing obstruction

Warnings:

None

SARJ DLA INSTALL – TASK DATA (Cont)



SARJ Race Ring and DLA Pinion Gear (gold)

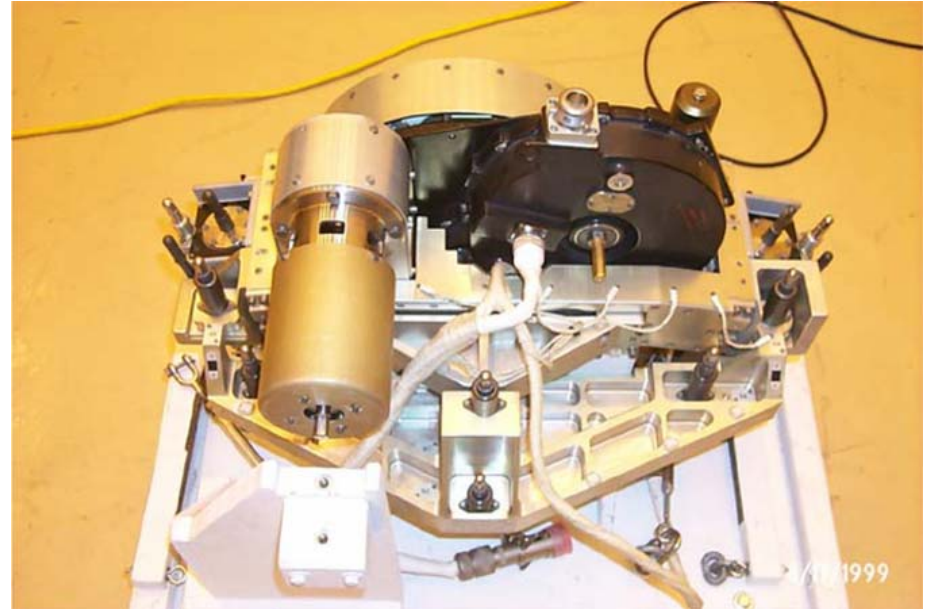

DLA

SARJ LAUNCH LOCK/LAUNCH RESTRAINT REMOVAL – TASK DATA

Estimated Task Duration:

	With RMS	Without RMS
One EV Crew	NA	0:20/LL, 0:15/LR

Tools:

EV3	EV4
PGT	PGT
6 Ext 7/16	6 Ext 7/16
APFR (backup)	APFR (backup)
Medium ORU transfer bag w/SLRI	Medium ORU transfer bag w/SLRI
Large Trash Bag	Ratchet wrench w/9 Ext rigid
If SLR Torque Multiplier req,d - no socket ext needed	

EVA Fasteners:

Fastener Name	Label	Head Size	Qty	Install Torque (ft-lb)	Release Torque (ft-lb)	Failure Torque (ft-lb)	Turns	RPM
MLI Cover Swing Bolts	NA	7/16	1-4 per cover	2.3-3.0	2.8	5.5	8-12	60
MLI Cover Inboard Fasteners	NA	7/16	4-6 per cover	3.1-3.6 gnd, 2.5 on orbit	3.4	13.7	7-9	60 rmv 30 inst
SARJ Launch Lock Fasteners	NA	7/16	4 per lock	22.1-23.7	32.6	148.5	13-15	60
SARJ Launch Restraint Fastener	NA	7/16	2 per	52.1-56.3	55.4	165.2	17	60
SARJ Launch Restraint Jack Screw	NA	7/16	1 per	3.9-12.5	12.0	139.3	3, 9 max	60

EVA Connectors:

Harness	From	To	Clamps (#)	Conn Size	Function
NA					

Foot Restraints:

Task	WIF	APFR w/ PGT	APFR w/ Torque Mult
Cover 1 Launch Lock (#8) Face 1	S3-31	7,RR,F,11	
Cover 2 Launch Lock (#9) Face 1	S3-31	7,RR,F,11	
Launch Restraint 1 B	S4-05	10,PP,H,12	10,PP,J,2
Cover 3 Face 1 – 2	S4-05	10,PP,F,1	
Cover 4 Launch Lock (#10) Face 2	S4-05	10,QQ,H,1	
Cover 5 DLA 1 Face 2	S3-28	2,PP,F,12	
Cover 6 Launch Lock (#11) Face 2	S3-28	2,QQ,D,11	
Launch Restraint 2	S3-29	9,QQ,E,11	9,QQ,E,12
Cover 7 Launch Lock (#12) Face 3	S3-29	9,QQ,E,12	
Cover 8 Launch Lock (#13) Face 3	S3-29	10,TT,F,12	
Cover 9 Launch Lock (#14) Face 3	S3-29	10,TT,F,12	
Cover 10 Launch Lock (#15) Face 3	S3-36	12,PP,A,1	
Launch Restraint 3 B	S4-06	3,SS,G,3	2,NN,F,12
Cover 11 Face 3 – 4	S3-36	12,PP,A,1	
Cover 12 Launch Lock (#16) Face 4	NA	NA	
Cover 13 Launch Lock (#1) Face 4	NA	NA	
Launch Restraint 4 B	S3-35	6,QQ,B,1	6,QQ,A,12
Cover 14 Face 4 – 5	S3-35	6,QQ,B,1	
Cover 15 Launch Lock (#2) Face 5	S3-34	1,TT,F,12	
Cover 16 Launch Lock (#3) Face 5	S3-34	10,PP,B,1	
Cover 17 Launch Lock (#4) Face 5	S3-30	9,PP,H,12	
Cover 18 Launch Lock (#5) Face 5	S3-30	9,PP,G,12	
Launch Restraint 5	S3-30	9,PP,F,12	9,PP,E,11
Cover 19 Launch Lock (#6) Face 6	S3-30	9,PP,F,12	
Cover 20 DLA 2 Face 6	S3-27	10,OO,F,12	
Cover 21 Launch Lock (#7) Face 6	S3-31	5,QQ,E,1	
Launch Restraint 6 B	S3-31	5,QQ,E,1	5,OO,E,1
Cover 22 Face 1 – 6	S3-31	5,QQ,E,1	

SARJ LAUNCH LOCK/LAUNCH RESTRAINT REMOVAL – TASK DATA (Cont)

Notes:

1. If any spring clamp assembly fails to snap completely out of the way, a gentle nudge may be required
2. There is no hardware constraint to the order of launch lock or launch restraint removal however to ensure that the launch restraint break away torque is below certified limits of EVA tools, it is recommended that the trunion longeron SLRs (#2 or #5) are removed last
3. All launch locks must be removed prior to any launch restraints. Ref flight rule C2-55
4. The bolts nearest the tether loop must be released prior to tethering to the shroud to avoid interference between the tether hook and PGT
5. The outboard swing bolts on the MLI covers should be released prior to the inboard cover bolts
6. When releasing the last SARJ launch lock, the two outboard bolts should be released prior to the inboard launch lock captive bolts
7. The SARJ Launch Restraint (SLR) comes off in three attached pieces via lanyards. The SLR consists of two clam shell halves retained by two (2) captive EVA bolts on the outer edges, with a central EVA jackscrew and a EVA tether loop on the upper half of the clamshell assembly
8. The IVA Tool Stack consists of the following: 1/4-in to 3/8-in female adapter, 1/4-in drive 4-in ext, 1/4-in drive universal joint, 1/4-in drive 3/8-in shallow-well socket, drop proof tether adapter

Cautions:

1. During re-installation of MLI covers, do not re-install swing bolts on the outboard SARJ race ring side (outboard bolts). This will preclude SARJ rotation
2. When using the jackscrew to release the launch restraint, do not exceed 9 turns. Half “moon-shaped” nuts on jackscrew may become detached if turned more than 9 times
3. Any single failure of bolts/latch assemblies will prevent SARJ activation
4. During removal of inboard MLI cover fasteners:
 - Limit turn count to minimum required for fastener release
 - Minimize side loading bolt head
 - Maintain axial force on fastener to compress spring during rotation

Warnings:

1. Prior to the removal of the last launch structure (launch lock or launch restraint), power must be off to the RJMCs and both deployed DLA pinion gears must be engaged to prevent free rotation of the SARJ
2. After removal of the last launch lock or launch restraint, crewmembers cannot translate outboard of SARJ until one DLA is in LOCK



SARJ Launch Restraint

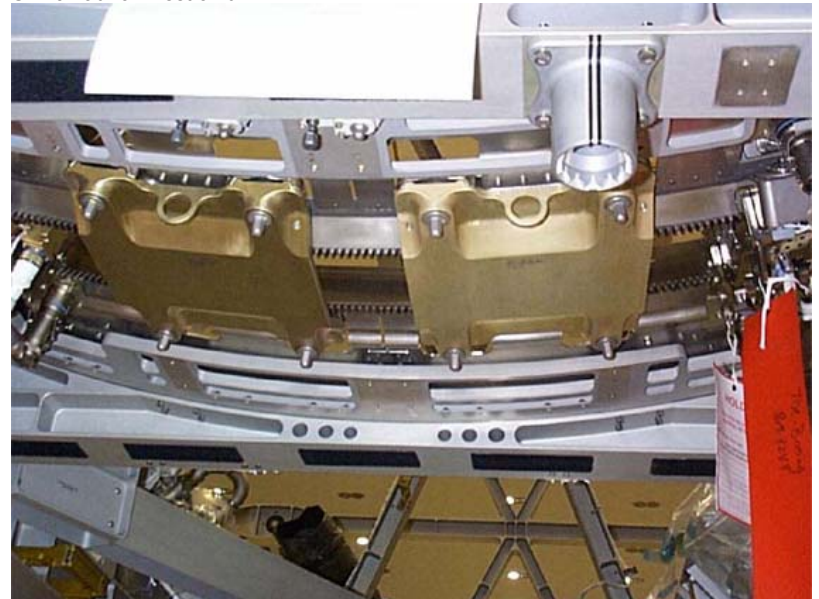

SARJ Launch Locks – Face 1

SARJ LAUNCH LOCK/LAUNCH RESTRAINT REMOVAL – TASK DATA (Cont)

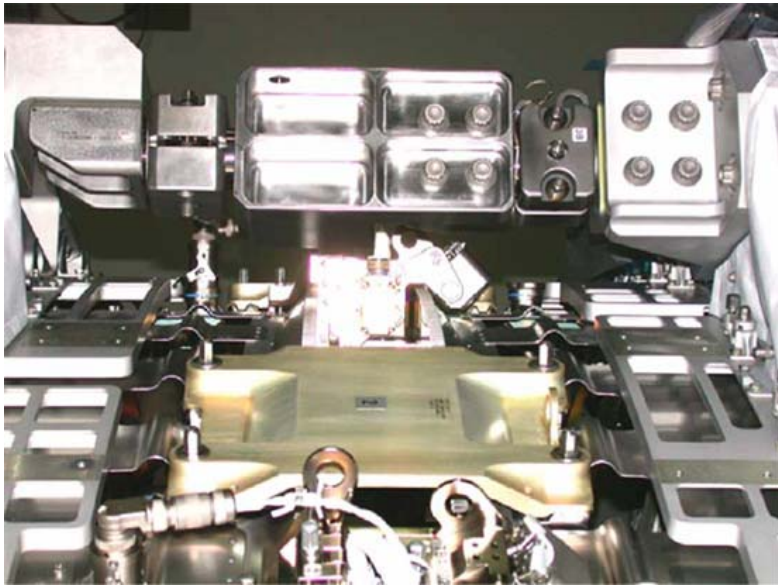

SARJ Launch Restraints – Face 1

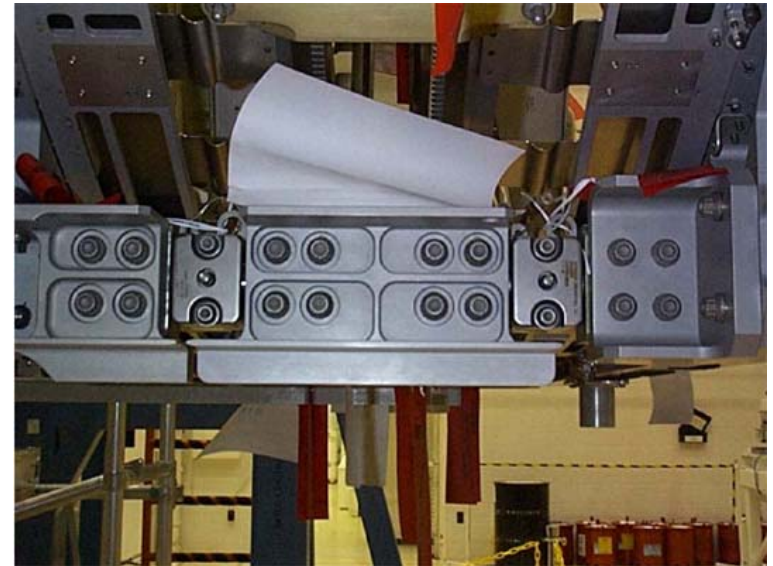

SARJ Launch Restraints – Face 1



SARJ Rail Alignment Pin

MT/CETA PATH/S4 MMOD SHIELD BOLT RELEASE – TASK DATA

Estimated Task Duration:

	With RMS	Without RMS
One EV Crew	NA	1:00
Two EV Crew	NA	0:30

Tools:

EV1	EV2
PGT	PGT
7/16 (wobble) Socket-6 ext	7/16 (wobble) Socket-6 ext
	EVA Temp Rail Stop

EVA Fasteners:

Fastener Name	Label	Head Size	Qty	Install Torque (ft-lb)	Release Torque (ft-lb)	Failure Torque (ft-lb)	Turns	RPM
MMOD Shield Bolt	Yes	7/16	4	37.5 gnd	42.2	93.5	1	10
SVS Target bolts	No	7/16	4	3.3-4.2	3.8	7.5	11.5	60
ETRS Bolts	No	7/16	2	4.2-6.6	NA	12.8	4-6	30

EVA Connectors:

Harness	From	To	Clamps (#)	Conn Size	Function
NA					

Foot Restraints:

Task	WIF	APFR Setting
Forward Inboard (#1)	S4-06	[7,WW,F,1]
Forward Outboard (#2)	S4-14	[6,WW,F12]
Aft Outboard Bolt (#3)	S4-13	[6,WW,F12]
Aft Inboard Bolt (#4)	S4-05	[7,WW,F,1]

Note:

- Requirement for releasing torque on IEA MMOD Shield Bolts is within 1 year of launch

Cautions:

- ETRS bolts are not captive. Bolts may be lost if released more than 15 turns
- During removal of SVS fasteners:
 - Limit turn count to minimum required for fastener release
 - Minimize side loading bolt head
 - Maintain axial force on fastener to compress spring during rotation

Warnings:

None

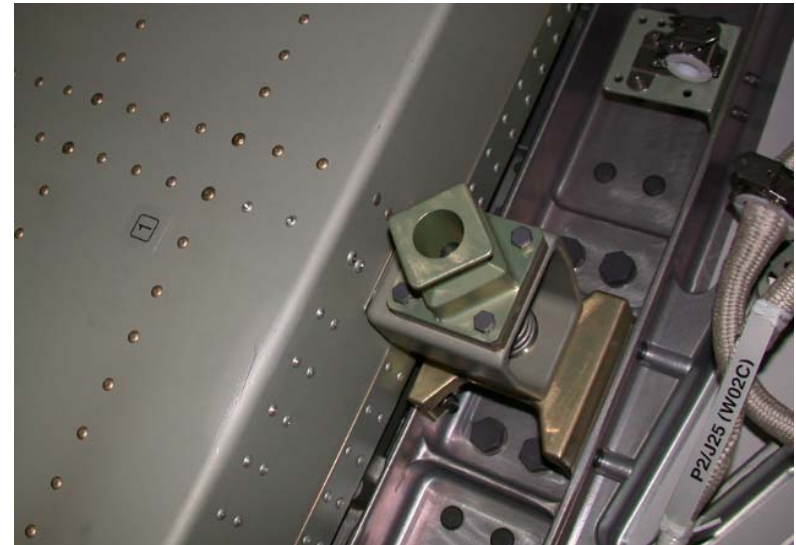

IEA MMOD Shield Bolt

MT/CETA PATH/S4 MMOD SHIELD BOLT RELEASE – TASK DATA (Cont)

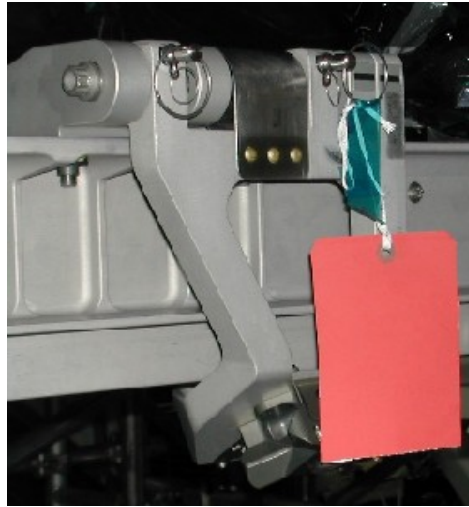

Tether Shuttle Stop – launch configuration



EVA Temporary Rail Stop (ETRS)



P3 Tether Shuttle Stop (stowed)



S3 SVS Target

This Page Intentionally Blank

EVA 3 SUMMARY TIMELINE

TIME HR : MIN	IV	EV1 (RY)	EV2 (OL)	
00:00		<u>POST DEPRESS</u> (00:05) <u>EGRESS/SETUP</u> (00:40)	<u>POST DEPRESS</u> (00:05) <u>EGRESS/SETUP</u> (00:40)	00:00
01:00		<u>2B RETRACT</u>	<u>2B RETRACT</u>	01:00
02:00				02:00
03:00				03:00
04:00	<p>THE FOLLOWING TASKS CAN BE PERFORMED AFTER 2B RETRACT IF TIME PERMITS, OR ON EVA 4:</p> <ul style="list-style-type: none"> • S3 DRAG LINK/KEEL PIN STOW (01:00) • S3/S4 CLOSEOUT (up to 01:00) • H2O/H2 VENT VALVE R&R (01:30) • LAB EWIS ANTENNA INSTALL (01:30) • NODE/SM LAN CABLE ROUTING (01:00) • SASA GIMBAL LOCKS (0:30) 			04:00
05:00	<ul style="list-style-type: none"> • GPS ANTENNA 4 REMOVAL (0:40) • ETVCG STANCHION INSTALL (0:45) • S3 PAS DEPLOY (01:00 + translation) 			05:00
06:00		<u>CLEANUP/INGRESS</u> (00:35)	<u>CLEANUP/INGRESS</u> (00:35)	06:00
		<u>PREREPRESS</u> (00:05)	<u>PREREPRESS</u> (00:05)	

EVA 3

PRE EVA 3 TOOL CONFIG

EV 1

- MWS
- BRT (L)
- RET (eq-eq)
- Swing Arm (R)
- RET (eq-eq)
- T-Bar
- RET (eq-eq) (2)
- WIF Adapter w/PIP pin
- RET (eq-eq) w/PIP pin
- Wire Ties (2)
- Small Shuttle Trash Bag
- Adj Equip Tethers (2, L & R gloves)
- D-Ring Extender (2, R & L)
- Waist Tether (2, L D-ring and R ext)
- SAFER
- WVS

EV 2

- MWS
- BRT (L)
- Wire Ties (3)
- RET (eq-eq)
- Swing Arm (R)
- RET (eq-eq)
- PGT [A1 2.5 ft-lb, CAL, MTL 30.5] S/N _____
- PGT Battery S/N _____
- 7/16 (wobble) Socket-6 ext
- T-Bar
- RET (eq-eq) (3)
- RET (eq-eq) w/pip-pin
- Wire Ties (2)
- Small ISS Trash Bag
- Adj Equip Tethers (2, L & R gloves)
- D-ring Extender (2, R & L)
- 85-ft Safety Tether
- Waist Tether (2, L D-ring and R ext)
- SAFER
- WVS

AIRLOCK CONFIG

- Staging Bag
- Fuse Tether
- PGT S/N _____
- PGT Battery S/N _____
- Wire Tie Caddy
- RAD S/N _____
- Connector Cleaner Tool Kit
- Probe
- Prybar
- Connector Pin Straightener
- Velcro/Tape Caddy
- IV Bag
- Towels (2)
- Contamination Detection Kit
- GP Caddy (2)
- Adjustable Thermal Mittens (2)
- Socket Caddy (hatch cont) w/eq-eq RET
- 1/2 Socket-8 ext
- 7/16 (wobble) Socket-6 ext (spare)
- DCM Plug (SAFER Hardmount) (2)
- Fuse Tether
- SLR Torque Multiplier (if SLRs still to be removed)
- NODE/LAN cable
- PGT [B1 12 ft-lb, CAL, MTL 30.5] S/N _____
- PGT Battery S/N _____
- 7/16 (wobble) Socket-6 ext
- Cheater Bar (w/Kapton Tape)
- 1.5" Bail Drive Lever (taped to Cheater Bar)
- Crewlock Bag (Vent Tools)
- Gamah Removal Tool
- Gamah Installation Tool
- Ratchet Wrench w/palm wheel
- 7/16 rigid Socket-2 ext
- H2 Vent Assembly w/sock
- RET (eq-eq) (3)
- MMOD T-Handle Tool (2)
- RET (eq-lg) (outside of bag)
- EWIS ORU Bag (Medium)
- Fuse Tether
- EWIS Cable
- OIH 297
- OIH 298
- Small ISS Trash Bag
- RET (eq-eq) (2) (outside of bag)

AIRLOCK (Cont)

- Crewlock Bag (Solar Array Tools)
- BRS Pin Contingency Tool (w/Tape)
- Loop Pin Puller (w/Tape)
- TPS Scraper (w/Tape)
- Compound Cutter/Needle Nose Pliers Caddy (w/Tape)
- EVA Scissors (w/Tape)
- Digital Camera
- Digital Camera L bracket
- Small ORU Bag (GPS)
- RET (eq-eq)
- GPS Connector Caps (2 – long wire tied together)
- RET (eq-lg) (outside of bag)
- S3 TRUSS**
- Crewlock EVA Bag – S3 – HR 3049
- Vise Grips
- Socket Caddy
- 5/8 (rigid) Socket-7.8 ext
- 5/8 (rigid) Socket-7.8 ext
- 7/16 (rigid) Socket-2 ext
- RET (eq-eq) w/PIP pin
- 3/8-in IVA Tool Stack w/DPT Adapter
- ISS ratchet wrench
- 7/16 (rigid) Socket-9 ext
- Round Torque Multiplier
- Rd TM Socket – 5/8 prd
- RET (eq-Lg) (outside of bag)
- External APFRs**
- S4-19 (13A.1 prep)
- S3-05
- P6-4B
- P6-11
- S0-07
- IAPFR Z1-3
- IAPFR Z1-1
- 55-ft Safety Tether (2) – Airlock External
- 85-ft Safety Tether – HR 3214 strung to airlock
- 85-ft Safety Tether – HR 3221 strung to airlock
- NOTE
- Prior to use, perform the following hardware inspections:
 1. RET cords for fraying
 2. No red line visible on safety and waist tether load Alleviation straps
 3. Check BRT/Ballstack for loose screws and play
 4. Check Kapton Tape on solar array tools for damage
 5. Inspect STS trash bags for deformation/damage

EVA 3 INHIBIT PAD

Orbiter

TCS

- L12 1. √TCS POWER – OFF

Ku-Band Antenna

- MCC-H 1. √KU-BAND Mask – active
2. √KU-BAND EVA Protect Box – active

RCS

If EV crew < 27 ft from FRCS:

- IV 1. √DAP: VERN, FREE, LO Z
O14,15,16 2. √RJDF F1, F2, F3, F4 MANF DRIVER (four) – OFF
LOGIC (four) – OFF
- MCC-H 3. √Above RCS config
- IV 4. √RCS F – ITEM 1 EXEC (*)
√JET DES F1U – ITEM 17 (*)
F3U – ITEM 19 (*)
F2U – ITEM 21 (*)

S-Band Antennas (during Lab endcone tasks)

NOTE

Possible loss of comm when forced LL FWD antenna

- IV If EV crew < 1.6 ft from S-Band antenna:
- A1R 1. S-BAND FM ANT – XMIT LOWER/RCVR UPPER
2. √MCC, lower antenna selected
If no comm, or on MCC call:
- C3 3. S-BAND PM ANT – LL FWD
When EVA crewmember at least 1.6 ft away from all S-Band upper antennas:
- C3 4. S-BAND PM ANT – GPC

Ground

Ground Radar

- MCC-H 1. √TOPO console, ground radar restrictions in place for EVA

USOS

PCU

- MCC-H 1. √PCUs (two) operational in discharge mode and one of the following:
A. CCS PCU EVA Hazard Control enabled
B. No more than two arrays unshunted
C. No more than two arrays pointed < 90 from velocity vector
- OR
2. One or no PCUs operational in discharge mode and one of the following:
A. No more than two arrays unshunted
B. No more than two arrays pointed < 90 from velocity vector

LAB Window

- IV If EV crew < 10 ft from window, close window shutter

INHIBITS IF SOLAR ARRAY TASKS PERFORMED

S-BAND (SASA) Antennas

- MCC-H 1. S1 SASA – Powered down
- BGA 2. 2B BGA angle = 227.8125
3. 2B Motor State – OFF
4. Latch 2 Pin Status – Latched
5. 2B SSU – shunted

TRRJ DLA

- MCC-H 1. Starboard radiator TRRJ parked at 0 degrees

SARJ

- MCC-H If EV crew working within 2 ft or outboard of SARJ:
1. √DLA (1) – LOCKED
2. All motor setpoints set to zero
3. All motors deselected
- OR
4. Both DLAs – LOCKED

EVA 3 INHIBIT PAD (Cont)

RSOS

SM Antennas

- | | |
|-------|--|
| MCC-M | 1. Global Timing Sys 1(400.1 MHz) [GTS] – Deactivate |
| IV | 2. ARISS (HAM radio) – Deactivate or VHF (144-146 MHz) TX only |

FGB Antennas

- | | |
|-------|--|
| IV | 1. ARISS (HAM radio) – Deactivate or VHF (144-146 MHz) TX only |
| MCC-M | 2. √FGB KURS P [KYPC P] – Deactivated |

Soyuz Antenna

- | | |
|-------|---|
| MCC-M | 1. √Soyuz KURS A [KYPC A] – Deactivated |
|-------|---|

FGB Thrusters

- | | |
|-------|---|
| MCC-M | 1. √FGB MCS unpowered |
| | 2. √All FGB Attitude Control Thruster Valves (80) – closed |
| | 3. √FGB Attitude Control Manifold Valves – closed
KШK1, KШK2, KШK4, KШK5, KШK9, OKO3, OKГ3, OKO6, OKГ6, OKO7, OKГ7, OKO8, OKГ8 |

Soyuz Thrusters

- | | |
|-------|---|
| MCC-M | 1. √Soyuz manifolds (4) – closed
ЭКО1, ЭКО2, ЭКГ1, ЭКГ2 |
| | 2. √Soyuz MCS unpowered |
| | 3. √Soyuz Attitude Control Thruster Valves (52) – closed |
| | 4. √Soyuz Main Engine Valves – closed
(K1, K2, K3, K4, K5, K6) |

NOTES, CAUTIONS, AND WARNINGS

EVA 3

NOTES

1. Bolt install: report torque and turns
2. Bolt release: report torque and turns if different from published range
3. EVA connectors: after disconnection and prior to connection; verify pin and EMI band integrity; verify connector free of FOD
4. Inspect QDs for damage prior to mating
5. Toolbox doors must be closed with one latch per door when EV crew not in immediate vicinity

CAUTION

Flight Specific

- A. Translation Path/Tether routing
1. Avoid contact with S1/P1 Radiator Beam
 2. During translation to 2B retract activities, fairlead safety tether along P6 to clear SSRMS path

ISS Generic Constraints

- B. Electrical Cables:
1. Avoid bend radius < 10 times cable diameter
- C. Fiber optic cables:
1. Avoid bend radius < 10 times cable diameter
 2. Avoid pulling on harness during mate/demate
- D. Fluid line flex hoses and QDs
1. Avoid bend radii < 5 in for hoses with diameter < 1 in on LAB, S0, S1, P1, and 10-in for hoses with diameter < 1-in on all other elements
 2. Avoid bend radii < 14 in for hoses with a diameter ≥ 1 in
 3. Additional care should be taken to not exceed bend radii when applying loads at the flexible hose to rigid tube stub interfaces
 4. Ensure fluid QD booties are fully closed prior to leaving worksite; wire tie if reqd
- E. For Structural Reasons:
1. Avoid vigorous body motions, quick grabs and kickoffs against tether restraints
 2. Avoid performing shaking motions (sinusoidal functions) more than four cycles
- If any of these occur, wait 2-5 min to allow structural response to dissipate
- F. Other:
1. ITT Cannon connector: On demated connectors, do not rotate collar or manipulate cable/connector using collar or connector tool
 2. WIS Antennas: do not use as handholds [Node 1, P6, Z1, P4, S4]
 3. Lubricant from Ku-Band SGANT gimbals [Z1], CMGs [Z1], and RTAS Ground Strap fasteners can contaminate EMU [P6, P4, S4]
 4. MLI handholds are not rated for crewmember translation loads
 5. CBM petal covers may not be used as handholds unless both launch restraint pins are engaged
 6. Do not close hatch until EMU water OFF for 2 min

CAUTION (Cont)

ISS Generic Constraints

- G. Avoid inadvertent contact with:
1. Grapple fixture shafts (dry lube)
 2. PIP pins
 3. EVA Crane [PMA 1]
 4. TCS Reflectors [PMA 2, PMA 3]
 5. APAS hardware [PMA 2, PMA 3]
 6. CETA Lights (Z-93 paint) [Lab, S1, Node 1]
 7. Deployed MISSEs
 8. Passive UMAs
 9. MBS VDU, MCU, CRPCMs and Cameras (tape radiative surface, silver Teflon)
 10. Deployed TUS cable
 11. S0 aft face radiator
 12. GPS Antennas (S13 paint) [S0]
 13. UHF Antennas [Lab, P1]
 14. ETCS Radiators [S1, P1]
 15. EETCS/PV Radiator bellows and panels [P6, P4, S4, S6]
 16. SASA RF Group [Z1, S1, P6]
 17. Heat pipe radiators [Z1]
 18. PCU cathode and HCA ports [Z1]
 19. Ku-Band Antenna (SGANT) dish [Z1]
 20. CMG cover/shells [Z1]
 21. SSRMS Cameras
 22. Open CBM petal covers and Lab window shutter

NOTES, CAUTIONS, AND WARNINGS (Cont)

WARNING

Flight Specific

A. Solar Array

1. Sharp edges:
 - a. SABB (skirt, swing bolts)
 - b. Solar cells
 - c. Springs along tension bar
 - d. Panel hinges
 - e. Guide cable burrs or frays
 - f. Mast Canister roller guides
 - g. Braided cables
 - h. Fastener exposed threads
 - i. Exposed bolts in rib cavities on mast canister
 - j. Keep hands away from SSRMS LEE opening, and snares
2. RF radiation exposure:
 - a. Stay 3 ft from S-Band (SASA) high gain antenna when powered [S1, P6]
 - b. Stay 1.3 ft from S-Band (SASA) low gain antenna when powered [S1, P6]
3. Avoid inadvertent contact with:
 - a. SSU, ECU, beta gimbal platform, mast canister, SAW blanket boxes unless the beta gimbal is locked and the motor is turned off
4. Pinch:
 - a. Lower SABB exposed reels and pulleys (guide wire and tensioning mechanisms)
 - b. Solar array mast during retraction
5. Other:
 - a. EV crew will only contact energized surfaces with approved tools that have been insulated with Kapton tape to prevent molten metal and shock
 - b. Solar array to be manipulated will be shunted prior to EV crew entering worksite

B. QDs

1. If QD is in FID when valve is opened (bail fwd), QD will leak and fluid line may whip
2. Do not rotate if in mated/valve open config

WARNING (Cont)

ISS Generic Constraints

C. Avoid inadvertent contact with:

1. Grapple fixture targets and target pins
2. Stay 2 ft from S1/P1 radiator beam rotational envelope when beam is free to rotate
3. Stay 5 ft from moving MT on face 1
4. Stay inboard of SARJ when active
5. Power must be turned off to electrical connectors prior to mating/demating to preclude arcing/sparking

D. Handrails

1. Handrails previously used for MISSE attachment may not be used as a safety tether point [A/L endcone 564 & 566, A/L Tank 2 nad/fwd & port/fwd, P6 5389]

E. Pinch

1. ITT Cannon Connector rotating housing
2. EV side of IV Hatch during Hatch operation (also snag hazard) [A/L]
3. LAB window shutter and CBM petal cover linkages during operation
4. NZGL connector linkage. Use caution when mating/locking

F. RF radiation exposure

1. Stay 1 ft from UHF antenna when powered [Lab, P1, PLB]

G. Sharp Edges:

1. Inner edges of WIF sockets
2. Back side of MMOD shield fasteners
3. PMA umbilical launch restraints – exposed threads
4. Adjustable Fuse Tether buckles stowed in Node Bag
5. Nickel coated braided copper ground straps may have frayed wires [P6, P4, S4]
6. Z1 handrail 6061 by the Ku-Band boom launch restraint [Z1]
7. Exposed fasteners on back of Z1 U-jumper male QD panel, if nutplate cap missing
8. Sharp edge – mating surfaces of EVA connectors. Avoid side loads during mating
9. Spring loaded captive EVA fasteners (e.g., SARJ MLI cover bolts); the end of the spring may protrude

WARNING (Cont)

ISS Generic Constraints (Cont)

H. Thermal:

1. EVA connectors with booties may become hot if left uncovered. Handling may need to be limited
2. PMA handrails may be hot. Handling may need to be limited
3. Turn off glove heaters when comfortable temp reached to prevent bladder damage. Do not pull fingers out of gloves when heaters are on
4. Uncovered trunnion pins may be hot
5. SSRMS/MBS operating Cameras and lights may radiate large amounts of heat
6. Stay 1 ft away from PMAs and MMOD shields > 270 degF if EMU sun visor up
7. Stay 1 ft away for no more than 15 min from PMAs and MMOD shields > 300 degF if EMU sun visor up
8. Stay 0.5 ft away from PMA and MMOD shields > 325 degF
9. Do not touch EMU protective visor if temp has been < -134 for >15 min
10. No EMU TMG contact of PMAs and MMOD shields when temp > 320 degF
11. No EMU boot contact with foot restraint when temp < -120 degF or > 200 degF

2B SOLAR ARRAY RETRACT (02:00 to 05:00)

IV/SSRMS	EV1	EV2
	<p>WARNING</p> <p>Sharp edge/pinch point/shock hazard: Avoid EMU contact with the following:</p> <ol style="list-style-type: none"> 1. Lower SABB exposed reels and pulleys (guide wire and tensioning mechanisms) 2. SABB skirt 3. Swing bolts 4. Springs on tension bar 5. Panel hinges 6. Guide wire frays 7. Braided cables 8. Fastener exposed threads 9. Exposed bolts in rib cavities on mast canister 10. Mast roller guides 11. FCC and Kapton part of solar array panels 	
	<ol style="list-style-type: none"> 1. Verify glove gauntlets cover wrist disconnects 2. Determine SAW problem and perform corresponding <u>SAW WORKAROUND</u> 3. If not performed on EVA 2 inspect the following: <ul style="list-style-type: none"> <input type="checkbox"/> Y-guides (4 per SABB should not be visible) <input type="checkbox"/> Center, outboard guide wire not rubbing against power cable <input type="checkbox"/> Foam pads in SABB base 4. Prior to retract, GCA SSRMS and EMU 3 ft away from array plane 	<ol style="list-style-type: none"> 1. Verify glove gauntlets cover wrist disconnects 2. Assist EV1 with clearance and tool management 3. As reach with tool permits free grommets on inboard guide wire 4. Prior to retract, translate below Mast Canister separation plane
<ol style="list-style-type: none"> 1. SSRMS to APFR egress location 	<p>EV1/EV2</p> <ol style="list-style-type: none"> 5. Give IV GO for retract 6. Monitor array retract; call ABORT if problem seen 7. Repeat steps 1 thru 6 until mast retracted to one bay out 8. Perform SABB/SAW survey to verify the following: <ul style="list-style-type: none"> <input type="checkbox"/> Blanket fully contained within blanket box <input type="checkbox"/> Outboard STE loops neatly stacked within goal posts <input type="checkbox"/> Upper blanket box cover guide pins/alignment tabs aligned with goal posts <input type="checkbox"/> Guide wires (3 per SABB) retracted with no slack 9. Give IV GO for final bay retraction 10. Verify guide wires remain tight and grommets are not caught between panels 11. If latching to be performed, verify latches aligned and within reach of latch pins on upper blanket box 	
	<p><u>2B CLEANUP</u></p> <ol style="list-style-type: none"> 12. Give SSRMS GO for translation to APFR egress location 13. Egress APFR 14. Tether swap to airlock safety tether; verify locked 15. Retrieve APFR/ WIF adapter 16. Relocate APFR to Z1-11 [2,TT,H,11]; retrieve fairlead 17. Translate to Airlock 18. Transfer WIF Adapter, cheater bar to EV2 19. Tether swap to S1 safety tether; verify locked 20. Stow both 55 ft safety tethers on airlock external D-ring; verify hooks locked, reels unlocked 21. Receive PGT from EV2 	<p><u>2B CLEANUP</u></p> <ol style="list-style-type: none"> 12. Retrieve Crewlock Bag and PGT from P6 HR 5307 13. Translate to Airlock; retrieve fairlead 14. Coordinate with MCC/IV for GO to attempt SASA bolts 15. Tether swap to S1 safety tether; verify locked 16. Stow spare 85 ft safety tether on fuse tether 17. Stow 2B Tools Crewlock Bag in Airlock 18. Retrieve digital camera from 2B Tools Crewlock Bag 19. Receive/stow WIF Adapter, Cheater Bar on fuse tether 20. Transfer PGT to EV1 21. Close thermal cover

2B SOLAR ARRAY RETRACT (02:00 to 05:00) (Cont)

IV/SSRMS	EV1	EV2
	<p style="text-align: center;"><u>SAW WORKAROUND</u></p> <p>Over-center Hinge Reset: A. GCA SSRMS to affected location on panel B. Use cheater bar to press metal panel hinge into normal configuration; avoid contact with guide wire</p> <p>Uneven Panel Distribution (causes stuck grommets during retract): C. GCA SSRMS to lower blanket box near center guide wire on affected solar array D. Use TPS scraper or cheater bar to evenly distribute panel folds along array (fluff); avoid contact with guide wire; GCA SSRMS along center guide wire as required</p> <p>Stuck Grommet:</p> <p style="text-align: center;"><u>NOTE</u> Provided a fray is not causing the grommet fault, panel fluffing near center guide wire will likely clear problems at all three guide wires</p> <p>If guide wire fray NOT suspected: E. GCA SSRMS to affected panel near center guide wire F. Use TPS scraper or cheater bar to evenly distribute panel folds (fluff); avoid contact with guide wire G. If no joy; perform steps as is guide wire fray suspected</p> <p>If guide wire fray is suspected: H. GCA SSRMS to affected grommet I. Use TPS scraper or cheater bar to free grommet; repeat as necessary for lower panel grommets as guide wire fray retracts</p> <p>Guide Wire Slack Due to Reel/Pulley Jam:</p> <div style="border: 1px solid black; padding: 5px; margin: 10px auto; width: fit-content;"> <p style="text-align: center;"><u>CAUTION</u> Guide wire can jump out of pulley track, attempt cable manipulation from inside blanket box first. If guide wire must be handled from outside of blanket box, avoid pulling guide wire to side of pulley plane</p> </div> <p>J. Verify all grommets on affected guide wire are loose K. GCA SSRMS to lower blanket box near affected guide wire L. Use needle nose pliers to pull cable out of reel; allow cable to retract</p> <p>Out of Plane Panels or Guide Wire Slack After Retract: M. Perform steps for stuck grommet N. If no joy; GCA SSRMS to goal posts of affected blanket O. Use gloved hand to realign STE loops between goal posts; avoid contact with FCC</p> <p>Y-Guide Reset P. Verify SABB is unlatched (low tension) Q. Use BRS Pin Tool on short skirt stiffener to lift tension bar; TPS scraper can be used assist with tension bar manipulation R. Lower tension bar on to Y-guide</p> <p>Leader Disconnected from Tension Bar S. If spring not connected to leader, inspect tension bar for spring condition and determine if it will interfere with latching T. If spring still connected to leader, use needle nose pliers to retain loose piece and cut leader with EVA scissors; stow in trash U. If spring needs to be cut from tension bar, use needle nose pliers to retain loose piece and cut spring with compound cutters; stow in trash</p>	

S3 KEEL PIN/DRAW LINK STOW (01:00)

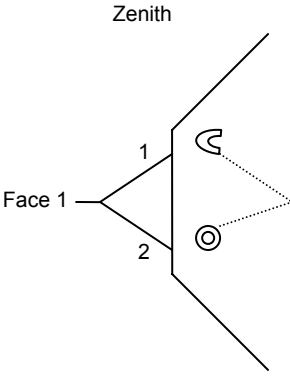
IV	EV1	EV2
<p>SSRMS support – Position SSRMS at S3 Keel Pin, S3 Face 1 for camera viewing</p>  <p>Keel Pin Launch and Stow Config (looking outboard)</p>	<p><u>REMOVE AND STOW DRAG LINK</u></p> <ol style="list-style-type: none"> 1. Translate to S3 2. APFR: From S3-28 to S3-05 [6,PP,L,10] 3. Install RET between Drag Link and Keel Pin (zenith aft Standoff) 4. Ingress APFR S3-05 [6,PP,L,10] 5. PGT[B3 18.4 ft-lb, CCW2 30 RPM, MTL 30.5]-6 ext 7/16: Release outboard drag link fastener (~11 turns) 6. Remove drag link fastener, remove drag link from clevis, Reinstall fastener ~3 turns by hand <p>7. Position drag link through face 1 and insert into retention/spring bracket</p> <p><u>REMOVE AND STOW KEEL PIN</u></p> <ol style="list-style-type: none"> 8. PGT[B2 16.0 ft-lb, CCW2 30 RPM, MTL 30.5]-6 ext 7/16: Release zenith clevis bolt (#1) ~22 turns 9. Remove zenith clevis bolt (#1), rotate keel to clear clevis; reinstall zenith clevis bolt ~3 turns by hand 10. Rotate keel to clear clevis 11. Rotate keel pin 180 deg; keep keel captive nuts facing the bulkhead while keel pin points into face 1 12. Position keel pin into the center retention ring in truss 13. Align keel clevis bolts above stow fittings 14. Secure clevis bolt (#2) with zenith soft dock retention fitting inside the truss 15. Egress APFR 	<p><u>TIGHTEN KEEL PIN NUT CLAMPS</u></p> <ol style="list-style-type: none"> 1. Translate to S3; photo op then temp stow digital camera 2. Remove PIP pin from S3 MT stop; stow in trash bag 3. If not already performed, PGT[A1 2.5 ft-lb, CW2 30 RPM, MTL 30.5] -6 ext 7/16: Tighten nadir and zenith nut clamp bolts (2) ~6 turns <ul style="list-style-type: none"> <input type="checkbox"/> Nadir <input type="checkbox"/> Zenith <p><u>REMOVE AND STOW DRAG LINK</u></p> <ol style="list-style-type: none"> 4. When outboard fastener reinstalled, tether to inboard fastener 5. PGT[B3 18.4 ft-lb, CCW2 30 RPM, MTL 30.5]-6 ext 7/16: Release inboard drag link fastener (~11 turns) 6. Remove inboard drag link fastener and stow in trash bag 7. Remove outboard drag link fastener; engage drag link clevis onto eye bracket 8. PGT[A5 7.0 ft-lb, CW2 30 RPM, MTL 30.5]-6 ext 7/16: Tighten outboard drag link fastener ~11 turns <p><u>REMOVE AND STOW KEEL PIN</u></p> <ol style="list-style-type: none"> 9. PGT[B2 16.0 ft-lb, CCW2 30 RPM, MTL 30.5]-6 ext 7/16: Release nadir clevis bolt (#2) ~22 turns (use RET to tension lanyard) 10. PGT[A3 4.8 ft-lb, CW2 30 RPM, MTL 30.5]-6 ext 7/16: Engage nadir clevis bolt (#2) ~22 turns to torque 11. Assist EV1 with keel beam handling 12. Align keel clevis bolts above stow fittings 13. Remove clevis bolt (#1), engage keel onto nadir eye bracket and reinstall clevis bolt 14. PGT[A3 4.8 ft-lb, CW2 30 RPM, MTL 30.5]-6 ext 7/16: Engage clevis bolt (#1) ~22 turns 15. Retrieve drag link tether

MT/CETA PATH/S4 MMOD SHIELD BOLT RELEASE (01:00)

IV	EV1/EV2
<p><u>DEMATE QD</u></p> <ol style="list-style-type: none"> 1. √Fwd white band visible, button up 2. Demate QD <p><u>MATE QD</u></p> <ol style="list-style-type: none"> 3. Inspect QDs for FOD or damage 4. √Detent button up 5. √Fwd white band not visible 6. Assess side loads 7. Mate QD; √Fwd white band visible 8. Perform snap back test (√Fwd white band visible) 9. Perform pull test, and visual gap test <p><u>OPEN QD VALVE</u></p> <ol style="list-style-type: none"> 10. Press button, move bail fwd (open valve) 11. √Aft white band visible, button up 12. Verify detent button can be depressed 	<p><u>ROTATE S1 MT STOP</u></p> <ol style="list-style-type: none"> 1. Translate to S1 MT stop (Face 1 S1/S3 interface) 2. Remove PIP pin from S1 bulkhead 3. Move MT stop away from notch in bulkhead (inboard) and rotate 180 deg to clear face 1 (MT stop will spring back to engage bulkhead notch) 4. Reinsert PIP pin into bulkhead; √PIP pin fully seated <p><u>REMOVE S3 SVS TARGET (IF NOT ALREADY PERFORMED)</u></p> <div data-bbox="743 448 1822 500" style="border: 1px solid black; padding: 5px; margin: 10px 0;"> <p style="text-align: center;">CAUTION To prevent loss of SVS target fasteners limit turn count, minimize side loading on bolt head, maintain axial force</p> </div> <ol style="list-style-type: none"> 5. PGT[A3 4.8 ft-lb, CCW3 60 RPM, MTL 30.5]-6 ext 7/16: Release SVS target fasteners (4) (~12 turns) <p><u>IEA MMOD SHIELD BOLT RELEASE (IF NOT ALREADY PERFORMED)</u></p> <ol style="list-style-type: none"> 6. Retrieve digital camera 7. PGT[B7 25.5 ft-lbs, CCW1 10 RPM, MTL 30.5]-6ext 7/16: Release IEA MMOD Shield bolts (4) =1 turn <ul style="list-style-type: none"> <input type="checkbox"/> Aft outboard #3 (HR 2228) <input type="checkbox"/> Aft inboard (#4) (HR 2203) <input type="checkbox"/> Fwd inboard (#1) (HR 2219) <input type="checkbox"/> Fwd outboard (#2) (HR 2227) <p><u>APFR RELOCATES</u></p> <ol style="list-style-type: none"> 8. APFR: from S3-05 to S4-18 [8,OO,C,1] (13A.1 get-ahead) 9. If EVA 2 did not perform, APFR: S4-04 to S4-19 (aft/nadir) [6,TT,J,11] (13a.1 get-ahead) <p><u>CONNECT S1 TO S3 FLUID LINE (GET AHEAD)</u></p> <ol style="list-style-type: none"> 10. Open TA clamp 11. For QDs F56 and QD F57, perform <u>DEMATE QD</u> steps in IV column 12. Close TA clamp 13. Remove QD cap from panel S1-A503-M3; stow in trash Bag 14. For QD F57 to S1-A503-M3, perform <u>MATE QD</u> steps in IV column 15. For QD F57, perform <u>OPEN VALVE</u> steps in IV column 16. Reinstall thermal bootie 17. BRT to S3 HR 3010 18. Open thermal bootie; remove QD cap from panel S3-A501-M1; stow in trash bag 19. For QD F56 to S3-A501-M1, perform <u>MATE QD</u> steps in IV column 20. For QD F56, perform <u>OPEN VALVE</u> steps in IV column 21. Reinstall thermal bootie

MT/CETA PATH/S4 MMOD SHIELD BOLT RELEASE (01:00) (Cont)

IV	EV1	EV2
	<p><u>S3/S4 CLEANUP</u></p> <ul style="list-style-type: none"> 22. Retrieve digital camera and SVS target if required 23. Translate to S1 HR 3221 24. On EV2 GO, attach EV2 Safety tether to D-ring extender; verify locked 25. Remove EV1 safety tether from S1 HR; stow on MWS 26. Translate to Airlock 27. Connect EV1 safety tether to external A/L D-ring; verify locked 28. Connect EV2 safety tether to external A/L D-Ring; verify locked 29. Give EV2 GO to disconnect waist tether 30. Transfer SVS target to EV2 	<p><u>S3/S4 CLEANUP</u></p> <ul style="list-style-type: none"> 22. If EVA 2 did not complete, retrieve Crewlock Bag from S3 HR 3049; perform Crewlock Bag inventory 23. Translate to airlock 24. Connect waist tether to airlock D-ring; verify locked 25. Give EV1 GO for safety tether swap 26. Stow Crewlock Bag in A/L 27. On EV1 GO, disconnect waist tether 28. Stow SVS target on fuse tether

H2O/H2 VENT VALVE CHANGEOUT (01:30)

IV	EV1	EV2													
<p>1. Verify with MCC Lab vent inhibits in place Verify Port Bulkhead Isolation Valve Lab: ECLSS: H2O Vent: Effector Commands <u>Water Vent Effector Commands</u> 'Port Isolation Valves' 'Inboard'</p> <p>√Position – Close RPCM LA1B B RPC 11 – Open, Close cmd inh</p> <p>2. Give EV crew GO for connector demates</p> <p>If PGT used for vent nozzle fasteners use settings: PGT[A7 9.2 ft-lb, CCW2 30 RPM, MTL 30.5]</p> <table border="1" data-bbox="109 951 543 1003"> <thead> <tr> <th>Turns to Hand Tight</th> <th>Turns to Torque</th> </tr> </thead> <tbody> <tr> <td> </td> <td> </td> </tr> </tbody> </table> <table border="1" data-bbox="109 1060 571 1138"> <thead> <tr> <th>Bolt</th> <th>Torque</th> <th>Turns</th> </tr> </thead> <tbody> <tr> <td>Nadir</td> <td> </td> <td> </td> </tr> <tr> <td>Zenith</td> <td> </td> <td> </td> </tr> </tbody> </table> <p>3. Inform MCC-H H2 vent installed and CLOSED</p>	Turns to Hand Tight	Turns to Torque			Bolt	Torque	Turns	Nadir			Zenith			<p><u>MMOD SHIELD REMOVAL</u></p> <ol style="list-style-type: none"> Retrieve Vent Tools Crewlock Bag from airlock Translate to Lab fwd/zenith endcone panel C2-03 Stow Crewlock Bag on Lab HR 263 Assess SSPTS bag for interference during MMOD shield temp stowage Install MMOD T-handle tool into C2-03 shield Install RET from T-handle to Lab HR 0271 Release Dzus fasteners (3) Temp stow shield using second RET to Lab HR 0280 Release outer/port MLI Dzus fastener Peel back MLI; restrain with RET to HRs PMA2-0403 and Lab-0280 <p><u>WATER VENT REMOVAL</u></p> <ol style="list-style-type: none"> Retrieve ratchet wrench and Gamah Removal Tool On IV GO: demate P1 from J1 and P2 from J2 BRT to HR 0270 Install Gamah Removal Tool on water vent feedthrough; push tool cw and radially inward Gamah Removal Tool – Engage Ratchet wrench -2 ext 7/16: Break torque on gamah fitting (~1 turn) Gamah Removal Tool – Release; stow in Crewlock bag Ratchet wrench -2 ext 7/16: Release vent nozzle fasteners (2)(~9-14 turns)(failure torque 13.8 ft-lb) Evaluate vent hose bending during nozzle removal from Lab Loosen gamah fitting by hand (~3-4 turns) Release TA clamps (1) for vent swap Stow vent assembly in Crewlock bag <p><u>H2 VENT INSTALLATION</u></p> <ol style="list-style-type: none"> Close TA clamps to restrain H2 vent electrical connectors (2) Position gamah fitting on feedthrough Engage gamah nut threads finger tight (~3.5 turns); Note location of sharpie mark on nut Position H2 vent nozzle at end ring bracket; start fasteners by hand (~2 turns) Install Gamah Installation Tool on vent feedthrough; Push tool ccw and radially inward Gamah Installation Tool – Engage Ratchet wrench -2 ext 7/16: Torque gamah fitting; Verify ~0.25 addition turn on nut at torque Inspect tube orientation Gamah Installation Tool – Release; stow in Crewlock bag Mate P1 to J1 and P2 to J2 PGT[A1 2.5 ft-lb, CW1 10 RPM, MTL 30.5]-6 ext 7/16: Torque vent nozzle fasteners (2)(~9-14 turns) Verify H2 vent nozzle – CLOSED <p><u>MMOD SHIELD INSTALLATION</u></p> <ol style="list-style-type: none"> Install MLI; verify MLI is under MMOD fastener brackets Engage MLI Dzus fastener Install MMOD shield with tabs under inner flange Engage Dzus fasteners (3)(engage center first) Retrieve RETs and T-handle tools Stow T-handle tools in Crewlock Bag Translate to Airlock Stow Crewlock Bag in Airlock 	<p><u>MMOD SHIELD INSTALLATION</u></p> <ol style="list-style-type: none"> Assist EV1 with shield install
Turns to Hand Tight	Turns to Torque														
Bolt	Torque	Turns													
Nadir															
Zenith															

LAB EWIS ANTENNA INSTALLATION (01:30)

IV	EV2																		
<p style="text-align: center;">NOTE</p> <p>Due to Big Loop Reconfigurations, if comm is required between ISS IV and EV crew, recommend using drag-thru BPSMU with shuttle ATU configured to A/G1</p> <p>IV 1. Notify MCC-H when ready for SSSR (UHF) reconfiguration</p> <p>MCC 2. Deactivate SSSR (UHF)</p> <p>IV 3. On MCC-H GO: A1R AUD CTR SL A/G1 – ON</p> <p><u>NOTE:</u> Big Loop comm is via hardline</p> <table border="1" style="width: 100%; border-collapse: collapse;"> <thead> <tr> <th colspan="3" style="text-align: center;">EWIS Handrails</th> </tr> <tr> <th style="text-align: center;">Bolt</th> <th style="text-align: center;">Torque</th> <th style="text-align: center;">Turns</th> </tr> </thead> <tbody> <tr> <td style="text-align: center;">298 stbd</td> <td></td> <td></td> </tr> <tr> <td style="text-align: center;">298 port</td> <td></td> <td></td> </tr> <tr> <td style="text-align: center;">297 stbd</td> <td></td> <td></td> </tr> <tr> <td style="text-align: center;">297 port</td> <td></td> <td></td> </tr> </tbody> </table> <p>When EWIS connector mates complete:</p> <p>IV 4. On MCC-H GO: A1R AUD CTR SL A/G1 - OFF</p> <p>MCC 5. Activate SSSR (UHF)</p> <p><u>NOTE:</u> Big Loop comm is via UHF</p>	EWIS Handrails			Bolt	Torque	Turns	298 stbd			298 port			297 stbd			297 port			<p><u>SETUP</u></p> <ol style="list-style-type: none"> 1. Retrieve EWIS ORU Bag (RETs stay on bag) 2. Retrieve MMOD T-Handle Tools (2) from Airlock Toolbox 2, slot 5 (zenith door) 3. Translate to Lab fwd nadir/port endcone C2-01 4. Stow EWIS ORU Bag with lid nadir on Lab HRs 205/207 and 266/262 <p><u>INSTALL LAB EWIS ANTENNA OIH</u></p> <ol style="list-style-type: none"> 5. Remove and temp stow SSPTS cable from OIH 276 6. PGT[B1 12.0 ft-lb, CCW2 30 RPM, MTL 30.5] - 6 ext 7/16: Break torque on OIH 276 fasteners (2) =1 turn only 7. PGT[A1 2.5 ft-lb, CCW2 30 RPM, MTL 30.5] - 6 ext 7/16: Release OIH 276 fasteners (2) ~7 turns 8. Push OIH release buttons; Temp stow OIH 276 9. Install EWIS ANT 12 (OIH 0297) with antenna pointing nadir (push release button to deploy shoes) 10. PGT[A2 3.8 ft-lb, CW2 30 RPM, MTL 30.5] - 6 ext 7/16: tighten EWIS OIH 0297 fasteners (2) (8 turns) 11. Remove cap from EWIS ANT 12 J1; stow in trash bag on fuse tether 12. Secure SSPTS cable to EWIS OIH 0297 13. PGT[B1 12.0 ft-lb, CCW2 30 RPM, MTL 30.5] - 6 ext 7/16: Break torque on OIH 278 fasteners (2) =1 turn only 14. PGT[A1 2.5 ft-lb, CCW2 30 RPM, MTL 30.5] - 6 ext 7/16: Release OIH 278 fasteners (2) ~7 turns 15. Push OIH release buttons; Temp stow OIH 278 16. Install EWIS ANT 11 (OIH 0298) with antenna pointing nadir (push release button to deploy shoes) 17. PGT[A2 3.8 ft-lb, CW2 30 RPM, MTL 30.5] - 6 ext 7/16: tighten EWIS OIH 0298 fasteners (2) (8 turns) 18. Remove cap from EWIS ANT 11 J1; stow in trash bag on fuse tether 19. Stow OIH 278 and 276 in EWIS ORU Bag <p><u>ROUTE EWIS CABLE TO ANTENNAS</u></p> <ol style="list-style-type: none"> 20. Retrieve EWIS cable P2; release wire ties as required 21. Remove cap from EWIS cable P2, stow in trash bag on fuse tether 22. Translate to EWIS ANT 12 with P2 23. Mate EWIS cable P2 to ANT 12 J1 24. Route cable to ANT 11; wire tie as required 25. Remove remaining caps (3) from EWIS cable; stow in trash bag on fuse tether <p><u>MATE EWIS CABLE TO LAB</u></p> <ol style="list-style-type: none"> 26. Install MMOD T-handle tool into C2-01 shield 27. Install RET from T-handle to Lab HR 0277 28. Release C2-01 Dzus fasteners (3) 29. Temp stow shield using second RET to HR 0282 30. Release nadir MLI Dzus fastener to expose connector P16 31. On MCC-H GO: Demate Lab P16 from J16 32. Mate EWIS cable P16A to J16 33. Mate EWIS cable J16A to P16 34. Feed EWIS cable to MMOD shield exit point 35. Reinstall MLI Dzus fastener 36. With EV1 assistance: Install MMOD shield C2-01 37. Engage Dzus fasteners (3)(engage center first) 38. Mate EWIS cable P1 to ANT 11 J1 <p><u>EWIS CLEANUP</u></p> <ol style="list-style-type: none"> 39. Retrieve EWIS ORU Bag 40. Translate to Airlock 41. Stow MMOD T-Handle tools on tool board; stow tool board in Airlock Toolbox 2, slot 5 (zenith door) 42. Close Toolbox door 43. Stow EWIS ORU Bag in Airlock
EWIS Handrails																			
Bolt	Torque	Turns																	
298 stbd																			
298 port																			
297 stbd																			
297 port																			

NODE/SM LAN CABLE ROUTING (01:00)

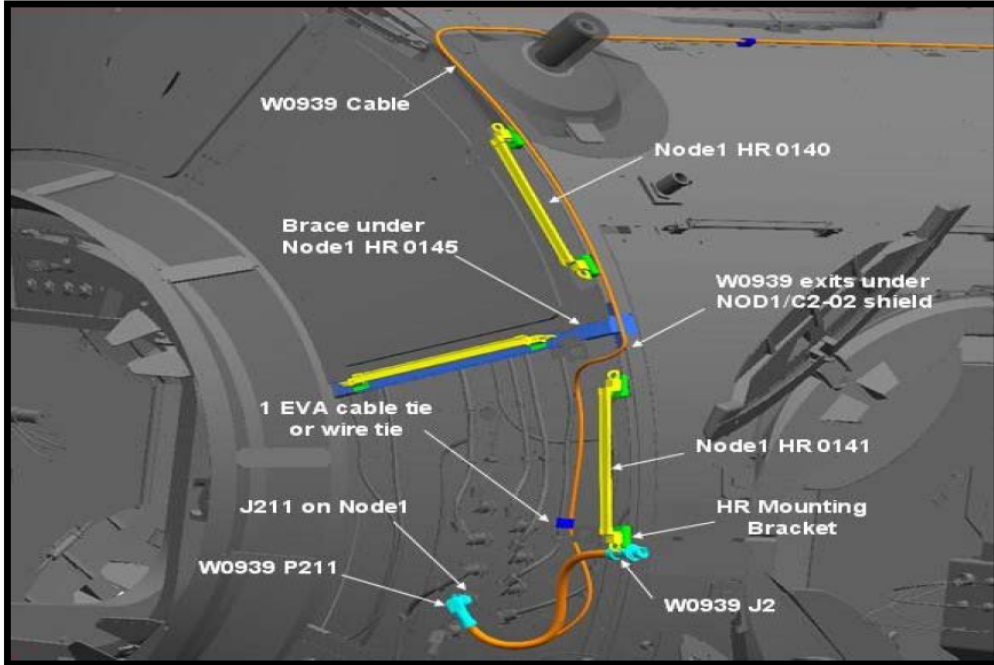
IV	EV1	EV2
<p>No inhibits are required for cable connection</p> 	<ol style="list-style-type: none"> 1. Retrieve MMOD T-Handle Tools (2) from Crewlock Bag in Airlock; transfer to EV2 2. Assist EV2 as required 	<ol style="list-style-type: none"> 1. Retrieve Node/LAN cable and Wire Tie Caddy from Airlock 2. Install MMOD T-handle tool into NOD1/C2-02 shield 3. Install RET from T-handle to Node HR 0139 4. Release Dzus fasteners (3) 5. Temp stow shield using second RET to Node HR 0145 6. Remove outer MLI Dzus fasteners (2) 7. Peel back MLI; restrain near inner radius with RETs to Lab HR 0221 and Node HR 0145 8. Remove cap from Node J211 9. Mate W0939-P211 to Node J211 10. Wire tie W0939-J2 to Node HR 0141 11. Begin cable routing to FGB zenith, wire tie as necessary: <ul style="list-style-type: none"> <input type="checkbox"/> Node HR 0141 <input type="checkbox"/> Node HR 0140 <input type="checkbox"/> Node HR 0139 <input type="checkbox"/> Node HR 0104 <input type="checkbox"/> PMA1 HR 0008 <input type="checkbox"/> PMA1 HR 0009 <input type="checkbox"/> FGB HR 1030 12. Translate to Node Port FWD 13. Retrieve RETs from MLI (Lab HR 0221 and Node HR 0145) 14. Install MLI; verify MLI is under MMOD fastener brackets 15. Engage MLI Dzus fasteners (2); capture MLI lanyard 16. Install MMOD shield with tabs under inner flange 17. Engage Dzus fasteners (3)(engage center first) 18. Retrieve RETs and T-handle tools; stow <p><u>NODE HR 120 REMOVAL (10A GET AHEAD)</u></p> <ol style="list-style-type: none"> 19. PGT[B1 12.0 ft-lb, CCW2 30 RPM, MTL 30.5] - 6 ext 7/16: Break torque on OIH 120 fasteners (2) =1 turn only 20. PGT[A1 2.5 ft-lb, CCW2 30 RPM, MTL 30.5] - 6 ext 7/16: Release OIH 120 fasteners (2) ~7 turns 21. Push OIH release buttons; remove OIH 120 22. Stow handrail in airlock

SASA GIMBAL LOCKS (00:30)

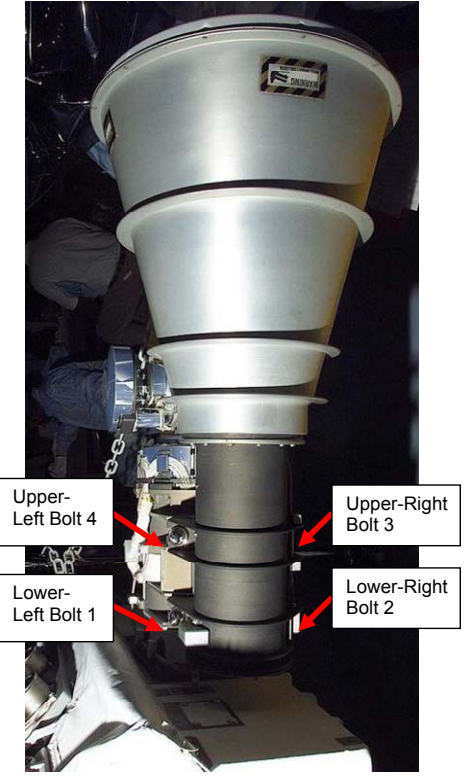
IV			EV																											
<table border="1"> <thead> <tr> <th>Gimbal Bolts</th> <th>Turns</th> <th>Torque</th> </tr> </thead> <tbody> <tr> <td colspan="3" style="text-align: center;">Release</td> </tr> <tr> <td>U-L bolt 4</td> <td></td> <td></td> </tr> <tr> <td>U-R bolt 3</td> <td></td> <td></td> </tr> <tr> <td colspan="3" style="text-align: center;">Re-Torque Initial / Final</td> </tr> <tr> <td>L-L bolt 1</td> <td>/</td> <td>NA /</td> </tr> <tr> <td>L-L bolt 2</td> <td>/</td> <td>NA /</td> </tr> <tr> <td>U-R bolt 3</td> <td>/</td> <td>NA /</td> </tr> <tr> <td>U-R bolt 4</td> <td>/</td> <td>NA /</td> </tr> </tbody> </table>			Gimbal Bolts	Turns	Torque	Release			U-L bolt 4			U-R bolt 3			Re-Torque Initial / Final			L-L bolt 1	/	NA /	L-L bolt 2	/	NA /	U-R bolt 3	/	NA /	U-R bolt 4	/	NA /	<ol style="list-style-type: none"> Translate to Z1 HR 6001 (near SASA spare) Remove shroud to access SASA spare gimbal locks PGT[B3 18.4 ft-lb, CCW2 30 RPM, MTL 30.5] - 6 ext 7/16: Loosen gimbal lock fasteners =2 turns only <ul style="list-style-type: none"> <input type="checkbox"/> Upper-Left bolt 4 (report torque and turns) <input type="checkbox"/> Upper-Right bolt 3 (report torque and turns) Manipulate gimbals with all bolts in place to slightly shift the square spacer block on all bolts to verify no loads exist Verify all four bolts still properly rotated to lock position and seated PGT[A3 4.8 ft-lb, CW2 30 RPM, MTL 30.5] - 6 ext 7/16: Rotate gimbal lock fasteners (4) =1 turn exactly in order shown <ul style="list-style-type: none"> <input type="checkbox"/> Lower-Left bolt 1 <input type="checkbox"/> Lower-Right bolt 2 <input type="checkbox"/> Upper-Right bolt 3 <input type="checkbox"/> Upper-Left bolt 4 PGT[A3 4.8 ft-lb, CW2 30 RPM, MTL 30.5] - 6 ext 7/16: Re-torque gimbal lock fasteners ~1-2 turns to torque in order shown <ul style="list-style-type: none"> <input type="checkbox"/> Lower-Left bolt 1 <input type="checkbox"/> Lower-Right bolt 2 <input type="checkbox"/> Upper-Right bolt 3 <input type="checkbox"/> Upper-Left bolt 4 Reinstall SASA shroud
Gimbal Bolts	Turns	Torque																												
Release																														
U-L bolt 4																														
U-R bolt 3																														
Re-Torque Initial / Final																														
L-L bolt 1	/	NA /																												
L-L bolt 2	/	NA /																												
U-R bolt 3	/	NA /																												
U-R bolt 4	/	NA /																												
																														

GPS ANTENNA #4 REMOVAL (00:40)

IV	EV
<p>1. Verify with MCC-H, ISS GPS Antenna #4 power inhibits in place</p> <p>RPCM S02B_E RPC 8 – Open, Close Cmd Inh RPCM S01A_E RPC 7 – Open, Close Cmd Inh</p>	<div data-bbox="684 250 1257 310" style="border: 1px solid black; padding: 5px; text-align: center;"><p><u>CAUTION</u> Avoid inadvertent contact with GPS Antenna (S-13 paint)</p></div> <ol style="list-style-type: none">1. Retrieve Small ORU Bag (GPS) from airlock2. Close thermal cover3. Translate to GPS Antenna #4 worksite (S0 lower-inboard)4. Temp stow GPS Ant ORU bag on HR 35095. BRT to HR 35086. Remove MLI shroud from antenna7. On IV GO, demate connectors (any order), temp stow as required:<ul style="list-style-type: none"><input type="checkbox"/> P696 from J1<input type="checkbox"/> P697 from J28. Tether to failed GPS antenna9. PGT[B7 25.5 ft-lb, CCW2 30 RPM, MTL 30.5] - 6 ext 7/16: Release bolts (4) in any order, ~10 turns; bolts will spring up when released10. Remove GPS antenna (expect 4 - 6 lb soft dock force)11. Stow failed GPS antenna in ORU Bag <p style="text-align: center;"><u>NOTE</u></p> <p style="text-align: center;">Connector caps are wire-tied together to prevent GPS antenna cables from being lost inside the truss</p> <ol style="list-style-type: none">12. Retrieve electrical connector caps from GPS ORU Bag; install electrical connector caps on electrical connectors:<ul style="list-style-type: none"><input type="checkbox"/> J1 dummy electrical cover to P696<input type="checkbox"/> J2 dummy electrical cover to P69713. Reconfigure MLI shroud, as reqd (MLI should not be above original antenna plane)14. Stow GPS Antenna ORU Bag on BRT

CP7 ETVCG STANCHION INSTALLATION (00:45)

IV	EV1	EV2						
<table border="1" data-bbox="109 764 459 889"> <thead> <tr> <th>Bolt</th> <th>Turns</th> <th>Torque</th> </tr> </thead> <tbody> <tr> <td>VSSA Bolt</td> <td></td> <td></td> </tr> </tbody> </table>	Bolt	Turns	Torque	VSSA Bolt			<p><u>ETVCG STANCHION RELEASE</u></p> <ol style="list-style-type: none"> 1. Translate to stanchion carrier on ESP-2 2. Tether to nadir/aft stanchion race track tether point 3. PGT[B7 25.5 ft-lb, CW2 30 RPM, MTL 30.5] - 6 ext 7/16: Release launch restraint bolts (2) ~9 turns (bolts spring out, black line visible) 4. Slide stanchion out of stowage interfaces (towards dummy box) 5. Install scoop on dummy box (handle towards stanchion base) 6. BRT to scoop 7. Translate via face 1 to ETVCG worksite (P1 nadir/inboard, CP-7) <div data-bbox="1052 496 1421 550" style="border: 1px solid black; padding: 5px; text-align: center;"> <p>CAUTION Avoid contact with P1 radiator beam</p> </div> <p><u>STANCHION INSTALL</u></p> <ol style="list-style-type: none"> 8. Softdock stanchion to CP-7 (race track outboard) <p style="text-align: center;"><u>NOTE</u> Do not allow socket to come off stanchion bolt head until complete</p> <ol style="list-style-type: none"> 9. PGT[B7 25.5 ft-lb, CW2 30 RPM, MTL 30.5] - 6 ext 7/16: Break torque on stanchion bolt, =1 turn only 10. PGT[B3 18.4 ft-lb, CW2 30 RPM, MTL 30.5] - 6 ext 7/16: Engage stanchion Bolt 9 turns until it drops out of launch position. Continue to push downward (6 lb push force reqd), engage stanchion bolt ~16 turns to torque 11. Retrieve small scoop  	<p><u>ETVCG STANCHION RELEASE</u></p> <ol style="list-style-type: none"> 1. Retrieve round scoop from airlock 2. Translate to stanchion carrier on ESP-2 3. Transfer round scoop to EV1 4. Assist EV1 with stanchion configuration for translation 5. Translate to CP-7 <p><u>STANCHION INSTALL</u></p> <ol style="list-style-type: none"> 6. Assist EV1 by holding stanchion perpendicular to CP-7
	Bolt	Turns	Torque					
VSSA Bolt								

S3 LOWER OUTBOARD PAS DEPLOY (01:00 + TRANSLATION TIME)

IV	EV1	EV2									
<p>1. Verify starboard SARJ locked</p> <table border="1" data-bbox="109 1154 474 1281"> <thead> <tr> <th></th> <th>Torque</th> <th>Turns</th> </tr> </thead> <tbody> <tr> <td>Diagonal Brace</td> <td></td> <td></td> </tr> <tr> <td>SARJ Brace</td> <td></td> <td></td> </tr> </tbody> </table>		Torque	Turns	Diagonal Brace			SARJ Brace			<ol style="list-style-type: none"> Retrieve hammer from Airlock Toolbox 1 (stbd), slot 1 (nadir door) Translate to deploy clevis on S3 Lower Outboard PAS PGT [B7 25.5 ft-lb, CCW2 30 RPM, MTL 30.5] - 6 ext 7/16: Release deployed clevis bracket bolts (4) ~10 turns; temp stow bracket <div data-bbox="573 391 1129 467" style="border: 1px solid black; padding: 5px; margin: 10px 0;"> <p style="text-align: center;">CAUTION</p> <p style="text-align: center;">When attempting to remove the Yoke PIP pin and ADP, do not impart more than 10 lbf</p> </div> <ol style="list-style-type: none"> Release the yoke PIP pin; secure using pre-installed wire tie Release ADP, secure using pre-installed wire tie <div data-bbox="573 610 1155 686" style="border: 1px solid black; padding: 5px; margin: 10px 0;"> <p style="text-align: center;">CAUTION</p> <p style="text-align: center;">Yoke ADP does not have stowage hole. Do not close ADP lock bracket when ADP is not inserted in a clevis hole</p> </div> <div data-bbox="934 735 1556 808" style="border: 1px solid black; padding: 5px; margin: 10px auto; width: fit-content;"> <p style="text-align: center;">CAUTION</p> <p style="text-align: center;">Do not lift diagonal strut more than ~7 deg out of rotation plane to prevent damage to hinge end</p> </div> <ol style="list-style-type: none"> Assist EV2 to position diagonal strut PGT [B7 25.5 ft-lb, CCW2 30 RPM, MTL 30.5] - 6 ext 7/16: Release Stow clevis bracket bolts (4) ~10 turns, temp stow bracket Once yoke clear, finger start all stow clevis bracket bolts (4) ~1-2 turns) PGT [B2 16.0 ft-lb, CW2 30 RPM, MTL 30.5] - 6 ext 7/16: Engage stow Clevis bolts (4) ~10 turns Orient deployed clevis bracket with alignment marks Finger start all deployed clevis bracket bolts (4) ~1-2 turns PGT [B2 16.0 ft-lb, CW2 30 RPM, MTL 30.5] - 6 ext 7/16: Engage deployed clevis bracket bolts (4) ~ 10 turns to hardstop PGT [RCW, MTL 30.5] - 6 ext 7/16: Engage deployed clevis bracket bolts (4) Release RET on diagonal brace strut; rotate to install PGT [B2 16.0 ft-lb, CW3 60 RPM, MTL 30.5] - 6 ext 7/16: Engage diagonal brace strut cone bolt ~38 turns Pull yoke gap spanner to unfold yoke Rotate PAS out of detent position Lower yoke into deployed clevis Release wire tie securing PIP pin and ADP to yoke Install yoke ADP; ✓lock bracket engaged 	<ol style="list-style-type: none"> Retrieve large gap spanner from airlock Translate to nadir hinges on the S3 Lower Outboard PAS Remove hinge line ADPs (2), insert in stowage hole, ✓lock bracket engaged Attach large gap spanner to yoke, loop back on itself; stow free end on nadir longeron HR 3051 PGT [B6 24.0 ft-lb, CCW2 30 RPM, MTL 30.5] - 6 ext 7/16: Release SARJ brace beam cone fastener =35 turns; do not exceed 37 turns Release brace launch restraint fastener ~1 turns Rotate brace to diagonal strut PGT [B2 16.0 ft-lb, CW2 30 RPM, MTL 30.5] - 6 ext 7/16: Attach SARJ brace to diagonal strut ~1 turn (or hand tighten) PGT [B6 24.0 ft-lb, CCW2 30 RPM, MTL 30.5] - 6 ext 7/16: Release SARJ diagonal strut cone fastener =35 turns; do not exceed 37 turns Move diagonal strut; temp stow clear using RET to HR 3043 or 3044 Route gap spanner to yoke Rotate yoke to detent (10 deg past vertical) Release gap spanner from HR 3051 (leave on yoke); temp stow free end Assist EV1 with diagonal brace strut reposition PGT [B6 24.0 ft-lb, CCW2 30 RPM, MTL 30.5] - 6 ext 7/16: Release SARJ brace launch restraint bolt from diagonal strut ~1 turns (or by hand) Rotate brace away from diagonal strut Re-insert launch restraint bolt into diagonal beam fitting ~1 turn PGT [B2 16.0 ft-lb, CW3 60 RPM, MTL 30.5] - 6 ext 7/16: Engage SARJ brace cone fastener ~38 turns to torque
	Torque	Turns									
Diagonal Brace											
SARJ Brace											

S3 LOWER OUTBOARD PAS DEPLOY (01:00 + TRANSLATION TIME) (Cont)

IV	EV1	EV2
<ol style="list-style-type: none"> 2. Perform RTL verification 3. Notify EV: RTL verification complete 	<ol style="list-style-type: none"> 21. Install yoke PIP pin 22. Translate to PAS UMA 23. Tether to EVA OVERRIDE anti-rotation cap hitch PIP pin; remove 24. Remove anti-rotation cap; stow in trash bag 25. Stow hammer in airlock toolbox 1, slot 1 	<ol style="list-style-type: none"> 19. Translate to each guide vane (3) and perform the following: <ol style="list-style-type: none"> A. Remove launch restraint PIP pins from guide vanes; stow in trash bag B. Inform IV/MCC-H: Ready for RTL checkout C. On IV GO: Depress and hold RTL for 15 seconds; then release D. On IV GO: Move to next guide vane 20. Release large gap spanner from yoke; stow in trash bag <div style="border: 1px solid black; padding: 5px; margin: 10px 0; text-align: center;"> <p>CAUTION EBCS target contains finished surface which could be damaged if contacted by EV crew</p> </div> 21. Translate to EBCS target 22. Verify EV2 clear of target 23. Remove EBCS target cover; stow on backside of target assembly

EVA 3 CLEANUP/INGRESS (00:35)

IV	EV1	EV2
<p>1. Perform WVS PWRDN (PHOTO/TV, <u>WVS CUE CARD</u>)</p> <p>2. Start 2-min timer</p>	<p><u>CLEANUP</u></p> <ol style="list-style-type: none"> 1. Relocate APFR/ingress aid from S0 aft/stbd wedge face WIF 07 to Airlock-11 [6,PP,F,6] (13a.1 get-ahead) 2. Perform tool inventory <p><u>INGRESS</u></p> <ol style="list-style-type: none"> 3. Attach Waist Tether (R) to EV2 Waist Tether; verify locked 4. Disconnect EV1 and EV2 Safety Tethers 5. Ingress airlock 6. Remove SCU from stowage pouch Remove DCM cover Attach SCU to DCM, check locked 7. Water – OFF 8. Close thermal cover; attach Velcro strap <div style="border: 1px solid black; padding: 5px; text-align: center; margin: 10px auto; width: fit-content;"> <p>CAUTION Do not close hatch until EMU water off for 2 min</p> </div> <ol style="list-style-type: none"> 9. Verify no hardware blocking hatch 10. EV Hatch handle – Preclose position 11. EV Hatch – close and lock 12. Go to PRE-REPRESS Cue Card 	<p><u>CLEANUP</u></p> <ol style="list-style-type: none"> 1. Translate to Airlock 2. Perform tool inventory <p><u>INGRESS</u></p> <ol style="list-style-type: none"> 3. Open Airlock Thermal Cover 4. Ingress airlock 5. Attach Waist Tether (L) to A/L D-ring; verify locked 6. Transfer Waist Tether (R) to EV1 7. Remove SCU from stowage pouch Remove DCM cover Attach SCU to DCM, check locked 8. Water – OFF

POST EVA 3 TOOL CONFIG

EV1

	MWS
	BRT (L)
	RET (eq-eq)
	Swing Arm (R)
	RET (eq-eq)
	PGT
	PGT Battery
	7/16 (wobble) Socket-6 ext
	T-Bar
	RET (eq-eq) (2)
	RET (eq-eq) w/PIP pin
	Wire Ties (2)
	Small Shuttle Trash Bag
	Adj Equip Tethers (2, L & R gloves)
	D-Ring Extender (2, R & L)
	Waist Tether (2, L D-ring and R ext)
	SAFER
	WVS

EV2

	MWS
	BRT (L)
	Wire Ties (3)
	RET (eq-eq)
	Swing Arm (R)
	RET (eq-eq)
	PGT
	PGT Battery
	7/16 (wobble) Socket-6 ext
	T-Bar
	RET (eq-eq) (3)
	RET (eq-eq) w/PIP pin
	Wire Ties (2)
	Small ISS Trash Bag
	Adj Equip Tethers (2, L & R gloves)
	D-ring Extender (2, R & L)
	Waist Tether (2, L D-ring and R ext)
	SAFER
	WVS

AIRLOCK CONFIG

	Staging Bag
	Fuse Tether
	PGT
	PGT Battery
	Wire Tie Caddy
	RAD S/N_____
	Connector Cleaner Tool Kit
	Probe
	Prybar
	Connector Pin Straightener
	Velcro/Tape Caddy
	SLR Torque Multiplier (if SLRs still to be removed)
	IV Bag
	Towels (2)
	Contamination Detection Kit
	GP Caddy (2)
	Adjustable Thermal Mittens (2)
	Socket Caddy (hatch cont) w/eq-eq RET
	1/2 Socket-8 ext
	7/16 (wobble) Socket-6 ext (spare)
	DCM Plug (SAFER Hardmount) (2)
	Fuse Tether
	NODE/LAN cable
	WIF Adapter w/PIP pin
	Cheater Bar (w/Kapton Tape)
	1.5" Bail Drive Lever (taped to Cheater Bar)
	Digital Camera
	Digital Camera L bracket
	85-ft Safety Tether
	(SVS Target)
	(Node OIH 120)
	Crewlock Bag (Vent Tools)
	Gamah Removal Tool
	Gamah Installation Tool
	Ratchet Wrench w/palm wheel
	7/16 rigid Socket-2 ext
	H2(H20) Vent Assembly w/sock
	RET (eq-eq) (3)
	MMOD T-Handle Tool (2)
	RET (eq-lg) (outside of bag)

Shading indicates items that may have been left outside depending upon which task completed
Bold indicates trash items

AIRLOCK CONFIG (Cont)

	Crewlock Bag (Solar Array Tools)
	BRS Pin Contingency Tool (w/Tape)
	Loop Pin Puller (w/Tape)
	TPS Scraper (w/Tape)
	Compound Cutter/Needle Nose Pliers Caddy (w/Tape)
	EVA Scissors (w/Tape)
	Small ORU Bag (GPS)
	RET (eq-eq)
	GPS Connector Caps (2 - long wire tied together)
	RET (eq-lg) (outside of bag)
	Crewlock EVA Bag
	Vise Grips
	Socket Caddy
	5/8 (rigid) Socket-7.8 ext
	5/8 (rigid) Socket-7.8 ext
	7/16 (rigid) Socket-2 ext
	RET (eq-eq) w/PIP pin
	3/8-in IVA Tool Stack w/DPT Adapter
	ISS ratchet wrench
	7/16 (rigid) Socket-9 ext
	Round Torque Multiplier
	Rd TM Socket – 5/8 prd
	RET (eq-Lg)(outside of bag)
	EWIS ORU Bag (Medium)
	Fuse Tether
	EWIS Cable
	OIH 297(276)
	OIH 298(278)
	Small ISS Trash Bag (with caps)
	RET (eq-eq) (2) (outside of bag)

External APFRs

S4-19 (13A.1 prep)
 S3-05
 P6-4B
 P6-11
 A/L-11
 IAPFR Z1-3
 IAPFR Z1-1

EVA 3 TASK DATA

2B SOLAR ARRAY RETRACT – TASK DATA

Estimated Task Duration:

	With RMS	Without RMS
One EV Crew	NA	NA
Two EV Crew	As long as it takes	NA

Tools:

EV1	EV2
WIF Adapter	Crewlock Bag
APFR	Digital Camera
Cheater Bar with 1.5" bail drive lever	BRT
Needle Nose Pliers	
Compound Cutters	
Loop Pin Puller	
TPS Scraper	
BRS Pin Tool	
EVA Scissors	

EVA Fasteners:

Fastener Name	Label	Head Size	Qty	Install Torque (ft-lb)	Release Torque (ft-lb)	Failure Torque (ft-lb)	Turns	RPM
NA								

EVA Connectors:

Harness	From	To	Clamps (#)	Conn Size	Function
NA					

Foot Restraints:

Task	WIF	APFR Setting
SSRMS	WIF Adapter	[12,PP,F,6]

Notes:

1. Provided a fray is not causing the grommet fault, panel fluffing near center guide wire will likely clear problems at all three guide wires

Cautions:

1. Guide wire can jump out of pulley track, attempt cable manipulation from inside blanket box first. If guide wire must be handled from outside of blanket box, avoid pulling guide wire to side of pulley plane

Warnings:

1. SASA Keepout Zone 0.9 meters. Avoid translation forward of 2B four bar linkage
2. Sharp edge/pinch point/shock hazard: Avoid EMU contact with the following:
 - Lower SABB exposed reels and pulleys (guide wire and tensioning mechanisms)
 - SABB skirt
 - Swing bolts
 - Springs on tension bar
 - Panel hinges
 - Guide wire frays
 - Braided cables
 - Fastener exposed threads
 - Exposed bolts in rib cavities on mast canister
 - Mast roller guides
 - FCC and Kapton part of solar array panels

Y-guide

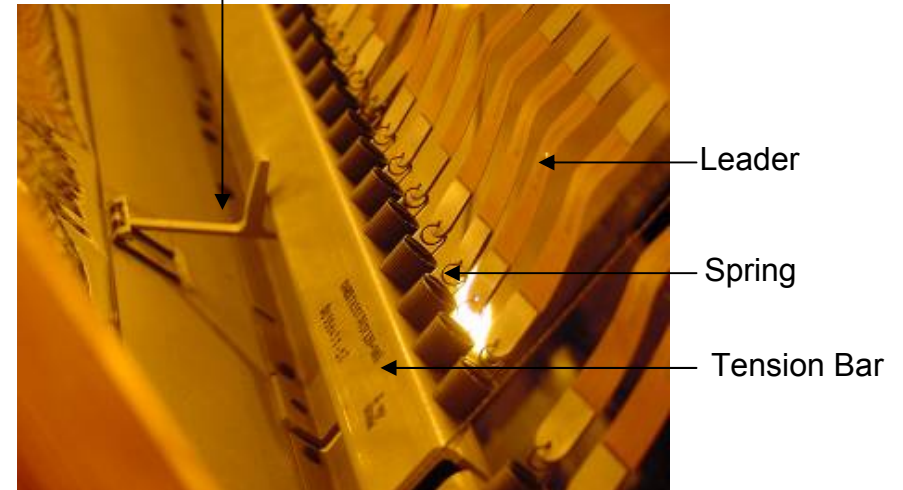

2B SOLAR ARRAY RETRACT – TASK DATA (Cont)

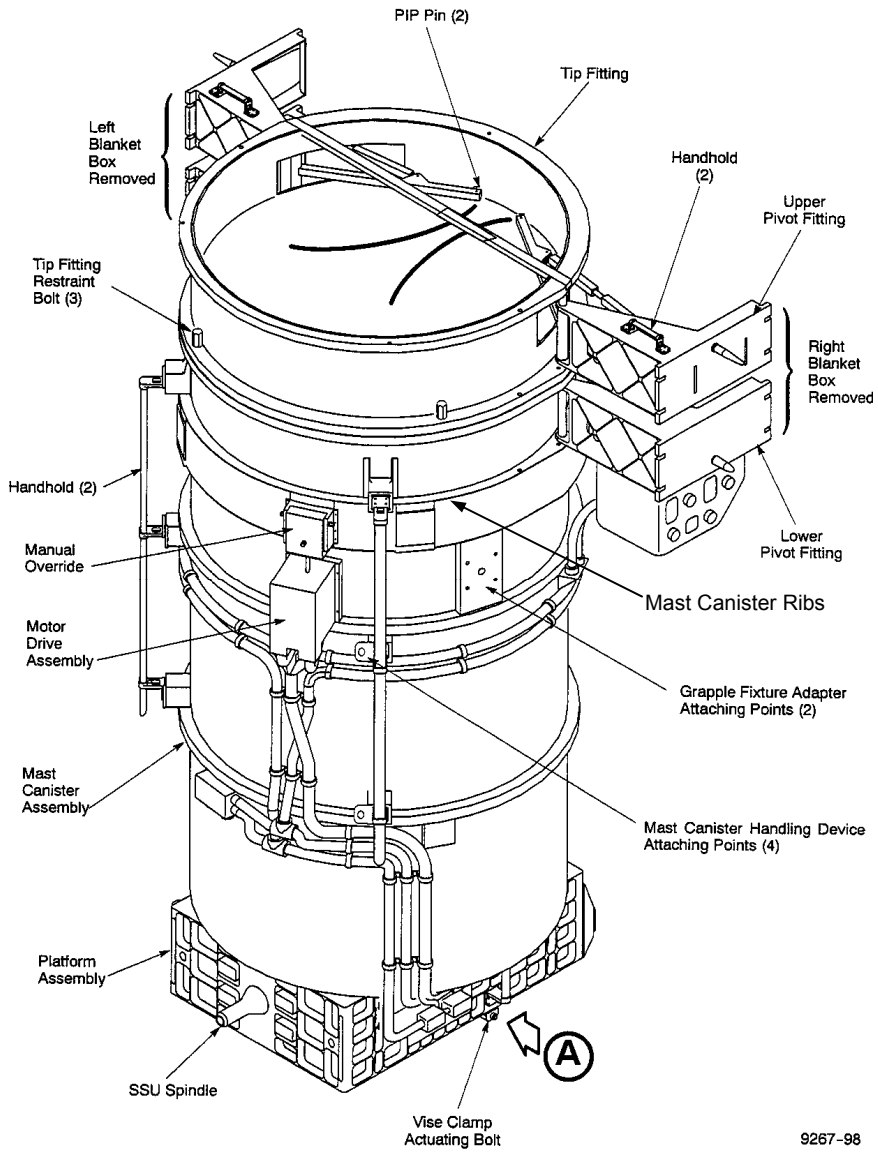

9267-98

Cover Guide Pins/alignment tab Goal Posts

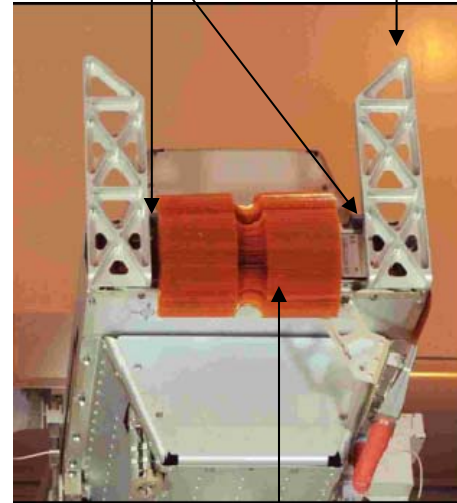

STE Loops
(FCC is inside BB)



2B SOLAR ARRAY RETRACT – TASK DATA (Cont)

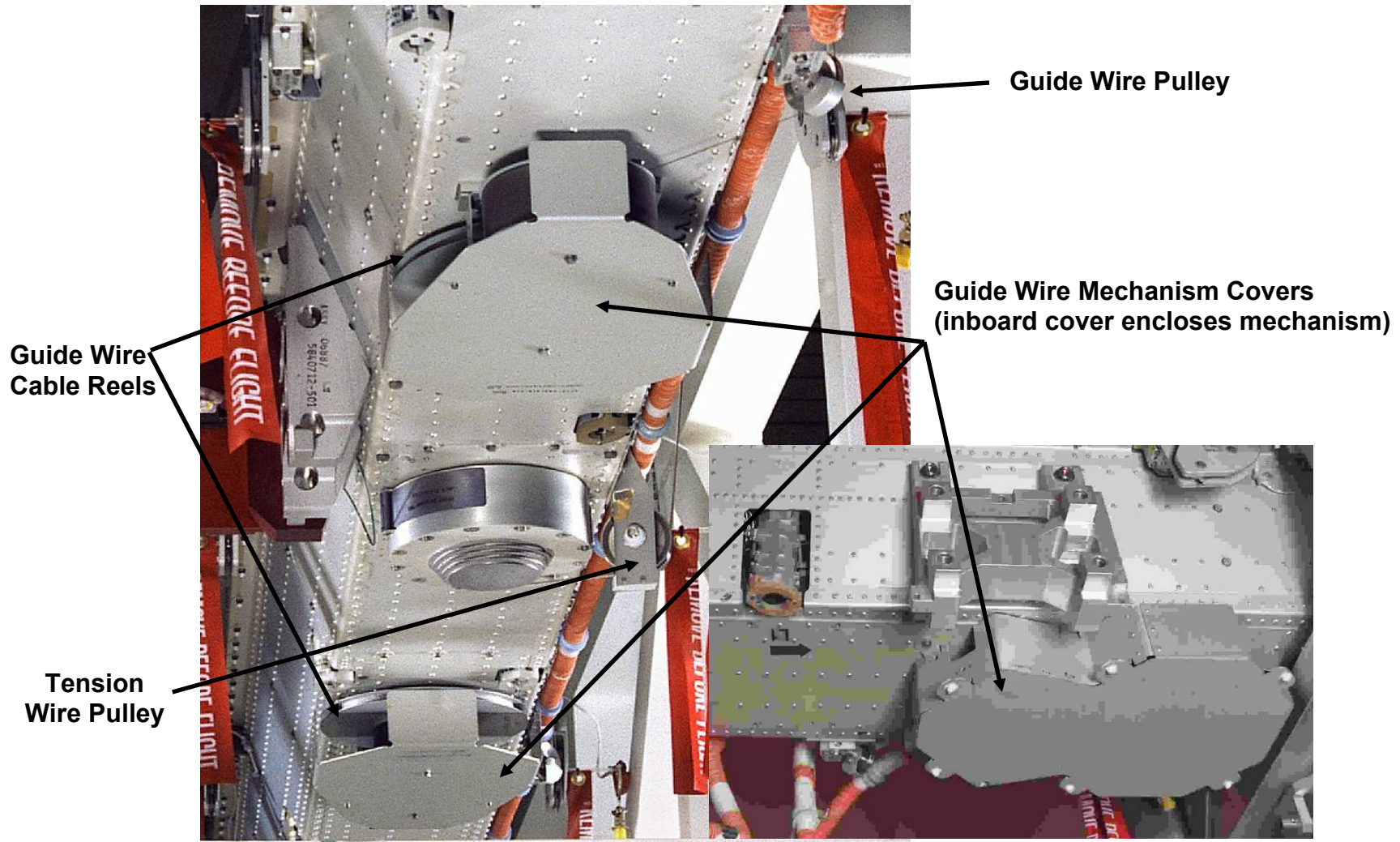

S3 KEEL PIN/DRAG LINK STOW – TASK DATA

Estimated Task Duration:

	With RMS	Without RMS
One EV Crew	NA	NA
Two EV Crew	NA	1:00

Tools:

EV1	EV2
PGT	PGT
6 Ext 7/16 wobble	6 Ext 7/16 wobble
APFR	
RET	

EVA Fasteners:

Fastener Name	Label	Head Size	Qty	Install Torque (ft-lb)	Release Torque (ft-lb)	Failure Torque (ft-lb)	Turns	RPM
Keel Nut Clamp Bolt	No	7/16	2	0-4.8 on orbit	NA	4.8	6	30
Keel Pin Structural Bolt	1stows in nadir clevis 2 stows in zenith soft dock	7/16	2	10.8-12.5 gnd 1.6-8.7 on orbit	12.8	22.2 remove 8.7 install	22	30
Drag Link Bolts	No	7/16	2	8-10 gnd 3-15.9 on orbit	11.7	32.3 remove 23.9 install	10.5	30

EVA Connectors:

Harness	From: Panel/ Connector	To: Panel/ Connector	Clamps (#)	Conn Size	Function
NA	NA	NA	NA	NA	NA

Foot Restraints:

Task	WIF	APFR Setting
Nadir keel bolt position	S3-31	[11,OO,F,12]
Zenith keel bolt position (EV1 nominal)	S3-05	[6,PP,L,10]

Notes:

Cautions:

1. Verify PGT clockwise (CW) setting prior to tightening nut clamp assembly. Opposite direction beyond 6 rotations can unscrew EVA bolt threads from the barrel nut which would disable the nut assembly. This means the loss of MT operations outboard of the keel location unless vice grips can be used to restrain nut during bolt release

Warnings:

S3 KEEL PIN/Drag LINK STOW – TASK DATA (Cont)



S3 Keel Pin/Drag Link – Launch Configuration

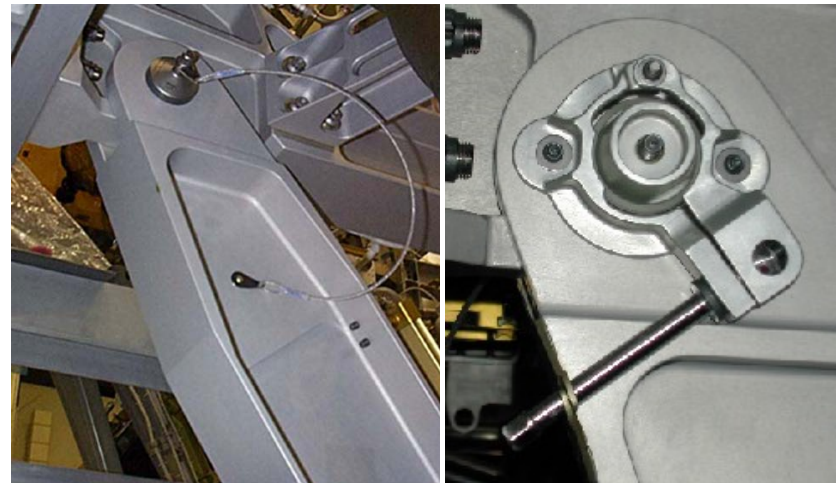

Keel Pin Attachment Fastener and Clamping Nut

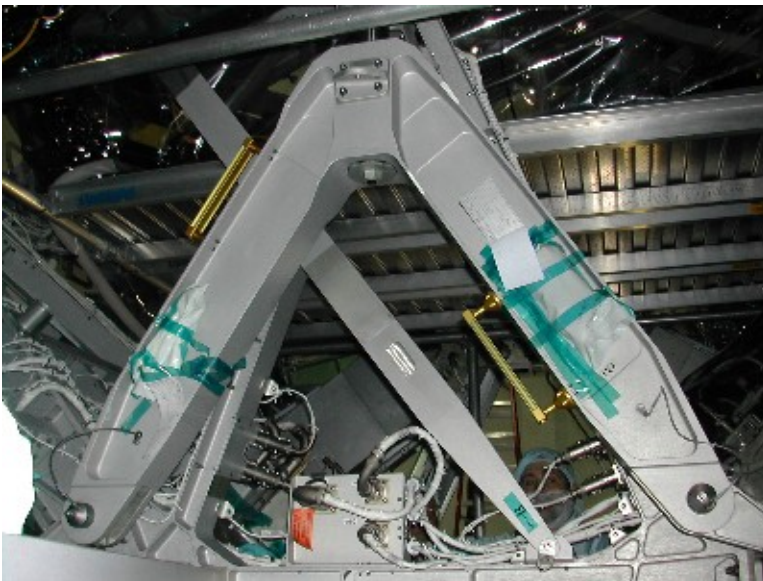

S3 Keel Pin/Drag Link – Stowed Configuration



Keel Pin Stowage Spring Clip

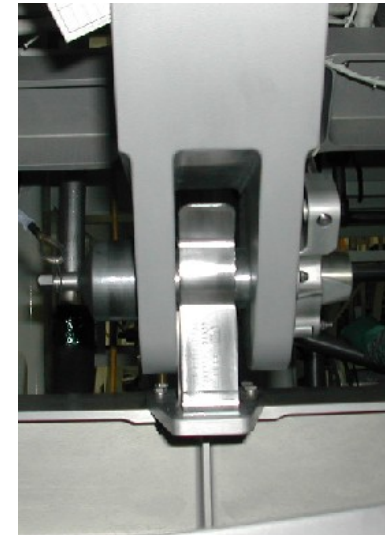

S3 KEEL PIN/DRAW LINK STOW – TASK DATA (Cont)



Keel Pin Stowage Clevis

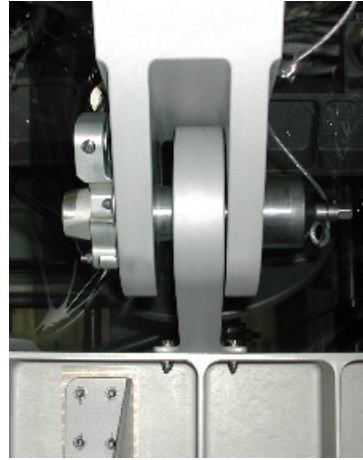

Drag Link Mouse Trap and Stow Clevis



Keel Pin Stowage Ring

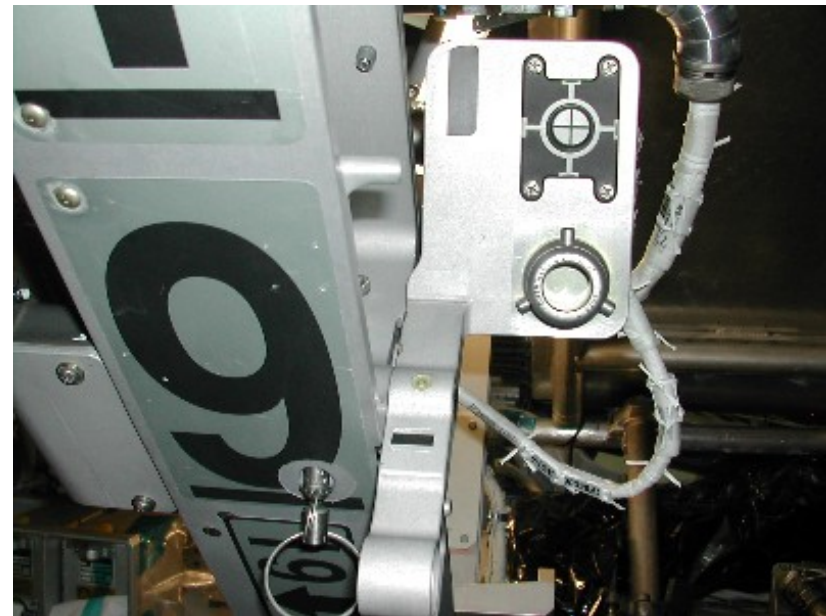

S3 MT Stop – Launch Configuration

MT/CETA PATH/S4 MMOD SHIELD BOLT RELEASE – TASK DATA

Estimated Task Duration:

	With RMS	Without RMS
One EV Crew	NA	2:00
Two EV Crew	NA	1:00

Tools:

EV1	EV2
PGT	PGT
7/16 (wobble) Socket-6 ext	7/16 (wobble) Socket-6 ext
	EVA Temp Rail Stop

EVA Fasteners:

Fastener Name	Label	Head Size	Qty	Install Torque (ft-lb)	Release Torque (ft-lb)	Failure Torque (ft-lb)	Turns	RPM
MMOD Shield Bolt	Yes	7/16	4	37.5 gnd	42.2	93.5	1	10
ETRS Bolts	No	7/16	2	2.5	NA	TDB	5	30

EVA Connectors:

Harness	From	To	Clamps (#)	Conn Size	Function
S1/S3 FLUID (1/4 INCH) JUMPER L13 QD F57	S1-A503 / M2	S1-A503 / M3	1 for entire jumper	1/4 inch	Ammonia line
S1/S3 FLUID (1/4 INCH) JUMPER L13 QD F56	S1-A504 / M1	S3-A501 / M1	NA	1/4 inch	Ammonia line

Foot Restraints:

Task	WIF	APFR Setting
Forward Inboard (#1)	S4-06	[7,WW,F,1]
Forward Outboard (#2)	S4-14	[6,WW,F12]
Aft Outboard Bolt (#3)	S4-13	[6,WW,F12]
Aft Inboard Bolt (#4)	S4-05	[7,WW,F,1]

Note:

- Requirement for releasing torque on IEA MMOD Shield Bolts is within 1 year of launch
- The S1 MT stop prevents the MT/CETA from moving past the S1/S3 interface plane when the S3 segment is not attached
- The S1 MT stop can be rotated in any direction
- Failure to fully reinstall S1 MT stop PIP pin can cause interference with MT translation

Cautions:

- S1-S3 1/4-in flexhose shall be firmly supported during installation to prevent damage due to excessive bending, kinking; tension, torsional loading or other excessive strain

Warnings:

- The ammonia lines will be launched with 80 psia N2 pad pressure. Potential hazard to the EVA crew

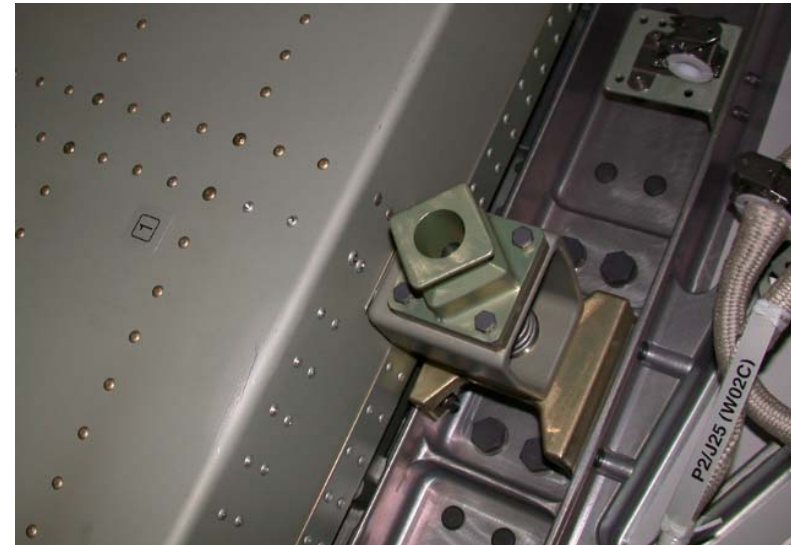

IEA MMOD Shield Bolt

MT/CETA PATH/S4 MMOD SHIELD BOLT RELEASE – TASK DATA (Cont)

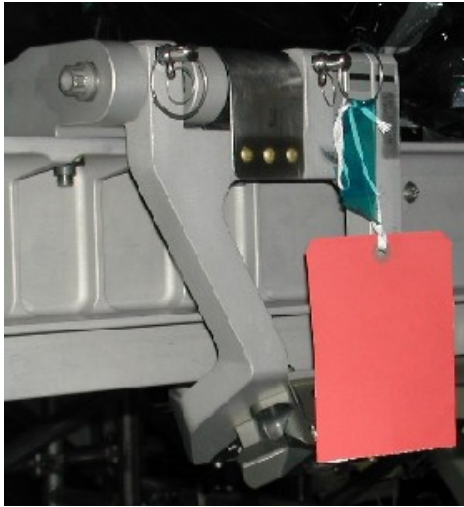

Tether Shuttle Stop – launch configuration



P1 MT Stop PIP Pin Fully Inserted (showing clearance to MT envelope)



P3 Tether Shuttle Stop (stowed)

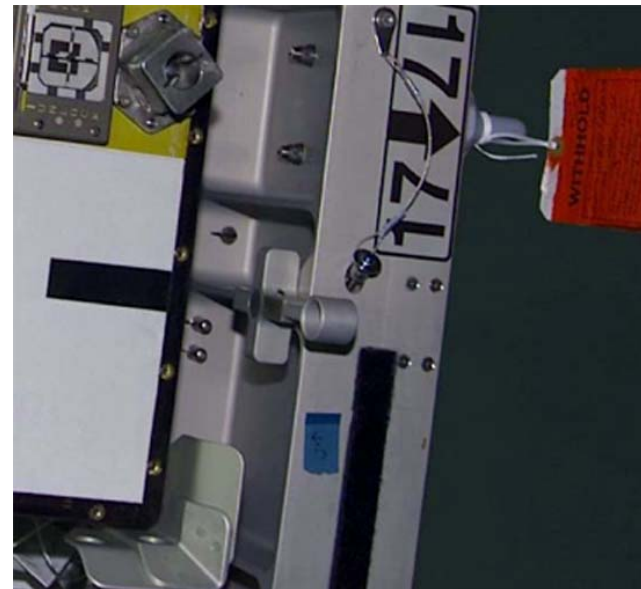

S1 MT Stop (deployed)

MT/CETA PATH/S4 MMOD SHIELD BOLT RELEASE – TASK DATA (Cont)



EVA Temporary Rail Stop (ETRS)

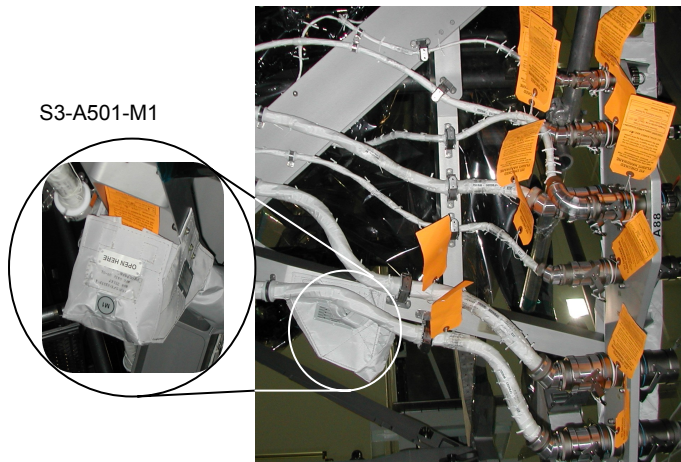

S3-A501-M1

Ammonia Jumper Connection (S3-A501-M1)

H2O/H2 VENT VALVE CHANGEOUT – TASK DATA

Estimated Task Duration:

	With RMS	Without RMS
One EV Crew	NA	1:30
Two EV Crew	NA	1:20

Tools:

EV1
Ratchet Wrench w/palm wheel
2 Ext 7/16 rigid
Gamah Removal Tool
Gamah Installation Tool
MMOD T-Handle Tool (2)
RETs (3)
Crewlock Bag
PGT
6 Ext 7/16 wobble

EVA Fasteners:

Fastener Name	Label	Head Size	Qty	Install Torque (ft-lb)	Release Torque (ft-lb)	Failure Torque (ft-lb)	Turns	RPM
Gamah	No		1				3-4	
Vent Nozzle Fastener	No	7/16	2	7 gnd 0-4 orbit	8.4	13.8	9-14	10

EVA Connectors:

Harness	From	To	Clamps (#)	Conn Size	Function
Water Vent P1	J1	NA	1		
Water Vent P2	J2	NA	1		
H2 Vent P1	NA	J1	1		
H2 Vent P2	NA	J2	1		

Foot Restraints:

Task	WIF	APFR Setting
Gamah Removal Installation	Lab-11	[6,RR,F,11]
Vent Nozzle Fasteners	Lab-11	[7,QQ,G,10]

Notes:

- Gamah nut should rotate at least 90 degrees during final torque. Less rotation is indicative of the installation tool disengaging from feedthrough
- When gamah nut sharpie mark can be used to count rotations

Cautions:

- MMOD panel must be fully seated prior engaging Dzus fasteners to prevent splaying

Warnings:

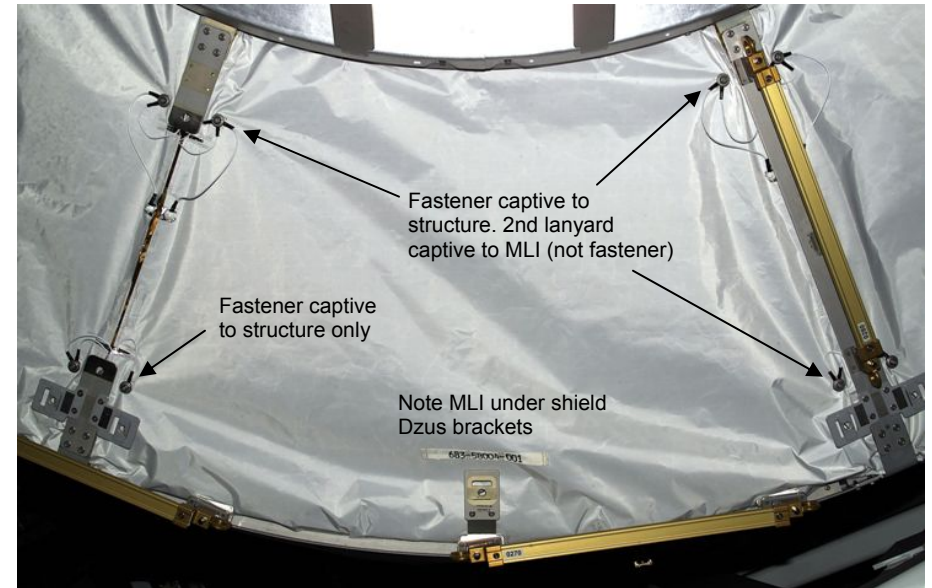

Lab Endcone with MMOD Shield C2-03 removed

H2O/H2 VENT VALVE CHANGEOUT – TASK DATA (Cont)

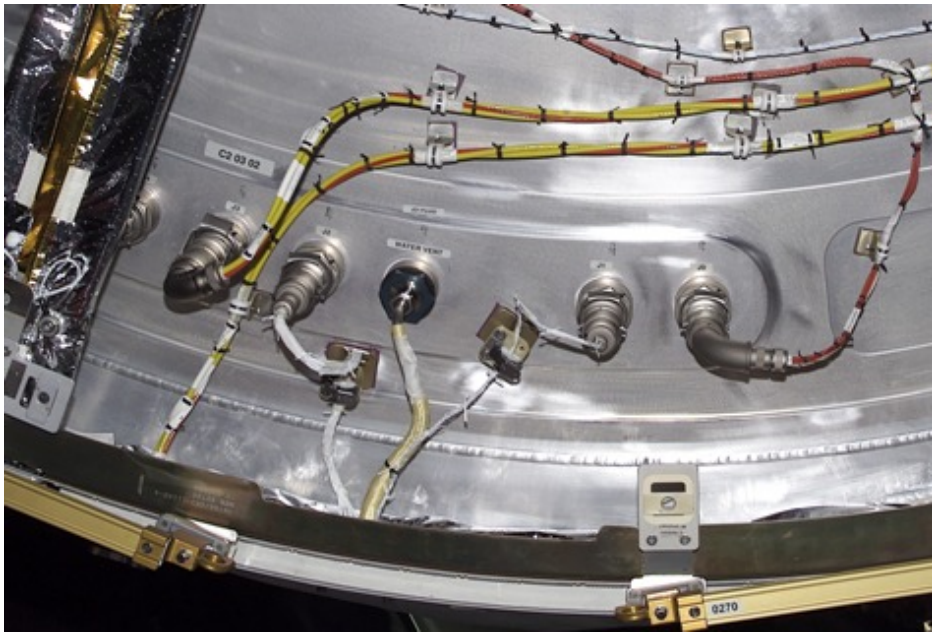

Water vent gamah fitting and electrical connectors

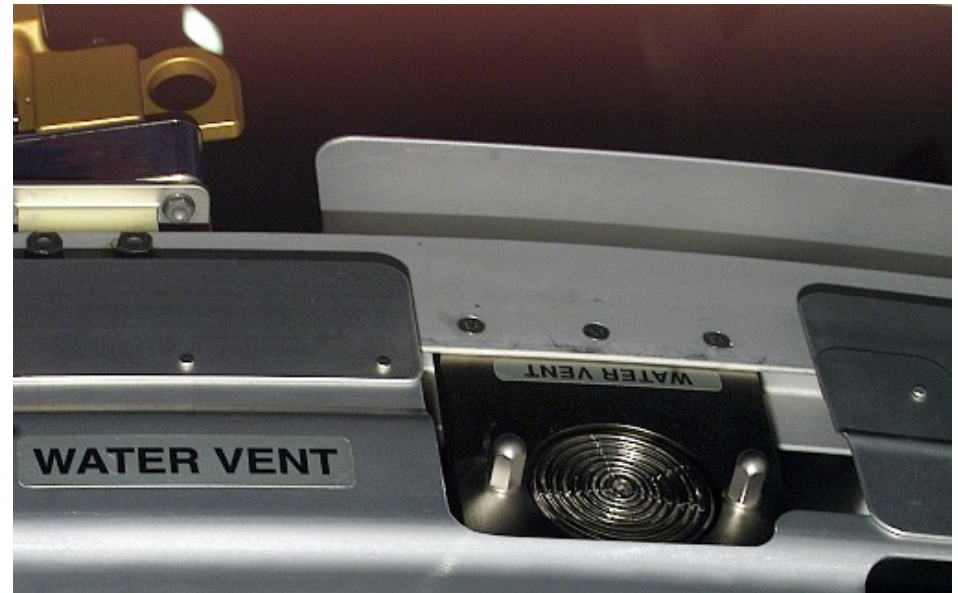

Water vent nozzle fittings



Vent nozzle bracket and MLI



Gamah Removal and Installation Tools

EWIS ANTENNA INSTALLATION – TASK DATA

Estimated Task Duration:

	With RMS	Without RMS
One EV Crew	NA	NA
Two EV Crew	NA	1:30

Tools:

EV1 (FF)	EV2 (FF)
	PGT
	MMOD Shield Tools (2)
	6 Ext 7/16
	BRT
	Wire Ties

EVA Fasteners:

Fastener Name	Label	Head Size	Qty	Install Torque (ft-lb)	Release Torque (ft-lb)	Failure Torque (ft-lb)	Turns	RPM
OIH Fastener	None	7/16	2 per	1.5-5.5	5.5	21.3	9.5	30

EVA Connectors:

Harness	From	To	Clamps (#)	Conn Size	Function
EWIS Cable P1	NA	ANT 11 J1	NA	21	
EWIS Cable P2	NA	ANT 12 J1	NA	21	
EWIS Cable P16A	NA	LAB J16	NA	25	
Lab P16	LAB J16	EWIS Cable J16A	NA	25	

Foot Restraints:

Task	WIF	APFR Setting
N/A		

Note:

1. If performed during EVA 3, entire task can be performed by EV2 alone with the exception of MMOD shield installation. If performed on EVA 4, task should be performed by both crewmembers

Cautions:

1. EVA crewmember shall be rigidly restrained during handrail installation or removal of OIH via APFR or rigidized BRT
2. EVA crewmember shall not be rigidly restrained to OIH that is being installed or removed
3. Do not use WIS antennas as handholds

Warnings:

1. Sharp edge – back side of MMOD shield fasteners
2. Sharp edge – PMA umbilical launch restraints – exposed threads
3. Avoid inadvertent contact with grapple fixture targets and target pins
4. PMA handrails may be hot. Handling may need to be limited
5. Stay > 1 ft away from PMAs and MMOD shields > 270 degF if EMU sun visor up
6. Stay > 0.5 ft away from PMAs and MMOD shields > 325 degF
7. No EMU TMG contact with PMAs or MMOD shields when temp > 320 degF

EWIS ANTENNA INSTALLATION – TASK DATA (Cont)

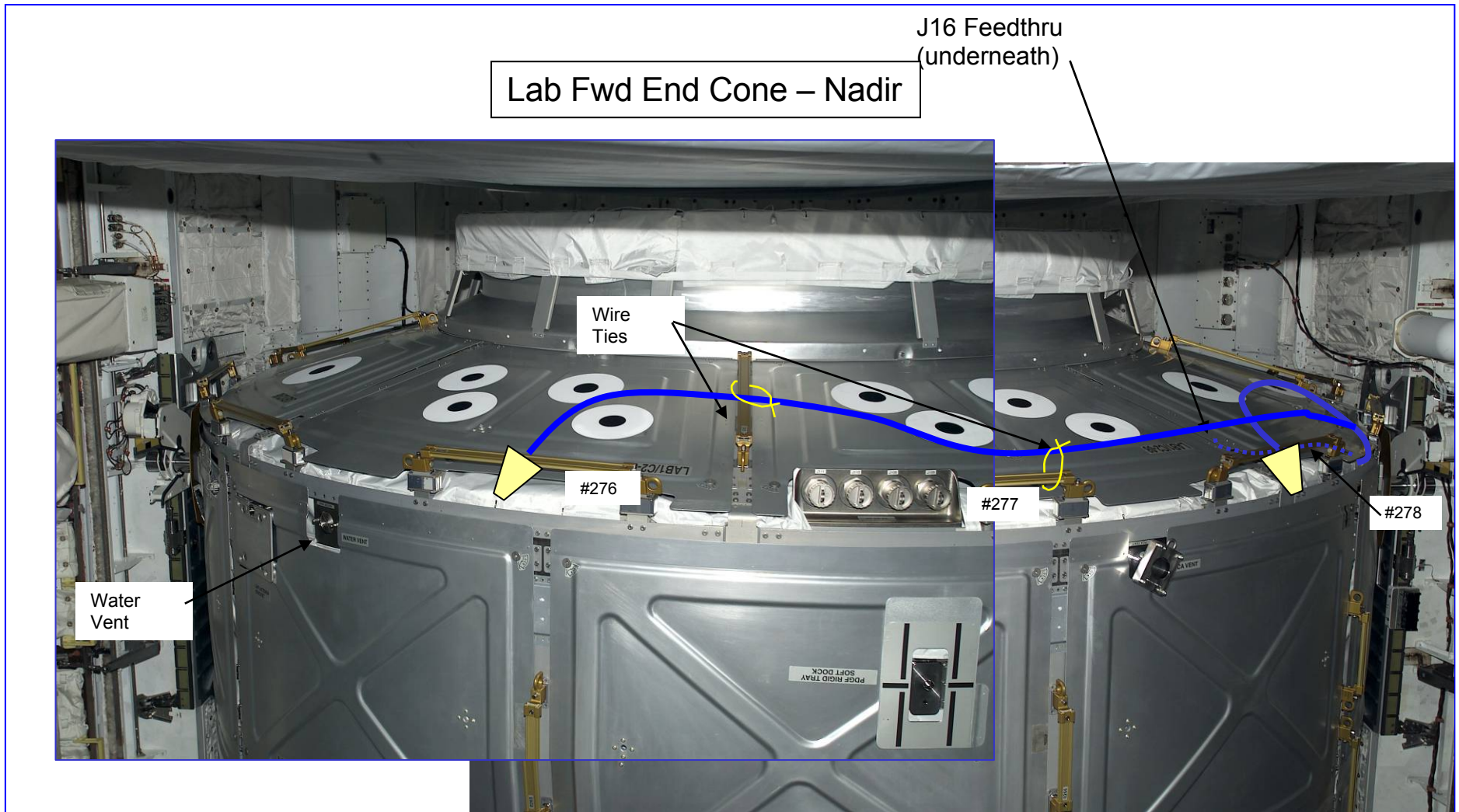

NODE/SM LAN CABLE ROUTING – TASK DATA

Tools:

EV1 (FF)	EV2 (FF)
PGT	PGT
MMOD shield T-Tools	Wire ties

Foot Restraints: None

EVA Fasteners:

Fastener Name	Label	Head Size	Qty	Install Torque (ft-lb)	Release Torque (ft-lb)	Failure Torque (ft-lb)	Turns	RPM
OIH Fastener	None	7/16	2 per	1.5-5.5	5.5	21.3	9.5	30

EVA Connectors:

Harness	From	To	Conn Size
W0939-P1		W0940-J1	
W0939-P211		Node-J211	
W0939-J2		Node-HR 141	
W0940-J1		W0939-P1	

Notes: N/A

Cautions:

1. EVA crewmember shall be rigidly restrained during handrail installation or removal of OIH via APFR or rigidized BRT
2. EVA crewmember shall not be rigidly restrained to OIH that is being installed or removed
3. Node Dzus fasteners may be difficult to engage. Apply firm downward force on fastener to ensure engagement

Warnings:

1. Sharp edge – back side of MMOD shield fasteners
2. Sharp edge – PMA umbilical launch restraints – exposed threads
3. Avoid inadvertent contact with grapple fixture targets and target pins
4. PMA handrails may be hot. Handling may need to be limited
5. Stay > 1 ft away from PMAs and MMOD shields > 270 degF if EMU sun visor up
6. Stay > 0.5 ft away from PMAs and MMOD shields > 325 degF
7. No EMU TMG contact with PMAs or MMOD shields when temp > 320 degF

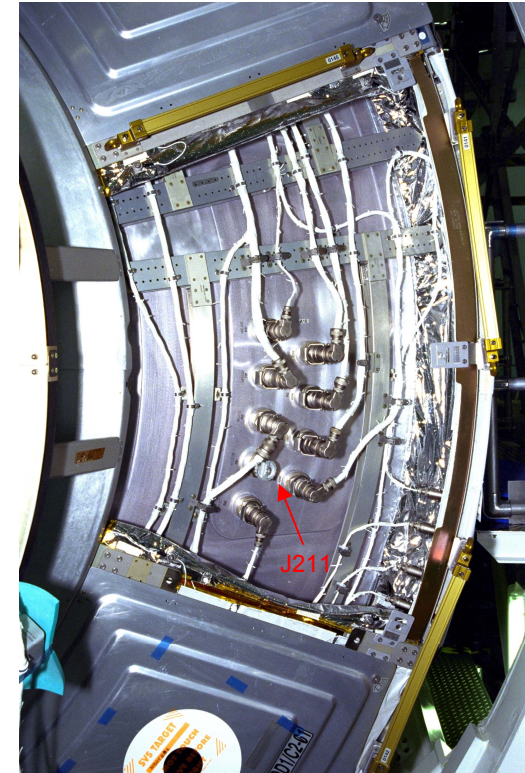

Node Port FWD – NOD1/C02-02
(MMOD Shield and MLI Cover removed)

NODE/SM LAN CABLE ROUTING – TASK DATA (Cont)

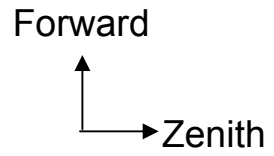
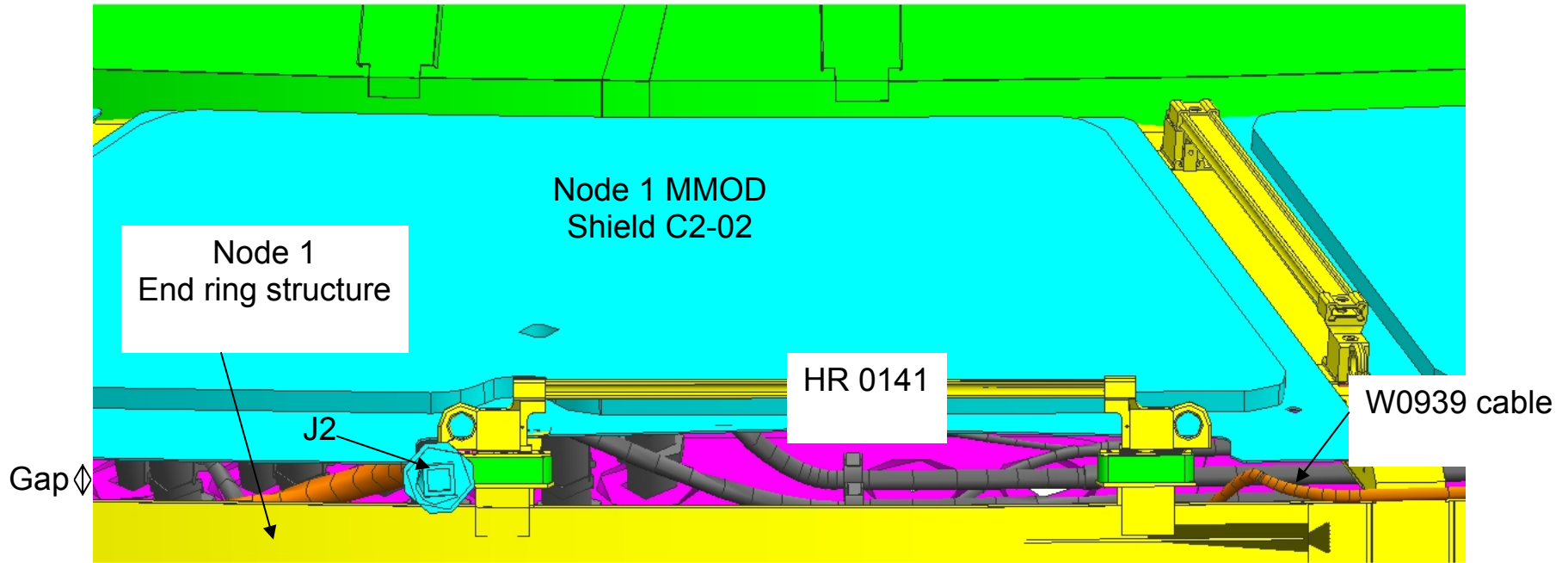

NODE/SM LAN CABLE ROUTING – TASK DATA (Cont)

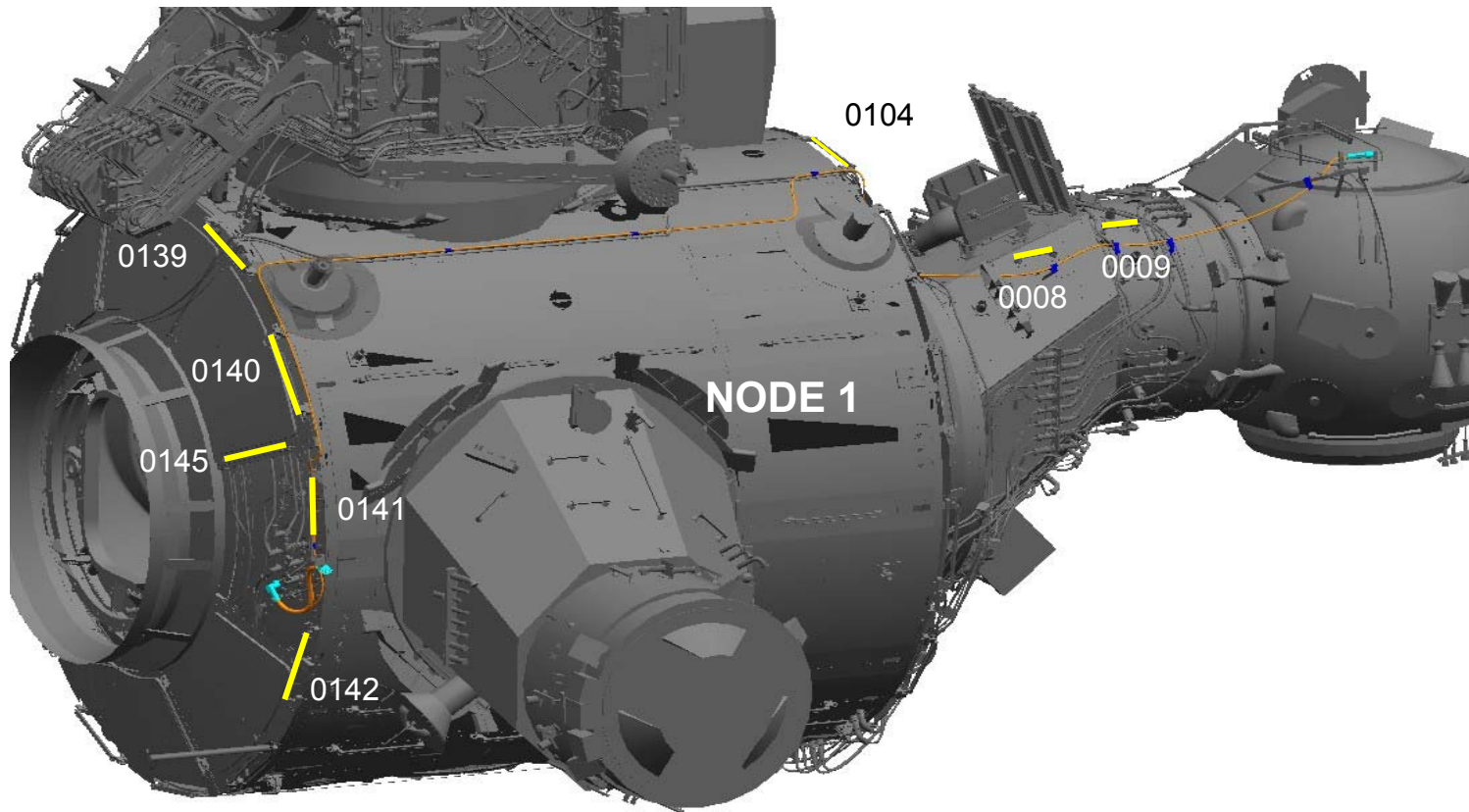

Port view of Node 1
Shield NOD1/C2-02
removed

SASA GIMBAL BOLT – TASK DATA

Estimated Task Duration:

	With RMS	Without RMS
One EV Crew	NA	00:30
Two EV Crew	NA	NA

Tools:

EV1
BRT
IAPFR (backup)
PGT
6 Ext 7/16 wobble

Foot Restraints:

Task	WIF	APFR Setting
Z1 Gimbal bolts	Z1 WIF 01	IAPFR [3,RR,H,12]

EVA Fasteners:

Fastener Name	Head Size	Qty	Install Torque (ft-lb)	Release Torque (ft-lb)	Failure Torque (ft-lb)	Turns	RPM
Gimbal Fasteners	7/16	4	16.7 gnd 3.8 on-orbit	18.1	13.9 install 46.4 release (first turn) 6.7 release (at hardstop)	4.5	30

EVA Connectors: None

Timeline Considerations:

1. SASA Gimbal bolts can be considered during translation back from 2B solar array retract tasks. This should only be considered if it will not risk higher priority objectives

Notes:

1. Torque and turns per STS-115 12A EVA Checklist
2. Gimbal bolts should be torqued in specified pattern so as to prevent misalignment of the gimbal locks during tightening and resulting in higher torques and possibly not reaching turn counts

Cautions:

1. Avoid contact SASA antennas and coatings

Warnings:

None

SASA GIMBAL BOLTS – TASK DATA (Cont)

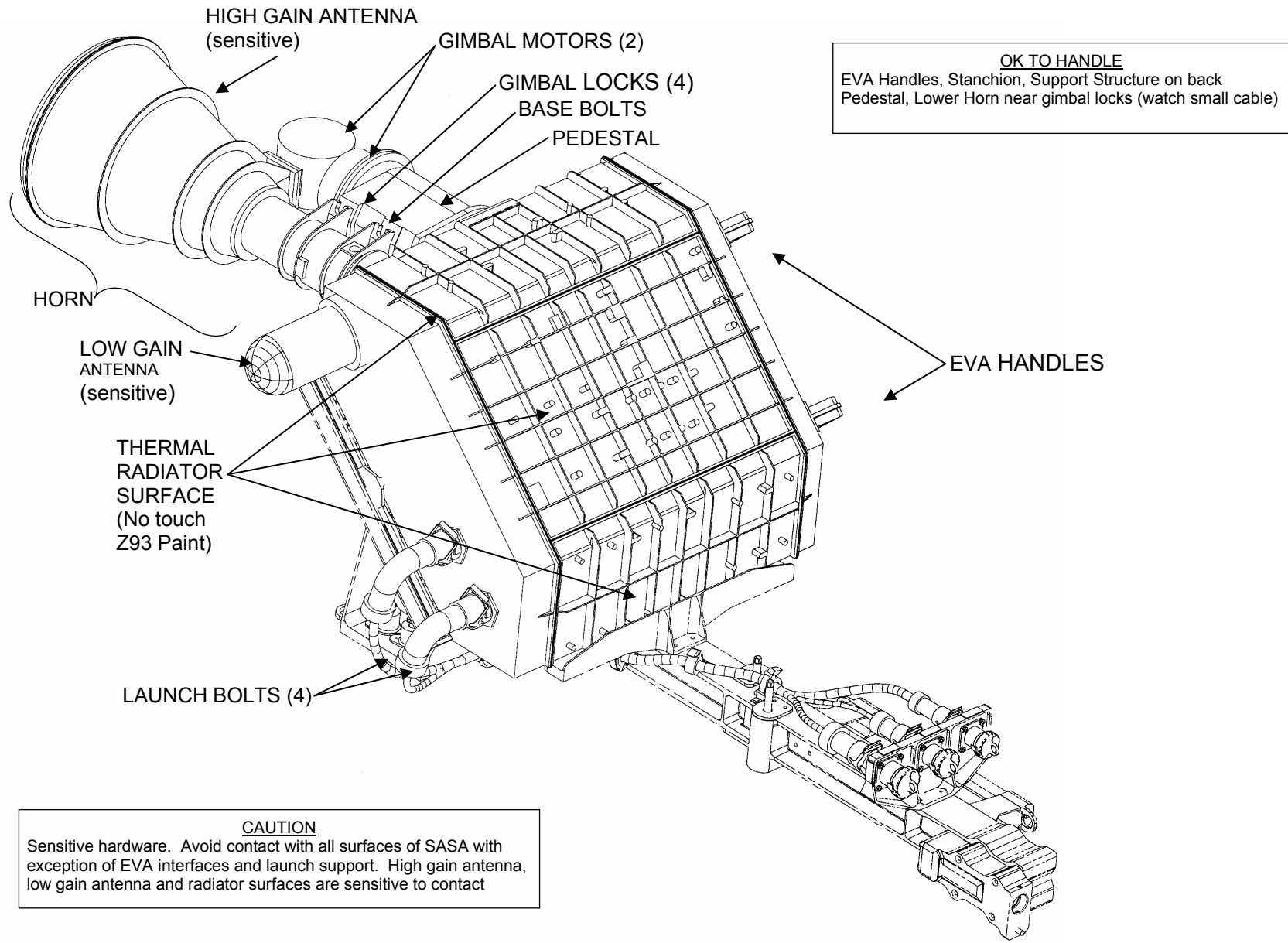

GPS ANTENNA #4 – TASK DATA

Estimated Task Duration:

	With RMS	Without RMS
One EV Crew	NA	00:40
Two EV Crew	NA	NA

Tools:

EV1 (FF)
Electrical caps
Wire Tie (32")
PGT w/ 7/16" wobble 6-in ext
Small ORU Bag

EVA Fasteners:

Fastener Name	Head Size	Qty	Removal Torque (ft-lb)	Failure Torque (ft-lb)	Turns	RPM
GPS Antenna #4 (Failed)	7/16	4	20.2	70.6	10	30

EVA Connectors:

Harness	From	To	Function
W4503	J1 (failed)	J1 (new)	GPS Antenna #4: Ops-1 & Htr-1 power
W4502	J2 (failed)	J2 (new)	GPS Antenna #4: Ops 2 & Htr-2 power

Notes:

1. Connector caps are wire-tied together to prevent GPS antenna cables from being lost inside the truss
2. Attach wire tie ends to connector caps so that there is at least 12" of wire separating the caps
3. Insure MLI is not above original antenna plane

Cautions:

1. Minimize contact with GPS Antenna S-13 paint
2. Thermal clock data for GPS Antenna 4 (with and without ORU bag):
 - a. 30 min to place failed GPS antenna in the ORU bag + 5 hr transfer clock
 - b. 60 min to place failed GPS antenna in the ORU bag + 2 hr transfer clock
 - c. If ORU bag not used, there is a 60-min clock to transfer the GPS antenna

GPS ANTENNA #4 – TASK DATA (Cont)

GPS Antenna Worksite

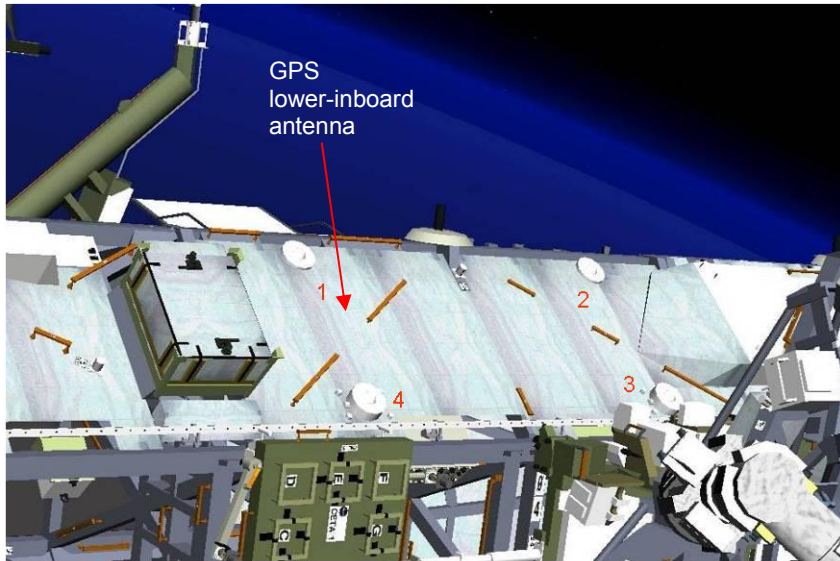

26

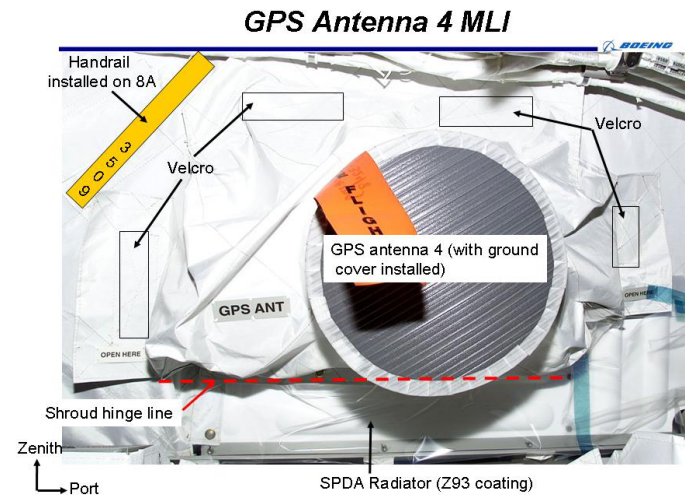
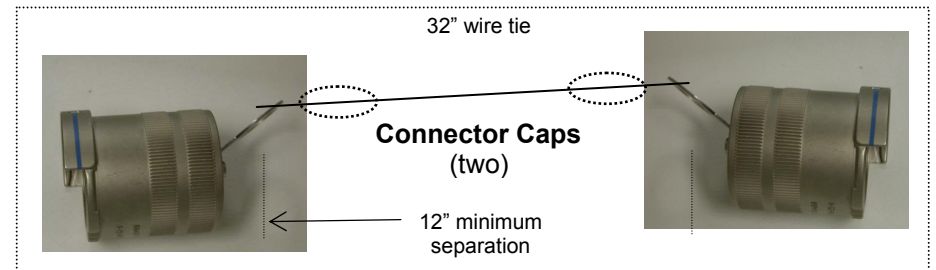

CP7 ETVCG STANCHION INSTALL – TASK DATA

Estimated Task Duration:

	Without SSRMS
Two EV Crew	00:45

Tools:

EV1 (FF)	EV2 (FF)
7/16 (wobble) socket-6 ext Round Scoop	7/16 (wobble) socket-6 ext

EVA Fasteners:

Fastener Name	Head Size	Qty	Install Torque (ft-lb)	Release Torque (ft-lb)	Failure Torque (ft-lb)	Turns
VSSA Launch Bolt	7/16	2	16.7	30.1	50.1	7-11.5
VSSA Stanchion Bolt	7/16	1	20.0	18.0	62.0	10, 16.5

Mass and Dimensions:

Item	Mass (lb)	Dimensions (in)
ETVCG Stanchion	51.0	16.6x13.0x58.2

S3 LOWER OUTBOARD PAS DEPLOY – TASK DATA

Estimated Task Duration:

	Without SSRMS
One EV Crew	na
Two EV Crew	01:00

Tools:

EV1	EV2
PGT	PGT
7/16 socket 6-in ext	7/16 socket 2-in ext
hammer	Adjustable equipment tether (2)
	Gap spanner (2 short)

EVA Fasteners:

Fastener Name	Head Size	Qty	Install Torque (ft-lb)	Release Torque (ft-lb)	Failure Torque (ft-lb)	Turns
SARJ Brace Launch Restraint Bolt	7/16	1	Finger tight	Per EVA 2	32.3	1-13.5
SARJ Brace cup/cone Bolt	7/16	1	7.1-22.1	Per EVA 2 (16.0)	Inst=22.1 Rel=14.0 hardstop 31.6 running	37
Diagonal cup/cone bolt	7/16	1	20.8-22.5 gnd 16.0 on orbit	22.7	Inst=22.1 Rel=14.0 hardstop 31.6 running	37
Stowage Clevis	7/16	4	22.5-27.5 gnd 16.0 on orbit	34.3	46.7 rel 44.5 inst	9-16.5
Deploy Clevis	7/16	4	22.5-27.5 gnd 30.5 on orbit	31.7	106.6 rel 44.7 inst	7-10.5

Inhibits:

Inhibit
Starboard SARJ Locked

Foot Restraint	WIF	Settings
Remove/Install Deployed/Stowed Clevis Brackets	S3 - 11	2,PP,G,12

Notes:

1. Can release 3 of 4 bolts on either stowed or deployed clevis bracket to rotate out of the way, due to mechanism design
2. UMA EVA Override anti-rotation cap must be removed prior to first use of UMA on UCCAS
3. EBCS target cover must be removed prior to cargo attachment to UCCAS. Protects target from MMOD and inadvertent contact. Remove as last activity
4. RAD or torque wrench may be needed for re-install of deployed clevis bracket if the yoke is installed prior to final torque of bracket bolts. It will likely exceed RAD limits and need to be returned for refurbishment
5. The following tether/gap spanner configuration is used to manipulate the PAS into the deployed position: Adjustable – short gap spanner – short gap spanner – Adjustable. Only short gap spanners are available on-orbit, and the adjustable tethers reduce hand fatigue by eliminating manipulation of French hooks

Cautions:

1. If yoke ADP and PIP pin do not release from towed clevis bracket with less than 10 lbf. The bracket fasteners must be loosened 4 turns on each bolt prior to releasing yoke ADP
2. Do not lift diagonal brace greater than 7 degrees out of rotation plane when rotating to temp stowage location so as to not bend hinge end
3. Do not close ADP lock bracket when ADP is not inserted in a stowage/clevis hole. The pin can fall apart
4. EBCS target has finished surface that is susceptible to damage by contact

Warnings:

None

S3 LOWER OUTBOARD PAS DEPLOY – TASK DATA (Cont)

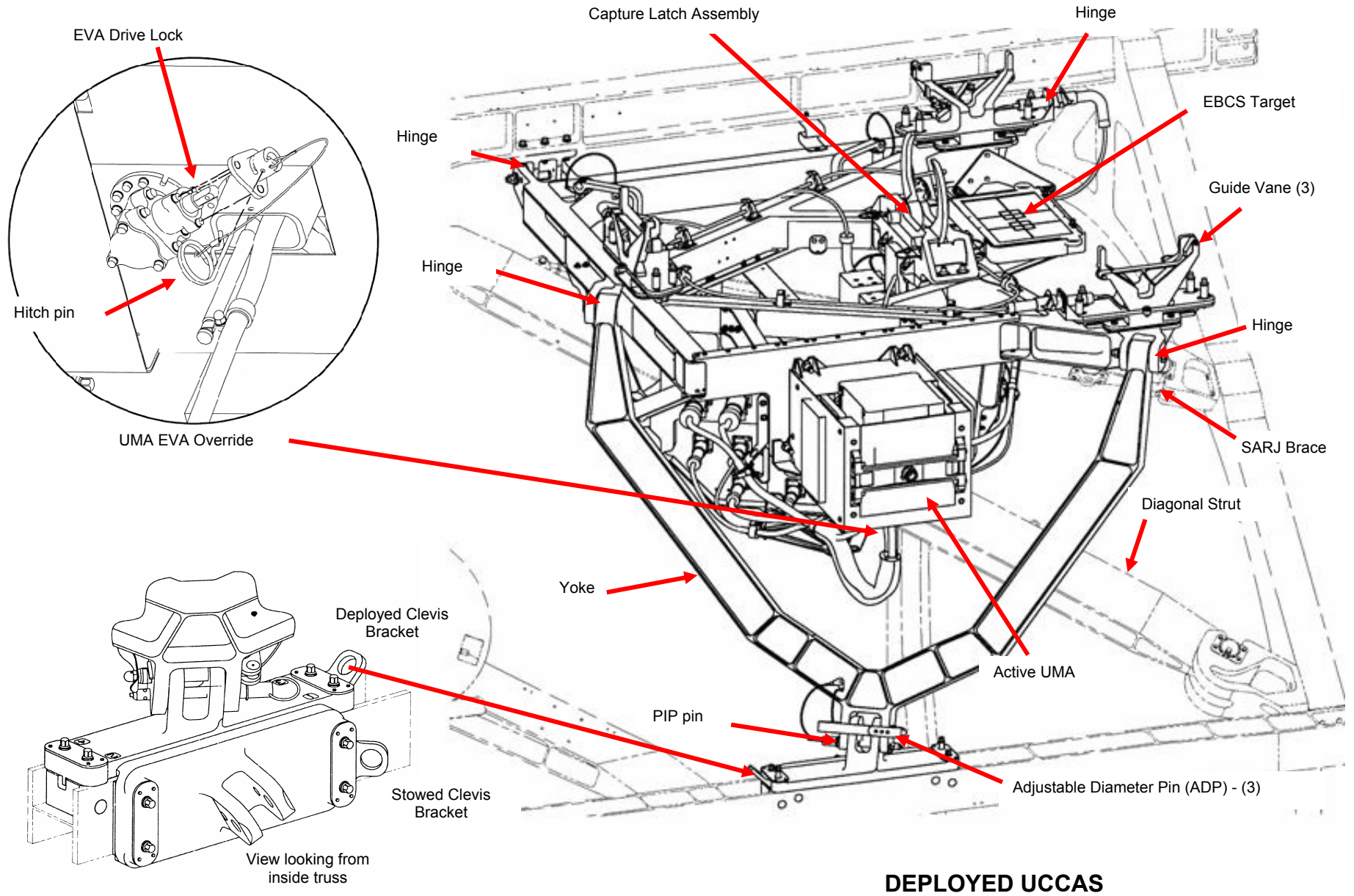

S3 LOWER OUTBOARD PAS DEPLOY – TASK DATA (Cont)

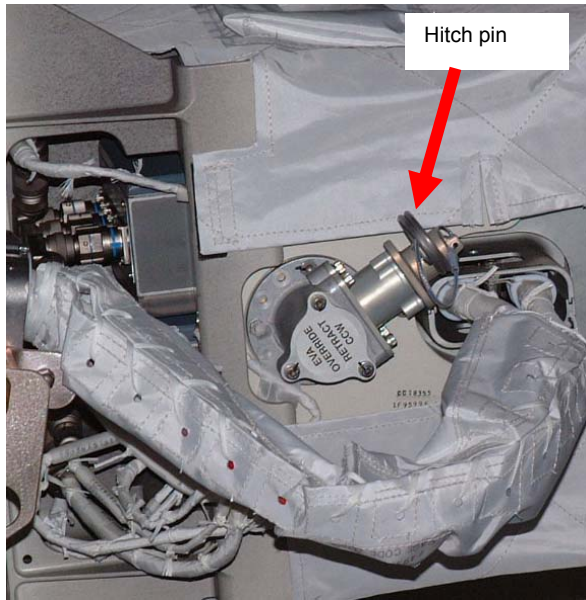

Active UMA EVA Override with Anti-Rotation Cap

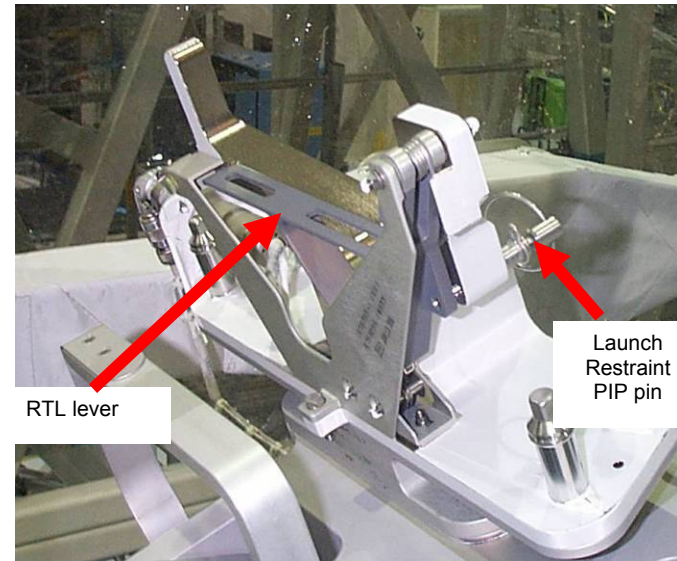

Guide Vane and RTL lever

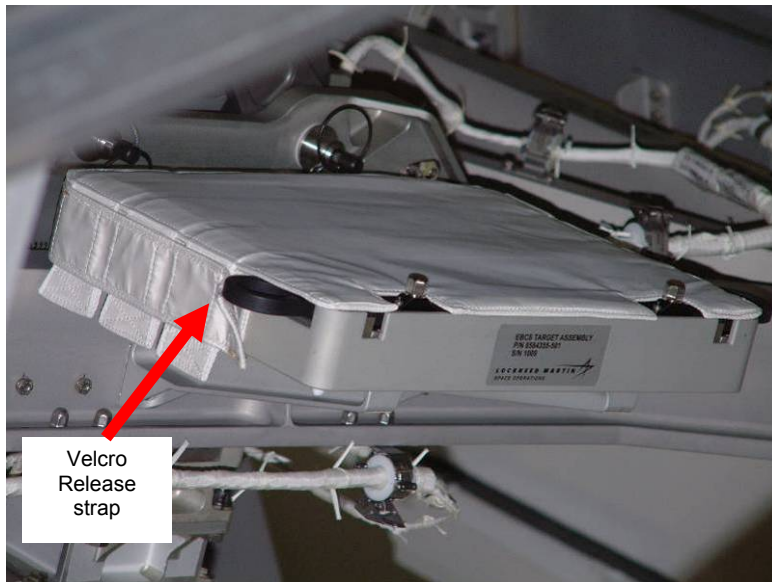

EBCS Target with Cover

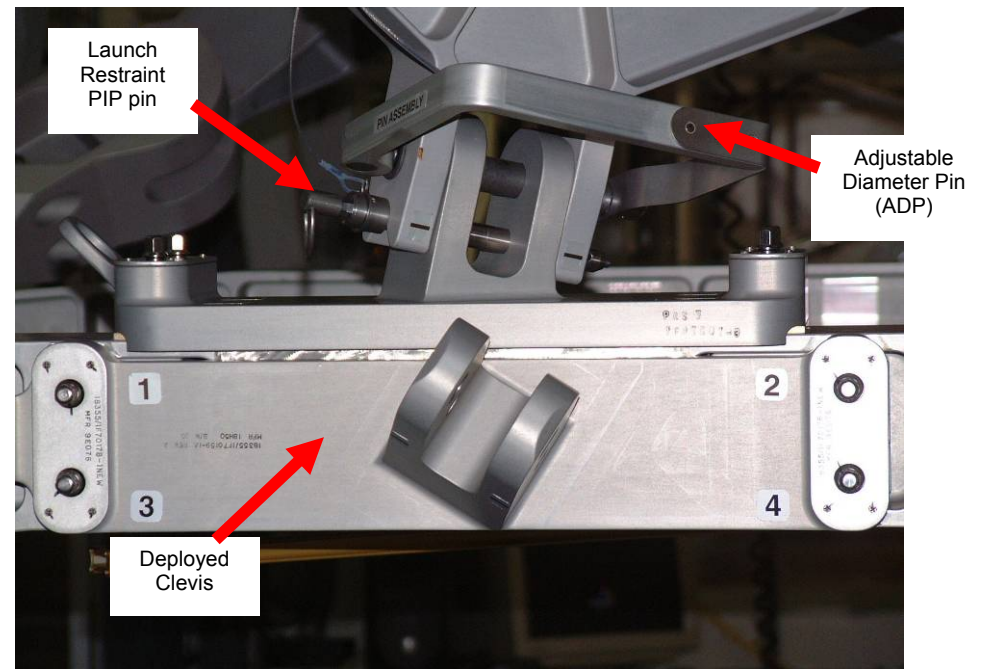

Deployed and Stowed Clevis Brackets (looking from zenith)

S3 LOWER OUTBOARD PAS DEPLOY – TASK DATA (Cont)

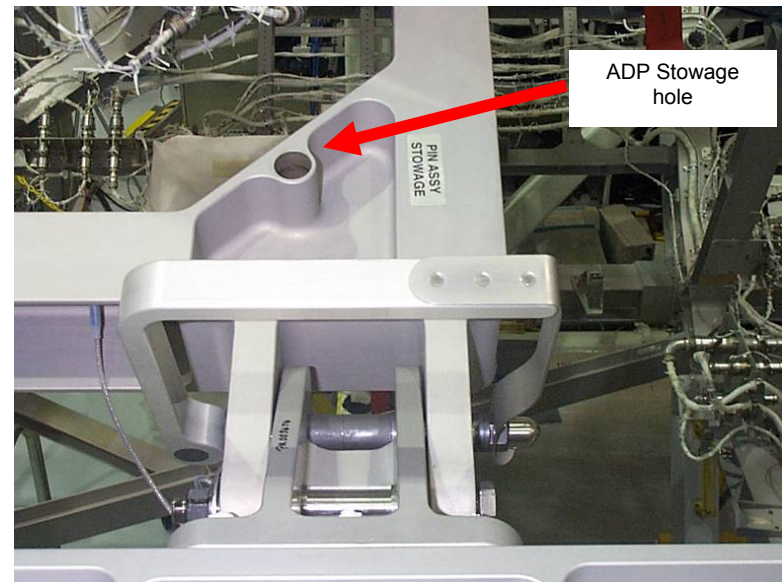
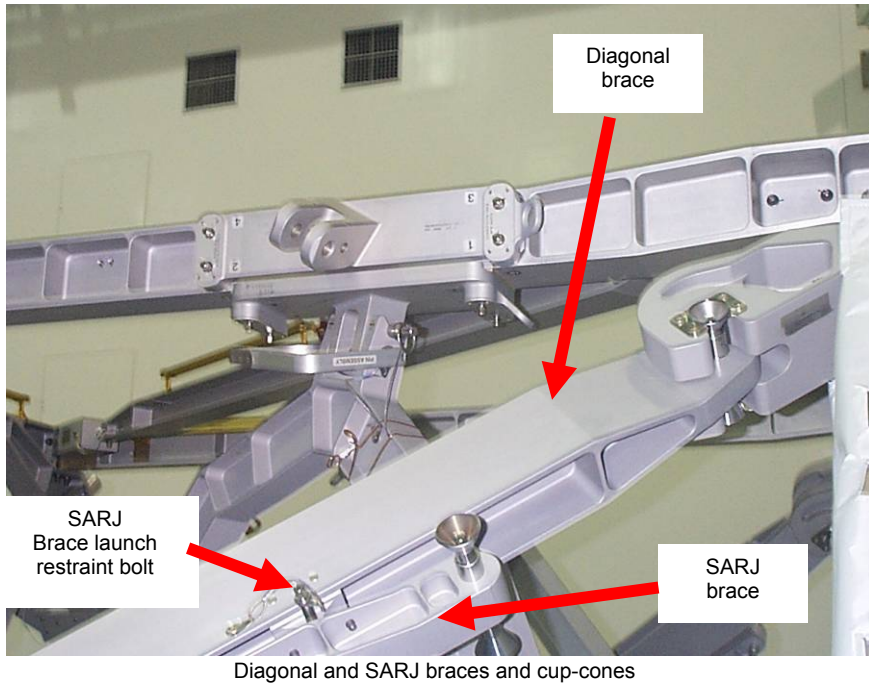

TOOLS AND STOWAGE

PGT CHECKOUT	8-3
PGSC-PGT CONNECTION (A31P AND 760XD)	8-4
PROGRAM PGT SETTINGS	8-5
DOWNLOAD/ERASE EVENT LOG	8-5
PGT CONTINGENCIES.....	8-6
TOOLBOX STOWAGE	FS 8-7
TOOLBOX PANEL AND SLOT LABELS	FS 8-8
Z1 TOOLBOX INTERNAL LAYOUT	FS 8-9
AIRLOCK TOOLBOX INTERNAL LAYOUT.....	FS 8-10

TOOLS AND
STOWAGE

**TOOLS AND
STOWAGE**

This Page Intentionally Blank

TOOLBOX STOWAGE

I

	Z1 PORT TOOLBOX	Z1 STBD TOOLBOX	A/L TOOLBOX 1 (STBD)	A/L TOOLBOX 2 (PORT)
SLOT # 1	SQUARE TM BOARD SQ TORQUE MULTIPLIER 7/16" FLUSH SQ SOCKET 7/16" PROUD SQ SOCKET 7/16" RECESSED SQ SOCKET	SQUARE TM BOARD SQ TORQUE MULTIPLIER 7/16" FLUSH SQ SOCKET 7/16" PROUD SQ SOCKET 7/16" RECESSED SQ SOCKET	HAMMER BOARD HAMMER	CABLE CUTTER BOARD COMPOUND CUTTERS (SM) SCISSORS
SLOT # 2		QD BAIL TOOL BOARD BMRRM LATCH TOOL QD BAIL DRIVE TOOL (1")	PLIERS BOARD NEEDLE NOSE PLIERS	
SLOT # 3	RATCHET BOARD 3/8" DRIVE RATCHET 7/16" X 12" WOBBLE SOCKET 7/16" X 2" RIGID SOCKET	RATCHET BOARD 3/8" DRIVE RATCHET 7/16" X 6" WOBBLE SOCKET		
SLOT # 4				
SLOT # 5	ROUND TM BOARD RND TORQUE MULTIPLIER 5/8" PROUD RND SOCKET 7/16" FLUSH RND SOCKET 7/16" PROUD RND SOCKET	ROUND TM BOARD 7/16" FLUSH RND SOCKET 7/16" PROUD RND SOCKET	ADJ WRENCH BOARD FORCEPS WRENCH, ADJ	T-HANDLE TOOL BOARD 1-3" T-TOOLS 2-8" T-TOOLS
SLOT # 6	TRASH BAG BOARD LARGE TRASH BAG SMALL TRASH BAG	TRASH BAG BOARD	HYDRAZINE BRUSH BOARD HYDRAZINE BRUSH	
SLOT # 7	SOCKET BOARD 5/32" BALL END ALLEN DR 1/2" X 8" WOBBLE SOCKET 5/16" X 7" RIGID SOCKET	SOCKET BOARD 5/32" BALL END ALLEN DR 1/2" X 8" WOBBLE SOCKET 5/16" X 7" RIGID SOCKET	PRD (Toolboard) PRD	PRD (Toolboard) PRD
PANEL # 8	CHEATER BAR PANEL ADJ EQUIP TETHER	CHEATER BAR PANEL CHEATER BAR ADJ EQUIP TETHER	TOOL CADDY PANEL CADDY, ISS (BUNGEE)	
PANEL # 9	18" SOCKET PANEL 7/16" X 18" WOBBLE SOCKET	18" SOCKET PANEL	BOLT PULLER PANEL BOLT PULLER MECHANICAL FINGER	LARGE CUTTER PANEL
EXTERNAL	1 SQUARE SCOOP 1 ROUND SCOOP w/D-HANDLE D-HANDLE on port side of toolbox	1 SQUARE SCOOP <u>NOTE</u> D-Handle will not stow on the side of this toolbox due to an interference with the CMG MLI		

TOOLBOX PANEL AND SLOT LABELS

NOTE

- A/L Toolbox: Slider feature located in center slot only (#3)
- CETA Toolbox: Slider feature located in all slots

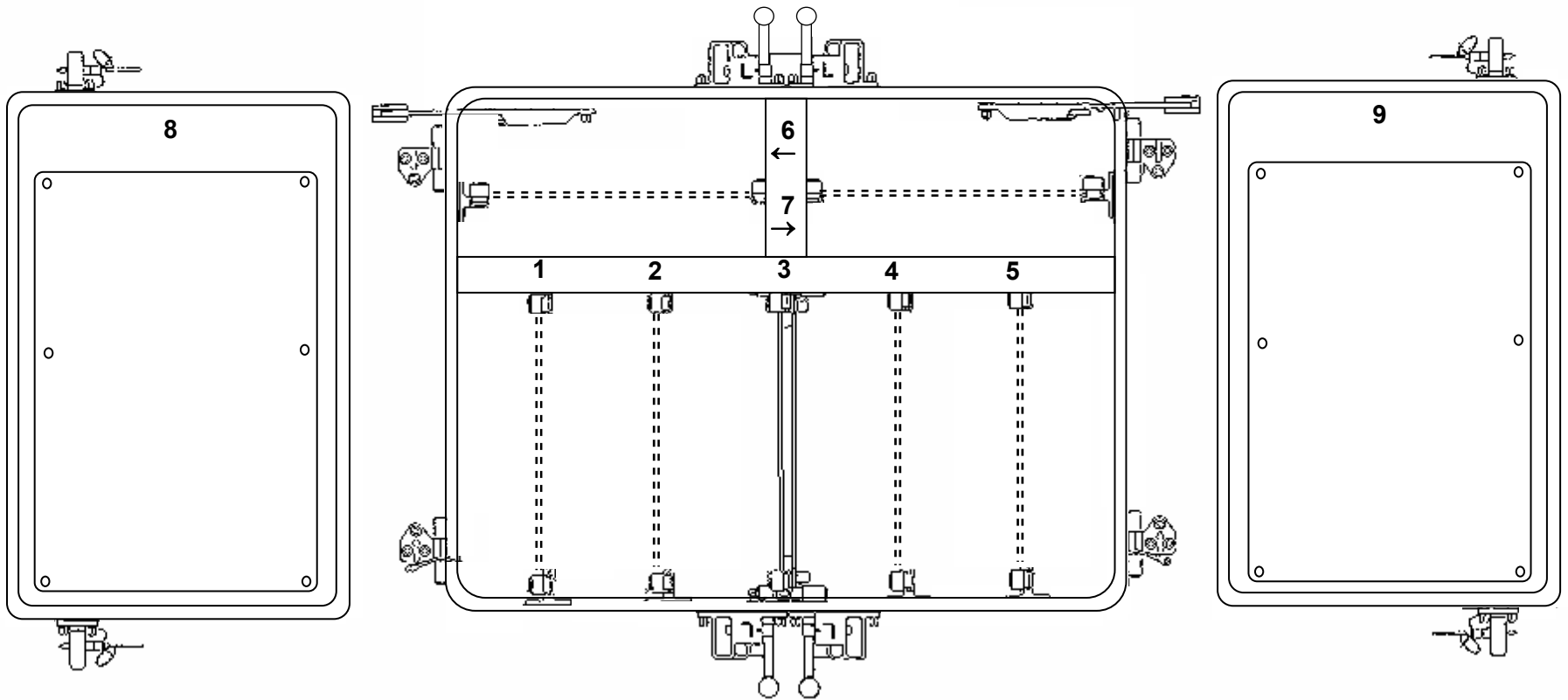

Z1 TOOLBOX INTERNAL LAYOUT

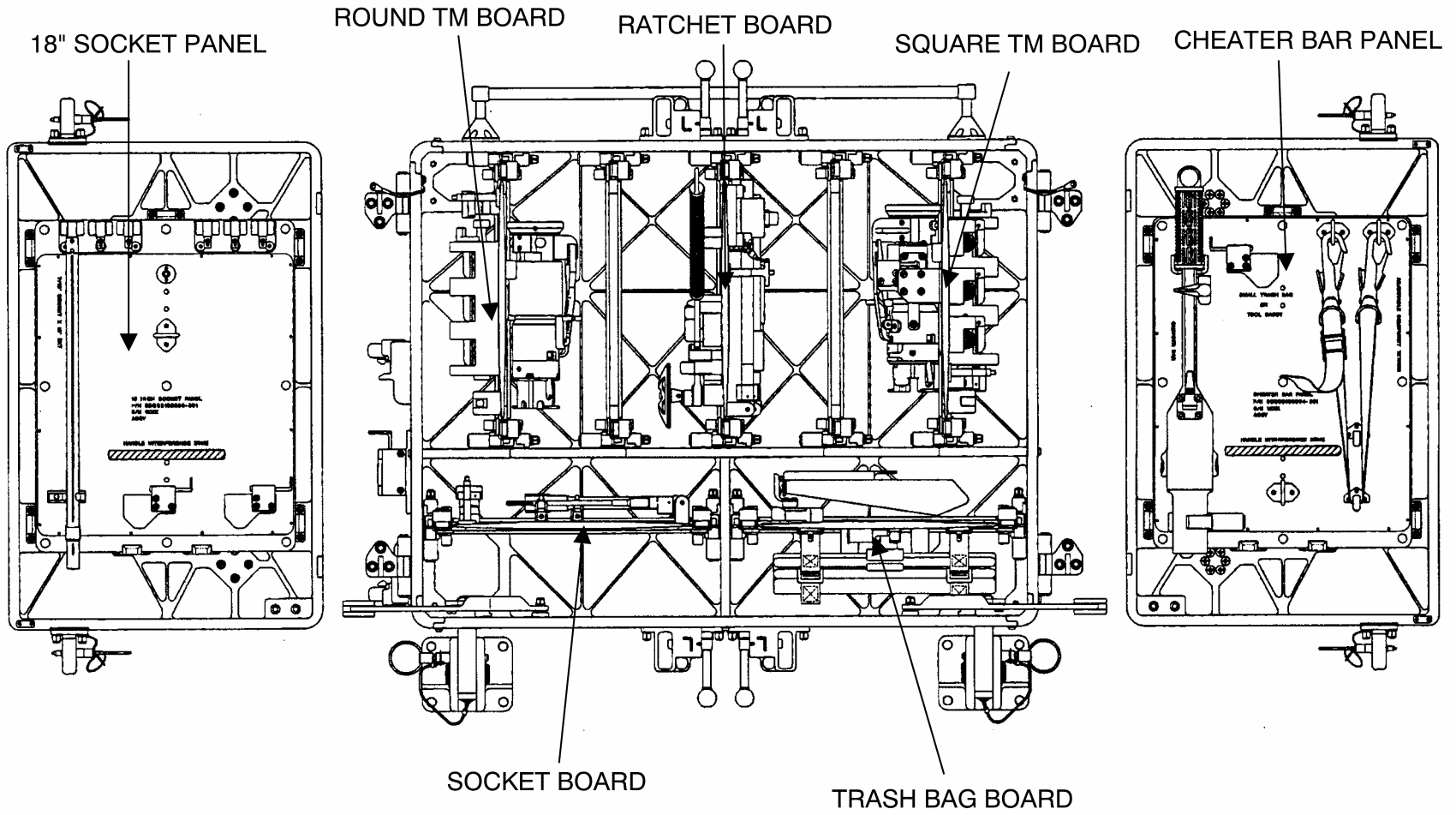

AIRLOCK TOOLBOX INTERNAL LAYOUT

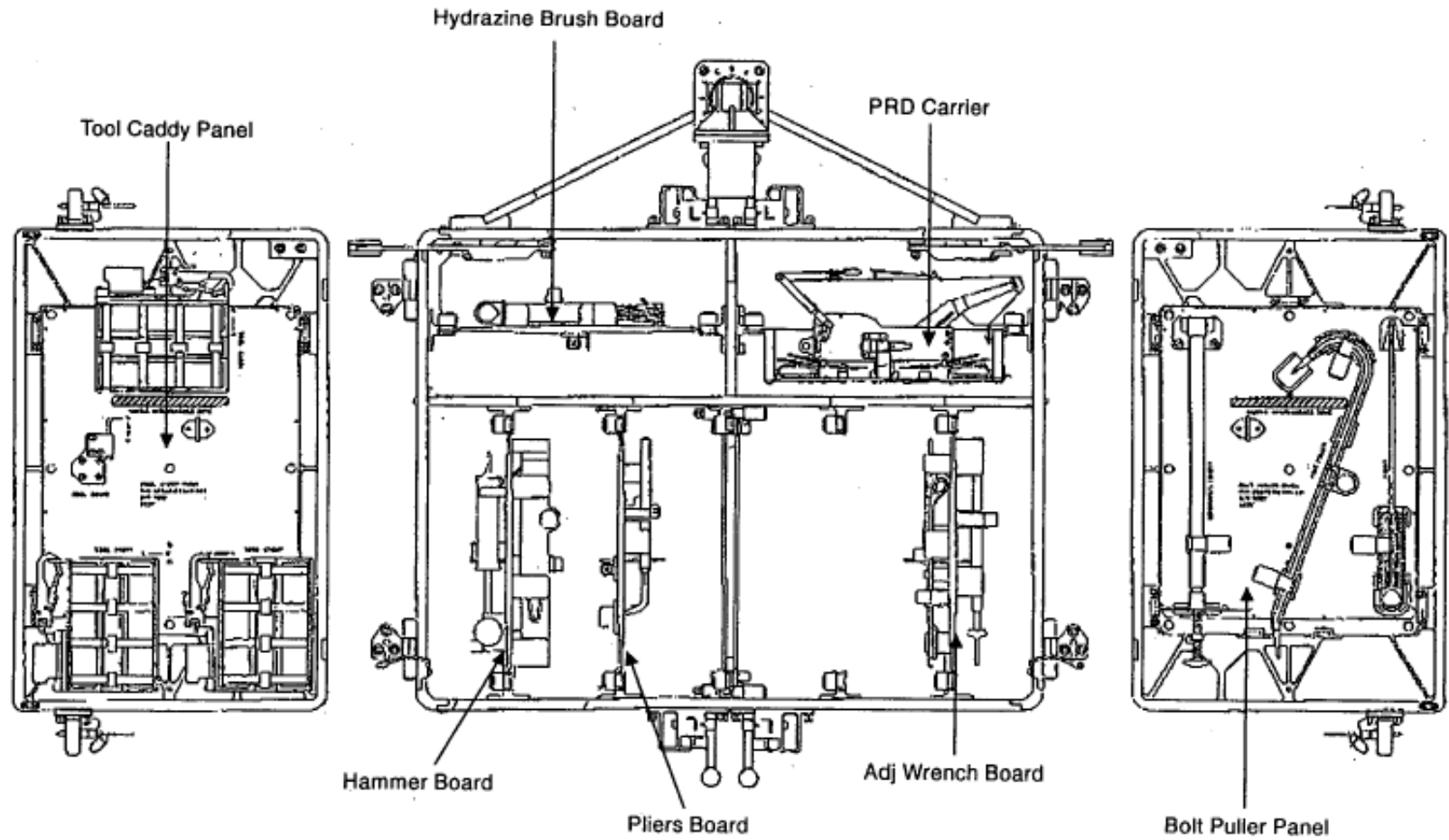

EMU MAINT/RECHARGE

WATER RECHARGE.....	TEMP FS 10-2
EMU POWERUP.....	TEMP FS 10-2
WATER FILL.....	TEMP FS 10-2
WATER FILL VERIFICATION.....	TEMP FS 10-2
EMU LiOH CHANGEOUT.....	10-4
MIDDECK EMU BATTERY RECHARGE (STAND-ALONE).....	10-4a
MIDDECK EMU BATTERY RECHARGE/LiOH REPLACEMENT.....	10-5
INITIATE.....	10-5
TERMINATE.....	10-6
IN-SUIT EMU BATTERY RECHARGE/CHARGE VERIFICATION.....	10-7
INITIATE.....	10-7
TERMINATE.....	10-7
EMU POWERDOWN.....	10-7
HELMET LIGHT/PGT BATTERY RECHARGE.....	10-8
INITIATE.....	10-8
TERMINATE.....	10-9
REBA BATTERY INSTALLATION.....	10-9
EMU BATTERY REMOVAL/INSTALL.....	10-10
HELMET LIGHT BULB CHANGEOUT.....	10-11
REBA BATTERY RECHARGE.....	10-12
INITIATE.....	10-12
TERMINATE.....	10-12
STS-117 CONSUMABLES TRACKING CUE CARD.....	FS CC 10-13
STS-117 BATTERY RECHARGE PLAN.....	FS CC 10-14
STS-117 LOGISTICS OVERVIEW.....	FS 10-15

WATER RECHARGE

IF EMU NOT ALREADY POWERED UP:

EMU POWERUP

- BOTH DCM 1. Retrieve, position SCUs; remove DCM covers
 2. Connect SCUs to DCM, √locked
 3. PWR – BATT

CAUTION

EMU must be on BATT pwr when
 airlock pwr supply is turned on

- AW18H 4. PWR/BATT CHGR EMU 1,2 MODE (two) – PWR
 BUS SEL (two) – MNA(MNB)
 MD(flr) 5. √EMU O2 ISOL VLV – OP
 AW82B 6. EV1,2 O2 vlv (two) – OP
 DCM 7. PWR – SCU

WATER FILL

- MO13Q 8. √ARLK H2O S/O VLV – OPEN (tb-OP)
 R11L 9. √SPLY H2O TKA OUTLET – CL (tb-CL)

SM 60 TABLE MAINT

- CRT 10. Use TKB quantity:
 PARAM ID – ITEM 1 +0 6 2 0 4 2 0 EXEC
 11. Log value before recharge

Recharge #	H2O TKB %
1	
2	
3	
4	
5	

- AW82D 12. √EMU 1,2 H2O WASTE tb (two) – CL
 SPLY (two) – OP (tb-OP)
 13. √H2O TKB quantity decreasing

NOTE

Full charge requires ~15 min

WATER FILL VERIFICATION

- DCM 14. √STATUS: 8-15 psi and stable for ~30 sec (indicates charging complete)

SM 60 TABLE MAINT

- CRT 15. Use TKB quantity:
 PARAM ID – ITEM 1 +0 6 2 0 4 2 0 EXEC
 16. Log value after recharge

Recharge #	H2O TKB %
1	
2	
3	
4	
5	

EMU MAINT/
 RECHARGE

Cont next page

TEMP FS 10-2

TOP

HOOK
VELCRO

STS-117 CONSUMABLES TRACKING CUE CARD

EV 1 – Ry: EMU 3010
EV 2 – Ol: EMU 3004

EV 3 – Fr: EMU 3018
EV 4 – Sw: EMU 3006

SAFER Usage: s/n 1005 and s/n 1006
ERCA Usage: s/n 16 and s/n 18

	LiOH/Metox (s/n or barcode)	EMU Battery (s/n)	HL Battery (s/n)	REBA (s/n)	PGT Battery (s/n)	PWR (s/n)
EVA 1 – FD 4	Metox for Campout/10.2 s/n <u>0012</u> , s/n <u>0013</u> EV1: s/n <u>2028</u> (LiOH) – <i>launched</i> EV2: s/n <u>2030</u> (LiOH) – <i>launched</i>	EV 1: s/n <u>2077</u> launched in suit EV 2: s/n <u>2038</u> launched in suit	EV 1: <u>1011, 1012</u> EV 2: <u>1013, 1014</u>	EV 1: <u>1003</u> EV 2: <u>1004</u>	EV 1: <u>5011</u> EV 2: <u>5012</u> (<u>5015</u> in spare PGT in C-Lk Staging Bag)	
Post EVA 1 – FD 4	Regen s/n <u>0012</u> , s/n <u>0013</u>	No EMU Battery charging	Recharge EVA 1 Batts in BSA	Recharge EVA 1 Batts from BSA	Recharge EVA 1 Batts in BSA	Fill: PWR s/n <u>1025</u> Dump: CWC s/n <u>1059</u>
FD5		EVA 1 EMU Batts (s/n <u>2077</u> , <u>2038</u>) in BSA				
EVA 2 – FD 6	Metox for Campout/10.2 s/n <u>0007</u> , s/n <u>0011</u> EV3: s/n <u>0015</u> (Mtx) EV4: s/n <u>0016</u> (Mtx)	EV 3: s/n <u>2039</u> EV 4: s/n <u>2040</u>	EV 3: <u>1015, 1017</u> EV 4: <u>1019, 1021</u>	EV 3: <u>1005</u> EV 4: <u>1011</u>	EV 3: <u>5013</u> EV 4: <u>5014</u> (<u>5015</u> in spare PGT in C-Lk Staging Bag)	
Post EVA 2 – FD 6	Regen s/n <u>0007</u> , s/n <u>0011</u>	No EMU Battery charging	Recharge EVA 2 Batts in BSA	Recharge EVA 2 Batts from BSA	Recharge EVA 2 Batts in BSA	Fill: PWR s/n <u>1025</u> If req'd use <u>1023</u> Dump: CWC s/n <u>1059</u>
FD 7		EVA 2 EMU Batts (s/n <u>2039</u> , <u>2040</u>) in BSA				
EVA 3 – FD 8	Metox for Campout/10.2 s/n <u>0017</u> , s/n <u>0020</u> EV1: s/n <u>2015</u> (LiOH) EV2: s/n <u>2017</u> (LiOH)	EV 1: s/n <u>2077</u> EV 2: s/n <u>2038</u>	EV 1: <u>1011, 1012</u> EV 2: <u>1013, 1014</u>	EV 1: <u>1003</u> EV 2: <u>1004</u>	EV 1: <u>5011</u> EV 2: <u>5012</u> (<u>5015</u> in spare PGT in C-Lk Staging Bag)	
Post EVA 3 – FD 8	Regen s/n <u>0017</u> , s/n <u>0020</u> <i>Only if no back to back EVA4</i>					Fill: PWR s/n <u>1023</u> Dump: CWC s/n <u>1059</u>
EVA 4	Metox for Campout/10.2 s/n <u>0019</u> , s/n <u>0021</u> EV3: s/n <u>0012</u> (Mtx) EV4: s/n <u>0013</u> (Mtx)	EV 3: s/n <u>2039</u> EV 4: s/n <u>2040</u>	EV 3: <u>1015, 1017</u> EV 4: <u>1019, 1021</u>	EV 3: <u>1005</u> EV 4: <u>1011</u>	EV 3: <u>5013</u> EV 4: <u>5014</u> (<u>5015</u> in spare PGT in C-Lk Staging Bag)	
Post EVA 4	Regen s/n <u>0019</u> , s/n <u>0021</u>					Fill: PWR s/n <u>1013</u> Dump: CWC s/n <u>1059</u>

EVA-5a/117/O/B

(reduced copy)

TOP
Back of 'STS-117 CONSUMABLES TRACKING CUE CARD'

HOOK
VELCRO

STS-117 BATTERY RECHARGE PLAN

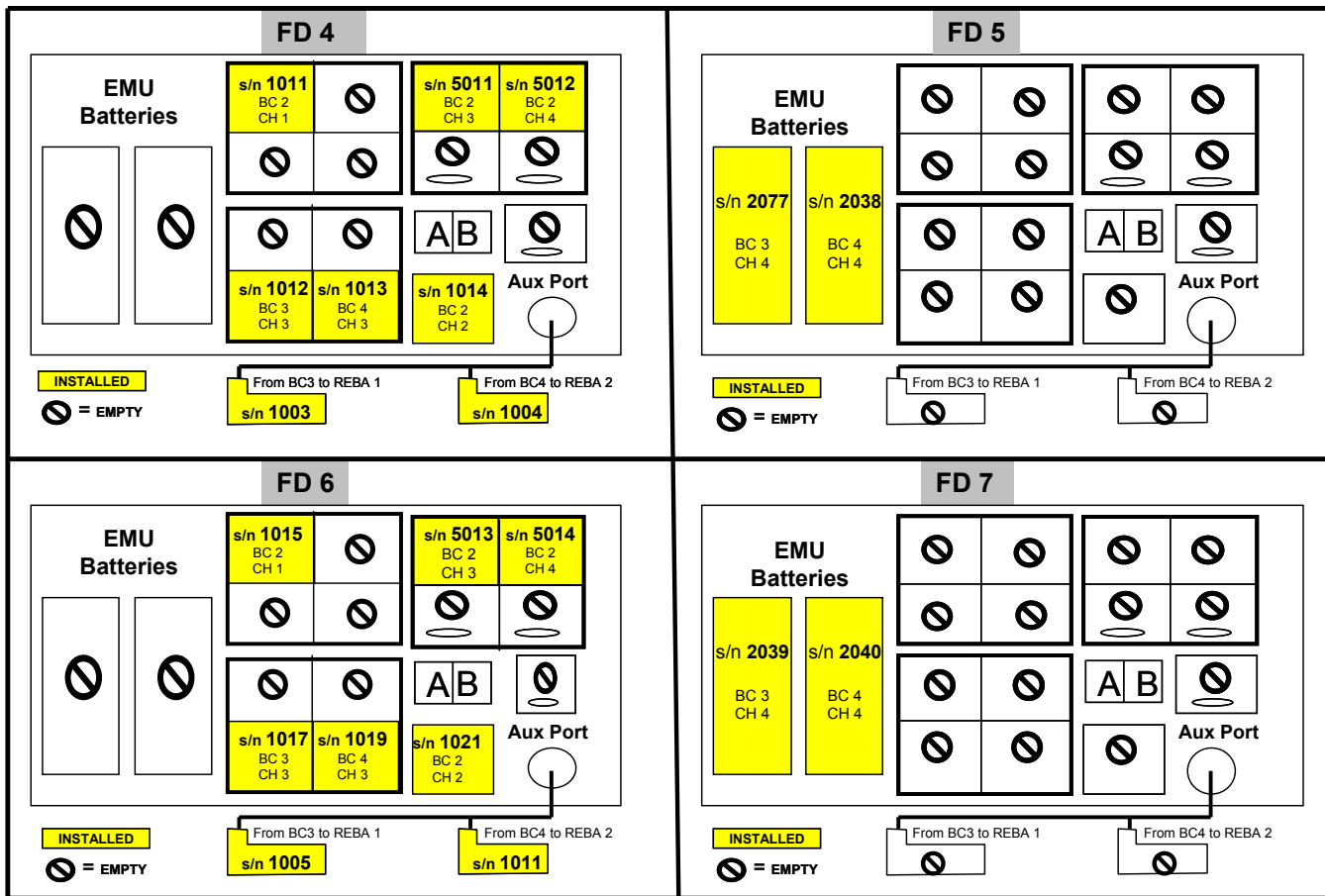

EVA-5b/117/O/B

(reduced copy)

STS-117 LOGISTICS OVERVIEW

ISS

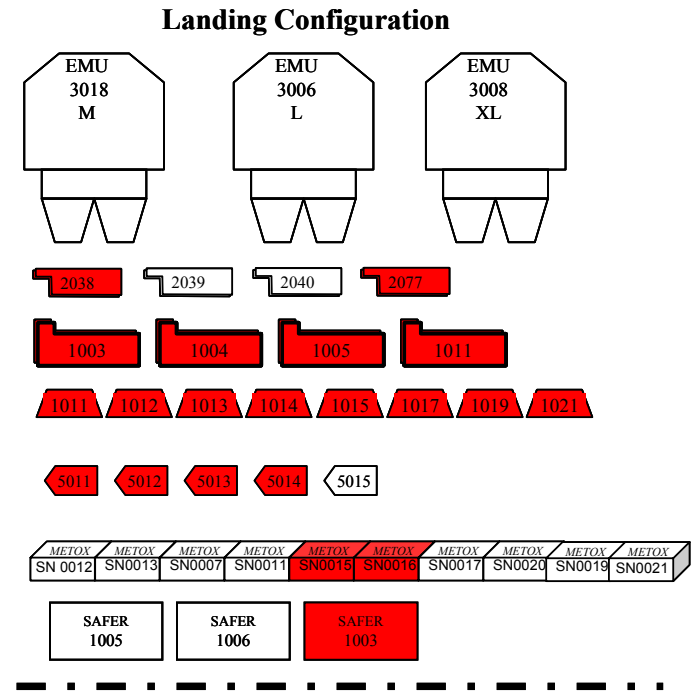
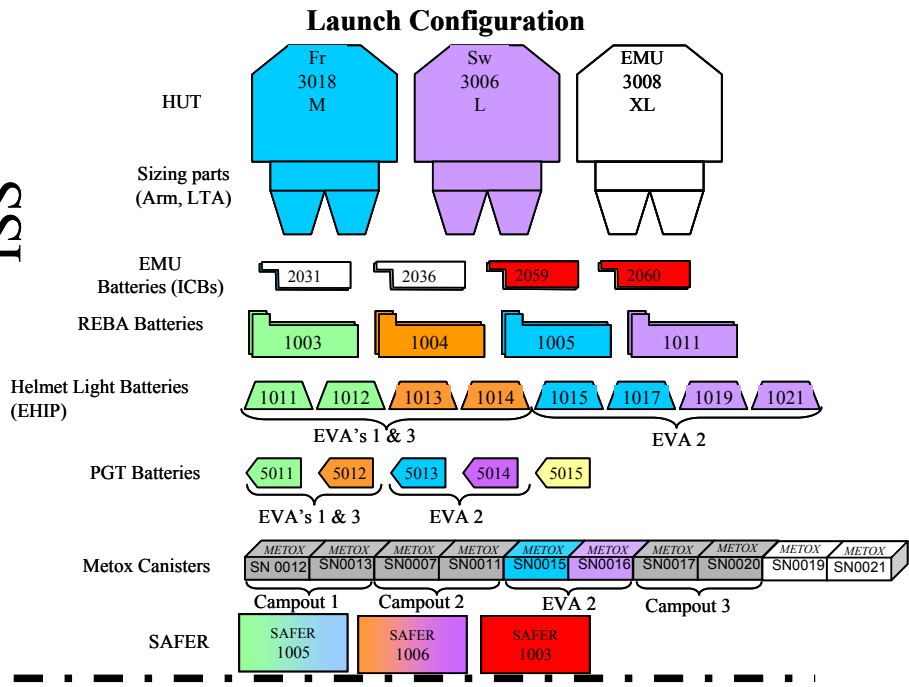

Shuttle

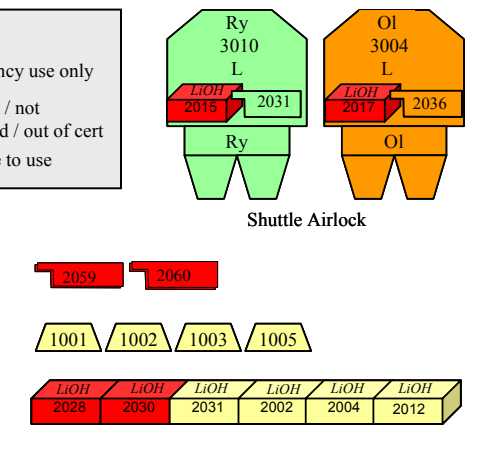
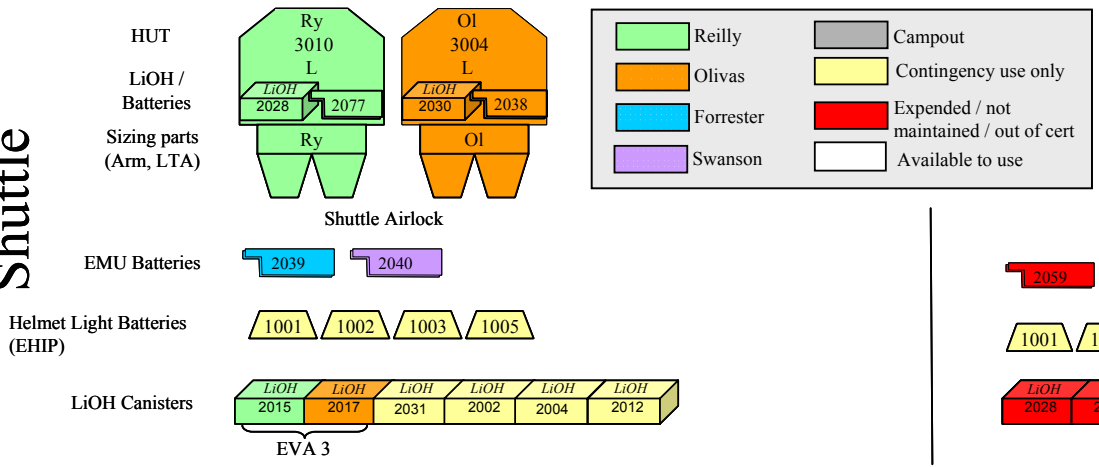

This Page Intentionally Blank

EMU CONTINGENCY PROCS

DISPLAY LOSS DURING POWER TRANSFER (WARM RESTART).....	TEMP FS 12-2
VACUUM H2O RECHARGE (MANNED).....	TEMP FS 12-2
LiOH REPLACEMENT (MANNED).....	12-3
BATTERY REPLACEMENT (MANNED)	12-4
WATER DUMP	12-6
SCU SWAP (UNMANNED).....	12-7
SCU SWAP (MANNED).....	12-7
EMU COLD RESTART (MANNED)	12-7
12.1 STS EVA DECONTAMINATION.....	12-8
CONTAMINATION TEST.....	12-15
SAFER BATTERY CHANGEOUT	12-18
BENDS TREATMENT ADAPTER (BTA) INSTALLATION (IN-SUIT)	12-19
BTA PREP	12-19
BTA TREATMENT	12-19
BENDS TREATMENT ADAPTER (BTA) INSTALLATION (POST SUIT DOFFING).....	12-21
BTA PREP	12-21
BTA TREATMENT	12-21
EMU RESIZE	12-24
STS-117 NOMINAL EMU SIZING	FS 12-27
STS-117/13A EMU CONTINGENCY RESIZE MATRIX	FS 12-29

EMU CONT
PROCS

DISPLAY LOSS DURING POWER TRANSFER (WARM RESTART)

- DCM If PWR – BATT and SCU connected:
- AW18H 1. √PWR/BATT CHGR EMU 1(2) BUS SEL – OFF
- DCM If PWR – SCU:
- 2. PWR – BATT
- AW18H 3. PWR/BATT CHGR EMU 1(2) BUS SEL – OFF

WARNING
Fan will be off from steps 4 to 9 during which time CO2 buildup is a concern

NOTE

Affected EMU will be without comm after step 6. Steps 6 and 7 should be read together before step 6 is performed

- DCM 4. FAN – OFF (expect FAN SW OFF msg, DISP – PRO)
- IV 5. Inform affected EV crewmember of impending comm loss
- DCM 6. PWR – SCU (7 sec)
- 7. PWR – BATT
- When power restart complete:
- 8. √Display – O2 POS XX, expect FAN SW OFF msg, DISP – PRO
- 9. As reqd, FAN – ON
- If display blank or locked up:
- 10. Contact MCC
- If SCU power desired:
- 11. √SCU connected to DCM
- AW18H 12. PWR/BATT CHGR EMU 1(2) MODE – PWR
BUS SEL – MNA(MNB)
- 13. √EMU INPUT 1(2) Volts = 18.0 – 20.0
- DCM 14. PWR – SCU
- DCM 15. √Display – O2 POS XX

VACUUM H2O RECHARGE (MANNED)

WARNING
Procedure should be used only if performing a contingency EVA

- EV 1. Perform AIRLOCK INGRESS, Cuff C/L, 30 (Close hatch, partially engage latches)
- 2. √Helmet purge vlv – cl, locked
- DCM 3. √PURGE vlv – cl (dn)
- 4. √WATER – OFF
- IV MO13Q 5. √ARLK H2O S/O VLV – OPEN (tb-OP)
- MD(flr) 6. √EMU O2 ISOL VLV – OP
- ML86B:C 7. √cb MNC EXT ARLK HTR LINE ZN 1,2 (two) – op
- AW82B 8. √EV-1(EV-2) O2 vlv – OP
- EV AW18H 9. PWR/BATT CHGR EMU 1(2) BUS SEL – MNA(MNB)
- DCM 10. PWR – SCU (fwd), WARN TONE
- IV R11L If SPLY H2O XOVR VLV closed (tb-CL or bp) (water transfer config):
- 11. SPLY H2O TKA OUTLET – CL (tb-CL)
- If SPLY H2O XOVR VLV open (tb-OP) (nominal config):
- L1 12. √RAD CNTLR OUT TEMP – NORM
- 13. √FLASH EVAP CNTLR PRI A,B (two) – OFF
- ML31C 14. SPLY H2O TKD OUTLET – CL (tb-CL)
- R11L 15. SPLY H2O TKB OUTLET – CL (tb-CL)
- √TKA OUTLET – CL (tb-CL)
- TKC INLET – CL (tb-CL)
- TKC OUTLET – OP (tb-OP)

STS-117 NOMINAL EMU SIZING

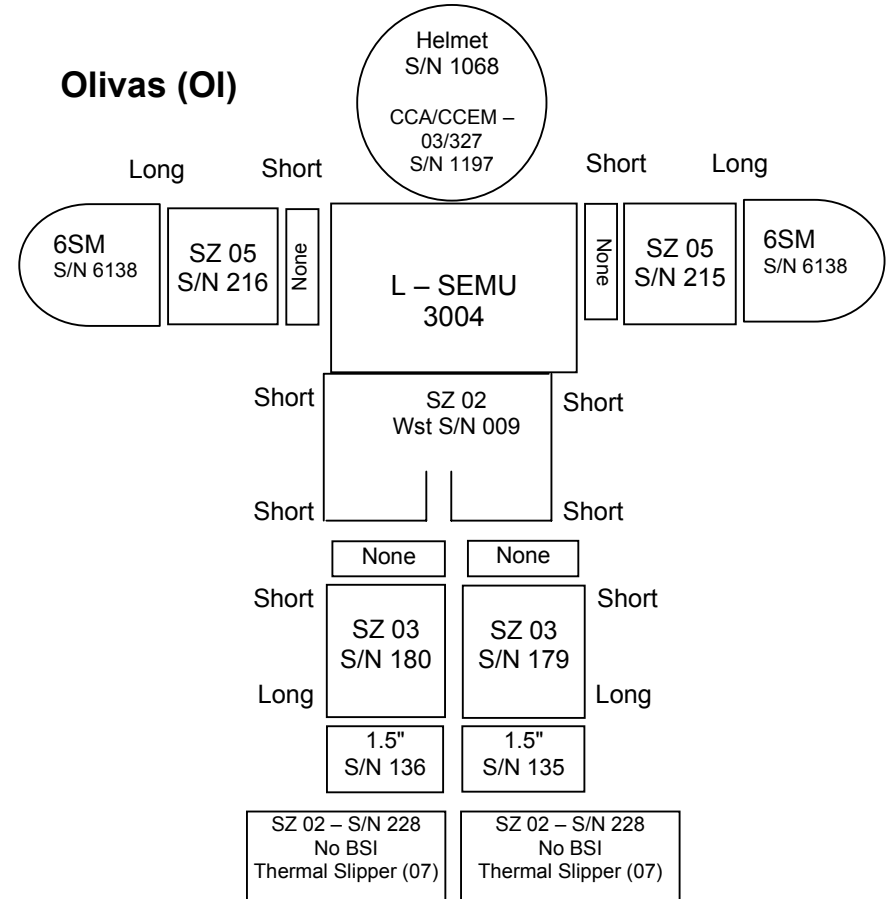
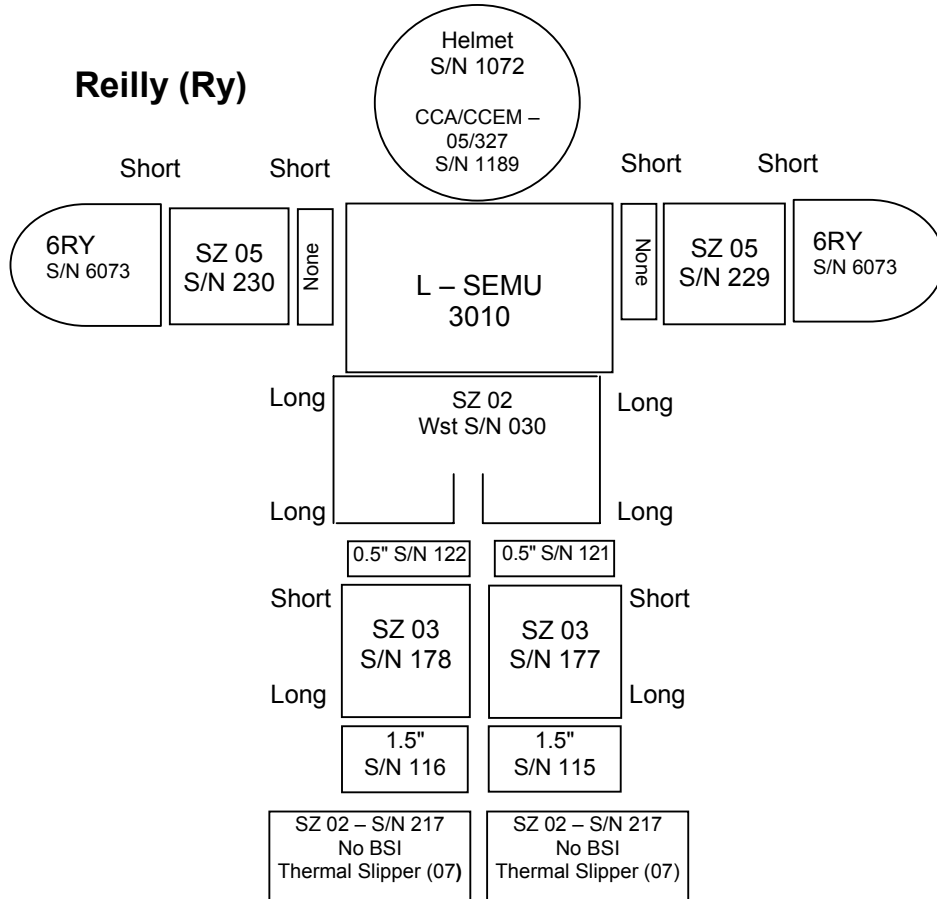

	Croakie/GRD	Fresnel Lens	Valsalva	LCVG/BLVD	MAG	TCU Top	TCU Bottom	Comfort Gloves	Socks
Reilly	GRD, Croakie	None	Val (1) EMU Servicing Kit	s/n 3182 06/05	711	L	L	Lg, Thin (-06)	Polyliners (XL) Thermax Liners (L)
Olivas	None	None	MV (1) EMU Servicing Kit	s/n 3206 06/05	709	L	L	(RS) Tipless	Polyliner (L)

STS-117 NOMINAL EMU SIZING (Cont)

Forrester (Fr)

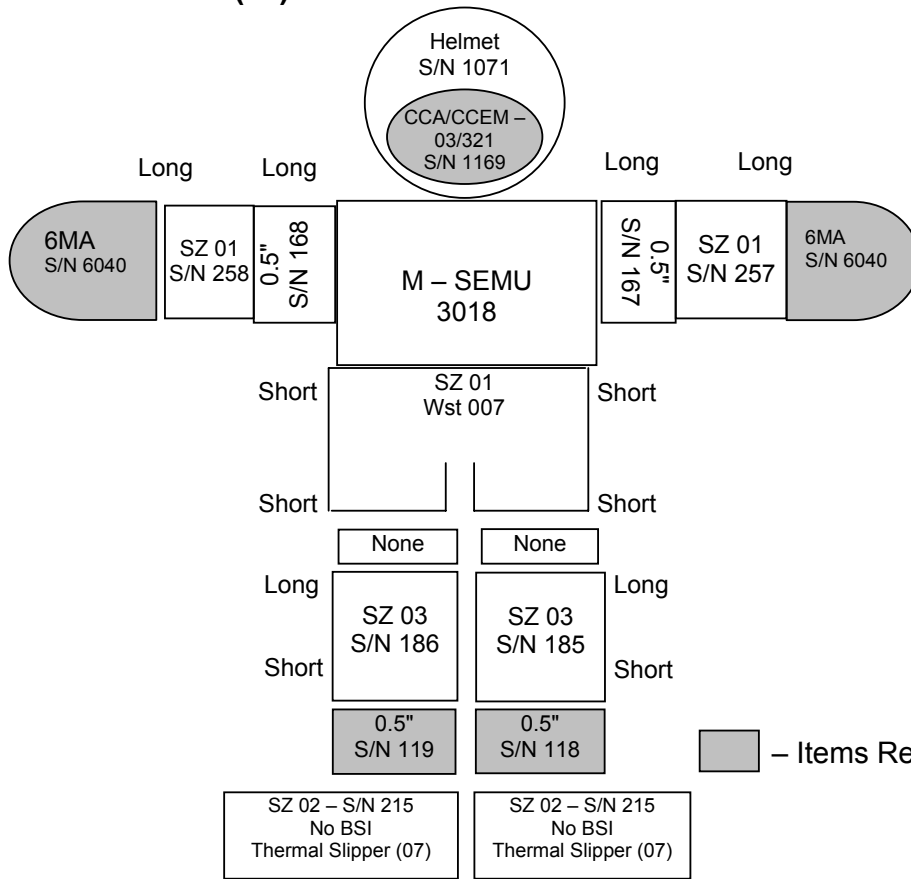

Swanson (Sw)

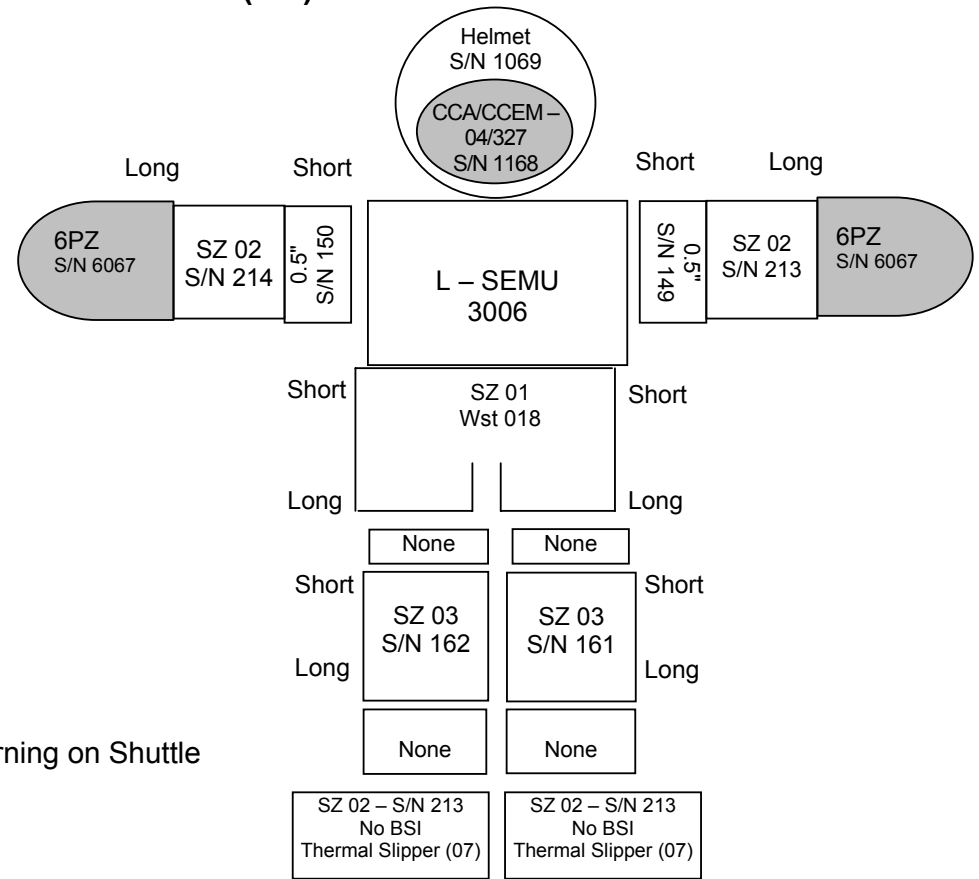

■ - Items Returning on Shuttle

	Croakie	Fresnel Lens	Valsalva	LCVG/BLVD	MAG	TCU Top	TCU Bottom	Comfort Gloves	Socks
Forrester	Mod [L]	None	Val (1) EMU Servicing Kit	s/n 3174 05/05	709	M	S	Lg, Thick (-12) Lg, Thin (-06)	Thermax Liners (L)
Swanson	GRD	None	MV (1) EMU Servicing Kit	s/n 3154 03/05	709	M	M	Lg, Thick (-12) Lg, Thin (-06)	Tube

STS-117/13A EMU CONTINGENCY RESIZE MATRIX

FOR LOSS OF:	EV1 – Reilly		EV2 – Olivas		EV3 – Forrester		EV4 – Swanson	
HUT/PLSS	(3010, Large) 1. Use SW Large HUT 2. Remove SW ring/arm/glove assys 3. Install RY arm/glove assys 4. √Red to Right 5. Remove SW LTA 6. Install RY LTA 7. Swap EMU PLSS identifier stripes 8. √Cams, √Locks		(3004, Large) 1. Use SW Large HUT 2. Remove SW ring/arm/glove assys 3. Install OL arm/glove assys 4. √Red to Right 5. Remove SW LTA 6. Install OL LTA 7. Swap EMU PLSS identifier stripes 8. √Cams, √Locks		(3018, Medium) 1. Use OL HUT, Large 2. Remove OL arm/glove assys 3. Install FR arms/gloves (no rings) 4. √Red to Right 5. Remove OL LTA 6. Install FR LTA 7. Swap EMU PLSS identifier stripes 8. √Cams, √Locks		(3006, Large) 1. Use OL HUT, Large 2. Remove OL arm/glove assys 3. Install SW ring/arm/glove assys 4. √Red to right 5. Remove OL LTA 6. Install SW LTA 7. Swap EMU PLSS identifier stripes 8. √Cams, √Locks	
Arm Cams	Upper- S	Lower- S	Upper- S	Lower- L	Upper- L	Lower- L	Upper- S	Lower- L
Waist Brief	(02 L-L) 1. Use ISS spare waist brief s/n 024 2. Adjust cams L-L 3. Install RY prime legs/rings/boots assys 4. Swap EMU identifier stripes 5. √Cams, √Locks		(02 S-S) 1. Use ISS spare waist brief s/n 024 2. Adjust cams S-S 3. Install OL prime legs/rings/boots assys 4. Swap EMU identifier stripes 5. √Cams, √Locks		(01 S-S) 1. Use spare waist brief s/n 021 2. Adjust cams S-S 3. Install FR prime legs/rings/boots assys 4. Swap EMU identifier stripes 5. √Cams, √Locks		(01 S-L) 1. Use ISS spare waist brief s/n 021 2. Adjust cams S-L 3. Install SW prime legs/boots assys 4. Swap EMU identifier stripes 5. √Cams, √Locks	
Cams	Upper- L	Lower- L	Upper- S	Lower- S	Upper- S	Lower- S	Upper- S	Lower- L
Gloves	(6RY) Use 6RY s/n 6081 backup (Middeck)		(6SM) Use 6SM s/n 6242 backup (Middeck)		(6MA) 1. Use 6MA s/n 6136 backup (Middeck) 2. Use thin spectra glove		(6PZ) 1. Use 6PZ s/n 6206 backup (Middeck) 2. Use thin spectra glove	
LCVG	(06, 07-Therm Slipper) 1. Use backup LCVG labeled "BU" (Middeck) 2. Transfer biomed, dosimeter		(06, 07-Therm Slipper) 1. Use backup LCVG labeled "BU" (Middeck) 2. Transfer biomed, dosimeter		(05, 07-Therm Slipper) 1. Use KT prime LCVG S/N 3176 on ISS 2. Transfer biomed, dosimeter		(05, 07-Therm Slipper) 1. Use KT prime LCVG S/N 3176 on ISS 2. Transfer biomed, dosimeter	
CCA	(05/327) Use RY B/U (Middeck)		(03/327) Use s/n 1177 on ISS		(03/321) Use FR B/U (Middeck)		(04/327) Use S/N 1183 on ISS	
Lower Arm Segment	(05) 1. Use B/U 05 arms (Middeck) 2. √Red to Right 3. √Cams, √Locks		(05) 1. Use B/U 05 arms (Middeck) 2. √Red to Right 3. √Cams, √Locks		(01) 1. Use B/U 01 arms (Middeck) 2. √Red to Right 3. √Cams, √Locks		(02) 1. Use B/U 02 arms (Shuttle Ext AL Bag) 2. √Red to Right 3. √Cams, √Locks	
Cams	Upper- S	Lower- S	Upper- S	Lower- L	Upper- L	Lower- L	Upper- S	Lower- L
Leg Segment	(03) 1. Use SW 03 leg segment 2. √Cams, √Locks		(03) 1. Use SW 03 leg segment 2. √Cams, √Locks		(03) 1. Use OL 03 leg segment 2. Adjust cams, √Locks		(03) 1. Use OL 03 leg segment 2. √Cams, √Locks	
Cams	Upper- S	Lower- L	Upper- S	Lower- L	Upper- L	Lower- S	Upper- S	Lower- L
Boot	(02) Use SW 02 boot (s/n 213)		(02) Use SW 02 boot (s/n 213)		(02) Use OL 02 boot (s/n 228)		(02) Use OL 02 boot (s/n 228)	
Sizing Rings	(0.5" Thigh, 1.5" Leg) 1. Use LA 0.5" Thigh Ring, s/n 119 or 120 on ISS 2. Use TU 1.5" leg ring, s/n 141 or 142 on ISS		(1.5" Leg) 1. Use TU 1.5" leg ring, s/n 141 or 142		(0.5" arm, 0.5" Leg) 1. Use WL 0.5" arm ring, s/n 120 or 121 on ISS 2. Use BB 0.5" leg ring, s/n 122 or 123 on ISS		(0.5" arm) 1. Use WL 0.5" arm ring, s/n 120 or 121 on ISS	

This Page Intentionally Blank

TPS REPAIR

The TPS Repair procedures listed below are not published in the hardcopy EVA Flight Supplement. These procedures will be uplinked realtime if they are required.

A PDF and a WORD version of the procedures can be found at:
<http://mod.jsc.nasa.gov/do3/FDF/FDFBooks/Status%20Sheets/index.html>.

Select the "As Flown" Status sheet for STS-117 and the link to the procedures can be found with the link to the EVA FS. The procedures can also be found on the FDF Books CD provided to the FAO console

BOOM TPS INSPECTION	
BOOM POINT INSPECTION SUMMARY TIMELINE	FS 13-3
BOOM POINT INSPECTION TOOL CONFIG.....	FS 13-4
BOOM POINT INSPECTION	FS 13-5
BOOM WLE MAPPING SUMMARY TIMELINE	FS 13-15
BOOM WLE MAPPING TOOL CONFIG	FS 13-17
BOOM WLE MAPPING	FS 13-18
EVA WLE MAPPING INSPECTION.....	FS 13-24
SAFER TPS INSPECTION	
SAFER TPS INSPECTION SUMMARY TIMELINE	FS 13-29
SAFER TPS INSPECTION TOOL CONFIG.....	FS 13-30
SAFER TPS INSPECTION	FS 13-31
BOOM CONTINGENCY	
BOOM FRGF SHAFT RELEASE	FS 13-37
BOOM FRGF SHAFT INSTALLATION	FS 13-38
BOOM EFGF SHAFT RELEASE	FS 13-40
BOOM MPM STOW/DEPLOY.....	FS 13-42
BOOM ASSISTED LATCHING	FS 13-43
TILE REPAIR	
EMU PREP FOR TPS REPAIR.....	FS 13-44
POST TPS REPAIR DOFFING	FS 13-45
EWA MATERIAL MIXING	FS 13-46
EWA REF DAT.....	FS 13-47
EWA TILE REPAIR – DOCKED/ORM SUMMARY TIMELINE	FS 13-48
EWA TILE REPAIR – DOCKED/ORM TOOL CONFIG.....	FS 13-49
EWA TILE REPAIR – DOCKED/ORM	FS 13-50
SSRMS GAP FILLER REMOVAL SUMMARY TIMELINE	FS 13-58
BOOM GAP FILLER REMOVAL SUMMARY TIMELINE	FS 13-59
GAP FILLER REMOVAL	FS 13-60
RCC REPAIR	
RCC CRACK REPAIR BAG ASSEMBLY.....	FS 13-65
TEMP SENSOR DISASSEMBLY POST-EVA.....	FS 13-68
RCC CRACK REPAIR BAG DISASSEMBLY POST-EVA	FS 13-69
TEMPERATURE PROBE ASSEMBLY	FS 13-71
CRM APPLICATOR ASSEMBLY	FS 13-71
CRM APPLICATOR NOZZLE INSTALLATION (DAY OF EVA).....	FS 13-72
RCC CRACK REPAIR.....	FS 13-73
RCC PLUG TRANSFER BAG ASSEMBLY	FS 13-85
NOTES, CAUTIONS, WARNINGS	
EVA TPS INSPECTION/REPAIR INHIBIT PAD.....	FS 13-97
TPS REPAIR CAUTIONS AND WARNINGS	FS 13-100
TPS REPAIR NOTES.....	FS 13-101
BOOM OPERATIONAL WARNINGS	FS 13-102
BOOM OPERATIONAL NOTES	FS 13-103

TPS REF DATA	
PREFERRED EMU POSITIONING FOR TPS REPAIR.....	FS 13-104
EVA TPS REACH AND ACCESS	FS 13-105
POINT INSPECTION REACH AND ACCESS WHILE DOCKED.....	FS 13-106
WLE MAPPING INSPECTION WHILE DOCKED	FS 13-108
TILE LAYUP.....	FS 13-109
85-FOOT SAFETY TETHER.....	FS 13-110
PFR ATTACHMENT DEVICE (PAD)	FS 13-111
WIF EXTENDER	FS 13-112
EVA DIGITAL CAMERA.....	FS 13-113
EVA IR CAMERA	FS 13-115
OVERLAY TILE REPAIR SYSTEM (OTRS)	FS 13-117
OTRS MARKING TEMPLATE AND INSULATION BAGS	FS 13-118
AUGER HOUSING.....	FS 13-119
OTRS RELEASED CONFIGURATION	FS 13-120
ORU BAG INSERT FOR OTRS	FS 13-121
BOOM REF DATA	
RTF BOOM OVERVIEW.....	FS 13-122
BOOM TRANSITIONS WITH MLI	FS 13-123
BOOM BASE END AND MODIFIED EFGF	FS 13-124
BOOM BASE END EFGF ADAPTER PLATE	FS 13-125
EVA-ASSISTED EFGF CONNECTOR DEMATE	FS 13-126
BOOM BASE END SADDLE AND MPM.....	FS 13-127
BOOM MID SECTION AND MODIFIED FRGF.....	FS 13-128
BOOM MID SECTION FRGF ADAPTER PLATE.....	FS 13-129
BOOM TIP END AND SENSORS	FS 13-130
BOOM SENSOR DETAILS	FS 13-132
SENSOR PACKAGE 1 (SP1): LDRI/ITVC	FS 13-134
SENSOR PACKAGE 2 (SP2): LCS.....	FS 13-136
POSSIBLE PRD ROUTING FOR EVA ASSISTED LATCHING	
OF BOOM IN MPMS.....	FS 13-138
BOOM CONTINGENCIES	FS 13-139
GRAPPLE SHAFTS	FS 13-140
PDGF GRAPPLE SHAFT COVER.....	FS 13-141
BOOM FRGF FSE.....	FS 13-142

UNSCHEDULED/CONTINGENCY EVA TASKS

I

13A WORKAROUNDS CRIBSHEET	TEMP FS 16-2
S1-S3 CAPTURE LATCH OVERRIDE	FS 16-13
S1-S3 MBA BOLT OVERRIDE	FS 16-19
S1-S3 SSAS CONTINGENCY BOLT INSTALL.....	FS 16-23
MANUAL OVERRIDE TO UNLATCH/LATCH (TENSION) SABB.....	FS 16-25
MANUAL RELEASE OF SABB RESTRAINT PINS	FS 16-27
MANUAL OVERRIDE TO EXTEND/RETRACT MAST	FS 16-30
SABB SPOOL RE-TENSION	FS 16-33
EVA ASSISTED DEPLOYMENT OF S4 SAW.....	FS 16-39
SSRMS JOINT DRIVE	FS 16-42
MANUAL SAW JETTISON	FS 16-47
BDCU BACKOUT	FS 16-53
REMOVE AND REPLACE DCSU	FS 16-56
REMOVE AND REPLACE PVCU LOWER.....	FS 16-61
MDM REMOVE AND REPLACE	FS 16-64
CANADIAN REMOTE POWER CONTROL MODULE (CRPCM)	
REMOVE/REPLACE.....	FS 16-68
MBSU REMOVE/REPLACE	FS 16-72
REMOVE AND REPLACE PFCS	FS 16-79

UNSCH/CONT
EVA TASKS

13A WORKAROUNDS CRIBSHEET

UNSCH/CONT
EVA TASKS

Procedure	Failure	Work-Around Steps
I. GENERIC	TA Clamps	
	1. TA clamps fail to release	A. With handle up, press down on top of rounded clamp B. With handle up, use tether hook to pry drawhook from capture pin
	NZGL Connectors	
	2. Connector fails to release from softdock	A. Verify bail is in fully demated position (aft) B. Inspect connector/bail for FOD C. Check alignment/side loads/interference D. Wiggle/jiggle connector E. On MCC GO: Use EVA hammer or similar tool to gently tap bottom of connector
	3. Connector fails to softdock	A. Inspect: <ul style="list-style-type: none"> ▪ FOD ▪ EMI band ▪ Bend radius ▪ Soft dock springs ▪ O-ring seal ▪ Connector keying features B. Verify bail is in fully demated position (aft) C. Check alignment/side loads/torsion D. Wiggle/jiggle connector
	4. Connector pin bent	A. Report bent pin location to MCC B. Verify pin gauge with MCC; retrieve connector pin straightener, straighten
	5. Connector FOD	A. On MCC GO: obtain Connector Cleaner Tool to remove FOD (A/L staging bag)
	6. Connector EMI band bent	A. On MCC GO: obtain Needle Nose Pliers or Forceps to remove band
	7. Connector bail linkage failure	A. Pull (to demate) or push (to mate) on connector backshell to assist bail motion B. On MCC GO: Tether hooks or Vise Grips may be used for additional leverage on bail
	8. Connector soft dock spring bent	A. On MCC GO: obtain Needle Nose Pliers, attempt to remove bent spring
9. Connector O-ring seal loose	A. Remove seal with tether hook B. On MCC GO: obtain Needle Nose Pliers to remove seal	

13A WORKAROUNDS CRIBSHEET (Cont)

Procedure	Failure	Work-Around Steps
	MMOD Shield	
	10. MMOD shield Dzus fastener fails to release <div style="border: 1px solid black; padding: 5px; margin: 5px 0;"> <p style="text-align: center;">WARNING</p> <p>Do not touch back side of MMOD Shields or handle fastener fragments due to sharp edges</p> <p>Fastener and shield/tool interface must be covered to avoid potential projectiles</p> </div>	<ul style="list-style-type: none"> A. Retrieve Pry Bar (A/L staging bag) and emptied Med ORU Bag B. Release other MMOD shield fasteners C. Assess clearance between MMOD shield and tools D. If possible, rotate fasteners to position tangs off of tools E. Place Med ORU Bag over failed fastener F. Insert prybar under MMOD shield by failed fastener; pry shield away from structure until fastener is free
	11. MMOD shield Dzus fastener fails to engage	<ul style="list-style-type: none"> A. Verify center fastener is engaged first B. Check Dzus fastener aligned with bracket C. Verify fastener clocking correct per alignment mark D. Push firmly and rotate E. Engage other fasteners: 2 of 3 required
	12. T-handle tool fails to engage shield	<ul style="list-style-type: none"> A. Remove adjacent fasteners; attempt reinstallation
	13. MLI grounding strap Dzus fails to release	<ul style="list-style-type: none"> A. Cut ground wire near Dzus
	APFR/IAPFR	
	14. APFR/IAPFR fails to install into WIF	<ul style="list-style-type: none"> A. Verify APFR/IAPFR collar in install position B. Check for FOD in WIF or structural interference C. Attempt APFR install in alternate clocking and/or WIF position D. If APFR does not install (APFR failure), use another APFR
	15. Joint fails to actuate	<ul style="list-style-type: none"> A. Verify no load is applied to joint B. For pitch joint, push knob in during rotation C. Increase force applied to free joint
	16. Boot becomes stuck in APFR boot plate	<ul style="list-style-type: none"> A. Remove 7/16-in EVA bolts (3) on heel plate using EVA ratchet or PGT: [B1 12.0 ft-lb, CCW2 30 RPM, MTL 30.5], 5 turns
	17. Boot becomes stuck in IAPFR boot plate	<ul style="list-style-type: none"> A. Remove 7/16-in EVA bolts on heel plate (2 per boot) using EVA ratchet or PGT: [B2 16.0 ft-lb, CCW2 30 RPM, MTL 30.5], 4 turns
	Safety Tether	
	18. 85-ft or 55-ft safety tether fails to tend	<ul style="list-style-type: none"> A. Verify safety tether reel is unlocked B. Pull out small amount of cable, allow reel to retract while holding cable slightly tensioned C. Tap side of reel housing during retract D. Use alternate safety tether
	19. Crew hook fails on load alleviating side or red mark on load alleviating strap showing	<ul style="list-style-type: none"> A. Use second Waist Tether to replace load alleviating strap; retrieve replacement safety tether

13A WORKAROUNDS CRIBSHEET (Cont)

Procedure	Failure	Work-Around Steps
	Torque Multiplier	
	20. Torque multiplier fails to release from fitting	A. Verify torque multiplier anti-backlash in neutral, if not, PGT[RCW, MTL 30.5] . Apply cw torque and push anti-backlash button to neutral position. B. PGT[A5 7.0 ft-lb, CCW2 30 RPM, MTL 30.5] - 5/32 Allen Drive : Release torque multiplier contingency release band pin 20 turns (do not exceed 28 turns). C. When contingency band springs open, remove torque multiplier; return torque multiplier IVA
	Scoops	
	21. Scoop will not release from fitting	A. PGT[A2 3.8 ft-lb, CCW2 30 RPM, MTL 30.5] - 5/32 Ball-end Drive Assy : Remove screws (non-captive) 5 turns
	Fluid QD Ops	
	Mating Ops	
	22. QD fails to mate	A. Check for debris, damage, or crystals; verify release ring is retracted B. Check alignment; verify no side loading present
	23. Release ring snap back test fails	A. Push release ring forward B. Demate and remate QD
	24. Gap check fails (visual or FID gauge)	A. Retract release ring, demate/remate QD
	Valve Ops	
	25. Bail fails to actuate (to valve open)	A. Check for debris, damage, or crystals; depress button, attempt to actuate B. Retrieve and use QD bail drive lever tool
	26. Detent button fails to pop up after bail actuation (to valve open)	A. Neutralize sideloads, apply greater opening force to QD bail handle B. Contact MCC for use of QD bail drive lever tool to apply greater force
	27. Detent button fails to depress <div style="border: 1px solid black; padding: 5px; width: fit-content; margin: 10px auto;"> <p style="text-align: center;">CAUTION</p> <p>Handle may kick back when button is depressed and pressure is built up in spring cavity from a leaking primary seal</p> </div>	A. Verify locking collar fully rotated B. Push bail handle fwd (to open) to relieve load on button while depressing detent button 1. If button depresses, vent by pulling bail aft until release ring covers aft white band 2. Push bail fwd to valve open; check button depresses C. On MCC GO: Retrieve QD bail drive lever tool to push bail fwd 1. Repeat step B with the QD bail drive lever tool D. Contact MCC to reduce NH3 temperature at affected QD, if possible E. On MCC GO: Install QD button depress tool (BDT)
	28. Bail fails to actuate or detent button fails to pop up after actuation (to valve close)	A. Inspect QD for retaining wire protrusion B. Neutralize possible side loading C. Depress button, increase force on bail D. Obtain and use QD bail drive lever tool

13A WORKAROUNDS CRIBSHEET (Cont)

Procedure	Failure	Work-Around Steps
	Demating Ops	
	29. Female QD fails to demate	A. Verify release ring is retracting fully while attempting to demate B. Verify line clamps are released C. Verify locking collar has been successfully rotated under detent button (for ½, ¾, 1 in QDs) – verifies button is all the way up D. For 1.5 in QD, verify trigger linkage is still attached to release ring; if not re-attach E. Neutralize sideloads or manipulate flexhose to relieve mating forces on female QD F. Apply greater retraction force to release ring and/or greater removal force to female QD while neutralizing sideloads G. Contact MCC for use of QD Release Tool (QRT) to apply greater force
	30. Bootie fails to remain securely closed	A. Install wire tie around bootie to keep QD fully covered
	31. Fluid cap will not demate	A. For 1/4, 1/2, and 1 in: <ul style="list-style-type: none"> • Retrieve QD cap tool (QD Tool Bag – A/L) • Reconfigure PGT [A4 6.3 ft-lb, CCW1 10 RPM, MTL 10.5]; install QD Cap Tool • Use cap tool to turn stuck cap a maximum of 2 turns (cap vents at ~2 turns). Finish removal of cap by hand (1 additional turn) B. If force too great for hand actuation or crystals visible around the QD (may have leaking male) re-install QD cap, notify MCC
	Leaks	
	32. Male QD leaks after cap removed	A. Re-install QD cap, notify MCC 1. Prepare for quick mate
	33. Female QD leaks during or after bail actuation (to valve open)	A. Return bail to closed position B. Perform release ring pull-back to verify no FID 1. If FID is observed, demate/remate QD 2. If no FID, neutralize sideloads, cycle bail to open position
	34. Mated QD leaks (valve open position)	A. Remove SPD, fully open valve (bail fwd) B. If leak continues, close valve (bail aft)
	35. Leaking QD – after SPD install	A. Remove SPD, open valve, verify detent button up, aft white line visible 1. If leak stops, rotate locking collar to lock B. Close valve, verify detent button up, fwd white line visible; rotate locking collar to lock C. If applicable, close valve of appropriate QD in flowpath, verify detent button up, fwd white line visible
	36. After demate, female QD leaks	A. Fully mate to destination male QD as quickly as possible

13A WORKAROUNDS CRIBSHEET (Cont)

Procedure	Failure	Work-Around Steps
	37. After demate, male QD leaks	A. Remate female QD to male and open valve (bail forward) <ol style="list-style-type: none"> 1. Depress button and use significant force to push bail forward, then release button 2. With QD in open position apply significant force to end of the female QD in back and forth, up and down directions 3. Attempt to close valve 4. Demate QDs, and inspect B. If applicable, close valve of appropriate QD in flowpath C. Install cap (exception: 3/4, 1.5 in)
	38. Frozen ammonia present on female/male QD	A. Leave QD exposed to vacuum; wait maximum of 5 min for sublimation (check periodically) B. If ammonia still present after 5 min, continue with operation
	SPDs	
	39. 1-in SPD spring-loaded capture point fails to install	A. Manually pivot capture point into place
	On-orbit Installed Handrails	
	40. OIH shoe will not engage in soft dock	A. Verify button depressed (shoe extended)
II. SSAS	41. Ready to Latch – fails to detect RTL	A. If camera views not adequate, EVA crew will provide visual RTL if sensors are in question
	42. Capture Latch Assembly failed closed	A. PGT[A7 9.2 ft-lb, CCW3 60 RPM, MTL 30.5]-6 ext 7/16: Drive manual override up to 60 turns B. Leave latch closed
III. SABB LAUNCH RESTRAINT	43. SABB launch restraint will not release	A. PGT[RCCW, MTL 30.5] RD TM w/5/8" PRD: Apply manual torque to fastener B. 3/8" Drive Ratchet – RD TM w/5/8" PRD: Apply ccw manual torque to fastener
IV. BETA GIMBAL LAUNCH RESTRAINT	44. Beta Gimbal launch restraint will not release	A. PGT[B7 25.5 ft-lb, CCW3 60 RPM, MTL 30.5] RD TM w/5/8" PRD: Apply torque, report release torque to MCC B. PGT[RCCW, MTL 30.5] RD TM w/5/8" PRD: Apply manual torque to fastener C. 3/8" Drive Ratchet – RD TM w/5/8" PRD: Apply ccw manual torque to fastener
V. 4-BAR LINKAGE	45. Four bar linkage does not deploy to the locked position	A. Push on 4-bar linkage until latches engage B. If required, install PRD between IEA and Beta Gimbal Assembly structure. Ratchet PRD to pull 4-bar into locked position

13A WORKAROUNDS CRIBSHEET (Cont)

Procedure	Failure	Work-Around Steps
VI. IEA KEEL PIN	46. IEA Keel Pin fastener will not release	<p>A. PGT[RCCW, MTL 30.5]-6 ext 7/16: Apply torque</p> <p>B. Ratchet wrench, 9 rigid ext 7/16: Apply torque</p> <p>C. Retrieve SQ TM w/ 7/16 PRD</p> <p>D. Ratchet wrench, SQ TM: Apply torque, 1 turn</p> <p>E. On MCC GO,</p> <div style="border: 1px solid black; padding: 5px; margin: 10px 0;"> <p style="text-align: center;">WARNING</p> <p>Sharp edge hazard, bolts have exposed threads</p> </div> <p>Remove keel pin nut plate:</p> <ol style="list-style-type: none"> 1. PGT[B1 12 ft-lb, CCW1 10 RPM, MTL 30.5]-6 ext 7/16: Drive ~14 turns 2. Release non-captive fasteners (2) and stow in trash 3. Unfasten hex nut with adjustable wrench and stow in trash 4. Translate to inboard side of keel housing and remove keel pin fastener 5. If jammed, use hammer to drive bolt out
VII. SAW	47. SABB strut locking collar does not engage after SABB unstow	<p>A. Insert SABB PIP pin when the Pivot Locking Mechanism is in BOX UNSTOWED position. Apply manual force to engage locking collar</p> <p>B. If locking sleeve is reset to the STOW position, cycle SABB to LAUNCH position and then back to the UNSTOWED position</p> <p>C. Install Locking Strut Aid</p>
	48. Mast Tip Fittings will not release	<p>A. On MCC GO, PGT[B7 25.5 ft-lb, CCW2 30 RPM, MTL 30.5]-6 ext 7/16: Apply torque, report release torque to MCC-H</p> <p>B. If free spinning nut plate:</p> <ol style="list-style-type: none"> 1. Retrieve vise grips 2. Attach vise grips to nut plate 3. Turn bolt while restraining nut plate
VIII. UTA CENTER BOLT	49. Loss of electrical connectivity between S3 and S4	<p>A. Check position of UTA center bolt Sharpie mark (Face 1 view), report position to MCC-H</p> <p>B. PGT[B2 16.0 ft-lb, CW1 10 RPM, MTL 25.5] 6 ext 7/16: Drive fastener, report torque to MCC</p>
IX. SARJ ACTIVATION	50. SARJ MLI Cover Spring Clamp Bolt will not release	<p>A. If free spinning nut plate suspected:</p> <ol style="list-style-type: none"> 1. Retrieve vise grips from Crewlock bag 2. Attach vise grips to bolt head 3. Turn bolt ccw while applying gentle pull force (do not fail bolt/retention clip)

13A WORKAROUNDS CRIBSHEET (Cont)

Procedure	Failure	Work-Around Steps
		<p>B. PGT[B7 25.5 ft-lb, CCW2 30 RPM, MTL 30.5]-6 ext 7/16: Drive bolt 1 turn only</p> <p>C. Remove spring clamp assembly and fail bolt/retention clip</p> <ol style="list-style-type: none"> 1. PGT[A3 4.8 ft-lb, CCW2 30 RPM, MTL 30.5] Drop proof tether adapter, 3/8" drive IVA socket tool stack 2. Release non-captive spring clamp 3/8" bolts/washers (x2 each) x9 turns, stow in trash bag 3. Move cover away from worksite to keep FOD clear of SARJ 4. Use vise grips to force spring clamp bolt out; potential FOD: bolt, spring, retaining clip, nut plate 5. Stow spring clamp assy and FOD in trash bag 6. Re-install MLI cover
	51. SARJ MLI Cover Inboard Bolt will not release	A. PGT[B7 25.5 ft-lb, CCW2 30 RPM, MTL 30.5]-6 ext 7/16: Drive bolt 1 turn; report release torque to MCC-H
	52. SARJ MLI Cover Inboard Bolt will not engage	A. Engage other inboard bolts. (Minimum number of bolts that must be re-installed is 2 of 4 or 3 of 6 per cover panel)
	53. SARJ Launch Lock will not release	A. Release other 3 bolts. PGT[RCCW, MTL 30.5]-6 ext 7/16: Apply manual torque to fastener
	54. SARJ Launch Restraint – retaining bolts will not release	<p>A. Retrieve SLR Torque Multiplier from A/L and cheater bar from Z1 stbd tool box.</p> <p>B. Install SLR Torque Multiplier on failed bolt</p> <p>C. PGT[B7 25.5 ft-lb, CCW2 30 RPM, MTL 30.5] MTM: Apply torque</p>
	55. SARJ Launch Restraint cannot be removed after retaining bolts released 18 turns	A. PGT[B7 25.5 ft-lb, CCW2 30 RPM, MTL 30.5]-6 ext 7/16: Drive jacking bolt maximum of 9 turns total
	56. DLA Lock Bolts 1A, 2A will not release	<p>A. PGT[B7 25.5 ft-lb, CCW2 30RPM, MTL 30.5]-6 ext 7/16: Report release torque to MCC-H</p> <p>B. PGT[RCCW, MTL 30.5]-6 ext 7/16: Break torque in manual ratchet mode</p> <p>C. Drive associated DLA Draw Bolt (1C CW or 2C CCW) 6 turns in clamp direction (moves follower arm enough to clear race ring structure during deploy), proceed with nominal procedure</p>
	57. DLA Draw Bolt 1C will not release (unable to break initial torque)	<p>A. BOLT 1A: PGT[A6 8.3 ft-lb, CCW2 30 RPM, MTL 30.5]-6 ext 7/16: Release 1 turn; re-attempt 1C</p> <p>B. If NO JOY: BOLT 1C: PGT[B7 25.5 ft-lb, CW1 10 RPM, MTL 30.5]-6 ext 7/16: Report release torque to MCC-H</p>
	58. DLA Draw Bolt 2C will not release (unable to break initial torque)	<p>A. BOLT 2A: PGT[A6 8.3 ft-lb, CCW2 30 RPM, MTL 30.5]-6 ext 7/16: Release 1 turn; re-attempt 2C</p> <p>B. If NO JOY: BOLT 2C: PGT[B7 25.5 ft-lb, CCW1 10 RPM, MTL 30.5]-6 ext 7/16: Report release torque to MCC-H</p>

13A WORKAROUNDS CRIBSHEET (Cont)

Procedure	Failure	Work-Around Steps
	59. DLA Launch Restraint Bolts 4A, 4B, 4C	A. PGT[RCCW, MTL 30.5]-6 ext 7/16: Break torque in manual ratchet mode B. Ratchet Wrench-6 ext 7/16: Break torque
IX. SARJ BRACE	60. Unable to release launch restraint bolt	A. PGT[B7 25.5 ft-lb, CCW2 30 RPM, MTL 30.5]-6 ext 7/16: Drive bolt 1 turn, report release torque to MCC
	61. Unable to re-engage launch restraint bolt	A. Secure launch restraint bolt with wire tie
	62. Unable to insert cones into cups	A. Restow SARJ brace in launch config
	63. Unable to break torque on brace cone fastener	A. PGT[B7 25.5 ft-lb, CW2 30 RPM, MTL 30.5]-6 ext 7/16: Drive fastener 1 turn, report release torque to MCC B. PGT[RCW, MTL 30.5]- 6 ext 7/16: Break torque in manual ratchet mode C. Ratchet Wrench-6 ext 7/16: Break torque
X. AJIS STRUTS	64. Unable to insert cones into cups	A. Restow AJIS Strut in launch config, installation of MLI strap not required
	65. Unable to break torque on brace cone fastener	A. PGT[B7 25.5 ft-lb, CW2 30 RPM, MTL 30.5]: Drive fastener 1 turn, report release torque to MCC
XI. SVS TARGET	66. SVS target bolt will not release	A. PGT[B7 25.5 ft-lb, CCW2 30 RPM, MTL 30.5]-6 ext 7/16: Drive bolt 1 turn B. PGT[RCCW, MTL 30.5]-6 ext 7/16: Drive bolt 1 turn
XII. REMOVE AND STOW DRAG LINK	67. Drag link fastener will not release <div style="border: 1px solid black; padding: 5px; width: fit-content; margin: 5px auto;"><p style="text-align: center;">WARNING</p><p style="text-align: center;">Nutplate rivets may break; potential sharp edges/debris</p></div>	A. Release other end then reattempt failed bolt B. PGT[B7 25.5 ft-lb, CCW2 30 RPM, MTL 30.5]-6 ext 7/16: Drive bolt 1 turn C. PGT[RCCW, MTL 30.5]-6 ext 7/16: (failure 32.3 ft-lb) Drive bolt 1 turn D. On MCC GO, Ratchet Wrench-6 ext 7/16: break torque
	68. Drag link fastener will not re-install	A. PGT[A7 9.2 ft-lb, CW2 30 RPM, MTL 30.5]: Apply torque, report torque to MCC B. If only one bolt functional, orient drag link as required to use good bolt for clevis bracket C. If NO JOY using other bolt, wire tie or tether drag link in stowage position
XIII. REMOVE/ STOW KEEL PIN	69. Nut retainer bolt is not sufficiently engaged <div style="border: 1px solid black; padding: 5px; width: fit-content; margin: 5px auto;"><p style="text-align: center;">WARNING</p><p style="text-align: center;">Bolt may shear at thread interface</p><p style="text-align: center;">Potential sharp edges and debris</p></div>	A. PGT[A2 3.8 ft-lb, CW2 30 RPM, MTL 30.5] (failure 5.4 ft-lb): Apply torque, report torque to MCC B. Use vise grips to retain nut during keel pin bolt release. Adjustable Wrench will not fit flats of nut
	70. Keel pin bolt will not release	A. Gently shake keel pin to relieve potential binding, reattempt bolt release B. PGT[B7 25.5 ft-lb, CCW2 30 RPM, MTL 30.5]: Drive bolt 1 turn, report release torque to MCC

13A WORKAROUNDS CRIBSHEET (Cont)

Procedure	Failure	Work-Around Steps
	71. Keel pin bolt is released from nut, but will not release from bracket	A. Use bolt puller (A/L toolbox 1) to free bolt from bracket
	72. Keel pin bolt will not reinstall	A. Stow keel pin bolt in keel with wire tie/tethers as necessary
XIV. PV RADIATOR	73. Cinch bolt fails to release	A. PGT[RCCW, MTL 30.5]-6 ext 7/16: Apply manual torque
XV. LAB VENT	74. H2 vent nozzle cannot be bent to fit through Lab end ring bracket	A. Remove gamah nut by hand B. Install vent nozzle through Lab end ring bracket C. Install gamah nut on feedthrough; use caution to reduce side loads during thread engagement
	75. Vent nozzle fasteners fail to release	A. PGT[B7 25.5 ft-lb, CCW2 30 RPM, MTL 30.5]: Drive bolt 1 turn. Warning: potential sharp edges if bolt fails NOTE If bolt fails during release, H2 vent can be held in place through Lab end ring bracket by compression from hose
	76. Vent nozzle fasteners cannot be reinstalled	A. Verify vent nozzle aligned with key feature on inside of end ring bracket; attempt bolt engagement by hand B. Leave nozzle in end ring bracket without bolts
XVI. GPS	77. GPS bolts will not release	A. PGT[RCCW, MTL 30.5]-6 ext 7/16: Break torque in manual ratchet mode B. Ratchet Wrench-6 ext 7/16: Break torque
	78. Unable to release antenna from soft dock	A. Rotate antenna cw (~25 deg) pull on antenna bolt flanges B. Retrieve bolt puller (A/L toolbox 1). With antenna rotated cw (~25 deg), position bolt puller close to soft dock pin to pry antenna out
XVII. ETVCG	79. FSE launch restraint bolts fails to release	A. PGT[RCCW, MTL 30.5]-6 ext 7/16: Reattempt restraint bolt release B. Ratchet Wrench-6 ext 7/16: Break torque C. On MCC GO: go to next stanchion and release
	80. Stanchion fails to slide off of FSE	A. Use EVA hammer to persuade stanchion
	81. Stanchion bolt doesn't release from launch position or drop	A. PGT[RCW, MTL 30.5]-6 ext 7/16: Break torque
	82. Stanchion bolt does not fully engage	A. Release stanchion bolt, verify alignment and reattempt B. PGT[B7 25.5 ft-lb, CW2 30 RPM, MTL 30.5]-6 ext 7/16: Reattempt stanchion bolt engage C. Remove stanchion, inspect bolt and truss interface, report to MCC

13A WORKAROUNDS CRIBSHEET (Cont)

Procedure	Failure	Work-Around Steps
	83. PGT socket comes off stanchion bolt	A. Attempt to reengage bolt B. Remove socket from PGT; engage socket on stanchion bolt, then put back on PGT C. Use ratchet wrench or torque wrench
XVIII. UCCAS	84. SARJ Brace Launch Lock bolt fails to release	A. PGT[B7 25.5 ft-lb, CCW2 30 RPM, MTL 30.5] : Drive bolt 1 turn B. PGT[RCCW, MTL 30.5] : Apply manual torque
	85. SARJ Brace cup/cone bolt fails to release	A. PGT[B7 25.5 ft-lb, CCW2 30 RPM, MTL 30.5] : Drive bolt 1 turn B. PGT[RCCW, MTL 30.5] : Apply manual torque
	86. SARJ Diagonal cup/cone bolt fails to release	A. PGT[B7 25.5 ft-lb, CCW2 30 RPM, MTL 30.5] : Drive bolt 1 turn B. PGT[RCCW, MTL 30.5] : Apply manual torque
	87. Strut cone cannot be removed from cup interface	A. Inspect for clearance between cup and cone, if reqd, PGT[A7 9.2 ft-lb, CCW2 30 RPM, MTL 30.5]-6 ext 7/16 : Release bolt to hardstop B. Wiggle brace (worked during VITT deploys) C. Retrieve hammer and tap brace
	88. Deploy bracket bolt fails to release	A. PGT[RCCW, MTL 30.5] : Apply manual torque B. Set torque wrench to 100 ft-lbs, attempt release of bolt. Stop applying force if torque wrench breaks over
	89. Yoke PIP pin will not release with less than 10 lbf	A. PGT[B7 25.5 ft-lb, CCW2 30 RPM, MTL 30.5]-6 ext 7/16 : Loosen stowage clevis bracket bolts (4) =4 turns B. Retrieve hammer, strike PIP pin in outward direction (hit it out)
	90. ADP will not release with less than 10 lbf	A. PGT[B7 25.5 ft-lb, CCW2 30 RPM, MTL 30.5]-6 ext 7/16 : Loosen stowage clevis bracket bolts (4) =4 turns B. With ADP in full open position, tap inward (engage more) with hammer. Reattempt removal
	91. Stowage bracket bolt fails to release	A. PGT[RCCW, MTL 30.5] : Apply manual torque B. Attempt release of PIP pin and ADP to free yoke, then reattempt
	92. Stowage bracket bolts will not fully torque	A. Temp stow stowage bracket; bring inside at end of task
	93. Yoke will not engage deploy clevis	A. Backout deploy clevis bolts and reattempt to engage yoke 1. PGT[RCCW, MTL 30.5]-6 ext 7/16 : Release clevis bolts (4) ~4-6 turns 2. Reattempt yoke, ADP, and PIP pin installation 3. PGT[B5 22.0 ft-lb, CW2 30 RPM, MTL 30.5]-6 ext 7/16 : Engage clevis bolts (4) to torque 4. PGT[RCW, MTL 30.5]-6 ext 7/16 : Apply final torque to clevis bolts B. If access to clevis bolts is restrictive, retrieve the torque wrench for steps A1-A4

13A WORKAROUNDS CRIBSHEET (Cont)

Procedure	Failure	Work-Around Steps
	94. PIP pin will not install	A. Open handle of ADP, reattempt PIP pin installation B. Manipulate yoke to align PIP pin holes, reattempt PIP pin installation C. Remove ADP, loosen deploy clevis bolts ~4-6 turns, reattempt installation of ADP and PIP pin
XIX. IEA MMOD SHIELD	95. Bolt fails to release	A. PGT[RCCW, MTL 30.5]-6 ext 7/16: Break torque B. Ratchet Wrench-6 ext 7/16: Break torque
XX. SASA	TBD	TBD

S1-S3 CAPTURE LATCH OVERRIDE

IV/SSRMS	EV1	EV2
<p><u>CAPTURE LATCH MANUAL DRIVE FOR FAILED OPEN CLA</u></p> <p>IV 1. First stage capture complete, GO to limp SSRMS</p> <p>MCC-H 2. Inhibit mechanism autosafing</p> <div data-bbox="222 480 669 691" style="border: 1px solid black; padding: 5px; margin: 10px 0;"> <p style="text-align: center;"><u>CAUTION</u></p> <p>Verify and maintain good communication with EV crew during manual override drive</p> <p>If SSRMS safing occurs during EVA manual drive of CLA, IV must notify EV crew to stop driving the manual override immediately to prevent SSRMS damage</p> </div> <p>IV 3. Give EV GO to continue latch closure</p> <p style="text-align: center;"><u>NOTE</u></p> <p>If less than 64 additional turns (105 total turns) before hard stop, capture latch closure not complete, go to <u>CAPTURE LATCH OVERRIDE WITH PRDs</u></p> <p>MCC-H 4. On EV GO, perform nominal MBA bolting</p>	<p><u>CAPTURE LATCH MANUAL DRIVE FOR FAILED OPEN CLA</u></p> <ol style="list-style-type: none"> 1. PGT[A6 8.3 ft-lb, CW1 10RPM, MTL 30.5]-6 ext 7/16: Drive manual override up to 42 turns to topological capture 2. On IV GO, rotate drive to hard stop (approx 85 turns, 127 total turns) 3. PGT[A6 8.3 ft-lb, CCW2 30RPM, MTL 30.5]-6 ext 7/16: Drive manual override 5 turns to final close position 4. Give IV GO for nominal MBA bolting 5. If NO JOY closing capture latch, continue with <u>CAPTURE LATCH OVERRIDE WITH PRDs</u> 	
<p><u>CAPTURE LATCH OVERRIDE WITH PRDs</u></p> <div data-bbox="222 1118 695 1312" style="border: 1px solid black; padding: 5px; margin: 10px 0;"> <p style="text-align: center;"><u>CAUTION</u></p> <p>If SSRMS safing occurs during PRD ratcheting, IV must notify crew to stop ratcheting immediately to prevent SSRMS damage</p> <p>Verify and maintain good communication with EV crew during PRD ratcheting</p> </div> <p>IV 1. First stage capture complete, GO to limp SSRMS</p>	<p><u>CAPTURE LATCH OVERRIDE WITH PRDs</u></p> <div data-bbox="835 1105 1331 1226" style="border: 1px solid black; padding: 5px; margin: 10px 0;"> <p style="text-align: center;"><u>CAUTION</u></p> <p>Do not exceed 200 lbf on EVA handrails while ratcheting with PRDs. When PRD actuating force increases sharply during bail throw, stop actuating</p> </div> <ol style="list-style-type: none"> 1. Install PRD on zenith longeron between handrails S1-3212 (outboard standoff) and S3 – 3013 (inboard standoff) with fixed end on S1 handrail 2. Pull minimum 6 inches slack in strap. Ratchet PRD snug (14 full strokes reqd) 3. Verify SSAS coarse pin engages cone 	<p><u>CAPTURE LATCH OVERRIDE WITH PRDs</u></p> <ol style="list-style-type: none"> 1. Install PRD between handrails S1-3200 (standoff by 5820) and S3 – 3000 (nadir CETA rail handrails) with fixed end on S1 handrail 2. Pull minimum 6 inches slack in strap. Ratchet PRD snug (14 full strokes reqd) 3. Verify SSAS coarse pin engages cone

S1-S3 CAPTURE LATCH OVERRIDE (Cont)

IV/SSRMS	EV1	EV2
<p>2. Give EV GO to continue ratcheting PRDs</p> <p>Locking Cap Installation:</p> <p>A. Position locking cap on bolt without engaging cap</p> <p>B. Rotate the cap ccw until the tab contacts structure</p> <p>C. Fully seat the cap onto the bolt</p> <p>If necessary to fully seat, rotate the locking cap cw up to 30 deg to align/engage the socket with the bolt head</p> <p>IV 3. On EV GO, perform nominal MBA bolting</p> <p><u>CONTINGENCY BOLT REMOVE</u></p> <p>IV 1. When MBA bolting complete and as assembly time permits, perform <u>CONTINGENCY BOLT REMOVE</u></p>	<p>4. On IV GO, ratchet PRD until trusses fully seated (0.5 inch bulkhead clearance) or PRD actuating force increases sharply during PRD bail throw</p> <p>5. Install contingency bolt 1B, DO NOT PRELOAD</p> <p>6. PGT[A7 9.2ft-lb, CW2 30RPM, MTL 30.5]-7.8 ext 5/8: If required, use RAD: Drive contingency bolt 1B (zenith) until bolt head seated</p> <p>7. DO NOT PRELOAD. Install and drive contingency bolt 2B (zenith CETA rail) until bolt head seated</p> <div style="border: 1px solid black; padding: 5px; text-align: center;"> <p>CAUTION Structural damage may occur if PRD tension is not released prior to preloading EVA contingency bolts</p> </div> <p>8. Release PRD and temp stow</p> <p>9. PGT[B7 25.5 ft-lb, CW2 30RPM, MTL 30.5]-7.8 ext 5/8: If required, use RAD: Drive contingency bolt 1B to torque</p> <p>10. PGT[RCW MTL 30.5]-7.8 ext 5/8: Ratchet contingency bolt 1B to torque</p> <p>11. Install locking cap onto bolt head</p> <p>12. PGT[B7 25.5 ft-lb, CW2 30 RPM, MTL 30.5]-7.8 ext 5/8: Drive contingency bolt 2B to torque</p> <p>13. PGT[RCW MTL 30.5]-7.8 ext 5/8: Ratchet contingency bolt 2B to torque</p> <p>14. Install locking cap onto bolt head</p> <p>15. Give IV GO to perform nominal MBA bolting</p> <p><u>CONTINGENCY BOLT REMOVE</u></p> <p>1. Remove locking cap from 1B bolt head</p> <p>2. PGT[B7 25.5 ft-lb, CCW2 30RPM, MTL 30.5]-7.8 ext 5/8: If required, use RAD: Drive contingency bolt 1B, remove and stow</p> <p>3. Remove locking cap from 2B bolt head</p> <p>4. Drive contingency bolt 2B, remove and stow</p>	<p>4. On IV GO, ratchet PRD until trusses fully seated (0.5 inch bulkhead clearance) or PRD actuating force increases sharply during PRD bail throw</p> <p>5. Install contingency bolt 3B, DO NOT PRELOAD</p> <p>6. PGT[A7 9.2 ft-lb, CW2 30RPM, MTL 30.5]-7.8 ext 5/8: If required, use RAD: Drive contingency bolt 3B (nadir CETA rail)) until bolt head seated</p> <p>7. DO NOT PRELOAD. Install and drive contingency bolt 4B (nadir) until bolt head seated</p> <p>8. Release PRD and temp stow</p> <p>9. PGT[B7 25.5 ft-lb, CW2 30RPM, MTL 30.5]-7.8 ext 5/8: If required, use RAD: Drive contingency bolt 3B to torque</p> <p>10. PGT[RCW MTL 30.5]-7.8 ext 5/8: Ratchet contingency bolt 3B to torque</p> <p>11. Install locking cap onto bolt head</p> <p>12. PGT[B7 25.5 ft-lb, CW2 30 RPM, MTL 30.5]-7.8 ext 5/8: Drive contingency bolt 4B to torque</p> <p>13. PGT[RCW MTL 30.5]-7.8 ext 5/8: Ratchet contingency bolt 4B to torque</p> <p>14. Install locking cap onto bolt head</p> <p>15. Give IV GO to perform nominal MBA bolting</p> <p><u>CONTINGENCY BOLT REMOVE</u></p> <p>1. Remove locking cap from 3B bolt head</p> <p>2. PGT[B7 25.5 ft-lb, CCW2 30RPM, MTL 30.5]-7.8 ext 5/8: If required, use RAD: Drive contingency bolt 3B, remove and stow</p> <p>3. Remove locking cap from 4B bolt head</p> <p>4. Drive contingency bolt 4B, remove and stow</p>

S1-S3 CAPTURE LATCH OVERRIDE – TASK DATA

Tools:

EV1	EV2
PGT	PGT
6 Ext 7/16	7.8 Ext 5/8
7.8 Ext 5/8	RAD
RAD	PRD
PRD	APFR (if required)
APFR (if required)	Contingency Bolts (2)
Contingency Bolts (2)	

EVA Fasteners:

Fastener Name	Label	Head Size	Qty	Install Torque (ft-lb)	Max Break Away Torque (ft-lb)	Failure Torque (ft-lb)	Turns	RPM
Manual Capture Latch Override bolt	Capture Latch EVA Override	7/16	1	8.3	3.3	14.6	127	10
Contingency Bolt at Trunion Longeron	1A, 1B, 4A, 4B	5/8	4	47.9	NA	60.8	43	30
Contingency Bolt at Zenith MT rail	2A, 2B	5/8	2	47.9	NA	83.3	43	30
Contingency Bolt at Nadir MT rail	3A, 3B	5/8	2	55.8	NA	145.8	43	30

EVA Connectors:

Harness	From	To	Clamps (#)	Conn Size	Function
NA					

Foot Restraints:

Task	WIF	APFR Setting
Aft-zenith position (MBA 1)	S1-31	(12,00,F,12)
Fwd-zenith position (MBA 2)	None	
Fwd-nadir position (MBA 3)	S3-05*	(11,00,F,12)*
Aft-nadir position (MBA 4)	S1-32	(12,00,F,12)

*Only a viable option if all other three MBAs are already installed

Mass: NA

Notes:

1. During the Capture Latch Override steps, the "B" bolts are used to avoid having to remove thermal covers. The "A" bolts are acceptable if the crewmember believes they have better access to them
2. There is no APFR worksite for MBA corner 2 (zenith CETA rail corner)
3. The APFR worksite for MBA corner 3 (nadir CETA rail corner) is only available if all other three MBAs are already installed

Cautions:

1. IV and SSRMS operator must maintain good communication with EV crew for the duration of the capture latch override task. If SSRMS safing occurs during the task, IV must notify EV crew to stop driving the manual override or ratcheting the PRDs immediately to prevent SSRMS damage
2. Do not exceed 200 lbf on EVA handrails while ratcheting with PRDs. When PRD actuating force increased sharply during bail throw, stop actuating
3. Structural damage may occur if PRD tension is not released prior to preloading EVA contingency bolts

Warnings:

None

S1-S3 CAPTURE LATCH OVERRIDE – TASK DATA (Cont)

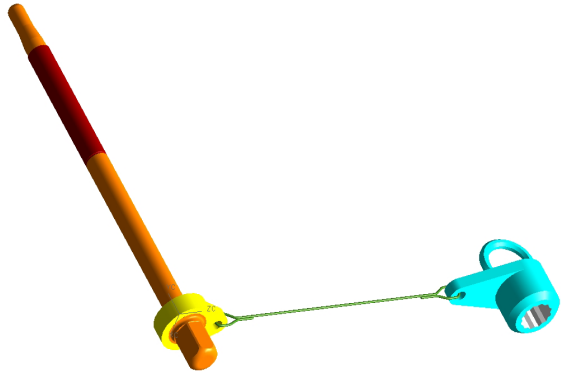

SSAS Contingency Bolt

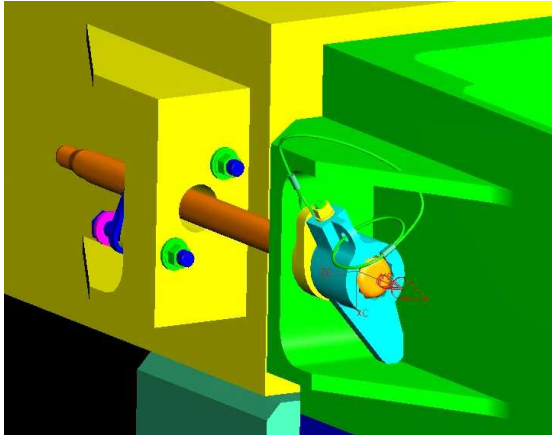

SSAS Contingency Bolt Installed



P1 Capture Latch and Capture Latch Manual Drive

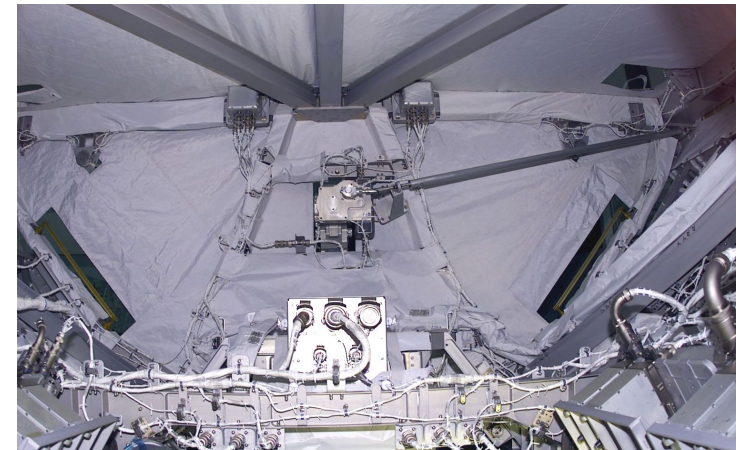

S1 Bay 15 – Internal view of CLA Mechanism

S1-S3 CAPTURE LATCH OVERRIDE – TASK DATA (Cont)

Hook PRD to S1 Handrail 3212 (outboard standoff)

Hook PRD to S3 Handrail 3013 (inboard standoff)

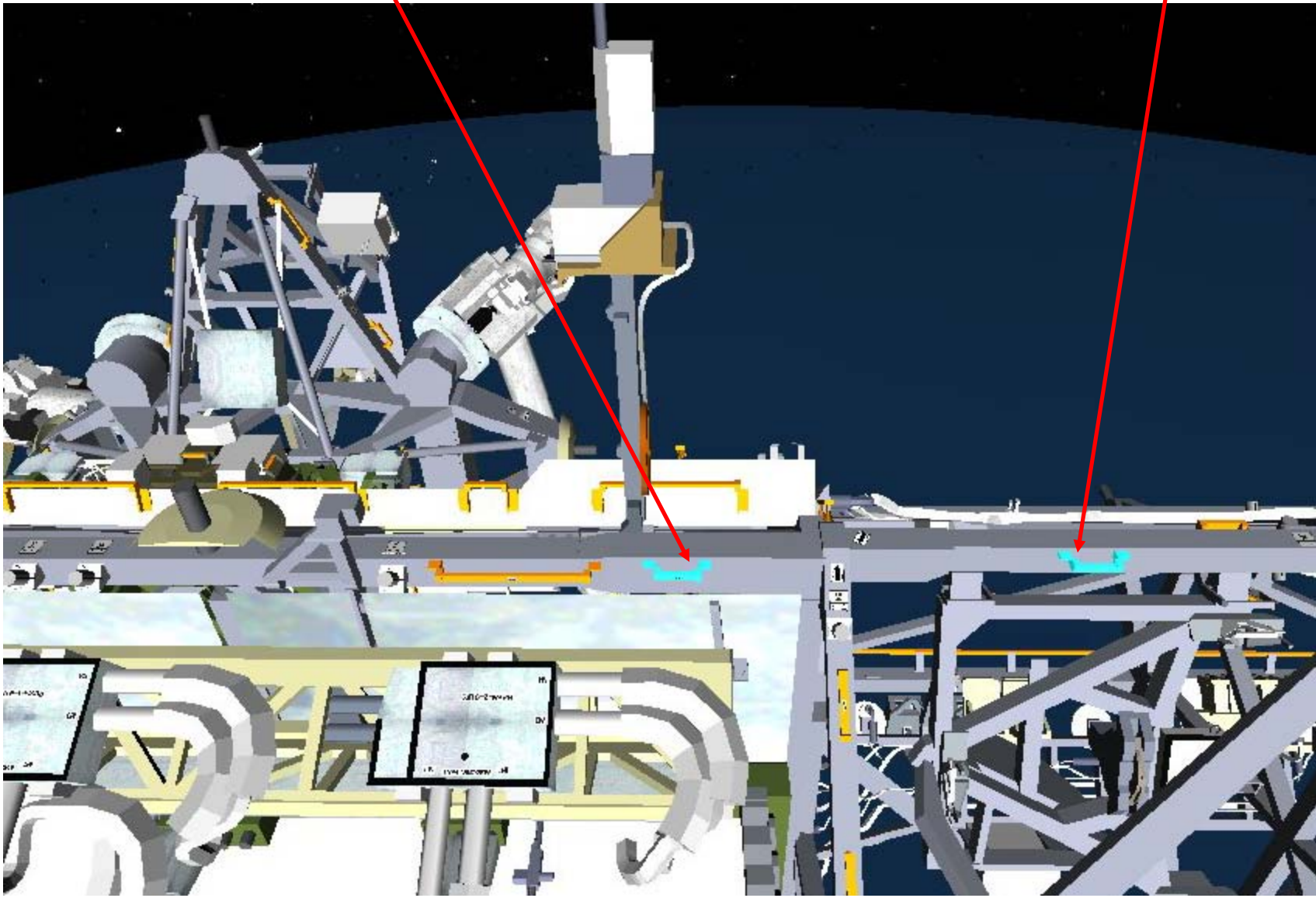

S1-S3 CAPTURE LATCH OVERRIDE – TASK DATA (Cont)

Hook PRD to S3 Handrail 3000

Hook PRD to S1 Handrail 3200 (standoff by 5820)

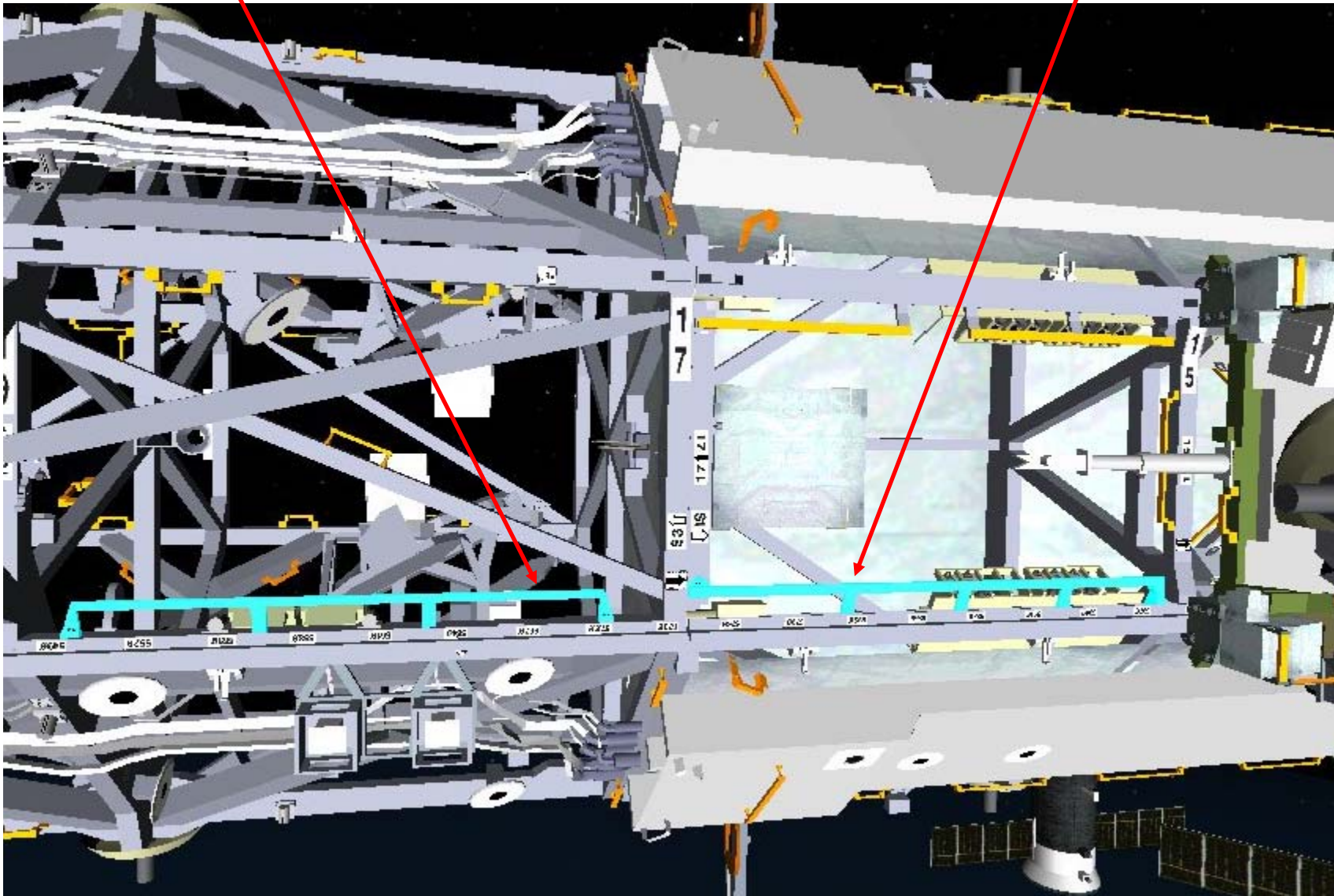

S1-S3 MBA BOLT OVERRIDE

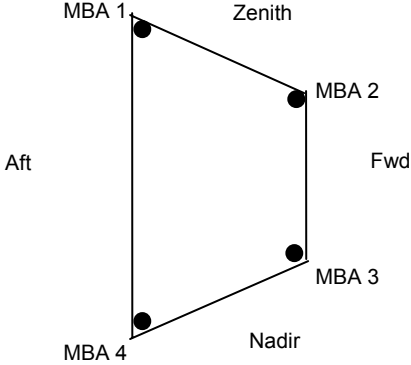
IV/RMS	EV1	EV2
<p>MBA locations which require <u>MBA MOTOR FAILURE</u> steps: _____, _____, _____, _____</p> <p>IV 1. Verify with MCC that the MBA gear train is at or above minimum temperature</p> <p>IV 2. Check for bolt tight switch "closed". If YES, bolting complete, stop PGT torque</p> <p>MBA locations which require <u>DUAL BBC FAILURE</u> steps: _____, _____, _____, _____</p> <p>Locking cap installation:</p> <ol style="list-style-type: none"> 1. Position locking cap on bolt without engaging cap 2. Rotate the cap ccw until the tab contacts structure 3. Fully seat the cap onto the bolt <p>If necessary to fully seat, rotate the locking cap cw up to 30 deg to align/engage the socket with the bolt head</p>	<p><u>MBA MOTOR FAILURE</u></p> <p style="text-align: center;"><u>NOTE</u></p> <p>MBA 1 and 2 override bolts are driven cw. MBA 3 and 4 override bolts are driven ccw</p> <div style="border: 1px solid black; padding: 5px; margin: 10px 0;"> <p style="text-align: center;"><u>CAUTION</u></p> <p>To prevent excessive preload, EV and IV crewmember will need to coordinate driving MBA override bolt in order to stop PGT torque when bolt tight switch (BTS) indication received</p> </div> <p>For each failed MBA:</p> <ol style="list-style-type: none"> 1. PGT[A6 8.3 ft-lb, CW3(CCW3) 60 RPM, MTL 30.5]-6 ext 7/16: Drive MBA override bolt approx 460 turns 2. If NO bolt tight switch closing, continue with procedure 3. Increase PGT torque incrementally starting with A7 9.2 ft-lb up to B3 18.4 ft-lb, drive MBA override bolt to torque, have IV check for bolt tight switch "closed" after each torque setting 4. If NO bolt tight switch "closed" at 18.4 ft-lb, install x2 SSAS contingency bolts at this MBA location per <u>SSAS CONTINGENCY BOLT INSTALL</u> <p><u>DUAL BBC FAILURE</u></p> <p style="text-align: center;"><u>NOTE</u></p> <p>MBA 1 and 2 override bolts are driven cw. MBA 3 and 4 override bolts are driven ccw</p> <p>For each failed MBA, perform the following steps (in order of MBA 3, 1, 2, 4):</p> <ol style="list-style-type: none"> 1. Install one contingency bolt (either A or B location) 2. PGT[B7 25.5 ft-lb, CW2 30 RPM, MTL 30.5]-7.8 ext 5/8: If required, use RAD: Drive contingency bolt to torque 3. PGT[RCW, MTL 30.5]-7.8 ext 5/8: Ratchet contingency bolt to torque 4. Drive failed MBA override bolt approx 460 turns: <ul style="list-style-type: none"> <input type="checkbox"/> MBA 3 & 4: PGT[A7 9.2 ft-lb, CCW3 60 RPM, MTL 30.5]-6 ext 7/16 <input type="checkbox"/> MBA 1 & 2: PGT[B1 12.0 ft-lb, CW3 60 RPM, MTL 30.5]-6 ext 7/16 	 <p>MBA Override Bolt</p>  <p>The diagram shows a quadrilateral representing the MBA locations. MBA 1 is at the top-left corner, MBA 2 is at the top-right corner, MBA 3 is at the bottom-right corner, and MBA 4 is at the bottom-left corner. The directions are labeled: Zenith (top), Nadir (bottom), Aft (left), and Fwd (right).</p>

S1-S3 MBA BOLT OVERRIDE (Cont)

IV/RMS	EV1	EV2
<p>Record final MBA torque and turns:</p> <p>MBA 3 _____ ft-lb _____ turns</p> <p>MBA 1 _____ ft-lb _____ turns</p> <p>MBA 2 _____ ft-lb _____ turns</p> <p>MBA 4 _____ ft-lb _____ turns</p>	<p>5. PGT[RCCW, MTL 30.5]-7.8 ext 5/8: Ratchet contingency bolt to break torque</p> <p>6. PGT[B7 25.5 ft-lb, CCW2 30 RPM, MTL 30.5]-7.8 ext 5/8: If required, use RAD: Drive contingency bolt and remove bolt</p>	

S1-S3 MBA BOLT OVERRIDE – TASK DATA

Tools:

EV1	EV2
PGT	PGT
6 Ext 7/16	6 Ext 7/16
7.8 Ext 5/8	7.8 Ext 5/8
APFR (if required)	APFR (if required)

EVA Fasteners:

Fastener Name	Label	Head Size	Qty	Install Torque (ft-lb)	Max Break Away Torque (ft-lb)	Failure Torque (ft-lb)	Turns	RPM
S1 MBA 1 Override bolt	Motorized Bolt 1 EVA Override	7/16	1	12.0	<2	20.3 (Note 3)	460	60
S1 MBA 2 Override bolt	Motorized Bolt 2 EVA Override	7/16	1	12.0	<2	21.3 (Note 3)	460	60
S1 MBA 3 Override bolt	Motorized Bolt 3 EVA Override	7/16	1	9.2	<2	17.7 (Note 3)	460	60
S1 MBA 4 Override bolt	Motorized Bolt 4 EVA Override	7/16	1	9.2	<2	16.8 (Note 3)	460	60
Contingency Bolt at Trunnion Longeron	1A, 1B, 4A, 4B	5/8	4	47.9	NA	60.8	43	30
Contingency Bolt at Zenith MT Rail	2A, 2B	5/8	2	47.9	NA	83.3	43	30
Contingency Bolt at Nadir MT Rail	3A, 3B	5/8	2	55.8	NA	145.8	43	30

EVA Connectors:

Harness	From	To	Clamps (#)	Conn Size	Function
NA					

Foot Restraints:

Task	WIF	APFR Setting
Aft-zenith position (MBA 1)	S1-31	(12,00,F,12)
Fwd-zenith position (MBA 2)	None	
Fwd-nadir position (MBA 3)	S3-05*	(11,00,F,12)*
Aft-nadir position (MBA 4)	S1-32	(12,00,F,12)

*Only a viable option if all other three MBAs are already installed

Mass: NA

Notes:

- For the S1 MBAs: MBA 1 and 2 override bolts are driven cw
MBA 3 and 4 override bolts are driven ccw
- For a MBA motor failure, it is assumed that the bolt tight switches will provide an indication. If the max torque is reached without a bolt tight switch, the MBA can be declared failed. Consequently, the EVA crewmember will need to install two contingency bolts
- For MBA motor failure, the failure torque for each MBA is 26.3 ft-lb (higher value because the sensor can measure torque better than the PGT can)
- For the Dual BBC failure case, a contingency bolt is used to seat the cup/cone. The Dual BBC failure case is treated as a non-instrumented bolt and installation is defined by torque and use turns as a secondary indicator
- There is no APFR worksite for MBA corner 2 (zenith CETA rail corner)
- The APFR worksite for MBA corner 3 (nadir CETA rail corner) is only available if all other three MBAs are already installed

Cautions:

- To prevent excessive preload, EV and IV crewmember will need to coordinate driving MBA override bolt in order to stop PGT torque when bolt tight switch (BTS) indication received (within 4 sec)

Warnings:

None

S1-S3 MBA BOLT OVERRIDE – TASK DATA (Cont)

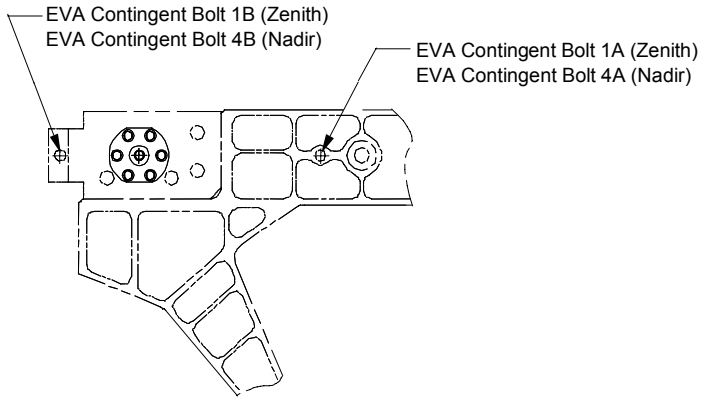

S1/S3 Trunnion Locations (Aft)

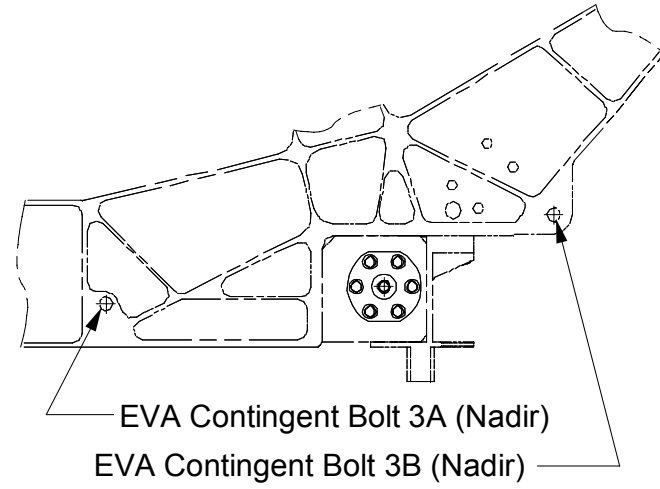

S1/S3 NADIR MT Rail Location (Fwd)

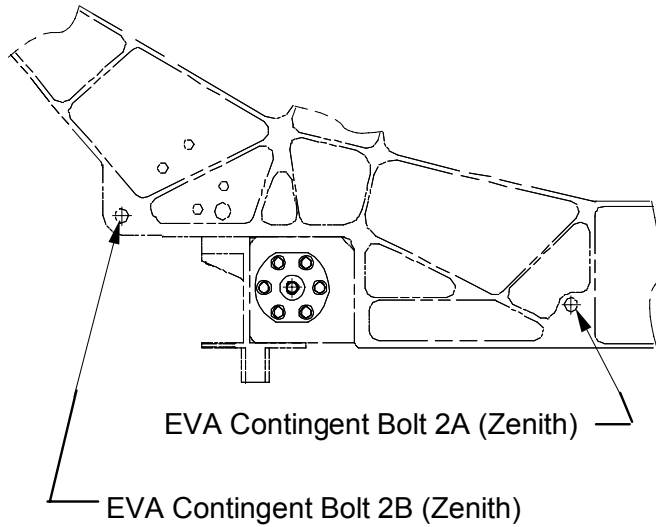

S1/S3 ZENITH MT Rail Location (Fwd)

S1-S3 SSAS CONTINGENCY BOLT INSTALL

IV/RMS	EV
<p>Locking cap installation:</p> <ol style="list-style-type: none"> 1. Position locking cap on bolt without engaging cap 2. Rotate the cap ccw until the tab contacts structure 3. Fully seat the cap onto the bolt <p>If necessary to fully seat, rotate the locking cap cw up to 30 deg to align/engage the socket with the bolt head</p> <p style="text-align: center;"><u>NOTE</u></p> <p>To maintain required torque tolerances, the EVA torque wrench must be kept in its bag when not in use</p>	<p><u>SSAS CONTINGENCY BOLT INSTALLATION</u></p> <p><u>ZENITH AND NADIR TRUNNION LONGERON LOCATIONS (MBA 1 AND 4)</u></p> <ol style="list-style-type: none"> 1. PGT[B5 22.0 ft-lb, CW2 30RPM, MTL 30.5]-7.8 ext 5/8: If required, use RAD: Install contingency bolt A and drive bolt to torque 2. PGT[B7 25.5 ft-lb, CW2 30RPM, MTL 30.5]-7.8 ext 5/8: If required, use RAD: Install contingency bolt B and drive bolt to torque 3. Torque Wrench 34 ft-lb-7.8 ext 5/8: Drive contingency bolt B to torque 4. Torque Wrench 45 ft-lb-7.8 ext 5/8: Drive contingency bolt A to torque 5. Torque Wrench 45 ft-lb-7.8 ext 5/8: Drive contingency bolt B to torque 6. Install locking caps <p><u>ZENITH MT RAIL LOCATION (MBA 2)</u></p> <ol style="list-style-type: none"> 1. PGT[B6 24.0 ft-lb, CW2 30RPM, MTL 30.5]-7.8 ext 5/8: If required, use RAD: Install contingency bolt 2A and drive bolt to torque 2. PGT[B7 25.5 ft-lb, CW2 30RPM, MTL 30.5]-7.8 ext 5/8: If required, use RAD: Install contingency bolt 2B and drive bolt to torque 3. Torque Wrench 48 ft-lb-7.8 ext 5/8: Drive contingency bolt 2B to torque 4. Torque Wrench 48 ft-lb-7.8 ext 5/8: Drive contingency bolt 2A to torque 5. Install locking caps <p><u>NADIR MT RAIL LOCATION (MBA 3)</u></p> <ol style="list-style-type: none"> 1. PGT[B7 25.5 ft-lb, CW2 30RPM, MTL 30.5]-7.8 ext 5/8: If required, use RAD: Install contingency bolt 3A and drive bolt to torque 2. Torque Wrench 28 ft-lb-7.8 ext 5/8: Drive contingency bolt 3A to torque 3. PGT[B7 25.5 ft-lb, CW2 30RPM, MTL 30.5]-7.8 ext 5/8: If required, use RAD: Install contingency bolt 3B and drive bolt to torque 4. Torque Wrench 56 ft-lb-7.8 ext 5/8: Drive contingency bolt 3B to torque 5. Torque Wrench 56 ft-lb-7.8 ext 5/8: Drive contingency bolt 3A to torque 6. Install locking caps

S1-S3 SSAS CONTINGENCY BOLT INSTALL – TASK DATA

Tools:

EV1	EV2
PGT	NA
7.8 Ext 5/8	
RAD (if required)	
APFR (if required)	

EVA Fasteners:

Fastener Name	Label	Head Size	Qty	Install Torque (ft-lb)	Max Break Away Torque (ft-lb)	Failure Torque (ft-lb)	Turns	RPM
Contingency Bolt at Trunion Longeron	1A, 1B, 4A, 4B	5/8	4	47.9	NA	60.8	43	30
Contingency Bolt at Zenith MT rail	2A, 2B	5/8	2	47.9	NA	83.3	43	30
Contingency Bolt at Nadir MT rail	3A, 3B	5/8	2	55.8	NA	145.8	43	30

EVA Connectors:

Harness	From	To	Clamps (#)	Conn Size	Function
NA					

Foot Restraints:

Task	WIF	APFR Setting
Aft-zenith position (MBA 1)	S1-31	(12,OO,F,12)
Fwd-zenith position (MBA 2)	None	
Fwd-nadir position (MBA 3)	S3-05*	(11, OO,F,12)*
Aft-nadir position (MBA 4)	S1-32	(12,OO,F,12)

*Only a viable option if all other three MBAs are already installed

Mass: NA

Notes:

1. To maintain required torque tolerances, the EVA torque wrench must be kept in its bag when not in use
2. There is no APFR worksite for MBA corner 2 (zenith CETA rail corner)
3. The APFR worksite for MBA corner 3 (nadir CETA rail corner) is only available if all other three MBAs are already installed

Cautions:

None

Warnings:

None

MANUAL OVERRIDE TO UNLATCH/LATCH (TENSION) SABB

IV/RMS	EV
<p>Identify Affected Power Channel XX = _____</p> <p><u>IF UNLATCHING SABB</u></p> <p>MCC-H 1. Perform {3.190 SAW XX FAILURE TO UNLATCH SABB REMOTELY} (SODF: EPS: MALFUNCTION: PRIMARY POWER)</p> <p>IV 2. GO for EV crew ingress at worksite</p> <p><u>IF TENSIONING SABB</u></p> <p>MCC-H 1. Perform {3.193 SAW XX FAILURE TO LATCH (TENSION) SABB REMOTELY} SODF: EPS: MALFUNCTION: PRIMARY POWER)</p> <p>THEN:</p> <p>IV 2. If required (see Task Data notes) – Verify affected SABB positioned over the IEA and BGA latched</p> <p>PCS PVM: EPS: BGA XX BGA XX 'ECU XX' Verify: Integ Cnt – Incrementing</p> <p>'BGA XX' Verify: Actual Angle, deg = 270.000 (± 0.5) (Left SABB) OR Actual Angle, deg = 90.000 (± 0.5) (Right SABB)</p> <p>Motor State – OFF Latch 1 Pin Status – Latched</p> <p>IV 3. GO for EV crew ingress at worksite</p> <p style="text-align: center;"><u>NOTE</u></p> <p>Free Drift or CMG Control with Thrusters Disabled is required while SABB is being unlatched/latched. Applies only while mechanisms are in motion</p> <p>MCC-H 4. Configure ISS/Orbiter attitude control to CMG Control with thrusters disabled</p> <p>IV 5. When task complete, give MCC-H GO to resume nominal attitude control</p>	<div style="border: 3px double black; padding: 5px; margin-bottom: 10px;"> <p style="text-align: center;"><u>WARNING</u></p> <p>Sharp edge/pinch point/entrapment hazard – Avoid contact with outboard underside of SABB due to exposed reels, guide-wire and tension mechanisms</p> <p style="text-align: center;">Avoid contact with blanket box latches during manual override operation</p> </div> <div style="border: 1px solid black; padding: 5px; margin-bottom: 10px;"> <p style="text-align: center;"><u>CAUTION</u></p> <p>Maintain a constant push force (3-10 lb) on the MDA fastener anti-rotation collar during fastener rotation</p> </div> <p><u>MANUAL OVERRIDE TO UNLATCH SABB</u></p> <ol style="list-style-type: none"> 1. On IV GO (see IV column, Unlatching SABB, step 2) – Enter worksite area 2. If required – APFR, setup and ingress (see Task Data for WIF position, APFR settings, and BGA angle) 3. Release PIP pin from back-up position lever 4. Move override lever to MANUAL position 5. Insert PIP pin into lock lever position 6. PGT[A6 8.3 ft-lb, CCW2 30 RPM, MTL 30.5]-2 ext 7/16: Push to engage MDA drive fastener (3-10 lb), apply torque, 48 ± 1 turns until visual indication of latch position or hard stop 7. Release PIP pin from override positioning lever 8. Move override lever to AUTOMATIC position 9. Insert PIP pin into lock lever position 10. PGT[RCCW, MTL 30.5]-2 ext 7/16: Push to engage MDA drive fastener (3-10 lb), apply torque, ¼ turn to engage clutch pins <p><u>MANUAL OVERRIDE TO tensioning SABB</u></p> <ol style="list-style-type: none"> 1. On IV GO (see IV column, Tensioning SABB, step 3) – Enter worksite area 2. If required – APFR, setup and ingress (see Task Data for WIF position, APFR settings, and BGA angle) 3. Release PIP pin from back-up position lever 4. Move override lever to MANUAL position 5. Insert PIP pin into lock lever position 6. PGT[A6 8.3 ft-lb, CW2 30 RPM, MTL 30.5]-2 ext 7/16: Push to engage MDA drive fastener (3-10 lb), apply torque, 48 ± 1 turns until visual indication of latch position or hard stop. The latches along the blanket box are visible and will move to the engaged position 7. Release PIP pin from override positioning lever 8. Move override lever to AUTOMATIC position 9. Insert PIP pin into lock lever position 10. PGT[RCW, MTL 30.5]-2 ext 7/16: Push to engage MDA drive fastener (3-10 lb), apply torque, ¼ turn to engage clutch pins

MANUAL OVERRIDE TO UNLATCH/LATCH (TENSION) SABB – TASK DATA

Estimated Task Duration:

	With RMS	Without RMS
One EV Crew	NA	0:30
Two EV Crew	NA	NA

Tools:

EV1	EV2
PGT	NA
2 Ext 7/16	

EVA Fasteners:

Fastener Name	Label	Head Size	Qty	Install Torque (ft-lb)	Max Break Away Torque (ft-lb)	Failure Torque (ft-lb)	Turns	RPM
SABB MDA Fastener	Yes	7/16	1 per	NA	7.5	12	48	30

EVA Connectors:

Harness	From	To	Clamps (#)	Conn Size	Function
NA					

Foot Restraints:

Task	WIF	APFR Setting	BGA Angle
IEA Non-keel side – Right SABB	P4/S4-26; P6/S6-38	(12,FF,F,3)	90
IEA Non-keel side – Left SABB	P4/S4-26; P6/S6-38	(12,FF,E,9)	270
IEA Keel side – Right SABB	P4/S4-25; P6/S6-37	(12,FF,F,3)	90
IEA Keel side – Left SABB	P4/S4-25; P6/S6-37	(12,FF,E,9)	270

Mass: NA

Notes:

1. It has been demonstrated in the NBL that the EVA crewmember can access the SABB Manual Override Fastener from a free floating position on the mast canister. If the EVA crew thinks they can actuate the SABB Manual Override Fastener from a free floating position on the mast canister, there is no need to position the BGA per IV step 2
2. Free Drift or CMG Control with Thrusters Disabled is required while SABB is being unlatched/latched. Applies only while mechanisms are in motion

Cautions:

1. Equipment damage – Maintain a constant push force (3-10 lb) on the MDA fastener anti-rotation collar during fastener rotation. Damage to the locking collar and/or the fastener could result if the collar is allowed to extend during fastener rotation
2. Equipment damage – Avoid contact with blanket box latches and mechanisms on underside of blanket box

Warnings:

1. Sharp edge/pinch point/entrapment hazard – Avoid contact with outboard underside of SABB due to exposed reels, guide-wire and tension mechanisms
2. Moving equipment. Avoid contact with blanket box latches during manual override operation

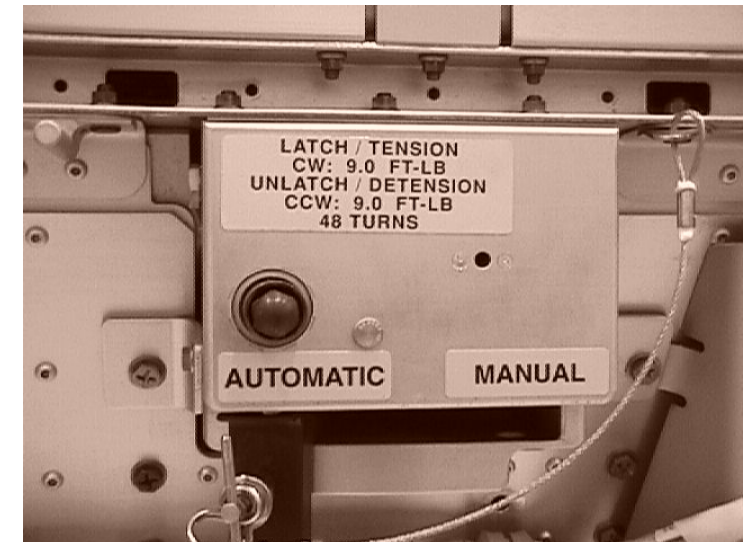

SABB MDA

MANUAL RELEASE OF SABB RESTRAINT PINS

IV	EV
<ol style="list-style-type: none"> 1. Position applicable BGA to angle per Task Data page 2. Secure BGA 3. Give EV crew GO to enter worksite 	<div style="border: 2px solid black; padding: 5px; margin-bottom: 10px;"> <p style="text-align: center;"><u>WARNING</u></p> <p>Sharp edge/pinch point/entrapment hazard: Avoid contact with outboard underside of SABB due to exposed reels, guide-wire and tension mechanisms</p> <p>Collision hazard: BRS Pin will extend ~1 inch from bottom of box when fired. Keep EMU and tools out of this area</p> </div> <div style="border: 1px solid black; padding: 5px; margin-bottom: 10px;"> <p style="text-align: center;"><u>CAUTION</u></p> <p>Actuation of BRS trigger with probe tool should not require excessive force. Application of excessive force may damage the BRS pin tool</p> </div> <ol style="list-style-type: none"> 1. Set up and ingress APFR (see Task Data page) 2. Induce sharp rap(s) to side of BRS pin housing with the hammer to release 3. If no joy, use the BRS pin release tool to actuate the trigger in the direction indicated by the arrow

MANUAL RELEASE OF SABB RESTRAINT PINS – TASK DATA

Estimated Task Duration:

	With RMS	Without RMS
One EV Crew	NA	1:00
Two EV Crew	NA	NA

Tools:

EV1	EV2
APFR	N/A
Ingress aid	
BRS Pin Contingency Tool	
Hammer	

EVA Fasteners:

Fastener Name	Label	Head Size	Qty	Install Torque (ft-lb)	Release Torque (ft-lb)	Failure Torque (ft-lb)	Turns	RPM
N/A								

EVA Connectors:

Harness	From	To	Clamps (#)	Conn Size	Function
NA					

Foot Restraints, Right SABB settings are in ():

IEA Side	Task	WIF	APFR Setting	BGA Angle
Non-Keel	Left (Right) SABB BRS Pin #1	S4-26, S6-38	12,FF,F,1 (6,FF,G,3)	284 (53)
	Left (Right) SABB BRS Pin #2	S4-26, S6-38	12,FF,F,9 (12,FF,G,3)	265 (78)
	Left (Right) SABB BRS Pin #3	S4-15, S6-27	10,FF,D,9 (9,FF,G,4)	281 (90)
	Left (Right) SABB BRS Pin #4	S4-15, S6-23	3,FF,F,8 (9,GG,G,3)	281 (90)
	Left (Right) SABB BRS Pin #5	S4-15, S6-27	3,FF,F,8 (3,GG,G,3)	281 (90)
	Left (Right) SABB BRS Pin #6	S4-11, S6-23	5,II,F,6 (7,FF,E,10)	281 (95)
	Left (Right) SABB BRS Pin #7	S4-11, S6-23	9,JJ,E,7 (7,KK,F,5)	281 (101)
Keel	Left (Right) SABB BRS Pin #1	S4-25, S6-37	12,FF,F,1 (6,FF,G,3)	284 (53)
	Left (Right) SABB BRS Pin #2	S4-25, S6-37	12,FF,F,9 (12,FF,G,3)	265 (78)
	Left (Right) SABB BRS Pin #3	S4-13, S6-25	10,FF,D,9 (9,FF,G,4)	281 (90)
	Left (Right) SABB BRS Pin #4	S4-13, S6-21	3,FF,F,8 (9,GG,G,3)	281 (90)
	Left (Right) SABB BRS Pin #5	S4-13, S6-27	3,FF,F,8 (3,GG,G,3)	281 (90)
	Left (Right) SABB BRS Pin #6	S4-09, S6-21	5,II,F,6 (7,FF,E,10)	281 (95)
	Left (Right) SABB BRS Pin #7	S4-09, S6-21	9,JJ,E,7 (7,KK,F,5)	281 (101)

Notes:

- When the trigger is actuated, the slider will slide down and lock the trigger in the actuated position. If the slider has moved down, the BRS pin may be have not fired due to solar array panel side loads
- If trigger/slider is not in actuated position, trigger must be actuated manually with probe tool
- Arrows (←) indicate direction of trigger actuation
- All triggers are on the MDA side of BRS pin
- Pin 3 is a blind operation, and pins 4, 5 require bending metal for access
- Some APFR settings have a body position that is rather close to the lower blanket box; in these instances, the ingress aid may be used to control body positioning to avoid hitting the helmet against the SABB

Cautions:

- Actuation of BRS trigger with probe tool should not require excessive force. Application of excessive force may damage the BRS pin tool

Warnings:

- Sharp edge/pinch point/entrapment hazard: Avoid contact with outboard underside of SABB due to exposed reels, guide-wire and tension mechanisms
- Collision hazard: BRS Pin will extend ~1 inch from bottom of box when fired. Keep EMU and tools out of this area

MANUAL RELEASE OF SABB RESTRAINT PINS – TASK DATA (Cont)

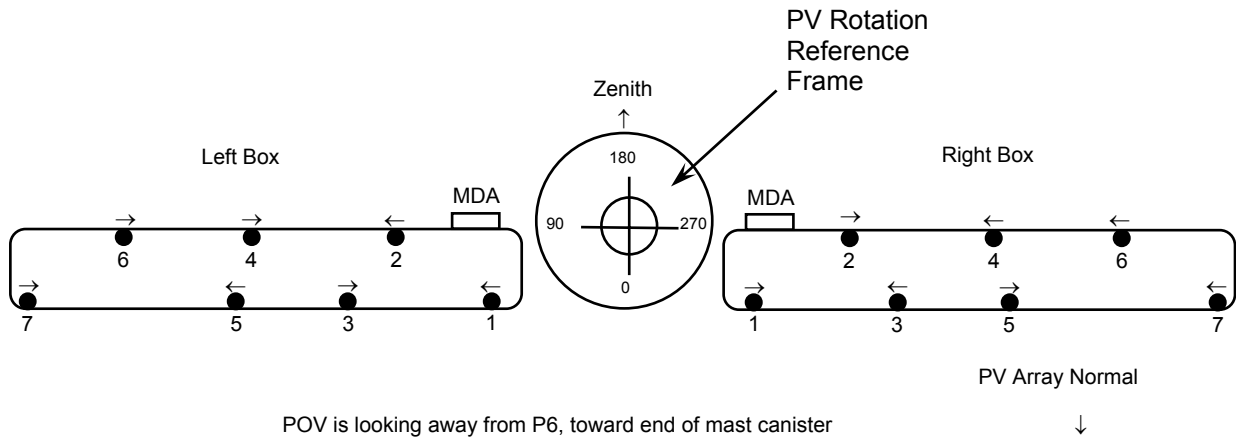
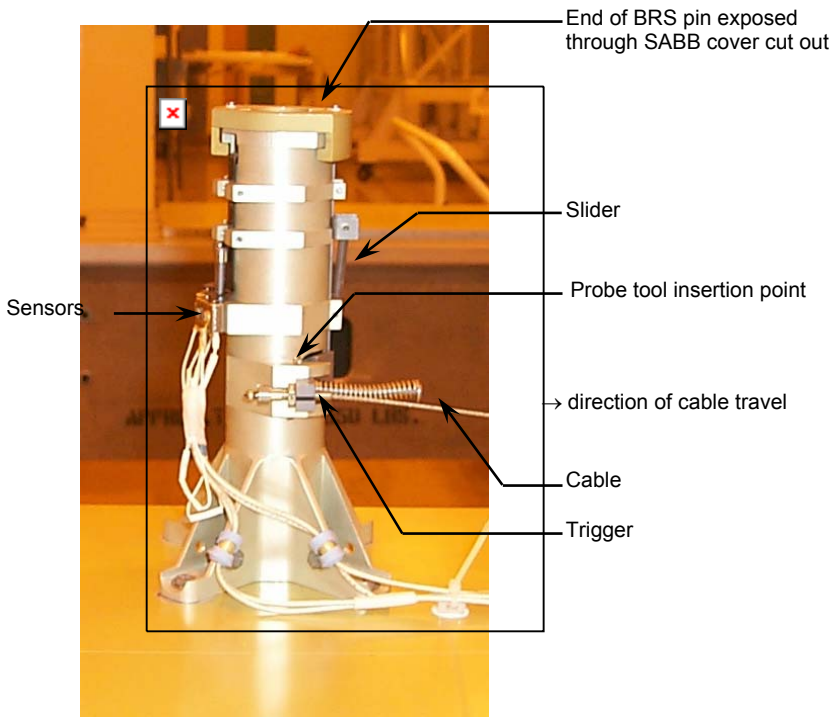

MANUAL OVERRIDE TO EXTEND/RETRACT MAST

IV	EV
<p>Identify Affected Power Channel XX = _____</p> <p>MCC-H 1. Perform {3.191 SAW XX FAILURE TO EXTEND MAST REMOTELY} (SODF: EPS: MALFUNCTION : PRIMARY POWER)</p> <p>OR</p> <p>Perform {3.192 SAW XX FAILURE TO RETRACT MAST REMOTELY} (SODF: EPS: MALFUNCTION: PRIMARY POWER)</p> <p>IV PCS 2. Verify affected SABB positioned over the IEA and BGA latched PVM: EPS: BGA XX BGA XX 'ECU XX' Verify: Integ Cnt – Incrementing</p> <p>'BGA XX' Verify: Actual Angle, deg = 180.000 (+/- 0.5) Motor State – OFF Latch 1 Pin Status – Latched</p> <p>IV 3. GO FOR EV CREW INGRESS AT WORKSITE</p> <p><u>NOTE</u> Free Drift or CMG Control with Thrusters Disabled is required while solar array is being deployed/retracted. Applies only while mechanisms are in motion</p> <p>MCC-H 4. Configure ISS/Orbiter attitude control to CMG Control with thrusters disabled</p> <p>MCC-H 5. On EV GO (see EV column, Extend Mast, step 7), place solar array blanket boxes in high tension, when complete, give EV GO to continue SAW deployment</p>	<div style="border: 2px solid black; padding: 5px; margin-bottom: 10px;"> <p style="text-align: center;"><u>WARNING</u></p> <p>Sharp edge/pinch point/entrapment hazard – Avoid contact with outboard underside of SABB due to exposed reels, guide-wire and tension mechanisms</p> <p>Avoid contact with blanket box latches during manual override operation</p> </div> <p style="text-align: center;"><u>MANUAL OVERRIDE TO EXTEND MAST</u></p> <div style="border: 1px solid black; padding: 5px; margin-bottom: 10px;"> <p style="text-align: center;"><u>CAUTION</u></p> <p>If excessive blanket panel "stiction" occurs during mast deployment, perform contingency incremental deployment</p> </div> <ol style="list-style-type: none"> 1. On IV GO (see IV column, step 3) – Enter worksite area 2. Set up and ingress APFR (see Task Data page) 3. Deploy MCHD PGT swing arm, install MCHD onto mast canister, zip nuts (4) 4. PGT[A5 7.0 ft-lb, CW2 30RPM, MTL 30.5]-2 ext 7/16: Secure MCHD fasteners (4) to hardstop 5. Ratchet -2 ext 7/16: Rotate Manual Override Actuator Shaft on left side of MDA 180 deg to disengage MDA, indicator – MANUAL 6. Place PGT in MCHD PGT swing arm <div style="border: 1px solid black; padding: 5px; margin-bottom: 10px;"> <p style="text-align: center;"><u>CAUTION</u></p> <p>Crew must monitor the tension bar. Stop SAW deployment if the tension bar rises more than 1.5 inches from the sill. PGT[A4 6.3 ft-lb, CW3 60 RPM, MTL 30.5]-2 ext 7/16: drive MDA EVA override fastener until tension bar returns to 1.5 inches from the sill. When panels release and tension bar returns to the sill, deployment can continue</p> </div> <p style="text-align: center;"><u>NOTE</u></p> <p>Insolation is not required for this task, unless needed for visual abort cues. As expected, the tension bar will rise 18 to 20 inches from the sill as the last half mast bay is deployed.</p> <p>Extension complete when: Visual observation of the last mast bay visual indicators (black/white, cross hatched). Hard stop, sharp rise in tool torque</p> <ol style="list-style-type: none"> 7. PGT[A7 9.2 ft-lb, CCW3 60 RPM, MTL 30.5]-2 ext 7/16: Drive MDA EVA override fastener until 1 mast bay is deployed (~ 78 turns), give MCC-H GO to place solar array blanket boxes in high tension 8. On MCC-H GO (see IV column, step 5), PGT[A7 9.2 ft-lb, CCW3 60RPM, MTL 30.5]-2 ext 7/16: Drive MDA EVA override fastener 2382 turns (x1 PGT battery will actuate approx 1300 turns), PGT battery changeout expected

MANUAL OVERRIDE TO EXTEND/RETRACT MAST (Cont)

IV	EV
<p>MCC-H 6. On EV GO – resume nominal attitude control</p>	<ol style="list-style-type: none"> 9. While holding the PGT – 2 ext 7/16 on the backup drive fastener, Ratchet – 2 ext 7/16 – rotate Manual Override Actuator Shaft 180 to disengage MDA, indicator – AUTOMATIC 10. Give MCC-H GO to resume nominal attitude control 11. Egress worksite, leave MCHD on mast canister <p><u>MANUAL OVERRIDE TO RETRACT MAST</u></p> <ol style="list-style-type: none"> 1. On IV GO (see IV column, step 3) – Enter worksite area 2. Set up and ingress APFR (see Task Data page) 3. Deploy MCHD PGT swing arm, install MCHD onto mast canister, zip nuts (4) 4. PGT[A5 7.0 ft-lb, CW2 30RPM, MTL 30.5]-2 ext 7/16: Secure MCHD fasteners (4) to hardstop 5. Ratchet -2 ext 7/16: Rotate Manual Override Actuator Shaft on left side of MDA 180 deg to disengage MDA, indicator – MANUAL 6. Place PGT in MCHD PGT swing arm 7. PGT[A7 9.2 ft-lb, CW3 60 RPM, MTL 30.5]-2 ext 7/16: Drive MDA EVA override fastener 2460 turns (x1 PGT battery will actuate approx 1300 turns), PGT battery changeout expected 8. While holding the PGT -2 ext 7/16 on the backup drive fastener, Ratchet -2 ext 7/16 – rotate Manual Override Actuator Shaft 180 to disengage MDA, indicator – AUTOMATIC 9. Give MCC-H GO to resume nominal attitude control 10. Egress worksite, leave MCHD on mast canister

MANUAL OVERRIDE TO EXTEND/RETRACT MAST – TASK DATA

Estimated Task Duration:

	With RMS	Without RMS
One EV Crew	NA	2:00
Two EV Crew	NA	NA

Tools:

EV1	EV2
PGT with 2 Ext 7/16	NA
Ratchet wrench with 2 Ext 7/16	
MCHD	
APFR	

EVA Fasteners:

Fastener Name	Label	Head Size	Qty	Install Torque (ft-lb)	Max Break Away Torque (ft-lb)	Failure Torque (ft-lb)	Turns	RPM
MCHD Fasteners	NA	7/16	4	7.0	8.1	11.0 (L) 12.2 (R)	Zip	10
Mast Canister Manual Override Actuator Shaft	Yes	7/16	2 per	NA	2.5	10	0.5	10
Mast Canister MDA Fastener	Yes	7/16	1 per	NA	9.0	19.3	2461	60

EVA Connectors:

Harness	From	To	Clamps (#)	Conn Size	Function
NA					

Foot Restraints:

Task	WIF	APFR Setting
IEA Keel Side	P6/S6-37, P4/S4-25	(12,FF,F,12)
IEA Non-keel side	P6/S6-38, P4/S4-26	(12,FF,F,12)

Mass: NA

Notes:

- Insulation is not required for this task, unless needed for visual abort cues. As expected, the tension bar will rise 18 to 20 inches from the sill as the last half mast bay is deployed
- Extension complete when: Visual observation of the last mast bay visual indicators (black/white, cross hatched). Hard stop, sharp rise in tool torque
- The mast canister needs to be positioned such that the MDA faces the direction of the IEA. This will allow an EV crewmember to set up an APFR to access the MDA
- In order to release MCHD fasteners from zipnuts, inward force on each bolt must be minimized

Cautions:

- Crew must monitor the tension bar. Stop SAW deployment if the tension bar rises more than 1.5 inches from the sill. Drive MDA EVA override fastener until tension bar returns to 1.5 inches from the sill. When panels release and tension bar returns to the sill, deployment can continue
- Equipment damage – Avoid contact with blanket box latches and mechanisms on underside of blanket box
- If monitoring IVA notes excessive blanket panel "stiction", during mast deployment, abort deployment. Coordinate with IVA to perform contingency incremental deploy. Not applicable for retraction

Warnings:

- Sharp edge/pinch point/entrapment hazard – Avoid contact with outboard underside of SABB due to exposed reels, guide-wire and tension mechanisms
- Moving equipment. Avoid contact with blanket box latches during manual override operation



Mast Canister MDA

SABB SPOOL RE-TENSION

IV/RMS	EV1	EV2
<p>Identify Affected Power Channel XX = _____</p> <p>Which SABB needs re-tensioning _____</p> <p>Which Tension Reel needs re-tensioning _____</p> <p>IV 1. Retract Affected SAW approx 1 mast bay only if Mast is fully deployed</p> <p>PCS PVM: EPS: SAW XX <div style="border: 1px solid black; padding: 2px;">SAW</div> 'Mast' sel Mast Commands</p> <p><div style="border: 1px solid black; padding: 2px;">SAW XX Mast</div></p> <p>cmd Mast – Retract Arm cmd Mast – Retract</p> <p>Wait approx 20 sec (~ 1 bay) cmd Mast – Abort</p> <p>√MDA Voltage, V < 10 (± 2.8)</p> <p>2. Unlatch affected SABB. If required: Perform {1.3.450 SAW XX SABB INITIAL UNLATCH} (SODF: EPS: ACTIVATION AND CHECKOUT: CHANNEL ACTIVATION), step 2 for LBB or step 3 for RBB (<u>NOTE</u>: BRS Pin visual checks can be ignored)</p> <p>MCC-H 3. Position and safe SAW for Tension Reel Task. Perform {2.101 PVM BGA XX ENGAGE ANTIROTATION LATCH} (SODF: EPS: NOMINAL: PRIMARY POWER), using the following values:</p> <p>If Right SABB (Inboard Reel) BGA XX Cmded Angle = 80.000 deg BGA XX Latch Select = 1 If Right SABB (Outboard Reel) BGA XX Cmded Angle = 93.000 deg BGA XX Latch Select = If Left SABB (Inboard Reel) BGA XX Cmded Angle = 285.000 deg BGA XX Latch Select = 2 If Left SABB (Outboard Reel) BGA XX Cmded Angle = 283.000 deg BGA XX Latch Select = 1</p>	<div style="border: 3px double black; padding: 5px; margin-bottom: 10px;"> <p style="text-align: center;"><u>WARNING</u></p> <p>Moving equipment hazard. Stay clear of SABB and capture latch mechanisms</p> <hr/> <p>Moving equipment hazard. Avoid contact with mast canister/beta gimbal during rotation of SAW</p> <hr/> <p>Sharp edges: Pulley shroud at machined edges Guide wire mechanism cover at machined edges Guide wire mechanism Guide wire pulley Guide wire Top flange of blanket box Protrusions (4) on tension reel housing</p> </div> <p><u>TENSION REEL TASK SETUP</u></p> <ol style="list-style-type: none"> Translate to S3 Set up APFR (see Task Data page) Ingress APFR 	<div style="border: 3px double black; padding: 5px; margin-bottom: 10px;"> <p style="text-align: center;"><u>WARNING</u></p> <p>Moving equipment hazard. Stay clear of SABB and capture latch mechanisms</p> <hr/> <p>Moving equipment hazard. Avoid contact with mast canister/beta gimbal during rotation of SAW</p> <hr/> <p>Sharp edges: Pulley shroud at machined edges Guide wire mechanism cover at machined edges Guide wire mechanism Guide wire pulley Guide wire Top flange of blanket box Protrusions (4) on tension reel housing</p> </div> <p><u>TENSION REEL TASK SETUP</u></p> <ol style="list-style-type: none"> Translate to S3 Set up APFR (see Task Data page) Ingress APFR using EV 1 ingress aid or EV 1 for assistance

SABB SPOOL RE-TENSION (Cont)

IV/RMS	EV1	EV2
<p>IV 4. SSRMS: SSRMS RECONFIGURATION FOR EVA SUPPORT (SODF: ROBO PROCEDURE REFERENCE)</p> <p>5. SRMS: SRMS RECONFIGURATION FOR EVA SUPPORT (FDF: PDRS PROCEDURE REFERENCE)</p> <p style="text-align: center;"><u>NOTE</u></p> <p>Free Drift or CMG Control with Thrusters Disabled is required while the EV crewmembers are handling the cable</p> <p>MCC-H 6. Configure ISS/Orbiter attitude control to CMG control with thrusters disabled</p> <p>IV 7. When task complete, give MCC-H GO to resume nominal attitude control</p>	<p><u>INSTALL CABLE ON OUTBOARD REEL</u></p> <p>1. Assist EV2 with cable as required</p> <p style="text-align: center;"><u>NOTE</u></p> <p>The reel will rotate a fraction of a turn without resistance. Some uneven tension and binding may be initially detected as internal mechanism seats. The 2.5 turn count begins when this minimal rotational resistance (approx 2-6 lb) is encountered. The tension reel housing will self tend back to initial position. Hand guidance is required to control rate</p> <p>2. Rotate tension reel ccw by hand approx 2.5-2.75 turns to hard stop</p> <p style="text-align: center;"><u>NOTE</u></p> <p>EV1 acts as the "clutch" on reel in case EV2 lets go. Tension reel housing will self tend back to initial position. Hand guidance is required to control rate of motion</p> <p>3. Maintain reel and help tend cable during EV2 alignment</p> <p>4. Inspect final cable routing on tension reel groves, through pulley, and clear of blanket box fasteners</p> <p>5. Take closeout photos</p> <p>6. Egress APFR</p> <p><u>INSTALL CABLE ON INBOARD REEL</u></p> <p>1. Set up APFR (see Task Data page)</p> <p>2. Ingress APFR</p> <p>3. Repeat <u>INSTALL CABLE ON OUTBOARD REEL</u> for the SABB inboard reel</p> <p>4. Give IV GO for solar array deploy</p>	<p><u>INSTALL CABLE ON OUTBOARD REEL</u></p> <p style="text-align: center;"><u>NOTE</u></p> <p>Pull cable on bottom side of blanket box running between pulley and tension reel. There will be approx 2 ft of cable slack. The tension bar will be pulled into position against blanket box</p> <p>1. Using the loop pin puller, pull slack on tension cable by pulling cable through pulley using light force (expect 5-10 lb pull force. If force is high, contact MCC)</p> <p>2. Align cable through pulley</p> <p>3. Maintain cable tension during reel rotation using loop pin puller</p> <p>4. Feed cable onto reel using loop pin puller as reel rotates back cw under it's own spring power</p> <p>5. Remove loop pin puller</p> <p>6. Egress APFR</p> <p><u>INSTALL CABLE ON INBOARD REEL</u></p> <p>1. Set up APFR (see Task Data page)</p> <p>2. Ingress APFR using EV1 ingress aid or EV1 for assistance</p> <p>3. Repeat <u>INSTALL CABLE ON OUTBOARD REEL</u> for the SABB inboard reel</p>

SABB SPOOL RE-TENSION (Cont)

IV/RMS	EV1	EV2
<p>MCC-H 8. Return SAW/BGA to Deploy Position. If required: Perform {2.101 PVM BGA XX ENGAGE ANTIROTATION LATCH} (SODF: EPS: NOMINAL: PRIMARY POWER)</p> <p>IV 9. Return to Nominal SAW Deploy Camera configuration (Truss Cameras, PLB Cameras, etc)</p> <p>10. SSRMS: SSRMS RECONFIGURATION FOR SAW VIEWING (SODF: ROBO PROCEDURE REFERENCE)</p> <p>11. SRMS: SRMS RECONFIGURATION FOR SAW VIEWING (FDF: PDRS PROCEDURE REFERENCE)</p> <p>MCC-H 12. Re-Latch (Tension) Affected SABB If required: Perform {1.3.452 SAW XX DEPLOY} (SODF: EPS: ACTIVATION AND CHECKOUT: CHANNEL ACTIVATION) step 13 for LBB, or step 14 for RBB</p>	<p>IF REQUIRED:</p> <p><u>TENSION REEL JAM CONTINGENCY</u></p> <ol style="list-style-type: none"> 1. If no rotational resistance or no hard stop (free spinning), call MCC 2. If excessive force (> 6 lb) or mechanism jam is encountered, go to <u>INSTALL CABLE ON INBOARD REEL</u> 3. EV guide tension reel back into initial position 4. IV Cycle SABB Latches. Perform {4.118 SAW XX RETRACT} (SODF: EPS: CORRECTIVE: PRIMARY POWER) steps 12 (13) for Unlatch OR steps 18 (19) for Latch 5. EV attempt outboard tension reel rotation 6. If smooth reel rotation, go to <u>INSTALL CABLE ON OUTBOARD REEL</u>, EV2, step 1 7. If jam or resistance encountered, repeat steps 4 and 5 8. If no joy, call MCC 	

SABB SPOOL RE-TENSION – TASK DATA

Estimated Task Duration:

	With RMS	Without RMS
One EV Crew	NA	NA
Two EV Crew	NA	1:00

Tools:

EV1	EV2
APFR	APFR
Ingress aid	Loop pin puller

EVA Fasteners:

Fastener Name	Label	Head Size	Qty	Install Torque (ft-lb)	Release Torque (ft-lb)	Failure Torque (ft-lb)	Turns	RPM
N/A								

EVA Connectors:

Harness	From	To	Clamps (#)	Conn Size	Function
NA					

Foot Restraints:

Task	WIF	APFR Setting	BGA Angle
IEA Non-keel side – SABB Outboard Reel EV1 access	P4/S4-11, P6/S6-23	(12, HH, F, 6)	283, 93
IEA Non-keel side – SABB Outboard Reel EV2 access	P4/S4-15, P6/S6-27	(10, HH, G, 1)	283, 93
IEA Non-keel side – SABB Inboard Reel EV1 access	P4/S4-26, P6/S6-38	(1, FF, F, 2)	285, 80
IEA Non-keel side – SABB Inboard Reel EV2 access	P4/S4-19, P6/S6-31	(5, GG, F, 7)	285, 80
IEA Keel side – SABB Outboard Reel EV1 access	P4/S4-09, P6/S6-21	(12, HH, F, 6)	283, 93
IEA Keel side – SABB Outboard Reel EV2 access	P4/S4-13, P6/S6-25	(10, HH, G, 1)	283, 93
IEA Keel side – SABB Inboard Reel EV1 access	P4/S4-25, P6/S6-37	(1, FF, F, 2)	285, 80
IEA Keel side – SABB Inboard Reel EV2 access	P4/S4-17, P6/S6-29	(5, GG, F, 7)	285, 80

Notes:

1. SABB Outboard Reel does not have a pulley shroud
2. Combination wrenches may be used if the tension reel fails to take up the tension cable slack

Cautions:

1. Equipment damage – Beware of close proximity to blanket box during ingress. Visually inspect cables prior to handling for fraying or jamming on structure or nearby cables
2. Do not allow uncontrolled CW rotation of tension reel
3. Do not manually wrap cable on reel housing

Warnings:

1. Sharp edges:
 - Pulley shroud at machined edges
 - Guide wire mechanism cover at machined edges
 - Guide wire mechanism
 - Guide wire pulley
 - Guide wire
 - Top flange of blanket box
 - Protrusions (4) on tension reel housing
2. Moving equipment hazard. Stay clear of SABB and capture latch mechanisms
3. Moving equipment hazard. Avoid contact with mast canister/beta gimbal during rotation of SAW

SABB SPOOL RE-TENSION – TASK DATA (Cont)

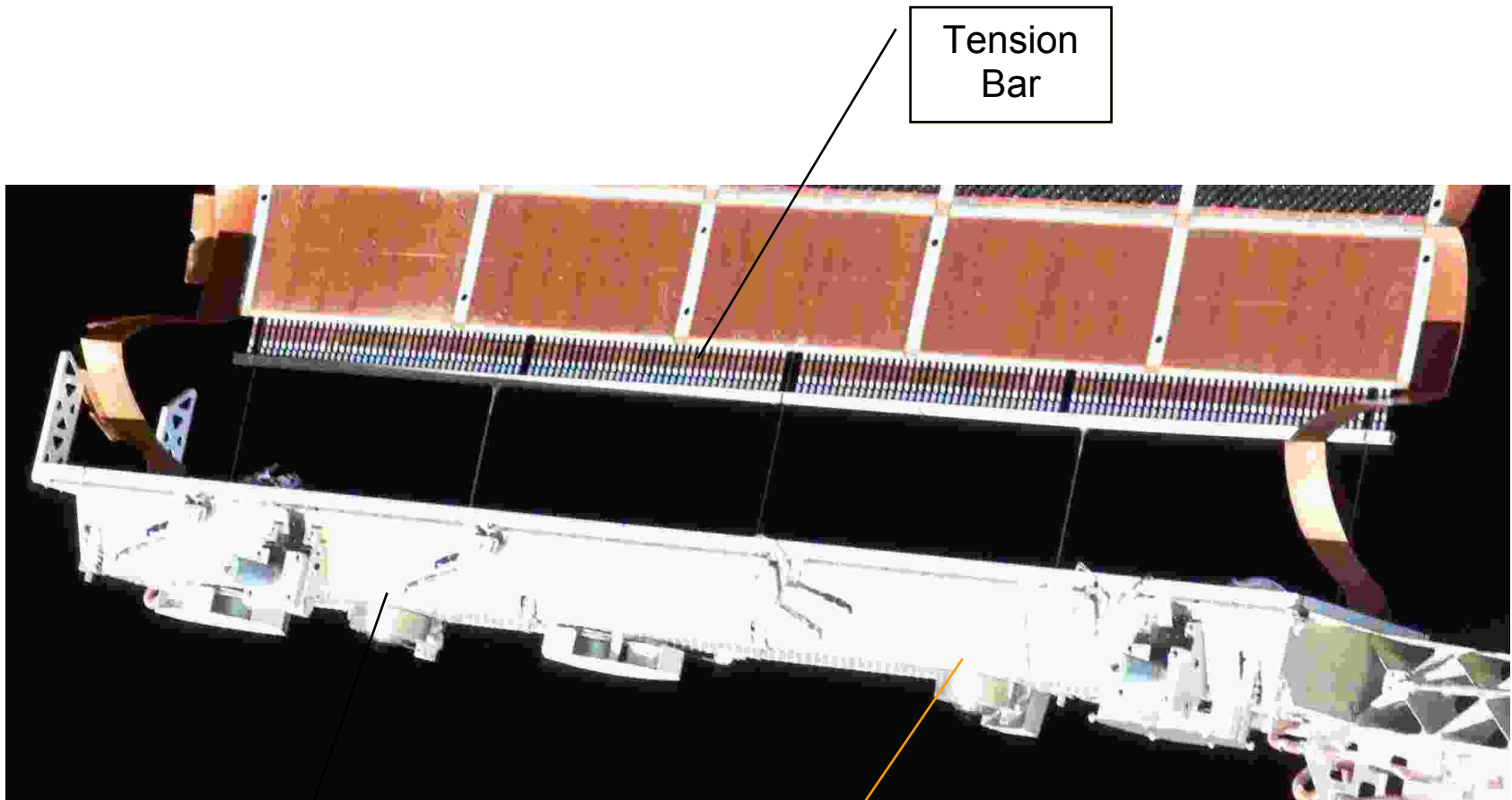

Tension
Bar

Outboard
TM

Inboard
TM

NOTE
No markings on these TMs.
Tension Bar in fully extended position

SABB SPOOL RE-TENSION – TASK DATA (Cont)



SABB Tensioning Reel Outboard

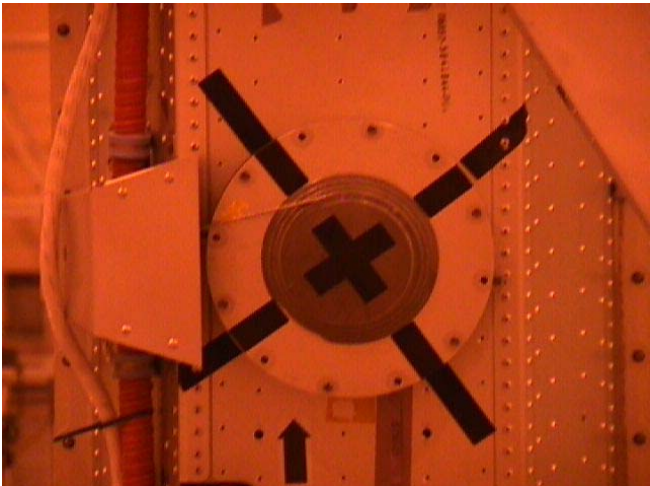

SABB Tensioning Reel Inboard

EVA ASSISTED DEPLOYMENT OF S4 SAW

IV/RMS	EV
<p>1. Retract SAW mast to one bay</p> <p>MCC-H 2. Position and safe SAW from rotation during EVA, Perform {2.101 PVM BGA XX ENGAGE ANTIROTATION LATCH} (SODF: EPS: NOMINAL: PRIMARY POWER), using the following values: BGA XX Cmded Angle = 0 deg BGA XX Latch Select = 1</p> <p>IV 3. Verify affected SABB positioned over the IEA and BGA latched PCS PVM: EPS: BGA XX BGA XX 'ECU XX' Verify: Integ Cnt – Incrementing</p> <p>'BGA XX' Verify: Actual Angle, deg = 0.000 (+/- 0.5) Motor State – OFF Latch 1 Pin Status – Latched</p> <p>MCC-H 4. Give GO for EV crew to setup at worksite</p> <p>5. Shunt SSU, inform EVA crew when complete</p>	<div style="border: 3px double black; padding: 5px; margin-bottom: 10px;"> <p style="text-align: center;"><u>WARNING</u></p> <p>Beta gimbal assembly must be LOCKED prior to the EVA crewmember entering the worksite and during the task</p> <hr/> <p>Due to potential electrical arcing hazard, the EVA crew must execute this task ONLY when the SSU is shunted, the mast is retracted to one bay, EVA crewmember helmet light is on spot only, and only during orbital eclipse</p> <hr/> <p>Due to potential electrical arcing hazard, avoid touching damage areas of FCC in order to avoid being exposed to SAW voltage</p> <hr/> <p>Sharp edge/pinch point/entrapment hazard – avoid contact with the mast, panels (other than the FCC strips), and blanket boxes</p> </div> <ol style="list-style-type: none"> 1. On MCC GO – Enter worksite area 2. Set up WIF Extender and APFR (see Task Data page) 3. Upon eclipse, set helmet light to spot light, verify 4. Ingress APFR 5. Identify sticky panels 6. Grasp FCC strip perpendicular to FCC fold and at least 1 inch from fold in FCC 7. Peel sticky panels away from each other in the direction of the hinge opening, to the first panel stiffener 8. Repeat steps 5 thru 7 until complete 9. Egress worksite, notify MCC when clear of the mast canister 10. Repeat steps 1 thru 9 for other SAW if required

EVA ASSISTED DEPLOYMENT OF S4 SAW – TASK DATA

Estimated Task Duration:

	With RMS	Without RMS
One EV Crew	NA	2:30 (both SABBs)
Two EV Crew	NA	NA

Tools:

EV1	EV2 (If required)
APFR	
WIF Extender	
APFR Ingress Aid (if required)	

EVA Fasteners:

Fastener Name	Label	Head Size	Qty	Install Torque (ft-lb)	Release Torque (ft-lb)	Failure Torque (ft-lb)	Turns	RPM
NA								

EVA Connectors:

Harness	From	To	Clamps (#)	Conn Size	Function
NA					

Foot Restraints:

Task	WIF	WIF Extender	APFR Setting
IEA Keel Side Right SABB	P6/S6-37, P4/S4-25	12, G, 7	12, PP, F, 5
IEA Keel Side Left SABB	P6/S6-37, P4/S4-25	2, G, 7	12, NN, F, 6
IEA Non-keel side Right SABB	P6/S6-38, P4/S4-26	12, G, 7	12, PP, F, 5
IEA Non-keel side Left SABB	P6/S6-38, P4/S4-26	2, G, 7	12, NN, F, 6

Mass: NA

Notes:

1. The mast canister needs to be positioned in the launch position (beta gimbal angle = 0) in order for the EVA crewmember to access both SABBs if required. Other beta gimbal angles may allow the EVA crewmember to access a single SABB
2. EVA crewmember does not need to separate the entire solar array panel. The intent is separate enough of the panel adhesion such that the tension of deployment will separate any additional adhesion

Cautions:

1. The solar array panels and blanket box should not be grasped due to load constraints. In particular, avoid contact with blanket box latches and mechanisms on underside of blanket box
2. Avoid using the outboard SABB FCC to separate the panels. Inadvertent loads into the outboard portion of the blanket box could compromise the functionality of the SAW
3. The FCC fold edge is the most likely area to be damaged. Crew should not handle the FCC within 1 inch of the fold in the FCC to prevent pinching the circuitry. Normal handling of FCC should not result in damage to FCC
4. Stop exerting loads into the foot restraint if the load alleviator trips. The EVA crewmember should be pay additional attention to loads exerted while in the APFR/WIF Extender. It will be easier to trip the load alleviator due to the crewmembers distance from structure

Warnings:

1. Beta gimbal assembly must be LOCKED prior to the EVA crewmember enter the worksite and during the EVA task
2. Due to potential electrical arcing hazard, the EVA crew must execute this task ONLY when the SSU is shunted, the mast is retracted to one bay, during orbital elipse, and with only the EMU spot light on
3. Due to potential electrical arcing hazard, avoid touching damage areas of FCC in order to avoid being exposed to SAW voltage
4. Sharp edge/pinch point/puncture/entrapment hazard – Avoid contact with the mast, panels (other than the FCC strips), and blanket boxes. The following are specific sharp edges or puncture hazards:
 - SABB panel hinge pins
 - SABB skirts
 - SABB swing bolts
 - Potential panel broken cells
 - Electrical connector fastener exposed threads
 - Tension bar springs
 - Guide wire cables
 - Mast canister stiffener ring fasteners exposed threads
 - Mast canister roller guides
 - Mast canister braided cables

EVA ASSISTED DEPLOYMENT OF S4 SAW – TASK DATA (Cont)



IEA Non Keel side – EVA crew access to right SABB



IEA Non Keel side – EVA crew access to left SABB



Grasping the SAW panel FCC



Separating the SAW panel FCC

SSRMS JOINT DRIVE

CAUTION



Avoid contact with:

1. ACU radiator surface: silver Teflon film (white in color).
2. CLA and CLPA radiator surface: silver Teflon film (white in color).
3. VDU radiator surface: silver Teflon film (white in color).
4. JEU radiator surface: Z93 paint.

NOTE

1. Gear ratio: 3.26 EVA Drive turns/1 degree of joint movement.
2. CW input to the EVA drive will produce CCW motion of the joint.
3. Starting from LEE, the order of the joints: roll, yaw, pitch.
4. The signs of the logical (indicated on RWS or PCS) and physical (indicated on EVA scale) angles are reversed for the shoulder roll, shoulder yaw, and wrist roll joint (i.e., +73.2 logical = -73.2 physical) regardless of which end is base.
5. Scale and Ambiguity Switch
 - Since the SSRMS joints can be rotated more than 360 degrees, there is an ambiguity switch that tells the crewmember whether to use the positive or negative scale.
 - The crew reads the scale using the black triangle on the fixed side of the joint. Located to the side of the black triangle (~90 degrees around the circumference of the joint) is the ambiguity switch. The switch has a pointer that indicates "+" or "-" to tell the crew which side of the scale to read. If the ambiguity switch points to "+" then the crew should read off the yellow scale (black text on yellow background). If the switch points to "-" then the crew should read off the black scale (yellow text on black background).
 - EVA Drive handle is on back side of joint (away from LEE), and scale triangle is across from it towards the LEE side.

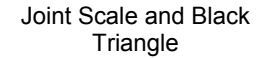
SSRMS JOINT DRIVE (Cont)

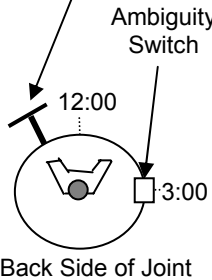
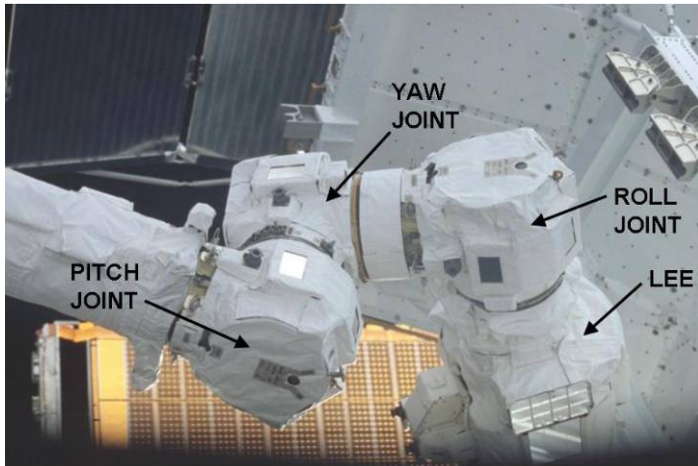
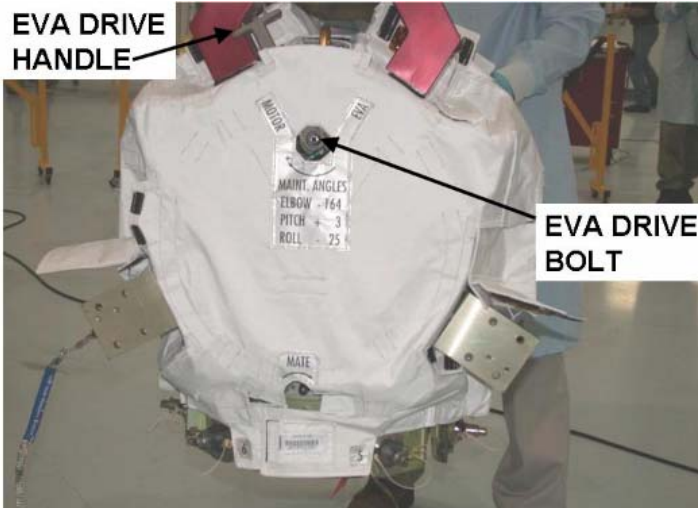
IV/RMS	EV1	REFERENCE
<p>SSRMS 1. <u>EVA JOINT DRIVE POSITION</u></p> <p>IV 2. Record ambiguity sensor reading and joint angle: _____ Monitor SSRMS joint angle. Report position to EV1. Give EV1 STOP when joint angle is at desired position</p>  <p>EVA Drive Handle (@ motor posn)</p>  <p>Joint Scale and Black Triangle</p>  <p>Ambiguity Switch</p>  <p>Back Side of Joint</p> <p>12:00</p> <p>3:00</p>	<ol style="list-style-type: none"> Translate to failed joint If required for body stabilization, install square scoop on joint micro fitting and attach BRT <p><u>INITIAL POSITION VERIFICATION</u></p> <ol style="list-style-type: none"> Verify initial joint position using the following: <ul style="list-style-type: none"> <input type="checkbox"/> Black triangle on fixed side of failed joint <input type="checkbox"/> Ambiguity sensor (90 degrees CW from EVA drive, toward front side of joint) <p><u>JOINT EVA DRIVE</u></p> <ol style="list-style-type: none"> Depress button and move EVA Drive Handle to EVA <p style="text-align: center;"><u>NOTE</u></p> <p>Joint will rotate in opposite direction of PGT</p> <ol style="list-style-type: none"> PGT[A1 2.5 ft-lb, CW2 or CCW2 30 RPM (as required), MTL 2.5]-6 ext 7/16: Drive EVA bolt in ± direction _____ turns to specified position Verify joint angle using scale and ambiguity sensor If possible, verify joint angle with IV If necessary, fine position joint using PGT in manual ratchet mode Depress button and move EVA Drive Handle to MOTOR If used, retrieve square scoop 	<p style="text-align: center;">REFERENCE</p>   <p>EVA DRIVE HANDLE</p> <p>EVA DRIVE BOLT</p>

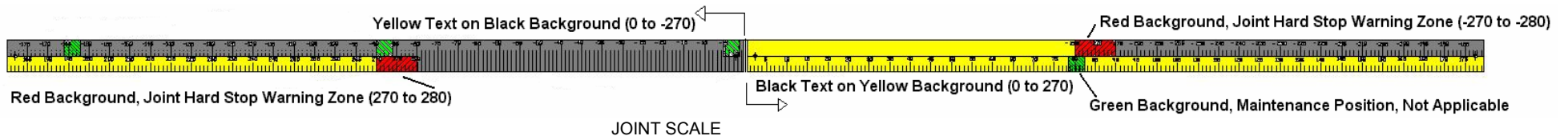

SSRMS JOINT DRIVE (Cont)

Task Data:

Table 1. Tools

EV1 (FF)
PGT
7/16 (wobble) Socket-6 ext
BRT
Square Scoop

Table 2. EVA Fasteners

Fastener Name	Label	Head Size	Qty	Min Drive Torque (ft-lb)	Max Drive Torque (ft-lb)	Failure Torque (ft-lb)	RPM
EVA Drive		7/16	1	1.25	2.5		30

Foot Restraints: N/A

SSRMS JOINT DRIVE (Cont)

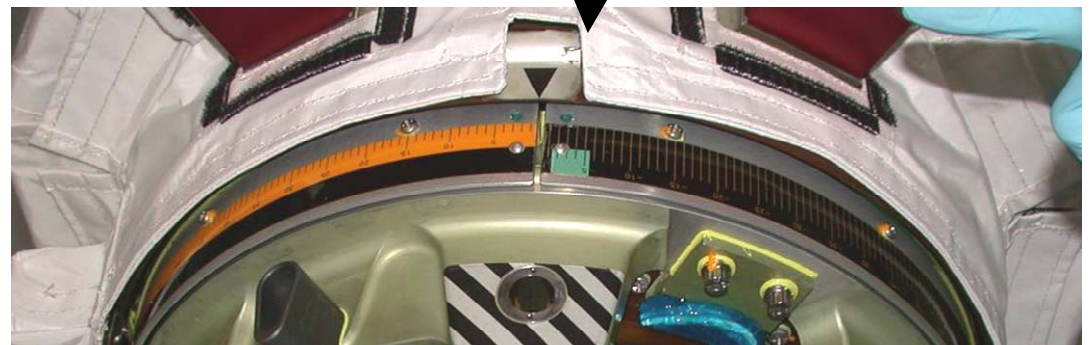
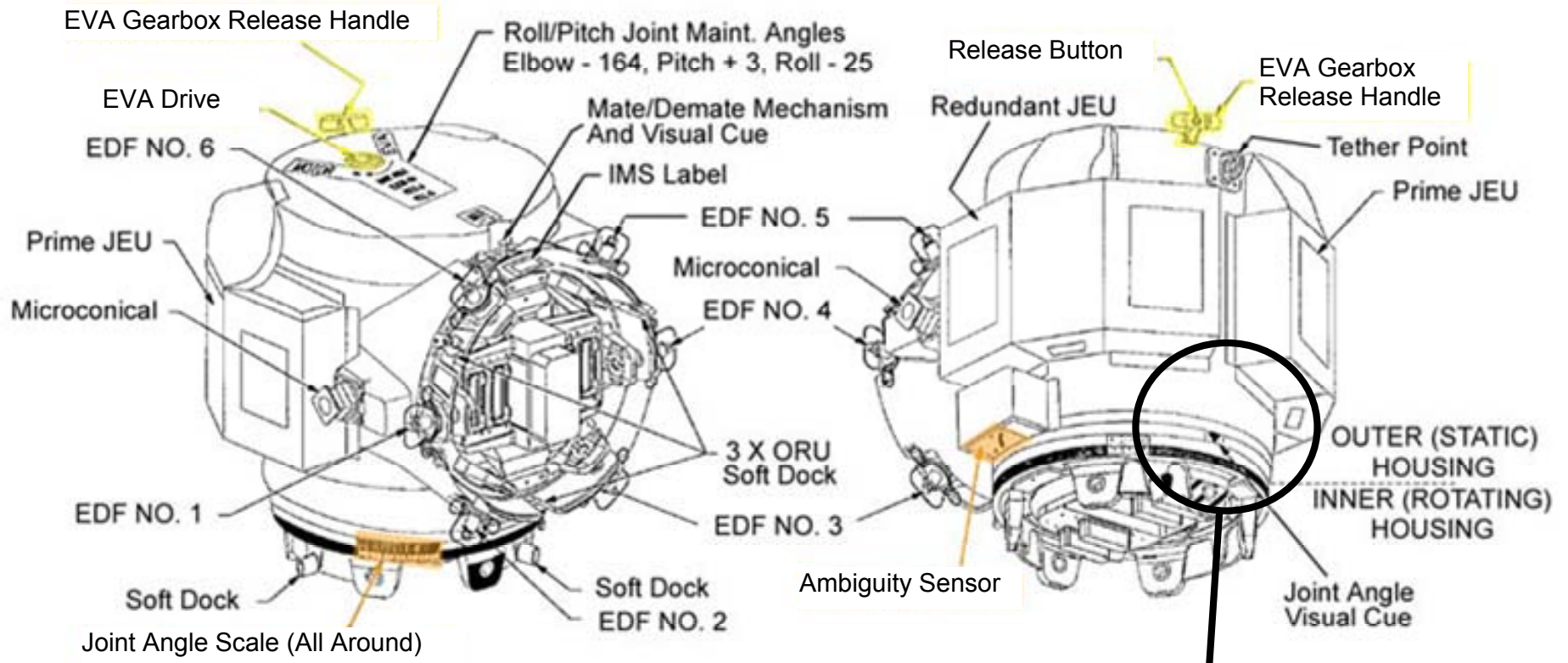

Figure 1.- Roll/Pitch Joint ORU.

SSRMS JOINT DRIVE (Cont)

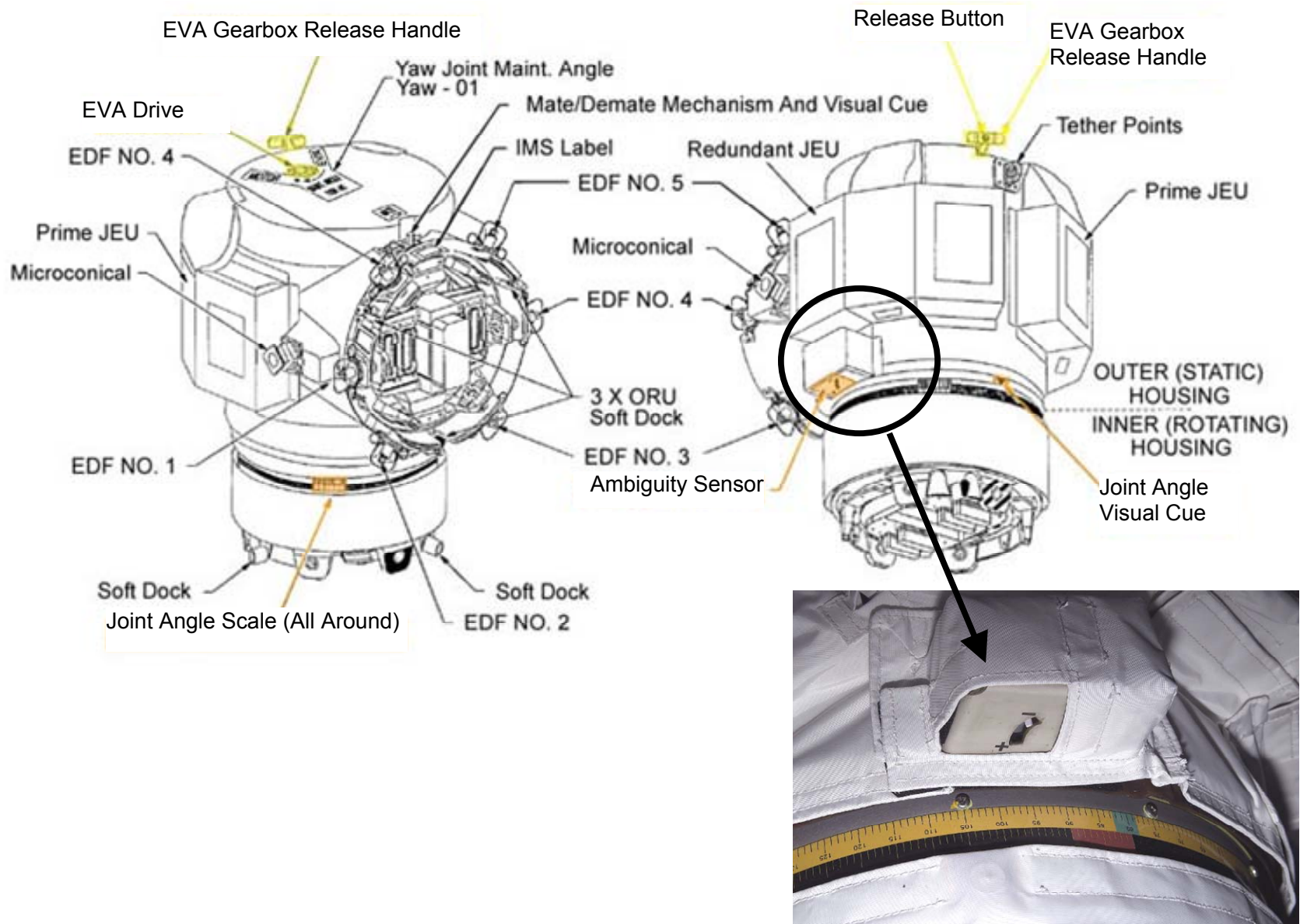

Figure 2.- YAW Joint ORU

MANUAL SAW JETTISON

PRIOR TO EVA:

1. Unstow SSU cover and place in crewlock
2. If ECU removal is planned, stow Medium ORU bag in crewlock
3. Remove SSU shunt plug adapter J5A and J6A caps and tether to tether point on SSU shunt plug adapter
4. Remove SSU shunt plug caps and mate SSU shunt plugs to SSU shunt plug adapter J5A and J6A (shunt plugs can go on either adapter receptacle)
5. Remove caps from SSU shunt plug adapter ground service equipment connectors
6. Stow SSU shunt plug adapter/shunt plugs, Cannon connector tool in EVA crewlock bag
7. If available, stow size 37 Cannon connector plug cap in EVA crewlock bag; if not available, will need to retrieve one from Z1

IV/RMS	EV1	EV2
<p>Identify Affected Power Channel XX = _____ and opposite deck Power Channel YY = _____</p> <p>MCC-H 1. Mnv/orient ISS for SAW jettison</p> <p>MCC-H 2. Position and safe SAW for SSU Removal Perform {2.101 PVM BGA XX ENGAGE ANTIROTATION LATCH} (SODF: EPS: NOMINAL: PRIMARY POWER)</p> <p>MCC-H 3. Verify solar array positioned for EV crew access to SSU and BGA latched PCS PVM: EPS: BGA XX BGA XX 'ECU XX' Verify: Integ Cnt – Incrementing</p> <p>'BGA XX' Verify: Actual Angle, deg = 270 Motor State – OFF Latch 1(2) Pin Status – Latched</p> <p>4. GO for EV ingress at SSU worksite</p> <p>MCC-H 5. Verify power connector inhibits in place before SSU Removal PCS PVM: EPS: DCSU XX DCSU XX 'DCSU XX' sel RBI 1 Verify: Cmded Position – Op</p>	<div style="border: 2px solid black; padding: 5px; margin-bottom: 10px;"> <p style="text-align: center;"><u>WARNING</u></p> <p>Voltage hazard exists at the connectors of the SSU. SSU must be safed before removal</p> <p>Electrical Shock Hazard. SSU Shunt Plug installation/removal and SSU removal/installation must occur during eclipse. STEPS DENOTED BY AN “E” MUST OCCUR DURING ECLIPSE. Crew must wait the specified wait periods for voltage drops to safe levels before proceeding. EV crew will need to move away from exposed electrical receptacles during day pass</p> <p>Protrusion Hazard. SSU alignment post protrudes beyond mast canister. Maintain clearances between structure and crewmember during SSU removal</p> <p>Collision Hazard. The solar array motion should be prevented by locking the BGA. This avoids a collision hazard with the EV crew if the EV crew is within 24 inches of the array rotational envelope</p> </div> <p><u>EVA SETUP</u></p> <ol style="list-style-type: none"> 1. If required, retrieve Sq TM with 7/16 Rec socket and square scoop from Z1 toolbox 2. If required, translate to Z1 forward face, demate Cannon connector cap from Z1 J259 or J260, stow in EVA crewlock bag 3. On MCC GO, translate to SSU worksite 4. Transfer tools and APFR with AIA to worksite 5. Set up APFR (see Task Data page) 	<div style="border: 2px solid black; padding: 5px; margin-bottom: 10px;"> <p style="text-align: center;"><u>WARNING</u></p> <p>Voltage hazard exists at the connectors of the SSU. SSU must be safed before removal</p> <p>Electrical Shock Hazard. SSU Shunt Plug installation/removal and SSU removal/installation must occur during eclipse. STEPS DENOTED BY AN “E” MUST OCCUR DURING ECLIPSE. Crew must wait the specified wait periods for voltage drops to safe levels before proceeding. EV crew will need to move away from exposed electrical receptacles during day pass</p> <p>Protrusion Hazard. SSU alignment post protrudes beyond mast canister. Maintain clearances between structure and crewmember during SSU removal</p> <p>Collision Hazard. The solar array motion should be prevented by locking the BGA. This avoids a collision hazard with the EV crew if the EV crew is within 24 inches of the array rotational envelope</p> </div> <p><u>EVA SETUP</u></p> <ol style="list-style-type: none"> 1. Translate to Mast Canister/Aux bag (PMA1 stbd by Node bag) 2. Retrieve MCHD 3. On MCC GO, translate to worksite 4. Temp stow MCHD and SSU cover 5. Translate to BMRRM 6. Remove BMRRM thermal shroud (peels back)

MANUAL SAW JETTISON (Cont)

IV/RMS	EV1	EV2
<p>Close Cmd – Inh Voltage: -4.2 – 4.2 Current: -7.5 – 7.5</p> <p>PCS PVM: EPS: SSU XX SSU XX 'BCDU YY1' (YY= opposite channel on IEA) sel CP RBI</p> <p>BCDU XX CP RBIs 'YY1 CP RBI' (YY= opposite channel on IEA) Verify: YY1 CP RBI Posn – Op</p> <p>MCC-H 6. Turn off and off point video camera luminaries, rpcm open and closed inhibited</p> <p>MCC-H 7. Give GO for BMRRM J1 demate and SSU shunt plug installation</p> <p>MCC-H 8. Give GO for SSU removal during 2nd ECLIPSE ONLY</p>	<div data-bbox="865 316 1230 727" data-label="Image"> </div> <p>SSU shunt plugs and adapter installed on mast canister with shroud open</p> <p>E6. On MCC GO (2 min wait after transition from insolation to eclipse), remove mast canister ground test port caps (2) and place in EVA trash bag</p> <p>E7. Position MLI shroud as shown above or folded against shunt plugs</p> <p>E8. Install SSU shunt plug adapter with bails facing outward, not against mast canister</p> <p>9. Reinstall MLI shroud</p> <p>10. Ingress APFR</p> <p><u>REMOVE FAILED SSU</u></p> <p>1. Install Sq TM onto primary fastener, √anti-backlash neutral</p> <p>E2. On MCC GO (5 min wait after transition from insolation to eclipse), PGT [A7 9.2 ft-lb, CCW2 30RPM, MTL 30.5]- Sq TM-7/16Rec: Drive PGT 5 turns</p> <p>E3. Remove Sq TM</p> <p>E4. Install Sq Scoop on SSU</p> <p>E5. PGT [A7 9.2 ft-lb, CCW2 30RPM, MTL 30.5]-12-ext-7/16: Drive fastener 10 turns</p>	<p>E7. On MCC GO, demate connector from BMRRM J1</p> <p>E8. Mate Cannon connector cap on BMRRM J1</p> <p>9. If reqd, reinstall BMRRM thermal shroud</p> <p><u>REMOVE FAILED SSU</u></p>

MANUAL SAW JETTISON (Cont)

IV/RMS	EV1	EV2
<p>9. Position and safe SAW for ECU Removal (if required) and SAW jettison. Perform {2.101 PVM BGA XX ENGAGE ANTI-ROTATION LATCH} (SODF: EPS: NOMINAL: PRIMARY POWER) using the following values:</p> <p style="padding-left: 40px;">BGA XX Cmded Angle = 180 deg BGA XX Latch Select = 1</p> <p>10. GO for EV ingress at ECU worksite</p> <p>MCC-H 11. Remove ECU power PCS PVM: EPS:BGA XX BGA XX</p> <p>sel RPCM YY A RPC 02 RPCM YY A RPC 02</p> <p>cmd RPC Position – Open (Verify – Op)</p> <p>(Expect Caution Message: BGA XX Loss of Comm)</p> <p>MCC-H 12. GO for ECU removal and BMRRM cable demate</p>	<p>E6. √Status indicator – UNLOCK E7. Remove SSU and hand to EV2 8. Clear BGA rotation plane for BGA rotation and inform IV when clear</p> <div style="border: 1px solid black; padding: 5px; text-align: center; margin: 20px 0;"> <p>WARNING Moving equipment hazard: Avoid contact with mast canister/beta gimbal during rotation of SAW</p> </div> <p><u>REMOVE ECU [if required]</u></p> <ol style="list-style-type: none"> 1. Set up and ingress APFR [see Task Data page] 2. On MCC GO, PGT[B1 12.0 ft-lb, CCW2 30RPM, MTL 30.5]-Sq TM w/7/16 REC: Release fastener 1 turn 3. Remove Sq TM 4. Install Square Scoop on ECU 5. PGT[B1 12.0 ft-lb, CCW2 30RPM, MTL 30.5]-6 ext 7/16: Release fastener 10 ± 2 turns 6. √Status indicator – UNLOCK 7. Remove ECU and stow in ORU transfer bag 	<ol style="list-style-type: none"> 1. Receive SSU and stow on SSU cover 2. Clear BGA rotation plane for BGA rotation and inform IV when clear <p><u>RELEASE BMRRM FASTENERS/CONNECTORS</u></p> <ol style="list-style-type: none"> 1. If not done already, remove BMRRM thermal shroud and temp stow 2. PGT[B6 24.0 ft-lb, CCW2 30RPM, MTL 10.5]-6 ext 7/16: Release BMRRM center fastener 17 turns 3. On MCC GO, disconnect the following connectors from the BMRRM: <ul style="list-style-type: none"> <input type="checkbox"/> Demate connector from J3 <input type="checkbox"/> Demate connector from J2

MANUAL SAW JETTISON – TASK DATA

Estimated Task Duration:

	Without RMS
One EV Crew	NA
Two EV Crew	3:00

Tools:

EV1	EV2
PGT	PGT
6 ext-7/16	6 ext-7/16
APFR/ingress aid	
Square TM with 7/16-in Recessed socket	
EVA crewlock bag	SSU cover
SSU shunt plug adapter	Mast Canister Handling Device
SSU shunt plugs (2)	
Size 33 Cannon conn plug cap	
Square scoop (2)	
Medium ORU bag (if reqd - for ECU)	

EVA Fasteners:

Fastener Name	Label	Head Size	Qty	Install Torque (ft-lb)	Max Break Away Torque (ft-lb)	Failure Torque (ft-lb)	Turns	RPM
SSU fastener	NA	7/16	1	6.3	35.7	264 (R)	11 ± 2	30
ECU fastener	NA	7/16	1	6.3	30.5	290.3 (R)	11 ± 2	30
BMRRM Center Fastener	NA	7/16	1	NA	16.0	54.0	17	30
MCHD Fasteners	NA	7/16	4	7.0	8.1	11.0 (l)	ZIP	10
Vice Clamp	NA	7/16	1	NA	5.2	20.1	19	30

EVA Connectors:

Harness	From	To	Clamps (#)	Conn Size	Function
W05 P23 J3		BMRRM J3		25	ECU feed; SSU Control pwr; 1553B
W06 P22 J2		BMRRM J2		25	ECU cross feed
		BMRRM J1		37	Primary power

Foot Restraints:

Task	WIF	APFR Setting	BGA Angle
Access to SSU (IEA non-keel side 4A/3A SAW)	P4/S4-23	4, PP, G, 9	270
Access to SSU (IEA keel side 2A/1A SAW)	P4/S4-24	4, PP, G, 9	270
Access to BMRRM (IEA non-keel side 4A/3ASAW)	P4/S4-28	9, NN, G, 3	Any
Access to BMRRM (IEA keel side 2A/1A SAW)	P4/S4-27	9, NN, G, 3	Any
Install MCHD and 4A/3A SAW jettison position (IEA non-keel side SAW)	P4/S4-26	6, FF, F, 6	180
Install MCHD and 2A/1A SAW jettison position (IEA keel side SAW)	P4/S4-25	6, FF, F, 6	180
Access to 4A/3A ECU	P4/S4-26	8, OO, A, 3	180
Access to 2A/1A ECU	P4/S4-25	8, OO, A, 3	180
Access to SSU (IEA non-keel side)	P6/S6-35	4, PP, G, 9	270
Access to SSU (IEA keel side)	P6/S6-33	4, PP, G, 9	270
Access to BMRRM (IEA non-keel side)	P6/S6-39	9, NN, G, 3	Any
Access to BMRRM (IEA keel side)	P6/S6-40	9, NN, G, 3	Any
Install MCHD and SAW jettison position (IEA non-keel side)	P6/S6-38	12, FF, F, 12	180
Install MCHD and SAW jettison position (IEA keel side)	P6/S6-37	12, FF, F, 12	180
Access to ECU (IEA non-keel side)	P6/S6-38	8, OO, A, 3	180
Access to ECU (IEA keel side)	P6/S6-37	8, OO, A, 3	180

ORU Mass: SSU – 186 lb

ECU – 90 lb

SAW – approx 2326 lb

MANUAL SAW JETTISON – TASK DATA (Cont)

Notes:

1. The MCHD has four deployable legs. Each leg has an EVA fastener which engages a zip nut on the mast canister hand rails. The MCHD also has a deployable PGT cradle assembly which is used to drive the mast canister MDA. The PGT cradle assembly is not required for the jettison procedure

Cautions:

None

Warnings:

1. Electrical Shock Hazard: Install SSU shunt plug adapter/SSU shunt plugs and remove SSU during orbital eclipse. Procedure specifies wait time before installing SSU shunt plug adapter/SSU shunt plugs and removing SSU to allow voltages to drop to safe levels
2. Protrusion Hazard: SSU alignment post protrudes beyond mast canister. Maintain clearances between structure and crewmember during SSU changeout
3. Voltage hazard may exist at connectors of the ECU and BMRRM. ECU and BMRRM must be safed before removal
4. Collision Hazard: The solar array motion should be inhibited to prevent a collision hazard with the EV crew because the EV crew may be within 24 inches of the array rotational envelope
5. Moving equipment hazard: Avoid contact with mast canister/beta gimbal during rotation of SAW
6. Mass handling – The crewmember will control the SAW mass with bent arms to avoid loading the EMU suit structure
7. Release mast canister with minimal tip-off rates



Mast Canister Handling Device (MCHD)

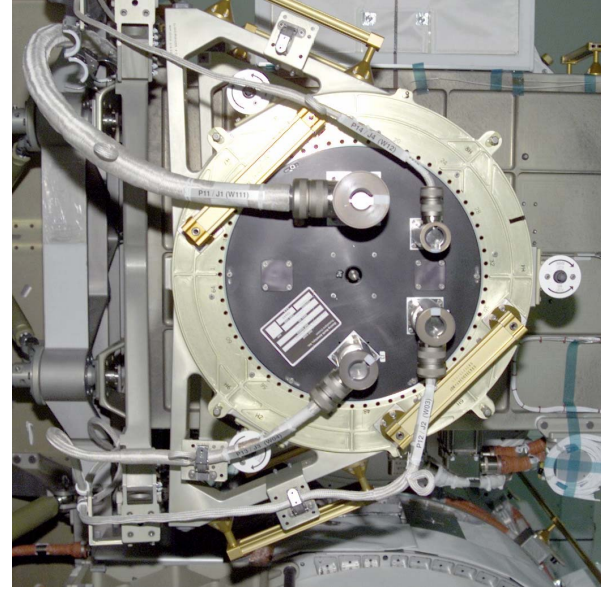

BMRRM connectors without BMRRM thermal cover

BCDU BACKOUT

IV	EV
<p>MCC-H 1. Verify SAW rotation inhibits complete 2. Verify power inhibits complete (see Task Data page)</p> <p>IV 3. Record S/N of failed BCDU:</p> <hr/> <div data-bbox="289 565 613 776" style="text-align: center;"> <p>Jacking bolt, Scoop install location</p> </div>	<ol style="list-style-type: none"> 1. Translate to IEA worksite 2. If reqd, install and ingress APFR (see Task Data page) 3. Verify failed BCDU P/N and S/N to IV <div data-bbox="884 383 1717 505" style="border: 1px solid black; padding: 5px; margin: 10px 0;"> <p style="text-align: center;">CAUTION</p> <p style="text-align: center;">Acme screws unfastened/fastened out of sequence could lead to jamming of BCDU</p> <hr/> <p style="text-align: center;">Avoid contacting BCDU mating surfaces (electrical connectors and cooling fins)</p> </div> <ol style="list-style-type: none"> 4. Install Sq TM onto H1 fitting, √anti-backlash neutral 5. PGT[B1 12.0 ft-lb, CCW2 30 RPM, MTL 30.5]-Sq TM with 7/16 Rec: Drive PGT 5 turns (1 turn at bolt) on H1 6. Remove Sq TM and install on H2 fitting, √anti-backlash neutral 7. PGT[B1 12.0 ft-lb, CCW2 30 RPM, MTL 30.5]-Sq TM with 7/16 Rec: Drive PGT 5 turns (1 turn at bolt) on H2 8. Remove Sq TM 9. PGT[B1 12.0 ft-lb, CCW2 30 RPM, MTL 30.5]-6 ext 7/16: Drive H1 minimum 5 turns 10. √Status indicator – UNLOCK 11. PGT[B1 12.0 ft-lb, CCW2 30 RPM, MTL 30.5]-6 ext 7/16: Drive H2, 5 turns 12. Perform WVS survey of BCDU final config

BCDU BACKOUT – TASK DATA

Estimated Task Duration:

	With RMS	Without RMS
One EV Crew	NA	0:45

Tools:

EV	
PGT	APFR (if reqd)
6 Ext 7/16 Socket	WIF Extender (if reqd)
Sq TM with 7/16 Rec Socket	

EVA Fasteners:

Fastener Name	Label	Head Size	Qty	Install Torque (ft-lb)	Break Away Torque (ft-lb)	Failure Torque (ft-lb)	Turns	RPM
H1 (Secondary Bolt)	H1	7/16	1	4.8	31.7	190.3 (R) 22.8 (I)	5-6	30
H2 (Primary Bolt)	H2	7/16	1	4.8	33.5	188.4 (R) 27.8 (I)	16-17	30

Foot Restraints:

Task	Fitting	WIF	WIF Extender	APFR Setting
Access to IEA BCDU 2B1 (1B1)	H1 H2	P6/S6 – 26 P6/S6 – 38		12, QQ, K, 12 9, QQ, J, 12
Access to IEA BCDU 2B2 (1B2)	H1 H2	P6/S6 – 18 P6/S6 – 22		10, QQ, G, 12 9, QQ, E, 12
Access to IEA BCDU 2B3 (1B3)	H1 H2	P6/S6 – 22 P6/S6 – 26		5, QQ, L, 12 3, QQ, G, 12
Access to IEA BCDU 4B1 (3B1)	H1 H2	P6/S6 – 25 P6/S6 – 21		12, QQ, B, 12 3, QQ, G, 12
Access to IEA BCDU 4B2 (3B2)	H1 H2	P6/S6 – 17 P6/S6 – 37		2, QQ, E, 12 3, QQ, B, 12
Access to IEA BCDU 4B3 (3B3)	H1 H2	P6/S6 – 21 P6/S6 – 25		7, QQ, A, 12 9, QQ, E, 12
Access to IEA BCDU 2A1 (1A1)	H1 H2	P4/S4 - 09 P4/S4 - 09	9, A, 1	12, QQ, G, 12 3, QQ, G, 12
Access to IEA BCDU 2A2 (1A2)	H1 H2	P4/S4 - 05 P4/S4 - 25		2, QQ, E, 12 3, QQ, B, 12
Access to IEA BCDU 2A3 (1A3)	H1 H2	P4/S4 - 09 P4/S4 - 13		7, QQ, A, 12 9, QQ, E, 12
Access to IEA BCDU 4A1 (3A1)	H1 H2	P4/S4 - 06 P4/S4 - 26	11, A, 1	10, QQ, G, 12 3, QQ, F, 12
Access to IEA BCDU 4A2 (3A2)	H1 H2	P4/S4 - 10 P4/S4 - 10	3, A, 3	3, QQ, L, 12 9, QQ, E, 12
Access to IEA BCDU 4A3 (3A3)	H1 H2	P4/S4 - 14 P4/S4 - 14	9, A, 3	9, QQ, A, 12 3, QQ, G, 12

EVA Connectors: NA

Notes:

- H1 is secondary bolt, H2 is primary bolt
- Removing BCDU from coldplate causes H1 status indicator to move from UNLOCK to LOCK
- The BCDU backout procedure does not actually remove the ORU from the truss, it just backs the H2 bolt out enough to demate the blind-mate connectors
- There is no hard stop when releasing H1 and H2 bolts; upon release, they will free spin

Cautions:

- Acme screws unfastened/fastened out of sequence could lead to jamming of BCDU. When unfastening Acme screws, H1 must be unfastened before H2
- Avoid contacting BCDU mating surfaces (electrical connectors and cooling fins)
- Fins on bottom of MBSU and coldplate are no touch
- Minimize force applied to H1 microfixture. It is not rated to withstand excessive loads

Warnings:

- Hazard voltage exist at the connectors of the BCDU. BCDU must be safed before removal

ORU Mass: 234 lbs

MCC Inhibits:

BCDU	Inhibits	BCDU	Inhibits
2B1 (P6)	DCSU 2B RBI 2 Op, Ci Inh BCDU 4B1 CP RBI Op	2A1 (P4)	DCSU 2A RBI 2 Op, Ci Inh BCDU 4A1 CP RBI Op
2B2 (P6)	DCSU 2B RBI 3 Op, Ci Inh BCDU 4B2 CP RBI Op	2A2 (P4)	DCSU 2A RBI 3 Op, Ci Inh BCDU 4A2 CP RBI Op
2B3 (P6)	DCSU 2B RBI 4 Op, Ci Inh BCDU 4B3 CP RBI Op	2A3 (P4)	DCSU 2A RBI 4 Op, Ci Inh BCDU 4A3 CP RBI Op
4B1 (P6)	TBD	4A1 (P4)	DCSU 4A RBI 2 Op, Ci Inh BCDU 2A1 CP RBI Op
4B2 (P6)	TBD	4A2 (P4)	DCSU 4A RBI 3 Op, Ci Inh BCDU 2A2 CP RBI Op
4B3 (P6)	TBD	4A3 (P4)	DCSU 4A RBI 4 Op, Ci Inh BCDU 2A3 CP RBI Op
1B1 (S6)	TBD	1A1 (S4)	TBD
1B2 (S6)	TBD	1A2 (S4)	TBD
1B3 (S6)	TBD	1A3 (S4)	TBD
3B1 (S6)	TBD	3A1 (S4)	TBD
3B2 (S6)	TBD	3A2 (S4)	TBD
3B3 (S6)	TBD	3A3 (S4)	TBD

BCDU BACKOUT – TASK DATA (Cont)

H2 Primary Fastener

Tether Loop

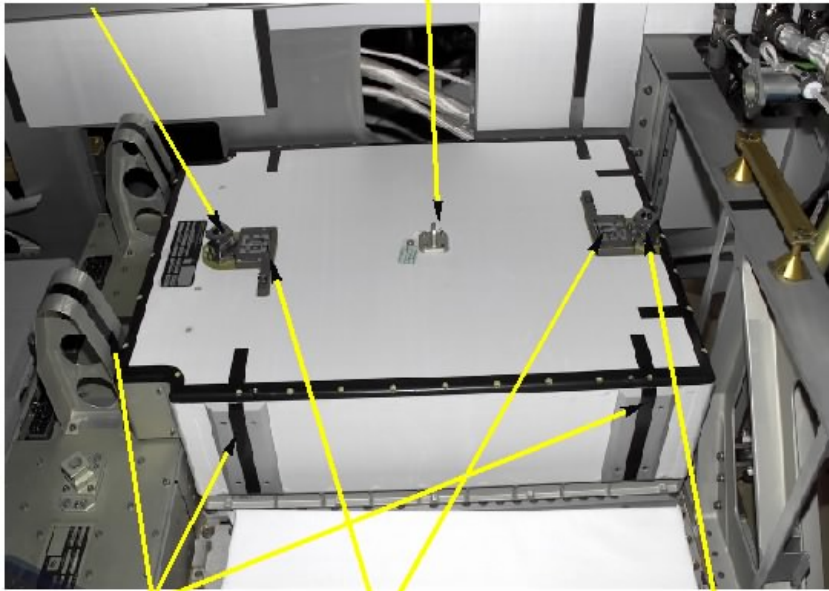

Alignment Marks

Lock Indicator

H1 Secondary Fastener

Lock Status Indicator

Micro Square

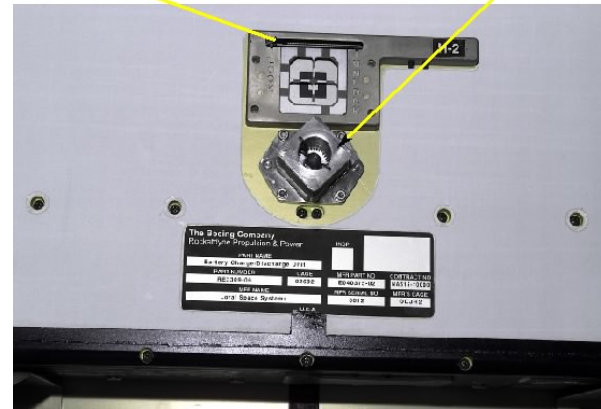

H2 Primary Fastener

Micro Square

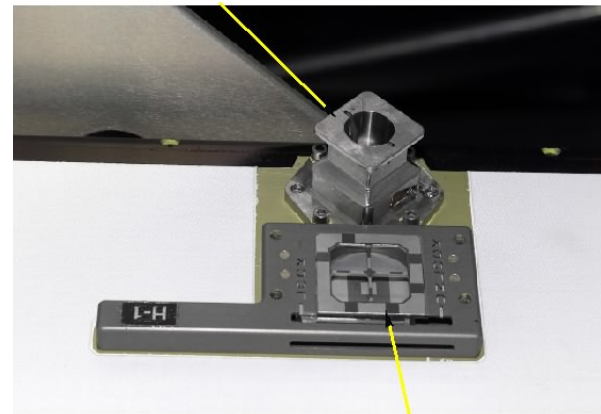

Lock Status Indicator

H1 Secondary Fastener

REMOVE AND REPLACE DCSU

IV	EV1	EV2
<p>MCC-H 1. Verify SAW rotation inhibits complete 2. Verify Inhibits for spare DCSU complete; give EV GO for DCSU removal</p>	<p><u>REMOVE SPARE DCSU FROM ESP1</u></p> <ol style="list-style-type: none"> 1. Translate to ESP1 worksite 2. Ingress APFR 3. Remove thermal cover 4. Transfer thermal cover to EV2 <div data-bbox="766 410 1293 505" style="border: 1px solid black; padding: 5px; margin: 10px 0;"> <p style="text-align: center;"><u>CAUTION</u> Acme screws unfastened/fastened out of sequence could lead to jamming of DCSU</p> </div> <ol style="list-style-type: none"> 5. Install Sq TM onto H1, √anti-backlash neutral 6. PGT[B1 12.0 ft-lb, CCW2 30RPM, MTL 30.5]-Sq TM-7/16Rec: Drive PGT 5 turns (1 turn at bolt) on H1 7. Remove Sq TM; Install on H2 fitting; √anti-backlash neutral 8. PGT[B1 12.0 ft-lb, CCW2 30RPM, MTL 30.5]-Sq TM-7/16Rec: Drive PGT 5 turns (1 turn at bolt) on H2 9. Remove Sq TM 10. PGT[B1 12.0 ft-lb, CCW2 30RPM, MTL 30.5]-6 ext-7/16: Drive H1 minimum 5 turns 11. √Status indicator – UNLOCK 12. Install Square scoop on H2 13. PGT[B1 12.0 ft-lb, CCW2 30RPM, MTL 30.5]-6 ext-7/16: Drive H2 minimum 16 turns 14. √Status indicator – UNLOCK 15. Remove DCSU from ESP1 FSE 16. Transfer spare DCSU to EV2 	<p><u>REMOVE SPARE DCSU FROM ESP1</u></p> <ol style="list-style-type: none"> 1. Translate to ESP1 worksite 2. Set up WIF Extender and APFR (see Task Data sheet) 3. Receive thermal cover from EV1 4. Temp stow thermal cover at worksite <ol style="list-style-type: none"> 5. Receive spare DCSU from EV1 and stow on BRT <div data-bbox="1444 954 1940 1057" style="border: 1px solid black; padding: 5px; margin: 10px 0;"> <p style="text-align: center;"><u>CAUTION</u> Avoid contacting DCSU mating surface (electrical connectors and cooling fins) with structure during translation with DCSU</p> </div>
<p>IV 3. Record S/N of failed DCSU: _____</p> <p>MCC-H 4. Verify electrical power inhibits complete. Give EV GO for DCSU removal</p>	<p><u>REMOVE FAILED DCSU</u></p> <ol style="list-style-type: none"> 1. Translate to IEA worksite 2. Set up and ingress APFR (see Task Data sheet) 3. Verify failed DCSU P/N and S/N to IV 4. Install Sq TM onto H1, √anti-backlash neutral <ol style="list-style-type: none"> 5. On MCC GO, PGT[B1 12.0 ft-lb, CCW2 30RPM, MTL 30.5]-Sq TM-7/16Rec: Drive PGT 5 turns (1 turn at bolt) on H1 	<p><u>REMOVE FAILED DCSU</u></p> <ol style="list-style-type: none"> 1. Translate to IEA worksite with spare DCSU

REMOVE AND REPLACE DCSU (Cont)

IV	EV1	EV2									
<p>IV 5. Record spare DCSU bolt data</p> <table border="1" data-bbox="184 760 567 860"> <thead> <tr> <th>Bolt</th> <th>Turns</th> <th>Torque</th> </tr> </thead> <tbody> <tr> <td>H1</td> <td>_____</td> <td>_____</td> </tr> <tr> <td>H2</td> <td>_____</td> <td>_____</td> </tr> </tbody> </table>	Bolt	Turns	Torque	H1	_____	_____	H2	_____	_____	<ol style="list-style-type: none"> 6. Remove Sq TM; Install on H2 fitting; √anti-backlash neutral 7. PGT[B1 12.0 ft-lb, CCW2 30RPM, MTL 30.5]-Sq TM-7/16: Drive PGT 5 turns (1 turn at bolt) on H2 8. Remove Sq TM 9. PGT[B1 12.0 ft-lb, CCW2 30RPM, MTL 30.5]-6 ext-7/16: Drive H1 minimum 5 turns 10. √Status indicator – UNLOCK 11. Install Square scoop on H2 12. PGT[B1 12.0 ft-lb, CCW2 30RPM, MTL 30.5]-6 ext-7/16: Drive H2 minimum 16 turns 13. √Status indicator – UNLOCK 14. Remove failed DCSU 15. Stow failed DCSU on BRT <p><u>INSTALL SPARE DCSU</u></p> <ol style="list-style-type: none"> 1. Receive spare DCSU from EV2 2. Install spare DCSU on IEA 3. √Status indicator on H1 and H2 are in UNLOCK 4. PGT[A3 4.8 ft-lb, CW2 30RPM, MTL 30.5]-6 ext-7/16: Drive H2, 16-17 turns 5. √Status indicator – LOCK 6. PGT[A3 4.8 ft-lb, CW2 30RPM, MTL 30.5]-6 ext-7/16: Drive H1, 5-6 turns 7. √Status indicator – LOCK 8. Remove Square scoop from H2 fitting 9. Egress and remove APFR 10. Give MCC-H GO to restore power to DCSU <p><u>STOW FAILED DCSU ON ESP1</u></p> <ol style="list-style-type: none"> 1. Translate to ESP1 worksite 2. Transfer failed DCSU to EV2 	<p><u>INSTALL SPARE DCSU</u></p> <ol style="list-style-type: none"> 1. Transfer spare DCSU to EV1 <p><u>STOW FAILED DCSU ON ESP1</u></p> <ol style="list-style-type: none"> 1. Translate to ESP1 worksite 2. Ingress APFR/WIF Extender 3. Receive failed DCSU from EV1 and install on ESP1 4. √Status indicator on H1 and H2 are in UNLOCK 5. PGT[A3 4.8 ft-lb, CW2 30RPM, MTL 30.5]-6 ext-7/16: Drive H2, 16-17 turns 6. √Status indicator – LOCK 7. PGT[A3 4.8 ft-lb, CW2 30RPM, MTL 30.5]-6 ext-7/16: Drive H1, 5-6 turns 8. √Status indicator – LOCK 9. Remove Square scoop from H2 fitting 10. Receive thermal cover from EV1 11. Install thermal cover over DCSU 12. Remove APFR and WIF Extender
Bolt	Turns	Torque									
H1	_____	_____									
H2	_____	_____									
<p>IV 6. Record failed DCSU bolt data</p> <table border="1" data-bbox="184 1117 567 1218"> <thead> <tr> <th>Bolt</th> <th>Turns</th> <th>Torque</th> </tr> </thead> <tbody> <tr> <td>H1</td> <td>_____</td> <td>_____</td> </tr> <tr> <td>H2</td> <td>_____</td> <td>_____</td> </tr> </tbody> </table>	Bolt	Turns	Torque	H1	_____	_____	H2	_____	_____	<ol style="list-style-type: none"> 3. Retrieve and transfer thermal cover to EV2 	
Bolt	Turns	Torque									
H1	_____	_____									
H2	_____	_____									

REMOVE AND REPLACE DCSU – TASK DATA

Estimated Task Duration:

Two EV Crew	2:30
-------------	------

Tools:

EV1 (RMS)	EV2 (FF)
PGT	PGT
6ext 7/16	6ext 7/16
Square TM w/7/16 in Rec Socket	Square TM w/7/16 in Rec Socket
Square scoop	Square scoop
APFR	APFR
	WIF Extender
BRT	BRT

EVA Fasteners:

Fastener Name	Label	Head Size	Qty	Install Torque (ft-lb)	Release Torque (ft-lb)	Failure Torque (ft-lb)	Turns	RPM
Fastener	H1	7/16	1	4.8	31.7	190.3 (R) 22.8 (I)	5-6	30
Fastener	H2	7/16	1	4.8	33.5	188.4 (R) 27.8 (I)	16-17	30

EVA Connectors:

Harness	From	To	Clamps (#)	Conn Size	Function
P3/J3	ESP1	FRAM	3		FSE Heater Power

Foot Restraints:

Task	WIF	APFR Setting	WIF Extender
P6 (S6) Non-keel side DCSU	P6-26 (S6-26)	12, PP, D, 12	N/A
P6 (S6) Keel side DCSU	P6-28 (S6-28)	12, PP, D, 12	N/A
P4 (S4) IEA Non-keel side DCSU	P4-14 (S4-14)	12, PP, D, 12	N/A
P4 (S4) IEA Keel side DCSU	P4-16 (S4-16)	12, PP, D, 12	N/A
Access to ESP1 DCSU (spare)	LAB 01-06	11, QQ, G, 12	6, B, 7

ORU Identification:

Task	Part Number	Serial Number
Spare DCSU	R072610	X830114
Failed DCSU	TBD	TBD

ORU Mass: DCSU = 217 lb, FSE = 154 lb

Notes:

1. Thermal conditioning of the spare DCSU before installation may be required (Preliminary LSAR time of 18 minutes)
2. DCSU will travel outward or inward as Acme screw H2 is unfastened or fastened
3. Lock SARJ when translating outboard of SARJ
4. A crewman on the RMS could also be used for ORU transfer to and from the worksite. This might also change the order of the task
5. If taking the FRAM with the DCSU, combined mass exceeds BRT capability
6. DO NOT USE the P6 IEA ORU placards. The label information is incorrect. Reference P6 ORU label mapping in Section 18
7. There is no hard stop when releasing H1 and H2 bolts; upon release, they will free spin

Cautions:

1. Acme screws unfastened/fastened out of sequence could lead to jamming of DCSU during removal/installation. When unfastening Acme screws, H1 must be unfastened before H2. When fastening Acme screws, H2 must be fastened before H1
2. Avoid contacting DCSU mating surface (electrical connectors and cooling fins) with structure during translation with DCSU
3. Ensure ORU is maintained level and perpendicular to stanchion during installation. Failure to comply may damage H2 status indicator probe
4. Minimize force applied to H1 microfixture. It is not rated to withstand excessive loads

Warnings:

1. Depending on worksite proximity to SAW rotation, MCC-H may need to inhibit SAW rotation to avoid collision with the EVA crewmembers
2. Hazard voltage exists at the mating connectors to the failed DCSU. DCSU interface must be safed before removal
3. If taking the FRAM with the DCSU, inhibit may be different. Connector must be released

REMOVE AND REPLACE DCSU – TASK DATA (Cont)

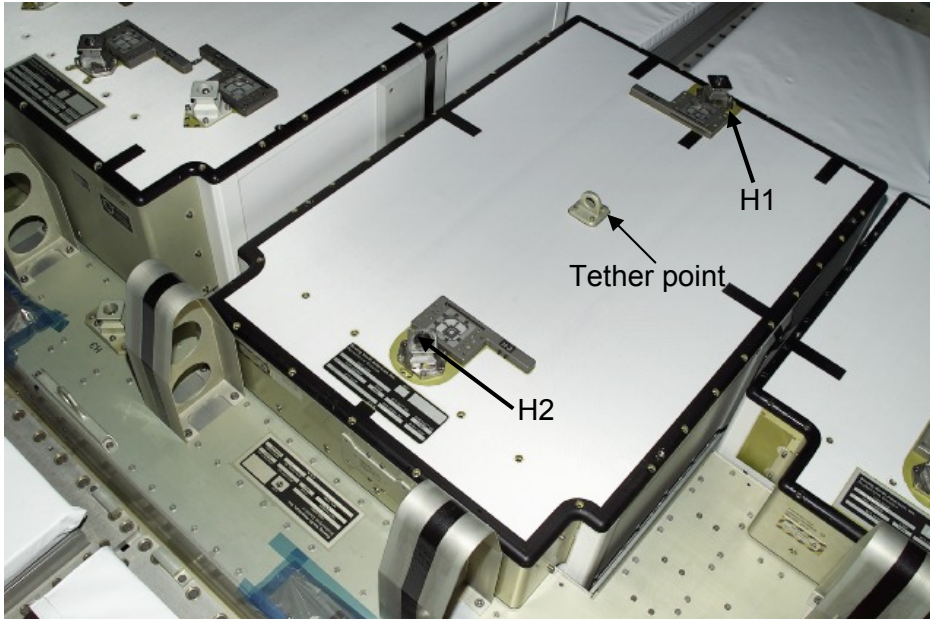

DCSU installed on P6 IEA

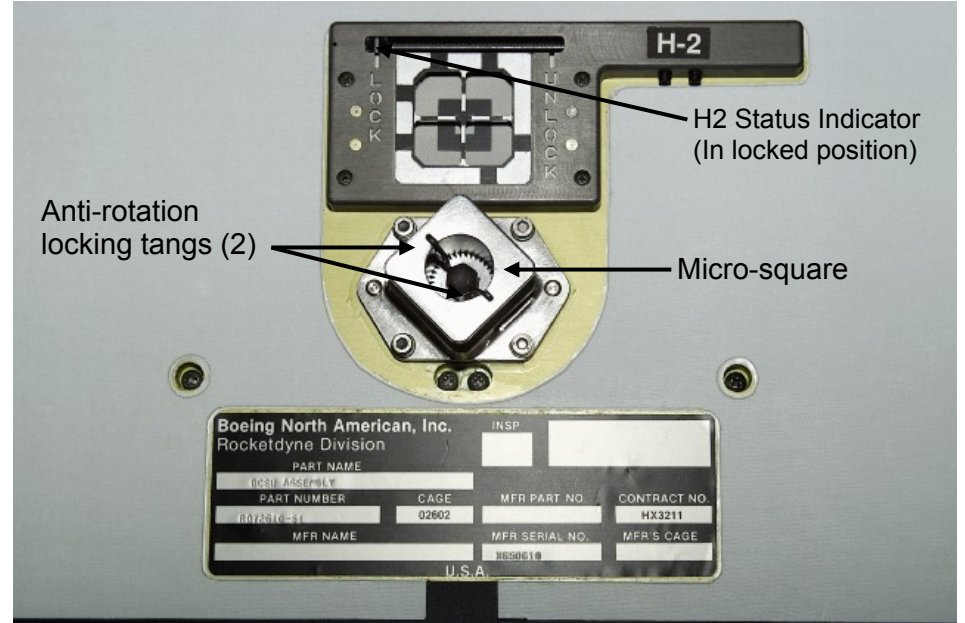

H2 Status Indicator in Locked position

REMOVE AND REPLACE DCSU – TASK DATA (Cont)

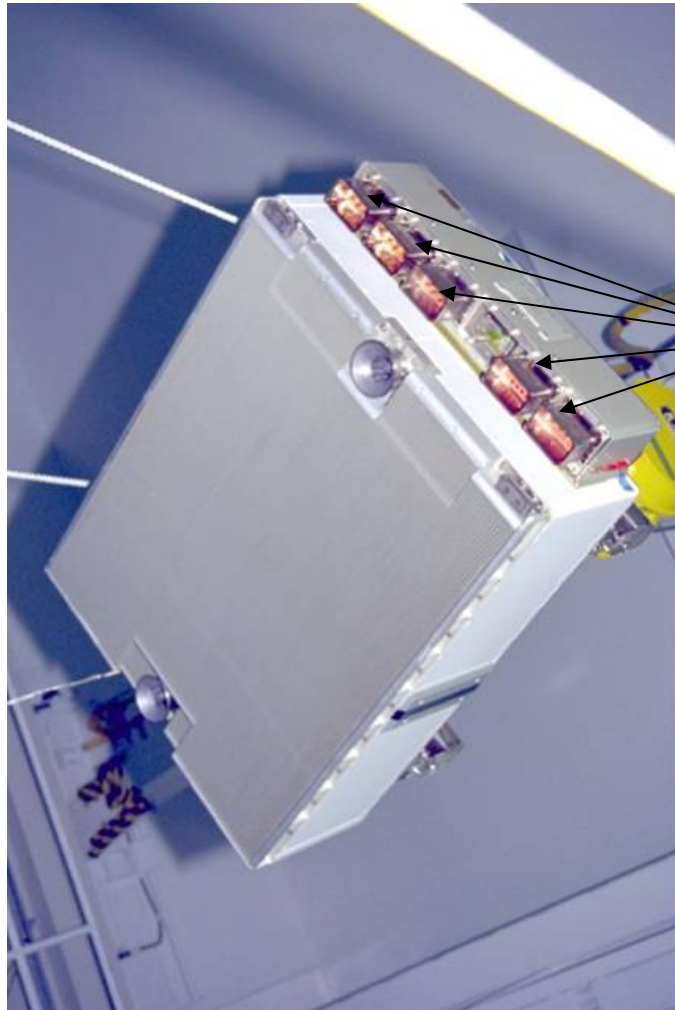

P6 IEA DCSU (prior to installation)

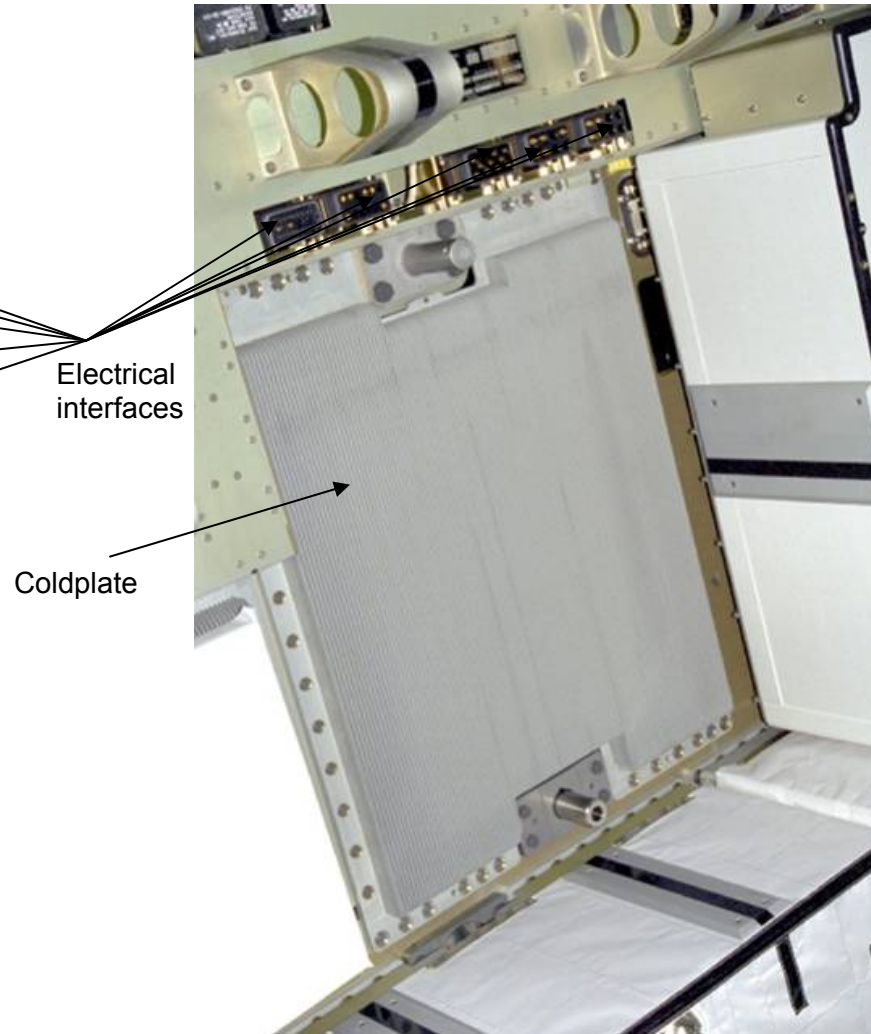

P6 IEA DCSU lower deck location (prior to installation)

REMOVE AND REPLACE PVCU LOWER

PRIOR TO EVA:

1. Remove connector cover plugs
2. Record New PVCU S/N _____
3. Stow in PVCU thermal cover
4. Attach Round scoop to PVCU micro conical fitting

IV/RMS	EV1	EV2
<ol style="list-style-type: none"> 1. Verify IEA PVCU power and data inhibits complete. Give EV a GO for PVCU removal 2. Record failed PVCU S/N _____ 3. Record bolt installation: final torque _____ turns _____ 	<p><u>REMOVE FAILED PVCU</u></p> <ol style="list-style-type: none"> 1. Verify failed PVCU serial number <div style="border: 1px solid black; padding: 5px; margin: 10px 0;"> <p style="text-align: center;"><u>CAUTION</u></p> <p>Tabs on the round TM interfere with the lock/unlock indicator next to the micro-conical in 4 out of the 6 possible attach positions. The interference could cause damage to the lock/unlock indicator during PVCU change out if the TM is not installed in the correct orientation</p> </div> <ol style="list-style-type: none"> 2. Install Round TM on failed PVCU attachment bolt micro-conical fitting so that the tabs will not interfere with the status indicator 3. On IV GO, PGT[B1 12.0 ft-lb, CCW2 30RPM, MTL 30.5]-Round TM, flush-7/16: Loosen attachment bolt 5 turns 4. Attach RET to tether point 5. Install Round scoop on failed PVCU 6. PGT[B7 25.5 ft-lb, CCW2 30RPM, MTL 30.5]-9ext-7/16: Loosen attachment bolt 15 turns 7. Verify status indicator – UNLOCK 8. Remove PVCU from IEA and temp stow <p><u>INSTALL NEW PVCU</u></p> <ol style="list-style-type: none"> 9. Retrieve new PVCU from thermal shroud 10. Install PVCU into soft dock IEA position 11. PGT[A3 4.8 ft-lb, CW2 30RPM, MTL 30.5]-9ext-7/16: Tighten attachment bolt 16 to 17 turns 12. Verify status indicator – LOCK 13. Release Round scoop from PVCU 14. Notify MCC that PVCU is installed 15. Release RET from tether point 16. Stow failed PVCU in thermal shroud 	

REMOVE AND REPLACE PVCU LOWER – TASK DATA

Estimated Task Duration:

One EV Crew	1:00
Two EV Crew	N/A

Tools:

EV1	EV2
PGT	
7/16 (wobble) Socket – 9 ext	
Round TM with 7/16 in flush	
Crewlock EVA Bag	
PVCU (spare) and thermal shroud	
Round Scoop (x2)	

EVA Fasteners:

Fastener Name	Label	Head Size	Qty	Install Torque (ft-lb)	Max Break Away Torque (ft-lb)	Failure Torque (ft-lb)	Turns	RPM
PVCU Attachment bolt	N/A	7/16	1	4.8	33.5	188.4 (R) 27.6 (I)	16 to 17	30

EVA Connectors:

Harness	From	To	Clamps (#)	Conn Size	Function
NA					

Foot Restraints:

Task	WIF	APFR Setting
ORU Access IEA Keel Side	P6 - 29	9, OO, F, 12
ORU Access IEA Non-Keel Side	P6 - 30	3, OO, F, 12

ORU Mass: 42 lb

PVCU Reference Info:

	Part Number	Serial Number
Spare PVCU	R071826-1	
PVCU on P6	R071826-1	
PVCU Cover	24700-10015-701	

Notes:

1. The keel side (also know as lower side) and non-keel side (also known as upper side) IEA PVCUs are not interchangeable due to dissimilar IEA structural interfaces
2. P6 IEA ORU location decal is incorrect. Refer to reference section for the correct reference information

Cautions:

1. Tabs on the round TM interfere with the lock/unlock indicator next to the micro-conical in 4 out of the 6 possible attach positions. The interference could cause damage to the lock/unlock indicator during PVCU change out if the TM is not installed such that the torque multiplier tabs do not interfere with travel of the status indicator

Warnings:

None

REMOVE AND REPLACE PVCU LOWER – TASK DATA (Cont)

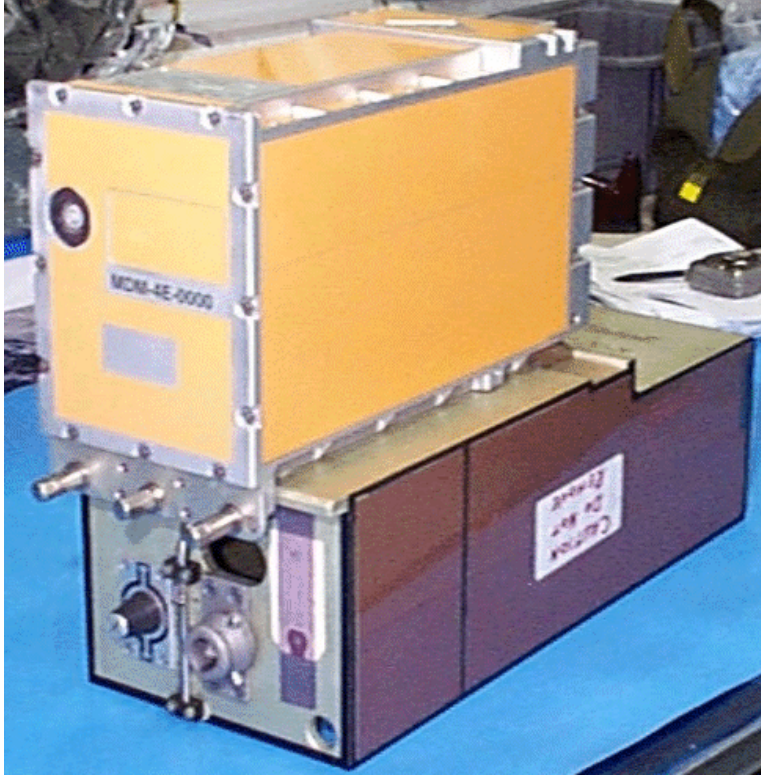

IEA MDM (PVCU)



IEA MDM (PVCU) with thermal cover

MDM REMOVE AND REPLACE (00:45)

OBJECTIVE: Generic procedure to replace a failed MDM ORU. Additional logistics and worksite specific information will be uplinked real time

PRIOR TO EVA:

1. Remove connector cover plugs
2. Record spare MDM S/N _____
3. Attach round scoop to spare MDM
4. Install spare MDM onto cover (ISS EVA Task Checklist 1.220.125) or into ORU bag

IV	EV
<p>MCC-H 1. Verify electrical power inhibits complete (see Task Data)</p>	<ol style="list-style-type: none"> 1. Translate to MDM worksite 2. Temp stow spare MDM 3. Inspect failed MDM and 1553 cables which mate to back of MDM for possible damage <input type="checkbox"/> Note – viewing may not be possible due to limited access
<p>IV 2. Record failed MDM EVA label number _____</p>	<p><u>REMOVE FAILED MDM</u></p> <ol style="list-style-type: none"> 1. If reqd, remove thermal cover 2. Report failed MDM EVA label number 3. Attach tether to MDM
<p>MCC-H 3. Give EV GO for MDM removal</p>	<p>On MCC GO, perform MDM removal:</p> <ol style="list-style-type: none"> 4. PGT[A5 7.0 ft-lb, CCW2 30 RPM, MTL 10.5]-6 ext 7/16: Release secondary bolts (x2), expect ~16 turns for MDM sizes 4 & 10 and ~7-14 turns for MDM size ESS 5. PGT[A5 7.0 ft-lb, CCW2 30 RPM, MTL 10.5]-6 ext 7/16: Release primary jack bolt (x1), expect ~33 turns for MDM sizes 4 & 10 and ~25-32 turns for MDM size ESS 6. Install Round Scoop on MDM 7. Slide failed MDM along guide rails to remove 8. Inspect failed MDM Cho-Therm and blindmate connections, report condition to MCC-H 9. Temp stow failed MDM
<p>IV 4. When MDM is removed from cover (ORU bag), record thermal clock start time: _____:_____:</p>	<p><u>INSTALL SPARE MDM</u></p> <ol style="list-style-type: none"> 1. Remove spare MDM from cover (ORU bag) 2. Inspect spare MDM Cho-Therm, truss coldplate, and blindmate connections for debris/damage 3. Align guide pins (x2) to bracket, slide spare MDM into soft-dock position <p style="text-align: center;"><u>NOTE</u></p> <p>To insure proper torque, verify PGT is straight on bolt and no side load is applied. Cycle PGT collar between each bolt, to reset turn count</p>

MDM REMOVE AND REPLACE (00:45) (Cont)

IV	EV																														
<p>IV 5. Record MDM bolt data, Initial Torquing</p> <table border="1"> <thead> <tr> <th>Bolt</th> <th>Turns</th> <th>Torque (ft-lb)</th> </tr> </thead> <tbody> <tr> <td>Primary Jack Bolt</td> <td></td> <td></td> </tr> <tr> <td>Secondary Bolt (Port)</td> <td></td> <td></td> </tr> <tr> <td>Secondary Bolt (Stbd)</td> <td></td> <td></td> </tr> </tbody> </table> <p>IV 6. Record MDM bolt data, Second Torquing</p> <table border="1"> <thead> <tr> <th>Bolt</th> <th>Turns</th> <th>Torque (ft-lb)</th> </tr> </thead> <tbody> <tr> <td>Primary Jack Bolt</td> <td></td> <td></td> </tr> <tr> <td>Secondary Bolt (Port)</td> <td></td> <td></td> </tr> <tr> <td>Secondary Bolt (Stbd)</td> <td></td> <td></td> </tr> </tbody> </table> <p>IV 7. Record MDM bolt data, Final Torquing</p> <table border="1"> <thead> <tr> <th>Bolt</th> <th>Turns</th> <th>Torque (ft-lb)</th> </tr> </thead> <tbody> <tr> <td>Primary Jack Bolt</td> <td></td> <td></td> </tr> </tbody> </table> <p>IV 8. When ORU is installed, record thermal clock time: _____:_____:_____</p> <p>IV 9. Give MCC-H GO to perform MDM power up and initial checkout</p> <p>IV 10. When power-up confirmed, record time: _____:_____:_____</p>	Bolt	Turns	Torque (ft-lb)	Primary Jack Bolt			Secondary Bolt (Port)			Secondary Bolt (Stbd)			Bolt	Turns	Torque (ft-lb)	Primary Jack Bolt			Secondary Bolt (Port)			Secondary Bolt (Stbd)			Bolt	Turns	Torque (ft-lb)	Primary Jack Bolt			<p><u>DRIVE MDM BOLTS: INITIAL TORQUING</u></p> <p style="text-align: center;"><u>NOTE</u></p> <p>The three different MDM sizes have slightly different turn counts; please reference Task Data for the exact turn count range per MDM size</p> <ol style="list-style-type: none"> PGT[A4 6.3 ft-lb, CW2 30 RPM, MTL 10.5]-6 ext 7/16: Drive primary jack bolt (x1) to torque, minimum ~25 turns expected If torque and/or minimum turns not achieved, contact MCC-H before driving secondary bolts PGT[A4 6.3 ft-lb, CW2 30 RPM, MTL 10.5]-6 ext 7/16: Drive secondary bolts (x2) to torque, minimum ~7 turns expected <p><u>DRIVE MDM BOLTS: SECOND TORQUING</u></p> <ol style="list-style-type: none"> PGT[A4 6.3 ft-lb, CW2 30 RPM, MTL 10.5]-6 ext 7/16: Drive primary jack bolt (x1) to torque, for expected 25-32 total turn count PGT[A4 6.3 ft-lb, CW2 30 RPM, MTL 10.5]-6 ext 7/16: Drive secondary bolts (x2) to torque, for expected 7-14 total turn count <p><u>DRIVE CENTER BOLT: FINAL TORQUING</u></p> <ol style="list-style-type: none"> PGT[A4 6.3 ft-lb, CW2 30 RPM, MTL 10.5]-6 ext 7/16: Drive primary jack bolt (x1) to torque, for expected 25-32 total turn count Remove Round Scoop Clean up worksite Give MCC-H GO for MDM power up <input type="checkbox"/> Perform WVS survey Stow failed MDM on cover (in ORU bag)
Bolt	Turns	Torque (ft-lb)																													
Primary Jack Bolt																															
Secondary Bolt (Port)																															
Secondary Bolt (Stbd)																															
Bolt	Turns	Torque (ft-lb)																													
Primary Jack Bolt																															
Secondary Bolt (Port)																															
Secondary Bolt (Stbd)																															
Bolt	Turns	Torque (ft-lb)																													
Primary Jack Bolt																															

MDM REMOVE AND REPLACE – TASK DATA

Tools:

EV	
PGT	MDM Cover (if reqd)
6 Ext 7/16	ORU Bag (if reqd)
Round Scoop	3" Scraper (if reqd)

EVA Fasteners:

Fastener Name	Label	Head Size	Qty	Install Torque (ft-lb)	Max Break Away Torque (ft-lb)	Failure Torque (ft-lb)	Turns	RPM
Primary Jack Bolt (Center)	N/A	7/16	1	6.3	6.5	9.2 (l) 14.7 (R)	See table below	30
Secondary Bolts (Outer)	N/A	7/16	2	6.3	6.5	9.2 (l) 14.7 (R)	See table below	30

Fastener Name	MDM Size	Turns to Remove	Turns to Install
Primary Jack Bolt (Center)	ESS	24.5-31.5	24.5-31.5
	4	33	25.4-31.5
	10	33	25.5-31.5
Secondary Bolts (Outer)	ESS	7-14	7-14
	4	16	7.5-14
	10	16	7.5-14

ORU Identification:

ORU	Part number	Serial Number	EVA Label Number
Spare MDM	8259065-910	98070105	MDM 16-1015
Failed MDM			

ORU	Height	Length	Width	Weight
EXT 1, EXT 2	10.5 inches	14.9 inches	16.4 inches	50.8 lbs

ORU Power Inhibits:

ORU (Size)	Location	Cover/Bag	Power Inhibits
Ext-1 (ESS)	S0 Bay 1 (Zenith)	MDM Cover	S01A_C RPC 01 (pwr) S02B_C RPC 02 (htr)
Ext-2 (ESS)	S0 Bay 1 (Nadir)	MDM Cover	S02B_C RPC 01 (pwr) S01A_C RPC 02 (htr)
N1-1 (10)	PMA1 (Zenith)	MDM Cover	N1RS1_A RPC 11 (pwr) N1RS1_A RPC 05, 06 (SDO) N1RS2_C RPC 15 (htr)
N1-2 (10)	PMA1 (Nadir)	MDM Cover	N1RS2_C RPC 13 (pwr) N1RS2_C RPC 03, 04 (SDO) N1RS1_C RPC 2 (htr)
P1-1 (4)	P1 Bay 14 (Zenith)	Small ORU Bag	P11A_B RPC 05 (pwr) P13A_G RPC 16 (htr)
P1-2 (10)	P1 Bay 14 (Nadir)	MDM Cover	P12B_C RPC 16 (pwr) P12B_C RPC 10--13 (SDO) P14B_G RPC 16 (htr)
PTR (4)	P1 Radiator Beam Zenith	Small ORU Bag	P12B_C RPC 03 (pwr) P12B_C RPC 04--06 (SDO) P14B_G RPC 11 (htr & thermostat)
S0-1 (10)	S0 Bay 0 (Zenith)	MDM Cover	S01A_C RPC 16 (pwr) S01A_D RPC 02--05 (SDO) S03A_E RPC 05 (htr)
S0-2 (10)	S0 Bay 0 (Nadir)	MDM Cover	S02B_C RPC 16 (pwr) S02B_D RPC 02--05 (SDO)
S1-1 (10)	S1 Bay 13 (Zenith)	MDM Cover	S11A_C RPC 16 (pwr) S11A_D RPC 10--13 (SDO) S13A_G RPC 16 (htr)
S1-2 (4)	S0 Bay 0 (Nadir)	Small ORU Bag	S12B_B RPC 05 (pwr) S14B_G RPC 16 (SDO)
STR (4)	S1 Radiator Beam Nadir	Small ORU Bag	S11A_C RPC 03 (pwr) S11A_C RPC 04--06 (SDO) S13A_G RPC 11 (htr & thermostat)
P3-1 (TBD)	TBD	TBD	TBD
P3-2 (TBD)	TBD	TBD	TBD
S3-1 (TBD)	TBD	TBD	TBD
S3-2 (TBD)	TBD	TBD	TBD

MDM REMOVE AND REPLACE – TASK DATA (Cont)

Notes:

1. To insure proper torque, verify PGT is straight on bolt and no side load is applied. Cycle PGT collar between each bolt, to reset turn count
2. MDM EVA label number is located on the front of the MDM
3. Secondary bolts spring out upon release; primary bolt free spins
4. Residual Cho-Therm material on truss coldplate may be removed using the 3" Scraper Tool, as reqd

Cautions:

1. Avoid contacting MDM Cho-Therm and electrical connector mating surfaces
2. Equipment damage – During MDM removal, ensure that the left and right captive fasteners are unfastened before loosening center jackscrew
3. The blind mate connectors are subject to damage as replacement unit is secured to structure. Ensure that the center jack bolt is tightened fully to properly engage blind mate connectors
4. Center jack bolt must first be installed minimum turns, at torque setting, for proper installation of outer bolts

Warnings:

1. Hazard voltage exists at the connectors of the MDM. MDM must be safed before removal



MDM Receptacle on P3



MDM Installed in Receptacle

CANADIAN REMOTE POWER CONTROL MODULE (CRPCM) REMOVE/REPLACE

OBJECTIVE:

Generic procedure to replace a failed CRPCM ORU. Additional logistic and worksite specific information as well as updated PGT settings, will be uplinked real time.

PRIOR TO EVA

1. Unstow spare CRPCM.
2. Remove blind mate connector covers; stow in Airlock.
3. Verify part number of spare CRPCM and record serial number on Task Data Sheet. Report P/N and S/N of spare unit to **MCC-H**.

WARNING

1. Due to touch temperatures, the EVA crew must avoid the volume extending 6" out from the front of the operating light on the MSS Camera/lights.
2. Hazard voltage exists at the connectors of the failed CRPCM. Failed CRPCM must be safed prior to removal.

CAUTION

Minimize contact with silver Teflon (white surface) on CRPCM and surrounding ORUs to avoid hardware damage.

NOTE

1. Although the bolt does not travel inside the CRPCM, the CRPCM itself is "jacked out" by the rotation of the bolt.
2. CRPCM softdocks are magnetic.

CANADIAN REMOTE POWER CONTROL MODULE (CRPCM) REMOVE/REPLACE (Cont)

IV	EV1	EV2																											
<p>1. On MCC-H GO for RPCM inhibit PCS P1(S0,S1,S3,P3,S4,P4): EPS: RPCM X <u>RPCM X RPC 1</u></p> <p>Verify RPC Position – Op √Close Cmd – Inh</p> <p>2. Give EV1 GO for CRPCM removal.</p> <p style="text-align: center;">Table 1. Required RPCM Inhibits</p> <table border="1" style="width: 100%; border-collapse: collapse;"> <thead> <tr> <th style="text-align: center;">MT/MBS Worksite</th> <th style="text-align: center;">Prime String CRPCM R&R</th> <th style="text-align: center;">Redundant CRPCM R&R</th> </tr> </thead> <tbody> <tr> <td style="text-align: center;">P1 worksite 7</td> <td style="text-align: center;">P1-4B_E</td> <td style="text-align: center;">P1-3A_E</td> </tr> <tr> <td style="text-align: center;">P1 worksite 6</td> <td style="text-align: center;">P1-4B_F</td> <td style="text-align: center;">P1-3A_F</td> </tr> <tr> <td style="text-align: center;">S0 worksite 5</td> <td style="text-align: center;">S0-4B_B</td> <td style="text-align: center;">S0-3A_B</td> </tr> <tr> <td style="text-align: center;">S0 worksite 4</td> <td style="text-align: center;">S0-4B_A</td> <td style="text-align: center;">S0-3A_A</td> </tr> <tr> <td style="text-align: center;">S1 worksite 3</td> <td style="text-align: center;">S1-4B_F</td> <td style="text-align: center;">S1-3A_F</td> </tr> <tr> <td style="text-align: center;">S1 worksite 2</td> <td style="text-align: center;">S1-4B_E</td> <td style="text-align: center;">S1-3A_E</td> </tr> <tr> <td style="text-align: center;">S3 worksite 1</td> <td style="text-align: center;">S3-4B_F</td> <td style="text-align: center;">S3-3A_F</td> </tr> <tr> <td style="text-align: center;">P3 worksite 8</td> <td style="text-align: center;">P3-4B_F</td> <td style="text-align: center;">P3-3A_F</td> </tr> </tbody> </table>	MT/MBS Worksite	Prime String CRPCM R&R	Redundant CRPCM R&R	P1 worksite 7	P1-4B_E	P1-3A_E	P1 worksite 6	P1-4B_F	P1-3A_F	S0 worksite 5	S0-4B_B	S0-3A_B	S0 worksite 4	S0-4B_A	S0-3A_A	S1 worksite 3	S1-4B_F	S1-3A_F	S1 worksite 2	S1-4B_E	S1-3A_E	S3 worksite 1	S3-4B_F	S3-3A_F	P3 worksite 8	P3-4B_F	P3-3A_F	<p><u>REMOVE FAILED CRPCM</u></p> <ol style="list-style-type: none"> 1. If required, setup and ingress APFR per Task Data Sheet. 2. Report failed CRPCM part number and serial number to IV. 3. Install square scoop on CRPCM. 4. Hold for IV GO. 5. PGT[B1 12.0 ft-lb, CCW2 30RPM, MTL 30.5]-6ext-7/16: Release CRPCM tie-down bolt ~17 to 19 turns 6. Remove failed CRPCM. Slide out of RPCA. 7. Transfer failed CRPCM to EV2. <p><u>INSTALL SPARE CRPCM</u></p> <ol style="list-style-type: none"> 8. Inspect RPCA and CRPCM interface for debris/damage. 9. Install replacement CRPCM into soft dock position. 10. PGT[B1 12.0 ft-lb, CW2 30RPM, MTL 30.5]-6ext-7/16: Drive CRPCM tie-down bolt ~17 to 19 turns. 11. Remove square scoop from CRPCM. 	<ol style="list-style-type: none"> 1. Receive failed CRPCM from EV1. Temporarily stow. 2. Transfer replacement CRPCM to EV1.
MT/MBS Worksite	Prime String CRPCM R&R	Redundant CRPCM R&R																											
P1 worksite 7	P1-4B_E	P1-3A_E																											
P1 worksite 6	P1-4B_F	P1-3A_F																											
S0 worksite 5	S0-4B_B	S0-3A_B																											
S0 worksite 4	S0-4B_A	S0-3A_A																											
S1 worksite 3	S1-4B_F	S1-3A_F																											
S1 worksite 2	S1-4B_E	S1-3A_E																											
S3 worksite 1	S3-4B_F	S3-3A_F																											
P3 worksite 8	P3-4B_F	P3-3A_F																											

CANADIAN REMOTE POWER CONTROL MODULE (CRPCM) REMOVE/REPLACE – TASK DATA

Table 2. Estimated Task Duration

	With RMS	Without RMS
One EV Crew	NA	1:00
Two EV Crew	NA	1:00

Table 3. Tools

EV1 (FF)	EV2 (FF)
PGT	Square scoop
6ext-7/16	
Square scoop	

Table 4. EVA Fasteners

Fastener Name	Label	Head Size	Qty	Install Torque (ft-lb)	Release Torque (ft-lb)	Failure Torque (ft-lb)	Turns	RPM
CRPCM tie-down bolt	N/A	7/16"	1	13.3	13.3	TBD	17 to 19	30

* Data obtained from MBS operating procedures - Annex4: MBS EVA maintenance procedures.

EVA Connectors: None

Table 5. Foot Restraints

Task	WIF	APFR Setting
CRPCM R&R	MBS-02	5,VV,B,12

ORU Mass: 19.4 lbs - 12.4" x 10.8" x 7.1"

Table 6. ORU Identification

	Part Number	Serial Number
Spare CRPCM	51800-0041-1	
Failed CRPCM	51800-0041-1	

*ORU mass, dimensions, and identification obtained from UF-2 flight launch and return manifest.

CANADIAN REMOTE POWER CONTROL MODULE (CRPCM) REMOVE/REPLACE – TASK DATA (Cont)

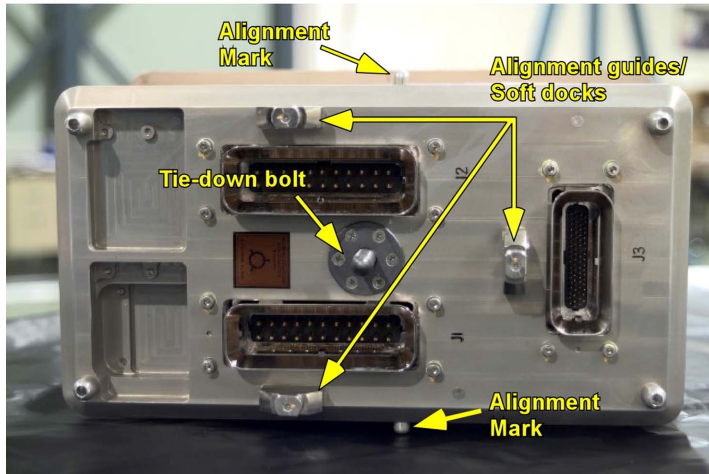

Figure 1.- Mating Side of CRPCM.

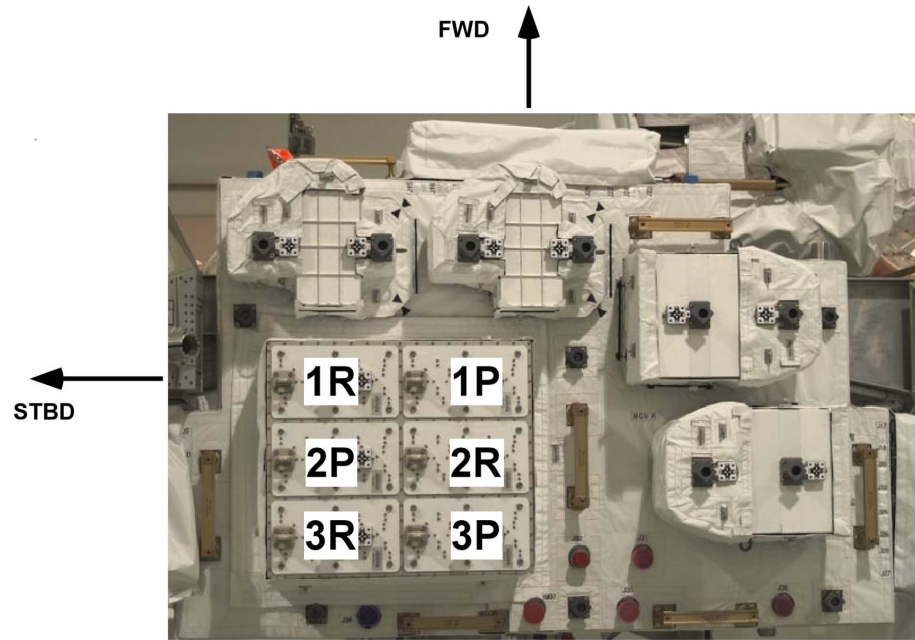

Figure 2.- CRPCM Layout on MBS.

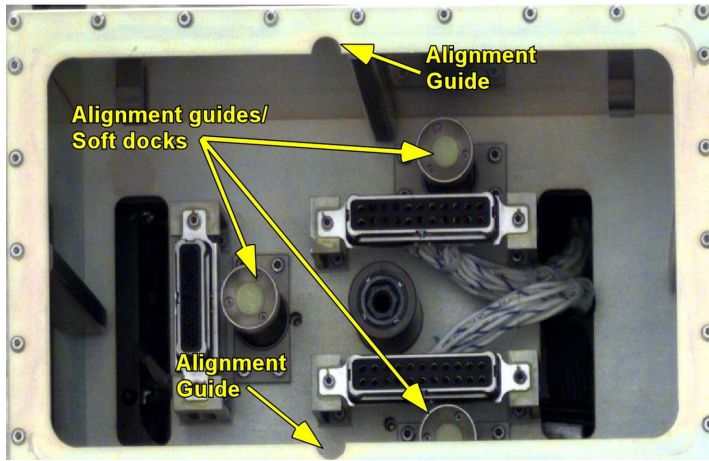

Figure 3.- CRPCM Interface on MBS.

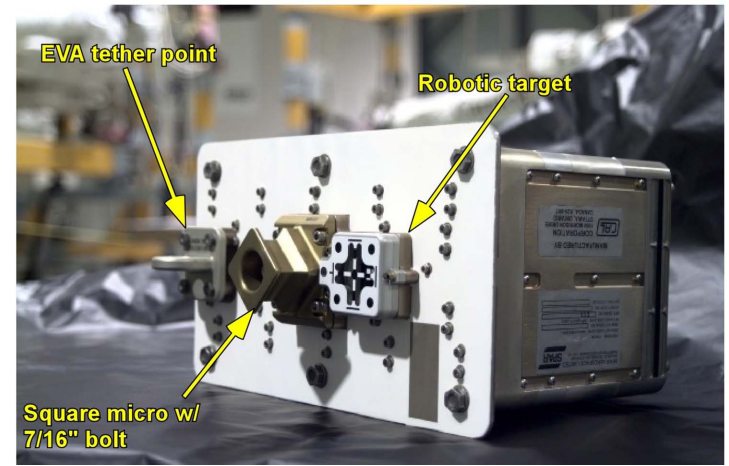
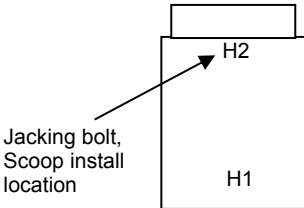

Figure 4.- Isometric View of CRPCM.

MBSU REMOVE/REPLACE (Cont)

IV/SSRMS	EV1(SSRMS)	EV2 (FF)
 <p>Jacking bolt, Scoop install location</p>	<p><u>MBSU REMOVAL</u></p> <div style="border: 2px solid black; background-color: yellow; padding: 5px; text-align: center; margin-bottom: 10px;"> CAUTION </div> <p>Acme screws unfastened/fastened out of sequence could lead to jamming of MBSU</p> <p>On MCC GO:</p> <ol style="list-style-type: none"> 1. PGT [B1 12.0 ft-lb, CCW2 30 RPM, MTL 30.5]-Sq TM-7/16Rec: Drive PGT 5 turns (1 turn at bolt) on H1 2. Remove Sq TM and install on H2 fitting; √anti-backlash neutral 3. PGT [B1 12.0 ft-lb, CCW2 30 RPM, MTL 30.5]-Sq TM-7/16Rec: Drive PGT 5 turns (1 turn at bolt) on H2 4. Transfer TM to EV2 5. PGT [B1 12.0 ft-lb, CCW2 30 RPM, MTL 30.5]-6 Ext 7/16: Drive H1 minimum 5 turns 6. √Status indicator - UNLOCK 7. Receive Sq Scoop from EV2; install on H2 8. PGT [B1 12.0 ft-lb, CCW2 30 RPM, MTL 30.5]-6 Ext 7/16: Drive H2 minimum 16 turns 9. √Status indicator – UNLOCK 10. Stow PGT <div style="border: 2px solid black; background-color: red; color: white; padding: 5px; text-align: center; margin-bottom: 10px;"> WARNING </div> <p>Avoid contact with intermeshing fins of the MBSU and coldplate</p> <ol style="list-style-type: none"> 11. Remove MBSU from coldplate (soft dock on H2 15-20 lbs) 	<p><u>MBSU REMOVAL</u></p> <ol style="list-style-type: none"> 1. Receive Sq TM from EV1; stow on MWS 2. Transfer Sq Scoop to EV1

MBSU REMOVE/REPLACE – TASK DATA

Estimated Task Duration:

	With SSRMS
One EV Crew	NA
Two EV Crew	3:00

Tools:

EV1	EV2
Square scoop	EVA Crewlock bag (optional)
PGT – 6 Ext 7/16	Square Scoop
WIF Adapter	EVA Ratchet 3/8 drive – 6 Ext 7/16 (backup)
Safety Tether (SSRMS)	Sq TM 7/16 rec
APFR	MUT EE
	Ballstack

EVA Fasteners:

Fastener Name	Label	Head Size	Qty	Install Torque (ft-lb)	Max Break Away Torque (ft-lb)	Failure Torque (ft-lb)	Turns	RPM
H1 (Secondary Bolt)	H1	7/16	1	4.8 (S0) 18.4 (FSE)	31.7	190.3 (R) 22.8 (I)	5-6	30
H2 (Primary Bolt)	H2	7/16	1	4.8 (S0) 18.4 (FSE)	33.5	188.4 (R) 27.8 (I)	16-17	30

Foot Restraints:

Task	WIF	Swing Arm Setting	APFR Setting
MBSU	SSRMS	N/A	12, PP, F, 6
MBSU 4A4B (CETA at Bay 02)	3	13, 12, GG	9, TT, F, 12
MBSU 1A1B (CETA at Bay 00)	3	13, 12, GG	9, TT, F, 12
MBSU 3A3B (CETA at Bay 00)	2	15, 12, GG	3, TT, F, 12
MBSU 2A2B (CETA at Bay 02)	2	15, 12, GG	3, TT, F, 12

ORU Data:

ORU	Part Number	Serial Number	Mass	Dimensions
MBSU 1A1B	R072591-41	X700385	236 lb	40" x 28" x 12"
MBSU 2A2B	R072591-41	X700386	236 lb	40" x 28" x 12"
MBSU 1A1B	R072591-41	C250636	236 lb	40" x 28" x 12"
MBSU 3AB	R072591-41	C250637	236 lb	40" x 28" x 12"
Spare MBSU	R072591-41	X652064	236 lb	40" x 28" x 12"
Spare MBSU	R072591-41	TBD	236 lb	40" x 28" x 12"

Notes:

- H1 is secondary bolt, H2 is primary bolt
- NO ACTION is required when Acme screw torque and appropriate number of turns has been met and the status indicator is not at the LOCKED position. Report anomaly
- Removing MBSU from coldplate causes H1 status indicator to move from UNLOCK to LOCK
- There is no hard stop when releasing H1 and H2 bolts; upon release, they will free spin
- Primary stanchion (H2) has ~15-20 lb soft dock force to overcome during MBSU removal and installation from/to FSE & coldplate
- H1 and H2 status indicators are not identical, see drawing below

Cautions:

- Acme screws unfastened/fastened out of sequence could lead to jamming of MBSU during removal. When unfastening Acme screws, H1 must be unfastened before H2. When fastening Acme screws, H2 must be fastened before H1
- Ensure ORU is maintained level and perpendicular to the tiedown stanchions during installation. Failure to comply may damage H2 status indicator probe
- Minimize force applied to H1 microfixture. It is not rated to withstand excessive loads
- There is a TBD thermal dwell time between the MBSU and coldplate. Wait TBD time, prior to driving bolts

Warnings:

- Hazard voltage exists at the connectors of the MBSU. MBSU must be safed before removal
- Avoid contact with intermeshing fins of the MBSU and coldplate due to sharp edge concerns

MBSU REMOVE/REPLACE – TASK DATA (Cont)

MBSU locations

Spare
MBSU



MBSU REMOVE/REPLACE – TASK DATA (Cont)

H2 Status Indicator

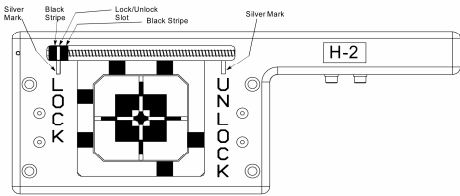

H1 Status Indicator

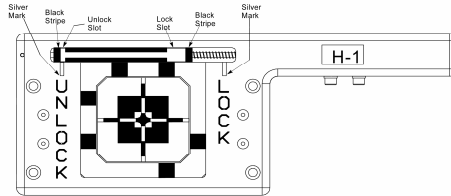

Positional Criteria
(Adhered to in accordance with torque and turns specified in LSAR procedure.)

Locked, Nominal: The lock/unlock slot should be centered in relation to the silver mark.

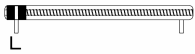

Unlocked, Nominal: The lock/unlock slot should be centered in relation to the silver mark.



Locked, Tolerance: The lock/unlock slot can be left or right of nominal by a distance no greater than the width of the black stripe.

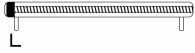
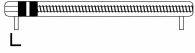

Unlocked, Tolerance: The lock/unlock slot can be left or right of nominal by a distance no greater than the width of the black stripe.



LOG-1010-01

Positional Criteria
(Adhered to in accordance with torque and turns specified in LSAR procedure.)

Unlocked, Nominal: The unlock slot should be centered in relation to the silver mark.



Locked, Nominal: The right edge of the lock slot should be flush with the right edge of the silver mark.



Unlocked, Tolerance: The unlock slot can be left or right of nominal by a distance no greater than the width of the black stripe.



Locked, Tolerance: The lock slot can be left or right of nominal by a distance no greater than the width of the black stripe.



LOG-1009-01



MBSU at worksite



Spare MBSU w/MLI attached to FRAM on ESP2

REMOVE AND REPLACE PFCS

IV	EV1	EV2
<p>MCC-H</p> <ol style="list-style-type: none"> 1. Verify SAW rotation inhibits complete 2. Verify inhibits for spare PFCS complete; give EV GO for PFCS removal 	<p><u>REMOVE SPARE PFCS</u></p> <ol style="list-style-type: none"> 1. Translate to P6 worksite 2. Ingress APFR 3. Remove thermal cover 4. Transfer thermal cover to EV2 <p><u>Demate FQDC H1</u></p> <ol style="list-style-type: none"> 5. On MCC GO, PGT[B1 12.0 ft-lb, CCW1 10RPM, MTL 30.5] – 6 ext 7/16: Break torque and drive QD H1 10 turns <div data-bbox="747 516 1356 708" style="border: 1px solid black; padding: 5px;"> <p style="text-align: center;"><u>CAUTION</u></p> <p>The torque necessary for the initial, break-free rotation of the QD drive point is greater than the maximum torque allowed when the drive point reaches internal mechanical stops. The PGT must not operate the drive point into the mechanical stops at the initial torque. Mechanical stops will be reached at 18 turns</p> </div> <ol style="list-style-type: none"> 6. PGT[A4 6.3 ft-lb, CCW2 30RPM, MTL 30.5] – 6 ext 7/16: Drive QD H1 to hard stop, ~8 turns 7. √Status indicator – DEMATE <p><u>Retract Acme screw and latch key from passive half</u></p> <ol style="list-style-type: none"> 8. PGT[A4 6.3 ft-lb, CW2 30RPM, MTL 30.5] – 6 ext 7/16: Drive QD H1 to hard stop, ~18 turns 9. √Status indicator remains at – DEMATE <p><u>Demate FQDC H2</u></p> <ol style="list-style-type: none"> 10. PGT[B1 12.0 ft-lb, CCW1 10RPM, MTL 30.5] – 6 ext 7/16: Break torque and drive QD H2 10 turns 11. PGT[A4 6.3 ft-lb, CCW2 30RPM, MTL 30.5] – 6 ext 7/16: Drive QD H2 to hard stop, ~8 turns 12. √Status indicator – DEMATE <p><u>Retract Acme screw and latch key from passive half</u></p> <ol style="list-style-type: none"> 13. PGT[A4 6.3 ft-lb, CW2 30RPM, MTL 30.5] – 6 ext 7/16: Drive QD H2 to hard stop, ~18 turns 14. √Status indicator remains at – DEMATE <div data-bbox="747 1219 1318 1295" style="border: 1px solid black; padding: 5px;"> <p style="text-align: center;"><u>CAUTION</u></p> <p>Acme screws unfastened/fastened out of sequence could lead to jamming of PFCS</p> </div> <p><u>Release Structural Fasteners</u></p> <ol style="list-style-type: none"> 15. Install Sq TM onto H3, √anti-backlash neutral 	<p><u>REMOVE SPARE PFCS</u></p> <ol style="list-style-type: none"> 1. Translate to P6 worksite 2. Set up WIF Extender and APFR (see Task Data page) 3. Receive thermal cover from EV1 4. Temp stow thermal cover at worksite

REMOVE AND REPLACE PFCS (Cont)

IV	EV1	EV2
<p>IV 3. Record S/N of failed PFCS: _____</p>	<p>16. PGT[B1 12.0 ft-lb, CCW2 30RPM, MTL 30.5] – Sq TM with 7/16 Rec: Drive PGT 5 turns (1 turn at bolt) on H3</p> <p>17. Remove Sq TM and install on H4, √anti-backlash neutral</p> <p>18. PGT[B1 12.0 ft-lb, CCW2 30RPM, MTL 30.5] – Sq TM with 7/16 Rec: Drive PGT 5 turns (1 turn at bolt) on H4</p> <p>19. Remove Sq TM</p> <p>20. PGT[B7 25.5 ft-lb, CCW2 30RPM, MTL 30.5] – 6 ext 7/16: Drive H3 minimum 5 turns</p> <p>21. √Status indicator – UNLOCK</p> <p>22. Install Square scoop on H4</p> <p>23. PGT[B7 25.5 ft-lb, CCW2 30RPM, MTL 30.5] – 6 ext 7/16: Drive H4 minimum 17 turns</p> <p>24. √Status indicator – UNLOCK</p> <p>25. Remove Spare PFCS</p> <p>26. Transfer spare PFCS to EV2</p> <p>27. Retrieve APFR</p> <p><u>REMOVE FAILED PFCS</u></p> <ol style="list-style-type: none"> Translate to Failed PFCS worksite Set up and ingress APFR (see Task Data sheet) Verify failed PFCS P/N and S/N to IV <p><u>Demate FQDC H1</u></p> <ol style="list-style-type: none"> On MCC GO, PGT[B1 12.0 ft-lb, CCW1 10RPM, MTL 30.5] – 6 ext 7/16: Break torque and drive QD H1 10 turns PGT[A4 6.3 ft-lb, CCW2 30RPM, MTL 30.5] – 6 ext 7/16: Drive QD H1 to hard stop, ~8 turns √Status indicator – DEMATE <p><u>Retract Acme screw and latch key from passive half</u></p> <ol style="list-style-type: none"> PGT[A4 6.3 ft-lb, CW2 30RPM, MTL 30.5] – 6 ext 7/16: Drive QD H1 to hard stop, ~18 turns √Status indicator remains at – DEMATE <p><u>Demate FQDC H2</u></p> <ol style="list-style-type: none"> PGT[B1 12.0 ft-lb, CCW1 10RPM, MTL 30.5] – 6 ext 7/16: Break torque and drive QD H2 10 turns PGT[A4 6.3 ft-lb, CCW2 30RPM, MTL 30.5] – 6 ext 7/16: Drive QD H2 to hard stop, ~8 turns √Status indicator – DEMATE 	<p>5. Receive spare PFCS from EV1 and stow on BRT</p> <div style="border: 1px solid black; padding: 5px; margin: 10px 0;"> <p style="text-align: center;"><u>CAUTION</u></p> <p style="text-align: center;">Avoid contacting PFCS mating surface (electrical and fluid connectors) with structure during translation with PFCS</p> </div> <p><u>REMOVE FAILED PFCS</u></p> <ol style="list-style-type: none"> Translate to IEA worksite with spare PFCS

REMOVE AND REPLACE PFCS (Cont)

IV	EV1	EV2
<p>MCC-H 4. Verify Inhibits for failed PFCS complete; give EV GO for PFCS removal</p>	<p><u>Retract Acme screw and latch key from passive half</u></p> <p>12. PGT[A4 6.3 ft-lb, CW2 30RPM, MTL 30.5] – 6 ext 7/16: Drive QD H2 to hardstop, ~18 turns</p> <p>13. ✓Status indicator remains at – DEMATE</p> <p><u>Release Structural Fasteners</u></p> <p>14. Install Sq TM onto H3, ✓anti-backlash neutral</p> <p>15. PGT[B1 12.0 ft-lb, CCW2 30RPM, MTL 30.5] – Sq TM with 7/16 Rec: Drive PGT 5 turns (1 turn at bolt) on H3</p> <p>16. Remove Sq TM and install on H4, ✓anti-backlash neutral</p> <p>17. PGT[B1 12.0 ft-lb, CCW2 30RPM, MTL 30.5] – Sq TM 7/16 Rec: Drive PGT 5 turns (1 turn at bolt) on H4</p> <p>18. Remove Sq TM</p> <p>19. PGT[B7 25.5 ft-lb, CCW2 30RPM, MTL 30.5] – 6 ext 7/16: Drive H3 minimum 5 turns</p> <p>20. ✓Status indicator – UNLOCK</p> <p>21. PGT[B7 25.5 ft-lb, CCW2 30RPM, MTL 30.5] – 6 ext 7/16: Drive H4 minimum 17 turns</p> <p>22. ✓Status indicator – UNLOCK</p> <p>23. On MCC GO, remove failed PFCS</p> <p>24. Stow failed PFCS on BRT</p> <p><u>INSTALL SPARE PFCS</u></p> <p>1. Receive spare PFCS from EV2 and install on IEA</p> <p>2. ✓Status indicator on H3 and H4 are in UNLOCK</p> <div style="border: 1px solid black; padding: 5px; margin: 10px 0;"> <p style="text-align: center;">CAUTION</p> <p>Attempting to mate QDs H1 and H2 before Acme screw H4 is fastened could lead to jamming of PFCS and breakage of QDs. Acme screw H4 must be fastened before QDs H1 and H2 are mated</p> </div> <p>3. PGT[A3 4.8 ft-lb, CW2 30RPM, MTL 30.5] – 6 ext 7/16: Drive H4, 16-17 turns</p> <p>4. ✓Status indicator – LOCK</p> <p>5. PGT[A3 4.8 ft-lb, CW2 30RPM, MTL 30.5] – 6 ext 7/16: Drive H3, 5-6 turns</p> <p>6. ✓Status indicator – LOCK</p> <p>7. Remove Square Scoop from H4 fitting</p> <p><u>Engage Acme screw and latch key to passive half</u></p> <p>8. PGT[B1 12.0 ft-lb, CCW230RPM, MTL 30.5] – 6 ext 7/16: Drive QD H2 to hardstop, ~18 turns</p>	<p>2. Install Square Scoop on H4</p> <p><u>INSTALL SPARE PFCS</u></p> <p>1. Transfer spare PFCS to EV1</p>

REMOVE AND REPLACE PFCS (Cont)

IV	EV1	EV2															
<p>IV 5. Record spare PFCS bolt data</p> <table border="1"> <thead> <tr> <th>Bolt</th> <th>Turns</th> <th>Torque</th> </tr> </thead> <tbody> <tr> <td>H1</td> <td>_____</td> <td>_____</td> </tr> <tr> <td>H2</td> <td>_____</td> <td>_____</td> </tr> <tr> <td>H3</td> <td>_____</td> <td>_____</td> </tr> <tr> <td>H4</td> <td>_____</td> <td>_____</td> </tr> </tbody> </table>	Bolt	Turns	Torque	H1	_____	_____	H2	_____	_____	H3	_____	_____	H4	_____	_____	<p><u>Mate FQDC H2</u></p> <p>9. PGT[B1 12.0 ft-lb, CW2 30RPM, MTL 30.5] – 6 ext 7/16: Drive QD H2 to hardstop, ~18 turns</p> <p>10. √Status indicator – MATE</p> <p><u>Engage Acme screw and latch key to passive half</u></p> <p>11. PGT[B1 12.0 ft-lb, CCW2 30RPM, MTL 30.5] – 6 ext 7/16: Drive QD H1 to hardstop, ~18 turns</p> <p><u>Mate FQDC H1</u></p> <p>12. PGT[B1 12.0 ft-lb, CW2 30RPM, MTL 30.5] – 6 ext 7/16: Drive QD H1 to hardstop, ~18 turns</p> <p>13. √Status indicator – MATE</p> <p>14. Egress and remove APFR</p> <p>15. Give MCC-H GO to restore power to PFCS</p> <p><u>INSTALL FAILED PFCS</u></p> <ol style="list-style-type: none"> Translate to P6 worksite Transfer failed PFCS to EV2 	<p><u>INSTALL FAILED PFCS</u></p> <ol style="list-style-type: none"> Translate to P6 worksite Ingress APFR/WIF Extender Receive failed PFCS from EV1 and install on ESP1 √Status indicator on H3 and H4 are in UNLOCK PGT[A3 4.8 ft-lb, CW2 30RPM, MTL 30.5] – 6 ext 7/16: Drive H4, 16-17 turns √Status indicator – LOCK PGT[A3 4.8 ft-lb, CW2 30RPM, MTL 30.5] – 6 ext 7/16: Drive H3, 5-6 turns √Status indicator – LOCK Remove Square Scoop from H4 fitting <p><u>Engage Acme screw and latch key to passive half</u></p> <p>10. PGT[B1 12.0 ft-lb, CCW2 30RPM, MTL 30.5] – 6 ext 7/16: Drive QD H2 to hardstop, ~18 turns</p> <p><u>Mate FQDC H2</u></p> <p>11. PGT[B1 12.0 ft-lb, CW2 30RPM, MTL 30.5] – 6 ext 7/16: Drive QD H2 to hardstop, ~18 turns</p> <p>12. √Status indicator – MATE</p> <p><u>Engage Acme screw and latch key to passive half</u></p> <p>13. PGT[B1 12.0 ft-lb, CCW2 30RPM, MTL 30.5] – 6 ext 7/16: Drive QD H1 to hardstop, ~18 turns</p> <p><u>Mate FQDC H1</u></p> <p>14. PGT[B1 12.0 ft-lb, CW2 30RPM, MTL 30.5] – 6 ext 7/16: Drive QD H1 to hardstop, ~18 turns</p>
Bolt	Turns	Torque															
H1	_____	_____															
H2	_____	_____															
H3	_____	_____															
H4	_____	_____															
<p>IV 6. Record failed PFCS bolt data</p> <table border="1"> <thead> <tr> <th>Bolt</th> <th>Turns</th> <th>Torque</th> </tr> </thead> <tbody> <tr> <td>H1</td> <td>_____</td> <td>_____</td> </tr> <tr> <td>H2</td> <td>_____</td> <td>_____</td> </tr> <tr> <td>H3</td> <td>_____</td> <td>_____</td> </tr> <tr> <td>H4</td> <td>_____</td> <td>_____</td> </tr> </tbody> </table>	Bolt	Turns	Torque	H1	_____	_____	H2	_____	_____	H3	_____	_____	H4	_____	_____		
Bolt	Turns	Torque															
H1	_____	_____															
H2	_____	_____															
H3	_____	_____															
H4	_____	_____															

REMOVE AND REPLACE PFCS (Cont)

IV	EV1	EV2
	3. Retrieve and transfer thermal cover to EV2	15. ✓Status indicator – MATE 16. Receive thermal cover from EV1 17. Install thermal cover 18. Remove APFR and WIF Extender

REMOVE AND REPLACE PFCS – TASK DATA

Estimated Task Duration:

Two EV Crew	3:00
-------------	------

Tools:

EV1	EV2
PGT	PGT
7/16" x 6" ext	7/16" x 6" ext
Square Torque Multiplier w/7/16" Recessed socket	Square Scoop
Square Scoop	APFR
APFR	WIF extender
BRT	BRT

EVA Fasteners:

Fastener Name	Label	Head Size	Qty	Install Torque (ft-lb)	Max Break Away Torque (ft-lb)	Failure Torque (ft-lb)	Turns	RPM
Fluid QD	H1	7/16"	1	12.0	7.5	33.3 (R) 27.1 (I)	18	30
Fluid QD	H2	7/16"	1	12.0	7.5	33.3 (R) 27.1 (I)	18	30
Fastener	H3	7/16"	1	4.8	31.7	190.3 (R) 22.8 (I)	5-6	30
Fastener	H4	7/16"	1	4.8	33.5	188.4 (R) 27.8(I)	16-17	30

EVA Connectors:

Harness	From	To	Clamps (#)	Conn Size	Function
P5 (ESP1)	ESP DF	PFCS J7	None	15	FSE Heater Power

Foot Restraints:

Task	WIF	APFR Setting	WIF Extender Setting
P6 IEA PFCS (Non-Keel side, 2B)	P6-19	12,QQ,A,12	N/A
P6 IEA PFCS (Keel side, 4B)	P6-20	12,QQ,L,12	N/A
S4 IEA PFCS (Non-Keel side)	S4-7	12,QQ,A,12	N/A
S4 IEA PFCS (Keel side)	S4-8	12,QQ,L,12	N/A
Spare PFCS on ESP1	LAB-01-06	8, MM, F, 12	7, B, 6
Other PFCS Locations	TBD	TBD	N/A

ORU Identification:

Task	Part Number	Serial Number
Spare PFCS	RE-2814-06	0008
P6 PFCS	RE-2814-05	Port-00004, Stbd-00002
Other PFCS Locations TBD	TBD	TBD

ORU Mass: PFCS=255 lb, FSE=103 lb

Notes:

1. Thermal conditioning of the spare PFCS before installation may be required
2. PFCS will travel outward or inward as Acme screw H4 is unfastened or fastened
3. Lock SARJ when translating outboard of SARJ
4. A crewman on the RMS could also be used for ORU transfer to and from the worksite. This might also change the order of the task
5. If taking the FRAM with the PFCS, combined mass exceeds BRT capability
6. DO NOT USE the P6 IEA ORU placards. The label information is incorrect. Reference P6 ORU label mapping in Section 18
7. There is no hard stop when releasing H3 and H4 bolts; upon release, they will free spin

Cautions:

1. Acme screws unfastened/fastened out of sequence could lead to jamming of PFCS during removal. When unfastening Acme screws, H3 must be unfastened before H4. When fastening Acme screws, H4 must be fastened before H3
2. Attempting to mate QDs H1 and H2 before Acme screw H4 is fastened could lead to jamming of PFCS and breakage of QDs. Acme screw H4 must be fastened before QDs H1 and H2 are mated
3. Avoid contacting PFCS mating surface (electrical and fluid connectors) with structure during translation with PFCS
4. Ensure ORU is maintained level and perpendicular to stanchion during installation. Failure to comply may damage H4 status indicator probe
5. Minimize force applied to H1 microfixture. It is not rated to withstand excessive loads

Warnings:

1. Voltage Hazard exists at the connectors of the failed PFCS. Failed PFCS must be safed before removal
2. Depending on worksite proximity to SAW rotation, MCC-H may need to inhibit SAW rotation to avoid collision with the EVA crewmembers
3. If taking the FRAM with the PFCS, inhibit may be different. Connector must be released

REMOVE AND REPLACE PFCS – TASK DATA (Cont)

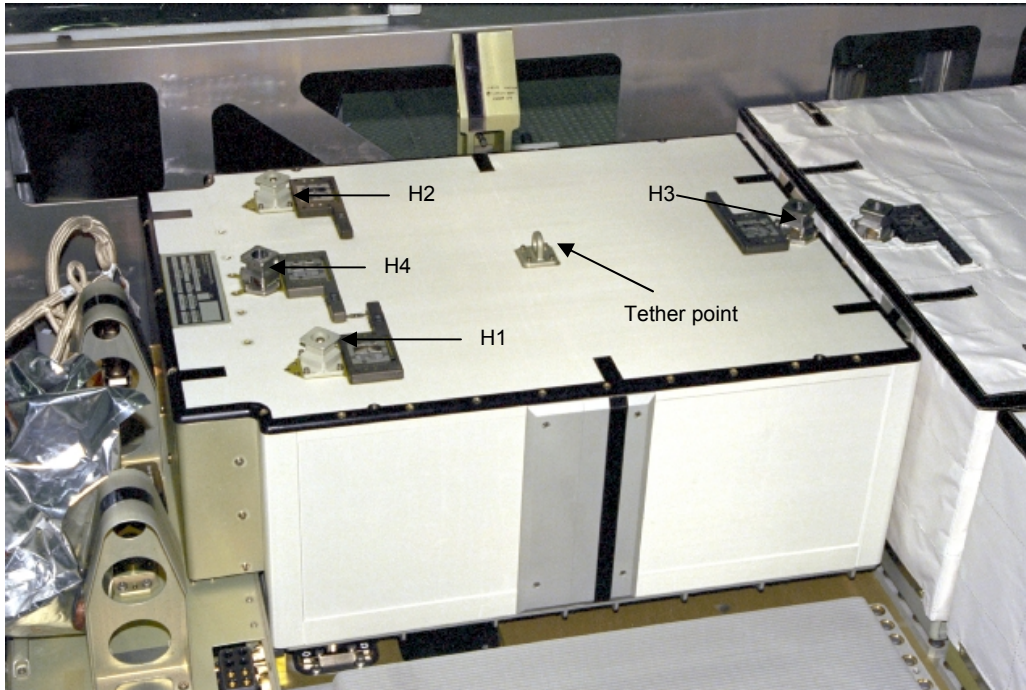

PFCS installed on P6 IEA (Port)



REMOVE AND REPLACE PFCS – TASK DATA (Cont)

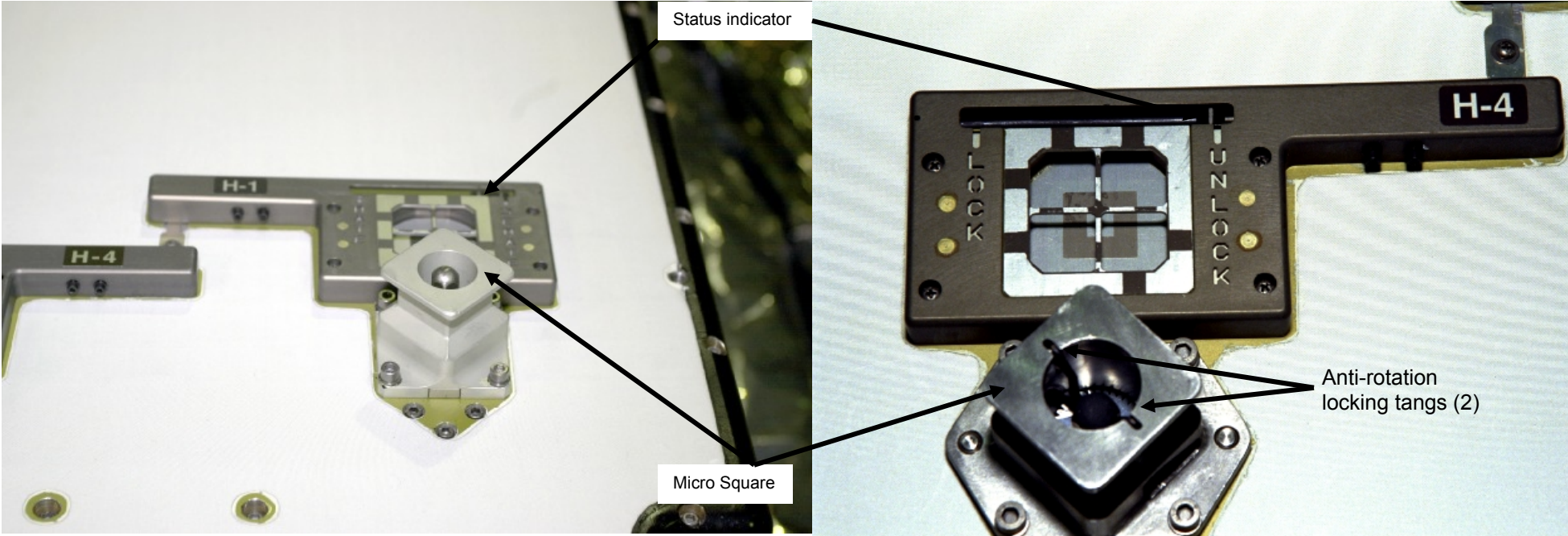

REMOVE AND REPLACE PFCS – TASK DATA (Cont)

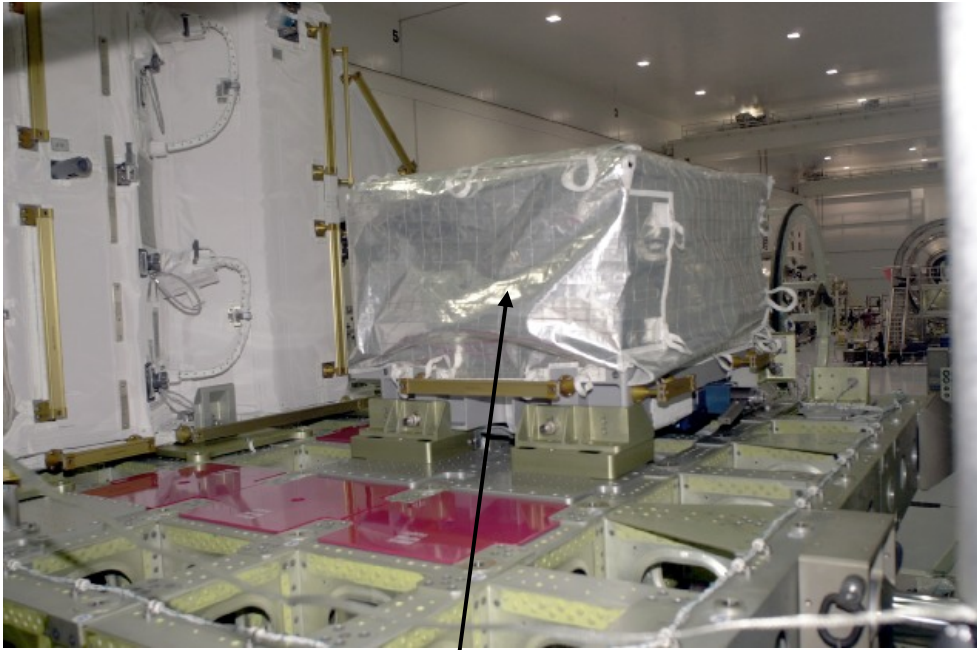

PFCS Thermal Cover

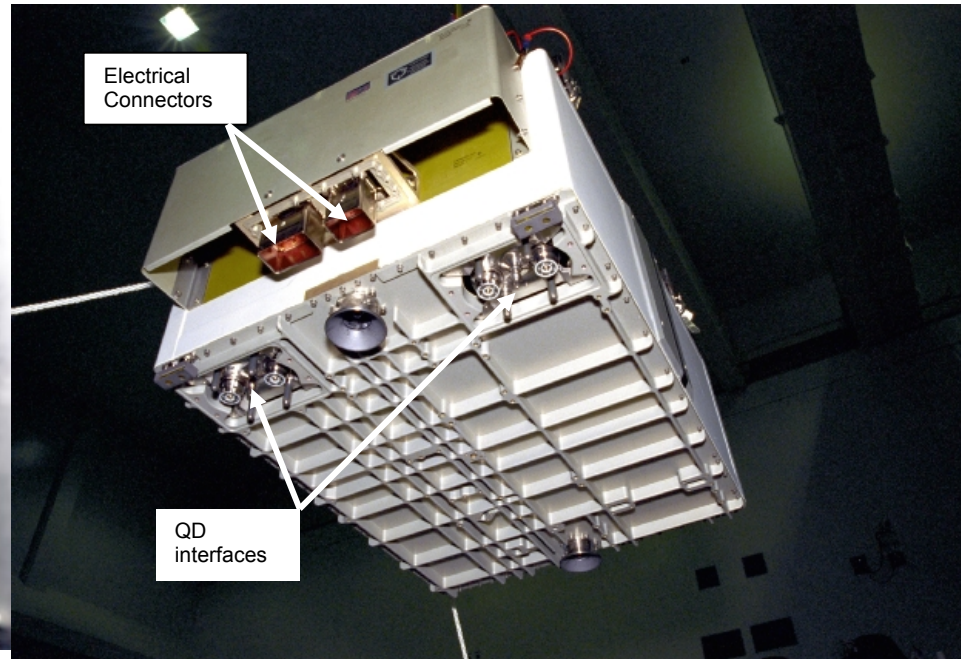

PFCS Mating Surfaces

This Page Intentionally Blank

FLIGHT SPECIFIC EVA REFERENCE

I

TRUSS SSAS COMPONENTS AT READY-TO-LATCH (RTL) POSITION	FS 18-3
BGA PRIMARY POWER CABLE CLAMPS	FS 18-4
RELEASE BETA GIMBAL LAUNCH RESTRAINTS	FS 18-5
FOUR BAR IN LOCKED POSITION	FS 18-6
SABB UNSTOW.....	FS 18-7
4-BAR STOWED AND DEPLOYED CONFIGURATIONS	FS 18-10
MAST CANISTER MDA	FS 18-11
SARJ DLA EVA BOLT CONFIG.....	FS 18-12
P4 UPPER ORU AND CABLE BOX NUMBERS.....	FS 18-13
P4 LOWER ORU AND CABLE BOX NUMBERS.....	FS 18-14
P6 UPPER ORU AND CABLE BOX NUMBERS.....	FS 18-15
P6 LOWER ORU AND CABLE BOX NUMBERS.....	FS 18-16
PRD USE FOR 4-BAR DEPLOY.....	FS 18-17
ESP-2 HANDRAILS AND WIFs – ZENITH	FS 18-18
ESP-2 HANDRAILS AND WIFs – NADIR	FS 18-19
CETA CART – TOP VIEW	FS 18-20
CETA SWINGARM AND WIF MARKINGS	FS 18-21
CETA CART COUPLERS	FS 18-22
STATUS INDICATORS (MBSU, DDCU, BCDU).....	FS 18-23

**FLIGHT SPECIFIC
EVA REF**

This Page Intentionally Blank

TRUSS SSAS COMPONENTS AT READY-TO-LATCH (RTL) POSITION

Fwd truss face SSAS RTL components (other SSAS RTL components at zenith and nadir edges of truss)

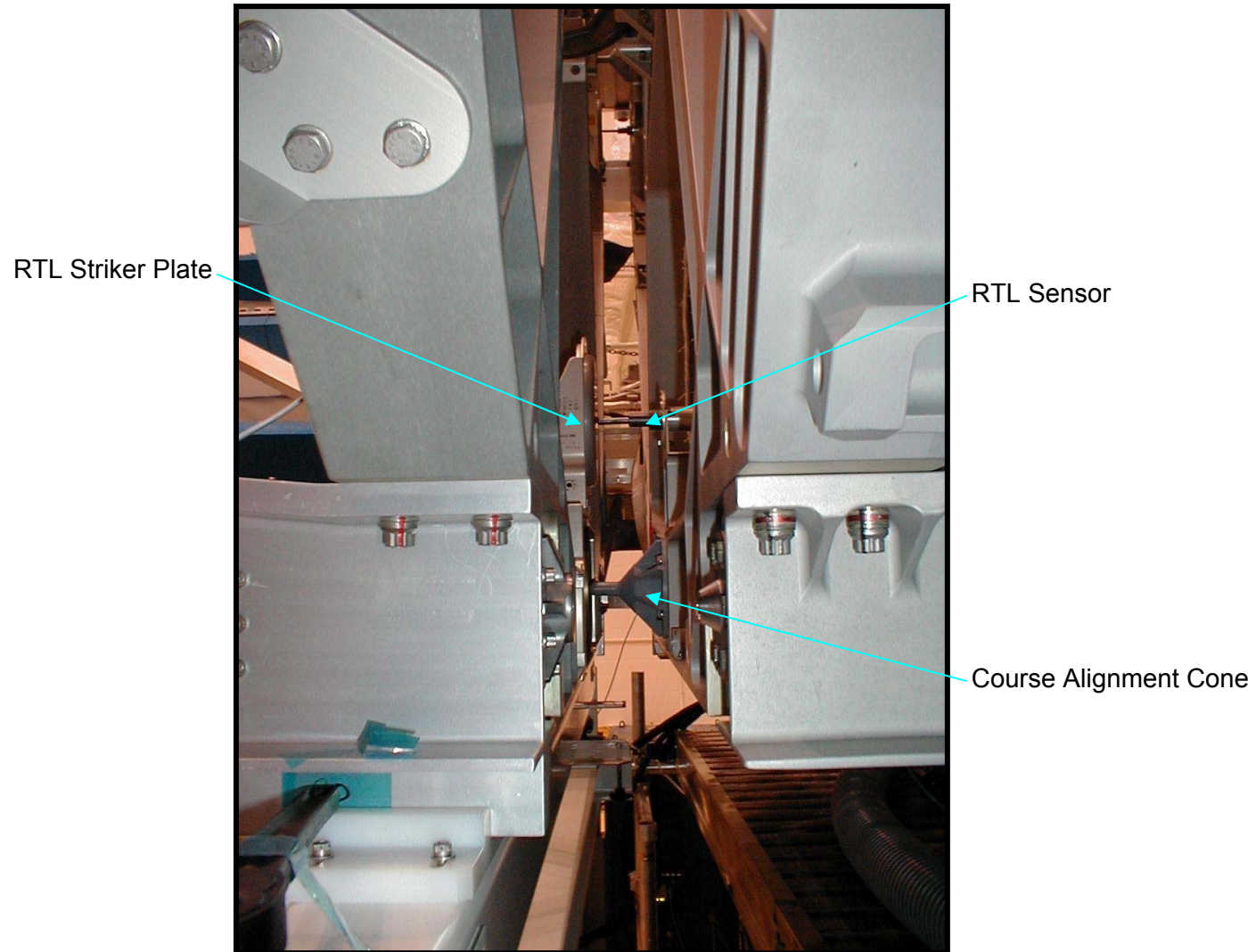

BGA PRIMARY POWER CABLE CLAMPS

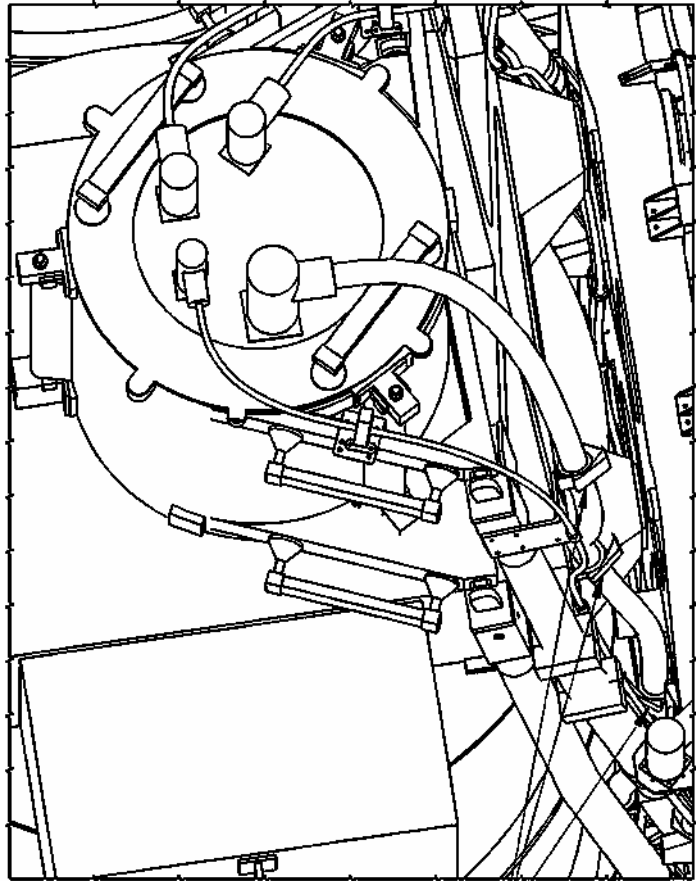

RELEASE BGA POWER CABLE FROM CLAMPS
PRIOR TO FOUR BAR DEPLOYMENT

FOUR BAR
LOWER SAA
(R075800)

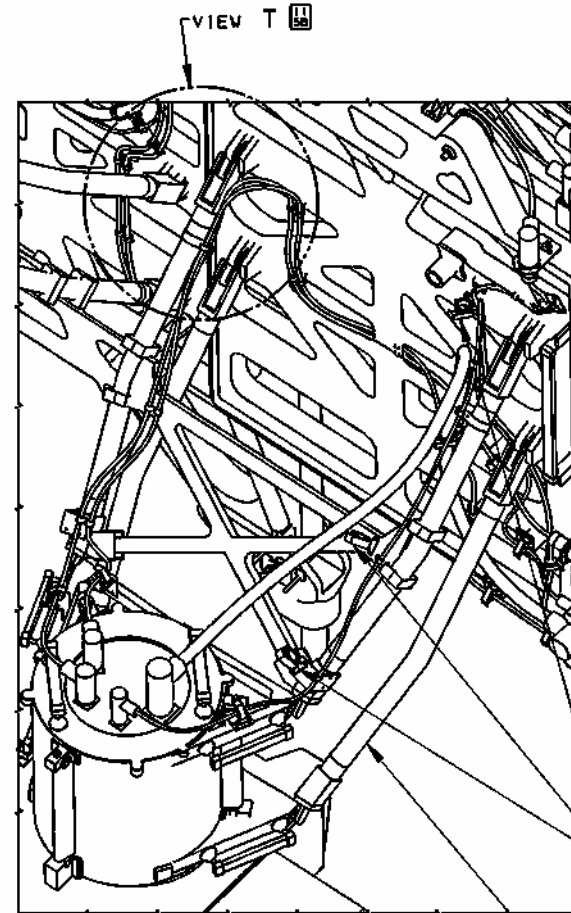

VIEW T

BGA POWER
CABLE CLAMPS
(R078501)

FOUR BAR
LOWER SAA
(R075800)

RELEASE BETA GIMBAL LAUNCH RESTRAINTS

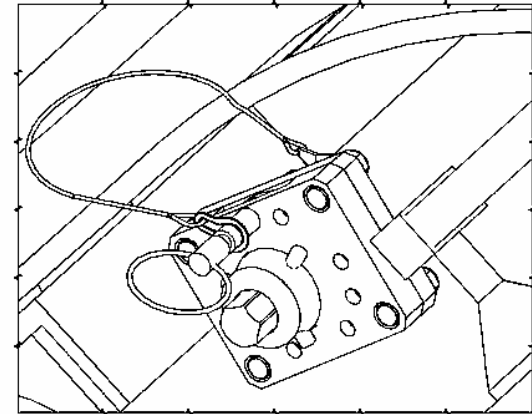
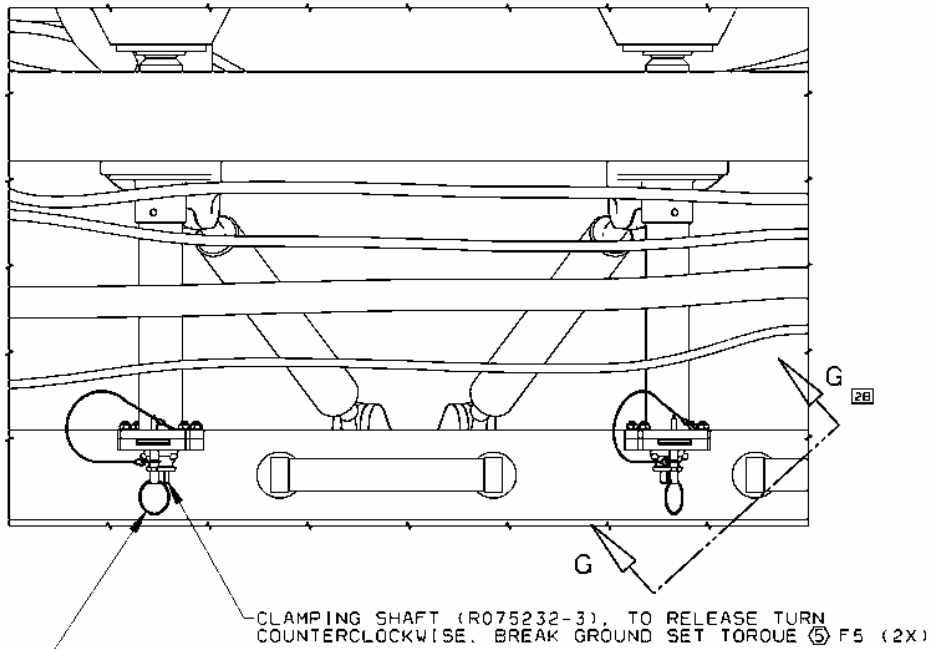

LAUNCH

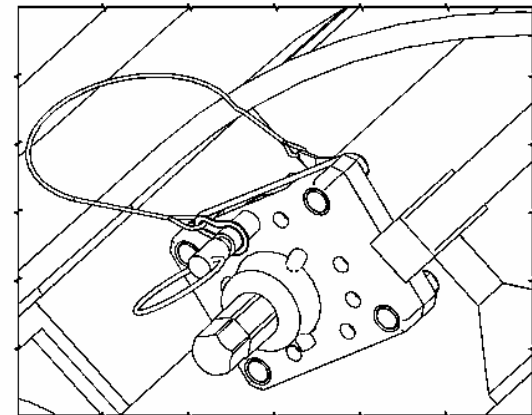

DEPLOYED

View G

FOUR BAR IN LOCKED POSITION

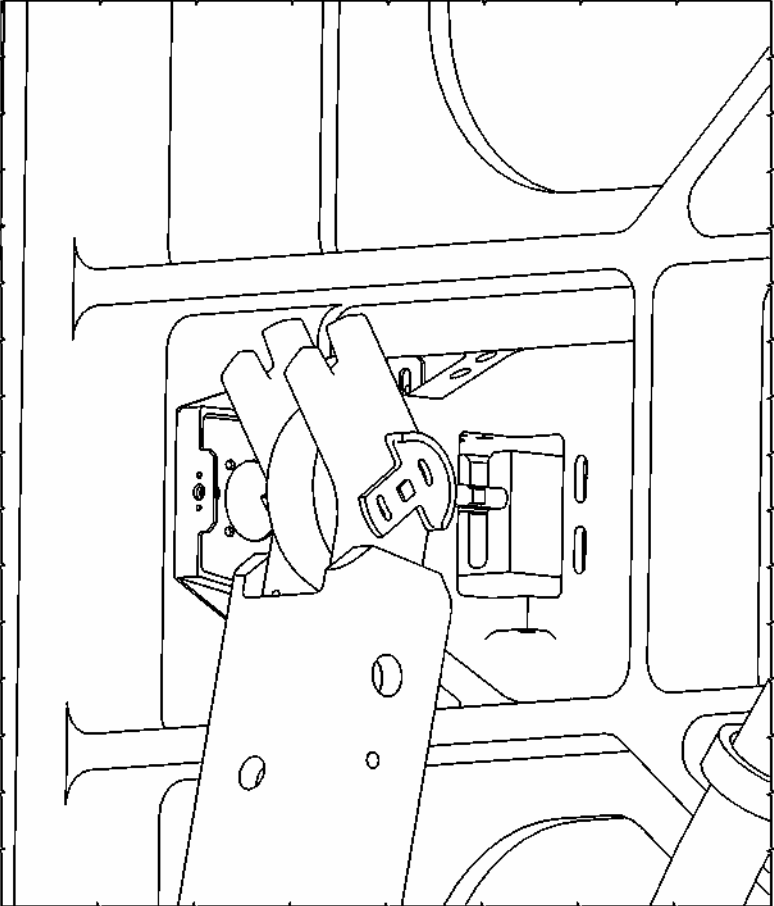

LAUNCH

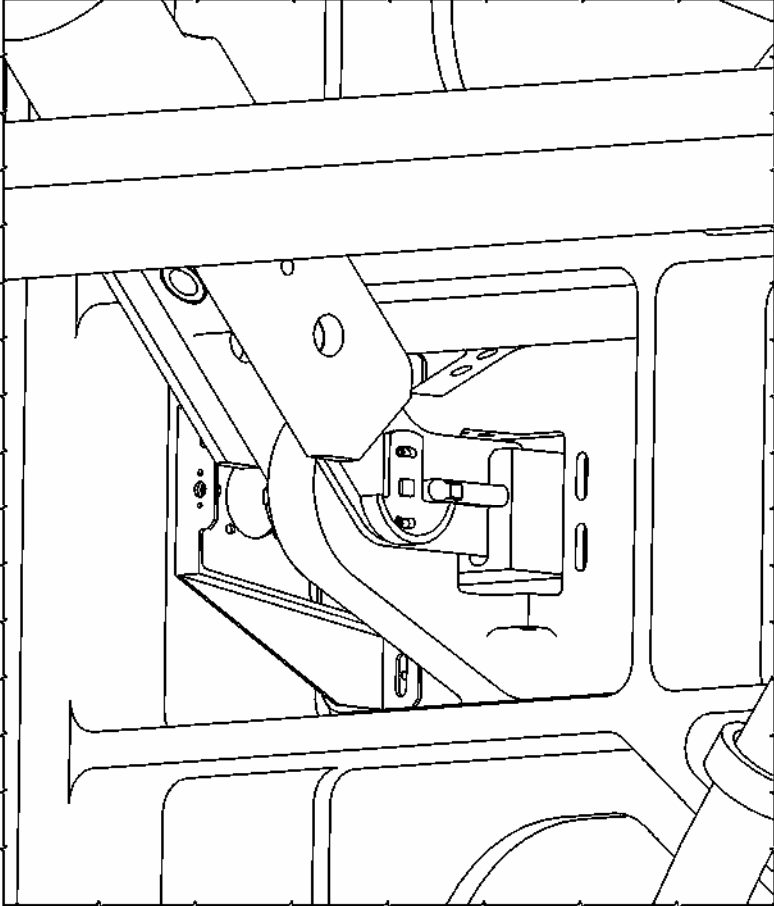

DEPLOYED

View T

SABB UNSTOW

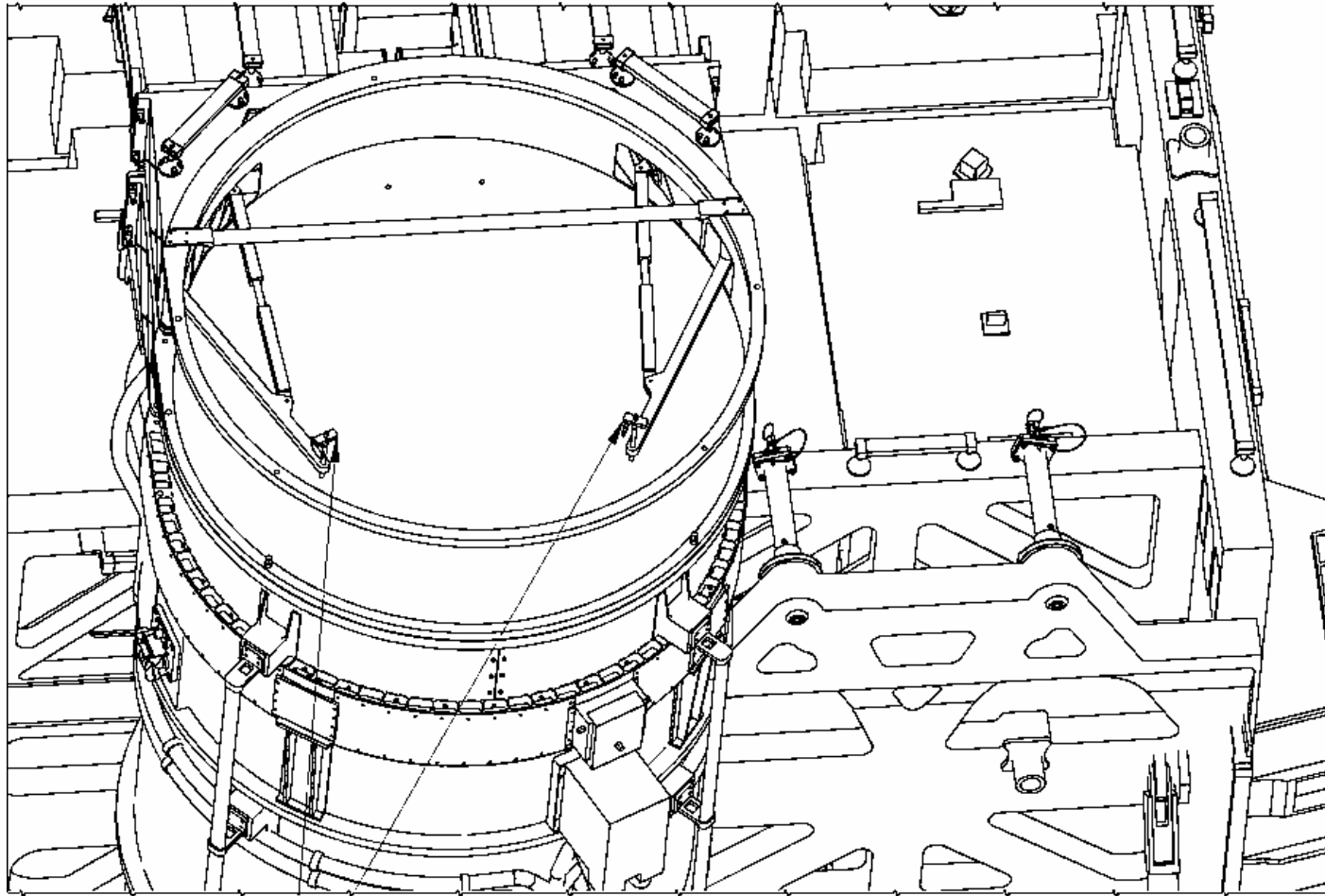

DISENGAGE PIP PINS FROM PIVOT LID
LMMS (5851426-001)

SABB UNSTOW (Cont)

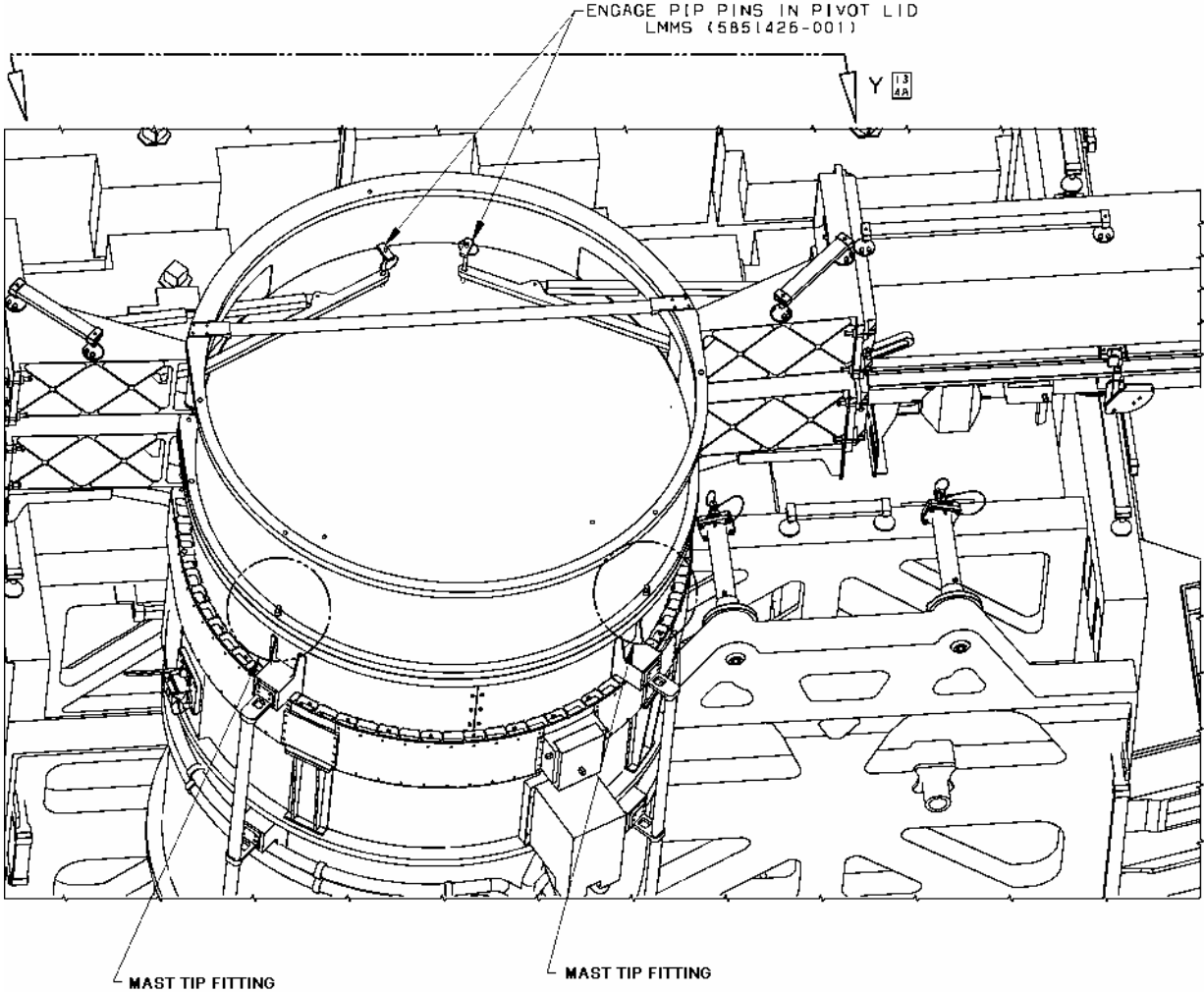

SABB UNSTOW (Cont)

TIP FITTING LMMS (5843517-003). TURN COUNTERCLOCKWISE TO BREAK GROUND SET TORQUE (5) F6. FASTENERS WILL POP UP WHEN DISENGAGED.

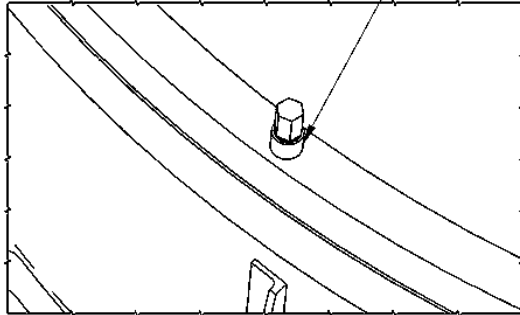

View W

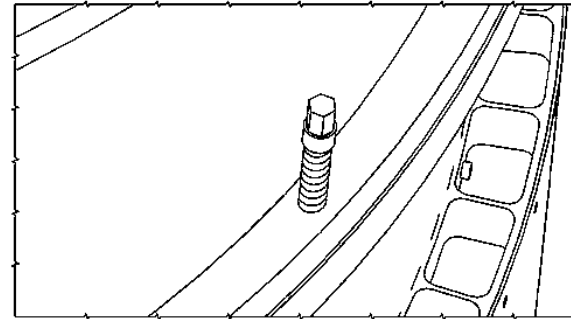

View AF

TIP FITTING INSTALLED
3 PLACES EACH MAST CANISTER

TIP FITTING DEPLOYED
3 PLACES EACH MAST CANISTER

VERIFY LOCKING SLEEVE LMMS (581331-001) IS IN LOCKED POSITION SHOWN, TYP UPPER AND LOWER BLANKET BOXES

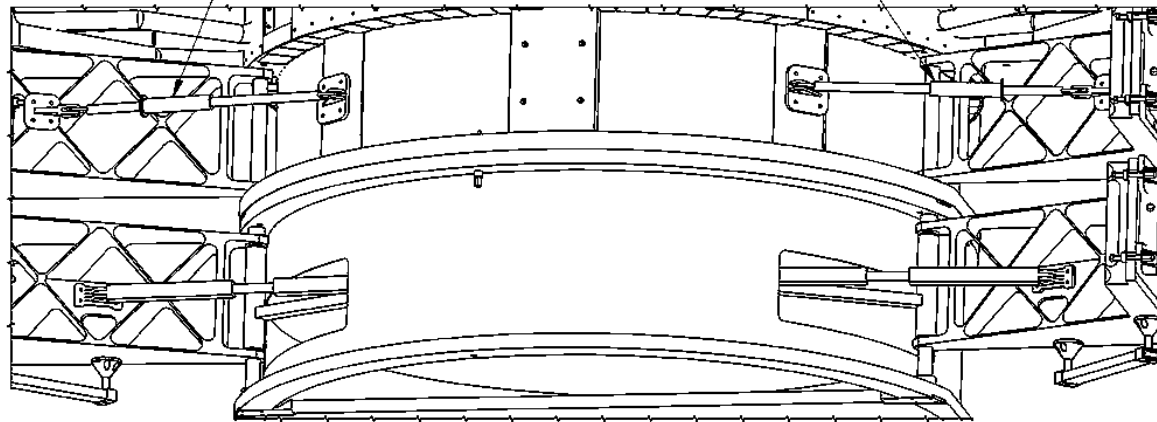

SOLAR ARRAY LOCKING ARMS

4-BAR STOWED AND DEPLOYED CONFIGURATIONS

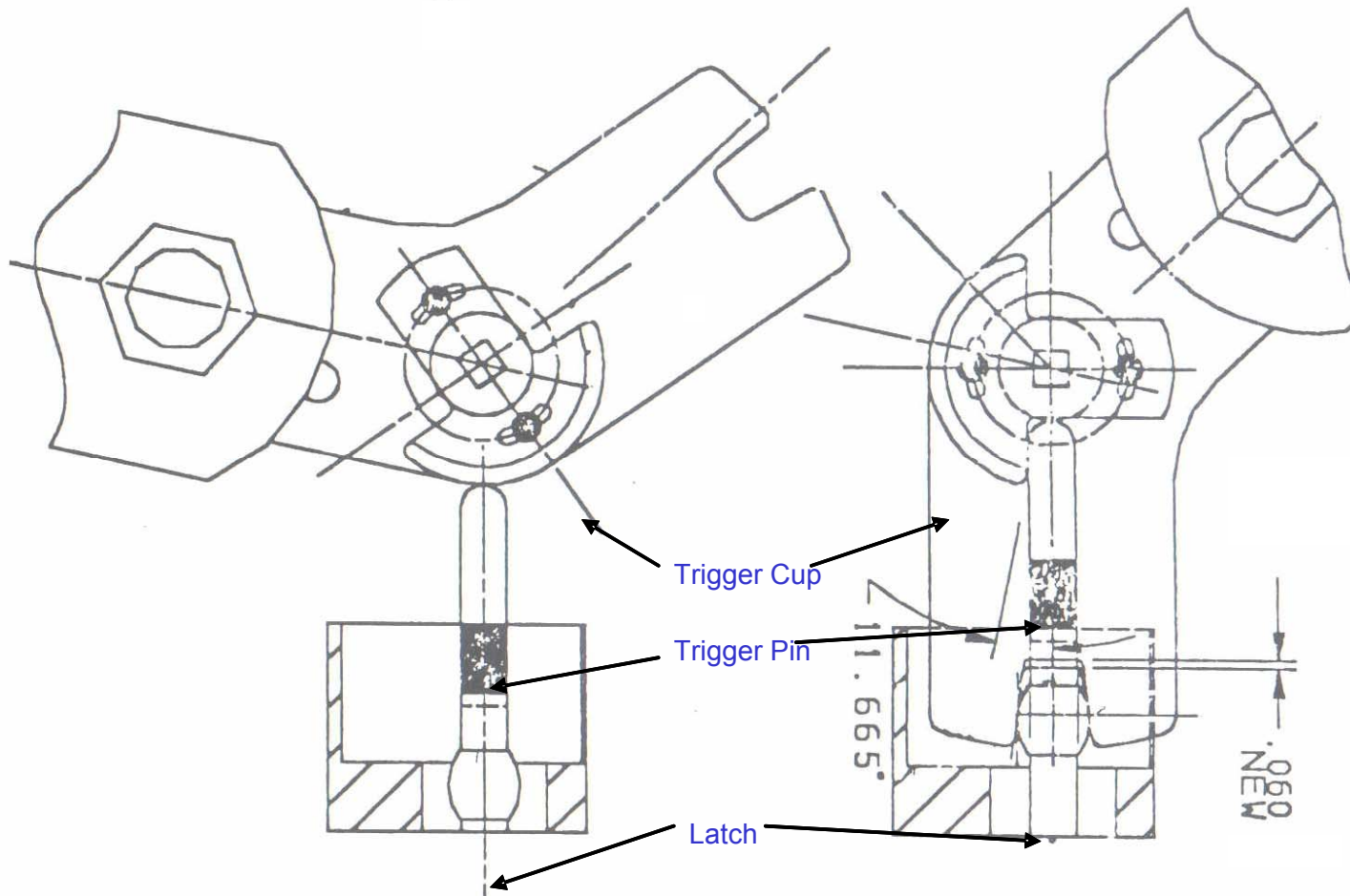

**Stowed
(Launch Configuration)**

**Deployed
(On-Orbit Configuration)**

MAST CANISTER MDA

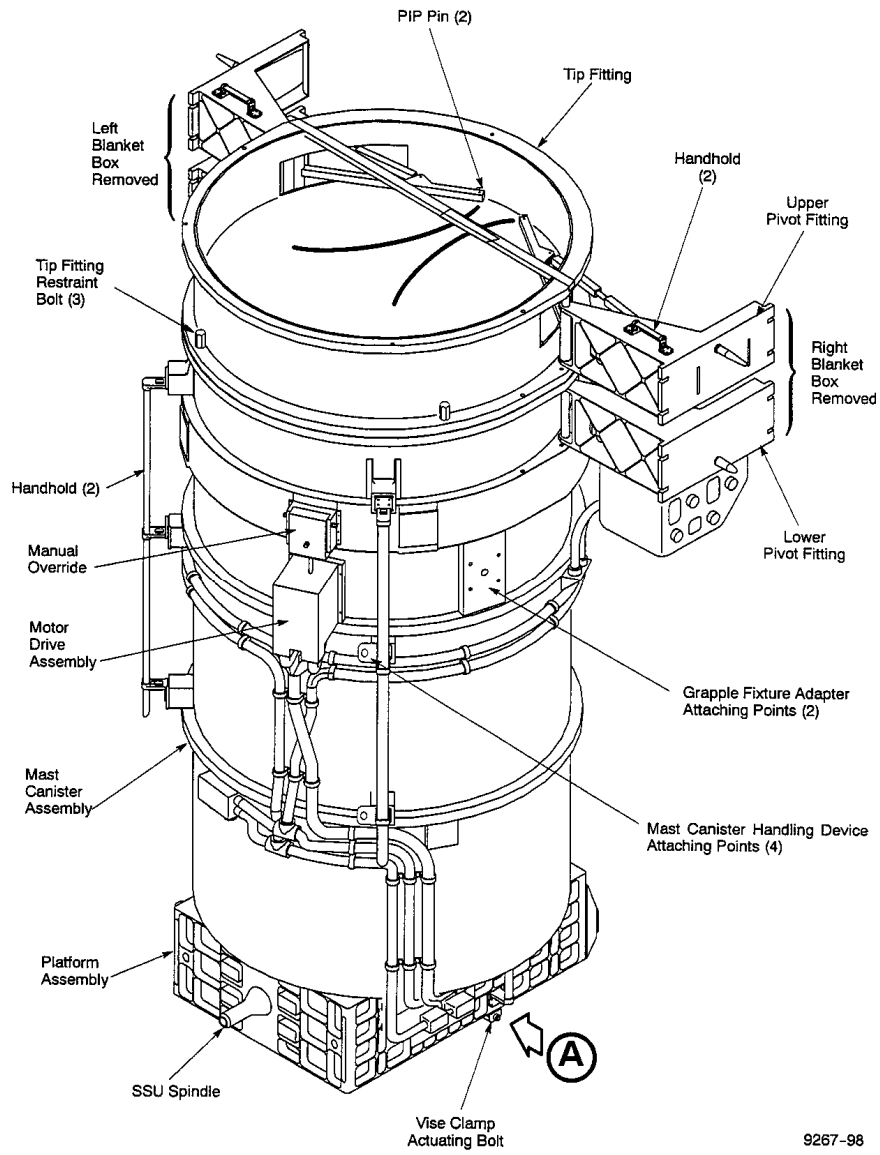

SARJ DLA EVA BOLT CONFIG

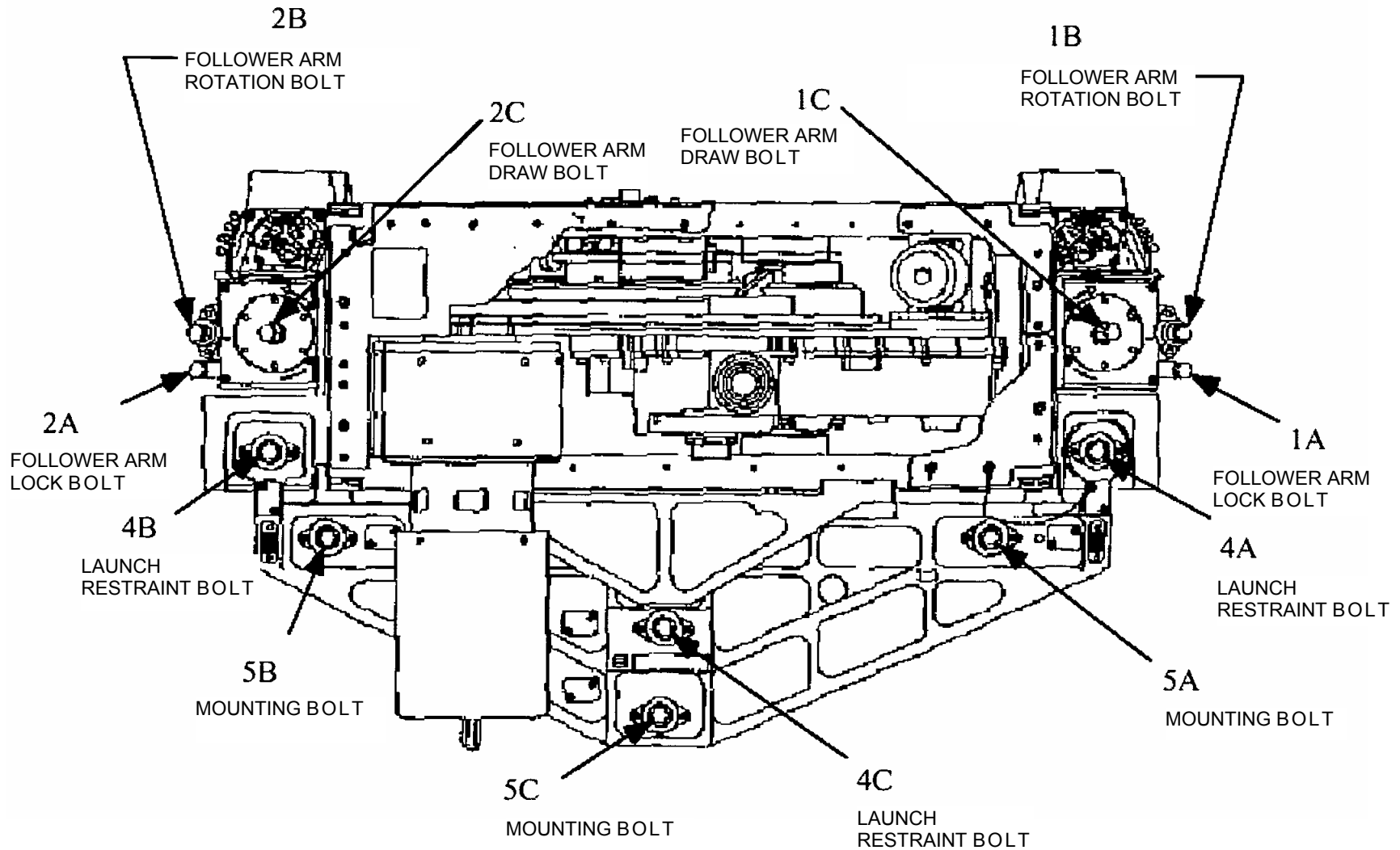

P4 UPPER ORU AND CABLE BOX NUMBERS

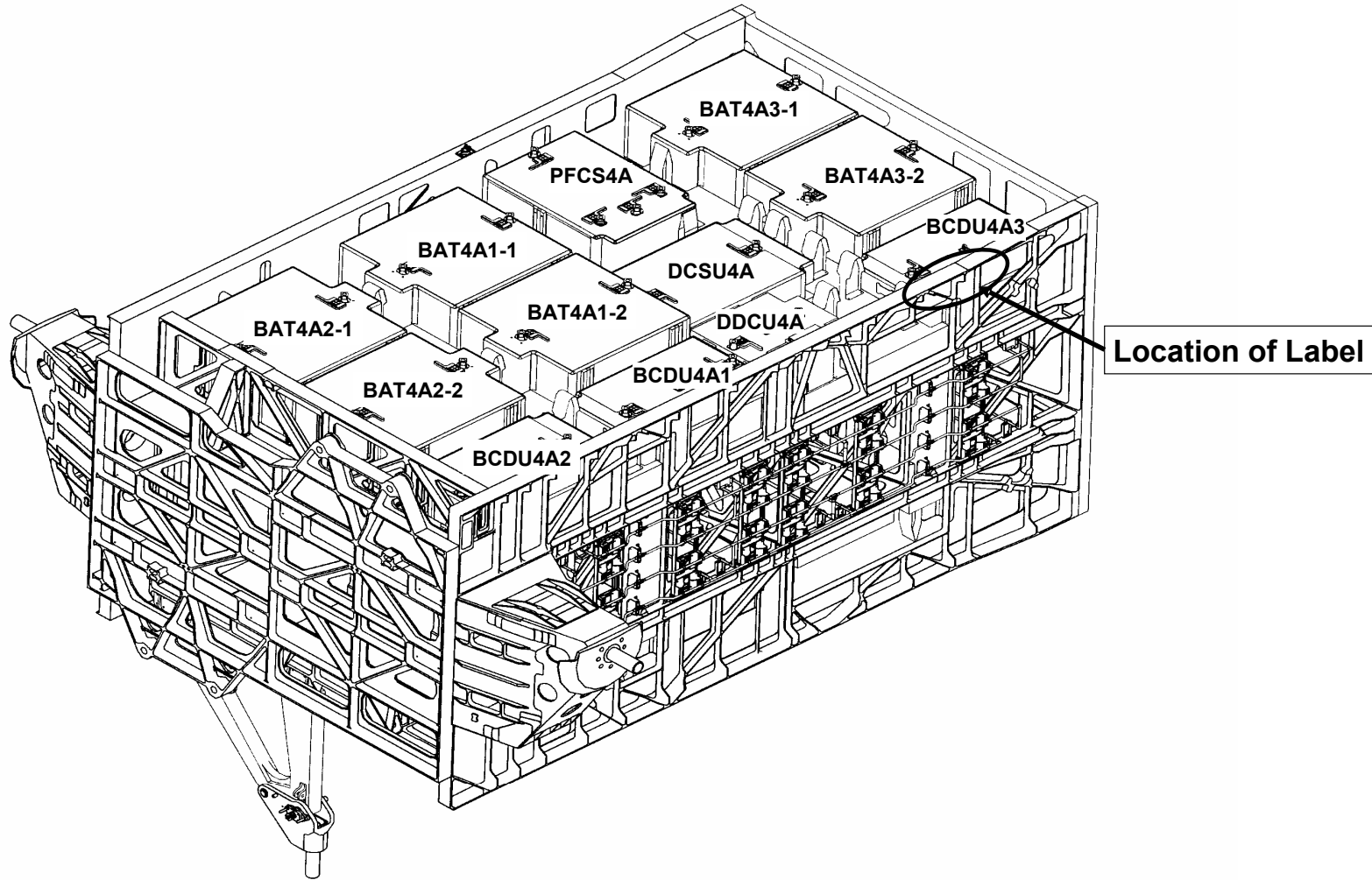

P4 LOWER ORU AND CABLE BOX NUMBERS

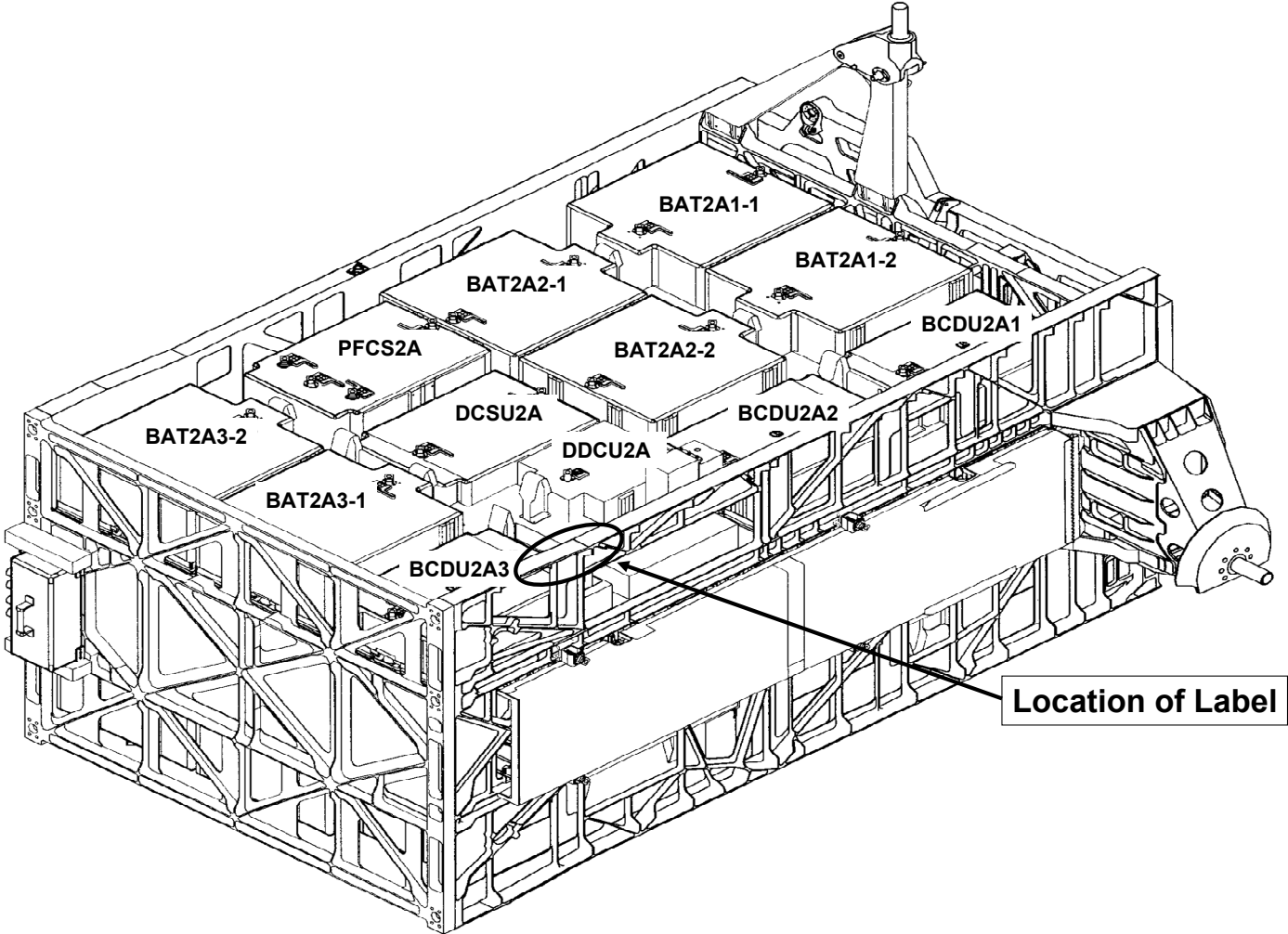

P6 UPPER ORU AND CABLE BOX NUMBERS

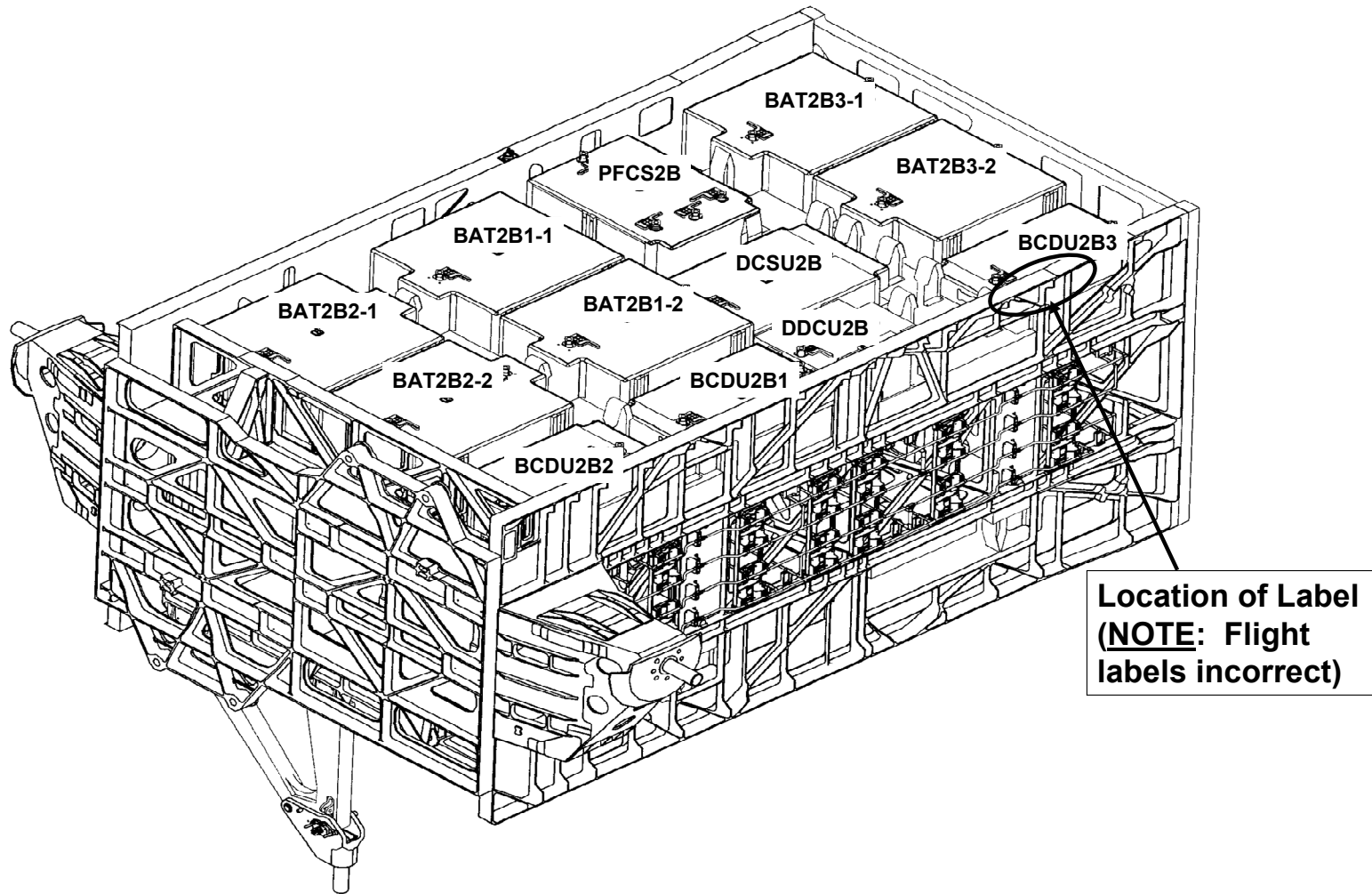

P6 LOWER ORU AND CABLE BOX NUMBERS

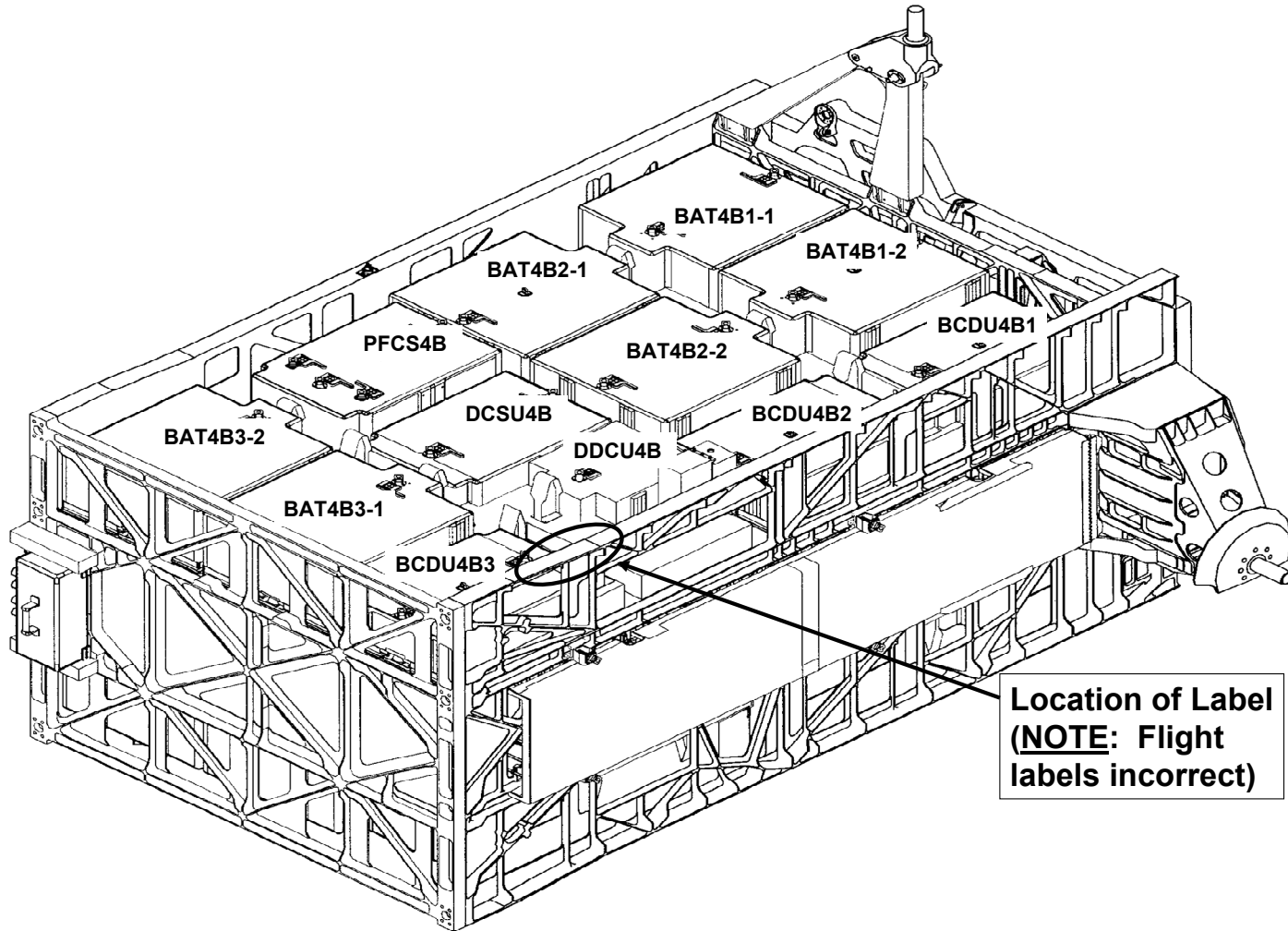

PRD USE FOR 4-BAR DEPLOY

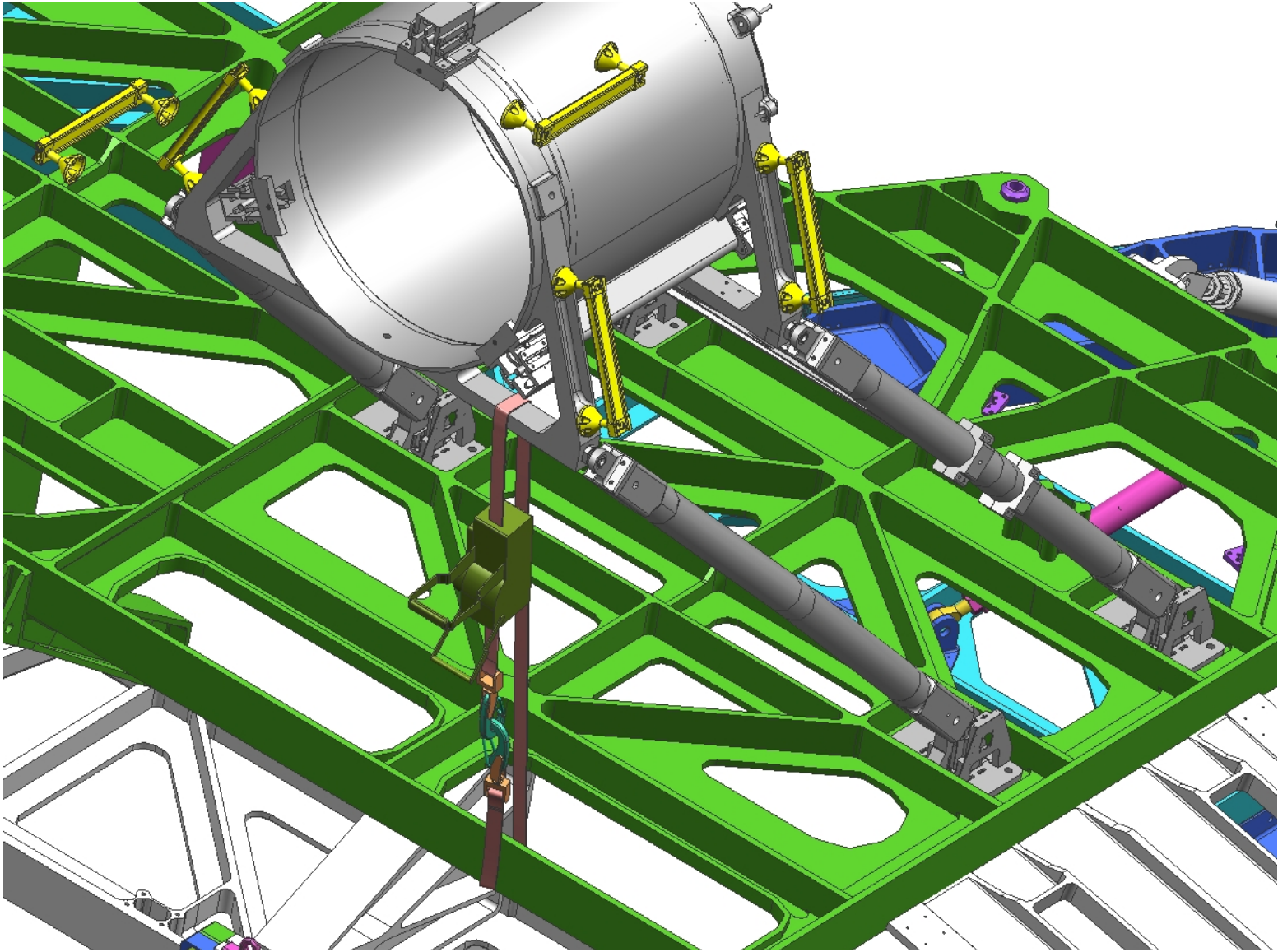

AIRLOCK

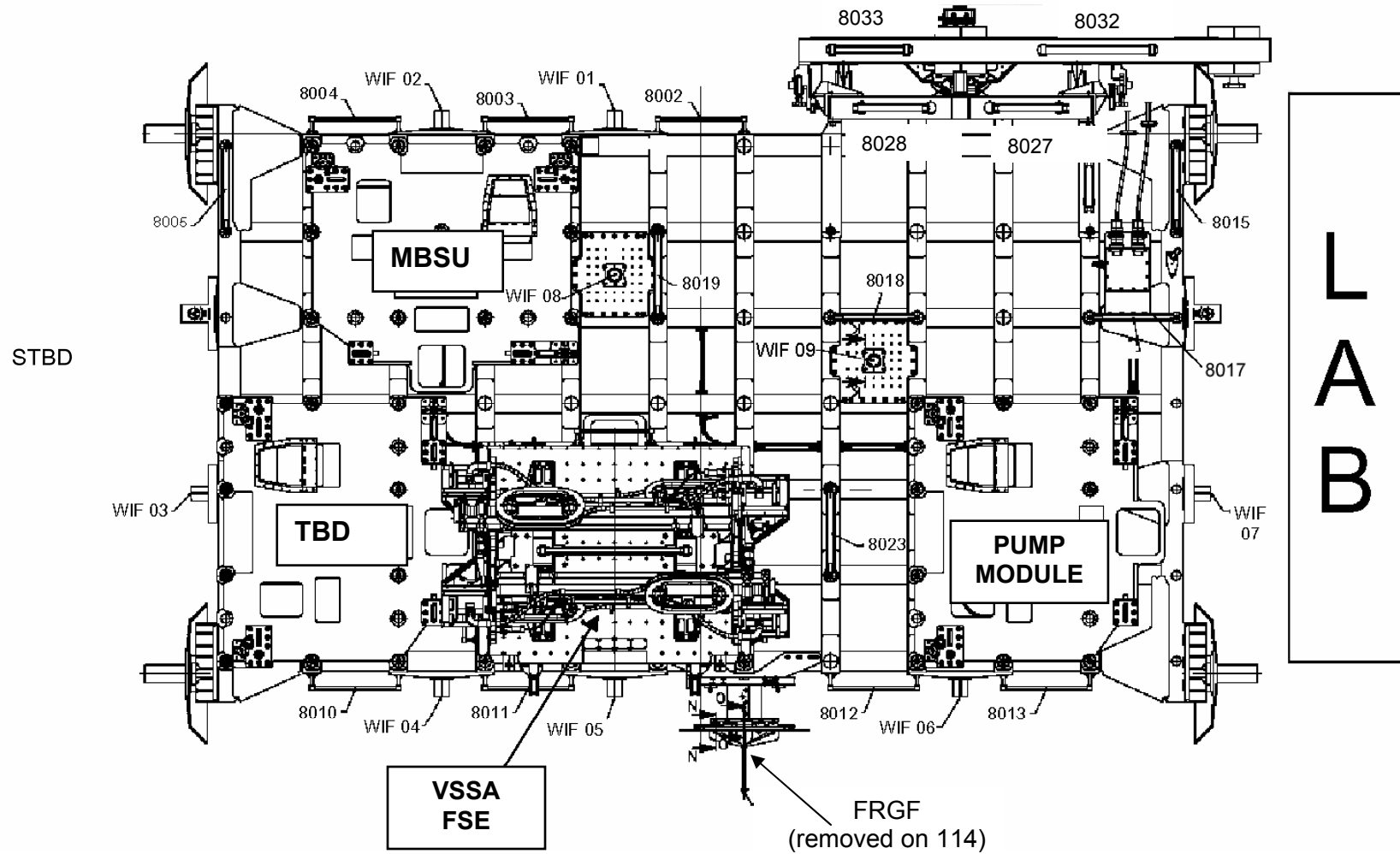

AIRLOCK

L
A
B

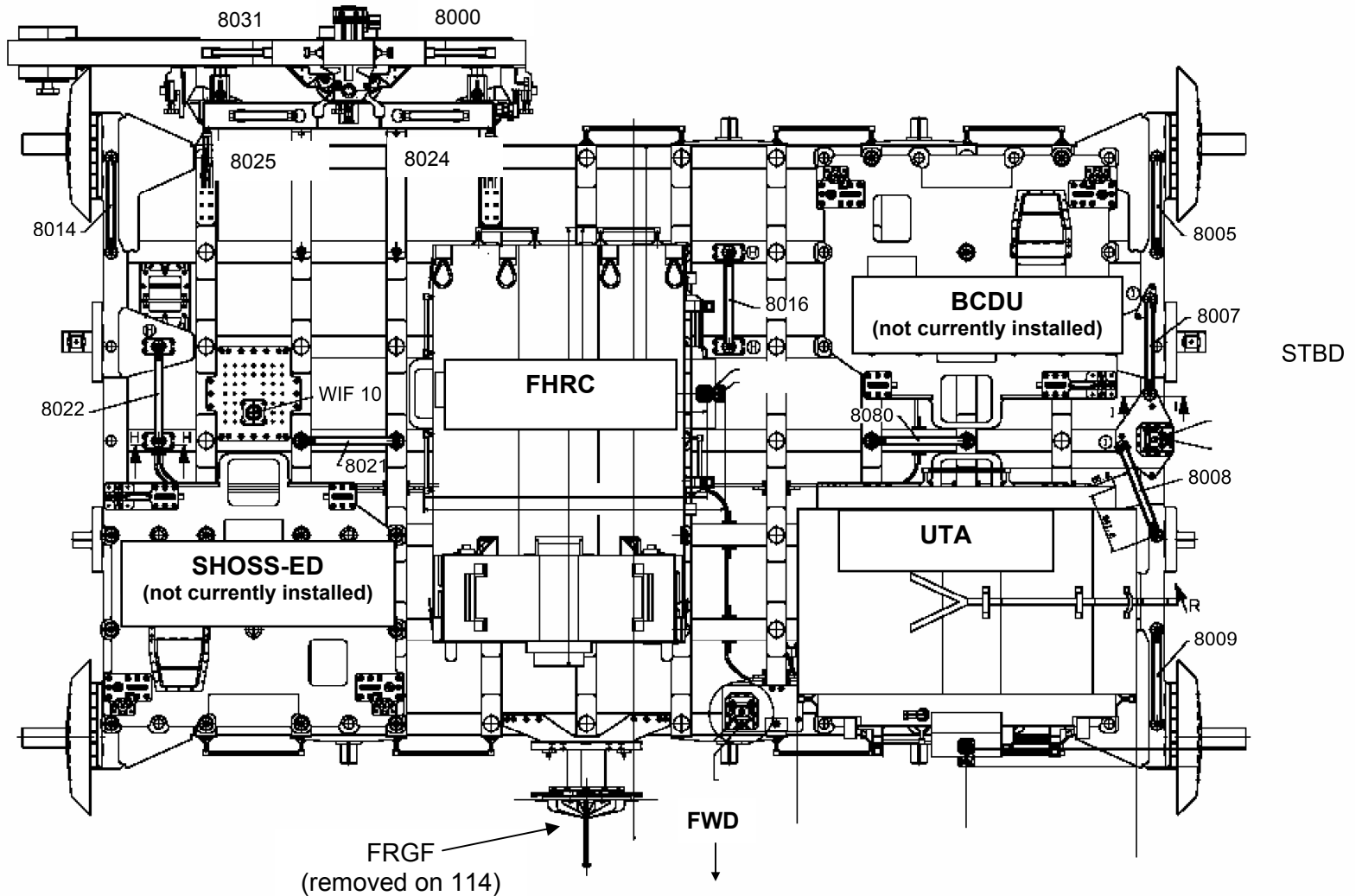

CETA CART – TOP VIEW

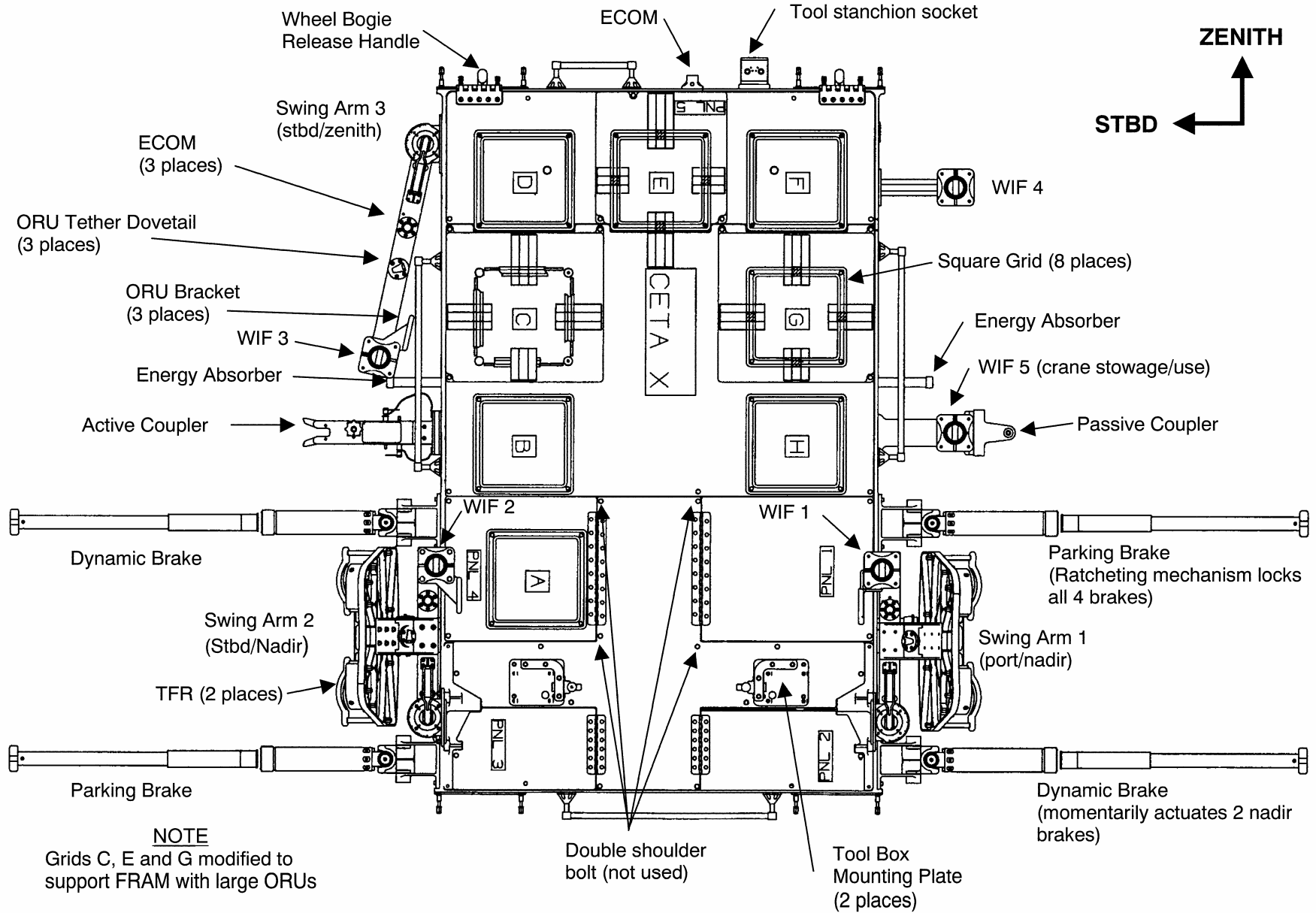

CETA CART COUPLERS

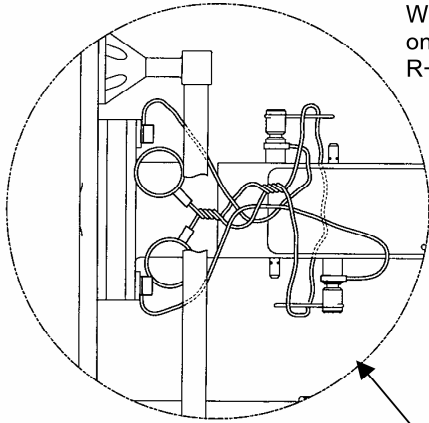

Wire ties required for launch only. Removed for coupler R+R

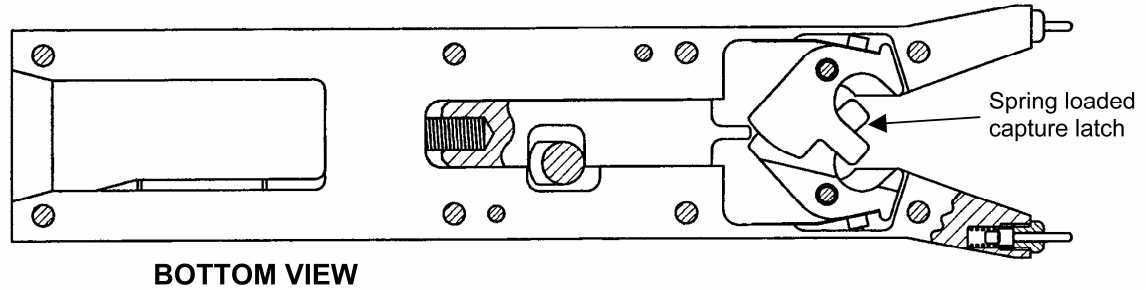

BOTTOM VIEW

Spring loaded capture latch

Compliance in indicated direction to allow for misalignment. Centering spring nominally constrains motion

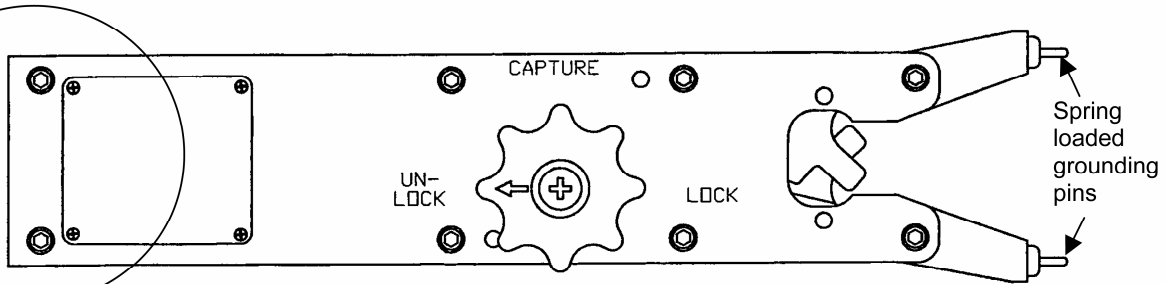

TOP VIEW

CAPTURE
UN-LOCK
LOCK

Spring loaded grounding pins

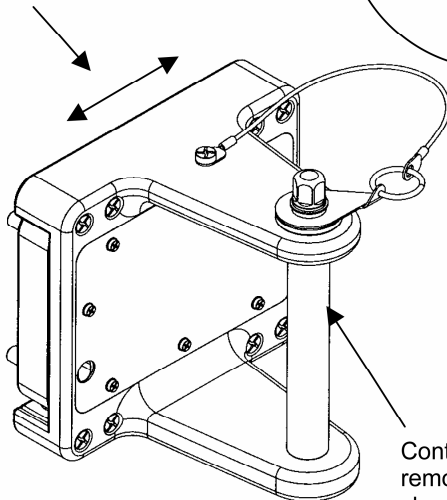

PASSIVE COUPLER

Contingency bolt removed if latch failed closed

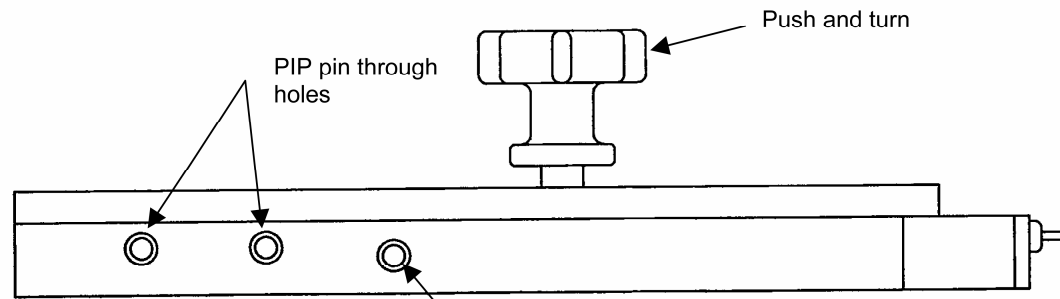

SIDE VIEW

PIP pin through holes

Push and turn

Threaded bolt hole not used

STATUS INDICATORS (MBSU, DDCU, BCDU)

H2 Status Indicator

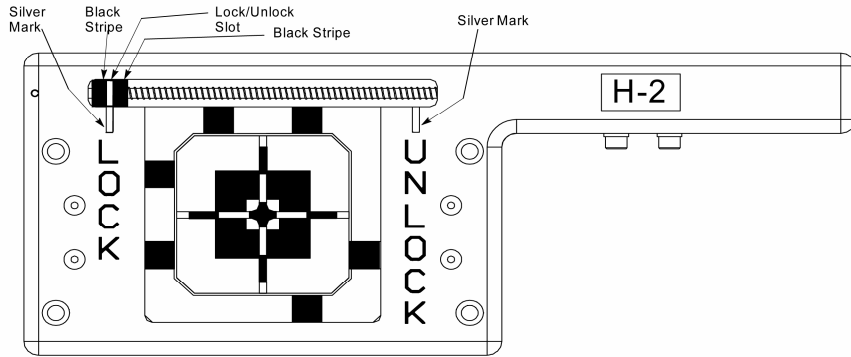

H1 Status Indicator

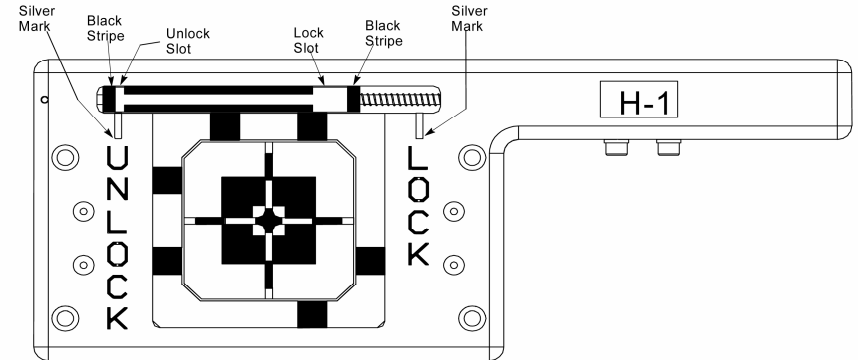

Positional Criteria

(Adhered to in accordance with torque and turns specified in LSAR procedure.)

Locked, Nominal: The lock/unlock slot should be centered in relation to the silver mark.

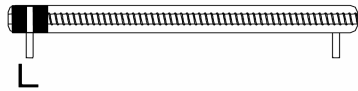

Unlocked, Nominal: The lock/unlock slot should be centered in relation to the silver mark.



Locked, Tolerance: The lock/unlock slot can be left or right of nominal by a distance no greater than the width of the black stripe.

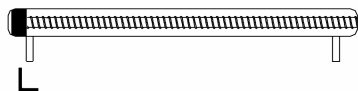
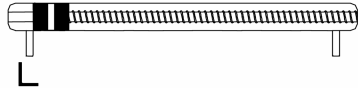

Unlocked, Tolerance: The lock/unlock slot can be left or right of nominal by a distance no greater than the width of the black stripe.

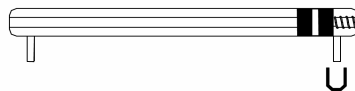
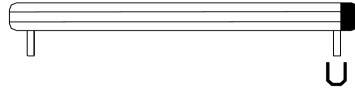

LOG-1010-01

Positional Criteria

(Adhered to in accordance with torque and turns specified in LSAR procedure.)

Unlocked, Nominal: The unlock slot should be centered in relation to the silver mark.



Locked, Nominal: The right edge of the lock slot should be flush with the right edge of the silver mark.



Unlocked, Tolerance: The unlock slot can be left or right of nominal by a distance no greater than the width of the black stripe.



Locked, Tolerance: The lock slot can be left of nominal by a distance no greater than the width of the black stripe.



LOG-1009-01

This Page Intentionally Blank



**EVA
CHECKLIST**

**STS
117**