

EVA Checklist

STS-120 Flight Supplement

**Mission Operations Directorate
EVA, Robotics, and Crew Systems
Operations Division**

**Final, Rev A
October 2, 2007**

NOTE

This supplement is to be integrated into the generic edition to provide a complete document for the specific flight. Some pages in the generic edition may be replaced with supplemental pages identified as 'TEMP'. These generic pages, if any, must be retained for use on future flights.

National Aeronautics and
Space Administration

Lyndon B. Johnson Space Center
Houston, Texas

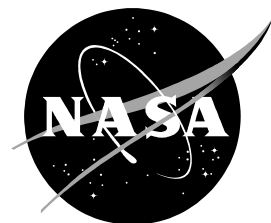

EVA CHECKLIST STS-120 FLT SUPPL

FINAL, REV A (Oct 2, 2007)

PCN-1 (Oct 8, 2007) Sheet 1 of 1

List of Implemented Change Requests (482s):

EVA FS-0119
EVA FS-0120

Incorporate the following:

1. Replace FS v thru FS xx
2. Replace FS 2-13 and FS 2-14
3. Replace FS 7-1 thru FS 7-4, FS 7-137 and FS 7-138, FS 7-149 and FS 7-150
After FS 7-150, add FS 7-150a thru FS 7-150ff (32 pages)
Replace FS 7-151 and FS 7-152, FS 7-161 and FS 7-162, FS 7-165 and FS 7-166
4. Replace FS 8-1 and FS 8-2, FS 8-17 and FS 8-18, FS 8-21 and FS 8-22
After FS 8-22, add FS 8-23 thru FS 8-26
5. Replace FS 16-3 and FS 16-4, FS 16-7 thru FS 16-10, FS 16-75 thru FS 16-80

Prepared by:

Book Manager for Allison Bolinger

Approved by:

Lead, EVA Systems Group for Tricia Mack
Lead, EVA Task Group for DINA COSTELLA

Accepted by:

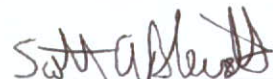
Chief, EVA and Crew Systems
Operations Branch for Angela Prince

Encl: 86 pages

File this PCN immediately behind the front cover as a permanent record

MISSION OPERATIONS DIRECTORATE

**EVA CHECKLIST
STS-120 FLIGHT SUPPLEMENT**

FINAL, REVISION A
October 2, 2007

PREPARED BY:



Allison T. Bolinger
Book Manager

APPROVED BY:



Tricia K. Mack
Lead, EVA Systems Group



Dina E. Contella
Lead, EVA Task Group



for Angela R. Prince
Chief, EVA and Crew Systems Operations Branch

This document is under the configuration control of the Crew Procedures Control Board (CPCB). All proposed changes must be submitted via FDF Workflow Crew Procedure Change Request (CR) to DO3/FDF Manager.

Additional distribution of this book for official use must be requested in writing to DO3/PMO Administrator. The request must include justification and requester's name, organization, position, and phone number. Contractor requests are made through the NASA or DOD organization supported. Deletions, reduction in quantity, or change of address may be submitted to DO3/FDF Management Office, 281-244-1184.

Incorporates the following:		
482#:	EVA FS-0096	EVA FS-0104
	EVA FS-0097B	EVA FS-0105
	EVA FS-0098	EVA FS-0106
	EVA FS-0099A	EVA FS-0107
	EVA FS-0100A	EVA FS-0108
	EVA FS-0101A	EVA FS-0117
	EVA FS-0102A	EVA FS-0118
	EVA FS-0103A	

AREAS OF TECHNICAL RESPONSIBILITY

Book Manager

DX32/A. Bolinger

281-483-3952

EVA CHECKLIST
STS-120 FLIGHT SUPPLEMENT

LIST OF EFFECTIVE PAGES

FINAL	06/08/07
REV A	10/02/07
PCN-1	10/08/07

Sign Off	*	120/FIN A	FS 2-21	120/FIN A
FS ii	*	120/FIN A	FS 2-22	120/FIN A
iii	*	generic	3-1	generic
iv	*	generic	3-2	generic
FS v	*	120/FIN A,1	3-3	generic
FS vi	*	120/FIN A,1	3-4	generic
FS vii	*	120/FIN A,1	3-5	generic
FS viii	*	120/FIN A,1	3-6	generic
FS ix	*	120/FIN A,1	3-7	generic
FS x	*	120/FIN A,1	3-8	generic
FS xi	*	120/FIN A,1	3-9	generic
FS xii	*	120/FIN A	CC 3-10	generic
FS xiii		120/FIN A	CC 3-11	generic
FS xiv		120/FIN A	3-12	generic
FS xv		120/FIN A,1	4-1	generic
FS xvi		120/FIN A,1	4-2	generic
FS xvii		120/FIN A,1	4-3	generic
FS xviii		120/FIN A,1	4-4	generic
FS xix		120/FIN A,1	4-5	generic
FS xx		120/FIN A,1	4-6	generic
1-1		generic	4-7	generic
1-2		generic	4-8	generic
1-3		generic	4-9	generic
1-4		generic	4-10	generic
1-5		generic	4-11	generic
1-6		generic	4-12	generic
1-7		generic	5-1	generic
1-8		generic	5-2	generic
1-9		generic	5-3	generic
1-10		generic	5-4	generic
TEMP FS 2-1		120/FIN A	A6-1	generic
TEMP FS 2-2		ALL/FIN A	CC A6-2	generic
2-3		generic	6-3	generic
2-4		generic	CC 6-4	generic
2-5		generic	FS 7-1	120/FIN A
2-6		generic	FS 7-2	120/FIN A,1
FS 2-7		120/FIN A	FS 7-3	120/FIN A
FS 2-8		120/FIN A	FS 7-4	120/FIN A,1
FS 2-9		120/FIN A	FS 7-5	120/FIN A
FS 2-10		120/FIN A	FS 7-6	120/FIN A
FS 2-11		120/FIN A	FS 7-7	120/FIN A
FS 2-12		120/FIN A	FS 7-8	120/FIN A
FS 2-13		120/FIN A	FS 7-9	120/FIN A
FS 2-14		120/FIN A,1	FS 7-10	120/FIN A
FS 2-15		120/FIN A	FS 7-11	120/FIN A
FS 2-16		120/FIN A	FS 7-12	120/FIN A
FS 2-17		120/FIN A	FS 7-13	120/FIN A
FS 2-18		120/FIN A	FS 7-14	120/FIN A
FS 2-19		120/FIN A	FS 7-15	120/FIN A
FS 2-20		120/FIN A	FS 7-16	120/FIN A

* – Omit from flight book

FS 7-17	120/FIN A	FS 7-71.....	120/FIN A
FS 7-18	120/FIN A	FS 7-72.....	120/FIN A
FS 7-19	120/FIN A	FS 7-73.....	120/FIN A
FS 7-20	120/FIN A	FS 7-74.....Δ	120/FIN A
FS 7-21	120/FIN A	FS 7-75.....Δ	120/FIN A
FS 7-22	120/FIN A	FS 7-76.....	120/FIN A
FS 7-23	Δ 120/FIN A	FS 7-77.....	120/FIN A
FS 7-24	120/FIN A	FS 7-78.....	120/FIN A
FS 7-25	120/FIN A	FS 7-79.....	120/FIN A
FS 7-26	120/FIN A	FS 7-80.....	120/FIN A
FS 7-27	120/FIN A	FS 7-81.....	120/FIN A
FS 7-28	120/FIN A	FS 7-82.....	120/FIN A
FS 7-29	120/FIN A	FS 7-83.....	120/FIN A
FS 7-30	120/FIN A	FS 7-84.....	120/FIN A
FS 7-31	120/FIN A	FS 7-85.....	120/FIN A
FS 7-32	120/FIN A	FS 7-86.....	120/FIN A
FS 7-33	120/FIN A	FS 7-87.....	120/FIN A
FS 7-34	120/FIN A	FS 7-88.....	120/FIN A
FS 7-35	120/FIN A	FS 7-89.....	120/FIN A
FS 7-36	Δ 120/FIN A	FS 7-90.....	120/FIN A
FS 7-37	120/FIN A	FS 7-91.....	120/FIN A
FS 7-38	120/FIN A	FS 7-92.....	120/FIN A
FS 7-39	120/FIN A	FS 7-93.....	120/FIN A
FS 7-40	120/FIN A	FS 7-94.....	120/FIN A
FS 7-41	120/FIN A	FS 7-95.....	120/FIN A
FS 7-42	120/FIN A	FS 7-96.....	120/FIN A
FS 7-43	120/FIN A	FS 7-97.....	120/FIN A
FS 7-44	120/FIN A	FS 7-98.....	120/FIN A
FS 7-45	120/FIN A	FS 7-99.....	120/FIN A
FS 7-46	120/FIN A	FS 7-100.....	120/FIN A
FS 7-47	120/FIN A	FS 7-101.....	120/FIN A
FS 7-48	120/FIN A	FS 7-102.....	120/FIN A
FS 7-49	120/FIN A	FS 7-103.....	120/FIN A
FS 7-50	120/FIN A	FS 7-104.....	120/FIN A
FS 7-51	120/FIN A	FS 7-105.....	120/FIN A
FS 7-52	120/FIN A	FS 7-106.....	120/FIN A
FS 7-53	120/FIN A	FS 7-107.....	120/FIN A
FS 7-54	120/FIN A	FS 7-108.....	120/FIN A
FS 7-55	120/FIN A	FS 7-109.....	120/FIN A
FS 7-56	120/FIN A	FS 7-110.....	120/FIN A
FS 7-57	120/FIN A	FS 7-111.....	120/FIN A
FS 7-58	120/FIN A	FS 7-112.....	120/FIN A
FS 7-59	120/FIN A	FS 7-113.....	120/FIN A
FS 7-60	120/FIN A	FS 7-114.....	120/FIN A
FS 7-61	120/FIN A	FS 7-115.....	120/FIN A
FS 7-62	120/FIN A	FS 7-116.....	120/FIN A
FS 7-63	120/FIN A	FS 7-117.....	120/FIN A
FS 7-64	Δ 120/FIN A	FS 7-118.....Δ	120/FIN A
FS 7-65	Δ 120/FIN A	FS 7-119.....	120/FIN A
FS 7-66	120/FIN A	FS 7-120.....	120/FIN A
FS 7-67	120/FIN A	FS 7-121.....	120/FIN A
FS 7-68	120/FIN A	FS 7-122.....	120/FIN A
FS 7-69	120/FIN A	FS 7-123.....	120/FIN A
FS 7-70	120/FIN A	FS 7-124.....	120/FIN A

Δ – Color page for pre-assigned users

FS 7-125	120/FIN A	FS 7-150cc	Δ 120/FIN A,1
FS 7-126	120/FIN A	FS 7-150dd	Δ 120/FIN A,1
FS 7-127	120/FIN A	FS 7-150ee	120/FIN A,1
FS 7-128	120/FIN A	FS 7-150ff	120/FIN A,1
FS 7-129	120/FIN A	FS 7-151	120/FIN A
FS 7-130	120/FIN A	FS 7-152	120/FIN A,1
FS 7-131	120/FIN A	FS 7-153	120/FIN A
FS 7-132	120/FIN A	FS 7-154	120/FIN A
FS 7-133	120/FIN A	FS 7-155	120/FIN A
FS 7-134	120/FIN A	FS 7-156	120/FIN A
FS 7-135	120/FIN A	FS 7-157	120/FIN A
FS 7-136	120/FIN A	FS 7-158	120/FIN A
FS 7-137	120/FIN A	FS 7-159	120/FIN A
FS 7-138	120/FIN A,1	FS 7-160	120/FIN A
FS 7-139	120/FIN A	FS 7-161	120/FIN A
FS 7-140	120/FIN A	FS 7-162	120/FIN A,1
FS 7-141	120/FIN A	FS 7-163	120/FIN A
FS 7-142	120/FIN A	FS 7-164	Δ 120/FIN A
FS 7-143	120/FIN A	FS 7-165	120/FIN A
FS 7-144	120/FIN A	FS 7-166	120/FIN A,1
FS 7-145	Δ 120/FIN A	FS 7-167	120/FIN A
FS 7-146	120/FIN A	FS 7-168	Δ 120/FIN A
FS 7-147	120/FIN A	FS 7-169	120/FIN A
FS 7-148	Δ 120/FIN A	FS 7-170	120/FIN A
FS 7-149	120/FIN A,1	FS 7-171	120/FIN A
FS 7-150	120/FIN A,1	FS 7-172	120/FIN A
FS 7-150a	120/FIN A,1	FS 7-173	120/FIN A
FS 7-150b	120/FIN A,1	FS 7-174	120/FIN A
FS 7-150c	120/FIN A,1	FS 7-175	120/FIN A
FS 7-150d	120/FIN A,1	FS 7-176	120/FIN A
FS 7-150e	120/FIN A,1	FS 7-177	120/FIN A
FS 7-150f	120/FIN A,1	FS 7-178	Δ 120/FIN A
FS 7-150g	120/FIN A,1	FS 7-179	120/FIN A
FS 7-150h	120/FIN A,1	FS 7-180	120/FIN A
FS 7-150i	120/FIN A,1	FS 7-181	120/FIN A
FS 7-150j	Δ 120/FIN A,1	FS 7-182	120/FIN A
FS 7-150k	120/FIN A,1	FS 7-183	120/FIN A
FS 7-150l	Δ 120/FIN A,1	FS 7-184	120/FIN A
FS 7-150m	120/FIN A,1	FS 7-185	120/FIN A
FS 7-150n	120/FIN A,1	FS 7-186	120/FIN A
FS 7-150o	120/FIN A,1	FS 7-187	120/FIN A
FS 7-150p	120/FIN A,1	FS 7-188	120/FIN A
FS 7-150q	120/FIN A,1	FS 7-189	120/FIN A
FS 7-150r	Δ 120/FIN A,1	FS 7-190	120/FIN A
FS 7-150s	120/FIN A,1	FS 7-191	120/FIN A
FS 7-150t	120/FIN A,1	FS 7-192	120/FIN A
FS 7-150u	Δ 120/FIN A,1	TEMP FS 8-1	120/FIN A,1
FS 7-150v	Δ 120/FIN A,1	TEMP FS 8-2	ALL/FIN A
FS 7-150w	120/FIN A,1	8-3	generic
FS 7-150x	120/FIN A,1	8-4	generic
FS 7-150y	Δ 120/FIN A,1	8-5	generic
FS 7-150z	Δ 120/FIN A,1	8-6	generic
FS 7-150aa	Δ 120/FIN A,1	8-7	generic
FS 7-150bb	Δ 120/FIN A,1	8-8	generic

Δ – Color page for pre-assigned users

FS 8-9	120/FIN A	12-5	generic
FS 8-10	120/FIN A	12-6	generic
FS 8-11	120/FIN A	12-7	generic
FS 8-12	120/FIN A	12-8	generic
FS 8-13	120/FIN A	12-9	generic
FS 8-14	120/FIN A	12-10	generic
FS 8-15	120/FIN A	12-11	generic
FS 8-16	120/FIN A	12-12	generic
FS 8-17	120/FIN A,1	12-13	generic
FS 8-18	120/FIN A	12-14	generic
FS 8-19	120/FIN A	12-15	generic
FS 8-20	120/FIN A	12-16	generic
FS 8-21	120/FIN A,1	12-17	generic
FS 8-22	120/FIN A	12-18	generic
FS 8-23	120/FIN A,1	12-19	generic
FS 8-24	Δ 120/FIN A,1	12-20	generic
FS 8-25	Δ 120/FIN A,1	12-21	generic
FS 8-26	120/FIN A,1	12-22	generic
9-1	generic	12-23	generic
9-2	generic	12-24	generic
9-3	generic	12-25	generic
9-4	generic	12-26	generic
9-5	generic	FS 12-27	120/FIN A
9-6	generic	FS 12-28	120/FIN A
TEMP FS 10-1	120/FIN A	FS 12-29	120/FIN A
TEMP FS 10-2	ALL/FIN A	FS 12-30	120/FIN A
10-3	generic	FS 12-31	120/FIN A
10-4	generic	FS 12-32	120/FIN A
10-4a	generic	FS 12-33	120/FIN A
10-4b	generic	FS 12-34	120/FIN A
10-5	generic	FS CC 12-35	120/FIN A
10-6	generic	FS CC 12-36	120/FIN A
10-7	generic	FS 13-1	120/FIN A
10-8	generic	FS 13-2	120/FIN A
10-9	generic	14-1	generic
10-10	generic	14-2	generic
10-11	generic	14-3	generic
10-12	generic	14-4	generic
10-13	generic	14-5	generic
10-14	generic	14-6	generic
FS CC 10-15	120/FIN A	14-7	generic
FS CC 10-16	120/FIN A	14-8	generic
FS CC 10-17	120/FIN A	14-9	generic
FS CC 10-18	120/FIN A	14-10	generic
11-1	generic	14-11	generic
11-2	generic	14-12	generic
11-3	generic	14-13	generic
11-4	generic	14-14	generic
12-i	generic	14-15	generic
12-ii	generic	14-16	generic
TEMP FS 12-1	120/FIN A	14-17	generic
TEMP FS 12-2	ALL/FIN A	14-18	generic
12-3	generic	14-19	generic
12-4	generic	14-20	generic

Δ – Color page for pre-assigned users

14-21	generic	FS 16-37	120/FIN A
14-22	generic	FS 16-38	120/FIN A
15-1	generic	FS 16-39	120/FIN A
15-2	generic	FS 16-40	120/FIN A
15-3	generic	FS 16-41	120/FIN A
15-4	generic	FS 16-42	120/FIN A
15-5	generic	FS 16-43	120/FIN A
15-6	generic	FS 16-44	120/FIN A
15-7	generic	FS 16-45	120/FIN A
15-8	generic	FS 16-46	120/FIN A
15-9	generic	FS 16-47	120/FIN A
15-10	generic	FS 16-48	120/FIN A
15-11	generic	FS 16-49	120/FIN A
15-12	generic	FS 16-50	120/FIN A
15-13	generic	FS 16-51	120/FIN A
15-14	generic	FS 16-52	120/FIN A
16-i	generic	FS 16-53	120/FIN A
16-ii	generic	FS 16-54	120/FIN A
TEMP FS 16-1	120/FIN A	FS 16-55	120/FIN A
TEMP FS 16-2	ALL/FIN A	FS 16-56	120/FIN A
FS 16-3	120/FIN A,1	FS 16-57	120/FIN A
FS 16-4	120/FIN A	FS 16-58	Δ 120/FIN A
FS 16-5	120/FIN A	FS 16-59	120/FIN A
FS 16-6	120/FIN A	FS 16-60	120/FIN A
FS 16-7	120/FIN A,1	FS 16-61	Δ 120/FIN A
FS 16-8	120/FIN A	FS 16-62	Δ 120/FIN A
FS 16-9	120/FIN A	FS 16-63	120/FIN A
FS 16-10	120/FIN A,1	FS 16-64	120/FIN A
FS 16-11	120/FIN A	FS 16-65	120/FIN A
FS 16-12	120/FIN A	FS 16-66	120/FIN A
FS 16-13	120/FIN A	FS 16-67	120/FIN A
FS 16-14	120/FIN A	FS 16-68	120/FIN A
FS 16-15	120/FIN A	FS 16-69	120/FIN A
FS 16-16	120/FIN A	FS 16-70	120/FIN A
FS 16-17	120/FIN A	FS 16-71	120/FIN A
FS 16-18	120/FIN A	FS 16-72	120/FIN A
FS 16-19	120/FIN A	FS 16-73	120/FIN A
FS 16-20	120/FIN A	FS 16-74	120/FIN A
FS 16-21	120/FIN A	FS 16-75	120/FIN A,1
FS 16-22	120/FIN A	FS 16-76	120/FIN A
FS 16-23	120/FIN A	FS 16-77	120/FIN A
FS 16-24	120/FIN A	FS 16-78	120/FIN A,1
FS 16-25	120/FIN A	FS 16-79	120/FIN A,1
FS 16-26	120/FIN A	FS 16-80	120/FIN A
FS 16-27	120/FIN A	FS 16-81	120/FIN A
FS 16-28	120/FIN A	FS 16-82	120/FIN A
FS 16-29	120/FIN A	FS 16-83	120/FIN A
FS 16-30	120/FIN A	FS 16-84	120/FIN A
FS 16-31	120/FIN A	FS 16-85	120/FIN A
FS 16-32	120/FIN A	FS 16-86	120/FIN A
FS 16-33	120/FIN A	FS 16-87	120/FIN A
FS 16-34	120/FIN A	FS 16-88	120/FIN A
FS 16-35	120/FIN A	FS 16-89	120/FIN A
FS 16-36	120/FIN A	FS 16-90	120/FIN A

Δ – Color page for pre-assigned users

FS 16-91Δ	120/FIN A	FS 18-33	120/FIN A
FS 16-92Δ	120/FIN A	FS 18-34Δ	120/FIN A
FS 16-93	120/FIN A	FS 18-35	120/FIN A
FS 16-94	120/FIN A	FS 18-36	120/FIN A
FS 16-95	120/FIN A	FS 18-37Δ	120/FIN A
FS 16-96	120/FIN A	FS 18-38	120/FIN A
FS 16-97	120/FIN A	FS 18-39Δ	120/FIN A
FS 16-98	120/FIN A	FS 18-40	120/FIN A
FS 16-99	120/FIN A	FS 18-41Δ	120/FIN A
FS 16-100	120/FIN A	FS 18-42	120/FIN A
FS 16-101	120/FIN A	FS 18-43	120/FIN A
FS 16-102	120/FIN A	FS 18-44Δ	120/FIN A
FS 16-103	120/FIN A	FS 18-45Δ	120/FIN A
FS 16-104	120/FIN A	FS 18-46Δ	120/FIN A
FS 16-105	120/FIN A	FS 18-47Δ	120/FIN A
FS 16-106	120/FIN A	FS 18-48Δ	120/FIN A
FS 16-107	120/FIN A	FS 18-49	120/FIN A
FS 16-108	120/FIN A	FS 18-50	120/FIN A
FS 16-109	120/FIN A	FS 18-51	120/FIN A
FS 16-110	120/FIN A	FS 18-52Δ	120/FIN A
17-1	generic	FS 18-53Δ	120/FIN A
17-2	generic	FS 18-54Δ	120/FIN A
FS 18-1	120/FIN A	FS 18-55Δ	120/FIN A
FS 18-2	120/FIN A	FS 18-56Δ	120/FIN A
FS 18-3	120/FIN A	FS 18-57Δ	120/FIN A
FS 18-4	120/FIN A	FS 18-58Δ	120/FIN A
FS 18-5	120/FIN A	FS 18-59Δ	120/FIN A
FS 18-6	120/FIN A	FS 18-60	120/FIN A
FS 18-7	120/FIN A	FS 18-61Δ	120/FIN A
FS 18-8	120/FIN A	FS 18-62Δ	120/FIN A
FS 18-9	120/FIN A	FS 18-63	120/FIN A
FS 18-10	120/FIN A	FS 18-64Δ	120/FIN A
FS 18-11	120/FIN A	FS 18-65	120/FIN A
FS 18-12	120/FIN A	FS 18-66	120/FIN A
FS 18-13	120/FIN A	FS 18-67	120/FIN A
FS 18-14Δ	120/FIN A	FS 18-68	120/FIN A
FS 18-15Δ	120/FIN A	FS 18-69	120/FIN A
FS 18-16Δ	120/FIN A	FS 18-70	120/FIN A
FS 18-17	120/FIN A	19-i	generic
FS 18-18	120/FIN A	19-ii	generic
FS 18-19	120/FIN A	19-1	generic
FS 18-20Δ	120/FIN A	19-2	generic
FS 18-21	120/FIN A	19-3	generic
FS 18-22	120/FIN A	19-4	generic
FS 18-23	120/FIN A	19-5	generic
FS 18-24	120/FIN A	19-6	generic
FS 18-25	120/FIN A	19-7	generic
FS 18-26	120/FIN A	19-8	generic
FS 18-27	120/FIN A	19-9	generic
FS 18-28	120/FIN A	19-10	generic
FS 18-29Δ	120/FIN A	19-11	generic
FS 18-30Δ	120/FIN A	19-12	generic
FS 18-31Δ	120/FIN A	20-1*	generic
FS 18-32	120/FIN A	20-2*	generic

Δ – Color page for pre-assigned users

* – Omit from flight book

EVA CUE CARDS

<u>Title</u>	<u>Ref. Page</u>	<u>Card No.</u>
SAFER CHECKOUT RESULTS (Front).....	CC 3-10	generic
SAFER STATUS TROUBLESHOOTING (Back)....	CC 3-11	generic
DEPRESS/REPRESS		
Nominal Configuration		
(Front).....	CC A6-2	generic
FAILED LEAK CHECK		
(Back of DEPRESS/REPRESS).....	CC 6-4	generic
STS-120/10A CONSUMABLES TRACKING		
CUE CARD		
(Front).....	FS CC 10-15	EVA-5a/120/O/A
(Back).....	FS CC 10-16	EVA-5b/120/O/A
STS-120/10A BATTERY RECHARGE PLAN		
CUE CARD		
(Front).....	FS CC 10-17	EVA-6a/120/O/A
(Back).....	FS CC 10-18	EVA-6b/120/O/A
EMERGENCY UNDOCKING CUE CARD		
(Front).....	FS CC 12-35	EVA-7a/120/O/A
(Back).....	FS CC 12-36	EVA-7b/120/O/A

This Page Intentionally Blank

CONTENTS

	<u>PAGE</u>
10.2 PSI CABIN	1-1
MASK PREBREATHE INITIATE	1-2
PREP FOR 10.2 PSI CABIN	1-3
CABIN DEPRESS TO 10.2 PSI.....	1-4
10.2 PSIA DEPRESS CHART	1-5
10.2 PSI CABIN CONFIG	1-6
MASK PREBREATHE TERMINATE	1-6
10.2 PSI MAINTENANCE	1-7
CABIN REPRESS TO 14.7 PSI.....	1-8
14.7 PSI CABIN CONFIG	1-9
AIRLOCK CONFIG.....	TEMP FS 2-1
AIRLOCK PREP	TEMP FS 2-2
EMU SWAP	2-3
BOOSTER FAN DEACTIVATION/REMOVAL.....	2-4
BOOSTER FAN INSTALLATION/ACTIVATION.....	2-4
EMU REMOVAL	2-4
EMU INSTALLATION	2-4
EMU CHECKOUT PREP.....	2-5
LTA RESTRAINT STRAP REMOVAL	2-6
LTA RESTRAINT STRAP INSTALLATION	2-6
EMU SWAP FOR EVA 2 (Wo → Tn).....	FS 2-7
EMU SWAP FOR EVA 3 (Tn → Wo).....	FS 2-8
EMU SWAP FOR EVA 5 (Pz & Wo → Wt & Mk).....	FS 2-9
EVA PREP FOR TRANSFER TO ISS.....	FS 2-10
EVA TRANSFER TO ISS	FS 2-16
EVA PREP FOR TRANSFER TO SHUTTLE	FS 2-17
EVA TRANSFER TO SHUTTLE.....	FS 2-20
EVA STOW.....	FS 2-21
CHECKOUTS.....	3-1
EMU CHECKOUT	3-2
EMU POWERUP AND COMM CHECK.....	3-2
PRIMARY REGULATOR/FAN/PUMP CHECK	3-4
SOP CHECK.....	3-5
BATTERY CHARGE CHECK INIT.....	3-6
BATTERY CHARGE CHECK TERM	3-6
EMU SWAP DURING CHECKOUT	3-7
POST EMU C/O RECONFIG	3-7
SAFER CHECKOUT	3-8
SELF TEST SEQUENCE	3-9
SAFER CHECKOUT RESULTS.....	CC 3-10
SAFER STATUS TROUBLESHOOTING	CC 3-11
REBA POWERED HARDWARE CHECKOUT	3-12
EVA PREP	4-1
MIDDECK PREP	4-2
EVA PREP.....	4-3
PREP FOR DONNING.....	4-3
EMU DONNING	4-5
EMU CHECK	4-7
EMU PURGE.....	4-7
EMU PREBREATHE	4-8
SAFER DONNING	4-8
EVA COMM CONFIG	4-10
EVA COMM DECONFIG	4-10
APPROVED NON-EMU HARDWARE MATRIX.....	4-11

EMU STATUS	5-1	
EMU STATUS	5-2	
DEPRESS/REPRESS	A6-1	
DEPRESS/REPRESS (NOM A/L)	CC A6-2	
FAILED LEAK CHECK	6-3	
FAILED LEAK CHECK (5 PSI)	CC 6-4	
FAILED LEAK CHECK (14.7/10.2 PSI)	CC 6-4	
TIMELINES	FS 7-1	I
STS-120 (10A) EVA TIMELINES OVERVIEW	FS 7-3	
EVA 1		
EVA 1 INHIBIT PAD.....	FS 7-5	
EVA 1 NOTES, CAUTIONS, AND WARNINGS	FS 7-7	
10A EVA 1 PRE BRIEF	FS 7-11	
EVA 1 SUMMARY TIMELINE.....	FS 7-15	
PRE EVA 1 TOOL CONFIG.....	FS 7-16	
EVA 1 A/L EGRESS AND SETUP	FS 7-18	
SASA RETRIEVE	FS 7-19	
S-BAND ANTENNA SUPPORT ASSEMBLY	FS 7-22	
S-BAND ANTENNA	FS 7-23	
NODE 2 PREP FOR UNBERTH.....	FS 7-24	
SASA STOW	FS 7-26	
NODE 2 FINAL PREP FOR UNBERTH.....	FS 7-29	
Z1-TO-P6 FLUID DISCONNECT	FS 7-33	
P6 AFT RADIATOR SHROUD DEPLOY	FS 7-38	
SSU MLI SHROUD INSTALL	FS 7-42	
EVA 1 CLEANUP AND A/L INGRESS.....	FS 7-44	
POST EVA 1 TOOL CONFIG	FS 7-45	
POST EVA 1/PRE EVA 2 TOOL CONFIG.....	FS 7-46	
EVA 2		
EVA 2 INHIBIT PAD.....	FS 7-47	
EVA 2 NOTES, CAUTIONS, AND WARNINGS	FS 7-50	
10A EVA 2 PRE BRIEF	FS 7-54	
EVA 2 SUMMARY TIMELINE.....	FS 7-57	
PRE EVA 2 TOOL CONFIG.....	FS 7-58	
EVA 2 A/L EGRESS AND SETUP	FS 7-60	
Z1-TO-P6 UMBILICAL DISCONNECT	FS 7-61	
DETACH P6 FROM Z1	FS 7-66	
NODE 2 OUTFITTING	FS 7-71	
S1 SFU CONFIG FOR CINCH FIRING	FS 7-76	
SFU PANEL A123 (PRE DEPLOY)	FS 7-78	
MBSU BYPASS JUMPER RECONFIG	FS 7-79	
RPCM S04B-C R&R	FS 7-82	
PDGF INSTALL ON NODE 2.....	FS 7-85	
EVA 2 CLEANUP AND A/L INGRESS.....	FS 7-89	
EVA 2 SPECIFIC GET-AHEADS – NODE 2 ACBM SHOWER		
CAP REMOVE	FS 7-90	
POST EVA 2 TOOL CONFIG	FS 7-91	
POST EVA 2/PRE EVA 3 TOOL CONFIG.....	FS 7-92	
EVA 3		
EVA 3 INHIBIT PAD.....	FS 7-93	
EVA 3 NOTES, CAUTIONS, AND WARNINGS	FS 7-96	
10A EVA 3 PRE BRIEF	FS 7-100	
EVA 3 SUMMARY TIMELINE.....	FS 7-103	
PRE EVA 3 TOOL CONFIG.....	FS 7-104	
EVA 3 A/L EGRESS AND SETUP.....	FS 7-106	

ATTACH P6 TO P5.....	FS 7-108
CONNECT P5 TO P6 UMBILICALS.....	FS 7-115
SSU MLI SHROUD REMOVAL.....	FS 7-119
OUTBOARD RADIATOR CINCH RELEASE.....	FS 7-121
P1 SFU CONFIG FOR CINCH FIRING.....	FS 7-124
S1 SFU CONFIG POST DEPLOY.....	FS 7-125
MBSU TRANSFER.....	FS 7-128
SAW DEPLOYMENT CLEANUP.....	FS 7-133
EVA 3 CLEANUP AND A/L INGRESS.....	FS 7-134
POST EVA 3 TOOL CONFIG.....	FS 7-135
POST EVA 3/PRE EVA 4 TOOL CONFIG.....	FS 7-136
GET-AHEADS.....	FS 7-137
P1 NTA BREAK TORQUE.....	FS 7-139
LAB CETA LIGHT REMOVE.....	FS 7-140
BSP REMOVE.....	FS 7-141
MMOD SHIELD REINSTALL.....	FS 7-142
EVA 4	
EVA 4 INHIBIT PAD.....	FS 7-149
EVA 4 NOTES, CAUTIONS, AND WARNINGS.....	FS 7-150a
10A EVA 4 PRE BRIEF.....	FS 7-150e
EVA 4 SUMMARY TIMELINE.....	FS 7-150h
PRE EVA 4 TOOL CONFIG.....	FS 7-150i
EVA 4 A/L EGRESS AND SETUP.....	FS 7-150k
T-RAD DTO.....	FS 7-150m
EVA 4 CLEANUP AND A/L INGRESS.....	FS 7-150u
POST EVA 4 TOOL CONFIG.....	FS 7-150ee
POST EVA 4/PRE EVA 5 TOOL CONFIG.....	FS 7-150ff
EVA 5	
EVA 5 INHIBIT PAD.....	FS 7-151
EVA 5 NOTES, CAUTIONS, AND WARNINGS.....	FS 7-154
10A EVA 5 PRE BRIEF.....	FS 7-158
EVA 5 SUMMARY TIMELINE.....	FS 7-159
PRE EVA 5 TOOL CONFIG.....	FS 7-160
EVA 5 A/L EGRESS AND SETUP.....	FS 7-161
SSPTS CABLE STOW.....	FS 7-162
PMA2/LAB UMBILICAL STOW.....	FS 7-165
TEMP STOW N2 TRAY AVIONICS UMBILICALS.....	FS 7-169
LAB CETA LIGHT RETRIEVE.....	FS 7-173
BSP RETRIEVE.....	FS 7-176
BASE BAND SIGNAL PROCESSOR (BSP).....	FS 7-178
P1 NTA BOLTS BREAK TORQUE.....	FS 7-179
REMOVE ACBM COVER, CBM SURVEY.....	FS 7-181
S0/N1 POWER CABLE/H-JUMPER HARNESS REMOVAL.....	FS 7-183
TOOL PREP.....	FS 7-187
VENT TOOL EXTENDER BAG RELOCATE.....	FS 7-189
EVA 5 CLEANUP AND A/L INGRESS.....	FS 7-190
POST EVA 5 TOOL CONFIG.....	FS 7-191
TOOLS AND STOWAGE	
PORT LIGHTWEIGHT TOOL STOWAGE ASSEMBLY (TSA).....	TEMP FS 8-2
PGT CHECKOUT.....	8-3
PGSC-PGT CONNECTION (A31P AND 760XD).....	8-4
PROGRAM PGT SETTINGS.....	8-5
DOWNLOAD/ERASE EVENT LOG.....	8-5
PGT CONTINGENCIES.....	8-6
PGT STANDARD SETTINGS.....	8-7

PISTOL GRIP TOOL	FS 8-9
TOOLBOX STOWAGE	FS 8-10
TOOLBOX PANEL AND SLOT LABELS	FS 8-11
Z1 TOOLBOX INTERNAL LAYOUT	FS 8-12
AIRLOCK TOOLBOX INTERNAL LAYOUT	FS 8-13
STBD QD BAG (EXTERNAL ON ISS AIRLOCK)	FS 8-14
PORT QD BAG (EXTERNAL ON ISS AIRLOCK)	FS 8-15
APFR MANAGEMENT – STS-120 (10A)	FS 8-16
SAFETY TETHER CONFIGURATION – STS-120 (10A)	FS 8-18
T-RAD IV PREPARATION	FS 8-19
TEMPERATURE SENSOR ASSEMBLY	FS 8-23
1.0" FOAM BRUSH NETTING REMOVAL	FS 8-23
DTO SAMPLE BAG ASSEMBLY	FS 8-24
CIPA DISCARD CONTAINER (CDC) MARKING	FS 8-25
POST EVA	9-1
POST EVA	9-2
SUIT DOFFING	9-2
SAFER DOFFING	9-2
EMU WATER RECHARGE	9-3
SAFER STOW	9-3
SUIT DRYING/SEAL WIPE	9-4
OXYGEN RECHARGE VERIFICATION	9-4
WATER FILL VERIFICATION	9-4
EMU POWERDOWN/OVERNIGHT STOW	9-5
EMU MAINT/RECHARGE	TEMP FS 10-1
WATER RECHARGE	TEMP FS 10-2
EMU POWERUP	TEMP FS 10-2
WATER FILL	TEMP FS 10-2
WATER FILL VERIFICATION	TEMP FS 10-2
EMU LiOH CHANGEOUT	10-4
MIDDECK EMU BATTERY RECHARGE (STAND-ALONE)	10-4a
MIDDECK EMU BATTERY RECHARGE/LiOH REPLACEMENT	10-5
INITIATE	10-5
TERMINATE	10-6
IN-SUIT EMU BATTERY RECHARGE/CHARGE VERIFICATION	10-7
INITIATE	10-7
TERMINATE	10-7
EMU POWERDOWN	10-7
HELMET LIGHT/PGT BATTERY RECHARGE	10-8
INITIATE	10-8
TERMINATE	10-9
REBA BATTERY INSTALLATION	10-9
EMU BATTERY REMOVAL/INSTALL	10-10
HELMET LIGHT BULB CHANGEOUT	10-11
REBA BATTERY RECHARGE	10-12
INITIATE	10-12
TERMINATE	10-13
STS-120/10A CONSUMABLES TRACKING CUE CARD	FS CC 10-15
STS-120/10A BATTERY RECHARGE PLAN CUE CARD	FS CC 10-17
POST EVA ENTRY PREP	11-1
POST EVA ENTRY PREP	11-2
SAFER ENTRY STOW	11-2
POST ISS EVA ENTRY PREP	11-3
SAFER ENTRY STOW	11-3

<u>OFF-NOMINAL PROCEDURES</u>	12-i
EMU CONTINGENCY PROC	TEMP FS 12-1
DISPLAY LOSS DURING POWER TRANSFER (WARM RESTART) ...	TEMP FS 12-2
VACUUM H2O RECHARGE (MANNED)	TEMP FS 12-2
LIOH REPLACEMENT (MANNED)	12-3
BATTERY REPLACEMENT (MANNED)	12-4
WATER DUMP	12-6
SCU SWAP (UNMANNED)	12-7
SCU SWAP (MANNED)	12-7
EMU COLD RESTART (MANNED).....	12-7
12.1 STS EVA DECONTAMINATION	12-8
CONTAMINATION TEST	12-15
SAFER BATTERY CHANGEOUT	12-18
BENDS TREATMENT ADAPTER (BTA) INSTALLATION (IN-SUIT).....	12-19
BTA PREP	12-19
BTA TREATMENT	12-19
BENDS TREATMENT ADAPTER (BTA) INSTALLATION (POST	
SUIT DOFFING)	12-21
BTA PREP	12-21
BTA TREATMENT	12-21
EMU RESIZE.....	12-24
EMU CONTINGENCY RESIZE MATRIX (STS-120/10A)	FS 12-27
EMU NOMINAL SIZING (STS-120/10A)	FS 12-29
EVA 2 EMU RESIZE FOR Tn.....	FS 12-30
EVA 5 EMU RESIZE FOR Wt AND Mk	FS 12-32
EMERGENCY UNDOCKING CUE CARD.....	FS CC 12-35
 TPS REPAIR.....	 FS 13-1
 ORBITER CONTINGENCY EVA.....	 14-1
PAYLOAD BAY EVA NOMENCLATURE	14-2
RMS/PRLA CONTINGENCY EVA	14-3
96 BOLT PRE-EVA TOOL CONFIG.....	14-13
96 BOLT EVA TIMELINE	14-14
CAPTURE LATCH MANUAL RELEASE (ODS/PMA).....	14-19
96 BOLT EVA LAYOUT.....	14-21
PLBD LATCH TOOL PLACEMENT WITH DUAL LATCH GANG FAILURES	14-22
 EVA CUFF CHECKLIST (CIL)	 15-1
NORMAL EVA STATUS.....	15-2
DCM CONFIGURATION	15-2
EMU MALFUNCTION INDEX.....	15-2
DECOMPRESSION SICKNESS (DCS)	15-3
DECOMPRESSION SICKNESS (DCS) (CONT).....	15-3
ABORT EVA.....	15-3
TERMINATE EVA.....	15-3
SUIT P EMERG.....	15-4
SOP O2 ON.....	15-4
BATT AMPS HIGH	15-4
BATT V DECAY OR BATT VDC LOW	15-4
SUIT P LOW.....	15-5
SUIT P HIGH	15-5
SOP P LOW	15-5
O2 USE HIGH	15-5
SUBLM PRESS	15-6

H2O GP LOW	15-6
RESRV H2O ON	15-6
H2O WP HIGH	15-6
NO VENT FLOW	15-7
CO2 HIGH OR MONITOR CO2	15-7
CO2 SNSR BAD	15-7
COMM FAILURE	15-7
AIR FLOW CONTAMINATION	15-8
LOSS OF COOLING	15-8
RLF V FAIL	15-8
MISC MSGS 1	15-8
MISC MSGS (CONT)/TIME LF	15-9
AIRLOCK LATCH DISCONNECT	15-9
AIRLOCK INGRESS	15-9
<u>FOLLOWING PAGES NOT IN EV CUFF</u>	
RADIATOR ACTUATOR DISCONNECT	15-9
PLBD DRIVE CUT	15-10
DOOR DRIVE RESTRAINT	15-10
DOOR DRIVE DISCONNECT	15-10
WINCH OPERATIONS	15-10
WINCH OPERATIONS (CONT)	15-11
3-PT TOOL INSTALLATION	15-11
CL LATCH TOOL	15-11
RMS JOINT ALIGN	15-11
MPM STOW/DEPLOY	15-12
RMS TIEDOWN	15-12
RMS FLIGHT RELEASABLE GRAPPLE FIXTURE RELEASE	15-12
PRLA OPEN/CLOSE	15-12
PRLA OPEN/CLOSE (CONT)	15-13
KU ANTENNA STOW	15-13
KU ANTENNA STOW (CONT)	15-13
AIRLOCK EGRESS	15-13
<u>FLIGHT SPECIFIC REFERENCE</u>	16-i
UNSCHEDULED/CONTINGENCY EVA TASKS	TEMP FS 16-1
10A WORKAROUNDS CRIBSHEET	FS 16-3
EVA 1 CONTINGENCIES	
CLEAR/RESTRAIN CBM CAPTURE LATCH	FS 16-17
MANUALLY OPEN/CLOSE CBM PETAL	FS 16-20
REMOVE/REPLACE CENTER DISK COVER	FS 16-25
REMOVE/REPLACE CBM CAPTIVE LATCH	FS 16-30
REMOVE/REPLACE CBM CONTROLLER PANEL ASSEMBLY (CPA)...	FS 16-35
REMOVE/REPLACE CBM PETAL	FS 16-43
REMOVE CBM READY-TO-LATCH (RTL)	FS 16-49
P6 ORU FLUID QD CLOSURE	FS 16-54
P6/Z1 VENTING	FS 16-60
EVA 2 CONTINGENCIES	
P6 RTAS SLEEVE REMOVAL	FS 16-62
Z1 CAPTURE LATCH FAILED CLOSED	FS 16-64
EVA 3 CONTINGENCIES	
16.1a RTAS GAP CLOSURE (CORNER 1 OR 2)	FS 16-66
16.1b RTAS GAP CLOSURE (CORNER 3 OR 4)	FS 16-68
CAPTURE BAR ROTATION	FS 16-69
ATTACH P6 TO P5 USING CONTINGENCY FASTENERS	FS 16-71
S1 RADIATOR MANUAL CINCH RELEASE	FS 16-74

S1 RADIATOR MANUAL OVERRIDE TO DEPLOY/RETRACT	FS 16-75
P6 RADIATOR MANUAL OVERRIDE TO DEPLOY/RETRACT	FS 16-76
MANUAL OVERRIDE TO DISENGAGE BETA GIMBAL ANTI-ROTATION LATCH.....	FS 16-81
BMRRM ANTI-ROTATION LATCH TABLE.....	FS 16-82
MANUAL OVERRIDE TO UNLATCH/LATCH (TENSION) SABB	FS 16-83
MANUAL OVERRIDE TO EXTEND/RETRACT MAST.....	FS 16-85
ASSISTED SOLAR ARRAY DEPLOY/RETRACT	FS 16-88
SABB SPOOL RE-TENSION	FS 16-94
MANUAL SAW JETTISON	FS 16-100
MISCELLANEOUS	
BMRRM REMOVE/REPLACE.....	FS 16-106
GENERIC EVA REFERENCE.....	17-1
FLIGHT SPECIFIC EVA REFERENCE.....	FS 18-1
PAYLOAD BAY CONFIG	FS 18-3
NODE 2	
NODE 2 ZENITH PORT HANDRAILS	FS 18-4
NODE 2 FWD END CONE	FS 18-5
NODE 2 NADIR STBD HANDRAILS	FS 18-6
NODE 2 PORT NADIR HANDRAILS.....	FS 18-7
NODE 2 STBD ZENITH HANDRAILS	FS 18-8
EVA 1	
TRUNNION COVER LABELING.....	FS 18-9
ACBM	FS 18-10
PCBM WITH CONTAMINATION COVERS.....	FS 18-11
CONTAMINATION COVER.....	FS 18-12
PCBM CONTAMINATION COVER.....	FS 18-13
CBM PETAL RELEASE	FS 18-14
Z1 FLUID QDs STOWED ON Z1	FS 18-15
PDGF SIDEWALL CARRIER.....	FS 18-16
PDGF UNDERSIDE.....	FS 18-17
PDGF EDF IN INSTALLED POSITION	FS 18-18
PDGF EDF IN RETRACTED POSITION	FS 18-19
EVA 2	
NODE 2 PDGF MOUNTING RING	FS 18-20
PDGF HORSESHOE CONNECTOR INTERFACE	FS 18-21
PDGF HORSESHOE CONNECTOR RECEPTACLE.....	FS 18-22
NODE 2 HORSESHOE CONNECTORS.....	FS 18-23
PDGF HORSESHOE CONNECTOR SOFT DOCK.....	FS 18-24
PDGF CONNECTOR INTERFACE	FS 18-25
NODE 2 CAP LANYARDS (INBOARD/AFT)	FS 18-26
NODE 2 CAP LANYARDS (INBOARD/FWD AND OUTBOARD/AFT)	FS 18-27
S1 SFU CONFIG FOR DEPLOY	FS 18-28
MBSU BYPASS JUMPER – PANELS A260 AND A200.....	FS 18-29
EVA 3	
P6 TO P5 MEASUREMENTS.....	FS 18-32
CANNON CONNECTOR CAPS INSTALLED ON P5	FS 18-33
P6 SINGLE POINT GROUNDS (SPG).....	FS 18-34
P6 OUTBOARD RADIATOR.....	FS 18-36
GAP CHECK TOOL	FS 18-37
P5 CAPTURE LATCH ASSEMBLY (CLA).....	FS 18-38
P6 SSU SHROUD MLI FOLDING SEQUENCE	FS 18-39
MBSU STACK-UP	FS 18-40
MBSU IN PAYLOAD BAY	FS 18-41

MBSU PASSIVE FRAM ON ESP-2	FS 18-42
MBSU ACTIVE FRAM FLIGHT SUPPORT EQUIPMENT	FS 18-43
MBSU ACTIVE FRAM CONTINGENCY PINS	FS 18-44
EVA 5	
LAB SSPTS BAGS	FS 18-45
NODE 2 ACBM COVER (SHOWER CAP) BELT STRAP	FS 18-46
NODE 2 ACBM COVER (SHOWER CAP) GROUNDING FASTENERS ..	FS 18-47
FGB/PMA 1 H-JUMPER 1/4	FS 18-48
LAB MMOD SHIELD.....	FS 18-49
LAB MMOD SHIELD TABS	FS 18-50
CONTINGENCY	
S1 RADIATOR OVERVIEW.....	FS 18-51
S1 RADIATOR CINCH RELEASE	FS 18-52
P5/P6 PRD ROUTING (CORNER 1).....	FS 18-53
P5/P6 PRD ROUTING (CORNER 2).....	FS 18-54
P5/P6 PRD ROUTING (CORNER 3).....	FS 18-55
P5/P6 PRD ROUTING (CORNER 4).....	FS 18-56
P5/P6 PRD ROUTING (STRAP ROUTING CORNER 4)	FS 18-57
P5/P6 PRD ROUTING (STRAP ROUTING CORNER 3)	FS 18-58
ORU CONTINGENCY TIE-DOWN DEFINITIONS	FS 18-60
LAB CETA LIGHT CONTINGENCY TIE-DOWN	FS 18-61
Z1 BSP CONTINGENCY TIE-DOWN.....	FS 18-63
Z1 SASA CONTINGENCY TIE-DOWN	FS 18-64
RPCM CONTINGENCY TIE-DOWN.....	FS 18-65
CETA CART – TOP VIEW	FS 18-66
CETA CART – SWING ARMS AND WIF MARKINGS.....	FS 18-67
CETA CART – COUPLERS.....	FS 18-68
CETA CART – WHEEL BOGIES.....	FS 18-69
STATUS INDICATORS (MBSU, DDCU, BCDU)	FS 18-70
<u>EVA EMERGENCY</u>	19-i
EMERGENCY PROCEDURES.....	19-1
EMERGENCY AIRLOCK REPRESS	19-3
EMERGENCY AIRLOCK REPRESS.....	19-4
POST EMERGENCY AIRLOCK REPRESS	19-4
SAFER RESCUE.....	19-5
SAFER RESCUE	19-6
DAP/EVA RESCUE/RETRIEVE	19-7
EVA ORBITER CONFIG.....	19-7
EVA RESCUE/RETRIEVE.....	19-9
19.1 DCS TREATMENT	19-10
CUE CARD CONFIGURATION	20-1

AIRLOCK CONFIG

AIRLOCK PREP	TEMP FS 2-2
EMU SWAP	2-3
BOOSTER FAN DEACTIVATION/REMOVAL	2-4
BOOSTER FAN INSTALLATION/ACTIVATION	2-4
EMU REMOVAL	2-4
EMU INSTALLATION	2-4
EMU CHECKOUT PREP	2-5
LTA RESTRAINT STRAP REMOVAL	2-6
LTA RESTRAINT STRAP INSTALLATION	2-6
EMU SWAP FOR EVA 2 (Wo → Tn)	FS 2-7
EMU SWAP FOR EVA 3 (Tn → Wo)	FS 2-8
EMU SWAP FOR EVA 5 (Pz & Wo → Wt & Mk)	FS 2-9
EVA PREP FOR TRANSFER TO ISS	FS 2-10
EVA TRANSFER TO ISS.....	FS 2-16
EVA PREP FOR TRANSFER TO SHUTTLE.....	FS 2-17
EVA TRANSFER TO SHUTTLE	FS 2-20
EVA STOW	FS 2-21

AIRLOCK
CONFIG

AIRLOCK PREP (50 min)

	Retrieve or unstow following equipment:
MF28G	3/8-in breaker bar, 4-in ext w/3/8-in drive
IFM Tool Kit	1/2-in socket w/3/8-in drive
Vol H	EMU Equipment Bag – attach to middeck wall
	Helmet Lights
	EVA Bag
	Contamination Detection Kit (location flight specific)
<hr/> FDF Locker	Cuff Checklists (2) – stow in EMU Equipment Bag
	<u>DEPRESS/REPRESS</u> Cue Card

- AW18A
1. ✓ Inner hatch Equal vlv (two) – OFF
 2. LTG FLOOD (four) – ON
 3. Remove from airlock, as reqd:
 - Airlock Stowage Bag
 - Airlock Floor Pallet using 3/8-in breaker bar, 4-in ext w/3/8-in drive, and 1/2-in socket w/3/8-in drive
 4. Stow Vol H Bags in Vol H
 5. Transfer to airlock:
 - EVA Bag – install on airlock wall
 - DEPRESS/REPRESS Cue Card
 - Helmet Lights
 - Contamination Detection Kit – install on airlock wall
 6. Install IVA foot restraint, as reqd
 7. Unbuckle SCU straps, Velcro SCU to wall
 8. Install EMU lights on helmets (EMU 1, EMU 2)
 9. Disconnect helmets from Airlock EMUs, temp stow
 10. Remove comm caps from LTA Restraint Bags and connect to electrical harnesses
 11. Install helmets (not reqd if proceeding directly to EMU Checkout)
 12. Remove LTA Restraint Bags
 13. Disconnect waist rings; remove and stow any equipment stowed in HUT/LTA
 14. Stow LTA Restraint Bags on AAPs
 15. ✓ Thermal cover clear of waist ring
 16. Waist ring – engage posn
 17. Connect LTA to HUT, lock
 18. Remove 20-g Crash Bag from middeck EMU, as reqd

EMU SWAP FOR EVA 2 (Wo → Tn) (30 min)

I

NOTE

This procedure assumes {1.240 POST EVA}
(SODF: ISS EVA SYS: EVA PREP/POST)
has been completed for EMU 3003 (Wo)

- EMU 3003 (Wo)
- 1. Remove Helmet Lights and EMU TV
Temporarily stow entire assembly
 - 2. If required, connect waist ring to HUT
 - 3. If required connect gloves to lower arms
 - 4. √Helmet installed, sunshades down, visor up, cover installed
 - 5. Remove EMU from fwd EDDA
Transfer EMU to Node 1
 - 6. Gather Wo EMU crew-specific items and place in Wo ECOK
Transfer ECOK to Node 1
- EMU 3018 (Tn)
- 7. If present, remove LTA Restraint Strap/Bag from EMU 3018 (Tn)
 - 8. Transfer EMU and Tn ECOK to E-Lk
Install EMU on fwd EDDA
 - 9. √Sunshades down, visors up, cover installed
 - 10. Install Helmet Lights and EMU TV and √REBA installed for EVA 5
per STS-120 CONSUMABLES TRACKING CUE CARD

EMU SWAP FOR EVA 3 (Tn → Wo) (30 min)

I

NOTE

This procedure assumes {1.240 POST EVA}
(SODF: ISS EVA SYS: EVA PREP/POST)
has been completed for EMU 3018 (Tn)

- EMU 3018 (Tn)
- 1. Remove Helmet Lights and EMU TV
Temporarily stow entire assembly
 - 2. If required, connect waist ring to HUT
 - 3. If required, connect gloves to lower arms
 - 4. ✓Helmet installed, sunshades down, visors up, cover installed
 - 5. Remove EMU from fwd EDDA
Transfer EMU to Node 1
 - 6. Gather Tn EMU crew-specific items and place in Tn ECOK
Transfer ECOK to Node 1
- EMU 3003 (Wo)
- 7. Transfer EMU 3003 (Wo) and Wo ECOK from Node 1 to E-Lk
Install EMU on fwd EDDA
 - 8. Install Helmet Lights and EMU TV
✓Sunshades down, visors up, cover installed

EMU SWAP FOR EVA 5 (Pz & Wo → Wt & Mk) (30 min)

I

NOTE

This procedure assumes {1.240 POST EVA}
(SODF: ISS EVA SYS: EVA PREP/POST)
has been completed for EMU 3004 (Pz) and
EMU 3003 (Wo)

- EMU 3004 (Pz) 1. Remove Helmet Lights and EMU TV
Temporarily stow entire assembly
2. √Helmet installed, sunshades down, visors up, cover installed
3. Remove EMU from aft EDDA
Transfer EMU to Node 1
4. Gather Pz EMU crew-specific items and place in Pz ECOK
Gather Pz EMU components drying post EVA 4
Transfer ECOK & drying components to Node 1
- EMU 3018 (Wt) 5. Transfer EMU 3018 (Wt) and Wt ECOK to E-Lk
Install EMU on aft EDDA
6. Install Helmet Lights and EMU TV per STS-120 CONSUMABLES
TRACKING CUE CARD
√Sunshades down, visors up, cover installed
- EMU 3003 (Wo) 7. Remove Helmet Lights and EMU TV
Temporarily stow entire assembly
8. √Helmet installed, sunshades down, visors up, cover installed
9. Remove EMU from fwd EDDA
Transfer EMU to Node 1
10. Gather Wo EMU crew-specific items and place in Wo ECOK
Gather Wo EMU components drying post EVA 4
Transfer ECOK & drying components to Node 1
- EMU 3006 (Mk) 11. Transfer EMU 3006 (Mk) and Mk ECOK to E-Lk
Install EMU on fwd EDDA
12. Install Helmet Lights and EMU TV per STS-120 CONSUMABLES
TRACKING CUE CARD
√Sunshades down, visors up, cover installed
13. √Wrist Mirrors (two) installed on EMUs
√ISS Cuff checklist installed on EMUs
14. √REBA installed for EVA 5 per STS-120 CONSUMABLES
TRACKING CUE CARD

EVA PREP FOR TRANSFER TO ISS (90 min)

- EMU 3003 (Pz), 1. √PWR – SCU
 EMU 3004 (Wo)
- DCM 2. √DCM PURGE vlv – op (up)
 3. √WATER – OFF, switch guard installed
 4. √O2 ACT – OFF
 5. Bungee the following bags to the forward bulkhead: Middeck Floor Port 1 (Bag A), Middeck Floor Stbd 1 (Bag C), Middeck Floor Stbd 2 (Bag D), and Ext A/L Floor Bag
 6. Configure/verify items stowed in the table below

EMU 3004 (Pz) Large

ITEM	STOWED LOCATION
<input type="checkbox"/> Helmet s/n 1068 (√sun shades down, visor up, cover installed) <input type="checkbox"/> Valsalva <input type="checkbox"/> Fresnel Lens (2) <input type="checkbox"/> Wrist Mirror <input type="checkbox"/> DIDB Restraint Bag <input type="checkbox"/> Pz Gloves (s/n 6248) <input type="checkbox"/> EMU Battery (s/n 2039) <input type="checkbox"/> LiOH Can (s/n _____) Record s/n <input type="checkbox"/> LTA (Pz)	EMU 3004
<input type="checkbox"/> Prime CCA (s/n 1165) NOTE: B/U CCA (s/n 1166) will go in Pz ECOK	LTA Restraint Bag
<input type="checkbox"/> ISS EVA Cuff C/L (EV1)	Middeck MF57C

EMU 3003 (Wo) X-Large

ITEM	STOWED LOCATION
<input type="checkbox"/> Helmet s/n 1072 (√sun shades down, visor up, cover installed) <input type="checkbox"/> Valsalva <input type="checkbox"/> Fresnel Lens (2) <input type="checkbox"/> Wrist Mirrors <input type="checkbox"/> DIDB Restraint Bag <input type="checkbox"/> Wo Gloves (s/n 6068) <input type="checkbox"/> EMU Battery (s/n 2040) <input type="checkbox"/> LiOH Can (s/n _____) Record s/n <input type="checkbox"/> LTA (Wo)	EMU 3003
<input type="checkbox"/> Prime CCA (s/n 1172)	LTA Restraint Bag
<input type="checkbox"/> ISS EVA Cuff C/L (EV2)	Middeck MF57C

EVA PREP FOR TRANSFER TO ISS (90 min) (Cont)

EMU Crew Options Kit (Pz ECOK)

ITEM	STOWED LOCATION
<input type="checkbox"/> LCVG w/biomed (Pz) (s/n 3205) <input type="checkbox"/> Ziplock Bags Pz EVAs #1, 2 & 3 <ul style="list-style-type: none"> <input type="checkbox"/> 3 MAGs <input type="checkbox"/> 3 Ziplock Bags <input type="checkbox"/> TCUs (top, bottom) <input type="checkbox"/> Wristlets <input type="checkbox"/> Comfort Gloves <input type="checkbox"/> Thermal Socks <input type="checkbox"/> Drink Bag Moleskin <input type="checkbox"/> 3 instep Moleskin (Not in EVA #1 Bag) <input type="checkbox"/> Mission Patch (Not in EVA #1 Bag) <input type="checkbox"/> National Flag (Not in EVA #1 Bag) <input type="checkbox"/> EV1 ID Stripes (Not in EVA #1 Bag) <input type="checkbox"/> Ziplock Bag PZ EVA #4/Contingency <ul style="list-style-type: none"> <input type="checkbox"/> 6 MAGs <input type="checkbox"/> 6 Ziplock Bags <input type="checkbox"/> TCUs (top, bottom) <input type="checkbox"/> Wristlets <input type="checkbox"/> Comfort Gloves <input type="checkbox"/> Thermal Socks <input type="checkbox"/> 6 Moleskin (Drink Bag & Instep) <input type="checkbox"/> Mission Patch <input type="checkbox"/> National Flag <input type="checkbox"/> EV1 ID Stripes <ul style="list-style-type: none"> <input type="checkbox"/> 6 Velcro Identifiers <input type="checkbox"/> B/U Fresnel lens <input type="checkbox"/> Spare Mesh Bag	Pz ECOK – Removed from HUT during EMU C/O
<input type="checkbox"/> Pz B/U gloves (s/n 6268)	Middeck Floor Port 1 (Bag A)
<input type="checkbox"/> B/U CCA (s/n 1166) NOTE: This is Tn B/U CCA also	Pz LTA Restraint Bag

EVA PREP FOR TRANSFER TO ISS (90 min) (Cont)

EMU Crew Options Kit (Wo ECOK)

ITEM	STOWED LOCATION
<input type="checkbox"/> LCVG w/biomed (Wo) (s/n 3196) <input type="checkbox"/> Ziplock Bags Wo EVAs #1 & #3 <ul style="list-style-type: none"> <input type="checkbox"/> 3 MAGs <input type="checkbox"/> 3 Ziplock Bags <input type="checkbox"/> TCUs (top, bottom) <input type="checkbox"/> Wristlets <input type="checkbox"/> Comfort Gloves <input type="checkbox"/> Tube Socks <input type="checkbox"/> Drink Bag Moleskin <input type="checkbox"/> Mission Patch (Not in EVA #1 Bag) <input type="checkbox"/> National Flag (Not in EVA #1 Bag) <input type="checkbox"/> EV2 ID Stripes (Not in EVA #1 Bag) <input type="checkbox"/> Ziplock Bag Wo EVA #4/Contingency <ul style="list-style-type: none"> <input type="checkbox"/> 6 MAGs <input type="checkbox"/> 6 Ziplock Bags <input type="checkbox"/> TCUs (top, bottom) <input type="checkbox"/> Wristlets <input type="checkbox"/> Comfort Gloves <input type="checkbox"/> Tube Socks <input type="checkbox"/> 7 Moleskin (Drink Bag & Instep) <input type="checkbox"/> Mission Patch <input type="checkbox"/> National Flag <input type="checkbox"/> EV2 ID Stripes <input type="checkbox"/> 6 Velcro Identifiers <input type="checkbox"/> B/U Fresnel lens (2) <input type="checkbox"/> Mesh Bags (6) NOTE: 6 labeled bags will be configured for transfer	Wo ECOK – Removed from HUT during EMU C/O
<input type="checkbox"/> Wo B/U gloves (s/n 6193)	Middeck Floor Port 1 (Bag A)

EVA PREP FOR TRANSFER TO ISS (90 min) (Cont)

EMU Crew Options Kit (Tn ECOK)

ITEM	STOWAGE LOCATION
<ul style="list-style-type: none"> <input type="checkbox"/> Ziplock Bag Tn Docked EVA, Stage EVA #1 & #2 <ul style="list-style-type: none"> <input type="checkbox"/> 3 MAGs <input type="checkbox"/> 3 Ziplock Bags <input type="checkbox"/> TCUs (top, bottom) <input type="checkbox"/> Wristlets <input type="checkbox"/> Tipless Comfort Gloves <input type="checkbox"/> Socks <input type="checkbox"/> Moleskin & Molesite <input type="checkbox"/> EV ID Stripes (Not in Stage 2 Bag) <u>NOTE:</u> Dashed for Docked EVA and White for Stage EVAs <input type="checkbox"/> Mission Patches 10A (1)/Inc 16 (2) <input type="checkbox"/> National Flag <input type="checkbox"/> 6 Velcro Identifiers <input type="checkbox"/> Fresnel lens (Not in Stage 2 Bag) <input type="checkbox"/> Ziplock Bag Tn Contingency <ul style="list-style-type: none"> <input type="checkbox"/> 4 MAGs <input type="checkbox"/> 4 Ziplock Bags <input type="checkbox"/> TCUs (top, bottom) <input type="checkbox"/> Wristlets <input type="checkbox"/> Tipless Comfort Gloves <input type="checkbox"/> Manzella Comfort Gloves (3 pair) <input type="checkbox"/> Socks <input type="checkbox"/> Moleskin & Molesite <input type="checkbox"/> Mission Patch (Inc 16) <input type="checkbox"/> National Flag <input type="checkbox"/> Spare Mesh Bag 	<p>Tn ECOK: Middeck Floor Stbd 1 (Bag C)</p>
<ul style="list-style-type: none"> <input type="checkbox"/> Prime CCA (s/n 1205) <input type="checkbox"/> Prime Legs (s/n 183 & 184) <input type="checkbox"/> Prime LCVG w/biomed (s/n 3139) <input type="checkbox"/> Tn Prime gloves (s/n 6130) <input type="checkbox"/> Tn B/U gloves (s/n 6132) 	<p>Middeck Floor Stbd 1 (Bag C)</p>

EVA PREP FOR TRANSFER TO ISS (90 min) (Cont)

EVA Systems 1 Mesh Bag

ITEM	STOWAGE LOCATION
<input type="checkbox"/> 10 DIDBs <u>NOTE:</u> Will be filled on FD3	Middeck Floor Stbd 2 (Bag D)
<input type="checkbox"/> 2 LiOH Cans (s/n _____ & _____) Record s/n	EXT Airlock Floor Bag
<input type="checkbox"/> 2 CSA-O2 (s/n 1041 & 1052)	MF71G
<input type="checkbox"/> STS-120/10A EVA Checklist (blue stripes) <input type="checkbox"/> ISS EVA SYSTEMS Checklist (blue stripes) <input type="checkbox"/> ISS EVA SYSTEMS Checklist (Transfer to ISS) <input type="checkbox"/> ISS EVA Cuff Checklist for Tn, Wt, Mk <input type="checkbox"/> STS-120/10A CONSUMABLES TRACKING CUE CARD <input type="checkbox"/> STS-120/10A BATTERY RECHARGE PLAN CUE CARD <input type="checkbox"/> EMERGENCY UNDOCKING CUE CARD	Middeck MF57C
<input type="checkbox"/> Contamination Detection Kit (CDK) (s/n 1001)	Middeck Floor Port 2 (Bag B)
<input type="checkbox"/> Bends Treatment Adaptor (BTA) (s/n 1009)	Middeck MA16J

EVA Systems 2 Mesh Bag

ITEM	STOWAGE LOCATION
<input type="checkbox"/> Tn B/U LCVG (s/n 3160) <input type="checkbox"/> Tn B/U Waist Brief (s/n 2041) (Bladder labeled s/n 005) <input type="checkbox"/> EMU Comfort Patch Kit	Middeck Floor Stbd 1 (Bag C)
<input type="checkbox"/> EMU Servicing Kit (s/n 5002) <u>NOTE:</u> Do not use for 10A EVAs	Volume H (INBD)
<input type="checkbox"/> 2 LiOH cans (s/n 2014 & 2017) <u>NOTE:</u> For 10A stage EVAs <input type="checkbox"/> Tn 2nd B/U gloves (s/n 6229)	Middeck Ceil Port 1 (Bag E)
<input type="checkbox"/> Over Gloves (Adjustable Protective Mittens) (3 pair)	Middeck Floor Port 1 (Bag A)

EVA Systems 3 Mesh Bag

ITEM	STOWAGE LOCATION
<input type="checkbox"/> Wt & Mk EVA Stripes <u>NOTE:</u> Wt – Red & Candycane; Mk – Candycane	EVA Systems 3 Mesh Bag (Wo ECOK)
<input type="checkbox"/> Wt Prime LCVG w/biomed (s/n 3197) <input type="checkbox"/> Mk Prime LCVG w/biomed (s/n 3202) <input type="checkbox"/> Wt B/U Lower Arms (s/n 265 & 266) <input type="checkbox"/> Wt B/U Boots (s/n 221) <input type="checkbox"/> Wt B/U thigh sizing ring (s/n 115 & 116) <input type="checkbox"/> Wt B/U 1.5" leg sizing ring (s/n 129 & 130) <input type="checkbox"/> Wt B/U CCA (s/n 1195) <input type="checkbox"/> Mk B/U Leg (s/n 157) <input type="checkbox"/> Mk B/U CCA (s/n 1179) <input type="checkbox"/> Wrist Mirrors (6) <input type="checkbox"/> Wt 2nd B/U gloves (s/n 6244) <input type="checkbox"/> "Wingless" DIDBs (2) – empty <u>NOTE:</u> Not in CTB 1114. For Orlan EVAs	Middeck Ceil Port 1 (Bag E) – Double CTB 1114 <u>NOTE:</u> All contents of CTB 1114 will be emptied

EVA PREP FOR TRANSFER TO ISS (90 min) (Cont)

1. Gather EVA TOOLS A, EVA TOOLS B, and EVA TOOLS C from Wo mesh bag
2. Configure items according to table below:

<u>Stowage Location</u>	<u>Item</u>	<u>EVA Needed</u>	<u>Mesh Bag</u>	
Middeck MF57E	<input type="checkbox"/> Right Angle Drive (qty 1)	1	A	
	<input type="checkbox"/> RPCM, Type II (qty 1, make sure NOT Type V)	2	B	
Middeck MF57H	<input type="checkbox"/> Gap spanners (qty 8 -307, qty 3 -305)	1	A	
	<input type="checkbox"/> Trunnion covers (qty 4)	2	B	
	<input type="checkbox"/> Keel Cover	2	B	
	<input type="checkbox"/> Orbit-Installed WIFs (OIWs) (qty 3)	2	B	
Ext A/L Floor Bag	<input type="checkbox"/> 85-ft safety tethers (qty 2)	1	A	
	<input type="checkbox"/> Adjustable tethers (qty 4)	1	A	
	<input type="checkbox"/> MWS baseplates (qty 2, will need to remove from T-Bar)	1	A	
Middeck Floor Port 1 (Bag A)	<input type="checkbox"/> QD Tool Bag (qty 1)	4	C	
	<input type="checkbox"/> Tile Repair Sample Box Insert (qty 1)	4	C	
	<input type="checkbox"/> Angled Stamp (qty 1)	4	C	
Middeck Floor Stbd 1 (Bag C)	<input type="checkbox"/> Wire Ties (qty 99 short, qty 18 long)	1	A	
Middeck Floor Stbd 2 (Bag D)	<input type="checkbox"/> Blue RETs (sm-sm) (qty 16)	1	A	
	<input type="checkbox"/> Blue RETs (sm-sm w/PIP pin) (qty 5)	1	A	
	<input type="checkbox"/> Blue RETs (Lg-sm) (qty 8)	1	A	
	<input type="checkbox"/> Large Trash Bag (qty 1)	1	A	
	<input type="checkbox"/> OIH carriers (qty 1)	2	B	
	<input type="checkbox"/> Orbit-Installed Handrails (OIHs) (qty 6)			
	<input type="checkbox"/> OIH carriers (qty 1)	2	B	
	<input type="checkbox"/> Orbit-Installed Handrails (OIHs) (qty 5)			
	in 0.5 CTB 1206			
	<input type="checkbox"/> EVA Scissors (taped, qty 1)	3	B	
	<input type="checkbox"/> Compound Cutter/Needle Nose Pliers Caddy (qty 1)	3	B	
<input type="checkbox"/> Compound Cutters (taped, qty 1)				
<input type="checkbox"/> Needle Nose Pliers (taped, qty 1)				
<input type="checkbox"/> Loop Pin Puller Caddy (qty 1)	3	B		
<input type="checkbox"/> Loop Pin Puller (taped, qty 1)				
Middeck Ceiling Stbd 1 (Bag G)	<input type="checkbox"/> Gel/Foam Brush Caddy (-305, qty 1) (with brush handle)	4	C	
	<input type="checkbox"/> Tipless brush handle (qty 1) from all Gel Brush Caddy (-303)	4	C	
	<input type="checkbox"/> Tipless brush handles (qty 2 total; 1 from each of 2 EWA kits – remove netted brush tip from each handle, stow brush tip in handle pocket)	4	C	
	<input type="checkbox"/> EVA Wipes (qty 7 total; 5 loose, 3 from 1 of the 2 EWA kits)	4	C	
	<input type="checkbox"/> Broom Clip Caddy (“MWS Tool Stowage Caddy”) (qty 1)	4	C	
	<input type="checkbox"/> Thermal Sensor (qty 1) and AA batteries (qty 3)	4	C	

EVA TRANSFER TO ISS

NOTE

This procedure assumes that transfer items were preconfigured per EVA PREP FOR TRANSFER TO ISS

1. Transfer the following EVA equipment to ISS:

Item	Destination	Transfer Status
EMU 3004 (Pz)	E-Lk aft EDDA	
EMU 3003 (Wo)	E-Lk fwd EDDA	
ECOK Mesh Bag (Pz)	E-Lk	
ECOK Mesh Bag (Wo)	E-Lk	
ECOK Mesh Bag (Tn)	Node 1	
Mesh Bag (EVA Systems 1)	Node 1	
Mesh Bag (EVA Systems 2)	Node 1	
Mesh Bag (EVA Systems 3)	Node 1	
Mesh Bag (EVA Tools A)	E-Lk	
Mesh Bag (EVA Tools B)	Node 1	
Mesh Bag (EVA Tools C)	Node 1	

2. Place Wo B/U CCA (s/n 1183) in Wo ECOK, located in Ziplock bag on EDDA
3. Remove the following ODF/FDF products from the 'EVA Systems 1' Mesh Bag and deploy in the E-Lk:
 - STS-120/10A EVA Checklist (blue stripe)
 - STS-120/10A CONSUMABLES TRACKING CUE CARD
 - STS-120/10A BATTERY RECHARGE PLAN CUE CARD
 - EMERGENCY UNDOCKING CUE CARD
 - C/L ISS EVA SYSTEMS (blue stripe)
 - C/L ISS EVA SYSTEMS (Transfer to ISS)
4. Remove Contamination Detection Kit from the 'EVA Systems 1' Mesh Bag and deploy in the A/L IV Bag in the Crewlock
5. Remove the Bends Treatment Adaptor (BTA) from the 'EVA Systems 1' Mesh Bag and deploy in the outside cover pocket of MO2 Bag s/n 1038
6. Remove two CSA-O2s from the 'EVA Systems 1' Mesh Bag and deploy in the Airlock
7. Report transfer status to MCC

EVA PREP FOR TRANSFER TO SHUTTLE (90 min)

- EMU 3004 (Pz), 1. Perform 1.307 REBA INSTALLATION/REMOVAL (ISS EVA SYS,
 EMU 3003 (Wo) AIRLOCK CONFIG) removal steps
2. Install expended LiOH canisters for return (use Launched/Landing config) per STS-120 CONSUMABLES TRACKING CUE CARD

NOTE

EMU Batteries for return are currently charging.
 Will be placed in EMUs prior to transferring EMUs

DCM

3. √PWR – SCU
4. √DCM PURGE vlv – op (up)
5. √WATER – OFF, switch guard installed
6. √O2 ACT – OFF
7. √Helmet sunshades down, visor up, cover installed
8. Locate EMU Servicing Kit s/n 5005 labeled “Use and Return on 120”.
 Unstow signal conditioner s/n 103
9. Unstow EMU Servicing Kit s/n 5002 from ‘EVA Systems 2’ mesh bag.
 Stow signal conditioner s/n 103 in this Servicing Kit
10. Deploy EMU Servicing Kit s/n 5002 in E-Lk for Post EVA 5.
 Stow EMU Servicing Kit s/n 5005 labeled “Use and Return on 120”
 in ‘EVA Systems 1’ mesh bag for return
11. Unstow Pz B/U comm cap (s/n 1166) from Pz ECOK and place in
 Tn ECOK
12. Unstow Wo B/U comm cap (s/n 1183) from Wo ECOK and place in
 ‘EVA Systems 3’ mesh bag
13. Configure/verify items stowed in the table below. **Bolded items are not available until after EVA 5**

EMU 3004 (Pz) (Large)	EMU 3003 (Wo) (XL)
<input type="checkbox"/> Helmet s/n 1068 (√sunshades down, visors up, cover installed) <input type="checkbox"/> Valsalva <input type="checkbox"/> Fresnel Lens (2) <input type="checkbox"/> Wrist Mirror <input type="checkbox"/> DIDB Restraint Bag <input type="checkbox"/> Pz Gloves (s/n 6248) <input type="checkbox"/> No EMU Battery NOTE: Currently charging, will be placed in EMU prior to transfer <input type="checkbox"/> Expended LiOH Can (s/n _____) <input type="checkbox"/> LTA (Pz) <input type="checkbox"/> CCA (s/n 1165) <input type="checkbox"/> ISS EVA Cuff C/L (EV1) NOTE: Will be removing cuff during EVA Stow	<input type="checkbox"/> Helmet s/n 1072 (√sunshades down, visors up, cover installed) <input type="checkbox"/> Valsalva <input type="checkbox"/> Fresnel Lens (2) <input type="checkbox"/> Wrist Mirrors <input type="checkbox"/> DIDB Restraint Bag <input type="checkbox"/> Wo Gloves (s/n 6068) <input type="checkbox"/> No EMU Battery NOTE: Currently charging, will be placed in EMU prior to transfer <input type="checkbox"/> Expended LiOH Can (s/n _____) <input type="checkbox"/> LTA (Wo) <input type="checkbox"/> CCA (s/n 1172) <input type="checkbox"/> ISS EVA Cuff C/L (EV2) NOTE: Will be removing cuff during EVA Stow

EVA PREP FOR TRANSFER TO SHUTTLE (90 min) (Cont)

<p>EMU Crew Option Kit (Pz)</p> <ul style="list-style-type: none"> <input type="checkbox"/> LCVG w/biomed (Pz) (s/n 3205) <input type="checkbox"/> Pz EVA #1, 2, 3, 4 Ziplock Bags <ul style="list-style-type: none"> <input type="checkbox"/> 3 MAGs/Ziplocks (less used) <input type="checkbox"/> TCUs (top, bottom) <input type="checkbox"/> Wristlets <input type="checkbox"/> Comfort Gloves <input type="checkbox"/> Thermal Socks <input type="checkbox"/> Moleskin (less used) <input type="checkbox"/> Fresnel Lens (Contingency only) <input type="checkbox"/> Spare Mesh Bag 	<p>EMU Crew Option Kit (Wo)</p> <ul style="list-style-type: none"> <input type="checkbox"/> LCVG w/biomed (Wo) (s/n 3196) <input type="checkbox"/> Wo EVA #1, 3, 4 Ziplock Bags <ul style="list-style-type: none"> <input type="checkbox"/> 3 MAGs/Ziplocks (less used) <input type="checkbox"/> TCUs (top, bottom) <input type="checkbox"/> Wristlets <input type="checkbox"/> Comfort Gloves <input type="checkbox"/> Tube Socks <input type="checkbox"/> Moleskin (less used) <input type="checkbox"/> Fresnel Lens (Contingency only)
<p>Mesh Bag (EVA Systems 1)</p> <ul style="list-style-type: none"> <input type="checkbox"/> 2 Expended LiOH Cans (s/n _____ & _____) <input type="checkbox"/> STS-120/10A EVA Checklist (blue stripe) <input type="checkbox"/> C/L ISS EVA SYSTEMS (blue stripe) <input type="checkbox"/> STS-120/10A CONSUMABLES TRACKING CUE CARD <input type="checkbox"/> STS-120/10A BATTERY RECHARGE PLAN CUE CARD <input type="checkbox"/> EMERGENCY UNDOCKING CUE CARD <input type="checkbox"/> EMU Servicing Kit (s/n 5005) <input type="checkbox"/> Pz B/U gloves (s/n 6268) <u>NOTE:</u> Was in Pz ECOK <input type="checkbox"/> Wo B/U gloves (s/n 6193) <u>NOTE:</u> Was in Wo ECOK <input type="checkbox"/> Pz & Wo Mission Patches, Flags, EV Stripes (For RTH Bag) 	

EVA PREP FOR TRANSFER TO SHUTTLE (90 min) (Cont)

EVA TOOL TRANSFER PREP

1. Gather EVA TOOLS A, EVA TOOLS B, and EVA TOOLS C mesh bags
2. Configure/verify items according to table below:

<u>Item</u>	<u>Available After EVA</u>	<u>Mesh Bag</u>
<input type="checkbox"/> LTA Cable (qty 1)	2	A
<input type="checkbox"/> Node 2 PCBM contamination covers (qty 8)	2	A
<input type="checkbox"/> Failed RPCM, Type II (qty 1)	2	A
<input type="checkbox"/> OIH carriers (qty 1, leaving 1 on-orbit for 1E)	2	A
<input type="checkbox"/> Node 2 CMB PIP pins (qty 4)	2	A
<input type="checkbox"/> PDGF mounting ring thermal cover (qty 1)	2	A
<input type="checkbox"/> Node 2 caps (qty 13)	2	A
<input type="checkbox"/> SSU MLI Shrouds (qty 2)	3	B
<input type="checkbox"/> Gel/Foam Brush Caddy (-305, qty 1)	4	B
<input type="checkbox"/> Broom Clip Caddy ("MWS Tool Stowage Caddy") (qty 1)	4	B
<input type="checkbox"/> Thermal Sensor (qty 1)	4	B
<input type="checkbox"/> Unused EVA Wipes (qty TBD)	4	B
<input type="checkbox"/> Red RETs (sm-sm) (qty TBD)	4	B
<input type="checkbox"/> Red RETs (sm-sm w/PIP pin) (qty TBD)	4	B
<input type="checkbox"/> 85-ft safety tethers (qty 2) Verify: #27 (s/n 1007) and #22 (s/n 1002)	5	C
<input type="checkbox"/> Adjustable tethers (qty 6) Verify: s/n 1010, 1013, 1014, 1015, 1036, 1037	5	C
<input type="checkbox"/> BSP (qty 1)	5	C

(**BOLD** items available after EVA 5)

EVA TRANSFER TO SHUTTLE

I

NOTE

This procedure assumes that transfer items were preconfigured per EVA PREP FOR TRANSFER TO SHUTTLE

1. Remove EMU batteries s/n 2039 & 2040 from BSA
2. Install EMU Battery s/n 2039 in EMU 3004 (Pz) and install EMU Battery s/n 2040 in EMU 3003 (Wo)
3. Transfer the following EVA equipment to SHUTTLE. Everything will be configured for landing after undock

Item	Destination	Transfer Status
EMU 3004 (Pz)	Temp Stow in Middeck	
EMU 3003 (Wo)	Temp Stow in Middeck	
ECOK Mesh Bag (Pz)	Temp Stow in Middeck	
ECOK Mesh Bag (Wo)	Temp Stow in Middeck	
Mesh Bag (EVA Systems 1)	Temp Stow in Middeck	
Mesh Bag (EVA Tools A)	Temp Stow in Middeck	
Mesh Bag (EVA Tools B)	Temp Stow in Middeck	
Mesh Bag (EVA Tools C)	Temp Stow in Middeck	

NOTE

'EVA Systems 2 and 3' mesh bags remain on ISS

4. Report transfer status to MCC

EVA STOW

1

NOTE

This procedure assumes that EVA Transfer to Shuttle, EMU Installation, and Post ISS EVA Entry Prep are complete

1. Unpack items in mesh bags and stow for landing per table below

EVA Mesh Bag	Item	Stowage Location
Tools A	<input type="checkbox"/> LTA Cable (qty 1)	Middeck Ceiling Port 1 (Bag E)
	<input type="checkbox"/> Node 2 PCBM contamination covers (qty 8)	
	<input type="checkbox"/> Failed RPCM, Type II (qty 1)	
	<input type="checkbox"/> OIH carrier (qty 1)	
	<input type="checkbox"/> Node 2 CMB PIP pins (qty 4)	
	<input type="checkbox"/> PDGF mounting ring thermal cover (qty 1)	
	<input type="checkbox"/> Node 2 caps (qty 13)	
Tools B	<input type="checkbox"/> SSU MLI Shrouds (qty 2)	Middeck Floor Stbd 2 (Bag D)
	<input type="checkbox"/> Gel/Foam Brush Caddy (-305, qty 1)	Middeck Ceiling Stbd 1 (Bag G)
	<input type="checkbox"/> Broom Clip Caddy ("MWS Tool Stowage Caddy") (qty 1)	
	<input type="checkbox"/> Thermal Sensor (qty 1)	
	<input type="checkbox"/> Unused EVA Wipes (qty TBD)	Middeck Floor Stbd 2 (Bag D)
	<input type="checkbox"/> Red RETs (sm-sm) (qty TBD)	
<input type="checkbox"/> Red RETs (sm-sm w/PIP pin) (qty TBD)		
Tools C	<input type="checkbox"/> 85-ft safety tethers (qty 2)	Ext A/L Floor Bag
	<input type="checkbox"/> Adjustable tethers (qty 6)	Middeck Floor Port 1 (Bag B)
	<input type="checkbox"/> BSP (qty 1)	
Systems 1	<input type="checkbox"/> 2 Expended LiOH Cans (s/n _____ & _____)	EXT Airlock Floor Bag
	<input type="checkbox"/> EMU Servicing Kit (s/n 5005)	Volume H NOTE: Check no loose items stowed in Volume H
	<input type="checkbox"/> Pz B/U gloves (s/n 6268)	Middeck Floor Port 2 (Bag A)
	<input type="checkbox"/> Wo B/U gloves (s/n 6193)	
	<input type="checkbox"/> Pz & Wo Mission Patches, Flags and Stripes	RTH Bag
<input type="checkbox"/> Remaining FDF/ODF items will be stowed per step 3, once procedure complete	Middeck MF57C	

2. Remove ISS Cuff Checklists from EMU 3004 (Pz) and EMU 3003 (Wo), temp stow
3. Stow remaining FDF/ODF items from 'EVA Systems 1' mesh bag in FDF/ODF locker (Middeck MF57C)
 - ISS Cuff Checklists (temp stowed)
 - FDF EVA Checklist
 - ISS EVA Systems Checklist
 - STS-120/10A CONSUMABLES TRACKING CUE CARD
 - STS-120/10A BATTERY RECHARGE PLAN CUE CARD
 - EMERGENCY UNDOCKING CUE CARD
4. Stow empty mesh bags (4) in EXT A/L Floor Bag
5. Inform MCC, EVA Stow is complete

This Page Intentionally Blank

TIMELINES

STS-120 (10A) EVA TIMELINES OVERVIEW	FS 7-3
EVA 1	
EVA 1 INHIBIT PAD	FS 7-5
EVA 1 NOTES, CAUTIONS, AND WARNINGS	FS 7-7
10A EVA 1 PRE BRIEF	FS 7-11
EVA 1 SUMMARY TIMELINE	FS 7-15
PRE EVA 1 TOOL CONFIG	FS 7-16
EVA 1 A/L EGRESS AND SETUP	FS 7-18
SASA RETRIEVE	FS 7-19
S-BAND ANTENNA SUPPORT ASSEMBLY	FS 7-22
S-BAND ANTENNA	FS 7-23
NODE 2 PREP FOR UNBERTH	FS 7-24
SASA STOW	FS 7-26
NODE 2 FINAL PREP FOR UNBERTH	FS 7-29
Z1-TO-P6 FLUID DISCONNECT	FS 7-33
P6 AFT RADIATOR SHROUD DEPLOY	FS 7-38
SSU MLI SHROUD INSTALL	FS 7-42
EVA 1 CLEANUP AND A/L INGRESS	FS 7-44
POST EVA 1 TOOL CONFIG	FS 7-45
POST EVA 1/PRE EVA 2 TOOL CONFIG	FS 7-46
EVA 2	
EVA 2 INHIBIT PAD	FS 7-47
EVA 2 NOTES, CAUTIONS, AND WARNINGS	FS 7-50
10A EVA 2 PRE BRIEF	FS 7-54
EVA 2 SUMMARY TIMELINE	FS 7-57
PRE EVA 2 TOOL CONFIG	FS 7-58
EVA 2 A/L EGRESS AND SETUP	FS 7-60
Z1-TO-P6 UMBILICAL DISCONNECT	FS 7-61
DETACH P6 FROM Z1	FS 7-66
NODE 2 OUTFITTING	FS 7-71
S1 SFU CONFIG FOR CINCH FIRING	FS 7-76
SFU PANEL A123 (PRE DEPLOY)	FS 7-78
MBSU BYPASS JUMPER RECONFIG	FS 7-79
RPCM S04B-C R&R	FS 7-82
PDGF INSTALL ON NODE 2	FS 7-85
EVA 2 CLEANUP AND A/L INGRESS	FS 7-89
EVA 2 SPECIFIC GET-AHEADS – NODE 2 ACBM SHOWER CAP REMOVE	FS 7-90
POST EVA 2 TOOL CONFIG	FS 7-91
POST EVA 2/PRE EVA 3 TOOL CONFIG	FS 7-92
EVA 3	
EVA 3 INHIBIT PAD	FS 7-93
EVA 3 NOTES, CAUTIONS, AND WARNINGS	FS 7-96
10A EVA 3 PRE BRIEF	FS 7-100
EVA 3 SUMMARY TIMELINE	FS 7-103
PRE EVA 3 TOOL CONFIG	FS 7-104
EVA 3 A/L EGRESS AND SETUP	FS 7-106
ATTACH P6 TO P5	FS 7-108
CONNECT P5 TO P6 UMBILICALS	FS 7-115
SSU MLI SHROUD REMOVAL	FS 7-119
OUTBOARD RADIATOR CINCH RELEASE	FS 7-121
P1 SFU CONFIG FOR CINCH FIRING	FS 7-124
S1 SFU CONFIG POST DEPLOY	FS 7-125
MBSU TRANSFER	FS 7-128
SAW DEPLOYMENT CLEANUP	FS 7-133
EVA 3 CLEANUP AND A/L INGRESS	FS 7-134
POST EVA 3 TOOL CONFIG	FS 7-135
POST EVA 3/PRE EVA 4 TOOL CONFIG	FS 7-136

GET-AHEADS.....	FS 7-137
P1 NTA BREAK TORQUE	FS 7-139
LAB CETA LIGHT REMOVE.....	FS 7-140
BSP REMOVE	FS 7-141
MMOD SHIELD REINSTALL	FS 7-142
EVA 4	
EVA 4 INHIBIT PAD.....	FS 7-149
EVA 4 NOTES, CAUTIONS, AND WARNINGS.....	FS 7-150a
10A EVA 4 PRE BRIEF.....	FS 7-150e
EVA 4 SUMMARY TIMELINE	FS 7-150h
PRE EVA 4 TOOL CONFIG.....	FS 7-150i
EVA 4 A/L EGRESS AND SETUP	FS 7-150k
T-RAD DTO.....	FS 7-150m
EVA 4 CLEANUP AND A/L INGRESS	FS 7-150u
POST EVA 4 TOOL CONFIG.....	FS 7-150ee
POST EVA 4/PRE EVA 5 TOOL CONFIG.....	FS 7-150ff
EVA 5	
EVA 5 INHIBIT PAD.....	FS 7-151
EVA 5 NOTES, CAUTIONS, AND WARNINGS.....	FS 7-154
10A EVA 5 PRE BRIEF.....	FS 7-158
EVA 5 SUMMARY TIMELINE	FS 7-159
PRE EVA 5 TOOL CONFIG.....	FS 7-160
EVA 5 A/L EGRESS AND SETUP	FS 7-161
SSPTS CABLE STOW.....	FS 7-162
PMA2/LAB UMBILICAL STOW.....	FS 7-165
TEMP STOW N2 TRAY AVIONICS UMBILICALS.....	FS 7-169
LAB CETA LIGHT RETRIEVE	FS 7-173
BSP RETRIEVE	FS 7-176
BASE BAND SIGNAL PROCESSOR (BSP).....	FS 7-178
P1 NTA BOLTS BREAK TORQUE	FS 7-179
REMOVE ACBM COVER, CBM SURVEY.....	FS 7-181
S0/N1 POWER CABLE/H-JUMPER HARNESS REMOVAL	FS 7-183
TOOL PREP.....	FS 7-187
VENT TOOL EXTENDER BAG RELOCATE	FS 7-189
EVA 5 CLEANUP AND A/L INGRESS	FS 7-190
POST EVA 5 TOOL CONFIG.....	FS 7-191

STS-120 (10A) EVA TIMELINES OVERVIEW

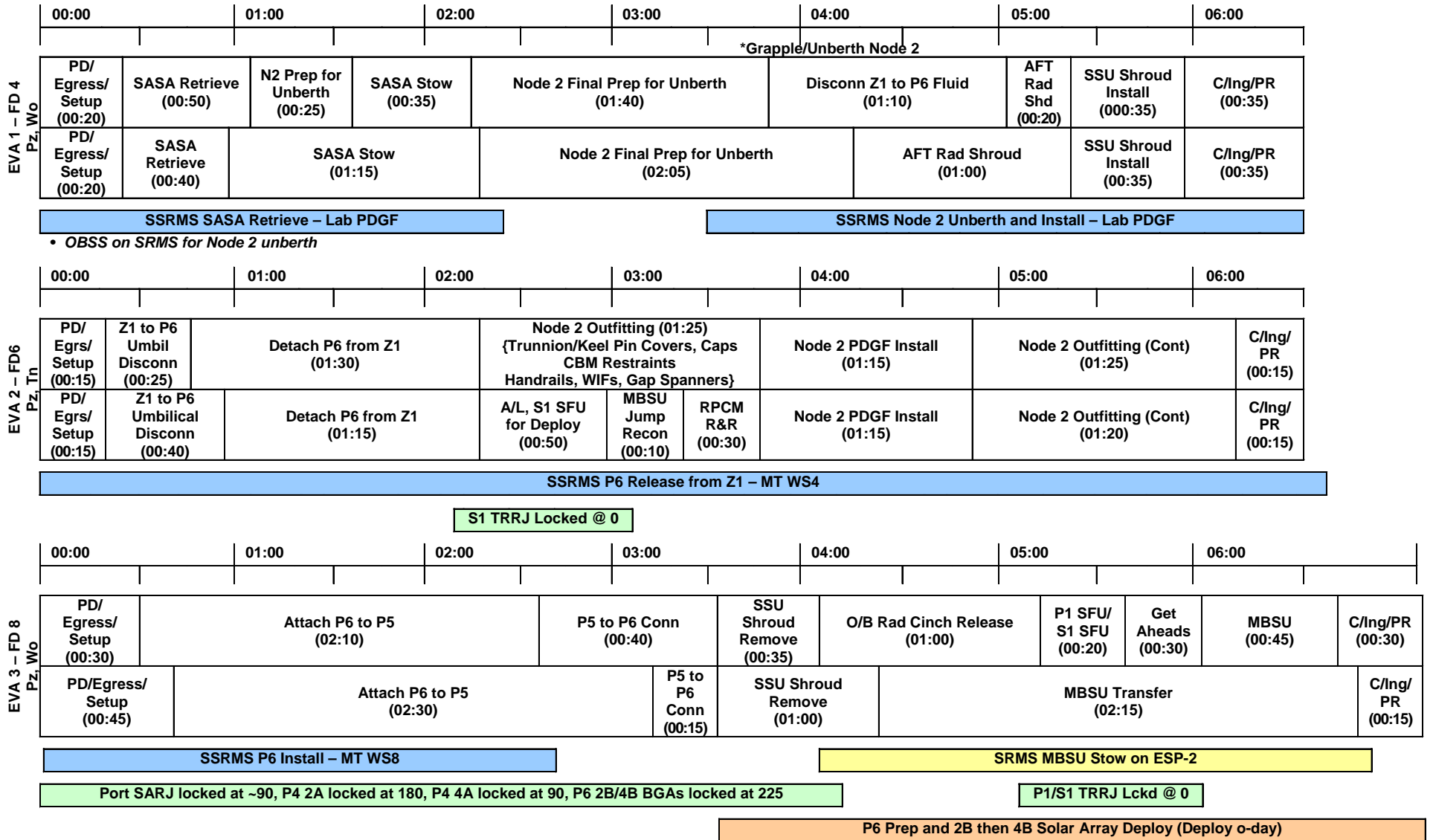

STS-120 (10A) EVA TIMELINES (Cont)

	00:00	01:00	02:00	03:00	04:00
EVA 4 – FD 10 Pz, Wo	PD/ Egress/ Setup (00:35)	T-RAD DTO (02:55)			C/lg/PR (01:15)
	PD/ Egress/ Setup (00:35)	T-RAD DTO (02:55)			C/lng/PR (01:15)

	00:00	01:00	02:00	03:00	04:00	05:00	06:00			
EVA 5 – FD 11 Wt, Mk	PD/ Egress /Setup (00:25)	SSPTS Cable Stow (00:20)	PMA2/ Lab Umbil Stow (00:40)	Lab CETA Light Remove (00:45)	Temp Stow N2 Stbd Tray Avionics (00:45)	BSP Retrieve (01:00)	Remove ACBM Cover, CBM Survey (00:50)	Mate S0/N1 SM Power Cable (00:40)	Tool Prep (00:40)	C/lg/PR (00:25)
	PD/ Egress /Setup (00:25)	SSPTS Cable Stow (00:20)	PMA2/ Lab Umbil Stow (00:00)	Temp Stow N2 Port Tray Avionics (01:10)		NTA bolts/Tool Prep (01:00)	Remove ACBM Cover, CBM Survey (00:50)	Configure PMA1/FGB H- Jumpers (00:50)	Tool Prep (00:30)	C/lng/PR (00:25)

EVA 1 INHIBIT PAD

Orbiter (1)

ALL EVAs	
TCS L12	1. √TCS POWER – OFF
KU-BAND ANTENNA {Performed during egress}	
MCC-H	1. √KU-BAND Mask – active 2. √KU-BAND EVA Protect Box – active
RCS {On call, EV crew not expected to be in this area} If EV crew < 27 ft from FRCS	
IV O14,15,16	1. √DAP: VERN, FREE, LO Z (ft specific check with GNC) 2. √RJDF F1, F2, F3, F4 MANF DRIVER (four) – OFF LOGIC (four) – OFF
MCC-H IV	3. √Above RCS config 4. √RCS F – ITEM 1 EXEC (*) √RCS FJET DES F1U – ITEM 17 (*) F3U – ITEM 19 (*) F2U – ITEM 21 (*)
S-BAND ANTENNAS {On call if Lab MMOD Shield reinstall attempted}	
NOTE Possible loss of comm when forced LL FWD antenna	
IV A1R	If EV crew < 2.0 ft from S-Band antenna 1. S-BAND FM ANT – XMIT LOWER/RCVR UPPER 2. √MCC, lower antenna selected
C3	If no comm, or on MCC GO 3. S-BAND PM ANT – LL FWD
C3	When EVA crewmember at least 2.0 ft away from all S-Band upper antennas 4. S-BAND PM ANT – GPC

Ground

ALL EVAs	
Ground Radar MCC-H	1. √TOPO console, ground radar restrictions in place for EVA
USOS (1)	
ALL EVAs	
NOTE PCUs may require up to 1 hr warm-up period before they are operational	
MCC-H	1. √PCUs (two) operational in discharge mode and one of the following: a. CCS PCU EVA hazard control enabled b. No more than two arrays unshunted c. No more than two arrays pointed < 90° from velocity vector
OR	
	2. One or no PCUs operational in discharge mode and one of the following: a. No more than two arrays unshunted b. No more than two arrays pointed < 90° from velocity vector
LOCATION DEPENDENT INHIBITS	
Lab Window	
IV	1. Close window shutter
KU-BAND (SGANT) Antenna {On call, EV crew not expected to be in this area}	
MCC-H	If EV crew < 3.3 ft from KU-BAND antenna 1. Park KU-BAND: 1.1 Pointing Mode – Inhibit 1.2 PLC – Reset 1.3 Autotrack Continuous Retry – Inhibit

EVA 1 INHIBIT PAD (Cont)

USOS (2)

LOCATION DEPENDENT INHIBITS	
S-BAND (SASA) ANTENNAS {On call, EV crew not expected to be in this area}	
MCC-H	If EV crew < 3.6 ft from S1 SASA [P1 SASA]
	1. P1 SASA [S1 SASA] – Active
	2. S1 SASA [P1 SASA] – Powered down

EVA 1 SPECIFIC INHIBITS	
SSPTS DEACTIVATION {Performed as part of Inhibit Pad}	
MCC-H	1. RPCM LA1A4A D RPC 3 – Open, Close Cmd Inhibit
	2. RPCM LA2A3B D RPC 1 – Open, Close Cmd Inhibit
	3. RPCM Z14B A RPC 2 – Open, Close Cmd Inhibit
	4. RPCM Z13B A RPC 2 – Open, Close Cmd Inhibit
SASA RELEASE FROM Z1 {Expect inhibits in place approximately during egress (starts 03:00 thermal clock for SASA)}	
MCC-H	1. RPCM Z14B B RPC 1 – Open, Close Cmd Inh
LTA CABLE DISCONNECT {Expect inhibits in place just prior to LTA cable disconnect (starts 01:45 thermal clock for LCS); do not remove inhibits until crew clear of hot SPDU connector}	
IV	1. Verify MCC-H GO, perform NODE 2 HEATER DEACT:
A15	APCU1,2 CONV(two) – OFF
CRT	SM 179 POWER TRANSFER
	√PTU 1, 2 APCU OUT VOLTS: < 10 V
A15	APCU 1, 2 OUTPUT (two) – OFF

USOS (3)

EVA 1 GET AHEAD INHIBITS	
LAB CETA LIGHT REMOVE {On Call}	
MCC-H	1. RPCM S01A C RPC 15 – Open, Close Cmd Inh
	2. RPCM S02B C RPC 15 – Open, Close Cmd Inh
BSP REMOVAL {On Call}	
MCC-H	1. RPCM Z14B B RPC 4 – Open, Close Cmd Inh
	2. RPCM Z13B B RPC 4 – Open, Close Cmd Inh

RSOS (1)

ALL EVAs	
SM Antennas	
IV	1. GTS – Deactivate
	2. ARISS – Deactivate or VHF (144-146 MHz) TX only
FGB Antennas	
MCC-M	1. √FGB KURS P [KYPC P] – Deactivated
Soyuz Thrusters	
MCC-M	1. √Soyuz manifolds (4) – closed ЭКО1, ЭКО2, ЭКГ1, ЭКГ2
	2. √Soyuz MCS unpowered
	3. √Soyuz Attitude Control Thruster Valves (52) – closed
	4. √Soyuz Main Engine Valves (K1, K2, K3, K4, K5, K6) – closed
FGB Thrusters	
MCC-M	1. √FGB MCS unpowered
	2. √All FGB Attitude Control Thruster Valves (80) – closed
	3. √FGB Attitude Control Manifold Valves – closed КШК1, КШК2, КШК4, КШК5, КШК9, ОКО3, ОКГ3, ОКО6, ОКГ6, ОКО7, ОКГ7, ОКО8, ОКГ8

EVA 1 NOTES, CAUTIONS, AND WARNINGS

NOTES

1. Bolt install: report torque and turns
2. Bolt release: report torque and turns if different from published range
3. EVA connectors: after disconnection and prior to connection; verify pin and EMI band integrity; verify connector free of FOD
4. Inspect QDs for damage prior to mating
5. Toolbox doors must be closed with one latch per door when EV crew not in immediate vicinity
6. Avoid contact with OBSS striker bars (Vitrolube coating)
7. MLI handholds are not rated for crewmember transition loads

CAUTION

ISS Constraints

- A. Avoid inadvertent contact with
1. Grapple fixture shafts (drylube)
 2. PIP pins
 3. EVA Crane [PMA1]
 4. TCS Reflectors [PMA2,PMA3]
 5. APAS hardware [PMA2,PMA3]
 6. CETA Lights (Z-93 paint) [LAB,S1,Node 1]
 7. Passive UMAs
 8. MBS VDU, MCU, CRPCMs, and Cameras (taped radiative surfaces, silver Teflon)
 9. Deployed TUS cable
 10. S0 aft face Radiator
 11. GPS Antennas (S13 paint) [S0]
 12. UHF Antennas [LAB,P1]
 13. ETCS Radiators [S1,P1]
 14. EETCS/PV Radiator bellows and panels [P6,P4,S4]
 15. SASA RF Group [Z1,S1,P1]
 16. Heat pipe radiators [Z1]
 17. PCU cathode and HCA ports [Z1]
 18. Ku-Band Antenna (SGANT) dish [Z1]
 19. CMG cover/shells [Z1]
 20. SSRMS Cameras
 21. Open CBM petal covers and LAB window shutter

CAUTION (Cont)

ISS Constraints (Cont)

- B. Electrical cables
1. Avoid bend radii < 10 times cable diameter
- C. Fiber optic cables
1. Avoid bend radii < 10 times cable diameter
 2. Avoid pulling on cable during mate/demate
- D. Fluid line flex hoses and QDs
1. Avoid bend radii < 5 in for hoses with diameter < 1 in on LAB, S0, S1, P1, and 10-in for hoses with diameter < 1 in on all other elements
 2. Avoid bend radii < 14 in for hoses with a diameter ≥ 1 in
 3. Additional care should be taken to not exceed bend radii when applying loads at the flexible hose to rigid tube stub interfaces
 4. Ensure fluid QD booties are fully closed prior to leaving worksite; wire tie if reqd
- E. For structural reasons
1. Avoid vigorous body motions, quick grabs and kickoffs against tether restraints
 2. Avoid performing shaking motions (sinusoidal functions) more than four cycles
 3. Avoid kicking S1/P1 radiator beam
If any of these occur, wait 2 to 5 min to allow structural response to dissipate

EVA 1 NOTES, CAUTIONS, AND WARNINGS (Cont)

CAUTION (Cont)

ISS Constraints (Cont)

F. Other

1. ITT Cannon connector: On demated connectors, do not rotate collar or manipulate cable/connector using collar or connector tool
2. WIS Antennas: do not use as handholds [Node 1,P6,Z1]
3. Lubricant from Ku-Band SGANT gimbals [Z1], CMGs [Z1], and RTAS Ground Strap fasteners [P6,P4,S4] can contaminate EMU
4. MLI handholds are not rated for crewmember translation loads
5. CBM petal covers may not be used as handholds unless both launch restraint pins are engaged

CAUTION (Cont)

Shuttle Constraints

G. Avoid inadvertent contact with

1. OBSS and SRMS Composite Sections and Cable Harnesses
2. LCS (silver Teflon) and LDRI (silver Teflon) and ITVC (gold foil) [OBSS]
3. WVS Antenna [ODS Truss & PLB Sill]
4. Payload Bay wire harnesses, cables, and connectors

H. No touch

1. LDRI diffuser [OBSS]
2. OBSS saddle contacts (when OBSS unberthed) [OBSS]
3. Monkey fur [PLB]
4. Cameras: metallic surfaces [PLB]
5. Ku-Band Antenna black dish and gold thermal blankets [PLB]

EVA 1 NOTES, CAUTIONS, AND WARNINGS (Cont)

WARNING

ISS Constraints

A. Avoid inadvertent contact with

1. Grapple fixture targets and target pins
2. SSU, ECU, beta gimbal platform, mast canister, SAW blanket boxes unless the beta gimbal is locked and the motor is turned off
3. Stay inboard of SARJ when active
4. Stay 2 ft from S1/P1 radiator beam rotational envelope when beam is free to rotate
5. Stay 5 ft from moving MT on face 1

B. Handrails

1. Handrails previously used for MISSE attachment may not be used as a safety tether point [A/L endcone 564 & 566, A/L Tank 2 nad/fwd & port/fwd, P6 5389]

C. Pinch

1. NZGL connector linkage. Use caution when mating/locking
2. ITT Cannon Connector rotating housing
3. EV side of IV Hatch during Hatch operation (also snag hazard) [A/L]
4. LAB window shutter and CBM petal cover linkages during operation

D. QDs

1. If QD is in FID when valve is opened (bail fwd), QD will leak and fluid line may whip
2. Do not rotate if in mated/valve open config

WARNING (Cont)

ISS Constraints (Cont)

E. RF radiation exposure

1. Stay 3.6 ft from S-Band (SASA) high gain Antenna when powered [S1,P1]
2. Stay 1.3 ft from S-Band (SASA) low gain Antenna when powered [S1,P1]
3. Stay 1 ft from UHF Antenna when powered [LAB,P1]

F. Sharp Edges

1. Inner edges of WIF sockets
2. Mating surfaces of EVA connectors. Avoid side loads during connector mating
3. Back side of MMOD shield fasteners
4. Spring loaded captive EVA fasteners (e.g., 6B-boxes, BMRRM); the end of the spring may protrude
5. PMA umbilical launch restraints-exposed bolt threads
6. Adjustable Fuse Tether (Fish Stringer) buckles stowed in Node Bag
7. Nickel coated braided copper Ground Straps may contain frayed wires [P6,P4,S4]
8. Z1 handrail 6061 by the Ku-Band boom launch restraint [Z1]
9. Solar Array Blanket Box [P6,S6]
10. Keep hands away from SSRMS LEE opening, and snares
11. Fastener threads on back of Z1 U-jumper male FQD panel, if nutplate cap missing

WARNING (Cont)

ISS Constraints (Cont)

G. Thermal

1. EVA connectors with booties may become hot if left uncovered. Handling may need to be limited
2. PMA handrails may be hot. Handling may need to be limited
3. Turn off glove heaters when comfortable temp reached to prevent bladder damage. Do not pull fingers out of gloves when heaters are on
4. Uncovered trunnion pins may be hot
5. SSRMS/MBS operating Cameras and lights may radiate large amounts of heat
6. Stay 1 ft away from PMAs and MMOD shields > 270 degF if EMU sun visor up
7. Stay at least 1 ft away for no more than 15 min from PMAs and MMOD shields > 300 degF if EMU sun visor up
8. Stay 0.5 ft away from PMA and MMOD shields > 325 degF
9. Do not touch EMU protective visor if temp has been < -134 for > 15 min
10. No EMU TMG contact of PMAs and MMOD shields when temp > 320 degF
11. No EMU boot contact with foot restraint when temp < -120 degF or > 200 degF

H. Electrical Shock Hazard

1. Stay \geq 2 ft from following ungrounded floating connectors if not inhibited: SSPTS on Lab fwd and stbd Node 1, H-jumper on FGB, MT cables, and S0 Bay 00, 02, and 03

EVA 1 NOTES, CAUTIONS, AND WARNINGS (Cont)

WARNING (Cont)

Shuttle Constraints

I. Arcing/Molten Debris

1. Stay \geq 2 ft from exposed EFGF connector when OBSS berthed, powered, and EFGF not grappled [PLB]
2. Stay \geq 2 ft from exposed Stbd Fwd MPM contacts [PLB]
3. Stay \geq 2 ft from exposed Node 2 SPDU connectors when OBSS grappled by SRMS and LCS is powered [PLB]

J. Pinch

1. PRLA operation [PLB]

K. RF radiation exposure

1. Stay 2.0 ft from S-Band Antenna when powered
2. Stay 1 ft from top and side of UHF PLB Antenna radome surface when in high powered mode [ODS truss]
3. Stay 0.33 ft from top and side of UHF PLB Antenna radome surface when in low powered mode [ODS truss]
4. Remain below the level of the PLB door mold line for first 20 in Aft of Fwd bulkhead when S-Band Antenna powered [PLB]
5. Remain on the inboard side of the Stbd slidewire (sill handrails if slidewire not installed) for first 20 ft Aft of Fwd bulkhead when Ku-Band Antenna powered [PLB]

WARNING (Cont)

Shuttle Constraints (Cont)

L. Sharp Edges

1. PRLA grounding wipers [PLB]
2. LDRI baffles (Also an entrapment hazard) [OBSS]
3. Keep hands away from SRMS EE opening and snares
4. TCS connector backshells have exposed threads

M. Thermal

1. Illuminated PLB lights; do not touch
2. OBSS grapple fixture shafts/cams may be hot. Limit handling if required
3. Stay 27 ft from PRCS when powered
4. Stay 3 ft from VRCS when powered
5. Stay 3 ft from APU when operating

N. Thruster Contamination

1. Stay out of the immediate vicinity of leaking jet or APU

10A EVA 1 PRE BRIEF

ROLES (ALL)

EV1: Scott EV2: Wheels IV: Paolo	Suit IV (pre): Peggy R1: Zambo R2: Steph	Suit IV (post): Peggy M1: Steph M2: Dan, M3: Clay
--	--	---

MILESTONES (ALL)

___:___ Wake-up	___:___ Start of Post Depress
___:___ EVA Prep Start	

COMM SET-UP (ALL)

Name	Loop Selected		Taking to	From	Used for
	STS	ISS			
Big Loop	A/G1	1	MCC-STS, MCC-ISS	STS, ISS, EMU	All EVA/(S)SRMS ops, emergencies
A/G2	A/G2	-	MCC-STS	STS, BPSMU	Non-EVA, non-emergencies, STS related
S/G2	-	2	MCC-ISS	ISS	Non-EVA, non-emergencies, ISS related
ICOM	ICOM	3	STS, ISS	STS, ISS, BPSMU	Comm. Not intended for ground
ICOM	-	5	ISS-A/L, EMUs	ISS-A/L, EMUs	ATU4, 5, 6 intercom pre/post EVA

NOTE: always start a transmission by stating the loop talking on (unless it is the Big Loop)

GENERAL EMERGENCIES (ALL)

For ISS or shuttle Fire/Depress/ATM Contamination:

- Everybody "safes" what he is doing, executes JEE (ISS crewmember will execute gray steps in A/L), and return to home vehicle
- For smoke/flames or ATM contamination, don PBAs or ИПК
- If no ammonia contamination, EVs and IV will retrieve equipment per Emergency Undocking cue card. MS2-Steph will help at the PMA
- If EVs in EVA, terminate EVA and return to ISS A/L (if possible, IV will join in A/L and assist)
- If suited in E/L => suit doff (+ power down if time permits)
- If C/L depressed => "fast" repress
- If E/L at 10.2 => expect immediate auto ("fast") repress

For EVA emergencies:

- Abort & terminate procedures (including incapacitated/lost EV) => non essential shuttle and ISS activities will be terminated, IV and CMOs will go to E/L as soon as EVs in C/L
- For lost crewmember/tool => CDR-PLT-MS2-IV in shuttle flight deck, if possible obtain 2 camera views (read pan/tilt angles) and HHL reading R/Rdot

(S)SRMS/EVA JOINT OPS (EV1, EV2, R1, R2, M1, M2, IV)

- Review of (S)SRMS general activities (DOUG review)
 - Review of sync points between EVA and (S)SRMS ops
 - Review of frame(s) of reference (ISS ACS, OBAS, body relevance)
 - Responsibilities for clearances => with R(M)1(2) (unless clearly handed off and acknowledged)
 - Anyone can call "All Stop, All Stop, All Stop" in case of impending unsafe situation or emergency. SRMS => Brakes ON; SSRMS => Safe even if heard only once
 - When arm(s) need to move during EVA => R(M)2 announce on Big Loop: initial motion, duration of motion, direction of motion, possible interference with EVA, end of motion
 - If GCA required => IV will verify (S)SRMS and EV(s) ready for GCA, and hands over EVA external COMM to R(M)2 and EVs
 - When joint activities completed, IV will verify EV1/2 clear and issue "Go for (S)SRMS maneuver"
- For GCA:
- EVX calls for requested motion, R(M)2 repeats request
 - When motion starts, EVX, acknowledge motion, counts down to stop motion
 - At the end of GCA, EVX calls "GCA complete", R(M)2 acknowledges, hands COMM back to IV

EVA PREP (EV1, EV2, IV, Suit IV)

- Camp-out review
- WCS usage, food/drink
- While at 10.2: shave, brush teeth, wash face, comb hair
- Wear mask if not at 10.2
- Tool config (last minute tools/equipment)
- E/L activities
- Parallel suit donning
- SAFER, MWS, tool, bag stowage
- 10.2 depress/repress review
- C/L depress review

REPRESS/POST-EVA (EV1, EV2, IV, Suit IV)

- Coldsoak
- C/L repress review
- Parallel Suit
- Food/drinks requests

10A EVA 1 PRE BRIEF (Cont)

EVA DETAILED REVIEW (EV1, EV2, IV)

- **Egress:** EV1 fwd, EV2 to LEE; install WIF adapter; fish stringer → A/L fwd (0555-0560); Med ORU bag → 0556 (zenith/outboard toolbox); SAFER checks; close thermal cover; translation adaptation
- **SASA Retrieve:** EV1: APFR retrieve/install on LEE, extend IA; GCA EV2 roll to worksite (PLSS very close to ONTO tank); NGZL cable demate (P3) may be difficult, jiggle as reqd; EV1 releases aft mast bolt; EV2 releases fwd mast bolt (PGT shared); 20# MAST soft dock → rock off?; caution with low and high gain antennas, Z93 paint; EV1 beware of Node 1 WETA antenna during leap frog; EV1 help GCA clear of A/L; EV2: caution w/mass handling (SASA = 228#)
- **Node 2 Prep:** EV1: drop off large trash bag on Node 2 HR 0369 after PLB tether swap; Horseshoe connectors; PDGF: install 4 adjustables, √ lanyards and break torque on all 4 EDFs (expect 2T to fully break torque), avoid curvic coupling, grapple shaft & target
- **SASA Stow:** hand start ~2T fwd launch bolts, then remaining four; if successful, take all six to final torque; EV2 GCA to APFR removal position, transfer to Node 2 WIF 17; on EV2 GO, EV1 txfr safety tether to STBD ODS truss (local waist tether first), remove WIF adapter from SRMS and release arm
- **Node 2 Final:** PDGF: EDF removals (3 additional turns), relocation protocol (“Transfer”, “Go,” “On”); caution w/curvic coupling, grapple shaft & target; EV1 fairlead tether to avoid PCBM seals during removal (8) and WVS inspection; EV1: LTA cable removal; EV2: cap removals (6) and reinstallation (1); return loaded lg. trash bags & cable to airlock; EV2 to Lab HR 0296, temp stow gap spanners on Lab; EV1 tether swap and relocation of EV2 ERCM to airlock aft tether point
- **Fluid QDs:** IV to read through 1st time, EV1 to articulate each step; challenge if key step not mentioned; minimize side loads; use APFR for demates/mates
- **Aft Radiator Shroud:** EV2 deploy long straps; both deploy shroud simo; avoid contact with radiator bellows and thermal outer coating
- **SSU Shroud:** crescent mark towards mast canister; install long strap 1st; photo ops; EV1: pick up C/L bag, SASA connector mate on Z1; EV2 → A/L
- **Ingress:** Med ORU bag, C/L bag and fish stringer (loaded) to pass in

CHICA MANTRAS (EV1, EV2, IV)

- | | |
|---|---|
| <ul style="list-style-type: none">• Day/Night Cycles<ul style="list-style-type: none">○ Lights – on○ Sun visor – day: down, night: up○ Cooling – as required○ Bayonets – locked○ Gloves:<ul style="list-style-type: none">▪ Heater – on/off as required▪ Inspect/report:<ul style="list-style-type: none">▪ RTV status▪ Vectran abrasions/cuts (specifically inspect thumb, index finger, C-cup)○ Condition: Alpha, Bravo, Charlie• Safety Tether Swap<ul style="list-style-type: none">○ Gates – closed○ Hooks – locked○ Reel – unlocked• PGT Ops<ul style="list-style-type: none">○ XX – turns○ YY – torque○ (Green light) | <ul style="list-style-type: none">• PGT Extensions<ul style="list-style-type: none">○ XXX installed on YYY○ Good pull test• Electrical Connectors<ul style="list-style-type: none">○ Pins straight○ No FOD○ EMI band – intact○ If mated – mated, good bend radius○ TA clamps – closed• APFR Install<ul style="list-style-type: none">○ Black on black○ Good pull test |
|---|---|

COMM PROTOCOL (EV1, EV2, IV)

- Short and concise (everybody stops to listen when COMM is “active”)
- Start with EVX, IV, R(M)X, then switch to names
- Give appropriate/timely info
- Anticipate when possible, do not overload
- Hand signals (between EVs and/or IV/ground via WVS) => review crew notebook

EMERGENCIES (EV1, EV2, IV)

- All emergencies => verbalize, IV leads, challenge-response protocol
- DCS => speak up for symptoms (verbalize)
- Abort & terminate procedures => as per cuff check list (review)
- Incapacitated crewmember => EV secures other EV to himself, returns to A/L, IV + CMO in A/L
- Lost Crewmember => call over Big Loop, request cameras and HHL reading, SAFER ops
- Hydrazine/NH3 contamination => IV will direct ops per checklist

10A EVA 1 PRE BRIEF (Cont)

GENERAL REMINDERS (EV1, EV2, IV)

- Verbalize any DCM messages
- Suit/gloves => stiffer than training H/W
- Glove heaters => it takes 2-3 min to feel heat
- EHIP lights => leave them on
- Translations => slow & deliberate, avoid feet first, check tethers often, check buddy when able
- Mass handling => one axis trans/rot at a time, watch for inertia
- Tether management => fairleads, stay clear of each other, 30 sec rule for snags or entanglements
- ORU control => positive transfer of control
- PGT ops => Red light – low torque, Green light – in torque window, Red/Green lights – HI torque
- PGT CAL procedure => Ratchet collar – Not motor, Speed collar – Cal, Pull trigger (CAL passed message)
- Video/cameras view for IV => change tapes, adjust WVS at SR/SS
- Errors & Lost tools => acknowledge and continue
- For lost tool/ORU => EVs verbalize what, when, direction, speed; IV gets 2 camera views / HHL (if possible)

This Page Intentionally Blank

EVA 1 SUMMARY TIMELINE

PET HR : MIN	IV/SSRMS	10A EVA 1 EV1 – Pz	EV2 – Wheels	PET HR : MIN
00:00	SSRMS: APFR install/ingress position	<u>A/L EGRESS SETUP</u> (00:20) • Post Depress/Egress	<u>A/L EGRESS SETUP</u> (00:20) • Post Depress/Egress	00:00
01:00	√MCC-H GO for SASA connector demate SSRMS: GCA to SASA handoff SSRMS: Mnvr to SASA sidewall carrier	<u>SASA RETRIEVE</u> (00:50) • Connector Release • SASA Remove • SASA Handoff	<u>SASA RETRIEVE</u> (00:10) • SASA Handoff	01:00
	02:00	SSRMS: SASA worksite setup SSRMS: GCA for SASA stow	<u>SASA STOW</u> (01:15) • SSMRS Mnvr to PLB	
03:00		SSRMS: SASA clearance SSRMS: APFR removal SSRSM: Node 2 pre-grapple	<u>SASA STOW</u> (00:35) • Soft dock SASA • Hand start fwd launch bolts (2) • Hand start aft launch bolts (2) • Drive launch bolts (4)	• Soft dock SASA • Hand start mast bolts (2)
	04:00	√MCC-H GO for LTA cable demate	<u>NODE 2 PREP FOR UNBERTH</u> (00:25) • Horseshoe Connector Partial Release • PDGF Partial Release	• Drive mast bolts (2) • Egress/remove APFR
<u>NODE 2 FINAL PREP FOR UNBERTH</u> (01:40) • PDGF Temp stow on Node 2 • PCBM Contamination cover remove • LTA Cable disconnect			<u>NODE 2 FINAL PREP FOR UNBERTH</u> (02:05) • PDGF Temp stow on Node 2 • PCBM Contamination cover remove • LTA Cable disconnect	
05:00	SSRMS: Node 2 grapple SSRMS: Node 2 unberth	<u>DISCONNECT Z1 TO P6 FLUID</u> (01:10) • Remove SPDs • Close valves • Demate from P6, mate to Z1 • Install male caps on P6	<u>NODE 2 FINAL PREP FOR UNBERTH</u> (02:05)	04:00
		<u>AFT RADIATOR SHROUD</u> (01:00) • Deploy port long strap • Deploy stbd long strap	<u>NODE 2 FINAL PREP FOR UNBERTH</u> (02:05)	
06:00	SSRMS: Node 2 grapple SSRMS: Node 2 unberth	<u>AFT RADIATOR SHROUD</u> (00:20) • Deploy stbd side of shroud	• Deploy port side of shroud	05:00
		<u>SSU SHROUD INSTALL</u> (00:35) • Install long strap on 2B (stbd) array • Install long strap on 4B (port) array • Install SASA cable on Z1	<u>SSU SHROUD INSTALL</u> (00:35) • Install short straps on 2B (stbd) array • Install short straps on 4B (port) array	
		<u>CLEANUP AND A/L INGRESS</u> (00:30)	<u>CLEANUP AND A/L INGRESS</u> (00:30)	06:00
		<u>PRE REPRESS</u> (00:05)	<u>PRE REPRESS</u> (00:05)	

PRE EVA 1 TOOL CONFIG

EV1

EMU D-rings

- 1 – Tether Extender on Left
- 2 – Waist Tethers
- 1 – 85-ft Safety Tether (A/L) on Left

MWS {baseplate from STS A, will need to install}

- Small trash bag [right inside]
 - 1 – Cap Size 17 (J3)
 - 2 – Adj (sm-sm) {from STS A}
- 2 – Wire ties
- Socket Caddy [left inside]
 - RAD, w/7/16-2 in ext S/N _____
- WIF adapter
 - 1 – RET (with PIP pin) [left] {from STS A}
- 2 – RET (sm-sm) [right] {from STS A}
- Swing Arm [right side]
 - PGT w/7/16-6 in ext [outside] S/N _____ (B5, CCW2, 30.5)
 - 1 – RET (sm-sm) {from STS A}
 - Ratchet w/o palm wheel with 7/16-2 in ext
 - 1 – RET (sm-sm) {from STS A}
- BRT [left side]
 - 2 – Adjustable tethers (for PDGF)
 - 3 – Wire Ties, short

- SAFER

Prior to EVA, inspect:

RET cord for damage

Small trash bag bristles for damage or deformation

Safety & waist tether load alleviating straps: no red

Total RETs sm-sm used – 11

RETs with PIP pin – 5

RETs Lg-sm – 7

Adj tethers – 12

EV2

EMU D-rings

- 1 – Tether Extender on Left
- 2 – Waist Tethers
- 1 – 85-ft Safety Tether (LEE tether) on Left

MWS {baseplate from STS A, will need to install}

- Small trash bag [right inside]
 - 6 – Gap Spanners (6-72" in series, attached to adj tether D-ring) {from STS A}
 - 1 – Adj (sm-sm) (to gap spanner)
- 2 – Wire ties
- 1 – RET (with PIP pin) [left] {from STS A}
- 2 – RET (sm-sm) [left, right] {from STS A}
- Swing Arm [right side]
 - PGT w/7/16-6 in ext S/N _____ (A7, CW2, 30.5)
 - 1 – RET (sm-sm) {from STS A}
- BRT [left side]
 - 1 – RET (sm-sm) {from STS A}
 - 2 – Wire Ties, short
 - 1 – Wire Ties, long
 - 2 – Adj (sm-sm) (one to be used for trash bag temp stow)

- SAFER

CREWLOCK (Cont)

- Staging Bag additions (see next page for standard)

- 1.0" BDT

- 1.0" AKT

- IV Bag

- 1 – RET (Lg-sm)

- Fish stringer

- EVA Camera/Bracket

- Crewlock bag #1

- 1 – Fish Stringer (for SPDs – sm hooks bundled on Lg hook)

- { 1 – Adj tether on outside (moved here from Lg trash bag during EVA)}

- Lg Trash bag (EV1)

- 1 – RET (Lg-sm) (inside bag) {from STS A}

- 1 – Adj (sm-sm) (outside bag)

- 1 – 85-ft Safety Tether (EV1 – PLB) {from STS A}

- Lg Trash bag (EV2) {from STS A}

- 1 – RET (Lg-sm) (inside bag) {from STS A}

- 1 – Adj (sm-sm) (outside bag)

- Sm Trash bag (EV2)

- S0 Gap spanners (1-45", 1-72"), hooked on strap {from STS A}

- Round Scoop (for CETA Light)

- Wire Tie Caddy

- 1 – RET (Lg-sm) {from STS A}

- Med ORU Bag

- 2 – RET (sm-sm) {from STS A}

- 2 – SSU shrouds

- EVA Camera/Bracket

- 2 – Adj on outside

Items remain in the A/L

PRE EVA 1 TOOL CONFIG (Cont)

CREWLOCK (Cont)

- 1 – RET (Lg-sm) {from STS A}
 - Med ORU Bag (for CETA light)
 - 1 – RET (with PIP pin) {from STS A}
- 1 – RET (Lg-sm) {from STS A}
 - 6B Box Cover
 - Dummy box
 - 1 – Adj tether {from STS A}
 - 1 – RET (sm-sm) {from STS A}
- 1 – RET (Lg-sm) {from STS A}
 - Crewlock bag #4 (MMOD Shield)
 - 3 – LDTDT
 - Wire Tie Caddy (on int)
 - 2 – MMOD T-Tool (on int)
 - GP Caddy (on int)
 - Vise Grips
 - Loop Pin Puller
 - Hammer (on RET w/PIP) {RET from STS A}
 - EVA Ratchet with IV socket (on RET w/PIP)
{RET from STS A}

Items remain in the A/L

CREWLOCK (Cont)

These items are expected to remain in the **Staging Bag** throughout EVAs except when noted

- Staging Bag
 - Fish Stringer 1
 - PGT (spare) with battery
 - Conn Cleaner Tool Kit
 - Conn Pin Straightener
 - Probe
 - Prybar
 - Round TM (RTAS cont, P1 NTA)
 - MWS key strap (wire tied to fish stringer)
 - {open hook}
 - {open hook}
 - Fish Stringer 2
 - Ratchet (GA stow)
 - Velcro/Tape Caddy (CBM cleaning)
 - Right Angle Drive (spare EVA 1,2,3)
 - Socket caddy (Cont)
 - 7/16-9 in ext
 - 7/16-12 in ext
 - Lg Cutter (EVA 2, GA stow)
 - Scraper (CBM cleaning, BSP)
 - {open hook}
 - {open hook}

These items are expected to remain in the **IV Bag** throughout EVAs

- IV Bag
 - Contamination Detection Kit
 - 6 – Gold Salt Coupons
 - 2 – Color Chart
 - ISS Contamination Sampler
 - Shuttle Contamination Sampler
 - 12 – Ammonia Draeger Tubes
 - 2 – SAFER HCM mounts (on 1 – RET)
 - 2 – GP Caddy (both on 1 – RET)
 - 4 – Thermal Mittens (1 pair per caddy)
 - Socket Caddy (on 1 – RET)
 - 7/16-6 in ext
 - 1/2-8 in ext
 - Mesh Bag with 2 – Towels

EVA 1 A/L EGRESS AND SETUP (00:20)

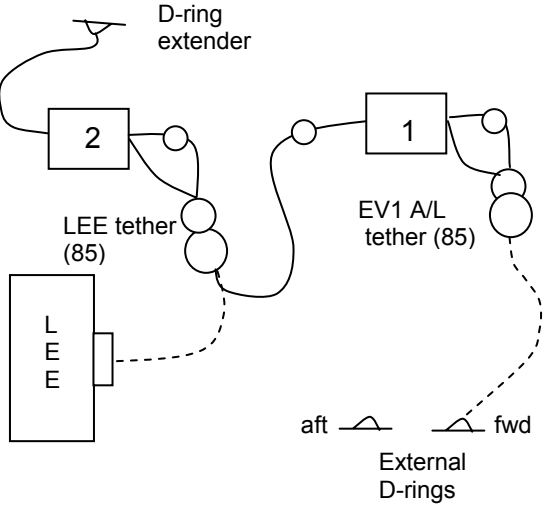
IV/SSRMS	EV1 – Pz (FF)	EV2 – Wheels (FF)
<p>SSRMS: APFR Install Position</p>  <div style="border: 1px solid black; padding: 5px; margin-top: 10px;"> <p>1 – 85-ft A/L tether – EV1 1 – 85-ft Payload Bay tether – EV1 (on trash bag) 1 – 85-ft LEE/Payload Bay/A/L tether – EV2</p> </div> <p>1. Post crew egress: WVS Software: Select page – RF Camera sel 'Advanced controls' S-Band level (two) – max</p>	<p><u>INITIAL CONFIG</u></p> <ol style="list-style-type: none"> Verify: <ul style="list-style-type: none"> <input type="checkbox"/> Right waist tether connected to EV2's 85-ft LEE Safety tether <input type="checkbox"/> Hook locked <p><u>EGRESS/INITIAL SETUP</u></p> <ol style="list-style-type: none"> Open hatch thermal cover Egress crewlock Attach EV1 85-ft safety tether to fwd A/L D-ring <ul style="list-style-type: none"> <input type="checkbox"/> <input checked="" type="checkbox"/> Gate closed <input type="checkbox"/> <input checked="" type="checkbox"/> Hook locked <input type="checkbox"/> <input checked="" type="checkbox"/> Reel unlocked Attach EV2 85-ft safety tether to LEE inboard tether point <ul style="list-style-type: none"> <input type="checkbox"/> <input checked="" type="checkbox"/> Gate closed <input type="checkbox"/> <input checked="" type="checkbox"/> Hook locked <input type="checkbox"/> EV2: <input checked="" type="checkbox"/> Reel unlocked <hr style="border-top: 1px dashed black;"/> <ol style="list-style-type: none"> Give EV2 GO to release waist tether Install WIF adapter (tether point forward) Receive fish stringer Attach fish stringer to A/L HR 0555 and 0560 (C/L fwd/stbd/nadir), cinch <hr style="border-top: 1px dashed black;"/> <ol style="list-style-type: none"> Receive Med ORU Bag Attach Med ORU Bag to HR 0556 (zenith/outboard toolbox) <hr style="border-top: 1px dashed black;"/> <ol style="list-style-type: none"> Verify SAFER config <ul style="list-style-type: none"> <input type="checkbox"/> <input checked="" type="checkbox"/> L Handle down (MAN ISO Vlv – Open) <input type="checkbox"/> <input checked="" type="checkbox"/> R Handle down (HCM – Closed) Perform translation adaptation 	<p><u>INITIAL CONFIG</u></p> <ol style="list-style-type: none"> Verify: <ul style="list-style-type: none"> <input type="checkbox"/> Right waist tether connected to A/L D-ring extender <input type="checkbox"/> Hook locked <p><u>EGRESS/INITIAL SETUP</u></p> <ol style="list-style-type: none"> On EV1 GO release right waist tether, attach to self Transfer fish stringer to EV1 Transfer Med ORU Bag to EV1 Egress crewlock Close hatch thermal cover Retrieve Lg trash bag from fish stringer Install Lg trash bag on right swing arm Verify SAFER config <ul style="list-style-type: none"> <input type="checkbox"/> <input checked="" type="checkbox"/> L Handle down (MAN ISO Vlv – Open) <input type="checkbox"/> <input checked="" type="checkbox"/> R Handle down (HCM – Closed) Perform translation adaptation

SASA RETRIEVE (00:50)

IV/SSRMS	EV1 – Pz (FF)	EV2 – Wheels (FF)
<p>{SASA RELEASE INHIBITS (Egress) RPCM Z14B B RPC 1 – Open, Close Cmd Inh}</p> <p><input type="checkbox"/> √MCC-H GO to demate SASA connector</p>	<p style="text-align: center;">CAUTION SASA hardware sensitive. Avoid contact with antennas and radiative surfaces</p> <p><u>APFR RETRIEVE AND SETUP</u></p> <ol style="list-style-type: none"> Translate to APFR on ESP-2 WIF 5 (ISS fwd) Configure APFR to (__, PP, F, 6); remove APFR Translate to SSRMS LEE GCA as reqd for APFR install Install APFR in WIF adapter (12, PP, F, 6) <ul style="list-style-type: none"> <input type="checkbox"/> √Locking collar black-on-black <input type="checkbox"/> Good pull test Translate to APFR/Ingress aid in A/L WIF 10 Swap Ingress Aid from WIF 10 APFR to SSRMS APFR Extend Ingress Aid Translate to SASA; assist EV2 with clearances as reqd <p style="text-align: center;">CAUTION Avoid inadvertent contact with Node 1 WETA antenna</p> <p><u>SASA RELEASE</u></p>	<p style="text-align: center;">CAUTION Avoid inadvertent contact with S0 radiator</p> <p><u>APFR SETUP</u></p> <ol style="list-style-type: none"> Translate to Z1 APFR (Z1 WIF 11) via ISS fwd path Verify APFR settings (12, SS, A, 12) Ingress Z1 APFR <p style="text-align: center;">CAUTION Avoid inadvertent contact with ONTO tank</p> <ol style="list-style-type: none"> Roll nadir to worksite, √ONTO tank clearances with EV1 <p><u>SASA RELEASE</u></p>
<ol style="list-style-type: none"> Give EV1 GO for P3 demate 	<ol style="list-style-type: none"> On IV GO, demate P3 from J3; temp stow Tether to SASA mast handrail BRT to A/L HR 0523 Release Aft Mast bolt (one) PGT, 7/16-6 in ext: B5, CCW2; ~8-10 turns Transfer PGT to EV2 <hr style="border-top: 1px dashed black;"/> <ol style="list-style-type: none"> Receive PGT from EV2 BRT to A/L HR 0537 	<hr style="border-top: 1px dashed black;"/> <ol style="list-style-type: none"> Receive PGT from EV1 Release Fwd Mast bolt (one) PGT, 7/16-6 in ext: B5, CCW2; ~8-10 turns Transfer PGT back to EV1 <hr style="border-top: 1px dashed black;"/>

SASA RETRIEVE (00:50) (Cont)

IV/SSRMS	EV1 – Pz (FF)	EV2 – Wheels (SSRMS)
<p>SASA dust cap J3 – Middle (size 17) <input type="checkbox"/></p> <p>SSRMS: GCA for APFR Ingress as reqd</p>	<p>8. Install dust cap onto SASA receptacle J3</p> <p><u>SASA LEAP FROG</u></p> <p>1. Receive SASA from EV2</p>	<p>4. Remove SASA from stowage location (20-lb pull force reqd, try to center force around soft dock)</p> <p>5. Present SASA connector panel end to EV1</p> <p><u>SASA LEAP FROG</u></p> <p>1. Transfer SASA to EV1</p> <p>2. Egress APFR</p> <p>3. Translate to SSRMS LEE</p> <p>4. GCA as reqd for APFR ingress</p> <p>5. Ingress SSRMS APFR, attach MWS EE to ingress aid</p> <p>6. Give IV GO for GCA to SASA handoff position</p>
<p>2. On EV GO, give SSMRS GO to mnvr to SASA handoff position SSRMS: GCA to SASA handoff position</p>	<p>2. Present SASA to EV2</p> <p>3. Release EV1's tether from SASA</p> <p>4. √Tools and tethers clear of worksite</p>	<p>7. Tether to SASA, receive SASA from EV1</p> <p>8. √Tools and tethers clear of worksite</p>
<p>3. Give SSMRS GO to mnvr to SASA sidewall carrier SSRMS: Mnvr to SASA sidewall carrier</p> <p>4. On M1/M2 GO, give EV1 GO to translate to fish stringer</p>	<p>5. Watch clearances between SASA and airlock until released by M1/M2</p> <p><u>TOOL RETRIEVE</u></p>	
	<p>1. On IV GO, translate to fish stinger at A/L</p> <p>2. Retrieve Lg trash bag (w/85-ft safety tether) from fish stringer at A/L</p> <p>3. Install Lg trash bag on left outside MWS T-bar</p> <p>4. Translate to Shuttle payload bay port side</p>	

SASA RETRIEVE – TASK DATA

Tools:

EV1 (FF)	EV2 (SSRMS)
PGT	
7/16-6 in	
Size 17 Connector Cap	

EVA Fasteners:

Fastener Name	Head Size	Install Torque (ft-lb)	Release Torque (ft-lb)	Failure Torque (ft-lb)	Turns	RPM
Mast Bolts	7/16"	9.2	15.1	52.1	7.5-9.5	30

EVA Connectors:

Harness	From	To	Conn Size	Function
W07S	SASA J3	Temp Stow	17	Heater Power

Foot Restraints:

Task	WIF	APFR Setting
SASA remove from Z1	Z1-11	12, SS, A, 12
SASA Handoff	LEE	12, PP, F, 6

SASA Mass – 228.0 lb/103 kg

SASA Thermal Clock – 3 hr from removal of heater power to installation on the PLB FSE (soft dock)

Note:

1. 12A crew had difficulty with removing Z1 SASA from soft dock. Attempt to apply pull force as close to the soft dock as possible to ease removal and apply a wiggle as necessary

Cautions:

1. Sensitive hardware. Avoid contact with all surfaces of SASA with exception of EVA interfaces and launch support structure. High gain antenna, low gain antenna, and radiator surfaces sensitive to contact
2. Watch for inadvertent contact: EV1 near Node 1 WETA antenna, EV2 near S0 aft radiator and ONTO tank

S-BAND ANTENNA SUPPORT ASSEMBLY

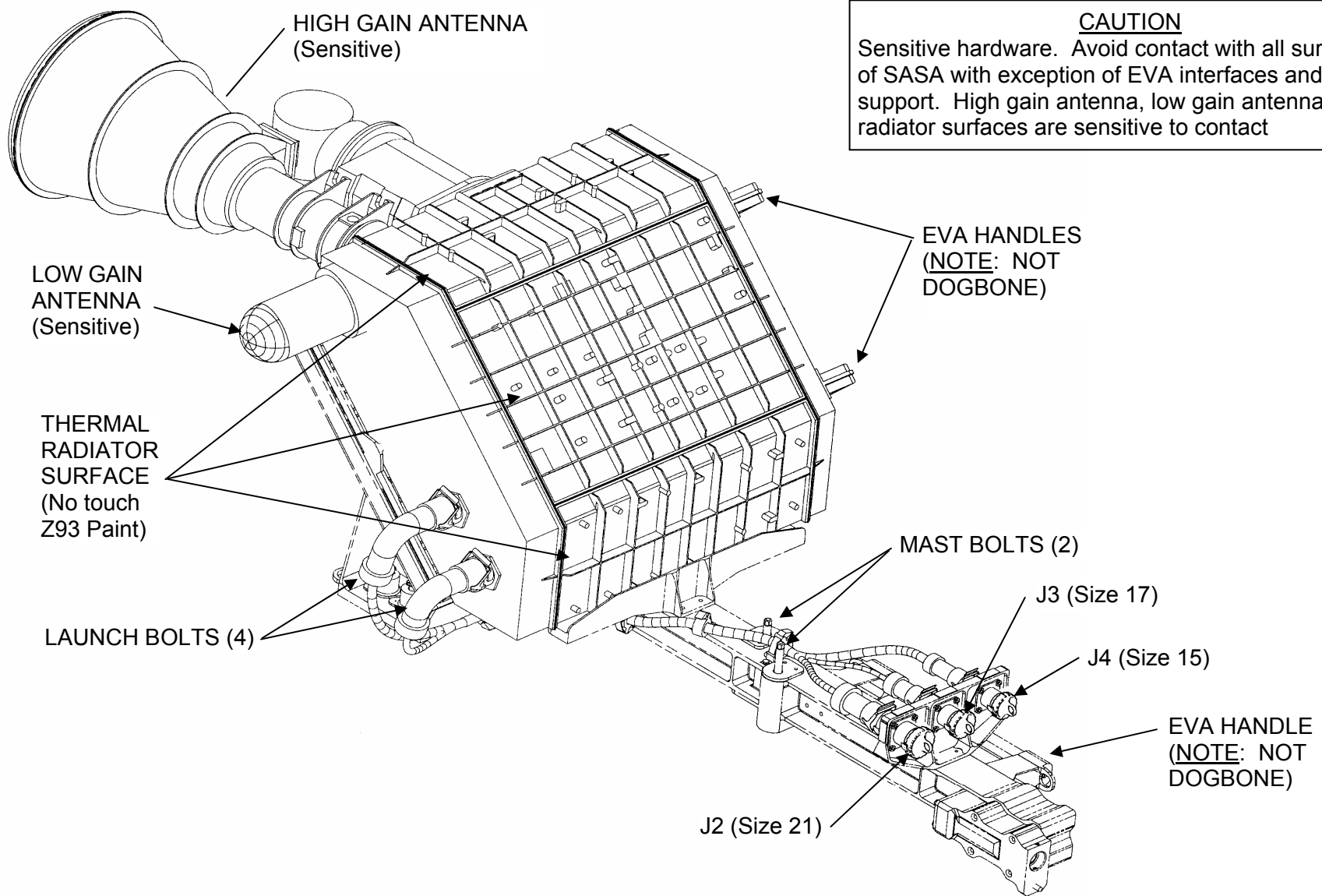

CAUTION
Sensitive hardware. Avoid contact with all surfaces of SASA with exception of EVA interfaces and launch support. High gain antenna, low gain antenna and radiator surfaces are sensitive to contact

S-BAND ANTENNA

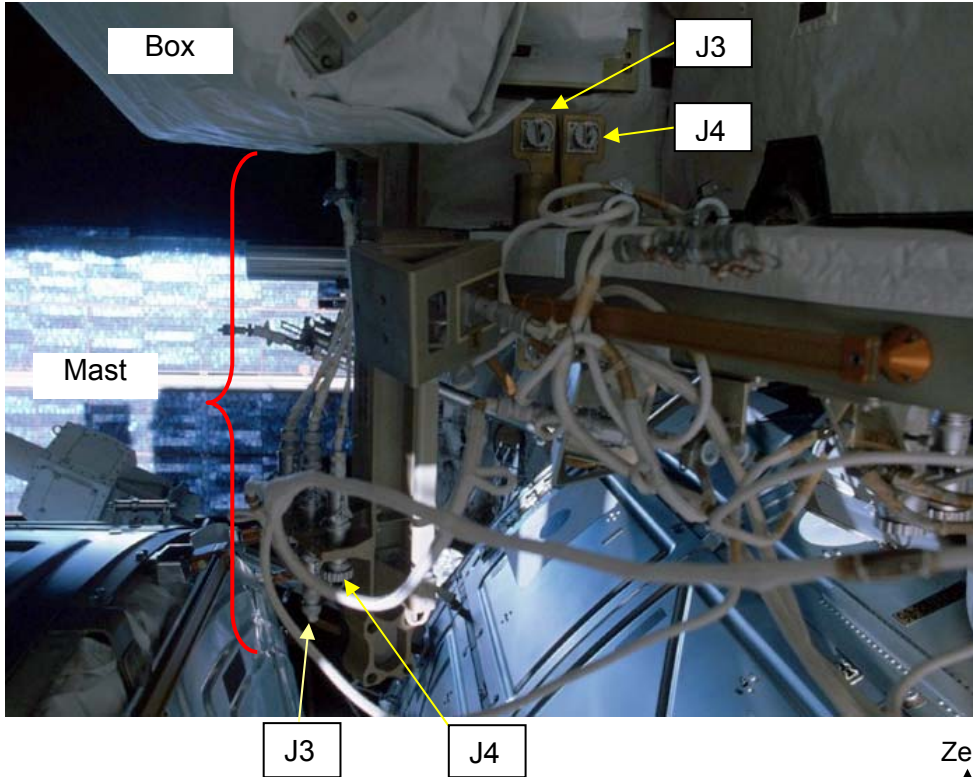

SASA STOWAGE ON Z1 – looking ISS aft

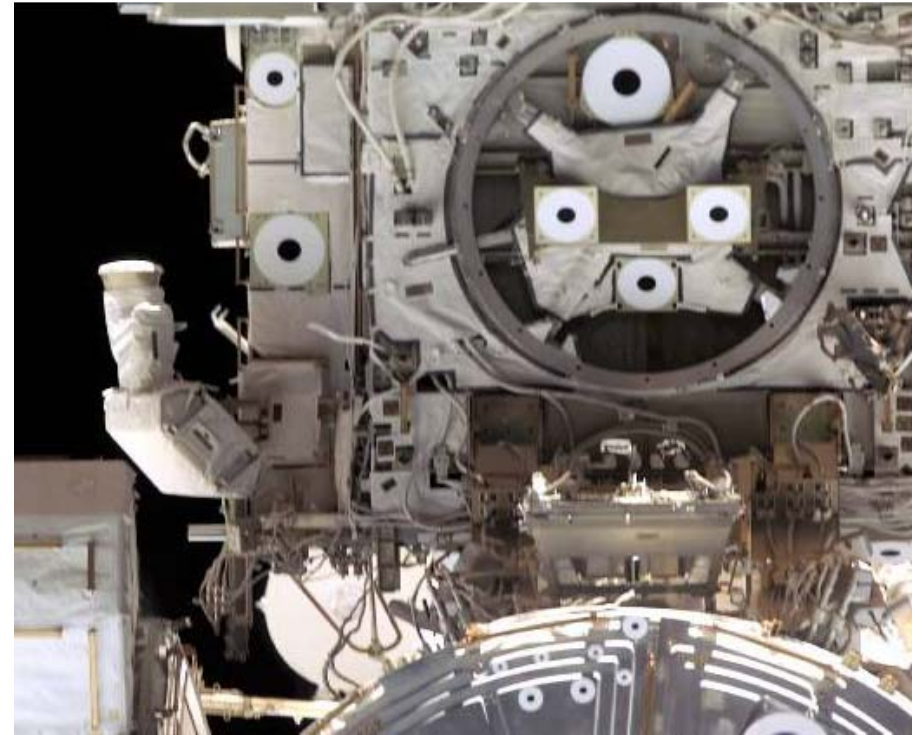

SASA STOWAGE ON Z1 – looking ISS aft
NOTE: S0 not installed yet

NODE 2 PREP FOR UNBERTH (00:25)

IV/SSRMS	EV1 – Pz (FF)	EV2 – Wheels (SSRMS)																							
<p>{PDGF HORSESHOE CONNECTOR RELEASE INHIBITS None}</p> <table border="1" data-bbox="170 662 573 834"> <thead> <tr> <th colspan="2">Node 2 Horse Shoe Connectors</th> </tr> <tr> <th>Connector</th> <th>Turns</th> </tr> </thead> <tbody> <tr> <td>P7/P5 (lower)</td> <td></td> </tr> <tr> <td>P6/P8 (upper)</td> <td></td> </tr> </tbody> </table> <table border="1" data-bbox="134 1089 609 1382"> <thead> <tr> <th>EDF Location</th> <th>√Lanyard</th> <th>Turns to break torque</th> </tr> </thead> <tbody> <tr> <td>Fwd/Lower</td> <td></td> <td></td> </tr> <tr> <td>Fwd/Upper</td> <td></td> <td></td> </tr> <tr> <td>Aft/Lower</td> <td></td> <td></td> </tr> <tr> <td>Aft/Upper</td> <td></td> <td></td> </tr> </tbody> </table>	Node 2 Horse Shoe Connectors		Connector	Turns	P7/P5 (lower)		P6/P8 (upper)		EDF Location	√Lanyard	Turns to break torque	Fwd/Lower			Fwd/Upper			Aft/Lower			Aft/Upper			<ol style="list-style-type: none"> 1. Translate to Shuttle payload bay (ODS) port side 2. Perform glove inspection 3. Tether swap to EV1 85-ft payload bay tether port of TSA <ul style="list-style-type: none"> <input type="checkbox"/> √Gate closed <input type="checkbox"/> √Hook locked <input type="checkbox"/> √Reel unlocked 4. Stow EV1 A/L tether at ODS 5. Translate to Node 2 HR 0369 (zenith, port) <p>HORSESHOE CONNECTOR RELEASE</p> <ol style="list-style-type: none"> 1. Temp stow Lg trash bag on HR 0369 2. Translate to Node 2 horseshoe connector launch bracket (BRT 0374), open MLI cover 3. Retract PDGF horseshoe connector engagement bolt (two) PGT, 7/16-6 in ext: A6, CCW2; 16 turns 4. Rotate square microfixtures (two) – unlock, 60 deg ccw 5. Verify horseshoe connectors can be removed 6. Reengage square microfixtures (two) – lock, 60 deg cw 7. Close horseshoe connector stowage MLI cover 8. Translate to PDGF (port, bay 5) <p>PDGF RELEASE</p> <div style="border: 3px double black; padding: 5px; margin: 10px auto; width: fit-content;"> <p style="text-align: center;">WARNING Avoid touching PDGF curvic coupling due to potential sharp edges</p> </div> <div style="border: 1px solid black; padding: 5px; margin: 10px auto; width: fit-content;"> <p style="text-align: center;">CAUTION Avoid touching PDGF grapple pin, target, and connector area</p> </div> <ol style="list-style-type: none"> 1. Install adj tethers (4) on PDGF <input type="checkbox"/> 2 aft <input type="checkbox"/> 2 fwd 2. Tether PDGF to PLB longeron tether point 3. Verify each EDF (4) has at least one retention lanyard intact 4. Break torque on EDFs (4) Ratchet wrench, 7/16-2 in ext; expect ~2 turns until torque decreases 5. Translate to SASA sidewall carrier 	<ol style="list-style-type: none"> 1. Mnv on SSRMS to PLB SASA Sidewall carrier (stbd bay 4) 2. Prior to entering PLB stow Ingress Aid Between knees
Node 2 Horse Shoe Connectors																									
Connector	Turns																								
P7/P5 (lower)																									
P6/P8 (upper)																									
EDF Location	√Lanyard	Turns to break torque																							
Fwd/Lower																									
Fwd/Upper																									
Aft/Lower																									
Aft/Upper																									

NODE 2 PREP FOR UNBERTH – TASK DATA

Tools:

EV1 (FF)	EV2 (FF)
PGT	
7/16-6 in	

EVA Fasteners:

Fastener	Head Size	Qty	Release Torque (ft-lb)	Failure Torque (ft-lb)	Turns	RPM
PDGF EDF	7/16	4	26.25	TBD	Release: 5 turns Install: 4-6 total turns	10
PDGF Conn	7/16	2	8.75	TBD	16 to yellow bad 18.5-19.5 to HS	30

EVA Connectors:

Task	From	To	Clamps (Qty)	Conn Size	Function
P6/P8	Node 2	PDGF	2	----	Data/Power
P7/P5	Node 2	PDGF	2	----	Data/Power

Foot Restraints: None

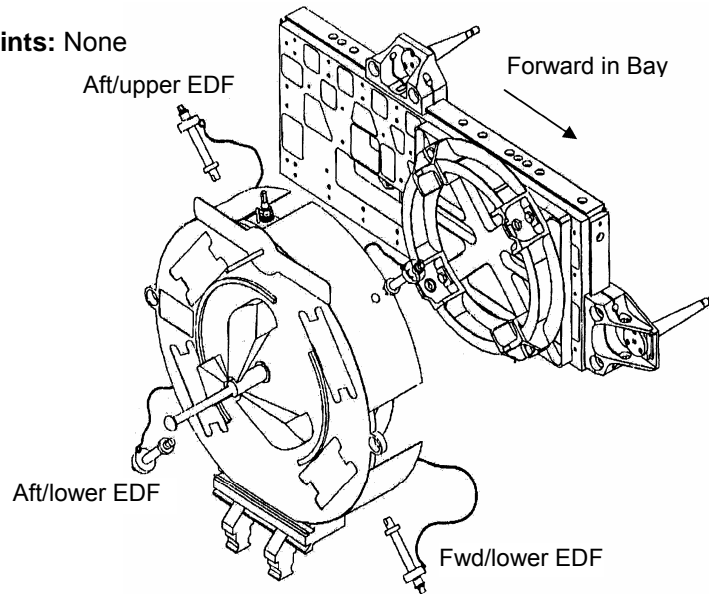

Warnings:

1. Avoid touching curvic coupling due to potential sharp edges

Cautions:

1. Avoid touching grapple pin, connector area, underside of PDGF, target

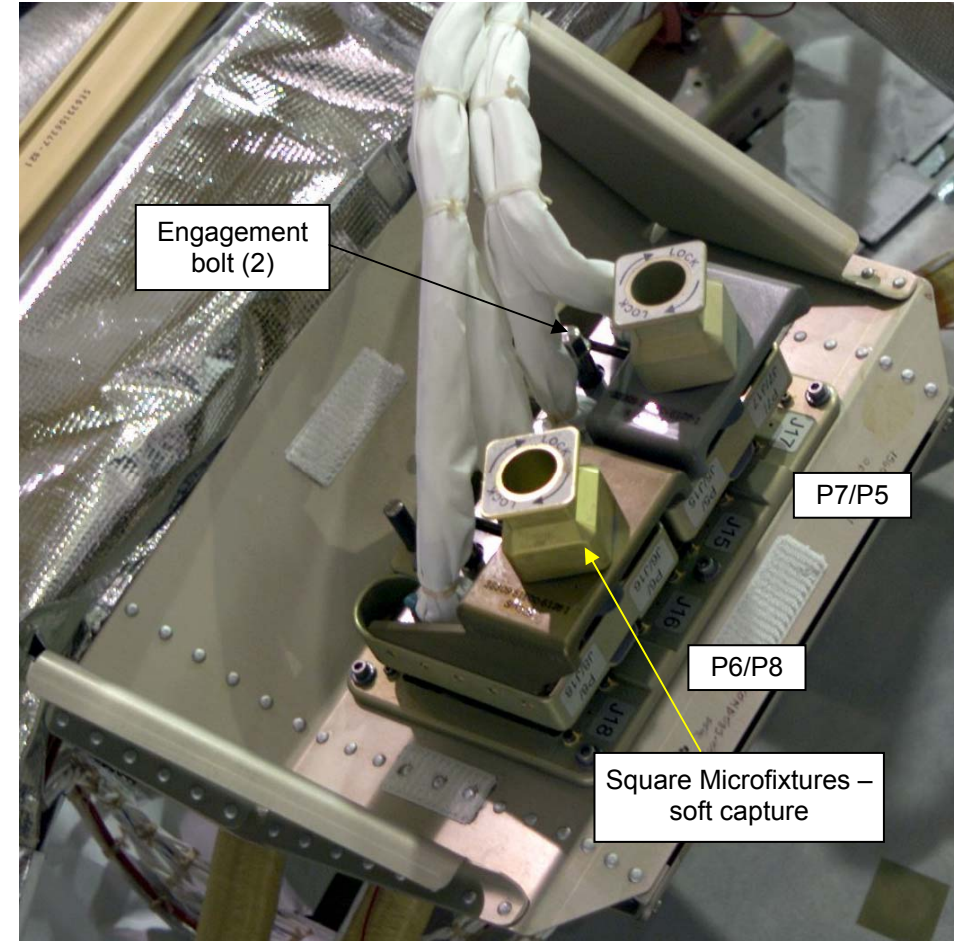

Node 2 Horseshoe connector Stowage

SASA STOW (01:15)

IV/SSRMS	EV1 – Pz (FF)	EV2 – Wheels (SSRMS)																									
SSRMS: SASA Worksite Setup SSRMS: GCA for SASA stow	<ol style="list-style-type: none"> Translate to SASA sidewall carrier (stbd bay 4) GCA SSRMS for SASA soft dock to carrier Assist EV2 with SASA soft dock, remaining clear of interface during mating Engage Fwd launch bolts (two) By hand: cw; 2 turns only 	<ol style="list-style-type: none"> GCA SSRMS for SASA soft dock to carrier Soft dock SASA to carrier GCA as reqd to access bolts 																									
	<ol style="list-style-type: none"> Engage Aft launch bolts (two) By hand: cw; 2 turns only 	<ol style="list-style-type: none"> Engage Mast bolts (two) By hand: cw; 2 turns only 																									
<p>SASA Bolt Data</p> <table border="1" data-bbox="111 797 600 1214"> <thead> <tr> <th colspan="2">Bolt</th> <th>Final Turns*</th> <th>Torque</th> </tr> </thead> <tbody> <tr> <td rowspan="2">Aft Launch</td> <td>Upper</td> <td></td> <td></td> </tr> <tr> <td>Lower</td> <td></td> <td></td> </tr> <tr> <td rowspan="2">Mast</td> <td>Fwd</td> <td></td> <td></td> </tr> <tr> <td>Aft</td> <td></td> <td></td> </tr> <tr> <td rowspan="2">Fwd Launch</td> <td>Upper</td> <td></td> <td></td> </tr> <tr> <td>Lower</td> <td></td> <td></td> </tr> </tbody> </table> <p>*Turns w/RAD should be counted at the bolt</p> <p>SSRMS: SASA Clearance</p>	Bolt		Final Turns*	Torque	Aft Launch	Upper			Lower			Mast	Fwd			Aft			Fwd Launch	Upper			Lower			<ol style="list-style-type: none"> If able to hand-start all 6 bolts, proceed with final torque (any order) If not able to hand-start all 6 bolts, secure with 2 adjustable tethers and proceed to step 12 Perform PGT socket swap: remove 7/16-6 in ext, stow on socket caddy, install RAD w/7/16-2 in ext on PGT Drive Aft launch bolts (two) PGT, RAD 7/16-2 in ext: A5,CW2; ~10.5 turns to HS Secure PGT with MWS EE when translating Drive Fwd launch bolts (two) PGT, RAD 7/16-2 in ext: A5,CW2; ~10.5 turns to HS Perform PGT socket swap: remove RAD w/7/16-2 in ext, stow on socket caddy, install 7/16-6 in ext on PGT 	<ol style="list-style-type: none"> If able to hand-start all 6 bolts, proceed with final torque (any order) If not able to hand-start all 6 bolts, secure with 2 adjustable tethers, and proceed to step 7 Drive Mast bolts (two) PGT, 7/16-6 in ext: A7,CW2; ~6.5 turns to HS Give M1/M2 GO for mnvr to SASA clearance position
Bolt		Final Turns*	Torque																								
Aft Launch	Upper																										
	Lower																										
Mast	Fwd																										
	Aft																										
Fwd Launch	Upper																										
	Lower																										

SASA STOW (01:15) (Cont)

IV/SSRMS	EV1 – Pz (FF)	EV2 – Wheels (SSRMS)
<p>SSRMS: When mnvr complete, give EV2 GO for APFR egress</p> <p>SSRMS: APFR Removal</p>	<p>12. Translate to MBSU sidewall carrier</p> <hr style="border-top: 1px dashed black;"/> <p>13. Remove WIF adapter from LEE, stow on MWS</p> <hr/> <p>14. On EV2 GO, transfer EV2's safety tether from LEE to stbd HR on ODS truss <input type="checkbox"/> √Gate closed <input type="checkbox"/> √Hook locked</p> <p>15. Give EV2 GO to release waist tether</p> <p>16. √Tools and tethers clear of SSRMS</p>	<p>8. On M1/M2 GO, egress APFR using Ingress Aid 9. Give SSRMS "Egress Complete" 10. Fold Ingress Aid to low profile</p> <p>11. GCA SSRMS for APFR removal using MBSU HR</p> <p>12. Remove APFR from WIF adapter, stow on BRT</p> <p>13. Translate to Node 2; install APFR in WIF 17 (4, TT, F, 12) <input type="checkbox"/> √Locking collar black-on-black <input type="checkbox"/> Good pull test</p> <p>14. Attach waist tether to structure <input type="checkbox"/> √Hook locked</p> <p>15. Give EV1 GO for tether swap</p> <p>16. On EV1 GO, release waist tether</p> <p>17. √Tools and tethers clear of SSRMS</p>
<p>1. Give SSRMS GO for mnvr to Node 2 pre-grapple SSRMS: Node 2 Pre-grapple</p>	<p>17. Translate to PDGF side wall carrier (port bay 5)</p>	<p>18. Translate to PDGF side wall carrier (port bay 5)</p>

SASA STOW – TASK DATA

Tools:

EV1 (FF)	EV2 (SSRMS)
PGT	PGT
7/16-6 in	7/16-6 in
7/16-2 in	
Right Angle Drive	

EVA Fasteners:

Fastener Name	Head Size	Install Torque (ft-lb)	Release Torque (ft-lb)	Failure Torque (ft-lb)	Turns	RPM
Launch Bolts	7/16"	7.0 (using RAD)	n/a	15.8	10.5-13.5	30
Mast Bolts	7/16"	9.2	15.1	15.8	7.5-10	30

EVA Connectors: None

Foot Restraints:

Task	WIF	APFR Setting
SASA install in PLB	LEE	12, PP, F, 6



SASA Thermal Clock – 3 hr from removal of heater power to installation on the PLB FSE (soft dock)

Cautions:

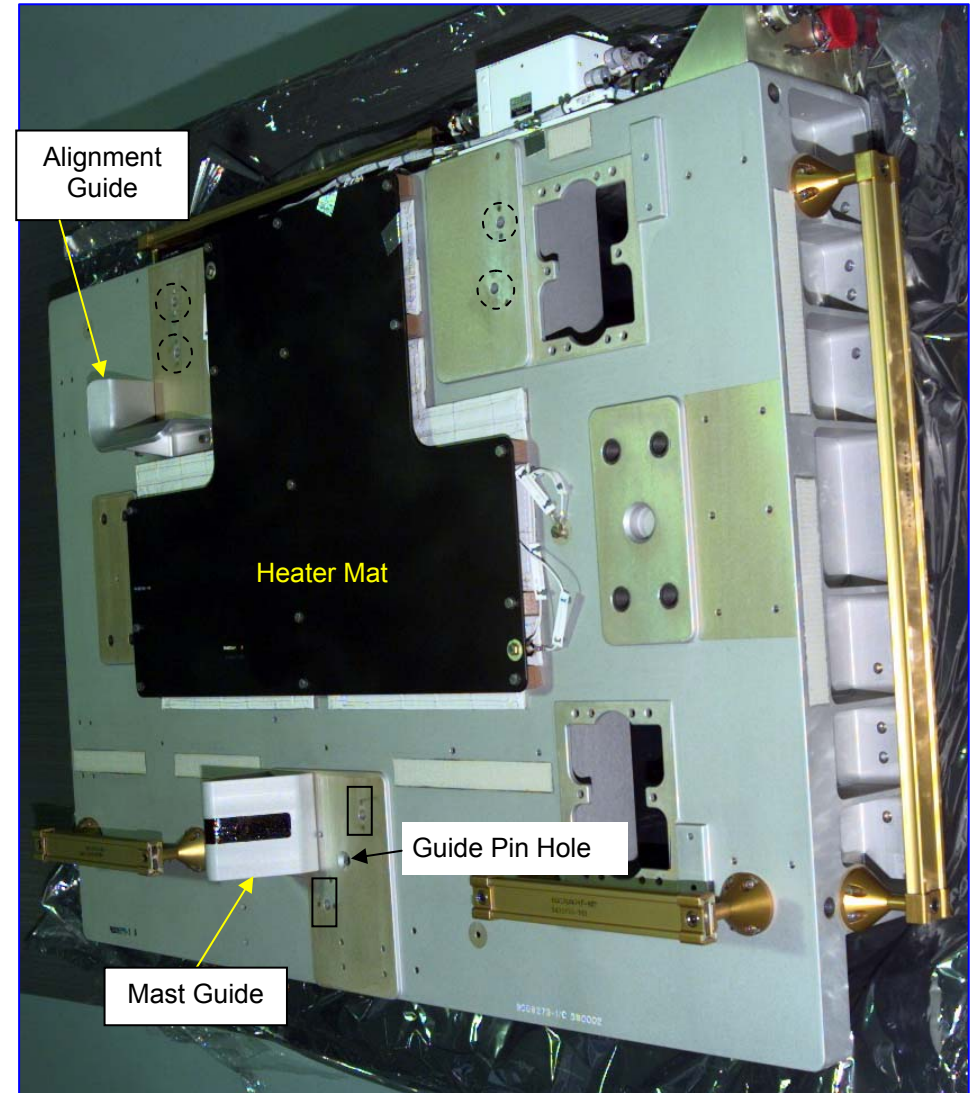
1. Sensitive hardware. Avoid contact with all surfaces of SASA with exception of EVA interfaces and launch support structure. High gain antenna, low gain antenna, and radiator surfaces sensitive to contact



SASA Sidewall Carrier

-  Launch Bolt holes
-  Mast Bolt Holes

NODE 2 FINAL PREP FOR UNBERTH (02:05)

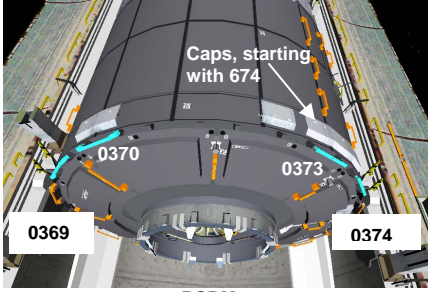
IV/SSRMS	EV1 – Pz (FF)	EV2 – Wheels (FF)															
<table border="1" data-bbox="134 448 581 740"> <thead> <tr> <th>EDF Location</th> <th>Turns to break torque</th> <th>Turns to release</th> </tr> </thead> <tbody> <tr> <td>Fwd/Lower</td> <td></td> <td></td> </tr> <tr> <td>Fwd/Upper</td> <td></td> <td></td> </tr> <tr> <td>Aft/Lower</td> <td></td> <td></td> </tr> <tr> <td>Aft/Upper</td> <td></td> <td></td> </tr> </tbody> </table> <p data-bbox="107 802 359 854"> <u>PDGF Translation Brief</u> <input type="checkbox"/> "Transfer"/"Go"/"On" </p>	EDF Location	Turns to break torque	Turns to release	Fwd/Lower			Fwd/Upper			Aft/Lower			Aft/Upper			<p data-bbox="621 331 810 355"><u>PDGF RELEASE</u></p> <ol data-bbox="621 363 1178 420" style="list-style-type: none"> 1. Perform glove inspection 2. Translate to PDGF sidewall carrier (port, bay 5) <div data-bbox="898 428 1633 521" style="border: 2px solid black; padding: 5px; text-align: center;"> <p>WARNING Avoid touching PDGF curvic coupling due to potential sharp edges</p> </div> <div data-bbox="875 540 1770 623" style="border: 1px solid black; padding: 5px; text-align: center;"> <p>CAUTION Avoid touching PDGF grapple pin, target, connector area, and underside of PDGF PDGF can not withstand kick loads once temp stowed</p> </div> <ol data-bbox="621 656 1199 959" style="list-style-type: none"> 3. Release EDF (3, leaving aft/upper for EV2) PGT, 7/16-6 in ext: B7, CCW2; 5 turns total 4. Ensure fwd EDFs (two) fully retracted (pulled out) 5. Remove PDGF 6. Reinsert EDFs (four) 7. Translate to PDGF stow location (Node 2 fwd) 8. Stow PDGF on Node 2 HR 0327, 0328 and 0315 with connectors facing outboard 	<p data-bbox="1291 331 1480 355"><u>PDGF RELEASE</u></p> <ol data-bbox="1291 363 1848 420" style="list-style-type: none"> 1. Perform glove inspection 2. Translate to PDGF sidewall carrier (port, bay 5) <div data-bbox="898 428 1633 521" style="border: 2px solid black; padding: 5px; text-align: center;"> <p>WARNING Avoid touching PDGF curvic coupling due to potential sharp edges</p> </div> <div data-bbox="875 540 1770 623" style="border: 1px solid black; padding: 5px; text-align: center;"> <p>CAUTION Avoid touching PDGF grapple pin, target, connector area, and underside of PDGF PDGF can not withstand kick loads once temp stowed</p> </div> <ol data-bbox="1291 631 1944 829" style="list-style-type: none"> 3. Attach tether to PDGF; release tether from PLB tether pt 4. Release aft/upper EDF bolt (one) PGT, 7/16-6 in ext: B7, CCW2; 5 turns total 5. Ensure aft EDFs (two) fully retracted (pulled out) 6. Assist EV1 with PDGF removal and temp stow
EDF Location	Turns to break torque	Turns to release															
Fwd/Lower																	
Fwd/Upper																	
Aft/Lower																	
Aft/Upper																	
 <p data-bbox="107 1208 478 1239"> <input type="checkbox"/> WVS Survey of PCBM seals </p> <p data-bbox="107 1360 478 1391"> <input type="checkbox"/> WVS Survey of PCBM seals </p>	<p data-bbox="621 987 898 1011"><u>PCBM COVER REMOVE</u></p> <div data-bbox="1014 1019 1633 1076" style="border: 1px solid black; padding: 5px; text-align: center;"> <p>CAUTION Avoid inadvertent contact with aft payload bay cameras</p> </div> <ol data-bbox="621 1109 1163 1382" style="list-style-type: none"> 1. Remove stbd PCBM contamination covers (4) 2. Transfer to EV2 3. Inspect stbd seals and report to MCC 4. Remove port PCBM contamination covers (4) 5. Transfer to EV2 6. Inspect port seals and report to MCC 	<p data-bbox="1291 987 1568 1011"><u>PCBM COVER REMOVE</u></p> <div data-bbox="1014 1019 1633 1076" style="border: 1px solid black; padding: 5px; text-align: center;"> <p>CAUTION Avoid inadvertent contact with aft payload bay cameras</p> </div> <ol data-bbox="1291 1081 1896 1382" style="list-style-type: none"> 1. Stow Lg trash bag on HR 0374 (zenith, stbd) 2. BRT to HR 0373 (feet over the can) 3. Receive contamination covers from EV1, stow in Lg trash bag 4. Translate to Lg trash bag on HR 0369 (zenith, port) 5. BRT to HR 0370 6. Receive contamination covers from EV1, stow in Lg trash bag 															

NODE 2 FINAL PREP FOR UNBERTH (02:05) (Cont)

IV/SSRMS	EV1 – Pz (FF)	EV2 – Wheels (FF)
<p>1. <input checked="" type="checkbox"/> MCC-H GO for NODE 2 HEATER DEACT</p> <p>2. A15 APCU1,2 CONV(two) – OFF CRT SM 179 POWER TRANSFER <input checked="" type="checkbox"/> PTU 1, 2 APCU OUT VOLTS: < 10 V A15 APCU 1, 2 OUTPUT (two) – OFF</p> <p><input type="checkbox"/> Once step 2 complete,</p>	<p>7. Transfer ratchet wrench from swing arm to Lg trash bag on HR 0369</p> <p>8. Retrieve Lg trash bag from HR 0369; stow on swing arm <input type="checkbox"/> Verify bayonet is locked</p> <p>LTA CABLE DISCONNECT</p> <p>1. Translate to SPDU (port side, bay 7) 2. Open TA clamps (2) at SPDU sill bracket 3. Remove cable from clamps; close clamps</p>	<p>7. Tether to MLI and remove Node 2 caps (stbd side) [674--702--673] and [671--672--670]; stow in Lg trash bag on HR 0374</p> <p>8. Retrieve Lg trash bag from HR 0374; stow on swing arm <input type="checkbox"/> Verify bayonet is locked</p>
<p>3. Give EV GO for LTA cable disconnect</p> <p><input type="checkbox"/> <input checked="" type="checkbox"/> EV1, EV2 clear of FRGF</p> <p>4. Give M1/2 GO for Node 2 grapple SSRMS: Node 2 Grapple</p> <p>5. If SASA not fully torqued down, translate to SASA sidewall carrier, complete SASA STOW</p>	<p>4. On IV GO, slide booties (2) back to expose connectors, disconnect connectors from J1 and J2</p> <p>5. Open TA clamps (3) on Node 2</p> <p>6. Tether to and remove cable from clamps; close clamps</p> <p>7. Slide booties (2) back to expose connectors, disconnect connectors J6XX and J6YY</p> <p>8. Coil cable and restrain with wire tie, stow on BRT</p> <p>9. Close MLI thermal cover on Node 2</p>	<p>9. Translate to ODS</p>
	<p>10. Translate to ODS</p>	<p>10. Translate to fwd/stbd Lab endcone (aft standoff of Lab HR 0296)</p>
<p><input type="checkbox"/> <input checked="" type="checkbox"/> EV1, EV2 clear of Node 2</p> <p>6. Give M1/2 GO for Node 2 unbeth SSRMS: Node 2 Unberth</p>	<p>11. Tether swap to EV1 A/L tether <input type="checkbox"/> <input checked="" type="checkbox"/> Gate closed; <input type="checkbox"/> <input checked="" type="checkbox"/> Hook locked; <input type="checkbox"/> <input checked="" type="checkbox"/> Reel unlocked</p> <p>12. Release 85-ft tether from ODS, attach to self</p>	<p>11. Attach waist tether to structure <input type="checkbox"/> <input checked="" type="checkbox"/> Hook locked</p> <p>12. Give EV1 GO to release 85-ft safety tether</p>

NODE 2 FINAL PREP FOR UNBERTH (02:05) (Cont)

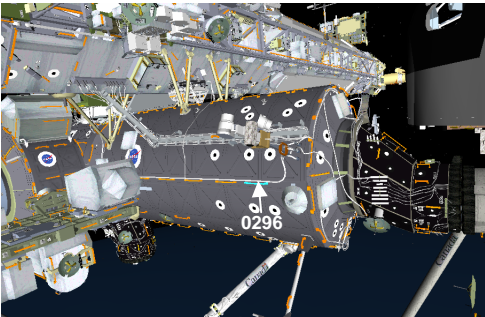
IV/SSRMS	EV1 – Pz (FF)	EV2 – Wheels (FF)
<p>7. When EVs out of SPDU 2 ft KOZ, perform the following: A15 APCU 2 OUTPUT – ON CONV – ON</p> <p>8. Notify MCC-H “LCS Heater Activation Complete”</p> 	<p>13. Daisy chain with EV2’s 85-ft safety tether; EV1 right waist tether to EV2’s 85-ft safety tether</p> <p>14. Translate to A/L</p> <p>15. Attach EV2’s 85-ft safety tether to aft A/L D-ring <input type="checkbox"/> √Gate closed <input type="checkbox"/> √Hook locked</p>	<p>13. Temp stow trash bag with gap spanners using adjustable tether on Lab HR 0296 (stbd/fwd, nadir of avionics tray)</p> <p>{Get-ahead opportunity: Lab gap spanner install (stbd, port or 120 Bypass)}</p>
	<p>16. Give EV2 GO to release waist tether</p> <p>17. Perform glove inspection</p> <p>18. Stow on A/L fish stringer: <input type="checkbox"/> LTA cable, <input type="checkbox"/> Lg trash bag with PCBM covers and ratchet wrench with 7/16-2 in ext, <input type="checkbox"/> WIF adapter, and <input type="checkbox"/> EV1 85-ft PLB safety tether</p> <p>19. Transfer Adj tether from Lg trash bag to crewlock bag</p> <p>20. Retrieve crewlock bag from fish stringer, stow on BRT with RET from MWS</p> <p>21. Translate to Z1/P6 fluid lines via ISS fwd path</p>	<p>14. On EV1 GO, release waist tether and translate to A/L around UHF antenna</p> <p>15. Perform glove inspection</p> <p>16. Stow Lg trash bag with PCBM covers and caps on FS</p> <p>17. Retrieve Sm trash bag from FS; stow on MWS</p> <p>18. Retrieve Med ORU bag from airlock, stow on BRT</p> <p>19. Translate to P6 aft radiator shroud via Z1 port/aft path; fairlead nadir of port Z1 toolbox (HR 6020)</p>

NODE 2 FINAL PREP FOR UNBERTH – TASK DATA

EVA Tools:

EV1 (FF)	EV2 (FF)
PGT	PGT
Lg Trash Bag	7/16-6 in
Lg-sm RET	Lg Trash Bag
	Lg-sm RET

EVA Fasteners:

Fastener	Head Size	Qty	Release Torque (ft-lb)	Failure Torque (ft-lb)	Turns	RPM
PDGF EDF	7/16	4	26.25	100	Release: 5 turns at bolt	30

EVA Connectors:

Harness	From	To	Clamps (Qty)	Conn Size	Function
LTA P6XX	Node 2 J6XX	Remove	3	17	
LTA P6YY	Node 2 J6YY	Remove		17	
LTA P1	SPDU J1	Remove	2	17	
LTA P2	SPDU J2	Remove		17	

Foot Restraints: None

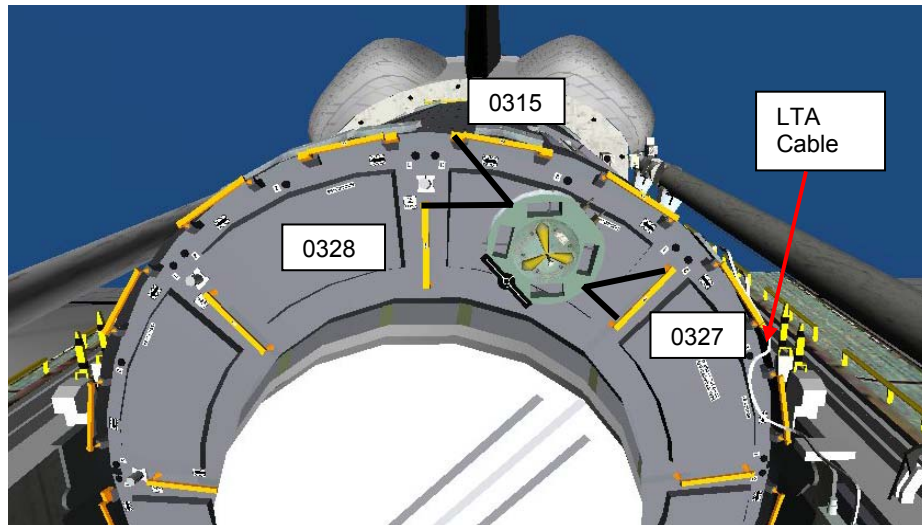

FS 7-32

Warnings:

1. Avoid touching curvic coupling due to potential sharp edges

Cautions:

1. Avoid touching grapple pin, connector area, underside of PDGF, target
2. Avoid contact with PCBM Seal
3. Avoid contact with payload bay cameras

Notes:

1. The preferred orientation of the PDGF temp stow on Node 2 is with connectors outboard to protect target. This is not a requirement
2. PCBM contamination covers must be removed prior to Node 2 mate to Node 1
3. Node 2 LTA cable must be disconnected prior to Node 2 removal from PLB

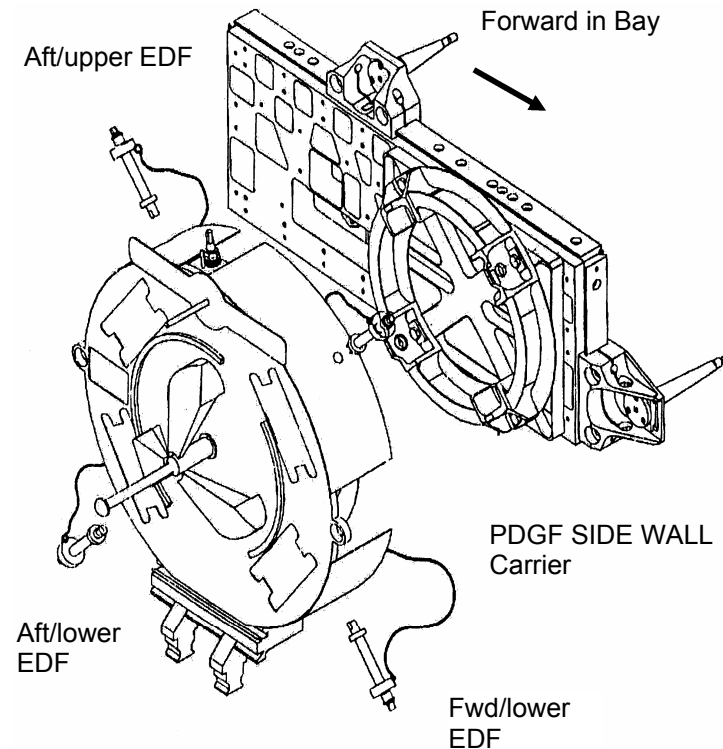

EVA/120/FIN A

Z1-TO-P6 FLUID DISCONNECT (01:10)

IV	EV1 – Pz (FF)	EV2 – Wheels (FF)
<p>SPD Removed:</p> <p>QD:</p> <input type="checkbox"/> F2 <input type="checkbox"/> F4 <input type="checkbox"/> F6 <input type="checkbox"/> F8 <p>QD Closed:</p> <p>QD:</p> <input type="checkbox"/> F2 <input type="checkbox"/> F4 <input type="checkbox"/> F6 <input type="checkbox"/> F8	<ol style="list-style-type: none"> 1. Temp stow crewlock bag on top of stbd Z1 toolbox 2. Release QD shroud 3. Reconfigure “Y”-strap into an “I”-strap (stbd side) 4. String out fish stringer from crewlock bag handrail to Z1 HR 6037 5. Attach fish stringer to SPDs (4) 6. Translate to Z1 WIF 11 APFR 7. Remove APFR, stow on BRT 8. Translate to Z1/P6 fluid lines 9. Install APFR in Z1 WIF 17 (4, KK, A, 1) <ul style="list-style-type: none"> <input type="checkbox"/> √Locking collar black-on-black <input type="checkbox"/> Good pull test 10. Open TA clamps as accessible (4 total) <p><u>REMOVE SPDs</u> – begin with F2</p> <div style="border: 1px solid black; padding: 5px; text-align: center;"> <p><u>CAUTION</u> Minimize QD torsional and side loads during bail operations and QD demating</p> </div> <ol style="list-style-type: none"> 11. BRT to P6 HR 5309 12. Push bail fwd with significant force (unstick male sleeve seals) 13. Pull bail aft against SPD 14. Push bail fwd again 15. Remove SPD 16. Verify detent button is fully installed 17. Repeat steps 12-16 for remaining QD SPDs: F4, F6, and F8 <p><u>CLOSE VALVES</u> – begin with F2</p> <ol style="list-style-type: none"> 18. Assess side loads prior to bail movement 19. To close valve: <ul style="list-style-type: none"> <input type="checkbox"/> <input type="checkbox"/> <input type="checkbox"/> <input type="checkbox"/> √Aft white band – visible <input type="checkbox"/> <input type="checkbox"/> <input type="checkbox"/> <input type="checkbox"/> √Detent button can be depressed <input type="checkbox"/> <input type="checkbox"/> <input type="checkbox"/> <input type="checkbox"/> Depress detent button <input type="checkbox"/> <input type="checkbox"/> <input type="checkbox"/> <input type="checkbox"/> Pull bail to aft position (QD mated; valve closed) <input type="checkbox"/> <input type="checkbox"/> <input type="checkbox"/> <input type="checkbox"/> √FWD white band – visible <input type="checkbox"/> <input type="checkbox"/> <input type="checkbox"/> <input type="checkbox"/> √Detent button – up 20. Rotate locking collar to locked position 21. Repeat steps 18-20 for remaining QDs: F4, F6, and F8 	<p>Perform P6 AFT RADIATOR SHROUD DEPLOY (00:55), FS 7-38</p> <p style="text-align: right;"><u>NOTE</u> If significant leak seen when closing valve, immediately re-open female</p>

Z1-TO-P6 FLUID DISCONNECT (01:10) (Cont)

IV	EV1 – Pz (FF)																										
<p>QD Demated from P6 and Mated to Z1:</p> <table border="0" style="width: 100%;"> <tr> <td style="width: 50%; vertical-align: top;"> <p>Demated from P6 Male QDs</p> <p>Female QD:</p> <table border="1" style="margin-left: 20px;"> <tr><td style="width: 20px; height: 15px;"></td><td style="width: 20px;">F2</td></tr> <tr><td style="width: 20px; height: 15px;"></td><td style="width: 20px;">F4</td></tr> <tr><td style="width: 20px; height: 15px;"></td><td style="width: 20px;">F6</td></tr> <tr><td style="width: 20px; height: 15px;"></td><td style="width: 20px;">F8</td></tr> </table> </td> <td style="width: 50%; vertical-align: top;"> <p>Mated to Z1 Dummy Male QDs</p> <p>Female QD:</p> <table border="1" style="margin-left: 20px;"> <tr><td style="width: 20px; height: 15px;"></td><td style="width: 20px;">F2</td></tr> <tr><td style="width: 20px; height: 15px;"></td><td style="width: 20px;">F4</td></tr> <tr><td style="width: 20px; height: 15px;"></td><td style="width: 20px;">F6</td></tr> <tr><td style="width: 20px; height: 15px;"></td><td style="width: 20px;">F8</td></tr> </table> </td> </tr> </table> <p style="margin-top: 20px;">Caps Installed on P6 male QDs:</p> <table border="1" style="margin-left: 20px;"> <tr><td style="width: 20px; height: 15px;"></td><td style="width: 20px;">M2</td></tr> <tr><td style="width: 20px; height: 15px;"></td><td style="width: 20px;">M4</td></tr> <tr><td style="width: 20px; height: 15px;"></td><td style="width: 20px;">M6</td></tr> <tr><td style="width: 20px; height: 15px;"></td><td style="width: 20px;">M8</td></tr> </table> <p style="margin-top: 20px;"><input type="checkbox"/> WVS of Z1 fluid lines and QDs</p>	<p>Demated from P6 Male QDs</p> <p>Female QD:</p> <table border="1" style="margin-left: 20px;"> <tr><td style="width: 20px; height: 15px;"></td><td style="width: 20px;">F2</td></tr> <tr><td style="width: 20px; height: 15px;"></td><td style="width: 20px;">F4</td></tr> <tr><td style="width: 20px; height: 15px;"></td><td style="width: 20px;">F6</td></tr> <tr><td style="width: 20px; height: 15px;"></td><td style="width: 20px;">F8</td></tr> </table>		F2		F4		F6		F8	<p>Mated to Z1 Dummy Male QDs</p> <p>Female QD:</p> <table border="1" style="margin-left: 20px;"> <tr><td style="width: 20px; height: 15px;"></td><td style="width: 20px;">F2</td></tr> <tr><td style="width: 20px; height: 15px;"></td><td style="width: 20px;">F4</td></tr> <tr><td style="width: 20px; height: 15px;"></td><td style="width: 20px;">F6</td></tr> <tr><td style="width: 20px; height: 15px;"></td><td style="width: 20px;">F8</td></tr> </table>		F2		F4		F6		F8		M2		M4		M6		M8	<p>22. Release dust caps wire tied to Z1 HR 6049; temp stow if reqd (Two caps will be released when 1 twist of wire tie released, remaining two caps will be released when remaining twist is released)</p> <p>23. Ingress APFR DEMATE QDs – begin with F2</p> <p>24. Assess side load potential prior to demate</p> <p>25. To demate QD: Pull back on release ring and remove female QD from male QD √FWD white band not visible (Release ring – retracted)</p> <p>26. Inspect male and female QD for debris, damage, or anomalous conditions</p> <p>MATE QDs</p> <p>27. Mate QD to Z1 dummy male QD √FWD white band – visible</p> <p>28. Perform Snapback Test Verify release ring snaps forward and forward white band still visible</p> <p>29. Perform Pull Test Stay clear of button and release ring</p> <p>30. Install fluid QD line in TA clamp</p> <p>31. Repeat steps 24-30 for QD F4</p> <p>32. Relocate APFR to Z1 WIF 20 (6, PP, F, 12) (can only reconfigure (__, __, F, 12) in WIF 17) <input type="checkbox"/> √Locking collar black-on-black; <input type="checkbox"/> Good pull test</p> <p>33. Ingress APFR</p> <p>34. Repeat steps 24-30 for QDs F6 and F8</p> <p>35. Install dust caps to P6 male QDs</p> <p>36. Verify lock tab is engaged</p> <p>37. Verify cap lanyards are not in separation plane</p> <p>38. Take WVS survey of QD worksite</p> <p>39. Install thermal blanket: <input type="checkbox"/> Stbd strap to HR 6049 <input type="checkbox"/> Port strap and itsy-bitsy corner strap to HR 6048 stbd standoff</p> <p>40. Stow fish stringer with SPDs in crewlock bag</p> <p>41. Inspect Z1/P6 interface for demate</p> <p>42. Translate to P6 aft radiator via stbd/aft path</p>
<p>Demated from P6 Male QDs</p> <p>Female QD:</p> <table border="1" style="margin-left: 20px;"> <tr><td style="width: 20px; height: 15px;"></td><td style="width: 20px;">F2</td></tr> <tr><td style="width: 20px; height: 15px;"></td><td style="width: 20px;">F4</td></tr> <tr><td style="width: 20px; height: 15px;"></td><td style="width: 20px;">F6</td></tr> <tr><td style="width: 20px; height: 15px;"></td><td style="width: 20px;">F8</td></tr> </table>		F2		F4		F6		F8	<p>Mated to Z1 Dummy Male QDs</p> <p>Female QD:</p> <table border="1" style="margin-left: 20px;"> <tr><td style="width: 20px; height: 15px;"></td><td style="width: 20px;">F2</td></tr> <tr><td style="width: 20px; height: 15px;"></td><td style="width: 20px;">F4</td></tr> <tr><td style="width: 20px; height: 15px;"></td><td style="width: 20px;">F6</td></tr> <tr><td style="width: 20px; height: 15px;"></td><td style="width: 20px;">F8</td></tr> </table>		F2		F4		F6		F8										
	F2																										
	F4																										
	F6																										
	F8																										
	F2																										
	F4																										
	F6																										
	F8																										
	M2																										
	M4																										
	M6																										
	M8																										

Z1-TO-P6 FLUID DISCONNECT – TASK DATA

EVA Tools:

EV1 (FF)	EV2 (FF)
N/A	N/A

EVA Fasteners: None

EVA Connectors: None

Foot Restraints:

Task	WIF	APFR Setting
F2, F4 Mate	Z1-17	4, KK, A, 1
F6, F8 Mate	Z1-20	6, PP, F, 12

Warnings:

Cautions:

1. Minimize QD torsional and side loads during bail operations and QD demating

Notes:

NOTE: FRGF has since been removed

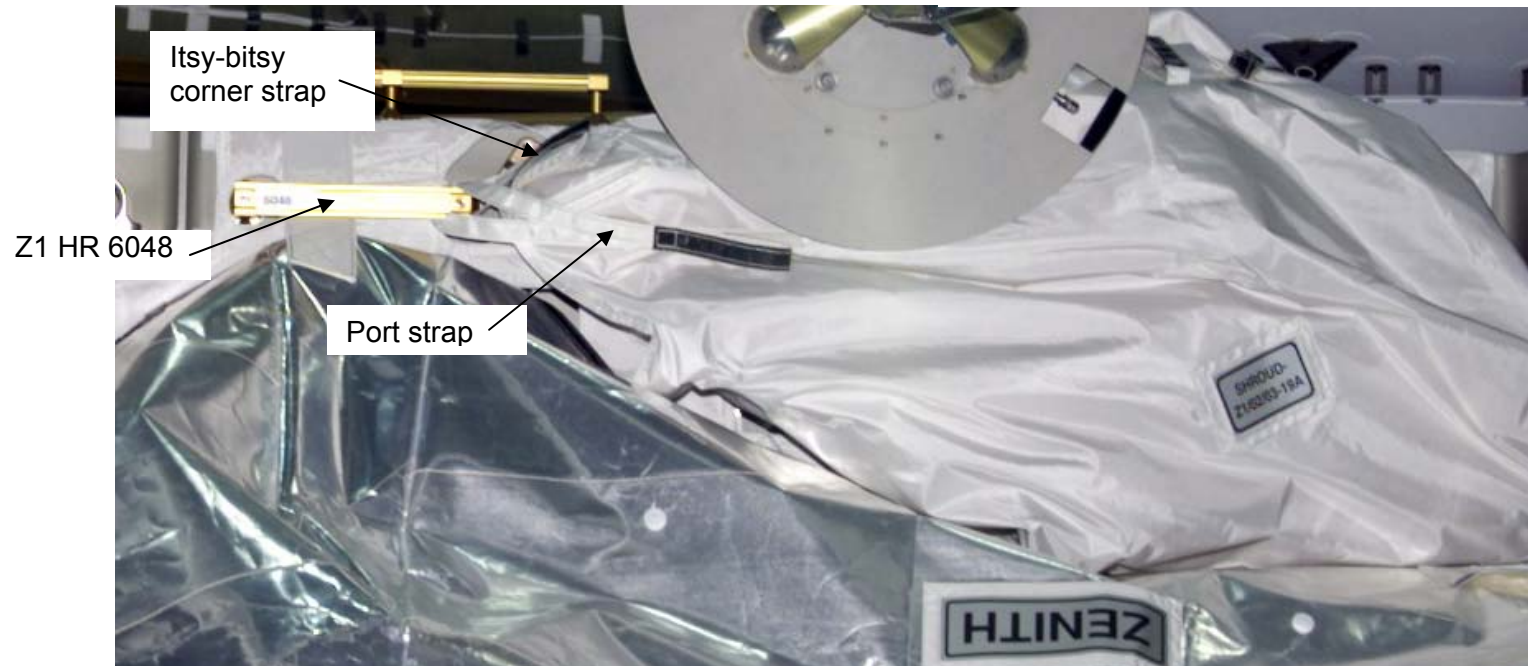

Z1 FLUID QD SHROUD STOWED IN FINAL CONFIGURATION

Z1-TO-P6 FLUID DISCONNECT – TASK DATA (Cont)

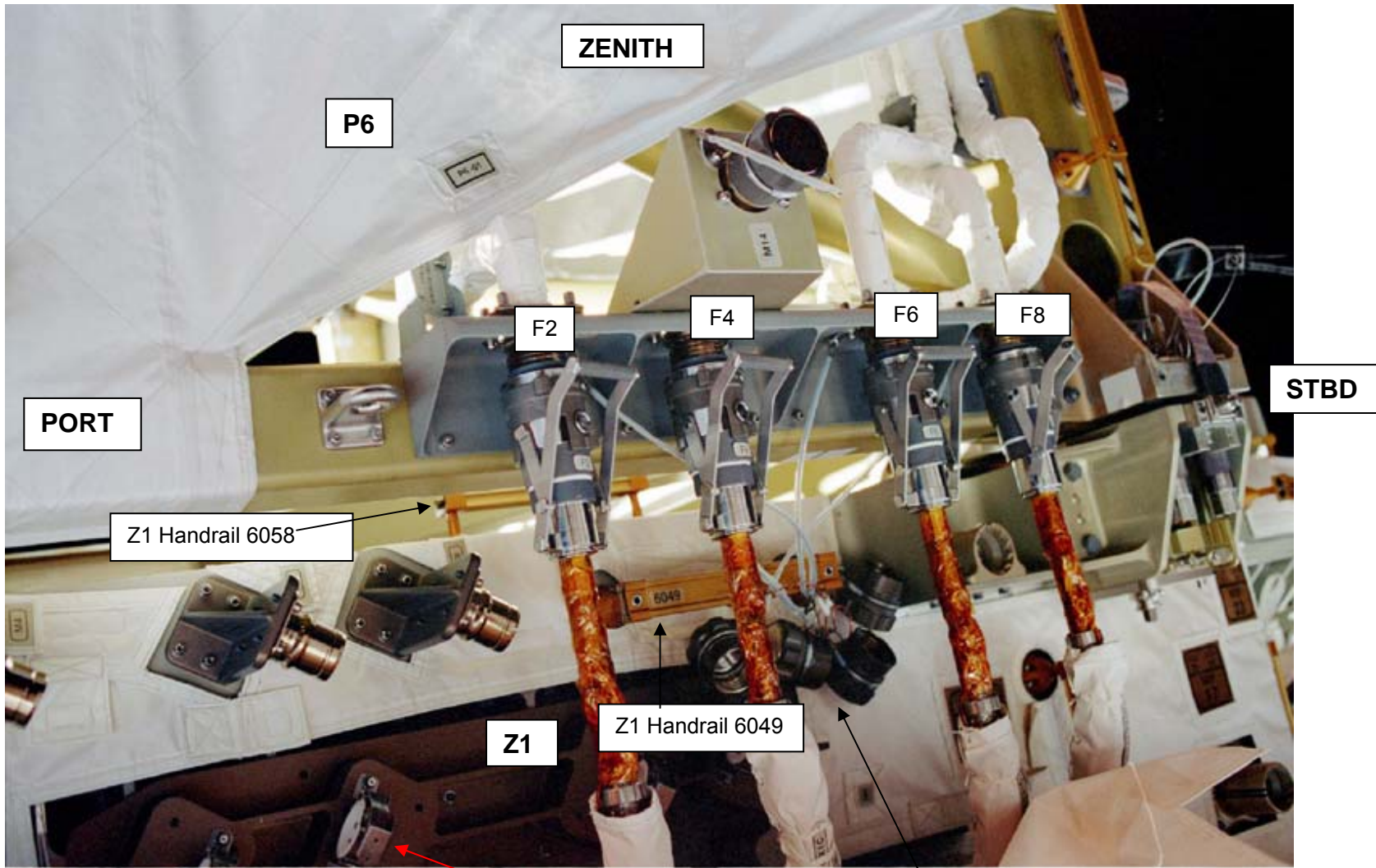

Aft view looking forward

TA Clamps (4)

Dust caps wire tied to Z1 HR 6049

Z1-TO-P6 FLUID LINES

Z1-TO-P6 FLUID DISCONNECT – TASK DATA (Cont)



Z1/02/03-19A – aft view looking fwd

Z1-TO-P6 FLUID LINE SHROUD

P6 AFT RADIATOR SHROUD DEPLOY (01:00)

IV	EV1 – Pz (FF)	EV2 – Wheels (FF)
	<div data-bbox="863 342 1539 402" style="border: 1px solid black; padding: 5px; text-align: center;"> <p>CAUTION Avoid contact with radiator bellows and thermal outer coating</p> </div> <div data-bbox="485 423 1108 1003" style="text-align: center;">  </div> <div data-bbox="422 1062 785 1089" style="border-top: 1px dashed black; padding-top: 5px;"> <p>SHROUD DEPLOY (STBD SIDE)</p> </div> <ol data-bbox="422 1094 1163 1398" style="list-style-type: none"> 1. Deploy stbd side of shroud over radiator partially 2. Return to shroud pouch (nadir) deploy remaining shroud 3. Attach short strap hook to P6 HR 5331 4. Release long guide strap from HR 5303, wrap around P6 HR 5331 and attach to P6 HR 5326; cinch tight 5. Translate to nadir end of shroud 6. Release black-tipped Velcro strap on end of shroud; thread through 2nd guide strap belt loop on shroud and refasten Velcro 7. Stow any remaining pouch Velcro straps and stow black belt strap in inside boot pocket 8. Translate to stbd SSU (2B) 	<ol data-bbox="1199 315 1877 342" style="list-style-type: none"> 1. Temp stow Med ORU bag on P6 HR 5314 (nadir/port keel) <div data-bbox="863 342 1539 402" style="border: 1px solid black; padding: 5px; text-align: center;"> <p>CAUTION Avoid contact with radiator bellows and thermal outer coating</p> </div> <div data-bbox="1199 435 1661 462" style="border-top: 1px dashed black; padding-top: 5px;"> <p>PORT SHROUD STRAP INITIAL DEPLOY</p> </div> <ol data-bbox="1199 467 1898 722" style="list-style-type: none"> 1. Release Velcro straps (3) on port shroud boot and feed through belt loops 2. Release black belt strap by pulling black loops on corners of boot (2) to open shroud pouch 3. Remove long guide strap hook from black loop, unstow strap from pouch 4. Translate with long strap to zenith end of PVR 5. Attach strap hook to P6 HR 5341 6. Translate nadir, then stbd to stbd pouch <div data-bbox="1199 753 1745 781" style="border-top: 1px dashed black; padding-top: 5px;"> <p>STARBOARD SHROUD STRAP INITIAL DEPLOY</p> </div> <ol data-bbox="1199 786 1856 1024" style="list-style-type: none"> 1. Release Velcro straps (3) on stbd shroud boot and feed through belt loops 2. Release black belt strap by pulling black loops on corners of boot (2) to open shroud pouch 3. Remove long guide strap hook from black loop, unstow strap from pouch 4. Translate with long strap to zenith end of PVR 5. Attach strap hook to P6 HR 5303 6. Translate nadir, then port to port side of shroud <div data-bbox="1199 1029 1961 1057" style="border-top: 1px dashed black; padding-top: 5px;"> <p>{Get-ahead opportunity: Relocate Med ORU Bag, FS 7-42, EV2 step 2}</p> </div> <div data-bbox="1199 1062 1562 1089" style="border-top: 1px dashed black; padding-top: 5px;"> <p>SHROUD DEPLOY (PORT SIDE)</p> </div> <ol data-bbox="1199 1094 1940 1424" style="list-style-type: none"> 1. Deploy port side of shroud over radiator partially 2. Return to shroud pouch (nadir) deploy remaining shroud 3. Attach short strap hook to P6 HR 5338 4. Release long guide strap from HR 5341, wrap around P6 HR 5338 and attach to P6 HR 5329; cinch tight 5. Translate to nadir end of shroud 6. Release black-tipped Velcro strap on end of shroud; thread through 2nd guide strap belt loop on shroud and refasten Velcro 7. Stow any remaining pouch Velcro straps and stow black belt strap in inside boot pocket 8. Retrieve Med ORU bag from HR 5314; stow on BRT 9. Translate to stbd SSU (2B)

P6 AFT RADIATOR SHROUD DEPLOY – TASK DATA

Tools:

EV1 (FF)	EV2 (FF)
N/A	N/A

EVA Fasteners: None

EVA Connectors: None

Foot Restraints: None

Cautions:

1. Avoid contact with radiator bellows and thermal outer coating

Notes:

1. Ground-installed gap spanners: 1 – from nadir standoff of HR 5303 to zenith standoff of HR 5326. 1 – from nadir standoff of HR 5341 to zenith standoff of HR 5329



Shroud Boot – belt strap release

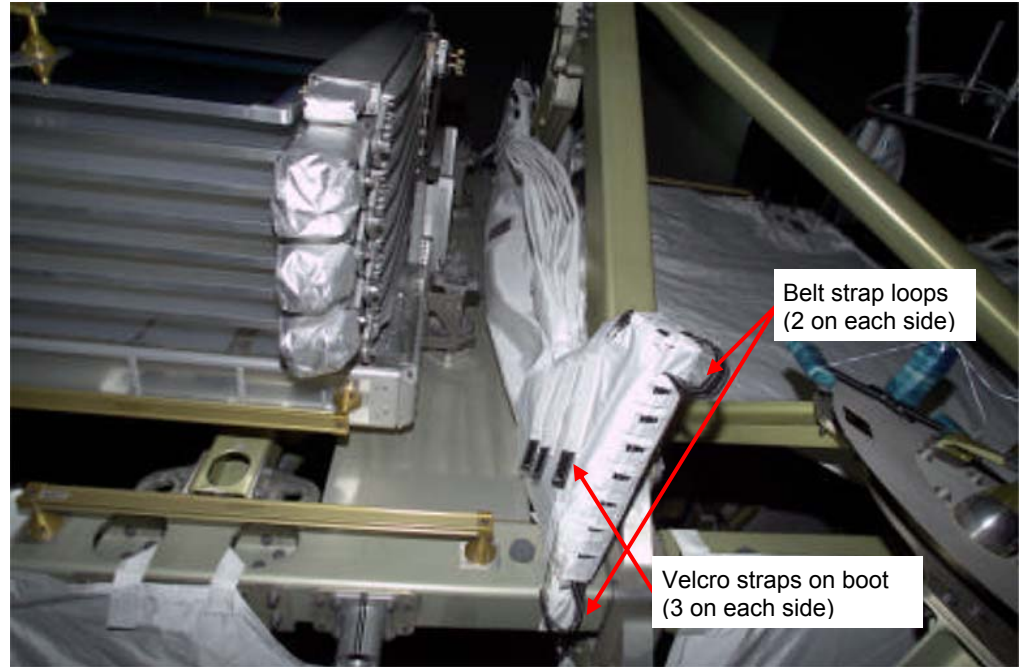

P6 AFT PVR Shroud – stowed

P6 AFT RADIATOR SHROUD DEPLOY – TASK DATA (Cont)

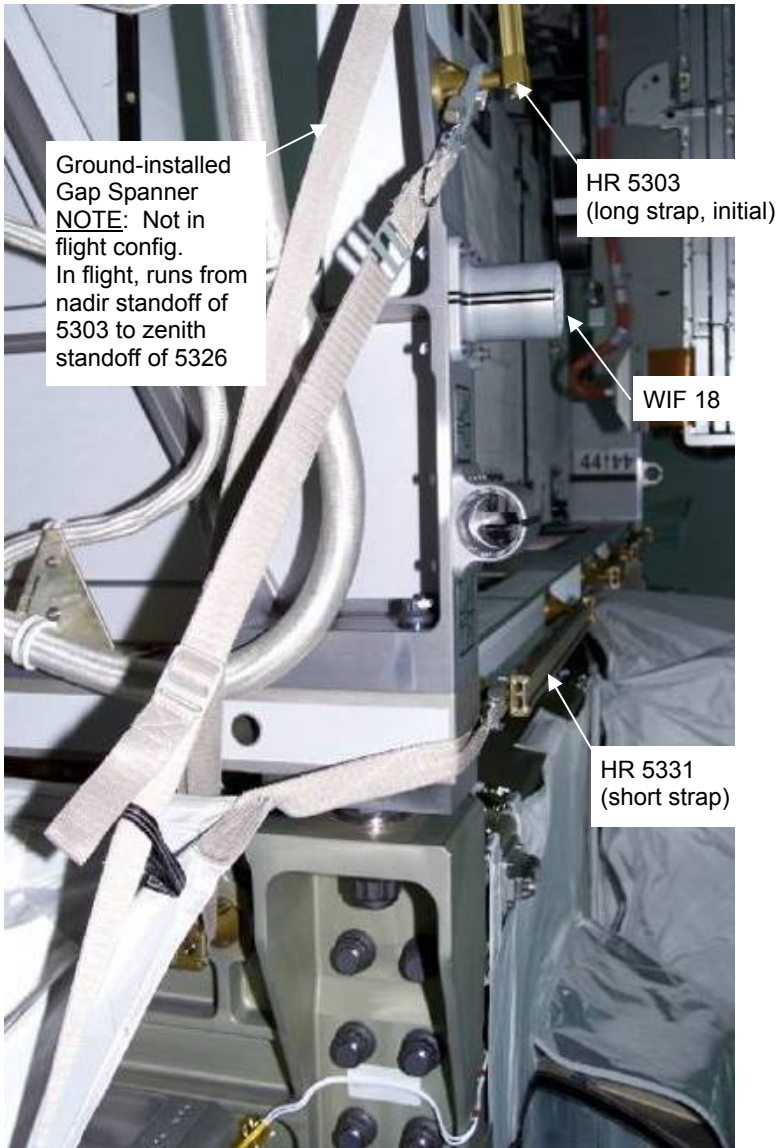

Stbd Strap Initial Routing

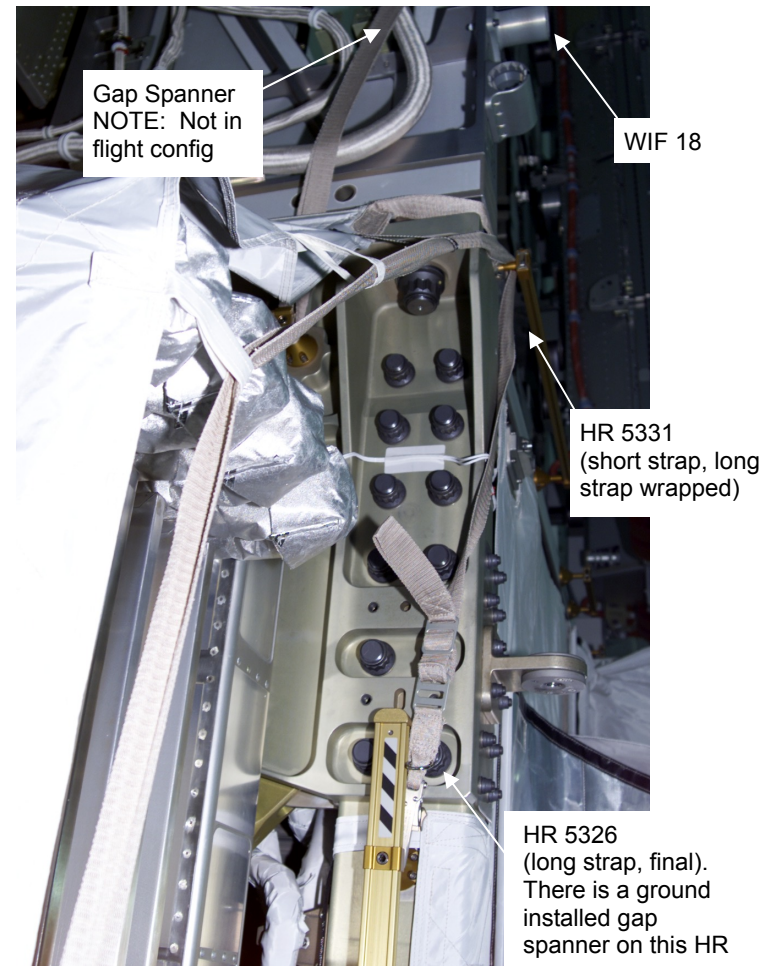

Stbd Strap Final Routing

P6 AFT RADIATOR SHROUD DEPLOY – TASK DATA (Cont)

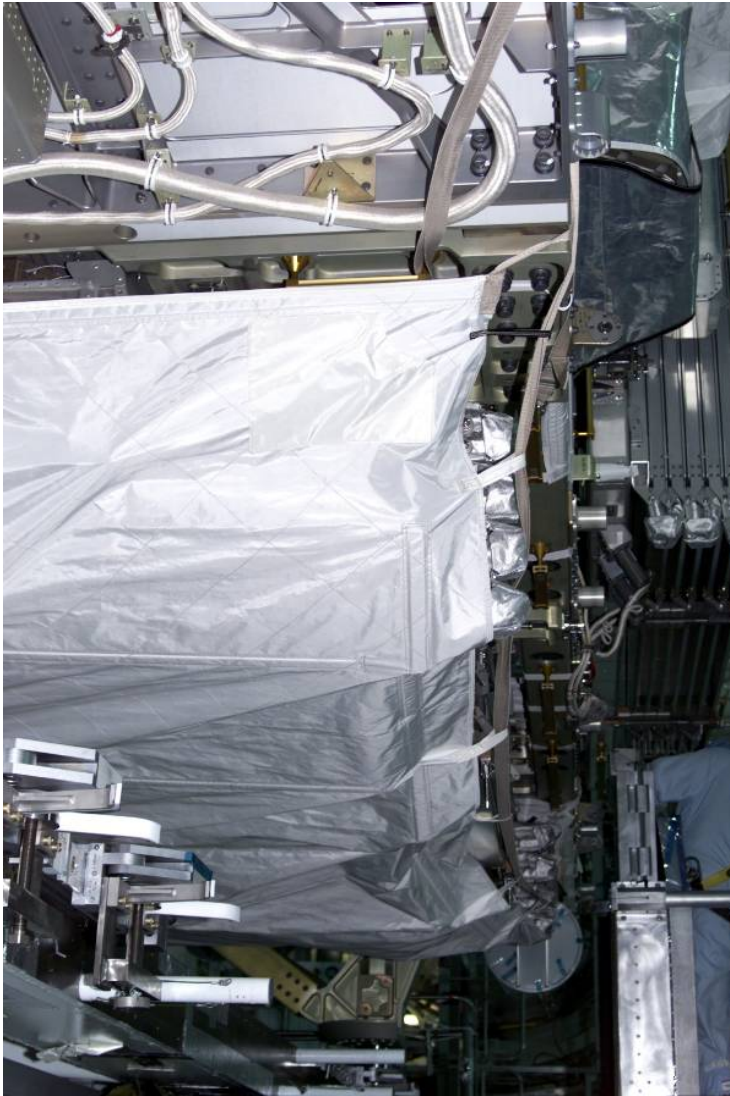

Shroud Installed



**Final Step – black Velcro strap on nadir end of shroud
routed through 2nd guide strap belt loop**

SSU MLI SHROUD INSTALL (00:35)

IV	EV1 – Scott (FF)	EV2 – Wheels (FF)				
<table border="1" data-bbox="111 1162 506 1240"> <tr> <td colspan="2">SASA Connector Mate to Z1</td> </tr> <tr> <td>P3→ ←J3 – Outboard</td> <td></td> </tr> </table>	SASA Connector Mate to Z1		P3→ ←J3 – Outboard		<p><u>2B (STBD) SHROUD INSTALL</u></p> <ol style="list-style-type: none"> 1. Perform glove inspection <hr style="border-top: 1px dashed black;"/> <ol style="list-style-type: none"> 2. Retrieve shroud from Med ORU bag 3. Install shroud over SSU; verify crescent alignment mark toward mast canister 4. Release long strap from pouch 5. Install long strap on right side of SSU (electrical cable side), routing strap beneath electrical connectors 6. Translate to Med ORU bag; retrieve other shroud <p><u>4B (PORT) SHROUD INSTALL</u></p> <ol style="list-style-type: none"> 1. Install shroud over SSU; verify crescent alignment mark toward mast canister 2. Release long strap from pouch 3. Install long strap on right side of SSU, routing strap beneath electrical connectors 4. Translate to SASA dummy panel via stbd/aft <p><u>SASA CONNECTOR MATE</u></p> <p style="text-align: center;"><u>NOTE</u></p> <p style="text-align: center;">√Connectors for straight pins, no FOD, EMI band intact, and good bend radius</p> <ol style="list-style-type: none"> 1. BRT to HR 6001 2. Remove cap from Z1 J3, stow in trash bag 3. Mate SASA connector P3 to Z1 dummy bracket J3 4. Translate to stbd Z1 toolbox; open stbd door 5. Retrieve cheater bar from Panel 8; stow on MWS 6. Retrieve crewlock bag from stbd Z1 toolbox; stow on BRT 7. Translate to A/L 	<p><u>2B (STBD) SHROUD INSTALL</u></p> <ol style="list-style-type: none"> 1. Perform glove inspection 2. Temp stow Med ORU bag on HR 5368 and 5360 <hr style="border-top: 1px dashed black;"/> <ol style="list-style-type: none"> 3. Assist EV1 as reqd 4. Secure Velcro flaps (2) 5. Install short straps (2) on left side of SSU (ECU side) 6. Translate to 4B (port) shroud <p><u>4B (PORT) SHROUD INSTALL</u></p> <ol style="list-style-type: none"> 1. Assist EV1 as reqd 2. Secure Velcro flaps (2) 3. Install short straps (2) on left side of SSU 4. Translate to Med ORU bag on HR 5368 and 5360 5. Verify contents of Med ORU bag: <ul style="list-style-type: none"> <input type="checkbox"/> EVA Camera <input type="checkbox"/> 2 – RET (sm-sm) <input type="checkbox"/> 2 – Adj (on outside of bag) 6. Retrieve Med ORU bag; stow on BRT 7. Translate to A/L via port/aft path; releasing fairlead
SASA Connector Mate to Z1						
P3→ ←J3 – Outboard						

SSU MLI SHROUD INSTALL – TASK DATA

EVA Tools:

EV1 (FF)	EV2 (FF)
N/A	N/A

EVA Fasteners:

EVA Connectors:

Harness	From	To	Conn Size
W07S	Temp Stow	Z1 J3	17

Foot Restraints: None

Cautions:

1. N/A

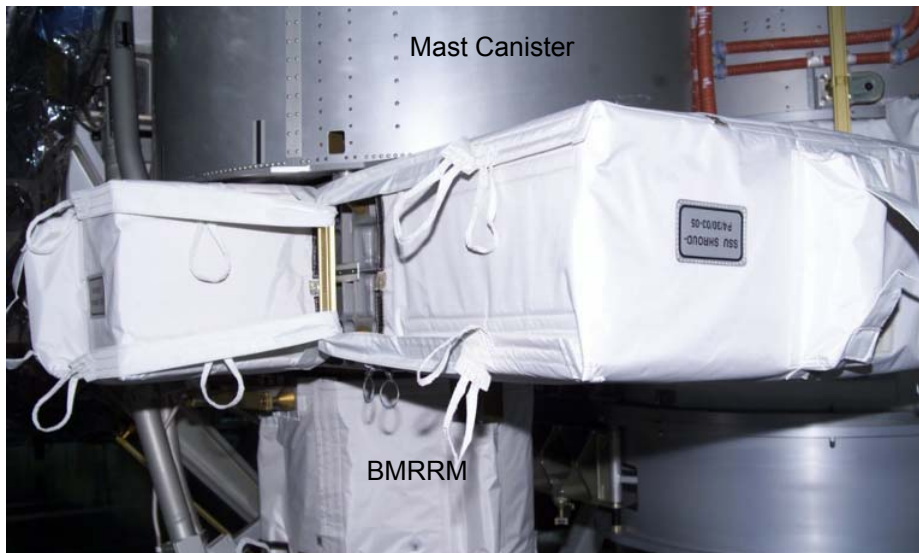

Left side of SSU shroud – 2 short straps



Right side of SSU shroud – 1 long strap

EVA 1 CLEANUP AND A/L INGRESS (00:35)

IV	EV1 – Pz (FF)	EV2 – Wheels (FF)
<p>1. Perform prior to ingress: WVS PWRDN (P/TV, <u>WVS CUE CARD</u>)</p>	<p>1. Translate to Airlock 2. Initiate cold soak 3. Stow C/L bag on fish stringer 4. Perform tool inventory 5. Transfer Med ORU bag to EV2 6. Transfer fish stringer to EV2</p>	<p>1. Translate to Airlock 2. Initiate cold soak 3. Temp stow Med ORU bag at Airlock 4. Perform tool inventory 5. Ingress Airlock 6. Receive Med ORU bag from EV1 7. Receive fish stringer from EV1 8. Connect right waist tether to A/L D-ring ext <input type="checkbox"/> √Hook locked</p>
	<p>7. On EV2 GO, disconnect EV2's airlock tether attach to right waist tether <input type="checkbox"/> √Hooks locked 8. Disconnect EV1 A/L safety tether from A/L, attach to self 9. Remove 55-ft safety tethers (2) from A/L D-rings; transfer to EV2 10. Translate to APFR on A/L WIF 10 (ISS aft) 11. Visually inspect APFR locking collar thoroughly; report condition to MCC-H 12. Translate to Airlock; ingress Airlock DCM 13. Retrieve SCU, remove DCM cover 14. Connect SCU to DCM, √Locked 15. Water – OFF 16. Hatch thermal cover – close 17. Secure thermal cover Velcro strap</p>	<p>9. Give EV1 GO to disconnect EV2 safety tether 10. Receive 55-ft safety tethers; temp stow DCM 11. Retrieve SCU, remove DCM cover 12. Connect SCU to DCM, √Locked 13. Water – OFF</p>
<p>CAUTION Do not close hatch until EMU water – OFF for 2 min</p>		
	<p>18. √EV Hatch clear of FOD and obstructions 19. EV Hatch – verify handle position per hatch decal; close and lock 20. Go to PRE REPRESS portion of {CREWLOCK DEPRESS/REPRESS CUE CARD} (SODF: ISS EVA SYS: EVA PREP/POST)</p>	<p>14. Go to PRE REPRESS portion of {CREWLOCK DEPRESS/REPRESS CUE CARD} (SODF: ISS EVA SYS: EVA PREP/POST)</p>

POST EVA 1 TOOL CONFIG

EV1

EMU D-rings

- 1 – Tether Extender on Left
- 2 – Waist Tethers
- 1 – 85-ft Safety Tether

MWS

- Small trash bag [right inside]
 - 1 – Cap Size 17 (J3)
- 2 – RET (sm-sm)
 - Cheater Bar
- 2 – Wire ties
- 1 – RET (with PIP pin)
- Socket Caddy [left inside]
 - RAD, w/7/16-2 in ext
- Swing Arm [right side]
 - PGT w/7/16-6 in ext
 - 1 – RET (sm-sm)
- BRT [left side]
 - 1 – RET
 - 3 – Wire Ties, short

- SAFER

CREWLOCK

- 1 – RET (Lg-sm)
 - Crewlock Bag #4 (MMOD Shield)

Total RETs sm-sm used – 11
RETs with PIP pin – 5
RETs Lg-sm – 7
Adj tethers – 6 (+4 on PDGF, 2 on trash bag)

EV2

EMU D-rings

- 1 – Tether Extender on Left
- 2 – Waist Tethers
- 1 – 85-ft Safety Tether

MWS

- Small trash bag [right inside]
- 2 – Wire ties
- 1 – RET (with PIP pin) [left]
- 2 – RET (sm-sm) [left, right]
- Swing Arm [right side]
 - PGT w/7/16-6 in ext
 - 1 – RET (sm-sm)
- BRT [left side]
 - 1 – RET (sm-sm)
 - 2 – Wire Ties, short
 - 1 – Wire Ties, long
 - 1 – Adj (sm-sm)

- SAFER

Additional Items Returned to Airlock

- PCBAM Contamination Covers (8 covers)
- LTA Cable with 2 wire ties
- SPDs (4)
- SASA Cap Size 17

Items left outside

- Small trash bag
 - Gap Spanners (72", 3 pairs)
 - 2 – Adj tether
- 4 – Adj tether (on PDGF)

CREWLOCK (Cont)

- 1 – RET (Lg-sm)
 - Med ORU Bag (for CETA light)
 - 1 – RET (with PIP pin)

Items remain in the A/L

CREWLOCK (Cont)

- Staging Bag
 - 1.0" BDT
 - 1.0" AKT
- IV Bag
- Fish stringer
 - WIF adapter
 - EVA Camera/Bracket
 - Crewlock bag #1
 - 1 – Fish Stringer w/4 SPDs
 - Adj tether on outside
 - LTA Cable with 2 wire ties
 - Lg Trash bag (EV1)
 - 1 – RET (Lg-sm) (inside bag)
 - PCBAM Contamination Covers (4)
 - 1 – 85-ft Safety Tether (EV1 – PLB)
 - Ratchet w/o palm wheel w/7/16-2 in ext
 - Lg Trash bag (EV2)
 - 1 – RET (Lg-sm) (inside bag)
 - PCBAM Contamination Covers (4)
 - 6 – Node 2 caps
 - 1 – Adj (sm-sm) (outside bag)
 - S0 Gap spanners (1 – 45", 1 – 72")
 - Wire Tie Caddy
 - Round Scoop (for CETA light)

- 1 – RET (Lg-sm)
 - Med ORU Bag
 - 2 – RET (sm-sm)
 - EVA Camera/Bracket
 - 2 – Adj on outside
 - 1 – RET (Lg-sm)
 - 6B Box Cover
 - Dummy box
 - 1 – Adj tether
 - 1 – RET (sm-sm)

POST EVA 1/PRE EVA 2 TOOL CONFIG

EV1

EMU D-rings

- 1 – Tether Extender on Left
- 2 – Waist Tethers
- 1 – 85-ft Safety Tether

MWS

- Small trash bag [right inside] {leave}
 - 1 – Cap J3 {to Return bag}
- 2 – RET (sm-sm)
 - Cheater Bar {to 10A bag}
- 1 – RET (with PIP pin)
- 2 – Wire ties
- Socket Caddy [left inside] {leave}
 - RAD, w/7/16-2 in ext {RAD to C/L Bag #2, 7/16-2 in to EV2's PGT}
- Swing Arm [right side]
 - PGT w/7/16-6 in ext {leave}
 - 1 – RET (sm-sm) {leave}
- BRT [left side] {leave}
 - 1 – RET (sm-sm)
 - 3 – Wire Ties

SAFER

CREWLOCK (Cont)

- 1 – RET (Lg-sm) {leave all except T-Tools}
 - Crewlock Bag #4 (MMOD Shield)
 - 2 – MMOD T-Tools needed for EVA 2}

Total RETs sm-sm used – 11 RETs with PIP pin – 5 RETs Lg-sm – 7 Adj tethers – 12

EV2

EMU D-rings

- 1 – Tether Extender on Left
- 2 – Waist Tethers
- 1 – 85-ft Safety Tether on Left

MWS

- Small trash bag [right inside] {leave}
- 2 – Wire ties
- 1 – RET (with PIP pin) [left]
- 2 – RET (sm-sm) [left, right]
- Swing Arm [right side]
 - PGT w/7/16-6 in ext {leave PGT, socket to socket caddy from 10A Bag}
 - 1 – RET (sm-sm)
- BRT [left side] {leave}
 - 1 – RET (sm-sm) {leave}
 - 2 – Wire Ties, short
 - 1 – Wire Ties, long
 - 1 – Adj tether {to Tether Staging}

SAFER

Additional Items Returned to Airlock

- PCBM Contamination Covers (8 covers) {to Return Bag}
- LTA Cable with 2 wire ties {to Return Bag}
- SPDs (4) {to Done Bag}
- SASA Cap Size 17 {to Return Bag}

CREWLOCK (Cont)

- 1 – RET (Lg-sm) {leave all}
 - Med ORU Bag (for CETA light)
 - 1 – RET (with PIP pin)
- 1 – RET (Lg-sm) {leave all}
 - 6B Box Cover
 - Dummy box
 - 1 – Adj tether
 - 1 – RET (sm-sm)

CREWLOCK

Staging Bag

- 1.0" BDT {move to Done Bag}
- 1.0" AKT {move to Done Bag}

IV Bag

Fish stringer {leave}

- WIF adapter {to Done Bag}
- EVA Camera/Bracket {to C/L Bag #3}
- Crewlock bag #1
 - 1 – Fish Stringer w/4 SPDs {leave fish stringer, SPDs to Done bag}
 - Adj tether on outside {leave}
- LTA Cable with 2 wire ties {to Return Bag}
- Lg Trash bag (EV1) {S/N 1009 to 10A Bag, S/N 1008 to Done Bag}
 - 1 – RET (Lg-sm) {to Tether Staging}
 - PCBM Contamination Covers (4) {to Return Bag}
- 1 – 85-ft Safety Tether (EV1 – PLB) {to 10A Bag}
- Ratchet w/o palm wheel w/ 7/16-2 in ext {to 10A Bag}
- Lg Trash bag (EV2) {S/N 1009 to 10A Bag, S/N 1008 to Done Bag}
 - 1 – RET (Lg-sm) {to Tether Staging}
 - 1 – Adj (sm-sm) {to Tether Staging}
 - 4 – PCBM Contamination Covers {to Return Bag}
 - 6 – Node 2 Caps {to Return Bag, except 1 – size 25, to C/L Bag #2}
- S0 Gap spanners (1 – 45", 1 – 72") {to C/L Bag #3}
- Wire Tie Caddy {to C/L Bag #3}
- Round Scoop (for CETA light) {to C/L Bag #3}

1 – RET (Lg-sm) {to Tether Staging}

Med ORU Bag {to Node}

- 2 – RET (sm-sm) {to Tether Staging}
- EVA Camera/Bracket {to C/L Bag #2}
- 2 – Adj on outside {to Tether Staging}

EVA 2 INHIBIT PAD

Orbiter (1)

ALL EVAs	
TCS L12	1. √TCS POWER – OFF
KU-BAND ANTENNA {Performed during egress}	
MCC-H	1. √KU-BAND Mask – active 2. √KU-BAND EVA Protect Box – active
RCS {On call, EV crew not expected to be in this area}	
If EV crew < 27 ft from FRCS	
IV O14,15,16	1. √DAP: VERN, FREE, LO Z (ft specific check with GNC) 2. √RJDF F1, F2, F3, F4 MANF DRIVER (four) – OFF LOGIC (four) – OFF
MCC-H IV	3. √Above RCS config 4. √RCS F – ITEM 1 EXEC (*) √RCS FJET DES F1U – ITEM 17 (*) F3U – ITEM 19 (*) F2U – ITEM 21 (*)
S-BAND ANTENNAS {On call, if Lab MMOD Shield reinstall attempted}	
NOTE Possible loss of comm when forced LL FWD antenna	
IV A1R	If EV crew < 2.0 ft from S-Band antenna 1. S-BAND FM ANT – XMIT LOWER/RCVR UPPER 2. √MCC, lower antenna selected
C3	If no comm, or on MCC GO 3. S-BAND PM ANT – LL FWD
C3	When EVA crewmember at least 2.0 ft away from all S-Band upper antennas 4. S-BAND PM ANT – GPC

Ground

All EVAs	
Ground Radar MCC-H	1. √TOPO console, ground radar restrictions in place for EVA
USOS (1)	
ALL EVAs	
PCU	
NOTE PCUs may require up to 1 hr warm-up period before they are operational	
MCC-H	1. √PCUs (two) operational in discharge mode and one of the following: a. CCS PCU EVA hazard control enabled b. No more than two arrays unshunted c. No more than two arrays pointed < 90° from velocity vector
OR	
	2. One or no PCUs operational in discharge mode and one of the following: a. No more than two arrays unshunted b. No more than two arrays pointed < 90° from velocity vector
LOCATION DEPENDENT INHIBITS	
Lab Window	
IV	1. Close window shutter
KU-BAND (SGANT) Antenna {On call, EV crew not expected to be in this area}	
MCC-H	If EV crew < 3.3 ft from KU-BAND antenna 1. Park KU-BAND: 1.1 Pointing Mode – Inhibit 1.2 PLC – Reset 1.3 Autotrack Continuous Retry – Inhibit

EVA 2

EVA 2 INHIBIT PAD (Cont)

USOS (2)

LOCATION DEPENDENT INHIBITS

S-BAND (SASA) ANTENNAS

{On call, EV crew not expected to be in this area}

MCC-H If EV crew < 3.6 ft from S1 SASA [P1 SASA]

1. P1 SASA [S1 SASA] – Active
2. S1 SASA [P1 SASA] – Powered down

EVA 2 SPECIFIC INHIBITS

SSPTS DEACTIVATION

{Performed as part of Inhibit Pad}

- MCC-H
1. RPCM LA1A4A D RPC 3 – Open, Close Cmd Inhibit
 2. RPCM LA2A3B D RPC 1 – Open, Close Cmd Inhibit
 3. RPCM Z14B A RPC 2 – Open, Close Cmd Inhibit
 4. RPCM Z13B A RPC 2 – Open, Close Cmd Inhibit

S1 SFU RECONFIGURATION

{Expect inhibits in place prior to egress}

- MCC-H
1. RPCM S11A_C RPC 4 – Open, Close Cmd Inhibit
 2. RPCM S11A_C RPC 5 – Open, Close Cmd Inhibit
 3. RPCM S11A_C RPC 6 – Open, Close Cmd Inhibit
 4. RPCM S11A_C RPC 7 – Open, Close Cmd Inhibit

MCC-H Since EV crew working within 2 ft of S1 TRRJ rotation envelope:

1. √DLA (1) – LOCKED

MBSU JUMPER RECONFIGURATION

{Expect inhibits in place prior to egress}

- MCC-H
1. MBSU 4A\4B RBI 8 – Open, Close Cmd Inh
 2. MBSU 2A\2B RBI 8 – Open, Close Cmd Inh

USOS (3)

EVA 2 SPECIFIC INHIBITS

DETACH P6 FROM Z1

{Expect inhibits in place prior to egress}

- MCC-H
1. RPCM Z13B B RPC 2 – Open, Close Cmd Inhibit
 2. RPCM Z13B B RPC 3 – Open, Close Cmd Inhibit
 3. RPCM Z14B B RPC 2 – Open, Close Cmd Inhibit
 4. RPCM Z14B B RPC 3 – Open, Close Cmd Inhibit
 5. RPCM 2B B RPC 1 – Open, Close Cmd Inhibit
 6. RPCM 4B B RPC 1 – Open, Close Cmd Inhibit
 7. DCSU 2B RBI 6 – Open, Close Cmd Inhibit
 8. MBSU 2 RBI 8 – Open, Close Cmd Inhibit
 9. DCSU 4B RBI 6 – Open, Close Cmd Inhibit
 10. MBSU 4 RBI 8 – Open, Close Cmd Inhibit

NODE 2 J612 CAP REMOVAL

{Expect inhibits in place approximately during egress}

- MCC-H
1. RPCM N21A4A B RPC 1 – Open, Close Cmd Inhibit
 2. RPCM N21A4A B RPC 2 – Open, Close Cmd Inhibit
 3. RPCM N21A4A B RPC 3 – Open, Close Cmd Inhibit
 4. RPCM N21A4A B RPC 4 – Open, Close Cmd Inhibit
 5. RPCM N21A4A B RPC 5 – Open, Close Cmd Inhibit
 6. RPCM N21A4A B RPC 12 – Open, Close Cmd Inhibit
 7. RPCM N21A4A B RPC 13 – Open, Close Cmd Inhibit
 8. RPCM N21A4A B RPC 14 – Open, Close Cmd Inhibit
 9. RPCM N21A4A B RPC 15 – Open, Close Cmd Inhibit
 10. RPCM N21A4A B RPC 16 – Open, Close Cmd Inhibit
 11. DDCU LA1A or LA4A Converter – OFF

RPCM REMOVE AND REPLACE

{Expect inhibits in place during EVA, once SSRMS ready}

- MCC-H
1. DDCU S14B Converter – OFF

EVA 2 INHIBIT PAD (Cont)

USOS (4)

EVA 2 GET AHEAD INHIBITS	
LAB CETA LIGHT REMOVE {On Call}	
MCC-H	1. RPCM S01A C RPC 15 – Open, Close Cmd Inh 2. RPCM S02B C RPC 15 – Open, Close Cmd Inh
BSP REMOVAL {On Call}	
MCC-H	1. RPCM Z14B B RPC 4 – Open, Close Cmd Inh 2. RPCM Z13B B RPC 4 – Open, Close Cmd Inh

RSOS (1)

ALL EVAs	
SM Antennas IV	1. GTS – Deactivate 2. ARISS – Deactivate or VHF (144-146 MHz) TX only
FGB Antennas MCC-M	1. √FGB KURS P [KYPC P] – Deactivated
Soyuz Thrusters MCC-M	1. √Soyuz manifolds (4) - closed ЭКО1, ЭКО2, ЭКГ1, ЭКГ2 2. √Soyuz MCS unpowered 3. √Soyuz Attitude Control Thruster Valves (52) – closed 4. √Soyuz Main Engine Valves (K1,K2,K3,K4,K5,K6) – closed
FGB Thrusters MCC-M	1. √FGB MCS unpowered 2. √All FGB Attitude Control Thruster Valves (80) – closed 3. √FGB Attitude Control Manifold Valves – closed КШК1, КШК2, КШК4, КШК5, КШК9, ОКО3, ОКГ3, ОКО6, ОКГ6, ОКО7, ОКГ 7, ОКО8, ОКГ8

EVA 2 NOTES, CAUTIONS, AND WARNINGS

NOTES

1. Bolt install: report torque and turns
2. Bolt release: report torque and turns if different from published range
3. EVA connectors: after disconnection and prior to connection; verify pins straight, connector free of FOD, EMI band intact; verify good bend radius after connected
4. Inspect QDs for damage prior to mating
5. Toolbox doors must be closed with one latch per door when EV crew not in immediate vicinity
6. Avoid contact with OBSS striker bars (Vitrolube coating)
7. MLI handholds are not rated for crewmember transition loads

CAUTION

ISS Constraints

- A. Avoid inadvertent contact with
1. Grapple fixture shafts (drylube)
 2. PIP pins
 3. EVA Crane [PMA1]
 4. TCS Reflectors [PMA2,PMA3]
 5. APAS hardware [PMA2,PMA3]
 6. CETA Lights (Z-93 paint) [LAB,S1,Node 1]
 7. Passive UMAs
 8. MBS VDU, MCU, CRPCMs, and Cameras (taped radiative surfaces, silver Teflon)
 9. Deployed TUS cable (nadir CETA rail)
 10. S0 aft face Radiator
 11. GPS Antennas (S13 paint) [S0]
 12. UHF Antennas [LAB,P1]
 13. ETCS Radiators [S1,P1]
 14. EETCS/PV Radiator bellows and panels [P6,P4,S4]
 15. SASA RF Group [S1,P1]
 16. Heat pipe radiators [Z1]
 17. PCU cathode and HCA ports [Z1]
 18. Ku-Band Antenna (SGANT) dish [Z1]
 19. CMG cover/shells [Z1]
 20. SSRMS Cameras
 21. Open CBM petal covers and LAB window shutter

CAUTION (Cont)

ISS Constraints (Cont)

- B. Electrical cables
1. Avoid bend radii < 10 times cable diameter
- C. Fiber optic cables
1. Avoid bend radii < 10 times cable diameter
 2. Avoid pulling on cable during mate/demate
- D. Fluid line flex hoses and QDs
1. Avoid bend radii < 5 in for hoses with diameter < 1 in on LAB, S0, S1, P1, and 10-in for hoses with diameter < 1 in on all other elements
 2. Avoid bend radii < 14 in for hoses with a diameter ≥ 1 in
 3. Additional care should be taken to not exceed bend radii when applying loads at the flexible hose to rigid tube stub interfaces
 4. Ensure fluid QD booties are fully closed prior to leaving worksite; wire tie if reqd
- E. For structural reasons
1. Avoid vigorous body motions, quick grabs and kickoffs against tether restraints
 2. Avoid performing shaking motions (sinusoidal functions) more than four cycles
 3. Avoid kicking S1/P1 radiator beam
If any of these occur, wait 2 to 5 min to allow structural response to dissipate

EVA 2 NOTES, CAUTIONS, AND WARNINGS (Cont)

CAUTION (Cont)

ISS Constraints (Cont)

F. Other

1. ITT Cannon connector: On demated connectors, do not rotate collar or manipulate cable/connector using collar or connector tool
2. WIS Antennas: do not use as handholds [Node 1,P6,Z1]
3. Lubricant from Ku-Band SGANT gimbals [Z1], CMGs [Z1], and RTAS Ground Strap fasteners [P6,P4,S4] can contaminate EMU
4. MLI handholds are not rated for crewmember translation loads
5. CBM petal covers may not be used as handholds unless both launch restraint pins are engaged

CAUTION (Cont)

Shuttle Constraints

G. Avoid inadvertent contact with

1. OBSS and SRMS Composite Sections and Cable Harnesses
2. LCS (silver Teflon) and LDRI (silver Teflon) and ITVC (gold foil) [OBSS]
3. WVS Antenna [ODS Truss & PLB Sill]
4. Payload Bay wire harnesses, cables, and connectors

H. No touch

1. LDRI diffuser [OBSS]
2. OBSS saddle contacts (when OBSS unberthed) [OBSS]
3. Monkey fur [PLB]
4. Cameras: metallic surfaces [PLB]
5. Ku-Band Antenna black dish and gold thermal blankets [PLB]

EVA 2 NOTES, CAUTIONS, AND WARNINGS (Cont)

WARNING

ISS Constraints

- A. Avoid inadvertent contact with
1. Grapple fixture targets and target pins
 2. SSU, ECU, beta gimbal platform, mast canister, SAW blanket boxes unless the beta gimbal is locked and the motor is turned off
 3. Stay inboard of SARJ when active
 4. Stay 2 ft from S1/P1 radiator beam rotational envelope when beam is free to rotate
 5. Stay 5 ft from moving MT on face 1
- B. Handrails
1. Handrails previously used for MISSE attachment may not be used as a safety tether point [A/L endcone 564 & 566, A/L Tank 2 nad/fwd & port/fwd, P6 5389]
- C. Pinch
1. NZGL connector linkage. Use caution when mating/locking
 2. ITT Cannon Connector rotating housing
 3. EV side of IV Hatch during Hatch operation (also snag hazard) [A/L]
 4. LAB window shutter and CBM petal cover linkages during operation
- D. QDs
1. If QD is in FID when valve is opened (bail fwd), QD will leak and fluid line may whip
 2. Do not rotate if in mated/valve open config

WARNING (Cont)

ISS Constraints (Cont)

- E. RF radiation exposure
1. Stay 3.6 ft from S-Band (SASA) high gain Antenna when powered [S1,P1]
 2. Stay 1.3 ft from S-Band (SASA) low gain Antenna when powered [S1,P1]
 3. Stay 1 ft from UHF Antenna when powered [LAB, P1]
- F. Sharp Edges
1. Inner edges of WIF sockets
 2. Mating surfaces of EVA connectors. Avoid side loads during connector mating
 3. Back side of MMOD shield fasteners
 4. Spring loaded captive EVA fasteners (e.g., 6B-boxes, BMRRM); the end of the spring may protrude
 5. PMA umbilical launch restraints-exposed bolt threads
 6. Adjustable Fuse Tether (Fish Stringer) buckles stowed in Node Bag
 7. Nickel coated braided copper Ground Straps may contain frayed wires [P6,P4,S4]
 8. Z1 handrail 6061 by the Ku-Band boom launch restraint [Z1]
 9. Solar Array Blanket Box [P6]
 10. Keep hands away from SSRMS LEE opening, and snares
 11. Fastener threads on back of Z1 U-jumper male FQD panel, if nutplate cap missing

WARNING (Cont)

ISS Constraints (Cont)

- G. Thermal
1. EVA connectors with booties may become hot if left uncovered. Handling may need to be limited
 2. PMA handrails may be hot. Handling may need to be limited
 3. Turn off glove heaters when comfortable temp reached to prevent bladder damage. Do not pull fingers out of gloves when heaters are on
 4. Uncovered trunnion pins may be hot
 5. SSRMS/MBS operating Cameras and lights may radiate large amounts of heat
 6. Stay 1 ft away from PMAs and MMOD shields > 270 degF if EMU sun visor up
 7. Stay at least 1 ft away for no more than 15 min from PMAs and MMOD shields > 300 degF if EMU sun visor up
 8. Stay 0.5 ft away from PMA and MMOD shields > 325 degF
 9. Do not touch EMU protective visor if temp has been < -134 for > 15 min
 10. No EMU TMG contact of PMAs and MMOD shields when temp > 320 degF
 11. No EMU boot contact with foot restraint when temp < -120 degF or > 200 degF
- H. Electrical Shock Hazard
1. Stay \geq 2 ft from following ungrounded floating connectors if not inhibited: SSPTS on Lab fwd and stbd Node 1, H-jumper on FGB, MT cables, and S0 Bay 00, 02, and 03

EVA 2 NOTES, CAUTIONS, AND WARNINGS (Cont)

WARNING (Cont)

Shuttle Constraints

I. Arcing/Molten Debris

1. Stay \geq 2 ft from exposed EFGF connector when OBSS berthed, powered, and EFGF not grappled [PLB]
2. Stay \geq 2 ft from exposed Stbd Fwd MPM contacts [PLB]
3. Stay \geq 2 ft from exposed Node 2 SPDU connectors when OBSS grappled by SRMS and LCS is powered [PLB]

J. Pinch

1. PRLA operation [PLB]

K. RF radiation exposure

1. Stay 2.0 ft from S-Band Antenna when powered
2. Stay 1 ft from top and side of UHF PLB Antenna radome surface when in high powered mode [ODS truss]
3. Stay 0.33 ft from top and side of UHF PLB Antenna radome surface when in low powered mode [ODS truss]
4. Remain below the level of the PLB door mold line for first 20 in Aft of Fwd bulkhead when S-Band Antenna powered [PLB]
5. Remain on the inboard side of the Stbd slidewire (sill handrails if slidewire not installed) for first 20 ft Aft of Fwd bulkhead when Ku-Band Antenna powered [PLB]

WARNING (Cont)

Shuttle Constraints (Cont)

L. Sharp Edges

1. PRLA grounding wipers [PLB]
2. LDRI baffles (Also an entrapment hazard) [OBSS]
3. Keep hands away from SRMS EE opening and snares
4. TCS connector backshells have exposed threads

M. Thermal

1. Illuminated PLB lights; do not touch
2. OBSS grapple fixture shafts/cams may be hot. Limit handling if required
3. Stay 27 ft from PRCS when powered
4. Stay 3 ft from VRCS when powered
5. Stay 3 ft from APU when operating

N. Thruster Contamination

1. Stay out of the immediate vicinity of leaking jet or APU

10A EVA 2 PRE BRIEF

ROLES (ALL)

EV1: Scott EV3: Dan IV: Paolo	Suit IV (pre): Peggy M1: Steph M2: Wheels	Suit IV (post): Peggy M3: Clay
-------------------------------------	---	-----------------------------------

MILESTONES (ALL)

___:___ Wake-up	___:___ Start of Post Depress
___:___ EVA Prep Start	

COMM SET-UP (ALL)

Name	Loop Selected		Taking to	From	Used for
	STS	ISS			
Big Loop	A/G1	1	MCC-STs, MCC-ISS	STS, ISS, EMU	All EVA/(S)SRMS ops, emergencies
A/G2	A/G2	-	MCC-STs	STS, BPSMU	Non-EVA, non-emergencies, STS related
S/G2	-	2	MCC-ISS	ISS	Non-EVA, non-emergencies, ISS related
ICOM	ICOM	3	STS, ISS	STS, ISS, BPSMU	Comm. Not intended for ground
ICOM	-	5	ISS-A/L, EMUs	ISS-A/L, EMUs	ATU4, 5, 6 intercom pre/post EVA

NOTE: always start a transmission by stating the loop talking on (unless it is the Big Loop)

GENERAL EMERGENCIES (ALL)

For ISS or shuttle Fire/Depress/ATM Contamination:

- Everybody "safes" what he is doing, executes JEE (ISS crewmember will execute gray steps in A/L), and return to home vehicle
- For smoke/flames or ATM contamination, don PBAs or ИПК
- If no ammonia contamination, EVs and IV will retrieve equipment per Emergency Undocking cue card. MS2-Steph will help at the PMA
- If EVs in EVA, terminate EVA and return to ISS A/L (if possible, IV will join in A/L and assist)
- If suited in E/L => suit doff (+ power down if time permits)
- If C/L depressed => "fast" repress
- If E/L at 10.2 => expect immediate auto ("fast") repress

For EVA emergencies:

- Abort & terminate procedures (including incapacitated/lost EV) => non essential shuttle and ISS activities will be terminated, IV and CMOs will go to E/L as soon as EVs in C/L
- For lost crewmember/tool => CDR-PLT-MS2-IV in shuttle flight deck, if possible obtain 2 camera views (read pan/tilt angles) and HHL reading R/Rdot

(S)SRMS/EVA JOINT OPS (EV1, EV3, R1, R2, M1, M2, IV)

- Review of (S)SRMS general activities (DOUG review)
- Review of sync points between EVA and (S)SRMS ops
- Review of frame(s) of reference (ISS ACS, OBAS, body relevance)
- Responsibilities for clearances => with R(M)1(2) (unless clearly handed off and acknowledged)
- Anyone can call "All Stop, All Stop, All Stop" in case of impending unsafe situation or emergency. SRMS => Brakes ON; SSRMS => Safe even if heard only once
- When arm(s) need to move during EVA => R(M)2 announce on Big Loop: initial motion, duration of motion, direction of motion, possible interference with EVA, end of motion
- If GCA required => IV will verify (S)SRMS and EV(s) ready for GCA, and hands over EVA external COMM to R(M)2 and EVs
- When joint activities completed, IV will verify EV1/2 clear and issue "Go for (S)SRMS maneuver"

For GCA:

- EVX calls for requested motion, R(M)2 repeats request
- When motion starts, EVX, acknowledge motion, counts down to stop motion
- At the end of GCA, EVX calls "GCA complete", R(M)2 acknowledges, hands COMM back to IV

EVA PREP (EV1, EV3, IV, Suit IV)

- Camp-out review
- WCS usage, food/drink
- While at 10.2: shave, brush teeth, wash face, comb hair
- Wear mask if not at 10.2
- Tool config (last minute tools/equipment)
- E/L activities
- Parallel suit donning
- SAFER, MWS, tool, bag stowage
- 10.2 depress/repress review
- C/L depress review

REPRESS/POST-EVA (EV1, EV3, IV, Suit IV)

- Coldsoak
- C/L repress review
- Parallel Suit
- Food/drinks requests

10A EVA 2 PRE BRIEF (Cont)

EVA DETAILED REVIEW (EV1, EV3, IV)

- **Egress:** Daisychain Egress: Dan out first, connects Scott's 85 to fwd point – then Dan's 85 to aft point. Scott hands BOJ 2 to Dan, then egresses with BOJ 1. Safer checks and then translate to Z1. Scott stows BOJ on Node 2 – Dan stows BOJ on Trunnion, deploys UTFS
- **Connectors:** Dan approaches from P6 side – watch SO radiator! Start on port side – 254 first – requires GO. Skip 253 and work toward Stbd. 253 last, requires GO. To mate – white on tip of connector touches white on receptacle, then rotate cw. After connectors, Dan stows connector tool at UTFS
- **P6 demate:** Scott engages Claw. Dan removes grounds straps – corners 1 then 2 then 4. Dan then unwinds, picks up RAD then moves aft to Corner 3. Scott picks up wrench and cheater bar from BOJ2 and breaks torque on corners 2 then 4, then 3 then 1. **NO translating on P6 during bolt driving!** At corner 3, Dan releases ground strap then releases RTAS bolt (may require adjusting APFR located at corner 3). After 27 turns at the bolt – should have 2-7 threads showing underneath. Scott loosens RTSA bolts 4 then 2, and then Dan loosens bolt 1. Scott moves to the Claw to release. Dan returns RAD to UTFS and picks up BOJ2 and goes to corner 3 to watch separation. At separation, EV ensures cups out of cones and pin clear of claw. Scott moves to Node 2, Dan stows BOJ 2 on Node 2, retrieves UTFS and returns to the Airlock
- **Node 2 outfitting:** Scott installs OIHs and WIFs. Ensure number on HR lines up with number on Node. Local reference frame for bolts is Left/Right. Cannot use HR for translation or stabilization until both bolts are torqued. Mind all the bits – lots of small parts. Don't get famous
- **SFU:** Dan returns the UTFS to the AL and picks up the RPCM. UP the CETA spur – temp stow the RPCM near on face 1 and heads Stbd to the SFU worksite. Non-obvious BRT site – swap the outer most 2 connectors
- **MBSU:** Back across face 1, pick up RPCM and continue port to MBSU worksite. Temp stow RPCM at RPCM site and enter S0. Swap connectors – might need to release TA clamps. Big power connectors
- **RPCM:** Standard R&R – ensure hook is on correctly (check IV). Check type and serial number of RPCM before removing. Return old RPCM to AL – pick up T-tool. Dan gives Scott a 5-min warning
- **PDGF:** Dan moves to Node 2, goes to PDGF worksite to remove MLI cover. Temp stow with RET out of the install worksite. Scott sets up APFR. Dan translates to PDGF temp stow site via standard aft/nadir translation path. Scott uses path that is more nadir. At the PDGF, release all adjustable, and Scott leads to the PDGF install site. "Transfer" – "Go" – "On" protocol. Translate slowly! Once at the install worksite, Dan releases and ingresses. Scott hands off and GCAs the install. EDFs are pressed in and then tightened with PGT. Horseshoe connectors next. Dan brings MLI back to BOJ2
- **Shower Cap:** If time permits, use adjustables from PDGF to assist wrapping up shower cap

CHICA MANTRAS (EV1, EV3, IV)

- | | |
|--|---|
| <ul style="list-style-type: none">• Day/Night Cycles<ul style="list-style-type: none">○ Lights – on○ Sun visor – day: down, night: up○ Cooling – as required○ Bayonets – locked○ Gloves:<ul style="list-style-type: none">▪ Heater – on/off as required▪ Inspect /report:<ul style="list-style-type: none">▪ RTV status▪ Vectran abrasions/cuts (specifically inspect thumb, index finger, C-cup)○ Condition: Alpha, Bravo, Charlie• Safety Tether Swap<ul style="list-style-type: none">○ Gates – closed○ Hooks – locked○ Reel – unlocked• PGT Ops<ul style="list-style-type: none">○ XX – turns○ YY – torque○ (Green light) | <ul style="list-style-type: none">• PGT Extensions<ul style="list-style-type: none">○ XXX installed on YYY○ Good pull test• Electrical Connectors<ul style="list-style-type: none">○ Pins straight○ No FOD○ EMI band – intact○ If mated – mated, good bend radius○ TA clamps – closed• APFR Install<ul style="list-style-type: none">○ Black on black○ Good pull test |
|--|---|

COMM PROTOCOL (EV1, EV3, IV)

- | |
|---|
| <ul style="list-style-type: none">• Short and concise (everybody stops to listen when COMM is "active")• Start with EVX, IV, R(M)X, then switch to names• Give appropriate/timely info• Anticipate when possible, do not overload• Hand signals (between EVs and/or IV/ground via WVS) => review crew notebook |
|---|

10A EVA 2 PRE BRIEF (Cont)

EMERGENCIES (EV1, EV3, IV)

- All emergencies => verbalize, IV leads, challenge-response protocol
- DCS => speak up for symptoms (verbalize)
- Abort & terminate procedures => as per cuff checklist (review)
- Incapacitated crewmember => EV secure other EV to himself, returns to A/L, IV + CMO in A/L
- Lost Crewmember => call over Big Loop, request cameras and HHL reading, SAFER ops
- Hydrazine/NH3 contamination => IV will direct ops per checklist

GENERAL REMINDERS (EV1, EV3, IV)

- Verbalize any DCM messages
- Suit/gloves => stiffer than training HW
- Glove heaters => it takes 2-3 min to feel heat
- EHIP lights => leave them on
- Translations => slow & deliberate, avoid feet first, check tethers often, check buddy when able
- Mass handling => one axis trans/rot at a time, watch for inertia
- Tether management => fairleads, stay clear of each other, 30 sec rule for snags or entanglements
- ORU control => positive transfer of control
- PGT ops => Red light – low torque, Green light – in torque window, Red/Green lights – HI torque
- PGT CAL procedure => Ratchet collar – Not motor, Speed collar – Cal, Pull trigger (CAL passed message)
- Video/cameras view for IV => change tapes, adjust WVS at SR/SS
- Errors & Lost tools => acknowledge and continue
- For lost tool/ORU => EVs verbalize what, when, direction, speed; IV gets 2 camera views/HHL (if possible)

EVA 2 SUMMARY TIMELINE

PET HR : MIN	IV/SSRMS	10A EVA 2 EV1 – Pz	EV3 – Tani	PET HR : MIN
00:00	SSRMS: P6 GRAPPLE	<u>EVA 2 A/L EGRESS & SETUP</u> (00:15) <ul style="list-style-type: none"> Post Depress/Egress Setup 	<u>EVA 2 A/L EGRESS & SETUP</u> (00:15) <ul style="list-style-type: none"> Post Depress/Egress Setup 	00:00
	√MCC-H GO for Z1 to P6 Umbilical disconnects	<u>Z1 TO P6 UMBILICAL DISCONNECT</u> (00:25) <ul style="list-style-type: none"> Disconnect Umbilicals (9) 	<u>Z1 TO P6 UMBILICAL DISCONNECT</u> (00:40) <ul style="list-style-type: none"> Disconnect Umbilicals (9) 	
01:00				01:00
		<u>DETACH P6 FROM Z1</u> (01:30) <ul style="list-style-type: none"> Engage CLA Break torque on RTAS bolts (4) Release bolt 4 Release bolt 2 Release CLA 	<u>DETACH P6 FROM Z1</u> (01:15) <ul style="list-style-type: none"> Release ground straps Release bolt 3 Release bolt 1 	
02:00	SSRMS: Demate P6 from Z1 SSRMS: MnvR to Handoff Posn			02:00
	√MCC-H GO for SFU Reconfig	<u>NODE 2 OUTFITTING</u> (01:25) <ul style="list-style-type: none"> Install Node 2 Handrails (11) Install Node 2 WIFs (3) Install Node 2 trunnion (4) and keel covers (1) Install gap spanners (2) Install J408 loopback connector Release CBM PIP pins (4) Release zenith CBM petal restraints (8) 	<u>SFU CONFIG FOR RAD DEPLOY</u> (00:50) <ul style="list-style-type: none"> Swap connectors 	
03:00	√MCC-H GO for MBSU Jumper Reconfig		<u>MBSU JUMPER</u> (00:10) <ul style="list-style-type: none"> Swap connectors 	03:00
	√MCC-H GO for RPCM R&R		<u>RPCM R&R</u> (00:30) <ul style="list-style-type: none"> Remove S04B-C RPCM Install new RPCM Stow failed in ORU bag 	
04:00		<u>NODE 2 PDGF INSTALL</u> (01:15) <ul style="list-style-type: none"> Relocate APFR Retrieve PDGF Soft dock PDGF Torque EDFs (4) Release horseshoe connectors (2) 	<u>NODE 2 PDGF INSTALL</u> (01:15) <ul style="list-style-type: none"> Remove thermal cover Retrieve PDGF Soft dock PDGF Torque EDFs (4) Install horseshoe connectors (2) 	04:00
05:00		<u>NODE 2 OUTFITTING (Cont)</u> (01:25) <ul style="list-style-type: none"> Complete remaining Node 2 outfitting Remove Node 2 outboard avionics caps (8) 	<u>NODE 2 OUTFITTING (Cont)</u> (01:20) <ul style="list-style-type: none"> Complete remaining Node 2 outfitting Remove Node 2 inboard avionics caps (18) 	05:00
06:00	EVA 2 Specific Get aheads: See end of procedure	<u>CLEANUP AND A/L INGRESS</u> (00:10) <u>PRE REPRESS</u> (00:05)	<u>CLEANUP AND A/L INGRESS</u> (00:10) <u>PRE REPRESS</u> (00:05)	06:00

PRE EVA 2 TOOL CONFIG

EV1

EMU D-rings

- 1 – Tether Extender on Left
- 2 – Waist Tethers
- 1 – 85-ft Safety Tether on Left

MWS

- Small trash bag [right inside]
 - Cannon Connector Tool {from 10A Bag}
 - 1 - RET (sm-sm)
- 1 – Adj tether [left]
- 2 – RET (sm-sm) [right]
- 1 – RET (with PIP pin) [left]
- 2 – Wire ties
- Socket caddy
 - 5/8-7.8 in ext {from 10A Bag}
- Swing Arm [right side]
 - PGT w/7/16-6 in ext S/N _____
(A6, CW3, 30.5)
 - RET (sm-sm)
- BRT [left side]
 - 1 – Wire Tie, short
 - 2 – Wire Ties, long
 - 1 – RET (sm-sm)
- SAFER

CREWLOCK

- OIH Carrier {STS B}/Fish stringer #1 {FS in C/L #1}
 - HR 0371 (18.9")
 - HR 0372 (18.9")
 - HR 0332 (24")
 - 72" gap spanner (on exposed HR end)
 - HR 0361(24")
 - Adj tether
 - HR 0359 (24")
 - HR 0352 (12")
 - HR 0345 (24")
 - 45" gap spanner (daisy chain)

Items remain in crewlock

EV3

EMU D-rings

- 1 – Tether Extender on Left
- 2 – Waist Tethers
- 1 – 85-ft Safety Tether on Left

MWS

- Small trash bag [right inside]
 - Cannon Connector Tool {from 10A Bag}
 - 1 – RET (sm-sm)
- 2 – RET (sm-sm) [right, left]
- 1 – RET (with PIP pin) [left]
- 2 – Wire ties
- Socket caddy {from 10A Bag}
 - 7/16-6 in ext {from EV1's PGT on EVA 1}
- Swing Arm [right side]
 - PGT w/7/16-2 in ext S/N _____
(A5, CCW2, 30.5)
 - RET (sm-sm)
- BRT [left side]
 - 2 – Wire Tie, short
 - 2 – Wire Ties, long
 - 1 – RET (sm-sm)
- SAFER

CREWLOCK (Cont)

- OIH Carrier {STS B}/Fish stringer #2 {FS in Tether Stage}
 - Cheater Bar {from 10A Bag}
 - HR 0346 (24")
 - HR 0353 (12")
 - HR 0360 (24")
 - HR 0358 (24")
 - WIF – 09

Prior to EVA, inspect:
RET cord for damage
Small trash bag bristles for damage or deformation
Safety & waist tether load alleviating straps: no red

Total RETs sm-sm used – 15
RETs with PIP pin – 5
RETs Lg-sm – 7
Adj tethers – 9 (+4 outside on PDGF, 2
on trash bag)

CREWLOCK (Cont)

- Staging Bag {no additions for this EVA}
- IV Bag
- Lg-sm RET on A/L D-ring ext
 - Small ORU Bag {from 10A Bag}
 - RPCM (verify protective caps removed) {STS B}
 - RET (sm-sm) (gate pointed away from RPCM)
 - MMOD T-Tool {from C/L #4}
 - RET (sm-sm)
- 1 – RET (Lg-sm)
 - BOJ 1 - OIH Carrier/Fish stringer #1 – adj tether
 - 2 – long wire ties from carrier to crewlock bag
 - Crewlock bag #1 (Node 2) – adj tether outside
 - 2 – Trunnion covers (aft/stbd, fwd/stbd) (on int) {STS B}
 - Loop-back connector for J408 (on int) {10A Bag}
 - Adj tether (on int) – Tani method
 - WIF 07 {STS B}
 - WIF 13 {STS B}
 - MMOD T-Tool on RET {from C/L #4}
- 1 – RET (Lg-sm)
 - BOJ 2 – OIH Carrier/Fish stringer #2 – adj tether
 - Fish stringer (for used tools; outside of OIH carrier)
 - 2 – long wire ties from carrier to crewlock bag
 - Crewlock bag #2 (RTAS) – adj tether outside
 - Adj tether (on int) – Tani method
 - Ratchet w/5/8-7.8 in ext {10A Bag}
 - RAD w/5/8-7.8 in ext {10A Bag} S/N _____
 - Keel cover (on int) {STS B}
 - 2 – Trunnion covers (aft/port, fwd/port) (on int) {STS B}
 - EVA Camera/Bracket {from Med ORU Bag}
 - 1 – Cap Size 25 (Node 2 J701) (on RET) {brought in on EVA 1}

PRE EVA 2 TOOL CONFIG (Cont)

CREWLOCK (Cont)

- 1 – RET (Lg-sm)
 - Crewlock Bag #3
 - Round Scoop (for CETA Light)
 - Wire Tie Caddy
 - S0 Gap Spanners (1 – 45", 1 – 72")
 - EVA Camera/Bracket
- 1 – RET (Lg-sm)
 - Med ORU Bag (for CETA Light)
 - 1 – RET (with PIP pin)
- 1 – RET (Lg-sm)
 - 6B Box Cover (BSP)
 - 1 – Adj tether
 - 1 – RET (sm-sm)
 - Dummy box
- 1 – RET (Lg-sm)
 - Crewlock bag #4 (MMOD Shield)
 - 3 – LDTDT
 - Wire Tie Caddy (on int)
 - GP Caddy (on int)
 - Vise Grips
 - Loop Pin Puller
 - Hammer (on RET w/PIP)
 - EVA Ratchet with IV socket (on RET w/PIP)
(MMOD T-Tools being used on this EVA)

Items remain in crewlock

EVA 2 A/L EGRESS AND SETUP (00:15)

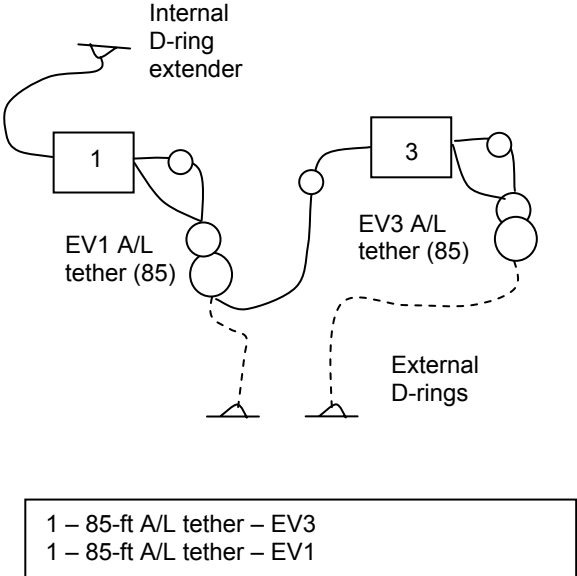
IV	EV1 – Pz (FF)	EV3 – Tani (FF)
<p>SSRMS: P6 Grapple</p>  <p>1 – 85-ft A/L tether – EV3 1 – 85-ft A/L tether – EV1</p> <p>1. Post crew egress: WVS Software: Select page – RF Camera sel 'Advanced controls' S-Band level (two) – max</p>	<p><u>INITIAL CONFIG</u></p> <p>1. Verify:</p> <ul style="list-style-type: none"> <input type="checkbox"/> Right waist tether connected to A/L D-ring extender <input type="checkbox"/> Hook locked <p><u>EGRESS/INITIAL SETUP</u></p> <hr/> <p>1. On EV3 GO, release EV1 right waist tether, attach to self</p> <p>2. Transfer BOJ 2 (Dan's) to EV3</p> <hr/> <p>3. Attach BOJ 1 (Scott's) to BRT RET</p> <p>4. Egress crewlock</p> <p>5. Stow BOJ 1 on BRT</p> <p>6. Close hatch thermal cover</p> <p>7. Verify SAFER config</p> <ul style="list-style-type: none"> <input type="checkbox"/> √L Handle down (MAN ISO Vlv – Open) <input type="checkbox"/> √R Handle down (HCM – Closed) <p>8. Translate to Node 2 HR 0331 (zenith) via forward translation path</p> <p>9. Temp stow BOJ 1 on Node 2 HR 0331</p> <p>10. Translate to Z1/P6 connector worksite</p> <p>11. Perform glove inspection</p>	<p><u>INITIAL CONFIG</u></p> <p>1. Verify:</p> <ul style="list-style-type: none"> <input type="checkbox"/> Right waist tether connected to EV1's 85-ft safety tether <input type="checkbox"/> Hook locked <p><u>EGRESS/INITIAL SETUP</u></p> <p>1. Open hatch thermal cover</p> <p>2. Egress crewlock</p> <p>3. Attach EV3 safety tether to aft A/L D-ring</p> <ul style="list-style-type: none"> <input type="checkbox"/> √Gate closed <input type="checkbox"/> √Hook locked <input type="checkbox"/> √Reel unlocked <p>4. Attach EV1 safety tether to fwd A/L D-ring</p> <ul style="list-style-type: none"> <input type="checkbox"/> √Gate closed <input type="checkbox"/> √Hook locked <input type="checkbox"/> √Reel unlocked <hr/> <p>5. Give EV1 GO to release EV1 waist tether from A/L D-ring extender</p> <hr/> <p>6. Receive BOJ 2 from EV1</p> <p>7. Stow BOJ 2 on BRT</p> <hr/> <p>8. Verify SAFER config</p> <ul style="list-style-type: none"> <input type="checkbox"/> √L Handle down (MAN ISO Vlv – Open) <input type="checkbox"/> √R Handle down (HCM – Closed) <p>9. Translate to Z1/P6 connector worksite via aft translation path; fairlead safety tether high</p> <p>10. Perform glove inspection</p>

Z1-TO-P6 UMBILICAL DISCONNECT (00:40)

IV	EV1 – Pz (FF)	EV3 – Tani (FF)																											
<p>{P6 DETACH INHIBITS (Egress) See Task Data Sheet}</p> <p><input type="checkbox"/> √With MCC all inhibits in place</p>	<div style="border: 1px solid black; padding: 5px; text-align: center;"> CAUTION Avoid inadvertent contact with S0 radiator </div> <p style="text-align: center;">NOTE For each connector: √Connectors for straight pins, no FOD, EMI band intact, and good bend radius</p> <p>1. Open TA clamps as required</p> <p><u>P254 1553 BUS B DATA DISCONNECT</u></p>	<p>1. Stow BOJ 2 on Z1 HR 6041 and 6040 (zenith/fwd/stbd keel)</p> <p><u>P254 1553 BUS B DATA DISCONNECT</u></p>																											
<p>1. Give EV GO for P254 demate</p>	<p>2. On IV GO, perform following demate, swap with dust cap from Z1:</p> <table border="1" style="margin-left: auto; margin-right: auto;"> <thead> <tr> <th style="text-align: left;">EV1 – Mate Connector to Z1</th> <th style="text-align: left;">EV3-Mate Cap P6</th> </tr> </thead> <tbody> <tr> <td>Z1 P254 → ← Z1 J154</td> <td>Cap to P6 J154</td> </tr> </tbody> </table>	EV1 – Mate Connector to Z1	EV3-Mate Cap P6	Z1 P254 → ← Z1 J154	Cap to P6 J154	<p style="text-align: center;">NOTE Soft dock – align connector shell tip white to receptacle backplate white. Mate – align connector shell tip white to receptacle backplate black</p>																							
EV1 – Mate Connector to Z1	EV3-Mate Cap P6																												
Z1 P254 → ← Z1 J154	Cap to P6 J154																												
<p><input type="checkbox"/> Notify MCC-H P254 mated to Z1 (GO to reconfig P6/Z1 1553 buses to Ch B)</p>	<p><u>POWER AND INST UMBILICAL DISCONNECTS</u></p> <p>3. Repeat steps 4-7 for the following 7 connectors:</p> <p>4. Receive EV3 connector tool</p> <p>5. Remove cap with connector tool, transfer to EV3</p> <p>6. Receive connector from EV3</p> <p>7. Install connector on Z1</p> <table border="1" style="margin-left: auto; margin-right: auto;"> <thead> <tr> <th style="text-align: left;">Swap Cap and Connector</th> <th style="text-align: left;">EV1 – Mate Connector to Z1</th> <th style="text-align: left;">EV3 – Mate Cap on P6</th> <th style="text-align: left;">Location</th> </tr> </thead> <tbody> <tr> <td>P255</td> <td>Z1 P255 → ← Z1 J155</td> <td>P6 cap → ← P6 J155</td> <td rowspan="3">Port</td> </tr> <tr> <td>P256</td> <td>Z1 P256 → ← Z1 J156</td> <td>P6 cap → ← P6 J156</td> </tr> <tr> <td>P257</td> <td>Z1 P257 → ← Z1 J157</td> <td>P6 cap → ← P6 J157</td> </tr> <tr> <td>P258</td> <td>Z1 P258 → ← Z1 J158</td> <td>P6 cap → ← P6 J158</td> <td rowspan="4">Stbd</td> </tr> <tr> <td>P259</td> <td>Z1 P259 → ← Z1 J159</td> <td>P6 cap → ← P6 J159</td> </tr> <tr> <td>P260</td> <td>Z1 P260 → ← Z1 J160</td> <td>P6 cap → ← P6 J160</td> </tr> <tr> <td>P261</td> <td>Z1 P261 → ← Z1 J161</td> <td>P6 cap → ← P6 J161</td> </tr> </tbody> </table>	Swap Cap and Connector	EV1 – Mate Connector to Z1	EV3 – Mate Cap on P6	Location	P255	Z1 P255 → ← Z1 J155	P6 cap → ← P6 J155	Port	P256	Z1 P256 → ← Z1 J156	P6 cap → ← P6 J156	P257	Z1 P257 → ← Z1 J157	P6 cap → ← P6 J157	P258	Z1 P258 → ← Z1 J158	P6 cap → ← P6 J158	Stbd	P259	Z1 P259 → ← Z1 J159	P6 cap → ← P6 J159	P260	Z1 P260 → ← Z1 J160	P6 cap → ← P6 J160	P261	Z1 P261 → ← Z1 J161	P6 cap → ← P6 J161	<p><u>POWER AND INST UMBILICAL DISCONNECTS</u></p> <p>2. Repeat steps 3-6 for the following 7 connectors:</p> <p>3. Transfer connector tool to EV1</p> <p>4. Receive connector tool and cap</p> <p>5. Remove connector on P6, transfer to EV1</p> <p>6. Install cap on P6</p>
Swap Cap and Connector	EV1 – Mate Connector to Z1	EV3 – Mate Cap on P6	Location																										
P255	Z1 P255 → ← Z1 J155	P6 cap → ← P6 J155	Port																										
P256	Z1 P256 → ← Z1 J156	P6 cap → ← P6 J156																											
P257	Z1 P257 → ← Z1 J157	P6 cap → ← P6 J157																											
P258	Z1 P258 → ← Z1 J158	P6 cap → ← P6 J158	Stbd																										
P259	Z1 P259 → ← Z1 J159	P6 cap → ← P6 J159																											
P260	Z1 P260 → ← Z1 J160	P6 cap → ← P6 J160																											
P261	Z1 P261 → ← Z1 J161	P6 cap → ← P6 J161																											

Z1-TO-P6 UMBILICAL DISCONNECT (00:40) (Cont)

IV	EV1 – Pz (FF)	EV3 – Tani (FF)				
<input type="checkbox"/> √With MCC: GO for P253 demate	<u>P253 1553 BUS A DATA DISCONNECT</u>	<u>P253 1553 BUS A DATA DISCONNECT</u>				
2. Give EV GO for P253 demate	8. If reqd, remain at worksite to assist EV3 with cable clean-up 9. Translate to Z1 CLA	7. On IV GO, perform following demate, swap with dust cap from Z1: <table border="1" data-bbox="1220 516 1892 586" style="margin-left: auto; margin-right: auto;"> <thead> <tr> <th data-bbox="1220 516 1619 548">EV1 – Mate Connector to Z1</th> <th data-bbox="1619 516 1892 548">EV3-Mate Cap P6</th> </tr> </thead> <tbody> <tr> <td data-bbox="1220 548 1619 586">Z1 P253 → ← Z1 J153</td> <td data-bbox="1619 548 1892 586">Cap to P6 J153</td> </tr> </tbody> </table> 8. Close remaining TA clamps (port and stbd side) 9. Translate to BOJ 2 on Z1	EV1 – Mate Connector to Z1	EV3-Mate Cap P6	Z1 P253 → ← Z1 J153	Cap to P6 J153
EV1 – Mate Connector to Z1	EV3-Mate Cap P6					
Z1 P253 → ← Z1 J153	Cap to P6 J153					

Z1-TO-P6 UMBILICAL DISCONNECT – TASK DATA

Tools:

EV1 (FF)	EV3 (FF)
Cannon Connector tool	Cannon Connector tool

EVA Fasteners: None

EVA Connectors:

Harness	From (P6)	To (Z1)	Size	Function	Inhibit
W204A-P253	J153 – sockets	J153	37	1553 Bus A (Bata)	None
W704A-P254	J154 – sockets	J154	37	1553 Bus B (Data)	None
W120C-P255	J155 – pins	J155	37	Operational power to S-Band XPDR and SASA from SPDA Z1-3B	RPCM Z13B B RPC 2 – Open, CL CMD Inh RPCM Z13B B RPC 3 – Open, CL CMD Inh
W140C-P256	J156 – pins	J156	37	Heater power to S-Band XPDR and S-Band SASA from SPDA Z1-4B	RPCM Z14B B RPC 2 – Open, CL CMD Inh RPCM Z14B B RPC 3 – Open, CL CMD Inh
W42-P257	J157 – sockets	J157	37	Power to/from RPCM 2B B RPC 1	RPCM 2B B RPC 1 – Open, CL CMD Inh
W46-P258	J158 – sockets	J158	37	Power to/from RPCM 4B B RPC 1	RPCM 4B B RPC 1 – Open, CL CMD Inh
W01A-P259	J159 – sockets	J159	37	Power to/from Channel 2B	DCSU 2B RBI 6 MBSU 2 RBI 8
W08A-P260	J160 – sockets	J160	37	Power to/from Channel 4B	DCSU 4B RBI 6 MBSU 4 RBI 8
W11A-P261	J161 – sockets	J161	19	Provide data to and from S-Band ACBSP (Z1) and S-Band XPDR-2 (P6) (Data/Instrumentation)	None

Foot Restraints: None

Cautions:

1. Data strings must be reconfigured between bus A and B connector demates

Warnings: None

Z1-TO-P6 UMBILICALS DISCONNECT – TASK DATA (Cont)

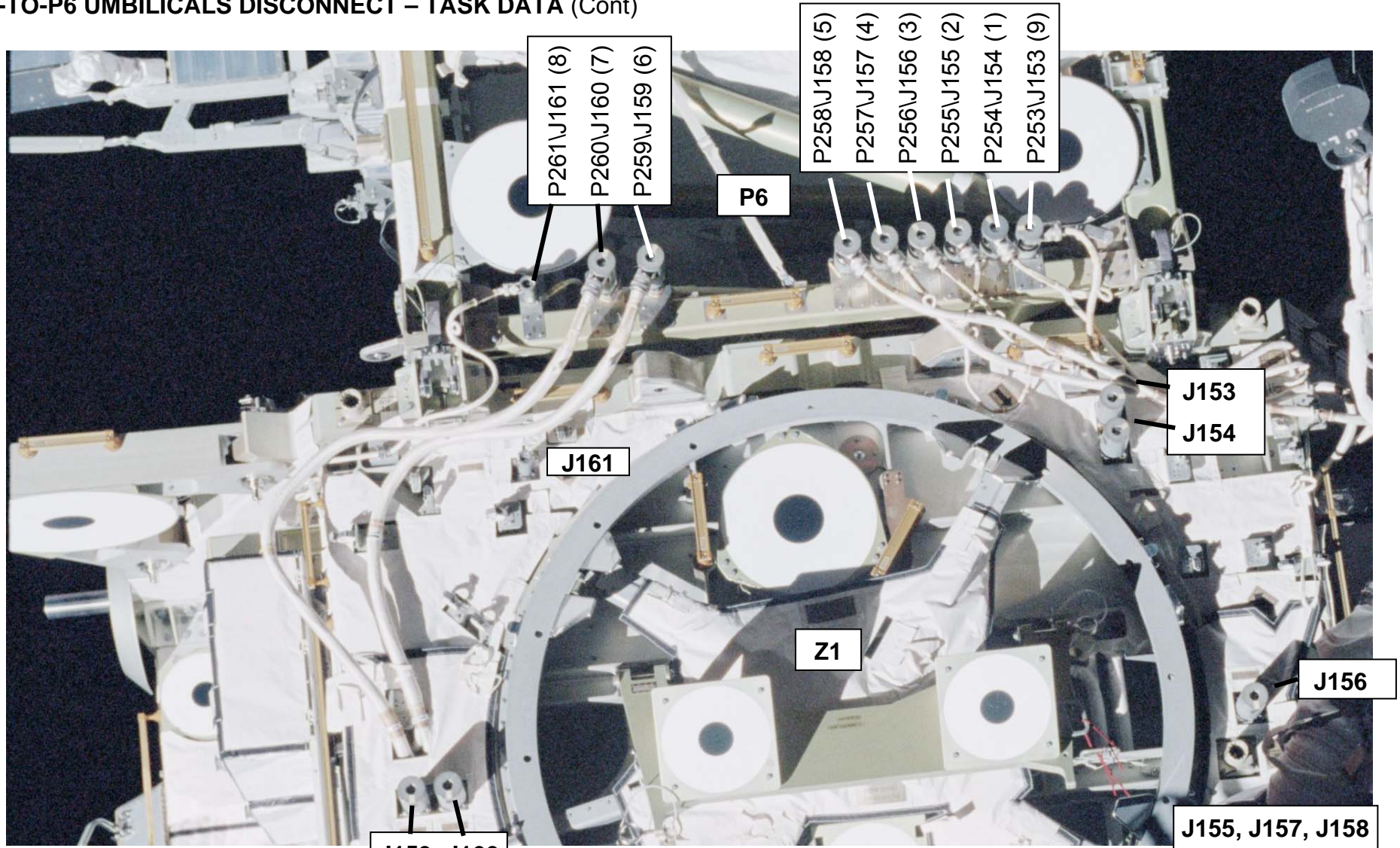

View Looking Aft

Z1-TO-P6 UMBILICALS – MATED

Z1-TO-P6 UMBILICALS DISCONNECT – TASK DATA (Cont)

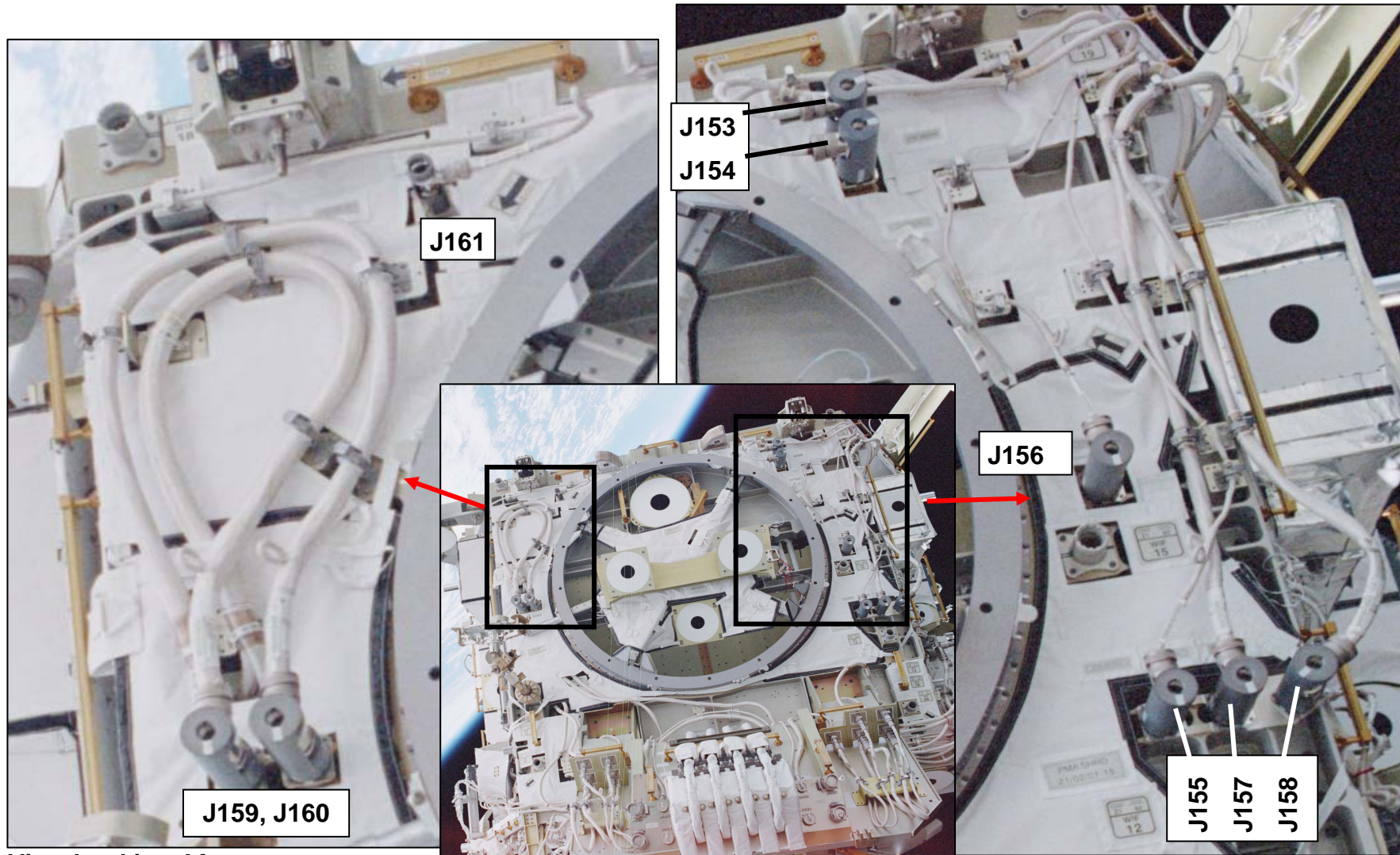

View Looking Aft

Z1-TO-P6 UMBILICALS – STOWED

DETACH P6 FROM Z1 (01:30)

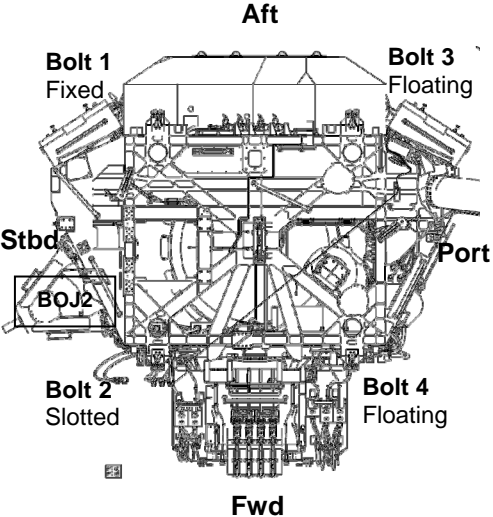
IV/SSRMS	EV1 – Pz (FF)	EV3 – Tani (FF)																																															
<p>SSRMS: P6 Grapple</p> <table border="1" data-bbox="107 451 585 667"> <thead> <tr> <th>Hardware</th> <th>Z1 location</th> </tr> </thead> <tbody> <tr> <td>RTAS bolt 1 – fixed</td> <td>Aft, Stbd</td> </tr> <tr> <td>RTAS bolt 2 – slotted</td> <td>Fwd, Stbd</td> </tr> <tr> <td>RTAS bolt 3 – floating</td> <td>Aft, Port</td> </tr> <tr> <td>RTAS bolt 4 – floating</td> <td>Fwd, Port</td> </tr> <tr> <td>Capture claw drive</td> <td>Fwd side</td> </tr> </tbody> </table>  <p>Z1 – Zenith side looking nadir Bolts on Z1 side</p>	Hardware	Z1 location	RTAS bolt 1 – fixed	Aft, Stbd	RTAS bolt 2 – slotted	Fwd, Stbd	RTAS bolt 3 – floating	Aft, Port	RTAS bolt 4 – floating	Fwd, Port	Capture claw drive	Fwd side	<div data-bbox="1083 331 1566 386" style="border: 1px solid black; padding: 2px;"> <p>CAUTION Avoid inadvertent contact with S0 radiator</p> </div> <p><u>ENGAGE Z1 CAPTURE LATCH</u></p> <ol style="list-style-type: none"> BRT to Z1 HR 6033 Drive Z1 capture latch PGT, 7/16-6in ext: A6, CW3; 100 turns PGT, 7/16-6in ext: A6, CW2; ~26 turns to HS Turns : _____ <p><u>BREAK TORQUE ON BOLTS 2, 4, 3 & 1</u></p> <ol style="list-style-type: none"> Retrieve ratchet wrench from C/L bag and cheater bar from fish stringer in BOJ Break torque on RTAS Bolt 2 Ratchet w/cheater bar, 5/8-7.8 in ext; ccw; 1/2 turn only Repeat step 4 for corners 4, 3, and 1 Fairlead safety tether nadir of EV3's safety tether <table border="1" data-bbox="642 987 1236 1133"> <thead> <tr> <th>Bolt Order</th> <th>BRT HR</th> <th>Torque Broken</th> </tr> </thead> <tbody> <tr> <td>Bolt 2 – Fwd, Stbd</td> <td>6039</td> <td></td> </tr> <tr> <td>Bolt 4 – Fwd, Port</td> <td>6034</td> <td></td> </tr> <tr> <td>Bolt 3 – Aft, Port</td> <td>6035</td> <td></td> </tr> <tr> <td>Bolt 1 – Aft, Stbd</td> <td>6038</td> <td></td> </tr> </tbody> </table> <ol style="list-style-type: none"> Unwind safety tether Stow cheater bar, ratchet (separate from cheater bar), and cannon connector tool on spare FS Perform PGT socket swap: remove 7/16-6 in ext, stow on socket caddy, install 5/8-7.8 in ext on PGT <div data-bbox="867 1312 1757 1401" style="border: 1px solid black; padding: 2px;"> <p>CAUTION Primary bolt hardware sensitive to crew loads. Do not apply a push/pull force on the RTAS primary bolt. Damage to self feeding nut may occur</p> </div>	Bolt Order	BRT HR	Torque Broken	Bolt 2 – Fwd, Stbd	6039		Bolt 4 – Fwd, Port	6034		Bolt 3 – Aft, Port	6035		Bolt 1 – Aft, Stbd	6038		<div data-bbox="1310 529 1980 623" style="border: 1px solid black; padding: 2px;"> <p>WARNING Exposed braided wire on ground straps and protruding spring on ground strap bolt may present sharp edge hazard</p> </div> <ol style="list-style-type: none"> Remove spare fish stringer from BOJ 2, temp stow on HR 6041 Stow cannon connector tool on spare fish stringer <p><u>RELEASE GROUND STRAPS ON CORNERS 1, 2, 4 & 3</u></p> <ol style="list-style-type: none"> Release Corner 1 Ground Strap from Z1 PGT, 7/16-2 in ext: A5, CCW2; ~6 turns Install Ground Strap on P6 By hand: cw; ~3 turns Fairlead safety tether just nadir of RTAS bolts Repeat steps 3 and 4 for corners 2 and 4 Translate to BOJ, retrieve RAD with 5/8-7.8 in ext from C/L bag Translate cw to corner 3, repeat steps 3 and 4 for corner 3 <p><u>NOTE:</u> If reqd at corner 3, pitch APFR to (6, FF, F, 12)</p> <table border="1" data-bbox="1272 1047 1959 1190"> <thead> <tr> <th>Ground Strap Order</th> <th>BRT HR</th> <th>Remove</th> <th>Stow</th> </tr> </thead> <tbody> <tr> <td>Corner 1 – Aft, Stbd</td> <td>6038</td> <td></td> <td></td> </tr> <tr> <td>Corner 2 – Fwd, Stbd</td> <td>6039</td> <td></td> <td></td> </tr> <tr> <td>Corner 4 – Fwd, Port</td> <td>6044</td> <td></td> <td></td> </tr> <tr> <td>Corner 3 – Aft, Port</td> <td>6035</td> <td></td> <td></td> </tr> </tbody> </table> <p><u>NOTE:</u> If pitched, reconfigure APFR back to (6, PP, F, 12)</p> <ol style="list-style-type: none"> Perform PGT socket swap: remove 7/16-2 in ext, stow on socket caddy, install RAD w/5/8-7.8 in ext on PGT <div data-bbox="1262 1312 1757 1401" style="border: 1px solid black; padding: 2px;"> <p>CAUTION Primary bolt hardware sensitive to crew loads. Do not apply a push/pull force on the RTAS primary bolt. Damage to self feeding nut may occur</p> </div>	Ground Strap Order	BRT HR	Remove	Stow	Corner 1 – Aft, Stbd	6038			Corner 2 – Fwd, Stbd	6039			Corner 4 – Fwd, Port	6044			Corner 3 – Aft, Port	6035		
Hardware	Z1 location																																																
RTAS bolt 1 – fixed	Aft, Stbd																																																
RTAS bolt 2 – slotted	Fwd, Stbd																																																
RTAS bolt 3 – floating	Aft, Port																																																
RTAS bolt 4 – floating	Fwd, Port																																																
Capture claw drive	Fwd side																																																
Bolt Order	BRT HR	Torque Broken																																															
Bolt 2 – Fwd, Stbd	6039																																																
Bolt 4 – Fwd, Port	6034																																																
Bolt 3 – Aft, Port	6035																																																
Bolt 1 – Aft, Stbd	6038																																																
Ground Strap Order	BRT HR	Remove	Stow																																														
Corner 1 – Aft, Stbd	6038																																																
Corner 2 – Fwd, Stbd	6039																																																
Corner 4 – Fwd, Port	6044																																																
Corner 3 – Aft, Port	6035																																																

DETACH P6 FROM Z1 (01:30) (Cont)

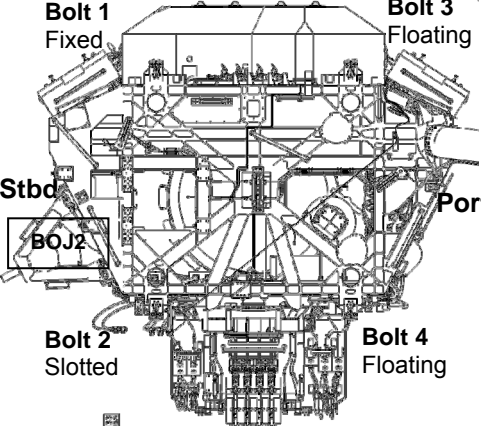
IV/SSRMS	EV1 – Pz (FF)	EV3 – Tani (FF)
<p style="text-align: center;">Aft</p>  <p style="text-align: center;">Fwd</p> <p style="text-align: center;">Z1 – Zenith side looking nadir Bolts on Z1 side</p> <ol style="list-style-type: none"> Notify M1 approaching P6 demate Prior to GO for P6 demate, verify <ul style="list-style-type: none"> <input type="checkbox"/> Tools and tethers clear <input type="checkbox"/> EV1 and EV3 in position for monitoring separation Once verification complete, give M1/M2 GO for P6 demate SSRMS: Demate P6 from Z1 	<p style="text-align: center;">NOTE</p> <p>Bolt 1 must be released last, preceded by bolt 2. The order of bolts 3 and 4 is not critical</p> <p><u>RELEASE FWD/PORT RTAS BOLT 4</u></p> <ol style="list-style-type: none"> BRT to HR 6034 Release RTAS Bolt 4 PGT, 5/8-7.8 in ext: B7,CCW2; 27 turns √2-7 threads visible by bolt shoulder <p><u>RELEASE FWD/STBD RTAS BOLT 2</u></p> <ol style="list-style-type: none"> BRT to HR 6039 	<p><u>RELEASE AFT/PORT RTAS BOLT 3</u></p> <ol style="list-style-type: none"> BRT to HR 6035 Release RTAS Bolt 3 PGT, RAD, 5/8-7.8 in ext: A7,CCW2; 27 turns at bolt √2-7 threads visible by bolt shoulder
	<ol style="list-style-type: none"> On EV3 GO, release RTAS Bolt 2 PGT, 5/8-7.8 in ext: B7,CCW2; 27 turns √2-7 threads visible by bolt shoulder Once Bolt 2 released, 	<ol style="list-style-type: none"> Once Bolt 3 released, give EV1 GO to release RTAS Bolt 2 <p><u>RELEASE AFT/STBD RTAS BOLT 1</u></p> <ol style="list-style-type: none"> BRT to HR 6038
	<ol style="list-style-type: none"> give EV3 GO to release RTAS Bolt 1 Perform PGT socket swap:, remove 5/8-7.8 in ext, stow on socket caddy, install 7/16-6 in ext on PGT 	<ol style="list-style-type: none"> On EV1 GO, Release RTAS Bolt 1 PGT, RAD, 5/8-7.8 in ext: A7,CCW2; 27 turns at bolt √2-7 threads visible by bolt shoulder
	<p><u>RELEASE Z1 CAPTURE LATCH</u></p> <ol style="list-style-type: none"> Verify separation plane clear BRT to Z1 HR 6033 On EV3 GO, release Z1 capture latch PGT, 7/16-6 in ext: A6, CCW3; 125 turns only Turns: _____ Translate to corner 2 to monitor P6 separation 	<ol style="list-style-type: none"> Verify separation plane clear Give EV1 GO for capture claw release Translate to BOJ 2 Remove RAD w/5/8-7.8 in ext from PGT, stow on spare FS Retrieve BOJ 2; stow on BRT Translate to corner 3 to monitor P6 separation
	<ol style="list-style-type: none"> Monitor separation until pins out of cups and capture bar clear of CLA Translate to Node 2 	<ol style="list-style-type: none"> Monitor separation until pins out of cups and capture bar clear of CLA Translate to Node 2

DETACH P6 FROM Z1 – TASK DATA

Tools:

EV1 (FF)	EV3 (FF)
Cheater bar	PGT
Ratchet	5/8-7.8 in ext
PGT	RAD
5/8-7.8 in ext	7/16-6 in ext
7/16-6 in ext	

EVA Fasteners:

Fastener Name	Label	Head Size	Install Torque (ft-lb)	Release Torque (ft-lb)	Failure Torque (ft-lb)	Turns	RPM
RTAS bolt	1,2,3,4	5/8"	57	77.7	146.0 (sleeve PIP pin failure)	24 min-36 max	30
Grounding Strap		7/16"	8.3	3.2	31.1	5-9	30
Z1 capture latch		7/16"	3.3 to close	7.5 to open	14.6	126 – close 125 only – open	30 – close 60 – open

EVA Connectors: None

Foot Restraints (Back-up):

Task	WIF	APFR Setting
Bolt 1	Z1-21	4, PP, H, 12
Bolt 2	Z1-11	2, OO, D, 1
Bolt 3	Z1-22	10, PP, H, 12
Bolt 4	Z1-12	9, PP, F, 12

Cautions:

1. Avoid inadvertent contact with S0 radiator
2. Primary bolt hardware sensitive to crew loads. Do not apply push force on bolt or damage to self feeding nut could occur

Warnings:

1. Exposed braided wire on ground straps and protruding spring on ground strap bolt may present sharp edge hazard

Notes:

1. Gap Check Tools (2) are located on Z1 corners 1 and 4.
2. P6 is safe for EVA translation with up to all bolts released and only CLA closed except during bolting operations
3. In order to utilize PGT speed of CCW3 (60 rpm) for CLA release, can only drive 125 turns, and not the full 127 turns to avoid damaging the mechanism (due to PGT torque over-shoots at low torques and high speeds)

DETACH P6 FROM Z1 – TASK DATA (Cont)

Ground strap stowage spot

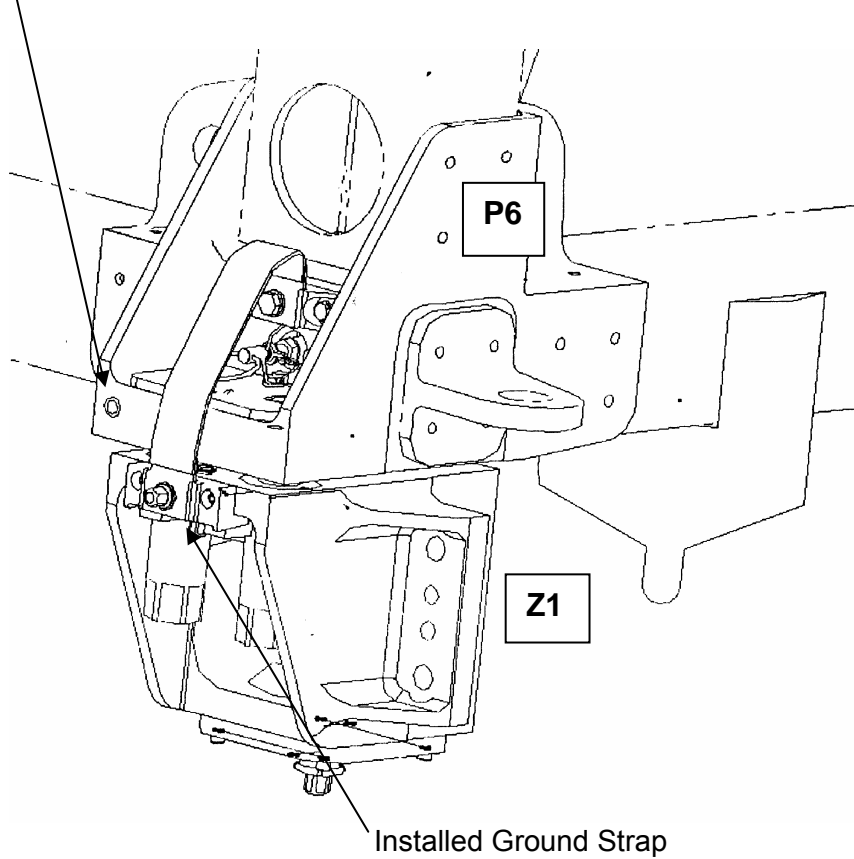

Ground Strap Installation spot

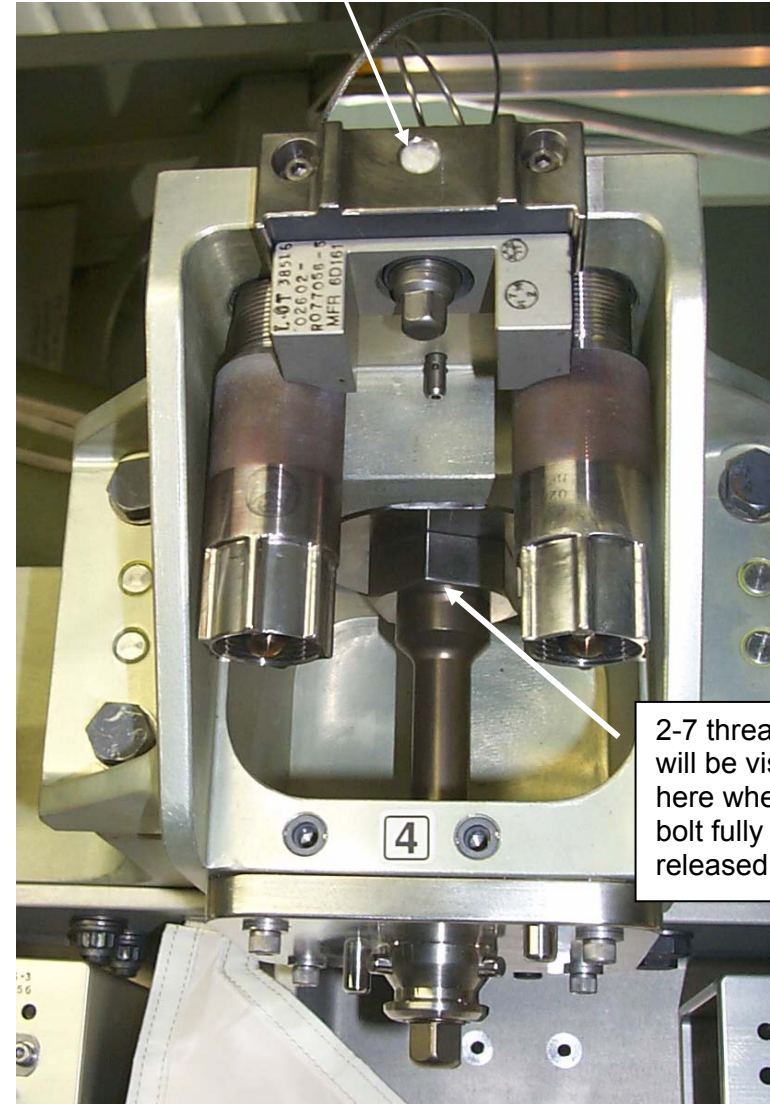

Z1 RTAS Primary Bolt (5/8 in)

DETACH P6 FROM Z1 – TASK DATA (Cont)

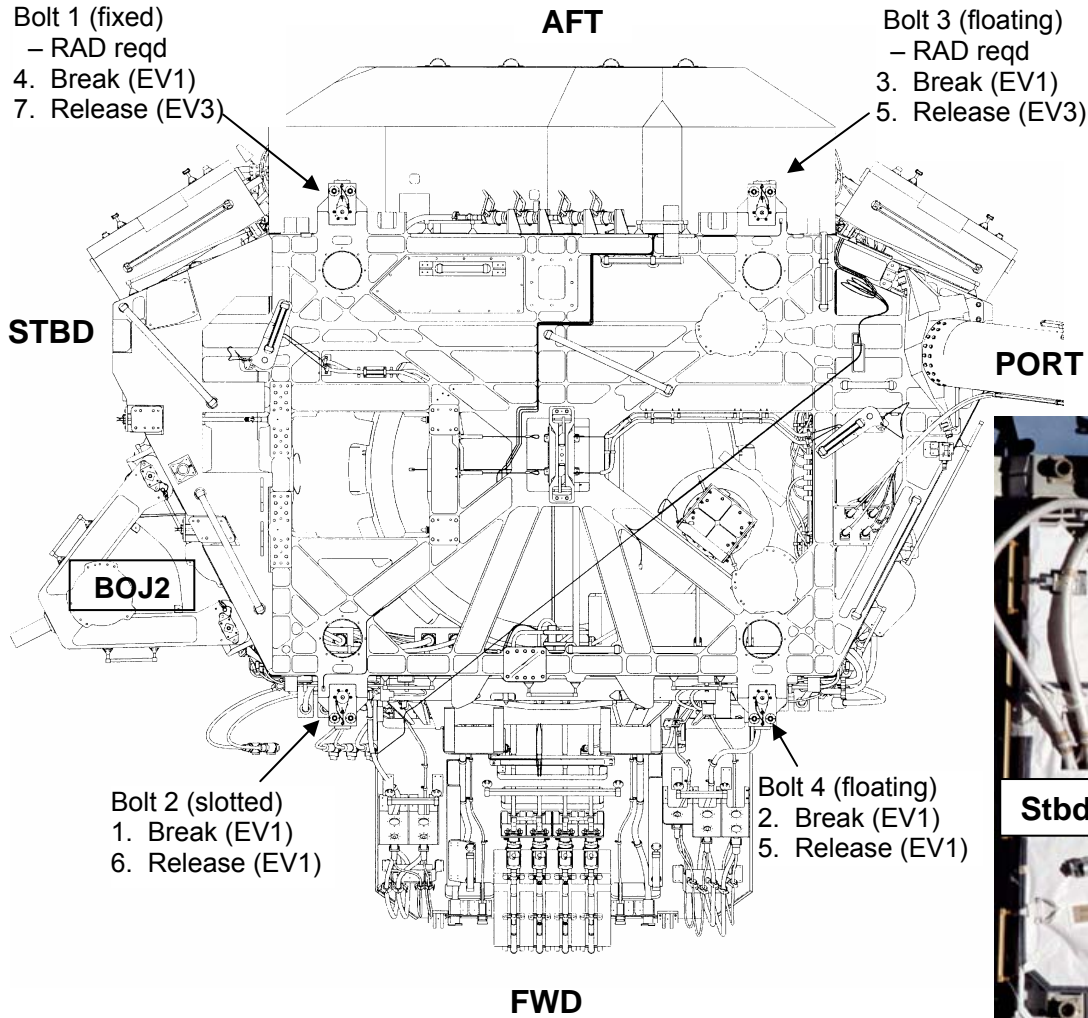

Z1 Zenith View Looking Nadir

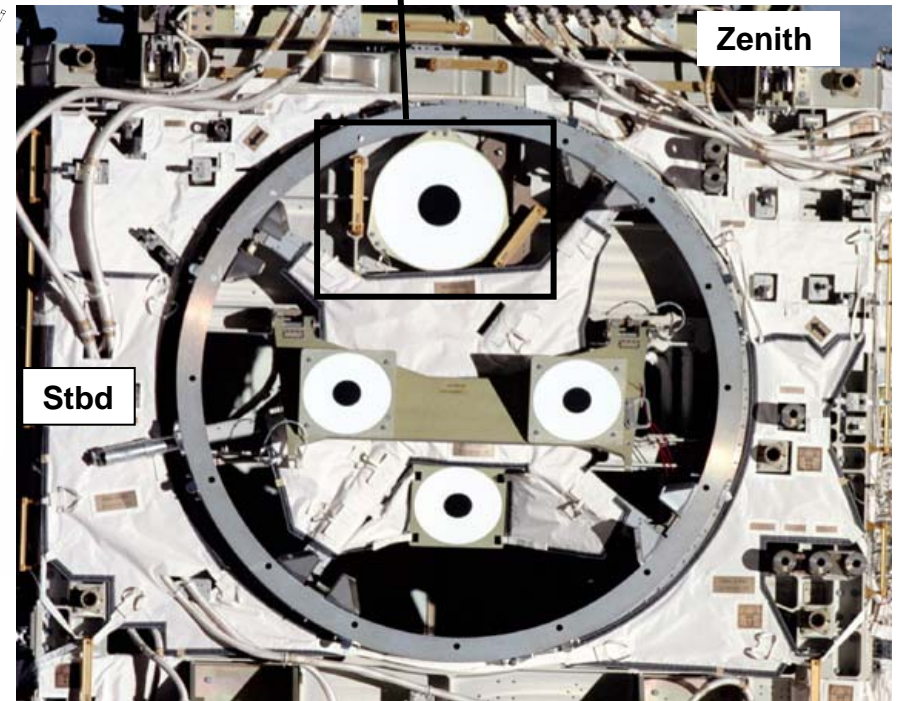
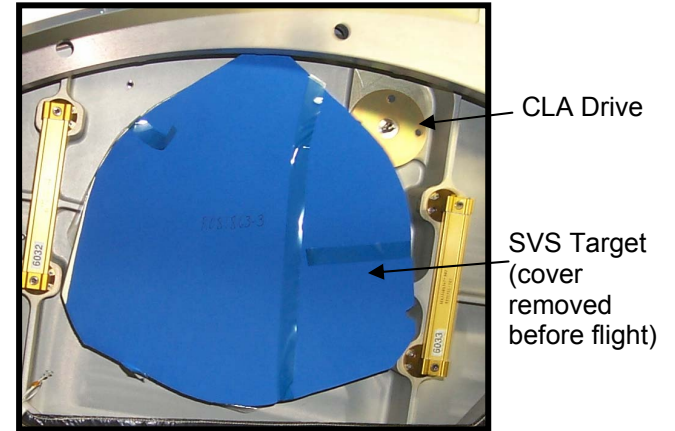

Z1 FWD View Looking Aft

NODE 2 OUTFITTING (02:50)

IV					EV1 – Pz (FF)		EV3 – Tani (FF)	
{J408/PDGF INSTALL INHIBITS None J612 CAP REMOVAL INHIBITS RPCM N21A4A B RPC 1 – Open, Close Cmd Inh RPC 2 – Open, Close Cmd Inh RPC 3 – Open, Close Cmd Inh RPC 4 – Open, Close Cmd Inh RPC 5 – Open, Close Cmd Inh RPC 12 – Open, Close Cmd Inh RPC 13 – Open, Close Cmd Inh RPC 14 – Open, Close Cmd Inh RPC 15 – Open, Close Cmd Inh RPC 16 – Open, Close Cmd Inh}					1. Translate to BOJ 1, Node 2 HR 0331 2. Perform glove inspection 3. Install:		Perform S1 SFU CONFIG FOR CINCH FIRING (00:50) Perform MBSU BYPASS JUMPER RECONFIG (00:10) Perform RPCM S04B-C R&R (00:30) Perform PDGF INSTALL ON NODE 2 (01:15)	
					<input type="checkbox"/>	<input type="checkbox"/>	HR 0371 inbrd end cone near WIF 07	
					<input type="checkbox"/>	<input type="checkbox"/>	HR 0372 inbrd end cone near M1, M2	
					<input type="checkbox"/>	<input type="checkbox"/>	WIF – 07 zenith/inbrd (tether pnt outbrd)	
					<input type="checkbox"/>	<input type="checkbox"/>	HR 0332 zenith/inbrd near M2 (w/gap span)	
					<input type="checkbox"/>	<input type="checkbox"/>	WIF – 13 zenith/inbrd near HR 0332 (tether pnt outbrd)	
					<input type="checkbox"/>	<input type="checkbox"/>	“I/F” Inboard/fwd trunnion cover (aft/stbd)	
					NOTE: Pin farther from trunnion too long			
					<input type="checkbox"/>	Install gap spanner 1 between HR 0342 and 0347 (inboard standoffs)		
					<input type="checkbox"/>	<input type="checkbox"/>	HR 0361 outbrd, near port/nadir trunnion	
					<input type="checkbox"/>	Loop back connector on J408 (outbrd/fwd)		
					<input type="checkbox"/> Remove MLI strap, <input type="checkbox"/> stow in trash bag,			
					<input type="checkbox"/> Remove MLI, <input type="checkbox"/> remove protective cap,			
					<input type="checkbox"/> Stow in trash bag, <input type="checkbox"/> install connector,			
					<input type="checkbox"/> Reinstall MLI			
					<input type="checkbox"/>	<input type="checkbox"/>	“O/F” Outboard/fwd trunnion cover (fwd/stbd)	
					<input type="checkbox"/>	<input type="checkbox"/>	HR 0359 zenith/fwd	
					<input type="checkbox"/>	<input type="checkbox"/>	HR 0352 zenith/fwd	
					<input type="checkbox"/>	<input type="checkbox"/>	HR 0345 zenith/fwd	
					<input type="checkbox"/>	Install gap spanner 2 between HR 0332 & 0345		
					NOTE: EV1 will break off from NODE 2 OUTFITTING and proceed with PDGF INSTALL ON NODE 2 when EV3 at PDGF worksite			
					Handrail Install 1. ✓ Handrail soft dock armed (push both buttons) 2. Install and soft dock handrail (arrow on bottom, align HR# to structure #, push in to soft dock) 3. Tighten handrail bolts (two) PGT, 7/16-6 in ext: A2, CW2; ~8 turns 4. Report turns and torque			
					WIF Install 1. Slide WIF into dove-tail fitting 2. Verify tabs (2) secure (down)			
					Trunnion Cover Install 1. Engage fasteners (2) (MMOD T-tool as reqd) 2. Verify Velcro mate			
					Gap Spanner Install 1. Verify sufficient slack via 90° in plane buckle twist			
					Keel Cover Install 1. Verify good mate of hi-mag Velcro			

HR	Bolt 1 (left)		Bolt 2 (right)	
	Turns	Torque	Turns	Torque
0371				
0372				
0332				
0361				
0359				
0352				
0345				

NODE 2 OUTFITTING (02:50) (Cont)

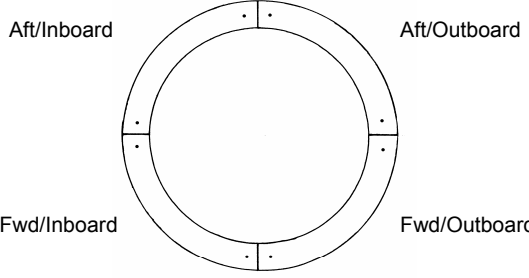
IV	EV1 – Pz (FF)	EV3 – Tani (FF)																													
<p><u>CBM Hatch PIP Release</u></p> <ol style="list-style-type: none"> Open hatch cover flap Remove pin, stow in trash bag Close hatch cover flap (except for Nadir CBM) <table border="1" data-bbox="109 467 718 716"> <thead> <tr> <th rowspan="2">HR</th> <th colspan="2">Bolt 1 (left)</th> <th colspan="2">Bolt 2 (right)</th> </tr> <tr> <th>Turns</th> <th>Torque</th> <th>Turns</th> <th>Torque</th> </tr> </thead> <tbody> <tr> <td>0360</td> <td></td> <td></td> <td></td> <td></td> </tr> <tr> <td>0353</td> <td></td> <td></td> <td></td> <td></td> </tr> <tr> <td>0346</td> <td></td> <td></td> <td></td> <td></td> </tr> <tr> <td>0358</td> <td></td> <td></td> <td></td> <td></td> </tr> </tbody> </table>  <p style="text-align: center;">ZENITH CBM RESTRAINTS</p> <p><input type="checkbox"/> √With MCC: GO for J612 cap removal</p>	HR	Bolt 1 (left)		Bolt 2 (right)		Turns	Torque	Turns	Torque	0360					0353					0346					0358					<p><input type="checkbox"/> Remove Zenith CBM PIP pin</p> <p>4. Remove Zenith CBM petal restraints:</p> <div style="border: 1px solid black; padding: 5px; margin: 10px 0;"> <p style="text-align: center;">CAUTION</p> <p>Be prepared for CBM petal movement when releasing launch restraint pins</p> <p>If using petal for translation both launch restraint must be engaged</p> </div> <p>CBM petal restraints:</p> <p>Aft/Inboard Aft/Outboard</p> <p><input type="checkbox"/> <input type="checkbox"/> <input type="checkbox"/> <input type="checkbox"/></p> <p>Fwd/Inboard Fwd/Outboard</p> <p><input type="checkbox"/> <input type="checkbox"/> <input type="checkbox"/> <input type="checkbox"/></p> <p><input type="checkbox"/> Remove Fwd CBM PIP pin</p> <p><input type="checkbox"/> Remove Nadir CBM PIP pin (leave cover open)</p> <p><input type="checkbox"/> Remove Aft CBM PIP pin</p> <p>5. Translate outboard to caps</p> <p>6. Tether to MLI and remove caps from the following outboard jacks; stow in trash bag, and reinstall the MLI cover:</p> <p>Outboard/Fwd:</p> <p><input type="checkbox"/> J614 (near HR 0359)</p> <p><input type="checkbox"/> J616 (near HR 0360)</p> <p>Outboard/Aft (near HR 0357):</p>	<ol style="list-style-type: none"> Translate to BOJ 2 at Node 2 HR 0325; staying under CETA light, fairlead tether along nadir row of circumference handrails Install: <ul style="list-style-type: none"> <input type="checkbox"/> <input type="checkbox"/> HR 0360 zenith/fwd, near HR 0359 <input type="checkbox"/> <input type="checkbox"/> HR 0353 zenith/fwd <input type="checkbox"/> <input type="checkbox"/> HR 0346 zenith/fwd <hr style="border-top: 1px dashed black;"/> <ul style="list-style-type: none"> <input type="checkbox"/> <input type="checkbox"/> HR 0358 zenith/aft, near outbrd/aft trunnion <input type="checkbox"/> <input type="checkbox"/> "O/A" Outboard/aft trunnion cover (fwd/port) <hr style="border-top: 1px dashed black;"/> <ul style="list-style-type: none"> <input type="checkbox"/> <input type="checkbox"/> "I/A" Inboard/aft trunnion cover (aft/port) <p>NOTE: Pin closer to trunnion too long</p> <ul style="list-style-type: none"> <input type="checkbox"/> Keel cover nadir/aft <input type="checkbox"/> <input type="checkbox"/> WIF – 09 near PDGF (tether point outbrd) Retrieve BOJ 2 Stow BOJ 2 on BRT Translate to aft/inboard caps Tether to MLI and remove caps from the following inboard jacks; stow in C/L bag and reinstall the MLI cover: Inboard/Aft (near HR 0300, listed nadir-most to zenith-most): <ul style="list-style-type: none"> <li style="margin-right: 10px;"><input type="checkbox"/> J102----- <li style="margin-right: 10px;"><input type="checkbox"/> J103----- <li style="margin-right: 10px;"><input type="checkbox"/> J104----- <li style="margin-right: 10px;"><input type="checkbox"/> J105 <li style="margin-right: 10px;"><input type="checkbox"/> J101----- <li style="margin-right: 10px;"><input type="checkbox"/> J663----- <li style="margin-right: 10px;"><input type="checkbox"/> J662----- <li style="margin-right: 10px;"><input type="checkbox"/> J661 <li style="margin-right: 10px;"><input type="checkbox"/> J660----- <li style="margin-right: 10px;"><input type="checkbox"/> J701----- <li style="margin-right: 10px;"><input type="checkbox"/> J664----- <li style="margin-right: 10px;"><input type="checkbox"/> J665 Retrieve single size 25 cap from BOJ2, install on Node 2 J701
HR		Bolt 1 (left)		Bolt 2 (right)																											
	Turns	Torque	Turns	Torque																											
0360																															
0353																															
0346																															
0358																															
<ol style="list-style-type: none"> Give EV GO for J612 cap removal <p><u>Handrail Install</u></p> <ol style="list-style-type: none"> Tighten handrail bolts (two) PGT, 7/16-6 in ext: A2, CW2; ~8 turns 	<p>On IV GO: <input type="checkbox"/> J612 ----- <input type="checkbox"/> J611----- <input type="checkbox"/> J613</p> <p>7. Retrieve BOJ 1; stow on BRT</p> <p>{Get-ahead opportunity: Node 2 Shower Cap Remove}</p> <p>8. Translate to A/L</p>	<p>{Get-ahead opportunity: Node 2 Shower Cap Remove}</p> <p>8. Translate to A/L</p>																													

NODE 2 OUTFITTING – TASK DATA

Tools:

EV1 (FF)	EV3 (FF)
PGT	PGT
7/16-6 in ext	7/16-6 in ext

EVA Fasteners:

Fastener	Head size	Qty	Install Torque (ft-lb)	Release Torque (ft-lb)	Failure Torque (ft-lb)	Turns	RPM
Handrail	7/16	2	1.5-5.5	5.5	21.3	8-9.5	30

EVA Connectors:

Harness	From	To	Size	Function
Loopback connector	N/A	Node 2 J408		PDGF terminator

Foot Restraints: None

Warnings: Inside of WIF is sharp edge hazard

Cautions: None

Note: The following grounding fastener pins are too long on the following trunnion covers; to ensure proper engagement, do not push pin in all the way

- I/A grounding fastener closer to trunnion pin
- I/F grounding fastener farther from trunnion pin



KEEL COVER – Bottom view

Hi-mag Velcro

NODE 2 OUTFITTING – TASK DATA (Cont)

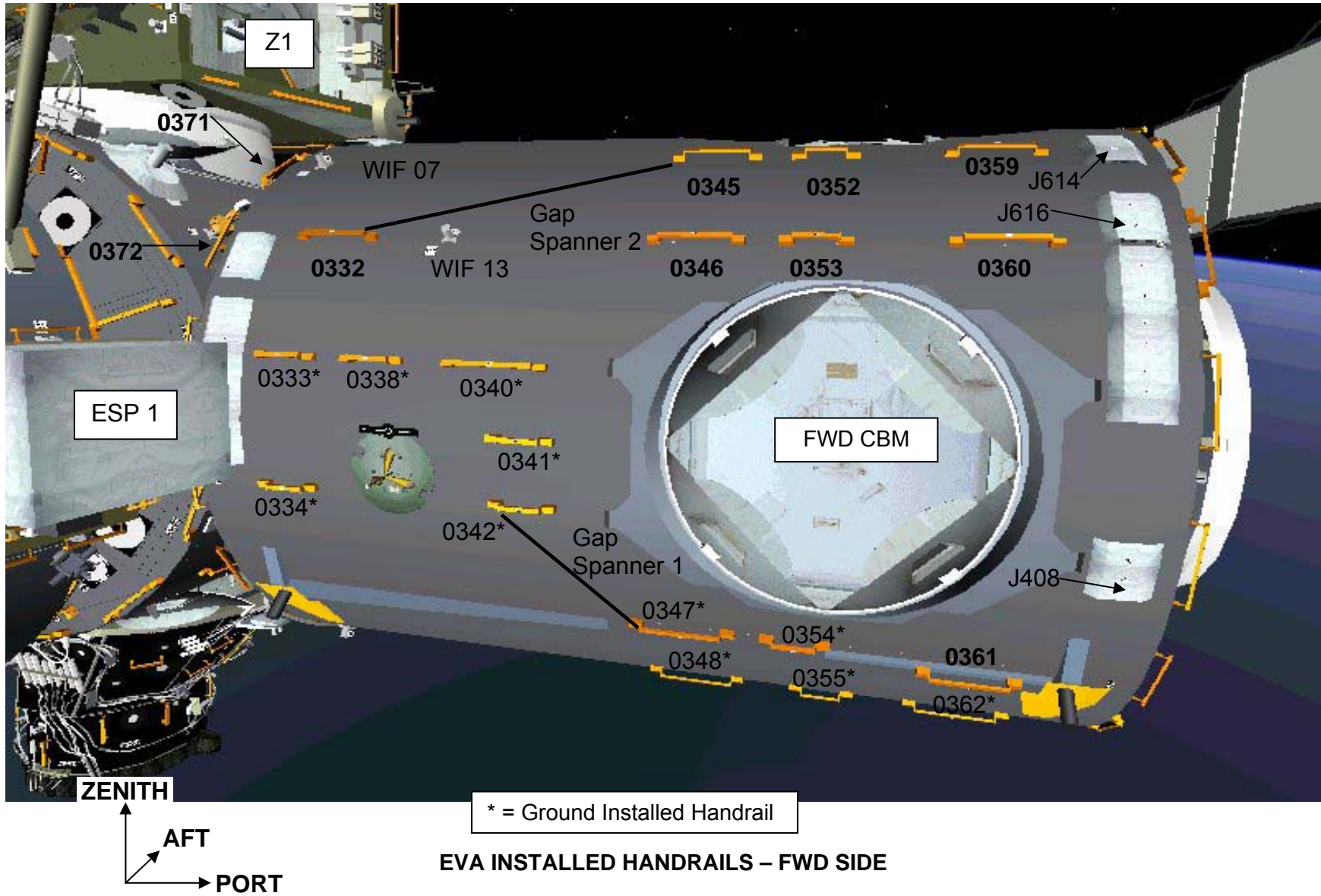

NODE 2 OUTFITTING – TASK DATA (Cont)

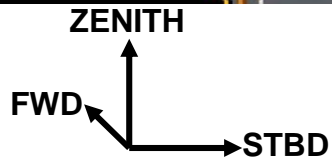
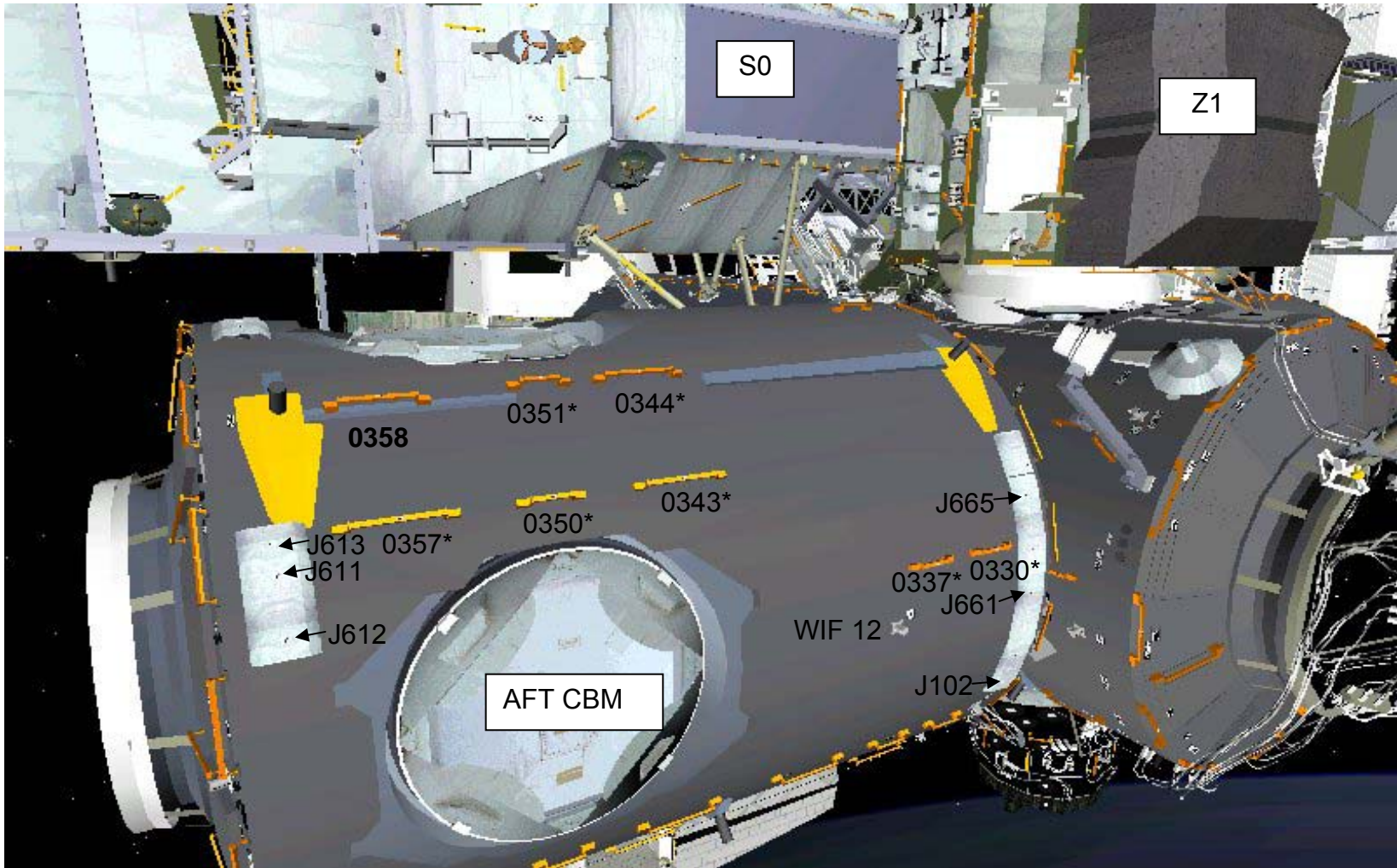

* = Ground Installed Handrail

EVA INSTALLED HANDRAILS – AFT SIDE

S1 SFU CONFIG FOR CINCH FIRING (00:50)

IV	EV1 – Pz (FF)	EV3 – Tani (FF)																								
<p>{SFU RECONFIG INHIBITS (In Inhibit Pad) RPCM S1-1A-C RPC 4 – Open, Close Cmd Inh 5 – Open, Close Cmd Inh 6 – Open, Close Cmd Inh 7 – Open, Close Cmd Inh}</p> <p><input type="checkbox"/> √With MCC all inhibits in place for SFU Config</p>		<ol style="list-style-type: none"> Temp stow BOJ 2 on Node 2 HR 0325, translate over OTD (crane) and under CETA light Translate to temp stowed fish stringer on Z1; retrieve fish stringer Translate to airlock Perform glove inspection Perform inventory of fish stringer Ingress airlock, stow fish stringer, retrieve sm ORU bag (with RPCM) Egress airlock, close hatch thermal cover Verify SAFER config: <ul style="list-style-type: none"> <input type="checkbox"/> √L Handle down (MAN ISO Vlv – Open); <input type="checkbox"/> √R Handle down (HCM – Closed) Translate to CETA spur Temp stow RPCM ORU Bag at CETA spur, HR 3413 Translate to S1 SFU Panel A123 on nadir radiator beam (translate nadir at CETA marker 6330, S1, Bay 11) BRT HR 3258 Perform glove inspection <p style="text-align: center;"><u>NOTE</u></p> <p style="text-align: center;">√Connectors for straight pins, no FOD, EMI band intact, and good bend radius</p>																								
<ol style="list-style-type: none"> Give EV GO for SFU Configure 		<ol style="list-style-type: none"> On IV GO, swap the following: <table border="1" style="margin-left: auto; margin-right: auto;"> <thead> <tr> <th colspan="4" style="text-align: center;">PNL A123 – Demate</th> </tr> </thead> <tbody> <tr> <td style="text-align: center;">P752</td> <td style="text-align: center;">← →</td> <td style="text-align: center;">J752</td> <td></td> </tr> <tr> <td style="text-align: center;">Dust cap</td> <td style="text-align: center;">← →</td> <td style="text-align: center;">J703</td> <td></td> </tr> <tr> <th colspan="4" style="text-align: center;">PNL A123 – Mate</th> </tr> <tr> <td style="text-align: center;">P752</td> <td style="text-align: center;">→ ←</td> <td style="text-align: center;">J703</td> <td></td> </tr> <tr> <td style="text-align: center;">Dust cap</td> <td style="text-align: center;">→ ←</td> <td style="text-align: center;">J752</td> <td></td> </tr> </tbody> </table> 	PNL A123 – Demate				P752	← →	J752		Dust cap	← →	J703		PNL A123 – Mate				P752	→ ←	J703		Dust cap	→ ←	J752	
PNL A123 – Demate																										
P752	← →	J752																								
Dust cap	← →	J703																								
PNL A123 – Mate																										
P752	→ ←	J703																								
Dust cap	→ ←	J752																								
<p><input type="checkbox"/> Notify MCC-H, SFU connector swap complete</p>		<ol style="list-style-type: none"> Retrieve RPCM ORU Bag from CETA spur, stow on BRT <div style="border: 1px solid black; padding: 5px; margin: 10px auto; width: fit-content;"> <p style="text-align: center;"><u>WARNING</u></p> <p style="text-align: center;">2' Keep Out Zone for floating cables between MT and MBS. Stay on UMA handrails during translation underneath MT</p> </div> Translate to RPCM R&R worksite (CETA marker 8130, S0, Bay 2); temp stow bag on HR 3523 Translate to MBSU Jumper worksite (CETA marker 8190, S0, Bay 4) 																								

S1 SFU CONFIG FOR CINCH FIRING – TASK DATA

Tools:

EV1 (FF)	EV3 (FF)
N/A	

EVA Fasteners: None

EVA Connectors:

Harness	From	To	Clamps	Size	Function
S1 P752-W5140	S1 J752	S1 J703	0	TBD	SFU Power
J703-Dust Cap	S1 J703	S1 J752	0	TBD	Protection

Foot Restraints: None

Warnings:

Cautions: None

Note:

SFU PANEL A123 (PRE DEPLOY)

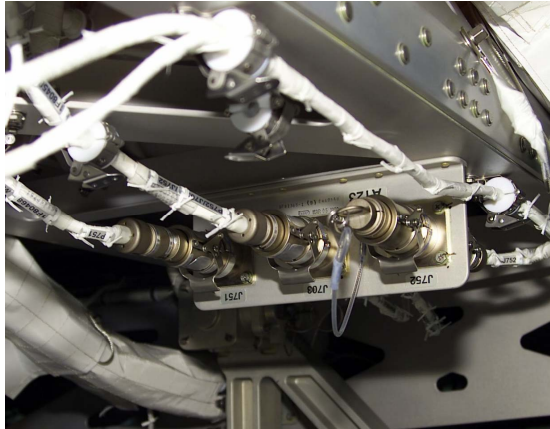

Configuration for cinch firing

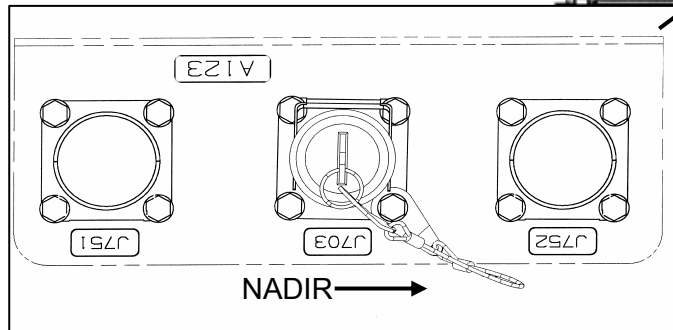
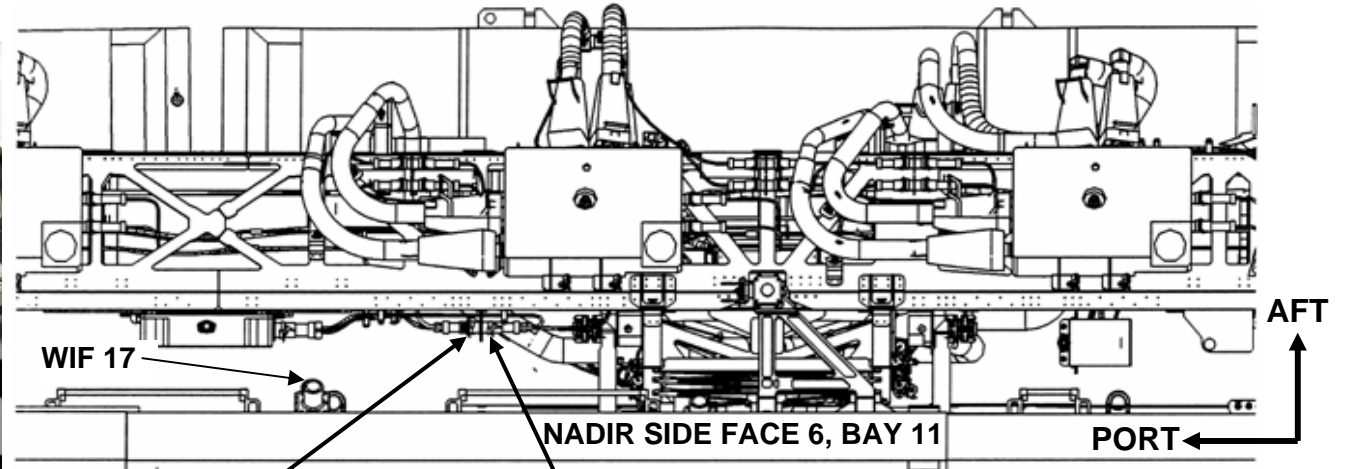

VIEW LOOKING STBD

NOTE: Cap actually lanyarded to J752

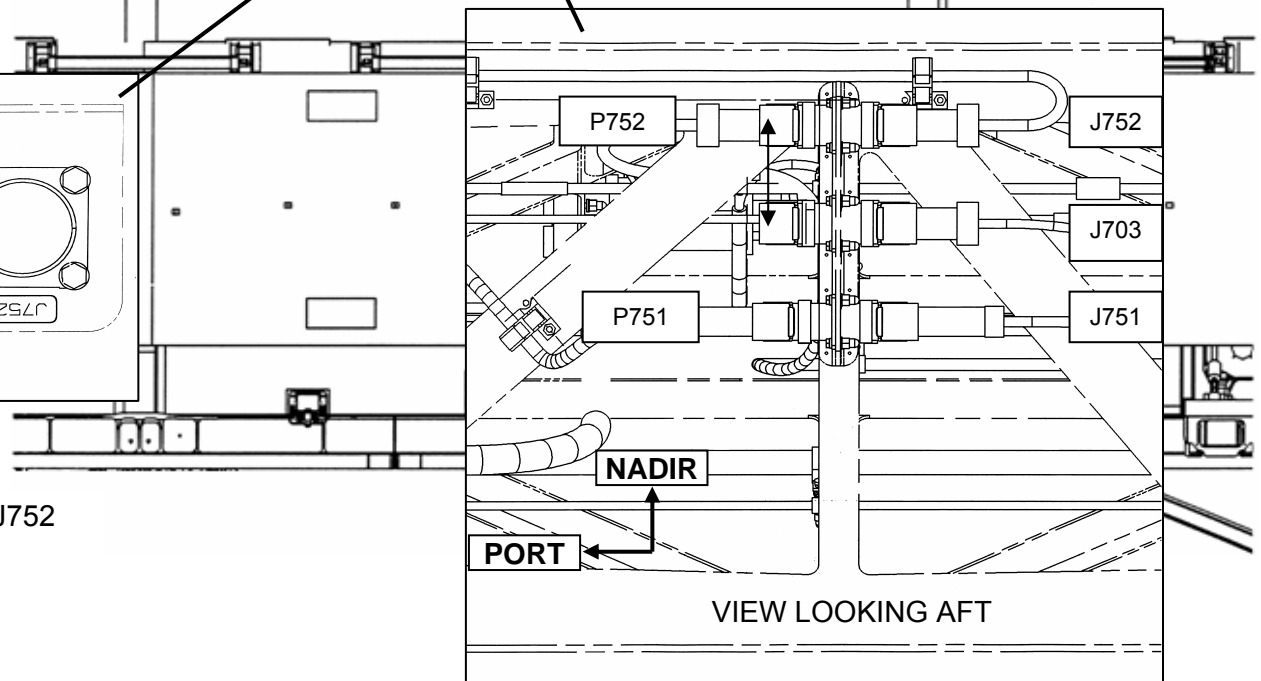

VIEW LOOKING AFT

MBSU BYPASS JUMPER RECONFIG (00:10)

IV	EV1 – Pz (FF)	EV3 – Tani (FF)																																																
<p>{MBSU BYPASS JUMPER RECONFIG INHIBITS (Egress) MBSU 4A/4B RBI 8 – Open, Close Cmd Inh MBSU 2A/2B RBI 8 – Open, Close Cmd Inh}</p> <p><input type="checkbox"/> √With MCC all inhibits in place for MBSU Bypass Jumper Reconfig</p>		<ol style="list-style-type: none"> Translate to MBSU Jumper worksite (CETA marker 8190, S0, Bay 4) Perform glove inspection Enter S0, bay 4 through forward face Release TA clamps as reqd <p style="text-align: center;"><u>NOTE</u></p> <p>√Connectors for straight pins, no FOD, EMI band intact, and good bend radius Panels can be done in any order</p>																																																
<ol style="list-style-type: none"> Give EV GO for MBSU Jumper Reconfig 		<p><u>A260 PANEL RECONFIG (NADIR)</u></p> <ol style="list-style-type: none"> On IV GO, swap P489 with P491: <table border="1" data-bbox="1335 719 1755 948"> <thead> <tr> <th colspan="4">PNL A260 - Demate</th> </tr> </thead> <tbody> <tr> <td>P489</td> <td>← →</td> <td>J491</td> <td></td> </tr> <tr> <td>P491</td> <td>← →</td> <td>J489</td> <td></td> </tr> <tr> <th colspan="4">PNL A260 - Mate</th> </tr> <tr> <td>P489</td> <td>→ ←</td> <td>J489</td> <td></td> </tr> <tr> <td>P491</td> <td>→ ←</td> <td>J491</td> <td></td> </tr> </tbody> </table> <ol style="list-style-type: none"> Install wire harness of P491 into TA clamp as reqd <p><u>A200 PANEL RECONFIG (ZENITH)</u></p> <ol style="list-style-type: none"> Swap P486 with P483: <table border="1" data-bbox="1335 1079 1755 1308"> <thead> <tr> <th colspan="4">PNL A200 - Demate</th> </tr> </thead> <tbody> <tr> <td>P486</td> <td>← →</td> <td>J483</td> <td></td> </tr> <tr> <td>P483</td> <td>← →</td> <td>J486</td> <td></td> </tr> <tr> <th colspan="4">PNL A200 - Mate</th> </tr> <tr> <td>P486</td> <td>→ ←</td> <td>J486</td> <td></td> </tr> <tr> <td>P483</td> <td>→ ←</td> <td>J483</td> <td></td> </tr> </tbody> </table> <ol style="list-style-type: none"> Install wire harness of P483 into TA clamp as reqd 	PNL A260 - Demate				P489	← →	J491		P491	← →	J489		PNL A260 - Mate				P489	→ ←	J489		P491	→ ←	J491		PNL A200 - Demate				P486	← →	J483		P483	← →	J486		PNL A200 - Mate				P486	→ ←	J486		P483	→ ←	J483	
PNL A260 - Demate																																																		
P489	← →	J491																																																
P491	← →	J489																																																
PNL A260 - Mate																																																		
P489	→ ←	J489																																																
P491	→ ←	J491																																																
PNL A200 - Demate																																																		
P486	← →	J483																																																
P483	← →	J486																																																
PNL A200 - Mate																																																		
P486	→ ←	J486																																																
P483	→ ←	J483																																																
<p>2. Notify MCC-H, MBSU Bypass Jumper Config complete</p>		<ol style="list-style-type: none"> Translate to RPCM Worksite (CETA marker 8100, S0, Bay 2) 																																																

MBSU BYPASS JUMPER RECONFIG – TASK DATA

Tools:

EV1 (FF)	EV3 (FF)
N/A	N/A

EVA Fasteners: None

EVA Connectors:

Harness	From	To	Size	Function
W4007-P486	A200-J483 (dummy)	W4039-J486	37	Power to/from Channel 4B
W4033-P483	W4039-J486	A200-J483	37	Power to/from Channel 4B
W4002-P489	A260-J491 (dummy)	W4002-P489	37	Power to/from Channel 2B
W4032-P491	W4038-J489	A260-J491	37	Power to/from Channel 2B

Foot Restraints: None

Cautions:

Warnings:

MBSU BYPASS JUMPER RECONFIG – TASK DATA (Cont)

AFT

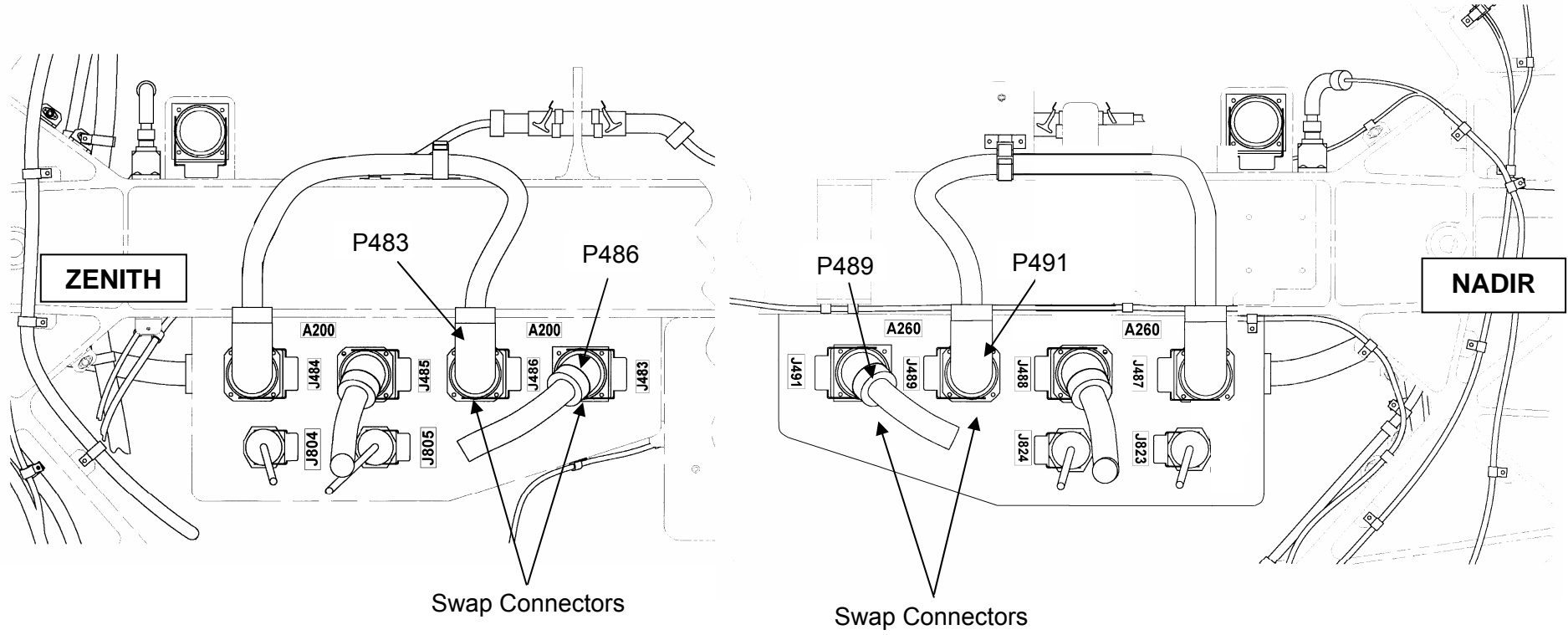

PNL A200 – Bay 4 View looking STBD

PNL A260 – Bay 4 View looking STBD

RPCM S04B-C R&R (00:30)

IV	EV1 – Pz (FF)	EV3 – Tani (FF)						
<p>{RPCM S04B-C R&R INHIBITS (wait for SSRMS) DDCU S14B Converter – OFF}</p> <p><input type="checkbox"/> √MCC-H all inhibits are in place for RPCM R&R</p>		<p>1. Translate to RPCM S04B-C (CETA marker 8100, S0 Bay 2), retrieve RPCM from temp stow location</p> <div style="border: 1px solid black; padding: 5px; text-align: center;"> <p><u>WARNING</u> Edges of RPCM housing may be sharp, use caution while handling</p> </div> <p>2. Verify correct RPCM: Map on truss “S0 4B-C”, RPCM Label S/N “9000” (3rd from outboard) 3. Open ORU Bag and transfer MMOD T-tool to trash bag 4. Tether to failed RPCM with ORU bag RET (gate pointed away from RPCM) 5. Install 7/16-6 in ext from socket caddy on to PGT</p>						
<p>1. Give EV3 GO for RPCM R&R</p> <p>RPCM Install data</p> <table border="1" style="width: 100%; border-collapse: collapse;"> <thead> <tr> <th style="width: 33%;">Bolt</th> <th style="width: 33%;">Turns</th> <th style="width: 33%;">Torque</th> </tr> </thead> <tbody> <tr> <td>Drive Screw</td> <td></td> <td></td> </tr> </tbody> </table>	Bolt	Turns	Torque	Drive Screw				<p>6. On IV GO, release RPCM Drive Screw PGT, 7/16-6 in ext: A7, CCW2; ~8 turns, push while turning <input type="checkbox"/> √Status indicator – UNLOCK 7. Remove failed RPCM, temp stow 8. Inspect guide rail for debris/damage 9. Remove new RPCM from ORU bag 10. Inspect RPCM connector interface for debris/damage 11. Install RPCM on guide rail and slide into softdock, √gate away from RPCM <input type="checkbox"/> √Status indicator – not below UNLOCK 12. Install RPCM Drive Screw PGT, 7/16-6 in ext: A2, CW2; 6-7 turns to HS, push while turning <input type="checkbox"/> √Status Indicator – LOCK</p>
Bolt	Turns	Torque						
Drive Screw								
<p>2. Notify MCC-H new RPCM installed (GO for RPCM power up and Checkout)</p>		<p>13. Stow failed RPCM in sm ORU bag; stow sm ORU bag on BRT 14. √MT translation path outboard is clear of EVA hardware</p> <div style="border: 1px solid black; padding: 5px; text-align: center;"> <p><u>WARNING</u> 2' Keep Out Zone for floating cables between MT and MBS. Stay on UMA handrails during translation underneath MT</p> </div> <p>15. Translate to Airlock 16. Ingress Airlock, stow sm ORU bag in airlock 17. Egress Airlock, close hatch thermal cover 18. Perform glove inspection 19. Verify SAFER config: <input type="checkbox"/> √L Handle down (MAN ISO Vlv – Open); <input type="checkbox"/> √R Handle down (HCM – Closed) 20. Translate to Node 2 PDGF worksite (nadir) via Z1 aft path</p>						

RPCM S04B-C R&R – TASK DATA

Tools:

EV1 (FF)	EV3 (FF)
	PGT
	7/16-6 in ext

EVA Fasteners:

Fastener Name	Head Size	Qty	Install Torque (ft-lb)	Release Torque (ft-lb)	Failure Torque (ft-lb)	Turns
RPCM Drive Screw	7/16	1	5.5 grnd 3.8 orbit	4.5	18.6 remv 8.5 install	8 rmv 6-7 install

EVA Connectors: None

Foot Restraints: None

ORU Identification:

	Serial Number
Spare RPCM	
Failed RPCM	9000

RPCM Tether Orientation



Note:

1. Installation of tether on RPCM tether point must be oriented such that the hook gate is facing the body of the RPCM. Otherwise interference between the SPDA frame and the RPCM will not allow hook removal

Caution:

1. Failure to use wobble socket, or socket with equivalent outer diameter, to release lock springs can result in damage to the RPCM Drive Screw Assembly
2. Do not operate drive screw with scoop attached to microconical. The wobble socket feature will not extend thru the round scoop
3. Failure to align and fully seat socket until lock springs have released can result in damage to RPCM Drive Screw Assembly
4. Combined linear and rotational motion on the socket while inserting, can result in damage to RPCM Drive Screw Assembly

Warning:

1. RPCM may have sharp edges, use caution while handling

Thermal Clocks:

- New RPCM in MLI bag – 6-hr transfer clock from removal from airlock to removal from bag
 2-hr activation clock from removal from bag to physically installed
- Old RPCM in MLI bag – 1.5-hr removal clock from physically removed to placement in MLI bag
 8-hr transfer clock from placement in bag to placement in airlock

RPCM S04B-C R&R – TASK DATA (Cont)

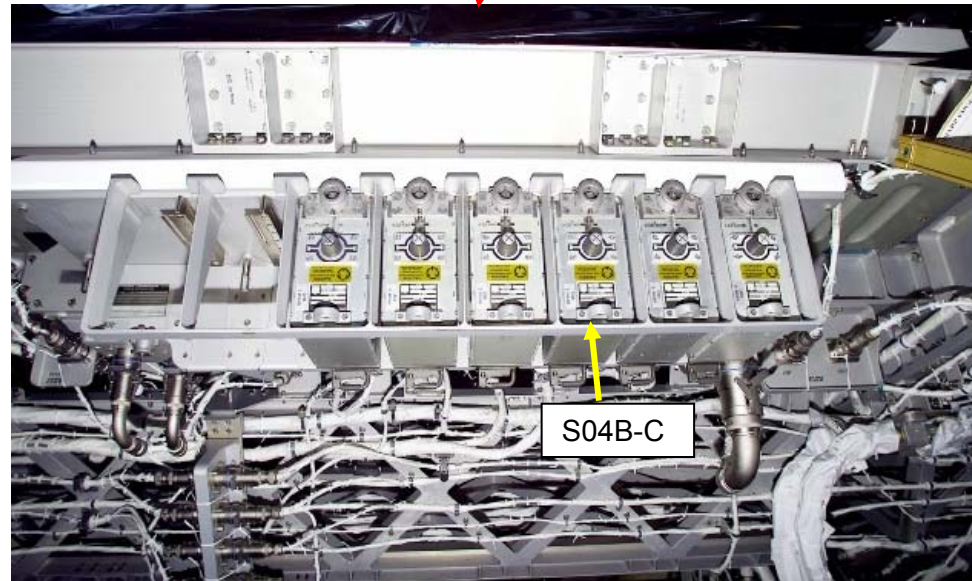
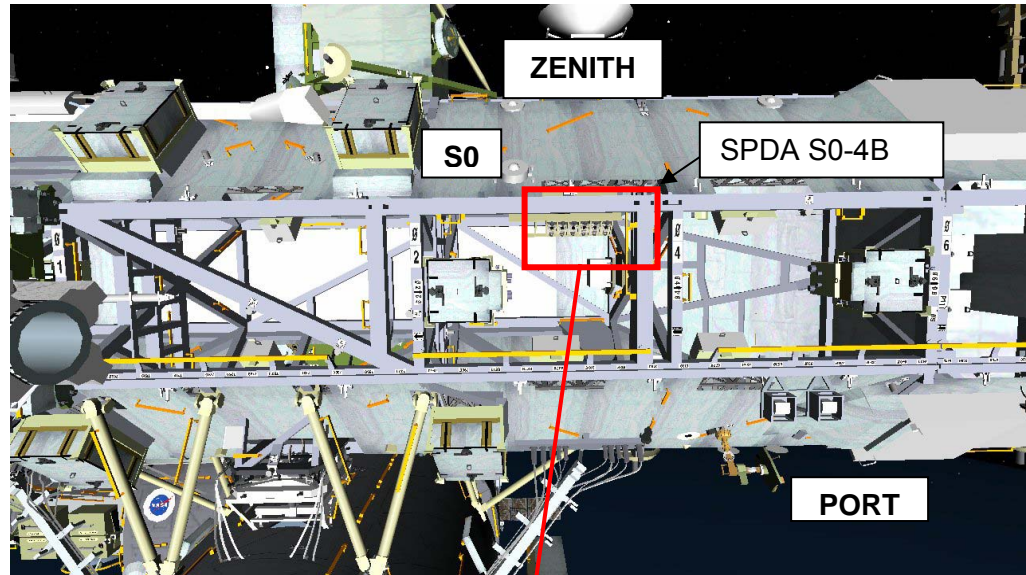
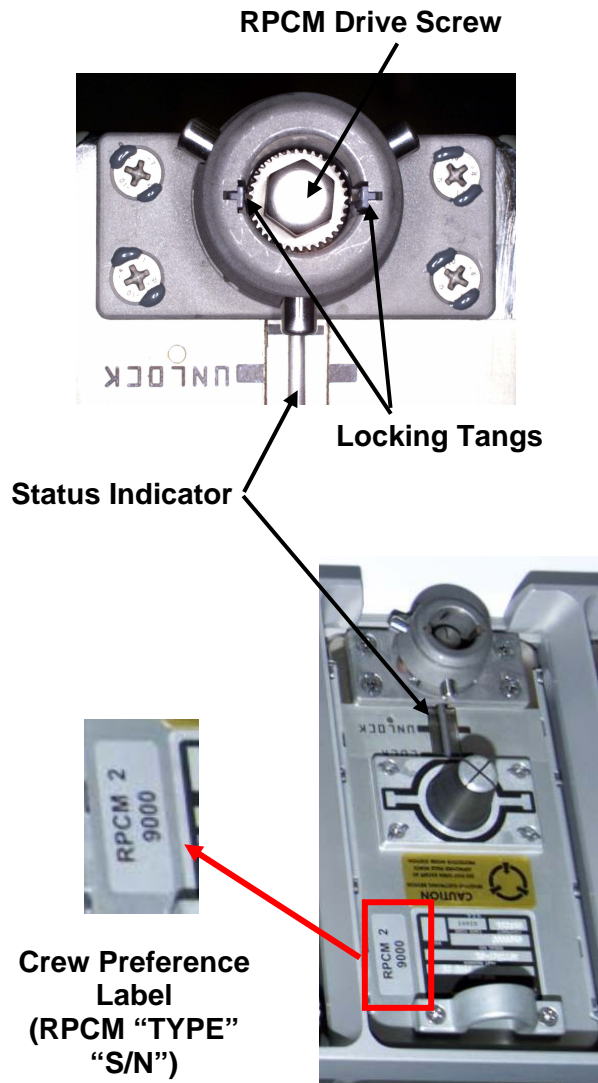

PDGF INSTALL ON NODE 2 (01:15)

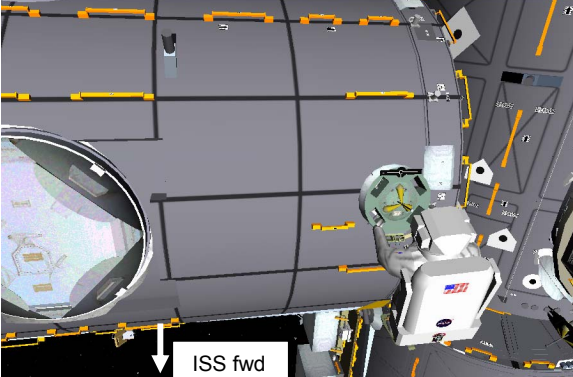
IV	EV1 – Pz (FF)	EV3 – Tani (FF)												
 <p style="text-align: center;">ISS fwd</p>	<ol style="list-style-type: none"> Retrieve APFR from Node 2 WIF 17 Translate to WIF 08, install APFR (2, QQ, E, 12) Translate to PDGF via aft/nadir keel path (NOTE: EV3's safety tether also routed along this path) 	<p><u>REMOVE MOUNTING RING THERMAL COVER</u></p> <ol style="list-style-type: none"> Translate to Node 2 PDGF mounting ring Perform glove inspection Tether to mounting ring thermal cover and remove grounding straps (2) using MMOD T-tool Remove cover, temp stow using RET Remate MLI tabs (4) to Velcro Translate to BOJ 2, temp stow MMOD T-tool and cover 												
<p><u>PDGF Translation Brief</u> □ "Transfer"/"Go"/"On"</p> <table border="1" data-bbox="191 1130 596 1369" style="margin-top: 20px;"> <thead> <tr> <th colspan="2">TURNS INITIAL TORQUE</th> </tr> <tr> <th>EDF</th> <th>Turns</th> </tr> </thead> <tbody> <tr> <td>Fwd/Outboard</td> <td></td> </tr> <tr> <td>Aft/Inboard</td> <td></td> </tr> <tr> <td>Fwd/Inboard</td> <td></td> </tr> <tr> <td>Aft/Outboard</td> <td></td> </tr> </tbody> </table>	TURNS INITIAL TORQUE		EDF	Turns	Fwd/Outboard		Aft/Inboard		Fwd/Inboard		Aft/Outboard		<div style="border: 1px solid black; padding: 5px; margin: 10px auto; width: fit-content;"> <p style="text-align: center;">WARNING</p> <p style="text-align: center;">Avoid touching curvic coupling due to potential sharp edges</p> </div> <div style="border: 1px solid black; padding: 5px; margin: 10px auto; width: fit-content;"> <p style="text-align: center;">CAUTION</p> <p style="text-align: center;">Avoid touching grapple pin, target, and underside of PDGF</p> </div> <p><u>PDGF RETRIEVE</u></p> <ol style="list-style-type: none"> Retrieve PDGF from Node 2 outboard endcone Translate to PDGF install location <p><u>PDGF INSTALL</u></p> <ol style="list-style-type: none"> Ensure all EDFs (four) fully retracted and lanyards clear, install PDGF onto mounting ring (target aft, align with black arrow on ring) Engage aft EDFs (two) (lanyard washer flush to retaining ring) <p style="text-align: center;">EDFs must be driven in a cross pattern (order not critical)</p> <p><u>INITIAL TORQUE</u></p> <ol style="list-style-type: none"> Drive Aft/Inboard EDF PGT, 7/16-6 in ext: A7, CW2; ~ 5 turns to torque stall Remove adjustable tethers, stow on MWS Drive Fwd/Outboard EDF PGT, 7/16-6 in ext: A7, CW2; ~ 5 turns to torque stall 	<p><u>PDGF RETRIEVE</u></p> <ol style="list-style-type: none"> Retrieve PDGF from Node 2 outboard endcone Translate to PDGF install location <p><u>PDGF INSTALL</u></p> <ol style="list-style-type: none"> Ingress APFR – roll to "D" as reqd for EDFs Ensure all EDFs (four) fully retracted and lanyards clear, install PDGF onto mounting ring (target aft, align with black arrow on ring) Engage fwd EDFs (two) (lanyard washer flush to retaining ring) <p style="text-align: center;"><u>NOTE</u></p> <p style="text-align: center;">EDFs must be driven in a cross pattern (order not critical)</p> <p><u>INITIAL TORQUE</u></p> <ol style="list-style-type: none"> Drive Fwd/Outboard EDF PGT, 7/16-6 in ext: A7, CW2; ~ 5 turns to torque stall Remove adjustable tethers, stow on MWS Drive Fwd/Inboard EDF PGT, 7/16-6 in ext: A7, CW2; ~ 5 turns to torque stall
TURNS INITIAL TORQUE														
EDF	Turns													
Fwd/Outboard														
Aft/Inboard														
Fwd/Inboard														
Aft/Outboard														

PDGF INSTALL ON NODE 2 (01:15) (Cont)

IV	EV1 – Pz (FF)	EV3 – Tani (FF)															
<p>Turns Final Torque</p> <table border="1"> <thead> <tr> <th>EDF</th> <th>Turns</th> <th>Torque</th> </tr> </thead> <tbody> <tr> <td>Fwd/Inboard</td> <td></td> <td></td> </tr> <tr> <td>Aft/Outboard</td> <td></td> <td></td> </tr> <tr> <td>Fwd/Outboard</td> <td></td> <td></td> </tr> <tr> <td>Aft/Inboard</td> <td></td> <td></td> </tr> </tbody> </table> <p><input type="checkbox"/> √MCC-H all inhibits are in place for PDGF Horseshoe connector install</p>	EDF	Turns	Torque	Fwd/Inboard			Aft/Outboard			Fwd/Outboard			Aft/Inboard			<p><u>FINAL TORQUE</u></p> <p>NOTE Tighten EDFs until at least 5 turns total and 25.5 ft-lb repeatable torque reached, less than a 1/4 turn before reaching torque</p> <p>11. Drive Aft/Outboard EDF PGT, 7/16-6 in ext: B7, CW2; ~0.5 turns repeatable</p> <p>12. Drive Aft/Inboard EDF PGT, 7/16-6 in ext: B7, CW2; ~0.5 turns repeatable</p> <p><u>HORSESHOE CONNECTOR RELEASE</u></p> <p>13. Translate to horseshoe connector launch bracket 14. Release TA clamps as reqd (expecting 3) 15. Open MLI cover</p>	<p><u>FINAL TORQUE</u></p> <p>NOTE Tighten EDFs until at least 5 turns total and 25.5 ft-lb repeatable torque reached, less than a 1/4 turn before reaching torque</p> <p>15. Drive Fwd/Inboard EDF PGT, 7/16-6 in ext: B7, CW2; ~0.5 turns repeatable</p> <p>16. Drive Fwd/Outboard EDF PGT, 7/16-6 in ext: B7, CW2; ~0.5 turns repeatable</p> <p>17. Egress APFR</p> <p><u>HORSESHOE CONNECTOR MATE</u></p> <p>18. Release horseshoe connector receptacle MLI cover</p>
EDF	Turns	Torque															
Fwd/Inboard																	
Aft/Outboard																	
Fwd/Outboard																	
Aft/Inboard																	
<p>1. Give EV1 GO for horseshoe connector demate</p> <p><u>HORSESHOE CONNECTOR</u></p> <table border="1"> <thead> <tr> <th>Connector</th> <th>Turns</th> <th>Torque</th> </tr> </thead> <tbody> <tr> <td>P6/P8 (inboard)</td> <td></td> <td></td> </tr> <tr> <td>P7/P5 (outboard)</td> <td></td> <td></td> </tr> </tbody> </table>	Connector	Turns	Torque	P6/P8 (inboard)			P7/P5 (outboard)			<p>16. On IV GO, rotate sq microfixtures (two) 60 deg ccw 17. Remove horseshoe connectors (P6/P8 first due to cable interference) 18. <u>Transfer horseshoe connectors to EV3</u></p> <p>19. Reinstall MLI cover over launch bracket 20. Install cable into empty TA clamps as reqd for appropriate cable length 21. Close any remaining open TA clamps</p> <p>Continue with NODE 2 OUTFITTING (02:50)</p>	<p>19. Release horseshoe connector receptacle engagement bolt (two) PGT, 7/16-6 in ext: A6, CCW2; 17 turns <input type="checkbox"/> √Yellow band visible on both receptacles</p> <p>20. Receive horseshoe connectors from EV1 21. Install horseshoe connector onto PDGF 22. P6/P8 → J6/J8 (inboard) 23. Rotate square microfixture – LOCK, 60 deg cw 24. P7/P5 → J7/J5 (outboard) 25. Rotate square microfixture – LOCK, 60 deg cw</p> <p>26. Drive horseshoe connector receptacle engagement bolt (two) PGT, 7/16-6 in ext: A6, CW2; 15-17 turns to HS 27. Route cable through wire-tie on HR 0335 28. Reinstall MLI cover, feeding horseshoe connector cables through opening created by flap in cover</p> <p>Continue with NODE 2 OUTFITTING (02:50)</p>						
Connector	Turns	Torque															
P6/P8 (inboard)																	
P7/P5 (outboard)																	

PDGF INSTALL ON NODE 2 – TASK DATA

EVA Tools:

EV1 (FF)	EV3 (FF)
PGT	MMOD T-tool
7/16-6 in ext	PGT
	7/16-6 in ext

EVA Fasteners:

Fastener	Head Size	Qty	Install Torque (ft-lb)	Release Torque (ft-lb)	Failure Torque (ft-lb)	Turns	RPM
PDGF EDF	7/16"	4	9.2 – initial 25.5 – final	25	100	Release: 5 turns at bolt Install: 4-6 total turns at bolt	10
PDGF Horseshoe Connector	7/16"	2		7.0-11.25	14.5	15-17 until yellow line visible 20 to hard stop	30

EVA Connectors:

Task	From	To	Clamps (Qty)	Conn Size	Function
P8/P6	Node 2	PDGF	2	---	Data/Power
P5/P7	Node 2	PDGF	2	----	Power/Data

Foot Restraints:

Task	WIF	APFR Setting
PDGF Install	Node2-08	2,QQ,C,12
PDGF Install – Backup	Node2-06	10, RR, H, 12

Cautions:

- Avoid touching grapple pin, connector area, underside of PDGF, target

Warning:

- Avoid touching curvic coupling due to potential sharp edges

PDGF INSTALL ON NODE 2 – TASK DATA (Cont)

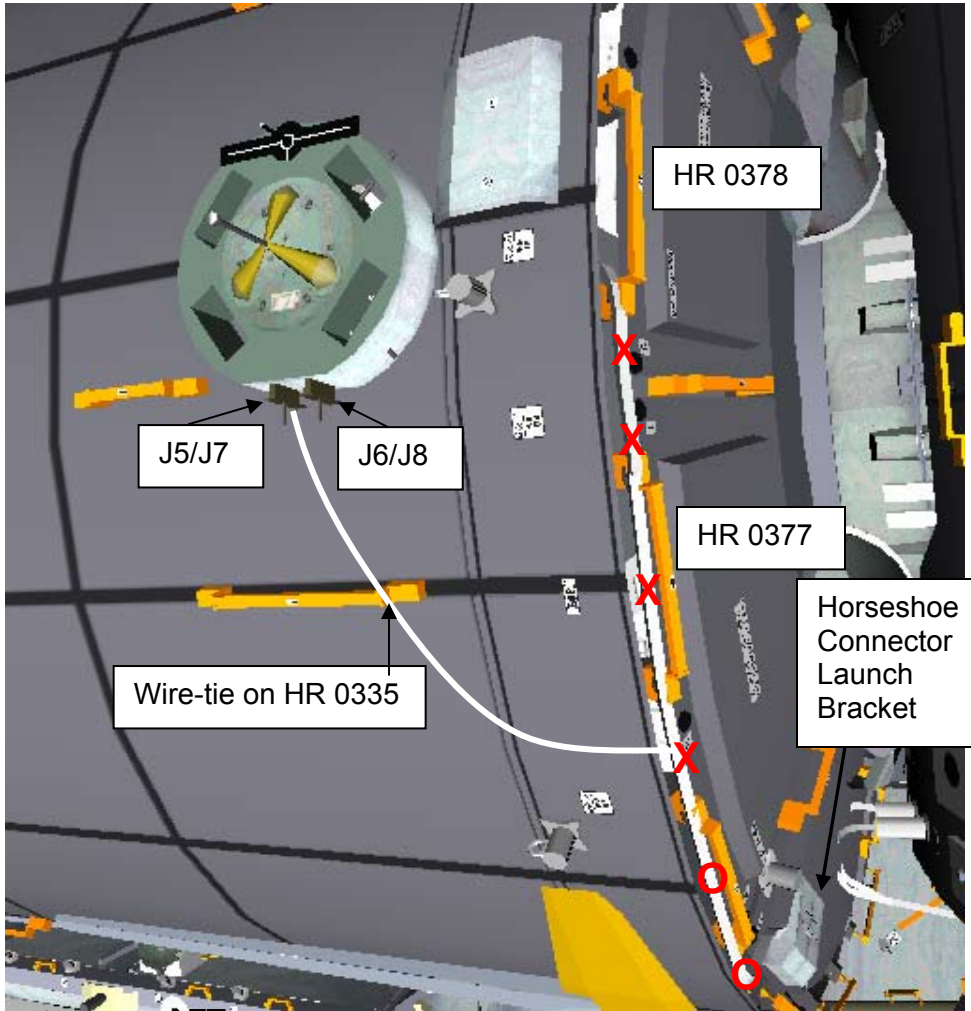

Node 2 PDGF Horseshoe Connectors Installed

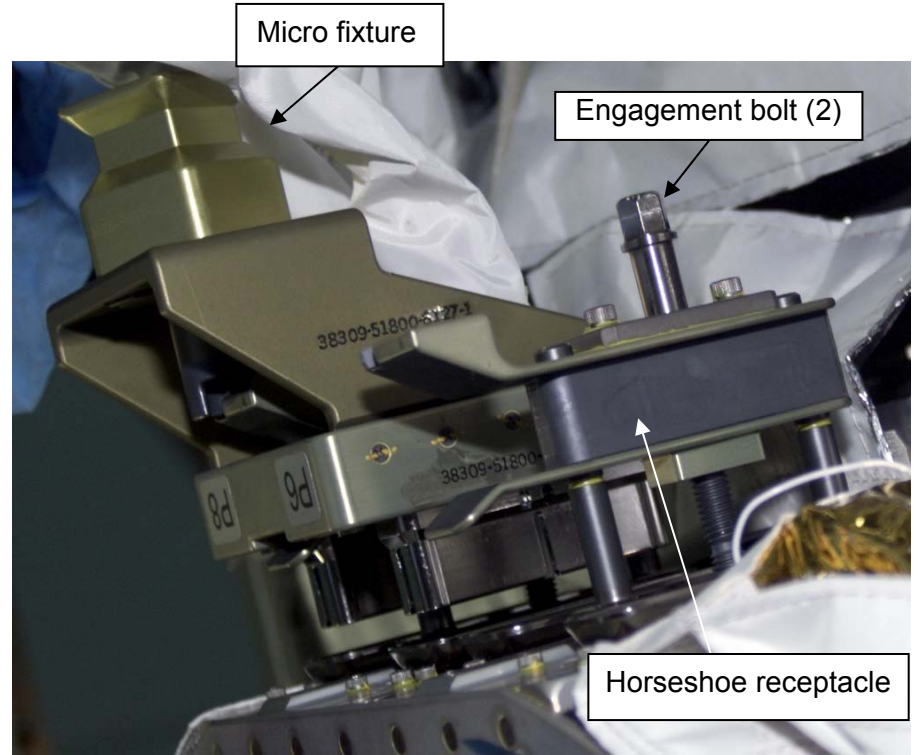

- – Cable Removed from TA Clamp
- X – Cable Installed in TA Clamp

PDGF OVERVIEW

EVA 2 CLEANUP AND A/L INGRESS (00:15)

IV	EV1 – Pz (FF)	EV3 – Tani (FF)
<p>1. Perform prior to ingress: WVS PWRDN (P/TV, <u>WVS CUE CARD</u>)</p>	<p>1. Translate to Airlock 2. Initiate cold soak 3. Perform tool inventory 4. Ingress Airlock 5. Stow BOJ 1 on Lg-sm RET</p> <hr/> <p>6. Receive BOJ 2 from EV3, stow on Lg-sm RET</p> <p>7. Connect right waist tether to A/L D-ring ext <input type="checkbox"/> ✓/Hook locked</p> <p>8. Give EV3 GO to disconnect EV1 safety tether</p> <p>DCM 9. Retrieve SCU, remove DCM cover 10. Connect SCU to DCM, ✓/Locked 11. Water – OFF</p>	<p>1. Translate to Airlock 2. Initiate cold soak 3. Perform tool inventory</p> <hr/> <p>4. Transfer BOJ 2 to EV1</p> <p>5. On EV1 GO disconnect EV1's A/L tether attach to right waist tether 6. Disconnect EV3 A/L safety tether from A/L, attach to self 7. Ingress Airlock</p> <p>DCM 8. Retrieve SCU, remove DCM cover 9. Connect SCU to DCM, ✓/Locked 10. Water – OFF 11. Hatch thermal cover – close 12. Secure thermal cover Velcro strap</p>
<p>CAUTION Do not close hatch until EMU water – OFF for 2 min</p>		
	<p>12. Go to PRE REPRESS portion of {CREWLOCK DEPRESS/REPRESS CUE CARD} (SODF: ISS EVA SYS: EVA PREP/POST)</p>	<p>13. ✓EV Hatch clear of FOD and obstructions 14. EV Hatch – verify handle position per hatch decal; close and lock 15. Go to PRE REPRESS portion of {CREWLOCK DEPRESS/REPRESS CUE CARD} (SODF: ISS EVA SYS: EVA PREP/POST)</p>

EVA 2 SPECIFIC GET AHEADS – NODE 2 ACBM SHOWER CAP REMOVE (00:45)

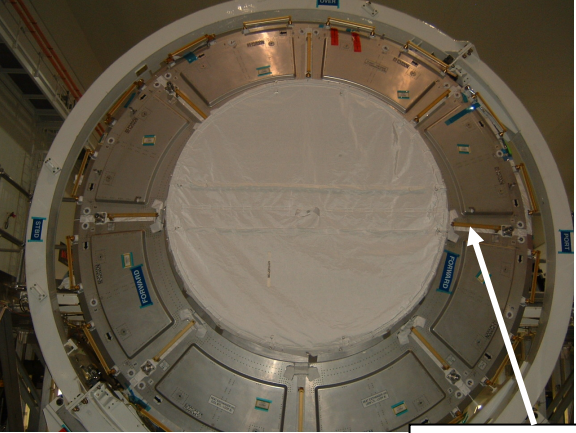
IV	EV1	EV2
 <p data-bbox="527 914 716 1036">Dzus ground strap and cinch strap release location</p>	<p data-bbox="747 370 1371 394">Tools Required: MMOD T-tool, wire ties, adj tethers (optional)</p> <ol data-bbox="747 431 1350 1310" style="list-style-type: none"> 1. Translate to Node 2 via Z1 fwd face <ul data-bbox="800 464 1224 488" style="list-style-type: none"> <input type="checkbox"/> Fairlead self at Z1 HR 6025 only 2. Translate to shower cap on ISS port end along zenith gap spanner 3. With EV2, fold shower cap in half 4. With EV2, fold shower cap in half twice more, attaching wire ties and/or adj tethers as reqd 5. Tether to shower cap 6. Secure shower cap into final bundle 7. Visually inspect Node 2 CBM to ensure that it is clear for PMA2 berthing 8. Perform glove inspection 9. Translate to Airlock with shower cap 10. Stow shower cap inside airlock 11. Close airlock hatch thermal cover 12. Verify SAFER config <ul data-bbox="800 1252 1318 1310" style="list-style-type: none"> <input type="checkbox"/> √L Handle down (MAN ISO Vlv – Open) <input type="checkbox"/> √R Handle down (HCM – Closed) 	<ol data-bbox="1392 431 2011 1149" style="list-style-type: none"> 1. Translate to shower cap along aft/nadir handrail path 2. Release thermal cover Velcro strap in order to loosen from ACBM stove pipe 3. Assist EV1, attaching wire ties and/or adj tethers as reqd 4. Release thermal cover Dzus fasteners (at 3:00) using MMOD T-tool 5. Secure shower cap into final bundle 6. Visually inspect Node 2 CBM to ensure that it is clear for PMA2 berthing 7. Perform glove inspection 8. Assist EV1 with shower cap stow in Airlock as required (if assisted, will need to unwind safety tether on way back)

POST EVA 2 TOOL CONFIG

EV1

EMU D-rings

- 1 – Tether Extender on left
- 2 – Waist Tethers
- 1 – 85-ft Safety tether

MWS

- Small trash bag
 - PIP pins (4)
 - J408 protective cap
 - J408 MLI strap
 - Node 2 caps
- 3 – Adj tether (2 from PDGF)
- 3 – RET (sm-sm)
- 1 – RET (with PIP pin)
- 2 – Wire ties
- Socket caddy
 - 5/8-7.8 in ext
- Swing Arm [right side]
 - PGT w/7/16-6 in ext
 - RET (sm-sm)
- BRT [left side]
 - 1 – Wire Tie, short
 - 2 – Wire Ties, long
 - 1 – RET (sm-sm)
- SAFER

Additional Items Returned to Airlock

- J408 protective cap
- J408 MLI strap
- PDGF mounting ring thermal cover
- Node 2 CBM hatch PIP pins (4)
- 17 – Node 2 caps

CREWLOCK (Cont)

- 1 – RET (Lg-sm)
 - 6B Box Cover (BSP)
 - 1 – Adj tether
 - 1 – RET (sm-sm)
 - Dummy box

EV3

EMU D-rings

- 1 – Tether Extender on left
- 2 – Waist Tethers
- 1 – 85-ft Safety tether

MWS

- Small trash bag
 - MMOD T-tool
 - RET (sm-sm)
 - Node 2 Caps
- 2 – Adj tether (from PDGF)
- 1 – RET (sm-sm)
- 1 – RET (with PIP pin)
- 2 – Wire ties
- Socket caddy
 - 7/16-2 in ext
- Swing Arm [right side]
 - PGT w/7/16-6 in ext
 - RET (sm-sm)
- BRT [left side]
 - 2 – Wire Tie, short
 - 2 – Wire Ties, long
 - 1 – RET (sm-sm)
- SAFER

CREWLOCK (Cont)

- 1 – RET (Lg-sm)
 - Med ORU Bag (for CETA Light)
 - RET w/PIP

- 1 – RET (Lg-sm)
 - Crewlock Bag #4 (for MMOD Shield)

Total RETs sm-sm used – 15
RETs with PIP pin – 5
RETs Lg-sm – 7
Adj tethers – 13 (+2 on trash bag)

Tools to remain in crewlock

CREWLOCK (Cont)

- Staging Bag
- IV Bag
- 1 – RET (Lg-sm)
 - Small ORU Bag
 - Failed RPCM
 - RET (sm-sm)
 - RET (sm-sm)
- 1 – RET (Lg-sm)
 - Crewlock bag #3
 - Round Scoop (for CETA Light)
 - Wire Tie Caddy
 - S0 Gap Spanners (1 – 45", 1 – 72")
 - EVA Camera/Bracket
- Fish stringer (spare tools)
 - 2 – Cannon Connector Tool
 - Cheater bar
 - Ratchet w/5/8-7.8 in ext
 - RAD w/5/8-7.8 in ext
- 1 – RET (Lg-sm)
 - BOJ 1 – adj tether
 - OIH Carrier /Fish stringer #1
 - Adj tether
 - Crewlock bag #1 (Node 2) – adj tether outside, wire ties
 - MMOD T-tool on RET
 - Adj tether (on int) – Tani method
 - PDGF mounting ring thermal cover on RET
- 1 – RET (Lg-sm)
 - BOJ 2 – adj tether
 - OIH Carrier /Fish stringer #2
 - Crewlock bag #2 (RTAS) – adj tether outside, wire ties
 - EVA Camera/Bracket
 - Adj tether (on int) – Tani method
 - 1 – RET

POST EVA 2/PRE EVA 3 TOOL CONFIG

EV1

EMU D-rings

- 1 – Tether Extender on left
- 2 – Waist Tethers
- 1 – 85-ft Safety tether

MWS

- Small trash bag {leave}
- PIP pins (4) {to Return Bag}
- J408 protective cap {to Return Bag}
- J408 MLI strap {to Return Bag}
- Node 2 caps {to Return Bag}
- 3 – Adj tether (2 from PDGF)
- 3 – RET (sm-sm)
- 1 – RET (with PIP pin)
- 2 – Wire ties
- Socket caddy {leave}
 - 5/8-7.8 in ext {leave}
- Swing Arm [right side]
 - PGT w/7/16-6 in ext {leave PGT, move socket to EV1's socket caddy}
 - RET (sm-sm)
 - BRT [left side] {leave}
 - 1 – Wire Tie, short
 - 2 – Wire Ties, long
 - 1 – RET (sm-sm)

- SAFER

Additional Items Returned to Airlock

- J408 protective cap {to Return Bag}
- J408 MLI strap {to Return Bag}
- PDGF mounting ring thermal cover {to Return Bag}
- Node 2 CBM hatch PIP pins (4) {to Return Bag}
- 17 – Node 2 caps {to Return Bag}

- 1 – RET (Lg-sm) {leave all}
- 6B Box Cover (BSP)
 - 1 – Adj tether
 - 1 – RET (sm-sm)
- Dummy box

EV3

EMU D-rings

- 1 – Tether Extender on left
- 2 – Waist Tethers
- 1 – 85-ft Safety tether

MWS

- Small trash bag {leave}
 - MMOD T-tool {to C/L bag #4, MMOD shield}
 - RET (sm-sm)
 - Node 2 Caps {to Return Bag}
 - 2 – Adj tether (from PDGF)
 - 1 – RET (sm-sm)
 - 1 – RET (with PIP pin)
 - 2 – Wire ties
 - Socket caddy {leave}
 - 7/16-2 in ext
 - Swing Arm [right side]
 - PGT w/7/16-6 in ext {leave}
 - RET (sm-sm)
 - BRT [left side] {leave}
 - 2 – Wire Tie, short
 - 2 – Wire Ties, long
 - 1 – RET (sm-sm)
- SAFER

CREWLOCK

- 1 – RET (Lg-sm) {leave all}
 - Med ORU Bag (for CETA Light) + RET w/PIP
- 1 – RET (Lg-sm) {leave all}
 - Crewlock Bag #4 (for MMOD Shield)

Total RETs sm-sm used – 15 RETs with PIP pin – 5 RETs Lg-sm – 7 Adj tethers – 13 (+2 on trash bag)

CREWLOCK (Cont)

- Staging Bag
- IV Bag
- 1 – RET (Lg-sm) {to Tether Staging}
 - Small ORU Bag {to Done bag}
 - Failed RPCM {to Return Bag}
 - RET (sm-sm) {to Tether Staging}
 - RET (sm-sm) {to Tether Staging}
- 1 – RET (Lg-sm)
 - Crewlock bag #3
 - Round Scoop (for CETA Light) {to int fish stringer}
 - Wire Tie Caddy {to int fish stringer}
 - S0 Gap Spanners (1 – 45", 1 – 72") {to int FS}
 - EVA Camera/Bracket {to int fish stringer}
- Fish stringer (spare tools) {make internal fish stringer}
 - 2 – Cannon Connector Tool {to EV1/2 trash bag}
 - Cheater bar {to Done bag}
 - Ratchet w/5/8-7.8 in ext {ratchet to C/L Bag #2, socket to Done bag}
 - RAD w/5/8-7.8 in ext {RAD to EV1 socket caddy, socket to EV2's socket caddy}
- 1 - RET (Lg-sm) {to Tether Staging}
 - OIH Carrier/Fish stringer #1 {Carrier and FS to Done bag}
 - Crewlock bag #1 (Node 2) – adj tether outside
 - MMOD T-Tool on RET {to C/L bag #4}
 - Adj tether (on int) {to Tether Staging}
 - PDGF mounting ring thermal cover {to Return Bag}
 - 1 – RET (sm-sm) {to Tether Staging}
- OIH Carrier/Fish stringer #2 {Carrier to Return Bag, FS to 10A Bag}
- Crewlock bag #2 (RTAS) – adj tether outside
 - EVA Camera/Bracket {to Med ORU Bag}
 - Adj tether (on int) {to Tether Staging}
 - 1 – RET {to Tether Staging}

EVA 3 INHIBIT PAD

Orbiter (1)

ALL EVAs	
TCS L12	1. √TCS POWER – OFF
KU-BAND ANTENNA {Performed during egress}	
MCC-H	1. √KU-BAND Mask – active 2. √KU-BAND EVA Protect Box – active
RCS {On call, EV crew not expected to be in this area} If EV crew < 27 ft from FRCS	
IV O14,15,16	1. √DAP: VERN, FREE, LO Z (ft specific check with GNC) 2. √RJDF F1, F2, F3, F4 MANF DRIVER (four) – OFF LOGIC (four) – OFF
MCC-H IV	3. √Above RCS config 4. √RCS F – ITEM 1 EXEC (*) √RCS FJET DES F1U – ITEM 17 (*) F3U – ITEM 19 (*) F2U – ITEM 21 (*)
S-BAND ANTENNAS {On call if Lab MMOD Shield reinstall attempted}	
NOTE Possible loss of comm when forced LL FWD antenna	
IV A1R	If EV crew < 2.0 ft from S-Band antenna 1. S-BAND FM ANT – XMIT LOWER/RCVR UPPER 2. √MCC, lower antenna selected
C3	If no comm, or on MCC GO 3. S-BAND PM ANT – LL FWD
C3	When EVA crewmember at least 2.0 ft away from all S-Band upper antennas 4. S-BAND PM ANT – GPC

Ground

All EVAs	
Ground Radar MCC-H	1. √TOPO console, ground radar restrictions in place for EVA
USOS (1)	
ALL EVAs	
PCU	
NOTE PCUs may require up to 1 hr warm-up period before they are operational	
MCC-H	1. √PCUs (two) operational in discharge mode and one of the following: a. CCS PCU EVA hazard control enabled b. No more than two arrays unshunted c. No more than two arrays pointed < 90° from velocity vector
OR	
	2. One or no PCUs operational in discharge mode and one of the following: a. No more than two arrays unshunted b. No more than two arrays pointed < 90° from velocity vector
LOCATION DEPENDENT INHIBITS	
Lab Window	
IV	1. Close window shutter
KU-BAND (SGANT) Antenna {On call, EV crew not expected to be in this area}	
MCC-H	If EV crew < 3.3 ft from KU-BAND antenna 1. Park KU-BAND: 1.1 Pointing Mode – Inhibit 1.2 PLC – Reset 1.3 Autotrack Continuous Retry – Inhibit

EVA 3

EVA 3 INHIBIT PAD (Cont)

USOS (2)

LOCATION DEPENDENT INHIBITS

S-BAND (SASA) ANTENNAS

{On call, EV crew not expected to be in this area}

MCC-H If EV crew < 3.6 ft from S1 SASA [P1 SASA]

1. P1 SASA [S1 SASA] – Active
2. S1 SASA [P1 SASA] – Powered down

EVA 3 SPECIFIC INHIBITS

SSPTS DEACTIVATION

{Performed as part of Inhibit Pad}

- MCC-H
1. RPCM LA1A4A D RPC 3 – Open, Close Cmd Inhibit
 2. RPCM LA2A3B D RPC 1 – Open, Close Cmd Inhibit
 3. RPCM Z14B A RPC 2 – Open, Close Cmd Inhibit
 4. RPCM Z13B A RPC 2 – Open, Close Cmd Inhibit

P6 TO P5 MATE

{Expect inhibits in place prior to egress}

- MCC-H
1. MBSU 2 RBI 8 – Open, Close Cmd Inhibit
 2. MBSU 4 RBI 8 – Open, Close Cmd Inhibit
- {The following cannot be confirmed, done before P6 deactivation}
3. DCSU 2B RBI 6 – Open, Close Cmd Inhibit
 4. DCSU 4B RBI 6 – Open, Close Cmd Inhibit

MCC-H Since EV crew working outboard of port SARJ:

Locked at 90 deg:

1. √DLA (1) – LOCKED
2. All motor setpoints set to zero
3. All motors deselected

OR

4. Both DLAs – LOCKED

USOS (3)

EVA 3 SPECIFIC INHIBITS (Cont)

P1 SFU RECONFIGURATION

{Expect inhibits in place prior to egress}

- MCC-H
1. RPCM P12B C RPC 4 – Open, Close Cmd Inhibit
 2. RPCM P12B C RPC 5 – Open, Close Cmd Inhibit
 3. RPCM P12B C RPC 6 – Open, Close Cmd Inhibit
 4. RPCM P12B C RPC 7 – Open, Close Cmd Inhibit

MCC-H Since EV crew working within 2 ft of P1 TRRJ rotation envelope:

1. √DLA (1) – LOCKED

S1 SFU RECONFIGURATION

{Expect inhibits in place prior to egress}

- MCC-H
1. RPCM S11A C RPC 4 – Open, Close Cmd Inhibit
 2. RPCM S11A C RPC 5 – Open, Close Cmd Inhibit
 3. RPCM S11A C RPC 6 – Open, Close Cmd Inhibit
 4. RPCM S11A C RPC 7 – Open, Close Cmd Inhibit

MCC-H Since EV crew working within 2 ft of S1 TRRJ rotation envelope:

1. √DLA (1) – LOCKED

SPARE MBSU RETRIEVE

{Expect inhibits in place just before task}

- IV
1. Verify MCC-H GO, perform for MBSU HEATER DEACT:
R1 PL AFT MNC – OFF

SPARE MBSU INSTALL

{Performed as part of Inhibit Pad}

- MCC-H
1. RPCM N1RS2-B RPC 6 – Open, Close Cmd Inhibit
 2. RPCM S04B-F RPC 10 – Open, Close Cmd Inhibit

EVA 3 INHIBIT PAD (Cont)

USOS (4)

EVA 3 GET AHEAD INHIBITS

LAB CETA LIGHT REMOVE

{On Call}

- MCC-H
1. RPCM S01A C RPC 15 – Open, Close Cmd Inh
 2. RPCM S02B C RPC 15 – Open, Close Cmd Inh

BSP REMOVAL

{On Call}

- MCC-H
1. RPCM Z14B B RPC 4 – Open, Close Cmd Inh
 2. RPCM Z13B B RPC 4 – Open, Close Cmd Inh

RSOS (1)

ALL EVAs

SM Antennas

- IV
1. GTS – Deactivate
 2. ARISS – Deactivate or VHF (144-146 MHz) TX only

FGB Antennas

- MCC-M
1. √FGB KURS P [KYPC P] – Deactivated

EVA 3 NOTES, CAUTIONS, AND WARNINGS

NOTES

1. Bolt install: report torque and turns
2. Bolt release: report torque and turns if different from published range
3. EVA connectors: after disconnection and prior to connection; verify pin and EMI band integrity; verify connector free of FOD
4. Inspect QDs for damage prior to mating
5. Toolbox doors must be closed with one latch per door when EV crew not in immediate vicinity
6. Avoid contact with OBSS striker bars (Vitrolube coating)
7. MLI handholds are not rated for crewmember transition loads

CAUTION

ISS Constraints

- A. Avoid inadvertent contact with
1. Grapple fixture shafts (drylube)
 2. PIP pins
 3. EVA Crane [PMA1]
 4. TCS Reflectors [PMA2,PMA3]
 5. APAS hardware [PMA2,PMA3]
 6. CETA Lights (Z-93 paint) [LAB,S1,Node 1]
 7. Passive UMAs
 8. MBS VDU, MCU, CRPCMs, and Cameras (taped radiative surfaces, silver Teflon)
 9. Deployed TUS cable
 10. S0 aft face Radiator
 11. GPS Antennas (S13 paint) [S0]
 12. UHF Antennas [LAB, P1]
 13. ETCS Radiators [S1, P1]
 14. EETCS/PV Radiator bellows and panels [P6,P4,S4]
 15. SASA RF Group [Z1,S1,P1]
 16. Heat pipe radiators [Z1]
 17. PCU cathode and HCA ports [Z1]
 18. Ku-Band Antenna (SGANT) dish [Z1]
 19. CMG cover/shells [Z1]
 20. SSRMS Cameras
 21. Open CBM petal covers and LAB window shutter

CAUTION (Cont)

ISS Constraints (Cont)

- B. Electrical cables
1. Avoid bend radii < 10 times cable diameter
- C. Fiber optic cables
1. Avoid bend radii < 10 times cable diameter
 2. Avoid pulling on cable during mate/demate
- D. Fluid line flex hoses and QDs
1. Avoid bend radii < 5 in for hoses with diameter < 1 in on LAB, S0, S1, P1, and 10-in for hoses with diameter < 1 in on all other elements
 2. Avoid bend radii < 14 in for hoses with a diameter ≥ 1 in
 3. Additional care should be taken to not exceed bend radii when applying loads at the flexible hose to rigid tube stub interfaces
 4. Ensure fluid QD booties are fully closed prior to leaving worksite; wire tie if reqd
- E. For structural reasons
1. Avoid vigorous body motions, quick grabs and kickoffs against tether restraints
 2. Avoid performing shaking motions (sinusoidal functions) more than four cycles
 3. Avoid kicking S1/P1 radiator beam
- If any of these occur, wait 2 to 5 min to allow structural response to dissipate

EVA 3 NOTES, CAUTIONS, AND WARNINGS (Cont)

CAUTION (Cont)

ISS Constraints (Cont)

F. Other

1. ITT Cannon connector: On demated connectors, do not rotate collar or manipulate cable/connector using collar or connector tool
2. WIS Antennas: do not use as handholds [Node 1,P6,Z1]
3. Lubricant from Ku-Band SGANT gimbals [Z1], CMGs [Z1], and RTAS Ground Strap fasteners [P6,P4,S4] can contaminate EMU
4. MLI handholds are not rated for crewmember translation loads
5. CBM petal covers may not be used as handholds unless both launch restraint pins are engaged

CAUTION (Cont)

Shuttle Constraints

G. Avoid inadvertent contact with

1. OBSS and SRMS Composite Sections and Cable Harnesses
2. LCS (silver Teflon) and LDRI (silver Teflon) and ITVC (gold foil) [OBSS]
3. WVS Antenna [ODS Truss & PLB Sill]
4. Payload Bay wire harnesses, cables, and connectors

H. No touch

1. LDRI diffuser [OBSS]
2. OBSS saddle contacts (when OBSS unberthed) [OBSS]
3. Monkey fur [PLB]
4. Cameras: metallic surfaces [PLB]
5. Ku-Band Antenna black dish and gold thermal blankets [PLB]

EVA 3 NOTES, CAUTIONS, AND WARNINGS (Cont)

WARNING

ISS Constraints

- A. Avoid inadvertent contact with
1. Grapple fixture targets and target pins
 2. SSU, ECU, beta gimbal platform, mast canister, SAW blanket boxes unless the beta gimbal is locked and the motor is turned off
 3. Stay inboard of SARJ when active
 4. Stay 2 ft from S1/P1 radiator beam rotational envelope when beam is free to rotate
 5. Stay 5 ft from moving MT on face 1
- B. Handrails
1. Handrails previously used for MISSE attachment may not be used as a safety tether point [A/L endcone 564 & 566, A/L Tank 2 nad/fwd & port/fwd, P6 5389]
- C. Pinch
1. NZGL connector linkage. Use caution when mating/locking
 2. ITT Cannon Connector rotating housing
 3. EV side of IV Hatch during Hatch operation (also snag hazard) [A/L]
 4. LAB window shutter and CBM petal cover linkages during operation
- D. QDs
1. If QD is in FID when valve is opened (bail fwd), QD will leak and fluid line may whip
 2. Do not rotate if in mated/valve open config

WARNING (Cont)

ISS Constraints (Cont)

- E. RF radiation exposure
1. Stay 3.6 ft from S-Band (SASA) high gain Antenna when powered [S1,P1,P6]
 2. Stay 1.3 ft from S-Band (SASA) low gain Antenna when powered [S1,P1,P6]
 3. Stay 1 ft from UHF Antenna when powered [LAB, P1]
- F. Sharp Edges
1. Inner edges of WIF sockets
 2. Mating surfaces of EVA connectors. Avoid side loads during connector mating
 3. Back side of MMOD shield fasteners
 4. Spring loaded captive EVA fasteners (e.g., 6B-boxes, BMRRM); the end of the spring may protrude
 5. PMA umbilical launch restraints-exposed bolt threads
 6. Adjustable Fuse Tether (Fish Stringer) buckles stowed in Node Bag
 7. Nickel coated braided copper Ground Straps may contain frayed wires [P6,P4,S4]
 8. Z1 handrail 6061 by the Ku-Band boom launch restraint [Z1]
 9. Solar Array Blanket Box [P6]
 10. Keep hands away from SSRMS LEE opening, and snares
 11. Fastener threads on back of Z1 U-jumper male FQD panel, if nutplate cap missing

WARNING (Cont)

ISS Constraints (Cont)

- G. Thermal
1. EVA connectors with booties may become hot if left uncovered. Handling may need to be limited
 2. PMA handrails may be hot. Handling may need to be limited
 3. Turn off glove heaters when comfortable temp reached to prevent bladder damage. Do not pull fingers out of gloves when heaters are on
 4. Uncovered trunnion pins may be hot
 5. SSRMS/MBS operating Cameras and lights may radiate large amounts of heat
 6. Stay 1 ft away from PMAs and MMOD shields > 270 degF if EMU sun visor up
 7. Stay at least 1 ft away for no more than 15 min from PMAs and MMOD shields > 300 degF if EMU sun visor up
 8. Stay 0.5 ft away from PMA and MMOD shields > 325 degF
 9. Do not touch EMU protective visor if temp has been < -134 for > 15 min
 10. No EMU TMG contact of PMAs and MMOD shields when temp > 320 degF
 11. No EMU boot contact with foot restraint when temp < -120 degF or > 200 degF
- H. Electrical Shock Hazard
1. Stay \geq 2 ft from following ungrounded floating connectors if not inhibited: SSPTS on Lab fwd and stbd Node 1, H-jumper on FGB, MT cables, and S0 Bay 00, 02, and 03

EVA 3 NOTES, CAUTIONS, AND WARNINGS (Cont)

WARNING (Cont)

Shuttle Constraints

I. Arcing/Molten Debris

1. Stay ≥ 2 ft from exposed EFGF connector when OBSS berthed, powered, and EFGF not grappled [PLB]
2. Stay ≥ 2 ft from exposed Stbd Fwd MPM contacts [PLB]
3. Stay ≥ 2 ft from exposed Node 2 SPDU connectors when OBSS grappled by SRMS and LCS is powered [PLB]

J. Pinch

1. PRLA operation [PLB]

K. RF radiation exposure

1. Stay 2.0 ft from S-Band Antenna when powered
2. Stay 1 ft from top and side of UHF PLB Antenna radome surface when in high powered mode [ODS truss]
3. Stay 0.33 ft from top and side of UHF PLB Antenna radome surface when in low powered mode [ODS truss]
4. Remain below the level of the PLB door mold line for first 20 in Aft of Fwd bulkhead when S-Band Antenna powered [PLB]
5. Remain on the inboard side of the Stbd slidewire (sill handrails if slidewire not installed) for first 20 ft Aft of Fwd bulkhead when Ku-Band Antenna powered [PLB]

WARNING (Cont)

Shuttle Constraints (Cont)

L. Sharp Edges

1. PRLA grounding wipers [PLB]
2. LDRI baffles (Also an entrapment hazard) [OBSS]
3. Keep hands away from SRMS EE opening and snares
4. TCS connector backshells have exposed threads

M. Thermal

1. Illuminated PLB lights; do not touch
2. OBSS grapple fixture shafts/cams may be hot. Limit handling if required
3. Stay 27 ft from PRCS when powered
4. Stay 3 ft from VRCS when powered
5. Stay 3 ft from APU when operating

N. Thruster Contamination

1. Stay out of the immediate vicinity of leaking jet or APU

10A EVA 3 PRE BRIEF

ROLES (ALL)

EV1: Scott EV2: Wheels IV: Paolo	Suit IV (pre) : Peggy R1: Zambo R2: Steph	Suit IV (post): Peggy M1: Steph M2: Dan, M3: Clay
--	---	---

MILESTONES (ALL)

___:___ Wake-up EVA Prep Start	___:___ Start of Post Depress
--------------------------------------	----------------------------------

COMM SETUP (ALL)

Name	Loop Selected		Taking to	From	Used for
	STS	ISS			
Big Loop	A/G1	1	MCC-STs, MCC-ISS	STS, ISS, EMU	All EVA/(S)SRMS ops, emergencies
A/G2	A/G2	-	MCC-STs	STS, BPSMU	Non-EVA, non-emergencies, STS related
S/G2	-	2	MCC-ISS	ISS	Non-EVA, non-emergencies, ISS related
ICOM	ICOM	3	STS, ISS	STS, ISS, BPSMU	Comm. Not intended for ground
ICOM	-	5	ISS-A/L, EMUs	ISS-A/L, EMUs	ATU4, 5, 6 intercom pre/post EVA

NOTE: always start a transmission by stating the loop talking on (unless it's the Big Loop)

GENERAL EMERGENCIES (ALL)

For ISS or shuttle Fire/Depress/ATM Contamination:

- Everybody "safes" what he is doing, executes JEE (ISS crewmember will execute gray steps in A/L), and return to home vehicle
- For smoke/flames or ATM contamination, don PBAs or ИПК
- If no ammonia contamination, EVs and IV will retrieve equipment per Emergency Undocking cue card. MS2-Steph will help at the PMA
- If EVs in EVA, terminate EVA and return to ISS A/L (if possible, IV will join in A/L and assist)
- If suited in E/L => suit doff (+ power down if time permits)
- If C/L depressed => "fast" repress
- If E/L at 10.2 => expect immediate auto ("fast") repress

For EVA emergencies:

- Abort & terminate procedures (including incapacitated/lost EV) => non essential shuttle and ISS activities will be terminated, IV and CMOs will go to E/L as soon as EVs in C/L
- For lost crewmember/tool => CDR-PLT-MS2-IV in shuttle flight deck, if possible obtain 2 camera views (read pan/tilt angles) and HHL reading R/Rdot

(S)SRMS/EVA JOINT OPS (EV1, EV2, R1, R2, M1, M2, IV)

- Review of (S)SRMS general activities (DOUG review)
 - Review of sync points between EVA and (S)SRMS ops
 - Review of frame(s) of reference (ISS ACS, OBAS, body relevance)
 - Responsibilities for clearances => with R(M)1(2) (unless clearly handed off and acknowledged)
 - Anyone can call "All Stop, All Stop, All Stop" in case of impending unsafe situation or emergency. SRMS => Brakes ON; SSRMS => Safe even if heard only once
 - When arm(s) need to move during EVA => R(M)2 announce on Big Loop: initial motion, duration of motion, direction of motion, possible interference with EVA, end of motion
 - If GCA required => IV will verify (S)SRMS and EV(s) ready for GCA, and hands over EVA external COMM to R(M)2 and EVs
 - When joint activities completed, IV will verify EV1/2 clear and issue "GO for (S)SRMS maneuver"
- For GCA:
- EVX calls for requested motion, R(M)2 repeats request
 - When motion starts, EVX, acknowledge motion, counts down to stop motion
 - At the end of GCA, EVX calls "GCA complete", R(M)2 acknowledges, hands COMM back to IV

EVA PREP (EV1, EV2, IV, Suit IV)

- Camp-out review
- WCS usage, food/drink
- While at 10.2: shave, brush teeth, wash face, comb hair
- Wear mask if not at 10.2
- Tool config (last minute tools/equipment)
- E/L activities
- Parallel suit donning
- SAFER, MWS, tool, bag stowage
- 10.2 depress/repress review
- C/L depress review

REPRESS/POST-EVA (EV1, EV2, IV, Suit IV)

- Coldsoak
- C/L repress review
- Parallel Suit
- Food/drinks requests

10A EVA 3 PRE BRIEF (Cont)

EVA DETAILED REVIEW (EV1, EV2, IV)

- **Egress:** EV1 pass Fishstringer and Med ORU bag (BRT) to EV2 (temp stow FS to HR 0555 and 0560); EV1 stow C/L bag #2 on BRT
- **Safety Tether Swap:** Translate up CETA rail and swap to tether shuttles; stow 55-ft tethers (EV1 leads forward to HR 3413 and EV2 aft to HR 3444)
- **Translate to P5:** EV1 to corner #1 (temp stow C/L bag #2 to HR 5203); EV2 pick up APFR from CETA cart 1 (install APFR in P5-05 and temp stow Med ORU bag on P5 HR 5215)
- **Release RTAS Bolt #1 (EV1):** By hand until flush with fine alignment cone, verify at all corners (EV1 corners 1 & 3, EV2 corners 2 & 4)
- **GCA P6 to "First Contact":** EV1 gives GCA motion calls; acknowledge arm motion; calls in cm – stop at 30cm and 15cm; either EV call 'first contact'
- **P5 Capture Latch (EV2):** CW ~ 20 turns to 'first contact'; SSRMS to limp; then CW ~ 106 turns; gap check (EV1 corners 1 & 3, EV2 corners 2 & 4)
- **RTAS Bolts Initial Tq (EV1):** RTAS bolts 1, 2, 4 and 3 ~ 27 turns to HS

CAUTION

Do not apply a push force on the primary bolt; bolt 1 must be fastened first, followed by bolt 2

- **RTAS Ground Straps (EV2):** Remove from P6 by hand – attach to P5; corner 4, 3, 1, 2

WARNING

Sharp edge hazard on ground straps

- **RTAS Bolt Final Tq:** EV1 torque bolt 1 & 3 – pass torque wrench to EV2; EV2 torque bolts 2 & 4 then stow torque wrench on C/L bag #2
- **P5 Capture Latch (EV2):** Release latch pre-load; CCW – 60 turns
- **Connect P6 Umbilicals:** EV1 – Open TA clamps x 10; cables P253, P260, P259; EV2 – cable P254; Need a GO prior to demating P253 and P254; P260 must be demated from P5 prior to P259 and must be mated to P6 prior to P259; Chica Mantra for connectors in play
- **P6 Single Point Ground Removal:** EV1 – Translate to nadir SPG near HR 5347; remove the nadir P6 SPG and install cap on J36; EV2 – Translate to zenith SPG near HR 5346; remove zenith P6 SPG and install cap on J36

WARNING

Avoid contact with P6 lug near HR 5333, along the corner 2 path between the long spacer and the IEA, potential sharp edge area

- **SSU Shroud Removal:** EV2 retrieve Med ORU bag and temp stow; Nadir SSU first (2B) then zenith SSU (4B); review folding sequence (long strap stowed in pocket, fold long strap end, then sides, and finally fold the short strap side, stow short straps, secure Velcro); EV2 retrieve Med ORU bag and return to A/L
- **Release PVR Cinches (EV1):** Release H12, H11, then in sequence H14, H16, H13 and H15; Release PVR Winch Pip Pins

CAUTION

Avoid contact with radiator bellows and thermal outer coating; Watch for stored energy in cinches

EVA DETAILED REVIEW (EV1, EV2, IV) (Cont)

WARNING

PVR panels are free to move after winch release; Give a GO when clear of radiator deploy envelope

- **Translate to S1 SFU Panel (EV1):** Retrieve APFR from P5-05 and C/L bag #3 from HR 5203; install APFR in CETA cart 2, WIF 5; Temp stow C/L bag #3 near CETA spur; SFU worksite at CETA marker 6330 – BRT to HR 6330; verify SFU reconfig inhibits in-place; Chica Mantra for connectors in play
 - **Translate to Nadir Side of Lab (EV2):** BRT to Med ORU bag; tether swap from shuttle to A/L tether; temp stow Med ORU bag near A/L; BRT to C/L bag #3; translate to Lab Nadir – stow C/L bag on HR 0232; retrieve APFR from Node 2 WIF 8; install PAD, APFR and 85-ft tether to SRMS; ingress; **NOTE** – Brief cadence for SRMS GCA using OBAS coordinates when Shuttle payload bay clearly visible as a reference, otherwise, use local reference calls or ISAACS coordinates
 - **Translate to A/L (EV1):** Stay on tether shuttle, work get-aheads as time permits
 - **MBSU Transfer:** EV1 translate to ESP2, install APFR in WIF 5, stow MBSU on ESP2; EV2 GCA to MBSU removal; assist EV1 with alignment and final stow of MBSU on ESP2; EV1 stow APFR in Lab WIF 6; EV2 GCA to APFR egress; remove APFR, PAD, and safety tether; stow APFR in Lab WIF 12
 - **Translate to A/L:** Work get-aheads as time permits; return to A/L
- Ingress:** Initiate cold soak; complete tool inventory; stow all bags in A/L; ingress (EV1 first – then EV2)

CHICA MANTRAS (EV1, EV2, IV)

- | | |
|--|--|
| <ul style="list-style-type: none">• Day/Night Cycles<ul style="list-style-type: none">○ Lights – on○ Sun visor – day: down, night: up○ Cooling – as required○ Bayonets – locked○ Gloves:• Heater – on/off as required• Inspect/report:<ul style="list-style-type: none">▪ RTV status▪ Vectran abrasions/cuts (specifically inspect thumb, index finger, C-cup)○ Condition: Alpha, Bravo, Charlie• Safety Tether Swap<ul style="list-style-type: none">○ Gates – closed○ Hooks – locked○ Reel – unlocked• PGT Ops<ul style="list-style-type: none">○ XX – turns○ YY – torque○ (Green light) | <ul style="list-style-type: none">• PGT Extensions<ul style="list-style-type: none">○ XXX installed on YYY○ Good pull test• Electrical Connectors<ul style="list-style-type: none">○ Pins straight○ No FOD○ EMI band – intact○ If mated – mated, good bend radius○ TA clamps – closed• APFR Install<ul style="list-style-type: none">○ Black on black○ Good pull test |
|--|--|

10A EVA 3 PRE BRIEF (Cont)

COMM PROTOCOL (EV1, EV2, IV)

- Short and concise (everybody stops to listen when COMM is “active”)
- Start with EVX, IV, R(M)X, then switch to names
- Give appropriate/timely info
- Anticipate when possible, do not overload
- Hand signals (between EVs and/or IV/ground via WVS) => review crew notebook

EMERGENCIES (EV1, EV2, IV)

- All emergencies => verbalize, IV leads, challenge-response protocol
- DCS => speak up for symptoms (verbalize)
- Abort & terminate procedures => as per cuff check list (review)
- Incapacitated crewmember => EV secure other EV to himself, returns to A/L, IV + CMO in A/L
- Lost Crewmember => call over Big Loop, request cameras and HHL reading, SAFER ops
- Hydrazine/NH3 contamination => IV will direct ops per check list

GENERAL REMINDERS (EV1, EV2, IV)

- Verbalize any DCM messages
- Suit/gloves => stiffer than training HW
- Glove heaters => it takes 2-3 min to feel heat
- EHIP lights => leave them on
- Translations => slow & deliberate, avoid feet first, check tethers often, check buddy when able
- Mass handling => one axis trans/rot at a time, watch for inertia
- Tether management => fairleads, stay clear of each other, 30 sec rule for snags or entanglements
- ORU control => positive transfer of control
- PGT ops => Red light – low torque, Green light – in torque window, Red/Green lights – HI torque
- PGT CAL procedure => Ratchet collar – Not motor, Speed collar – Cal, Pull trigger (CAL passed message)
- Video/cameras view for IV => change tapes, adjust WVS at SR/SS
- Errors & Lost tools => acknowledge and continue
- For lost tool/ORU => EVs verbalize what, when, direction, speed; IV gets 2 camera views/HHL (if possible)

EVA 3 SUMMARY TIMELINE

PET HR : MIN	IV/SSRMS	10A EVA 3 EV1 – Pz	EV2 – Wheels	PET HR : MIN
00:00	SSRMS: P6 Pre-install setup	<u>EVA 3 A/L EGRESS AND SETUP</u> (00:30) <ul style="list-style-type: none"> Post Depress/Egress Setup 	<u>EVA 3 A/L EGRESS AND SETUP</u> (00:45) <ul style="list-style-type: none"> Post Depress/Egress Setup 	00:00
01:00	SSRMS: P6 Pre-install SSRMS: GCA to first contact SSRMS: Limp after initial CLA contact	<u>ATTACH P6 to P5</u> (02:10) <ul style="list-style-type: none"> GCA at 130 cm GCA at 30 cm GCA at 15 cm GCA to first contact Back off Bolt 1 Bolt initial torque Bolt 1 and 3 final torque 	<u>ATTACH P6 to P5</u> (02:30) <ul style="list-style-type: none"> Open CLA GCA at 130 cm GCA at 30 cm GCA at 15 cm GCA to first contact Drive CLA Ground strap install Bolt 2 and 4 final torque Release CLA 	01:00
02:00	SSRMS: P6 ungrapple			02:00
03:00	√MCC-H GO for P5 to P6 umbilicals	<u>CONNECT P5 to P6 UMBILICALS</u> (00:40) <ul style="list-style-type: none"> Connect umbilicals (4) Remove nadir SPG 	<u>CONNECT P5 to P6 UMBILICALS</u> (00:15) <ul style="list-style-type: none"> Connect umbilicals (4) Remove zenith SPG 	03:00
04:00	√MCC-H in CMG Control SRMS: APFR install/ingress	<u>SSU SHROUD REMOVE</u> (00:35)	<u>SSU SHROUD REMOVE</u> (01:00)	04:00
05:00	SRMS: MBSU retrieval setup SRMS: MBSU clearance √MCC-H GO for SFU Reconfig	<u>OUTBD RADIATOR CINCH RELEASE</u> (01:00) <ul style="list-style-type: none"> Release cinches (6) Release winch PIP pin 	<u>MBSU TRANSFER</u> (02:15) <ul style="list-style-type: none"> Set up SRMS Mnvr to PLB Retrieve MBSU from PLB Mnvr to ESP-2 	05:00
06:00	SRMS: MBSU handoff SRMS: APFR egress SRMS: APFR removal	<u>SFU: P1 CONFIG FOR/S1 POST DEPLOY</u> (00:20) <u>GET AHEADS</u> (00:30) <u>MBSU TRANSFER</u> (00:45) <ul style="list-style-type: none"> Set up APFR at ESP-2 Receive MBSU Install MBSU 	<ul style="list-style-type: none"> Hand off MBSU Egress APFR Clean up SRMS 	06:00
07:00		<u>SAW DEPLOY CLEANUP AND A/L INGRESS</u> (00:25) <u>PRE REPRESS</u> (00:05)	<u>CLEANUP AND A/L INGRESS</u> (00:10) <u>PRE REPRESS</u> (00:05)	07:00

PRE EVA 3 TOOL CONFIG

EV1

EMU D-rings

- 1 – Tether Extender on Left
- 2 – Waist Tethers
- 1 – 85-ft Safety Tether (TS)
- 1 – 55-ft Safety Tether (A/L)

MWS

- Small trash bag [right inside]
 - Cannon Connector tool {from Used Tools FS}
 - 1 – RET (sm-sm)
- 1 – Adj tether [right]
- 1 – RET (with PIP pin) [right]
- 1 – RET (sm-sm) [left]
- 2 – Wire ties
- Socket caddy [left inside]
 - 5/8-7.8 in ext
 - 7/16-6 in ext {from EV1s PGT}
 - RAD {from Used Tool fish stringer} S/N _____
- Swing Arm [right side]
 - PGT S/N _____
(A7, CW2, 30.5)
 - 1 – RET (sm-sm)
- BRT [left side]
 - 3 – Wire Ties, short
 - 1 – RET (sm-sm)
- SAFER

EV2

EMU D-rings

- 1 – Tether Extender on Left
- 2 – Waist Tethers
- 1 – 85-ft Safety Tether (TS)
- 1 – 55-ft Safety Tether (A/L)

MWS

- Small trash bag [right inside]
 - Cannon Connector tool {from Used Tools FS}
 - 1 – RET (sm-sm)
- 1 – Adj tether [left]
- 1 – RET (with PIP pin) [left]
- 1 – RET (sm-sm) [right]
- 2 – Wire ties
- Socket caddy [left inside]
 - 5/8-7.8 in ext {from Used Tools FS RAD}
- Swing Arm [right side]
 - PGT w/7/16-6 in ext S/N _____
(A6, CW3, 30.5)
 - 1 – RET (sm-sm)
- BRT [left side]
 - 1 – Wire Tie, short
 - 2 – Wire Tie, long
 - 1 – RET (sm-sm)
- SAFER

CREWLOCK (cont)

- Staging Bag additions
 - Spare Torque Wrench
- IV Bag
- Fish stringer
 - C/L bag #2 – adj tether on outside
 - Torque Wrench (set to 57 ft-lb)
(outside of bag) w/2 wire ties {from 10A Bag}
 - 1 – RET (sm-sm)
 - EV1 85-ft safety tether (P5) {from 10A bag}
 - EV2 85-ft safety tether (P5) {from STS A}
 - Ratchet w/7/16-6 in ext (on int) (for radiator cont) {from Used Tools FS}
 - Round TM w/5/8 socket (on int) (for NTA break torque GA)
 - C/L bag #3 – adj tether on outside
 - PAD (√in SD) (on int) {from 10A Bag}
 - WIF Adapter
 - EVA Camera/Bracket {from internal FS}
 - S0 Gap Spanners (1 – 45", 1 – 72")
 - Round Scoop (for CETA Light)
 - Wire Tie Caddy
- 1 – RET (Lg-sm)
 - Med ORU bag (SSU shrouds) {from Node}
 - 6 – RET (sm-sm) {from Tether Staging}
 - EVA Camera/Bracket {from C/L Bag #2}
 - 2 – Adj tether on outside {from Tether Staging}

Prior to EVA, inspect:
RET cord for damage
Small trash bag bristles for damage or deformation
Safety & waist tether load alleviating straps: no red

Total RETs sm-sm used – 16
RETs with PIP pin – 5
RETs Lg-sm – 6
Adj tethers – 7 (+2 on trash bag)

Items remain in crewlock

PRE EVA 3 TOOL CONFIG (Cont)

CREWLOCK (Cont)

- 1 – RET (Lg-sm)
 - C/L Bag#1 (Solar Array Tools)
 - BRS Pin Contingency Tool (w/Tape) {from 10A Bag}
 - Loop Pin Puller (w/Tape) {from STS B}
 - TPS Scraper (w/Tape) {from Staging Bag}
 - Compound Cutter/Needle Nose Pliers Caddy (w/Tape) {from STS B}
 - Hockey Stick {from 10A Bag}
 - 1 – RET (Lg-sm)
 - Cheater Bar (w/Kapton Tape) {from 10A Bag}
 - 1.5" Bail Drive Lever (taped to Cheater Bar)
 - 1 – RET (Lg-sm)
 - Med ORU Bag (for CETA light)
 - 1 – RET (with PIP pin)
 - 1 – RET (Lg-sm)
 - 6B Box Cover
 - Dummy box
 - 1 – Adj tether
 - 1 – RET (sm-sm)
 - 1 – RET (Lg-sm)
 - Crewlock bag #4 (MMOD Shield)
 - 3 – LDTDT
 - Wire Tie Caddy (on int)
 - 2 – MMOD T-Tool (on int) (used on EVA 2)
 - GP Caddy (on int)
 - Vise Grips
 - Loop Pin Puller
 - Hammer (on RET w/PIP)
 - EVA Ratchet with IV socket (on RET w/PIP)

Tools remain in crewlock

EVA 3 A/L EGRESS AND SETUP (00:45)

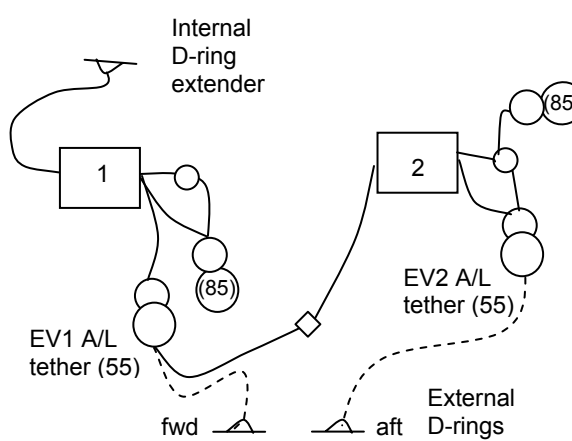
IV	EV1 – Pz (FF)	EV2 – Wheels (FF)
 <p>Internal D-ring extender</p> <p>EV1 A/L tether (55)</p> <p>EV2 A/L tether (55)</p> <p>External D-rings: fwd, aft</p> <div style="border: 1px solid black; padding: 5px; width: fit-content;"> <p>1 – 55-ft A/L tether – EV1 → On CM</p> <p>1 – 55-ft A/L tether – EV2 → On CM</p> <p>1 – 85-ft TS tether – EV1 → On CM</p> <p>1 – 85-ft TS tether – EV2 → On CM</p> <p>1 – 85-ft P5 tether – EV1 → C/L bag #2</p> <p>1 – 85-ft P5 tether – EV2 → C/L bag #2</p> </div> <p>Start Torque Wrench thermal clock (3:30) PET = _____</p> <p>1. Post crew egress: WVS Software: Select page – RF Camera sel 'Advanced controls' S-Band level (two) – max</p>	<p>INITIAL CONFIG</p> <p>1. Verify:</p> <ul style="list-style-type: none"> <input type="checkbox"/> Right waist tether connected to A/L D-ring extender <input type="checkbox"/> Hook locked <p>EGRESS/INITIAL SETUP</p> <hr/> <p>1. On EV2 GO, release EV1 right waist tether, attach to self</p> <p>2. Transfer fish stringer (with crewlock bags) to EV2</p> <hr/> <p>3. Transfer SSU Med ORU bag to EV2</p> <hr/> <p>4. Egress crewlock</p> <p>5. Close hatch thermal cover</p> <p>6. Retrieve C/L bag #2 (w/torque wrench) from fish stringer</p> <p>7. Stow C/L bag #2 on BRT</p>	<p>INITIAL CONFIG</p> <p>1. Verify:</p> <ul style="list-style-type: none"> <input type="checkbox"/> Right waist tether connected to EV1's 55-ft safety tether <input type="checkbox"/> Hook locked <p>EGRESS/INITIAL SET-UP</p> <p>1. Open hatch thermal cover</p> <p>2. Egress crewlock</p> <p>3. Attach EV2 55-ft safety tether to aft A/L D-ring</p> <ul style="list-style-type: none"> <input type="checkbox"/> √Gate closed <input type="checkbox"/> √Hook locked <input type="checkbox"/> √Reel unlocked <p>4. Attach EV1 55-ft safety tether to fwd A/L D-ring</p> <ul style="list-style-type: none"> <input type="checkbox"/> √Gate closed <input type="checkbox"/> √Hook locked <input type="checkbox"/> √Reel unlocked <hr/> <p>5. Give EV1 GO to release EV1 waist tether from A/L D-ring extender</p> <p>6. Verify SAFER config</p> <ul style="list-style-type: none"> <input type="checkbox"/> √L Handle down (MAN ISO Vlv – Open) <input type="checkbox"/> √R Handle down (HCM – Closed) <hr/> <p>7. Receive fish stringer</p> <p>8. Attach fish stringer to A/L HR 0555 and 0560 (C/L fwd/stbd/nadir), cinch</p> <hr/> <p>9. Receive SSU Med ORU bag</p> <p>10. Stow SSU Med ORU bag on BRT</p> <hr/> <p>11. Translate to tether shuttles via aft crewlock path; following EV1</p>

EVA 3 A/L EGRESS AND SETUP (00:45) (Cont)

IV	EV1 – Pz (FF)	EV2 – Wheels (FF)
	<p>8. Verify SAFER config <input type="checkbox"/> √L Handle down (MAN ISO Vlv – Open) <input type="checkbox"/> √R Handle down (HCM – Closed)</p> <p>9. Translate to tether shuttles via fwd path; leading EV2, fairleading tightly along CETA spur</p> <p>10. Retrieve tether shuttle</p> <p>11. Install on CETA rail (outboard) <input type="checkbox"/> √Locked</p> <hr style="border-top: 1px dashed black;"/> <p>12. Attach 85-ft safety tether to tether shuttle <input type="checkbox"/> √Gate closed <input type="checkbox"/> √Hook locked <input type="checkbox"/> √Reel unlocked</p> <p>13. Remove A/L 55-ft tether</p> <p>14. Stow on HR 3413 (CETA handrail bridge)</p> <div style="border: 3px double black; padding: 5px; margin: 10px 0;"> <p style="text-align: center;">WARNING</p> <p>2' Keep Out Zone for floating cables between MT and MBS. Stay on UMA handrails during translation underneath MT</p> </div> <p>15. Translate along nadir CETA rail to P5 Corner 1 (P5 nadir/fwd)</p> <p>16. Perform glove inspection</p>	<p>12. Retrieve tether shuttle</p> <p>13. Install on CETA rail (inboard) <input type="checkbox"/> √Locked</p> <p>14. Attach 85-ft safety tether to tether shuttle <input type="checkbox"/> √Gate closed <input type="checkbox"/> √Hook locked <input type="checkbox"/> √Reel unlocked</p> <p>15. Remove A/L 55-ft tether</p> <p>16. Stow on HR 3444 (port of HR bridge)</p> <p>17. Translate to CETA cart 2 (inboard-most), WIF 2 (stbd TFR swing arm)</p> <p>18. Transfer Med ORU bag from BRT to MWS</p> <p>19. Retrieve APFR and stow on BRT</p> <p>20. Translate along zenith CETA rail to P5 WIF 05 (P5 aft) – remain on Face 1 until SARJ, then translate aft, outboard, then nadir</p> <p>21. Perform glove inspection</p>

ATTACH P6 TO P5 (02:30)

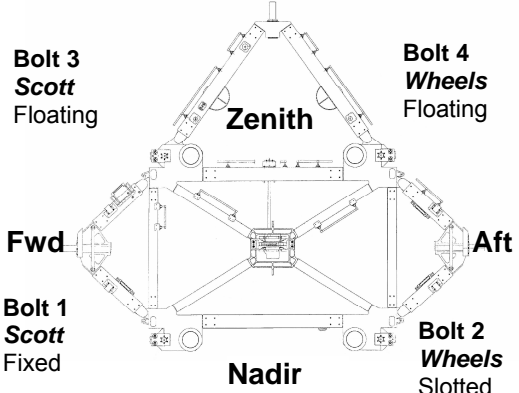
IV/SSRMS	EV1 – Pz (FF)	EV2 – Wheels (FF)																														
<p>Current P6 location: 130 cm out and 2m ISS fwd (Pre-install Setup)</p>  <p>P5 – Port side looking stbd Bolts on P5 side</p> <ol style="list-style-type: none"> 1. Notify M1 approaching P6 mate 	<ol style="list-style-type: none"> 1. Temp stow C/L bag #2 at corner 1, HR 5203 2. Temp stow EV2 85-ft P5 safety tether near corner 2 3. Swap to 85-ft P5 safety tether on P5 HR 5202 <ul style="list-style-type: none"> <input type="checkbox"/> √Gate closed <input type="checkbox"/> √Hook locked <input type="checkbox"/> √Reel unlocked 4. Stow 85-ft TS safety tether on P5 HR 5201 <p><u>RELEASE BOLT AT CORNER 1</u></p> <div style="border: 2px solid black; padding: 5px; text-align: center;"> <p>WARNING Avoid contact with exposed bolt tip and damaged P5 EWIS connector bail, potential sharp edges</p> </div> <ol style="list-style-type: none"> 1. Translate to corner 1 2. Retract RTAS Bolt 1 By hand: ccw; ~3-5 turns until bolt tip flush with fine alignment cone plane <p><u>READY TO MATE VERIFICATION</u></p> <ol style="list-style-type: none"> 1. Perform following steps for Bolts 1 and 3: <table border="1" data-bbox="787 1140 1927 1367"> <thead> <tr> <th></th> <th>Bolt 1 EV1</th> <th>Bolt 2 EV2</th> <th>Bolt 3 EV1</th> <th>Bolt 4 EV2</th> </tr> </thead> <tbody> <tr> <td>√P5 RTAS Primary bolt below fine alignment cone plane</td> <td></td> <td></td> <td></td> <td></td> </tr> <tr> <td>√P5 RTAS 2-7 threads visible by bolt shoulder</td> <td></td> <td></td> <td></td> <td></td> </tr> <tr> <td>√P6 RTAS Primary ball/bearing centered</td> <td></td> <td></td> <td></td> <td></td> </tr> <tr> <td>√P6 RTAS Contingency ball/nuts (2) centered</td> <td></td> <td></td> <td></td> <td></td> </tr> <tr> <td>√P5-P6 mating I/F free of debris</td> <td></td> <td></td> <td></td> <td></td> </tr> </tbody> </table> <ol style="list-style-type: none"> 2. Translate to corner 1 		Bolt 1 EV1	Bolt 2 EV2	Bolt 3 EV1	Bolt 4 EV2	√P5 RTAS Primary bolt below fine alignment cone plane					√P5 RTAS 2-7 threads visible by bolt shoulder					√P6 RTAS Primary ball/bearing centered					√P6 RTAS Contingency ball/nuts (2) centered					√P5-P6 mating I/F free of debris					<ol style="list-style-type: none"> 1. Install APFR in P5-05 (10,QQ,C,11) <ul style="list-style-type: none"> <input type="checkbox"/> √Locking collar black-on-black <input type="checkbox"/> Good pull test 2. Temp stow Med ORU bag on P5 HR 5215 <hr style="border-top: 1px dashed black;"/> <ol style="list-style-type: none"> 3. Retrieve EV2 85-ft P5 safety tether 4. Swap to 85-ft P5 safety tether on P5 HR 5226 <ul style="list-style-type: none"> <input type="checkbox"/> √Gate closed <input type="checkbox"/> √Hook locked <input type="checkbox"/> √Reel unlocked 5. Stow 85-ft TS safety tether on P5 HR 5201 <p><u>READY TO MATE VERIFICATION</u></p> <ol style="list-style-type: none"> 1. Translate to corner 2 2. Perform following steps for Bolts 2 and 4: <ol style="list-style-type: none"> 3. Remain at corner 4
	Bolt 1 EV1	Bolt 2 EV2	Bolt 3 EV1	Bolt 4 EV2																												
√P5 RTAS Primary bolt below fine alignment cone plane																																
√P5 RTAS 2-7 threads visible by bolt shoulder																																
√P6 RTAS Primary ball/bearing centered																																
√P6 RTAS Contingency ball/nuts (2) centered																																
√P5-P6 mating I/F free of debris																																

ATTACH P6 TO P5 (02:30) (Cont)

IV/SSRMS	EV1 – Pz (FF)	EV2 – Wheels (FF)								
<input type="checkbox"/> √EV1, EV2 ready for P6 motion aft 2 m										
2. Give M1/M2 GO for mnvr to P6 Pre-install	1. Monitor clearances as required (specifically SSRMS boom to blanket box)									
3. Handover to M1/M2 for “130” GCA Pre-brief	2. Participate in IV GCA pre-brief, acknowledge items									
<input type="checkbox"/> √EV1, EV2 ready for GCA	3. Verify tools and tethers clear from P5 & P6 I/F									
4. Give M1/M2 GO for “SSRMS GCA to First Contact”	4. GCA SSRMS to 30 cm, fly out as reqd 5. GCA SSRMS to 15 cm, call for final alignment corrections as reqd (M1 give “15” pre-brief) 6. GCA to first contact 7. √All four alignment pins are within alignment cups ENGAGE P5 CAPTURE LATCH	ENGAGE P5 CAPTURE LATCH <div style="border: 2px solid black; padding: 5px; text-align: center;"> <p>WARNING EV crewmembers must remain clear of P6/P5 mating interface</p> </div>								
<input type="checkbox"/> √M1 GO to drive CLA to Impending Contact		1. BRT HR 5239								
	1. Position to monitor capture latch motion (going to call just prior to first contact) 2. Prior to contact, report “CLA Impending Contact”	2. Drive P5 CLA PGT, 7/16-6 in ext: A6, CW3; until EV1 call “CLA Impending Contact” (~20 turns) Turns: _____								
<input type="checkbox"/> √SSRMS in Limp Mode 5. Handover to M1/M2 for CLA closure Pre-brief										
<p style="text-align: center;"><u>NOTE</u></p> Gap between all four P6 and P5 housing surfaces must be < 0.6 in prior to primary bolt driving	3. Monitor CLA motion 4. √Gap with small equip hook on corners 1 and 2 <table border="1" style="width: 100%; border-collapse: collapse;"> <tr> <td style="width: 25%;">Corner 1</td> <td style="width: 25%;"></td> <td style="width: 25%;">Corner 2</td> <td style="width: 25%;"></td> </tr> </table>	Corner 1		Corner 2		3. Drive P5 CLA , annunciating turns PGT, 7/16-6 in ext: A6, CW1; to HS (~106 turns) Turns/Torque: _____ 4. √Gap with small equip hook on corners 3 and 4 <table border="1" style="width: 100%; border-collapse: collapse;"> <tr> <td style="width: 25%;">Corner 3</td> <td style="width: 25%;"></td> <td style="width: 25%;">Corner 4</td> <td style="width: 25%;"></td> </tr> </table>	Corner 3		Corner 4	
Corner 1		Corner 2								
Corner 3		Corner 4								

ATTACH P6 TO P5 (02:30) (Cont)

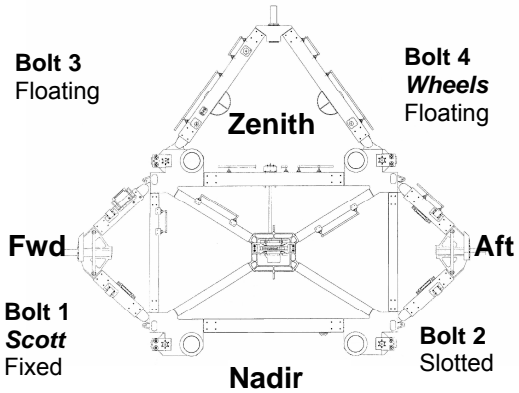
IV/SSRMS	EV1 – Pz (FF)	EV2 – Wheels (FF)																																																	
<p>NOTE Gap between all four P6 and P5 housing surfaces must be < .478 in after primary bolt seating</p>  <p>P5 – Port side looking stbd Bolts on P5 side</p>	<p>RTAS BOLTS INITIAL TORQUE</p> <div style="border: 1px solid black; padding: 5px; margin: 10px 0;"> <p align="center">CAUTION</p> <p>Primary bolt hardware sensitive to crew loads. Do not apply a push force on the RTAS primary bolt. Damage to self feeding nut may result</p> </div> <p align="center">NOTE</p> <p>EV1: Bolt 1 must be fastened first, followed by Bolt 2. The order of Bolt 3 and 4 is not critical EV2: Ground strap retaining washer may fully release if cross threaded EV1 and EV2: P6 is not approved for translation during bolting</p> <ol style="list-style-type: none"> Install RAD w/5/8-7.8 in socket on PGT Drive RTAS Bolt 1 PGT, RAD, 5/8-7.8 in ext: A7,CW2; ~ 27 turns to HS <input type="checkbox"/> √Bolt shoulder is seated against housing Drive RTAS Bolt 2 PGT, RAD, 5/8-7.8 in ext: A7,CW2; ~ 27 turns to HS <input type="checkbox"/> √Bolt shoulder is seated against housing Perform PGT socket swap; stow RAD on socket caddy, install 5/8-7.8 in ext on PGT Drive RTAS Bolts 4 and 3 PGT, 5/8-7.8 in ext: B7,CW2; ~ 27 turns to HS <input type="checkbox"/> √Bolt shoulder is seated against housing <table border="1" data-bbox="701 1138 1369 1398"> <thead> <tr> <th>Bolt Order</th> <th>BRT</th> <th>Turns</th> <th>Torque</th> <th>√Seated</th> </tr> </thead> <tbody> <tr> <td>Bolt 1 – nadir /fwd</td> <td>5203</td> <td></td> <td></td> <td></td> </tr> <tr> <td>Bolt 2 – nadir/aft</td> <td>5226</td> <td></td> <td></td> <td></td> </tr> <tr> <td>Bolt 4 – zenith/aft</td> <td>5237</td> <td></td> <td></td> <td></td> </tr> <tr> <td>Bolt 3 – zenith/fwd</td> <td>5233</td> <td></td> <td></td> <td></td> </tr> </tbody> </table>	Bolt Order	BRT	Turns	Torque	√Seated	Bolt 1 – nadir /fwd	5203				Bolt 2 – nadir/aft	5226				Bolt 4 – zenith/aft	5237				Bolt 3 – zenith/fwd	5233				<p>RTAS GROUND STRAPS</p> <div style="border: 1px solid black; padding: 5px; margin: 10px 0;"> <p align="center">WARNING</p> <p>Exposed braided wire on ground straps and protruding spring on ground strap bolt may present sharp edge hazard</p> </div> <ol style="list-style-type: none"> Release Corner 4 P6 Ground Strap from P6 By hand: ccw; ~3 turns If no joy: PGT, 7/16-6 in ext: B1, CCW2; 3 turns Install P6 Ground Strap on P5 Start by hand then: PGT, 7/16-6 in ext: A6, CW2; ~6 turns to HS Repeat steps 1 and 2 for corners 3, 1, and 2 <table border="1" data-bbox="1421 1094 1982 1382"> <thead> <tr> <th>Grnd Strap Order</th> <th>BRT HR</th> <th>Turns</th> <th>Torque</th> </tr> </thead> <tbody> <tr> <td>Corner 4</td> <td>5237</td> <td></td> <td></td> </tr> <tr> <td>Corner 3</td> <td>5233</td> <td></td> <td></td> </tr> <tr> <td>Corner 1</td> <td>5203</td> <td></td> <td></td> </tr> <tr> <td colspan="4">Unwind safety tether and undo fairlead</td> </tr> <tr> <td>Corner 2</td> <td>5226</td> <td></td> <td></td> </tr> </tbody> </table>	Grnd Strap Order	BRT HR	Turns	Torque	Corner 4	5237			Corner 3	5233			Corner 1	5203			Unwind safety tether and undo fairlead				Corner 2	5226		
Bolt Order	BRT	Turns	Torque	√Seated																																															
Bolt 1 – nadir /fwd	5203																																																		
Bolt 2 – nadir/aft	5226																																																		
Bolt 4 – zenith/aft	5237																																																		
Bolt 3 – zenith/fwd	5233																																																		
Grnd Strap Order	BRT HR	Turns	Torque																																																
Corner 4	5237																																																		
Corner 3	5233																																																		
Corner 1	5203																																																		
Unwind safety tether and undo fairlead																																																			
Corner 2	5226																																																		

ATTACH P6 TO P5 (02:30) (Cont)

IV/SSRMS	EV1 – Pz (FF)	EV2 – Wheels (FF)																								
<p>6. Once all 4 RTAS bolts mated and verified tools and tethers clear, give SSRMS GO for P6 Ungrapple</p>	<p>6. Translate to C/L bag at corner 1 (backtrack to unwind safety tether) 7. Retrieve torque wrench from C/L bag 8. Transfer 5/8-7.8 in ext from PGT to torque wrench 9. Transfer 7/16-6 in ext from socket caddy to PGT</p> <p><u>RTAS BOLT 1 AND 3 FINAL TORQUE</u></p> <p>1. Torque RTAS Bolts 1 and 3 Torque Wrench, 5/8-7.8 in ext: 57 ft-lb cw, to torque √Gap with small equip hook</p> <table border="1" data-bbox="751 613 1325 789"> <thead> <tr> <th>Bolt Order</th> <th>BRT</th> <th>Turns to torque</th> <th>Gap √</th> </tr> </thead> <tbody> <tr> <td>Bolt 1 – nadir /fwd</td> <td>5203</td> <td></td> <td></td> </tr> <tr> <td>Bolt 3 – zenith/fwd</td> <td>5224</td> <td></td> <td></td> </tr> </tbody> </table> <p>2. Transfer torque wrench to EV2</p> <p>3. Translate to P6 umbilical worksite</p>	Bolt Order	BRT	Turns to torque	Gap √	Bolt 1 – nadir /fwd	5203			Bolt 3 – zenith/fwd	5224			<p><u>RTAS BOLT 2 AND 4 FINAL TORQUE</u></p> <p>1. Receive torque wrench from EV1 2. Torque RTAS Bolts 2 and 4 Torque Wrench, 5/8-7.8 in ext: 57 ft-lb cw, to torque √Gap with small equip hook</p> <table border="1" data-bbox="1388 963 1961 1138"> <thead> <tr> <th>Bolt Order</th> <th>BRT</th> <th>Turns to torque</th> <th>Gap √</th> </tr> </thead> <tbody> <tr> <td>Bolt 2 – nadir/aft</td> <td>5226</td> <td></td> <td></td> </tr> <tr> <td>Bolt 4 – zenith/aft</td> <td>5236</td> <td></td> <td></td> </tr> </tbody> </table>	Bolt Order	BRT	Turns to torque	Gap √	Bolt 2 – nadir/aft	5226			Bolt 4 – zenith/aft	5236		
Bolt Order	BRT	Turns to torque	Gap √																							
Bolt 1 – nadir /fwd	5203																									
Bolt 3 – zenith/fwd	5224																									
Bolt Order	BRT	Turns to torque	Gap √																							
Bolt 2 – nadir/aft	5226																									
Bolt 4 – zenith/aft	5236																									
		<p>3. Remove 5/8-7.8 in socket, stow on socket caddy 4. Stow torque wrench in torque wrench bag on C/L bag with RET</p> <p><u>RELEASE P5 CAPTURE LATCH PRE-LOAD</u></p> <p>1. Once all 4 RTAS bolts torqued, Drive P5 CLA PGT, 7/16-6 in ext: A6, CCW3; 60 turns 2. Translate to P5/P6 umbilical worksite</p>																								

ATTACH P6 TO P5 (RTAS) – TASK DATA

Tools:

EV1 (FF)	EV2 (FF)
PGT	PGT
5/8-7.8 in ext	5/8-7.8 in ext
Torque Wrench	Torque Wrench
7/16-6 in ext	7/16-6 in ext

EVA Fasteners:

Fastener Name	Label	Head Size	Install Torque (ft-lb)	Release Torque (ft-lb)	Failure Torque (ft-lb)	Turns	RPM
P5 capture latch		7/16"	3.3 (to close)	7.5 (to open)	14.6	126 – close 60 – open	60 initial, 30 – close 60 – open
P5 RTAS bolts (Initial)	1,2,3,4	5/8"	w/RAD: 9.2 w/o RAD: 25.5	N/A	119.7	24 turns min, 36 turns max	30
P5 RTAS bolts (Final)	1,2,3,4	5/8"	57	N/A	119.7	Until torque reached	N/A
P6 Grounding Strap	N/A	7/16"	8.3	12.0	Inst: 11.8 Rel: 31.1	Inst: 5-8 Rel: ~3	30
Gap Check Tool	N/A	7/16"		8.3	12.2	12-14	30

EVA Connectors: None

Foot Restraints:

Task	WIF	APFR Setting	NOTE
Capture CLA drive	P5-03	P,QQ,D,1	
RTAS bolt 1	P5-04	11,PP,C,12	
RTAS bolt 2	P5-05	2,FF,L,10	APFR position is within sweep of SSU for beta angles 240-15 deg on SA 4A
RTAS bolt 3	P5-04	11,XX,E,2	
RTAS bolt 4	P5-05	2,TT,G,12	

Cautions:

1. Primary bolt hardware sensitive to crew loads. Do not apply push force on bolt or damage to self feeding nut could occur
2. Due to fault currents and EMI, 2 ground straps are required prior to activation, all 4 are required for activation

Warnings:

1. Avoid contact with exposed bolt tip and damaged EWIS connector bail on corner 1 due to potential sharp edges
2. When captive EVA fasteners are released then engaged, the pop-up spring could protrude out between the bolt head and housing producing a puncture hazard
3. Exposed braided wire on ground straps and protruding spring on ground strap bolt may present sharp edge hazard
4. EMU collision hazard. EV1 and EV2 must stay below the plane defined by P5/P6 interface until needed for verification of ready to latch condition
5. Pinch Hazard. Area between P6 and P5 must be clear prior to latch actuation to prevent crew injury

Notes:

RTAS GAP CHECK:

Minimum: 0.330 inches

Nominal: 0.406 inches

Maximum before primary bolt driving: 0.576 inches

Maximum after primary bolt seating: 0.478 inches

RET hook: 0.43 inches

7/16-6 in ext drop-proof tether end: 0.66 inches

1. Gap Check Tools (2) are located on P5 inboard and outboard Corner 1
2. Translation on P6 not permitted during bolting (however, no requirement on number of RTAS bolts for limited activities)
3. Due to anomaly during launch lock removal on corner 1, there is a greater likelihood that the self feeding nut may be damaged

ATTACH P6 TO P5 (RTAS) – TASK DATA (Cont)

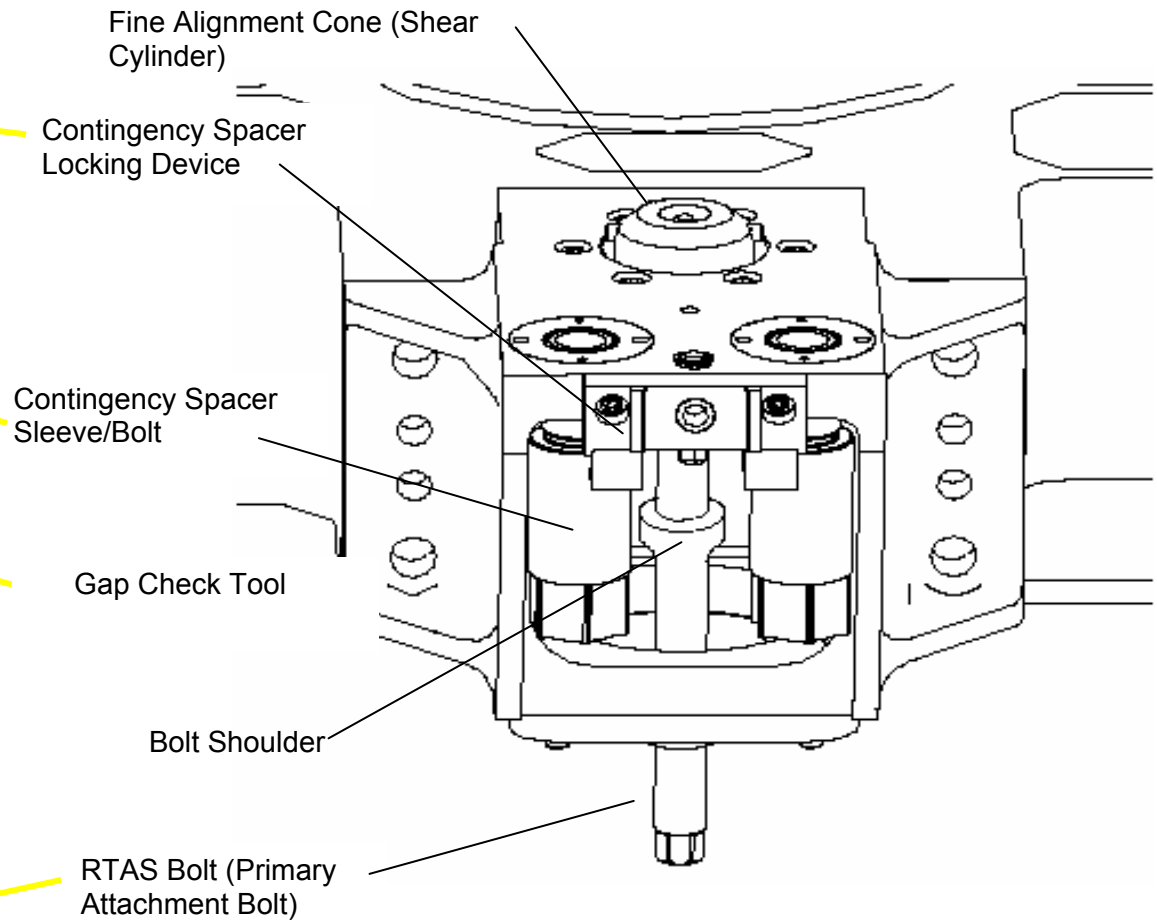
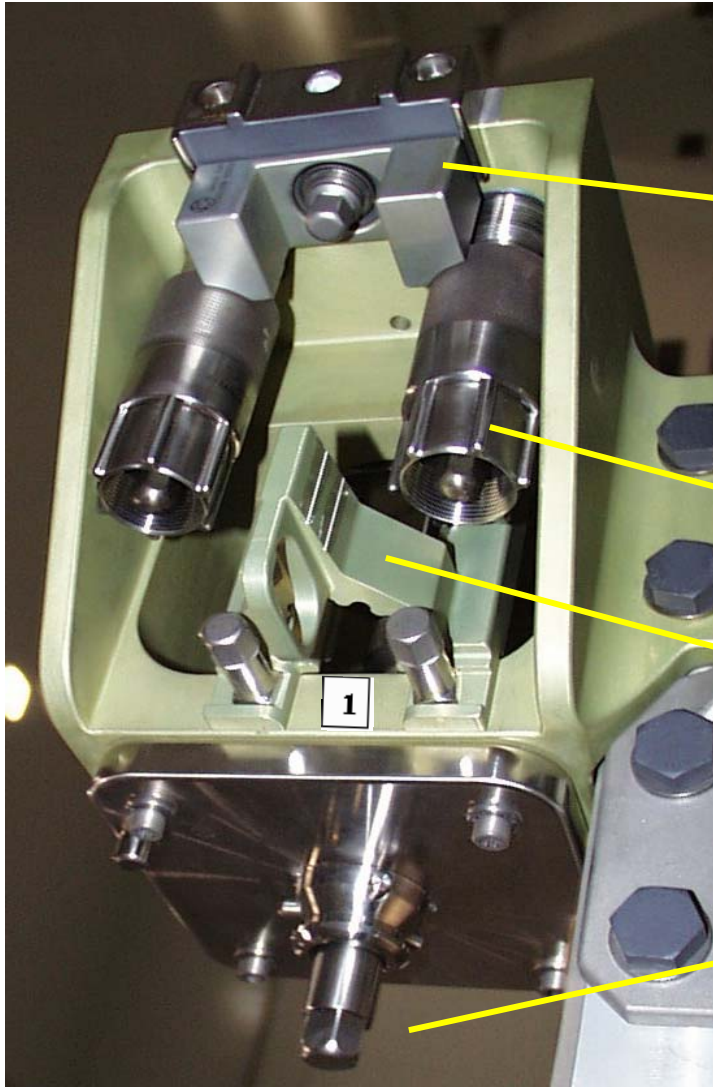

RTAS P5 SIDE

ATTACH P6 TO P5 (RTAS) – TASK DATA (Cont)

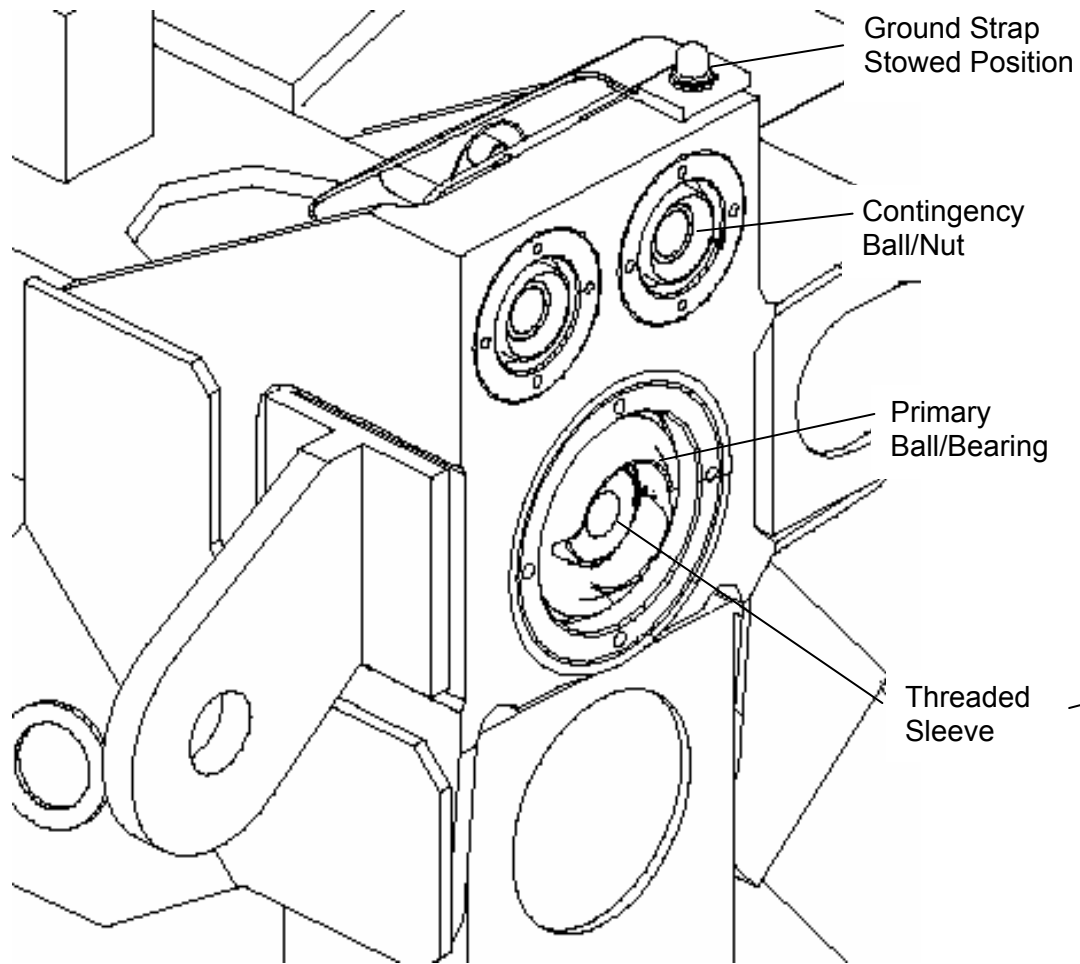

RTAS P6 SIDE

CONNECT P5 TO P6 UMBILICALS (00:40)

IV	EV1 – Pz (FF)	EV2 – Wheels (FF)																											
<p>{P6 TO P5 INHIBITS See Task Data sheet}</p> <p><input type="checkbox"/> √With MCC-H all inhibits in place</p>	<p>CONNECT P6 UMBILICALS</p> <p>1. Open TA clamps (x10: 2-P253, 2-P254, 3-P259, 3-P260)</p> <p style="text-align: center;">NOTE</p> <p style="text-align: center;">√Connectors for straight pins, no FOD, EMI band intact, and good bend radius</p>	<p>CONNECT P6 UMBILICALS</p> <p>1. Assist EV1 as reqd</p>																											
<p>1. Give EV GO for P253 demate</p> <p><input type="checkbox"/> Notify MCC-H P253 mated to P6 (GO to reconfig P6/Z1 1553 buses to Ch A)</p> <p><input type="checkbox"/> √With MCC-H GO for P254 demate</p>	<p>2. On IV GO, perform following demate/mates, swap connector cap from P5 to P6:</p> <table border="1" data-bbox="527 662 1965 737"> <thead> <tr> <th>Demate cap from P6</th> <th>Demate cable from P5</th> <th>Mate cable to P6</th> <th>Mate cap on P5</th> </tr> </thead> <tbody> <tr> <td>P6 cap ← →P6 J153</td> <td>P5 P253← →P5 J153</td> <td><input type="checkbox"/> P5 P253→ ←P6 J153</td> <td><input type="checkbox"/> P6 cap → ← P5 J153</td> </tr> </tbody> </table> <hr style="border-top: 1px dashed black;"/> <table border="1" data-bbox="722 797 1946 894"> <thead> <tr> <th>Demate cap from P6</th> <th>Demate cable from P5</th> <th>Demate cable from P5</th> </tr> </thead> <tbody> <tr> <td>P6 cap ← →P6 J160</td> <td>P5 P260← →P5 J160</td> <td>P5 P259← →P5 J159</td> </tr> <tr> <td colspan="3">EV1: Keep cap on Tool</td> </tr> </tbody> </table> <p>3. Ingress APFR and continue with cap/connector swap</p> <table border="1" data-bbox="722 987 1946 1097"> <thead> <tr> <th>Mate cable to P6</th> <th>EV2 - Demate cap from P6</th> <th>Mate cable to P6</th> </tr> </thead> <tbody> <tr> <td><input type="checkbox"/> P5 P260→ ←P6 J160</td> <td>P6 cap ← →P6 J159</td> <td><input type="checkbox"/> P5 P259→ ←P6 J159</td> </tr> <tr> <td colspan="3">EV1: Keep cap on RET</td> </tr> </tbody> </table>	Demate cap from P6	Demate cable from P5	Mate cable to P6	Mate cap on P5	P6 cap ← →P6 J153	P5 P253 ← →P5 J153	<input type="checkbox"/> P5 P253→ ←P6 J153	<input type="checkbox"/> P6 cap → ← P5 J153	Demate cap from P6	Demate cable from P5	Demate cable from P5	P6 cap ← →P6 J160	P5 P260 ← →P5 J160	P5 P259 ← →P5 J159	EV1: Keep cap on Tool			Mate cable to P6	EV2 - Demate cap from P6	Mate cable to P6	<input type="checkbox"/> P5 P260→ ←P6 J160	P6 cap ← →P6 J159	<input type="checkbox"/> P5 P259→ ←P6 J159	EV1: Keep cap on RET				
Demate cap from P6	Demate cable from P5	Mate cable to P6	Mate cap on P5																										
P6 cap ← →P6 J153	P5 P253 ← →P5 J153	<input type="checkbox"/> P5 P253→ ←P6 J153	<input type="checkbox"/> P6 cap → ← P5 J153																										
Demate cap from P6	Demate cable from P5	Demate cable from P5																											
P6 cap ← →P6 J160	P5 P260 ← →P5 J160	P5 P259 ← →P5 J159																											
EV1: Keep cap on Tool																													
Mate cable to P6	EV2 - Demate cap from P6	Mate cable to P6																											
<input type="checkbox"/> P5 P260→ ←P6 J160	P6 cap ← →P6 J159	<input type="checkbox"/> P5 P259→ ←P6 J159																											
EV1: Keep cap on RET																													
<p>2. Give EV GO to demate P254</p> <p><input type="checkbox"/> Notify MCC-H P254 mated (GO for P6 activation)</p>	<p>4. On IV GO, EV2 perform:</p> <table border="1" data-bbox="527 1219 1965 1294"> <thead> <tr> <th>Demate cap from P6</th> <th>Demate cable from P5</th> <th>Mate cable to P6</th> <th>Mate cap on P5</th> </tr> </thead> <tbody> <tr> <td>P6 cap ← →P6 J154</td> <td>P5 P254← →P5 J154</td> <td><input type="checkbox"/> P5 P254→ ←P6 J154</td> <td><input type="checkbox"/> P6 cap → ← P5 J154</td> </tr> </tbody> </table> <p>5. Clean up worksite, verify TA clamps closed as reqd</p>	Demate cap from P6	Demate cable from P5	Mate cable to P6	Mate cap on P5	P6 cap ← →P6 J154	P5 P254 ← →P5 J154	<input type="checkbox"/> P5 P254→ ←P6 J154	<input type="checkbox"/> P6 cap → ← P5 J154																				
Demate cap from P6	Demate cable from P5	Mate cable to P6	Mate cap on P5																										
P6 cap ← →P6 J154	P5 P254 ← →P5 J154	<input type="checkbox"/> P5 P254→ ←P6 J154	<input type="checkbox"/> P6 cap → ← P5 J154																										

CONNECT P5 TO P6 UMBILICALS (00:40) (Cont)

IV	EV1 – Pz (FF)	EV2 – Wheels (FF)
	<p>6. Transfer cap on RET to EV2</p> <p>7. Translate to P6 nadir Single Point Ground (SPG), via corner 1 path (fwd/nadir), near P6 HR 5347</p> <p>8. Tether to and remove nadir SPG</p> <p>9. Install cap on P6 J36</p> <p>10. Translate to nadir SSU, via corner 1 path (fwd/nadir)</p>	<p>2. Receive cap from EV1</p> <p>3. Translate to P6 zenith Single Point Ground (SPG) via corner 3 path (fwd/zen), near P6 HR 5346</p> <p>4. Tether to and remove zenith SPG</p> <p>5. Install cap on P6 J36</p> <p>6. Translate to Med ORU Bag, HR 5209</p> <p>7. Retrieve Med ORU bag; stow on BRT</p> <div data-bbox="1356 719 1881 841" style="border: 1px solid black; padding: 5px; margin: 10px 0;"> <p style="text-align: center;"><u>WARNING</u></p> <p style="text-align: center;">Avoid contact with P6 lug near HR 5333, along corner 2 path between long spacer and IEA, potential sharp edge</p> </div> <p>8. Translate to nadir SSU via corner 2 path (nadir/aft)</p> <p>9. Temp stow Med ORU bag on P6 HR 5358 and HR 5361 (outboard of radiator)</p>

CONNECT P5 TO P6 UMBILICALS – TASK DATA

Tools:

EV1 (FF)	EV2 (FF)
Cannon Connector tool	Cannon Connector tool
APFR	

EVA Fasteners: None

EVA Connectors:

Harness	From (P5)	To (P6)	Clamps	Size	Inhibit	Function
P253-W02	J153	J153 – sockets	1	37	N/A	1553 Bus A (Data)
P254-W07	J154	J154 – sockets	1	37	N/A	1553 Bus B (Data)
P259-W01	J159	J159 – sockets	4	37	DCSU 2B RBI 6 – Open, Close Cmd Inh MBSU 2 RBI 8 – Open, Close Cmd Inh	Power to/from Ch 2B
P260-W08	J160	J160 – sockets	4	37	DCSU 4B RBI 6 – Open, Close Cmd Inh MBSU 4 RBI 8 – Open, Close Cmd Inh	Power to/from Ch 4B

Foot Restraints:

Task	WIF	APFR Setting
Power connector mate	P5-05	10, QQ, C, 11
Data connector mate (optional)	P5-06	9, SS, A, 11

Cautions:

Warnings:

1. Avoid contact with P6 lug near HR 5333, along corner 2 path between long spacer and IEA, potential sharp edge

Timeline Considerations:

1. Due to cable interference, P260 must be demated from P5 prior to P259. P260 must also be mated to P6 prior to P259

Note:

1. Tool interference exists on the P5 P260 connector
2. In order to prevent side-loads on connectors, will need to react cable stiffness

Single Point Ground Tether point



P6 MMOD SHIELD – ISS FWD FACE (SARJ AT 90)
SINGLE POINT GROUNDS CIRCLED

CONNECT P5 TO P6 UMBILICALS – TASK DATA (Cont)

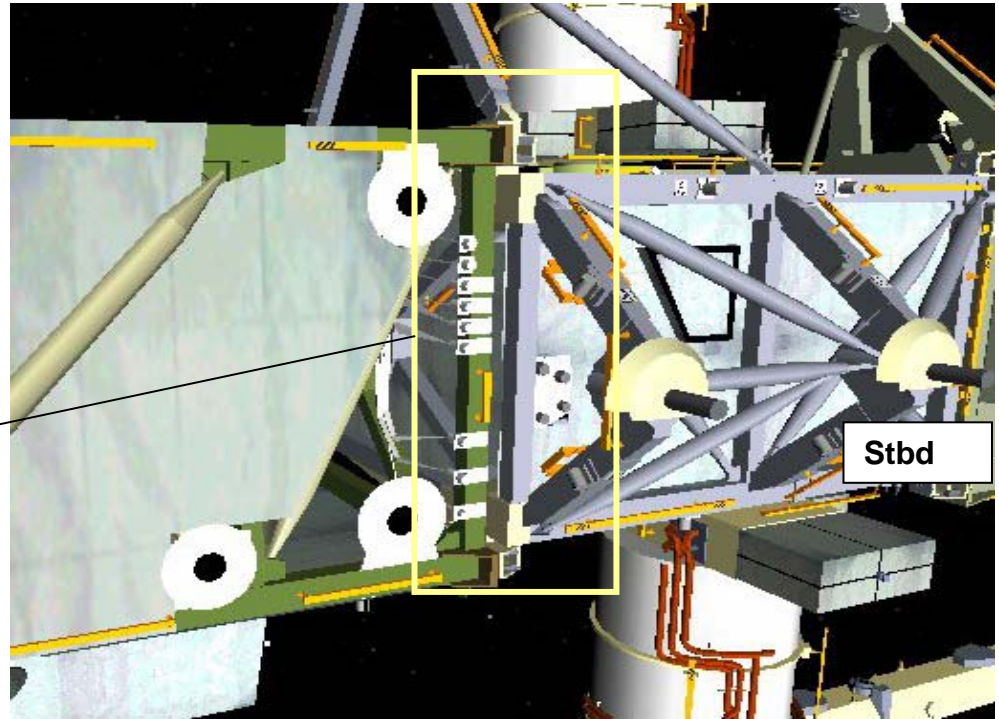
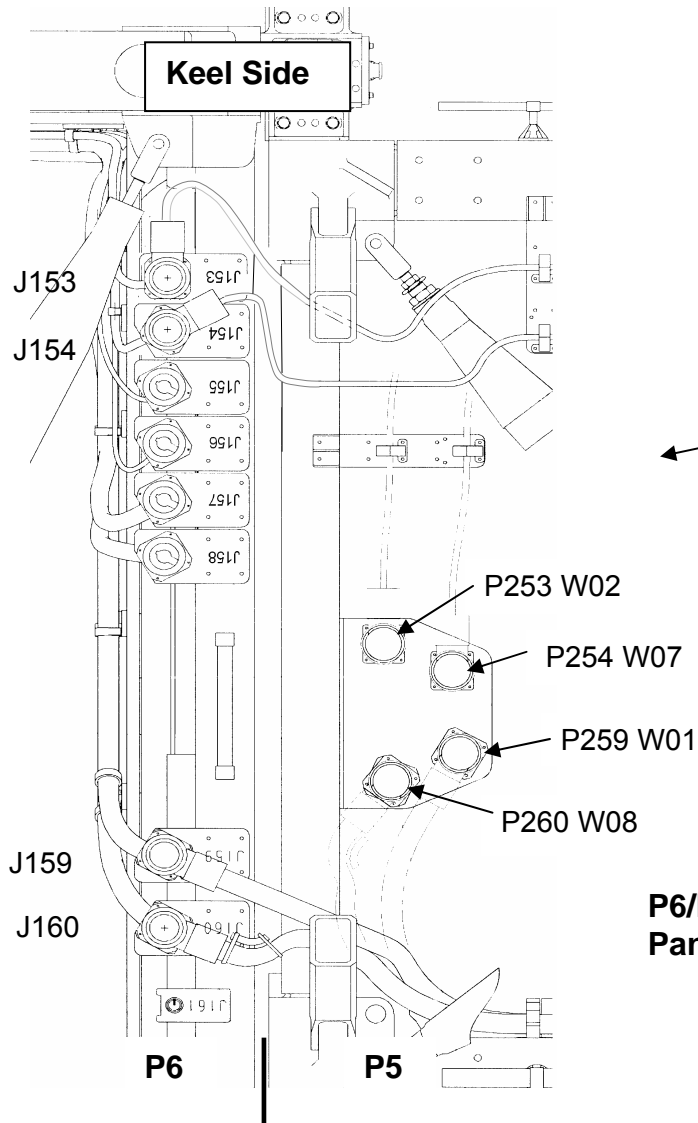

View Radiator Side

P6/P5 Connector Panels

P5 TO P6 UMBILICALS

SSU MLI SHROUD REMOVAL (01:00)

IV	EV1 – Pz (FF)	EV2 – Wheels (FF)
<p><u>SSU MLI FOLDING SEQUENCE</u></p> <ol style="list-style-type: none"> 1. ✓ Long strap stowed in pocket 2. Fold in sewn short side 3. Fold in long sides 4. Fold in shroud half 5. Stow short straps inside bundle 6. Secure Velcro 	<ol style="list-style-type: none"> 1. Stow cannon connector tool and P6 SPG in Med ORU Bag 2. Retrieve EVA camera from Med ORU bag; stow on swing arm 3. Position near nadir SSU (2B) 4. Release long strap 5. Stow long strap in pocket 6. Remove shroud 7. Fold shroud (see IV column) 8. Translate to zenith SSU (4B) 9. Repeat steps 4-7 for zenith shroud 10. Time permitting, take photos <hr style="border-top: 1px dashed black;"/> <ol style="list-style-type: none"> 11. Receive 5/8-7.8 in socket from EV2; stow on socket caddy (in preparation for NTA break torque get ahead) 12. Translate to outboard radiator worksite, H12 (outboard cinch) 	<ol style="list-style-type: none"> 1. Open Med ORU Bag 2. Stow cannon connector tool and P6 SPG in Med ORU Bag 3. Stage RETs outside of Med ORU bag in preparation for shroud stow 4. Position near nadir SSU (2B) 5. Release short straps (2) 6. Assist EV1 7. Fold shroud (see IV column) 8. Stow SSU shroud in Med ORU bag (on P6 HR 5358) 9. Translate to zenith SSU (4B) 10. Repeat steps 6-9 for zenith shroud 11. Time permitting, take photos 12. <u>Transfer one 5/8-7.8 in ext from socket caddy to EV1</u> 13. Retrieve Med ORU bag, stow on BRT 14. Translate to tether swap location, P5 5107 15. Swap from P5 85-ft to tether shuttle 85-ft Safety tether <ul style="list-style-type: none"> <input type="checkbox"/> ✓Gate closed <input type="checkbox"/> ✓Hook locked <input type="checkbox"/> ✓Reel unlocked 16. Stow P5 85-ft Safety tether in C/L bag at corner 1 17. Translate to CETA spur 18. Swap from TS 85-ft to A/L 55-ft Safety tether on HR 3444 <ul style="list-style-type: none"> <input type="checkbox"/> ✓Gate closed <input type="checkbox"/> ✓Hook locked <input type="checkbox"/> ✓Reel unlocked 19. Stow TS 85-ft safety tether on MWS 20. Remove tether shuttle, stow on stowage location <ul style="list-style-type: none"> <input type="checkbox"/> ✓Locked 21. Translate to Airlock

SSU MLI SHROUD INSTALL – TASK DATA

EVA Tools:

EV1 (FF)	EV2 (FF)
N/A	N/A

EVA Fasteners: None

EVA Connectors: None

Foot Restraints: None

Cautions:

1. N/A

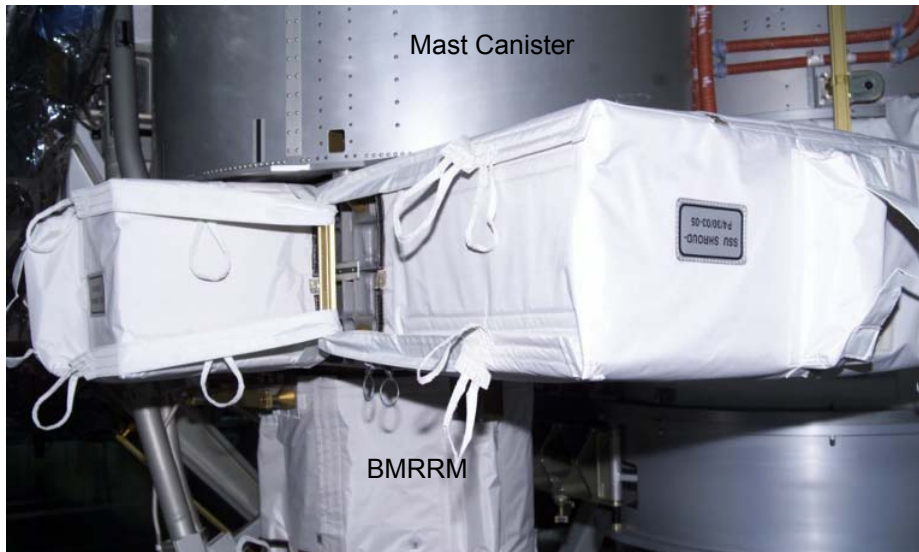

Left side of SSU shroud – 2 short straps



Right side of SSU shroud – 1 long strap

OUTBOARD RADIATOR CINCH RELEASE (01:00)

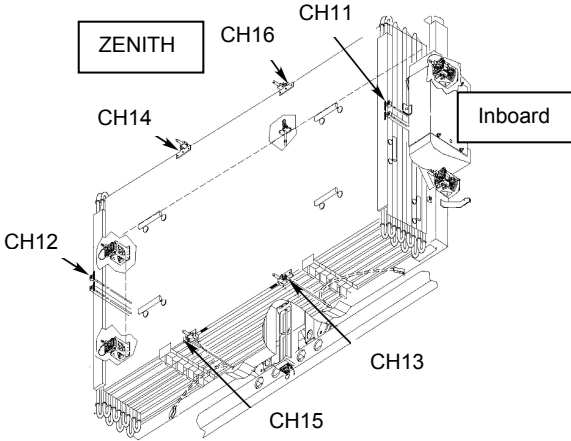
IV	EV1 – Pz (FF)																								
	<p>RELEASE PVR CINCHES</p> <div style="border: 1px solid black; padding: 5px; margin: 5px 0;"> <p style="text-align: center;"><u>WARNING</u></p> <p style="text-align: center;">Avoid contact with P6 lug near HR 5333, corner between H13 and H11, potential sharp edge</p> </div> <div style="border: 1px solid black; padding: 5px; margin: 5px 0;"> <p style="text-align: center;"><u>CAUTION</u></p> <p style="text-align: center;">Avoid contact with radiator bellows and thermal outer coating</p> </div> <ol style="list-style-type: none"> 1. Release PVR Cinches H11 and H12, followed by H13 - H16 (any order) PGT, 7/16-6 in ext; B7, CCW2; 8-14 turns as reqd to disengage 2. Stow cinch in clip, verify positive retention <table border="1" style="width: 100%; border-collapse: collapse; margin-top: 10px;"> <thead> <tr> <th style="width: 5%;"></th> <th style="width: 25%;">Cinch</th> <th style="width: 20%;">BRT – HR</th> <th style="width: 5%;"></th> <th style="width: 25%;">Cinch</th> <th style="width: 20%;">BRT – HR</th> </tr> </thead> <tbody> <tr> <td style="text-align: center;">√</td> <td>H12 outboard</td> <td>5362</td> <td style="text-align: center;">√</td> <td>H11 inboard</td> <td>5334 (head fwd, feet aft)</td> </tr> <tr> <td></td> <td>H16 zenith</td> <td>5343</td> <td></td> <td>H15 nadir</td> <td>5353</td> </tr> <tr> <td></td> <td>H14 zenith</td> <td>5354</td> <td></td> <td>H13 nadir</td> <td>5342</td> </tr> </tbody> </table>		Cinch	BRT – HR		Cinch	BRT – HR	√	H12 outboard	5362	√	H11 inboard	5334 (head fwd, feet aft)		H16 zenith	5343		H15 nadir	5353		H14 zenith	5354		H13 nadir	5342
		Cinch	BRT – HR		Cinch	BRT – HR																			
√	H12 outboard	5362	√	H11 inboard	5334 (head fwd, feet aft)																				
	H16 zenith	5343		H15 nadir	5353																				
	H14 zenith	5354		H13 nadir	5342																				
<p><input type="checkbox"/> √With MCC-H in CMG control/thrusters inhibited</p> <table border="1" style="width: 100%; border-collapse: collapse; margin-bottom: 5px;"> <tr> <td style="width: 50%; padding: 2px;">Inboard PIP pin</td> <td style="width: 50%; padding: 2px;">Outboard PIP pin</td> </tr> </table> <ol style="list-style-type: none"> 1. Give EV1 GO to pull winch PIP pins 2. Once winches released and EV crew clear of radiator deploy envelope, give MCC-H GO for radiator deploy 	Inboard PIP pin	Outboard PIP pin	<p>RELEASE OUTBOARD AND INBOARD PVR WINCH PIP PIN</p> <div style="border: 1px solid black; padding: 5px; margin: 5px 0;"> <p style="text-align: center;"><u>WARNING</u></p> <p style="text-align: center;">Moving hardware hazard. PVR panels are free to move after winch release</p> </div> <ol style="list-style-type: none"> 1. Verify tools and tethers clear of deploy envelope 2. On IV GO, release outboard and inboard winch bar PIP pin from winch clevis 3. Remove winch bar from radiator panel, reinsert PIP pin into winch clevis 4. Verify PIP pin, lanyard and winch bar clear of radiator deploy envelope 5. Translate to tether swap location P5 5201; avoiding contact with deploying radiator 6. Swap from P5 85-ft to tether shuttle 85-ft Safety tether <ul style="list-style-type: none"> <input type="checkbox"/> √Gate closed <input type="checkbox"/> √Hook locked <input type="checkbox"/> √Reel unlocked 7. Stow P5 85-ft safety tether on MWS 																						
Inboard PIP pin	Outboard PIP pin																								

OUTBOARD RADIATOR CINCH RELEASE (01:00) (Cont)

IV	EV1 – Pz (FF)
<p>3. Notify MCC-H that EV crew is inboard of SARJ</p> <p>4. Record APFR settings: CETA 2, WIF 5 __, __ (__, __, __, __)</p>	<p>8. Translate to P5 WIF 5, retrieve APFR and stow on BRT</p> <p>9. Translate to C/L Bag temp stow location, HR 5203</p> <p>10. Retrieve C/L bag and stow on MWS</p> <div data-bbox="842 480 1503 594" style="border: 3px double black; padding: 5px; text-align: center;"> <p><u>WARNING</u> 2' Keep Out Zone for floating cables between MT and MBS. Stay on UMA handrails during translation underneath MT</p> </div> <p>11. Translate to CETA cart 2 (inboard-most); notify IV when crossing SARJ</p> <hr style="border-top: 1px dashed black;"/> <p>12. Install APFR on CETA 2, WIF 5 (port/middle) report setting</p> <ul style="list-style-type: none"> <input type="checkbox"/> √Locking collar black-on-black <input type="checkbox"/> √Good pull test <p>13. Translate to P1 SFU (P1 Bay 12, CETA marker 9270)</p>

OUTBOARD RADIATOR CINCH RELEASE – TASK DATA

Tools:

EV1 (FF)	EV2 (FF)
PGT	PGT
7/16-6 in ext	7/16-6 in ext

EVA Fasteners:

Fastener Name	Label	Head Size	Qty	Release Torque (ft-lb)	Failure Torque (ft-lb)	Turns
Cinch	H11-H16	7/16"	6	H11-H12: 15.8 H13-H16: 24.6	H11-H12: 35.7 H13-H16: 39.7	8-14

EVA Connectors: None

Foot Restraints:

Task	WIF	APFR Setting
Cinch H12	P6-31	2, VV, H, 1
Cinch H14	P6-36	1, PP, L, 9
Cinch H16	P6-20	1, SS, E, 1
Cinch H11	P6-20	6, WW, G, 1
Cinch H15	P6-35	1, PP, C, 3
Cinch H13	P6-19	12, SS, H, 11

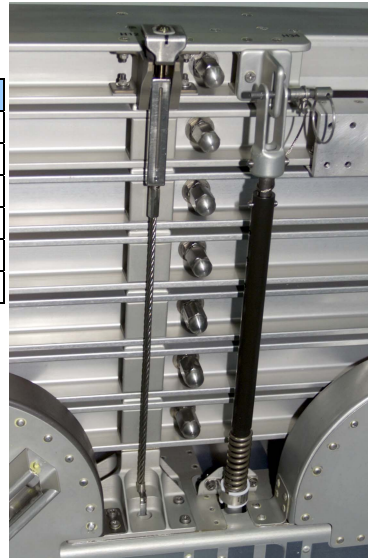

RADIATOR CINCH AND WINCH PIP PIN

Warnings:

1. Moving hardware hazard. Radiators are free to move after winches released
2. ISS must be CMG-Thruster inhibited during partial deployment when unwinded to avoid damage to PV radiator
3. 2' Keep-Out Zone for floating cables between MT and MBS. Stay on UMA handrails during translation underneath MT

Notes:

1. Incidental contact with silver radiator surface is acceptable
2. H11 and H12 must be released prior to the others

Constraints:

1. APFR ingress/egress cannot happen concurrently with radiator deploy

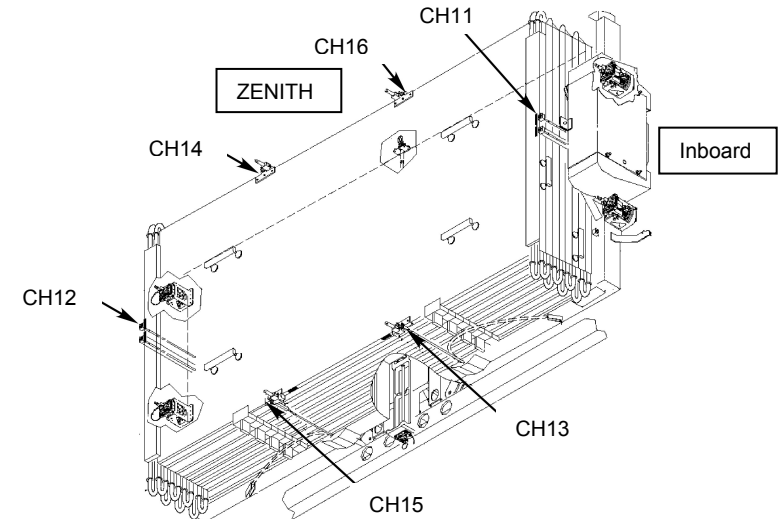

P1 SFU CONFIG FOR CINCH FIRING (00:10)

IV	EV1 – Pz (FF)	EV2 – Wheels																								
<p>{P1 SFU RECONFIG INHIBITS (In Inhibit Pad) RPCM P12B C RPC 4 – Open, Close Cmd Inh 5 – Open, Close Cmd Inh 6 – Open, Close Cmd Inh 7 – Open, Close Cmd Inh}</p> <p><input type="checkbox"/> √With MCC all inhibits in place for SFU Configure</p>	<p>1. Translate to P1 SFU Panel A123 on zenith radiator beam (translate zenith at CETA marker 9270, P1, Bay 12)</p> <p>2. Temp stow crewlock bag</p> <p>3. BRT to HR 3634</p> <p style="text-align: center;"><u>NOTE</u> √Connectors for straight pins, no FOD, EMI band intact, and good bend radius</p>																									
<p>1. Give EV GO for SFU Configure</p> <p><input type="checkbox"/> Notify MCC-H, SFU connector swap complete</p>	<p>4. On IV GO, swap the following:</p> <table border="1" data-bbox="926 716 1495 946"> <thead> <tr> <th colspan="4" style="text-align: center;">PNL A123 – Demate</th> </tr> </thead> <tbody> <tr> <td style="text-align: center;">P752</td> <td style="text-align: center;">← →</td> <td style="text-align: center;">J752</td> <td></td> </tr> <tr> <td style="text-align: center;">Dust cap</td> <td style="text-align: center;">← →</td> <td style="text-align: center;">J703</td> <td></td> </tr> <tr> <th colspan="4" style="text-align: center;">PNL A123 – Mate</th> </tr> <tr> <td style="text-align: center;">P752</td> <td style="text-align: center;">→ ←</td> <td style="text-align: center;">J703</td> <td></td> </tr> <tr> <td style="text-align: center;">Dust cap</td> <td style="text-align: center;">→ ←</td> <td style="text-align: center;">J752</td> <td></td> </tr> </tbody> </table> <p>5. Retrieve crewlock bag; stow on BRT</p> <p>6. Time permitting, perform P1 NTA BOLTS BREAK TORQUE (00:15) (in <u>GET-AHEADS</u> section)</p> <p>7. Translate to CETA handrail bridge, temp stow crewlock bag</p> <p>8. Translate to S1 SFU panel A123 on nadir radiator beam (CETA marker 6330)</p>	PNL A123 – Demate				P752	← →	J752		Dust cap	← →	J703		PNL A123 – Mate				P752	→ ←	J703		Dust cap	→ ←	J752		
PNL A123 – Demate																										
P752	← →	J752																								
Dust cap	← →	J703																								
PNL A123 – Mate																										
P752	→ ←	J703																								
Dust cap	→ ←	J752																								

S1 SFU CONFIG POST DEPLOY (00:10)

IV	EV1 – Pz (FF)	EV2 – Wheels																								
<p>{SFU RECONFIG INHIBITS (in Inhibit Pad) RPCM S1-1A-C RPC 4 – Open, Close Cmd Inh 5 – Open, Close Cmd Inh 6 – Open, Close Cmd Inh 7 – Open, Close Cmd Inh}</p> <p><input type="checkbox"/>√With MCC-H all inhibits in place for SFU Configure</p>	<ol style="list-style-type: none"> Translate to S1 SFU panel A123 on nadir radiator Beam (CETA marker 6330) BRT HR 3258 Perform glove inspection <p style="text-align: center;"><u>NOTE</u></p> <p>√Connectors for straight pins, no FOD, EMI band intact, and good bend radius</p>																									
<ol style="list-style-type: none"> Give EV GO for SFU Configure 	<ol style="list-style-type: none"> On IV GO, swap the following: <table border="1" data-bbox="1024 662 1593 894" style="margin-left: auto; margin-right: auto;"> <thead> <tr> <th colspan="4" style="text-align: center;">PNL A123 - Demate</th> </tr> </thead> <tbody> <tr> <td style="text-align: center;">Dust cap</td> <td style="text-align: center;">← →</td> <td style="text-align: center;">J752</td> <td style="width: 20px;"></td> </tr> <tr> <td style="text-align: center;">P752</td> <td style="text-align: center;">← →</td> <td style="text-align: center;">J703</td> <td></td> </tr> <tr> <th colspan="4" style="text-align: center;">PNL A123 - Mate</th> </tr> <tr> <td style="text-align: center;">Dust cap</td> <td style="text-align: center;">→ ←</td> <td style="text-align: center;">J703</td> <td></td> </tr> <tr> <td style="text-align: center;">P752</td> <td style="text-align: center;">→ ←</td> <td style="text-align: center;">J752</td> <td></td> </tr> </tbody> </table> 	PNL A123 - Demate				Dust cap	← →	J752		P752	← →	J703		PNL A123 - Mate				Dust cap	→ ←	J703		P752	→ ←	J752		
PNL A123 - Demate																										
Dust cap	← →	J752																								
P752	← →	J703																								
PNL A123 - Mate																										
Dust cap	→ ←	J703																								
P752	→ ←	J752																								
<ol style="list-style-type: none"> Notify MCC-H, SFU connector swap complete (GO for heater powerup) 	<ol style="list-style-type: none"> Translate to CETA spur √MT translation path outboard is clear of EVA hardware Retrieve C/L bag; stow on BRT (remain on tether shuttle) Translate to airlock; temp stow C/L bag at airlock Perform glove inspection As time permits, perform GET-AHEADS (00:30) 																									

P1/S1 SFU CONFIG – TASK DATA

Tools:

EV1 (FF)	EV2 (FF)
N/A	

EVA Fasteners: None

EVA Connectors:

P1:

Harness	From	To	Clamps	Size	Function
P1P752-WXX	P1 J752	P1 J703	0	TBD	SFU Power
J703-Dust Cap	P1 J703	P1 J752	0	TBD	Protection

S1:

Harness	From	To	Clamps	Size	Function
S1 P752-W5140	S1 J703	S1 J752	0	TBD	Heater Power
J703-Dust Cap	S1 J752	S1J703	0	TBD	Protection

Foot Restraints: None

Warnings:

Cautions: None

Note:

P1/S1 SFU CONFIG – TASK DATA (Cont)

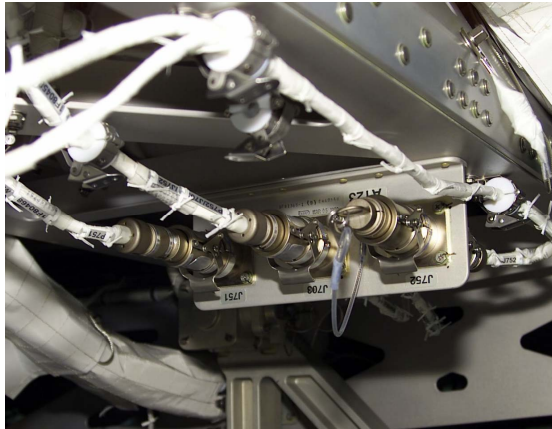

Configuration for cinch firing

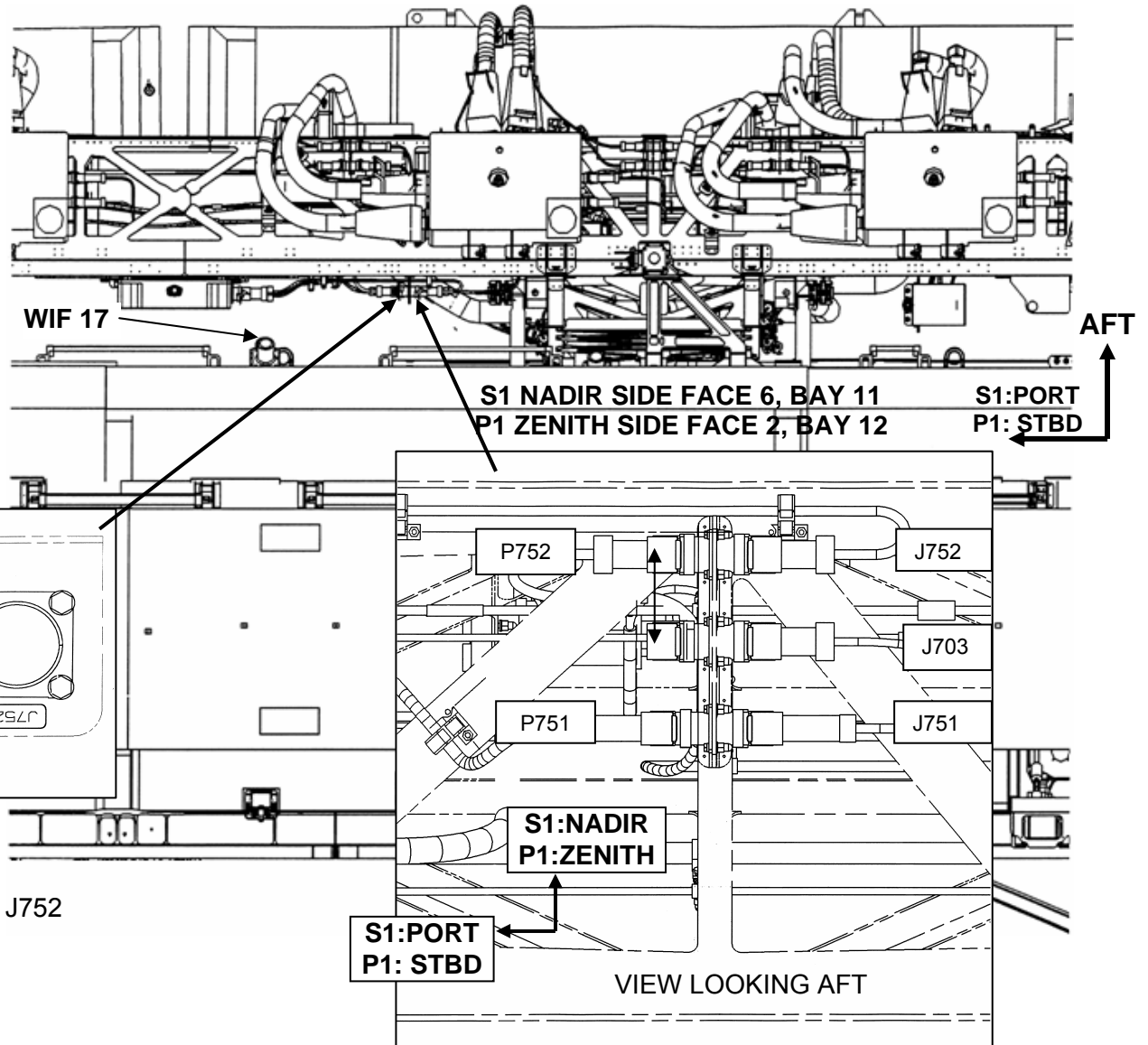

SFU PANEL A123 (FINAL CONFIG)

S1: VIEW LOOKING STBD
 P1: VIEW LOOKING PORT
NOTE: Cap actually lanyarded to J752

MBSU TRANSFER (02:15)

IV/SRMS	EV1 – Pz (FF)	EV2 – Wheels (SRMS)
<p><input type="checkbox"/> √SRMS at PAD/APFR Install/Ingress location</p> <p>1. √MCC-H GO for MBSU HEATER DEACT: 2. R1 PL AFT MNC – OFF</p> <p>SRMS: GCA to APFR Ingress</p>		<ol style="list-style-type: none"> 1. Translate to Airlock; temp stow Med ORU bag outside of Airlock 2. Perform glove inspection 3. Retrieve C/L bag #3 from fish stringer; stow on BRT 4. Translate to nadir side of Lab 5. Temp stow C/L bag on Lab HR 0232 <p><u>PAD/APFR INSTALL</u></p> <ol style="list-style-type: none"> 1. Remove PAD/WIF adapter from C/L bag 2. <input type="checkbox"/> √PAD in SD (soft dock) 3. Install PAD w/WIF adapter onto SRMS, PFR socket toward end effector 4. Rotate knob cw to CL (closed); lock knob 5. Translate to Node 2 WIF 8 6. Remove APFR, stow on BRT 7. Translate to SRMS 8. Install APFR onto PAD (4,II,F,6) <ul style="list-style-type: none"> <input type="checkbox"/> √Locking collar black-on-black <input type="checkbox"/> Good pull test 9. Perform safety tether swap onto SRMS black D-ring <ul style="list-style-type: none"> <input type="checkbox"/> √Gate closed <input type="checkbox"/> √Hook locked <input type="checkbox"/> √Reel unlocked 10. Stow EV2 A/L safety tether on Lab HR 0239 11. GCA as reqd for APFR ingress, ingress APFR 12. Attach MWS EE to ingress aid <p><u>MBSU RETRIEVE</u></p> <ol style="list-style-type: none"> 1. <input type="checkbox"/> √Tools and tethers clear of worksite
<p>3. Give SRMS GO to mnvr to PLB SRMS: MBSU Retrieval Setup (PLB, stbd bay 6)</p> <p><input type="checkbox"/> Once step 2 complete,</p>		<ol style="list-style-type: none"> 2. Prior to entering payload bay, stow ingress aid between knees 3. GCA SRMS for MBSU Retrieval 4. Tether to MBSU
<p>4. Give EV GO for MBSU Removal</p>		<ol style="list-style-type: none"> 5. On IV GO, release FRAM Primary Bolt PGT, 7/16-6in ext: A4, CCW2; ~11 turns to HS, push while turning to release anti-rotation device (~10 lb)

MBSU TRANSFER (02:15) (Cont)

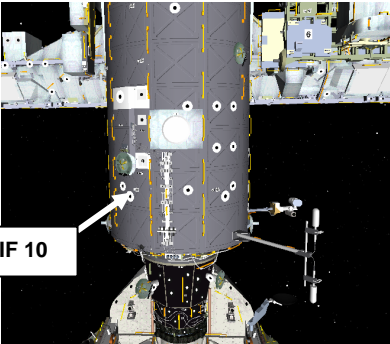
IV/SRMS	EV1 – Pz (FF)	EV2 – Wheels (SRMS)						
<p>{MBSU INSTALL ON ESP-2 SITE 6 INHIBITS RPCM N1RS2-B RPC 6 – Open, Close Cmd Inh RPCM S04B-F RPC 10 – Open, Close Cmd Inh}</p>	<ol style="list-style-type: none"> Translate to APFR in Z1 WIF 20 (ISS aft) Retrieve APFR; stow on BRT Translate to ESP-2 WIF 5 Install APFR in WIF 5 with settings (4, PP, G, 1) <ul style="list-style-type: none"> <input type="checkbox"/> √Locking collar black-on-black <input type="checkbox"/> √Good pull test 	<ol style="list-style-type: none"> √Status indicator “in” Remove MBSU, from magnetic soft dock (15-20 lb reqd for removal) Verify FRAM clear of coarse alignment guides 						
<ol style="list-style-type: none"> Give SRMS GO to mnvr to MBSU Clearance SRMS: MBSU Clearance 	<p><u>MBSU STOW ON ESP-2</u></p> <ol style="list-style-type: none"> Ingress APFR If time permits, reconfigure PGT to A4, CW2 GCA SRMS for MBSU handoff Rotate MBSU for correct alignment 	<ol style="list-style-type: none"> √Tools and tethers clear of worksite 						
<ol style="list-style-type: none"> Give SRMS GO to mnvr to MBSU handoff SRMS: MBSU Handoff <p><input type="checkbox"/> √MCC-H GO to install MBSU on ESP-2</p>	<ol style="list-style-type: none"> Receive MBSU/FRAM from EV2 	<p><u>MBSU STOW ON ESP-2</u></p> <ol style="list-style-type: none"> GCA SRMS for MBSU handoff Rotate MBSU for correct alignment Hand off MBSU/FRAM to EV1 						
<ol style="list-style-type: none"> Give EV GO for MBSU Install <table border="1" data-bbox="109 854 648 938"> <thead> <tr> <th></th> <th>Turns</th> <th>Torque</th> </tr> </thead> <tbody> <tr> <td>FRAM Primary Bolt</td> <td></td> <td></td> </tr> </tbody> </table>		Turns	Torque	FRAM Primary Bolt			<ol style="list-style-type: none"> On IV GO, soft dock MBSU/FRAM, magnetic soft dock Drive FRAM Primary Bolt PGT, 7/16-6in ext: A4, CW2; ~11 turns to HS, push while turning to release anti-rotation device (~10 lb) √Status indicator “out” Egress APFR 	<ol style="list-style-type: none"> GCA as reqd to assist EV1 with MBSU/FRAM soft dock and install <p><u>APFR EGRESS AND PAD/APFR REMOVE</u></p> <ol style="list-style-type: none"> √Tools and tethers clear of worksite
	Turns	Torque						
FRAM Primary Bolt								
<ol style="list-style-type: none"> Give SRMS GO to mnvr to APFR Egress SRMS: APFR Egress/Removal 	<p>{If performing solar array assistance, proceed to: SAW DEPLOYMENT CLEANUP}</p> <p>{If not performing solar array assistance:}</p> <ol style="list-style-type: none"> If time permitting, translate to Lab WIF _____ stow APFR with settings of (____, ____, ____, ____) (EVA 4 get-ahead) <ul style="list-style-type: none"> <input type="checkbox"/> √Locking collar black-on-black <input type="checkbox"/> √Good pull test Translate to CETA spur for tether swap 	<ol style="list-style-type: none"> Once at Lab, egress APFR GCA as reqd for APFR removal Perform safety tether swap onto A/L safety tether <ul style="list-style-type: none"> <input type="checkbox"/> √Gate closed <input type="checkbox"/> √Hook locked <input type="checkbox"/> √Reel unlocked Stow 85-ft safety tether in C/L bag Remove APFR stow on BRT Remove PAD/WIF adapter from SRMS; pull out then rotate knob out of J-lock, then rotate knob ccw to OP (open) position Stow PAD/WIF adapter in C/L bag 						

MBSU TRANSFER (02:15) (Cont)

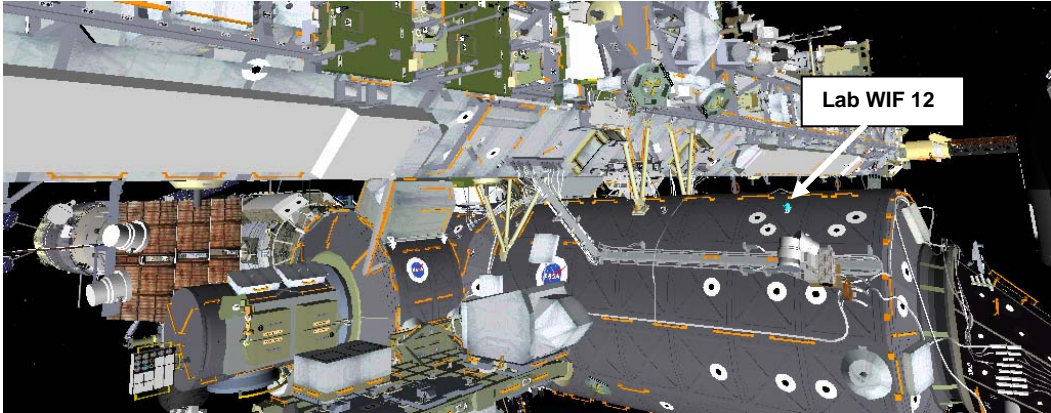
IV/SRMS	EV1 – Pz (FF)	EV2 – Wheels (SRMS)
<p>9. Once EV2 tools and tethers clear of arm, notify R1 SRMS is clear to mnvr</p> <p>10. Record APFR settings if in Lab WIF 04: (__, __, __, __)</p> 	<p>12. Swap from TS 85-ft safety tether to A/L 55-ft safety tether</p> <ul style="list-style-type: none"> <input type="checkbox"/> √Gate closed <input type="checkbox"/> √Hook locked <input type="checkbox"/> √Reel unlocked <p>13. Stow TS 85-ft safety tether on MWS</p> <p>14. Remove tether shuttle, stow on stowage location</p> <ul style="list-style-type: none"> <input type="checkbox"/> √Locked <p>15. Translate to Airlock</p>	<p>9. If time permitting, translate to Lab WIF 12 (stbd side, zenith of Lab avionics tray), stow APFR with settings of (11, QQ,L, 12) (Inc 16 get ahead)</p> <ul style="list-style-type: none"> <input type="checkbox"/> √Locking collar black-on-black; <input type="checkbox"/> √Good pull test <p>Or install APFR in Lab WIF 04 (nadir/port); stow APFR in low profile</p> <p>10. Retrieve C/L bag, stow on BRT</p> <p>11. Translate to Airlock; temp stow C/L bag</p>

MBSU TRANSFER – TASK DATA

Tools:

EV1 (FF)	EV2 (SRMS)
PGT	PGT
7/16-6 in	7/16-6 in

EVA Fasteners:

Fastener	Label	Head size	Qty	Install Torque (ft-lb)	Release Torque (ft-lb)	Failure Torque (ft-lb)	Turns	RPM
FRAM Primary Drive Bolt	FRAM Activation Drive Lock	7/16	1	6.3	6.3	21	11	30

EVA Connectors: None

Foot Restraints:

Task	WIF	APFR Setting
MBSU Retrieve	SRMS w/PAD	4,II,F,6
MBSU Stow on ESP-2	ESP-2 – 5	4,PP,G,1

MBSU Mass – 525.0 lb/238 kg

MBSU Thermal Clock – 6 hr from removal of heater power in PLB to heater activation on ESP-2

Warnings:

Cautions: None

Note:

- FRAM has a 5.5 lb magnetic soft dock at fwd 2 corners and a 3.5 lb soft dock at aft 2 corners
- Primary bolt turn count:
Release:
 - After 3-4 turns, aft pins remove from clevis
 - After 5 turns, blindmate connectors begin to demate
 - After 8-9 turns, front pins remove from clevis
 Install:
 - After 3-4 turns front pins install (increased resistance)
 - After 7 turns blindmate connectors begin to mate
 - After 8-9 turns, aft pins install in clevis

MBSU TRANSFER – TASK DATA (Cont)

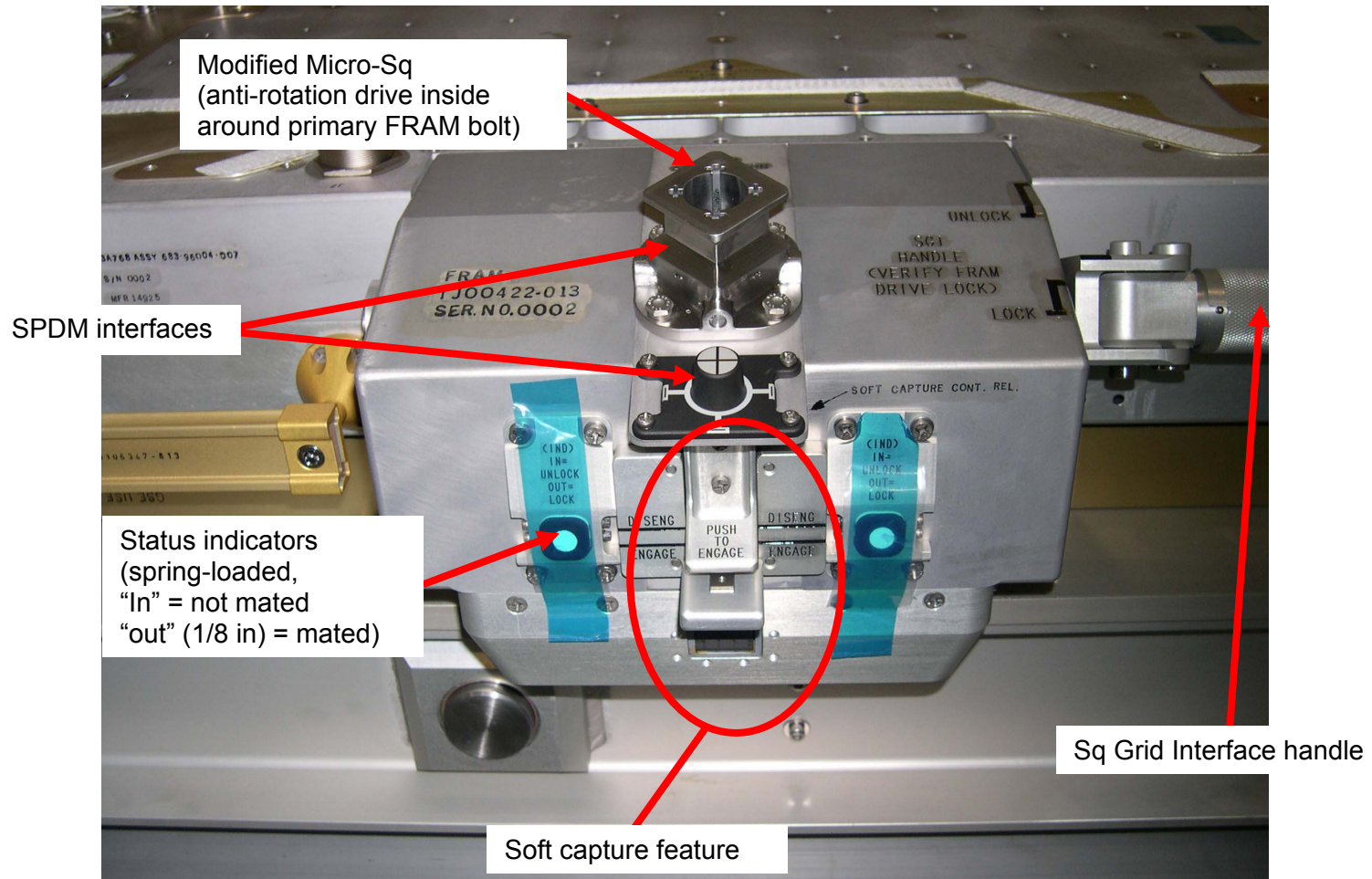

SAW DEPLOYMENT CLEANUP (00:25)

IV/SRMS	EV1 – Pz (FF)	EV2 – Wheels (SRMS)
<input type="checkbox"/> √With MCC-H that SARJ is locked	<ol style="list-style-type: none"> 1. Translate to Airlock 2. Retrieve crewlock bag #1 with SAW tools 3. Translate CETA spur 4. Retrieve P5 85-ft safety tether, stow on MWS 	
	<ol style="list-style-type: none"> 5. Translate to TBD HR, perform safety tether swap <ul style="list-style-type: none"> <input type="checkbox"/> √Gate closed <input type="checkbox"/> √Hook locked <input type="checkbox"/> √Reel unlocked 6. Translate to SAW viewing position <div style="border: 1px solid black; padding: 5px; margin: 5px 0;"> <p style="text-align: center;"><u>WARNING</u> BGA not locked unless EV crew requires access to array</p> </div> 7. Watch array deploy, taking photos as reqd 8. Once complete, translate to TBD HR, perform safety tether swap to 85-ft TS tether <ul style="list-style-type: none"> <input type="checkbox"/> √Gate closed <input type="checkbox"/> √Hook locked <input type="checkbox"/> √Reel unlocked 9. Translate to CETA spur for tether swap 10. Swap from TS 85-ft safety tether to A/L 55-ft safety tether <ul style="list-style-type: none"> <input type="checkbox"/> √Gate closed <input type="checkbox"/> √Hook locked <input type="checkbox"/> √Reel unlocked 11. Stow TS 85-ft safety tether on MWS 12. Retrieve P5 85-ft safety tether, stow on MWS 13. Remove tether shuttle, stow on stowage location <ul style="list-style-type: none"> <input type="checkbox"/> √Locked 14. Translate to Airlock 	

EVA 3 CLEANUP AND A/L INGRESS (00:30)

IV	EV1 – Pz (FF)	EV2 – Wheels (FF)
<p>1. Perform prior to ingress: WVS PWRDN (P/TV, <u>WVS CUE CARD</u>)</p>	<p>1. Translate to Airlock 2. Initiate EMU cold soak 3. Perform tool inventory 4. <u>Ingress Airlock</u> 5. <u>Receive Med ORU from EV2, stow</u> 6. <u>Receive fish stringer from EV2, stow</u> 7. Connect right waist tether to A/L D-ring extender <input type="checkbox"/> √Hook locked 8. <u>Pass A/L safety tether to EV2</u> DCM 9. Retrieve SCU, remove DCM cover 10. Connect SCU to DCM, √Locked 11. Water – OFF</p>	<p>1. Translate to Airlock 2. Initiate EMU cold soak 3. Perform tool inventory 4. <u>Transfer Med ORU bag to EV1</u> 5. <u>Transfer fish stringer to EV1</u> 6. <u>Receive EV1 A/L safety tether, stow on handrail</u> <input type="checkbox"/> √Hook unlocked <input type="checkbox"/> √Reel unlocked 7. <u>Attach right waist tether to EV1's left waist tether</u> <input type="checkbox"/> √Hook locked 8. <u>Disconnect EV2 A/L safety tether, stow on handrail</u> <input type="checkbox"/> √Hook unlocked <input type="checkbox"/> √Reel unlocked 9. Ingress Airlock DCM 10. Retrieve SCU, remove DCM cover 11. Connect SCU to DCM, √Locked 12. Water – OFF 13. Hatch thermal cover – close 14. Secure thermal cover Velcro strap</p>
<p>CAUTION Do not close hatch until EMU water – OFF for 2 min</p>		
	<p>12. Go to PRE REPRESS portion of {CREWLOCK DEPRESS/REPRESS CUE CARD} (SODF: ISS EVA SYS: EVA PREP/POST)</p>	<p>15. √EV Hatch clear of FOD and obstructions 16. EV Hatch – verify handle position per hatch decal; close and lock 17. Go to PRE REPRESS portion of {CREWLOCK DEPRESS/REPRESS CUE CARD} (SODF: ISS EVA SYS: EVA PREP/POST)</p>

POST EVA 3 TOOL CONFIG

EV1

EMU D-rings

- 1 – Tether Extender on Left
- 2 – Waist Tethers
- 2 – 85-ft Safety Tether (TS, P5)

MWS

- Small trash bag [right inside]
 - 1 – RET (sm-sm)
- 1 – Adj tether [right]
- 1 – RET (with PIP pin) [left]
- 1 – RET (sm-sm) [right]
- 2 – Wire ties
- Socket caddy [left inside]
 - RAD
 - 5/8-7.8 in ext
- Swing Arm [right side]
 - PGT w/7/16-6 in ext
 - 1 – RET (sm-sm)
- BRT [left side]
 - 3 Wire Ties
 - 1 – RET (sm-sm)
- SAFER

RETs sm-sm – 16
RETs w/PIP pin – 5
RETs Lg-sm – 6
Adj tethers – 7 (+2 on trash bag)

ADDITIONAL ITEMS RETURNED TO AIRLOCK

- 2 – SSU MLI Shrouds
- 2 – P6 Single Point Grounds

Tools to remain in crewlock

EV2

EMU D-rings

- 1 – Tether Extender on Left
- 2 – Waist Tethers

MWS

- Small trash bag [right inside]
 - 1 – RET (sm-sm)
- 1 – Adj tether [left]
- 1 – RET (with PIP pin) [left]
- 1 – RET (sm-sm) [right]
- 2 – Wire ties
- Socket caddy [left inside]
 - 5/8-7.8 in ext
- Swing Arm [right side]
 - PGT w/7/16-6 in ext
 - 1 – RET (sm-sm)
- BRT [left side]
 - 3 Wire Ties
 - 1 – RET (sm-sm)
- SAFER

CREWLOCK

- 1 – RET (Lg-sm)
- C/L Bag#1 (Solar Array Tools)
 - BRS Pin Contingency Tool (w/Tape)
 - Loop Pin Puller (w/Tape)
 - TPS Scraper (w/Tape)
 - Compound Cutter/Needle Nose Pliers Caddy (w/Tape)
 - Hockey Stick
- 1 – RET (Lg-sm)
 - Cheater Bar (w/Kapton Tape)
 - 1.5" Bail Drive Lever (taped to Cheater Bar)
- 1 – RET (Lg-sm)
 - 6B Box Cover
 - Dummy box
 - 1 – Adj tether
 - 1 – RET (sm-sm)

CREWLOCK (cont)

- Staging Bag
- Spare Torque Wrench
- IV Bag
- Fish stringer
 - C/L bag #2– adj tether on outside
 - Torque Wrench (outside of bag) w/2 wire ties
 - 1 – RET (sm-sm)
 - EV2 85-ft Safety Tether (P5)
 - Ratchet w/7/16-6 in ext
 - Round TM w/5/8 socket
- C/L bag #3 – adj tether on outside
 - PAD
 - WIF Adapter
 - EVA Camera/Bracket
 - EV2 85-ft Safety Tether (TS)
- S0 Gap Spanners (1 – 45", 1 – 72")
- Round Scoop (for CETA light)
- Wire Tie Caddy
- 1 – RET (Lg-sm)
 - Med ORU Bag
 - 2 – RET (sm-sm)
 - 2 – SSU shrouds
 - 2 – RET (sm-sm)
 - 2 – P6 SPGs
 - 2 – RET (sm-sm)
 - 2 – Cannon Connector Tools
 - EVA Camera/Bracket
 - 2 – Adj on outside
- 1 – RET (Lg-sm)
 - Med ORU Bag (for CETA light)
 - 1 – RET (with PIP pin)
- 1 – RET (Lg-sm)
 - Crewlock Bag #4 (MMOD Shield)

POST EVA 3/PRE EVA 4 TOOL CONFIG

EV1

EMU D-rings

- 1 – Tether Extender on Left
- 2 – Waist Tethers
- 2 – 85-ft Safety Tether (TS, P5) {leave}

MWS

- Small trash bag [right inside] {leave}
 - 1 – RET (sm-sm)
- 1 – Adj tether [right]
- 1 – RET (with PIP pin) [left]
- 1 – RET (sm-sm) [right]
- 2 – Wire ties
- Socket caddy [left inside] {leave}
 - RAD {to Done Bag} S/N _____
 - 5/8-7.8 in ext {to Done Bag}
- Swing Arm [right side]
 - PGT w/7/16-6 in ext {leave} S/N _____
 - 1 – RET (sm-sm)
- BRT [left side] {leave}
 - 3 Wire Ties
 - 1 – RET (sm-sm)
- SAFER

RETs sm-sm – 16 RETs w/PIP pin – 5 RETs Lg-sm – 6 Adj tethers – 7 (+2 on trash bag)
--

ADDITIONAL ITEMS RETURNED TO AIRLOCK

- 2 – SSU MLI Shrouds {to Return bag}
- 2 – P6 Single Point Grounds {to Done bag}

EV2

EMU D-rings

- 1 – Tether Extender on Left
- 2 – Waist Tethers

MWS

- Small trash bag [right inside] {leave}
 - 1 – RET (sm-sm)
- 1 – Adj tether [left] {to Tether Staging}
- 1 – RET (with PIP pin) [left]
- 1 – RET (sm-sm) [right]
- 2 – Wire ties
- Socket caddy [left inside] {to C/L Bag #2}
 - 5/8-7.8 in ext {leave on socket caddy}
- Swing Arm [right side]
 - PGT w/7/16-6 in ext {leave} S/N _____
 - 1 – RET (sm-sm)
- BRT [left side] {leave}
 - 3 Wire Ties
 - 1 – RET (sm-sm)
- SAFER

CREWLOCK

- 1 – RET (Lg-sm) {to Tether Staging}
- C/L Bag#1 (Solar Array Tools) {leave}
 - BRS Pin Contingency Tool (w/Tape)
 - Loop Pin Puller (w/Tape)
 - TPS Scraper (w/Tape) {to Staging Bag}
 - Compound Cutter/Needle Nose Pliers Caddy (w/Tape)
 - Hockey Stick
- 1 – RET (Lg-sm)
 - Cheater Bar (w/Kapton Tape) {from Done Bag}
 - 1.5" Bail Drive Lever (taped to Cheater Bar)
- 1 – RET (Lg-sm) {leave all}
 - 6B Box Cover
 - Dummy box
 - 1 – Adj tether
 - 1 – RET (sm-sm)

CREWLOCK

- Staging Bag
 - Spare Torque Wrench {to Done Bag}
- IV Bag
- Fish stringer (internal)
 - C/L bag #2 – adj tether on outside
 - Torque Wrench (set to 57 ft-lb) (outside of bag) w/2 wire ties {to Done Bag}
 - 1 – RET (sm-sm) {to Tether Staging}
 - EV2 85-ft safety tether (P5) {27 or 22, to Return bag, 26 or 28, Tether Staging}
 - Ratchet w/ 7/16-6 in ext {to Done Bag}
 - Round TM w/5/8 socket {leave}
- C/L bag #3 – adj tether on outside
 - PAD {to Done Bag}
 - WIF Adapter {to Done Bag}
 - EVA Camera/Bracket {to C/L Bag #2}
 - EV2 85-ft safety tether (TS) {27 or 22, to Return bag, 26 or 28, Tether Staging}
- S0 Gap Spanners (1 - 45", 1 – 72") {to 6B Box Cover}
- Round Scoop (for CETA light) {to C/L Bag #2}
- Wire Tie Caddy {to EV4 swing arm}
- 1 – RET (Lg-sm) {to Tether Staging}
 - Med ORU Bag {to Node?}
 - 2 – RET (sm-sm) {to Tether Staging}
 - 2 – SSU shrouds {to Return bag}
 - 2 – RET (sm-sm) {to Tether Staging}
 - 2 – P6 SPGs {to Done Bag}
 - 2 – RET (sm-sm) {to Tether Staging}
 - 2 – Cannon Connector Tools {to Done Bag}
 - EVA Camera/Bracket {to Done Bag}
 - 2 – Adj on outside {to Tether Staging}
- 1 – RET (Lg-sm) {leave all}
 - Med ORU Bag (for CETA light)
 - 1 – RET (with PIP pin)
- 1 – RET (Lg-sm) {leave all}
 - Crewlock Bag #4 (MMOD Shield)

GET-AHEADS

IV	EV (FF)
	<p><u>N2 VENT TOOL RETRIEVE AND VENT TOOL ADAPTER RELOCATE (00:15)</u> Tools Required: 2 – equipment tethers</p> <ol style="list-style-type: none">1. Open port fluid QD bag on zenith side of crewlock, paying attention while opening and manipulating tools inside bag2. Retrieve N2 vent tool (middle left of bag); stow on MWS3. Retrieve VTA (upper right of bag)4. Close fluid QD bag (verify Velcro and 1/4 turn fasteners)5. Translate to VTE bag (outboard)6. Open VTE bag, stow VTA using integral equipment hook7. Close VTE bag (verify Velcro and 1/4 turn fasteners)8. Translate to Airlock9. Stow N2 vent tool in Airlock <p><u>VTE BAG RELOCATE (00:30)</u> Tools Required: BRT, RET</p> <ol style="list-style-type: none">1. Tether to and remove VTE bag (outboard bag) on zenith side of crewlock2. Translate to S0 face 33. Stow VTE bag on handrails 3425 (inboard standoff) and 3430 (2 straps to outboard standoff) (leave 4th strap free) (see Task Data for picture) <p><u>TOOL STOW (00:10 per tool)</u> Tools Required: equipment tether per tool</p> <ol style="list-style-type: none">1. Retrieve any of the following tools from Airlock: Large Cutter, Ratchet Wrench (1 or 2 – verify no socket installed on ratchet)2. Stow tools in the following tool box:<ul style="list-style-type: none">Large Cutter: A/L Toolbox 2 (port), Door Panel 9 (open nadir door)Ratchet Wrench: Z1 Port and Stbd Toolboxes, Slot 3 (open port door, panel is in center)

GET-AHEADS (Cont)

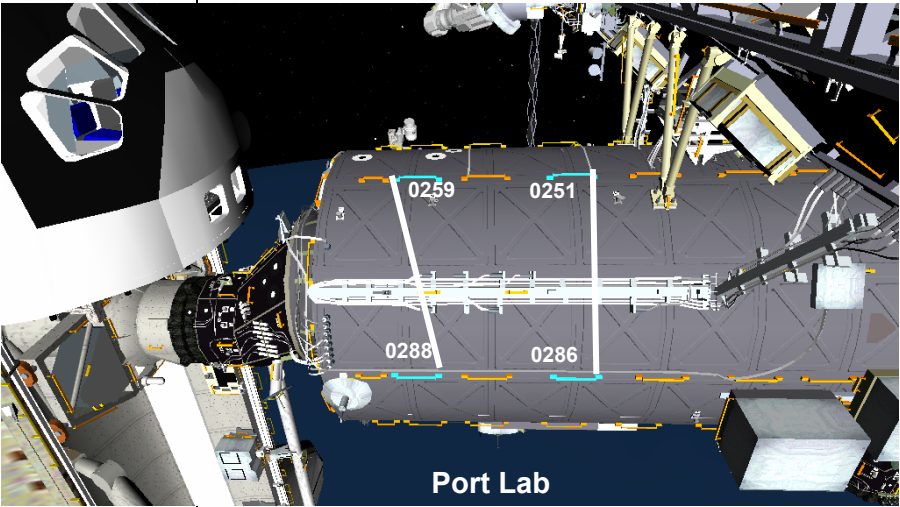
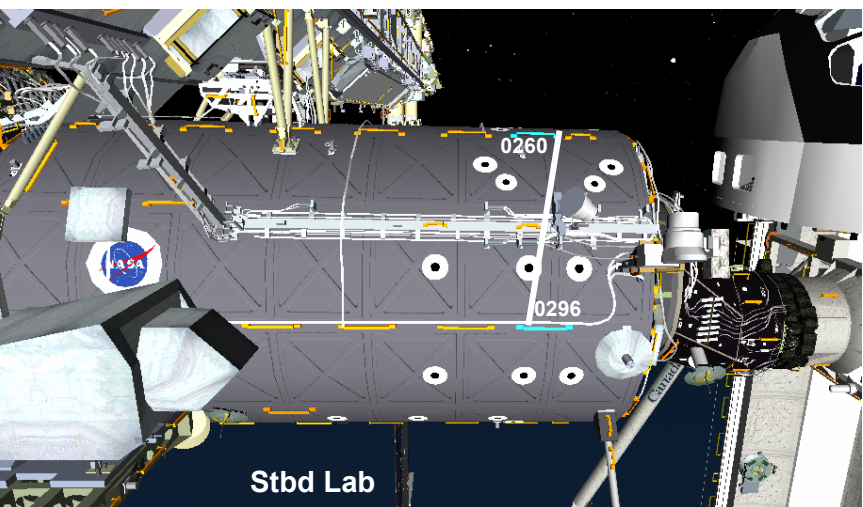
IV	EV (FF)
<p>{AVIONICS INHIBITS See FS 7-152}</p>	<p>NODE 2 AVIONICS TRAY CABLE DISCONNECTS/TEMP STOW (01:30) Tools Required: wire tie caddy (ensure plane for Node 2 fluid tray clear, PMA demate and Node 2 mating area clear for robotics) (00:30) Stbd: 5 cables wire tied to Lab HR 0273 and HR 0274 (zenith: P670 and 671; nadir: P672, 673, 674) (01:00) Port: 5 cables wire tied to Lab HR 0226, 0288, 0287, 0286 (zenith: P103, 102, 105, 104, 101), 6 wire tied to HR 0226, 0288, 0287, 0286 (nadir: P662, 663, 660, 661, 665, 664)</p> <p>GAP SPANNER INSTALLATION (01:00) Tools Required: None Lab (all gap spanners in trash bag stow on Lab HR 0296 on EVA 1): (00:15) Hwy 110 completion: 2 -307, from aft HR 0286 to aft 0251; ensure 180° buckle rotation For Stbd and Port gap spanners, leave excess slack if Lab avionics not yet disconnected and temp stowed (00:15) Stbd: 2 -307, from aft standoff HR 0296, through fwd HR on stbd avionics tray, to fwd HR 0260 (00:15) Port: 2 -307, from aft HR 0288, through fwd HR on port avionics tray, to fwd HR 0259 If all gap spanners installed, retrieve small trash bag, bring inside</p> <p>S0 (gap spanners on fish stringer in Airlock): (00:15) Zenith: -305 + -307, Zenith standoff 3424 (face 2) to Zenith standoff 3427 (face 3), routed underneath handrail 3425; ensure 180° buckle rotation</p>
 <p style="text-align: center;">Port Lab</p>	 <p style="text-align: center;">Stbd Lab</p>

GET-AHEADS – P1 NTA BREAK TORQUE

IV				EV (FF)																				
<table border="1"> <thead> <tr> <th>Bolt</th> <th>√Break Torque</th> <th>Turns</th> <th>Torque to reinstall</th> </tr> </thead> <tbody> <tr> <td>1 (nadir)</td> <td></td> <td></td> <td></td> </tr> <tr> <td>2</td> <td></td> <td></td> <td></td> </tr> <tr> <td>3</td> <td></td> <td></td> <td></td> </tr> <tr> <td>4 (zenith)</td> <td></td> <td></td> <td></td> </tr> </tbody> </table>				Bolt	√Break Torque	Turns	Torque to reinstall	1 (nadir)				2				3				4 (zenith)				<p><u>PT NTA BREAK TORQUE</u> (00:15)</p> <p>Tools required: Round torque multiplier with 5/8” socket, PGT, 5/8-7.8 in ext</p> <ol style="list-style-type: none"> 1. Translate to P1 NTA, CETA marker 8670 P1, Bay 06; temp stow crewlock bag 2. Remove 7/16-6 in ext from PGT; stow on socket caddy 3. Retrieve round torque multiplier from crewlock bag; verify anti-backlash neutral 4. Install torque multiplier on NTA bolt 5. BRT to HR 3617 (DO NOT BRT TO NTA HR OR CETA HR) 6. Break torque on NTA bolts (4) using torque multiplier PGT, (without socket) with torque multiplier: B7, CCW2; ~5 turns on PGT (1 turn on bolt) 7. Stow torque multiplier in crewlock bag 8. Perform PGT socket swap: remove 5/8-7.8 in ext from socket caddy, install on PGT 9. Drive NTA bolts (4) PGT, 5/8-7.8 in ext: B6, CW2, 30.5; ~1 turn to HS 10. Perform PGT socket swap: remove 5/8-7.8 in ext, stow on socket caddy, install 7/16-6 in ext on PGT 11. Retrieve crewlock bag; stow on BRT
				Bolt	√Break Torque	Turns	Torque to reinstall																	
				1 (nadir)																				
				2																				
				3																				
4 (zenith)																								

GET-AHEADS – LAB CETA LIGHT REMOVE

IV	EV (FF)																								
<p>{LAB CETA LIGHT RETRIEVE INHIBITS RPCM S01A C RPC 15 – Open, Close Cmd Inh RPCM S02B C RPC 15 – Open, Close Cmd Inh}</p> <p><input type="checkbox"/> √MCC-H GO to demate CETA Light connectors</p>	<p>LAB CETA LIGHT RETRIEVE (0:45) Tools required: PGT with 7/16-6 in ext, BRT, 1 – RET, Round Scoop (optional), Med ORU bag (remains in Airlock)</p> <div style="border: 1px solid black; padding: 5px; margin: 10px auto; width: fit-content;"> <p style="text-align: center;">CAUTION CETA Light paint is sensitive. Avoid unnecessary contact</p> </div> <ol style="list-style-type: none"> 1. (Optional) Translate to Airlock; retrieve round scoop from fish stringer 2. Translate to Lab CETA light (Lab stbd avionics tray) 																								
<ol style="list-style-type: none"> 1. Give EV GO for CETA light cable demate 	<ol style="list-style-type: none"> 3. On IV GO, swap following connectors: <table border="1" style="margin: 10px auto; width: 60%;"> <thead> <tr> <th colspan="4" style="text-align: center;">CETA Light Stanchion Panel A2 – Demate</th> </tr> </thead> <tbody> <tr> <td style="width: 25%;">P101</td> <td style="width: 10%; text-align: center;">← →</td> <td style="width: 25%;">J101</td> <td style="width: 40%;"></td> </tr> <tr> <td>P102</td> <td style="text-align: center;">← →</td> <td>J102</td> <td></td> </tr> <tr> <th colspan="4" style="text-align: center;">Lab Avionics Tray Panel A150 E – Mate</th> </tr> <tr> <td>P101</td> <td style="text-align: center;">→ ←</td> <td>J261</td> <td></td> </tr> <tr> <td>P102</td> <td style="text-align: center;">→ ←</td> <td>J262</td> <td></td> </tr> </tbody> </table> 4. BRT to HR 0296 5. If retrieved, attach round scoop to CETA light 6. Tether to CETA light 7. Release stanchion bolt PGT, 7/16-6 in ext: B7, CCW2; ~18-19.5 turns 8. Remove CETA light; stow on BRT if using round scoop 9. Translate to Airlock 10. Stow CETA light inside empty Med ORU bag in Airlock 11. Close hatch thermal cover 12. Verify SAFER config <ul style="list-style-type: none"> <input type="checkbox"/> √L Handle down (MAN ISO Vlv – Open) <input type="checkbox"/> √R Handle down (HCM – Closed) 	CETA Light Stanchion Panel A2 – Demate				P101	← →	J101		P102	← →	J102		Lab Avionics Tray Panel A150 E – Mate				P101	→ ←	J261		P102	→ ←	J262	
CETA Light Stanchion Panel A2 – Demate																									
P101	← →	J101																							
P102	← →	J102																							
Lab Avionics Tray Panel A150 E – Mate																									
P101	→ ←	J261																							
P102	→ ←	J262																							

GET-AHEADS – BSP REMOVE

IV	EV (FF)												
<p>{BSP RETRIEVE INHIBITS RPCM Z14B B RPC 4 – Open, Close Cmd Inh RPCM Z13B B RPC 4 – Open, Close Cmd Inh}</p> <p><input type="checkbox"/> √MCC-H GO to remove BSP</p>	<p>BSP REMOVAL (00:45) Tools required: PGT with 7/16-6 in ext; 6B box cover with dummy box and equipment tethers</p> <ol style="list-style-type: none"> 1. Translate to Airlock, retrieve 6B box cover and dummy box 2. Close hatch thermal cover 3. Verify SAFER config: <ul style="list-style-type: none"> <input type="checkbox"/> √L Handle down (MAN ISO Vlv – Open); <input type="checkbox"/> √R Handle down (HCM – Closed) 4. Translate to Z1 BSP (stbd) 5. Remove dummy box from 6B Box cover, temp stow 6. Open BSP thermal cover (“garage door”) and tether to BSP tether point 												
<p>1. Give EV GO for BSP remove</p> <p>Dummy Box Bolt Data</p> <table border="1" data-bbox="113 898 690 1101"> <thead> <tr> <th>Bolt</th> <th>Turns</th> <th>Torque</th> </tr> </thead> <tbody> <tr> <td>Center Jack</td> <td></td> <td></td> </tr> <tr> <td>Outer Fastener (Nadir)</td> <td></td> <td></td> </tr> <tr> <td>Outer Fastener (Zenith)</td> <td></td> <td></td> </tr> </tbody> </table>	Bolt	Turns	Torque	Center Jack			Outer Fastener (Nadir)			Outer Fastener (Zenith)			<ol style="list-style-type: none"> 7. On IV GO, release BSP outer fasteners (2) PGT, 7/16-6 in ext; A7, CCW2; 15 turns 8. Release BSP center jack bolt PGT, 7/16-6 in ext; A7, CCW2; 33 turns 9. Release BSP by sliding it along guide pins 10. Inspect BSP cotherm for damage and Z1 cold plate for cotherm debris 11. Stow BSP on 6B box cover; wrap with MLI cover 12. Retrieve dummy box, install on Z1 13. Drive BSP center jack bolt PGT, 7/16-6 in ext; A7, CW2; ~25-30 turns to HS 14. Drive BSP outer fasteners (2) PGT, 7/16-6 in ext; A7, CW2; ~7-12 turns to HS 15. Close BSP thermal cover 16. Retrieve 6B box cover/BSP 17. Translate to Airlock 18. Stow 6B box cover/BSP on Lg-sm in airlock 19. Close hatch thermal cover 20. Verify SAFER config <ul style="list-style-type: none"> <input type="checkbox"/> √L Handle down (MAN ISO Vlv – Open) <input type="checkbox"/> √R Handle down (HCM – Closed)
Bolt	Turns	Torque											
Center Jack													
Outer Fastener (Nadir)													
Outer Fastener (Zenith)													

GET-AHEADS – MMOD SHIELD REINSTALL

IV	EV1 (FF)	EV2 (FF)
<p>APFR Setting (good for clamshell): LAB, WIF 11 (9, NN, L, 11)</p>	<p><u>MMOD SHIELD REINSTALL</u> (00:30 for Plan A only, 0:45 for Plan A and B and 1:00 Plan A, B and C for 2 EVs)</p> <p>Tools required: MMOD Crewlock Bag #4: wire tie caddy, EVA ratchet with DPTA w/IV 1/4" Allen, Hammer, 2 – MMOD T-tools, 3 – Long Duration Tie Down tethers, GP caddy with vise grips and loop pin puller</p> <p><u>SETUP</u></p> <ol style="list-style-type: none"> 1. Translate up stbd side of Lab to H2 Vent MMOD shield (Lab FWD zenith); shield C2-03 (one w/meatball) 2. BRT to HR 270 3. Using T-tool that is in place, attempt move shield slightly (see if the center fastener is stuck in hard); may need to loosen Adj tethers <p><u>PLAN A</u></p> <ol style="list-style-type: none"> 4. Attempt installation of center and stbd fasteners (2 of 3 fasteners required) 5. If successful, skip to cleanup; if unsuccessful, go to Plan B <p><u>PLAN B</u></p> <ol style="list-style-type: none"> 6. Wire tie shield in place (1 wire tie = 1 Dzus) <p style="text-align: center;"><u>NOTE</u></p> <p>Wire tie must positively capture the Dzus fastener (either 2 wraps around or 1 wrap and a double twist) and positively capture structure on the Lab.</p> <p>Wire tie must pull shield flat against structure and in toward centerline of module.</p> <p>Verify both ends of wire tie attached securely so that if wire tie breaks each end will still be attached</p> <ol style="list-style-type: none"> 7. Take closeout photos of shield and tiedown 8. If successful, skip to cleanup; if unsuccessful, go to Plan C <p><u>PLAN C</u></p> <ol style="list-style-type: none"> 9. Install LDTDT to stretch across the shield (HR 0269 stbd standoff to HR 0280 nadir standoff) 10. Exchange short MMOD tool for Long MMOD tool; one crewmember must retain positive control of shield 11. Install Adj from T tool to HR 0270 (13A Adj tethers may not remain EVA) 	<p><u>SETUP</u></p> <ol style="list-style-type: none"> 1. Retrieve CL Bag 2. Translate up port side of Lab to H2 Vent MMOD shield (Lab FWD zenith); shield C2-03 (one w/meatball) 3. Temp stow CL Bag on HR 269 (BRT to HR 269 as reqd) <p><u>PLAN A</u></p> <ol style="list-style-type: none"> 4. Attempt installation of port fastener (2 of 3 fasteners required) 5. If successful, skip to cleanup; if unsuccessful, go to Plan B <p><u>PLAN B</u></p> <ol style="list-style-type: none"> 6. Wire tie shield in place (1 wire tie = 1 Dzus) <p style="text-align: center;"><u>NOTE</u></p> <ol style="list-style-type: none"> 7. Take closeout photos of shield and tiedown 8. If successful, skip to cleanup; if unsuccessful, go to Plan C <p><u>PLAN C</u></p> <ol style="list-style-type: none"> 9. Retrieve Long Duration Tie down tether (LDTDT) and Long MMOD Tool from ORU bag 10. Install LDTDT to stretch across the shield (HR 0269 stbd standoff to HR 0280 nadir standoff) 11. Exchange short MMOD tool for Long MMOD tool; one crewmember must retain positive control of shield 12. Install new Adj from T tool to HR 0270 (13A Adj tethers may not remain EVA)

GET-AHEADS – MMOD SHIELD REINSTALL (Cont)

IV	EV1 (FF)	EV2 (FF)
	<p>12. After ~5 min, revisit LDTD and retighten; strap may loosen due to stretching</p> <p>13. Take closeout photos of shield and tiedown</p> <p><u>CLEANUP</u></p> <p>14. Receive CL Bag; attach to BRT</p> <p>15. Retrieve 3 Adj tethers that were installed on shield; stow in trash bag {13A adj tethers left EVA may not be used and must be returned to Houston}</p>	<p>13. After ~5 min, revisit LDTD and retighten; strap may loosen due to stretching</p> <p>14. Take closeout photos of shield and tiedown</p> <p><u>CLEANUP</u></p> <p>15. Pass CL Bag to EV2</p> <p>16. Inventory ORU Bag</p> <p>17. Retrieve ORU Bag; attach to BRT</p>

GET-AHEADS – TASK DATA

Tools:

EV (FF)	EV (FF)	EV (FF)	EV (FF)	
P1 NTA Break Torque	Lab CETA Light	BSP	Lab MMOD Shield	
PGT	PGT	PGT	Wire Tie Caddy	2 – MMOD T-tools
5/8-7.8 in ext	7/16-6 in ext	7/16-6 in ext	EVA Ratchet with DPTA with IV 1/4" Allen	Vide Grips
Round torque multiplier	Round Scoop (optional)	6B Box Cover	Hammer	Loop Pin Puller
5/8" socket (for TM)		Dummy Box	3 – Long Duration Tethers	

EVA Fasteners:

Fastener	Label	Head size	Qty	Install Torque (ft-lb)	Release Torque (ft-lb)	Failure Torque (ft-lb)	Turns	RPM
NTA Bolt	1-4	5/8"	4	24.0	127.5	TBD	1 turn	30
CETA Light Stanchion Bolt	N/A	7/16"	1	20.9	25.5 (max-34.7, due to thermal)	165.9	18-19.5	30
BSP Outer Fasteners	N/A	7/16"	2	N/A	12.3	14.8	15	30
BSP Center Jacking	N/A	7/16"	1	N/A	12.3	14.8	33	30
Dummy Box Center Jacking	N/A	7/16"	1	9.2	N/A	13.2	24.5-29.5	30
Dummy Box Outer Fasteners	N/A	7/16"	2	9.2	N/A	13.2	7-12	30

EVA Connectors:

Harness	From	To	Clamps	Size	Function
P101 (W9101)	CETA Light J101	Lab Tray J261	N/A	15	Sec Pwr 2B/1A
P102 (W9102)	CETA Light J252	Lab Tray J262	N/A	15	Sec Pwr 2B/1A

Foot Restraints: None

Warnings:

Cautions: None

Note:

VENT TOOL BAG RELOCATE TO S0 – TASK DATA

SO-bo (VTA)



S116E06130

N2 Vent Tool

Port Fluid QD Bag



S116E06137

Vent Tool Extender Bag

VENT TOOL BAG RELOCATE TO S0 – TASK DATA (Cont)

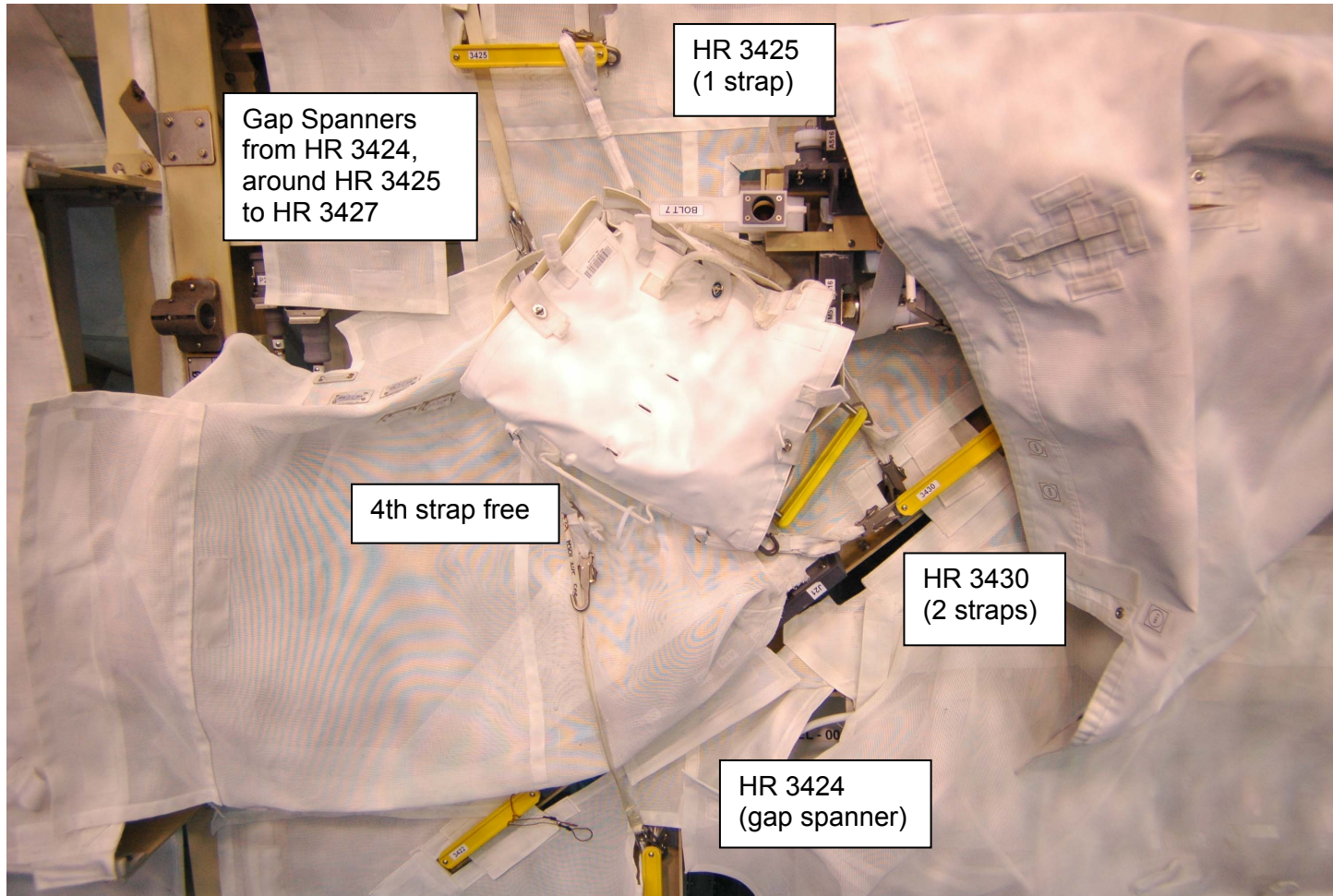

Vent Tool Extender Bag Temp Stow – S0 Face 02

P1 NTA BOLT BREAK TORQUE – TASK DATA

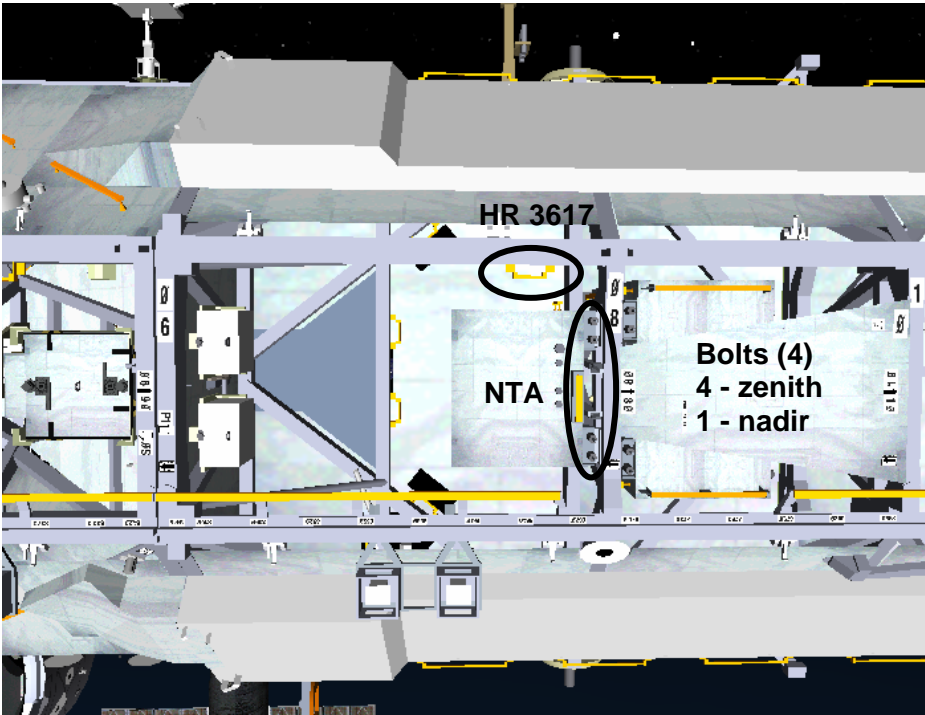

LAB MMOD SHIELD INSTALL – TASK DATA

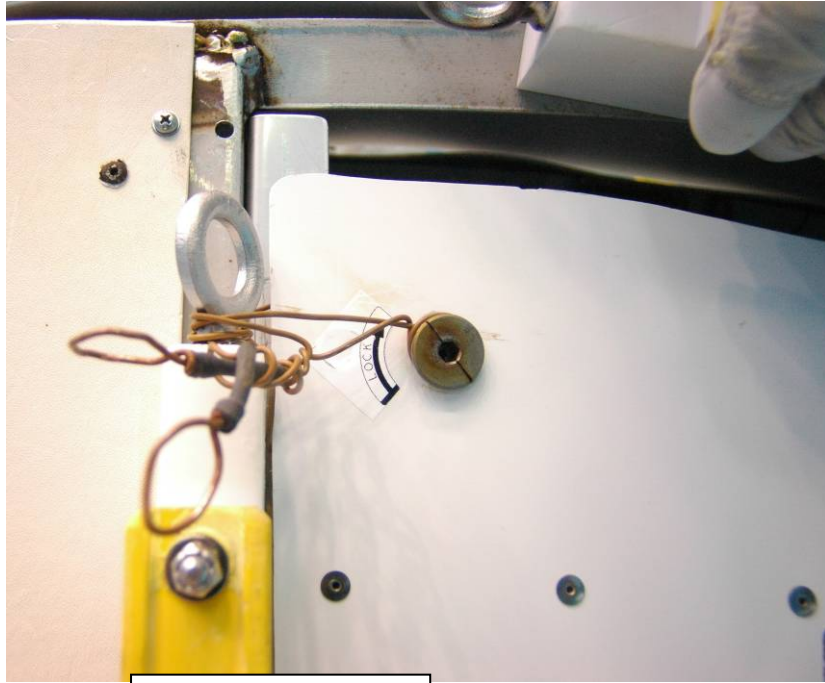

Plan B – with HR

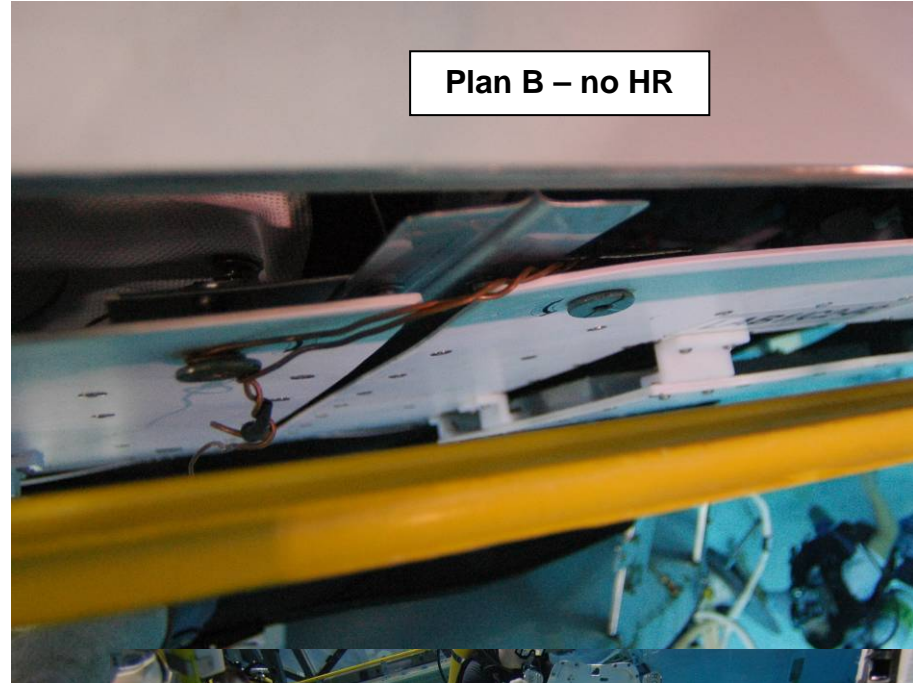

Plan B – no HR

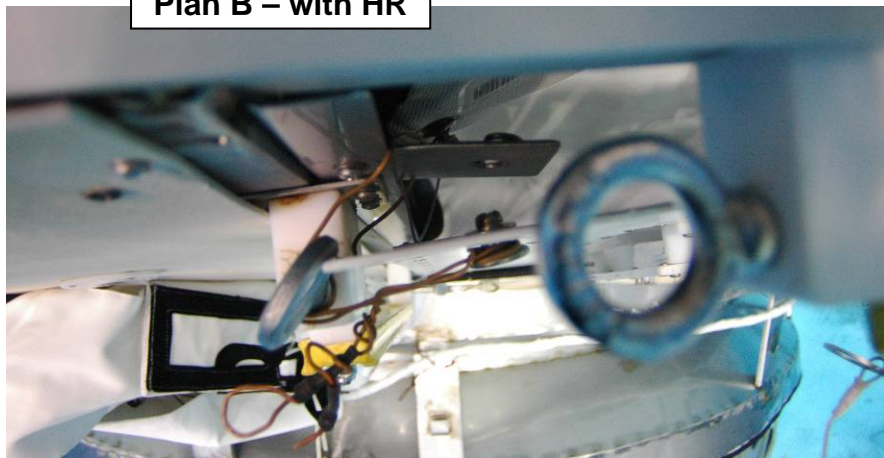

NOTE: These photos are examples of wire tie options achieved in the NBL; actual wire tie routing will be developed real time

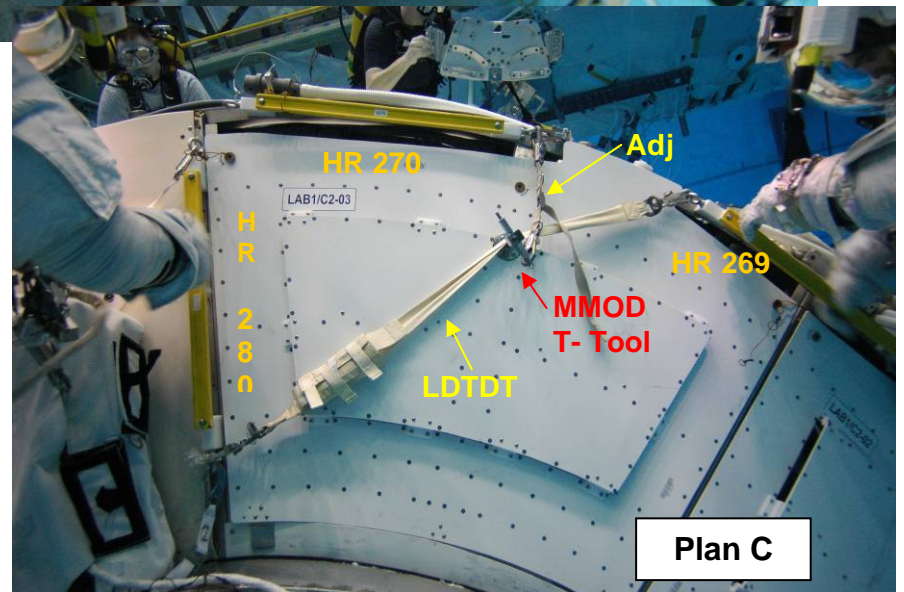

Plan C

EVA 4 INHIBIT PAD

Orbiter (1)

ALL EVAs	
TCS L12	1. √TCS POWER – OFF
KU-BAND ANTENNA {Performed during egress}	
MCC-H	1. √KU-BAND Mask – active 2. √KU-BAND EVA Protect Box – active
RCS {On call, EV crew not expected to be in this area} If EV crew < 27 ft from FRCS	
IV O14,15,16	1. √DAP: VERN, FREE, LO Z (ft specific check with GNC) 2. √RJDF F1, F2, F3, F4 MANF DRIVER (four) – OFF LOGIC (four) – OFF
MCC-H IV	3. √Above RCS config 4. √RCS F – ITEM 1 EXEC (*) √RCS FJET DES F1U – ITEM 17 (*) F3U – ITEM 19 (*) F2U – ITEM 21 (*)
S-BAND ANTENNAS {On call if Lab MMOD Shield reinstall attempted}	
NOTE Possible loss of comm when forced LL FWD antenna	
IV A1R	If EV crew < 2.0 ft from S-Band antenna 1. S-BAND FM ANT – XMIT LOWER/RCVR UPPER 2. √MCC, lower antenna selected
C3	If no comm, or on MCC GO 3. S-BAND PM ANT – LL FWD
C3	When EVA crewmember at least 2.0 ft away from all S-Band upper antennas 4. S-BAND PM ANT – GPC

Ground

All EVAs	
Ground Radar MCC-H	1. √TOPO console, ground radar restrictions in place for EVA
USOS (1)	
ALL EVAs	
PCU	
NOTE PCUs may require up to 1 hr warm-up period before they are operational	
MCC-H	1. √PCUs (two) operational in discharge mode and one of the following: a. CCS PCU EVA hazard control enabled b. No more than two arrays unshunted c. No more than two arrays pointed < 90° from velocity vector
OR	
	2. One or no PCUs operational in discharge mode and one of the following: a. No more than two arrays unshunted b. No more than two arrays pointed < 90° from velocity vector
LOCATION DEPENDENT INHIBITS	
Lab Window	
IV	1. Close window shutter
KU-BAND (SGANT) Antenna {On call, EV crew not expected to be in this area}	
MCC-H	If EV crew < 3.3 ft from KU-BAND antenna 1. Park KU-BAND: 1.1 Pointing Mode – Inhibit 1.2 PLC – Reset 1.3 Autotrack Continuous Retry – Inhibit

EVA 4 INHIBIT PAD (Cont)

USOS (2)

LOCATION DEPENDENT INHIBITS

S-BAND (SASA) ANTENNAS

{On call, EV crew not expected to be in this area}

MCC-H If EV crew < 3.6 ft from S1 SASA [P1 SASA]

1. P1 SASA [S1 SASA] – Active
2. S1 SASA [P1 SASA] – Powered down

EVA 4 SPECIFIC INHIBITS

SSPTS DEACTIVATION

{Performed as part of Inhibit Pad}

- MCC-H
1. RPCM LA1A4A D RPC 3– Open, Close Cmd Inhibit
 2. RPCM LA2A3B D RPC 1– Open, Close Cmd Inhibit
 3. RPCM Z14B A RPC 2 – Open, Close Cmd Inhibit
 4. RPCM Z13B A RPC 2 – Open, Close Cmd Inhibit

USOS (3)

EVA 4 GET AHEAD INHIBITS

LAB CETA LIGHT REMOVE

{On Call}

- MCC-H
1. RPCM S01A C RPC 15 – Open, Close Cmd Inh
 2. RPCM S02B C RPC 15 – Open, Close Cmd Inh

BSP REMOVAL

{On Call}

- MCC-H
1. RPCM Z14B B RPC 4 – Open, Close Cmd Inh
 2. RPCM Z13B B RPC 4 – Open, Close Cmd Inh

RSOS (1)

ALL EVAs

SM Antennas

IV

1. GTS – Deactivate
2. ARISS – Deactivate or VHF (144-146 MHz) TX only

EVA 4 NOTES, CAUTIONS, AND WARNINGS

NOTES

1. Bolt install: report torque and turns
2. Bolt release: report torque and turns if different from published range
3. EVA connectors: after disconnection and prior to connection; verify pin and EMI band integrity; verify connector free of FOD
4. Inspect QDs for damage prior to mating
5. Toolbox doors must be closed with one latch per door when EV crew not in immediate vicinity
6. Avoid contact with OBSS striker bars (Vitrolube coating)

CAUTION

ISS Constraints

- A. **Avoid inadvertent contact with**
1. **Grapple fixture shafts (drylube)**
 2. PIP pins
 3. EVA Crane [PMA1]
 4. TCS Reflectors [PMA2, PMA3]
 5. APAS hardware [PMA2, PMA3]
 6. CETA Lights (Z-93 paint) [LAB, S1, Node 1]
 7. Passive UMAs
 8. MBS VDU, MCU, CRPCMs, and Cameras (taped radiative surfaces, silver Teflon)
 9. Deployed TUS cable
 10. S0 aft face Radiator
 11. GPS Antennas (S13 paint) [S0]
 12. UHF Antennas [LAB, P1]
 13. ETCS Radiators [S1, P1]
 14. EETCS/PV Radiator bellows and panels [P6, P4, S4]
 15. SASA RF Group [Z1, S1, P1]
 16. Heat pipe radiators [Z1]
 17. PCU cathode and HCA ports [Z1]
 18. Ku-Band Antenna (SGANT) dish [Z1]
 19. CMG cover/shells [Z1]
 20. SSRMS Cameras
 21. **Open CBM petal covers and LAB window shutter**

CAUTION (Cont)

ISS Constraints (Cont)

- B. Electrical cables
1. Avoid bend radii < 10 times cable diameter
- C. Fiber optic cables
1. Avoid bend radii < 10 times cable diameter
 2. Avoid pulling on cable during mate/demate
- D. Fluid line flex hoses and QDs
1. Avoid bend radii < 5 in for hoses with diameter < 1 in on LAB, S0, S1, P1, and 10-in for hoses with diameter < 1 in on all other elements
 2. Avoid bend radii < 14 in for hoses with a diameter ≥ 1 in
 3. Additional care should be taken to not exceed bend radii when applying loads at the flexible hose to rigid tube stub interfaces
 4. Ensure fluid QD booties are fully closed prior to leaving worksite; wire tie if reqd
- E. **For structural reasons**
1. **Avoid vigorous body motions, quick grabs and kickoffs against tether restraints**
 2. **Avoid performing shaking motions (sinusoidal functions) more than four cycles**
 3. **Avoid kicking S1/P1 radiator beam**
If any of these occur, wait 2 to 5 min to allow structural response to dissipate

EVA 4 NOTES, CAUTIONS, AND WARNINGS (Cont)

CAUTION (Cont)

ISS Constraints (Cont)

F. Other

1. ITT Cannon connector: On demated connectors, do not rotate collar or manipulate cable/connector using collar or connector tool
2. WIS Antennas: do not use as handholds [Node 1, P6, Z1]
3. Lubricant from Ku-Band SGANT gimbals [Z1], CMGs [Z1], and RTAS Ground Strap fasteners [P6,P4,S4] can contaminate EMU
4. MLI handholds are not rated for crewmember translation loads
5. CBM petal covers may not be used as handholds unless both launch restraint pins are engaged

CAUTION (Cont)

Shuttle Constraints

G. **Avoid inadvertent contact with**

1. OBSS and SRMS Composite Sections and Cable Harnesses
2. LCS (silver Teflon) and LDRI (silver Teflon) and ITVC (gold foil) [OBSS]
3. WVS Antenna [ODS Truss & PLB Sill]
4. Payload Bay wire harnesses, cables, and connectors

H. **No touch**

1. LDRI diffuser [OBSS]
2. OBSS saddle contacts (when OBSS unberthed) [OBSS]
3. Monkey fur [PLB]
4. Cameras: metallic surfaces [PLB]
5. Ku-Band Antenna black dish and gold thermal blankets [PLB]

EVA 4 NOTES, CAUTIONS, AND WARNINGS (Cont)

WARNING

ISS Constraints

A. Avoid inadvertent contact with

1. Grapple fixture targets and target pins
2. SSU, ECU, beta gimbal platform, mast canister, SAW blanket boxes unless the beta gimbal is locked and the motor is turned off
3. Stay inboard of SARJ when active
4. Stay 2 ft from S1/P1 radiator beam rotational envelope when beam is free to rotate
5. Stay 5 ft from moving MT on face 1

B. Handrails

1. Handrails previously used for MISSE attachment may not be used as a safety tether point [A/L endcone 564 & 566, A/L Tank 2 nad/fwd & port/fwd, P6 5389]

C. Pinch

1. NZGL connector linkage. Use caution when mating/locking
2. ITT Cannon Connector rotating housing
3. EV side of IV Hatch during Hatch operation (also snag hazard) [A/L]
4. LAB window shutter and CBM petal cover linkages during operation

D. QDs

1. If QD is in FID when valve is opened (bail fwd), QD will leak and fluid line may whip
2. Do not rotate if in mated/valve open config

WARNING (Cont)

ISS Constraints (Cont)

E. RF radiation exposure

1. Stay 3.6 ft from S-Band (SASA) high gain Antenna when powered [S1,P1,P6]
2. Stay 1.3 ft from S-Band (SASA) low gain Antenna when powered [S1,P1,P6]
3. Stay 1 ft from UHF Antenna when powered [LAB, P1]

F. Sharp Edges

1. Inner edges of WIF sockets
2. Mating surfaces of EVA connectors. Avoid side loads during connector mating
3. Back side of MMOD shield fasteners
4. Spring loaded captive EVA fasteners (e.g., 6B-boxes, BMRRM); the end of the spring may protrude
5. PMA umbilical launch restraints-exposed bolt threads
6. Adjustable Fuse Tether (Fish Stringer) buckles stowed in Node Bag
7. Nickel coated braided copper Ground Straps may contain frayed wires [P6, P4, S4]
8. Z1 handrail 6061 by the Ku-Band boom launch restraint [Z1]
9. Solar Array Blanket Box [P6]
10. Keep hands away from SSRMS LEE opening, and snares
11. Fastener threads on back of Z1 U-jumper male FQD panel, if nutplate cap missing

WARNING (Cont)

ISS Constraints (Cont)

G. Thermal

1. EVA connectors with booties may become hot if left uncovered. Handling may need to be limited
2. PMA handrails may be hot. Handling may need to be limited
3. Turn off glove heaters when comfortable temp reached to prevent bladder damage. Do not pull fingers out of gloves when heaters are on
4. Uncovered trunnion pins may be hot
5. SSRMS/MBS operating Cameras and lights may radiate large amounts of heat
6. Stay 1 ft away from PMAs and MMOD shields > 270 degF if EMU sun visor up
7. Stay at least 1 ft away for no more than 15 min from PMAs and MMOD shields > 300 degF if EMU sun visor up
8. Stay 0.5 ft away from PMA and MMOD shields > 325 degF
9. Do not touch EMU protective visor if temp has been < -134 for > 15 min
10. No EMU TMG contact of PMAs and MMOD shields when temp > 320 degF
11. No EMU boot contact with foot restraint when temp < -120 degF or > 200 degF

H. Electrical Shock Hazard

1. Stay \geq 2 ft from following ungrounded floating connectors if not inhibited: SSPTS on Lab fwd and stbd Node 1, H-jumper on FGB, MT cables, and S0 Bay 00, 02, and 03

EVA 4 NOTES, CAUTIONS, AND WARNINGS (Cont)

WARNING (Cont)

Shuttle Constraints

I. Arcing/Molten Debris

1. Stay \geq 2 ft from exposed EFGF connector when OBSS berthed, powered, and EFGF not grappled [PLB]
2. Stay \geq 2 ft from exposed Stbd Fwd MPM contacts [PLB]
3. Stay \geq 2 ft from exposed Node 2 SPDU connectors when OBSS grappled by SRMS and LCS is powered [PLB]

J. Pinch

1. PRLA operation [PLB]

K. RF radiation exposure

1. Stay 2.0 ft from S-Band Antenna when powered
2. Stay 1 ft from top and side of UHF PLB Antenna radome surface when in high powered mode [ODS truss]
3. Stay 0.33 ft from top and side of UHF PLB Antenna radome surface when in low powered mode [ODS truss]
4. Remain below the level of the PLB door mold line for first 20 in Aft of Fwd bulkhead when S-Band Antenna powered [PLB]
5. Remain on the inboard side of the Stbd slidewire (sill handrails if slidewire not installed) for first 20 ft Aft of Fwd bulkhead when Ku-Band Antenna powered [PLB]

WARNING (Cont)

Shuttle Constraints (Cont)

L. Sharp Edges

1. PRLA grounding wipers [PLB]
2. LDRI baffles (Also an entrapment hazard) [OBSS]
3. Keep hands away from SRMS EE opening and snares
4. TCS connector backshells have exposed threads

M. Thermal

1. Illuminated PLB lights; do not touch
2. OBSS grapple fixture shafts/cams may be hot. Limit handling if required
3. Stay 27 ft from PRCS when powered
4. Stay 3 ft from VRCS when powered
5. Stay 3 ft from APU when operating

N. Thruster Contamination

1. Stay out of the immediate vicinity of leaking jet or APU

10A EVA 4 PRE BRIEF

ROLES (ALL)

EV1: Scott EV2: Wheels Onboard IV: Paolo	Suit IV (pre): Peggy Ground IV: Steve	Suit IV (post): Clay
--	--	----------------------

MILESTONES (ALL)

__:__:__ Wake-up EVA Prep Start	__:__:__ Start of Post Depress
---------------------------------------	-----------------------------------

COMM SET-UP (ALL)

Name	Loop Selected		Taking to	From	Used for
	STS	ISS			
Big Loop	A/G1	1	MCC-STS, MCC-ISS	STS, ISS, EMU	All EVA(S)SRMS ops, emergencies
A/G2	A/G2	-	MCC-STS	STS, BPSMU	Non-EVA, non- emergencies, STS related
S/G2	-	2	MCC-ISS	ISS	Non-EVA, non- emergencies, ISS related
ICOM	ICOM	3	STS, ISS	STS, ISS, BPSMU	Comm. Not intended for ground
ICOM	-	5	ISS-A/L, EMUs	ISS-A/L, EMUs	ATU4, 5, 6 intercom pre/post EVA

NOTE: always start a transmission by stating the loop talking on (unless it is the Big Loop)

GENERAL EMERGENCIES (ALL)

<p>For ISS or shuttle Fire/Depress/ATM Contamination:</p> <ul style="list-style-type: none"> • Everybody "safes" what he is doing, executes JEE (ISS crewmember will execute gray steps in A/L), and return to home vehicle • For smoke/flames or ATM contamination, don PBAs or ИПК • If no ammonia contamination, EVs and IV will retrieve equipment per Emergency Undocking cue card. MS2-Steph will help at the PMA • If EVs in EVA, terminate EVA and return to ISS A/L (if possible, IV will join in A/L and assist) • If suited in E/L => suit doff (+ power down if time permits) • If C/L depressed => "fast" repress • If E/L at 10.2 => expect immediate auto ("fast") repress <p>For EVA emergencies:</p> <ul style="list-style-type: none"> • Abort & terminate procedures (including incapacitated/lost EV) => non essential shuttle and ISS activities will be terminated, IV and CMOs will go to E/L as soon as EVs in C/L • For lost crewmember/tool => CDR-PLT-MS2-IV in shuttle flight deck, if possible obtain 2 camera views (read pan/tilt angles) and HHL reading R/Rdot

EVA PREP (EV1, EV2, IV, Suit IV)

- Camp-out review
- WCS usage, food/drink
- While at 10.2: shave, brush teeth, wash face, comb hair
- Wear mask if not at 10.2
- Tool config (last minute tools/equipment)
- E/L activities
- Parallel suit donning
- SAFER, MWS, tool, bag stowage
- 10.2 depress/repress review
- C/L depress review

REPRESS/POST-EVA (EV1, EV2, IV, Suit IV)

- Coldsoak
- C/L repress review
- Parallel Suit
- Food/drinks requests

10A EVA 4 PRE BRIEF (Cont)

EVA DETAILED REVIEW (EV1, EV2, IV)

- **IV General Notes:** T-RAD transfer and prep done the day before EVA, with knob left off until morning of EVA. **Must be placed in STOW position at end of Prebreathe with IV wearing gloves and goggles.** (Knob needs to be installed prior to going to vacuum, or dispenser might not function). IVA duties will be shared between Paolo (egress → Lab arrival; Lab departure → ingress) and Swanny (worksites setup, sample prep, tool/sample stow); Paolo to remain responsible for WVS and camera views, day/night checks, and will be b/u for Swanny in case of comm loss (start 10' timer at the completion of a T-RAD dispense pass over the samples → if no comm with MCC, purge if slow dispense for half of initial dispense time)
- **Egress:** O2 actuator cover on when SCU removed; EV1 out first with 85' to fwd airlock D, EV2 to aft; pass out sample bag to EV1; EV2 takes large ORU bag; after SAFER checks and hatch MLI, EV2 leads to aft nadir Lab worksite, fairleading tightly to inbd radial HR on equipment lock and along ONTO tank to airlock-Lab gap spanner, to one HR row zenith; EV2 stays stbd, EV1 stays port
- **Worksite setup:** Comm check with Swanny; EV2 sets up large ORU bag with hingeline ISS forward (aft standoffs 0244 and 0249 for EV2; aft standoffs 0245 and 250 for EV1); EV1 sets up sample bag with hingeline ISS stbd (aft standoffs 0232 and 0245 for EV1; special cinching along 0231 and 0244 for EV2); EV1 transfers APFR from ESP-2 WIF 5 to Lab WIF 4, clocking 1:00; EV2 opens bags; EV2 installs T-RAD on EV1 in APFR, keeping as loose as possible but precluding riding up over SAFER; EV1 checks tensioning by sweeping out DTO motions; EV2 caution: holster on EV1 swingarm a risk to visor/helmet → translate across large ORU bag biased ISS fwd; EV2 stages large trash bag, EVA wipe, foam brush caddy (install brushes), broom clip caddy; EV1 lowers MWS T-bar
- **T-RAD Activation:** EV2 temp measurement of nozzle; EV1 verifies flow shutoff valve is OPEN, gun in SAFE, stows/restrains in holster; EV2 opens MLI and transfers know from STOW port to PRESSURE, turns ~5T cw to hard stop, then back off 1.5T ccw, verify pressure increasing, close flap
- **STA-54 Ops:** Trigger, Flow, Release voice protocol; holster gun when not in use; wipe up material immediately; perform glove inspections periodically, and watch for drippage in holster; comment on mixing, swirling, white chunks (if seen), bubbling, expansion, sheen, texture, subjective viscosity; periodically inspect melamine brushes for damage and discoloration
- **5" line in Scraper Bin:** report thickness and width; time per calls
- **Purge into CDC:** purge per MCC instructions, visual observations
- **Second line into Scraper Bin:** deltas between first (Part A) and this (mixed) line?
- **4 small dispenses in corners:** vary trigger pull lengths, tamp, observe
- **Three layers of ~10' each:** review detailed timeline and sample instructions (some require tamping at each layer, others none whatsoever); anticipate material expansion based on earlier dispenses, and attempt to meet but not exceed desired underfill and/or ramp; lightly tamp underfilled repairs to get rid of meniscus at edges

- **T-RAD Depressurization:** EV2 opens MLI, relocates knob from PRESSURE to VENT, ~3T cw, observe pressure reading, reinstall MLI
- **Tool Cleanup:** Stow dirty tools/tips in large trash bag; close sample bag; EV1 raise MWS T-bar and transfer holster; inventory large ORU bag and close; EV2 BRT's and transfers sample bag to PLB; EV1 babysits it while EV2 opens stbd TSA for stowage (hingeline to hingeline); then stow CDC (from EV1) and large trash bag in stbd TSA (OK to use red RETs); EV1 removes T-RAD and stows it and holster using two criss-crossed Shuttle adjustable tethers (install gun MLI first); return to airlock, with EV1 leading and picking up large ORU bag along the way; cold soak and tool inventory
- **Ingress:** EV2 in first; pass in large ORU bag; daisy chain and EV1 ingress (avoid touching STA-54 contaminated gloves/tools to hatch sealing surface and edges of hatch); O2 actuator cover removed to allow SCU connection

CHICA MANTRAS (EV1, EV2, IV)

- | | |
|---|---|
| <ul style="list-style-type: none">• Day/Night Cycles<ul style="list-style-type: none">• Lights – on• Sun visor – day: down, night: up• Cooling – as required• Bayonets – locked• Gloves:<ul style="list-style-type: none">▪ Heater – on/off as required▪ Inspect/report:<ul style="list-style-type: none">▪ RTV status▪ Vectran abrasions/cuts (specifically inspect thumb, index finger, C-cup)• Condition: Alpha, Bravo, Charlie• Safety Tether Swap<ul style="list-style-type: none">• Gates – closed• Hooks – locked• Reel – unlocked• PGT Ops<ul style="list-style-type: none">• XX – turns• YY – torque• (Green light) | <ul style="list-style-type: none">• PGT Extensions<ul style="list-style-type: none">• XXX installed on YYY• Good pull test• Electrical Connectors<ul style="list-style-type: none">• Pins straight• No FOD• EMI band – intact• If mated – mated, good bend radius• TA clamps – closed• APFR Install<ul style="list-style-type: none">• Black on black• Good pull test |
|---|---|

10A EVA 4 PRE BRIEF (Cont)

COMM PROTOCOL (EV1, EV2, IV)

- Short and concise (everybody stops to listen when COMM is “active”)
- Start with EVX, IV, R(M)X, then switch to names
- Give appropriate/timely info
- Anticipate when possible, do not overload
- Hand signals (between EVs and/or IV/ground via WVS) => review crew notebook

EMERGENCIES (EV1, EV2, IV)

- All emergencies => verbalize, IV leads, challenge-response protocol
- DCS => speak up for symptoms (verbalize)
- Abort & terminate procedures => as per cuff check list (review)
- Incapacitated crewmember => EV secures other EV to himself, returns to A/L, IV + CMO in A/L
- Lost Crewmember => call over Big Loop, request cameras and HHL reading, SAFER ops
- Hydrazine/NH3 contamination => IV will direct ops per checklist

GENERAL REMINDERS (EV1, EV2, IV)

- Verbalize any DCM messages
- Suit/gloves => stiffer than training H/W
- Glove heaters => it takes 2-3 min to feel heat
- EHIP lights => leave them on
- Translations => slow & deliberate, avoid feet first, check tethers often, check buddy when able
- Mass handling => one axis trans/rot at a time, watch for inertia
- Tether management => fairleads, stay clear of each other, 30 sec rule for snags or entanglements
- ORU control => positive transfer of control
- PGT ops => Red light – low torque, Green light – in torque window, Red/Green lights – HI torque
- PGT CAL procedure => Ratchet collar – Not motor, Speed collar – Cal, Pull trigger (CAL passed message)
- Video/cameras view for IV => change tapes, adjust WVS at SR/SS
- Errors & Lost tools => acknowledge and continue
- For lost tool/ORU => EVs verbalize what, when, direction, speed; IV gets 2 camera views/HHL (if possible)

EVA 4 SUMMARY TIMELINE

PET HR : MIN	IV/SSRMS	10A EVA 4 EV1 – Pz	EV2 – Wheels	PET HR : MIN
00:00		<u>EVA 4 A/L EGRESS AND SETUP (00:35)</u> <ul style="list-style-type: none"> • Post Depress • Egress/Setup 	<u>EVA 4 A/L EGRESS AND SETUP (00:35)</u> <ul style="list-style-type: none"> • Post Depress • Egress/Setup 	00:00
01:00		<u>T-RAD DTO (02:55)</u> <ul style="list-style-type: none"> • Worksite Setup (01:05) • Sample Preparation & Photography (01:25) • Tool Cleanup (00:25) 	<u>T-RAD DTO (02:55)</u> <ul style="list-style-type: none"> • Worksite Setup (01:05) • Sample Preparation & Photography (01:25) • Tool Cleanup (00:25) 	01:00
02:00				02:00
03:00				03:00
04:00		<u>EVA 4 CLEANUP AND INGRESS (01:15)</u> <ul style="list-style-type: none"> • PLB ops (00:55) • Ingress/Pre-Repress (00:20) 	<u>EVA 4 CLEANUP AND INGRESS (01:15)</u> <ul style="list-style-type: none"> • PLB ops (00:55) • Ingress/Pre-Repress (00:20) 	04:00
05:00				05:00
06:00				06:00

PRE EVA 4 TOOL CONFIG

EV1

EMU D-rings

- 1 – Tether Extender on Left
- 2 – Waist Tethers
- 1 – 85-ft Safety Tether (A/L)

MWS

- Small trash bag [right inside]
 - EVA Wipe
 - 1 – RET (sm-sm)
- 1 – RET (with PIP pin) [right]
- 1 – RET (sm-sm) [left]
- 2 – Wire ties
- Swing Arm [right side]
 - T-RAD holster (on outside bayonet)
 - 1 – RET (sm-sm)
- BRT [left side]
 - 3 – Wire Ties, short
 - 1 – RET (sm-sm)
- SAFER
- O2 actuator cover

EV2

EMU D-rings

- 1 – Tether Extender on Left
- 2 – Waist Tethers
- 1 – 85-ft Safety Tether (A/L)

MWS

- Small trash bag [right inside]
 - EVA Wipe
 - 1 – RET (sm-sm)
- 1 – RET (with PIP pin) [left]
- 1 – RET (sm-sm) [right]
- 2 – Wire ties
- Swing Arm [right side]
 - 1 – RET (with PIP pin)
- BRT [left side]
 - 3 – Wire Ties, short
 - 1 – RET (sm-sm)
- SAFER
- O2 actuator cover

CREWLOCK

- RET (Lg-sm, Blue) on outside of bag, install hook on side opposite handrail
- Sample bag (Tile Sample Bag)
 - 4 – Adj Tether on outside of bag (1 on to each hinge-side corner tether loop, 1 to each opening-side corner strap)
 - 1 – Lg-sm Adj to Sample bag internal lid strap
 - DTO insert (with strong box and pedestals)
 - Sample bag hinge-line corner strap hooks to DTO insert tether points
 - Tile samples strong box, lid secured with hood flap
 - 1 – RET (sm-sm) from strong box lid to Sample bag internal lid strap
 - 3 – brush pedestals, installed with snaps
 - 2 – Angled stamps
 - 2 – RET (sm-sm)
 - Brush Handle
 - RET (sm-sm)

CREWLOCK (Cont)

Staging Bag

- PGT w/7/16-6 in ext S/N _____
- Digital camera w/bracket
- 2 – EVA Wipes (from EWA kit)

RET (Lg-sm, Blue) on outside of bag

- Large ORU Bag
 - 4 – Adj Tether on outside of bag (1 on each tether loop)
 - 2 – 85-ft Safety Tether (PLB) (under T-RAD)
 - T-RAD (day of EVA, end of prebreathe – put knob in STOW position with IV wearing gloves and goggles)
 - RET (with PIP pin)
 - 1 – Adj Tether (fully extended on handrail)
 - 1 – Adj Tether (fully extended on bottom soft strap)
- Fish Stringer
 - CIPA Discard Container (with 5 wipes)
 - 3 – EVA wipes
 - Large Trash Bag
 - 1 – RET (sm-sm)
 - Adj Tether (one end hooked on ¼ turn receptacle, then wrapped around bag)
 - Broom Clip Caddy
 - 1 – RET (sm-sm)
 - Scraper (not taped, on right when wearing)
 - Brush Handle (tipless, on left when wearing)
 - Gel/Foam Brush Caddy with brush handle on int
 - Additional brush handle
 - 1 – RET (sm-sm)
 - 2 – RETs (sm-sm)
 - 1" foam brush tips (5) (remove netting from 4 brushes before EVA)
 - Temperature Sensor (on end of FS)
 - 1 – RET (with PIP pin) (hooked to FS strap)
 - EVA digital camera with bracket (using bracket RET to FS strap, on end opposite temperature sensor)

Items to remain in crewlock

Prior to EVA, inspect:
 RET cord for damage
 Small trash bag bristles for damage or deformation
 Safety & waist tether load alleviating straps: no red

Total RETs sm-sm used – 16 (RED)
 RETs with PIP pin – 5 (RED)
 RETs Lg-sm – 2 (BLUE)
 Adj tethers – 11
 Lg-sm Adj – 1

PRE EVA 4 TOOL CONFIG (Cont)

T-RAD (85-ft tethers beneath)

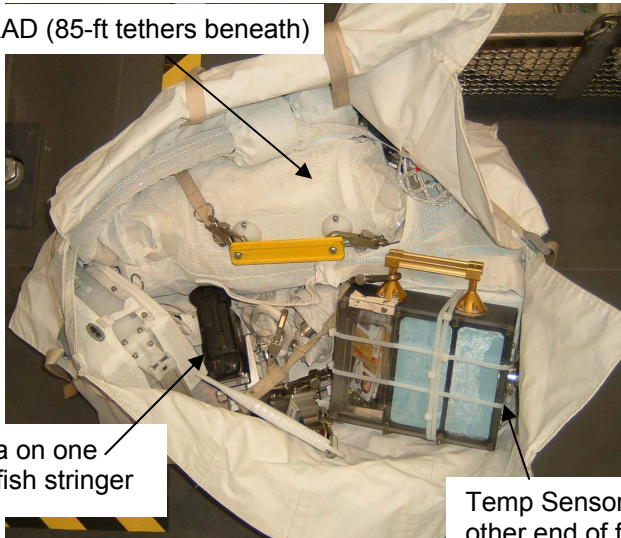

Camera on one end of fish stringer

Temp Sensor on other end of fish stringer (under CDC)

Lg ORU Bag – Inside



4 – Adj tethers criss-crossed

Lg ORU Bag – Outside

(NOTE: Safety tethers will now be inside Lg ORU bag)

Sm-sm RET from strongbox lid to Sample Bag lid

Lg-sm Adj to Sample Bag lid

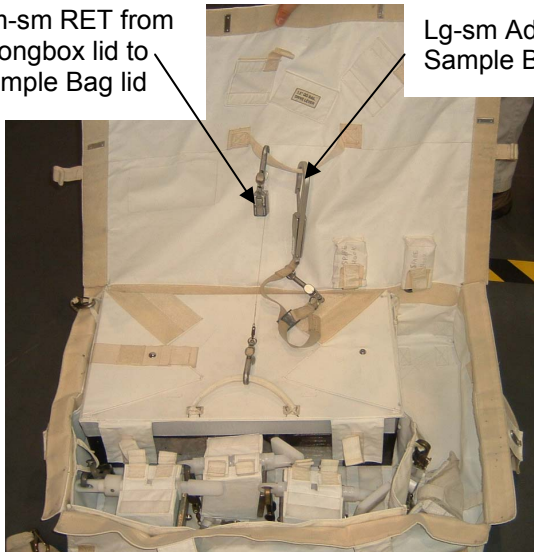

Sample Bag – Inside



Sample Bag – Inside

4 – Adj tethers criss-crossed

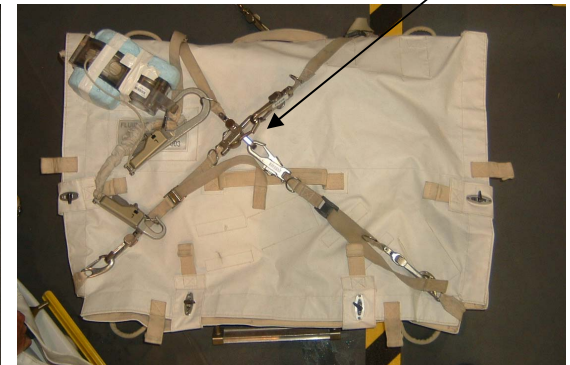

Sample Bag – Outside

(NOTE: Safety tethers will now be inside Lg ORU bag)

EVA 4 A/L EGRESS AND SETUP (00:35)

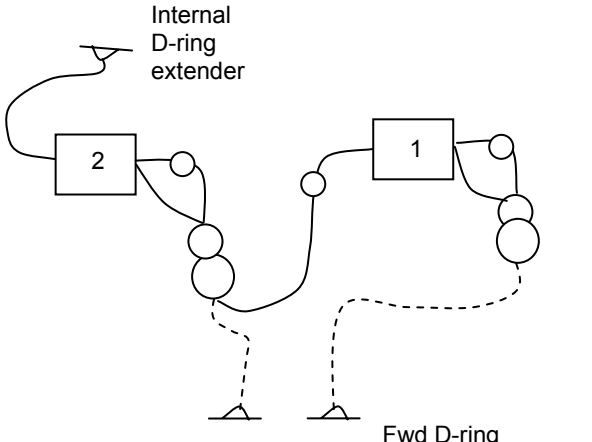
IV	EV1 – Pz (FF)	EV2 – Wheels (FF)
 <p>Internal D-ring extender</p> <p>Fwd D-ring</p> <div style="border: 1px solid black; padding: 5px; width: fit-content;"> <p>1 – 85-ft A/L tether – EV1 1 – 85-ft A/L tether – EV2</p> </div> <p>1. Post crew egress: WVS Software: Select page – RF Camera sel 'Advanced controls' S-Band level (two) – max</p>	<p><u>INITIAL CONFIG</u></p> <ol style="list-style-type: none"> Verify: <ul style="list-style-type: none"> <input type="checkbox"/> Right waist tether connected to EV2's 85-ft safety tether <input type="checkbox"/> Hook locked Install O2 actuator cover <p><u>EGRESS/INITIAL SETUP</u></p> <ol style="list-style-type: none"> Open hatch thermal cover Egress crewlock Attach EV1 85-ft safety tether to fwd A/L D-ring <ul style="list-style-type: none"> <input type="checkbox"/> √Gate closed <input type="checkbox"/> √Hook locked <input type="checkbox"/> √Reel unlocked Attach EV2 85-ft safety tether to aft A/L D-ring tether point <ul style="list-style-type: none"> <input type="checkbox"/> √Gate closed <input type="checkbox"/> √Hook locked <input type="checkbox"/> EV2: √Reel unlocked <hr style="border-top: 1px dashed black;"/> <ol style="list-style-type: none"> Give EV2 GO to release waist tether <hr style="border-top: 1px dashed black;"/> <ol style="list-style-type: none"> Receive Sample bag from EV2 Attach Sample bag to BRT <hr style="border-top: 1px dashed black;"/> <ol style="list-style-type: none"> Assist EV2 with Lg ORU bag BRT stow 	<p><u>INITIAL CONFIG</u></p> <ol style="list-style-type: none"> Verify: <ul style="list-style-type: none"> <input type="checkbox"/> Right waist tether connected to A/L D-ring extender <input type="checkbox"/> Hook locked Install O2 actuator cover <p><u>EGRESS/INITIAL SETUP</u></p> <ol style="list-style-type: none"> On EV1 GO release right waist tether, attach to self Transfer Sample bag to EV1 Attach Lg ORU bag to BRT RET Egress crewlock; transfer Lg ORU bag to EV1 as reqd Stow Lg ORU bag on BRT Close hatch thermal cover

EVA 4 A/L EGRESS AND SETUP (00:35) (Cont)

IV	EV1 – Pz (FF)	EV2 – Wheels (FF)
<p>2. Comm handover to Ground IV</p>	<p>9. Verify SAFER config <input type="checkbox"/> √L Handle down (MAN ISO Vlv – Open) <input type="checkbox"/> √R Handle down (HCM – Closed)</p> <p>10. Translate to Lab via nadir/port path; following EV2 (keeping safety tether “on top” to later translate to ESP-2 for APFR retrieval)</p> <p>11. Translate to aft standoff of HR 0245</p> <p>12. Perform glove inspection</p> <p>13. Comm handover with Ground IV</p>	<p>7. Verify SAFER config <input type="checkbox"/> √L Handle down (MAN ISO Vlv – Open) <input type="checkbox"/> √R Handle down (HCM – Closed)</p> <p>8. Translate to Lab via nadir/stbd path; EV2 leading, fairleading safety tether on HR 0230 and 0237</p> <p>9. Translate to aft standoff of HR 0249</p> <p>10. Perform glove inspection</p> <p>11. Comm handover with Ground IV</p>

- Duties to remain with Onboard IV
- Day/Night Checks
 - 10 min purge timer in the event of comm loss
 - Response to any EMU malfunctions

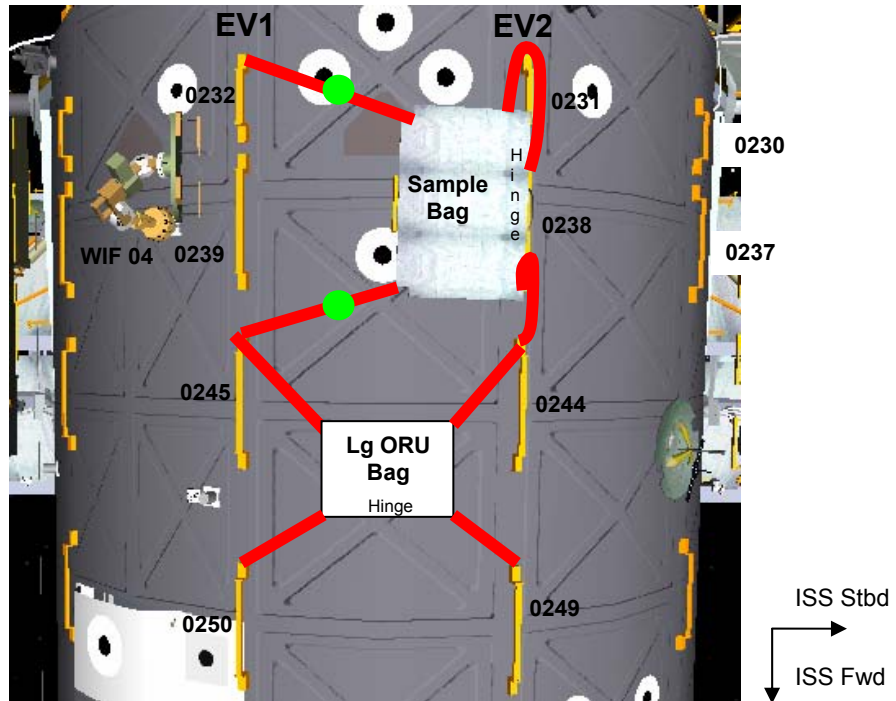

T-RAD DTO (02:55)

IV	EV1 – Pz (FF)	EV2 – Wheels (FF)
	<p><u>WORKSITE SETUP</u> (01:05)</p> <ol style="list-style-type: none"> 1. Stow port straps of Sample bag w/hinge line stbd; securing hinge snugly against HR 0238 and 0231 <ul style="list-style-type: none"> <input type="checkbox"/> Port/fwd tether on bag corner strap to aft standoff HR 0245 <input type="checkbox"/> Port/aft tether on bag corner strap to aft standoff HR 0232 2. Cinch Sample bag as reqd to center strong box in EV1's work envelope (<u>NOTE</u>: APFR boot plate aft of WIF) 3. Stow port tethers of Lg ORU bag w/hinge line fwd <ul style="list-style-type: none"> <input type="checkbox"/> Port/fwd tether to aft standoff HR 0250 <input type="checkbox"/> Port/aft tether to aft standoff HR 0245 4. Cinch Lg ORU bag as reqd 5. Translate to ESP-2 WIF 5 (fwd) 6. Tether to and retrieve APFR; stow on BRT 7. Translate to Lab WIF 4 (nadir/port/aft) 8. Install APFR in Lab WIF 4 (1, TT, C, 11) <ul style="list-style-type: none"> <input type="checkbox"/> √Locking collar black-on-black <input type="checkbox"/> Good pull test 9. Ingress APFR <hr style="border-top: 1px dashed black;"/> <ol style="list-style-type: none"> 10. Receive gun from EV2 11. Hold gun off to right side to allow EV2 to configure T-RAD canister 	<p><u>WORKSITE SETUP</u> (01:05)</p> <ol style="list-style-type: none"> 1. Temp stow Lg ORU bag <ul style="list-style-type: none"> <input type="checkbox"/> Stbd/fwd tether to aft standoff HR 0249 2. Translate to Sample bag worksite 3. Stow stbd tether of Sample bag w/hinge line stbd; securing hinge snugly against HR 0238 and 0231 <ul style="list-style-type: none"> <input type="checkbox"/> Stbd/fwd tether on bag tether loop thru fwd standoff 0238 to aft standoff HR 0244 <input type="checkbox"/> Stbd/aft tether on bag tether loop around aft standoff HR 0231 and hooked to aft 0238 4. Cinch Sample bag as reqd to center strong box in EV1's work envelope (<u>NOTE</u>: APFR boot plate aft of WIF) 5. Stow stbd tethers of Lg ORU bag w/hinge line fwd <ul style="list-style-type: none"> <input type="checkbox"/> Stbd/fwd tether to aft standoff HR 0249 <input type="checkbox"/> Stbd/aft tether to aft standoff HR 0244 6. Cinch Lg ORU bag as reqd 7. Open Sample bag lid; secure lid using Lg-sm adj tether by wrapping tether around HR 0238 and looping back to tether hook or D-ring 8. Open Lg ORU bag lid, securing open by using integral internal adjustable straps to HR 0250 and 0249 9. Tether to and remove T-RAD from ORU bag 10. Translate to EV1 11. Give EV1 T-RAD gun around EV1 right side <hr style="border-top: 1px dashed black;"/> <ol style="list-style-type: none"> 12. Secure T-RAD behind EV1 such that hose elbow joint faces fwd 13. Attach fully extended adj tether from canister handrail to EV1's right suit D-ring

T-RAD DTO (02:55) (Cont)

IV	EV1 – Pz (FF)	EV2 – Wheels (FF)
<p style="text-align: center;"><u>NOTE</u></p> <p>On gun gauge, green range is 40-120 degF with 5 deg increments</p>	<p>12. Once canister secured, work with EV2 to determine optimal adj tether lengths by sweeping out DTO motions, using gun swivels, and faking gun in holster</p>	<p>14. Attach fully extended adj tether from canister bottom soft strap to EV1's left suit D-ring</p> <p>15. Work with EV1 to determine optimal adj tether lengths (both fairly loose)</p>
	<p>CAUTION</p> <p>Do not squeeze T-RAD gun trigger prior to pressurization, it may cause the gun to not flow properly</p>	
	<p>13. Remove gun MLI; stow on hose</p> <p>14. Report gun temperature on gun gauge (~where in green/red) _____</p> <p>15. Stow gun in holster on swing arm</p>	<p>16. Assist EV1 with stowage of gun MLI</p> <p>17. Translate to Lg ORU bag to begin staging tools</p>
	<p>16. Receive CDC from EV2; stow on BRT</p> <p>17. Verify best orientation of CDC on BRT by performing dry run, accessing both closed bins and scraper bin</p> <p>18. Retrieve foam brush handle from Sample bag pedestal</p>	<p>18. Retrieve CDC from fish stringer; transfer to EV1</p> <p>19. Retrieve Lg trash bag from fish stringer; stage between bags</p> <p>20. Configure adj tether from 1/4 turn fitting to trash bag mouth to aid in opening</p> <p>21. Retrieve EVA wipe from fish stringer; stage near sample bag lid</p> <p>22. Retrieve foam brush caddy from fish stringer; stage between bags using 2 RETs</p>
	<p>19. Install foam tip on brush handle</p> <p>20. Stow brush handle with tip back in pedestal</p>	<p>23. Open foam tip side of caddy ("M-X" side); offer to EV1</p>

T-RAD DTO (02:55) (Cont)

IV	EV1 – Pz (FF)	EV2 – Wheels (FF)
<p style="text-align: center;"><u>NOTE</u> For temperature sensor: 0°F = -18°C 20°F = -7°C 40°F = 4°C 60°F = 16°C 80°F = 27°C</p>	<p>21. Lower MWS T-Bar; flip cuff checklist back</p> <p>22. Open sample strongbox lid</p> <p>23. Retrieve T-RAD gun from holster; offer nozzle to EV2</p> <p>24. Perform DTO dry run with nozzle at ½-in from and normal to surface simulating cavity access to all samples</p> <p>25. Verify gun flow shutoff knob – OPEN</p> <p>26. Verify gun in SAFE; stow gun in holster</p> <p>27. Close sample strongbox lid; secure using hood flap</p>	<p>24. Retrieve broom clip caddy from fish stringer</p> <p>25. Install foam tip on brush handle; temp stow broom clip caddy between bags or on self (MWS right outside)</p> <p>26. If installed on MWS, verify brush handle is on inboard clip and tip is pointed down</p> <p>27. Close lid on foam brush caddy and temp stow</p> <p>28. Retrieve temperature sensor from Lg ORU bag</p> <p>29. Turn temperature sensor – ON</p> <p>30. Take temperature of nozzle (near the tip) _____°C</p> <p>31. Close temp sensor display cover and probe tip cover</p> <p>32. Stow temperature sensor in Lg ORU Bag</p> <p>33. Translate to T-RAD on EV1's right side</p> <p>34. Remove T-RAD top MLI (2-snaps, 2-1/4 turn fasteners, and Velcro) to expose EVA knob</p>

T-RAD DTO (02:55) (Cont)

IV/SSRMS	EV1 – Pz (FF)	EV2 – Wheels (FF)
	<p><u>T-RAD PRESSURIZATION</u></p> <p>1. Restrain gun in holster and with gloved hand while EV2 is pressurizing T-RAD</p> <hr style="border-top: 1px dashed black;"/> <p style="text-align: right;"><u>NOTE</u></p> <p>Wipe STA-54 from visor as soon as possible.</p> <p>Use “Trigger...Flow...Release” protocol. For purges, IV will count down to release.</p> <p>First line in CDC will help MCC determine flow rate.</p> <p>Holster gun when not flowing</p>	<p><u>T-RAD PRESSURIZATION</u></p> <ol style="list-style-type: none"> 1. Once EV1 has verified gun restrained, remove EVA knob from STOW port (~5 turns ccw) 2. Install EVA knob into PRESSURE port (~5 turns cw to hard stop); back off 1.5 turns ccw 3. Verify pressure increasing; report T-RAD pressure _____ psi 4. Close MLI flap, Velcro and 1/4 turn fastener as reqd 5. Translate back to staged tools on HR 0244

T-RAD DTO (02:55) (Cont)

<p style="text-align: center;">IV</p>	<p style="text-align: center;">EV1 – Pz (FF) EV2 – Wheels (FF)</p>
<div style="border: 1px solid black; padding: 5px; margin-bottom: 20px;"> <p><u>Flow rate, as determined by initial CDC line:</u></p> <ul style="list-style-type: none"> • Length of line = 5 inches • Width (note that lines are 1/2 in apart) = C inches • Thickness = B inches (note that nozzle OD is 0.75 inches and ID is 0.5 inches) • Length of trigger pull = D seconds • Flow rate = $(5 \text{ in} \times B \times C) / D = \text{_____ in}^3/\text{sec}$ <p><u>20 in³ purge time, based on flow rate:</u></p> <p>@ 0.2 in³/sec = 100 sec + 15 sec margin = 115 sec @ 0.3 in³/sec = 67 sec+ 15 sec margin = 82 sec @ 0.4 in³/sec = 50 sec+ 15 sec margin = 65 sec @ 0.5 in³/sec = 40 sec+ 15 sec margin = 55 sec</p> </div> <p style="text-align: center;"><u>NOTE</u></p> <p>On gun gauge, green range is 40-120 degF with 5 deg increments.</p> <p>For temperature sensor:</p> <p>0°F = -18°C 20°F = -7°C 40°F = 4°C 60°F = 16°C 80°F = 27°C</p>	<p><u>INITIAL MATERIAL CHARACTERIZATION AND PURGE</u></p> <ol style="list-style-type: none"> 1. Dispense 1 line into CDC scraper bin along one long edge 2. Report approximate thickness and width of line right after dispense 3. Watch line for ~ less than 1 min, reporting expansion (<u>NOTE</u>: part A only) 4. Purge into CDC closed bin for X min (see IV column), reporting visual dispense information and expansion 5. Report temperature on gun gauge (~where in green/red) _____ 6. Dispense 1 line into middle of scraper bin <ul style="list-style-type: none"> • Discuss for approx 1 min (unless unusually interesting) • Report any differences between this line and the first line • Report any flow rate changes • Report if homogeneous 7. Practice up to four small repairs in the corners of the scraper bin <ul style="list-style-type: none"> • Spend less than ~3 min total on small repairs • Vary length of trigger pulls as desired • Tamp as desired 8. Report any closed purge bin changes in material expansion 9. Push CDC out of work envelope 10. Open strongbox lid; secure Velcro flaps under hood flaps as reqd 11. Take temperature of nozzle _____°C 12. Take temperature of Aluminum in 4x4 sample _____°C 13. Close temperature sensor display cover and probe tip cover 14. Stow temperature sensor in Lg ORU Bag 15. Report temperature on gun gauge (~where in green/red) _____

T-RAD DTO (02:55) (Cont)

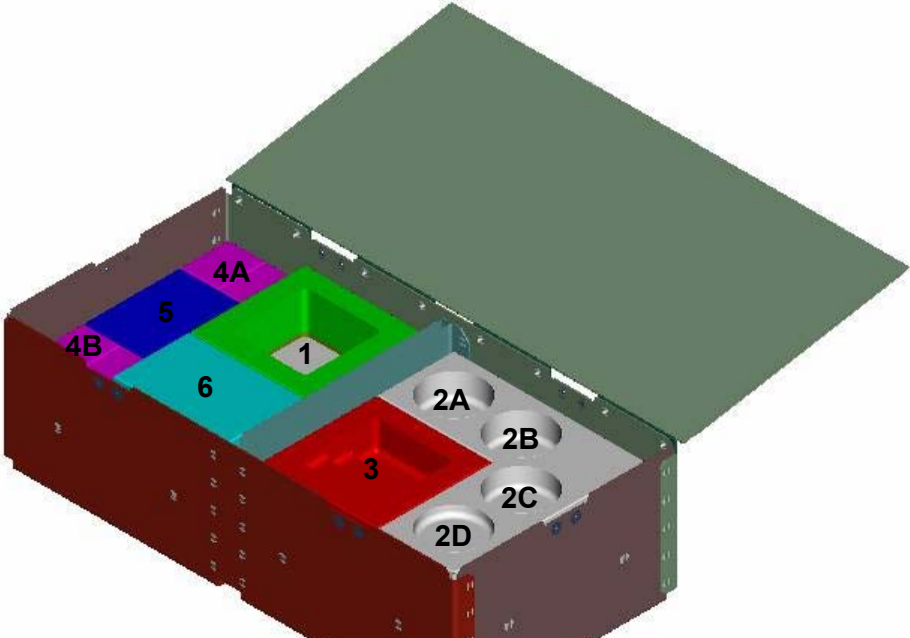
IV	EV1 – Pz (FF) EV2 – Wheels (FF)																																	
	<p style="text-align: center;">CAUTION</p> <p>EV2 assist EV1 in verifying swivels do not impact tile samples</p> <p style="text-align: center;">NOTE</p> <p>Each layer should be dispensed in ~10 min.</p> <p>Continue to tamp any previous samples as required.</p> <p>Attempt flat repairs, tamping out meniscus. If slightly overfilled, try to meet specs at edges (allow center to rise if required)</p> <ol style="list-style-type: none"> Apply 1 layer at a time to first 6 samples, starting with the 4x4, moving to the right to apply to all 4 circular samples, and then one layer in multi-level damage (note that 2D is just a dollop) Tamp samples as indicated on left Apply 2nd layer when satisfied with previous layer, within ~10 min, or on MCC call (skip any repairs that are already full) On 3rd layer, assess flow after multi-level fill: <ul style="list-style-type: none"> If flow acceptable: <ul style="list-style-type: none"> Fill first layer of ALL remaining repairs (4A, 4B, 5, 6) If flow slow: <ul style="list-style-type: none"> Report temperature on gun gauge (~where in green/red) _____ Perform purge into CDC by leaning away from samples (exact purge location, time on MCC call) Tamp previous samples as indicated above, and tamp all new samples like a repair Apply additional layers and tamp as required; MCC might request purges (lean back if purge required into CDC) Take temperature of nozzle _____ °C Close temperature sensor display cover and probe tip cover Stow temperature sensor in Lg ORU Bag Report temperature on gun gauge (~where in green/red) _____ Perform photogrammetry per the P/TV C/L, 5-39, when o-day during cleanup 																																	
<table border="1"> <thead> <tr> <th>#</th> <th>Goal Fill (Requirement)</th> <th>Tamp</th> </tr> </thead> <tbody> <tr> <td>1</td> <td>OML (no tolerance)</td> <td>Tamp like repair (all layers)</td> </tr> <tr> <td>2A</td> <td>OML (no tolerance)</td> <td>Tamp like repair (all layers)</td> </tr> <tr> <td>2B</td> <td>OML (no tolerance)</td> <td>Smooth only, no tamping (all layers)</td> </tr> <tr> <td>2C</td> <td>OML (no tolerance)</td> <td>1st layer: Light tamp. Subs: Smooth only</td> </tr> <tr> <td>2D</td> <td>OML (no tolerance)</td> <td>Tamp like repair (all layers)</td> </tr> <tr> <td>3</td> <td>.25 under (cover top shelf)</td> <td>Tamp like repair (all layers)</td> </tr> <tr> <td>4A</td> <td>Just cover bottom shelf (cover shelf)</td> <td>Tamp like repair (all layers)</td> </tr> <tr> <td>4B</td> <td>Right at upper shelf (don't exceed)</td> <td>Tamp like repair (all layers)</td> </tr> <tr> <td>5</td> <td>.25 under, ramp aft to RCG (don't exceed)</td> <td>Tamp like repair (all layers)</td> </tr> <tr> <td>6</td> <td>.25 under (don't exceed 0.1 under)</td> <td>Tamp like repair (all layers)</td> </tr> </tbody> </table>	#	Goal Fill (Requirement)	Tamp	1	OML (no tolerance)	Tamp like repair (all layers)	2A	OML (no tolerance)	Tamp like repair (all layers)	2B	OML (no tolerance)	Smooth only, no tamping (all layers)	2C	OML (no tolerance)	1st layer: Light tamp. Subs: Smooth only	2D	OML (no tolerance)	Tamp like repair (all layers)	3	.25 under (cover top shelf)	Tamp like repair (all layers)	4A	Just cover bottom shelf (cover shelf)	Tamp like repair (all layers)	4B	Right at upper shelf (don't exceed)	Tamp like repair (all layers)	5	.25 under, ramp aft to RCG (don't exceed)	Tamp like repair (all layers)	6	.25 under (don't exceed 0.1 under)	Tamp like repair (all layers)	
#	Goal Fill (Requirement)	Tamp																																
1	OML (no tolerance)	Tamp like repair (all layers)																																
2A	OML (no tolerance)	Tamp like repair (all layers)																																
2B	OML (no tolerance)	Smooth only, no tamping (all layers)																																
2C	OML (no tolerance)	1st layer: Light tamp. Subs: Smooth only																																
2D	OML (no tolerance)	Tamp like repair (all layers)																																
3	.25 under (cover top shelf)	Tamp like repair (all layers)																																
4A	Just cover bottom shelf (cover shelf)	Tamp like repair (all layers)																																
4B	Right at upper shelf (don't exceed)	Tamp like repair (all layers)																																
5	.25 under, ramp aft to RCG (don't exceed)	Tamp like repair (all layers)																																
6	.25 under (don't exceed 0.1 under)	Tamp like repair (all layers)																																

T-RAD DTO (02:55) (Cont)

IV	EV1 – Pz (FF)	EV2 – Wheels (FF)
<p>1. Comm handover to on-board IV</p>	<p><u>T-RAD DEPRESSURIZATION</u></p> <p>1. Close sample strongbox lid; secure using hood flap</p> <p>2. Comm handover to on-board IV</p> <p><u>TOOL CLEANUP (00:25)</u></p> <p>1. Inspect gloves/self for STA-54 (wipe as necessary)</p> <p>2. Inspect EV2 for STA-54 (wipe as necessary)</p> <p>3. Perform inventory of Sample bag (leaving any tools on pedestals, some tools may be in Lg trash bag):</p> <ul style="list-style-type: none"> <input type="checkbox"/> 2 – Angled Stamps (with 2 RETs) <input type="checkbox"/> 1" Foam brush (with RET) <input type="checkbox"/> EVA Wipe (with RET) <input type="checkbox"/> RET from strong box lid <input type="checkbox"/> Lg-sm Adj (need to remove) <p>4. Close Sample bag with EV2 assistance if reqd; retrieve Lg-sm adj from lid; stow in Lg ORU bag</p>	<p><u>T-RAD DEPRESSURIZATION</u></p> <p>1. Translate to T-RAD on EV1's right side</p> <p>2. Remove top MLI to expose EVA knob</p> <p>3. Remove EVA knob from PRESSURE port (~3 turns ccw)</p> <p>4. Install EVA knob into VENT port (~3 turns cw)</p> <p>5. Using pressure gauge on top of T-RAD, report any pressure changes</p> <p>6. Reinstall top MLI</p> <p>7. Comm handover to on-board IV</p> <p><u>TOOL CLEANUP (00:25)</u></p> <p>1. Inspect gloves/self for STA-54 (wipe as necessary)</p> <p>2. Inspect EV1 for STA-54 (wipe as necessary)</p> <p>3. Stow any used wipes in Lg trash bag, using dirty tools to aid in stowage</p> <p>4. Stow any dirty tools in Lg trash bag</p> <p>5. If not contaminated, remove adj tether from Lg trash bag; stow in Lg ORU Bag</p> <p>6. Assist EV1 with Sample bag closure; retrieve Lg-sm Adj from lid; stow in Lg ORU bag</p>

T-RAD DTO (02:55) (Cont)

IV	EV1 – Pz (FF)	EV2 – Wheels (FF)
	<ul style="list-style-type: none"> 5. Raise MWS T-Bar 6. Remove 3 of 4 adj tethers from Sample bag; transfer to EV2 7. Transfer holster (with T-RAD gun) from swing arm to MWS T-Bar 8. Egress APFR 9. Perform quick re-inspection of gloves for STA-54 10. Translate to PMA2, following EV2 	<ul style="list-style-type: none"> 7. Stow foam brush caddy (with 2-RETs), EVA camera and broom clip caddy on fish stringer in Lg ORU bag 8. Perform inventory of Lg ORU bag (some tools may be in Lg trash bag): <ul style="list-style-type: none"> <input type="checkbox"/> Fish stringer <ul style="list-style-type: none"> <input type="checkbox"/> EVA Camera <input type="checkbox"/> Broom Clip Caddy (with RET) <ul style="list-style-type: none"> <input type="checkbox"/> 3" Scraper <input type="checkbox"/> Brush Handle <input type="checkbox"/> Temperature Sensor (with PIP pin RET) <input type="checkbox"/> 2 EVA wipes <input type="checkbox"/> Foam Brush Caddy (with 3 RETs) <input type="checkbox"/> 3 – adj tethers (from Sample bag) <input type="checkbox"/> 1 – Lg-sm adj tether (from Sample bag) 9. Close Lg ORU bag lid 10. Retrieve Lg trash bag; stow on swing arm 11. Tether to Sample bag; remove final adj tether; stow tether on MWS; stow Sample bag on BRT 12. Perform quick re-inspection of gloves for STA-54 13. Translate to PMA2, leading EV1

EVA 4 CLEANUP AND A/L INGRESS (01:15)

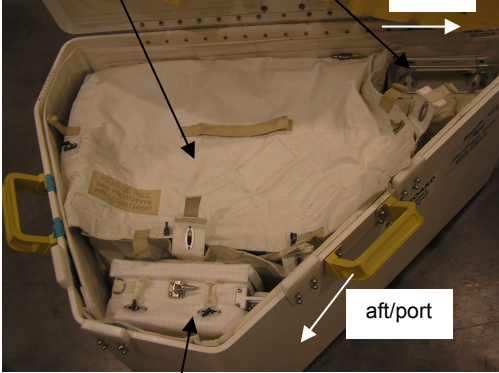
IV	EV1 – Pz (FF)	EV2 – Wheels (FF)
<p>Sample Bag w/hinge along TSA hinge</p> <p>CDC in fwd notch</p>  <p>Gel Brush Caddy shown, replace with Lg trash bag</p>	<p><u>PLB OPS</u> (00:55)</p> <ol style="list-style-type: none"> Translate to PMA2, following EV2 Tend Sample bag as EV2 translates to stbd TSA <div style="border: 1px solid black; padding: 5px; text-align: center;"> <p>CAUTION Avoid contact with SSOR and WVS antennas, PLB cameras and Ku-Band antenna during TSA Ops</p> </div> <ol style="list-style-type: none"> Transfer Sample bag to EV2 <hr style="border-top: 1px dashed black;"/> <ol style="list-style-type: none"> Transfer CDC to EV2 <div style="border: 1px solid black; padding: 5px; text-align: center;"> <p>CAUTION Tools in port TSA are friction fit. Use caution when opening</p> </div> <ol style="list-style-type: none"> Translate to port TSA; open lid (4 latches) Tether to and retrieve 2 – adj tethers from TSA (old-style hooks, only friction-fit in TSA) Open flight-specific compartment for T-RAD stowage Remove T-RAD gun from holster; attach tether to tether point on hose below gun 	<p><u>PLB OPS</u> (00:55)</p> <ol style="list-style-type: none"> Translate to PMA2, leading EV1 Temp stow Sample bag on PMA HR 0417; verifying bag will not contact FRGF <div style="border: 1px solid black; padding: 5px; text-align: center;"> <p>CAUTION Only use sides of Sample bag to stow in TSA. Avoid applying force to area where strong box is located to prevent damage to tile samples</p> </div> <ol style="list-style-type: none"> Translate to stbd TSA; open lid (4 latches) <hr style="border-top: 1px dashed black;"/> <ol style="list-style-type: none"> Receive Sample bag from EV1 Stow Sample bag with bag hinge along TSA hinge; attach integral strap equipment hook to TSA D-ring <hr style="border-top: 1px dashed black;"/> <ol style="list-style-type: none"> Receive CDC from EV1; stow in foam notch in fwd corner of TSA; attach RET to TSA D-ring Remove Lg trash bag from swing arm; stow in outboard opening of TSA; attach RET to Sample bag handrail Close stbd TSA (all 4 latches) <ol style="list-style-type: none"> Translate to port TSA; assist EV1 as reqd

EVA 4 CLEANUP AND A/L INGRESS (01:15) (Cont)

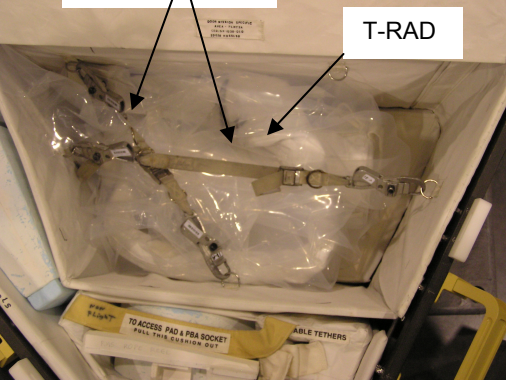
IV	EV1 – Pz (FF)	EV2 – Wheels (FF)
	<ol style="list-style-type: none"> 9. Remove gun MLI from hose; install MLI on gun 10. Release T-RAD adj tethers from suit D-rings 11. Remove 2 – adj tethers from T-RAD; stow on MWS 12. Stow T-RAD in port TSA; attach RET from T-RAD to TSA D-ring 13. Stow holster in port TSA; attach RET from holster to TSA D-ring 14. Criss-cross Shuttle adjustable tethers across top of T-RAD, running from TSA D-ring to D-ring on opposite side 15. Close port TSA (all 4 latches) 16. Verify PLB free of tethers, tools 17. Translate to Lg ORU bag on Lab nadir 18. Clean-up and remove Lg ORU bag from worksite; stow on BRT 19. Translate to airlock; EV1 leading to deconflict tethers 	<ol style="list-style-type: none"> 10. Verify PLB free of tethers, tools 11. Translate to Lg ORU bag on Lab nadir 12. Assist EV1 with Lg ORU bag removal 13. Translate to airlock; following EV1 to deconflict tethers

EVA 4 CLEANUP AND A/L INGRESS (01:15) (Cont)

IV	EV1 – Pz (FF)	EV2 – Wheels (FF)
<p>1. Perform prior to ingress: WVS PWRDN (P/TV, <u>WVS CUE CARD</u>)</p>	<p><u>INGRESS</u> (00:20)</p> <ol style="list-style-type: none"> Translate to Airlock Initiate EMU cold soak Perform tool inventory Perform glove inspection for STA-54 and cuts Transfer Lg ORU bag to EV2 	<p><u>INGRESS</u> (00:20)</p> <ol style="list-style-type: none"> Translate to Airlock Initiate EMU cold soak Perform tool inventory Perform glove inspection for STA-54 and cuts Ingress Airlock Receive Lg ORU from EV1, stow
	<p>CAUTION Avoid touching STA-54 contaminated gloves/tools to airlock hatch sealing surface and edges of hatch</p>	
	<ol style="list-style-type: none"> On EV2 GO, disconnect EV2's airlock tether attach to right waist tether <input type="checkbox"/> √Hooks locked Disconnect EV1 A/L safety tether from A/L, attach to self Ingress airlock Inspect sealing surface for contamination Open O2 actuator cover DCM 11. Retrieve SCU, remove DCM cover 12. Connect SCU to DCM, √Locked 13. Water – OFF 14. Hatch thermal cover – close 15. Secure thermal cover Velcro strap 	<ol style="list-style-type: none"> Connect right waist tether to A/L D-ring ext <input type="checkbox"/> √Hook locked Give EV1 GO to disconnect EV2 safety tether Inspect sealing surface for contamination Open O2 actuator cover DCM 11. Retrieve SCU, remove DCM cover 12. Connect SCU to DCM, √Locked 13. Water – OFF
	<p>CAUTION Do not close hatch until EMU water – OFF for 2 min</p>	
	<ol style="list-style-type: none"> √EV Hatch clear of FOD and obstructions EV Hatch – verify handle position per hatch decal; close and lock Go to PRE REPRESS portion of {CREWLOCK DEPRESS/REPRESS CUE CARD} (SODF: ISS EVA SYS: EVA PREP/POST) 	<ol style="list-style-type: none"> Go to PRE REPRESS portion of {CREWLOCK DEPRESS/REPRESS CUE CARD} (SODF: ISS EVA SYS: EVA PREP/POST)

T-RAD DTO – TASK DATA

Tools:

EV1 (FF)	EV2 (SSRMS)
See Tool Config	

EVA Fasteners:

Fastener Name	Head Size	Install Torque (ft-lb)	Release Torque (ft-lb)	Failure Torque (ft-lb)	Turns	RPM
N/A						

EVA Connectors:

Harness	From	To	Conn Size	Function
N/A				

Foot Restraints:

Task	WIF	APFR Setting
T-RAD DTO	Lab-04	1, TT, C, 11

Note:

1. Temperature gauge on T-RAD gun ranges from 40°-120°. Tick marks are in 5° increments
2. When not in use, temperature sensor should be kept in ORU bag and display flap should be closed (to keep within operational thermal range), and tip should be covered (to protect tip)
3. Temperature sensor measurement could take up to 10 sec to stabilize
4. STA-54 usable mixed quantity = 100-110 in³ (not including non-mixed 20 in³)

5. Conservative quantity of mixed material used (assumes no expansion, not including 20 in³ of known-purged non-mixed material):

First bead into scraper bin: diameter of .5", assuming 5" long cylindrical bead with a 2x factor for slow hand movements = $\pi*(.5"/2)^2*5"*2 = 2 \text{ in}^3$

Second bead into scraper bin: diameter of .5", assuming 5" long cylindrical bead with a 2x factor for slow hand movements = $\pi*(.5"/2)^2*5"*2 = 2 \text{ in}^3$

4 dollops into scraper bin: ~0.5 in³ each = 2 in³

Wastage during initial purge ~10 in³

Purge after 3rd layer = ~10 in³

Sample quantity = 78.5 in³

Total quantity: 104.5 in³

6. If dispense is slow, turn over 6 in³ per purge for gun volume
7. Wipe STA-54 from visor as soon as possible
8. Holster gun when not flowing

Cautions:

1. Avoid contact with SSOR and WVS antennas, PLB cameras and Ku-Band antenna during TSA Ops
2. Avoid touching STA-54 contaminated gloves/tools to airlock hatch sealing surface and edges of hatch
3. Tools in port TSA are friction fit. Use caution when opening
4. Only use sides of Sample bag to stow in TSA. Avoid applying force to area where strong box is located to prevent damage to tile samples
5. EV2 assist EV1 in verifying swivels do not impact tile samples
6. Do not squeeze T-RAD gun trigger prior to pressurization, it may cause the gun to not flow properly

Warnings:

T-RAD DTO – TASK DATA (Cont)

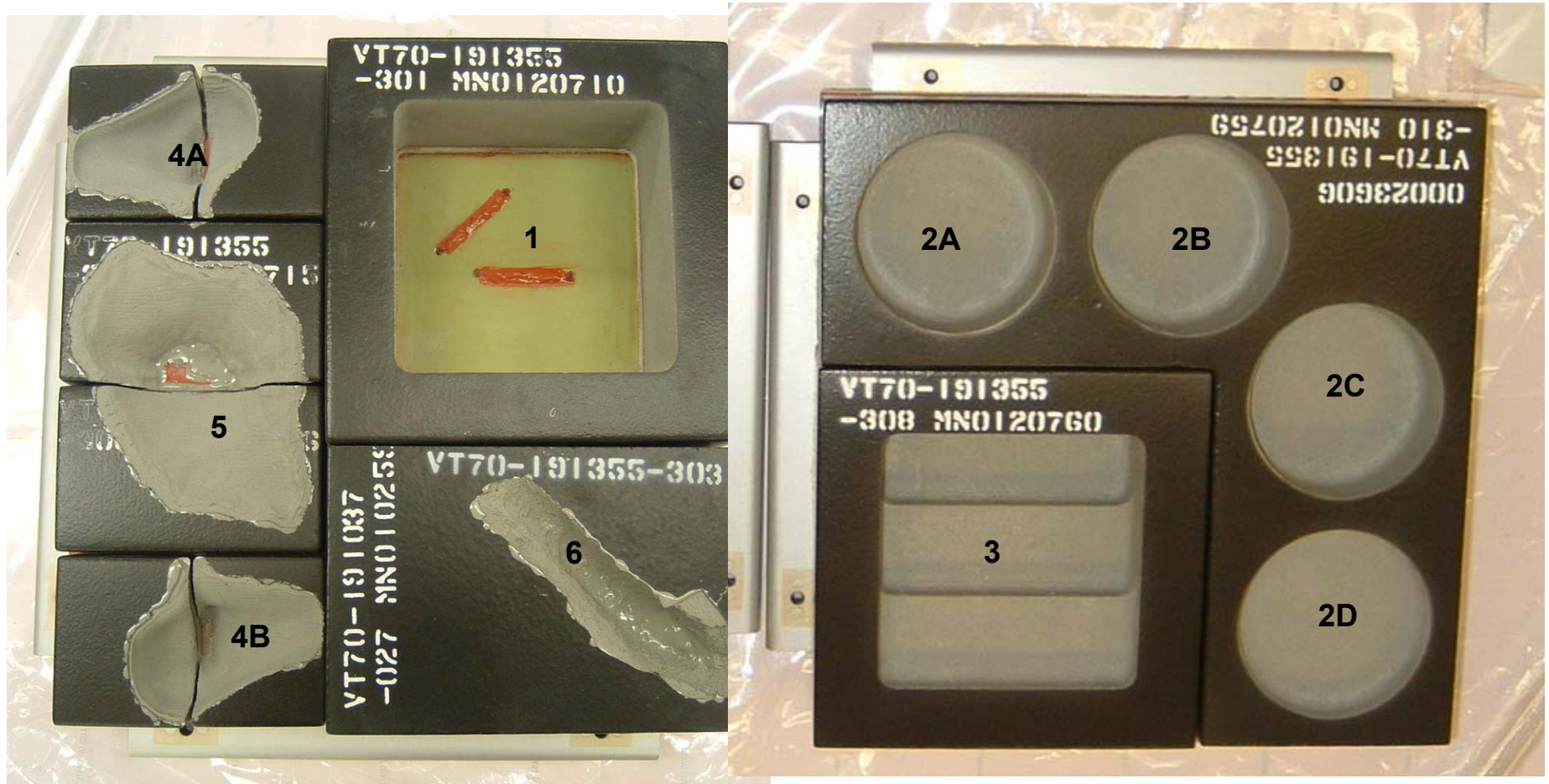

Flight DTO Samples with Emittance Primer. Hinge line at top of photo

T-RAD DTO – TASK DATA (Cont)

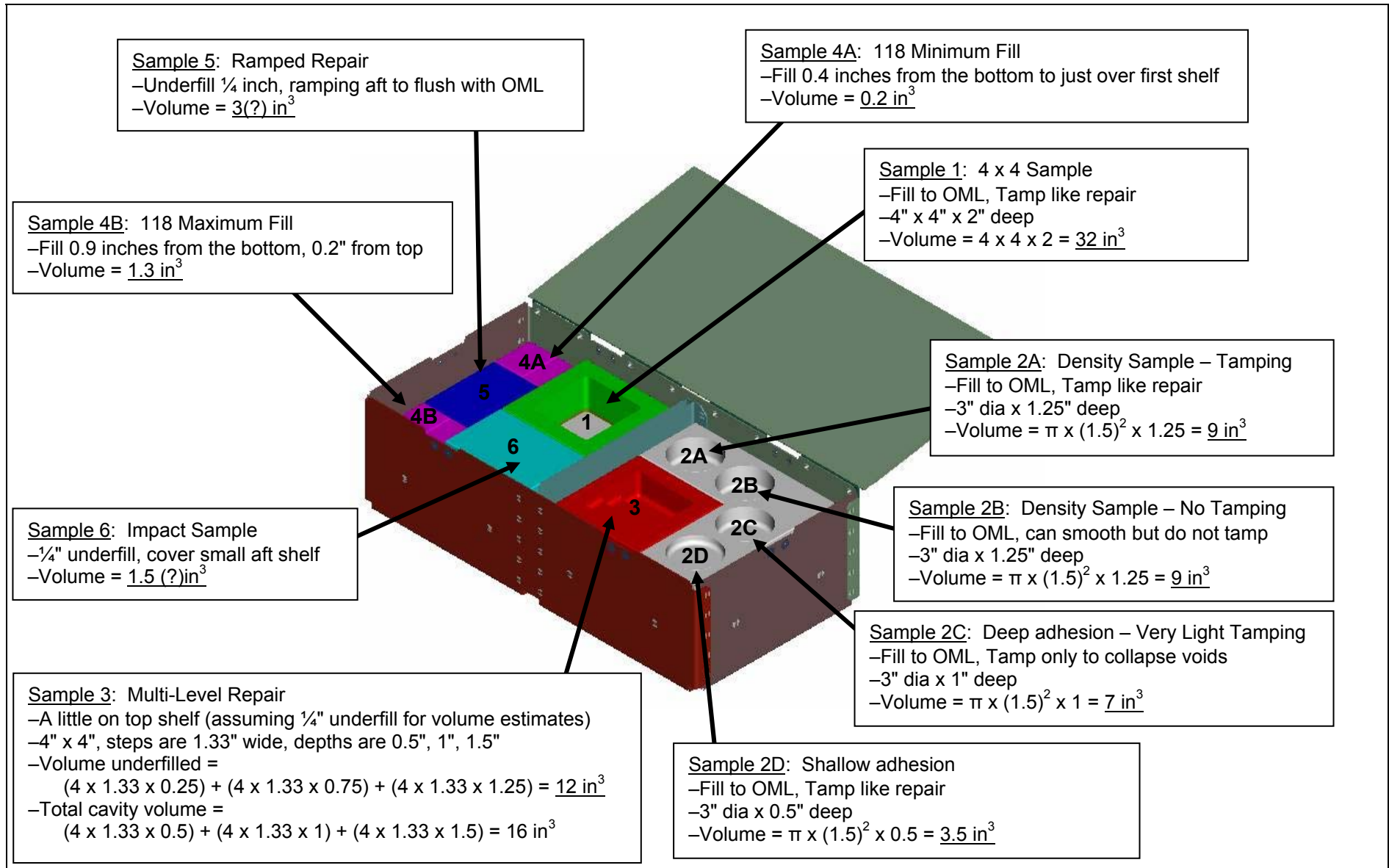

T-RAD DTO – TASK DATA (Cont)

Sample 4A – Minimum Fill

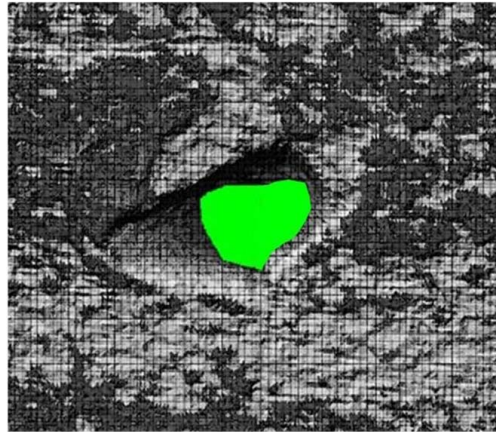
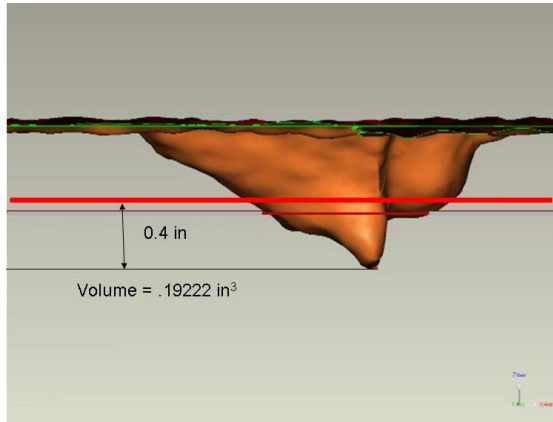

Sample 4B – Maximum Fill

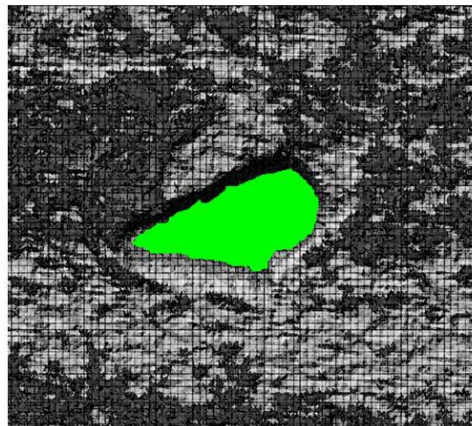
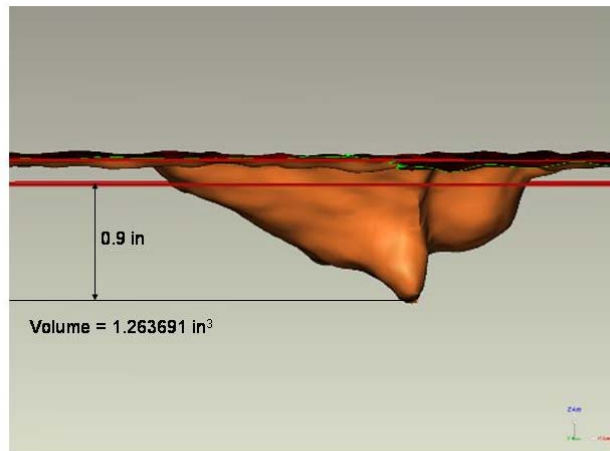

NOTE
Flight Sample orientation is 180 deg out from
fill level illustrations

T-RAD DTO – TASK DATA (Cont)

Sample 5 – Ramped Repair

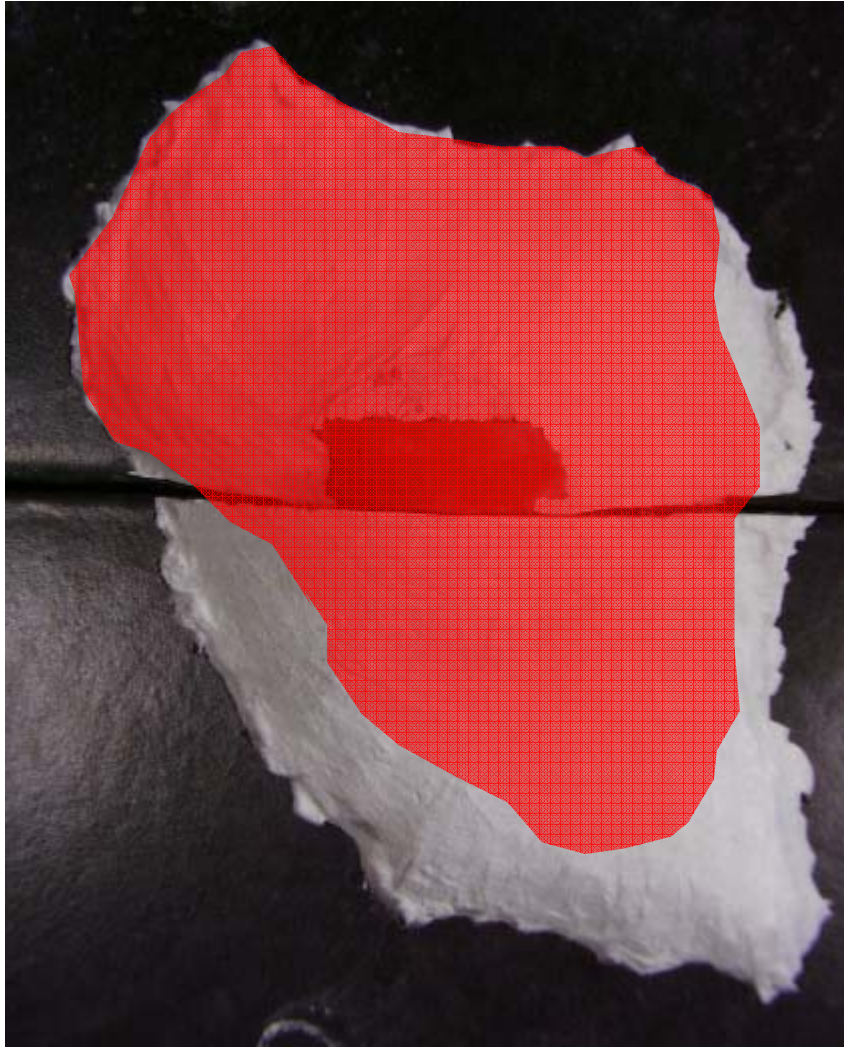

Fill Level Illustration



Flight Sample

T-RAD DTO – TASK DATA (Cont)

Sample 6 – Impact Sample

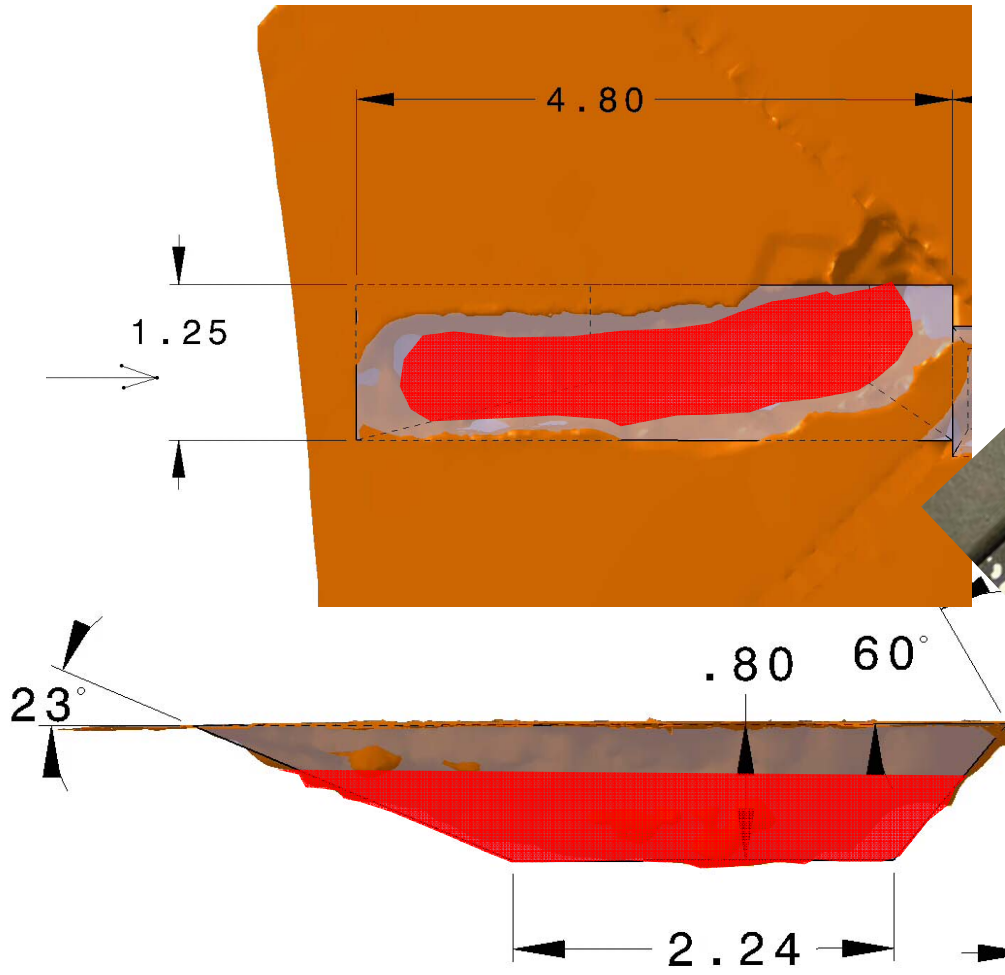

Fill Level Illustration

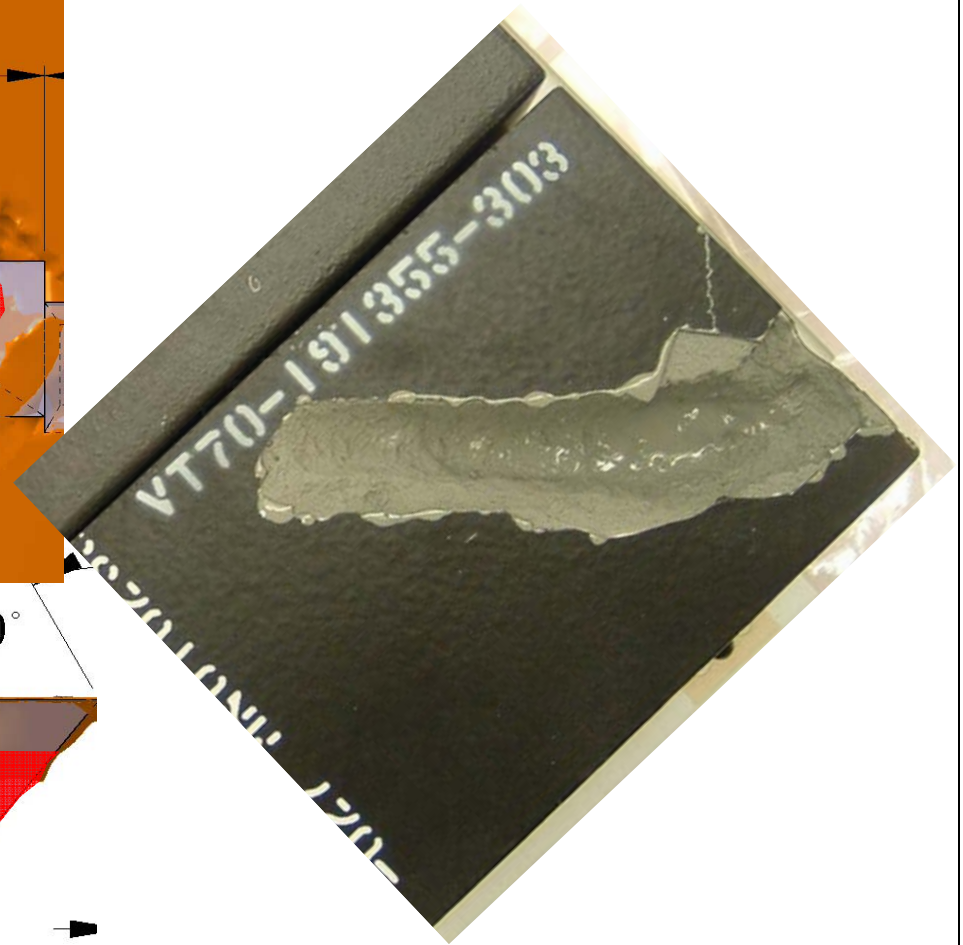

Flight Sample (rotated to match fill level illustrations)

T-RAD DTO – TASK DATA (Cont)

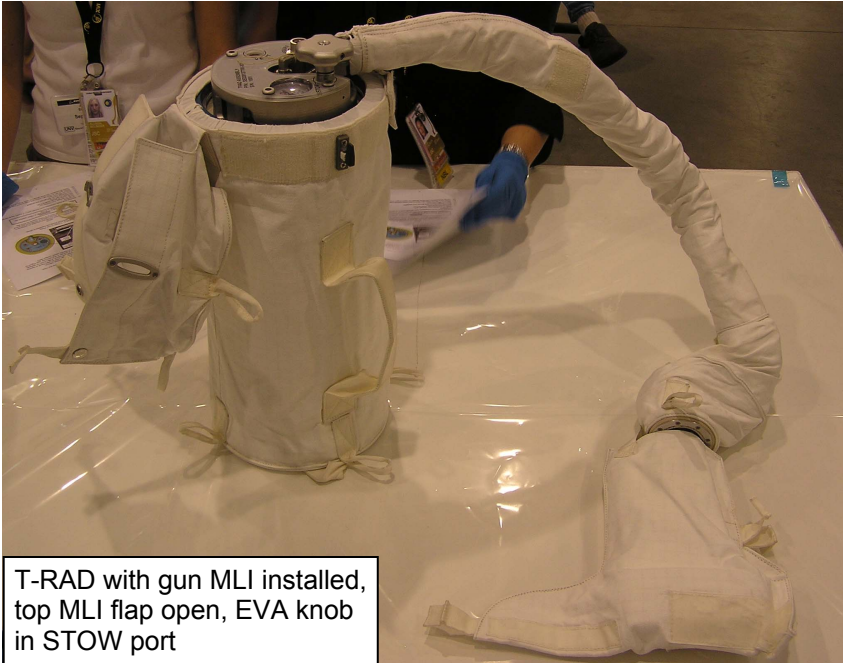

T-RAD with gun MLI installed, top MLI flap open, EVA knob in STOW port



T-RAD gun with safety in SAFE and flow shut-off knob in OPEN

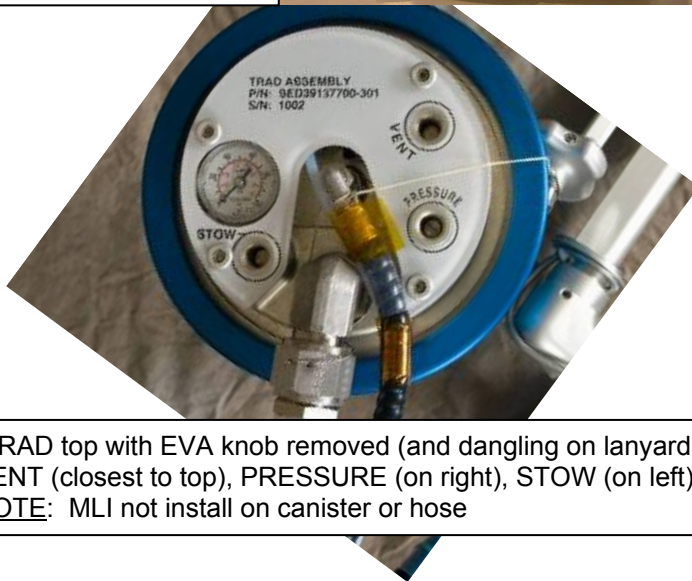

T-RAD top with EVA knob removed (and dangling on lanyard). VENT (closest to top), PRESSURE (on right), STOW (on left).
NOTE: MLI not install on canister or hose

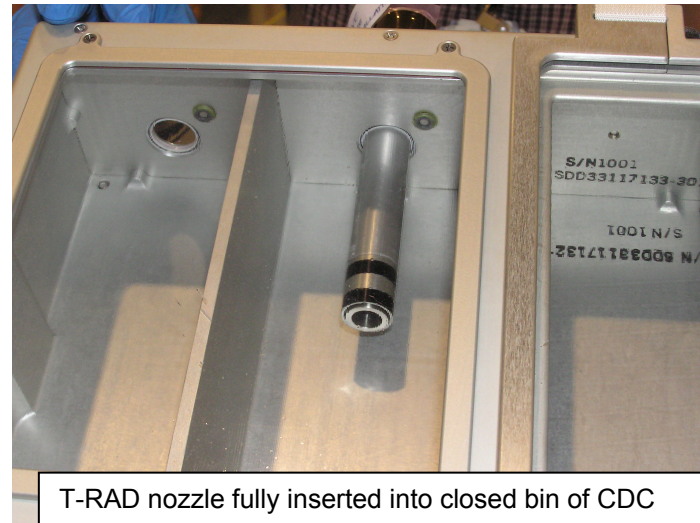

T-RAD nozzle fully inserted into closed bin of CDC

POST EVA 4 TOOL CONFIG

EV1

EMU D-rings

- 1 – Tether Extender on Left
- 2 – Waist Tethers
- 1 – 85-ft Safety Tether (PLB)

MWS

- Small trash bag [right inside]
 - EVA Wipe
 - 1 – RET (sm-sm)
- 1 – RET (with PIP pin) [right]
- 2 – Adj tethers (from T-RAD)
- 2 – Wire ties
- Swing Arm [right side]
- BRT [left side]
 - 1 – RET (sm-sm)
 - 3 – Wire Ties, short
- SAFER
- O2 actuator cover

PORT TSA

- 1 – RET (sm-sm)
 - T-RAD
 - 2 – Shuttle-style adj tethers
- 1 – RET (sm-sm)
 - Holster

Total RETs sm-sm used – 16 (RED) RETs with PIP pin – 5 (RED) RETs Lg-sm – 2 (BLUE) Adj tethers – 11 Lg-sm Adj – 1

EV2

EMU D-rings

- 1 – Tether Extender on Left
- 2 – Waist Tethers
- 1 – 85-ft Safety Tether (PLB)

MWS

- Small trash bag [right inside]
 - EVA Wipe
 - 1 – RET (sm-sm)
- 1 – RET (with PIP pin) [left]
- 1 – Adj tether (from Sample Bag)
- 1 – RET (sm-sm)
- 2 – Wire ties
- Swing Arm [right side]
- BRT [left side]
 - 3 – Wire Ties, short
- SAFER
- O2 actuator cover

STBD TSA

- 1 – RET (sm-sm)
 - Sample bag (Tile Sample Bag)
 - Tile samples strong box
 - 1 – RET (sm-sm) from strong box lid to Sample bag internal lid strap
 - Hinge-line strap hook to strong box tether point
 - 3 – brush pedestals
 - 2 – Angled stamps
 - 2 – RET (sm-sm)
 - Brush Handle
 - RET (sm-sm)
 - EVA Wipe
 - RET (sm-sm)
- 1 – RET (with PIP pin)
 - Lg Trash Bag
- 1 – RET (sm-sm)
 - CDC

CREWLOCK (Cont)

Staging Bag

- PGT w/7/16-6 in ext S/N _____
- Digital camera w/flash/bracket
- 2 – EVA Wipes (from EWA kit)

RET (Lg-sm, Blue) (from Sample bag)

RET (Lg-sm, Blue) on outside of bag

Large ORU Bag

- Adj Tether (4) on outside of bag
- 1 – RET (with PIP pin) (from T-RAD)
- 4 – Adj tether (3 from Sample bag, 1 from Lg trash bag)
- 1 – Lg-sm Adj from Sample bag
- Fish Stringer #1
 - 2 – EVA wipes
- Broom Clip Caddy
 - 1 – RET (sm-sm)
 - Scraper (not taped)
 - Brush Handle (from Gel Brush Kit)
- Temperature Sensor
 - 1 – RET (with PIP pin) (hooked to FS strap)
- EVA digital camera with bracket
- Gel/Foam Brush Caddy
 - 3 – RETs (sm-sm)

Items to remain in crewlock

POST EVA 4/PRE EVA 5 TOOL CONFIG

EV1

EMU D-rings

- 1 – Tether Extender on Left
- 2 – Waist Tethers
- 1 – 85-ft Safety Tether (PLB) {leave}

MWS

- Small trash bag [right inside] {leave}
 - EVA Wipe {to Return Bag}
 - 1 – RET (sm-sm) {to Return Bag}
- 1 – RET (with PIP pin) [right] {to Return Bag}
- 2 – Adj tethers (from T-RAD) {to Tether Staging}
 - 2 – Wire ties
 - Swing Arm [right side]
 - BRT [left side] {leave}
 - 1 – RET (sm-sm) {to Return Bag}
 - 3 – Wire Ties, short
- SAFER
- O2 actuator cover

PORT TSA

- 1 – RET (sm-sm)
 - T-RAD
 - 2 – Shuttle-style adj tethers
- 1 – RET (sm-sm)
 - Holster

Total RETs sm-sm used – 16 (RED) RETs with PIP pin – 5 (RED) RETs Lg-sm – 2 (BLUE) Adj tethers – 11 Lg-sm Adj – 1

EV2

EMU D-rings

- 1 – Tether Extender on Left
- 2 – Waist Tethers
- 1 – 85-ft Safety Tether (PLB) {leave}

MWS

- Small trash bag [right inside] {leave}
 - EVA Wipe {to Return Bag}
 - 1 – RET (sm-sm) {to Return Bag}
- 1 – RET (with PIP pin) [left] {to Return Bag}
- 1 – Adj tether (from Sample Bag) {to Tether Staging}
 - 1 – RET (sm-sm) {to Return Bag}
 - 2 – Wire ties
 - Swing Arm [right side]
 - BRT [left side] {leave}
 - 3 – Wire Ties, short
- SAFER
- O2 actuator cover

STBD TSA

- 1 – RET (sm-sm)
 - Sample bag (Tile Sample Bag)
 - Tile samples strong box
 - 1 – RET (sm-sm) from strong box lid to Sample bag internal lid strap
 - Hinge-line strap hook to strong box tether point
 - 3 – brush pedestals
 - 2 – Angled stamps
 - 2 – RET (sm-sm)
 - Brush Handle
 - RET (sm-sm)
 - EVA Wipe
 - RET (sm-sm)
- 1 – RET (with PIP pin)
 - Lg Trash Bag
- 1 – RET (sm-sm)
 - CDC

CREWLOCK (Cont)

Staging Bag

- PGT w/7/16-6 in ext S/N _____
- Digital camera w/flash/bracket
- 2 – EVA Wipes (from EWA kit) {to Return Bag}

- RET (Lg-sm, Blue) (from Sample bag) {to Tether Staging}
- RET (Lg-sm, Blue) {to Tether Staging}
- Large ORU Bag {to Done Bag or Node 1}
 - Adj Tether (4) {to Tether Staging}
 - 1 – RET (with PIP pin) (from T-RAD) {to Return Bag}
 - 4 – Adj tether {to Tether Staging}
 - 1 – Lg-sm Adj from Sample bag {to Tether Staging}
 - Fish Stringer #1 {to C/L Bag #2}
 - 2 – EVA wipes {to Return Bag}
 - Broom Clip Caddy {to Return Bag}
 - 1 – RET (sm-sm) {to Return Bag}
 - Scraper (not taped) {to Return Bag}
 - Brush Handle {to Return Bag}
 - Temperature Sensor {to Return Bag}
 - 1 – RET (with PIP pin) {to Return Bag}
 - EVA digital camera with bracket
 - Gel/Foam Brush Caddy {to Return Bag}
 - 3 – RETs (sm-sm) {to Return Bag}

ALL RED RETS (BOTH SM-SM AND PIP PIN) ARE TO RETURN ON SHUTTLE

LEAVE ALL BLUE RET (LG-SM) ON ISS

EVA 5 INHIBIT PAD

Orbiter (1)

ALL EVAs

TCS

- L12 1. √TCS POWER – OFF

KU-BAND ANTENNA

{Performed during egress}

- MCC-H 1. √KU-BAND Mask – active
2. √KU-BAND EVA Protect Box – active

RCS

{On call, EV crew not expected to be in this area}

If EV crew < 27 ft from FRCS

- IV 1. √DAP: VERN, FREE, LO Z (ft specific check with GNC)
O14,15,16 2. √RJDF F1, F2, F3, F4 MANF DRIVER (four) – OFF
LOGIC (four) – OFF
- MCC-H 3. √Above RCS config
- IV 4. √RCS F – ITEM 1 EXEC (*)
√RCS FJET DES F1U – ITEM 17 (*)
F3U – ITEM 19 (*)
F2U – ITEM 21 (*)

S-BAND ANTENNAS

{EVA crew expected to be in this area during SSPTS and PMA tasks}

NOTE

Possible loss of comm when forced LL FWD antenna

- IV If EV crew < 2.0 ft from S-Band antenna
- A1R 1. S-BAND FM ANT – XMIT LOWER/RCVR UPPER
2. √MCC, lower antenna selected
- If no comm, or on MCC GO
- C3 3. S-BAND PM ANT – LL FWD
- When EVA crewmember at least 2.0 ft away from all S-Band upper antennas
- C3 4. S-BAND PM ANT – GPC

Ground

All EVAs

Ground Radar

- MCC-H 1. √TOPO console, ground radar restrictions in place for EVA

USOS (1)

ALL EVAs

PCU

NOTE

PCUs may require up to 1 hr warm-up period before they are operational

- MCC-H 1. √PCUs (two) operational in discharge mode and one of the following:
a. CCS PCU EVA hazard control enabled
b. No more than two arrays unshunted
c. No more than two arrays pointed < 90° from velocity vector
- OR
2. One or no PCUs operational in discharge mode and one of the following:
a. No more than two arrays unshunted
b. No more than two arrays pointed < 90° from velocity vector

LOCATION DEPENDENT INHIBITS

Lab Window

{EVA crew expected to be in this area during translation on Lab}

- IV 1. Close window shutter

KU-BAND (SGANT) Antenna

{On call, EV crew not expected to be in this area}

MCC-H If EV crew < 3.3 ft from KU-BAND antenna

1. Park KU-BAND:
1.1 Pointing Mode – Inhibit
1.2 PLC – Reset
1.3 Autotrack Continuous Retry – Inhibit

EVA 5 INHIBIT PAD (Cont)

USOS (2)

LOCATION DEPENDENT INHIBITS**S-BAND (SASA) ANTENNAS**

{On call, EV crew not expected to be in this area}

MCC-H If EV crew < 3.6 ft from S1 SASA [P1 SASA]

1. P1 SASA [S1 SASA] – Active
2. S1 SASA [P1 SASA] – Powered down

SARJ

{On call, EV crew not expected to be in this area}

MCC-H If EV crew working within 2 ft or outboard of SARJ:

1. √DLA (1) – LOCKED
2. All motor setpoints set to zero
3. All motors deselected

OR

4. Both DLAs – LOCKED

EVA 5 SPECIFIC INHIBITS**SSPTS CABLE DEMATE**

{Expect inhibits in place prior to egress}

- | | |
|-------|--|
| MCC-H | <ol style="list-style-type: none"> 1. RPCM Z13B A RPC 2 – Open, Close Cmh Inh 2. RPCM Z14B A RPC 2 – Open, Close Cmh Inh 3. RPCM LA2A3B D RPC 1 – Open, Close Cmh Inh 4. RPCM LA1A4A D RPC 3 – Open, Close Cmh Inh 5. DDCU LA1A OR LA4A CONVERTER – Off 6. DDCU LA2A OR LA3B CONVERTER – Off |
|-------|--|

- | | |
|----|--|
| IV | <ol style="list-style-type: none"> 1. A15 √OPCU 1, 2 CONV (two) – OFF |
|----|--|

PMA2 TO LAB UMBILICAL DISCONNECT

{Expect inhibits in place prior to egress}

- | | |
|-------|---|
| MCC-H | <ol style="list-style-type: none"> 1. RPCM LA1B C RPC 1 – 14 – Open, Close Cmd Inh |
|-------|---|

USOS (2)

EVA 5 SPECIFIC INHIBITS**LAB CETA LIGHT REMOVE**

{Expect inhibits in place just prior to task (starts 01:15 thermal clock)}

- | | |
|-------|--|
| MCC-H | <ol style="list-style-type: none"> 1. RPCM S01A C RPC 15 – Open, Close Cmd Inh 2. RPCM S02B C RPC 15 – Open, Close Cmd Inh |
|-------|--|

LAB TRAY AVIONICS RELEASE

{Expect inhibits in place prior to egress}

- | | |
|-------|--|
| MCC-H | <ol style="list-style-type: none"> 1. MBSU 1 RBI 10 & 11 – Open, Close Cmd Inhibit 2. MBSU 2 RBI 3 & 10 – Open, Close Cmd Inhibit 3. MBSU 3 RBI 2 & 3 – Open, Close Cmd Inhibit 4. MBSU 4 RBI 2 & 10 – Open, Close Cmd Inhibit 5. RPCM S01A_D RPC 2, 4 & 5 – Open, Close Cmd Inhibit 6. RPCM S02B_D RPC 2, 4 & 5 – Open, Close Cmd Inhibit 7. RPCM S03A_C RPC 1 & 2 – Open, Close Cmd Inhibit 8. RPCM S04B_C RPC 3 & 4 – Open, Close Cmd Inhibit |
|-------|--|

BSP REMOVAL

{Expect inhibits in place just prior to task}

- | | |
|-------|--|
| MCC-H | <ol style="list-style-type: none"> 1. RPCM Z14B B RPC 4 – Open, Close Cmd Inh 2. RPCM Z13B B RPC 4 – Open, Close Cmd Inh |
|-------|--|

S0/N1 SM POWER CABLE INSTALL/H-JUMPER REMOVAL

{Expect inhibits in place just prior to task}

- | | |
|-------|---|
| MCC-H | <ol style="list-style-type: none"> 1. RPCM Z14B A RPC 1 – Open, Close Cmd Inh 2. RPCM Z14B A RPC 3 – Open, Close Cmd Inh 3. MBSU 2 RBI 5 – Open, Close Cmd Inh 4. MBSU 3 RBI 5 – Open, Close Cmd Inh 5. MBSU 4 RBI 5 – Open, Close Cmd Inh |
|-------|---|

EVA 5 INHIBIT PAD (Cont)

RSOS (1)

ALL EVAs

SM Antennas

- IV
1. GTS – Deactivate
 2. ARISS – Deactivate or VHF (144-146 MHz) TX only

FGB Antennas

- MCC-M
1. ARISS – Deactivate
 2. √FGB KURS P [KYPC P] – Deactivate

Soyuz Antennas

- MCC-M
1. √Soyuz KURS A [KYPC A] – Deactivate

FGB Thrusters

- MCC-M
1. √FGB MCS unpowered
 2. √All FGB Attitude Control Thruster Valves (80) – closed
 3. √FGB Attitude Control Manifold Valves – closed KШK1, KШK2, KШK4, KШK5, KШK9, OKO3, OKГ3, OKO6, OKГ6, OKO7, OKГ7, OKO8, OKГ8

Soyuz Thrusters

- MCC-M
1. √Soyuz manifolds (4) – closed ЭKO1, ЭKO2, ЭKГ1, ЭKГ2
 2. √Soyuz MCS unpowered
 3. √Soyuz Attitude Control Thruster Valves (52) – closed
 4. √Soyuz Main Engine Valves (K1, K2, K3, K4, K5, K6) – closed

EVA 5 NOTES, CAUTIONS, AND WARNINGS

NOTES

1. Bolt install: report torque and turns
2. Bolt release: report torque and turns if different from published range
3. EVA connectors: after disconnection and prior to connection; verify pin and EMI band integrity; verify connector free of FOD
4. Inspect QDs for damage prior to mating
5. Toolbox doors must be closed with one latch per door when EV crew not in immediate vicinity
6. Avoid contact with OBSS striker bars (Vitrolube coating)
7. MLI handholds are not rated for crewmember transition loads

CAUTION

ISS Constraints

- A. Avoid inadvertent contact with
1. Grapple fixture shafts (drylube)
 2. PIP pins
 3. EVA Crane [PMA1]
 4. TCS Reflectors [PMA2,PMA3]
 5. APAS hardware [PMA2,PMA3]
 6. CETA Lights (Z-93 paint) [LAB,S1,Node 1]
 7. Passive UMAs
 8. MBS VDU, MCU, CRPCMs, and Cameras (taped radiative surfaces, silver Teflon)
 9. Deployed TUS cable
 10. S0 aft face Radiator
 11. GPS Antennas (S13 paint) [S0]
 12. UHF Antennas [LAB,P1]
 13. ETCS Radiators [S1,P1]
 14. EETCS/PV Radiator bellows and panels [P6,P4,S4]
 15. SASA RF Group [S1,P1]
 16. Heat pipe radiators [Z1]
 17. PCU cathode and HCA ports [Z1]
 18. Ku-Band Antenna (SGANT) dish [Z1]
 19. CMG cover/shells [Z1]
 20. SSRMS Cameras
 21. Open CBM petal covers and LAB window shutter

CAUTION (Cont)

ISS Constraints (Cont)

- B. Electrical cables
1. Avoid bend radii < 10 times cable diameter
- C. Fiber optic cables
1. Avoid bend radii < 10 times cable diameter
 2. Avoid pulling on cable during mate/demate
- D. Fluid line flex hoses and QDs
1. Avoid bend radii < 5 in for hoses with diameter < 1 in on LAB, S0, S1, P1, and 10-in for hoses with diameter < 1 in on all other elements
 2. Avoid bend radii < 14 in for hoses with a diameter ≥ 1 in
 3. Additional care should be taken to not exceed bend radii when applying loads at the flexible hose to rigid tube stub interfaces
 4. Ensure fluid QD booties are fully closed prior to leaving worksite; wire tie if reqd
- E. For structural reasons
1. Avoid vigorous body motions, quick grabs and kickoffs against tether restraints
 2. Avoid performing shaking motions (sinusoidal functions) more than four cycles
 3. Avoid kicking S1/P1 radiator beam
If any of these occur, wait 2 to 5 min to allow structural response to dissipate

EVA 5 NOTES, CAUTIONS, AND WARNINGS (Cont)

CAUTION (Cont)

ISS Constraints (Cont)

F. Other

1. ITT Cannon connector: On demated connectors, do not rotate collar or manipulate cable/connector using collar or connector tool
2. WIS Antennas: do not use as handholds [Node 1,P6,Z1]
3. Lubricant from Ku-Band SGANT gimbals [Z1], CMGs [Z1], and RTAS Ground Strap fasteners [P6,P4,S4] can contaminate EMU
4. MLI handholds are not rated for crewmember translation loads
5. CBM petal covers may not be used as handholds unless both launch restraint pins are engaged

CAUTION (Cont)

Shuttle Constraints

G. Avoid inadvertent contact with

1. OBSS and SRMS Composite Sections and Cable Harnesses
2. LCS (silver Teflon) and LDRI (silver Teflon) and ITVC (gold foil) [OBSS]
3. WVS Antenna [ODS Truss & PLB Sill]
4. Payload Bay wire harnesses, cables, and connectors

H. No touch

1. LDRI diffuser [OBSS]
2. OBSS saddle contacts (when OBSS unberthed) [OBSS]
3. Monkey fur [PLB]
4. Cameras: metallic surfaces [PLB]
5. Ku-Band Antenna black dish and gold thermal blankets [PLB]

EVA 5 NOTES, CAUTIONS, AND WARNINGS (Cont)

WARNING

ISS Constraints

A. Avoid inadvertent contact with

1. Grapple fixture targets and target pins
2. SSU, ECU, beta gimbal platform, mast canister, SAW blanket boxes unless the beta gimbal is locked and the motor is turned off
3. Stay inboard of SARJ when active
4. Stay 2 ft from S1/P1 radiator beam rotational envelope when beam is free to rotate
5. Stay 5 ft from moving MT on face 1

B. Handrails

1. Handrails previously used for MISSE attachment may not be used as a safety tether point [A/L endcone 564 & 566, A/L Tank 2 nad/fwd & port/fwd, P6 5389]

C. Pinch

1. NZGL connector linkage. Use caution when mating/locking
2. ITT Cannon Connector rotating housing
3. EV side of IV Hatch during Hatch operation (also snag hazard) [A/L]
4. LAB window shutter and CBM petal cover linkages during operation

D. QDs

1. If QD is in FID when valve is opened (bail fwd), QD will leak and fluid line may whip
2. Do not rotate if in mated/valve open config

WARNING (Cont)

ISS Constraints (Cont)

E. RF radiation exposure

1. Stay 3.6 ft from S-Band (SASA) high gain Antenna when powered [S1,P1]
2. Stay 1.3 ft from S-Band (SASA) low gain Antenna when powered [S1,P1]
3. Stay 1 ft from UHF Antenna when powered [LAB, P1]

F. Sharp Edges

1. Inner edges of WIF sockets
2. Mating surfaces of EVA connectors. Avoid side loads during connector mating
3. Back side of MMOD shield fasteners
4. Spring loaded captive EVA fasteners (e.g., 6B-boxes, BMRRM); the end of the spring may protrude
5. PMA umbilical launch restraints-exposed bolt threads
6. Adjustable Fuse Tether (Fish Stringer) buckles stowed in Node Bag
7. Nickel coated braided copper Ground Straps may contain frayed wires [P6,P4,S4,S6]
8. Z1 handrail 6061 by the Ku-Band boom launch restraint [Z1]
9. Solar Array Blanket Box [P4,S4,P6]
10. Keep hands away from SSRMS LEE opening, and snares
11. Fastener threads on back of Z1 U-jumper male FQD panel, if nutplate cap missing

WARNING (Cont)

ISS Constraints (Cont)

G. Thermal

1. EVA connectors with booties may become hot if left uncovered. Handling may need to be limited
2. PMA handrails may be hot. Handling may need to be limited
3. Turn off glove heaters when comfortable temp reached to prevent bladder damage. Do not pull fingers out of gloves when heaters are on
4. Uncovered trunnion pins may be hot
5. SSRMS/MBS operating Cameras and lights may radiate large amounts of heat
6. Stay 1 ft away from PMAs and MMOD shields > 270 degF if EMU sun visor up
7. Stay at least 1 ft away for no more than 15 min from PMAs and MMOD shields > 300 degF if EMU sun visor up
8. Stay 0.5 ft away from PMA and MMOD shields > 325 degF
9. Do not touch EMU protective visor if temp has been < -134 for > 15 min
10. No EMU TMG contact of PMAs and MMOD shields when temp > 320 degF
11. No EMU boot contact with foot restraint when temp < -120 degF or > 200 degF

H. Electrical Shock Hazard

1. Stay \geq 2 ft from following ungrounded floating connectors if not inhibited: SSPTS on Lab fwd and stbd Node 1, H-jumper on FGB, MT cables, and S0 Bay 00, 02, and 03

EVA 5 NOTES, CAUTIONS, AND WARNINGS (Cont)

WARNING (Cont)

Shuttle Constraints

I. Arcing/Molten Debris

1. Stay ≥ 2 ft from exposed EFGF connector when OBSS berthed, powered, and EFGF not grappled [PLB]
2. Stay ≥ 2 ft from exposed Stbd Fwd MPM contacts [PLB]
3. Stay ≥ 2 ft from exposed Node 2 SPDU connectors when OBSS grappled by SRMS and LCS is powered [PLB]

J. Pinch

1. PRLA operation [PLB]

K. RF radiation exposure

1. Stay 2.0 ft from S-Band Antenna when powered
2. Stay 1 ft from top and side of UHF PLB Antenna radome surface when in high powered mode [ODS truss]
3. Stay 0.33 ft from top and side of UHF PLB Antenna radome surface when in low powered mode [ODS truss]
4. Remain below the level of the PLB door mold line for first 20 in Aft of Fwd bulkhead when S-Band Antenna powered [PLB]
5. Remain on the inboard side of the Stbd slidewire (sill handrails if slidewire not installed) for first 20 ft Aft of Fwd bulkhead when Ku-Band Antenna powered [PLB]

WARNING (Cont)

Shuttle Constraints (Cont)

L. Sharp Edges

1. PRLA grounding wipers [PLB]
2. LDRI baffles (Also an entrapment hazard) [OBSS]
3. Keep hands away from SRMS EE opening and snares
4. TCS connector backshells have exposed threads

M. Thermal

1. Illuminated PLB lights; do not touch
2. OBSS grapple fixture shafts/cams may be hot. Limit handling if required
3. Stay 27 ft from PRCS when powered
4. Stay 3 ft from VRCS when powered
5. Stay 3 ft from APU when operating

N. Thruster Contamination

1. Stay out of the immediate vicinity of leaking jet or APU

10A EVA 5 PRE BRIEF

EVA PREP:

- * Follow procedures carefully
- * PBA and SCU are pure O2
- * Do not force connections

A/L CONFIG and TOOLS:

- * Crew lock bag for contingencies stays in the A/L
- * ORU bag for CETA light stow will stay in the A/L

EGRESS PLAN:

- * EV2 to A/L D-ring extender; EV1 R waist to EV2 safety tether
- * EV1 egresses and attaches own safety tether to A/L, EV2 attached to base of CETA spur handrail
- * EV2 hands out 6B box/cover for temp stowage, attaches crew lock bag to self, (Both large-small RETs stay in the A/L attached to tether extender)
- * EV2 closes thermal cover
- * Both check SAFER handles down and down

TRANSLATION:

- * EV1 fairleads stbd of EV2 CETA rail translation path
- * Check tethers often
- * Check each other's tethers, when possible
- * Awareness of sensitive hardware in your work area (bend radii on cables, SHUTTLE)
- * Review translation paths (DOUG/photos)

TETHERS and TOOLS:

- * Follow good tethering protocol on all tools – “Good RET”
- * Pull test everything (PGT sockets, APFRs, etc)

GLOVE CHECKS:

- * Before/after pre-determined tasks, day/night cycles
- * Especially careful inspection of thumb/forefinger

SSPTS and PMA Cables:

- * Be aware of Shuttle and clearance issues
- * Monitor cable bend radii
- * Make sure FRGF and stovepipe/PMA interface clear when complete
- * Report connector status after de-mating
- * Minimize translation on the stovepipe

Avionics Tray Cable Stowage:

- * Monitor cable bend radii
- * Report connector status after de-mating

Gap Spanners:

- * Ensure cables clear
- * “Skid” 180 deg to loosen

CETA Light:

- * Remove/stow in A/L ORU bag

P1 NTA:

- * Review translation path

ACBM Cover Removal and Stow:

- * Good comm to ensure that we have appropriate control

H-jumper:

- * Description of de-mates (review labeling)
- * No longer need to move bail back on PMA side

BSP Remove:

- * Don't stow hardware near radiator behind BSP
- * Ensure forward lip of BSP interfaces with cover

COMM PROTOCOL:

- * Give IV know status during work and when complete
- * Give IV status on location during translation

SUIT MAL PROTOCOL:

Challenge-response led by IV or nominal suit

CONNECTORS:

- * Check pin straightness
- * No FOD in receptacle
- * Good EMI band
- * Proper bend radius

PGT OPS:

- * Check settings with IV
 - * Pull test on all socket installs
 - * Report Turn count
 - * Report lights and actual torque from PGT display
- Red light – Low torque, green light – in torque window, Both – Hi torque
Cal Procedure – Ratchet Collar – Not motor, Speed Collar – Cal, Pull trigger

KEEP OUT ZONES:

TBD

DAY/NIGHT TRANSITIONS: (IV will call)

- * Lights, visor, glove heaters, check all tools secure, adjust suit temp if desired

INGRESS PLAN:

EV2 in first, then tether to D-ring extender
EV1 disconnect EV2 safety tether, connect it to right waist tether
EV1 disconnect own safety tether
EV1 in feet first with an EV2 assist
Check hatch seal clear before closing

EVA 5 SUMMARY TIMELINE

PET HR : MIN	IV	10A EVA 5 EV4 – Wt	EV5 – Mk	PET HR : MIN
00:00	IV: Orbiter S-band inhibits √MCC-H GO for SSPTS cable demate	POST DEPRESS (00:05) EVA 5 EGRESS/SETUP (00:20) SSPTS CABLE STOW (00:20)	POST DEPRESS (00:05) EVA 5 EGRESS/SETUP (00:20) SSPTS CABLE STOW (00:20)	00:00
01:00	√MCC-H GO for PMA2/Lab umbilical demate	PMA2/LAB UMBIL STOW (00:40)	PMA2/LAB UMBIL STOW (01:00)	01:00
	√MCC-H GO for Lab CETA light remove	LAB CETA LIGHT (00:45)	TEMP STOW N2 PORT TRAY AVIONICS (01:10)	
02:00		TEMP STOW N2 STBD TRAY AVIONICS (00:45)		02:00
03:00	√MCC-H GO for BSP retrieve	BSP RETRIEVE (01:00)	P1 NTA BOLT RELEASE/TOOL PREP (01:00)	03:00
04:00		REMOVE AND STOW ACBM COVER, CBM SURVEY (00:50)	REMOVE AND STOW ACBM COVER, CBM SURVEY (00:50)	04:00
05:00	√MCC-H GO for Russian power reconfig	MATE S0/N1 SM POWER CABLE (00:40) TOOL PREP (00:40)	CONFIGURE PMA1/FGB H-JUMPERS (00:50) TOOL PREP (00:30)	05:00
06:00		EVA 5 CLEANUP/INGRESS (00:20)	EVA 5 CLEANUP/INGRESS (00:20)	06:00
		PRE-REPRESS (00:05)	PRE-REPRESS (00:05)	

PRE EVA 5 TOOL CONFIG

EV4

EMU D-rings

- 2 – Tether Extender
- 2 – Waist Tethers
- 1 – 85-ft Safety Tether on Left D-ring ext

MWS

- Small trash bag [right inside w/wire tie]
- 1 – Adj tether [left]
- 1 – RET (with PIP pin) [left]
- 2 – RET (sm-sm) [right]
- 2 – Wire ties
- Socket caddy [left inside]
 - 7/16-2 in ext (for PAS)
- Swing Arm [right side]
 - PGT w/7/16-6 in ext (B1, CW2, 30.5) S/N _____
 - 1 – RET (sm-sm)
 - Wire Tie Caddy
 - 1 – long wire tie
 - 1 – RET (sm-sm)
- BRT [left side]
 - 2 – long wire ties tied together
 - 2 – short wire ties
 - 1 – RET (sm-sm)

- SAFER

Prior to EVA, inspect:
 RET cord for damage
 Small trash bag bristles for damage or deformation
 Safety & waist tether load alleviating straps: no red

Total RETs sm-sm used – 14
 RETs with PIP pin – 5
 RETs Lg-sm – 5
 Adj tethers – 2 (+2 on trash bag)

EV5

EMU D-rings

- 2 – Tether Extender
- 2 – Waist Tethers
- 1 – 85-ft Safety Tether on Left D-ring ext

MWS

- Small trash bag [right inside w/wire tie]
- 1 – RET (with PIP pin) [left]
- 2 – RET (sm-sm) [right]
- 2 – Wire ties
- Swing Arm [right side]
 - PGT (no socket) S/N _____ (B1, CCW1, 30.5)
 - 1 – RET (sm-sm)
 - Wire Tie Caddy
 - 1 – RET (sm-sm)
- BRT [left side]
 - 2 – long wire ties tied together
 - 2 – short wire ties
 - 1 – RET (sm-sm)

- SAFER

- 1 – RET (Lg-sm)
- Crewlock bag #4 (MMOD Shield)
 - 3 – LDTDT
 - Wire Tie Caddy (on int)
 - 1 – MMOD T-tool (on int)
 - GP Caddy (on int)
 - Vise Grips
 - Loop Pin Puller
 - Hammer (on RET w/PIP)
 - EVA Ratchet with IV socket (on RET w/PIP)

Items remain in the A/L

CREWLOCK (cont)

Staging Bag additions

- 3" scraper {from solar array cont C/L bag}

IV Bag

1 - RET (Lg-sm)

- C/L bag #2 – adj tether on outside
 - EVA Camera and Bracket
 - Fish stringer (w/free hook outside door on soft handle, on int)
 - Lab Caps (8) – J101 (15), J102 (15), J103 (17), J104 (15), J105 (15), J106 (21), J115 (25), J117 (25)
 - MMOD T-tool (int)
 - Int hook outside door for H-jumper
 - Round torque multiplier with 5/8" socket (on int)
 - Round Scoop (on RET)
 - 1 – RET (sm-sm)
 - Socket caddy (on RET)
 - 5/8-7.8 in ext
 - 7/16-6 in ext
 - 1 – RET (sm-sm)

1 - RET (Lg-sm)

- 6B Box Cover (BSP)
 - 1 – Adj tether
 - Dummy box
 - S0 Gap Spanners (1 – 45", 1 – 72"), wrapped with a wire tie
 - 1 – RET (sm-sm)

1 – RET (Lg-sm)

- Med ORU Bag (for CETA Light once removed)
 - 1 – RET (with PIP pin)

- 1 – RET (Lg-sm) (for Node 2 Shower Cap)

EVA 5 A/L EGRESS AND SETUP (00:25)

IV	EV4 – Wt (FF)	EV5 – Mk (FF)
<p>1. Post crew egress: WVS Software: Select page – RF Camera sel ‘Advanced controls’ S-Band level (two) – max</p>	<p><u>INITIAL CONFIG</u> 1. Verify: <input type="checkbox"/> Left waist tether connected to EV5’s 85-ft safety tether <input type="checkbox"/> hook locked</p> <p><u>EGRESS/INITIAL SET-UP</u> 1. Open hatch thermal cover 2. Egress crewlock 3. Attach EV4 85-ft safety tether to fwd A/L D-ring <input type="checkbox"/> √Gate closed <input type="checkbox"/> √Hook locked <input type="checkbox"/> √Reel unlocked 4. Translate to CETA spur HR 3401 (base of CETA spur) 5. Attach EV5 85-ft safety tether to HR 3401 <input type="checkbox"/> √Gate closed <input type="checkbox"/> √Hook locked <input type="checkbox"/> √Reel unlocked 6. Give EV5 GO to release waist tether 7. Assist EV5 as reqd 8. Verify SAFER config <input type="checkbox"/> √L Handle down (MAN ISO Vlv – Open) <input type="checkbox"/> √R Handle down (HCM – Closed) 9. Translate to Lab stbd SSPTS bag via CETA spur, face 1 CETA rail, then stbd Lab strut path; fairlead up CETA spur then stbd of CETA rail (~1/2 bay) 10. Perform glove inspection</p>	<p><u>INITIAL CONFIG</u> 1. Verify: <input type="checkbox"/> Right waist tether to A/L D-ring Extender; √hook locked <input type="checkbox"/> 85-ft safety tether to EV4’s left waist tether</p> <p><u>EGRESS/INITIAL SET-UP</u> 1. Egress crewlock 2. Retrieve 6B box cover/dummy box 3. Temp stow 6B box cover near Airlock, on inboard A/L toolbox zenith handrail (out of translation path) 4. Attach Lg-Sm RET from cover to A/L D-ring ext 5. Retrieve crewlock bag from Airlock 6. Stow crewlock bag on BRT 7. Attach Lg-sm RET from crewlock bag to A/L D-ring ext 8. On EV4 GO, release right waist tether, stow on self 9. Close hatch thermal cover 10. Verify SAFER config <input type="checkbox"/> √L Handle down (MAN ISO Vlv – Open) <input type="checkbox"/> √R Handle down (HCM – Closed) 11. Translate to Lab zenith SSPTS bag via CETA spur, then port Lab strut 12. Perform glove inspection</p>

SSPTS CABLE STOW (00:20)

IV	EV4 – Wt (FF)	EV5 – Mk (FF)
<p><u>{SSPTS CABLE DEMATE INHIBITS</u> RPCM Z13B A RPC 2 – Open, Close Cmh Inh RPCM Z14B A RPC 2 – Open, Close Cmh Inh RPCM LA2A3B D RPC 1 – Open, Close Cmh Inh RPCM LA1A4A D RPC 3 – Open, Close Cmh Inh DDCU LA1A OR LA4A CONVERTER – Off DDCU LA2A OR LA3B CONVERTER – Off}</p> <p>1. Since EV crew < 2.0 ft from S-Band antenna</p> <p>A1R 1. S-BAND FM ANT – XMIT LOWER/RCVR UPPER 2. √MCC, lower antenna selected If no comm, or on MCC GO</p> <p>C3 3. S-BAND PM ANT – LL FWD</p> <p><input type="checkbox"/> √With MCC all inhibits in place for SSPTS cable demate</p> <p>2. Give EV GO for SSPTS cable demate</p>	<p><u>TEMP STOW SSPTS BAG W9303 (STBD)</u></p> <p>1. Translate to Lab stbd SSPTS bag</p> <div data-bbox="947 467 1843 558" style="border: 2px solid black; padding: 5px; text-align: center;"> <p><u>WARNING</u> Avoid unnecessary contact with Lab stovepipe. May present sharp edge hazard</p> </div> <div data-bbox="785 591 1934 675" style="border: 1px solid black; padding: 5px; text-align: center;"> <p><u>CAUTION</u> Watch clearances with Orbiter during SSPTS cable activities Avoid with inadvertent contact with partially installed Lab MMOD shield (zenith/stbd, with NASA meatball)</p> </div> <p>2. Disconnect straps 1 and 2, wrapped around stove pipe bracket and connected to bag D-ring</p> <p>3. Flip W9303 bag so that side A is up</p> <p style="text-align: center;"><u>NOTE</u> Ensure safety tethers are not underneath SSPTS bag when flipped</p> <p>4. Secure straps 1 and 2 to Lab HR 0296 fwd standoff</p> <p>5. Move strap 4 from nadir end of HR 0274 to zenith</p> <p>6. On IV GO, demate J16A from P16</p> <p>7. Stow PMA cable with wire tie; verify bootie covering cable</p> <p>8. Open side A of W9303</p> <p>9. Stow cable in side A of W9303 (do no mate to cap)</p> <p>10. Close side A of W9303</p> <p>11. Perform glove inspection</p> <p>12. Translate to PMA2/Lab umbilicals; keeping feet aft for Orbiter clearances</p>	<p><u>TEMP STOW SSTPS BAG W9302 (ZENITH/PORT)</u></p> <p>1. Translate to zenith port SSPTS bag</p> <p>2. Temp stow crewlock bag near PMA2/Lab umbilical worksite using adjustable tether (HR 0236)</p> <p>3. Disconnect straps 1 and 2, wrapped around stove pipe bracket and connected to bag D-ring</p> <p>4. Flip W9302 bag so that side A is up</p> <p>5. Secure strap 1 to Lab HR 0264 aft standoff</p> <p>6. Secure strap 2 to Lab HR 0263 fwd standoff</p> <p>7. On IV GO, demate J3A from P3</p> <p>8. Stow PMA cable in TA clamp (use wire tie if reqd); verify bootie covering cable</p> <p>9. Open side A of W9302</p> <p>10. Stow cable in side A of W9302 (do no mate to cap)</p> <p>11. Close side A of W9302</p> <p>12. Perform glove inspection</p> <p>13. Translate to PMA2/Lab umbilicals</p>

SSPTS CABLE STOW – TASK DATA

Tools: None

EVA Fasteners: None

EVA Connectors:

Harness	From	To	Clamps (qty)	Conn Size	Function
J3A	P3	A side of W9302	N/A	25	Power – CH 1/4 to OPCU-2
J16A	P16	A side of W9303	N/A	25	Power – CH 2/3 to OPCU-1

Foot Restraints: None

Timeline Considerations:

Notes: None

Cautions:

1. Watch clearances with Orbiter during SSPTS cable activities

Warnings:

1. Minimize translational use of stove pipe brackets

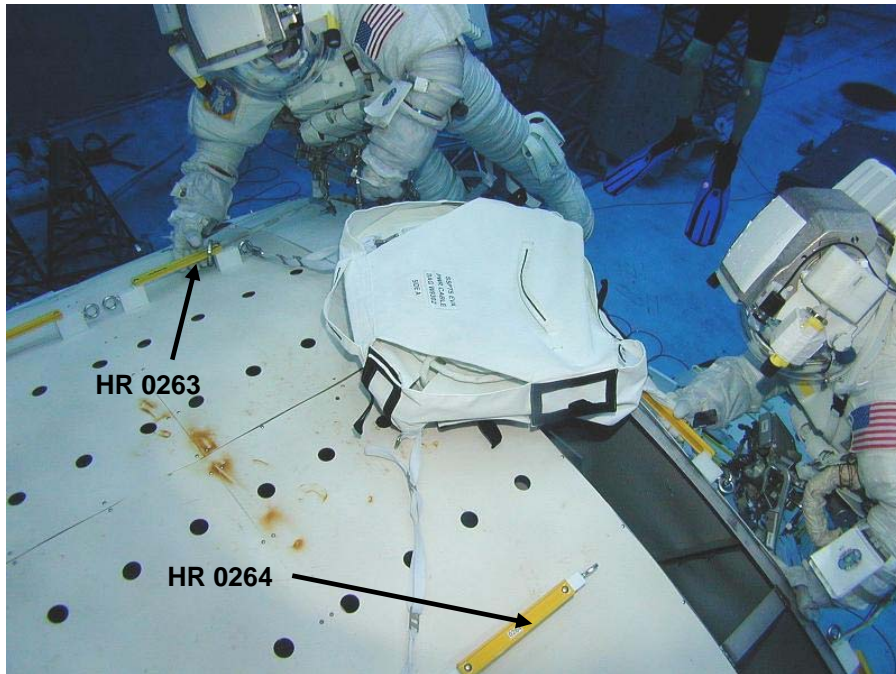

SSPTS bag W9302 (zenith/port) temp stowed on Lab

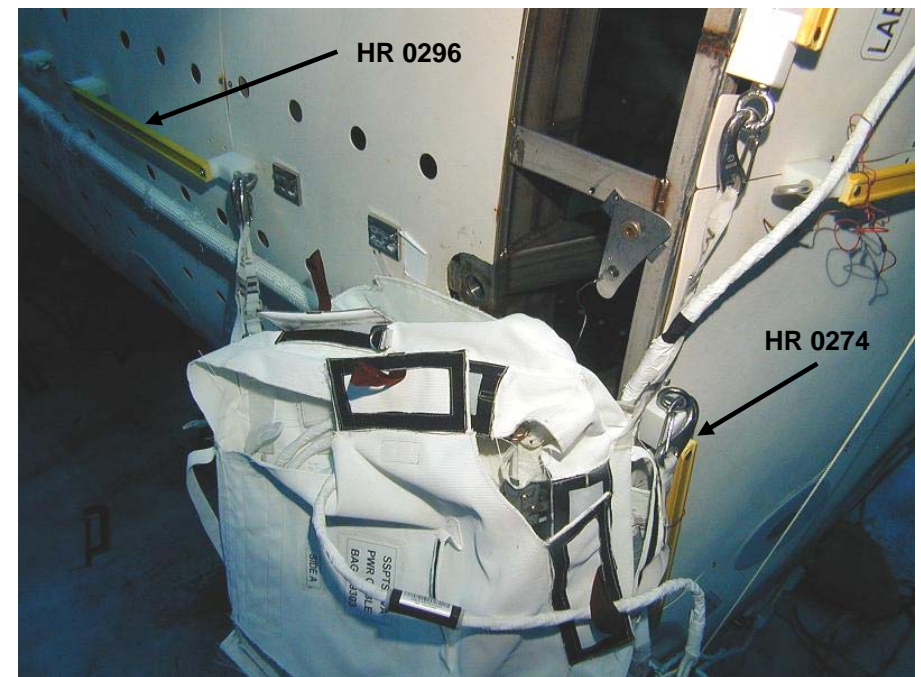

SSPTS bag W9303 (stbd) temp stowed on Lab

SSPTS CABLE STOW – TASK DATA (Cont)

SSPTS Cable Routing When Connected to PMA2

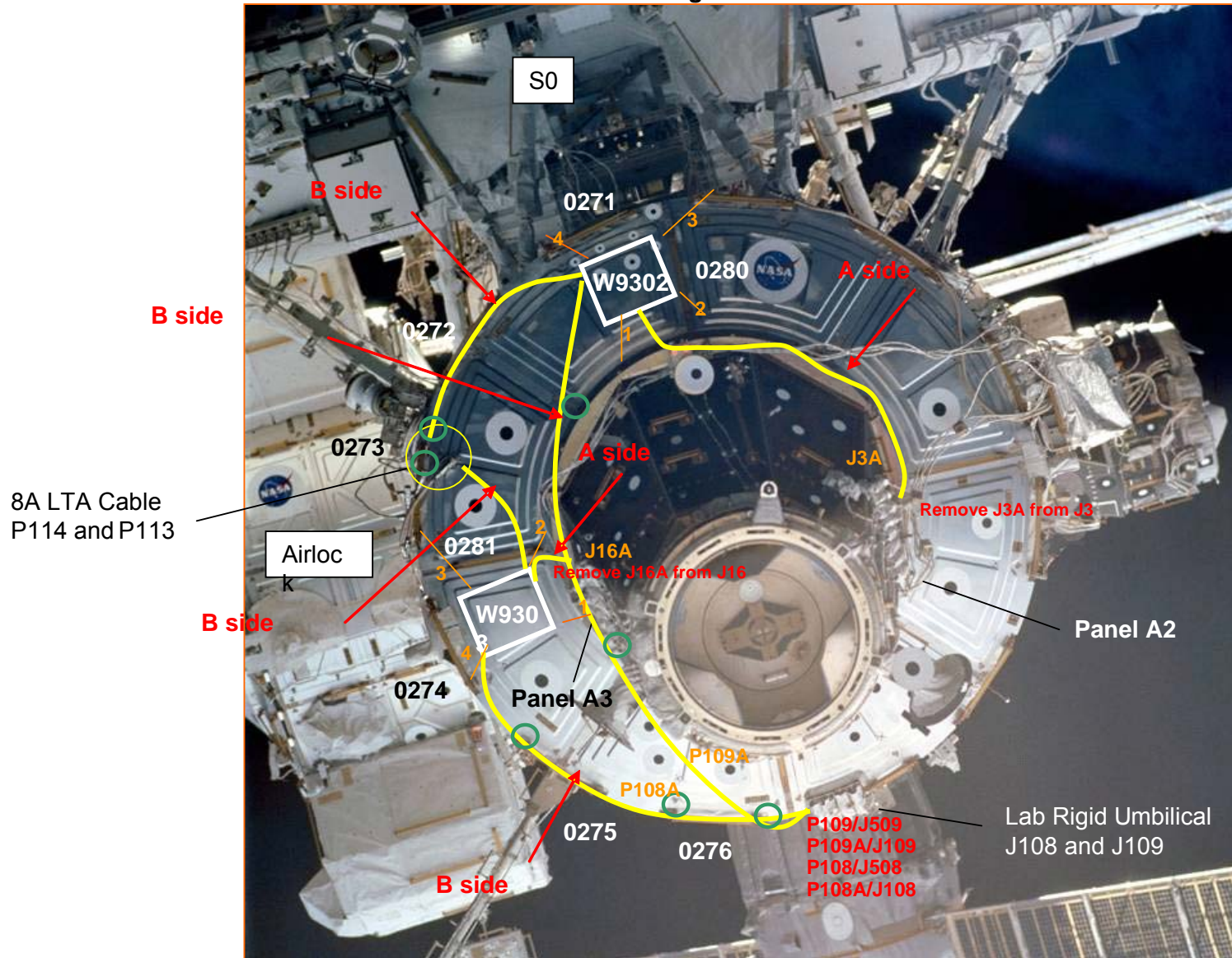

PMA2/LAB UMBILICAL STOW (01:00)

IV	EV4 – Wt (FF)	EV5 – Mk (FF)
<p><u>{PMA2/LAB UMBILICAL DEMATE INHIBITS</u> RPCM LA1B C RPC 1-14 – Open, Close Cmd Inh</p> <p>IV: Keep Orbiter S-Band inhibits in place}</p> <p><input type="checkbox"/> √With MCC all inhibits in place for PMA2/Lab umbilical demate</p> <p>1. Give EV GO for PMA2/Lab umbilical demate</p>	<p><u>RELEASE PMA2 REDUNDANT UMBILICALS</u></p> <p style="text-align: center;"><u>NOTE</u> √Connectors for straight pins, no FOD, EMI band intact, and good bend radius Connector P613 has a missing rivet on the bail</p> <div style="border: 1px solid black; padding: 5px; text-align: center;"> <p><u>CAUTION</u> Avoid bend radii < 10 times cable diameter; Avoid pulling on cable during mate/demate</p> </div> <ol style="list-style-type: none"> 1. Translate to PMA2 2. Slide booties off all 8 connectors at Lab panel 3. Wire tie into primary and redundant bundles if not already done 4. On IV GO, release primary connectors from Lab panel: <ul style="list-style-type: none"> <input type="checkbox"/> P611/J103 – primary (size 17) <input type="checkbox"/> P613/J105 – primary* (NOTE: missing rivet) (15) <input type="checkbox"/> P612/J106 – primary (21) <input type="checkbox"/> P610/J117 – primary (25) 5. Transfer primary umbilicals to EV5 6. Release redundant connectors from Lab panel: <ul style="list-style-type: none"> <input type="checkbox"/> P616/J101 – redundant (15) <input type="checkbox"/> P615/J102 – redundant (15) <input type="checkbox"/> P614/J 104 – redundant (15) <input type="checkbox"/> P609/J115 – redundant (25) 7. Verify tether clear of cables 	<p><u>RELEASE PMA2 REDUNDANT UMBILICALS</u></p> <ol style="list-style-type: none"> 1. Translate to PMA2 2. Release wire ties as necessary, expect: <ul style="list-style-type: none"> <input type="checkbox"/> Lab HR 0269 <input type="checkbox"/> Lab HR 0268 3. Translate to crewlock bag 4. Tether to and remove fish stringer with caps 5. Temp stow fish stringer near umbilical worksite (suggest Lab HR 0269) 6. Receive umbilicals from EV4

PMA2/LAB UMBILICAL STOW (01:00) (Cont)

IV	EV4 – Wt (FF)	EV5 – Mk (FF)
<p>2. When EVA crewmember at least 2.0 ft away from all S-Band upper antennas C3 S-BAND PM ANT – GPC</p> <p><input type="checkbox"/> √With MCC all inhibits in place for disconnecting Lab avionics cables</p> <p>3. Give EV GO for disconnecting Lab avionics cables</p>	STOW PMA2 REDUNDANT UMBILICALS	STOW PMA2 PRIMARY UMBILICALS
	<p>CAUTION Watch clearances with Orbiter during PMA cable activities</p>	
	<ol style="list-style-type: none"> 1. Route redundant umbilical assy for temp stow on PMA2 (stbd/zenith side) 2. Secure cables in clamps as necessary <ul style="list-style-type: none"> <input type="checkbox"/> C13 Clamp <input type="checkbox"/> C12 Clamp <input type="checkbox"/> C11 Clamp <input type="checkbox"/> C10 Clamp <input type="checkbox"/> C09 Clamp <input type="checkbox"/> C08 Clamp 3. As necessary: use wire ties for additional restraint <ul style="list-style-type: none"> <input type="checkbox"/> Recommend HR 0415 (zenith/stbd) <input type="checkbox"/> Recommend HR 0416 (nadir/stbd) <input type="checkbox"/> Recommend HR 0418 (stbd) 4. Verify harness clear of PMA2 CBM mating surface and grapple fixture; verify booties covering cables 5. Perform glove inspection 6. Translate to crewlock bag 7. Retrieve round scoop from crewlock bag; stow on MWS 8. Translate to Lab stbd avionics tray 	<ol style="list-style-type: none"> 1. Route primary umbilical assy for temp stow on PMA2 (nadir/port side) 2. Secure cables in clamps as necessary <ul style="list-style-type: none"> <input type="checkbox"/> C06 Clamp <input type="checkbox"/> C05 Clamp <input type="checkbox"/> C04 Clamp <input type="checkbox"/> C03 Clamp <input type="checkbox"/> C02 Clamp <input type="checkbox"/> C01 Clamp 3. As necessary: use wire ties for additional restraint <ul style="list-style-type: none"> <input type="checkbox"/> Recommend HR 0411 (nadir/port) <input type="checkbox"/> Recommend HR 0412 (nadir/port) <input type="checkbox"/> Recommend HR 0408 (zenith/port) <input type="checkbox"/> Recommend HR 0403 (port) 4. Verify harness clear of PMA2 CBM mating surface and grapple fixture; verify booties covering cables 5. Perform glove inspection 6. Translate to fish stringer with caps 7. Install caps (8) on Lab jacks: J101 (size 15) to J117 (size 25) Zenith-most: <input type="checkbox"/> J101 <input type="checkbox"/> J102 <input type="checkbox"/> J103 <input type="checkbox"/> J104 <input type="checkbox"/> J105 <input type="checkbox"/> J106 <input type="checkbox"/> J115 <input type="checkbox"/> J117:Nadir-most 8. Tether to and restow fish stringer in crewlock bag 9. Receive small trash bag with gap spanners from EV4 10. On IV GO, demate P664, P665 in preparation for gap spanner installation 11. Retrieve 2 – gap spanners from trash bag 12. Install gap spanners from aft standoff of HR 0288, through avionics tray handrail to fwd standoff of HR 0259 13. Translate to Lab port avionics tray

PMA2/LAB UMBILICAL STOW – TASK DATA

Tools:

EV4 (FF)	EV5 (FF)
Wire ties	Wire ties

EVA Fasteners: None

EVA Connectors:

Harness	From	To	Clamps	Size	Function
P609	J115	Temp stow		25	None
P610	J117	Temp stow		25	None
P611	J103	Temp stow		17	Data – RTDs, GNC Moding
P612	J106	Temp stow		21	Shell Heaters
P613	J105	Temp stow		15	Data – 1553 A, Video
P614	J104	Temp stow		15	Data – 1553 B, Video
P615	J102	Temp stow		15	None
P616	J101	Temp stow		15	Data – Audio

Foot Restraints:

Task	WIF	APFR Setting

Timeline Considerations:

Note:

1. Verify pin and EMI band integrity
2. Verify connector free of FOD

Cautions:

1. Avoid bend radii < 10 times cable diameter
2. Avoid pulling on cable during mate/demate

Warnings:

PMA2/LAB UMBILICAL STOW – TASK DATA (Cont)

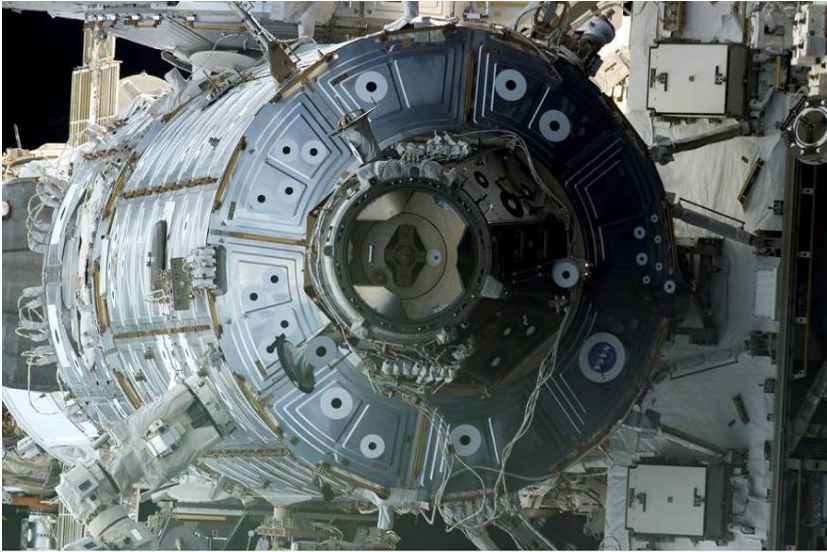

Figure 1. PMA2 umbilicals on STS-114

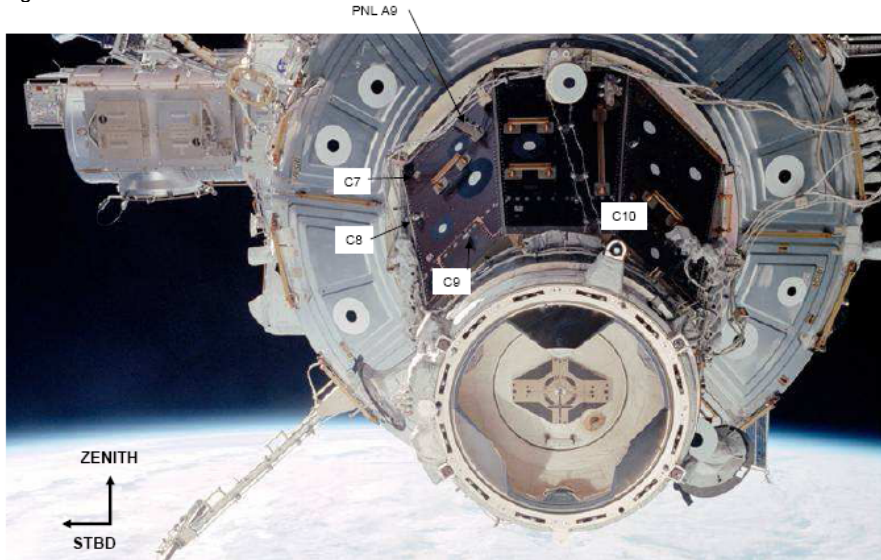

Figure 3. PMA2 umbilical routing to Lab

PMA 2 TO LAB CONNECTORS

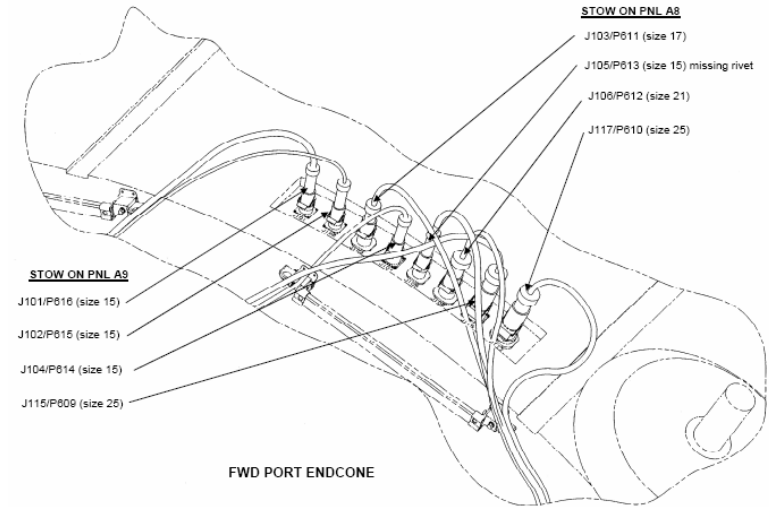

Figure 2. PMA2-to-Lab connectors on Lab panel

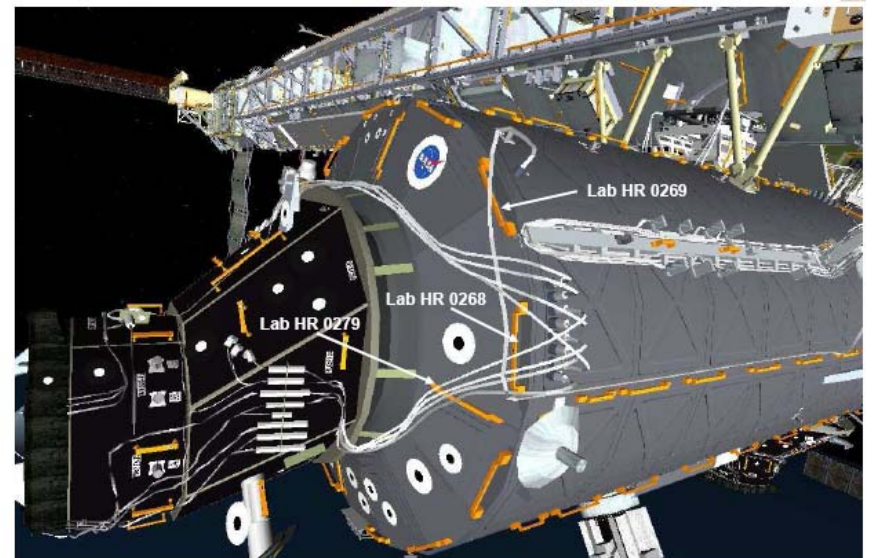

Figure 4. Handrails for PMA2 Umbilical disconnect from Lab

TEMP STOW N2 TRAY AVIONICS UMBILICALS (01:10)

IV	EV4 – Wt (FF)	EV5 – Mk (FF)												
<p>{LAB TRAY AVIONICS RELEASE INHIBITS MBSU 1 RBI 10 & 11 – Open, Close Cmd Inh MBSU 2 RBI 3 & 10 – Open, Close Cmd Inh MBSU 3 RBI 2 & 3 – Open, Close Cmd Inh MBSU 4 RBI 2 & 10 – Open, Close Cmd Inh RPCM S01A_D RPC 2, 4 & 5 – Op, Cl Cmd Inh RPCM S02B_D RPC 2, 4 & 5 – Op, Cl Cmd Inh RPCM S03A_C RPC 1 & 2 – Open, C Cmd Inh RPCM S04B_C RPC 3 & 4 – Open, Cl Cmd Inh}</p> <p><input type="checkbox"/> √With MCC all inhibits in place for disconnecting Lab avionics cables</p> <ol style="list-style-type: none"> Give EV GO for disconnecting Lab avionics cables 	<p>Perform LAB CETA LIGHT RETRIEVE (00:45)</p> <p><u>TEMP STOW STBD AVIONICS UMBILICALS</u></p> <ol style="list-style-type: none"> Translate to Lab stbd avionics tray Perform glove inspection On IV GO, release avionics umbilicals from dummy panels on stbd tray: <ul style="list-style-type: none"> <input type="checkbox"/> P670 from J251 (zenith) <input type="checkbox"/> P671 from J252 (zenith) Complete Lab CETA light umbilical mate: <table border="1" data-bbox="705 678 1356 792" style="margin-left: 20px;"> <thead> <tr> <th colspan="4">Lab Avionics Tray Panel A150 E – Mate</th> </tr> </thead> <tbody> <tr> <td style="text-align: center;">P101</td> <td style="text-align: center;">→ ←</td> <td style="text-align: center;">J261</td> <td></td> </tr> <tr> <td style="text-align: center;">P102</td> <td style="text-align: center;">→ ←</td> <td style="text-align: center;">J262</td> <td></td> </tr> </tbody> </table> Continue release of avionics umbilicals from dummy panels on stbd tray: <ul style="list-style-type: none"> <input type="checkbox"/> P672 from J256 (nadir) <input type="checkbox"/> P673 from J255 (nadir) <input type="checkbox"/> P674 from J257 (nadir) Release TA-clamps where necessary; close after umbilical released Wire tie umbilicals together Wire tie zenith bundle to Lab HR 0273; nadir bundle to Lab HR 0274 Verify all umbilicals clear for Node 2 mating and fluid tray installation Perform glove inspection Cinch down stbd gap spanner (verify 180 deg rotation) Translate to airlock for BSP retrieval Perform glove inspection 	Lab Avionics Tray Panel A150 E – Mate				P101	→ ←	J261		P102	→ ←	J262		<p><u>TEMP STOW PORT AVIONICS UMBILICALS</u></p> <ol style="list-style-type: none"> Translate to Lab port avionics tray On IV GO, release avionics umbilicals from dummy panels on zenith side of port tray: <ul style="list-style-type: none"> <input type="checkbox"/> P103 from J648 (zenith) <input type="checkbox"/> P102 from J646 (zenith) <input type="checkbox"/> P105 from J649 (zenith) <input type="checkbox"/> P104 from J647 (zenith) <input type="checkbox"/> P101 from J654 (zenith) Wire tie umbilicals together Wire tie bundle to Lab HR 0288, 0287 Release avionics umbilicals from dummy panels on nadir side of port tray: <ul style="list-style-type: none"> <input type="checkbox"/> P662 from J652 (nadir) <input type="checkbox"/> P663 from J653 (nadir) <input type="checkbox"/> P660 from J650 (nadir) <input type="checkbox"/> P661 from J651 (nadir) <input type="checkbox"/> P665 from J656 (nadir) <input type="checkbox"/> P664 from J655 (nadir) Wire tie umbilicals together Wire tie bundles to Lab HR 0288, 0287, and 0286 Verify all umbilicals clear for Node 2 mating and fluid tray installation Cinch down fwd/port gap spanner (verify 180 deg rotation) Retrieve final 2 – gap spanners from small trash bag Stow small trash bag in crewlock bag Retrieve crewlock bag; stow on BRT Translate to Hwy 110, install gap spanners from trash bag to aft standoff of HR 0286 to aft standoff of HR 0251; cinch down (verify 180 deg rotation) Perform glove inspection Translate to P1 NTA via port Lab strut, then Face 1 Temp stow crewlock bag on CETA rail
Lab Avionics Tray Panel A150 E – Mate														
P101	→ ←	J261												
P102	→ ←	J262												

TEMP STOW N2 TRAY AVIONICS UMBILICALS – TASK DATA SHEET

Tools:

EV4 (FF)	EV5 (FF)
Wire Ties	Wire Ties

EVA Fasteners: None

EVA Connectors:

Harness	From	To	Clamps	Size	Function
P670	J251	Temp Stow		25	Power to DDCU N2P2A
P671	J252	Temp Stow		25	Power to DDCU N202B
P672	J256	Temp Stow		25	Power to DDCU N2P3A
P673	J255	Temp Stow		25	Power to DDCU N203A
P674	J257	Temp Stow		25	Power to S0-1 MDM SDO card 6A Power to S0-2 MDM SDO card 8A Power to S0-2 MDM SDO card 8B
P101	J648	Temp Stow		15	Data Node 2 PDGF video 1
P102	J646	Temp Stow		25	Node 2 PDGF power 1
P103	J649	Temp Stow		15	Data Node 2 PDGF video 3
P104	J647	Temp Stow		25	Node 2 PDGF power 2
P105	J654	Temp Stow		15	Data Node 2 PDGF video 2
P662	J652	Temp Stow		25	Power to DDCU N2S4A
P663	J653	Temp Stow		25	Power to DDCU N2D4B
P660	J650	Temp Stow		25	Power to DDCU N2S1B
P661	J651	Temp Stow		25	Power to DDCU N2D1B
P665	J656	Temp Stow		13	Data Node 2 Port VSCA video
P664	J655	Temp Stow		25	Power to S0-2 MDM SDO card 6A Power to S0-1 MDM SDO card 8A Power to S0-1 MDM SDO card 8B

Timeline Considerations:

Note:

Cautions:

Warnings:

Foot Restraints:

TEMP STOW N2 AVIONICS UMBILICALS – TASK DATA SHEET (Cont)

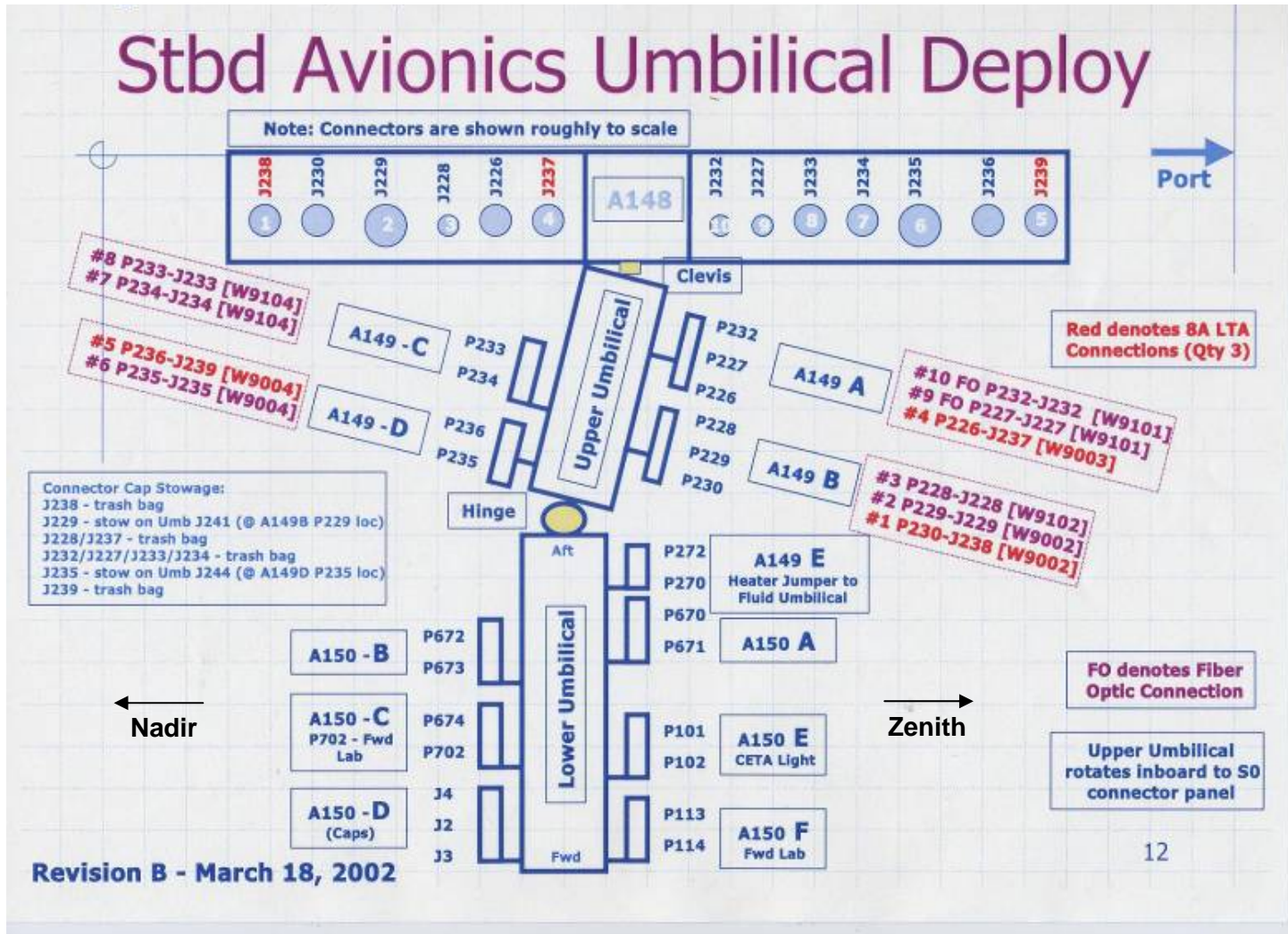

TEMP STOW N2 AVIONICS UMBILICALS – TASK DATA SHEET (Cont)

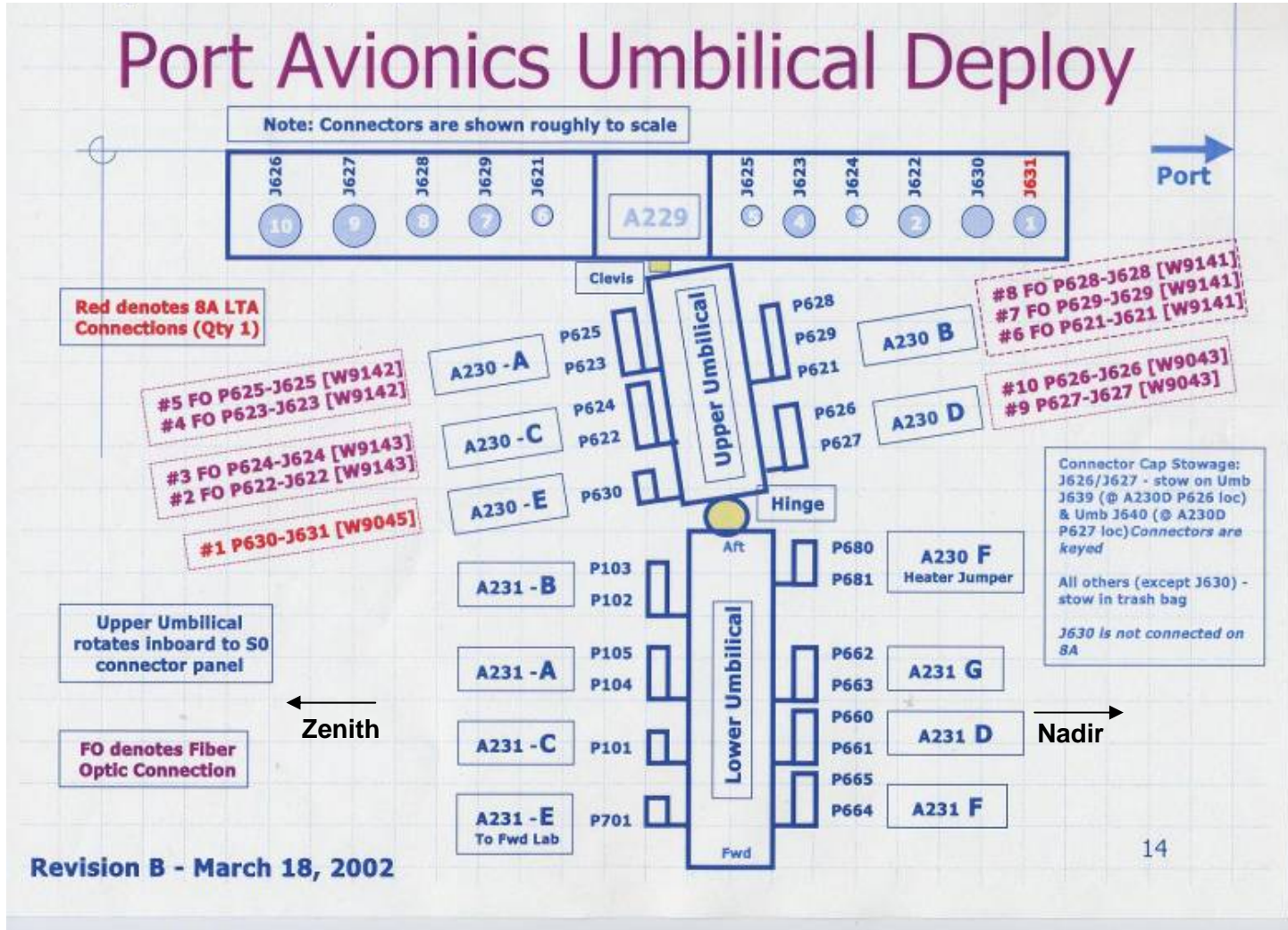

LAB CETA LIGHT RETRIEVE (00:45)

IV	EV4 – Wt (FF)												
<p>{LAB CETA LIGHT REMOVE INHIBITS RPCM S01A C RPC 15 – Open, Close Cmd Inh RPCM S02B C RPC 15 – Open, Close Cmd Inh}</p> <p><input type="checkbox"/> √With MCC all inhibits in place for disconnecting Lab avionics cables</p> <p>1. Give EV GO for disconnecting Lab avionics cables</p> <p><input type="checkbox"/> √With MCC all inhibits in place for CETA light remove</p> <p>2. Give EV GO for Lab CETA light connector demate</p>	<ol style="list-style-type: none"> 1. Translate to Lab CETA light 2. On IV GO, demate connectors P670, P671 in preparation for gap spanner install; temp stow 3. Translate to small trash bag with gap spanners (HR 0296) 4. Retrieve 2 – gap spanners from small trash bag 5. Install gap spanners from aft standoff of HR 0296, through avionics tray handrail to fwd standoff of HR 0260 6. Transfer small trash bag with gap spanners to EV 5 <div style="border: 1px solid black; padding: 5px; text-align: center; margin: 10px auto; width: fit-content;"> <p>CAUTION CETA Light paint is sensitive. Avoid unnecessary contact</p> </div> <ol style="list-style-type: none"> 7. Attach round scoop to CETA light 8. On IV GO, demate the following connectors (temp stow for later mate): <table border="1" style="margin: 10px auto; border-collapse: collapse;"> <thead> <tr> <th colspan="4" style="text-align: center;">CETA Light Stanchion Panel A2 – Demate</th> </tr> </thead> <tbody> <tr> <td style="text-align: center;">P101</td> <td style="text-align: center;">← →</td> <td style="text-align: center;">J101</td> <td></td> </tr> <tr> <td style="text-align: center;">P102</td> <td style="text-align: center;">← →</td> <td style="text-align: center;">J102</td> <td></td> </tr> </tbody> </table> <ol style="list-style-type: none"> 9. BRT to avionics tray handrail 10. Verify tethered to CETA light via round scoop or tether point 11. Release Stanchion Bolt PGT, 7/16-6 in ext: B7, CCW2; ~18-19.5 turns 12. Remove CETA light; stow on BRT 13. Translate to Airlock 14. Ingress Airlock; temp stow CETA light/round scoop inside Med ORU bag 15. Close Airlock hatch thermal cover 16. Verify SAFER config <ul style="list-style-type: none"> <input type="checkbox"/> √L Handle down (MAN ISO Vlv – Open) <input type="checkbox"/> √R Handle down (HCM – Closed) 17. Translate to Lab stbd avionics tray 	CETA Light Stanchion Panel A2 – Demate				P101	← →	J101		P102	← →	J102	
CETA Light Stanchion Panel A2 – Demate													
P101	← →	J101											
P102	← →	J102											

LAB CETA LIGHT RETRIEVE – TASK DATA

Tools:

EV4 (FF)	EV5 (FF)
PGT	
7/16-6 in ext	
Round Scoop	

EVA Fasteners:

Fastener Name	Label	Head Size	Qty	Release Torque (ft-lb)	Failure Torque (ft-lb)	Turns	RPM
CETA Light Stanchion Bolt	N/A	7/16	1	25.5 (max-34.7, due to thermal)	165.9	18-19.5	30

EVA Connectors:

Harness	From	To	Clamps	Size	Function
P101 (W9101)	CETA Light J101	Lab Tray J261	N/A	15	Sec Pwr 2B/1A
P102 (W9102)	CETA Light J252	Lab Tray J262	N/A	15	Sec Pwr 2B/1A

Foot Restraints: None

Lab CETA Light Thermal Clock: With no MLI bag, 1.25 hr from removal of heater power until transfer to airlock
 With MLI bag, 1.5 hr from removal of heater power until placement in bag, and 8 hr from placement in bag until transfer to airlock

Timeline Considerations:

Note:

Cautions:

1. CETA Light paint is sensitive. Avoid unnecessary contact

Warnings:

LAB CETA LIGHT RETRIEVE – TASK DATA (Cont)

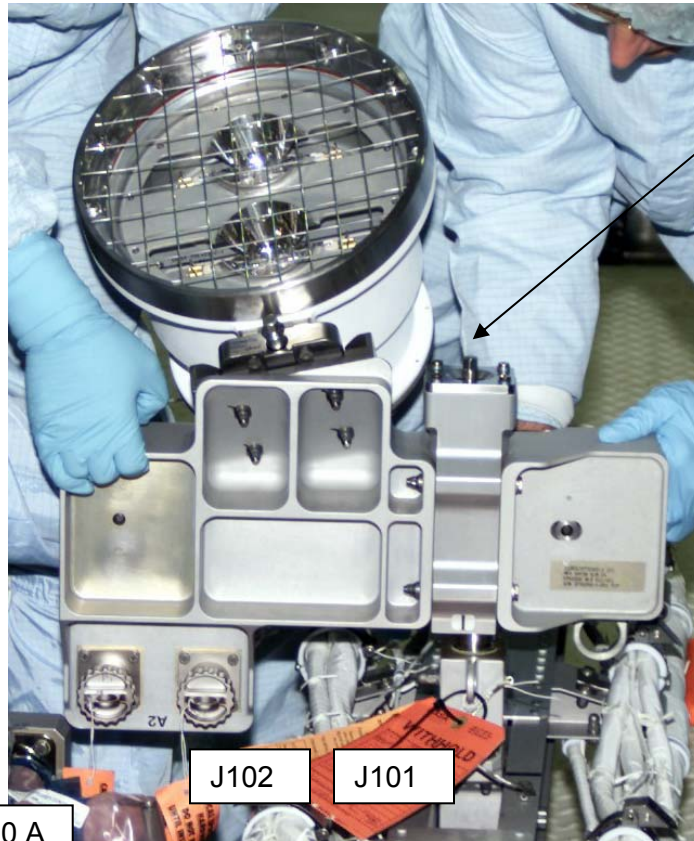

View looking forward

7/16-in Stanchion bolt

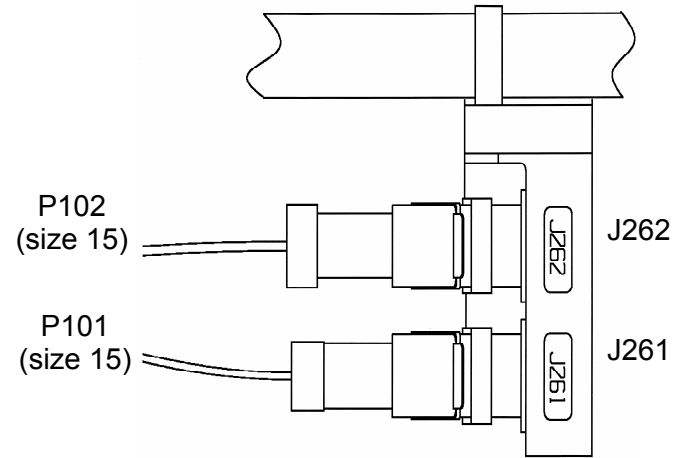

VIEW A-A

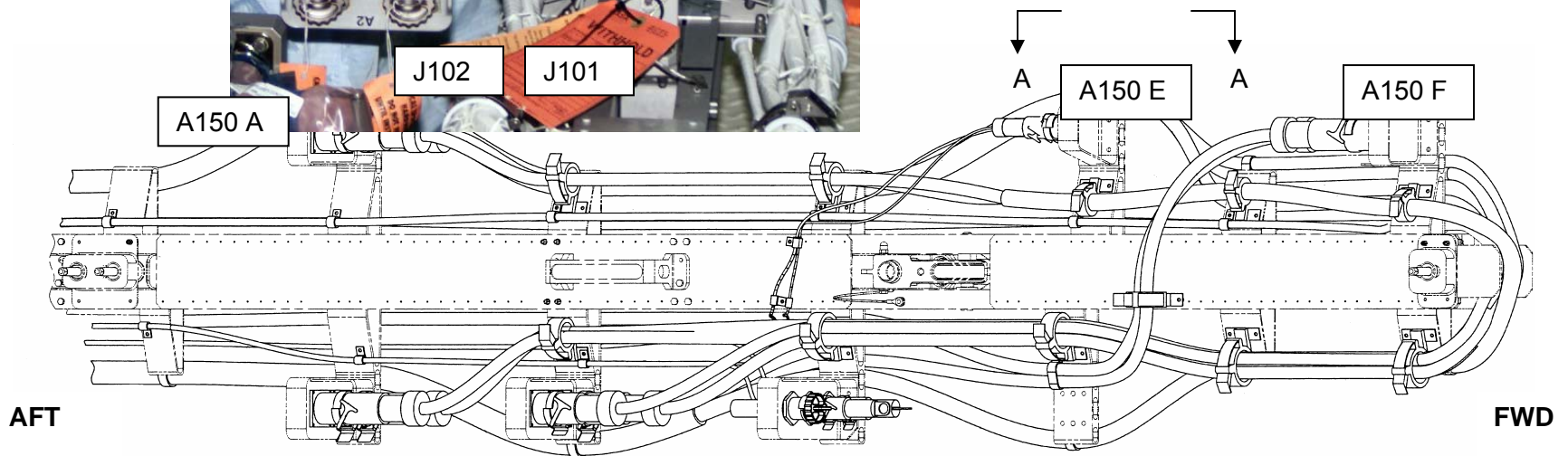

BSP RETRIEVE (01:00)

IV	EV4 – Wt (FF)	EV5 – Mk (FF)												
<p><u>BSP RETRIEVE INHIBITS</u> RPCM Z14B B RPC 4 – Open, Close Cmd Inh RPCM Z13B B RPC 4 – Open, Close Cmd Inh}</p> <p><input type="checkbox"/> √MCC-H GO to remove BSP 1. Give EV GO for BSP remove</p> <p>Dummy Box Bolt Data</p> <table border="1" data-bbox="111 1052 667 1166"> <thead> <tr> <th>Bolt</th> <th>Turns</th> <th>Torque</th> </tr> </thead> <tbody> <tr> <td>Center Jack</td> <td></td> <td></td> </tr> <tr> <td>Outer Fastener (Nadir)</td> <td></td> <td></td> </tr> <tr> <td>Outer Fastener (Zenith)</td> <td></td> <td></td> </tr> </tbody> </table>	Bolt	Turns	Torque	Center Jack			Outer Fastener (Nadir)			Outer Fastener (Zenith)			<p><u>BSP REMOVAL</u></p> <ol style="list-style-type: none"> 1. Retrieve 6B box cover with dummy box from A/L 2. Transfer S0 gap spanners from 6B box cover to trash bag 3. Translate to Z1 BSP (stbd) 4. Remove dummy box from 6B box cover; temp stow (suggest A/L HR 0522) 5. Open BSP thermal cover (“garage door”) 6. Tether to BSP tether point 7. BRT to HR 6001 8. On IV GO, release BSP outer fasteners (2) PGT, 7/16-6 in ext; A7, CCW2; 15 turns 9. Release BSP center jack bolt PGT, 7/16-6 in ext; A7, CCW2; 33 turns 10. Release BSP by sliding it along guide pins 11. Inspect BSP cotherm for damage 12. Inspect Z1 cold plate for cotherm debris 13. Stow BSP on 6B box cover; wrap with MLI cover <p><u>DUMMY BOX INSTALL</u></p> <ol style="list-style-type: none"> 14. Retrieve dummy box, install on Z1 15. Drive BSP center jack bolt PGT, 7/16-6 in ext; A7, CW2; ~25-30 turns to HS 16. Drive BSP outer fasteners (2) PGT, 7/16-6 in ext; A7, CW2; ~7-12 turns to HS 17. Close BSP thermal cover 18. Retrieve 6B box cover/BSP 19. Translate to Airlock 20. Stow 6B Box Cover/BSP on Lg-sm in airlock 21. Close hatch thermal cover 22. Translate to Node 2 port endcone 	
Bolt	Turns	Torque												
Center Jack														
Outer Fastener (Nadir)														
Outer Fastener (Zenith)														

SP RETRIEVE – TASK DATA

Tools:

EV1 (FF)	EV2 (FF)
PGT	
7/16-6 in	
6B Box Cover	
Dummy Box	

EVA Fasteners:

Fastener	Label	Head size	Qty	Install Torque (ft-lb)	Release Torque (ft-lb)	Failure Torque (ft-lb)	Turns	RPM
BSP Outer Fasteners	N/A	7/16"	2	N/A	12.3	14.8	15	30
BSP Center Jacking	N/A	7/16"	1	N/A	12.3	14.8	33	30
Dummy Box Center Jacking	N/A	7/16"	1	9.2	N/A	13.2	24.5-29.5	30
Dummy Box Outer Fasteners	N/A	7/16"	2	9.2	N/A	13.2	7-12	30

EVA Connectors: None

Mass and Dimensions:

Item	Mass (lb)	Dimensions (in)

Foot Restraints: None

BPS Thermal Clock: 2 hr from removal of heater power until transfer to Airlock

Note:

Cautions:

Warnings:

BASE BAND SIGNAL PROCESSOR (BSP)

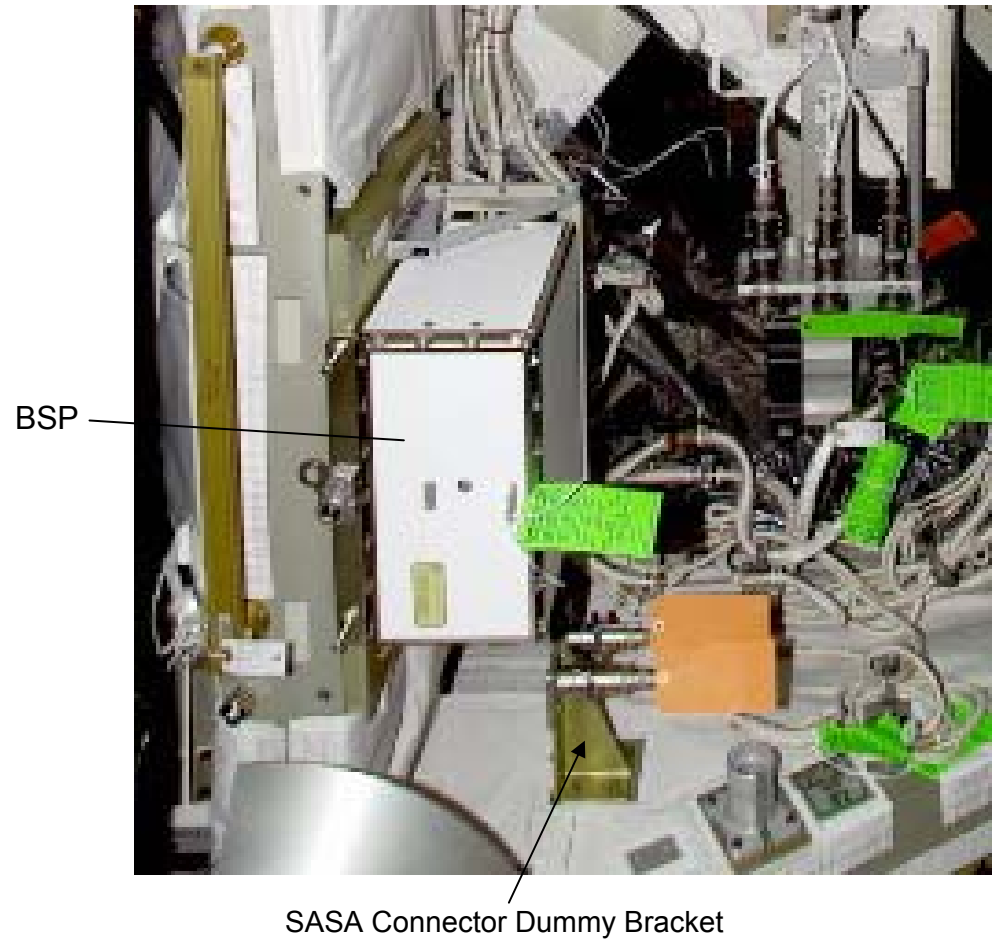
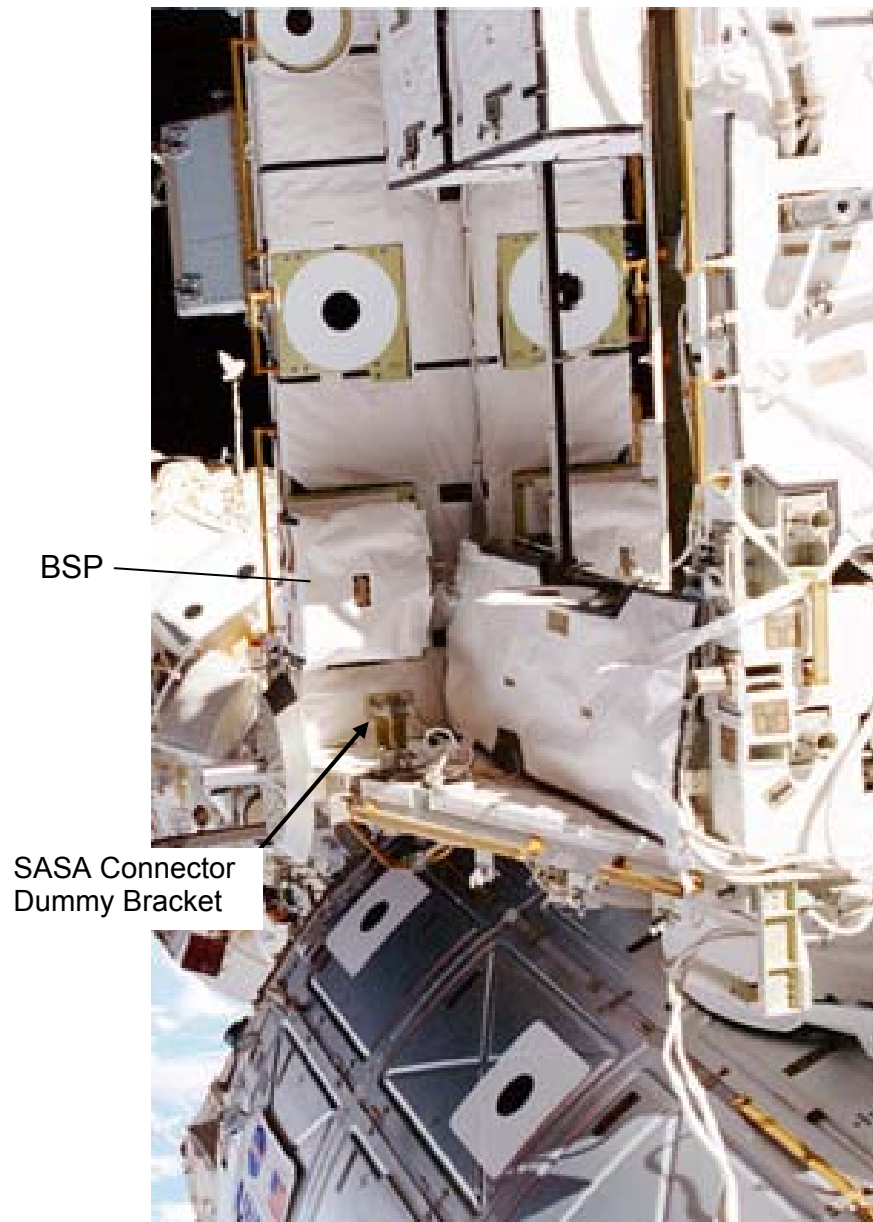

P1 NTA BOLTS BREAK TORQUE (00:20)

IV				EV5 – Mk (FF)																							
<table border="1"> <thead> <tr> <th>Bolt number</th> <th>√Break Torque</th> <th>Turns</th> <th>Re-torque (ft-lb)</th> </tr> </thead> <tbody> <tr> <td>1 (nadir)</td> <td></td> <td></td> <td></td> </tr> <tr> <td>2</td> <td></td> <td></td> <td></td> </tr> <tr> <td>3</td> <td></td> <td></td> <td></td> </tr> <tr> <td>4 (zenith)</td> <td></td> <td></td> <td></td> </tr> </tbody> </table>				Bolt number	√Break Torque	Turns	Re-torque (ft-lb)	1 (nadir)				2				3				4 (zenith)				<p><u>NOTE</u> This task is to be performed if time is permitting</p>			
				Bolt number	√Break Torque	Turns	Re-torque (ft-lb)																				
				1 (nadir)																							
				2																							
				3																							
4 (zenith)																											
<ol style="list-style-type: none"> 1. Translate to P1 NTA, CETA marker 8670 P1, Bay 06 2. Temp stow crewlock bag 																											
<ol style="list-style-type: none"> 3. Retrieve round torque multiplier from crewlock bag; verify anti-backlash neutral 4. Install round torque multiplier on NTA bolt 5. BRT to HR 3617 (DO NOT BRT TO NTA HR OR CETA HR) 																											
<ol style="list-style-type: none"> 6. Break torque on NTA bolts (4) using torque multiplier PGT, (without socket) with torque multiplier: B7, CCW2, 30.5; ~5 turns on PGT (1 turn on bolt) 																											
<ol style="list-style-type: none"> 7. Stow torque multiplier in crewlock bag 																											
<ol style="list-style-type: none"> 8. Retrieve socket caddy from crewlock bag; stow on MWS 9. Swap 5/8-7.8 in ext from socket caddy to PGT 																											
<ol style="list-style-type: none"> 10. Drive NTA bolts (4) PGT, 5/8-7.8 in ext: B6, CW2, 30.5; ~1 turn to HS 																											
<ol style="list-style-type: none"> 11. Swap 5/8-7.8 in ext from PGT to socket caddy (leave PGT w/o socket); stow socket caddy in crewlock bag 12. Retrieve crewlock bag; stow on BRT 																											
<ol style="list-style-type: none"> 13. Translate to CETA spur; √MT translation path outboard is clear of EVA hardware 																											
<ol style="list-style-type: none"> 14. Translate to airlock; stow crewlock bag on HR 0547 																											
<ol style="list-style-type: none"> 15. Retrieve MMOD T-tool from crewlock bag; stow in trash bag 																											
<ol style="list-style-type: none"> 16. Translate to Node 2 endconce via zenith crewlock, zenith/aft Node 1 and primary nadir/aft Node 2 handrail path 																											
<p><u>NOTE</u> Watch for CETA light on Node 1 port while translating</p>																											
<ol style="list-style-type: none"> 17. Perform glove inspection 																											

P1 NTA BOLTS BREAK TORQUE – TASK DATA

Tools:

EV4 (FF)	EV5 (FF)
	PGT
	Round Torque Multiplier with 5/8" socket

EVA Fasteners:

Fastener	Head Size	Qty	Release Torque (ft-lb)	Failure Torque (ft-lb)	Turns	RPM
NTA Bolt	5/8"	4	127.5	TBD	1 turn at bolt	30

EVA Connectors: None

Foot Restraints: None

Warnings:

Cautions: None

Note:

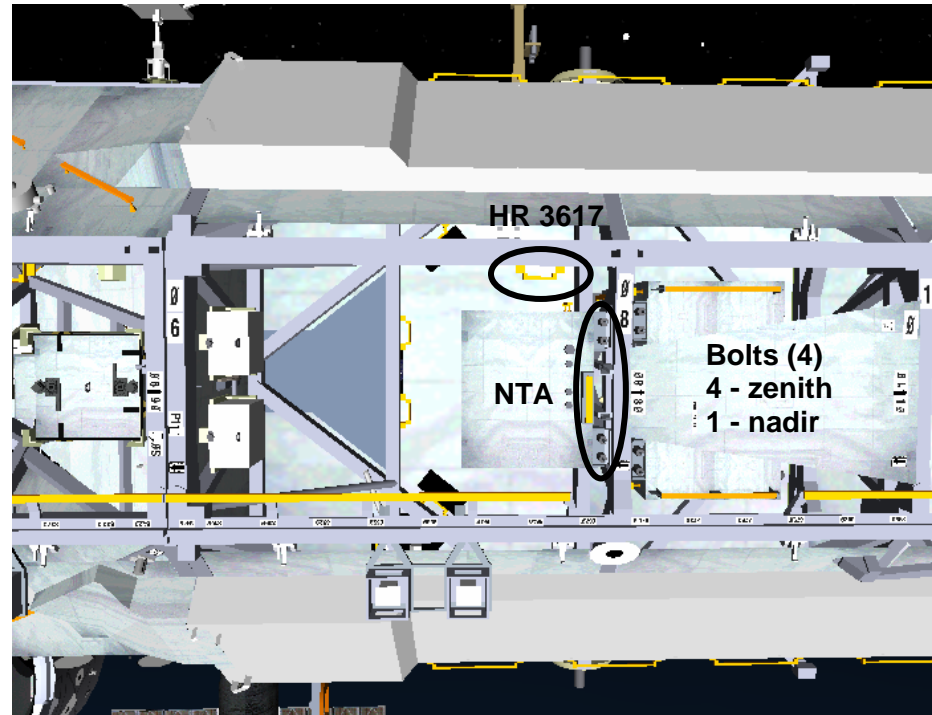

REMOVE ACBM COVER, CBM SURVEY (00:50)

IV	EV4 – Wt (FF)	EV5 – Mk (FF)
	<p><u>REMOVE NODE 2 ACBM THERMAL COVER</u></p> <ol style="list-style-type: none"> 1. Translate to Node 2 via Z1 fwd face <ul style="list-style-type: none"> <input type="checkbox"/> Fairlead self at Z1 HR 6025 only 2. Translate to shower cap on ISS port end along zenith gap spanner 3. With EV5, fold shower cap in half 4. With EV5, fold shower cap in half twice more; attaching wire ties as necessary 5. Tether to shower cap 6. Secure shower cap into final bundle 7. Visually inspect the Node 2 CBM to ensure that it is clear for PMA2 berthing 8. Translate to Airlock with shower cap 9. Stow shower cap inside Airlock 10. Close airlock hatch thermal cover 11. Verify SAFER config <ul style="list-style-type: none"> <input type="checkbox"/> √L Handle down (MAN ISO Vlv – Open) <input type="checkbox"/> √R Handle down (HCM – Closed) 12. Translate to Node 1 fwd stbd/zenith endcone 13. Perform glove inspection 	<p><u>REMOVE NODE 2 ACBM THERMAL COVER</u></p> <ol style="list-style-type: none"> 1. Translate to shower cap along aft/nadir handrail path 2. Release thermal cover Velcro strap in order to loosen from ACBM stove pipe 3. Assist EV4; attaching wire ties as necessary 4. Release thermal cover Dzus fasteners (at 3:00) using MMOD T-tool 5. Secure shower cap into final bundle 6. Visually inspect the Node 2 CBM to ensure that it is clear for PMA2 berthing 7. Assist EV4 with shower cap stow in airlock as required (if assisted, will need to unwind safety tether on way back) 8. Translate to PMA1/FBG zenith face via aft/zenith Node 1 9. Perform glove inspection

REMOVE ACBM COVER, CBM SURVEY – TASK DATA

Tools:

EV4 (FF)	EV5 (FF)
Wire Ties	Wire Ties
	MMOD T-tool

EVA Fasteners: None

EVA Connectors: None

Connector Inhibits: None

Foot Restraints: None

Timeline Considerations:

Note:

Cautions:

Warnings:

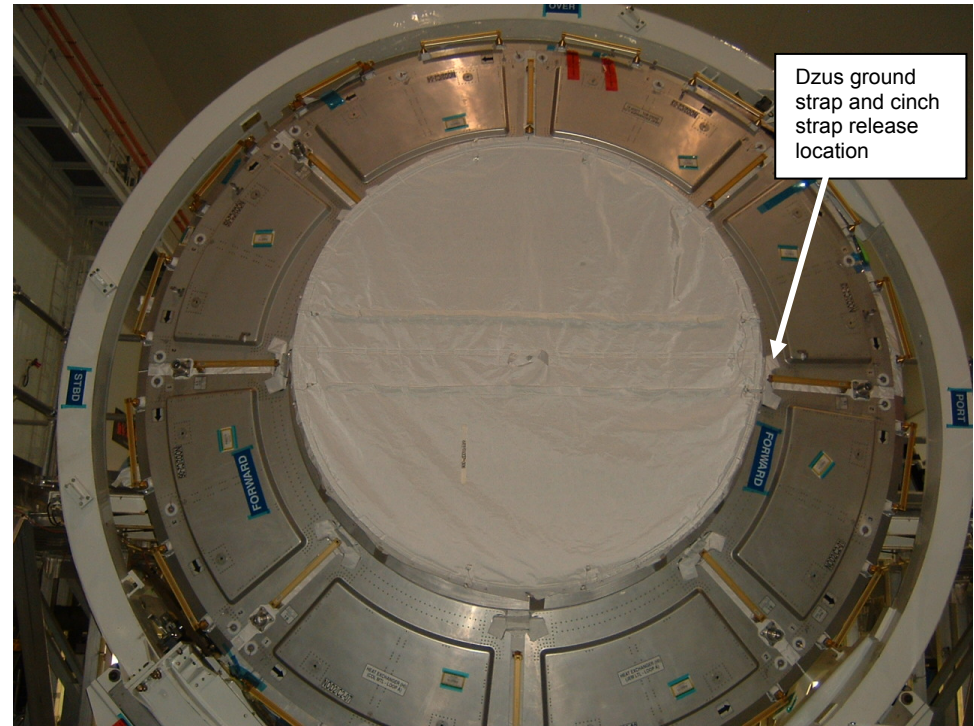

Node 2 ACBM Thermal Cover (Shower Cap)

S0/N1 POWER CABLE/H-JUMPER HARNESS REMOVAL (00:50)

IV/SRMS	EV4 – Wt (FF)	EV5 – Mk (FF)
<p><u>{S0/N1 POWER CABLE/H-JUMPER REMOVE INHIBITS</u> RPCM Z14B A RPC 03 – Open, Close Cmd Inh RPCM Z14B A RPC 01 – Open, Close Cmd Inh MBSU 2 RBI 5 – Open, Close Cmd Inh MBSU 3 RBI 5 – Open, Close Cmd Inh MBSU 4 RBI 5 – Open, Close Cmd Inh}</p> <p>1. Once EV4 step 9 complete, notify MCC-H: SM Power cable install complete (GO to close MBSU 4 RBI 5)</p>	<p><u>MATE S0/N1 SM POWER CABLE/H-JUMPER REMOVE</u> 1. Translate to Node 1 fwd stbd/zenith endcode</p> <p style="text-align: center;">NOTE √Connectors for straight pins, no FOD, EMI band intact, and good bend radius</p> <p>2. Demate: <input type="checkbox"/> Z1 P150 (W36C) from Node 1 J650 <input type="checkbox"/> S0 P651 (W4014) from Node 1 J651</p> <p>3. Inspect and mate: <input type="checkbox"/> S0 P651 (W4014) onto J872 on S0 swing arm</p> <p>4. Demate: <input type="checkbox"/> S0 P650 (W4012) from J871 on S0 swing arm</p> <p>5. Un-wire tie S0/N1 SM Power Cable (W4020) from HR 1003L (S0 Tray H1) on S0 tray</p> <p>6. Route SM cable and S0 P650 to Node 1 J651/J650</p> <p>7. Remove cap from S0/N1 SM Power Cable P651A; stow in trash bag</p> <p>8. Inspect and mate: <input type="checkbox"/> S0 P650 (W4012) onto Node 1 J650 <input type="checkbox"/> Jumper P651A to Node 1 J651</p> <p>9. Cleanup cable as necessary</p> <p>10. Translate to Z1 stbd/nadir face (aft corner, nadir of WIF 02)</p> <p>11. Inspect and mate: <input type="checkbox"/> Z1 P150 (W36C) onto Z1 J650 (inboard)</p> <p>12. Install in TA clamps as reqd (3 or 4)</p> <p>13. Clean up cable slack as required</p> <p>14. Perform WVS photo closeout of connectors</p> <p>15. Translate to Airlock</p>	<p><u>PORT H-JUMPER REMOVAL (CHANNEL 1/4)</u> 1. Translate to PMA1/FGB zenith face via aft Node 1 2. BRT to PMA HR 0004</p> <p>3. Slide back thermal booties to expose connectors from: <input type="checkbox"/> H-Jumper: P16A, P17A <input type="checkbox"/> FGB P16 <input type="checkbox"/> FGB P17</p> <p>4. Attach RET to H-jumper</p> <p>5. Demate connector: <input type="checkbox"/> Jumper J17A from FGB P17 <input type="checkbox"/> Jumper J16A from FGB P16 <input type="checkbox"/> Jumper P17A from PMA1 J17 <input type="checkbox"/> Jumper P16A from PMA1 J16</p> <p>6. Remove H-Jumper; stow on self via attached wire tie</p> <p>7. Inspect and mate: <input type="checkbox"/> FGB P17 to PMA1 J17 <input type="checkbox"/> FGB P16 to PMA1 J16</p> <p>8. Perform WVS photo closeout of connectors</p> <p>9. Re-install thermal booties</p> <p>10. Perform glove inspection</p> <p>11. Translate to temp stowed crewlock bag on Airlock via zenith/aft Node 1 path</p> <p>12. Temp stow H-jumper on crewlock bag using exposed equipment hook</p> <p>13. Translate to Airlock</p>

S0/N1 POWER CABLE/H-JUMPER HARNESS REMOVAL – TASK DATA

Tools:

EV3 (FF)	EV4 (FF)

EVA Fasteners: N/A

EVA Connectors:

Harness	From	To	Size	Function	Inhibit
Z1 P150 (W36C?)	N1 J650	Z1 J650	25	Secondary Power to CHT 22	RPCM Z14B A 03 – Open, Close Cmd Inh
S0 P651 (W4014)	N1 J651	S0 swing arm J872	25	MBSU 2 Power to CHT 23 and 24	MBSU 3 RBI 5 – Open, Close Cmd Inh
S0 P650 (W40XX)	S0 swing arm J87??	N1 J650	25	Primary Power to CHTs 21 and 22	MBSU 2 RBI 5 – Open, Close Cmd Inh
S0/N1 Jumper P651A	Temp Stow	N1 J651	25	MBSU 4 Power to CHT 23 and 24	MBSU 4 RBI 5 – Open, Close Cmd Inh
H-Jumper J17A	FGB P17		25	Secondary Power to ARCUs 53 and 54	RPCM Z14B A 01 – Open, Close Cmd Inh
H-Jumper J16A	FGB P16		25	Secondary Power to CHT 21 Secondary Power to CHT 22	RPCM Z14B A 01 – Open, Close Cmd Inh RPCM Z14B A 03 – Open, Close Cmd Inh
H-Jumper P17A	PMA1 J17		25	Secondary Power to ARCUs 53 and 54, CHT 21	RPCM Z14B A 01 – Open, Close Cmd Inh
H-Jumper P16A	PMA1 J16		25	Secondary Power to CHT 22	RPCM Z14B A 03 – Open, Close Cmd Inh
FGB P17		PMA1 J17	25	Secondary Power to ARCUs 53 and 54	RPCM Z14B A 01 – Open, Close Cmd Inh
FGB P16		PMA1 J16	25	Primary Power to CHTs 21 and 22	MBSU 2 RBI 5 – Open, Close Cmd Inh

Foot Restraints: None

Timeline Considerations:

- EV4 step 2 first box (demate Z1P150 from Node 1 J650), step 4 (demate S0 P650 from swing arm), step 8 first box (mate S0 P650 to Node 1 J650), and steps 10-14 (mate of Z1 P150 to Z1 J650) are part of the H-jumper removal task. The remainder of EV4 steps are the SM power cable install. These tasks are intermingled for time lining efficiency

Note:

- Verify pin and EMI band integrity
- Verify connector free of FOD

Cautions:

Warnings:

S0/N1 POWER CABLE/H-JUMPER HARNESS REMOVAL – TASK DATA (Cont)

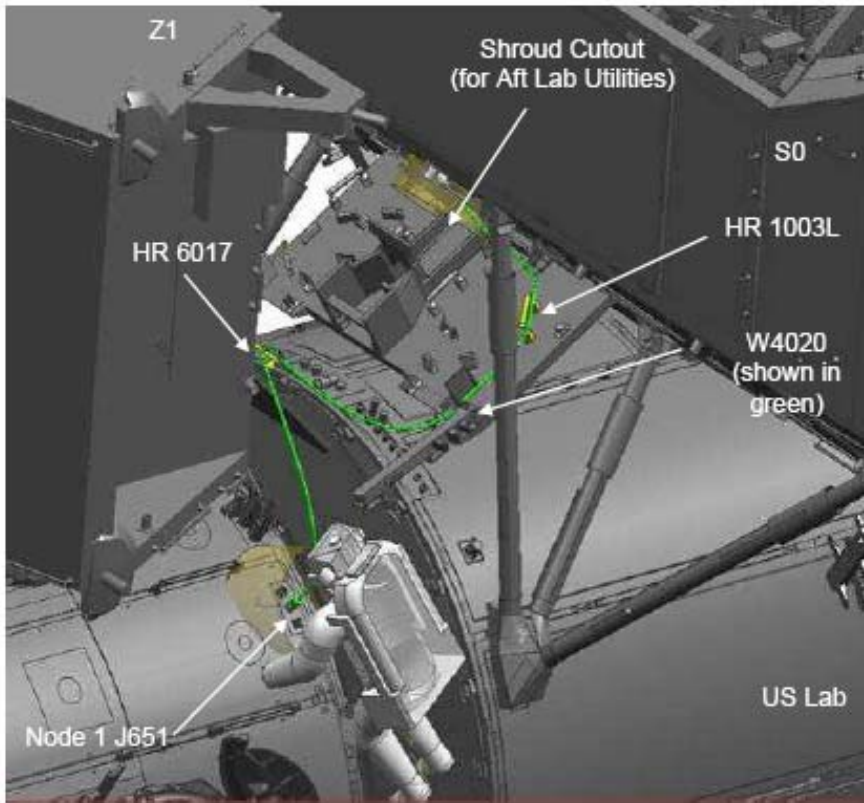

Figure 1. Installing Node 1 end of S0/N1 SM Power Cable into Node 1 J651

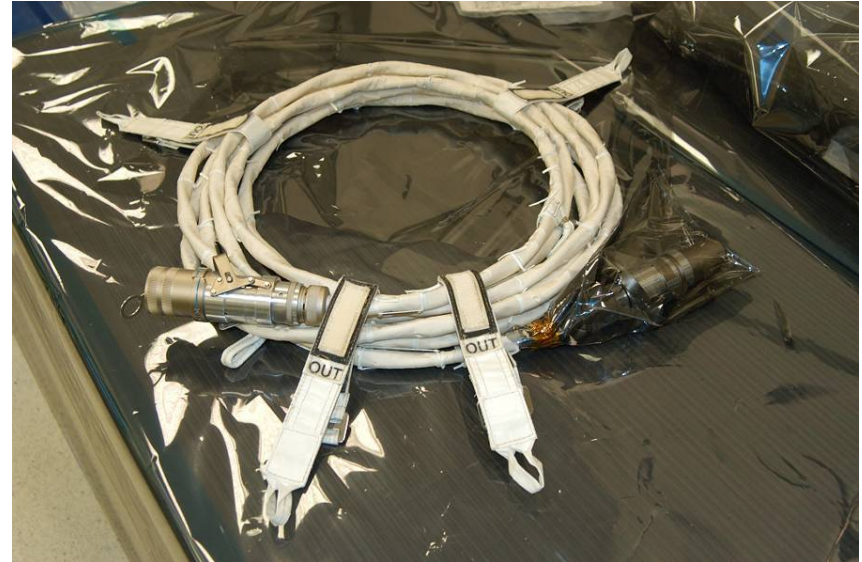
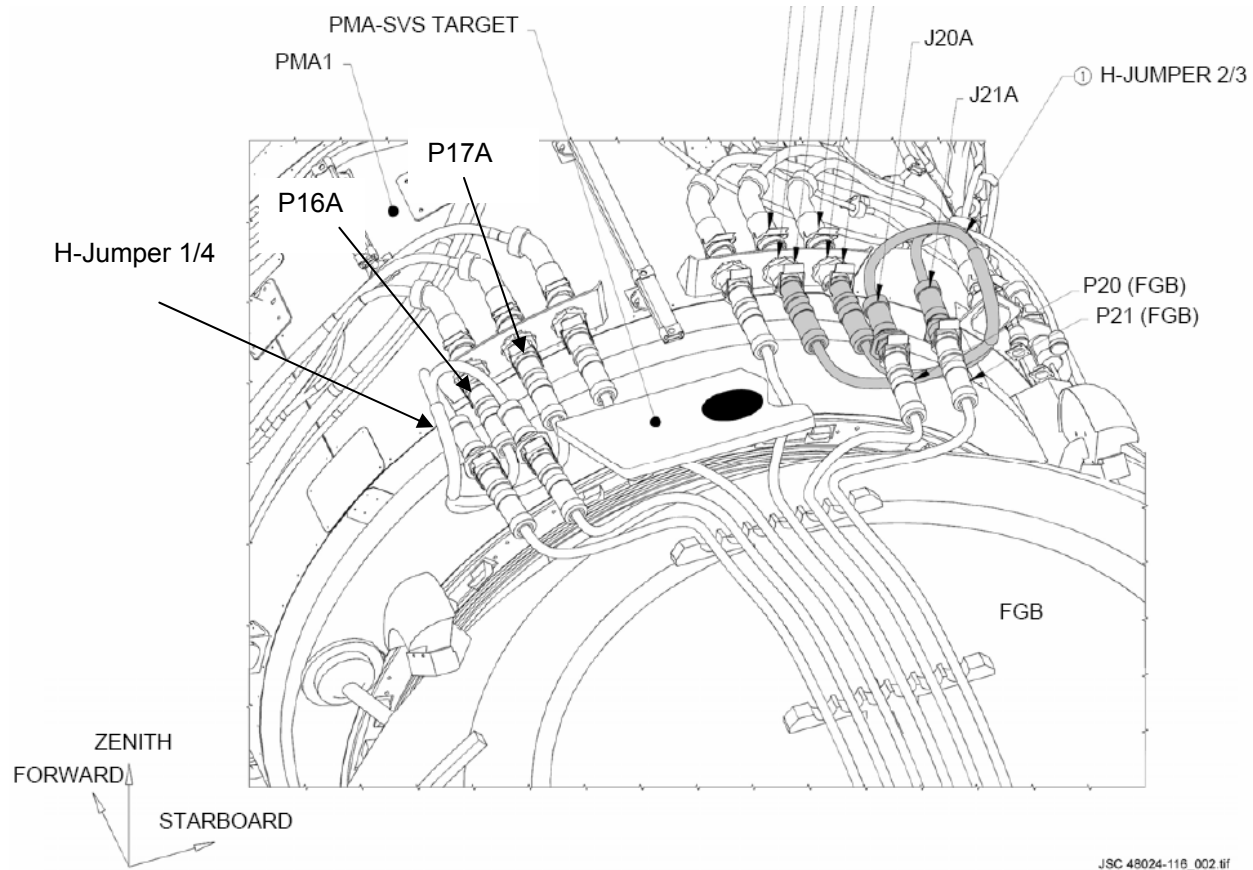

Figure 2: S0/N1 SM Power Cable



Figure 3. Node 1 J651

S0/N1 POWER CABLE/H-JUMPER HARNESS REMOVAL – TASK DATA (Cont)



TOOL PREP (00:40)

IV	EV4 – Wt (FF)	EV5 – Mk (FF)
	<ol style="list-style-type: none">1. Translate to port fluid QD bag on zenith side of crewlock2. Tether to and retrieve vent tool adapter from port fluid QD bag, paying attention while opening and manipulating tools inside bag3. Tether to and retrieve N2 vent tool adapter from port fluid QD bag, temp stow4. Close fluid QD bag (verify Velcro and 1/4 turn fasteners) 5. Translate to VTE bag (outboard)6. Open VTE bag, stow vent tool adapter using integral equipment hook7. Close VTE bag (verify Velcro and 1/4 turn fasteners) 8. Tether to and remove VTE bag9. Translate to S0 face 3 10. Install S0 gap spanners from trash bag from zenith standoff of HR 3424, routed underneath HR 3425, to zenith standoff of HR 3427 (verify 180 deg rotation) 11. Stow VTE bag on handrails 3425 (inboard standoff) and 3430 (2 straps to outboard standoff) (leave 4th strap free) 12. Translate to N2 vent tool temp stow location; retrieve tool 13. Translate to Airlock	

TOOL PREP – TASK DATA

Tools:

EV4 (FF)	EV5 (FF)

EVA Fasteners:

Fastener Name	Label	Head Size	Qty	Release Torque (ft-lb)	Failure Torque (ft-lb)	Turns

EVA Connectors: None

Foot Restraints:

Task	WIF	APFR Setting

Timeline Considerations:

Note:

Cautions:

Warnings:

VENT TOOL EXTENDER BAG RELOCATE

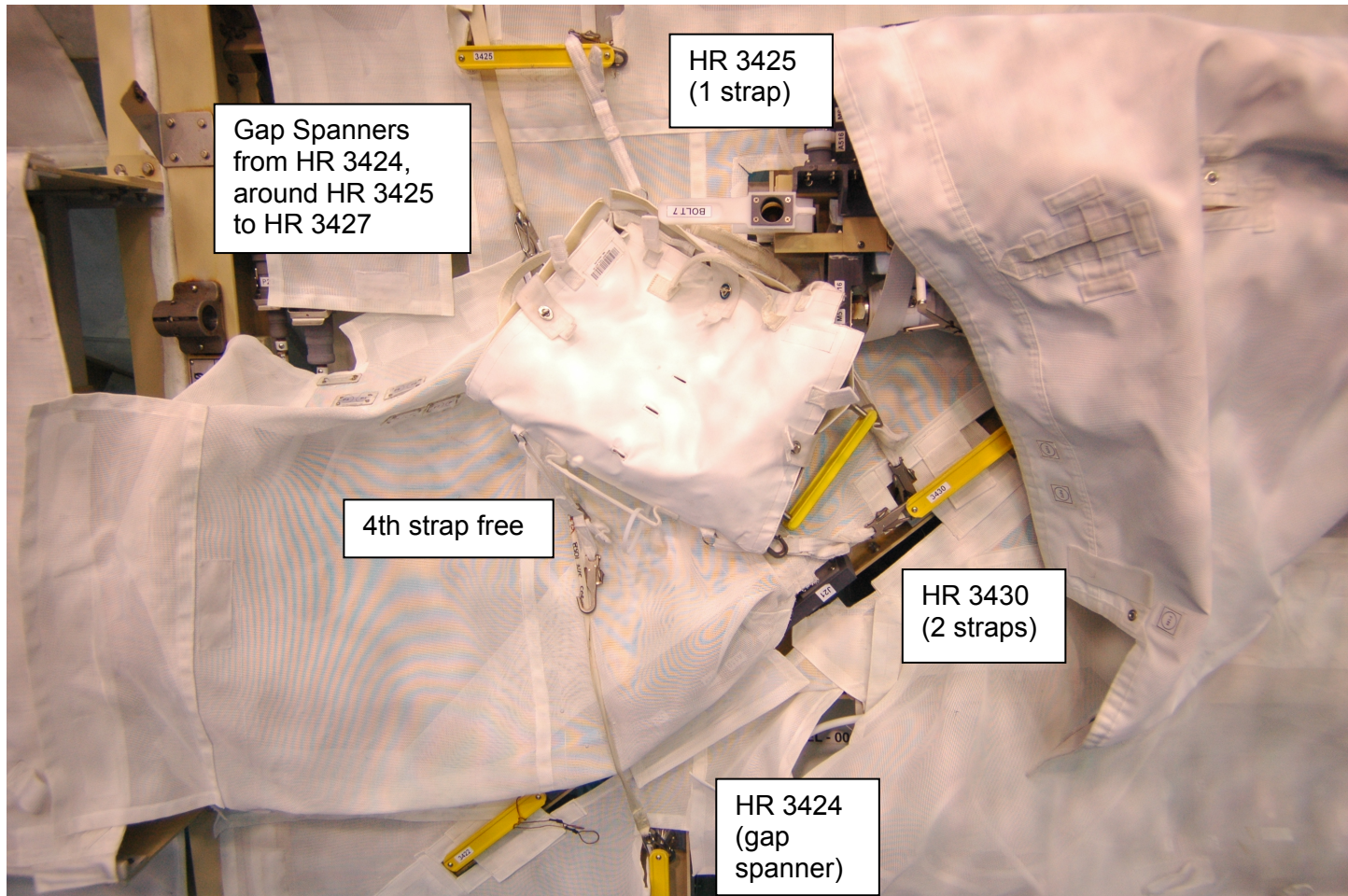

Vent Tool Extender Bag Temp Stow – S0 Face 02

EVA 5 CLEANUP AND A/L INGRESS (00:25)

IV	EV4 – Wt (FF)	EV5 – Mk (FF)
<p>1. Perform prior to ingress: WVS PWRDN (P/TV, <u>WVS CUE CARD</u>)</p>	<p>1. Translate to CETA spur HR 3401 2. Perform tool inventory 3. Retrieve crewlock bag from A/L HR ; stow on BRT 4. On EV5 GO, disconnect EV5's safety tether; attach to left waist tether <input type="checkbox"/> √Hooks locked 5. Translate to airlock 6. Transfer crewlock bag to EV5 7. Disconnect EV4 A/L safety tether from A/L, attach to self 8. Ingress airlock DCM 9. Retrieve SCU, remove DCM cover 10. Connect SCU to DCM, √Locked 11. Water – OFF 12. Hatch thermal cover – close 13. Secure thermal cover Velcro strap 14. √EV Hatch clear of FOD and obstructions 15. EV Hatch – verify handle position per hatch decal; close and lock 16. Go to PRE REPRESS portion of {CREWLOCK DEPRESS/REPRESS CUE CARD} (SODF: ISS EVA SYS: EVA PREP/POST)</p>	<p>1. Translate to Airlock 2. Perform tool inventory 3. Ingress Airlock 4. Connect right waist tether to UIA D-ring <input type="checkbox"/> √Hook locked 5. Give EV4 GO to disconnect EV5 safety tether 6. Receive crewlock bag from EV4 DCM 7. Retrieve SCU, remove DCM cover 8. Connect SCU to DCM, √Locked 9. Water – OFF 10. Go to PRE REPRESS portion of {CREWLOCK DEPRESS/REPRESS CUE CARD} (SODF: ISS EVA SYS: EVA PREP/POST)</p>

CAUTION
 Do not close hatch until EMU water – OFF for 2 min

POST EVA 5 TOOL CONFIG

EV4

EMU D-rings

- 1 – Tether Extender on Left
- 2 – Waist Tethers
- 1 – 85-ft Safety Tether

MWS

- Small trash bag [right inside]
 - 1 – RET (sm-sm)
- 1 – Adj tether [right]
- 1 – RET (with PIP pin) [left]
- 1 – RET (sm-sm) [right]
- 2 – Wire ties
- Socket Caddy
 - 7/16-2 in ext
- Swing Arm [right side]
 - PGT w/7/16-6 in ext
 - 1 – RET (sm-sm)
 - Wire Tie Caddy
 - 1 – RET (sm-sm)
- BRT [left side]
 - 2 – long wire ties tied together
 - 2 – short wire ties
 - 1 – RET (sm-sm)

- SAFER

RETs sm-sm – 14 RETs w/PIP pin – 5 RETs Lg-sm – 5 Adj tethers – 4
--

EV5

EMU D-rings

- 1 – Tether Extender on Left
- 2 – Waist Tethers
- 1 – 85-ft Safety Tether

MWS

- Small trash bag [right inside]
 - 1 – RET (sm-sm)
- 1 – RET (with PIP pin) [left]
- 1 – RET (sm-sm) [right]
- 2 – Wire ties
- Swing Arm [right side]
 - PGT
 - 1 – RET (sm-sm)
 - Wire Tie Caddy
 - 1 – RET (sm-sm)
- BRT [left side]
 - 2 – long wire ties tied together
 - 2 – short wire ties
 - 1 – RET (sm-sm)

- SAFER

ADDITIONAL ITEMS RETURNED TO A/L

- BSP
- H-Jumper
- Lab CETA Light
- Node 2 Shower Cap

- 1 – RET (Lg-sm)
- Crewlock bag #4 (MMOD Shield)
 - 3 – LDTDT
 - Wire Tie Caddy (on int)
 - 1 – MMOD T-tool (on int)
 - GP Caddy (on int)
 - Vise Grips
 - Loop Pin Puller
 - Hammer (on RET w/PIP)
 - EVA Ratchet with IV socket (on RET w/ PIP)

CREWLOCK

- Staging Bag
 - 3" Scraper
- IV Bag

Lg-sm RET

- 6B box cover (BSP)
 - 1 – Adj tether
 - 1 – RET (sm-sm)
 - BSP

1 - RET (Lg-sm)

- C/L bag #1
 - H-jumper
 - MMOD T-tool
 - Fish stringer (from caps)
 - EVA Camera and Bracket
 - Round torque multiplier with 5/8" socket (on int)
 - 1 – RET (sm-sm)
 - Round Scoop (on RET)
 - 1 – RET (sm-sm)
 - Socket caddy (on RET)
 - 5/8-7.8 in ext
 - 7/16-6 in ext
 - 1 – RET (sm-sm)
 - Small trash bag (from gap spanners)
 - 2 – Adj tether
- 1 - RET (Lg-sm)
 - Med ORU Bag
 - 1 – RET (with PIP pin)
 - Lab CETA Light (exposed jacks need to be taped once inside)

1 – RET (Lg-sm)

- Node 2 Shower Cap

This Page Intentionally Blank

TOOLS AND STOWAGE

PORT LIGHTWEIGHT TOOL STOWAGE ASSEMBLY (TSA)	TEMP FS 8-2
PGT CHECKOUT	8-3
PGSC-PGT CONNECTION (A31P AND 760XD)	8-4
PROGRAM PGT SETTINGS	8-5
DOWNLOAD/ERASE EVENT LOG	8-5
PGT CONTINGENCIES.....	8-6
PGT STANDARD SETTINGS.....	8-7
PISTOL GRIP TOOL.....	FS 8-9
TOOLBOX STOWAGE	FS 8-10
TOOLBOX PANEL AND SLOT LABELS	FS 8-11
Z1 TOOLBOX INTERNAL LAYOUT	FS 8-12
AIRLOCK TOOLBOX INTERNAL LAYOUT.....	FS 8-13
STBD QD BAG (EXTERNAL ON ISS AIRLOCK)	FS 8-14
PORT QD BAG (EXTERNAL ON ISS AIRLOCK).....	FS 8-15
APFR MANAGEMENT – STS-120 (10A).....	FS 8-16
SAFETY TETHER CONFIGURATION – STS-120 (10A).....	FS 8-18
T-RAD IV PREPARATION.....	FS 8-19
TEMPERATURE SENSOR ASSEMBLY	FS 8-23
1.0" FOAM BRUSH NETTING REMOVAL	FS 8-23
DTO SAMPLE BAG ASSEMBLY	FS 8-24
CIPA DISCARD CONTAINER (CDC) MARKING	FS 8-25

**TOOLS AND
STOWAGE**

PORT LIGHTWEIGHT TOOL STOWAGE ASSEMBLY (TSA)

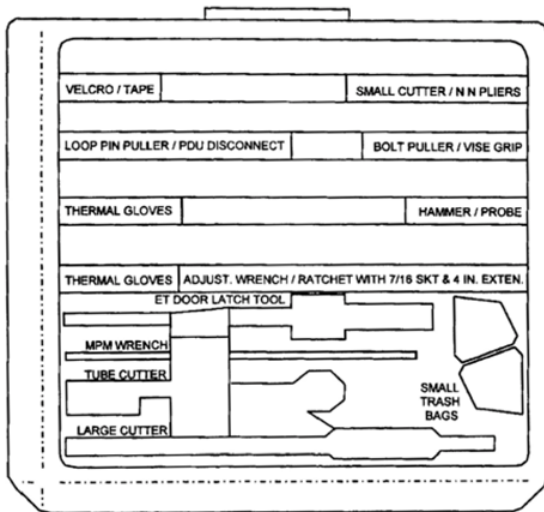
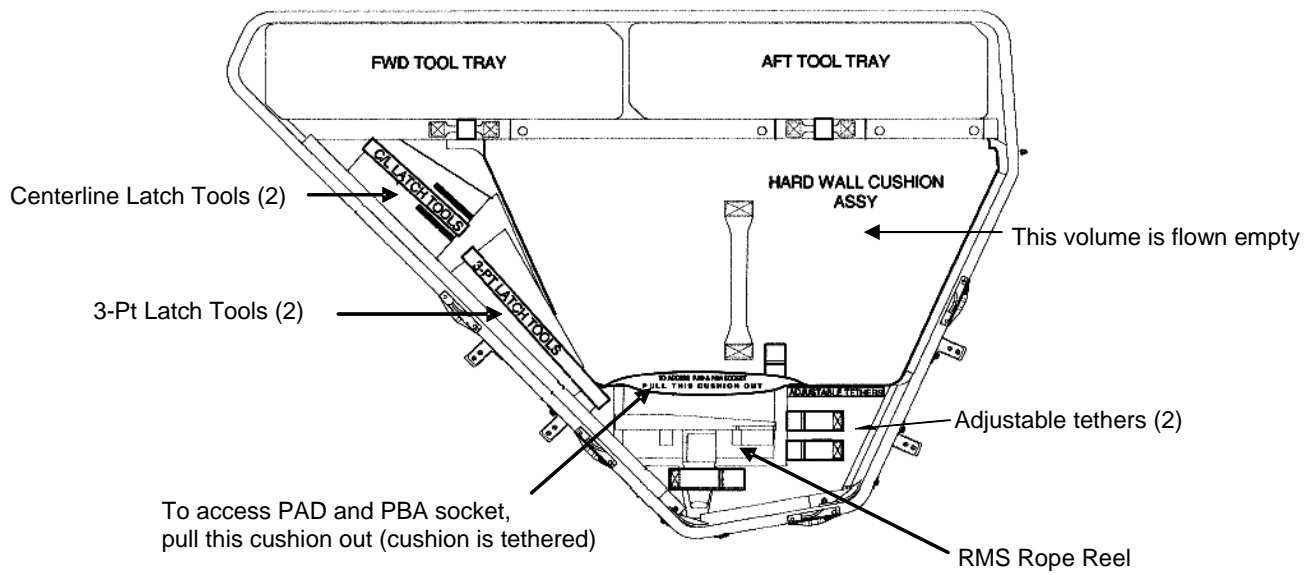

Forward Tray layout and Labels

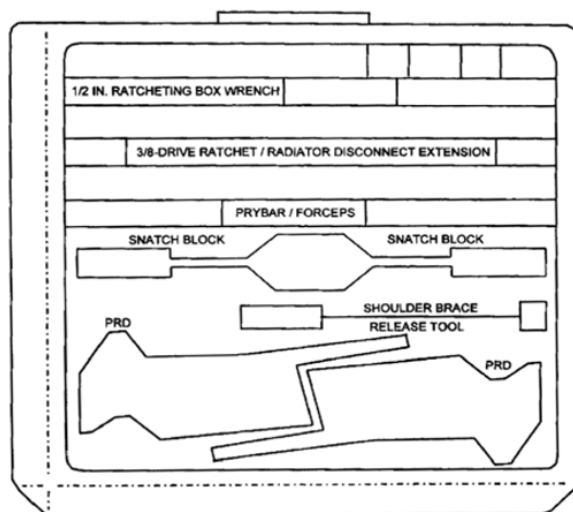

Aft Tray Layout and Labels



TOOLS AND STOWAGE

PISTOL GRIP TOOL

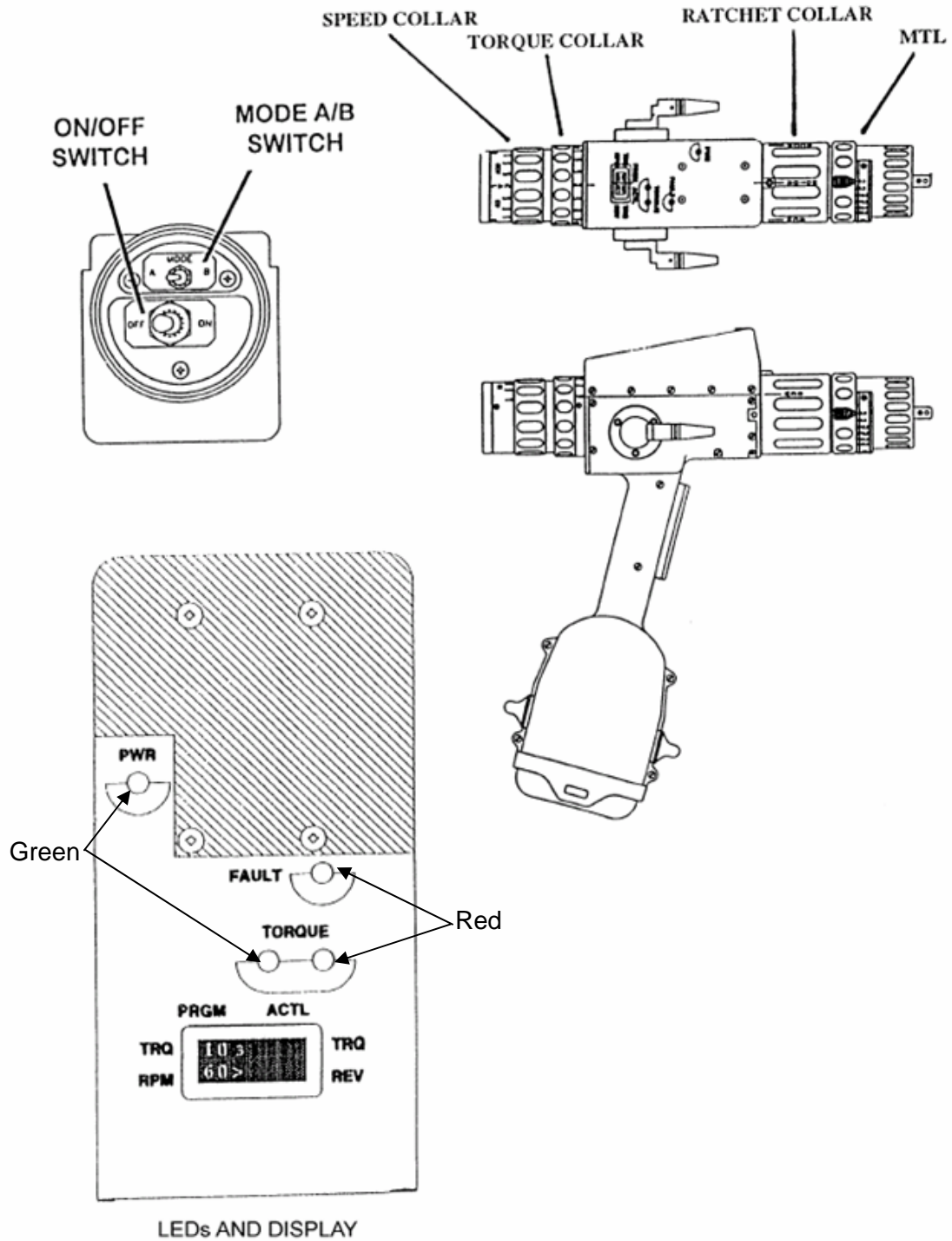

TOOLBOX STOWAGE

I

	Z1 PORT TOOLBOX {all slots have sliders}	Z1 STBD TOOLBOX {all slots have sliders}	A/L TOOLBOX 1 (STBD)	A/L TOOLBOX 2 (PORT)
SLOT # 1	SQUARE TM BOARD {stbd door} SQ TORQUE MULTIPLIER 7/16" FLUSH SQ SOCKET 7/16" PROUD SQ SOCKET 7/16" RECESSED SQ SOCKET	SQUARE TM BOARD {stbd door} SQ TORQUE MULTIPLIER 7/16" FLUSH SQ SOCKET 7/16" PROUD SQ SOCKET 7/16" RECESSED SQ SOCKET	HAMMER BOARD {nadir door}	CABLE CUTTER BOARD COMPOUND CUTTERS (SM) SCISSORS {zenith door}
SLOT # 2		QD BAIL TOOL BOARD {stbd door} BMRRM LATCH TOOL QD BAIL DRIVE TOOL (1")	PLIERS BOARD {nadir door} NEEDLE NOSE PLIERS	
SLOT # 3	RATCHET BOARD {middle} 7/16" X 12" WOBBLE SOCKET 7/16" X 2" RIGID SOCKET	RATCHET BOARD {middle} 7/16" X 6" WOBBLE SOCKET	{only slot with slider}	{only slot with slider}
SLOT # 4				
SLOT # 5	ROUND TM BOARD {port door} RND TORQUE MULTIPLIER 5/8" PROUD RND SOCKET 7/16" FLUSH RND SOCKET 7/16" PROUD RND SOCKET	ROUND TM BOARD {port door} 7/16" FLUSH RND SOCKET 7/16" PROUD RND SOCKET	ADJ WRENCH BOARD FORCEPS WRENCH, ADJ {zenith door}	T-HANDLE TOOL BOARD 1-8" T-TOOLS {nadir door}
SLOT # 6	TRASH BAG BOARD {stbd door} LARGE TRASH BAG SMALL TRASH BAG	TRASH BAG BOARD {stbd door}	HYDRAZINE BRUSH BOARD HYDRAZINE BRUSH {nadir door}	
SLOT # 7	SOCKET BOARD {port door} 5/32" BALL END ALLEN DR 1/2" X 8" WOBBLE SOCKET 5/16" X 7" RIGID SOCKET	SOCKET BOARD {port door} 5/32" BALL END ALLEN DR 1/2" X 8" WOBBLE SOCKET 5/16" X 7" RIGID SOCKET	PRD (Toolboard) {zenith door} PRD	PRD (Toolboard) {nadir door} PRD
PANEL # 8	CHEATER BAR PANEL {stbd door} ADJ EQUIP TETHER	CHEATER BAR PANEL {stbd door} CHEATER BAR ADJ EQUIP TETHER	TOOL CADDY PANEL {nadir door} CADDY, ISS (BUNGEE)	
PANEL # 9	18" SOCKET PANEL {port door} 7/16" X 18" WOBBLE SOCKET	18" SOCKET PANEL {port door}	BOLT PULLER PANEL BOLT PULLER MECHANICAL FINGER {zenith door}	LARGE CUTTER PANEL {nadir door}
EXTERNAL	1 SQUARE SCOOP 1 ROUND SCOOP w/D-HANDLE D-HANDLE on port side of toolbox	1 SQUARE SCOOP <u>NOTE</u> D-Handle will not stow on the side of this toolbox due to an interference with the CMG MLI		

TOOLBOX PANEL AND SLOT LABELS

NOTE

- A/L Toolbox: Slider feature located in center slot (#3)
- Z1/CETA Toolbox: Slider feature located in all slots

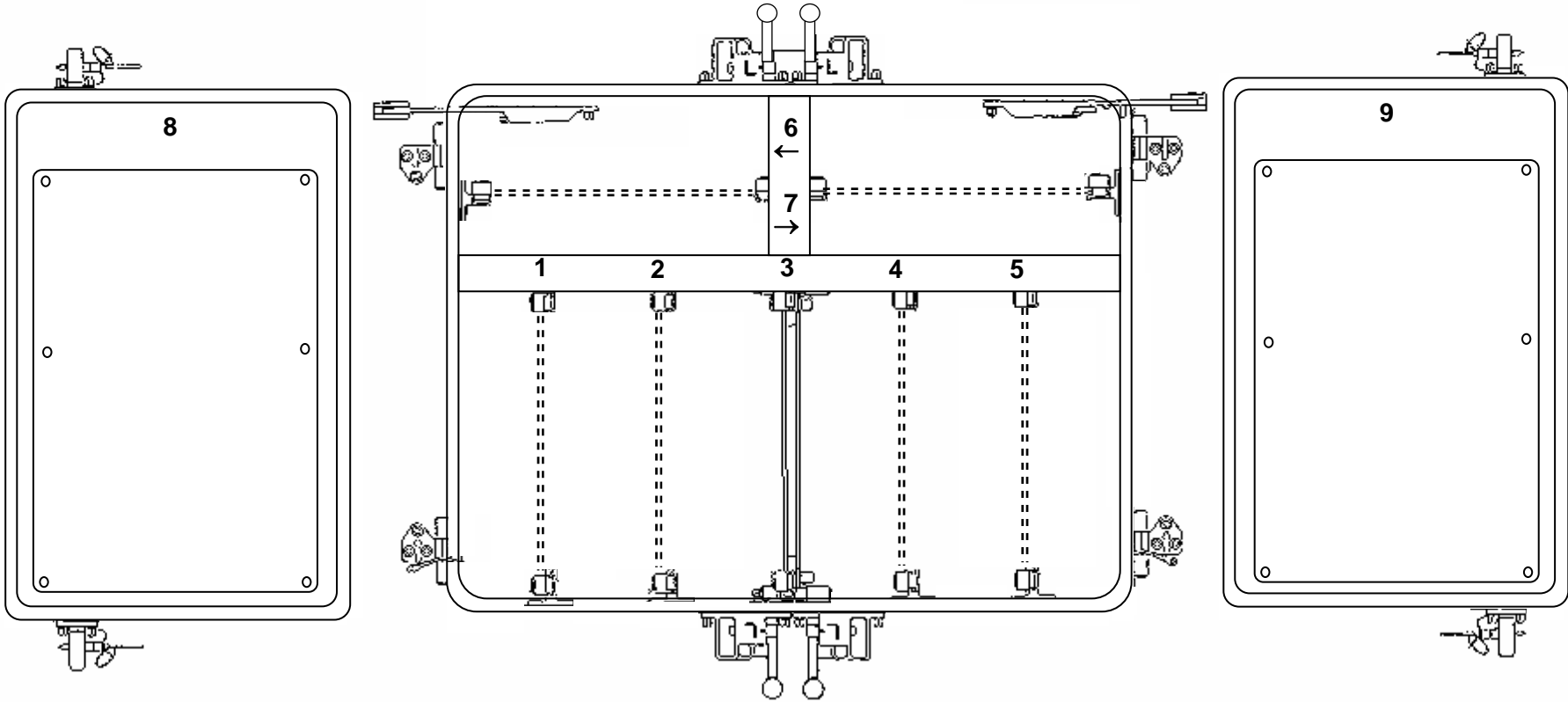

Z1 TOOLBOX INTERNAL LAYOUT

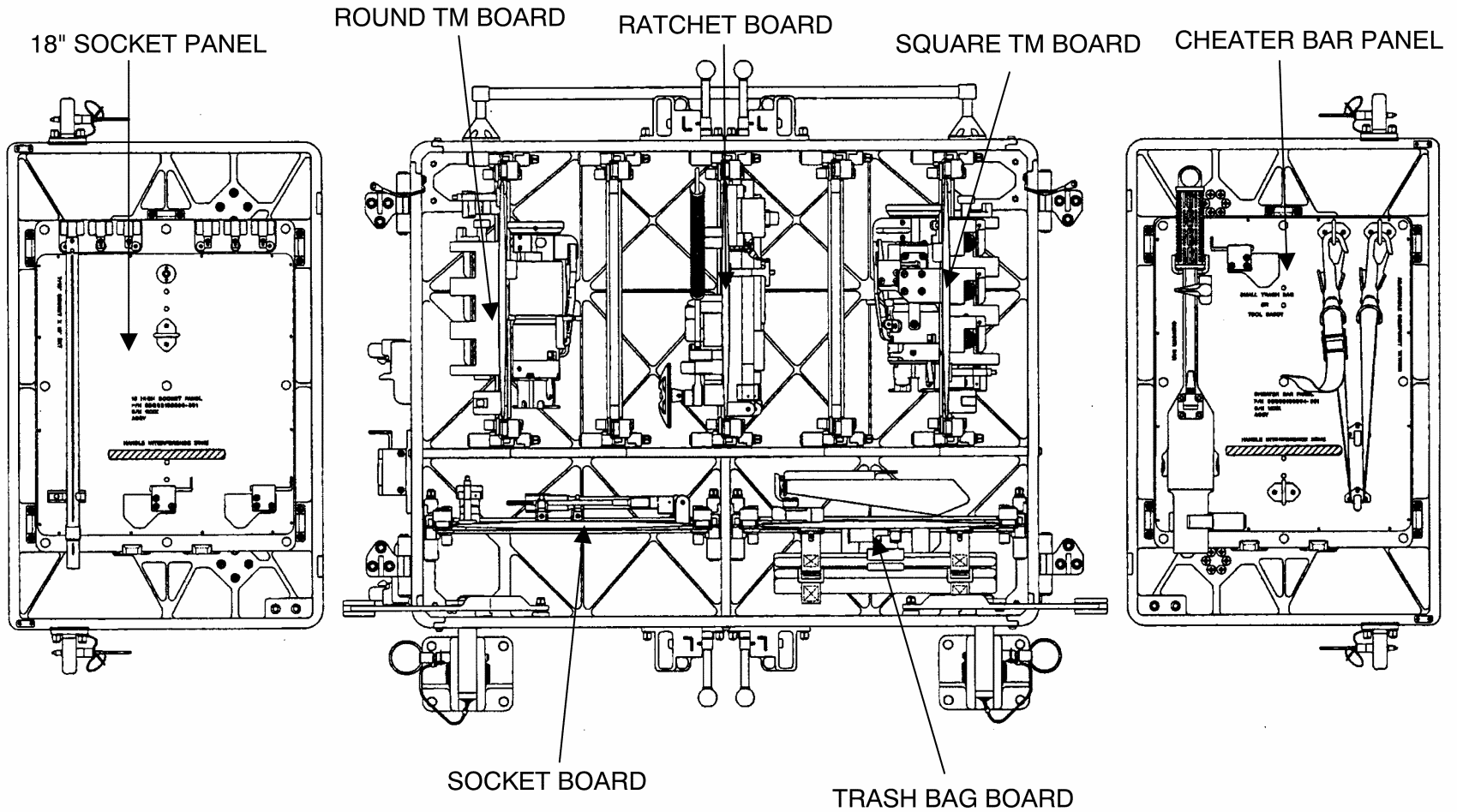

AIRLOCK TOOLBOX INTERNAL LAYOUT

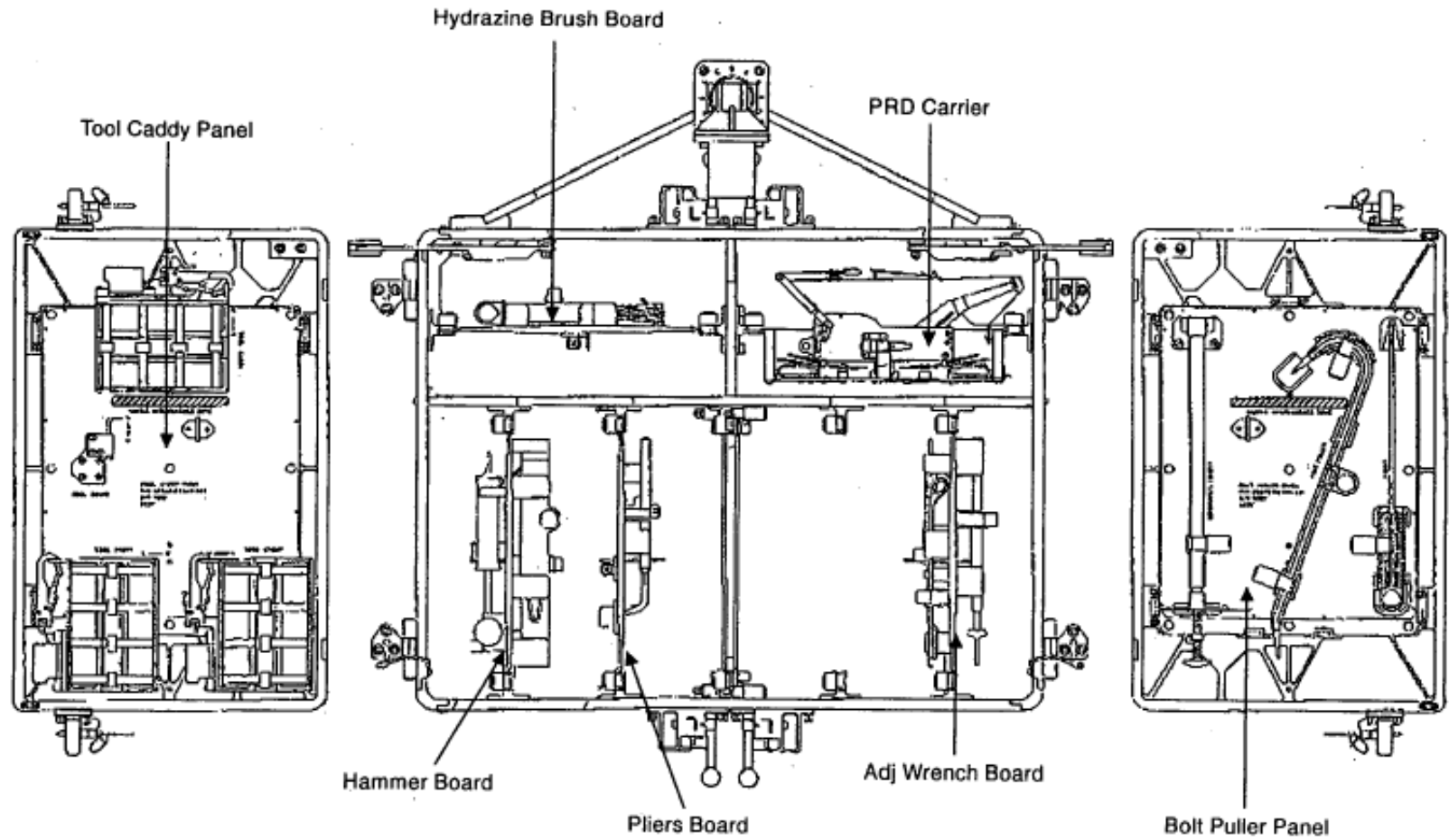

STBD QD BAG (EXTERNAL ON ISS AIRLOCK)

STBD QD BAG (SEG33114667-301)			
#	TOOL	PART#	LOCATION IN BAG
1.	1/4" cap tool	GD2043725	☐ 1/4" cap tool (pocket)
2.	1/2" cap tool	GD2043730	☐ 1/2" cap tool (pocket)
3.	1" cap tool	GD2043325	☐ 1" cap tool (pocket)
4.	3/4" & 1" QD Bail Drive lever	SDG33113838-703	☐ 3/4" & 1" QD Bail Drive Lever pouch on lid
5.	1.5" QD Bail Drive Lever	SDG33113837-701	☐ 1.5" QD bail Drive Lever pouch on lid
6.	1.5" QRT & FID Gauge	SEG33114617-701	☐ 1.5" QRT & FID Gauge (pocket)
7.	3/4" & 1" QRT & FID Gauge	SEG33114616-701	☐ 3/4" & 1" QRT & FID Gauge (pocket)
8.	1" H2O/N2 Vent Tool – F	1F98593-1	☐ 1" H2O/N2 Vent Tool – F (pocket)
9.	1" NH3/N2 Vent Tool – F	1F98589-1	☐ 1" NH3/N2 Vent Tool – F (pocket)
10.	1" NH3/N2 Vent Tool – M	1F98596-1	☐ 1" NH3/N2 Vent Tool – M (pocket)
11.	1.5" NH3/N2 Vent Tool – F	1F9859-1	☐ 1.5" NH3/N2 Vent Tool – F (pocket)
12.	3/4" NH3/N2 Vent Tool – F	1F98597-1	☐ 3/4" NH3/N2 Vent Tool – F (pocket)
13.	1/4" NH3/N2 Vent Tool – F	1F98592-1	☐ 1/4" NH3/N2 Vent Tool – F (pocket)



PORT QD BAG (EXTERNAL ON ISS AIRLOCK)

PORT QD BAG (SEG33114667-301/1001)			
#	TOOL	PART #	LOCATION IN BAG
1.	1/4" cap tool	GD2043725	<input type="checkbox"/> 1/4" cap tool (pocket)
2.	1/2" cap tool	GD2043730	<input type="checkbox"/> 1/2" cap tool (pocket)
3.	1.5" NH3/N2 Vent Tool – F	1F9859-1	<input type="checkbox"/> 1.5" NH3/N2 Vent Tool – F (pocket)
4.	1" H2O/N2 Vent Tool – F	1F98593-1	<input type="checkbox"/> 1" H2O/N2 Vent Tool – F (pocket)
5.	3/4" NH3/N2 Vent Tool – F	1F98597-1	<input type="checkbox"/> 3/4" NH3/N2 Vent Tool – F (pocket)
6.	1" NH3/N2 Vent Tool – M	1F98596-1	<input type="checkbox"/> 1" NH3/N2 Vent Tool – M (pocket)
7.	1/4" NH3/N2 Vent Tool – F	1F98592-1	<input type="checkbox"/> 1/4" NH3/N2 Vent Tool – F (pocket)
8.	Vent Tool Adapters (2)	SEG33119079-301	<input type="checkbox"/> One VTA goes in the 3/4" & 1" QRT & FID Gauge pouch; the other goes in the 1.5" QRT & FID Gauge pouch <input type="checkbox"/> Each VTA must be tethered inside the bag using 1 adj tether for each <input type="checkbox"/> See picture B
9.	1/4" BDT	SEG33114984-301	<input type="checkbox"/> Stowed on top of 1/4" Vent Tool <input type="checkbox"/> Must be tethered to inside of bag using 1 adj <input type="checkbox"/> See picture A
10.	3/4" BDT	SEG33114986-301	<input type="checkbox"/> Stowed on top of 1/4" Vent Tool, tethers to bag internal loops using BDT integral tether <input type="checkbox"/> See picture A
11.	3/4" AKT	SEG33114983-301	<input type="checkbox"/> Stowed with vent tool adapters in QRT & FID pouches <input type="checkbox"/> Must be tethered to inside of bag using 1 adj <input type="checkbox"/> See picture A

3/4" BDT is tethered to internal bag loop using integral tool tether

3/4" AKT stowed with VTAs in QRT & FID pouch

1/4" and 3/4" BDTs are stowed on top of 1/4" vent tool

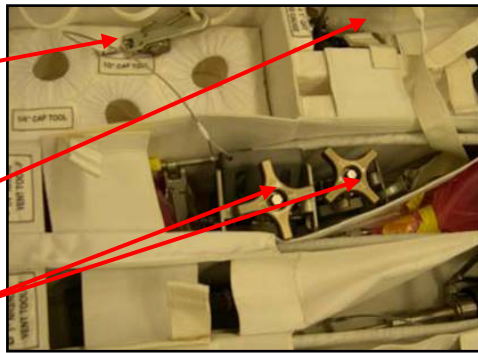

PICTURE A: BDT AND AKT STOWAGE

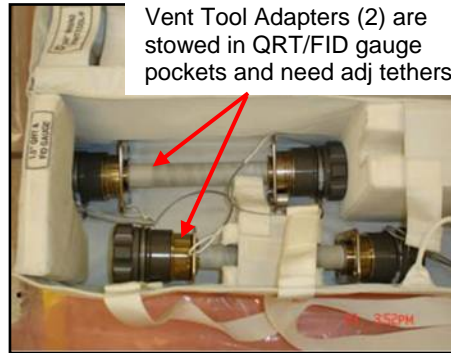

PICTURE B: VENT TOOL ADAPTER STOWAGE

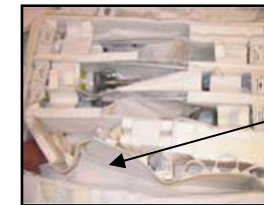

Port QD Bag launch config with insert peeled back

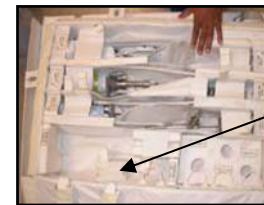

Port QD Bag with insert re-attached to bag wall

APFR MANAGEMENT – STS-120 (10A)

APFR DESIGNATOR	APFR 1 (8A, 13A.1 Pitch knob problem)	APFR 2 (US EVA 9 Pitch knob problem)	APFR 3 S/N 1005 no pitch knob prob 9A-inc12	APFR 4 (TS, old ORU tether, heat shield)	APFR 5 (TS, old ORU tether, heat shield)	APFR 6 (heat shield removed on 12A.1 stage)	APFR 7 S/N 1008 (locking collar difficult) Ingress aid	IAPFR 1	IAPFR 2	CRANE (old ORU tether)	TS	ORU stanchion/ TERA (headless)
EVA 1	CETA 1 WIF 4 [9,SS,F,12] Y/P [12,FF]	Z1 WIF 11 [12, SS, A, 12]	ESP2 WIF 05 [4, PP, G, 1]	Z1 WIF 08 [7,PP,B,6] TS installed at 4 o'clock points port/nadir	PMA1 WIF 2 [12,KK,F,6]	CETA 2 WIF 2 [10,UU,D,12] Y/P [12, FF]	A/L WIF 10 [12,PP,A,6]	Z1 WIF 1 [12,PP,F,12]	Z1 WIF 3 [6,PP,F,12]	PMA1 WIF 5	S0 port wedge face	S0 port wedge face
SASA Retrieve		Z1 WIF 11 [12,SS,A,12]	SSRMS [12,PP,F,6] Ingress Aid				Remove Ingress Aid move to APFR3					
SASA stow			Node2 WIF 17 [4,TT,F,12]									
Z1 to P6 FQD disconnect		Z1 WIF 17 [4,KK,A,1] Move to: Z1 WIF 20 [6,PP,F,12]										
EVA 2	CETA 1 WIF 4 [9,SS,F,12] Y/P [12,FF]	Z1 WIF 20 [6,PP,F,12]	Node2 WIF 17 [4,TT,F,12] Ingress aid	Z1 WIF 08 [7,PP,B,6]	PMA1 WIF 2 [12,KK,F,6]	CETA 2 WIF 2 [10,UU,D,12] Y/P [12, FF]	A/L WIF 10 [12,PP,A,6] No Ingress aid	Z1 WIF 1 [12,PP,F,12]	Z1 WIF 3 [6,PP,F,12]	PMA1 WIF 5	S0 port wedge face	S0 port wedge face
Corner 3 Ground strap release interference		Z1 WIF 20 [6,FF,F,12]										
Bolt 3 RTAS release interference		Z1 WIF 20 [6,PP,F,12]										
PDGF Install			Node2 WIF 08 [2,QQ,E,12]									
EVA 3	CETA 1 WIF 4 [9,SS,F,12] Y/P [12,FF]	Z1 WIF 20 [6,PP,F,12]	Node2 WIF 08 [2,QQ,E,12] Ingress aid	Z1 WIF 08 [7,PP,B,6]	PMA1 WIF 2 [12,KK,F,6]	CETA 2 WIF 2 [10,UU,D,12] Y/P [12, FF]	A/L WIF 10 [12,PP,A,6] No Ingress aid	Z1 WIF 1 [12,PP,F,12]	Z1 WIF 3 [6,PP,F,12]	PMA1 WIF 5	S0 port wedge face	S0 port wedge face
Attach P6 to P5 Power Umbilicals						P5 WIF 05 [10,QQ,C,11]						
Cleanup						CETA2 WIF5 [, , , ,] (for 1E)						
MBSU Removal in PLB			SRMS [4,II,F,6]									
MBSU install at ESP-2		ESP2 WIF 05 [4,PP,G,1]										

APFR MANAGEMENT – STS-120 (10A) (Cont)

APFR DESIGNATOR	APFR 1 (8A, 13A.1 Pitch knob problem)	APFR 2 (US EVA 9 Pitch knob problem)	APFR 3 S/N 1005 no pitch knob prob 9A-inc12 Ingress aid	APFR 4 (TS, old ORU tether, heat shield)	APFR 5 (TS, old ORU tether, heat shield)	APFR 6 (heat shield removed on 12A.1 stage)	APFR 7 S/N 1008 (locking collar difficult)	IAPFR 1	IAPFR 2	CRANE (old ORU tether)	TS	ORU stanchion/ TERA (headless)
Cleanup		Get ahead: Lab WIF 4 [1, TT, C, 11] (for EVA 4)	Lab WIF 04 [TBD] Get ahead: Lab WIF12 [11,QQ,L,12]									
EVA 4	CETA 1 WIF 4 [9,SS,F,12] Y/P [12,FF]	ESP2 WIF 05 [4,PP,G,1] or Lab WIF 4 [1, TT, C, 11]	Lab WIF 04 [TBD] or Lab WIF12 [11,QQ,L,12]	Z1 WIF 08 [7,PP,B,6]	PMA1 WIF 2 [12,KK,F,6]	CETA 2 WIF 5 [TBD] Y/P [12, FF]	A/L WIF 10 [12,PP,A,6] No Ingress aid	Z1 WIF 1 [12,PP,F,12]	Z1 WIF 3 [6,PP,F,12]	PMA1 WIF 5	S0 port wedge face	S0 port wedge face
T-RAD DTO		Lab WIF4 [1, TT, C, 11]										
EVA 5	CETA 1 WIF 4 [9,SS,F,12] Y/P [12,FF]	Lab WIF4 [1, TT, C, 11]	Lab WIF 04 [TBD] or Lab WIF12 [11,QQ,L,12]	Z1 WIF 08 [7,PP,B,6]	PMA1 WIF 2 [12,KK,F,6]	CETA 2 WIF 5 [TBD] Y/P [12, FF]	A/L WIF 10 [12,PP,A,6] No Ingress aid	Z1 WIF 1 [12,PP,F,12]	Z1 WIF 3 [6,PP,F,12]	PMA1 WIF 5	S0 port wedge face	S0 port wedge face
Get ahead			Get ahead: Lab WIF12 [11,QQ,L,12] (for Inc 16)									
Post EVA 5	CETA 1 WIF 4 [9,SS,F,12] Y/P [12,FF]	Lab WIF4 [1, TT, C, 11]	Lab WIF 04 [TBD] or Lab WIF12 [11,QQ,L,12] Ingress aid	Z1 WIF 08 [7,PP,B,6] TS installed at 4 o'clock points port/nadir	PMA1 WIF 2 [12,KK,F,6]	CETA 2 WIF 5 [TBD] Y/P [12, FF]	A/L WIF 10 [12,PP,A,6] No Ingress aid	Z1 WIF 1 [12,PP,F,12]	Z1 WIF 3 [6,PP,F,12]	PMA1 WIF 5	S0 port wedge face	S0 port wedge face

SAFETY TETHER CONFIGURATION – STS-120 (10A)

I

	55-ft Safety Tethers							85-ft Safety Tethers			
	#59 SN 1007 Sm-sm	#66 SN 1016 Sm-sm	#60 SN 1008 Lg-sm (LAS needs inspection prior to use)	#70 or 1020 Lg-sm (LAS needs inspection prior to use)	#71 SN 1021 Lg-sm	#72 SN 1022 Lg-sm	#73 SN 1023 Lg-sm	#26 SN 1006 85-ft Lg-sm	#28 SN 1008 85-ft Lg-sm	#22 SN 1002 85-ft Lg-sm	#27 SN 1007 85-ft Lg-sm
Pre EVA1	INSIDE Tether Staging Area	INSIDE Tether Staging Area	S0 HH 3539 or 3530 Tether on 3539 had some retracting issues	S0 HH 3530 or 3539 Tether on 3539 had some retracting issues	OUTSIDE A/L on D-ring	OUTSIDE A/L on D-ring	INSIDE Tether Staging Area (AR written against this one)	INSIDE Tether Staging Area	INSIDE Tether Staging Area	INSIDE Shuttle Middeck	INSIDE Shuttle Middeck
EVA 1					X (retrieve)	X (retrieve)		X	X	X	
EVA 2								X	X		
EVA 3					X	X		X	X	X	X
EVA 4					X	X		X	X		
EVA 5								X	X		
Post EVA 5	INSIDE Tether Staging Area	INSIDE Tether Staging Area	S0 HH 3539 or 3530	S0 HH 3530 or 3539	OUTSIDE A/L on D-ring	OUTSIDE A/L on D-ring	INSIDE Tether Staging Area	INSIDE Tether Staging Area	INSIDE Tether Staging Area	INSIDE Shuttle Middeck	INSIDE Shuttle Middeck

T-RAD IV PREPARATION

WARNING

Do not perform this procedure until given a GO from MCC-H

1. On MCC-H GO, obtain latex gloves (WCS glove dispenser) and goggles (CCK in MA9N)
2. Remove T-RAD from stowage location (Double Locker MA9D/F)
3. Remove 5" nozzle from nozzle cushion (small block of foam stowed with T-RAD); remove Kapton tape from ends
4. Visually inspect clear areas of containment bag for milky-white, oily liquid and inspect the pigmat strips of the containment bag for white flaky residue

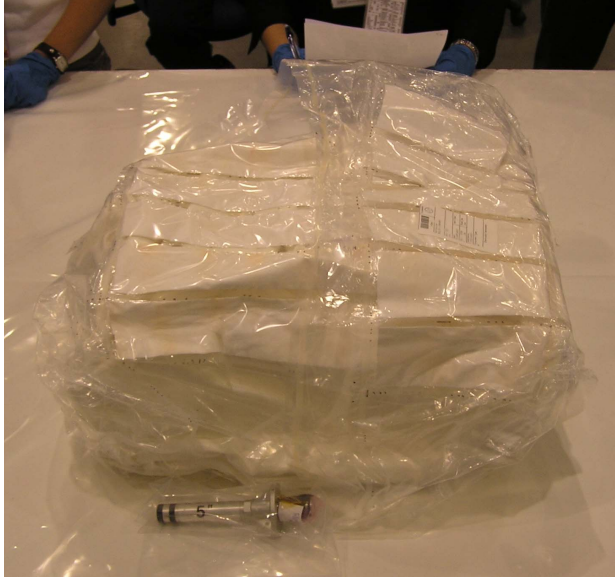

Figure 1.- T-RAD Stowage (Containment Bag on Left, Nomex Sacks (2) on Right)

WARNING

White residue is a byproduct of A1100 reaction with pigmat blanket. Milky-white, oily liquid in the containment bag may be liquid A-1100 (which is corrosive to eyes and skin – Tox 2). If present, do not open Containment Bag or Nomex sack; contact MCC

5. Don gloves and goggles
6. If no white residue present, cut Containment Bag between heat seals on short edge, near zipper end of Nomex sack (do not cut through pigmant) and remove Nomex sack
7. Inspect the fabric of the outer sack for white residue or wetted areas
8. Unzip outer Nomex sack, fold lid back, unzip inner Nomex sack, and remove T-RAD
9. Inspect top MLI cover (non-handle end) for evidence of leakage: clear to milky liquid or residue

NOTE

Do not unfasten the 1/4 turn fastener located below the hose

10. Open top MLI cover (2- 1/4 turn fasteners, 2 – snaps, Velcro)
11. Inspect entire top surface of T-RAD and interior of MLI cover for leakage, paying special attention to the Part B plunger O-ring vent hole (figure 2)
12. If leakage present, replace T-RAD in Nomex sacks; contact MCC

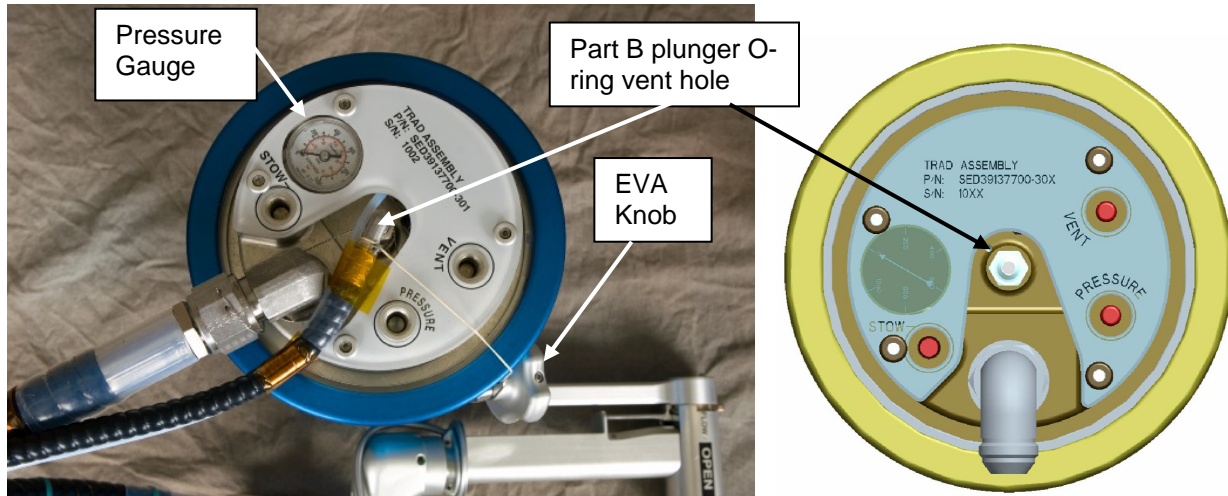

Figure 2.- T-RAD Cover Plate
(MLI not shown and eva knob not installed in photo)

NOTE

Do not place EVA knob in STOW port until end of EMU PREBREATHE prior to IV hatch closure on EVA day (provides an additional O-ring barrier to leakage)

WARNING

Do not put EVA knob in PRESSURE or VENT position as this could create a leak of A1100

13. Remove tape and foam from EVA knob, leave knob dangling on lanyard
14. Verify no leakage from STOW port
15. Verify pressure gauge reading 0 psi
16. Reinstall top MLI cover
17. If no leakage found, doff gloves and goggles
18. Transfer T-RAD and 5" nozzle to ISS A/L
19. Remove MLI from gun
20. Attach gun MLI to hose MLI Velcro and wrap around hose MLI (figure 3)
21. Verify temperature (via temp gauge) on back of gun in the green zone



Figure 3.- T-RAD and Gun MLI

22. Retrieve CDC from 10A Mesh Bag/Lg ORU Bag
23. Perform fit check of 5" nozzle to both ports on CDC
24. Report fit check results to MCC-H
25. Thread nozzle cw into gun body until threads bottom out (~7 turns total)
26. After ~5 turns lock pin will engage; will need to depress lock pin at least once and continue to rotate the nozzle cw to achieve full turn count (figure 4).
Suggest using RET PIP pin to depress lock pin
27. Rotate nozzle back ccw until lock pin engages

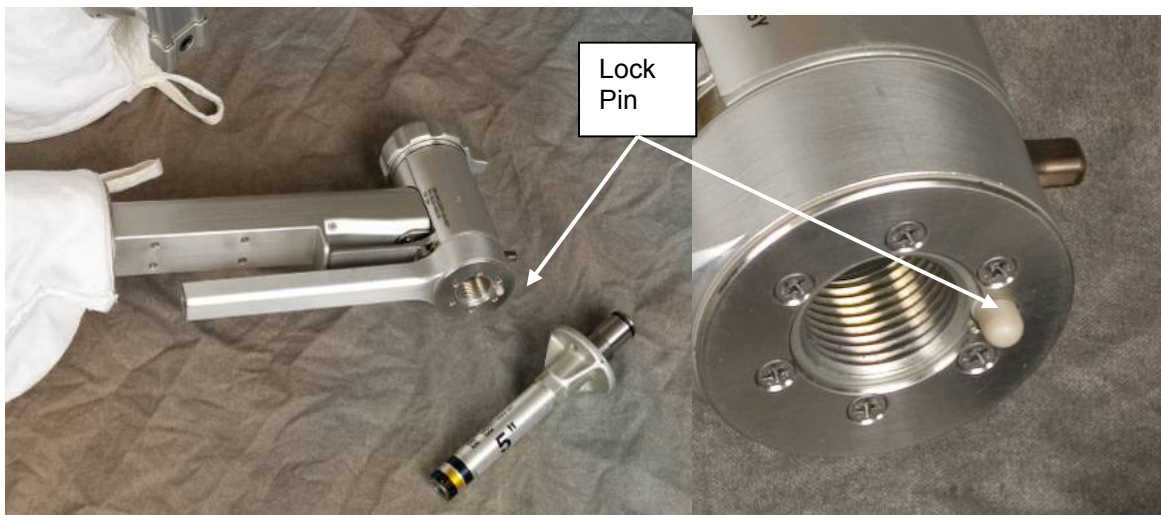

Figure 4.- Nozzle Installation

28. Verify emergency flow control knob on back of gun in OPEN position (figure 5)
29. Verify trigger safety in SAFE position
30. Re-install gun MLI
31. Stow T-RAD in Lg ORU bag
32. Stage gloves and goggles inside Airlock for day of EVA knob install

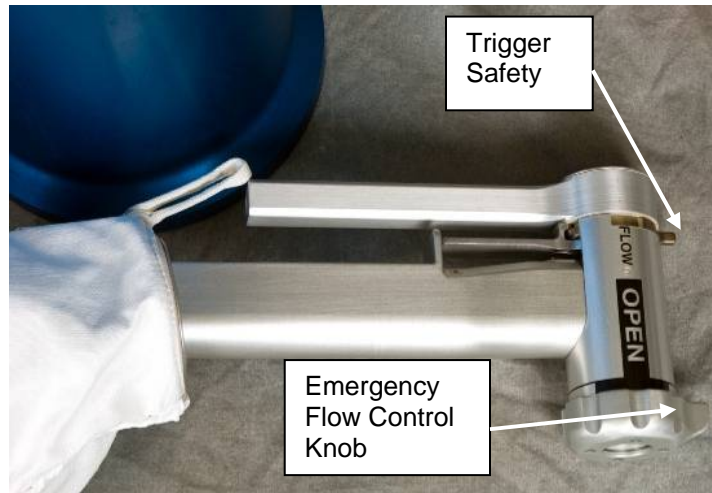

Figure 5.- Gun Nomenclature. Note that valve shown CLOSED in this photo (not correct configuration) and the nozzle not installed

TEMPERATURE SENSOR ASSEMBLY

- Temp Sensor
1. Retrieve Temperature Sensor and 3 AA Alkaline batteries from EVA TOOLS C mesh bag
 2. Main Power sw – OFF
 3. Peel back MLI and remove battery compartment lid by turning captive thumbscrew ccw 3 turns
 4. Install 3 AA Alkaline batteries into back of probe
 5. Reinstall battery compartment lid by turning thumbscrew cw 3 turns until finger tight
 6. Reinstall MLI flap over battery compartment
 7. Main Power sw – ON
 8. Open display MLI flap and probe tip MLI flap
 9. Push Display Wake button
 10. Verify display operational
 11. Using light contact onto wall or locker, depress ribbon until probe tip is in contact with surface
 12. When temp stabilizes, read temp, IV record _____ (expect ~21 degC)
 13. Verify clear RTV on tip of probe does not appear damaged (still intact)
 14. Close MLI flap over probe tip
 15. Main Power sw – OFF
 16. Close display flap; stow temp sensor in EVA TOOLS C mesh bag or Lg ORU Bag (if already packing)

1.0" FOAM BRUSH NETTING REMOVAL

1. Retrieve Gel/Foam Brush Caddy (-305) from EVA TOOLS C mesh bag
2. Retrieve scissors from EMU Servicing Kit

CAUTION

Avoid cutting or nicking the foam tip during netting removal operations

3. Use brush handle to remove a 1.0" foam tip from caddy (M-X side of caddy)
4. Use scissors to carefully cut netting from brush, cutting as close to the tip base as possible and attempting to minimize FOD
5. Reinsert foam tip into caddy
6. Repeat steps 3-5 for 3 additional foam tips, leaving a total of 4 1.0" foam tips without netting
7. Mark the exposed end of the remaining foam tip with intact netting to differentiate it from the others
8. Stow Gel/Foam Brush Caddy in EVA TOOLS C mesh bag or Lg ORU Bag (if already packing)
9. Stow scissors in EMU Servicing Kit

DTO SAMPLE BAG ASSEMBLY

I



Figure 1.- Launch configuration of DTO insert

1. Retrieve Sample Bag (containing DTO insert) from EVA TOOLS C mesh bag
2. Remove Tool Pedestals (3) from side of DTO insert; temp stow
3. Unfold DTO insert and assemble per figure 2

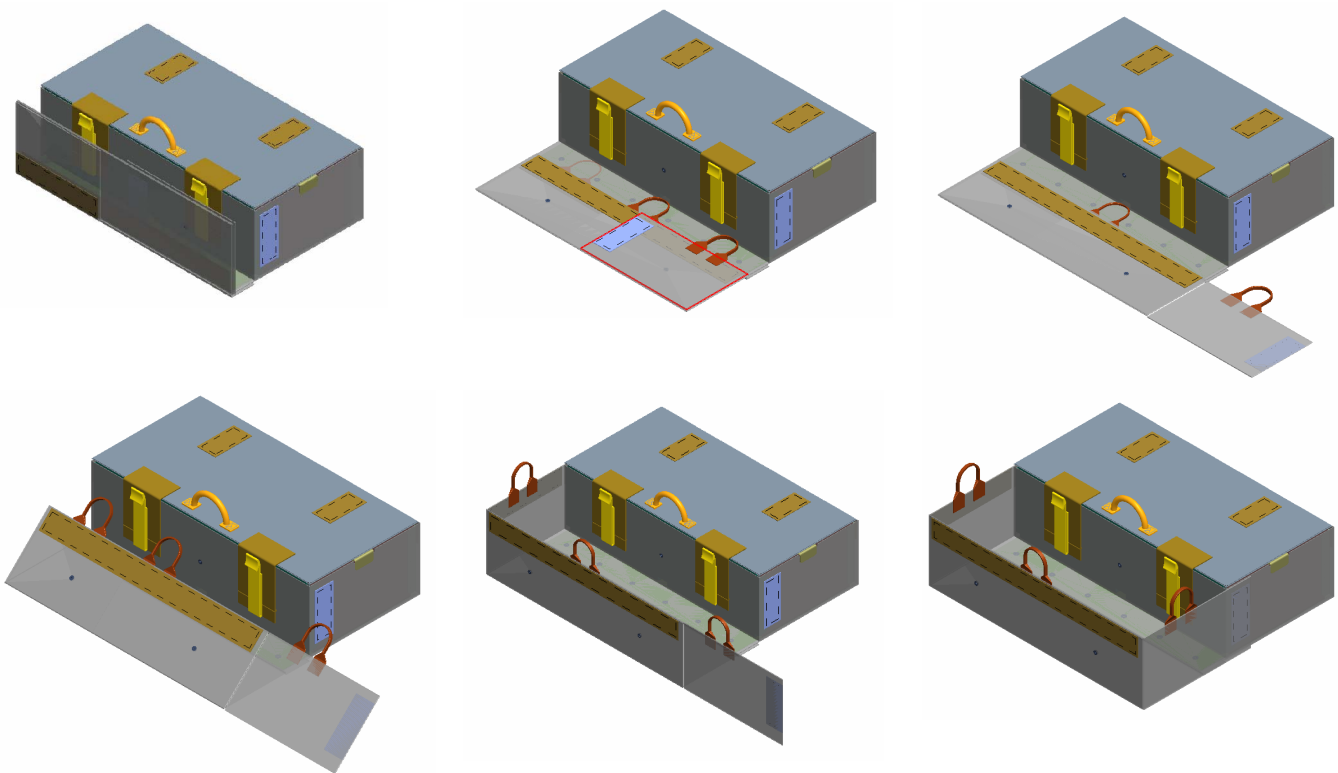

Figure 2.- Folding sequence of DTO insert (not shown in Sample Bag)

DTO SAMPLE BAG ASSEMBLY (Cont)

4. Install Tool Pedestals (3) using Velcro and snaps (2) on either side. All pedestals should angle in the same direction, with the high end on the left, per figure 3. Start snap with end closest to pedestal

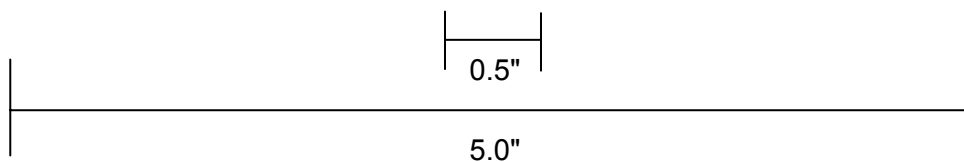

Figure 3.- Fully assembled Sample Bag with DTO insert

5. Verify Velcro mate around perimeter of DTO Insert
6. Attach Sample Bag corner equipment hooks (2) closest to tile strongbox hinge line to tether points of DTO Insert, per figure 3
7. Open tile strongbox lid and inspect tile samples. Notify MCC-H of any off-nominal conditions and/or damage to tile samples
8. Secure lid closed with Velcro on hood flap
9. Pack Sample bag with tools per the EVA 4 TOOL CONFIG

CIPA DISCARD CONTAINER (CDC) MARKING

1. Retrieve CDC from 10A Mesh Bag
2. Open scraper bin on CDC
3. Apply 2 pairs of lines spanning the width of the scraper bin, placing lines within pairs 0.5" apart (using template below)
4. Add tick marks on each line, 5" apart (using template below)
5. Stow CDC in EVA TOOLS C mesh bag or Lg ORU Bag (if already packing)



This Page Intentionally Blank

EMU MAINT/RECHARGE

WATER RECHARGE.....	TEMP FS 10-2
EMU POWERUP.....	TEMP FS 10-2
WATER FILL.....	TEMP FS 10-2
WATER FILL VERIFICATION.....	TEMP FS 10-2
EMU LiOH CHANGEOUT.....	10-4
MIDDECK EMU BATTERY RECHARGE (STAND-ALONE).....	10-4a
MIDDECK EMU BATTERY RECHARGE/LiOH REPLACEMENT.....	10-5
INITIATE.....	10-5
TERMINATE.....	10-6
IN-SUIT EMU BATTERY RECHARGE/CHARGE VERIFICATION.....	10-7
INITIATE.....	10-7
TERMINATE.....	10-7
EMU POWERDOWN.....	10-7
HELMET LIGHT/PGT BATTERY RECHARGE.....	10-8
INITIATE.....	10-8
TERMINATE.....	10-9
REBA BATTERY INSTALLATION.....	10-9
EMU BATTERY REMOVAL/INSTALL.....	10-10
HELMET LIGHT BULB CHANGEOUT.....	10-11
REBA BATTERY RECHARGE.....	10-12
INITIATE.....	10-12
TERMINATE.....	10-13
STS-120/10A CONSUMABLES TRACKING CUE CARD.....	FS CC 10-15
STS-120/10A BATTERY RECHARGE PLAN CUE CARD.....	FS CC 10-17

WATER RECHARGE

IF EMU NOT ALREADY POWERED UP:

EMU POWERUP

- BOTH DCM 1. Retrieve, position SCUs; remove DCM covers
 2. Connect SCUs to DCM, √locked
 3. PWR – BATT

CAUTION

EMU must be on BATT pwr when
 airlock pwr supply is turned on

- AW18H 4. PWR/BATT CHGR EMU 1,2 MODE (two) – PWR
 BUS SEL (two) – MNA(MNB)
 MD(flr) 5. √EMU O2 ISOL VLV – OP
 AW82B 6. EV1,2 O2 vlv (two) – OP
 DCM 7. PWR – SCU

WATER FILL

- MO13Q 8. √ARLK H2O S/O VLV – OPEN (tb-OP)
 R11L 9. √SPLY H2O TKA OUTLET – CL (tb-CL)

SM 60 TABLE MAINT

- CRT 10. Use TKB quantity:
 PARAM ID – ITEM 1 +0 6 2 0 4 2 0 EXEC
 11. Log value before recharge

Recharge #	H2O TKB %
1	
2	
3	
4	
5	

- AW82D 12. √EMU 1,2 H2O WASTE tb (two) – CL
 SPLY (two) – OP (tb-OP)
 13. √H2O TKB quantity decreasing

NOTE

Full charge requires ~15 min

WATER FILL VERIFICATION

- DCM 14. √STATUS: **H2O WP** 8-15 psi and stable for ~30 sec (indicates charging complete)

SM 60 TABLE MAINT

- CRT 15. Use TKB quantity:
 PARAM ID – ITEM 1 +0 6 2 0 4 2 0 EXEC
 16. Log value after recharge

Recharge #	H2O TKB %
1	
2	
3	
4	
5	

EMU MAINT/
 RECHARGE

Cont next page

TEMP FS 10-2

120

EVA/ALL/FIN A

TOP

HOOK
VELCRO

STS-120/10A CONSUMABLES TRACKING CUE CARD

HOOK
VELCRO

EV1 – Pz: EMU 3004
EV2 – Wo: EMU 3003

EV3 – Tn: EMU 3018
EV4 – Wt: EMU 3018

EV5 – Mk: EMU 3006

SAFER Usage: s/n 1004 and s/n 1006

	LiOH/Metox (s/n)	EMU Battery (s/n)	HL Battery (s/n)	REBA (s/n)	PGT Battery (s/n)	EVA Cameras	PWR (s/n)
Launched/ Landing	EV1: <u>s/n _____</u> (LiOH) EV2: <u>s/n _____</u> (LiOH) Record s/n	EV1: <u>s/n 2039</u> EV2: <u>s/n 2040</u>					
EVA 1 – FD 4	Metox for Campout/10.2 <u>s/n 0007,0011</u> Spare Metox: <u>s/n 0020,0021</u> EV1: <u>s/n _____</u> (LiOH)- launched EV2: <u>s/n _____</u> (LiOH)- launched	EV1: <u>s/n 2038</u> EV2: <u>s/n 2041</u>	EV1: <u>s/n 1011,1012</u> EV2: <u>s/n 1013,1014</u>	EV1: <u>s/n 1003</u> EV2: <u>s/n 1004</u>	EV1: <u>s/n 1004</u> EV2: <u>s/n 1005</u> (<u>s/n 1008</u> in spare PGT in C-Lk Staging Bag)	EV1: <u>s/n 1010</u> Address 16 EV2: <u>s/n 1007</u> Address 18	
Post EVA 1 – FD 4	Regen <u>s/n 0007,0011</u>	No EMU Battery charging	Recharge EVA 1 Batts in BSA	Recharge EVA 1 Batts from BSA	Recharge EVA 1 Batts in BSA		Fill w/PWRs in this order: <u>s/n 1026,1027,1023</u> Dump to CWC <u>s/n 1059</u>
FD5		EVA 1 EMU Batts (<u>s/n 2038,2041</u>) in BSA					
EVA 2 – FD 6	Metox for Campout/10.2 <u>s/n 0012,0013</u> Spare Metox: <u>s/n 0020,0021</u> EV1: <u>s/n 0015</u> (Mtx) EV3: <u>s/n 0016</u> (Mtx)	EV1: <u>s/n 2063</u> EV3: <u>s/n 2077</u>	EV1: <u>s/n 1015,1017</u> EV3: <u>s/n 1019,1021</u>	EV1: <u>s/n 1003</u> EV3: <u>s/n 1011</u>	EV1: <u>s/n 1006</u> EV3: <u>s/n 1009</u> (<u>s/n 1008</u> in spare PGT in C-Lk Staging Bag)	EV1: <u>s/n 1010</u> Address 16 EV3: <u>s/n 1007</u> Address 18	
Post EVA 2 – FD 6	Regen <u>s/n 0012,0013</u>	No EMU Battery charging	Recharge EVA 2 Batts in BSA	Recharge EVA 2 Batts from BSA	Recharge EVA 2 Batts in BSA		Fill w/PWRs in this order: <u>s/n 1026,1027,1023</u> Dump to CWC <u>s/n 1059</u>
FD 7		EVA 2 EMU Batts (<u>s/n 2063,2077</u>) in BSA					
EVA 3 – FD 8	Metox for Campout/10.2 <u>s/n 0017,0019</u> Spare Metox: <u>s/n 0020,0021</u> EV1: <u>s/n _____</u> (LiOH) EV2: <u>s/n _____</u> (LiOH) LiOH in 'EVA Systems 1'	EV1: <u>s/n 2038</u> EV2: <u>s/n 2041</u>	EV1: <u>s/n 1011,1012</u> EV2: <u>s/n 1013,1014</u>	EV1: <u>s/n 1003</u> EV2: <u>s/n 1004</u>	EV1: <u>s/n 1004</u> EV2: <u>s/n 1005</u> (<u>s/n 1008</u> in spare PGT in C-Lk Staging Bag)	EV1: <u>s/n 1010</u> Address 16 EV2: <u>s/n 1007</u> Address 18	

EVA-5a/120/O/A

(reduced copy)

TOP
BACK OF 'STS-120/10A CONSUMABLES TRACKING CUE CARD'

HOOK
VELCRO

STS-120/10A CONSUMABLES TRACKING CUE CARD (Cont)

HOOK
VELCRO

	LiOH/Metox (s/n)	EMU Battery (s/n)	HL Battery (s/n)	REBA (s/n)	PGT Battery (s/n)	EVA Cameras	PWR (s/n)
Post EVA 3 – FD 8	Regen <u>s/n 0017.0019</u>	No EMU Battery Charging	Recharge EVA 3 Batts in BSA	Recharge EVA 3 Batts from BSA	Recharge EVA 3 Batts from BSA		Fill w/PWRs in this order: <u>s/n 1026,1027,1023</u> Dump to CWC <u>s/n 1059</u>
EVA 4 – FD 10	Metox for Campout/10.2 <u>s/n 0007,0011</u> Spare Metox: <u>s/n 0020,0021</u> EV1: <u>s/n 0012</u> (Mtx) EV2: <u>s/n 0013</u> (Mtx)	EV1: <u>s/n 2039</u> EV2: <u>s/n 2040</u>	EV1: <u>s/n 1015,1017</u> EV2: <u>s/n 1019,1021</u>	EV1: <u>s/n 1003</u> EV2: <u>s/n 1004</u>	EV1: <u>s/n 1006</u> EV2: <u>s/n 1009</u> (<u>s/n 1008</u> in spare PGT in C-Lk Staging Bag)	EV1: <u>s/n 1010</u> Address 16 EV2: <u>s/n 1007</u> Address 18	
Post EVA 4 – FD 10	No Metox Regens						Fill w/PWRs in this order: <u>s/n 1026,1027,1023</u> Dump to CWC <u>s/n 1059</u>
EVA 5 – FD 11	Metox for Campout/10.2 <u>s/n 0017,0019</u> Spare LiOH: <u>s/n 2014,2017</u> in 'EVA Systems 2' Mesh Bag EV3: <u>s/n 0020</u> (Mtx) EV4: <u>s/n 0021</u> (Mtx) (Metox has been spare in E-Lk)	EV4: <u>s/n 2077</u> EV5: <u>s/n 2063</u>	EV4: <u>s/n 1011,1012</u> EV5: <u>s/n 1013,1014</u>	EV4: <u>s/n 1011</u> EV5: <u>s/n 1005</u>	EV4: <u>s/n 1004</u> EV5: <u>s/n 1005</u> (<u>s/n 1008</u> in spare PGT in C-Lk Staging Bag)	EV4: <u>s/n 1010</u> Address 16 EV5: <u>s/n 1007</u> Address 18	
FD 11 (During EVA 5)		EVA 4 EMU Batts (<u>s/n 2039,2040</u>) in BSA **Will be placed in EMUs for Landing**					
Post EVA 5 – FD 11	Regen <u>s/n 0017,0019</u>						Fill w/PWRs in this order: <u>s/n 1026,1027,1023</u> Dump to CWC <u>s/n 1059</u>

EVA-5b/120/O/A

(reduced copy)

FS CC 10-16

EVA/120/FIN A

TOP

HOOK
VELCRO

STS-120/10A BATTERY RECHARGE PLAN CUE CARD

HOOK
VELCRO

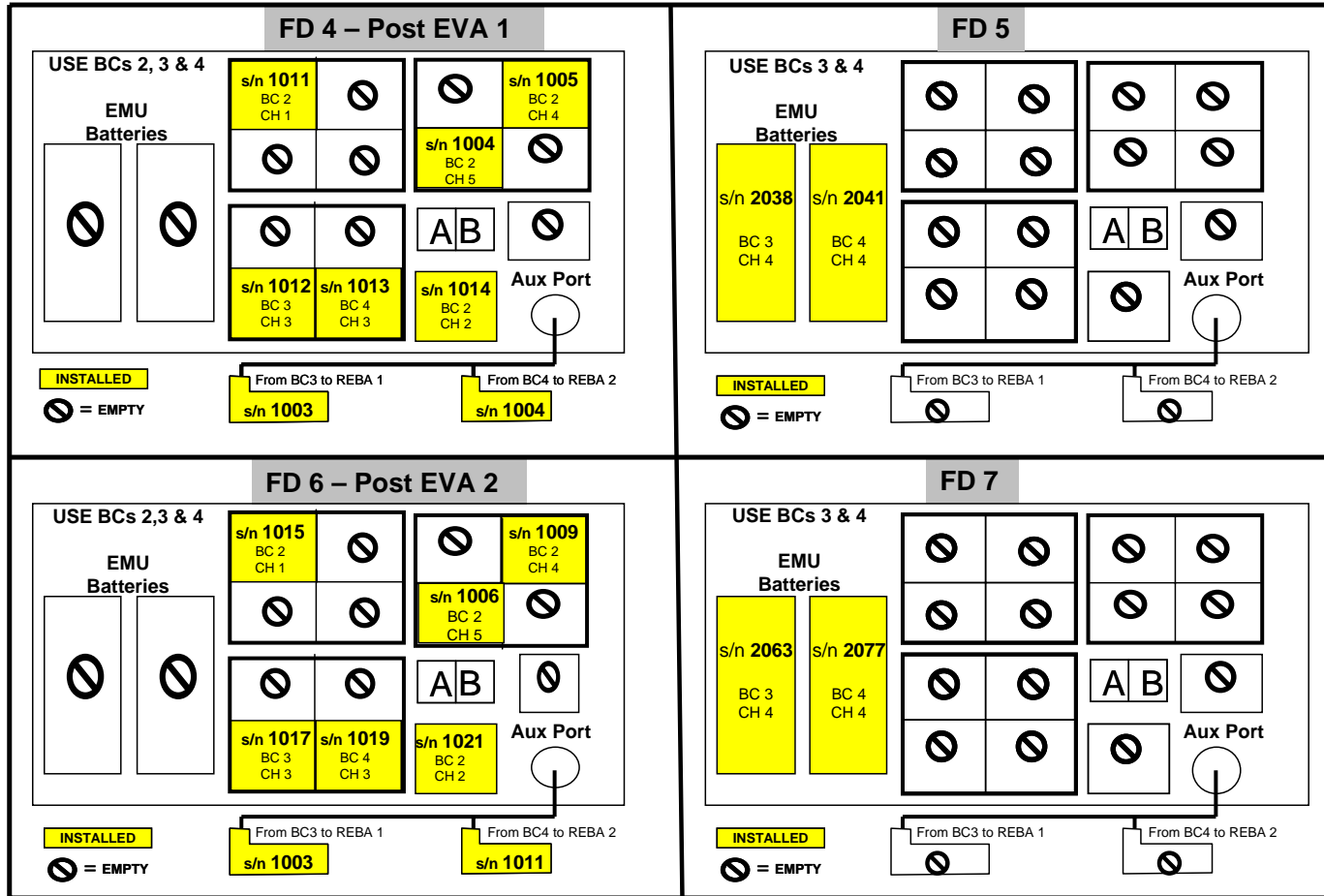

EVA-6a/120/O/A

(reduced copy)

TOP
 BACK OF 'STS-120/10A BATTERY RECHARGE PLAN CUE CARD'

HOOK
VELCRO

STS-120/10A BATTERY RECHARGE PLAN CUE CARD (Cont)

HOOK
VELCRO

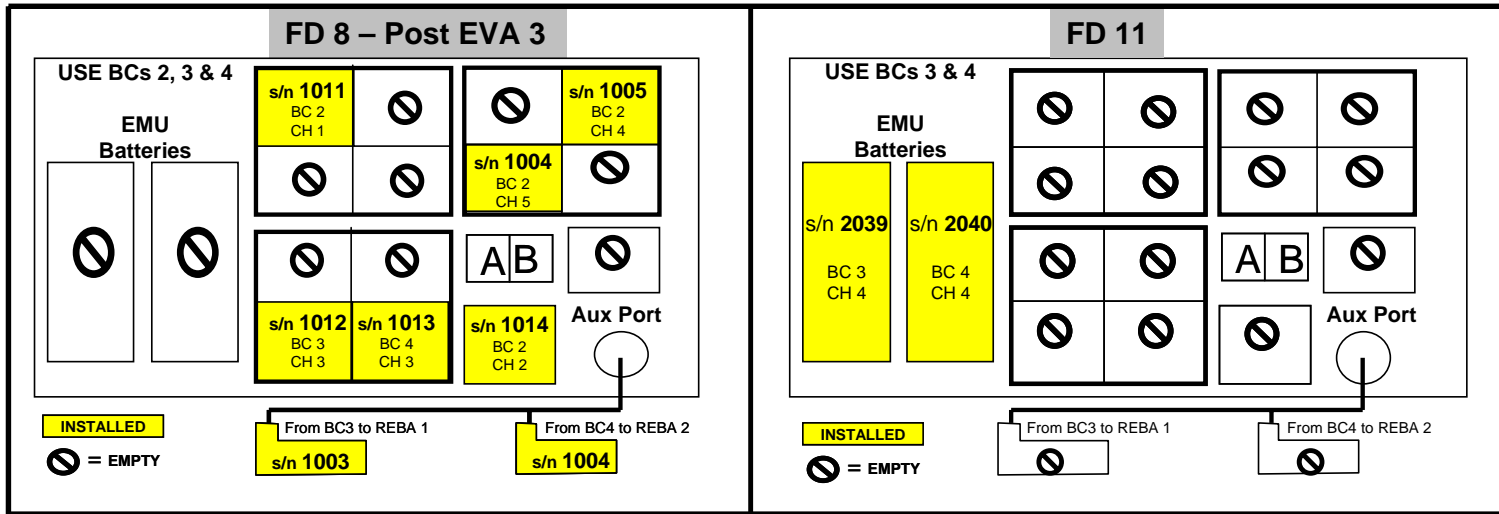

EVA-6b/120/O/A

(reduced copy)

EMU CONTINGENCY PROCS

DISPLAY LOSS DURING POWER TRANSFER (WARM RESTART).....	TEMP FS	12-2
VACUUM H2O RECHARGE (MANNED).....	TEMP FS	12-2
LiOH REPLACEMENT (MANNED).....		12-3
BATTERY REPLACEMENT (MANNED)		12-4
WATER DUMP		12-6
SCU SWAP (UNMANNED).....		12-7
SCU SWAP (MANNED).....		12-7
EMU COLD RESTART (MANNED)		12-7
12.1 STS EVA DECONTAMINATION.....		12-8
CONTAMINATION TEST.....		12-15
SAFER BATTERY CHANGEOUT		12-18
BENDS TREATMENT ADAPTER (BTA) INSTALLATION (IN-SUIT)		12-19
BTA PREP		12-19
BTA TREATMENT		12-19
BENDS TREATMENT ADAPTER (BTA) INSTALLATION (POST SUIT DOFFING).....		12-21
BTA PREP		12-21
BTA TREATMENT		12-21
EMU RESIZE		12-24
EMU CONTINGENCY RESIZE MATRIX (STS-120/10A).....	FS	12-27
EMU NOMINAL SIZING (STS-120/10A).....	FS	12-29
EVA 2 EMU RESIZE FOR Tn.....	FS	12-30
EVA 5 EMU RESIZE FOR Wt AND Mk	FS	12-32
EMERGENCY UNDOCKING CUE CARD	FS CC	12-35

EMU CONT
PROCS

DISPLAY LOSS DURING POWER TRANSFER (WARM RESTART)

- DCM If PWR – BATT and SCU connected:
 AW18H 1. √PWR/BATT CHGR EMU 1(2) BUS SEL – OFF
 DCM If PWR – SCU:
 2. PWR – BATT
 AW18H 3. PWR/BATT CHGR EMU 1(2) BUS SEL – OFF

WARNING
 Fan will be off from steps 4 to 9 during which time CO2 buildup is a concern

NOTE

Affected EMU will be without comm after step 6. Steps 6 and 7 should be read together before step 6 is performed

- DCM 4. FAN – OFF (expect FAN SW OFF msg, DISP – PRO)
 IV 5. Inform affected EV crewmember of impending comm loss
 DCM 6. PWR – SCU (7 sec)
 7. PWR – BATT
 When power restart complete:
 8. √Display – O2 POS XX, expect FAN SW OFF msg, DISP – PRO
 9. As reqd, FAN – ON
 If display blank or locked up:
 10. Contact MCC
 If SCU power desired:
 11. √SCU connected to DCM
 AW18H 12. PWR/BATT CHGR EMU 1(2) MODE – PWR
 BUS SEL – MNA(MNB)
 13. √EMU INPUT 1(2) Volts = 18.0 – 20.0
 DCM 14. PWR – SCU
 DCM 15. √Display – O2 POS XX

VACUUM H2O RECHARGE (MANNED)

WARNING
 Procedure should be used only if performing a contingency EVA

- EV 1. Perform AIRLOCK INGRESS, Cuff C/L, 30 (Close hatch, partially engage latches)
 2. √Helmet purge vlv – cl, locked
 DCM 3. √PURGE vlv – cl (dn)
 4. √WATER – OFF
 IV MO13Q 5. √ARLK H2O S/O VLV – OPEN (tb-OP)
 MD(flr) 6. √EMU O2 ISOL VLV – OP
 ML86B:C 7. √cb MNC EXT ARLK HTR LINE ZN 1,2 (two) – op
 AW82B 8. √EV-1(EV-2) O2 vlv – OP
 EV AW18H 9. PWR/BATT CHGR EMU 1(2) BUS SEL – MNA(MNB)
 DCM 10. PWR – SCU (fwd), WARN TONE
 IV R11L If SPLY H2O XOVR VLV closed (tb-CL or bp) (water transfer config):
 11. SPLY H2O TKA OUTLET – CL (tb-CL)
 If SPLY H2O XOVR VLV open (tb-OP) (nominal config):
 L1 12. √RAD CNTLR OUT TEMP – NORM
 13. √FLASH EVAP CNTLR PRI A,B (two) – OFF
 ML31C 14. SPLY H2O TKD OUTLET – CL (tb-CL)
 R11L 15. SPLY H2O TKB OUTLET – CL (tb-CL)
 √TKA OUTLET – CL (tb-CL)
 TKC INLET – CL (tb-CL)
 TKC OUTLET – OP (tb-OP)

EMU CONTINGENCY RESIZE MATRIX (STS-120/10A)

1

FOR LOSS OF:	EV1 – Parazynski	EV2 – Wheelock	EV3 – Tani	EV4 – Whitson	EV5 – Malenchenko
HUT/PLSS	Use Large HUT s/n 3006 from ISS 1. Remove gloves/lower arms/arm rings 2. Use prime Pz gloves/arms/arm rings 3. √Arm red disconnect to right, √locks, √cams 4. Use prime Pz LTA 5. Swap EMU PLSS identifier stripes, mission patch, and national flag	Use XL HUT s/n 3008 from ISS 1. Remove gloves/lower arms/arm rings 2. Use prime Wo gloves/arms/arm rings 3. √Arm red disconnect to right, √locks, √cams 4. Use prime Wo LTA 5. Swap EMU PLSS identifier stripes, mission patch, and national flag	Use L HUT s/n 3006 from ISS 1. Remove gloves/lower arms 2. Use prime Tn gloves 3. Use size 02 lower arms s/n 214(R) and 213(L) from ISS, cams S/L 4. Use 0.5 arm ring s/n 150(R) and 149(L) from ISS 5. √Arm red disconnect to right, √locks, √cams 6. Use prime Tn LTA 7. Swap EMU PLSS identifier stripes, mission patch, and national flag	Use Large HUT s/n 3004 transferred from shuttle 1. Remove gloves/lower arms/arm rings 2. Use prime Wt gloves/arms/no arm rings 3. √Arm red disconnect to right, √locks, √cams 4. Use prime Wt waist brief/leg 5. Use 1.0 leg sizing ring s/n 118 (R) and s/n 117(L) on ISS 6. Use 02 boots s/n 213 on ISS with 02 BSI installed with toe cap 7. Swap EMU PLSS identifier stripes, mission patch, and national flag	Use Large HUT s/n 3004 transferred from shuttle 1. Remove gloves/lower arms/arm rings 2. Use prime Mk gloves/arms/arm rings 3. √Arm red disconnect to right, √locks, √cams 4. Use prime Mk LTA Swap EMU PLSS identifier stripes, mission patch, and national flag
CCA	Use size 05/323 CCA s/n 1166 from Pz ECOK	Use size 04/327 CCA s/n 1183 from Wo ECOK	Use size 05/323 CCA s/n 1166 from Pz ECOK	Use size 01/327 CCA s/n 1195 from Wt ECOK	Use size 03/321 CCA s/n 1179 from Mk ECOK
Lower Arm Segment	Use size 05 lower arm s/n 164(R) or s/n 163(L) from ISS (red = right, blue = left). Cams S/L 1. Use prime Pz gloves 2. √Locks, √cams	Use size 02 lower arm s/n 320(R) or s/n 319(L) from ISS (red = right, blue = left). Cams S/L 1. Use prime Wo gloves 2. √Locks, √cams	Use size 03 lower arm s/n 218(R) or s/n 217(L) from ISS (red = right, blue = left). Cams S/L 1. Use prime Tn gloves 2. √Locks, √cams	Use size 00 lower arm s/n 265 (R) or s/n 266(L) transferred from 'EVA Systems 3' bag (red = right, blue = left). Cams L/L 1. Use prime Wt gloves 2. √Locks, √cams	Use size 02 lower arm s/n 320 (R) or s/n 319(L) from ISS (red = right, blue = left). Cams L/L 1. Use prime Mk gloves 2. √Locks, √cams
Gloves	1 st Back-up: Use 6PZ gloves s/n 6268 from Pz ECOK 2 nd Back-up: Use 6PZ gloves s/n 6245 from Middeck Floor Port 1 (Bag A)	1 st Back-up: Use 6PZ gloves s/n 6193 from Wo ECOK 1. Adjust arm cams to Long/Long 2 nd Back-up: Use 6Pz gloves s/n 6245 from Middeck Floor Port 1 (Bag A)	1 st Back-up: Use 6TS gloves s/n 6132 from Tn ECOK 2 nd Back-up: Use 6WS gloves s/n 6229 'EVA Systems 2' mesh bag 1. Adjust arm cams to Short/Short	1 st Back-up: Use 6WT gloves s/n 6114 from Wt ECOK 2 nd Back-up: Use 6RH gloves s/n 6244 'EVA Systems 3' mesh bag 1. Adjust arm cams to Short/Long	Use 6MA gloves s/n 6140 from Mk ECOK 1. Adjust arm cams to Short/Long
Waist Brief	Use size 02 waist brief s/n 2041 (005) from 'EVA Systems 2' bag. Cams S/L 1. Use prime Pz legs/leg rings/boots 2. √Locks, √cams 3. Swap EMU brief identifier stripes	Use size 02 waist brief s/n 2056 (024) from ISS. Cams S/S 1. Use prime Wo legs/leg rings/boots 2. √Locks, √cams Swap EMU brief identifier stripes	Use size 02 waist brief s/n 2041 (005) from 'EVA Systems 2' bag. Cams S/L 1. Use prime Tn legs/leg rings/boots 2. √Locks, √cams Swap EMU brief identifier stripes	Use size 01 waist brief s/n 2081 (018) from ISS. Cams S/S 1. Use prime Wt legs/leg rings/boots 2. √Locks, √cams Swap EMU brief identifier stripes	Use size 01 waist brief s/n 2081 (018) from ISS. Cams S/L 1. Use prime Mk legs/leg rings/boots 2. √Locks, √cams Swap EMU brief identifier stripes

EMU CONTINGENCY RESIZE MATRIX (STS-120/10A) (Cont)

FOR LOSS OF:	EV1 – Parazynski	EV2 – Wheelock	EV3 – Tani	EV4 – Whitson	EV5 – Malenchenko
Leg Segment	Use size 03 leg s/n 162(R) or 161(L) from ISS. Cams S/L 1. Use prime waist brief/leg rings/boots 2. √Locks, √cams	Use size 03 leg s/n 162(R) or 161(L) from ISS. Cams S/L 1. Use prime waist brief/leg rings/boots 2. √Locks, √cams	Use size 01 leg s/n 149 from ISS. Cams S/L 1. Use prime waist brief/leg rings/boots 2. √Locks, √cams	Use size 01 leg s/n 149 from ISS. Cams S/L 1. Use prime waist brief/leg & thigh rings/boots 2. √Locks, √cams	Use size 02 leg s/n 157 from 'EVA Systems 3' bag. Cams S/L 1. Use prime waist brief/leg rings/boots 2. √Locks, √cams
Boot	Use size 02 boots s/n 213 from ISS 1. Remove BSI/Toe Caps 2. Use prime waist brief/legs/leg rings 3. √Locks	Use size 02 boots s/n 213 from ISS 1. Remove BSI/Toe Caps 2. Use prime waist brief/legs/leg rings 3. √Locks	Use size 02 boots s/n 213 from ISS. No BSI/Toe Cap Installed 1. Use prime waist brief/legs/leg rings 2. √Locks	Use size 01 boots s/n 221 from 'EVA Systems 3' bag 1. Remove BSI/Toe Cap 2. Use prime waist brief/legs/leg rings 3. √Locks	Use size 02 boots s/n 213 from ISS. 03 BSI/Toe Cap Installed 1. Use prime waist brief/legs/leg rings 2. √Locks
Sizing Rings	<ul style="list-style-type: none"> • <u>1.5 Leg</u>: Use s/n 138(R) or 137 (L) from ISS 	<ul style="list-style-type: none"> • <u>0.5 arm</u>: Use s/n 121(R) or 120(L) from ISS • <u>0.5 Leg</u>: Use s/n 119(R) or 118 (L) from ISS 	<ul style="list-style-type: none"> • <u>1.0 Leg</u>: Use s/n 118(R) or 117(L) from ISS 	<ul style="list-style-type: none"> • <u>0.5 arm</u>: Use s/n 121(R) or 120(L) from ISS • <u>0.5 thigh</u>: Use s/n 115(R) or 116(L) from 'EVA Systems 3' bag • <u>1.5 Leg</u>: Use s/n 129(R) or 130 (L) transferred 'EVA Systems 3' bag 	<ul style="list-style-type: none"> • <u>0.5 arm</u>: Use s/n 121(R) or 120(L) from ISS • <u>0.5 Leg</u>: No sizing rings; Use prime 02 legs change cams to L/L
LCVG	Use backup LCVG s/n 3206 from middeck 1. Transfer biomed, dosimeter	Use backup LCVG s/n 3206 from middeck 1. Transfer biomed, dosimeter	Use backup LCVG s/n 3160 from 'EVA Systems 2' bag 1. Transfer biomed, dosimeter	Use backup LCVG s/n 3191 from ISS. Needs to be filled 1. Transfer biomed, dosimeter	Use backup LCVG s/n 3203 from ISS. Needs to be filled 1. Transfer biomed, dosimeter

EMU NOMINAL SIZING (STS-120/10A)

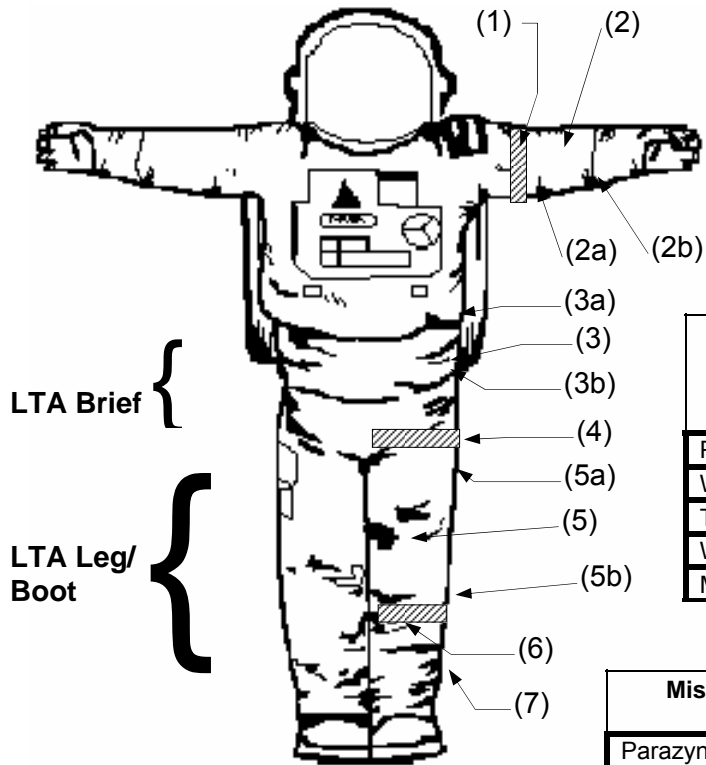

SEMU	(1) Arm Sizing Ring	(2a) Arm Cam	(2) Lower Arm	(2b) Wrist Cam	HUT
Parazynski (3004)	--	Short	05	Long	L (03)
Wheelock (3003)	0.5	Short	02	Long	XL (04)
Tani (3018)	--	Short	03	Long	M (02)
Whitson (3018)	0.5	Long	00	Long	M(02)
Malenchenko (3006)	0.5	Long	02	Long	L(03)

LTA	(3a) Brief Upper Cam	(3) Adjust Waist Brief	(3b) Brief Lower Cam	(4) Thigh Sizing Ring	(5a) Thigh Cam	(5) Leg Segment	(5b) Leg Cam	(6) Leg Sizing Ring	(7) Boot/ Insert-Type
Parazynski	Short	02	Long	--	Short	03	Long	1.5	02/NO BSI
Wheelock	Short	02	Short	--	Short	03	Long	.5	02/NO BSI
Tani	Short	02	Long	--	Short	01	Long	1.0	02/NO BSI
Whitson	Short	01	Short	0.5	Short	01	Long	1.5	01/NO BSI
Malenchenko	Short	01	Long	--	Short	02	Long	.5	02/03 BSI

Misc	LCVG/ BLVD	TCU top/ Bottom/MAG	Prime Gloves/ s/n	b/u Gloves/ s/n	CCA/ CCEM	Valsalva	Fresnel Lens (diopters)
Parazynski	06/05	L/L/711	6PZ/6248	6PZ/6268	05/323	Modified	1.5 (two)
Wheelock	05/05	L/M/709	6PZ/6068	6PZ/6193	04/327	Modified	1.5/6.0
Tani	04/04	S/M/709	6TS/6130	6TS/6132	05/321	Original	--
Whitson	01/03	S/L/709	6WT/6115	6WT/6114	01/327	Original	4.0
Malenchenko	04/05	M/M/709	6MA/6196	6MA/6140	03/321	Original	3.0 (two)

EVA 2 EMU RESIZE FOR Tn (20 min)

NOTE

This procedure assumes EMU SWAP for EVA 2 has been completed for EMU 3018 (Tn)

1. Remove Helmet (s/n 1067) from EMU 3018 (Tn); temp stow
2. Retrieve Tn 1 CCA (s/n 1205) from Tn ECOK, connect to EMU 3018 (Tn) Electrical Harness
3. Install Helmet (s/n 1067) onto EMU 3018 (Tn). Verify sunshades down, visors up. Install cover
4. Remove Wrist Disconnect Covers and stow in 'EVA Systems 3' mesh bag
5. Retrieve ISS EVA Cuff Checklist from 'EVA Systems 1' mesh bag and install on left arm
6. Retrieve Tn 1 Gloves (s/n 6130) from Tn ECOK; install on EMU 3018 (Tn)
7. Retrieve Wrist Mirrors (2) from 'EVA Systems 3' mesh bag, install on EMU 3018 (Tn)
8. Remove Boots (s/n 215) and Leg Sizing Rings (s/n 142 and 143) from EMU 3018 (Tn); temp stow
9. Remove Legs (s/n 185 and 186) from EMU 3018 (Tn); stow in 'EVA Systems 3' mesh bag
10. Retrieve Tn Legs (s/n 183 and 184) from Tn ECOK, install on EMU 3018 (Tn)
11. Install Leg Sizing Rings (s/n 142 and 143) and Boots (s/n 215) on EMU 3018 (Tn)
12. Retrieve STS-120 mission patch, dashed ID stripes, and USA flag from Tn ECOK, install on EMU
13. Prepare comfort gloves
14. Verify cam configurations per EMU NOMINAL SIZING (STS-120/10A) (EMU CONT PROCS)
Refer to figures 1-3 for reference to cam adjustments

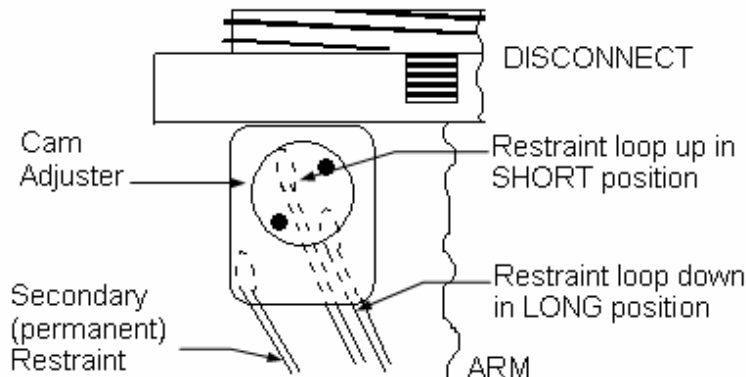

Figure 1.- Arm Cam Adjustment (0.25 inch per cam).

NOTE

Cam Adjuster rotates in only one direction.

Cam Adjuster should click and lock in the full SHORT and full LONG positions.

Cam positions/arms must be symmetric;
likely minimum of four cams to be adjusted

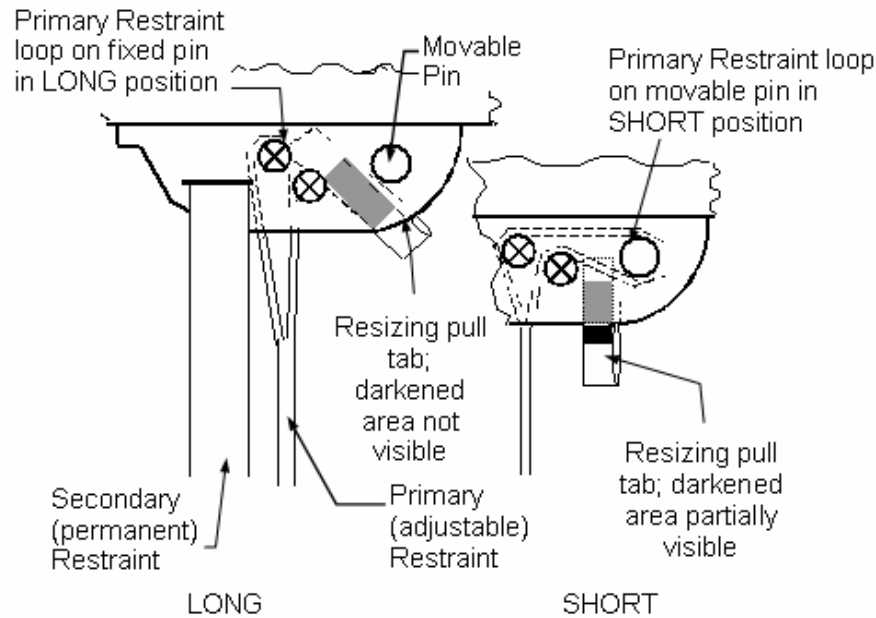

Figure 2.- Waist Cam adjustment (1.0 inch per cam).

NOTE

After adjusting, verify restraint is routed around proper pin; material is not damaged, twisted, or pinched; and the movable pin is fully inserted.

With restraint in LONG position, the darkened area on resizing pull tab should not be easily visible.

With restraint in SHORT position, the darkened area on resizing pull tab should be easily visible.

Cam positions must be symmetric; minimum of two cams to be adjusted

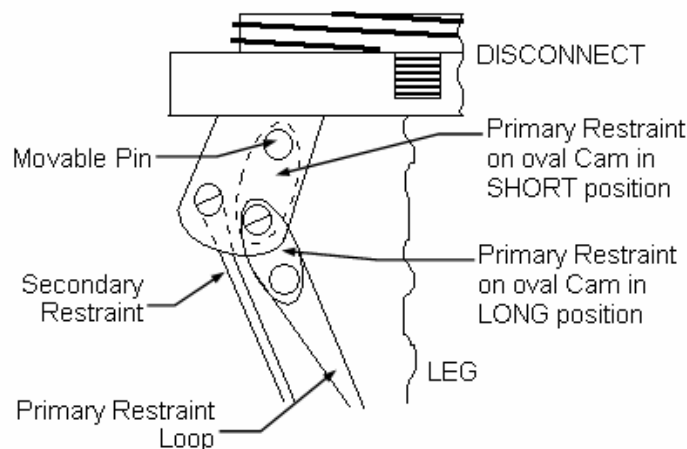

Figure 3.- Leg Cam Adjustment (0.5 inch per cam).

NOTE

After adjusting, verify restraint is routed around the oval cam; material is not damaged, twisted, or pinched; and the movable pin is fully inserted.

Cam positions/legs must be symmetric; likely minimum of four cams to be adjusted

EVA 5 EMU RESIZE FOR Wt AND Mk (60 min)

NOTE

EMU 3018 will be sized from Tn to Wt. EMU 3008 is a spare EMU that has Wt hardware stowed on it. EMU 3006 is sized for Mk

1. Remove Helmet Lights and EMU TV assembly; temp stow, as required for EVA 3 (will be installed on EMU 3003 (Wo))
2. Remove Helmet (s/n 1067) from EMU 3018 (Tn); temp stow
3. Disconnect TN 1 CCA (s/n 1205) from EMU 3018 Electrical Harness; stow in Tn ECOK
4. Remove Wrist Mirrors (2) from EMU 3018 (Tn); temp stow
5. Remove Tn 1 Gloves (s/n 6130) and ISS EVA Cuff Checklist from EMU 3018 (Tn), stow in Tn ECOK
6. Remove Lower Arms (s/n 219 and 220) from EMU 3018 (Tn); stow in Tn ECOK
7. Remove complete LTA (s/n 2056; waist 024) from EMU 3018 (Tn) (including Waist Brief, Legs, Sizing Rings, and Boots); temp stow
8. Remove STS-120 mission patch, dashed ID stripes, and USA flag; stow in Tn ECOK
9. Retrieve WT 1 CCA (s/n 1174) from Wt ECOK, connect to EMU 3018 (Wt) Electrical Harness
10. Retrieve Helmet (s/n 1070) from EMU 3008 (spare) and install helmet on EMU 3018 (Wt)
11. Install Helmet (s/n 1067) on EMU 3008 (spare). Verify sunshades down, visors up. Install cover
12. Retrieve Arm Rings (s/n 167 and 168) and Lower Arms (s/n 261 and 262) that were prestaged with EMU 3008 (spare) and install on EMU 3018 (Wt)
13. Retrieve Wt 1 Gloves (s/n 6115) from Wt ECOK; install on EMU 3018 (Wt)
14. Install Wrist Mirrors (2) on EMU 3018 (Wt)
15. Retrieve complete LTA (s/n 2053; waist 021) from EMU 3008 (spare) (including Waist Brief, Leg Assembly, Sizing Rings, and Boots); install on EMU 3018 (Wt)
16. Install complete LTA (s/n 2056; waist 024) on EMU 3008 (spare) (including Waist Brief, Leg Assembly, Sizing Rings, and Boots)
17. Retrieve USA flag, Inc 16 patch, and red ID stripes from Wt Stage #1 bag in WT ECOK; install on EMU 3018 (Wt)
18. Retrieve candycane ID stripes from the 'EVA Systems 3' mesh bag, install on EMU 3018 (Wt) and 3006 (Mk)
19. Retrieve ISS EVA Cuff Checklists from 'EVA Systems 1' mesh bag and install on left arm of EMU 3018 (Wt) and 3006 (Mk)
20. Retrieve wrist mirrors (2) from 'EVA Systems 3' mesh bag and install on EMU 3006 (Mk)
21. Retrieve Wt prime LCVG (s/n 3197) and Mk prime LCVG (s/n 3202) from 'EVA Systems 3' mesh bag and stow in Wt and Mk ECOKs
22. Retrieve Wt backup CCA (s/n 1195) and Mk backup CCA (s/n 1178) from 'EVA Systems 3' mesh bag and stow in Wt and Mk ECOKs
23. Verify cam configurations per EMU NOMINAL SIZING (STS-120/10A) (EMU CONT PROCS)
Refer to figures 1-3 for reference to cam adjustments

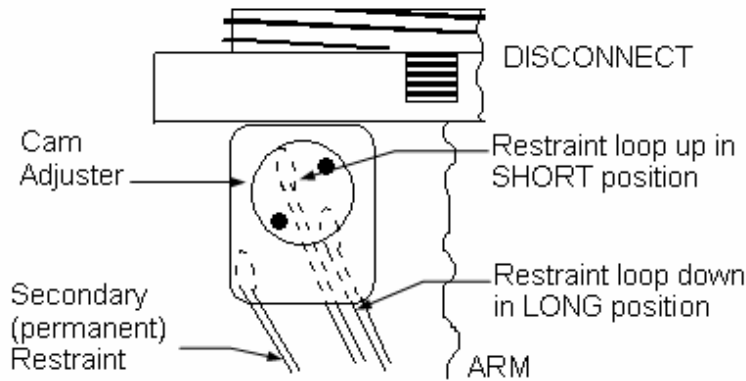

Figure 1.- Arm Cam Adjustment (0.25 inch per cam).

NOTE

Cam Adjuster rotates in only one direction.

Cam Adjuster should click and lock in the full SHORT and full LONG positions.

Cam positions/arms must be symmetric;
likely minimum of four cams to be adjusted

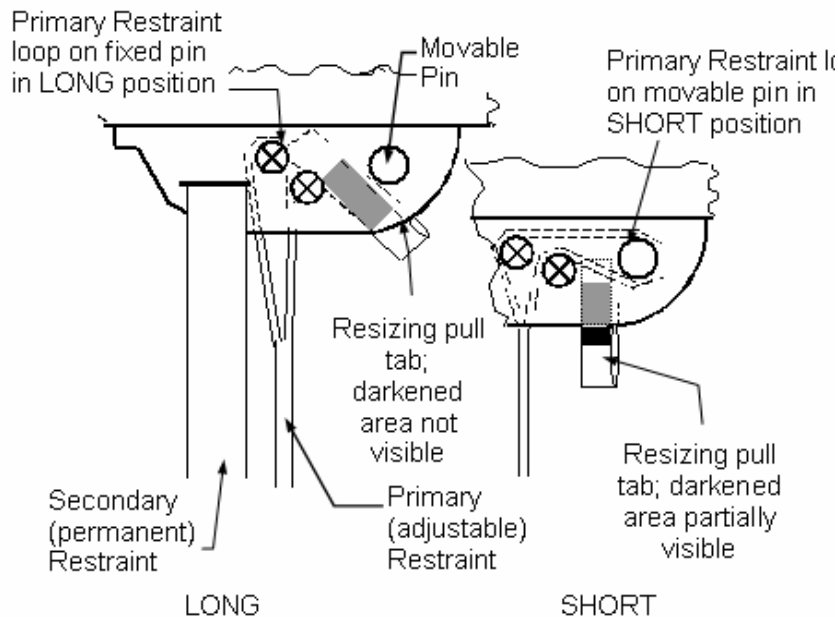

Figure 2.- Waist Cam Adjustment (1.0 inch per cam).

NOTE

After adjusting, verify restraint is routed around proper pin; material is not damaged, twisted, or pinched; and the movable pin is fully inserted.

With restraint in LONG position, the darkened area on resizing pull tab should not be easily visible.

With restraint in SHORT position, the darkened area on resizing pull tab should be easily visible.

Cam positions must be symmetric; minimum of two cams to be adjusted

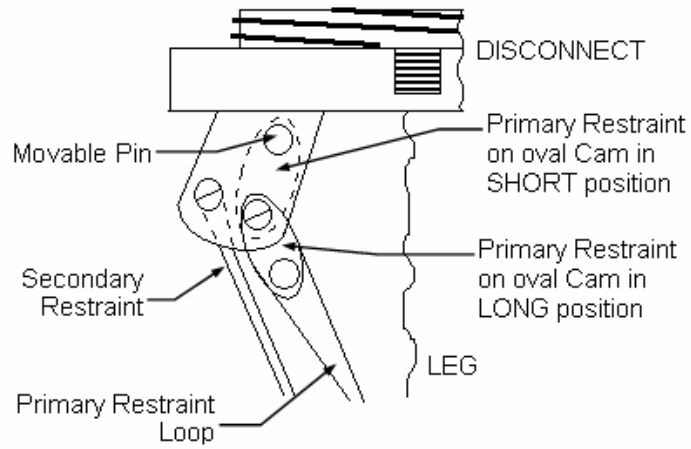

Figure 3.- Leg Cam Adjustment (0.5 inch per cam).

NOTE

After adjusting, verify restraint is routed around the oval cam; material is not damaged, twisted, or pinched; and the movable pin is fully inserted.

Cam positions/legs must be symmetric; likely minimum of four cams to be adjusted

TOP

HOOK
VELCRO

EMERGENCY UNDOCKING CUE CARD

**Gather and transfer the following to Shuttle
(listed in order of priority):**

1. EMU 3004 (Pz) and 3003 (Wo)
2. CCAs (Pz & Wo)
3. Gloves (Pz & Wo)
4. LCVG (Pz & Wo)
5. EMU Batteries (2 (s/n 2039 & 2040 desirable))
6. 85-ft Safety Tethers (2)
7. ECOK (Pz & Wo)
8. Adjustable Equipment Tethers (6)
9. EMU Servicing Kit labeled 'Use and Return on 120'
10. RETs (11 (Red desirable))
11. RCC Repair Thermal Sensor (1)

EVA-7a/120/O/A

TOP
BACK OF 'EMERGENCY UNDOCKING CUE CARD'



HOOK
VELCRO



EVA-7b/120/O/A



TPS REPAIR

The TPS Repair procedures listed below are not published in the hardcopy EVA Flight Supplement. These procedures will be uplinked realtime if they are required.

A PDF and a WORD version of the procedures can be found at:
<http://mod.jsc.nasa.gov/do3/FDF/FDFBooks/Status%20Sheets/index.html>.

Select the "As Flown" Status sheet for STS-120 and the link to the procedures can be found with the link to the EVA FS. The procedures can also be found on the FDF Books CD provided to the FAO console

BOOM TPS INSPECTION	
BOOM POINT INSPECTION SUMMARY TIMELINE	FS 13-3
BOOM POINT INSPECTION TOOL CONFIG.....	FS 13-4
BOOM POINT INSPECTION	FS 13-5
BOOM WLE MAPPING SUMMARY TIMELINE	FS 13-15
BOOM WLE MAPPING TOOL CONFIG	FS 13-17
BOOM WLE MAPPING	FS 13-18
EVA WLE MAPPING INSPECTION.....	FS 13-24
SAFER TPS INSPECTION	
SAFER TPS INSPECTION SUMMARY TIMELINE	FS 13-29
SAFER TPS INSPECTION TOOL CONFIG.....	FS 13-30
SAFER TPS INSPECTION	FS 13-31
BOOM CONTINGENCY	
BOOM FRGF SHAFT RELEASE	FS 13-37
BOOM FRGF SHAFT INSTALLATION	FS 13-38
BOOM EFGF SHAFT RELEASE	FS 13-40
BOOM MPM STOW/DEPLOY.....	FS 13-42
BOOM ASSISTED LATCHING	FS 13-43
TILE REPAIR	
EMU PREP FOR TPS REPAIR.....	FS 13-44
POST TPS REPAIR DOFFING	FS 13-45
EWA MATERIAL MIXING	FS 13-46
EWA REF DATA	FS 13-47
EWA TILE REPAIR – DOCKED/ORM SUMMARY TIMELINE	FS 13-48
EWA TILE REPAIR – DOCKED/ORM TOOL CONFIG.....	FS 13-49
EWA TILE REPAIR – DOCKED/ORM	FS 13-50
SSRMS GAP FILLER REMOVAL SUMMARY TIMELINE	FS 13-58
BOOM GAP FILLER REMOVAL SUMMARY TIMELINE	FS 13-59
GAP FILLER REMOVAL.....	FS 13-60
RCC REPAIR	
RCC CRACK REPAIR BAG ASSEMBLY.....	FS 13-65
TEMP SENSOR DISASSEMBLY POST-EVA.....	FS 13-68
RCC CRACK REPAIR BAG DISASSEMBLY POST-EVA	FS 13-69
TEMPERATURE PROBE ASSEMBLY	FS 13-71
CRM APPLICATOR ASSEMBLY	FS 13-71
CRM APPLICATOR NOZZLE INSTALLATION (DAY OF EVA).....	FS 13-72
RCC CRACK REPAIR.....	FS 13-73
RCC PLUG TRANSFER BAG ASSEMBLY	FS 13-85
NOTES, CAUTIONS, WARNINGS	
EVA TPS INSPECTION/REPAIR INHIBIT PAD.....	FS 13-97
TPS REPAIR CAUTIONS AND WARNINGS	FS 13-100
TPS REPAIR NOTES.....	FS 13-101
BOOM OPERATIONAL WARNINGS	FS 13-102
BOOM OPERATIONAL NOTES	FS 13-103

TPS REF DATA	
PREFERRED EMU POSITIONING FOR TPS REPAIR.....	FS 13-104
EVA TPS REACH AND ACCESS	FS 13-105
POINT INSPECTION REACH AND ACCESS WHILE DOCKED.....	FS 13-106
WLE MAPPING INSPECTION WHILE DOCKED	FS 13-108
TILE LAYUP	FS 13-109
85-FOOT SAFETY TETHER.....	FS 13-110
PFR ATTACHMENT DEVICE (PAD)	FS 13-111
WIF EXTENDER	FS 13-112
EVA DIGITAL CAMERA.....	FS 13-113
EVA IR CAMERA	FS 13-115
OVERLAY TILE REPAIR SYSTEM (OTRS)	FS 13-117
OTRS MARKING TEMPLATE AND INSULATION BAGS	FS 13-118
AUGER HOUSING.....	FS 13-119
OTRS RELEASED CONFIGURATION	FS 13-120
ORU BAG INSERT FOR OTRS	FS 13-121
BOOM REF DATA	
RTF BOOM OVERVIEW	FS 13-122
BOOM TRANSITIONS WITH MLI	FS 13-123
BOOM BASE END AND MODIFIED EFGF	FS 13-124
BOOM BASE END EFGF ADAPTER PLATE	FS 13-125
EVA-ASSISTED EFGF CONNECTOR DEMATE	FS 13-126
BOOM BASE END SADDLE AND MPM.....	FS 13-127
BOOM MID SECTION AND MODIFIED FRGF	FS 13-128
BOOM MID SECTION FRGF ADAPTER PLATE.....	FS 13-129
BOOM TIP END AND SENSORS	FS 13-130
BOOM SENSOR DETAILS	FS 13-132
SENSOR PACKAGE 1 (SP1): LDRI/ITVC	FS 13-134
SENSOR PACKAGE 2 (SP2): LCS.....	FS 13-136
POSSIBLE PRD ROUTING FOR EVA ASSISTED LATCHING	
OF BOOM IN MPMS	FS 13-138
BOOM CONTINGENCIES	FS 13-139
GRAPPLE SHAFTS	FS 13-140
PDGF GRAPPLE SHAFT COVER.....	FS 13-141
BOOM FRGF FSE.....	FS 13-142

UNSCHEDULED/CONTINGENCY EVA TASKS

UNSCH/CONT
EVA TASKS

10A WORKAROUNDS CRIBSHEET	FS 16-3
EVA 1 CONTINGENCIES	
CLEAR/RESTRAIN CBM CAPTURE LATCH	FS 16-17
MANUALLY OPEN/CLOSE CBM PETAL	FS 16-20
REMOVE/REPLACE CENTER DISK COVER	FS 16-25
REMOVE/REPLACE CBM CAPTIVE LATCH.....	FS 16-30
REMOVE/REPLACE CBM CONTROLLER PANEL ASSEMBLY (CPA)	FS 16-35
REMOVE/REPLACE CBM PETAL.....	FS 16-43
REMOVE CBM READY-TO-LATCH (RTL).....	FS 16-49
P6 ORU FLUID QD CLOSURE	FS 16-54
P6/Z1 VENTING.....	FS 16-60
EVA 2 CONTINGENCIES	
P6 RTAS SLEEVE REMOVAL.....	FS 16-62
Z1 CAPTURE LATCH FAILED CLOSED.....	FS 16-64
EVA 3 CONTINGENCIES	
16.1a RTAS GAP CLOSURE (CORNER 1 OR 2)	FS 16-66
16.1b RTAS GAP CLOSURE (CORNER 3 OR 4)	FS 16-68
CAPTURE BAR ROTATION	FS 16-69
ATTACH P6 TO P5 USING CONTINGENCY FASTENERS.....	FS 16-71
S1 RADIATOR MANUAL CINCH RELEASE	FS 16-74
S1 RADIATOR MANUAL OVERRIDE TO DEPLOY/RETRACT	FS 16-75
P6 RADIATOR MANUAL OVERRIDE TO DEPLOY/RETRACT	FS 16-76
MANUAL OVERRIDE TO DISENGAGE BETA GIMBAL	
ANTI-ROTATION LATCH.....	FS 16-81
BMRRM ANTI-ROTATION LATCH TABLE.....	FS 16-82
MANUAL OVERRIDE TO UNLATCH/LATCH (TENSION) SABB.....	FS 16-83
MANUAL OVERRIDE TO EXTEND/RETRACT MAST	FS 16-85
ASSISTED SOLAR ARRAY DEPLOY/RETRACT	FS 16-88
SABB SPOOL RE-TENSION	FS 16-94
MANUAL SAW JETTISON.....	FS 16-100
MISCELLANEOUS	
BMRRM REMOVE/REPLACE	FS 16-106

This Page Intentionally Blank

10A WORKAROUNDS CRIBSHEET
FLIGHT SPECIFIC – NOMINAL TASKS

EVA 1

1.1 Z1 SASA

A. SASA connector J3 will not demate from SASA	See GENERIC, NZGL CONNECTOR
B. Mast bolts will not release from Z1	<ol style="list-style-type: none"> 1. Increase PGT setting to: B7, CCW2, 30.5 2. If no joy, take PGT to manual RCCW, 30.5 3. On MCC-H GO, use ratchet wrench to break torque
C. SASA will not release from soft dock	<ol style="list-style-type: none"> 1. Verify removal is slow and forces are applied as close to the soft dock as possible (might need to grab around the mast beam itself rather than the closest handrail) 2. Apply a wiggle, centered near the soft dock 3. On MCC-H GO, retrieve prybar from ISS A/L, Staging Bag, apply prybar force near softdock
D. Mast/Launch bolts will not hand-start on sidewall carrier	<ol style="list-style-type: none"> 1. If 5 of 6 successfully hand-started, go to press with PGT torquing 2. If fewer than 5 hand-started, secure SASA to sidewall carrier with adjustable tethers, allow SASA to thermally dwell while completing NODE 2 FINAL PREP FOR UNBERTH (desire at least 30 min of dwell time) 3. If no joy after dwelling, transfer SASA back to Z1 installation location, reinstall mast bolts with PGT settings of: A7, CW2, 30.5
E. Mast/Launch bolts will not engage on sidewall carrier using PGT after hand-starting	<ol style="list-style-type: none"> 1. If 5 of 6 successfully installed, safe to land 2. If fewer than 5 installed, back out all bolts by hand or PGT if already torqued (use settings: Mast: A7, CCW2 and Launch w/RAD: A5, CCW2) rethread, reattempt installation 3. Increase PGT setting to: B7, CW2 for 1 turn only, then return to nominal PGT settings (Mast: A7, CW2; Launch: w/RAD: A5, CW2)
F. SASA connector J3 will not mate to Z1 dummy panel	<ol style="list-style-type: none"> 1. See GENERIC, NZGL CONNECTOR 2. If no joy, wire tie connector to handrail; report to MCC-H

1.2 NODE 2 HORSESHOE CONNECTOR RELEASE

A. Horseshoe connector engagement bolt will not release	<ol style="list-style-type: none"> 1. Increase PGT setting to B2, CCW2, 30.5 for 1 turn only, then return to A6, CCW2 2. If no joy, take PGT to manual RCCW 3. On MCC-H GO, use ratchet wrench to break torque
B. Horseshoe connector microfixture will not rotate	<ol style="list-style-type: none"> 1. Attempt to off-load microfixture by adjusting cable harnesses or applying a push/pull force on the horseshoe 2. If no joy, wait until EVA 2 to use square scoop from door of Z1 port or stbd toolbox for more leverage
C. Horseshoe connector will not slide off of receptacle once turns reached	<ol style="list-style-type: none"> 1. Verify soft capture microfixture disengaged 2. Verify yellow band visible on back side of bolt; if not, continue to release bolt until hardstop 3. Report perceived problem to MCC-H

10A WORKAROUNDS CRIBSHEET (Cont)

1.3 PDGF RELEASE/TEMP STOW

A. Both EDF retaining lanyards missing/not intact	<ol style="list-style-type: none"> 1. Tether to EDF prior to driving 2. After release, fully remove EDF and stow EDF in trash bag (will need to bring out on EVA 2 for installation)
B. Torque cannot be broken on EDF	<ol style="list-style-type: none"> 1. If high torque, retrieve cheater bar from Z1 stbd toolbox (stbd door) 2. If body position issue, request SSRMS-based EV2 for assistance
C. Once 5 turns achieved, EDF will not release from PDGF	<ol style="list-style-type: none"> 1. Use ratchet wrench to lightly tap bolt head and re-attempt release 2. If no joy, retrieve hammer from TSA fwd tray; lightly tap bolt head and re-attempt release 3. Using equipment hooks, attempt to pry around bolt head/under retaining washer to release 4. If no joy, on MCC-H GO, need to reinstall all 4 EDFs: torque in a star pattern: initial torque A7, CW1, 5 turns, then final torque B7, CW1, 30.5 ~0.5 turns repeatable
D. PDGF can not be removed from sidewall carrier	<ol style="list-style-type: none"> 1. Ensure all 4 EDFs are released and retracted, twist PDGF while pulling to work it off, avoiding curvic coupling 2. On MCC-H GO, retrieve prybar from ISS A/L, Staging Bag 3. If no joy, on MCC-H GO, need to reinstall all 4 EDFs: torque in a star pattern: Initial torque A7, CW1, 5 turns, then final torque B7, CW1, 30.5 ~0.5 turns repeatable

1.4 Z1 TO P6 FLUID LINES

A. SPD will not release	<ol style="list-style-type: none"> 1. Verify both locking tangs are releasing
<p data-bbox="181 1136 756 1199">B. Detent button fails to depress (before valve close)</p> <div data-bbox="269 1213 716 1398" style="border: 1px solid black; padding: 5px; margin: 10px 0;"> <p style="text-align: center;">WARNING</p> <p>Bail handle may kick back if button is released and pressure is built up in spring cavity from a leaking primary seal</p> </div>	<ol style="list-style-type: none"> 1. Verify locking collar is rotated to unlocked position 2. Push bail handle fwd (to open) to relieve load on button while depressing detent button <ol style="list-style-type: none"> a. If button depresses, vent by pulling bail aft until release ring covers aft white band b. Push bail fwd to valve open; check button depresses 3. Retrieve QD bail drive lever tool (ISS A/L, Stbd Fluid QD Bag) <ol style="list-style-type: none"> a. Repeat step 2 with the QD bail drive lever; notify MCC-H 4. On MCC-H GO, retrieve 1.0" button depress tool and anti-kickback tool from ISS A/L, Staging Bag
C. Bail fails to actuate or detent button fails to pop up after actuation (to valve close)	<ol style="list-style-type: none"> 1. Inspect QD for retaining wire protrusion 2. Neutralize possible side loading 3. Depress button, increase force on bail 4. Obtain and use QD bail drive lever tool (ISS A/L, Stbd Fluid QD Bag)
D. Female QD fails to demate	<ol style="list-style-type: none"> 1. Verify release ring is fully retracted while attempting to demate 2. Verify TA clamps are released 3. Verify locking collar has been successfully rotated under detent button – verifies button is all the way up 4. Neutralize side loads or manipulate flexhose to relieve mating forces on female QD

10A WORKAROUNDS CRIBSHEET (Cont)

1.4 Z1 TO P6 FLUID LINES (Cont)

D. Female QD fails to demate (Cont)	<ol style="list-style-type: none"> 5. Apply greater retraction force to release ring and/or greater removal force to female QD while neutralizing sideloads 6. Contact MCC-H for use of QD Release Tool (QRT) to apply greater force (ISS A/L, Stbd Fluid QD Bag)
E. QD fails to mate	<ol style="list-style-type: none"> 1. Check for debris, damage, or crystals; verify release ring is retracted 2. Check alignment; verify no side loading present 3. Wire tie Z1 female QD in place
F. Release ring snap back test fails	<ol style="list-style-type: none"> 1. Push release ring forward 2. Demate and remate QD
G. Cap will not fully install onto P6 (lock tabs will not engage)	<ol style="list-style-type: none"> 1. Remove cap and re-attempt installation 2. If no joy, attempt to install cap on neighboring male QD (if lanyard will allow) 3. If still not joy, thread the cap on as far as possible and press (locking tabs for launch only)
H. Z1 MLI fails to install as expected	Attempt installation using alternate handrails. Use wire ties to ensure attachment if required
MATE QD: √Fwd white band – visible, verify release ring snaps forward and forward white band still visible, perform pull test	DEMATE QD: Pull back on release ring, √Release ring – retracted (FWD white band not visible)
OPEN VALVE: √Fwd white band visible, depress detent button, push bail to fwd position, √aft white band visible, √detent button pops back up)	CLOSE VALVE: √Aft white visible, depress detent button, pull bail to aft position, √fwd white band visible, √detent button pops back up
I. Leak seen when valve closed but female still mated to P6 (either female shows NH3 crystals on exterior or MCC-H verifies accumulator qty decreasing after valve closure)	<ol style="list-style-type: none"> 1. If crystals are minimal and dissipating, then proceed with nominal procedure 2. Re-open the valve, wiggle (apply significant force in a back/forth and side/side motion) female QD forcefully (moves male sleeve), reattempt to close female 3. If no joy, close (or verify closed) other female in same loop (F2, F4 – Loop A; F6, F8 – Loop B) 4. If still leaking, notify MCC-H and provide description of magnitude of leak (MCC-H to monitor accumulators on Z1 and P6 to determine if the leak is on the male or female half) 5. If no joy and still leaking, reattempt step 2 6. Based on MCC-H response go to J. (leaking male) or K. (leaking female)
J. Leaking Male: Once Z1 female demated from P6, leak seen from P6 male	<ol style="list-style-type: none"> 1. If leak is small (accumulator qty stable/small visible leak), immediately install cap and continue with nominal procedure 2. If leak is significant (accumulator qty decreasing/stuck open male or rolled o-ring), mate Z1 female back to P6, then open valve. Stop and coordinate next steps with MCC-H (will probably perform P6 ORU FLUID QD CLOSURE to take the ammonia-filled ORUs out of the loop to maintain their spare status) 3. On MCC-H GO, vent P6 lines via P6/Z1 VENTING

10A WORKAROUNDS CRIBSHEET (Cont)

1.4 Z1 TO P6 FLUID LINES (Cont)

<p>K. Leaking Female: Once Z1 female demated from P6, leak seen from Z1 female</p>	<ol style="list-style-type: none"> 1. If crystals are minimal and dissipating, then proceed with nominal procedure 2. Close (or verify closed) other female in same loop (F2, F4 – Loop A; F6, F8 – Loop B) 3. If leak is significant and not manageable, then re-mate female QD to P6 male and open valve 4. On MCC-H GO, vent Z1 lines via P6/Z1 VENTING
--	--

1.5 P6 AFT RADIATOR SHROUD

<p>A. Black belt strap pulled wrong way through boot (tightening rather than loosening)</p>	<p>Fish out belt strap using equipment tether hook or wire tie</p>
<p>B. Shroud strap will not reach checklist-specified handrail due to interference with ground-installed gap spanner</p>	<p>Take strap to alternate handrail; notify MCC-H</p>

1.6 SSU MLI SHROUDS

<p>A. Straps and/or Velcro flaps will not hold shroud secure</p>	<p>Use wire tie to hold blanket together or to handrail, ensuring BGA rotation plane clear</p>
--	--

EVA 2

2.1 Z1 TO P6 ELECTRICAL CONNECTORS

<p>A. Cable fails to release from P6</p>	<ol style="list-style-type: none"> 1. Check for FOD, damage or misalignment 2. Verify cable routing not impeding connector rotation 3. Use cannon connector tool for more leverage 4. On MCC-H GO, for cables P255, 256, 257, 258, 261: retrieve Lg cutter from ISS A/L, Staging Bag, cut cable
<p>B. Connector/Cap fails to softdock</p>	<ol style="list-style-type: none"> 1. Verify collar unlocked – white on connector shell tip should align with white on receptacle backplate 2. Check for FOD or damage
<p>C. Connector/Cap fails to lock</p>	<ol style="list-style-type: none"> 1. Remove connector/cap, check for FOD or damage 2. Check alignment, remate, rock connectors back and forth as required (once locked, white on connector shell tip should align with black on receptacle backplate) 3. Use cannon connector tool for more leverage 4. If cannon connector cap, bring inside If Z1 cable, secure in TA clamps, wire tie connector in place
<p>D. High cable stiffness prevents mating</p>	<ol style="list-style-type: none"> 1. Verify all necessary TA clamps are released 2. Use two crewmembers/APFR
<p>E. Connector/jack pin bent</p>	<ol style="list-style-type: none"> 1. Report bent pin location to MCC-H 2. On MCC-H GO: retrieve pin straightener from ISS A/L, Staging Bag; straighten pins
<p>F. Connector/jack FOD</p>	<p>On MCC-H GO: obtain Connector Cleaner Tool from ISS A/L, Staging Bag to remove FOD</p>
<p>G. Connector EMI band bent</p>	<p>On MCC-H GO: obtain Needle Nose Pliers or Forceps to remove band</p>

10A WORKAROUNDS CRIBSHEET (Cont)

2.2 Z1 TO P6 DETACH

A. Z1 CLA will not engage	<ol style="list-style-type: none"> 1. If can not achieve initial motion, increase settings to A7, CW3 for 5 turns, then back down to A6, CW3 2. If PGT torques out mid-travel, contact MCC-H 3. On MCC-H GO, route PRDs
B. P6 ground strap will not release from Z1	<ol style="list-style-type: none"> 1. Check worksite for FOD 2. Increase PGT setting to: B5, CCW2, 30.5 3. If bolt did not turn, increase PGT setting to: B7, CCW2, 30.5 drive one turn only, then return to B5 4. On MCC-H GO, retrieve Lg cutter from ISS A/L, Staging Bag, cut ground strap
C. Once release from Z1, Fairchild fastener on ground strap is missing washer	<ol style="list-style-type: none"> 1. If positive control on bolt, press with temp install 2. If bolt completely removes from ground strap, attempt installation by re-inserting bolt in ground strap at temp stow location 3. If no joy, place bolt in trash bag, wire tie ground strap out of separation plane if necessary
D. P6 ground strap cross threads during install onto P6	<ol style="list-style-type: none"> 1. Ensure EV crew begins installation manually, back-off thread engagement and re-attempt 2. If no joy, wire tie ground strap out of separation plane
E. RTAS primary bolt will not break torque	<ol style="list-style-type: none"> 1. Reattempt with EV3 assistance 2. Retrieve round torque multiplier with 5/8 in proud socket from A/L staging bag; attempt to break torque using ratchet wrench on TM, ~1/2 turn on bolt (5:1 turn ratio) 3. If no joy, break torque and release remaining bolts per procedure then refer to P6 RTAS SLEEVE REMOVAL
F. RTAS primary bolt binds after break torque	<ol style="list-style-type: none"> 1. Attempt to release bolt with ratchet wrench and cheater bar, not to exceed 145 ft-lb (to avoid damage to the P6 sleeve PIP pin preventing sleeve removal) 2. If no joy, break torque and release remaining bolts per procedure then refer to P6 RTAS SLEEVE REMOVAL
G. Z1 CLA will not release	<ol style="list-style-type: none"> 1. Increase PGT setting to: A7, CCW2 2. Refer to Z1 CAPTURE LATCH FAILED CLOSED

2.3 S1 SFU RECONFIGURATION

A. Connector issues	<ol style="list-style-type: none"> 1. See GENERIC, NZGL CONNECTOR 2. If no joy, reconfigure to original: P752 to J752 and Dust cap to J703
---------------------	--

2.4 MBSU BYPASS JUMPER RECONFIGURATION

See GENERIC, NZGL CONNECTOR

See GENERIC, TA CLAMP

2.5 RPCM R&R

A. RPCM jacking bolt will not release	<ol style="list-style-type: none"> 1. Verify socket is fully installed on the bolt (releases the anti-rotation locking tangs) 2. Increase PGT setting to: B1, CCW2, 30.5
B. Spare RPCM did not achieve full turns (6 turns)	<ol style="list-style-type: none"> 1. Verify RET hook installed correctly 2. Remove RPCM with PGT settings: A7, CCW2, 30.5, verify no FOD 3. Reattempt installation with PGT settings: A2, CW2, 30.5 4. If no joy, contact MCC-H
C. Status indicator did not travel to LOCK	As long as torque and turns achieved, no action – press with next task

10A WORKAROUNDS CRIBSHEET (Cont)

2.6 NODE 2 OUTFITTING

<p>HANDRAIL PRIORITY BY SIZE: 24": 0361, 0346, 0360, 0358, 0332, 0345, 0359 12": 0353, 0352 18.9": 0372, 0371</p>	<p>WIF PRIORITY: WIF 13, 07, 09</p>
<p>A. Handrail will not install in seat track or fails to soft dock</p>	<ol style="list-style-type: none"> 1. Verify rigid BRT 2. Verify handrail shoes are completely released and soft dock armed 3. Check for FOD 4. Verify handrail bolt completely released – if not, use PGT settings: A1, CCW2 5. Rotate handrail 180 deg, reattempt installation; notify MCC-H 6. If no joy, attempt to install another handrail at this location and try this handrail in another location (see priority list above)
<p>B. Handrail bolt fails to fully engage</p>	<ol style="list-style-type: none"> 1. If torqued, remove handrail with PGT settings: A2, CCW2 to break torque, then A1 CCW2 for removal, if not torqued, use A1, CCW2 for removal, check for FOD, attempt to re-install 2. Increase PGT setting to: A3, CW2 3. If no joy, attempt to install another handrail at this location and try this handrail in another location (see priority list above)
<p>C. WIF fails to soft dock</p>	<ol style="list-style-type: none"> 1. Check for FOD and structural interference, cycle soft dock pins; attempt reinstallation 2. Verify WIF being installation is co-planar 3. Install alternate WIF 4. Attempt installation in alternate location (see priority above) 5. Return WIF to ground
<p>D. Zenith CBM petal release will not release</p>	<ol style="list-style-type: none"> 1. Wrap adjustable tether strap or equipment hook around latch to aid in release 2. If no joy, can be release via IV bolt-driving command
<p>E. Trunnion cover grounding fastener will not install</p>	<ol style="list-style-type: none"> 1. If 1 of 2 fasteners installed successfully, no action – press with next task 2. If both fasteners will not install, contact MCC-H

2.7 NODE 2 PDGF INSTALL

<p>A. PDGF will not soft dock on to mounting ring</p>	<ol style="list-style-type: none"> 1. Verify all 4 EDFs are fully retracted 2. Verify PDGF orientation (target pointing ISS aft) 3. Verify MLI tabs covering Velcro surrounding mounting ring secure and not protruding
<p>B. EDF will not insert (greater than 1/4" gap between washers, but appears to be through all clevis/lug holes)</p>	<ol style="list-style-type: none"> 1. Ensure lanyards are not snagged between washers 2. Verify EDF fully seated on internal hex head and aligned by pushing in and rotating the EDF. May require up to 30 deg of rotation 3. Remove EDF, wiggle and re-attempt installation 4. On MCC-H GO, remove EDF from TBD PDGF, swap with failed
<p>C. After TBD cycles, unable to torque EDFs to final torque</p>	<ol style="list-style-type: none"> 1. Release all EDFs, reattempt installation 2. On MCC-H GO, remove EDF from TBD PDGF, swap with failed
<p>D. PDGF horseshoe connector receptacle bolts will not release</p>	<p>Increase PGT setting to: B1, CCW2, 30.5 for 1 turn only, then return to A6, CCW2</p>
<p>E. Horseshoe connector microfixture will not rotate to unlock</p>	<ol style="list-style-type: none"> 1. Attempt to off-load microfixture by adjusting cable harnesses or applying a push/pull force on the horseshoe 2. If no joy, retrieve square scoop from door of Z1 port or stbd toolbox

10A WORKAROUNDS CRIBSHEET (Cont)

2.7 NODE 2 PDGF INSTALL (Cont)

F. Horseshoe connector will not slide off of receptacle	<ol style="list-style-type: none">1. Verify yellow band visible on back side of bolt2. Verify engagement bolt is fully released to hardstop, use PGT settings: A5, CCW2, 30.5
G. Horseshoe connectors will not slide on to PDGF	<ol style="list-style-type: none">1. Verify yellow band visible on back side of receptacles, release horseshoe connector receptacle engagement bolt to hardstop, use PGT settings: A6, CCW2, 30.52. Release horseshoe connector receptacle bolt to hardstop; reattempt installation
H. Horseshoe connector microfixture will not rotate to lock	<ol style="list-style-type: none">1. Attempt to off-load microfixture by adjusting cable harnesses or applying a push/pull force on the horseshoe2. Remove horseshoe connector, inspect for FOD, reattempt installation3. If no joy, retrieve square scoop from door of Z1 port or stbd toolbox
I. Horseshoe connectors attach bolt will not install	<ol style="list-style-type: none">1. Remove horseshoe connector, inspect for FOD, reattempt installation2. Increase PGT setting to: A7, CW2 for 1 turn only, then back to A6, CW2
J. Once mated, horseshoe connector cables will not route through opening in MLI	Route cables under MLI (between Node 2 and MLI)

10A WORKAROUNDS CRIBSHEET (Cont)

EVA 3

3.1 P6 INSTALL ON P5

A. P5 Corner 1 will not retract by hand	Use PGT w/RAD settings: A7, CCW2
B. Pre-install inspection of P6 corners show that primary and/or contingency ball/nuts are not centered	On MCC-H GO and when within reach, center ball/nut with gloved hand
C. Pre-install inspection of P5 corners 2, 3 or 4 shows exposed threads on primary RTAS bolt	<ol style="list-style-type: none"> 1. Attempt to retract bolt tip to flush using gloved hand 2. If no joy, PGT: B1, CCW2 or RAD for corner 2: A7, CCW2
D. P5 CLA will not engage	<ol style="list-style-type: none"> 1. If can not achieve initial motion, increase settings to A7, CW3 for 5 turns, then back down to A6, CW3 2. If PGT torques out mid-travel, contact MCC-H 3. Refer to P5/P6 PRD ROUTING, <u>FLIGHT SPECIFIC EVA REFERENCE</u>. Install PRDs on Corners 1 and 4 Verify: CMG control, desat request inhibited, SSRMS: Brakes on for PRD routing and in Limp mode for PRD ratcheting. EV1 and EV2 ratchet both PRDs simultaneously, verify SSRMS in good config after each ratchet throw
E. P5/P6 gap check fails on one corner	<ol style="list-style-type: none"> 1. Verify gap is being checked in correct location (at ground strap installation location) 2. Remove gap check tool (on corner 1) with PGT settings: A6, CCW2; 12-14 turns, check gap 3. If gap reading less than 0.6 line (shoulder of the tool), GO to press with nominal procedure 4. If tool hits at shoulder (reading greater than .6) for Corner 1 or 2, refer to 16.1a RTAS GAP CLOSURE 5. If tool hits at shoulder (reading greater than .6) on Corner 3 or 4, then proceed with Corner 1 and 2 install to initial torque PGT w/RAD: A7, CW2; ~27 turns to HS 6. Perform gap check at Corners 3 and 4. If gap reading less than 0.6 line (shoulder of the tool), GO to press with nominal initial torque of Corners 3 and 4 7. If tool hits at shoulder (reading greater than .6) for Corner 3 or 4, refer to 16.1b RTAS GAP CLOSURE
F. P5/P6 gap check fails on more than one corner	Contact MCC-H (will consider releasing CLA and backing P6 off)
G. For any of the following P5 Primary Bolt contingencies: a. Does not achieve full torque b. Bolt shoulder has a gap (is not seated against nut)	Refer to ATTACH P6 TO P5 USING CONTINGENCY FASTENERS
H. P5 gap check tool will not release from outboard corner 1	<ol style="list-style-type: none"> 1. Check worksite for FOD 2. If bolt did not turn, increase PGT setting to B7, CCW2 drive 1 turn only, then return to original PGT setting: A6, CCW2 3. Retrieve gap check tool from inboard corner 1
I. Once release from P6, Fairchild fastener on ground strap is missing washer	If positive control on bolt, press with install
J. P6 ground strap cross threads during install onto P5 lug	<ol style="list-style-type: none"> 1. Ensure EV crew begins installation manually 2. Back-off thread engagement and re-attempt
K. P6 ground strap will not seat properly onto P5 lug (ground strap is not flush to surface or PGT stalls)	<ol style="list-style-type: none"> 1. Check ground strap alignment 2. Increase PGT torque setting to B1, CW2
L. Primary bolt free spins and does not advance into P6 nut (PGT does not "see" torque) (possible broken self-feeding nut)	If bolt free spins, push P5 bolt axially toward P6 while driving PGT until bolt threads begin to engage P6 nut (under load)

10A WORKAROUNDS CRIBSHEET (Cont)

3.2 P5 TO P6 ELECTRICAL CONNECTORS

A. Cable fails to release from P5	<ol style="list-style-type: none"> 1. Check for FOD, damage or misalignment 2. Verify cable routing not impeding connector rotation 3. Use cannon connector tool for more leverage 4. Verify P260 demated from P5 and mated to P6 prior to P259
B. Connector/Cap fails to softdock	<ol style="list-style-type: none"> 1. Verify collar unlocked – white on connector shell tip should align with white on receptacle backplate 2. Check for FOD or damage
C. Connector/Cap fails to lock	<ol style="list-style-type: none"> 1. Remove connector/cap, check for FOD or damage 2. Check alignment, remate, rock connectors back and forth as required (once locked, white on connector shell tip should align with black on receptacle backplate) 3. Use cannon connector tool for more leverage (NOTE: can only use tool for part of the throw on P260 due to strut interference)
D. High cable stiffness prevents mating	<ol style="list-style-type: none"> 1. Verify all necessary TA clamps are released 2. Use two crewmembers/APFR
E. Connector/jack pin bent	<ol style="list-style-type: none"> 1. Report bent pin location to MCC-H 2. On MCC-H GO: retrieve pin straightener from ISS A/L, Staging Bag; straighten pins
F. Connector/jack FOD	On MCC-H GO: obtain Connector Cleaner Tool from ISS A/L, Staging Bag to remove FOD
G. Connector EMI band bent	On MCC-H GO: obtain Needle Nose Pliers or Forceps to remove band

3.3 P6 OUTBOARD RADIATOR

A. Unable to break torque on cinch bolt	<ol style="list-style-type: none"> 1. Verify PGT socket is fully installed on bolt (depressing anti-rotation feature) 2. Take PGT to manual RCCW, 30.5 Break torque then resume release with PGT settings: B7, CCW2, 30.5 3. If no joy, retrieve ratchet wrench from crewlock bag and re-attempt to break torque then resume release with PGT settings: B7, CCW2, 30.5 4. If issue due to radiator expansion, ask for EV2's assistance to compress radiator
B. Unable to release cinch bolt after torque broken	<ol style="list-style-type: none"> 1. If issue due to radiator expansion, attempt to compress radiator solo 2. Verify bolt released full amount of turns (~14) 3. If single person compression not enough, ask for EV2's assistance to compress radiator
C. Cinch fails to stow in cinch clip	Wire tie cinch to adjacent handrail, verify not in radiator deployment envelope
D. PIP pin fails to release	Attach equipment tether hook to PIP pin loop to provide more leverage
E. Winch bar interferes with radiator deploy	Use adjustable tether or wire tie to secure winch bar out of deployment envelope

3.4 P1 SFU RECONFIG

A. Connector issues	<ol style="list-style-type: none"> 1. See GENERIC, NZGL CONNECTOR 2. If no joy, reconfigure to original: P752 to J752 and Dust cap to J703
---------------------	--

10A WORKAROUNDS CRIBSHEET (Cont)

3.5 S1 SFU RECONFIG

A. Connector issues	<ol style="list-style-type: none"> 1. See GENERIC, NZGL CONNECTOR 2. If no joy, reconfigure to original: P752 to J703 and Dust cap to J752
B. SFU fails to fire (cinches didn't release)	Refer to S1 RADIATOR MANUAL CINCH RELEASE
C. S1 outboard radiators fail to deploy (cinches released)	Refer to S1 RADIATOR MANUAL OVERRIDE TO DEPLOY/RETRACT

3.6 MBSU TRANSFER

A. Primary FRAM bolt fails to release from sidewall carrier	<ol style="list-style-type: none"> 1. Increase PGT settings to: B2, CCW2, 30.5 for 1 turn only to break torque, return PGT settings to: A4, CCW2, 30.5 2. If no joy, engage contingency locking pins (4) to secure MBSU for ride home (see procedure below). 4/4 cont pins required for landing loads. (consider egressing arm for lower contingency pin access)
B. Primary FRAM bolt fails to engage on ESP-2	<ol style="list-style-type: none"> 1. Verify active FRAM fully seated on passive FRAM, check for FOD, back out primary FRAM bolt fully with PGT settings: A7, CCW2, 30.5; re-attempt engagement with PGT settings: A7, CW2, 30.5 2. If no joy, engage contingency locking pins (4) (see procedure below). 3/4 cont pins required for on-orbit loads
<u>Contingency Locking Pin Installation:</u>	<ol style="list-style-type: none"> 1. FRAM FWD Cont Pins: PGT settings: A4, CW2, 30.5, TBD turns (see equation below for turns) <ol style="list-style-type: none"> a. Can increase PGT to B2 for 1 turn only if A4 no joy 2. FRAM AFT Cont Pins: PGT settings: B1, CW2, 30.5, TBD turns (see equation below for turns) <div style="border: 1px solid black; padding: 5px; margin-top: 10px;"> <p>FWD CONT PINS:</p> <ul style="list-style-type: none"> ➤ Turns = $14.11 - (1.25 \times \text{Primary bolt turns})$ <p>AFT CONT PINS:</p> <ul style="list-style-type: none"> ➤ The rear cont pin can be installed if the primary turn count is 6.5 turns or less ➤ With greater than 6.5 turn on the primary bolt, the cont pin is not needed, and in some cases where most turns have been engaged by the primary bolt, cannot be installed ➤ Turns = $16.858 - (1.25 \times \text{Primary bolt turns})$ </div>

10A WORKAROUNDS CRIBSHEET (Cont)

EVA 5

5.1 SSPTS BAG RELOCATE

See GENERIC, NZGL CONNECTOR

5.2 PMA2 TO LAB UMBILICAL DISCONNECT

See GENERIC, NZGL CONNECTOR

See GENERIC, TA CLAMP

5.3 LAB AVIONICS TRAY CABLE DISCONNECT

See GENERIC, NZGL CONNECTOR

See GENERIC, TA CLAMP

5.4 LAB CETA LIGHT REMOVE

A. Stanchion Bolt does not release	<ol style="list-style-type: none">1. Use manual ratchet on PGT, RCCM, drive bolt 1 turn only, return to nominal settings of B7, CCW2, 30.52. If no joy, retrieve ratchet wrench (from TBD) and re-attempt to break torque
B. Connector issues	See GENERIC, NZGL CONNECTOR

5.5 NODE 2 ACBM SHOWER CAP REMOVE

A. Will not fit in the airlock	Secure in TBD location with wire ties (jettison during stage)
--------------------------------	---

5.6 RUSSIAN POWER RECONFIG

A. Connector issues	See GENERIC, NZGL CONNECTOR
---------------------	-----------------------------

5.7 Z1 BSP RETRIEVE

A. Outer or center jack bolt fails to break initial torque	<ol style="list-style-type: none">1. For center jack bolt, reattempt with same setting while pulling box out2. Increase PGT setting to B7, CCW2, 30.5 for 1 turn only, reattempt to release at previous setting: A7, CCW2, 30.5
B. Co-therm debris left on Z1 coldplate	<ol style="list-style-type: none">1. Attempt to remove cotherm with gloved hand2. If no joy, retrieve 3" TPS scraper from ISS A/L, Staging Bag (if EVA 3, scraper in Solar Array Cont crewlock bag in airlock) and re-attempt cotherm removal3. Remove BSP MLI if required for better access (MLI held on by Velcro and 2 grounding straps. Release minimal amount of Velcro to aid in re-installation)
C. BSP dummy box will not install	<ol style="list-style-type: none">1. Verify MLI not impeding installation. Remove BSP MLI if required for better access (MLI held on by Velcro and 2 grounding straps. Release minimal amount of Velcro to aid in re-installation)2. Verify base of BSP flush with coldplate3. Remove box, inspect rail and bolt interface for debris4. Attempt reinstall5. If no joy, increase PGT setting to B1, CW2, 30.56. If no joy, increase PGT setting to B2, CW2, 30.5

10A WORKAROUNDS CRIBSHEET (Cont)

5.7 Z1 BSP RETRIEVE (Cont)

D. BSP will not install on to 6B box cover	<ol style="list-style-type: none"> 1. Verify soft-dock features that accept box standoffs are springing open freely when box installed. If not, using release ring, move soft dock to open position, install box and then release the ring to engage the soft dock 2. Translate BSP to airlock without cover, avoiding contact with exposed connectors
--	--

FLIGHT SPECIFIC – CONTINGENCY TASKS

GENERIC ORUs

A. TBD	
--------	--

GENERIC

NZGL CONNECTOR

A. Connector fails to demate	<ol style="list-style-type: none"> 1. Verify bail fully thrown and undamaged 2. Inspect connector/bail for FOD 3. Check alignment/side loads 4. Wiggle/jiggle connector, pull on connector back shell away from cap/jack for additional leverage 5. Attach 2 hooks from adjustable tether to connector bail, use adjustable strap to pull bail into demated position (this works better after bail/linkage has passed over-center feature) 6. Check for harness interference 7. Increase force on bail
B. Connector fails to soft dock	<ol style="list-style-type: none"> 1. Verify bail fully aft 2. Verify plug half shell is aligned with jack half shell, avoid rolling/rocking plug onto jack (this could possibly unseat soft dock springs; it is also possible for keying feature to prevent soft dock). Once half shells are aligned, connector should snap into soft dock position with little force
C. Connector fails to mate	<ol style="list-style-type: none"> 1. Detach from soft dock and inspect the following: <ol style="list-style-type: none"> a. Pins b. FOD c. EMI band d. bend radius e. bail linkages/rivets f. soft dock springs g. O-ring seal on non-active side or main joint gasket inside receptacle h. connector keying features 2. Cycle bail while disconnected, push on connector back shell toward cap/jack for additional leverage 3. Verify half-shells are fully seated on both sides
D. Connector pin bent (16,20,22 gauge)	<ol style="list-style-type: none"> 1. Rotate connector to bail up position, describe pin condition. If possible, obtain WVS view or interface 2. On MCC-H GO, retrieve pin straightener (ISS A/L Staging Bag) or needle nose pliers (stbd A/L toolbox, slot 2); attempt pin repair (this is based on pin size and MCC-H will verify actual pin size prior to retrieving tool)

10A WORKAROUNDS CRIBSHEET (Cont)

NZGL CONNECTOR (Cont)

E. Connector FOD	<ol style="list-style-type: none"> 1. On MCC-H GO, obtain connector cleaner tool from ISS A/L Staging Bag; use entire cartridge prior to re-entry to the airlock <p style="text-align: center;"><u>NOTE</u></p> <p>One N2 cartridge is already captured onto the CCT (the other is lanyarded inside caddy). In order to puncture cartridge, it must be threaded into CCT until indicator line passes out of sight under the collar of the CCT</p>
F. Connector EMI band bent	On MCC-H GO, obtain needle nose pliers (stbd A/L toolbox, slot 2) or forceps to remove band
G. Connector bail linkage failure	On MCC-H GO, re-attempt connector mate with broken bail. Vice grips may be used for additional leverage or hand on backshell (hand on back shell is easiest once linkage/bail has passed over-center feature)
H. Connector soft dock spring bent	On MCC-H GO, obtain needle nose pliers (stbd A/L toolbox, slot 2); attempt to remove bent spring
I. Connector O-ring or Main Joint Gasket seal loose (used as a moisture seal in 1G only, not needed on orbit)	<ol style="list-style-type: none"> 1. Remove seal with tether hook 2. If no joy, on MCC-H GO, obtain needle nose pliers (stbd A/L toolbox, slot 2) to remove seal
J. Twist cap will not release	<ol style="list-style-type: none"> 1. On MCC-H GO, increase force 2. On MCC-H GO, attach equipment hook to cap tether point and use strap of adj tether to assist with cap release

PAD

A. Release knob fails to rotate open	<ol style="list-style-type: none"> 1. Verify knob in release position 2. Attempt to rotate knob using 7/16 in Ratchet on knob's 7/16 in hex stud 3. Release contingency release bar by rotating captive release bolts (2) 5 turns, PGT settings: A6, CCW2, 30.5
B. Release knob fails to rotate close	<ol style="list-style-type: none"> 1. Verify knob in release position 2. Stow PAD, retrieve backup PAD from crew bag <p><u>NOTE:</u> PAD in crew lock can't be left outside because of paint</p>

TA CLAMP

A. TA clamp fails to release	<ol style="list-style-type: none"> 1. With handle up, press down on top of rounded clamp 2. With handle up, use tether hook to pry drawhook from capture pin
------------------------------	--

TSA

A. Latch fails to open	Release 7/16" EVA bolt on latch bracket, rotate bracket clear of latch tongue
B. Latch fails to close	Close remaining latches (3 of 4 required for landing)

APFR

A. APFR fails to install in WIF	<ol style="list-style-type: none"> 1. Verify APFR collar in install position 2. Check for FOD in WIF or structural interference 3. Attempt APFR install in alternate position. If no joy (APFR failure), use another APFR
B. Joint fails to actuate	<ol style="list-style-type: none"> 1. Verify no load is applied to joint 2. Increase force applied to free joint
C. EMU boot becomes stuck in bootplate	Release EVA bolts on heel plate, 5 turns with PGT settings: B1, CCW2, 30.5

10A WORKAROUNDS CRIBSHEET (Cont)

SAFETY TETHER

A. 55-ft safety tether fails to retract/tend	<ol style="list-style-type: none">1. Verify reel is unlocked2. Verify tether reel opening is clear of FOD3. Pull out small amount of cable, allow reel to retract while holding cable slightly tensioned4. If no joy, create big loop with extended cable and wire tie to reel housing
B. 85-ft safety tether fails to retract/tend	<ol style="list-style-type: none">1. Verify reel is unlocked2. Verify tether reel opening and cable guide is clear of FOD (ensure nothing is blocking cable from retracting)3. Pull out small amount of cable, allow reel to retract while holding cable slightly tensioned
C. Safety tether red stripe showing (any length)	Safety tether cannot be used. Replace with spare safety tether, refer to SAFETY TETHER CONFIGURATION, <u>TOOLS AND STOWAGE</u> , for closest spare safety tether

TORQUE MULTIPLIER

A. Torque Multiplier fails to release from fitting	<ol style="list-style-type: none">1. Verify anti-backlash feature in neutral; if not: take PGT to manual ratchet: RCW, 30.5: Apply cw torque and push anti-backlash button to neutral posn2. Release torque multiplier contingency release band pin 20 turns (do not exceed 28 turns with PGT, 5/32" Allen Driver: A5, CCW2, 30.53. When contingency band springs open, remove TM
--	---

SCOOPS

A. Scoop will not release from fitting	Remove screws (not captive), 5 turns each with PGT, 5/32" Allen Driver: A2, CCW2, 30.5
--	--

CLEAR/RESTRAIN CBM CAPTURE LATCH (00:30)

Objective: To clear CBM failed Capture Latch from mating interface and restrain via EVA to allow mating operations to continue

Assumptions: Corresponding CBM Petal Cover for failed latch has been fully deployed via commanding or EVA

IV/SSRMS	EV1	EV2
	<div data-bbox="758 354 1268 451" style="border: 1px solid black; padding: 5px; margin-bottom: 10px;"> <p style="text-align: center;">CAUTION</p> <p>During any CBM operation, avoid contact with sealing surface</p> </div> <ol style="list-style-type: none"> 1. Configure/set up APFR and tools as reqd; transfer to worksite 2. Clear capture latch from CBM mating interface. Restrain capture latch with wire ties, sm-sm RET, or adj equip tethers out of contact zone of CBM ring (latch can be secured to turnbuckle (2 pl), fabric loops, or cable of center disk cover) 3. If capture latch cannot be cleared/restrained from mating interface, it must be removed entirely. See REMOVE/REPLACE CBM CAPTURE LATCH procedure 4. Clean up worksite 5. Visually inspect CBM mating interface, ensure it is clear of latch, wire ties, MLI, and any other equipment or FOD 	<div data-bbox="1415 354 1925 451" style="border: 1px solid black; padding: 5px; margin-bottom: 10px;"> <p style="text-align: center;">CAUTION</p> <p>During any CBM operation, avoid contact with sealing surface</p> </div> <ol style="list-style-type: none"> 1. Configure/set up APFR and tools as reqd; transfer to worksite 2. Assist EV1 as reqd 3. Clean up worksite 4. Visually inspect CBM mating interface, ensure it is clear of latch, wire ties, MLI, and any other equipment or FOD

EVA 1 CONTINGENCIES

CLEAR/RESTRAIN CBM CAPTURE LATCH – TASK DATA

Tools:

EV1	EV2
Wire Tie Caddy	
Sm-sm RET (2)	
Adj Equip tethers (2)	

Cautions:

1. During operation, avoid contact with CBM sealing surface
2. Do not use petals as hand hold unless launch restraints have been engaged

Notes:

1. CBM CPAs do not have to be powered down for this activity

Foot Restraints:

Task	WIF	CETA Position	Swing Arm Settings	APFR Setting
Node 1 Port CBM – Fwd half	NOD 05	N/A	N/A	11, RR, G, 12
Node 1 Port CBM – Aft half	NOD 03	N/A	N/A	11, QQ, G, 1
Node 1 Nadir CBM	SSRMS	N/A	N/A	TBD

* Not verified in NBL

Petal/Latch Locations:

Element/Location	Petal/Latch 1	Petal/Latch 2	Petal/Latch 3	Petal/Latch 4
Node 1 Nadir	Aft Stbd	Fwd Stbd	Fwd Port	Aft Port
Node 1 Port	Fwd Zenith	Aft Zenith	Aft Nadir	Fwd Nadir
Lab Forward	Zenith Stbd	Zenith Port	Nadir Port	Nadir Stbd
Node 2 Nadir	Aft Stbd	Fwd Stbd	Fwd Port	Aft Port
Node 2 Port	Fwd Zenith	Aft Zenith	Aft Nadir	Fwd Nadir
Node 2 Zenith	Aft Port	Fwd Port	Fwd Stbd	Aft Stbd
Node 2 Starboard	Fwd Nadir	Aft Nadir	Aft Zenith	Fwd Zenith
Node 2 Forward	Zenith Stbd	Zenith Port	Nadir Port	Nadir Stbd

CLEAR/RESTRAIN CBM CAPTURE LATCH – TASK DATA (Cont)

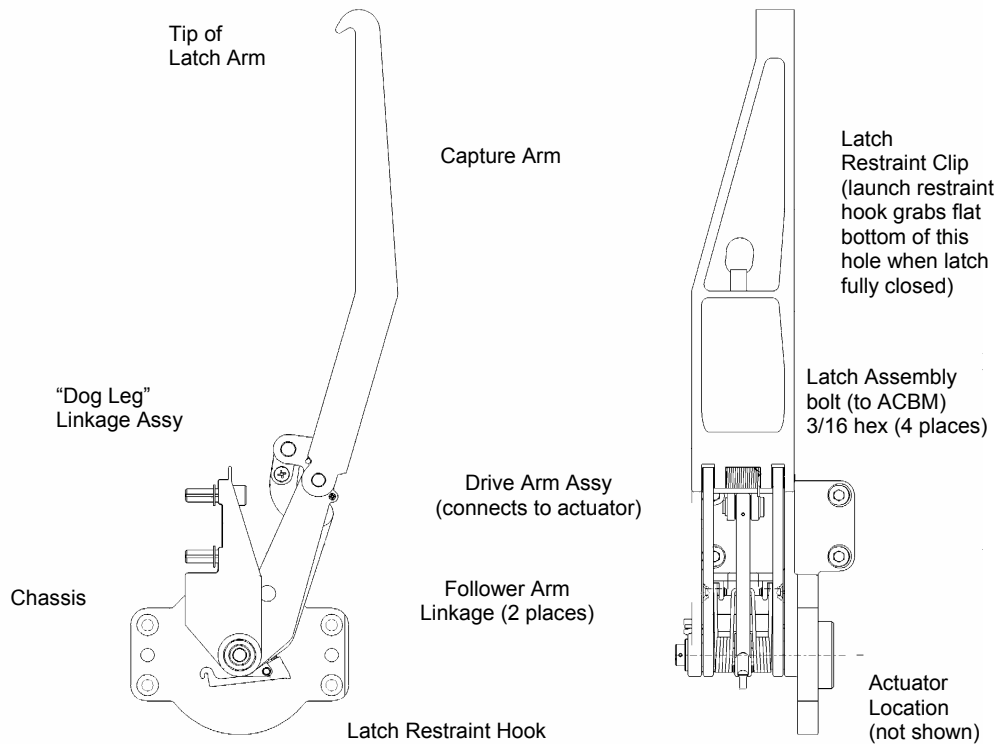

CBM CAPTURE LATCH NOMENCLATURE

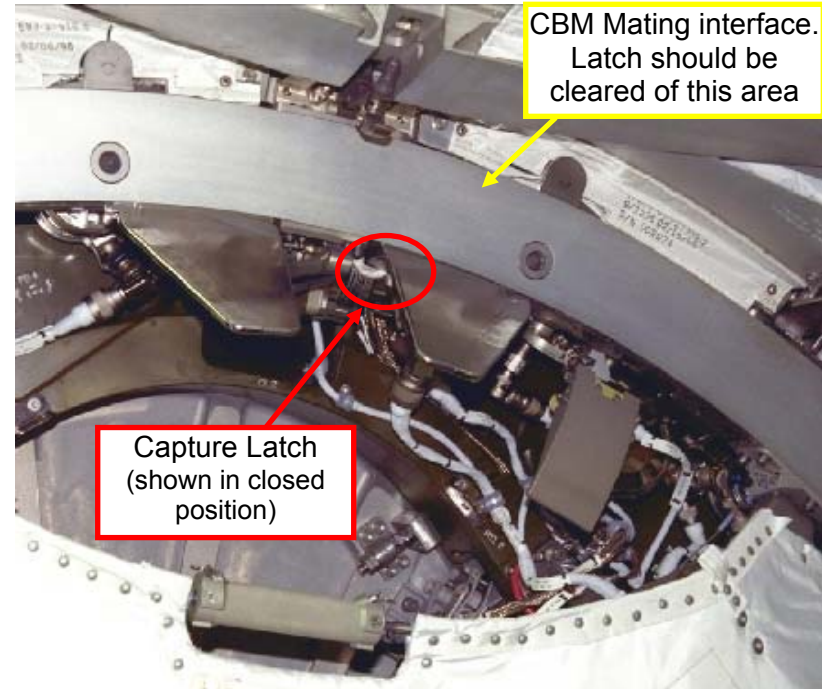

CBM CAPTURE LATCH LOCATION AND CBM MATING INTERFACE

MANUALLY OPEN/CLOSE CBM PETAL (00:30)

Objective: To manually open/close Node 1 radial Common Berthing Mechanism (CBM) petal via EVA due to CBM contingency

IV/SSRMS	EV1	EV2
	<div data-bbox="758 310 1268 407" style="border: 1px solid black; padding: 5px; text-align: center;"> <p><u>CAUTION</u> During any CBM operation, avoid contact with sealing surface</p> </div> <p><u>OPEN PETAL</u></p> <ol style="list-style-type: none"> 1. Configure/set up APFR and tools as reqd; transfer to worksite <div data-bbox="758 561 1220 659" style="border: 1px solid black; padding: 5px; text-align: center;"> <p><u>CAUTION</u> Do not use petal(s) as hand hold until launch restraints have been engaged</p> </div> <ol style="list-style-type: none"> 2. Engage first petal launch restraint for failed petal, push button in 3. PGT [A6, CCW2, 30.5]-6 Ext 7/16: Release roller link release bolt (inner-most, one going thru petal) until capture latch disengaged, up to 12-13 turns <p style="text-align: center;"><u>NOTE</u> Visually verify capture latch tip is no longer engaged on petal roller link</p> <ol style="list-style-type: none"> 4. PGT [A6, CW2, 10.5]-6 Ext 7/16: Retighten roller link release bolt up to 12-13 turns 5. While restraining petal, release first launch restraint (tether hook) 6. Slowly, allow petal to open 7. Clean up worksite <p><u>CLOSE PETAL</u></p> <ol style="list-style-type: none"> 1. Close petal (1-2 lb force reqd); hold 2. Reengage first launch restraint (push in button) 	<div data-bbox="1415 310 1925 407" style="border: 1px solid black; padding: 5px; text-align: center;"> <p><u>CAUTION</u> During any CBM operation, avoid contact with sealing surface</p> </div> <p><u>OPEN PETAL</u></p> <ol style="list-style-type: none"> 1. Configure/set up APFR and tools as reqd; transfer to worksite <div data-bbox="1415 561 1877 659" style="border: 1px solid black; padding: 5px; text-align: center;"> <p><u>CAUTION</u> Do not use petal(s) as hand hold until launch restraints have been engaged</p> </div> <ol style="list-style-type: none"> 2. Engage second petal launch restraint for failed petal, push button in 3. Assist EV1 as reqd <ol style="list-style-type: none"> 4. While restraining petal, release second launch restraint (tether hook) 5. Slowly, allow petal to open 6. Clean up worksite <p><u>CLOSE PETAL</u></p> <ol style="list-style-type: none"> 1. Close petal (1-2 lb force reqd); hold 2. Reengage second launch restraint (push in button)

MANUALLY OPEN/CLOSE CBM PETAL – TASK DATA

Tools:

EV1	EV2
PGT	BRT
7/16-6in ext	Adjustable Tether
Adjustable Tether	

EVA Fasteners:

Fastener Name	Label	Head Size	Qty	Install Torque (ft-lb)	Release Torque (ft-lb)	Failure Torque (ft-lb)	Turns	RPM
Roller Link Release Bolt	N/A	7/16"	1	8.3	8.3	12.1	12-13	30

* Standard PGT settings assumed

Foot Restraints:

Task	WIF	CETA Position	Swing Arm Settings	APFR Setting
Port CBM – Fwd half	NOD 05	N/A	N/A	11, RR, G, 12
Port CBM – Aft half	NOD 03	N/A	N/A	11, QQ, G, 1
Nadir CBM	SSRMS	N/A	N/A	TBD

* Not verified in NBL

Petal/Latch Locations:

Element/Location	Petal/Latch 1	Petal/Latch 2	Petal/Latch 3	Petal/Latch 4
Node 1 Nadir	Aft Stbd	Fwd Stbd	Fwd Port	Aft Port
Node 1 Port	Fwd Zenith	Aft Zenith	Aft Nadir	Fwd Nadir
Lab Forward	Zenith Stbd	Zenith Port	Nadir Port	Nadir Stbd
Node 2 Nadir	Aft Stbd	Fwd Stbd	Fwd Port	Aft Port
Node 2 Port	Fwd Zenith	Aft Zenith	Aft Nadir	Fwd Nadir
Node 2 Zenith	Aft Port	Fwd Port	Fwd Stbd	Aft Stbd
Node 2 Starboard	Fwd Nadir	Aft Nadir	Aft Zenith	Fwd Zenith
Node 2 Forward	Zenith Stbd	Zenith Port	Nadir Port	Nadir Stbd

Cautions:

1. During operation, avoid contact with CBM sealing surface
2. Do not use petals as hand hold unless launch restraints have been engaged

Notes:

1. CBM CPAs do not have to be powered down for this activity

MANUALLY OPEN/CLOSE CBM PETAL – TASK DATA (Cont)

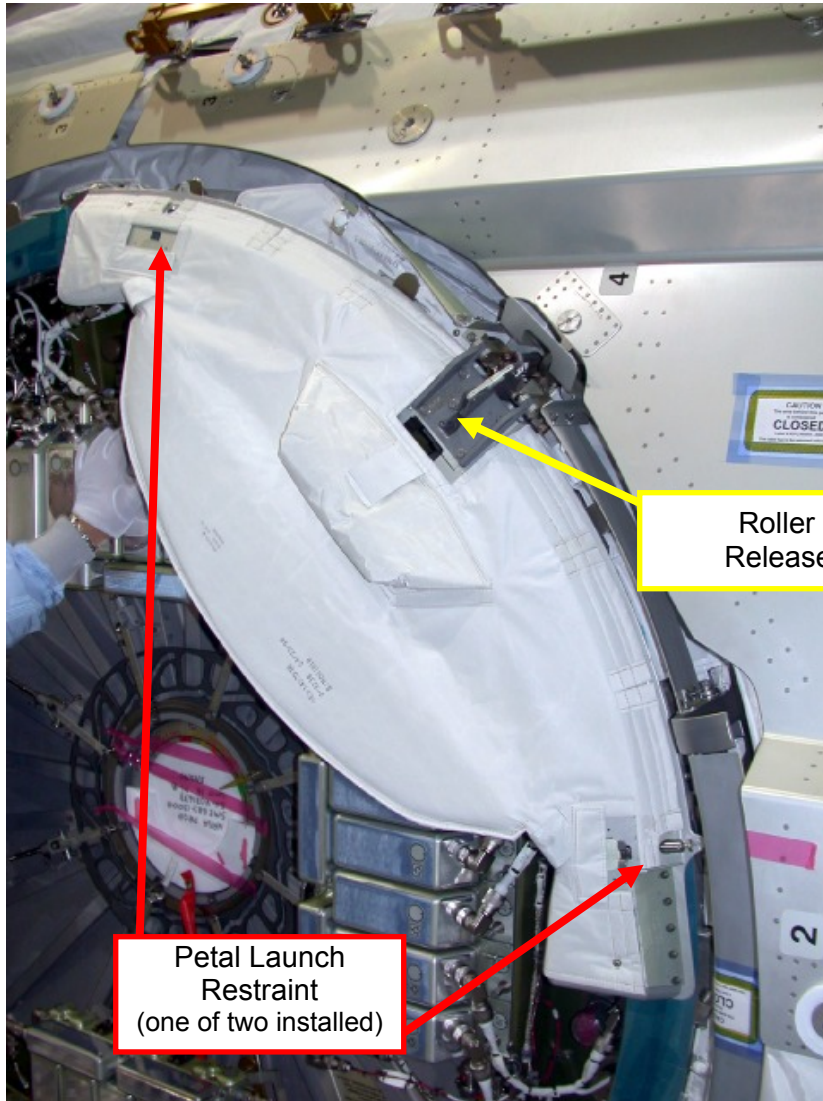

CBM PETAL

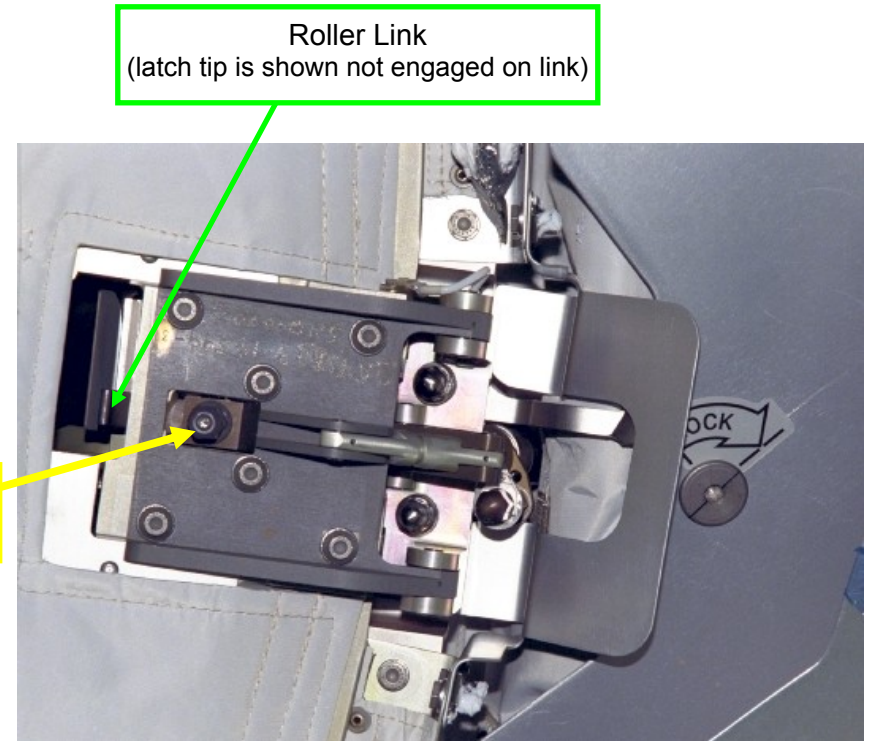

CBM PETAL DEPLOY MECHANISM

MANUALLY OPEN/CLOSE CBM PETAL – TASK DATA (Cont)

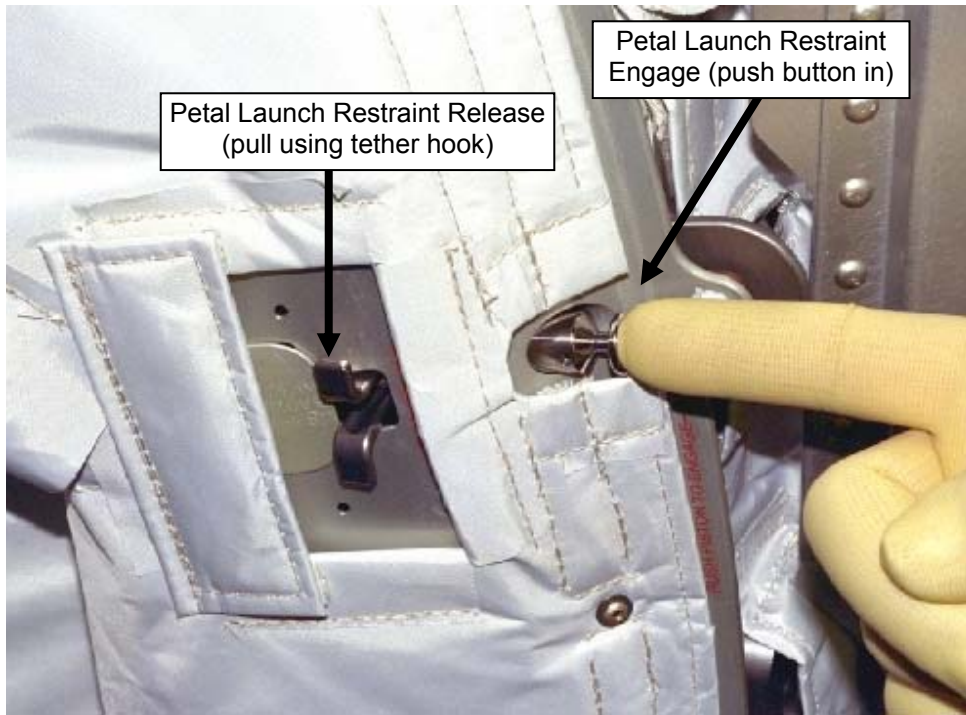

CBM PETAL LAUNCH RESTRAINT OPERATION

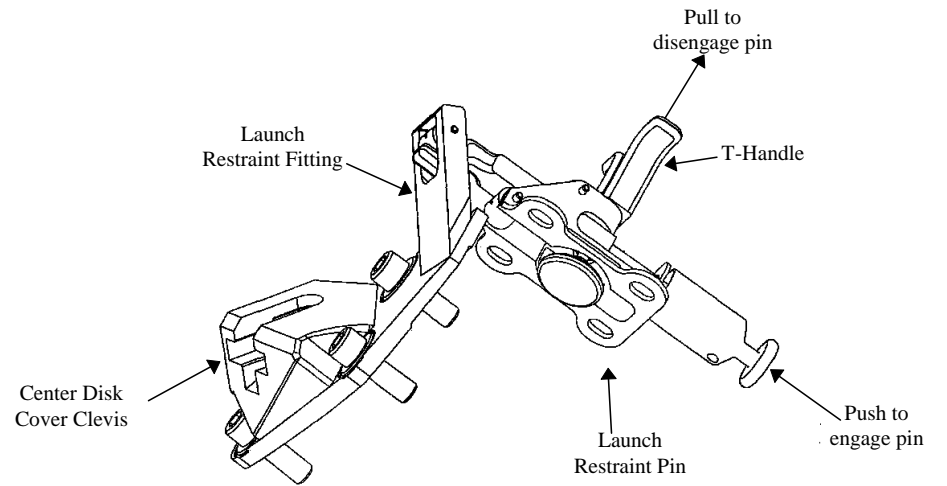

CBM PETAL LAUNCH RESTRAINT MECHANISM

MANUALLY OPEN/CLOSE CBM PETAL – TASK DATA (Cont)



PETAL LAUNCH RESTRAINT RELEASE USING ADJUSTABLE TETHER STRAP

REMOVE/REPLACE CENTER DISK COVER (00:30)

IV Tools reqd for this procedure: See Task Data Sheet for more info

IV/SSRMS	EV1	EV2
	<div style="border: 1px solid black; padding: 5px; text-align: center; margin-bottom: 10px;"> <p>CAUTION During any CBM operation, avoid contact with sealing surface</p> </div> <p><u>COVER REMOVAL (1 quadrant)</u></p> <ol style="list-style-type: none"> 1. Configure/set up APFR and tools as reqd; transfer to worksite 2. Access turnbuckle at desired Center Disk Cover quadrant 3. Engage 1/4-in Socket IVA Tool assembly (on ratchet) on turnbuckle PIP pin hex head (1 of 2). Turn ccw 1/2 turn 4. Repeat step 3 for second turnbuckle PIP pin 5. Attach tether equipment hook to PIP pin ring (pin non-captive). Grasp equipment hook and unscrew pin ccw 4 turns until free from turnbuckle. Ring will remain on tether 6. Repeat step 5 for second turnbuckle PIP pin 7. Open Center Disk Cover flap below turnbuckle to view Instructions 8. Rotate turnbuckle in "LOOSEN" direction to release cable tension (~20-30 turns) 9. Configure retractable tethers to cinch back cover 10. Pull PIP pins from pulleys (two) to be removed, one per pulley 11. Stow pulley PIP pins (two) in Standoff Bar ends 12. Remove each pulley from clevis. Use a tether to keep pulley away from CBM mating interface 13. Cinch adjustable tether as required 14. Remove PIP pins (two) from Standoff Bar (pivot point). Remove Standoff Bar by rotating inward 45 deg. Use a tether to clear worksite <p><u>COVER REINSTALL</u></p> <ol style="list-style-type: none"> 1. Release/stow tethers used to restrain cover 2. Reattach Standoff Bar, rotate outward 45 deg to reinstall cover quadrant 3. Insert pulleys (two) back into clevises (two) 4. Reinstall pulley PIP pins (1 per pulley) 5. Reinstall Standoff Bar PIP pins if time permits (2 per standoff) 6. Repeat steps 2-5 as reqd for other CBM quadrants 7. Secure cover using tethers or wire ties as reqd 8. Clean up worksite 	

REMOVE/REPLACE CENTER DISK COVER – TASK DATA

Tools:

EV1 (FF)	EV2 (FF)
Retractable Tethers (2) w/small equipment hook	
Adjustable Tether	
Wire Ties	
IV: 1/4" Socket, 3/8" Drive	
EVA Ratchet	
Drop Proof Tether Adapter	

EVA Fasteners:

Fastener Name	Label	Head Size	Qty	Install Torque (ft-lb)	Release Torque (ft-lb)	Failure Torque (ft-lb)	Turns	RPM
Turnbuckle PIP Pin Fastener	N/A	1/4"	4	TBD	TBD	TBD	0.5	--

Notes:

1. If removing Center Disk Cover for CPA R&R, only one quadrant reqd to be removed
2. Turnbuckle PIP pin functions somewhat like a set screw and is nominally disengaged by pulling ring and rotating 1/4 turn. However, since it can easily pop back to the engaged position while rotating the turnbuckle, the entire pin is unscrewed for EVA operations

IV Tool Setup:

1. Attach 1/4" Socket, 3/8" Drive to Drop Proof Tether Adapter
2. Attach assembly to EVA ratchet

REMOVE/REPLACE CENTER DISK COVER – TASK DATA (Cont)

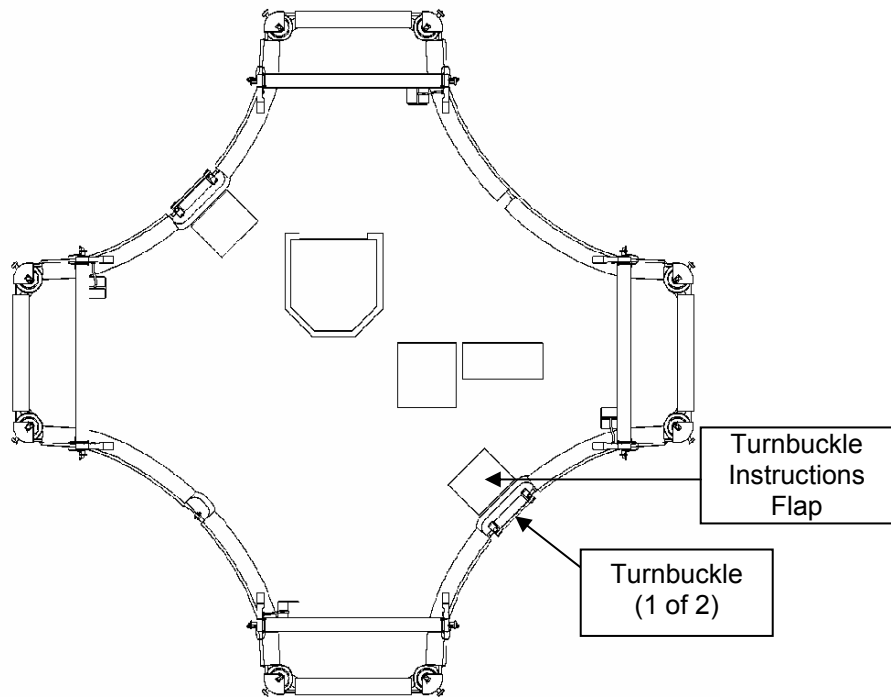

CENTER DISK COVER DRAWING

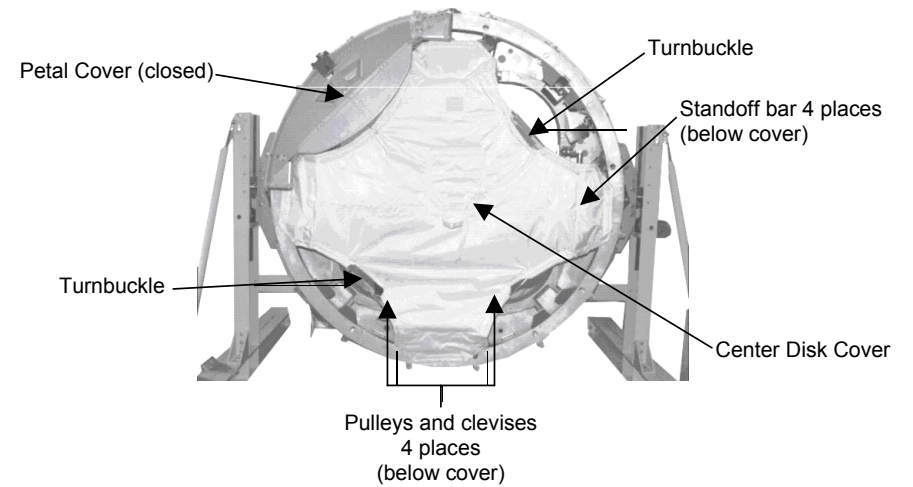

CENTER DISK COVER PHOTO

REMOVE/REPLACE CENTER DISK COVER – TASK DATA



TURNBUCKLE PIP PINS (1 OF 2 SHOWN)



TOOL INTERFACE WITH TURNBUCKLE PIP PIN

REMOVE/REPLACE CENTER DISK COVER – TASK DATA



TETHER INTERFACE WITH TURNBUCKLE PIP PIN RING

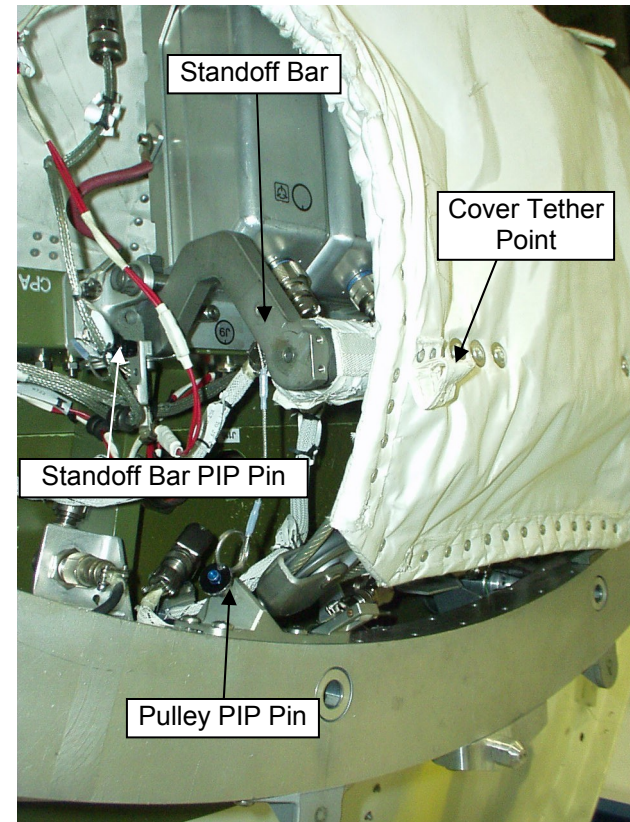

CLEVIS AND PULLEY PIP PIN LOCATIONS

REMOVE/REPLACE CBM CAPTURE LATCH (01:30)

Objective: To remove and replace CBM failed Capture Latch via EVA to allow mating operations to continue

Assumptions: Corresponding CBM Petal Cover for failed latch has been fully deployed via commanding or EVA

IV/SSRMS	EV1	EV2
<p>1. √Inhibits in place for affected capture latch (see Task Data Sheet)</p>	<div data-bbox="751 386 1276 495" style="border: 1px solid black; padding: 5px; margin-bottom: 10px;"> <p style="text-align: center;"><u>WARNING</u></p> <p>Power must be removed from CPA prior to EVA maintenance</p> </div> <div data-bbox="751 513 1276 613" style="border: 1px solid black; padding: 5px; margin-bottom: 10px;"> <p style="text-align: center;"><u>CAUTION</u></p> <p>During any CBM operation, avoid contact with sealing surface</p> </div> <p><u>CAPTURE LATCH REMOVAL</u></p> <ol style="list-style-type: none"> 1. Configure/set up APFR and tools as reqd; transfer to worksite 2. If reqd, open petal cover corresponding to failed capture latch: MANUALLY OPEN/CLOSE CBM PETAL, open steps only 3. PGT [A7 (8.2 ft-lb), CCW2, 30.5]-3/16" Allen Driver: Remove captive fasteners (four) and ground strap on capture latch assembly, 14.5 turns 4. Tether to capture latch assembly with wire tie 5. On IV GO, Disconnect connectors P2 and P3 from capture Latch actuator (2 1/2 turns) (use connector tool as reqd) 6. Remove capture latch assembly 7. Remove capture latch and stow (use trash bag as reqd for loose pieces) 8. If capture latch assembly not being replaced, position ground strap and connector cables such that alignment guides, CBM sealing surface, RTLs are clear 	<div data-bbox="1411 386 1936 495" style="border: 1px solid black; padding: 5px; margin-bottom: 10px;"> <p style="text-align: center;"><u>WARNING</u></p> <p>Power must be removed from CPA prior to EVA maintenance</p> </div> <div data-bbox="1411 513 1936 613" style="border: 1px solid black; padding: 5px; margin-bottom: 10px;"> <p style="text-align: center;"><u>CAUTION</u></p> <p>During any CBM operation, avoid contact with sealing surface</p> </div> <p><u>CAPTURE LATCH REMOVAL</u></p> <ol style="list-style-type: none"> 1. Configure/set up APFR and tools as reqd; transfer to worksite 2. Assist EV1 as reqd

REMOVE/REPLACE CBM CAPTURE LATCH (01:30) (Cont)

IV/SSRMS	EV1	EV2
	<p><u>CAPTURE LATCH REPLACE</u></p> <ol style="list-style-type: none"> 1. Mate connectors P3 and P2 on replacement capture latch (use connector tool as required) 2. Position capture latch for installation 3. Re-position grounding strap on closest CLA captive fastener 4. PGT [A3, CW2, 5.5]-3/16" Allen Driver: Tighten captive fasteners (four) on capture latch Assembly, 14.5 turns 5. If required, close corresponding petal cover: MANUALLY OPEN/CLOSE CBM PETAL, close steps only 6. Clean up worksite 7. Visually inspect CBM mating interface, ensure it is clear of latch, wire ties, MLI, and any other equipment or FOD 	<p><u>CAPTURE LATCH REPLACE</u></p> <ol style="list-style-type: none"> 1. Assist EV1 as reqd 2. Clean up worksite 3. Visually inspect CBM mating interface, ensure it is clear of latch, wire ties, MLI, and any other equipment or FOD

REMOVE/REPLACE CBM CAPTURE LATCH – TASK DATA

Tools:

EV1 (FF)	EV2 (FF)
Wire Tie Caddy	BRT
3/16" Allen Driver	
Connector Tool, Sm locking electrical	
Small trash bag	
PGT	
BRT	

EVA Fasteners:

Fastener Name	Label	Head Size	Qty	Install Torque (ft-lb)	Release Torque (ft-lb)	Failure Torque (ft-lb)	Turns	RPM
Capture Latch Captive Fastener Release	N/A	3/16"	4	N/A	9.2	13.6	14.5	30
Capture Latch Captive Fastener Install	N/A	3/16"	4	4.8	N/A	8.6	14.5	30

* Standard PGT settings assumed

Foot Restraints:

Task	WIF	CETA Position	Swing Arm Settings	APFR Setting
N1 Port CBM – Fwd half	NOD 05	N/A	N/A	11, RR, G, 12
N1 Port CBM – Aft half	NOD 03	N/A	N/A	11, QQ, G, 1
N1 Nadir CBM	SSRMS	N/A	N/A	TBD

* Not verified in NBL

Warnings:

1. Power must be removed from CPA prior to this task

Cautions:

1. During operation, avoid contact with CBM sealing surface

Notes:

1. Connectors are fully mated when Red Indicator Ring is no longer visible
2. Center Disk cover may need to be removed for access with the long 3/16" Allen Driver tool

Petal/Latch Locations:

Element/Location	Petal/Latch 1	Petal/Latch 2	Petal/Latch 3	Petal/Latch 4
Node 1 Nadir	Aft Stbd	Fwd Stbd	Fwd Port	Aft Port
Node 1 Port	Fwd Zenith	Aft Zenith	Aft Nadir	Fwd Nadir
Lab Forward	Zenith Stbd	Zenith Port	Nadir Port	Nadir Stbd
Node 2 Nadir	Aft Stbd	Fwd Stbd	Fwd Port	Aft Port
Node 2 Port	Fwd Zenith	Aft Zenith	Aft Nadir	Fwd Nadir
Node 2 Zenith	Aft Port	Fwd Port	Fwd Stbd	Aft Stbd
Node 2 Starboard	Fwd Nadir	Aft Nadir	Aft Zenith	Fwd Zenith
Node 2 Forward	Zenith Stbd	Zenith Port	Nadir Port	Nadir Stbd

REMOVE/REPLACE CBM CAPTURE LATCH – TASK DATA (Cont)

CPA Power Inhibits:

Element/Location	CPA	Primary RPCM	Secondary RPCM
Node 1 Nadir	CPA 1	RPCM N13B B RPC 03	RPCM N14B B RPC 11
Node 1 Nadir	CPA 2	RPCM N13B B RPC 04	RPCM N14B B RPC 12
Node 1 Nadir	CPA 3	RPCM N13B B RPC 05	RPCM N14B B RPC 13
Node 1 Nadir	CPA 4	RPCM N13B B RPC 06	RPCM N14B B RPC 14
Node 1 Port	CPA 1	RPCM N1RS2 C RPC 07	RPCM N1RS1 B RPC 05
Node 1 Port	CPA 2	RPCM N1RS2 C RPC 08	RPCM N1RS1 B RPC 06
Node 1 Port	CPA 3	RPCM N1RS2 C RPC 10	RPCM N1RS1 B RPC 13
Node 1 Port	CPA 4	RPCM N1RS2 C RPC 11	RPCM N1RS1 B RPC 14
Lab Forward	CPA 1	RPCM LA1B B RPC 4	RPCM LA2B B RPC 4
Lab Forward	CPA 2	RPCM LA1B B RPC 3	RPCM LA2B B RPC 3
Lab Forward	CPA 3	RPCM LA1B B RPC 2	RPCM LA2B B RPC 2
Lab Forward	CPA 4	RPCM LA1B B RPC 1	RPCM LA2B B RPC 1
Node 2 Nadir	CPA 1	RPCM N21B4B A RPC 1	RPCM N22B3A B RPC 1
Node 2 Nadir	CPA 2	RPCM N21B4B A RPC 3	RPCM N22B3A B RPC 3
Node 2 Nadir	CPA 3	RPCM N21B4B A RPC 2	RPCM N22B3A B RPC 2
Node 2 Nadir	CPA 4	RPCM N21B4B A RPC 4	RPCM N22B3A B RPC 4
Node 2 Port	CPA 1	RPCM N21B4B A RPC 5	RPCM N22B3A B RPC 5
Node 2 Port	CPA 2	RPCM N21B4B A RPC 11	RPCM N22B3A B RPC 11
Node 2 Port	CPA 3	RPCM N21B4B A RPC 6	RPCM N22B3A B RPC 6
Node 2 Port	CPA 4	RPCM N21B4B A RPC 12	RPCM N22B3A B RPC 12
Node 2 Zenith	CPA 1	RPCM N21A4A C RPC 1	RPCM N22A3B A RPC 1
Node 2 Zenith	CPA 2	RPCM N21A4A C RPC 3	RPCM N22A3B A RPC 3
Node 2 Zenith	CPA 3	RPCM N21A4A C RPC 2	RPCM N22A3B A RPC 2
Node 2 Zenith	CPA 4	RPCM N21A4A C RPC 4	RPCM N22A3B A RPC 4
Node 2 Starboard	CPA 1	RPCM N21B4B A RPC 13	RPCM N22B3A B RPC 13
Node 2 Starboard	CPA 2	RPCM N21B4B A RPC 15	RPCM N22B3A B RPC 15
Node 2 Starboard	CPA 3	RPCM N21B4B A RPC 14	RPCM N22B3A B RPC 14
Node 2 Starboard	CPA 4	RPCM N21B4B A RPC 16	RPCM N22B3A B RPC 16
Node 2 Forward	CPA 1	RPCM N21A4A C RPC 13	RPCM N22A3B A RPC 13
Node 2 Forward	CPA 2	RPCM N21A4A C RPC 15	RPCM N22A3B A RPC 15
Node 2 Forward	CPA 3	RPCM N21A4A C RPC 14	RPCM N22A3B A RPC 14
Node 2 Forward	CPA 4	RPCM N21A4A C RPC 16	RPCM N22A3B A RPC 16

REMOVE/REPLACE CBM CAPTURE LATCH – TASK DATA (Cont)

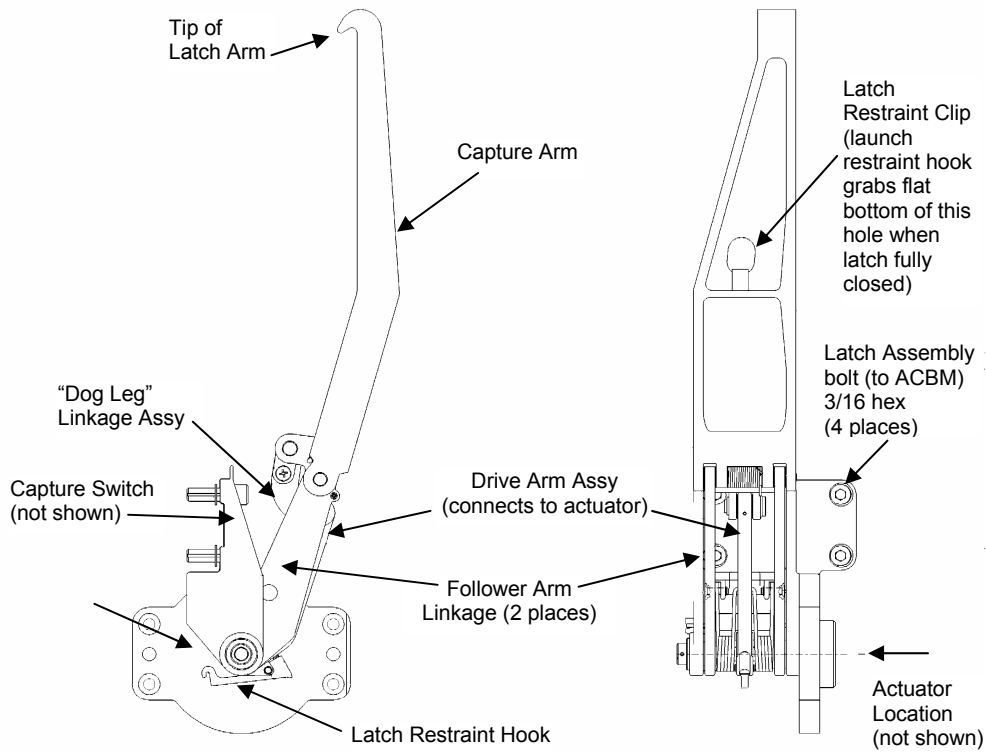

CBM CAPTURE LATCH NOMENCLATURE

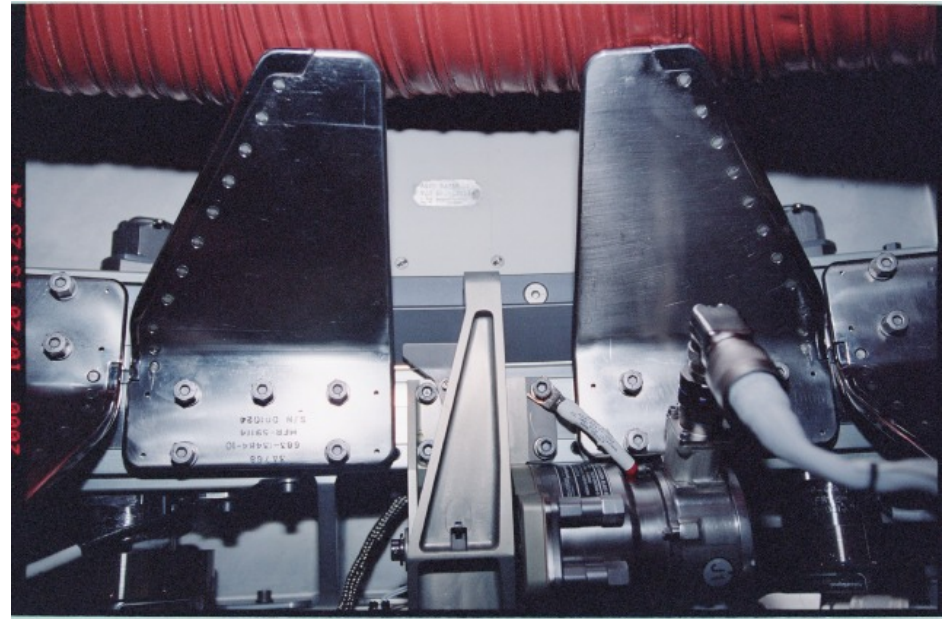

CBM CAPTURE LATCH LOCATION

REMOVE/REPLACE CBM CONTROLLER PANEL ASSEMBLY (CPA) (02:00)

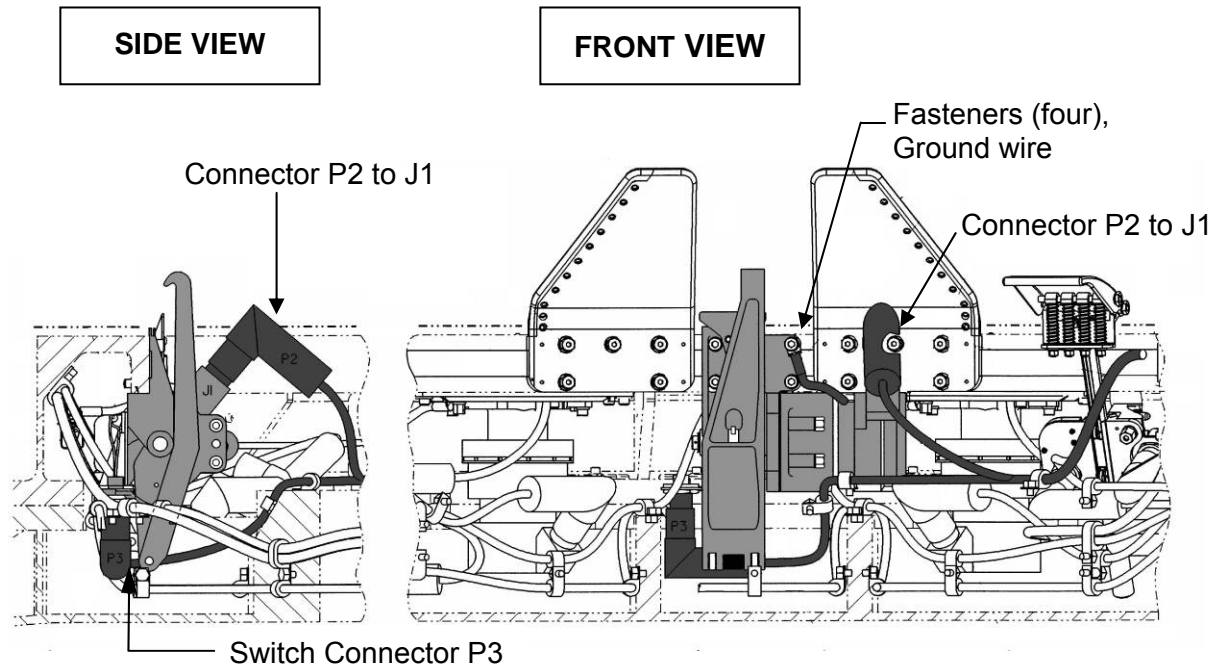

CAPTURE LATCH ASSEMBLY (CLA) (SHOWN IN CLOSED POSITION)

REMOVE/REPLACE CBM CONTROLLER PANEL ASSEMBLY (CPA) (02:00) (Cont)

Objective: To remove and replace failed CBM Controller Panel Assembly (CPA)

Assumptions: Corresponding CBM Petal Covers (two) for failed CPA have been fully deployed via commanding or EVA

IV Tools reqd for this procedure and must be retrieved prior to EVA. See Task Data Sheet for more info

IV/SSRMS	EV1	EV2
<p>1. √Inhibits in place for affected CPA (see Task Data Sheet)</p> <p>Record S/N of spare CPA _____</p> <p>Record S/N of failed CPA _____</p>	<div style="border: 3px double black; padding: 5px; text-align: center;"> <p>WARNING</p> <p>Power must be removed from CPA prior to EVA maintenance</p> </div> <div style="border: 1px solid black; padding: 5px; text-align: center;"> <p>CAUTION</p> <p>During any CBM operation, avoid contact with sealing surface</p> </div> <p><u>CPA REMOVAL</u></p> <ol style="list-style-type: none"> 1. Configure/set up APFR tools as reqd; transfer to worksite 2. Remove Center Disk Cover corresponding quadrant: Perform REMOVE/REPLACE CENTER DISK COVER, COVER REMOVAL, removal steps only 3. Attach CBM Tether Point to seat track on failed CPA 4. Demate cable connectors J1-J9 on CPA (9 total) (use connector tool as reqd) 5. Disconnect grounding straps (two) from CPA with EVA ratchet, 5/32-in Ball End Allen Driver 6. Tether to CBM Tether Point on CPA <div style="text-align: center;"> <p><u>NOTE</u></p> <p>Do not use EVA 7/16" socket on CPA fasteners – will disassemble fastener</p> </div> <ol style="list-style-type: none"> 7. PGT [A6, CCW2, 30.5] IV 7/16" w/DPTA: Release fasteners (five) on CPA 13-14 turns 8. Detach from bulkhead 9. Stow CPA 	<div style="border: 3px double black; padding: 5px; text-align: center;"> <p>WARNING</p> <p>Power must be removed from CPA prior to EVA maintenance</p> </div> <div style="border: 1px solid black; padding: 5px; text-align: center;"> <p>CAUTION</p> <p>During any CBM operation, avoid contact with sealing surface</p> </div> <p><u>CPA REMOVAL</u></p> <ol style="list-style-type: none"> 1. Configure/set up APFR tools as reqd; transfer to worksite 2. Assist EV1 as reqd

REMOVE/REPLACE CBM CONTROLLER PANEL ASSEMBLY (CPA) – TASK DATA

Tools:

EV1	EV2
PGT	BRT
Spare CPA	
CBM Tether Point (1 of 2)	
5/32-in Ball End Allen Driver	
CBM Tether Point (for failed unit)	
Connector Tool, Sm locking electrical	
EVA ratchet	
IV: 7/16" Socket, 3/8" Drive	
Drop Proof Tether Adapter	

EVA Fasteners:

Fastener Name	Label	Head Size	Qty	Install Torque (ft-lb)	Release Torque (ft-lb)	Failure Torque (ft-lb)	Turns	RPM
CPA Removal Fastener		7/16"	5	3.8	8.3	Rel/12.0 Inst/6.0	13-14	30
CPA Ground Strap Fastener		5/32"	2	hand tight	~3	~5	6.5	30

* Standard PGT settings assumed

EVA Connectors:

Harness	From	To	Function
W7(2)0	P(2)	J1	Power cable
W7(2)1	P(2)	J2	Data cable
W7(2)2	P(2)	J3	Power cable
W7(2)3	P(2)	J4	Data cable
P1 to J5 LCH CONT	P1	J5	Bolt/latch cable
P1 to J6 LCH CONT	P1	J6	Bolt/latch cable
P1 to J7 LCH CONT	P1	J7	Bolt/latch cable
P1 to J8 LCH CONT	P1	J8	Bolt/latch cable
P1 to J9 LCH CONT	P1	J9	Bolt/latch cable

Foot Restraints:

Task	WIF	CETA Position	Swing Arm Settings	APFR Setting
Node 1 Port CBM – Fwd half	NOD 05	N/A	N/A	11, RR, G, 12
Node 1 Port CBM – Aft half	NOD 03	N/A	N/A	11, QQ, G, 1
Node 1 Nadir CBM	SSRMS	N/A	N/A	TBD

* Not verified in NBL

Warnings:

1. Power must be removed from CPA prior to EVA maintenance

Cautions:

1. During operation, avoid contact with CBM sealing surface

Notes:

1. Do not use an EVA 7/16" socket on CPA Removal Fasteners. Although it is possible to remove these fasteners using this socket, the EVA socket is too long and it is possible to simultaneously engage and remove the entire bolt assembly, making it non-captive. To prevent this, the IV 7/16" socket will be used with the DPT
2. There is no real aligning feature for the CPA other than the Removal Fastener bolt holes, therefore reinstalling can be difficult. It may be easiest to start a few bolts by hand (2 bolts furthest out radially have proven easiest with EVA Glove). Note CPA is properly aligned when bolt plate is flush with end of Node bulkhead
3. During installation, to prevent binding of CPA Removal Fasteners, can turn each fastener a few turns, then repeat until torque is met
4. CPA Connectors are fully mated when Red Indicator Ring is no longer visible

REMOVE/REPLACE CBM CONTROLLER PANEL ASSEMBLY (CPA) – TASK DATA (Cont)

Petal/Latch Locations:

Element/Location	Petal/Latch 1	Petal/Latch 2	Petal/Latch 3	Petal/Latch 4
Node 1 Nadir	Aft Stbd	Fwd Stbd	Fwd Port	Aft Port
Node 1 Port	Fwd Zenith	Aft Zenith	Aft Nadir	Fwd Nadir
Lab Forward	Zenith Stbd	Zenith Port	Nadir Port	Nadir Stbd
Node 2 Nadir	Aft Stbd	Fwd Stbd	Fwd Port	Aft Port
Node 2 Port	Fwd Zenith	Aft Zenith	Aft Nadir	Fwd Nadir
Node 2 Zenith	Aft Port	Fwd Port	Fwd Stbd	Aft Stbd
Node 2 Starboard	Fwd Nadir	Aft Nadir	Aft Zenith	Fwd Zenith
Node 2 Forward	Zenith Stbd	Zenith Port	Nadir Port	Nadir Stbd

CPA Locations:

Element/Location	CPA 1	CPA 2	CPA 3	CPA 4
Node 1 Nadir	Stbd	Fwd	Port	Aft
Node 1 Port	Zenith	Aft	Nadir	Fwd
Lab Forward	Zenith	Port	Nadir	Starboard
Node 2 Nadir	Stbd	Fwd	Port	Aft
Node 2 Port	Zenith	Aft	Nadir	Fwd
Node 2 Zenith	Port	Fwd	Stbd	Aft
Node 2 Starboard	Nadir	Aft	Zenith	Fwd
Node 2 Forward	Zenith	Port	Nadir	Stbd

CPA Power Inhibits:

Element/Location	CPA	Primary RPCM	Secondary RPCM
Node 1 Nadir	CPA 1	RPCM N13B B RPC 03	RPCM N14B B RPC 11
Node 1 Nadir	CPA 2	RPCM N13B B RPC 04	RPCM N14B B RPC 12
Node 1 Nadir	CPA 3	RPCM N13B B RPC 05	RPCM N14B B RPC 13
Node 1 Nadir	CPA 4	RPCM N13B B RPC 06	RPCM N14B B RPC 14
Node 1 Port	CPA 1	RPCM N1RS2 C RPC 07	RPCM N1RS1 B RPC 05
Node 1 Port	CPA 2	RPCM N1RS2 C RPC 08	RPCM N1RS1 B RPC 06
Node 1 Port	CPA 3	RPCM N1RS2 C RPC 10	RPCM N1RS1 B RPC 13
Node 1 Port	CPA 4	RPCM N1RS2 C RPC 11	RPCM N1RS1 B RPC 14
Lab Forward	CPA 1	RPCM LA1B B RPC 4	RPCM LA2B B RPC 4
Lab Forward	CPA 2	RPCM LA1B B RPC 3	RPCM LA2B B RPC 3
Lab Forward	CPA 3	RPCM LA1B B RPC 2	RPCM LA2B B RPC 2
Lab Forward	CPA 4	RPCM LA1B B RPC 1	RPCM LA2B B RPC 1
Node 2 Nadir	CPA 1	RPCM N21B4B A RPC 1	RPCM N22B3A B RPC 1
Node 2 Nadir	CPA 2	RPCM N21B4B A RPC 3	RPCM N22B3A B RPC 3
Node 2 Nadir	CPA 3	RPCM N21B4B A RPC 2	RPCM N22B3A B RPC 2
Node 2 Nadir	CPA 4	RPCM N21B4B A RPC 4	RPCM N22B3A B RPC 4
Node 2 Port	CPA 1	RPCM N21B4B A RPC 5	RPCM N22B3A B RPC 5
Node 2 Port	CPA 2	RPCM N21B4B A RPC 11	RPCM N22B3A B RPC 11
Node 2 Port	CPA 3	RPCM N21B4B A RPC 6	RPCM N22B3A B RPC 6
Node 2 Port	CPA 4	RPCM N21B4B A RPC 12	RPCM N22B3A B RPC 12
Node 2 Zenith	CPA 1	RPCM N21A4A C RPC 1	RPCM N22A3B A RPC 1
Node 2 Zenith	CPA 2	RPCM N21A4A C RPC 3	RPCM N22A3B A RPC 3
Node 2 Zenith	CPA 3	RPCM N21A4A C RPC 2	RPCM N22A3B A RPC 2
Node 2 Zenith	CPA 4	RPCM N21A4A C RPC 4	RPCM N22A3B A RPC 4
Node 2 Starboard	CPA 1	RPCM N21B4B A RPC 13	RPCM N22B3A B RPC 13
Node 2 Starboard	CPA 2	RPCM N21B4B A RPC 15	RPCM N22B3A B RPC 15
Node 2 Starboard	CPA 3	RPCM N21B4B A RPC 14	RPCM N22B3A B RPC 14
Node 2 Starboard	CPA 4	RPCM N21B4B A RPC 16	RPCM N22B3A B RPC 16
Node 2 Forward	CPA 1	RPCM N21A4A C RPC 13	RPCM N22A3B A RPC 13
Node 2 Forward	CPA 2	RPCM N21A4A C RPC 15	RPCM N22A3B A RPC 15
Node 2 Forward	CPA 3	RPCM N21A4A C RPC 14	RPCM N22A3B A RPC 14
Node 2 Forward	CPA 4	RPCM N21A4A C RPC 16	RPCM N22A3B A RPC 16

REMOVE/REPLACE CBM CONTROLLER PANEL ASSEMBLY (CPA) – TASK DATA (Cont)

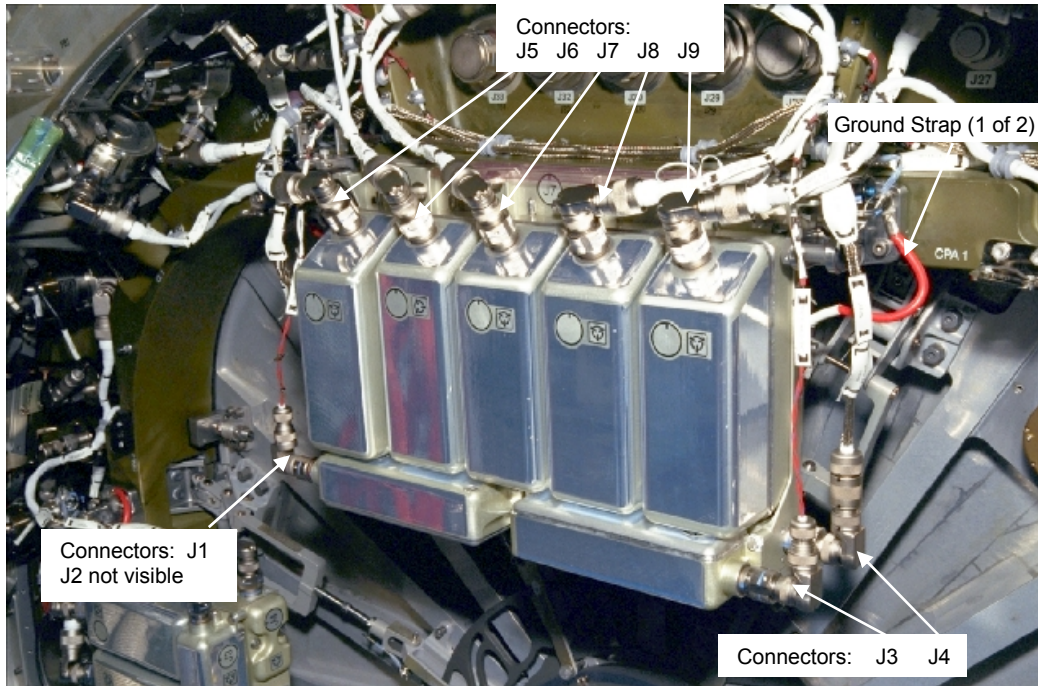

CBM CPA CONNECTORS AND GROUND STRAP
(CENTER DISK COVER REMOVED)

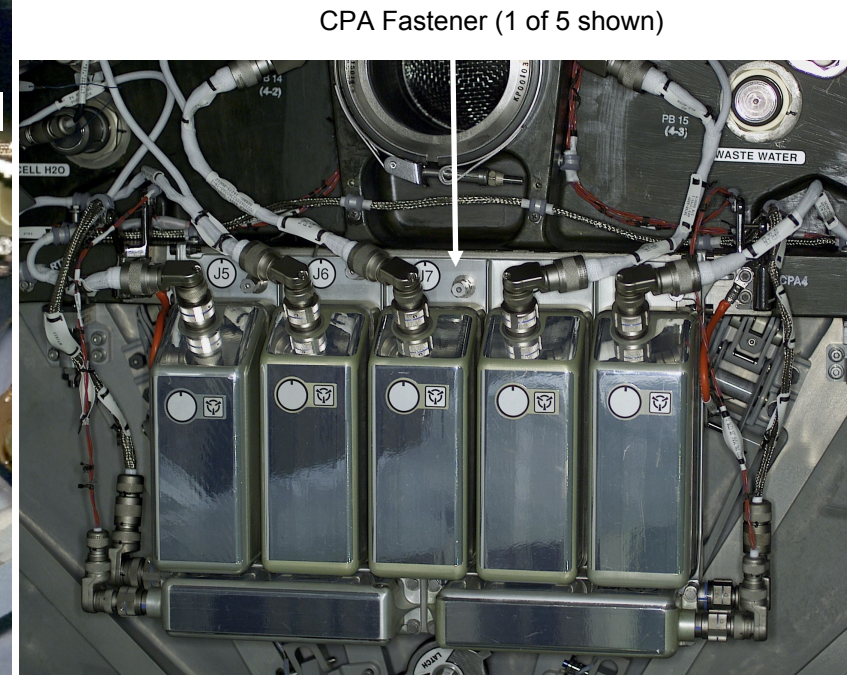

CBM CPA FASTENER LOCATIONS

REMOVE/REPLACE CBM CONTROLLER PANEL ASSEMBLY (CPA) – TASK DATA (Cont)

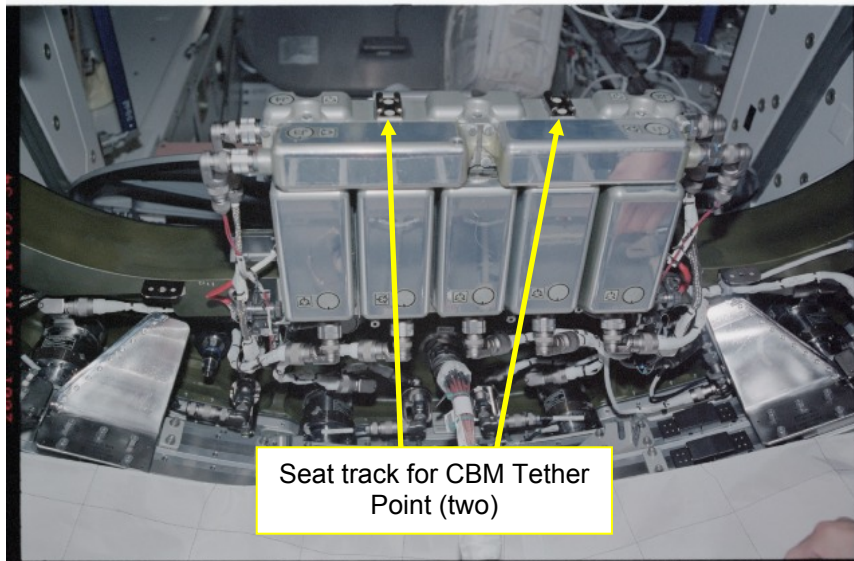

SEAT TRACK FOR CBM TETHER POINT INSTALLATION

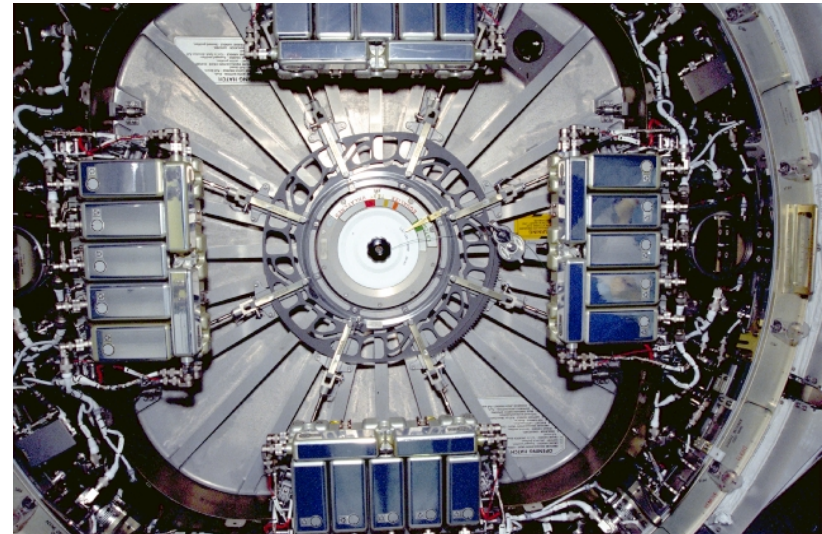

EXTERNAL VIEW OF CBM CPAs INSTALLED
(CENTER DISK COVER REMOVED)

REMOVE/REPLACE CBM CONTROLLER PANEL ASSEMBLY (CPA) – TASK DATA (Cont)

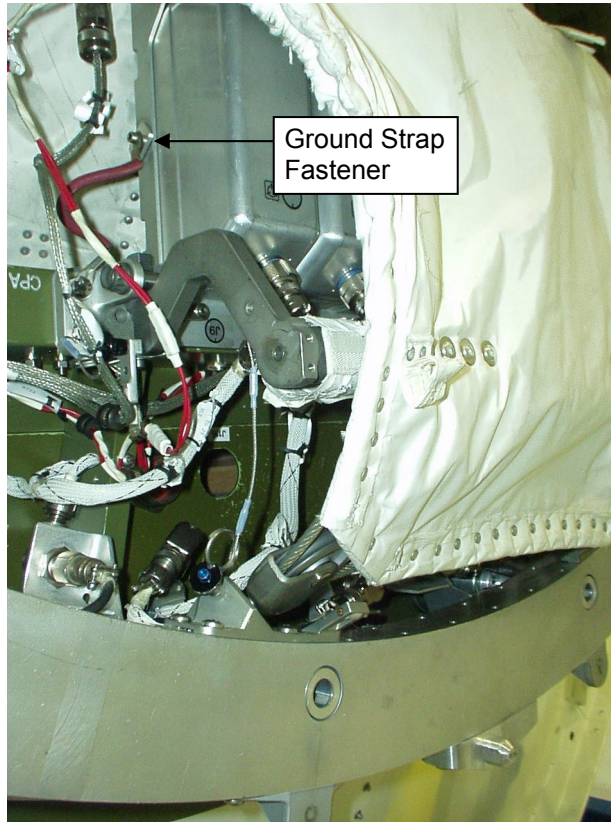

**CPA GROUND STRAP FASTENER
(CENTER DISK COVER INSTALLED)**

REMOVE/REPLACE CBM PETAL (00:30)

Objective: To manually open/close Node 1 radial Common Berthing Mechanism (CBM) petal via EVA due to CBM contingency

IV/SSRMS	EV1	EV2
<p style="text-align: center;"><u>NOTE</u> It is preferable to remove/replace petal from closed position</p> <p><u>NOTE:</u> Questions about direction to turn bolt</p>	<div style="border: 1px solid black; padding: 5px; text-align: center; margin-bottom: 10px;"> <p><u>CAUTION</u> During any CBM operation, avoid contact with sealing surface</p> </div> <p><u>PETAL REMOVAL</u></p> <ol style="list-style-type: none"> 1. Configure/set up APFR and tools as reqd; transfer to worksite <div style="border: 1px solid black; padding: 5px; text-align: center; margin-bottom: 10px;"> <p><u>CAUTION</u> Do not use petal(s) as handhold until launch restraints have been engaged</p> </div> <ol style="list-style-type: none"> 2. If petal in fully closed position: Engage first petal launch restraint for failed petal, push button in 3. PGT [A4, CW2, 30.5]-6 Ext 7/16: Turn Actuator Lock-out Bolt (outer-most bolt) to disable spring actuator ~18 turns 4. PGT [A6, CCW2, 30.5]-6 Ext 7/16: Turn Roller Link Release Bolt up to 12-13 turns to disengage Capture Latch 5. Visually verify Capture Latch is not engaged on Petal Roller Link 6. PGT [A6, CW2, 10.5]-6 Ext 7/16: Retighten Roller Link Release Bolt up to 12-13 turns 7. Attach tether to petal hinge linkage 8. PGT [B4, CCW2, 30.5]-6 Ext 7/16: Remove Petal Attachment Bolts (two) ~12 turns 9. If launch restraints engaged, release first launch restraint 10. Remove petal 	<div style="border: 1px solid black; padding: 5px; text-align: center; margin-bottom: 10px;"> <p><u>CAUTION</u> During any CBM operation, avoid contact with sealing surface</p> </div> <p><u>PETAL REMOVAL</u></p> <ol style="list-style-type: none"> 1. Configure/set up APFR and tools as reqd; transfer to worksite <div style="border: 1px solid black; padding: 5px; text-align: center; margin-bottom: 10px;"> <p><u>CAUTION</u> Do not use petal(s) as handhold until launch restraints have been engaged</p> </div> <ol style="list-style-type: none"> 2. If petal in fully closed position: Engage second petal launch restraint for failed petal, push button in 3. Assist EV1 as reqd 4. If launch restraints engaged, release second launch restraint 5. Remove petal

REMOVE/REPLACE CBM PETAL (00:30) (Cont)

IV/SSRMS	EV1	EV2
<p><u>NOTE:</u> Questions about direction to turn bolt</p>	<p><u>PETAL REPLACE</u></p> <ol style="list-style-type: none"> 1. Configure/set up APFR and tools as reqd; transfer to worksite 2. Position replacement petal 3. If petal in closed position: Engage first launch restraint (push button in) 4. PGT [A7, CW2, 30.5]-6 Ext 7/16: Engage Petal Attachment Bolts (two) 12 turns, apply pressure on bolt while turning to ensure engagement 5. Remove tether from petal 6. PGT [A7, CCW2, 10.5]-6 Ext 7/16: Reengage Actuator Lock-out Bolt (outer-most bolt) ~12 turns 7. While holding petal, release first launch restraint 8. Clean up worksite 9. Visually inspect CBM mating interface, ensure it is clear of latch, wire ties, MLI and any other equipment or FOD 	<p><u>PETAL REPLACE</u></p> <ol style="list-style-type: none"> 1. Configure/set up APFR and tools as reqd; transfer to worksite 2. Assist EV1 as reqd 3. If petal in closed position: Engage second launch restraint (push button in) 4. While holding petal, release second launch restraint 5. Clean up worksite 6. Visually inspect CBM mating interface, ensure it is clear of latch, wire ties, MLI and any other equipment or FOD

REMOVE/REPLACE CBM PETAL – TASK DATA

Tools:

EV1	EV2
PGT	BRT
7/16-6in ext	Adjustable Tether
Adjustable Tether	
BRT	

EVA Fasteners:

Fastener Name	Label	Head Size	Qty	Install Torque (ft-lb)	Release Torque (ft-lb)	Failure Torque (ft-lb)	Turns	RPM
Roller Link Release Bolt	N/A	7/16"	1	8.3	8.3	12.0	up to 12-13	30
Petal Attachment Bolt	N/A	7/16"	2	9.2	19.4	26.1/Rel 13.1/Inst	12	30
Actuator Lock-out Bolt	N/A	7/16"	1	9.2	9.2	~15	TBD	30

* Standard PGT settings assumed

Foot Restraints:

Task	WIF	CETA Position	Swing Arm Settings	APFR Setting
Node 1 Port CBM – Fwd half	NOD 05	N/A	N/A	11, RR, G, 12
Node 1 Port CBM – Aft half	NOD 03	N/A	N/A	11, QQ, G, 1
Node 1 Nadir CBM	SSRMS	N/A	N/A	TBD

* Not verified in NBL

Warnings:

1. Do not use petals as hand hold unless launch restraints have been engaged

Cautions:

1. During operation, avoid contact with CBM sealing surface

Notes:

1. CBM CPAs do not have to be powered down for this activity
2. It is preferable to remove/replace petal from closed position, thus allowing crew to disable actuator spring

Petal/Latch Locations:

Element/Location	Petal/Latch 1	Petal/Latch 2	Petal/Latch 3	Petal/Latch 4
Node 1 Nadir	Aft Stbd	Fwd Stbd	Fwd Port	Aft Port
Node 1 Port	Fwd Zenith	Aft Zenith	Aft Nadir	Fwd Nadir
Lab Forward	Zenith Stbd	Zenith Port	Nadir Port	Nadir Stbd
Node 2 Nadir	Aft Stbd	Fwd Stbd	Fwd Port	Aft Port
Node 2 Port	Fwd Zenith	Aft Zenith	Aft Nadir	Fwd Nadir
Node 2 Zenith	Aft Port	Fwd Port	Fwd Stbd	Aft Stbd
Node 2 Starboard	Fwd Nadir	Aft Nadir	Aft Zenith	Fwd Zenith
Node 2 Forward	Zenith Stbd	Zenith Port	Nadir Port	Nadir Stbd

REMOVE/REPLACE CBM PETAL – TASK DATA (Cont)

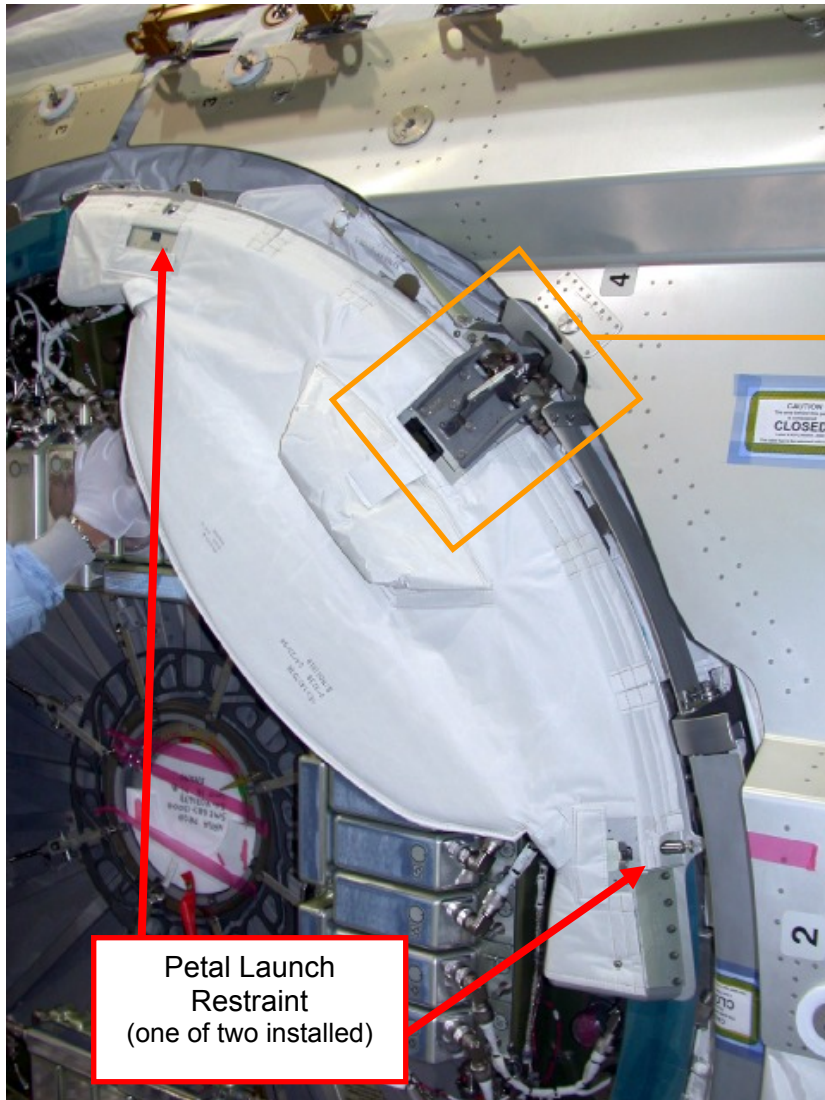

CBM PETAL

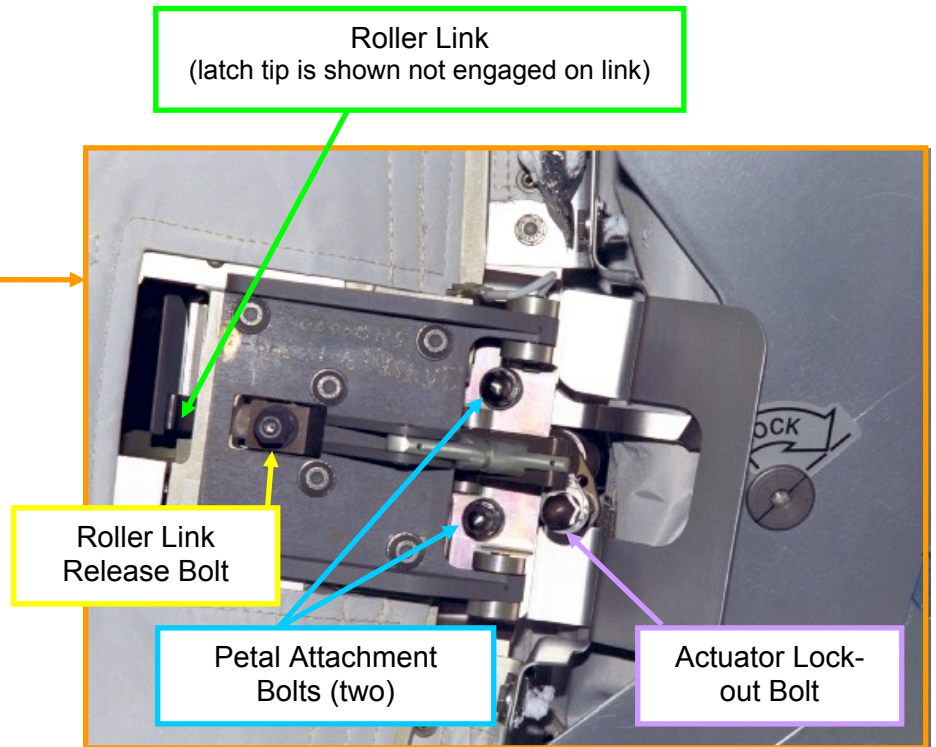

CBM PETAL DEPLOY MECHANISM

REMOVE/REPLACE CBM PETAL – TASK DATA (Cont)

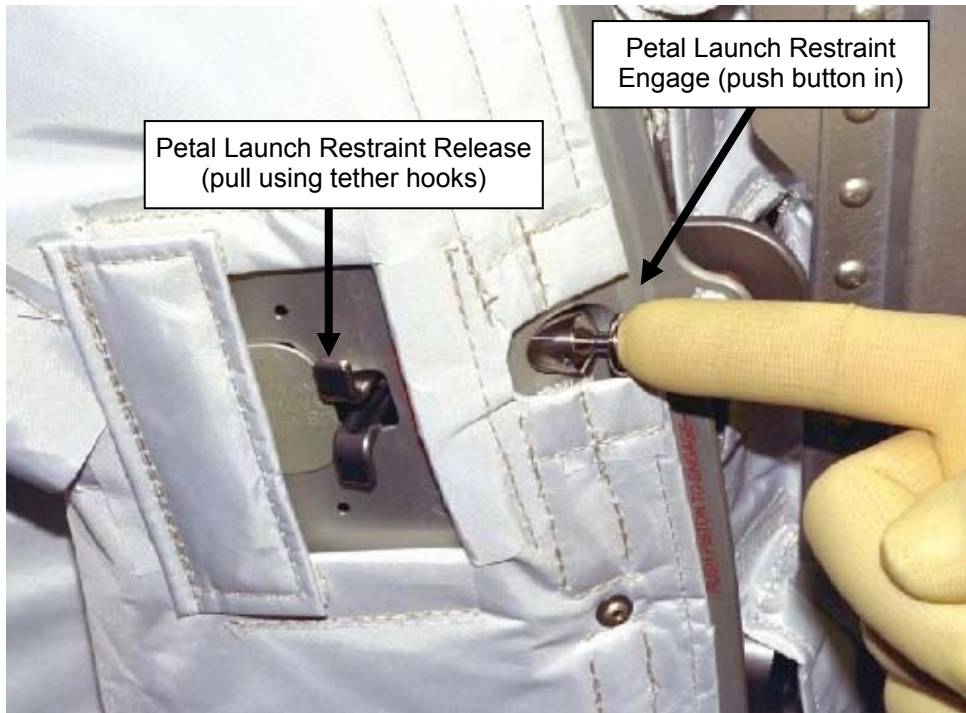

CBM PETAL LAUNCH RESTRAINT OPERATION

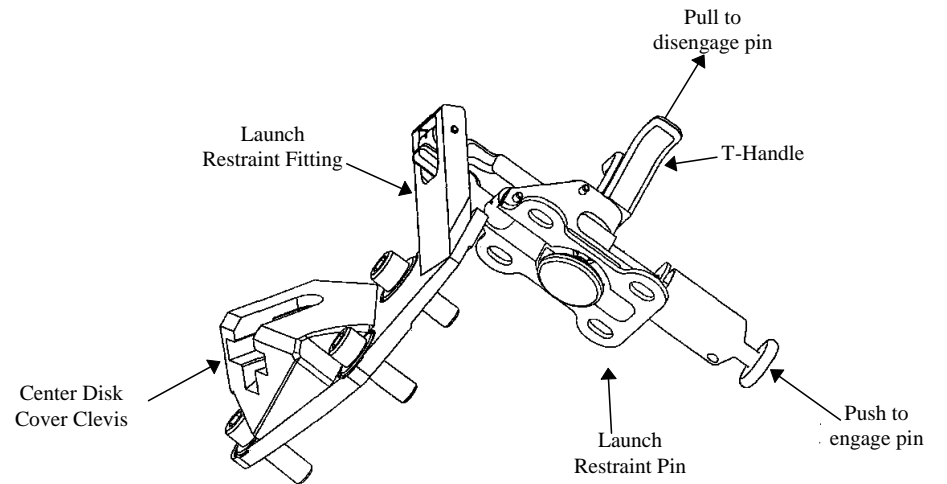

CBM PETAL LAUNCH RESTRAINT MECHANISM

REMOVE/REPLACE CBM PETAL – TASK DATA (Cont)



PETAL LAUNCH RESTRAINT RELEASE USING ADJUSTABLE TETHER STRAP

REMOVE CBM READY-TO-LATCH (RTL) (00:45)

Objective: To remove a CBM failed Ready-To-Latch via EVA to allow mating operations to continue

Assumptions: Corresponding CBM Petal Cover for failed RTL has been fully deployed via commanding or EVA

IV/SSRMS	EV1	EV2
<p>1. √Inhibits in place for affected RTL (see Task Data Sheet)</p>	<div style="border: 2px solid black; padding: 5px; margin-bottom: 10px; text-align: center;"> <p><u>WARNING</u></p> <p>Power must be removed from CPA prior to EVA maintenance</p> </div> <div style="border: 1px solid black; padding: 5px; margin-bottom: 10px; text-align: center;"> <p><u>CAUTION</u></p> <p>During any CBM operation, avoid contact with sealing surface</p> </div> <p><u>RTL REMOVAL</u></p> <ol style="list-style-type: none"> 1. Configure/setup APFR & tools as reqd; transfer to worksite 2. Remove center disk cover as reqd: REMOVE/REPLACE CENTER DISK COVER, COVER REMOVAL, steps 1-11 3. Verify power removed before continuing 4. PGT [A4, CCW2, 30.5]-RAD/DPTA/ 3/8": Remove RTL fasteners (2), 13.5 turns at bolt 5. Tether to RTL assembly 6. Disconnect data connector from RTL (use connector tool as required) 7. Remove RTL and stow (use trash bag as reqd for loose pieces) 8. Reinstall MMOD center cover as required: REMOVE/REPLACE CENTER DISK COVER, COVER REINSTALL, steps 1-5 9. Clean up worksite 10. Visually inspect CBM mating interface, ensure it is clear of latch, wire ties, MLI, and any other equipment or FOD 	<p><u>RTL REMOVAL</u></p> <ol style="list-style-type: none"> 1. Configure/setup APFR & tools as reqd; transfer to worksite 2. Assist EV1 as required

REMOVE CBM READY-TO-LATCH (RTL) – TASK DATA

Tools:

EV1 (FF)	EV2 (FF)
PGT	BRT
IV: 3/8" Socket	
Drop Proof Tether Adapter (DPTA)	
Connector Tool, Sm locking elec	
Small trash bag	
EVA ratchet	
BRT	
Right Angle Drive (RAD)	

EVA Fasteners:

Fastener Name	Label	Head Size	Qty	Install Torque (ft-lb)	Release Torque (ft-lb)	Failure Torque (ft-lb)	Turns	RPM
Capture Latch Captive Fastener Release	N/A	3/8"	1	N/A	6.3	10.6	13.5	30

* Standard PGT settings assumed

Foot Restraints:

Task	WIF	CETA Position	Swing Arm Settings	APFR Setting
N1 Port CBM – FWD half	NOD 05	N/A	N/A	11, RR, G, 12
N1 Port CBM – Aft half	NOD 03	N/A	N/A	11, QQ, G, 1
N1 Nadir CBM	SSRMS	N/A	N/A	

* Not verified in NBL

Warnings:

1. Power must be removed from CPA prior to this task

Cautions:

1. During operation, avoid contact with CBM sealing surface

Notes:

1. Connectors are fully mated when red indicator ring is no longer visible
2. Fit check of RAD/DPTA/3/8-in socket has not been verified – note DPTA is not shown in photo
3. CPA number in Power Inhibits chart below corresponds to RTL number; e.g., CPA 2 is for RTL 2
4. Task might also be accomplished using ratchet wrench/DPTA/3/8-in socket

Petal/Latch Locations:

Element/Location	Petal/Latch 1	Petal/Latch 2	Petal/Latch 3	Petal/Latch 4
Node 1 Nadir	Aft Stbd	Fwd Stbd	Fwd Port	Aft Port
Node 1 Port	Fwd Zenith	Aft Zenith	Aft Nadir	Fwd Nadir
Lab Forward	Zenith Stbd	Zenith Port	Nadir Port	Nadir Stbd
Node 2 Nadir	Aft Stbd	Fwd Stbd	Fwd Port	Aft Port
Node 2 Port	Fwd Zenith	Aft Zenith	Aft Nadir	Fwd Nadir
Node 2 Zenith	Aft Port	Fwd Port	Fwd Stbd	Aft Stbd
Node 2 Starboard	Fwd Nadir	Aft Nadir	Aft Zenith	Fwd Zenith
Node 2 Forward	Zenith Stbd	Zenith Port	Nadir Port	Nadir Stbd

REMOVE CBM READY-TO-LATCH (RTL) – TASK DATA (Cont)

CPA Power Inhibits:

Element/Location	CPA	Primary RPCM	Secondary RPCM
Node 1 Nadir	CPA 1	RPCM N13B B RPC 03	RPCM N14B B RPC 11
Node 1 Nadir	CPA 2	RPCM N13B B RPC 04	RPCM N14B B RPC 12
Node 1 Nadir	CPA 3	RPCM N13B B RPC 05	RPCM N14B B RPC 13
Node 1 Nadir	CPA 4	RPCM N13B B RPC 06	RPCM N14B B RPC 14
Node 1 Port	CPA 1	RPCM N1RS2 C RPC 07	RPCM N1RS1 B RPC 05
Node 1 Port	CPA 2	RPCM N1RS2 C RPC 08	RPCM N1RS1 B RPC 06
Node 1 Port	CPA 3	RPCM N1RS2 C RPC 10	RPCM N1RS1 B RPC 13
Node 1 Port	CPA 4	RPCM N1RS2 C RPC 11	RPCM N1RS1 B RPC 14
Lab Forward	CPA 1	RPCM LA1B B RPC 4	RPCM LA2B B RPC 4
Lab Forward	CPA 2	RPCM LA1B B RPC 3	RPCM LA2B B RPC 3
Lab Forward	CPA 3	RPCM LA1B B RPC 2	RPCM LA2B B RPC 2
Lab Forward	CPA 4	RPCM LA1B B RPC 1	RPCM LA2B B RPC 1
Node 2 Nadir	CPA 1	RPCM N21B4B A RPC 1	RPCM N22B3A B RPC 1
Node 2 Nadir	CPA 2	RPCM N21B4B A RPC 3	RPCM N22B3A B RPC 3
Node 2 Nadir	CPA 3	RPCM N21B4B A RPC 2	RPCM N22B3A B RPC 2
Node 2 Nadir	CPA 4	RPCM N21B4B A RPC 4	RPCM N22B3A B RPC 4
Node 2 Port	CPA 1	RPCM N21B4B A RPC 5	RPCM N22B3A B RPC 5
Node 2 Port	CPA 2	RPCM N21B4B A RPC 11	RPCM N22B3A B RPC 11
Node 2 Port	CPA 3	RPCM N21B4B A RPC 6	RPCM N22B3A B RPC 6
Node 2 Port	CPA 4	RPCM N21B4B A RPC 12	RPCM N22B3A B RPC 12
Node 2 Zenith	CPA 1	RPCM N21A4A C RPC 1	RPCM N22A3B A RPC 1
Node 2 Zenith	CPA 2	RPCM N21A4A C RPC 3	RPCM N22A3B A RPC 3
Node 2 Zenith	CPA 3	RPCM N21A4A C RPC 2	RPCM N22A3B A RPC 2
Node 2 Zenith	CPA 4	RPCM N21A4A C RPC 4	RPCM N22A3B A RPC 4
Node 2 Starboard	CPA 1	RPCM N21B4B A RPC 13	RPCM N22B3A B RPC 13
Node 2 Starboard	CPA 2	RPCM N21B4B A RPC 15	RPCM N22B3A B RPC 15
Node 2 Starboard	CPA 3	RPCM N21B4B A RPC 14	RPCM N22B3A B RPC 14
Node 2 Starboard	CPA 4	RPCM N21B4B A RPC 16	RPCM N22B3A B RPC 16
Node 2 Forward	CPA 1	RPCM N21A4A C RPC 13	RPCM N22A3B A RPC 13
Node 2 Forward	CPA 2	RPCM N21A4A C RPC 15	RPCM N22A3B A RPC 15
Node 2 Forward	CPA 3	RPCM N21A4A C RPC 14	RPCM N22A3B A RPC 14
Node 2 Forward	CPA 4	RPCM N21A4A C RPC 16	RPCM N22A3B A RPC 16

REMOVE CBM READY-TO-LATCH (RTL) – TASK DATA (Cont)

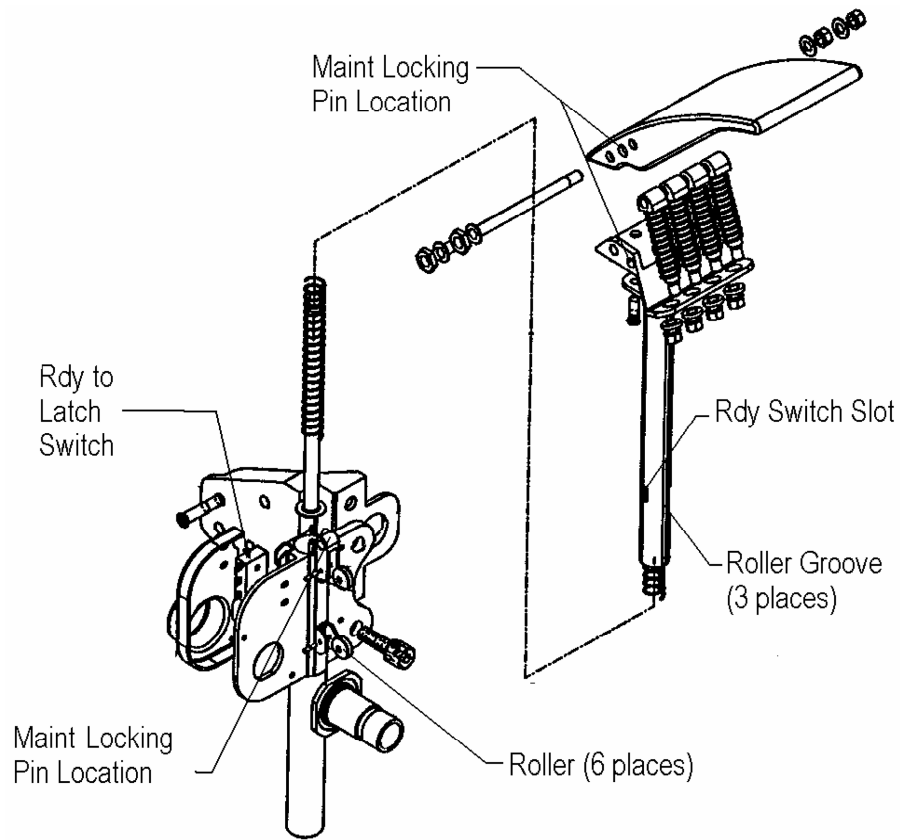

CBM RTL Nomenclature

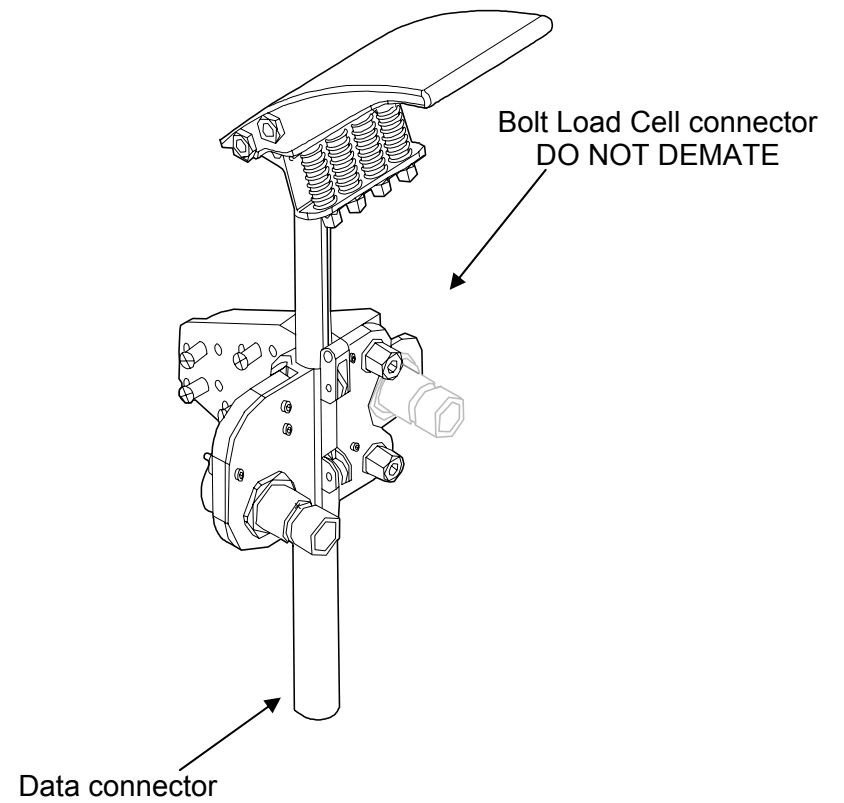

REMOVE CBM READY-TO-LATCH (RTL) – TASK DATA (Cont)

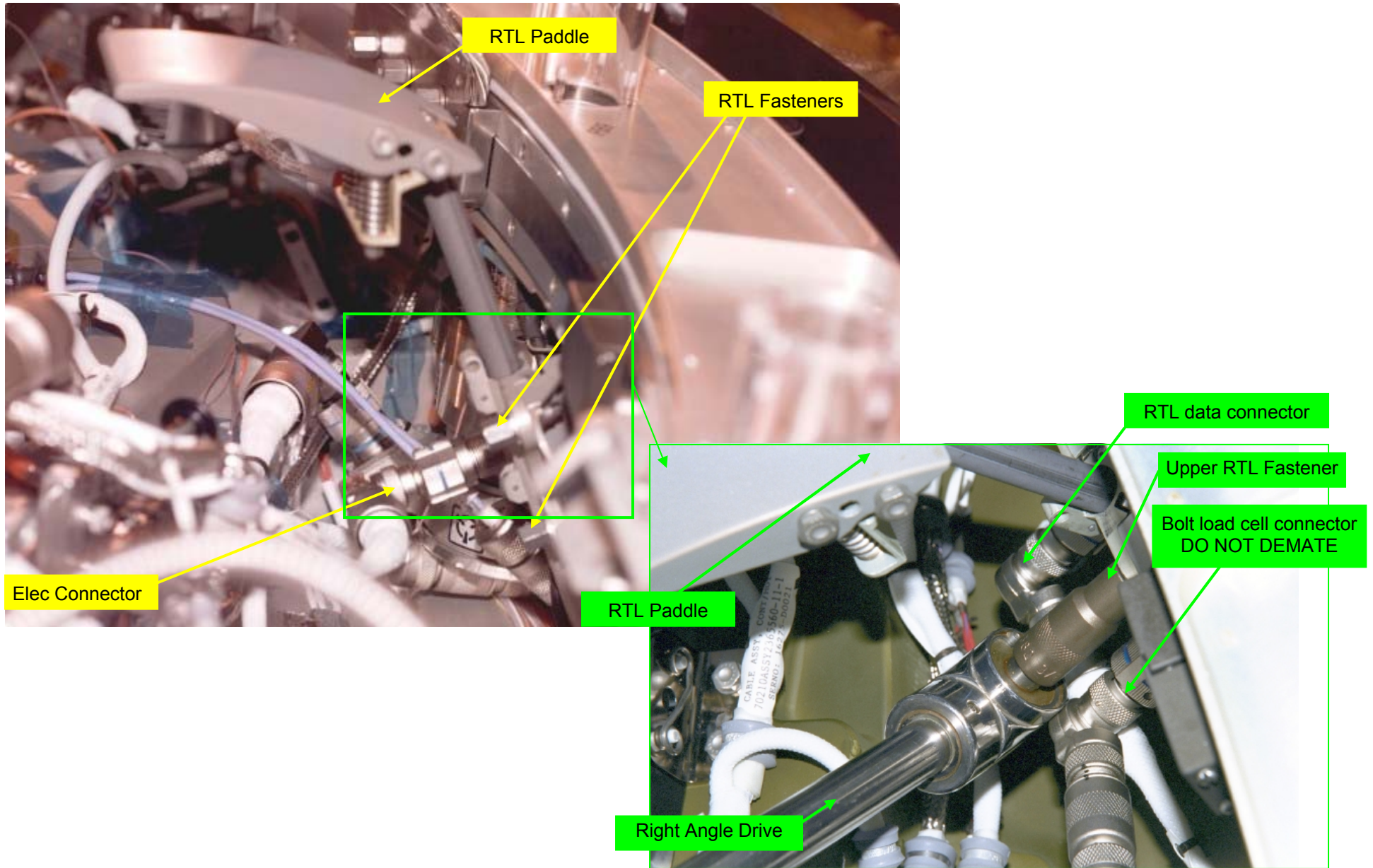

P6 ORU FLUID QD CLOSURE (00:45)

IV/SSRMS	EV1 – Pz (FF)	EV2 – Wheels (FF)
	<p>If M2 (M8) leaking (00:20): <u>PFCS FQDC CLOSURE</u></p> <ol style="list-style-type: none"> 1. Translate to PFCS (two), zenith of stbd radiator 2. Remove shroud on PFCS 3. Translate to zenith PFCS for leaking M2 Translate to nadir PFCS for leaking M8 4. Break torque on PFCS FQDC drive bolt H2 PGT, 7/16-6 in ext; B1, CCW1; 10 turns 5. Demate PFCS FQDC drive bolt H2 PGT, 7/16-6 in ext; A5, CCW2; ~8 turns to HS 6. √Status indicator – DEMATE 7. Retract PFCS FQDC drive bolt H2 PGT, 7/16-6 in ext; A5, CW2; ~18 turns to HS 8. √Status indicator – DEMATE 9. Reinstall PFCS shroud 10. On MCC-H GO, perform P6/Z1 VENTING <p>If M4 (M6) leaking (00:45): <u>PV STBD RADIATOR FQDC CLOSURE</u></p> <ol style="list-style-type: none"> 1. Translate to Z1 port toolbox 2. Open port door, retrieve 7/16-18 in ext from door panel; stow on socket caddy 3. Translate to stbd radiator FQDC shroud (zenith of radiator) 4. Remove stbd radiator MLI shroud (long and short straps, similar to P6 aft radiator shroud) 5. Stage RET for FQDC shroud restraint 6. Release FQDC Shroud bolts (4) (H5, H6, H8, H9) PGT, 7/16-6 in ext; A7, CCW2; 7 turns (For P6 Stbd radiator, RAD may be necessary for bolts closest to the PFCS, use PGT: A6, CCW2) 	<p><u>PV AFT RADIATOR FQDC CLOSURE</u></p> <ol style="list-style-type: none"> 1. Secure aft radiator shroud as soon as feasible 2. Translate to aft radiator FQDC shroud (zenith of radiator) 3. Stage RET for FQDC shroud restraint 4. Release FQDC Shroud bolts (4) (H5, H6, H8, H9) PGT, 7/16-6 in ext; A7, CCW2; 7 turns 5. Remove FQDC shroud and restrain w/RET

P6 ORU FLUID QD CLOSURE (00:45) (Cont)

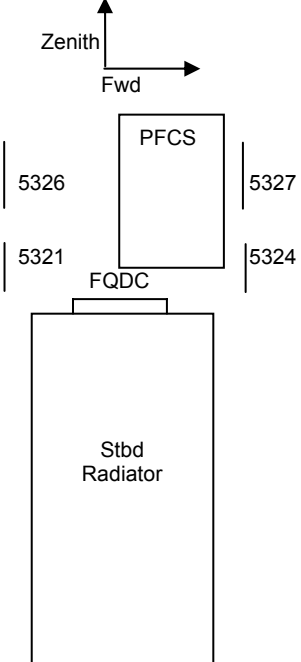
IV/SSRMS	EV1 – Pz (FF)	EV2 – Wheels (FF)
<p><u>Stbd Radiator Shroud Reinstall</u></p> <ol style="list-style-type: none"> Fwd side straps: long strap to nadir standoff HR5327 short strap to nadir standoff HR5324 Aft side straps: long strap to nadir standoff HR5326 short strap to nadir standoff HR5321 Cinch long straps as reqd Verify radiator HRs and PVRGF posts are through the shroud cut outs  <p>The diagram illustrates the assembly of the Stbd Radiator. At the top is the PFCS (Passive Fluid Control System) connected to the FQDC (Fluid Quality Detection Control). The PFCS is supported by standoffs 5326 and 5327. The FQDC is supported by standoffs 5321 and 5324. Below the FQDC is the Stbd Radiator. A coordinate system indicates Zenith is up and Fwd is right.</p>	<ol style="list-style-type: none"> Remove FQDC shroud and restrain w/RET Perform PGT socket swap: remove 7/16-6 in ext, stow on socket caddy, install 7/16-18 in ext on PGT Break torque on FQDC drive bolt H18 (H19 for M6) PGT, 7/16-18 in ext; B1, CCW2; 10 turns If required to correct FQDC alignment, attach adj tether to inner loop of FQDC housing Extend FQDC drive bolt H18 (H19 for M6) PGT, 7/16-18 in ext; B1, CCW2; ~8 turns to HS <ul style="list-style-type: none"> Verify four guide cones squarely engage springs during Demate Verify 90-deg cam rotation during last 1/4 turn (indicating latch key rotation to the disengaged position) Retract FQDC drive bolt H18 (H19 for M6) PGT, 7/16-18 in ext; A5, CW2; ~18 turns to HS <ul style="list-style-type: none"> Verify guide cones remain engaged in springs Verify 90-deg cam rotation on third turn (cam reset) Perform PGT socket swap: remove 7/16-18 in ext, stow on socket caddy, install 7/16-6 in ext on PGT If used to correct FQDC alignment, remove adj tether from FQDC shroud Install shroud over FQDC (use alignment pin H7) Engage FQDC Shroud bolts (4) (H5, H6, H8, H9) PGT, 7/16-6 in ext; A7, CW2; ~7 turns, push bolts to engage bolt threads Reinstall radiator MLI shroud (See IV Column for procedure) Transfer 7/16-18 in extension to EV2 	<ol style="list-style-type: none"> Assist EV1 with radiator MLI shroud reinstallation as reqd Receive 7/16-18 in extension from EV1

P6 ORU FLUID QD CLOSURE (00:45) (Cont)

IV/SSRMS	EV1 – Pz (FF)	EV2 – Wheels (FF)
	<p><u>PFCS FQDC CLOSURE</u></p> <ol style="list-style-type: none"> 1. Translate to PFCS (two), zenith of stbd radiator 2. Remove shroud on PFCS 3. Translate to zenith PFCS for leaking M2 Translate to nadir PFCS for leaking M8 4. Break torque on PFCS FQDC drive bolt H1 PGT, 7/16-6 in ext; B1, CCW1; 10 turns 5. Demate PFCS FQDC drive bolt H1 PGT, 7/16-6 in ext; A5, CCW2; ~8 turns to HS 6. √Status indicator – DEMATE 7. Retract PFCS FQDC drive bolt H1 PGT, 7/16-6 in ext; A5, CW2; ~18 turns to HS 8. √Status indicator – DEMATE 9. Reinstall PFCS shroud <hr style="border-top: 1px dashed black;"/> <ol style="list-style-type: none"> 10. Receive 7/16-18 in ext from EV2; stow on socket caddy 11. On MCC-H GO, perform P6/Z1 VENTING 	<ol style="list-style-type: none"> 8. Perform PGT socket swap: remove 7/16-6 in ext, stow on socket caddy, install 7/16-18 in ext on PGT 9. Break torque on FQDC drive bolt H18 (H19 for M6) PGT, 7/16-18 in ext; B1, CCW2; 10 turns 10. If required to correct FQDC alignment, attach adj tether to inner loop of FQDC housing 11. Extend FQDC drive bolt H18 (H19 for M6) PGT, 7/16-18 in ext; B1, CCW2; ~8 turns to HS <ul style="list-style-type: none"> <input type="checkbox"/> Verify four guide cones squarely engage springs during demate <input type="checkbox"/> Verify 90-deg cam rotation during last 1/4 turn (indicating latch key rotation to the disengaged position) 12. Retract FQDC drive bolt H18 (H19 for M6) PGT, 7/16-18 in ext; A5, CW2; ~18 turns to HS <ul style="list-style-type: none"> <input type="checkbox"/> Verify guide cones remain engaged in springs <input type="checkbox"/> Verify 90-deg cam rotation on third turn (cam reset) 13. Perform PGT socket swap: remove 7/16-18 in ext, stow on RET PIP pin, install 7/16-6 in ext on PGT 14. If used to correct FQDC alignment, remove adj tether from FQDC shroud 15. Install shroud over FQDC (use alignment pin H7) 16. Engage FQDC Shroud bolts (4) (H5, H6, H8, H9) PGT, 7/16-6 in ext; A7, CW2; ~7 turns, push bolts to engage bolt threads 17. Transfer 7/16-18 in ext back to EV1 (to stow on socket caddy)

P6 ORU FLUID QD CLOSURE – TASK DATA

Tools:

EV1	EV2
PGT	PGT
6 Ext 7/16	6 Ext 7/16
18 Ext 7/16	
RET	

EVA Fasteners:

Fastener Name	Label	Head Size	Qty	Install Torque (ft-lb)	Max Break Away Torque (ft-lb)	Failure Torque (ft-lb)	Turns	RP M
PFCS FQDC	H1, H2	7/16	2	12.0	7.5	33.3 (R) 27.1 (I)	18	30
Rad FQDC Shroud bolts	H5, H6, H8, H9	7/16	4	9.2	6.7	21.2 (R) 18.1 (I)	7	30
Rad FQDC	H18, H19	7/16	2	8.1-13 (gnd)	7.5	10.7	18	30

*Indicates Max On-Orbit Installation Torque

EVA Connectors:

Harness	From	To	Clamps (#)	Conn Size	Function
NA					

Foot Restraints:

Task	WIF	APFR Setting

Notes:

Cautions:

1. Equipment damage. Avoid contact with radiator bellows

Warnings:

1. Moving equipment. Avoid contact with panels and mechanisms during extension of radiator



PVR FQDC – NOTE “B” and “A” Labeling incorrect

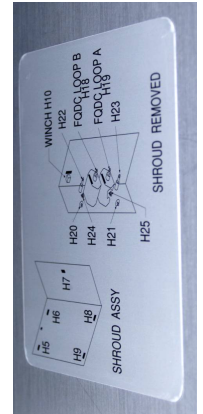
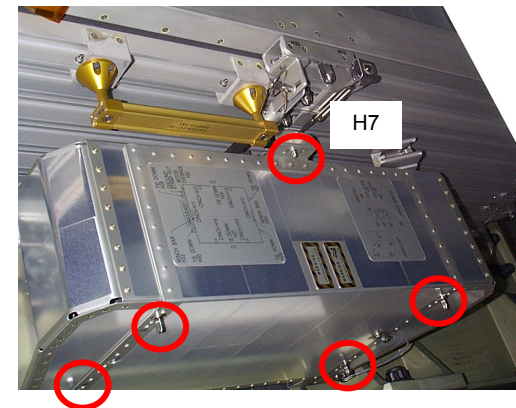

PVR FQDC – Note shroud labeling of Loop A and Loop B incorrect

P6 ORU FLUID QD CLOSURE – TASK DATA (Cont)

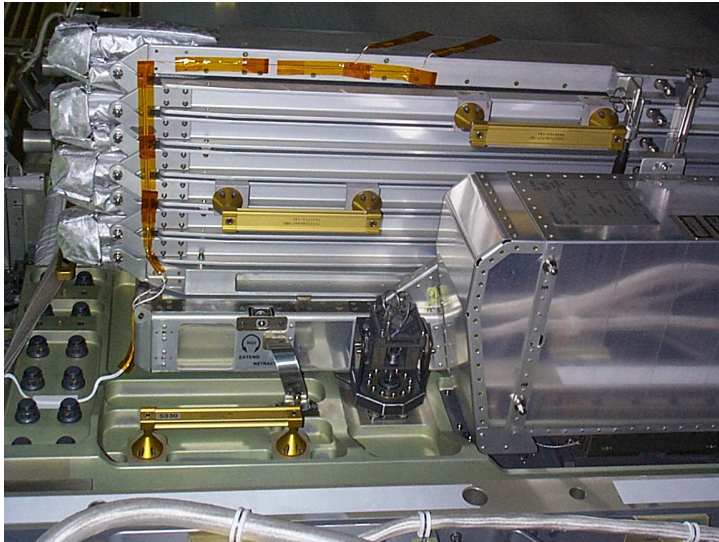

PV Radiator – FQDC Shroud

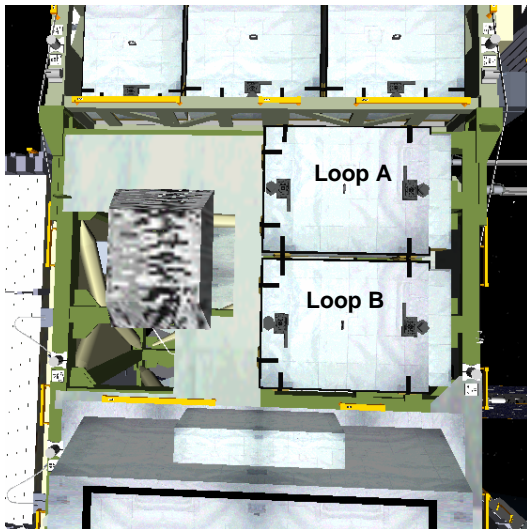
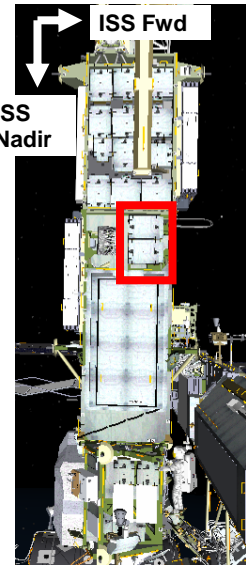

PFCS (Shroud Removed)

PVR EVA Interfaces

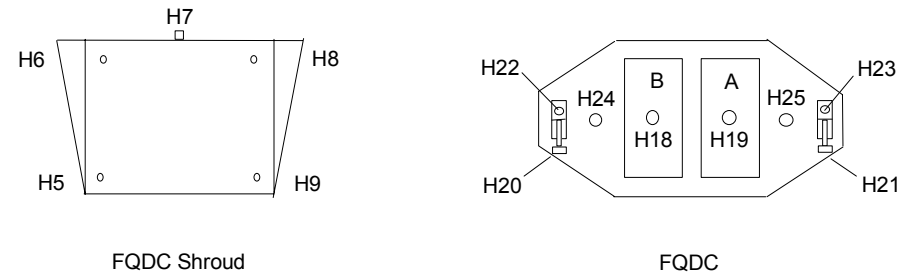
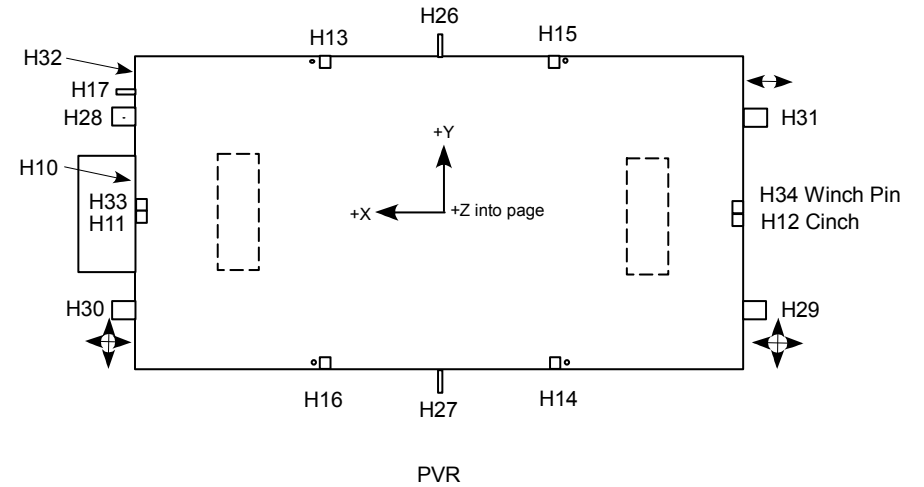

- H5,6,9,8 = FQDC Shroud Fasteners
- H7 = FQDC Shroud Alignment Pin
- H10 = Winch Drive
- H11 - H16 = Cinches
- H17 = Grounding Strap
- H18 - H19 = FQDC Drive bolts
- H20 - H21 = Carrier Slider bolts
- H22 - H23 = Carrier to PVR Attach
- H24 - H25 = Carrier to IEA Attach
- H26 - H27 = Center Bolts
- H28 - H31 = Corner Bolts
- H32 = Manual Deploy/Retract
- H33-H34 = Winch PIP pins

P6 ORU FLUID QD CLOSURE – TASK DATA (Cont)

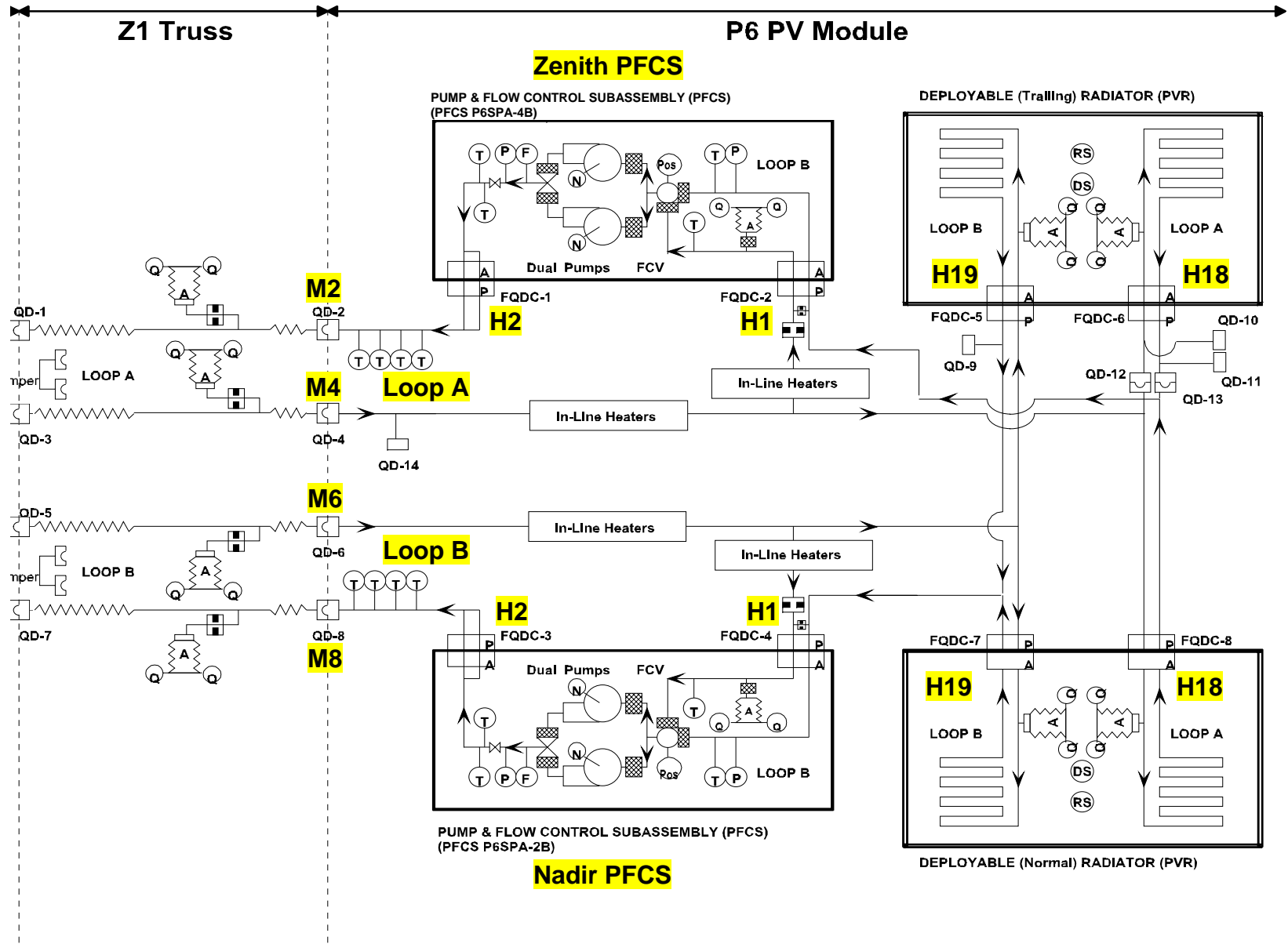

P6/Z1 VENTING (00:15)

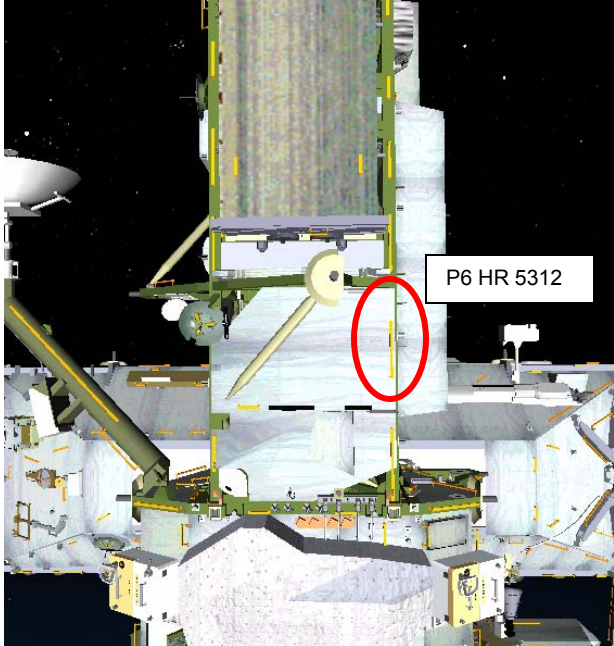
IV/SSRMS	EV1 – Pz (FF)	EV2 – Wheels (FF)
	<p><u>Z1 FEMALE QD LINE VENTING</u></p> <ol style="list-style-type: none"> 1. Translate to port Fluid QD Bag 2. Open bag and retrieve Vent Tool Adapter (VTA, SO-bo) from upper right of bag 3. Close fluid QD bag (verify Velcro and 1/4 turn fasteners) 4. Translate to VTE bag (outboard) 5. Open VTE bag 6. Remove caps from both ends of VTA; remove cap from 1.0" vent tool 7. Mate one end of VTA to 1.0" vent tool; open valve 8. Close VTE bag (verify Velcro and 1/4 turn fasteners) 9. Tether to and remove VTE bag 10. Translate to Z1/P6 fluid QD worksite 11. Temp stow VTE bag 12. Open VTE bag; retrieve VTA – vent tool – VTE and MUT EE 13. Translate up P6 aft/stbd path 14. Install MUT EE to P6 HR 5312 15. Attach VTE nozzle to MUT EE; verify that nozzle is pointed away from structure (might require reorienting nozzle) 16. Translate to leaking female QD, securing VTE line as reqd 17. Per MCC-H direction, prepare to mate the vent tool to either the leaking female QD or the adjacent female on the same loop (i.e., F2, F4; F6, F8) 18. If female mated, close and demate leaking female QD; if leaking female, aim female away 19. Mate __ female to VTA; open valve 	<p><u>Z1 FEMALE QD LINE VENTING</u></p> <ol style="list-style-type: none"> 1. Assist EV1 as reqd 

P6/Z1 VENTING (00:15) (Cont)

IV/SSRMS	EV1 – Pz (FF)	EV2 – Wheels (FF)
	<p><u>P6 MALE QD LINE VENTING</u></p> <ol style="list-style-type: none"> 1. Translate to VTE bag (outboard) 2. Tether to and remove VTE bag 3. Translate to Z1/P6 fluid QD worksite 4. Temp stow VTE bag 5. Open VTE bag; retrieve vent tool – VTE and MUT EE 6. Translate up P6 aft/stbd path 7. Install MUT EE to P6 HR 5312 8. Attach VTE nozzle to MUT EE; verify that nozzle is pointed away from structure (might require reorienting nozzle) 9. Translate to leaking male QD, securing VTE line as reqd 10. Close and demate female QD from leaking male QD 11. Mate vent tool to leaking male QD; open valve 	<p><u>P6 MALE QD LINE VENTING</u></p> <ol style="list-style-type: none"> 1. Assist EV1 as reqd

EVA 2 CONTINGENCIES

P6 RTAS SLEEVE REMOVAL

IV	EV1 – Pz (FF)	EV2 – Dan
<p>SSRMS: Grappled, brakes on</p> <p style="text-align: center;"><u>NOTE</u> If PIP pin cannot be removed, may need to drive RTAS primary bolt CW to off-load PIP pin. May also require Round Torque Multiplier with 5/8" socket if torque is too great</p>	<div style="border: 1px solid black; padding: 5px; margin-bottom: 10px; text-align: center;"> <p>CAUTION</p> <p>All RTAS other than failed RTAS and the Z1 CLA should be fully released before removing the failed RTAS sleeve</p> </div> <ol style="list-style-type: none"> 1. Install APFR (see task data) 2. Release spherical bearing locking plate bolt on P6 PGT, 7/16-6 in ext; A5,CCW2; 12-14 turns 3. Remove spherical bearing locking plate, temp stow 4. Remove sleeve retention PIP pin on failed RTAS (P6 side) 5. Secure PIP pin to keep clear of Z1/P6 mating interface 6. Reinstall spherical bearing locking plate bolt on P6 PGT, 7/16-6 in ext; A5,CW2; 14 turns 7. Verify P6/Z1 mating interface is clear and ready for demate 8. Verify CLA motion 	<ol style="list-style-type: none"> 1. Verify P6/Z1 mating interface is clear and ready for demate 2. Partially open Z1 CLA PGT, 7/16-6 in ext; A6 CCW2; TBD turns to allow enough travel for P6
<ol style="list-style-type: none"> 1. Notify M1/M2 "Capture claw partially open, GO for SSRMS mode to limp" <p style="background-color: #e0e0e0; padding: 2px;">Once M1/M2 confirmed SSRMS limped,</p>	<div style="border: 1px solid black; padding: 5px; margin-bottom: 10px; text-align: center;"> <p>WARNING</p> <p>EV crewmembers should remain clear of P6/Z1 mating interface. P6 will move away from Z1 when RTAS sleeve is driven out</p> </div> <ol style="list-style-type: none"> 9. On IV GO, release RTAS Primary Bolt Bolt 2 or 4: PGT, 5/8-7.8 in ext; B7,CCW1; ~19 turns Bolt 1 or 3: PGT, RAD, 5/8-7.8 in ext; B1,CCW1; ~19 turns 10. Verify RTAS sleeve has been removed from RTAS housing 	<ol style="list-style-type: none"> 3. Monitor P6 Motion
<ol style="list-style-type: none"> 2. Give EV GO for primary bolt release <p style="background-color: #e0e0e0; padding: 2px;">Once M1/M2 confirmed SSRMS brakes on</p>	<ol style="list-style-type: none"> 4. Give EV GO to fully open capture claw 	<ol style="list-style-type: none"> 4. On IV GO, fully open Z1 CLA PGT, 7/16-6 in ext; A6 CCW2; TBD turns to HS
<ol style="list-style-type: none"> 3. Notify M1/M2 "RTAS sleeve removed, GO for SSRMS brakes on" <p style="background-color: #e0e0e0; padding: 2px;">Once M1/M2 confirmed SSRMS brakes on</p>	<ol style="list-style-type: none"> 5. Give SSRMS GO for P6 demate 	
<p><u>NOTE</u> RTAS contingency bolt will be required for P6 mating at corner where sleeve was removed</p>		

P6 RTAS SLEEVE REMOVAL – TASK DATA

EVA Tools:

EV1 (FF)	EV2 (FF)
PGT	N/A
7/16-6 in ext	
5/8-7.8 in ext	
APFR	

EVA Fasteners:

Fastener	Head Size	Qty	Install Torque (ft-lb)	Release Torque (ft-lb)	Failure Torque (ft-lb)	Turns	RPM
Z1 CLA	7/16	1	7.5	7.5	14.6	127	30
RTAS Primary bolt	5/8	1/RTAS	57	77.7	544	~19	10
Spherical bearing locking plate bolt	7/16	1/RTAS	3.0	3.25	9.5	14	10

EVA Connectors: None

Foot Restraints:

Task	WIF	APFR Setting
Z1 capture latch	Z1-18	6,OO,F,12
Aft/Stbd RTAS bolt (bolt #1)	Z1-21	4,PP,H,12
Fwd/Stbd RTAS bolt (bolt #2)	Z1-11	2,OO,D,1
Aft/Port RTAS bolt (bolt #3)	Z1-22	10,PP,H,12
Fwd/Port RTAS bolt (bolt #4)	Z1-12	9,PP,F,12

Warnings:

EV crewmembers should remain clear of P6/Z1 mating interface. P6 will move away from Z1 when RTAS sleeve is driven out

Cautions:

1. All RTAS other than failed RTAS and the Z1 capture claw should be fully released before removing the failed RTAS sleeve

Notes:

Z1 CAPTURE LATCH FAILED CLOSED (00:30)

IV	EV1 – Pz (FF)	EV2 – Wheels
	<p><u>ROTATE CAPTURE BAR</u></p> <ol style="list-style-type: none"> Retrieve 7/16-18 in ext socket from Z1 port toolbox Install APFR Z1 WIF 19 (10,V V,F,11); ingress Open thermal shroud flap to access capture bar Loosen capture bar disk clamp bolt PGT, 7/16-18 in ext; A7, CCW2; ~2.5-3 turns to HS Manually turn capture bar disk center bolt PGT, 7/16-18 in ext; RCW; ~turn until clamp bolt is at the end of disc slot, rotating capture bar to disengage Position (~.33 turn) <p style="text-align: center;"><u>NOTE</u> Crewmember may need to remove MWS to ingress long spacer</p> <ol style="list-style-type: none"> Tighten capture bar disk clamp bolt PGT, 7/16-18 in ext; A5, CW2; ~2.5-3 turns to HS Egress APFR <p><u>FOR Z1</u></p>	<p><u>FOR Z1</u></p> <ol style="list-style-type: none"> Release PIP pin on EVA handle CLA PIP PIN RELEASE (Z1 stbd) Rotate EVA handle to disengage position Give EV1 GO to rotate port handle
	<ol style="list-style-type: none"> On EV2 GO, release PIP pin on EVA handle CLA PIVOT PIN RELEASE (Z1 port) Rotate EVA handle to disengage position √Capture latch claws released Rotate EVA handle back to engage position; reinstall PIP pin Close P6 thermal shroud 	<ol style="list-style-type: none"> √Capture latch claws released Rotate EVA handle back to engage position; reinstall PIP pin

Z1 CAPTURE LATCH FAILED CLOSED – TASK DATA

EVA Tools:

EV1 (FF)	EV2 (FF)
PGT	N/A
7/16-18 in ext	
APFR	

EVA Fasteners:

Fastener	Head Size	Qty	Install Torque (ft-lb)	Release Torque (ft-lb)	Failure Torque (ft-lb)	Turns	RPM
Capture bar disk clamp bolt	7/16	1	7.0	9.2	13.1 (rel) 10.6 (inst)	2.5-3.0	30
Capture bar disk center bolt	7/16	1	N/A	30.5	116.8	.33	N/A

EVA Connectors: None

Foot Restraints:

Task	WIF	APFR Setting
Z1 capture bar	Z1-19	10,V,V,F,11

Warnings:

Cautions:

Notes:

1. Crewmember may need to remove MWS to ingress long spacer
Starboard handle must be rotated before port handle for Z1 CLA release

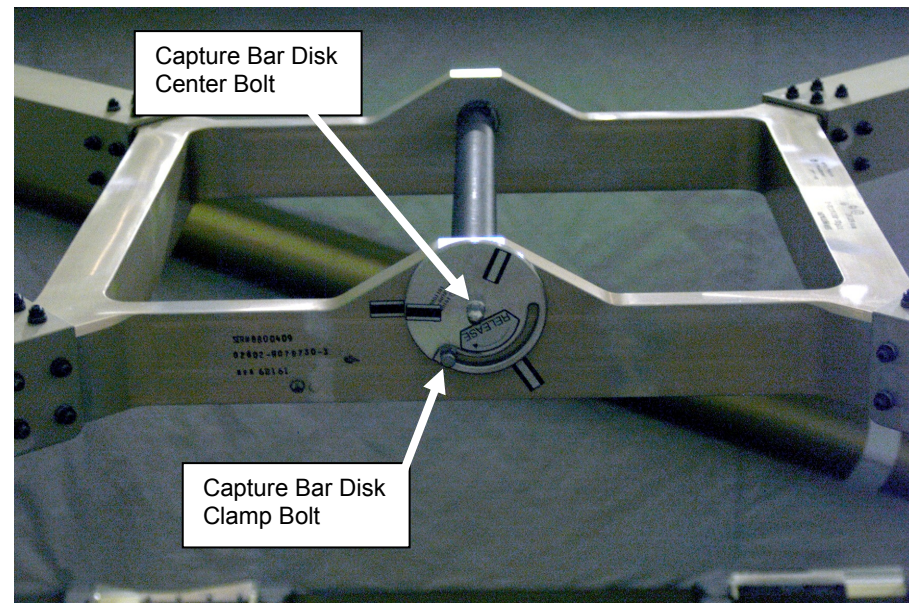

FS 16-65

EVA/120/FIN A

16.1a RTAS GAP CLOSURE (CORNER 1 OR 2)

During ATTACH P6 to P5 Gap > 0.6 after CLA closure Assumes CLA had ~126 turns (127 total, one turn previously completed) and torqued to HS

As required, unbolt Gap Check Tool Bolt (2) (also called Contingency Spacer Lock Tool) PGT, 7/16-6 in ext; A6, CCW2; 12-14 turns Stow tool in C/L bag or trash bag after operations

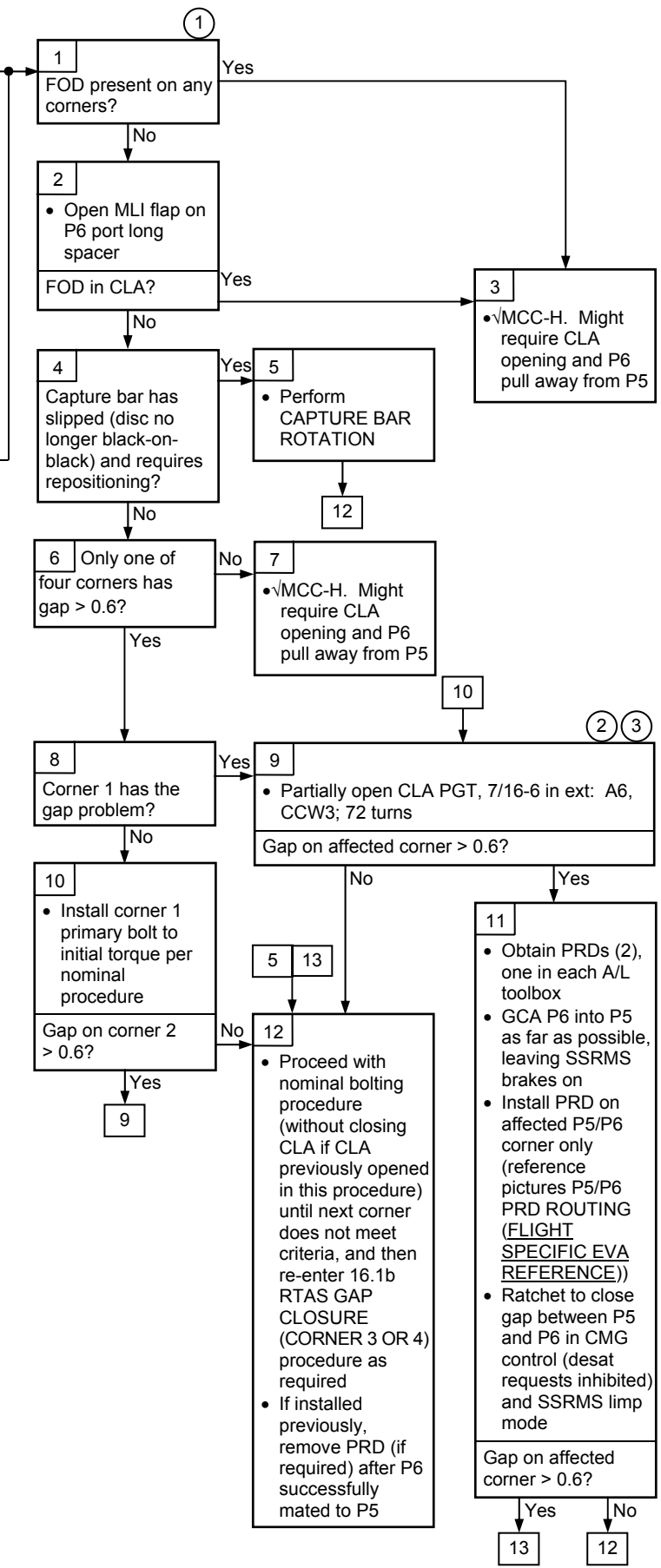

① Gap = distance between passive and active RTAS housings. Gap must not be greater than 0.6 in prior to driving primary bolt. Gap must not be greater than 0.478 in after primary bolt is driven to allow for shear loading. Measuring tools: Small crew hook = 0.430 in; drop proof tether end of 7/16 in-6 in ext = 0.66 in; S5/P5 contingency spacer locking tool thickness range = 0.3 to 0.6 in

② Structure warped or hardware interference (hardware interference more likely)

③ P6 might 'rock' such that gap appears on different corner. If Corner 1 meets gap criteria and one other corner does not meet gap criteria, continue with nominal procedure for corner 1 and then re-assess affected corner

EVA 3 CONTINGENCIES

16.1a (Cont)

11

13

- Remove PRD
- SSRMS brakes ON
- Release corner 1 if required
PGT, 5/8-7.8 in ext: B7, CCW2; 27 turns, √2-7 threads visible
- Verify separation plane clear
- Open CLA fully
PGT, 7/16-6 in ext: A6, CCW3; 55 turns or as required to HS
- SSRMS drive P6 out to 30 cm or as required to allow EV crew to visually and tactilely assess P6 nuts/bearings
- EV crew assess whether primary bearing is centered and capable of sliding from sliding ~0.160" in all directions for corner 1 or side for corner 2. Center P6 bearing as required
- Verify no FOD between elements, in P6 nuts, in coarse alignment holes/cones
- Perform nominal GCA and bolting procedure and re-enter RTAS GAP CLOSURE as required

14

- If no joy, √MCC-H

16.1b RTAS GAP CLOSURE (CORNER 3 OR 4)

During ATTACH P6 to P5
Gap > 0.6 after CLA closure and corner 1, 2 successful install to initial torque

As required, unbolt Gap Check Tool Bolt (2) (also called Contingency Spacer Lock Tool)

PGT, 7/16-6 in ext; A6, CCW2; 12-14 turns.

Stow tool in C/L bag or trash bag after operations

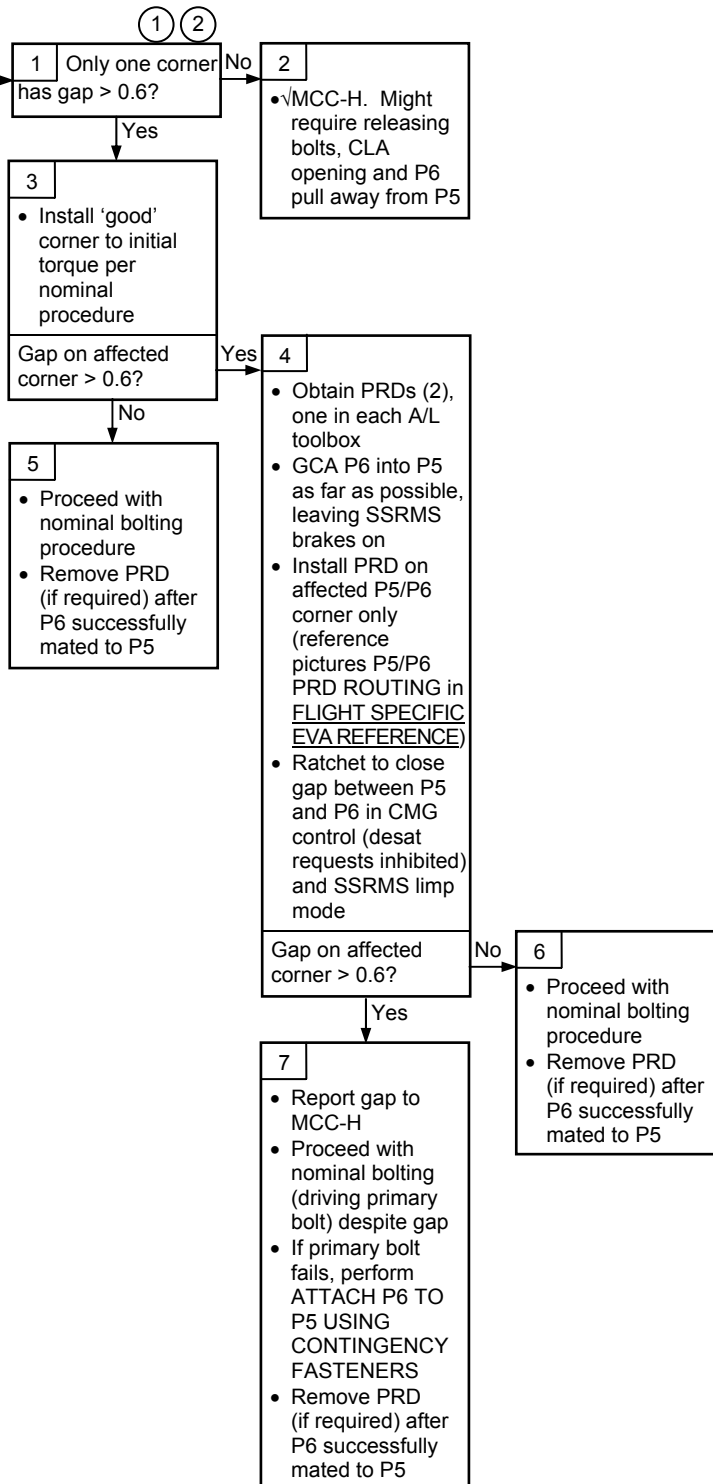

①
Gap = distance between passive and active RTAS housings. Gap must not be greater than 0.6 in prior to driving primary bolt. Gap must not be greater than 0.478 in after primary bolt is driven to allow for shear loading. Measuring tools: Small crew hook = 0.430 in; drop proof tether end of 7/16 in-6 in ext = 0.66 in; S5/P5 contingency spacer locking tool thickness range = 0.3 to 0.6 in

②
Structure warped or hardware interference (hardware interference more likely)

CAPTURE BAR ROTATION (00:30)

IV	EV1 – Pz (FF)	EV2 – Wheels
<p>1. √SSRMS grappled, brakes on</p>	<p><u>ROTATE P6 CAPTURE BAR</u></p> <ol style="list-style-type: none"> 1. Retrieve 7/16-18 in ext socket from Z1 port toolbox 2. Partially open P5 CLA (capture latch) PGT, 7/16-6 in ext: A6, CCW3; 75 turns <p style="text-align: center;"><u>NOTE</u></p> <p style="text-align: center;">EV may need to remove MWS to ingress long spacer.</p> <p style="text-align: center;">If APFR access required, check MCC for settings</p> <ol style="list-style-type: none"> 3. Open P6 thermal shroud flap to access capture bar if not done previously 4. Loosen capture bar disk clamp bolt PGT, 7/16-18 in ext; A7, CCW2; ~2.5-3 turns to HS 5. Manually turn capture bar disk center bolt PGT, 7/16-18 in ext; RCCW, turn until clamp bolt is at the end of disc slot (rotating capture bar to re-engaged position; black on black) 6. Tighten capture bar disk clamp bolt PGT, 7/16-18 in ext; A5, CW2; ~2.5-3 turns to HS 7. Close P6 thermal shroud 8. Close P5 CLA (capture latch) per nominal procedure 	

CAPTURE BAR ROTATION – TASK DATA

EVA Tools:

EV1 (FF)	EV2 (FF)
PGT	N/A
7/16-18 in ext	
7/16-6 in ext	

EVA Fasteners:

Fastener	Head Size	Qty	Install Torque (ft-lb)	Release Torque (ft-lb)	Failure Torque (ft-lb)	Turns	RPM
Capture bar disk clamp bolt	7/16	1	7.0	9.2	13.1 (rel) 10.6 (inst)	2.5-3.0	30
Capture bar disk center bolt	7/16	1	N/A	30.5	116.8	.33	N/A

EVA Connectors: None

Foot Restraints:

Task	WIF	APFR Setting

Warnings:

Cautions:

Notes:

1. Crewmember may need to remove MWS to ingress long spacer

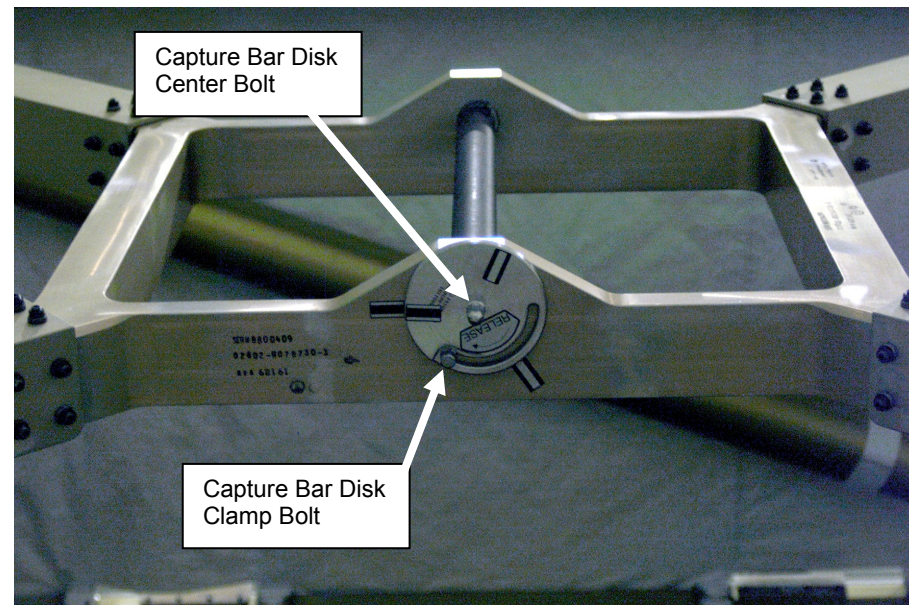

ATTACH P6 TO P5 USING CONTINGENCY FASTENERS

IV	EV1 – Pz (FF)	EV2 – Wheels
<p>1. Initial RTAS gap: _____</p> <p>2. Circle which contingency sleeve used: Left or Right</p>	<p style="text-align: center;"><u>NOTE</u></p> <p>EVA worksite per nominal bolt engagement.</p> <p>Contingency Spacer Lock Tools are at P5 inboard and outboard RTAS corner 1.</p> <p>Only one Contingency Fastener is required</p> <ol style="list-style-type: none"> 1. Remove ground straps if required 2. Unbolt Gap Check Tool Bolt (2) (also called Contingency Spacer Lock Tool) PGT, 7/16-6 in ext; A6,CCW2; 12-14 turns 3. Measure RTAS gap, record gap <div style="border: 1px solid black; padding: 5px; margin: 10px 0;"> <p style="text-align: center;"><u>CAUTION</u></p> <p>Do not loosen P5 contingency spacer locking bolt more than 1 turn. Excessive turns of spacer locking bolt may cause guide washer to come out of slot and snap ring washer to bend</p> </div> <ol style="list-style-type: none"> 4. Loosen contingency spacer locking bolt PGT, 7/16-6 in ext; B2,CCW1; 1 turn only 5. Tighten spacer sleeve until snug against P6 spherical bearing (~10 turns cw) 6. Notify IV which contingency sleeve used (“Left” or “Right” when looking at corner number) 7. Verify spacer sleeve aligned within nut by jiggling back end of P6 contingency ball/nut <p style="text-align: center;"><u>NOTE</u></p> <p>Contingency spacer sleeve may need to be rotated to allow tool installation, prefer ccw rotation</p> <ol style="list-style-type: none"> 8. Install Contingency Spacer Lock Tool over contingency spacer sleeve (friction fit) 9. Fasten contingency spacer locking bolt PGT, 7/16-6 in ext; B2,CW1; 1 turn only 10. Tighten RTAS contingency bolt PGT, 7/16-6 in ext; B1,CW2; 7-9 turns. Bolt will come out of launch position and move ~2 in fwd 11. Push bolt ~0.5 in to contact nut 	

ATTACH P6 TO P5 USING CONTINGENCY FASTENERS (Cont)

IV	EV1 – Pz (FF)	EV2 – Wheels
<p>3. Final RTAS gap: _____</p>	<ol style="list-style-type: none"> 12. Continue to tighten RTAS contingency bolt PGT, 7/16-6 in ext; B1,CW2; 9.5-11.5 turns to HS 13. Torque RTAS contingency bolt Torque Wrench, 7/16-6 in ext; 57 ft-lb 14. Remove Contingency Spacer Lock Tool from sleeve 15. Measure gap; report to MCC-H 16. Stow Contingency Spacer Lock Tool in trash bag 17. Remove spherical bearing locking plate bolt on P6 PGT, 7/16-6 in ext; A5,CCW2; 12-14 turns 18. Stow plate with wire tie to adjacent handrail 19. Install ground strap per nominal ATTACH P6 TO P5 procedure 	

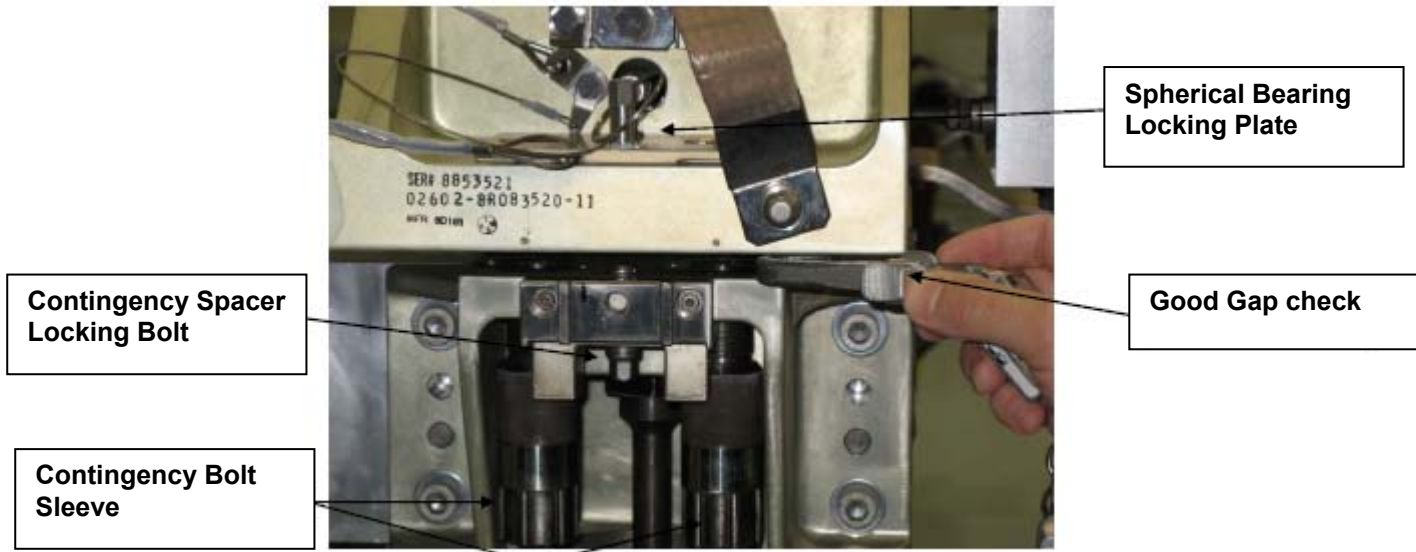

ATTACH P6 TO P5 USING CONTINGENCY FASTENERS – TASK DATA

EVA Tools:

EV1 (FF)	EV2 (FF)
PGT	N/A
7/16-6 in ext	
Torque Wrench	

EVA Fasteners:

Fastener	Head Size	Qty	Ground Install Torque (ft-lb)	Release Torque (ft-lb)	Failure Torque (ft-lb)	Turns	RPM
Gap Check Tool bolt (Contingency spacer lock tool bolt)	7/16"	2/Tool	~4	4.3	12.2	12-14	30
Contingency spacer locking bolt	7/16"	1/RTAS	~7	16	31.1	1 turn max	N/A
RTAS contingency bolt	7/16"	2/RTAS	57	N/A	115.2	7-9: release from uplock 9.5-11.5: install	30
Spherical bearing locking plate bolt	7/16"	1/RTAS	~3.0	3.0	12.2	12-14	10

EVA Connectors: None

Foot Restraints: See nominal procedure

Warnings:

Cautions:

- Do not loosen P5 contingency spacer locking bolt more than 1 turn. Excessive turns of spacer locking bolt may cause guide washer to come out of slot and cause snap ring washer to bend

Notes:

- EVA worksite per nominal bolt engagement. Contingency spacer lock tool is at RTAS corner #1 on inboard and outboard of P5
- If contingency spacer sleeve needs to be rotated to allow tool installation, rotate ccw
- Contingency bolt will come out of launch position and move ~2 in fwd after 7 turns

S1 RADIATOR MANUAL CINCH RELEASE

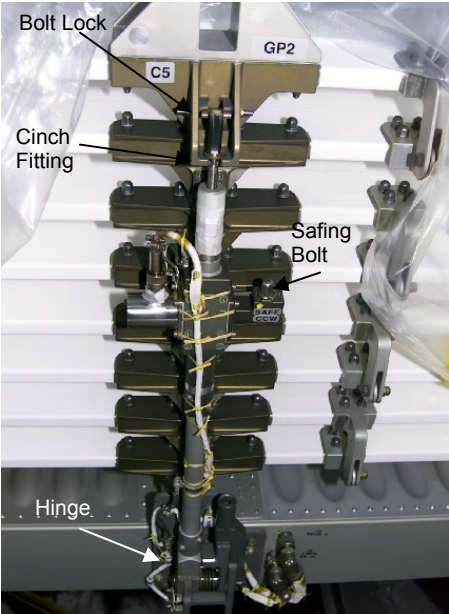
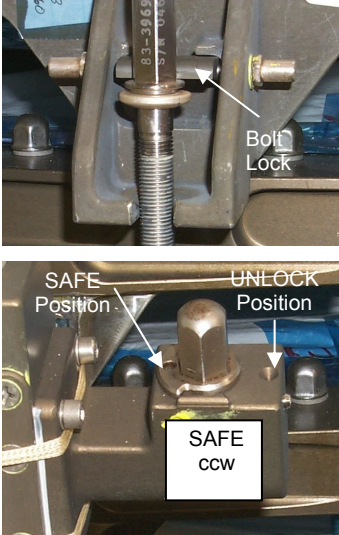
IV	EV1 (FF)	EV2 (FF)
<p>IV/MCC-H: 1. Verify power is OFF to SFU 2. Verify which cinch(es) to be released</p> <p>NOTE Verify the socket extension rotates the cinch bolt locking tab downward prior to releasing bolt.</p> <p>Cinch will rotate away from radiator when bolt is clear of cinch fitting</p> 	<p>CINCH RELEASE</p> <div style="border: 1px solid black; padding: 5px; margin: 5px 0;"> <p style="text-align: center;">CAUTION</p> <p>Avoid tool and tether contact with top of radiators (Z-93 paint)</p> </div> <ol style="list-style-type: none"> Set up APFR per EV2 column, will need a different setting for ingress Rotate Pin Puller Safing bolt PGT, 7/16-6in ext, RCCW, 30.5 (manual ratchet), 0.5 turns to the SAFE position (so auto pin will not fire) Release cinch bolt PGT, 7/16-6 in ext, B7, CCW1, 30.5 (25.5 ft-lb, 10 RPM), until clear of cinch fitting (~6-8 turns) If higher torque required to break torque, use PGT in manual PGT, 7/16-6 in ext, RCCW, 30.5 (manual ratchet) Allow cinch to rotate away from radiator Verify cinch is locked in deployed detent 	<p>APFR Setups assuming TRRJ at 0 deg: (Settings are for cinch worksite, will need different ingress setting)</p> <p>Outboard (stbd-most)</p> <p>C1: S1-32 (bay 15, nadir); [8, NN, F, 12] C2: S1-32 (bay 15, nadir); [8, NN, C, 1] C3: S1-23 (bay 13, zenith); WIF-E [3, I, 7]; [6, FF, F, 12] C4: BRT (S3 too close for APFR) C5: S1-31 (bay 15 zenith); [3, PP, D, 12] C6: S1-31 (bay 15 zenith); [3, PP, G, 12]</p> <p>Inboard (port-most)</p> <p>C1: S1-10 (bay 9, nadir); [8, NN, F, 12] C2: S1-10 (bay 9, nadir); [8, NN, C, 1] C3: S1-4 (bay 5, nadir); WIF-E [9, M, 7]; [8, FF, B, 10] C4: S1-16 (bay 11, zenith); WIF-E [3, J, 7]; [7, FF, D, 11] C5: S1-9 (bay 9 zenith); [1, FF, A, 3] or S1-5; [11, FF, A, 3] C6: S1-9 (bay 9 zenith); [11, FF, A, 3]</p> 

S1 RADIATOR MANUAL OVERRIDE TO DEPLOY/RETRACT

IV	EV1 (FF)	EV2 (FF)
<p>IV/MCC-H: 1. Verify telemetry is enabled through radiator IMCA 2. Verify ISS in CMG control/free drift prior to deploy</p> 	<p><u>NOTE</u> This task will involve reprogramming of the PGT to achieve a speed of 20 RPM Manual override is location on side opposite RBVMs</p> <p><u>MANUAL DEPLOY</u></p> <ol style="list-style-type: none"> 1. Set up APFR per EV2 column 2. √PGT turn count at 0.0 3. Drive manual override through its maximum torque region PGT, 7/16-6 in ext; B1, CW1, 30.5 (12.0 ft-lb, 5 RPM), stop at 20 turns 4. √PGT turn count at 0.0 5. Drive manual override till close to the deploy stop PGT, 7/16-6 in ext; A7, CW2, 30.5 (9.2 ft-lb, 20 RPM), stop at 95 turns 6. Drive manual override to lightly preload on the deploy stop PGT, 7/16-6 in ext; A1, CW1, 30.5 (2.5 ft-lb, 5 RPM), to torque stop (~2-6 turns) 7. √PGT turn count at 0.0 8. Drive manual override to preload on the deploy stop PGT, 7/16-6 in ext; B1, CW1, 30.5 (12.0 ft-lb, 5 RPM), stop at 2.5 turns or torque (whichever comes first) <p><u>MANUAL RETRACT</u></p> <ol style="list-style-type: none"> 1. Set up APFR per EV2 column 2. √PGT turn count at 0.0 3. Drive manual override through maximum torque region PGT, 7/16-6 in ext; A6, CCW2, 30.5 (8.3 ft-lb, 20 RPM), stop at 115 turns 4. Drive manual override to preload on the retract stop. PGT, 7/16-6 in ext; A6, CCW1, 30.5 (8.3 ft-lb, 5 RPM) stop on torque (~4-8 turns) 	<p>APFR Setups assuming TRRJ at 0 deg: (Settings are for manual override worksite, will need different ingress setting) Outboard (stbd-most) Override: S3-01 (bay 17, zenith); [2, PP, F, 12]</p> <p>Inboard (port-most) Override: S1-11 (bay 9, zenith); [1, FF, A, 3]</p> <p><u>NOTE</u> Verify the socket extension disengages the override bolt locking mechanism</p> <p><u>NOTE</u> Verify the socket extension disengages the override bolt locking mechanism</p>

P6 RADIATOR MANUAL OVERRIDE TO DEPLOY/RETRACT

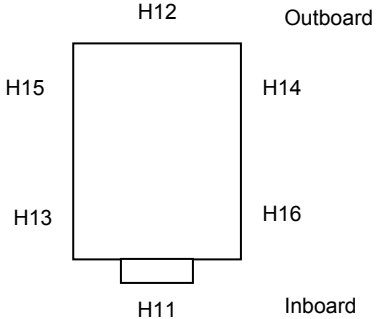
IV	EV1	EV2
<p>MCC-H 1. Verify PVR motor OFF</p> <p style="text-align: center;"><u>NOTE</u> Free Drift or CMG Control with Thrusters Disabled is required while radiator is being deployed/retracted. Applies only while mechanisms are in motion</p> <p>MCC-H 2. Configure ISS/Orbiter attitude control to CMG Control with thrusters disabled or Orbiter and ISS in free drift</p> <p>IV 3. Give EV crew GO for extend/retract radiator</p> <p>IV 4. On EV GO, CMD nominal attitude control</p> <div style="text-align: center;">  </div>	<p><u>MANUAL OVERRIDE TO EXTEND (RETRACT) RADIATOR</u></p> <ol style="list-style-type: none"> 1. If required, APFR, set up and ingress (see Task Data for WIF position and APFR settings) 2. On IV GO, release PVR MDA fastener H32 PGT, 7/16- 6 in ext; B1 (12 ft-lb), CCW2 (CW2) 30 RPM, MTL 30.5; push to engage (5 lb) ~45 turns to HS 3. If required to re-engage H32 locking collar PGT, 7/16- 6 in ext; RCCW (RCW), MTL 30.5; ~1/6 turn until collar pops up completely and re-engages 4. Report to IV, radiator deployment (retraction) complete <p>If retracting, re-install PVR cinches using the procedure below. Manual compression of the radiator panels may be required to install cinches (two crewmember operation):</p> <ul style="list-style-type: none"> <input type="checkbox"/> Cinch H11 <input type="checkbox"/> Cinch H13 <input type="checkbox"/> Cinch H15 	<p>If retracting, re-install PVR cinches using the procedure below. Manual compression of the radiator panels may be required to install cinches (two crewmember operation):</p> <ul style="list-style-type: none"> <input type="checkbox"/> Cinch H12 <input type="checkbox"/> Cinch H14 <input type="checkbox"/> Cinch H16

P6 RADIATOR MANUAL OVERRIDE TO DEPLOY/RETRACT (Cont)

IV	EV1	EV2																																						
	REINSTALL PVR CINCHES	REINSTALL PVR CINCHES																																						
	<ol style="list-style-type: none"> 1. Position for cinch H11 installation 2. Verify cinch H11 bolt is engaged in last thread (to maximize clearance); verify fixed end pulled all the way out and seated properly in bracket 3. Compress radiator panels and assess cinch H11 installation 4. If EV1 and EV2 both GO for cinch install 5. Give EV2 GO for cinch install, install cinch H11 6. Remove winch bar PIP pin (H33); align winch bar clevis to lug on radiator; re-install PIP pin 7. If NO GO for cinch install, assess winch bar installation 8. If GO for winch installation: 9. Remove winch bar PIP pin (H33) 10. Give EV2 GO for winch install, compress radiator panels, align winch bar clevis to lug on radiator, re-install PIP pin 11. Remove FQDC shroud per steps below 12. Retract winch per steps below 13. Replace FQDC shroud per steps below 14. If NO GO for winch install: 15. Remove FQDC shroud per steps below 16. Extend winch per steps below 17. Remove winch bar PIP pin (H33) 18. Give EV2 GO for winch install; align winch bar clevis to lug on radiator; re-install PIP pin 19. Retract winch per steps below 20. Replace FQDC shroud per steps below 21. Install cinch H11 22. Tension cinch H11 PGT, 7/16-6 in ext; A3 (4.8 ft-lb), CW2 (30 RPM), MTL 30.5; push 5 lb, ~6-14 turns to HS 23. Install and tension cinches H13 and H15 PGT, 7/16-6 in ext; A3 (4.8 ft-lb), CW2 (30 RPM), MTL 30.5; push 5 lb, ~6-14 turns to HS, each 24. Tighten cinch H11 PGT, 7/16-6 in ext; A3 (4.8 ft-lb), CW2 (30 RPM), MTL 30.5; push 5 lb, turn to HS 	<ol style="list-style-type: none"> 1. Position for cinch H12 installation 2. Verify cinch H12 bolt is engaged in last thread (to maximize clearance); verify fixed end pulled all the way out and seated properly in bracket 3. Compress radiator panels and assess cinch H12 installation 4. If EV1 and EV2 GO for cinch install 5. On GO from EV1, install cinch H12 6. Remove winch bar PIP pin (H34); align winch bar clevis to lug on radiator; re-install PIP pin 7. If NO GO for cinch install, assess winch bar installation 8. If GO for winch installation: 9. Remove winch bar PIP pin (H34) 10. On GO from EV1, compress radiator panels, align winch bar clevis to lug on radiator, re-install PIP pin 11. If NO GO for winch install: 12. Remove winch bar PIP pin (H34) 13. On GO from EV1, compress radiator panels, align winch bar clevis to lug on radiator, re-install PIP pin 14. Install cinch H12 15. Tension cinch H12 PGT, 7/16-6 in ext; A3 (4.8 ft-lb), CW2 (30 RPM), MTL 30.5; push 5 lb, ~6-14 turns to HS 16. Install and tension cinches H14 and H16 PGT, 7/16-6 in ext; A3 (4.8 ft-lb), CW2 (30 RPM), MTL 30.5; push 5 lb, ~6-14 turns to HS, each 17. Tighten cinch H12 PGT, 7/16-6 in ext; A3 (4.8 ft-lb), CW2 (30 RPM), MTL 30.5; push 5 lb, turn to HS 																																						
<table style="width: 100%; border-collapse: collapse;"> <thead> <tr> <th style="text-align: left; border-bottom: 1px solid black;">Cinch (initial Torque)</th> <th style="text-align: left; border-bottom: 1px solid black;">Torque/Turns</th> </tr> </thead> <tbody> <tr><td>H11</td><td>____/____</td></tr> <tr><td>H12</td><td>____/____</td></tr> <tr><td>H13</td><td>____/____</td></tr> <tr><td>H14</td><td>____/____</td></tr> <tr><td>H15</td><td>____/____</td></tr> <tr><td>H16</td><td>____/____</td></tr> </tbody> </table> <table style="width: 100%; border-collapse: collapse;"> <thead> <tr> <th style="text-align: left; border-bottom: 1px solid black;">Cinch (Final Torque)</th> <th style="text-align: left; border-bottom: 1px solid black;">Torque/Turns</th> </tr> </thead> <tbody> <tr><td>H11</td><td>____/____</td></tr> <tr><td>H12</td><td>____/____</td></tr> <tr><td>H13</td><td>____/____</td></tr> <tr><td>H14</td><td>____/____</td></tr> <tr><td>H15</td><td>____/____</td></tr> <tr><td>H16</td><td>____/____</td></tr> </tbody> </table> <table style="width: 100%; border-collapse: collapse;"> <thead> <tr> <th style="text-align: left; border-bottom: 1px solid black;">Cinch (Manual Torque)</th> <th style="text-align: left; border-bottom: 1px solid black;">Turns</th> </tr> </thead> <tbody> <tr><td>H11</td><td>_____</td></tr> <tr><td>H12</td><td>_____</td></tr> <tr><td>H13</td><td>_____</td></tr> <tr><td>H14</td><td>_____</td></tr> </tbody> </table>	Cinch (initial Torque)	Torque/Turns	H11	____/____	H12	____/____	H13	____/____	H14	____/____	H15	____/____	H16	____/____	Cinch (Final Torque)	Torque/Turns	H11	____/____	H12	____/____	H13	____/____	H14	____/____	H15	____/____	H16	____/____	Cinch (Manual Torque)	Turns	H11	_____	H12	_____	H13	_____	H14	_____		
Cinch (initial Torque)	Torque/Turns																																							
H11	____/____																																							
H12	____/____																																							
H13	____/____																																							
H14	____/____																																							
H15	____/____																																							
H16	____/____																																							
Cinch (Final Torque)	Torque/Turns																																							
H11	____/____																																							
H12	____/____																																							
H13	____/____																																							
H14	____/____																																							
H15	____/____																																							
H16	____/____																																							
Cinch (Manual Torque)	Turns																																							
H11	_____																																							
H12	_____																																							
H13	_____																																							
H14	_____																																							

P6 RADIATOR MANUAL OVERRIDE TO DEPLOY/RETRACT (Cont)

IV	EV1	EV2
<p>H15 H16</p> <p>_____</p> <p>_____</p>	<ol style="list-style-type: none"> 25. Tighten cinch H11 PGT, 7/16-6 in ext ; RCW, MTL 30.5; 3/4 turn 26. Verify anti-rotation device is up; if not, rotate bolt cw until up, max 60 deg 27. Tighten cinches H13 and H15 PGT, 7/16-6 in ext; A3 (4.8 ft-lb), CW2 (30 RPM), MTL 30.5; push 5 lb, turn to HS 28. Tighten cinches H13 and H15 PGT, 7/16-6 in ext; RCW, MTL 30.5; 3/8 turn 29. Verify anti-rotation device is up; if not, rotate bolt cw until up, max 60 deg (x2) <p><u>REMOVE FQDC SHROUD</u></p> <ol style="list-style-type: none"> 1. Stage RET for FQDC shroud restraint 2. Release FQDC shroud bolts (4) PGT, 7/16-6 in ext; A7 (9.2 ft-lb), CCW2 (30 RPM), MTL 30.5, 7 turns 3. Restrain FQDC shroud w/RET <p><u>EXTEND WINCH</u></p> <ol style="list-style-type: none"> 1. Actuate H10 bolt PGT, 7/16-6 in ext; A1 (2.5 ft-lb), CW1 (10 RPM), MTL 30.5; push 5 lb, extend winch bars until winch bar clevis aligns with radiator lug (=20 turns max) <p><u>RETRACT WINCH</u></p> <ol style="list-style-type: none"> 1. PGT[A1 2.5 ft-lb, CCW1 10 RPM, MTL 30.5]-6ext 7/16: Actuate H10 bolt, push 5 lb, fully retract winch bars (~25 turns max) <p><u>REPLACE FQDC SHROUD</u></p> <ol style="list-style-type: none"> 1. Retrieve FQDC Shroud 2. Engage FQDC shroud bolts (4) PGT, 7/16-6 in ext; A7 (9.2 ft-lb), CW2 (30 RPM), MTL 30.5, 7 turns to HS 3. Retrieve RET 	<ol style="list-style-type: none"> 18. Tighten cinch H12 PGT, 7/16-6 in ext ; RCW, MTL 30.5; 3/4 turn 19. Verify anti-rotation device is up; if not, rotate bolt cw until up, max 60 deg 20. Tighten cinches H14 and H16 PGT, 7/16-6 in ext; A3 (4.8 ft-lb), CW2 (30 RPM), MTL 30.5; push 5 lb, turn to HS 21. Tighten cinches H14 and H16 PGT, 7/16-6 in ext; RCW, MTL 30.5; 3/8 turn 22. Verify anti-rotation device is up; if not, rotate bolt cw until up, max 60 deg (x2)

P6 RADIATOR MANUAL OVERRIDE TO DEPLOY/RETRACT – TASK DATA

Estimated Task Duration:

	With RMS	Without RMS
One EV Crew	NA	0:30 (E)
Two EV Crew	NA	1:30 I

Tools:

EV1	EV2
PGT	PGT
6 Ext 7/16	6 Ext 7/16
APFR	
RET	

EVA Fasteners:

Fastener Name	Label	Head Size	Qty	Install Torque (ft-lb)	Max Break Away Torque (ft-lb)	Failure Torque (ft-lb)	Turns	RPM
PVR MDA	H32	7/16	1	12.0	19.1*	25.2	45-50	30
Cinch bolts	H11-H12	7/16	2	4.8	15.8	35.7	8-14	30
Cinch bolts	H13-H16	7/16	4	4.8	24.6	39.7	8-14	30
FQDC Shroud bolts	H5, H6, H8, H9	7/16	4	9.2	6.7	21.2 I 18.1 (I)	7	30
Winch bolt	H10	7/16	1	2.5	4.4*	6.4	25 I 20 (I)	30

*Indicates Max On-Orbit Installation Torque

EVA Connectors:

Harness	From	To	Clamps (#)	Conn Size	Function
NA					

Foot Restraints:

Task	WIF	APFR Setting
PVR MDA worksite	P6 – 16	(5,PP, E, 1)

Mass: NA

Notes:

1. Free drift or CMG Control with Thrusters Disabled is required while radiator is being deployed/retracted. Applies only while mechanisms are in motion

Cautions:

1. Equipment damage. Avoid contact with radiator bellows
2. Winch mechanism extension may fail due to excess slack if extended beyond 20 turns from launch state, or beyond 25 turns from fully retracted state
3. Avoid putting high axial loads on winch bolt; retaining mechanism for locking device may fail. Still usable if failure occurs, but no locking capability

Warnings:

1. Moving equipment. Avoid contact with panels and mechanisms during extension of radiator

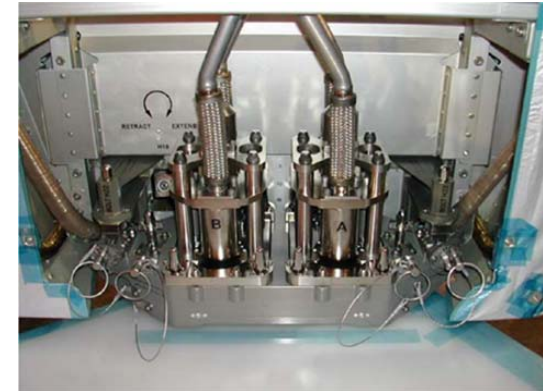

PVR FQDC

P6 RADIATOR MANUAL OVERRIDE TO DEPLOY/RETRACT – TASK DATA (Cont)

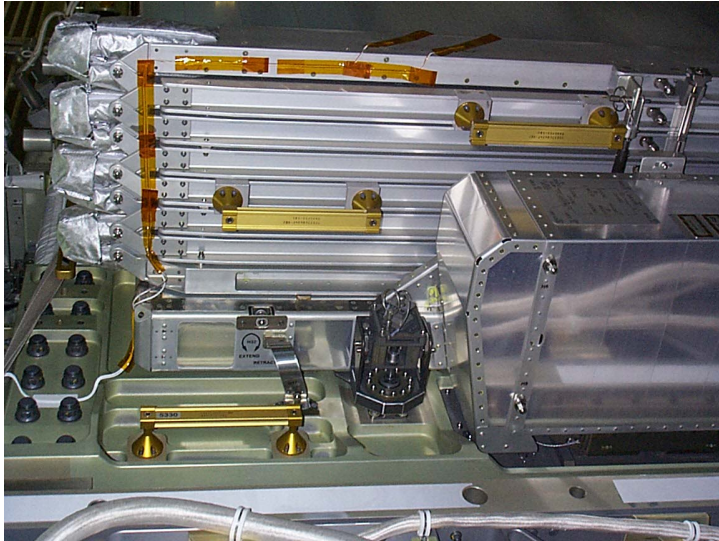

PV Radiator – MDA H32 Fastener Located Near Ground Strap



PV Radiator MDA Fastener

PVR EVA Interfaces

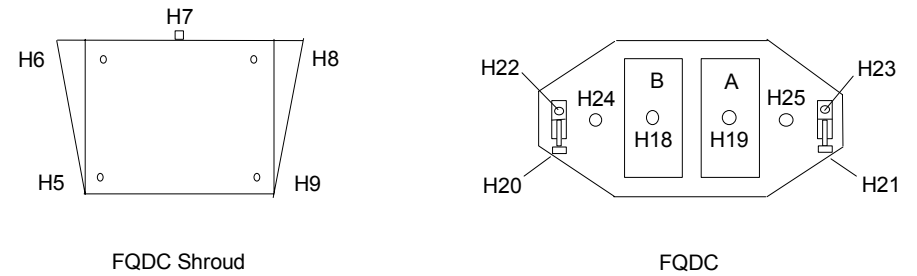
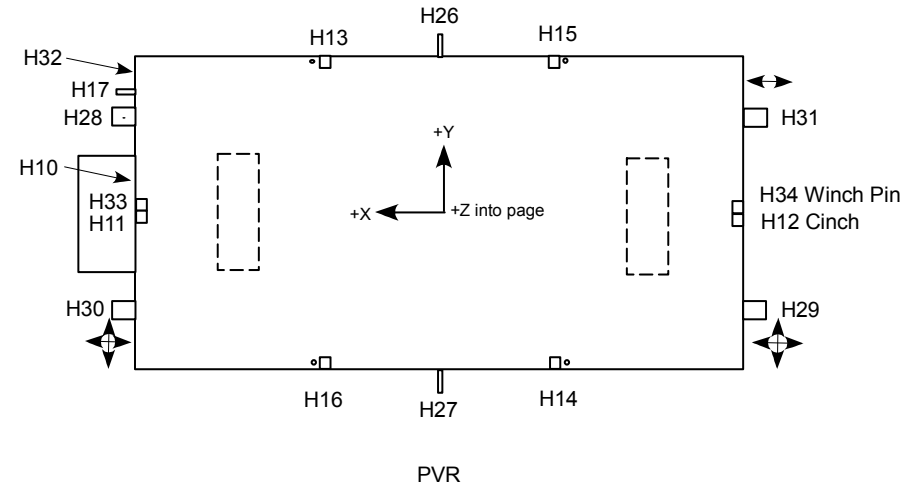

- H5,6,9,8 = FQDC Shroud Fasteners
- H7 = FQDC Shroud Alignment Pin
- H10 = Winch Drive
- H11- H16 = Cinches
- H17 = Grounding Strap
- H18 - H19 = FQDC Drive bolts
- H20 - H21 = Carrier Slider bolts
- H22 - H23 = Carrier to PVR Attach
- H24 - H25 = Carrier to IEA Attach
- H26 - H27 = Center Bolts
- H28 - H31 = Corner Bolts
- H32 = Manual Deploy/Retract
- H33-H34 = Winch PIP pins

MANUAL OVERRIDE TO DISENGAGE BETA GIMBAL ANTI-ROTATION LATCH (01:00)

TIME (HR:MN)	IV/RMS	EV1	EV2
01:00	<p>MCC-H 1. BGA 4B(2B) ANTI-ROTATION LATCH FAIL TO UNLATCH REMOTELY (ISS EPS GENERIC, <u>MALFUNCTION PROCEDURES</u>)</p> <p>IV PCS 2. Determine Anti-rotation latch posn P6: EPS: BGA 4B(2B) <u>BGA 4B(2B)</u></p> <p>'ECU 4B(2B)' Verify Integ Cnt – Incrementing</p> <p>'BGA 4B(2B)' Record Actual Angle = _____deg Motor State - _____ Latch 1 Pin Status - _____ Latch 2 Pin Status - _____</p> <p>Refer to BMRRM Anti-Rotation Latch Table to determine beta gimbal anti-rotation latch access hole: Anti-rotation latch posn = (Hole#)</p> <p>IV PCS 3. ✓Anti-rotation latch released P6: EPS: BGA 4B(2B) <u>BGA 4B(2B)</u></p> <p>'ECU 4B(2B)' Verify Integ Cnt – Incrementing</p> <p>'BGA 4B(2B)' Verify: Latch 1 Pin Status – Unlatched Latch 2 Pin Status – Unlatched</p>	<p>Stbd Tool Box/QD BDT Board: Obtain BMRRM anti-rotation latch tool</p> <p>1. Port SAW BGA APFR: P6-39 (9,QQ,H,12) Stbd SAW BGA APFR: P6-40 (9,NN,G,3)</p> <p>2. Insert tool into designated beta gimbal hole to depress and release anti-rotation latch. Use indicator mark on tool for correct insertion depth</p>	

BMRRM ANTI-ROTATION LATCH TABLE

Hole	Latch 1 Angle	Latch 2 Angle	Cable Restricts Access		
1	0	267.1875			
2	5.625	272.8125			
3	11.25	278.4375			
4	16.875	284.0625			
5	22.5	289.6875			
6	28.125	295.3125	J1 – Primary Power		
7	33.75	300.9375	J1 – Primary Power		
8	39.375	306.5625	J1 – Primary Power		
9	45	312.1875	J1 – Primary Power		
10	50.625	317.8125			
11	56.25	323.4375			
12	61.875	329.0625			
13	67.5	334.6875			
14	73.125	340.3125			
15	78.75	345.9375			
16	84.375	351.5625			
17	90	357.1875			
18	95.625	2.8125			
19	101.25	8.4375			
20	106.875	14.0625			
21	112.5	19.6875			
22	118.125	25.3125			
23	123.75	30.9375	J4 – 1553 Bus B		
24	129.375	36.5625	J4 – 1553 Bus B		
25	135	42.1875	J4 – 1553 Bus B		
26	140.625	47.8125			
27	146.25	53.4375			
28	151.875	59.0625			
29	157.5	64.6875			
30	163.125	70.3125			
31	168.75	75.9375			
32	174.375	81.5625			
33	180	87.1875			
34	185.625	92.8125			
35	191.25	98.4375			
36	196.875	104.0625			
37	202.5	109.6875			
38	208.125	115.3125			
39	213.75	120.9375			
40	219.375	126.5625			
41	225	132.1875			
42	230.625	137.8125	J2 – Secondary Pwr (RPCM XX A RPC 2)		
43	236.25	143.4375	J2 – Secondary Pwr (RPCM XX A RPC 2)		
44	241.875	149.0625	J2 – Secondary Pwr (RPCM XX A RPC 2)		
45	247.5	154.6875			
46	253.125	160.3125			
47	258.75	165.9375			
48	264.375	171.5625			
49	270	177.1875			
50	275.625	182.8125			
51	281.25	188.4375	J3 – 1553 Bus A and Sec Pwr (RPCM XX A RPC 1)		
52	286.875	194.0625	J3 – 1553 Bus A and Sec Pwr (RPCM XX A RPC 1)		
53	292.5	199.6875	J3 – 1553 Bus A and Sec Pwr (RPCM XX A RPC 1)		
54	298.125	205.3125			
55	303.75	210.9375			
56	309.375	216.5625			
57	315	222.1875			
58	320.625	227.8125			
59	326.25	233.4375			
60	331.875	239.0625			
61	337.5	244.6875			
62	343.125	250.3125			
63	348.75	255.9375			
64	354.375	261.5625			

MANUAL OVERRIDE TO UNLATCH/LATCH (TENSION) SABB

IV/RMS	EV
<p>Identify Affected Power Channel XX = _____</p> <p><u>IF UNLATCHING SABB</u></p> <p>MCC-H 1. Perform {3.190 SAW XX FAILURE TO UNLATCH SABB REMOTELY} (SODF: EPS: MALFUNCTION: PRIMARY POWER)</p> <p>IV 2. GO for EV crew ingress at worksite</p> <p><u>IF TENSIONING SABB</u></p> <p>MCC-H 1. Perform {3.193 SAW XX FAILURE TO LATCH (TENSION) SABB REMOTELY} SODF: EPS: MALFUNCTION: PRIMARY POWER)</p> <p>THEN:</p> <p>IV 2. If required (see Task Data notes), Verify affected SABB positioned over the IEA and BGA latched</p> <p>PCS PVM: EPS: BGA XX BGA XX 'ECU XX' Verify: Integ Cnt – Incrementing</p> <p>'BGA XX' Verify: Actual Angle, deg = 270.000 (± 0.5) (Left SABB) OR Actual Angle, deg = 90.000 (± 0.5) (Right SABB)</p> <p>Motor State – OFF Latch 1 Pin Status – Latched</p> <p>IV 3. GO for EV crew ingress at worksite</p> <p style="text-align: center;"><u>NOTE</u></p> <p>Free Drift or CMG Control with Thrusters Disabled is required while SABB is being unlatched/latched. Applies only while mechanisms are in motion</p> <p>MCC-H 4. Configure ISS/Orbiter attitude control to CMG Control with thrusters disabled</p> <p>IV 5. When task complete, give MCC-H GO to resume nominal attitude control</p>	<div style="border: 3px double black; padding: 5px; margin-bottom: 10px;"> <p style="text-align: center;">WARNING</p> <p>Sharp edge/pinch point/entrapment hazard – Avoid contact with outboard underside of SABB due to exposed reels, guide-wire and tension mechanisms</p> <p style="text-align: center;">Avoid contact with blanket box latches during manual override operation</p> </div> <div style="border: 1px solid black; padding: 5px; margin-bottom: 10px;"> <p style="text-align: center;">CAUTION</p> <p>Maintain a constant push force (3-10 lb) on the MDA fastener anti-rotation collar during fastener rotation</p> </div> <p><u>MANUAL OVERRIDE TO UNLATCH SABB</u></p> <ol style="list-style-type: none"> 1. On IV GO (see IV column, Unlatching SABB, step 2) – Enter worksite area 2. If required, APFR, setup and ingress (see Task Data for WIF position, APFR settings, and BGA angle) 3. Release PIP pin from back-up position lever 4. Move override lever to MANUAL position 5. Insert PIP pin into lock lever position 6. Drive MDA drive fastener PGT, 7/16-2 in ext; A6 (8.3 ft-lb), CCW2 (30 RPM), MTL 30.5; push to engage (3-10 lb), 48 ± 1 turns until visual indication of latch position or HS 7. Release PIP pin from override positioning lever 8. Move override lever to AUTOMATIC position 9. Insert PIP pin into lock lever position 10. Drive MDA drive fastener (opposite direction) PGT 7/16-2 in ext; RCW, MTL 30.5; Push to engage (3-10 lb), ¼ turn to engage clutch pins <p><u>MANUAL OVERRIDE TO TENSIONING SABB</u></p> <ol style="list-style-type: none"> 1. On IV GO (see IV column, Tensioning SABB, step 3), Enter worksite area 2. If required, APFR, setup and ingress (see Task Data for WIF position, APFR settings, and BGA angle) 3. Release PIP pin from back-up position lever 4. Move override lever to MANUAL position 5. Insert PIP pin into lock lever position 6. Drive MDA drive fastener PGT, 7/16-2 in ext; A6 (8.3 ft-lb), CW2 (30 RPM), MTL 30.5; push to engage (3-10 lb), 48 ± 1 turns until visual indication of latch position or HS. The latches along the blanket box are visible and will move to the engaged position 7. Release PIP pin from override positioning lever 8. Move override lever to AUTOMATIC position 9. Insert PIP pin into lock lever position 10. Drive MDA drive fastener (opposite direction) PGT 7/16-2 in ext; RCCW, MTL 30.5; Push to engage (3-10 lb), ¼ turn to engage clutch pins

MANUAL OVERRIDE TO UNLATCH/LATCH (TENSION) SABB – TASK DATA

Estimated Task Duration:

	With RMS	Without RMS
One EV Crew	NA	00:30
Two EV Crew	NA	NA

Tools:

EV1	EV2
PGT	NA
2 Ext 7/16	

EVA Fasteners:

Fastener Name	Label	Head Size	Qty	Install Torque (ft-lb)	Max Break Away Torque (ft-lb)	Failure Torque (ft-lb)	Turns	RPM
SABB MDA Fastener	Yes	7/16	1 per	NA	7.5	12	48	30

EVA Connectors:

Harness	From	To	Clamps (#)	Conn Size	Function
NA					

Foot Restraints:

Task	WIF	APFR Setting	BGA Angle
IEA Non-keel side – Right SABB	P4/S4-26; P6/S6-38	(12,FF,F,3)	90
IEA Non-keel side – Left SABB	P4/S4-26; P6/S6-38	(12,FF,E,9)	270
IEA Keel side – Right SABB	P4/S4-25; P6/S6-37	(12,FF,F,3)	90
IEA Keel side – Left SABB	P4/S4-25; P6/S6-37	(12,FF,E,9)	270

Mass: NA

Notes:

1. It has been demonstrated in the NBL that the EVA crewmember can access the SABB Manual Override Fastener from a free floating position on the mast canister. If the EVA crew thinks they can actuate the SABB Manual Override Fastener from a free floating position on the mast canister, there is no need to position the BGA per IV step 2
2. Free Drift or CMG Control with Thrusters Disabled is required while SABB is being unlatched/latched. Applies only while mechanisms are in motion

Cautions:

1. Equipment damage – Maintain a constant push force (3-10 lb) on the MDA fastener anti-rotation collar during fastener rotation. Damage to the locking collar and/or the fastener could result if the collar is allowed to extend during fastener rotation
2. Equipment damage – Avoid contact with blanket box latches and mechanisms on underside of blanket box

Warnings:

1. Sharp edge/pinch point/entrapment hazard – Avoid contact with outboard underside of SABB due to exposed reels, guide-wire and tension mechanisms
2. Moving equipment. Avoid contact with blanket box latches during manual override operation

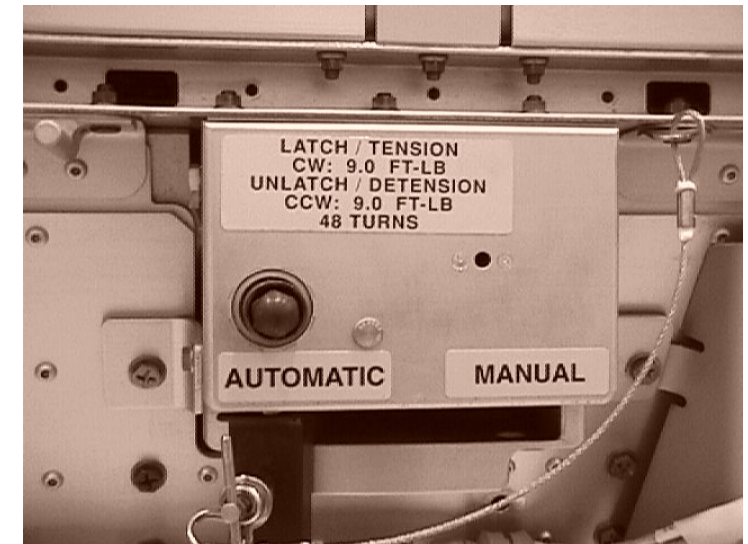

SABB MDA

MANUAL OVERRIDE TO EXTEND/RETRACT MAST

IV	EV
<p>Identify Affected Power Channel XX = _____</p> <p>MCC-H 1. Perform {3.191 SAW XX FAILURE TO EXTEND MAST REMOTELY} (SODF: EPS: MALFUNCTION: PRIMARY POWER)</p> <p>OR</p> <p>Perform {3.192 SAW XX FAILURE TO RETRACT MAST REMOTELY} (SODF: EPS: MALFUNCTION: PRIMARY POWER)</p> <p>IV 2. Verify affected SABB positioned over the IEA and BGA latched PVM: EPS: BGA XX BGA XX 'ECU XX' Verify: Integ Cnt – Incrementing</p> <p>'BGA XX' Verify: Actual Angle, deg = 180.000 (+/- 0.5) Motor State – OFF Latch 1 Pin Status– Latched</p> <p>IV 3. GO FOR EV CREW INGRESS AT WORKSITE</p> <p>NOTE Free Drift or CMG Control with Thrusters Disabled is required while solar array is being deployed/retracted. Applies only while mechanisms are in motion</p> <p>MCC-H 4. Configure ISS/Orbiter attitude control to CMG Control with thrusters disabled</p>	<div style="border: 2px solid black; padding: 5px; margin-bottom: 10px;"> <p style="text-align: center;">WARNING</p> <p>Sharp edge/pinch point/entrapment hazard – Avoid contact with outboard underside of SABB due to exposed reels, guide-wire and tension mechanisms</p> <p>Avoid contact with blanket box latches during manual override operation</p> </div> <p>MANUAL OVERRIDE TO EXTEND MAST</p> <div style="border: 1px solid black; padding: 5px; margin-bottom: 10px;"> <p style="text-align: center;">CAUTION</p> <p>If excessive blanket panel "stiction" occurs during mast deployment, perform contingency incremental deployment</p> </div> <ol style="list-style-type: none"> 1. On IV GO (see IV column, step 3), enter worksite area 2. Set up and ingress APFR (see Task Data page) 3. If reqd, Deploy MCHD PGT swing arm, install MCHD onto mast canister, zip nuts (4) 4. If reqd, secure MCHD fasteners (4) PGT, 7/16-2 in ext; A5 (7.0 ft-lb), CW2 (30 RPM), MTL 30.5; to HS 5. Rotate Manual Override Actuator Shaft on left side of MDA Ratchet, 7/16-2 in ext; cw; 180 deg to disengage MDA, indicator – MANUAL 6. If reqd, place PGT in MCHD PGT swing arm <div style="border: 1px solid black; padding: 5px; margin-bottom: 10px;"> <p style="text-align: center;">CAUTION</p> <p>Crew must monitor the tension bar. Stop SAW deployment if the tension bar rises more than 1.5 inches from the sill. Drive MDA EVA override fastener until tension bar returns to 1.5 inches from the sill: PGT, 7/16-2 in ext; A7 (9.2 ft-lb), CW3 (60 RPM), MTL 30.5. When panels release and tension bar returns to the sill, deployment can continue</p> </div> <p style="text-align: center;">NOTE</p> <p>Insolation is not required for this task, unless needed for visual abort cues. As expected, the tension bar will rise 18 to 20 inches from the sill as the last half mast bay is deployed.</p> <p>Extension complete when: Visual observation of the last mast bay visual indicators (black/white, cross hatched). Hard stop, sharp rise in tool torque.</p> <p>If reqd, off-load drive shaft with IVA pipe wrench. Apply load from the right to the left above the torsion spring in the coupler. Switch to manual mode while holding torque on the coupler</p> <ol style="list-style-type: none"> 7. Drive MDA EVA override fastener PGT, 7/16-2 in ext; A7 (9.2 ft-lb), CCW3 (60 RPM), MTL 30.5; ~78 turns until 1 mast bay is deployed 8. Give MCC-H GO to place solar array blanket boxes in high tension

MANUAL OVERRIDE TO EXTEND/RETRACT MAST (Cont)

IV	EV
<p>MCC-H 5. On EV GO (see EV column, Extend Mast, step 8), place solar array blanket boxes in high tension, when complete, give EV GO to continue SAW deployment</p> <p>MCC-H 6. On EV GO – resume nominal attitude control</p>	<p>9. On MCC-H GO (see IV column, step 5), drive MDA EVA override fastener PGT, 7/16-2 in ext; A7 (9.2 ft-lb), CCW3 (60 RPM), MTL 30.5; 2382 turns (x1 PGT battery will actuate approx 1300 turns), PGT battery changeout expected</p> <p>10. While holding the PGT with 7/16-2 in ext on the backup drive fastener, Ratchet with 7/16-2 in ext – rotate Manual Override Actuator Shaft 180 to disengage MDA, indicator – AUTOMATIC</p> <p>11. Give MCC-H GO to resume nominal attitude control</p> <p>12. Egress worksite, if utilized, leave MCHD on mast canister</p> <p><u>MANUAL OVERRIDE TO RETRACT MAST</u></p> <p>1. On IV GO (see IV column, step 3), Enter worksite area</p> <p>2. Set up and ingress APFR (see Task Data page)</p> <p>3. If reqd, deploy MCHD PGT swing arm, install MCHD onto mast canister, zip nuts (4)</p> <p>4. If reqd, secure MCHD fasteners (4) PGT, 7/16-2 in ext; A5 (7.0 ft-lb), CW2 (30 RPM), MTL 30.5; to HS</p> <p>5. Rotate manual override actuator shaft on left side of MDA Ratchet, 7/16-2 in ext; cw; 180 deg to disengage MDA, indicator – MANUAL</p> <p>6. If reqd, place PGT in MCHD PGT swing arm</p> <p>7. Drive MDA EVA override fastener PGT, 7/16-2 in ext; A7 (9.2 ft-lb), CW3 (60 RPM), MTL 30.5; 2460 turns (x1 PGT battery will actuate approx 1300 turns), PGT battery changeout expected</p> <p>8. While holding the PGT with 7/16-2 in ext on the backup drive fastener, Ratchet with 7/16-2 in ext – rotate Manual Override Actuator Shaft 180 deg to disengage MDA, indicator – AUTOMATIC</p> <p>9. Give MCC-H GO to resume nominal attitude control</p> <p>10. Egress worksite, if utilized, leave MCHD on mast canister</p>

MANUAL OVERRIDE TO EXTEND/RETRACT MAST – TASK DATA

Estimated Task Duration:

	With RMS	Without RMS
One EV Crew	NA	02:00
Two EV Crew	NA	NA

Tools:

EV1	EV2
PGT with 7/16-2 in ext	NA
Ratchet wrench with 7/16-2 in ext	
If reqd, MCHD	
APFR	

EVA Fasteners:

Fastener Name	Label	Head Size	Qty	Install Torque (ft-lb)	Max Break Away Torque (ft-lb)	Failure Torque (ft-lb)	Turns	RPM
MCHD Fasteners	NA	7/16	4	7.0	8.1	11.0 (L) 12.2 (R)	Zip	10
Mast Canister Manual Override Actuator Shaft	Yes	7/16	2 per	NA	2.5	10	0.5	10
Mast Canister MDA Fastener	Yes	7/16	1 per	NA	9.0	19.3	2461	60

EVA Connectors:

Harness	From	To	Clamps (#)	Conn Size	Function
NA					

Foot Restraints:

Task	WIF	APFR Setting
IEA Keel Side	P6/S6-37, P4/S4-25	(12,FF,F,12)
IEA Non-keel side	P6/S6-38, P4/S4-26	(12,FF,F,12)

Mass: NA

Notes:

- Insulation is not required for this task, unless needed for visual abort cues. As expected, the tension bar will rise 18 to 20 inches from the sill as the last half mast bay is deployed
- Extension complete when: Visual observation of the last mast bay visual indicators (black/white, cross hatched). Hard stop, sharp rise in tool torque
- The mast canister needs to be positioned such that the MDA faces the direction of the IEA. This will allow an EV crewmember to set up an APFR to access the MDA
- In order to release MCHD fasteners from zipnuts, inward force on each bolt must be minimized

Cautions:

- Crew must monitor the tension bar. Stop SAW deployment if the tension bar rises more than 1.5 inches from the sill. Drive MDA EVA override fastener until tension bar returns to 1.5 inches from the sill. When panels release and tension bar returns to the sill, deployment can continue
- Equipment damage – Avoid contact with blanket box latches and mechanisms on underside of blanket box
- If monitoring IVA notes excessive blanket panel "stiction", during mast deployment, abort deployment. Coordinate with IVA to perform contingency incremental deploy. Not applicable for retraction

Warnings:

- Sharp edge/pinch point/entrapment hazard – Avoid contact with outboard underside of SABB due to exposed reels, guide-wire and tension mechanisms
- Moving equipment. Avoid contact with blanket box latches during manual override operation



Mast Canister MDA

ASSISTED SOLAR ARRAY DEPLOY/RETRACT

WARNING

1. Sharp edges:
 - a. SABB (skirt, swing bolts)
 - b. Solar cells
 - c. Springs along tension bar
 - d. Panel hinges
 - e. Guide cable burrs or frays
 - f. Mast Canister roller guides
 - g. Braided cables
 - h. Fastener exposed threads
 - i. Exposed bolts in rib cavities on mast canister
2. Shock hazard:
 - a. Avoid EMU contact with FCC and Kapton part of solar array panels
 - a. EV crew will only contact energized surfaces with approved tools that have been insulated with Kapton tape to prevent molten metal and shock
 - b. Solar array to be manipulated will be shunted prior to EV crew entering worksite
3. Pinch:
 - a. Lower SABB exposed reels and pulleys (guide wire and tensioning mechanisms)
 - b. Solar array mast during deploy/retraction
4. Avoid inadvertent contact with:
 - a. SSU, ECU, beta gimbal platform, mast canister, SAW blanket boxes unless the beta gimbal is locked and the motor is turned off

ASSISTED SOLAR ARRAY DEPLOY/RETRACT (Cont)

IV/SSRMS	EV1	EV2
Deploy Solar Array	<p style="text-align: center;"><u>ASSISTED DEPLOY</u></p> <ol style="list-style-type: none"> 1. Verify glove gauntlets cover wrist disconnects 2. Determine SAW problem (perform full <u>SAW SURVEY FOR DEPLOY</u> below as required) 3. Perform <u>SAW WORKAROUND</u> for problem seen 4. Layback below Mast Canister separation plane, and give GO for deploy 5. Monitor array, call ABORT if problem seen 6. Repeat steps 1 thru 5 as required, translating in or away as required <p style="text-align: center;"><u>SAW SURVEY FOR DEPLOY (IF REQD)</u></p> <ol style="list-style-type: none"> 1. Prior to deploy, perform SABB/SAW survey to verify the following: <ul style="list-style-type: none"> <input type="checkbox"/> Tension reels are spooled (2 per SABB) <input type="checkbox"/> No slack in tension cables (2 per SABB) <input type="checkbox"/> Center, outboard guide wires run through pulleys and reels (3 per SABB, but cannot check inboard guide wire due to cover) <input type="checkbox"/> Center, outboard guide wire not rubbing against power cable (3 per SABB, but cannot check inboard guide wire due to cover) <input type="checkbox"/> No slack in guide wires (3 per SABB) 	
Retract Solar Array Retract Solar Array	<p style="text-align: center;"><u>ASSISTED RETRACT</u></p> <ol style="list-style-type: none"> 1. Verify glove gauntlets cover wrist disconnects 2. Determine SAW problem (perform full <u>INITIAL SAW SURVEY PRIOR TO RETRACT</u> below as reqd) 3. Perform <u>SAW WORKAROUND</u> for problem seen 4. Layback below Mast Canister separation plane, and give GO for retract 5. Monitor array, call ABORT if problem seen 6. Repeat steps 1 thru 5 as reqd, until 1 bay out 7. Perform <u>1 BAY OUT SAW SURVEY DURING FINAL RETRACT</u> 8. Give IV GO for final bay retraction 9. Verify guide wires remain tight and grommets are not caught between panels 10. If latching to be performed, verify latches aligned and within reach of latch pins on upper blanket box <p style="text-align: center;"><u>INITIAL SAW SURVEY PRIOR TO RETRACT (IF REQD)</u></p> <ol style="list-style-type: none"> 1. Prior to retract, perform SABB/SAW survey to verify the following: <ul style="list-style-type: none"> <input type="checkbox"/> Y-guides (4 per SABB) should not be visible <input type="checkbox"/> Center, outboard guide wire not rubbing against power cable <input type="checkbox"/> Foam pads in SABB base (7 per SABB) not overlapping and appear seated in original location (look through leaders) <p style="text-align: center;"><u>1 BAY OUT SAW SURVEY DURING FINAL RETRACT</u></p> <ol style="list-style-type: none"> 1. Perform SABB/SAW survey to verify the following: <ul style="list-style-type: none"> <input type="checkbox"/> Blanket fully contained within blanket box <input type="checkbox"/> Outboard STE loops neatly stacked within goal posts <input type="checkbox"/> Upper blanket box cover guide pins/alignment tabs aligned with goal posts <input type="checkbox"/> Guide wires (3 per SABB) retracted with no slack 	

ASSISTED SOLAR ARRAY DEPLOY/RETRACT (Cont)

IV/SSRMS	EV1	EV2
	<u>SAW WORKAROUND</u>	
	<p>Over-center Hinge Reset:</p> <p>A. Use cheater bar to press metal panel hinge into normal configuration; avoid contact with guide wire</p> <p>Uneven Panel Distribution (causes stuck grommets during retract):</p> <p>B. Get as close as possible to lower blanket box near center guide wire on affected solar array</p> <p>C. Use TPS scraper or cheater bar to evenly distribute panel folds along array (fluff); avoid contact with guide wire</p> <p>Stuck Grommet:</p> <p style="text-align: center;"><u>NOTE</u></p> <p>Provided a fray is not causing the grommet fault, panel fluffing near center guide wire will likely clear problems at all three guide wires</p> <p>If guide wire fray NOT suspected:</p> <p>D. Get as close as possible to affected panel near center guide wire</p> <p>E. Use TPS scraper or cheater bar to evenly distribute panel folds (fluff); avoid contact with guide wire</p> <p>F. If no joy; perform steps as if guide wire fray suspected</p> <p>If guide wire fray is suspected:</p> <p>G. Use TPS scraper or cheater bar to free grommet; repeat as necessary for lower panel grommets as guide wire fray retracts</p> <p>If bunching of panels above ~11.5 bays is seen (known fray):</p> <p>H. IV retract to the '12 bays deployed' configuration</p> <p style="text-align: center;"><u>NOTE</u></p> <p>If grommets are difficult to see, grommets are located on all outward folds (relative to EV crew), so folds can be counted.</p> <p>Procedure assumes fray is between 16th and 17th grommet, although it is possible that fray is between 15th and 16th grommet</p> <p>I. Pull grommets down using TPS scraper (or other tool) until 16 grommets above fray, remainder below fray</p> <p>J. IV re-attempt deploy</p> <p>Guide Wire Slack Due to Reel/Pulley Jam:</p> <div style="border: 1px solid black; padding: 5px; margin: 10px 0;"> <p style="text-align: center;"><u>CAUTION</u></p> <p>Guide wire can jump out of pulley track, attempt cable manipulation from inside blanket box first. If guide wire must be handled from outside of blanket box, avoid pulling guide wire to side of pulley plane</p> </div> <p>K. Verify all grommets on affected guide wire are loose</p> <p>L. Use needle nose pliers to pull cable out of reel; allow cable to retract</p> <p>Out of Plane Panels or Guide Wire Slack after Retract:</p> <p>M. Perform steps for stuck grommet</p> <p>N. If no joy; GCA SSRMS (if available) to goal posts of affected blanket</p> <p>O. Use gloved hand to realign STE loops between goal posts; avoid contact with FCC</p> <p>Y-Guide Reset</p> <p>P. Verify SABB is unlatched (low tension)</p> <p>Q. Use BRS Pin Tool on short skirt stiffener to lift tension bar; TPS scraper can be used assist with tension bar manipulation</p> <p>R. Lower tension bar on to Y-guide</p> <p>Leader Disconnected from Tension Bar</p> <p>S. If spring not connected to leader, inspect tension bar for spring condition and determine if it will interfere with latching</p> <p>T. If spring still connected to leader, use needle nose pliers to retain loose piece and cut leader with EVA scissors; stow in trash</p> <p>U. If spring needs to be cut from tension bar, use needle nose pliers to retain loose piece and cut spring with compound cutters; stow in trash</p>	

ASSISTED SOLAR ARRAY DEPLOY/RETRACT – TASK DATA

Estimated Task Duration:

	With RMS	Without RMS
One EV Crew	NA	NA
Two EV Crew	As long as it takes	As long as it takes

Tools:

EV1	EV2
APFR	Crewlock Bag
Cheater Bar with 1.5" bail drive lever	Digital Camera
Needle Nose Pliers	BRT
Compound Cutters	
Loop Pin Puller	
TPS Scraper	
BRS Pin Tool	
EVA Scissors	

EVA Fasteners:

Fastener Name	Label	Head Size	Qty	Install Torque (ft-lb)	Release Torque (ft-lb)	Failure Torque (ft-lb)	Turns	RPM
NA								

EVA Connectors:

Harness	From	To	Clamps (#)	Conn Size	Function
NA					

Foot Restraints:

Task	WIF	APFR Setting

Notes:

1. Provided a fray is not causing the grommet fault, panel fluffing near center guide wire will likely clear problems at all three guide wires

Cautions:

1. Guide wire can jump out of pulley track, attempt cable manipulation from inside blanket box first. If guide wire must be handled from outside of blanket box, avoid pulling guide wire to side of pulley plane

Warnings:

1. Sharp edge/pinch point/shock hazard: Avoid EMU contact with the following:
 - Lower SABB exposed reels and pulleys (guide wire and tensioning mechanisms)
 - SABB skirt
 - Swing bolts
 - Springs on tension bar
 - Panel hinges
 - Guide wire frays
 - Braided cables
 - Fastener exposed threads
 - Exposed bolts in rib cavities on mast canister
 - Mast roller guides
 - FCC and Kapton part of solar array panels

Y-guide

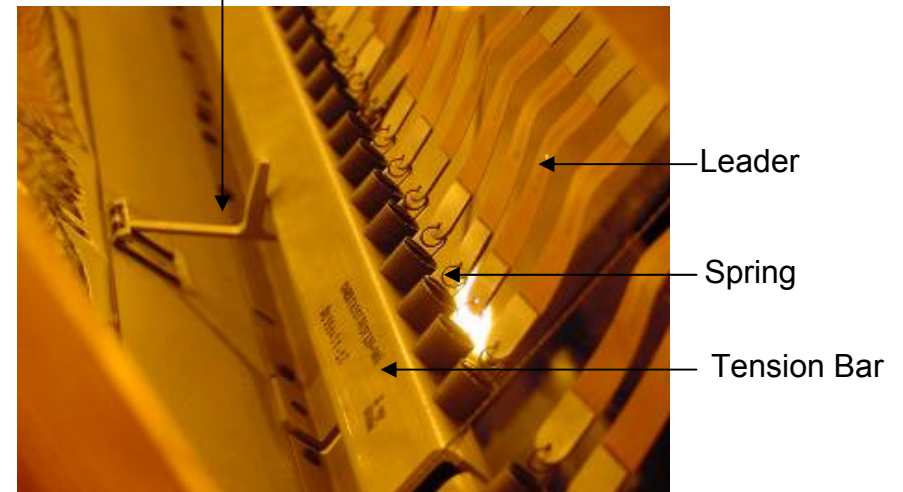

ASSISTED SOLAR ARRAY DEPLOY/RETRACT – TASK DATA (Cont)

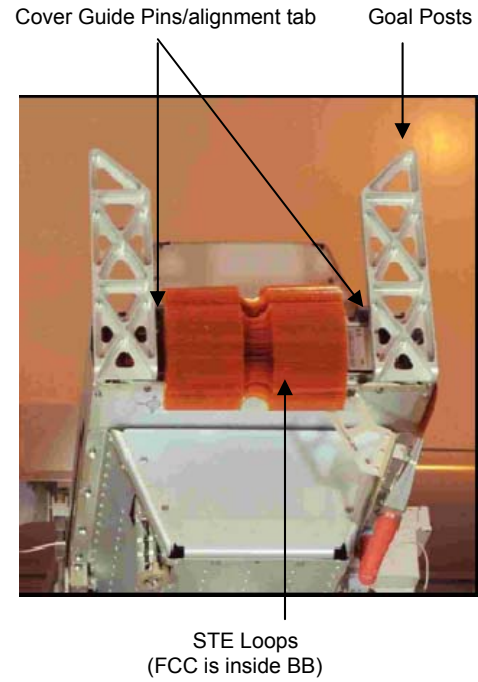
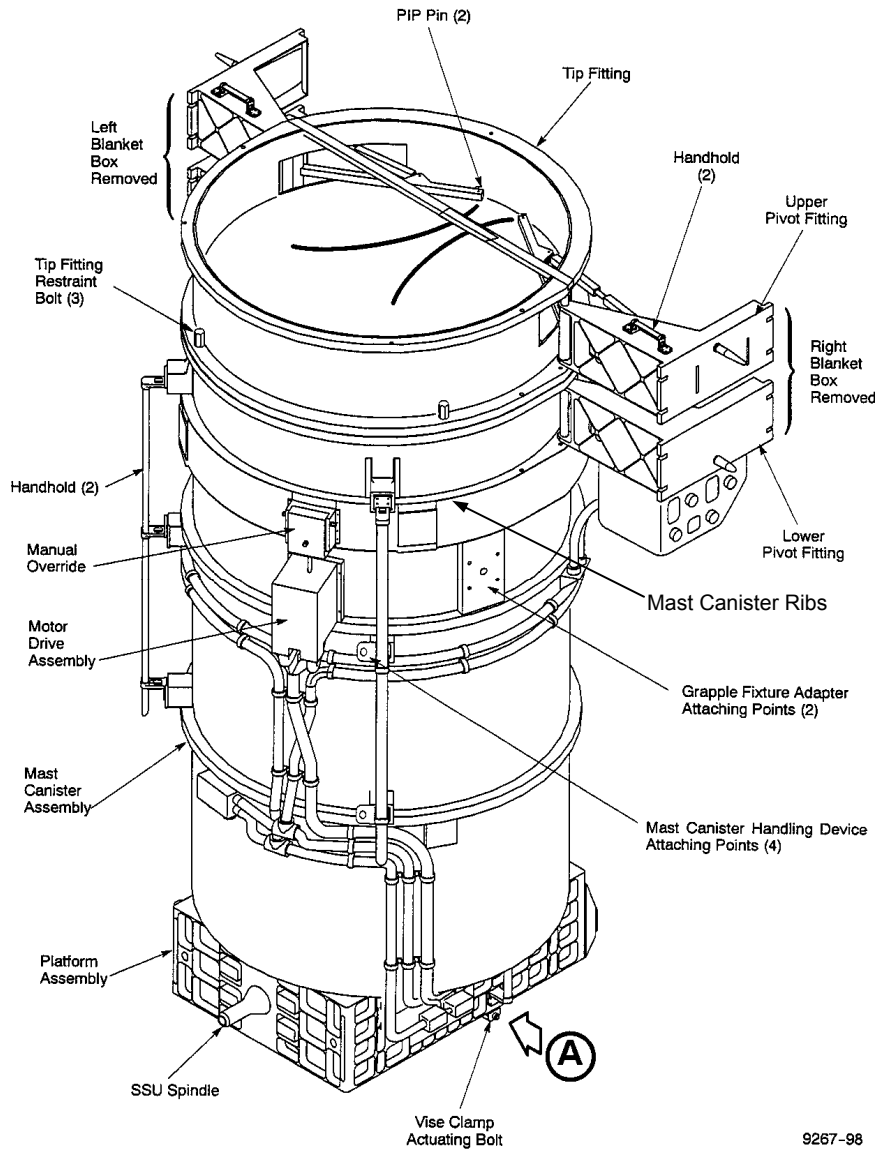

ASSISTED SOLAR ARRAY DEPLOY/RETRACT – TASK DATA (Cont)

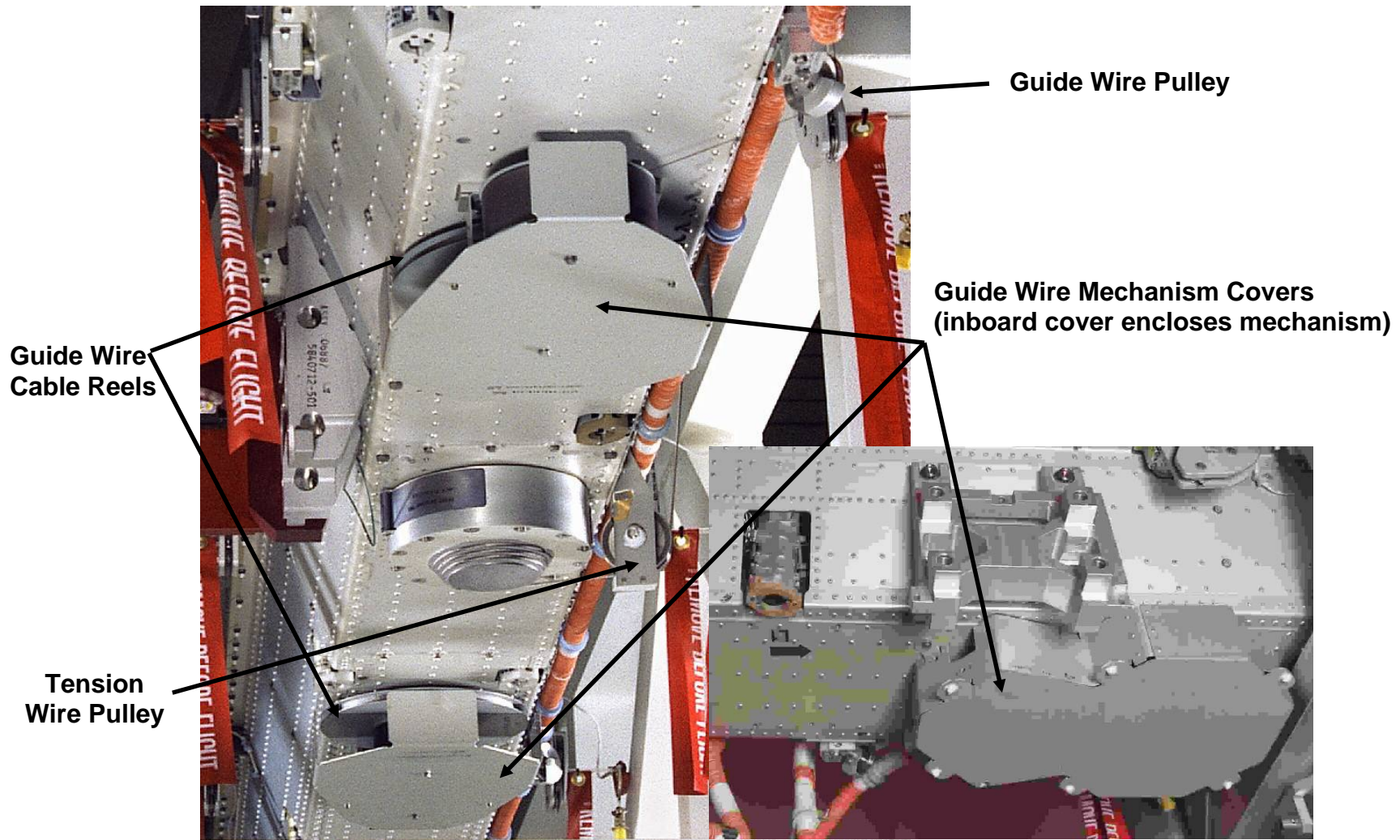

SABB SPOOL RE-TENSION

IV/RMS	EV1	EV2
<p>Identify Affected Power Channel XX = _____</p> <p>Which SABB needs re-tensioning _____</p> <p>Which Tension Reel needs re-tensioning _____</p> <p>IV 1. Retract Affected SAW approx 1 mast bay only if Mast is fully deployed</p> <p>PCS PVM: EPS: SAW XX <div style="border: 1px solid black; padding: 2px;">SAW</div> 'Mast' sel Mast Commands</p> <p><div style="border: 1px solid black; padding: 2px;">SAW XX Mast</div></p> <p>cmd Mast – Retract Arm cmd Mast – Retract</p> <p>Wait approx 20 sec (~ 1 bay) cmd Mast – Abort</p> <p>√MDA Voltage, V < 10 (± 2.8)</p> <p>2. Unlatch affected SABB. If required: Perform {1.3.450 SAW XX SABB INITIAL UNLATCH} (SODF: EPS: ACTIVATION AND CHECKOUT: CHANNEL ACTIVATION), step 2 for LBB or step 3 for RBB (NOTE: BRS Pin visual checks can be ignored)</p> <p>MCC-H 3. Position and safe SAW for Tension Reel Task. Perform {2.101 PVM BGA XX ENGAGE ANTIROTATION LATCH} (SODF: EPS: NOMINAL: PRIMARY POWER), using the following values:</p> <p>If Right SABB (Inboard Reel) BGA XX Cmded Angle = 80.000 deg BGA XX Latch Select = 1 If Right SABB (Outboard Reel) BGA XX Cmded Angle = 93.000 deg BGA XX Latch Select = If Left SABB (Inboard Reel) BGA XX Cmded Angle = 285.000 deg BGA XX Latch Select = 2 If Left SABB (Outboard Reel) BGA XX Cmded Angle = 283.000 deg BGA XX Latch Select = 1</p>	<div style="border: 3px double black; padding: 5px; margin-bottom: 10px;"> <p style="text-align: center;"><u>WARNING</u></p> <p>Moving equipment hazard. Stay clear of SABB and capture latch mechanisms</p> <hr/> <p>Moving equipment hazard. Avoid contact with mast canister/beta gimbal during rotation of SAW</p> <hr/> <p>Sharp edges: Pulley shroud at machined edges Guide wire mechanism cover at machined edges Guide wire mechanism Guide wire pulley Guide wire Top flange of blanket box Protrusions (4) on tension reel housing</p> </div> <p style="text-align: center;"><u>TENSION REEL TASK SETUP</u></p> <p>1. Translate to P6</p> <p>2. Set up APFR (see Task Data page)</p> <p>3. Ingress APFR</p>	<div style="border: 3px double black; padding: 5px; margin-bottom: 10px;"> <p style="text-align: center;"><u>WARNING</u></p> <p>Moving equipment hazard. Stay clear of SABB and capture latch mechanisms</p> <hr/> <p>Moving equipment hazard. Avoid contact with mast canister/beta gimbal during rotation of SAW</p> <hr/> <p>Sharp edges: Pulley shroud at machined edges Guide wire mechanism cover at machined edges Guide wire mechanism Guide wire pulley Guide wire Top flange of blanket box Protrusions (4) on tension reel housing</p> </div> <p style="text-align: center;"><u>TENSION REEL TASK SETUP</u></p> <p>1. Translate to P6</p> <p>2. Set up APFR (see Task Data page)</p> <p>3. Ingress APFR using EV 1 ingress aid or EV 1 for assistance</p>

SABB SPOOL RE-TENSION (Cont)

IV/RMS	EV1	EV2
<p>IV 4. SSRMS: SSRMS RECONFIGURATION FOR EVA SUPPORT (SODF: ROBO PROCEDURE REFERENCE)</p> <p>5. SRMS: SRMS RECONFIGURATION FOR EVA SUPPORT (FDF: PDRS PROCEDURE REFERENCE)</p> <p style="text-align: center;"><u>NOTE</u></p> <p>Free Drift or CMG Control with Thrusters Disabled is required while the EV crewmembers are handling the cable</p> <p>MCC-H 6. Configure ISS/Orbiter attitude control to CMG control with thrusters disabled</p> <p>IV 7. When task complete, give MCC-H GO to resume nominal attitude control</p>	<p><u>INSTALL CABLE ON OUTBOARD REEL</u></p> <p>1. Assist EV2 with cable as required</p> <p style="text-align: center;"><u>NOTE</u></p> <p>The reel will rotate a fraction of a turn without resistance. Some uneven tension and binding may be initially detected as internal mechanism seats. The 2.5 turn count begins when this minimal rotational resistance (approx 2-6 lb) is encountered. The tension reel housing will self tend back to initial position. Hand guidance is required to control rate</p> <p>2. Rotate tension reel ccw by hand approx 2.5-2.75 turns to hard stop</p> <p style="text-align: center;"><u>NOTE</u></p> <p>EV1 acts as the "clutch" on reel in case EV2 lets go. Tension reel housing will self tend back to initial position. Hand guidance is required to control rate of motion</p> <p>3. Maintain reel and help tend cable during EV2 alignment</p> <p>4. Inspect final cable routing on tension reel grooves, through pulley, and clear of blanket box fasteners</p> <p>5. Take closeout photos</p> <p>6. Egress APFR</p> <p><u>INSTALL CABLE ON INBOARD REEL</u></p> <p>1. Set up APFR (see Task Data page)</p> <p>2. Ingress APFR</p> <p>3. Repeat <u>INSTALL CABLE ON OUTBOARD REEL</u> for the SABB inboard reel</p> <p>4. Give IV GO for solar array deploy</p>	<p><u>INSTALL CABLE ON OUTBOARD REEL</u></p> <p style="text-align: center;"><u>NOTE</u></p> <p>Pull cable on bottom side of blanket box running between pulley and tension reel. There will be approx 2 ft of cable slack. The tension bar will be pulled into position against blanket box</p> <p>1. Using the loop pin puller, pull slack on tension cable by pulling cable through pulley using light force (expect 5-10 lb pull force. If force is high, contact MCC)</p> <p>2. Align cable through pulley</p> <p>3. Maintain cable tension during reel rotation using loop pin puller</p> <p>4. Feed cable onto reel using loop pin puller as reel rotates back cw under it's own spring power</p> <p>5. Remove loop pin puller</p> <p>6. Egress APFR</p> <p><u>INSTALL CABLE ON INBOARD REEL</u></p> <p>1. Set up APFR (see Task Data page)</p> <p>2. Ingress APFR using EV1 ingress aid or EV1 for assistance</p> <p>3. Repeat <u>INSTALL CABLE ON OUTBOARD REEL</u> for the SABB inboard reel</p>

SABB SPOOL RE-TENSION (Cont)

IV/RMS	EV1	EV2
<p>MCC-H 8. Return SAW/BGA to Deploy Position. If reqd: Perform {2.101 PVM BGA XX ENGAGE ANTIROTATION LATCH} (SODF: EPS: NOMINAL: PRIMARY POWER)</p> <p>IV 9. Return to Nominal SAW Deploy Camera configuration (Truss Cameras, PLB Cameras, etc)</p> <p>10. SSRMS: SSRMS RECONFIGURATION FOR SAW VIEWING (SODF: ROBO PROCEDURE REFERENCE)</p> <p>11. SRMS: SRMS RECONFIGURATION FOR SAW VIEWING (FDF: PDRS PROCEDURE REFERENCE)</p> <p>MCC-H 12. Re-Latch (Tension) Affected SABB If reqd: Perform {1.3.452 SAW XX DEPLOY} (SODF: EPS: ACTIVATION AND CHECKOUT: CHANNEL ACTIVATION) step 13 for LBB, or step 14 for RBB</p>	<p>IF REQD:</p> <p><u>TENSION REEL JAM CONTINGENCY</u></p> <ol style="list-style-type: none"> 1. If no rotational resistance or no hard stop (free spinning), call MCC 2. If excessive force (> 6 lb) or mechanism jam is encountered, go to <u>INSTALL CABLE ON INBOARD REEL</u> 3. EV guide tension reel back into initial position 4. IV Cycle SABB Latches. Perform {4.118 SAW XX RETRACT} (SODF: EPS: CORRECTIVE: PRIMARY POWER) steps 12 (13) for Unlatch OR steps 18 (19) for Latch 5. EV attempt outboard tension reel rotation 6. If smooth reel rotation, go to <u>INSTALL CABLE ON OUTBOARD REEL</u>, EV2, step 1 7. If jam or resistance encountered, repeat steps 4 and 5 8. If no joy, call MCC 	

SABB SPOOL RE-TENSION – TASK DATA

Estimated Task Duration:

	With RMS	Without RMS
One EV Crew	NA	NA
Two EV Crew	NA	1:00

Tools:

EV1	EV2
APFR	APFR
Ingress aid	Loop pin puller

EVA Fasteners:

Fastener Name	Label	Head Size	Qty	Install Torque (ft-lb)	Release Torque (ft-lb)	Failure Torque (ft-lb)	Turns	RPM
N/A								

EVA Connectors:

Harness	From	To	Clamps (#)	Conn Size	Function
NA					

Foot Restraints:

Task	WIF	APFR Setting	BGA Angle
IEA Non-keel side – SABB Outboard Reel EV1 access	P4/S4-11, P6/S6-23	(12, HH, F, 6)	283, 93
IEA Non-keel side – SABB Outboard Reel EV2 access	P4/S4-15, P6/S6-27	(10, HH, G, 1)	283, 93
IEA Non-keel side – SABB Inboard Reel EV1 access	P4/S4-26, P6/S6-38	(1, FF, E, 2)	285, 80
IEA Non-keel side – SABB Inboard Reel EV2 access	P4/S4-19, P6/S6-31	(5, GG, F, 7)	285, 80
IEA Keel side – SABB Outboard Reel EV1 access	P4/S4-09, P6/S6-21	(12, HH, F, 6)	283, 93
IEA Keel side – SABB Outboard Reel EV2 access	P4/S4-13, P6/S6-25	(10, HH, G, 1)	283, 93
IEA Keel side – SABB Inboard Reel EV1 access	P4/S4-25, P6/S6-37	(1, FF, E, 2)	285, 80
IEA Keel side – SABB Inboard Reel EV2 access	P4/S4-17, P6/S6-29	(5, GG, F, 7)	285, 80

Notes:

1. SABB Outboard Reel does not have a pulley shroud
2. Combination wrenches may be used if the tension reel fails to take up the tension cable slack

Cautions:

1. Equipment damage – Beware of close proximity to blanket box during ingress. Visually inspect cables prior to handling for fraying or jamming on structure or nearby cables
2. Do not allow uncontrolled cw rotation of tension reel
3. Do not manually wrap cable on reel housing

Warnings:

1. Sharp edges:
 - Pulley shroud at machined edges
 - Guide wire mechanism cover at machined edges
 - Guide wire mechanism
 - Guide wire pulley
 - Guide wire
 - Top flange of blanket box
 - Protrusions (4) on tension reel housing
2. Moving equipment hazard. Stay clear of SABB and capture latch mechanisms
3. Moving equipment hazard. Avoid contact with mast canister/beta gimbal during rotation of SAW

SABB SPOOL RE-TENSION – TASK DATA (Cont)

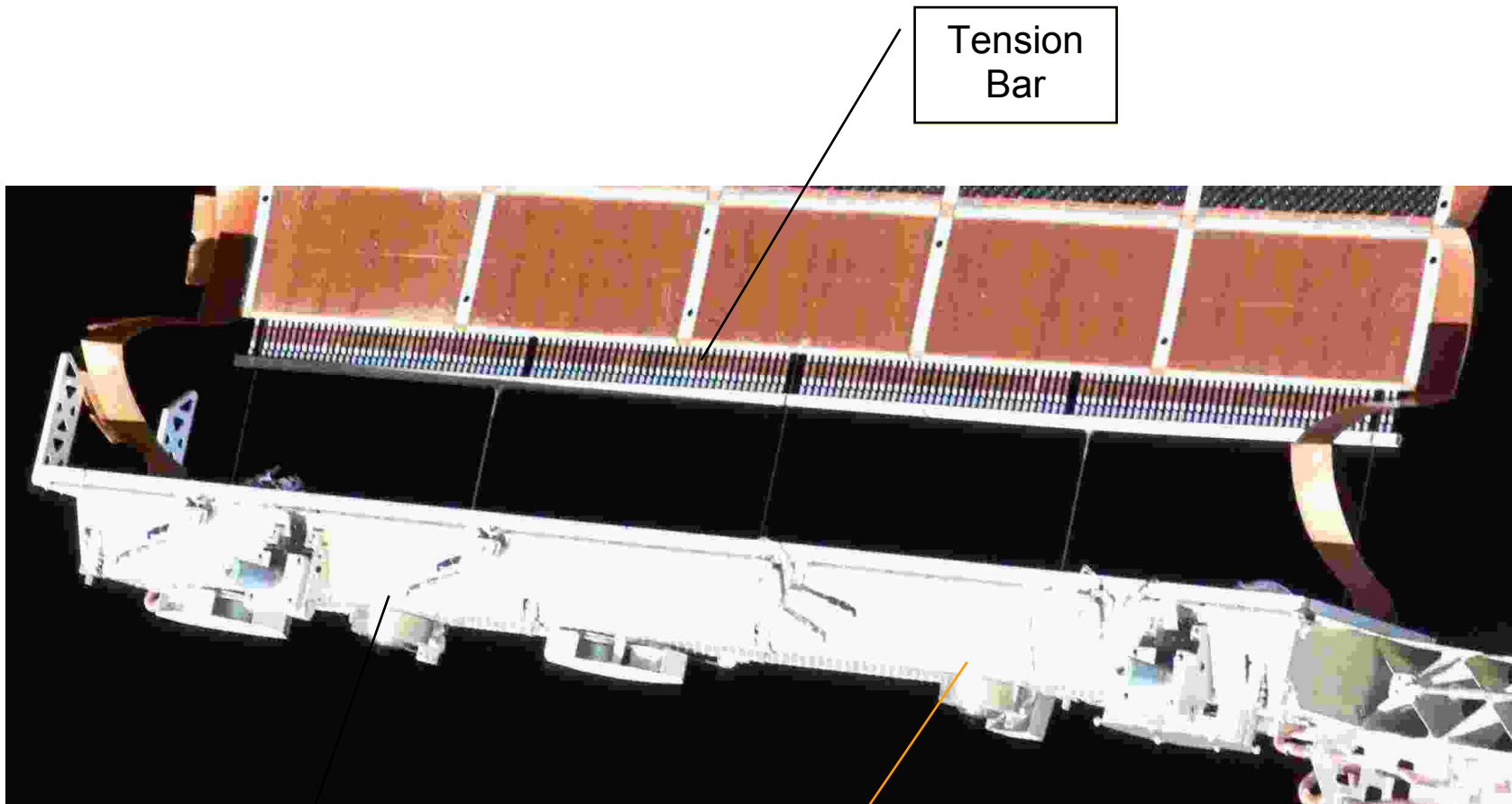

Tension
Bar

Outboard
TM

Inboard
TM

NOTE
No markings on these TMs, markings are not on P6.
Tension Bar in fully extended position

SABB SPOOL RE-TENSION – TASK DATA (Cont)

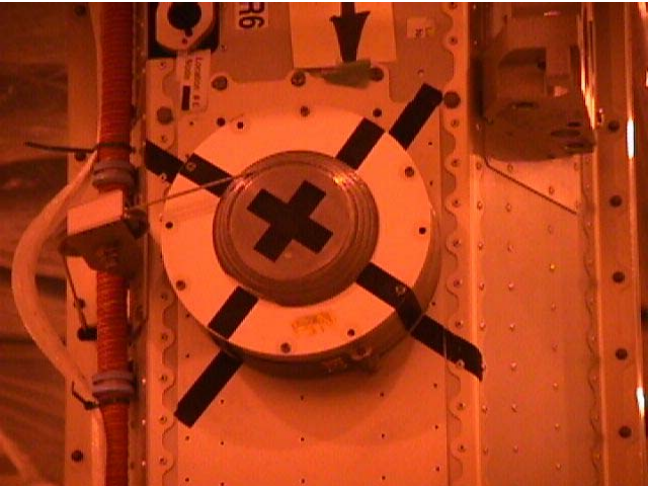

SABB Tensioning Reel Outboard – markings not on P6

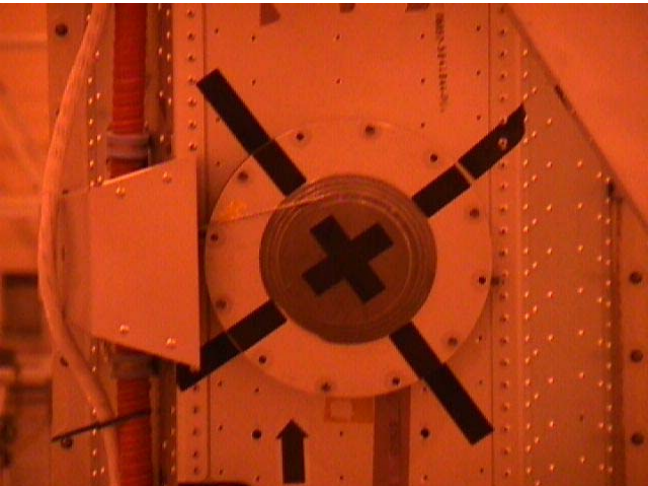

SABB Tensioning Reel Inboard – markings not on P6

MANUAL SAW JETTISON

PRIOR TO EVA:

1. Unstow SSU cover and place in crewlock
2. If ECU removal is planned, stow Medium ORU bag in crewlock
3. Remove SSU shunt plug adapter J5A and J6A caps and tether to tether point on SSU shunt plug adapter
4. Remove SSU shunt plug caps and mate SSU shunt plugs to SSU shunt plug adapter J5A and J6A (shunt plugs can go on either adapter receptacle)
5. Remove caps from SSU shunt plug adapter ground service equipment connectors
6. Stow SSU shunt plug adapter/shunt plugs, Cannon connector tool in EVA crewlock bag
7. If available, stow size 37 Cannon connector plug cap in EVA crewlock bag; if not available, will need to retrieve one from Z1

IV/RMS	EV1	EV2
<p>Identify Affected Power Channel XX = _____ and opposite deck Power Channel YY = _____</p> <p>MCC-H 1. Mnv/orient ISS for SAW jettison</p> <p>MCC-H 2. Position and safe SAW for SSU Removal Perform {2.101 PVM BGA XX ENGAGE ANTIROTATION LATCH} (SODF: EPS: NOMINAL: PRIMARY POWER)</p> <p>MCC-H 3. Verify solar array positioned for EV crew access to SSU and BGA latched PCS PVM: EPS: BGA XX BGA XX 'ECU XX' Verify: Integ Cnt – Incrementing 'BGA XX' Verify: Actual Angle, deg = 270 Motor State – OFF Latch 1(2) Pin Status – Latched</p> <p>4. GO for EV ingress at SSU worksite</p> <p>MCC-H 5. Verify power connector inhibits in place before SSU Removal PCS PVM: EPS: DCSU XX DCSU XX 'DCSU XX' sel RBI 1 Verify: Cmdded Position – Op</p>	<div style="border: 2px solid black; padding: 5px; margin-bottom: 10px;"> <p style="text-align: center;"><u>WARNING</u></p> <p>Voltage hazard exists at the connectors of the SSU. SSU must be safed before removal</p> <p>Electrical Shock Hazard. SSU Shunt Plug installation/removal and SSU removal/installation must occur during eclipse. STEPS DENOTED BY AN “E” MUST OCCUR DURING ECLIPSE. Crew must wait the specified wait periods for voltage drops to safe levels before proceeding. EV crew will need to move away from exposed electrical receptacles during day pass</p> <p>Protrusion Hazard. SSU alignment post protrudes beyond mast canister. Maintain clearances between structure and crewmember during SSU removal</p> <p>Collision Hazard. The solar array motion should be prevented by locking the BGA. This avoids a collision hazard with the EV crew if the EV crew is within 24 inches of the array rotational envelope</p> </div> <p><u>EVA SETUP</u></p> <ol style="list-style-type: none"> 1. If required, retrieve Sq TM with 7/16 Rec socket and square scoop from Z1 toolbox 2. If required, translate to Z1 forward face, demate Cannon connector cap from Z1 J259 or J260, stow in EVA crewlock bag 3. On MCC GO, translate to SSU worksite 4. Transfer tools and APFR with AIA to worksite 5. Set up APFR (see Task Data page) 	<div style="border: 2px solid black; padding: 5px; margin-bottom: 10px;"> <p style="text-align: center;"><u>WARNING</u></p> <p>Voltage hazard exists at the connectors of the SSU. SSU must be safed before removal</p> <p>Electrical Shock Hazard. SSU Shunt Plug installation/removal and SSU removal/installation must occur during eclipse. STEPS DENOTED BY AN “E” MUST OCCUR DURING ECLIPSE. Crew must wait the specified wait periods for voltage drops to safe levels before proceeding. EV crew will need to move away from exposed electrical receptacles during day pass</p> <p>Protrusion Hazard. SSU alignment post protrudes beyond mast canister. Maintain clearances between structure and crewmember during SSU removal</p> <p>Collision Hazard. The solar array motion should be prevented by locking the BGA. This avoids a collision hazard with the EV crew if the EV crew is within 24 inches of the array rotational envelope</p> </div> <p><u>EVA SETUP</u></p> <ol style="list-style-type: none"> 1. Translate to Mast Canister/Aux bag (PMA1 stbd by Node bag) 2. Retrieve MCHD 3. On MCC GO, translate to worksite 4. Temp stow MCHD and SSU cover 5. Translate to BMRRM 6. Remove BMRRM thermal shroud (peels back)

MANUAL SAW JETTISON (Cont)

IV/RMS	EV1	EV2
<p>Close Cmd – Inh Voltage: -4.2 – 4.2 Current: -7.5 – 7.5</p> <p>PCS PVM: EPS: SSU XX SSU XX 'BCDU YY1' (YY= opposite channel on IEA) sel CP RBI</p> <p>BCDU XX CP RBIs 'YY1 CP RBI' (YY= opposite channel on IEA) Verify: YY1 CP RBI Posn – Op</p> <p>MCC-H 6. Turn off and off point video camera luminaries, rpcm open and closed inhibited</p> <p>MCC-H 7. Give GO for BMRRM J1 demate and SSU shunt plug installation</p> <p>MCC-H 8. Give GO for SSU removal during 2nd ECLIPSE ONLY</p>	<div data-bbox="877 316 1241 727" data-label="Image"> </div> <p>SSU shunt plugs and adapter installed on mast canister with shroud open</p> <p>E6. On MCC GO (2 min wait after transition from insolation to eclipse), remove mast canister ground test port caps (2) and place in EVA trash bag</p> <p>E7. Position MLI shroud as shown above or folded against shunt plugs</p> <p>E8. Install SSU shunt plug adapter with bails facing outward, not against mast canister</p> <p>9. Reinstall MLI shroud</p> <p>10. Ingress APFR</p> <p><u>REMOVE FAILED SSU</u></p> <p>1. Install Sq TM onto primary fastener, √anti-backlash neutral</p> <p>E2. On MCC GO (5 min wait after transition from insolation to eclipse), Release SSU fastener 1 turn PGT, Sq TM-7/16 Rec; B1 (12.0 ft-lb), CCW2 (30 RPM), MTL 30.5; 1 turn on bolt = 5 turns from PGT</p> <p>E3. Remove Sq TM</p> <p>E4. Install Sq Scoop on SSU</p> <p>E5. Release SSU fastener PGT, 7/16-6 in ext; B1 (12.0 ft-lb), CCW2 (30 RPM), MTL 30.5; 10 turns</p>	<p>E7. On MCC GO, demate connector from BMRRM J1</p> <p>E8. Mate Cannon connector cap on BMRRM J1</p> <p>9. If reqd, reinstall BMRRM thermal shroud</p> <p><u>REMOVE FAILED SSU</u></p>

MANUAL SAW JETTISON (Cont)

IV/RMS	EV1	EV2
<p>9. Position and safe SAW for ECU Removal (if required) and SAW jettison. Perform {2.101 PVM BGA XX ENGAGE ANTI-ROTATION LATCH} (SODF: EPS: NOMINAL: PRIMARY POWER) using the following values:</p> <p style="padding-left: 40px;">BGA XX Cmded Angle = 180 deg BGA XX Latch Select = 1</p> <p>10. GO for EV ingress at ECU worksite</p> <p>MCC-H 11. Remove ECU power PCS PVM: EPS:BGA XX BGA XX</p> <p style="padding-left: 40px;">sel RPCM YY A RPC 02 RPCM YY A RPC 02</p> <p style="padding-left: 40px;">cmd RPC Position – Open (Verify – Op)</p> <p style="padding-left: 40px;">(Expect Caution Message: BGA XX Loss of Comm)</p> <p>MCC-H 12. GO for ECU removal and BMRRM cable demate</p>	<p>E6. √Status indicator – UNLOCK E7. Remove SSU and hand to EV2</p> <p>2. Clear BGA rotation plane for BGA rotation and inform IV when clear</p> <div style="border: 2px solid black; padding: 5px; text-align: center; margin: 10px 0;"> <p>WARNING Moving equipment hazard: Avoid contact with mast canister/beta gimbal during rotation of SAW</p> </div> <p><u>REMOVE ECU (if reqd)</u></p> <ol style="list-style-type: none"> 1. Set up and ingress APFR [see Task Data page] 2. On MCC GO, release ECU fastener 1 turn PGT, Sq TM-7/16 Rec; B1 (12.0 ft-lb), CCW2 (30 RPM), MTL 30.5; 1 turn on bolt = 5 turns from PGT 3. Remove Sq TM 4. Install Square Scoop on ECU 5. Release ECU fastener PGT, 7/16-6 in ext; B1 (12.0 ft-lb), CCW2 (30 RPM), MTL 30.5; 10 ± 2 turns 6. √Status indicator – UNLOCK 7. Remove ECU and stow in ORU transfer bag 	<ol style="list-style-type: none"> 1. Receive SSU and stow on SSU cover 2. Clear BGA rotation plane for BGA rotation and inform IV when clear <p><u>RELEASE BMRRM FASTENERS/CONNECTORS</u></p> <ol style="list-style-type: none"> 1. If not done already, remove BMRRM thermal shroud and temp stow 2. Release BMRRM center fastener PGT, 7/16-6 in ext; B6 (24.0 ft-lb), CCW2 (30 RPM), MTL 10.5; 17 turns 3. On MCC GO, disconnect the following connectors from the BMRRM: <ul style="list-style-type: none"> <input type="checkbox"/> Demate connector from J3 <input type="checkbox"/> Demate connector from J2

MANUAL SAW JETTISON (Cont)

IV/RMS	EV1	EV2
<p>MCC-H 13. Give GO for MCHD installation</p> <p>MCC-H 14. Give GO for jettison</p>	<p><u>INSTALL MCHD</u></p> <ol style="list-style-type: none"> 1. On MCC GO, set up and ingress APFR (see Task Data page) 2. Deploy MCHD appendages 3. Install MCHD on mast canister 4. Fasten MCHD corner attach fasteners (4) PGT, 7/16-6 in ext; A5 (7.0 ft-lb), CW2 (30 RPM), MTL 30.5; to HS <p><u>MANUAL SAW JETTISON</u></p> <ol style="list-style-type: none"> 1. Using MCHD, move mast canister from beta gimbal at a velocity less than 1 ft/min. Move mast canister 2 ft from beta gimbal separation plane. Correct wing attitude as reqd to achieve stability 2. Release MCHD 3. Monitor SAW separation 4. When SAW is clear, egress worksite 	<p><u>MANUAL SAW JETTISON</u></p> <ol style="list-style-type: none"> 1. On MCC GO, release platform vice clamp fastener PGT, 7/16-6 in ext; B1 (12.0 ft-lb), CCW2 (30 RPM), MTL 10.5; 19 turns to HS 2. When complete, give EV1 GO for SAW motion 3. Call out separation distance until 2-ft separation achieved 4. Monitor SAW separation

MANUAL SAW JETTISON – TASK DATA

Estimated Task Duration:

	Without RMS
One EV Crew	NA
Two EV Crew	03:00

Tools:

EV1	EV2
PGT	PGT
6 ext-7/16	6 ext-7/16
APFR/ingress aid	
Square TM with 7/16-in Recessed socket	
EVA crewlock bag	SSU cover
SSU shunt plug adapter	Mast Canister Handling Device
SSU shunt plugs (2)	
Size 33 Cannon conn plug cap	
Square scoop (2)	
Medium ORU bag (if reqd - for ECU)	

EVA Fasteners:

Fastener Name	Label	Head Size	Qty	Install Torque (ft-lb)	Max Break Away Torque (ft-lb)	Failure Torque (ft-lb)	Turns	RPM
SSU fastener	NA	7/16	1	6.3	35.7	264 (R)	11 ± 2	30
ECU fastener	NA	7/16	1	6.3	30.5	290.3 (R)	11 ± 2	30
BMRRM Center Fastener	NA	7/16	1	NA	16.0	54.0	17	30
MCHD Fasteners	NA	7/16	4	7.0	8.1	11.0 (l)	ZIP	10
Vice Clamp	NA	7/16	1	NA	5.2	20.1	19	30

EVA Connectors:

Harness	From	To	Clamps (#)	Conn Size	Function
W05 P23 J3		BMRRM J3		25	ECU feed; SSU Control pwr; 1553B
W06 P22 J2		BMRRM J2		25	ECU cross feed
		BMRRM J1		37	Primary power

Foot Restraints:

Task	WIF	APFR Setting	BGA Angle
Access to SSU (IEA non-keel side 4A/3A SAW)	P4/S4-23	4, PP, G, 9	270
Access to SSU (IEA keel side 2A/1A SAW)	P4/S4-24	4, PP, G, 9	270
Access to BMRRM (IEA non-keel side 4A/3ASAW)	P4/S4-28	9, NN, G, 3	Any
Access to BMRRM (IEA keel side 2A/1A SAW)	P4/S4-27	9, NN, G, 3	Any
Install MCHD and 4A/3A SAW jettison position (IEA non-keel side SAW)	P4/S4-26	6, FF, F, 6	180
Install MCHD and 2A/1A SAW jettison position (IEA keel side SAW)	P4/S4-25	6, FF, F, 6	180
Access to 4A/3A ECU	P4/S4-26	8, OO, A, 3	180
Access to 2A/1A ECU	P4/S4-25	8, OO, A, 3	180
Access to SSU (IEA non-keel side)	P6/S6-35	4, PP, G, 9	270
Access to SSU (IEA keel side)	P6/S6-33	4, PP, G, 9	270
Access to BMRRM (IEA non-keel side)	P6/S6-39	9, NN, G, 3	Any
Access to BMRRM (IEA keel side)	P6/S6-40	9, NN, G, 3	Any
Install MCHD and SAW jettison position (IEA non-keel side)	P6/S6-38	12, FF, F, 12	180
Install MCHD and SAW jettison position (IEA keel side)	P6/S6-37	12, FF, F, 12	180
Access to ECU (IEA non-keel side)	P6/S6-38	8, OO, A, 3	180
Access to ECU (IEA keel side)	P6/S6-37	8, OO, A, 3	180

ORU Mass: SSU – 186 lb

ECU – 90 lb SAW – approx 2326 lb

MANUAL SAW JETTISON – TASK DATA (Cont)

Notes:

1. The MCHD has four deployable legs. Each leg has an EVA fastener which engages a zip nut on the mast canister hand rails. The MCHD also has a deployable PGT cradle assembly which is used to drive the mast canister MDA. The PGT cradle assembly is not required for the jettison procedure

Cautions:

None

Warnings:

1. Electrical Shock Hazard: Install SSU shunt plug adapter/SSU shunt plugs and remove SSU during orbital eclipse. Procedure specifies wait time before installing SSU shunt plug adapter/SSU shunt plugs and removing SSU to allow voltages to drop to safe levels
2. Protrusion Hazard: SSU alignment post protrudes beyond mast canister. Maintain clearances between structure and crewmember during SSU changeout
3. Voltage hazard may exist at connectors of the ECU and BMRRM. ECU and BMRRM must be safed before removal
4. Collision Hazard: The solar array motion should be inhibited to prevent a collision hazard with the EV crew because the EV crew may be within 24 inches of the array rotational envelope
5. Moving equipment hazard: Avoid contact with mast canister/beta gimbal during rotation of SAW
6. Mass handling – The crewmember will control the SAW mass with bent arms to avoid loading the EMU suit structure
7. Release mast canister with minimal tip-off rates

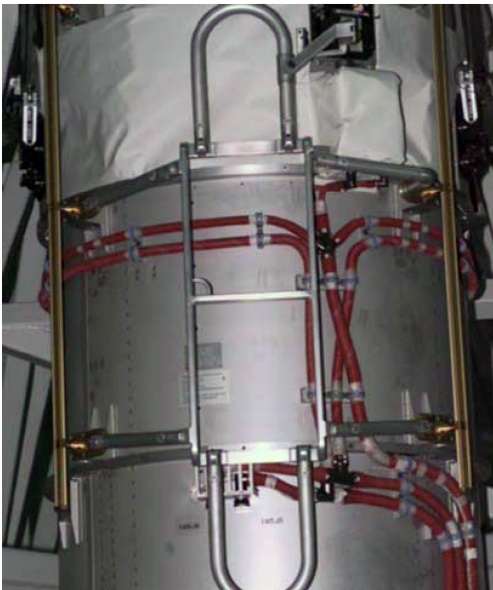

Mast Canister Handling Device (MCHD)

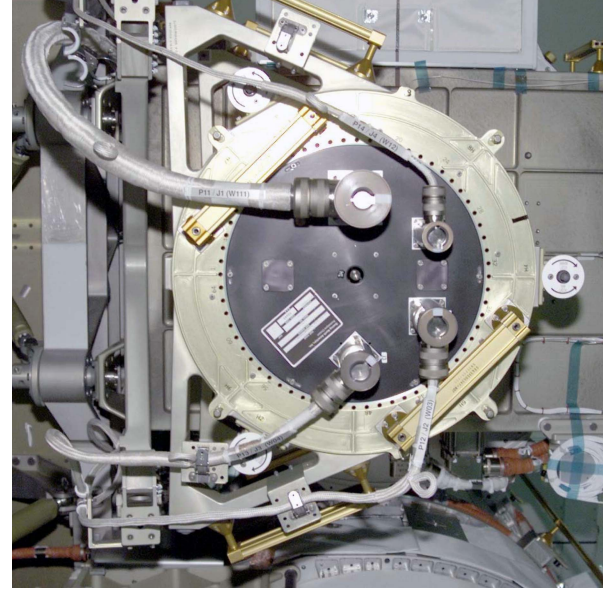

BMRM connectors without BMRM thermal cover

MISC

BMRRM REMOVE/REPLACE

IV/RMS	EV1	EV2
<p>IV: 1. Safe Channel B for EV2 terminator install and EV1 J2 and J4 demate Verify ISS perform P6 PREPARATION FOR 4B BMRRM R&R steps 11 & 12 complete GO for EV1 step 5 and EV2 steps 2-3</p> <p>IV: 2. When EV2 steps 2-3 complete ISS perform P6 PREPARATION FOR 4B BMRRM R&R steps 13 & 14</p> <p>IV: 3. Prior to eclipse, safe Primary Power for EV1 J1 demate ISS perform P6 PREPARATION FOR 4B BMRRM R&R steps 15 & 16 GO for EV1 step 6</p> <p>IV: 4. If IV step 2 not successful, EV2 steps E5 and E6 required</p> <p>IV: 5. Safe Channel A for EV1 J3 demate ISS perform P6 PREPARATION FOR 4B BMRRM R&R steps 17 & 18 GO for EV1 step E9</p>	<p><u>REMOVE OLD BMRRM</u></p> <ol style="list-style-type: none"> PGT[A5 7.0 ft-lb, CCW2 30RPM, MTL 10.5]-6ext 7/16: Unfasten BMRRM housing bolts (H6, H7, H8, H9) 8 +/- 1 turns, verify bolts spring up PGT[A5 7.0 ft-lb, CCW2 30RPM, MTL 10.5]-6ext 7/16: Drive dual latch bolts (H3, H2, H4) 15 turns PGT[A1 2.5 ft-lb, CCW2 30RPM, MTL 5.5]-6ext 7/16: Drive dual latch bolts (H4, H2, H3) to hard stop, 8 turns expected (23 ± 2 turns total expected) Release remaining T/A clamps On IV GO, demate connectors from BMRRM J4, J2 receptacles <ol style="list-style-type: none"> On IV GO, demate J1 receptacle Secure demated connectors clear of BMRRM removal area Notify IV when complete <div style="border: 2px solid black; padding: 5px; text-align: center; margin: 10px 0;"> <p>WARNING STEPS DENOTED BY AN "E" MUST OCCUR DURING ECLIPSE TO PREVENT POSSIBLE HOT CONNECTOR MATE OLD BMRRM HAS SHARP EDGE HAZARD</p> </div> <ol style="list-style-type: none"> On IV GO, demate connector from the BMRRM J3 receptacles Secure demated connectors clear of BMRRM removal area PGT[B1 12.0 ft-lb, CCW2 30RPM, MTL 10.5]-6ext 7/16: Release BMRRM center bolt H1, 10 turns Remove old BMRRM from Beta Gimbal housing assembly Transfer old BMRRM to EV2 	<p><u>REMOVE OLD BMRRM</u></p> <ol style="list-style-type: none"> Verify dual latches engaged to mast canister platform On IV GO, demate W19 P1 from JBOX 6 J2 Mate 1553B terminator cap 10955J to JBOX 6 J2 Notify IV when complete <div style="border: 2px solid black; padding: 5px; text-align: center; margin: 10px 0;"> <p>WARNING STEPS DENOTED BY AN "E" MUST OCCUR DURING ECLIPSE TO PREVENT POSSIBLE HOT CONNECTOR MATE OLD BMRRM HAS SHARP EDGE HAZARD</p> </div> <ol style="list-style-type: none"> If reqd: On IV GO, demate W05 P1 from JBOX 4 J2 If reqd: Mate 1553B terminator cap 10956J to JBOX 4 J2 If reqd: Notify IV when E5 and E6 complete Translate to vice clamp worksite PGT[A4 6.3 ft-lb, CCW2 30RPM, MTL 10.5]-6ext 7/16: Unfasten vice clamp bolt, 19 ± 2 turns Receive old BMRRM from EV1 and stow on MUT EE/Ballstack/MUT EE

BMRRM REMOVE/REPLACE (Cont)

IV/RMS	EV1	EV2
<p>IV: 6. Notify ISS EV1 step E20 complete GO for ISS perform EPS RETURN TO NOMINAL CONFIG POST 4B BMRRM R&R steps 1-4</p> <p>IV: 7. If Eclipse time permits, GO for EV1 step 21 Else, verify ISS perform EPS RETURN TO NOMINAL CONFIG POST 4B BMRRM R&R steps 1-4 complete GO for EV1 step 21</p> <p>IV: 8. Verify ISS perform EPS RETURN TO NOMINAL CONFIG POST 4B BMRRM R&R step 1 complete GO for EV2 steps 16 & 17</p> <p>IV: 9. Notify MCC-H EV1 step 21 and EV2 step 17 complete</p>	<p>INSTALL NEW BMRRM</p> <p>E14. PGT[B1 12.0 ft-lb, CCW2 30RPM, MTL 10.5]-6ext 7/16: Release new BMRRM center bolt H1, 10 turns, verify center bolt springs up</p> <p>E15. Remove new BMRRM from housing</p> <p>E16. Position new BMRRM for EV2 verification of lever latch position</p> <p>E17. Use alignment mark to clock BMRRM; Install new BMRRM in Beta Gimbal housing assembly</p> <p>E18. Push center bolt H1 to soft capture BMRRM to platform</p> <p>E19. PGT[A6 8.3 ft-lb, CW2 30RPM, MTL 10.5]-6ext 7/16: Fasten center bolt H1 to hard stop, notify EV2 center bolt hard stop, turns will vary due to zip nut feature</p> <p>E20. Mate J3 connector to the new BMRRM, notify IV when complete</p> <p>21. On IV GO, mate connectors to the new BMRRM J1, J2 and J4 receptacles, notify IV when complete</p> <p>22. PGT[A4 6.3 ft-lb, CW2 30RPM, MTL 5.5]-6ext 7/16: Start each bolt before driving to hard stop, fasten BMRRM housing bolts (H7, H9, H6, H8) 8 ± 1 turns</p> <p>23. PGT[A6 8.3 ft-lb, CW2 30RPM, MTL 10.5]-6ext 7/16: Drive dual latch bolts (H3, H2, H4) to hard stop, 23 ± 2 turns expected</p> <p>24. Receive old BMRRM from EV2</p> <p>25. Position old BMRRM for EV2 verification of lever latch position</p> <p>26. Using alignment pin to clock BMRRM, stow old BMRRM in housing</p> <p>27. Push in center bolt H1 to set soft capture</p> <p>28. Inspect old BMRRM for contaminants</p> <p>29. PGT[A6 8.3 ft-lb, CW2 30RPM, MTL 10.5]-6ext 7/16: Fasten center bolt H1 to hard stop on old BMRRM, turns will vary due to zip nut feature</p> <p>30. Install connector cover on old BMRRM</p> <p>31. Stow old BMRRM RET on old BMRRM</p>	<p>INSTALL NEW BMRRM</p> <p>E11. Verify lever latch in latched position on new BMRRM</p> <p>E12. Assist EV1 with alignment of new BMRRM into Beta Gimbal housing assembly</p> <p>E13. If reqd, On IV GO, Demate terminator cap 10956J from JBOX 4 J2</p> <p>E14. If reqd, Mate W05 P1 to JBOX 4 J2, notify IV when complete</p> <p>15. PGT[A3 5.0 ft-lb, CW2 30RPM, MTL 5.5]-6ext 7/16: Fasten vice clamp bolt, 19 ± 2 turns, verify locking collar engages, install vice clamp contingency tool with wire tie if reqd</p> <p>16. Verify dual latch blocks are still flush on platform</p> <p>17. On IV GO, Demate terminator cap 10955J from JBOX 6 J2</p> <p>18. Mate W19 P1 to JBOX 6 J2, notify IV when complete</p> <p>19. Stow terminator connector</p> <p>20. Verify dual latches released from mast canister platform</p> <p>21. Retrieve old BMRRM by releasing MUT from BGA HR</p> <p>22. Transfer old BMRRM to EV1</p> <p>23. Verify lever latch in latched position on old BMRRM</p>

BMRRM REMOVE/REPLACE (Cont)

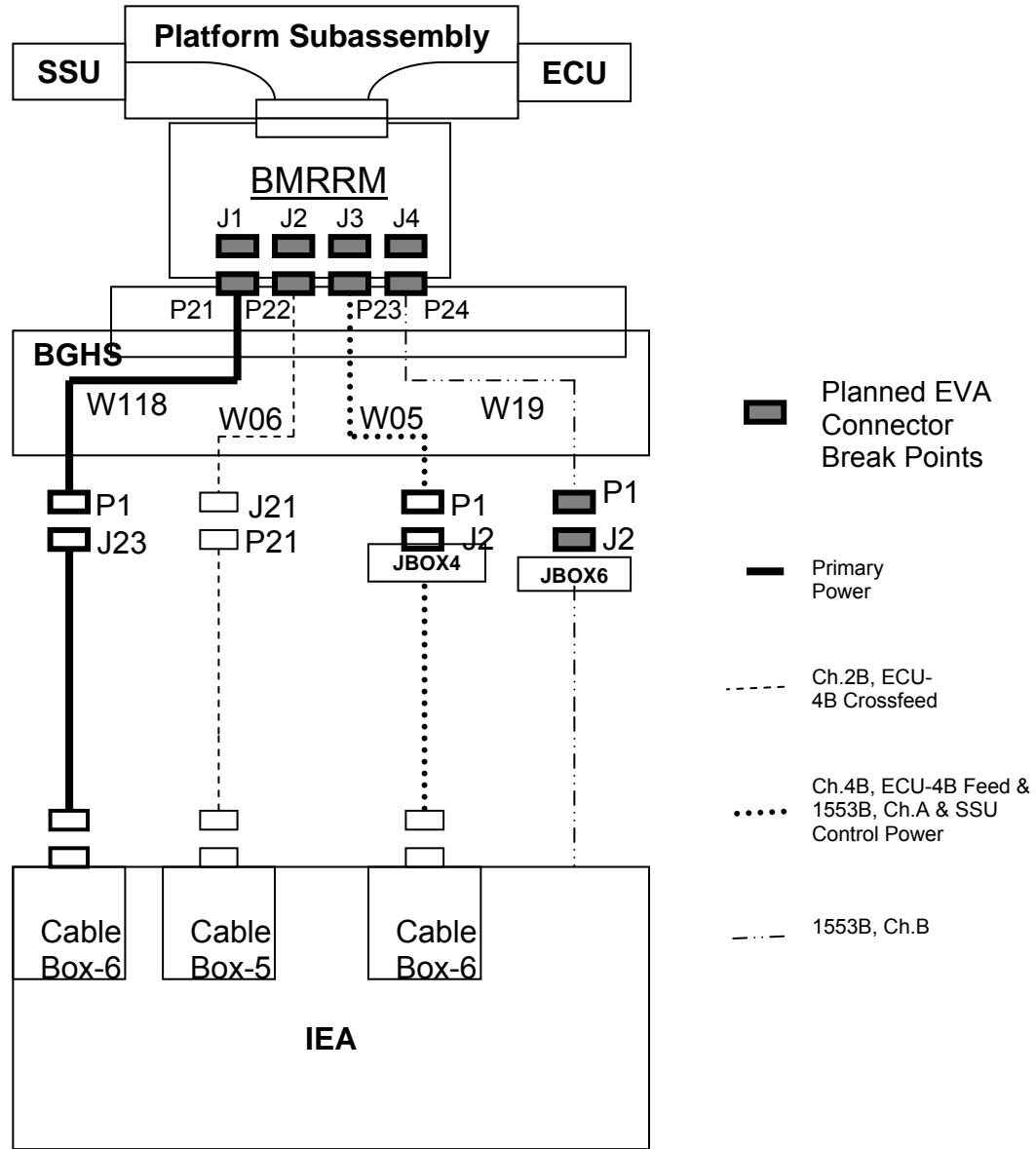

BMRRM REMOVE/REPLACE – TASK DATA

Estimated Task Duration:

	With RMS	Without RMS
One EV Crew	NA	NA
Two EV Crew	NA	03:00

Tools:

EV1 (RMS)	EV2 (FF)
PGT	Crewlock bag
6ext 7/16	Vice clamp locking tool
Cannon connector tool	Cannon Connector tool
Round scoop	J23 Connector Cap
Ball stack (2)	JBOX 6 J2 terminator cap
MUT end effector (3)	JBOX 4 J2 terminator cap
APFR	

EVA Fasteners:

Fastener Name	Label	Head Size	Qty	Install Torque (ft-lb)	Release Torque (ft-lb)	Failure Torque	Failure Torque	Turns	RPM
Dual Latches	H2, H3, H4	7/16	3	2.5 SAW Latch	8.3 BMRRM Latch	3.4 SAW Latch	47 BMRRM Latch	23 +/- 2	N/A
BMRRM Center Fastener	H1	7/16	1	8.3	10.5		51.6	10 +/- 2	N/A
BMRRM Housing Fasteners	H6, H7, H8, H9	7/16	4	5.5	7.0		15.5	8 +/- 1	N/A
Vice Clamp Fastener	None	7/16	1	2.5	5.0		8	19 +/- 2	N/A

EVA Connectors:

Harness	From	To	Clamps (#)	Conn Size	Function
W111 P11		2B BMRRM J1			Primary power
W03 P12		2B BMRRM J2			
W04 P13		2B BMRRM J3			
W12 P14		2B BMRRM J4			
W118 P21		4B BMRRM J1		37	Primary power
W118 P1		W18 J23		37	Primary power
W06 P22		4B BMRRM J2			ECU-2B cross feed
W05 P23		4B BMRRM J3		25	ECU-4B feed; SSU 4B Control pwr; 1553B, Bus A
W05 P1		J2 (JBOX 4)		25	ECU-4B feed; SSU 4B Control pwr; 1553B, Bus A
W19 P24		4B BMRRM J4		19	1553B, Bus B
W19 P1		J2 (JBOX 6)		19	1553B, Bus B

Foot Restraints:

Task	WIF	APFR Setting
Access to Stbd SAW BMRRM	P6-39	9, NN, G, 3
Access to Port SAW BMRRM	P6-40	9, NN, G, 3
BMRRM change-out support	P6-34	12, QQ, K, 2
BMRRM change-out support	P6-36	1, HH, L, 12
Access to Stbd SAW SSU	P6-35	4, PP, H, 9
Access to Port SAW SSU	P6-33	4, PP, H, 9

ORU Mass: BMRRM = 142 lb Cover = 69 lb

BMRRM REMOVE/REPLACE – TASK DATA (Cont)

Notes:

1. Translation technique: The BMRRM within the ORU cover can be attached to the EVA crewmember via the BRT and Round Scoop. The EVA crewmember should attach an additional tether between themselves and the ORU cover to prevent uncontrolled motion
2. Fastener turn counts in the procedures are in reference to the bolt head
3. Recommend spare BMRRM temp stowage configuration: MUT end effector; ball stack, round scoop attached to cover microconical. A second tether should be tethered between the cover and structure
4. The three dual latches are used to latch the housing to the platform. Order of operation is not important
5. Three Dual Latches are equipped with locking collars. Collars must be pushed and held while rotating bolt heads
6. BMRRM center bolt is equipped with a spring and will pop out when fully unfastened
7. Vice Clamp Assembly actuating bolt is equipped with a locking collar. Collar must be pushed and held while rotating the bolt head
8. Four captive fasteners securing BMRRM to the housing are equipped with springs and will pop out when fully unfastened
9. Center bolt on the bottom of the platform assembly is a ZIP bolt. The number of turns to tighten to hard stop depends on how far the center bolt is pushed into the ZIP nut
10. BMRRM housing fasteners must be pushed lightly to start thread engagement
11. Vernier thrusters with CMG are allowed for attitude control during the BMRRM ORU changeout

Cautions:

1. FPP solar arrays, probes, and RF box are sensitive to impact loads. FPP (located in WIF P6-39) will interfere with BMRRM remove and replace procedure. FPP can be relocated to an alternate WIF. Grounding pin can be removed from grounding lug if necessary
2. Hardware Damage. The Vice clamp fastener may "back out" if the fastener locking collar does not engage after the spare BMRRM is installed. Vice clamp locking collar must be installed to prevent inadvertent rotation of Vice clamp bolt. Installation of Vice clamp collar locking tool will be required if vice clamp locking collar fails to engage
3. Minimize loads on Mast Platform when only Dual Latch Fasteners are engaged
4. Loss of ISS Hardware. Failure to engage the BMRRM Dual latches prior to failed BMRRM removal will result in SAW release

Warnings:

1. Excessive loads into the EMU: The EVA crewmember should translate at a rate no greater than 1.6 fps when the EVA crewmember is translating with the BMRRM attached to their BRT
2. Crew must remain 24 inches from rotating starboard SAW
3. Sharp Edge Hazard. The flange at the base of the failed BMRRM is sharp. Handle the BMRRM only by the EVA handle holds. Avoid contact with the end of the BMRRM opposite of the BMRRM face plate. The flange at the base of the replacement BMRRM is not sharp but should be avoided to avoid hardware damage
4. Umbilical mate/demate inhibits/constraints must be verified to avoid HOT connector mate/demate

FLIGHT SPECIFIC EVA REFERENCE

PAYLOAD BAY CONFIG.....	FS 18-3
NODE 2	
NODE 2 ZENITH PORT HANDRAILS	FS 18-4
NODE 2 FWD END CONE	FS 18-5
NODE 2 NADIR STBD HANDRAILS.....	FS 18-6
NODE 2 PORT NADIR HANDRAILS	FS 18-7
NODE 2 STBD ZENITH HANDRAILS.....	FS 18-8
EVA 1	
TRUNNION COVER LABELING	FS 18-9
ACBM.....	FS 18-10
PCBM WITH CONTAMINATION COVERS	FS 18-11
CONTAMINATION COVER	FS 18-12
PCBM CONTAMINATION COVER	FS 18-13
CBM PETAL RELEASE	FS 18-14
Z1 FLUID QDs STOWED ON Z1	FS 18-15
PDGF SIDEWALL CARRIER.....	FS 18-16
PDGF UNDERSIDE	FS 18-17
PDGF EDF IN INSTALLED POSITION.....	FS 18-18
PDGF EDF IN RETRACTED POSITION	FS 18-19
EVA 2	
NODE 2 PDGF MOUNTING RING	FS 18-20
PDGF HORSESHOE CONNECTOR INTERFACE.....	FS 18-21
PDGF HORSESHOE CONNECTOR RECEPTACLE	FS 18-22
NODE 2 HORSESHOE CONNECTORS	FS 18-23
PDGF HORSESHOE CONNECTOR SOFT DOCK	FS 18-24
PDGF CONNECTOR INTERFACE.....	FS 18-25
NODE 2 CAP LANYARDS (INBOARD/AFT).....	FS 18-26
NODE 2 CAP LANYARDS (INBOARD/FWD AND OUTBOARD/AFT)	FS 18-27
S1 SFU CONFIG FOR DEPLOY.....	FS 18-28
MBSU BYPASS JUMPER – PANELS A260 AND A200	FS 18-29
EVA 3	
P6 TO P5 MEASUREMENTS	FS 18-32
CANNON CONNECTOR CAPS INSTALLED ON P5	FS 18-33
P6 SINGLE POINT GROUNDS (SPG)	FS 18-34
P6 OUTBOARD RADIATOR	FS 18-36
GAP CHECK TOOL	FS 18-37
P5 CAPTURE LATCH ASSEMBLY (CLA)	FS 18-38
P6 SSU SHROUD MLI FOLDING SEQUENCE.....	FS 18-39
MBSU STACK-UP.....	FS 18-40
MBSU IN PAYLOAD BAY	FS 18-41
MBSU PASSIVE FRAM ON ESP-2.....	FS 18-42
MBSU ACTIVE FRAM FLIGHT SUPPORT EQUIPMENT	FS 18-43
MBSU ACTIVE FRAM CONTINGENCY PINS.....	FS 18-44
EVA 5	
LAB SSPTS BAGS.....	FS 18-45
NODE 2 ACBM COVER (SHOWER CAP) BELT STRAP.....	FS 18-46
NODE 2 ACBM COVER (SHOWER CAP) GROUNDING FASTENERS.....	FS 18-47
FGB/PMA 1 H-JUMPER 1/4.....	FS 18-48
LAB MMOD SHIELD	FS 18-49
LAB MMOD SHIELD TABS.....	FS 18-50

FLIGHT SPECIFIC
EVA REFERENCE

CONTINGENCY

S1 RADIATOR OVERVIEW	FS 18-51
S1 RADIATOR CINCH RELEASE	FS 18-52
P5/P6 PRD ROUTING (CORNER 1)	FS 18-53
P5/P6 PRD ROUTING (CORNER 2)	FS 18-54
P5/P6 PRD ROUTING (CORNER 3)	FS 18-55
P5/P6 PRD ROUTING (CORNER 4)	FS 18-56
P5/P6 PRD ROUTING (STRAP ROUTING CORNER 4).....	FS 18-57
P5/P6 PRD ROUTING (STRAP ROUTING CORNER 3).....	FS 18-58
ORU CONTINGENCY TIE-DOWN DEFINITIONS.....	FS 18-60
LAB CETA LIGHT CONTINGENCY TIE-DOWN.....	FS 18-61
Z1 BSP CONTINGENCY TIE-DOWN	FS 18-63
Z1 SASA CONTINGENCY TIE-DOWN.....	FS 18-64
RPCM CONTINGENCY TIE-DOWN	FS 18-65
CETA CART – TOP VIEW	FS 18-66
CETA CART – SWING ARMS AND WIF MARKINGS	FS 18-67
CETA CART – COUPLERS	FS 18-68
CETA CART – WHEEL BOGIES	FS 18-69
STATUS INDICATORS (MBSU, DDCU, BCDU).....	FS 18-70

FLIGHT SPECIFIC
EVA REFERENCE

PAYLOAD BAY CONFIG

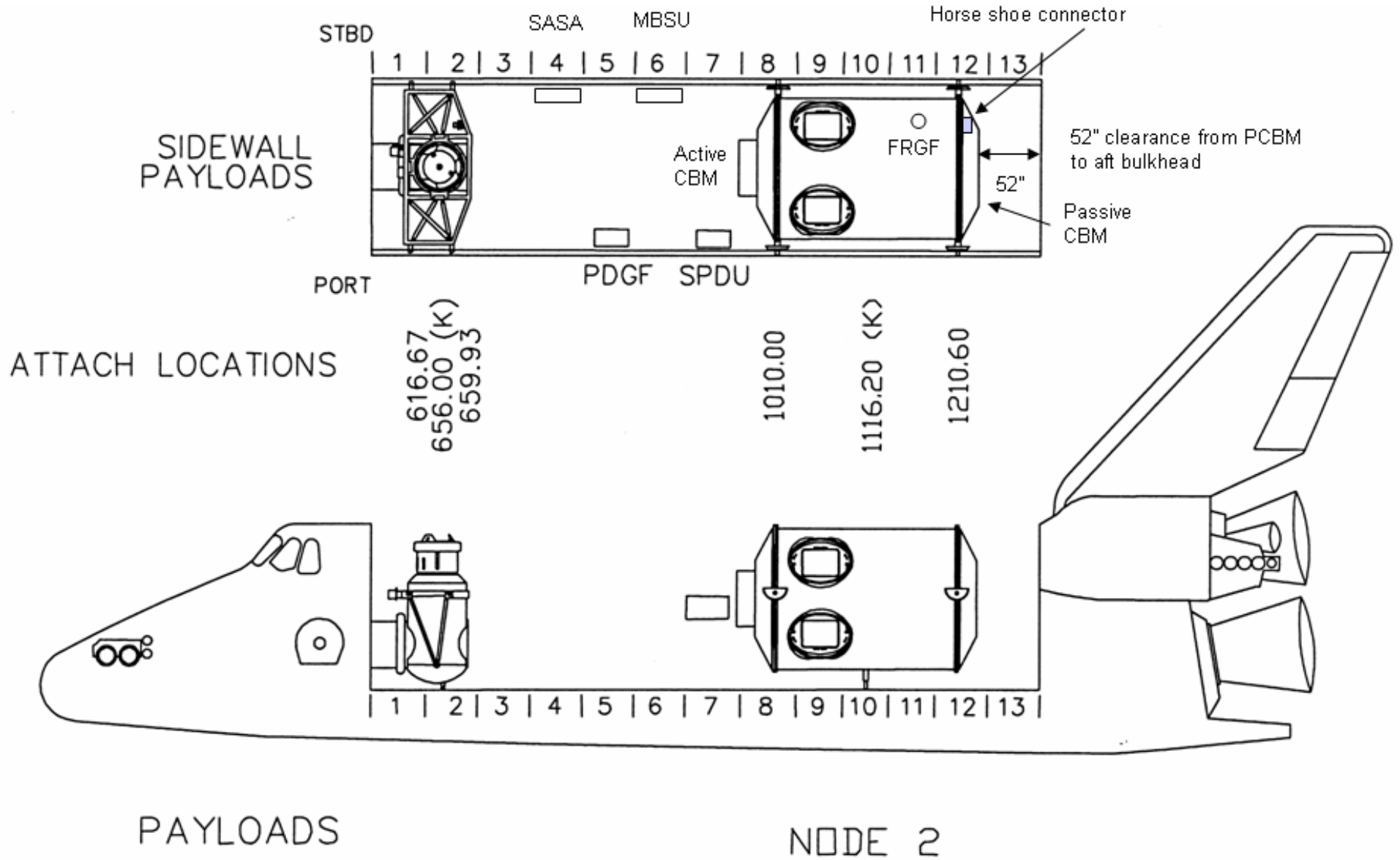

NODE 2

NODE 2 ZENITH PORT HANDRAILS

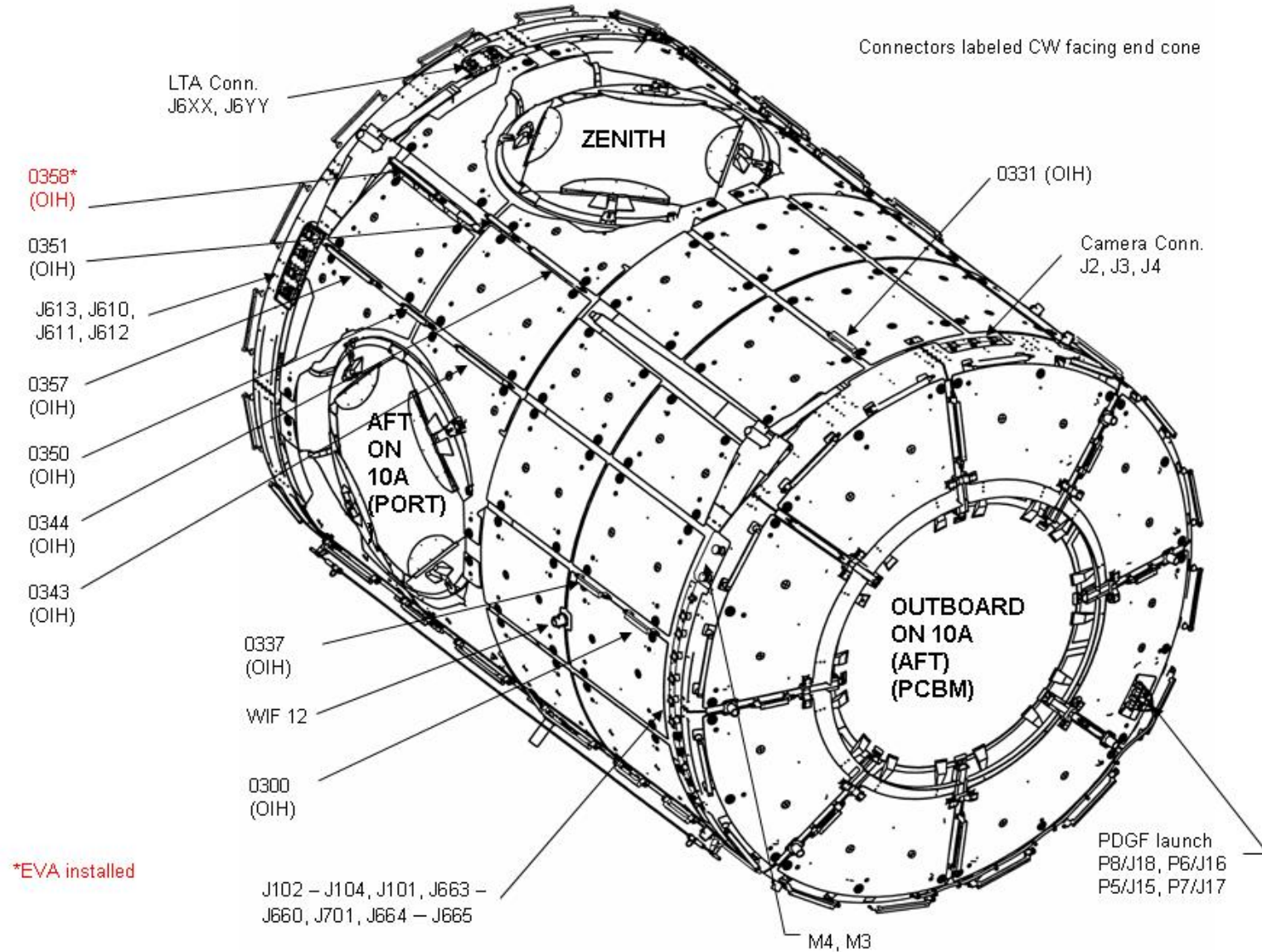

NODE 2 NADIR STBD HANDRAILS

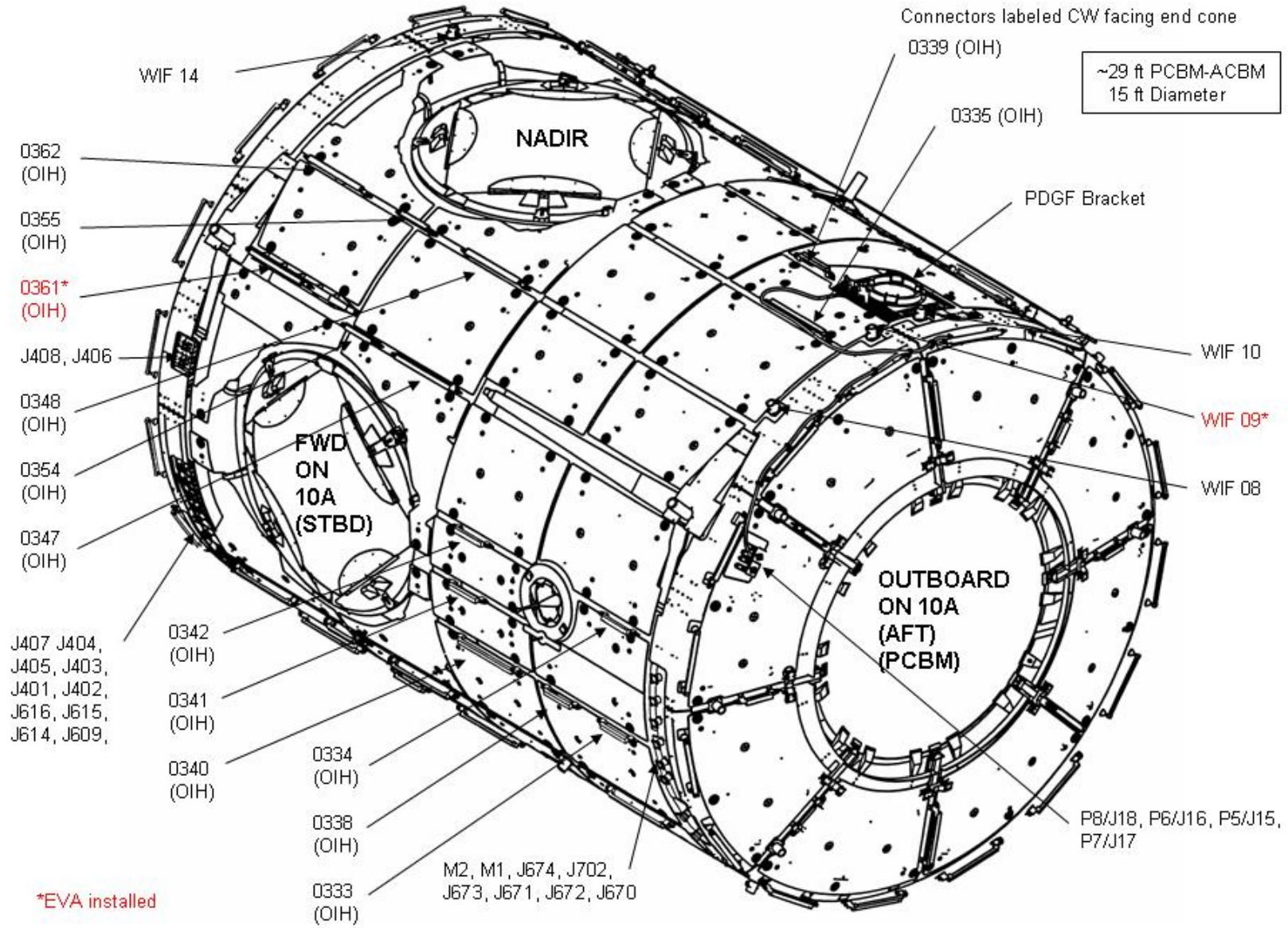

NODE 2 PORT NADIR HANDRAILS

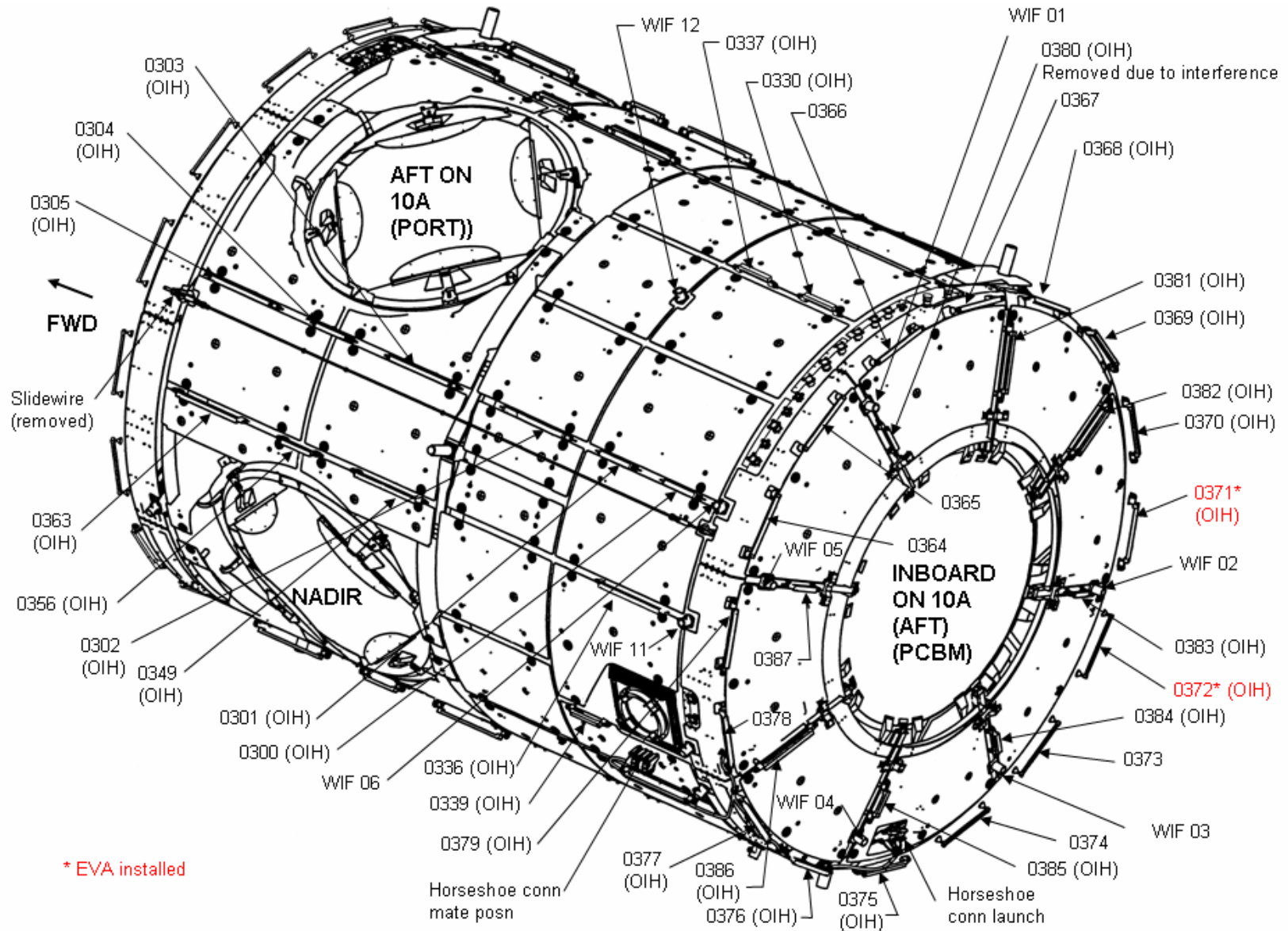

NODE 2 STBD ZENITH HANDRAILS

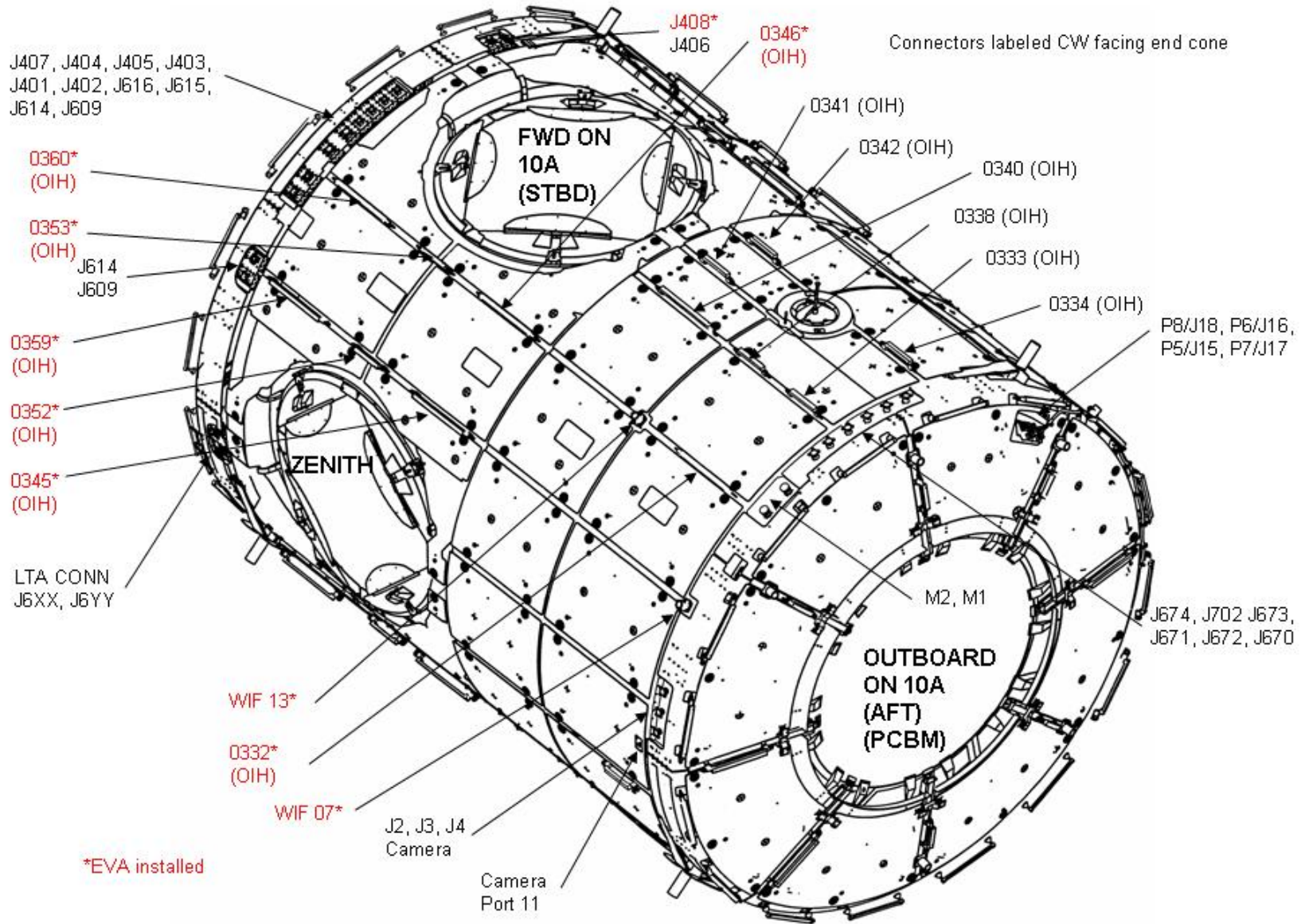

TRUNNION COVER LABELING

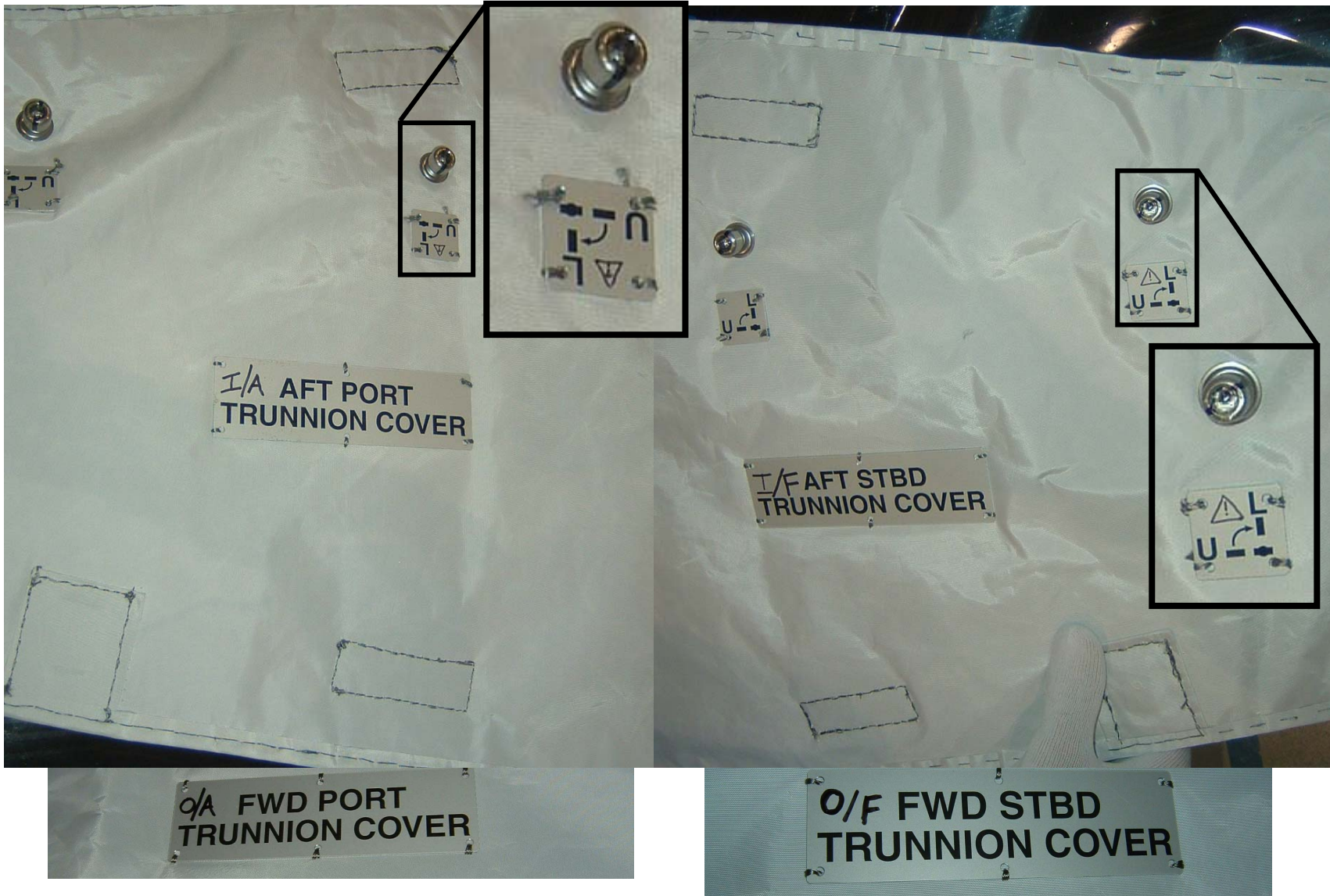

ACBM

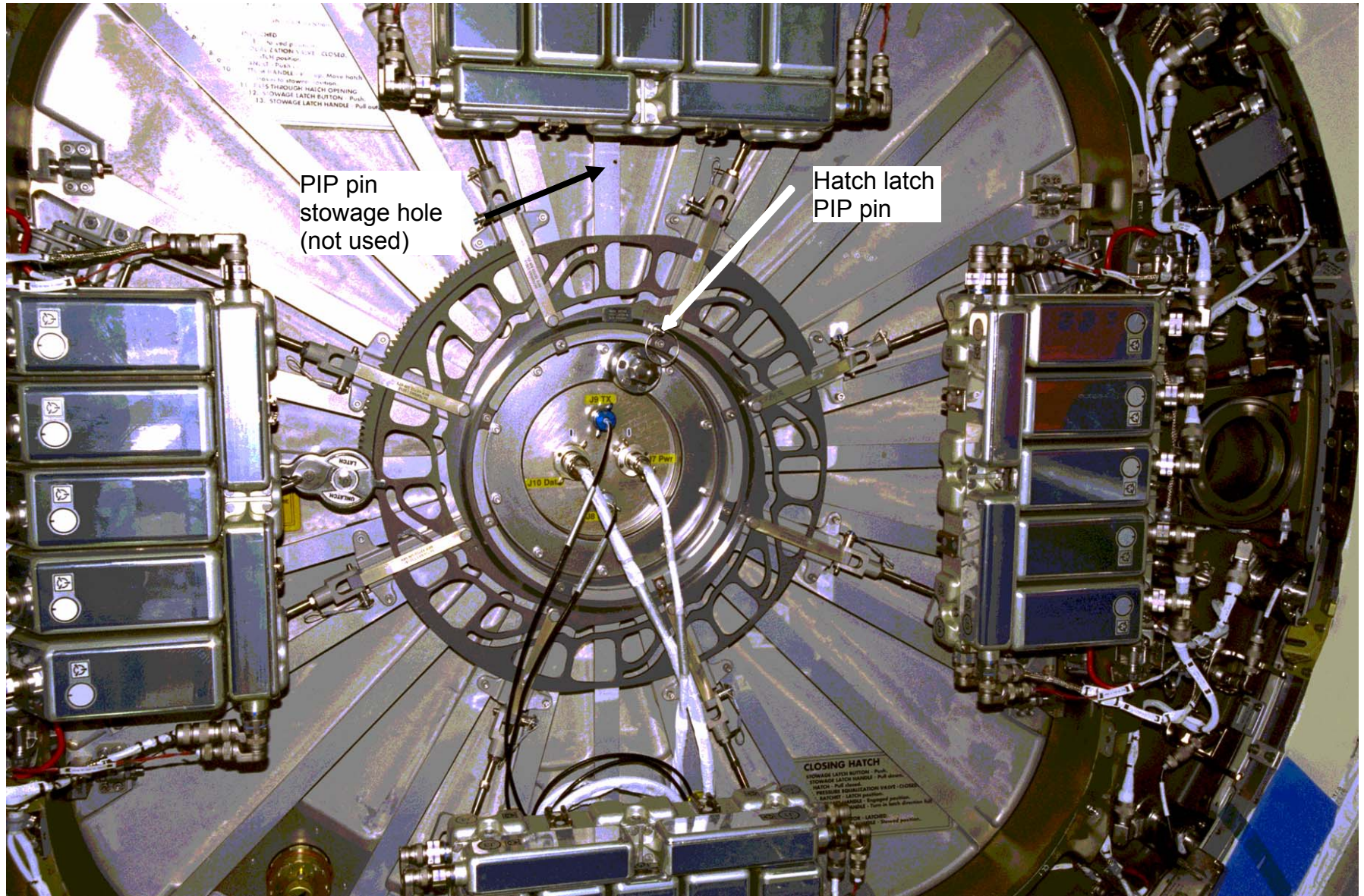

PCBM WITH CONTAMINATION COVERS



CONTAMINATION COVER



FS 18-12

EVA/120/FIN A

PCBM CONTAMINATION COVER



Dual lock
fastener

Tether point and
release strap

CBM PETAL RELEASE

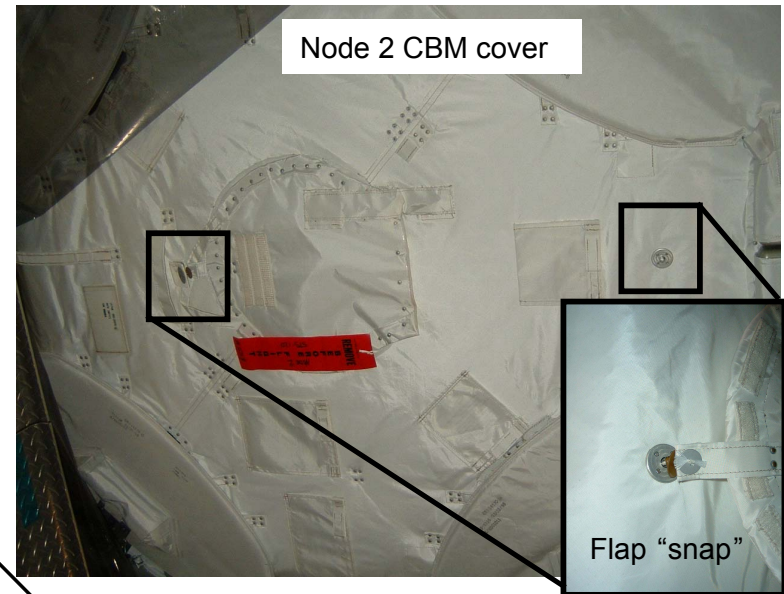
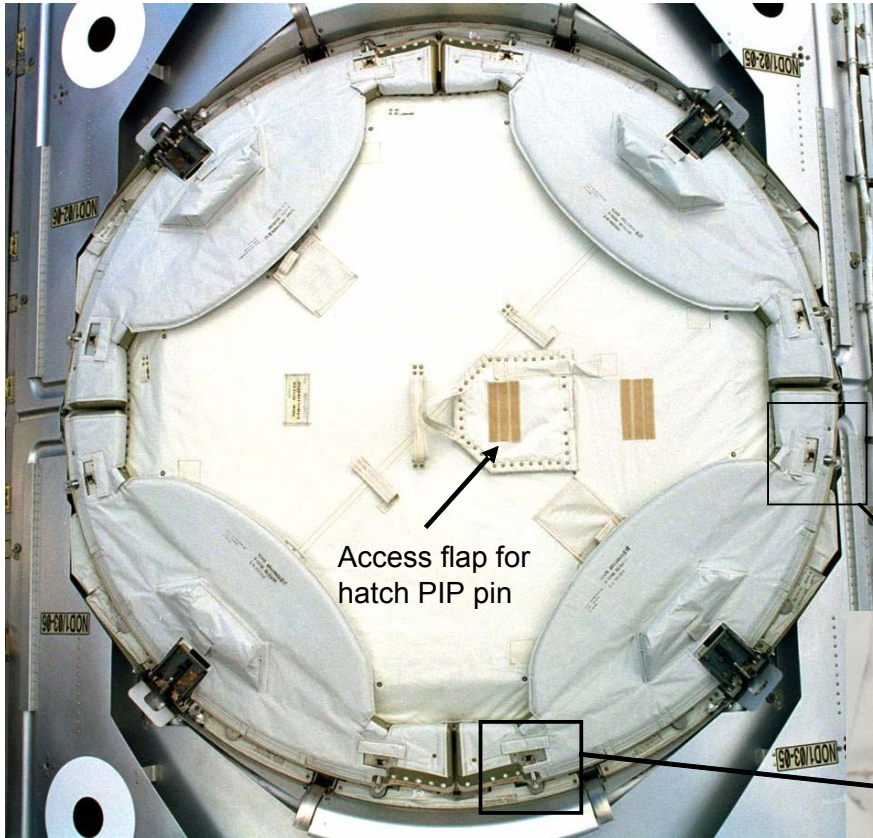

NOTE: Node 1 CBM – Node 2 CBMs look slightly different

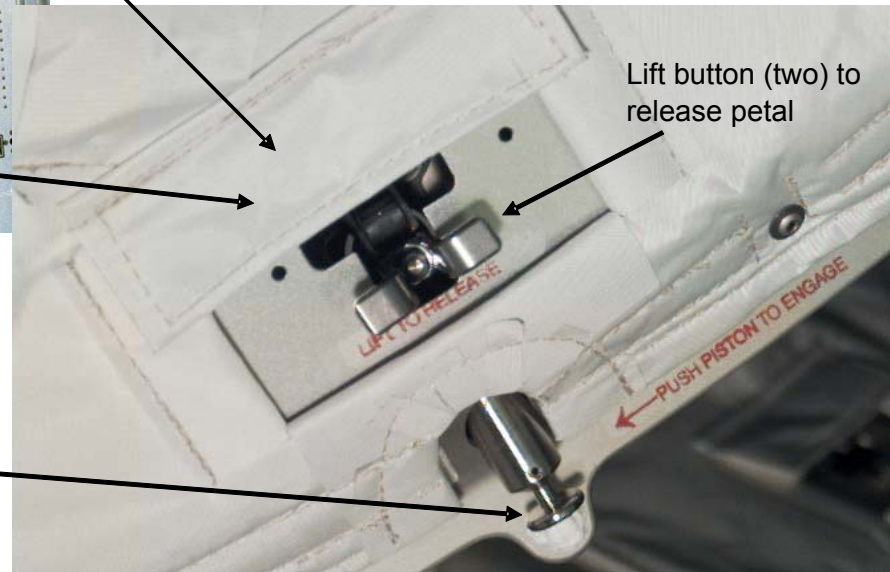

Z1 FLUID QDs STOWED ON Z1



PDGF SIDEWALL CARRIER

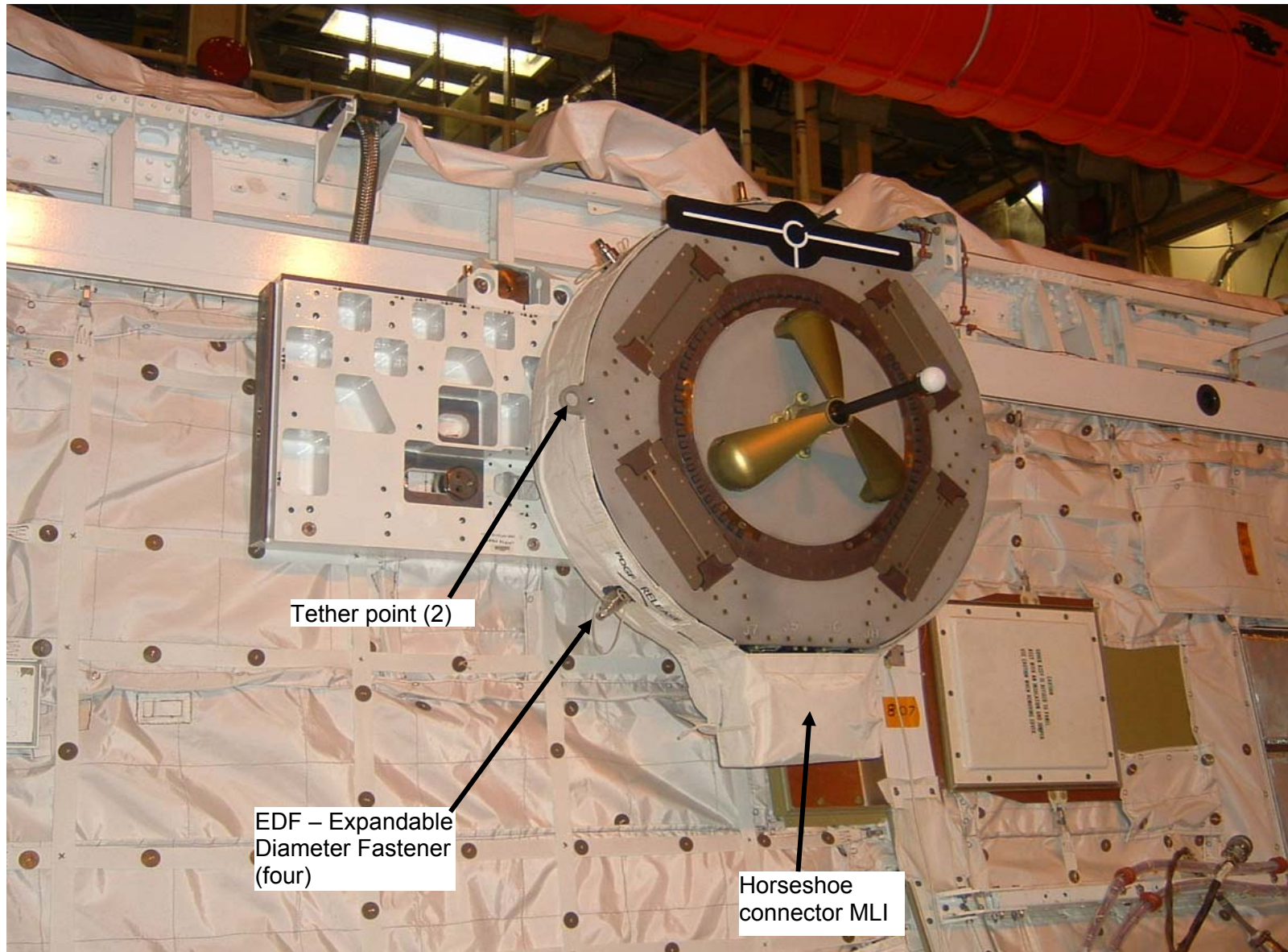

PDGF UNDERSIDE

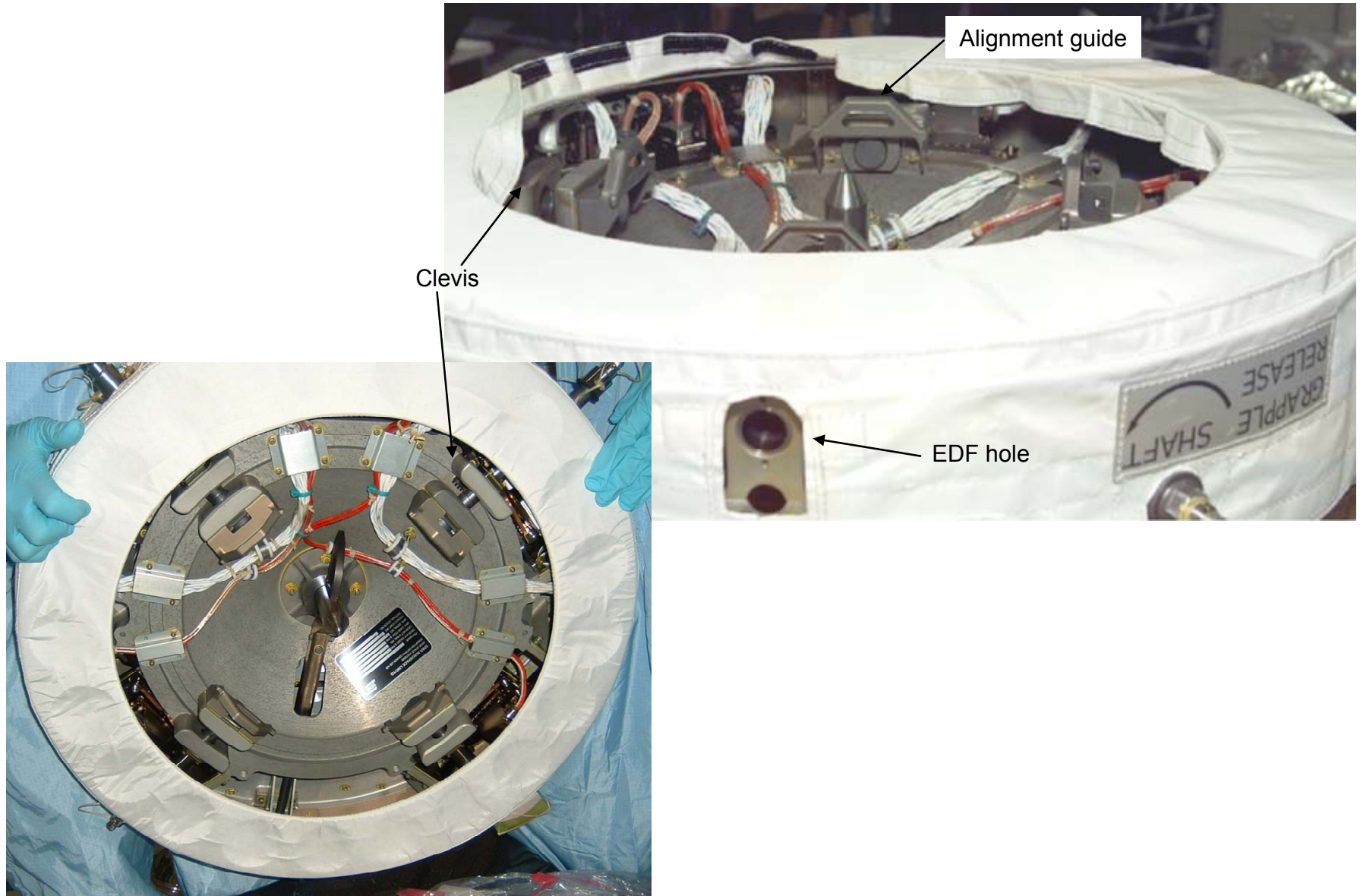

PDGF EDF IN INSTALLED POSITION

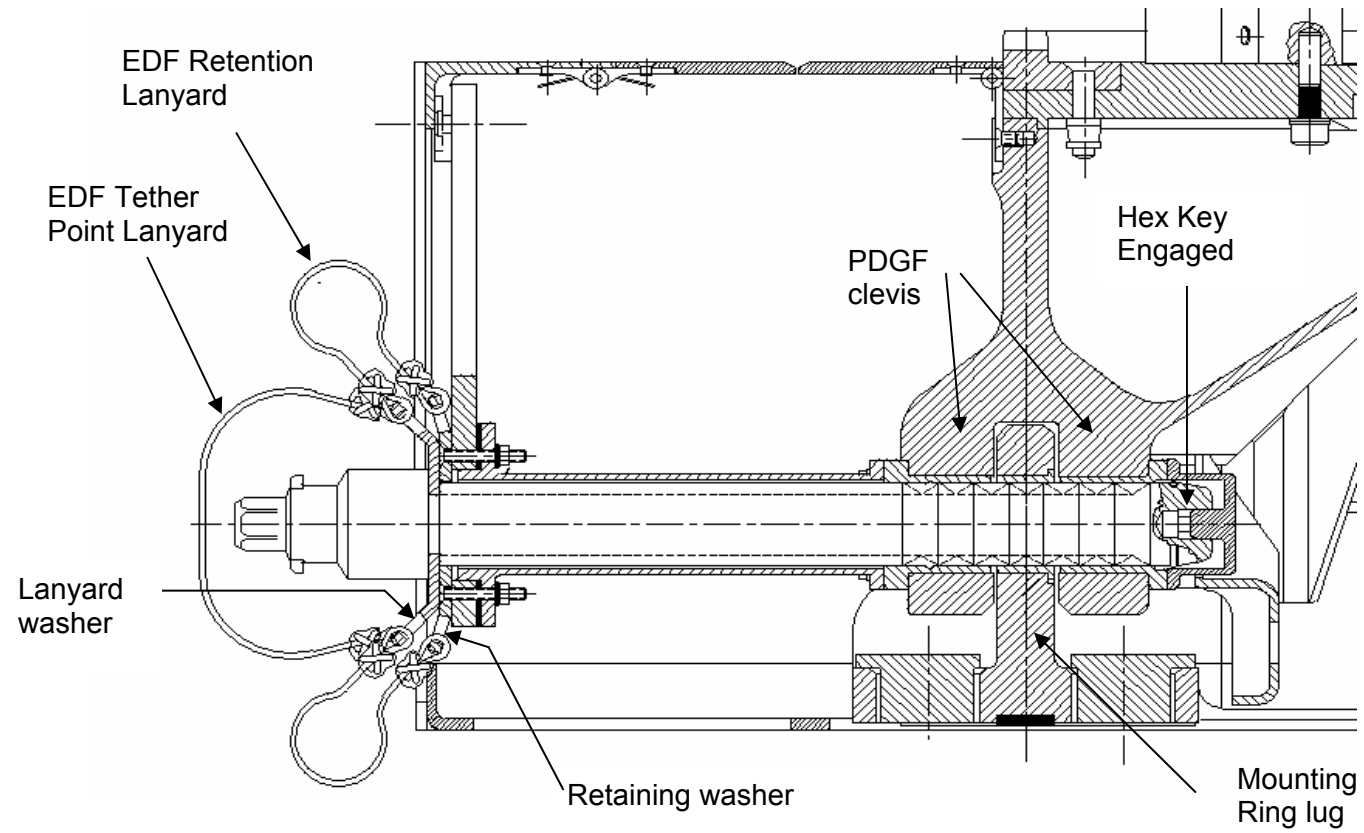

PDGF EDF IN RETRACTED POSITION

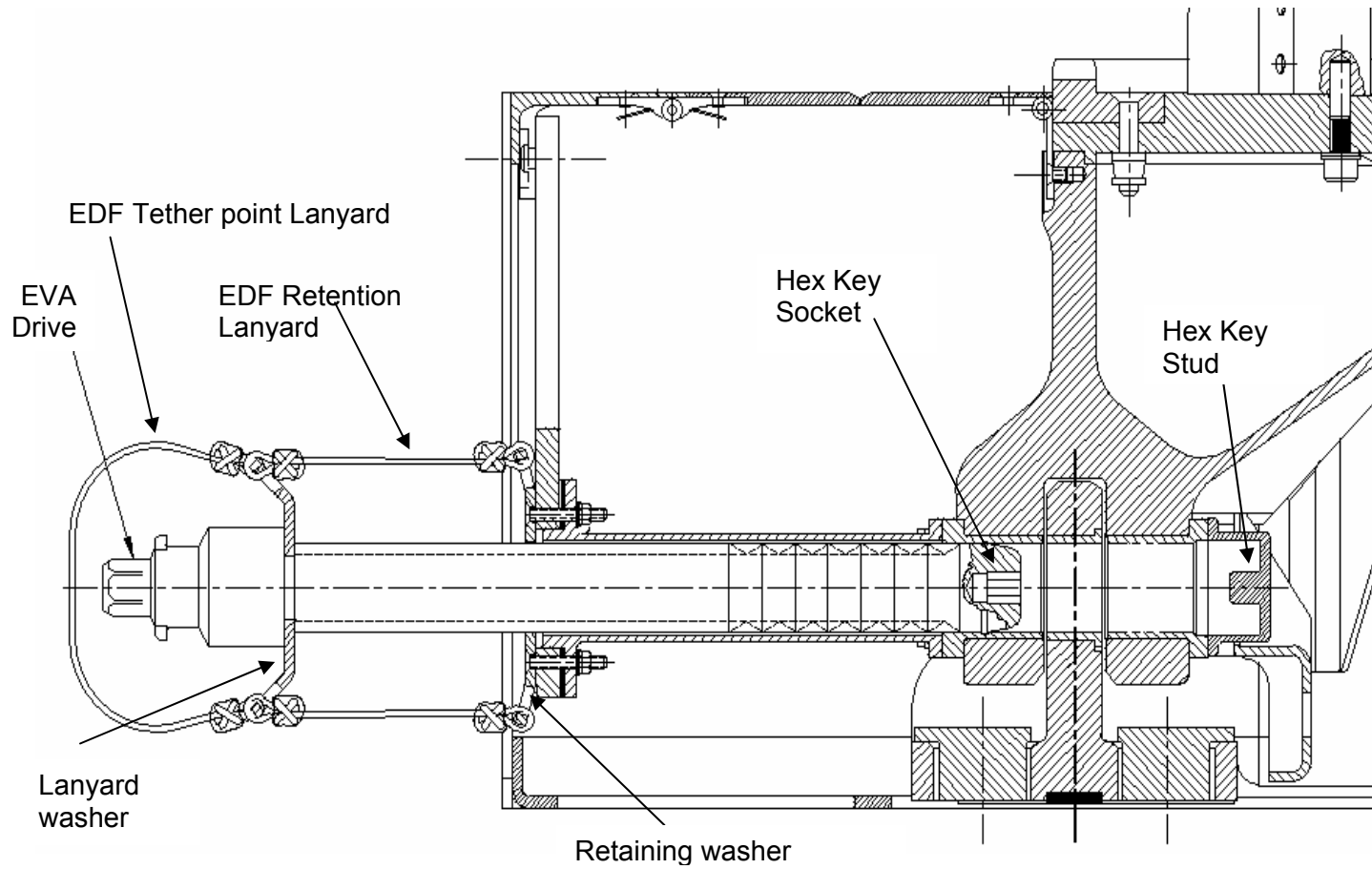

NODE 2 PDGF MOUNTING RING

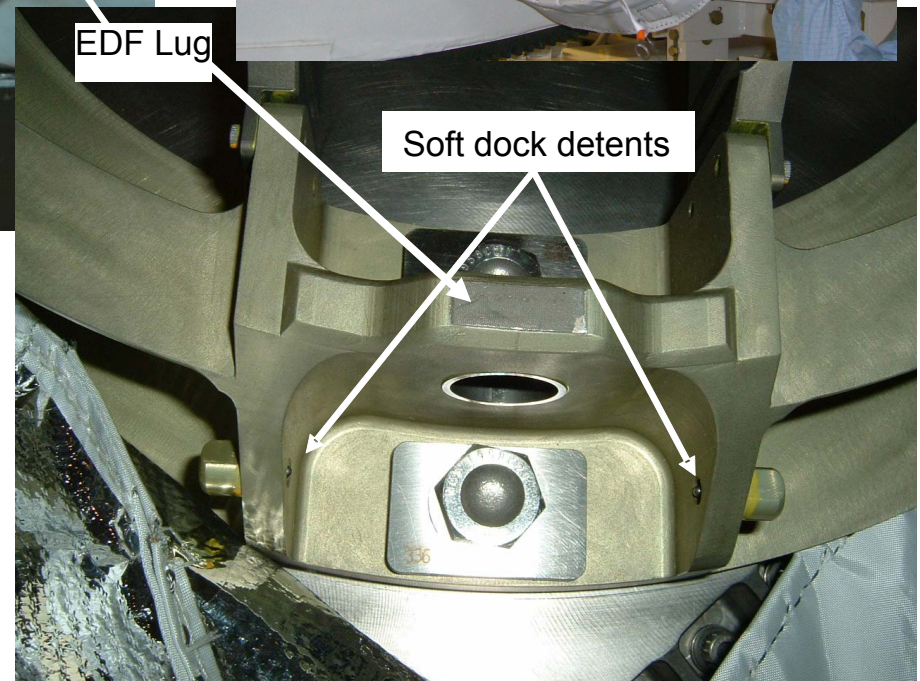
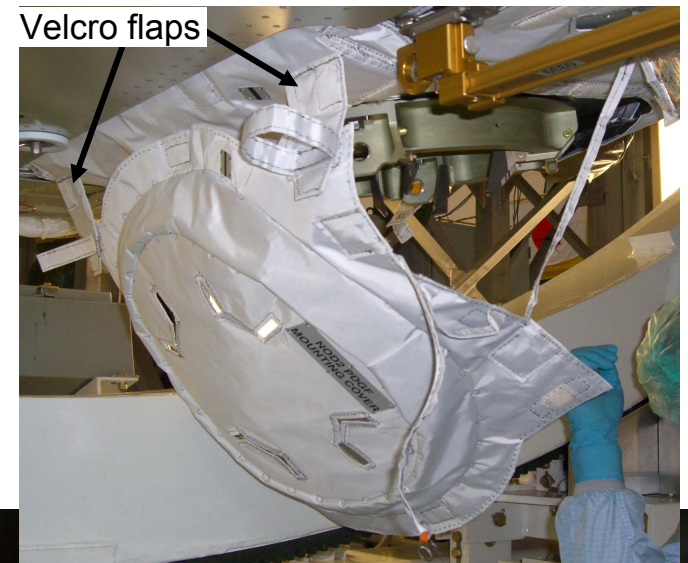
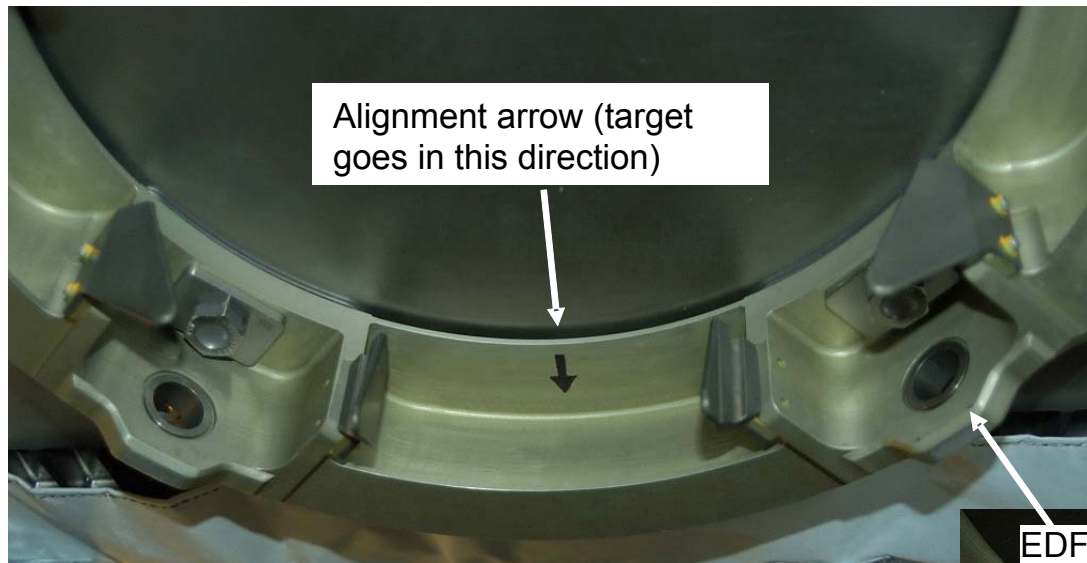

PDGF HORSESHOE CONNECTOR INTERFACE

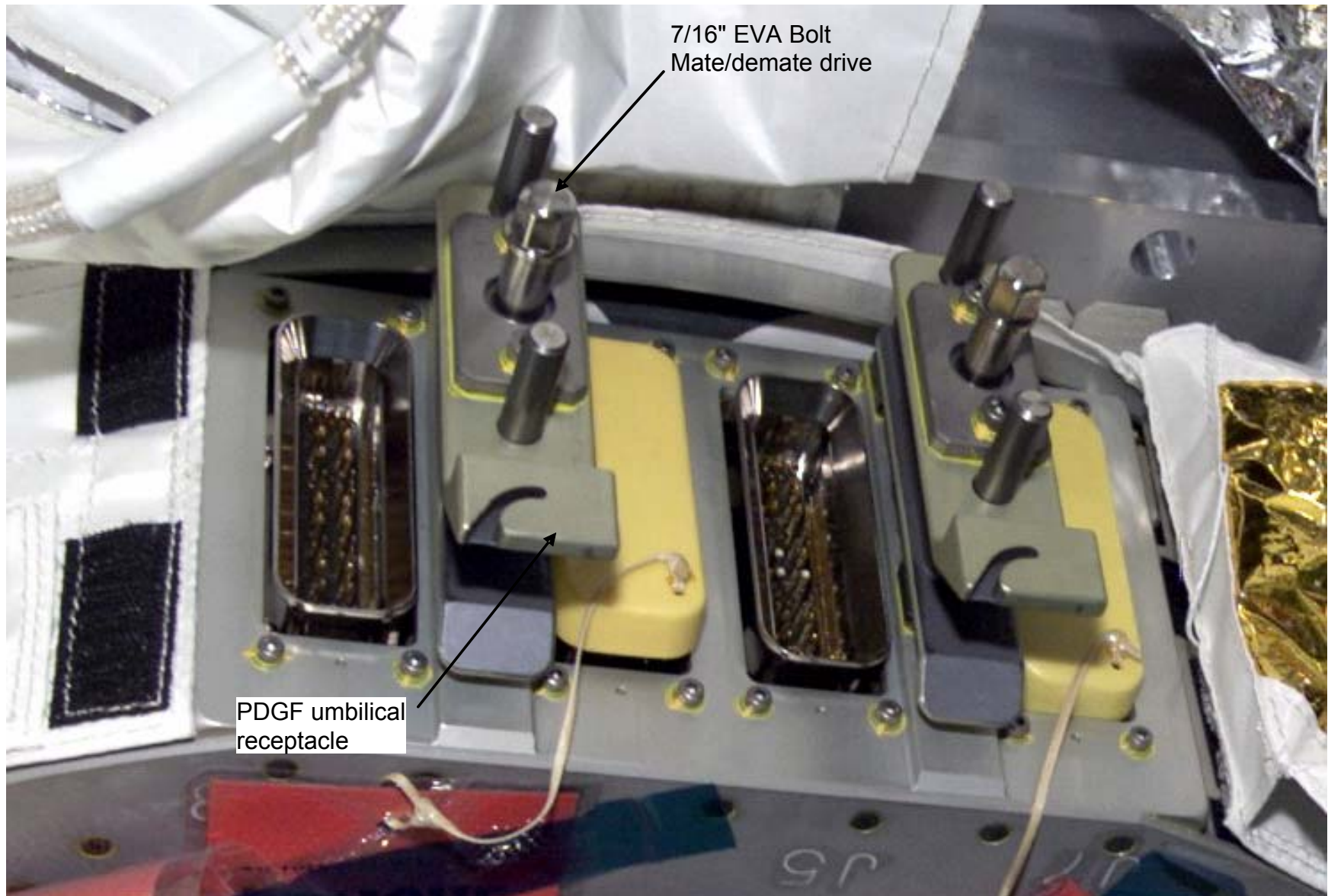

PDGF HORSESHOE CONNECTOR RECEPTACLE

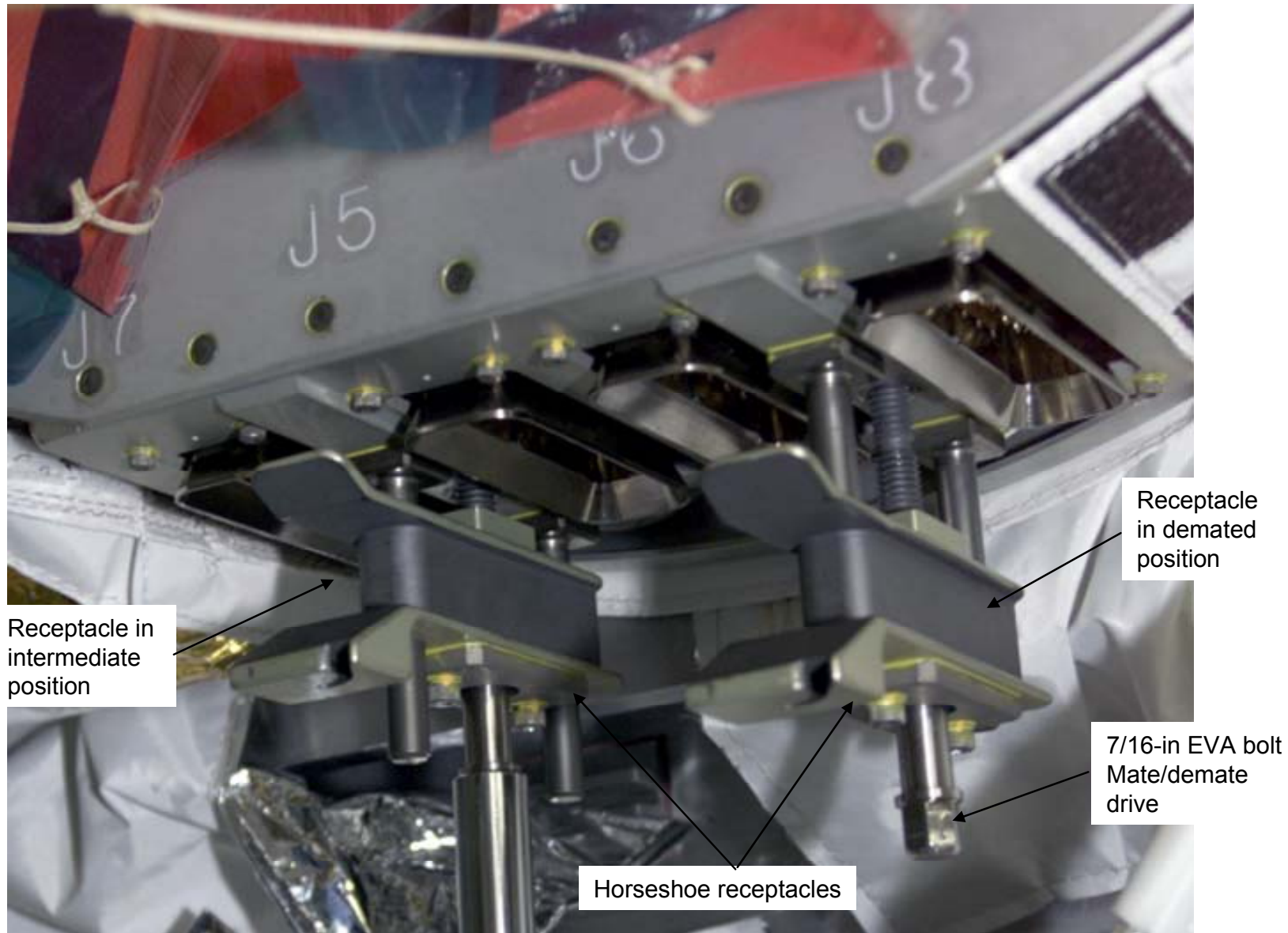

NODE 2 HORSESHOE CONNECTORS

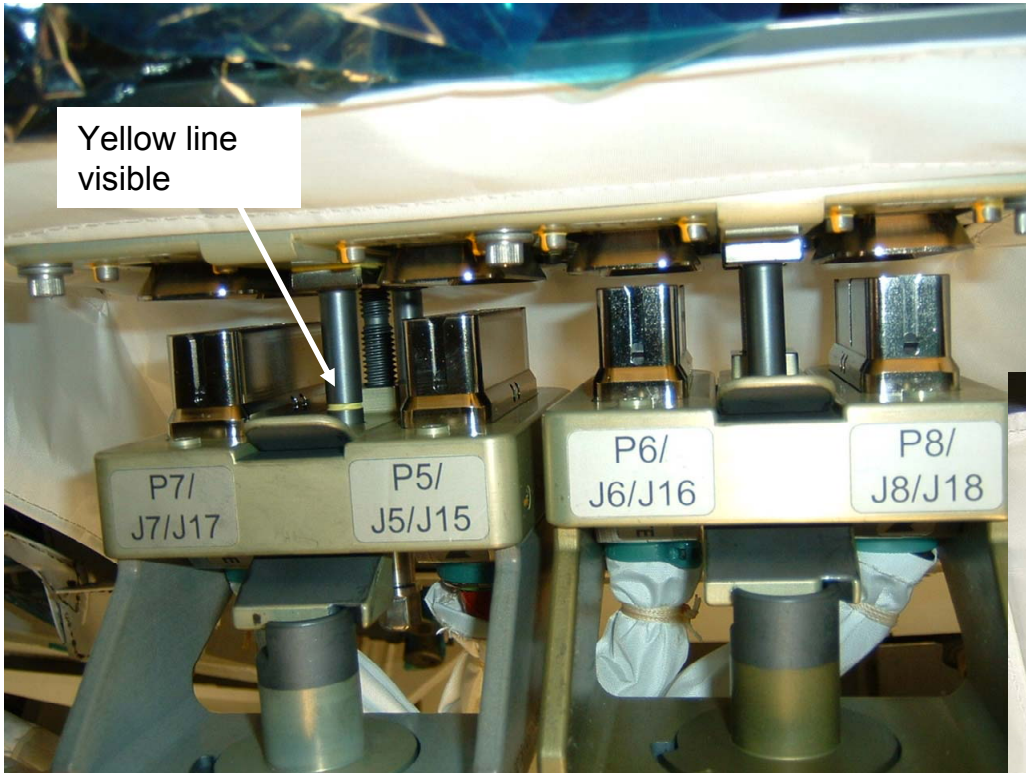

Horseshoe connector engagement bolt released, with microfixture still in locked position



Horseshoe connectors released and removed

PDGF HORSESHOE CONNECTOR SOFT DOCK

NOTE: Labeling on Node 2
horseshoe is different than in photo



Connector prior to soft dock

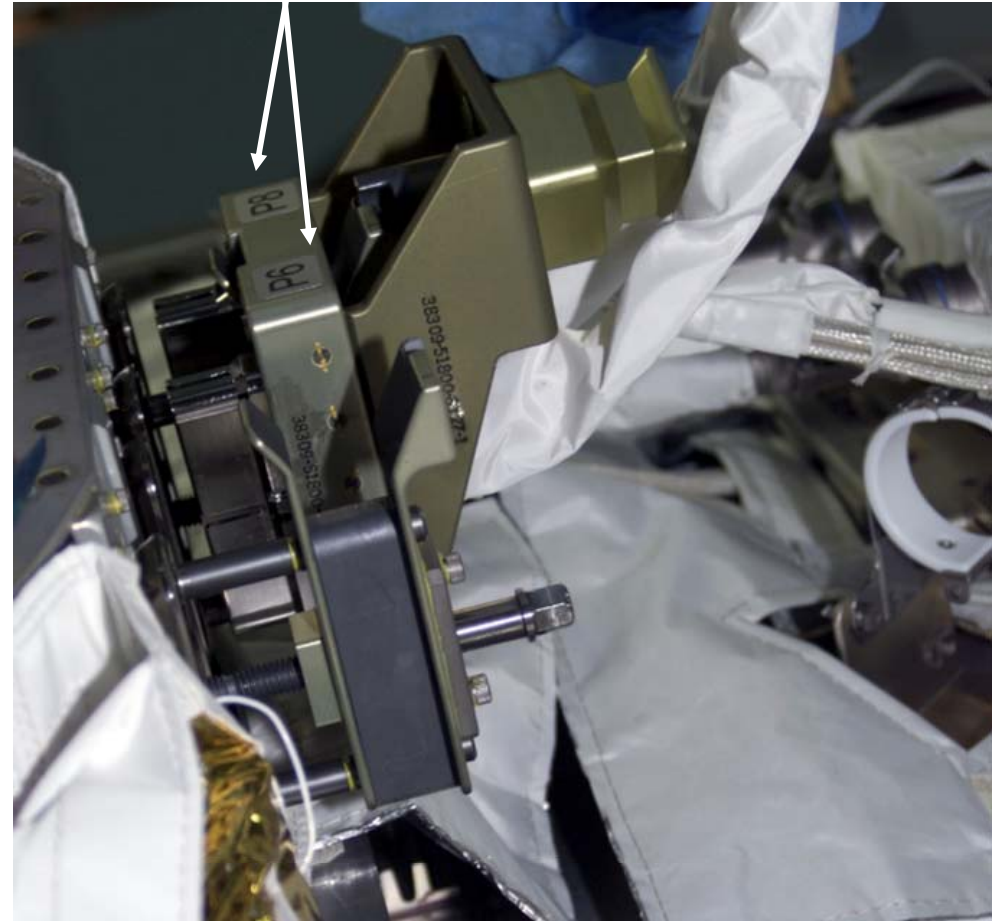

Connector soft docked and in the
demated position

PDGF CONNECTOR INTERFACE

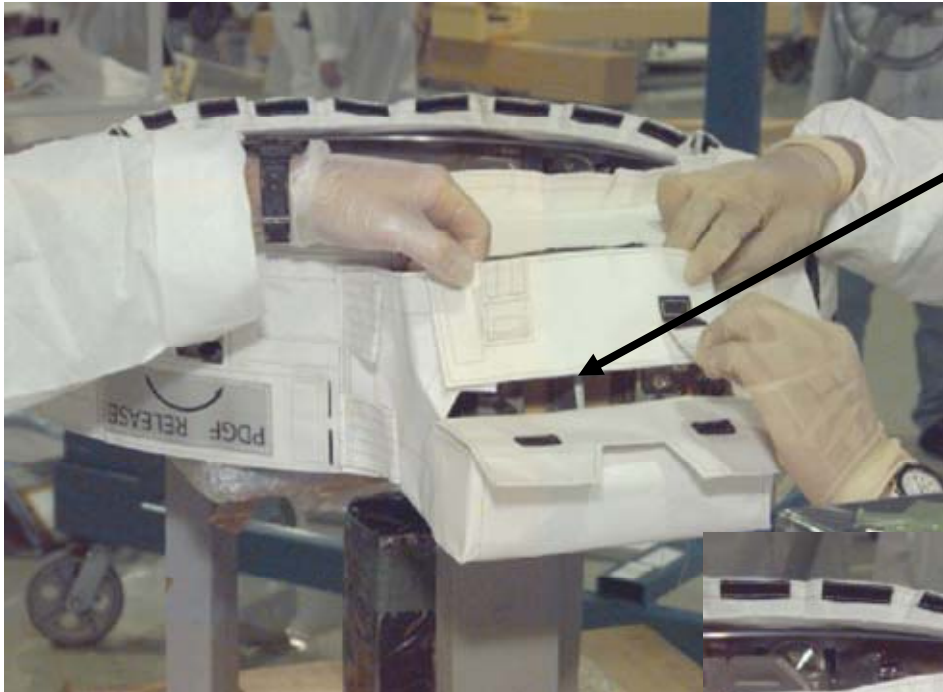

Feed horseshoe connector
umbilicals through this
opening



NODE 2 CAP LANYARDS (INBOARD/AFT)

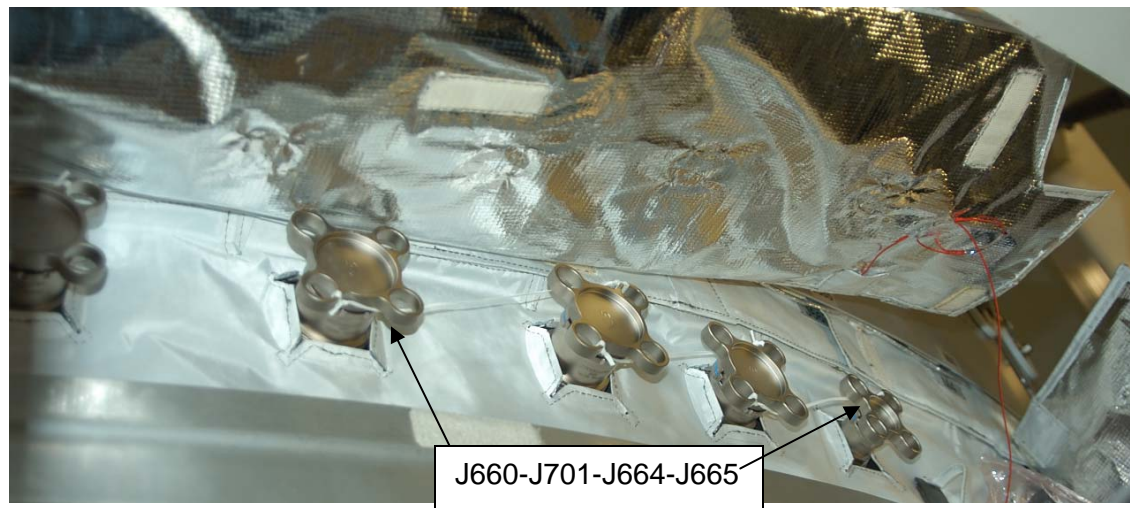
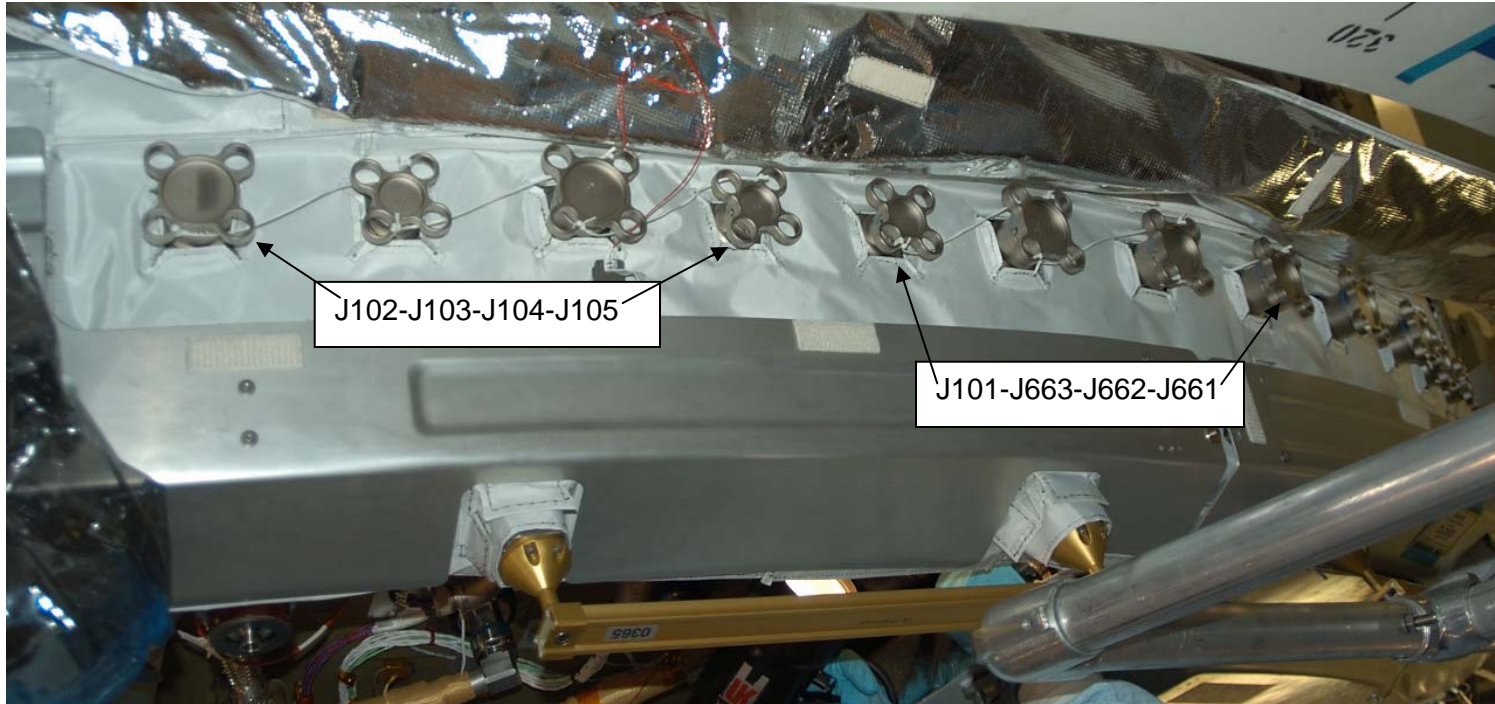

NODE 2 CAP LANYARDS (INBOARD/FWD AND OUTBOARD/AFT)

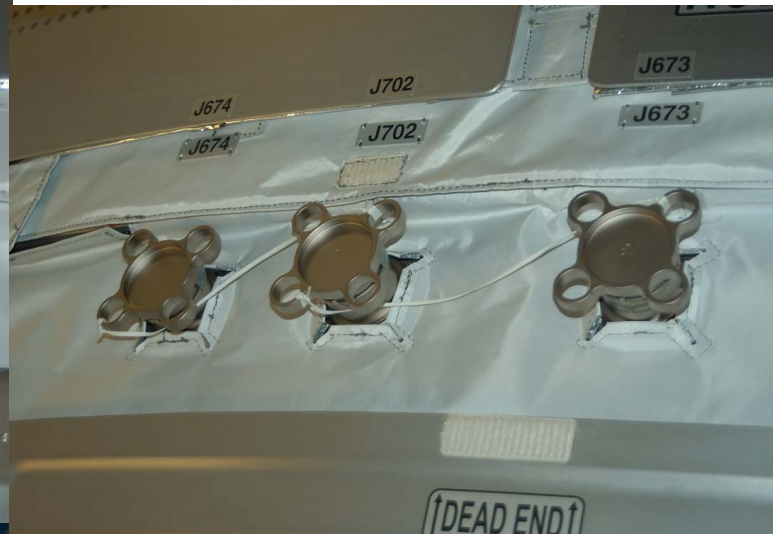

S1 SFU CONFIG FOR DEPLOY

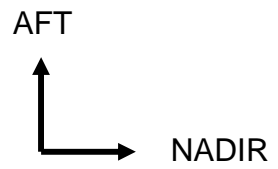
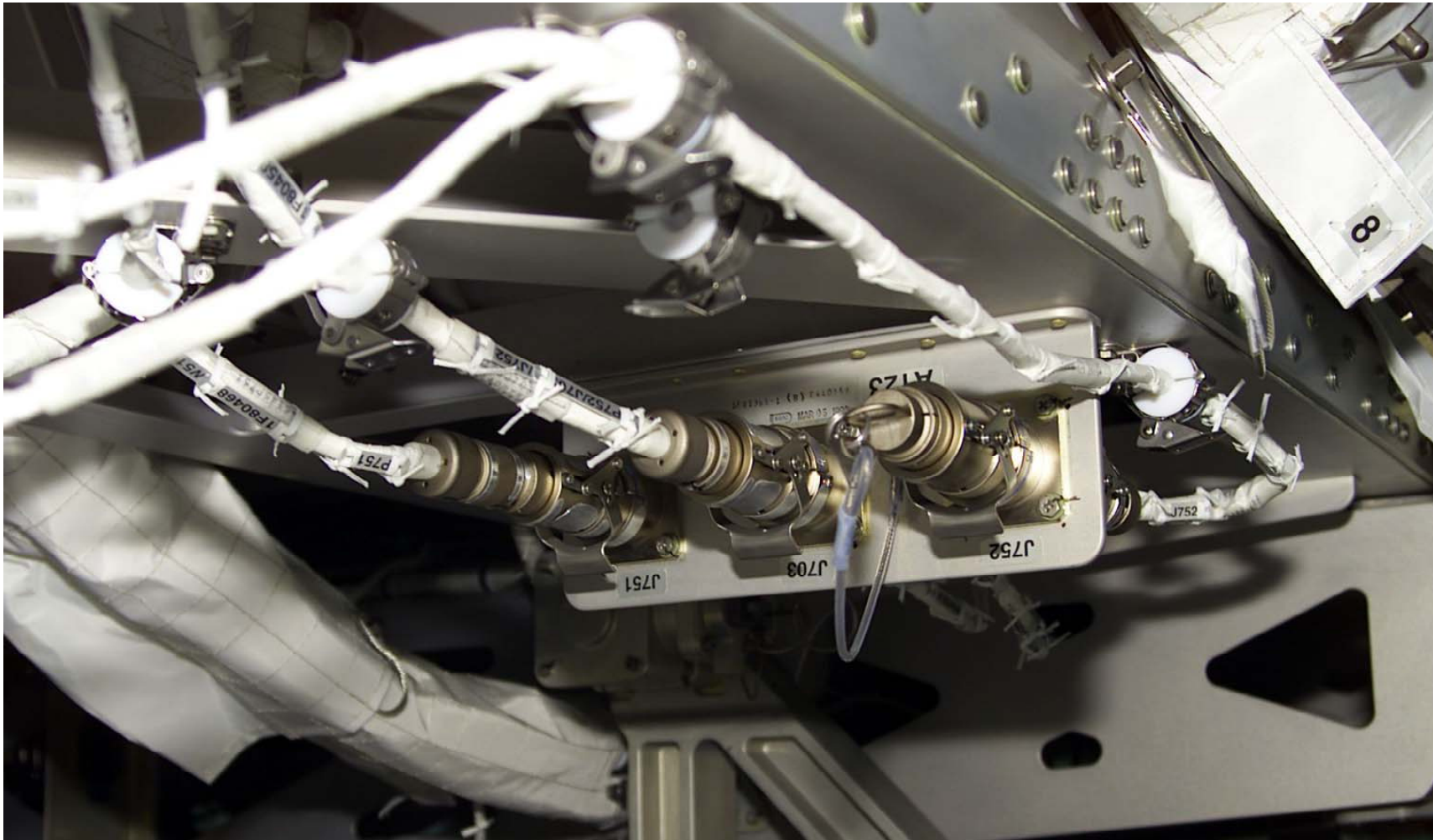

MBSU BYPASS JUMPER – PANELS A260 AND A200

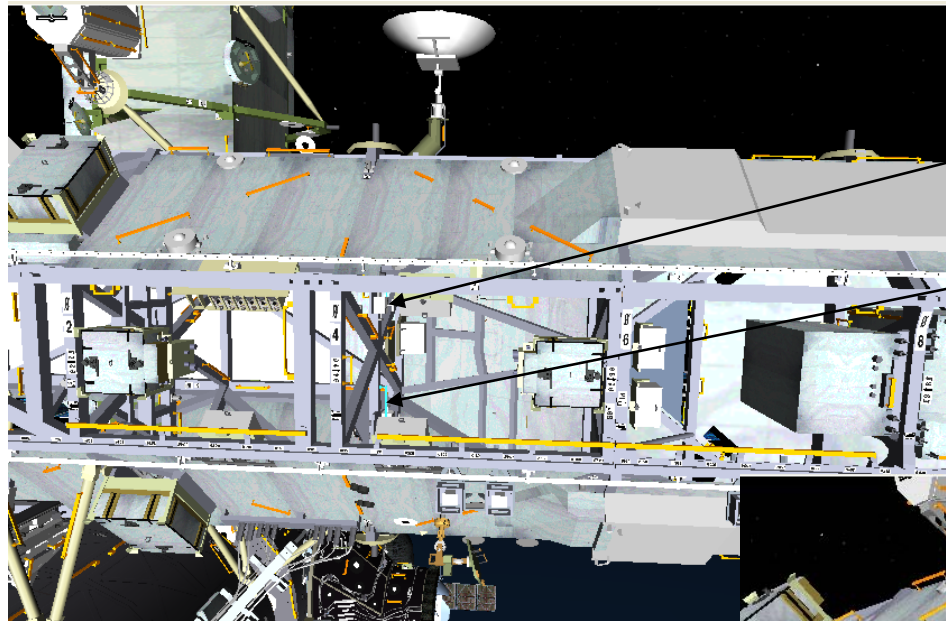

S0, Bay 4

HR 3533
Panel A200

HR 3536
Panel A260

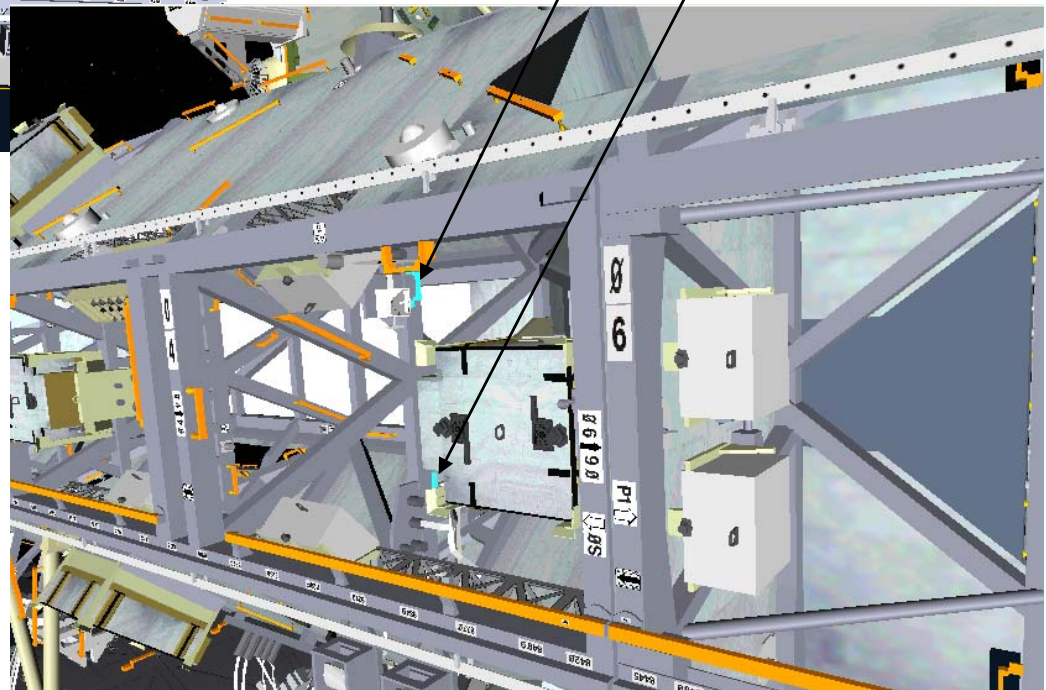

MBSU BYPASS JUMPER – PANELS A260 AND A200 (Cont)

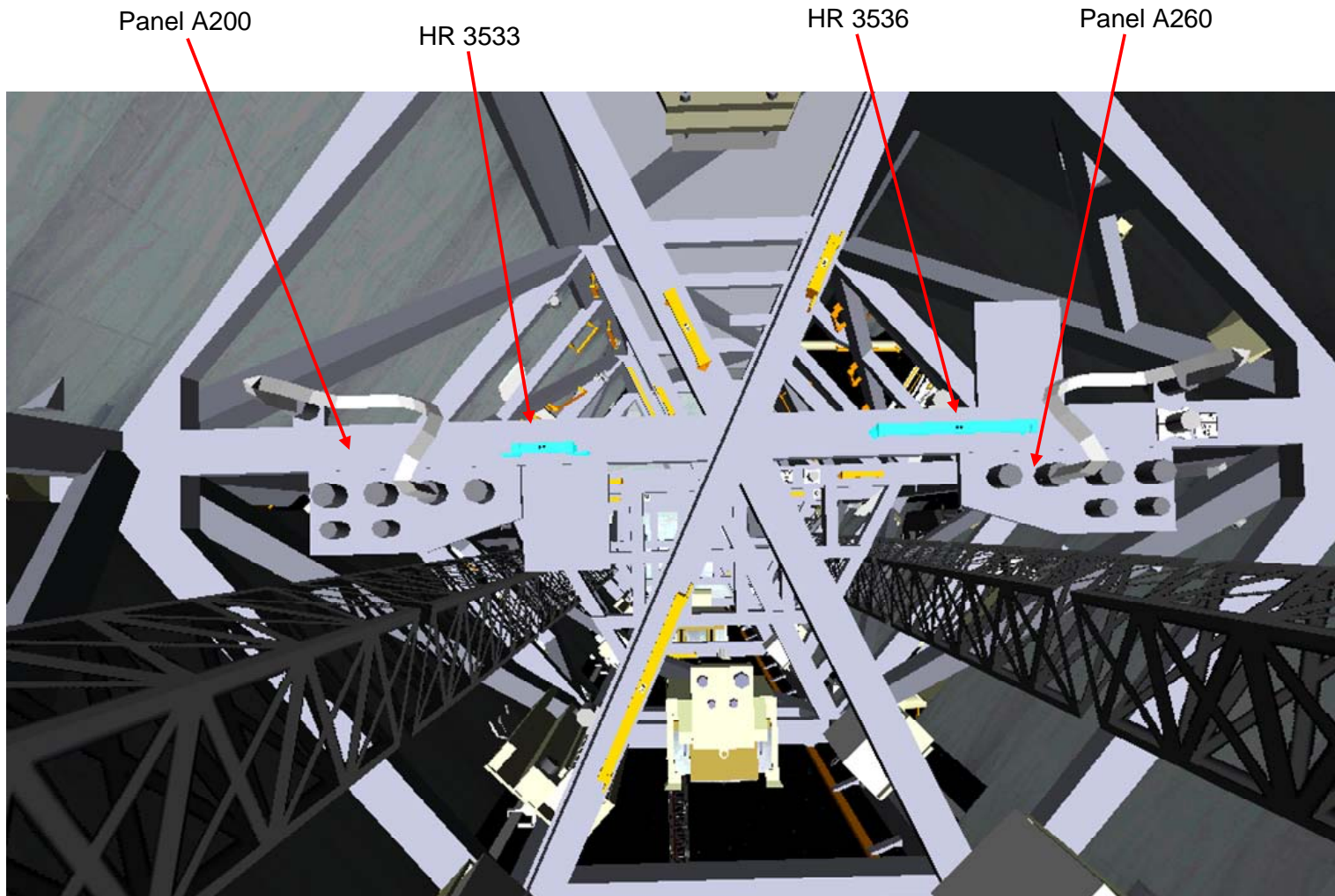

ISS Nadir
ISS Fwd

View looking stbd

NOTE: Jumper routing not flight-like

MBSU BYPASS JUMPER – PANELS A20 AND A200 (Cont)

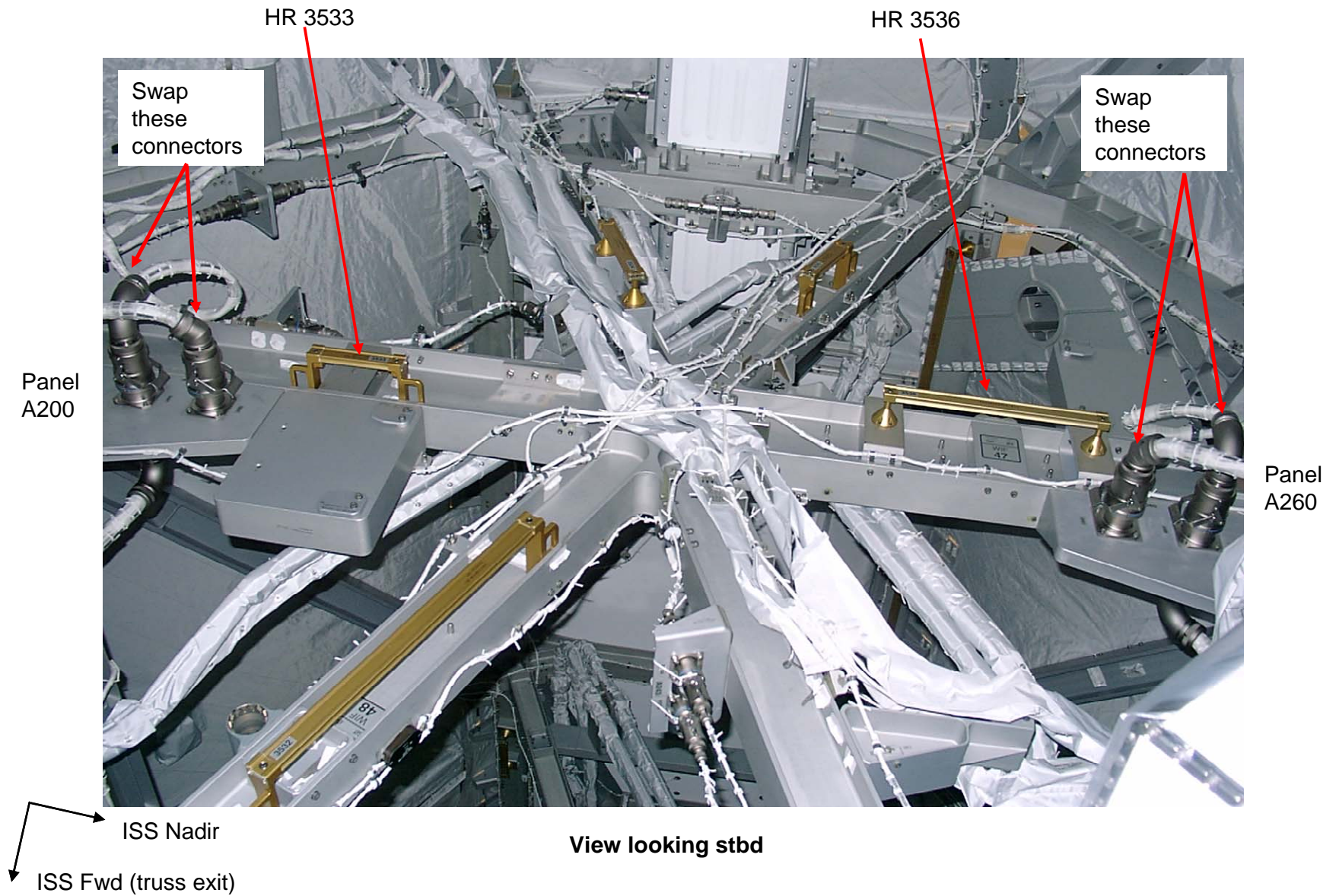

P6 TO P5 MEASUREMENTS

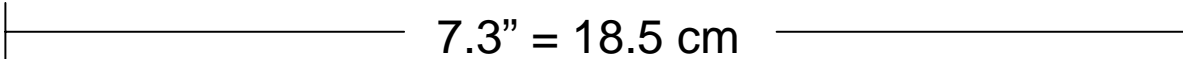
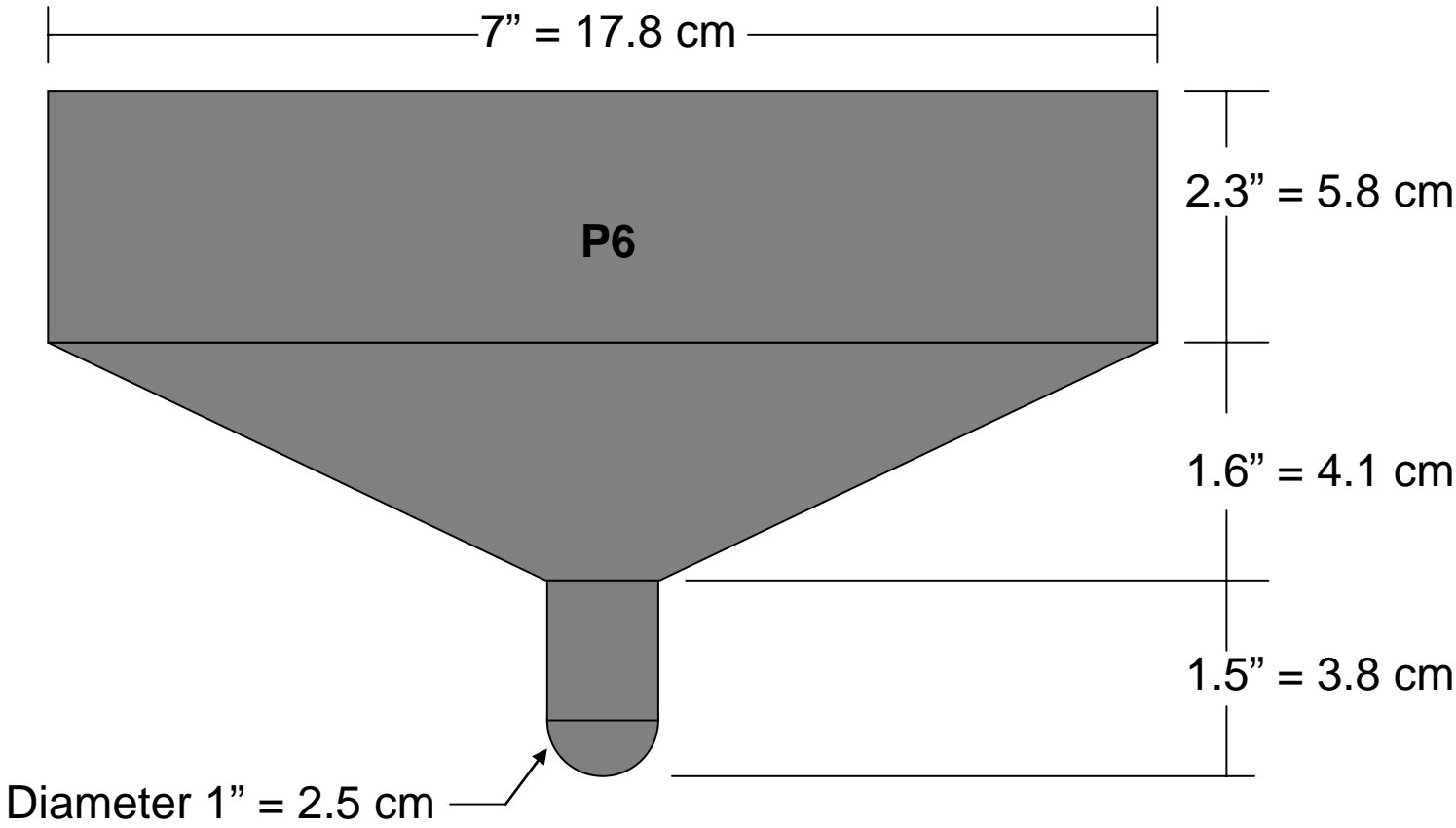

CANNON CONNECTOR CAPS INSTALLED ON P5

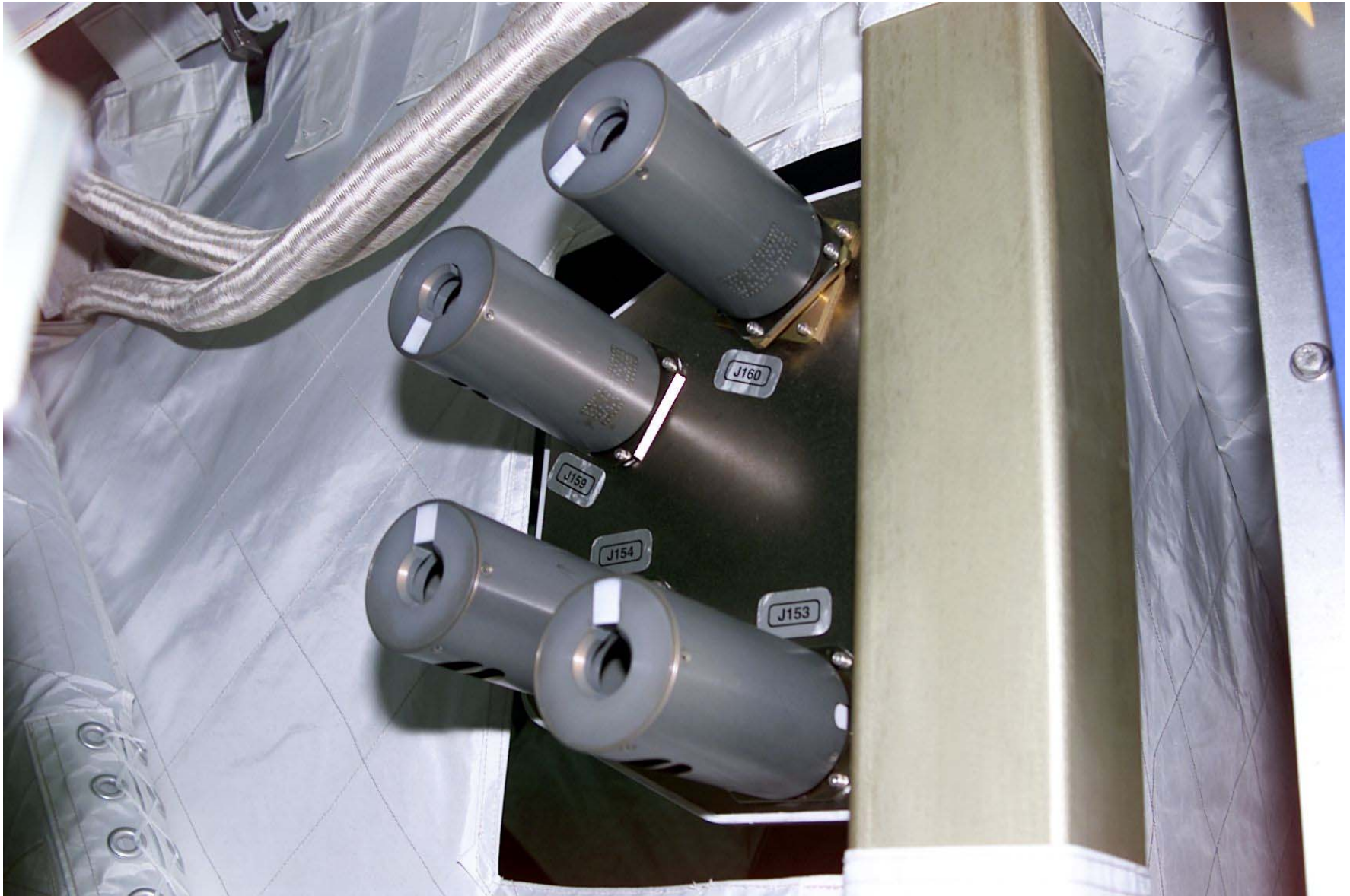

P6 SINGLE POINT GROUNDS (SPG)

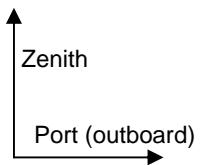
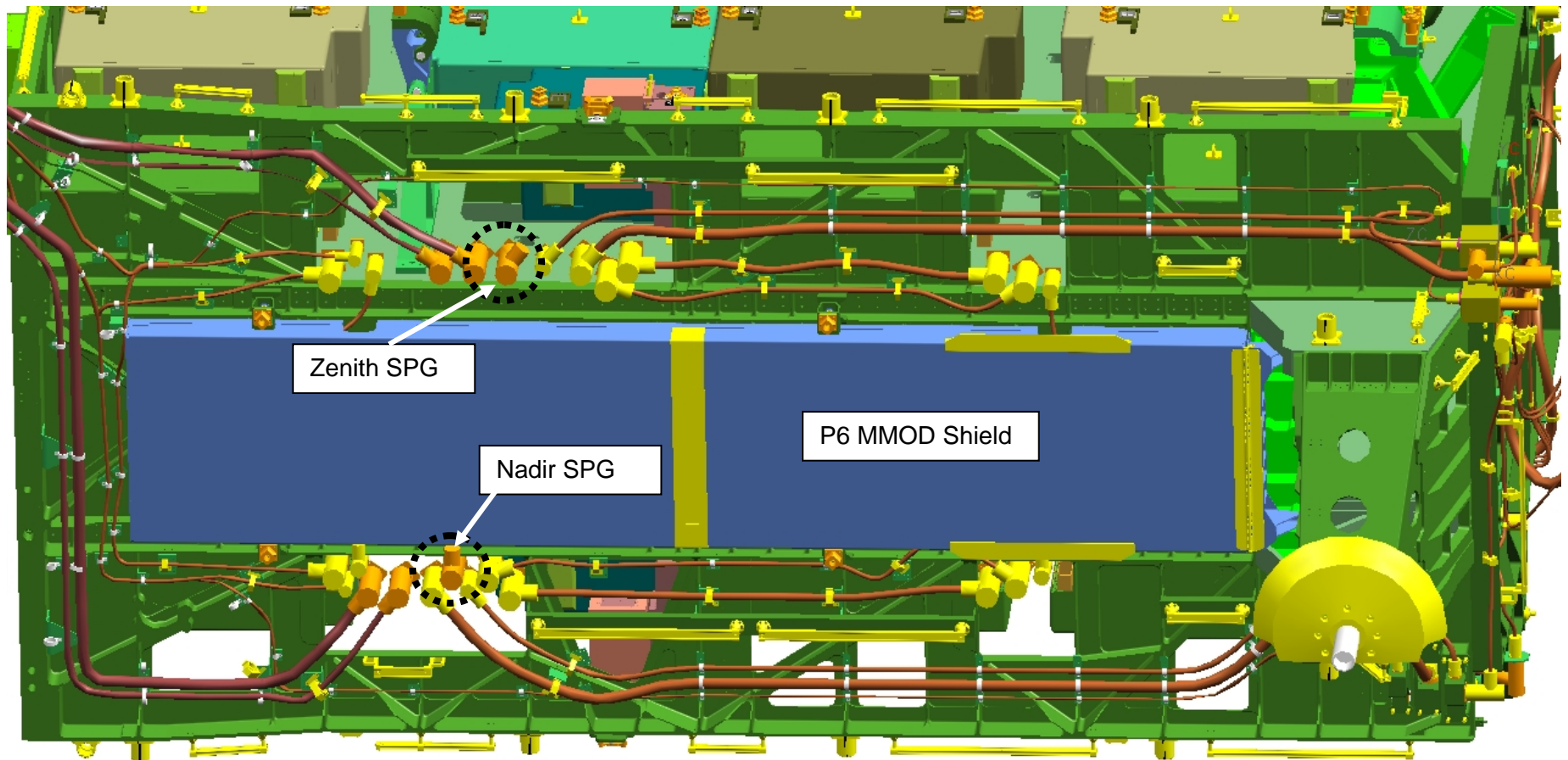

P6 SINGLE POINT GROUNDS (SPG) (Cont)



Zenith SPG

Nadir SPG



NOTE: Cannon Connector tool installed on connector nadir of SPG

P6 OUTBOARD RADIATOR

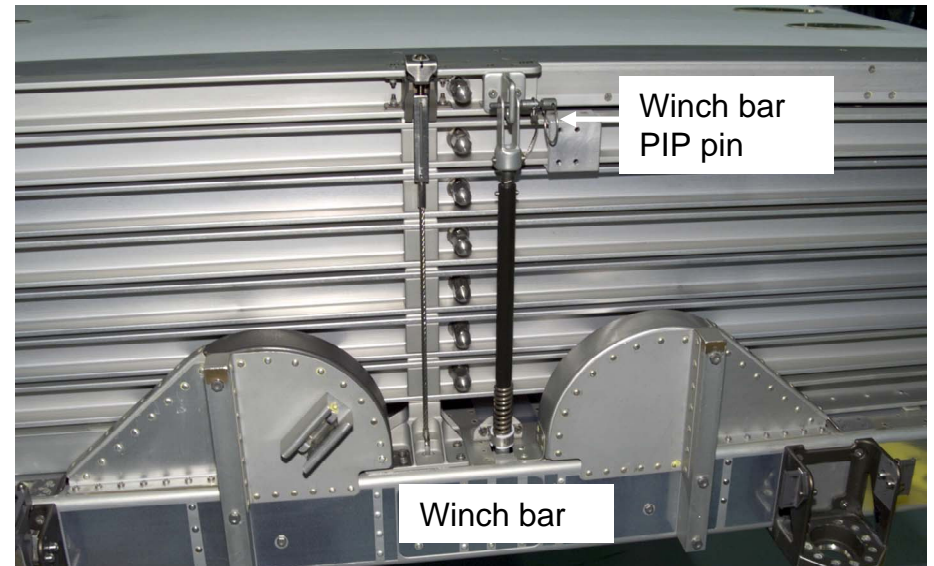
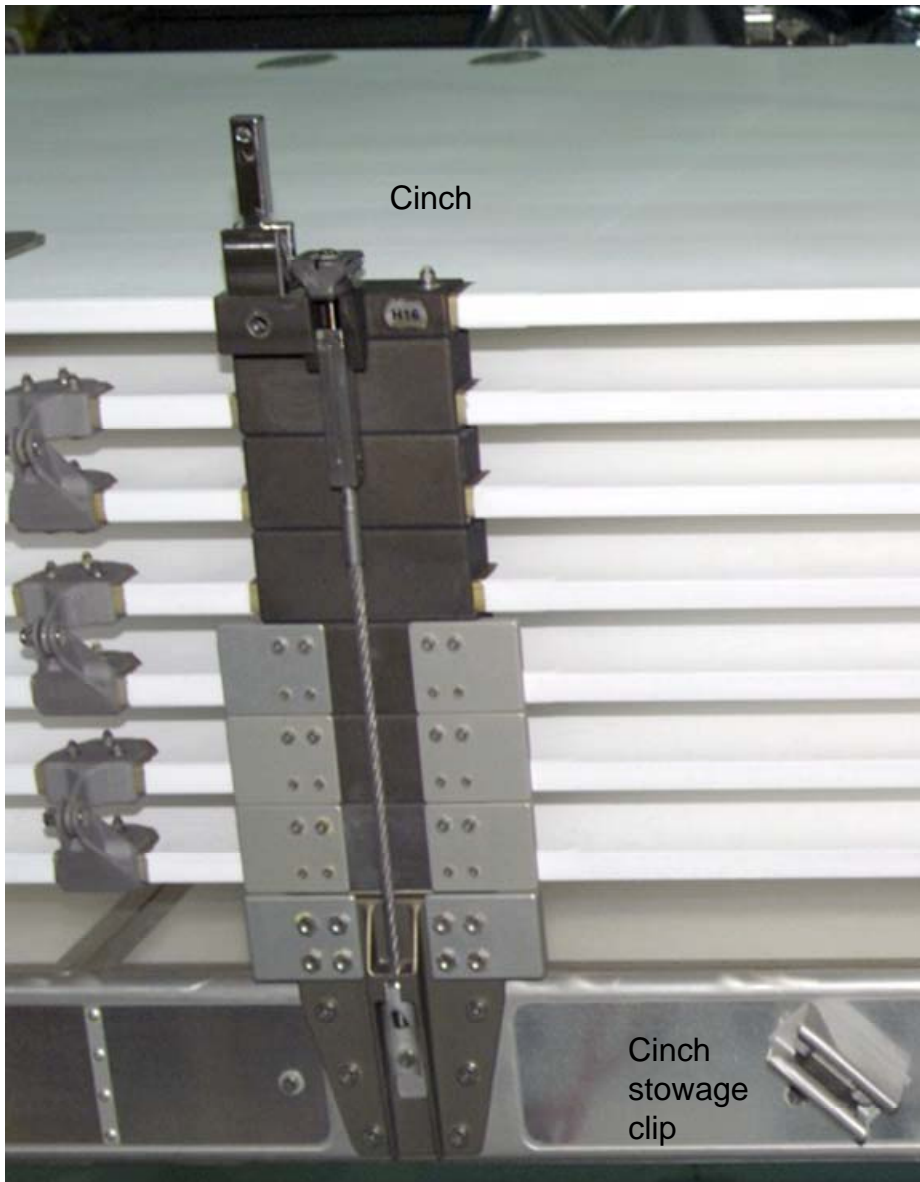

GAP CHECK TOOL

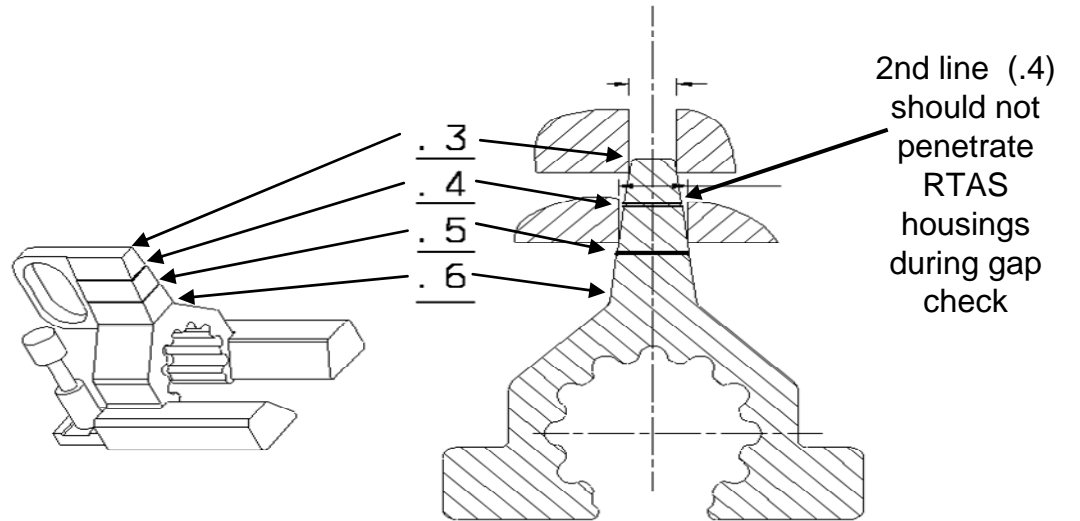
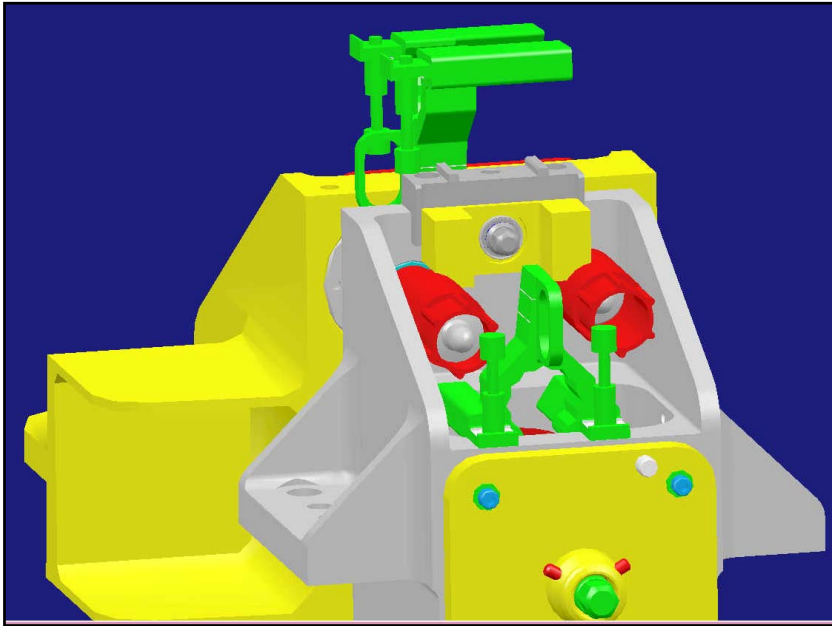

LAUNCH POSITION
(RTAS corner #1)



TOOL REMOVED

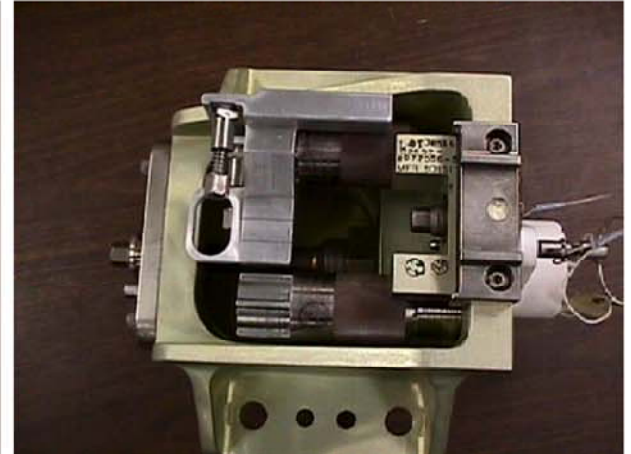

TOOL INSTALLED ON
RTAS CONTINGENCY SPACER SLEEVE

P5 CAPTURE LATCH ASSEMBLY (CLA)

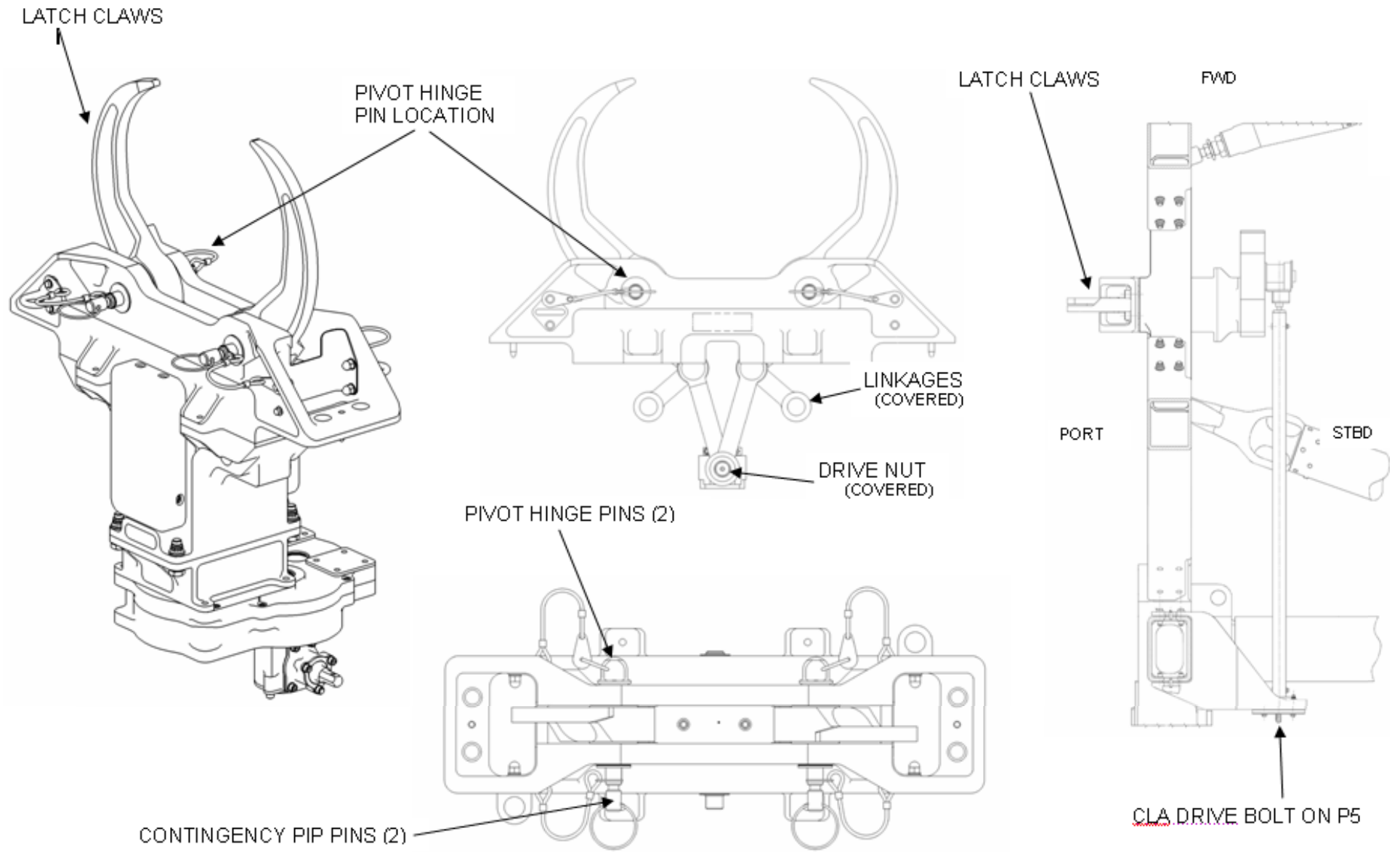

P6 SSU SHROUD MLI FOLDING SEQUENCE



1. Remove shroud



2. Fold in sewn short side



3. Fold in long sides



3. Fold in long sides



4. Fold shroud in half



5. Stow short straps inside bundle
6. Secure Velcro on man-purse

MBSU STACK-UP

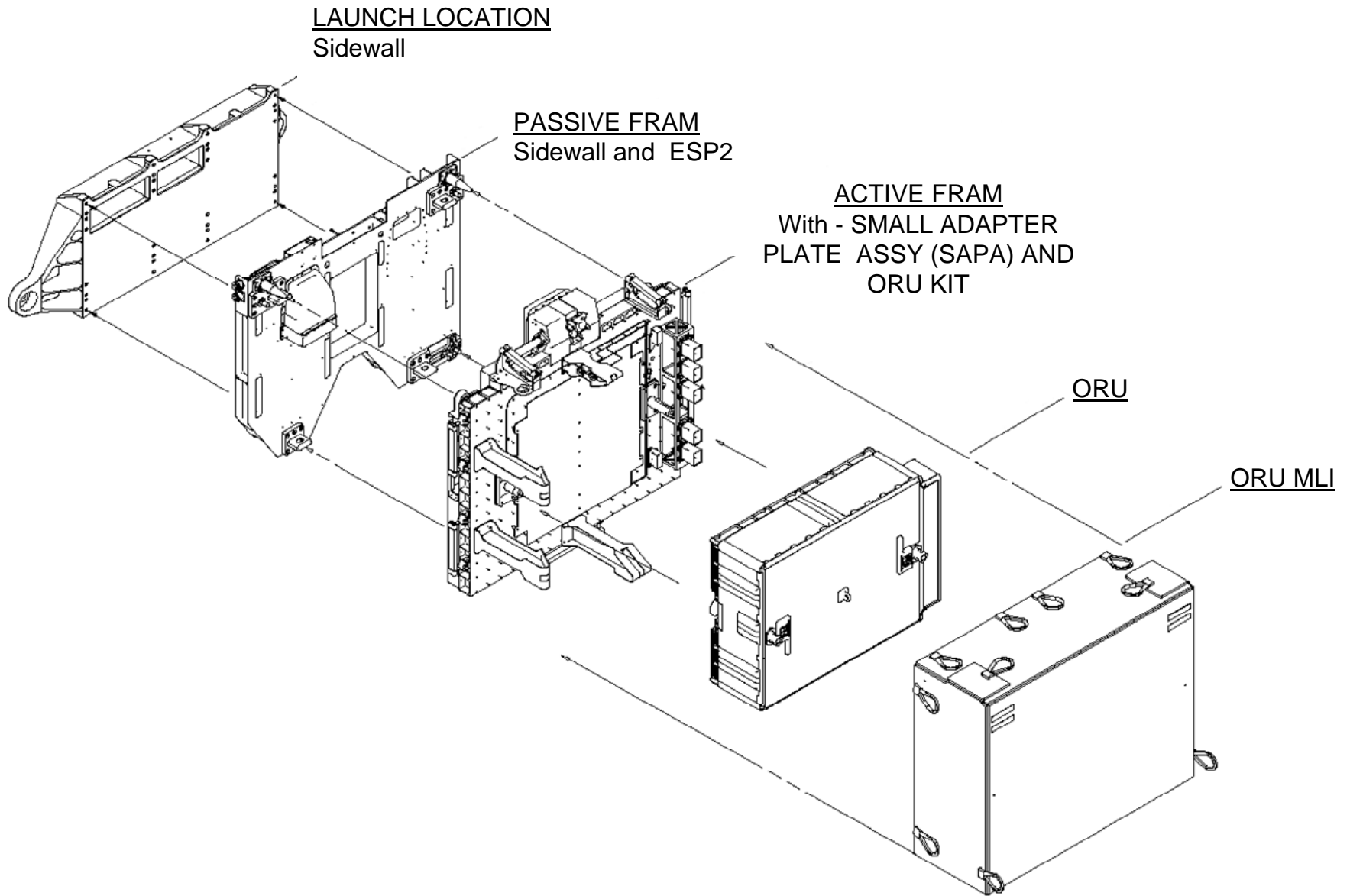

MBSU IN PAYLOAD BAY

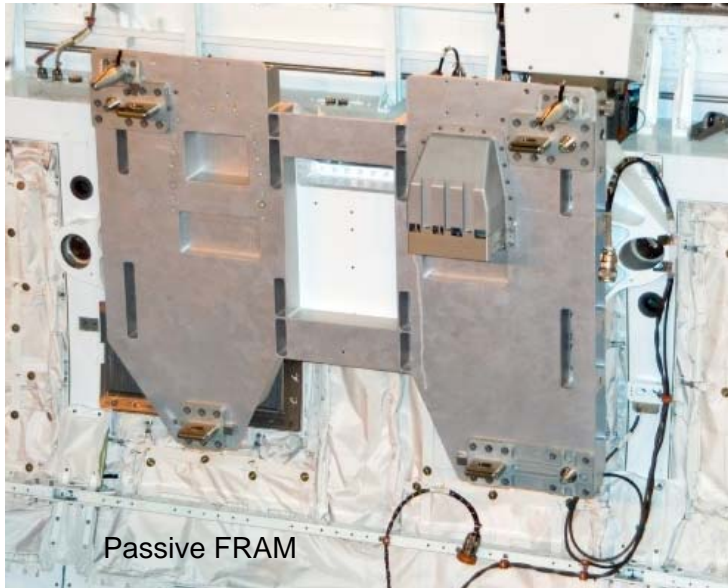

Passive FRAM



MBSU/Active FRAM on Passive FRAM



Active FRAM Primary Bolt

MBSU PASSIVE FRAM ON ESP-2

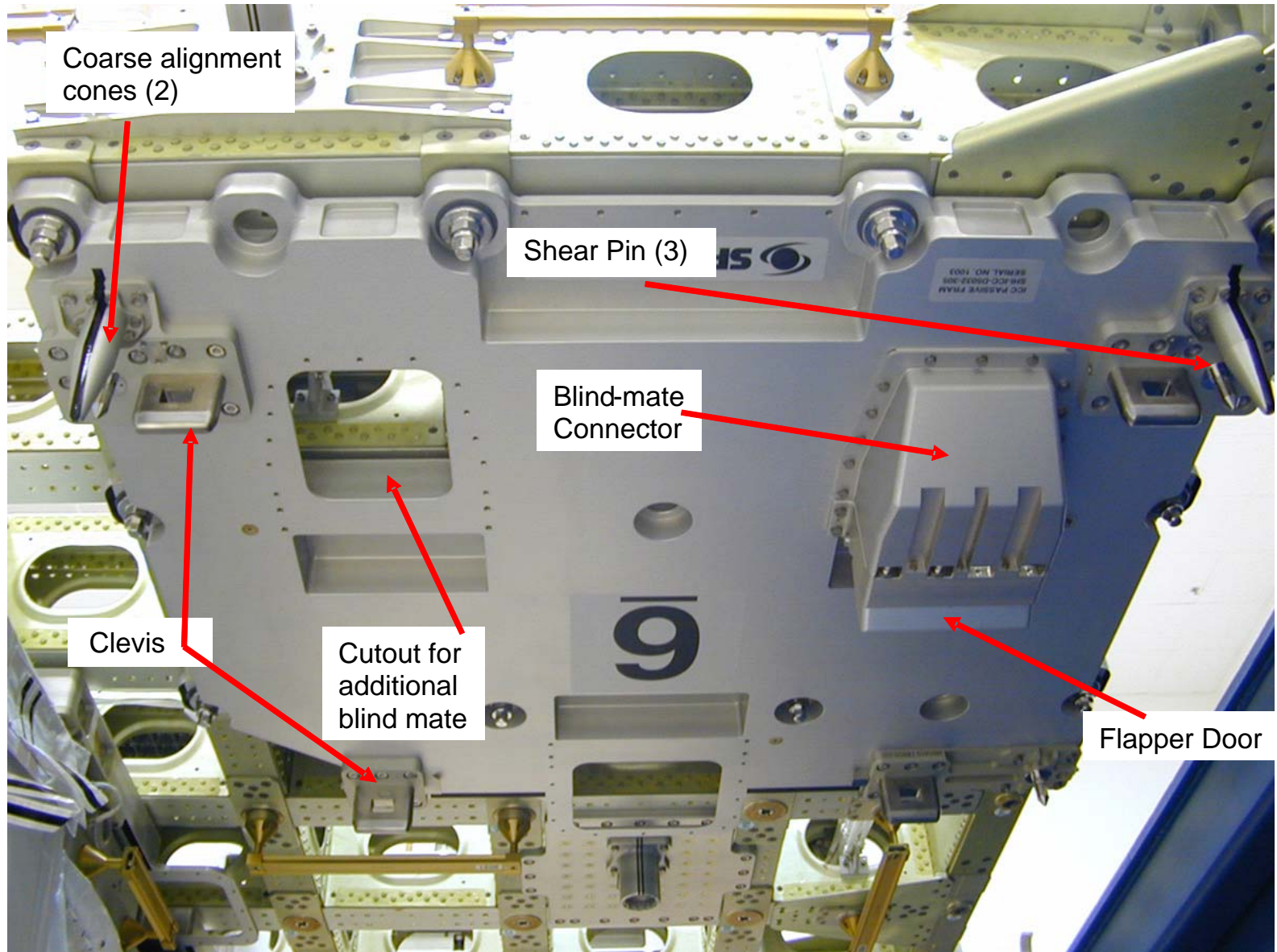

Lab

FHRC

MBSU ACTIVE FRAM FLIGHT SUPPORT EQUIPMENT

MBSU FSE
ON ACTIVE
FRAM

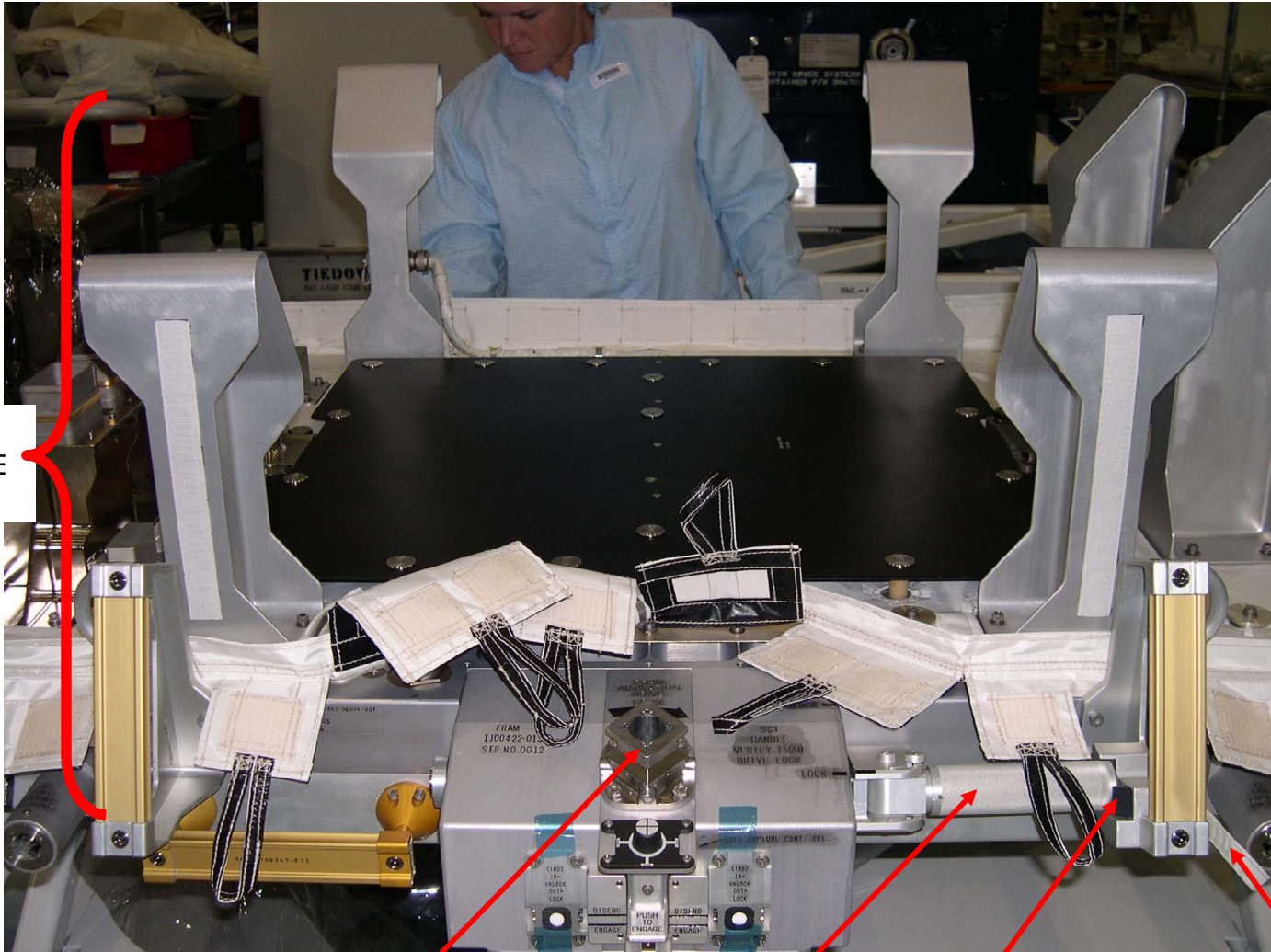

Primary Bolt

Override Lever

Lever Locking
Tab

Lanyard to pull
to retract lever
locking tab

MBSU ACTIVE FRAM CONTINGENCY PINS

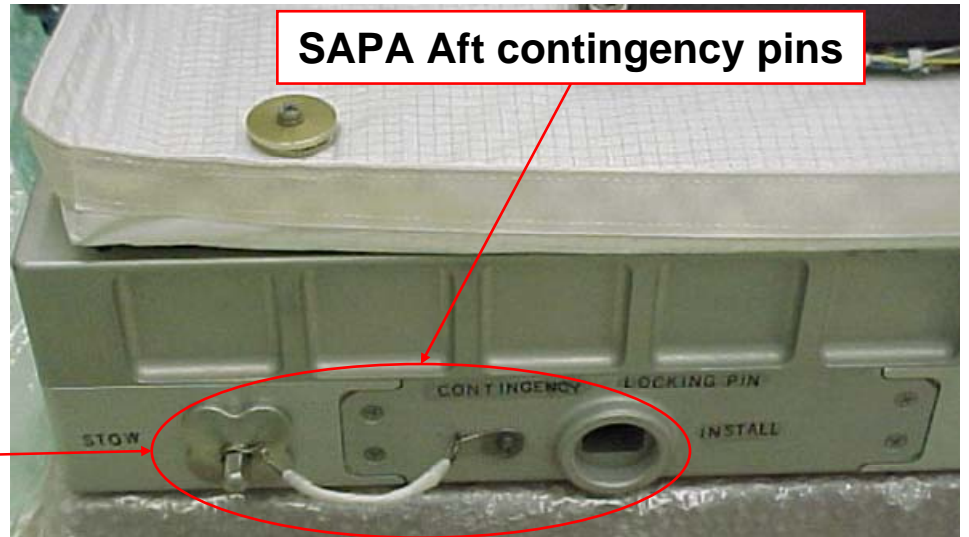
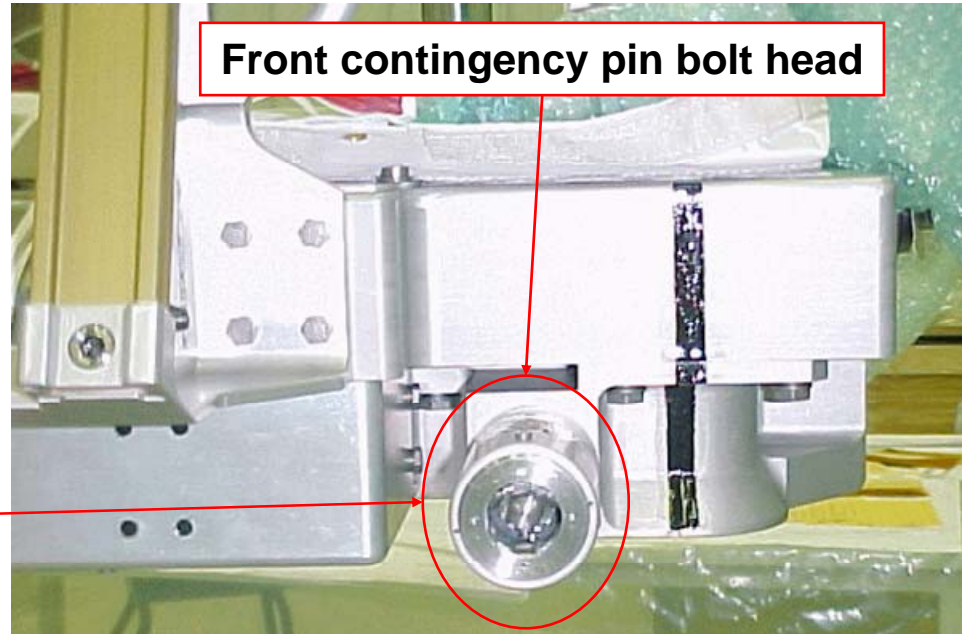
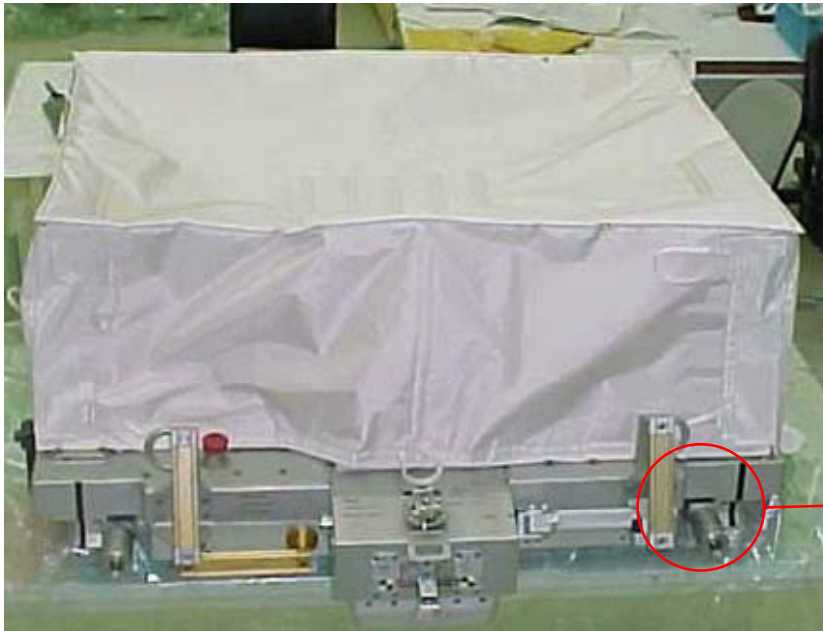

LAB SSPTS BAGS

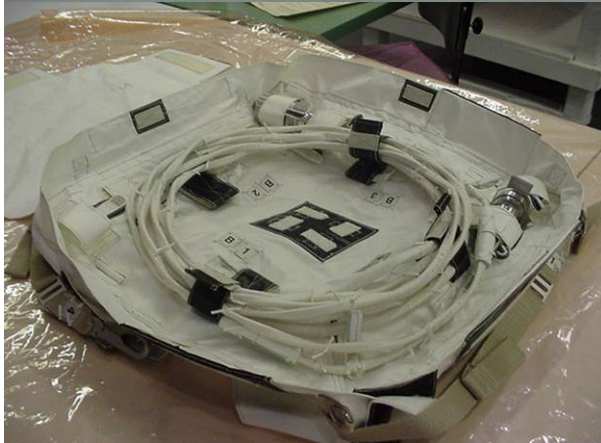

FS 18-45

EVA/120/FIN A

EVA 5

NODE 2 ACBM COVER (SHOWER CAP) BELT STRAP



Belt strap routed around stovepipe clip

NODE 2 ACBM COVER (SHOWER CAP) GROUNDING FASTENERS



Velcro to release belt strap

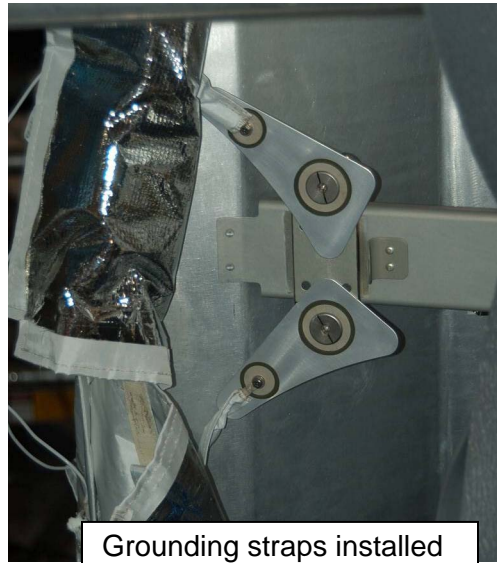

Grounding straps installed

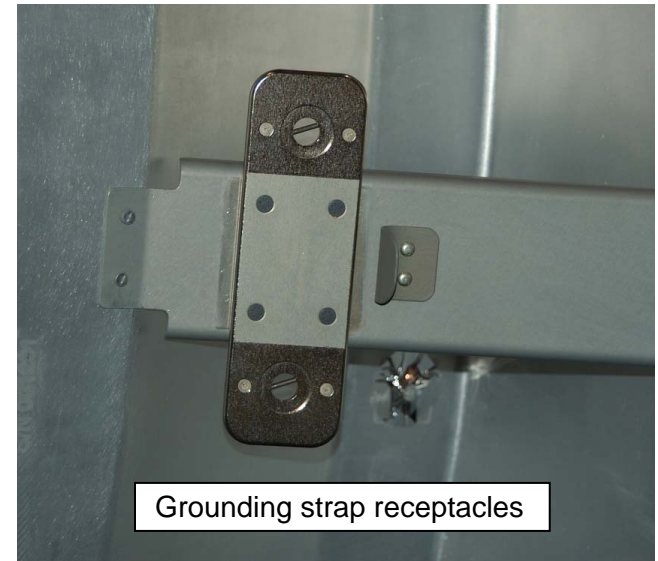

Grounding strap receptacles

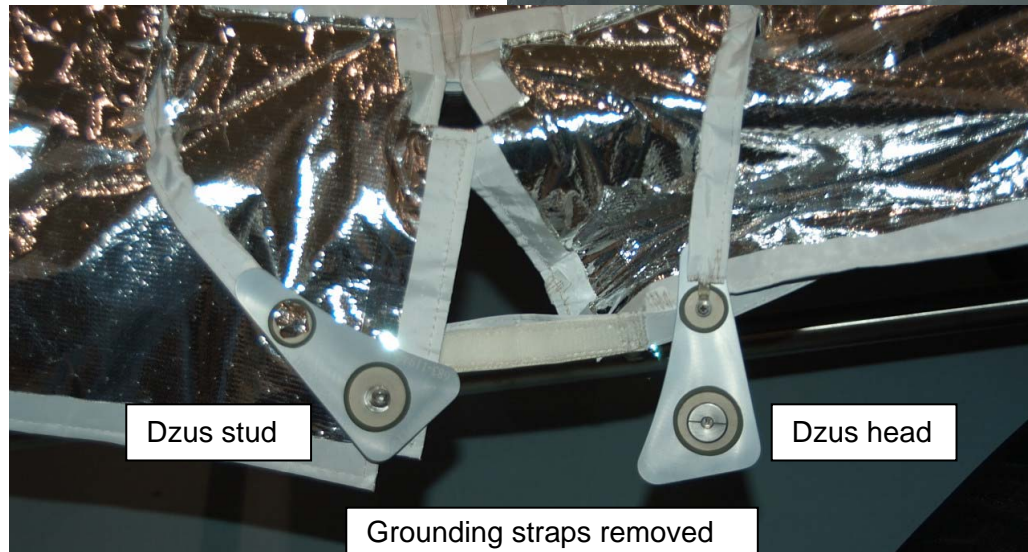

Dzus stud

Dzus head

Grounding straps removed

FGB/PMA 1 H-JUMPER 1/4

1. Peel back booties on H-jumper (2) and FGB (2)

NOTE: H-Jumper 2/3 removed on 12A.1

2. Demate H-jumper from FGB cables

3. Demate H-jumper from PMA cables on feed-through bracket

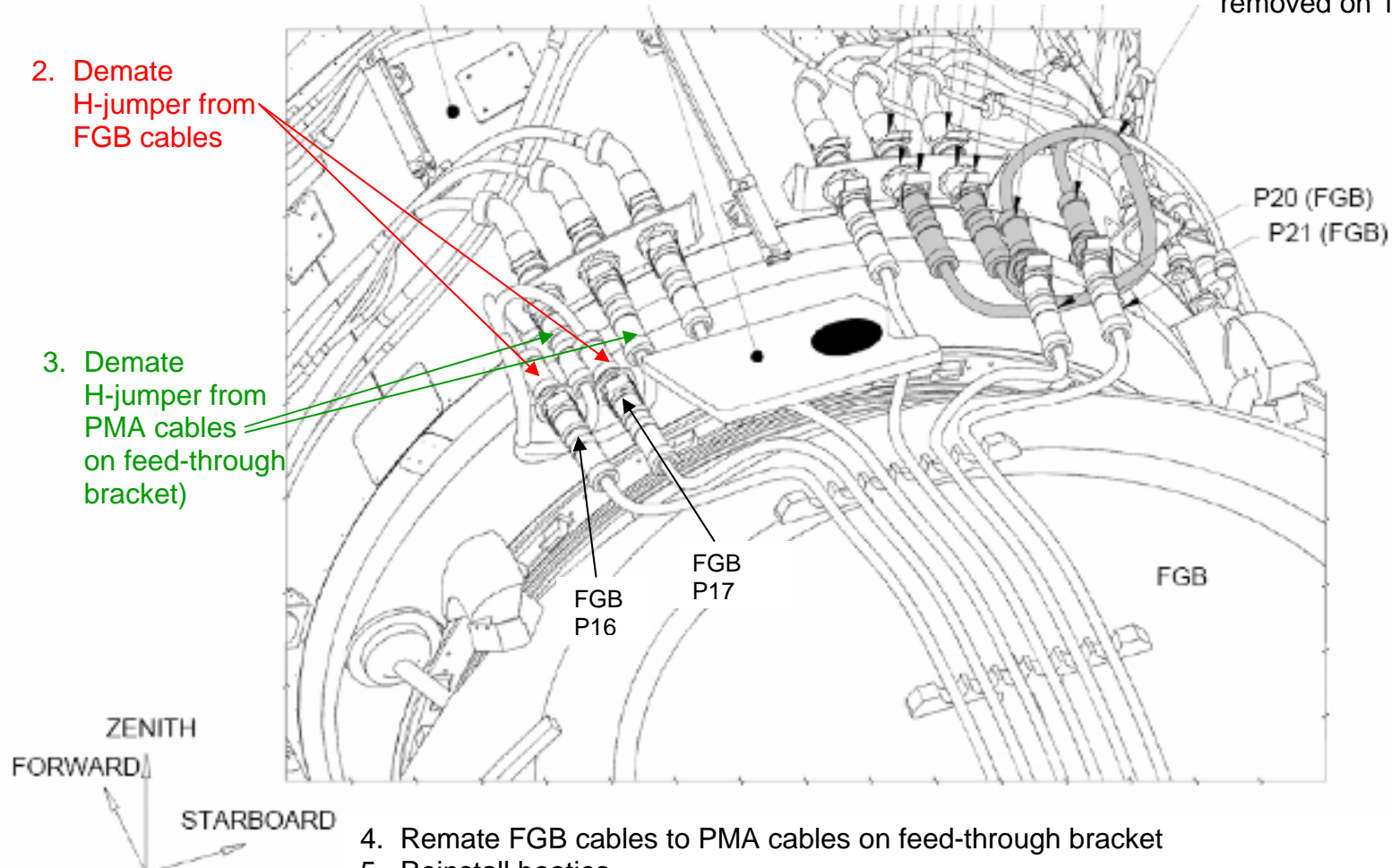

4. Remate FGB cables to PMA cables on feed-through bracket
5. Reinstall booties

LAB MMOD SHIELD

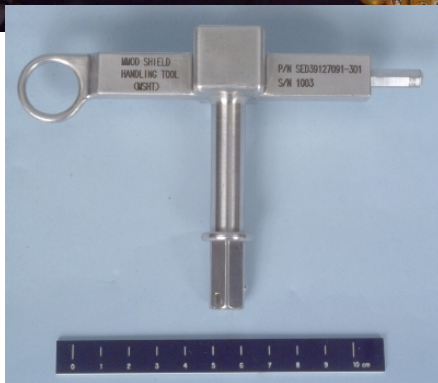
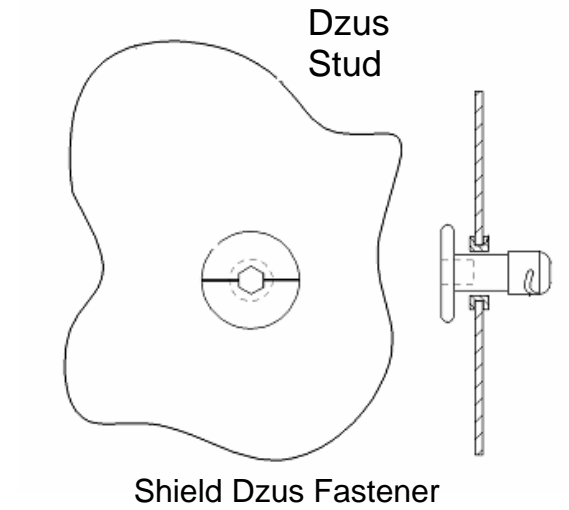
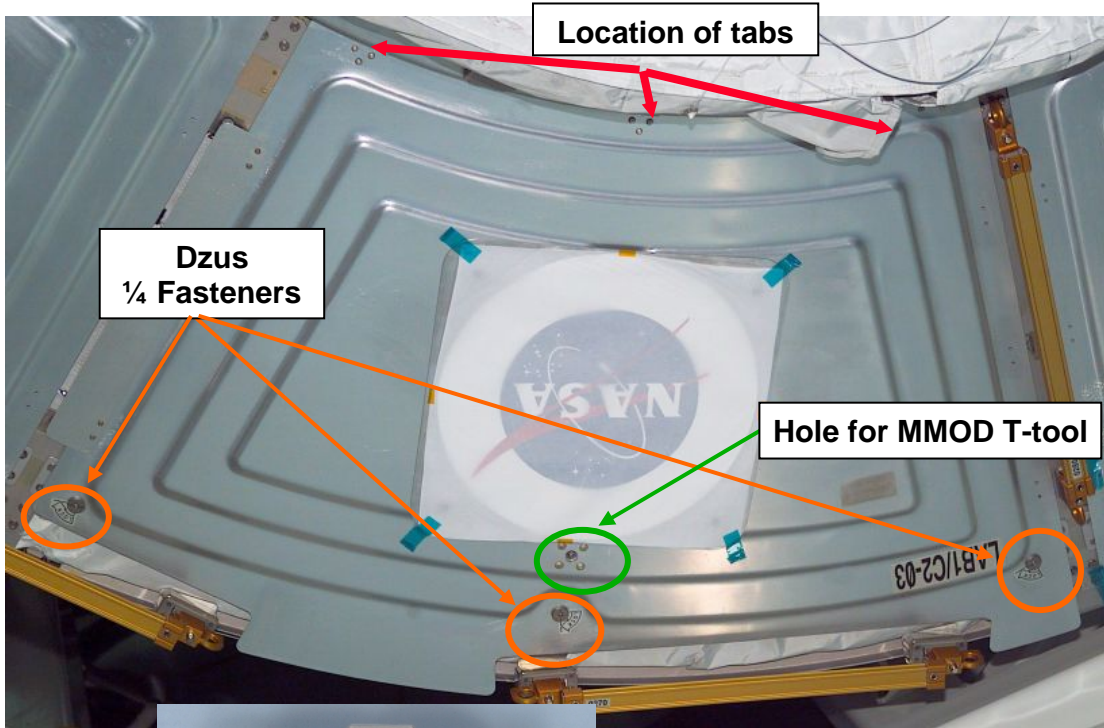

MMOD T-tool



LAB MMOD SHIELD TABS

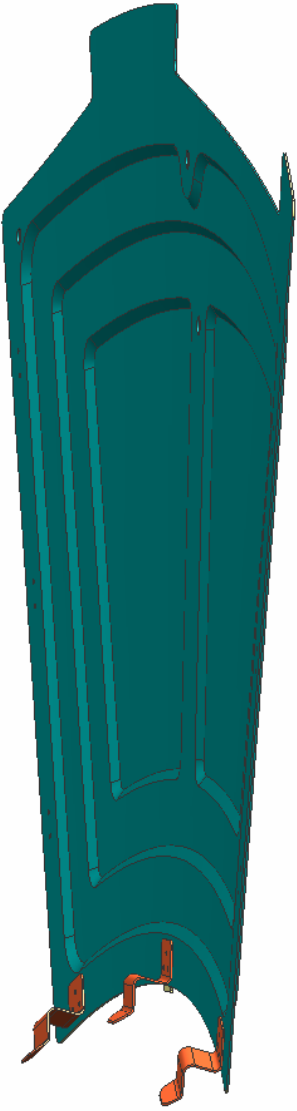
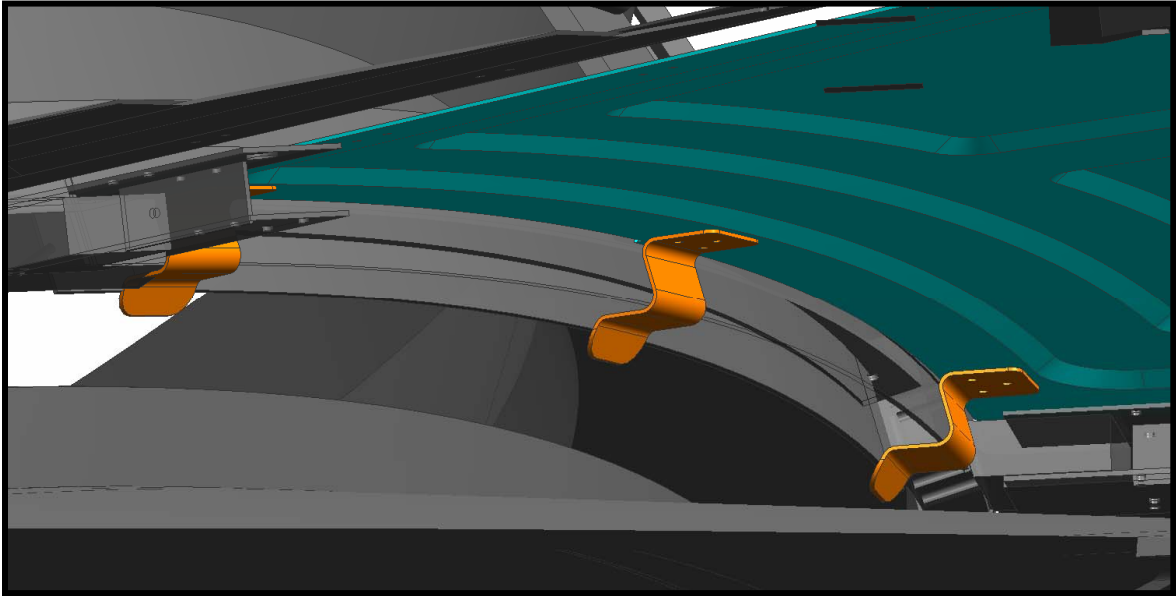
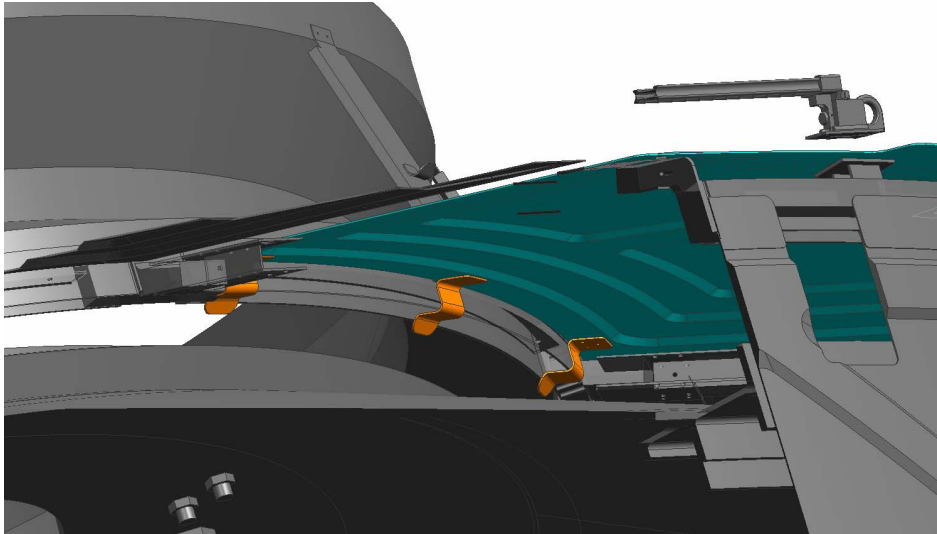

FS 18-50

EVA/120/FIN A

S1 RADIATOR OVERVIEW

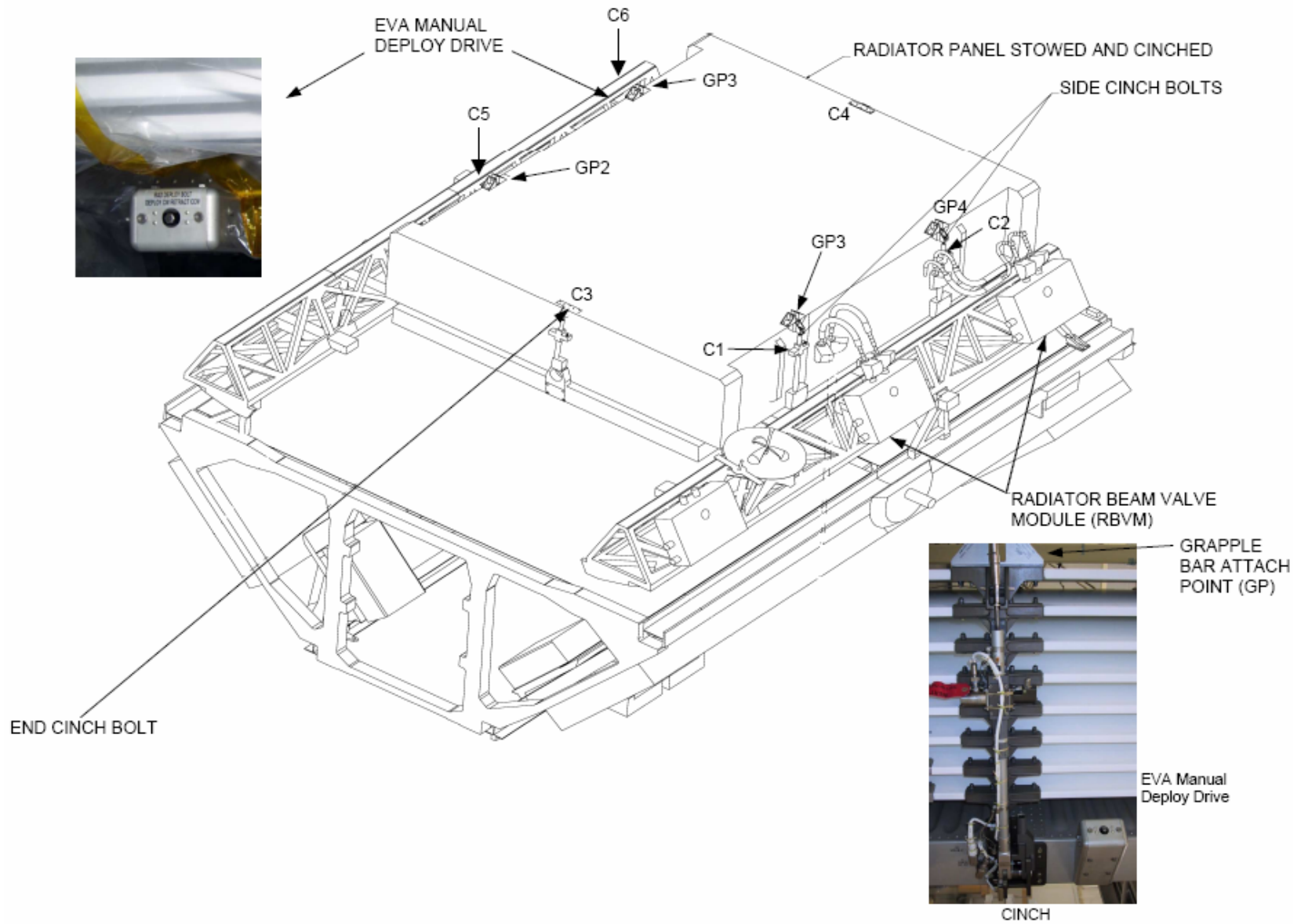

FS 18-51

EVA/120/FIN A

CONTINGENCY

CONTINGENCY

S1 RADIATOR CINCH RELEASE

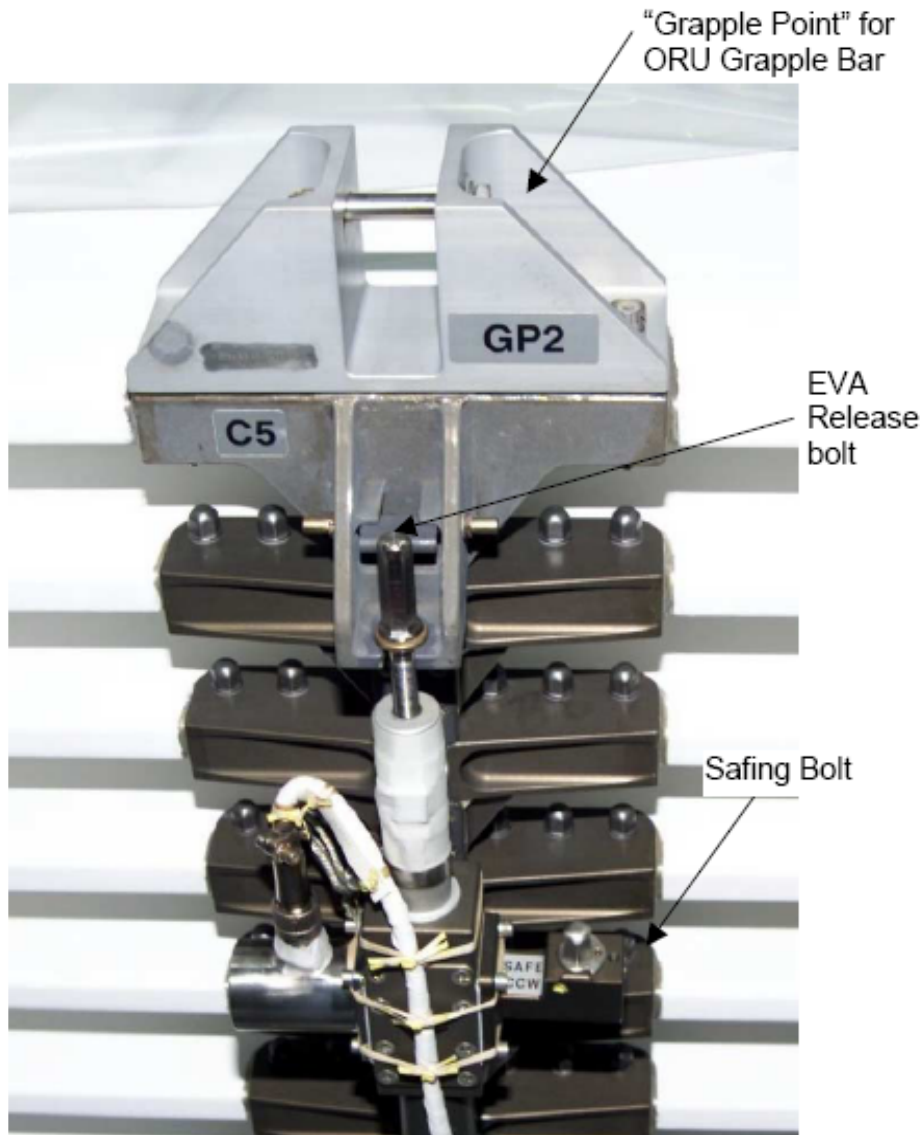

CINCH INSTALLED

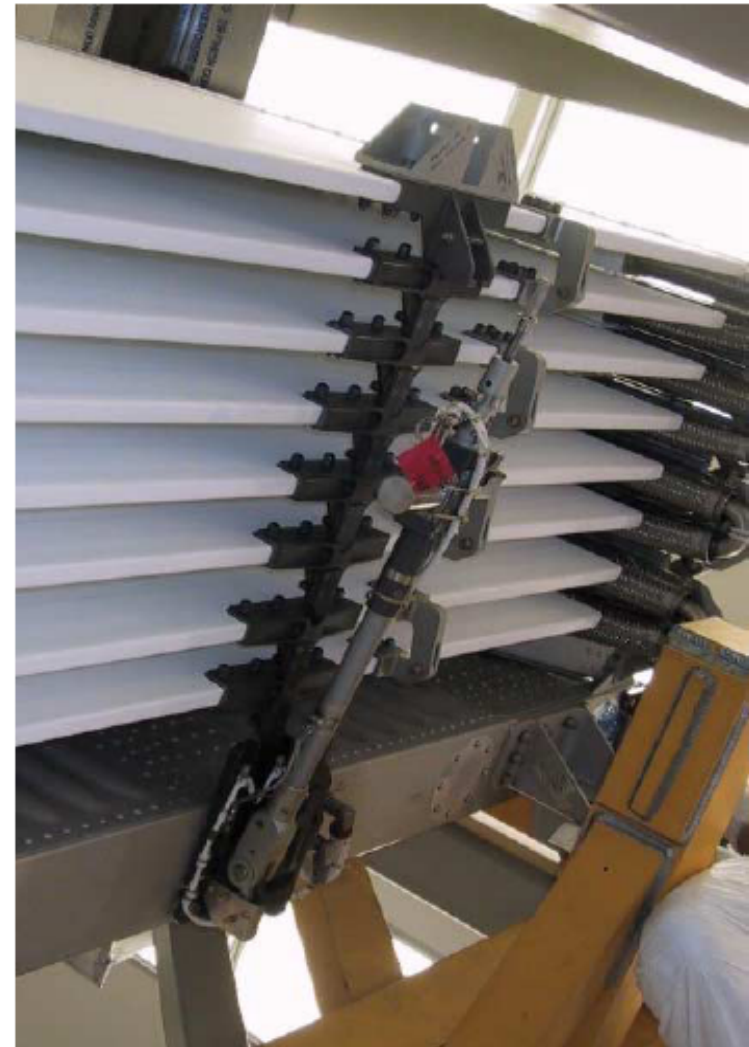

CINCH DEPLOYED

P5/P6 PRD ROUTING (CORNER 1)

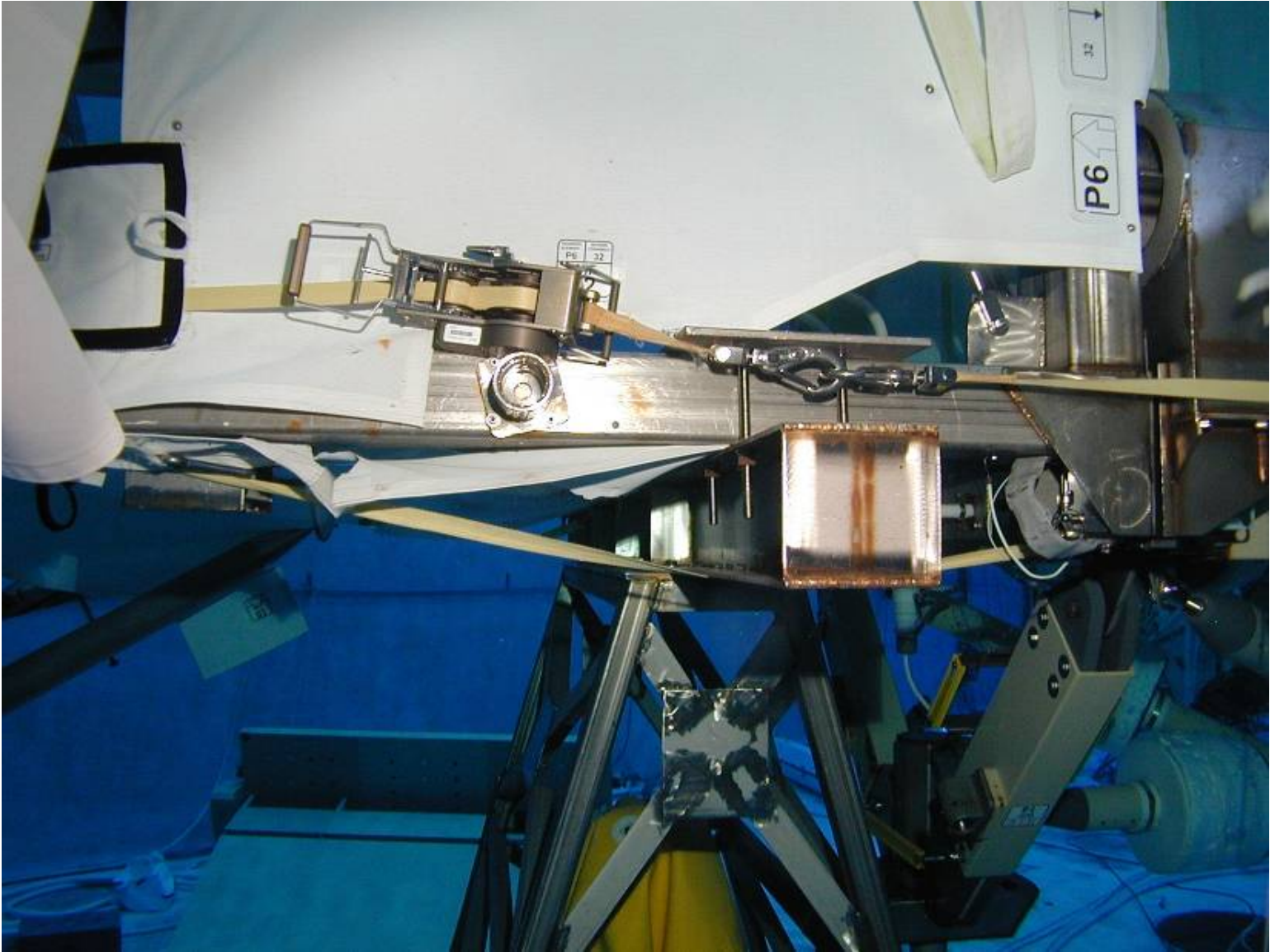

P5/P6 PRD ROUTING (CORNER 2)

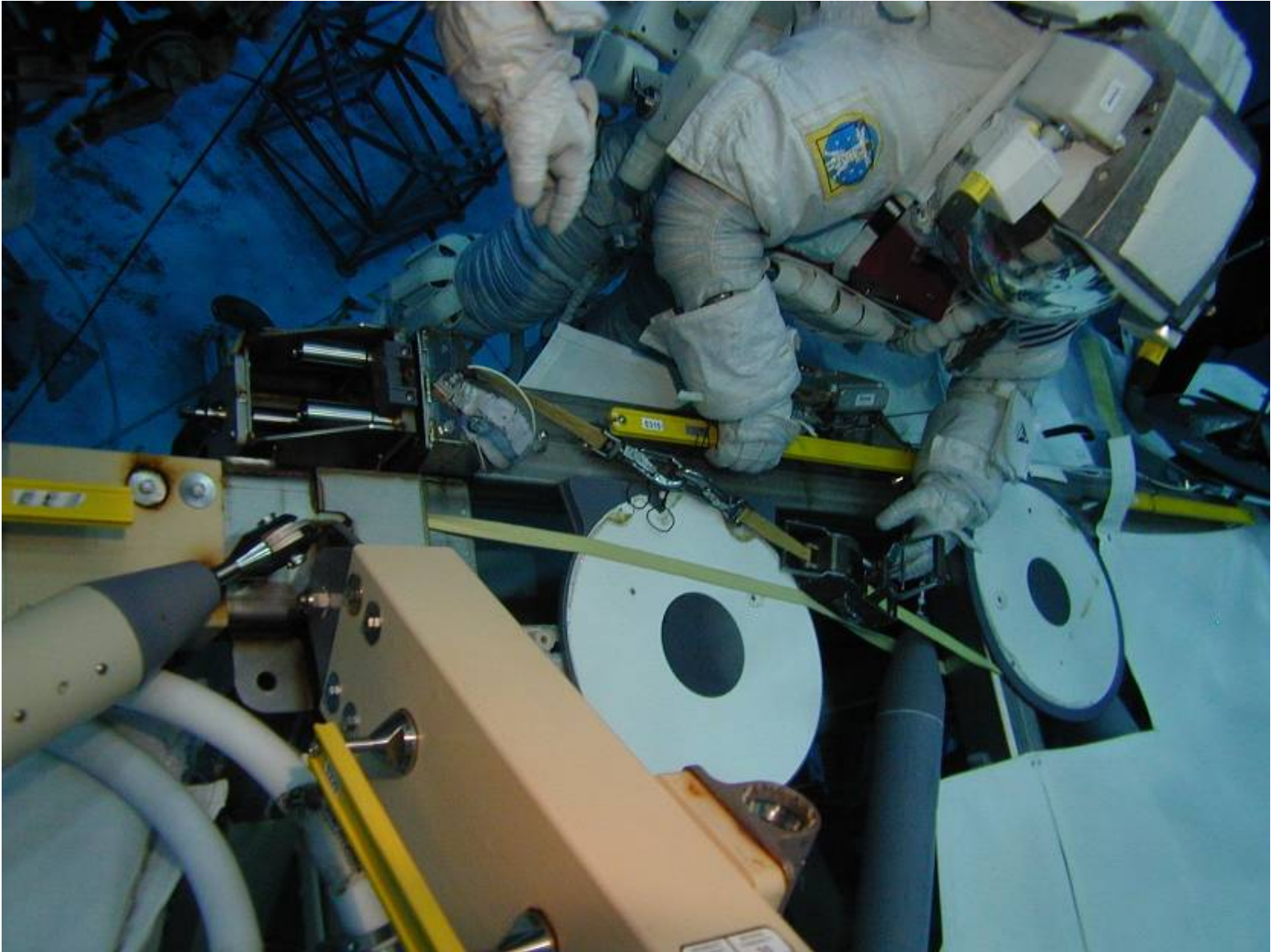

P5/P6 PRD ROUTING (CORNER 3)

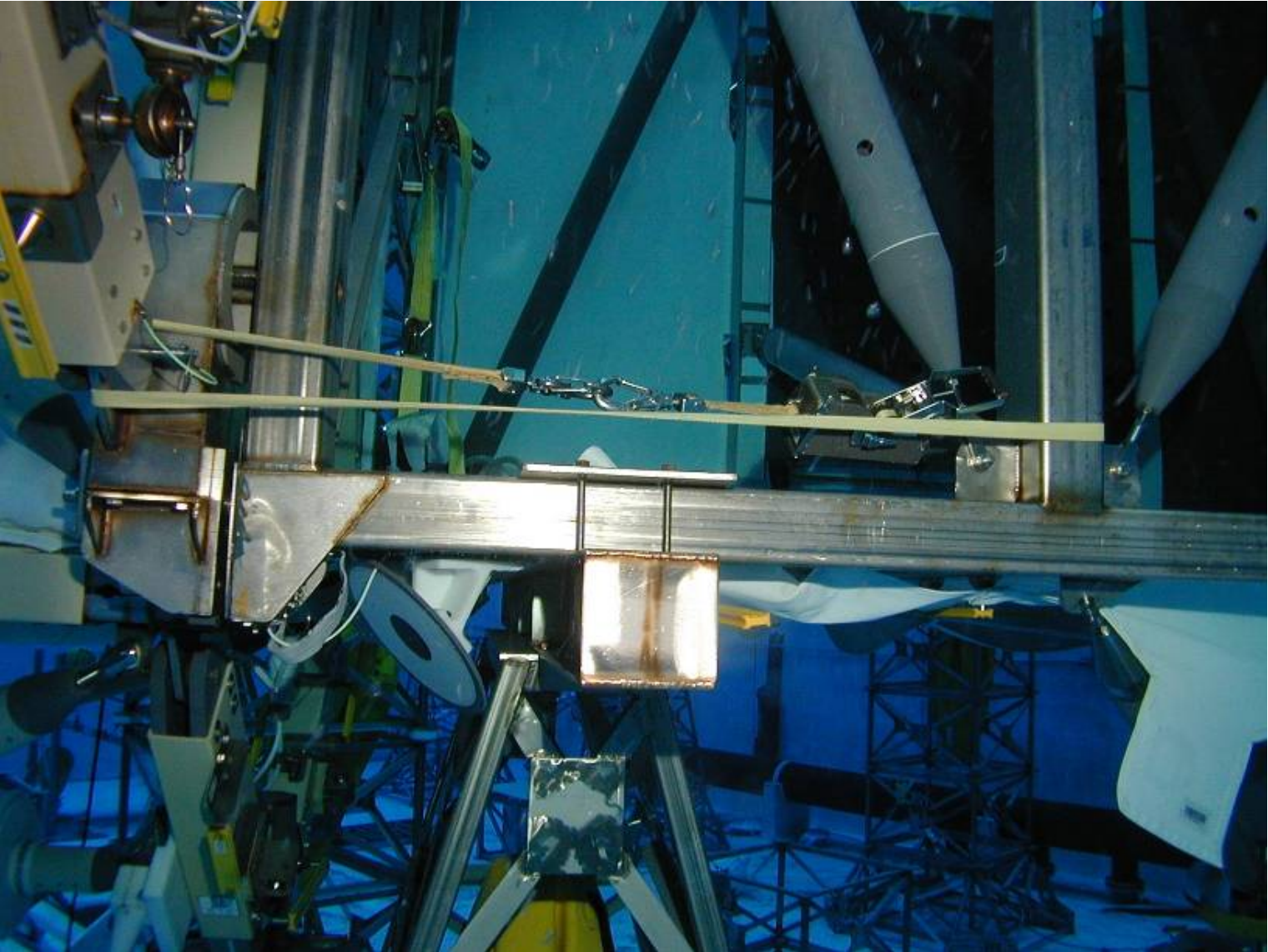

P5/P6 PRD ROUTING (CORNER 4)

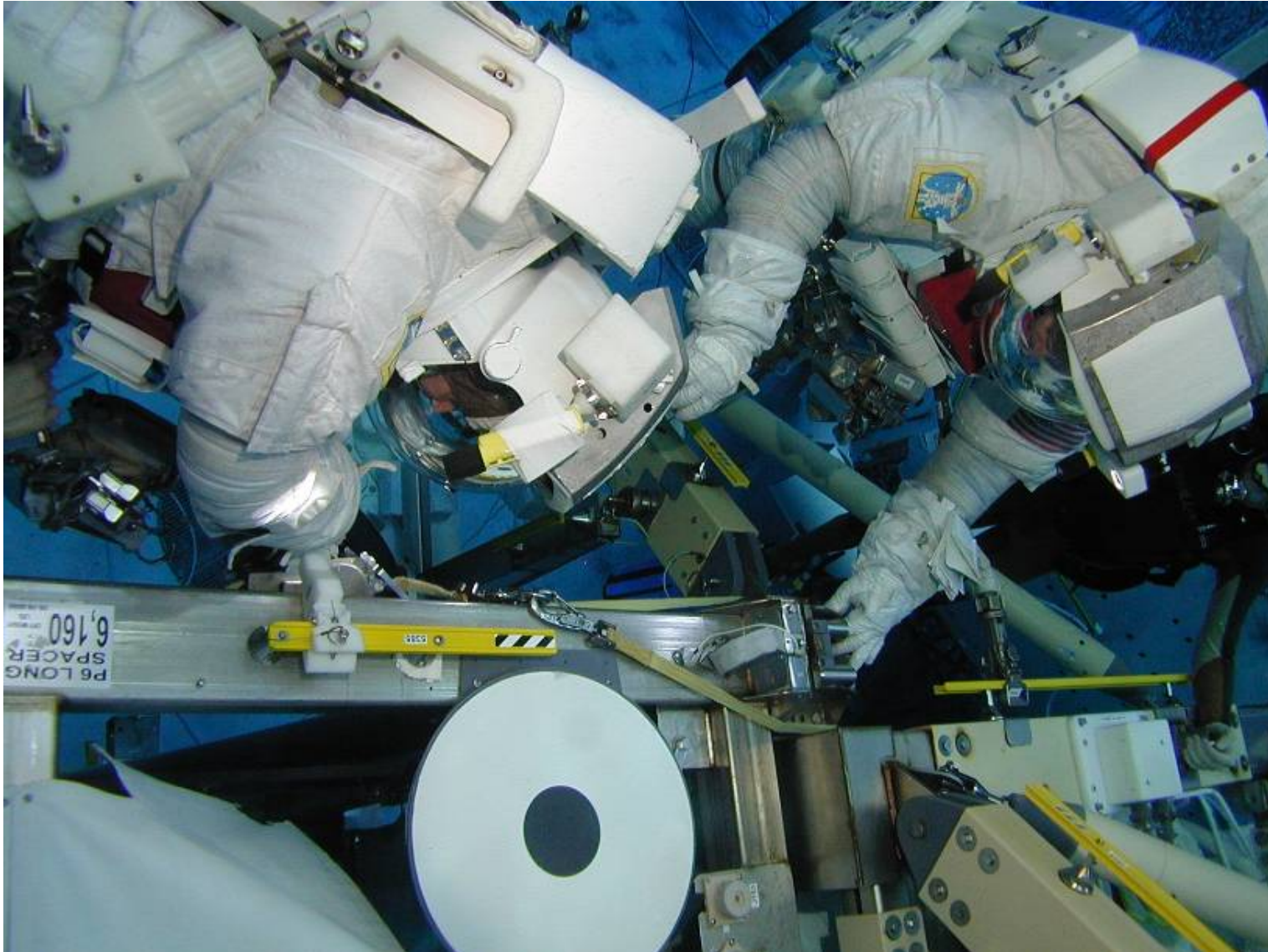

P5/P6 PRD ROUTING (STRAP ROUTING CORNER 4)

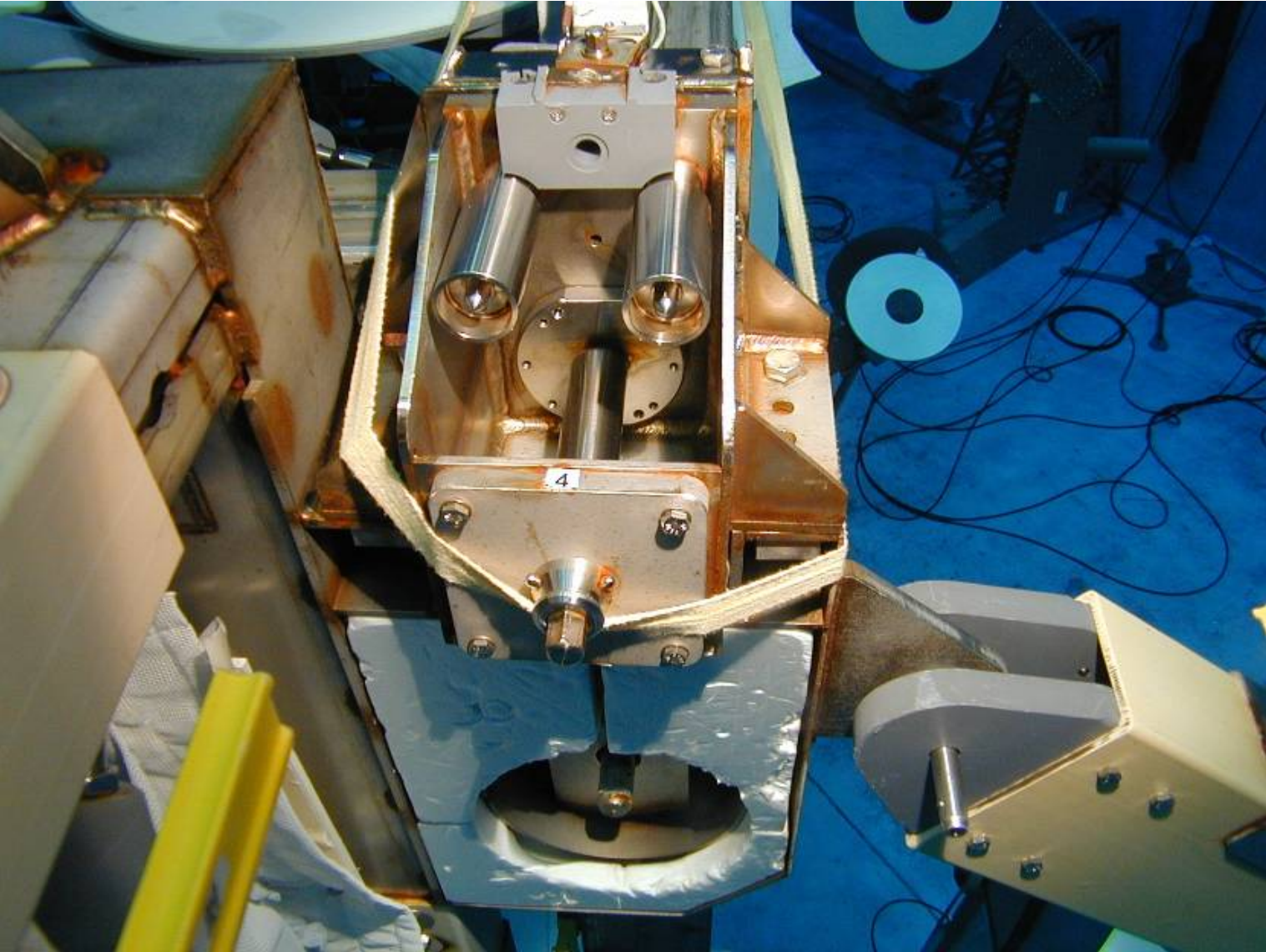

P5/P6 PRD ROUTING (STRAP ROUTING CORNER 3)

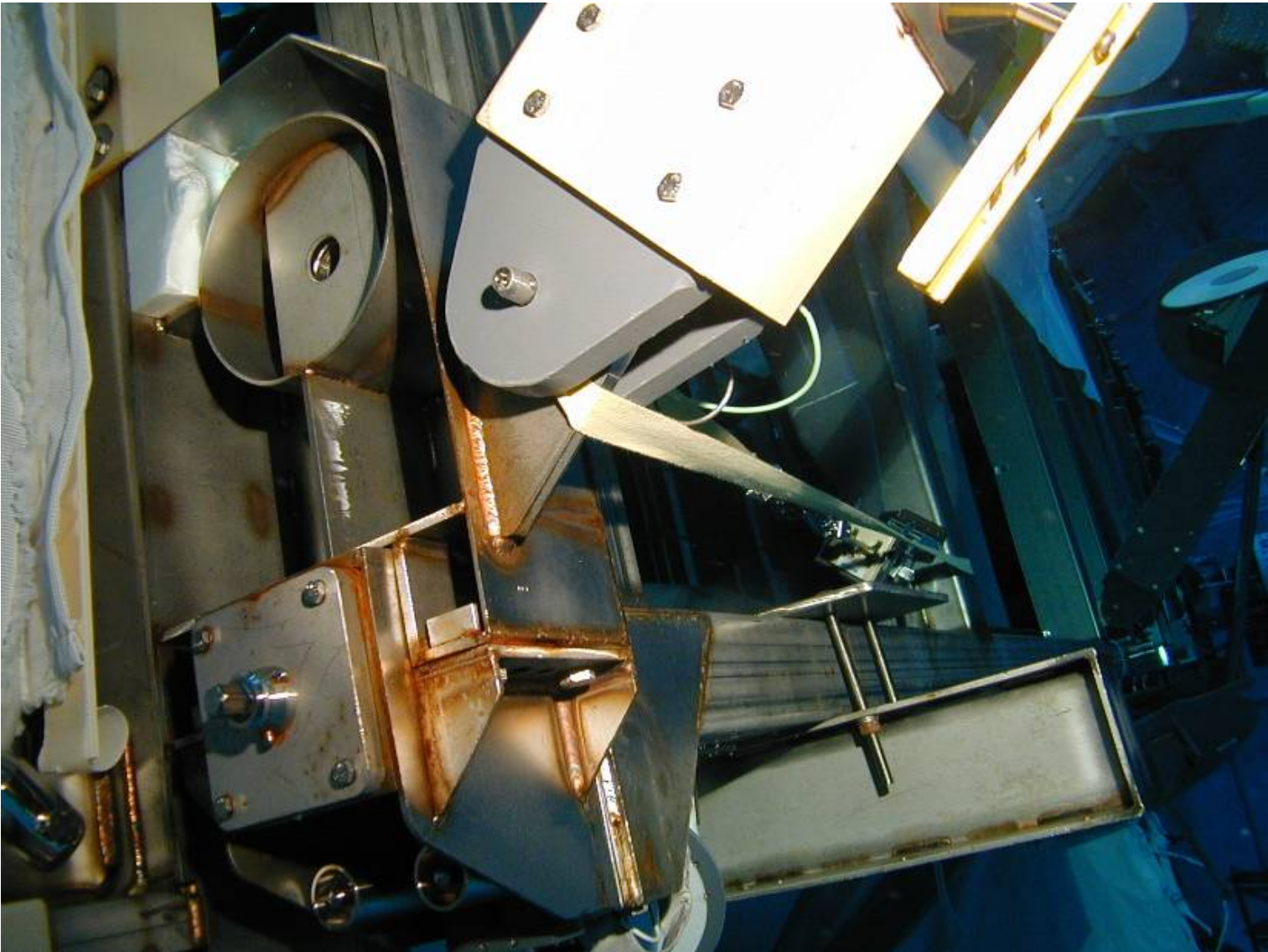

P5/P6 PRD ROUTING (STRAP ROUTING CORNER 3) (Cont)



ORU CONTINGENCY TIE-DOWN DEFINITIONS

Adjustable Tether (16-26")

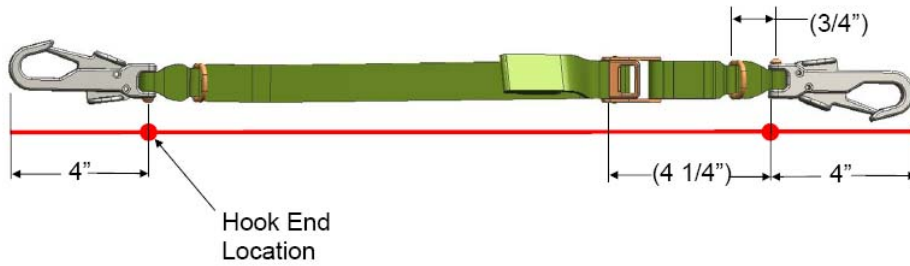

Adjustable Tether End To End Configuration (32-52")

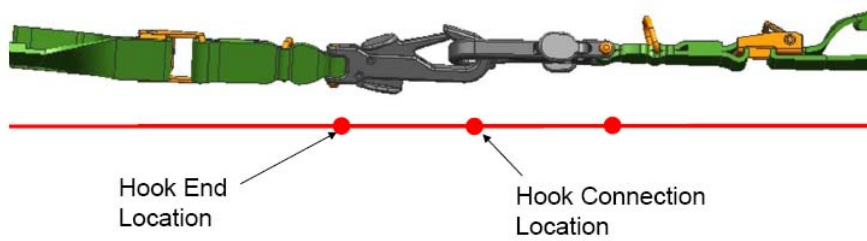

Long Duration Tie Down Tether (24-84")

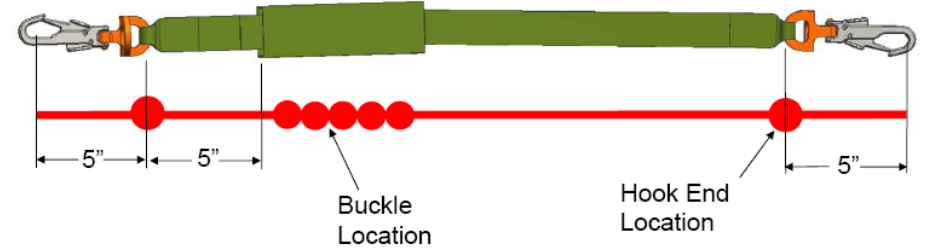

Long Duration Tie Down Tether End To End Configuration (48-168")

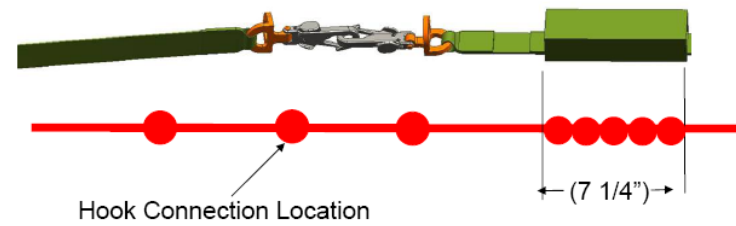

LAB CETA LIGHT CONTINGENCY TIE-DOWN

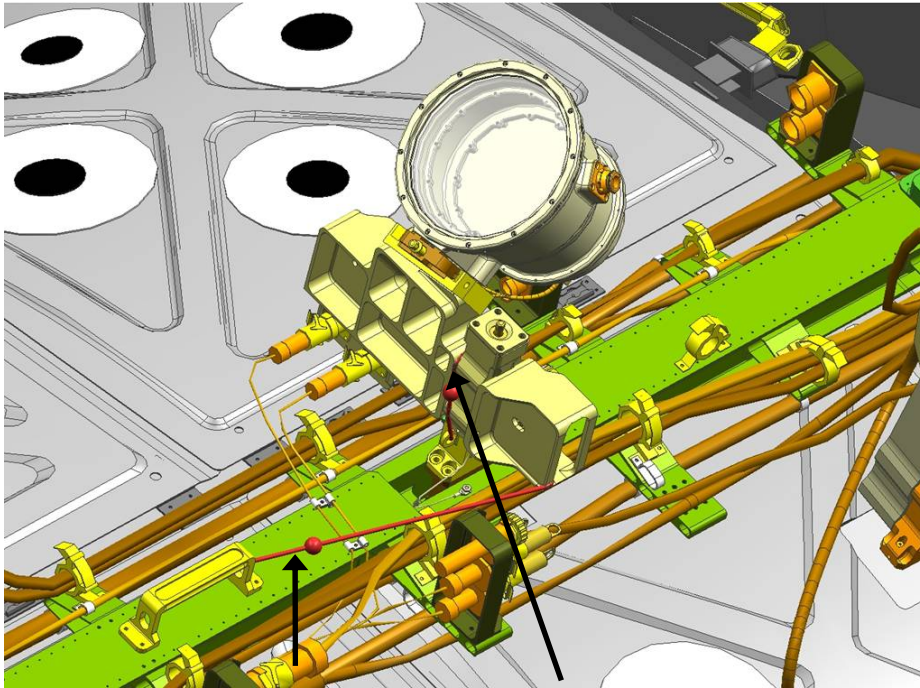

Tether 1
(Adjustable)
Length = 25.9"

Tether 2
(Adjustable)
Length = 21.6"

Avionics
Umbilical
Handrail

Tether 1
(Adjustable)

Tether 1 is an Adjustable Tether. It hooks onto the tether loop of the Avionics Umbilical Handrail, travels through the opening of the Upper Stanchion Housing and hooks onto the D-ring of Tether 2. The length of the tether is approximately 25.9"

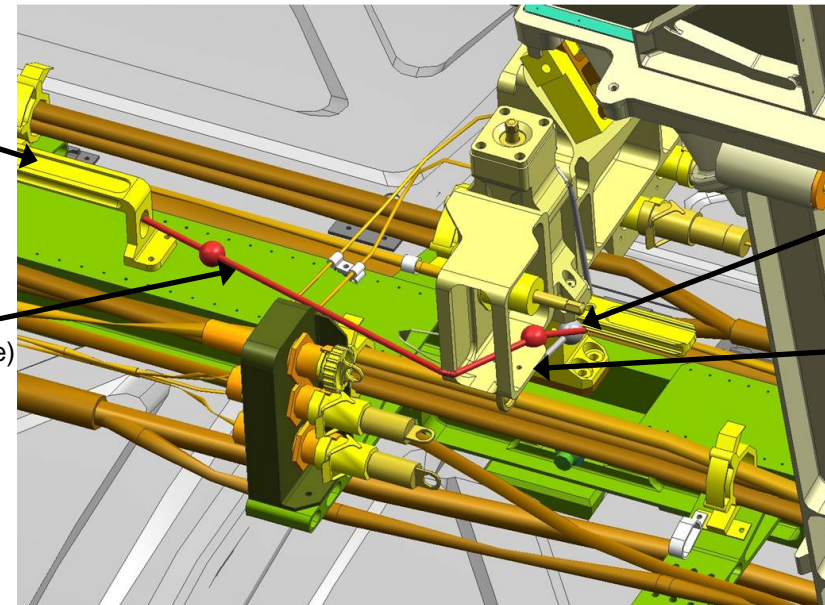

Tether 2
D-ring

Upper
Stanchion
Housing

LAB CETA LIGHT CONTINGENCY TIE-DOWN (Cont)

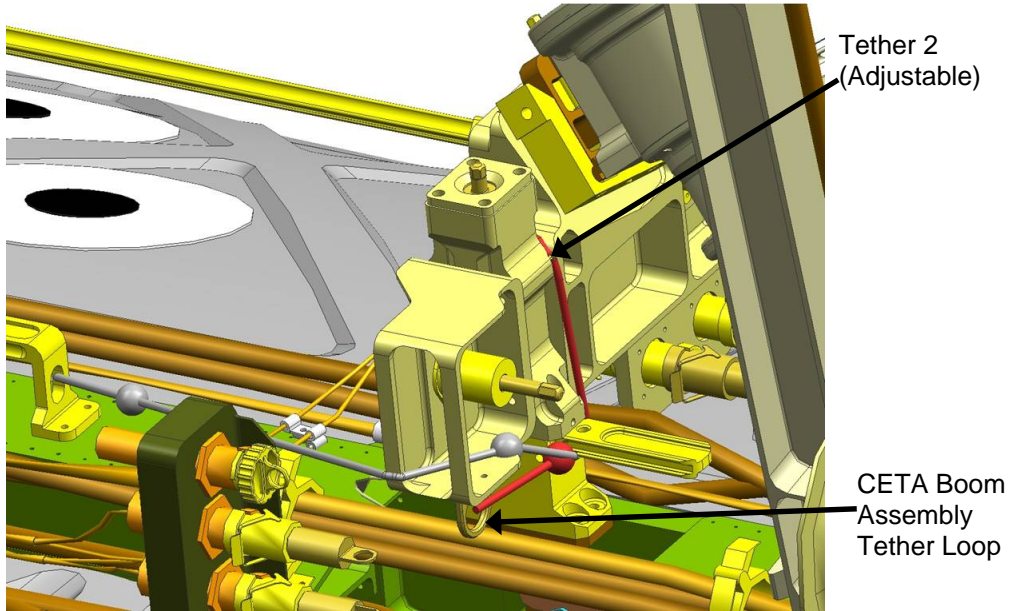

Tether 2 is an Adjustable Tether. It hooks onto the tether loop of the CETA Boom Assembly, travels around the protruding dog bone, up over the CETA Boom Assembly, and hooks onto the Tether Loop of the Upper Stanchion Housing. The length of the tether is approximately 21.6"

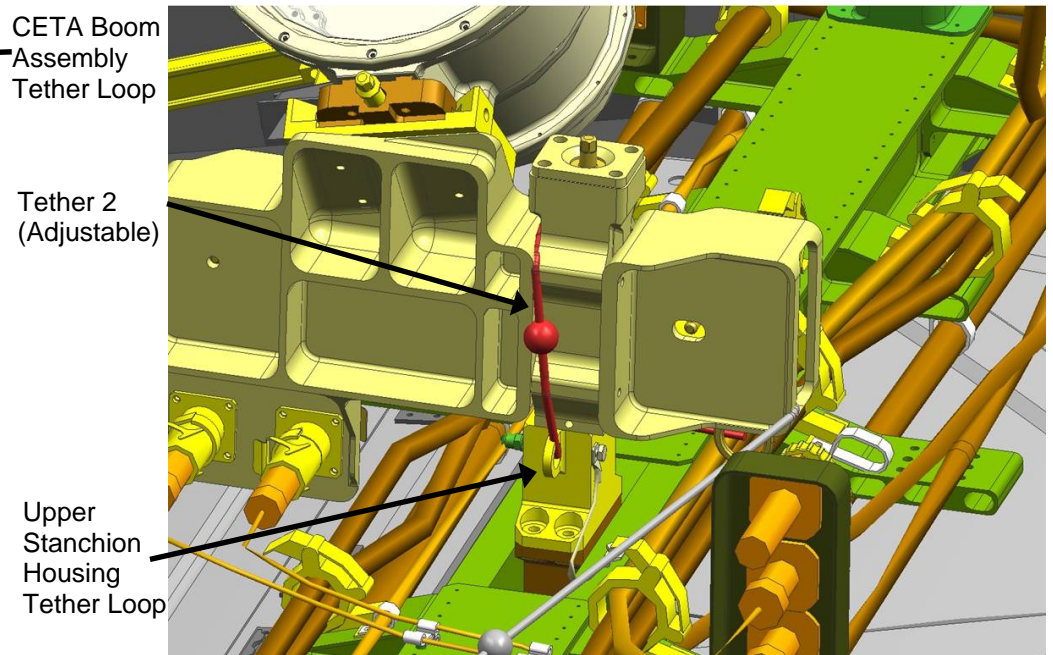

Z1 BSP CONTINGENCY TIE-DOWN

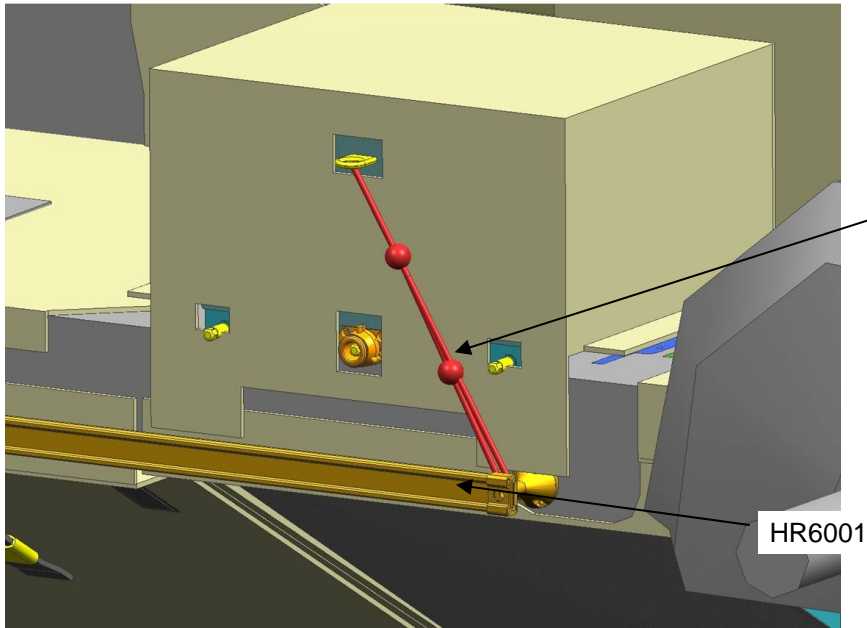

Tether 1 hooks onto the tether hook of the Z1 BSP, travels around the stanchion of HR6001, and hooks onto its own D-ring

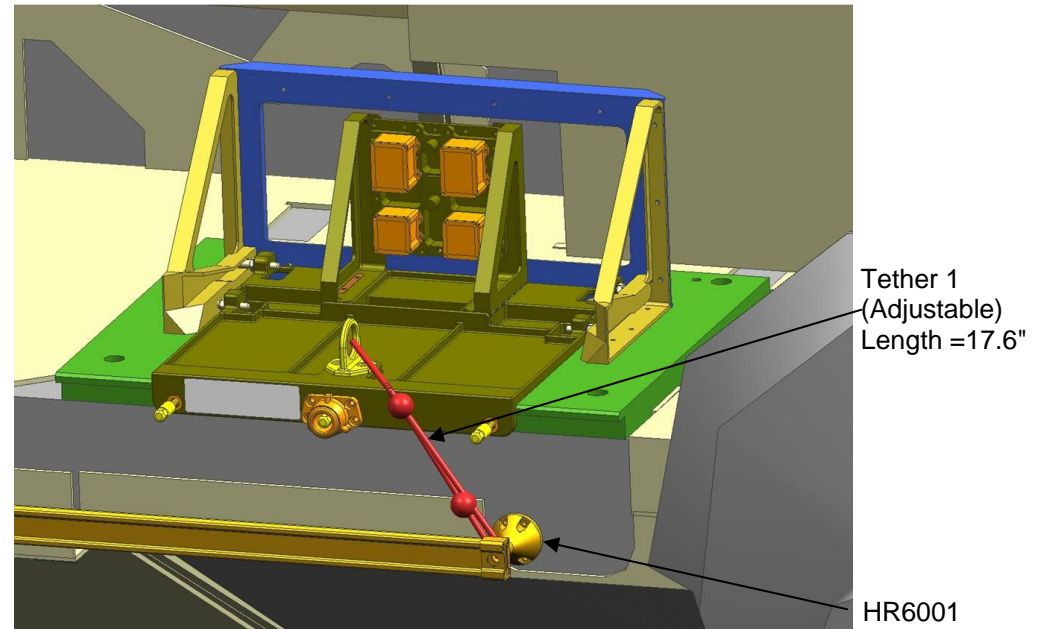

Z1 SASA CONTINGENCY TIE-DOWN

Tether 1
Length = 36.2"

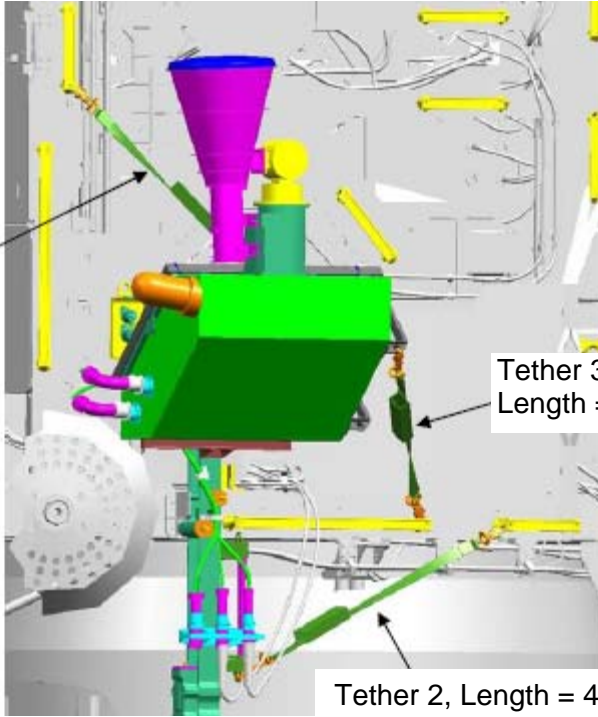

Tether 3,
Length = 36.1"

Tether 2, Length = 43.5"

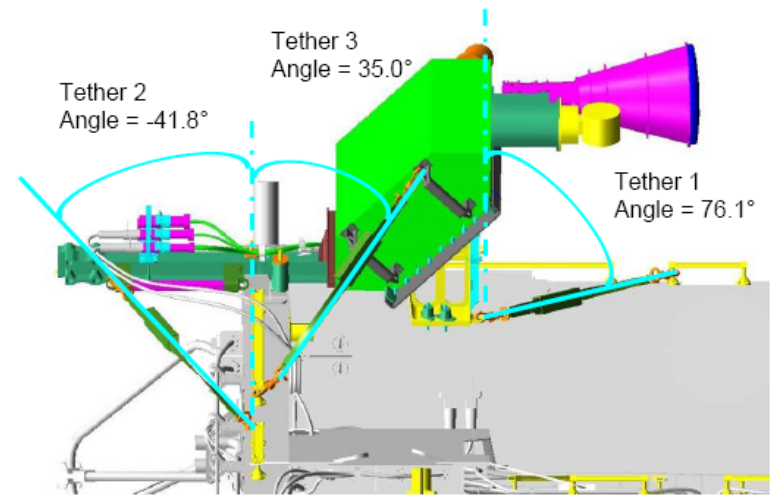

Tether 2
Angle = -41.8°

Tether 3
Angle = 35.0°

Tether 1
Angle = 76.1°

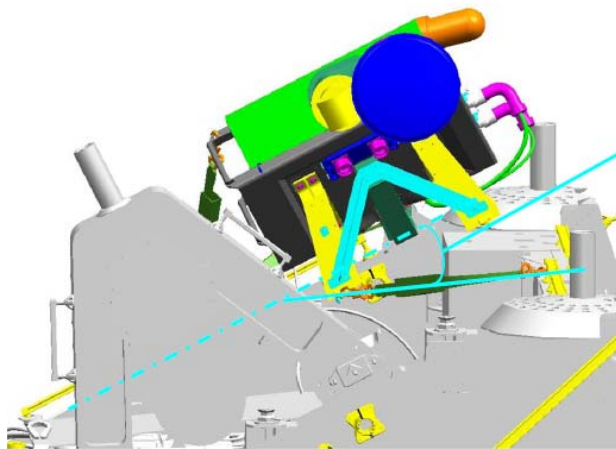

Tether 1
Angle = 12.9°

Tether 2
Angle = 6.9°



Tether 3
Angle = 57.0°

RPCM CONTINGENCY TIE-DOWN

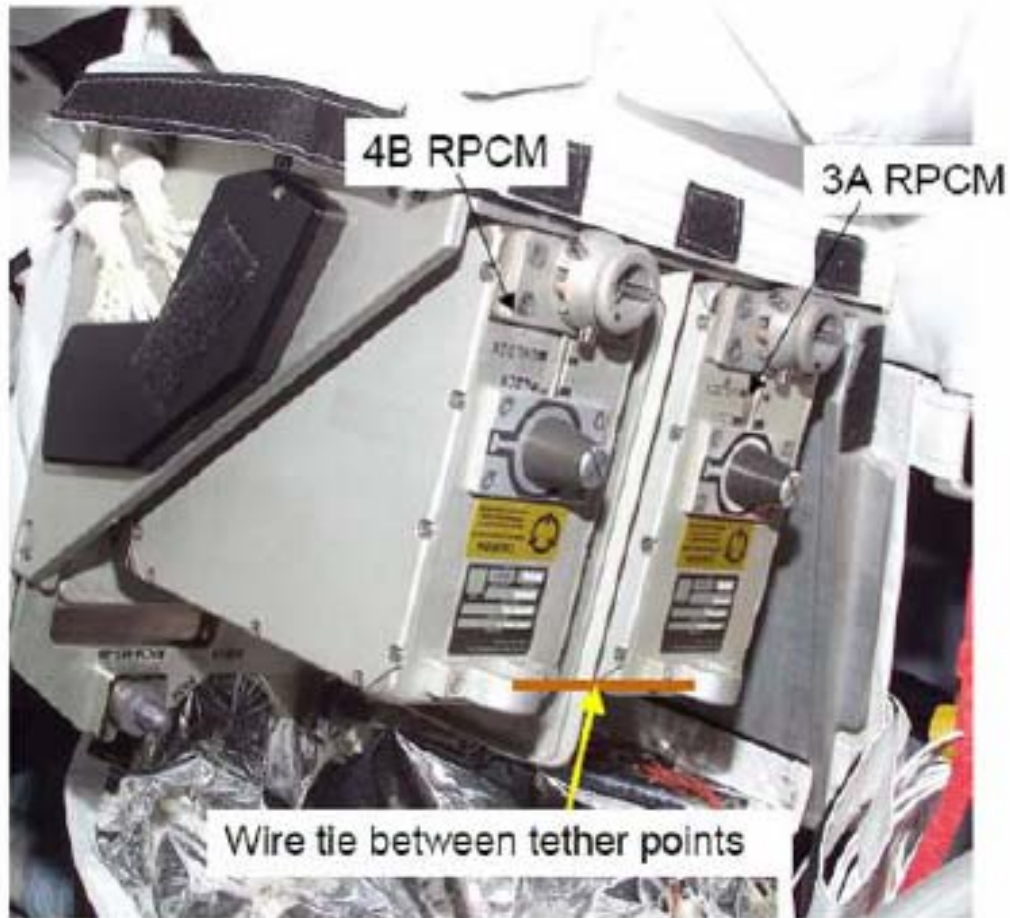

CETA CART – TOP VIEW

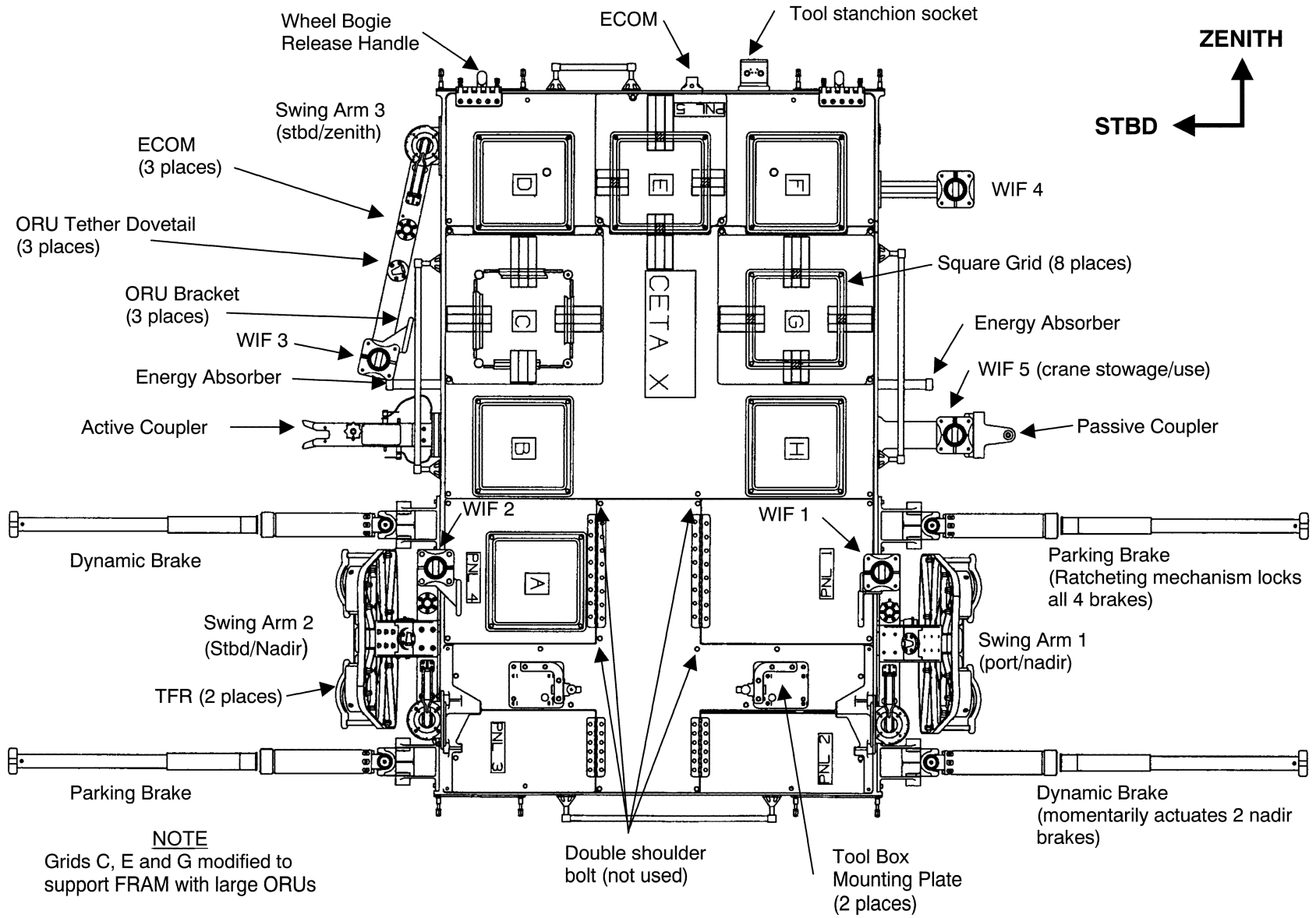

CETA CART – SWING ARMS AND WIF MARKINGS

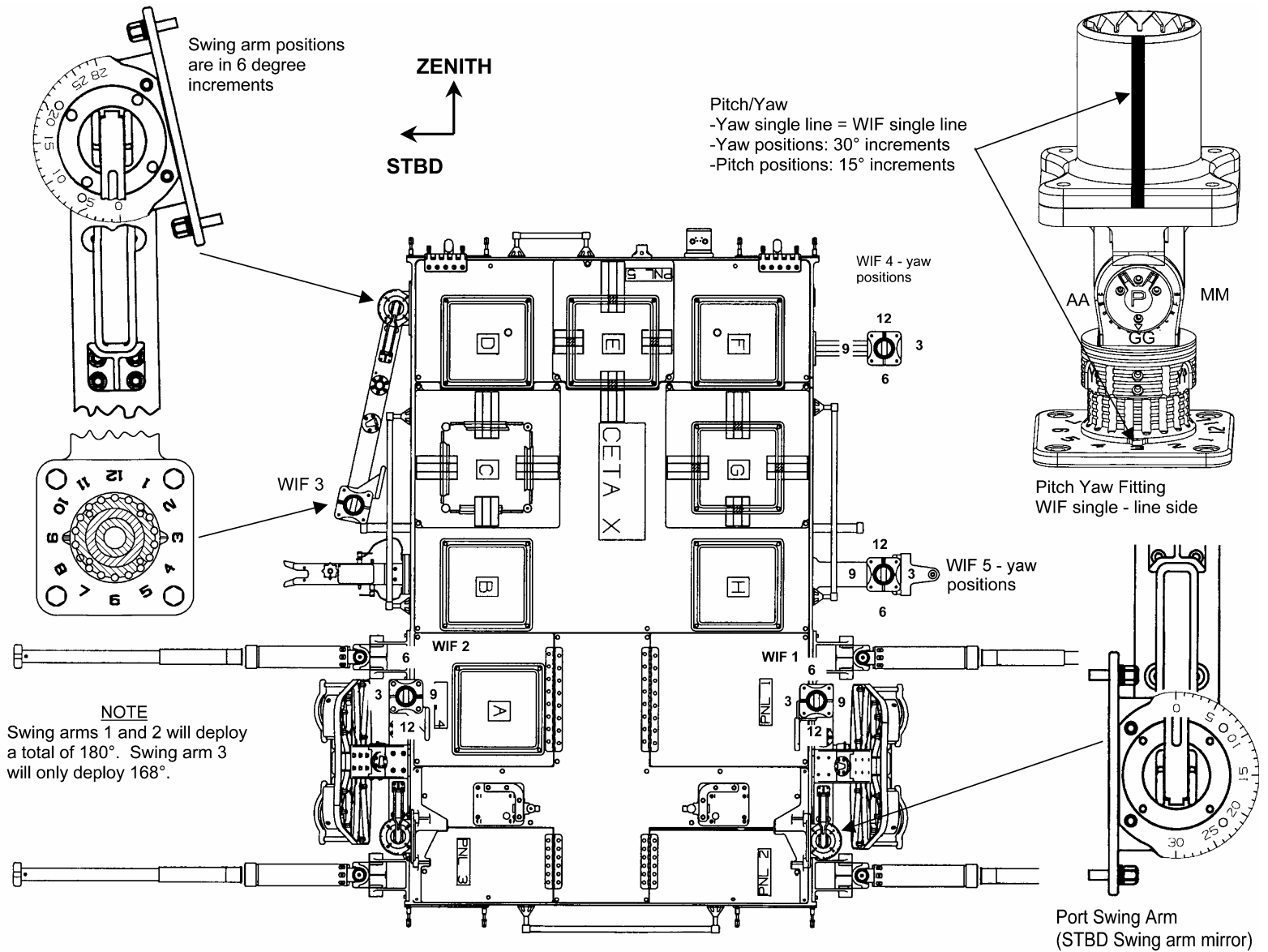

CETA CART – COUPLERS

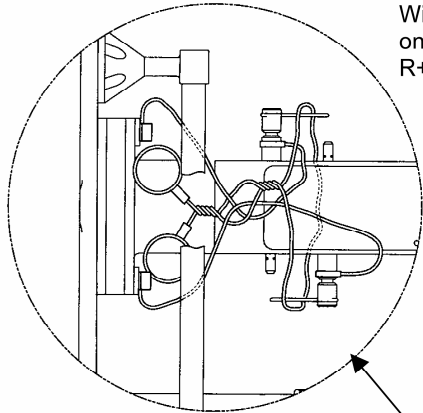

Wire ties required for launch only. Removed for coupler R+R

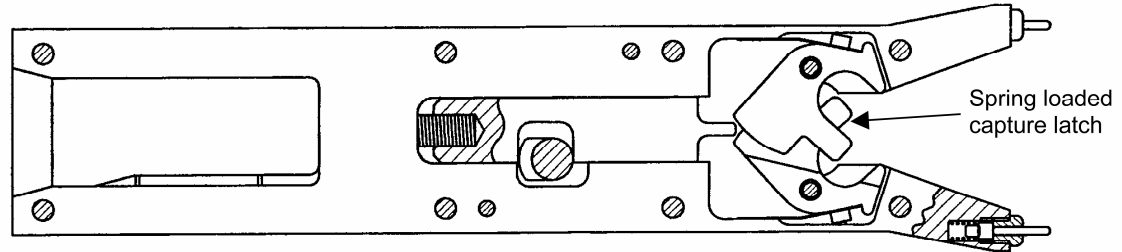

BOTTOM VIEW

Compliance in indicated direction to allow for misalignment. Centering spring nominally constrains motion

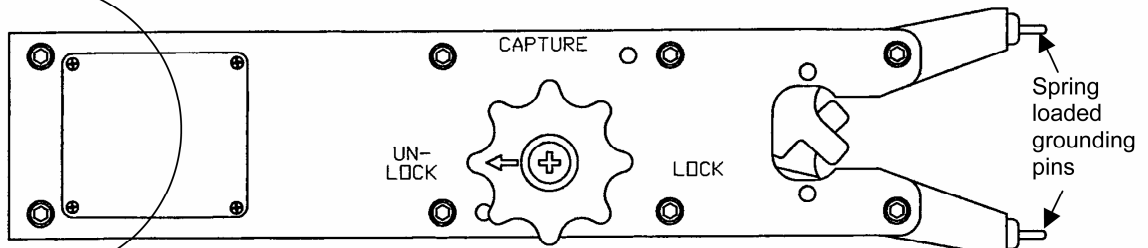

TOP VIEW

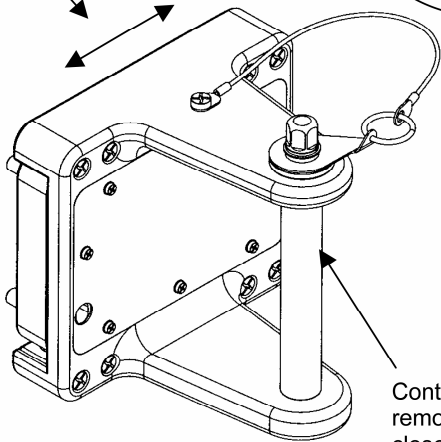

PASSIVE COUPLER

Contingency bolt removed if latch failed closed

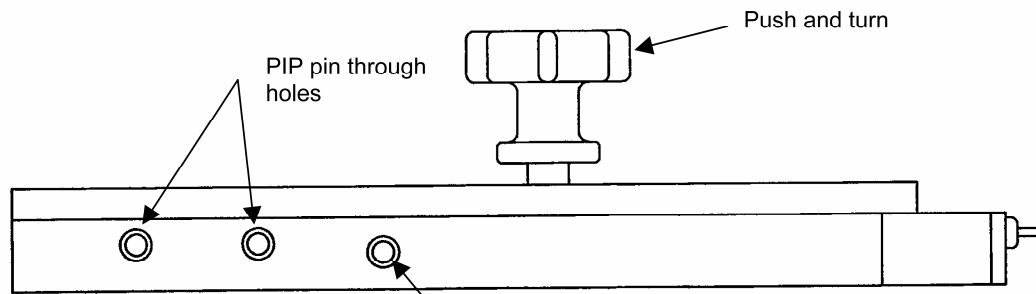

SIDE VIEW

CETA CART – WHEEL BOGIES

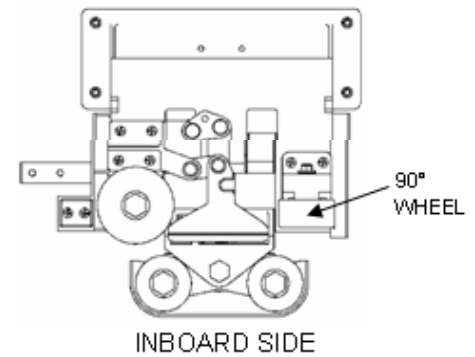
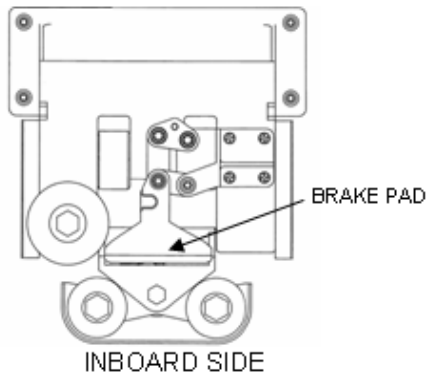
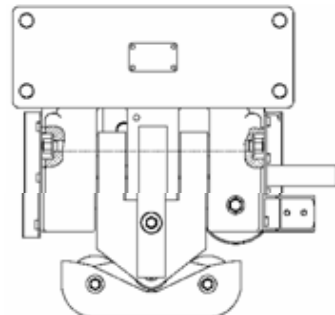
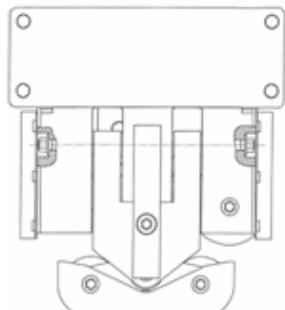
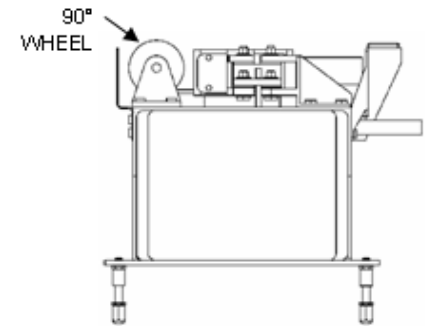
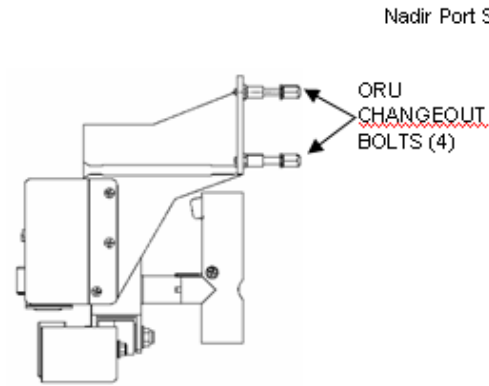
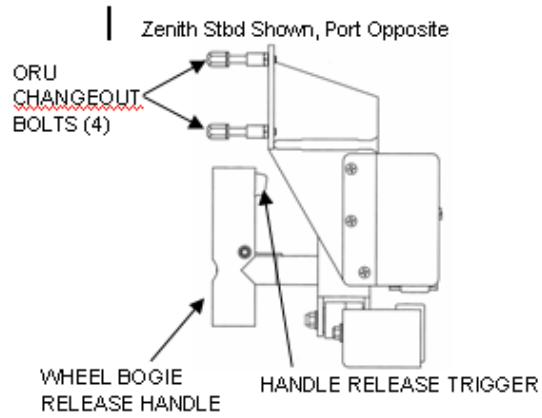

STATUS INDICATORS (MBSU, DDCU, BCDU)

H2 Status Indicator

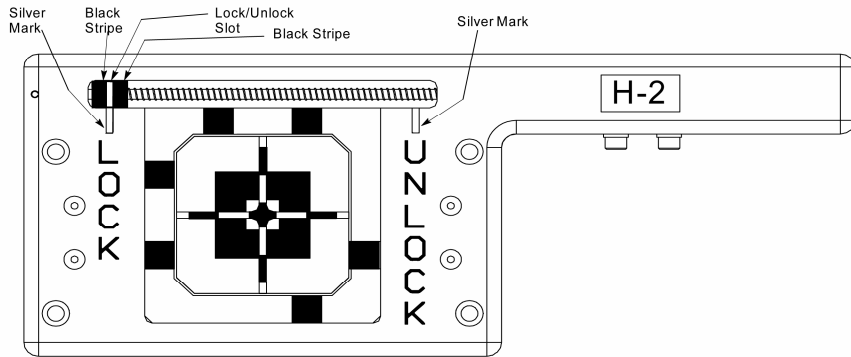

H1 Status Indicator

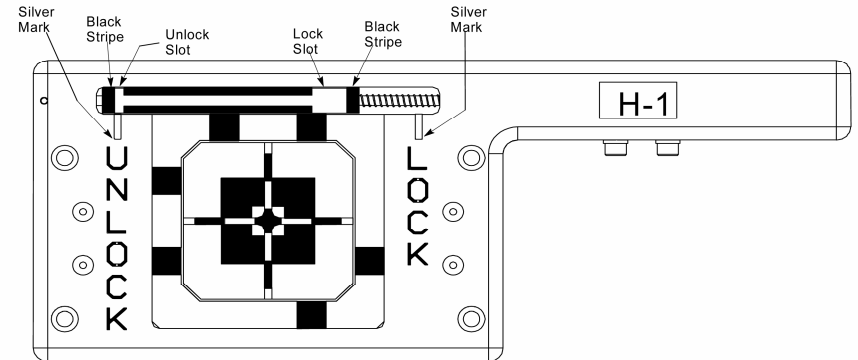

Positional Criteria

(Adhered to in accordance with torque and turns specified in LSAR procedure.)

Locked, Nominal: The lock/unlock slot should be centered in relation to the silver mark.

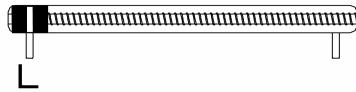

Unlocked, Nominal: The lock/unlock slot should be centered in relation to the silver mark.

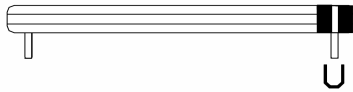

Locked, Tolerance: The lock/unlock slot can be left or right of nominal by a distance no greater than the width of the black stripe.

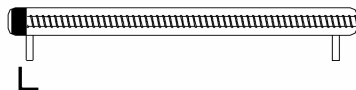
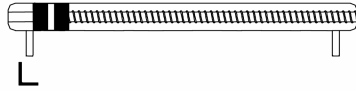

Unlocked, Tolerance: The lock/unlock slot can be left or right of nominal by a distance no greater than the width of the black stripe.

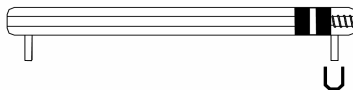
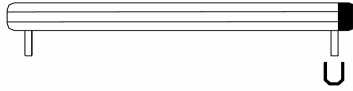

LOG-1010-01

Positional Criteria

(Adhered to in accordance with torque and turns specified in LSAR procedure.)

Unlocked, Nominal: The unlock slot should be centered in relation to the silver mark.



Locked, Nominal: The right edge of the lock slot should be flush with the right edge of the silver mark.



Unlocked, Tolerance: The unlock slot can be left or right of nominal by a distance no greater than the width of the black stripe.



Locked, Tolerance: The lock slot can be left of nominal by a distance no greater than the width of the black stripe.



LOG-1009-01



EVA CHECKLIST

STS
120