

EVA Checklist

STS-124 Flight Supplement

**Mission Operations Directorate
EVA, Robotics, and Crew Systems
Operations Division**

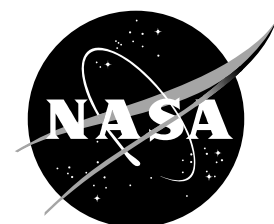
**Final
May 2, 2008**

NOTE

This supplement is to be integrated into the generic edition to provide a complete document for the specific flight. Some pages in the generic edition may be replaced with supplemental pages identified as 'TEMP'. These generic pages, if any, must be retained for use on future flights.

National Aeronautics and
Space Administration

Lyndon B. Johnson Space Center
Houston, Texas



| | |
|--|----------------------------|
| EVA CHECKLIST STS-124 FLT SUPPL | FINAL (May 2, 2008) |
|--|----------------------------|

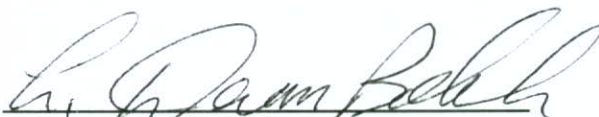
PCN-1 (May 12, 2008) Sheet 1 of 1

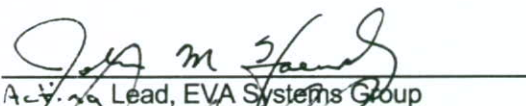
List of Implemented Change Requests (482s):

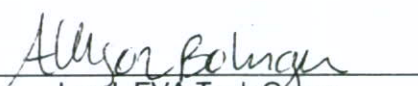
EVA FS-0080
EVA FS-0081

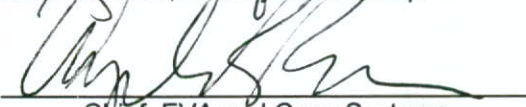
Incorporate the following:

1. Replace FS v thru FS xiv
2. Replace FS 2-7 thru FS 2-16
3. Replace section 7 (152 pages)
4. Replace FS 8-13 and FS 8-14
5. Replace FS CC 10-15 and FS CC 10-16
6. Replace FS 16-9 thru FS 16-16
7. Replace FS 18-97 and FS 18-98

Prepared by: 
Book Manager

Approved by: 
Acting Lead, EVA Systems Group


Acting Lead, EVA Task Group

Accepted by: 
Chief, EVA and Crew Systems
Operations Branch

Encl: 186 pages


| |
|---|
| File this PCN immediately behind the front cover as a permanent record |
|---|

MISSION OPERATIONS DIRECTORATE


**EVA CHECKLIST
STS-124 FLIGHT SUPPLEMENT**

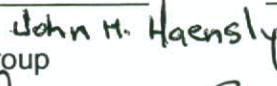
FINAL
May 2, 2008


PREPARED BY:



L. Devan Bolch
Book Manager

APPROVED BY:


~~Tricia J. Maack~~ John M. Spaulding
Acting Lead, EVA Systems Group


John H. Haensly


~~Dina E. Contella~~ Allison T. Bolinger
Acting Lead, EVA Task Group


Angela R. Prince
Chief, EVA and Crew Systems Operations Branch

This document is under the configuration control of the Crew Procedures Control Board (CPCB). All proposed changes must be submitted via FDF Workflow Crew Procedure Change Request (CR) to DO3/FDF Manager.

Additional distribution of this book, for official use only, may be requested in writing to DO3/PMO Administrator. The request must include justification and requester's name, organization, position, and phone number. Contractor requests are made through the NASA or DOD organization supported. Deletions, reduction in quantity, or change of address may be submitted to DO3/FDF Management Office, 281-244-1184.

| Incorporates the following: | |
|-----------------------------|-------------|
| 482#: | EVA FS-0171 |
| | EVA FS-0172 |
| | EVA FS-0173 |
| | EVA FS-0174 |
| | EVA FS-0175 |
| | EVA FS-0176 |
| | EVA FS-0177 |
| | EVA FS-0178 |
| | EVA FS-0179 |

AREAS OF TECHNICAL RESPONSIBILITY

Book Manager

DX32/L. Bolch

281-483-6830

EVA CHECKLIST
STS-124 FLIGHT SUPPLEMENT

LIST OF EFFECTIVE PAGES

| | FINAL PCN-1 | 05/02/08 05/12/08 | |
|-------------------|----------------|----------------------|-------------|
| Sign Off | * 124/FIN | 3-3 | generic |
| FS ii | * 124/FIN | 3-4 | generic |
| iii | * generic | 3-5 | generic |
| iv | * generic | 3-6 | generic |
| FS v | * 124/FIN 1 | 3-7 | generic |
| FS vi | * 124/FIN 1 | 3-8 | generic |
| FS vii | * 124/FIN 1 | 3-9 | generic |
| FS viii | * 124/FIN 1 | CC 3-10 | generic |
| FS ix | * 124/FIN 1 | CC 3-11 | generic |
| FS x | * 124/FIN 1 | 3-12 | generic |
| FS xi | * 124/FIN 1 | 4-1 | generic |
| FS xii | * 124/FIN | 4-2 | generic |
| FS xiii | 124/FIN | 4-3 | generic |
| FS xiv | 124/FIN 1 | 4-4 | generic |
| FS xv | 124/FIN | 4-5 | generic |
| FS xvi | 124/FIN | 4-6 | generic |
| FS xvii | 124/FIN | 4-7 | generic |
| FS xviii | 124/FIN | 4-8 | generic |
| FS xix | 124/FIN | 4-9 | generic |
| FS xx | 124/FIN | 4-10 | generic |
| 1-1 | generic | 4-11 | generic |
| 1-2 | generic | 4-12 | generic |
| 1-3 | generic | 5-1 | generic |
| 1-4 | generic | 5-2 | generic |
| 1-5 | generic | 5-3 | generic |
| 1-6 | generic | 5-4 | generic |
| 1-7 | generic | A6-1 | generic |
| 1-8 | generic | CC A6-2 | generic |
| 1-9 | generic | 6-3 | generic |
| 1-10 | generic | CC 6-4 | generic |
| TEMP FS 2-1 | 124/FIN | FS 7-1 | 124/FIN 1 |
| TEMP FS 2-2 | 124/FIN | FS 7-2 | 124/FIN 1 |
| 2-3 | generic | FS 7-3 | 124/FIN 1 |
| 2-4 | generic | FS 7-4 | 124/FIN 1 |
| TEMP FS 2-5 | 124/FIN | FS 7-5 | 124/FIN 1 |
| TEMP FS 2-6 | ALL/FIN | FS 7-6 | 124/FIN 1 † |
| FS 2-7 | 124/FIN | FS 7-7 | 124/FIN 1 |
| FS 2-8 | 124/FIN 1 | FS 7-8 | 124/FIN 1 |
| FS 2-9 | 124/FIN 1 | FS 7-9 | 124/FIN 1 |
| FS 2-10 | 124/FIN 1 | FS 7-10 | 124/FIN 1 † |
| FS 2-11 | 124/FIN 1 | FS 7-11 | 124/FIN 1 † |
| FS 2-12 | 124/FIN | FS 7-12 | 124/FIN 1 † |
| FS 2-13 | 124/FIN | FS 7-13 | 124/FIN 1 † |
| FS 2-14 | 124/FIN 1 | FS 7-14 | 124/FIN 1 |
| FS 2-15 | 124/FIN | FS 7-15 | 124/FIN 1 |
| FS 2-16 | 124/FIN 1 | FS 7-16 | 124/FIN 1 |
| 3-1 | generic | FS 7-17 | 124/FIN 1 † |
| 3-2 | generic | FS 7-18 | 124/FIN 1 † |

* – Omit from flight book
† – Color page in flight book

| | | | |
|---------------|-------------|---------------|-------------|
| FS 7-19 | 124/FIN 1 | FS 7-75..... | 124/FIN 1 |
| FS 7-20 | † 124/FIN 1 | FS 7-76..... | † 124/FIN 1 |
| FS 7-21 | † 124/FIN 1 | FS 7-77..... | † 124/FIN 1 |
| FS 7-22 | † 124/FIN 1 | FS 7-78..... | † 124/FIN 1 |
| FS 7-23 | † 124/FIN 1 | FS 7-79..... | 124/FIN 1 |
| FS 7-24 | † 124/FIN 1 | FS 7-80..... | † 124/FIN 1 |
| FS 7-25 | † 124/FIN 1 | FS 7-81..... | † 124/FIN 1 |
| FS 7-26 | † 124/FIN 1 | FS 7-82..... | † 124/FIN 1 |
| FS 7-27 | † 124/FIN 1 | FS 7-83..... | 124/FIN 1 |
| FS 7-28 | † 124/FIN 1 | FS 7-84..... | † 124/FIN 1 |
| FS 7-29 | 124/FIN 1 | FS 7-85..... | † 124/FIN 1 |
| FS 7-30 | 124/FIN 1 | FS 7-86..... | 124/FIN 1 |
| FS 7-31 | † 124/FIN 1 | FS 7-87..... | 124/FIN 1 |
| FS 7-32 | † 124/FIN 1 | FS 7-88..... | † 124/FIN 1 |
| FS 7-33 | † 124/FIN 1 | FS 7-89..... | 124/FIN 1 |
| FS 7-34 | † 124/FIN 1 | FS 7-90..... | † 124/FIN 1 |
| FS 7-35 | 124/FIN 1 | FS 7-91..... | † 124/FIN 1 |
| FS 7-36 | † 124/FIN 1 | FS 7-92..... | † 124/FIN 1 |
| FS 7-37 | † 124/FIN 1 | FS 7-93..... | 124/FIN 1 |
| FS 7-38 | † 124/FIN 1 | FS 7-94..... | 124/FIN 1 |
| FS 7-39 | 124/FIN 1 | FS 7-95..... | 124/FIN 1 |
| FS 7-40 | † 124/FIN 1 | FS 7-96..... | 124/FIN 1 |
| FS 7-41 | † 124/FIN 1 | FS 7-97..... | † 124/FIN 1 |
| FS 7-42 | † 124/FIN 1 | FS 7-98..... | 124/FIN 1 |
| FS 7-43 | † 124/FIN 1 | FS 7-99..... | 124/FIN 1 |
| FS 7-44 | 124/FIN 1 | FS 7-100..... | 124/FIN 1 |
| FS 7-45 | † 124/FIN 1 | FS 7-101..... | † 124/FIN 1 |
| FS 7-46 | † 124/FIN 1 | FS 7-102..... | † 124/FIN 1 |
| FS 7-47 | 124/FIN 1 | FS 7-103..... | † 124/FIN 1 |
| FS 7-48 | † 124/FIN 1 | FS 7-104..... | † 124/FIN 1 |
| FS 7-49 | 124/FIN 1 | FS 7-105..... | 124/FIN 1 |
| FS 7-50 | 124/FIN 1 | FS 7-106..... | 124/FIN 1 |
| FS 7-51 | 124/FIN 1 | FS 7-107..... | 124/FIN 1 |
| FS 7-52 | 124/FIN 1 | FS 7-108..... | † 124/FIN 1 |
| FS 7-53 | 124/FIN 1 | FS 7-109..... | 124/FIN 1 |
| FS 7-54 | 124/FIN 1 | FS 7-110..... | 124/FIN 1 |
| FS 7-55 | 124/FIN 1 | FS 7-111..... | † 124/FIN 1 |
| FS 7-56 | 124/FIN 1 | FS 7-112..... | 124/FIN 1 |
| FS 7-57 | 124/FIN 1 | FS 7-113..... | † 124/FIN 1 |
| FS 7-58 | † 124/FIN 1 | FS 7-114..... | 124/FIN 1 |
| FS 7-59 | 124/FIN 1 | FS 7-115..... | 124/FIN 1 |
| FS 7-60 | 124/FIN 1 | FS 7-116..... | 124/FIN 1 |
| FS 7-61 | 124/FIN 1 | FS 7-117..... | 124/FIN 1 |
| FS 7-62 | † 124/FIN 1 | FS 7-118..... | † 124/FIN 1 |
| FS 7-63 | † 124/FIN 1 | FS 7-119..... | † 124/FIN 1 |
| FS 7-64 | † 124/FIN 1 | FS 7-120..... | † 124/FIN 1 |
| FS 7-65 | † 124/FIN 1 | FS 7-121..... | † 124/FIN 1 |
| FS 7-66 | 124/FIN 1 | FS 7-122..... | 124/FIN 1 |
| FS 7-67 | 124/FIN 1 | FS 7-123..... | 124/FIN 1 |
| FS 7-68 | † 124/FIN 1 | FS 7-124..... | † 124/FIN 1 |
| FS 7-69 | † 124/FIN 1 | FS 7-125..... | † 124/FIN 1 |
| FS 7-70 | † 124/FIN 1 | FS 7-126..... | † 124/FIN 1 |
| FS 7-71 | † 124/FIN 1 | FS 7-127..... | 124/FIN 1 |
| FS 7-72 | † 124/FIN 1 | FS 7-128..... | 124/FIN 1 |
| FS 7-73 | † 124/FIN 1 | FS 7-129..... | 124/FIN 1 |
| FS 7-74 | 124/FIN 1 | FS 7-130..... | † 124/FIN 1 |

† – Color page in flight book

| | | | | |
|--------------------|---|-----------|--------------------|-----------|
| FS 7-131 | † | 124/FIN 1 | 10-13 | generic |
| FS 7-132 | † | 124/FIN 1 | 10-14 | generic |
| FS 7-133 | | 124/FIN 1 | FS CC 10-15..... | 124/FIN 1 |
| FS 7-134 | | 124/FIN 1 | FS CC 10-16..... | 124/FIN |
| FS 7-135 | † | 124/FIN 1 | 11-1 | generic |
| FS 7-136 | † | 124/FIN 1 | 11-2 | generic |
| FS 7-137 | † | 124/FIN 1 | 11-3 | generic |
| FS 7-138 | † | 124/FIN 1 | 11-4 | generic |
| FS 7-139 | | 124/FIN 1 | 12-i..... | generic |
| FS 7-140 | | 124/FIN 1 | 12-ii..... | generic |
| FS 7-141 | † | 124/FIN 1 | TEMP FS 12-1 | 124/FIN |
| FS 7-142 | † | 124/FIN 1 | TEMP FS 12-2..... | ALL/FIN |
| FS 7-143 | | 124/FIN 1 | 12-3 | generic |
| FS 7-144 | | 124/FIN 1 | 12-4 | generic |
| FS 7-145 | † | 124/FIN 1 | 12-5 | generic |
| FS 7-146 | † | 124/FIN 1 | 12-6 | generic |
| FS 7-147 | | 124/FIN 1 | 12-7 | generic |
| FS 7-148 | | 124/FIN 1 | 12-8 | generic |
| FS 7-149 | † | 124/FIN 1 | 12-9 | generic |
| FS 7-150 | | 124/FIN 1 | 12-10 | generic |
| FS 7-151 | | 124/FIN 1 | 12-11 | generic |
| FS 7-152 | | 124/FIN 1 | 12-12 | generic |
| TEMP FS 8-1 | | 124/FIN | 12-13 | generic |
| TEMP FS 8-2 | | ALL/FIN | 12-14 | generic |
| 8-3 | | generic | 12-15 | generic |
| 8-4 | | generic | 12-16 | generic |
| 8-5 | | generic | 12-17 | generic |
| 8-6 | | generic | 12-18 | generic |
| 8-7 | | generic | 12-19 | generic |
| 8-8 | | generic | 12-20 | generic |
| FS 8-9 | | 124/FIN | 12-21 | generic |
| FS 8-10 | | 124/FIN | 12-22 | generic |
| FS 8-11 | | 124/FIN | 12-23 | generic |
| FS 8-12 | | 124/FIN | 12-24 | generic |
| FS 8-13 | | 124/FIN | 12-25 | generic |
| FS 8-14 | | 124/FIN 1 | 12-26 | generic |
| 9-1 | | generic | FS 12-27..... | 124/FIN |
| 9-2 | | generic | FS 12-28..... | 124/FIN |
| 9-3 | | generic | FS CC 12-29..... | 124/FIN |
| 9-4 | | generic | FS CC 12-30..... | 124/FIN |
| 9-5 | | generic | FS 13-1..... | 124/FIN |
| 9-6 | | generic | FS 13-2..... | 124/FIN |
| TEMP FS 10-1 | | 124/FIN | 14-1 | generic |
| TEMP FS 10-2 | | ALL/FIN | 14-2 | generic |
| 10-3 | | generic | 14-3 | generic |
| 10-4 | | generic | 14-4 | generic |
| 10-4a..... | | generic | 14-5 | generic |
| 10-4b..... | | generic | 14-6 | generic |
| 10-5 | | generic | 14-7 | generic |
| 10-6 | | generic | 14-8 | generic |
| 10-7 | | generic | 14-9 | generic |
| 10-8 | | generic | 14-10 | generic |
| 10-9 | | generic | 14-11 | generic |
| 10-10..... | | generic | 14-12 | generic |
| 10-11..... | | generic | 14-13 | generic |
| 10-12..... | | generic | 14-14 | generic |

† – Color page in flight book

| | | | |
|-------------------|-----------|-----------------|---------|
| 14-15..... | generic | FS 16-33..... | 124/FIN |
| 14-16..... | generic | FS 16-34..... | 124/FIN |
| 14-17..... | generic | FS 16-35..... † | 124/FIN |
| 14-18..... | generic | FS 16-36..... | 124/FIN |
| 14-19..... | generic | FS 16-37..... | 124/FIN |
| 14-20..... | generic | FS 16-38..... | 124/FIN |
| 14-21..... | generic | FS 16-39..... | 124/FIN |
| 14-22..... | generic | FS 16-40..... † | 124/FIN |
| 15-1..... | generic | FS 16-41..... | 124/FIN |
| 15-2..... | generic | FS 16-42..... | 124/FIN |
| 15-3..... | generic | FS 16-43..... | 124/FIN |
| 15-4..... | generic | FS 16-44..... | 124/FIN |
| 15-5..... | generic | FS 16-45..... | 124/FIN |
| 15-6..... | generic | FS 16-46..... † | 124/FIN |
| 15-7..... | generic | FS 16-47..... † | 124/FIN |
| 15-8..... | generic | FS 16-48..... | 124/FIN |
| 15-9..... | generic | FS 16-49..... | 124/FIN |
| 15-10..... | generic | FS 16-50..... | 124/FIN |
| 15-11..... | generic | FS 16-51..... † | 124/FIN |
| 15-12..... | generic | FS 16-52..... † | 124/FIN |
| 15-13..... | generic | FS 16-53..... † | 124/FIN |
| 15-14..... | generic | FS 16-54..... † | 124/FIN |
| 16-i..... | generic | FS 16-55..... † | 124/FIN |
| 16-ii..... | generic | FS 16-56..... † | 124/FIN |
| TEMP FS 16-1..... | 124/FIN | FS 16-57..... † | 124/FIN |
| TEMP FS 16-2..... | 124/FIN | FS 16-58..... † | 124/FIN |
| FS 16-3..... | 124/FIN | FS 16-59..... † | 124/FIN |
| FS 16-4..... | 124/FIN | FS 16-60..... † | 124/FIN |
| FS 16-5..... | 124/FIN | FS 16-61..... † | 124/FIN |
| FS 16-6..... | 124/FIN | FS 16-62..... † | 124/FIN |
| FS 16-7..... | 124/FIN | FS 16-63..... † | 124/FIN |
| FS 16-8..... | 124/FIN | FS 16-64..... † | 124/FIN |
| FS 16-9..... | 124/FIN | FS 16-65..... † | 124/FIN |
| FS 16-10..... | 124/FIN 1 | FS 16-66..... † | 124/FIN |
| FS 16-11..... | 124/FIN 1 | FS 16-67..... † | 124/FIN |
| FS 16-12..... † | 124/FIN | FS 16-68..... † | 124/FIN |
| FS 16-13..... | 124/FIN 1 | FS 16-69..... | 124/FIN |
| FS 16-14..... † | 124/FIN 1 | FS 16-70..... | 124/FIN |
| FS 16-15..... | 124/FIN 1 | FS 16-71..... | 124/FIN |
| FS 16-16..... | 124/FIN | FS 16-72..... | 124/FIN |
| FS 16-17..... | 124/FIN | FS 16-73..... † | 124/FIN |
| FS 16-18..... † | 124/FIN | FS 16-74..... | 124/FIN |
| FS 16-19..... † | 124/FIN | 17-1..... | generic |
| FS 16-20..... † | 124/FIN | 17-2..... | generic |
| FS 16-21..... | 124/FIN | FS 18-1..... | 124/FIN |
| FS 16-22..... | 124/FIN | FS 18-2..... | 124/FIN |
| FS 16-23..... † | 124/FIN | FS 18-3..... | 124/FIN |
| FS 16-24..... † | 124/FIN | FS 18-4..... | 124/FIN |
| FS 16-25..... † | 124/FIN | FS 18-5..... | 124/FIN |
| FS 16-26..... | 124/FIN | FS 18-6..... | 124/FIN |
| FS 16-27..... | 124/FIN | FS 18-7..... | 124/FIN |
| FS 16-28..... | 124/FIN | FS 18-8..... | 124/FIN |
| FS 16-29..... | 124/FIN | FS 18-9..... | 124/FIN |
| FS 16-30..... † | 124/FIN | FS 18-10..... † | 124/FIN |
| FS 16-31..... † | 124/FIN | FS 18-11..... † | 124/FIN |
| FS 16-32..... † | 124/FIN | FS 18-12..... † | 124/FIN |

† – Color page in flight book

| | | | | | |
|----------|---|---------|-----------|---|-----------|
| FS 18-13 | † | 124/FIN | FS 18-69 | † | 124/FIN |
| FS 18-14 | † | 124/FIN | FS 18-70 | † | 124/FIN |
| FS 18-15 | † | 124/FIN | FS 18-71 | † | 124/FIN |
| FS 18-16 | † | 124/FIN | FS 18-72 | † | 124/FIN |
| FS 18-17 | † | 124/FIN | FS 18-73 | † | 124/FIN |
| FS 18-18 | † | 124/FIN | FS 18-74 | † | 124/FIN |
| FS 18-19 | † | 124/FIN | FS 18-75 | † | 124/FIN |
| FS 18-20 | † | 124/FIN | FS 18-76 | † | 124/FIN |
| FS 18-21 | † | 124/FIN | FS 18-77 | † | 124/FIN |
| FS 18-22 | † | 124/FIN | FS 18-78 | † | 124/FIN |
| FS 18-23 | † | 124/FIN | FS 18-79 | † | 124/FIN |
| FS 18-24 | † | 124/FIN | FS 18-80 | † | 124/FIN |
| FS 18-25 | † | 124/FIN | FS 18-81 | † | 124/FIN |
| FS 18-26 | † | 124/FIN | FS 18-82 | † | 124/FIN |
| FS 18-27 | † | 124/FIN | FS 18-83 | † | 124/FIN |
| FS 18-28 | † | 124/FIN | FS 18-84 | † | 124/FIN |
| FS 18-29 | † | 124/FIN | FS 18-85 | † | 124/FIN |
| FS 18-30 | † | 124/FIN | FS 18-86 | † | 124/FIN |
| FS 18-31 | † | 124/FIN | FS 18-87 | † | 124/FIN |
| FS 18-32 | | 124/FIN | FS 18-88 | † | 124/FIN |
| FS 18-33 | † | 124/FIN | FS 18-89 | † | 124/FIN |
| FS 18-34 | † | 124/FIN | FS 18-90 | † | 124/FIN |
| FS 18-35 | † | 124/FIN | FS 18-91 | † | 124/FIN |
| FS 18-36 | | 124/FIN | FS 18-92 | † | 124/FIN |
| FS 18-37 | † | 124/FIN | FS 18-93 | † | 124/FIN |
| FS 18-38 | † | 124/FIN | FS 18-94 | † | 124/FIN |
| FS 18-39 | † | 124/FIN | FS 18-95 | † | 124/FIN |
| FS 18-40 | † | 124/FIN | FS 18-96 | † | 124/FIN |
| FS 18-41 | † | 124/FIN | FS 18-97 | † | 124/FIN 1 |
| FS 18-42 | † | 124/FIN | FS 18-98 | † | 124/FIN |
| FS 18-43 | † | 124/FIN | FS 18-99 | † | 124/FIN |
| FS 18-44 | † | 124/FIN | FS 18-100 | † | 124/FIN |
| FS 18-45 | † | 124/FIN | FS 18-101 | † | 124/FIN |
| FS 18-46 | † | 124/FIN | FS 18-102 | † | 124/FIN |
| FS 18-47 | † | 124/FIN | FS 18-103 | † | 124/FIN |
| FS 18-48 | † | 124/FIN | FS 18-104 | † | 124/FIN |
| FS 18-49 | | 124/FIN | FS 18-105 | † | 124/FIN |
| FS 18-50 | † | 124/FIN | FS 18-106 | † | 124/FIN |
| FS 18-51 | † | 124/FIN | FS 18-107 | | 124/FIN |
| FS 18-52 | † | 124/FIN | FS 18-108 | † | 124/FIN |
| FS 18-53 | † | 124/FIN | FS 18-109 | † | 124/FIN |
| FS 18-54 | † | 124/FIN | FS 18-110 | † | 124/FIN |
| FS 18-55 | † | 124/FIN | FS 18-111 | † | 124/FIN |
| FS 18-56 | † | 124/FIN | FS 18-112 | | 124/FIN |
| FS 18-57 | † | 124/FIN | FS 18-113 | † | 124/FIN |
| FS 18-58 | † | 124/FIN | FS 18-114 | | 124/FIN |
| FS 18-59 | † | 124/FIN | FS 18-115 | † | 124/FIN |
| FS 18-60 | † | 124/FIN | FS 18-116 | † | 124/FIN |
| FS 18-61 | † | 124/FIN | FS 18-117 | † | 124/FIN |
| FS 18-62 | † | 124/FIN | FS 18-118 | † | 124/FIN |
| FS 18-63 | † | 124/FIN | FS 18-119 | † | 124/FIN |
| FS 18-64 | † | 124/FIN | FS 18-120 | † | 124/FIN |
| FS 18-65 | † | 124/FIN | FS 18-121 | † | 124/FIN |
| FS 18-66 | † | 124/FIN | FS 18-122 | † | 124/FIN |
| FS 18-67 | † | 124/FIN | FS 18-123 | † | 124/FIN |
| FS 18-68 | † | 124/FIN | FS 18-124 | † | 124/FIN |

† – Color page in flight book

| | | |
|-----------------|---|---------|
| FS 18-125 | † | 124/FIN |
| FS 18-126 | † | 124/FIN |
| FS 18-127 | † | 124/FIN |
| FS 18-128 | † | 124/FIN |
| FS 18-129 | † | 124/FIN |
| FS 18-130 | | 124/FIN |
| 19-i | | generic |
| 19-ii | | generic |
| 19-1 | | generic |
| 19-2 | | generic |
| 19-3 | | generic |
| 19-4 | | generic |
| 19-5 | | generic |
| 19-6 | | generic |
| 19-7 | | generic |
| 19-8 | | generic |
| 19-9 | | generic |
| 19-10 | | generic |
| 19-11 | | generic |
| 19-12 | | generic |
| 19-13 | | generic |
| 19-14 | | generic |
| 20-1 | * | generic |
| 20-2 | * | generic |

† – Color page in flight book

* – Omit from flight book

EVA CUE CARDS

| <u>Title</u> | <u>Ref. Page</u> | <u>Card No.</u> |
|---|------------------|-----------------|
| SAFER CHECKOUT RESULTS (Front)..... | CC 3-10 | generic |
| SAFER STATUS TROUBLESHOOTING (Back) | CC 3-11 | generic |
| DEPRESS/REPRESS (NOM A/L) (Front)..... | CC A6-2 | generic |
| FAILED LEAK CHECK (Back of DEPRESS/REPRESS) | CC 6-4 | generic |
| STS-124/1J EMU CONSUMABLES TRACKING CUE CARD (Front)..... | FS CC 10-15 | EVA-4a/124/O/B |
| STS-124/1J BATTERY RECHARGE PLAN CUE CARD (Back) | FS CC 10-16 | EVA-4b/124/O/A |
| STS-124/1J EMERGENCY UNDOCK EVA TRANSFER CUE CARD (Front)..... | FS CC 12-29 | EVA-5a/124/O/A |
| STS-124/1J EXPEDITED SUIT DOFFING CUE CARD (Back) | FS CC 12-30 | EVA-5b/124/O/A |

This Page Intentionally Blank

CONTENTS

PAGE

10.2 PSI CABIN 1-1
 MASK PREBREATHE INITIATE 1-2
 PREP FOR 10.2 PSI CABIN 1-3
 CABIN DEPRESS TO 10.2 PSI..... 1-4
 10.2 PSIA DEPRESS CHART 1-5
 10.2 PSI CABIN CONFIG 1-6
 MASK PREBREATHE TERMINATE 1-6
 10.2 PSI MAINTENANCE 1-7
 CABIN REPRESS TO 14.7 PSI..... 1-8
 14.7 PSI CABIN CONFIG 1-9

AIRLOCK CONFIG..... TEMP FS 2-1
 AIRLOCK PREP TEMP FS 2-2
 EMU SWAP 2-3
 BOOSTER FAN DEACTIVATION/REMOVAL..... 2-4
 BOOSTER FAN INSTALLATION/ACTIVATION..... 2-4
 EMU REMOVAL 2-4
 EMU INSTALLATION 2-4
 EMU CHECKOUT PREP TEMP FS 2-5
 LTA RESTRAINT STRAP REMOVAL TEMP FS 2-6
 LTA RESTRAINT STRAP INSTALLATION TEMP FS 2-6
 EVA PREP FOR TRANSFER TO ISS FS 2-7
 EVA TRANSFER TO ISS FS 2-10
 EMU COMPONENT SWAP FS 2-11
 EVA PREP FOR TRANSFER TO SHUTTLE FS 2-13
 EVA TRANSFER TO SHUTTLE FS 2-15
 EVA STOW..... FS 2-16

CHECKOUTS..... 3-1
 EMU CHECKOUT 3-2
 EMU POWERUP AND COMM CHECK..... 3-2
 PRIMARY REGULATOR/FAN/PUMP CHECK 3-4
 SOP CHECK..... 3-5
 BATTERY CHARGE CHECK INIT..... 3-6
 BATTERY CHARGE CHECK TERM 3-6
 EMU SWAP DURING CHECKOUT 3-7
 POST EMU C/O RECONFIG 3-7
 SAFER CHECKOUT 3-8
 SELF TEST SEQUENCE 3-9
 SAFER CHECKOUT RESULTS..... CC 3-10
 SAFER STATUS TROUBLESHOOTING CC 3-11
 REBA POWERED HARDWARE CHECKOUT 3-12

EVA PREP 4-1
 MIDDECK PREP 4-2
 EVA PREP..... 4-3
 PREP FOR DONNING..... 4-3
 EMU DONNING 4-5
 EMU CHECK 4-7
 EMU PURGE..... 4-7
 EMU PREBREATHE 4-8
 SAFER DONNING 4-8
 EVA COMM CONFIG 4-10
 EVA COMM DECONFIG 4-10
 APPROVED NON-EMU HARDWARE MATRIX..... 4-11

| | |
|---|----------|
| EMU STATUS | 5-1 |
| EMU STATUS | 5-2 |
| DEPRESS/REPRESS | A6-1 |
| DEPRESS/REPRESS (NOM A/L) | CC A6-2 |
| FAILED LEAK CHECK | 6-3 |
| FAILED LEAK CHECK (5 PSI) | CC 6-4 |
| FAILED LEAK CHECK (14.7/10.2 PSI) | CC 6-4 |
| TIMELINES | FS 7-1 |
| EVA 1 | |
| 1J EVA 1 SUMMARY | FS 7-3 |
| 1J EVA 1 BRIEFING CARD | FS 7-4 |
| 1J EVA 1 TOOL CONFIGURATION | FS 7-6 |
| 1J EVA 1 INHIBIT PAD | FS 7-8 |
| 1J EVA 1 NOTES, CAUTIONS, WARNINGS | FS 7-10 |
| EGRESS/EVA SETUP | FS 7-14 |
| SRMS ELBOW CAMERA RESTRAINT REMOVAL AND BOOM HANDOFF TO SSRMS | FS 7-15 |
| JPM PREP | FS 7-29 |
| S3/S4 SARJ COVER REMOVE AND TBA #5 INSTALL | FS 7-38 |
| S3/S4 SARJ DATUM A INSPECTION | FS 7-46 |
| CLEANING TECHNIQUE DTO | FS 7-49 |
| CLEANUP AND INGRESS | FS 7-53 |
| EVA 2 | |
| 1J EVA 2 SUMMARY | FS 7-55 |
| 1J EVA 2 BRIEFING CARD | FS 7-56 |
| 1J EVA 2 TOOL CONFIGURATION | FS 7-58 |
| 1J EVA 2 INHIBIT PAD | FS 7-60 |
| 1J EVA 2 NOTES, CAUTIONS, WARNINGS | FS 7-62 |
| EGRESS/SETUP | FS 7-66 |
| JTVE INSTALLATION | FS 7-67 |
| JEM OUTFITTING | FS 7-74 |
| S1 NTA AND ESP3 NTA PREP | FS 7-85 |
| CP 9 ETVCG RETRIEVE | FS 7-89 |
| CLEANUP AND INGRESS | FS 7-93 |
| EVA 3 | |
| 1J EVA 3 SUMMARY | FS 7-94 |
| 1J EVA 3 BRIEFING CARD | FS 7-95 |
| 1J EVA 3 TOOL CONFIGURATION | FS 7-97 |
| 1J EVA 3 INHIBIT PAD | FS 7-99 |
| 1J EVA 3 NOTES, CAUTIONS, WARNINGS | FS 7-101 |
| EGRESS/EVA SETUP | FS 7-105 |
| S1 NTA REMOVAL | FS 7-106 |
| SWAP NTA AT ESP3 | FS 7-109 |
| S1 NTA INSTALLATION | FS 7-112 |
| WVE/EVE TASK – WINDOW LL – ACBM MMOD SHIELDS – SSRMS CLEANUP TASKS | FS 7-116 |
| CP 9 ETVCG INSTALL | FS 7-122 |
| CLEANUP AND INGRESS | FS 7-127 |
| GET-AHEADS | |
| 1J EVA GET-AHEADS INHIBIT PAD | FS 7-128 |
| NODE 2 QD THERMAL BLANKET INSTALL | FS 7-129 |
| WETA INSTALL CP1 | FS 7-133 |
| S3/S4 SARJ LAUNCH RESTRAINT REMOVAL | FS 7-139 |
| S1 FHRC P-CLAMP RELEASE | FS 7-143 |
| NODE 1 MMOD SHIELD CLEANUP | FS 7-147 |
| PORT SARJ INSPECTION | FS 7-150 |

| | | |
|--|---------|-------|
| TOOLS AND STOWAGE | TEMP FS | 8-1 |
| PORT LIGHTWEIGHT TOOL STOWAGE ASSEMBLY (TSA)..... | TEMP FS | 8-2 |
| PGT CHECKOUT | | 8-3 |
| PGSC-PGT CONNECTION (A31P AND 760XD)..... | | 8-4 |
| PROGRAM PGT SETTINGS..... | | 8-5 |
| DOWNLOAD/ERASE EVENT LOG..... | | 8-5 |
| PGT CONTINGENCIES | | 8-6 |
| PGT STANDARD SETTINGS | | 8-7 |
| TOOLBOX STOWAGE..... | FS | 8-9 |
| TOOLBOX PANEL AND SLOT LABELS..... | FS | 8-10 |
| Z1 TOOLBOX INTERNAL LAYOUT..... | FS | 8-11 |
| AIRLOCK TOOLBOX INTERNAL LAYOUT | FS | 8-12 |
| APFR MANAGEMENT – STS-124/1J | FS | 8-13 |
| SAFETY TETHER CONFIGURATION – STS-124/1J..... | FS | 8-14 |
| | | |
| POST EVA | | 9-1 |
| POST EVA..... | | 9-2 |
| SUIT DOFFING..... | | 9-2 |
| SAFER DOFFING..... | | 9-2 |
| EMU WATER RECHARGE..... | | 9-3 |
| SAFER STOW | | 9-3 |
| SUIT DRYING/SEAL WIPE | | 9-4 |
| OXYGEN RECHARGE VERIFICATION..... | | 9-4 |
| WATER FILL VERIFICATION..... | | 9-4 |
| EMU POWERDOWN/OVERNIGHT STOW..... | | 9-5 |
| | | |
| EMU MAINT/RECHARGE..... | TEMP FS | 10-1 |
| WATER RECHARGE | TEMP FS | 10-2 |
| EMU POWERUP | TEMP FS | 10-2 |
| WATER FILL..... | TEMP FS | 10-2 |
| WATER FILL VERIFICATION..... | TEMP FS | 10-2 |
| EMU LiOH CHANGEOUT | | 10-4 |
| MIDDECK EMU BATTERY RECHARGE (STAND-ALONE) | | 10-4a |
| MIDDECK EMU BATTERY RECHARGE/LiOH REPLACEMENT | | 10-5 |
| INITIATE | | 10-5 |
| TERMINATE | | 10-6 |
| IN-SUIT EMU BATTERY RECHARGE/CHARGE VERIFICATION | | 10-7 |
| INITIATE | | 10-7 |
| TERMINATE | | 10-7 |
| EMU POWERDOWN..... | | 10-7 |
| HELMET LIGHT/PGT BATTERY RECHARGE | | 10-8 |
| INITIATE | | 10-8 |
| TERMINATE | | 10-9 |
| REBA BATTERY INSTALLATION..... | | 10-9 |
| EMU BATTERY REMOVAL/INSTALL..... | | 10-10 |
| HELMET LIGHT BULB CHANGEOUT | | 10-11 |
| REBA BATTERY RECHARGE | | 10-12 |
| INITIATE | | 10-12 |
| TERMINATE | | 10-13 |
| STS-124/1J EMU CONSUMABLES TRACKING CUE CARD..... | FS CC | 10-15 |
| STS-124/1J BATTERY RECHARGE PLAN CUE CARD | FS CC | 10-16 |
| | | |
| POST EVA ENTRY PREP | | 11-1 |
| POST EVA ENTRY PREP..... | | 11-2 |
| SAFER ENTRY STOW..... | | 11-2 |
| POST ISS EVA ENTRY PREP..... | | 11-3 |

| | |
|--|--------------|
| <u>OFF-NOMINAL PROCEDURES</u> | 12-i |
| EMU CONTINGENCY PROC | TEMP FS 12-1 |
| DISPLAY LOSS DURING POWER TRANSFER (WARM RESTART) | TEMP FS 12-2 |
| VACUUM H2O RECHARGE (MANNED) | TEMP FS 12-2 |
| LIOH REPLACEMENT (MANNED) | 12-3 |
| BATTERY REPLACEMENT (MANNED) | 12-4 |
| WATER DUMP | 12-6 |
| SCU SWAP (UNMANNED) | 12-7 |
| SCU SWAP (MANNED) | 12-7 |
| EMU COLD RESTART (MANNED) | 12-7 |
| 12.1 STS EVA DECONTAMINATION | 12-8 |
| CONTAMINATION TEST | 12-15 |
| SAFER BATTERY CHANGEOUT | 12-18 |
| BENDS TREATMENT ADAPTER (BTA) INSTALLATION (IN-SUIT) | 12-19 |
| BTA PREP | 12-19 |
| BTA TREATMENT | 12-19 |
| BENDS TREATMENT ADAPTER (BTA) INSTALLATION (PPOST SUIT DOFFING) | 12-21 |
| BTA PREP | 12-21 |
| BTA TREATMENT | 12-21 |
| EMU RESIZE | 12-24 |
| EMU NOMINAL SIZING (STS-124/1J) | FS 12-27 |
| EMU CONTINGENCY RESIZE MATRIX (STS-124/1J) | FS 12-28 |
| STS-124/1J EMERGENCY UNDOCK EVA TRANSFER CUE CARD | FS CC 12-29 |
| STS-124/1J EXPEDITED SUIT DOFFING CUE CARD | FS CC 12-30 |
| TPS REPAIR | FS 13-1 |
| ORBITER CONTINGENCY EVA | 14-1 |
| PAYLOAD BAY EVA NOMENCLATURE | 14-2 |
| RMS/PRLA CONTINGENCY EVA | 14-3 |
| 96 BOLT PRE-EVA TOOL CONFIG | 14-13 |
| 96 BOLT EVA TIMELINE | 14-14 |
| CAPTURE LATCH MANUAL RELEASE (ODS/PMA) | 14-19 |
| 96 BOLT EVA LAYOUT | 14-21 |
| PLBD LATCH TOOL PLACEMENT WITH DUAL LATCH GANG FAILURES | 14-22 |
| EVA CUFF CHECKLIST (CIL) | 15-1 |
| NORMAL EVA STATUS | 15-2 |
| DCM CONFIGURATION | 15-2 |
| EMU MALFUNCTION INDEX | 15-2 |
| DECOMPRESSION SICKNESS (DCS) | 15-3 |
| DECOMPRESSION SICKNESS (DCS) (CONT) | 15-3 |
| ABORT EVA | 15-3 |
| TERMINATE EVA | 15-3 |
| SUIT P EMERG | 15-4 |
| SOP O2 ON | 15-4 |
| BATT AMPS HIGH | 15-4 |
| BATT V DECAY OR BATT VDC LOW | 15-4 |
| SUIT P LOW | 15-5 |
| SUIT P HIGH | 15-5 |
| SOP P LOW | 15-5 |
| O2 USE HIGH | 15-5 |
| SUBLM PRESS | 15-6 |
| H2O GP LOW | 15-6 |
| RESRV H2O ON | 15-6 |
| H2O WP HIGH | 15-6 |

| | |
|--------------------------------|------|
| NO VENT FLOW | 15-7 |
| CO2 HIGH OR MONITOR CO2 | 15-7 |
| CO2 SNSR BAD..... | 15-7 |
| COMM FAILURE | 15-7 |
| AIR FLOW CONTAMINATION | 15-8 |
| LOSS OF COOLING | 15-8 |
| RLF V FAIL..... | 15-8 |
| MISC MSGS 1 | 15-8 |
| MISC MSGS (CONT)/TIME LF..... | 15-9 |
| AIRLOCK LATCH DISCONNECT | 15-9 |
| AIRLOCK INGRESS..... | 15-9 |

FOLLOWING PAGES NOT IN EV CUFF

| | |
|---|-------|
| RADIATOR ACTUATOR DISCONNECT | 15-9 |
| PLBD DRIVE CUT..... | 15-10 |
| DOOR DRIVE RESTRAINT | 15-10 |
| DOOR DRIVE DISCONNECT | 15-10 |
| WINCH OPERATIONS..... | 15-10 |
| WINCH OPERATIONS (CONT) | 15-11 |
| 3-PT TOOL INSTALLATION | 15-11 |
| CL LATCH TOOL | 15-11 |
| RMS JOINT ALIGN | 15-11 |
| MPM STOW/DEPLOY..... | 15-12 |
| RMS TIEDOWN..... | 15-12 |
| RMS FLIGHT RELEASABLE GRAPPLE FIXTURE RELEASE | 15-12 |
| PRLA OPEN/CLOSE | 15-12 |
| PRLA OPEN/CLOSE (CONT) | 15-13 |
| KU ANTENNA STOW..... | 15-13 |
| KU ANTENNA STOW (CONT) | 15-13 |
| AIRLOCK EGRESS..... | 15-13 |

| | |
|---|--------------|
| <u>FLIGHT SPECIFIC REFERENCE</u> | 16-i |
| UNSCCHEDULED/CONTINGENCY EVA TASKS | TEMP FS 16-1 |
| 1J WORKAROUNDS CRIBSHEET | TEMP FS 16-2 |
| MANUALLY OPEN/CLOSE CBM PETAL | FS 16-16 |
| REMOVE/REPLACE CENTER DISK COVER | FS 16-21 |
| REMOVE/REPLACE CBM CONTROLLER PANEL ASSEMBLY (CPA)..... | FS 16-26 |
| CLEAR/RESTRAIN CBM CAPTURE LATCH | FS 16-33 |
| REMOVE/REPLACE CBM CAPTURE LATCH | FS 16-36 |
| REMOVE CBM READY-TO-LATCH (RTL) | FS 16-42 |
| REMOVE/REPLACE CBM PETAL..... | FS 16-48 |
| 1J ISS ORU TIE-DOWN PLAN | FS 16-53 |
| MANUAL RELEASE OF HRM..... | FS 16-69 |
| JEM RMS JEU REMOVE/REPLACE | FS 16-72 |

| | |
|----------------------------|------|
| GENERIC EVA REFERENCE..... | 17-1 |
|----------------------------|------|

| | |
|---|----------|
| FLIGHT SPECIFIC EVA REFERENCE..... | FS 18-1 |
| STS-124 PAYLOAD BAY LAYOUT | FS 18-3 |
| JEM PM | |
| HANDRAILS AND WIF LOCATIONS – PORT ENDCONE | FS 18-4 |
| HANDRAILS AND WIF LOCATIONS – STARBOARD ENDCONE | FS 18-5 |
| HANDRAILS AND WIF LOCATIONS – ZENITH FACE | FS 18-6 |
| HANDRAILS AND WIF LOCATIONS – FORWARD FACE | FS 18-7 |
| HANDRAILS AND WIF LOCATIONS – NADIR FACE..... | FS 18-8 |
| HANDRAILS AND WIF LOCATIONS – AFT FACE | FS 18-9 |
| OVERALL DIMENSIONS AND MASS INFORMATION..... | FS 18-10 |
| PORT ENDCONE | FS 18-11 |
| JEM RMS JOINT NUMBERING | FS 18-13 |

| | |
|---|-----------|
| LTA CABLE | FS 18-14 |
| PCBM | FS 18-18 |
| PCBM CONTAMINATION COVER..... | FS 18-19 |
| WINDOW SHUTTER | FS 18-21 |
| JTVE BOOM..... | FS 18-22 |
| JTVE BOOM INSTALLED..... | FS 18-24 |
| JTVE BOOM RECEPTACLE | FS 18-25 |
| JTVE BOOM RECEPTACLE AND CONNECTOR CAP | FS 18-26 |
| JTVE BOOM LABELING AND CONNECTOR..... | FS 18-27 |
| JTVE CAMERAS AND LAUNCH LOCKS..... | FS 18-28 |
| EVE LAUNCH LOCK | FS 18-29 |
| WVE LAUNCH LOCK..... | FS 18-32 |
| WVE AND EVE MLI..... | FS 18-36 |
| ACBM MMOD SHIELD LAUNCH LOCK BOLTS..... | FS 18-37 |
| ACBM MMOD SHIELD DEPLOY DOOR/HANDLE | FS 18-38 |
| ACBM MMOD SHIELD DEPLOYED..... | FS 18-40 |
| PCBM MLI REMOVAL..... | FS 18-42 |
| PCBM PIP PIN..... | FS 18-45 |
| RMS JEU COVERS..... | FS 18-47 |
| TRUNNION/KEEL COVERS..... | FS 18-51 |
| OBSS | |
| OVERVIEW ON TRUSS..... | FS 18-52 |
| KEEP-ALIVE UMBILICAL WORKSITE..... | FS 18-53 |
| OBSS ON TRUSS – FLY AROUND PHOTOS..... | FS 18-54 |
| KEEP-ALIVE UMBILICAL COMPONENTS | FS 18-56 |
| KEEP-ALIVE DEVICE – ATTACHED | FS 18-57 |
| KEEP-ALIVE DEVICE – DETACHED..... | FS 18-58 |
| P411 CONNECTOR COVER..... | FS 18-59 |
| AVIONICS BOX | FS 18-60 |
| OSE | FS 18-61 |
| NODE 2 | |
| PORT ACBM WINDOW COVER..... | FS 18-69 |
| PORT ACBM HATCH PETAL DEPLOY | FS 18-71 |
| PORT ACBM LAUNCH LOCK..... | FS 18-72 |
| FLUID QD MLI INSTALL..... | FS 18-73 |
| S3 SARJ | |
| TRUNDLE BEARING ASSEMBLY – ON-ORBIT..... | FS 18-75 |
| TRUNDLE BEARING ASSEMBLY – INSTALLATION DIAGRAM | FS 18-84 |
| LAUNCH RESTRAINT DIAGRAM..... | FS 18-86 |
| LAUNCH RESTRAINT ON-ORBIT | FS 18-87 |
| 6A LAUNCH RESTRAINT – ETRS INSTALLED | FS 18-88 |
| 1A LAUNCH RESTRAINT | FS 18-89 |
| 6A LAUNCH RESTRAINT – LAUNCH CONFIG..... | FS 18-90 |
| 6A LAUNCH RESTRAINT – LAUNCH CONFIG (BACK SIDE)..... | FS 18-91 |
| FACE 6/1/2 ON-ORBIT..... | FS 18-92 |
| FACE 4 LAUNCH CONFIG..... | FS 18-93 |
| LAUNCH RESTRAINT CLAM SHELL | FS 18-95 |
| LAUNCH RESTRAINT MUSHROOM-SHAPED FITTING | FS 18-96 |
| COVER/TBA/DLA LABELING..... | FS 18-97 |
| COVER 18 REMOVED – DIVOT REGION..... | FS 18-99 |
| NTA | |
| NOMENCLATURE..... | FS 18-100 |
| ESP3 MLI..... | FS 18-101 |
| S1 CLOSEUP VIEW | FS 18-102 |
| S1 ON-ORBIT (FWD VIEW) | FS 18-103 |
| S1 ON-ORBIT (AFT VIEW)..... | FS 18-104 |

| | |
|--|-----------|
| S1 ON-ORBIT (AFT VIEW) MLI REMOVED | FS 18-105 |
| S1 SOFT DOCK..... | FS 18-106 |
| ESP3 | |
| HANDRAILS/WIFs – STARBOARD SIDE | FS 18-108 |
| HANDRAILS/WIFs – PORT SIDE..... | FS 18-109 |
| P1/CP9 ETVCG | |
| CAMERA LABELED | FS 18-110 |
| CAMERA LOCK..... | FS 18-111 |
| CAMERA STANCHION/DUMMY BOX LABELED | FS 18-112 |
| WORKSITE OVERVIEW | FS 18-113 |
| DRAWING LABELED | FS 18-114 |
| DUMMY BOX INSTALLED | FS 18-115 |
| WETA | |
| ASSEMBLY PHOTOS | FS 18-118 |
| MISC | |
| SRMS ELBOW CAMERA STRAP | FS 18-120 |
| MCAS PIP PIN REMOVAL AND RTL CHECKOUT..... | FS 18-121 |
| MCAS EBCS MLI REMOVAL | FS 18-122 |
| 1J EVA WORKSITES OVERVIEW | FS 18-123 |
| TRANSLATION PATHS | |
| EVA 1: A/L TO OBSS | FS 18-124 |
| EVA 1: OBSS TO JEM PM IN PLD BAY | FS 18-125 |
| EVA 2: A/L TO JEM PM ENDCONE..... | FS 18-126 |
| EVA 2: A/L TO S1 AND ESP3 NTA..... | FS 18-127 |
| EVA 3: A/L TO S1 AND ESP3 NTA..... | FS 18-128 |
| EVA 3: A/L TO JEM PM ENDCONE..... | FS 18-129 |
| <u>EVA EMERGENCY</u> | 19-i |
| EMERGENCY PROCEDURES..... | 19-1 |
| EMERGENCY AIRLOCK REPRESS | 19-3 |
| EMERGENCY AIRLOCK REPRESS..... | 19-4 |
| POST EMERGENCY AIRLOCK REPRESS..... | 19-4 |
| SAFER RESCUE..... | 19-5 |
| SAFER RESCUE | 19-6 |
| DAP/EVA RESCUE/RETRIEVE | 19-7 |
| EVA ORBITER CONFIG..... | 19-7 |
| EVA RESCUE/RETRIEVE..... | 19-9 |
| 19.1 DCS TREATMENT | 19-10 |
| CONTINGENCY SHUTTLE AIRLOCK INGRESS FROM ISS | 19-13 |
| CUE CARD CONFIGURATION | 20-1 |

This Page Intentionally Blank

AIRLOCK CONFIG

| | |
|---|-------------|
| AIRLOCK PREP | TEMP FS 2-2 |
| EMU SWAP | 2-3 |
| BOOSTER FAN DEACTIVATION/REMOVAL | 2-4 |
| BOOSTER FAN INSTALLATION/ACTIVATION | 2-4 |
| EMU REMOVAL | 2-4 |
| EMU INSTALLATION | 2-4 |
| EMU CHECKOUT PREP | TEMP FS 2-5 |
| LTA RESTRAINT STRAP REMOVAL | TEMP FS 2-6 |
| LTA RESTRAINT STRAP INSTALLATION | TEMP FS 2-6 |
| EVA PREP FOR TRANSFER TO ISS | FS 2-7 |
| EVA TRANSFER TO ISS..... | FS 2-10 |
| EMU COMPONENT SWAP | FS 2-11 |
| EVA PREP FOR TRANSFER TO SHUTTLE..... | FS 2-13 |
| EVA TRANSFER TO SHUTTLE | FS 2-15 |
| EVA STOW | FS 2-16 |

**AIRLOCK
CONFIG**

AIRLOCK PREP (50 min)

| | |
|-------------------|--|
| | Retrieve or unstow following equipment: |
| MF28G | 3/8-in breaker bar, 4-in ext w/3/8-in drive |
| IFM Tool Kit | 1/2-in socket w/3/8-in drive |
| Vol H | EMU Equipment Bag – attach to middeck wall Helmet Lights |
| MD Floor Bag G | Retrieve SAFER HCM hard mount (DCM plug) and stow in EVA Bag EVA Bag |
| <hr/> | Contamination Detection Kit (location flight specific) |
| FDF Locker | Cuff Checklists (2) – stow in EMU Equipment Bag <u>DEPRESS/REPRESS</u> Cue Card |

- AIRLOCK CONFIG
- AW18A
1. ✓ Inner hatch Equal vlv (two) – OFF
 2. LTG FLOOD (four) – ON
 3. Remove from airlock, as reqd:
Airlock Stowage Bag
Airlock Floor Pallet using 3/8-in breaker bar, 4-in ext w/3/8-in drive, and
1/2-in socket w/3/8-in drive
 4. Stow Vol H Bags in Vol H
 5. Transfer to airlock:
EVA Bag – install on airlock wall
DEPRESS/REPRESS Cue Card
Helmet Lights
Contamination Detection Kit – install on airlock wall
 6. Install IVA foot restraint, as reqd
 7. Unbuckle SCU straps, Velcro SCU to wall
 8. Install EMU lights on helmets (EMU 1, EMU 2)
 9. Disconnect helmets from Airlock EMUs, temp stow
 10. Remove comm caps from LTA Restraint Bags and connect to electrical harnesses
 11. Install helmets (not reqd if proceeding directly to EMU Checkout)
 12. Remove LTA Restraint Bags
 13. Disconnect waist rings; remove and stow any equipment stowed in HUT/LTA
 14. Stow LTA Restraint Bags on AAPs
 15. ✓ Thermal cover clear of waist ring
 16. Waist ring – engage posn
 17. Connect LTA to HUT, lock
 18. Remove 20-g Crash Bag from middeck EMU, as reqd

EMU CHECKOUT PREP (30 min)

- AW18A 1. LTG FLOOD (four) – ON
2. Remove Airlock Floor Bag from airlock (as reqd)
3. Unbuckle SCU straps, Velcro SCU to wall
4. Disconnect helmets from airlock EMU, temp stow
5. ✓DIDB Restraint Bags installed
- EMUs 6. Remove comm caps s/n 1172 (Fs1 prime), s/n 1175 (Cf prime), s/n 1204 (Ga1 prime), s/n 1202 (Cf backup) from LTA restraint bag pouches. Stow Cf prime and backup CCA in CF CTB in MA16D
7. Connect comm caps to electrical harnesses
8. Remove LTA Restraint Bags (reference LTA Restraint Strap Removal, next page, as reqd)
9. Disconnect waist rings
10. Remove/temp stow ECOKs
- ECOK 11. Retrieve/temp stow mesh bags labeled 'EMU SYSTEMS 1' and 'EVA TOOLS TRANSFER'
- MD Floor 12. Retrieve LCVGs
Bag D (NOTE: LCVGs will be used during EMU Checkout)
- Vol H 13. Unstow from Volume H:
Inboard bag – SCOFs (2) from EMU Equipment Bag
EHIP batteries (4)
EMU Servicing Kit (s/n 5002)
14. Stow in EMU SYSTEMS 1:
EMU Servicing Kit (s/n 5002), EHIP batteries (4)
15. Temp stow EMU SYSTEMS 1 for use in EVA PREP FOR TRANSFER TO ISS
- MDK Wall 16. Temp stow SCOFs for EMU Checkout
17. Stow LTA Restraint Bags on AAPs (rolled up on lower AAP cross bar as reqd)
18. Remove EMUs from AAPs
19. Unzip thermal cover, report LiOH s/n to MCC:

EV1 LiOH _____ EV2 LiOH _____
20. Zip and resecure thermal cover
21. Reinstall EMUs in AAPs
22. ✓Thermal cover clear of waist ring
23. Waist ring – engage posn
24. Connect LTA to HUT, lock

LTA RESTRAINT STRAP REMOVAL (15 min)

NOTE

May be performed on EMU 1 and 2 simultaneously.
Perform steps as reqd for current EMU config

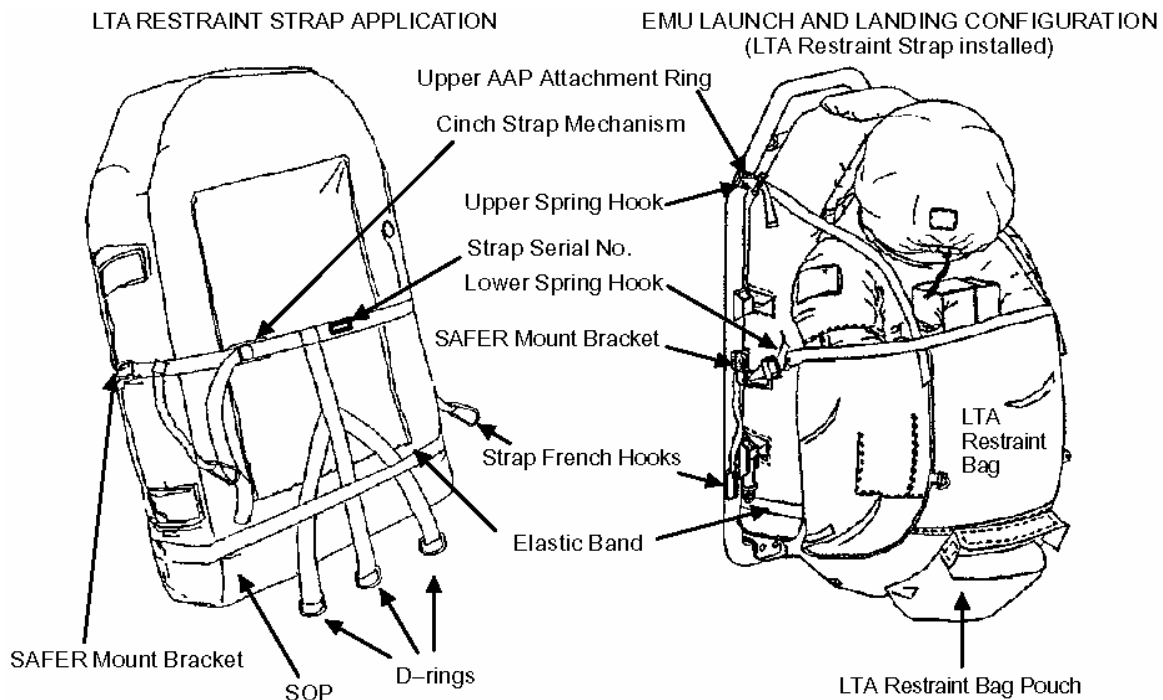
1. As reqd, remove comm cap from LTA Restraint Bag; temp stow
2. Remove EMU from AAP
3. Disconnect all restraint attachments from SAFER mount brackets (two)
4. Loosen cinch strap mechanism, remove SAFER mount brackets
5. Remove strap from PLSS
6. Stow strap in LTA Restraint Bag Pouch with D-rings (three) connected
7. Engage EMU in AAP
8. Stow LTA Restraint Bag/strap

LTA RESTRAINT STRAP INSTALLATION (15 min)

NOTE

May be performed on EMU 1 and 2 simultaneously. Perform steps as reqd for current EMU config. Procedure written to install in Launch/Landing config shown below

1. Unstow LTA Restraint Bag/strap
2. Remove EMU from AAP
3. Install SAFER mount brackets (two)
4. Install elastic band of strap around SOP
5. Tighten cinch strap mechanism
6. Attach strap French hooks (two) to SAFER mount brackets
7. Engage EMU in AAP
8. Stow LTA, suit arms inside LTA Restraint Bag
9. Connect upper spring hooks (two) over suit shoulders to upper AAP attachment rings (two)
10. Connect lower spring hooks (two) around suit arms to SAFER mount brackets (two)
11. Tighten all LTA bag straps with bag as high as possible on EMU



NOTE

French hooks should be attached to SAFER mount brackets for launch and landing

EVA PREP FOR TRANSFER TO ISS (115 min)

- EMU 3015 (Fs), 1. √PWR – SCU
 EMU 3017 (Ga)
- DCM 2. √DCM PURGE vlv – op (up)
 3. √WATER – OFF, switch guard installed
 4. √O2 ACT – OFF
- EMU 3015 (Fs), 5. Install LTA Restraint Bag as required for transfer
 EMU 3017 (Ga)
6. Configure/verify items stowed in the tables below

EMU 3015 (Fs) Large

| Item | Stowed Location |
|---|-------------------|
| <input type="checkbox"/> Helmet s/n 1076 (√sun shades down, visor up, cover installed) <ul style="list-style-type: none"> <input type="checkbox"/> Valsalva <input type="checkbox"/> Fresnel Lens (2) <input type="checkbox"/> Wrist Mirrors <input type="checkbox"/> DIDB Restraint Bag <input type="checkbox"/> Fs Gloves (s/n 6212) <input type="checkbox"/> EMU Battery (s/n 2067) <input type="checkbox"/> LiOH Can Record s/n ____ <input type="checkbox"/> LTA (Fs) | EMU 3015 |
| <input type="checkbox"/> Prime CCA (s/n 1172) | LTA Restraint Bag |
| <input type="checkbox"/> ISS EVA Cuff C/L (EV1) | Middeck MF57E |

EMU 3017 (Ga) Medium

| Item | Stowed Location |
|--|-------------------|
| <input type="checkbox"/> Helmet s/n 1071 (√sun shades down, visor up, cover installed) <ul style="list-style-type: none"> <input type="checkbox"/> Valsalva <input type="checkbox"/> Wrist Mirrors <input type="checkbox"/> DIDB Restraint Bag <input type="checkbox"/> Ga Gloves (s/n 6085) <input type="checkbox"/> EMU Battery (s/n 2072) <input type="checkbox"/> LiOH Can Record s/n ____ <input type="checkbox"/> LTA (Ga) | EMU 3017 |
| <input type="checkbox"/> Prime CCA (s/n 1204) | LTA Restraint Bag |
| <input type="checkbox"/> ISS EVA Cuff C/L (EV2) | Middeck MF57E |

EVA PREP FOR TRANSFER TO ISS (115 min) (Cont)

EMU Crew Options Kit (Fs ECOK)

| Item | Stowed Location |
|---|------------------------|
| <input type="checkbox"/> LCVG w/biomed (Fs) (s/n 3163) | MD Floor Bag D |
| <input type="checkbox"/> Ziplock Bags Fs EVA #1, 2 & 3 <ul style="list-style-type: none"> <input type="checkbox"/> 2 MAGs <input type="checkbox"/> 2 Ziplock Bags <input type="checkbox"/> TCUs (top, bottom) <input type="checkbox"/> Wristlets <input type="checkbox"/> Comfort Gloves <input type="checkbox"/> Thermal Socks <input type="checkbox"/> Crew Preference Items (TBD) <input type="checkbox"/> Mission Patch <input type="checkbox"/> National Flag <input type="checkbox"/> EV1 ID Stripes | Inside HUT |

EMU Crew Options Kit (Ga ECOK)

| Item | Stowed Location |
|---|------------------------|
| <input type="checkbox"/> LCVG w/biomed (Ga) (s/n 3204) | MD Floor Bag D |
| <input type="checkbox"/> Ziplock Bags Ga EVA #1, 2 & 3 <ul style="list-style-type: none"> <input type="checkbox"/> 2 MAGs <input type="checkbox"/> 2 Ziplock Bags <input type="checkbox"/> TCUs (top, bottom) <input type="checkbox"/> Wristlets <input type="checkbox"/> Comfort Gloves (Spectra) (Orange band for backup) <input type="checkbox"/> Comfort Gloves (Manzella) (Prime) <input type="checkbox"/> Crew Socks <input type="checkbox"/> Mission Patch <input type="checkbox"/> National Flag <input type="checkbox"/> EV2 ID Stripes <input type="checkbox"/> Mesh Bags (2) GA#3 and GA#4 | Inside HUT |

EVA PREP FOR TRANSFER TO ISS (115 min) (Cont)

EVA Systems 1 Mesh Bag

| Item | Stowage Location |
|--|-------------------------|
| <input type="checkbox"/> 6 Filled DIDBs | MD Floor Bag D |
| <input type="checkbox"/> STS-124/1J EVA Checklist (orange stripe) <input type="checkbox"/> ISS EVA SYSTEMS Checklist (red stripe) <input type="checkbox"/> ISS EVA SYSTEMS Checklist (Transfer to ISS) <input type="checkbox"/> ISS EVA Cuff Checklist (Spare) <input type="checkbox"/> STS-124/1J CONSUMABLES TRACKING CUE CARD <input type="checkbox"/> STS-124/1J BATTERY RECHARGE PLAN CUE CARD (back of Consumables CC) <input type="checkbox"/> STS-124/1J EMERGENCY UNDOCK EVA TRANSFER CUE CARD <input type="checkbox"/> STS-124/1J EXPEDITED SUIT DOFFING CUE CARD (back of Emergency Undock CC) | Middeck MF57E |
| <input type="checkbox"/> EMU Battery (s/n 2073) | MD Ceil Bag D |
| <input type="checkbox"/> EMU Servicing Kit s/n 5002 <input type="checkbox"/> EHIP Batteries (4) (s/n 1028, 1029, 1031, 1035) | Vol H |

EVA Tools Transfer Bag

| Item | Stowage Location |
|--|-------------------------|
| <input type="checkbox"/> 85-ft Safety Tethers (2) (s/n 1002, 1003) <input type="checkbox"/> Adj Equip Tethers (-307) (6) <input type="checkbox"/> NTA QD Booties (4) <input type="checkbox"/> LTA Caps (2) <input type="checkbox"/> Dummy Box <input type="checkbox"/> EVA Gap Gauge (s/n 1005) <input type="checkbox"/> Pistol Grip Tool (s/n 1002) | MD Floor Bag D |
| <input type="checkbox"/> EV SARJ Cleaning Scrapers (2) (s/n 1001, 1002) | MD Floor Bag A |
| <input type="checkbox"/> Broom Clip Caddy (MWSTSC) | MD Floor Bag G |

EVA TRANSFER TO ISS (115 min)

NOTE

This procedure assumes that transfer items were preconfigured per EVA PREP FOR TRANSFER TO ISS

1. Transfer the following EVA equipment to ISS:

| Item | Destination | Transfer Status |
|-------------------------------|---------------|-----------------|
| EMU 3015 (Fs) | E-Lk aft EDDA | |
| EMU 3017 (Ga) | E-Lk fwd EDDA | |
| ECOK Mesh Bag (Fs) | E-Lk | |
| ECOK Mesh Bag (Ga) | E-Lk | |
| Mesh Bag (EVA Systems 1) | E-Lk | |
| Mesh Bag (EVA Tools Transfer) | E-Lk | |

2. Remove LTA Restraint Bag and Strap and stow for return to Shuttle, GA#3 Mesh Bag (as required)
3. Remove following ODF/FDF products from EVA Systems 1 Mesh Bag and deploy in E-Lk:
 - STS-124/1J EVA Checklist (orange stripe)
 - ISS EVA SYSTEMS C/L (red stripe)
 - ISS EVA SYSTEMS C/L (Transfer to ISS)
 - STS-124/1J EMU CONSUMABLES TRACKING CUE CARD
 - STS-124/1J BATTERY RECHARGE PLAN CUE CARD (back of Consumables CC)
 - STS-124/1J EMERGENCY UNDOCK EVA TRANSFER CUE CARD
 - STS-124/1J EXPEDITED SUIT DOFFING CUE CARD (back of Emergency Undock CC)
 - ISS EVA Cuff Checklist (spare) – stow in SODF locker
4. Gather and stow ISS EVA Systems Checklist (1) and Cuff Checklists (3) currently on ISS in EVA Systems 1 Mesh Bag for return on STS-124
5. Remove EHIP batteries (4) and EMU battery (1) from EVA Systems 1 Mesh Bag and temp stow in MO-2 bag with EVA batteries
6. Remove LiOH canister from Fs (EMU 3015), cap and stow in MO-2 with Metox cans, install Metox (s/n 0020) for EVA 1
7. Install Helmet Lights w/batteries and EMU TV (per STS-124/1J EMU Consumables Tracking CC)
8. Remove following tools from EVA Tools Transfer Mesh Bag:
 - PGT (s/n 1002) and install PGT battery (s/n 1008) from MO2 Bag, PGT Mesh Bag for EV1 use. Perform PGT CHECKOUT (TOOLS AND STOWAGE)
 - 85-ft Safety Tethers (2) and attach to MWS
 - Adjustable Equip Tethers (6) and use as appropriate
 - EVA Gap Gauge and SARJ scrapers (2) and stow in MED ORU (SARJ) bag
 - LTA caps (2) and stow in Large ORU bag
9. Retrieve crew hygiene and preference items (as required)
10. Perform EVA 1 TOOL CONFIG as time permits
11. Report transfer status to MCC as time permits

EMU COMPONENT SWAP (30 min)

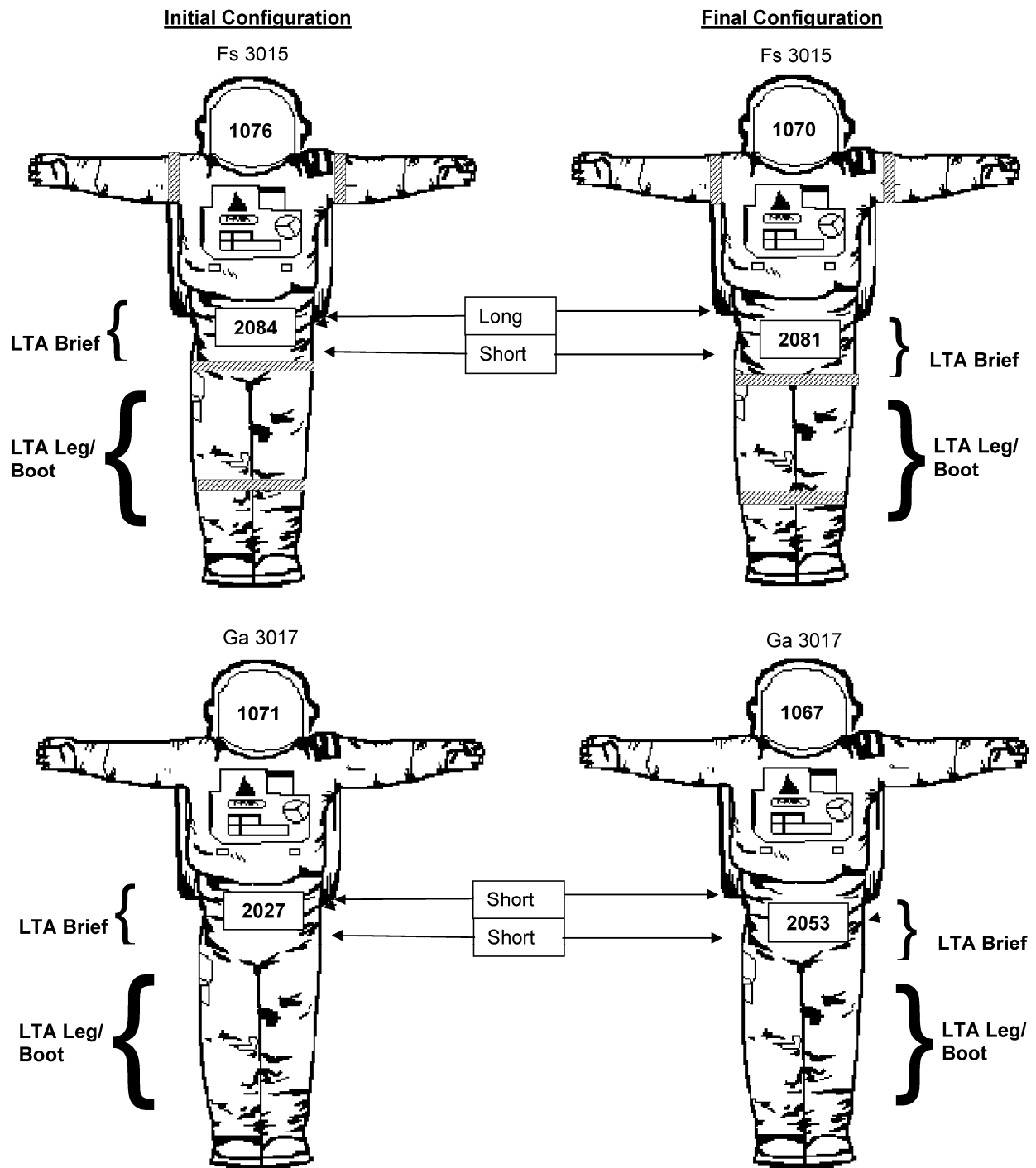
Fs EMU (3015)

1. Disconnect helmet s/n 1076 from Fs EMU s/n 3015
2. Remove Fresnel lenses from Fs helmet s/n 1076
3. Disconnect helmet s/n 1070 from EMU 3018
4. Install Fs Fresnel lenses in helmet s/n 1070. If needed, Fresnel lenses can be positioned using moleskin map in FS2 ECOK
5. Install helmet s/n 1070 on Fs EMU s/n 3015. Install helmet s/n 1076 on EMU s/n 3018
6. On Fs EMU (s/n 3015) remove both leg assemblies from waist/brief and stow waist/brief in the MO-2 Bag 1010
7. Retrieve waist/brief s/n 2053 from MO-2 Bag 1010 and install on Fs EMU s/n 3015. Reattach lower legs/boots (ensuring right boot on right leg)
8. Verify Fs waist/brief (s/n 2081) cams adjustment (top long/bottom short)
9. Install EMU battery (s/n 2065)
10. ✓Expend LiOH canister from EVA 3 installed

Ga EMU (3017)

11. Disconnect helmet s/n 1071 from Ga EMU s/n 3017
12. Disconnect helmet s/n 1067 from EMU 3003
13. Install helmet s/n 1067 on Ga EMU s/n 3017. Install helmet s/n 1071 on EMU s/n 3003
14. On Ga EMU (s/n 3017), remove leg assemblies (s/n 159 and s/n 160) from waist/brief and temp stow
15. Remove leg assemblies (s/n 185 and s/n 186) from EMU 3003 and temp stow
16. Swap waist/brief (s/n 2075) on Ga EMU with waist/brief (s/n 2081) on EMU 3003
17. Reattach leg assemblies s/n 159 and s/n 160 on Ga EMU 3017 and s/n 185 and s/n 186 on EMU 3003 (ensuring right boot on right leg)
18. Verify Ga waist/brief (s/n 2053) cams adjustments (top short/bottom short)
19. Install EMU battery (s/n 2066)
20. Install expended LiOH canister from EVA 1

EMU COMPONENT SWAP (30 min) (Cont)



EVA PREP FOR TRANSFER TO SHUTTLE (60 min)

EMU PACK-UP (45 min)

- BOTH EMUs**
1. Perform 1.307 REBA INSTALLATION/REMOVAL (ISS EVA SYS, AIRLOCK CONFIG), removal steps
 2. Install expended LiOH canisters from EVA 1 (record s/n in EMU tables below)
 3. Install EMU batteries per EMU tables below
 4. Remove ISS EVA Cuff C/L (2) from EMUs (3015 and 3017) and stow in SODF locker

DCM

5. √PWR-SCU
6. √DCM PURGE vlv – op (up)
7. √WATER – OFF, switch guard installed
8. √O2 ACT – OFF
9. √Helmet sun visors down, cover installed
10. Locate EMU Servicing Kit s/n 5005 on ISS
11. Unstow EMU Servicing Kit s/n 5002 from EVA Systems 1 Mesh Bag
12. Remove METOX O-rings (orange) from EMU Servicing Kit (s/n 5005) and stow in EMU Servicing Kit (s/n 5002)
13. Stow EMU Servicing Kit s/n 5002 in MO-2 bag labeled ‘EVA Prep & Ops’
14. Stow EMU Servicing Kit s/n 5005 in EVA Systems 1 Mesh Bag for return
15. Stow ECOKs in EMUs
16. Configure/verify items stowed in table below
(NOTE: **bolded** items differ from pre-docking config)

| EMU 3015 (L) (Fs) | EMU 3017 (M) (Ga) |
|--|---|
| <input type="checkbox"/> Helmet s/n 1070 (√sun visors down, cover installed) <ul style="list-style-type: none"> <input type="checkbox"/> Valsalva <input type="checkbox"/> Fresnel Lens (2) | <input type="checkbox"/> Helmet s/n 1067 (√sun visors down, cover installed) <ul style="list-style-type: none"> <input type="checkbox"/> Valsalva |
| <input type="checkbox"/> Wrist Mirrors | <input type="checkbox"/> Wrist Mirrors (2) |
| <input type="checkbox"/> DIDB Restraint Bag | <input type="checkbox"/> DIDB Restraint Bag |
| <input type="checkbox"/> CCA (s/n 1172) | <input type="checkbox"/> CCA (s/n 1204) |
| <input type="checkbox"/> Fs Gloves (s/n 6212) | <input type="checkbox"/> Ga Gloves (s/n 6085) |
| <input type="checkbox"/> EMU Battery (s/n 2065) | <input type="checkbox"/> EMU Battery (s/n 2066) |
| <input type="checkbox"/> LiOH Can (s/n _____) | <input type="checkbox"/> LiOH Can (s/n _____) |
| <input type="checkbox"/> LTA | <input type="checkbox"/> LTA |
| <input type="checkbox"/> No ERCA | <input type="checkbox"/> No ERCA |
| <input type="checkbox"/> No Helmet Lights | <input type="checkbox"/> No Helmet Lights |
| <input type="checkbox"/> No Cuff C/L | <input type="checkbox"/> No Cuff C/L |
| <input type="checkbox"/> No REBA | <input type="checkbox"/> No REBA |

EVA PREP FOR TRANSFER TO SHUTTLE (60 min) (Cont)

| | |
|---|---|
| <p style="text-align: center;"><u>EMU Crew Option Kit (Fs)</u></p> <ul style="list-style-type: none"> <input type="checkbox"/> LCVG w/biomed (Fs) (s/n 3163) <input type="checkbox"/> Fs EVAs #1, 2, 3 Ziplock Bags <ul style="list-style-type: none"> <input type="checkbox"/> 3 MAGs (less used) <input type="checkbox"/> TCUs (top, bottom) <input type="checkbox"/> Wristlets <input type="checkbox"/> Comfort Gloves <input type="checkbox"/> Thermal Socks liners <input type="checkbox"/> Fresnel Lens <input type="checkbox"/> Mission Patch <input type="checkbox"/> National Flag | <p style="text-align: center;"><u>EMU Crew Option Kit (Ga)</u></p> <ul style="list-style-type: none"> <input type="checkbox"/> LCVG w/biomed (Ga) (s/n 3204) <input type="checkbox"/> Ga EVAs #1, 2, and 3 Ziplock Bags <ul style="list-style-type: none"> <input type="checkbox"/> 3 MAGs (less used) <input type="checkbox"/> TCUs (top, bottom) <input type="checkbox"/> Wristlets <input type="checkbox"/> Comfort Gloves <input type="checkbox"/> Crew Socks <input type="checkbox"/> Mission Patch <input type="checkbox"/> National Flag <input type="checkbox"/> Spare Mesh Bags (GA#3 and GA#4) |
| <p style="text-align: center;"><u>Mesh Bag (EVA Systems 1)</u></p> <ul style="list-style-type: none"> <input type="checkbox"/> STS-124/1J EVA Checklist (orange stripes) <input type="checkbox"/> C/L ISS EVA SYSTEMS (red stripe) <input type="checkbox"/> STS-124/1J EMU CONSUMABLES TRACKING CUE CARD <input type="checkbox"/> STS-124/1J BATTERY RECHARGE PLAN CUE CARD (back of Consumables CC) <input type="checkbox"/> STS-124/1J EMERGENCY UNDOCK EVA TRANSFER CUE CARD <input type="checkbox"/> STS-124/1J EXPEDITED SUIT DOFFING CUE CARD (back of Emergency Undock CC) <input type="checkbox"/> ISS EVA SYSTEM C/L (Old from ISS) <input type="checkbox"/> Cuff Checklists (3) (Old from ISS) <input type="checkbox"/> EMU Servicing Kit (s/n 5005) <input type="checkbox"/> EMU Battery (s/n 2070) <input type="checkbox"/> EHIP Batteries (4) (s/n 1011, 1015, 1017, 1019) | <p style="text-align: center;"><u>Mesh Bag (EVA Tools Transfer)</u></p> <ul style="list-style-type: none"> <input type="checkbox"/> 85-ft Safety Tethers (2) (s/n 1002, 1003) <input type="checkbox"/> Adj Equip Tethers (-307) (6) <input type="checkbox"/> Pistol Grip Tool (s/n 1005) <input type="checkbox"/> Medium ORU Transfer Bag (s/n 1005) <input type="checkbox"/> EVA Gap Gauge (s/n 1006) <input type="checkbox"/> Broom Clip Caddy (MWSTSC) <input type="checkbox"/> MUT End Effector (s/n 1001) |

EVA TRANSFER TO SHUTTLE (30 min)

I

NOTE

This procedure assumes that transfer items were preconfigured per EVA PREP FOR TRANSFER TO SHUTTLE

1. Transfer the following EVA equipment to Shuttle:

| Item | Destination | Transfer Status |
|-------------------------------|--------------------|------------------------|
| EMU 3015 (Fs) | Middeck Temp Stow | |
| EMU 3017 (Ga) | Middeck Temp Stow | |
| ECOK Mesh Bag (Fs) | Middeck Temp Stow | |
| ECOK Mesh Bag (Ga) | Middeck Temp Stow | |
| Mesh Bag (EVA Systems 1) | Middeck Temp Stow | |
| Mesh Bag (EVA Tools Transfer) | Middeck Temp Stow | |

EVA STOW (90 min)

NOTE

This procedure assumes that EVA Transfer to Shuttle, EMU Installation, and Post ISS EVA Entry Prep are complete

1. Unpack items in mesh bags and stow for landing per the table below

| <u>EVA Mesh Bag</u> | <u>Item</u> | <u>Stowage Location</u> |
|---|---|--|
| EVA Tools Transfer | <input type="checkbox"/> 85-ft Tethers (2) (s/n 1002, 1003) | MD Floor Bag D |
| | <input type="checkbox"/> Adj Equip Tethers (6) | TBD |
| | <input type="checkbox"/> EVA Gap Gauge (s/n 1006) | |
| | <input type="checkbox"/> PGT (s/n 1005) | MD Floor Bag G |
| | <input type="checkbox"/> Broom Clip Caddy (MWSTSC) | |
| | <input type="checkbox"/> Medium ORU Transfer Bag (s/n 1005) | |
| EVA Systems 1 | <input type="checkbox"/> MUT End Effector (s/n 1001) | TBD |
| | <input type="checkbox"/> EMU Servicing Kit (s/n 5005) | Volume H In-board <u>NOTE</u> : Check no loose items stowed in Volume H |
| | <input type="checkbox"/> EHIP Batteries (s/n 1011, 1015, 1017, 1019) | |
| | <input type="checkbox"/> Remaining FDF/ODF items will be stowed per step 2, once procedure complete | Middeck MF57E |
| <input type="checkbox"/> EMU Battery (s/n 2070) | MD Ceil Bag D | |

2. Stow remaining FDF/ODF items from EVA Systems 1 Mesh Bag in FDF/ODF locker (Middeck MF57E):
 - ISS Cuff Checklists
 - FDF EVA Checklist
 - ISS EVA Systems Checklist
 - STS-124/1J EMU CONSUMABLES TRACKING CUE CARD
 - STS-124/1J BATTERY RECHARGE PLAN CUE CARD (back of Consumables CC)
 - STS-124/1J EMERGENCY UNDOCK EVA TRANSFER CUE CARD
 - STS-124/1J EXPEDITED SUIT DOFFING CUE CARD (back of Emergency Undock CC)
3. Stow empty mesh bags (4) in Ext A/L Floor Bag
4. Inform MCC, EVA stow complete

TIMELINES

| | |
|--|----------|
| EVA 1 | |
| 1J EVA 1 SUMMARY | FS 7-3 |
| 1J EVA 1 BRIEFING CARD | FS 7-4 |
| 1J EVA 1 TOOL CONFIGURATION | FS 7-6 |
| 1J EVA 1 INHIBIT PAD | FS 7-8 |
| 1J EVA 1 NOTES, CAUTIONS, WARNINGS..... | FS 7-10 |
| EGRESS/EVA SETUP | FS 7-14 |
| SRMS ELBOW CAMERA RESTRAINT REMOVAL AND BOOM HANDOFF TO SSRMS..... | FS 7-15 |
| JPM PREP | FS 7-29 |
| S3/S4 SARJ COVER REMOVE AND TBA #5 INSTALL..... | FS 7-38 |
| S3/S4 SARJ DATUM A INSPECTION | FS 7-46 |
| CLEANING TECHNIQUE DTO | FS 7-49 |
| CLEANUP AND INGRESS..... | FS 7-53 |
| EVA 2 | |
| 1J EVA 2 SUMMARY | FS 7-55 |
| 1J EVA 2 BRIEFING CARD | FS 7-56 |
| 1J EVA 2 TOOL CONFIGURATION | FS 7-58 |
| 1J EVA 2 INHIBIT PAD | FS 7-60 |
| 1J EVA 2 NOTES, CAUTIONS, WARNINGS..... | FS 7-62 |
| EGRESS/SETUP | FS 7-66 |
| JTVE INSTALLATION | FS 7-67 |
| JEM OUTFITTING..... | FS 7-74 |
| S1 NTA AND ESP3 NTA PREP | FS 7-85 |
| CP 9 ETVCG RETRIEVE | FS 7-89 |
| CLEANUP AND INGRESS..... | FS 7-93 |
| EVA 3 | |
| 1J EVA 3 SUMMARY | FS 7-94 |
| 1J EVA 3 BRIEFING CARD | FS 7-95 |
| 1J EVA 3 TOOL CONFIGURATION | FS 7-97 |
| 1J EVA 3 INHIBIT PAD | FS 7-99 |
| 1J EVA 3 NOTES, CAUTIONS, WARNINGS..... | FS 7-101 |
| EGRESS/EVA SETUP | FS 7-105 |
| S1 NTA REMOVAL | FS 7-106 |
| SWAP NTA AT ESP3..... | FS 7-109 |
| S1 NTA INSTALLATION | FS 7-112 |
| WVE/EVE TASK – WINDOW LL – ACBM MMOD SHIELDS – SSRMS CLEANUP TASKS..... | FS 7-116 |
| CP 9 ETVCG INSTALL | FS 7-122 |
| CLEANUP AND INGRESS..... | FS 7-127 |
| GET-AHEADS | |
| 1J EVA GET-AHEADS INHIBIT PAD..... | FS 7-128 |
| NODE 2 QD THERMAL BLANKET INSTALL | FS 7-129 |
| WETA INSTALL CP1 | FS 7-133 |
| S3/S4 SARJ LAUNCH RESTRAINT REMOVAL..... | FS 7-139 |
| S1 FHRC P-CLAMP RELEASE | FS 7-143 |
| NODE 1 MMOD SHIELD CLEANUP..... | FS 7-147 |
| PORT SARJ INSPECTION | FS 7-150 |

This Page Intentionally Blank

1J EVA 1 SUMMARY

| TIME | IV | EV1 (FF) | EV2 (FF) |
|-------------|----|---|---|
| 00:00-00:05 | | POST DEPRESS (00:05) | POST DEPRESS (00:05) |
| 00:05-00:15 | | EGRESS (00:10) | EGRESS (00:10) |
| 00:15-00:35 | | EVA SETUP (00:20) | EVA SETUP (00:20) |
| 00:35-00:55 | | SRMS Elbow Camera LL Release (00:20) | Boom Transfer to Shuttle (01:50) <ul style="list-style-type: none"> • Release KAU cable straps • Remove Boom Sensor Package Bag • Release SSBADs • Stow Boom Keep-Alive Power Equipment |
| 00:55-01:15 | | Open Node 2 Port and Nadir Hatch Window Cover (00:20) | |
| 01:15-01:25 | | MCAS RTL Checkout (00:10) | |
| 01:25-01:55 | | Boom Transfer to Shuttle (00:30) <ul style="list-style-type: none"> • Release Boom Keep-Alive Power Equipment | |
| 01:55-02:25 | | JPM Prep (01:50) <ul style="list-style-type: none"> • Disconnect and stow LTA cable • Remove PCBM Covers • Inspect CBM | |
| 02:25-03:45 | | | JPM Prep (01:40) <ul style="list-style-type: none"> • Disconnect and stow LTA cable • Remove PCBM Contamination Covers • Inspect CBM • Retrieve large ORU bag |
| 03:45-04:05 | | Release JEM PM window LLs (00:20) | |
| 04:05-04:50 | | S3/S4 SARJ Datum A Inspection (00:45) | S3/S4 SARJ TBA Install (01:30) |
| 04:50-05:35 | | S3/S4 SARJ Cleaning DTO (00:45) | |
| 05:35-06:00 | | GET-AHEADS (00:25) | GET-AHEADS (00:25) |
| 06:00-06:25 | | CLEANUP/INGRESS (00:25) | CLEANUP/INGRESS (00:25) |
| 06:25-06:30 | | PRE REPRESS (00:05) | PRE REPRESS (00:05) |
| 06:30 | | | |

- Get-Ahead: – Node 2 QD Thermal Blanket Install (00:30)
 – S3/S4 SARJ Launch Restraint Removal (01:45)
 – WETA Install CP1 (01:15)
 – Node 1 MMOD Shield Cleanup (01:00)
 – FHRC P-Clamp Release (01:00)

EVA 1

1J EVA 1 BRIEFING CARD

EV1 _____
EV2 _____
IV _____
R1/M1 _____

EVA Prep start (GMT) ____/____:____
Depress to 10.2 _____
Start Purge _____
PET 00:00 _____

Flight Day Prior to EVA – General Briefing (All)

1. EVA Prep

- Get-up Plan – clothing and EMU equipment bag – EV1
- Prebreathe protocol review (Notes and Warnings) – IV
- Equipment lock activities – IV responsibilities
- Suit donning plan – special requests – EV's, IV's
- SAFER, MWS, tools, C-Lk positions, bag stowage – EV2
- Airlock depress review – IV

2. EV Crew Procedure Review – EV1

- Egress Plan
- Order of tasks (summary timeline)
- Translation plan, fairleads, and tether swaps
- Hazards
- Ingress Plan

3. Robotics – R1/M1

- SRMS/SSRMS initial position, maneuvers, clearances
- Coordinate Frames
- SRMS/SSRMS comm protocol review – expected calls, use first names
- GCA – when, where, handover language
- Cameras
- Contingencies
 - Suit anomalies while ingressed

Flight Day Prior to EVA – Additional Briefing (EV, IV)

4. Communications – CDR, IV

- Overall setup: big loop, A/G2, S/G2, ICOM, Hardline, remind EV crew when mode swapping
- EV/IV comm protocol review – Use EV1(2) for DCM sw throws (all time in A/L), use first names otherwise

5. General Procedure Review – EV1

- Get-ahead tasks
- Constraints – ground and flight – IV
- Notes, Cautions, and Warnings review – IV
- Contingency procedures – crib sheet

6. Emergencies Review – EV1

- Emergency suit doff and power down during EVA prep
- Loss of comm
- EMU malfunctions
- Lost tools
- Lost crewmember
- DCS
- Abort and Terminate scenarios, protocols
- Hand signal reviews

7. Post EVA – IV's

- Suit doffing responsibilities
- Post EVA plan

√Expedited Suit Doffing cue card pre-positioned for EVA day

1J EVA 1 BRIEFING CARD (Cont)

EVA Day, prior to Prebreathe Protocol

1. Reminders

- Translate slow (then space is like water). Relax grip
 - o Be extra careful on non-standard routes or orientations
 - o Don't hop
- Tether Discipline
 - o Check all gates closed and hooks locked; check reel locked/unlocked
 - o Local tether when stopped. Check tethers before you leave
 - o When something is attached to a tether, don't grab the tether by the hook
 - o Good pull tests
- APFR ops
- Be disciplined when tired
- Hazards: payloads, etc
- Openness: when you have boot or glove pain let us know
- OK for IV and ground to check on us. If you need update, ask
- Monitor safety tether. Hold peanut when necessary
- Let mistakes pass
- If you get a mal, read the caution and warning message so everyone knows what it is
- Manage frustration (slow down, if needed)
- Cold soak before ingress
- Verify PGT settings. PGT collars are easy to bump
- Read turns, torque, green light
- SSRMS: coordinate frames and positive GCA handovers
- Review first post-egress steps
- Review abort/terminate priorities and procedures
- Glove Checks
- Day/night reconfigurations
- Translation Adaptation plan

IV Checklist Verification Items

1. Generic

- Day/Night Cycles
 - √Lights, visors, gloves and heaters, tethers, and MWS
- √Load Alleviating Strap on Safety Tethers not damaged
 - Crew report: "**Safety Tether strap looks good**"
- √Safety Tether Crew Hook Slidelocks are locked
 - Crew Report: "**Locked and locked**"
- √Both SAFER valves down at egress
 - Crew Report: "**Both handles down**"
- √APFR locking collar Black-on-black and pull test
 - Crew Report: "**Black-on-black, good pull test**"
- √PGT Green light on for bolt engage
 - May get Lo Torque msg at bolt release
 - Crew Report: "**XX turns, green light, XX ft-lb**"
- √Latches closed on lid, door, etc (i.e., √in landing config)
 - Crew Report: "**XX Latches done**"
- √Connectors for no bent pins, no FOD, inhibits in place
 - Crew Report: "**Pins good, no FOD, bend radius OK**"
 - Crew Report: "**Are inhibits in place?**"

2. Task Specific

- √Tethers and Tools clear prior to SSRMS ORU movement
 - Each EV report: "**Tethers and tools clear**"

3. Tool inventory

- √Tethers on MWS
- Confirm all others as standard unless removed

1J EVA 1 TOOL CONFIGURATION

EV1

EMU D-rings

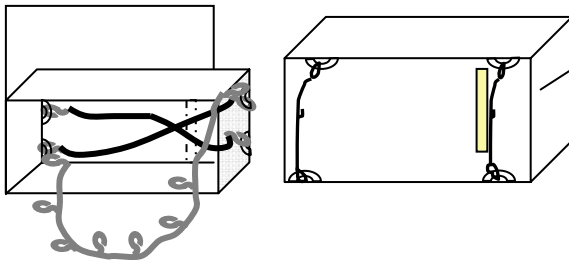
- Ext on left side
- Ext on right side
- Waist Tethers (left Ext to MWS, √locked)
- Waist Tethers (right D-ring to ERCM, √locked)
- 85-ft Safety Tether (right Ext, √locked)
- 85-ft Safety Tether – spare (right Ext, √locked)

MWS

- Small Trash Bag
- 2 – Wire ties as tether loops
- RET (with PIP pin)
- Long Wire tie (Overgloves)
 - 1 pair – Overgloves
- RET
- 3 – Adj Equipment Tether
- Swing Arm (right side)
 - RET (Attach to PGT)
 - PGT s/n 1002 w/6-in ext
- BRT (left side)
 - RET
 - 2 – wire ties
- SAFER/WVS

Opening of Large ORU Bag

Bottom of Large ORU Bag



Prior to EVA, perform the following hardware inspections:

1. RET cords for fraying
2. No red line visible on safety and waist tether load Alleviation straps
3. Inspect ISS trash bags for deformation/damage
4. Inspect EMU gloves for damage

Use **RED** RETs only

EV2

EMU D-rings

- Ext on left side
- Ext on right side
- Waist Tethers (left Ext to MWS, √locked)
- Waist Tethers (right D-ring to ERCM, √locked)
- 85-ft Safety Tether (right Ext, √locked)
- 85-ft Safety Tether – spare (right Ext, √locked)

MWS

- Wire tie to secure trash bag (with tether loops)
 - Small Trash Bag
 - 2 – Gap spanner (daisy chained)
- 2 – Wire ties as tether loops
- RET (with PIP pin)
- 2 – RET
- Wire tie (Overgloves)
 - 1 pair – Overgloves
- 2 – Adj Equipment Tether
- Swing Arm (right side)
 - RET (Attach to PGT)
 - PGT s/n 1008 w/6-in ext
- BRT (left side)
 - RET
 - 2 – wire ties (1 long, 1 short)
- SAFER/WVS

CREWLOCK

- Large-Sm RET
 - Crewlock Bag #1 (Get-Aheads)
 - Socket Caddy
 - 12-in ext 7/16
 - RAD w/2-Ext 7/16
 - MMOD shield handling tool (long)
 - Wire Tie Caddy (w/6 Long wire ties)
 - Loop pin puller
 - 2 – RET
 - Node 2 thermal blankets (2)
 - 1 short & 1 long wire tie
- Large-Sm RET
 - WETA w/Rd Scoop
- Large-Sm RET
 - Large ORU bag
 - 55-ft Safety tether
 - 2 – Adjustables (eq-eq) (diag int loops)
 - Adj Fuse Tether (lg-ig) (int loops)
 - LTA Caps (2)
 - Camera w/bracket
 - 2 – Adjustables (eq-eq) (outside of bag)

CREWLOCK (Cont)

- D-ring extender on A/L D-ring
- Large-Sm RET
 - Medium ORU bag (OBSS)
 - 2 – Adjustables (outside of bag)
 - RET (eq-eq)
 - Ratchet
 - 2-in ext 7/16-in
 - 2 – RET (eq-eq)
 - Boom Sensor bag
 - KAD
 - P411 Connector
 - RET (eq-eq)
 - Wire Tie
 - P411 Connector Bolt Over-ride
 - Large-Sm RET
 - Medium ORU bag (SARJ)
 - 2 – Adjustables (lg-sm) (outside of bag)
 - Towel w/wire tie
 - Adjustable
 - Adj Fuse Tether (lg-ig) (int loops)
 - 2 – EVA wipes
 - Adjustable (√hook orientation on TBA Mount)
 - Spare TBA (2 parts and verify NO IV Cap)
 - Ratchet
 - 9-in ext 7/16-in
 - Large trash bag
 - EVA Scissors
 - BRS pin tool
 - TBA Electrical Connector Cap
 - Camera w/bracket and flash
 - Adj Fuse Tether (lg-ig) (int loops) (Deploy)
 - Short wire tie
 - RET (eq-eq)
 - 2 – Adjustables
 - 2 – EVA wipes
 - Velcro/tape caddy
 - Grease Gun
 - Broom clip caddy
 - Scraper
 - Feeler gauge
 - 4 – SLR/Stubs

1J EVA 1 TOOL CONFIGURATION (Cont)

Staging Bag

- Adjustable Fuse Tether
 - Connector Cleaner Tool Kit
 - PGT s/n 1001
 - PGT Battery s/n _____
 - Pin Straightener Assy
 - Probe
- Adjustable Fuse Tether
 - Torque Wrench and bag
 - LDTD Tether
 - MMWS Key Strap Assembly
 - Pry Bar
 - Hammer

IV Bag

- Towel w/wire tie
- Contamination Detection Kit w/watch
 - Hydrazine Detector (Gold Salt Coupon) (6)
 - Color Chart (2)
 - ISS Contamination Detection Sampler (2)
 - Shuttle Contamination Detection Sampler (2)
 - Nitrogen Dioxide Detector (Oxidizer Draeger Tube) (6)
 - Ammonia Detector (NH3 Draeger Tube) (6)
- 2 – GP Caddy
 - 2 – Adj Thermal Mittens
- 3 – RET
 - Socket Caddy (hatch cont)
 - 1/2 socket 8-in ext (hatch)
 - 7/16 socket 6-in ext (spare)
 - DCM plug (2) (SAFER hardmount)

1J EVA 1 INHIBIT PAD

Orbiter

| | |
|---|---|
| ALL EVAs | |
| TCS L12 | 1. √TCS POWER – OFF |
| KU-BAND ANTENNA | |
| MCC-H | 1. √KU-BAND Mask – active 2. √KU-BAND EVA Protect Box – active |
| RCS | |
| IV O14,15,16 | If EV crew < 27 ft from FRCS 1. √DAP: VERN, FREE, LO Z (flt specific check with GNC) 2. √RJDF F1, F2, F3, F4 MANF DRIVER (four) – OFF LOGIC (four) – OFF |
| MCC-H IV | 3. √Above RCS config 4. √RCS F – ITEM 1 EXEC (*) √JET DES F1U – ITEM 17 (*) F3U – ITEM 19 (*) F2U – ITEM 21 (*) |
| S-BAND ANTENNAS (Not Expected) | |
| <u>NOTE</u> Possible loss of comm when forced LL FWD antenna | |
| IV A1R | If EV crew < 2 feet from S-Band antenna 1. S-BAND FM ANT – XMIT LOWER/RCVR UPPER 2. √MCC, lower antenna selected |
| C3 | If no comm, or on MCC GO 3. S-BAND PM ANT – LL FWD |
| C3 | When EVA crewmember at least 2 ft away from all S-Band upper antennas: 4. S-BAND PM ANT – GPC |

USOS

| | |
|---|---|
| ALL EVAs | |
| PCU | |
| <u>NOTE</u> PCUs may require up to 1 hr warm-up period before they are operational | |
| MCC-H | 1. √PCUs (two) operational in discharge mode and one of the following: a. CCS PCU EVA hazard control FDIR enabled b. No more than two arrays unshunted and oriented < 105° from velocity vector |
| OR | |
| | 2. One or no PCUs operational in discharge mode and no more than two arrays unshunted and oriented < 105° from velocity vector |
| LOCATION DEPENDENT INHIBITS | |
| IV | Lab Window If EV crew less than 10 ft from window or in window FOV, close window shutter |
| MCC-H | Mobile Transporter If EV crew < 1.5 meters from MT 1. √MT latched |

Ground

| | |
|--------------|--|
| All EVAs | |
| Ground Radar | |
| MCC-H | 1. √TOPO console, ground radar restrictions in place for EVA |

1J EVA 1 INHIBIT PAD (Cont)

USOS

LOCATION DEPENDENT INHIBITS

S-BAND (SASA) ANTENNAS

- MCC-H During OBSS Transfer:
1. P1 SASA – Active
 2. S1 SASA – Powered down

TRRJ (S1 required, P1 get ahead)

- MCC-H S1 TRRJ:
1. $\sqrt{\text{DLA}}$ (1) – LOCKED at 0, +60 to +80, -100 to -120
- P1 TRRJ (On call for FHRC):
1. $\sqrt{\text{DLA}}$ (1) – LOCKED at 0

SARJ

- MCC-H Stbd SARJ:
1. $\sqrt{\text{DLA}}$ 1(2) – LOCKED at 300
 2. All motor setpoints set to zero
 3. All motors deselected
- OR
4. Both DLAs – LOCKED at 300

FPMU

- MCC-H During OBSS Transfer:
1. FPMU power – Off

RSOS

ALL EVAs

SM Antennas

- IV
1. GTS – Deactivate
 2. ARISS (Ham Radio) – Deactivate or VHF (144-146 MHz) TX only

Task Specific

KAU Inhibits, to be performed during Boom Transfer To Shuttle

- MCC-H
1. RPCM s11a-b RPC 1 – OPEN, CLOSE CMD INHIBIT
RPCM s11a-b RPC 13 – OPEN, CLOSE CMD INHIBIT
 2. RPCM s12b-b RPC 2 – OPEN, CLOSE CMD INHIBIT
RPCM s12b-b RPC 12 – OPEN, CLOSE CMD INHIBIT

LTA CABLE DISCONNECT

Inhibits will be performed by IV crew just prior to LTA cable disconnect (actions in timeline)

1J EVA 1 NOTES, CAUTIONS, WARNINGS

NOTES

1. Bolt install: report torque and turns
2. Bolt release: report torque and turns if different from published range
3. EVA connectors: after disconnection and prior to connection; verify pin and EMI band integrity; verify connector free of FOD
4. Inspect QDs for damage prior to mating
5. Toolbox doors must be closed with one latch per door when EV crew not in immediate vicinity
6. Avoid contact with OBSS striker bars (Vitrolube coating)

CAUTION

ISS Constraints

- A. Avoid inadvertent contact with
1. Grapple fixture shafts (drylube)
 2. PIP pins
 3. EVA crane [PMA1]
 4. TCS reflectors [PMA2,PMA3]
 5. APAS hardware [PMA2,PMA3]
 6. CETA lights (Z-93 paint) [LAB,S1,Node 1]
 7. Deployed MISSEs [COL EPF]
 8. Passive UMAs
 9. MBS/SSRMS/SPDM/JEMRMS taped radiative surfaces: VDU, ACU, JEU, LEU, MCU, CRPCMs, and cameras
 10. Deployed TUS cable [Nadir CETA rail]
 11. S0 aft face radiator
 12. GPS antennas (S13 paint) [S0]
 13. UHF antennas [LAB,P1]
 14. ETCS radiator flexhoses and panels [S1,P1]
 15. EETCS/PV radiator flexhoses, bellows and panels [P6,P4,S4,S6]
 16. SASA RF group [S1,P1]
 17. Heat pipe radiators [Z1]
 18. PCU cathode and HCA ports [Z1]
 19. Ku-Band antenna (SGANT) dish [Z1]
 20. CMG cover/shells [Z1]
 21. SPDM SJEU, EP, OTCM, LEU, and LEE VDU radiator surfaces
 22. Open CBM petal covers, LAB window shutter, and JPM window shutter
 23. FPMU [S1]
 24. OTSD
 25. COL HAM radio antennas [COL-Nadir]
 26. JTVE Cameras

CAUTION (Cont)

ISS Constraints (Cont)

- B. Electrical cables
1. Avoid bend radii < 10 times cable diameter
- C. Fiber optic cables
1. Avoid bend radii < 10 times cable diameter
 2. Avoid pulling on cable during mate/demate
- D. Fluid line flex hoses and QDs
1. Avoid bend radii < 5 in for hoses with diameter < 1 in on LAB, S0, S1, and P1 and 10-in for hoses with diameter < 1 in on all other elements
 2. Avoid bend radii < 14 in for hoses with a diameter ≥ 1 in
 3. Additional care should be taken to not exceed bend radii when applying loads at the flexible hose to rigid tube stub interfaces
 4. Ensure fluid QD booties are fully closed prior to leaving worksite; wire tie if reqd

1J EVA 1 NOTES, CAUTIONS, WARNINGS (Cont)

CAUTION (Cont)

ISS Constraints (Cont)

- E. For structural reasons
1. Avoid vigorous body motions, quick grabs and kickoffs against tether restraints
 2. Avoid performing shaking motions (sinusoidal functions) more than four cycles
 3. Avoid kicking S1/P1 radiator beam.
If any of these occur, wait 2 to 5 min to allow structural response to dissipate
- F. Other
1. ITT Cannon connector: On demated connectors, do not rotate collar or manipulate cable/connector using collar or connector tool
 2. WIS Antennas: do not use as handholds [Node 1,Lab,P6,Z1]
 3. Lubricant from Ku-Band SGANT gimbals [Z1], CMGs [Z1], and RTAS Ground Strap fasteners [P6,P4,S4,S6] can contaminate EMU
 4. MLI handholds are not rated for crewmember translation loads
 5. CBM petal covers may not be used as handholds unless both launch restraint pins are engaged
 6. Prevent inadvertent contact of the tether shuttle with ETRS when P3/S3 Tether Shuttle Stop raised away from rail

CAUTION (Cont)

Shuttle Constraints

- G. Avoid inadvertent contact with
1. OBSS and SRMS composite sections and cable harnesses
 2. LCS (silver Teflon) and LDRI (silver Teflon) and ITVC (gold foil) [OBSS]
 3. WVS antenna [ODS Truss & PLB Sill]
 4. Payload Bay wire harnesses, cables, and connectors
- H. No Touch
1. LDRI diffuser [OBSS]
 2. OBSS saddle contacts (when OBSS unberthed) [OBSS]
 3. Monkey fur [PLB]
 4. Cameras: metallic surfaces [PLB]
 5. Ku-Band antenna black dish and gold thermal blankets [PLB]

1J EVA 1 NOTES, CAUTIONS, WARNINGS (Cont)

WARNING

ISS Constraints

A. Avoid inadvertent contact with

1. Grapple fixture targets and target pins
2. SSU, ECU, beta gimbal platform, mast canister, SAW blanket boxes unless the beta gimbal is locked and the motor is turned off
3. Stay inboard of SARJ when active
4. Stay 2 ft from S1/P1 radiator beam rotational envelope when beam is free to rotate
5. Stay 5 ft from moving MT on face 1
6. SOLAR and EuTEF [COL EPF]

B. Handrails

1. Handrails previously used for MISSE attachment may not be used as a safety tether point [A/L endcone 564 & 566, A/L Tank 2 nad/fwd & port/fwd, P6 5389]

C. Pinch

1. NZGL connector linkage. Use caution when mating/locking
2. ITT Cannon Connector rotating housing
3. EV side of IV Hatch during Hatch operation (also snag hazard) [A/L]
4. LAB window shutter, CBM petal cover, and JPM window shutter linkages during operation
5. JEMRMS HRM capture latches

WARNING (Cont)

ISS Constraints (Cont)

D. QDs

1. If QD is in FID when valve is opened (bail fwd), QD will leak and fluid line may whip
2. Do not rotate if in mated/valve open config

E. RF radiation exposure

1. Stay 3.6 ft from S-Band (SASA) high gain Antenna when powered [S1,P1]
2. Stay 1.3 ft from S-Band (SASA) low gain Antenna when powered [S1,P1]
3. Stay 1 ft from UHF Antenna when powered [LAB,P1]

F. Sharp Edges

1. Inner edges of WIF sockets
2. APFR active WIF probes
3. Mating surfaces of EVA connectors. Avoid side loads during connector mating
4. Back side of MMOD shield fasteners
5. Spring loaded captive EVA fasteners (e.g., 6B-boxes, BMRRM, RTAS, SARJ covers); end of spring may protrude
6. PMA umbilical launch restraints-exposed bolt threads
7. Adjustable Fuse Tether (Fish Stringer) buckles stowed in Node Bag
8. Nickel coated braided copper Ground Straps may contain frayed wires [P6,P4,S4,S6]

WARNING (Cont)

ISS Constraints (Cont)

F. Sharp Edges (Cont)

9. Solar Array Blanket Box [P6,S6]
10. Keep hands away from SSRMS LEE/POA/SPDM LEE/JEMRMS opening, snares and PDGF curvic coupling (teeth)
11. SPDM OTCM gripper jaws
12. Fastener threads on back of Z1 U-jumper male FQD panel, if nutplate cap missing
13. Outboard MT rail attachment lug near P6 handrail 5333 and gap spanner
14. P2 connector on EWIS box TAA-06 [Zenith Face 1 of P5 – SARJ at 0 deg]
15. Port/Aft portion of A/L circular HR [HR 0506]
16. Interior of JEMRMS HRMs
17. JEM A/L hatch corners

G. Thermal

1. EVA connectors with booties may become hot if left uncovered. Handling may need to be limited
2. PMA handrails may be hot. Handling may need to be limited
3. Turn off glove heaters when comfortable temp reached to prevent bladder damage. Do not pull fingers out of gloves when heaters are on
4. Uncovered trunnion pins may be hot
5. SSRMS/MBS/SPDM/JEMRMS operating cameras and lights may radiate large amounts of heat

1J EVA 1 NOTES, CAUTIONS, WARNINGS (Cont)

WARNING (Cont)

ISS Constraints (Cont)

G. Thermal (Cont)

- Stay ≥ 1 ft away from PMAs and MMOD shields > 270 degF if EMU sun visor up; limit time to 15 min or less if > 300 degF
- Stay at least 0.5 ft away from PMA and MMOD shields > 325 degF
- Do not touch EMU protective visor if temp has been < -134 degF for > 15 min
- No EMU TMG contact with PMAs and MMOD shields > 320 degF
- No EMU boot contact with foot restraint when temp < -120 or > 200 degF
- Columbus end cones may violate touch temperature constraints when $-75 \leq \beta \leq -60$ or $60 \leq \beta \leq 75$
- PDGF surfaces may not meet touch temperature requirements for unlimited contact when $\beta \leq -70$ or $\beta \geq 70$
- JPM port end cones may violate touch temperature constraints when $\beta > 60$

H. Electrical Shock

- Stay ≥ 2 ft from ungrounded floating connectors if not unpowered:
 - SSPTS connectors [NOD1 Stbd/Fwd HR 0130, LAB Stbd/Fwd HR 0273, PMA2 Stbd & Port]
 - MBS Cross-Connect jumpers (translate past these using UMA handrails)
 - S0 EVA Power Cables [inside S0 Bay 00 Face 4, Bay 01 Face 3]
 - ESP2 jumper [inside S0 Bay 03 Face 4]
- Do not touch SPDM CLPA 1 electrical connector prior to camera installation

WARNING (Cont)

Shuttle Constraints

I. Arcing/Molten Debris

- Stay ≥ 2 ft from exposed EFGF connector when OBSS berthed, powered, and EFGF not grappled [PLB]
- Stay ≥ 2 ft from exposed Stbd Fwd MPM contacts [PLB]
- Stay above PLB sill when within 1 ft of powered ROEU connector [PLB]

J. Pinch

- PRLA in operation [PLB]

K. RF Radiation Exposure

- Stay 3.28 ft from S-Band Antenna when powered
- Stay 1 ft from top and side of UHF PLB Antenna radome surface when in high powered mode [ODS truss]
- Stay 0.33 ft from top and side of UHF PLB Antenna radome surface when in low powered mode [ODS truss]
- Remain below level of PLB door mold line for first 20 in Aft of Fwd bulkhead when S-Band Antenna powered [PLB]
- Remain on inboard side of Stbd slidewire (sill handrails if slidewire not installed) for first 20 ft Aft of Fwd bulkhead when Ku-Band Antenna powered [PLB]

WARNING (Cont)

Shuttle Constraints

L. Sharp Edges

- PRLA grounding wipers [PLB]
- LDRI baffles (Also an entrapment hazard) [OBSS]
- Keep hands away from SRMS EE opening and snares
- TCS connector backshells have exposed threads [ODS]

M. Thermal

- Illuminated PLB lights; do not touch
- OBSS grapple fixture shafts/cams may be hot. Limit handling if required
- Stay 27 ft from PRCS when powered
- Stay 3 ft from VRCS when powered
- Stay 3 ft from APU when operating

N. Contamination

- Stay out of the immediate vicinity of leaking jet or APU

O. Lasers

- Do not look at LDRI diffuser or LCS laser aperture window

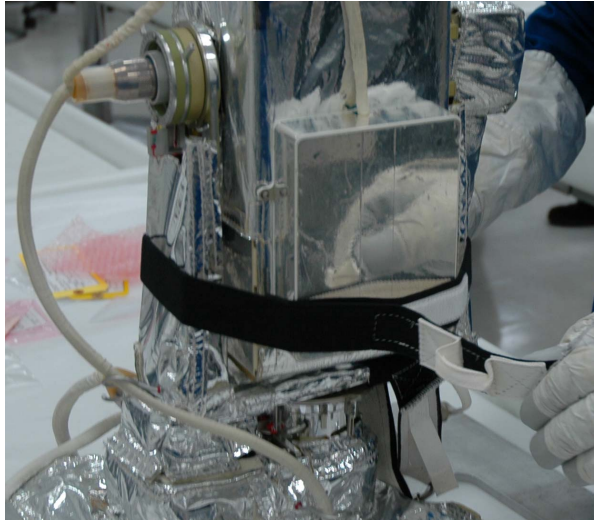
EGRESS/EVA SETUP

| IV | EV1 (FF) | EV2 (FF) |
|--|--|---|
| <ol style="list-style-type: none"> 1. Start recorders 2. ✓Initial Condition 3. WVS Software: Select page – RF camera Sel 'Advanced Controls' S-Band Level (two) – Max (required after EV1 and EV2 egress airlock) | <p>Initial Condition: D-ring extender with left waist tether</p> <p><u>EGRESS</u></p> <ol style="list-style-type: none"> 1. Open A/L thermal cover 2. Egress A/L 3. Connect 85-ft safety tether to hr anchor point fwd: <ul style="list-style-type: none"> ✓Anchor bail closed and slider locked ✓Reel end bails closed and double locked ✓Reels unlocked 4. Receive crew lock bag (Get-Ahead) 5. Receive and temp stow large ORU bag 6. Receive and temp stow Med ORU bag (SARJ) 7. Receive and hold medium ORU bag (OBSS) 8. Connect EV2 85-ft safety tether to anchor point aft 9. ✓EV2 Safety tether config: Anchor bail closed, slider locked, and Reel unlocked 10. ✓EV2 SAFER MAN ISOL vlv – OP (dn) and HCM (dn) ✓ERCA – green LED 11. Perform translation adaptation around A/L 12. INSPECT GLOVES | <p>Initial Condition: Forward UIA D-ring with left waist tether</p> <p><u>EGRESS</u></p> <ol style="list-style-type: none"> 1. Release EV1 from A/L D-ring 2. Verify safety tether conf: <ul style="list-style-type: none"> ✓Reel end bails closed and double locked ✓Reels unlocked 3. Hand out bags to EV1 <ul style="list-style-type: none"> ☐ Crew lock bag (Get-Ahead) ☐ large ORU bag ☐ medium ORU bag (SARJ) ☐ medium ORU bag (OBSS) on BRT RET 4. Hand out hook of 85-ft safety tether to EV1 5. On EV1 GO, release waist tether from UIA D-ring 6. Egress A/L 7. Stow medium ORU bag on BRT 8. ✓EV1 Safety tether config: Anchor bail closed, slider locked, and Reel unlocked 9. ✓EV1 SAFER MAN ISOL vlv – OP (dn) and HCM (dn) ✓ERCA – green LED 10. Close A/L thermal cover 11. Perform translation adaptation around A/L 12. INSPECT GLOVES |

SRMS ELBOW CAMERA RESTRAINT REMOVAL AND BOOM HANDOFF TO SSRMS (Cont)

| IV | EV1 | EV2 |
|--|---|---|
| <p>2. Get a GO from both crewmembers for SSRMS Maneuver to KAD/P411 retrieval position</p> <p>SSRMS: Receive GO for Maneuver to KAD/P411 removal position</p> <p>3. Inhibits in place during SSRMS translation to KAD/P411 retrieval position</p> <p>4. <input checked="" type="checkbox"/> MCC-H KAU inhibits in place before KAU Umbilical demated</p> <p><input checked="" type="checkbox"/> RPCM S11A-B RPC 1 – Open, close cmd inh</p> <p><input checked="" type="checkbox"/> RPCM S11A-B RPC 13 – Open, close cmd inh</p> <p><input checked="" type="checkbox"/> RPCM S12B-B RPC 2 – Open, close cmd inh</p> <p><input checked="" type="checkbox"/> RPCM S12B-B RPC 12 – Open, close cmd inh</p> <p>Thermal Clock Start: _____</p> <p>5. Give EV crew GO to perform KAU Disconnect</p> <p>6. When caps installed onto KAU Avionics box, give MCC-H GO to power KAU Avionics box</p> <p>SSRMS: EVA GO to move to JOCAS start position</p> <p>7. <input type="checkbox"/> Visually inspect MLI</p> | <p><u>RETRIEVE KAD AND P411 CONNECTOR</u></p> <div style="border: 3px double black; padding: 5px; text-align: center;"> <p><u>WARNING</u></p> <p>Crew Shock hazard: KAU umbilical must be disconnected from KAU avionics box before KAD removed from BOOM</p> </div> <p>15. <input checked="" type="checkbox"/> P411 connector LED – On</p> <p>16. Translate greater than 2 ft from KAD when boom in KAD/P411 retrieval position</p> <p>17. Give SSRMS operator a GO for maneuver to KAD/P411 removal position</p> <p>18. <input checked="" type="checkbox"/> P411 connector LED – Off</p> <p>19. Receive a “GO” from EV2 that KAU umbilical disconnected</p> <p>20. Release P411 connector, adjustable to KAD</p> <p>21. Release KAD from boom</p> <p>22. Hand KAD and P411 connector to EV2</p> <p>23. Give SSRMS operator GO to move to JOCAS start position</p> <p>24. INSPECT GLOVES</p> <p>25. Translate to A/L</p> <p>26. Retrieve large ORU bag</p> | <p><u>RETRIEVE KAD AND P411 CONNECTOR (00:45)</u></p> <div style="border: 3px double black; padding: 5px; text-align: center;"> <p><u>WARNING</u></p> <p>Crew Shock hazard: KAU umbilical must be disconnected from KAU avionics box before KAD removed from BOOM</p> </div> <p>20. Monitor KAU umbilical during SSRMS Boom translation</p> <p>21. Give SSRMS operator GO for maneuver to KAD/P411 removal position</p> <p>22. On MCC-H GO, perform following:</p> <ul style="list-style-type: none"> <input type="checkbox"/> EV1 Confirm P411 LED – Off <input type="checkbox"/> Release two KAU umbilical electrical connectors from KAU Avionics box <p>23. Give EV1 GO when KAU umbilical disconnected</p> <p>24. Install caps on KAU Avionics box receptacles and connector socks on KAU umbilical connectors</p> <p>25. Give GO to power KAU Avionics box</p> <p>26. Reattach Umbilical to HRs with Velcro straps and wire ties</p> <p>27. Release connectors (2) from KAD, cover umbilical connectors with connector socks</p> <p>28. <input type="checkbox"/> Visually inspect MLI</p> <p>29. Stow KAD and P411 connector in medium ORU bag</p> <p>30. Install Outboard SSBAD Y-slider PIP pin #1 (Retract SSBAD fully toward OSE to install PIP pin)</p> <p>31. Place mid and outboard SSBADs slider knob into position #1; re-install PIP pin in knob</p> <p>32. INSPECT GLOVES</p> <p><u>CLEANUP</u></p> <p>33. Verify worksite clear and TRRJ clear to rotate</p> <p>34. Translate to A/L</p> <p>35. Retrieve Adj tethers (2) from Med ORU bag (OBSS) and stow on Med ORU bag (SARJ)</p> <p>36. Stow Medium ORU bag (OBSS) inside A/L</p> <p>37. Close Thermal Cover</p> <p>38. INSPECT GLOVES</p> |

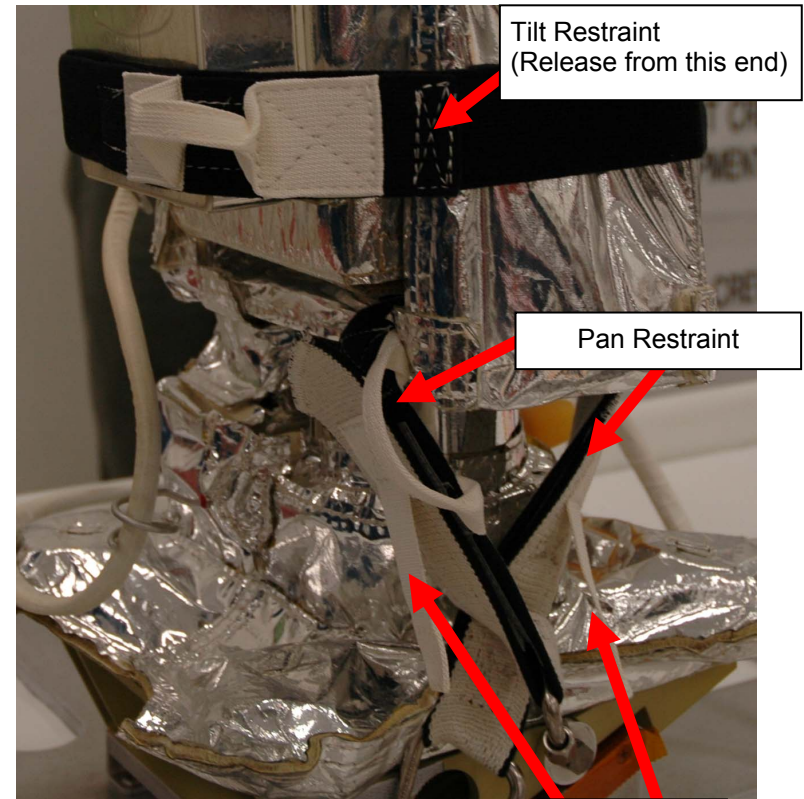
SRMS CAMERA LAUNCH RESTRAINT REMOVAL – TASK DATA



Tilt Camera Stops –
Two (No Touch)

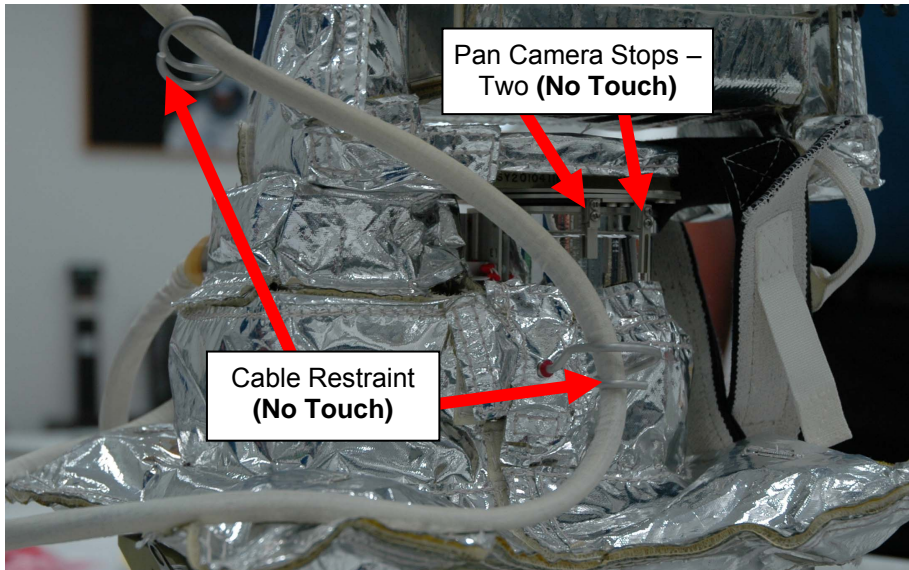


Tilt Restraint
(Release from this end)



Pan Restraint

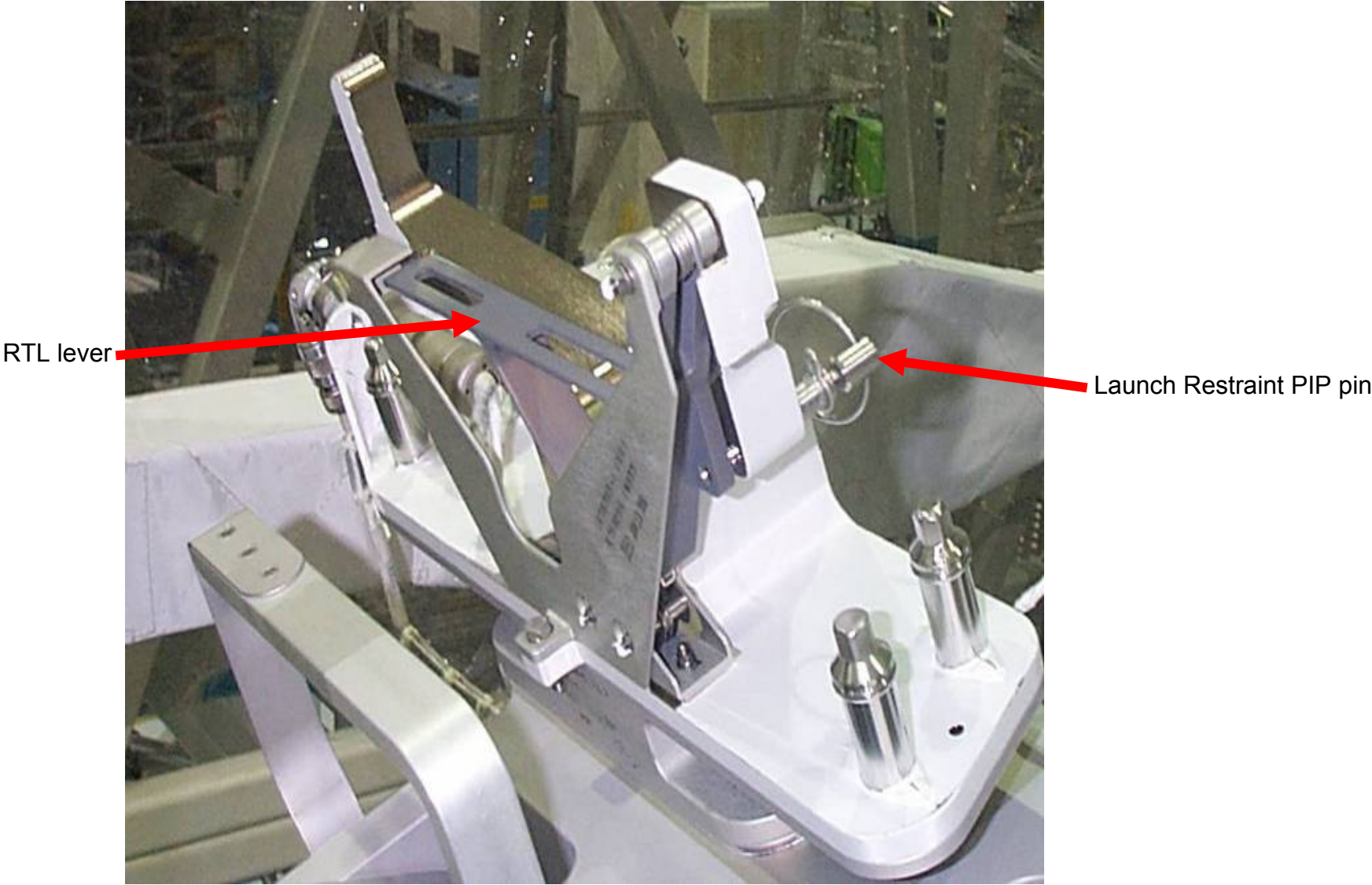
Release tabs



Pan Camera Stops –
Two (No Touch)

Cable Restraint
(No Touch)

MCAS RTL CHECKOUT – TASK DATA



OBSS KEEP-ALIVE UMBILICAL REMOVAL – TASK DATA

Estimated Task Duration:

| | With RMS | Without RMS |
|-------------|----------|-------------|
| One EV Crew | NA | NA |
| Two EV Crew | NA | 01:50 |

ORU Identification:

| ORU | Part number | Serial Number |
|------------------------|-------------------|---------------|
| Avionics Mast Assembly | 260213-206829-551 | 201 |
| Harness W21 | 260213-207103-551 | N/A |
| KAD | 260213-206807-551 | 201 |
| P411 Connector Cover | 260213-206862-551 | 202 |

ORU Specs:

| ORU | Dimensions | Mass |
|------------------------|---|--------------------|
| Avionics Mast Assembly | 30.6 x 15.1 x 13 | 67.3 lb (30.53 kg) |
| Harness W21 | 31 feet | 12.7 lb (5.74 kg) |
| KAD | 13 x 13 x 11 (with Connector Caps installed) | 17.5 lb (7.93 kg) |
| P411 Connector Cover | 8.3 x 7.0 x 6.1 | 2.3 lb |

Tools:

| EV1 (FF) | EV2 (FF) |
|----------|----------|
| None | None |

EVA Connectors:

| Harness | From | To | Type | Conn Size | Function |
|---------|--------------|--------------|----------|-----------|-------------------|
| W21 | Avionics box | KAD | Wing-Lok | Series IV | OBSS heater power |
| W22/W23 | PNL A114 | Avionics box | NZGL | 15 & 13 | OBSS heater power |

Connector Inhibits:

| Task | Inhibit |
|------------------------------|---|
| J223 TO P223 J225 TO P225 | RPCM S11A-B RPC 1 & 13 – Open, close cmd inh AND Demate required prior to KAD removal |
| J224 TO P224 J226 TO P226 | RPCM S12B_B RPCS 2&12 – Open and close inh AND Demate required prior to KAD removal |

P411 Notes:

1. There are two LED bulbs
2. Only SP1 power is available at the P411 connector. Hence, if LEDs are off does not necessarily mean that SP2 power is also OFF
3. Ground and/or ISS PCS will be prime for confirming power is OFF to P411 before disconnecting electrical plugs
4. Gently pull out PIP pin to detent, else will come all the way out of P411 fixture (pin will still be tethered to P411, but worth noting)
5. PIP pin is actually only a “Pull” pin – no push is necessary; only pull
6. After removing PIP pin, P411 connector cover fixture is fairly tight and requires some effort to pull free. Rocking a little helps

EFGF Notes:

1. Okay to grab cams, but NOT grapple pin or camera target

KAD Notes:

1. Made from standard SSBAD based on a PAD (PFR Attachment Device), but with much bigger paddles for electrical contact
2. Removes exactly like standard PAD, ccw to release
3. After release, push paddles closed to protect contacts
4. There are two arrow decals on the KAD:
 - Big One: points to Sensor package end of OBSS
 - Small One: used to align electrical connector

Avionics Box Notes:

1. Connector caps will be stowed under Velcro strap prior to being installed after W21 cable disconnected

Cable (W21 Harness) Notes:

1. Pocket type MLI flap installed to cover cable ends after demated from KAD and Avionics box

General Notes:

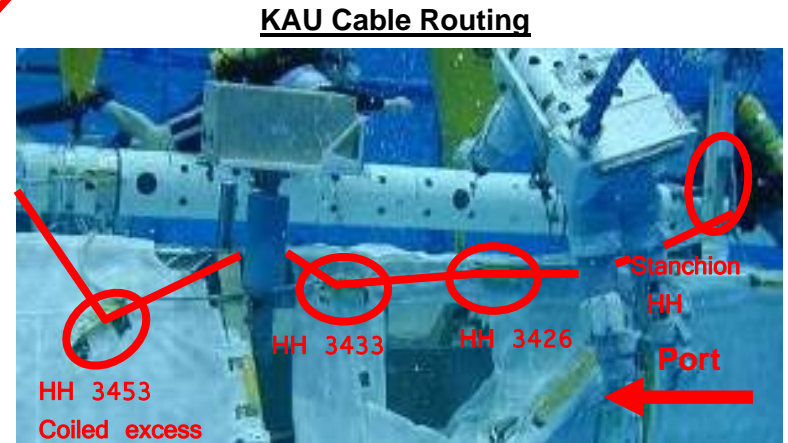
1. To release/attach all KAU/KAD electrical connectors turn 90 deg ccw/cw to end of travel. May be hard to feel in pressurized glove
2. Electrical connectors and caps are keyed. Receptacle has an arrow that should match up red mark on fin of connector to mate

Cautions:

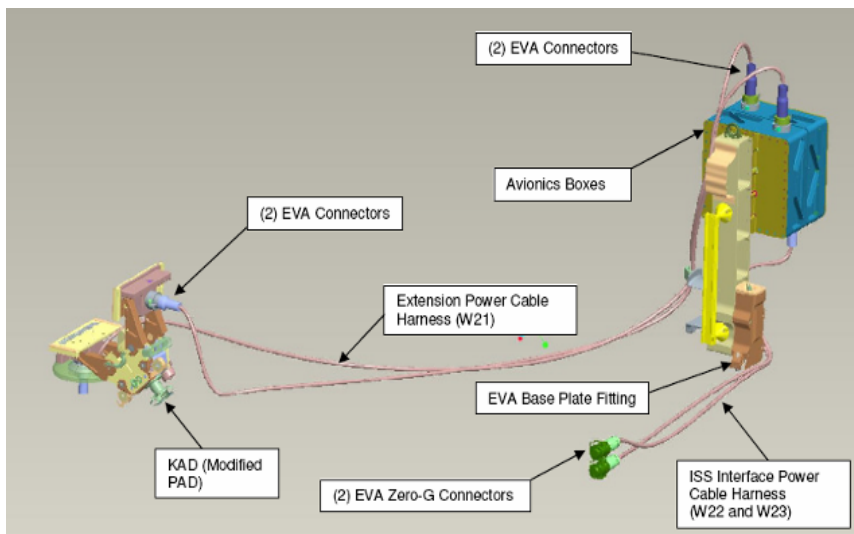
1. Do not touch OBSS grapple pin
2. Do not touch KAD electrical contacts (on paddles)
3. Do not touch KAD/OBSS bumpers – dry lube on surfaces
4. Avoid contact with OBSS striker bar after KAD release

Warnings:

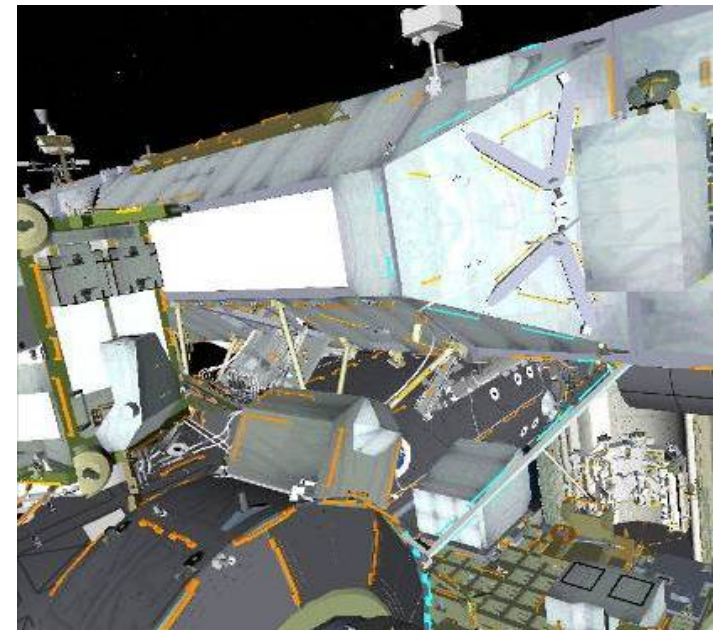
BOOM HANDOFF – TASK DATA



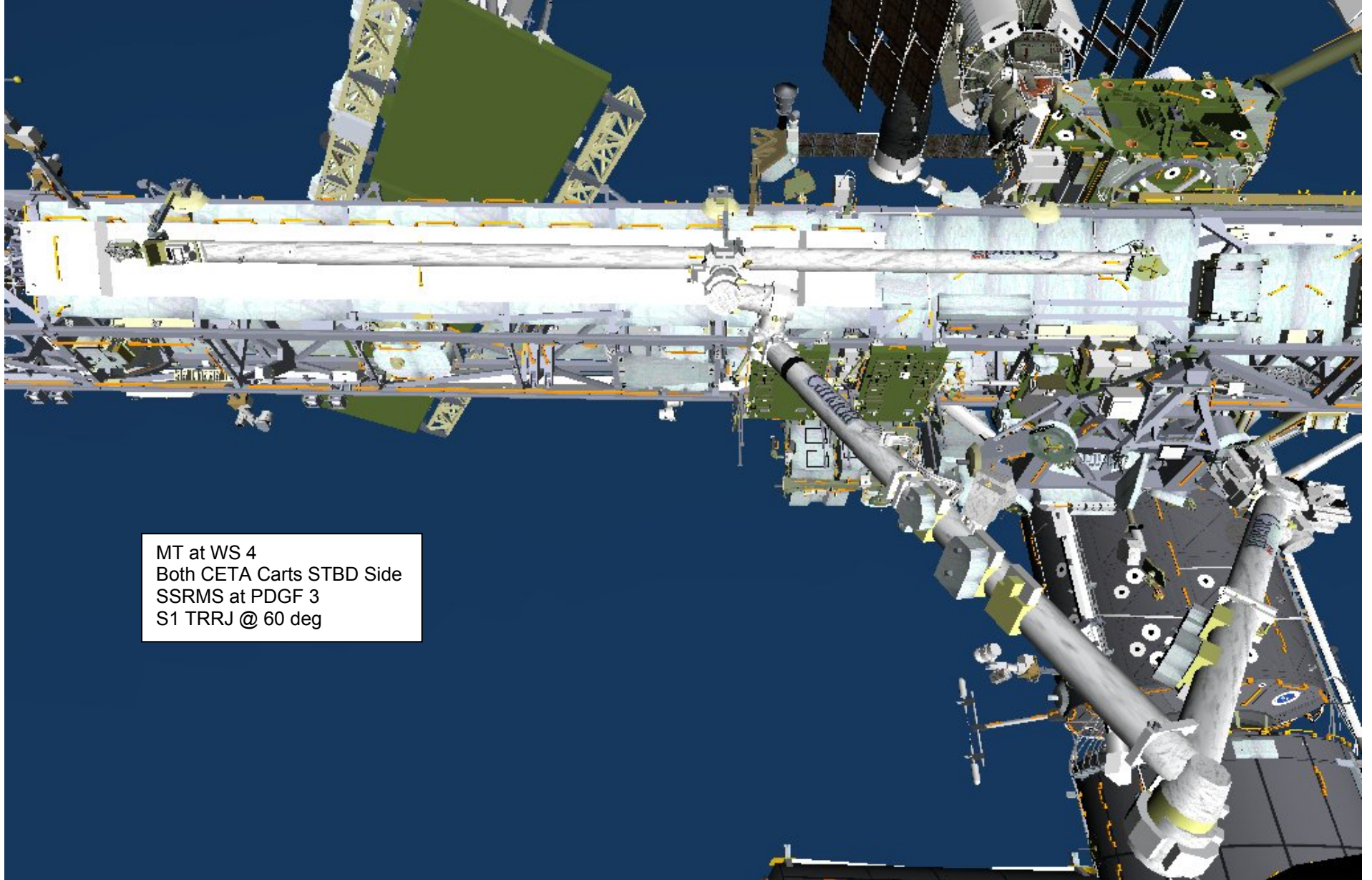
OBSS KAU components



Translation Path to OBSS worksite

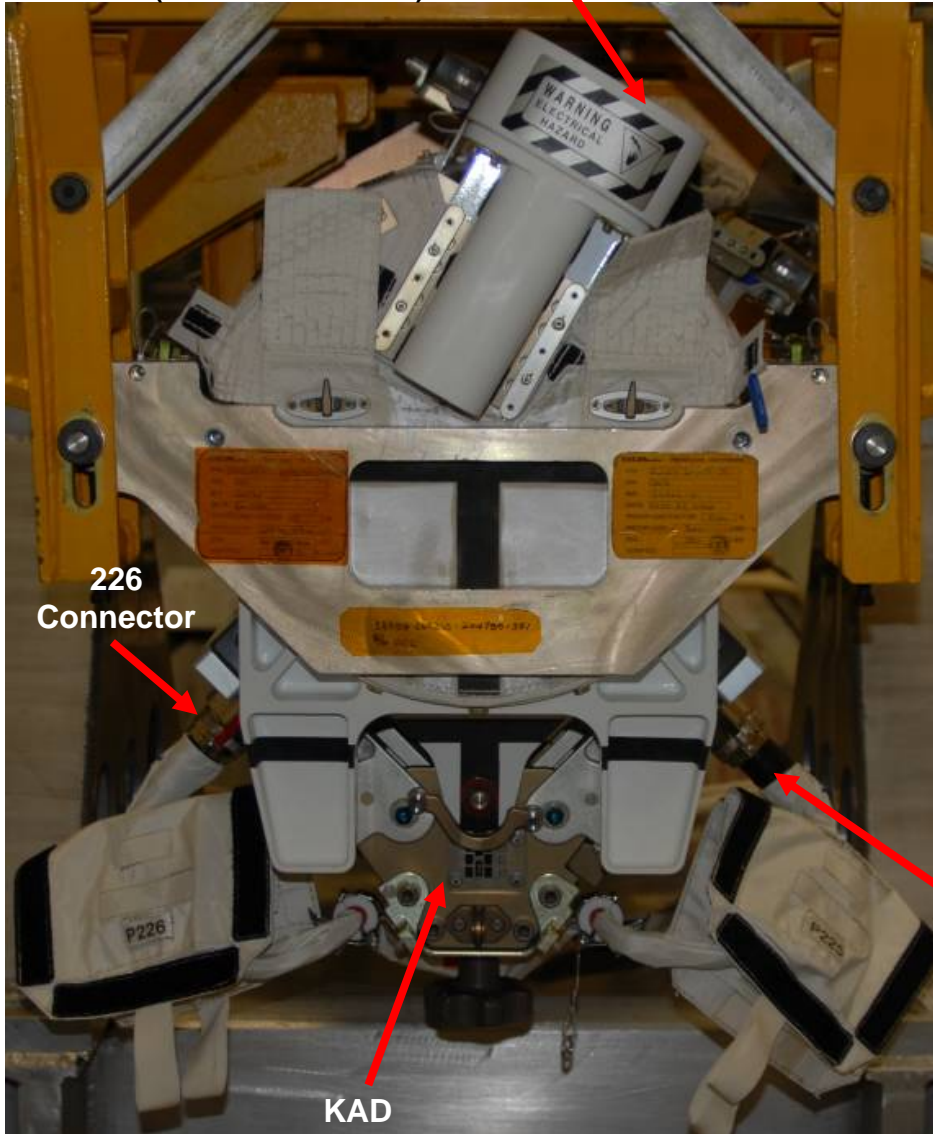


BOOM HANDOFF – TASK DATA (Cont)

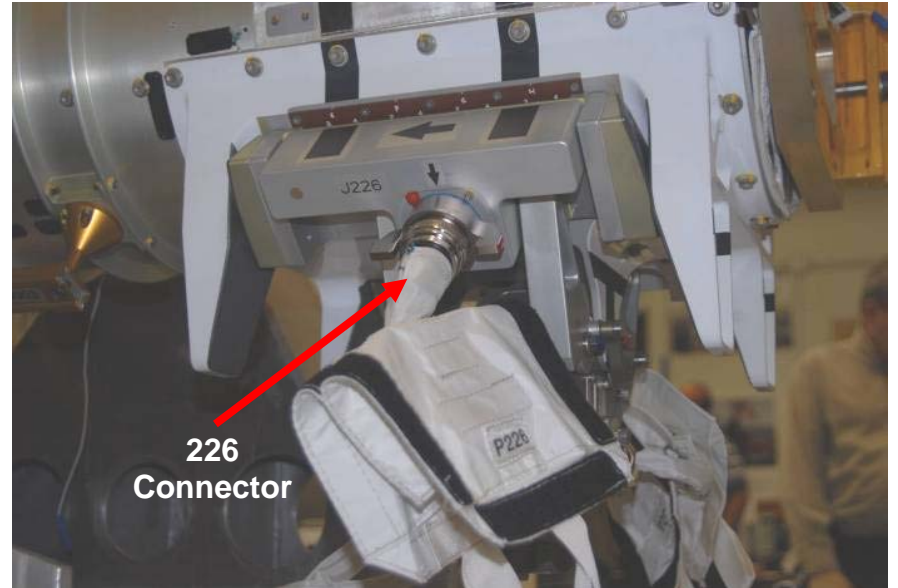


BOOM HANDOFF – TASK DATA (Cont)

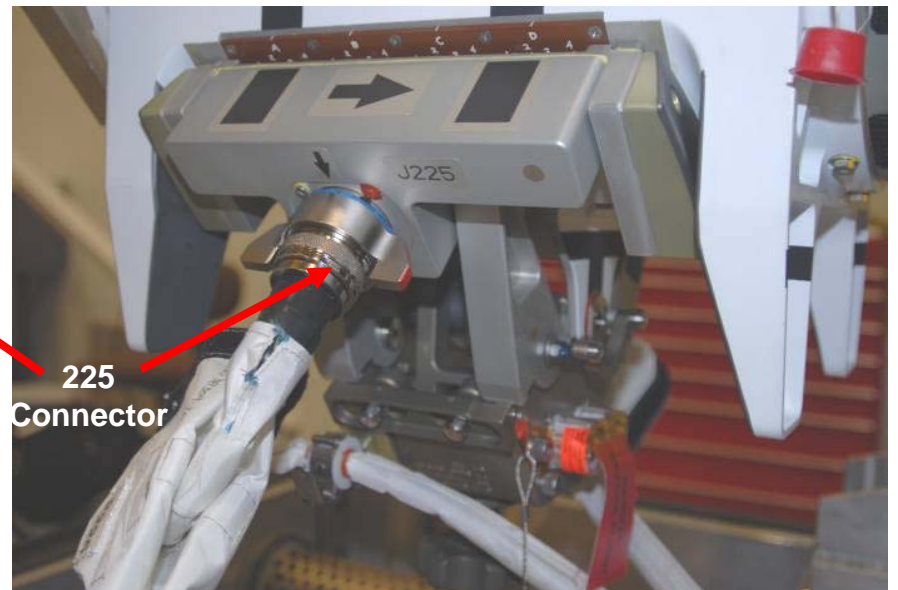
P411 Connector Attaches Here
(Not Shown in Photo)



Looking at End of Boom (P411 Connector Cover End)



226 Connector

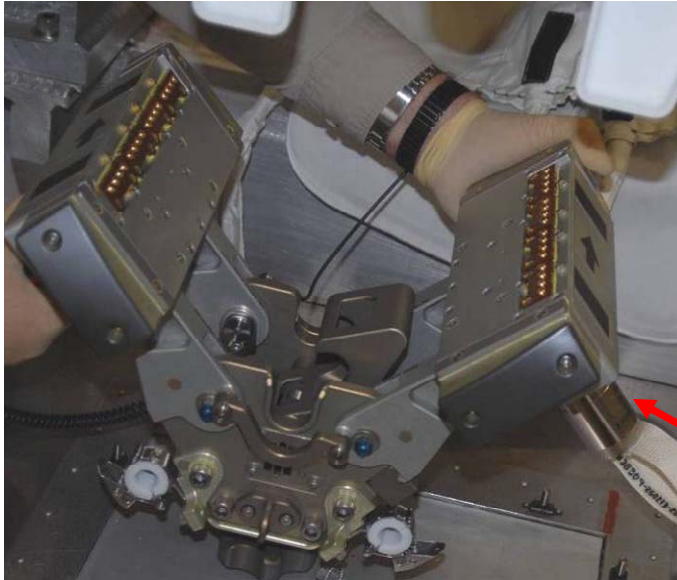


225 Connector

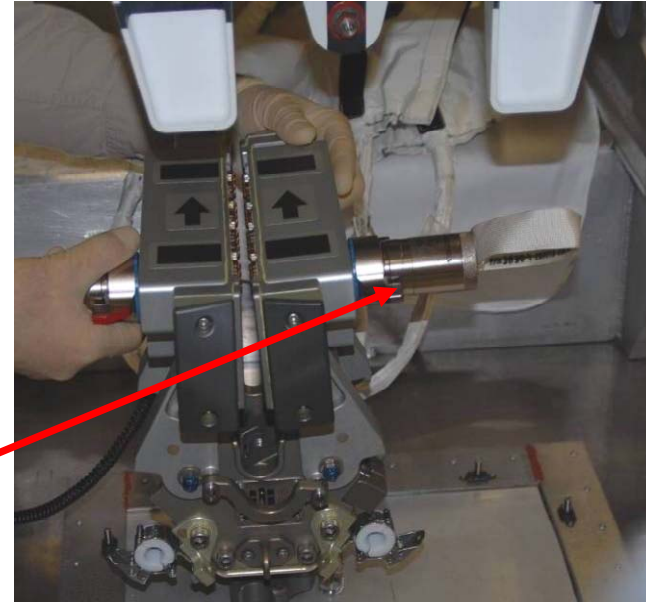
BOOM HANDOFF – TASK DATA (Cont)

Photos of KAD Detached from OBSS

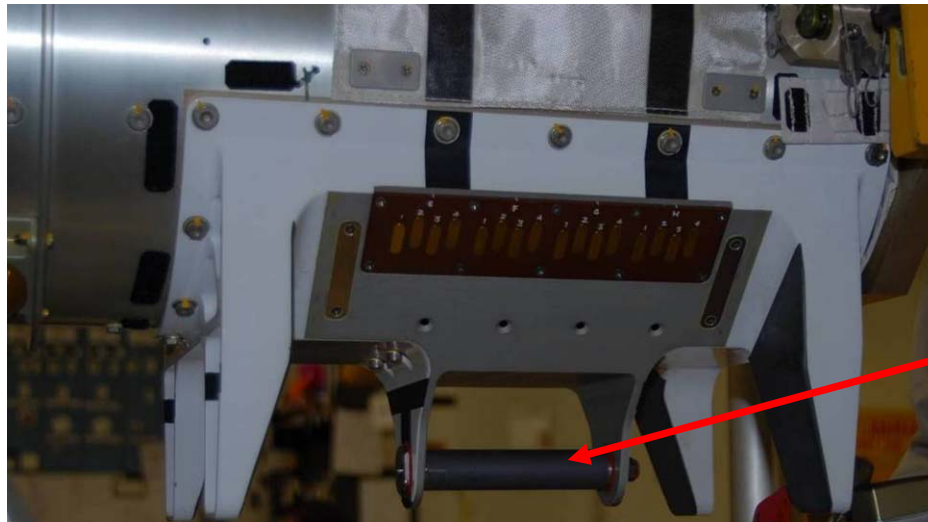
KAD Open



KAD Closed



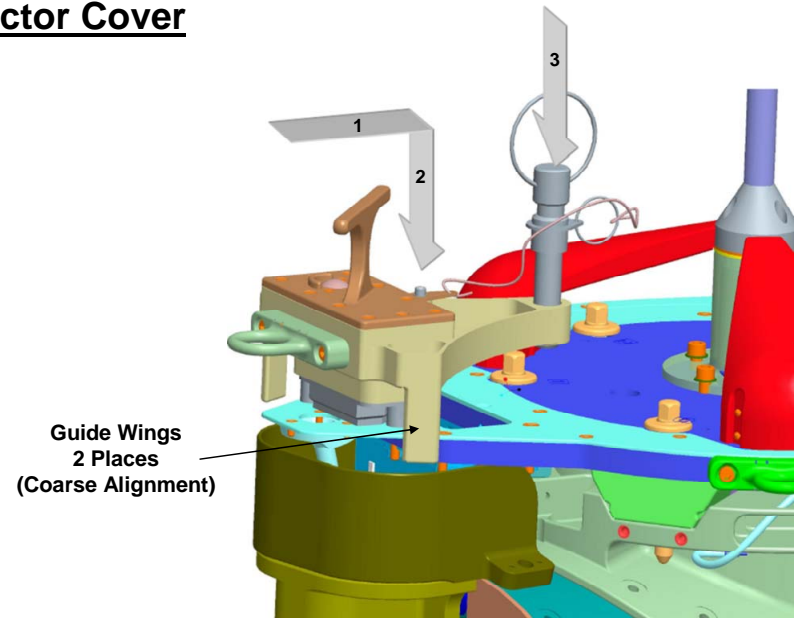
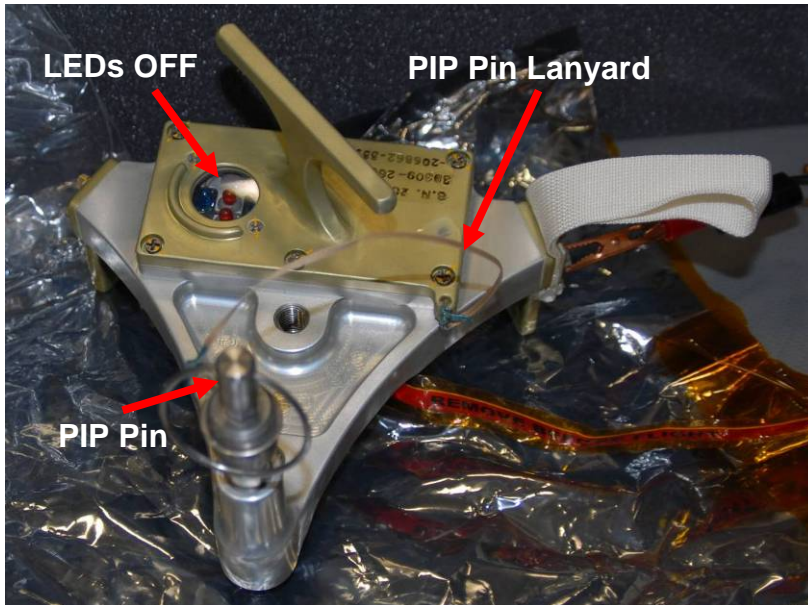
NOTE: Connector
Cap Installed



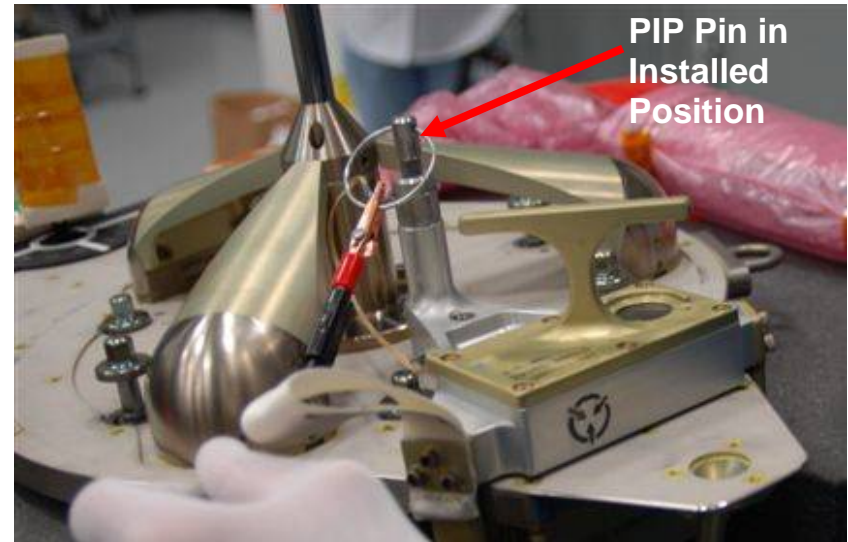
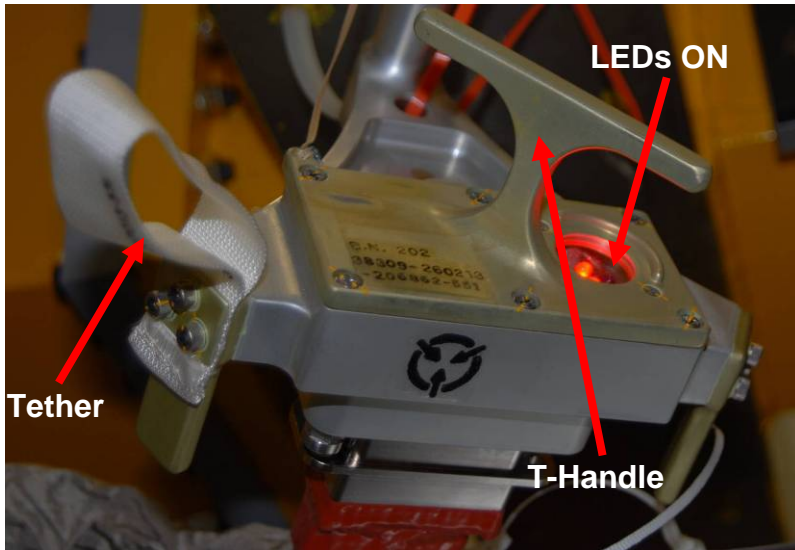
**OBSS Striker Bar
(KAD Removed)**

BOOM HANDOFF – TASK DATA (Cont)

Photos of P411 Connector Cover

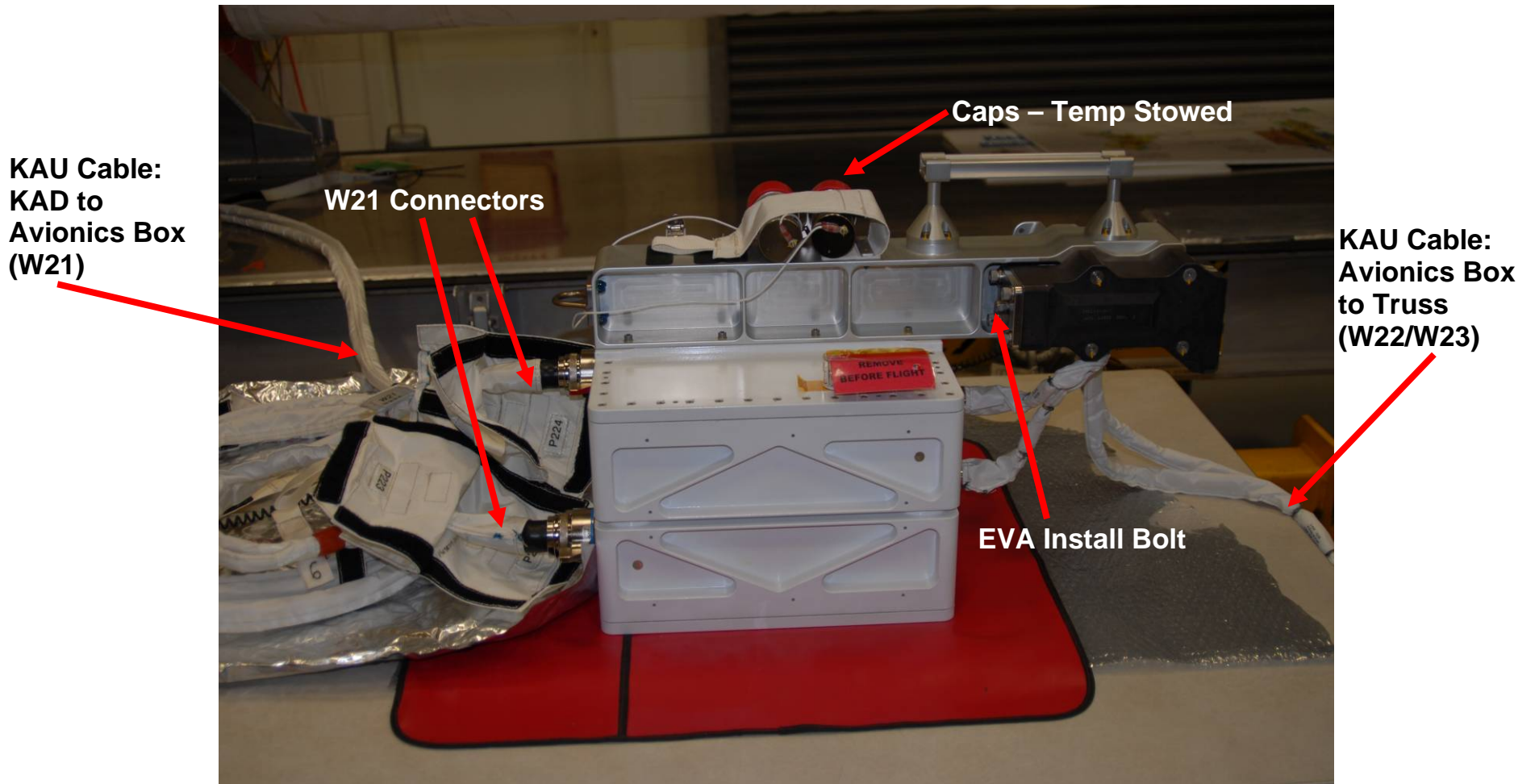


P411 Installed on Grapple Fixture

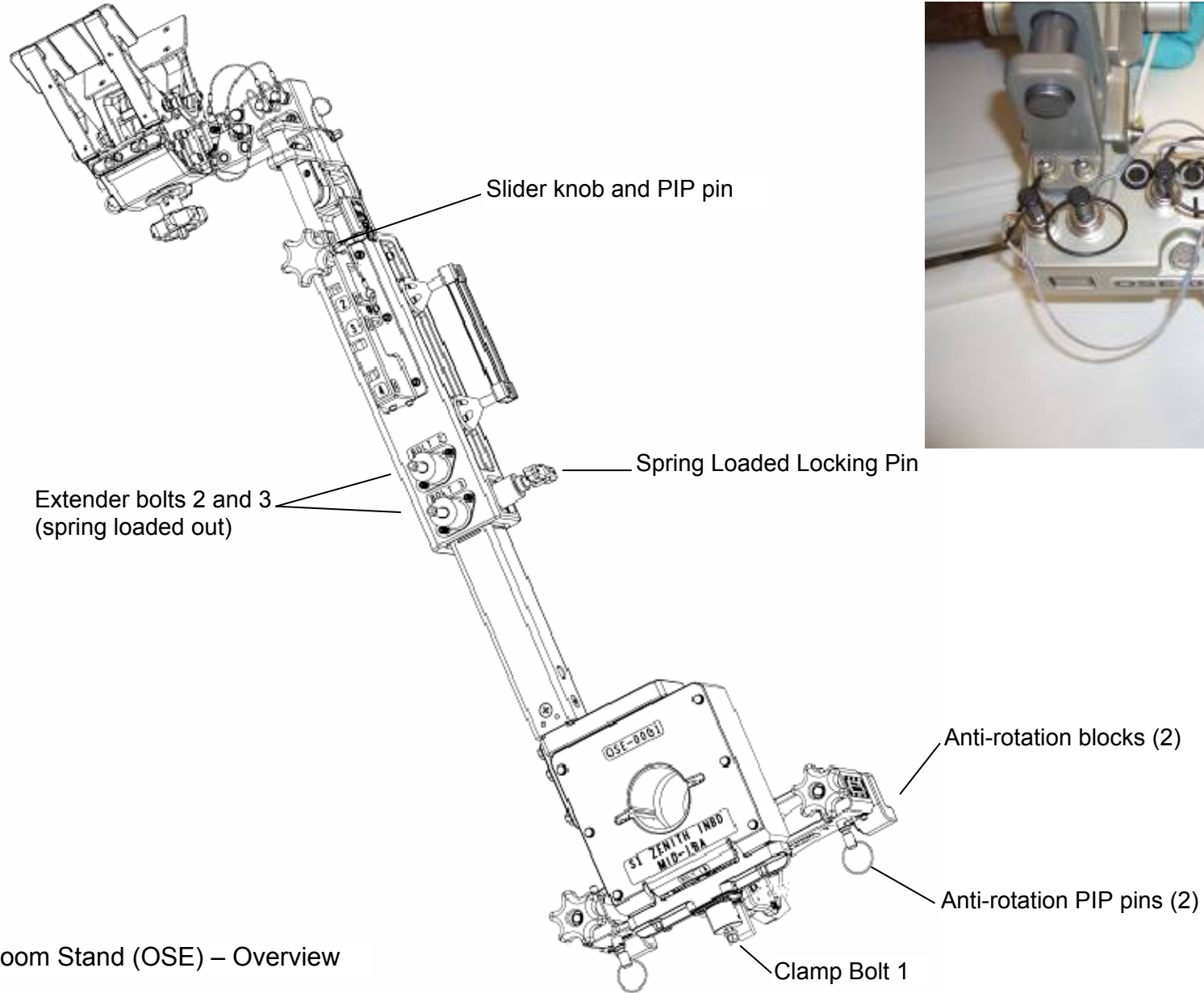


BOOM HANDOFF – TASK DATA (Cont)

Avionics box

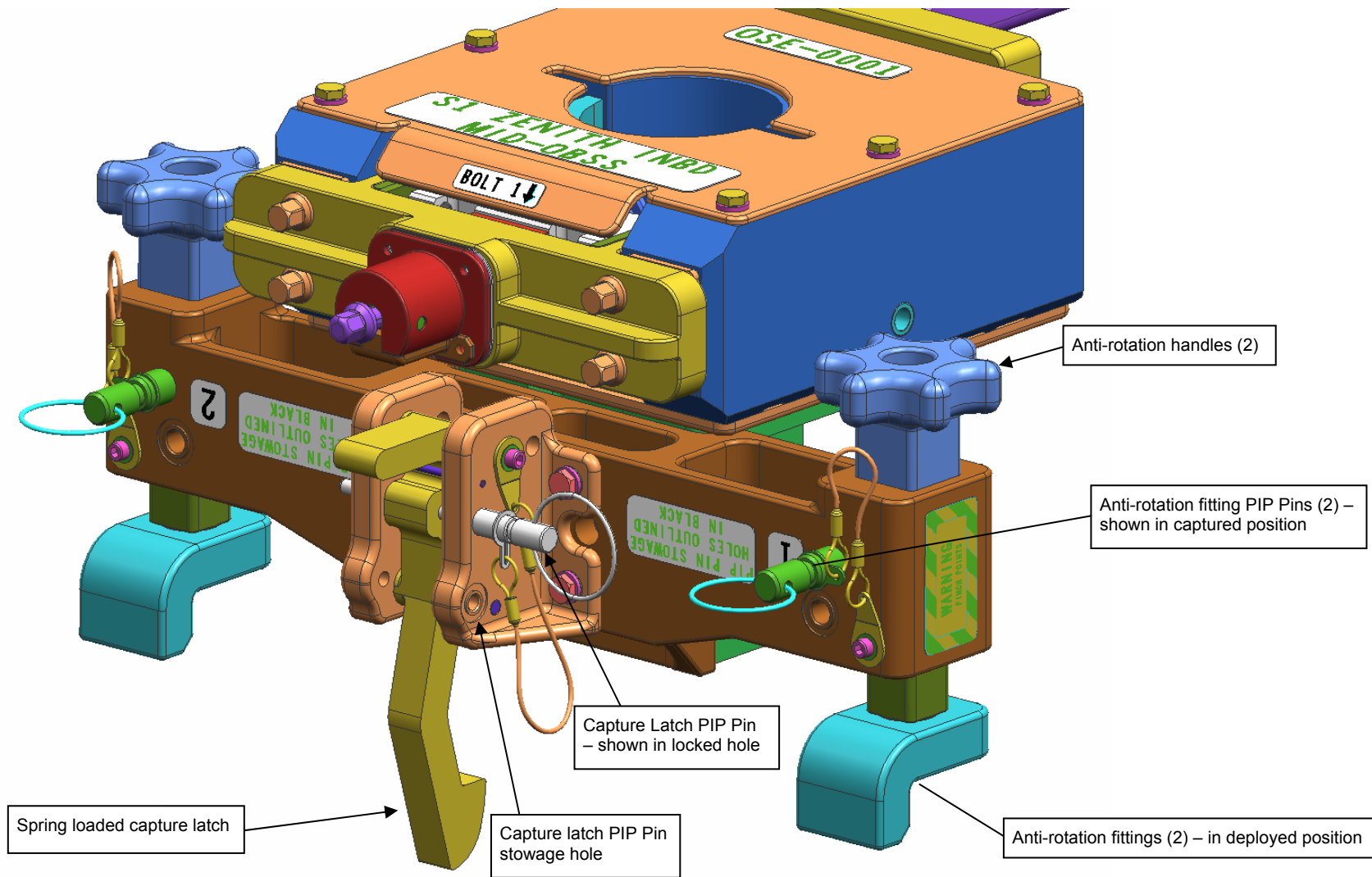


BOOM HANDOFF – TASK DATA (Cont)

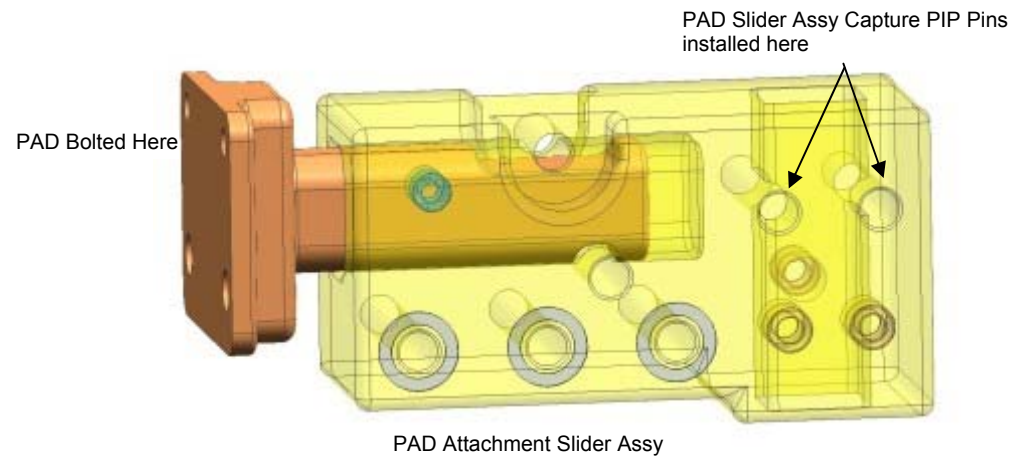
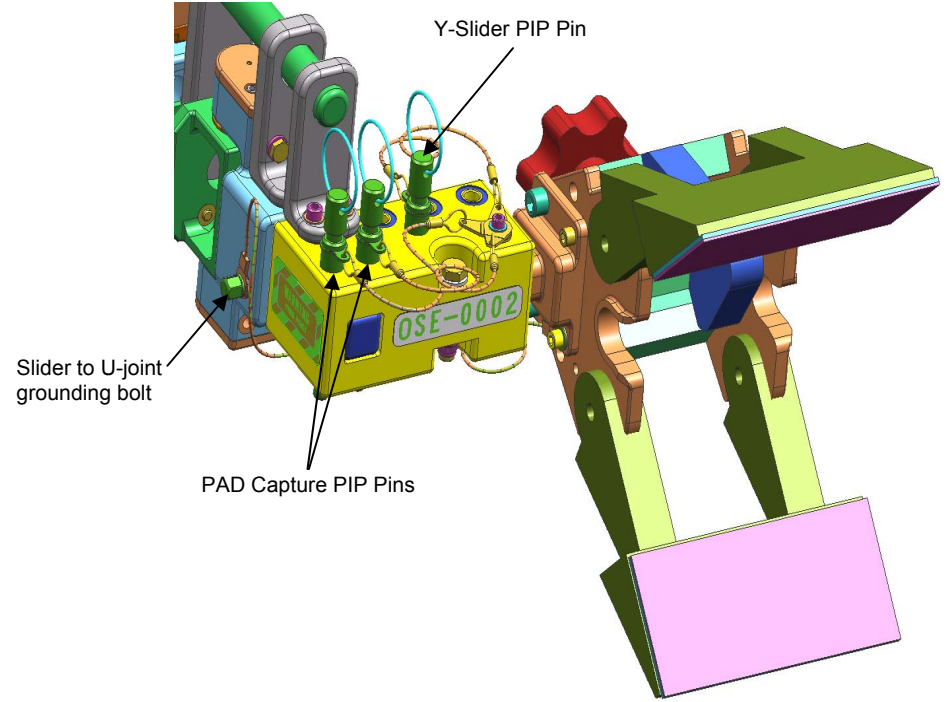
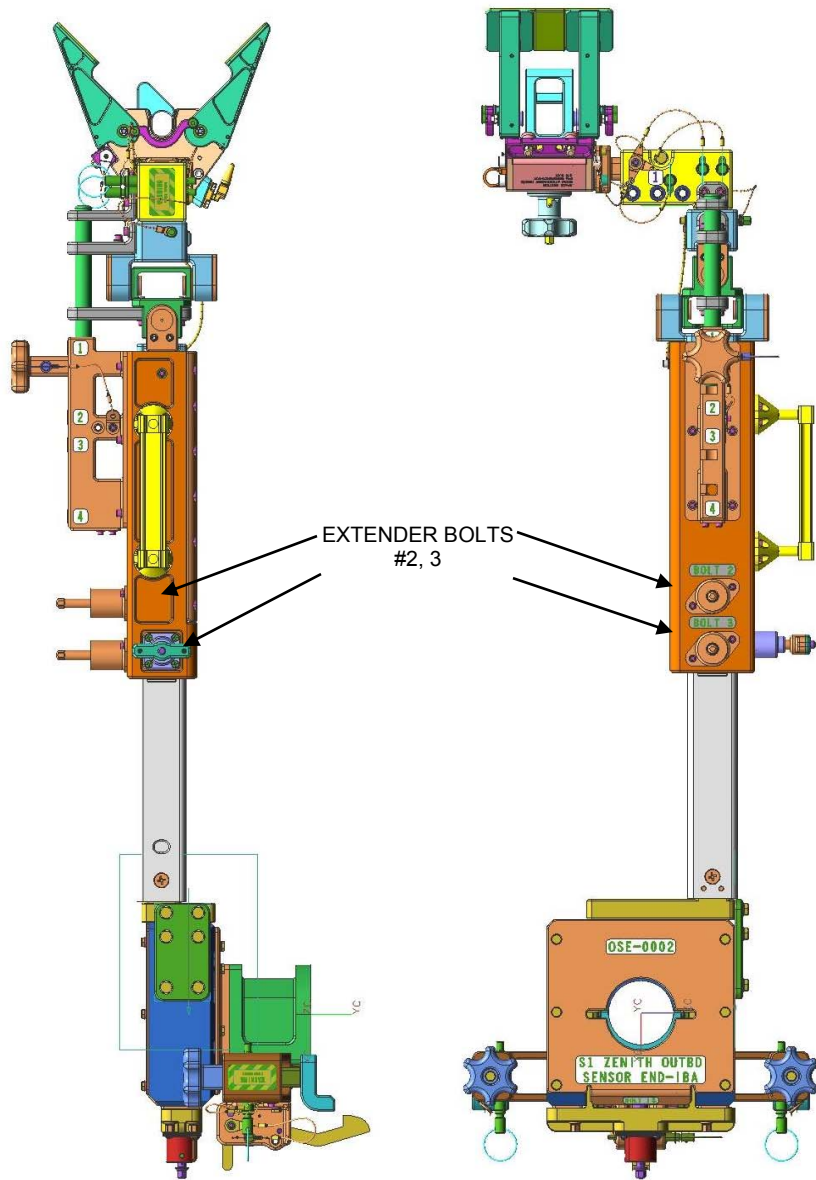


Boom Stand (OSE) – Overview

BOOM HANDOFF – TASK DATA (Cont)



BOOM HANDOFF – TASK DATA (Cont)



JPM PREP

| IV | EV1 | EV2 |
|--|--|--|
| <p style="text-align: center;">Safety tether swaps</p> <p>Starting tether swap ✓Local tether set</p> <p>Tether swap complete ✓Spare anchor on HR XXXX, bail closed, slider locked ✓Double-locked to the reel ✓Airlock tether stowed on HR XXXX ✓Reels unlocked</p> <p style="text-align: center;">Safety tether swap to A/L Tether</p> <p>Tether swap complete ✓Double-locked to the reel on my airlock tether ✓Spare tether stowed on t-bar ✓Reels unlocked</p> <ol style="list-style-type: none"> 1. Stow PLB camera B 2. Give MCC-H GO for CBM petal ops when EV crew clear of worksite if required 3. ✓MCC-H GO for JPM HEATER DEACT 4. A15 APCU 1,2 CONV (two) – OFF CRT SM 179 POWER TRANSFER ✓PTU 1,2 APCU OUT VOLTS: < 10 V A15 APCU 1,2 OUTPUT (two) – OFF 5. Once step 4 complete, give EV1 GO for LTA cable disconnect | <div style="border: 3px double black; padding: 5px; text-align: center;"> <p>WARNING</p> <p>Crew Shock hazard: 2 ft KOZ of SSPTS connectors Port and STBD of PMA2</p> </div> <p>DISCONNECT LTA CABLES</p> <ol style="list-style-type: none"> 1. Translation to end of Node 2 via Lab Strut to Lab Zenith around Port of JLP 2. Perform tether swap ✓Locally tethered ✓Spare tether anchored to PMA2 HR(0402)_____ 3. Translate along port side of payload bay, adjustable tether fairlead in payload bay (HR_____) 4. Fairlead once at end of payload 5. INSPECT GLOVES 6. Temp stow large ORU bag <div style="border: 1px solid black; padding: 5px; text-align: center;"> <p>CAUTION</p> <p>Avoid contact with PLB camera B</p> </div> <ol style="list-style-type: none"> 7. On MCC-H GO, perform following steps: <ul style="list-style-type: none"> ❑ Release cable from TA clamps (3), close TA clamps ❑ On JPM, demate LTA cables (2) (P107/J107, P157/J157) ❑ Wrap cables around all 3 cleats starting with inboard most cleat ❑ Secure entire length of Velcro straps ❑ Mate LTA cables to payload bay LTA cable tray. ✓No bent pins, FOD, good EMI band ❑ Install caps on JEM PM LTA receptacles ❑ Cover receptacles/caps with MLI FLAP ❑ Give GO for LTA/OBSS power up | <div style="border: 3px double black; padding: 5px; text-align: center;"> <p>WARNING</p> <p>Crew Shock hazard: 2 ft KOZ of SSPTS connectors Port and STBD of PMA2</p> </div> <p>PREP FOR JEM LTA AND PCBM COVER TASKS</p> <ol style="list-style-type: none"> 1. Translate to Node 2 HR 0331 2. Install Gap Spanner between Node 2 HR 0331 and 0344 3. Translate end of Node 2 via Lab Zenith around Port of JLP 4. Perform tether swap ✓Locally tethered ✓Spare tether anchored to PMA2 HR(0417)_____ 5. Translate along port side of payload bay, adjustable tether fairlead once in payload bay 6. Fairlead at end of payload bay 7. INSPECT GLOVES |

JPM PREP (Cont)

| IV | EV1 | EV2 |
|--|---|--|
| <p>6. On MCC-H direction, power up OBSS Heaters A15 APCU 2 OUTPUT – ON CONV – ON</p> <p>Thermal Clock Stop: _____</p> <p>7. Notify MCC-H OBSS Heater Activation complete</p> | <p><u>PCBM CONTAMINATION COVER REMOVAL</u></p> <div style="border: 1px solid black; padding: 5px; text-align: center;"> <p><u>CAUTION</u> Avoid contact with CBM sealing surface</p> </div> <p>8. Attach Large ORU bag to HR (1134) _____ (stbd bag HR standoff to stbd JPM HR standoff) using adj equipment tether</p> <p>9. Tether door flap to HR (1140) _____</p> <p>10. Remove contamination covers (8):</p> <p style="margin-left: 20px;">a. Remove covers; transfer to EV2</p> <p style="margin-left: 20px;">b. <input type="checkbox"/> Visually inspect PCBM ring as covers are removed</p> <p style="margin-left: 40px;"><input type="checkbox"/> stbd/nadir</p> <p style="margin-left: 40px;"><input type="checkbox"/> stbd/zenith</p> <p style="margin-left: 40px;"><input type="checkbox"/> port/nadir (translate down port side to worksite)</p> <p style="margin-left: 40px;"><input type="checkbox"/> port/zenith</p> <p>11. Close and cinch Large ORU bag</p> <p>12. INSPECT GLOVES</p> <p><u>RELEASE FORWARD WINDOW LAUNCH LOCKS</u></p> <p>13. PGT [A6 (8.3), CCW2, 30.5]-6"-Ext-7/16": Disengage fwd (PLB Stbd) window launch lock bolts (3); expect 9-11 turns</p> <p>14. Translate back to PMA2 tether swap location</p> <p>15. Perform tether swap</p> <p style="margin-left: 20px;">√Locally tethered</p> <p style="margin-left: 20px;">√Double locked to A/L safety tether</p> <p style="margin-left: 20px;">√Retrieve spare safety tether</p> <p style="margin-left: 20px;">√Bails closed and reels unlocked</p> | <p><u>PCBM CONTAMINATION COVER REMOVAL</u></p> <div style="border: 1px solid black; padding: 5px; text-align: center;"> <p><u>CAUTION</u> Avoid contact with CBM sealing surface</p> </div> <p>8. Attach Large ORU bag on HR(1148) _____, HR(1139), and HR(1140) using adj equipment tethers</p> <p>9. Remove contamination covers (8):</p> <p style="margin-left: 20px;">a. Receive PCBM contamination cover; stow on fuse tether eq hook (single hook)</p> <p style="margin-left: 40px;"><input type="checkbox"/> stbd/nadir</p> <p style="margin-left: 40px;"><input type="checkbox"/> stbd/zenith</p> <p style="margin-left: 40px;"><input type="checkbox"/> port/nadir (translate down port side to worksite)</p> <p style="margin-left: 40px;"><input type="checkbox"/> port/zenith</p> <p>10. Stow fuse tether, and covers in Lg ORU bag</p> <p>11. Secure contamination covers under diagonal adj tether</p> <p>12. Close and cinch Large ORU bag</p> <p>13. INSPECT GLOVES</p> <p><u>CLEANUP</u></p> <p>14. Retrieve large ORU bag stow on BRT</p> <p>15. Translate back to PMA2 tether swap location</p> <p>16. Perform tether swap</p> <p style="margin-left: 20px;">√Locally tethered</p> <p style="margin-left: 20px;">√Double locked to A/L safety tether</p> <p style="margin-left: 20px;">√Retrieve spare safety tether</p> <p style="margin-left: 20px;">√Bails closed and reels unlock</p> <p>17. Translate to A/L, stow large ORU bag into A/L and receive med ORU bag (SARJ)</p> <p>18. INSPECT GLOVES</p> |

JPM PREP – TASK DATA

Translation Path to JPM in PLD Bay



JPM PREP – TASK DATA (Cont)

Launch Through Activation Cable (LTA)

Estimated Task Duration:

| | With SSRMS | Without SSRMS |
|-------------|------------|---------------|
| One EV Crew | N/A | 00:15 |
| Two EV Crew | N/A | N/A |

ORU Identification:

| ORU | Part number | Serial Number |
|------------------------|----------------------------|---------------|
| LTA Connector Caps (2) | NZGL-RPC-N-25-0-MS | N/A |
| LTA Cable (2) | V845-774885 V845-774886 | -002 -002 |

ORU Specs:

| ORU | Dimensions (in) | Mass (lb) |
|------------------------|-----------------------------|------------|
| LTA Connector Caps (2) | 2.4 (diameter) x 2.2 – each | 0.3 (each) |
| LTA Cable (2) | Approx 107 inches | |

Tools:

| | EV1 | EV2 |
|--|------|------|
| | None | None |

Foot Restraints:

| Task | WIF | APFR Setting |
|-----------|-----|--------------|
| LTA Cable | N/A | N/A |

Electrical Connectors:

| Harness | Cable | From | To | Clamps (#) | Size | Function |
|---------------|-------|------|---------------------|------------|------|--------------|
| 3260CA901-403 | P107 | J107 | ECSH/LTA Cable Tray | 3 | 25 | Heater, Data |
| | P157 | J157 | | | 25 | Heater, Data |

Connector Inhibits:

| Task | Inhibit |
|----------------|--|
| P107 FROM J107 | A15/APCU 1,2 CONV (TWO) – OFF A15/APCU 1,2 OUTPUT (TWO) – OFF |
| P157 FROM J157 | |

Fasteners:

| Fastener Name | Head Size | Qty | Install Torque (ft-lb) | Release Torque (ft-lb) | Failure Torque (ft-lb) | Turns |
|---------------|-----------|-----|------------------------|------------------------|------------------------|-------|
| None | | | | | | |

Notes:

- JEM LTA cable must be disconnected prior to JEM removal from PLB

Cautions:

- Avoid contact with PCBM sealing surface once the contamination cover is removed

Warnings:

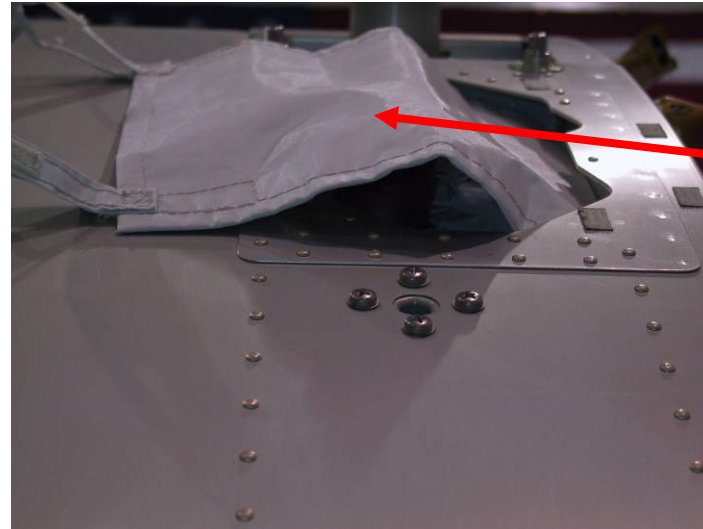
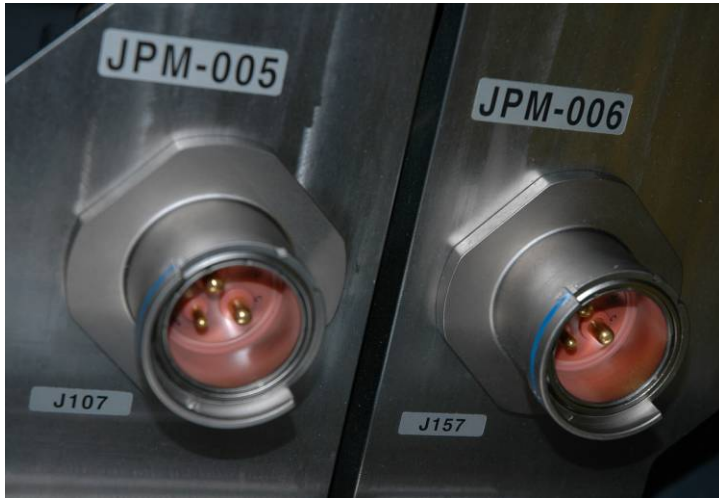
- Shock hazard. Verify power off before demating JPM LTA cables

LTA Connector Cap

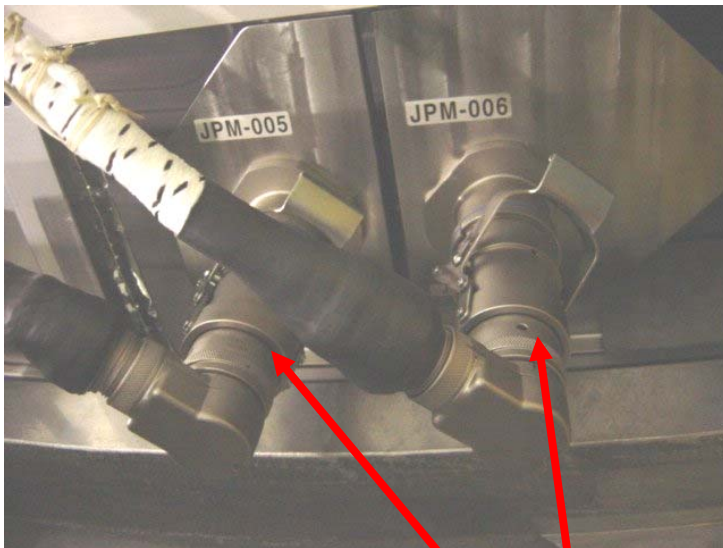


JPM PREP – TASK DATA (Cont)

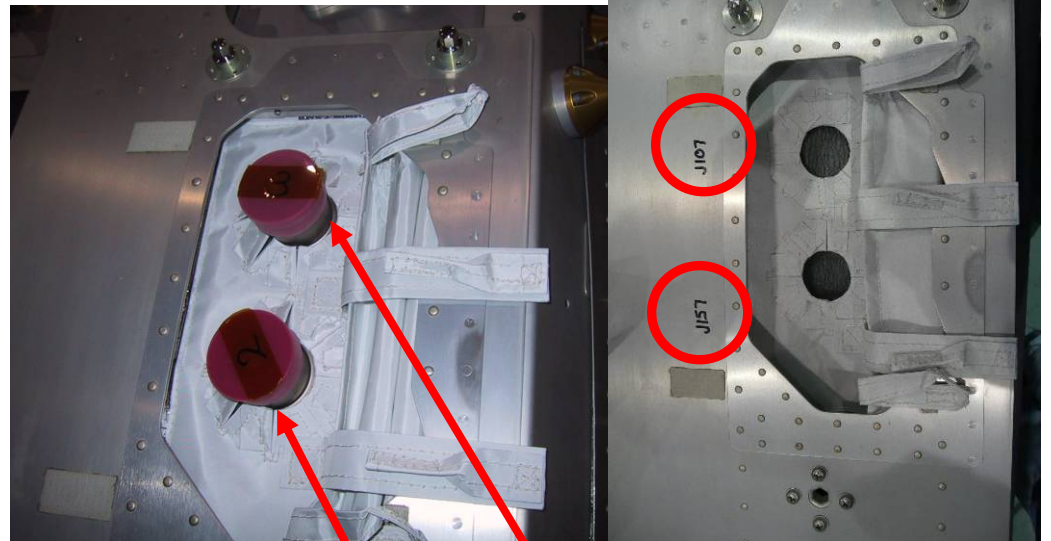
Photos of LTA Cables



LTA Cable MLI Cover



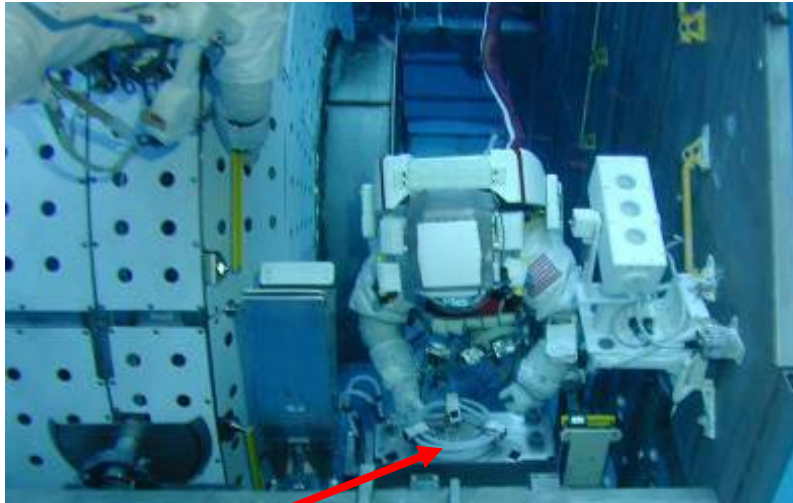
LTA Cables Attached to JEM



LTA Cables NOT Attached to JEM (Red Connector Covers – are GSE)

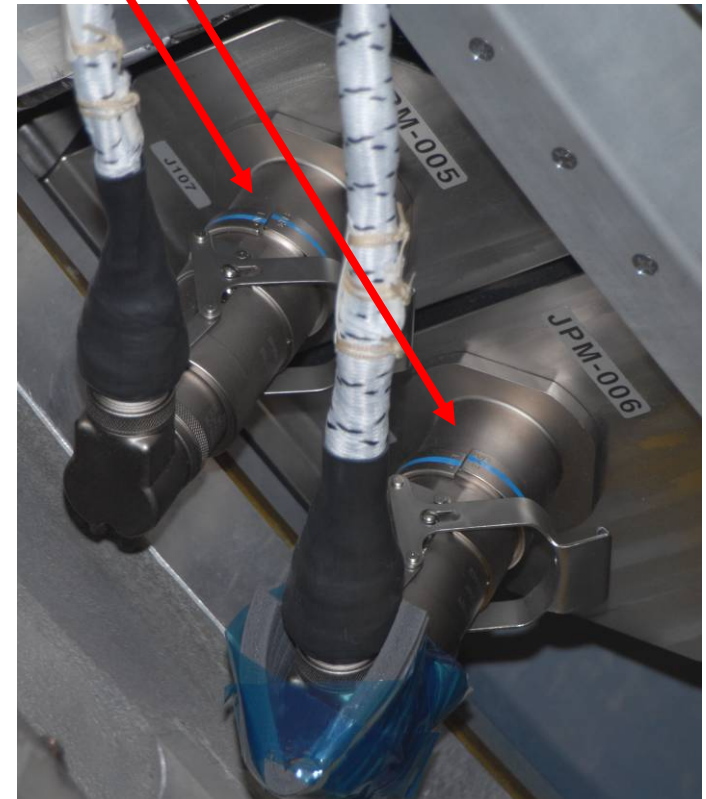
JPM PREP – TASK DATA (Cont)

Photos of LTA Cables (Cont)

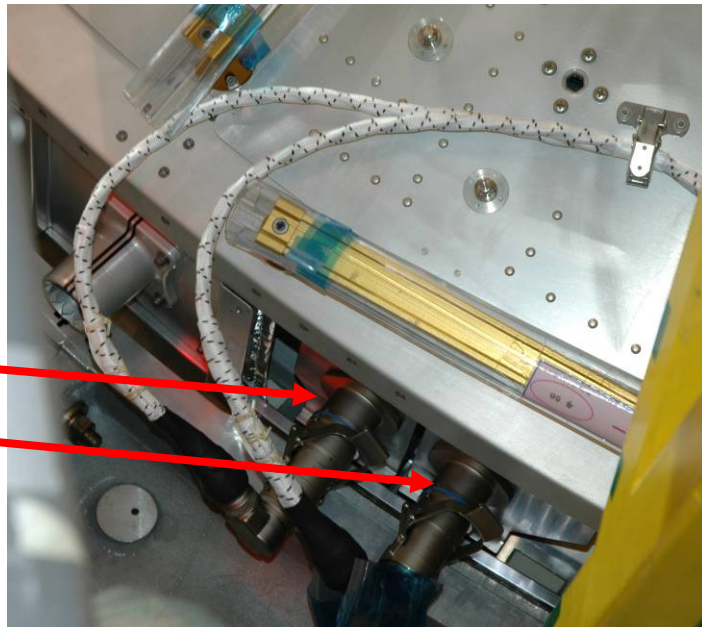


LTA Cable Stow Location

LTA Cables Attached to JEM



LTA Cables Attached to JEM



JPM PREP – TASK DATA (Cont)

JEM PCBM Contamination Covers Removal

Estimated Task Duration:

| | With SSRMS | Without SSRMS |
|-------------|------------|---------------|
| One EV Crew | N/A | N/A |
| Two EV Crew | N/A | 00:40 |

ORU Identification:

| ORU | Part number | Serial Number |
|-------------------------------------|-------------|----------------|
| JEM PCBM Contamination Covers – (8) | 683-13603-1 | -001 thru -008 |

ORU Specs:

| ORU | Dimensions (mm) | Mass (lb) |
|-------------------------------------|-----------------|---------------|
| JEM PCBM Contamination Covers – (8) | 785 x 85 x 20 | 1.2625 (each) |

Tools:

| EV1 | EV2 |
|-----|-----|
| N/A | |

Notes:

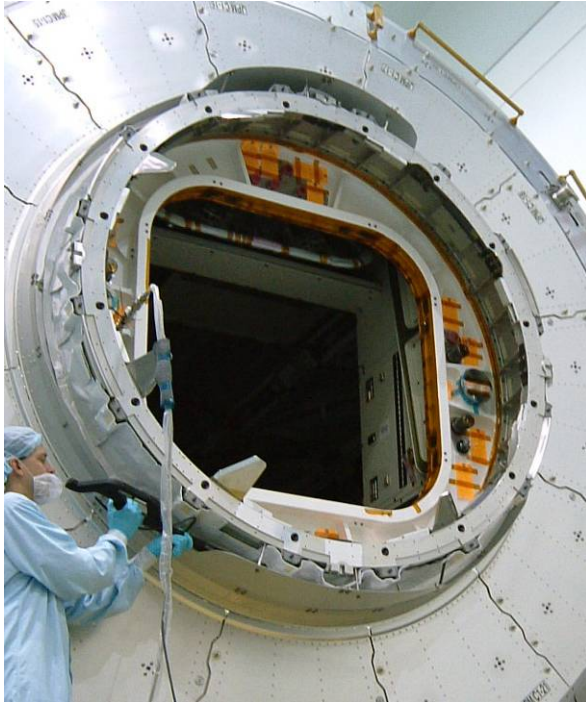
Cautions:

1. Avoid contact with PCBM sealing surface once contamination cover removed

Warnings:

JPM PREP – TASK DATA (Cont)

JEM MLI Removal/Contamination Cover Worksite



Contamination Cover Installed (8 in total)



Contamination Cover Removed (8 in total)



JPM PREP – TASK DATA (Cont)

JEM Window Launch Lock (LL) Release

Estimated Task Duration:

| | With SSRMS | Without SSRMS |
|-------------|------------|---------------|
| One EV Crew | N/A | 00:20 |
| Two EV Crew | N/A | N/A |

Tools:

| EV1 (FF) | EV2 |
|------------------------------|-----|
| PGT 6" ext – 7/16" Socket | N/A |

Foot Restraints:

| Task | WIF | APFR Setting |
|---------------|-----|--------------|
| JEM Window LL | N/A | N/A |

Connector Inhibits:

| Task | Inhibit |
|---------------|---------|
| JEM Window LL | NONE |

Fasteners:

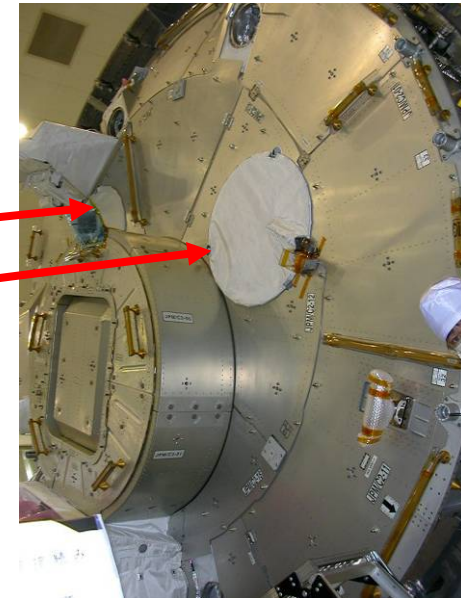
| Fastener Name | Head Size | Qty | Install Torque (ft-lb) | Release Torque (ft-lb) | Failure Torque (ft-lb) | Turns |
|---|-----------|----------------------------|------------------------|------------------------|------------------------|--------|
| JEM Fwd/Aft (2 Window Shutters Total) Window Launch Locks | 7/16 | 3 each window – 6 Total | 5.3 | 6.2 | 31.0 | 9-10.5 |

Notes:

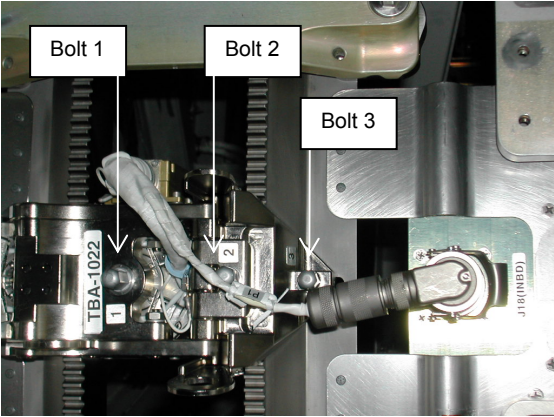
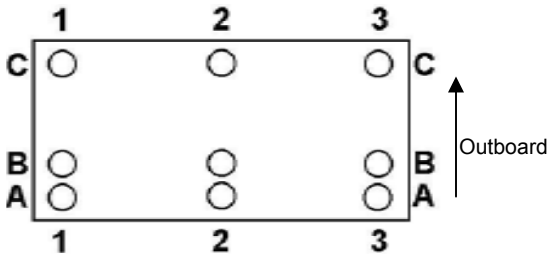
Cautions:

Warnings:

**Window Shutters
(2 Total)**



S3/S4 SARJ COVER REMOVE AND TBA #5 INSTALL

| IV/SSRMS | EV2 (FF) |
|---|--|
|  <p style="text-align: center;">INBOARD→</p>  <p style="text-align: center;">SARJ MLI Cover</p> | <p>TBA INSTALL SETUP</p> <ol style="list-style-type: none"> Translate up CETA spur to S1 HH 3239 (face 1) Perform tether swap S1 <ul style="list-style-type: none"> √Locally tethered √Spare tether anchored to S1 HR _____ √A/L tether stowed on S1 HR _____ √Anchor bail closed and slider locked √Reel end bails closed and double locked √Reels unlocked Translate to S3/S4 interface, cover 20 (face 6) Temp stow Med ORU bag (SARJ) INSPECT GLOVES <div style="border: 1px solid black; padding: 5px; margin: 10px 0;"> <p style="text-align: center;">WARNING</p> <p>Sharp edge – spring loaded captive EVA fasteners (SARJ MLI cover bolts); ends of springs may protrude Avoid contact with any exposed sharp edges during cover removal, TBA install, and SARJ inspection</p> </div> <div style="border: 1px solid black; padding: 5px; margin: 10px 0;"> <p style="text-align: center;">CAUTION</p> <p>The following precautions should be taken to prevent loss of inboard MLI cover fasteners during removal:</p> <ul style="list-style-type: none"> • Limit turn count to minimum required for fastener release • Minimize side loading of bolt head • Maintain axial force on fastener to compress spring during rotation </div> <p>REMOVE MLI COVER 20</p> <ol style="list-style-type: none"> Attach RET between cover 20 and cover 1 (face 1) PGT[A6 (8.3), CCW2, 30.5]-6" Ext 7/16": Release inboard MLI cover fasteners (4) = 9 turns Remove MLI cover and temp stow Retrieve Camera and take pictures of inner ring where TBA Mount contacts ring (Outer canted surface and Datum A) |

S3/S4 SARJ COVER REMOVE AND TBA #5 INSTALL (Cont)

| IV/SSRMS | EV2 (FF) |
|---|--|
| <p>1. Record Bolt 2: Final Torque____ Turns____</p> <p>2. Record Bolt 1: Final Torque____ Turns____</p> <p>3. Record Bolt 3: Final Torque____ Turns____</p> | <p><u>INSTALL TBA #5</u></p> <p>10. Retrieve EVA wipe (#____) from Med ORU bag</p> <p>11. Use EVA wipe to clean all inboard and outboard race ring surfaces (where clamp mounts)</p> <p>12. Invert wipe, secure with Velcro strap, and stow in large trash bag</p> <p>13. Retrieve mount package from Med ORU bag</p> <p>14. Verify mount clamping leg open</p> <p>15. Engage mount onto race ring, aligning mount boss with slot in race ring</p> <p>16. Close mount clamping leg</p> <p>17. PGT[A2 (3.8), CW2, 30.5]-6" Ext 7/16": Engage bolt 3 (mount bolt) exactly 2 turns</p> <p>18. Release mount tether</p> <p>19. Retrieve bearing package from Med ORU bag</p> <p>20. Engage bearing package onto mount, guiding bearing arm through race ring</p> <p>21. PGT[A3 (4.8), CW2, 30.5]-6" Ext 7/16": Engage bolt 2 (draw bolt) 10.5-13 turns to torque until preload arm engages race ring (bearing package will also move toward SARJ and mount package)</p> <p>22. PGT[A5 (7.0), CW2, 30.5]-6" Ext 7/16": Engage bolt 1 (bearing preload bolt) 5-7 turns to torque</p> <p>23. Release bearing tether</p> <p>24. PGT[A2 (3.8), CW2, 30.5]-6" Ext 7/16": Tighten bolt 3 (mount bolt) ~4 turns to torque</p> <p>25. Remove dust cap stow in trash bag</p> <p>26. Mate P1 to inboard receptacle J13 on SARJ race ring</p> <p><u>INSTALL MLI COVER</u></p> <p>27. Retrieve and install MLI cover 20</p> <p>28. Engage all four bolts before final torque</p> <p>29. PGT[A1 (2.5), CW2, MTL 30.5]-6 ext 7/16: Engage inboard MLI cover fasteners (4) ~9 turns</p> <p>30. Release RET from cover 1</p> <p>31. INSPECT GLOVES</p> |

TBA INSTALL – TASK DATA

Estimated Task Duration:

| | With RMS | Without RMS |
|-------------|----------|-------------|
| One EV Crew | N/A | N/A |
| Two EV Crew | N/A | 01:30 |

Tools:

| EV1 | EV2 |
|------------------------------|-----|
| PGT | |
| 7/16 (wobble) Socket – 6 ext | |
| Crewlock EVA Bag | |
| TBA (spare) | |

EVA Fasteners:

| Fastener Name | Label | Head Size | Qty | Install Torque (ft-lb) | Release Torque (ft-lb) | Failure Torque (ft-lb) | Turns | RPM |
|--------------------------|-------|-----------|---------|------------------------|-------------------------|-------------------------|---------|-----|
| SARJ Cover Bolts | N/A | 4 or 6 | 7/16-in | 0.8-3.8 on-orbit | Expect: 3.4 PGT: 8.3 | Remv: 13.7 Inst: 3.8 | 7-9 | 30 |
| TBA Bearing Preload Bolt | 1 | 1 | 7/16-in | 7.0 | PGT: 6.3 | Install: 9.4. | 5-7 | 30 |
| TBA Draw Bolt | 2 | 1 | 7/16-in | 4.8 | PGT: 6.3 | Install: 6.9 | 10.5-13 | 30 |
| TBA Mount Bolt | 3 | 1 | 7/16-in | 3.8 | PGT: 4.8 | Install: 4.9 | 4-6 | 30 |

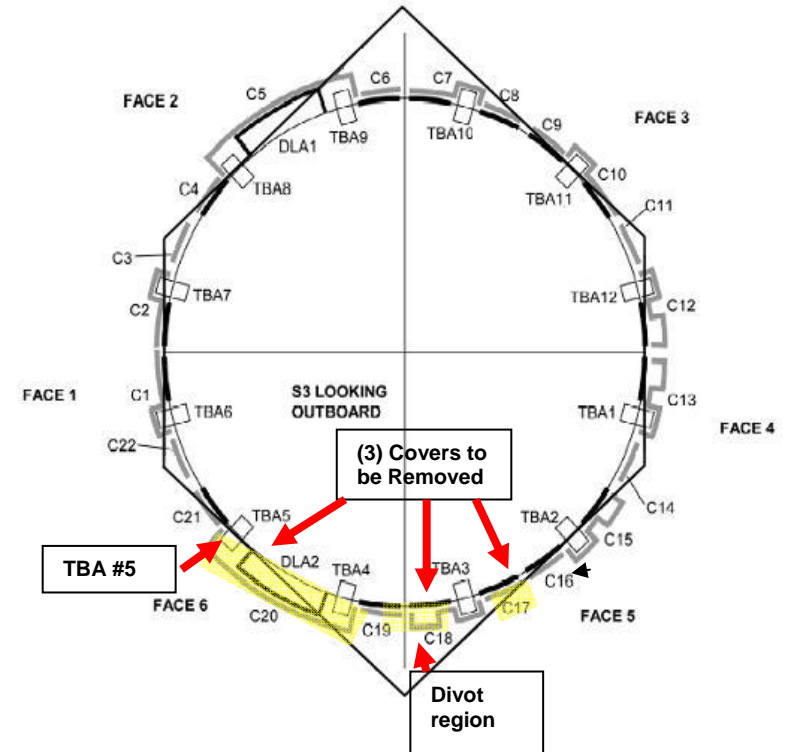
EVA Connectors:

| Harness | From | To | Clamps (#) | Conn Size | Function |
|---------------------------|------------------|----------------------------|------------|-----------|-----------------------|
| TBA electrical harness P1 | Hardwired to TBA | SARJ Inboard connector J13 | 0 | 15 | Power and data to TBA |

Foot Restraints:

| Task | WIF | APFR Setting |
|--------------|-----|--------------|
| Not Required | | |

ORU Mass: 16 lbs

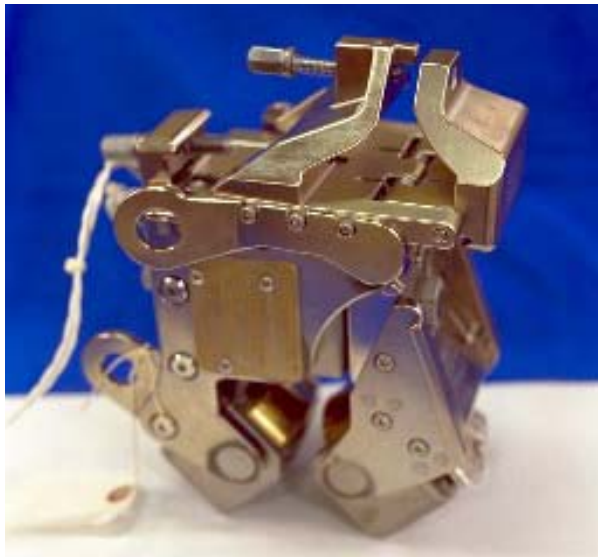


TBA INSTALL – TASK DATA (Cont)

TBA Reference Info:

| TBA Location Number | S3 TBA Serial Number | MLI Cover # | # MLI Cover Bolts (Type) | S3 Inboard SARJ Conn Label |
|---------------------|----------------------|-------------|--------------------------|----------------------------|
| TBA1 | TBA-1032 | 13 | 6 | J9(INBD) |
| TBA2 | TBA-1029 | 15 | 6 | J10(INBD) |
| TBA3 | TBA-1033 | 18 | 6 | J11(INBD) |
| TBA4 | TBA-1035 | 20 | 4 (DLA) | J12(INBD) |
| TBA5 | TBA-1039 | 20 | 4 (DLA) | J13(INBD) |
| TBA6 | TBA-1017 | 1 | 6 | J14(INBD) |
| TBA7 | TBA-1036 | 2 | 6 | J15(INBD) |
| TBA8 | TBA-1031 | 5 | 4 (DLA) | J16(INBD) |
| TBA9 | TBA-1030 | 5 | 4 (DLA) | J17(INBD) |
| TBA10 | TBA-1037 | 7 | 6 | J18(INBD) |
| TBA11 | TBA-1023 | 10 | 6 | J19(INBD) |
| TBA12 | TBA-1034 | 12 | 6 | J20(INBD) |

Trundle bearing and mount assembly



Mount assembly installed on SARJ ring



Notes:

- Each TBA ORU consists of a bearing package and a mount assembly, which are a matched drilled set. They are always removed and replaced together, but must be separated to do so
- Two spare TBA assemblies were flown on ULF-1 (s/n 1038, s/n 1039) Part number for bearing package: 06887 5846485. Part number for mount package: 55864 400K100
- TBAs adjacent to DLAs have specific tether requirements. During installation of new mount assemblies in these locations, the tether must be engaged outward from the inside on the mount, else the rigid side of the tether hook will become trapped between the DLA and TBA tether point, prohibiting hook removal after the mount has been installed
- Mount bolt (Bolt 3) spring loaded. When depressed with enough force (approximately 2 lb), the bolt end pushes against threaded interface, overcoming two ball detents that hold clamping leg in closed position. Clamping leg will then spring open, freeing mount from race ring. In order to engage treads during TBA installation, rotation of bolt must begin prior to pressing in on fastener to preclude inadvertent opening of clamping leg
- Mount bolt (Bolt 3) must be partially released during bearing installation and removal to increase tolerance between bearing and mount interface
- Tether-hook must be removed from mount during bearing package installation and removal due to interference
- Clamping leg closure accomplished by placing gloved hand through gap in two race rings and pressing clamp against ring
- DLA covers may require 2 crewmembers to reinstall due to size and tight clearances

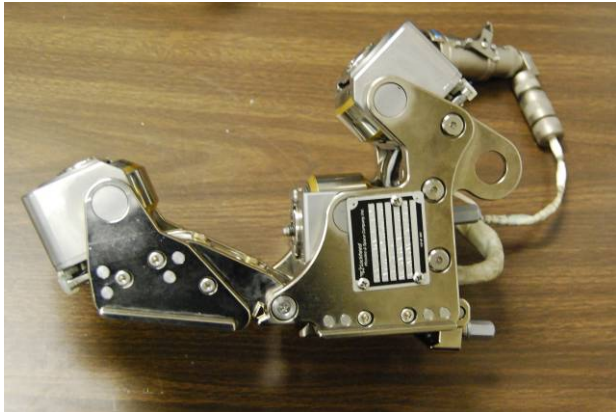
Cautions:

- SARJ Race Ring not tolerant to nicks and scratches. Exercise care within vicinity of Race Ring while handling components
- Do not reengage outboard MLI cover spring clamps during re-installation of cover. Spring clamp engagement will preclude future SARJ rotation

Warnings:

- Verify SARJ locked (one DLA locked, one DLA engaged) to prevent rotation while EV crew in vicinity of rotational plane plus 2 feet

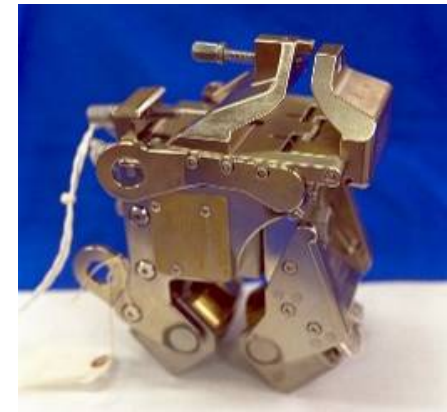
S3/S4 SARJ COVER REMOVE AND TBA #5 INSTALL – TASK DATA



Bearing Package Assembly



Mount Assembly



Trundle Bearing Assembly



Slot in Race Ring to align Mount Boss



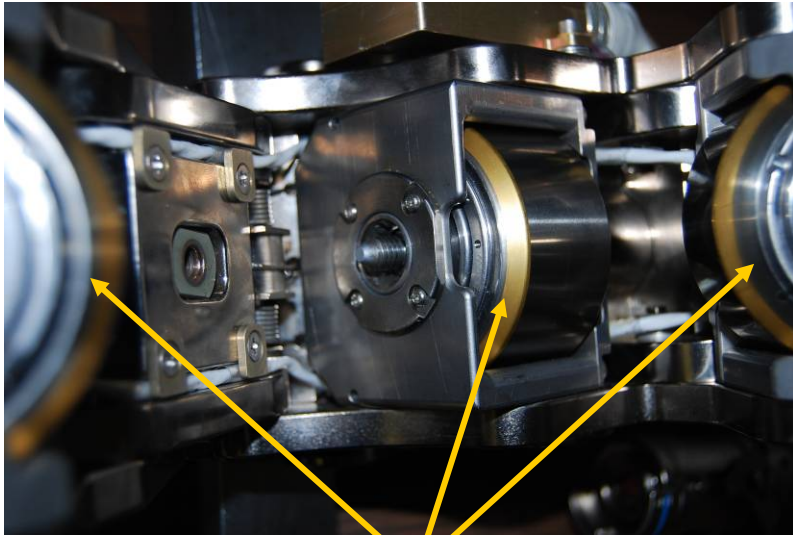
Mount Assy on Race Ring, mount clamp leg open (initial position)



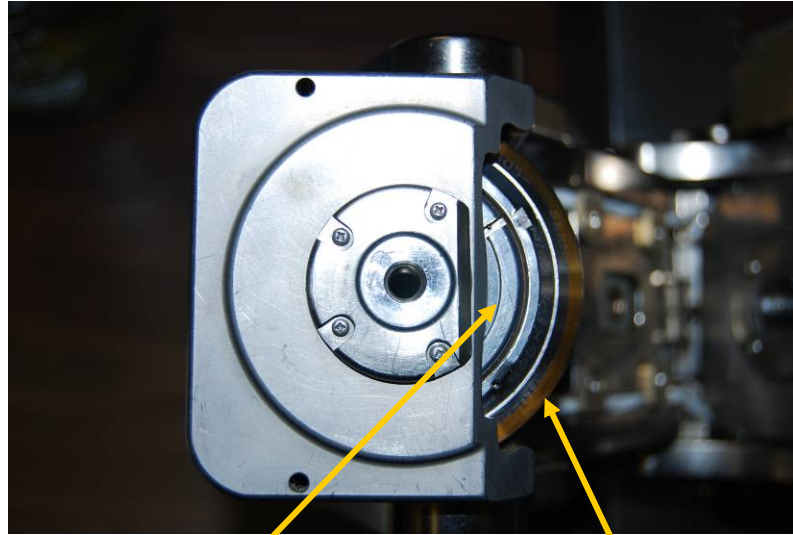
Mount Assy on Race Ring, mount clamp leg closed (final position)

Mount Assembly installed on SARJ ring

S3/S4 SARJ COVER REMOVE AND TBA #5 INSTALL – TASK DATA (Cont)

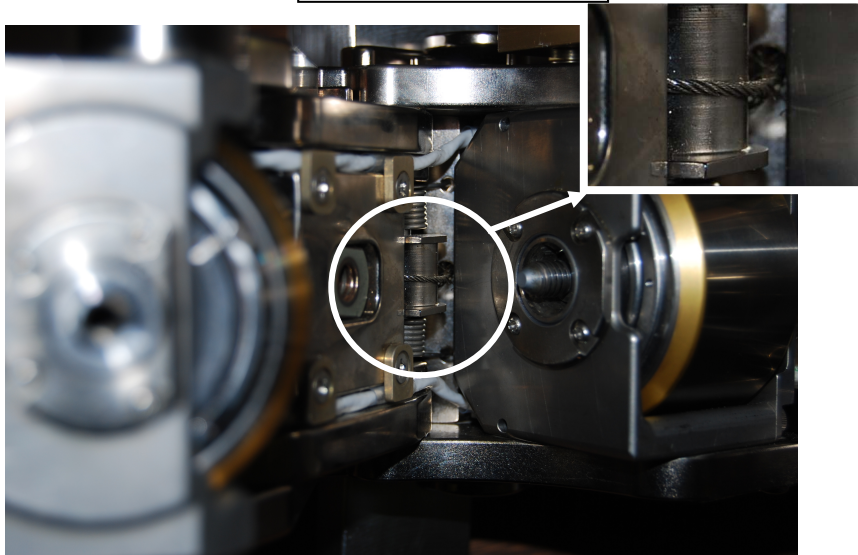


Roller Bearings

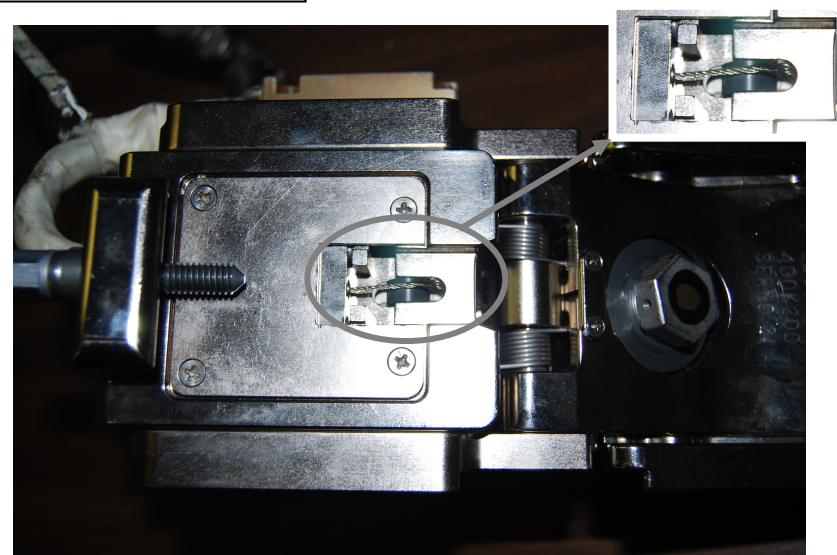


Inner bearing – stationary

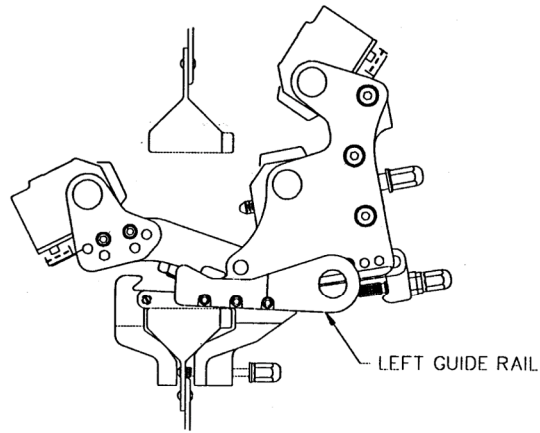
Outer bearing – rotates



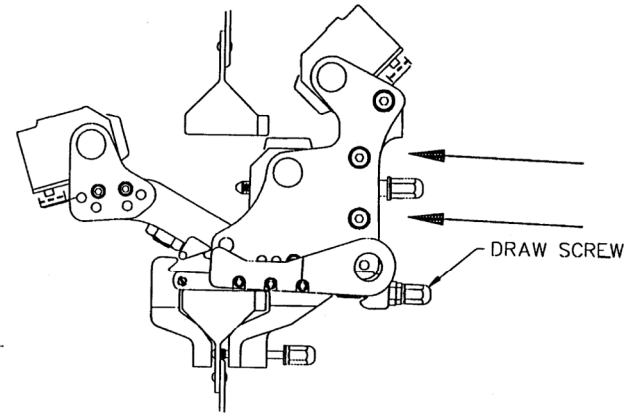
Inspect Cable for Frays Insets show frayed cable on ground unit



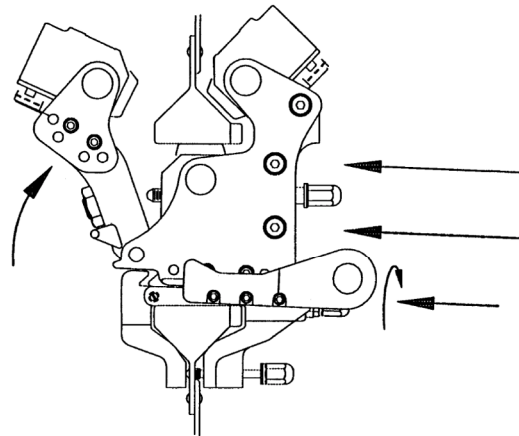
S3/S4 SARJ COVER REMOVE AND TBA #5 INSTALL – TASK DATA (Cont)



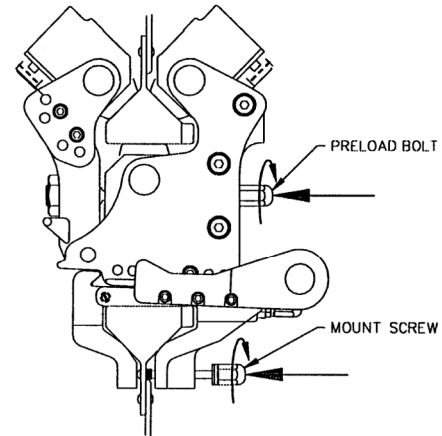
INSERT BEARING PACKAGE ASSEMBLY INTO MOUNT ASSEMBLY



SLIDE BEARING PACKAGE ASSEMBLY INTO MOUNT UNTIL DRAW SCREW ENGAGES ITS INSERT

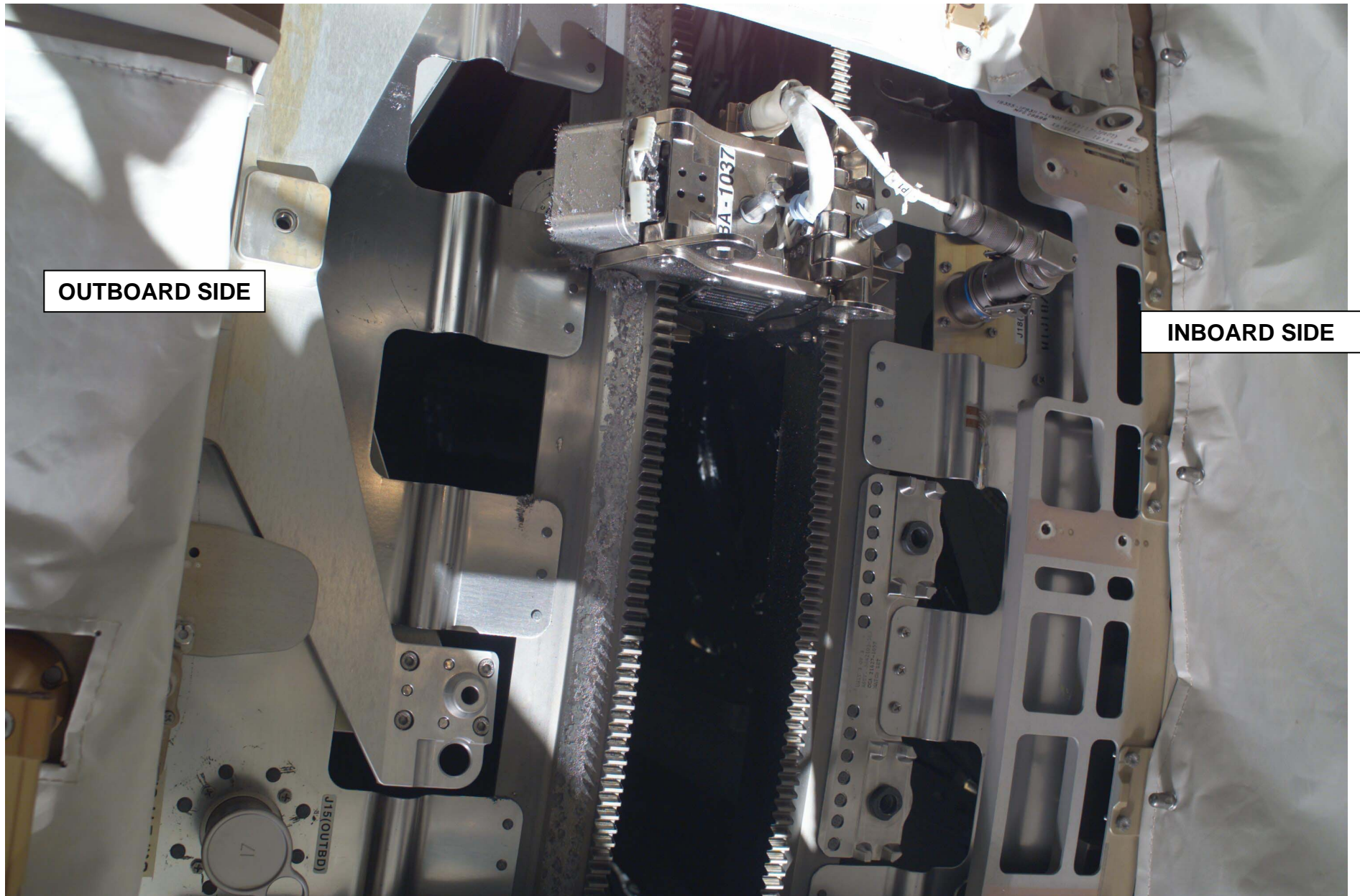


DRIVING BEARING PACKAGE ASSEMBLY REMAINDER OF ITS TRAVEL WITH DRAW SCREW AUTOMATICALLY CLOSES PRELOAD ARM

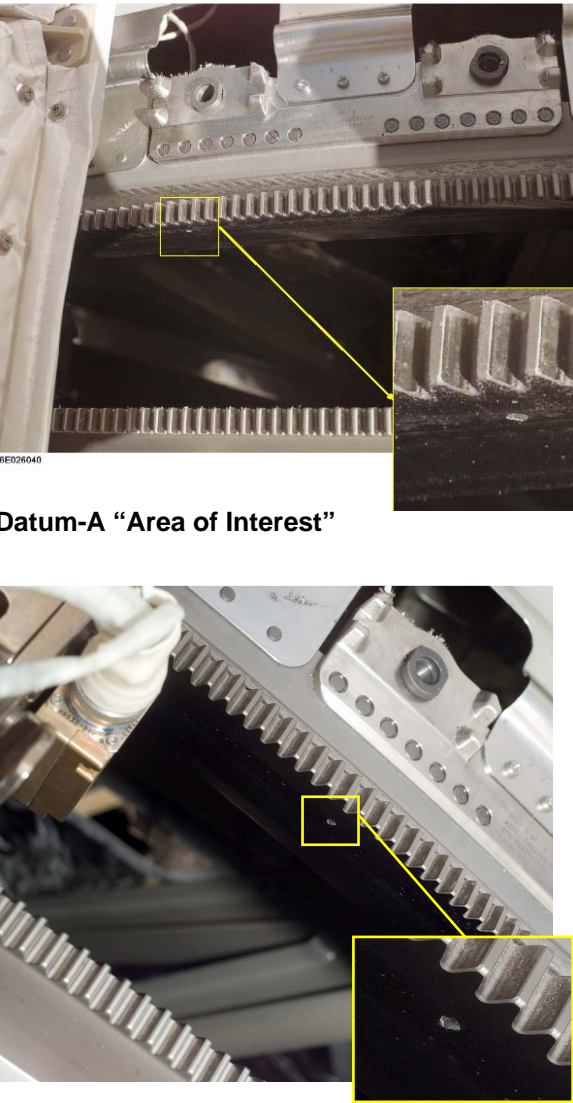


ENGAGE AND TORQUE PRELOAD BOLT AND MOUNT SCREW

S3/S4 SARJ – TASK DATA



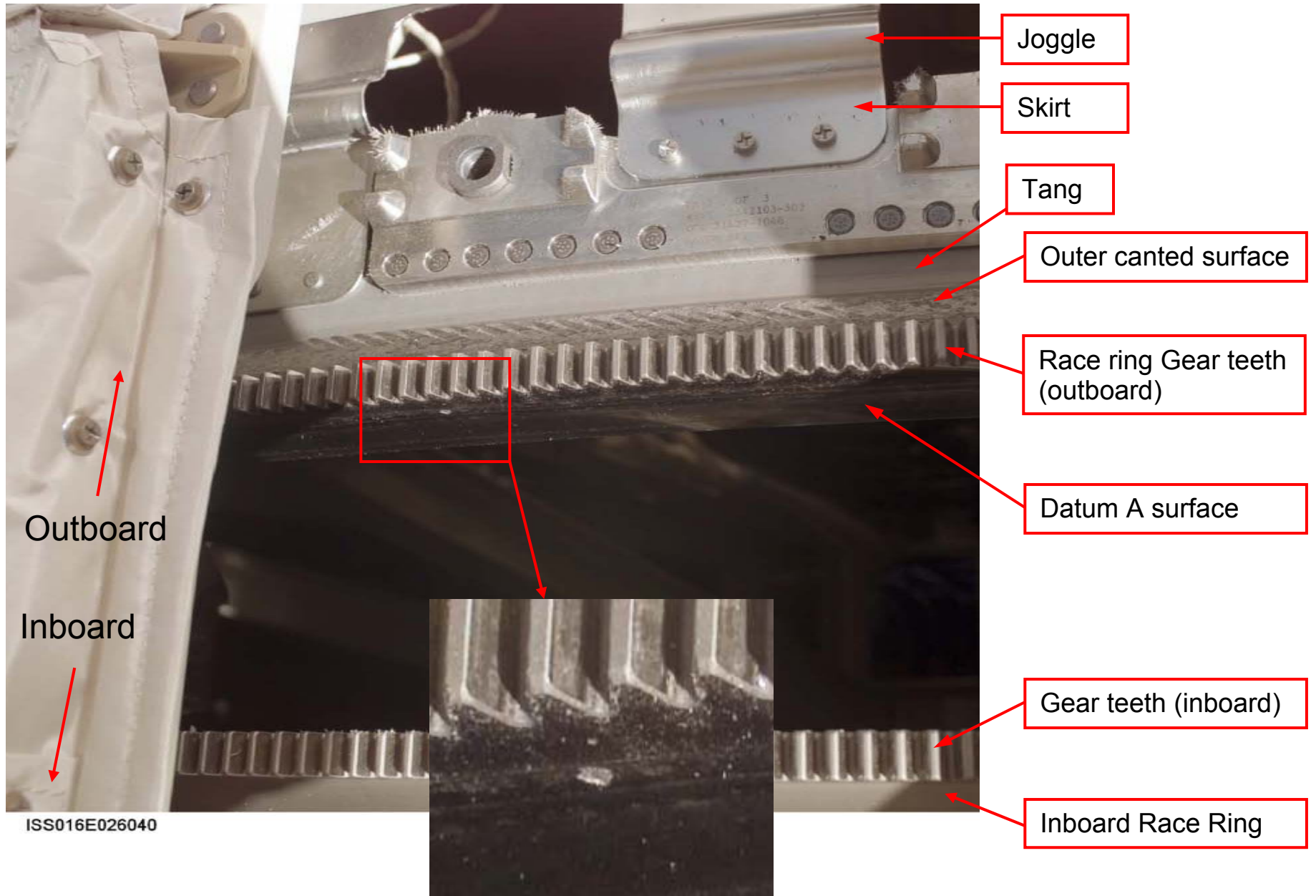
S3/S4 SARJ DATUM A INSPECTION

| IV | EV1 (FF) |
|--|--|
|  <p data-bbox="113 824 445 849">Datum-A "Area of Interest"</p> | <p data-bbox="695 248 989 272">DATUM A INSPECTION</p> <div data-bbox="751 285 1717 492" style="border: 1px solid black; padding: 5px;"> <p data-bbox="1167 298 1297 323" style="text-align: center;"><u>WARNING</u></p> <p data-bbox="764 326 1650 386">Sharp edge – spring loaded captive EVA fasteners (SARJ MLI cover bolts); ends of springs may protrude</p> <p data-bbox="764 388 1478 415">Sharp edge – may be created on edge of scraper during use</p> <p data-bbox="764 423 1696 483">Avoid contact with any exposed sharp edges during cover removal, TBA install, and SARJ inspection</p> </div> <div data-bbox="751 500 1644 751" style="border: 1px solid black; padding: 5px;"> <p data-bbox="1136 505 1255 529" style="text-align: center;"><u>CAUTION</u></p> <p data-bbox="764 532 1614 592">The following precautions should be taken to prevent loss of inboard MLI cover fasteners during removal:</p> <ul data-bbox="793 597 1598 691" style="list-style-type: none"> • Limit turn count to minimum required for fastener release • Minimize side loading of bolt head • Maintain axial force on fastener to compress spring during rotation <p data-bbox="764 721 1625 748">To avoid leaving residue, do not use Kapton tape on the Datum A surface</p> </div> <ol data-bbox="695 786 1976 1398" style="list-style-type: none"> 1. Translate up CETA spur to S1 HH 3239 (face 1) 2. Perform tether swap S1 <ul style="list-style-type: none"> √Locally tethered √Spare tether anchored to S1 HR _____ √A/L tether stowed on S1 HR _____ √Anchor bail closed and slider locked √Reel end bails closed and double locked √Reels unlocked 3. Translate to S3/S4 interface, cover 18 (face 5) 4. INSPECT GLOVES 5. RET MLI cover 18 to adjacent cover 6. PGT [A6 (8.3), CCW2, 30.5]-6"-Ext-7/16": Release inboard cover fasteners (6), 9 turns only (add single turns incrementally as required for release) 7. Remove MLI cover and temp stow 8. RET MLI cover 17 to adjacent cover 9. PGT [A6 (8.3), CCW2, 30.5]-6"-Ext-7/16": Release inboard cover fasteners (4), 9 turns only (add single turns incrementally as required for release) 10. Remove MLI cover and temp stow |

S3/S4 SARJ DATUM A INSPECTION (Cont)

| IV | EV1 (FF) |
|---|---|
| <div data-bbox="136 305 550 638" style="border: 1px solid black; padding: 5px;"> <p><u>Rockwell C Hardness</u> Core = 35 Nitrited Surface = 70</p> <p>Softer than Core:</p> <ul style="list-style-type: none"> • Feeler Gauge (< 25) • Scraper (~30) <p>Harder than Core:</p> <ul style="list-style-type: none"> • BRS Pin Tool (50) </div> | <p><u>DATUM A INSPECTION (Cont)</u></p> <ol style="list-style-type: none"> 11. Locate Area of Interest (AOI) 12. Perform visual inspection of AOI and adjacent Datum A surface and report conditions 13. Retrieve Camera, take photos of AOI 14. In preparation for DTO, take photos of outboard outer canted surface of entire exposed section of race ring, both Covers 17 and 18 15. Retrieve broom clip caddy with scraper and feeler gauge from ORU bag 16. Drag feeler gauge along AOI (do not scrape), attempting to determine if divot or debris. Utilize different angles of attack and different tool-to-surface angles. Can also start with tool in center of AOI and work outwards 17. Stow feeler gauge and retrieve scraper from broom clip caddy <p style="text-align: center;"><u>NOTE</u> Debris may liberate suddenly. Be prepared for rapid movements</p> <ol style="list-style-type: none"> 18. Using scraper, verify nature of AOI. Use scraping motion or straight edge alignment to determine 19. If determined to be debris, attempt to liberate with scraper using as much force as required 20. If debris liberated, describe condition of underlying surface <ol style="list-style-type: none"> a. Does surface look like neighboring, clean Datum A? b. Was a divot created? If so, characterize using either the feeler gauge or scraper c. Is some debris still present? If so, attempt to liberate with scraper 21. If nature of AOI inconclusive, stow scraper and retrieve BRS pin tool 22. Using BRS pin tool, reattempt determination, using as much force as can be applied with scraping only (no hammering) 23. Stow BRS pin tool in ORU bag |

S3/S4 SARJ DATUM A INSPECTION – TASK DATA



CLEANING TECHNIQUE DTO

| IV | EV1 (FF) |
|----|--|
| | <p><u>CLEANING TECHNIQUE DTO</u></p> <p><u>WET SCRAPING</u></p> <ol style="list-style-type: none">1. Retrieve EVA wipe (#____) and grease gun from ORU bag2. Stage EVA wipe near worksite3. Prep grease gun:<ol style="list-style-type: none">a. Engage teeth by rotating plunger 180 deg (black triangle up)b. Remove MLI tip coverc. Rotate shutoff knob such that FLOW pointing toward nozzle4. Under cover 18, identify a section of race ring and describe condition to MCC-H, including any landmarks5. Dispense a ~6" bead of grease on outboard outer canted surface6. Describe adhesiveness of grease7. If grease will not adhere to outer canted surface, grease can be applied to race ring tang8. Safe and stow grease gun:<ol style="list-style-type: none">a. Disengage teeth by rotating plunger 180 deg (black triangle down)b. Rotate shutoff knob such that FLOW is perpendicular to nozzlec. Install MLI tip cover |

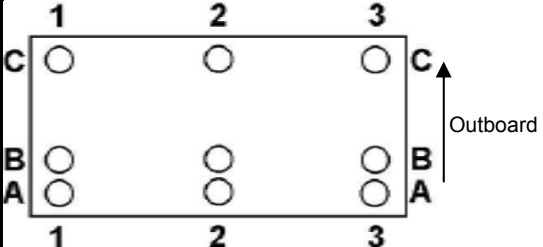
CLEANING TECHNIQUE DTO (Cont)

| IV | EV1 (FF) |
|----|---|
| | <p><u>WET SCRAPING</u> (Cont)</p> <ol style="list-style-type: none"> 9. Using scraper, spread grease evenly along surface 10. Scrape greased section along circumference of race ring. Also try perpendicular to circumference, moving tool in both long motions and short motions <ol style="list-style-type: none"> a. Which method of scraping removed more debris? b. Which was easier to do? 11. Retrieve staged EVA wipe and remove grease from tip of scraper 12. Describe amount of debris visible in grease <ol style="list-style-type: none"> a. Is any debris visible? If so, what is nature of debris? b. Is it easy/hard to distinguish debris from grease? Does it depend on lighting? c. Would using white grease make this determination easier? 13. Stow scraper in broom clip caddy 14. Describe outer canted surface to MCC-H <ol style="list-style-type: none"> a. How much debris was liberated? b. What was the nature of this debris (i.e., very fine talcum-powder like dust or larger particles)? c. Able to remove any larger "pancakes?" d. How much force does it take to liberate pancakes? e. How much grease left on surface? 15. Clean greased surface with previously used EVA wipe <ol style="list-style-type: none"> a. How much grease was picked up on EVA wipe? b. How much debris was in grease? c. How much grease still left on race ring? 16. Invert wipe, secure with Velcro strap, and stow in large trash bag |

CLEANING TECHNIQUE DTO (Cont)

| IV | EV1 (FF) |
|----|--|
| | <p><u>WET WIPING</u></p> <ol style="list-style-type: none"> 17. Translate to cover 17 18. Retrieve clean EVA wipe (# _____) and grease gun from ORU bag 19. Stage wipe near worksite 20. Prep grease gun: <ol style="list-style-type: none"> a. Engage teeth by rotating plunger 180 deg (black triangle up) b. Remove MLI tip cover c. Rotate shutoff knob such that FLOW pointing toward nozzle 21. Identify a new section of race ring and describe condition to MCC-H, including any landmarks 22. Dispense a ~6" bead of grease on outboard outer canted surface 23. Safe and stow grease gun: <ol style="list-style-type: none"> a. Disengage teeth by rotating plunger 180 deg (black triangle down) b. Rotate shutoff knob such that FLOW is perpendicular to nozzle c. Install MLI tip cover 24. Retrieve temp stowed EVA wipe 25. Spread grease with EVA wipe, then attempt to remove grease and debris with wipe <ol style="list-style-type: none"> a. Does the grease spread easier with wipe than with scraper? b. How much debris is wipe picking up? c. How does this debris compare to debris picked up from wet scraper d. How much grease is left on outer canted surface? 26. Invert wipe, secure with Velcro strap, and stow in large trash bag |

CLEANING TECHNIQUE DTO (Cont)

| IV | EV1 (FF) |
|--|---|
|  <p>SARJ MLI Cover</p> | <p><u>WET WIPING (Cont)</u></p> <ol style="list-style-type: none"> 27. Retrieve clean EVA wipe (#_____) and scraper from ORU bag 28. Stage EVA wipe near worksite 29. Scrape greased, wiped section and describe results <ol style="list-style-type: none"> a. Does scraper pick up more/less debris after surface is pre-wiped? b. What is the nature of debris? c. Is force required to liberate and pancakes less after surface pre-wiped? 30. Retrieve EVA wipe and remove grease from tip of scraper and excess grease from outboard outer canted surface <ol style="list-style-type: none"> a. How much grease was picked up on EVA wipe? b. How much debris was visible in grease? c. How does this grease/debris amount compare with wipe used to clean after previous scraping test? 31. Invert wipe, secure with Velcro strap, and stow in large trash bag 32. Stow broom clip caddy with scraper and feeler gauge in ORU bag 33. INSPECT GLOVES for grease (clean with towel if required) <p><u>PHOTO CLOSEOUT</u></p> <ol style="list-style-type: none"> 34. Retrieve camera 35. Take photos of Datum A AOI 36. Take photos of outer canted surface of entire exposed section of race ring, specifically of areas where DTO performed 37. Stow camera, retrieve MLI covers 17 and 18 and reinstall 38. PGT[A1 (2.5), CW2, 30.5] 6"-Ext-7/16": Install inboard cover fasteners (6 for 18, 4 for 17), ~8 turns. (Partially engage all MLI cover fasteners prior to final torque) 39. Stow tools/tethers in medium ORU bag (SARJ) and stow on BRT 40. INSPECT GLOVES 41. Translate back to A/L |

CLEANUP AND INGRESS

| IV | EV1 (FF) | EV2 (FF) |
|---|---|--|
| <p>Prior to Ingress:</p> <ol style="list-style-type: none"> 1. Perform WVS PWRDN (PHOTO/TV, <u>WVS CUE CARD</u>) | <p><u>CLEANUP</u></p> <ol style="list-style-type: none"> 1. Perform tool inventory 2. INSPECT GLOVES 3. Inspect EV2 for SARJ debris <p><u>INGRESS</u></p> <ol style="list-style-type: none"> 4. On EV2 GO, release the anchor side of EV2 safety tether 5. Hand in crew lock bag (Get-Aheads), and Med ORU bag (SARJ) 6. Connect waist tether to D-ring extender on A/L D-ring 7. Release EV1 A/L safety tether anchor point 8. Ingress A/L 9. Remove SCU from stowage pouch 10. Remove DCM cover; Velcro to DCM 11. Connect SCU to DCM; √SCU Locked 12. WATER – OFF (fwd), expect <u>H2O IS OFF</u> msg 13. Close thermal cover: attach Velcro strap <div data-bbox="674 889 1226 987" style="border: 1px solid black; padding: 5px; margin: 10px auto; width: fit-content;"> <p style="text-align: center;"><u>CAUTION</u> Do not close hatch until EMU Water OFF for 2 min. Verify outer hatch clear of hardware</p> </div> <ol style="list-style-type: none"> 14. Verify outer hatch clear of hardware 15. Verify handle position per hatch decal; close and lock hatch <p>Go to PRE-REPRESS (<u>DEPRESS/REPRESS Cue Card</u>)</p> | <p><u>CLEANUP</u></p> <ol style="list-style-type: none"> 1. Perform tool inventory 2. INSPECT GLOVES 3. Inspect EV1 for SARJ debris 4. Ingress A/L <p><u>INGRESS</u></p> <ol style="list-style-type: none"> 5. Attach waist tether to UIA D-ring 6. Receive crew lock bag (Get-Aheads), and Med ORU bag (SARJ) 7. Remove SCU from stowage pouch 8. Remove DCM cover; Velcro to DCM 9. Connect SCU to DCM; √SCU Locked 10. WATER – OFF (fwd), expect <u>H2O IS OFF</u> msg <p>Go to PRE-REPRESS (<u>DEPRESS/REPRESS Cue Card</u>)</p> |

This Page Intentionally Blank

1J EVA 2 SUMMARY

| TIME | IV | EV1 (FF) | EV2 (FF) |
|-------------|----|---|---|
| 00:00-00:05 | | POST DEPRESS (00:05) | POST DEPRESS (00:05) |
| 00:05-00:35 | | EGRESS/SETUP (00:30) | EGRESS/SETUP (00:30) |
| 00:35-01:25 | | Install Aft JTVE (00:50) | Install Fwd JTVE (00:50) |
| 01:25-02:25 | | Remove JEM RMS Thermal Covers (6) and EE MLI (01:00) | Remove JEM RMS Thermal Covers (6) and EE MLI (01:00) |
| 02:25-02:50 | | Zenith ACBM (00:25) <ul style="list-style-type: none"> • Remove ACBM Cover • Release MMOD Shield Launch Restraints • Relocate Hatch PIP pin • Inspect CBM | Zenith ACBM (00:25) <ul style="list-style-type: none"> • Remove ACBM Cover • Release MMOD Shield Launch Restraints • Relocate Hatch PIP pin • Inspect CBM |
| 02:50-03:30 | | Install Trunnion (4) and Keel Cover (00:40) | Install Trunnion (4) and Keel Cover (00:40) |
| 03:30-05:00 | | Prep ESP3 NTA (01:30) | Prep S1 NTA (01:30) |
| 05:00-06:00 | | CP9 ETVCG RETRIEVE (01:00) | CP9 ETVCG RETRIEVE (01:00) |
| 06:00-06:25 | | CLEANUP/INGRESS (00:25) | CLEANUP/INGRESS (00:25) |
| 06:25-06:30 | | PRE REPRESS (00:05) | PRE REPRESS (00:05) |
| 06:30 | | | |

Get-Ahead: – Port SARJ Inspection (00:30-00:45)
– Node 2 QD Thermal Blanket Install (00:30)
– S3/S4 SARJ Launch Restraint Removal (01:45)
– Node 1 MMOD Shield Cleanup (01:00)
– FHRC P-Clamp Release (01:00)

EVA 2

1J EVA 2 BRIEFING CARD

EV1 _____
EV2 _____
IV _____
R1/M1 _____

EVA Prep start (GMT) _____/_____:_____
Depress to 10.2 _____:_____
Start Purge _____:_____
PET 00:00 _____:_____

Flight Day Prior to EVA – General Briefing (All)

1. EVA Prep
 - Get-up Plan – clothing and EMU equipment bag – EV1
 - Prebreathe protocol review (Notes and Warnings) – IV
 - Equipment lock activities – IV responsibilities
 - Suit donning plan – special requests – EV's, IV's
 - SAFER, MWS, tools, C-Lk positions, bag stowage – EV2
 - Airlock depress review – IV
2. EV Crew Procedure Review – EV1
 - Egress Plan
 - Order of tasks (summary timeline)
 - Translation plan, fairleads, and tether swaps
 - Hazards
 - Ingress Plan
3. Robotics – R1/M1
 - SRMS/SSRMS initial position, maneuvers, clearances
 - Coordinate Frames
 - SRMS/SSRMS comm protocol review – expected calls, use first names
 - GCA – when, where, handover language
 - Cameras
 - Contingencies
 - Suit anomalies while ingressed

Flight Day Prior to EVA – Additional Briefing (EV, IV)

4. Communications – CDR, IV
 - Overall setup: big loop, A/G2, S/G2, ICOM, Hardline, remind EV crew when mode swapping
 - EV/IV comm protocol review – Use EV1(2) for DCM sw throws (all time in A/L), use first names otherwise
5. General Procedure Review – EV1
 - Get-ahead tasks
 - Constraints – ground and flight – IV
 - Notes, Cautions, and Warnings review – IV
 - Contingency procedures – crib sheet
6. Emergencies Review – EV1
 - Emergency suit doff and power down during EVA prep
 - Loss of comm
 - EMU malfunctions
 - Lost tools
 - Lost crewmember
 - DCS
 - Abort and Terminate scenarios, protocols
 - Hand signal reviews
7. Post EVA – IV's
 - Suit doffing responsibilities
 - Post EVA plan

√Expedited Suit Doffing cue card pre-positioned for EVA day

1J EVA 2 BRIEFING CARD (Cont)

EVA Day, prior to Prebreathe Protocol

1. Reminders

- Translate slow (then space is like water). Relax grip
 - o Be extra careful on non-standard routes or orientations
 - o Don't hop
- Tether Discipline
 - o Check all gates closed and hooks locked; check reel locked/ unlocked
 - o Local tether when stopped. Check tethers before you leave
 - o When something is attached to a tether, don't grab the tether by the hook
 - o Good pull tests
- APFR ops
- Be disciplined when tired
- Hazards: payloads, etc
- Openness: when you have boot or glove pain let us know
- OK for IV and ground to check on us. If you need update, ask
- Monitor safety tether. Hold peanut when necessary
- Let mistakes pass
- If you get a mal, read the caution and warning message so everyone knows what it is
- Manage frustration (slow down, if needed)
- Cold soak before ingress
- Verify PGT settings. PGT collars are easy to bump
- Read turns, torque, green light
- SSRMS: coordinate frames and positive GCA handovers
- Review first post-egress steps
- Review abort/terminate priorities and procedures
- Glove Checks
- Day/night reconfigurations
- Translation Adaptation plan

IV Checklist Verification Items

1. Generic

- Day/Night Cycles
 - √Lights, visors, gloves and heaters, tethers, and MWS
- √Load Alleviating Strap on Safety Tethers not damaged
 - Crew report: "**Safety Tether strap looks good**"
- √Safety Tether Crew Hook Slidelocks are locked
 - Crew Report: "**Locked and locked**"
- √Both SAFER valves down at egress
 - Crew Report: "**Both handles down**"
- √APFR locking collar Black-on-black and pull test
 - Crew Report: "**Black-on-black, good pull test**"
- √PGT Green light on for bolt engage
 - May get Lo Torque msg at bolt release
 - Crew Report: "**XX turns, green light, XX ft-lb**"
- √Latches closed on lid, door, etc (i.e., √in landing config)
 - Crew Report: "**XX Latches done**"
- √Connectors for no bent pins, no FOD, inhibits in place
 - Crew Report: "**Pins good, no FOD, bend radius OK**"
 - Crew Report: "**Are inhibits in place?**"

2. Task Specific

- √Tethers and Tools clear prior to SSRMS ORU movement
 - Each EV report: "**Tethers and tools clear**"

3. Tool inventory

- √Tethers on MWS
- Confirm all others as standard unless removed

1J EVA 2 TOOL CONFIGURATION

EV1

EMU D-rings

- Ext on left side
- Ext on right side
- Waist Tethers (left Ext to MWS, √locked)
- Waist Tethers (right D-ring to ERCM, √locked)
- 85-ft Safety Tether (right Ext, √locked)
- 85-ft Safety Tether – spare (right Ext, √locked)

MWS

- Long wire tie (over gloves)
- Small Trash Bag
- 2 – Wire ties as tether loops
- RET (with PIP pin)
- RET
- 2 – Adj Equipment Tether
- Swing Arm (right side)
 - RET (Attach to PGT)
 - PGT s/n 1002 w/6-in ext
- BRT (left side)
 - 2 – Wire ties (1 short & 1 long)
 - RET
- SAFER/WVS

CREWLOCK

- D-ring extender on A/L D-ring
- Large-Sm RET
 - Crewlock Bag #1 (Get-Aheads)
 - Socket Caddy
 - 12-Ext 7/16
 - RAD w/2-Ext 7/16
 - 9-in ext 7/16-in
 - MMOD shield handling tool (long)
 - Wire Tie Caddy (w/6 Long wire ties)
 - Loop pin puller
 - 2 – RET
 - Node 2 QD thermal blankets (2)
 - Wire Ties (1 long & 1 short/blanket)

Prior to EVA, perform the following hardware inspections:

1. RET cords for fraying
2. No red line visible on safety and waist tether load Alleviation straps
3. Inspect ISS trash bags for deformation/damage
4. Inspect EMU gloves for damage Levers

Use **RED** RETs only

EV2

EMU D-rings

- Ext on left side
- Ext on right side
- Waist Tethers (left Ext to MWS, √locked)
- Waist Tethers (right D-ring to ERCM, √locked)
- 85-ft Safety Tether (right Ext, √locked)
- 85-ft Safety Tether – spare (right Ext, √locked)

MWS

- Wire tie (over gloves)
- Wire tie to secure trash bag (with tether loops)
 - Small Trash Bag
 - RET (with PIP pin)
- 2 – Wire ties as tether loops
- RET (with PIP pin)
- RET
- 2 – Adj Equipment Tether
- Swing Arm (right side)
 - RET (Attach to PGT)
 - PGT s/n 1008 w/6-in ext
- BRT (left side)
 - 3 – Wire ties (2 short & 1 long)
 - RET
- SAFER/WVS

CREWLOCK (Cont)

- Large-Sm RET
 - EV2's JTVE w/boom – FWD(√ IV cap removed)
 - Adj Equipment Tether (on Handrail)
 - Jettison/Stowage Bag Over JTVE
 - Small wire tie to launch lock
 - Crewlock Bag
 - Adjustable (holding C-Lk bag)
 - TRC – 04 (Fwd/Port)
 - TRC – 05 (Keel)
 - Adjustable
 - 2 – NTA FQD Thermal Booties
 - Camera w/bracket
 - Socket Caddy
 - RET
 - Ratchet Wrench w/7.8-in ext 5/8-in
 - Palm Wheel

CREWLOCK (Cont)

- Large-Sm RET
 - Large ORU bag
 - 2 – Adj Equipment Tether (Outside of bag)
 - RET
 - Long wire tie
 - TRC – 03 (Aft/Port)
 - TRC – 02 (Fwd/Stbd)
 - TRC – 01 (Aft/Stbd)
 - EV1's JTVE w/boom – AFT(√ IV cap removed)
 - Jettison/Stowage Bag Over JTVE
 - Small wire tie to launch lock
 - Adj Fuse Tether (Ig-Ig) (int loops)
 - 7 – JEM RMS joint/EE covers
 - (2) RET
 - 2 – JEM PM JTVE Caps
 - Adj Fuse Tether (Ig-Ig) (int loops)
 - Vice Grips
 - Wire Tie (to restrain to bottom of bag)
 - Needle Nose Pliers
 - Wire Tie (to restrain to bottom of bag)
 - 7/16 box end wrench
 - Wire Tie (to restrain to bottom of bag)
 - Crewlock Bag with 2 RETs
 - 2 – Kapton Tape (on lid) w/labels
 - Adjustable (holding C-Lk bag)
 - Torque Multiplier 5/8 proud
 - Dummy box
 - RET (with PIP Pin) (for 5th item)
 - Rd Scoop (returns on ETVCG)
 - Adjustable
 - 2 – NTA FQD Thermal Booties
 - Ratchet Wrench w/7.8-in ext 5/8-in
 - Palm Wheel
 - RET (eq-eq)
 - EVA wipe
 - 2 – Adjustable (outside to attach camera)
 - Camera w/bracket and flash (outside bag)

1J EVA 2 TOOL CONFIGURATION (Cont)

Staging Bag

- Adjustable Fuse Tether
 - Connector Cleaner Tool Kit
 - PGT s/n 1001
 - PGT Battery s/n _____
 - Pin Straightener Assy
 - Probe
- Adjustable Fuse Tether
 - Torque Wrench and bag
 - LDTD Tether
 - MMWS Key Strap Assembly
 - Pry Bar
 - Hammer

IV Bag

- 2 – Towels w/wire ties
- Contamination Detection Kit w/watch
 - Hydrazine Detector (Gold Salt Coupon) (6)
 - Color Chart (2)
 - ISS Contamination Detection Sampler (2)
 - Shuttle Contamination Detection Sampler (2)
 - Nitrogen Dioxide Detector (Oxidizer Draeger Tube) (6)
 - Ammonia Detector (NH3 Draeger Tube) (6)
- 2 – GP Caddy
 - 2 – Adj Thermal Mittens
- 3 – RET
 - Socket Caddy (hatch cont)
 - 1/2 socket 8-in ext (hatch)
 - 7/16 socket 6-in ext (spare)
 - DCM plug (2) (SAFER hardmount)

1J EVA 2 INHIBIT PAD

Orbiter

| | |
|------------|---------------------|
| TCS L12 | 1. √TCS POWER – OFF |
|------------|---------------------|

| | |
|--------------------------|---|
| KU-BAND ANTENNA MCC-H | 1. √KU-BAND Mask – active 2. √KU-BAND EVA Protect Box – active |
|--------------------------|---|

| | |
|-----------------|---|
| RCS | If EV crew < 27 ft from FRCS: |
| IV O14,15,16 | 1. √DAP: VERN, FREE, LO Z (flt specific check with GNC) 2. √RJDF F1, F2, F3, F4 MANF DRIVER (four) – OFF LOGIC (four) – OFF |
| MCC-H | 3. √Above RCS config |
| IV | 4. √RCS F – ITEM 1 EXEC (*) √JET DES F1U – ITEM 17 (*) F3U – ITEM 19 (*) F2U – ITEM 21 (*) |

| | |
|---|---|
| S-BAND ANTENNAS (Not Expected) | |
| <u>NOTE</u> Possible loss of comm when forced LL FWD antenna | |
| IV | If EV crew < 2 ft from S-Band antenna |
| A1R | 1. S-BAND FM ANT – XMIT LOWER/RCVR UPPER 2. √MCC, lower antenna selected |
| C3 | If no comm, or on MCC GO 3. S-BAND PM ANT – LL FWD |
| C3 | When EVA crewmember at least 2 ft away from all S-Band upper antennas 4. S-BAND PM ANT – GPC |

Ground

| | |
|-----------------------|--|
| Ground Radar MCC-H | 1. √TOPO console, ground radar restrictions in place for EVA |
|-----------------------|--|

USOS

| | |
|-------|---|
| PCU | <u>NOTE</u> PCUs may require up to 1 hr warm-up period before they are operational |
| MCC-H | 1. √PCUs (two) operational in discharge mode and one of following: a. CCS PCU EVA hazard control FDIR enabled b. No more than two arrays unshunted and oriented < 105° from the velocity vector |
| OR | 2. One or no PCUs operational in discharge mode and no more than two arrays unshunted and oriented < 105° from velocity vector |

| | |
|------------------|---|
| Lab Window IV | If EV crew less than 10 ft from window or in window FOV, close window shutter |
|------------------|---|

| | |
|------------------|---|
| JPM Window IV | If EV crew translating on end cone of JPM, close window shutter |
|------------------|---|

| | |
|-----------------------------|---|
| Mobile Transporter MCC-H | If EV crew < 1.5 meters from MT 1. √MT latched |
|-----------------------------|---|

| | |
|---------------|---|
| TRRJ MCC-H | S1 TRRJ 1. √DLA (1) – Locked at -90 to -60 or +60 to +90 P1 TRRJ 1. √DLA (1) – Locked at +15 to +90 or -90 to -165 |
|---------------|---|

1J EVA 2 INHIBIT PAD (Cont)

USOS (Cont)

SARJ (Port – Required , Starboard – Get-Ahead)
MCC-H Stbd SARJ (on call for get-aheads):
1. √DLA 1(2) – LOCKED at any angle
2. All motor setpoints set to zero
3. All motors deselected
OR
4. Both DLAs – LOCKED at any angle

Port SARJ:
1. √DLA 1(2) – LOCKED at any angle
2. All motor setpoints set to zero
3. All motors deselected
OR
4. Both DLAs – LOCKED at any angle

RSOS

SM Antennas
IV 1. GTS – Deactivate
2. ARISS (Ham Radio) – Deactivate or VHF (144-146 MHz) TX only

TASK SPECIFIC INHIBITS

CP9 ETVCG Inhibits, to be performed prior to ETVCG demate:
MCC-H 1. CP9 ETVCG in parked position (-180 deg pan, -90 deg tilt)

2. RPCM P11A_A RPC 1 OPEN AND CLOSE INH
RPCM P11A_A RPC 15 OPEN AND CLOSE INH
RPCM P12B_A RPC 2 OPEN AND CLOSE INH
RPCM P12B_A 16 OPEN AND CLOSE INH

NTA Inhibits, to be performed prior to electrical connector demating:
MCC-H RPCM S1 2B_A RPC 10 – OPEN, CL CMD INH
RPCM S1 1A_A RPC 11 – OPEN, CL CMD INH
RPCM S1 1A_C RPC 12 – OPEN, CL CMD INH
S1-1 MDM SDO CARD SLOT 8 CHANNELS 0-6 OPEN

JTVE Inhibits, to be performed prior to JTVE installation:
SSIPC JTVE F

CPB A SW 1 Open
PDB WS RPC 8 Open
PDB A1 RPC 6 Open
PDB A1 RPC 8 Open
PIB B2 120V HI SW 1 Open

JTVE A

CPB B SW 1 Open
PDB B2 RPC 4 Open
PDB B2 RPC 7 Open
PDB B2 RPC 8 Open
PIB A2 120V HI SW 2 Open

JEMRMS Heaters, to be verified prior to JEMRMS thermal cover removal
SSIPC Verify only one heater string active on JEMRMS

1J EVA 2 NOTES, CAUTIONS, WARNINGS

NOTES

1. Bolt install: report torque and turns
2. Bolt release: report torque and turns if different from published range
3. EVA connectors: after disconnection and prior to connection; verify pin and EMI band integrity; verify connector free of FOD
4. Inspect QDs for damage prior to mating
5. Toolbox doors must be closed with one latch per door when EV crew not in immediate vicinity
6. Avoid contact with OBSS striker bars (Vitrolube coating)

CAUTION

ISS Constraints

- A. Avoid inadvertent contact with
1. Grapple fixture shafts (drylube)
 2. PIP pins
 3. EVA crane [PMA1]
 4. TCS reflectors [PMA2,PMA3]
 5. APAS hardware [PMA2,PMA3]
 6. CETA lights (Z-93 paint) [LAB,S1,Node 1]
 7. Deployed MISSEs [COL EPF]
 8. Passive UMAs
 9. MBS/SSRMS/SPDM/JEMRMS taped radiative surfaces: VDU, ACU, JEU, LEU, MCU, CRPCMs, and cameras
 10. Deployed TUS cable [Nadir CETA rail]
 11. S0 aft face radiator
 12. GPS antennas (S13 paint) [S0]
 13. UHF antennas [LAB,P1]
 14. ETCS radiator flexhoses and panels [S1,P1]
 15. EETCS/PV radiator flexhoses, bellows and panels [P6,P4,S4,S6]
 16. SASA RF group [S1,P1]
 17. Heat pipe radiators [Z1]
 18. PCU cathode and HCA ports [Z1]
 19. Ku-Band antenna (SGANT) dish [Z1]
 20. CMG cover/shells [Z1]
 21. SPDM SJEU, EP, OTCM, LEU, and LEE VDU radiator surfaces
 22. Open CBM petal covers, LAB window shutter, and JPM window shutter
 23. FPMU [S1]
 24. OTSD
 25. COL HAM radio antennas [COL-Nadir]
 26. JTVE Cameras

CAUTION (Cont)

ISS Constraints (Cont)

- B. Electrical cables
1. Avoid bend radii < 10 times cable diameter
- C. Fiber optic cables
1. Avoid bend radii < 10 times cable diameter
 2. Avoid pulling on cable during mate/demate
- D. Fluid line flex hoses and QDs
1. Avoid bend radii < 5 in for hoses with diameter < 1 in on LAB, S0, S1, and P1 and 10-in for hoses with diameter < 1-in on all other elements
 2. Avoid bend radii < 14 in for hoses with a diameter ≥ 1 in
 3. Additional care should be taken to not exceed bend radii when applying loads at the flexible hose to rigid tube stub interfaces
 4. Ensure fluid QD booties are fully closed prior to leaving worksite; wire tie if reqd

1J EVA 2 NOTES, CAUTIONS, WARNINGS (Cont)

CAUTION (Cont)

ISS Constraints (Cont)

- E. For structural reasons
1. Avoid vigorous body motions, quick grabs and kickoffs against tether restraints
 2. Avoid performing shaking motions (sinusoidal functions) more than four cycles
 3. Avoid kicking S1/P1 radiator beam.
If any of these occur, wait 2 to 5 min to allow structural response to dissipate
- F. Other
1. ITT Cannon connector: On demated connectors, do not rotate collar or manipulate cable/connector using collar or connector tool
 2. WIS Antennas: do not use as handholds [Node 1, Lab, P6, Z1]
 3. Lubricant from Ku-Band SGANT gimbals [Z1], CMGs [Z1], and RTAS Ground Strap fasteners [P6, P4, S4, S6] can contaminate EMU
 4. MLI handholds are not rated for crewmember translation loads
 5. CBM petal covers may not be used as handholds unless both launch restraint pins are engaged
 6. Prevent inadvertent contact of the tether shuttle with ETRS when P3/S3 Tether Shuttle Stop raised away from rail

CAUTION (Cont)

Shuttle Constraints

- G. Avoid inadvertent contact with
1. OBSS and SRMS composite sections and cable harnesses
 2. LCS (silver Teflon) and LDRI (silver Teflon) and ITVC (gold foil) [OBSS]
 3. WVS antenna [ODS Truss & PLB Sill]
 4. Payload Bay wire harnesses, cables, and connectors
- H. No Touch
1. LDRI diffuser [OBSS]
 2. OBSS saddle contacts (when OBSS unberthed) [OBSS]
 3. Monkey fur [PLB]
 4. Cameras: metallic surfaces [PLB]
 5. Ku-Band antenna black dish and gold thermal blankets [PLB]

1J EVA 2 NOTES, CAUTIONS, WARNINGS (Cont)

WARNING

ISS Constraints

- A. Avoid inadvertent contact with
1. Grapple fixture targets and target pins
 2. SSU, ECU, beta gimbal platform, mast canister, SAW blanket boxes unless the beta gimbal is locked and the motor is turned off
 3. Stay inboard of SARJ when active
 4. Stay 2 ft from S1/P1 radiator beam rotational envelope when beam is free to rotate
 5. Stay 5 ft from moving MT on face 1
 6. SOLAR and EuTEF [COL EPF]
- B. Handrails
1. Handrails previously used for MISSE attachment may not be used as a safety tether point [A/L endcone 564 & 566, A/L Tank 2 nad/fwd & port/fwd, P6 5389]
- C. Pinch
1. NZGL connector linkage. Use caution when mating/locking
 2. ITT Cannon Connector rotating housing
 3. EV side of IV Hatch during Hatch operation (also snag hazard) [A/L]
 4. LAB window shutter, CBM petal cover, and JPM window shutter linkages during operation
 5. JEMRMS HRM capture latches

WARNING (Cont)

ISS Constraints (Cont)

- D. QDs
1. If QD is in FID when valve is opened (bail fwd), QD will leak and fluid line may whip
 2. Do not rotate if in mated/valve open config
- E. RF radiation exposure
1. Stay 3.6 ft from S-Band (SASA) high gain Antenna when powered [S1,P1]
 2. Stay 1.3 ft from S-Band (SASA) low gain Antenna when powered [S1,P1]
 3. Stay 1 ft from UHF Antenna when powered [LAB,P1]
- F. Sharp Edges
1. Inner edges of WIF sockets
 2. APFR active WIF probes
 3. Mating surfaces of EVA connectors. Avoid side loads during connector mating
 4. Back side of MMOD shield fasteners
 5. Spring loaded captive EVA fasteners (e.g., 6B-boxes, BMRRM, RTAS, SARJ covers); end of spring may protrude
 6. PMA umbilical launch restraints-exposed bolt threads
 7. Adjustable Fuse Tether (Fish Stringer) buckles stowed in Node Bag
 8. Nickel coated braided copper Ground Straps may contain frayed wires [P6,P4,S4,S6]

WARNING (Cont)

ISS Constraints (Cont)

- F. Sharp Edges (Cont)
9. Solar Array Blanket Box [P6,S6]
 10. Keep hands away from SSRMS LEE/POA/SPDM LEE/JEMRMS opening, snares and PDGF curvic coupling (teeth)
 11. SPDM OTCM gripper jaws
 12. Fastener threads on back of Z1 U-jumper male FQD panel, if nutplate cap missing
 13. Outboard MT rail attachment lug near P6 handrail 5333 and gap spanner
 14. P2 connector on EWIS box TAA-06 [Zenith Face 1 of P5 – SARJ at 0 deg]
 15. Port/Aft portion of A/L circular HR [HR 0506]
 16. Interior of JEMRMS HRMs
 17. JEM A/L hatch corners
- G. Thermal
1. EVA connectors with booties may become hot if left uncovered. Handling may need to be limited
 2. PMA handrails may be hot. Handling may need to be limited
 3. Turn off glove heaters when comfortable temp reached to prevent bladder damage. Do not pull fingers out of gloves when heaters are on
 4. Uncovered trunnion pins may be hot
 5. SSRMS/MBS/SPDM/JEMRMS operating cameras and lights may radiate large amounts of heat

1J EVA 2 NOTES, CAUTIONS, WARNINGS (Cont)

WARNING (Cont)

ISS Constraints (Cont)

G. Thermal (Cont)

6. Stay ≥ 1 ft away from PMAs and MMOD shields > 270 degF if EMU sun visor up; limit time to 15 min or less if > 300 degF
7. Stay at least 0.5 ft away from PMA and MMOD shields > 325 degF
8. Do not touch EMU protective visor if temp has been < -134 degF for > 15 min
9. No EMU TMG contact with PMAs and MMOD shields > 320 degF
10. No EMU boot contact with foot restraint when temp < -120 or > 200 degF
11. Columbus end cones may violate touch temperature constraints when $-75 \leq \beta \leq -60$ or $60 \leq \beta \leq 75$
12. PDGF surfaces may not meet touch temperature requirements for unlimited contact when $\beta \leq -70$ or $\beta \geq 70$
13. JPM port end cones may violate touch temperature constraints when $\beta > 60$

H. Electrical Shock

1. Stay ≥ 2 ft from ungrounded floating connectors if not unpowered:
 - SSPTS connectors [NOD1 Stbd/Fwd HR 0130, LAB Stbd/Fwd HR 0273, PMA2 Stbd & Port]
 - MBS Cross-Connect jumpers (translate past these using UMA handrails)
 - S0 EVA Power Cables [inside S0 Bay 00 Face 4, Bay 01 Face 3]
 - ESP2 jumper [inside S0 Bay 03 Face 4]
2. Do not touch SPDM CLPA 1 electrical connector prior to camera installation

WARNING (Cont)

Shuttle Constraints

I. Arcing/Molten Debris

1. Stay ≥ 2 ft from exposed EFGF connector when OBSS berthed, powered, and EFGF not grappled [PLB]
2. Stay ≥ 2 ft from exposed Stbd Fwd MPM contacts [PLB]
3. Stay above PLB sill when within 1 ft of powered ROEU connector [PLB]

J. Pinch

1. PRLA in operation [PLB]

K. RF Radiation Exposure

1. Stay 3.28 ft from S-Band Antenna when powered
2. Stay 1 ft from top and side of UHF PLB Antenna radome surface when in high powered mode [ODS truss]
3. Stay 0.33 ft from top and side of UHF PLB Antenna radome surface when in low powered mode [ODS truss]
4. Remain below level of PLB door mold line for first 20 in Aft of Fwd bulkhead when S-Band Antenna powered [PLB]
5. Remain on inboard side of Stbd slidewire (sill handrails if slidewire not installed) for first 20 ft Aft of Fwd bulkhead when Ku-Band Antenna powered [PLB]

WARNING (Cont)

Shuttle Constraints

L. Sharp Edges

1. PRLA grounding wipers [PLB]
2. LDRI baffles (Also an entrapment hazard) [OBSS]
3. Keep hands away from SRMS EE opening and snares
4. TCS connector backshells have exposed threads [ODS]

M. Thermal

1. Illuminated PLB lights; do not touch
2. OBSS grapple fixture shafts/cams may be hot. Limit handling if required
3. Stay 27 ft from PRCS when powered
4. Stay 3 ft from VRCS when powered
5. Stay 3 ft from APU when operating

N. Contamination

1. Stay out of the immediate vicinity of leaking jet or APU


O. Lasers

1. Do not look at LDRI diffuser or LCS laser aperture window

EGRESS/SETUP

| IV | EV1 (FF) | EV2 (FF) |
|---|--|--|
| <ol style="list-style-type: none"> 1. Start recorders 2. √Initial Condition 3. WVS Software: Select page – RF camera Sel 'Advanced Controls' S-Band Level (two) – Max (required after EV1 and EV2 egress airlock) | <p>Initial Condition: D-ring extender with left waist tether</p> <p><u>EGRESS</u></p> <ol style="list-style-type: none"> 1. Open A/L thermal cover 2. Egress A/L 3. Connect 85-ft safety tether to HR anchor point fwd: <ul style="list-style-type: none"> √Anchor bail closed and slider locked √Reel end bails closed and double locked √Reels Unlocked 4. Receive and temp stow crewlock bag (Get-Aheads) 5. Receive and stow JTVE/large ORU bag on BRT 6. Connect EV2 85-ft safety tether to anchor point aft 7. Receive and stow JTVE/crewlock bag package on EV2 BRT 8. √EV2 Safety tether config: Anchor bail closed, slider locked, and reel unlocked 9. √EV2 SAFER MAN ISOL vlv – OP (dn) and HCM (dn) √ERCA – green LED 10. INSPECT GLOVES | <p>Initial Condition: Forward UIA D-ring with left waist tether</p> <p><u>EGRESS</u></p> <ol style="list-style-type: none"> 1. Release EV1 from A/L D-ring 2. Hand out crewlock bag (Get-Aheads) to EV1 3. Hand out JTVE/Large ORU bag package to EV1 4. Hand out hook of 85-ft safety tether to EV1 5. Verify safety tether conf <ul style="list-style-type: none"> √Reel end bails closed and double locked √Reels unlocked 6. On EV1 GO release waist tether from UIA D-ring 7. Hand out JTVE/crewlock bag package to EV1 8. Egress A/L 9. √EV1 safety tether config: anchor bail closed, slider locked, and reel UNLOCKED 10. √EV1 SAFER MAN ISOL VLV – OP (dn) and HCM (dn) √ERCA – green LED 11. Close A/L thermal cover 12. INSPECT GLOVES |

JTVE INSTALLATION

| IV | EV1 | EV2 |
|---|--|--|
| <p>1. √MCC-H – Inhibit JTVEs; give EV crew GO to perform JTVE Install</p> <div style="border: 1px solid black; padding: 5px; margin: 10px 0;"> <p style="text-align: center;">Safety tether swaps</p> <p>Starting tether swap √Local tether set</p> <p>Tether swap complete √Spare anchor on HR XXXX, bail closed, slider locked √Double-locked to reel √Airlock tether stowed on HR XXXX √Reels unlocked</p> <p style="text-align: center;">Safety tether swap to A/L Tether</p> <p>Tether swap complete √Double-locked to reel on airlock tether √Spare tether stowed on t-bar √Reels unlocked</p> </div> <p><u>FWD JTVE</u> Torque: _____ Turns: _____</p> <p><u>AFT JTVE</u> Torque: _____ Turns: _____</p> <p>2. Give MCC-H GO for Fwd and Aft JTVE heater powerup once both JTVE connectors are mated</p> | <p><u>INSTALL JTVE(s)</u></p> <ol style="list-style-type: none"> Lead translation (Nadir Route) to JPM Perform tether swap Remove Over Gloves if required √Locally tethered √Spare tether anchored to JPM HR (1105) _____ √A/L tether stowed on JPM HR (1131) _____ √Anchor bail closed and slider locked √Reel end bails closed and double locked √Reels unlocked Stow large ORU bag zenith/stbd side of JPM (HRS 1172, 1173, 1124, 1186); temp stow Crewlock bag Translate counterclockwise on JPM to fwd JTVE install position Assist EV2 with FWD JTVE installation <p style="text-align: center;"><u>NOTE</u></p> <p> Visually inspect all MLI with the JTVE installation</p> <ol style="list-style-type: none"> On MCC-H GO: release cap attached to J512 (fwd)/J522 (AFT) from JPM, stow in large ORU bag Mate JTVE stanchion electrical plug P512 (fwd)/P522 (AFT) to JEM PM J512 (fwd)/J522 (aft) (VERIFY GOOD EMI BAND, NO FOD, GOOD BEND RADIUS) Install thermal bootie over JTVE electrical plug Visually inspect camera for operation Give MCC-H GO for Fwd/Aft JTVE heater powerup Translate to large ORU bag and retrieve aft JTVE Translate to Aft JTVE worksite Repeat camera installation steps for Aft JTVE INSPECT GLOVES | <p><u>INSTALL JTVE(s)</u></p> <ol style="list-style-type: none"> Follow EV1 to JPM Perform tether swap Remove over gloves if required √Locally tethered √Spare tether anchored to JPM HR(1104) _____ √A/L tether stowed on Node 2 HR(0302) _____ √Anchor bail closed and slider locked √Reel end bails closed and double locked √Reels unlocked Fairlead around JPM HR (1103) _____ Translate clockwise along JEM PM to Fwd JTVE installation location Temp stow crew lock bag Remove Jettison/Stowage bag PGT [B5 (19.4), CCW2, 30.5]-6" Ext -7/16" Release launch lock bolts (3). Expect 15-16 turns, remove camera bolts first and base last. Tether to LL before last bolt is released Install MLI over camera base bolt holes where L.L. was installed Stow Launch Lock into Jettison/Stowage bag and stow Jettison/Stowage bag into large ORU bag Install JTVE stanchion base in receptacle; verify alignment markings PGT [A2 (3.8), CW2, 30.5] 6" Ext-7/16" – Engage JTVE stanchion bolt, expect 9 turns. Report torque and turns to MCC-H Install slider cover over JTVE structure Visually inspect camera for operation Translate to aft JTVE worksite Assist EV1 with aft JTVE installation if required Repeat JTVE installation steps for Aft JTVE INSPECT GLOVES |

JTVE INSTALLATION – TASK DATA

Estimated Task Duration:

| | With SSRMS | Without SSRMS |
|-------------|------------|---------------|
| One EV Crew | N/A | N/A |
| Two EV Crew | N/A | 00:50 |

Tools:

| EV1 | EV2 |
|------------------------------|-----|
| PGT 6" ext – 7/16" Socket | |

ORU Identification:

| ORU | Part number | Serial Number |
|-------------------|-------------|---------------|
| JTVE Camera (Fwd) | 80AS51520/ | -101 |
| JTVE Camera (Aft) | 80AS51520 | -102 |

ORU Specs:

| ORU | Dimensions (in/mm) | Mass (lb/kg) |
|----------------------------------|----------------------------------|--------------|
| JTVE Camera (Fwd) | 12.6x14.75x25.59/ 320x370x650 | 39.9/18.1 |
| JTVE Camera (Aft) | 12.6x14.75x25.59/ 320x370x650 | 39.9/18.1 |
| JTVE Connector Cap (2) – Fwd/Aft | Dia.2.4x2.2 inches | 0.3/0.14 |

EVA Fasteners:

| Fastener Name | Head Size | Qty | Install Torque (ft-lb) | Release Torque (ft-lb) | Failure Torque (ft-lb) | Turns |
|-----------------------------|-----------|------------------------|------------------------|------------------------|------------------------|----------------------|
| JTVE Launch Lock (LL) Bolts | 7/16" | 8 (4 fwd/ 4 aft) | – | 19 | 33.7 | 15-Upper 16-Lower |
| JTVE Stanchion Bolt | 7/16" | 2 (1 fwd/ 1 aft) | 1.8-2.3 | – | 16.0 | 9 |

EVA Connectors:

| Harness | To | Clamps (#) | Conn size | Function |
|--------------------|----------|------------|------------------|----------------------------|
| Forward JTVE P512A | JPM J512 | None | NZGL-RPC-N-25-MS | Video, Power, Data, Heater |
| Aft JTVE P522A | JPM J522 | None | NZGL-RPC-N-25-MS | Video, Power, Data, Heater |

Connector Inhibits:

| Task | Inhibit |
|--------------|--|
| Forward JTVE | CPB A SW 1 open PDB WS RPC 8 open PDB A1 RPC 6 Open PDB A1 RPC 8 Open PIB B2 120V HI SW 1 Open |
| Aft JTVE | CPB B SW 1 open PDB B2 RPC 4 open PDB B2 RPC 7 Open PDB B2 RPC 8 Open PIB A2 120V HI SW 2 Open |

Notes:

- For JTVE LL bolts, IV crew will completely loosen one bolt and break torque for remaining three bolts before EVA for each stanchion
- Pin side of connector is on JPM. Socket side is on JTVE

Cautions:

- Avoid contact with light, white paint and silver surfaces

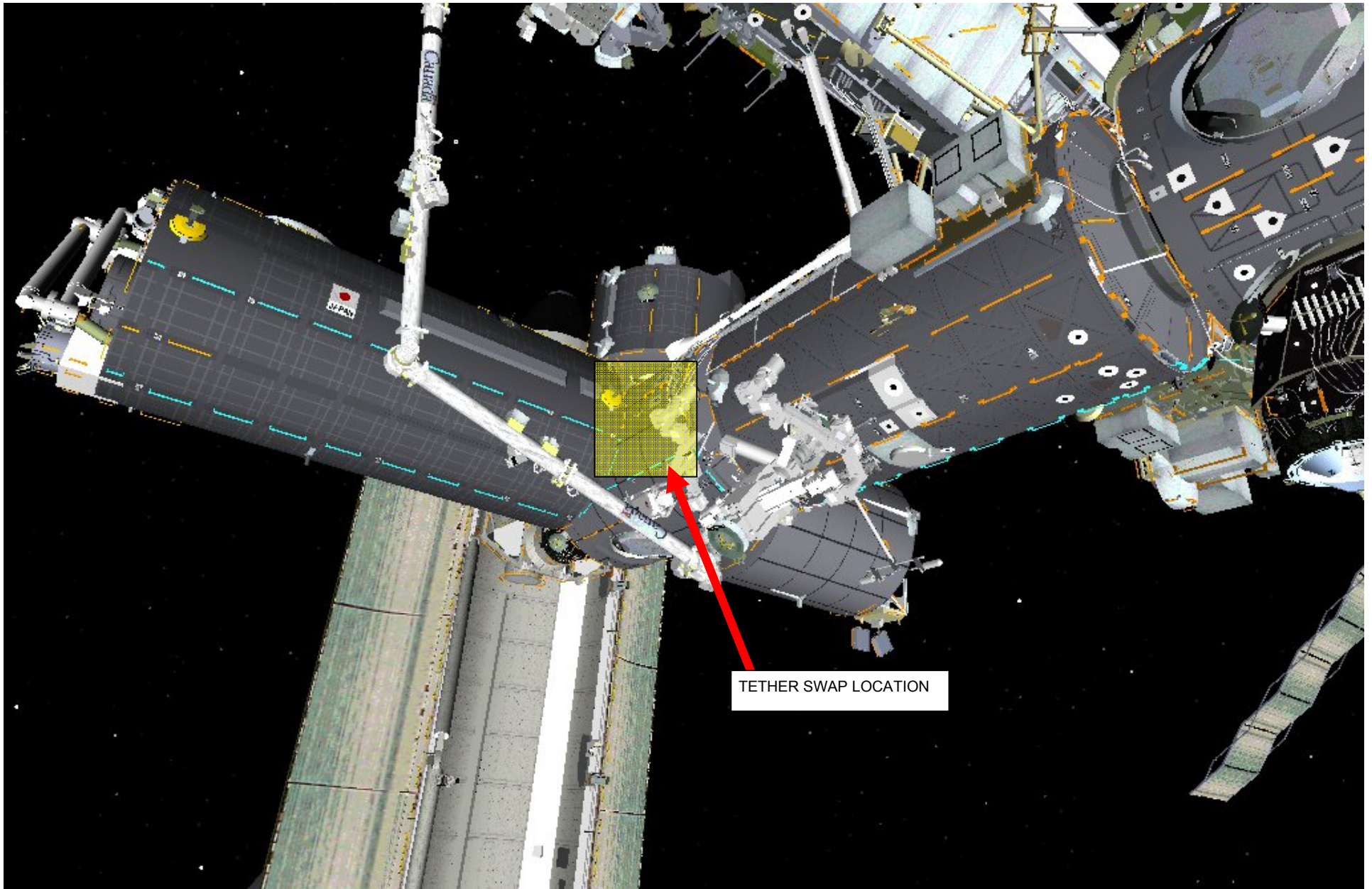
Warnings:

- Pinch hazard with stanchion base and receptacle

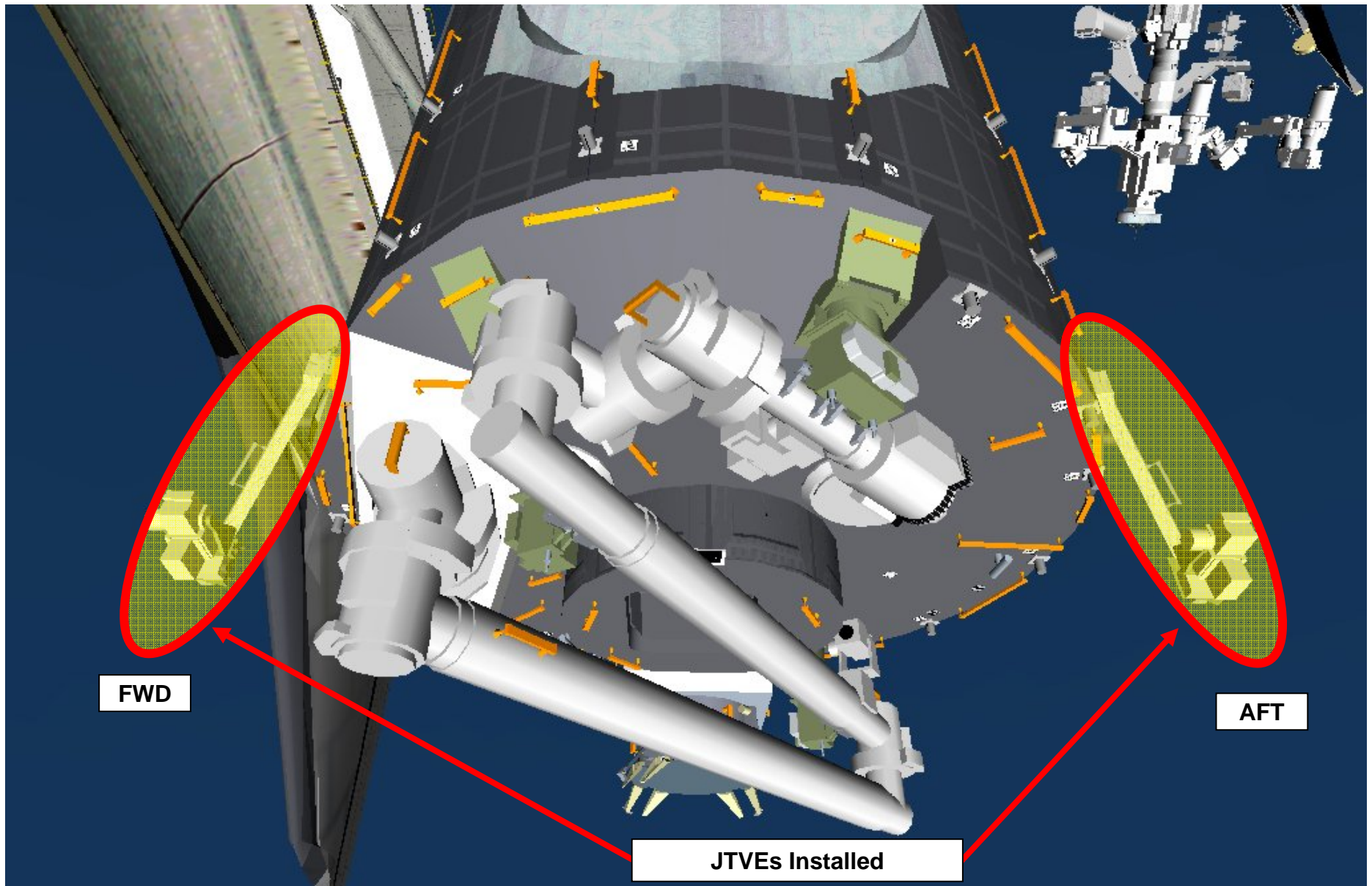


Photo of JTVE Boom (1 of 2)

JTVE INSTALLATION – TASK DATA (Cont)

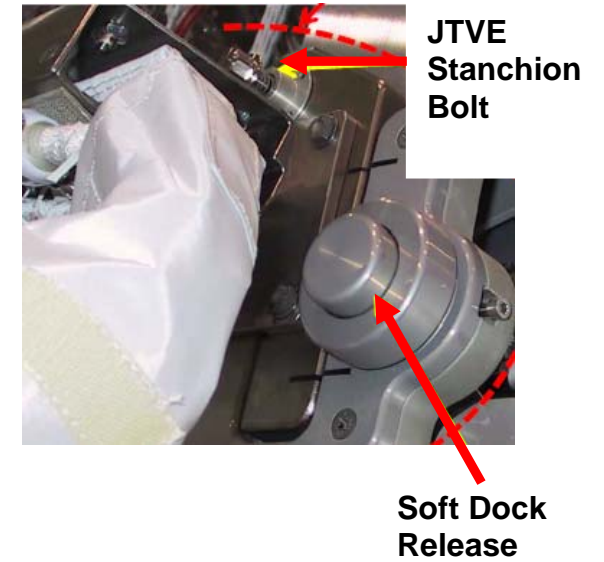
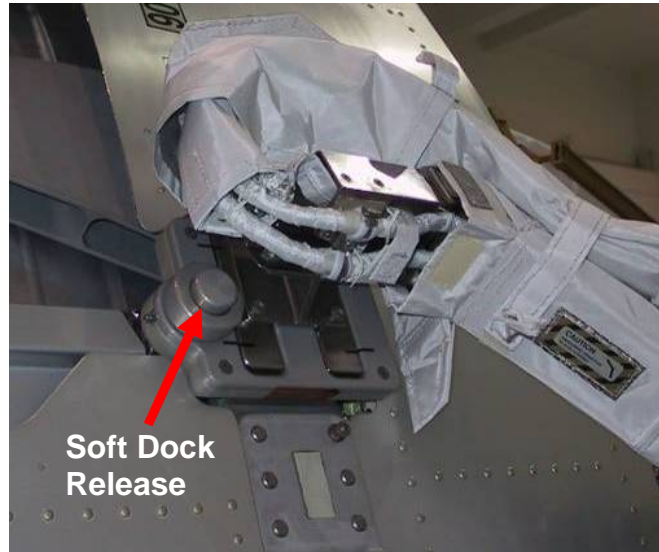
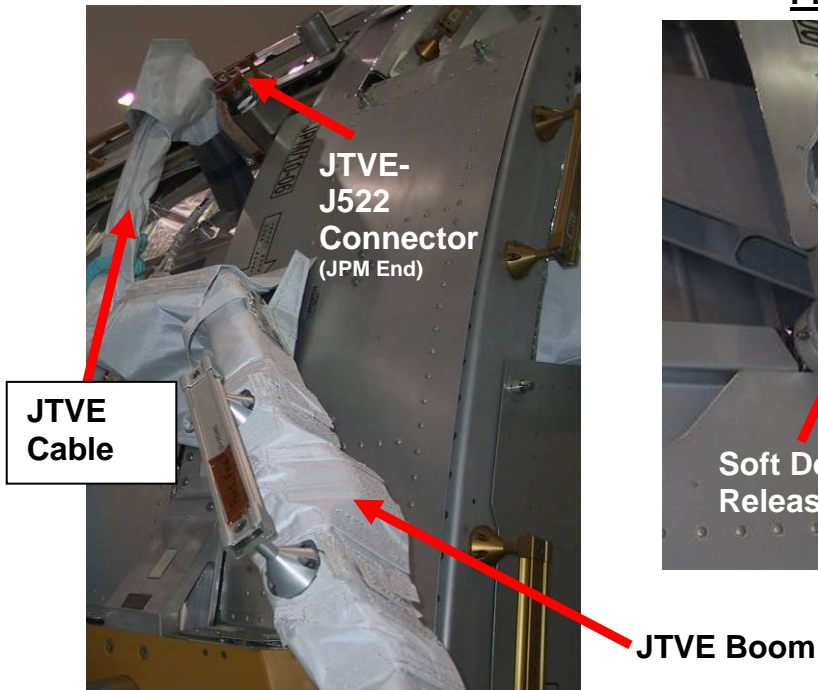


JTVE INSTALLATION – TASK DATA (Cont)

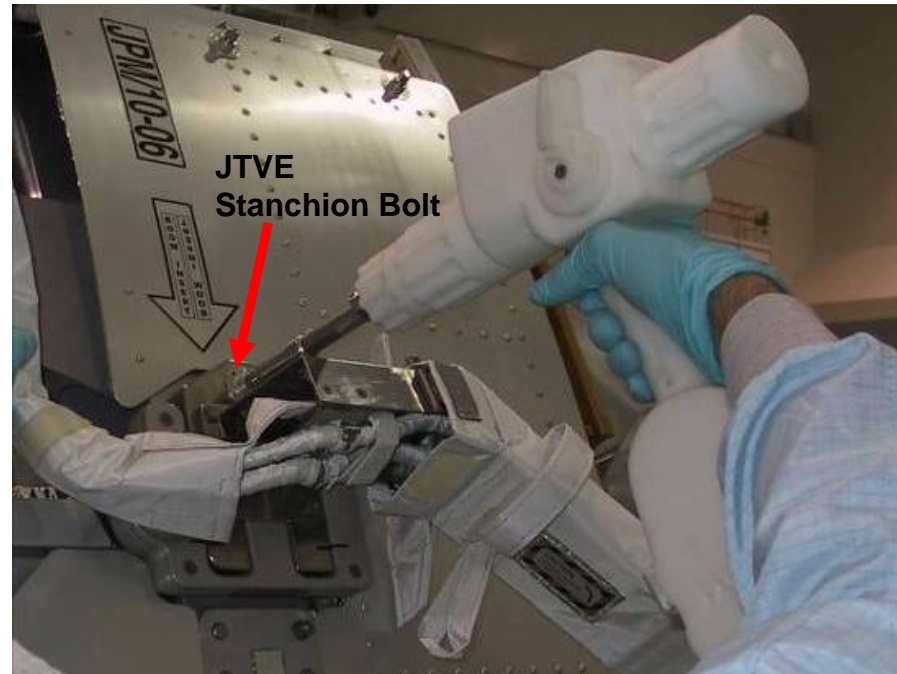


JTVE INSTALLATION – TASK DATA (Cont)

Photos of JTVE Installation



JTVE Stanchion Base



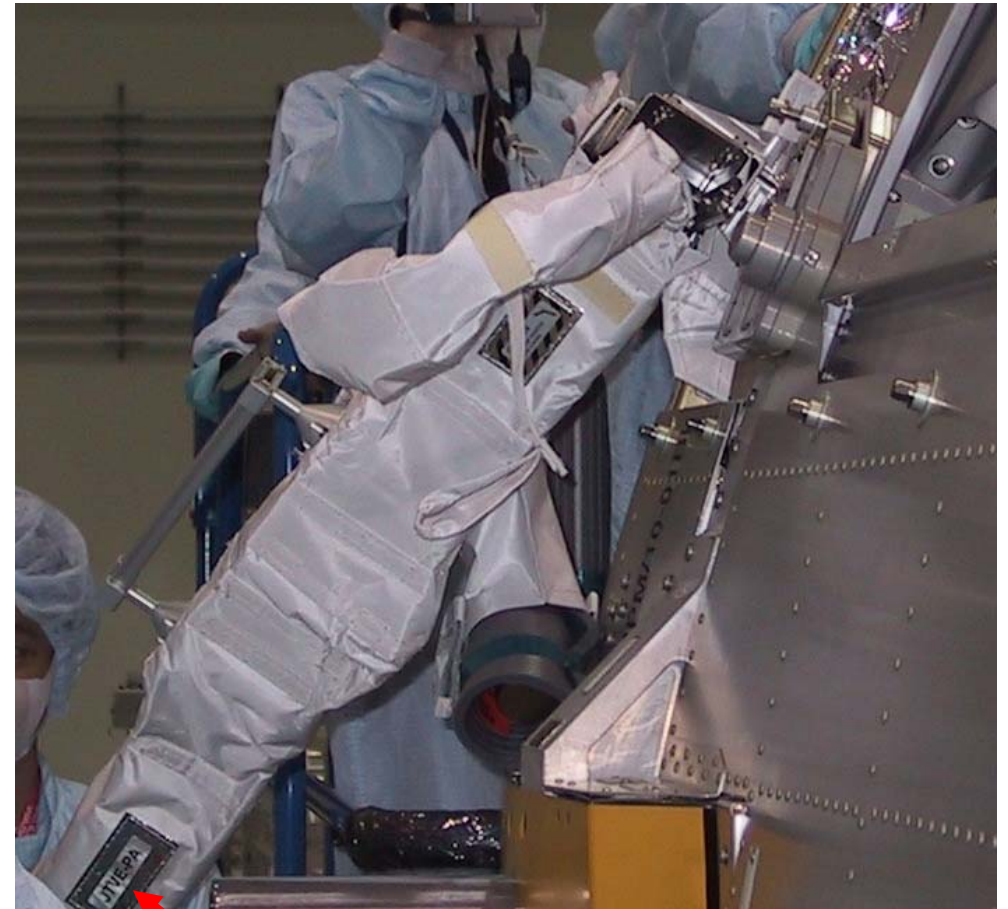
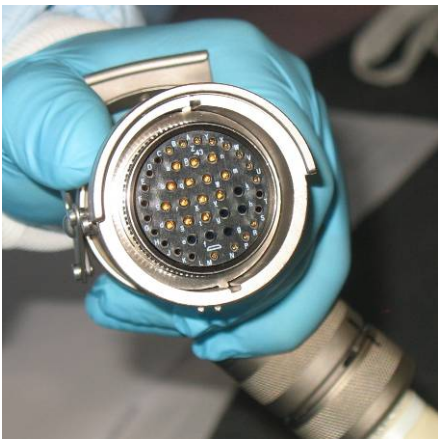
JTVE INSTALLATION – TASK DATA (Cont)

JTVE Labeling

“FP”
(FP = Forward Port)



JTVE P522 Connector
(JTVE Cable End)



“PA”
(PA = Port Aft)

JTVE INSTALLATION – TASK DATA (Cont)

Photos of JTVE Cameras & Launch Locks



Launch Lock Installed





**Launch Lock Installed
(MLI Removed)**

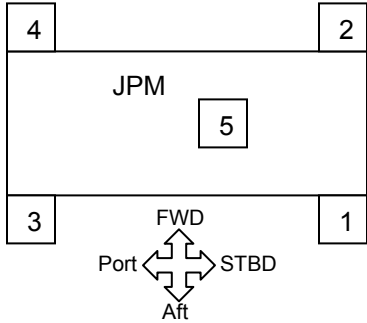


**Launch Lock Installed
(Labeling Shown)**

JEM OUTFITTING

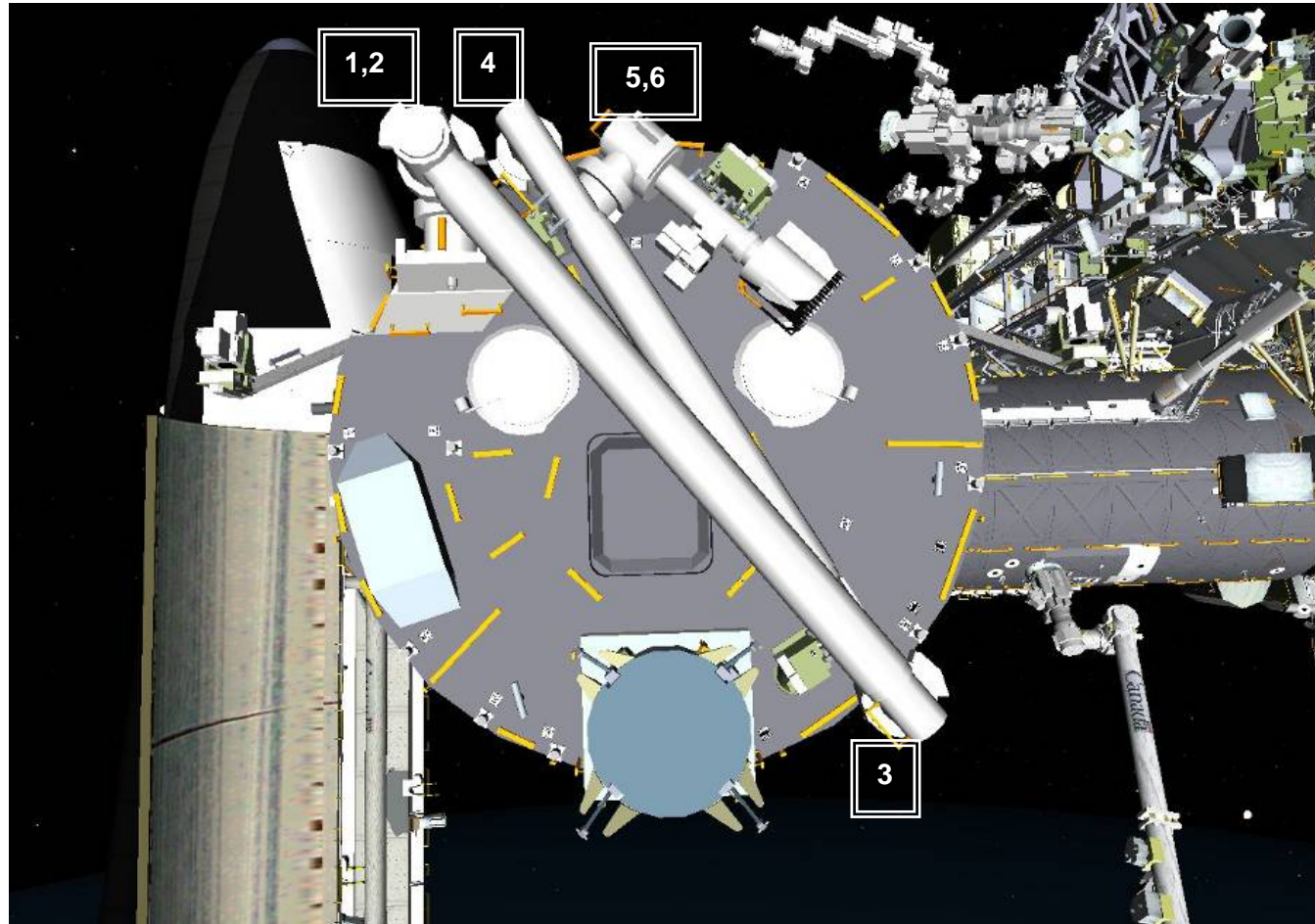
| IV | | | | EV1 | EV2 |
|----|-------|------------|--------------------|--|---|
| | Cover | GND Velcro | Surrounding Velcro | <p><u>REMOVE MLI COVERS ON JEUS</u></p> <p style="text-align: center;"><u>NOTE</u> Verify all surrounding Velcro is attached</p> <div style="border: 1px solid black; padding: 5px; text-align: center;"> <p><u>CAUTION</u> Avoid contact with JTVES</p> </div> <ol style="list-style-type: none"> 1. Translate to JEM RMS joints 5, 3, EE, and 6 2. Release MLIs on joints 5, 3, EE, and 6 (release two 1/4 fasteners and pull releasing bonding wire Velcro) 3. Stow JEM RMS Joint and EE MLI into Large ORU bag 4. INSPECT GLOVES <p><u>RELEASE ACBM MLI COVER, MMOD SHIELD FASTENERS, AND INSPECT CBM</u></p> <p style="text-align: center;"><u>NOTE</u> Verify all surrounding Velcro is attached</p> <div style="border: 3px double black; padding: 5px; text-align: center;"> <p><u>WARNING</u> MMOD shield launch lock bolts may have sharp edges. Avoid contact with bolts and bolt interface</p> </div> <ol style="list-style-type: none"> 5. Translate to Aft side of ACBM 6. As reqd, assist EV2 with Port and Stbd ACBM cover 7. Assist EV2 with stowing covers into large ORU bag 8. Release PIP pin from hatch, stow in trash bag 9. PGT [A6 (8.3), CCW2, 30.5]6" Ext-7/16": Release aft MMOD Shield launch lock bolts (2). Expect ~10 turns 10.  Visually inspect MLI 11. Inspect CBM for debris/damage 12. Check MMOD shield grounding wires clear of ACBM mating surface <p><u>INSTALL TRUNNION AND KEEL COVERS</u></p> <ol style="list-style-type: none"> 13. Retrieve trunnion/keel covers from crewlock bag and install on JEM PM: | <p><u>REMOVE MLI COVERS ON JEUS</u></p> <p style="text-align: center;"><u>NOTE</u> Verify all surrounding Velcro is attached</p> <div style="border: 1px solid black; padding: 5px; text-align: center;"> <p><u>CAUTION</u> Avoid contact with JTVES</p> </div> <ol style="list-style-type: none"> 1. Translate to JEM RMS shoulder joint 2. Release MLIs on joints 5, 4, 2 and 1 (release two 1/4 fasteners and pull releasing bonding wire Velcro) 3. Stow JEM RMS Joint MLI into Large ORU bag 4. INSPECT GLOVES <p><u>RELEASE ACBM MLI COVER, MMOD SHIELD FASTENERS, AND INSPECT CBM</u></p> <p style="text-align: center;"><u>NOTE</u> Verify all surrounding Velcro is attached</p> <div style="border: 3px double black; padding: 5px; text-align: center;"> <p><u>WARNING</u> MMOD shield launch lock bolts may have sharp edges. Avoid contact with bolts and bolt interface</p> </div> <ol style="list-style-type: none"> 5. Translate to Fwd side of ACBM (HR 1174) 6. Release port most section of ACBM 7. Stow ACBM MLI cover into Large ORU bag 8. Release Stbd ACBM MLI cover (HR1173) 9. Stow ACBM MLI cover into Large ORU bag 10. PGT [A6 (8.3), CCW2, 30.5]6" Ext-7/16": Release fwd MMOD Shield launch lock bolts (2). Expect ~10 turns 11.  Visually inspect MLI <p><u>INSTALL TRUNNION AND KEEL COVERS</u></p> <ol style="list-style-type: none"> 12. Retrieve trunnion covers from crewlock bag and install on JEM PM: |

JEM OUTFITTING (Cont)

| IV | EV1 | EV2 |
|--|--|--|
| <p>1. Inform MCC-H EV crew clear of JPM endcone and GO for JTVE operation powerup</p>  <p>The diagram shows a rectangular JPM endcone. Callout 4 is at the top-left corner, 2 at the top-right, 3 at the bottom-left, and 1 at the bottom-right. Callout 5 is in the center. Below the rectangle, four arrows point outwards labeled FWD (up), Aft (down), Port (left), and STBD (right).</p> | <ul style="list-style-type: none"> <input type="checkbox"/> TRC-03 Aft/Port Trunnion <input type="checkbox"/> TRC-01 Aft/Stbd Trunnion <input type="checkbox"/> TRC-02 Fwd/Stbd Trunnion <p><u>CLEANUP</u></p> <ol style="list-style-type: none"> 14. INSPECT GLOVES 15. Retrieve crewlock bag with Misc tools 16. Translate to tether swap location 17. Perform tether swap <ul style="list-style-type: none"> √Locally tethered √Double locked to A/L safety tether √Retrieve spare safety tether √Bails closed and reels unlocked Don overgloves if required | <ul style="list-style-type: none"> <input type="checkbox"/> TRC-04 Fwd/Port Trunnion <input type="checkbox"/> TRC-05 Keel <p><u>CLEANUP</u></p> <ol style="list-style-type: none"> 13. INSPECT GLOVES 14. Retrieve large ORU bag and stow crewlock bag w/thermal booties outside of ORU bag 15. Translate to tether swap location 16. Perform tether swap <ul style="list-style-type: none"> √Locally tethered √Double locked to A/L safety tether √Retrieve spare safety tether √Bails closed and reels unlocked Don overgloves if required 17. Translate back to A/L to stow large ORU bag outside of A/L |

JEM OUTFITTING – TASK DATA

JEM RMS Joint Labels

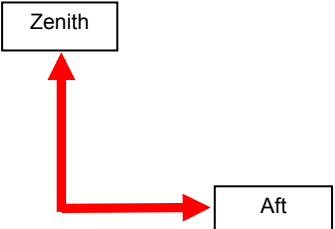
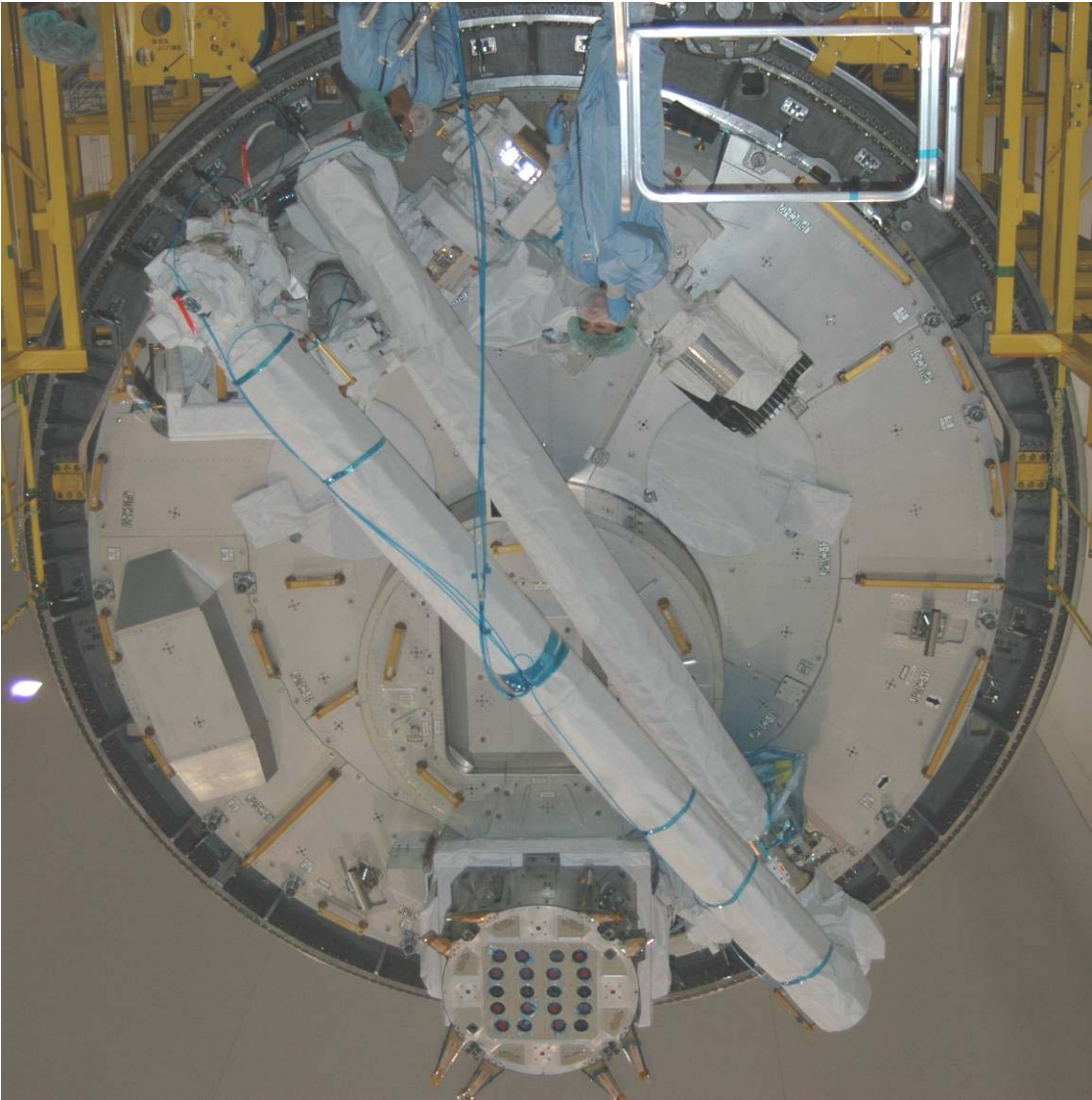


JEM Joint Numbering

| | |
|----------------|------------------|
| 1=Shoulder Yaw | 2=Shoulder Pitch |
| 3=Elbow Pitch | 4=Wrist Pitch |
| 5=Wrist Yaw | 6=Wrist Roll |

JEM OUTFITTING – TASK DATA (Cont)

Photo of JEM Endcone/JEM RMS



JEM OUTFITTING – TASK DATA (Cont)

JEM JEU Cover Removal

Estimated Task Duration:

| | With SSRMS | Without SSRMS |
|-------------|------------|---------------|
| One EV Crew | N/A | N/A |
| Two EV Crew | N/A | 01:00 |

ORU Identification:

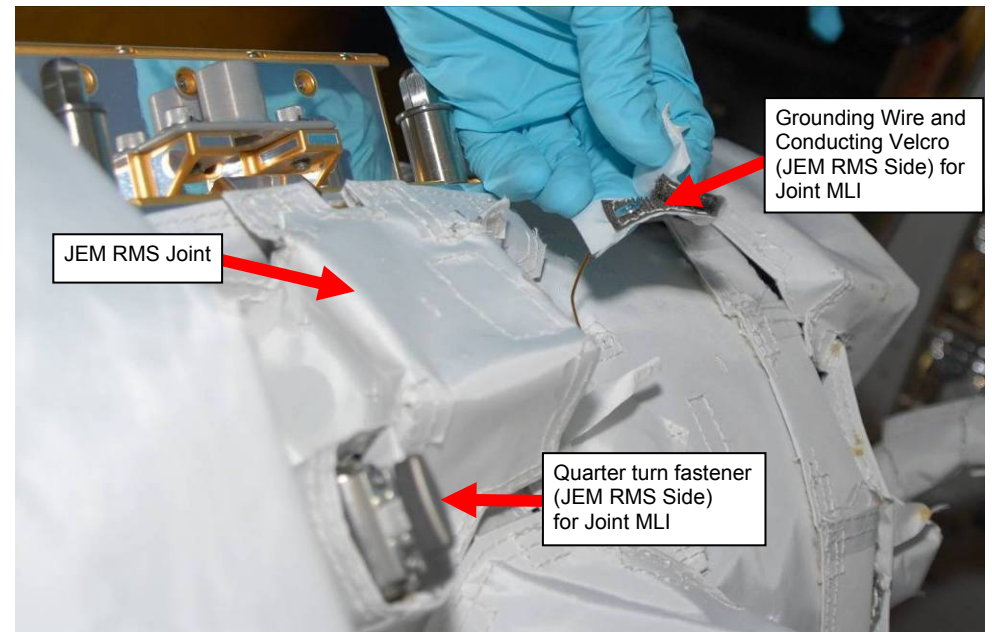
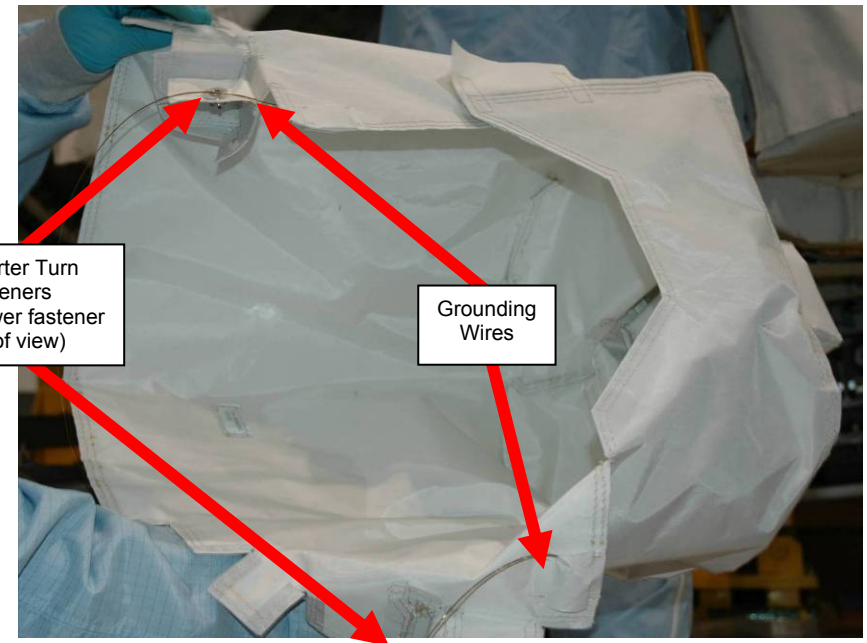
| ORU | Part number | Serial Number |
|-----------------------------|-------------|---------------|
| JEM RMS Covers | | |
| JEM JEU (Joints 1,3,4,6) | 006446700G1 | |
| JEU MLI (Joint 2) | 006446701G1 | |
| JEU MLI (Joint 5) | 006446702G1 | |
| EE MLI | 006446703G1 | |

ORU Specs:

| ORU | Dimensions (in ³ x mm ³) | Mass (lb/kg) |
|-----------------------------|--|-----------------|
| JEM JEU (Joints 1,3,4,6) | 16.02x18.31x19.3/ 407x465x492 | 1.46/0.66 |
| JEU MLI (Joint 2) | 16.02x18.31x16.6/ 407x465x422 | 1.39/0.63 |
| JEU MLI (Joint 5) | 16.02x18.31x16.6/ 407x465x422 | 1.39/0.63 |
| EE MLI | 15.75x22.76x25.8/ 400x578x656 | 1.46/0.66 |

Tools:

| EV1 | EV2 |
|-----|-----|
| N/A | N/A |



JEM OUTFITTING – TASK DATA (Cont)

JEM Zenith ACBM MMOD Shield Launch Lock (LL) Bolts

Estimated Task Duration:

| | With SSRMS | Without SSRMS |
|-------------|------------|---------------|
| One EV Crew | N/A | N/A |
| Two EV Crew | N/A | 00:15 |

Tools:

| EV1 | EV2 |
|--------------------------|-----|
| PGT 6" – 7/16" Socket | |

Foot Restraints:

| Task | WIF | APFR Setting |
|--------------|-----|--------------|
| ACBM MMOD LL | N/A | N/A |

Connector Inhibits:

| Task | Inhibit |
|--------------|---------|
| ACBM MMOD LL | None |

Fasteners:

| Fastener Name | Head Size | Qty | Install Torque (ft-lb) | Release Torque (ft-lb) | Failure Torque (ft-lb) | Turns |
|---------------------|-----------|-------------------------|------------------------|------------------------|------------------------|-------|
| ACBM MMOD Shield LL | 7/16" | 4 Total- 2 Fwd/2 Aft | – | 6.2 | 31 | 10 |

Notes:

Cautions:

1. Ensure MMOD Shield Grounding wire clear of CBM Surface

Warnings:

1. Do not touch threaded (sharp) end of MMOD LL Bolts

JEM OUTFITTING – TASK DATA (Cont)

JPM ACBM MLI & PIP Pin Removal

Estimated Task Duration:

| | With SSRMS | Without SSRMS |
|-------------|------------|---------------|
| One EV Crew | N/A | N/A |
| Two EV Crew | N/A | 00:15 |

ORU Identification:

| ORU | Part number | Serial Number |
|--------------------------------|-------------|---------------|
| ACBM MLI cover (port half) | T7-53617 | -111 |
| ACBM MLI cover (stbd half) | T7-53617 | -101 |
| ACBM Hatch Launch Lock PIP Pin | 56790B3 | -09 |

ORU Specs:

| ORU | Dimensions | Mass |
|----------------------------|---------------------------------|---------|
| ACBM MLI cover (port half) | 52.0x114.2x5.9/ 1320x2900x15 | 5.8/2.6 |
| ACBM MLI cover (stbd half) | 52.0x114.2x5.9/ 1320x2900x15 | 5.8/2.6 |
| ACBM Hatch PIP Pin | N/A | N/A |

Tools:

| | EV1 | EV2 |
|--|------|------|
| | None | None |

Foot Restraints:

| Task | WIF | APFR Setting |
|------|-----|--------------|
| None | N/A | N/A |

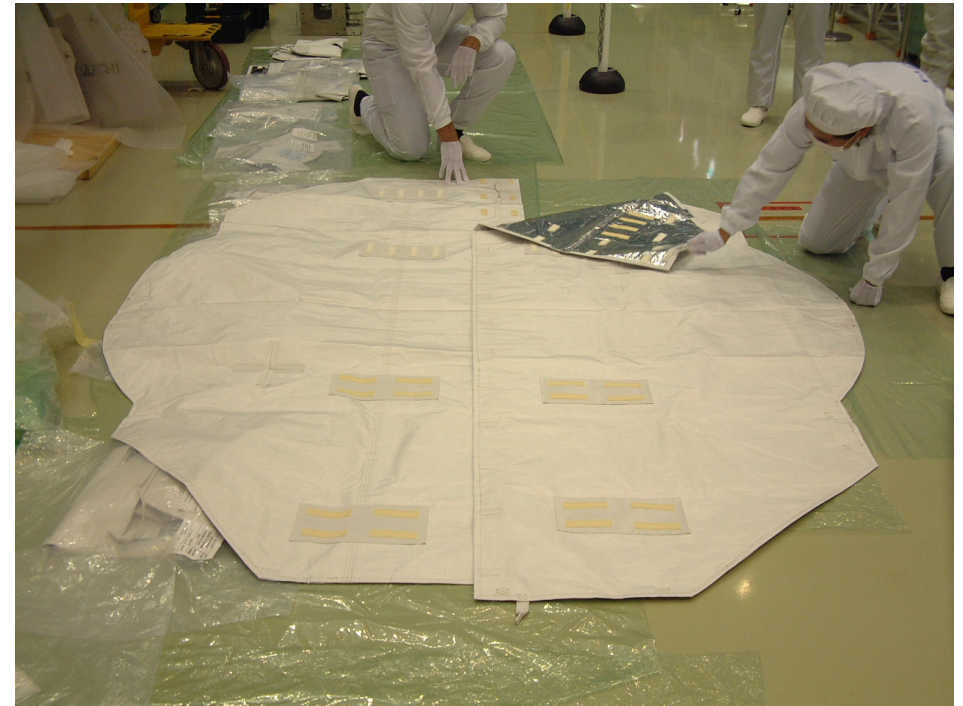
Fasteners:

| Fastener Name | Head Size | Qty | Install Torque (ft-lb) | Release Torque (ft-lb) | Failure Torque (ft-lb) | Turns |
|---------------|-----------|-----|------------------------|------------------------|------------------------|-------|
| None | N/A | N/A | N/A | N/A | N/A | N/A |

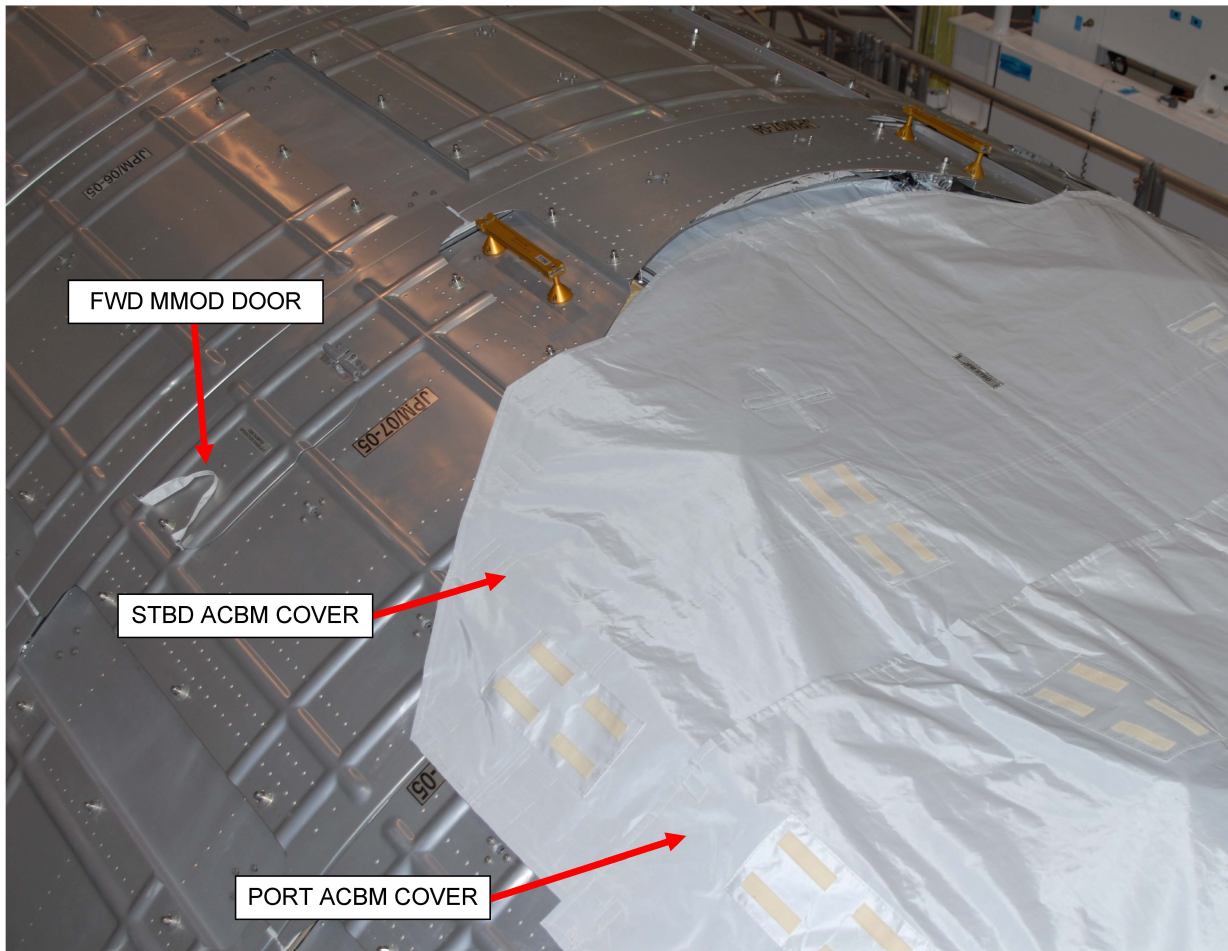
Notes:

Cautions:

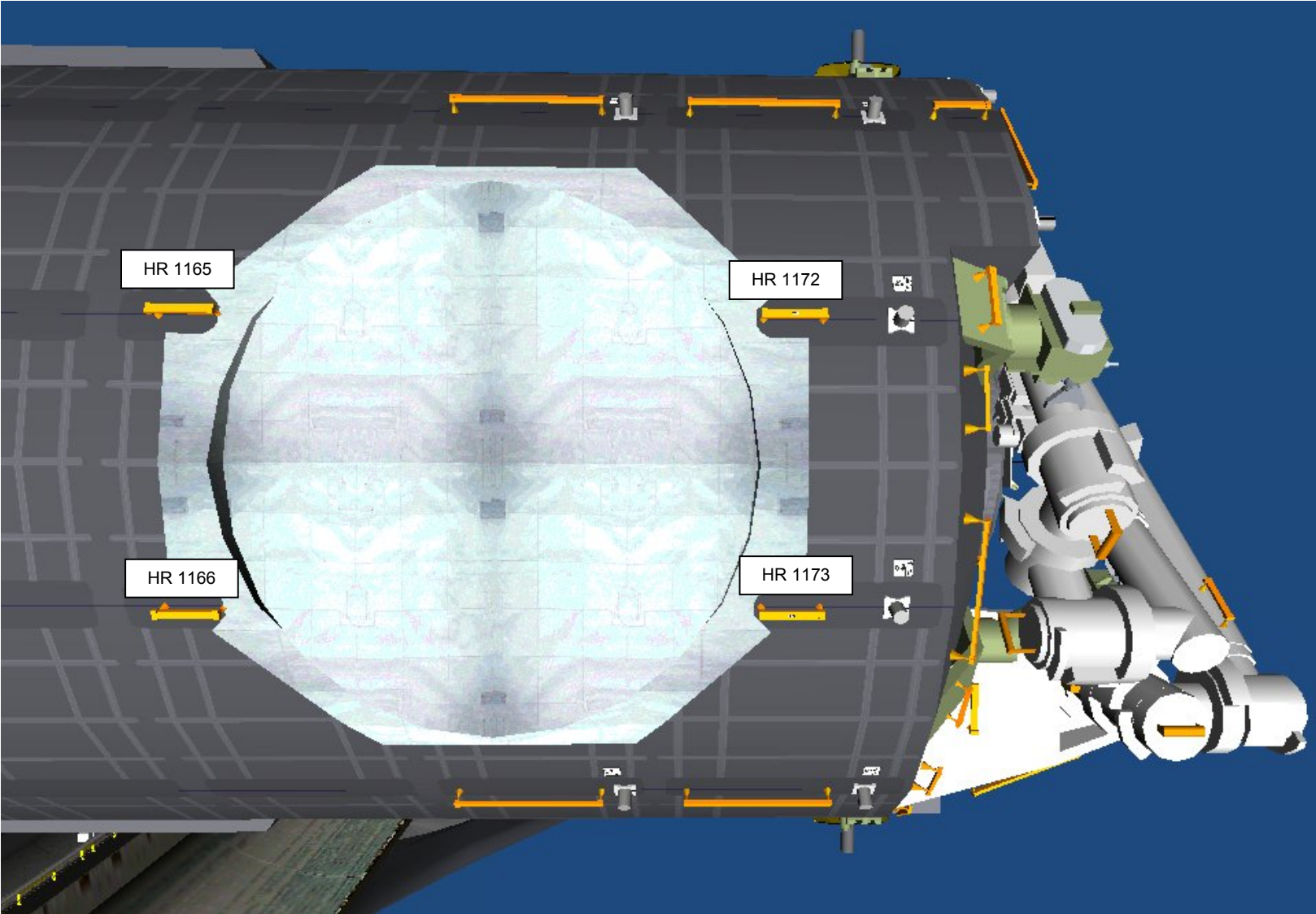
Warnings:



JEM OUTFITTING – TASK DATA (Cont)



JEM OUTFITTING – TASK DATA (Cont)



JEM OUTFITTING – TASK DATA (Cont)

JPM Trunnion/Keel Covers

Estimated Task Duration:

| | With SSRMS | Without SSRMS |
|-------------|------------|---------------|
| One EV Crew | N/A | N/A |
| Two EV Crew | N/A | 00:40 |

ORU Identification:

| ORU | Qty | Part Number | Mass (lb/kg) | Dimensions (in) |
|-----------------------------------|-----|-------------|--------------|-------------------|
| JPM Trunnion MLI Cover (stbd-aft) | 1 | TRC-01 | 1.76/0.8 | 950x560x140 (in) |
| JPM Trunnion MLI Cover (stbd-fwd) | 1 | TRC-02 | 1.76/0.8 | 950x560x140 (in) |
| JPM Trunnion MLI Cover (port-aft) | 1 | TRC-03 | 1.76/0.8 | 950x560x140 (in) |
| JPM Trunnion MLI Cover (port-fwd) | 1 | TRC-04 | 1.76/0.8 | 950x560x140 (in) |
| JPM Keel pin MLI Cover | 1 | TRC-05 | 0.88/0.4 | 660(dia)x380 (in) |

Tools:

| EV1 | EV2 |
|------|------|
| None | None |

Fasteners:

| Fastener Name | Head Size | Qty | Install Torque (ft-lb) | Release Torque (ft-lb) | Failure Torque (ft-lb) | Turns |
|---------------|-----------|-----|------------------------|------------------------|------------------------|-------|
| None | N/A | N/A | N/A | N/A | N/A | N/A |

Notes:

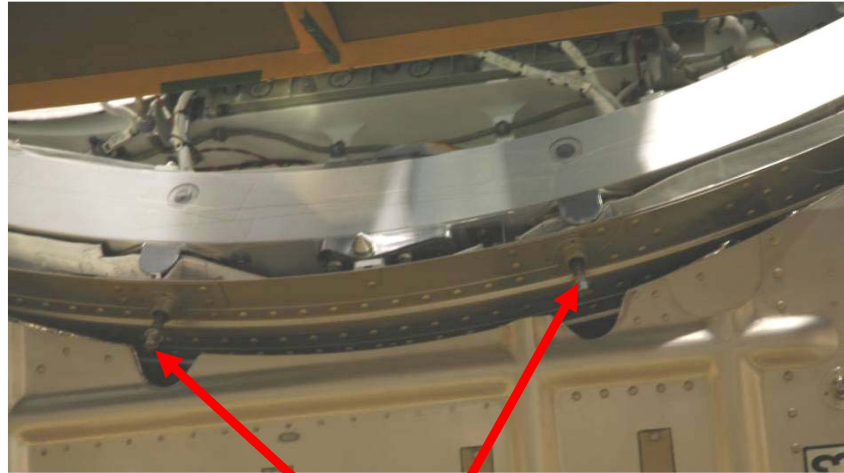
Cautions:

Warnings:

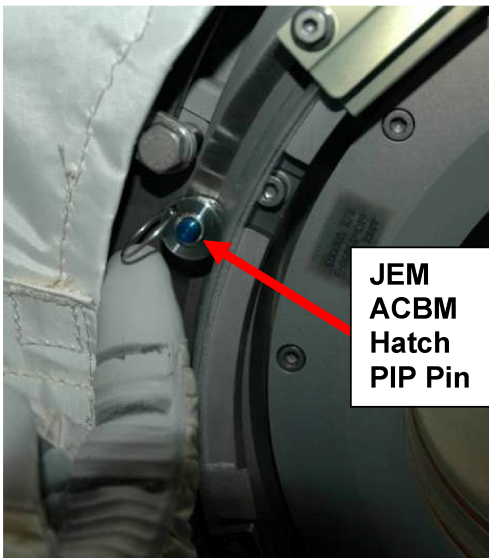
JEM OUTFITTING – TASK DATA (Cont)



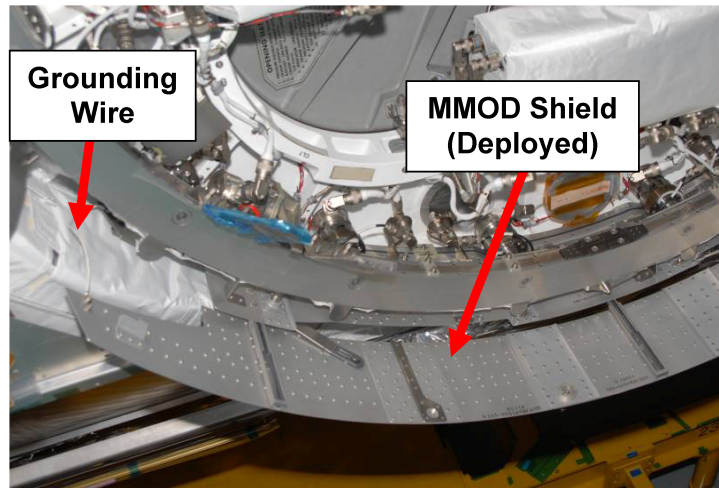
ACBM Cover MLI Removal



**MMOD Shield LL Bolts
(2 of 4 shown)**

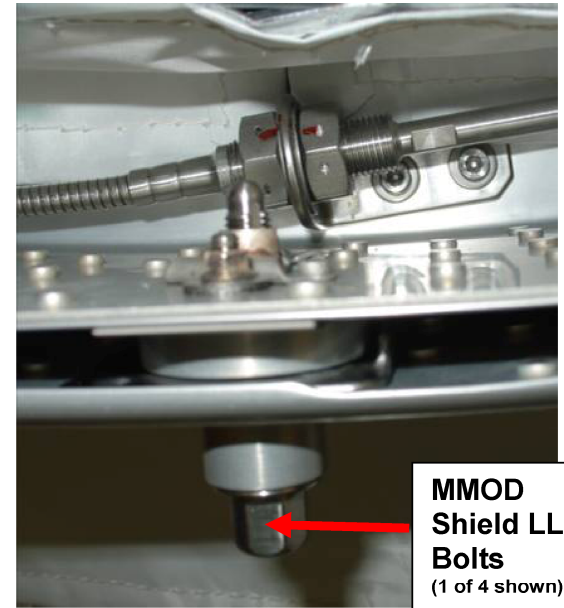


**JEM
ACBM
Hatch
PIP Pin**



**Grounding
Wire**

**MMOD Shield
(Deployed)**



**MMOD
Shield LL
Bolts
(1 of 4 shown)**

S1 NTA AND ESP3 NTA PREP

| IV | EV1 | EV2 | | | | | | | | | | |
|---|--|--------|--------|---|--|---|--|---|--|---|--|--|
| <p>1. Give MCC-H GO to put ATA isolation in work</p> <p>2. When ATA isolation complete, give EV GO to close NTA valves</p> <div data-bbox="100 375 611 711" style="border: 1px solid black; background-color: #e0ffe0; padding: 5px;"> <p>BLOCK A – CLOSE VALVE</p> <ol style="list-style-type: none"> √Aft white band visible √Detent button fully installed, up, and can be depressed Push bail fwd (open) with significant force to unstick male seal Assess side load prior to bail movement Press detent button and move bail aft to close valve √Fwd white band visible √Detent button up </div> <p>3. When FQD valves closed, give MCC-H GO for leak check</p> <div data-bbox="100 797 611 1024" style="border: 1px solid black; background-color: #e0ffff; padding: 5px;"> <p>BLOCK B – Demate QD</p> <ol style="list-style-type: none"> Assess and counteract side loads Pull back on release ring Demate QD √Fwd white band not visible (√release ring – retracted) Inspect QDs for debris or damage </div> <p>4. Verify Fluid QD lines routed under shroud straps</p> <div data-bbox="100 1101 611 1425" style="border: 1px solid black; background-color: #ffffe0; padding: 5px;"> <p>BLOCK C – MATE QD</p> <ol style="list-style-type: none"> Inspect QDs for debris or damage √Detent button – up √Fwd white band – not visible Assess and counteract side loads Mate QD √Fwd white band – visible Snapback test (√Fwd white band still visible) Pull test Visual gap test </div> | <div data-bbox="688 251 1234 391" style="border: 3px double black; padding: 5px; text-align: center;"> <p>WARNING</p> <p>NTA fluid QD lines and clamps may be hot if exposed to direct sun. Avoid contact with hardware until shaded ~20 min</p> </div> <p>ESP3 NTA PREP</p> <ol style="list-style-type: none"> Translate to CETA 1 Retrieve APFR from CETA 1 WIF 4 (zenith/port) Attach crew lock bag to APFR Translate to ESP3 WIF 5 Perform tether swap on P1 <ul style="list-style-type: none"> √Locally tethered √Spare tether anchored to P1 HR(3602)_____ √A/L tether stowed on P1 HR(3602)_____ √Anchor bail closed and slider locked √Reel end bails closed and double locked √Reels unlocked Continue translation to ESP3 Install APFR in ESP3 WIF 05 [12,FF,A,2] INSPECT GLOVES Retrieve crew lock bag Translate to nadir side of spare NTA Remove overgloves if required Open spare NTA nadir MLI cover, install thermal booties on both N2 FQD lines Close MLI cover Don overgloves if required Translate to zenith side of Spare NTA Open spare NTA zenith MLI cover Use TM (5/8 proud) with PGT: PGT [B7 (25.5), CCW2, 30.5], break torque on (4) bolts, order does not matter, 5 turns on PGT Re-torque: PGT [B6 (24.0), CW2, 30.5]-7.8"-Ext 5/8": – Engage (4) bolts, order does not matter <p>ESP3 spare NTA Torque and Turns</p> <table border="1" data-bbox="640 1279 911 1438"> <thead> <tr> <th>Bolt #</th> <th>Torque</th> </tr> </thead> <tbody> <tr> <td>1</td> <td></td> </tr> <tr> <td>2</td> <td></td> </tr> <tr> <td>3</td> <td></td> </tr> <tr> <td>4</td> <td></td> </tr> </tbody> </table> | Bolt # | Torque | 1 | | 2 | | 3 | | 4 | | <div data-bbox="1352 251 1898 391" style="border: 3px double black; padding: 5px; text-align: center;"> <p>WARNING</p> <p>NTA fluid QD lines and clamps may be hot if exposed to direct sun. Avoid contact with hardware until shaded ~20 min</p> </div> <p>S1 NTA PREP</p> <ol style="list-style-type: none"> Translate to fwd side of S1 NTA Temp stow crewlock bag (consider fairlead location) Retrieve NTA QD booties Translate zenith to aft side of S1 NTA Remove overgloves if required Open thermal shroud by sliding from zenith to nadir along guide straps <div data-bbox="1352 646 1881 737" style="border: 1px solid black; padding: 5px; text-align: center;"> <p>CAUTION</p> <p>Fluid line clamp nearest line origin at NTA must remain closed to prevent crimping</p> </div> <ol style="list-style-type: none"> On IV GO: Close valve BLOCK A on NTA fluid line F46 (zenith)/F47 (nadir) Repeat steps for second FQD Give MCC-H GO for leak check Open fluid line TA clamps on NTA When leak check complete: Demate NTA fluid line BLOCK B F46 (zenith)/F47 (nadir) from ATA QD M1/M2 <p style="text-align: center;">NOTE</p> <p>Ensure fluid QD lines routed under shroud straps</p> <ol style="list-style-type: none"> On IV GO: Mate QD F46(zenith)/F47 (nadir) BLOCK C to NTA dummy receptacle M2 (zenith)/M3(nadir) Stow QD F46(zenith)/F47 (nadir) N2 line in clamps Repeat steps for other FQD line Give MCC GO for NTA venting Install FQD thermal booties on FQDs Close all TA clamps on NTA Close S1 thermal shroud INSPECT GLOVES Don overgloves if required Translate to forward face of NTA Using ratchet wrench w/7.8-in 5/8 socket, break torque on (4) bolts, order does not matter |
| Bolt # | Torque | | | | | | | | | | | |
| 1 | | | | | | | | | | | | |
| 2 | | | | | | | | | | | | |
| 3 | | | | | | | | | | | | |
| 4 | | | | | | | | | | | | |

S1 NTA AND ESP3 NTA PREP (Cont)

| IV | EV1 | EV2 | | | | | | | | | | |
|--|--------|--------|---|--|---|--|---|--|---|--|--|---|
| <p>S1 NTA Torque and Turns</p> <table border="1" data-bbox="100 363 426 524"> <thead> <tr> <th>Bolt #</th> <th>Torque</th> </tr> </thead> <tbody> <tr> <td>1</td> <td></td> </tr> <tr> <td>2</td> <td></td> </tr> <tr> <td>3</td> <td></td> </tr> <tr> <td>4</td> <td></td> </tr> </tbody> </table> <p>5. When NTA venting complete, verify NTA inhibits in place; give EV crew GO for NTA electrical connector demate</p> <p>RPCM S1 2B_A RPC 10 – OPEN, CL CMD INH RPCM S1 1A_A RPC 11 – OPEN, CL CMD INH RPCM S1 1A_C RPC 12 – OPEN, CL CMD INH S1-1 MDM SDO Card Slot 8 Channels 0-6 Open</p> | Bolt # | Torque | 1 | | 2 | | 3 | | 4 | | <p>19. Socket swap back to 6-ext 7/16 20. Close MLI cover 21. INSPECT GLOVES 22. Retrieve crewlock bag 23. Translate to CP 9 ETVCG</p> | <p>23. PGT [B6 (24.0), CW2, 30.5]-7.8"-Ext 5/8": – Engage (4) bolts order, does not matter 24. Socket swap back to 6-ext 7/16</p> <p>25. Open clamps restraining electrical cables (6) 26. Remove overgloves if required 27. On IV/MCC GO, demate NTA electrical connectors: <ul style="list-style-type: none"> <input type="checkbox"/> S1-P631 from NTA J1 <input type="checkbox"/> S1-P632 from NTA J2 <input type="checkbox"/> S1-P633 from NTA J3 28. Bundle cables together and wire tie to S1 zenith; verify clear of MT rails 29. INSPECT GLOVES 30. Don overgloves if required 31. Retrieve crewlock bag 32. If time permits, translate to CP 9 ETVCG</p> |
| Bolt # | Torque | | | | | | | | | | | |
| 1 | | | | | | | | | | | | |
| 2 | | | | | | | | | | | | |
| 3 | | | | | | | | | | | | |
| 4 | | | | | | | | | | | | |

S1 NTA AND ESP3 NTA PREP – TASK DATA

Estimated Task Duration:

| | With SSRMS | Without SSRMS |
|-------------|------------|---------------|
| One EV Crew | N/A | 01:30 |
| Two EV Crew | N/A | N/A |

Tools:

| EV1 | EV2 |
|-----|---|
| N/A | PGT Round Scoop 7.8 – 5/8" Rigid Socket NTA QD Booties |

Foot Restraints:

| Task | WIF | APFR Setting |
|----------------|------------|--------------|
| S1 NTA Prep | N/A | N/A |
| ESP3 NTA Prepl | ESP3 WIF 5 | 12,FF,A,2 |

EVA Connectors:

| Harness | To | Clamps (#) | Conn size | Function |
|---------|--------|------------|-----------|----------|
| S1-P631 | NTA J1 | 2 | 15 | Data |
| S1-P632 | NTA J2 | 1 | 15 | Data |
| S1-P633 | NTA J3 | 3 | 17 | Power |

EVA Fluid QD's (Failed/Old/Empty NTA):

| Line Name | From | To | Clamps (#) | QD Size | Function |
|-----------|-----------|--------|------------|---------|-------------------|
| F46 | ATA QD M1 | NTA M2 | 3 | ¼ inch | Nitrogen pressure |
| F47 | ATA QD M2 | NTA M3 | 3 | ¼ inch | Nitrogen pressure |

Connector Inhibits:

| Task | Inhibit |
|------------------|--|
| S1-631 to NTA J1 | None required |
| S1-632 to NTA J2 | None required |
| S1-633 to NTA J3 | RPCM S1 2B_A RPC 10 – OPEN, CL CMD INH RPCM S1 1A_A RPC 11 – OPEN, CL CMD INH RPCM S1 1A_C RPC 12 – OPEN, CL CMD INH S1-1 MDM SDO Card Slot 8 Channels 0-6 Open |

EVA Fasteners:

| Fastener Name | Head Size | Qty | Install Torque (ft-lb) | Release Torque (ft-lb) | Failure Torque (ft-lb) | Turns |
|------------------------------------|-----------|-----|------------------------|------------------------|------------------------|---------|
| NTA Bolts – S1/ESP3 [Break Torque] | 5/8 | 4 | | 93.0 | 186.5 | 15-17.5 |
| NTA Bolts – S1/ESP3 [Re-Torque] | 5/8 | 4 | 24 | | 47.9 | 15-17.5 |

ORU Identification:

| ORU | Part number | Serial Number |
|--------|-------------|---------------------------------|
| S1 NTA | 1F96000-1 | 0002 (S1 EMPTY) 005 (ESP3 FULL) |

Notes:

1. Ensure Fluid QD lines routed under shroud straps

Cautions:

1. NTA Fluid QD lines and clamps may be hot is exposed to direct sun. Avoid contact until shaded ~20 min
2. Avoid pulling electrical cables. Avoid bend radii less than 10 times cable diameter
3. The fluid line clamp nearest line origin at NTA must remain closed to prevent crimping

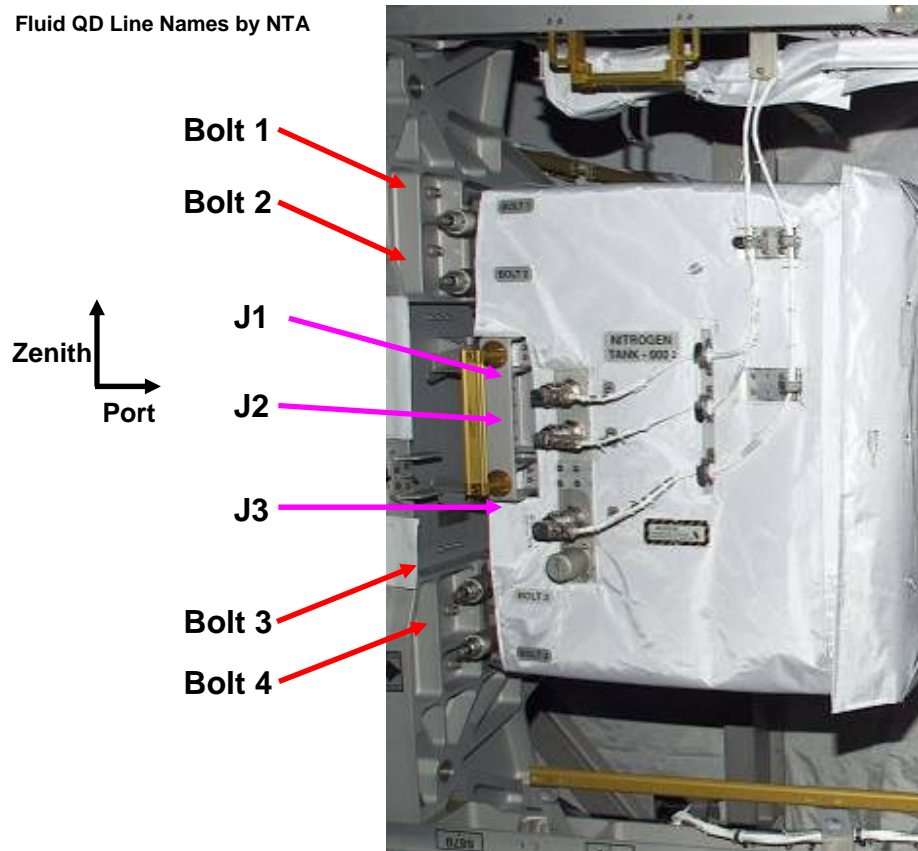
Warnings:

1. Verify electrical inhibits in place prior to electrical mate/demate
2. Verify S1 TRRJ rotation inhibits in place

S1 NTA AND ESP3 NTA PREP – TASK DATA (Cont)

Nitrogen Tank Assembly (Front Side: Electrical Connectors & Bolts)

Fluid QD Line Names by NTA

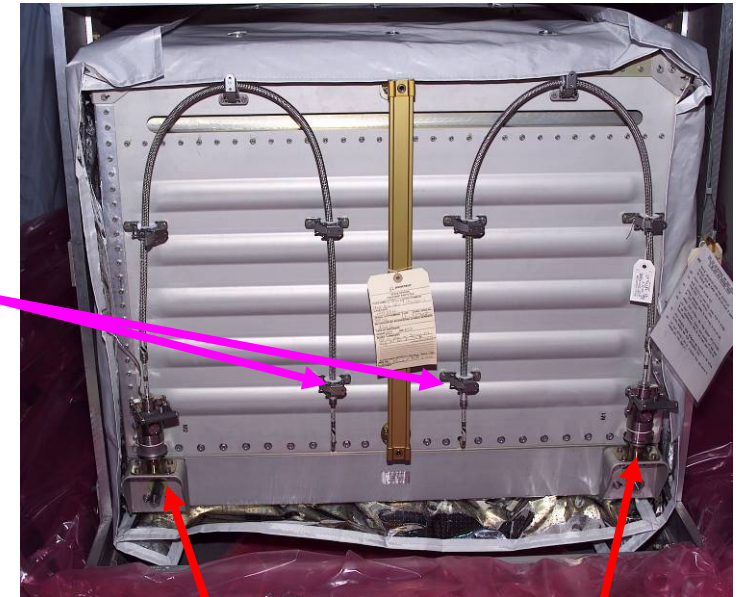


| Old S1 NTA (Empty/Failed) | New S1 NTA (Full/Spare) |
|---------------------------|-------------------------|
| F46 (Zenith) | F1/M2/M1 (Zenith) |
| F47 (Nadir) | F2/M3/M2 (Nadir) |

Nitrogen Tank Assembly (Aft Side: Electrical Connectors & Bolts)

Two N2 fluid QD lines on the Aft face of the NTA connect to the ATA on truss face 4

TA Clamp nearest each line origin must remain closed



M3 Dummy Receptacle (Spare NTA)

M2 Dummy Receptacle (Spare NTA)

CP 9 ETVCG RETRIEVE

| IV | EV | | | | | | | | | | | | |
|--|--------|--------|-------|--------|--|--|-------------|--|--|-------------|--|--|--|
| <p>1. Verify w/MCC that CP9 in park position (-180 deg pan and -90 deg tilt)</p> <p>2. Give MCC-H GO to put camera inhibits in place: RPCM P11A_A RPC 1 OPEN AND CLOSE INH RPCM P11A_A RPC 15 OPEN AND CLOSE INH RPCM P12B_A RPC 2 OPEN AND CLOSE INH RPCM P12B_A 16 OPEN AND CLOSE INH</p> <p>3. √MCC-H camera Inhibits in place, and get start time for thermal clock Thermal Clock Start: _____</p> <p>Dummy Box Bolts:</p> <table border="1"> <thead> <tr> <th>Bolt</th> <th>Torque</th> <th>Turns</th> </tr> </thead> <tbody> <tr> <td>Center</td> <td></td> <td></td> </tr> <tr> <td>Outer (fwd)</td> <td></td> <td></td> </tr> <tr> <td>Outer (aft)</td> <td></td> <td></td> </tr> </tbody> </table> | Bolt | Torque | Turns | Center | | | Outer (fwd) | | | Outer (aft) | | | <div style="border: 1px solid black; padding: 5px; text-align: center;"> <p>CAUTION Avoid contact with light (Z-93 paint) and camera (silver teflon)</p> </div> <p><u>FAILED CAMERA REMOVAL</u></p> <ol style="list-style-type: none"> 1. Retrieve dummy box/round scoop, temp stow on stanchion 2. Translate to P1 CP9 camera location 3. Take camera pan/tilt lever to LOCKED (may have to assist with positioning camera to stowed posn) 4. Tether to failed ETVCG light 5. PGT [A7 (9.2), CCW2, 30.5]-6"Ext-7/16": Release outer bolts (2) ~12 turns 6. PGT [A7(9.2), CCW2, 30.5]-6"Ext-7/16": Release center jacking bolt ~30 turns 7. Attach round scoop to failed camera fitting 8. Remove failed camera (soft dock wedges) 9. Temp stow camera with 2 tethers <p><u>INSTALL DUMMY BOX</u></p> <ol style="list-style-type: none"> 10. Verify blind mate connector on stanchion mount clear of FOD 11. Retrieve dummy box 12. Install dummy box (soft dock wedges) 13. PGT [A7 (9.2), CW2, 30.5]-6"Ext-7/16": Drive center jacking bolt ~24-30 turns (hard stop) 14. PGT [A7 (9.2), CW2, 30.5]-6"Ext-7/16": Drive outer bolts (2) ~6-12 turns (hard stop) 15. Retrieve Crewlock bag and temp stow between BRT and ETVCG 16. Attach BRT to failed camera and position behind back 17. INSPECT GLOVES 18. Translate to tether swap location 19. Perform tether swap <ul style="list-style-type: none"> √Locally tethered √Double locked to A/L safety tether √Retrieve spare safety tether √Bails closed and reels unlock 20. Translate to A/L and stow camera (ETVCG) in A/L |
| Bolt | Torque | Turns | | | | | | | | | | | |
| Center | | | | | | | | | | | | | |
| Outer (fwd) | | | | | | | | | | | | | |
| Outer (aft) | | | | | | | | | | | | | |

CP 9 ETVCG RETRIEVE – TASK DATA

Estimated Task Duration:

| | Without SSRMS |
|-------------|---------------|
| One EV Crew | 1.0 |

Tools:

*Can be performed by either crew member

| EV1 (FF) | EV2 |
|-------------|-----|
| PGT | N/A |
| Round Scoop | |
| BRT | |

EVA Fasteners:

| Fastener Name | Head Size | Qty | Install Torque (ft-lb) | Failure Torque (ft-lbs) | Turns | RPM |
|--------------------|-----------|-----|------------------------------|--------------------------------|--------------------------------|--------------------------|
| Outer bolts | 7/16" | 2 | 9.2 (release and install) | 14.8 (release/13.2 install) | 6-12 (release and install) | 30 (release and install) |
| Center (Jack) Bolt | 7/16" | 1 | 9.2 (release and install) | 14.8 (release/13.2 install) | 24-30 (release and install) | 30 (release and install) |

Connector Inhibits:

| Task | Inhibit |
|-----------------------|--|
| P1 – J1 Blind mate | RPCM P11A_A RPC 1 OPEN AND CLOSE INH RPCM P11A_A RPC 15 OPEN AND CLOSE INH RPCM P12B_A RPC 2 OPEN AND CLOSE INH RPCM P12B_A 16 OPEN AND CLOSE INH |

Notes:

1. Camera bolts have no hard stop. They free spin when released
2. There is no anti-rotation device on camera bolts
3. Camera soft dock force is ~10 lb
4. An equipment hook will not fit around camera tether point; light tether point must be used
5. Pan/tilt unit lock lever requires a push to turn lever 90 deg to go from lock to unlock, and from unlock back to lock. Both unlock and lock positions sit in detents
6. If pan/tilt lock lever becomes unlocked, pan/tilt joints can begin to move and back-drive motor. This is undesirable and can damage hardware
7. Pan/tilt lock lever can only be locked if pan/tilt mechanism is in home position (camera lens facing TVCIC bolt box)

Cautions:

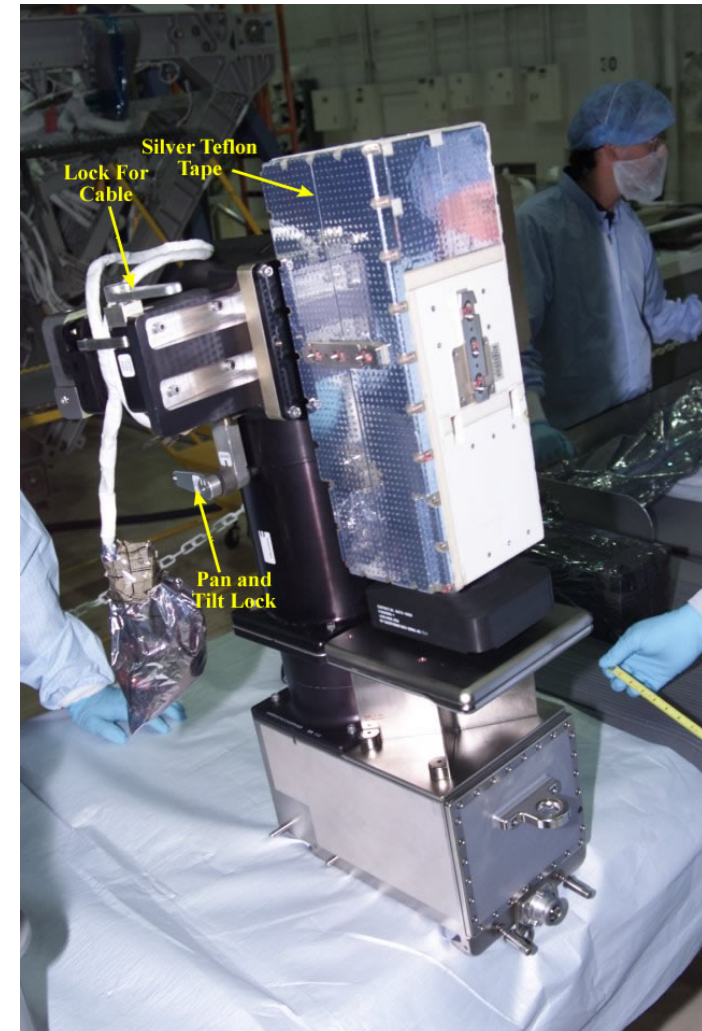
1. Avoid contact with light (Z-93 paint) and camera (silver Teflon)

Warnings:

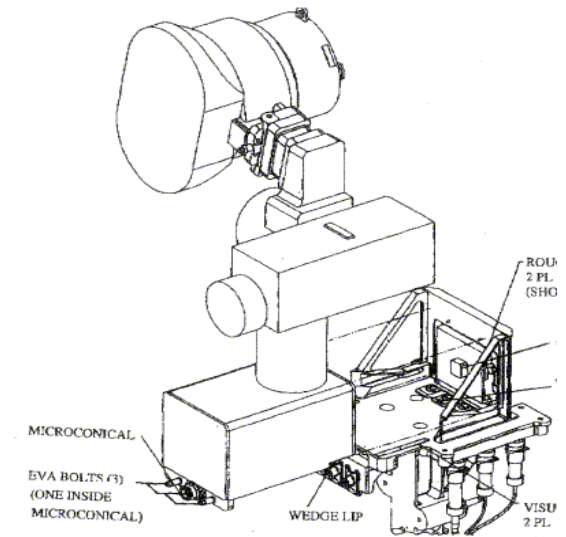
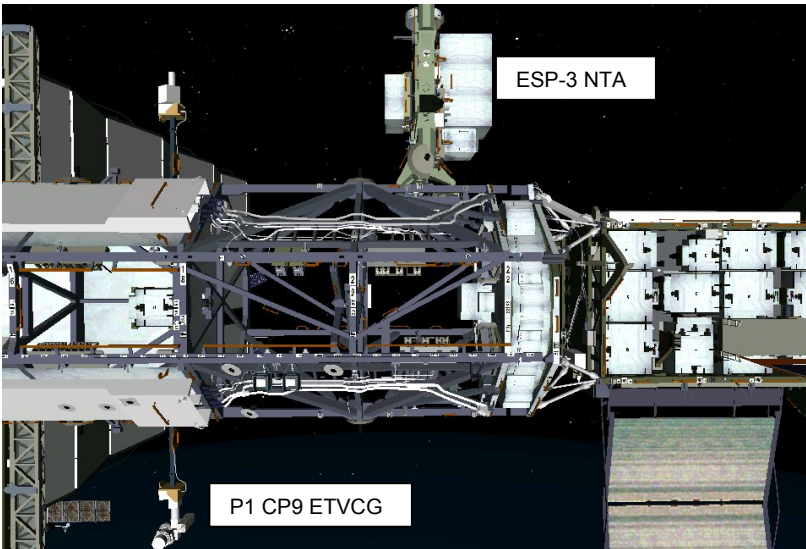
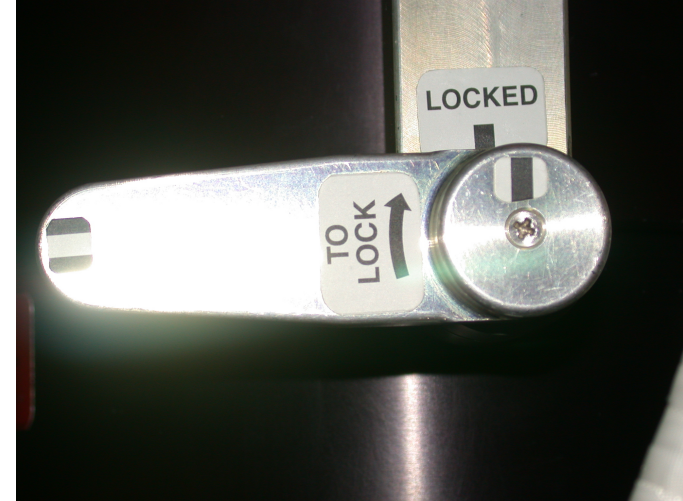
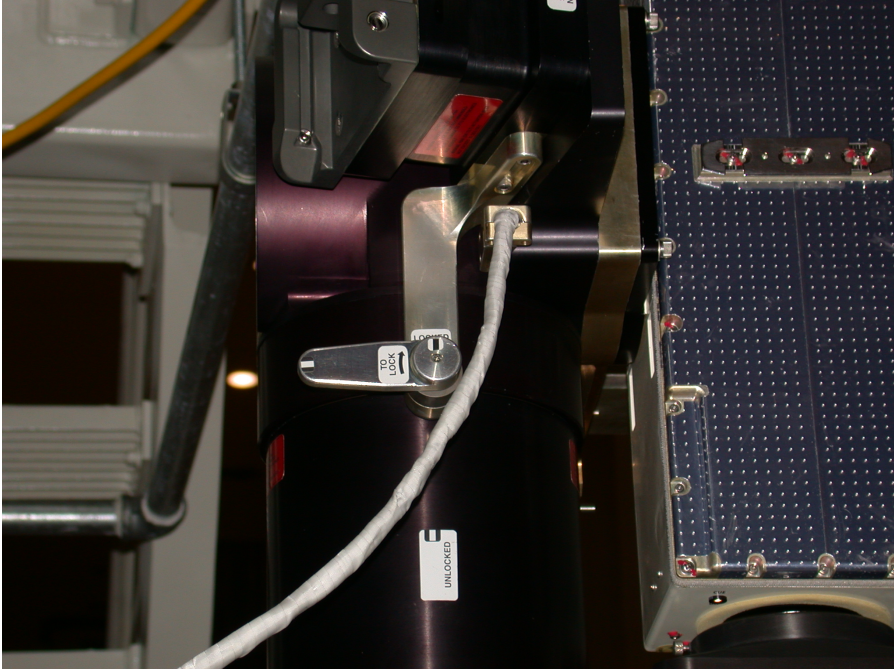
N/A

Timeline Considerations:

N/A



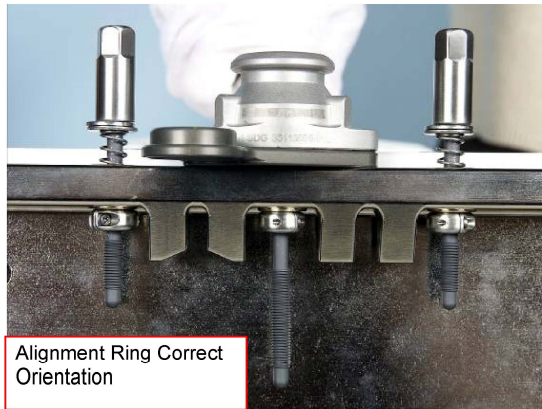
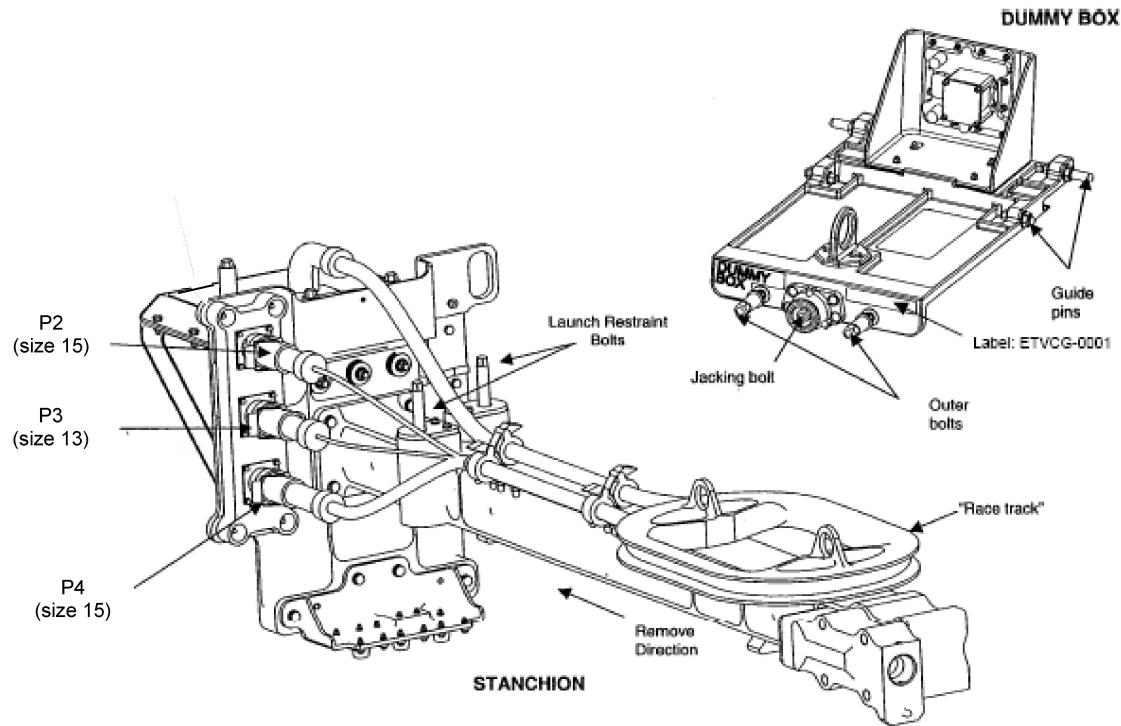
CP 9 ETVCG RETRIEVE – TASK DATA (Cont)



ARINC on TVCIC which interfaces with the EVGSS.

ETVCG

CP 9 ETVCG RETRIEVE – TASK DATA (Cont)



CLEANUP AND INGRESS

| IV | EV1 (FF) | EV2 (FF) |
|---|--|--|
| <p>Prior to Ingress:</p> <ol style="list-style-type: none"> 1. Perform WVS PWRDN (PHOTO/TV, <u>WVS CUE CARD</u>) | <p><u>CLEANUP</u></p> <ol style="list-style-type: none"> 1. Perform tool inventory 2. Pass in tools and hardware <ul style="list-style-type: none"> <input type="checkbox"/> 3 – Crewlock bags <input type="checkbox"/> Large ORU bag <p><u>INGRESS</u></p> <ol style="list-style-type: none"> 3. On EV2 GO, release anchor side of EV2 safety tether 4. Connect waist tether to D-ring extender on A/L D-ring 5. Release EV1 A/L safety tether anchor point 6. Remove camera from swing arm as required 7. Ingress A/L 8. Remove SCU from stowage pouch 9. Remove DCM cover; Velcro to DCM 10. Connect SCU to DCM; \surdSCU Locked 11. WATER – OFF (fwd), expect <u>H2O IS OFF</u> msg 12. Close thermal cover; attach Velcro strap <div style="border: 1px solid black; padding: 5px; margin: 10px auto; width: fit-content;"> <p style="text-align: center;"><u>CAUTION</u> Do not close hatch until EMU water off for 2 min. Verify outer hatch clear of hardware</p> </div> <ol style="list-style-type: none"> 13. Verify outer hatch clear of hardware 14. Verify handle position per hatch decal; close and lock hatch <p>Go to PRE-REPRESS (<u>DEPRESS/REPRESS Cue Card</u>)</p> | <p><u>CLEANUP</u></p> <ol style="list-style-type: none"> 1. Perform tool inventory 2. Remove camera from swing arm as required 3. Ingress A/L 4. Receive and stow tools and hardware in A/L <ul style="list-style-type: none"> <input type="checkbox"/> 3 – Crewlock bags <input type="checkbox"/> Large ORU bag <p><u>INGRESS</u></p> <ol style="list-style-type: none"> 5. Attach waist tether to UIA D-ring <ol style="list-style-type: none"> 6. Remove SCU from stowage pouch 7. Remove DCM cover; Velcro to DCM 8. Connect SCU to DCM; \surdSCU Locked <ol style="list-style-type: none"> 9. WATER – OFF (fwd), expect <u>H2O IS OFF</u> msg <p>Go to PRE-REPRESS (<u>DEPRESS/REPRESS Cue Card</u>)</p> |

EVA 3

1J EVA 3 SUMMARY

| TIME | IV | EV1 (FF) | EV2 (FF) |
|-------------|----|--|-------------------------------|
| 00:00-00:05 | | POST DEPRESS (00:05) | POST DEPRESS (00:05) |
| 00:05-00:35 | | EGRESS/SETUP (00:30) | EGRESS/SETUP (00:30) |
| 00:35-01:25 | | RETRIEVE ESP3 NTA (01:10) | REMOVE S1 NTA (00:50) |
| 01:25-01:45 | | | STOW S1 NTA ON FRAM (00:20) |
| 01:45-01:55 | | STOW S1 NTA ON FRAM (00:30) | RETRIEVE SPARE NTA (00:10) |
| 01:55-02:15 | | | S1 NTA INSTALL (00:55) |
| 02:15-02:50 | | CLEANUP ESP3 WORKSITE (00:40) | |
| 02:50-02:55 | | | SSRMS CLEANUP (00:45) |
| 02:55-03:35 | | JEMRMS WVE/EVE MLI AND LAUNCH LOCK RETRIEVAL (01:15) | |
| 03:35-04:10 | | | S1 NTA FQD CONNECTION (00:35) |
| 04:10-04:25 | | RELEASE AFT WINDOW LL BOLTS (00:15) | CP9 ETVCG INSTALL (01:45) |
| 04:25-04:55 | | DEPLOY FWD AND AFT ACBM MMOD SHIELDS (00:30) | |
| 04:55-05:40 | | CP9 ETVCG INSTALL (01:00) | |
| 05:40-05:55 | | | |
| 05:55-06:15 | | CLEANUP/INGRESS (00:20) | CLEANUP/INGRESS (00:20) |
| 06:15-06:20 | | PRE REPRESS (00:05) | PRE REPRESS (00:05) |
| 06:20 | | | |

- Get-Ahead: – Port SARJ Inspection (00:30-00:45)
 – Node 2 QD Thermal Blanket Install (00:30)
 – S3/S4 SARJ Launch Restraint Removal (01:45)
 – WETA Install CP1 (01:15)
 – Node 1 MMOD Shield Cleanup (01:00)
 – FHRC P-Clamp Release (01:00)

1J EVA 3 BRIEFING CARD

EV1 _____
EV2 _____
IV _____
R1/M1 _____

EVA Prep start (GMT) ____/____:____
Depress to 10.2 _____
Start Purge _____
PET 00:00 _____

Flight Day Prior to EVA – General Briefing (All)

1. EVA Prep

- Get-up Plan – clothing and EMU equipment bag – EV1
- Prebreathe protocol review (Notes and Warnings) – IV
- Equipment lock activities – IV responsibilities
- Suit donning plan – special requests – EV's, IV's
- SAFER, MWS, tools, C-Lk positions, bag stowage – EV2
- Airlock depress review – IV

2. EV Crew Procedure Review – EV1

- Egress Plan
- Order of tasks (summary timeline)
- Translation plan, fairleads, and tether swaps
- Hazards
- Ingress Plan

3. Robotics – R1/M1

- SRMS/SSRMS initial position, maneuvers, clearances
- Coordinate Frames
- SRMS/SSRMS comm protocol review – expected calls, use first names
- GCA – when, where, handover language
- Cameras
- Contingencies
 - Suit anomalies while ingressed

Flight Day Prior to EVA – Additional Briefing (EV, IV)

4. Communications – CDR, IV

- Overall setup: big loop, A/G2, S/G2, ICOM, Hardline, remind EV crew when mode swapping
- EV/IV comm protocol review – Use EV1(2) for DCM sw throws (all time in A/L), use first names otherwise

5. General Procedure Review – EV1

- Get-ahead tasks
- Constraints – ground and flight – IV
- Notes, Cautions, and Warnings review – IV
- Contingency procedures – crib sheet

6. Emergencies Review – EV1

- Emergency suit doff and power down during EVA prep
- Loss of comm
- EMU malfunctions
- Lost tools
- Lost crewmember
- DCS
- Abort and Terminate scenarios, protocols
- Hand signal reviews

7. Post EVA – IV's

- Suit doffing responsibilities
- Post EVA plan

√Expedited Suit Doffing cue card pre-positioned for EVA day

1J EVA 3 BRIEFING CARD (Cont)

EVA Day, prior to Prebreathe Protocol

1. Reminders

- Translate slow (then space is like water). Relax grip
 - Be extra careful on non-standard routes or orientations
 - Don't hop
- Tether Discipline
 - Check all gates closed and hooks locked; check reel locked/unlocked
 - Local tether when stopped. Check tethers before you leave
 - When something is attached to a tether, don't grab the tether by the hook
 - Good pull tests
- APFR ops
- Be disciplined when tired
- Hazards: payloads, etc
- Openness: when you have boot or glove pain let us know
- OK for IV and ground to check on us. If you need update, ask
- Monitor safety tether. Hold peanut when necessary
- Let mistakes pass
- If you get a mal, read the caution and warning message so everyone knows what it is
- Manage frustration (slow down, if needed)
- Cold soak before ingress
- Verify PGT settings. PGT collars are easy to bump
- Read turns, torque, green light
- SSRMS: coordinate frames and positive GCA handovers
- Review first post-egress steps
- Review abort/terminate priorities and procedures
- Glove Checks
- Day/night reconfigurations
- Translation Adaptation plan

IV Checklist Verification Items

1. Generic

- Day/Night Cycles
 - √Lights, visors, gloves and heaters, tethers, and MWS
- √Load Alleviating Strap on Safety Tethers not damaged
 - Crew report: **"Safety Tether strap looks good"**
- √Safety Tether Crew Hook Slidelocks are locked
 - Crew Report: **"Locked and locked"**
- √Both SAFER valves down at egress
 - Crew Report: **"Both handles down"**
- √APFR locking collar Black-on-black and pull test
 - Crew Report: **"Black-on-black, good pull test"**
- √PGT Green light on for bolt engage
 - May get Lo Torque msg at bolt release
 - Crew Report: **"XX turns, green light, XX ft-lb"**
- √Latches closed on lid, door, etc (i.e., √in landing config)
 - Crew Report: **"XX Latches done"**
- √Connectors for no bent pins, no FOD, inhibits in place
 - Crew Report: **"Pins good, no FOD, bend radius OK"**
 - Crew Report: **"Are inhibits in place?"**

2. Task Specific

- √Tethers and Tools clear prior to SSRMS ORU movement
 - Each EV report: **"Tethers and tools clear"**

3. Tool inventory

- √Tethers on MWS
- Confirm all others as standard unless removed

1J EVA 3 TOOL CONFIGURATION

EV1

EMU D-rings

- Ext on left side
- Ext on right side
- Waist Tethers (left Ext to MWS, √locked)
- Waist Tethers (right D-ring to ERCM, √locked)
- 85-ft Safety Tether (right Ext, √locked)
- 85-ft Safety Tether – spare (right Ext, √locked)

MWS

- Small Trash Bag
 - RET (with PIP pin)
 - 7.8-Ext 5/8 rigid socket
- 2 – Wire ties as tether loops
- RET
- 2 – Adj Equipment Tether
- Long wire tie (Over Gloves)
- Swing Arm (right side)
 - RET (Attach to PGT)
 - PGT s/n 1002
- BRT (left side)
 - RET
 - 2 – short wire ties

EV2

EMU D-rings

- Ext on left side
- Ext on right side
- Waist Tethers (left Ext to MWS, √locked)
- Waist Tethers (right D-ring to ERCM, √locked)
- 85-ft Safety Tether (right Ext, √locked)
- 85-ft Safety Tether – spare (right Ext, √locked)

MWS

- Wire tie to secure trash bag (with tether loops)
- Small Trash Bag
 - RET (with PIP pin)
 - 7.8-Ext 5/8 rigid socket
- 2 – Wire ties as tether loops
- RET (with PIP pin)
 - WIF Adapter
- 2 – Adj Equipment Tether
- Wire tie (Over Gloves)
- Swing Arm (right side)
 - RET (Attach to PGT)
 - PGT s/n 1008
- BRT (left side)
 - RET
 - 2 – short wire ties
- RET
 - Rd Scoop

CREWLOCK

- D-ring extender on A/L D-ring
- Large-Sm RET (Do not leave in A/L: Used for Tie-Down)
 - Large ORU Bag
 - 3 – RET
 - CP9 ETVCG (Camera)
 - Rd Scoop
 - Adjustable (Outside of bag)
- Large-Sm RET
 - WETA

CREWLOCK (Cont)

- Large-Sm RET
 - Med ORU Bag
 - Fish Stringer (Adj Fuse tether)
 - RET (For MLI)
 - Digital Camera w/ bracket and Flash
 - RET
 - 2 – Adjustable (NTA Conn Caps)
 - Rd Scoop-Ballstack-MUT EE
 - RET
 - Socket Caddy
 - 2-Ext 7/16
 - 6-Ext 7/16
 - Fish Stringer (Adj Fuse tether)
 - Velcro/tape caddy
 - Ballstack-MUT EE
 - RET
 - Ratchet wrench
 - 7/16 box end ratchet wrench
 - Round TM w/5/8-in proud socket
 - 2 – Adjustable (Outside of bag)
 - WVE/EVE LL w/MLI (2)
- Large-Sm RET
 - Crewlock Bag #1 (Get-Aheads)
 - MMOD shield handling tool (long)
 - Wire Tie Caddy (w/6 Long wire ties)
 - Loop pin puller
 - 1 – RET
 - Node 2 thermal blankets (2)
 - Wire Ties (1 long and 1 short/blanket)
 - RET
 - Scissors
- Large-Sm RET
 - Crewlock Bag
 - Socket Caddy
 - 6-Ext 7/16
 - 9-Ext 7/16
 - 12-Ext 7/16
 - RET
 - RAD w/2-Ext 7/16
 - Digital Camera and bracket

Prior to EVA, perform the following hardware inspections:

1. RET cords for fraying
2. No red line visible on safety and waist tether load Alleviation straps
3. Inspect ISS trash bags for deformation/damage
4. Inspect EMU gloves for damage

Use **RED** RETs only

1J EVA 3 TOOL CONFIGURATION (Cont)

Staging Bag

- Adjustable Fuse Tether
 - Connector Cleaner Tool Kit
 - PGT s/n 1001
 - PGT Battery s/n _____
 - Pin Straightener Assy
 - Probe
- Adjustable Fuse Tether
 - Torque Wrench and bag
 - LDTD Tether
 - MMWS Key Strap Assembly
 - Pry Bar
 - Hammer

IV Bag

- 2 – Towels w/wire ties
- Contamination Detection Kit w/watch
 - Hydrazine Detector (Gold Salt Coupon) (6)
 - Color Chart (2)
 - ISS Contamination Detection Sampler (2)
 - Shuttle Contamination Detection Sampler (2)
 - Nitrogen Dioxide Detector (Oxidizer Draeger Tube) (6)
 - Ammonia Detector (NH3 Draeger Tube) (6)
- 2 – GP Caddy
 - 2 – Adj Thermal Mittens
- 3 – RET
 - Socket Caddy (hatch cont)
 - 1/2 socket 8-in ext (hatch)
 - 7/16 socket 6-in ext (spare)
 - DCM plug (2) (SAFER hardmount)

1J EVA 3 INHIBIT PAD

ALL EVAs

| | |
|------------|---------------------|
| TCS L12 | 1. √TCS POWER – OFF |
|------------|---------------------|

| | |
|--------------------------|---|
| KU-BAND ANTENNA MCC-H | 1. √KU-BAND Mask – active 2. √KU-BAND EVA Protect Box – active |
|--------------------------|---|

| | |
|-----------------|---|
| RCS | If EV crew < 27 ft from FRCS |
| IV O14,15,16 | 1. √DAP: VERN, FREE, LO Z (flt specific check with GNC) 2. √RJDF F1, F2, F3, F4 MANF DRIVER (four) – OFF LOGIC (four) – OFF |
| MCC-H | 3. √Above RCS config |
| IV | 4. √RCS F – ITEM 1 EXEC (*) √JET DES F1U – ITEM 17 (*) F3U – ITEM 19 (*) F2U – ITEM 21 (*) |

| | |
|--------------------------------|--|
| S-BAND ANTENNAS (not expected) | <u>NOTE</u> Possible loss of comm when forced LL FWD antenna |
| IV A1R | If EV crew < 2 ft from S-Band antenna 1. S-BAND FM ANT – XMIT LOWER/RCVR UPPER 2. √MCC, lower antenna selected |
| C3 | If no comm, or On MCC GO 3. S-BAND PM ANT – LL FWD |
| C3 | When EVA crewmember at least 2 ft away from all S-Band upper antennas 4. S-BAND PM ANT – GPC |

Ground

All EVAs

| | |
|-----------------------|--|
| Ground Radar MCC-H | 1. √TOPO console, ground radar restrictions in place for EVA |
|-----------------------|--|

USOS

| | |
|-------|---|
| PCU | <u>NOTE</u> PCUs may require up to 1 hr warm-up period before they are operational |
| MCC-H | 1. √PCUs (two) operational in discharge mode and one of the following: a. CCS PCU EVA hazard control FDIR enabled b. No more than two arrays unshunted and oriented < 105° from velocity vector |
| | OR |
| | 2. One or no PCUs operational in discharge mode and no more than two arrays unshunted and oriented < 105° from velocity vector |

LOCATION DEPENDENT INHIBITS

| | |
|---------------------------------|---|
| Lab Window (not expected) IV | If EV crew less than 10 ft from window or in window FOV, close window shutter |
| JPM Window IV | If EV crew translating on end cone of JPM, close window shutter |
| Mobile Transporter MCC-H | If EV crew < 1.5 meters from MT 1. √MT latched |

1J EVA 3 INHIBIT PAD (Cont)

USOS (Cont)

JEMRMS WVE/EVE
 SSIPC PDB_RMS_Ext4_Vout (JRRC00SWPS08V): 0.0 V (for MA EE TVC)
 PDB_RMS_Ext2_Vout (JRRC00SWPS07V): 0.0 V (for MA ELBOW TVC)
 VCU_b_TVC_MA_EE_Sig_Status (JSDC00FCC40AJ) – No_signal (for MA EE TVC)
 VCU_b_TVC_ELBOW_Sig_Status (JSDC00FCC409J) – No_signal (for MA ELBOW TVC)

If above status is not all true, perform {JEMRMS DEACTIVATION – SSIPC}, steps 1 to 3 for each inhibit

JEMRMS Main Mode must be stand-by prior to EVA 3. SSIPC verifies following inhibits:

MDP_Main_Mode (JRRC00SWMT68J) – Stby Mode
 PDB_RMS_Ext2_Vout (JRRC00SWPS07V): 0.0 V

If the above status is not all true, Perform {JEMRMS DEACTIVATION PRP}, steps 3 and 4

SARJ
 MCC-H Port SARJ:

1. $\sqrt{\text{DLA}}$ (1) – LOCKED at 0 to +39, +115 to +140, +190 to +213, +288 to +360
2. All motor setpoints set to zero
3. All motors deselected

OR

4. Both DLAs – LOCKED

TRRJ
 MCC-H S1 TRRJ:

1. $\sqrt{\text{DLA}}$ (1) – LOCKED at -90 to -60 or +60 to +90

MCC-H P1 TRRJ:

1. $\sqrt{\text{DLA}}$ (1) – LOCKED at +15

RSOS

ALL EVAs

SM Antennas

- | | | |
|----|----------------------|---|
| IV | 1. GTS | – Deactivate |
| | 2. ARISS (Ham Radio) | – Deactivate or VHF (144-146 MHz) TX only |

TASK SPECIFIC INHIBITS

NTA Inhibits, to be verified prior to start of EVA 3:

MCC-H RPCM S1 2B_A RPC 10 – OPEN, CL CMD INH
 RPCM S1 1A_A RPC 11 – OPEN, CL CMD INH
 RPCM S1 1A_C RPC 12 – OPEN, CL CMD INH
 S1-1 MDM SDO CARD SLOT 8 CHANNELS 0-6 OPEN

CP9 ETVCG Inhibits, to be performed prior to ETVCG mate:

MCC-H RPCM P11A_A RPC 1 OPEN AND CLOSE INH
 RPCM P11A_A RPC 15 OPEN AND CLOSE INH
 RPCM P12B_A RPC 2 OPEN AND CLOSE INH
 RPCM P12B_A 16 OPEN AND CLOSE INH

JPM JTVE Inhibits, to be performed after ESP3 tasks complete

SSIPC CPB a and CPB b must be shut down prior to EVA 3. SSIPC verifies following inhibits:

Verify PDB_WS_RPC08_(CPB_a)_Posn (JSDC00FCPB0QJ) – Op

If PDB_WS_RPC08_(CPB_a)_Posn (JSDC00FCPB0QJ) – Cl, perform {JPM CPB AND TVC ACTIVATION(DEACTIVATION) – SSIPC}, steps 4.1 (for TVC EXT F) and 4.2 (for CPB a), then Verify PDB_b2_RPC04_(CPB_b)_Posn (JSDC00FCP40FJ) – Op

If PDB_b2_RPC04_(CPB_b)_Posn (JSDC00FCP40FJ) – Cl, perform {JPM CPB AND TVC ACTIVATION(DEACTIVATION) – SSIPC}, steps 4.1 (for TVC EXT A) and 4.2 (for CPB b)

1J EVA 3 NOTES, CAUTIONS, WARNINGS

NOTES

1. Bolt install: report torque and turns
2. Bolt release: report torque and turns if different from published range
3. EVA connectors: after disconnection and prior to connection; verify pin and EMI band integrity; verify connector free of FOD
4. Inspect QDs for damage prior to mating
5. Toolbox doors must be closed with one latch per door when EV crew not in immediate vicinity
6. Avoid contact with OBSS striker bars (Vitrolube coating)

CAUTION

ISS Constraints

- A. Avoid inadvertent contact with
1. Grapple fixture shafts (drylube)
 2. PIP pins
 3. EVA crane [PMA1]
 4. TCS reflectors [PMA2,PMA3]
 5. APAS hardware [PMA2,PMA3]
 6. CETA lights (Z-93 paint) [LAB,S1,Node 1]
 7. Deployed MISSEs [COL EPF]
 8. Passive UMAs
 9. MBS/SSRMS/SPDM/JEMRMS taped radiative surfaces: VDU, ACU, JEU, LEU, MCU, CRPCMs, and cameras
 10. Deployed TUS cable [Nadir CETA rail]
 11. S0 aft face radiator
 12. GPS antennas (S13 paint) [S0]
 13. UHF antennas [LAB,P1]
 14. ETCS radiator flexhoses and panels [S1,P1]
 15. EETCS/PV radiator flexhoses, bellows and panels [P6,P4,S4,S6]
 16. SASA RF group [S1,P1]
 17. Heat pipe radiators [Z1]
 18. PCU cathode and HCA ports [Z1]
 19. Ku-Band antenna (SGANT) dish [Z1]
 20. CMG cover/shells [Z1]
 21. SPDM SJEU, EP, OTCM, LEU, and LEE VDU radiator surfaces
 22. Open CBM petal covers, LAB window shutter, and JPM window shutter
 23. FPMU [S1]
 24. OTSD
 25. COL HAM radio antennas [COL-Nadir]
 26. JTVE Cameras

CAUTION (Cont)

ISS Constraints (Cont)

- B. Electrical cables
1. Avoid bend radii < 10 times cable diameter
- C. Fiber optic cables
1. Avoid bend radii < 10 times cable diameter
 2. Avoid pulling on cable during mate/demate
- D. Fluid line flex hoses and QDs
1. Avoid bend radii < 5 in for hoses with diameter < 1 in on LAB, S0, S1, and P1 and 10-in for hoses with diameter < 1-in on all other elements
 2. Avoid bend radii < 14 in for hoses with a diameter ≥ 1 in
 3. Additional care should be taken to not exceed bend radii when applying loads at the flexible hose to rigid tube stub interfaces
 4. Ensure fluid QD booties are fully closed prior to leaving worksite; wire tie if reqd

1J EVA 3 NOTES, CAUTIONS, WARNINGS (Cont)

CAUTION (Cont)

ISS Constraints (Cont)

- E. For structural reasons
1. Avoid vigorous body motions, quick grabs and kickoffs against tether restraints
 2. Avoid performing shaking motions (sinusoidal functions) more than four cycles
 3. Avoid kicking S1/P1 radiator beam.
If any of these occur, wait 2 to 5 min to allow structural response to dissipate
- F. Other
1. ITT Cannon connector: On demated connectors, do not rotate collar or manipulate cable/connector using collar or connector tool
 2. WIS Antennas: do not use as handholds [Node 1, Lab, P6, Z1]
 3. Lubricant from Ku-Band SGANT gimbals [Z1], CMGs [Z1], and RTAS Ground Strap fasteners [P6, P4, S4, S6] can contaminate EMU
 4. MLI handholds are not rated for crewmember translation loads
 5. CBM petal covers may not be used as handholds unless both launch restraint pins are engaged
 6. Prevent inadvertent contact of the tether shuttle with ETRS when P3/S3 Tether Shuttle Stop raised away from rail

CAUTION (Cont)

Shuttle Constraints

- G. Avoid inadvertent contact with
1. OBSS and SRMS composite sections and cable harnesses
 2. LCS (silver Teflon) and LDRI (silver Teflon) and ITVC (gold foil) [OBSS]
 3. WVS antenna [ODS Truss & PLB Sill]
 4. Payload Bay wire harnesses, cables, and connectors
- H. No Touch
1. LDRI diffuser [OBSS]
 2. OBSS saddle contacts (when OBSS unberthed) [OBSS]
 3. Monkey fur [PLB]
 4. Cameras: metallic surfaces [PLB]
 5. Ku-Band antenna black dish and gold thermal blankets [PLB]

1J EVA 3 NOTES, CAUTIONS, WARNINGS (Cont)

WARNING

ISS Constraints

A. Avoid inadvertent contact with

1. Grapple fixture targets and target pins
2. SSU, ECU, beta gimbal platform, mast canister, SAW blanket boxes unless the beta gimbal is locked and the motor is turned off
3. Stay inboard of SARJ when active
4. Stay 2 ft from S1/P1 radiator beam rotational envelope when beam is free to rotate
5. Stay 5 ft from moving MT on face 1
6. SOLAR and EuTEF [COL EPF]

B. Handrails

1. Handrails previously used for MISSE attachment may not be used as a safety tether point [A/L endcone 564 & 566, A/L Tank 2 nad/fwd & port/fwd, P6 5389]

C. Pinch

1. NZGL connector linkage. Use caution when mating/locking
2. ITT Cannon Connector rotating housing
3. EV side of IV Hatch during Hatch operation (also snag hazard) [A/L]
4. LAB window shutter, CBM petal cover, and JPM window shutter linkages during operation
5. JEMRMS HRM capture latches, WVE/EVE

WARNING (Cont)

ISS Constraints (Cont)

D. QDs

1. If QD is in FID when valve is opened (bail fwd), QD will leak and fluid line may whip
2. Do not rotate if in mated/valve open config

E. RF radiation exposure

1. Stay 3.6 ft from S-Band (SASA) high gain Antenna when powered [S1,P1]
2. Stay 1.3 ft from S-Band (SASA) low gain Antenna when powered [S1,P1]
3. Stay 1 ft from UHF Antenna when powered [LAB,P1]

F. Sharp Edges

1. Inner edges of WIF sockets
2. APFR active WIF probes
3. Mating surfaces of EVA connectors. Avoid side loads during connector mating
4. Back side of MMOD shield fasteners
5. Spring loaded captive EVA fasteners (e.g., 6B-boxes, BMRRM, RTAS, SARJ covers); end of spring may protrude
6. PMA umbilical launch restraints-exposed bolt threads
7. Adjustable Fuse Tether (Fish Stringer) buckles stowed in Node Bag
8. Nickel coated braided copper Ground Straps may contain frayed wires [P6,P4,S4,S6]

WARNING (Cont)

ISS Constraints (Cont)

F. Sharp Edges (Cont)

9. Solar Array Blanket Box [P6,S6]
10. Keep hands away from SSRMS LEE/POA/SPDM LEE/JEMRMS opening, snares and PDGF curvic coupling (teeth)
11. SPDM OTCM gripper jaws
12. Fastener threads on back of Z1 U-jumper male FQD panel, if nutplate cap missing
13. Outboard MT rail attachment lug near P6 handrail 5333 and gap spanner
14. P2 connector on EWIS box TAA-06 [Zenith Face 1 of P5 – SARJ at 0 deg]
15. Port/Aft portion of A/L circular HR [HR 0506]
16. Interior of JEMRMS HRMs
17. JEM A/L hatch corners

G. Thermal

1. EVA connectors with booties may become hot if left uncovered. Handling may need to be limited
2. PMA handrails may be hot. Handling may need to be limited
3. Turn off glove heaters when comfortable temp reached to prevent bladder damage. Do not pull fingers out of gloves when heaters are on
4. Uncovered trunnion pins may be hot
5. SSRMS/MBS/SPDM/JEMRMS operating cameras and lights may radiate large amounts of heat

1J EVA 3 NOTES, CAUTIONS, WARNINGS (Cont)

WARNING (Cont)

ISS Constraints (Cont)

G. Thermal (Cont)

- Stay ≥ 1 ft away from PMAs and MMOD shields > 270 degF if EMU sun visor up; limit time to 15 min or less if > 300 degF
- Stay at least 0.5 ft away from PMA and MMOD shields > 325 degF
- Do not touch EMU protective visor if temp has been < -134 degF for > 15 min
- No EMU TMG contact with PMAs and MMOD shields > 320 degF
- No EMU boot contact with foot restraint when temp < -120 or > 200 degF
- Columbus end cones may violate touch temperature constraints when $-75 \leq \beta \leq -60$ or $60 \leq \beta \leq 75$
- PDGF surfaces may not meet touch temperature requirements for unlimited contact when $\beta \leq -70$ or $\beta \geq 70$
- JPM port end cones may violate touch temperature constraints when $\beta > 60$

H. Electrical Shock

- Stay ≥ 2 ft from ungrounded floating connectors if not unpowered:
 - SSPTS connectors [NOD1 Stbd/Fwd HR 0130, LAB Stbd/Fwd HR 0273, PMA2 Stbd & Port]
 - MBS Cross-Connect jumpers (translate past these using UMA handrails)
 - S0 EVA Power Cables [inside S0 Bay 00 Face 4, Bay 01 Face 3]
 - ESP2 jumper [inside S0 Bay 03 Face 4]
- Do not touch SPDM CLPA 1 electrical connector prior to camera installation

WARNING (Cont)

Shuttle Constraints

I. Arcing/Molten Debris

- Stay ≥ 2 ft from exposed EFGF connector when OBSS berthed, powered, and EFGF not grappled [PLB]
- Stay ≥ 2 ft from exposed Stbd Fwd MPM contacts [PLB]
- Stay above PLB sill when within 1 ft of powered ROEU connector [PLB]

J. Pinch

- PRLA in operation [PLB]

K. RF Radiation Exposure

- Stay 3.28 ft from S-Band Antenna when powered
- Stay 1 ft from top and side of UHF PLB Antenna radome surface when in high powered mode [ODS truss]
- Stay 0.33 ft from top and side of UHF PLB Antenna radome surface when in low powered mode [ODS truss]
- Remain below level of PLB door mold line for first 20 in Aft of Fwd bulkhead when S-Band Antenna powered [PLB]
- Remain on inboard side of Stbd slidewire (sill handrails if slidewire not installed) for first 20 ft Aft of Fwd bulkhead when Ku-Band Antenna powered [PLB]

WARNING (Cont)

Shuttle Constraints

L. Sharp Edges

- PRLA grounding wipers [PLB]
- LDR1 baffles (Also an entrapment hazard) [OBSS]
- Keep hands away from SRMS EE opening and snares
- TCS connector backshells have exposed threads [ODS]

M. Thermal

- Illuminated PLB lights; do not touch
- OBSS grapple fixture shafts/cams may be hot. Limit handling if required
- Stay 27 ft from PRCS when powered
- Stay 3 ft from VRCS when powered
- Stay 3 ft from APU when operating

N. Contamination

- Stay out of the immediate vicinity of leaking jet or APU

O. Lasers

- Do not look at LDR1 diffuser or LCS laser aperture window

EGRESS/EVA SETUP

| IV | EV1 (FF) | EV2 (FF) |
|---|---|---|
| <p>1. Start recorders</p> <p>2. √Initial Condition</p> <p>3. WVS Software: Select page – RF camera Sel 'Advanced Controls' S-Band Level (two) – Max (required after EV1 and EV2 egress airlock)</p> <p>4. Verify NTA inhibits are in place Give EV crew GO to translate around NTA electrical connectors and for mate of connectors</p> <p>RPCM S1 2B_A RPC 10 – OPEN, CL CMD INH RPCM S1 1A_A RPC 11 – OPEN, CL CMD INH RPCM S1 1A_C RPC 12 – OPEN, CL CMD INH S1-1 MDM SDO Card Slot 8 Channels 0-6 Open</p> | <p>Initial Condition: Forward UIA D-ring with left waist tether √Hooks locked</p> <p><u>EGRESS</u></p> <p>1. Release EV2 from A/L D-ring</p> <p>2. Hand out (2) Crewlock bags</p> <p>3. Hand out Med ORU bag</p> <p>4. Hand out hook of 85-ft safety tether to EV1</p> <p>5. Verify safety tether config √Reel end bails closed and double locked √Reel unlocked</p> <p>6. On EV2 GO, release waist tether from UIA D-ring</p> <p>7. Egress A/L</p> <p>8. √EV2 Safety tether config: Anchor bail closed, slider locked, and reel unlocked</p> <p>9. √EV2 SAFER MAN ISOL vlv – OP (dn) and HCM (dn) and √ERCA – green LED</p> <p>10. Close A/L thermal cover</p> <p>11. INSPECT GLOVES</p> <p>12. Retrieve APFR from A/L Stbd Tool Box</p> <p>13. Translate to WIF-Extender at ESP2 WIF-03 (Pitch A), Install APFR (12,NN,F,6) in WIF-Extender <input type="checkbox"/> Black on Black <input type="checkbox"/> Pull Test</p> <p>14. Retrieve APFR/WIF-Extender</p> <p>15. Translate to SSRMS set-up worksite</p> | <p>Initial Condition: D-ring extender with left waist tether √Hooks locked</p> <p><u>EGRESS</u></p> <p>1. Open A/L thermal cover</p> <p>2. Egress A/L</p> <p>3. Connect 85-ft safety tether to HR anchor point aft √Anchor bail closed and slider locked √Reel end bails closed and double locked √Reels unlocked</p> <p>4. Temp stow (2) Crewlock bags</p> <p>5. Receive Med ORU bag and stow on BRT</p> <p>6. Connect EV1 85-ft safety tether to anchor point fwd √Anchor bail closed and slider locked</p> <p>7. √EV1 Safety tether config: Anchor bail closed, slider locked, and reel unlocked</p> <p>8. √EV1 SAFER MAN ISOL vlv – OP (dn) and HCM (dn) √ERCA – green LED</p> <p>9. INSPECT GLOVES</p> <p>10. Translate to SSRMS set-up worksite</p> |

S1 NTA REMOVAL

| IV | EV1 | EV2 |
|--|--|--|
| <p>SSRMS: EVA GCA Arm set-up pos</p> <div style="border: 1px solid black; padding: 5px; margin: 5px 0;"> <p style="text-align: center;">Safety tether swaps</p> <p>Starting tether swap √Local tether set</p> <p>Tether swap complete √Spare anchor on HR XXXX, bail closed, slider locked √Double-locked to the reel √Airlock tether stowed on HR XXXX √Reel unlocked</p> <p style="text-align: center;">Safety tether swap to A/L Tether</p> <p>Tether swap complete √Double-locked to the reel on my airlock tether √Spare tether stowed on t-bar √Reel unlocked</p> </div> <p>SSRMS: EVA GCA APFR ingress pos</p> <ol style="list-style-type: none"> Confirm EV2 is in good config for SSRMS translation, step 13 | <p><u>SET UP SSRMS</u></p> <ol style="list-style-type: none"> Hand off WIF-Extender/APFR to EV2 <p><u>REMOVE S1 NTA</u></p> <ol style="list-style-type: none"> Retrieve Med ORU bag and translate to P1 tether swap location INSPECT GLOVES | <p><u>SET UP SSRMS</u></p> <ol style="list-style-type: none"> Temp stow Med ORU bag top of CETA Spur As needed, GCA SSRMS to perform arm setup When time gap presents itself, perform tether swap onto SSRMS EE HR √Locally tethered to SSRMS √Spare tether anchored to EE HR √A/L tether stowed on S1 HR(3204) _____ √Anchor bail closed and slider locked √Reel end bails closed and double locked √Reels unlocked Install WIF Adapter into SSRMS (install tether point fwd) Install WIF X into WIF Adapter: CL: 6 P: A Ext: 7 <input type="checkbox"/> Black on Black <input type="checkbox"/> Pull Test Install APFR in WIF X [12, NN, F, 6] <input type="checkbox"/> Black on Black <input type="checkbox"/> Pull Test <p><u>REMOVE S1 NTA</u></p> <ol style="list-style-type: none"> Place soft dock in “non-capture” position √Local tether clear of SSRMS GCA SSRMS for APFR ingress Install Waist tether to APFR and ingress APFR PGT [B7 (25.5), CCW2, 30.5]-7.8"-Ext 5/8" – Release bolts (4) ~15-17.5 turns Install round scoop on bolt #1 Perform following before NTA released: <ol style="list-style-type: none"> Attach RET to NTA √Boots are locked into boot plate √Cooling, glove heaters, visor, tools, tethers √Soft dock in “non-capture” position Remove overgloves if required INSPECT GLOVES GCA SSRMS to remove the NTA (√Orientation of scoop) Once clear, give SSRMS operator GO for translation to ESP3 |

S1 NTA REMOVAL – TASK DATA

Estimated Task Duration:

| | With SSRMS | Without SSRMS |
|-------------|------------|---------------|
| One EV Crew | 00:50 | N/A |
| Two EV Crew | N/A | N/A |

Tools:

| EV1 | EV2 |
|-----|---|
| N/A | PGT Round Scoop 7.8 – 5/8" Rigid Socket WIF – X WIF Adapter APFR |

Foot Restraints:

| Task | WIF | APFR Setting |
|----------------|----------------------|-------------------|
| S1 NTA Removal | WIF – X in WIF Adap. | CL: 6 P: A Ext: 7 |
| S1 NTA Removal | APFR in WIF – X | 12, NN, F, 6 |

EVA Connectors:

| Harness | To | Clamps (#) | Conn size | Function |
|---------|--------|------------|-----------|----------|
| S1-P631 | NTA J1 | 2 | 15 | Data |
| S1-P632 | NTA J2 | 1 | 15 | Data |
| S1-P633 | NTA J3 | 3 | 17 | Power |

EVA Fluid QD's (Failed/Old/Empty NTA):

| Line Name | From | To | Clamps (#) | QD Size | Function |
|-----------|-----------|--------|------------|---------|-------------------|
| F46 | ATA QD M1 | NTA M2 | 3 | ¼ inch | Nitrogen pressure |
| F47 | ATA QD M2 | NTA M3 | 3 | ¼ inch | Nitrogen pressure |

Connector Inhibits:

| Task | Inhibit |
|------------------|--|
| S1-631 to NTA J1 | None required |
| S1-632 to NTA J2 | None required |
| S1-633 to NTA J3 | RPCM S1 2B_A RPC 10 – OPEN, CL CMD INH RPCM S1 1A_A RPC 11 – OPEN, CL CMD INH RPCM S1 1A_C RPC 12 – OPEN, CL CMD INH S1-1 MDM SDO Card Slot 8 Channels 0-6 Open |

EVA Fasteners:

| Fastener Name | Head Size | Qty | Install Torque (ft-lb) | Release Torque (ft-lb) | Failure Torque (ft-lb) | Turns |
|---------------------|-----------|-----|------------------------|------------------------|------------------------|---------|
| NTA Bolts (release) | 5/8 | 4 | N/A | 93.0 | 186.5 | 15-17.5 |
| NTA Bolts (install) | 5/8 | 4 | 24 | | 47.9 | 15-17.5 |

ORU Identification:

| ORU | Part number | Serial Number |
|--------|-------------|---------------------------------|
| S1 NTA | 1F96000-1 | 0002 (S1 EMPTY) 005 (ESP3 FULL) |

Notes:

1. Ensure Fluid QD lines routed under shroud straps

Cautions:

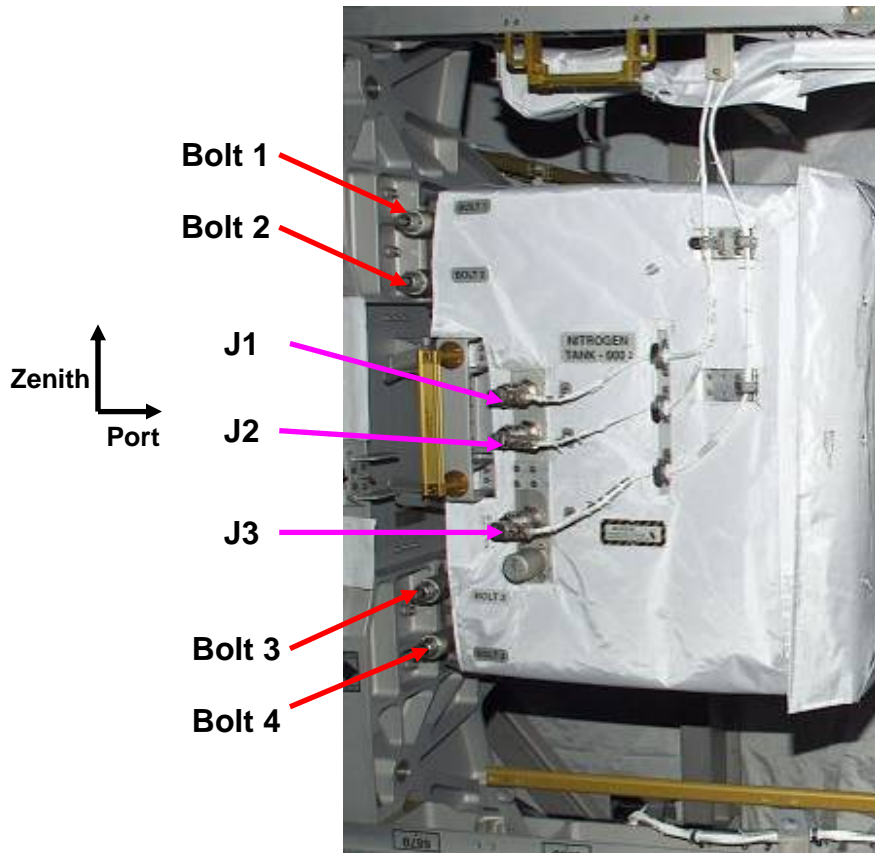
1. NTA Fluid QD lines and clamps may be hot if exposed to direct sun. Avoid contact until shaded ~20 min
2. Avoid pulling electrical cables. Avoid bend radii less than 10 times the cable diameter
3. The fluid line clamp nearest the line origin at the NTA must remain closed to prevent crimping

Warnings:

1. Verify electrical inhibits in place prior to electrical mate/demate
2. Verify S1 TRRJ rotation inhibits in place

S1 NTA REMOVAL – TASK DATA (Cont)

Nitrogen Tank Assembly (Front Side: Electrical Connectors & Bolts)



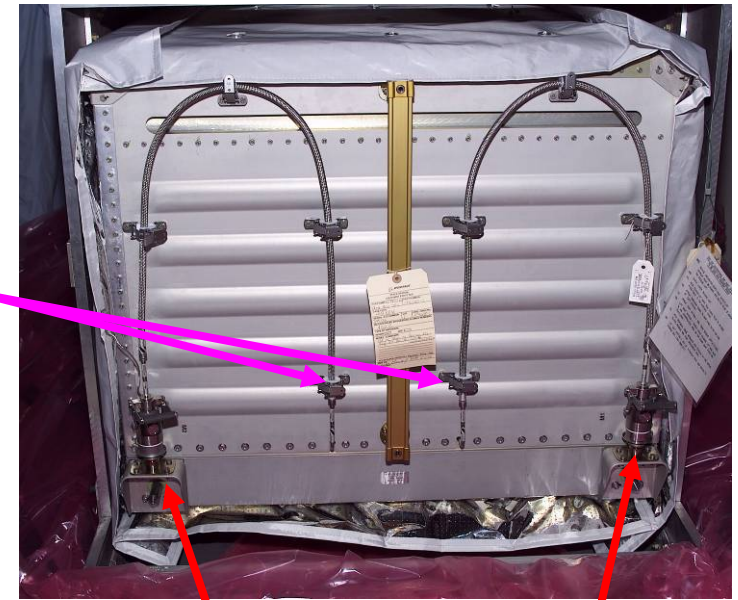
Fluid QD Line Names by NTA

| Old S1 NTA (Empty/Failed) | New S1 NTA (Full/Spare) Female Name/Dummy Male/ATA Male |
|---------------------------|--|
| F46 (Zenith) | F1/M2/M1 (Zenith) |
| F47 (Nadir) | F2/M3/M2 (Nadir) |

Nitrogen Tank Assembly (Aft Side: Electrical Connectors & Bolts)

Two N2 fluid QD lines on the Aft face of the NTA connect to the ATA on truss face 4

TA Clamp nearest each line origin must remain closed



M3 Dummy Receptacle (Spare NTA)

M2 Dummy Receptacle (Spare NTA)

SWAP NTA AT ESP3

| IV | EV1 | EV2 |
|---|---|---|
| <div style="border: 1px solid black; padding: 5px; margin-bottom: 10px;"> <p style="text-align: center;">Safety tether swaps</p> <p>Starting tether swap ✓Local tether set</p> <p>Tether swap complete ✓Spare anchor on HR XXXX, bail closed, slider locked ✓Double-locked to the reel ✓Airlock tether stowed on HR XXXX ✓Reel unlocked</p> <p style="text-align: center;">Safety tether swap to A/L Tether</p> <p>Tether swap complete ✓Double-locked to the reel on my airlock tether ✓Spare tether stowed on t-bar ✓Reel unlocked</p> </div> | <p><u>RETRIEVE ESP3 NTA</u></p> <ol style="list-style-type: none"> 1. Perform tether swap <ul style="list-style-type: none"> ✓Locally tethered ✓Spare tether anchored to P1 HR(3600) _____ ✓A/L tether stowed on P1 HR(3600) _____ ✓Anchor bail closed and slider locked ✓Reel end bails closed and double locked ✓Reels unlocked 2. Translate to ESP3 spare NTA 3. Temp Stow Med ORU bag (Zenith/Inboard/aft) 4. INSPECT GLOVES 5. NTA Prep for release: <ul style="list-style-type: none"> <input type="checkbox"/> Configure Fish Stringer on HR – Retrieve MLI RET <input type="checkbox"/> Open MLI flap 1 & ~2; attempt to keep tent intact <input type="checkbox"/> Verify APFR ESP-3 WIF 05 [12,FF,A,2] 6. Demate electrical connector caps (3) and temp stow 7. Ingress APFR 8. PGT [B7 (25.5), CCW2, 30.5]-7.8"-Ext 5/8" – Release bolts (4) ~15-17.5 turns 9. Perform following before last bolt released: <ol style="list-style-type: none"> a. Install RET onto NTA b. Retrieve Rd Scoop-MB from fish stringer c. Install Rd scoop-MB on bolt #3 d. Remove overgloves if required 10. Config PGT [B2 (16.0), CW2, 30.5] 11. Remove NTA from FRAM 12. Stow NTA Rd scoop-MB on HR(8316)_____ (Zenith) and RET to HR 13. Don overgloves if required 14. Egress APFR 15. Translate to Fwd side of MLI tent <p><u>STOW S1 NTA ON FRAM</u></p> <ol style="list-style-type: none"> 16. Assist EV2 with stowage of NTA on FRAM 17. Pass EV2 PGT for Bolt #4 | <p><u>STOW S1 NTA ON FRAM</u></p> <ol style="list-style-type: none"> 1. GCA SSRMS to install NTA onto FRAM 2. Stow NTA on FRAM 3. Receive PGT from EV1 |

SWAP NTA AT ESP3 (Cont)

| IV | EV1 | EV2 | | | | | | | | | | | | | | | | | | | | |
|--|--------|--------|---|---|---|--|--|--|---|--|--|--|---|--|--|--|---|--|--|--|---|--|
| <p>Stowed NTA Torque and Turns</p> <table border="1" data-bbox="107 418 562 581"> <thead> <tr> <th>Bolt #</th> <th>Torque</th> <th>Turns</th> <th>MTL <input checked="" type="checkbox"/></th> </tr> </thead> <tbody> <tr> <td>4</td> <td></td> <td></td> <td></td> </tr> <tr> <td>1</td> <td></td> <td></td> <td></td> </tr> <tr> <td>2</td> <td></td> <td></td> <td></td> </tr> <tr> <td>3</td> <td></td> <td></td> <td></td> </tr> </tbody> </table> <p>1. <input checked="" type="checkbox"/> Visually inspect MLI on NTA</p> <p>2. Tool Inventory EV1:</p> <p>3. Give EV crew big picture words</p> <p>4. Verify JTVE Inhibits in place</p> | Bolt # | Torque | Turns | MTL <input checked="" type="checkbox"/> | 4 | | | | 1 | | | | 2 | | | | 3 | | | | <p>18. PGT [B2 (16.0), CW2, 30.5]-7.8"-Ext 5/8":: engage each Bolt, 18-21 turns</p> <ul style="list-style-type: none"> <input type="checkbox"/> NTA Bolt 1 <input type="checkbox"/> NTA Bolt 2 <input type="checkbox"/> NTA Bolt 3 <p>19. Cycle PGT Ratchet collar to RCW; verify MTL = 30.5</p> <p>20. Using manual ratchet, drive NTA bolts 1-4 to MTL slip 3</p> <p>21. Connect electrical connector caps (3)</p> <p>22. Install MLI on NTA, retrieve RET</p> <p>23. Close all ¼ turn fasteners</p> <p>24. <input checked="" type="checkbox"/> Visually inspect MLI on NTA</p> <p><u>CLEANUP</u></p> <p>25. Retrieve and stow Rd scoop-MB</p> <p>26. Swap PGT socket to 6-Ext 7/16</p> <p>27. Perform tool inventory</p> <p>28. Retrieve Med ORU bag attach to boot plate of APFR</p> <p>29. Retrieve APFR</p> <p>30. INSPECT GLOVES</p> <p>31. Translate to tether swap location</p> <p>32. Perform tether swap</p> <ul style="list-style-type: none"> √Locally tethered √Double locked to A/L safety tether √Retrieve spare safety tether √Bails closed and reels unlocked | <p>4. PGT [B2 (16.0), CW2, 30.5] 7.8"-Ext 5/8":: engage Bolt #4 18-21 turns</p> <p>5. Remove Rd scoop from S1 NTA</p> <p><u>RETRIEVE SPARE NTA FROM SCOOP-MB</u></p> <p>6. GCA SSRMS to retrieve spare NTA from Rd scoop-MB</p> <p>7. Install Rd scoop onto bolt #1 of ESP3 NTA oriented parallel with NTA</p> <p>8. Attach RET to NTA before Rd scoop released</p> <p>9. Perform following before NTA is released:</p> <ul style="list-style-type: none"> a. Attach RET to NTA b. √Boots are locked into boot plate c. √Cooling, glove heaters, visor, tools, tethers d. INSPECT GLOVES <p>10. Release Rd scoop from spare NTA</p> <p>11. Give SSRMS operator GO to translate back to S1</p> |
| Bolt # | Torque | Turns | MTL <input checked="" type="checkbox"/> | | | | | | | | | | | | | | | | | | | |
| 4 | | | | | | | | | | | | | | | | | | | | | | |
| 1 | | | | | | | | | | | | | | | | | | | | | | |
| 2 | | | | | | | | | | | | | | | | | | | | | | |
| 3 | | | | | | | | | | | | | | | | | | | | | | |

SWAP NTA AT ESP3 – TASK DATA

Estimated Task Duration:

| | With SSRMS | Without SSRMS |
|-------------|------------|---------------|
| Two EV Crew | 00:30 | N/A |

Tools:

| EV1 | EV2 |
|-------------------------|-------------------------|
| BRT | BRT |
| PGT | PGT |
| 7.8 – 5/8" Rigid Socket | Round Scoop |
| APFR | 7.8 – 5/8" Rigid Socket |
| MUT | WIF – X |
| Ball Stack | WIF Adapter |
| Round Scoop | APFR |

EVA Fasteners:

| Fastener Name | Head Size | Qty | Install Torque (ft-lb) | Release Torque (ft-lb) | Failure Torque (ft-lb) | Turns |
|---------------|-----------|-----|------------------------|------------------------|------------------------|---------|
| NTA Bolts | 5/8 | 4 | 30.5 | 24 | 186.5 | 15-17.5 |

Foot Restraints:

| EV | Task | WIF | Setting |
|-----------|---------------|---------------|--|
| 1 (FF) | ESP3 NTA Prep | ESP2, WIF 5 | APFR [12,FF,A,2] |
| 2 (SSRMS) | ESP3 NTA Prep | SSRMS w/WIFEX | WIFEX CL: 6 P: A Ext: 7/APFR [12,NN,F,6] |

Inhibits:

| Task | Inhibit |
|---------------|---------|
| ESP3 NTA Prep | None |

ORU Identification:

| ORU | Part number | Serial Number |
|--------|-------------|---------------------------------|
| S1 NTA | 1F96000-1 | 0002 (S1 EMPTY) 005 (ESP3 FULL) |

Notes:

- Part numbers for the NTA caps
 - 2 each NGZL-RPC-N-15-0-LP (cloverleaf)
 - 1 each NGZL-RPC-N-17-0-MS (gas cap)

Cautions:

- Avoid pulling electrical cables. Avoid bend radii less than 10 times the cable diameter
- Avoid contact with grapple fixture shaft and pin


Warnings:



S1 NTA INSTALLATION (Cont)

| IV | EV1 | EV2 |
|--|-----|---|
| <p>BLOCK A – DEMATE QD</p> <ol style="list-style-type: none"> 1. ✓ Detent button – up 2. Assess & counteract side loads 3. Pull back on release ring 4. Demate QD 5. ✓ Fwd white band not visible (✓ release ring - retracted) <p>BLOCK B – MATE QD</p> <ol style="list-style-type: none"> 1. Inspect QDs for FOD or damage 2. ✓ Detent button – up 3. ✓ Fwd white band – not visible 4. Assess & counteract side loads 5. Mate QD 6. ✓ Fwd white band – visible 7. Snapback test (✓ Fwd white band still visible) 8. Pull test 9. Visual gap test 10. Assess Side loads before Valve Open <p>BLOCK C – Open Valve</p> <ol style="list-style-type: none"> 1. Press detent button – down, move bail fwd 2. ✓ Aft white band visible; ✓ Detent button – up 3. Verify detent button can be depressed <ol style="list-style-type: none"> 1. Inform MCC-H: S1 NTA FQDs Mated and valves Open 2. Give EV crew big picture words <p><u>NOTE:</u> Depending on Crew and Time, either crewmember may retrieve CP9 camera</p> | | <ol style="list-style-type: none"> 19. Stow APFR in A/L stbd tool box (6,XX,F,6) report settings <ul style="list-style-type: none"> <input type="checkbox"/> Black on Black <input type="checkbox"/> Pull Test 20. Translate to crewlock bag at A/L <ul style="list-style-type: none"> <input type="checkbox"/> Retrieve 7/16 socket stow on PGT <input type="checkbox"/> Stow: 5/8 socket, Rd Scoop, WIF Adapter, and wire ties 21. Stow WIF-Extender in ESP-2 WIF 3 (Stbd), report settings <ul style="list-style-type: none"> <input type="checkbox"/> Black on Black <input type="checkbox"/> Pull Test <p><u>S1 NTA FQD CONNECTION</u></p> <ol style="list-style-type: none"> 22. Translate to aft side of S1 NTA 23. Remove overgloves if required 24. Open S1 thermal shroud <div data-bbox="1320 824 1923 951" style="border: 1px solid black; padding: 5px; margin: 10px 0;"> <p style="text-align: center;"><u>CAUTION</u></p> <p style="text-align: center;">The fluid line clamp nearest the line origin at the NTA must remain closed to prevent crimping</p> </div> <ol style="list-style-type: none"> 25. Open TA clamps holding FQD lines <p style="text-align: center;"><u>NOTE</u></p> <p style="text-align: center;">Ensure Fluid QD lines routed under shroud straps</p> 26. On IV GO: Demate NTA fluid line QD F1 (zenith)/F2 (nadir) from NTA dummy receptacle M2 (zenith)/M3 (nadir) BLOCK A 27. On IV GO: Mate QD F1 (zenith)/F2 (nadir) BLOCK B to ATA QD M1 (zenith)/M2 (nadir) 28. Open valve BLOCK C 29. <input type="checkbox"/> Visually inspect FQDs 30. Repeat steps for other NTA FQD 31. Verify thermal booties installed on fluid lines 32. Close clamps on NTA 33. <input type="checkbox"/> Visually inspect FQD thermal booties and clamps 34. Close S1 thermal shroud |

S1 NTA INSTALLATION (Cont)

| IV | EV1 | EV2 |
|----|-----|---|
| | | <ul style="list-style-type: none">35.  Visually inspect thermal shroud36. INSPECT GLOVES37. Don overgloves if required38. Translate to A/L, retrieve CP9 camera (ETVCG) |

S1 NTA INSTALLATION – TASK DATA

Estimated Task Duration:

| | With SSRMS | Without SSRMS |
|-------------|------------|---------------|
| One EV Crew | 01:40 | N/A |

Tools:

| EV1 | EV2 |
|-----|---|
| N/A | PGT Round Scoop 7.8 – 5/8" Rigid Socket WIF – X WIF Adapter APFR |

Foot Restraints:

| EV | Task | WIF | Setting |
|-----------|---------------|---------------|---|
| 1 (FF) | ESP3 NTA Prep | ESP3, WIF 5 | APFR [12,FF,A,2] |
| 2 (SSRMS) | ESP3 NTA Prep | SSRMS w/WIF-X | WIFEX CL:6 P: A Ext: 7/APFR [12,NN,F,6] |

EVA Connectors:

| Harness | To | Clamps (#) | Conn size | Function |
|---------|--------|------------|-----------|----------|
| S1-P631 | NTA J1 | 2 | 15 | Data |
| S1-P632 | NTA J2 | 1 | 15 | Data |
| S1-P633 | NTA J3 | 3 | 17 | Power |

EVA Fluid QDs (Spare/New/Full Tank):

| Line Name | From | To | Clamps (#) | QD Size | Function |
|------------|--------------|-----------|------------|---------|-------------------|
| (F2/M3/M2) | NTA Dummy M3 | ATA QD M2 | 3 | ¼ inch | Nitrogen pressure |
| (F1/M2/M1) | NTA Dummy M2 | ATA QD M1 | 3 | ¼ inch | Nitrogen pressure |

Connector Inhibits:

| Task | Inhibit |
|------------------|--|
| S1-631 to NTA J1 | None required |
| S1-632 to NTA J2 | None required |
| S1-633 to NTA J3 | RPCM S1 2B_A RPC 10 – OPEN, CL CMD INH RPCM S1 1A_A RPC 11 – OPEN, CL CMD INH RPCM S1 1A_C RPC 12 – OPEN, CL CMD INH S1-1 MDM SDO Card Slot 8 Channels 0-6 Open |

EVA Fasteners:

| Fastener Name | Head Size | Qty | Install Torque (ft-lb) | Release Torque (ft-lb) | Failure Torque (ft-lb) | Turns |
|---------------------|-----------|-----|------------------------|------------------------|------------------------|---------|
| NTA Bolts Engage S1 | 5/8 | 4 | 24.0 | N/A | 47.9 | 15-17.5 |

ORU Identification:

| ORU | Part number | Serial Number |
|--------|-------------|---------------------------------|
| S1 NTA | 1F96000-1 | 0002 (S1 EMPTY) 005 (ESP3 FULL) |

Notes:

1. Ensure Fluid QD lines routed under shroud straps

Cautions:

1. NTA Fluid QD lines and clamps may be hot if exposed to direct sun. Avoid contact with hardware until shaded ~20 min
2. Avoid pulling electrical cables. Avoid bend radii less than 10 times the cable diameter
3. The fluid line clamp nearest the line origin at the NTA must remain closed to prevent crimping

Warnings:

1. Verify electrical inhibits in place prior to connector mates
2. Verify TRRJ anti-rotation inhibits in place for N2 line access

WVE/EVE TASK – WINDOW LL – ACBM MMOD SHIELDS – SSRMS CLEANUP TASKS

| IV | EV1 | EV2 | | | | | | | | | |
|---|--------|--------|-------|----------|--|--|----------|--|--|--|--|
| <p>Safety tether swaps Starting tether swap √Local tether set</p> <p>Tether swap complete √Spare anchor on HR XXXX, bail closed, slider locked √Double-locked to the reel √Airlock tether stowed on HR XXXX √Reels Unlocked</p> <p>Safety tether swap to A/L Tether Tether swap complete √Double-locked to the reel on my airlock tether √Spare tether stowed on t-bar √Reels Unlocked</p> <p>ACBM MMOD Shield Door Bolts</p> <table border="1" data-bbox="107 1003 592 1101"> <thead> <tr> <th>Bolt</th> <th>Torque</th> <th>Turns</th> </tr> </thead> <tbody> <tr> <td>Fwd Door</td> <td></td> <td></td> </tr> <tr> <td>Aft Door</td> <td></td> <td></td> </tr> </tbody> </table> <p>1. Give EV crew big picture words</p> <p>2. When EV crew clear of JPM end cone give GO to check out JPM window shutter</p> <p><u>NOTE:</u> Depending on Crew and Time, either crewmember may retrieve CP9 camera</p> | Bolt | Torque | Turns | Fwd Door | | | Aft Door | | | <p><u>JEM RMS WVE/EVE</u></p> <ol style="list-style-type: none"> Translate to JPM RMS via Lab Strut to Lab Install APFR in Lab WIF 7 any settings (6,PP,F,12) _____ <input type="checkbox"/> Black on Black <input type="checkbox"/> Pull Test Retrieve Med ORU bag and stow on BRT Translate to tether swap location for WVE/EVE task Perform tether swap – Remove overgloves if required √Locally tethered √Spare tether anchored to JEM PM HR (1105) _____ √A/L tether stowed on JEM PM HR (1131) _____ √Anchor bail closed and slider locked √Reel end bails closed and double locked √Reels unlocked <div data-bbox="884 748 1213 808" style="border: 1px solid black; padding: 5px; text-align: center;"> <p>CAUTION Avoid contact with JTVEs</p> </div> <ol style="list-style-type: none"> Temp stow Med ORU bag HR(1119) _____ INSPECT GLOVES Release WVE MLI (Release one 1/4 turn fastener and release Velcro strap) PGT [B7 (25.5), CCW2, 30.5] -6" Ext-7/16": – launch lock bolts (5). Expect 15-16 turns (base bolts last) Attach Velcro MLI to base bolt holes <input type="checkbox"/> Visually inspect MLI around WVE and EVE Stow LL and MLI in Med ORU bag HR(1119) _____ Repeat steps 8-12 for EVE MLI and LL (EVE LL has 4 bolts) <p><u>RELEASE AFT WINDOW LAUNCH LOCK BOLTS</u></p> <ol style="list-style-type: none"> PGT [A6 (8.3), CCW2, 30.5] -6" Ext-7/16": – Release launch lock bolts (3); ~10 turns <p><u>DEPLOY FWD AND AFT ACBM MMOD SHIELDS</u></p> <ol style="list-style-type: none"> PGT [A2 (3.8), CCW2, 30.5] -6" Ext-7/16": – Release locking bolt; ~10 turns and rotate handle to the deploy position PGT [A2 (3.8), CW2, 30.5] 6" Ext-7/16": – Install locking bolt on cover; ~10 turns | |
| Bolt | Torque | Turns | | | | | | | | | |
| Fwd Door | | | | | | | | | | | |
| Aft Door | | | | | | | | | | | |

WVE/EVE TASK – WINDOW LL – ACBM MMOD SHIELDS – SSRMS CLEANUP TASKS (Cont)

| IV | EV1 | EV2 |
|----|--|-----|
| | <p>17. Repeat steps 15-16 for other shield 18. INSPECT GLOVES</p> <p><u>CLEANUP</u> 19. Retrieve Med ORU bag 20. Translate to tether swap location</p> <p>21. Perform tether swap ✓Locally tethered ✓Double locked to A/L safety tether ✓Retrieve spare safety tether ✓Bails closed and reels unlocked – Don overgloves if required</p> <p>22. Translate back to A/L to stow Med ORU bag</p> | |

JEM RMS WVE/EVE – TASK DATA

Estimated Task Duration:

| | With SSRMS | Without SSRMS |
|-------------|------------|---------------|
| One EV Crew | N/A | N/A |
| Two EV Crew | N/A | 01:15 |

ORU Identification:

| ORU | Part number | Serial Number |
|---------------------|-------------------------|---------------|
| EVE/WVE MLI Cover | 06463750/ 06463750 | N/A |
| EVE/WVE Launch Lock | 006464116/ 006466125 | N/A |

ORU Specs:

| ORU | Dimensions (in/mm) | Mass (lb/kg) |
|-----------------|---------------------------------------|--------------|
| EVE MLI Cover | 17.20x25.12x15.55/ 437x638x395 | 2.37/1.06 |
| WVE MLI Cover | 18.31x22.36x14.76/ 465x568x375 | 2.37/1.06 |
| EVE Launch Lock | 4.63x6.36x11.67/ 117.5x161.6x296.3 | 4.76/2.16 |
| WVE Launch Lock | 4.55x8.15x12.17/ 115.5x207x309.2 | 5.22/2.37 |

Tools:

| | EV1 | EV2 |
|------------------------------|-----|-----|
| PGT 6" ext – 7/16" Socket | | |

Foot Restraints:

| Task | WIF | APFR Setting |
|-------------------|-----|--------------|
| WVE/EVE LL | N/A | N/A |
| WVE/EVE Joint MLI | N/A | N/A |

Connector Inhibits:

| Task | Inhibit |
|-------------------|---------|
| WVE/EVE LL | None |
| WVE/EVE Joint MLI | None |

Fasteners:

| Fastener Name | Head Size | Qty | Install Torque (ft-lb) | Release Torque (ft-lb) | Failure Torque (ft-lb) | Turns |
|-----------------|-----------|-----|------------------------|------------------------|------------------------|----------------------|
| EVE Launch Lock | 7/16" | 4 | - | 18.3 | 33.0 | 15-Upper 16-Lower |
| WVE Launch Lock | 7/16" | 5 | - | 18.3 | 33.0 | 15-Upper 16-Lower |

Notes:

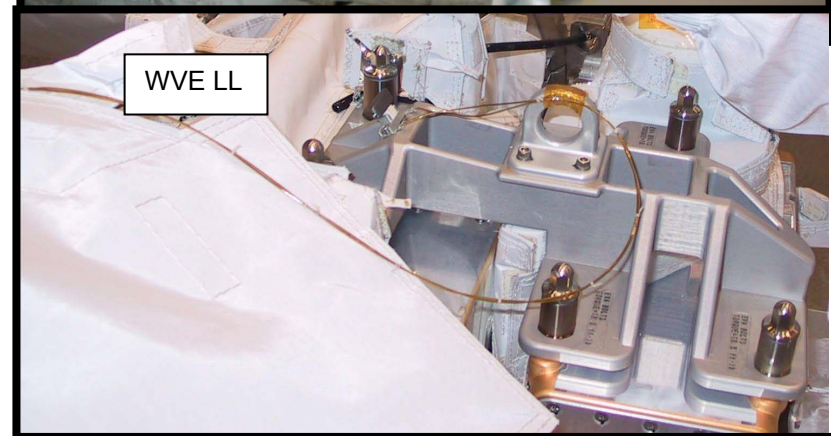
1. The launch lock for both EVE and WVE are attached together by grounding wire
2. WVE has 5 bolts
3. EVE has 4 bolts
4. One of quarter turn fasteners for EVE/WVE MLI is on launch lock itself

Cautions:

1. Avoid contact with light, white paint and silver surfaces

Warnings:

1. Pinch hazard – after LL released, WVE/EVE free to move



RELEASE JEM WINDOW LAUNCH LOCKS – TASK DATA

JEM Window Launch Lock (LL) Release

Estimated Task Duration:

| | With SSRMS | Without SSRMS |
|-------------|------------|---------------|
| One EV Crew | N/A | 00:15 |
| Two EV Crew | N/A | N/A |

Tools:

| EV1 (FF) | EV2 |
|------------------------------|-----|
| PGT 6" ext – 7/16" Socket | N/A |

Foot Restraints:

| Task | WIF | APFR Setting |
|---------------|-----|--------------|
| JEM Window LL | N/A | N/A |

Connector Inhibits:

| Task | Inhibit |
|---------------|---------|
| JEM Window LL | NONE |

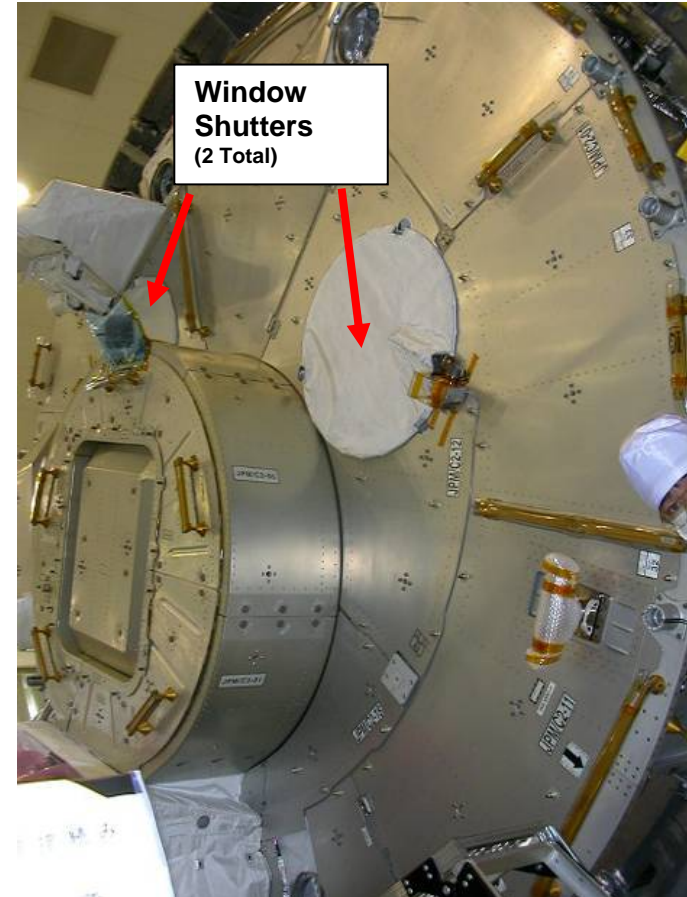
Fasteners:

| Fastener Name | Head Size | Qty | Install Torque (ft-lb) | Release Torque (ft-lb) | Failure Torque (ft-lb) | Turns |
|---|-----------|-------------------------|------------------------|------------------------|------------------------|--------|
| JEM Fwd/Aft (2 Window Shutters Total) Window Launch Locks | 7/16 | 3 each window – 6 Total | 5.3 | 6.2 | 31.0 | 9-10.5 |

Notes:

Cautions:

Warnings:



DEPLOY PORT AND STBD ACBM MMOD SHIELDS – TASK DATA

JEM ACBM MMOD Shield Deploy

Estimated Task Duration:

| | With SSRMS | Without SSRMS |
|-------------|------------|---------------|
| One EV Crew | N/A | 00:30 |

Tools:

| EV1 | EV2 |
|------------------------------|-----|
| PGT 6" ext – 7/16" Socket | N/A |

Foot Restraints:

| Task | WIF | APFR Setting |
|-------------------------|-----|--------------|
| ACBM MMOD Shield Ops | N/A | N/A |

EVA Fasteners:

| Fastener Name | Head Size | Qty | Install Torque (ft-lb) | Release Torque (ft-lb) | Failure Torque (ft-lb) | Turns |
|---------------------------|-----------|------------------|------------------------|------------------------|------------------------|-------|
| ACBM Handle Cover Bolt | 7/16" | 2 (1Fwd/1Aft) | 2.1 | 2.1 | 16.0 | >10 |

Notes:

1. There is a ball detent to keep the MMOD door open

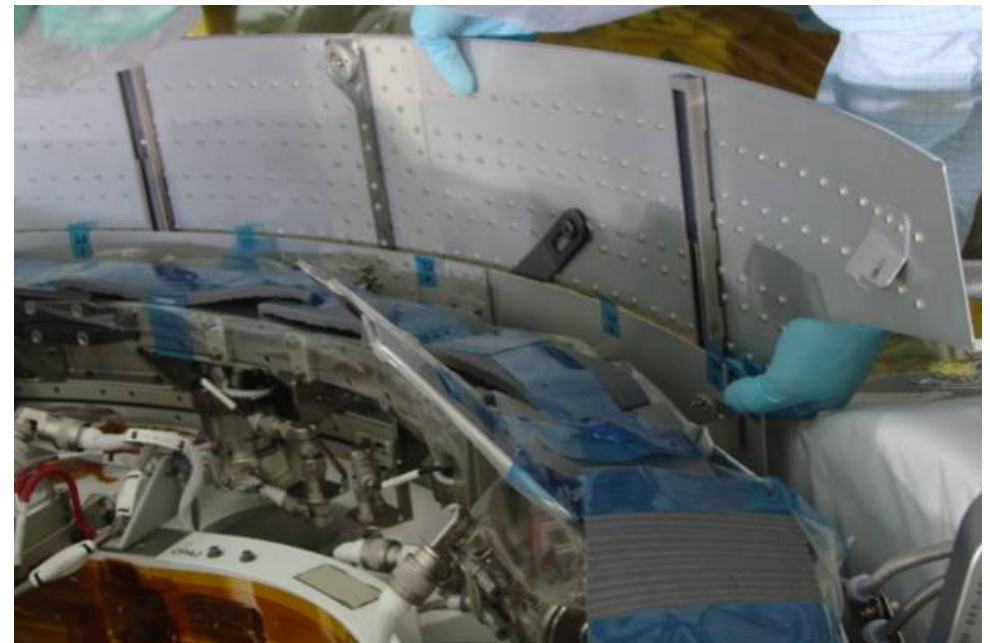
Cautions:

1. N/A

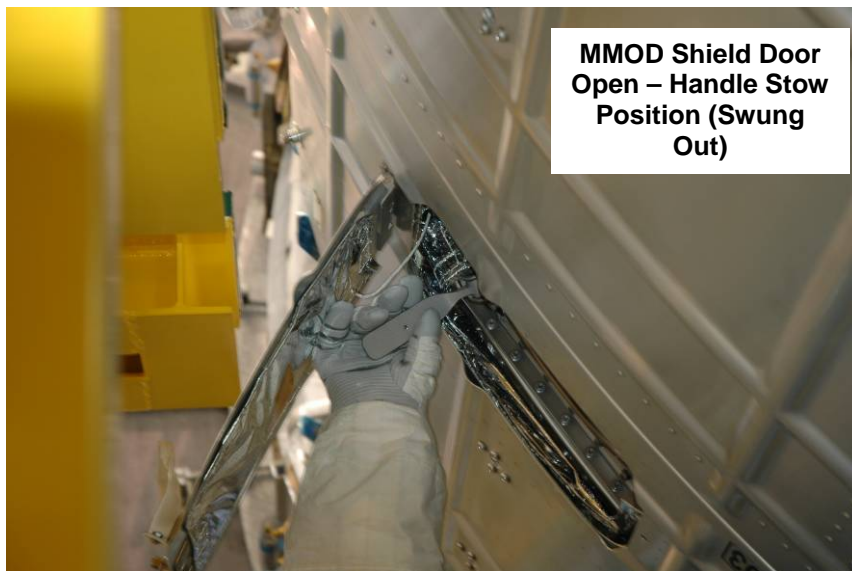
Warnings:

1. N/A

ACBM Shield Deployed



DEPLOY PORT AND STBD ACBM MMOD SHIELDS – TASK DATA (Cont)



CP 9 ETVCG INSTALL

| IV | EV (FF) | | | | | | | | | | | | |
|--|---------|--------|-------|--------|--|--|-------------|--|--|-------------|--|--|--|
| <p>1. √MCC-H ETVCG Inhibits in place:</p> <p>RPCM P11A_A RPC 1 OPEN AND CLOSE INH RPCM P11A_A RPC 15 OPEN AND CLOSE INH RPCM P12B_A RPC 2 OPEN AND CLOSE INH RPCM P12B_A 16 OPEN AND CLOSE INH</p> <p>Camera Bolts:</p> <table border="1" style="width: 100%; border-collapse: collapse;"> <thead> <tr> <th>Bolt</th> <th>Torque</th> <th>Turns</th> </tr> </thead> <tbody> <tr> <td>Center</td> <td></td> <td></td> </tr> <tr> <td>Outer (fwd)</td> <td></td> <td></td> </tr> <tr> <td>Outer (aft)</td> <td></td> <td></td> </tr> </tbody> </table> <p>2. Give MCC-H GO to Power up camera</p> | Bolt | Torque | Turns | Center | | | Outer (fwd) | | | Outer (aft) | | | <p style="text-align: center;"><u>NOTE</u> Either crewmember may perform</p> <p><u>CAMERA RETRIEVAL FROM A/L</u></p> <ol style="list-style-type: none"> 1. Retrieve Camera/large ORU bag from A/L (leave Lg-sm RET on camera/bag); stow on BRT 2. Close airlock thermal cover 3. √SAFER MAN ISOL vlv – OP (dn) and HCM (dn) 4. Translate toward P1/P3 interface; fairlead to keep tether clear of TRRJ/Radiator 5. Perform tether swap <ul style="list-style-type: none"> √Locally tethered √Spare tether anchored to P1 HR _____ √A/L tether stowed on P1 HR _____ √Anchor bail closed and slider locked √Reel end bails closed and double locked √Reel unlocked 6. Translate to P1 Camera Install location (CP9) 7. Temp stow camera/large ORU bag 8. Fairlead around HR 3679 9. INSPECT GLOVES <p><u>DUMMY BOX REMOVAL</u></p> <ol style="list-style-type: none"> 10. Tether to dummy box 11. PGT [A5 (7.0), CCW2, MTL 30.5] -6" Ext -7/16": <input type="checkbox"/> <input type="checkbox"/> Release dummy box left and right captive fasteners 7-12 turns 12. PGT[A5(7.0), CCW2, MTL 30.5] -6" Ext-7/16": <input type="checkbox"/> Release center jack screw 24-30 turns 13. Remove dummy box; stow into bag 14. Inspect blind mate connector on stanchion <p><u>CAMERA INSTALL</u></p> <ol style="list-style-type: none"> 15. RET to light tether point 16. Retrieve camera 17. Inspect blind mate connector on stanchion and camera 18. Install camera on the stanchion by sliding it along two guide pins into soft dock position 19. Remove round scoop; stow into large ORU bag 20. PGT[A7(9.2), CW2, MTL 30.5] -6" Ext 7/16": Push in and engage center jack bolt to hardstop ~24-30 turns. Report torque and turns 21. Visually check for contact between CAMERA front wedge and support structure 22. PGT[A7(9.2), CW2, MTL 30.5] -6" -Ext 7/16": Push in and engage left and right fasteners to hardstop ~7-12 turns. Report torque and turns |
| Bolt | Torque | Turns | | | | | | | | | | | |
| Center | | | | | | | | | | | | | |
| Outer (fwd) | | | | | | | | | | | | | |
| Outer (aft) | | | | | | | | | | | | | |

CP 9 ETVCG INSTALL (Cont)

| IV | EV (FF) |
|-----------|--|
| | 23. Unlock camera pan/tilt unit 24. Perform Tool Inventory 25. INSPECT GLOVES 26. Retrieve large ORU bag 27. Translate to tether swap location 28. Perform tether swap √Locally tethered √Double locked to A/L safety tether √Retrieve spare safety tether √Bails closed and reels unlocked 29. Translate to A/L |

CP 9 ETVCG INSTALL – TASK DATA

Estimated Task Duration:

| | Without SSRMS |
|-------------|---------------|
| One EV Crew | 1.0 |

Tools:

*Can be performed by either crew member

| EV1 (FF) | EV2 |
|-------------|-----|
| PGT | N/A |
| Round Scoop | |
| BRT | |

EVA Fasteners:

| Fastener Name | Head Size | Qty | Install Torque (ft-lb) | Failure Torque (ft-lbs) | Turns | RPM |
|--------------------|-----------|-----|---------------------------|----------------------------------|-----------------------------|--------------------------|
| Outer bolts | 7/16" | 2 | 9.2 (release and install) | 14.8 (release)/ 13.2 install) | 6-12 (release and install) | 30 (release and install) |
| Center (Jack) Bolt | 7/16" | 1 | 9.2 (release and install) | 14.8 (release)/ 13.2 install) | 24-30 (release and install) | 30 (release and install) |

Connector Inhibits:

| Task | Inhibit |
|-----------------------|--|
| P1 – J1 Blind mate | RPCM P11A_A RPC 1 OPEN AND CLOSE INH RPCM P11A_A RPC 15 OPEN AND CLOSE INH RPCM P12B_A RPC 2 OPEN AND CLOSE INH RPCM P12B_A 16 OPEN AND CLOSE INH |

Notes:

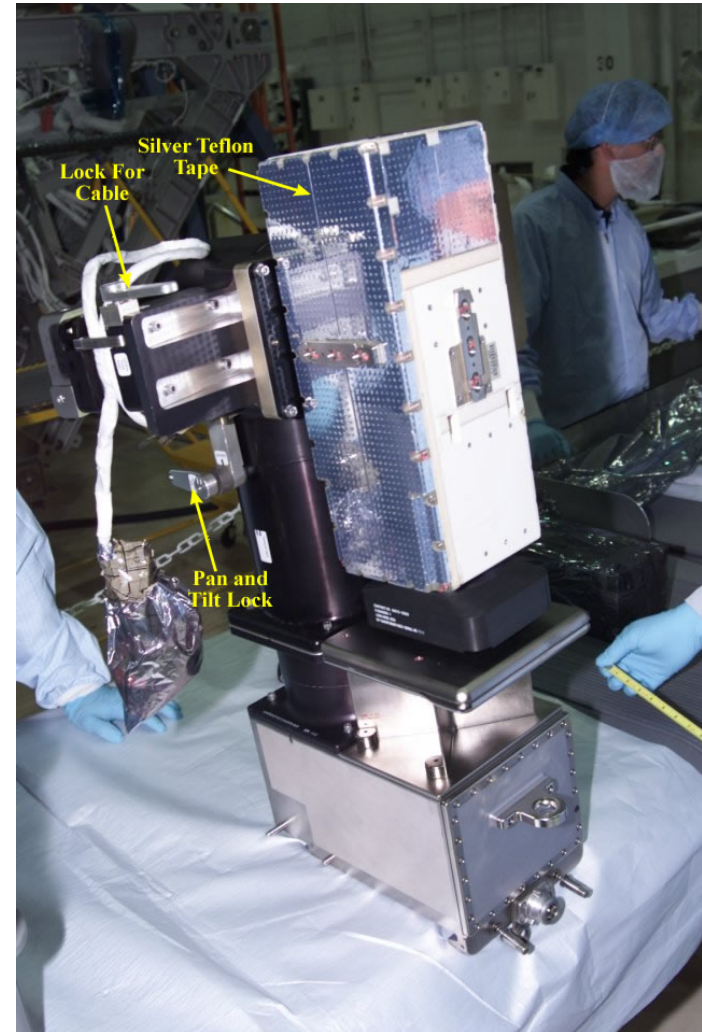
1. The Camera bolts have no hard stop. They free spin when released
2. There is no anti-rotation device on the camera bolts
3. Camera soft dock force is ~10 lb
4. An equipment hook will not fit around camera tether point; light tether point must be used
5. Pan/tilt unit lock lever requires a push to turn the lever 90 deg to go from lock to unlock, and from unlock back to lock. Both unlock and lock positions sit in detents
6. If pan/tilt lock lever becomes unlocked, pan/tilt joints can begin to move and back-drive motor. This is undesirable and can damage the hardware
7. Pan/tilt lock lever can only be locked if pan/tilt mechanism is in home position (camera lens facing TVCIC bolt box)

Cautions:

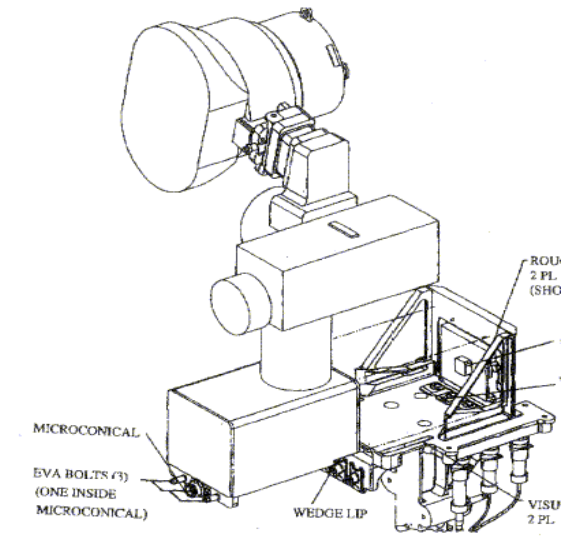
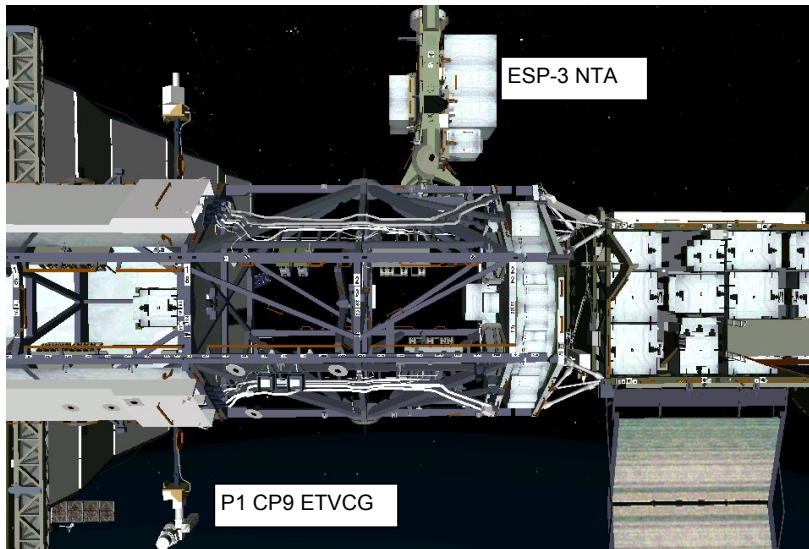
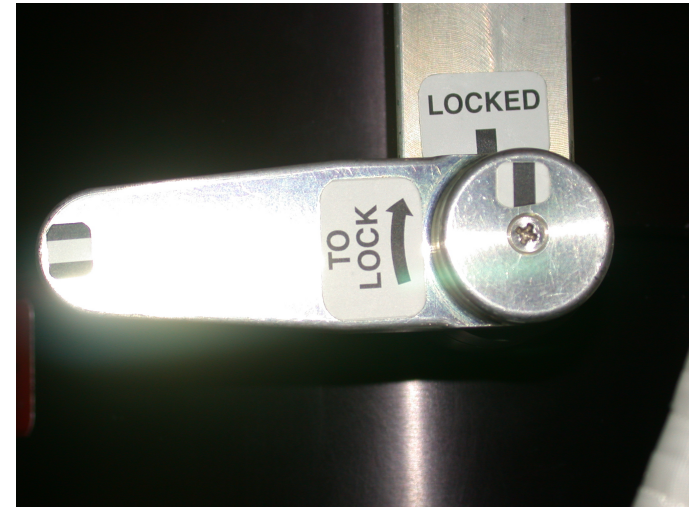
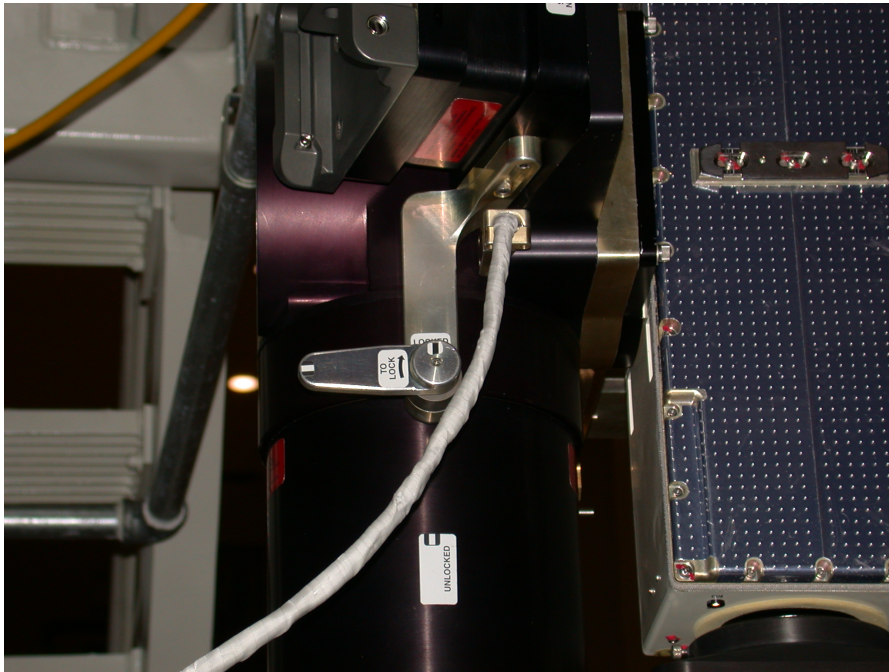
1. Avoid contact with light (Z-93 paint) and camera (silver Teflon)

Warnings:

Timeline Considerations:



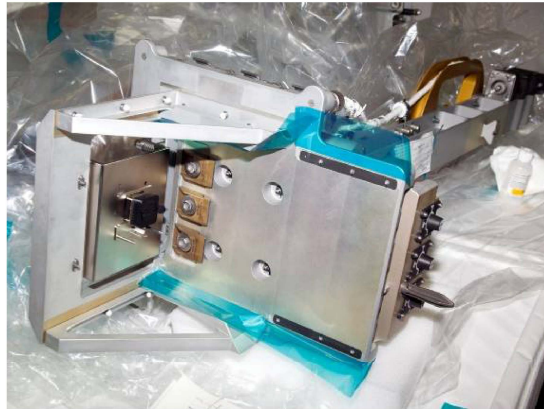
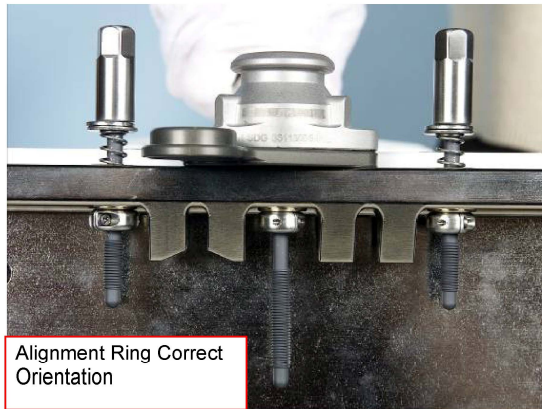
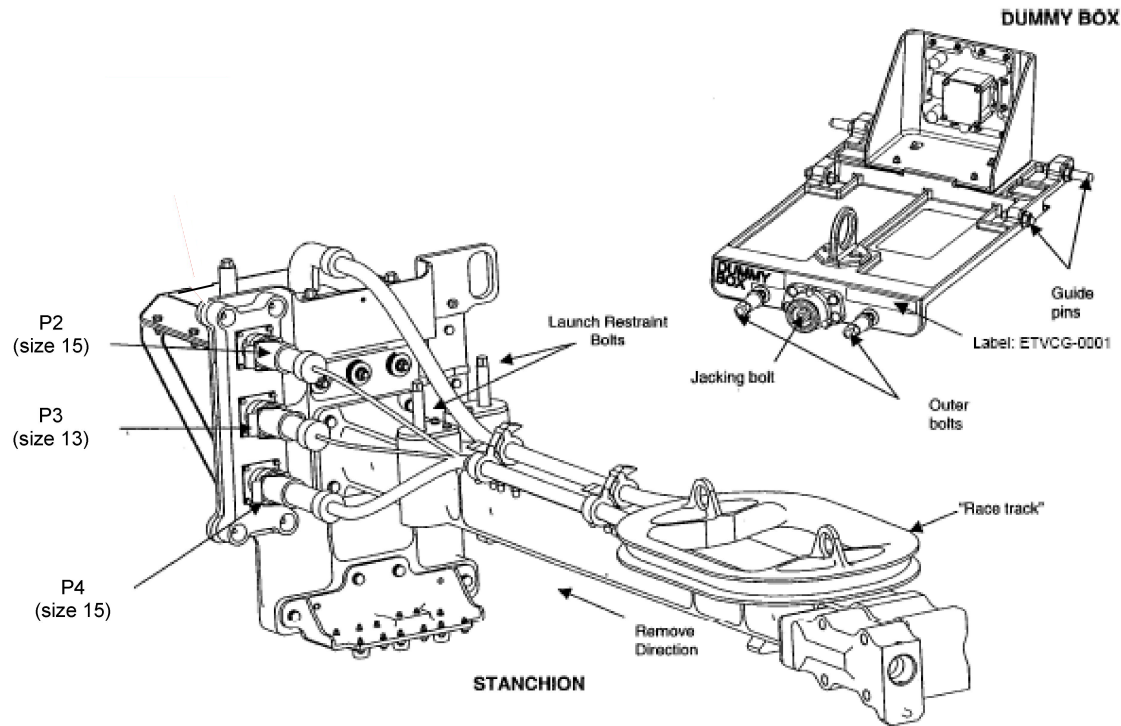
CP 9 ETVCG INSTALL – TASK DATA (Cont)



ARINC on TVCIC which interfaces with the EVGSS.

ETVCG

CP 9 ETVCG INSTALL – TASK DATA (Cont)



1J EVA GET-AHEADS INHIBIT PAD

WETA

WETA Inhibits, to be performed for WETA installation:

- MCC-H
1. RPCM S31A_A RPC 15 – Open, Close Cmd Inhibit
RPCM S31A_A RPC 16 – Open, Close Cmd Inhibit
 2. RPCM S32B_A RPC 15 – Open, Close Cmd Inhibit
RPCM S32B_A RPC 16 – Open, Close Cmd Inhibit

WETA

TRRJ

MCC-H S1 TRRJ:

1. √DLA (1) – LOCKED at any angle

S3/S4 SARJ LAUNCH RESTRAINT REMOVAL

SARJ

MCC-H

Stbd SARJ:

1. √DLA (1) – LOCKED
2. All motor setpoints set to zero
3. All motors deselected

OR

4. Both DLAs – LOCKED

S1/P1 FHRC P-CLAMP RELEASE

TRRJ

MCC-H If EV crew working within 2 ft of S1 or P1 TRRJ rotation envelope:

For FHRC Hose Box P-Clamps

1. √DLA (1) – LOCKED

For FHRC Torque Box P-Clamps

1. √DLA (1) – LOCKED at 0 deg

NODE 2 FLUID QD THERMAL BLANKET INSTALL

SSPTS Inhibits, to be performed prior to Node 2 Fluid QD thermal blanket install

MCC If EV crew < 2 ft from ungrounded SSPTS connector:

1. RPCM LA2A3B_D RPC 1 – Open, Close Cmd Inhibit
2. RPCM Z13B_A RPC 2 – Open, Close Cmd Inhibit
3. RPCM LA1A4A_D RPC 3 – Open, Close Cmd Inhibit
4. RPCM Z14B_A RPC 2 – Open, Close Cmd Inhibit

PORT SARJ INSPECTION

SARJ

MCC-H



Port SARJ:

1. √DLA (1) – LOCKED
2. All motor setpoints set to zero
3. All motors deselected

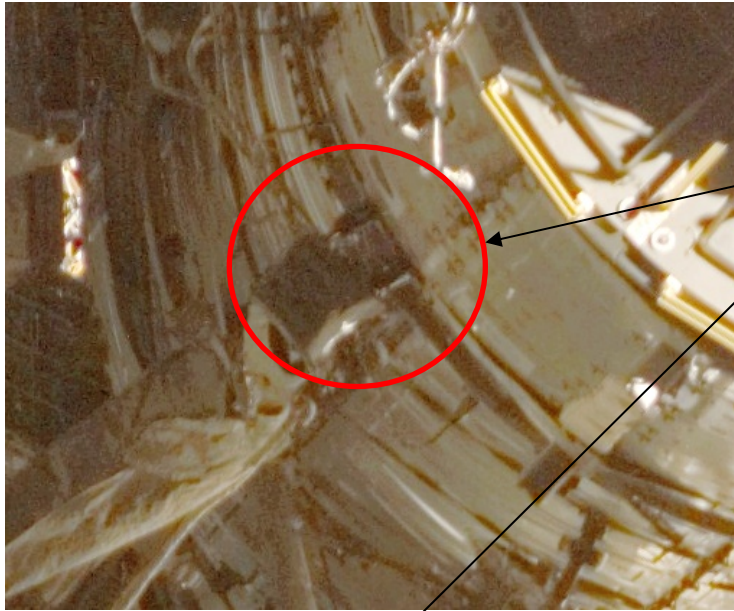
OR

4. Both DLAs – LOCKED

NODE 2 QD THERMAL BLANKET INSTALL

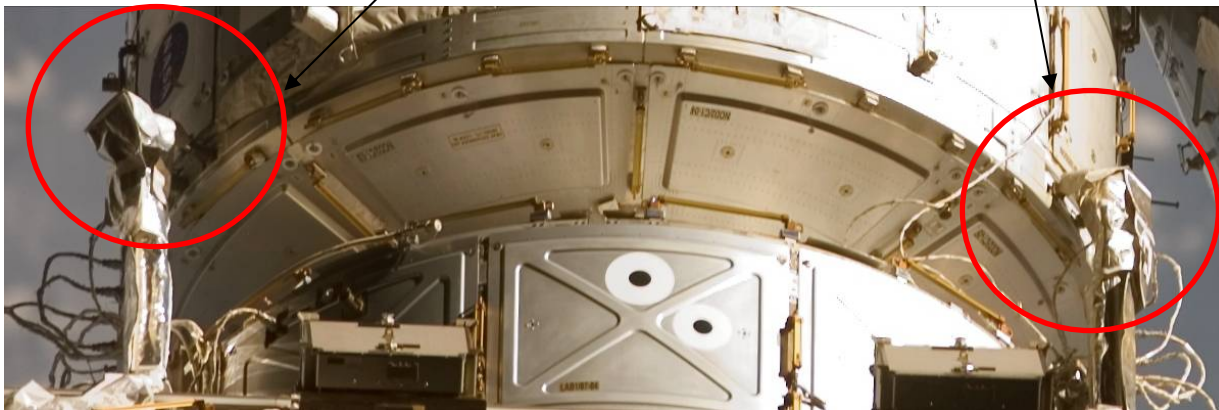
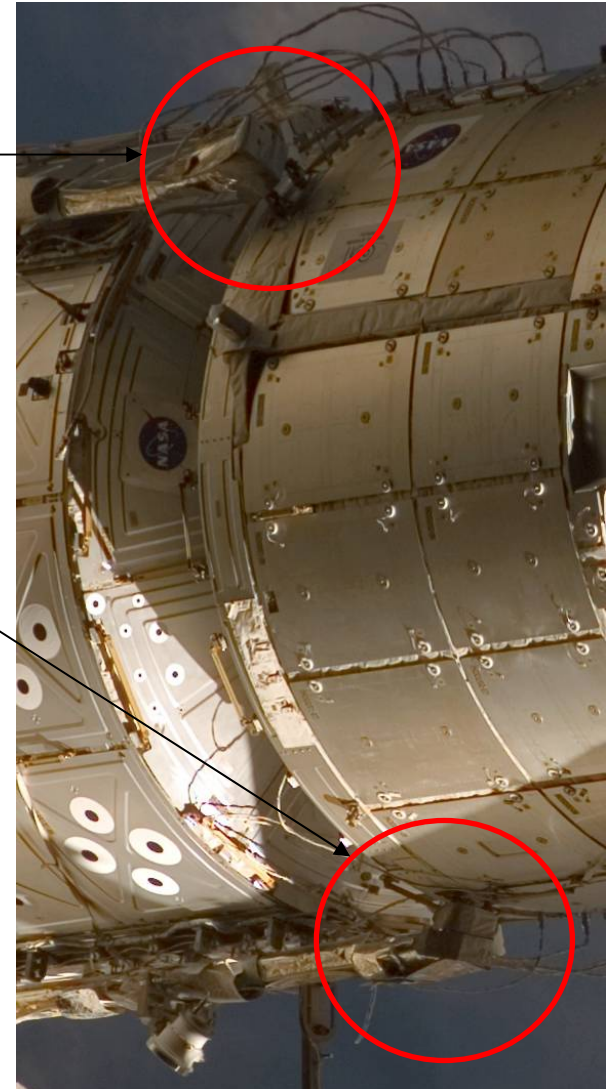
| IV | EV1 (FF) | EV2 (FF) |
|--|--|--|
| <p>1. √MCC-H SSPTS Inhibits in place</p> | <div data-bbox="627 261 1157 375" style="border: 3px double black; padding: 5px; text-align: center;"> <p>WARNING Crew Shock hazard: 2 ft KOZ of SSPTS connectors Stbd/Fwd of Lab</p> </div> <div data-bbox="648 407 1184 508" style="border: 1px solid black; padding: 5px; text-align: center;"> <p>CAUTION Limit handling loads to < 25 lb on Fluid QDs and lines</p> </div> <p><u>THERMAL BLANKET INSTALL</u></p> <ol style="list-style-type: none"> 1. Don overgloves if required 2. Translate to Node 2 Fluid QDs 3. Use preconfigured short wire tie to attach to one of QD bails 4. Wrap MLI around pair of QDs 5. Wrap preconfigured long wire tie around MLI to secure it or wire tie from second MLI tether point (on outside) to handrail or other item nearby to hold MLI wrapped around QDs 6.  Visually inspect MLI 7. Repeat steps for other side 8. Translate to A/L | <div data-bbox="1373 261 1902 375" style="border: 3px double black; padding: 5px; text-align: center;"> <p>WARNING Crew Shock hazard: 2 ft KOZ of SSPTS connectors Stbd/Fwd of Lab</p> </div> <div data-bbox="1373 407 1908 508" style="border: 1px solid black; padding: 5px; text-align: center;"> <p>CAUTION Limit handling loads to < 25 lb on Fluid QDs and lines</p> </div> <p><u>THERMAL BLANKET INSTALL</u></p> <ol style="list-style-type: none"> 1. Don overgloves if required 2. Translate to Node 2 Fluid QDs 3. Use preconfigured short wire tie to attach to one of QD bails 4. Wrap MLI around pair of QDs 5. Wrap preconfigured long wire tie around MLI to secure it or wire tie from second MLI tether point (on outside) to handrail or other item nearby to hold MLI wrapped around QDs 6.  Visually inspect MLI 7. Repeat steps for other side 8. Translate to A/L |

NODE 2 QD THERMAL BLANKET INSTALL – TASK DATA

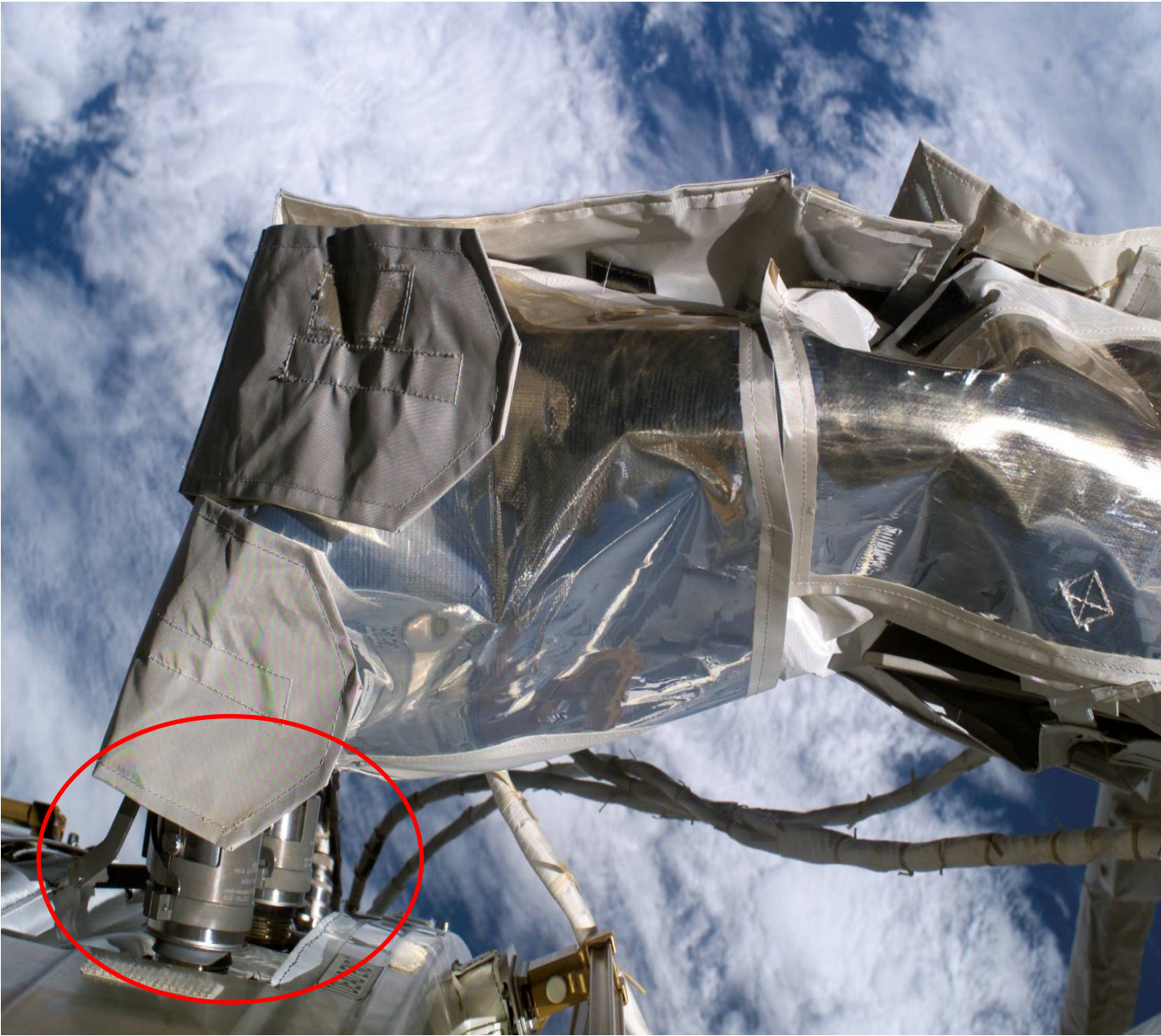


Port QDs

Stbd QDs



NODE 2 QD THERMAL BLANKET INSTALL – TASK DATA (Cont)



NODE 2 QD THERMAL BLANKET INSTALL – TASK DATA (Cont)



Proof of concept from NBL mockup

Reference only: These photos do not imply specific blankets to be used for this task



Node 2 MLI blanket section, Post EVA



Node 2 MLI blanket section, pre-flight

WETA INSTALL CP1

| IV | EV1 | EV2 |
|--|---|--|
| <p>1. √MCC-H WETA inhibits in place:</p> <p>RPCM S31A_A RPC 15 – Open, Close Cmd Inh RPC 16 – Open, Close Cmd Inh</p> <p>RPCM S31A_A RPC 15 – Open, Close Cmd Inh RPC 16 – Open, Close Cmd Inh</p> | <p style="text-align: center;"><u>NOTE</u> Either crewmember may perform</p> <p><u>WETA RETRIEVAL</u></p> <ol style="list-style-type: none"> 1. Translate to A/L if reqd 2. Assist EV2 as reqd 3. Translate to S0; fairlead near CETA spur (w/adj on HR 3413) 4. Translate via Face 1 S1/S3 interface (keep visual on EV2 & WETA) 5. Perform tether swap S1 if reqd <ul style="list-style-type: none"> √Locally tethered √Spare tether anchored to S1 HR _____ √A/L tether stowed on S1 HR _____ √Anchor bail closed and slider locked √Reel end bails closed and double locked √Reels unlocked 6. Translate Zenith/Aft at Bay 17 to S3 Face 4 WETA Install location (CP-1), inboard of VSSA <p><u>DUMMY BOX REMOVAL</u></p> <ol style="list-style-type: none"> 7. Tether to dummy box 8. PGT [A5 (7.0), CCW2, MTL 30.5] -6" -Ext 7/16": <ul style="list-style-type: none"> <input type="checkbox"/> <input type="checkbox"/> Release dummy box left and right captive fasteners 7-12 turns 9. PGT[A5 (7.0), CCW2, MTL 30.5] -6"Ext 7/16": <ul style="list-style-type: none"> <input type="checkbox"/> Release center jack screw 24-30 turns 10. Remove dummy box; stow in bag for return to A/L <p><u>WETA INSTALL</u></p> <ol style="list-style-type: none"> 11. Receive WETA from EV2 12. Install WETA on the stanchion by sliding it along two guide pins into soft dock position 13. Remove round scoop; stow in bag for return to A/L 14. PGT[A7 (9.2), CW2, MTL 30.5]-6" -Ext 7/16": | <p style="text-align: center;"><u>NOTE</u> Either crewmember may perform</p> <p><u>WETA RETRIEVAL</u></p> <ol style="list-style-type: none"> 1. Retrieve WETA w/round scoop from airlock (leave Lg-sm RET in A/L); stow on BRT 2. Close airlock thermal cover 3. √SAFER MAN ISOL viv – OP (dn) and HCM (dn) 4. Translate via nadir path toward S1/S3 interface, Fairlead to keep tether clear of TRRJ/Radiator 5. Perform tether swap S1 if reqd <ul style="list-style-type: none"> √Locally tethered √Spare tether anchored to S1 HR _____ √A/L tether stowed on S1 HR _____ √Anchor bail closed and slider locked √Reel end bails closed and double locked √Reels unlocked 6. Translate to S3 Face 4 WETA Install location (CP1), outboard of VSSA; poor man fairlead after grapple fixture <p><u>WETA INSTALL</u></p> <ol style="list-style-type: none"> 7. Hand WETA to EV1 |

WETA INSTALL CP1 (Cont)

| IV | | | EV1 | EV2 |
|-------------------------------------|--------|-------|---|---|
| | Torque | Turns | <p>Push in and engage center jack bolt to hardstop ~24-30 turns</p> <p>← Report torque and turns</p> <p>15. Visually check for contact between WETA front wedge and support structure</p> <p>16. PGT[A7 (9.2), CW2, MTL 30.5]-6"-Ext 7/16": Push in and engage left and right fasteners to hardstop ~7-12 turns</p> <p>← Report torque and turns</p> <p>17. Remove thermal shroud from WETA; stow in bag for return to A/L</p> <p>18. Perform Tool Inventory</p> <p>19. Inspect gloves</p> <p>20. Translate to tether swap location</p> <p>21. Perform tether swap</p> <ul style="list-style-type: none"> √Locally tethered √Double locked to A/L safety tether √Retrieve spare safety tether √Bails closed and reels unlocked <p>22. Translate to A/L</p> | <p>8. Retrieve EVA Scissors from Crewlock bag and cut Lacing cord on connector caps</p> <p>9. On IV GO: Demate deadface connectors and connector cap from panel A78 J2, J3 and J4; temp stow</p> <p>10. Release TA Clamps</p> <p>11. Demate W8200 cable connectors P2, P3 and P4 from dummy panel A296</p> <p>12. Mate W8200 cable connectors to S3 panel A78 receptacles</p> <ul style="list-style-type: none"> <input type="checkbox"/> P2 to J2 <input type="checkbox"/> P3 to J3 <input type="checkbox"/> P4 to J4 <p>13. Mate deadface connectors and cap to A296 dummy panel</p> <p>14. Give IV/MCC-H GO to power up WETA</p> <p>15. Wire Tie cables as necessary</p> <p>16. Perform Tool Inventory</p> <p>17. Inspect gloves</p> <p>18. Translate to S1 tether swap location if required</p> <p>19. Perform tether swap</p> <ul style="list-style-type: none"> √Locally tethered √Double locked to A/L safety tether √Retrieve spare safety tether √Bails closed and Reels unlocked <p>20. Translate to A/L</p> |
| WETA (Center) | | | | |
| WETA (Outer – Left/stbd) | | | | |
| WETA (Outer – Right/port) | | | | |
| 2. Give MCC-H GO to power up WETA | | | | |

WETA ANTENNA INSTALL – TASK DATA

Estimated Task Duration:

| | With SSRMS | Without SSRMS |
|-------------|------------|---------------|
| One EV Crew | N/A | Approx 01:10 |
| Two EV Crew | N/A | 01:15 |

ORU Identification:

| ORU | Part number | Serial Number |
|------|--------------|---------------|
| WETA | 16103320-301 | 1003 |

ORU Specs:

| ORU | Dimensions (in) | Mass (lb) |
|------|-----------------|-----------|
| WETA | 34x18x18 | 105.8 |

Tools:

| EV2 (FF) | EV3 (FF) |
|------------------------------|------------------|
| PGT | PGT |
| 7/16 x 6" wobble | 7/16 x 6" wobble |
| Round Scoop (on WETA in A/L) | |
| Wire ties | |

Foot Restraints: None

EVA Fasteners:

| Fastener Name | Head Size | Qty | Install Torque (ft-lb) | Release Torque (ft-lb) | Failure Torque (ft-lb) | Turns | RPM |
|--------------------|-----------|-----|------------------------|------------------------|------------------------|-----------|-----|
| Dummy Box (Outer) | 7/16 | 2 | N/A | 7.0 | 17.1 | 6.8-11.8 | 30 |
| Dummy Box (Center) | 7/16 | 1 | N/A | 7.0 | 17.1 | 24.4-30.4 | 30 |
| WETA (Outer) | 7/16 | 2 | 9.2 | N/A | 13.2 | 6.8-12.8 | 30 |
| WETA (Center) | 7/16 | 1 | 9.2 | N/A | 13.2 | 24.4-30.4 | 30 |

Electrical Connectors:

| Harness | From | To | Conn Size |
|---------------------|------------------|------------------|-----------|
| Dead Face Connector | S3 J2 | VSSA Dummy Panel | |
| Dead Face Connector | S3 J3 | VSSA Dummy Panel | |
| Connector Cap | S3 J4 | VSSA Dummy Panel | |
| W8200-P2 | VSSA Dummy Panel | S3 J2 | 15 |
| W8200-P3 | VSSA Dummy Panel | S3 J3 | 13 |
| W8200-P4 | VSSA Dummy Panel | S3 J4 | 15 |

Connector Inhibits:

1. RPCM S31A_A RPC 15 – Open, Close Cmd Inhibit
2. RPCM S31A_A RPC 16 – Open, Close Cmd Inhibit
3. RPCM S32B_A RPC 15 – Open, Close Cmd Inhibit
4. RPCM S32B_A RPC 16 – Open, Close Cmd Inhibit

Timeline Considerations

1. N/A

Notes:

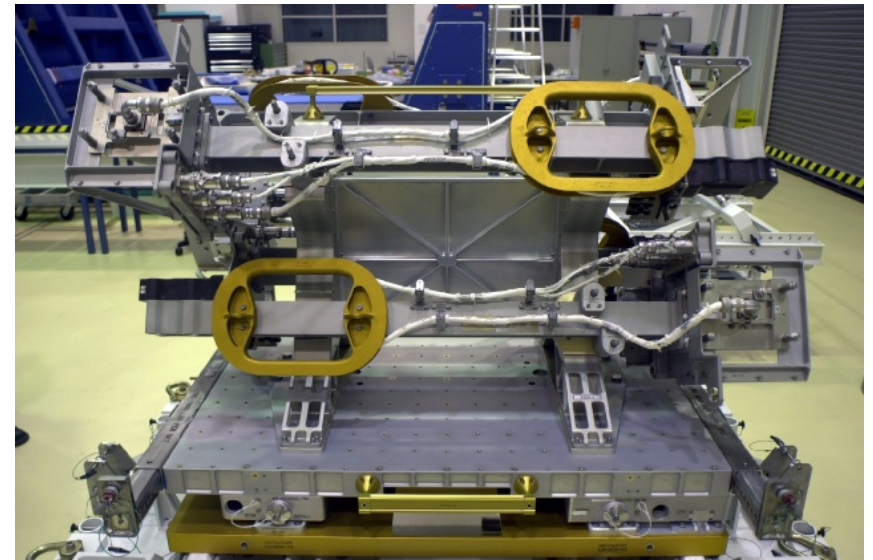
1. Dummy panel A296 is on bottom of VSSA mounting plate ~4 ft from S3 face 4; S3 A78 is just inside S3 face 4
2. Thermal clock is 9 hrs w/MLI or 4 hrs without MLI

Cautions:

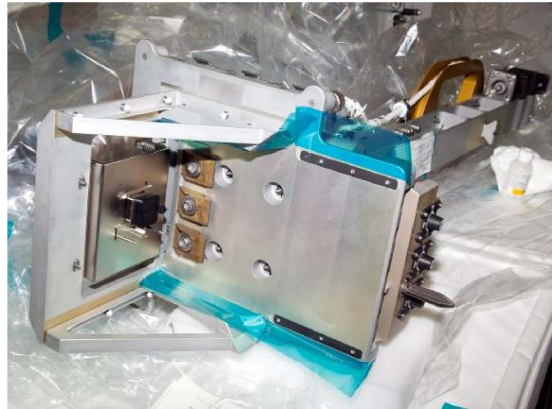
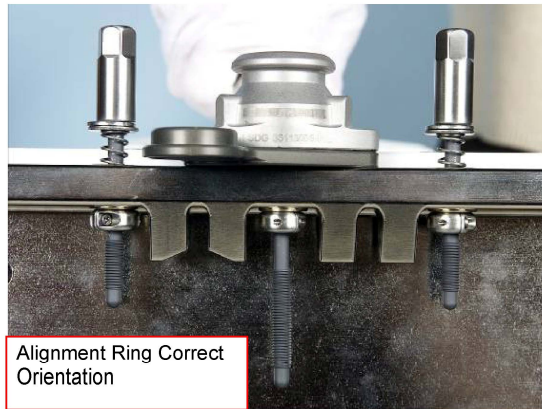
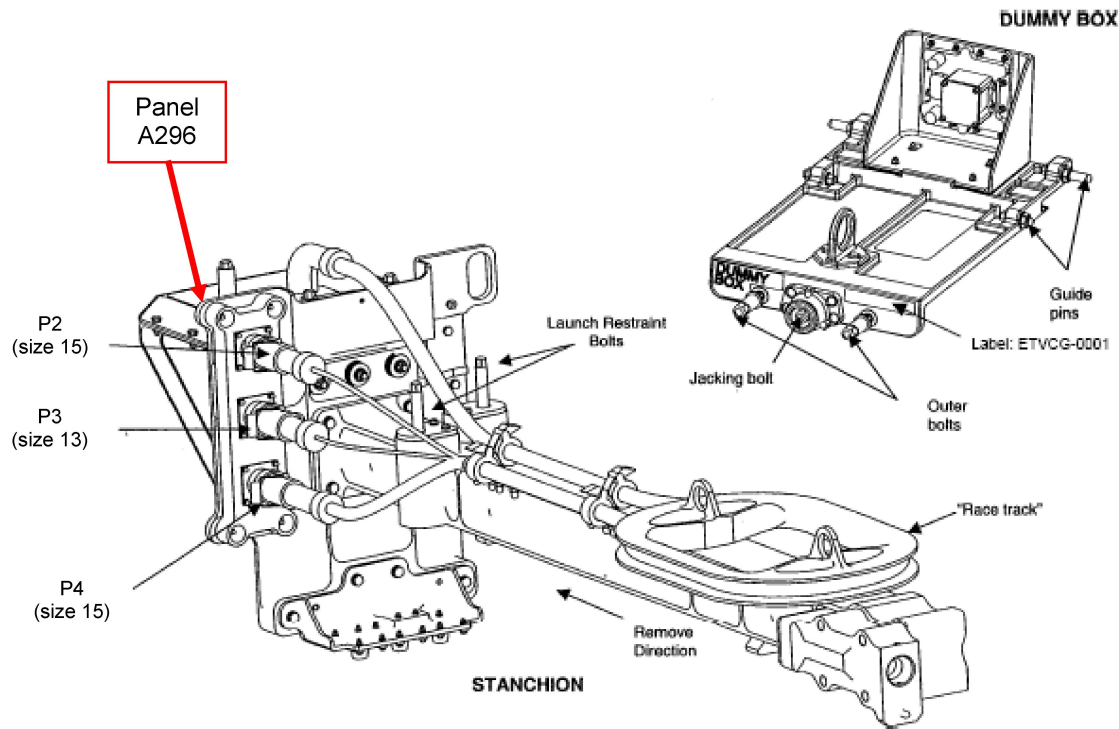
1. N/A

Warnings:

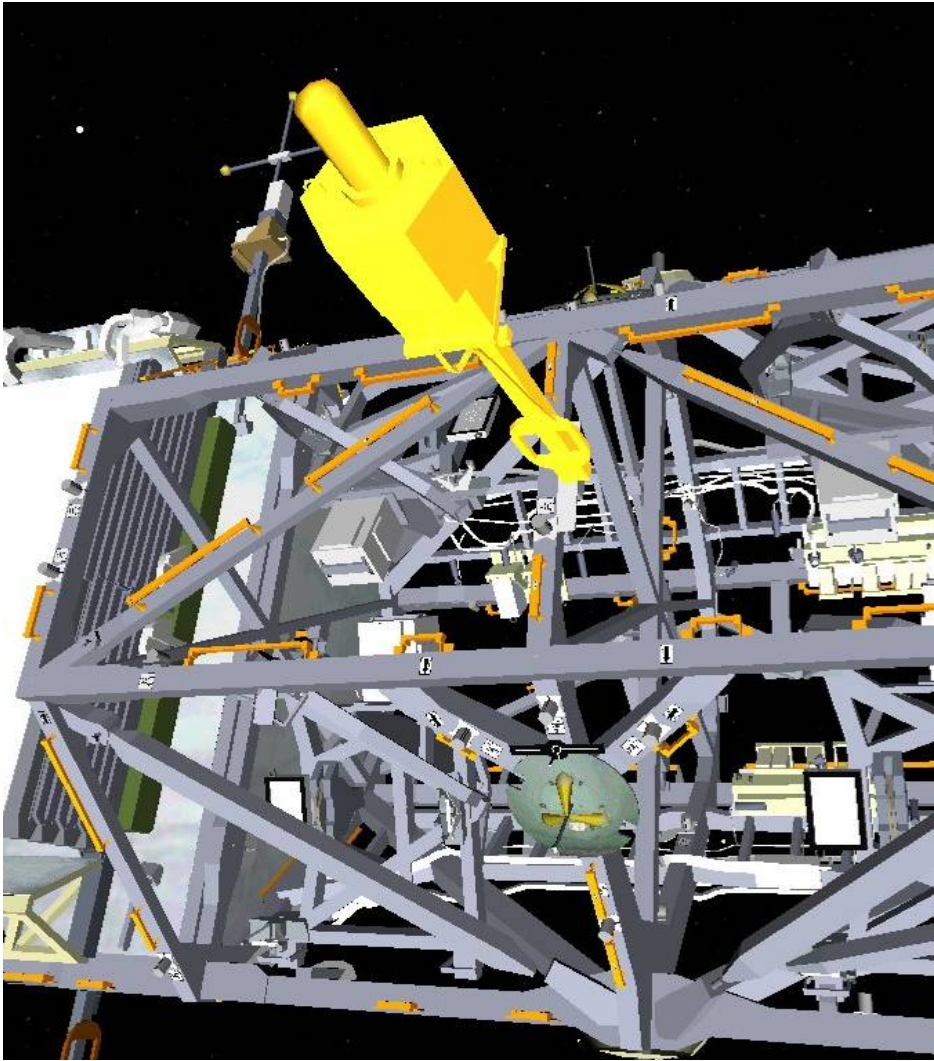
1. N/A



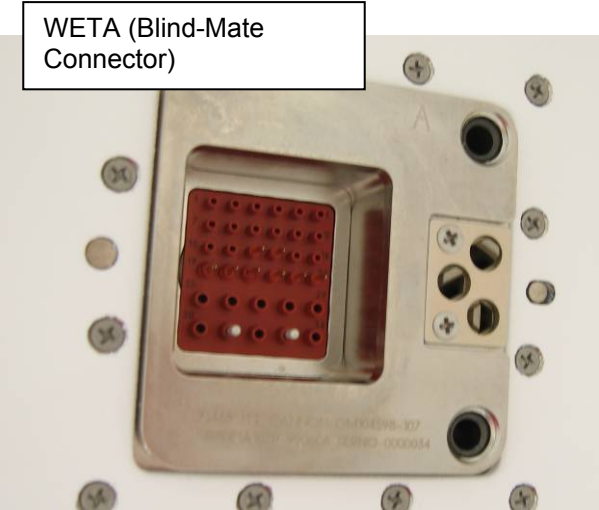
WETA ANTENNA INSTALL – TASK DATA (Cont)



WETA ANTENNA INSTALL – TASK DATA (Cont)



WETA ANTENNA INSTALL – TASK DATA (Cont)



S3/S4 SARJ LAUNCH RESTRAINT REMOVAL

| IV | EV (FF) |
|----|---|
| | <p><u>REMOVE SARJ LAUNCH RESTRAINT</u></p> <ol style="list-style-type: none"> 1. Deploy Tether Shuttle Stop 2. Temp stow Med ORU bag 3. Ratchet wrench-9 ext7/16: Break torque on retaining bolts (2) (55 ft-lb) 4. Tether to rail stub and clam shell 5. PGT[B7 (25.5), CCW2, 30.5]-6" -Ext 7/16": Release retaining bolts (2) 9 turns <div style="border: 1px solid black; padding: 5px; margin: 10px auto; width: fit-content;"> <p style="text-align: center;">CAUTION Do not exceed 9 turns on clam shell jack bolt</p> </div> <ol style="list-style-type: none"> 6. If both side of clamshell not loosened on "mushroom-shaped" fittings – PGT[B7 (25.5), CCW2, 30.5]-6" Ext 7/16": Release jack bolt (1) up to 3 turns 7. PGT[B7 (25.5), CCW2, 30.5]-6" -Ext 7/16": Release retaining bolts (2) (~9 turns) 8. Remove clam shell from "mushroom-shaped" fitting 9. Stow clam shell and rail stub in Med ORU bag 10. Repeat steps for remaining SLRs, as time permits 11. Retrieve Med ORU bag 12. INSPECT GLOVES 13. Translate back to A/L 14. Tether swap <ul style="list-style-type: none"> √Locally tethered √Double locked to A/L safety tether √Retrieve spare safety tether |

S3/S4 SARJ LAUNCH RESTRAINT REMOVAL – TASK DATA

Estimated Task Duration:

| | With RMS | Without RMS |
|-------------|----------|-------------|
| One EV Crew | NA | 01:45 |
| Two EV Crew | NA | NA |

Tools:

| EV3 (FF) | EV4 (FF) |
|-------------------------|-------------------------|
| PGT | PGT |
| 6 Ext 7/16 | 6 Ext 7/16 |
| APFR | APFR |
| Medium ORU transfer bag | Medium ORU transfer bag |
| Large trash bag | Ratchet wrench |
| Ratchet wrench | |

EVA Fasteners:

| Fastener Name | Label | Head | Qty | Install Torque (ft-lb) | Release Torque (ft-lb) | Failure Torque (ft-lb) | Turns | RPM |
|---------------------------------|-------|------|---------------|--------------------------|------------------------|------------------------|-----------|-------------------------|
| MLI Cover Inboard Fasteners | NA | 7/16 | 4-6 per cover | 3.1-3.6 gnd 2.5 on orbit | 3.4 | 13.7 | 7-9 | 60 remove 30 install |
| SARJ Launch Restraint Fastener | NA | 7/16 | 2 per | 52.1-56.3 | 55.4 | 165.2 | 18 | 60 |
| SARJ Launch Restraint Jack Bolt | NA | 7/16 | 1 per | 3.9-12.5 | 12.0 | 139.3 | 3 (9 max) | 30 |

EVA Connectors:

| Harness | From | To | Clamps (#) | Conn Size | Function |
|---------|------|----|------------|-----------|----------|
| NA | | | | | |

General Notes:

- The SARJ Launch Restraint (SLR) clamshell comes off in three attached pieces via lanyards. The SLR consists of two clam shell halves retained by two (2) captive EVA bolts on the outer edges, with a central EVA jackscrew and a EVA tether loop on the upper half of the clamshell assembly

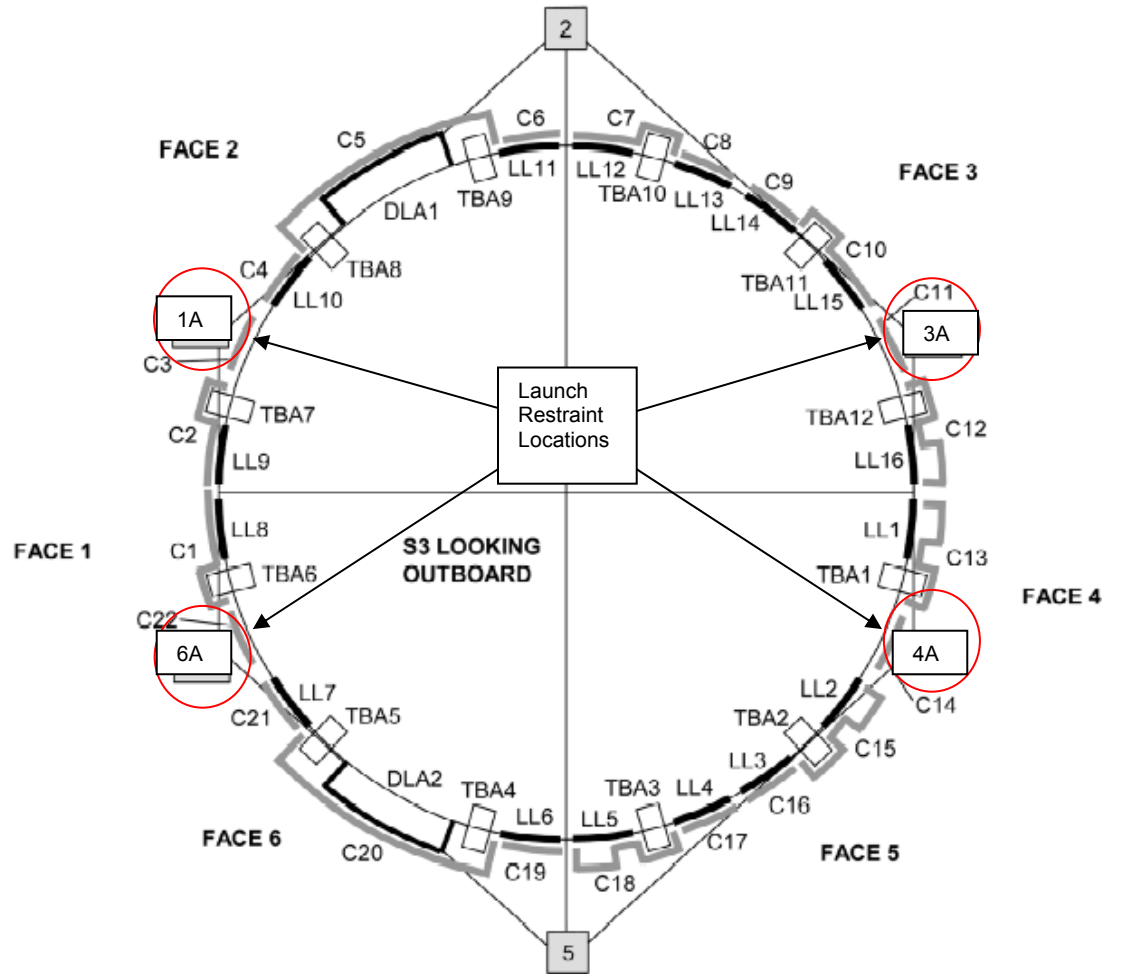
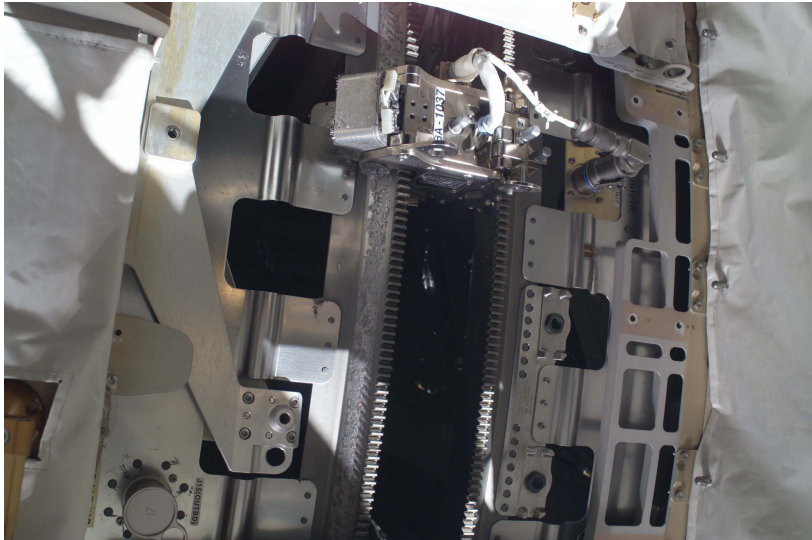
Cautions:

- When using the jackscrew to release the launch restraint, do not exceed 9 turns. Half "moon-shaped" nuts on jackscrew are not captive and may become detached if turned more than 9 turns

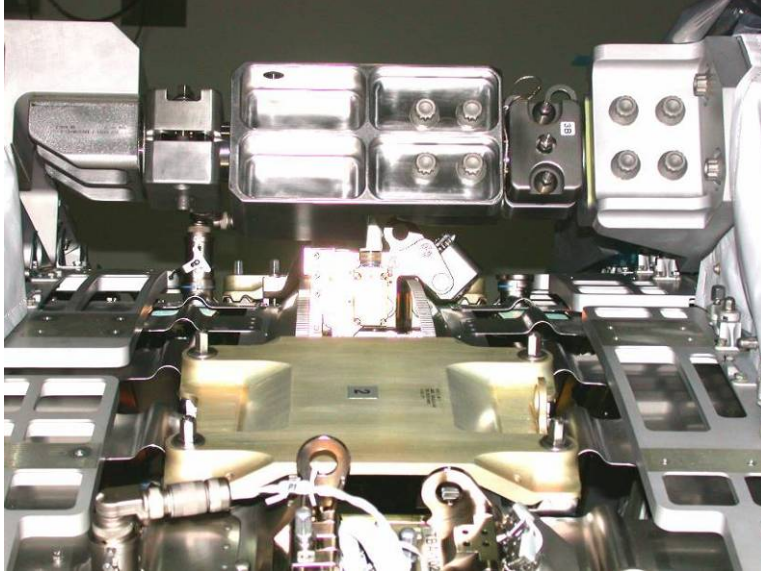
Warnings:

None

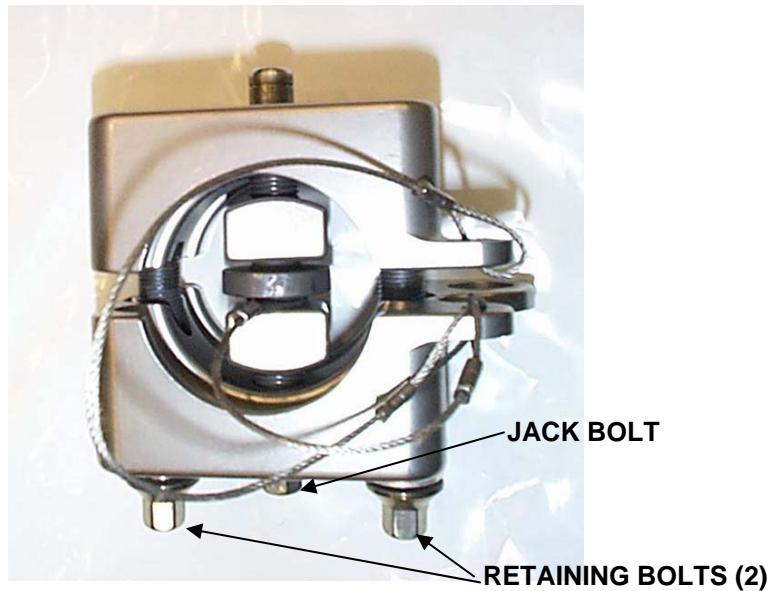
S3/S4 SARJ LAUNCH RESTRAINT REMOVAL – TASK DATA (Cont)



S3/S4 SARJ LAUNCH RESTRAINT REMOVAL – TASK DATA (Cont)



SARJ Launch Restraints – Face 1



SARJ Launch Restraint

S1 FHRC P-CLAMP RELEASE

| IV | EV1 | EV2 |
|--|--|--|
| <p>S1 FHRC P-Clamps: Bay 13 Hose Box (6) Bay 11 Stinger (6)</p> <p>P1 FHRC P-Clamps Bay 14 Hose Box (6) Bay 12 Stinger (6)</p> | <p><u>RELEASE FHRC P-CLAMPS [TORQUE BOX]</u></p> <ol style="list-style-type: none"> 1. Temp stow crew lock bag 2. Receive EV2 6-in-Ext-7/16 stow onto socket caddy 3. Hand off RAD to EV2 4. Locate Torque Box P-Clamps 5. PGT [B7 (25.5), CCW2, 30.5]-6"-Ext-7/16": Release Torque Box P-clamps (5) ~7-12.5 turns (possibly released with 12") 6. PGT [B7 (25.5), CCW2, 30.5]-12"-EXT-7/16": Release torque box P-Clamp closest to M2 which requires 12" Ext ~7-12.5 turns 7. Receive RAD from EV 2, and stow on socket caddy 8. Stow 12"-EXT-7/16 onto socket caddy 9. INSPECT GLOVES 10. Retrieve crew lock bag 11. Translate to A/L or if time, translate to P1 FHRC Repeat steps to release all the clamps at P1 | <p><u>RELEASE FHRC P-CLAMPS [HOSE BOX]</u></p> <ol style="list-style-type: none"> 1. Hand off 6-in-EXT-7/16 to EV1 2. Receive RAD from EV1 and place on PGT 3. Locate hose box P-Clamps in bay 13 4. PGT [A7 (9.2), CCW2, 30.5]- RAD – 2"-EXT-7/16": Release hose box P-Clamps (6); start at end furthest from QD ~7-12.5 turns 5. Release hose box TA clamp 6. Hand off RAD to EV1 7. INSPECT GLOVES 8. Translate to A/L or Translate to P1 FHRC Repeat steps to release all the clamps at P1 |

S1 FHRC P-CLAMP RELEASE – TASK DATA

Estimated Task Duration:

| | With SSRMS | Without SSRMS |
|-------------|------------|---------------|
| One EV Crew | N/A | 01:00 |
| Two EV Crew | N/A | N/A |

ORU Specs:

| ORU | Dimensions (inches) | Mass (lbm) |
|------|---------------------|------------------------|
| FHRC | 60.27 X 30.4 X 36.5 | Dry – 397 Wet – 457 |

Tools:

| EV1 | EV2 |
|---|-----|
| PGT 6 inch – 7/16" Wobble Socket 12 inch – 7/16" Rigid Socket Rad w/2 inch – 7/16" Rigid Socket Ratchet Wrench BRT | |

Foot Restraints:

| Task | WIF | APFR Setting |
|---------------|-----|--------------|
| FHRC P-Clamps | N/A | N/A |

Fasteners:

| Fastener Name | PGT | Socket | Qty | Turns | Install Torque (ft-lb) | Release Torque (ft-lb) | Failure Torque (ft-lb) |
|---|----------------|--------------------|-----|------------|------------------------|------------------------|------------------------|
| Hose Box P-Clamps | B1, CCW2, 30.5 | RAD w/2" ext | 6 | 6-12.5 CCW | 5.4 (Ground Install) | 9.2 | 12.6 |
| Stinger P-Clamps (one closest to M2 requires 12") | B1, CCW2, 30.5 | 6" 7/16 wobble | 5 | 7-12.5 CCW | 5.4 (Ground Install) | 9.2 | 12.6 |
| | B1, CCW2, 30.5 | 12" 7/16 wobble | 1 | 7-12.5 CCW | 5.4 (Ground Install) | 9.2 | 12.6 |

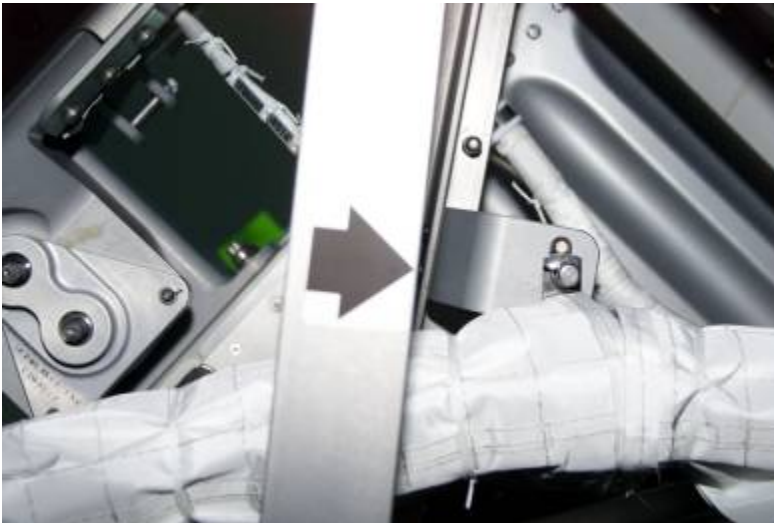
Notes:

TRRJ must be locked to access hose box P-clamps. TRRJ must be locked at 0 to access torque box P-clamps

Cautions:

Warnings:

S1 FHRC P-CLAMP RELEASE – TASK DATA (Cont)



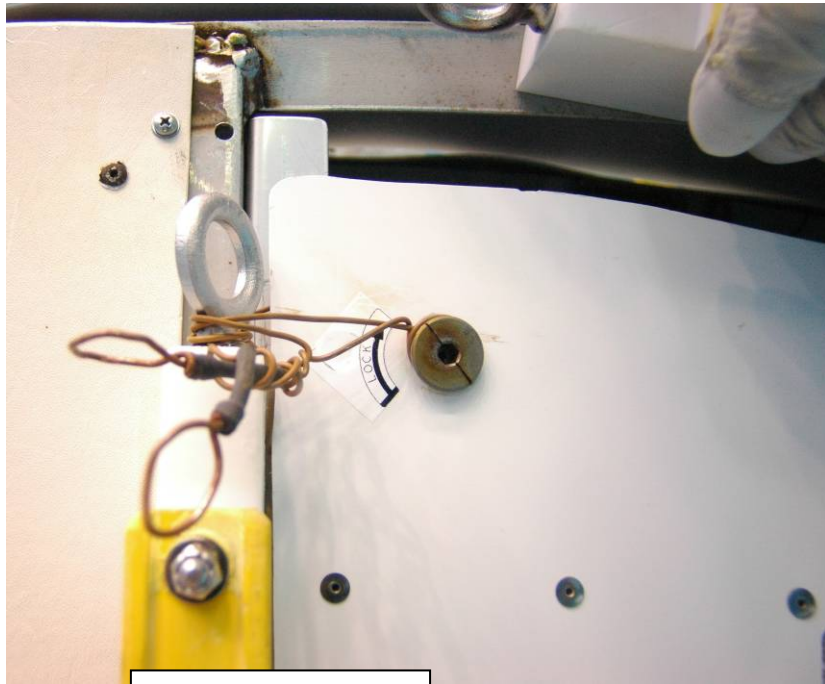
NODE 1 MMOD SHIELD CLEANUP

| IV | EV1 | EV2 |
|----|--|---|
| | <p><u>SETUP</u></p> <ol style="list-style-type: none"> Translate to Node LAN cable shield (Node FWD port); shield C2-02 Assess alignment; may need to loosen Adj tethers <p><u>PLAN A</u></p> <ol style="list-style-type: none"> Attempt installation of center and nadir fasteners (2 of 3 fasteners required) If successful, skip to cleanup; if unsuccessful, go to Plan B <p><u>PLAN B</u></p> <ol style="list-style-type: none"> Wire tie shield in place (1 wire tie = 1 Dzus) <p style="text-align: center;"><u>NOTE</u></p> <p>Wire tie must positively capture the Dzus fastener (either 2 wraps around or 1 wrap and a double twist) and positively capture structure on the Node.</p> <p>Wire tie must pull shield flat against structure and in toward centerline of module.</p> <p>Verify both ends of wire tie attached securely so that if wire tie breaks each end will still be attached</p> <ol style="list-style-type: none"> Take closeout photos of shield and tiedown If successful, skip to cleanup; if unsuccessful, go to Plan C | <p><u>SETUP</u></p> <ol style="list-style-type: none"> Retrieve C/Lk bag Translate to Node LAN cable shield (Node FWD port); shield C2-02 Temp stow crew lock bag Fairlead tether clear of C2-02 BRT or local tether to HR 140 Attempt installation of MMOD shield; provide basic alignment and shield manipulation per EV2 directions <p><u>PLAN A</u></p> <ol style="list-style-type: none"> Attempt installation of zenith fastener (2 of 3 fasteners required) If successful, skip to cleanup; if unsuccessful, go to Plan B <p><u>PLAN B</u></p> <ol style="list-style-type: none"> Wire tie shield in place (1 wire tie = 1 Dzus) <p style="text-align: center;"><u>NOTE</u></p> <p>Wire tie must positively capture the Dzus fastener (either 2 wraps around or 1 wrap and a double twist) and positively capture structure on the Node.</p> <p>Wire tie must pull shield flat against structure and in toward centerline of module.</p> <p>Verify both ends of wire tie attached securely so that if wire tie breaks each end will still be attached</p> <ol style="list-style-type: none"> Take closeout photos of shield and tiedown If successful, skip to cleanup; if unsuccessful, go to Plan C |

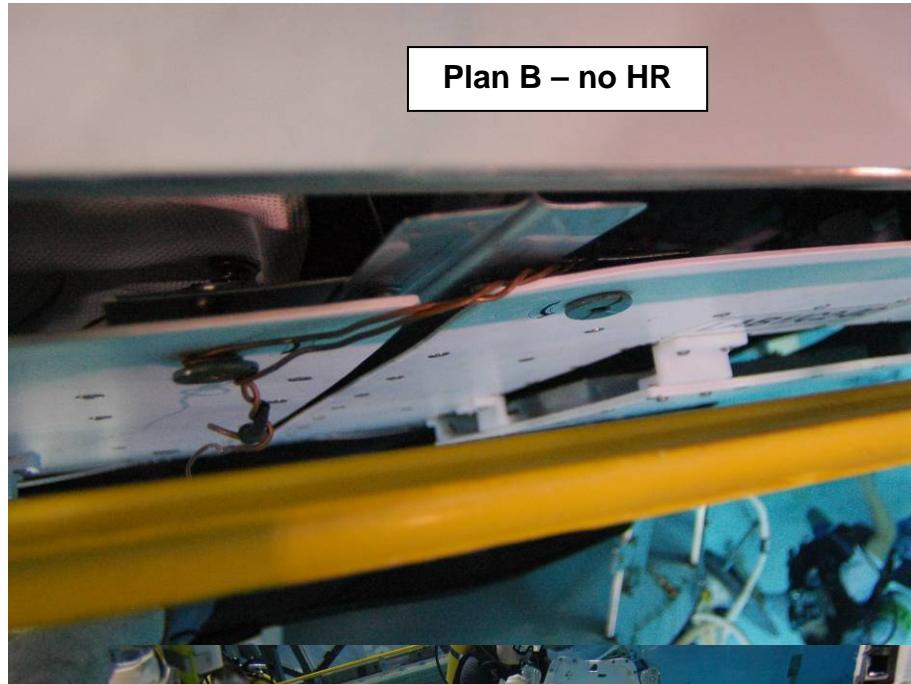
NODE 1 MMOD SHIELD CLEANUP (Cont)

| IV | EV1 | EV2 |
|----|--|--|
| | <p><u>PLAN C</u></p> <ol style="list-style-type: none"> 8. Install LDTDT to stretch across the shield (HR 145 stbd/nadir standoff to HR 142 zenith standoff) 9. Install Adj from T tool to HR 0141 (13A Adj tethers may not remain EVA) 10. After ~5 min, revisit LDTD and retighten; strap may loosen due to stretching <p><u>CLEANUP</u></p> <ol style="list-style-type: none"> 11. Retrieve 3 Adj tethers that were installed on shield; stow in trash bag (13A adj tethers left EVA may not be used and must be returned to Houston) 12. Perform Tool Inventory 13. Inspect gloves | <p><u>PLAN C</u></p> <ol style="list-style-type: none"> 12. Retrieve Long Duration Tie down tether (LDTDT) from A/L Staging Bag 13. Install LDTDT to stretch across the shield ((HR 145 stbd/nadir standoff to HR 142 zenith standoff) 14. Install new Adj from T tool to HR 0141 (13A Adj tethers may not remain EVA) 15. After ~5 min, revisit LDTD and retighten; strap may loosen due to stretching 16. Take closeout photos of shield and tiedown <p><u>CLEANUP</u></p> <ol style="list-style-type: none"> 17. Perform Tool Inventory (include crew lock bag) 18. Retrieve crew lock bag; attach to BRT 19. Inspect gloves 20. Stow crew lock bag in A/L |

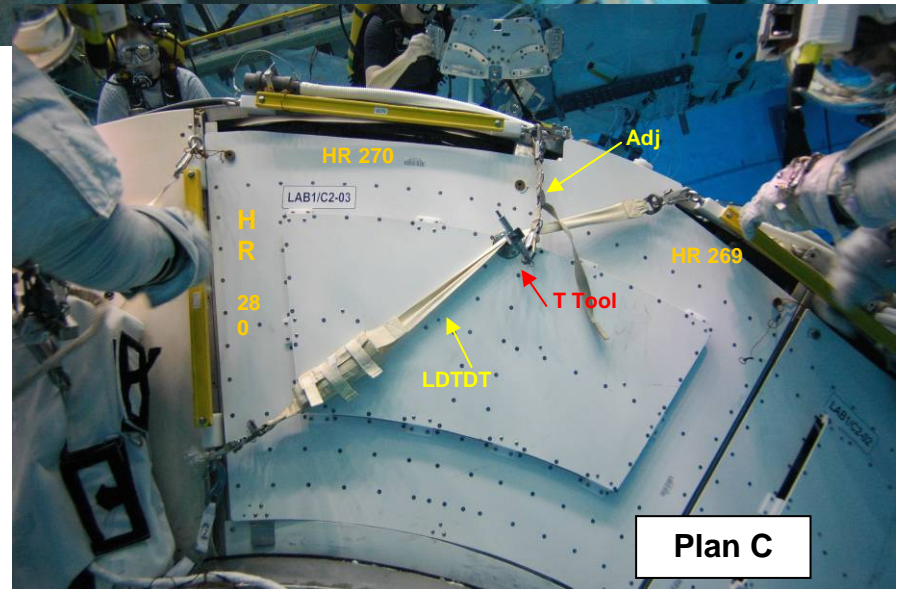
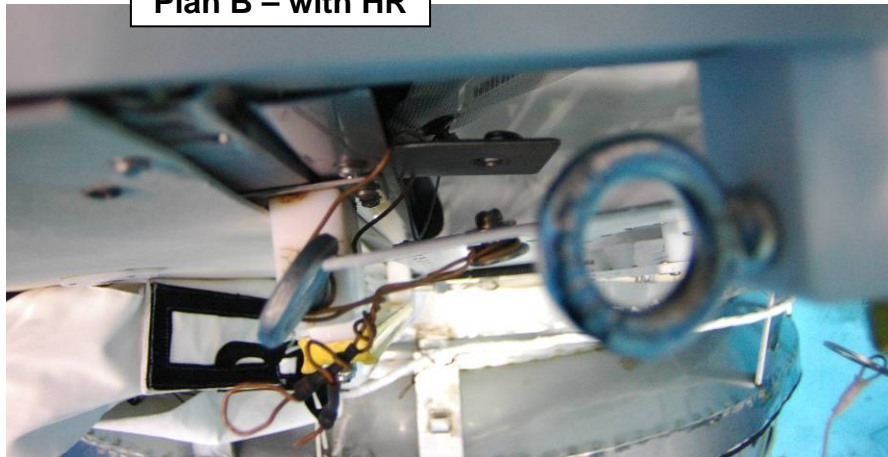
NODE 1 MMOD SHIELD CLEANUP – TASK DATA



Plan B – with HR



Plan B – no HR



Plan C

NOTE: These photos are examples of wire tie options achieved in the NBL; actual wire tie routing will be developed real time

PORT SARJ INSPECTION

| IV | EV1 (FF) |
|----|--|
| | <p data-bbox="548 250 869 277"><u>PORT SARJ INSPECTION</u></p> <div data-bbox="558 293 1829 402" style="border: 3px double black; padding: 5px;"> <p data-bbox="1129 305 1255 329" style="text-align: center;"><u>WARNING</u></p> <p data-bbox="569 334 1808 394">Sharp edge – spring loaded captive EVA fasteners (SARJ MLI cover bolts); ends of springs may protrude Avoid contact with any exposed sharp edges during cover removal, TBA install, and SARJ inspection</p> </div> <div data-bbox="558 436 1812 657" style="border: 1px solid black; padding: 5px;"> <p data-bbox="1121 443 1243 467" style="text-align: center;"><u>CAUTION</u></p> <p data-bbox="564 472 1797 500">The following precautions should be taken to prevent loss of inboard MLI cover fasteners during removal:</p> <ul data-bbox="615 505 1436 597" style="list-style-type: none"> • Limit turn count to minimum required for fastener release • Minimize side loading of bolt head • Maintain axial force on fastener to compress spring during rotation <p data-bbox="564 602 1787 657">To avoid leaving residue, do not use Kapton tape on outboard bearing surfaces (outer canted, Datum A, or inner canted)</p> </div> <ol data-bbox="548 691 1986 1328" style="list-style-type: none"> 1. Translate to any double Cover (verify outboard SLR stub will not prohibit cover removal or installation) 2. RET cover to adjacent cover 3. PGT[A6 (8.3), CCW2, 30.5] -6"-Ext-7/16": Release inboard cover fasteners, 9 turns only (add single turns incrementally as required for release) 4. Remove MLI cover and temp stow 5. Perform visual inspection of the following and report conditions to IV: <ol style="list-style-type: none"> A. General condition of all exposed SARJ surfaces <ol style="list-style-type: none"> I. Outer race ring surface: <ol style="list-style-type: none"> a. Outer canted surface b. Datum A surface II. Outboard skirt and joggles III. Outboard race ring gear teeth IV. Trundle Bearing housing B. Answer the following questions: <ol style="list-style-type: none"> I. Is there any visual debris accumulation on hardware? If so describe II. Do the outboard bearing surfaces (outer canted, Datum A) appear uniform? Are there any changes in color or surface finish across the length of the roller contact area? III. Is there a discernable wear path on the bearing surface? If so, describe 6. If visible debris accumulation, retrieve a Kapton tape strip (#____) from Velcro/Tape Caddy, take sample of debris on non-bearing surfaces |

PORT SARJ INSPECTION (Cont)

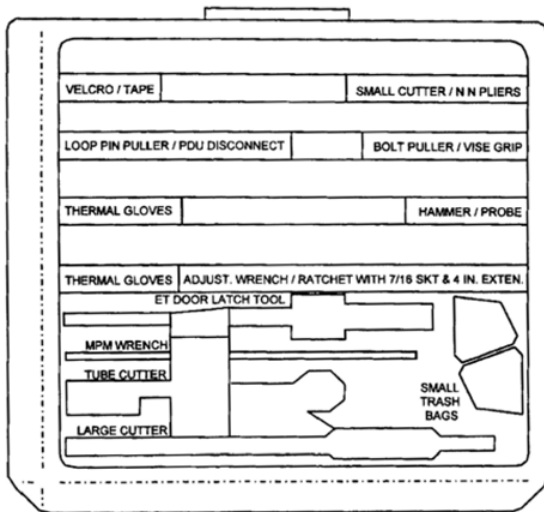
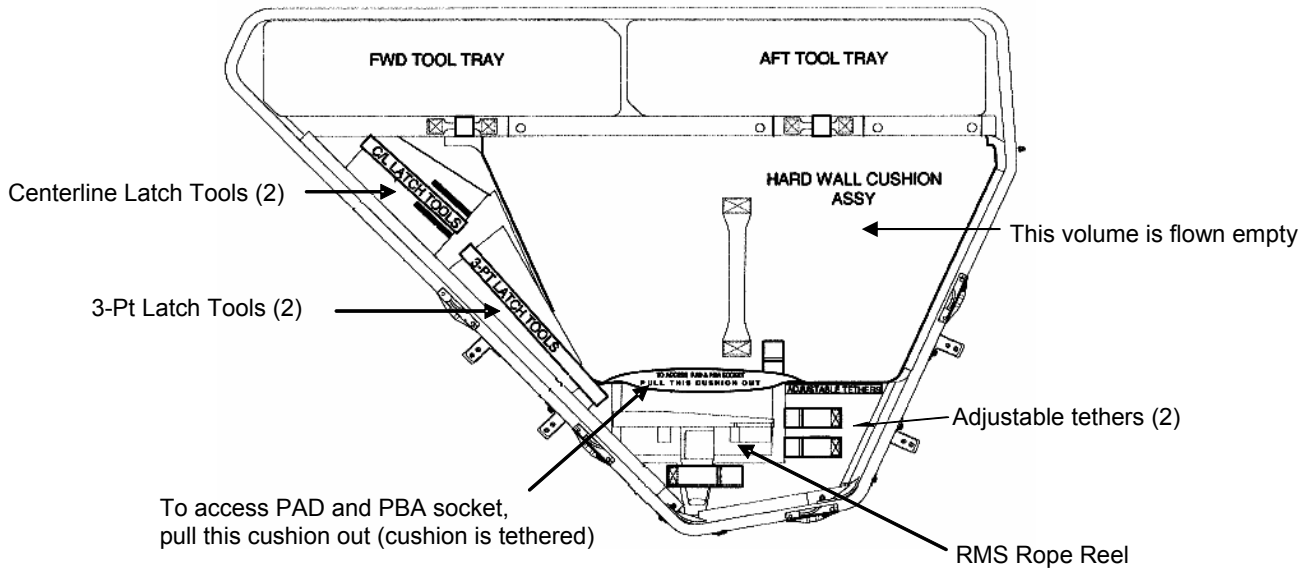
| IV | EV1 (FF) |
|----|---|
| | <p><u>PORT SARJ INSPECTION (Cont)</u></p> <ol style="list-style-type: none">7. Fold tape strip in half, sticky side to sticky side, and stow in trash bag8. Retrieve EVA wipe (#____), take sample of outboard outer canted surface with wipe9. Invert wipe, secure with Velcro strap, and stow in bag10. Retrieve digital camera from bag11. Take images of the following hardware. Take 4-6 close photos of each surface to capture entire surface once photos are combined<ol style="list-style-type: none">A. Entire exposed outer canted surface of outboard race ring at normal incidenceB. Outboard race ring Datum A surface12. Retrieve SARJ cover from temp stow location and install13. PGT[A1 (2.5), CW2, 30.5] -6"-Ext-7/16": drive inboard cover fasteners, ~8 turns (Partially engage all MLI cover fasteners prior to final torque) |

This Page Intentionally Blank

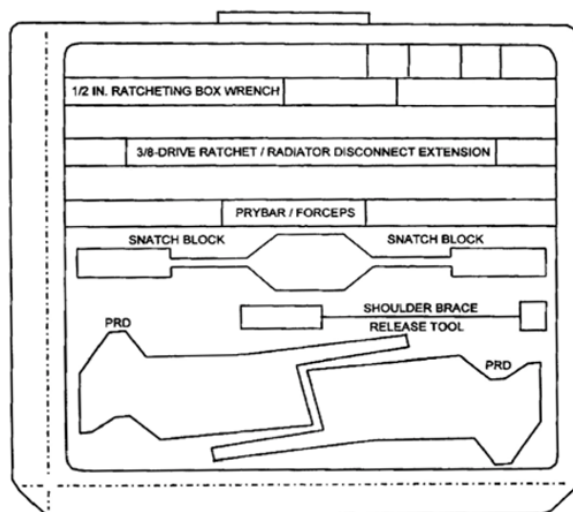
TOOLS AND STOWAGE

| | |
|--|-------------|
| PORT LIGHTWEIGHT TOOL STOWAGE ASSEMBLY (TSA) | TEMP FS 8-2 |
| PGT CHECKOUT | 8-3 |
| PGSC-PGT CONNECTION (A31P AND 760XD) | 8-4 |
| PROGRAM PGT SETTINGS | 8-5 |
| DOWNLOAD/ERASE EVENT LOG | 8-5 |
| PGT CONTINGENCIES..... | 8-6 |
| PGT STANDARD SETTINGS..... | 8-7 |
| TOOLBOX STOWAGE | FS 8-9 |
| TOOLBOX PANEL AND SLOT LABELS | FS 8-10 |
| Z1 TOOLBOX INTERNAL LAYOUT | FS 8-11 |
| AIRLOCK TOOLBOX INTERNAL LAYOUT..... | FS 8-12 |
| APFR MANAGEMENT – STS-124/1J..... | FS 8-13 |
| SAFETY TETHER CONFIGURATION – STS-124/1J | FS 8-14 |

PORT LIGHTWEIGHT TOOL STOWAGE ASSEMBLY (TSA)



Forward Tray layout and Labels



Aft Tray Layout and Labels



TOOLS AND STOWAGE

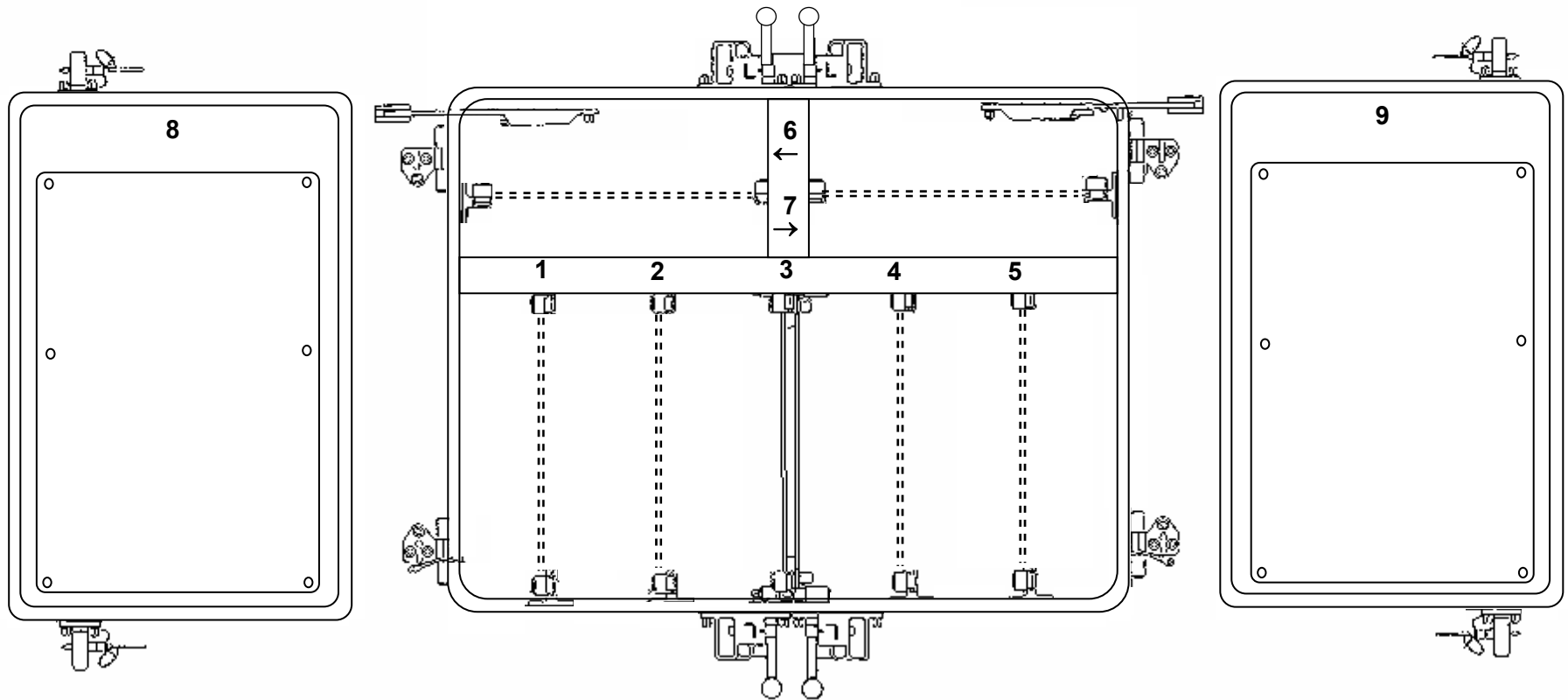
TOOLBOX STOWAGE

| | Z1 PORT TOOLBOX {all slots have sliders} | Z1 STBD TOOLBOX {all slots have sliders} | A/L TOOLBOX 1 (STBD) | A/L TOOLBOX 2 (PORT) |
|------------------|---|---|--|--|
| SLOT # 1 | SQUARE TM BOARD {stbd door} SQ TORQUE MULTIPLIER 7/16" FLUSH SQ SOCKET 7/16" PROUD SQ SOCKET 7/16" RECESSED SQ SOCKET | SQUARE TM BOARD {stbd door} SQ TORQUE MULTIPLIER 7/16" FLUSH SQ SOCKET 7/16" PROUD SQ SOCKET 7/16" RECESSED SQ SOCKET | HAMMER BOARD {nadir door} | CABLE CUTTER BOARD COMPOUND CUTTERS (SM) SCISSORS {zenith door} |
| SLOT # 2 | | QD BAIL TOOL BOARD {stbd door} BMRRM LATCH TOOL QD BAIL DRIVE TOOL (1") | PLIERS BOARD {nadir door} NEEDLE NOSE PLIERS | |
| SLOT # 3 | RATCHET BOARD {middle} 7/16" X 12" WOBBLE SOCKET 7/16" X 2" RIGID SOCKET | RATCHET BOARD {middle} 7/16" X 6" WOBBLE SOCKET | {only slot with slider} | {only slot with slider} |
| SLOT # 4 | | | | |
| SLOT # 5 | ROUND TM BOARD {port door} RND TORQUE MULTIPLIER 5/8" PROUD RND SOCKET 7/16" FLUSH RND SOCKET 7/16" PROUD RND SOCKET | ROUND TM BOARD {port door} 7/16" FLUSH RND SOCKET 7/16" PROUD RND SOCKET | ADJ WRENCH BOARD FORCEPS WRENCH, ADJ {zenith door} | T-HANDLE TOOL BOARD 1-8" T-TOOLS {nadir door} |
| SLOT # 6 | TRASH BAG BOARD {stbd door} LARGE TRASH BAG SMALL TRASH BAG | TRASH BAG BOARD {stbd door} | HYDRAZINE BRUSH BOARD HYDRAZINE BRUSH {nadir door} | |
| SLOT # 7 | SOCKET BOARD {port door} 5/32" BALL END ALLEN DR 1/2" X 8" WOBBLE SOCKET 5/16" X 7" RIGID SOCKET | SOCKET BOARD {port door} 5/32" BALL END ALLEN DR 1/2" X 8" WOBBLE SOCKET 5/16" X 7" RIGID SOCKET | PRD (Toolboard) {zenith door} PRD | PRD (Toolboard) {nadir door} PRD |
| PANEL # 8 | CHEATER BAR PANEL {stbd door} ADJ EQUIP TETHER | CHEATER BAR PANEL {stbd door} CHEATER BAR ADJ EQUIP TETHER | TOOL CADDY PANEL {nadir door} CADDY, ISS (BUNGEE) | |
| PANEL # 9 | 18" SOCKET PANEL {port door} 7/16" X 18" WOBBLE SOCKET | 18" SOCKET PANEL {port door} | BOLT PULLER PANEL BOLT PULLER MECHANICAL FINGER {zenith door} | LARGE CUTTER PANEL {nadir door} |
| EXTERNAL | 1 SQUARE SCOOP 1 ROUND SCOOP w/D-HANDLE D-HANDLE on port side of toolbox | 1 SQUARE SCOOP <u>NOTE</u> D-Handle will not stow on the side of this toolbox due to an interference with the CMG MLI | | |

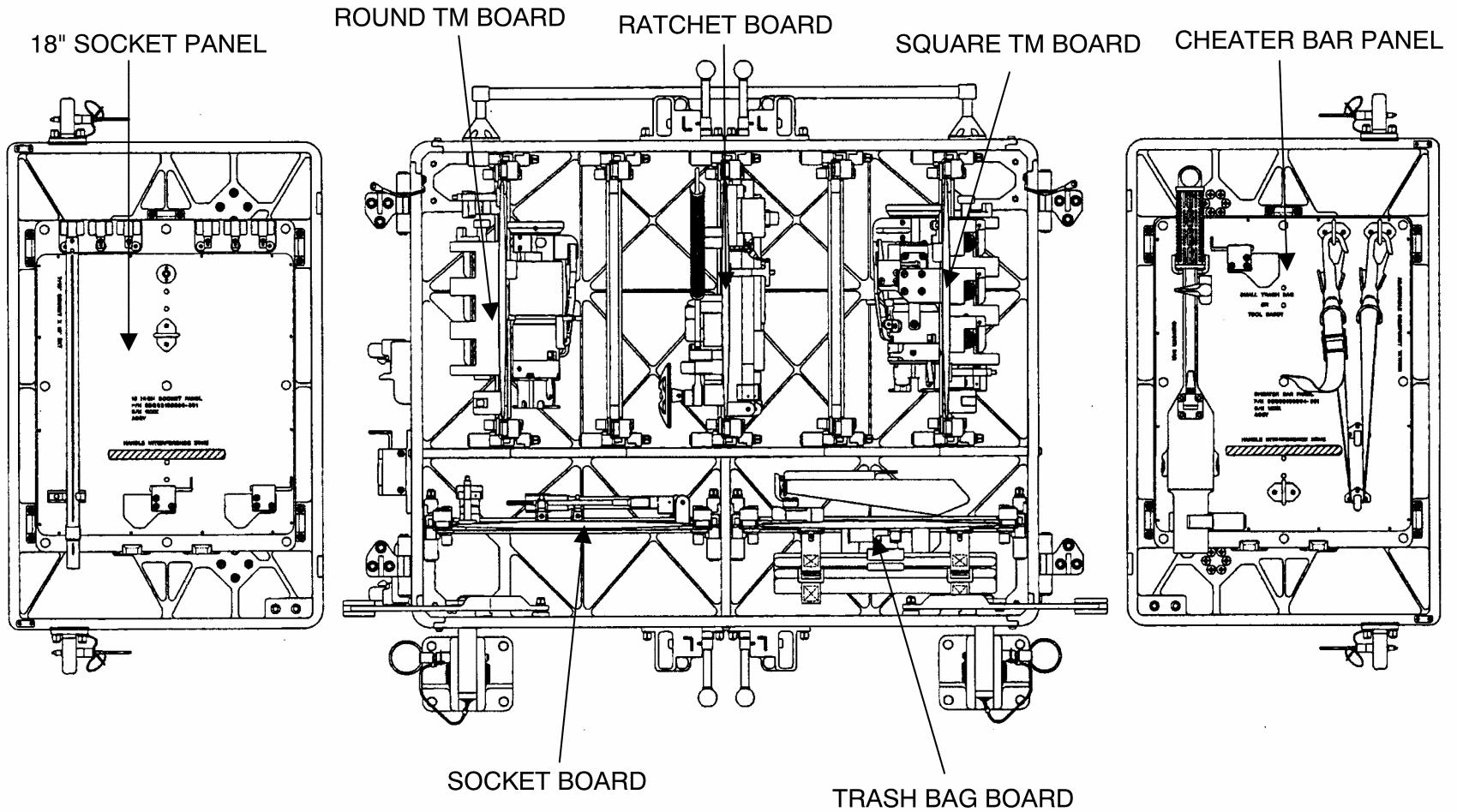
TOOLBOX PANEL AND SLOT LABELS

NOTE

- A/L Toolbox: Slider feature located in center slot (#3)
- Z1/CETA Toolbox: Slider feature located in all slots

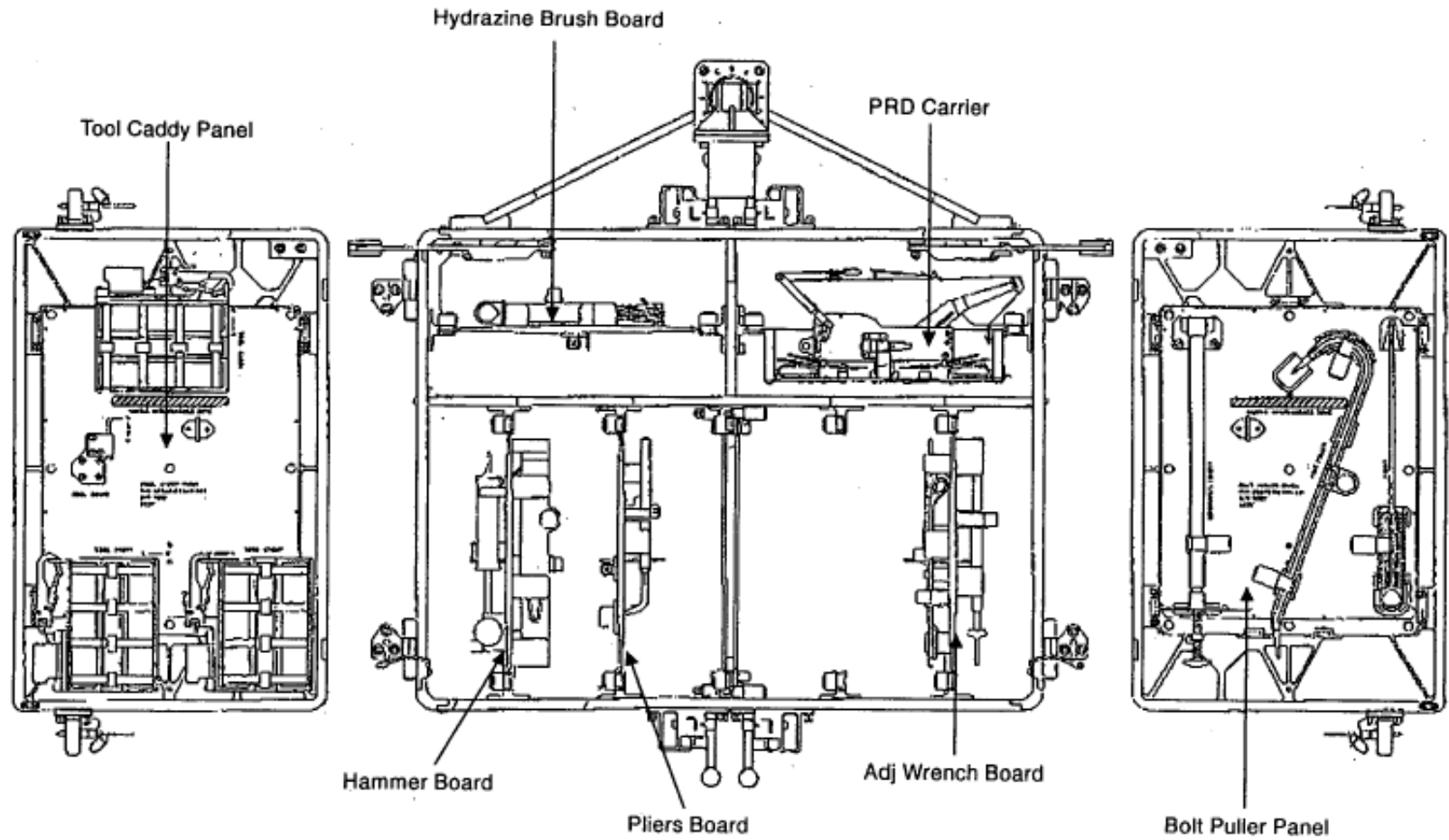


Z1 TOOLBOX INTERNAL LAYOUT



DOORS SHOWN REMOVED AND ROTATED 180° FROM CLOSED POSITION FOR CLARITY.

AIRLOCK TOOLBOX INTERNAL LAYOUT



APFR MANAGEMENT – STS-124/1J

| APFR DESIGNATOR | APFR 1 (8A, 13A.1 Pitch knob problem) | APFR 2 (US EVA 9 Pitch knob problem, 10A sticky locking collar) | APFR 3 s/n 1005 (no pitch knob prob 9A-inc12 suspected sharp edge on locking collar) | APFR 4 (TS, old ORU tether, heat shield) | APFR 5 (TS, old ORU tether, heat shield) | APFR 6 (heat shield removed on 12A.1 stage) | APFR 7 s/n 1008 | IAPFR 1 | IAPFR 2 | CRANE (old ORU tether) | TS | ORU stanchion/ TERA headless | OTSD |
|------------------------|---|---|--|--|--|---|---------------------------|-----------------------|----------------------|----------------------------------|--------------------|--|---------------|
| Post STS-123 | CETA 1 WIF 4 [12,PP,F,6] Y/P [12,FF] | Lab WIF 4 [1,TT,C,11] | Stbd A/L tool box [6,XX,F,6] | Z1 WIF 08 [7,PP,B,6] TS at 4 o'clock | PMA1 WIF 2 [12,KK,F,6] | S1 WIF 1 (10,TT,L,12) ingress aid | Lab WIF 11 [1,QQ,A,12] | Z1 WIF 1 [12,PP,F,12] | Z1 WIF 3 [6,PP,F,12] | PMA1 WIF 5 | S0 port wedge face | S0 port wedge face | S0 WIF 7 CL=7 |
| STS-124 EVA 1 | | | | | | | | | | | | | |
| | CETA 1 WIF 4 [12,PP,F,6] Y/P [12,FF] | Lab WIF 4 [1,TT,C,11] | Stbd A/L tool box [6,XX,F,6] | Z1 WIF 08 [7,PP,B,6] TS at 4 o'clock | PMA1 WIF 2 [12,KK,F,6] | S1 WIF 1 (10,TT,H,12) ingress aid | Lab WIF 11 [11,QQ,A,12] | Z1 WIF 1 [12,PP,F,12] | Z1 WIF 3 [6,PP,F,12] | PMA1 WIF 5 | S0 port wedge face | S0 port wedge face | S0 WIF 7 CL=7 |
| STS-124 EVA 2 | | | | | | | | | | | | | |
| | ESP-3 WIF 5 [12,FF,A,2] | | | | | | | | | | | | |
| STS-124 EVA 3 | | | | | | | | | | | | | |
| S1 NTA R&R | ESP-3 WIF 5 [12,FF,A,2] | | SSRMS [12,NN,F,6] WIF-X Cl:6,P:A,Ext:7 | | | | | | | | | | |
| Cleanup | Lab WIF 7 [6,PP,F,12] | | Stbd A/L tool box [6,XX,F,6] | | | | | | | | | | |
| Post STS-124 | Lab WIF 7 [6,PP,F,12] | Lab WIF 4 [1,TT,C,11] | Stbd A/L tool box [6,XX,F,6] | Z1 WIF 08 [7,PP,B,6] TS at 4 o'clock | PMA1 WIF 2 [12,KK,F,6] | S1 WIF 1 (10,TT,H,12) ingress aid | Lab WIF 11 [11,QQ,A,12] | Z1 WIF 1 [12,PP,F,12] | Z1 WIF 3 [6,PP,F,12] | PMA1 WIF 5 | S0 port wedge face | S0 port wedge face | S0 WIF 7 CL=7 |

SAFETY TETHER CONFIGURATION – STS-124/1J

| | 55-ft tethers | | | | | | | 85-ft tethers | | | |
|-------------------|-------------------------------------|---|---|---|--|--|-------------------------------------|---|---|-------------------------------------|-------------------------------------|
| | #59 s/n 1007 Sm-sm | #71 s/n 1021 Lg-sm (1JA – slow retractor) | #72 s/n 1022 Lg-sm (had 10A – retraction issues) | #73 s/n 1023 Lg-sm (AR written against this one) | #60 s/n 1008 Lg-sm (has retracting issues) | #70 s/n 1020 Lg-sm | #66 s/n 1016 Sm-sm | #22 s/n 1002 (Shuttle safety tethers) | #23 s/n 1003 (Shuttle safety tethers) | #26 s/n 1006 Lg-sm | #28 s/n 1008 Lg-sm |
| Post 123 EVA 5 | INSIDE tether staging area | INSIDE tether staging area | INSIDE tether staging area | INSIDE tether staging area | S0 HH 3539 LAS Inspected on 1JA, GO for future use | S0 HH 3529 LAS Inspected on 1JA, GO for future use | INSIDE tether staging area | Returned to shuttle | Returned to shuttle | INSIDE tether staging area | INSIDE tether staging area |
| 123 stage | -----same----- | | | | | | | -----same----- | | | |
| Post 124 EVA 3 | INSIDE tether staging area | INSIDE tether staging area | INSIDE tether staging area | INSIDE tether staging area | S0 HH 3539 or HH 3530 Tether on 3539 had retracting issues | S0 HH 3539 or HH 3530 Tether on 3539 had retracting issues | INSIDE tether staging area | Returned to shuttle | Returned to shuttle | INSIDE tether staging area | INSIDE tether staging area |

NOTE

During US EVA #8, EV2 reported that her 55-ft safety tether (P/N SEG33106674-307 s/n 1023, #73) was not retracting properly. EV2 attempted to perform the usual technique of pulling out some cable and then letting it reel in, but there came a point when EV2 was neither able to extend or retract the line with 6-8 ft of tether cable still extended. EV2 also cycled the tether from UNLOCK to LOCK and back to UNLOCK, with no joy. The tether was temp stowed as is until later (EV2 was attached to an 85-ft tether at this point.) During EVA cleanup, EV1 attempted to troubleshoot the tether, placing it in LOCK and extending quite a few more feet of cable from the tether. When the tether was placed back in UNLOCK it retracted completely, with a little bit of coaxing for the last couple feet of cable (typical behavior). The tether was brought inside. No further action required

EMU MAINT/RECHARGE

| | |
|---|--------------|
| WATER RECHARGE..... | TEMP FS 10-2 |
| EMU POWERUP..... | TEMP FS 10-2 |
| WATER FILL | TEMP FS 10-2 |
| WATER FILL VERIFICATION | TEMP FS 10-2 |
| EMU LiOH CHANGEOUT | 10-4 |
| MIDDECK EMU BATTERY RECHARGE (STAND-ALONE)..... | 10-4a |
| MIDDECK EMU BATTERY RECHARGE/LiOH REPLACEMENT | 10-5 |
| INITIATE | 10-5 |
| TERMINATE..... | 10-6 |
| IN-SUIT EMU BATTERY RECHARGE/CHARGE VERIFICATION..... | 10-7 |
| INITIATE | 10-7 |
| TERMINATE..... | 10-7 |
| EMU POWERDOWN | 10-7 |
| HELMET LIGHT/PGT BATTERY RECHARGE | 10-8 |
| INITIATE | 10-8 |
| TERMINATE..... | 10-9 |
| REBA BATTERY INSTALLATION | 10-9 |
| EMU BATTERY REMOVAL/INSTALL | 10-10 |
| HELMET LIGHT BULB CHANGEOUT | 10-11 |
| REBA BATTERY RECHARGE | 10-12 |
| INITIATE | 10-12 |
| TERMINATE..... | 10-13 |
| STS-124/1J EMU CONSUMABLES TRACKING CUE CARD | FS CC 10-15 |
| STS-124/1J BATTERY RECHARGE PLAN CUE CARD..... | FS CC 10-16 |

WATER RECHARGE

IF EMU NOT ALREADY POWERED UP:

EMU POWERUP

- BOTH DCM 1. Retrieve, position SCUs; remove DCM covers
 2. Connect SCUs to DCM, √locked
 3. PWR – BATT

CAUTION

EMU must be on BATT pwr when
 airlock pwr supply is turned on

- AW18H 4. PWR/BATT CHGR EMU 1,2 MODE (two) – PWR
 BUS SEL (two) – MNA(MNB)
 MD(flr) 5. √EMU O2 ISOL VLV – OP
 AW82B 6. EV1,2 O2 vlv (two) – OP
 DCM 7. PWR – SCU

WATER FILL

- MO13Q 8. √ARLK H2O S/O VLV – OPEN (tb-OP)
 R11L 9. √SPLY H2O TKA OUTLET – CL (tb-CL)

SM 60 TABLE MAINT

- CRT 10. Use TKB quantity:
 PARAM ID – ITEM 1 +0 6 2 0 4 2 0 EXEC
 11. Log value before recharge

| Recharge # | H2O TKB % |
|------------|-----------|
| 1 | |
| 2 | |
| 3 | |
| 4 | |
| 5 | |

- AW82D 12. √EMU 1,2 H2O WASTE tb (two) – CL
 SPLY (two) – OP (tb-OP)
 13. √H2O TKB quantity decreasing

NOTE

Full charge requires ~15 min

WATER FILL VERIFICATION

- DCM 14. √STATUS: **H2O WP** 8-15 psi and stable for ~30 sec (indicates charging complete)

SM 60 TABLE MAINT

- CRT 15. Use TKB quantity:
 PARAM ID – ITEM 1 +0 6 2 0 4 2 0 EXEC
 16. Log value after recharge

| Recharge # | H2O TKB % |
|------------|-----------|
| 1 | |
| 2 | |
| 3 | |
| 4 | |
| 5 | |

TOP

**HOOK
VELCRO**

STS-124/1J EMU CONSUMABLES TRACKING CUE CARD

AIRLOCK Operations

| EVA | 1 | 2 | 3 |
|---|--------------------------|-------------------------------------|-------------------------|
| METOX for Campout & 10.2 Ops (s/ns) (B/Cs) | 0007/0011 7802J/7792J | 0017/0019 7811J/7807J (Regen) | 0012/0013 none/7794J |
| PWR (EMU Water Bag) (s/n) | 1007 | 1007 & 1023 | 1023 |
| CWC (Contingency Water Container) (s/n) | 1059 | 1059 | 1059 |

| EVA | EV | LiOH (s/n) (B/C) | METOX (s/n) (B/C) | EMU Battery | REBA (s/n) | Helmet Light Battery (s/n) | ERCA (Address) | SAFER (s/n) | PGT Battery (s/n) | PGT Spare Battery (s/n) |
|-----|----------------------|------------------|--|----------------------------------|--------------------|--|----------------|-------------|--------------------|------------------------------|
| 1 | EV1 – Fs EMU 3015 | N/A | 0020 7795J | 2067 (Recharge) | 1004 (Recharge) | 1022/1030 (Recharge) | 16 | 1004 | 1008 (Recharge) | 1004 |
| | EV2 – Ga EMU 3017 | s/n _____ | N/A | 2072 (Recharge) | 1011 (Recharge) | 1025/1026 (Recharge) | 18 | 1007 | 1009 (Recharge) | |
| | | | | Recharge FD5 | Recharge FD4 | Recharge FD4 | | | Recharge FD4 | Recharge FD4 (as reqd) |
| 2 | EV1 – Fs EMU 3015 | N/A | 0015 7686J | 2073 | 1004 (Recharge) | 1011/1015 (Recharge) | 16 | 1004 | 1008 (Recharge) | 1004 |
| | EV2 – Ga EMU 3017 | N/A | 0016 7796J | 2071 | 1011 (Recharge) | 1017/1019 (Recharge) | 18 | 1007 | 1009 (Recharge) | |
| | | | Regen Campout Canisters (0017/0019) | Recharge FD7 (as required) | Recharge FD6 | Recharge FD6 for return on STS-124 | | | Recharge FD6 | Recharge FD6 (as reqd) |
| 3 | EV1 – Fs EMU 3015 | s/n _____ | N/A | 2067 | 1004 | 1022/1030 | 16 | 1004 | 1008 | 1004 |
| | EV2 – Ga EMU 3017 | N/A | 0021 7814J | 2072 | 1011 | 1025/1026 | 18 | 1007 | 1009 | |

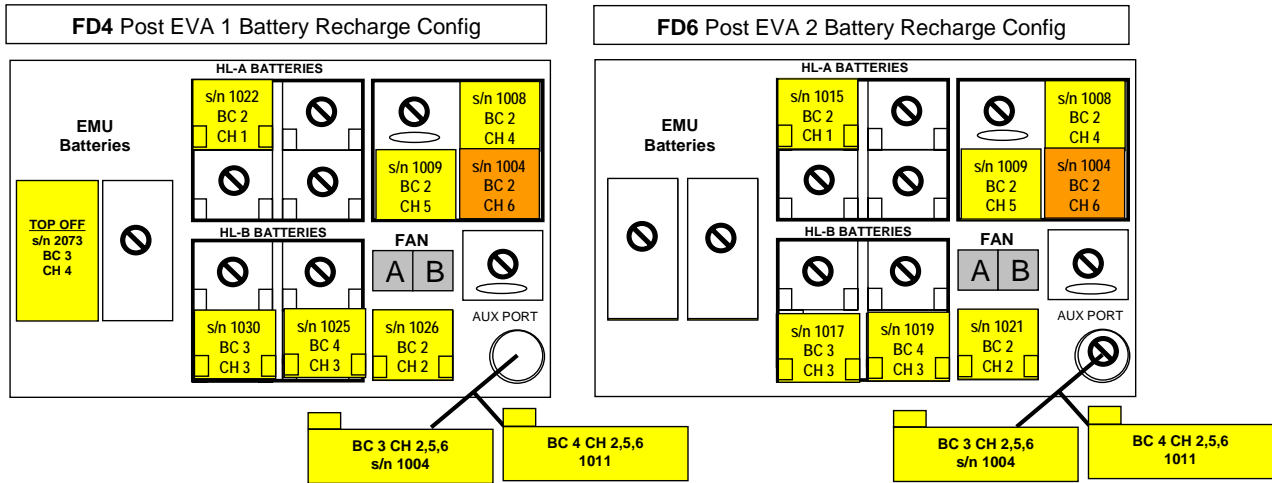
EVA-4a/124/O/B

(reduced copy)

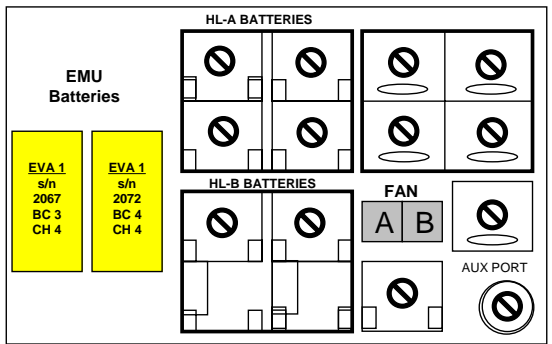
TOP
 BACK OF 'STS-124/1J EMU CONSUMABLES TRACKING CUE CARD'

**HOOK
 VELCRO**

STS-124/1J BATTERY RECHARGE PLAN CUE CARD



FD5 Post EVA 1 EMU Battery Recharge Config



**s/n 1004
 BC 2
 CH 6** - As required

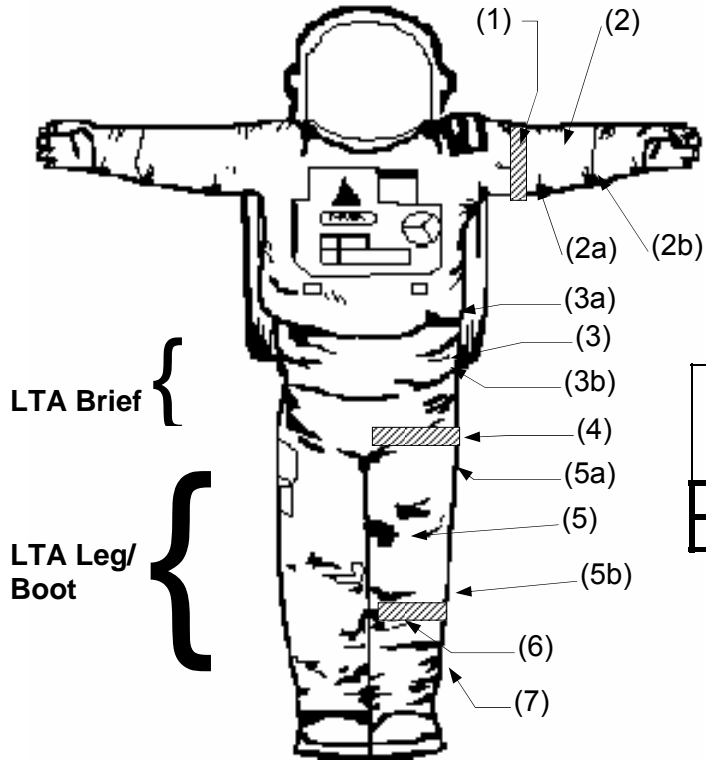
EVA-4b/124/O/A

(reduced copy)

EMU CONTINGENCY PROCS

DISPLAY LOSS DURING POWER TRANSFER (WARM RESTART)..... TEMP FS 12-2
VACUUM H2O RECHARGE (MANNED)..... TEMP FS 12-2
LiOH REPLACEMENT (MANNED)..... 12-3
BATTERY REPLACEMENT (MANNED) 12-4
WATER DUMP 12-6
SCU SWAP (UNMANNED)..... 12-7
SCU SWAP (MANNED)..... 12-7
EMU COLD RESTART (MANNED) 12-7
12.1 STS EVA DECONTAMINATION..... 12-8
CONTAMINATION TEST..... 12-15
SAFER BATTERY CHANGEOUT 12-18
BENDS TREATMENT ADAPTER (BTA) INSTALLATION (IN-SUIT) 12-19
 BTA PREP 12-19
 BTA TREATMENT 12-19
BENDS TREATMENT ADAPTER (BTA) INSTALLATION (POST SUIT DOFFING) 12-21
 BTA PREP 12-21
 BTA TREATMENT 12-21
EMU RESIZE 12-24
EMU NOMINAL SIZING (STS-124/1J) FS 12-27
EMU CONTINGENCY RESIZE MATRIX (STS-124/1J) FS 12-28
STS-124/1J EMERGENCY UNDOCK EVA TRANSFER CUE CARD FS CC 12-29
STS-124/1J EXPEDITED SUIT DOFFING CUE CARD FS CC 12-30

EMU NOMINAL SIZING (STS-124/1J)



| SEMU | (1) Arm Sizing Ring | (2a) Arm Cam | (2) Lower Arm | (2b) Wrist Cam | HUT |
|---------------|---------------------|--------------|---------------|----------------|--------|
| Fossum (3015) | 0.5 | Short | 03 | Long | L (03) |
| Garan (3017) | -- | Short | 04 | Long | M (02) |

| LTA | (3a) Brief Upper Cam | (3) Adjust Waist Brief | (3b) Brief Lower Cam | (4) Thigh Sizing Ring | (5a) Thigh Cam | (5) Leg Segment | (5b) Leg Cam | (6) Leg Sizing Ring | (7) Boot/ Insert-Type |
|--------|----------------------|------------------------|----------------------|-----------------------|----------------|-----------------|--------------|---------------------|-----------------------|
| Fossum | Long | 01 | Short | -- | Short | 03 | Long | .5 | 02/NO BSI |
| Garan | Short | 01 | Short | -- | Short | 03 | Long | .5 | 02/NO BSI |

| Misc | LCVG/ BLVD | TCU top/ Bottom/MAG | Prime Gloves/ s/n | b/u Gloves/ s/n | Cont Gloves/ s/n | CCA/ CCEM | Valsalva | Fresnel Lens (diopters) |
|--------|------------|---------------------|-------------------|-----------------|------------------|-----------|----------|-------------------------|
| Fossum | 04/05 | L/L/709 | 6BB/6212 | 6BB/6219 | 6BB/6093 | 04/327 | Original | 2.5 & 5 |
| Garan | 05/04 | L/XL/711 | 6NO/6085 | 6NO/6274 | 6NO/6088 | 03/327 | Original | --- |

EMU CONTINGENCY RESIZE MATRIX (STS-124/1J)

| FOR LOSS OF: | EV1 – Fossum | EV2 – Garan (Medium Hut) | EV2 – Garan (Large Hut) |
|--------------------------|---|---|---|
| HUT/PLSS | Use Large HUT s/n 3004 from ISS 1. Remove gloves/lower arms/arm rings 2. Use prime Fs (6BB) gloves/arms/arm rings 3. ✓Arm red disconnect to right, ✓locks, ✓cams 4. Use prime Fs LTA 5. Swap EMU PLSS identifier stripes, mission patch, and national flag | Use Med HUT s/n 3018 from ISS 1. Remove gloves/lower arms/arm rings 2. Use prime Ga (6NO) gloves/arms/arm rings 3. ✓Arm red disconnect to right, ✓locks, ✓cams 4. Use prime Ga LTA 5. Swap EMU PLSS identifier stripes, mission patch, and national flag | Use Large HUT s/n 3004 from ISS 1. Use prime Ga (6NO) gloves, LTA and Helmet 2. Swap EMU PLSS identifier stripes, mission patch, and national flag 3. ✓0.5 Arm rings s/n 167 and s/n 168 4. ✓Size 03 lower arms s/n 219 and s/n 220 5. ✓Cams S/S |
| CCA | Use size 04/327 CCA s/n 1183 from ISS | Use size 03/327 CCA s/n 1177 from ISS (28P) | Use size 03/327 CCA s/n 1177 from ISS (28P) |
| Lower Arm Segment | Use size 03 lower arm s/n 217 (R) or s/n 218 (L) from Shuttle transfer (Cf b/u) (red = right, blue = left). Cams S/L 1. Use prime Fs gloves 2. ✓Locks, ✓cams | Use size 04 lower arm s/n 225 (R) or s/n 226 (L) from ISS (red = right, blue = left). Cams S/L 1. Use prime Ga gloves 2. ✓Locks, ✓cams | Use size 03 lower arm s/n 217 (R) or s/n 218 (L) from Shuttle transfer (Cf b/u) (red = right, blue = left). Cams S/S 1. Use prime Ga gloves ✓Locks, ✓cams |
| Gloves | Back-up: Use 6BB gloves s/n 6219 from ext A/L Floor Bag Contingency: Use 6BB gloves s/n 6093 from ext A/L Floor Bag. Adjust wrist cams to Short | Back-up: Use 6NO gloves s/n 6274 from ext A/L Floor Bag. Adjust wrist cams to Short Contingency: Use 6NO gloves s/n 6088 from ext A/L Floor Bag | Back-up: Use 6NO gloves s/n 6274 from Ext A/L Floor Bag. Adjust wrist cams to Short Contingency: Use 6NO gloves s/n 6088 from ext A/L Floor Bag |
| Waist Brief | Use size 01 waist brief s/n 2081 (018) from ISS. Cams L/S 1. Use prime Fs legs/leg rings/boots 2. ✓Locks, ✓cams 3. Swap EMU brief identifier stripes | Use size 01 waist brief s/n 2053 (024) from ISS. Cams S/S 1. Use prime Ga legs/leg rings/boots 2. ✓Locks, ✓cams 3. Swap EMU brief identifier stripes | Use size 01 waist brief s/n 2053 (024) from ISS. Cams S/S 1. Use prime GA legs/leg rings/boots 2. ✓Locks, ✓cams 3. Swap EMU brief identifier stripes |
| Leg Segment | Use size 03 leg s/n 185 (R) or 186 (L) from ISS. Cams S/L 1. Use prime waist brief/leg rings/boots 2. ✓Locks, ✓cams | Use size 03 leg s/n 185 (R) or 186 (L) from ISS. Cams S/L 1. Use prime waist brief/leg rings/boots 2. ✓Locks, ✓cams | Use size 03 leg s/n 185 (R) or 186 (L) from ISS. Cams S/L 1. Use prime waist brief/leg rings/boots 2. ✓Locks, ✓cams |
| Boot | Use size 02 boots s/n 213 from ISS 1. Remove BSI/Toe Caps 2. Use prime waist brief/legs/leg rings 3. ✓Locks | Use size 02 boots s/n 213 from ISS 1. Remove BSI/Toe Caps 2. Use prime waist brief/legs/leg rings 3. ✓Locks | Use size 02 boots s/n 213 from ISS 1. Remove BSI/Toe Caps 2. Use prime waist brief/legs/leg rings 3. ✓Locks |
| Sizing Rings | <ul style="list-style-type: none"> ▪ 0.5 arm: Use s/n 120 (R) or 121 (L) from ISS ▪ 0.5 Leg: Use s/n 134 (R) or 135 (L) from ISS | <ul style="list-style-type: none"> ▪ 0.5 Leg: Use s/n 134 (R) or 135 (L) from ISS | <ul style="list-style-type: none"> ▪ 0.5 arm: Use s/n 120 (R) or 121 (L) from ISS ▪ 0.5 Leg: Use s/n 134 (R) or 135 (L) from ISS |
| LCVG | Use backup LCVG s/n 3214 from middeck. (Dry) Reference ISS EVA System C/L; 1.525 LCVG Water Fill 1. Transfer biomed, dosimeter | Use backup LCVG s/n 3214 from middeck. (Dry) Reference ISS EVA System C/L; 1.525 LCVG Water Fill 1. Transfer biomed, dosimeter | Use backup LCVG s/n 3214 from middeck. (Dry) Reference ISS EVA System C/L; 1.525 LCVG Water Fill 1. Transfer biomed, dosimeter |

TOP

HOOK
VELCRO

**STS-124/1J EMERGENCY UNDOCK EVA TRANSFER
CUE CARD**

Transfer following to shuttle:

Critical:

1. EMU 3015 (Fs) and EMU 3017 (Ga) w/LTA and Helmet
2. CCAs (Fs and Ga)
3. Gloves (Fs and Ga)
4. LCVG (Fs and Ga)
5. EMU Batteries (2)
6. 85-ft Safety Tethers (2)
7. Adjustable Equipment Tethers (6)

Desired:

1. ECOKs (Fs and Ga)
2. EMU Servicing Kit
3. EVA Systems Bag 1

Leave behind if possible:

1. METOX canisters
2. REBAs
3. ERCA (TV) & Helmet Lights with Batteries

EVA-5a/124/O/A

TOP

Back of 'STS-124/1J EMERGENCY UNDOCK EVA TRANSFER CUE CARD'

HOOK
VELCRO

STS-124/1J EXPEDITED SUIT DOFFING CUE CARD

CAUTION

Verify EV crew is clear of hatch mechanism

IV 1. When equalization complete: open IV Hatch per decal

SAFER DOFFING (5 min)

SAFER 1. Remove Latch covers
2. Latch → ENG
3. Latch ccw until release (~90 deg)
4. Doff SAFER

SUIT DOFFING (10 min)

DCM 5. O2 ACT – OFF
6. PURGE vlv → Open (up)
PLSS 7. sw REBA → OFF (toward left arm of suit)
8. Engage EMU in EDDA
PLSS 9. EMU TV Power Cable ←|→ EMU TV
DCM 10. √SUIT P < 0.4
11. Gloves ←|→ EMU
12. Helmet ←|→ EMU
DCM 13. sw FAN → OFF
14. Doff EMU
15. If taking EMU to Shuttle:

UIA sw PWR EV 1,2 (two) – OFF
√PWR EV 1,2 LEDs (four) – OFF

DCM SCU ←|→ DCM
LTA →|← HUT
Gloves →|← EMU
Helmet →|← EMU

Go to STS-124/1J EMERGENCY UNDOCK
EVA TRANSFER CUE CARD (opposite side)

EVA-5b/124/O/A

TPS REPAIR

The TPS Repair procedures listed below are not published in the hardcopy EVA Flight Supplement. These procedures will be uplinked realtime if they are required.

A PDF and a WORD version of the procedures can be found at:
<http://mod.jsc.nasa.gov/do3/FDF/FDFBooks/Status%20Sheets/index.html>.

Select the "As Flown" Status sheet for STS-124 and the link to the procedures can be found with the link to the EVA FS. The procedures can also be found on the FDF Books CD provided to the FAO console

| | |
|--|-----------|
| BOOM TPS INSPECTION | |
| BOOM POINT INSPECTION SUMMARY TIMELINE | FS 13-3 |
| BOOM POINT INSPECTION TOOL CONFIG..... | FS 13-4 |
| BOOM POINT INSPECTION | FS 13-5 |
| BOOM WLE MAPPING SUMMARY TIMELINE | FS 13-15 |
| BOOM WLE MAPPING TOOL CONFIG | FS 13-17 |
| BOOM WLE MAPPING | FS 13-18 |
| EVA WLE MAPPING INSPECTION..... | FS 13-24 |
| SAFER TPS INSPECTION | |
| SAFER TPS INSPECTION SUMMARY TIMELINE | FS 13-29 |
| SAFER TPS INSPECTION TOOL CONFIG..... | FS 13-30 |
| SAFER TPS INSPECTION | FS 13-31 |
| BOOM CONTINGENCY | |
| BOOM FRGF SHAFT RELEASE | FS 13-37 |
| BOOM FRGF SHAFT INSTALLATION | FS 13-38 |
| BOOM EFGF SHAFT RELEASE | FS 13-40 |
| BOOM MPM STOW/DEPLOY..... | FS 13-42 |
| BOOM ASSISTED LATCHING | FS 13-43 |
| TILE REPAIR | |
| EMU PREP FOR TPS REPAIR..... | FS 13-44 |
| POST TPS REPAIR DOFFING | FS 13-45 |
| EWA MATERIAL MIXING | FS 13-46 |
| EWA REF DATA | FS 13-47 |
| EWA TILE REPAIR – DOCKED/ORM SUMMARY TIMELINE | FS 13-48 |
| EWA TILE REPAIR – DOCKED/ORM TOOL CONFIG..... | FS 13-49 |
| EWA TILE REPAIR – DOCKED/ORM | FS 13-50 |
| SSRMS GAP FILLER REMOVAL SUMMARY TIMELINE | FS 13-58 |
| BOOM GAP FILLER REMOVAL SUMMARY TIMELINE | FS 13-59 |
| GAP FILLER REMOVAL..... | FS 13-60 |
| RCC REPAIR | |
| RCC CRACK REPAIR BAG ASSEMBLY..... | FS 13-65 |
| TEMP SENSOR DISASSEMBLY POST-EVA..... | FS 13-68 |
| RCC CRACK REPAIR BAG DISASSEMBLY POST-EVA | FS 13-69 |
| TEMPERATURE PROBE ASSEMBLY | FS 13-71 |
| CRM APPLICATOR ASSEMBLY | FS 13-71 |
| CRM APPLICATOR NOZZLE INSTALLATION (DAY OF EVA)..... | FS 13-72 |
| RCC CRACK REPAIR..... | FS 13-73 |
| RCC PLUG TRANSFER BAG ASSEMBLY | FS 13-85 |
| NOTES, CAUTIONS, WARNINGS | |
| EVA TPS INSPECTION/REPAIR INHIBIT PAD..... | FS 13-97 |
| TPS REPAIR CAUTIONS AND WARNINGS | FS 13-100 |
| TPS REPAIR NOTES..... | FS 13-101 |
| BOOM OPERATIONAL WARNINGS | FS 13-102 |
| BOOM OPERATIONAL NOTES | FS 13-103 |

| | |
|---|-----------|
| TPS REF DATA | |
| PREFERRED EMU POSITIONING FOR TPS REPAIR..... | FS 13-104 |
| EVA TPS REACH AND ACCESS | FS 13-105 |
| POINT INSPECTION REACH AND ACCESS WHILE DOCKED..... | FS 13-106 |
| WLE MAPPING INSPECTION WHILE DOCKED | FS 13-108 |
| TILE LAYUP | FS 13-109 |
| 85-FOOT SAFETY TETHER..... | FS 13-110 |
| PFR ATTACHMENT DEVICE (PAD) | FS 13-111 |
| WIF EXTENDER | FS 13-112 |
| EVA DIGITAL CAMERA..... | FS 13-113 |
| EVA IR CAMERA | FS 13-115 |
| OVERLAY TILE REPAIR SYSTEM (OTRS) | FS 13-117 |
| OTRS MARKING TEMPLATE AND INSULATION BAGS | FS 13-118 |
| AUGER HOUSING..... | FS 13-119 |
| OTRS RELEASED CONFIGURATION | FS 13-120 |
| ORU BAG INSERT FOR OTRS | FS 13-121 |
| BOOM REF DATA | |
| RTF BOOM OVERVIEW | FS 13-122 |
| BOOM TRANSITIONS WITH MLI | FS 13-123 |
| BOOM BASE END AND MODIFIED EFGF | FS 13-124 |
| BOOM BASE END EFGF ADAPTER PLATE | FS 13-125 |
| EVA-ASSISTED EFGF CONNECTOR DEMATE | FS 13-126 |
| BOOM BASE END SADDLE AND MPM..... | FS 13-127 |
| BOOM MID SECTION AND MODIFIED FRGF..... | FS 13-128 |
| BOOM MID SECTION FRGF ADAPTER PLATE..... | FS 13-129 |
| BOOM TIP END AND SENSORS | FS 13-130 |
| BOOM SENSOR DETAILS | FS 13-132 |
| SENSOR PACKAGE 1 (SP1): LDRI/ITVC | FS 13-134 |
| SENSOR PACKAGE 2 (SP2): LCS..... | FS 13-136 |
| POSSIBLE PRD ROUTING FOR EVA ASSISTED LATCHING | |
| OF BOOM IN MPMS | FS 13-138 |
| BOOM CONTINGENCIES | FS 13-139 |
| GRAPPLE SHAFTS | FS 13-140 |
| PDGF GRAPPLE SHAFT COVER..... | FS 13-141 |
| BOOM FRGF FSE..... | FS 13-142 |

UNSCHEDULED/CONTINGENCY EVA TASKS

I

UNSCH/CONT
EVA TASKS

| | |
|--|--------------|
| 1J WORKAROUNDS CRIBSHEET | TEMP FS 16-2 |
| MANUALLY OPEN/CLOSE CBM PETAL | FS 16-15 |
| REMOVE/REPLACE CENTER DISK COVER..... | FS 16-20 |
| REMOVE/REPLACE CBM CONTROLLER PANEL ASSEMBLY (CPA) | FS 16-25 |
| CLEAR/RESTRAIN CBM CAPTURE LATCH..... | FS 16-32 |
| REMOVE/REPLACE CBM CAPTURE LATCH..... | FS 16-35 |
| REMOVE CBM READY-TO-LATCH (RTL)..... | FS 16-41 |
| REMOVE/REPLACE CBM PETAL | FS 16-47 |
| 1J ISS ORU TIE-DOWN PLAN | FS 16-52 |
| MANUAL RELEASE OF HRM | FS 16-68 |
| JEM RMS JEU REMOVE/REPLACE..... | FS 16-71 |

1J WORKAROUNDS CRIBSHEET

| TASK | FAILURE | ACTION |
|--|--|---|
| I. Generic | | |
| APFR/IAPFR | | |
| A. | APFR/IAPFR fails to install into WIF | <ol style="list-style-type: none"> 1. Verify APFR collar in install position (black-on-black) 2. Check for FOD in WIF or structural interference 3. Attempt APFR install in alternate clocking 4. If no joy, attempt APFR install in alternate WIF 5. If no joy, APFR failure – Use another APFR |
| B. | Joint fails to actuate | <ol style="list-style-type: none"> 1. Verify no load is applied to joint and/or jiggle APFR joint while actuating knob – For pitch joint, push knob in during rotation (Class I pitch joints known to be stiff) 2. Increase force applied in order to free joint |
| C. | Boot becomes stuck in APFR boot plate | <ol style="list-style-type: none"> 1. Have other EV crewmember assist with getting boot out 2. Loosen 7/16-in EVA bolts (3) on heel clip using EVA ratchet or PGT: PGT: [B1 (12.0), CCW2, 30.5], 7/16 - 6-ext 3. Remove 7/16-in EVA bolts (3) on heel clip using EVA ratchet or PGT: PGT: [B1 (12.0), CCW2, 30.5], 7/16 - 6-ext 5 turns (Captive bolts, non-captive heel clip) |
| D. | Boot becomes stuck in IAPFR boot plate | <ol style="list-style-type: none"> 1. Have other EV crewmember assist with getting boot out 2. If wearing Small EMU boot, have other EV crewmember adjust boot sizing to Large 3. Loosen 7/16-in EVA bolts (2) on heel clip using EVA ratchet or PGT: PGT: [B2 (16.0), CCW2, 30.5], 7/16 - 6-ext 4. Remove 7/16-in EVA bolts (2) on heel clip using EVA ratchet or PGT: PGT: [B2 (16.0), CCW2, 30.5], 7/16 - 6-ext 4 turns (Captive bolts, non-captive heel clip) |
| Ballstack | | |
| A. | ECOM fails to release from ISS Structure | On MCC-H GO: Tether ballstack to handrail and leave outside |
| B. | ECOM fails to release from MUT EE | Leave together and return inside |
| C. | Ballstack fails to rigidize | On MCC-H GO: Use secondary tethers to assist in restraining payload |
| EVA Wrench (Torque & Ratchet) | | |
| A. | Ratchet teeth slip | Ratchet to new set of teeth and reapply torque |
| B. | Wrench does not ratchet | Hold ratchet selector and socket in opposite hands and rotate in opposite directions |
| Fluid QD Ops | | |
| Mating Ops | | |
| A. | QD fails to mate | <ol style="list-style-type: none"> 1. Check for debris, damage, or crystals 2. Verify release ring is retracted (Fwd white band is not visible) 3. Check alignment and verify no side loads |
| B. | Release ring snap back test fails | <ol style="list-style-type: none"> 1. Push release ring forward (Release ring will not slide fwd if QD is in FID) 2. Demate QD, verify fwd white band not visible, and remate QD |
| C. | Gap check fails (visual or FID gauge) | Retract release ring, demate QD, verify fwd white band not visible, and remate QD |

1J WORKAROUNDS CRIBSHEET (Cont)

| TASK | FAILURE | ACTION |
|------|--|---|
| | Valve Ops | |
| | D. Detent button is partially unthreaded | <ol style="list-style-type: none"> 1. Re-thread detent button <ol style="list-style-type: none"> a. Load bail handle (button will free spin if not loaded) <ul style="list-style-type: none"> – If valve is open, pull bail handle aft – If valve is closed, push bail handle fwd b. Rotate button cw (8 turns max) |
| | E. Detent button is missing <div style="text-align: center;"> <u>NOTE</u> Detent button is only required for BDT ops and 1 in SPD ops </div> | <ol style="list-style-type: none"> 1. Use equipment hook to depress detent button shaft 2. Use tether strap around gloved finger to depress detent button shaft 3. Retrieve and use Beta Gimbal Antirotation Latch Tool to depress detent button shaft 4. On MCC-H GO: Install spare detent button (Buttons are stowed IVA and must be configured prior to EVA use) |
| | F. Bail fails to actuate to valve open | <ol style="list-style-type: none"> 1. Check for debris, damage, or crystals 2. Retrieve and use QD bail drive lever (3/4, 1, & 1-1/2 in only); notify MCC-H |
| | G. Detent button fails to pop up after bail actuation to valve open | <ol style="list-style-type: none"> 1. Neutralize sideloads 2. Apply greater opening force to QD bail handle 3. Retrieve and use QD bail drive lever (3/4, 1, & 1-1/2 in only); notify MCC-H 4. If applicable, retrieve and install SPD; notify MCC-H |
| | H. Detent button fails to depress during valve closing <div style="border: 1px solid black; padding: 5px; width: fit-content;"> <p style="text-align: center; margin: 0;">WARNING</p> <p style="margin: 0;">Bail may kick back and contact crew when button is depressed if a leaking primary seal allowed pressure build-up in spring cavity</p> </div> | <ol style="list-style-type: none"> 1. Verify locking collar fully rotated (1/2, 3/4, & 1 in only) 2. Push and hold bail handle fwd (to open) with significant force to relieve load on button while simultaneously depressing detent button <ul style="list-style-type: none"> – If button depresses, vent by pulling bail aft until release ring covers aft white band – Push bail fwd to valve open and check button depresses 3. Retrieve QD bail drive lever and repeat step 2 (3/4, 1, & 1-1/2 in only); notify MCC-H 4. Contact MCC to reduce NH3 temperature if possible 5. On MCC-H GO: Retrieve and install QD button depress tool (BDT) (1/4, 3/4, & 1 in only) |
| | I. Bail fails to actuate or detent button fails to pop up after actuation to valve closed | <ol style="list-style-type: none"> 1. Inspect QD for retaining wire protrusion 2. Neutralize possible side loading 3. Depress button and increase force on bail 4. Retrieve and use QD bail drive lever (3/4, 1, & 1-1/2 in only); notify MCC-H |
| | Demating Ops | |
| | J. Female QD fails to demate | <ol style="list-style-type: none"> 1. Verify release ring is fully retracted while attempting to demate 2. Verify TA or P clamps are released 3. Verify locking collar can be rotated under detent button (1/2, 3/4, & 1 in only) 4. Verify trigger linkage is still attached to release ring (1-1/2 in only) 5. Neutralize sideloads or manipulate flexhose to relieve mating forces on female QD 6. Apply greater force to release ring and female QD 7. Retrieve and use QD release tool (QRT) to apply greater force; notify MCC-H |
| | K. Thermal bootie fails to remain securely closed | Install wire tie around bootie to keep QD fully covered |

1J WORKAROUNDS CRIBSHEET (Cont)

| TASK | FAILURE | ACTION |
|------|---|---|
| | L. Cap will not demate | <ol style="list-style-type: none"> 1. Verify pulling out on cap before rotating to ensure locking tab is disengaged 2. Wait for day pass if possible and reattempt cap removal 3. If force is too great for hand actuation or crystals visible around the QD, male may be leaking; notify MCC-H <ul style="list-style-type: none"> – Prepare for quick mate on MCC-H GO 4. Retrieve QD cap tool (1/4, 1/2, & 1 in only) <ul style="list-style-type: none"> – Use QD cap tool to turn stuck cap a maximum of 2 turns (cap vents at ~2 turns). Finish removal of cap by hand (~1 additional turn) |
| | Leaks | |
| | M. Mated QD leaks in valve open position | <ol style="list-style-type: none"> 1. Remove SPD and fully open valve 2. If leak continues, close valve |
| | N. Male QD leaks after cap removal | Reinstall cap; notify MCC-H <ul style="list-style-type: none"> – Prepare for quick mate on MCC-H GO |
| | O. Female QD leaks during or after bail actuation to valve open | <ol style="list-style-type: none"> 1. Return bail to aft (closed) position 2. Perform release ring snap back test <ul style="list-style-type: none"> – If FID is observed, demate and remate QD – If no FID, neutralize sideloads and cycle bail to open position |
| | P. Leaking QD after SPD install | <ol style="list-style-type: none"> 1. Remove SPD, open valve fully, verify detent button is up, and aft white line is visible <ul style="list-style-type: none"> – If leak stops, rotate locking collar to lock 2. Close valve, verify detent button is up, fwd white line is visible, and rotate locking collar to lock 3. If applicable, close valve of appropriate QD in flowpath, verify detent button is up, and fwd white line is visible |
| | Q. Female QD leaks after demate | Fully mate to destination male as quickly as possible |
| | R. Male QD leaks after demate (male sleeve may be visibly stuck open) | <ol style="list-style-type: none"> 1. Remate female QD and open valve <ol style="list-style-type: none"> a. Depress button and use significant force to push bail forward; release button b. With QD in open position apply significant force to aft end of the female QD in back and forth, up and down directions c. Attempt to close valve d. Demate QD and inspect 2. If applicable, close valve of appropriate QD in flowpath, verify detent button is up, and fwd white line is visible 3. Install cap (1/4, 1/2, & 1 in only) |
| | S. Leak detected by MCC-H after valve ops (possible male sleeve stuck open) | <ol style="list-style-type: none"> 1. Cycle QD to open position <ol style="list-style-type: none"> a. Depress button and use significant force to push bail forward; release button b. With QD in open position, apply significant force to aft end of female QD in back and forth, up and down directions c. Attempt to close valve d. Demate QD and inspect 2. If applicable, close valve of appropriate QD in flowpath, verify detent button is up, and fwd white line is visible |
| | T. Frozen NH3 present on female or male QD | <ol style="list-style-type: none"> 3. Leave QD exposed to vacuum; wait maximum of 5 min for sublimation (check periodically) 4. On MCC-H GO: Continue QD ops |

1J WORKAROUNDS CRIBSHEET (Cont)

| TASK | FAILURE | ACTION |
|------|--|---|
| | MMOD Shield | |
| | A. MMOD shield Dzus fastener fails to release | <ol style="list-style-type: none"> 1. On MCC-H GO: Retrieve pry bar and emptied med ORU bag 2. Release other Dzus fasteners 3. Assess clearance between MMOD shield and tools 4. If possible, rotate fastener to position tangs off of tools 5. Place med ORU bag over failed fastener 6. Insert pry bar under MMOD shield by failed fastener and pry shield away from structure |
| | <div style="border: 3px double black; padding: 5px; text-align: center;"> <p>WARNING</p> <p>Do not touch back side of MMOD shield or handle fastener fragments due to sharp edges</p> <p>Fastener and shield/tool interface must be covered to avoid potential projectiles</p> </div> | |
| | B. MMOD shield Dzus fastener fails to engage | <ol style="list-style-type: none"> 1. Verify center fastener is engaged first 2. Check Dzus fastener aligned with bracket 3. Verify fastener clocking correct per alignment mark 4. Push firmly and rotate 5. Engage other fasteners: 2 out of 3 required 6. Install one end of wire tie around Dzus fastener and the other end to nearby handrail |
| | C. T-handle tool fails to engage shield | Remove adjacent fasteners and attempt reinstallation |
| | D. MLI grounding strap Dzus fails to release | On MCC-H GO: Cut ground wire near Dzus fastener |
| | MUT EE | |
| | A. MUT EE jaws fail to release | <ol style="list-style-type: none"> 1. Verify locking collar fully released 2. Shake MUT EE while depressing paddles (try to alleviate sideloads from handrail) 3. Release MUT EE ECOM socket and tether MUT EE to structure |
| | MWS EE | |
| | A. MWS EE is sticky | Known problem. Report degree of stickiness to MCC-H and any noted correlation with thermal environment. Post EVA, report s/n of affected unit (s/n located on "stem" of T-bar) |
| | NZGL Connectors | |
| | A. Bail bar fails to slide over-center | <ol style="list-style-type: none"> 1. Inspect bail for FOD 2. Inspect bail linkage for damage and report to MCC-H 3. Check alignment and sideloads 4. Increase force on bail 5. On MCC-H GO: Retrieve vise grips to help increase force on bail |
| | B. Backshell fails to slide (after over-center mechanism has been overcome) | <ol style="list-style-type: none"> 1. Inspect bail and connector for FOD 2. Inspect bail linkage for damage and report to MCC-H 3. Check alignment and sideloads 4. Wiggle/jiggle connector while pushing or pulling on backshell 5. Attach 2 hooks from adj tether to connector bail and use adj strap to pull bail into demated position 6. On MCC-H GO: Retrieve vise grips to help increase force on bail |
| | C. Connector fails to release from soft dock | <ol style="list-style-type: none"> 1. Verify bail fully thrown and undamaged 2. Check alignment and sideloads 3. Relieve compression on connector interface by pulling backshell away from jack 4. Wiggle/jiggle connector |

1J WORKAROUNDS CRIBSHEET (Cont)

| TASK | FAILURE | ACTION |
|------|-----------------------------------|---|
| | D. Connector fails to soft dock | <ol style="list-style-type: none"> 1. Verify correct plug and jack 2. Verify bail fully aft 3. Inspect following: <ul style="list-style-type: none"> – O-ring seal – FOD – Bend radius – Soft dock springs – Connector keying feature 4. Verify alignment (avoid rolling or rocking plug as this could unseat soft dock springs) <ul style="list-style-type: none"> – Connector should snap into soft dock with little force once half shells are aligned |
| | E. Connector fails to mate | <ol style="list-style-type: none"> 1. Verify half-shells are fully seated on both sides 2. Detach from soft dock and inspect: <ul style="list-style-type: none"> – Pins – FOD – EMI band – Bend radius – Bail linkages and rivets – Soft dock springs – O-ring seal and main joint gasket – Connector keying feature 3. Cycle bail while disconnected (push on connector backshell toward cap/jack for additional leverage) |
| | F. Connector pin bent | <ol style="list-style-type: none"> 1. Rotate connector to bail up position and describe pin location and condition <ul style="list-style-type: none"> – Obtain WVS view of interface if possible 2. On MCC-H GO: Retrieve pin straightener (A/L staging bag) and attempt pin repair (16, 20, or 22 gauge pins only) 3. On MCC-H GO: Retrieve needle nose pliers (stbd A/L toolbox, slot 2) and attempt pin repair <ul style="list-style-type: none"> – MCC-H will verify pin size prior to retrieving tools |
| | G. Connector FOD | <ol style="list-style-type: none"> 1. On MCC-H GO: Retrieve connector cleaner tool (A/L staging bag) <p style="text-align: center;"><u>NOTE</u></p> <p>One N2 cartridge is already captured in the tool (the other is lanyarded inside the caddy). In order to puncture the cartridge, it must be threaded into the tool until the indicator line passes out of sight under the collar of the tool.</p> <p>Puncture connector cleaner cartridge only when ready to perform actual cleaning.</p> <p>Use entire N2 cartridge prior to reentering airlock</p> 2. Attempt cleaning |
| | H. Connector EMI band bent | <p>On MCC-H GO: Retrieve needle nose pliers or forceps (stbd A/L toolbox) to remove band <ul style="list-style-type: none"> – Bail may need to be pushed forward while demated to expose EMI band for removal </p> |
| | I. Connector bail linkage failure | <p>On MCC-H GO: Re-attempt connector mate with broken bail <ul style="list-style-type: none"> – Tether hook or vise grips may be used for additional leverage – Hand on backshell is easiest once bail linkage has passed over-center </p> |

1J WORKAROUNDS CRIBSHEET (Cont)

| TASK | FAILURE | ACTION |
|-------------------------------|--|--|
| | J. Connector soft dock spring bent | On MCC-H GO: Retrieve needle nose pliers and remove bent spring |
| | K. Connector o-ring or main joint gasket seal loose (seal and o-ring required in 1-G only) | <ol style="list-style-type: none"> 1. With PIP pin attempt to reseal O-ring or main joint gasket 2. Remove seal with tether hook 3. On MCC-H GO: Retrieve needle nose pliers (stbd A/L toolbox, slot 2) and remove seal |
| | L. Twist (connector) cap will not release | <ol style="list-style-type: none"> 1. On MCC-H GO: Increase force 2. On MCC-H GO: Attach equip hook to cap tether point and use strap of adj tether to release cap |
| On-Orbit Installed HR | | |
| | A. HR will not install in seat track or fails to soft dock | <ol style="list-style-type: none"> 1. Verify rigid BRT 2. Verify HR shoes are completely released and soft dock armed 3. Check for FOD 4. Verify HR bolt completely released: PGT [A1, CCW2] 5. Rotate HR 180 deg and reattempt installation; notify MCC-H 6. Attempt to install a different HR at this location |
| | B. HR bolt fails to fully engage | <ol style="list-style-type: none"> 1. If torqued, remove HR: <ul style="list-style-type: none"> – PGT [A2, CCW2] to break torque – PGT [A1, CCW2] for removal – Check for FOD and reinstall 2. Increase PGT setting: [A3, CW2] 3. Attempt to install a different HR at this location |
| On-Orbit Installed WIF | | |
| | A. WIF fails to soft dock | <ol style="list-style-type: none"> 1. Check for FOD and structural interference, cycle soft dock pins; reattempt installation 2. Verify WIF is co-planar 3. Install a different WIF at this location 4. Attempt installation of WIF in a different location 5. Return WIF to ground |
| PAD | | |
| | A. Release knob fails to rotate open | <ol style="list-style-type: none"> 1. Verify knob in release position (J-hook not locked) 2. Attempt to rotate knob using ratchet on knob 7/16-in hex stud 3. Release contingency release bar captive bolts (2); PGT [A6, CCW2, 30.5] 7/16 - 6 ext; 5 turns |
| PGT | | |
| | A. No LEDs | <ol style="list-style-type: none"> 1. Perform LED test 2. Use display torque |
| | B. LEDs and torque messages do not agree | Use torque message and notify MCC-H |
| | C. Mode switch breaks | Retrieve spare PGT from A/L |
| LCD Messages | | |
| | D. BATTERY HITEMP | <ol style="list-style-type: none"> 1. If alternate battery available, power off and change battery 2. Retrieve spare PGT from A/L 3. Power off and switch to ratchet mode |
| | E. BATTERY LOTEMP (blinking) | <ol style="list-style-type: none"> 1. Drive tool with no load to increase battery temperature 2. If alternate battery available, power off and change battery 3. Retrieve spare PGT from A/L 4. Power off and switch to ratchet mode |
| | F. BATTERY LOVOLT (blinking) | <ol style="list-style-type: none"> 1. Continue using tool until unable to deliver sufficient torque 2. Retrieve spare PGT from A/L 3. Power off and switch to ratchet mode |

1J WORKAROUNDS CRIBSHEET (Cont)

| TASK | FAILURE | ACTION |
|----------------------|--|---|
| | G. CAL FAILED | <ol style="list-style-type: none"> 1. Press, release trigger to repeat calibration 2. Power cycle and calibrate 3. Retrieve spare PGT from A/L 4. Power off and switch to ratchet mode |
| | H. COLLAR ERROR | <ol style="list-style-type: none"> 1. Cycle torque and speed collars to clear error 2. Power cycle and calibrate 3. Retrieve spare PGT from A/L 4. Power off and switch to ratchet mode |
| | I. COMPAR ERROR | <ol style="list-style-type: none"> 1. Cycle torque collar and A/B mode switch 2. Power cycle and calibrate 3. Retrieve spare PGT from A/L 4. Power off and switch to ratchet mode |
| | J. EEPROM WR ERR (blinking) | <ol style="list-style-type: none"> 1. Power cycle and calibrate 2. Retrieve spare PGT from A/L 3. Power off and switch to ratchet mode |
| | K. HI TORQ | <ol style="list-style-type: none"> 1. If fault occurs during engagement and MTL did not slip; contact MCC-H 2. Power cycle and calibrate 3. Retrieve spare PGT from A/L 4. Power off and switch to ratchet mode |
| | L. HICURR | <ol style="list-style-type: none"> 1. Reattempt operation – Can be caused by excessive rotation of the PGT body while torquing 2. Power cycle and calibrate 3. Retrieve spare PGT from A/L 4. Power off and switch to ratchet mode |
| | M. HYBRID HITEMP | <ol style="list-style-type: none"> 1. Power cycle and calibrate 2. Retrieve spare PGT from A/L 3. Power off and switch to ratchet mode |
| | N. LO TORQ | <ol style="list-style-type: none"> 1. Reattempt operation until desired torque is reached 2. Power cycle and calibrate 3. Retrieve spare PGT from A/L 4. Power off and switch to ratchet mode |
| | O. LOCURR | <ol style="list-style-type: none"> 1. Reattempt operation 2. Power cycle and calibrate 3. Retrieve spare PGT from A/L 4. Power off and switch to ratchet mode |
| | P. LOG IS FULL (blinking) | Continue operation |
| | Q. MOTOR HITEMP | <ol style="list-style-type: none"> 1. Retrieve spare PGT from A/L 2. Power off and switch to ratchet mode |
| | R. OVER CURR | <ol style="list-style-type: none"> 1. Power cycle and calibrate 2. Retrieve spare PGT from A/L 3. Power off and switch to ratchet mode |
| | S. SLFTST FAIL X | <ol style="list-style-type: none"> 1. Power cycle and calibrate 2. Retrieve spare PGT from A/L 3. Power off and switch to ratchet mode |
| Safety Tether | | |
| | A. Safety tether fails to retract/tend | <ol style="list-style-type: none"> 1. Verify reel is unlocked 2. Verify tether reel and/or cable guide (for 85-ft tethers) is clear of FOD 3. Pull out small amount of cable and allow reel to retract while holding light tension on the cable 4. Tap side of reel housing during retraction 5. Report ID # of faulty tether to MCC-H and use alternate safety tether |
| | B. Safety tether red stripe showing (any length) | Safety tether cannot be used – Report ID # of faulty tether to MCC-H – Use alternate safety tether |

1J WORKAROUNDS CRIBSHEET (Cont)

| TASK | FAILURE | ACTION |
|--------------------------|--|--|
| | C. Crew hook fails | <ol style="list-style-type: none"> On load alleviating end: Use waist tether to replace alleviating strap <ul style="list-style-type: none"> Report ID # of faulty tether to MCC-H Retrieve replacement safety tether On anchor end: Report ID # of faulty tether to MCC-H and use an alternate safety tether |
| | D. Level wind fails (85 ft only) | On MCC-H GO: Release level wind mechanism bypass on back of safety tether |
| Scoops | | |
| | A. Scoop will not release from fitting | <ol style="list-style-type: none"> If actuator will not pull back while in locked position, tap actuator with tool to release On MCC-H GO: Leave scoop in place On MCC-H GO: Remove non-captive contingency screws; 5 turns: PGT [A5, CCW2, 30.5] 5/32 Allen drive <ul style="list-style-type: none"> Square Scoop: 4 screws Round Scoop: 7 screws |
| Socket Caddy | | |
| | A. Socket fails to release from socket caddy | <ol style="list-style-type: none"> Verify PIP pin fully inserted into drop proof tether interface on socket Reattempt using a different PIP pin |
| TA Clamp | | |
| | A. TA clamp fails to release | <ol style="list-style-type: none"> With handle up, press down on top of rounded clamp With handle up, use tether hook to pry drawhook from capture pin |
| Tether Shuttle | | |
| | A. Tether shuttle will not release from CETA/MT rail | On MCC-H GO: Remove non-captive screws (2) at hingeline to release nadir section with slide lock: PGT [A7, CCW1, 30.5] 5/32 Allen drive |
| Torque Multiplier | | |
| | A. TM will not release from fitting | <ol style="list-style-type: none"> Verify TM anti-backlash in neutral; if not: PGT [RCW, 30.5]. Apply cw torque and push anti-backlash button to neutral. Reattempt removal Attempt to rock off of fitting (Square TM only) On MCC-H GO: Release TM contingency release band pin 20 turns (do not exceed 28 turns) PGT [A5, CCW2, 30.5]. When band springs open, remove TM |
| TSA | | |
| | A. Latch fails to open | Release 7/16 EVA bolt on latch bracket; rotate bracket clear of latch |
| | B. Latch fails to close | Close remaining latches (3 of 4 required for landing) |

1J WORKAROUNDS CRIBSHEET (Cont)

Flight Specific:

| TASK | FAILURE | ACTION |
|-------------------------------|--|--|
| II. BOOM TRANSFER | KAD Release | |
| | A. KAD release knob fails to rotate open | <ol style="list-style-type: none"> 1. Verify knob in release position 2. Attempt to rotate knob using 7/16-in Ratchet on knob 7/16-in hex stud 3. PGT [A6 (8.3 ft-lb), CCW2, 30.5] 7/16-6 Ext: Release contingency release bar captive bolts (2); 5 turns |
| | P411 Connector Release | |
| | A. P411 Connector Fails to Release | <ol style="list-style-type: none"> 1. Install contingency bolts into P411 connector <ol style="list-style-type: none"> a. PGT [A1(2.5), CW2, 30.5] 7/16-6 Ext: Until bolts make contact with plate b. PGT [A1(2.5), CW2, 30.5] 7/16-6 Ext: 1/4 turn on each bolt alternating back and forth until P411 connector is released 2. Retrieve Pry Bar and pry on each side of P411 connector until connector is released |
| | OBSS Release | |
| | A. OBSS fails to Release from SSBAD | <ol style="list-style-type: none"> 1. Verify knob in release position 2. Attempt to rotate knob using 7/16-in Ratchet on knob 7/16-in hex stud 3. Remove PAD Capture PIP Pins (RET to PAD) 4. PGT [A6 (8.3 ft-lb), CCW2, 30.5] 7/16-6 Ext: Release contingency release bar captive bolts (2); 5 turns 5. Release (2) extension bolts PGT [A5 (7.0 ft-lb), CCW2, 30.5] pull T-handle and Retract OSE 6. OSE Rotate Around Trunnion (after each step attempt SSBAD release): <ul style="list-style-type: none"> – Release Anti-rotation fitting PIP Pins (2) – Disengage Anti-rotation fittings (2) by pulling up Anti-rotation handles (2) #1 & #2 – Retract Drive Clamp “Bolt 1” PGT [B7, 25.5 ft-lb, CCW 2, 30 RPM, MTL 30.5] 11-15 turns until hard stop, rotate around trunnion – Release capture latch PIP Pin, insert PIP pin into stow location (RET to OSE) – Disengage capture latch and insert PIP pin in Locked Open position – Rotated OSE around Trunnion to relieve load between OBSS and SSBAD – Once OBSS is released, clean up OSE: <ul style="list-style-type: none"> – Rotate OSE back into nominal position and perform the above step in the opposite order 7. Use PGT [B3 18.4 ft-lb, CW2, 30.5]-7/16X6" 11-15 turns until hard stop to reinstall Drive Clamp “Bolt 1”. Verify OSE fully attached – view clamping mechanism through OSE cover slot |
| III. JPM LTA CABLE DISCONNECT | A. Connector fails to demate | <ol style="list-style-type: none"> 1. See NZGL Connectors (GENERIC TASKS) 2. On MCC-H GO, attempt to disconnect cables from PLB side, cut cable clip and stow cables on JPM w/TA clamps and wire ties 3. Check MCC-H for cable cut options (this will leave hot cables in PLB once APCU 2 power is reenabled for OBSS) |
| | B. Connector fails to softdock on ECSH | Use wire tie to secure connector/cable (NOTE: connector will be hot once APCU 2 power is re-enabled) |

1J WORKAROUNDS CRIBSHEET (Cont)

| TASK | FAILURE | ACTION |
|-------------------------------------|--|---|
| | C. Connector cap fails to install on JPM | 1. Return cap IVA <div style="text-align: center;"> <p><u>NOTE</u></p> <p>Connector J107/157 will have exposed and energized pins when HCTLs are powered. Check with MCC-H for further restrictions</p> </div> <div style="text-align: center; border: 2px solid black; padding: 5px; margin: 10px auto; width: fit-content;"> <p><u>WARNING</u></p> <p>Do not push MLI cover into connector (Risk of pin short)</p> </div> 2. For cap failure, install MLI cover without cap(s) and caps from JTVE can be installed on subsequent EVA |
| IV. CBM CONTAMINATION COVER REMOVAL | A. FOD found on CBM | <div style="text-align: center; border: 2px solid black; padding: 5px; margin: 10px auto; width: fit-content;"> <p><u>WARNING</u></p> <p>Do not touch PCBM sealing surface after Contamination covers are removed</p> </div> Clean FOD from CBM seals |
| | B. PCBM IVA MLI cover pulled free of Velcro | 1. Attempt to re-seat Velcro on IVA MLI cover 2. On MCC GO, obtain Compound Cutter from A/L toolbox #2, slot #1. Attempt to remove IVA MLI cover from PCBM and cut grounding wires |
| V. S1/ESP3 NTA REMOVAL/ PREP | A. NTA bolt fails to break torque with ratchet | 1. Use TM with PGT: PGT [B7 (25.5 ft-lb), CCW2, 30.5] 2. Break torque on other bolts and reattempt suspect bolt 3. Ratchet wrench with cheater bar: Break torque on fastener. DO NOT use cheater bar with TM |
| VI. NTA REMOVAL FROM S1/ESP3 | A. NTA Bolt fails to release | Use PGT in manual ratchet [RCCW, 30.5] |
| | B. NTA Bolt jams | 1. Use PGT in manual ratchet [RCCW, 30.5] 2. Do not perform R&R <ul style="list-style-type: none"> a. Reinstall bolts b. Tether old NTA to structure handrail c. Check MCC for further stow plans |
| | C. Soft dock pin fails to retract | Retrieve scoop and attempt rotation |
| | D. NTA fails to remove from rail | 1. Inspect for MLI interference with rails 2. Check MCC-H |
| VII. NTA INSTALL IN S1 | A. NTA fails to install on rails | Inspect for MLI interference with rails |
| | B. NTA soft dock pin fails to engage | Press on |
| | C. NTA bolt fails to engage | 1. Use PGT in manual ratchet [RCW, 30.5] 2. If less than 4 of 4 bolts achieved: tether NTA with Adj tether |

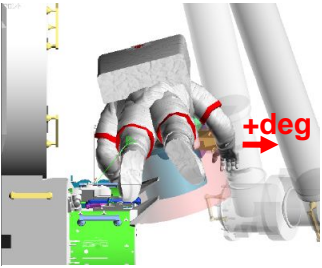
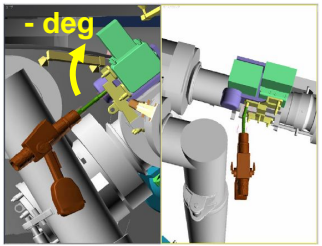

1J WORKAROUNDS CRIBSHEET (Cont)

| TASK | FAILURE | ACTION |
|--|--|---|
| <p>VIII. NTA N2 LINE DISCONNECT</p> | <p>A. Male QD fast leak detected by THOR when valve closed but NTA female QD still mated to ATA male QD</p> <p>Blue – Ground action Black – EVA action</p> | <ol style="list-style-type: none"> 1. If leak is identified by THOR to be a gross leak (leaking down GN2 pressure in a matter of minutes), allow GN2 to leak down completely before demating QD 2. Ground: Command Both NTA isolation valves to closed to isolate affected QD and prepare for NTA pressure adjustment 3. Demate female QD once vented and inspect for stop plug seal damage. Also inspect male QD for stuck open sleeve 4. If female stop plug seal shows damage, then stop and terminate procedure for associated side of ATA. Do not remate QD as permanent damage to male QD would likely occur If inspection of female QD is nominal, remate and reopen QD valve. After opening, push bail forward toward opening position against stop with significant force 5. With QD valve still open, apply <u>significant</u> force to back side of female QD (not the flexline) in the up-and-down and side-to-side direction to help unstick male sleeve 6. Close QD valve and demate female QD to verify if unsticking of male sleeve was successful by repeating visual inspection of male sleeve, as in step 3 above 7. If inspection of male sleeve is nominal, remate female QD and reopen QD valve 8. Ground: Open NTA Supply Valve 9. Ground: Set GPRV to pressure of affected (lower pressure) ATA tank 10. Ground: Open affected NTA isolation valve 11. Ground: Reset GPRV to pressure of opposite (nominal pressure) ATA tank 12. Ground: Reopen remaining NTA Isolation Valve 13. Return to nominal procedure at point of QD valve closure 14. If no joy and still leaking, demate QD, proceed with nominal EVA plan and notify THOR that associated ATA will have to remain isolated due to leak until replacement NTA is installed |
| | <p>B. Male QD slow leak detected by THOR when valve closed but NTA female QD still mated to ATA male QD</p> | <ol style="list-style-type: none"> 1. If leak was identified by THOR to be small (not indicative of stuck open male sleeve), then cycle valve to open and closed up to 2x. THOR and MER Mgr determine if the amount of leak requires repress of ATA Tank with GN2 before final demate 2. If no joy and still leaking, demate QD, proceed with nominal EVA plan and notify THOR that associated ATA will have to remain isolated due to the leak until replacement NTA is installed |
| | <p>C. Leak detected from the first NTA female QD while mated or demated (NOTE: opposite ATA tank pressure will decrease along with NTA Out Press)</p> | <ol style="list-style-type: none"> 1. Ground: Close both NTA Isol Valves 2. Ground: Open NTA Supply Valve 3. Ground: Set GPRV setpoint to pressure of affected (lower pressure) ATA tank 4. Ground: Open NTA Isol Valve to affected ATA tank 5. Ground: Reset GPRV to pressure of unaffected (nominal pressure) ATA tank 6. Return to nominal procedure at point of QD valve closure |

1J WORKAROUNDS CRIBSHEET (Cont)

| TASK | FAILURE | ACTION |
|--|---|---|
| | D. Leak detected from the second NTA female QD while mated or demated | Proceed with nominal EVA procedure |
| VIII. JTVE INSTALLATION | A. Slider softdock latch is stuck and Boom cannot slide in | 1. Press Slider release button and install the Boom 2. Retrieve Vise Grip or Needle Nose Pliers, and pull pin which is located outside of Slider release button to actuate softdock latch |
| | B. Slider softdock latch does not work after Boom slides in | Press a pin which is located outside of Slider release button and actuate softdock latch |
| | C. Slider bolt jams | 1. Set PGT torque to PGT [B1 (12.0), CCW2, 30.5] and loosen. Then reset torque to PGT [A3 (4.8), CW2, 30.5] and attempt to re-tighten bolt 2. Set PGT torque PGT [B1 (12.0), CCW2, 30.5] and loosen. Then reset torque to PGT [B1 (12.0), CW2, 30.5] and attempt to re-tighten bolt 3. Tie down Boom slider with wire tie |
| | D. Boom connector cannot mate | 1. See Generic workarounds 2. If no joy with Generic workaround, bring JTVE back into A/L |
| | E. Boom connector MLI cannot be secured on the connector properly | Tie down connector MLI with wire tie |
| | F. JTVE LL bolt does not release with recommended torque | 1. Increase torque up to PGT [B7 (25.5), CCW2, 30.5] 2. Use Ratchet wrench and be prepared for possible debris |
| IX. JEMRMS MLI COVER REMOVAL | A. 1/4-turn fastener cannot unlock/rotate | Retrieve Vise Grip tool and rotate fastener with tool |
| | B. 1/4-turn fastener is inaccessible due to JEMRMS launch configuration (especially J5 Cover) | Retry after JEMRMS is partially deployed in EVA 3 |
| X. JPM WINDOW LL RELEASE | A. JPM Window Shutter launch lock bolt does not release with recommended torque | 1. Increase torque PGT [B7 (25.5), CCW2, 30.5] , and be prepared for possible debris 2. Use PGT in Manual Ratchet (RCCW 30.5) or use ratchet wrench, and be prepared for possible debris |
| XI. ZENITH ACBM PREP | A. Permanent MLI on the ACBM came off with ACBM EVA MLI cover removal | <div style="border: 2px solid black; padding: 5px; width: fit-content; margin: 0 auto;"> <p>WARNING Do not touch ACBM sealing surface</p> </div> <p>Attempt to reseat Velcro of permanent MLI</p> |
| | B. CBM Hatch PIP pin cannot be released | Use equipment hook, Adjustable tether strap, or wire tie to obtain the required leverage to release PIP pin |
| | C. CBM Bumper launch lock bolt does not release with recommended torque | <p>NOTE</p> <p>Bolt is designed to shear at nut plate</p> <p>1. Increase torque up to PGT [B7 (25.5), CCW2, 30.5], and be prepared for possible debris 2. Use Ratchet wrench and be prepared for possible debris</p> |
| XII. JPM TRUNNION COVER INSTALL | A. Cover cannot be installed due to Velcro anomaly | 1. No action required if 3 Velcro patches mated 2. Bring back inside and prep with wire ties for future EVA or wrap wire tie(s) around installed covers at base of pin and tie other end of wire tie to closest hand rail |

1J WORKAROUNDS CRIBSHEET (Cont)

| TASK | FAILURE | ACTION |
|---|---|---|
| XIII. JEMRMS WVE/EVE MLI & LAUNCH LOCK RETRIEVAL | A. 1/4-turn fastener cannot unlock/rotate | Retrieve Vise Grip, need nose pliers, or box end wrench tool from bag and rotate fastener with Vise Grips |
| | B. LL bolt does not release with recommended torque | Use Ratchet Wrench and be prepared for possible debris |
| | C. LL bolt is inaccessible due to JEMRMS  (EVE)  (WVE) | <ol style="list-style-type: none"> 1. Use Ratchet Wrench 2. Use Box End Wrench 3. On MCC GO, maneuver JEMRMS to make crew access possible <div style="border: 2px solid black; padding: 5px; margin: 10px 0;"> <p style="text-align: center;">WARNING</p> <p>Stay away from JEMRMS (Translate clear of JPM RMS). On MCC-H GO, return to the worksite</p> </div> <ul style="list-style-type: none"> - For EVE, rotate Joint 1 (+deg: Move the arm/EVE outward, -deg: Inward) - For WVE, rotate Joint 6 (+deg: WVE/LL face down, -deg: Face up) |
| XIV. DEPLOY ACBM MMOD SHIELD DOOR | A. Handle cover bolt does not release with recommended torque | <ol style="list-style-type: none"> 1. Increase PGT torque up to PGT [B1 (12.0), CCW2, 30.5] 2. Increase PGT torque up to PGT [B7 (25.5), CCW2, 30.5], and be prepared for possible debris 3. Use PGT in Manual Ratchet (RCCW 30.5) or use ratchet wrench, and be prepared for possible debris |
| | B. Handle cover bolt jammed when installed | <ol style="list-style-type: none"> 1. Set PGT torque to PGT [A5 (7.0), CCW2, 30.5], A5(7.0 ft-lb) and loosen. Then reset torque to PGT [A2 (3.8 ft-lb), CW2, 30.5] and attempt to re-tighten bolt 2. If no joy, leave as is (Spring hinge will keep door closed) |
| XV. DEPLOY ACBM MMOD SHIELD | A. Handle lever cannot pull down  | <ol style="list-style-type: none"> 1. Check handle lever configured 90 deg up correctly to unlatch handle 2. Attempt to deploy shield while jiggling lever 3. Check Launch Lock bolts are fully loosened by PGT [A6 (8.3 ft-lb), CCW2, 30.5], 10 turns 4. Wrap Adj around lever and pull on adj (above Cam buckle) to deploy shield |

1J WORKAROUNDS CRIBSHEET (Cont)

| TASK | FAILURE | ACTION |
|-------------------------------|---|--|
| XVI. ETVCG | A. ETVCG is not oriented correctly for removal (should be in park position) or will not pan to park position (camera lens should point zenith and directly toward TVCIC structure (bolt housing)) | 1. Contact MCC 2. Manually align (pan/tilt lock lever will not lock unless camera is in home position) |
| | B. ETVCG pan/tilt lever won't rotate | 1. Check worksite for FOD 2. Increase force, re-attempt 3. Contact MCC |
| | C. ETVCG outer bolt does not release | 1. Check worksite for FOD 2. Increase PGT setting to B7 for ONE turn only. Reset PGT to A7 for full run-out of bolt |
| | D. ETVCG center jacking bolt does not release | 1. Check worksite for FOD 2. Check outer bolts to make sure they are fully backed out 3. Increase PGT torque setting to B7 for ONE turn only. Reset PGT to A7 for full run-out of bolt |
| | E. ETVCG center jacking bolt does not engage | Remove camera, inspect rail and bolt interface from damage, attempt re-installation, ensure outer bolts are retracted |
| | F. ETVCG center jacking bolt does not reach minimum turn count (24 turns) | Increase PGT torque setting to B1; re-attempt |
| | G. ETVCG outer bolt does not engage | 1. Check worksite for FOD 2. Engage opposite outer bolt, re-attempt driving failed bolt 3. Increase PGT torque setting to B1, re-attempt 4. Contact MCC |
| XVIII. SARJ MLI COVERS | A. MLI Cover Inboard Bolt will not break initial torque | 1. Increase PGT [B7 (25.5 ft-lb), CCW2, 30.5] , reattempt for 1 turn, then return to original torque setting of [A6 (8.3), CCW2, 30.5] 2. If free spinning nut plate suspected: a. Retrieve vise grips from Staging Bag b. Attach vise grips to bolt head c. Turn bolt ccw while applying gentle pull force (do not fail bolt) |
| | B. MLI Cover Inboard Bolt will not engage | Engage other inboard bolts. Minimum number of bolts that must be re-installed is any 2 of 4 or any 4 or 6 per cover panel (for 6 fastener covers, if one fastener in each pair engaged then 3 of 6 is the min) |

MANUALLY OPEN/CLOSE CBM PETAL (00:30)

Objective: To manually open/close radial Common Berthing Mechanism (CBM) petal via EVA due to CBM contingency

| IV/SSRMS | EV1 | EV2 |
|----------|--|---|
| | <div data-bbox="758 321 1264 415" style="border: 1px solid black; padding: 5px; text-align: center;"> <p>CAUTION During any CBM operation, avoid contact with sealing surface</p> </div> <p><u>OPEN PETAL</u></p> <ol style="list-style-type: none"> 1. Configure/set up APFR and tools as reqd; transfer to worksite <div data-bbox="758 570 1220 664" style="border: 1px solid black; padding: 5px; text-align: center;"> <p>CAUTION Do not use petal(s) as hand hold until launch restraints have been engaged</p> </div> <ol style="list-style-type: none"> 2. Engage first petal launch restraint for failed petal, push button in 3. PGT [A6, CCW2, 30.5]-6 Ext 7/16: Release roller link release bolt (inner-most, one going thru petal) until capture latch disengaged, up to 12-13 turns <p style="text-align: center;"><u>NOTE</u> Visually verify capture latch tip is no longer engaged on petal roller link</p> <ol style="list-style-type: none"> 4. PGT [A6, CW2, 10.5]-6 Ext 7/16: Retighten roller link release bolt up to 12-13 turns 5. While restraining petal, release first launch restraint (adj tether strap) 6. Slowly, allow petal to open 7. Clean up worksite <p><u>CLOSE PETAL</u></p> <ol style="list-style-type: none"> 1. Close petal (1-5 lb force reqd); hold 2. Reengage first launch restraint (push in button) | <div data-bbox="1415 321 1921 415" style="border: 1px solid black; padding: 5px; text-align: center;"> <p>CAUTION During any CBM operation, avoid contact with sealing surface</p> </div> <p><u>OPEN PETAL</u></p> <ol style="list-style-type: none"> 1. Configure/set up APFR and tools as reqd; transfer to worksite <div data-bbox="1415 570 1877 664" style="border: 1px solid black; padding: 5px; text-align: center;"> <p>CAUTION Do not use petal(s) as hand hold until launch restraints have been engaged</p> </div> <ol style="list-style-type: none"> 2. Engage second petal launch restraint for failed petal, push button in 3. Assist EV1 as reqd <ol style="list-style-type: none"> 4. While restraining petal, release second launch restraint (adj tether strap) 5. Slowly, allow petal to open 6. Clean up worksite <p><u>CLOSE PETAL</u></p> <ol style="list-style-type: none"> 1. Close petal (1-2 lb force reqd); hold 2. Reengage second launch restraint (push in button) |

MANUALLY OPEN/CLOSE CBM PETAL – TASK DATA

Tools:

| EV1 | EV2 |
|-------------------|-------------------|
| PGT | BRT |
| 7/16-6 in ext | Adjustable Tether |
| Adjustable Tether | |

EVA Fasteners:

| Fastener Name | Label | Head Size | Qty | Install Torque (ft-lb) | Release Torque (ft-lb) | Failure Torque (ft-lb) | Turns | RPM |
|--------------------------|-------|-----------|-----|------------------------|------------------------|------------------------|-------|-----|
| Roller Link Release Bolt | N/A | 7/16" | 1 | 8.3 | 8.3 | 12.1 | 12-13 | 30 |

* Standard PGT settings assumed

Foot Restraints:

| Task | WIF | CETA Position | Swing Arm Settings | APFR Setting |
|---------------------|--------|---------------|--------------------|---------------|
| Port CBM – Fwd half | NOD 05 | N/A | N/A | 11, RR, G, 12 |
| Port CBM – Aft half | NOD 03 | N/A | N/A | 11, QQ, G, 1 |
| Nadir CBM | SSRMS | N/A | N/A | TBD |

* Not verified in NBL

Petal/Latch Locations:

| Element/Location | Petal/Latch 1 | Petal/Latch 2 | Petal/Latch 3 | Petal/Latch 4 |
|------------------|---------------|---------------|---------------|---------------|
| Node 1 Nadir | Aft Stbd | Fwd Stbd | Fwd Port | Aft Port |
| Node 1 Port | Fwd Zenith | Aft Zenith | Aft Nadir | Fwd Nadir |
| Lab Forward | Zenith Stbd | Zenith Port | Nadir Port | Nadir Stbd |
| Node 2 Nadir | Aft Stbd | Fwd Stbd | Fwd Port | Aft Port |
| Node 2 Port | Fwd Zenith | Aft Zenith | Aft Nadir | Fwd Nadir |
| Node 2 Zenith | Aft Port | Fwd Port | Fwd Stbd | Aft Stbd |
| Node 2 Starboard | Fwd Nadir | Aft Nadir | Aft Zenith | Fwd Zenith |
| Node 2 Forward | Zenith Stbd | Zenith Port | Nadir Port | Nadir Stbd |
| JEM Zenith | Fwd Stbd | Aft Stbd | Aft Port | Fwd Port |

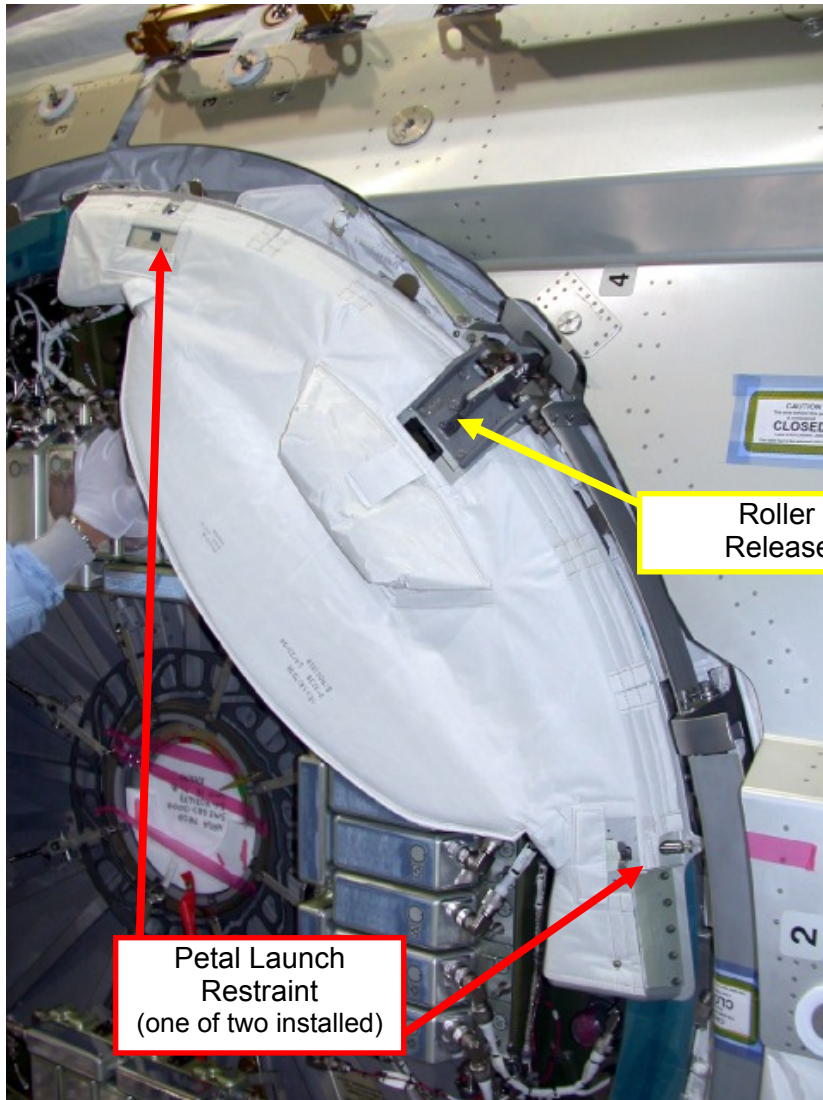
Cautions:

1. During operation, avoid contact with CBM sealing surface
2. Do not use petals as hand hold unless launch restraints have been engaged

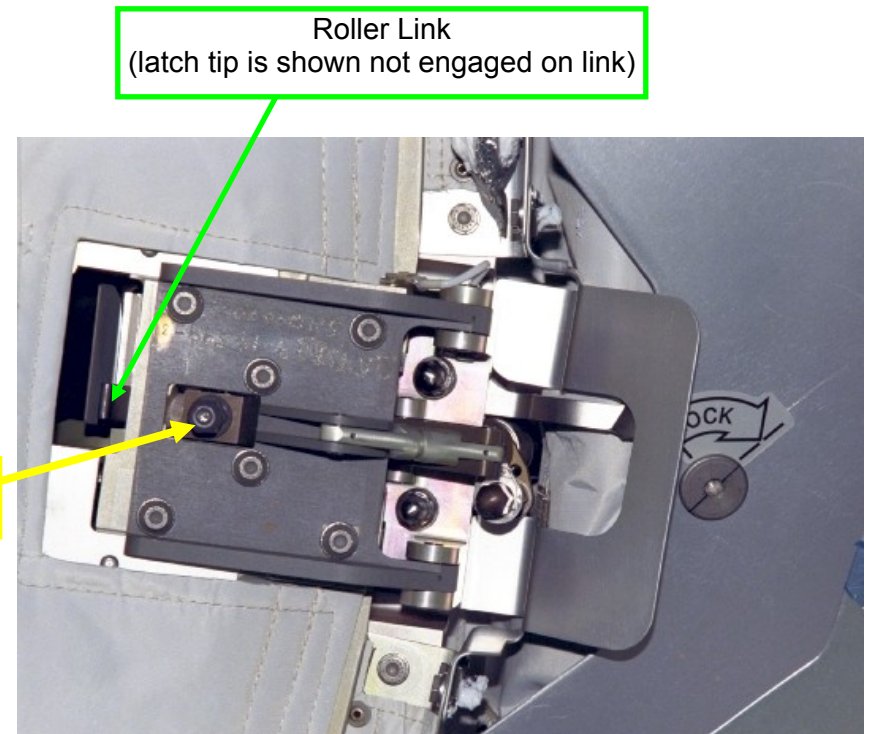
Notes:

1. CBM CPAs do not have to be powered down for this activity

MANUALLY OPEN/CLOSE CBM PETAL – TASK DATA (Cont)

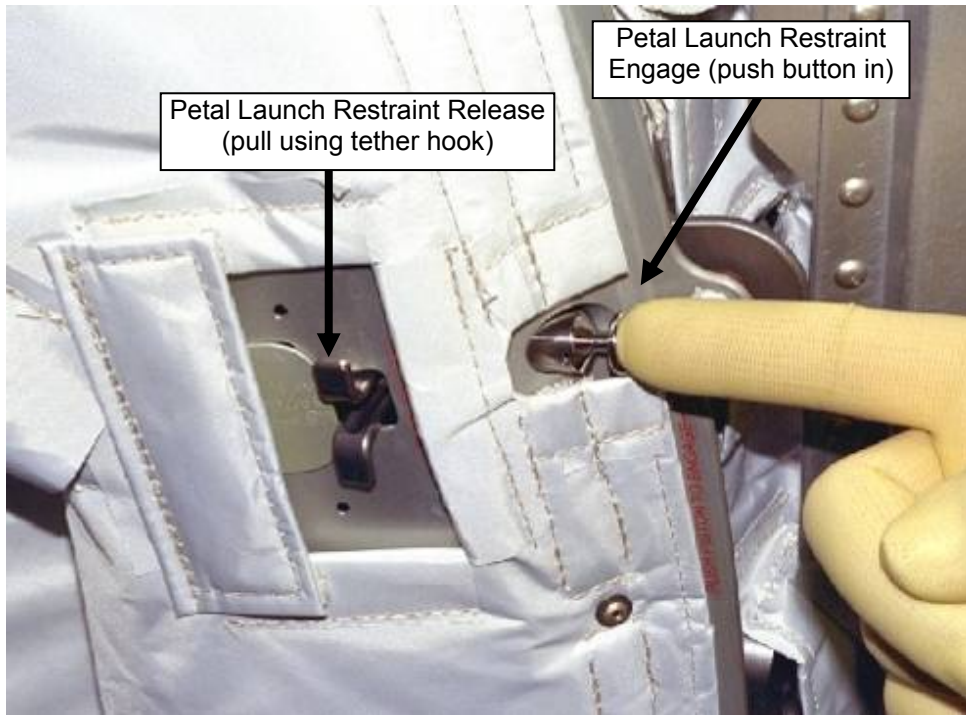


CBM PETAL

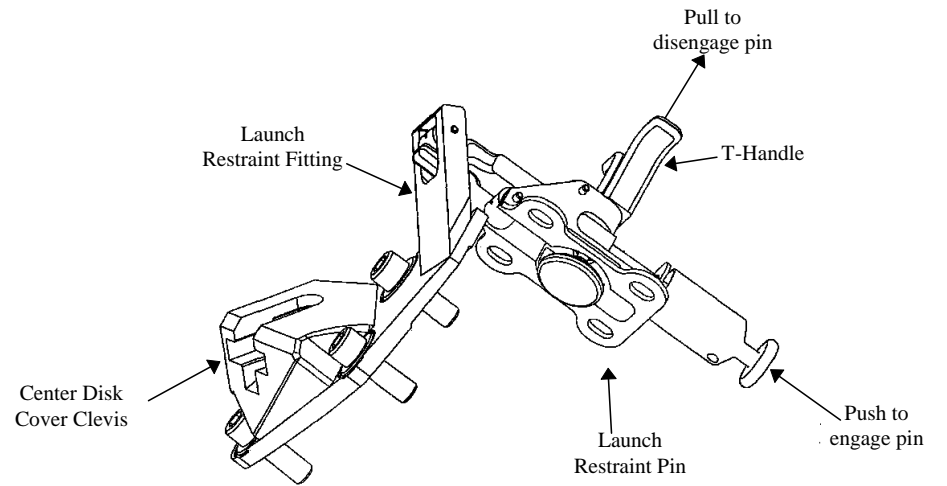


CBM PETAL DEPLOY MECHANISM

MANUALLY OPEN/CLOSE CBM PETAL – TASK DATA (Cont)



CBM PETAL LAUNCH RESTRAINT OPERATION



CBM PETAL LAUNCH RESTRAINT MECHANISM

MANUALLY OPEN/CLOSE CBM PETAL – TASK DATA (Cont)



PETAL LAUNCH RESTRAINT RELEASE USING ADJUSTABLE TETHER STRAP

REMOVE/REPLACE CENTER DISK COVER (00:30)

| IV/SSRMS | EV1/EV2 |
|----------|---|
| | <div data-bbox="743 256 1503 321" style="border: 1px solid black; padding: 5px; text-align: center;"> <p>CAUTION During any CBM operation, avoid contact with sealing surface</p> </div> <p><u>COVER REMOVAL</u> (1 quadrant)</p> <ol style="list-style-type: none"> 1. Configure/set up APFR and tools as reqd; transfer to worksite 2. Access turnbuckle at desired Center Disk Cover quadrant 3. Remove PIP pin with socket 4. Repeat step 3 for second turnbuckle PIP pin 5. Open Center Disk Cover flap below turnbuckle to view Instructions 6. Rotate turnbuckle in "LOOSEN" direction to release cable tension (~20-30 turns) 7. Configure retractable tethers to cinch back cover 8. Pull PIP pins from pulleys (two) to be removed, one per pulley 9. Stow pulley PIP pins (two) in Standoff Bar ends 10. Remove each pulley from clevis. Use a tether to keep pulley away from CBM mating interface 11. Cinch adjustable tether as required 12. Remove PIP pins (two) from Standoff Bar. Remove Standoff Bar by rotating inward 45 deg. Use a tether to clear worksite <p><u>COVER REINSTALL</u></p> <ol style="list-style-type: none"> 1. Release/stow tethers used to restrain cover 2. Reattach Standoff Bar, rotate outward 45 deg to reinstall cover quadrant 3. Insert pulleys (two) back into clevises (two) 4. Reinstall pulley PIP pins (1 per pulley) 5. Reinstall Standoff Bar PIP pins if time permits (2 per standoff) 6. Repeat steps 2-5 as reqd for other CBM quadrants 7. If feasible, re-tighten cable by rotating turnbuckles in the "TIGHTEN" direction per instructions 8. Return turnbuckle PIP pins to the engaged slot (turn 90 deg) 9. Secure cover using tethers or wire ties as reqd 10. Clean up worksite |

REMOVE/REPLACE CENTER DISK COVER – TASK DATA

Tools:

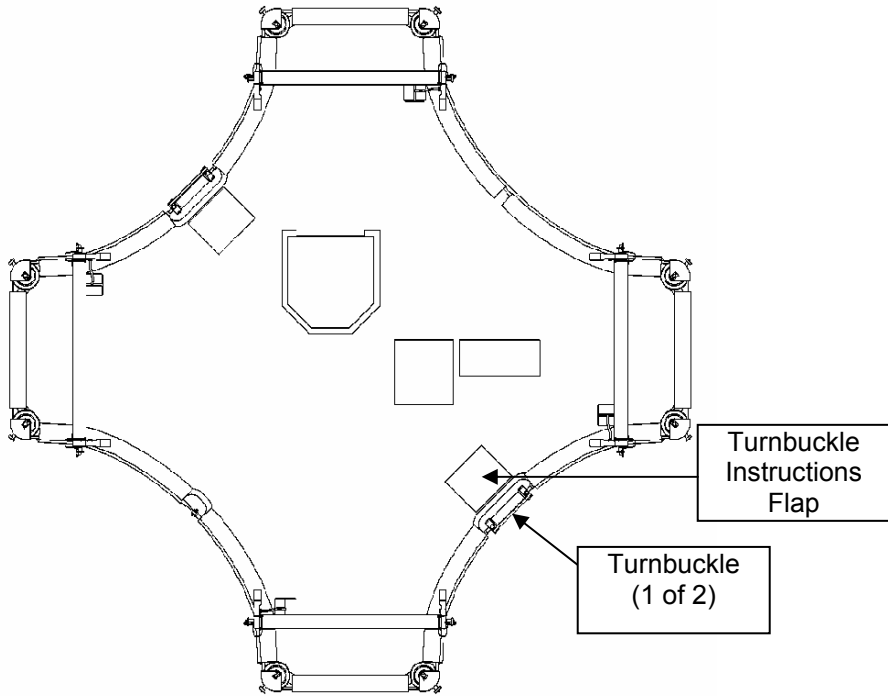
| EV1 (FF) | EV2 (FF) |
|--|----------|
| Retractable Tethers (2) w/small equipment hook | |
| Adjustable Tether | |
| Wire Ties | |
| | |
| | |
| | |

EVA Fasteners: N/A

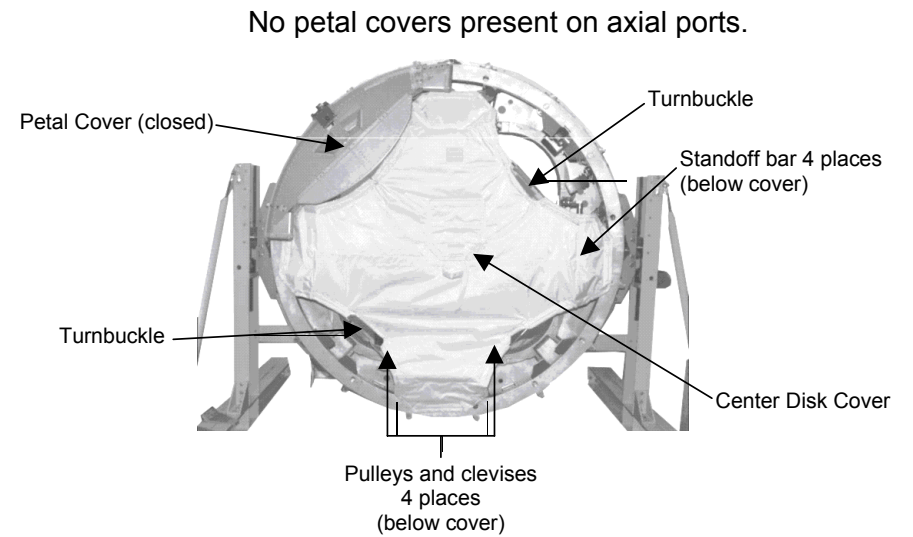
Notes:

1. If removing Center Disk Cover for CPA R&R, only one quadrant reqd to be removed
2. Securing cover with wire ties or tethers is required if the pulleys are not able to be returned to the clevises and the cable tightened. The requirement for securing the cover is to verify all hardware is out of the capture and mating plane of the CBM

REMOVE/REPLACE CENTER DISK COVER – TASK DATA (Cont)



CENTER DISK COVER DRAWING

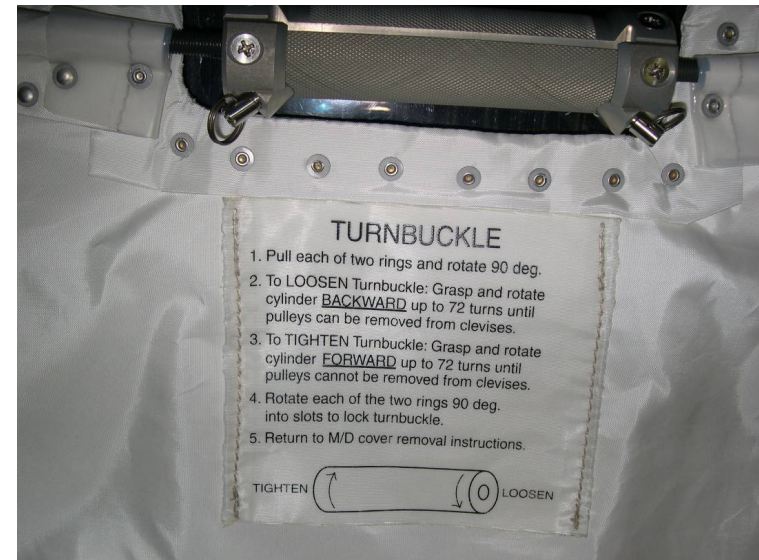


CENTER DISK COVER PHOTO

REMOVE/REPLACE CENTER DISK COVER – TASK DATA (Cont)

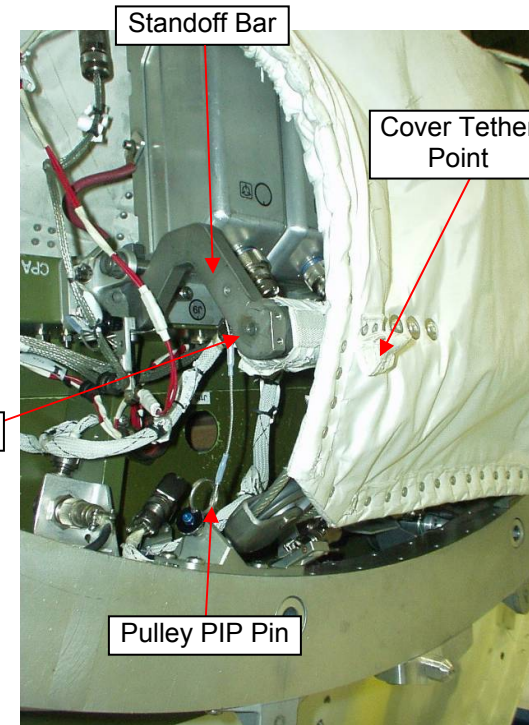
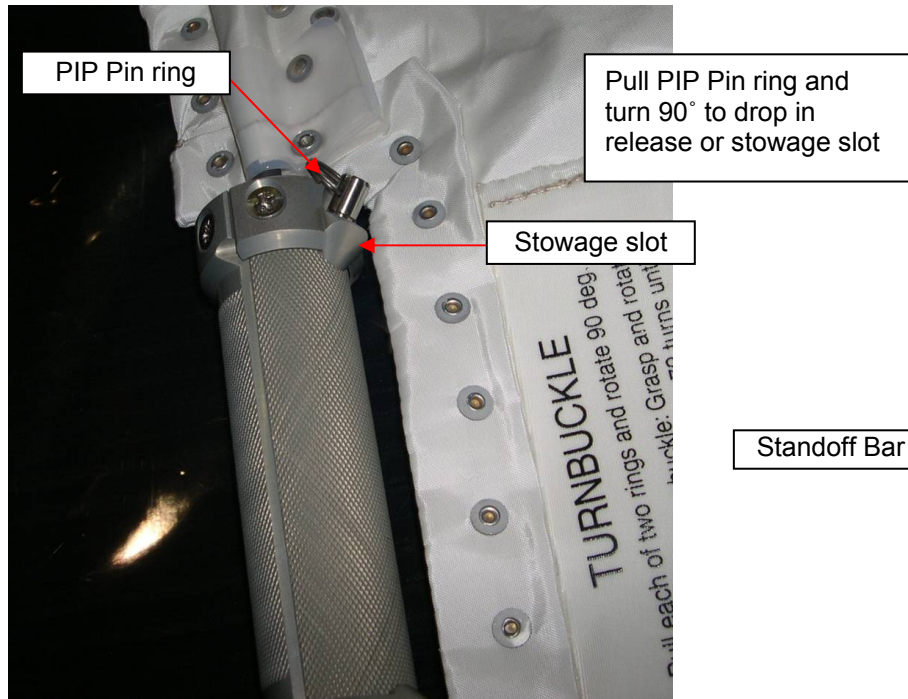


CBM CENTER DISK COVER FLAP INSTRUCTIONS



CBM CENTER DISK COVER TURNBUCKLE INSTRUCTIONS

REMOVE CBM READY-TO-LATCH (RTL) – TASK DATA (Cont)



REMOVE/REPLACE CBM CONTROLLER PANEL ASSEMBLY (CPA) (02:00)

Objective: To remove and replace failed CBM Controller Panel Assembly (CPA)

Assumptions: Corresponding CBM Petal Covers (two) for failed CPA have been fully deployed via commanding or EVA

IV Tools reqd for this procedure and must be retrieved prior to EVA. See Task Data for more info

| IV/SSRMS | EV1 | EV2 |
|--|--|---|
| <p>1. √Inhibits in place for affected CPA (see Task Data)</p> <p>Record s/n of spare CPA _____</p> <p>Record s/n of failed CPA _____</p> | <div data-bbox="760 418 1276 529" style="border: 3px double black; padding: 5px; text-align: center;"> <p><u>WARNING</u> Power must be removed from CPA prior to EVA maintenance</p> </div> <div data-bbox="760 548 1264 643" style="border: 1px solid black; padding: 5px; text-align: center;"> <p><u>CAUTION</u> During any CBM operation, avoid contact with sealing surface</p> </div> <p><u>CPA REMOVAL</u></p> <ol style="list-style-type: none"> 1. Configure/set up APFR tools as reqd; transfer to worksite 2. Remove Center Disk Cover corresponding quadrant: Perform REMOVE/REPLACE CENTER DISK COVER, COVER REMOVAL, removal steps only 3. Attach CBM Tether Point to seat track on failed CPA 4. Demate cable connectors J1-J9 on CPA (use connector tool as reqd) 5. Disconnect grounding straps (two) from CPA with EVA ratchet, 5/32-in Ball End Allen Driver 6. Tether to CBM Tether Point on CPA <div data-bbox="781 1123 1226 1214" style="text-align: center;"> <p><u>NOTE</u> Do not use EVA 7/16" socket on CPA fasteners – will disassemble fastener</p> </div> <ol style="list-style-type: none"> 7. PGT [A6, CCW2, 30.5] IV 7/16" w/DPTA: Release fasteners (five) on CPA 13-14 turns 8. Detach from bulkhead 9. Stow CPA | <div data-bbox="1438 418 1955 529" style="border: 3px double black; padding: 5px; text-align: center;"> <p><u>WARNING</u> Power must be removed from CPA prior to EVA maintenance</p> </div> <div data-bbox="1438 548 1942 643" style="border: 1px solid black; padding: 5px; text-align: center;"> <p><u>CAUTION</u> During any CBM operation, avoid contact with sealing surface</p> </div> <p><u>CPA REMOVAL</u></p> <ol style="list-style-type: none"> 1. Configure/set up APFR tools as reqd; transfer to worksite 2. Assist EV1 as reqd |

REMOVE/REPLACE CBM CONTROLLER PANEL ASSEMBLY (CPA) – TASK DATA

Tools:

| EV1 | EV2 |
|---------------------------------------|-----|
| PGT | BRT |
| Spare CPA | |
| CBM Tether Point (1 of 2) | |
| 5/32-in Ball End Allen Driver | |
| CBM Tether Point (for failed unit) | |
| Connector Tool, Sm locking electrical | |
| EVA ratchet | |
| IV: 7/16" Socket, 3/8" Drive | |
| Drop Proof Tether Adapter | |

EVA Fasteners:

| Fastener Name | Label | Head Size | Qty | Install Torque (ft-lb) | Release Torque (ft-lb) | Failure Torque (ft-lb) | Turns | RPM |
|---------------------------|-------|-----------|-----|------------------------|------------------------|------------------------|---------|-----|
| CPA Removal Fastener | N/A | 7/16" | 5 | 3.8 | 8.3 | Rel/12.1 Inst/6.0 | 13-14.5 | 30 |
| CPA Ground Strap Fastener | N/A | 5/32" | 2 | hand tight | 2.0 | Rel/5.4 Inst/2.9 | 6.5 | 30 |

* Standard PGT settings assumed

EVA Connectors:

| Harness | From | To | Function |
|-------------------|------|----|------------------|
| W7(2)0 | P(2) | J1 | Power cable |
| W7(2)1 | P(2) | J2 | Data cable |
| W7(2)2 | P(2) | J3 | Power cable |
| W7(2)3 | P(2) | J4 | Data cable |
| P1 to J5 LCH CONT | P1 | J5 | Bolt/latch cable |
| P1 to J6 LCH CONT | P1 | J6 | Bolt/latch cable |
| P1 to J7 LCH CONT | P1 | J7 | Bolt/latch cable |
| P1 to J8 LCH CONT | P1 | J8 | Bolt/latch cable |
| P1 to J9 LCH CONT | P1 | J9 | Bolt/latch cable |

Foot Restraints:

| Task | WIF | CETA Position | Swing Arm Settings | APFR Setting |
|---------------------|--------|---------------|--------------------|---------------|
| Port CBM – Fwd half | NOD 05 | N/A | N/A | 11, RR, G, 12 |
| Port CBM – Aft half | NOD 03 | N/A | N/A | 11, QQ, G, 1 |
| Nadir CBM | SSRMS | N/A | N/A | TBD |

* Not verified in NBL

Warnings:

1. Power must be removed from CPA prior to EVA maintenance

Cautions:

1. During operation, avoid contact with CBM sealing surface

Notes:

1. Do not use an EVA 7/16" socket on CPA Removal Fasteners. Although it is possible to remove these fasteners using this socket, the EVA socket is too long and it is possible to simultaneously engage and remove the entire bolt assembly, making it non-captive. To prevent this, the IV 7/16" socket will be used with the DPT
2. There is no real aligning feature for the CPA other than the Removal Fastener bolt holes, therefore reinstalling can be difficult. It may be easiest to start a few bolts by hand (2 bolts furthest out radially have proven easiest with EVA Glove). Note CPA is properly aligned when bolt plate is flush with end of Node bulkhead
3. During installation, to prevent binding of CPA Removal Fasteners, can turn each fastener a few turns, then repeat until torque is met
4. CPA Connectors are fully mated when Red Indicator Ring is no longer visible

REMOVE/REPLACE CBM CONTROLLER PANEL ASSEMBLY (CPA) – TASK DATA (Cont)

Petal/Latch Locations:

| Element/Location | Petal/Latch 1 | Petal/Latch 2 | Petal/Latch 3 | Petal/Latch 4 |
|------------------|---------------|---------------|---------------|---------------|
| Node 1 Nadir | Aft Stbd | Fwd Stbd | Fwd Port | Aft Port |
| Node 1 Port | Fwd Zenith | Aft Zenith | Aft Nadir | Fwd Nadir |
| Lab Forward | Zenith Stbd | Zenith Port | Nadir Port | Nadir Stbd |
| Node 2 Nadir | Aft Stbd | Fwd Stbd | Fwd Port | Aft Port |
| Node 2 Port | Fwd Zenith | Aft Zenith | Aft Nadir | Fwd Nadir |
| Node 2 Zenith | Aft Port | Fwd Port | Fwd Stbd | Aft Stbd |
| Node 2 Starboard | Fwd Nadir | Aft Nadir | Aft Zenith | Fwd Zenith |
| Node 2 Forward | Zenith Stbd | Zenith Port | Nadir Port | Nadir Stbd |
| JEM Zenith | Fwd Stbd | Aft Stbd | Aft Port | Fwd Port |

CPA Locations:

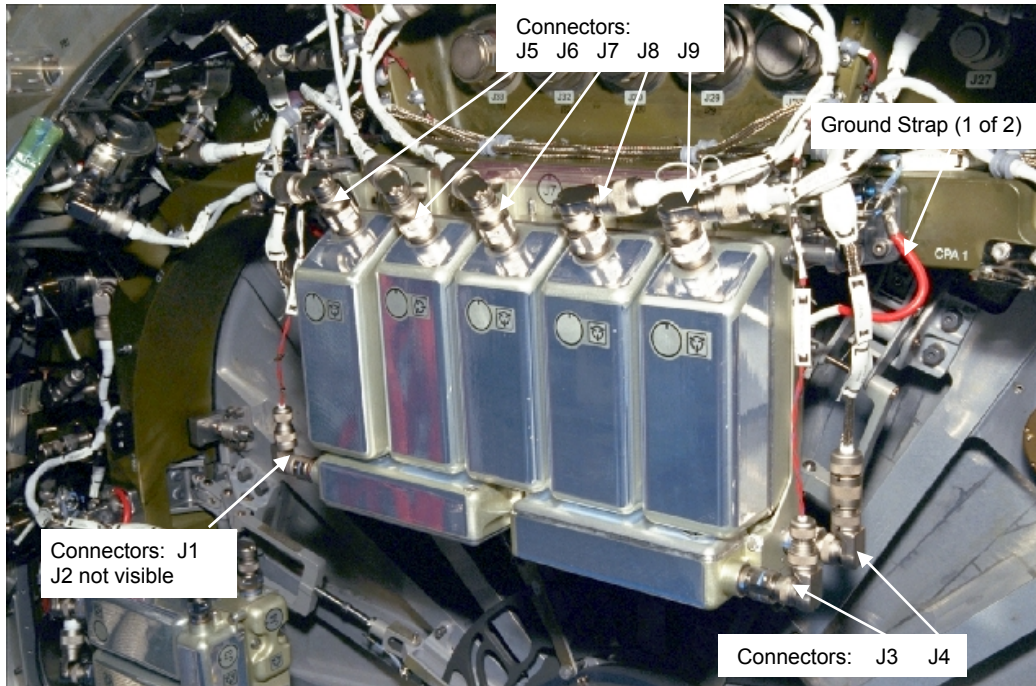
| Element/Location | CPA 1 | CPA 2 | CPA 3 | CPA 4 |
|------------------|--------|-------|--------|-----------|
| Node 1 Nadir | Stbd | Fwd | Port | Aft |
| Node 1 Port | Zenith | Aft | Nadir | Fwd |
| Lab Forward | Zenith | Port | Nadir | Starboard |
| Node 2 Nadir | Stbd | Fwd | Port | Aft |
| Node 2 Port | Zenith | Aft | Nadir | Fwd |
| Node 2 Zenith | Port | Fwd | Stbd | Aft |
| Node 2 Starboard | Nadir | Aft | Zenith | Fwd |
| Node 2 Forward | Zenith | Port | Nadir | Stbd |
| JEM Zenith | Stbd | Aft | Port | Fwd |

See S&M 2.514 Generic Procedures
for complete safing steps

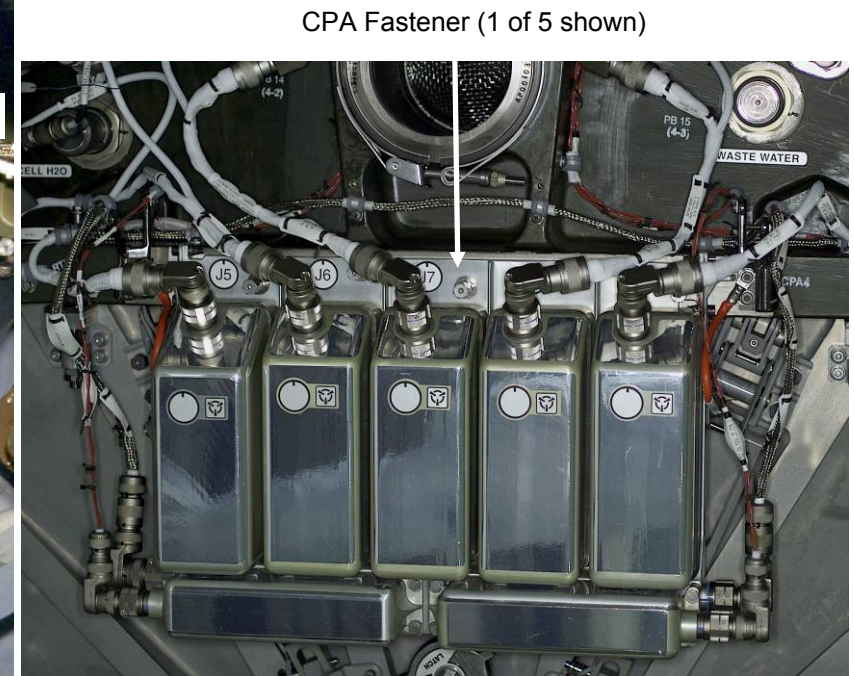
CPA Power Inhibits:

| Element/Location | CPA | Primary RPCM | Secondary RPCM |
|------------------|--------------------|----------------------|----------------------|
| Node 1 Nadir | CPA 1 | RPCM N13B B RPC 03 | RPCM N14B B RPC 11 |
| Node 1 Nadir | CPA 2 | RPCM N13B B RPC 04 | RPCM N14B B RPC 12 |
| Node 1 Nadir | CPA 3 | RPCM N13B B RPC 05 | RPCM N14B B RPC 13 |
| Node 1 Nadir | CPA 4 | RPCM N13B B RPC 06 | RPCM N14B B RPC 14 |
| Node 1 Port | CPA 1 | RPCM N1RS2 C RPC 07 | RPCM N1RS1 B RPC 05 |
| Node 1 Port | CPA 2 | RPCM N1RS2 C RPC 08 | RPCM N1RS1 B RPC 06 |
| Node 1 Port | CPA 3 | RPCM N1RS2 C RPC 10 | RPCM N1RS1 B RPC 13 |
| Node 1 Port | CPA 4 | RPCM N1RS2 C RPC 11 | RPCM N1RS1 B RPC 14 |
| Lab Forward | CPA 1 | RPCM LA1B B RPC 4 | RPCM LA2B B RPC 4 |
| Lab Forward | CPA 2 | RPCM LA1B B RPC 3 | RPCM LA2B B RPC 3 |
| Lab Forward | CPA 3 | RPCM LA1B B RPC 2 | RPCM LA2B B RPC 2 |
| Lab Forward | CPA 4 | RPCM LA1B B RPC 1 | RPCM LA2B B RPC 1 |
| Node 2 Nadir | CPA 1 | RPCM N21B4B A RPC 1 | RPCM N22B3A B RPC 1 |
| Node 2 Nadir | CPA 2 | RPCM N21B4B A RPC 3 | RPCM N22B3A B RPC 3 |
| Node 2 Nadir | CPA 3 | RPCM N21B4B A RPC 2 | RPCM N22B3A B RPC 2 |
| Node 2 Nadir | CPA 4 | RPCM N21B4B A RPC 4 | RPCM N22B3A B RPC 4 |
| Node 2 Port | CPA 1 | RPCM N21B4B A RPC 5 | RPCM N22B3A B RPC 5 |
| Node 2 Port | CPA 2 | RPCM N21B4B A RPC 11 | RPCM N22B3A B RPC 11 |
| Node 2 Port | CPA 3 | RPCM N21B4B A RPC 6 | RPCM N22B3A B RPC 6 |
| Node 2 Port | CPA 4 | RPCM N21B4B A RPC 12 | RPCM N22B3A B RPC 12 |
| Node 2 Zenith | CPA 1 | RPCM N21A4A C RPC 1 | RPCM N22A3B A RPC 1 |
| Node 2 Zenith | CPA 2 | RPCM N21A4A C RPC 3 | RPCM N22A3B A RPC 3 |
| Node 2 Zenith | CPA 3 | RPCM N21A4A C RPC 2 | RPCM N22A3B A RPC 2 |
| Node 2 Zenith | CPA 4 | RPCM N21A4A C RPC 4 | RPCM N22A3B A RPC 4 |
| Node 2 Starboard | CPA 1 | RPCM N21B4B A RPC 13 | RPCM N22B3A B RPC 13 |
| Node 2 Starboard | CPA 2 | RPCM N21B4B A RPC 15 | RPCM N22B3A B RPC 15 |
| Node 2 Starboard | CPA 3 | RPCM N21B4B A RPC 14 | RPCM N22B3A B RPC 14 |
| Node 2 Starboard | CPA 4 | RPCM N21B4B A RPC 16 | RPCM N22B3A B RPC 16 |
| Node 2 Forward | CPA 1 | RPCM N21A4A C RPC 13 | RPCM N22A3B A RPC 13 |
| Node 2 Forward | CPA 2 | RPCM N21A4A C RPC 15 | RPCM N22A3B A RPC 15 |
| Node 2 Forward | CPA 3 | RPCM N21A4A C RPC 14 | RPCM N22A3B A RPC 14 |
| Node 2 Forward | CPA 4 | RPCM N21A4A C RPC 16 | RPCM N22A3B A RPC 16 |
| JEM Zenith | CPAs 1, 2, 3, 4 | RPCM PDBa2 RPC 4 | RPCMPDBb1 RPC 5 |

REMOVE/REPLACE CBM CONTROLLER PANEL ASSEMBLY (CPA) – TASK DATA (Cont)

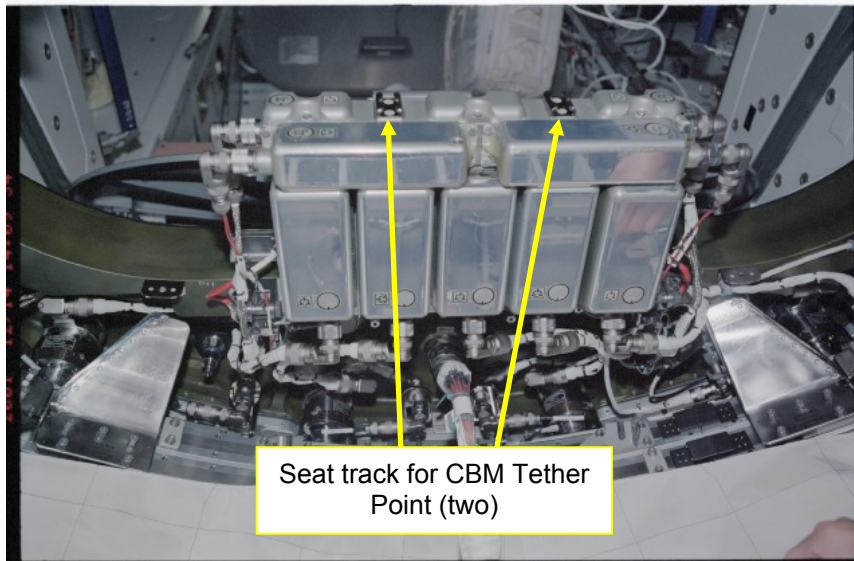


CBM CPA CONNECTORS AND GROUND STRAP
(CENTER DISK COVER REMOVED)

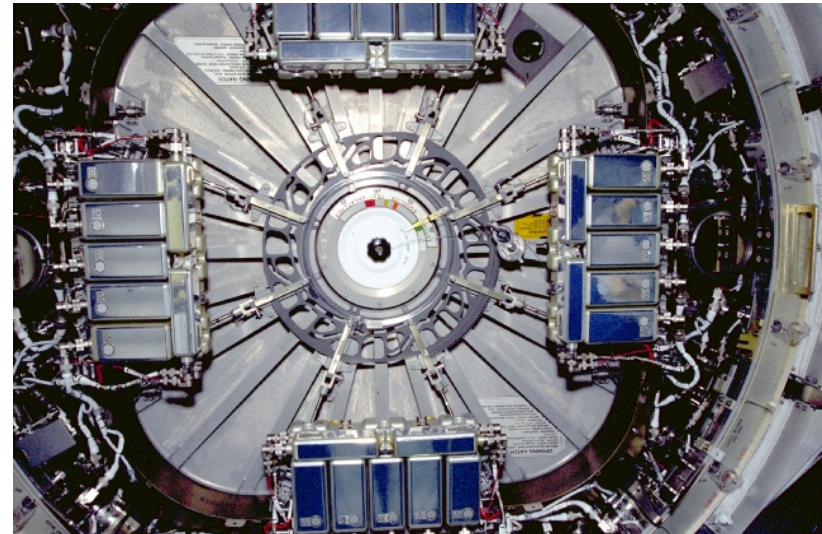


CBM CPA FASTENER LOCATIONS

REMOVE/REPLACE CBM CONTROLLER PANEL ASSEMBLY (CPA) – TASK DATA (Cont)

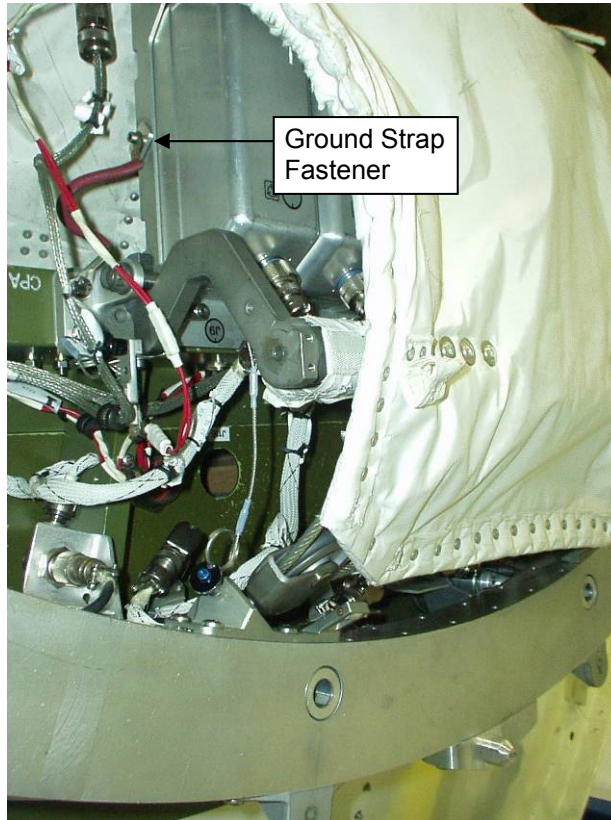


SEAT TRACK FOR CBM TETHER POINT INSTALLATION



EXTERNAL VIEW OF CBM CPAs INSTALLED
(CENTER DISK COVER REMOVED)

REMOVE/REPLACE CBM CONTROLLER PANEL ASSEMBLY (CPA) – TASK DATA (Cont)



**CPA GROUND STRAP FASTENER
(CENTER DISK COVER INSTALLED)**

CLEAR/RESTRAIN CBM CAPTURE LATCH (00:30)

Objective: To clear CBM failed Capture Latch from mating interface and restrain via EVA to allow mating operations to continue

Assumptions: Corresponding CBM Petal Cover for failed latch has been fully deployed via commanding or EVA

| IV/SSRMS | EV1 | EV2 |
|----------|---|---|
| | <div data-bbox="758 354 1272 446" style="border: 1px solid black; padding: 5px; text-align: center;"> <p>CAUTION During any CBM operation, avoid contact with sealing surface</p> </div> <ol style="list-style-type: none"> 1. Configure/set up APFR and tools as reqd; transfer to worksite 2. Clear capture latch from CBM mating interface. Restrain capture latch with wire ties, sm-sm RET, or adj equip tethers out of contact zone of CBM ring (latch can be secured to turnbuckle (2 pl), fabric loops, or cable of center disk cover) 3. If capture latch cannot be cleared/restrained from mating interface, it must be removed entirely. See REMOVE/REPLACE CBM CAPTURE LATCH procedure 4. Clean up worksite 5. Visually inspect CBM mating interface, ensure it is clear of latch, wire ties, MLI, and any other equipment or FOD | <div data-bbox="1415 354 1929 446" style="border: 1px solid black; padding: 5px; text-align: center;"> <p>CAUTION During any CBM operation, avoid contact with sealing surface</p> </div> <ol style="list-style-type: none"> 1. Configure/set up APFR and tools as reqd; transfer to worksite 2. Assist EV1 as reqd 3. Clean up worksite 4. Visually inspect CBM mating interface, ensure it is clear of latch, wire ties, MLI, and any other equipment or FOD |

CLEAR/RESTRAIN CBM CAPTURE LATCH – TASK DATA

Tools:

| EV1 | EV2 |
|-----------------------|-----|
| Wire Tie Caddy | |
| Sm-sm RET (2) | |
| Adj Equip tethers (2) | |
| | |

Cautions:

1. During operation, avoid contact with CBM sealing surface
2. Do not use petals as hand hold unless launch restraints have been engaged

Notes:

1. CBM CPAs do not have to be powered down for this activity

Foot Restraints:

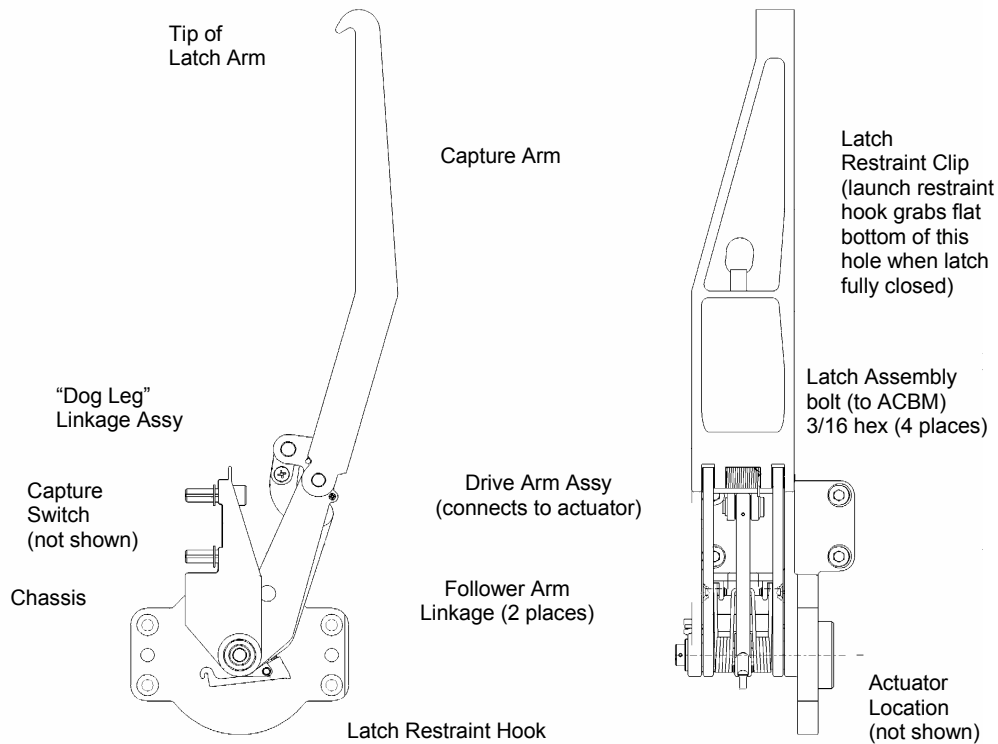
| Task | WIF | CETA Position | Swing Arm Settings | APFR Setting |
|------------------------|--------|---------------|--------------------|---------------|
| N1 Port CBM – Fwd half | NOD 05 | N/A | N/A | 11, RR, G, 12 |
| N1 Port CBM – Aft half | NOD 03 | N/A | N/A | 11, QQ, G, 1 |
| N1 Nadir CBM | SSRMS | N/A | N/A | TBD |
| | | | | |

* Not verified in NBL

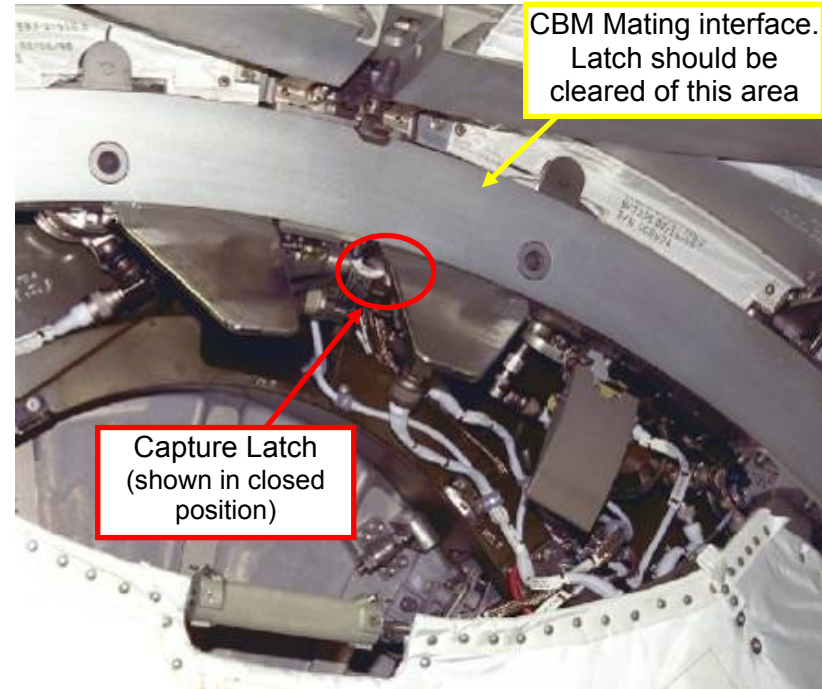
Petal/Latch Locations:

| Element/Location | Petal/Latch 1 | Petal/Latch 2 | Petal/Latch 3 | Petal/Latch 4 |
|------------------|---------------|---------------|---------------|---------------|
| Node 1 Nadir | Aft Stbd | Fwd Stbd | Fwd Port | Aft Port |
| Node 1 Port | Fwd Zenith | Aft Zenith | Aft Nadir | Fwd Nadir |
| Lab Forward | Zenith Stbd | Zenith Port | Nadir Port | Nadir Stbd |
| Node 2 Nadir | Aft Stbd | Fwd Stbd | Fwd Port | Aft Port |
| Node 2 Port | Fwd Zenith | Aft Zenith | Aft Nadir | Fwd Nadir |
| Node 2 Zenith | Aft Port | Fwd Port | Fwd Stbd | Aft Stbd |
| Node 2 Starboard | Fwd Nadir | Aft Nadir | Aft Zenith | Fwd Zenith |
| Node 2 Forward | Zenith Stbd | Zenith Port | Nadir Port | Nadir Stbd |
| JEM Zenith | Fwd Stbd | Aft Stbd | Aft Port | Fwd Port |

CLEAR/RESTRAIN CBM CAPTURE LATCH – TASK DATA (Cont)



CBM CAPTURE LATCH NOMENCLATURE



CBM CAPTURE LATCH LOCATION AND CBM MATING INTERFACE

REMOVE/REPLACE CBM CAPTURE LATCH (01:30)

Objective: To remove and replace CBM failed Capture Latch via EVA to allow mating operations to continue

Assumptions: Corresponding CBM Petal Cover for failed latch has been fully deployed via commanding or EVA

| IV/SSRMS | EV1 | EV2 |
|---|---|---|
| <p>1. √Inhibits in place for affected capture latch (see Task Data)</p> | <div data-bbox="751 386 1268 500" style="border: 3px double black; padding: 5px; text-align: center;"> <p><u>WARNING</u> Power must be removed from CPA prior to EVA maintenance</p> </div> <div data-bbox="751 516 1268 613" style="border: 1px solid black; padding: 5px; text-align: center;"> <p><u>CAUTION</u> During any CBM operation, avoid contact with sealing surface</p> </div> <p><u>CAPTURE LATCH REMOVAL</u></p> <ol style="list-style-type: none"> 1. Configure/set up APFR and tools as reqd; transfer to worksite 2. If reqd, open petal cover corresponding to failed capture latch: MANUALLY OPEN/CLOSE CBM PETAL, open steps only 3. PGT [A7 (8.2 ft-lb), CCW2, 30.5]-3/16" Allen Driver: Remove captive fasteners (four) and ground strap on capture latch assembly, 14.5 turns 4. Tether to capture latch assembly with wire tie 5. On IV GO, Disconnect connectors P2 and P3 from capture Latch actuator (2 1/2 turns) (use connector tool as reqd) 6. Remove capture latch assembly 7. Remove capture latch and stow (use trash bag as reqd for loose pieces) 8. If capture latch assembly not being replaced, position ground strap and connector cables such that alignment guides, CBM sealing surface, RTLs are clear | <div data-bbox="1409 386 1925 500" style="border: 3px double black; padding: 5px; text-align: center;"> <p><u>WARNING</u> Power must be removed from CPA prior to EVA maintenance</p> </div> <div data-bbox="1409 516 1925 613" style="border: 1px solid black; padding: 5px; text-align: center;"> <p><u>CAUTION</u> During any CBM operation, avoid contact with sealing surface</p> </div> <p><u>CAPTURE LATCH REMOVAL</u></p> <ol style="list-style-type: none"> 1. Configure/set up APFR and tools as reqd; transfer to worksite 2. Assist EV1 as reqd |

REMOVE/REPLACE CBM CAPTURE LATCH (01:30) (Cont)

| IV/SSRMS | EV1 | EV2 |
|----------|--|--|
| | <p><u>CAPTURE LATCH REPLACE</u></p> <ol style="list-style-type: none"> 1. Mate connectors P3 and P2 on replacement capture latch (use connector tool as required) 2. Position capture latch for installation 3. Re-position grounding strap on closest CLA captive fastener 4. PGT [A3, CW2, 5.5]-3/16" Allen Driver: Tighten captive fasteners (four) on capture latch Assembly, 14.5 turns 5. If required, close corresponding petal cover: MANUALLY OPEN/CLOSE CBM PETAL, close steps only 6. Clean up worksite 7. Visually inspect CBM mating interface, ensure it is clear of latch, wire ties, MLI, and any other equipment or FOD | <p><u>CAPTURE LATCH REPLACE</u></p> <ol style="list-style-type: none"> 1. Assist EV1 as reqd 2. Clean up worksite 3. Visually inspect CBM mating interface, ensure it is clear of latch, wire ties, MLI, and any other equipment or FOD |

REMOVE/REPLACE CBM CAPTURE LATCH – TASK DATA

Tools:

| EV1 (FF) | EV2 (FF) |
|---------------------------------------|----------|
| Wire Tie Caddy | BRT |
| 3/16" Allen Driver | |
| Connector Tool, Sm locking electrical | |
| Small trash bag | |
| PGT | |
| BRT | |

EVA Fasteners:

| Fastener Name | Label | Head Size | Qty | Install Torque (ft-lb) | Release Torque (ft-lb) | Failure Torque (ft-lb) | Turns | RPM |
|--|-------|-----------|-----|------------------------|------------------------|------------------------|-------|-----|
| Capture Latch Captive Fastener Release | N/A | 3/16" | 4 | N/A | 9.2 | 13.6 | 14.5 | 30 |
| Capture Latch Captive Fastener Install | N/A | 3/16" | 4 | 4.8 | N/A | 8.6 | 14.5 | 30 |

* Standard PGT settings assumed

Foot Restraints:

| Task | WIF | CETA Position | Swing Arm Settings | APFR Setting |
|------------------------|--------|---------------|--------------------|---------------|
| N1 Port CBM – Fwd half | NOD 05 | N/A | N/A | 11, RR, G, 12 |
| N1 Port CBM – Aft half | NOD 03 | N/A | N/A | 11, QQ, G, 1 |
| N1 Nadir CBM | SSRMS | N/A | N/A | TBD |

* Not verified in NBL

Warnings:

1. Power must be removed from CPA prior to this task

Cautions:

1. During operation, avoid contact with CBM sealing surface

Notes:

1. Connectors are fully mated when Red Indicator Ring is no longer visible
2. Center Disk cover may need to be removed for access with the long 3/16" Allen Driver
3. Only EVA approved 3/16" Allen Driver is in the Node Bag. If necessary IV tools has a 3/16" Allen Driver but must process paperwork to approve for EVA

Petal/Latch Locations:

| Element/Location | Petal/Latch 1 | Petal/Latch 2 | Petal/Latch 3 | Petal/Latch 4 |
|------------------|---------------|---------------|---------------|---------------|
| Node 1 Nadir | Aft Stbd | Fwd Stbd | Fwd Port | Aft Port |
| Node 1 Port | Fwd Zenith | Aft Zenith | Aft Nadir | Fwd Nadir |
| Lab Forward | Zenith Stbd | Zenith Port | Nadir Port | Nadir Stbd |
| Node 2 Nadir | Aft Stbd | Fwd Stbd | Fwd Port | Aft Port |
| Node 2 Port | Fwd Zenith | Aft Zenith | Aft Nadir | Fwd Nadir |
| Node 2 Zenith | Aft Port | Fwd Port | Fwd Stbd | Aft Stbd |
| Node 2 Starboard | Fwd Nadir | Aft Nadir | Aft Zenith | Fwd Zenith |
| Node 2 Forward | Zenith Stbd | Zenith Port | Nadir Port | Nadir Stbd |
| JEM Zenith | Fwd Stbd | Aft Stbd | Aft Port | Fwd Port |

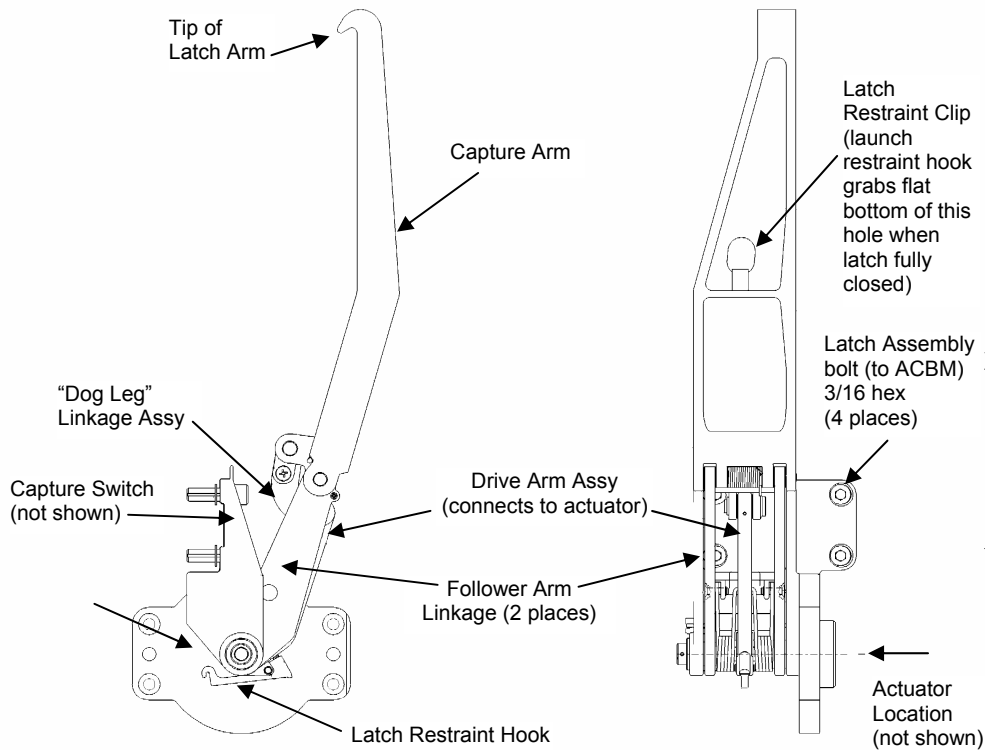
REMOVE/REPLACE CBM CAPTURE LATCH – TASK DATA (Cont)

CPA Power Inhibits:

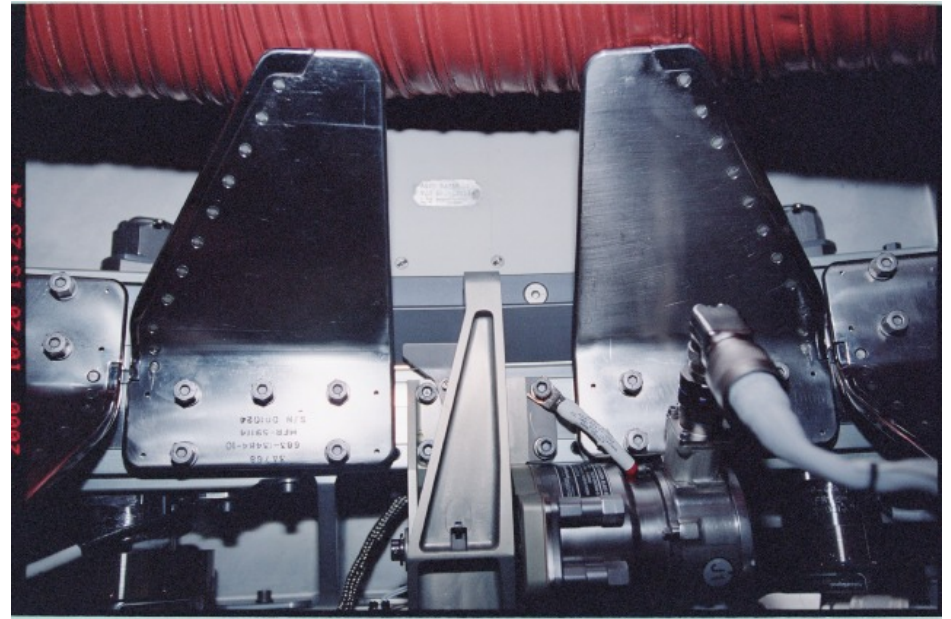
| Element/Location | CPA | Primary RPCM | Secondary RPCM |
|------------------|-----------------|----------------------|----------------------|
| Node 1 Nadir | CPA 1 | RPCM N13B B RPC 03 | RPCM N14B B RPC 11 |
| Node 1 Nadir | CPA 2 | RPCM N13B B RPC 04 | RPCM N14B B RPC 12 |
| Node 1 Nadir | CPA 3 | RPCM N13B B RPC 05 | RPCM N14B B RPC 13 |
| Node 1 Nadir | CPA 4 | RPCM N13B B RPC 06 | RPCM N14B B RPC 14 |
| Node 1 Port | CPA 1 | RPCM N1RS2 C RPC 07 | RPCM N1RS1 B RPC 05 |
| Node 1 Port | CPA 2 | RPCM N1RS2 C RPC 08 | RPCM N1RS1 B RPC 06 |
| Node 1 Port | CPA 3 | RPCM N1RS2 C RPC 10 | RPCM N1RS1 B RPC 13 |
| Node 1 Port | CPA 4 | RPCM N1RS2 C RPC 11 | RPCM N1RS1 B RPC 14 |
| Lab Forward | CPA 1 | RPCM LA1B B RPC 4 | RPCM LA2B B RPC 4 |
| Lab Forward | CPA 2 | RPCM LA1B B RPC 3 | RPCM LA2B B RPC 3 |
| Lab Forward | CPA 3 | RPCM LA1B B RPC 2 | RPCM LA2B B RPC 2 |
| Lab Forward | CPA 4 | RPCM LA1B B RPC 1 | RPCM LA2B B RPC 1 |
| Node 2 Nadir | CPA 1 | RPCM N21B4B A RPC 1 | RPCM N22B3A B RPC 1 |
| Node 2 Nadir | CPA 2 | RPCM N21B4B A RPC 3 | RPCM N22B3A B RPC 3 |
| Node 2 Nadir | CPA 3 | RPCM N21B4B A RPC 2 | RPCM N22B3A B RPC 2 |
| Node 2 Nadir | CPA 4 | RPCM N21B4B A RPC 4 | RPCM N22B3A B RPC 4 |
| Node 2 Port | CPA 1 | RPCM N21B4B A RPC 5 | RPCM N22B3A B RPC 5 |
| Node 2 Port | CPA 2 | RPCM N21B4B A RPC 11 | RPCM N22B3A B RPC 11 |
| Node 2 Port | CPA 3 | RPCM N21B4B A RPC 6 | RPCM N22B3A B RPC 6 |
| Node 2 Port | CPA 4 | RPCM N21B4B A RPC 12 | RPCM N22B3A B RPC 12 |
| Node 2 Zenith | CPA 1 | RPCM N21A4A C RPC 1 | RPCM N22A3B A RPC 1 |
| Node 2 Zenith | CPA 2 | RPCM N21A4A C RPC 3 | RPCM N22A3B A RPC 3 |
| Node 2 Zenith | CPA 3 | RPCM N21A4A C RPC 2 | RPCM N22A3B A RPC 2 |
| Node 2 Zenith | CPA 4 | RPCM N21A4A C RPC 4 | RPCM N22A3B A RPC 4 |
| Node 2 Starboard | CPA 1 | RPCM N21B4B A RPC 13 | RPCM N22B3A B RPC 13 |
| Node 2 Starboard | CPA 2 | RPCM N21B4B A RPC 15 | RPCM N22B3A B RPC 15 |
| Node 2 Starboard | CPA 3 | RPCM N21B4B A RPC 14 | RPCM N22B3A B RPC 14 |
| Node 2 Starboard | CPA 4 | RPCM N21B4B A RPC 16 | RPCM N22B3A B RPC 16 |
| Node 2 Forward | CPA 1 | RPCM N21A4A C RPC 13 | RPCM N22A3B A RPC 13 |
| Node 2 Forward | CPA 2 | RPCM N21A4A C RPC 15 | RPCM N22A3B A RPC 15 |
| Node 2 Forward | CPA 3 | RPCM N21A4A C RPC 14 | RPCM N22A3B A RPC 14 |
| Node 2 Forward | CPA 4 | RPCM N21A4A C RPC 16 | RPCM N22A3B A RPC 16 |
| JEM Zenith | CPAs 1, 2, 3, 4 | RPCM PDBa2 RPC 4 | RPCMPDBb1 RPC 5 |

See S&M 2.514 Generic Procedures
for complete safing steps

REMOVE/REPLACE CBM CAPTURE LATCH – TASK DATA (Cont)

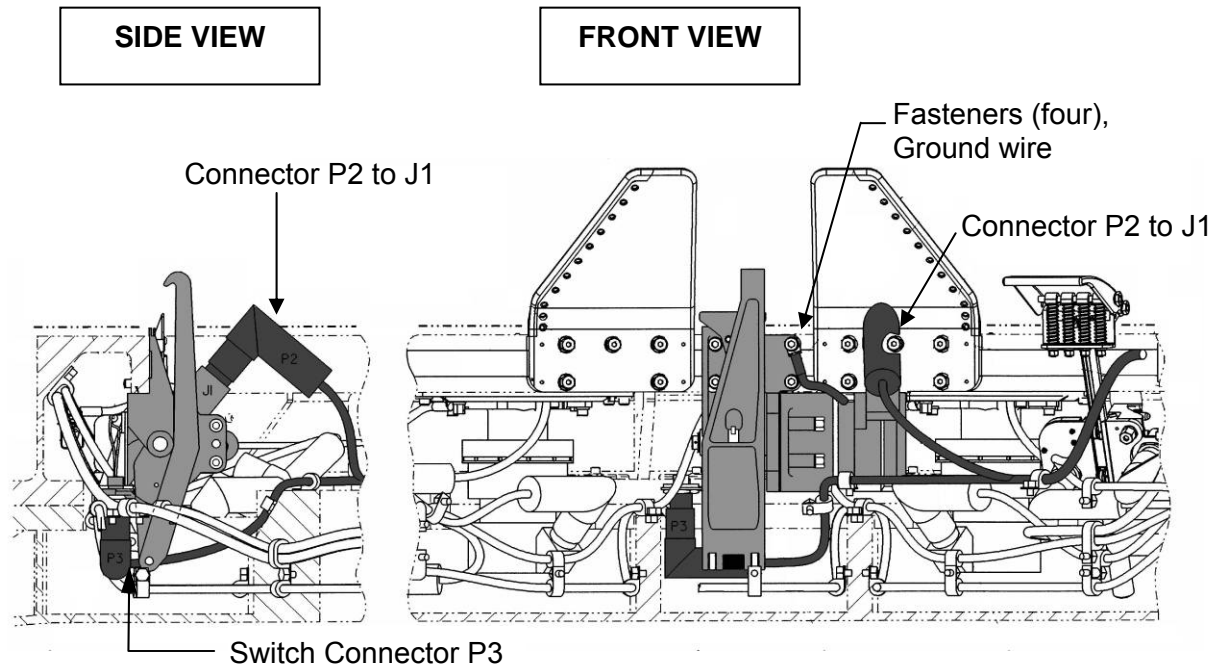


CBM CAPTURE LATCH NOMENCLATURE



CBM CAPTURE LATCH LOCATION

REMOVE/REPLACE CBM CAPTURE LATCH – TASK DATA (Cont)



CAPTURE LATCH ASSEMBLY (CLA) (SHOWN IN CLOSED POSITION)

REMOVE CBM READY-TO-LATCH (RTL) (00:45)

Objective: To remove a CBM failed Ready-To-Latch via EVA to allow mating operations to continue

Assumptions: Corresponding CBM Petal Cover for failed RTL has been fully deployed via commanding or EVA

| IV/SSRMS | EV1 | EV2 |
|---|--|---|
| <p>1. √Inhibits in place for affected RTL (see Task Data)</p> | <div style="border: 3px double black; padding: 5px; margin-bottom: 10px; text-align: center;"> <p><u>WARNING</u></p> <p>Power must be removed from CPA prior to EVA maintenance</p> </div> <div style="border: 1px solid black; padding: 5px; margin-bottom: 10px; text-align: center;"> <p><u>CAUTION</u></p> <p>During any CBM operation, avoid contact with sealing surface</p> </div> <p><u>RTL REMOVAL</u></p> <ol style="list-style-type: none"> 1. Configure/set up APFR and tools as reqd; transfer to worksite 2. Remove center disk cover as reqd: REMOVE/REPLACE CENTER DISK COVER, COVER REMOVAL, steps 1-12 3. Verify power removed before continuing 4. PGT [A4, CCW2, 30.5]-RAD/DPTA/3/8": Remove RTL fasteners (2), 13.5 turns 5. Tether to RTL assembly 6. Disconnect data connector from RTL (use connector tool as required) 7. Remove RTL and stow (use trash bag as reqd for loose pieces) 8. Reinstall MMOD center cover as required: REMOVE/REPLACE CENTER DISK COVER, COVER REINSTALL, steps 1-10 9. Clean up worksite 10. Visually inspect CBM mating interface, ensure it is clear of latch, wire ties, MLI, and any other equipment or FOD | <p><u>RTL REMOVAL</u></p> <ol style="list-style-type: none"> 1. Configure/set up APFR and tools as reqd; transfer to worksite 2. Assist EV1 as required |

REMOVE CBM READY-TO-LATCH (RTL) – TASK DATA

Tools:

| EV1 (FF) | EV2 (FF) |
|----------------------------------|----------|
| PGT | BRT |
| 3/8" Socket | |
| Drop Proof Tether Adapter (DPTA) | |
| Connector Tool, Sm locking elec | |
| Small trash bag | |
| EVA ratchet | |
| BRT | |
| Right Angle Drive (RAD) | |

EVA Fasteners:

| Fastener Name | Label | Head Size | Qty | Install Torque (ft-lb) | Release Torque (ft-lb) | Failure Torque (ft-lb) | Turns | RPM |
|--|-------|-----------|-----|------------------------|------------------------|------------------------|-------|-----|
| Capture Latch Captive Fastener Release | N/A | 3/8" | 1 | N/A | 6.3 | 10.6 | 13.5 | 30 |

* Standard PGT settings assumed

Foot Restraints:

| Task | WIF | CETA Position | Swing Arm Settings | APFR Setting |
|---------------------|--------|---------------|--------------------|---------------|
| Port CBM – FWD half | NOD 05 | N/A | N/A | 11, RR, G, 12 |
| Port CBM – Aft half | NOD 03 | N/A | N/A | 11, QQ, G, 1 |
| Nadir CBM | SSRMS | N/A | N/A | |
| | | | | |

* Not verified in NBL

Warnings:

1. Power must be removed from CPA prior to this task

Cautions:

1. During operation, avoid contact with CBM sealing surface

Notes:

1. Connectors are fully mated when red indicator ring is no longer visible
2. Fitcheck of RAD/DPTA/3/8-in socket has not been verified – note DPTA is not shown in photo
3. CPA number in Power Inhibits chart below corresponds to RTL number; e.g., CPA 2 is for RTL 2

Petal/Latch Locations:

| Element/Location | Petal/Latch 1 | Petal/Latch 2 | Petal/Latch 3 | Petal/Latch 4 |
|------------------|---------------|---------------|---------------|---------------|
| Node 1 Nadir | Aft Stbd | Fwd Stbd | Fwd Port | Aft Port |
| Node 1 Port | Fwd Zenith | Aft Zenith | Aft Nadir | Fwd Nadir |
| Lab Forward | Zenith Stbd | Zenith Port | Nadir Port | Nadir Stbd |
| Node 2 Nadir | Aft Stbd | Fwd Stbd | Fwd Port | Aft Port |
| Node 2 Port | Fwd Zenith | Aft Zenith | Aft Nadir | Fwd Nadir |
| Node 2 Zenith | Aft Port | Fwd Port | Fwd Stbd | Aft Stbd |
| Node 2 Starboard | Fwd Nadir | Aft Nadir | Aft Zenith | Fwd Zenith |
| Node 2 Forward | Zenith Stbd | Zenith Port | Nadir Port | Nadir Stbd |
| JEM Zenith | Fwd Stbd | Aft Stbd | Aft Port | Fwd Port |

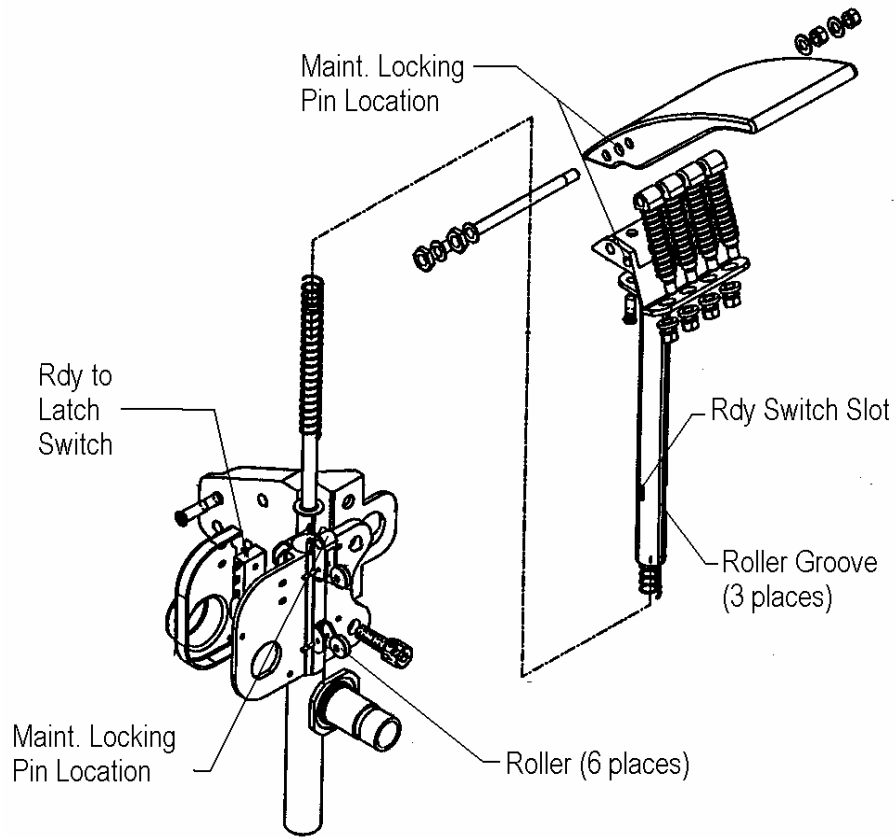
REMOVE/REPLACE CBM CAPTURE LATCH – TASK DATA (Cont)

CPA Power Inhibits:

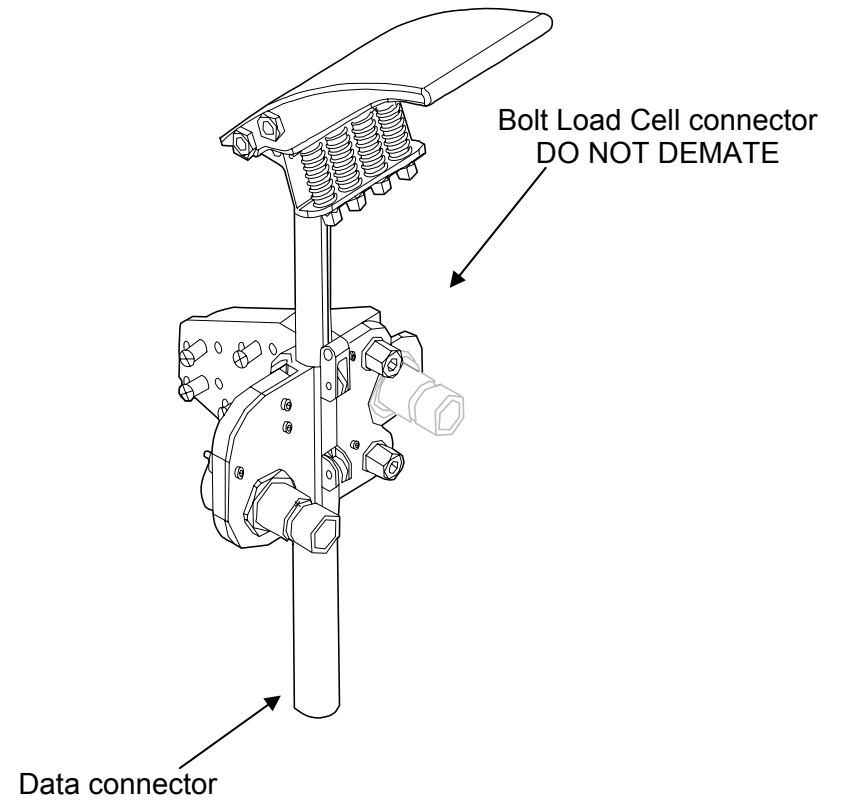
| Element/Location | CPA | Primary RPCM | Secondary RPCM |
|------------------|--------------------|----------------------|----------------------|
| Node 1 Nadir | CPA 1 | RPCM N13B B RPC 03 | RPCM N14B B RPC 11 |
| Node 1 Nadir | CPA 2 | RPCM N13B B RPC 04 | RPCM N14B B RPC 12 |
| Node 1 Nadir | CPA 3 | RPCM N13B B RPC 05 | RPCM N14B B RPC 13 |
| Node 1 Nadir | CPA 4 | RPCM N13B B RPC 06 | RPCM N14B B RPC 14 |
| Node 1 Port | CPA 1 | RPCM N1RS2 C RPC 07 | RPCM N1RS1 B RPC 05 |
| Node 1 Port | CPA 2 | RPCM N1RS2 C RPC 08 | RPCM N1RS1 B RPC 06 |
| Node 1 Port | CPA 3 | RPCM N1RS2 C RPC 10 | RPCM N1RS1 B RPC 13 |
| Node 1 Port | CPA 4 | RPCM N1RS2 C RPC 11 | RPCM N1RS1 B RPC 14 |
| Lab Forward | CPA 1 | RPCM LA1B B RPC 4 | RPCM LA2B B RPC 4 |
| Lab Forward | CPA 2 | RPCM LA1B B RPC 3 | RPCM LA2B B RPC 3 |
| Lab Forward | CPA 3 | RPCM LA1B B RPC 2 | RPCM LA2B B RPC 2 |
| Lab Forward | CPA 4 | RPCM LA1B B RPC 1 | RPCM LA2B B RPC 1 |
| Node 2 Nadir | CPA 1 | RPCM N21B4B A RPC 1 | RPCM N22B3A B RPC 1 |
| Node 2 Nadir | CPA 2 | RPCM N21B4B A RPC 3 | RPCM N22B3A B RPC 3 |
| Node 2 Nadir | CPA 3 | RPCM N21B4B A RPC 2 | RPCM N22B3A B RPC 2 |
| Node 2 Nadir | CPA 4 | RPCM N21B4B A RPC 4 | RPCM N22B3A B RPC 4 |
| Node 2 Port | CPA 1 | RPCM N21B4B A RPC 5 | RPCM N22B3A B RPC 5 |
| Node 2 Port | CPA 2 | RPCM N21B4B A RPC 11 | RPCM N22B3A B RPC 11 |
| Node 2 Port | CPA 3 | RPCM N21B4B A RPC 6 | RPCM N22B3A B RPC 6 |
| Node 2 Port | CPA 4 | RPCM N21B4B A RPC 12 | RPCM N22B3A B RPC 12 |
| Node 2 Zenith | CPA 1 | RPCM N21A4A C RPC 1 | RPCM N22A3B A RPC 1 |
| Node 2 Zenith | CPA 2 | RPCM N21A4A C RPC 3 | RPCM N22A3B A RPC 3 |
| Node 2 Zenith | CPA 3 | RPCM N21A4A C RPC 2 | RPCM N22A3B A RPC 2 |
| Node 2 Zenith | CPA 4 | RPCM N21A4A C RPC 4 | RPCM N22A3B A RPC 4 |
| Node 2 Starboard | CPA 1 | RPCM N21B4B A RPC 13 | RPCM N22B3A B RPC 13 |
| Node 2 Starboard | CPA 2 | RPCM N21B4B A RPC 15 | RPCM N22B3A B RPC 15 |
| Node 2 Starboard | CPA 3 | RPCM N21B4B A RPC 14 | RPCM N22B3A B RPC 14 |
| Node 2 Starboard | CPA 4 | RPCM N21B4B A RPC 16 | RPCM N22B3A B RPC 16 |
| Node 2 Forward | CPA 1 | RPCM N21A4A C RPC 13 | RPCM N22A3B A RPC 13 |
| Node 2 Forward | CPA 2 | RPCM N21A4A C RPC 15 | RPCM N22A3B A RPC 15 |
| Node 2 Forward | CPA 3 | RPCM N21A4A C RPC 14 | RPCM N22A3B A RPC 14 |
| Node 2 Forward | CPA 4 | RPCM N21A4A C RPC 16 | RPCM N22A3B A RPC 16 |
| JEM Zenith | CPAs 1, 2, 3, 4 | RPCM PDBa2 RPC 4 | RPCMPDBb1 RPC 5 |

See S&M 2.514 Generic Procedures
for complete safing steps

REMOVE CBM READY-TO-LATCH (RTL) – TASK DATA (Cont)

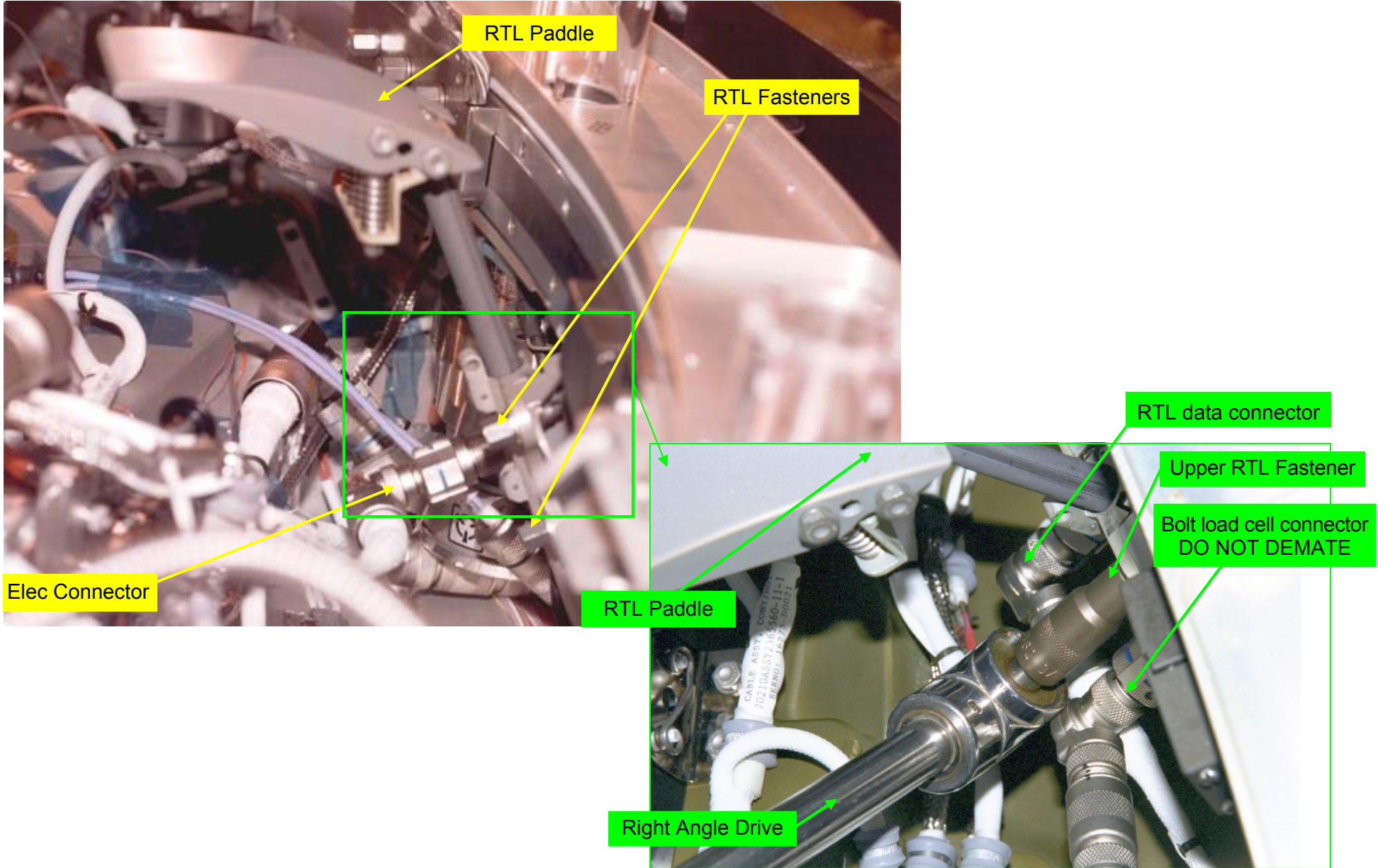


CBM RTL Nomenclature



CBM RTL

REMOVE CBM READY-TO-LATCH (RTL) – TASK DATA (Cont)



REMOVE CBM READY-TO-LATCH (RTL) – TASK DATA (Cont)



PETAL LAUNCH RESTRAINT RELEASE USING ADJUSTABLE TETHER STRAP

REMOVE/REPLACE CBM PETAL (00:30)

Objective: To manually open/close radial Common Berthing Mechanism (CBM) petal via EVA due to CBM contingency

| IV/SSRMS | EV1 | EV2 |
|---|--|---|
| <p style="text-align: center;"><u>NOTE</u></p> <p>It is preferable to remove/replace petal from closed position</p> | <div style="border: 1px solid black; padding: 5px; text-align: center;"> <p><u>CAUTION</u></p> <p>During any CBM operation, avoid contact with sealing surface</p> </div> <p><u>PETAL REMOVAL</u></p> <ol style="list-style-type: none"> 1. Configure/set up APFR and tools as reqd; transfer to worksite <div style="border: 1px solid black; padding: 5px; text-align: center;"> <p><u>CAUTION</u></p> <p>Do not use petal(s) as handhold until launch restraints have been engaged</p> </div> <ol style="list-style-type: none"> 2. If petal in fully closed position: Engage first petal launch restraint for failed petal, push button in 3. PGT [A7, CW2, 30.5]-6 Ext 7/16: Turn Actuator Lock-out Bolt (outer-most bolt) to disable spring actuator ~23-24 turns 4. PGT [A6, CCW2, 30.5]-6 Ext 7/16: Turn Roller Link Release Bolt up to 12-13 turns to disengage Capture Latch 5. Visually verify Capture Latch is not engaged on Petal Roller Link 6. PGT [A6, CW2, 10.5]-6 Ext 7/16: Retighten Roller Link Release Bolt up to 12-13 turns 7. Attach tether to petal hinge linkage 8. PGT [B4, CCW2, 30.5]-6 Ext 7/16: Remove Petal Attachment Bolts (two) ~12 turns 9. If launch restraints engaged, release first launch restraint 10. Remove petal | <div style="border: 1px solid black; padding: 5px; text-align: center;"> <p><u>CAUTION</u></p> <p>During any CBM operation, avoid contact with sealing surface</p> </div> <p><u>PETAL REMOVAL</u></p> <ol style="list-style-type: none"> 1. Configure/set up APFR and tools as reqd; transfer to worksite <div style="border: 1px solid black; padding: 5px; text-align: center;"> <p><u>CAUTION</u></p> <p>Do not use petal(s) as handhold until launch restraints have been engaged</p> </div> <ol style="list-style-type: none"> 2. If petal in fully closed position: Engage second petal launch restraint for failed petal, push button in 3. Assist EV1 as reqd 4. If launch restraints engaged, release second launch restraint 5. Remove petal |

REMOVE/REPLACE CBM PETAL (00:30) (Cont)

| IV/SSRMS | EV1 | EV2 |
|----------|--|---|
| | <p><u>PETAL REPLACE</u></p> <ol style="list-style-type: none"> 1. Configure/set up APFR and tools as reqd; transfer to worksite 2. Position replacement petal 3. If petal in closed position: Engage first launch restraint (push button in) 4. PGT [A7, CW2, 30.5]-6 Ext 7/16: Engage Petal Attachment Bolts (two) 12 turns, apply pressure on bolt while turning to ensure engagement 5. Remove tether from petal 6. PGT [A2, CCW2, 10.5]-6 Ext 7/16: Reengage Actuator Lock-out Bolt (outer-most bolt) ~23-24 turns 7. While holding petal, release first launch restraint 8. Clean up worksite 9. Visually inspect CBM mating interface, ensure it is clear of latch, wire ties, MLI and any other equipment or FOD | <p><u>PETAL REPLACE</u></p> <ol style="list-style-type: none"> 1. Configure/set up APFR and tools as reqd; transfer to worksite 2. Assist EV1 as reqd 3. If petal in closed position: Engage second launch restraint (push button in) 4. While holding petal, release second launch restraint 5. Clean up worksite 6. Visually inspect CBM mating interface, ensure it is clear of latch, wire ties, MLI and any other equipment or FOD |

REMOVE CBM READY-TO-LATCH (RTL) – TASK DATA

Tools:

| EV1 | EV2 |
|-------------------|-------------------|
| PGT | BRT |
| 7/16-6 in ext | Adjustable Tether |
| Adjustable Tether | |
| BRT | |

EVA Fasteners:

| Fastener Name | Label | Head Size | Qty | Install Torque (ft-lb) | Release Torque (ft-lb) | Failure Torque (ft-lb) | Turns | RPM |
|--------------------------|-------|-----------|-----|------------------------|------------------------|------------------------|-------------|-----|
| Roller Link Release Bolt | N/A | 7/16 in | 1 | 8.3 | 8.3 | 12.1 | up to 12-13 | 30 |
| Petal Attachment Bolt | N/A | 7/16 in | 2 | 9.2 | 19.4 | 26.1/Rel 13.1/Inst | 12 | 30 |
| Actuator Lock-out Bolt | N/A | 7/16 in | 1 | 3.8 | 9.2 | 15/Rel 6.3/Inst | 23-24 | 30 |

* Standard PGT settings assumed

Foot Restraints:

| Task | WIF | CETA Position | Swing Arm Settings | APFR Setting |
|---------------------|--------|---------------|--------------------|---------------|
| Port CBM – Fwd half | NOD 05 | N/A | N/A | 11, RR, G, 12 |
| Port CBM – Aft half | NOD 03 | N/A | N/A | 11, QQ, G, 1 |
| Nadir CBM | SSRMS | N/A | N/A | TBD |

* Not verified in NBL

Warnings:

1. Do not use petals as hand hold unless launch restraints have been engaged

Cautions:

1. During operation, avoid contact with CBM sealing surface

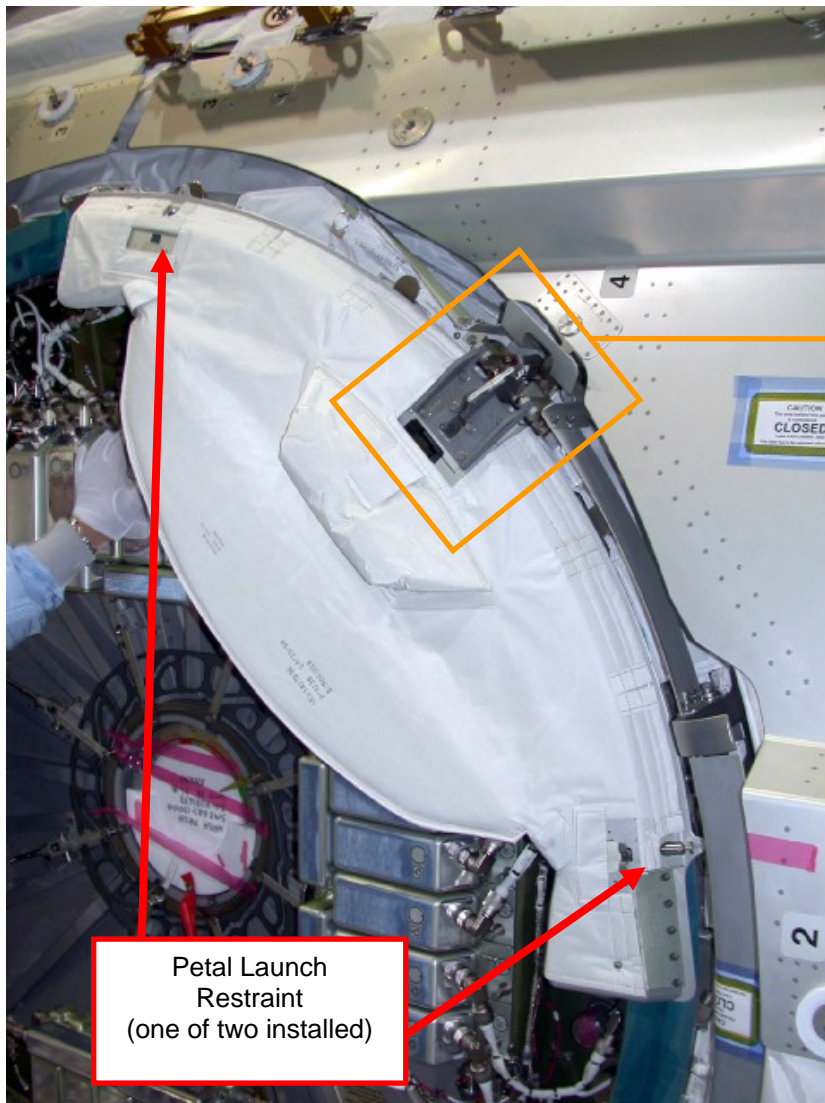
Notes:

1. CBM CPAs do not have to be powered down for this activity
2. It is preferable to remove/replace petal from closed position, thus allowing crew to disable actuator spring

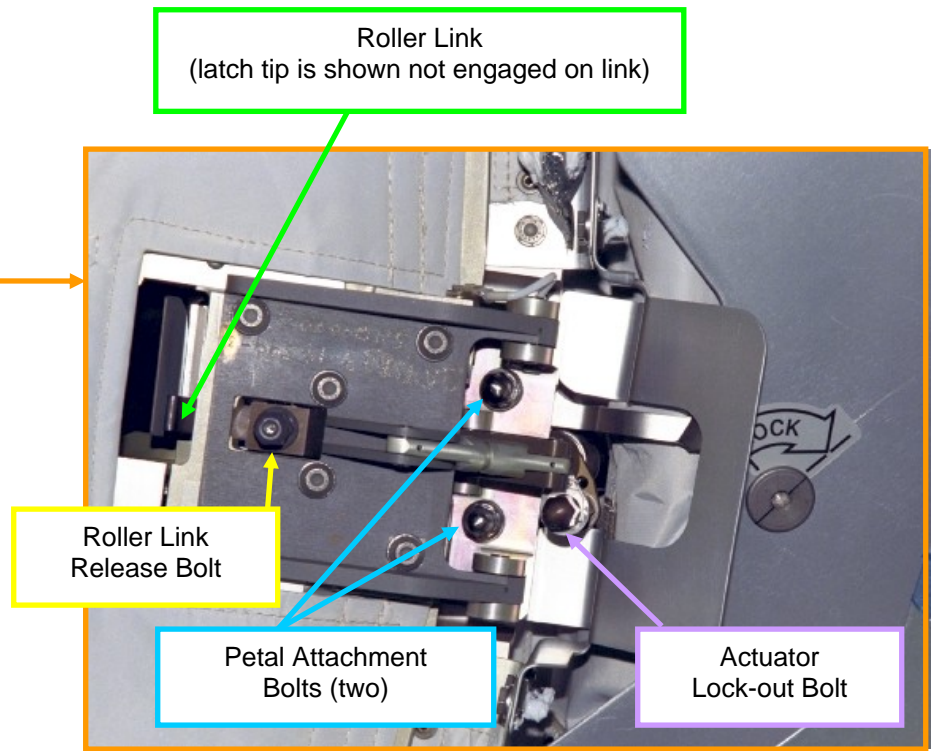
Petal/Latch Locations:

| Element/Location | Petal/Latch 1 | Petal/Latch 2 | Petal/Latch 3 | Petal/Latch 4 |
|------------------|---------------|---------------|---------------|---------------|
| Node 1 Nadir | Aft Stbd | Fwd Stbd | Fwd Port | Aft Port |
| Node 1 Port | Fwd Zenith | Aft Zenith | Aft Nadir | Fwd Nadir |
| Lab Forward | Zenith Stbd | Zenith Port | Nadir Port | Nadir Stbd |
| Node 2 Nadir | Aft Stbd | Fwd Stbd | Fwd Port | Aft Port |
| Node 2 Port | Fwd Zenith | Aft Zenith | Aft Nadir | Fwd Nadir |
| Node 2 Zenith | Aft Port | Fwd Port | Fwd Stbd | Aft Stbd |
| Node 2 Starboard | Fwd Nadir | Aft Nadir | Aft Zenith | Fwd Zenith |
| Node 2 Forward | Zenith Stbd | Zenith Port | Nadir Port | Nadir Stbd |
| JEM Zenith | Fwd Stbd | Aft Stbd | Aft Port | Fwd Port |

REMOVE CBM READY-TO-LATCH (RTL) – TASK DATA (Cont)

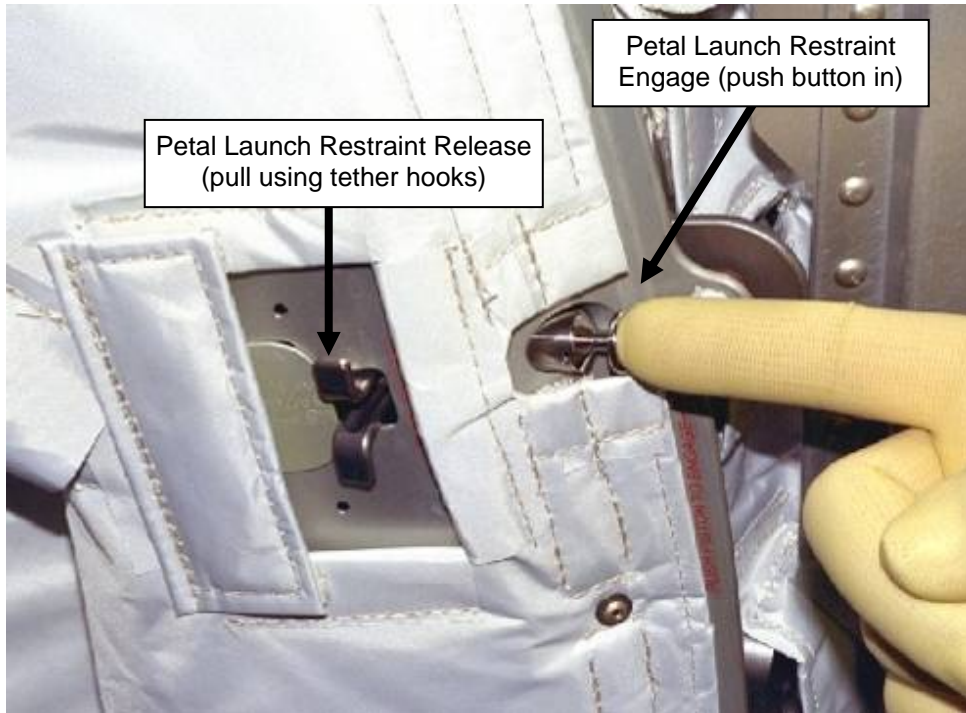


CBM PETAL

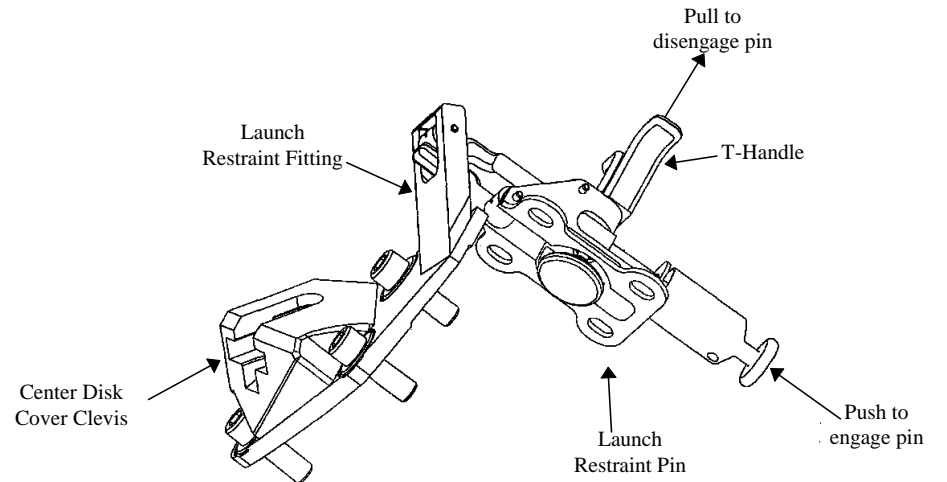


CBM PETAL DEPLOY MECHANISM

REMOVE CBM READY-TO-LATCH (RTL) – TASK DATA (Cont)



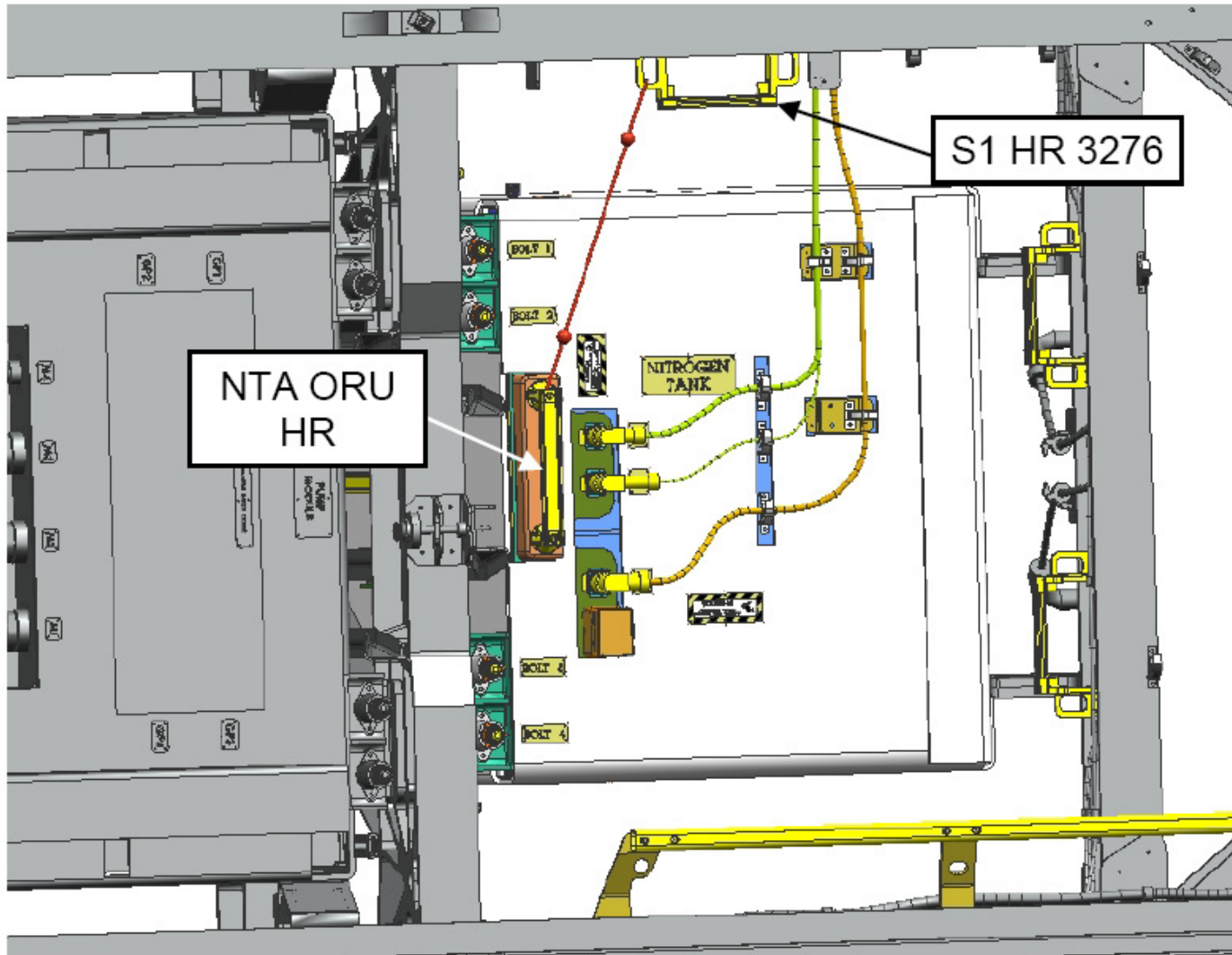
CBM PETAL LAUNCH RESTRAINT OPERATION



CBM PETAL LAUNCH RESTRAINT MECHANISM

1J ISS ORU TIE-DOWN PLAN

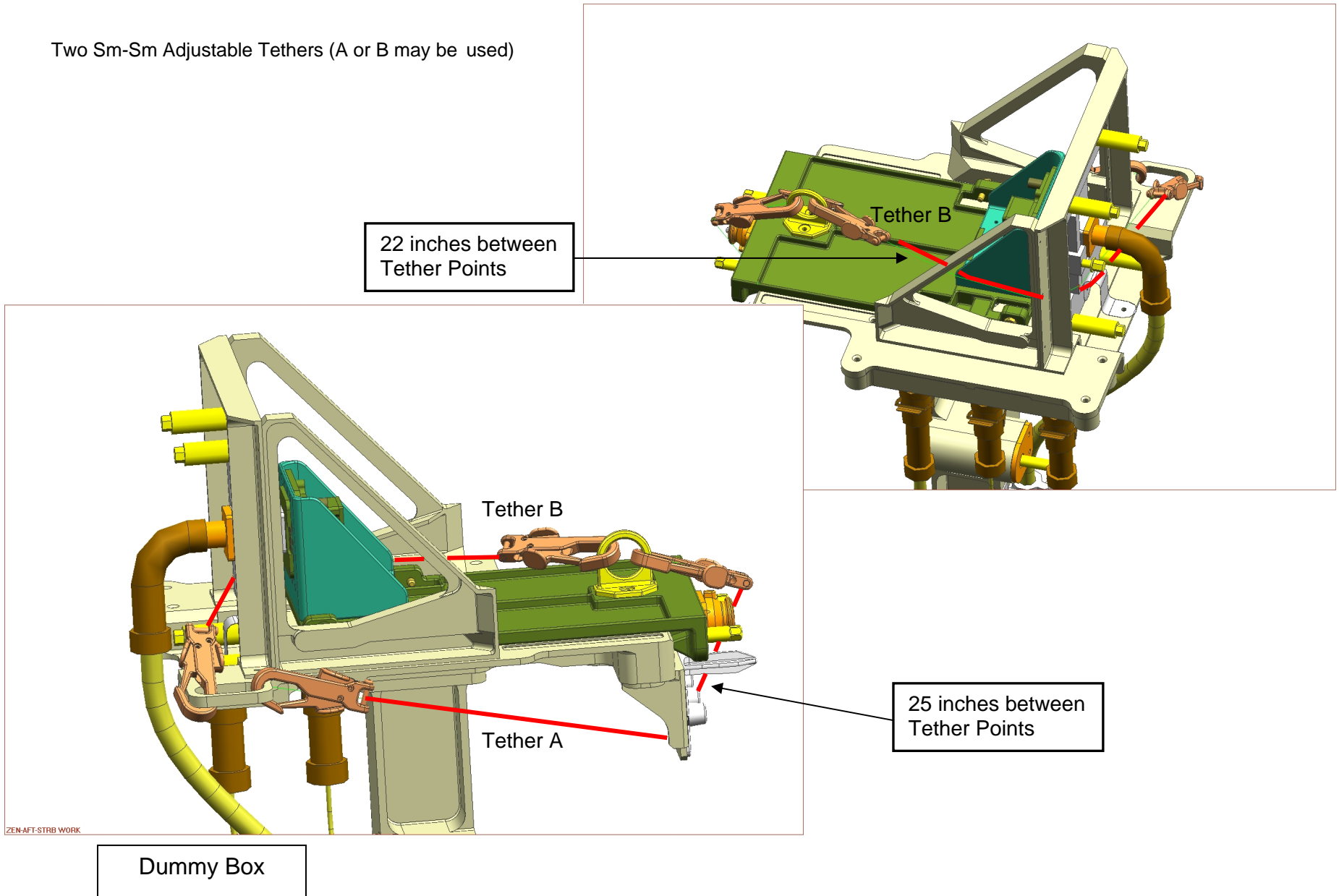
NTA on S1



Adjustable Tether is hooked on stanchion of NTA ORU handrail and on stanchion of S1 handrail 3276. The total length of tether is approximately 21.5 inches

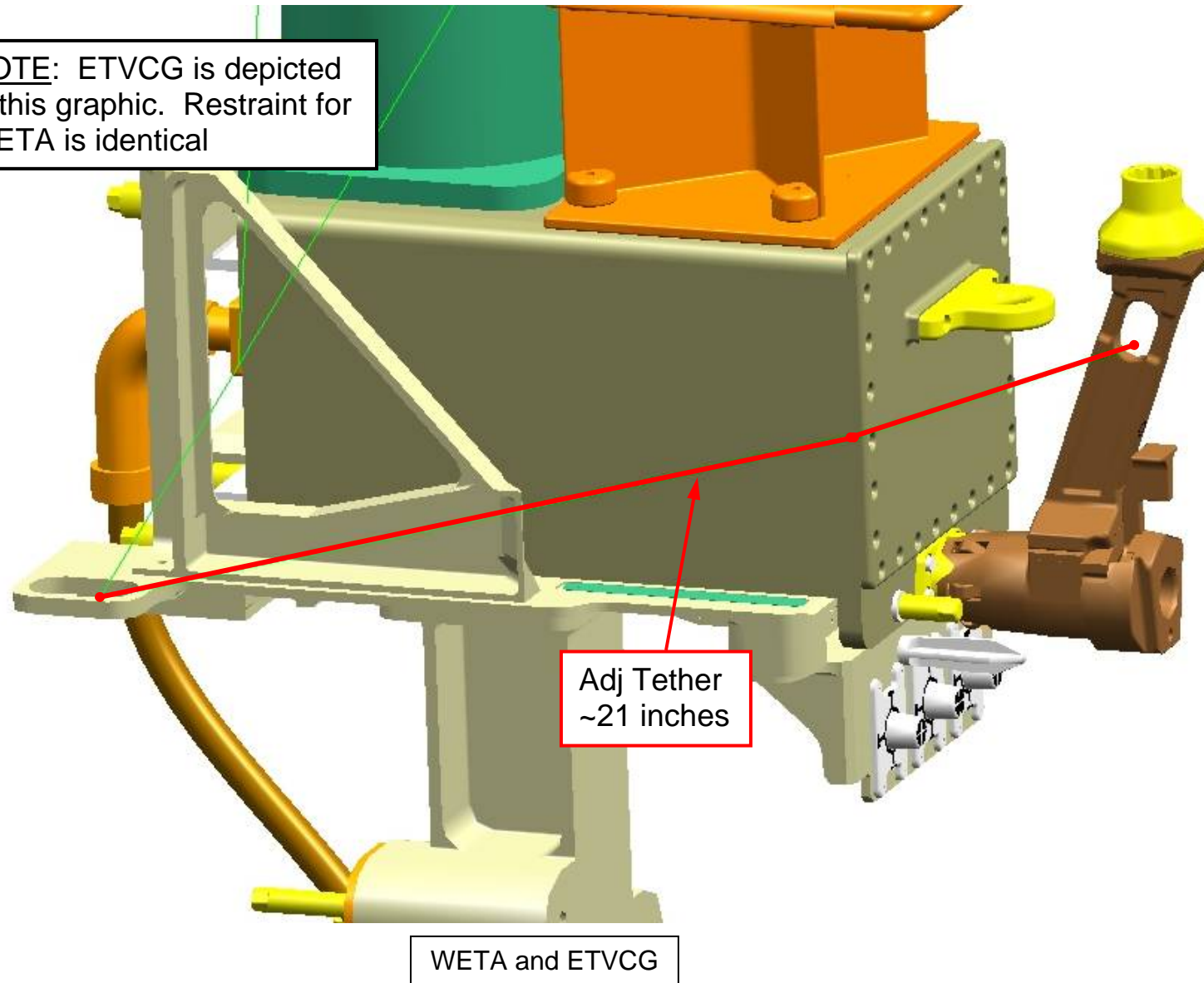
1J ISS ORU TIE-DOWN PLAN (Cont)

Two Sm-Sm Adjustable Tethers (A or B may be used)



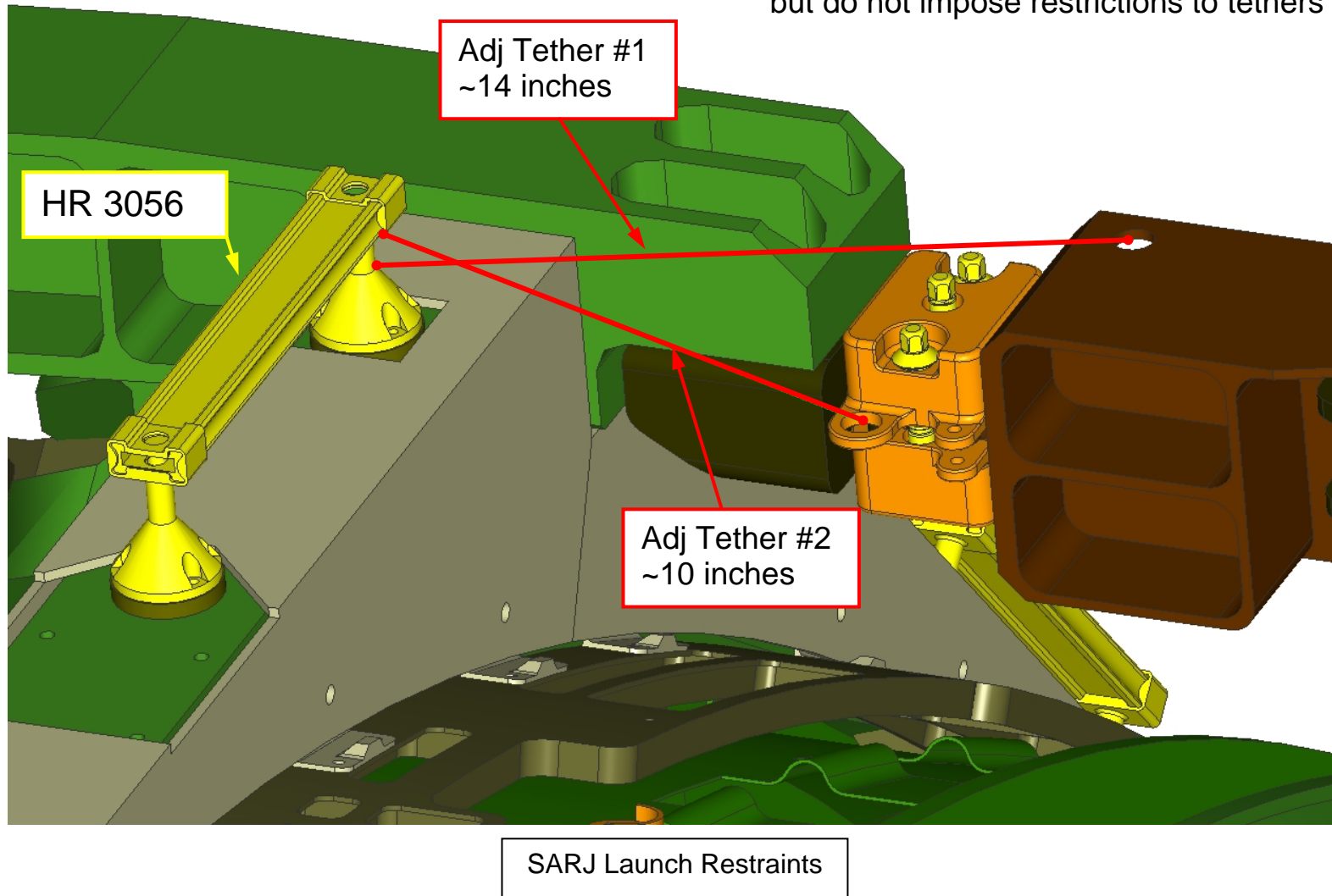
1J ISS ORU TIE-DOWN PLAN (Cont)

NOTE: ETVCG is depicted in this graphic. Restraint for WETA is identical



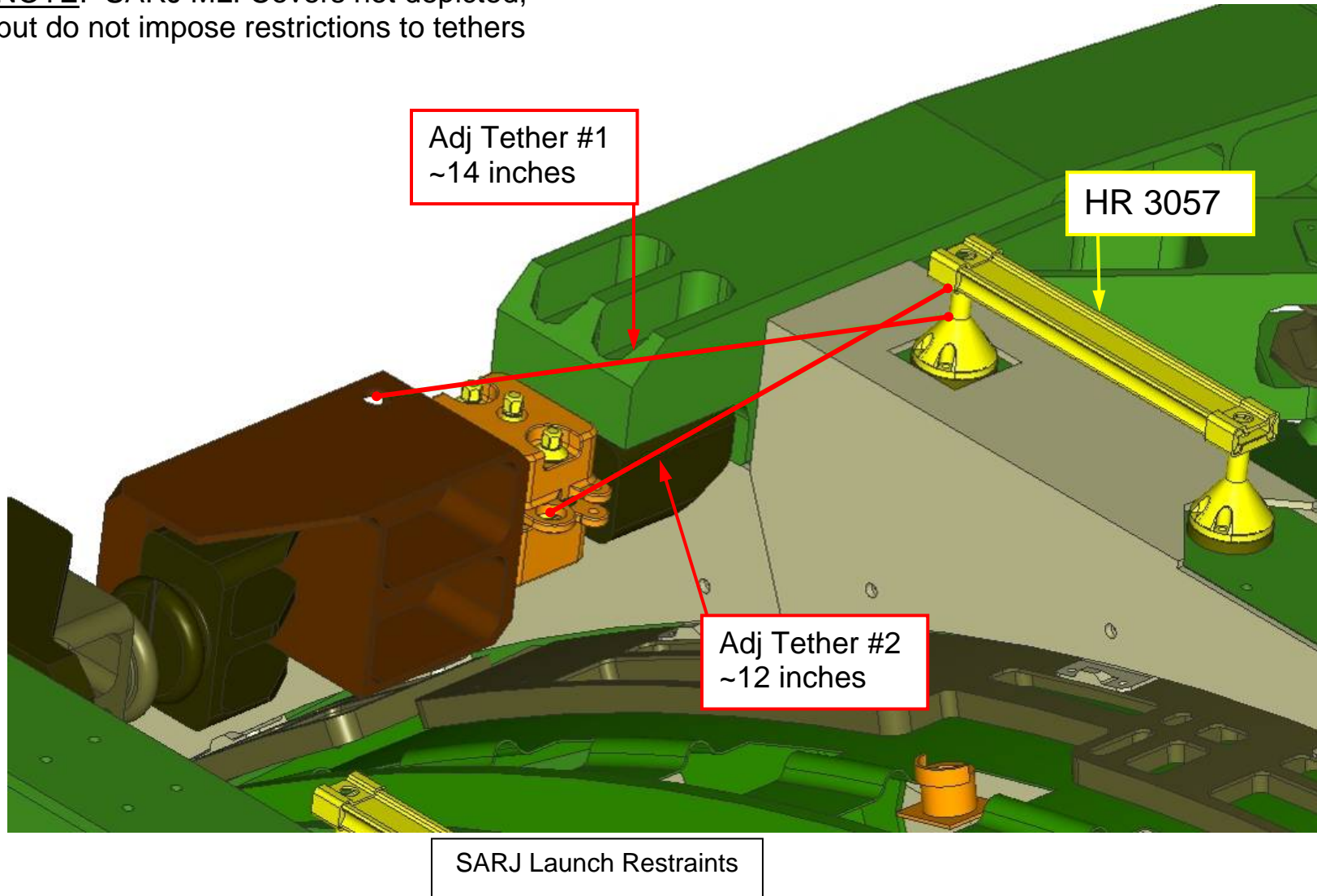
1J ISS ORU TIE-DOWN PLAN (Cont)

NOTE: SARJ MLI Covers not depicted, but do not impose restrictions to tethers



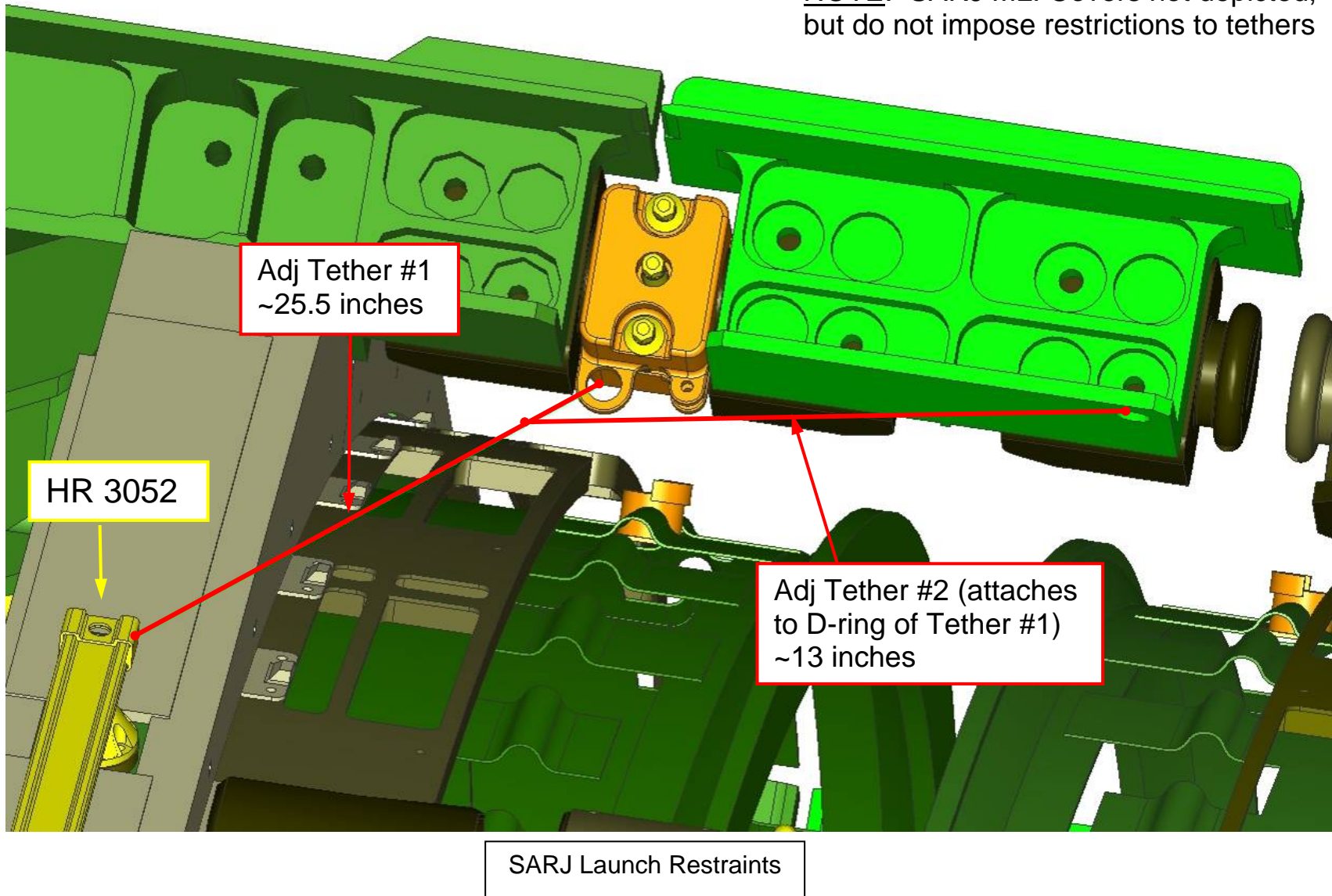
1J ISS ORU TIE-DOWN PLAN (Cont)

NOTE: SARJ MLI Covers not depicted, but do not impose restrictions to tethers



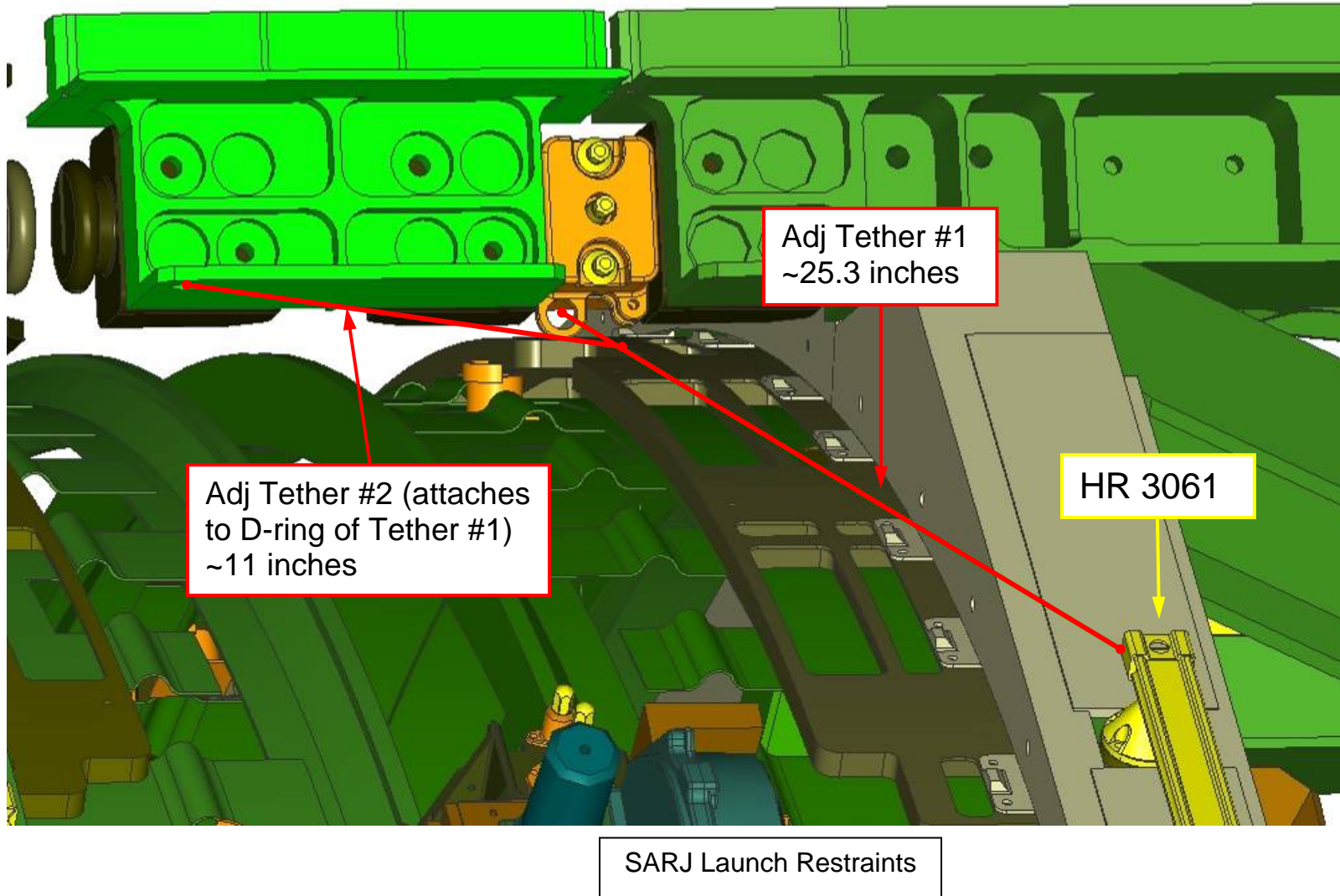
1J ISS ORU TIE-DOWN PLAN (Cont)

NOTE: SARJ MLI Covers not depicted, but do not impose restrictions to tethers



1J ISS ORU TIE-DOWN PLAN (Cont)

NOTE: SARJ MLI Covers not depicted, but do not impose restrictions to tethers

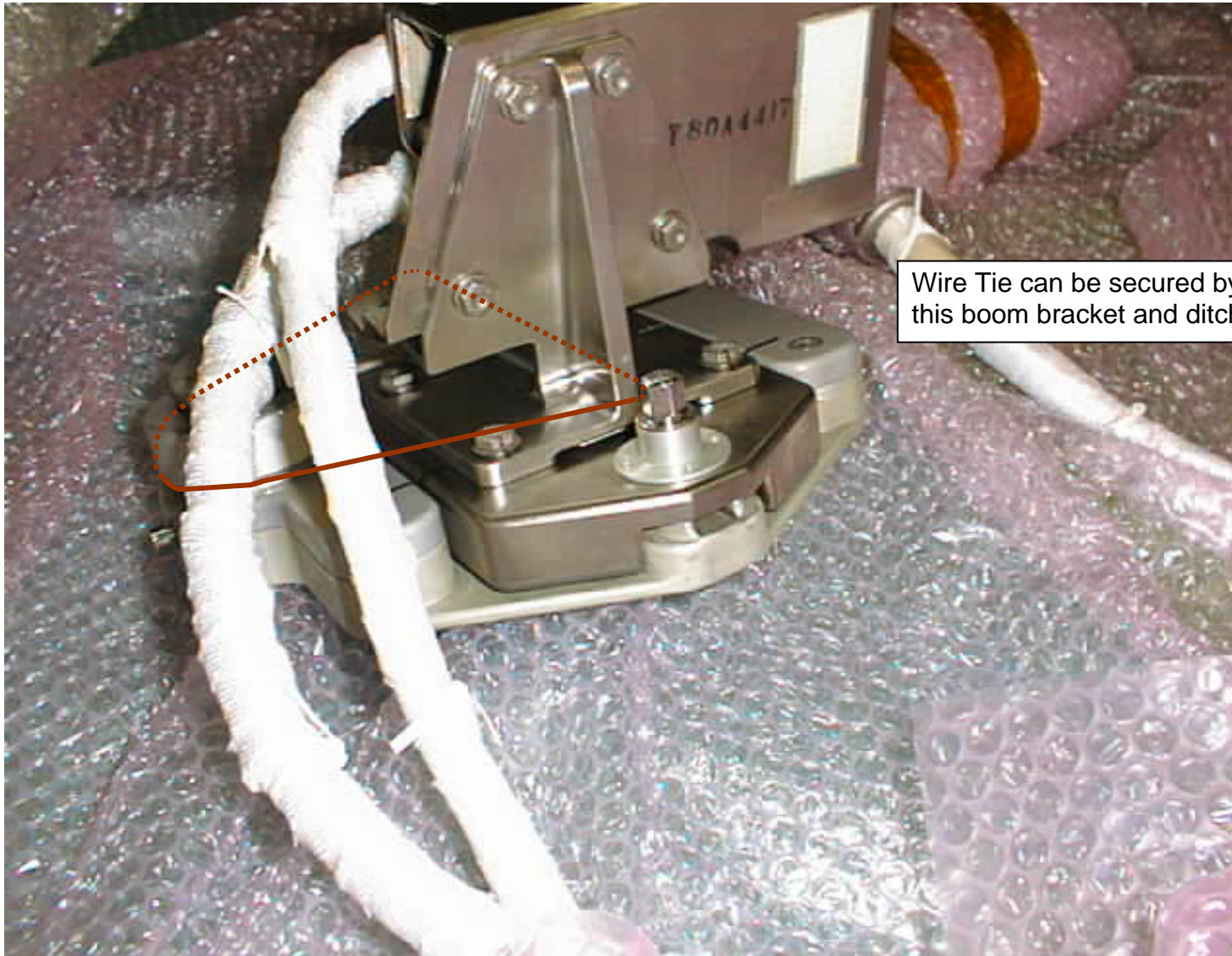


1J ISS ORU TIE-DOWN PLAN (Cont)



JTVE

1J ISS ORU TIE-DOWN PLAN (Cont)



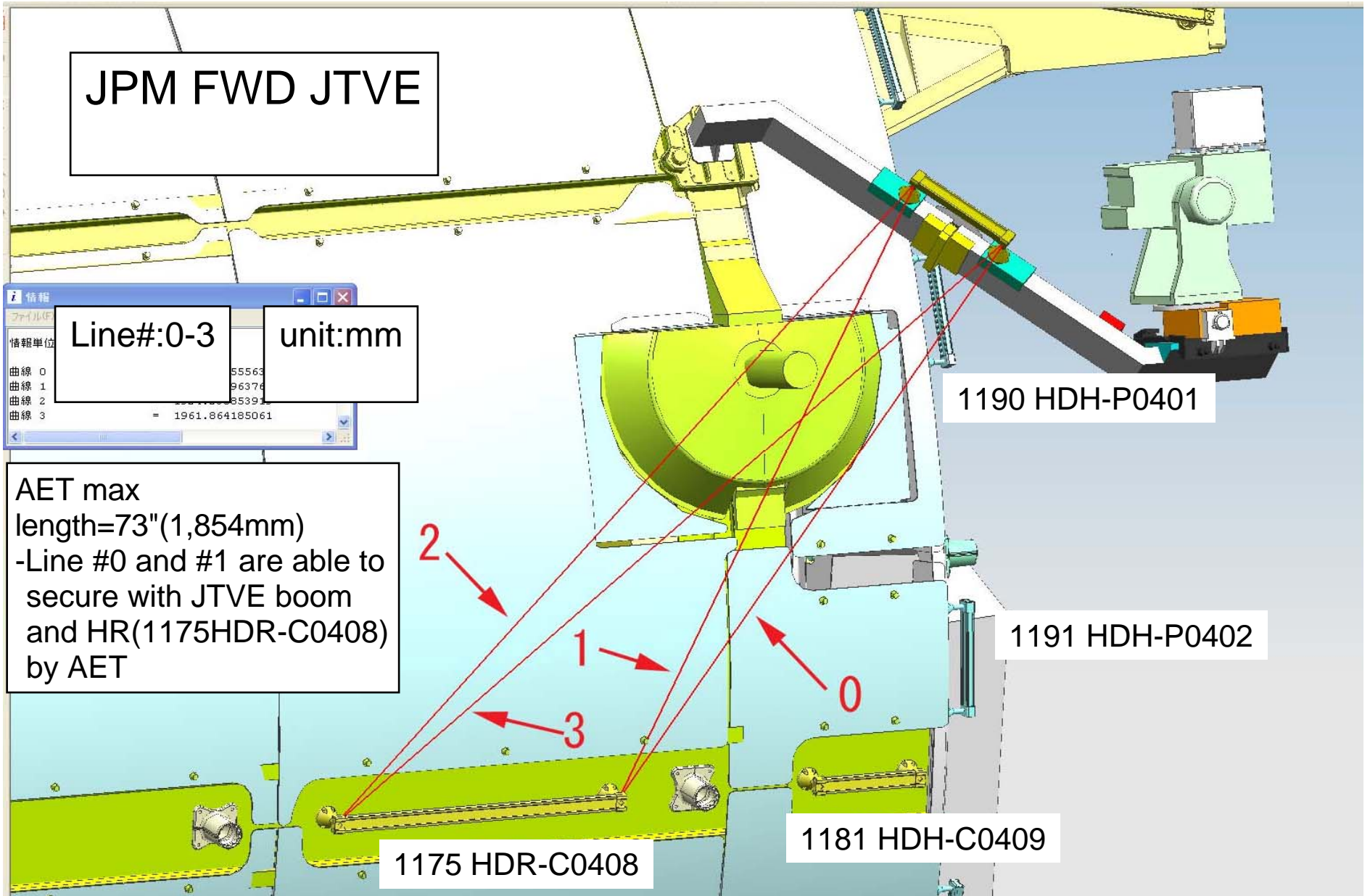
JTVE

1J ISS ORU TIE-DOWN PLAN (Cont)



JTVE Installed

1J ISS ORU TIE-DOWN PLAN (Cont)



1J ISS ORU TIE-DOWN PLAN (Cont)

JPM FWD JTVE

AET max length=73"(1,854mm)
-Line #1 to #4, all lines are available with AET

情報

ファイル(F) 編集(E)

情報リストの作成元 : syscad
 日付 : 2008/01/25 13:55:18
 現在の作業/パート : C:\DATA\ITOU\CIE07084\JP:
 ノード名 : jtmcie13

メートル

4.795933399
 .487211557
.283144956

1

01/25 13:55:36
 : C:\DATA\ITOU\CIE07084\JP:
 ノード名 : jtmcie13

情報単位 ミリメートル

曲線 0 = 46.330367224
 曲線 1 = 346.882636991
 曲線 2 = 132.256663772

全円弧長 = 525.469667987

2

情報リストの作成元 : syscad
 日付 : 2008/01/25 13:55:54
 現在の作業/パート : C:\DATA\ITOU\CIE07084\JP:
 ノード名 : jtmcie13

情報単位 ミリメートル

曲線 0 = 69.073069943
 曲線 1 = 346.036256665

全円弧長 = 415.109326608

3

情報リストの作成元 : syscad
 日付 : 2008/01/25 13:56:12
 現在の作業/パート : C:\DATA\ITOU\CIE07084\JP:
 ノード名 : jtmcie13

情報単位 ミリメートル

曲線 0 = 294.746581118
 曲線 1 = 64.428212319
 曲線 2 = 105.043656261

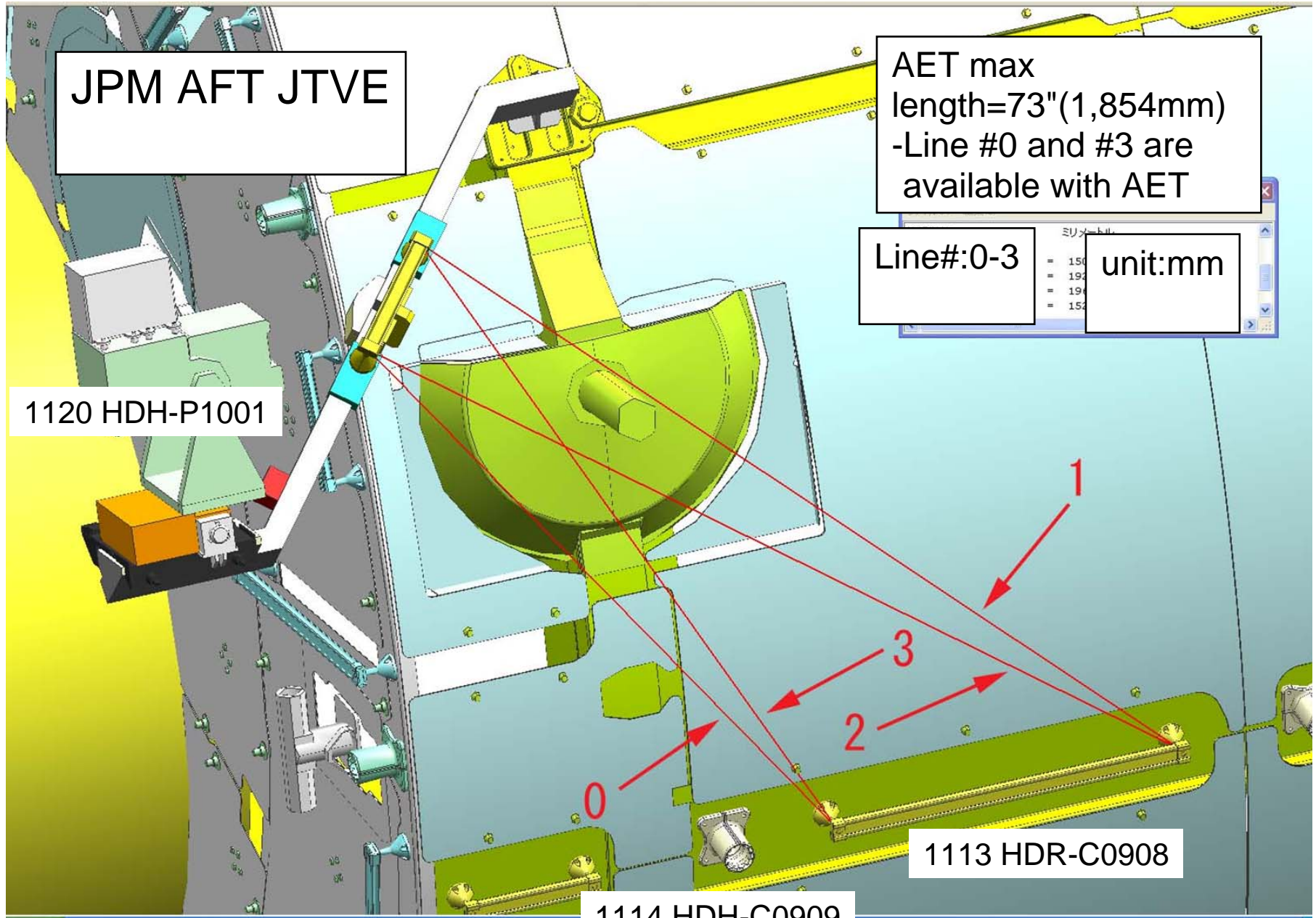
全円弧長 = 464.218449698

4

1190 HDH-P0401

unit:mm

1J ISS ORU TIE-DOWN PLAN (Cont)



1J ISS ORU TIE-DOWN PLAN (Cont)

The image shows a 3D CAD model of a mechanical assembly, likely a tie-down system. A software window on the left displays technical data for four different components, each with its own set of curve and arc length information. Red arrows labeled 1 through 4 point from these data blocks to specific parts of the 3D model. A text box at the top right provides information about the AET (Automatic Edge Tensioning Tool) used for securing the lines. Another text box at the bottom right identifies the manufacturer as JPM AFT JTVE. A label '1120 HDH-P1001' is also present at the bottom.

AET max
length=73"(1,854mm)
-Line #1 to #4, all lines
are available to
secure with AET

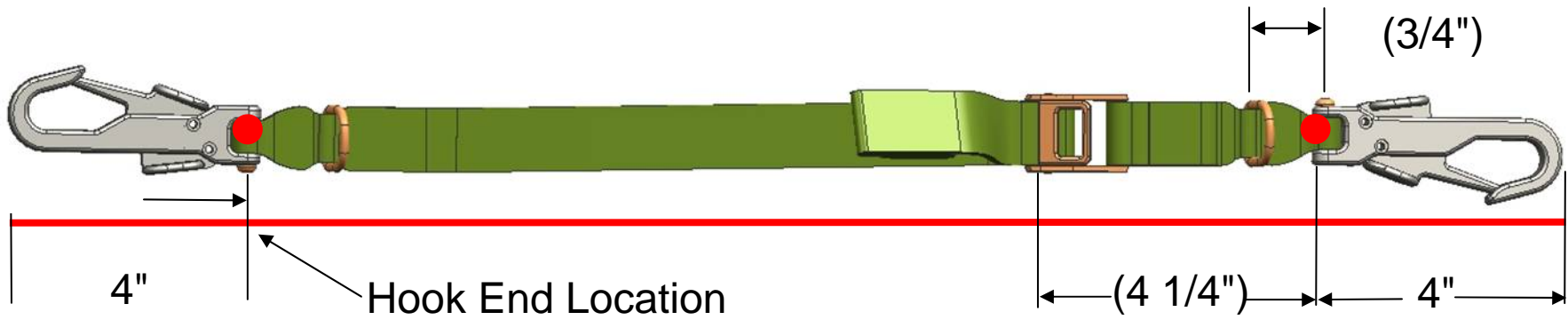
JPM AFT JTVE

unit:mm

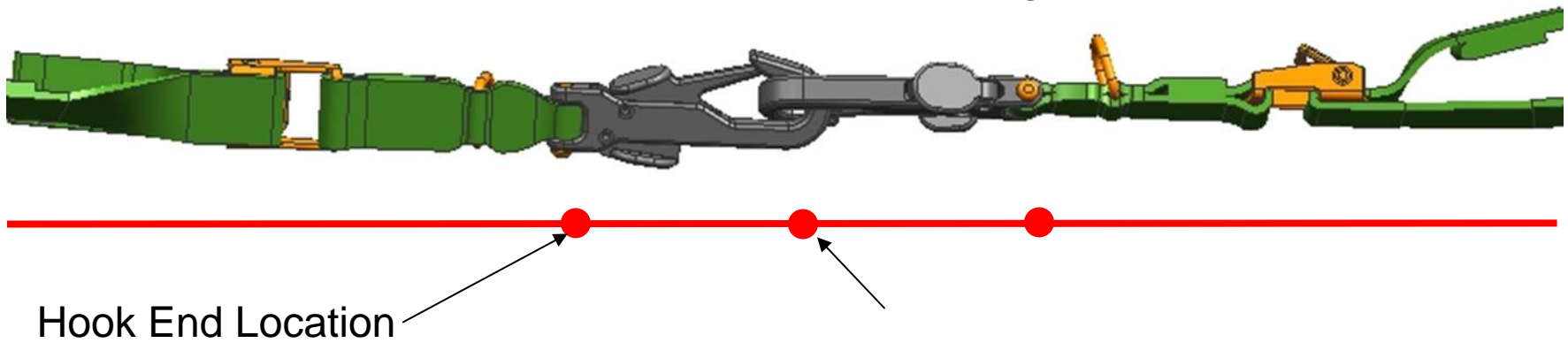
1120 HDH-P1001

| 情報 | |
|---------------|------------------------|
| ファイル(F) 編集(E) | |
| ----- | |
| 情報リストの作成元 : | syscad |
| 日付 | 2008/01/25 14:17:18 |
| 現在の作業パート | : C:\DATA\ITOU\CIE0708 |
| ノード名 | : jtmcie13 |
| ----- | |
| 情報単位 | ミリメートル |
| 曲線 0 | = 67.035955475 |
| 曲線 1 | = 352.018801757 |
| 全円弧長 | = <u>419.054757232</u> |
| ----- | |
| 情報リストの作成元 : | syscad |
| 日付 | 2008/01/25 14:17:36 |
| 現在の作業パート | : C:\DATA\ITOU\CIE0708 |
| ノード名 | : jtmcie13 |
| ----- | |
| 情報単位 | ミリメートル |
| 曲線 0 | = 407.126092872 |
| 曲線 1 | = 122.273632051 |
| 曲線 2 | = 62.232650773 |
| 全円弧長 | = <u>591.632375695</u> |
| ----- | |
| 情報リストの作成元 : | syscad |
| 日付 | 2008/01/25 14:17:54 |
| 現在の作業パート | : C:\DATA\ITOU\CIE0708 |
| ノード名 | : jtmcie13 |
| ----- | |
| 情報単位 | ミリメートル |
| 曲線 0 | = 66.260770110 |
| 曲線 1 | = 346.812499867 |
| 全円弧長 | = <u>413.073269977</u> |
| ----- | |
| 情報リストの作成元 : | syscad |
| 日付 | 2008/01/25 14:18:06 |
| 現在の作業パート | : C:\DATA\ITOU\CIE0708 |
| ノード名 | : jtmcie13 |
| ----- | |
| 情報単位 | ミリメートル |
| 曲線 0 | = 105.639330471 |
| 曲線 1 | = 64.701017883 |
| 曲線 2 | = 339.706633567 |
| 全円弧長 | = <u>510.046981922</u> |

1J ISS ORU TIE-DOWN PLAN (Cont)

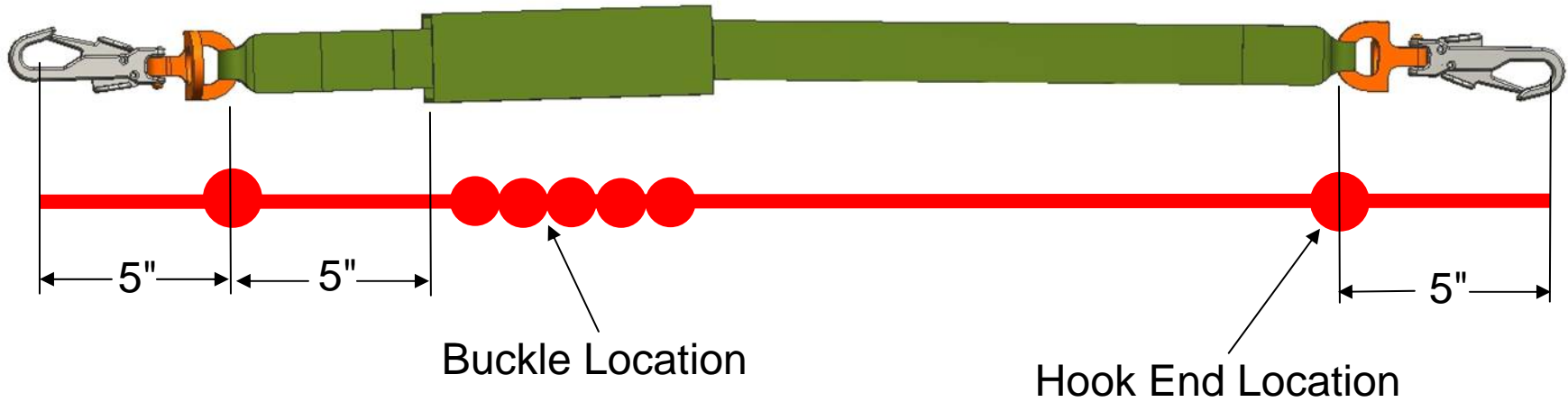


Adjustable Tether End-To-End Configuration (32-52")

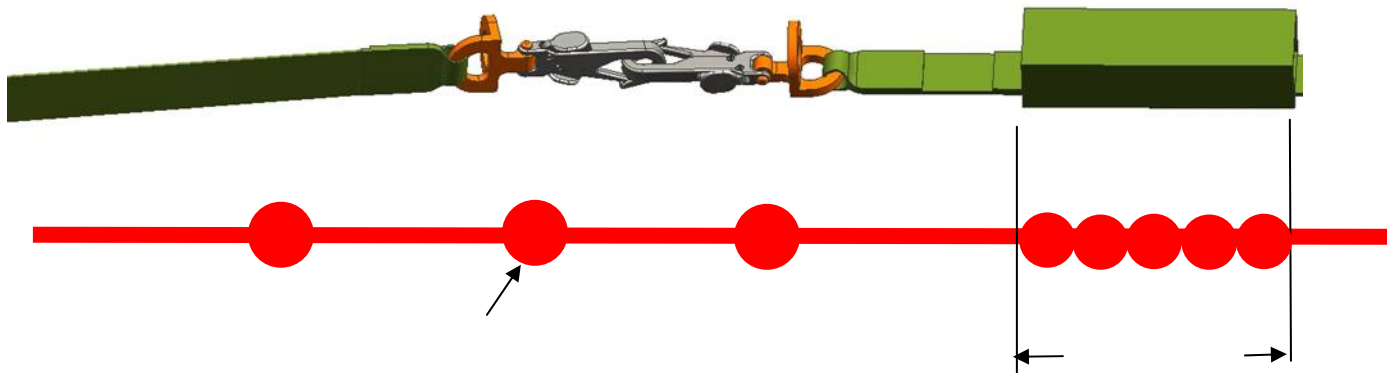


1J ISS ORU TIE-DOWN PLAN (Cont)

Long Duration Tie Down Tether (24-84")



Long Duration Tie Down Tether End-To-End Configuration (48-168")



MANUAL RELEASE OF HRM

| IV | EV1 (FF) | EV2 (FF) |
|----|---|----------|
| | <p data-bbox="468 250 705 277"><u>RELEASE OF HRM</u></p> <ol data-bbox="468 310 798 337" style="list-style-type: none">1. Translate to failed HRM <div data-bbox="548 370 976 483" style="border: 2px solid black; padding: 5px; margin: 10px 0;"><p data-bbox="695 383 827 410" style="text-align: center;"><u>WARNING</u></p><p data-bbox="564 415 957 472" style="text-align: center;">Do not touch the latching arms of hold and release mechanisms</p></div> <ol data-bbox="468 516 1150 824" style="list-style-type: none">2. Remove MLI from bolt3. PGT [A3 (4.8), CCW3, 30.5] W/2" EXT – engage EVA drive bolt, 413.5 turns for HRMs #1 & 2, 477 turns for HRM #34. Verify Release indicator UP (1 for HRMs #1 & 2 and 2 for HRM #3)5. ✓HRM latching arm open | |

MANUAL RELEASE OF HRM – TASK DATA

Estimated Task Duration:

| | With SSRMS | Without SSRMS |
|-------------|------------|---------------|
| One EV Crew | N/A | TBD |
| Two EV Crew | N/A | TBD |

Tools:

| EV1 | EV2 |
|-------------------------------------|-----|
| BRT PGT 2" ext – 7/16" Socket | |

ORU Identification:

| ORU | Part number | Serial Number |
|-----|-------------|---------------|
| | | |
| | | |

EVA Fasteners:

| Fastener Name | Head Size | Qty | Install Torque (ft-lb) | Release Torque (ft-lb) | Failure Torque (ft-lb) | Turns |
|---------------------------|-----------|-----|------------------------|------------------------|------------------------|-------|
| HRM #1&2 – EVA Drive Bolt | 7/16" | 1 | 0.82-2.73 | 2.73 | 6.80 | 413.5 |
| HRM #3 – EVA Drive Bolt | 7/16" | 1 | 0.82-2.73 | 2.73 | 6.80 | 477 |

Notes:

- 1.

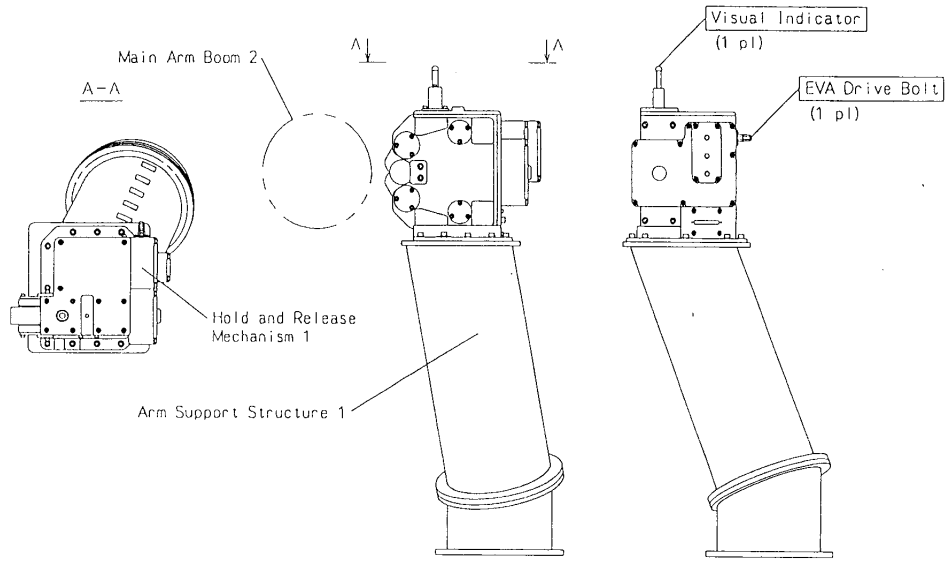
Cautions:

- 1.

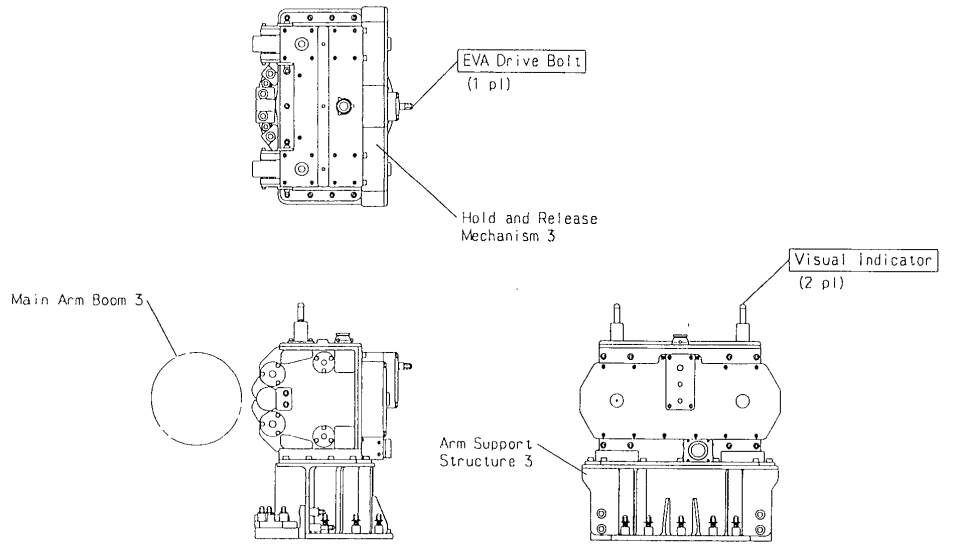
Warnings:

1. Do not touch the latching arms of hold and release mechanisms

MANUAL RELEASE OF HRM – TASK DATA (Cont)



Hold and Release Mechanism 1 (HRM 1)



Hold and Release Mechanism 3 (HRM 3)

JEM RMS JEU REMOVE/REPLACE

| IV | EV (FF) |
|----|--|
| | <p><u>REMOVAL OF JEU</u></p> <ol style="list-style-type: none"> Translate to failed JEU <div data-bbox="556 329 1075 516" style="border: 1px solid black; padding: 5px; margin: 10px 0;"> <p style="text-align: center;"><u>CAUTION</u></p> <p>Contact to silver teflon area on JEU could cause scratch of silver teflon and contamination to silver teflon. Failure to comply could result in degradation of optical characteristic of silver teflon area</p> </div> <ol style="list-style-type: none"> Remove MLI cover from CLM bolt Check indicator of CLM (black dot = lock) Push button of CLM Check indicator of CLM (no black dot = unlock) PGT [A1 (2.5), CCW2, 30.5] W/2" EXT – engage CLM bolt 15 turns to demate connector Verify connector separation Attach MMOD Shield T-handle tool (2) to failed JEU PGT [B7 (25.5), CCW2, 30.5] W/2" EXT – engage JEU bolts (5) 7-10 turns Remove failed JEU <p><u>REPLACE JEU</u></p> <ol style="list-style-type: none"> Retrieve spare JEU Align Alignment markings on JEU with alignment markings on Joint and install JEU to JHU <p style="text-align: center;"><u>NOTE</u></p> <p style="text-align: center;">Softdock is 4.2-6.4 lb of force to install JEU to JHU</p> <ol style="list-style-type: none"> PGT [B6 (24.0), CW2, 30.5] W/2" EXT – engage JEU bolts (5) 16 turns PGT [A1 (2.5), CW2, 30.5] W/2" EXT – engage CLM bolt 15 turns to mate connector Verify connector mated, attach MLI cover to CLM bolt Retrieve failed JEU |

JEM RMS JEU REMOVE/REPLACE – TASK DATA (Cont)

Estimated Task Duration:

| | With SSRMS | Without SSRMS |
|-------------|------------|---------------|
| One EV Crew | N/A | TBD |
| Two EV Crew | N/A | TBD |

Tools:

| EV1 | EV2 |
|--|-----|
| BRT PGT 2" ext – 7/16" Socket MMOD Shield T-handle tool (3) | |

ORU Identification:

| ORU | Part number | Serial Number |
|-----|-------------|---------------|
| | | |
| | | |

EVA Fasteners:

| Fastener Name | Head Size | Qty | Install Torque (ft-lb) | Release Torque (ft-lb) | Failure Torque (ft-lb) | Turns |
|---------------|-----------|-----|------------------------|------------------------|------------------------|---------|
| CLM | 7/16" | 1 | 2.29 | 3.41 | Rel: 24.1 Inst: 3.9 | 15 |
| JEU Bolt | 7/16" | 5 | 19.6-24.5 | 18.7-22.8 | 33.7 | 6.9-9.8 |

Notes:

1.

Cautions:

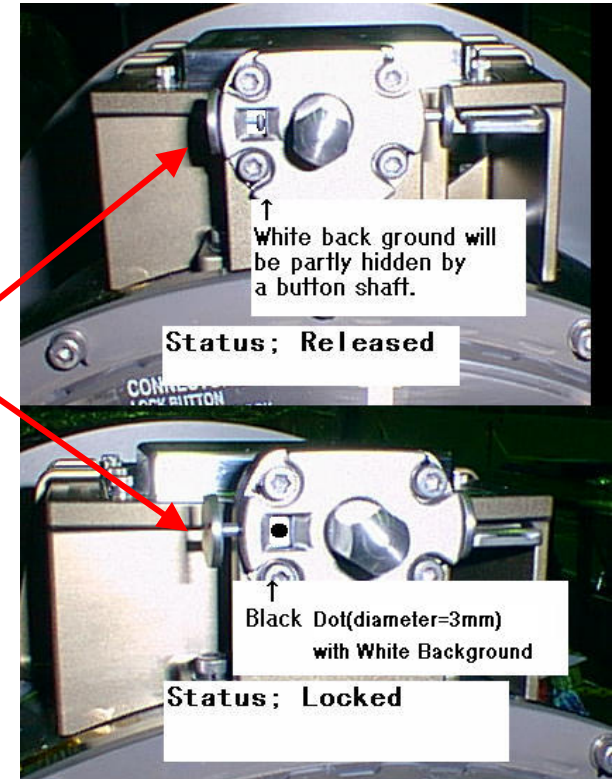
1.

Warnings:

1. Do not touch the latching arms of hold and release mechanisms

CLM Indication

CLM Button



FLIGHT SPECIFIC EVA REFERENCE

I

STS-124 PAYLOAD BAY LAYOUT FS 18-3

JEM PM

- HANDRAILS AND WIF LOCATIONS – PORT ENDCONE FS 18-4
- HANDRAILS AND WIF LOCATIONS – STARBOARD ENDCONE FS 18-5
- HANDRAILS AND WIF LOCATIONS – ZENITH FACE FS 18-6
- HANDRAILS AND WIF LOCATIONS – FORWARD FACE FS 18-7
- HANDRAILS AND WIF LOCATIONS – NADIR FACE FS 18-8
- HANDRAILS AND WIF LOCATIONS – AFT FACE FS 18-9
- OVERALL DIMENSIONS AND MASS INFORMATION FS 18-10
- PORT ENDCONE FS 18-11
- JEM RMS JOINT NUMBERING FS 18-13
- LTA CABLE FS 18-14
- PCBM FS 18-18
- PCBM CONTAMINATION COVER FS 18-19
- WINDOW SHUTTER FS 18-21
- JTVE BOOM FS 18-22
- JTVE BOOM INSTALLED FS 18-24
- JTVE BOOM RECEPTACLE FS 18-25
- JTVE BOOM RECEPTACLE AND CONNECTOR CAP FS 18-26
- JTVE BOOM LABELING AND CONNECTOR FS 18-27
- JTVE CAMERAS AND LAUNCH LOCKS FS 18-28
- EVE LAUNCH LOCK FS 18-29
- WVE LAUNCH LOCK FS 18-32
- WVE AND EVE MLI FS 18-36
- ACBM MMOD SHIELD LAUNCH LOCK BOLTS FS 18-37
- ACBM MMOD SHIELD DEPLOY DOOR/HANDLE FS 18-38
- ACBM MMOD SHIELD DEPLOYED FS 18-40
- PCBM MLI REMOVAL FS 18-42
- PCBM PIP PIN FS 18-45
- RMS JEU COVERS FS 18-47
- TRUNNION/KEEL COVERS FS 18-51

OBSS

- OVERVIEW ON TRUSS FS 18-52
- KEEP-ALIVE UMBILICAL WORKSITE FS 18-53
- OBSS ON TRUSS – FLY AROUND PHOTOS FS 18-54
- KEEP-ALIVE UMBILICAL COMPONENTS FS 18-56
- KEEP-ALIVE DEVICE – ATTACHED FS 18-57
- KEEP-ALIVE DEVICE – DETACHED FS 18-58
- P411 CONNECTOR COVER FS 18-59
- AVIONICS BOX FS 18-60
- OSE FS 18-61

NODE 2

- PORT ACBM WINDOW COVER FS 18-69
- PORT ACBM HATCH PETAL DEPLOY FS 18-71
- PORT ACBM LAUNCH LOCK FS 18-72
- FLUID QD MLI INSTALL FS 18-73

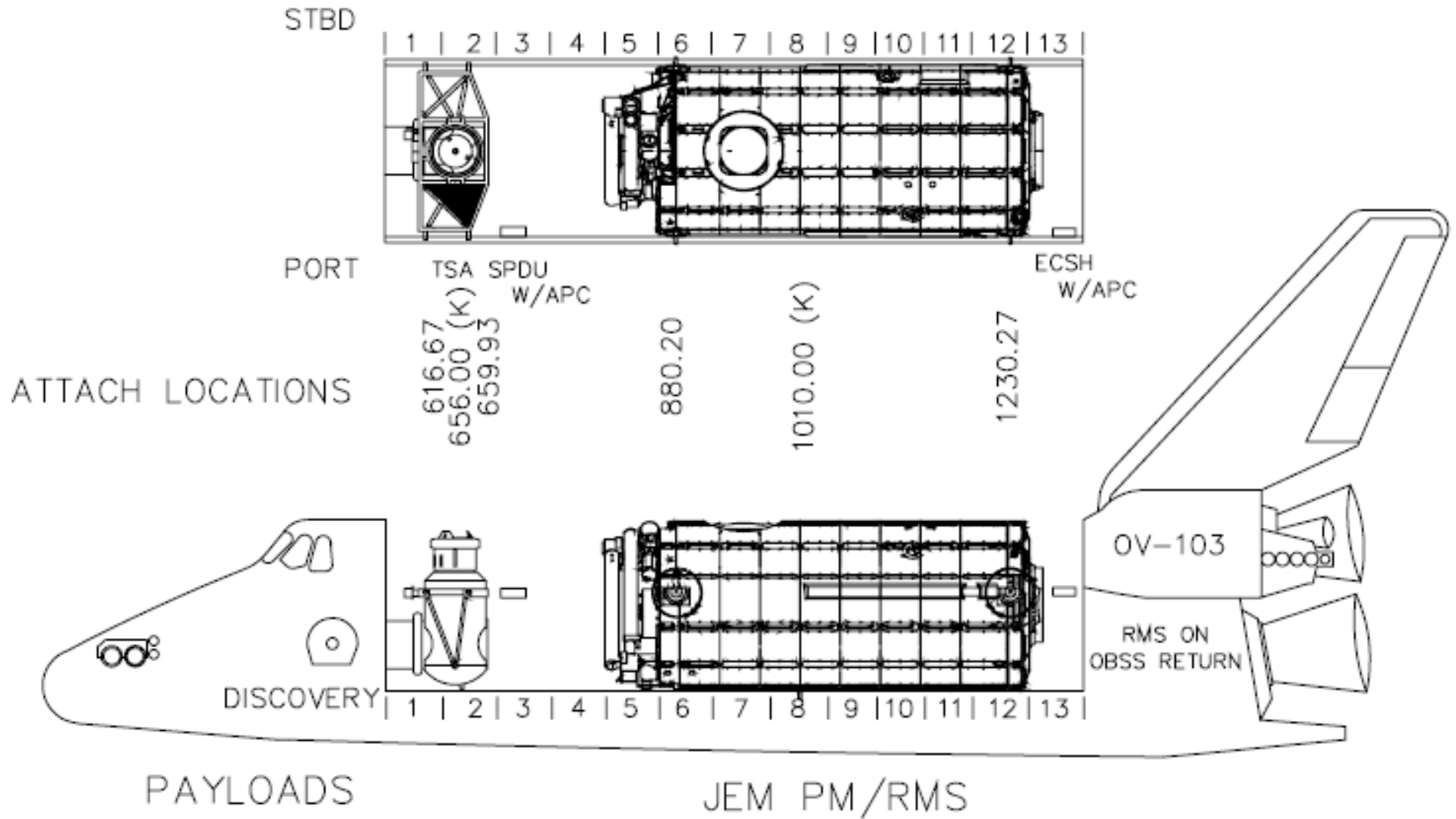
S3 SARJ

- TRUNDLE BEARING ASSEMBLY – ON-ORBIT FS 18-75
- TRUNDLE BEARING ASSEMBLY – INSTALLATION DIAGRAM FS 18-84
- LAUNCH RESTRAINT DIAGRAM FS 18-86
- LAUNCH RESTRAINT ON-ORBIT FS 18-87
- 6A LAUNCH RESTRAINT – ETRS INSTALLED FS 18-88
- 1A LAUNCH RESTRAINT FS 18-89
- 6A LAUNCH RESTRAINT – LAUNCH CONFIG FS 18-90

FLIGHT SPECIFIC
EVA REFERENCE

| | |
|---|-----------|
| 6A LAUNCH RESTRAINT – LAUNCH CONFIG (BACK SIDE) | FS 18-91 |
| FACE 6/1/2 ON-ORBIT | FS 18-92 |
| FACE 4 LAUNCH CONFIG | FS 18-93 |
| LAUNCH RESTRAINT CLAM SHELL | FS 18-95 |
| LAUNCH RESTRAINT MUSHROOM-SHAPED FITTING | FS 18-96 |
| COVER/TBA/DLA LABELING | FS 18-97 |
| COVER 18 REMOVED – DIVOT REGION | FS 18-99 |
| NTA | |
| NOMENCLATURE | FS 18-100 |
| ESP3 MLI | FS 18-101 |
| S1 CLOSEUP VIEW..... | FS 18-102 |
| S1 ON-ORBIT (FWD VIEW)..... | FS 18-103 |
| S1 ON-ORBIT (AFT VIEW) | FS 18-104 |
| S1 ON-ORBIT (AFT VIEW) MLI REMOVED..... | FS 18-105 |
| S1 SOFT DOCK..... | FS 18-106 |
| ESP3 | |
| HANDRAILS/WIFs – STBD SIDE | FS 18-108 |
| HANDRAILS/WIFs – PORT SIDE | FS 18-109 |
| P1/CP9 ETVCG | |
| CAMERA LABELED..... | FS 18-110 |
| CAMERA LOCK | FS 18-111 |
| CAMERA STANCHION/DUMMY BOX LABELED | FS 18-112 |
| WORKSITE OVERVIEW..... | FS 18-113 |
| DRAWING LABELED..... | FS 18-114 |
| DUMMY BOX INSTALLED..... | FS 18-115 |
| WETA | |
| ASSEMBLY PHOTOS..... | FS 18-118 |
| MISC | |
| SRMS ELBOW CAMERA STRAP..... | FS 18-120 |
| MCAS PIP PIN REMOVAL AND RTL CHECKOUT | FS 18-121 |
| MCAS EBCS MLI REMOVAL..... | FS 18-122 |
| 1J EVA WORKSITES OVERVIEW | FS 18-123 |
| TRANSLATION PATHS | |
| EVA 1: A/L TO OBSS..... | FS 18-124 |
| EVA 1: OBSS TO JEM PM IN PLD BAY | FS 18-125 |
| EVA 2: A/L TO JEM PM ENDCONE | FS 18-126 |
| EVA 2: A/L TO S1 AND ESP3 NTA | FS 18-127 |
| EVA 3: A/L TO S1 AND ESP3 NTA | FS 18-128 |
| EVA 3: A/L TO JEM PM ENDCONE | FS 18-129 |

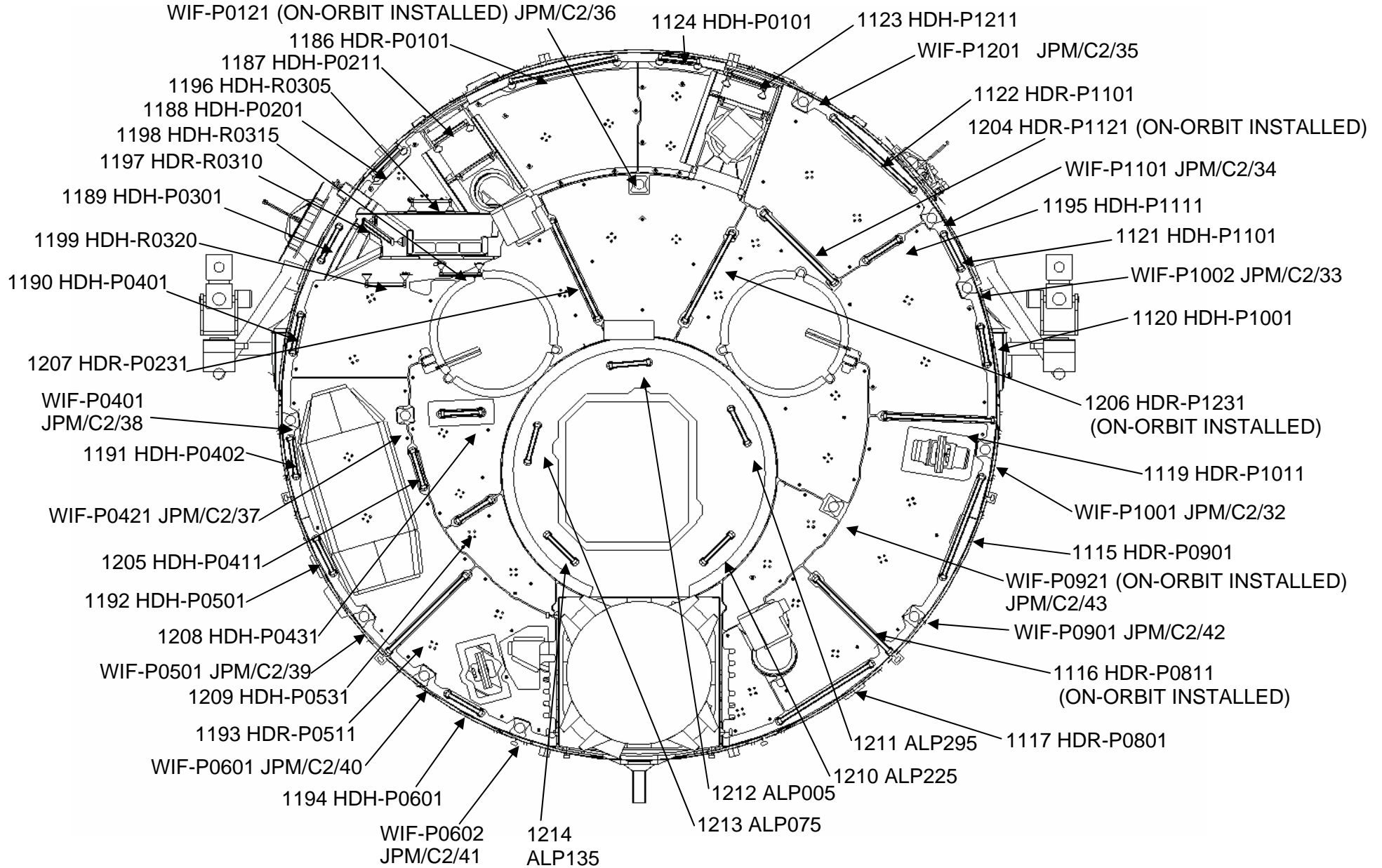
STS-124 PAYLOAD BAY LAYOUT



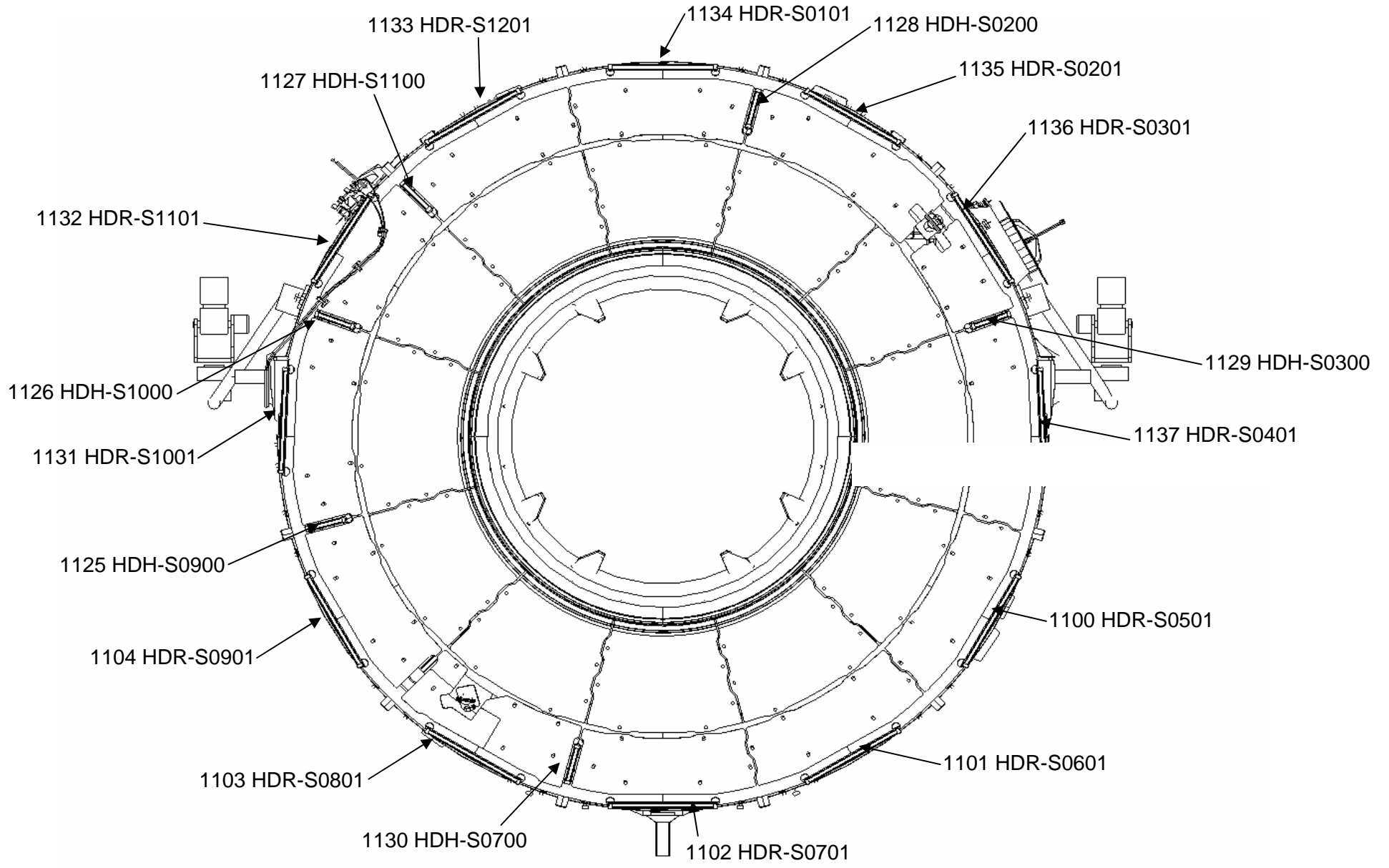
NOTE: OBSS is not installed for ascent, but will be installed for re-entry

JEM PM

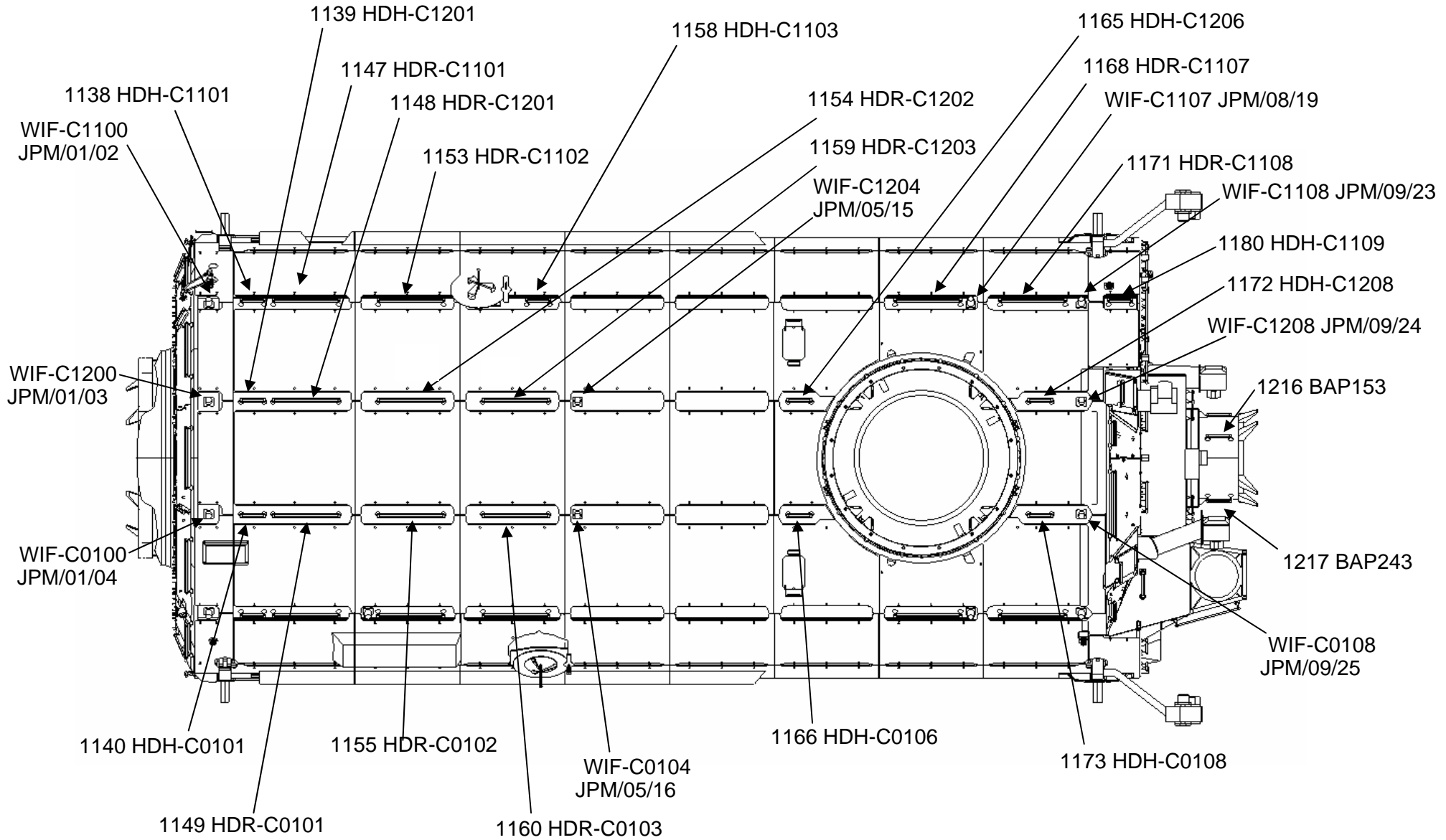
JEM PM HANDRAILS AND WIF LOCATIONS – PORT ENDCONE



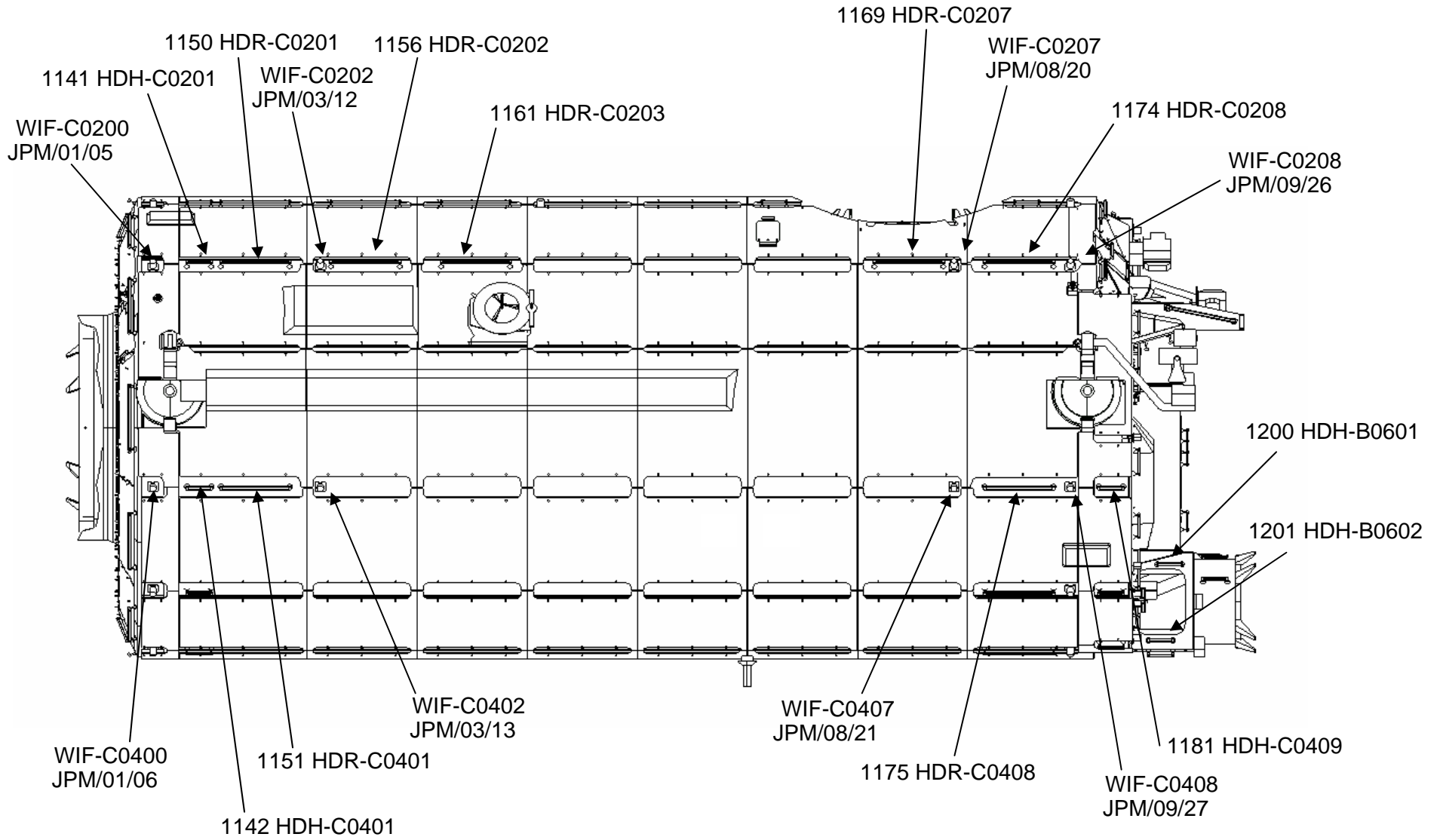
JEM PM HANDRAILS AND WIF LOCATIONS – STARBOARD ENDCONE



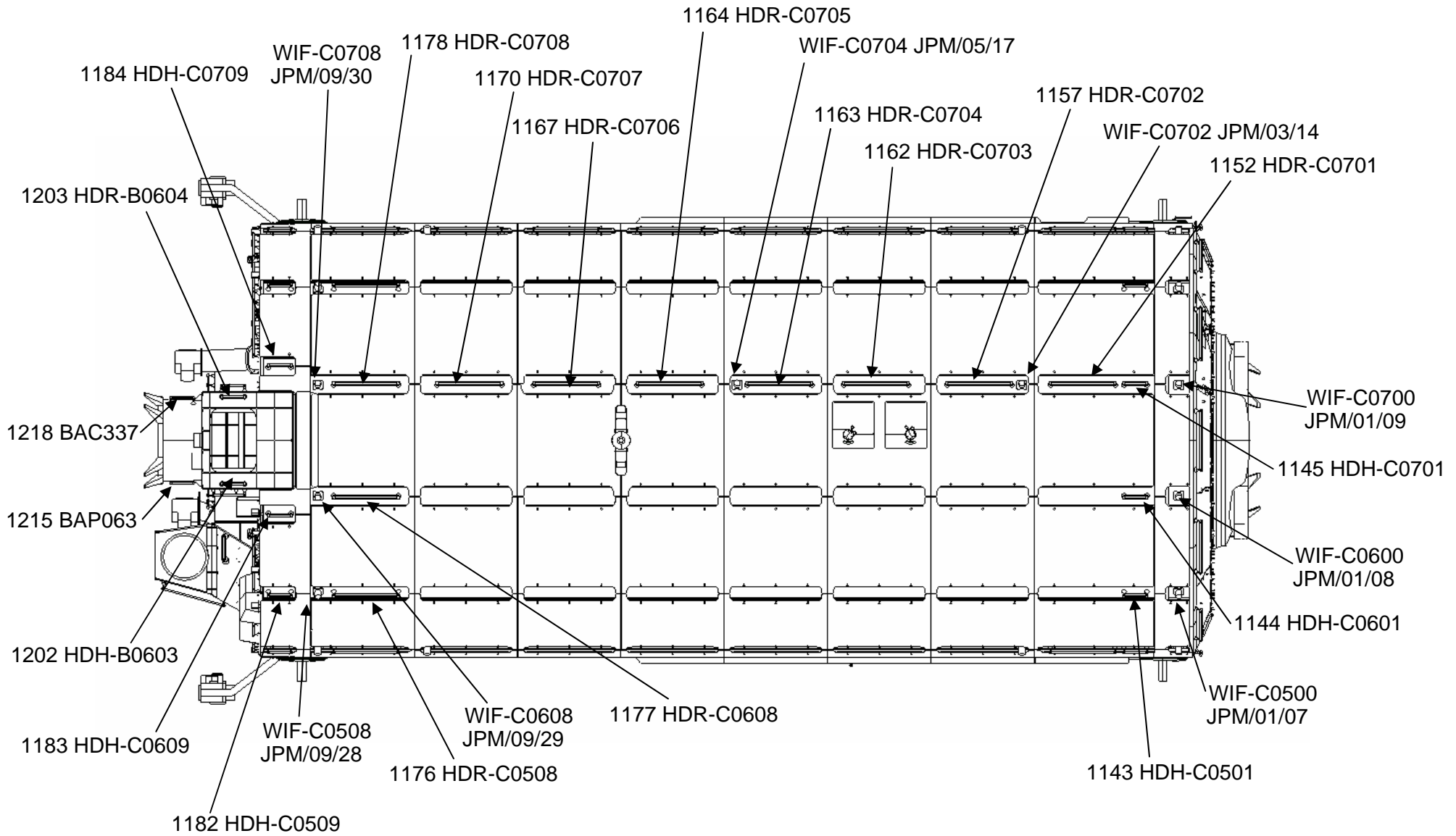
JEM PM HANDRAILS AND WIF LOCATIONS – ZENITH FACE



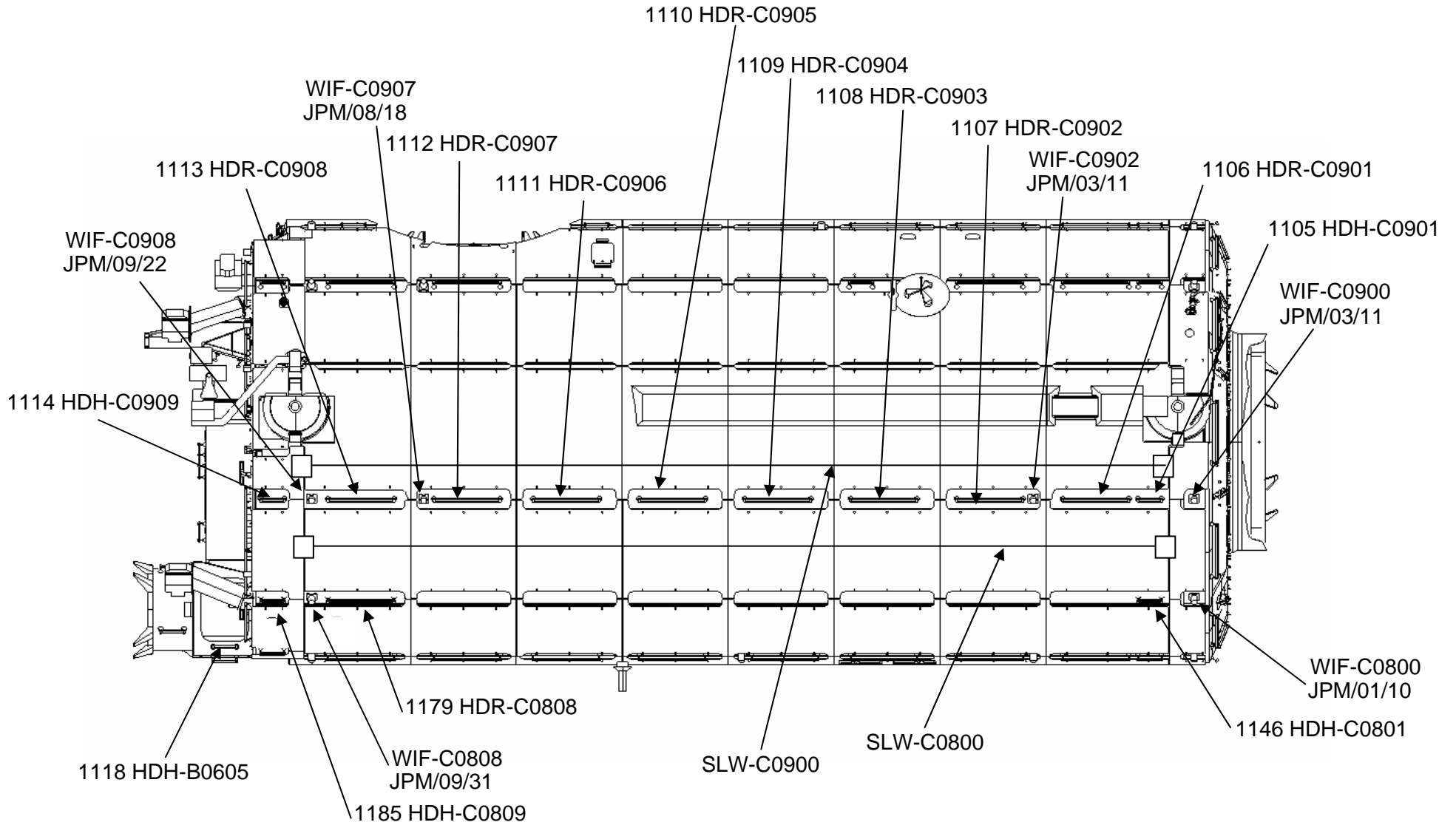
JEM PM HANDRAILS AND WIF LOCATIONS – FORWARD FACE



JEM PM HANDRAILS AND WIF LOCATIONS – NADIR FACE

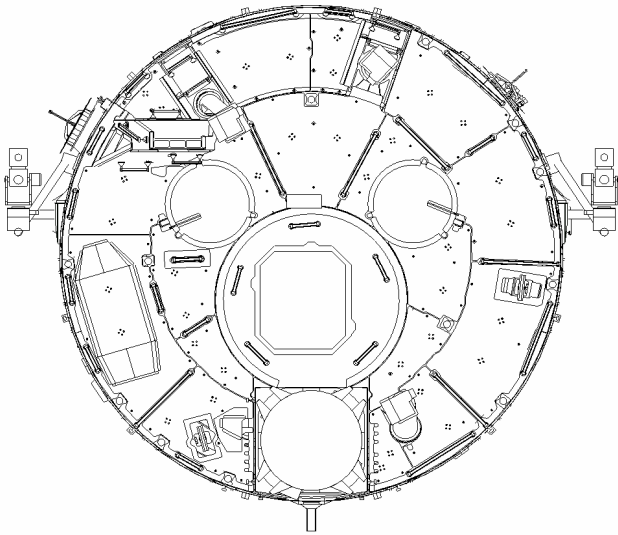


JEM PM HANDRAILS AND WIF LOCATIONS – AFT FACE

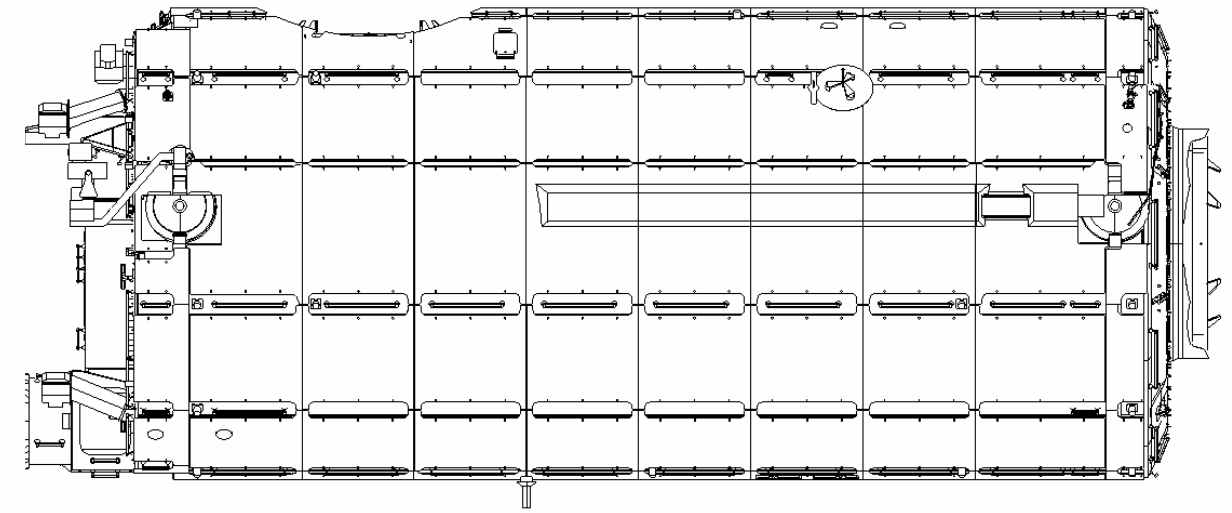


JEM PM OVERALL DIMENSIONS AND MASS INFORMATION

Approx 15' Diameter



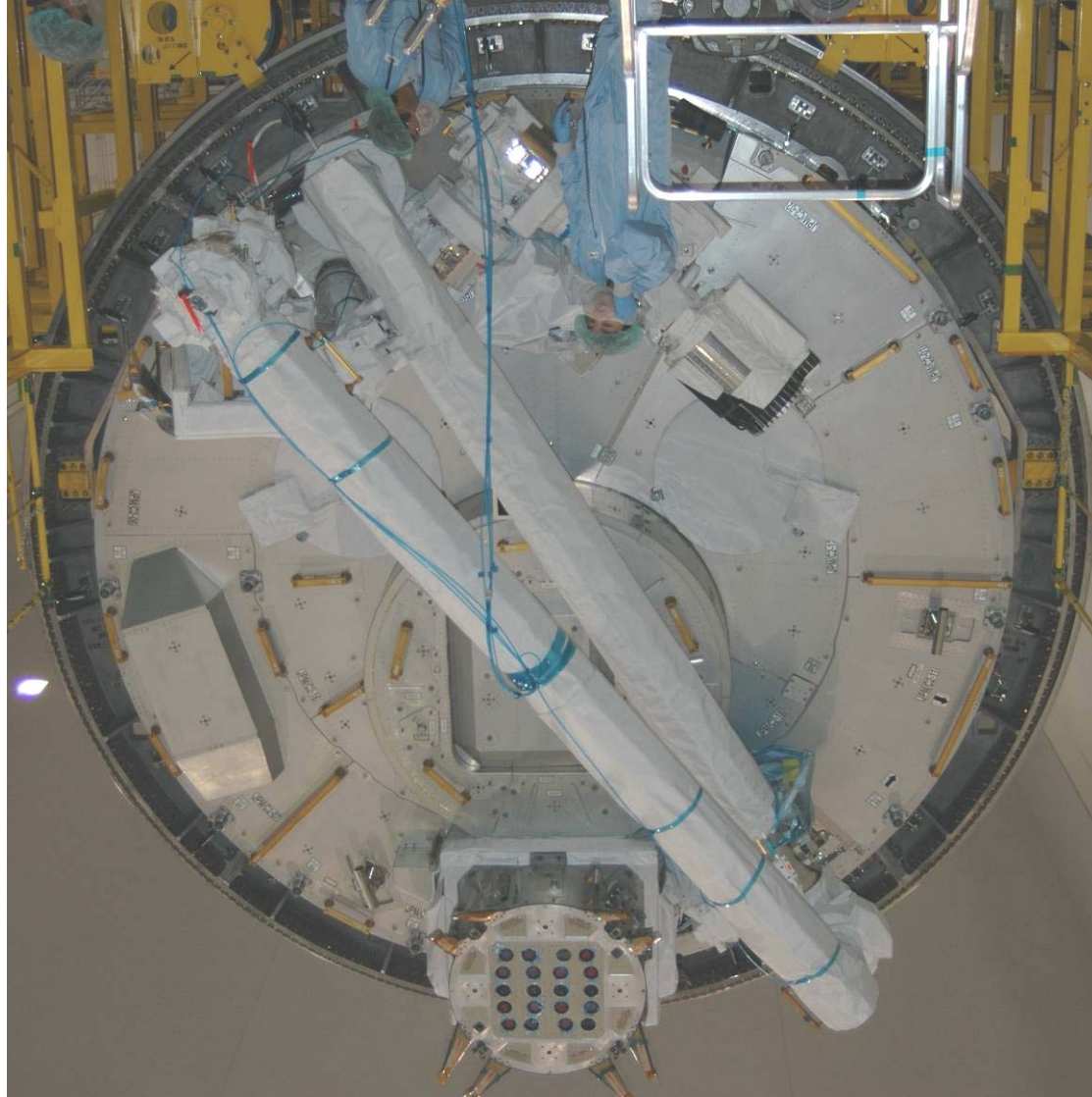
Approx 37' Diameter



Approximate Launched JEM Weight 32,600 lb

PORT ENDCONE

Photo of JEM Endcone/JEM RMS

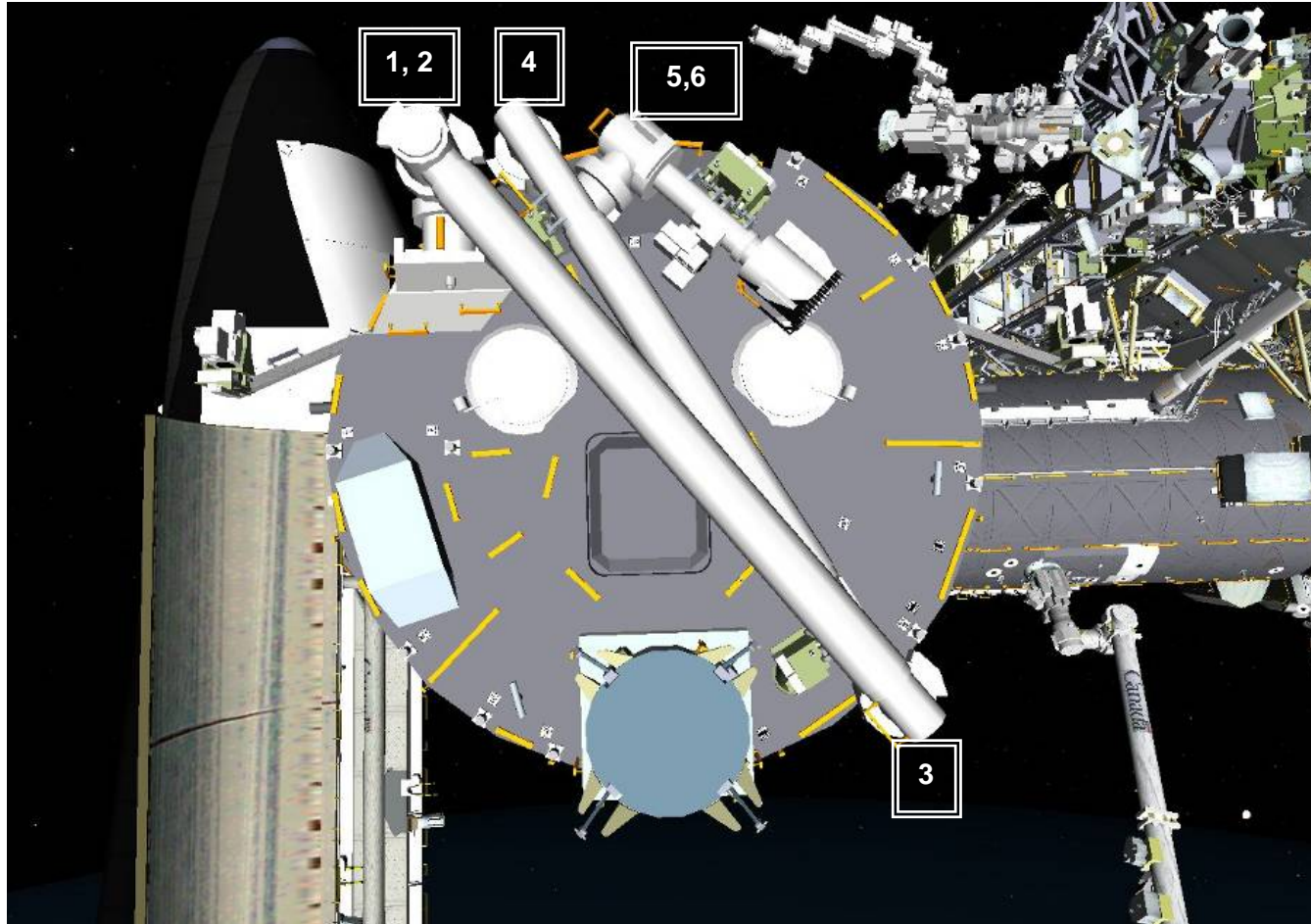


PORT ENDCONE (Cont)



JEM RMS JOINT NUMBERING

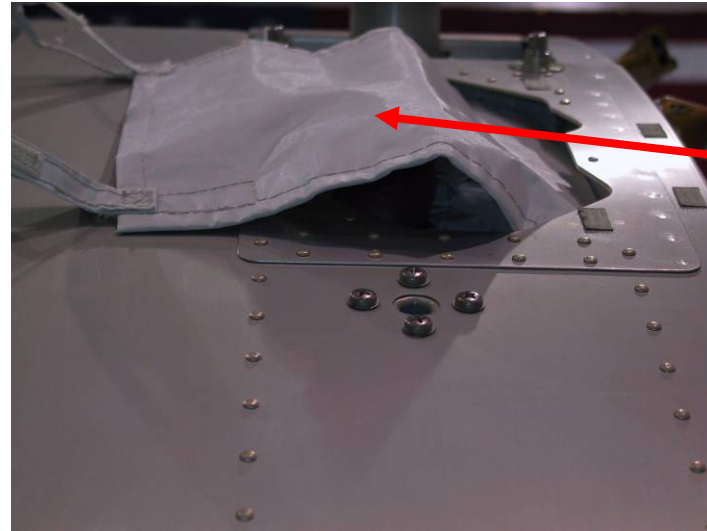
JEM RMS Joint Labels



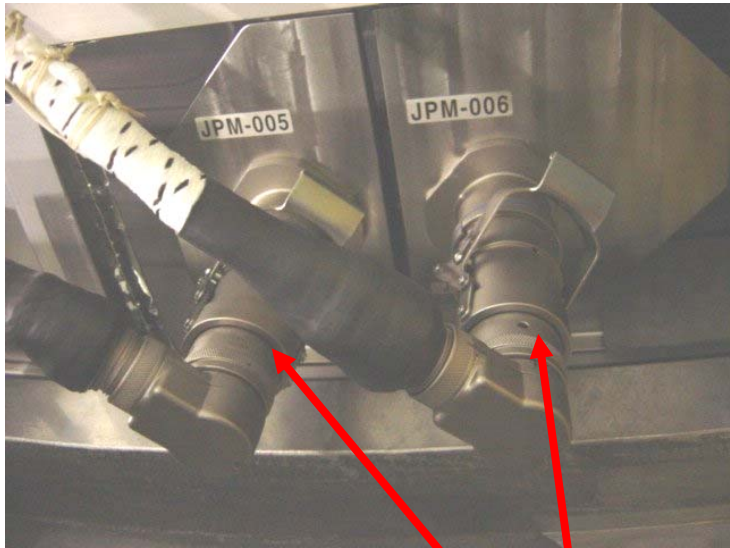
JEM Joint Numbering

| | |
|----------------|------------------|
| 1=Shoulder Yaw | 2=Shoulder Pitch |
| 3=Elbow Pitch | 4=Wrist Pitch |
| 5=Wrist Yaw | 6=Wrist Roll |

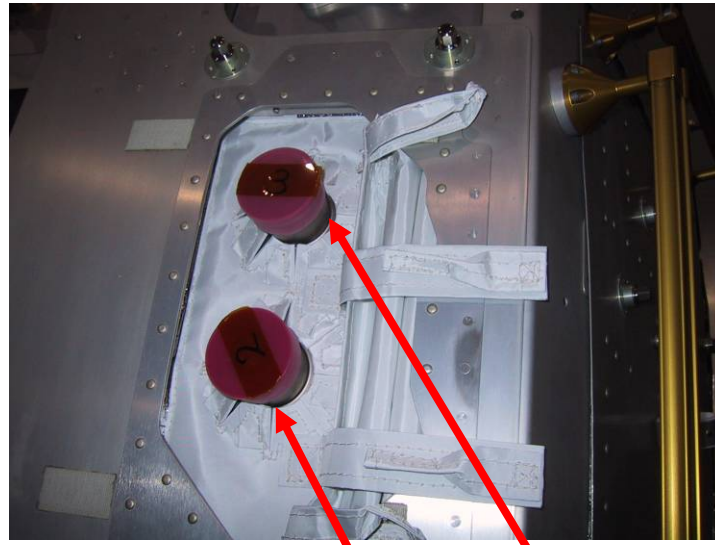
LTA CABLE



LTA Cable MLI Cover

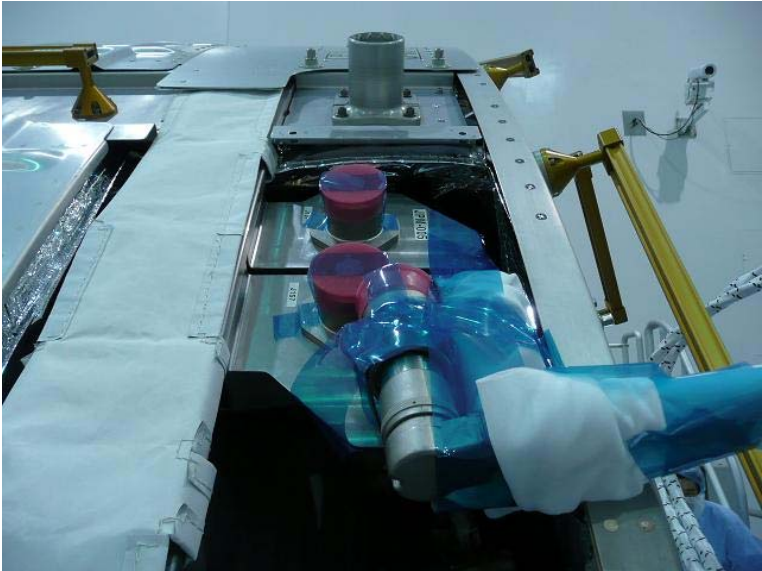
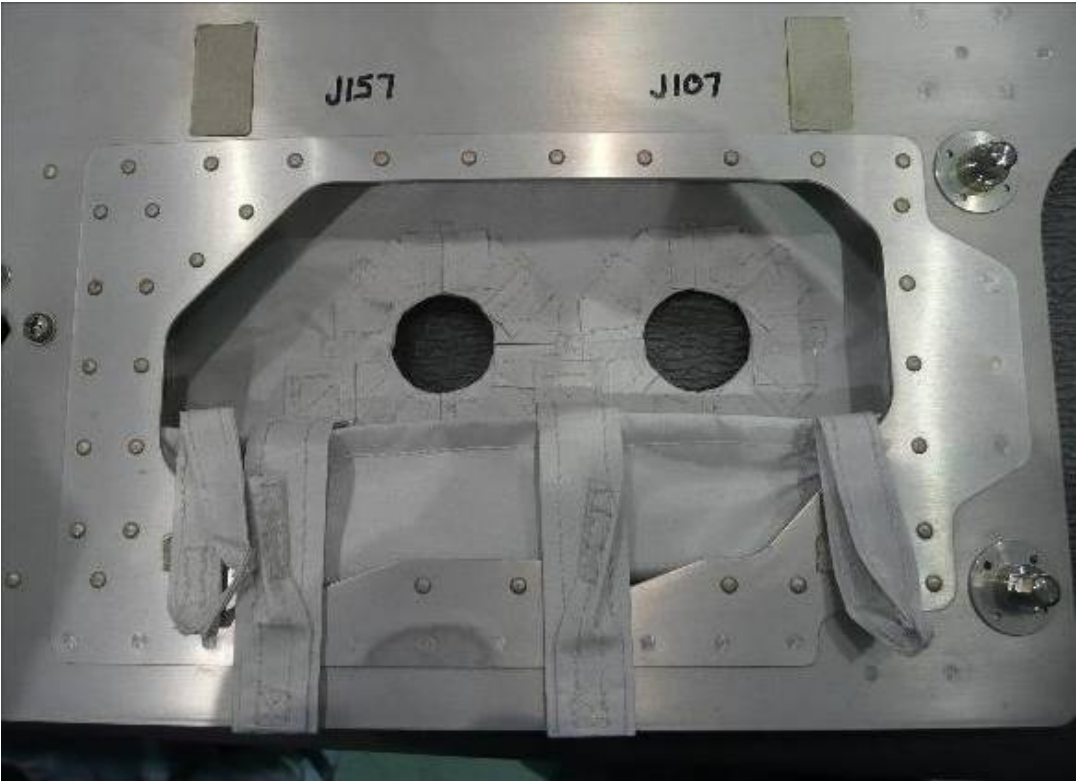


LTA Cables Attached to JEM



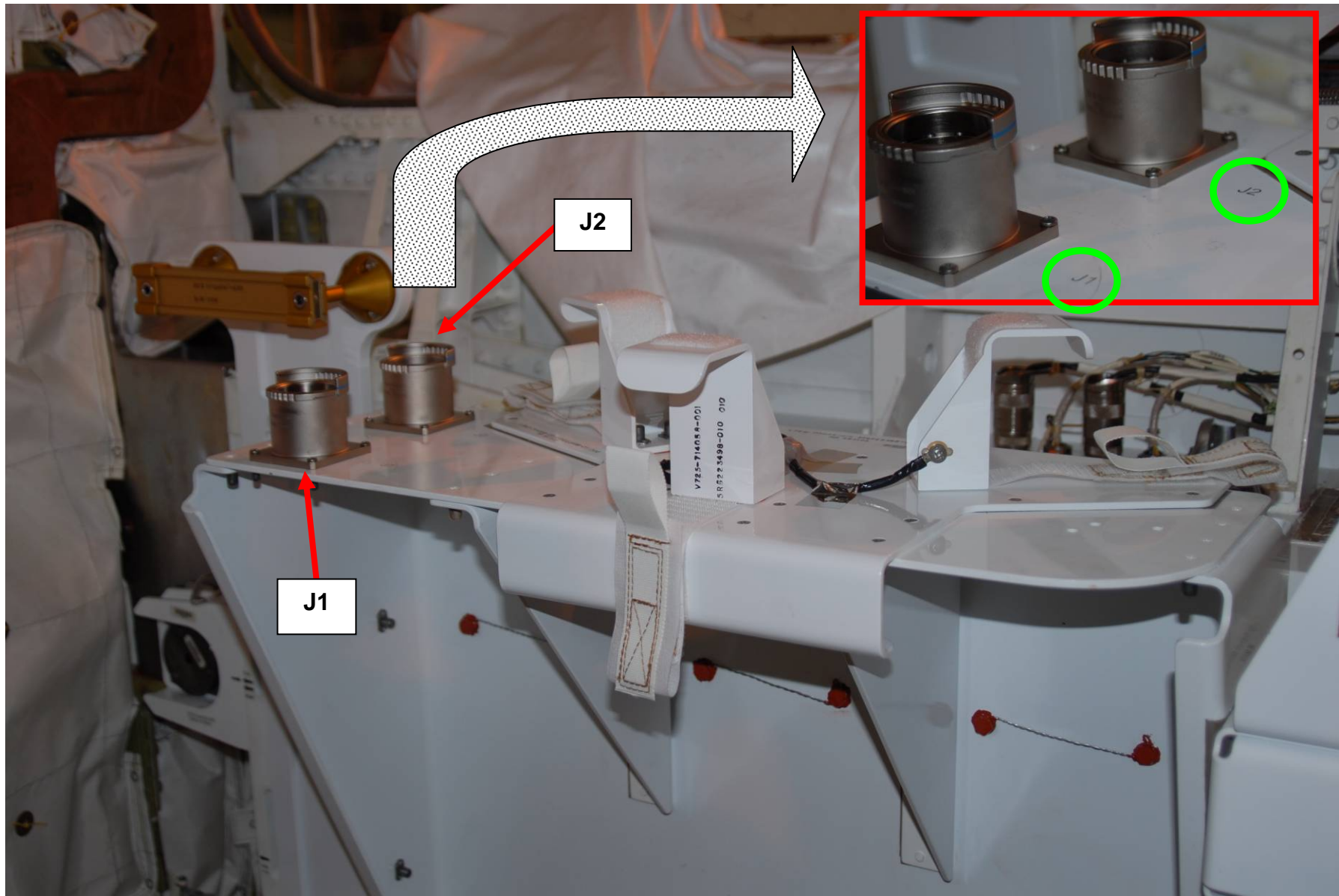
LTA Cables NOT Attached to JEM
(Red Connector Covers – are GSE)

LTA CABLE (Cont)

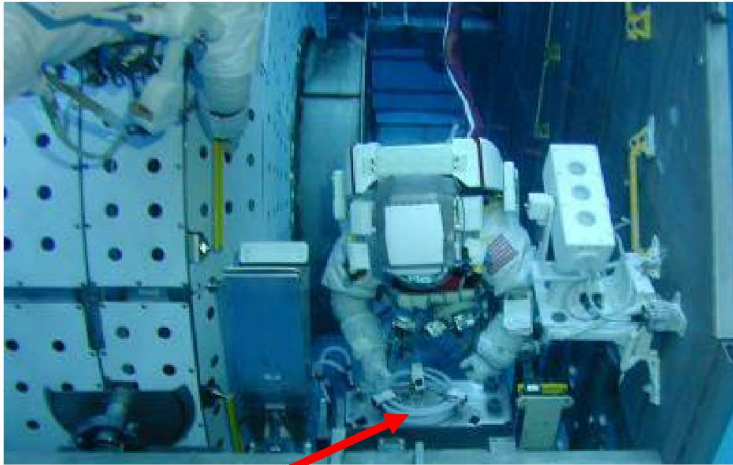


LTA CABLE (Cont)

ECSH LAYOUT



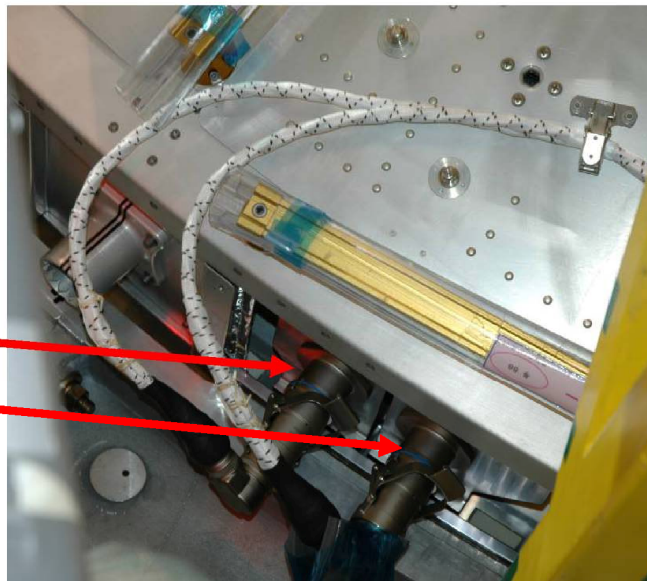
LTA CABLE (Cont)



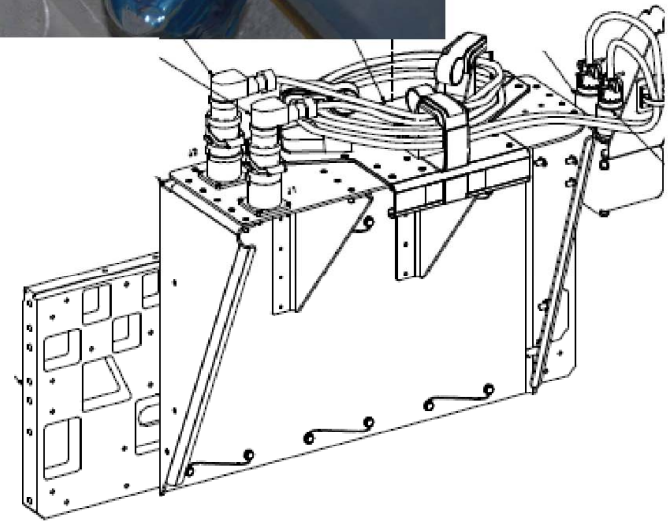
LTA Cable Stow Location



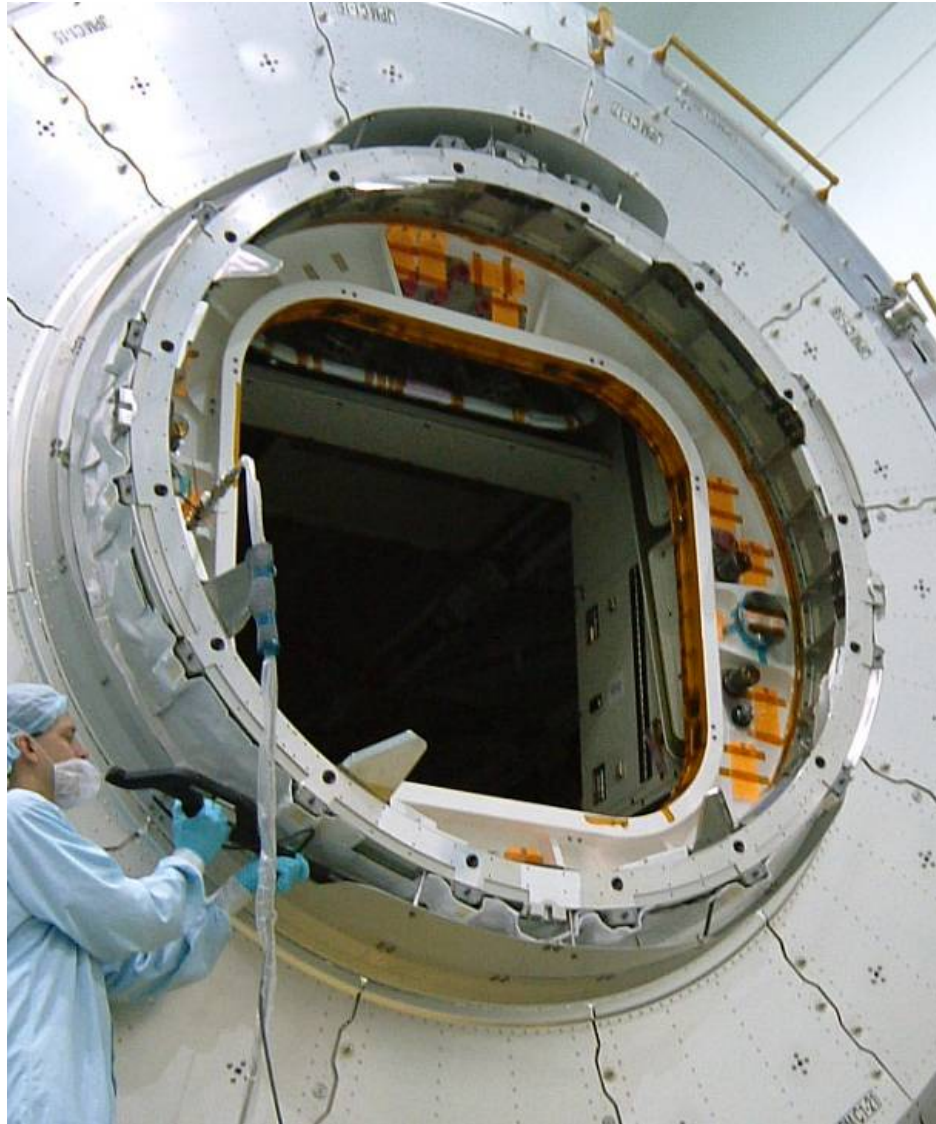
LTA Cables Attached to JEM



LTA Cables Attached to JEM



PCBM



FS 18-18

EVA/124/FIN

PCBM CONTAMINATION COVER



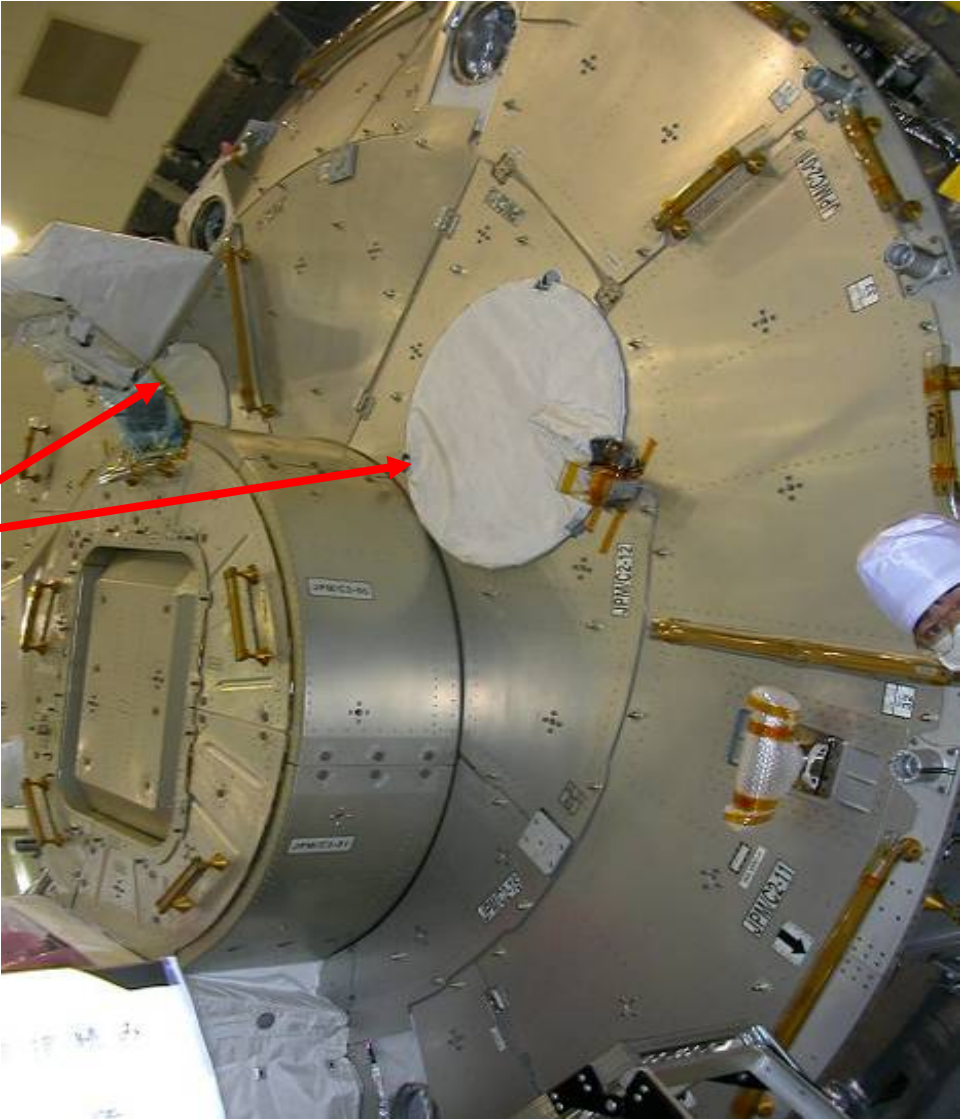
PCBM CONTAMINATION COVER (Cont)

Contamination Cover Removed (8 in total)

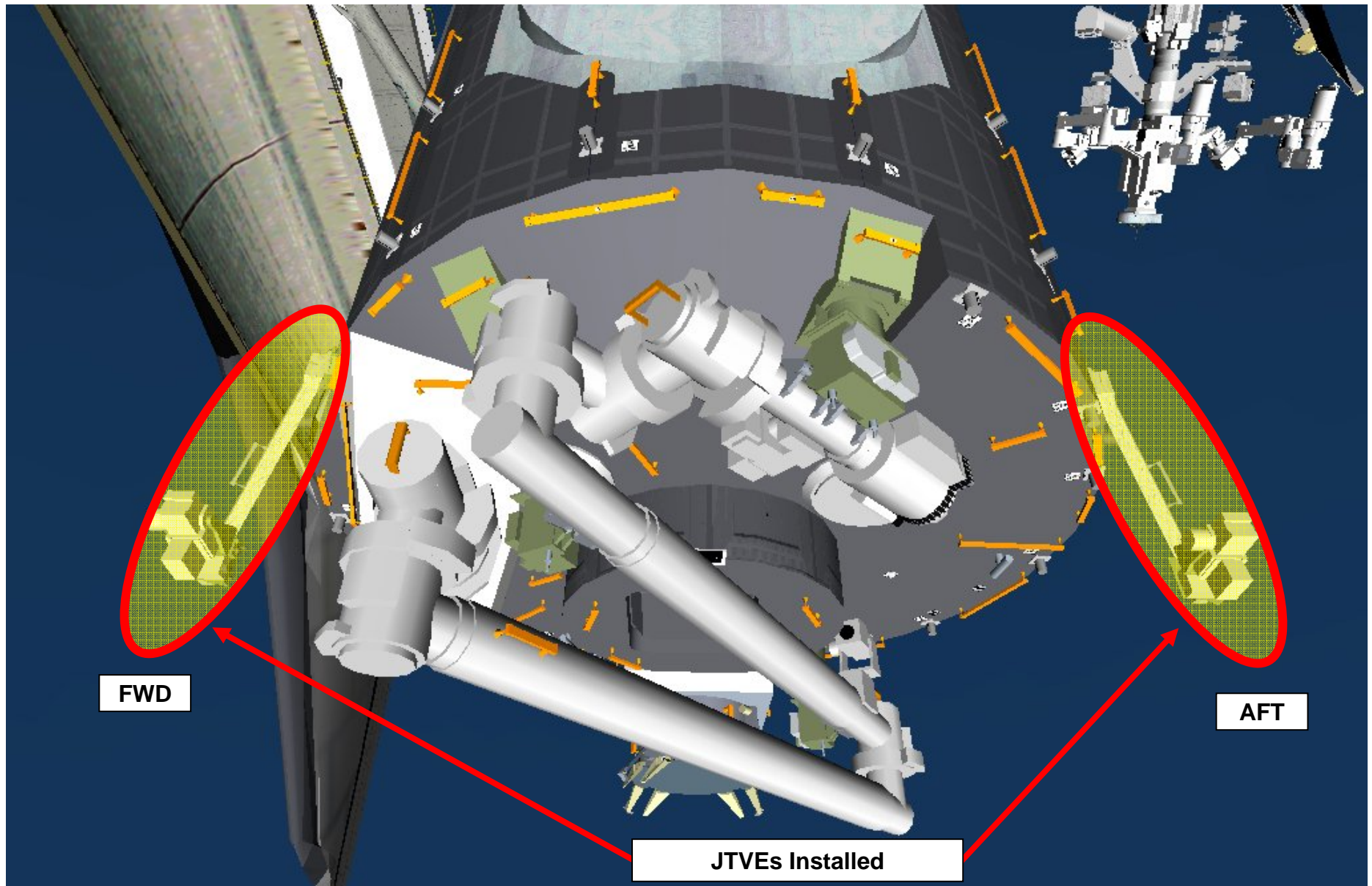


WINDOW SHUTTER

Window Shutters (2 Total)



JTVE BOOM

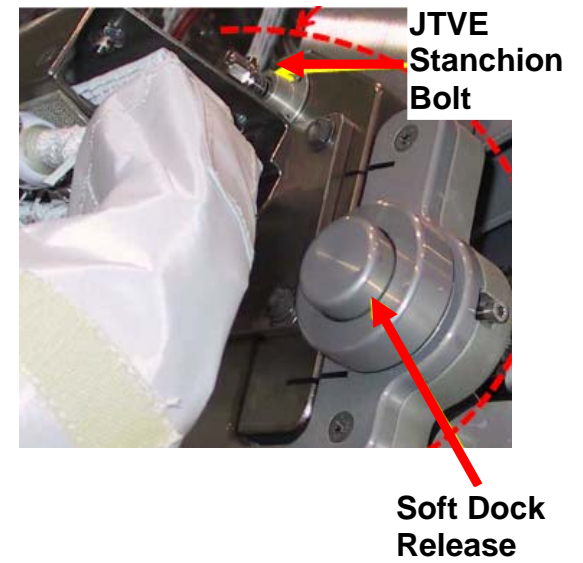
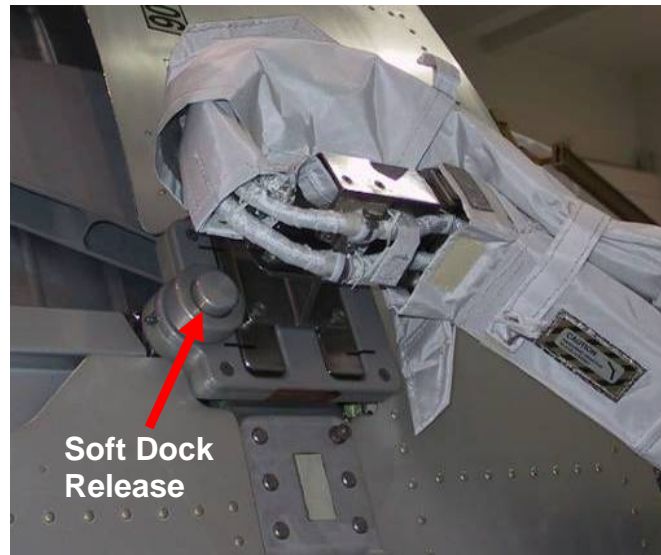
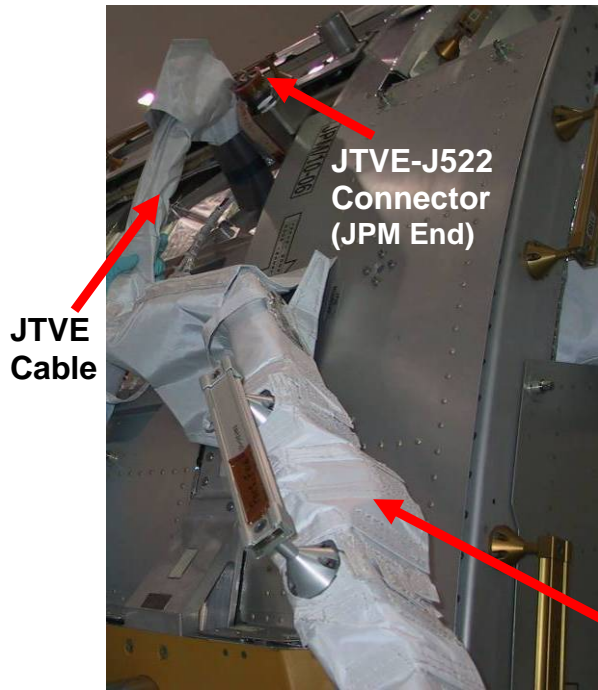


JTVE BOOM (Cont)

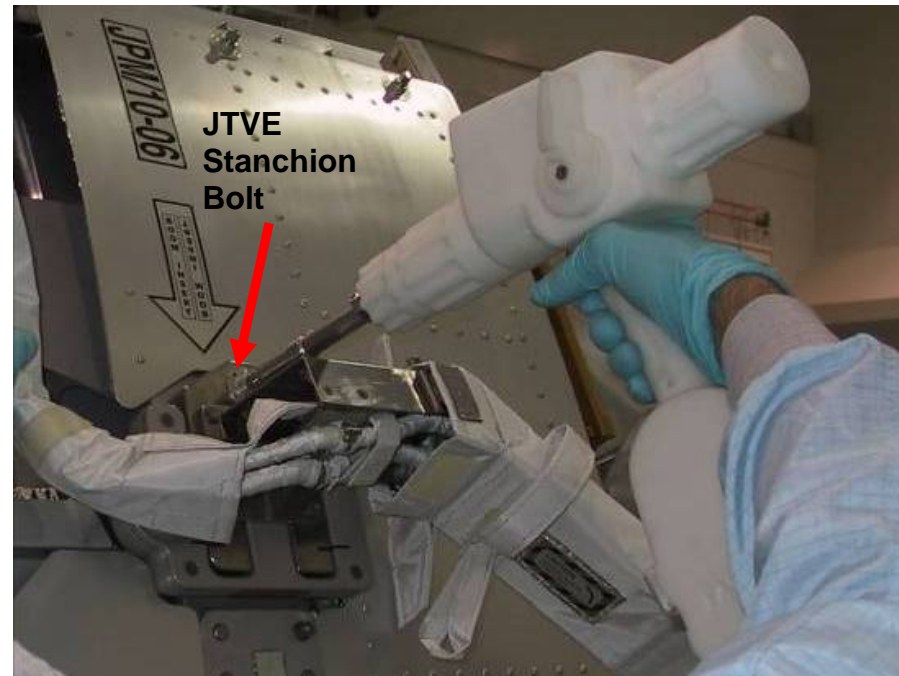


NOTE: Camera not installed

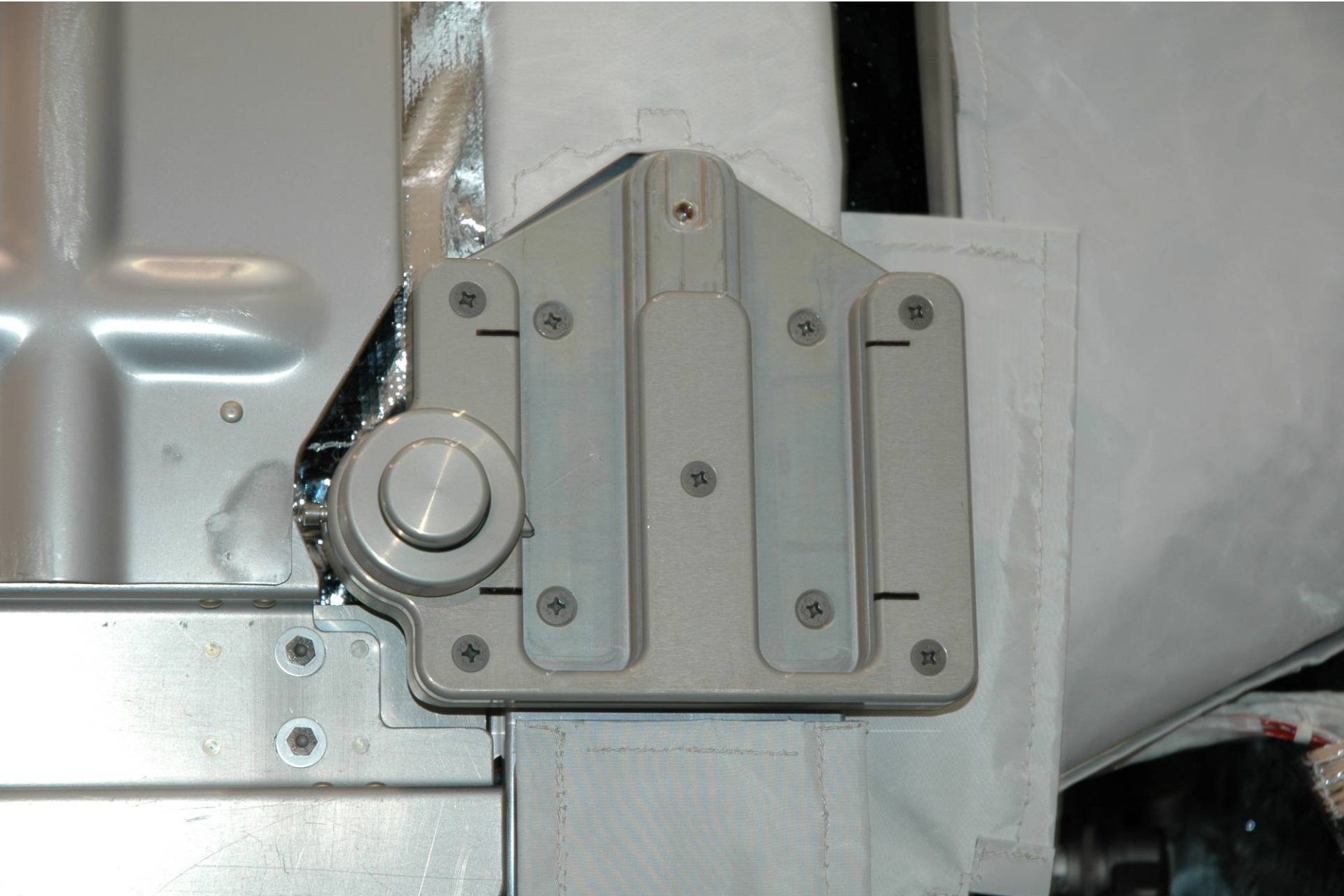
JTVE BOOM INSTALLED



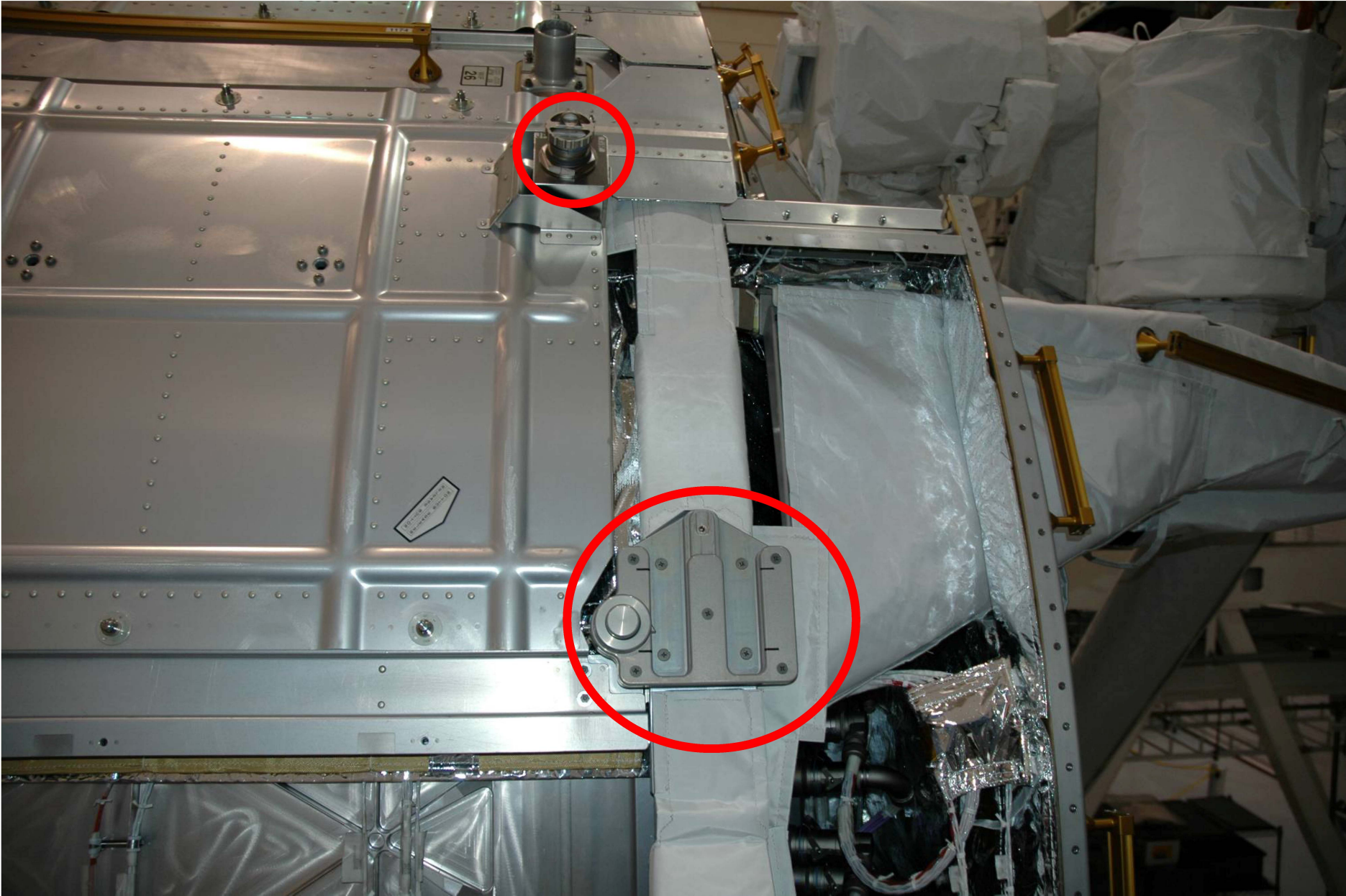
JTVE Stanchion Base



JTVE BOOM RECEPTACLE



JTVE BOOM RECEPTACLE AND CONNECTOR CAP

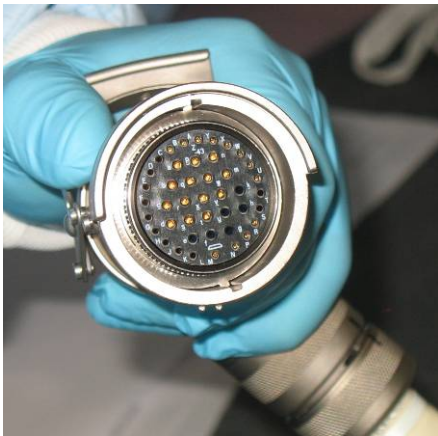


JTVE BOOM LABELING AND CONNECTOR

“FP”
(FP = Forward Port)



JTVE P522 Connector
(JTVE Cable End)



JTVE Labeling



“PA”
(PA = Port Aft)

JTVE CAMERAS AND LAUNCH LOCKS



Launch Lock Installed

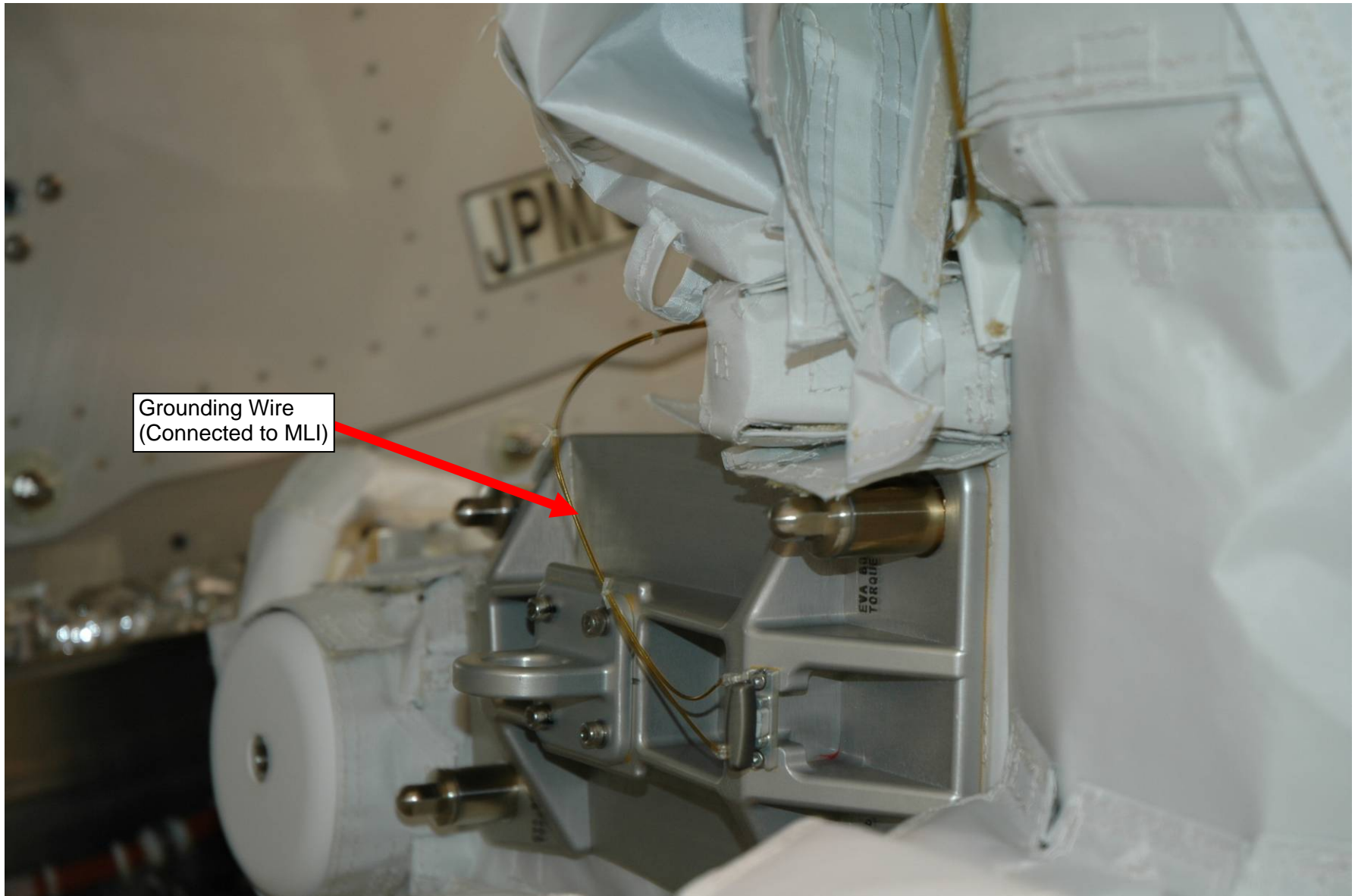


**Launch Lock Installed
(MLI Removed)**

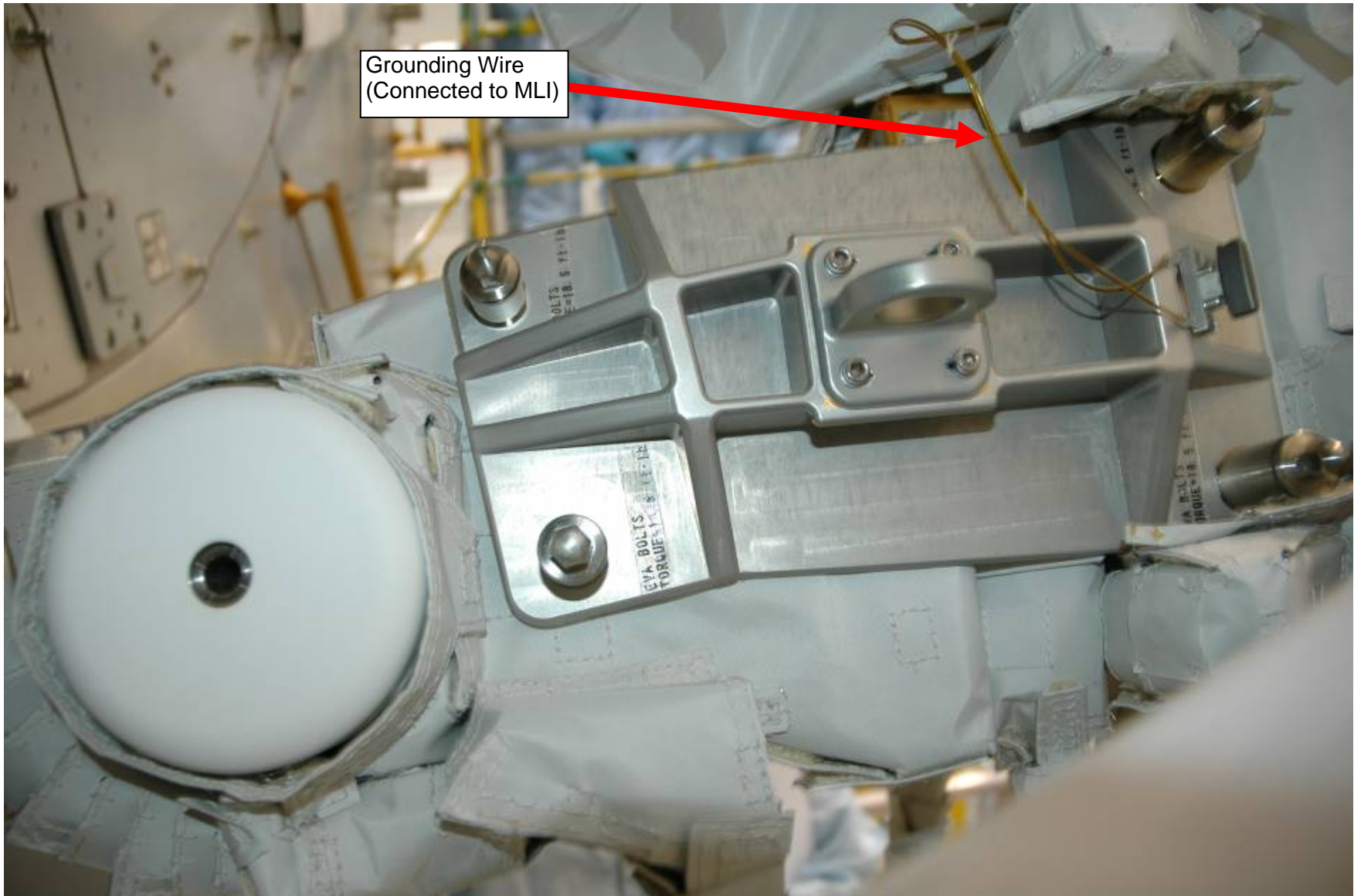


**Launch Lock Installed –
(Labeling Shown)**

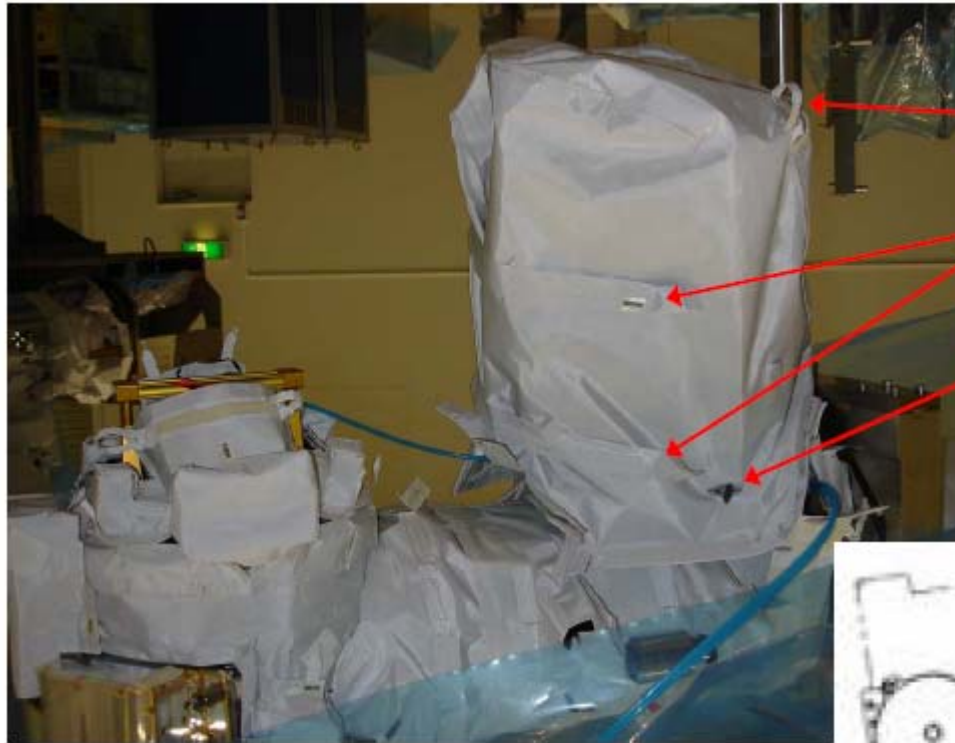
EVE LAUNCH LOCK



EVE LAUNCH LOCK (Cont)



EVE LAUNCH LOCK (Cont)

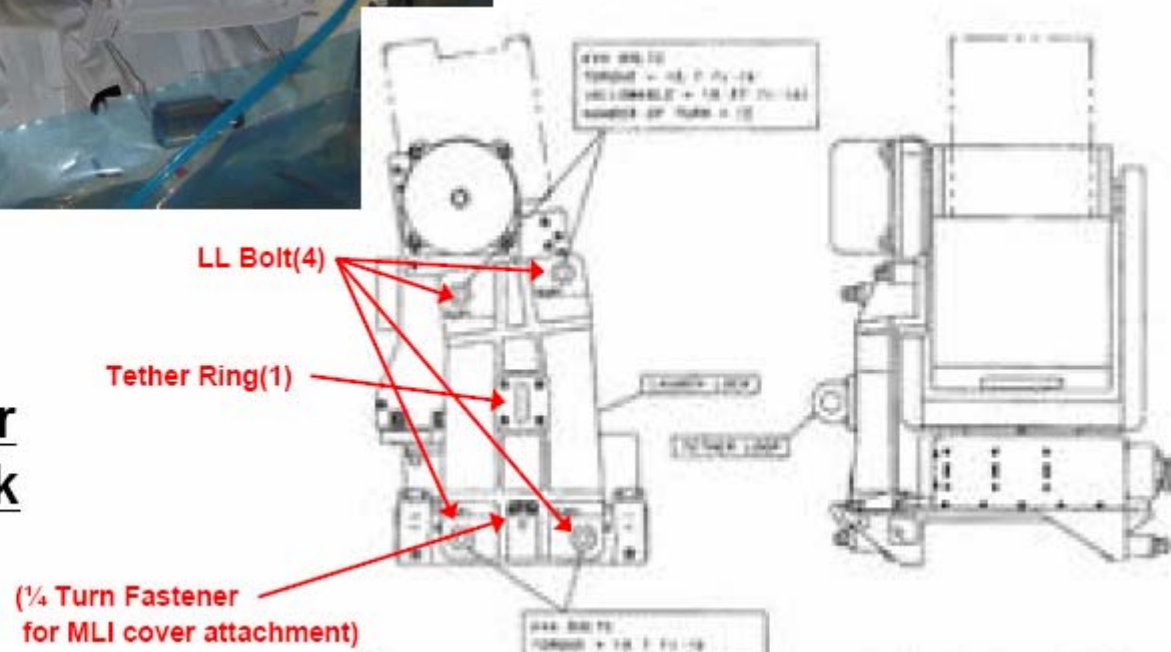


Tether Point(1)

Belt(2)

1/4 Turn Fastener(1)

EVE MLI Cover & Launch Lock



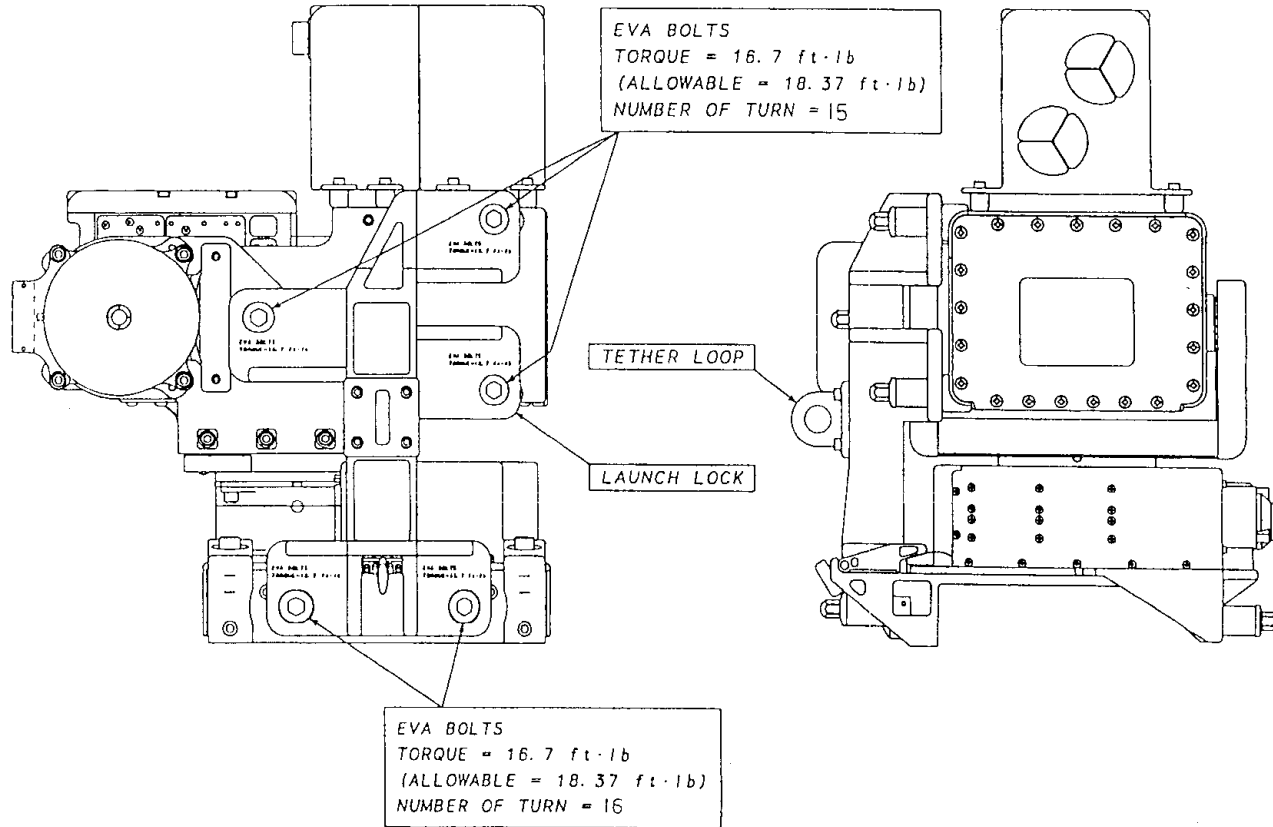
LL Bolt(4)

Tether Ring(1)

1/4 Turn Fastener
for MLI cover attachment)

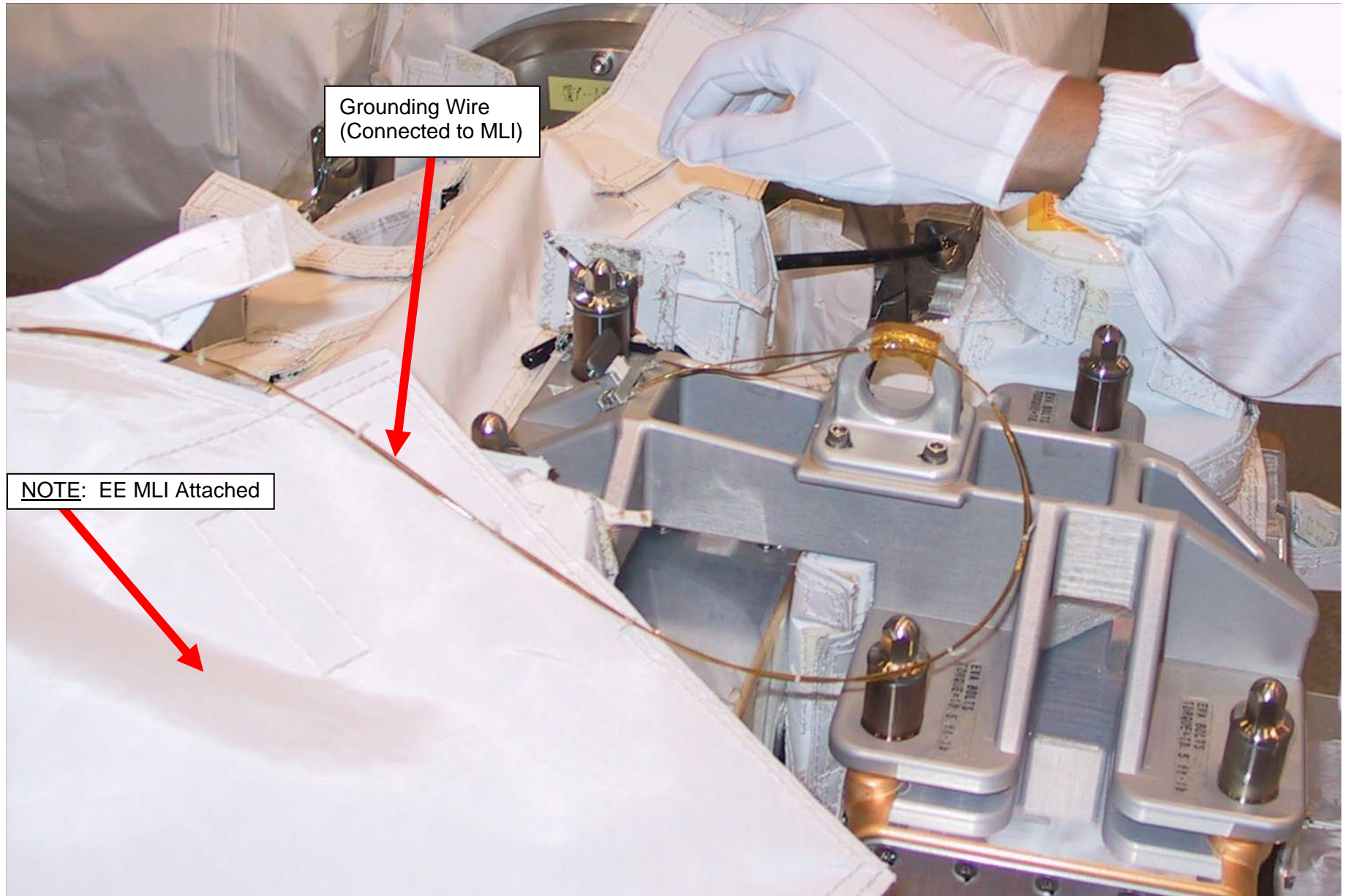
WVE LAUNCH LOCK

CONFIGURATION OF VE

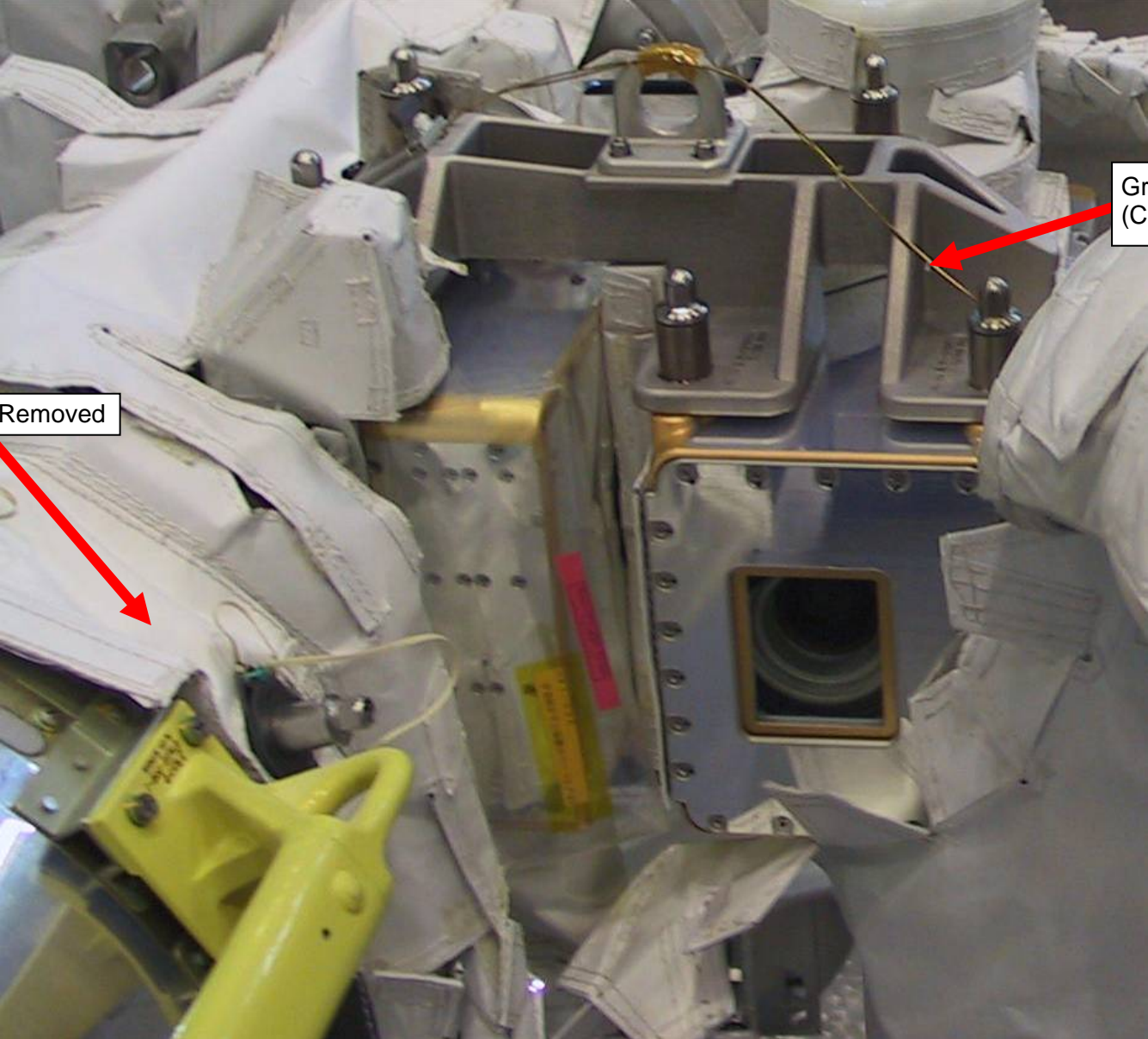


WRIST VISION EQUIPMENT

WVE LAUNCH LOCK (Cont)



WVE LAUNCH LOCK (Cont)



Grounding Wire
(Connected to MLI)

NOTE: EE MLI Removed

WVE LAUNCH LOCK (Cont)

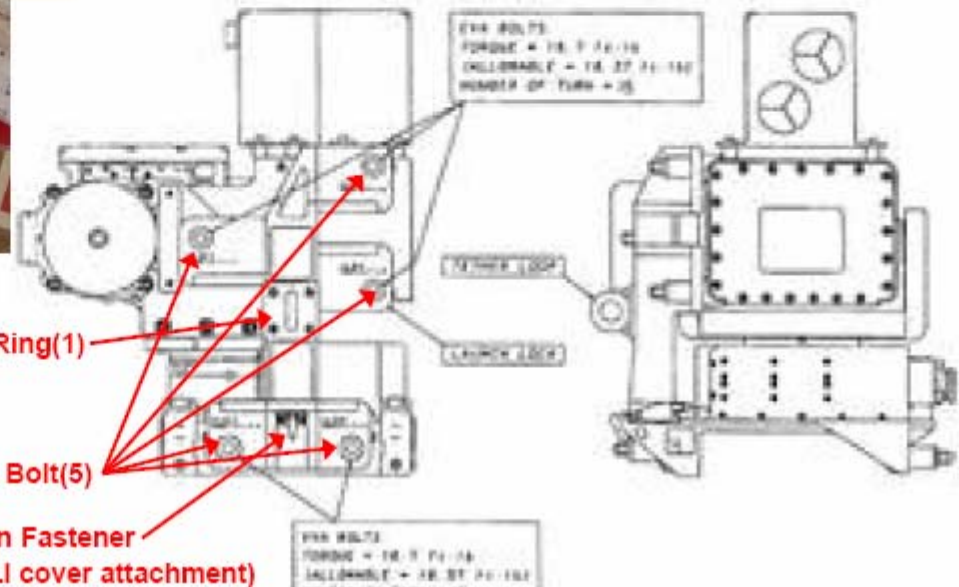


Tether Point(1)

Belt(1)

¼ Turn Fastener(1)

WVE MLI Cover & Launch Lock



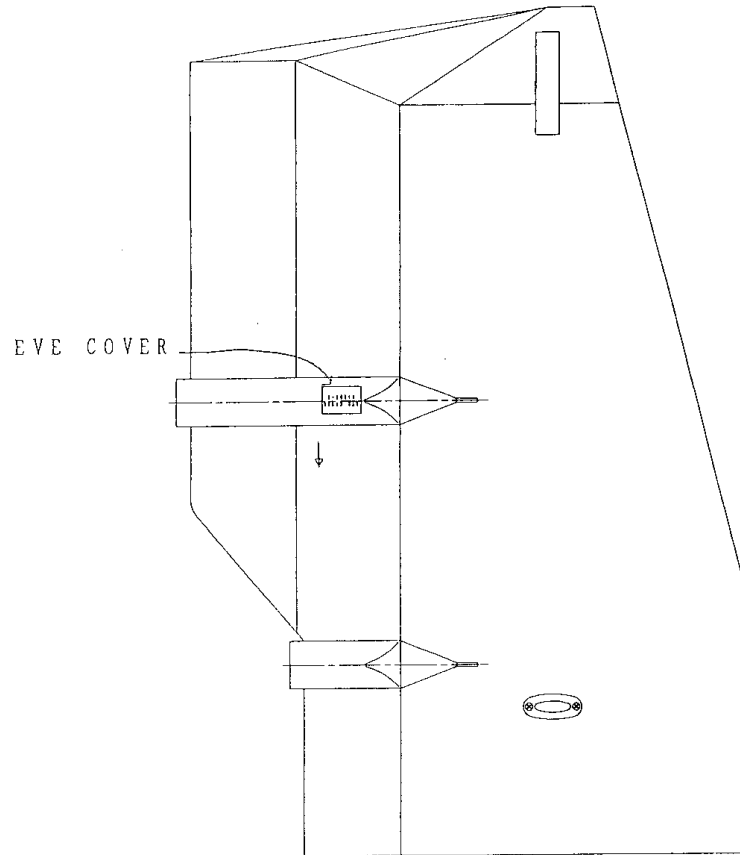
Tether Ring(1)

LL Bolt(5)

¼ Turn Fastener
for MLI cover attachment)

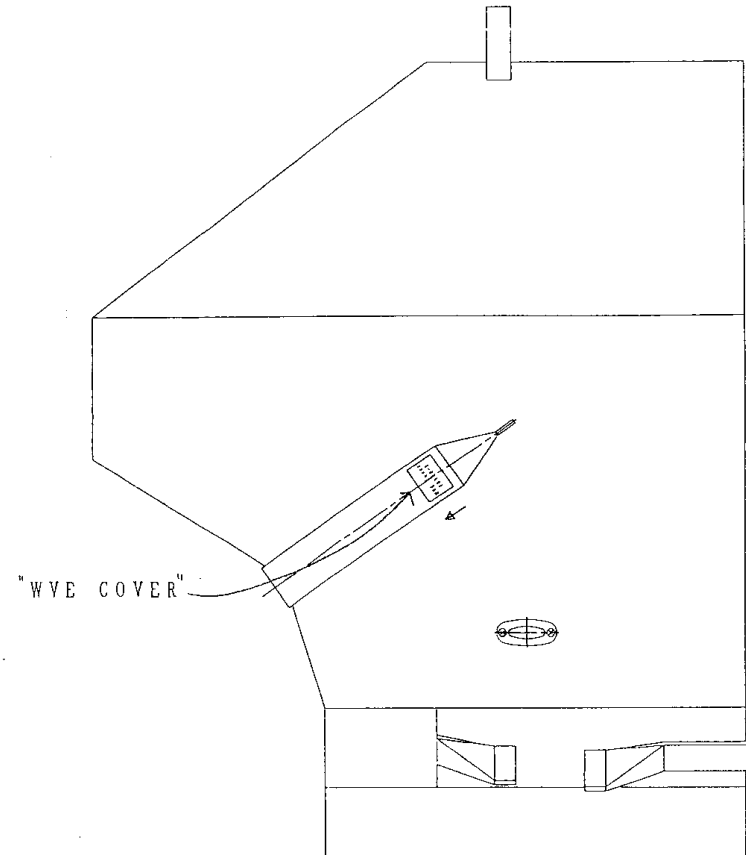
WVE AND EVE MLI

21



Elbow Vision Equipment Thermal Cover

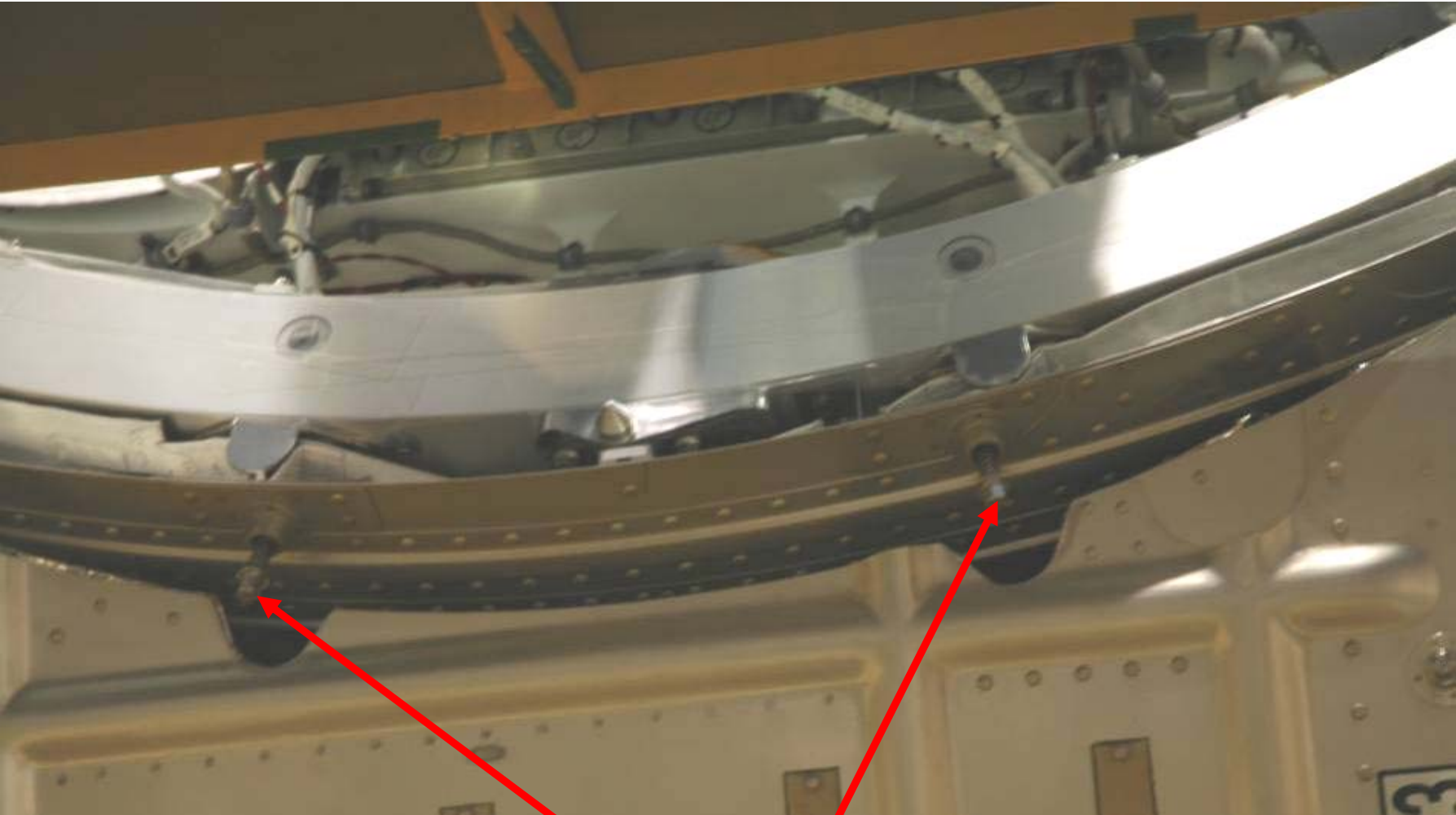
図3 (8/19) ラベル位置



Wrist Vision Equipment Thermal Cover

図3 (9/19) ラベル位置

ACBM MMOD SHIELD LAUNCH LOCK BOLTS



**MMOD Shield LL Bolts
(2 of 4 shown)**

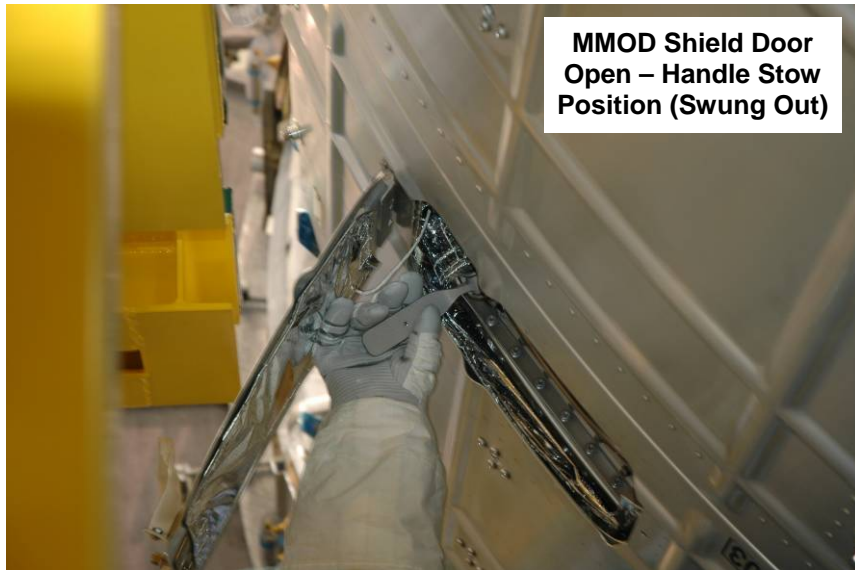
ACBM MMOD SHIELD DEPLOY DOOR/HANDLE



MMOD Shield Door Closed



MMOD Shield Door Open - Handle Stow Position



MMOD Shield Door Open - Handle Stow Position (Swung Out)

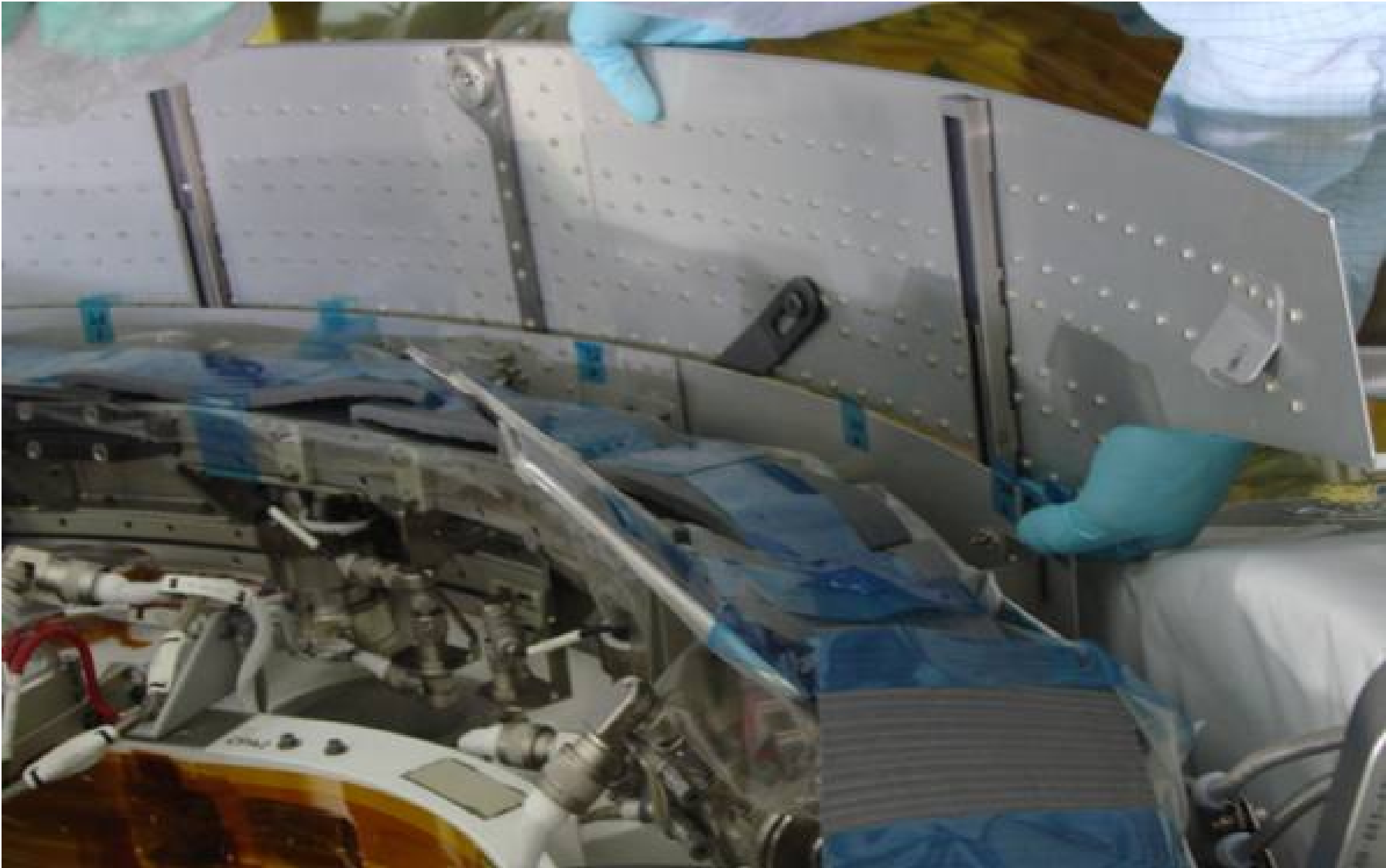


MMOD Shield Door Open - Handle Deploy Position (Swung Out)

ACBM MMOD SHIELD DEPLOY DOOR/HANDLE (Cont)



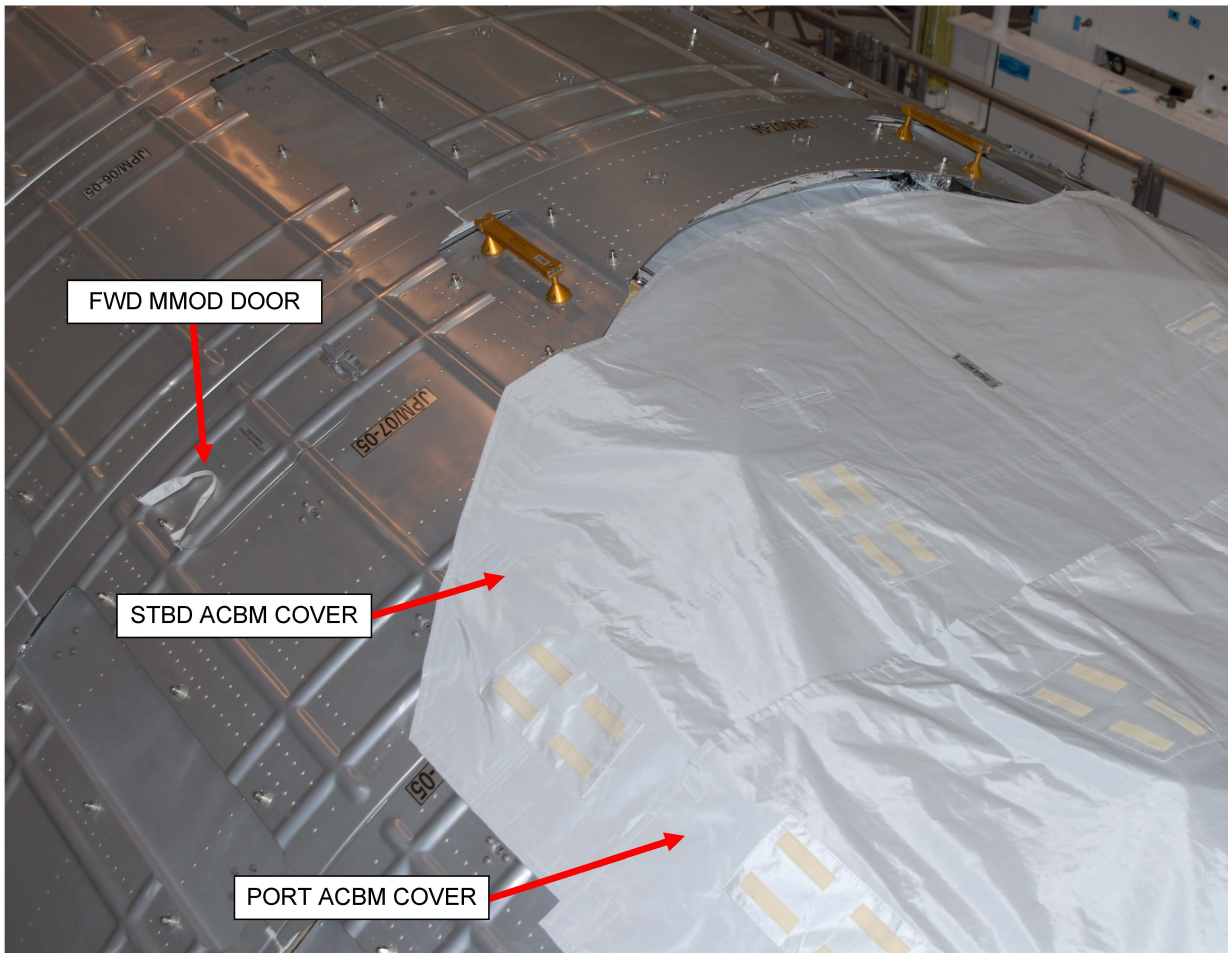
ACBM MMOD SHIELD DEPLOYED



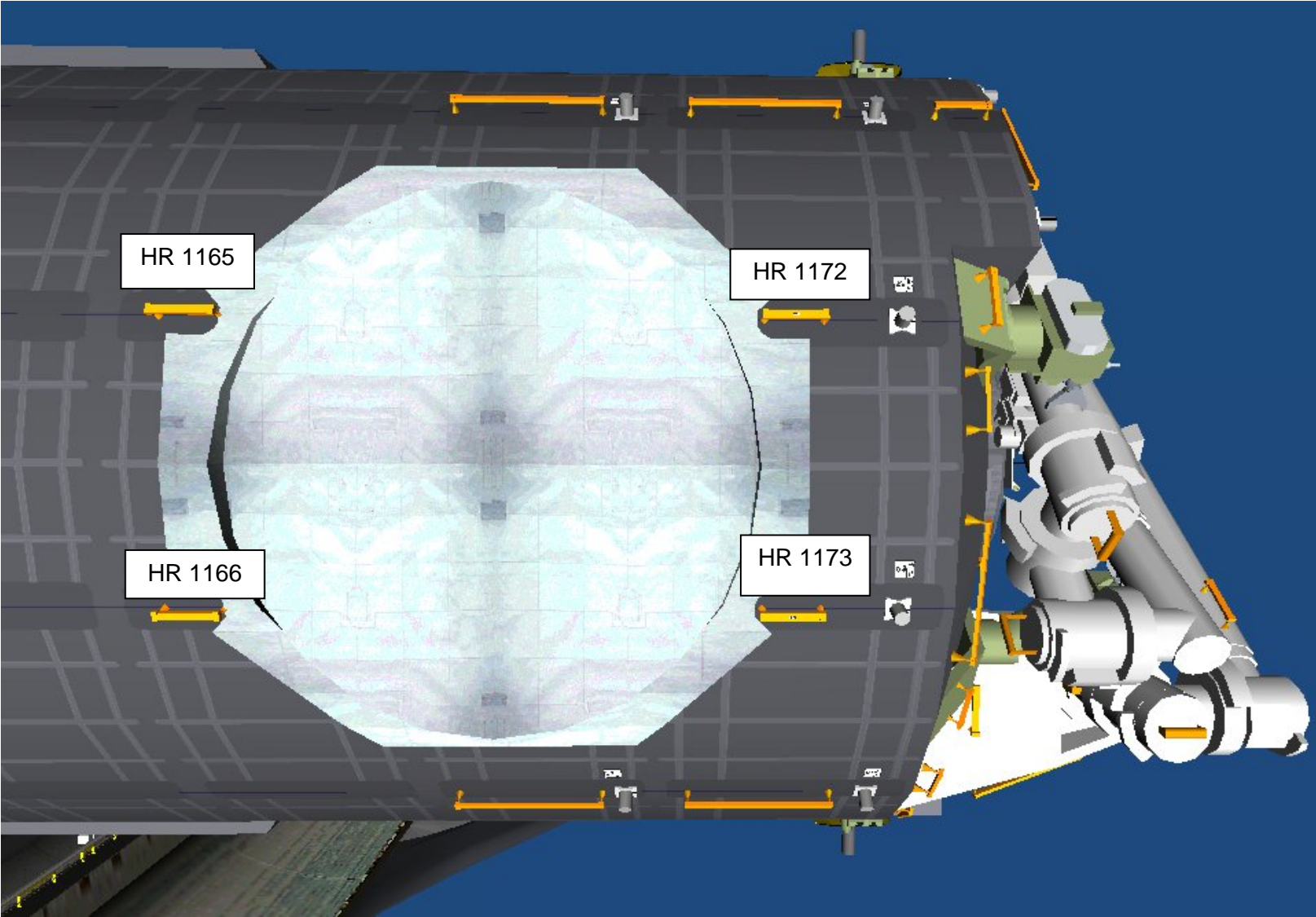
PCBM MLI REMOVAL



PCBM MLI REMOVAL (Cont)



PCBM MLI REMOVAL (Cont)

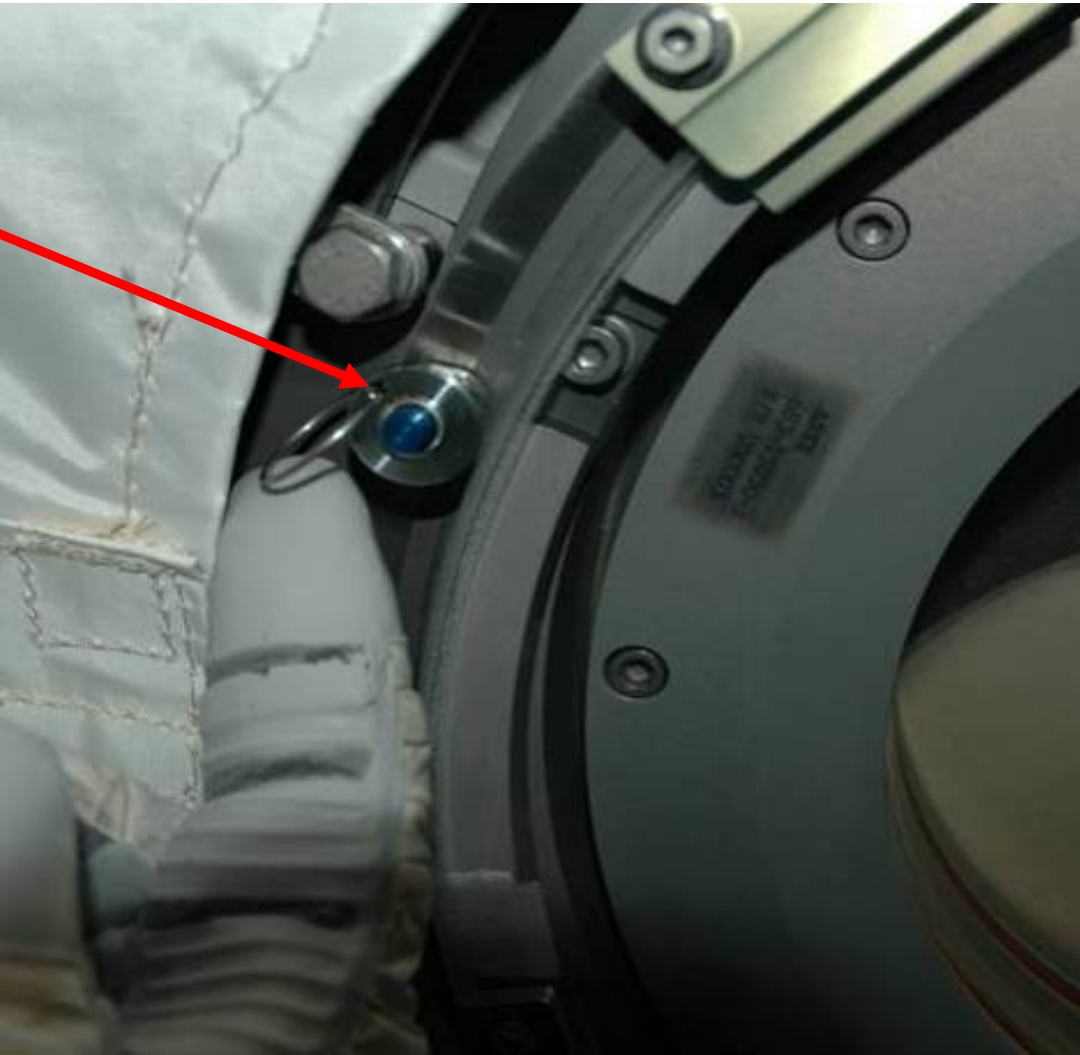


PCBM PIP PIN

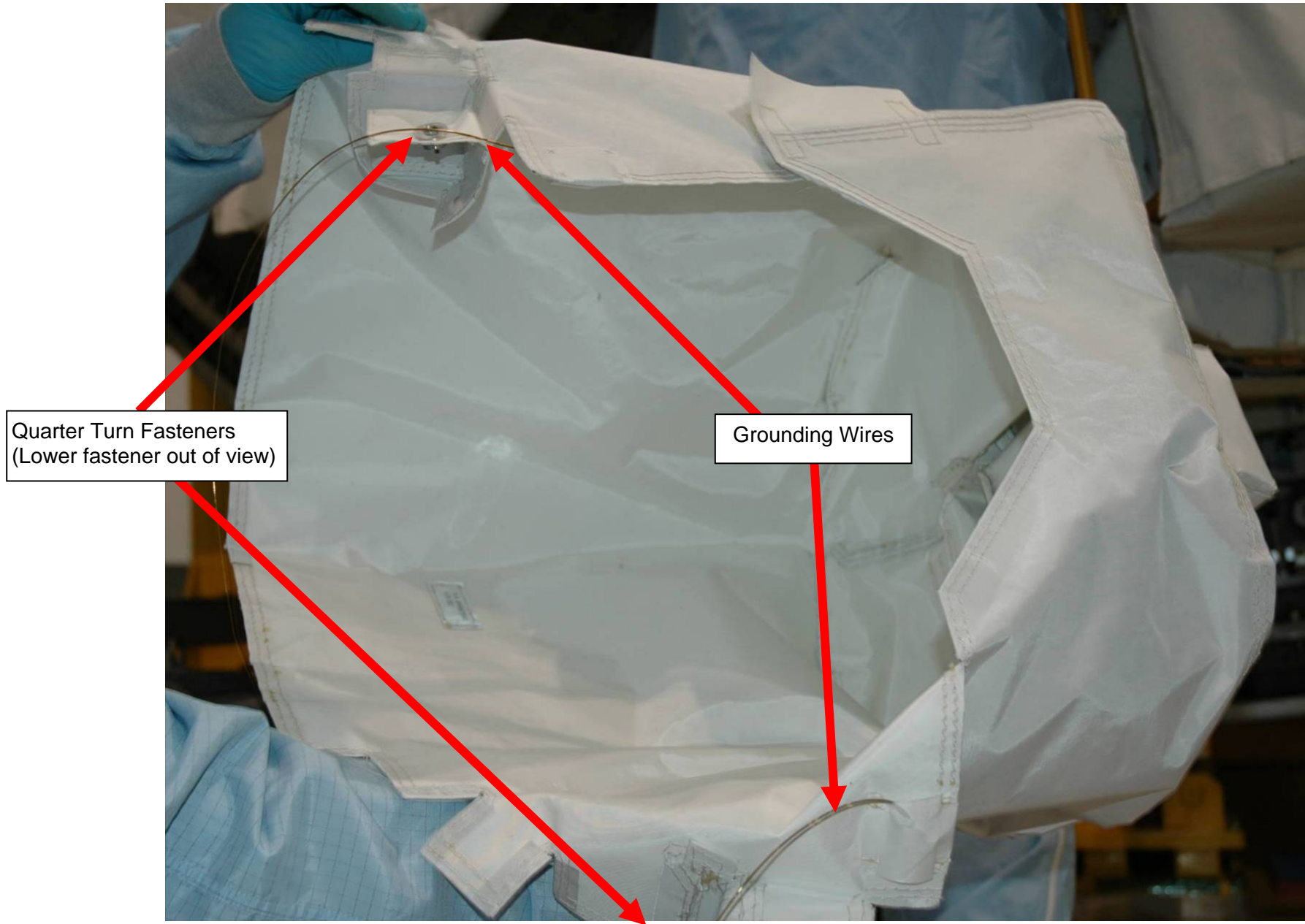


PCBM PIP PIN (Cont)

JEM ACBM Hatch PIP Pin



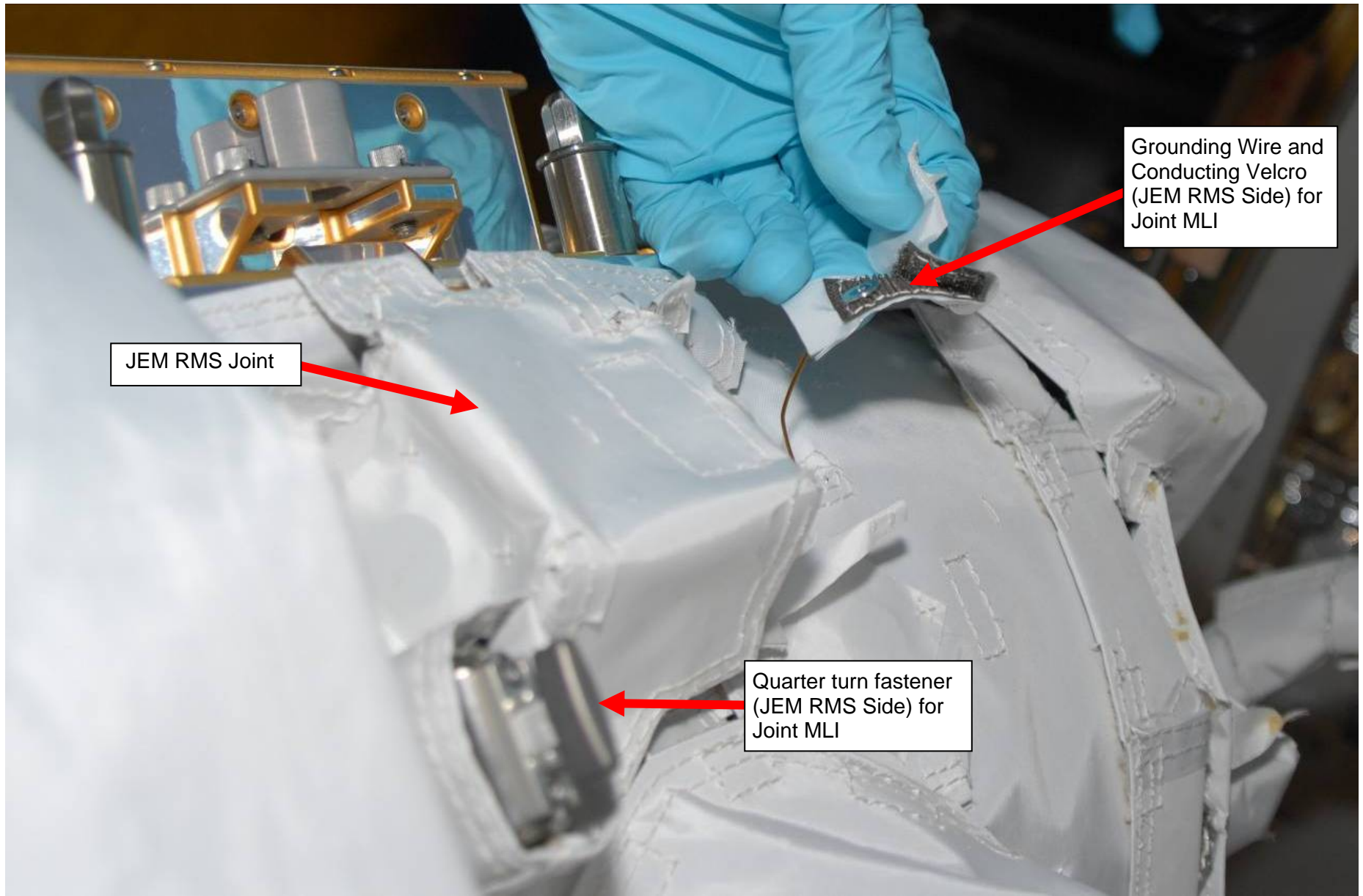
RMS JEU COVERS



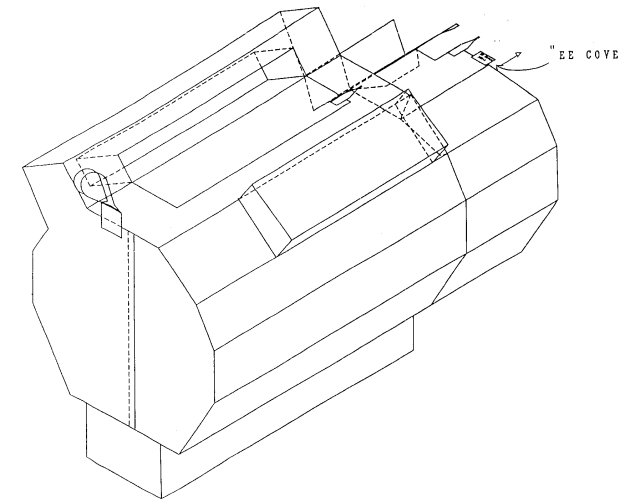
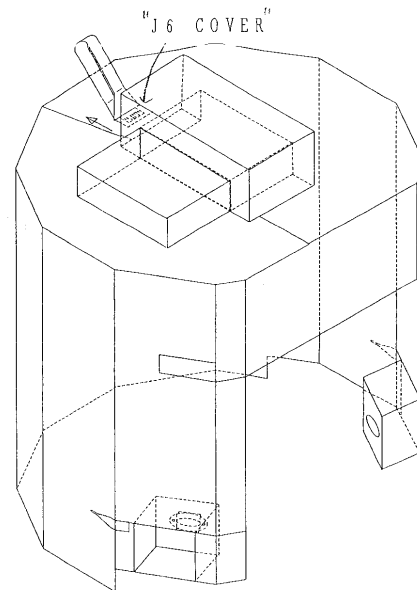
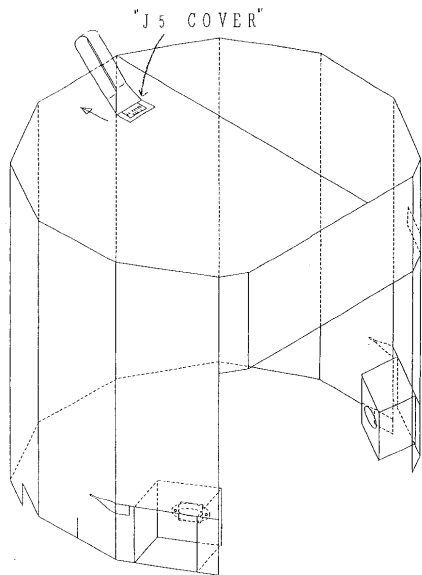
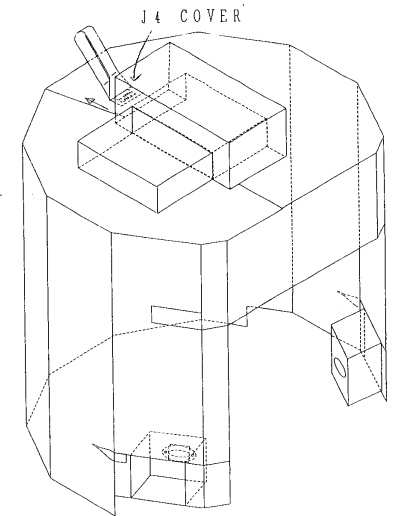
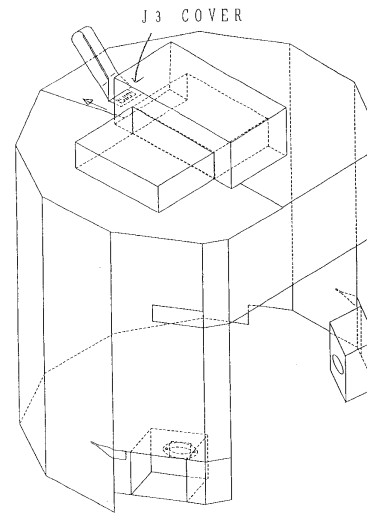
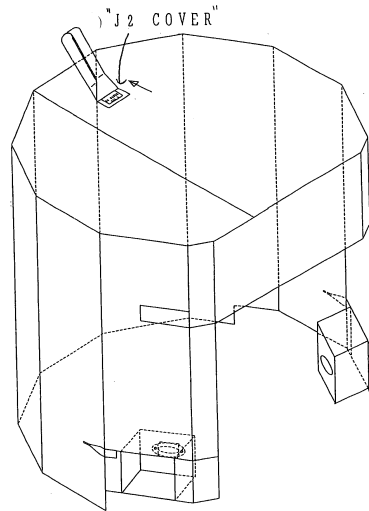
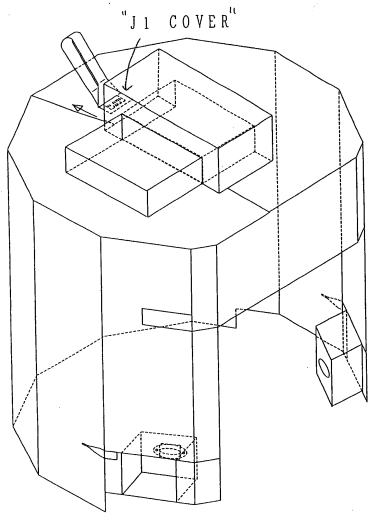
Quarter Turn Fasteners
(Lower fastener out of view)

Grounding Wires

RMS JEU COVERS (Cont)



RMS JEU COVERS (Cont)

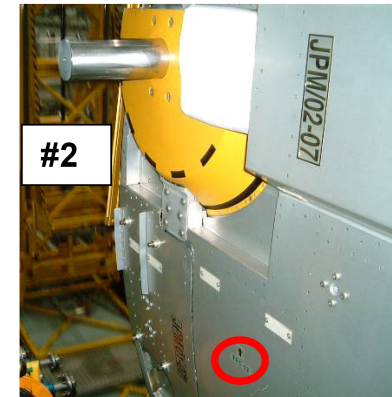
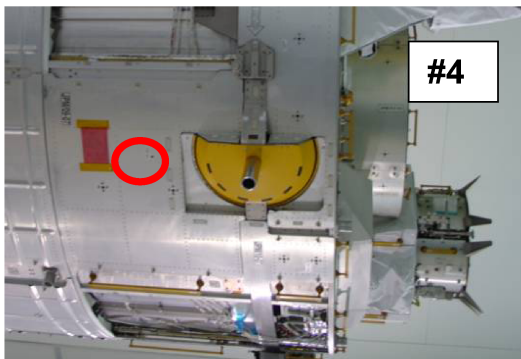
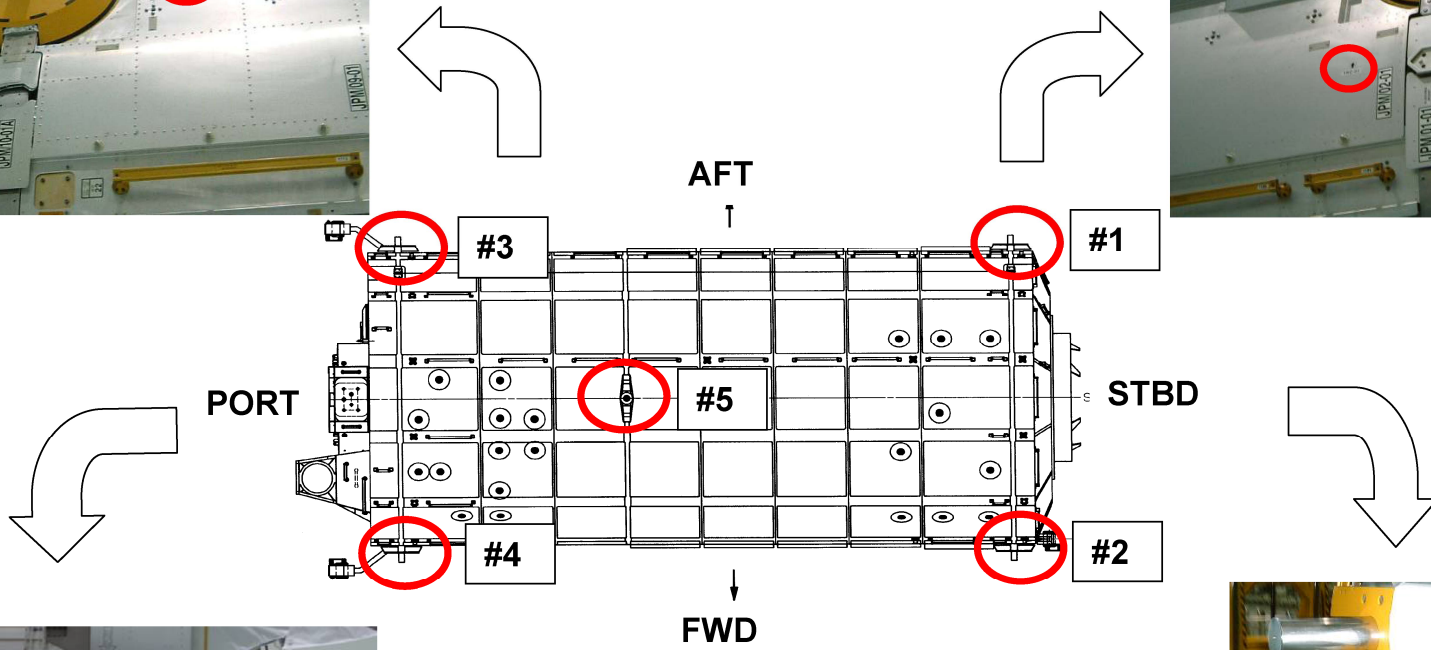
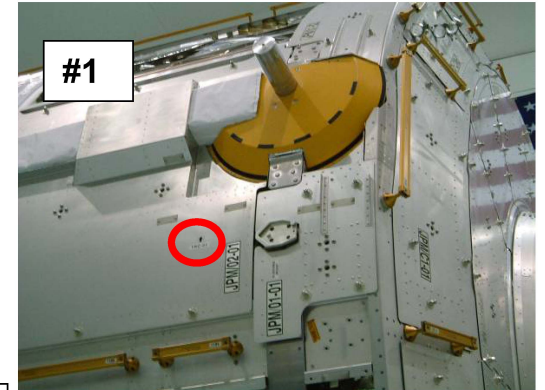
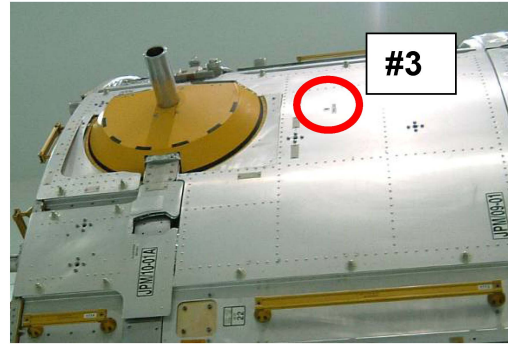


Thermal Cover of End Effector

RMS JEU COVERS (Cont)



TRUNNION/KEEL COVERS

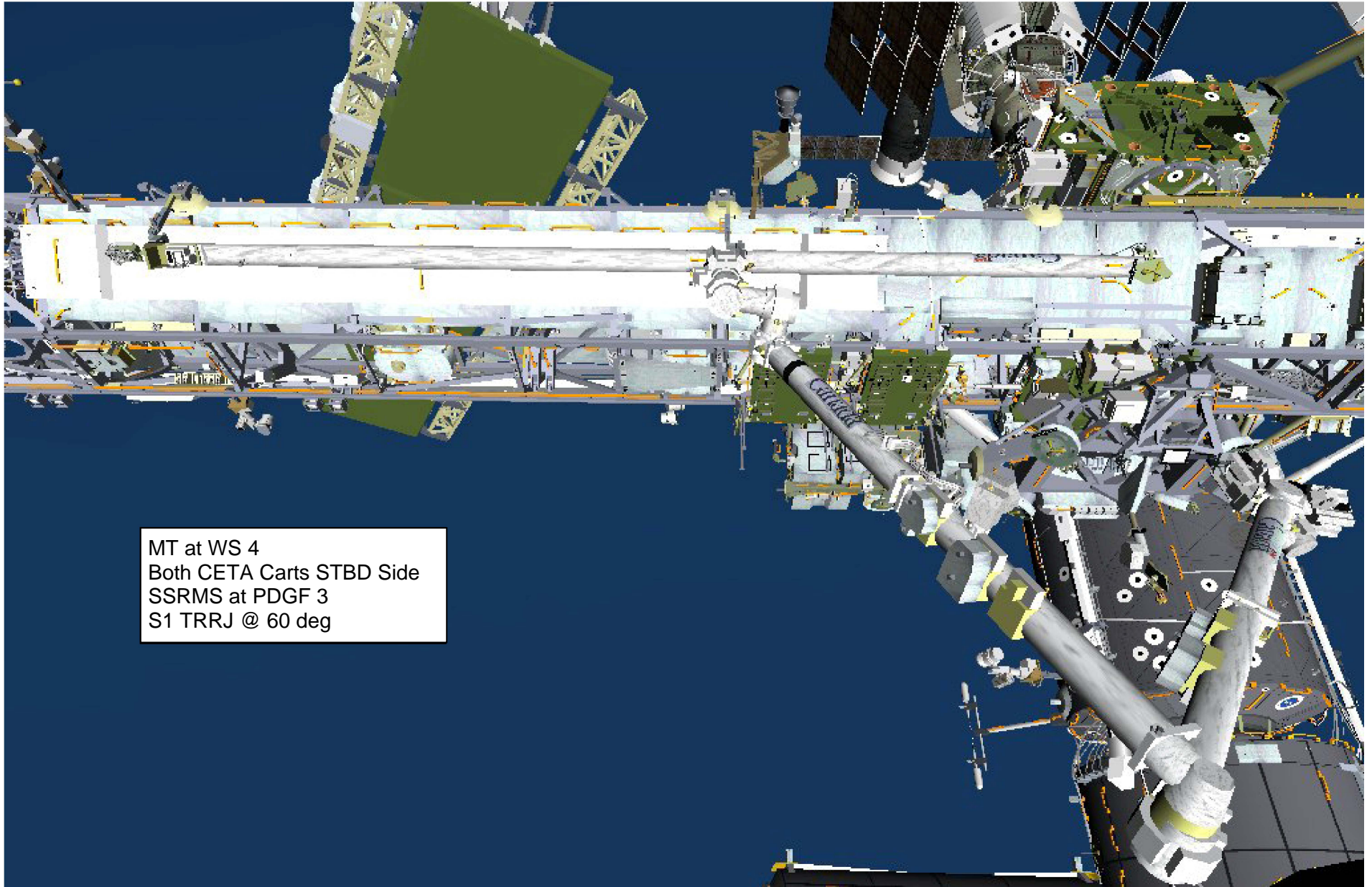


FS 18-51

EVA/124/FIN

OBSS

OVERVIEW ON TRUSS



KEEP-ALIVE UMBILICAL WORKSITE

OBSS Worksite Overview

**P411
Connector
Cover**

KAD

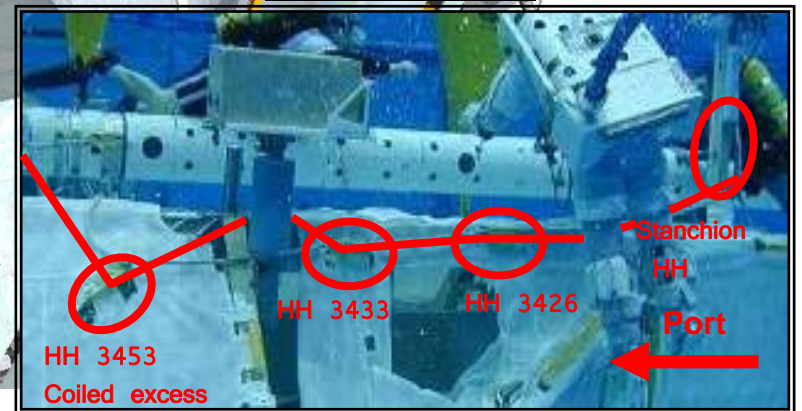
KAU Cable (W21)

PORT

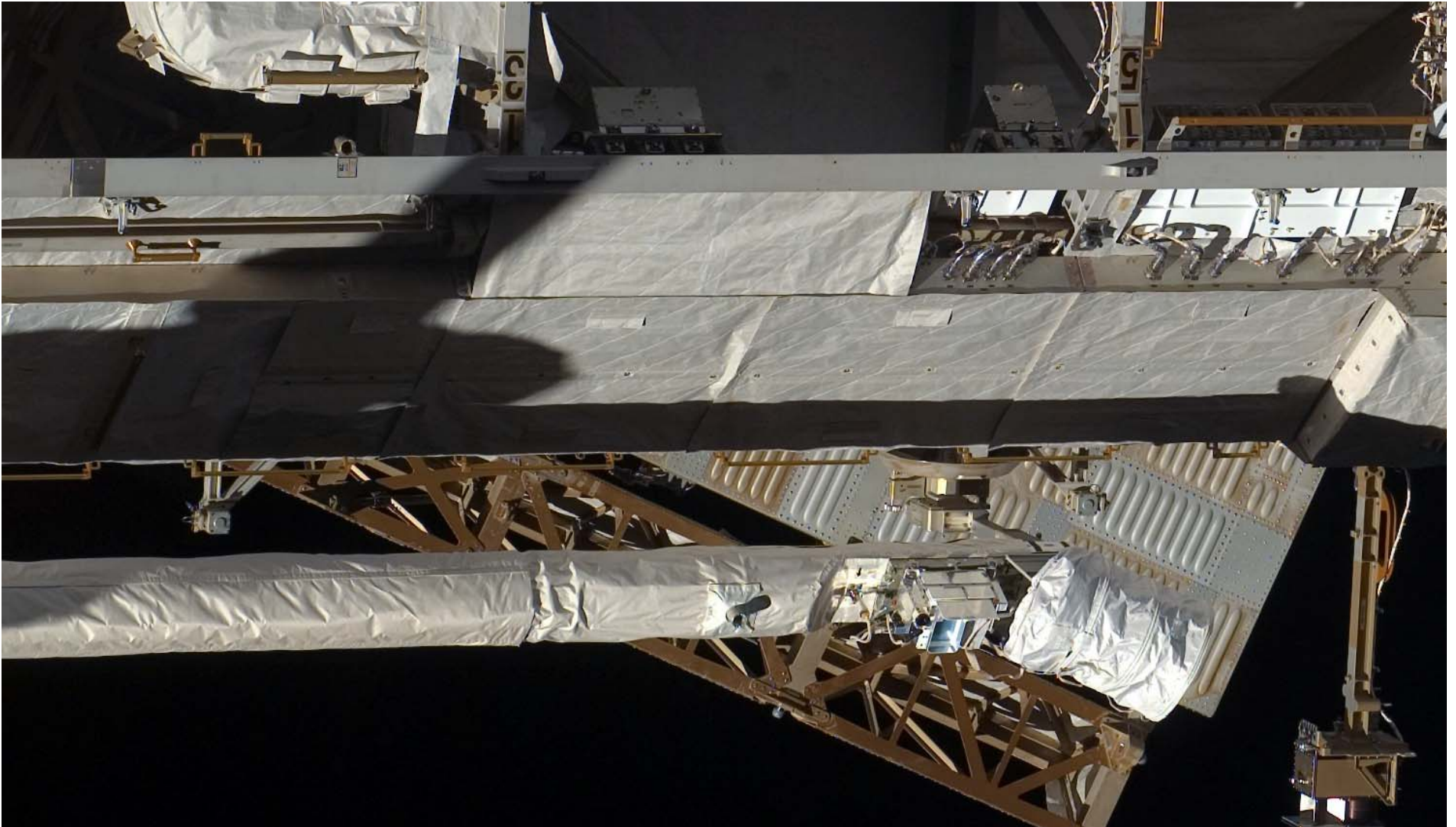
OBSS

Avionics Box

KAU Cable Routing



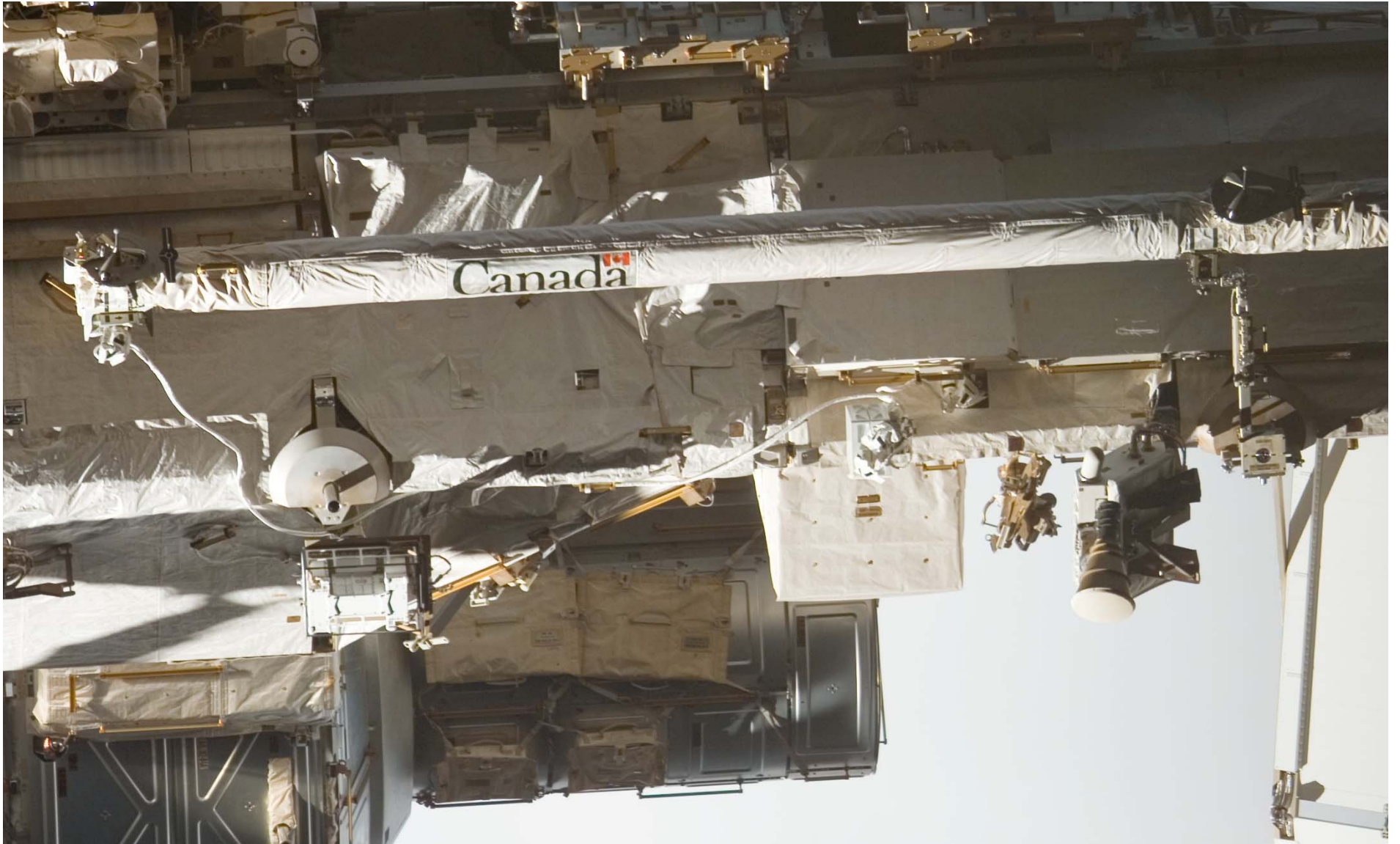
OBSS ON TRUSS – FLY AROUND PHOTOS



FS 18-54

EVA/124/FIN

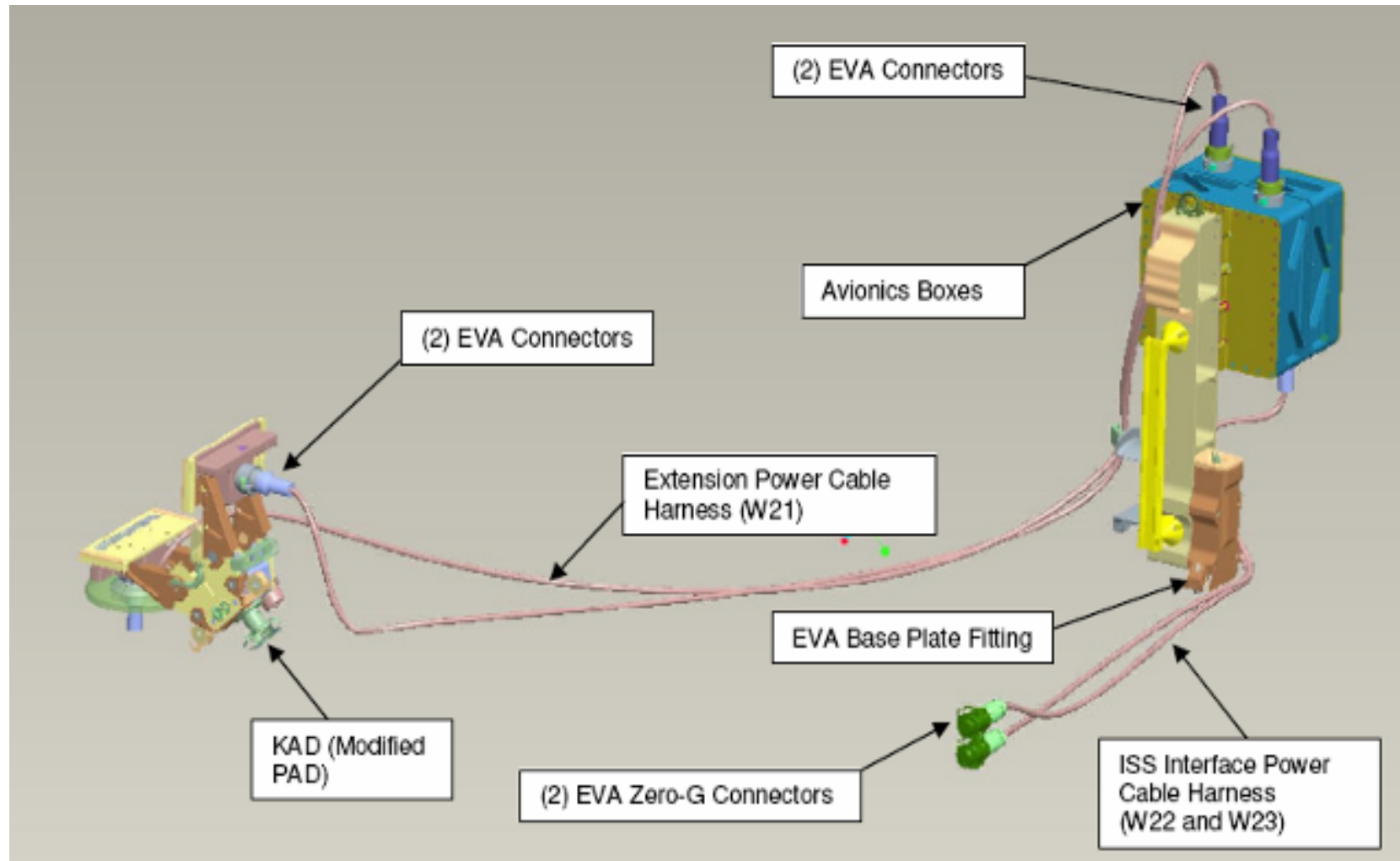
OBSS ON TRUSS – FLY AROUND PHOTOS (Cont)



FS 18-55

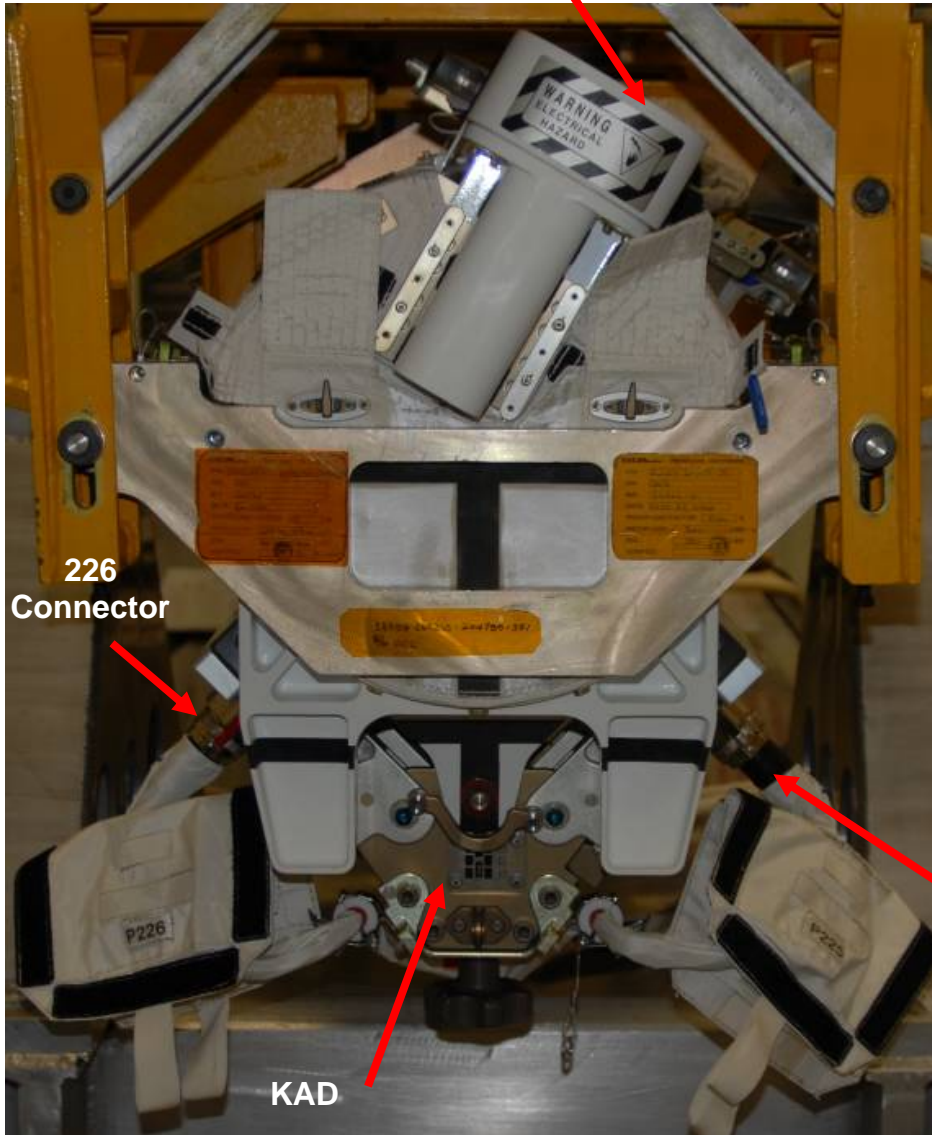
EVA/124/FIN

KEEP-ALIVE UMBILICAL COMPONENTS

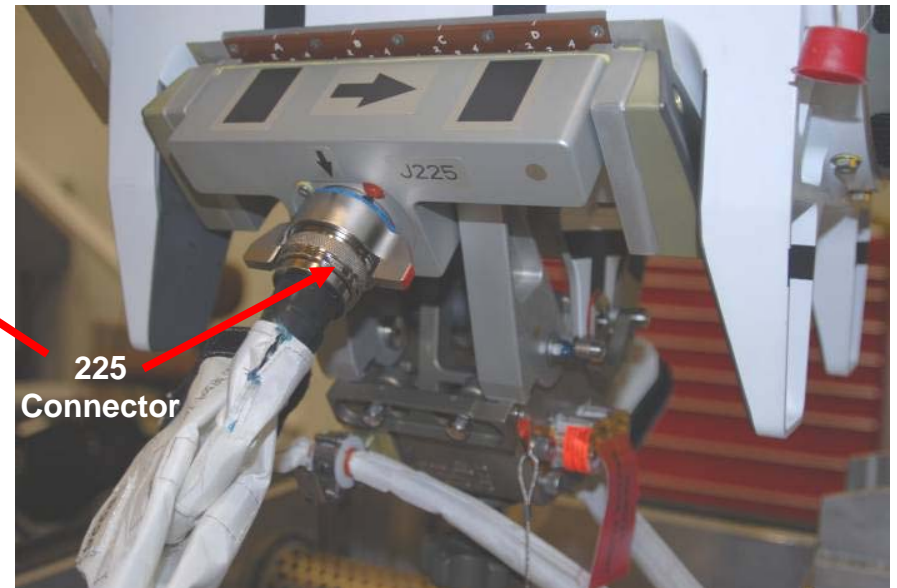
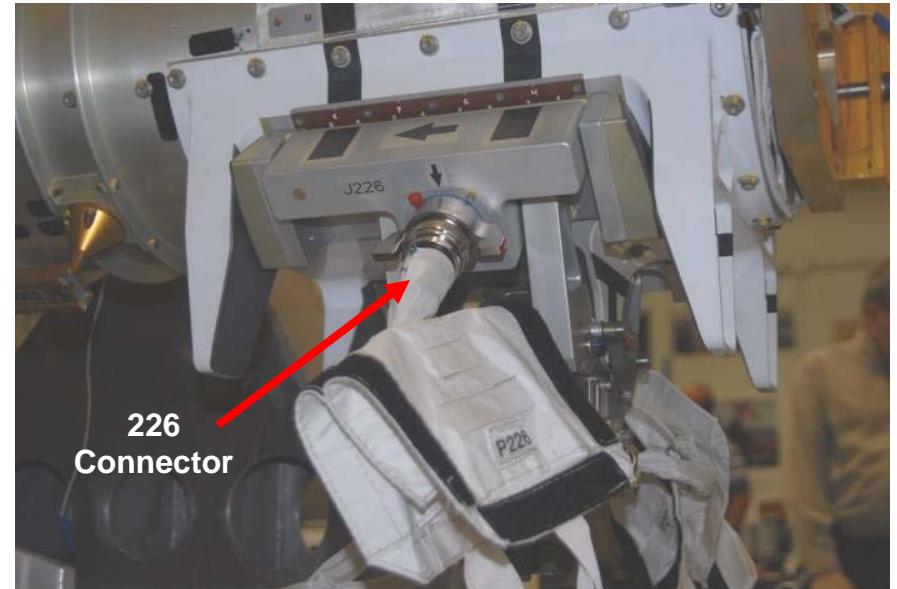


KEEP-ALIVE DEVICE – ATTACHED

P411 Connector Attaches Here
(Not Shown in Photo)

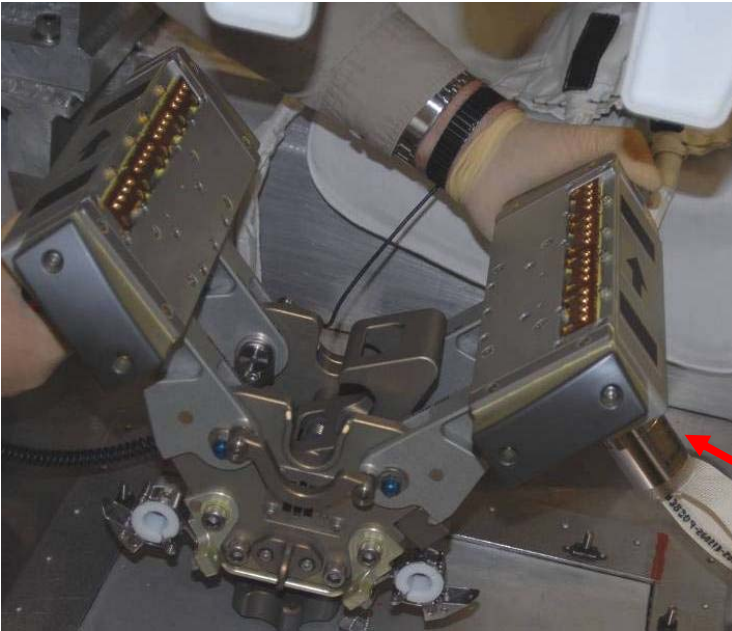


Looking at End of Boom (P411 Connector Cover End)

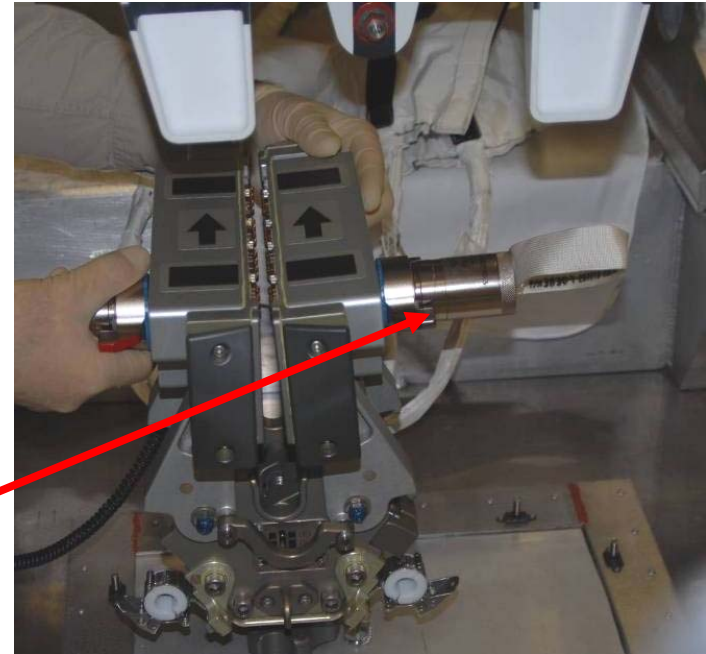


KEEP-ALIVE DEVICE – DETACHED

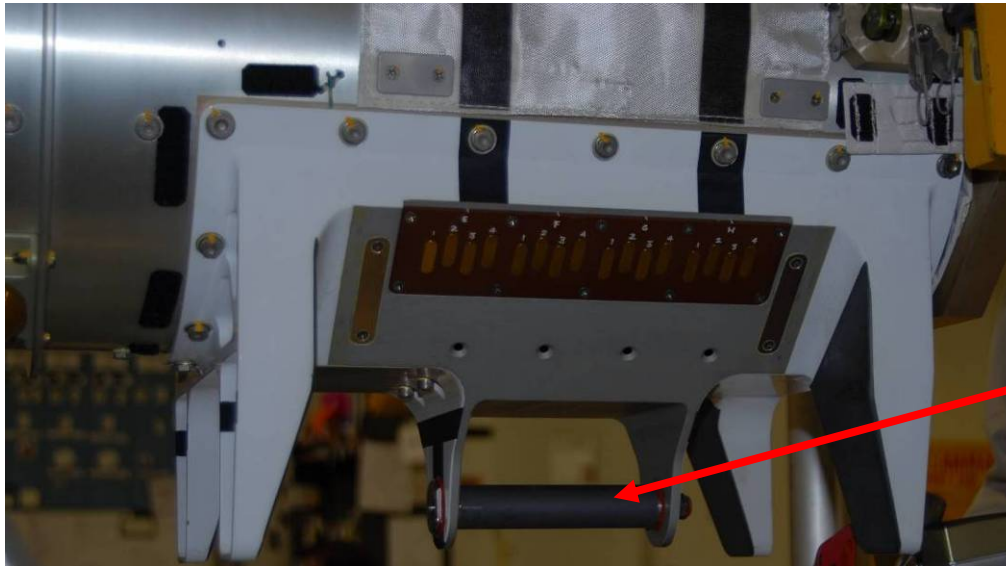
KAD Open



KAD Closed

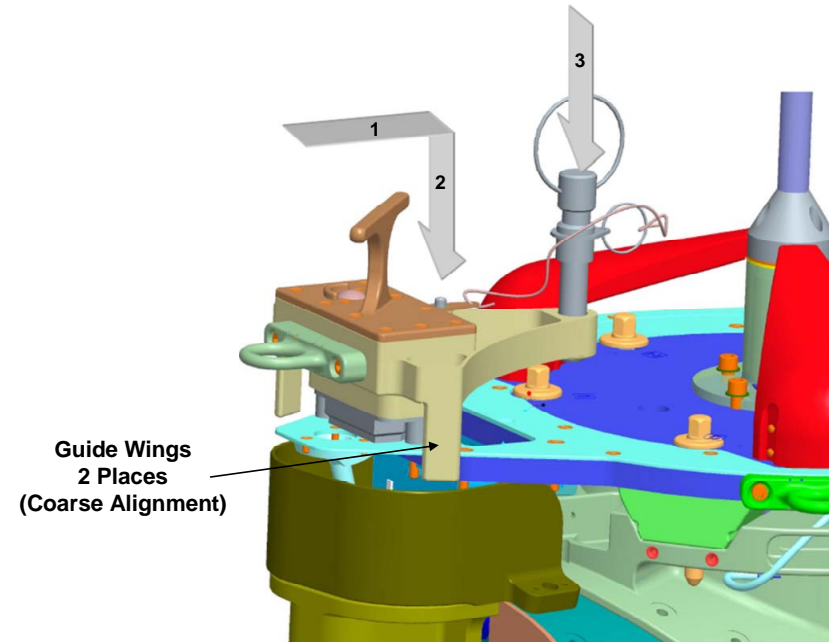
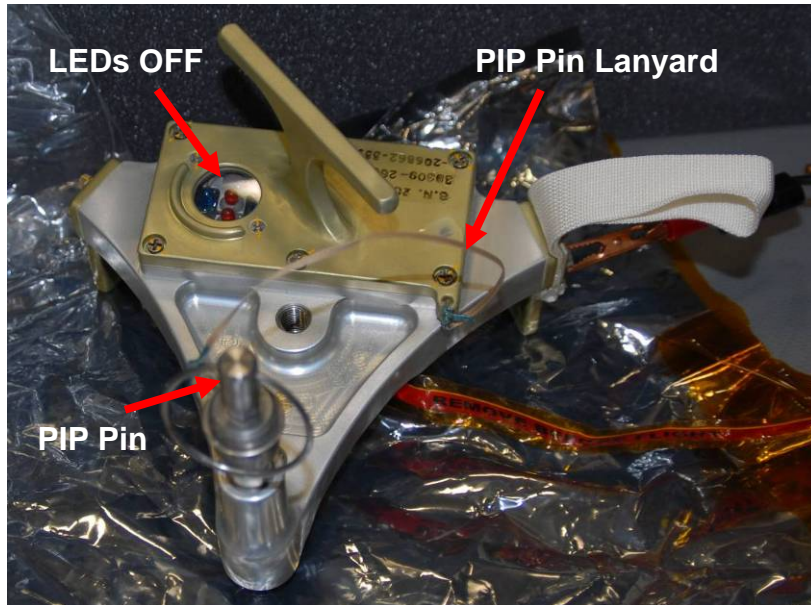


**NOTE: Connector
Cap Installed**

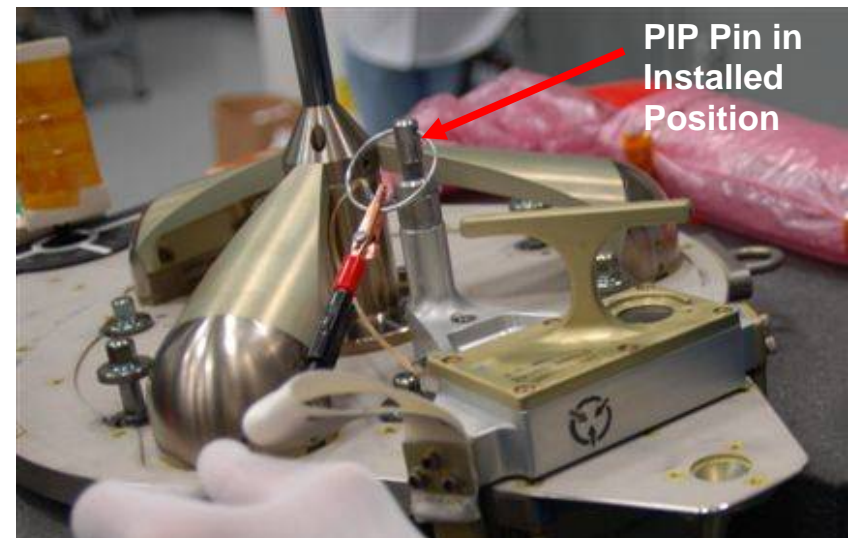
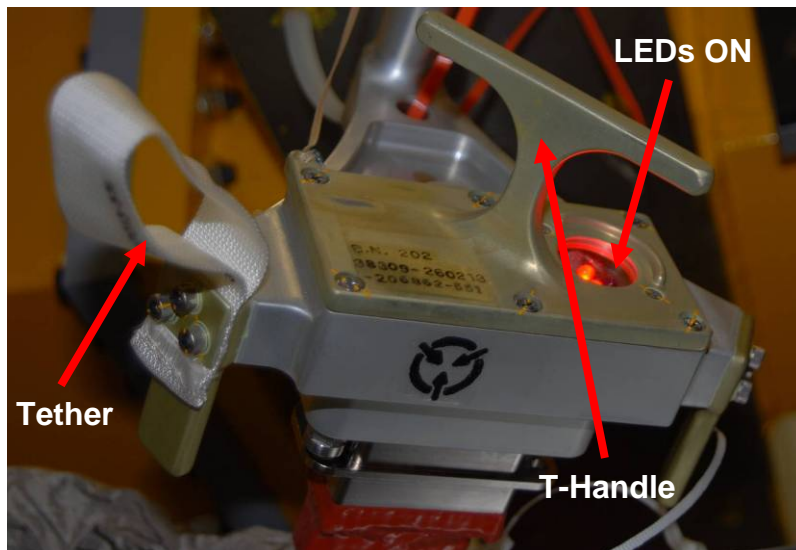


**OBSS Striker Bar
(KAD Removed)**

P411 CONNECTOR COVER

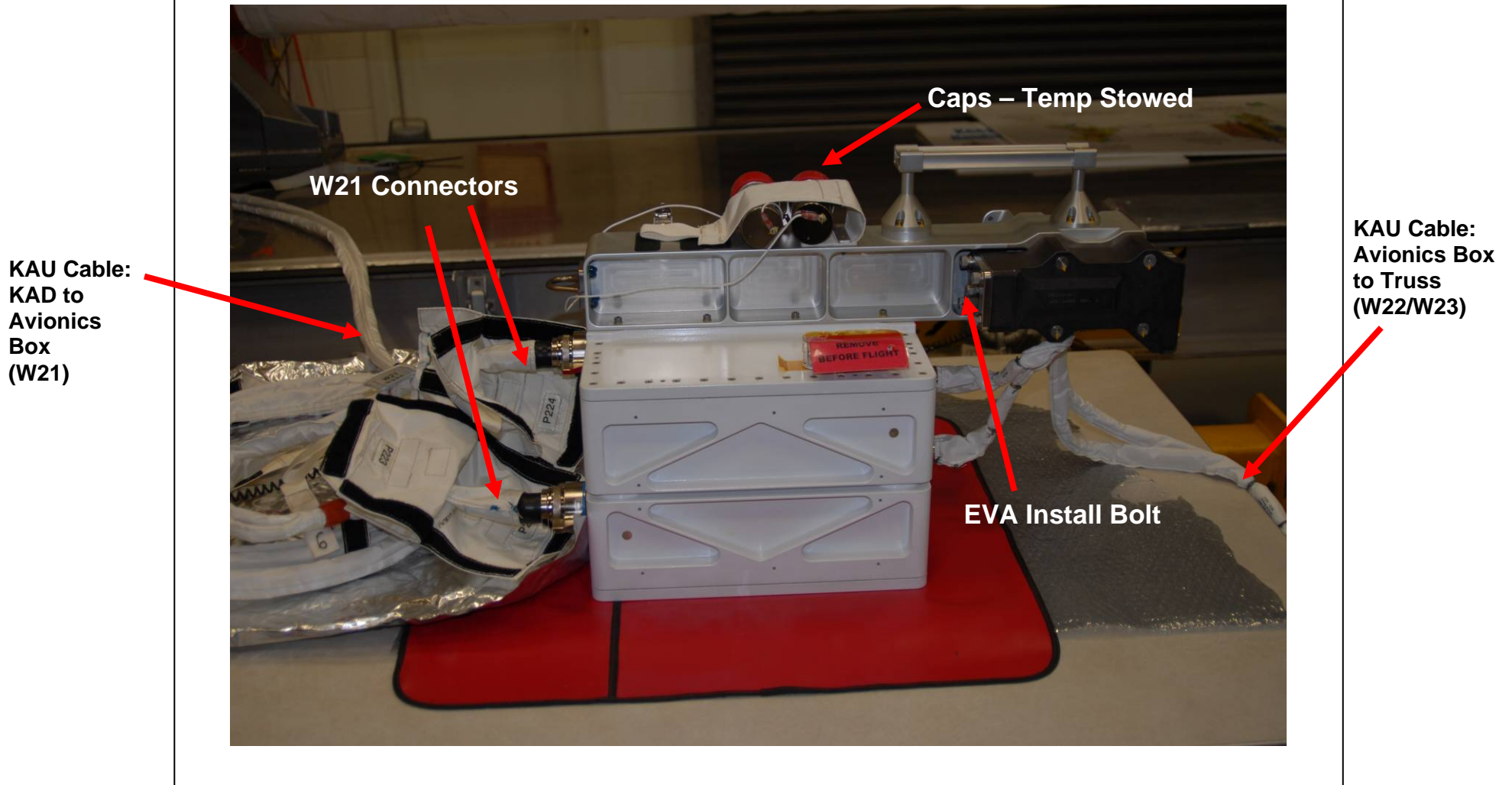


P411 Installed on Grapple Fixture

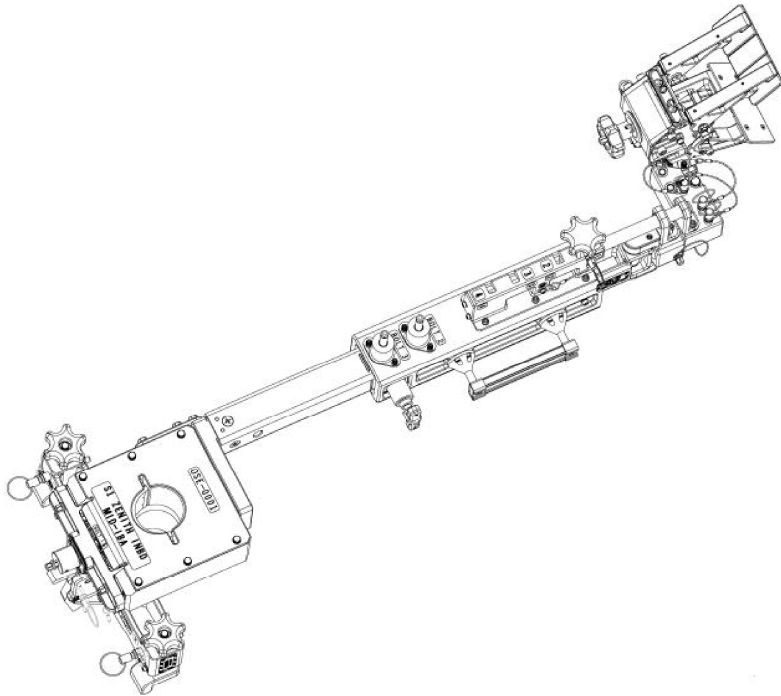
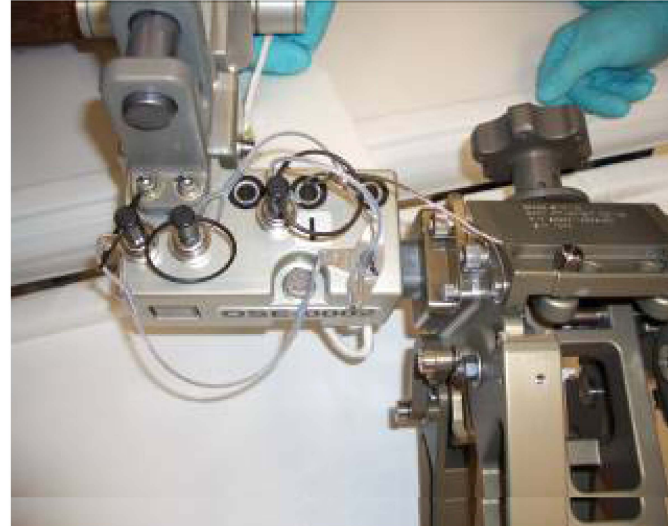


AVIONICS BOX

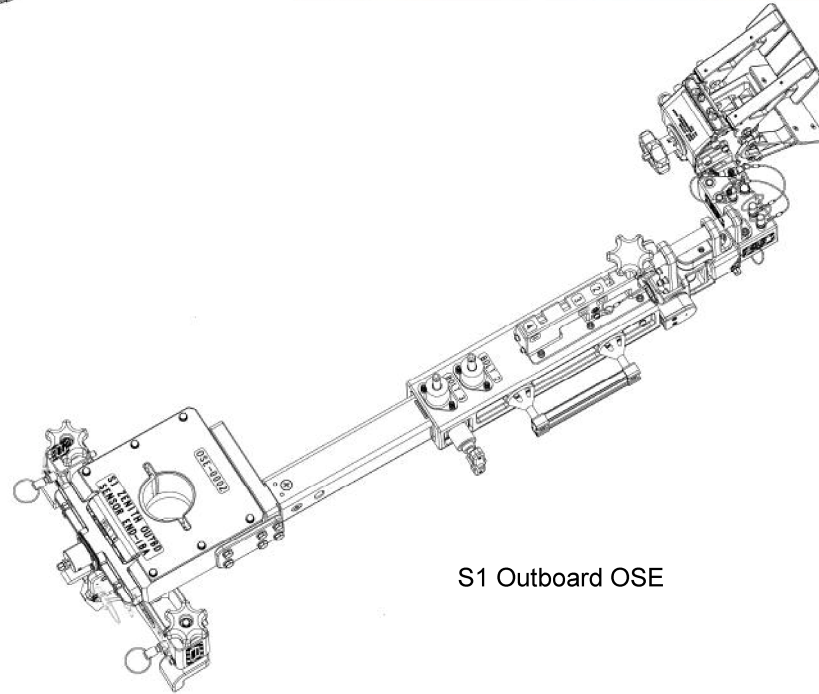
Avionics box



OSE

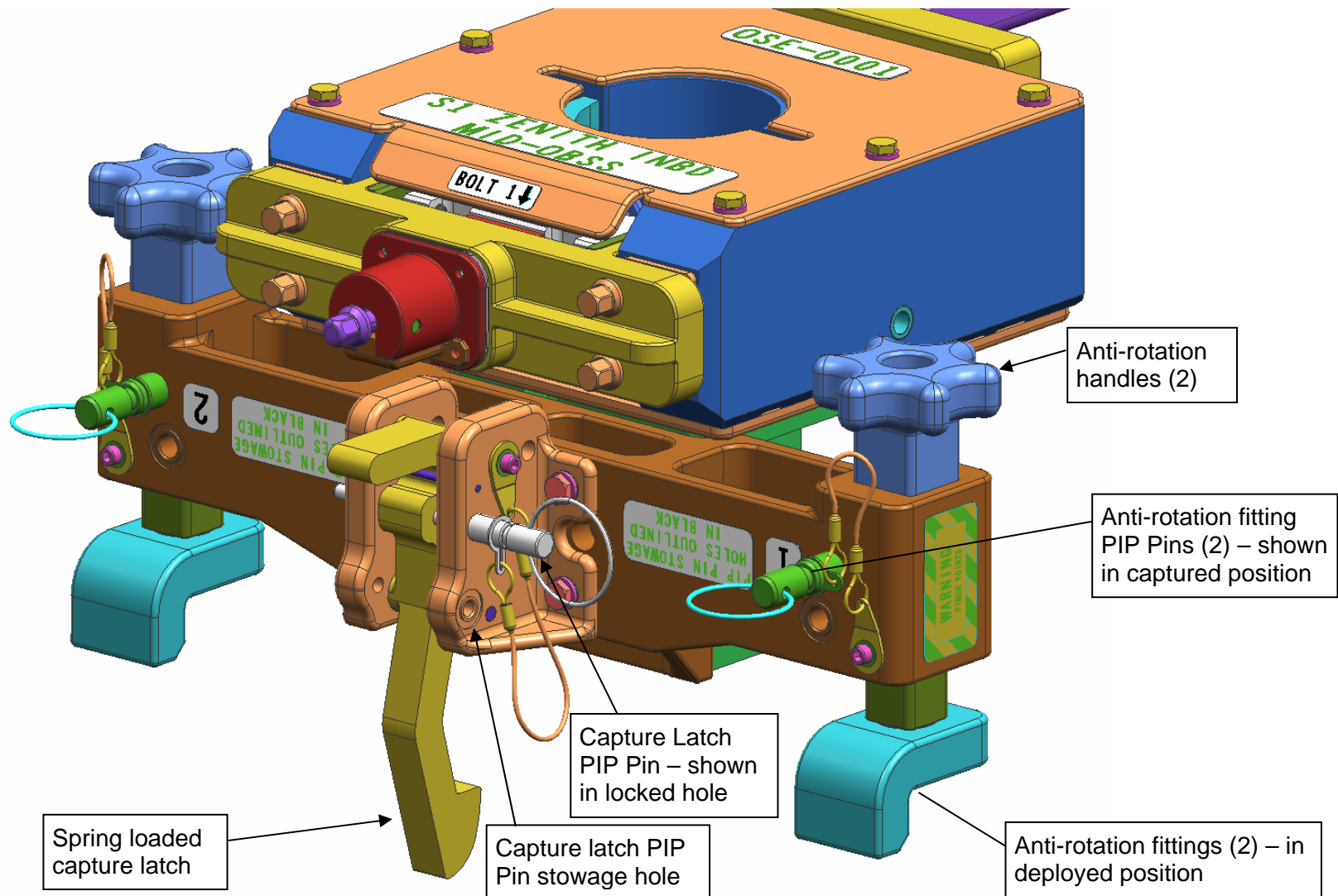


S1 Inboard OSE

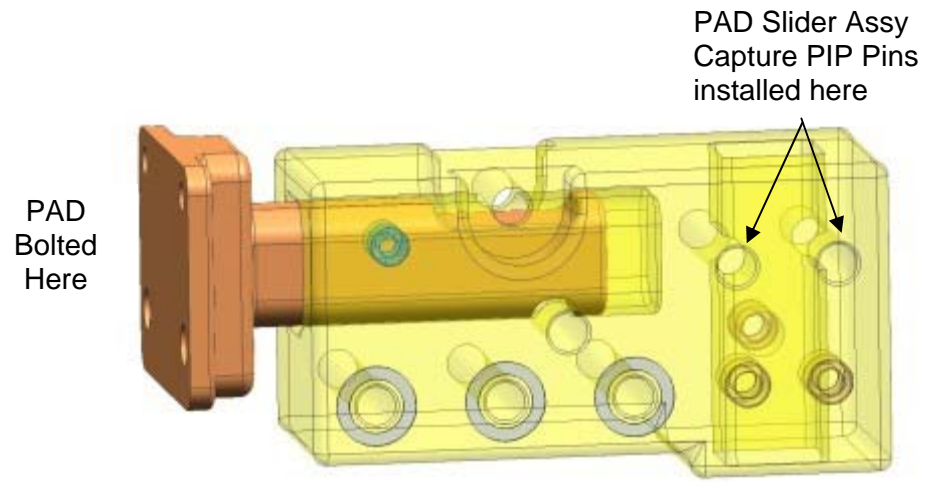
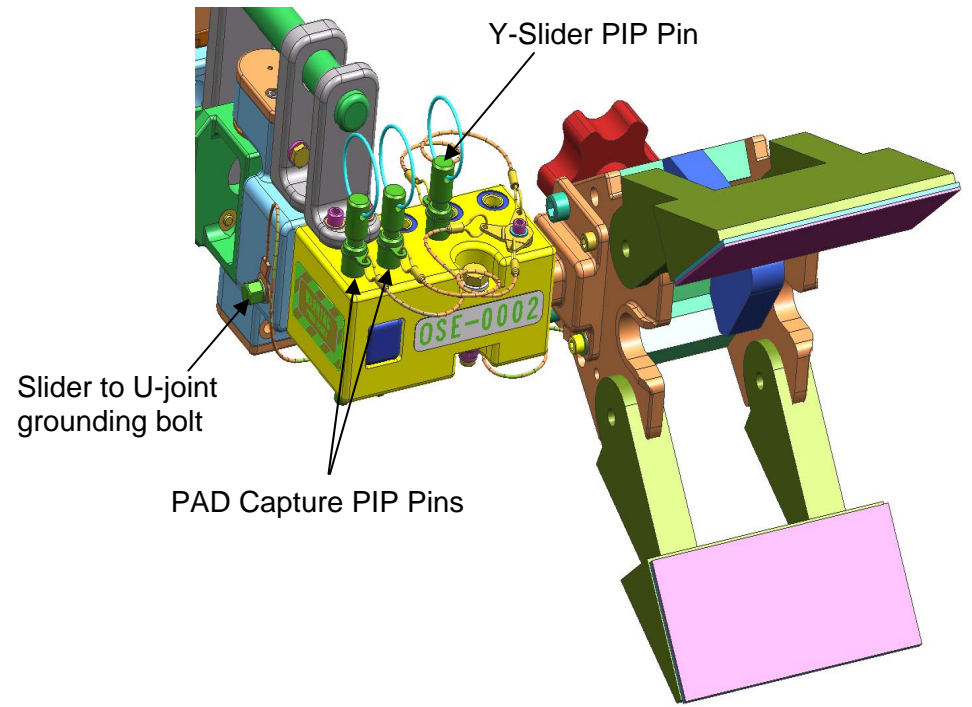
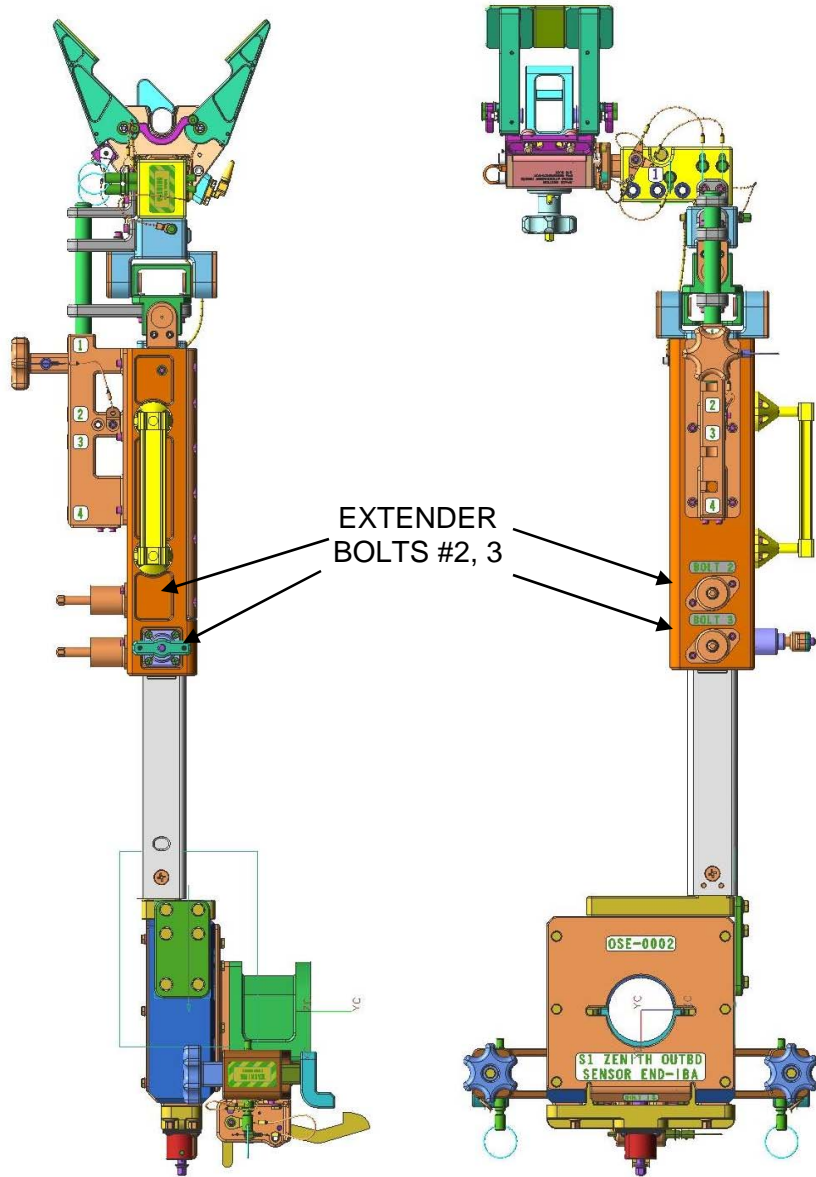


S1 Outboard OSE

OSE (Cont)

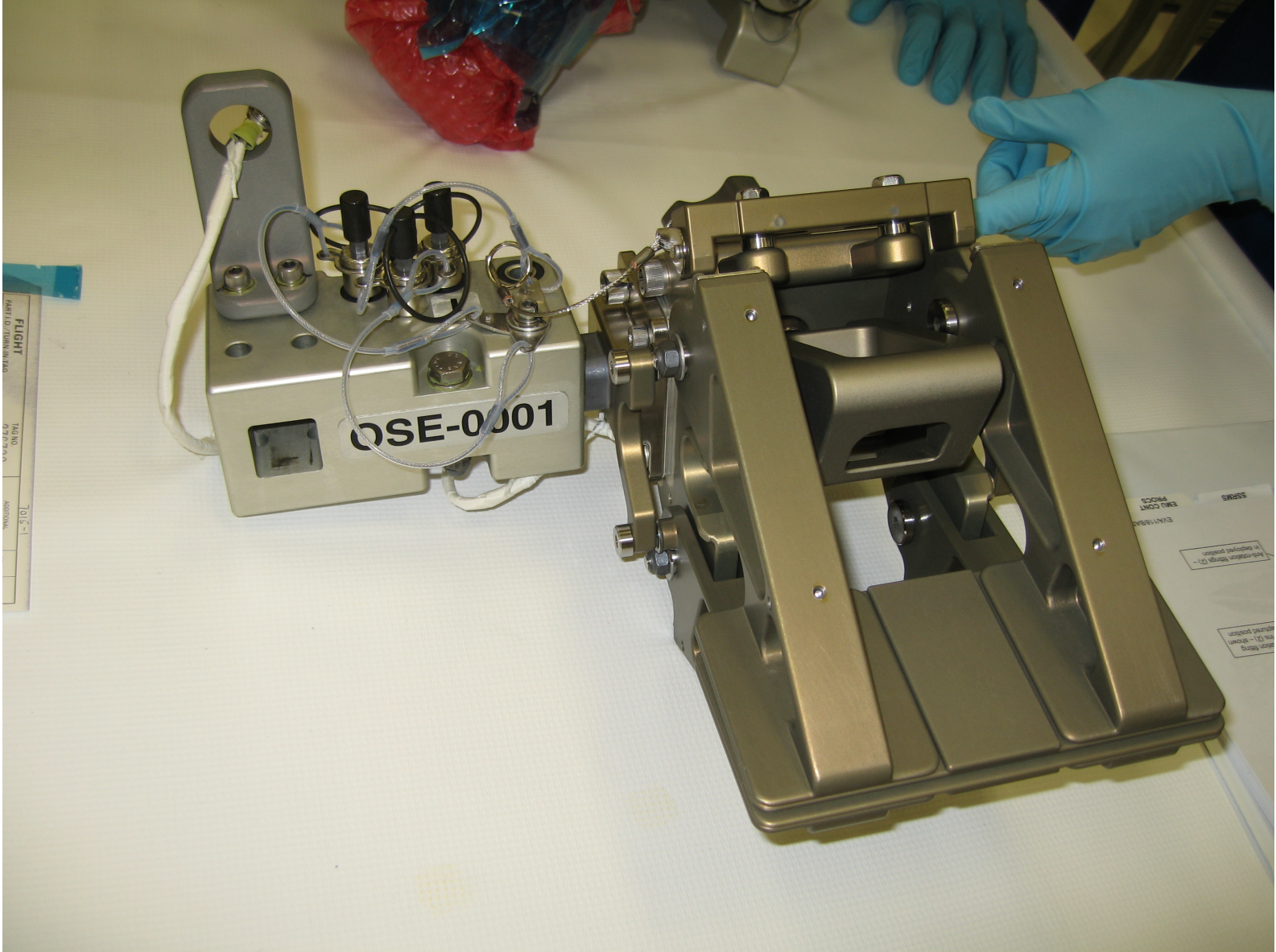


OSE (Cont)



PAD Attachment Slider Assy

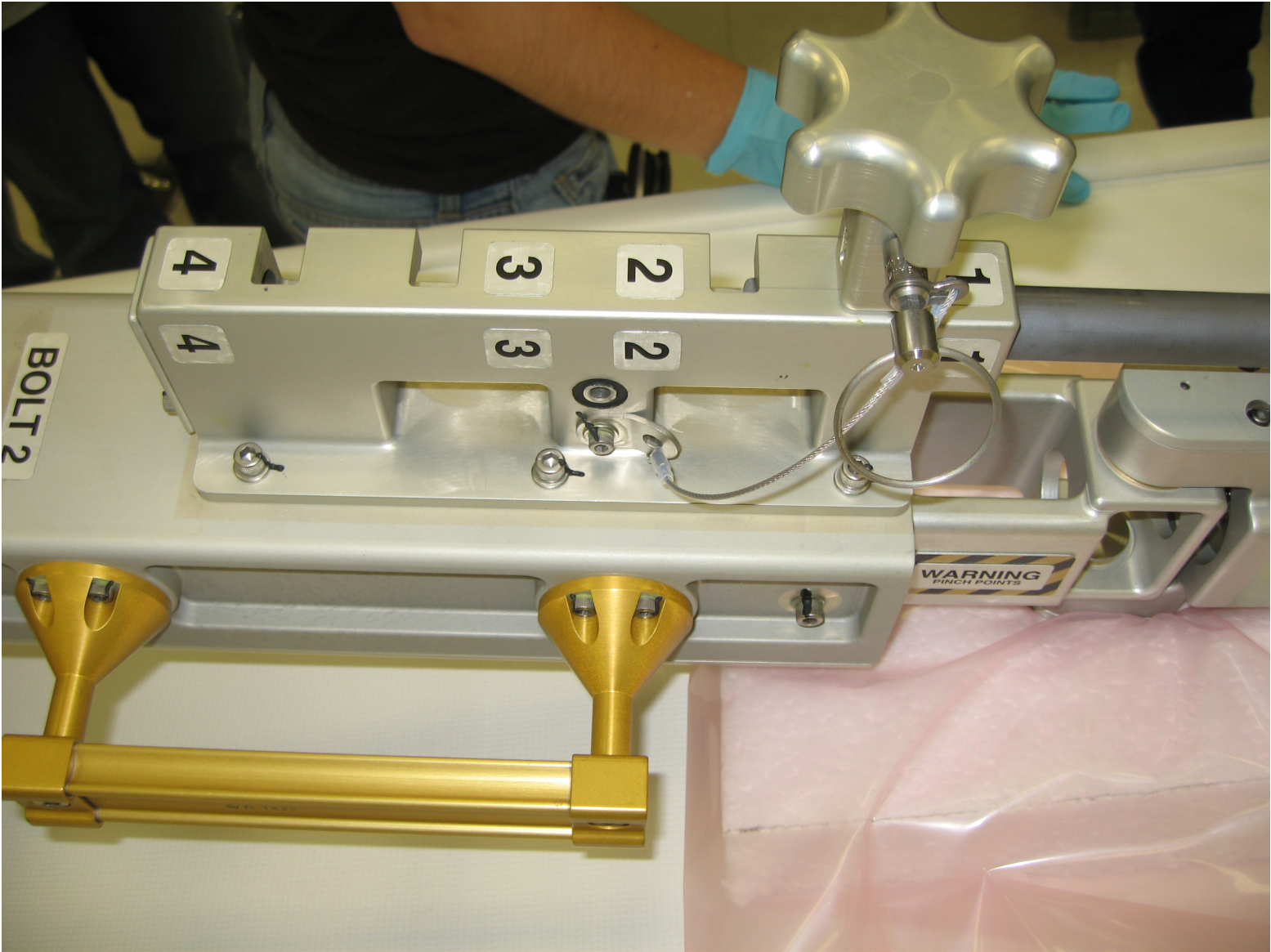
OSE (CONT)



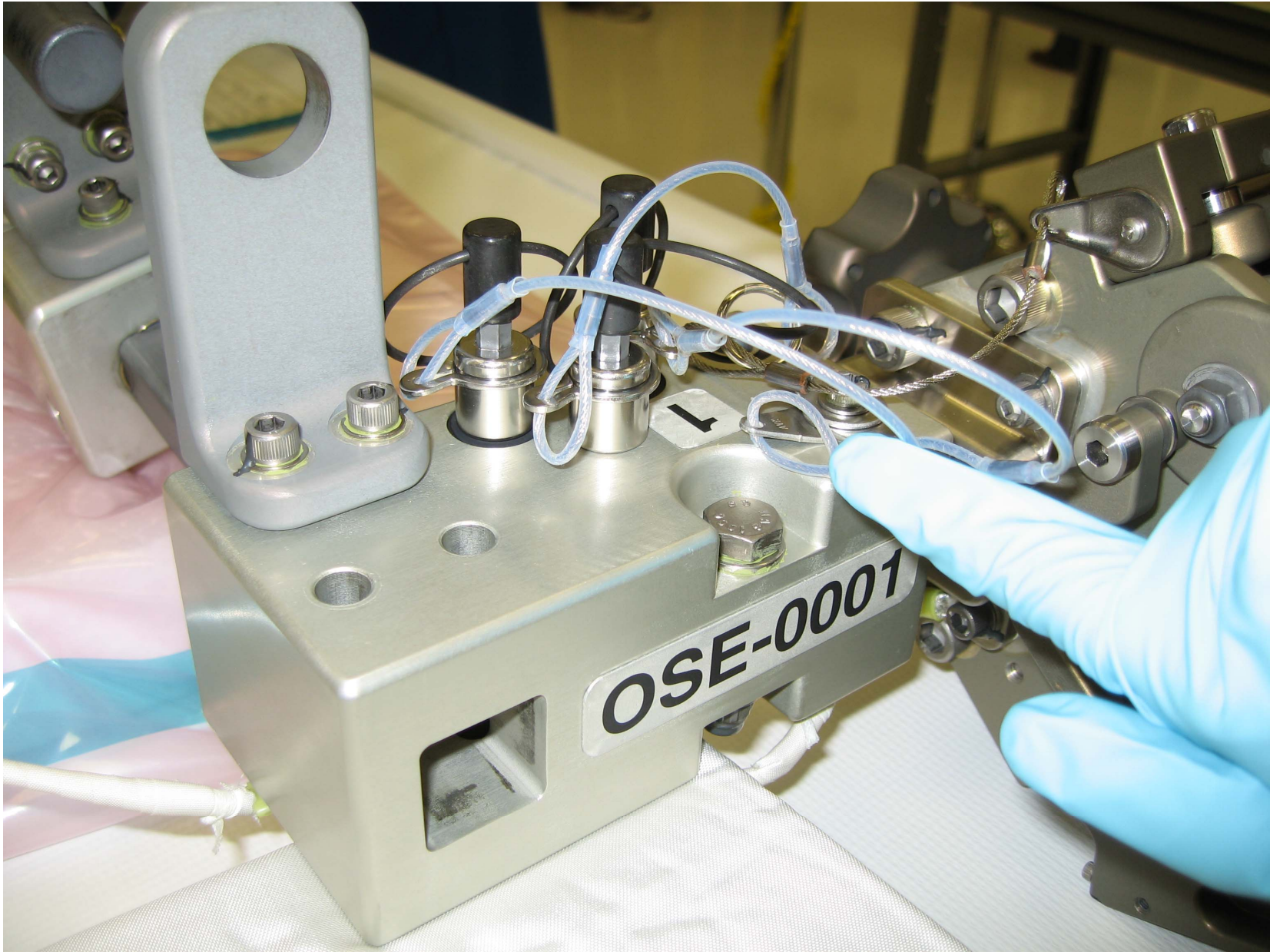
OSE (Cont)



OSE (Cont)



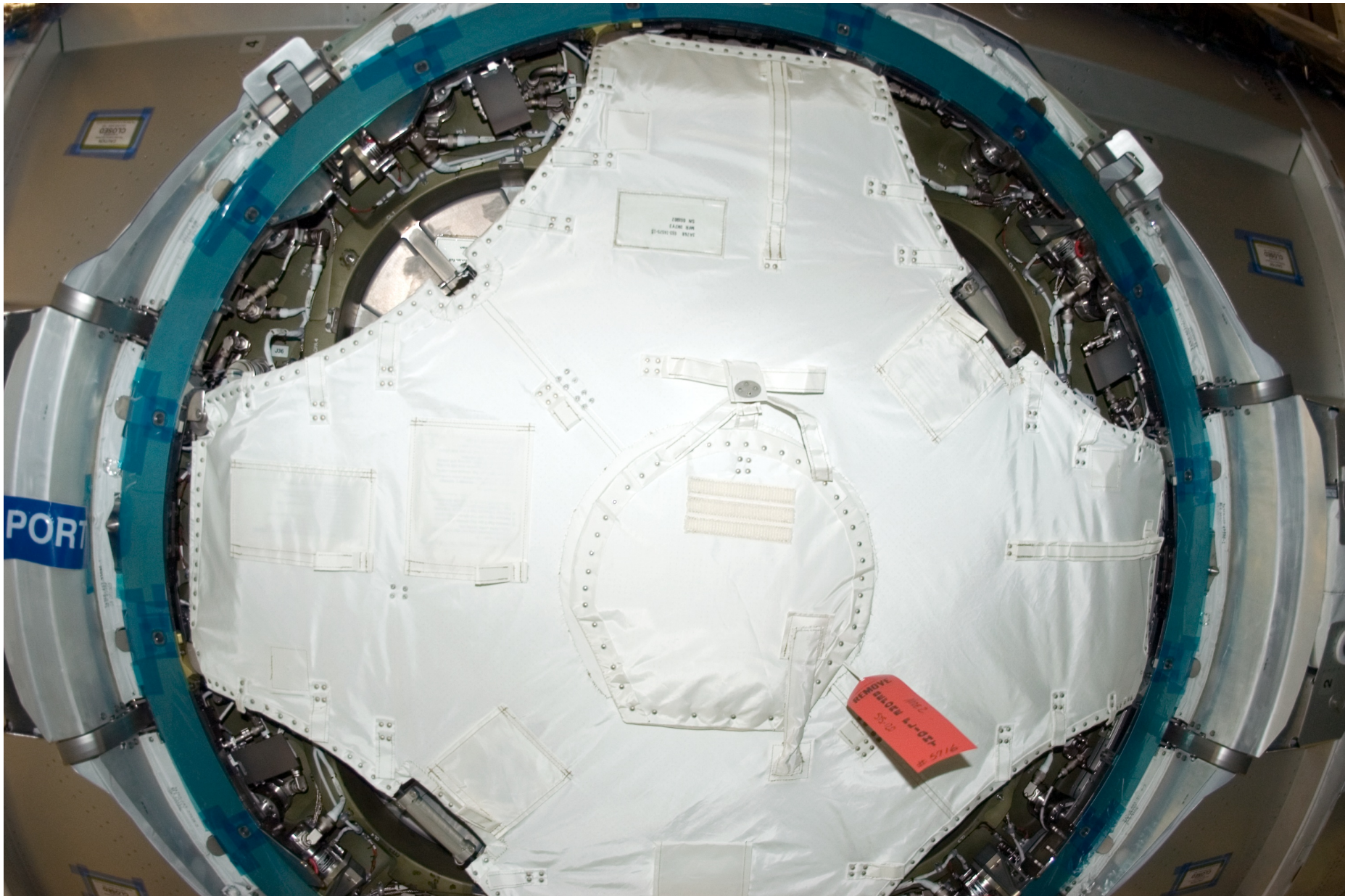
OSE (Cont)



OSE (Cont)



PORT ACBM WINDOW COVER

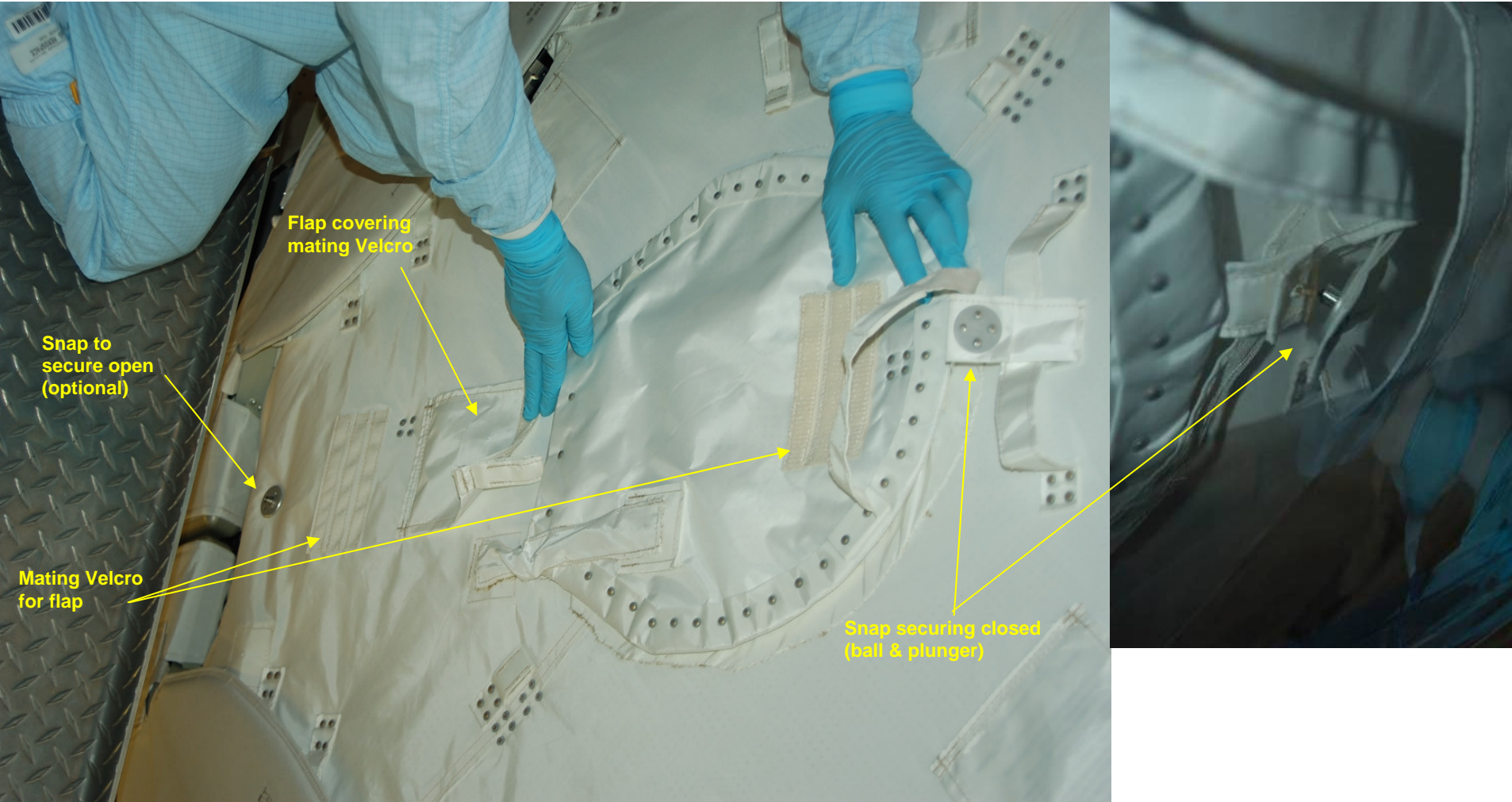


FS 18-69

EVA/124/FIN

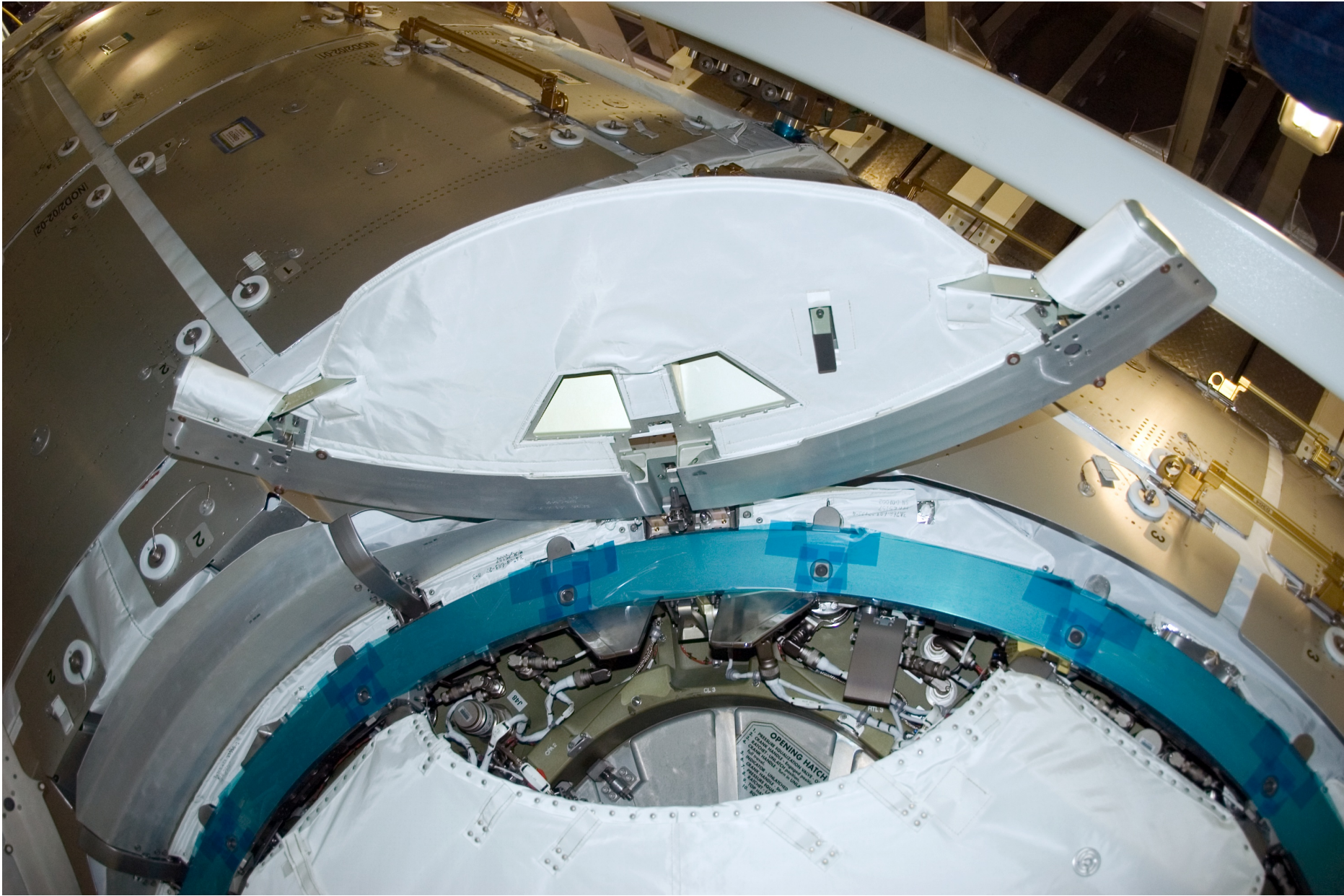
NODE 2

PORT ACBM WINDOW COVER (Cont)



CBCS Flap

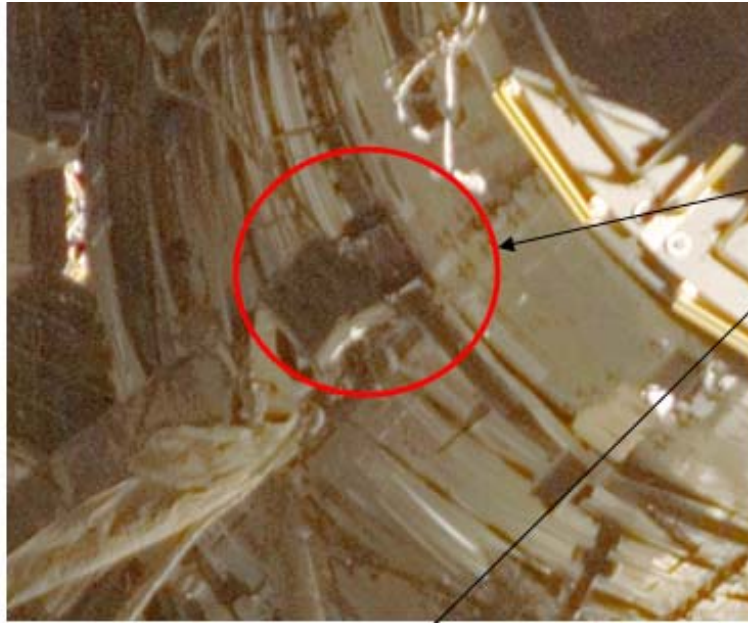
PORT ACBM HATCH PETAL DEPLOY



PORT ACBM LAUNCH LOCK

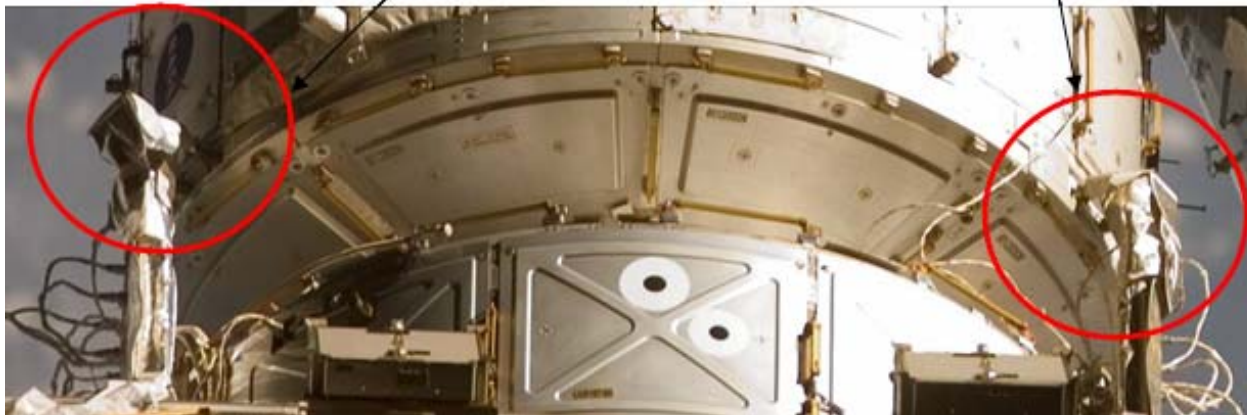
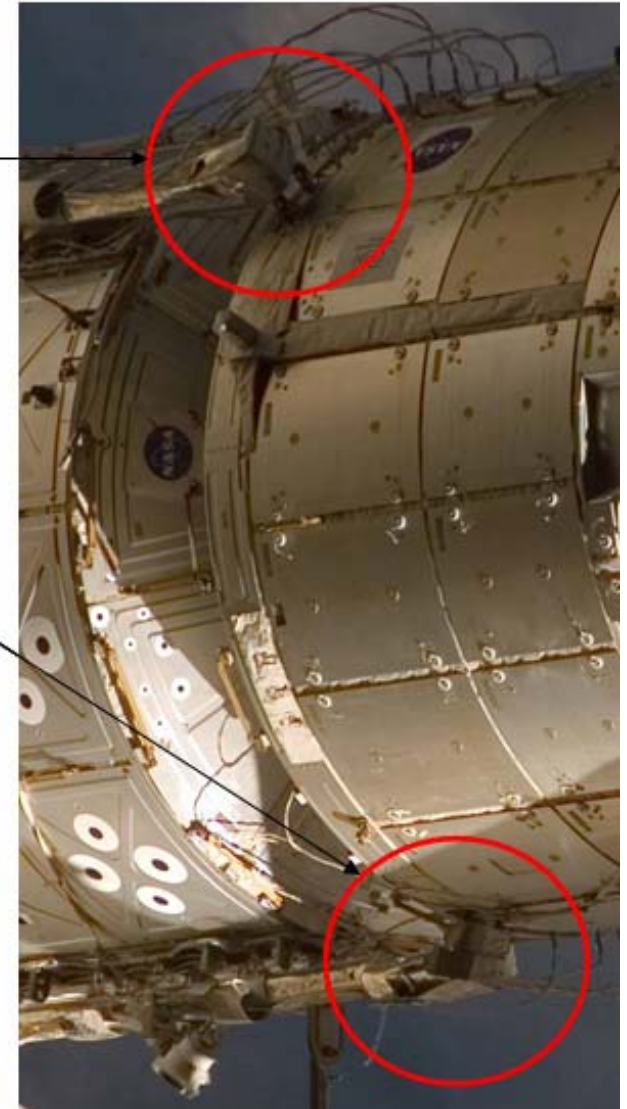


FLUID QD MLI INSTALL



Port QDs

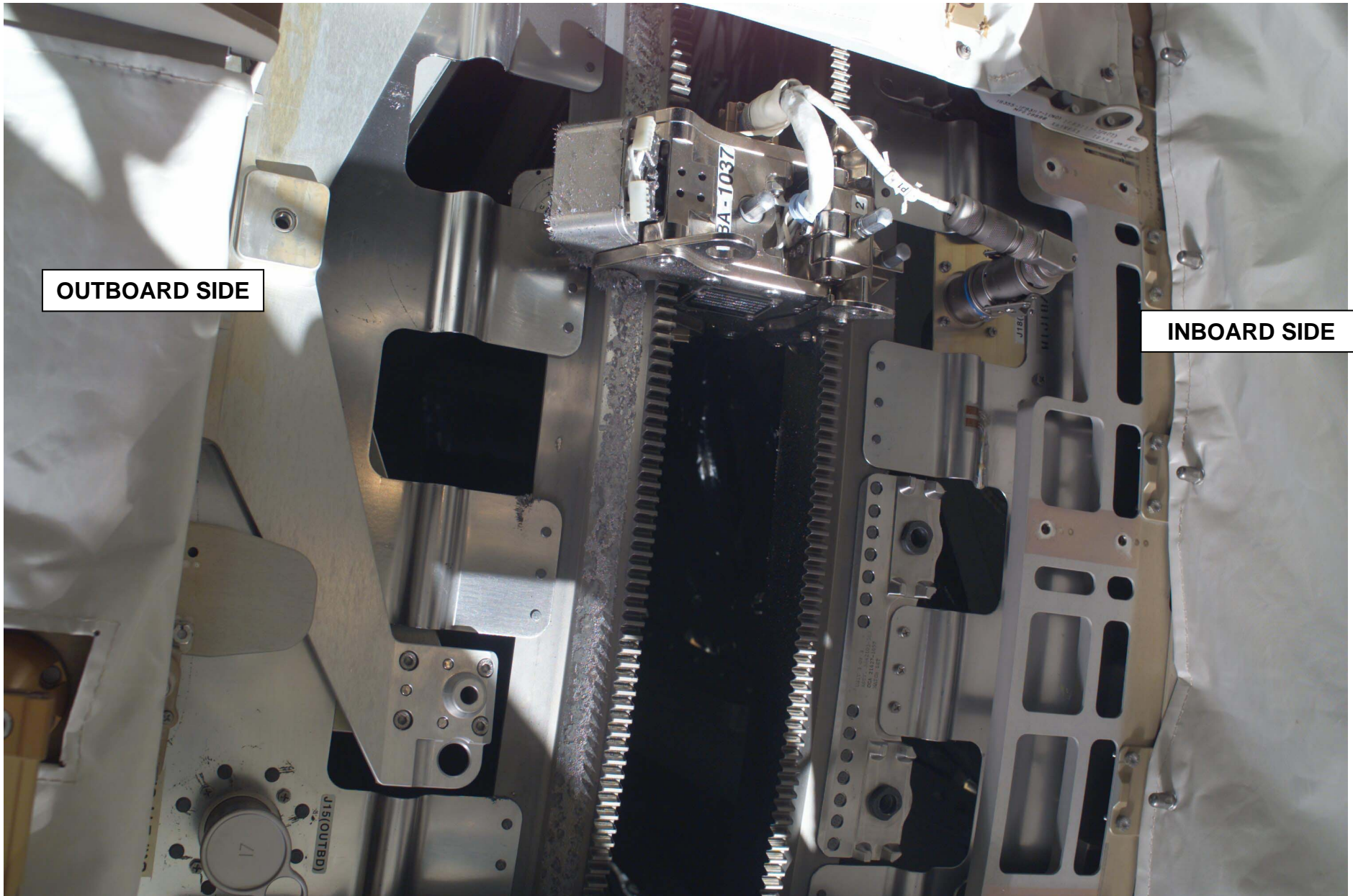
Stbd QDs



FLUID QD MLI INSTALL (Cont)



TRUDLE BEARING ASSEMBLY – ON ORBIT



FS 18-75

EVA/124/FIN

S3 SARJ

TRUNDLE BEARING ASSEMBLY (Cont)

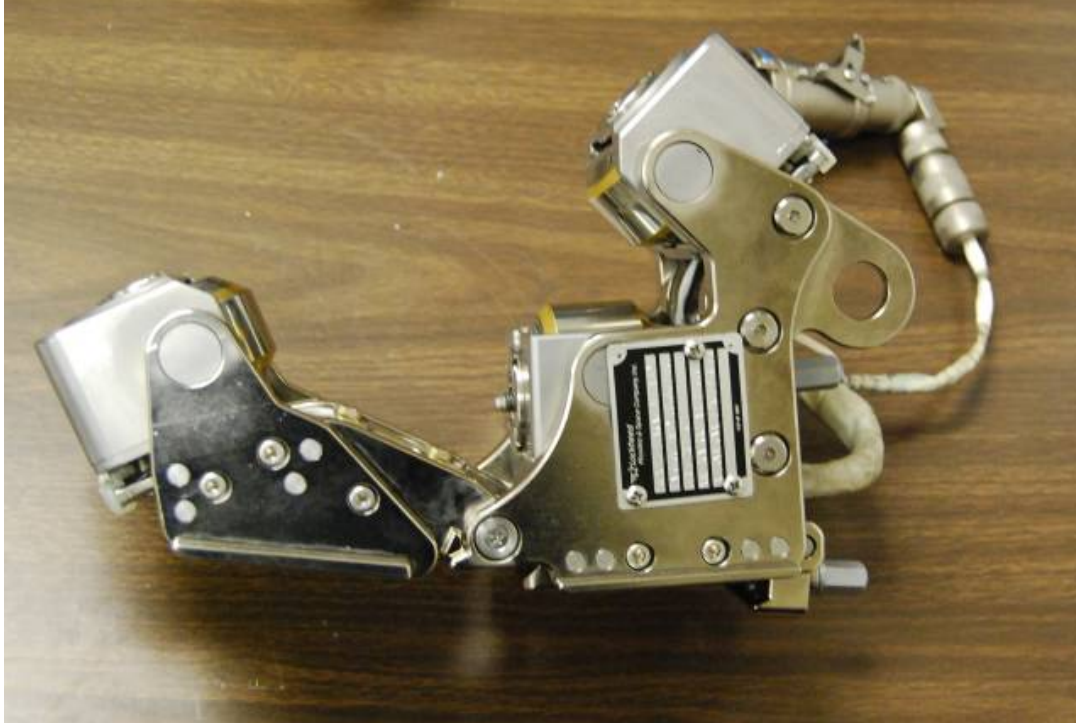
Trundle bearing
and mount
assembly



Mount assembly
installed
on SARJ ring



TRUNDLE BEARING ASSEMBLY (Cont)

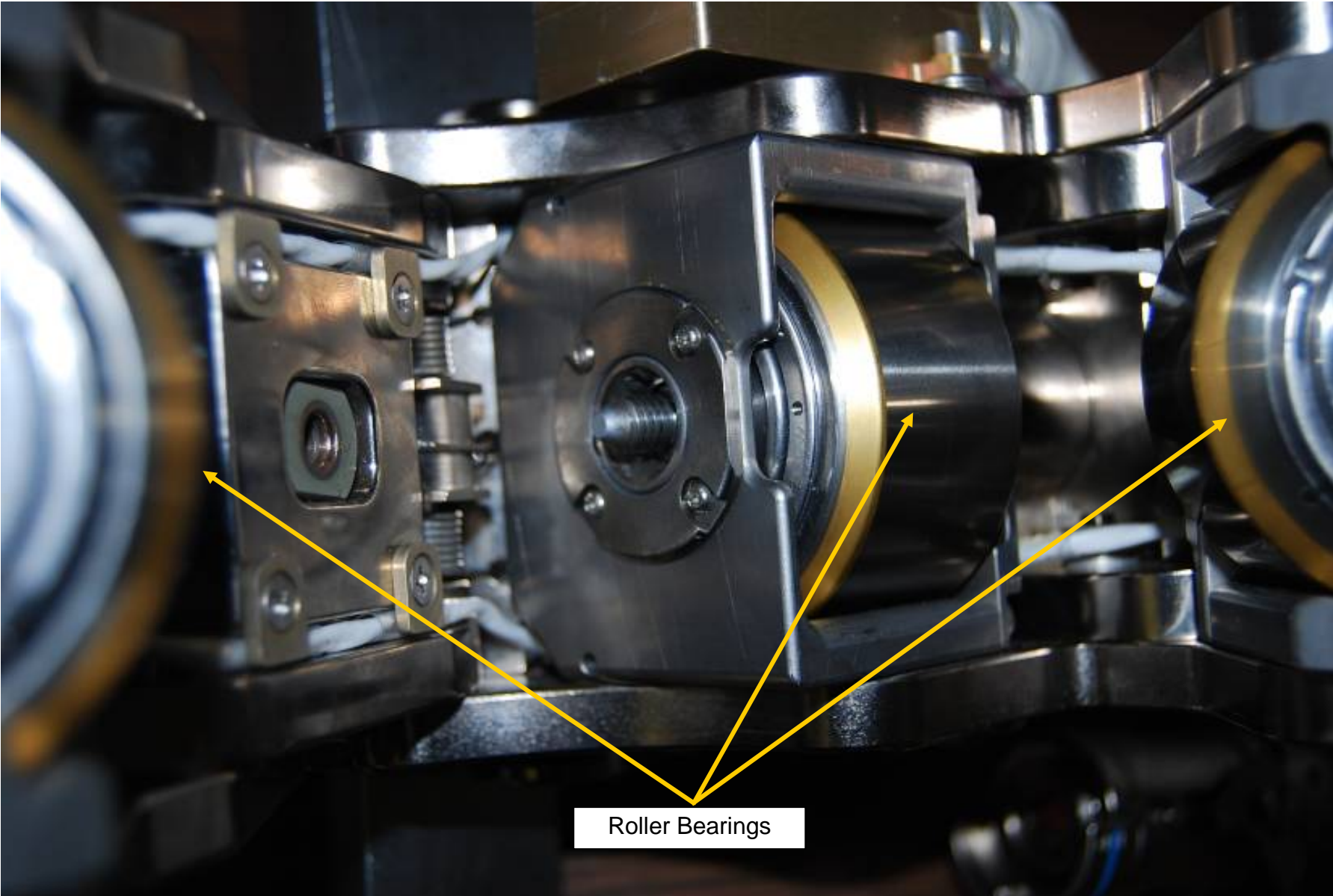


Bearing Package Assembly



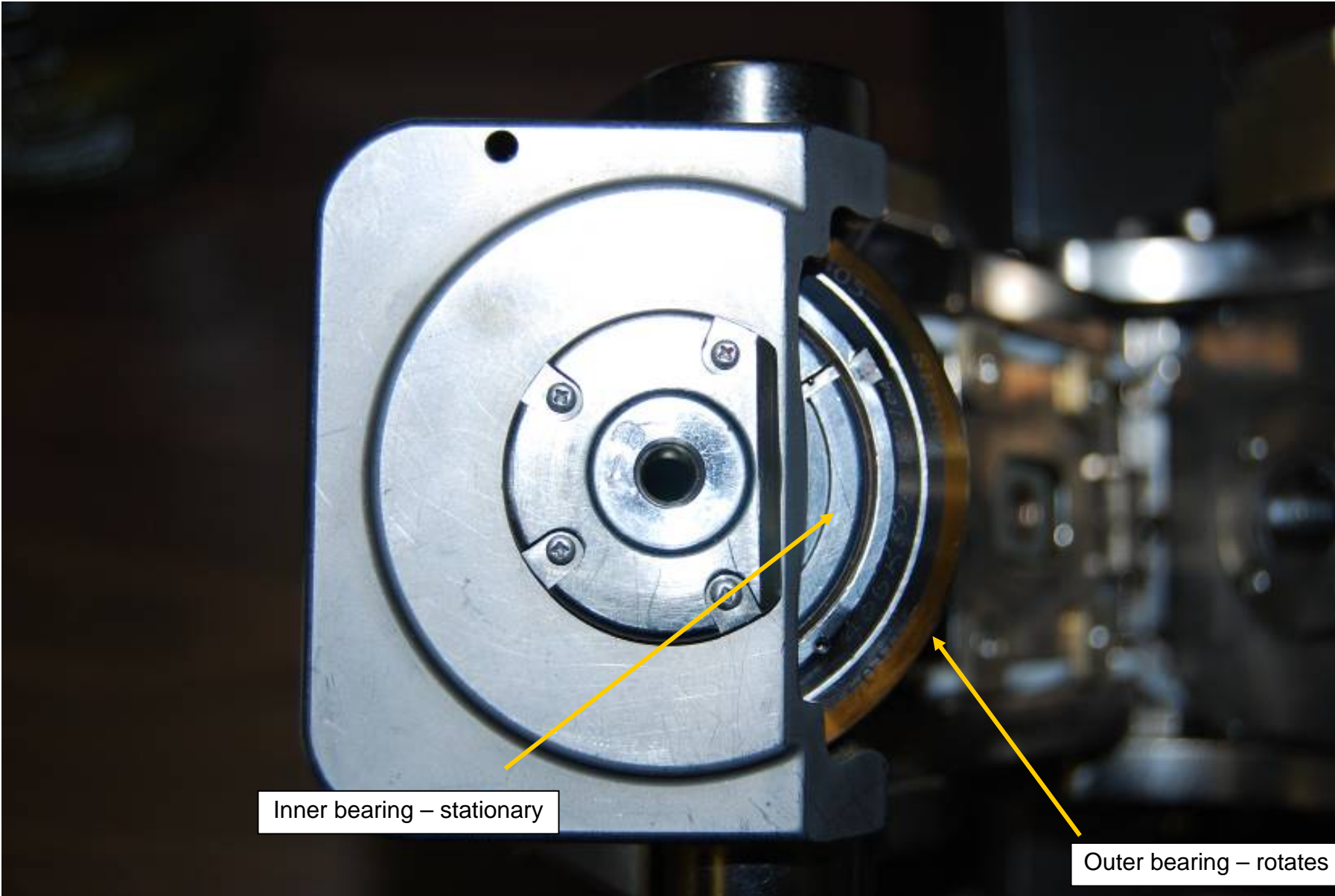
Mount Assembly

TRUNDLE BEARING ASSEMBLY (Cont)

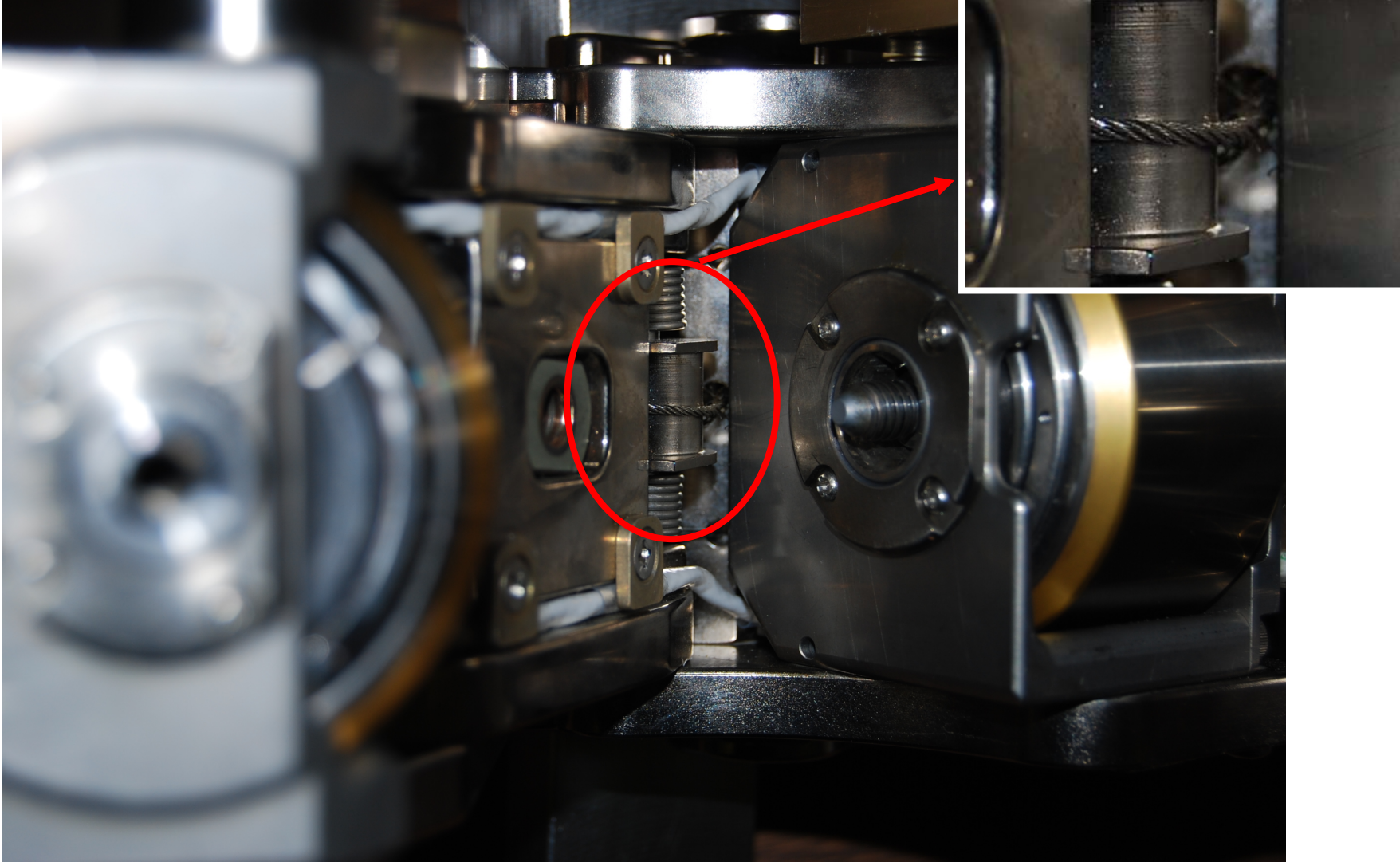


Roller Bearings

TRUNDLE BEARING ASSEMBLY (Cont)

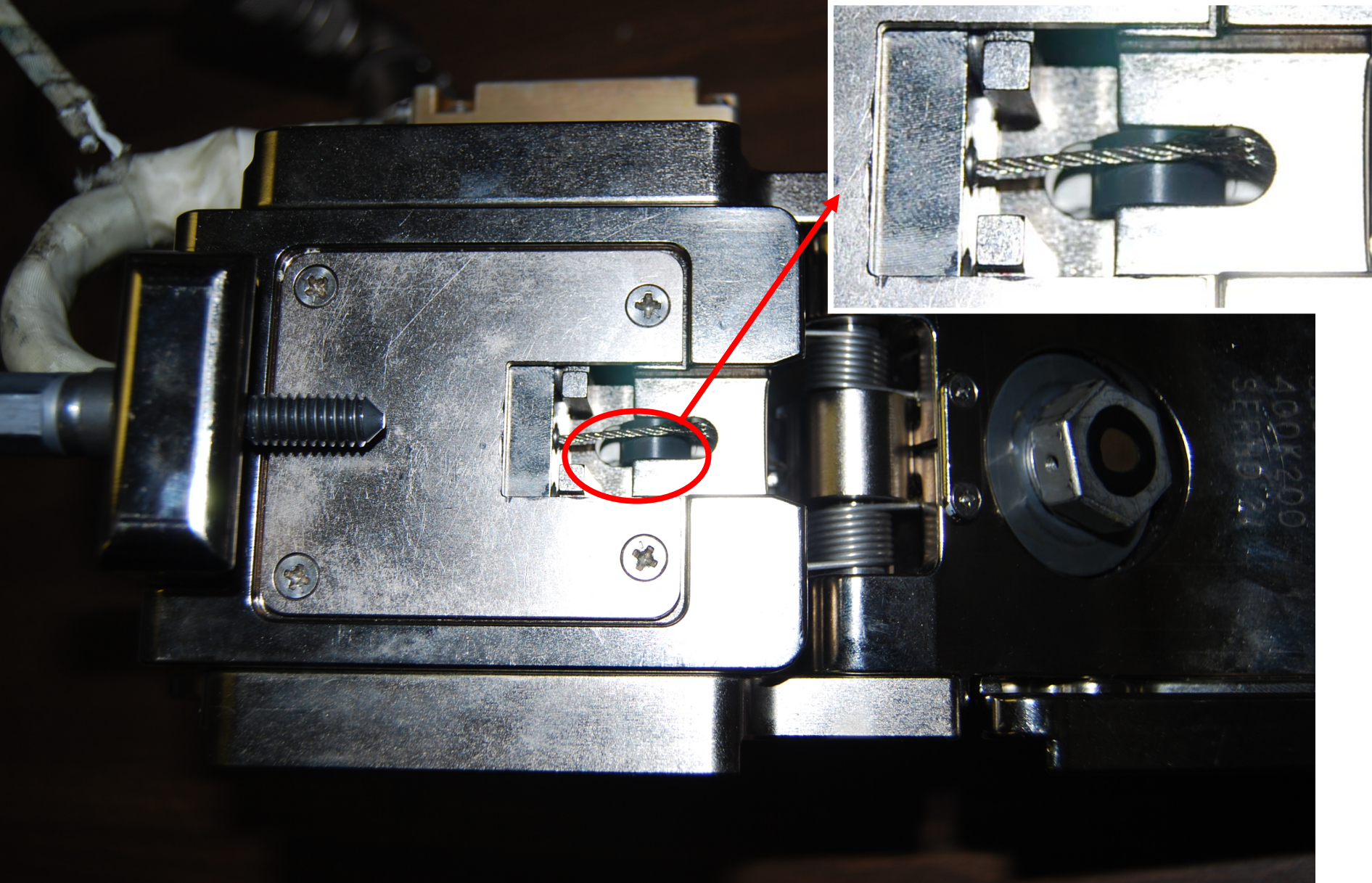


TRUNDLE BEARING ASSEMBLY (Cont)

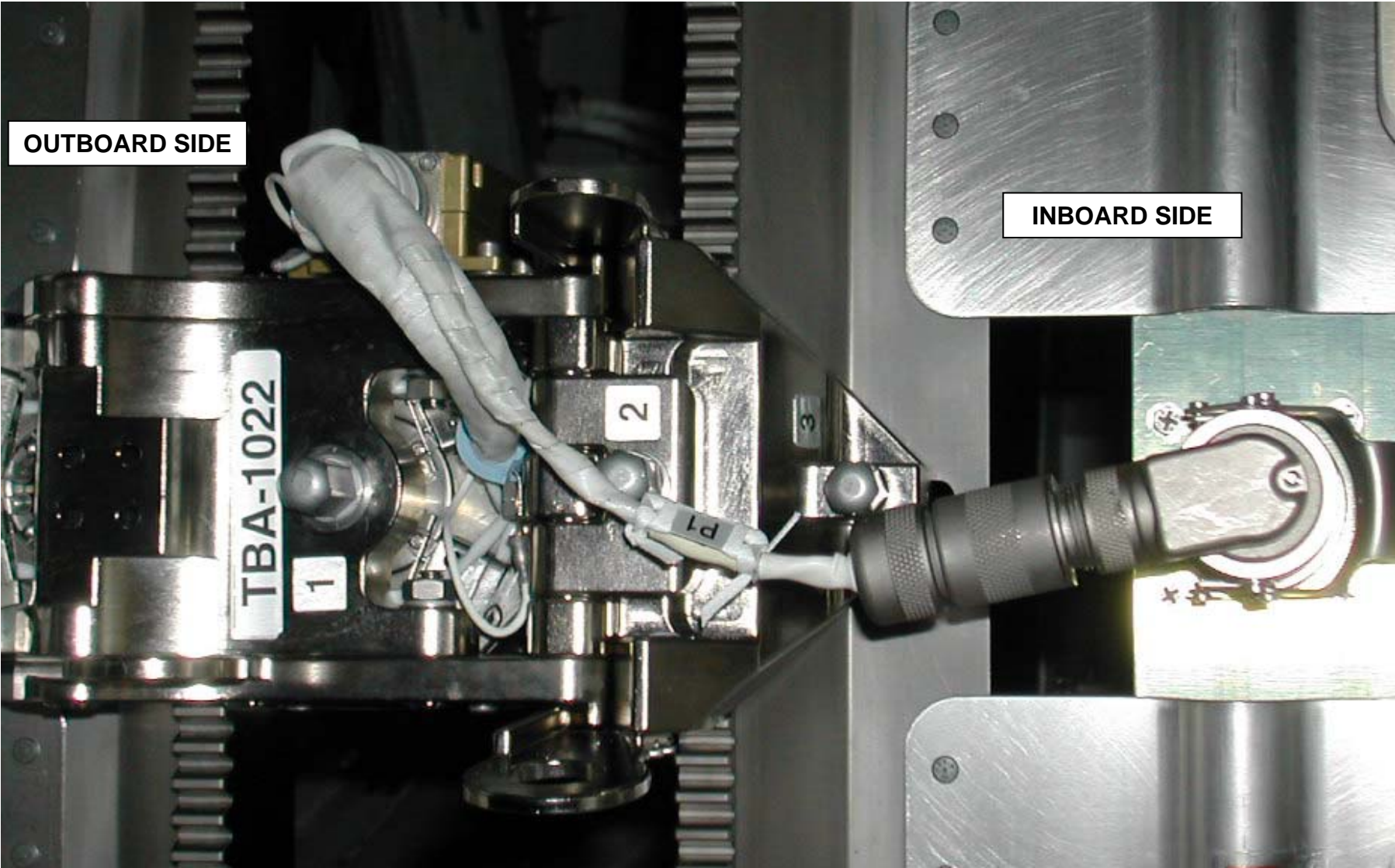


Inspect Cable for Frays Insets show frayed cable on ground unit

TRUNDLE BEARING ASSEMBLY (Cont)



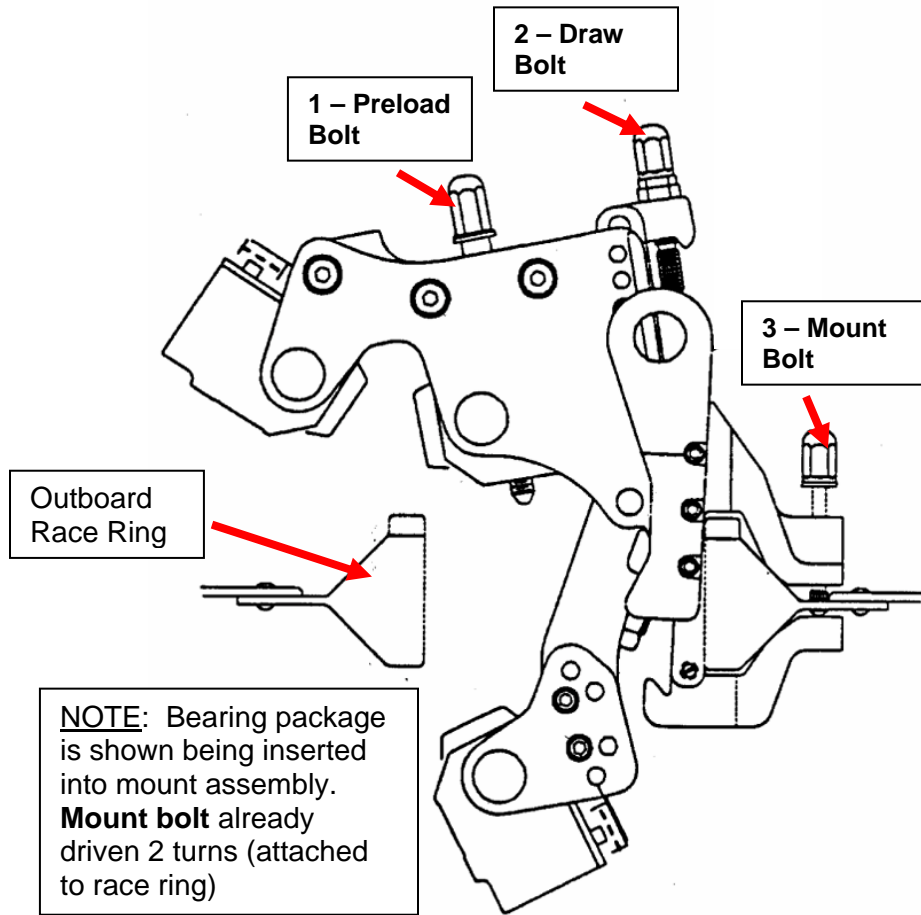
TRUNDLE BEARING ASSEMBLY (Cont)



TRUNDLE BEARING ASSEMBLY – INSTALLATION DIAGRAM

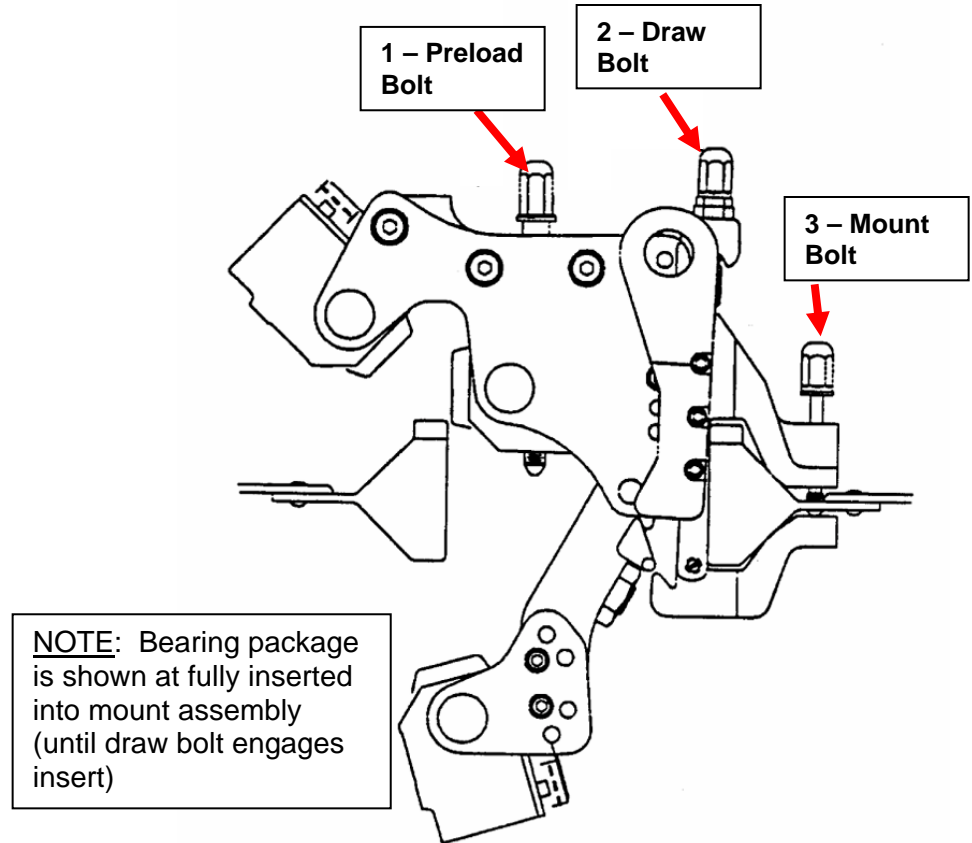
STEP 1/4

Initial Insertion of Bearing into Mount



STEP 2/4

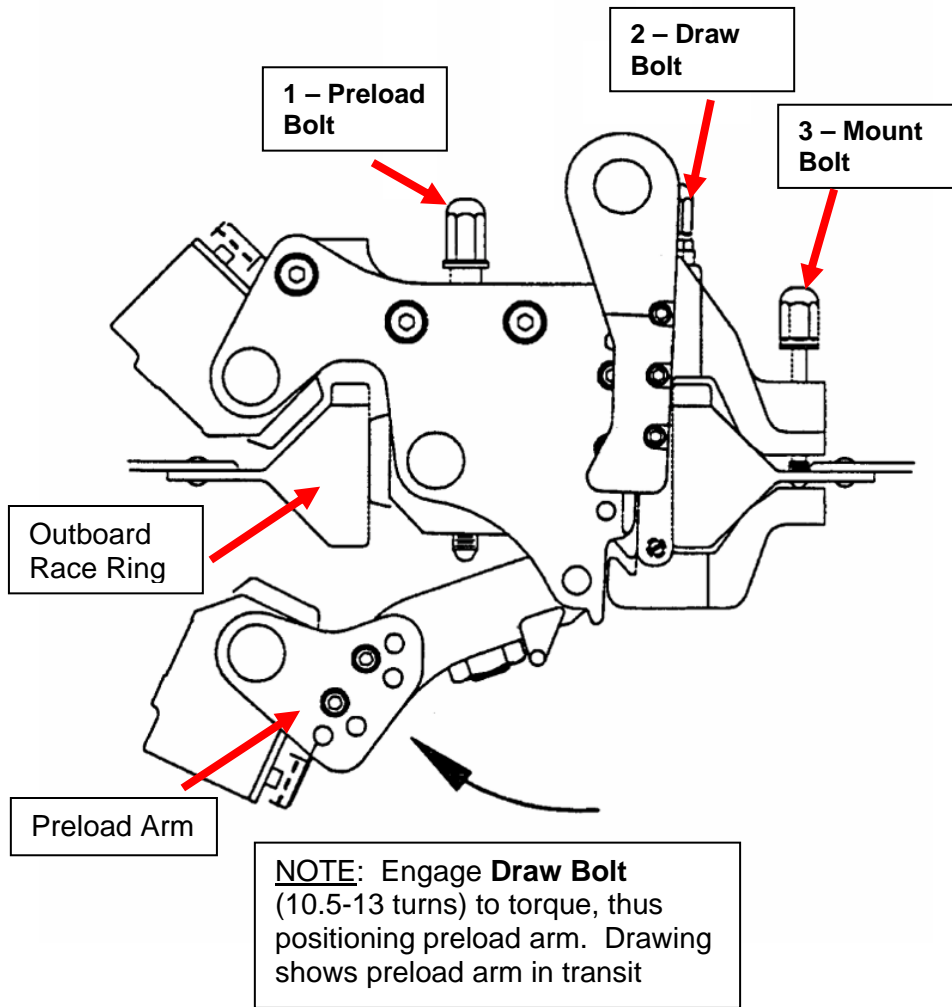
Fully Inserted Bearing into Mount



TRUNDLE BEARING ASSEMBLY – INSTALLATION DIAGRAM (Cont)

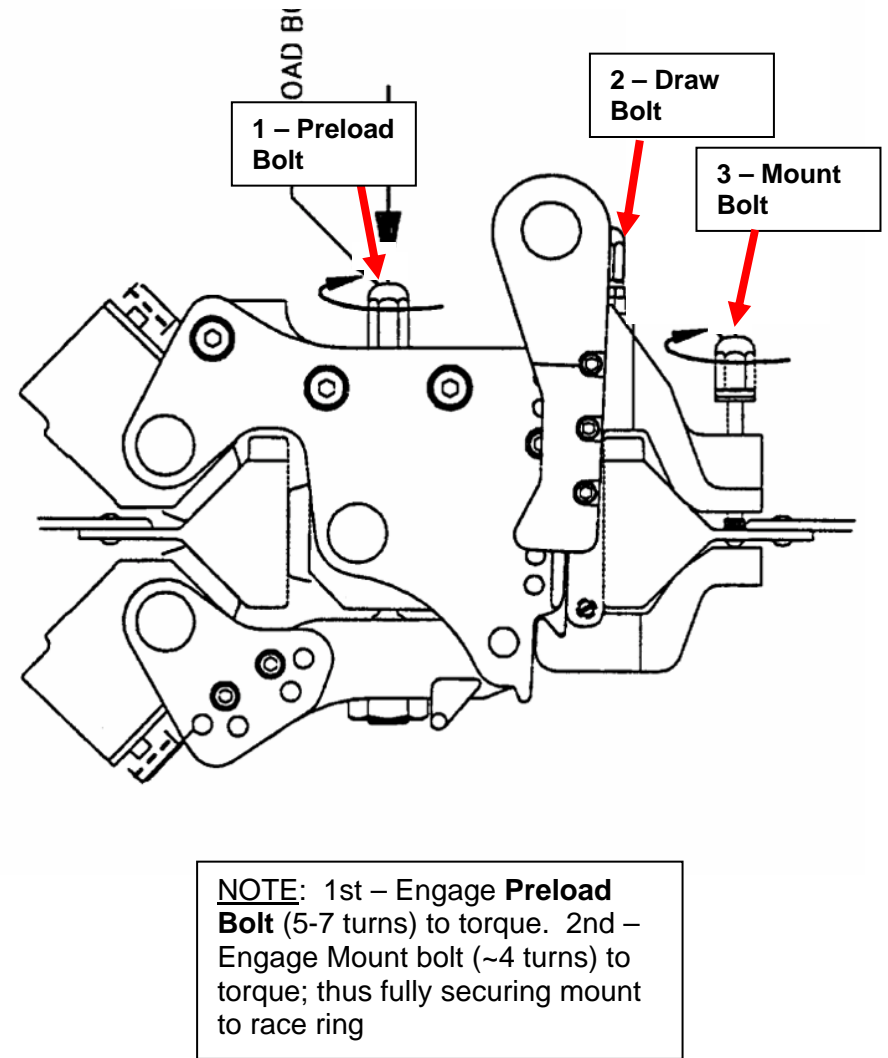
STEP 3/4

Position Pre-Load Arm toward Race Ring

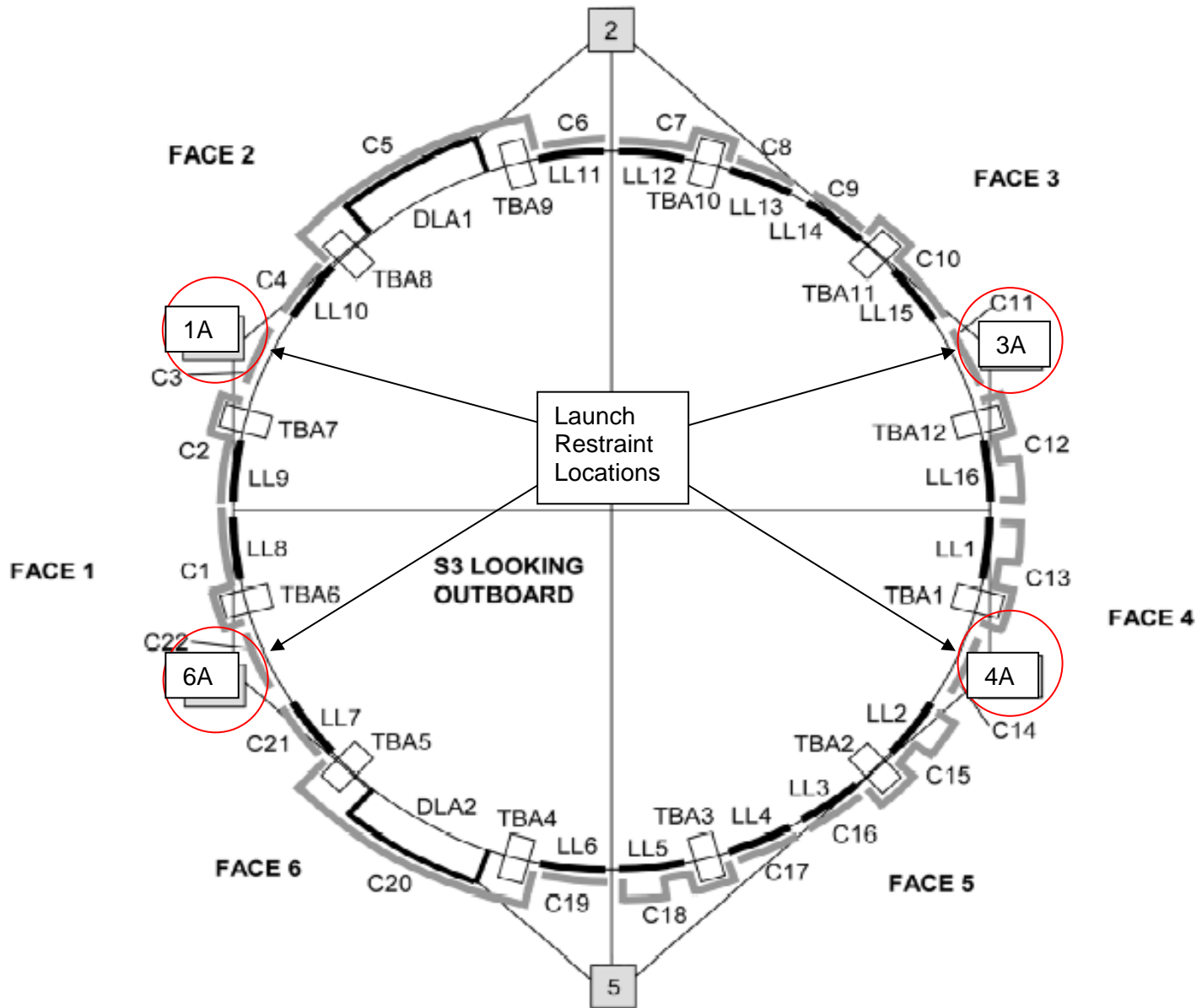


STEP 4/4

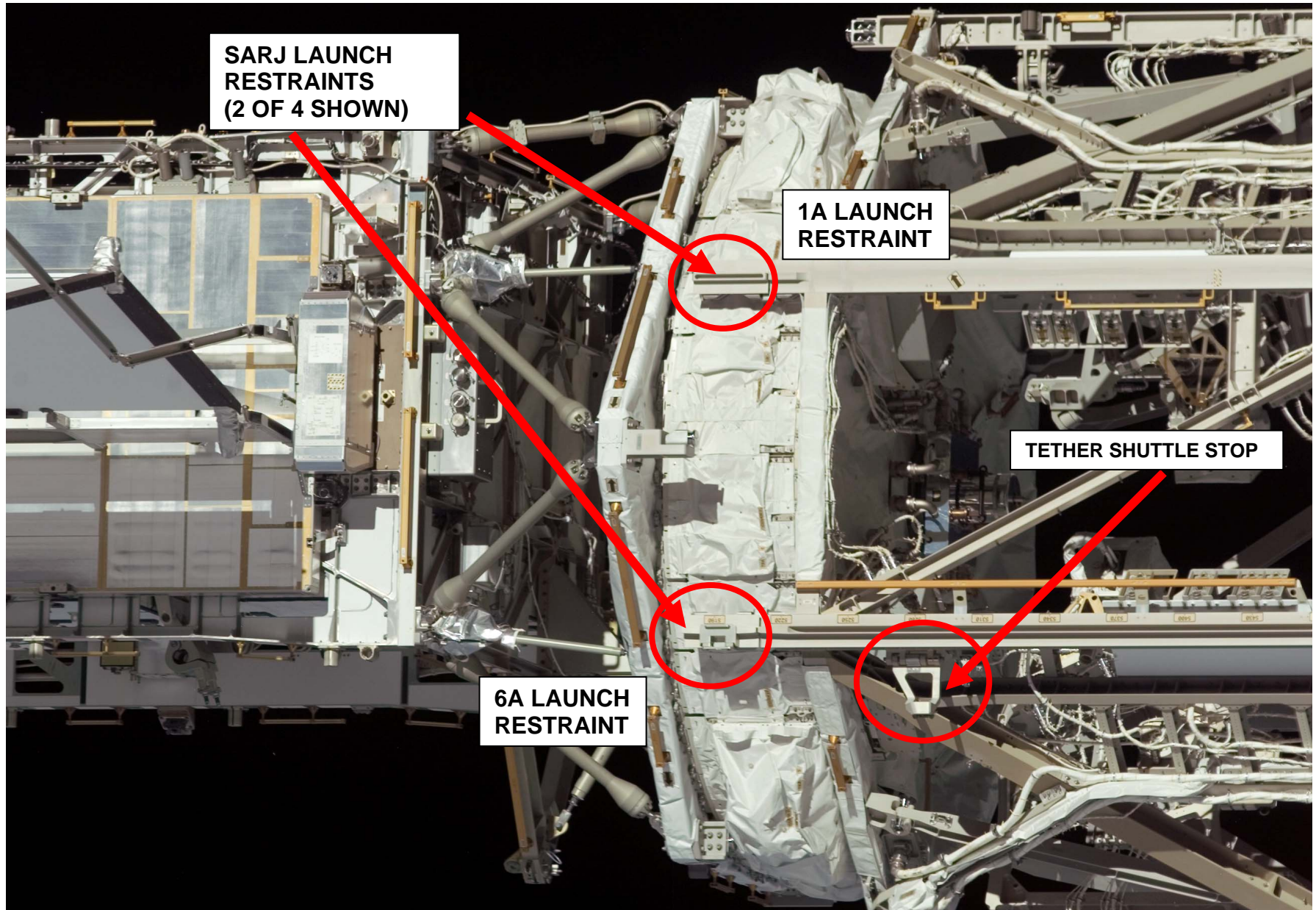
Set Preload & Secure Mount Package



LAUNCH RESTRAINT DIAGRAM



LAUNCH RESTRAINT ON-ORBIT



6A LAUNCH RESTRAINT – ETRS INSTALLED



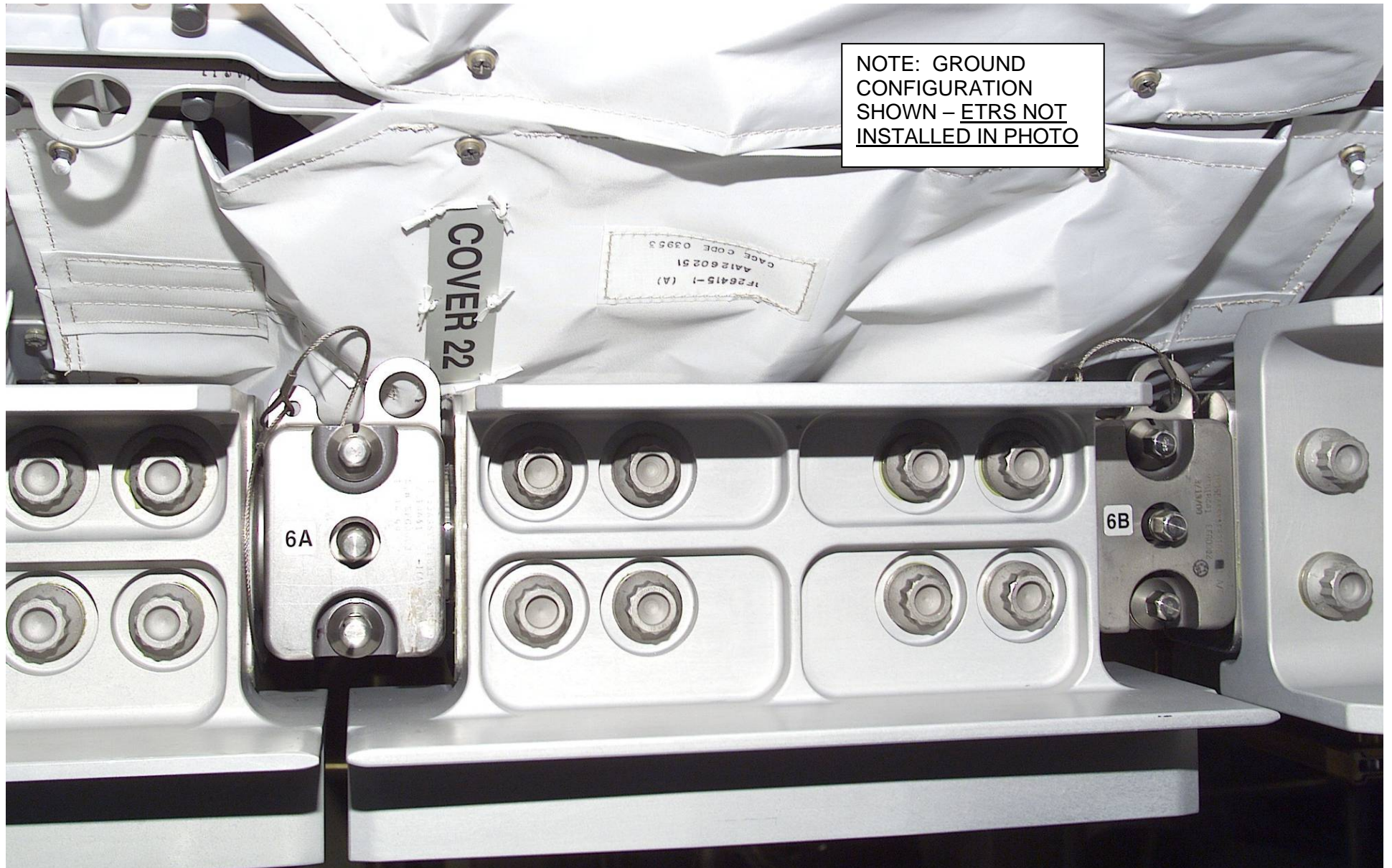
1A LAUNCH RESTRAINT



FS 18-89

EVA/124/FIN

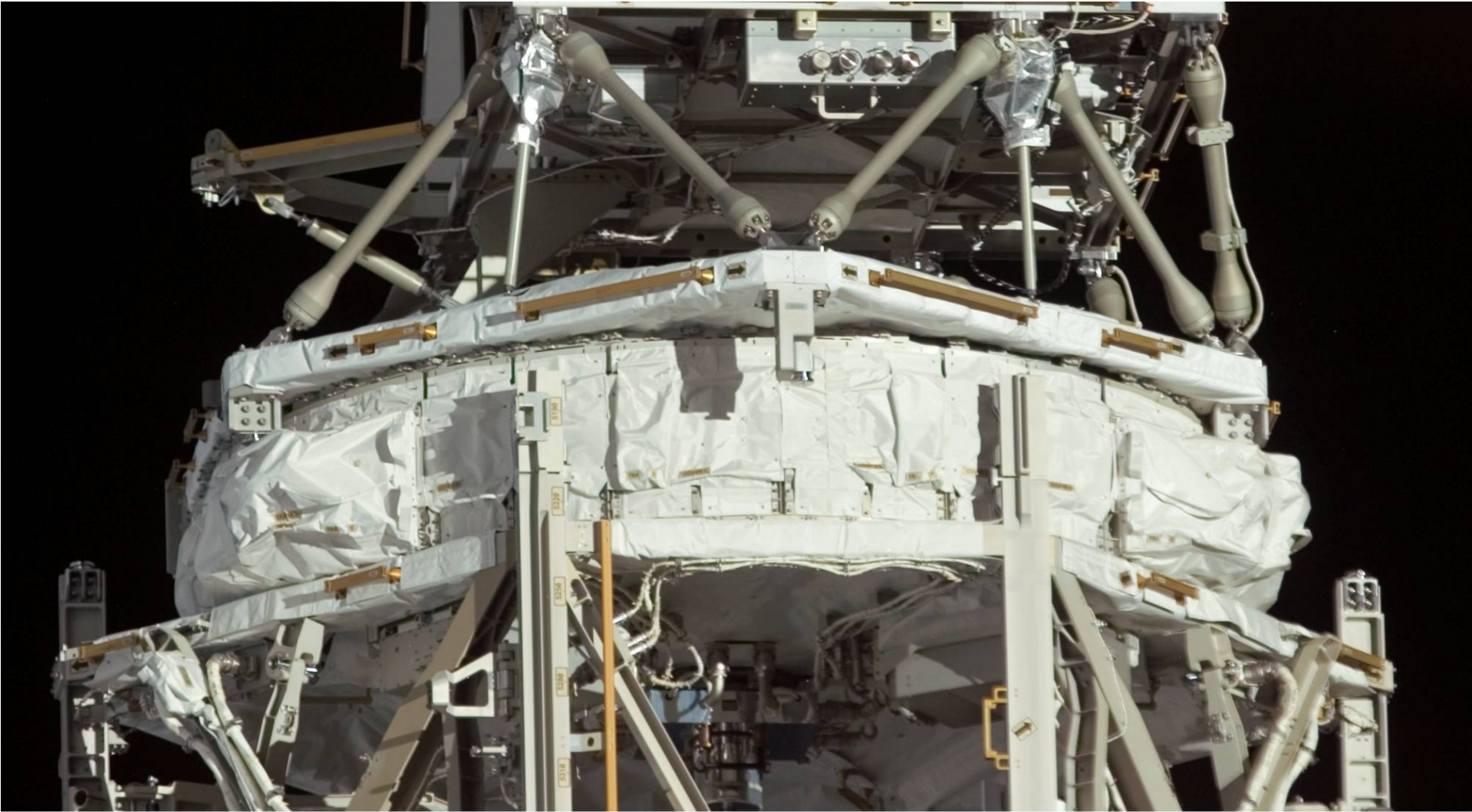
6A LAUNCH RESTRAINT – LAUNCH CONFIG



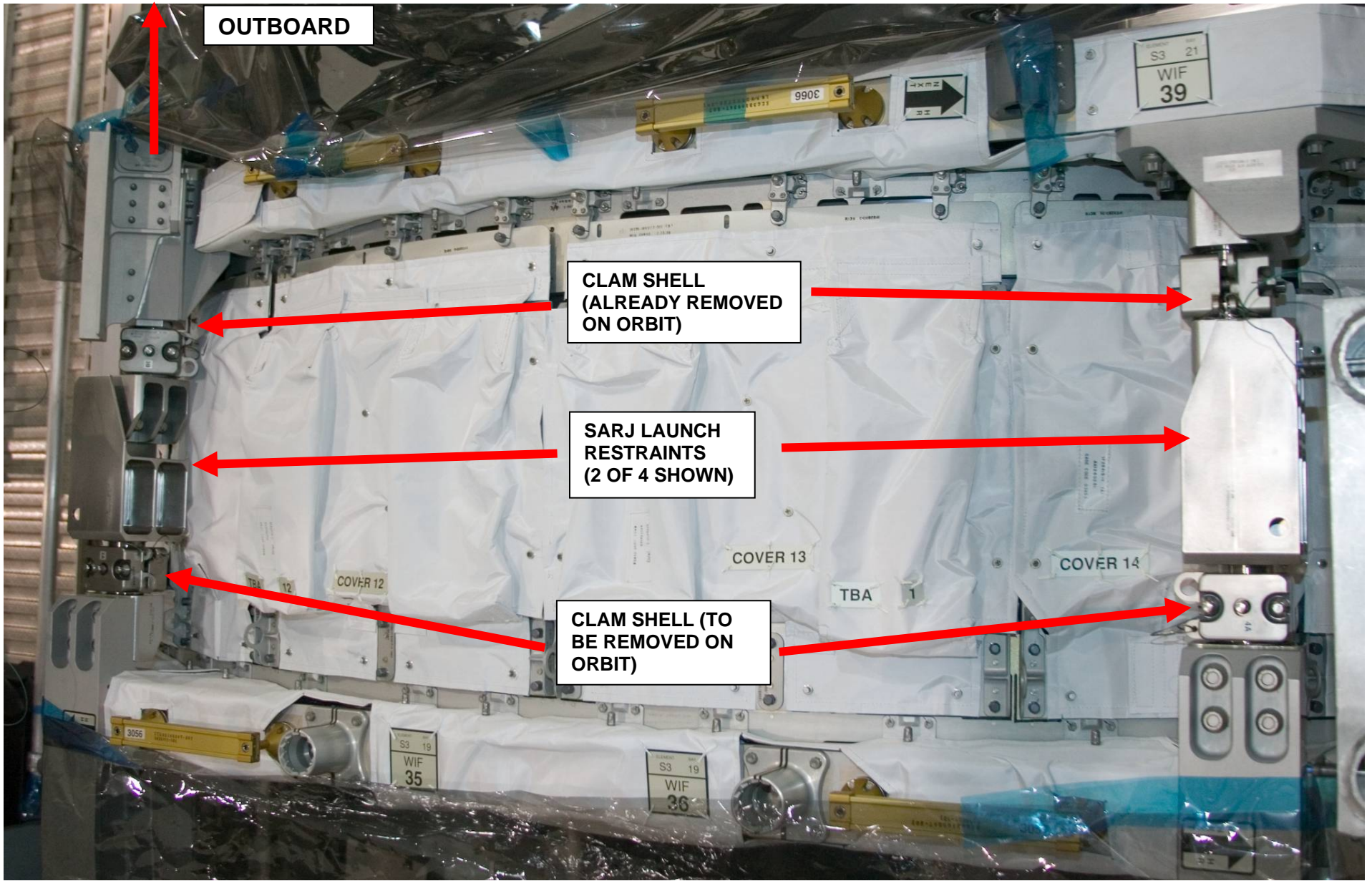
6A LAUNCH RESTRAINT – LAUNCH CONFIG (BACK SIDE)



FACE 6/1/2 ON-ORBIT



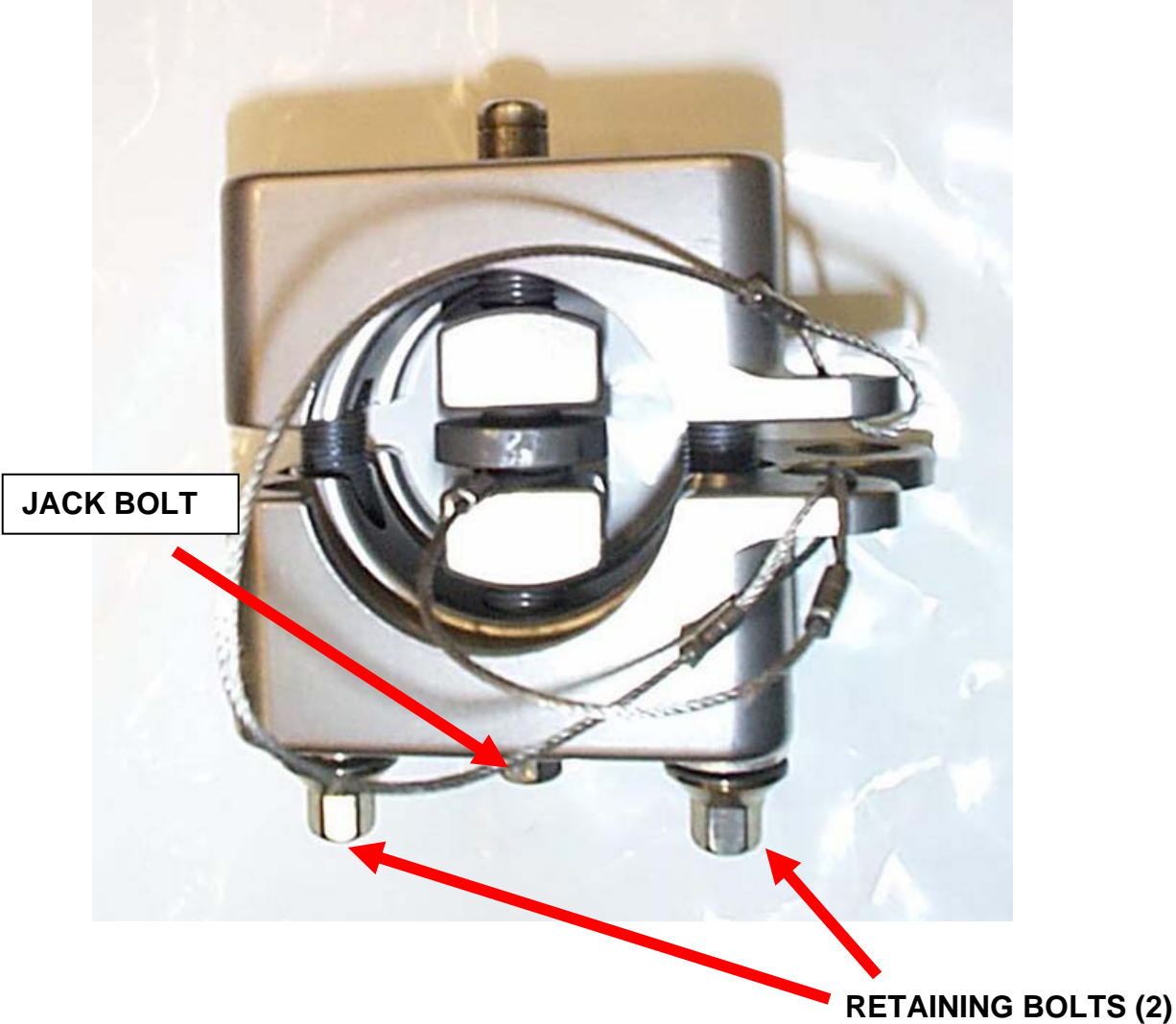
FACE 4 LAUNCH CONFIG



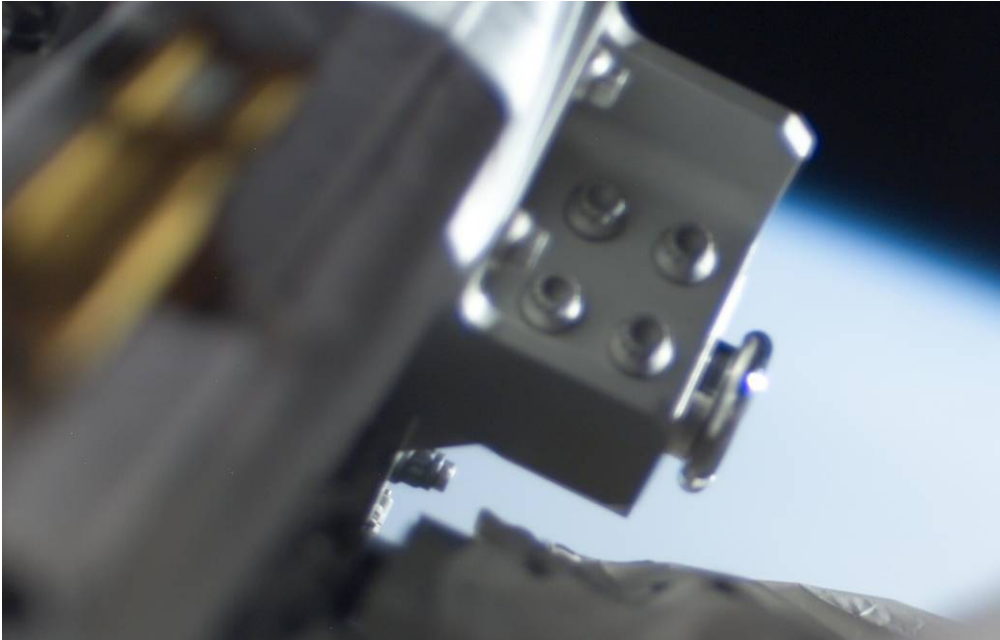
FACE 4 LAUNCH CONFIG (Cont)



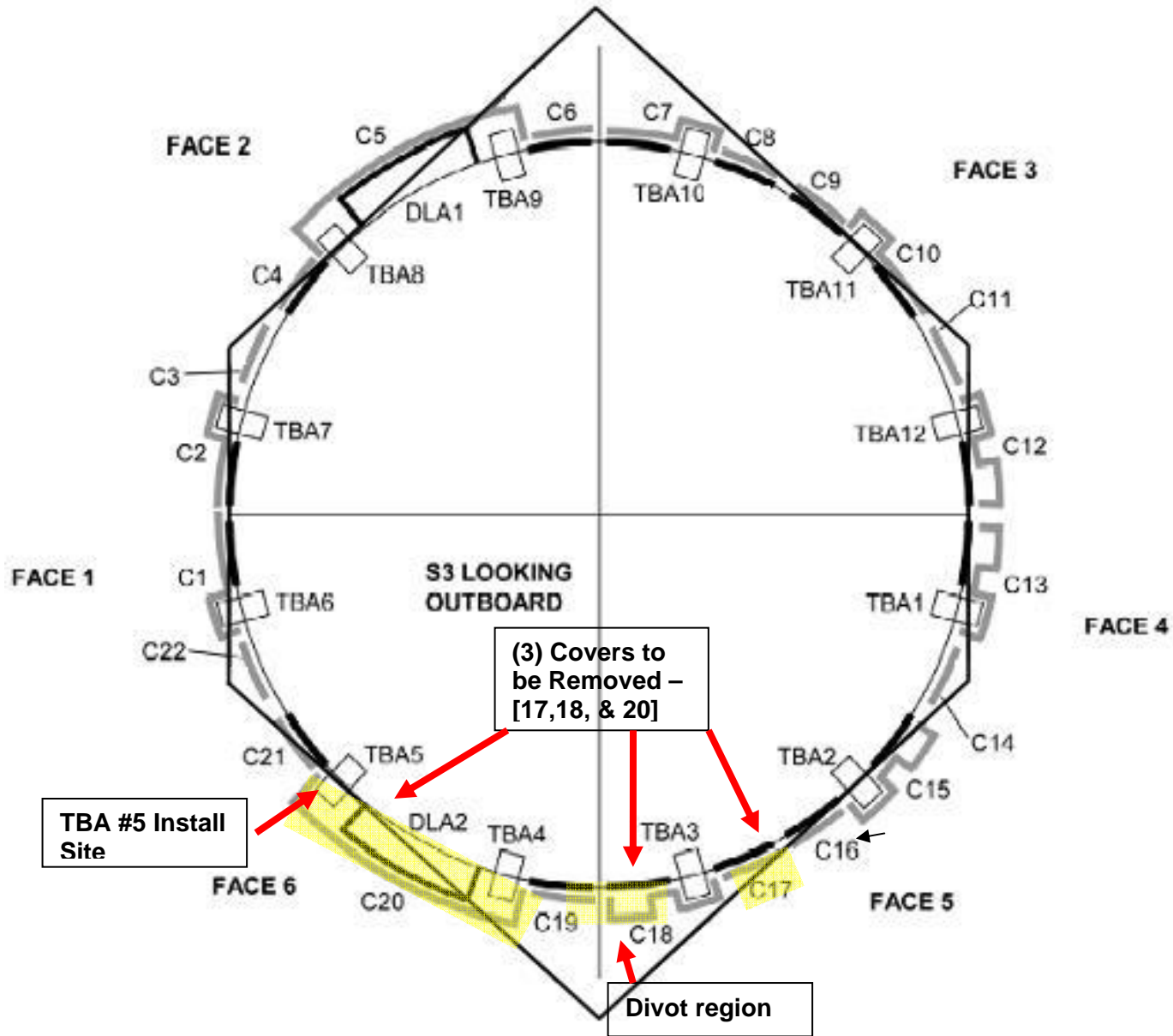
LAUNCH RESTRAINT CLAM SHELL



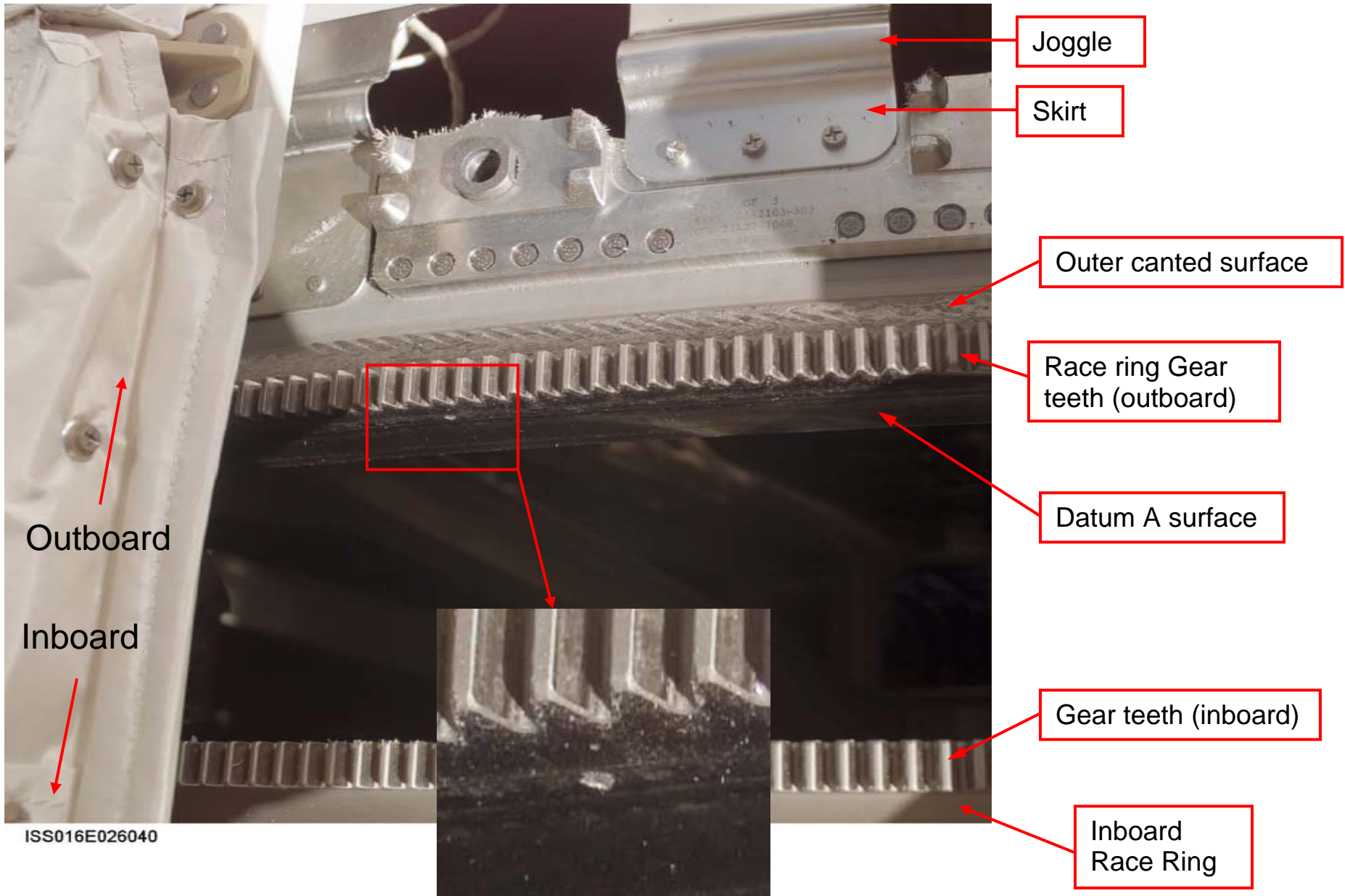
LAUNCH RESTRAINT MUSHROOM-SHAPED FITTING



COVER/TBA/DLA LABELING



COVER 18 REMOVED – DIVOT REGION



ISS016E026040

FS 18-99

EVA/124/FIN

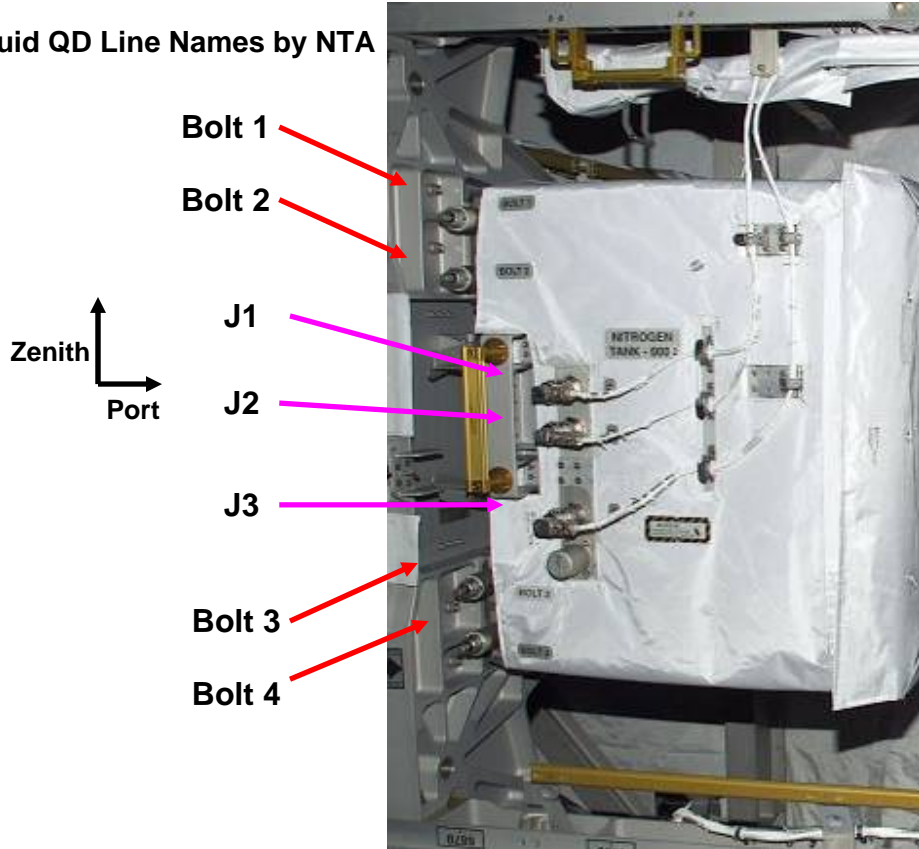
NTA

NTA

NOMENCLATURE

Nitrogen Tank Assembly (Front Side: Electrical Connectors & Bolts)

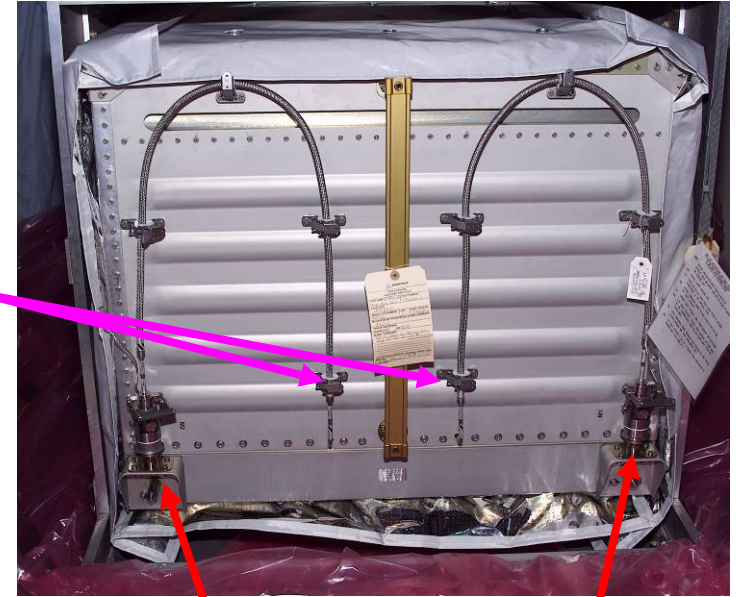
Fluid QD Line Names by NTA



Nitrogen Tank Assembly (Aft Side: Electrical Connectors & Bolts)

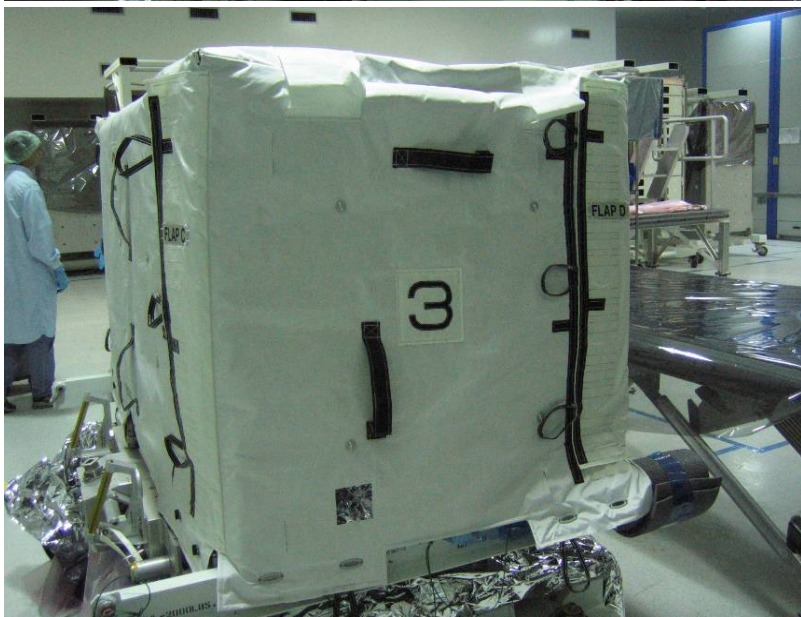
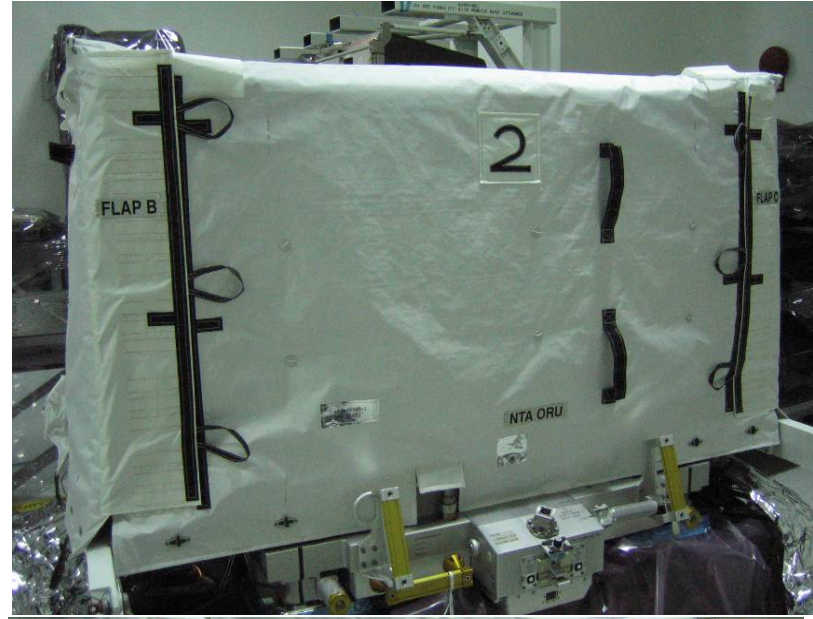
Two N2 fluid QD lines on the Aft face of the NTA

TA Clamp nearest each line origin must remain

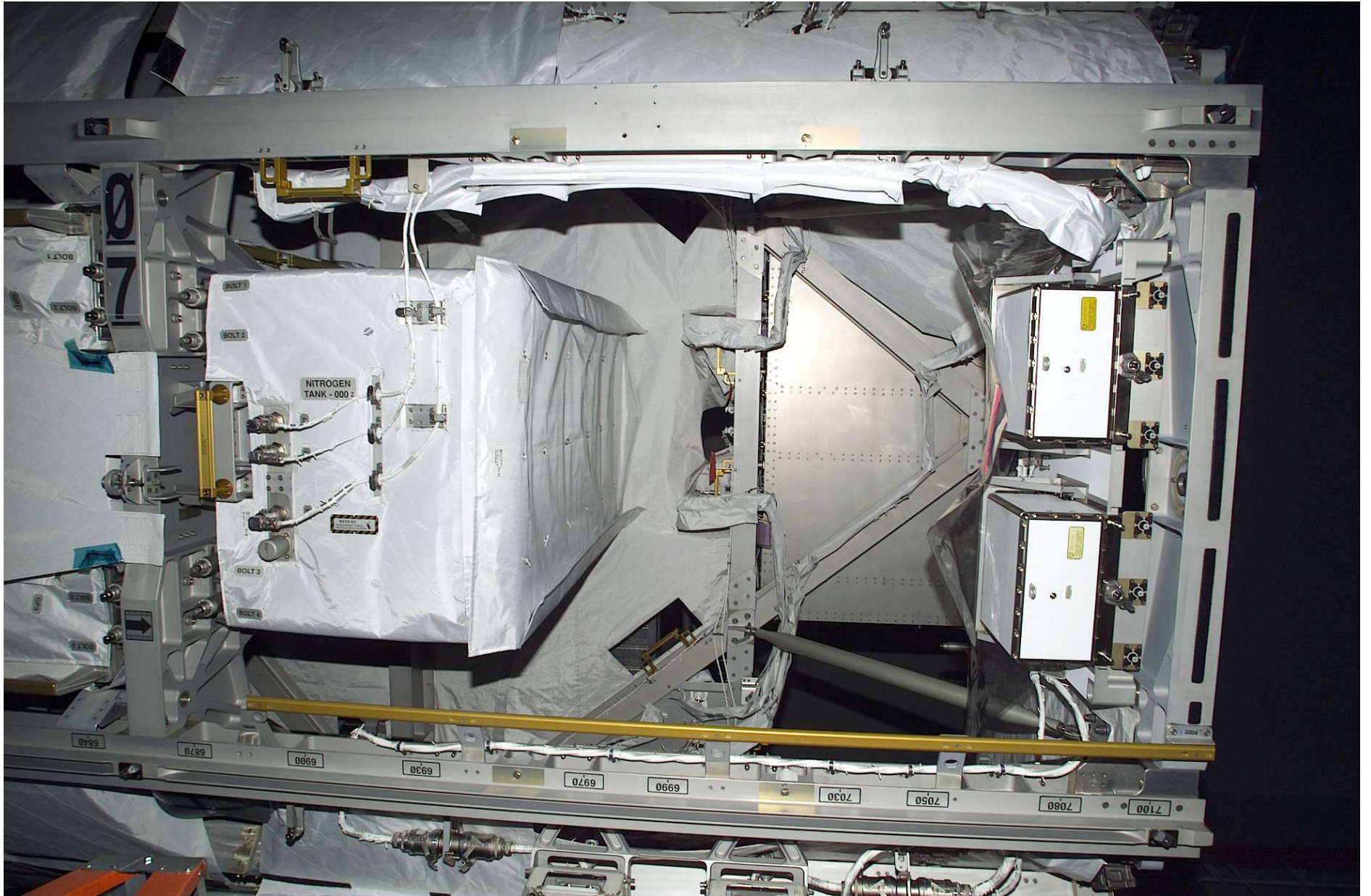


| Old S1 NTA (Empty/Failed) | New S1 NTA (Full/Spare) |
|---------------------------|---------------------------------|
| | Female Name/Dummy Male/ATA Male |
| F46 (Zenith) | F1/M2/M1 (Zenith) |
| F47 (Nadir) | F2/M3/M2 (Nadir) |

ESP3 MLI



S1 CLOSEUP VIEW



FS 18-102

EVA/124/FIN

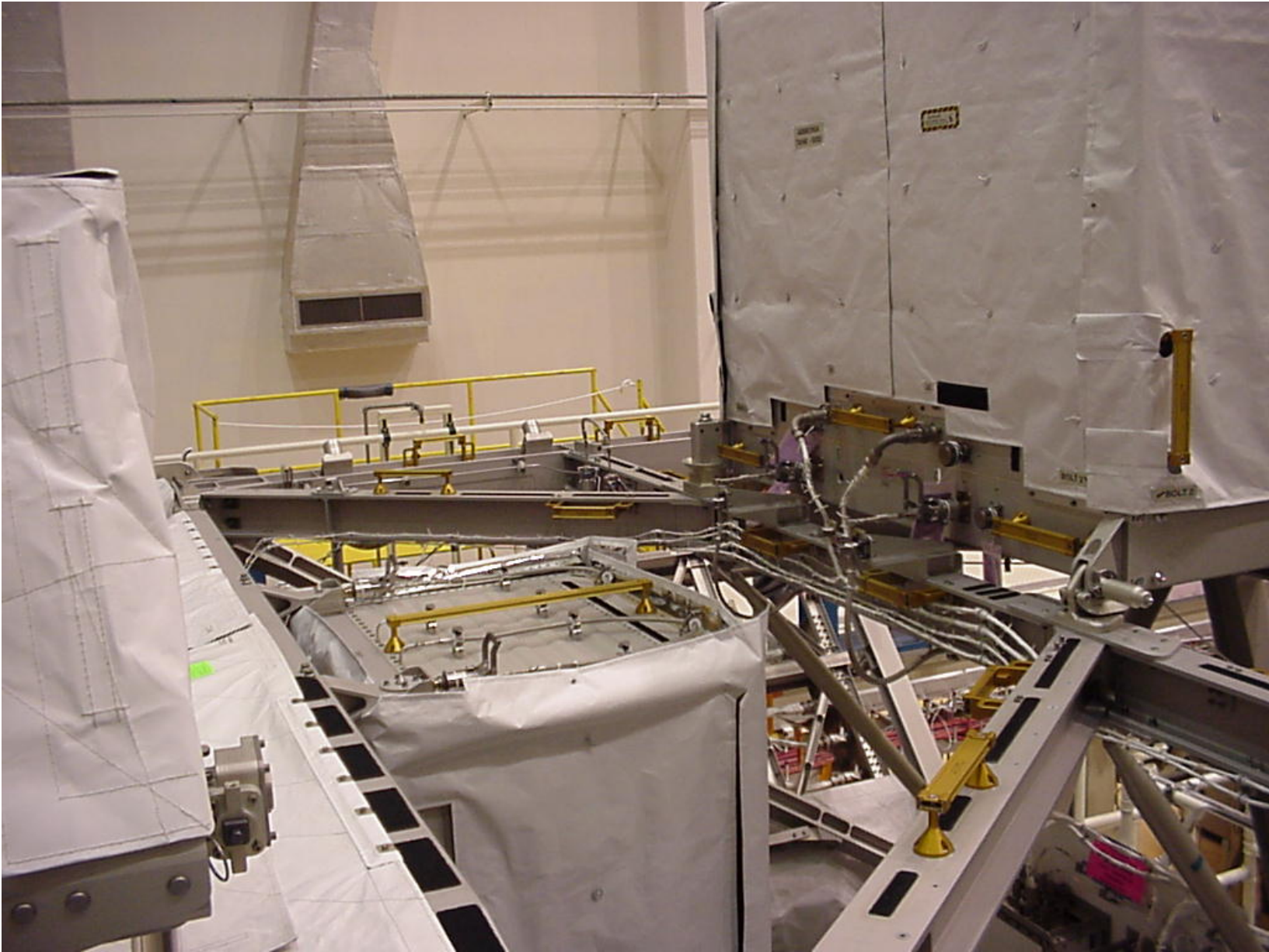
S1 ON-ORBIT (FWD VIEW)



S1 ON-ORBIT (AFT VIEW)

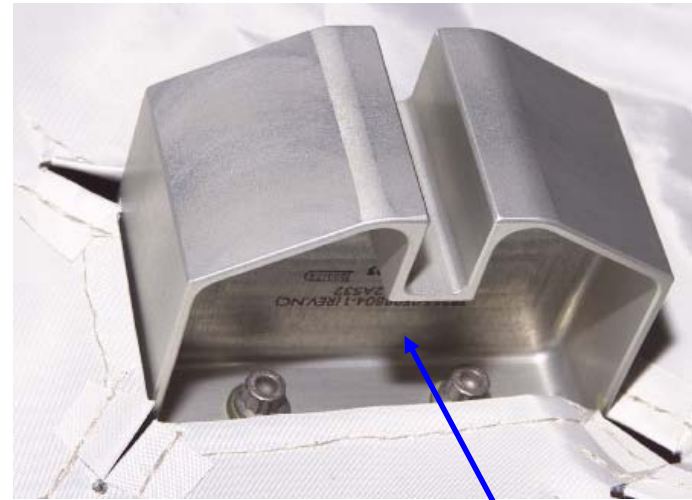
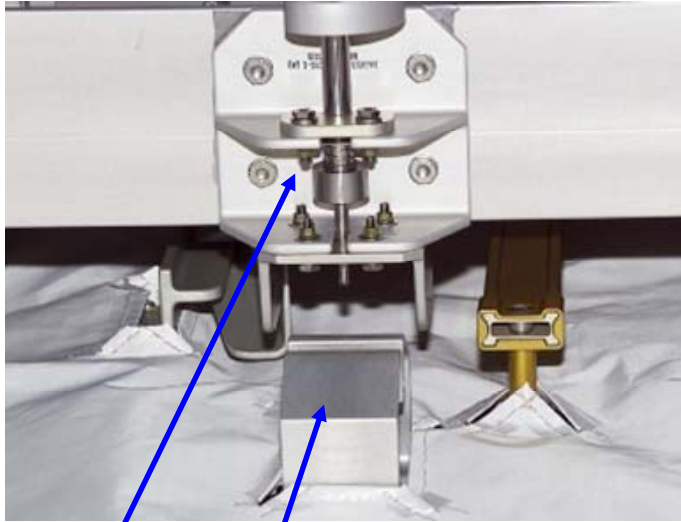


S1 ON-ORBIT (AFT VIEW) MLI REMOVED



S1 SOFT DOCK

← Micro-conical (out of picture)

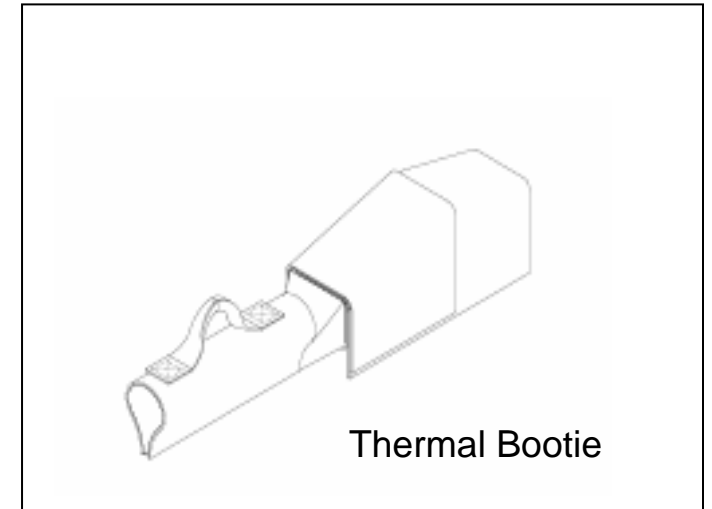
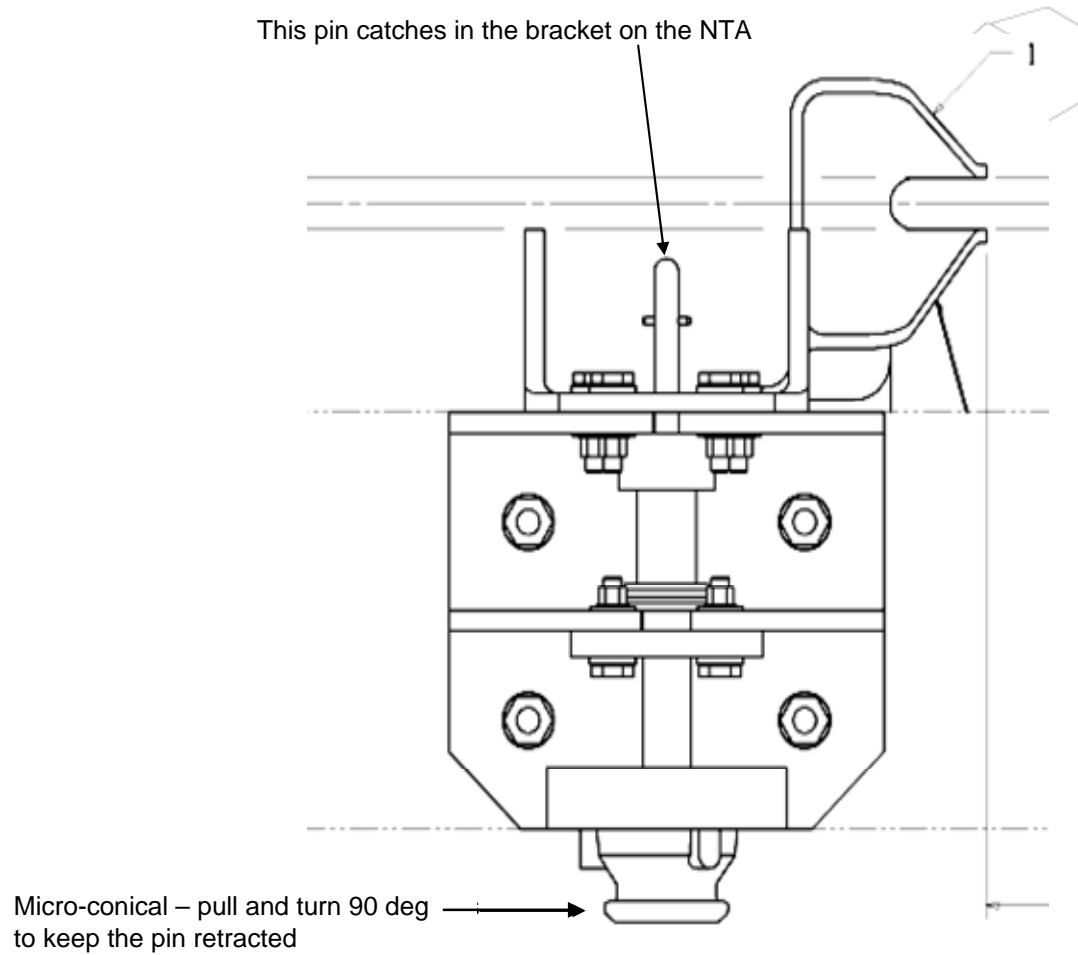


Soft dock bracket
Soft dock mechanism



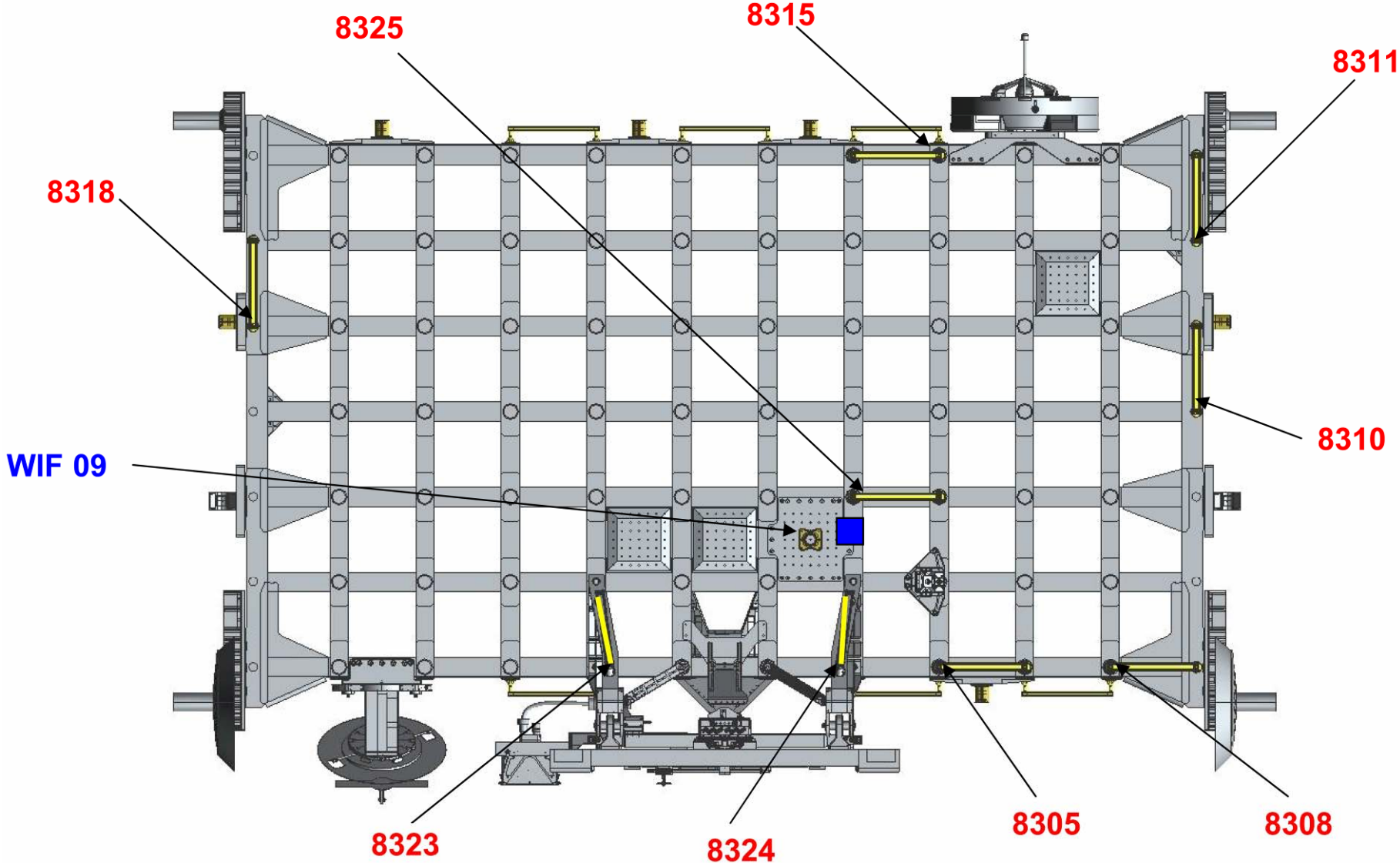
Soft dock bracket
Location of soft dock mechanism

S1 SOFT DOCK (Cont)

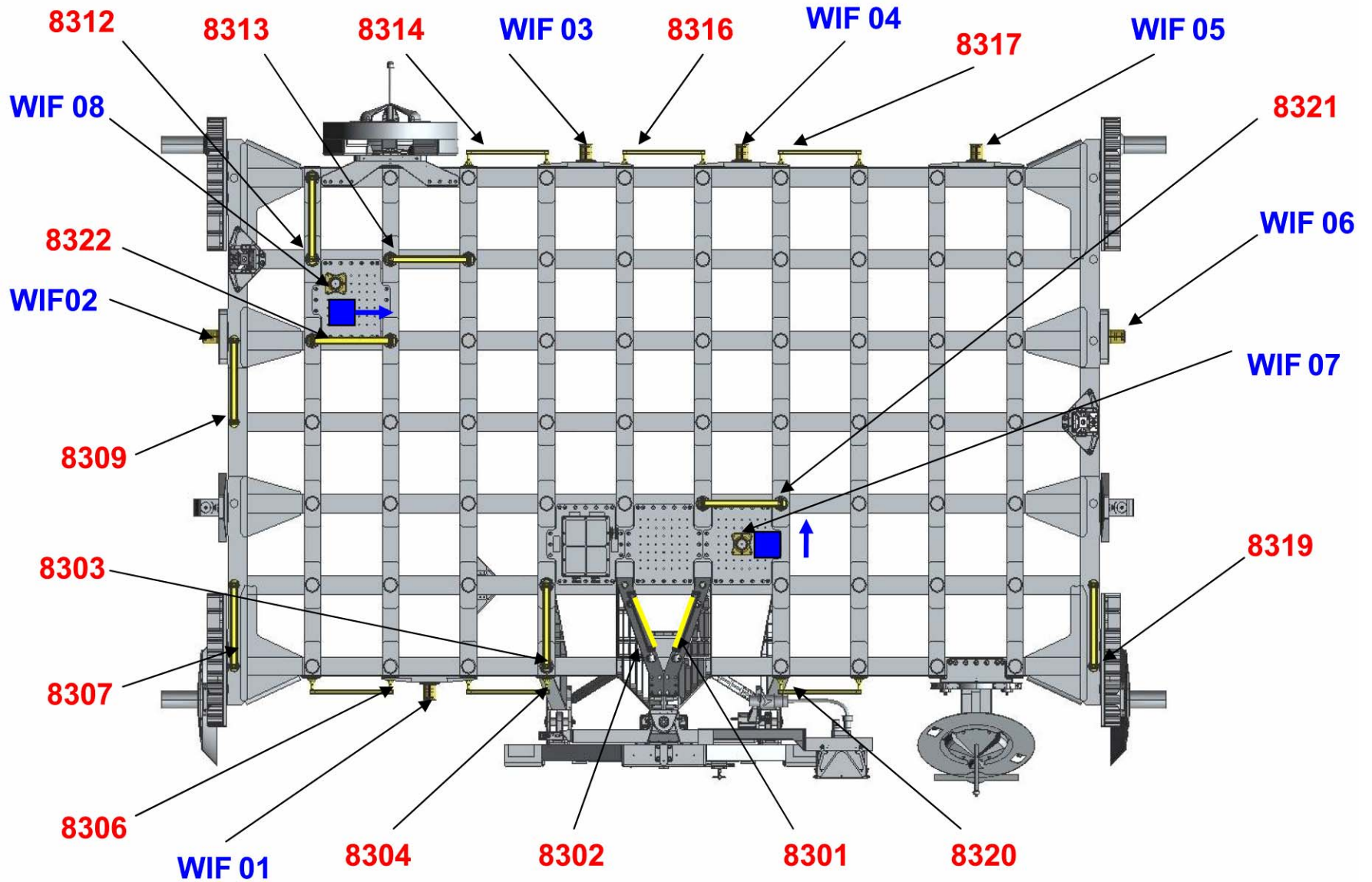


ESP3

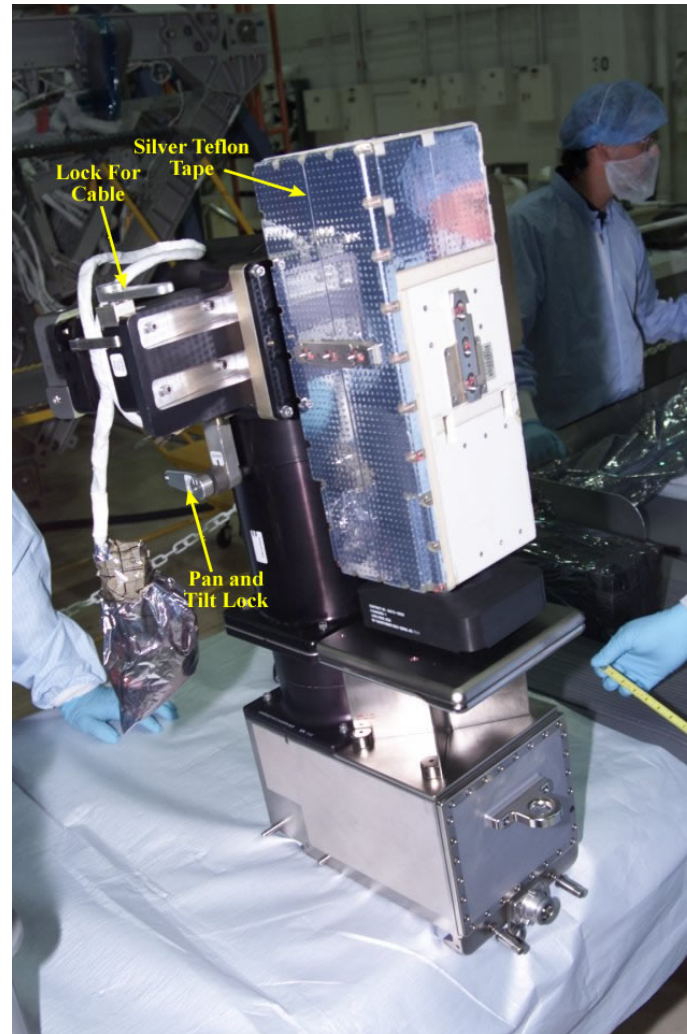
ESP3 HANDRAILS/WIFs – STBD SIDE



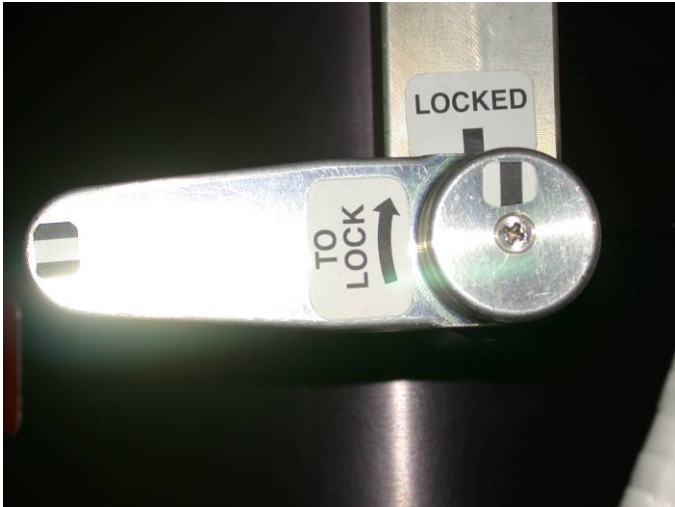
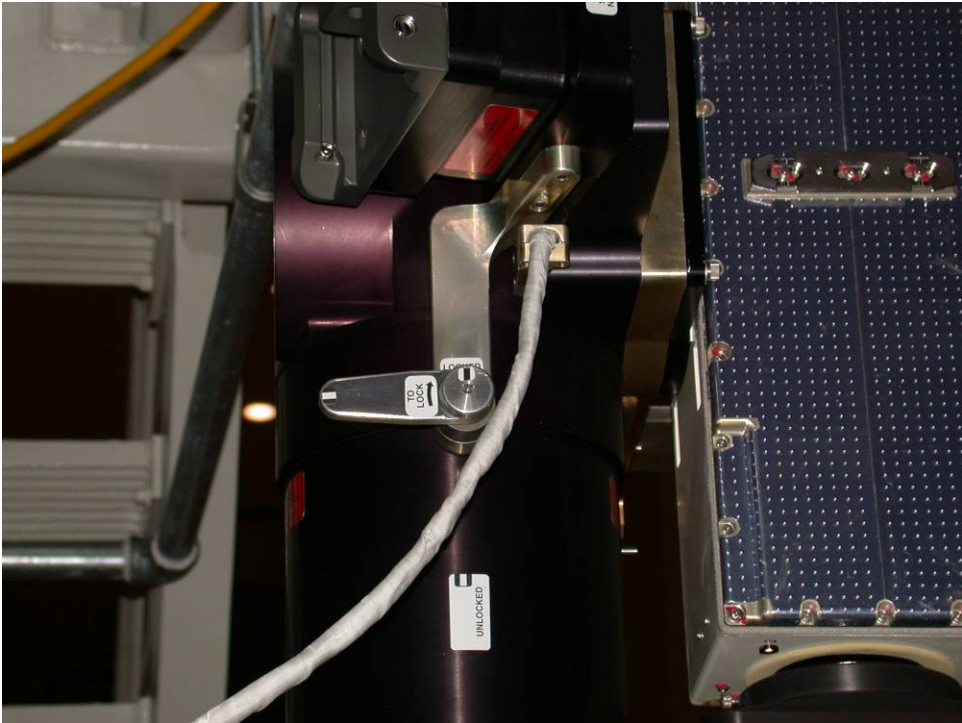
ESP3 HANDRAILS/WIFs – PORT SIDE



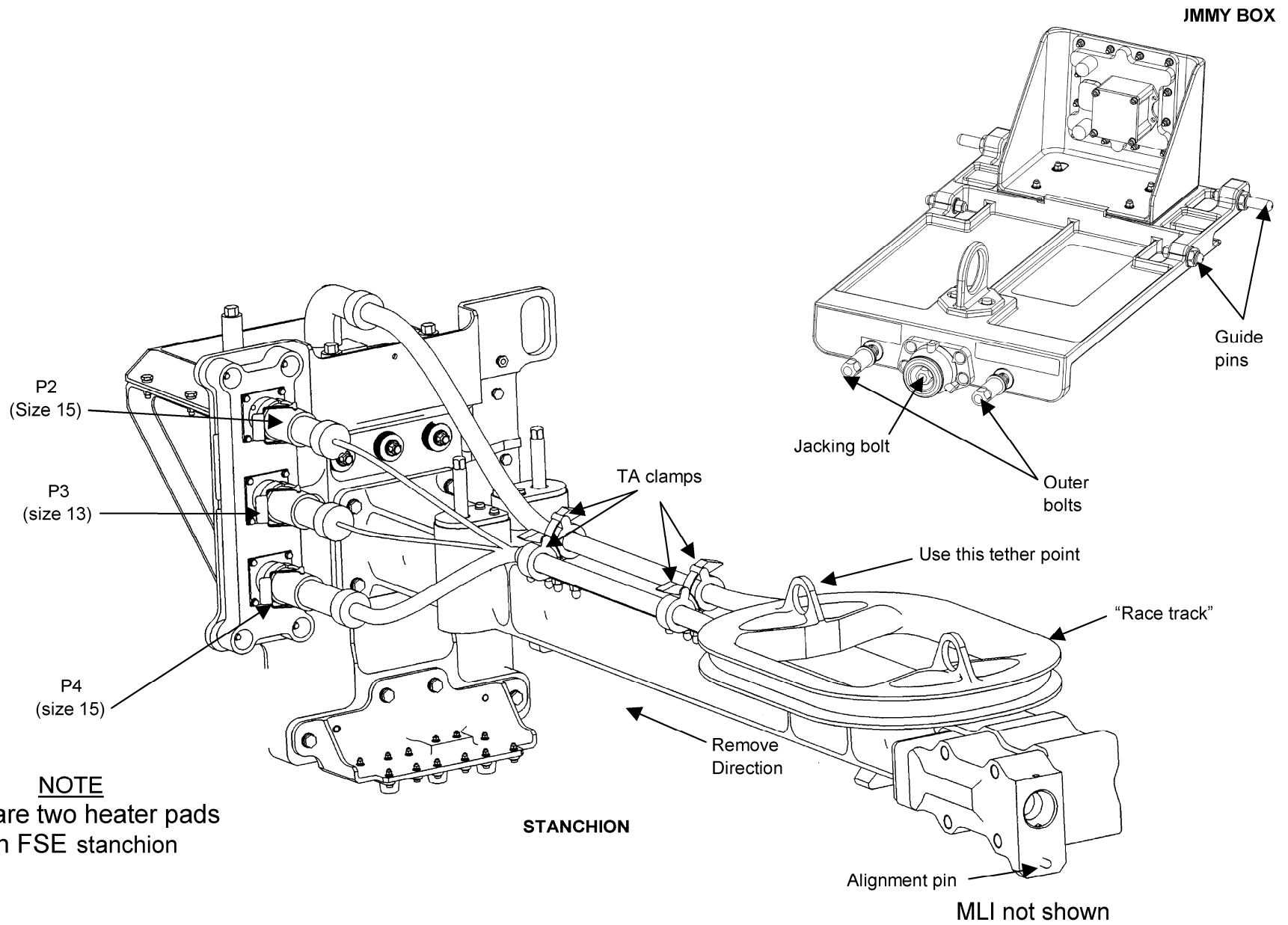
CAMERA LABELED



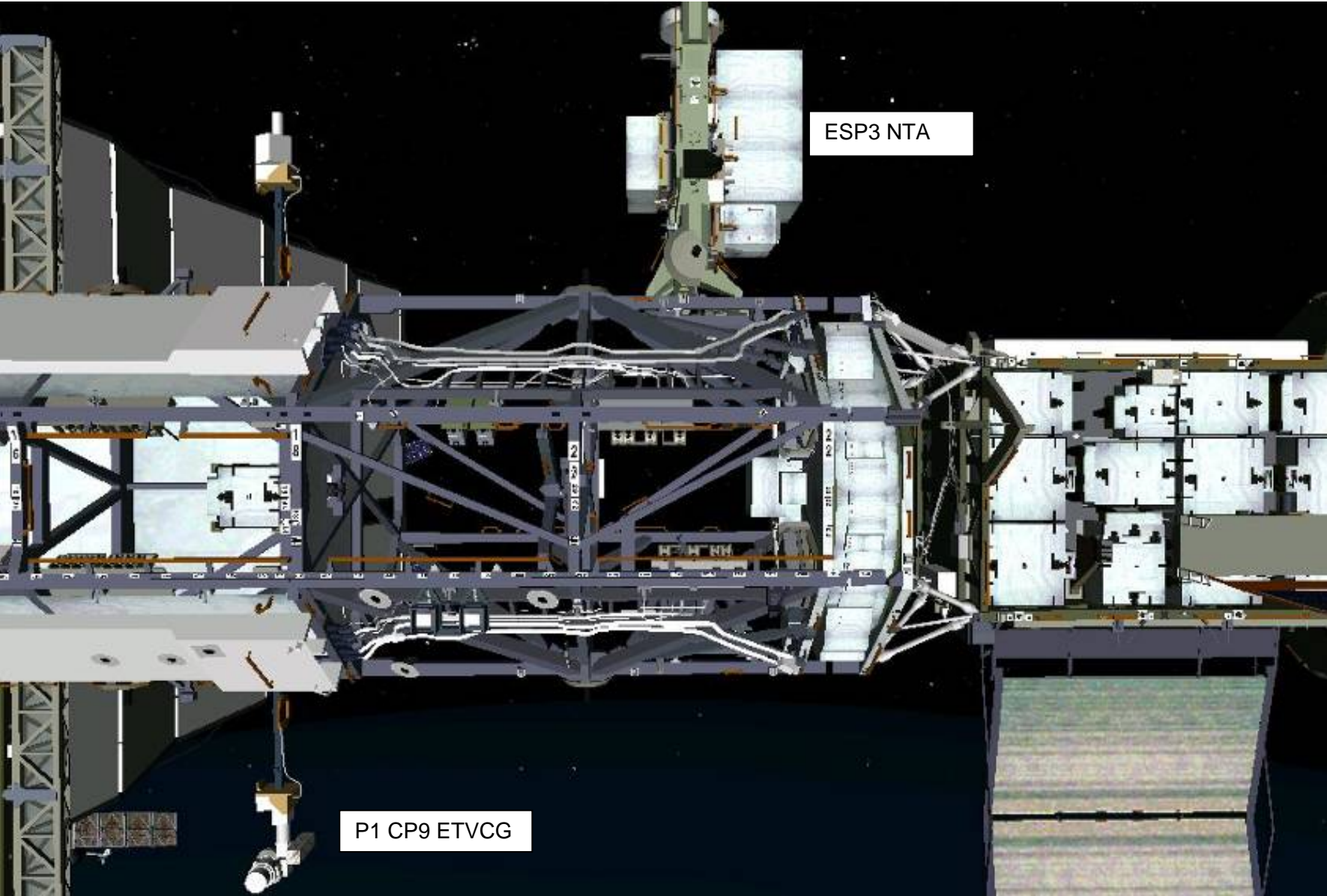
CAMERA LOCK



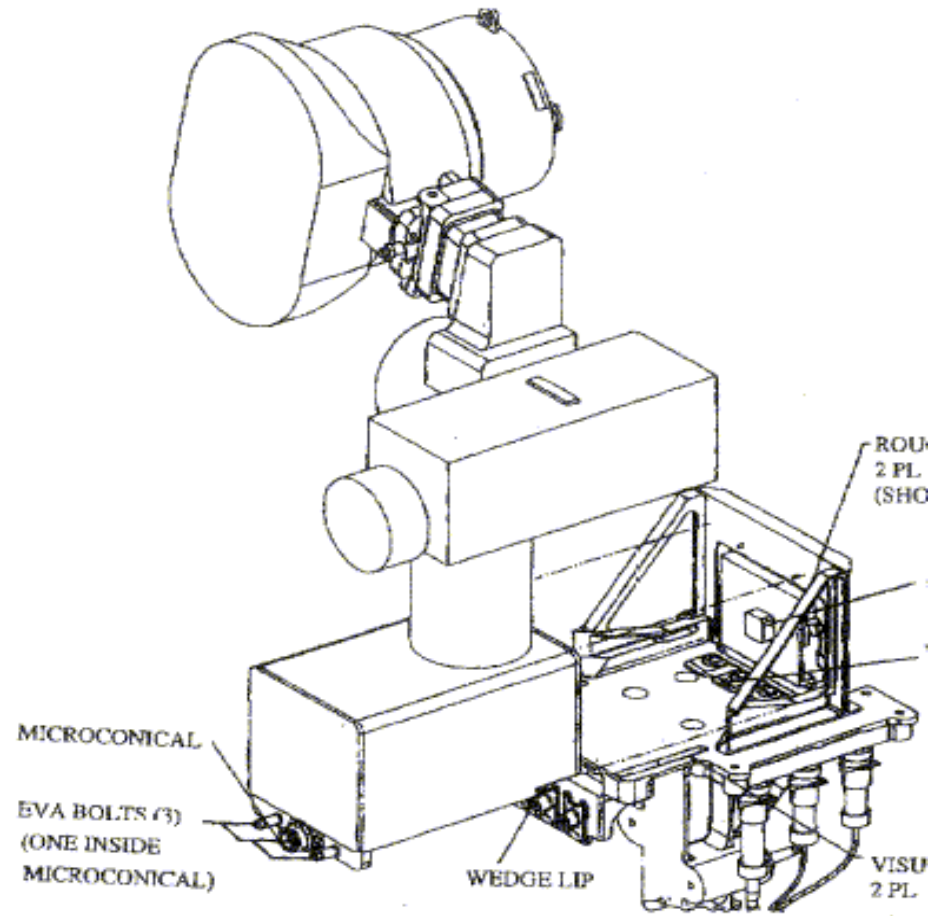
CAMERA STANCHION/DUMMY BOX LABELED



WORKSITE OVERVIEW



DRAWING LABELED



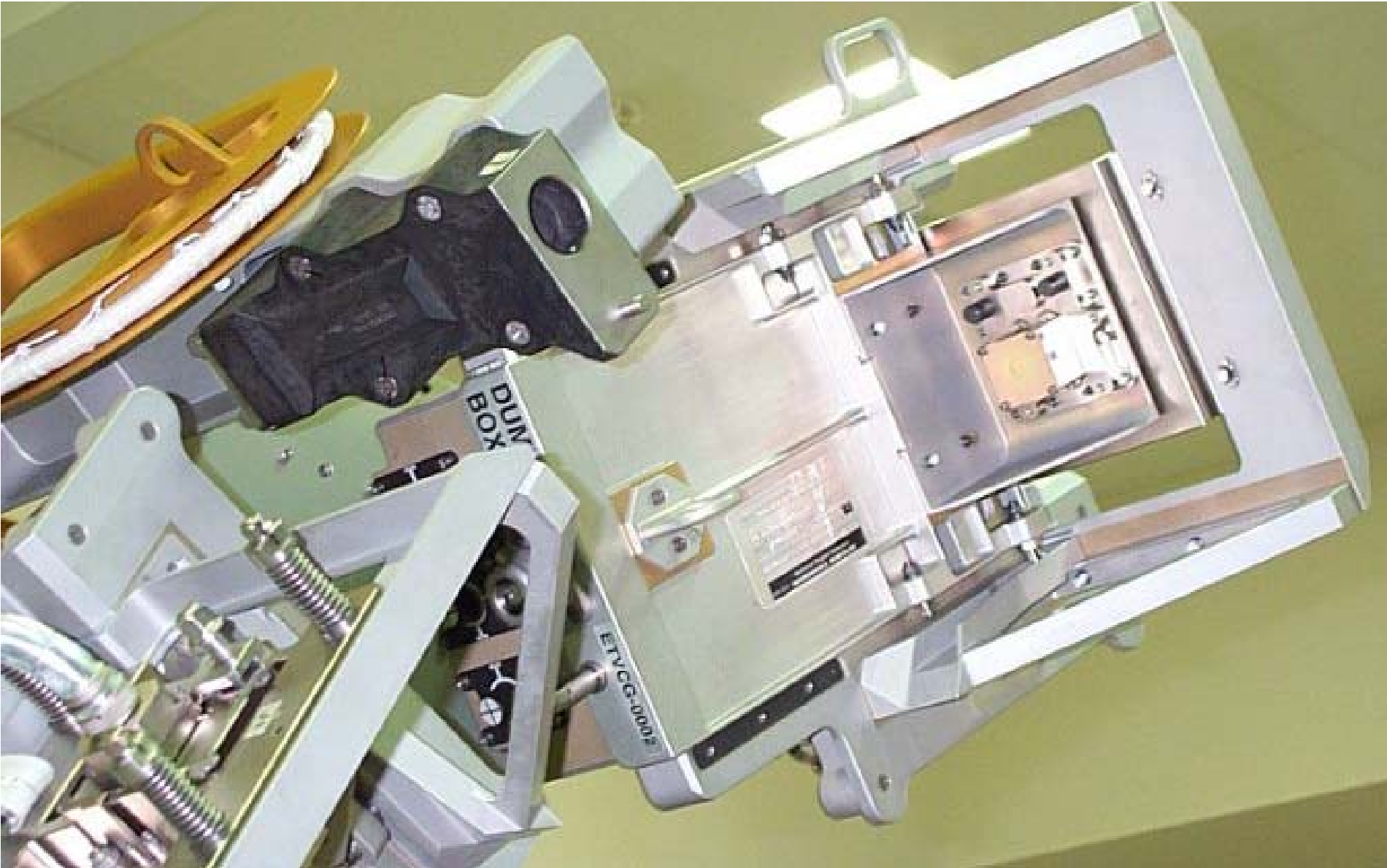
ARINC on TVCIC which interfaces
with the EVGSS.

ETVCG

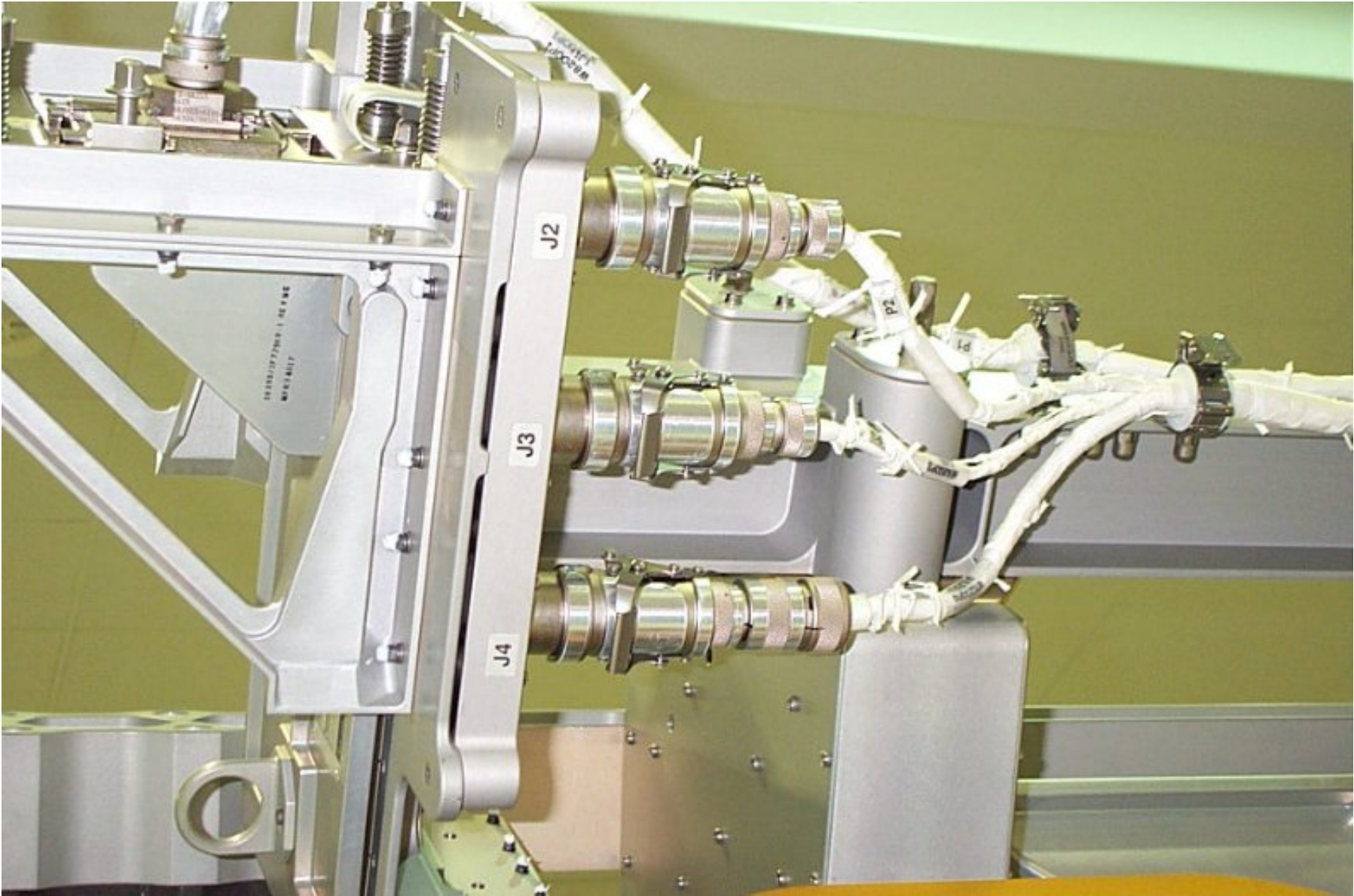
DUMMY BOX INSTALLED



DUMMY BOX INSTALLED (Cont)



DUMMY BOX INSTALLED (Cont)



ASSEMBLY PHOTOS

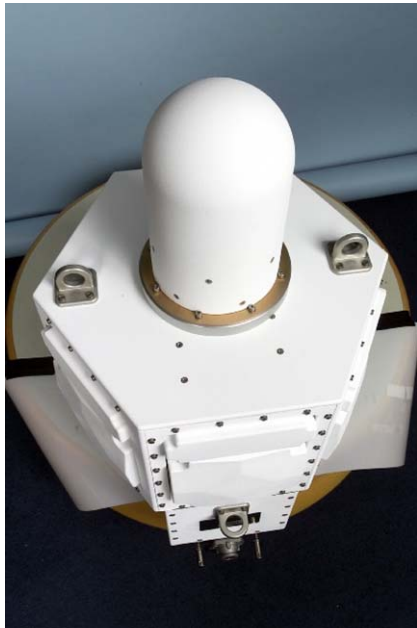


FS 18-118



EVA/124/FIN

ASSEMBLY PHOTOS (Cont)

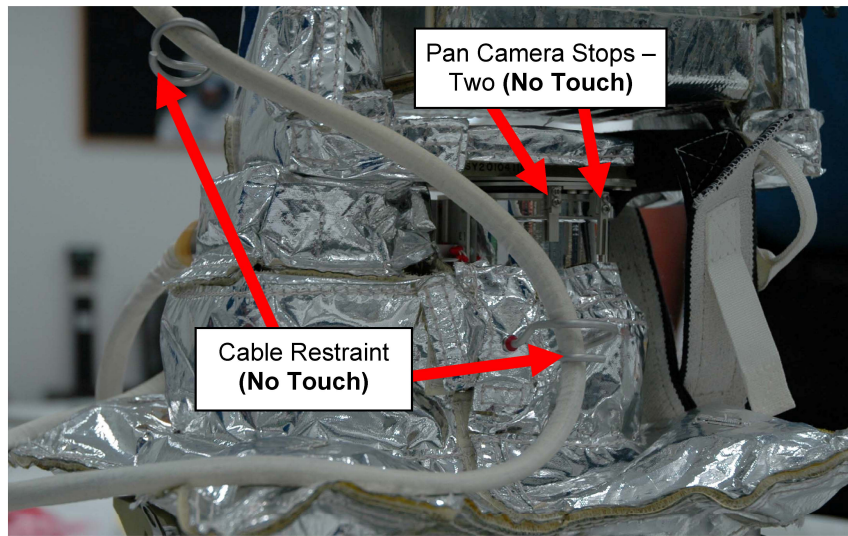
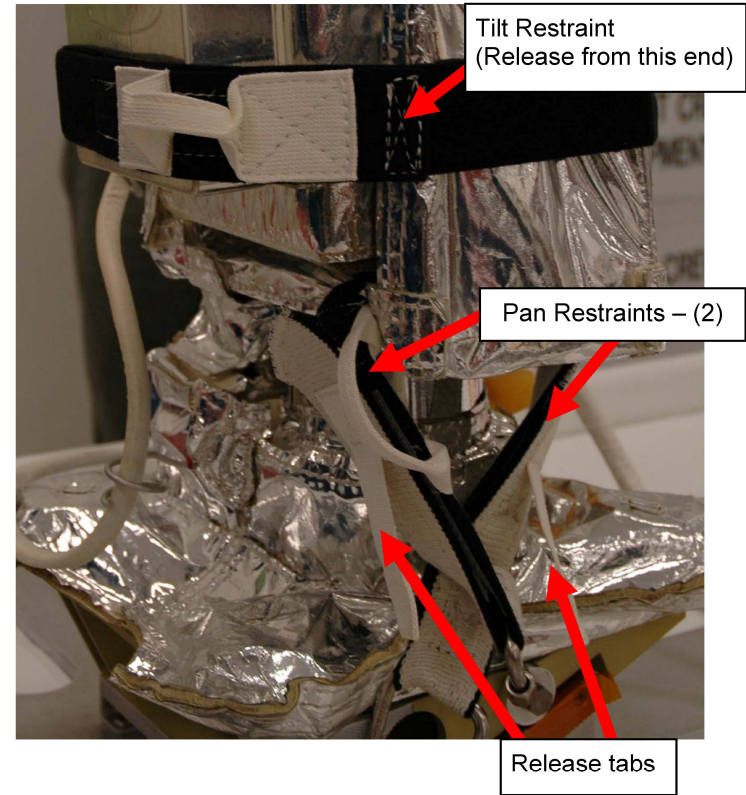
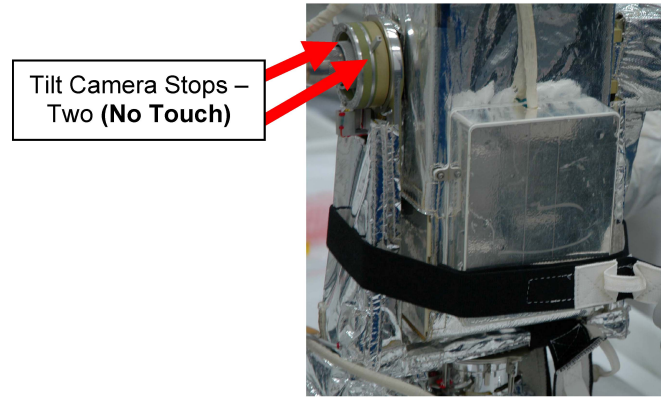
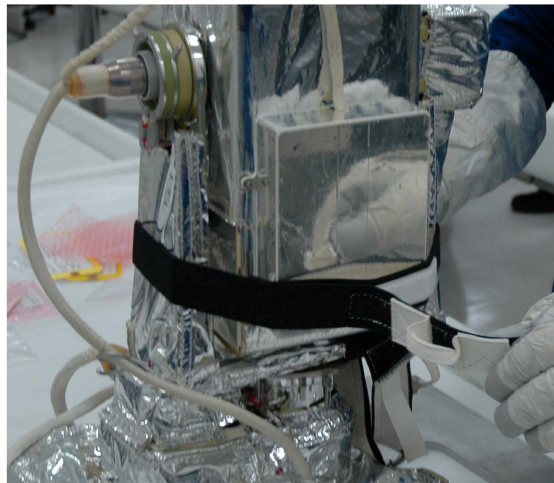
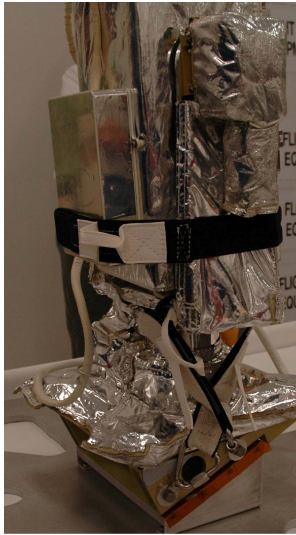


FS 18-119

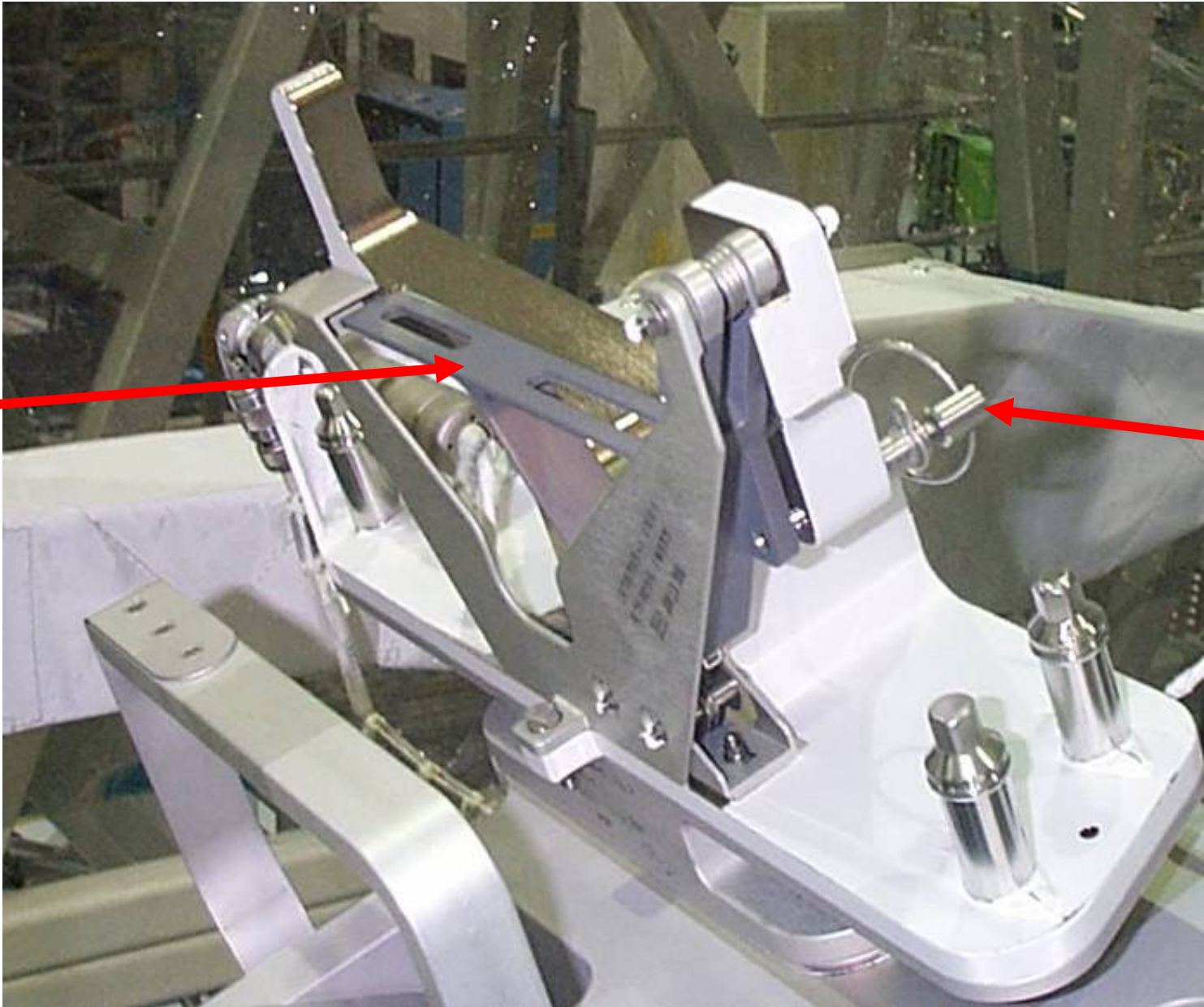
EVA/124/FIN

MISC

SRMS ELBOW CAMERA STRAP



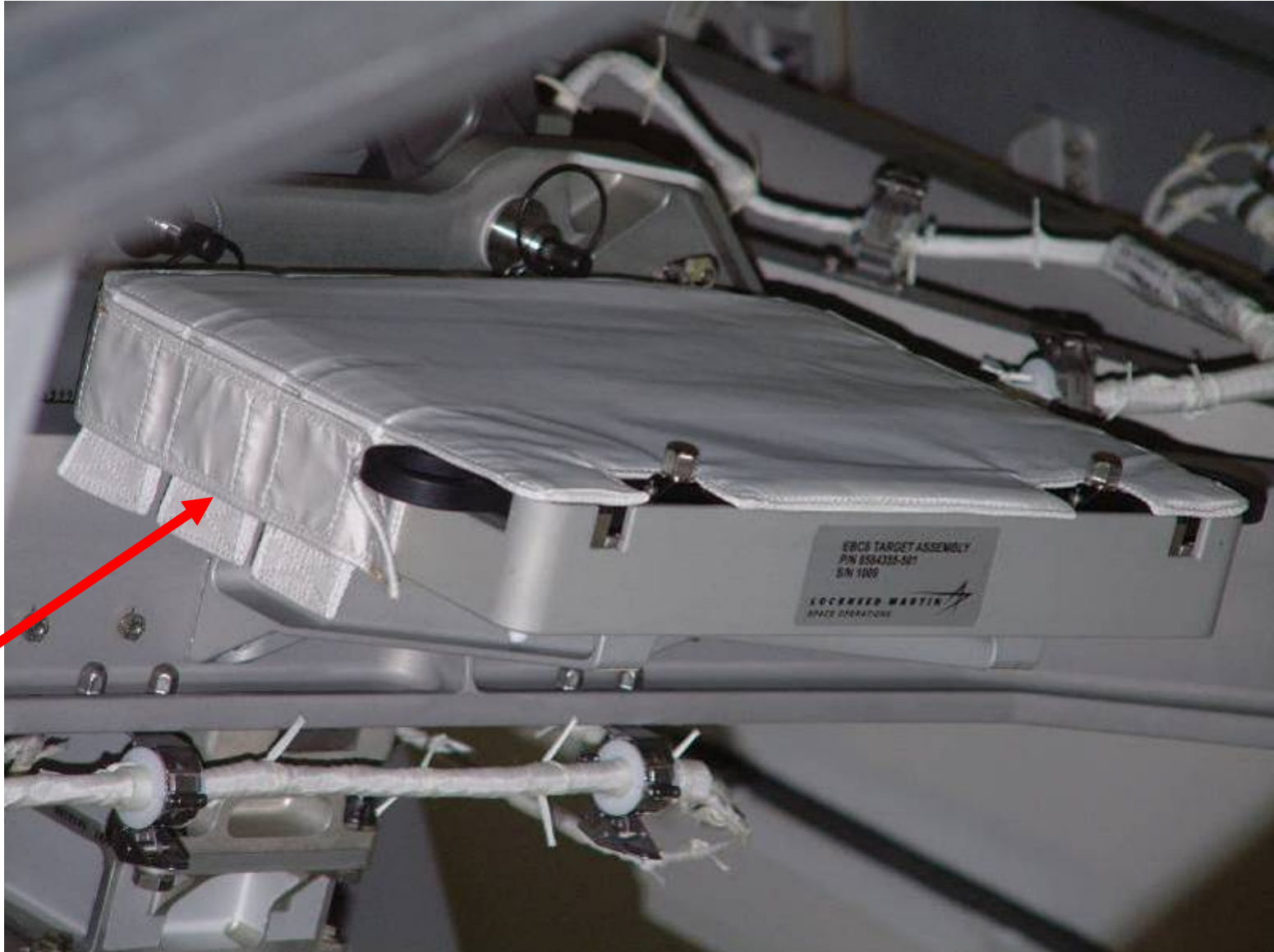
MCAS PIP PIN REMOVAL AND RTL CHECKOUT



RTL lever

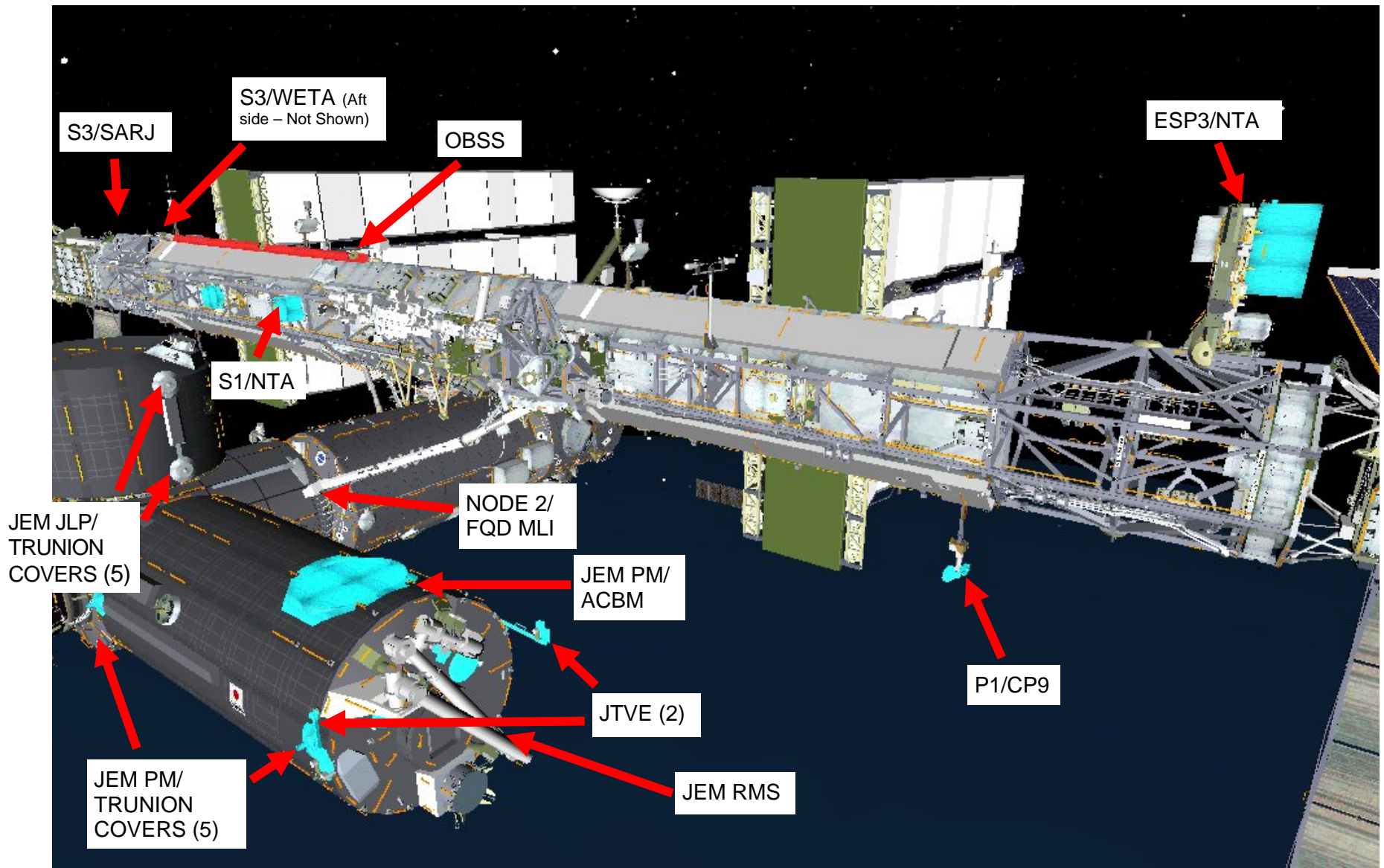
Launch
Restraint
PIP pin

MCAS EBCS MLI REMOVAL



Velcro
Strap
Release

1J EVA WORKSITES OVERVIEW



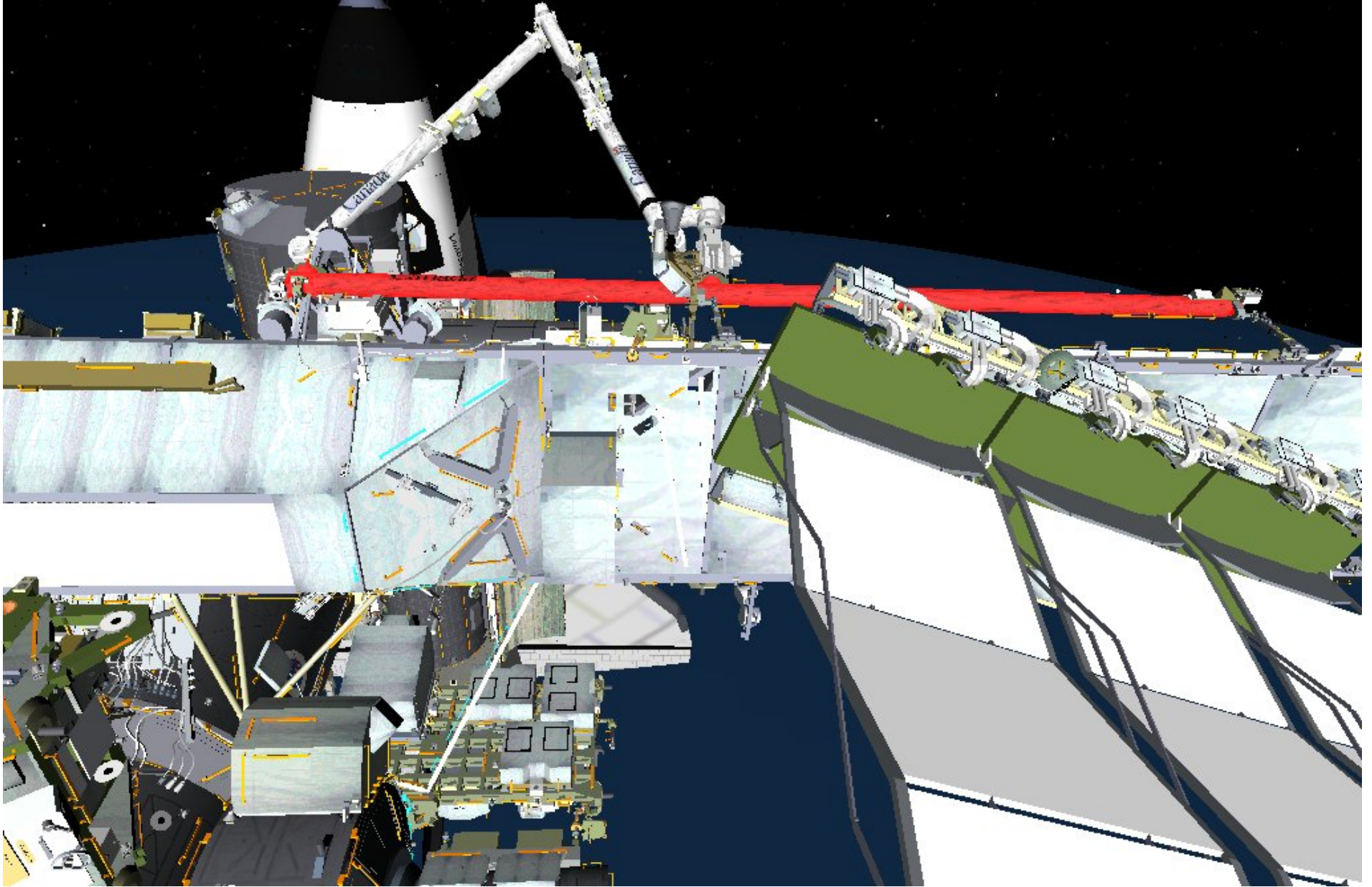
FS 18-123

EVA/124/FIN

**TRANSLATION
PATHS**

TRANSLATION PATHS

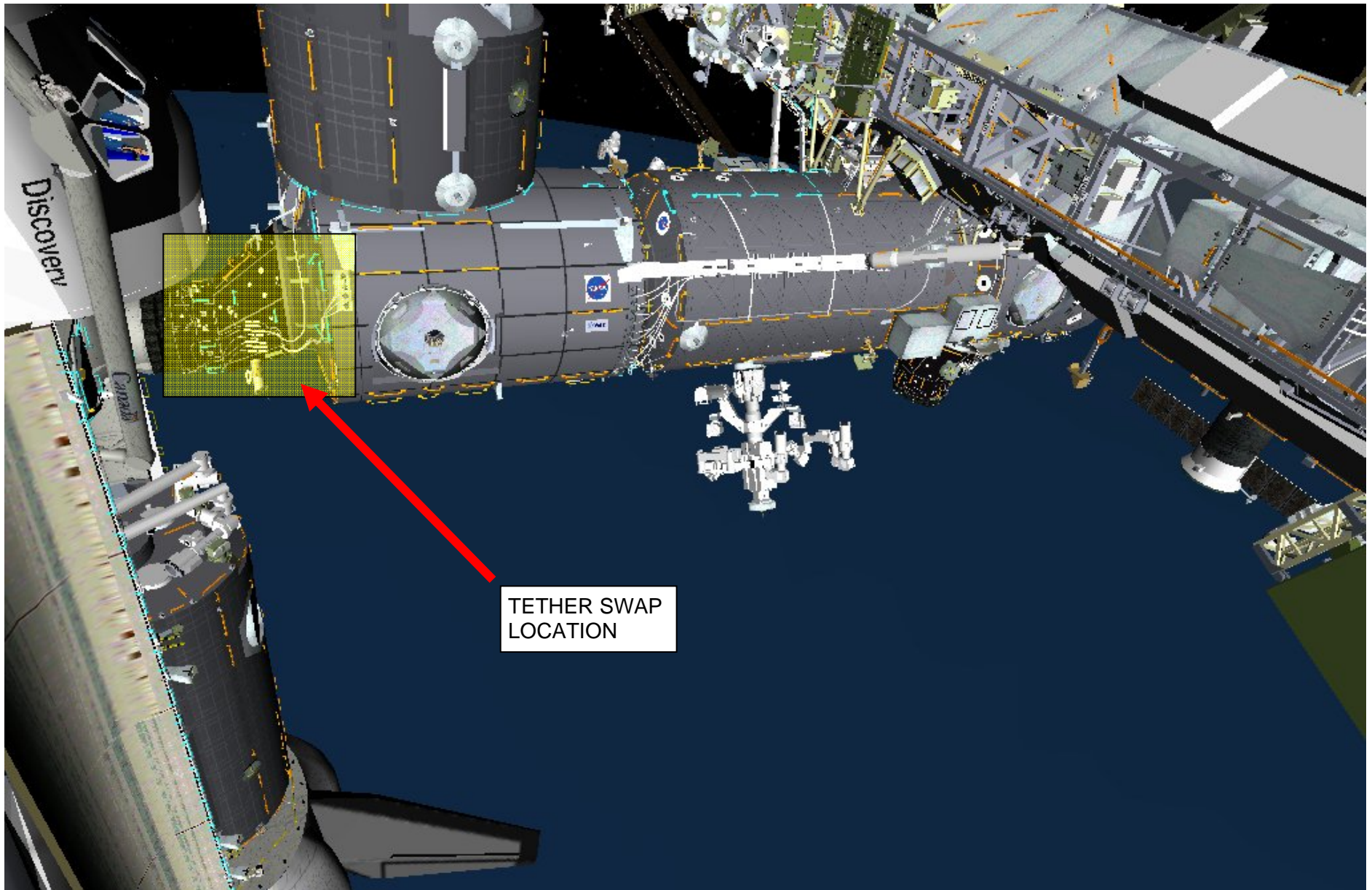
EVA 1: A/L TO OBSS



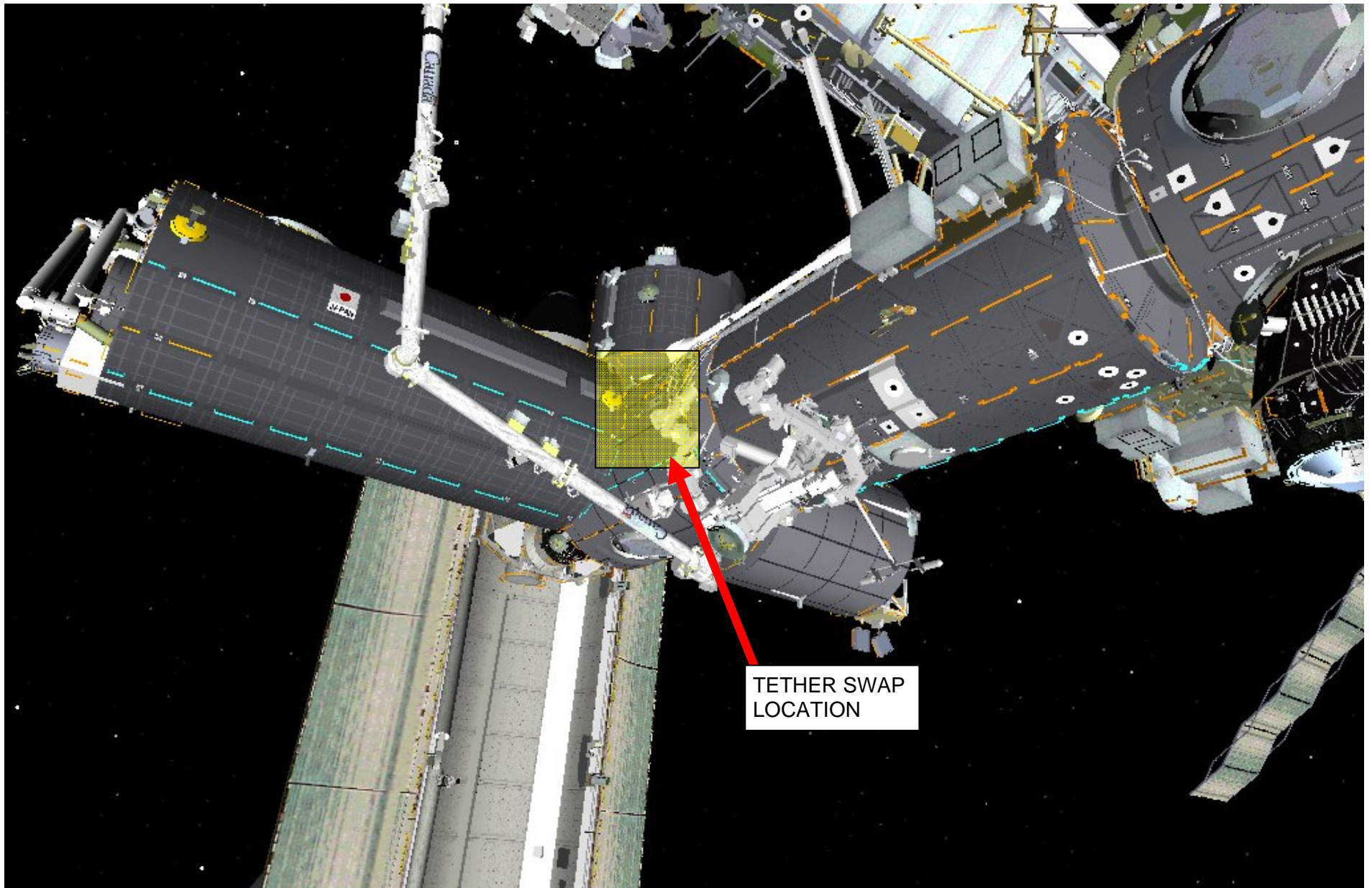
FS 18-124

EVA/124/FIN

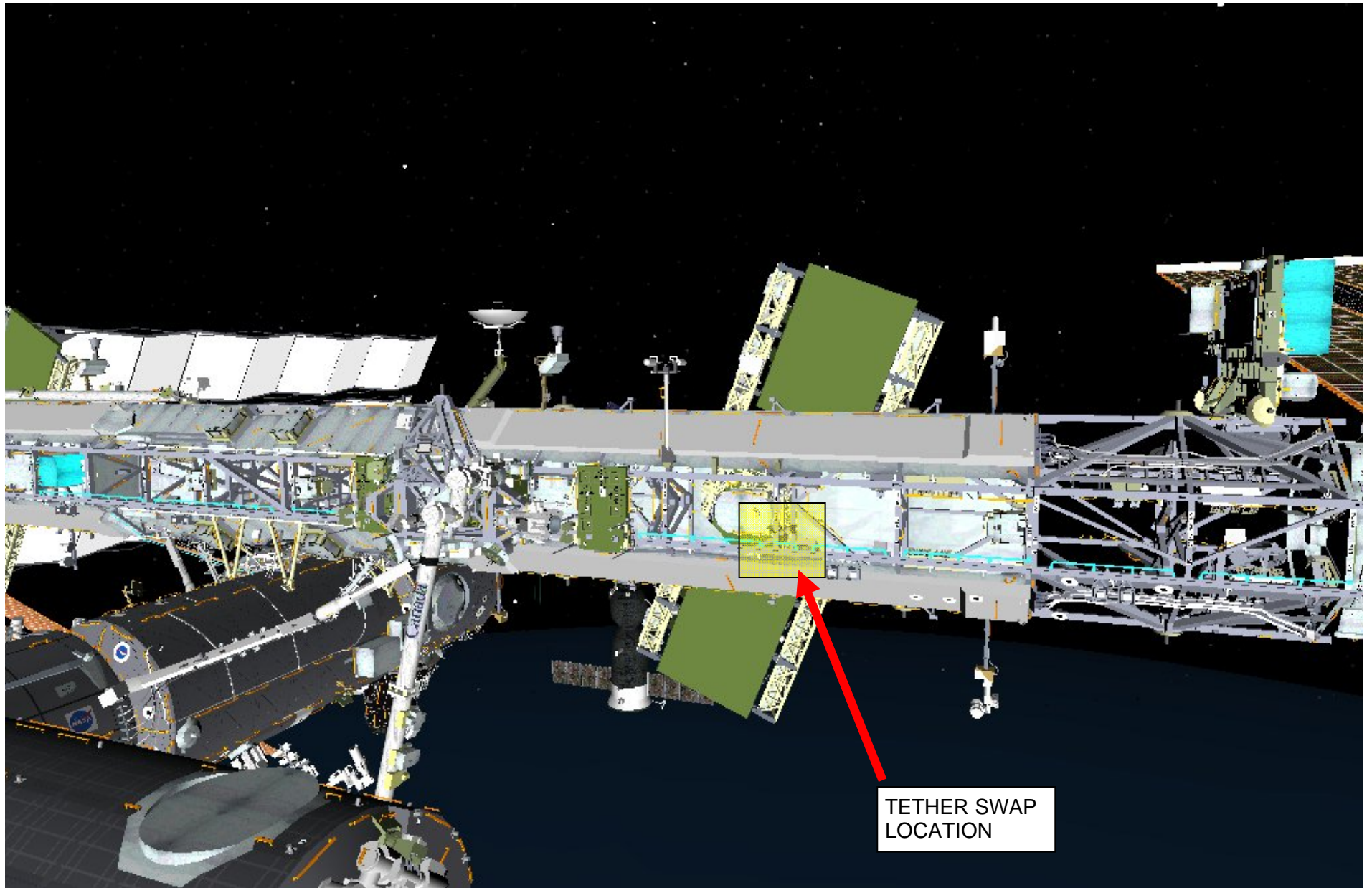
EVA 1: OBSS TO JEM PM IN PLD BAY



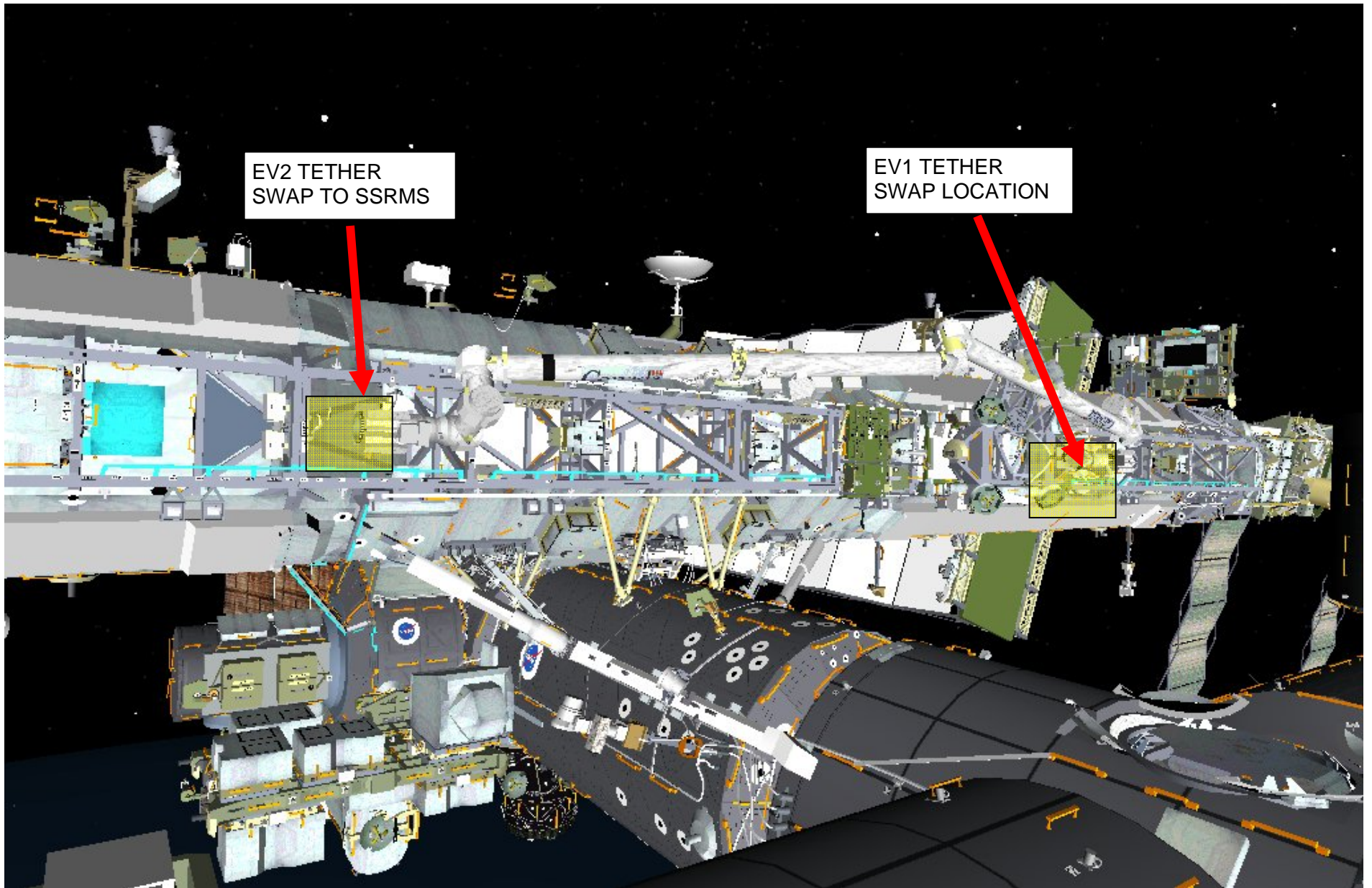
EVA 2: A/L TO JEM PM ENDCONE



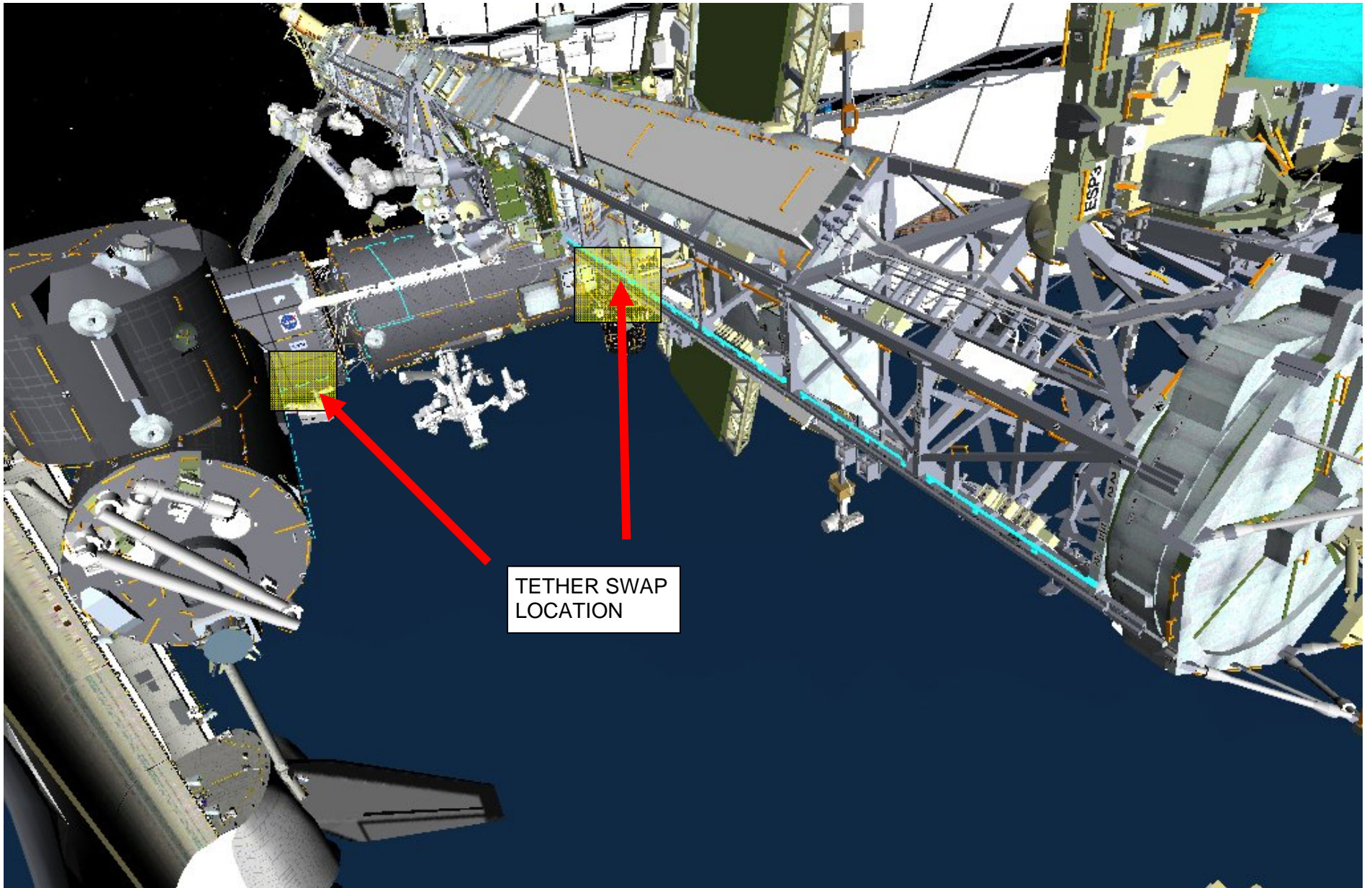
EVA 2: A/L TO S1 AND ESP3 NTA



EVA 3: A/L TO S1 AND ESP3 NTA



EVA 3: A/L TO JEM PM ENDCONE



This Page Intentionally Blank



EVA CHECKLIST

STS 124