

# EVA Checklist

## STS-133 Flight Supplement

---

**Mission Operations Directorate  
EVA, Robotics, and Crew Systems  
Operations Division**

**Final  
October 15, 2010**

### **NOTE**

This supplement is to be integrated into the generic edition to provide a complete document for the specific flight. Some pages in the generic edition may be replaced with supplemental pages identified as 'TEMP'. These generic pages, if any, must be retained for use on future flights.

National Aeronautics and  
Space Administration

**Lyndon B. Johnson Space Center**  
Houston, Texas





MISSION OPERATIONS DIRECTORATE

**EVA CHECKLIST  
STS-133 FLIGHT SUPPLEMENT**

FINAL  
October 15, 2010

PREPARED BY:

  
\_\_\_\_\_  
Lionel D. Bolch  
Book Manager

APPROVED BY:

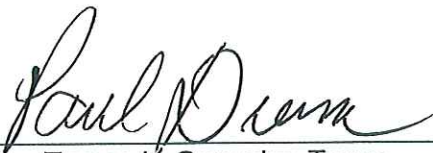
  
\_\_\_\_\_  
*Acting for* Tomas L. Gonzalez-Torres  
Lead, EVA Systems Group

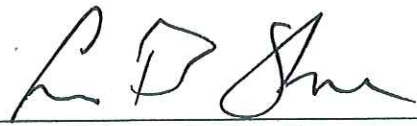
  
\_\_\_\_\_  
*for* Zebulon L. Scoville  
Lead, EVA Task Group

  
\_\_\_\_\_  
Munish P. Patel  
Chief, EVA Operations Branch

This document is under the configuration control of the Crew Procedures Control Board (CPCB). All proposed changes must be submitted via Change Request Workflow (CRW) to DO3/FDF Manager.

Additional distribution of this book, for official use only, may be requested in writing to DO3/PMO Administrator. The request must include justification and requester's name, organization, position, and phone number. Contractor requests are made through the NASA or DOD organization supported. Deletions, reduction in quantity, or change of address may be submitted to DO3/FDF Management Office, 281-244-1184.

Incorporates the following:		
482#:	EVA FS-0377	EVA FS-0382
	EVA FS-0378	EVA FS-0383
	EVA FS-0379	EVA FS-0384
	EVA FS-0380	EVA FS-0385
	EVA FS-0381	

AREAS OF TECHNICAL RESPONSIBILITY

Book Manager

DX3/L. Bolch

281-483-6830

EVA CHECKLIST  
STS-133 FLIGHT SUPPLEMENT

**LIST OF EFFECTIVE PAGES**

FINAL      10/15/10

Sign Off .....	*	133/FIN	3-5 .....	generic
FS ii .....	*	133/FIN	3-6 .....	generic
iii .....	*	generic	3-7 .....	generic
iv .....	*	generic	3-8 .....	generic
FS v .....	*	133/FIN	3-8a .....	generic
FS vi .....	*	133/FIN	3-8b .....	generic
FS vii .....	*	133/FIN	3-9 .....	generic
FS viii .....	*	133/FIN	CC 3-10 .....	generic
FS ix .....	*	133/FIN	CC 3-11 .....	generic
FS x .....	*	133/FIN	3-12 .....	generic
FS xi .....		133/FIN	4-1 .....	generic
FS xii .....		133/FIN	4-2 .....	generic
FS xiii .....		133/FIN	4-3 .....	generic
FS xiv .....		133/FIN	4-4 .....	generic
FS xv .....		133/FIN	4-5 .....	generic
FS xvi .....		133/FIN	4-6 .....	generic
1-1 .....		generic	4-7 .....	generic
1-2 .....		generic	4-8 .....	generic
1-3 .....		generic	4-9 .....	generic
1-4 .....		generic	4-10 .....	generic
1-5 .....		generic	4-11 .....	generic
1-6 .....		generic	4-12 .....	generic
1-7 .....		generic	5-1 .....	generic
1-8 .....		generic	5-2 .....	generic
1-9 .....		generic	5-3 .....	generic
1-10 .....		generic	5-4 .....	generic
TEMP FS 2-1 .....		133/FIN	A6-1 .....	generic
TEMP FS 2-2 .....		ALL/FIN	CC A6-2 .....	generic
2-3 .....		generic	6-3 .....	generic
2-4 .....		generic	CC 6-4 .....	generic
TEMP FS 2-5 .....		133/FIN	FS 7-1 .....	133/FIN
TEMP FS 2-6 .....		ALL/FIN	FS 7-2 .....	133/FIN
FS 2-7 .....		133/FIN	FS 7-3 .....	133/FIN
FS 2-8 .....		133/FIN	FS 7-4 .....	⊗ 133/FIN
FS 2-9 .....		133/FIN	FS 7-5 .....	133/FIN
FS 2-10 .....		133/FIN	FS 7-6 .....	⊗ 133/FIN
FS 2-11 .....		133/FIN	FS 7-7 .....	133/FIN
FS 2-12 .....		133/FIN	FS 7-8 .....	133/FIN
FS 2-13 .....		133/FIN	FS 7-9 .....	133/FIN
FS 2-14 .....		133/FIN	FS 7-10 .....	⊗ 133/FIN
FS 2-15 .....	⊗	133/FIN	FS 7-11 .....	⊗ 133/FIN
FS 2-16 .....	⊗	133/FIN	FS 7-12 .....	133/FIN
FS 2-17 .....	⊗	133/FIN	FS 7-13 .....	⊗ 133/FIN
FS 2-18 .....	⊗	133/FIN	FS 7-14 .....	⊗ 133/FIN
3-1 .....		generic	FS 7-15 .....	133/FIN
3-2 .....		generic	FS 7-16 .....	133/FIN
3-3 .....		generic	FS 7-17 .....	⊗ 133/FIN
3-4 .....		generic	FS 7-18 .....	133/FIN

\* – Omit from flight book

⊗ – Flight copies of this page contain color

FS 7-19	⊗	133/FIN	FS 7-75		133/FIN
FS 7-20	⊗	133/FIN	FS 7-76	⊗	133/FIN
FS 7-21		133/FIN	FS 7-77		133/FIN
FS 7-22		133/FIN	FS 7-78		133/FIN
FS 7-23	⊗	133/FIN	FS 7-79	⊗	133/FIN
FS 7-24		133/FIN	FS 7-80		133/FIN
FS 7-25		133/FIN	FS 7-81		133/FIN
FS 7-26	⊗	133/FIN	FS 7-82		133/FIN
FS 7-27		133/FIN	FS 7-83	⊗	133/FIN
FS 7-28	⊗	133/FIN	FS 7-84	⊗	133/FIN
FS 7-29		133/FIN	FS 7-85	⊗	133/FIN
FS 7-30	⊗	133/FIN	FS 7-86	⊗	133/FIN
FS 7-31		133/FIN	FS 7-87	⊗	133/FIN
FS 7-32	⊗	133/FIN	FS 7-88		133/FIN
FS 7-33		133/FIN	FS 7-89	⊗	133/FIN
FS 7-34		133/FIN	FS 7-90		133/FIN
FS 7-35	⊗	133/FIN	FS 7-91		133/FIN
FS 7-36	⊗	133/FIN	FS 7-92		133/FIN
FS 7-37		133/FIN	FS 7-93		133/FIN
FS 7-38		133/FIN	FS 7-94	⊗	133/FIN
FS 7-39	⊗	133/FIN	FS 7-95	⊗	133/FIN
FS 7-40		133/FIN	FS 7-96		133/FIN
FS 7-41	⊗	133/FIN	FS 7-97	⊗	133/FIN
FS 7-42	⊗	133/FIN	FS 7-98		133/FIN
FS 7-43	⊗	133/FIN	FS 7-99	⊗	133/FIN
FS 7-44	⊗	133/FIN	FS 7-100	⊗	133/FIN
FS 7-45	⊗	133/FIN	FS 7-101	⊗	133/FIN
FS 7-46	⊗	133/FIN	FS 7-102		133/FIN
FS 7-47	⊗	133/FIN	FS 7-103		133/FIN
FS 7-48		133/FIN	FS 7-104	⊗	133/FIN
FS 7-49	⊗	133/FIN	FS 7-105	⊗	133/FIN
FS 7-50		133/FIN	FS 7-106	⊗	133/FIN
FS 7-51	⊗	133/FIN	FS 7-107	⊗	133/FIN
FS 7-52		133/FIN	FS 7-108	⊗	133/FIN
FS 7-53		133/FIN	FS 7-109		133/FIN
FS 7-54		133/FIN	FS 7-110	⊗	133/FIN
FS 7-55	⊗	133/FIN	TEMP FS 8-1		133/FIN
FS 7-56	⊗	133/FIN	TEMP FS 8-2	⊗	133/FIN
FS 7-57	⊗	133/FIN	8-3		generic
FS 7-58	⊗	133/FIN	8-4		generic
FS 7-59	⊗	133/FIN	8-5		generic
FS 7-60	⊗	133/FIN	8-6		generic
FS 7-61		133/FIN	8-7		generic
FS 7-62	⊗	133/FIN	8-8		generic
FS 7-63		133/FIN	FS 8-9	⊗	133/FIN
FS 7-64		133/FIN	FS 8-10		133/FIN
FS 7-65	⊗	133/FIN	FS 8-11		133/FIN
FS 7-66	⊗	133/FIN	FS 8-12		133/FIN
FS 7-67		133/FIN	FS 8-13		133/FIN
FS 7-68	⊗	133/FIN	FS 8-14		133/FIN
FS 7-69		133/FIN	FS 8-15	⊗	133/FIN
FS 7-70	⊗	133/FIN	FS 8-16	⊗	133/FIN
FS 7-71		133/FIN	FS 8-17	⊗	133/FIN
FS 7-72		133/FIN	FS 8-18		133/FIN
FS 7-73		133/FIN	FS 8-19	⊗	133/FIN
FS 7-74	⊗	133/FIN	FS 8-20	⊗	133/FIN

⊗ – Flight copies of this page contain color

FS 8-21 .....	⊗	133/FIN	12-19 .....	generic
FS 8-22 .....	⊗	133/FIN	12-20 .....	generic
FS 8-23 .....	⊗	133/FIN	12-21 .....	generic
FS 8-24 .....		133/FIN	12-22 .....	generic
FS 8-25 .....		133/FIN	12-23 .....	generic
FS 8-26 .....		133/FIN	12-24 .....	generic
FS 8-27 .....		133/FIN	12-24a .....	generic
FS 8-28 .....	⊗	133/FIN	12-24b .....	generic
9-1 .....		generic	12-25 .....	generic
9-2 .....		generic	12-26 .....	generic
9-3 .....		generic	FS CC 12-27 .....	⊗ 133/FIN
9-4 .....		generic	FS CC 12-28 .....	⊗ 133/FIN
9-5 .....		generic	FS 12-29 .....	⊗ 133/FIN
9-6 .....		generic	FS 12-30 .....	133/FIN
TEMP FS 10-1 .....		133/FIN	FS CC 12-31 .....	133/FIN
TEMP FS 10-2 .....		ALL/FIN	FS CC 12-32 .....	133/FIN
10-3 .....		generic	FS 13-1 .....	133/FIN
10-4 .....		generic	FS 13-2 .....	133/FIN
10-4a .....		generic	14-1 .....	generic
10-4b .....		generic	14-2 .....	generic
10-5 .....		generic	14-3 .....	generic
10-6 .....		generic	14-4 .....	generic
10-7 .....		generic	14-5 .....	generic
10-8 .....		generic	14-6 .....	generic
10-9 .....		generic	14-7 .....	generic
10-10 .....		generic	14-8 .....	generic
10-11 .....		generic	14-9 .....	generic
10-12 .....		generic	14-10 .....	generic
10-13 .....		generic	14-11 .....	generic
10-14 .....		generic	14-12 .....	generic
FS CC 10-15 .....		133/FIN	14-13 .....	generic
FS CC 10-16 .....	⊗	133/FIN	14-14 .....	generic
11-1 .....		generic	14-15 .....	generic
11-2 .....		generic	14-16 .....	generic
11-3 .....		generic	14-17 .....	generic
11-4 .....		generic	14-18 .....	generic
12-i .....		generic	14-19 .....	generic
12-ii .....		generic	14-20 .....	generic
TEMP FS 12-1 .....		133/FIN	14-21 .....	generic
TEMP FS 12-2 .....		ALL/FIN	14-22 .....	generic
12-3 .....		generic	15-1 .....	generic
12-4 .....		generic	15-2 .....	generic
12-5 .....		generic	15-3 .....	generic
12-6 .....		generic	15-4 .....	generic
12-7 .....		generic	15-5 .....	generic
12-8 .....		generic	15-6 .....	generic
12-9 .....		generic	15-7 .....	generic
12-10 .....		generic	15-8 .....	generic
12-11 .....		generic	15-9 .....	generic
12-12 .....		generic	15-10 .....	generic
12-13 .....		generic	15-11 .....	generic
12-14 .....		generic	15-12 .....	generic
12-15 .....		generic	15-13 .....	generic
12-16 .....		generic	15-14 .....	generic
12-17 .....		generic	16-i .....	generic
12-18 .....		generic	16-ii .....	generic
			TEMP FS 16-1 .....	133/FIN
			TEMP FS 16-2 .....	133/FIN

⊗ – Flight copies of this page contain color

FS 16-3	⊗	133/FIN	FS 16-61	⊗	133/FIN
FS 16-4		133/FIN	FS 16-62	⊗	133/FIN
FS 16-5		133/FIN	17-1	*	generic
FS 16-6		133/FIN	17-2	*	generic
FS 16-7		133/FIN	FS 18-1		133/FIN
FS 16-8		133/FIN	FS 18-2		133/FIN
FS 16-9		133/FIN	FS 18-3	⊗	133/FIN
FS 16-10		133/FIN	FS 18-4	⊗	133/FIN
FS 16-11		133/FIN	FS 18-5	⊗	133/FIN
FS 16-12		133/FIN	FS 18-6	⊗	133/FIN
FS 16-13		133/FIN	FS 18-7		133/FIN
FS 16-14		133/FIN	FS 18-8	⊗	133/FIN
FS 16-15	⊗	133/FIN	FS 18-9	⊗	133/FIN
FS 16-16		133/FIN	FS 18-10	⊗	133/FIN
FS 16-17		133/FIN	FS 18-11	⊗	133/FIN
FS 16-18		133/FIN	FS 18-12	⊗	133/FIN
FS 16-19		133/FIN	FS 18-13		133/FIN
FS 16-20		133/FIN	FS 18-14	⊗	133/FIN
FS 16-21		133/FIN	FS 18-15	⊗	133/FIN
FS 16-22		133/FIN	FS 18-16	⊗	133/FIN
FS 16-23	⊗	133/FIN	FS 18-17	⊗	133/FIN
FS 16-24	⊗	133/FIN	FS 18-18	⊗	133/FIN
FS 16-25	⊗	133/FIN	FS 18-19	⊗	133/FIN
FS 16-26		133/FIN	FS 18-20	⊗	133/FIN
FS 16-27		133/FIN	FS 18-21	⊗	133/FIN
FS 16-28		133/FIN	FS 18-22	⊗	133/FIN
FS 16-29		133/FIN	FS 18-23	⊗	133/FIN
FS 16-30		133/FIN	FS 18-24	⊗	133/FIN
FS 16-31		133/FIN	FS 18-25	⊗	133/FIN
FS 16-32		133/FIN	FS 18-26		133/FIN
FS 16-33		133/FIN	FS 18-27		133/FIN
FS 16-34		133/FIN	FS 18-28	⊗	133/FIN
FS 16-35		133/FIN	FS 18-29	⊗	133/FIN
FS 16-36		133/FIN	FS 18-30	⊗	133/FIN
FS 16-37		133/FIN	FS 18-31	⊗	133/FIN
FS 16-38		133/FIN	FS 18-32	⊗	133/FIN
FS 16-39		133/FIN	FS 18-33	⊗	133/FIN
FS 16-40		133/FIN	FS 18-34	⊗	133/FIN
FS 16-41		133/FIN	FS 18-35	⊗	133/FIN
FS 16-42		133/FIN	FS 18-36	⊗	133/FIN
FS 16-43		133/FIN	FS 18-37	⊗	133/FIN
FS 16-44		133/FIN	FS 18-38	⊗	133/FIN
FS 16-45		133/FIN	FS 18-39	⊗	133/FIN
FS 16-46	⊗	133/FIN	FS 18-40	⊗	133/FIN
FS 16-47	⊗	133/FIN	FS 18-41	⊗	133/FIN
FS 16-48	⊗	133/FIN	FS 18-42	⊗	133/FIN
FS 16-49	⊗	133/FIN	FS 18-43	⊗	133/FIN
FS 16-50	⊗	133/FIN	FS 18-44	⊗	133/FIN
FS 16-51	⊗	133/FIN	FS 18-45	⊗	133/FIN
FS 16-52	⊗	133/FIN	FS 18-46	⊗	133/FIN
FS 16-53	⊗	133/FIN	FS 18-47	⊗	133/FIN
FS 16-54	⊗	133/FIN	FS 18-48	⊗	133/FIN
FS 16-55	⊗	133/FIN	FS 18-49	⊗	133/FIN
FS 16-56	⊗	133/FIN	FS 18-50	⊗	133/FIN
FS 16-57	⊗	133/FIN	FS 18-51	⊗	133/FIN
FS 16-58	⊗	133/FIN	FS 18-52	⊗	133/FIN
FS 16-59	⊗	133/FIN	FS 18-53	⊗	133/FIN
FS 16-60	⊗	133/FIN	FS 18-54	⊗	133/FIN

⊗ – Flight copies of this page contain color

\* – Omit from flight book



FS 18-55 .....	⊗	133/FIN
FS 18-56 .....	⊗	133/FIN
FS 18-57 .....	⊗	133/FIN
FS 18-58 .....	⊗	133/FIN
FS 18-59 .....	⊗	133/FIN
FS 18-60 .....	⊗	133/FIN
FS 18-61 .....	⊗	133/FIN
FS 18-62 .....	⊗	133/FIN
FS 18-63 .....	⊗	133/FIN
FS 18-64 .....	⊗	133/FIN
FS 18-65 .....	⊗	133/FIN
FS 18-66 .....	⊗	133/FIN
FS 18-67 .....	⊗	133/FIN
FS 18-68 .....	⊗	133/FIN
FS 18-69 .....	⊗	133/FIN
FS 18-70 .....	⊗	133/FIN
FS 18-71 .....	⊗	133/FIN
FS 18-72 .....	⊗	133/FIN
19-i .....		generic
19-ii .....		generic
19-1 .....		generic
19-2 .....		generic
19-3 .....		generic
19-4 .....		generic
19-5 .....		generic
19-6 .....		generic
19-7 .....		generic
19-8 .....		generic
19-9 .....		generic
19-10 .....		generic
19-11 .....		generic
19-12 .....		generic
19-13 .....		generic
19-14 .....		generic
20-1 .....	*	generic
20-2 .....	*	generic

⊗ – Flight copies of this page contain color  
\* – Omit from flight book

## EVA CUE CARDS

<u>Title</u>	<u>Ref. Page</u>	<u>Card No.</u>
SAFER CHECKOUT RESULTS (Front).....	CC 3-10	generic
SAFER STATUS TROUBLESHOOTING (Back) .....	CC 3-11	generic
DEPRESS/REPRESS (NOM A/L) (Front).....	CC A6-2	generic
FAILED LEAK CHECK (Back of DEPRESS/REPRESS) .....	CC 6-4	generic
STS-133 CONSUMABLES TRACKING CUE CARD (Front).....	FS CC 10-15	EVA-4a/133/O/A
STS-133 EVA BATTERY RECHARGE CUE CARD (Back).....	FS CC 10-16	EVA-4b/133/O/A
EMERGENCY UNDOCKING EVA TRANSFER (Front) .....	FS CC 12-27	EVA-5a/133/O/A
EXPEDITED SUIT DOFFING CUE CARD (Back) .....	FS CC 12-28	EVA-5b/133/O/A
EVA PREBREATHE CUE CARD SUPPLEMENT (EXERCISE PROTOCOL) (Front).....	FS CC 12-31	EVA-6a/133/O/A
(Back).....	FS CC 12-32	EVA-6b/133/O/A

## CONTENTS

	<u>PAGE</u>
10.2 PSI CABIN .....	1-1
MASK PREBREATHE INITIATE .....	1-2
PREP FOR 10.2 PSI CABIN .....	1-3
CABIN DEPRESS TO 10.2 PSI.....	1-4
10.2 PSIA DEPRESS CHART .....	1-5
10.2 PSI CABIN CONFIG.....	1-6
MASK PREBREATHE TERMINATE .....	1-6
10.2 PSI MAINTENANCE.....	1-7
CABIN REPRESS TO 14.7 PSI.....	1-8
14.7 PSI CABIN CONFIG.....	1-9
AIRLOCK CONFIG.....	TEMP FS 2-1
AIRLOCK PREP .....	TEMP FS 2-2
EMU SWAP .....	2-3
BOOSTER FAN DEACTIVATION/REMOVAL.....	2-4
BOOSTER FAN INSTALLATION/ACTIVATION.....	2-4
EMU REMOVAL .....	2-4
EMU INSTALLATION.....	2-4
EMU CHECKOUT PREP .....	TEMP FS 2-5
LTA RESTRAINT STRAP REMOVAL .....	TEMP FS 2-6
LTA RESTRAINT STRAP INSTALLATION .....	TEMP FS 2-6
EVA PREP FOR TRANSFER TO ISS.....	FS 2-7
POST DOCKING EVA TRANSFER AND RECONFIG.....	FS 2-9
POST EVA RECONFIG AND TRANSFER TO SHUTTLE .....	FS 2-11
EVA UNPACK AND STOW .....	FS 2-14
SAFER CHECKOUT AND SWAP .....	FS 2-15
EMU PLSS TAB INSTALL.....	FS 2-17
CHECKOUTS.....	3-1
EMU CHECKOUT .....	3-2
EMU POWERUP AND COMM CHECK.....	3-2
PRIMARY REGULATOR/FAN/PUMP CHECK.....	3-4
SOP CHECK.....	3-5
BATTERY CHARGE CHECK INIT.....	3-6
BATTERY CHARGE CHECK TERM .....	3-6
EMU SWAP DURING CHECKOUT .....	3-7
POST EMU C/O RECONFIG.....	3-7
SAFER CHECKOUT .....	3-8
SELF TEST SEQUENCE .....	3-9
SAFER CHECKOUT RESULTS.....	CC 3-10
SAFER STATUS TROUBLESHOOTING .....	CC 3-11
REBA POWERED HARDWARE CHECKOUT .....	3-12
EVA PREP .....	4-1
MIDDECK PREP .....	4-2
EVA PREP.....	4-3
PREP FOR DONNING.....	4-3
EMU DONNING.....	4-5
EMU CHECK .....	4-7
EMU PURGE.....	4-7
EMU PREBREATHE .....	4-8
SAFER DONNING .....	4-8
EVA COMM CONFIG.....	4-10
EVA COMM DECONFIG .....	4-10
APPROVED NON-EMU HARDWARE MATRIX.....	4-11
EMU STATUS .....	5-1
EMU STATUS .....	5-2

DEPRESS/REPRESS .....	A6-1
DEPRESS/REPRESS (NOM A/L) .....	CC A6-2
FAILED LEAK CHECK .....	6-3
FAILED LEAK CHECK (5 PSI) .....	CC 6-4
FAILED LEAK CHECK (14.7/10.2 PSI) .....	CC 6-4
TIMELINES .....	FS 7-1
STS-133/ULF5 EVA SUMMARY TIMELINES .....	FS 7-2
EVA 1	
EVA 1 SUMMARY TIMELINE .....	FS 7-3
EVA 1 TOOL CONFIGURATION .....	FS 7-4
EVA 1 BRIEFING CARD .....	FS 7-7
EVA 1 INHIBIT PAD .....	FS 7-8
EVA 1 NOTES, CAUTIONS, WARNINGS .....	FS 7-10
EGRESS/EVA SETUP .....	FS 7-17
J612 EXTENSION CABLE INSTALL .....	FS 7-19
SSRMS SETUP .....	FS 7-21
VENT TOOL EXTENSION BAG/APFR TO ESP-2 .....	FS 7-22
VENT TOOL SETUP .....	FS 7-23
FAILED PM RETRIEVE FROM POA .....	FS 7-24
FAILED PM INSTALL ON ESP-2 .....	FS 7-25
APFR RETRIEVE/TOOL STANCHION RELOCATE .....	FS 7-28
SSRMS CLEANUP .....	FS 7-29
CP3 CAMERA WEDGE INSTALL .....	FS 7-30
GET-AHEAD – STBD CETA RAIL STUB INSTALL .....	FS 7-31
GET-AHEAD – STOW TETHER SHUTTLE STOP AND S3 MT STOP .....	FS 7-32
MESSAGE IN A BOTTLE .....	FS 7-33
CLEANUP/INGRESS .....	FS 7-34
EVA 2	
EVA 2 SUMMARY TIMELINE .....	FS 7-48
EVA 2 TOOL CONFIGURATION .....	FS 7-49
EVA 2 BRIEFING CARD .....	FS 7-52
EVA 2 INHIBIT PAD .....	FS 7-53
EVA 2 NOTES, CAUTIONS, WARNINGS .....	FS 7-55
EGRESS/SETUP .....	FS 7-62
SSRMS SETUP .....	FS 7-64
VENT OPS AND QD BAG CLEANUP .....	FS 7-65
LWAPA RETRIEVE .....	FS 7-67
ELC4 ExPCA MLI REMOVAL/JSB RETRIEVE .....	FS 7-68
LWAPA INSTALL .....	FS 7-69
SPDM CLPA 1 INSTALL, EP 1 COVER REMOVAL .....	FS 7-70
SSRMS CLEANUP .....	FS 7-71
SSRMS ELBOW CLPA COVER INSTALL .....	FS 7-72
P3 CETA LIGHT INSTALL .....	FS 7-73
P1 RBVM MLI REPAIR .....	FS 7-74
P1 GRAPPLE FIXTURE BEAM TROUBLESHOOT .....	FS 7-75
NODE 3 MLI REMOVAL .....	FS 7-79
POA CLA AND SPDM CLPA LENS COVER INSTALL .....	FS 7-80
CLEANUP/INGRESS .....	FS 7-81
GET-AHEADS	
STS-133/ULF5 GET-AHEADS .....	FS 7-88
PORT CETA CART RECONFIG .....	FS 7-89
SPDM CLPA 2 COVER INSTALL .....	FS 7-90
POA CLA LENS COVER INSTALL .....	FS 7-91
S1 FHRC P-CLAMPS .....	FS 7-92
STRELA ADAPTER RELOCATE .....	FS 7-96
S0 GROUNDING BOOTIE INSTALL .....	FS 7-101
TOOL RECONFIG .....	FS 7-102
CP13 LIGHT R&R .....	FS 7-109

TOOLS AND STOWAGE .....	TEMP FS	8-1
STARBOARD LIGHTWEIGHT TOOL STOWAGE ASSEMBLY (TSA)...	TEMP FS	8-2
PGT CHECKOUT .....		8-3
PGSC-PGT CONNECTION (A31P AND 760XD).....		8-4
PROGRAM PGT SETTINGS.....		8-5
DOWNLOAD/ERASE EVENT LOG.....		8-5
PGT CONTINGENCIES .....		8-6
PGT STANDARD SETTINGS .....		8-7
SAFETY TETHERS POST STS-133/ULF5 .....	FS	8-9
APFR MANAGEMENT – STS-133 (ULF5).....	FS	8-10
TOOLBOX STOWAGE – STS-133 (ULF5) .....	FS	8-11
TOOLBOX PANEL AND SLOT LABELS.....	FS	8-12
Z1 TOOLBOX INTERNAL LAYOUT .....	FS	8-13
AIRLOCK TOOLBOX INTERNAL LAYOUT .....	FS	8-14
FLUID QD BAG LAYOUT .....	FS	8-15
VENT TOOL EXTENSION BAG LAYOUT – STOWED ON PORT CETA CART...	FS	8-17
PUMP MODULE JUMPER BAG – STOWED ON PORT CETA CART .....	FS	8-17
CREW TETHER INSPECTIONS.....	FS	8-18
CLPA IVA UNPACKING .....	FS	8-25
APFR THERMAL SHIELD REMOVAL .....	FS	8-28
POST EVA .....		9-1
POST EVA.....		9-2
SUIT DOFFING.....		9-2
SAFER DOFFING.....		9-2
EMU WATER RECHARGE.....		9-3
SAFER STOW .....		9-3
SUIT DRYING/SEAL WIPE .....		9-4
OXYGEN RECHARGE VERIFICATION.....		9-4
WATER FILL VERIFICATION.....		9-4
EMU POWERDOWN/OVERNIGHT STOW.....		9-5
EMU MAINT/RECHARGE.....	TEMP FS	10-1
WATER RECHARGE .....	TEMP FS	10-2
EMU POWERUP .....	TEMP FS	10-2
WATER FILL.....	TEMP FS	10-2
WATER FILL VERIFICATION.....	TEMP FS	10-2
EMU LiOH CHANGEOUT .....		10-4
MIDDECK EMU BATTERY RECHARGE (STAND-ALONE) .....		10-4a
MIDDECK EMU BATTERY RECHARGE/LiOH REPLACEMENT .....		10-5
INITIATE .....		10-5
TERMINATE .....		10-6
IN-SUIT EMU BATTERY RECHARGE/CHARGE VERIFICATION .....		10-7
INITIATE .....		10-7
TERMINATE .....		10-7
EMU POWERDOWN.....		10-7
HELMET LIGHT/PGT BATTERY RECHARGE .....		10-8
INITIATE .....		10-8
TERMINATE .....		10-9
REBA BATTERY INSTALLATION.....		10-9
EMU BATTERY REMOVAL/INSTALL.....		10-10
HELMET LIGHT BULB CHANGEOUT .....		10-11
REBA BATTERY RECHARGE .....		10-12
INITIATE .....		10-12
TERMINATE .....		10-13
STS-133 CONSUMABLES TRACKING CUE CARD .....	FS CC	10-15
STS-133 EVA BATTERY RECHARGE PLAN CUE CARD .....	FS CC	10-16

POST EVA ENTRY PREP .....	11-1
POST EVA ENTRY PREP .....	11-2
SAFER ENTRY STOW .....	11-2
POST ISS EVA ENTRY PREP .....	11-3
<u>OFF-NOMINAL PROCEDURES</u> .....	12-i
EMU CONTINGENCY PROCS .....	TEMP FS 12-1
DISPLAY LOSS DURING POWER TRANSFER (WARM RESTART) ...	TEMP FS 12-2
VACUUM H2O RECHARGE (MANNED) .....	TEMP FS 12-2
LIOH REPLACEMENT (MANNED) .....	12-3
BATTERY REPLACEMENT (MANNED) .....	12-4
WATER DUMP .....	12-6
SCU SWAP (UNMANNED) .....	12-7
SCU SWAP (MANNED) .....	12-7
EMU COLD RESTART (MANNED) .....	12-7
12.1 STS EVA DECONTAMINATION .....	12-8
CONTAMINATION TEST .....	12-15
SAFER BATTERY CHANGEOUT .....	12-18
BENDS TREATMENT ADAPTER (BTA) INSTALLATION (IN-SUIT) .....	12-19
BTA PREP .....	12-19
BTA TREATMENT .....	12-20
BENDS TREATMENT ADAPTER (BTA) INSTALLATION (POST SUIT DOFFING)...	12-21
BTA PREP .....	12-21
BTA TREATMENT .....	12-22
EMU RESIZE .....	12-25
EMERGENCY UNDOCKING EVA TRANSFER .....	FS CC 12-27
EXPEDITED SUIT DOFFING CUE CARD .....	FS CC 12-28
STS-133 NOMINAL EMU SIZING .....	FS 12-29
EMU CONTINGENCY RESIZE MATRIX (STS-133/ULF5) .....	FS 12-30
EVA PREBREATHE CUE CARD SUPPLEMENT (EXERCISE PROTOCOL)...	FS CC 12-31
 TPS REPAIR .....	 FS 13-1
 ORBITER CONTINGENCY EVA .....	 14-1
PAYLOAD BAY EVA NOMENCLATURE .....	14-2
RMS/PRLA CONTINGENCY EVA .....	14-3
96 BOLT PRE-EVA TOOL CONFIG .....	14-13
96 BOLT EVA TIMELINE .....	14-14
CAPTURE LATCH MANUAL RELEASE (ODS/PMA) .....	14-19
96 BOLT EVA LAYOUT .....	14-21
PLBD LATCH TOOL PLACEMENT WITH DUAL LATCH GANG FAILURES .....	14-22
 EVA CUFF CHECKLIST (CIL) .....	 15-1
NORMAL EVA STATUS .....	15-2
DCM CONFIGURATION .....	15-2
EMU MALFUNCTION INDEX .....	15-2
DECOMPRESSION SICKNESS (DCS) .....	15-3
DECOMPRESSION SICKNESS (DCS) (CONT) .....	15-3
ABORT EVA .....	15-3
TERMINATE EVA .....	15-3
SUIT P EMERG .....	15-4
SOP O2 ON .....	15-4
BATT AMPS HIGH .....	15-4
BATT V DECAY OR BATT VDC LOW .....	15-4
SUIT P LOW .....	15-5
SUIT P HIGH .....	15-5
SOP P LOW .....	15-5

O2 USE HIGH .....	15-5
SUBLM PRESS .....	15-6
H2O GP LOW .....	15-6
RESRV H2O ON .....	15-6
H2O WP HIGH .....	15-6
NO VENT FLOW .....	15-7
CO2 HIGH OR MONITOR CO2 .....	15-7
CO2 SNSR BAD .....	15-7
COMM FAILURE .....	15-7
AIR FLOW CONTAMINATION .....	15-8
LOSS OF COOLING .....	15-8
RLF V FAIL .....	15-8
MISC MSGS 1 .....	15-8
MISC MSGS (CONT)/TIME LF .....	15-9
AIRLOCK LATCH DISCONNECT .....	15-9
AIRLOCK INGRESS .....	15-9

FOLLOWING PAGES NOT IN EV CUFF

RADIATOR ACTUATOR DISCONNECT .....	15-9
PLBD DRIVE CUT .....	15-10
DOOR DRIVE RESTRAINT .....	15-10
DOOR DRIVE DISCONNECT .....	15-10
WINCH OPERATIONS .....	15-10
WINCH OPERATIONS (CONT) .....	15-11
3-PT TOOL INSTALLATION .....	15-11
CL LATCH TOOL .....	15-11
RMS JOINT ALIGN .....	15-11
MPM STOW/DEPLOY .....	15-12
RMS TIEDOWN .....	15-12
RMS FLIGHT RELEASABLE GRAPPLE FIXTURE RELEASE .....	15-12
PRLA OPEN/CLOSE .....	15-12
PRLA OPEN/CLOSE (CONT) .....	15-13
KU ANTENNA STOW .....	15-13
KU ANTENNA STOW (CONT) .....	15-13
AIRLOCK EGRESS .....	15-13

<u>FLIGHT SPECIFIC REFERENCE</u> .....	16-i
UNSCCHEDULED/CONTINGENCY EVA TASKS .....	TEMP FS 16-1
STS-133/ULF5 WORKAROUNDS CRIBSHEET .....	TEMP FS 16-2
EVA 1 CONTINGENCIES .....	TEMP FS 16-2
EVA 2 CONTINGENCIES .....	FS 16-6
GET-AHEAD CONTINGENCIES .....	FS 16-10
GENERIC CONTINGENCIES .....	FS 16-12
RELEASE ROEU LATCHES .....	FS 16-34
LATCH ROEU LATCHES .....	FS 16-37
STOW ROEU ARM .....	FS 16-40
MATE ROEU ARM .....	FS 16-43
ROEU OVERVIEW .....	FS 16-45
RADIATOR GRAPPLE FIXTURE STOWAGE BEAM TIEDOWNS .....	FS 16-46
CAMERA PORT 13 TIEDOWN .....	FS 16-49
S3 FORWARD-NADIR CLAM SHELL AND STUB TIEDOWN .....	FS 16-50
S3 FORWARD-ZENITH CLAM SHELL AND STUB TIEDOWN .....	FS 16-51
ETRS TIEDOWN .....	FS 16-52
SPDM CLPA1 TIEDOWN .....	FS 16-53
CP3 STANCHION TIEDOWN .....	FS 16-54
CP3 WEDGE TIEDOWN .....	FS 16-56
CP3 STANCHION/WEDGE TIEDOWN .....	FS 16-57
P3 CETA LIGHT TIEDOWN .....	FS 16-58
PUMP MODULE TIEDOWN (ESP-2) .....	FS 16-59
AGB TIEDOWN .....	FS 16-60

GENERIC EVA REFERENCE.....	17-1
FLIGHT SPECIFIC EVA REFERENCE.....	FS 18-1
PAYLOAD BAY LAYOUT .....	FS 18-2
ELC 4.....	FS 18-4
PMM .....	FS 18-8
ROEU .....	FS 18-10
PRLA .....	FS 18-12
EVA 1	
J612 EXT AND NODE 3 CABLE .....	FS 18-16
PUMP MODULE .....	FS 18-18
VENT TOOL .....	FS 18-22
Z1 RPCM MLI .....	FS 18-24
CP3 CAMERA WEDGE .....	FS 18-25
CP3 CAMERA AND VSSA .....	FS 18-28
STBD CETA RAIL STUB .....	FS 18-30
TETHER SHUTTLE STOP .....	FS 18-35
S3 MT STOP .....	FS 18-36
JAXA MESSAGE IN A BOTTLE .....	FS 18-37
EVA 2	
LWAPA .....	FS 18-38
ELC4 ExPCA MLI .....	FS 18-45
SPDM CLPA 1 .....	FS 18-48
SPDM EP 1.....	FS 18-53
P3 CETA LIGHT .....	FS 18-57
P1 RBVM BOOTIE.....	FS 18-59
P1 RADIATOR GRAPPLE STOW BEAMS.....	FS 18-61
NODE 3 MLI .....	FS 18-64
CLA/CLPA LENS COVER .....	FS 18-65
GET-AHEADS	
LAB CP13 LIGHT .....	FS 18-66
S1 FHRC P-CLAMP RELEASE .....	FS 18-69
STRELA ADAPTER.....	FS 18-70
PORT CETA CART RECONFIG.....	FS 18-72
<u>EVA EMERGENCY</u> .....	19-i
EMERGENCY PROCEDURES.....	19-1
EMERGENCY AIRLOCK REPRESS .....	19-3
EMERGENCY AIRLOCK REPRESS.....	19-4
POST EMERGENCY AIRLOCK REPRESS .....	19-4
SAFER RESCUE.....	19-5
SAFER RESCUE .....	19-6
DAP/EVA RESCUE/RETRIEVE .....	19-7
EVA ORBITER CONFIG.....	19-7
EVA RESCUE/RETRIEVE.....	19-9
19.1 DCS TREATMENT .....	19-10
CONTINGENCY SHUTTLE AIRLOCK INGRESS FROM ISS .....	19-13
CUE CARD CONFIGURATION .....	20-1



## AIRLOCK CONFIG

AIRLOCK PREP .....	TEMP FS 2-2
EMU SWAP .....	2-3
BOOSTER FAN DEACTIVATION/REMOVAL .....	2-4
BOOSTER FAN INSTALLATION/ACTIVATION .....	2-4
EMU REMOVAL .....	2-4
EMU INSTALLATION .....	2-4
EMU CHECKOUT PREP .....	TEMP FS 2-5
LTA RESTRAINT STRAP REMOVAL .....	TEMP FS 2-6
LTA RESTRAINT STRAP INSTALLATION .....	TEMP FS 2-6
EVA PREP FOR TRANSFER TO ISS .....	FS 2-7
POST DOCKING EVA TRANSFER AND RECONFIG .....	FS 2-9
POST EVA RECONFIG AND TRANSFER TO SHUTTLE.....	FS 2-11
EVA UNPACK AND STOW .....	FS 2-14
SAFER CHECKOUT AND SWAP .....	FS 2-15
EMU PLSS TAB INSTALL .....	FS 2-17

AIRLOCK  
CONFIG

## AIRLOCK PREP (50 min)

	Retrieve or unstow following equipment:
MF28G	3/8-in breaker bar, 4-in ext w/3/8-in drive
IFM Tool Kit	1/2-in socket w/3/8-in drive
Vol H	EMU Equipment Bag – attach to middeck wall
	Helmet Lights
	EVA Bag
	Contamination Detection Kit (location flight specific)
FDF Locker	Cuff Checklists (2) – stow in EMU Equipment Bag
	<u>DEPRESS/REPRESS</u> Cue Card

- AW18A
1. ✓ Inner hatch Equal vlv (two) – OFF
  2. LTG FLOOD (four) – ON
  3. Remove from airlock, as reqd:
    - Airlock Stowage Bag
    - Airlock Floor Pallet using 3/8-in breaker bar, 4-in ext w/3/8-in drive, and 1/2-in socket w/3/8-in drive
  4. Stow Vol H Bags in Vol H
  5. Transfer to airlock:
    - EVA Bag – install on airlock wall
    - DEPRESS/REPRESS Cue Card
    - Helmet Lights
    - Contamination Detection Kit – install on airlock wall
  6. Install IVA foot restraint, as reqd
  7. Unbuckle SCU straps, Velcro SCU to wall
  8. Install EMU lights on helmets (EMU 1, EMU 2) and perform pull test to verify latches fully seated in helmet brackets
  9. Disconnect helmets from Airlock EMUs, temp stow
  10. Remove comm caps from LTA Restraint Bags and connect to electrical harnesses
  11. Install helmets (not reqd if proceeding directly to EMU Checkout)
  12. Remove LTA Restraint Bags
  13. Disconnect waist rings; remove and stow any equipment stowed in HUT/LTA
  14. Stow LTA Restraint Bags on AAPs
  15. ✓ Thermal cover clear of waist ring
  16. Waist ring – engage posn
  17. Connect LTA to HUT, lock
  18. Remove 20-g Crash Bag from middeck EMU, as reqd

## EMU CHECKOUT PREP (30 min)

- Airlock
1. LTG FLOOD (four) – on
  2. Remove Airlock Floor Bag from Airlock
  3. Unbuckle SCU straps, Velcro SCU to wall
  4. Disconnect helmets from EMUs, temp stow
  5. ✓DIDB Restraint Bags installed
  6. Remove comm caps (4) from LTA Restraint Bags (kangaroo pouches)  
For EMU 3008 – Starboard Side (Ko)  
Connect comm cap Ko1 to EMU electrical harness  
Temp stow comm cap Ko2 (for Ko ECOK, step 9)  
For EMU 3004 – Port Side (Dr)  
Connect comm cap Dr1 to EMU electrical harness  
Temp stow comm cap Dr2 (for Dr ECOK, step 9)
  7. Disconnect LTA Restraint Bag from EMUs; temp stow on bottom of AAP
  8. Disconnect waist rings; remove Ko, Dr ECOKs and LCVGs
  9. Stow comm caps: Ko2 in Ko ECOK, Dr2 in Dr ECOK
  10. Temp stow LCVGs for EMU Checkout
  11. Remove EVA Sys Transfer Bag from Ko ECOK
  12. ✓Thermal cover clear of waist rings
  13. Waist rings – engage position
  14. Connect LTAs to HUTs, lock
  15. Transfer ECOKs and EVA Sys Transfer Bag to Middeck for  
EVA Prep for Transfer to ISS (EVA, Airlock Config)
- Middeck  
Vol H  
(MD23R)
16. Unstow from Volume H Bags:  
EVA 1 INBD Bag:  
EMU Servicing Kit s/n 5005 – Stow in EVA Sys Transfer Bag  
EHIP Light s/n 1007 – Stow in EVA Sys Transfer Bag  
EMU Equipment Bag Shared Compartment  
EVA 2 OBD Bag:  
EMU Equipment Bag Crew Specific Compartments
  17. Restow Volume H Bags
  18. Assemble EMU Equipment Bag and temp stow in Middeck  
Will be used for EMU Checkout then stowed in EVA Sys Transfer Bag
- MF57K
19. Unstow ISS EVA Cuff C/L (2) from SODF locker  
Install Ko and Dr C/L on EMUs, left arm

## LTA RESTRAINT STRAP REMOVAL (15 min)

### NOTE

May be performed on EMU 1 and 2 simultaneously.  
Perform steps as reqd for current EMU config

1. As reqd, remove comm cap from LTA Restraint Bag; temp stow
2. Remove EMU from AAP
3. Disconnect all restraint attachments from SAFER mount brackets (two)
4. Loosen cinch strap mechanism, remove SAFER mount brackets
5. Remove strap from PLSS
6. Stow strap in LTA Restraint Bag Pouch with D-rings (three) connected
7. Engage EMU in AAP
8. Stow LTA Restraint Bag/strap

## LTA RESTRAINT STRAP INSTALLATION (15 min)

### NOTE

May be performed on EMU 1 and 2 simultaneously. Perform steps as reqd for current EMU config. Procedure written to install in Launch/Landing config shown below

1. Unstow LTA Restraint Bag/strap
2. Remove EMU from AAP
3. Install SAFER mount brackets (two)
4. Install elastic band of strap around SOP
5. Tighten cinch strap mechanism
6. Attach strap French hooks (two) to SAFER mount brackets
7. Engage EMU in AAP
8. Stow LTA, suit arms inside LTA Restraint Bag
9. Connect upper spring hooks (two) over suit shoulders to upper AAP attachment rings (two)
10. Connect lower spring hooks (two) around suit arms to SAFER mount brackets (two)
11. Tighten all LTA bag straps with bag as high as possible on EMU

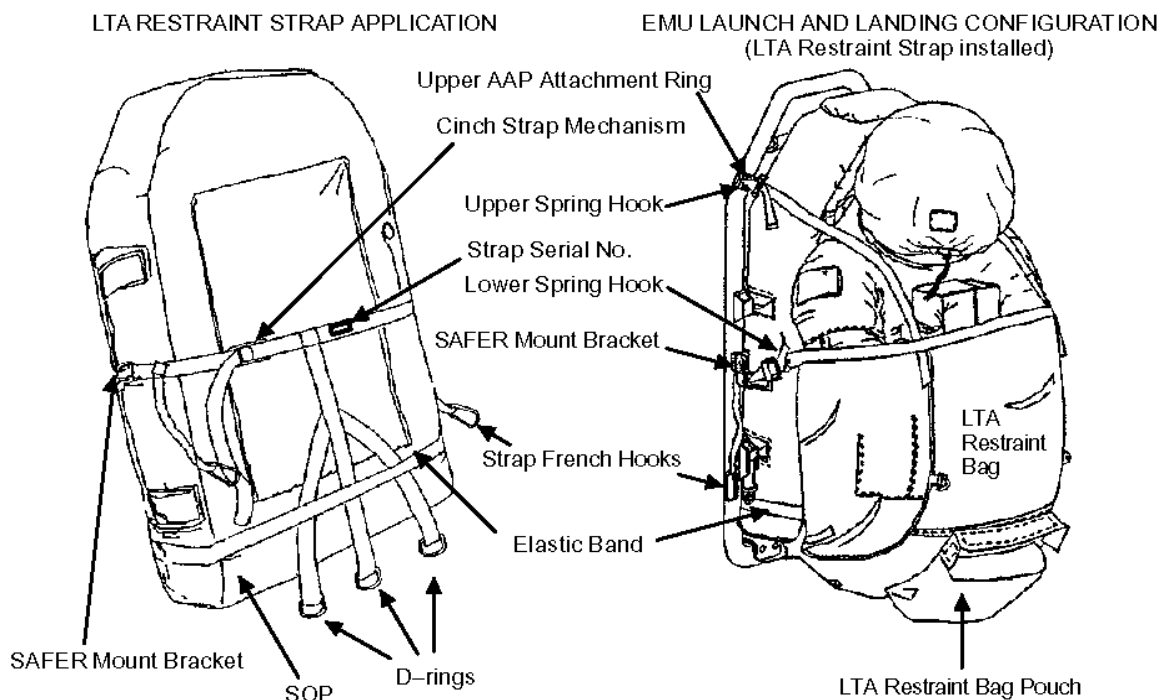

### NOTE

French hooks should be attached to SAFER mount brackets for launch and landing

## EVA PREP FOR TRANSFER TO ISS (90 min)

- BOTH EMUs/  
DCM
1. √PWR – SCU
  2. √PURGE vlv – op (up)
  3. √WATER – OFF, switch guard installed
  4. √O2 ACT – OFF
- Airlock/  
Middeck
5. Retrieve the following:

Ko ECOK
Dr ECOK
EVA Sys Transfer Bag
Tether Temp Stow Bag (from Dr ECOK)
A/L Floor Bag

- A/L Floor Bag
6. Remove both 85-ft Safety Tethers (#25, #27) from A/L Floor Bag; place in Tether Temp Stow Bag. Temp stow in Middeck for duration of docked ops
  7. Verify/configure items according to tables below:

<u>EMU 3008 (Ko)</u>	<u>EMU 3004 (Dr)</u>
<input type="checkbox"/> DIDB Restraint Bag <input type="checkbox"/> Comm Cap (Ko1) (installed during EMU C/O prep) <input type="checkbox"/> Helmet (√sun shade down, cover installed) <input type="checkbox"/> Valsalva <input type="checkbox"/> EMU Gloves (Ko1) <input type="checkbox"/> Cuff C/L (installed during EMU C/O Prep) <input type="checkbox"/> Wrist Mirrors (2) <input type="checkbox"/> LTA	<input type="checkbox"/> DIDB Restraint Bag <input type="checkbox"/> Comm Cap (Dr1) (installed during EMU C/O prep) <input type="checkbox"/> Helmet (√sun shade down, cover installed) <input type="checkbox"/> Valsalva <input type="checkbox"/> EMU Gloves (Dr1) <input type="checkbox"/> Cuff C/L (installed during EMU C/O Prep) <input type="checkbox"/> Wrist Mirrors (2) <input type="checkbox"/> LTA

<u>ECOKs</u>	
<input type="checkbox"/> ECOK (Ko) <input type="checkbox"/> Ko EVA 1,2 Ziplock Bags <ul style="list-style-type: none"> <li>• MAGs (4 w/Ziplock Bags)</li> <li>• TCUs (top, bottom)</li> <li>• Socks</li> <li>• Wristlets</li> <li>• Comfort Gloves</li> <li>• EV identifier stripes (EV1)</li> <li>• Moleskin</li> <li>• Mission patch</li> <li>• US flag</li> </ul> <input type="checkbox"/> Bag labeled “Transfer for Coleman” <input type="checkbox"/> LCVG (Ko1) (with biomed sternal harness and signal conditioner – stowed after EMU C/O) <input type="checkbox"/> B/U Comm Cap (Ko2 from LTA Restraint Bag Kangaroo Pouch) <input type="checkbox"/> DIDBs (2 filled from A/L Floor Bag) <input type="checkbox"/> B/U Gloves (Ko2) (from Bag “C”)	<input type="checkbox"/> ECOK (Dr) <input type="checkbox"/> Dr EVA 1,2 Ziplock Bags <ul style="list-style-type: none"> <li>• MAGs (4 w/Ziplock Bags)</li> <li>• TCUs (top, bottom)</li> <li>• Socks</li> <li>• Wristlets</li> <li>• Comfort Gloves</li> <li>• EV identifier stripes (EV2)</li> <li>• Moleskin</li> <li>• Mission patch</li> <li>• US flag</li> <li>• Croakie</li> </ul> <input type="checkbox"/> LCVG (Dr1) (with biomed sternal harness and signal conditioner – stowed after EMU C/O) <input type="checkbox"/> B/U Comm Cap (Dr2 from LTA Restraint Bag Kangaroo Pouch) <input type="checkbox"/> DIDBs (2 filled from A/L Floor Bag) <input type="checkbox"/> B/U Gloves (Dr2) (from Bag “C”)

**EVA PREP FOR TRANSFER TO ISS (90 min) (Cont)**

EVA SYS TRANSFER BAG	FROM
<input type="checkbox"/> EMU Servicing Kit (s/n 5005) <input type="checkbox"/> EHIP Light (s/n 1007)	Already in Sys Transfer Bag from EMU C/O Prep
<input type="checkbox"/> EMU Equipment Bag <ul style="list-style-type: none"> <li><input type="checkbox"/> Shared Compartment               <ul style="list-style-type: none"> <li><input type="checkbox"/> SCOFs (2)</li> <li><input type="checkbox"/> LTA Donning Handles (2)</li> <li><input type="checkbox"/> BSC Contingency Tool (Pry Bar)</li> <li><input type="checkbox"/> Scissors</li> <li><input type="checkbox"/> MWC Jumpers (2)</li> </ul> </li> <li><input type="checkbox"/> Crew Specific Compartments (2)</li> </ul>	Middeck – Temp stowed during EMU Checkout Prep
<input type="checkbox"/> ISS EVA Systems Checklist (2) with No Stripe and Green Stripe (Brown remains in locker for IV) <input type="checkbox"/> FDF: EVA Checklist STS-133 (1) with Green Stripe currently in use (Blue remains in locker for IV) <input type="checkbox"/> EVA Ziplock <ul style="list-style-type: none"> <li><input type="checkbox"/> <u>STS-133 CONSUMABLES TRACKING/ STS-133 BATTERY RECHARGE CUE CARD</u></li> <li><input type="checkbox"/> <u>EXPEDITED SUIT DOFFING/EMERGENCY UNDOCKING EVA TRANSFER CUE CARD</u></li> <li><input type="checkbox"/> <u>EVA PREBREATHE CUE CARD</u></li> <li><input type="checkbox"/> <u>STS-133 EVA EXERCISE PREBREATHE SUPPLEMENT CUE CARD</u></li> <li><input type="checkbox"/> <u>AMMONIA CONTAMINATION CUE CARD</u></li> </ul>	FDF/SODF Locker MF57K

AIRLOCK FLOOR BAG – Bag I
<input type="checkbox"/> EMU Battery (s/n 2091) <input type="checkbox"/> BTA (s/n 1004) <input type="checkbox"/> MWS Baseplate (2) (s/n 1023, 1009) <input type="checkbox"/> MWS T-Bar (2) (s/n 1029, 1002) <input type="checkbox"/> MWS Key Strap (s/n 1001) <input type="checkbox"/> Torque Wrench (s/n 1008) <input type="checkbox"/> ORU Tool Kit (s/n 1005) <input type="checkbox"/> CLA Lens Covers w/MLI (6) <input type="checkbox"/> Adj Eq Tethers (6) (s/n 1014, 1015, 1082, 1087, 1088, 1089) <input type="checkbox"/> Green RETs (5) in “EVA #2 RETs” Ziplock Bag (s/n 4397, 4398, 4399, 4400, 4401) <input type="checkbox"/> Green RETs (6) in “Green RETs for Transfer” Ziplock Bag (s/n 4402, 4403, 4404, 4405, 4406, 4407) <input type="checkbox"/> LiOH (CCC) (2) (s/n 2014, 2017)

## POST DOCKING EVA TRANSFER AND RECONFIG (90 min)

### NOTE

This procedure assumes that transfer items were preconfigured per EVA PREP FOR TRANSFER TO ISS

1. Transfer the following EVA equipment to ISS:

Item	Final Destination	Xfer Status
EMU 3008 (Ko)	E-Lk aft EDDA	
EMU 3004 (Dr)	E-Lk fwd EDDA	
ECOK (Ko)	E-Lk	
ECOK (Dr)	E-Lk	
EVA Sys Transfer Bag	Node 1 (Zenith)	
A/L Floor Bag	Node 1 (Zenith)	

EVA Sys  
Transfer Bag

2. Unstow following Items and position in E-Lk  
From EVA Sys Transfer Bag:
  - ISS EVA Sys Checklist (2)
  - STS-133 FDF EVA Checklist
  - STS-133 CONSUMABLES TRACKING/STS-133 BATTERY RECHARGE CUE CARD
  - EXPEDITED SUIT DOFFING/EMERGENCY UNDOCKING EVA TRANSFER CUE CARD
  - AMMONIA CONTAMINATION CUE CARD – Replace old copy with new version in Contamination Detection Kit in C-Lk Endcone IV Bag (Throw away old copy)
  - EHIP Light 1007 – Temp stow for install
  - EMU Equipment Bag

### NOTE

Do not swap EMU Servicing Kit until post EVA 2  
(remains in EVA Sys Transfer Bag)

E-Lk

3. Swap SCOFs between old and new EMU Equipment Bags  
Final stowage locations:
  - SCOFs 1011, 1013 – stowed in new EMU Equipment Bag
  - SCOFs 1012, 1014 – stowed in old EMU Equipment Bag
4. Remove old EMU Equipment Bag from current location and replace with new EMU Equipment Bag  
Stow old EMU Equipment Bag in EVA Sys Transfer Bag

**POST DOCKING EVA TRANSFER AND RECONFIG (90 min) (Cont)**

5. Configure items according to table:

<b>ITEM</b>	<b>CURRENT LOCATION</b>	<b>FINAL LOCATION</b>
<input type="checkbox"/> BTA (s/n 1004)	A/L Floor Bag	A/L101, MO2 'Prep and Ops' Bag, Outside Pocket
<input type="checkbox"/> MWS Baseplate (s/n 1023) attached to MWS T-Bar (s/n 1029)	A/L Floor Bag	A/L100 Behind Closeout in CTB 1013
<input type="checkbox"/> Torque Wrench (s/n 1008)	A/L Floor Bag	A/L101, MO2 'Prep and Ops' Bag
<input type="checkbox"/> ORU Tool Kit (s/n 1005)	A/L Floor Bag	A/L1D0 Behind Closeout
<input type="checkbox"/> EHIP Light (s/n 1011) <input type="checkbox"/> ISS EVA Systems Checklist – OLD COPY	Pregather Bag	EVA Sys Transfer Bag
<input type="checkbox"/> BTA (s/n 1003) <input type="checkbox"/> MWS Baseplate (s/n 1005) MWS T-Bar (s/n 1006) <input type="checkbox"/> Torque Wrench (s/n 1002) – Possibly Lost	Pregather Bag	A/L Floor Bag
<input type="checkbox"/> Bag labeled "Transfer for Coleman"	ECOK (Ko)	Hand off to Scott Kelly

EMU 3008/3004 6. Install Helmet Lights/EMU TV assembly per STS-133 CONSUMABLES TRACKING CUE CARD

7. Report transfer status to **MCC-H** as time permits



## POST EVA RECONFIG AND TRANSFER TO SHUTTLE (120 min)

This procedure assumes [1.240 POST EVA](#) (SODF: ISS  
EVA SYS: EVA PREP/POST) has been completed  
following EVA 2

- EMU 3008/3004
1. Remove the following and stow in MO2 'Prep and Ops' bag s/n 1038:  
  REBAs  
    Helmet Light EHIP batteries
  2. Remove EMU batteries  
Stow EMU Batt 2091 in MO2 'Prep and Ops' bag s/n 1038 to leave on ISS  
Stow EMU Batt 2086 in A/L Floor Bag for transfer back to Shuttle
  3. Verify LiOH and install EMU batteries per STS-133 CONSUMABLES TRACKING CUE CARD
  4. Remove Cuff C/L from EMUs; remove any crew preference pages and stow for personal preference. Stow Cuff C/L in EVA Sys Transfer Bag
  5. Connect gloves
  6. Remove Helmet Lights and EMU TV  
Stow items in E-Lk
  7. Helmet ←|→ HUT
  8. Remove Comm Cap. Stow in EVA Sys Transfer Bag
  9. Helmet →|← HUT
  10. ✓Helmet installed, sun shades down, cover installed
  11. Remove B/U gloves from ECOK. Stow in EVA Sys Transfer Bag
  12. Retrieve LCVG (Ko/Dr) from Shuttle Middeck Bag "C"
  13. Insert LCVG (Dr) and LCVG (Ko) into EMU 3004  
Connect LTA
  14. Insert ECOK (Ko), ECOK (Dr), and LCVG (Ko/Dr 2) into EMU 3008  
Connect LTA
  15. Remove EMU Servicing Kit s/n 5005 from EVA Sys Transfer Bag and deploy in A/L
  16. Gather EMU Servicing Kit s/n 5004 and stow in EVA Sys Transfer Bag
  17. Retrieve remaining CLA Lens Covers w/MLI (2) from A/L Floor Bag and stow in A/L1D2, 1.0 CTB 1078
  18. Gather Red RETs (26) from tether staging area and temp stow for A/L Floor Bag:  
 sm-sm (15) (s/n 4172, 4261, 4263, 4264, 4369, 4370, 4371, 4372, 4374, 4376, 4379, 4380, 4381, 4240, 4239)  
 Lg-sm (7) (s/n 4253, 4074, 4249, 4250, 4251, 4367, 4368)  
 PIP pin (4) (s/n 4241, 4054, 4080, 4242)

**POST EVA RECONFIG AND TRANSFER TO SHUTTLE (120 min) (Cont)**

19. Gather Red RETs (3) from A/L1D0 CTB 1075 (in Ziplock labeled "Check MCC Prior to Use") and temp stow for A/L Floor Bag:
  - sm-sm s/n 4270
  - Lg-sm s/n 4262
  - PIP pin s/n 4328
20. Retrieve remaining Green RETs (6) (s/n 4402, 4403, 4404, 4405, 4406, 4407) from A/L Floor Bag and deploy in Tether Staging Area
21. Stow Red RETs in A/L Floor Bag. Use slots from CLA Lens Covers as necessary
22. Remove any patches, flags, stripes from EMUs and stow for personal preference. Remove EMUs from EDDAs
23. Config/verify items listed below are in specified bags  
Transfer bags and EMUs to shuttle

<b><u>EMU 3008 (Ko)</u></b>	<b><u>EMU 3004 (Dr)</u></b>
<input type="checkbox"/> DIDB Restraint Bag	<input type="checkbox"/> DIDB Restraint Bag
<input type="checkbox"/> ECOK (Ko)	<input type="checkbox"/> LCVG (Dr)
<input type="checkbox"/> ECOK (Dr)	<input type="checkbox"/> LCVG (Ko)
<input type="checkbox"/> LCVG (Ko/Dr)	<input type="checkbox"/> Helmet (√sun shade down, cover installed)
<input type="checkbox"/> Helmet (√sun shade down, cover installed)	<input type="checkbox"/> Valsalva
<input type="checkbox"/> Valsalva	<input type="checkbox"/> EMU Gloves (Dr1)
<input type="checkbox"/> EMU Gloves (Ko1)	<input type="checkbox"/> Wrist Mirror (2) (take worst from A/L)
<input type="checkbox"/> Wrist Mirror (2) (take worst from A/L)	<input type="checkbox"/> EMU Battery (s/n 2088)
<input type="checkbox"/> EMU Battery (s/n 2087)	<input type="checkbox"/> LiOH (2014)
<input type="checkbox"/> LiOH (2017)	<input type="checkbox"/> LTA
<input type="checkbox"/> LTA	

<b>EVA SYS TRANSFER BAG</b>
<input type="checkbox"/> Ko2 and Dr2 Gloves
<input type="checkbox"/> 4 Comm Caps
<input type="checkbox"/> ISS EVA Systems Checklist (2) with Green Stripe and OLD COPY
<input type="checkbox"/> FDF: EVA Checklist with Green Stripe
<input type="checkbox"/> <u>STS-133 CONSUMABLES TRACKING/STS-133 BATTERY RECHARGE CUE CARD</u>
<input type="checkbox"/> <u>EXPEDITED SUIT DOFFING/EMERGENCY UNDOCKING EVA TRANSFER CUE CARD</u>
<input type="checkbox"/> <u>EVA PREBREATHE CUE CARD</u>
<input type="checkbox"/> <u>STS-133 EVA EXERCISE PREBREATHE SUPPLEMENT CUE CARD</u>
<input type="checkbox"/> Cuff C/L (2)
<input type="checkbox"/> EMU Servicing Kit s/n 5004 (labeled "For use and return on STS-133")
<input type="checkbox"/> EHIP Light 1011
<input type="checkbox"/> EMU Equipment Bag (Shared and Crew Specific Compartments)
<input type="checkbox"/> SCOFs (2) (s/n 1012, 1014)
<input type="checkbox"/> LTA Donning Handles (1 pair) (s/n 128)
<input type="checkbox"/> BSC Contingency Tool (s/n 5011) – Pry Bar
<input type="checkbox"/> Scissors
<input type="checkbox"/> MWC Jumpers (2) (s/n 038, 039)

**POST EVA RECONFIG AND TRANSFER TO SHUTTLE (120 min) (Cont)**

<b>A/L FLOOR BAG</b>
<input type="checkbox"/> Torque Wrench (s/n 1002) – Possibly Lost
<input type="checkbox"/> MWS Baseplates (2) (s/n 1005 and 1009)
<input type="checkbox"/> T-Bars (2) (s/n 1002 and 1006)
<input type="checkbox"/> Expended LiOHs (2) (s/n 2023, 2006)
<input type="checkbox"/> Red RETs (29)
<input type="checkbox"/> sm-sm (16) (s/n 4172, 4261, 4263, 4264, 4270, 4369, 4370, 4371, 4372, 4374, 4376, 4379, 4380, 4381, 4240, 4239)
<input type="checkbox"/> Lg-sm (8) (s/n 4253, 4074, 4249, 4250, 4251, 4262, 4367, 4368)
<input type="checkbox"/> PIP pin (5) (s/n 4238, 4241, 4054, 4080, 4242)
<input type="checkbox"/> Adj Eq Tethers (6) (s/n 1014, 1015, 1082, 1087, 1088, 1089)
<input type="checkbox"/> BTA (s/n 1003)
<input type="checkbox"/> EMU Battery (s/n 2086)

24. Report to **MCC-H** when transfer complete

## EVA UNPACK AND STOW (80 min)

### NOTE

This procedure assumes that transfer items were preconfigured per EVA PREP FOR TRANSFER TO SHUTTLE

1. Unpack and stow items per table below; report status to **MCC-H** when complete:

Item	Initial Location (After Transfer)	Final Destination (On Shuttle)	Transfer Status
<input type="checkbox"/> EMU 3008 (Ko)		Stbd – AAP	
<input type="checkbox"/> EMU 3004 (Dr)		Port – AAP	
<input type="checkbox"/> EMU Servicing Kit <input type="checkbox"/> EMU Equipment Bag Shared Compartment <input type="checkbox"/> EHIP Light 1011	EVA Sys Transfer Bag	Vol H (MD23R) EVA 1 INBD Bag	
<input type="checkbox"/> EMU Equipment Bag Crew Specific Compartments	EVA Sys Transfer Bag	Vol H (MD23R) EVA 2 OBD Bag	
<input type="checkbox"/> Cuff C/L (2) <input type="checkbox"/> ISS EVA Systems Checklist (2) <input type="checkbox"/> FDF: EVA Checklist <input type="checkbox"/> <u>STS-133 CONSUMABLES TRACKING/ STS-133 BATTERY RECHARGE CUE CARD</u> <input type="checkbox"/> <u>EXPEDITED SUIT DOFFING/EMERGENCY UNDOCKING EVA TRANSFER CUE CARD</u> <input type="checkbox"/> <u>EVA PREBREATHE CUE CARD</u> <input type="checkbox"/> <u>STS-133 EVA EXERCISE PREBREATHE SUPPLEMENT CUE CARD</u>	EVA Sys Transfer Bag	SODF Locker (MF57K)	
<input type="checkbox"/> Ko2 and Dr2 Gloves	EVA Sys Transfer Bag	Bag “C”	
<input type="checkbox"/> 4 Comm Caps	EVA Sys Transfer Bag	2 per Kangaroo pouch	
<input type="checkbox"/> 85-ft Safety Tethers (2)	Tether Temp Stow Bag	A/L Floor Bag	
<input type="checkbox"/> Empty Tether Temp Stow Bag	Middeck	A/L Floor Bag	
<input type="checkbox"/> Empty EVA Systems Transfer Bag	Middeck	A/L Floor Bag	
<input type="checkbox"/> Airlock Floor Bag	Middeck	Airlock Deck	

## SAFER CHECKOUT AND SWAP (45 min)

### NOTE

SAFER 1003 will be left on ISS in A/L Stowage Bag.  
SAFER 1006 will be returned in Launch/Landing Bag  
(CTB Triple) with foam cutouts

- |                |  |
|----------------|--|
| SAFER 1006     | 1. Retrieve from stowed location and remove from A/L Stowage Bag   |
| SAFER 1003     | 2. Retrieve bag with SAFER from PMM  |
|                | 3. Remove SAFER 1003; temp stow power switch guard   |
|                | 4. Perform <u>SAFER CHECKOUT</u> (EVA, <u>CHECKOUTS</u> )<br>Stow SAFER and <u>SAFER CHECKOUT RESULTS</u> Cue Card in<br>A/L Stowage Bag to leave on ISS |
| SAFER 1006 HCM | 5. Install power switch guard from 1003  |
|                | 6. ✓Inhibitor installed, properly engaged  |
|                | 7. ✓MAN ISOL vlv – CL (up)   |
|                | 8. Install SAFER 1006 in Launch/Landing Bag<br>Refer to figures 1, 2, and 3, for stowage configuration   |
|                | 9. Install SAFER 1006 <u>SAFER CHECKOUT RESULTS</u> Cue Card in<br>Launch/Landing Bag  |



Figure 1.- SAFER stow and configuration.



Figure 2.- SAFER foam block.

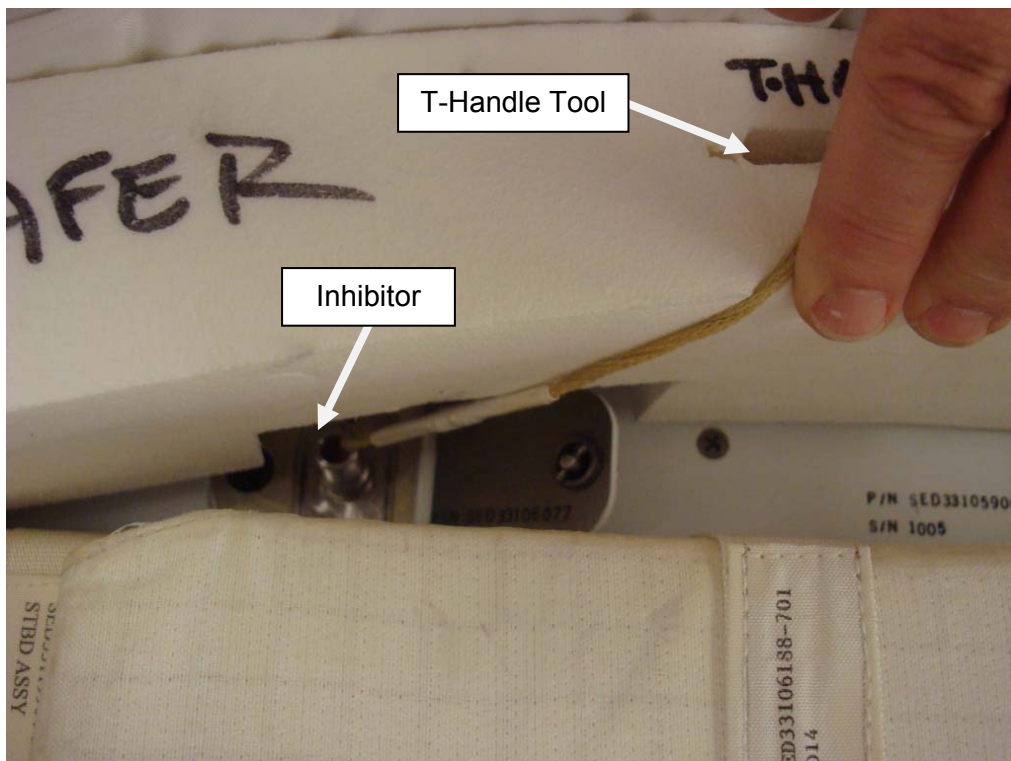

Figure 3.- T-Handle tool lanyard routing.

## EMU PLSS TAB INSTALL (10 min)

### OBJECTIVE:

To assemble Kapton lanyard for PLSS zippers. This procedure allows crewmembers to easily unzip PLSS with gloved hands in case of a Metox canister changeout

### MATERIALS:

Kapton Tape – NOD1O4\_B1 .5 CTB 1178 (1 inch width)

### TOOLS:

Scissors – EMU Servicing Kit, E-Lk Deployed

1. Gather Kapton tape and scissors
2. Cut 8-in piece of Kapton tape
3. Fold tape lengthwise over onto itself in half, twice



Figure 1.- Fold tape.

4. Smooth out creases to make flat surface  
NOTE: Tape does not have to be completely flat



Figure 2.- Creasing tape.

## EMU PLSS TAB INSTALL (10 min) (Cont)

5. Hold one end of tape and fold over the tip lengthwise, then thread it through hole on the zipper

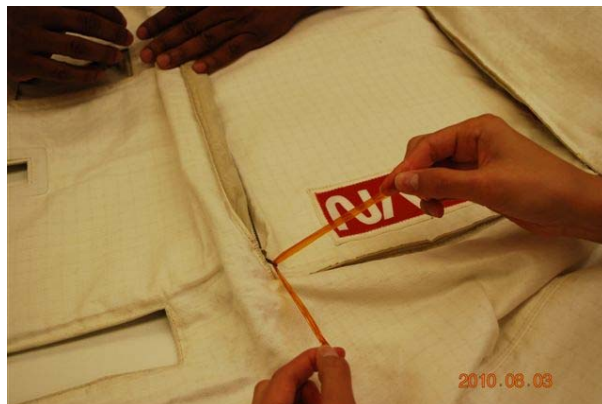

Figure 3.- Threading tape.

6. Pull through zipper hole doubling the tape, making lanyard tails
7. Wrap a second piece of tape onto the lanyard tails starting at the tail end with adhesive side down



Figure 4.- Wrapping lanyard.

8. Continue wrapping tape in a corkscrew pattern
9. Tuck Kapton lanyard under TMG and Velcro down



TIMELINES

STS-133/ULF5 EVA SUMMARY TIMELINES .....	FS 7-2
EVA 1	
EVA 1 SUMMARY TIMELINE .....	FS 7-3
EVA 1 TOOL CONFIGURATION .....	FS 7-4
EVA 1 BRIEFING CARD .....	FS 7-7
EVA 1 INHIBIT PAD .....	FS 7-8
EVA 1 NOTES, CAUTIONS, WARNINGS .....	FS 7-10
EGRESS/EVA SETUP .....	FS 7-17
J612 EXTENSION CABLE INSTALL .....	FS 7-19
SSRMS SETUP.....	FS 7-21
VENT TOOL EXTENSION BAG/APFR TO ESP-2.....	FS 7-22
VENT TOOL SETUP.....	FS 7-23
FAILED PM RETRIEVE FROM POA .....	FS 7-24
FAILED PM INSTALL ON ESP-2 .....	FS 7-25
APFR RETRIEVE/TOOL STANCHION RELOCATE .....	FS 7-28
SSRMS CLEANUP.....	FS 7-29
CP3 CAMERA WEDGE INSTALL.....	FS 7-30
GET-AHEAD – STBD CETA RAIL STUB INSTALL .....	FS 7-31
GET-AHEAD – STOW TETHER SHUTTLE STOP AND S3 MT STOP .....	FS 7-32
MESSAGE IN A BOTTLE.....	FS 7-33
CLEANUP/INGRESS .....	FS 7-34
EVA 2	
EVA 2 SUMMARY TIMELINE .....	FS 7-48
EVA 2 TOOL CONFIGURATION .....	FS 7-49
EVA 2 BRIEFING CARD .....	FS 7-52
EVA 2 INHIBIT PAD .....	FS 7-53
EVA 2 NOTES, CAUTIONS, WARNINGS .....	FS 7-55
EGRESS/SETUP .....	FS 7-62
SSRMS SETUP.....	FS 7-64
VENT OPS AND QD BAG CLEANUP.....	FS 7-65
LWAPA RETRIEVE.....	FS 7-67
ELC4 ExPCA MLI REMOVAL/JSB RETRIEVE.....	FS 7-68
LWAPA INSTALL .....	FS 7-69
SPDM CLPA 1 INSTALL, EP 1 COVER REMOVAL.....	FS 7-70
SSRMS CLEANUP.....	FS 7-71
SSRMS ELBOW CLPA COVER INSTALL.....	FS 7-72
P3 CETA LIGHT INSTALL .....	FS 7-73
P1 RBVM MLI REPAIR.....	FS 7-74
P1 GRAPPLE FIXTURE BEAM TROUBLESHOOT.....	FS 7-75
NODE 3 MLI REMOVAL .....	FS 7-79
POA CLA AND SPDM CLPA LENS COVER INSTALL.....	FS 7-80
CLEANUP/INGRESS .....	FS 7-81
GET-AHEADS	
STS-133/ULF5 GET-AHEADS .....	FS 7-88
PORT CETA CART RECONFIG .....	FS 7-89
SPDM CLPA 2 COVER INSTALL .....	FS 7-90
POA CLA LENS COVER INSTALL .....	FS 7-91
S1 FHRC P-CLAMPS.....	FS 7-92
STRELA ADAPTER RELOCATE .....	FS 7-96
S0 GROUNDING BOOTIE INSTALL .....	FS 7-101
TOOL RECONFIG.....	FS 7-102
CP13 LIGHT R&R .....	FS 7-109

TIMELINES

# TIMELINES

## STS-133/ULF5 EVA SUMMARY TIMELINES

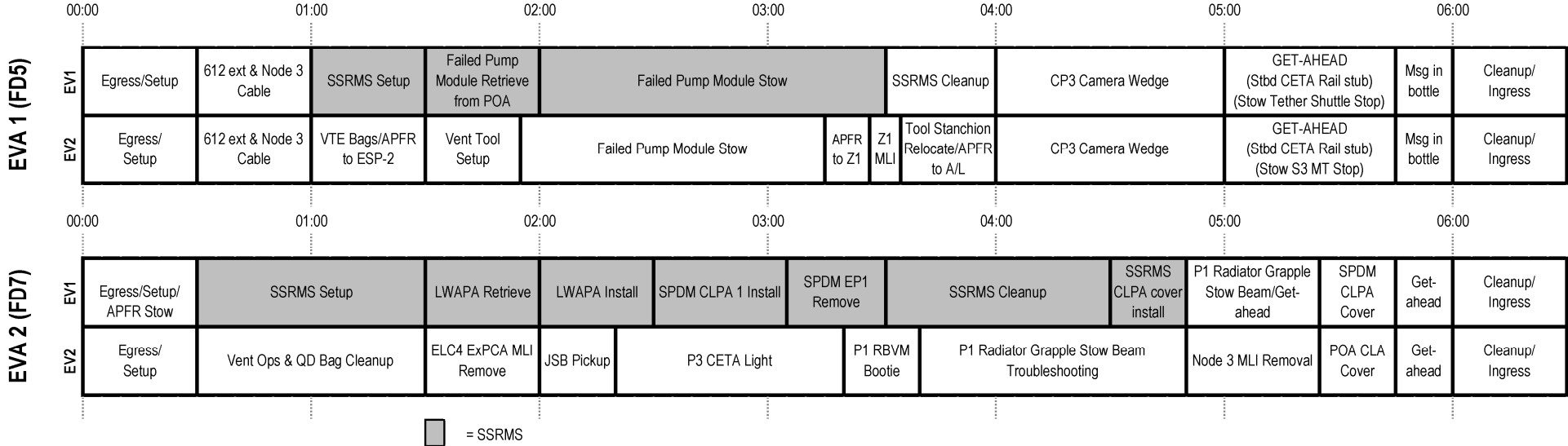

- Get-aheads**
1. Starboard CETA Rail Stubs Install
  2. Stow S3 MT Stop & Tether Shuttle Stop
  3. Reconfigure Port CETA Cart
  4. Strela Adapter Relocate
  5. CP13 CETA Light R&R
  6. Remove S1FHRC P-Clamps
  7. Install S0 Grounding Bootie/inside Bay 3
  8. Tool Reconfiguration

# EVA 1 SUMMARY TIMELINE

PET	IV/SSRMS	EV1 – Kopra (SSRMS/FF)	EV2 – Drew (FF)	
00:00		<u>POST DEPRESS</u> (00:05)	<u>POST DEPRESS</u> (00:05)	00:00
		<u>EGRESS/SETUP</u> (00:25)	<u>EGRESS/SETUP</u> (00:25)	
	• VERIFY J612 EXT CABLE INHIBITS	<u>J612 EXT CABLE INSTALL</u> (00:30)	<u>J612 EXT CABLE INSTALL</u> (00:30)	
01:00		<u>SSRMS SETUP</u> (00:30)	<u>VENT TOOL EXTENSION BAGS/APFR TO ESP-2</u> (00:30)	01:00
	• VERIFY ESP-2 PM FSE INHIBITS	<u>FAILED PUMP MODULE RETRIEVE FROM POA</u> (00:30)	<u>VENT TOOL SETUP</u> (00:25)	
02:00		<u>FAILED PUMP MODULE INSTALL ON ESP-2</u> (01:30)	<u>FAILED PUMP MODULE STOW</u> (01:15)	02:00
03:00			<u>APFR TO Z1</u> (00:15)	03:00
	• VERIFY CP3 CAMERA INHIBITS	<u>SSRMS CLEANUP</u> (00:30)	<u>Z1 RPCM MLI</u> (00:10)	
			<u>TOOL STANCHION RELOCATE/APFR TO A/L</u> (00:25)	
04:00		<u>CP3 CAMERA WEDGE INSTALL</u> (01:00)	<u>CP3 CAMERA WEDGE INSTALL</u> (01:00)	04:00
	• VERIFY S3 SARJ LOCKED			
05:00		<u>GET-AHEAD</u> (00:45) • Stbd CETA Rail Stub Install • Stow Tether Shuttle Stop	<u>GET-AHEAD</u> (00:45) • Stbd CETA Rail Stub Install • Stow S3 MT Stop	05:00
06:00		<u>MESSAGE IN A BOTTLE</u> (00:15)	<u>MESSAGE IN A BOTTLE</u> (00:15)	06:00
		<u>CLEANUP &amp; INGRESS</u> (00:30)	<u>CLEANUP &amp; INGRESS</u> (00:30)	06:00
06:30	PET 6:30			06:30

# EVA 1

## EVA 1 TOOL CONFIGURATION

### EV1

- MWS
  - BRT (L)
    - RET (sm-sm) (both hooks to front loop)
    - Wire Tie (2 short)
  - T-Bar
    - RET w/PIP Pin
    - Adj Equip Tether (2) (inside)
    - Wire Tie (3) – bunny ears (w/tape), trash bag
    - Small ISS Trash Bag (R outside w/wire tie)
      - P612 Cap
      - J612A Cap
    - RET (sm-sm)
  - Swing Arm (R)
    - RET (sm-sm)
      - PGT [B7 25.5 ft-lb, CAL, MTL 30.5] s/n \_\_\_\_\_
      - PGT Battery s/n \_\_\_\_\_
      - 7/16 (wobble) Socket-6" ext
  - D-ring Extender (2, R & L D-ring)
    - Safety Tether Pack (L D-ring ext)
  - Waist Tether (1, R on D-ring)

### EV2

- MWS
  - BRT (L)
    - RET (sm-sm)
      - MUT EE (in BRT jaws)
    - Wire Tie (3 short)
  - T-Bar
    - RET w/PIP Pin
    - Adj Equip Tether (inside)
    - Wire Tie (3) – bunny ears (w/tape), trash bag
    - Small ISS Trash Bag (R inside w/wire tie)
    - RET w/PIP Pin
      - 7/16 (wobble) Socket-6" ext (in trash bag)
      - 7/16 Socket-2" ext (in trash bag)
  - Swing Arm (R)
    - RET (sm-sm)
      - PGT [A2 3.8 ft-lb, CAL, MTL 30.5] s/n \_\_\_\_\_
      - PGT Battery s/n \_\_\_\_\_
      - 7/16 Socket-2" ext
      - 7/16 (wobble) Socket-6" ext
  - D-ring Extender (2, R & L D-ring)
    - Safety Tether Pack (L D-ring ext)
  - Waist Tether (1, R on D-ring ext)

### CREWLOCK

- RET (Lg-Sm)
  - Crewlock Bag (PM Cap Bag)
    - Adj tether (outside – tie down)
    - RET (sm-sm) (outside)
      - 55-ft Safety Tether (hooks to same door handle)
        - Fish Stringer (White tape Lg hook near free hook)
          - Free Hook
          - J3 Cap (size 21)
          - M1 QD Cap (1.5")
          - M2 QD Cap (1.5")
            - Wire Tie
          - M3 QD Cap (1.5")
          - M4 QD Cap (1/4")
          - J2 Cap (size 15)
          - Adj Equip Tether (Lg-sm)
  - Socket Caddy
    - 7/16 (wobble) Socket-6" ext (EMU Left side)
    - 5/8 Socket-7.8" ext (EMU Right side)
  - Rd Scoop
  - WIF Adapter
  - Ratchet Wrench (w/palm wheel)
    - 7/16 Socket-2" ext

- RET (Lg-Sm)
  - Small ORU Bag (Stub Bag)
    - Adj tether (outside – tie down)
    - RET (sm-sm) (outside)
      - CP3 Stanchion Wedge (outside under strap)
        - RET (sm-sm)
          - Rail Stub w/ETRS (Nadir)
        - RET (sm-sm)
          - Clam Shell 6A (Nadir) (RET to lanyard)
      - RET (sm-sm)
        - Adj Eq Tether
          - Rail Stub (Zenith)
      - RET (sm-sm)
        - Clam Shell 1A (Zenith) (RET to lanyard)
    - RET (sm-sm)
      - Prybar

#### Tether Counts:

Red RETs (sm-sm) = 15      RETs (PIP Pin) = 4  
 Green RETs (sm-sm) = 0      Adj Equip Tether = 10  
 RETs (Lg-sm) = 4              Shuttle Adj Equip Tether = 0

### CREWLOCK (Cont)

- RET (Lg-Sm)
  - Crewlock Bag (Get-ahead Bag)
    - Adj tether (outside)
      - RET (sm-sm) (outside)
        - Camera w/Bracket (secured to outside of bag)
        - Adj tether (Integral RET to D-ring)
          - CLA Lens Cover MLI Case
            - CLA Lens Cover (POA)
          - CLPA2 Lens Cover MLI Case
            - CLPA2 Lens Cover (SPDM)
        - S0 Cable Grounding Bootie
        - JAXA: Msg-in-a-Bottle ( open, 2 turns from closed)
        - Wire Tie Caddy
          - 5 long, 4 short wire ties
        - RET (sm-sm) (for Ratchet Wrench)
        - RET w/PIP Pin
          - 7/16 Socket-18" ext
        - RET (sm-sm)
          - Sq Scoop
    - RET (Lg-Sm)
      - J612 Ext Cable
        - 3 wire ties girth hitched to cable (tape on wire tie closest to 90 deg connector)
      - APFR
    - Crewlock Bag 2 (Tool Relocations)
      - Adj Equip Tether (on outside)
      - Vise Grips (stbd toolbox) (Int RET 1)
      - Probe (stbd toolbox) (Int RET 2)
      - Pin Straightener Assy (port toolbox) (Int RET 3)
      - Adj Equip Tether (Int RET 4)
        - Short MMOD T-Handle Tool (port toolbox)
        - Short MMOD T-Handle Tool (port toolbox)

#### NOTE: Prior to use, inspect the following hardware:

- All RET cords for fraying
- Inspect Load Alleviating Straps and D-ring Extenders; ref CREW TETHER INSPECTIONS, ISS EVA Tasks Checklist:
  1. MMOD/general damage
  2. Discoloration
  3. Tack Stitching
  4. Red Band
- ISS Trash Bag: √Bristle deformation/damage, after having stowed tools in trash bag. √Zipper closed, √bag empty
- BRT joint screws not loose

## EVA 1 TOOL CONFIGURATION (Cont)

### STAGING BAG

- Fish Stringer #1 (outside tether)
  - Velcro/Tape Caddy (hook #2)
  - PGT (hook #3) s/n 1006
    - PGT Battery s/n 1004
    - 7/16 (wobble) Socket-6" ext
  - Ratchet Wrench (hook #5)
    - 7/16 (rigid) Socket-9" ext
  - 2 – Long duration tie-down tether (hook #6)
  - Spare WIF Adapter (hook #7)
  - Spare 55-ft Safety Tether
- Fish Stringer #2 (inside tether)
  - ERAD (hook #1) s/n \_\_\_\_\_
  - Connector Cleaner Tool Kit (hook #2)
  - Needlenose Pliers (hook #6)
  - MWS Key Strap Assy (on wire tie, to strap)

### IV BAG

- Ammonia Contamination Cue Card
- 2 – Towels (wrapped with wire tie)
- Contamination Detection Kit
- RET (sm-sm) (Black)
  - 2 – DCM Plug (SAFER Hardmount)
- RET (sm-sm) (Black)
  - 2 – GP Caddy
    - 2 – Thermal Mitten (pair)
- RET (sm-sm) (Black)
  - Socket Caddy
    - 1/2 (wobble) Socket-8" ext
    - 7/16 (wobble) Socket-6" ext

### EVA 1 Pre-Config

Item	Stow Location
A/L Floor Bag	
CLPA Lens Covers (2)	Crewlock Bag (Get-aheads)

# EVA 1 TOOL CONFIGURATION (Cont)

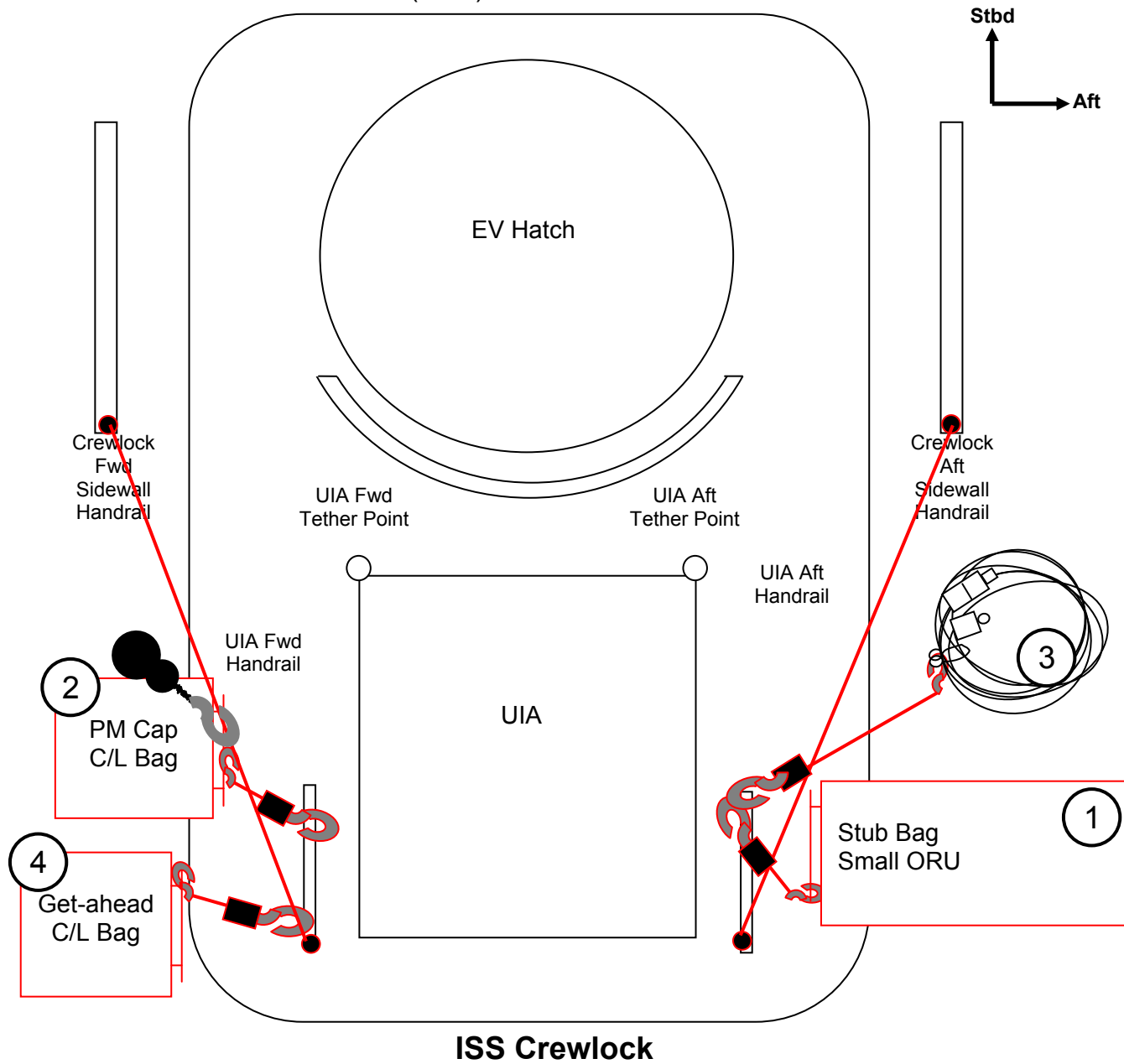

	Lg-Sm RET
	Sm-Sm RET
	Adj Equip Tether
	Adj Fuse Tether
	Integrated Crewlock Bag Tether
	A/L Bungee
	85-ft Safety Tether
	55-ft Safety Tether
	Long Wire Tie
	Wire Tie Caddy
	Large Trash Bag
	PGT with Socket
	EVA Camera with Bracket
	Indicates Retrieval Order

**Tool Legend**

# EVA 1 BRIEFING CARD

## Flight Day Prior to EVA

1. EVA Prep
  - Campout – overnight bag checklist, EMU equipment bag – EV1
  - Get-up plan – target to wake up 20 minutes early (egress on time), bio-med attached prior to opening hatch – EV1
  - Prebreathe protocol review (Notes and Warnings) – Suit-up IV
  - Task IV verifies tools on suits per timeline – Task IV
  - Suit-up IV verifies bag/tool configuration within crewlock – Suit-up IV
  - Suit donning plan – special requests – EV's, IV's
  - Airlock depress review – Suit-up IV
  
2. EV Crew Procedure Review
  - Summary timeline + get-ahead tasks – Task IV
  - Notes, Cautions, and Warnings review – Task IV
  - Contingency procedures – cribsheet – Task IV
  - First actions – EV1, EV2
  - EVA-specific concerns – ammonia contamination – EV1 and all
  
3. Communications – EV1
  - Airlock – Hardline, transition to Big Loop, EV1/EV2 calls in sequence
  - Task – Big loop, A/G2 (Discovery), S/G2 if robo-specific
  - Robotics – coordinate frames (POA, ESP-2), GCA protocol (EV, IV, M1)
  
4. Emergencies Review – EV1
  - Loss of comm – confirm config (pri, low, volume), clear obstructions, alt, frequency change (hand signals)
  - EMU malfunctions – read DCM message, say page number, IV runs it – say if “Terminate” or “Abort”
  - Lost tools – velocity and direction estimate, when last seen
  - Rapid return to airlock, incapacitated crewmember (drop the green hook, yellow structure hook on ICM)
  
5. Lessons Learned – EV1 and all

## EVA 1 INHIBIT PAD

### Orbiter

ALL EVAs	
TCS (Prior to Egress) IV L12	1. √TCS POWER – OFF Install Switch Guard to remain in place through EVA 2
Ku-Band Antenna (Prior to Egress) <b>MCC-H</b> (INCO)	
	1. √KU-BAND Mask – active 2. √KU-BAND EVA Protect Box – active
RCS (Prior to Egress) EV crew < 27 feet from FRCS	
IV O14,15,16	1. √DAP: VERN, FREE, LO Z 2. √RJDF F1, F2, F3, F4 MANF DRIVER (four) – OFF LOGIC (four) – OFF
<b>MCC-H</b> (Prop) IV	3. √Above RCS config 4. √RCS F – ITEM 1 EXEC (*) √JET DES F1U – ITEM 17 (*) F3U – ITEM 19 (*) F2U – ITEM 21 (*)

### Ground

ALL EVAs	
Ground Radar (Prior to Egress) <b>MCC-H</b> (TOPO)	
	1. √TOPO console, ground radar restrictions in place for EVA

### USOS (1)

ALL EVAs	
PCU (Prior to Egress)	
<b>NOTE</b>	
PCUs may require up to a 1-hour warmup period before they are operational.	
<b>MCC-H</b> (PHALCON)	
	1. √PCUs (two) operational in discharge mode and one of the following: <ul style="list-style-type: none"> <li>a. CCS PCU EVA hazard control FDIR enabled</li> <li>b. No more than two arrays unshunted and oriented &lt;105° from velocity vector</li> </ul> If one or both PCUs failed
	2. No more than two arrays unshunted and oriented <105° from velocity vector

### USOS (2)

ALL EVAs	
CUCU (Prior to Egress) IV (LAB104)	1. √cb POWER A, B [two] – OPEN 2. √cb LINK 1,2 [two] – OPEN
And One of the following Inhibit pairs: <b>MSFC/PRO</b>	
	3a. Express Rack 2 Locker 6 – Power Removed 3b. Express Rack 6 Locker 7 – Power Removed
OR	
IV	4a. Express Rack 2 Locker 6 – OFF 4b. Express Rack 6 Locker 7 – OFF
LOCATION DEPENDENT INHIBITS	
Cupola Windows (Not expected)	
IV	If EV crew less than 10 feet from window or in window FOV, coordinate shutter opening/closing with EV crew and minimize time shutter is open
LAB Window (Not expected)	
IV	EV crew expected < 10 feet from window or in window FOV, close window shutter
Mobile Transporter (Prior to Egress)	
<b>MCC-H</b> (ROBO)	EV crew expected <1.5 meters from MT 1. √MT latched
S1 TRRJ (CP3 Camera Wedge) (Prior to Egress)	
<b>MCC-H</b> (THOR)	EV crew working within 2 feet of S1 TRRJ rotation envelope 1. √DLA (1) – LOCKED at -15
J612 Extension Cable Install (Prior to Egress)	
<b>MCC-H</b> – THOR	
	1. RPCM N1RS1_B – RPCs 1,2,15,16 – Open and Close Cmd Inhibited 2. DDCU Z14B Converter - OFF
Spare PM Install on ESP-2 (Prior to Egress)	
<b>MCC-H</b>	1. √RPCM S04B_F RPC 10 Open/Close Inh – PM Heater 1 Pwr 2. √RPCM N1RS2_B RPC 6 Open/Close Inh – PM Heater 2 Pwr



## EVA 1 INHIBIT PAD (Cont)

### USOS (3)

#### LOCATION DEPENDENT INHIBITS

CP3 Camera Wedge Install (At start of crew translation to worksite)

#### **MCC-H**

Stow Camera (pan = -180, tilt = -90)

RPCM S11A A RPC 1 open and close inhibited (Camera luminaire)

RPCM S11A A RPC 15 open and close inhibited (ETVCG)

RPCM S12B A RPC 2 open and close inhibited (ETVCG heater)

RPCM S12B A RPC 16 open and close inhibited (Camera luminaire heater)

Starboard SARJ (CETA Rail Stub Install, SARJ Cover) (Prior to Egress)

#### **MCC-H**

S3 SARJ locked at 345°

1. √DLA (1) – LOCKED
2. All motor setpoints set to zero
3. All motors deselected

### JEM

#### ALL EVAs

ICS-EF Antenna (Prior to Egress)

#### **SSIPC**

1. ICS MOD – OFF
2. ICS UPC – OFF
3. ICS HPA – OFF
4. “HPA ON” and “UPC ON” commands are cleared (not present) in the ICS stored command queue

### RSOS (1)

#### ALL EVAs

SM Antennas (Prior to Egress)

#### **IV**

1. GTS – Deactivate
2. ARISS (Ham Radio) – Deactivate

IMPULSE (Prior to Egress)

#### **MCC-M**

1. IMPULSE (ИПИ-100) – Is not activated

## EVA 1 NOTES, CAUTIONS, WARNINGS

### NOTES

1. Bolt install: Report torque and turns
2. Bolt release: Report torque and turns if different from published range
3. EVA connectors: After disconnection and prior to connection; verify pin and EMI band integrity; verify connector free of FOD
4. Inspect QDs for damage prior to mating
5. Toolbox doors must be closed with one latch per door when EV crew not in immediate vicinity
6. 85-ft safety tether retract force may affect body positioning
7. CETA Cart brake handle wire ties must be replaced after crew loading

### CAUTION

#### ISS Generic Constraints

##### A. Avoid inadvertent contact with

1. Grapple fixture shafts (drylube)
2. PIP Pins
3. Passive UMAs
4. MBS/SSRMS/SPDM taped radiative surfaces: VDU, ACU, JEU, LEU, MCU, CRPCMs, and Cameras
5. SPDM SJEU, EP, OTCM, LEU, and LEE VDU radiator surfaces
6. OTSD

##### B. Electrical cables

1. Avoid bend radii < 10 times cable diameter

##### C. Fiber optic cables

1. Avoid bend radii < 10 times cable diameter
2. Avoid pulling on cable during mate/demate

##### D. Fluid line flex hoses and QDs

1. Avoid bend radii < 14 in for hoses with a diameter  $\geq 1$  in
2. Additional care should be taken to not exceed bend radii when applying loads at the flexible hose to rigid tube stub interfaces
3. Ensure fluid QD booties are fully closed prior to leaving worksite; wire tie if required
4. Avoid bend radii < 5 in for hoses with diameter < 1 in on LAB, S0, S1, P1, and 10 in for hoses with diameter < 1 in on all other elements

### CAUTION

#### ISS Generic Constraints (Cont)

##### E. For structural reasons

1. Avoid vigorous body motions, quick Retrieves and kickoffs against tether restraints
2. Avoid performing shaking motions (sinusoidal functions) more than four cycles

##### F. Other

1. ITT Cannon connector: On demated connectors, do not rotate collar or manipulate cable/connector using collar or connector tool
2. MLI handholds are not rated for crewmember translation loads

## EVA 1 NOTES, CAUTIONS, WARNINGS (Cont)

### CAUTION

#### ISS Truss Constraints

##### A. Avoid inadvertent contact with

1. CETA lights (Z-93 paint)  
[LAB,S1,NODE 1]
2. Deployed TUS cable [Zenith, Nadir  
CETA rail]
3. S0 aft face radiator
4. GPS antennas (S13 paint) [S0,JLP]
5. UHF antennas [LAB,P1]
6. ETCS radiator flexhoses and panels  
[S1,P1]
7. EETCS/PV radiator flexhoses,  
bellows and panels [P6,P4,S4,S6]
8. SASA RF group [S1,P1]
9. Heat pipe radiators [Z1]
10. PCU cathode and HCA ports [Z1]
11. Ku-Band antenna (SGANT) dish [Z1]
12. CMG cover/shells [Z1]
13. FPMU [P1]
14. SASA high and low gain antennas and  
radiator surfaces [Z1]
15. Deployed MISSEs
16. OTP on HAB Tray [S0]

##### B. For structural reasons

1. Avoid kicking S1/P1 radiator beam.  
If any of these occur, wait 2 to 5 min to  
allow structural response to dissipate

### CAUTION

#### ISS Truss Constraints (Cont)

##### C. Other

1. WIS antennas: Do not use as  
handholds [NODE 1,LAB,P6,Z1]
2. Lubricant from Ku-Band SGANT  
gimbals [Z1], CMGs [Z1], and RTAS  
ground strap fasteners [P6,P4,S4,S6]  
can contaminate EMU
3. Prevent inadvertent contact of the  
tether shuttle with ETRS when the  
P3 tether shuttle stop is raised away  
from the rail

### CAUTION

#### ISS U.S. Pressurized Elements Constraints

##### A. Avoid inadvertent contact with

1. EVA crane [PMA1]
2. TCS reflectors [PMA2,PMA3]
3. APAS hardware [PMA2,PMA3]
4. CETA lights (Z-93 paint)  
[LAB,S1,NODE 1]
5. UHF antennas [LAB,P1]
6. Open CBM petal covers and  
LAB/Cupola window shutter
7. S0/NODE 2 fluid tray hardlines at  
NODE 2 end, which are limited to 25 lb

##### B. Other

1. WIS antennas: Do not use as  
handholds [NODE 1,LAB,P6,Z1]
2. CBM petal covers may not be used as  
handholds unless both launch restraint  
pins are engaged

## EVA 1 NOTES, CAUTIONS, WARNINGS (Cont)

### CAUTION

#### **ISS I.P. Elements Constraints**

##### COL

- A. Avoid inadvertent contact with
1. COL ARISS and AIS antennas [COL-Nadir]

##### JEM

- A. Avoid inadvertent contact with
1. GPS antennas (S13 paint) [S0,JLP]
  2. Open JPM window shutter
  3. JTVE, WVE/EVE, JEF VE cameras
  4. JEMRMS taped radiative surfaces [JEU,EE,Cameras]
  5. JEM A/L target and pins
  6. JEF ORUs and EFUs (paint and lubricant)
  7. MAXI front and top panel (paint)
  8. SEDA-AP sensors (HIT, SDOM, and AOM) and MPAC & SEED
  9. Trunnions and UCMs (paint and lubricant) [JEF Payloads]
  10. RAIDS covers on end of HREP
  11. ICS-EF Ka-Band antenna dish
  12. Small Fine Arm (paint, coating and lubricant)
- B. For structural reasons
1. Avoid kicking MMOD shields between JLP and JPM
  2. Avoid tool impact on ICS-EF sensor

### CAUTION

#### **Shuttle Constraints**

- A. Avoid inadvertent contact with
1. OBSS and SRMS composite sections joint torque arms, grapple fixture shafts, and cable harnesses
  2. LCS (silver Teflon) and LDRI (silver Teflon) and ITVC (gold foil) [OBSS]
  3. WVS antenna [ODS truss and PLB sill]
  4. Payload bay and camera wire harnesses, cables, cable guides, and connectors
  5. Avoid contact with OBSS striker bars (Vitrolube coating)
- B. No touch
1. LDRI diffuser [OBSS]
  2. OBSS saddle contacts (when OBSS unberthed) [OBSS]
  3. Monkey fur [PLB]
  4. Cameras: Metallic surfaces [PLB]
  5. Ku-Band antenna black dish and gold thermal blankets [PLB]

## EVA 1 NOTES, CAUTIONS, WARNINGS (Cont)

### WARNING

#### ISS Generic Constraints

- A. Avoid inadvertent contact with
1. Grapple fixture targets and target pins
- B. Pinch
1. NZGL connector linkage. Use caution when mating/locking
  2. ITT Cannon connector rotating housing
  3. PDGF connector doors
- C. QDs
1. If QD is in FID when valve is opened (bail fwd), QD will leak and fluid line may whip
  2. Do not rotate if in mated/valve open configuration
  3. Bail may kick back suddenly when detent button is depressed if pressure has built up in spring cavity
- D. Sharp Edges
1. Inner edges of WIF sockets
  2. APFR active WIF probes
  3. Mating surfaces of EVA connectors  
Avoid side loads during connector mating
  4. Back side of MMOD shield fasteners
  5. Spring loaded captive EVA fasteners (e.g., 6B-boxes, BMRRM, RTAS, SARJ Covers); the end of the spring may protrude
  6. SPDM OTCM gripper jaws
  7. Keep hands away from SSRMS LEE/POA/SPDM LEE opening, snares, and PDGF curvic coupling (teeth)
  8. MMOD strikes on ISS exterior

### WARNING

#### ISS Generic Constraints (Cont)

- E. Thermal
1. EVA connectors with booties may become hot if left uncovered.  
Handling may need to be limited
  2. Turn off glove heaters when comfortable temperature reached to prevent bladder damage. Do not pull fingers out of gloves when heaters are on
  3. Uncovered trunnion pins may be hot
  4. SSRMS/MBS/SPDM operating cameras and lights may radiate large amounts of heat
  5. Do not touch EMU protective visor if temperature has been  $< -134$  degF for  $> 15$  min
  6. No EMU boot contact with foot restraint when temperature  $< -120$  degF or  $> 200$  degF
  7. PDGF surfaces may not meet touch temperature requirements for unlimited contact when  $\beta \leq -70$  or  $\beta \geq 70$
- F. Electrical Shock
1. Do not touch SPDM CLPA 1 electrical connector prior to camera installation

### WARNING

#### ISS Truss Constraints

- A. Avoid inadvertent contact
1. SSU, ECU, beta gimbal platform, mast canister, SAW blanket boxes unless the beta gimbal is locked and the motor is turned off
  2. Stay inboard of SARJ when active
  3. Stay 2 ft from S1/P1 radiator beam rotational envelope when beam is free to rotate
  4. Stay 5 ft from moving MT on face 1
  5. Stay 3.3 ft from Ku-band (SGANT Antenna) when powered
- B. RF radiation exposure
1. Stay 3.6 ft from S-Band (SASA) high gain antenna when powered [S1,P1]
  2. Stay 1.3 ft from S-Band (SASA) low gain antenna when powered [S1,P1]
  3. Stay 3 ft from UHF antenna when powered [LAB,P1]
- C. Sharp Edges
1. Solar array blanket box [P6,S6]
  2. Fastener threads on back of Z1 U-jumper male FQD panel, if nutplate cap missing
  3. Outboard MT rail attachment lug near P6 handrail 5333 and gap spanner
  4. P2 connector on EWIS box TAA-06 [Zenith/Forward Corner 1 of P5 – SARJ at 0 deg]
  5. Nickel coated braided copper ground straps may contain frayed wires [P6,P4,S4,S6]
  6. MMOD strikes on Z1 toolboxes

## EVA 1 NOTES, CAUTIONS, WARNINGS (Cont)

### WARNING

#### ISS Truss Constraints (Cont)

##### D. Electrical Shock

1. Stay  $\geq 2$  ft from ungrounded floating connectors if powered  
S0 EVA power cables (inside S0 Bay 00 Face 4, Bay 01 Face 3)  
ESP-2 jumper (inside S0 Bay 03 Face 4)

##### E. Thermal

1. ELC may exceed touch temperatures when  $\beta > 75$  deg

### WARNING

#### ISS U.S. Pressurized Elements Constraints

##### A. Handrails

1. Handrails previously used for MISSE attachment may not be used as a safety tether point [A/L endcone 564 and 566, A/L Tank 2 Nad/Fwd and Port/Fwd, P6 5389]

##### B. Pinch

1. EV side of IV Hatch during Hatch operation (also snag hazard) [A/L]
2. LAB/Cupola window shutter and CBM petal cover linkages during operation

##### C. RF radiation exposure

1. Stay 1 ft from UHF antenna when powered [LAB, P1]

##### D. Sharp Edges

1. PMA umbilical launch restraints – exposed bolt threads
2. Adjustable fuse tether (Fish Stringer) buckles stowed in Node Bag
3. Port/Aft portion of A/L circular HR [HR 0506]
4. A/L HR 0537 (Eq Lock Zenith)
5. PMM ROEU and ROFU panels (zenith endcone)

### WARNING

#### ISS U.S. Pressurized Elements Constraints (Cont)

##### E. Thermal

1. PMA handrails may be hot. Handling may need to be limited
2. Stay  $\geq 1$  ft away from PMAs and MMOD shields  $> 270$  degF if EMU sun visor up; limit time to 15 min or less if  $> 300$  degF
3. Stay at least 0.5 ft away from PMA and MMOD shields  $> 325$  degF
4. No EMU TMG contact with PMAs and MMOD shields  $> 320$  degF

##### F. Electrical Shock

1. Stay  $\geq 2$  ft from ungrounded floating connectors if powered. SSPTS connectors include NOD1 Stbd/Fwd HR 0130, LAB Stbd/Fwd HR 0273, PMA2 Stbd

##### G. Fluid QDs

1. Do not translate on gap spanners restraining NODE 3 – LAB NH3 jumpers

## EVA 1 NOTES, CAUTIONS, WARNINGS (Cont)

### WARNING

#### ISS I.P. Elements Constraints

##### COL

A. Avoid inadvertent contact with

1. SOLAR [COL EPF]

B. Thermal

1. Columbus end cones may violate touch temperature constraints when  $-75 \leq \beta \leq -60$  or  $60 \leq \beta \leq 75$

##### JEM

A. Avoid inadvertent contact with

1. ICS-EF sensors

B. Pinch

1. JPM window shutter linkages during operation
2. JEM cameras (JVTEs, EVE, WVE, and JEF VEs)
3. JEM EFU latching arms
4. JEF SSE latch
5. ICS-EF antenna boom
6. SEDA-AP mast
7. SMILES antenna rotating area
8. HREP hinge sides and RAIDS pinch areas
9. JEMRMS EE
10. JEMRMS Small Fine Arm (SFA) joints and booms

### WARNING

#### ISS I.P. Elements Constraints (Cont)

##### JEM (Cont)

C. Sharp Edges

1. Interior of JEMRMS HRMs
2. JEMRMS EE opening and snares
3. JEM A/L hatch corners
4. ICS-EF AHM gears
5. MAXI visual star camera
6. SMILES baffles (two), baffle base bare bolts, and Cold Sky Terminator (CST)
7. HREP baffles (four) [Star tracker aperture Zenith and three instrument baffles Aft]
8. SFAs Electro-Mechanical GF (EMGF)

D. RF radiation exposure

1. Stay 0.3 ft from Fwd/Aft JPM PROX antenna

E. Thermal

1. JPM Port End Cones and JLP Port Nadir may violate touch temperature constraints when  $\beta > 60$  deg
2. JEMRMS/JTVE/JEFVE operating cameras and lights may radiate large amounts of heat

### WARNING

#### Shuttle Constraints

A. Arcing/Molten Debris

1. Stay  $\geq 2$  ft from exposed EFGF connector when OBSS berthed, powered, and EFGF not grappled [PLB]
2. Stay  $\geq 2$  ft from exposed Stbd Fwd MPM contacts [PLB]
3. Stay above PLB sill when within 1 ft of powered ROEU connector [PLB]

B. Pinch

1. PRLA operation [PLB]

C. RF radiation exposure

1. Stay 3.28 ft from S-Band antenna when powered
2. Stay 1 ft from top and side of UHF PLB antenna radome surface when in high powered mode [ODS truss]
3. Stay 0.33 ft from top and side of UHF PLB antenna radome surface when in low powered mode [ODS truss]
4. Remain below the level of the PLB door mold line for first 20 in Aft of Fwd bulkhead when S-Band antenna powered [PLB]
5. Remain on the inboard side of the Stbd slidewire (sill handrails if slidewire not installed) for first 20 ft Aft of Fwd bulkhead when Ku-Band antenna powered [PLB]

## EVA 1 NOTES, CAUTIONS, WARNINGS (Cont)

### WARNING

#### **Shuttle Constraints (Cont)**

##### D. Sharp Edges

1. PRLA grounding wipers [PLB]
2. LDRI baffles (also an entrapment hazard) [OBSS]
3. Keep hands away from SRMS EE opening and snares
4. TCS connector backshells have exposed threads [ODS]

##### E. Thermal

1. Illuminated PLB lights; do not touch
2. OBSS grapple fixture shafts/cams may be hot. Limit handling if required
3. Stay 27 ft from PRCS when powered
4. Stay 3 ft from VRCS when powered
5. Stay 3 ft from APU when operating

##### F. Contamination

1. Stay out of the immediate vicinity of leaking jet or APU

##### G. Lasers

1. Do not look at LDRI diffuser or LCS laser aperture window

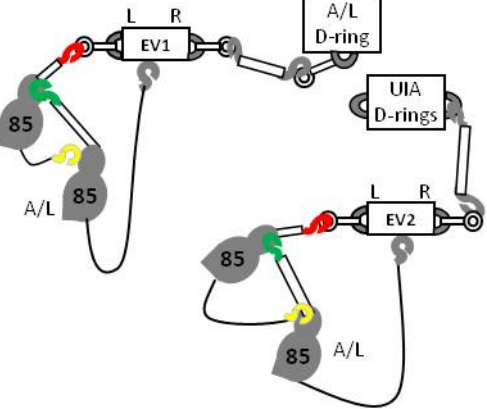

# EGRESS/EVA SETUP (00:25)

IV/SSRMS	EV1 – Kopra	EV2 – Drew
 <p>The diagram shows two External Vehicle (EV) units, EV1 and EV2, connected to the International Space Station (ISS) structure. EV1 is connected to an A/L D-ring and a UIA D-ring. EV2 is connected to an A/L D-ring. Various tethers and hooks are shown, including red, green, and yellow hooks, and 85mm A/L connectors. The diagram is labeled with 'L' and 'R' for left and right sides of the EV units.</p> <ol style="list-style-type: none"> <li>1. Start hatch thermal cover clock PET (30 min) ___ : ___</li> <li>2. <b>Give EV1 GO</b> to release Waist Tether from A/L internal D-ring</li> <li>3. <b>Give EV2 GO</b> to release Waist Tether from A/L UIA</li> </ol>	<p><b>Initial Configuration:</b></p> <ol style="list-style-type: none"> <li>1. <input checked="" type="checkbox"/> All gates closed and hooks locked <ul style="list-style-type: none"> <li><input type="checkbox"/> R Waist Tether to R D-ring extender</li> <li><input type="checkbox"/> R Waist Tether to A/L internal D-ring extender</li> <li><input type="checkbox"/> Red suit hook to L D-ring extender</li> <li><input type="checkbox"/> Green fairlead hook to crew ERCM (not locked)</li> <li><input type="checkbox"/> Yellow anchor hook to fairlead ERCM</li> <li><input type="checkbox"/> Structure anchor hook to MWS</li> <li><input type="checkbox"/> ERCM reels unlocked</li> </ul> </li> </ol> <p><u>EGRESS/SETUP (00:25)</u></p> <ol style="list-style-type: none"> <li>2. ← Open hatch thermal cover</li> <li>3. Egress A/L</li> <li>4. EV1 structure anchor to fwd external D-ring <ul style="list-style-type: none"> <li><input type="checkbox"/> <input checked="" type="checkbox"/> Gate closed, hook locked, reel unlocked</li> </ul> </li> <li>5. <b>On IV GO</b>, release EV1 Waist Tether from A/L internal D-ring extender</li> <li>6. Receive Stub bag; stow on A/L HR _____ (HR 0550)</li> <li>7. Receive PM Cap bag; stow on ESP-2 HR _____ (HR 8003)</li> <li>8. Receive J612 cable; stow on BRT</li> <li>9. Receive EV2 structure anchor; attach to aft external D-ring <ul style="list-style-type: none"> <li><input type="checkbox"/> <input checked="" type="checkbox"/> Gate closed, hook locked, reel unlocked</li> </ul> </li> </ol>	<p><b>Initial Configuration:</b></p> <ol style="list-style-type: none"> <li>1. <input checked="" type="checkbox"/> All gates closed and hooks locked <ul style="list-style-type: none"> <li><input type="checkbox"/> R Waist Tether to R D-ring extender</li> <li><input type="checkbox"/> R Waist Tether to A/L UIA</li> <li><input type="checkbox"/> Red suit hook to L D-ring extender</li> <li><input type="checkbox"/> Green fairlead hook to crew ERCM (not locked)</li> <li><input type="checkbox"/> Yellow anchor hook to fairlead ERCM</li> <li><input type="checkbox"/> Structure anchor hook to MWS</li> <li><input type="checkbox"/> ERCM reels unlocked</li> </ul> </li> </ol> <p><u>EGRESS/SETUP (00:25)</u></p> <ol style="list-style-type: none"> <li>2. Transfer Stub bag to EV1; stow Lg-sm RET on A/L D-ring ext</li> <li>3. Transfer PM Cap bag to EV1; stow Lg-sm RET on A/L D-ring ext</li> <li>4. Transfer J612 cable to EV1; stow Lg-sm RET on A/L D-ring ext</li> <li>5. Transfer EV2 structure anchor to EV1</li> <li>6. <b>On IV GO</b>, release Waist Tether from A/L UIA D-ring</li> <li>7. Egress A/L</li> </ol>

EV1 & EV2

**EGRESS/EVA SETUP (00:25) (Cont)**

<b>IV/SSRMS</b>	<b>EV1 – Kopra</b>	<b>EV2 – Drew</b>
<p>4. Stop hatch thermal cover clock PET (30 min) ___ : ___</p> <p>5. Post crew egress: WVS Software:     Select page – RF camera     Sel 'Advanced Controls'     S-Band Level (two) – Max</p>	<p>10. √WVS – green LED</p> <p>11. √MWS tabs up, tethers clear, visors/lights</p> <p>12. Verify SAFER config  <input type="checkbox"/> √L handle down (MAN ISO Vlv – Open)  <input type="checkbox"/> √R handle down, door closed (HCM – Closed)</p>	<p>8. √WVS – green LED</p> <p>9. √MWS tabs up, tethers clear, visors/lights</p> <p>10. Verify SAFER config  <input type="checkbox"/> √L handle down (MAN ISO Vlv – Open)  <input type="checkbox"/> √R handle down, door closed (HCM – Closed)</p> <p>11. Close hatch thermal cover</p> <p>12. Perform translation adaptation</p>

**EV1 & EV2**

## J612 EXTENSION CABLE INSTALL (00:30)

IV/SSRMS	EV1 – Kopra (FF)	EV2 – Drew (FF)
<p>1. √MCC-H: J612 inhibits in place</p> 	<p><u>J612 EXTENSION CABLE INSTALL</u> (00:30)</p> <ol style="list-style-type: none"> <li>Translate to J612 worksite via N2 Tank 03 gap spanner (lead)</li> <li>Fairlead at A/L HR _____ (HR 0502)</li> </ol> <p style="text-align: center;"><u>NOTE</u> Avoid inadvertent contact with LAB NPV and Node 3 NH3 lines</p> <div style="border: 1px solid black; padding: 5px; margin: 10px auto; width: fit-content;"> <p style="text-align: center;"><u>CAUTION</u></p> <ul style="list-style-type: none"> <li>Do not translate on gap spanners restraining NH3 MLI and jumpers</li> <li>Do not tether or BRT to handrails with attached gap spanners restraining NH3 MLI and Jumpers</li> </ul> </div> <ol style="list-style-type: none"> <li>Local tether to Node 1 HR 0132</li> <li>Remove dust cap from extension cable connector P612; stow in small trash bag</li> <li>Remove dust cap from extension cable connector J612A; stow in small trash bag</li> <li>Release white wire tie</li> <li>Demate airlock cable (W015) from Node 1 J612           <ul style="list-style-type: none"> <li><input type="checkbox"/> Airlock cable (W015) P1 ← → Node 1 J612</li> </ul> </li> <li>Mate J612 extension cable to Node 1 J612           <ul style="list-style-type: none"> <li><input type="checkbox"/> Extension cable P612 → ← Node 1 J612</li> </ul> </li> <li>Wire tie extension cable to Node HR 0132</li> <li>Transfer airlock cable and ext cable to EV2</li> <li>Translate to Node 3 endcone HR 0667</li> <li>Remove Node 3 end of gap spanner (HR 0668 – fwd) as reqd</li> <li>Open TA-clamps (2) and remove 612 cable slack</li> <li>Replace Node 3 gap spanner (HR 0668 – fwd) as reqd</li> <li>Pull slack through Node 3 HR 0681 wire tie. (Wire tie is captive to cable, but can slide on cable)</li> <li>Pull slack through Node 1 HR 0142 wire tie. (Wire tie is captive to cable, but can slide on cable)</li> </ol>	<p><u>J612 EXTENSION CABLE INSTALL</u> (00:30)</p> <ol style="list-style-type: none"> <li>Translate to Lab HR 0237 via N2 Tank 03 gap spanner</li> <li>Attach MUT EE to Lab HR 0237 (fwd end of HR)           <ul style="list-style-type: none"> <li><input type="checkbox"/> ECOM pointing nadir/port</li> <li><input type="checkbox"/> Rotate Locking collar to hard stop</li> </ul> </li> </ol> <p style="text-align: center;"><u>NOTE</u> Avoid inadvertent contact with LAB NPV and Node 3 NH3 lines</p> <ol style="list-style-type: none"> <li>Local tether to Node 1 HR 0133 (J612 worksite)</li> <li>Assist EV1 with clearances to NH3 lines</li> </ol> <ol style="list-style-type: none"> <li>Receive airlock cable and ext cable from EV1</li> <li>Mate airlock cable to extension cable           <ul style="list-style-type: none"> <li><input type="checkbox"/> Airlock cable P1 → ← Extension cable J612A</li> </ul> </li> <li>Verify thermal bootie on airlock cable in place, fully covering airlock cable connector P1; wire tie as reqd</li> <li>Wire tie connectors to Node 1 HR 0134 or Lab HR 0217 w/ext cable integral wire tie</li> <li>Wire tie airlock cable slack to Node 1 HRs 0133 or EH1 (aft of HR 0133)</li> <li>Release Node 3 612 cable from Node 1 HR 0132</li> </ol>

EV1 & EV2

**J612 EXTENSION CABLE INSTALL (00:30) (Cont)**

IV/SSRMS	EV1 – Kopra (FF)	EV2 – Drew (FF)
2. Notify <b>MCC-H</b> when J612 task complete	17. CHECK GLOVES	11. Move Node 3 612 cable to Node 1 HR 0134 or Lab HR 0217; secure with integral cable wire tie 12. CHECK GLOVES

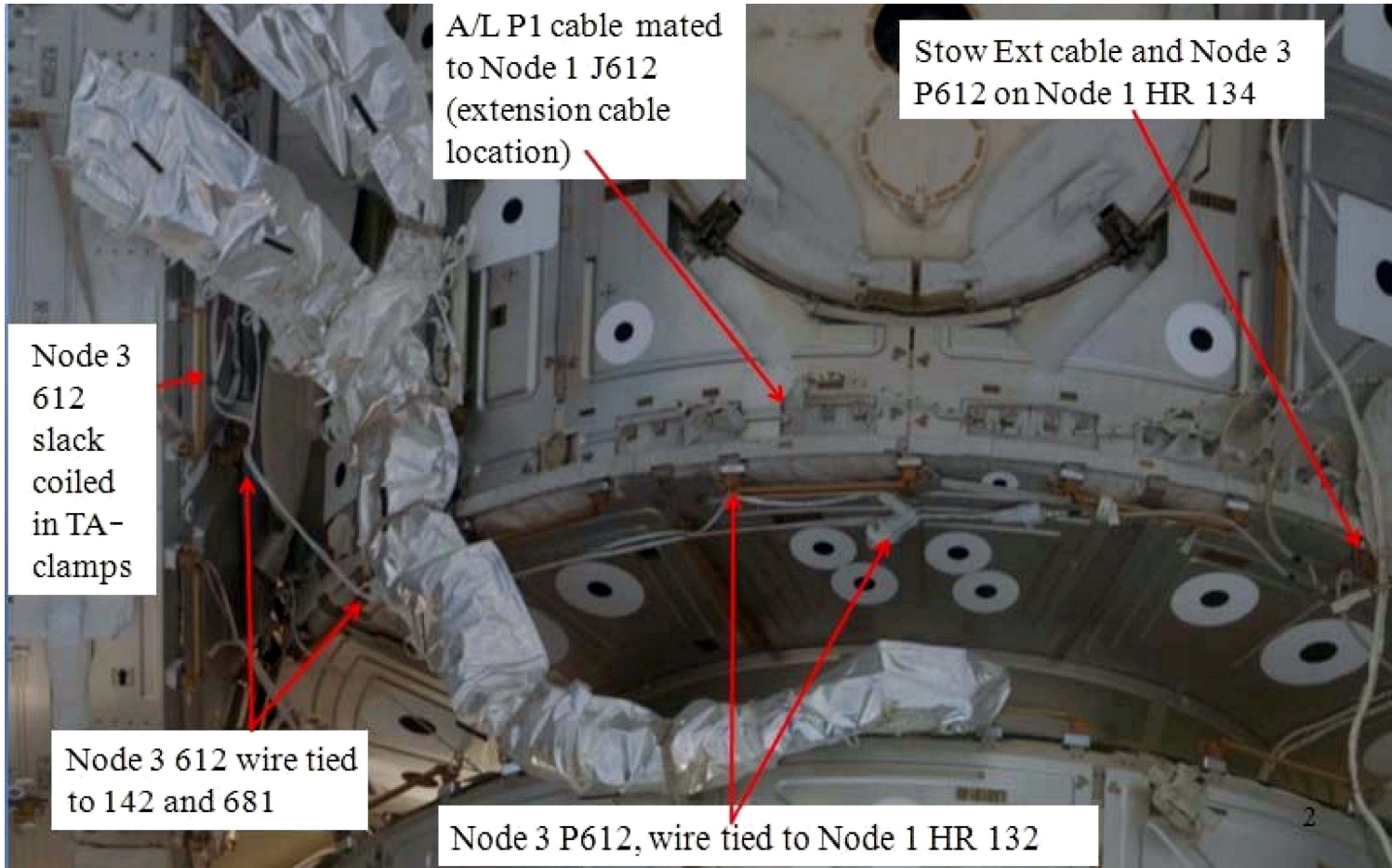

EV1 & EV2

## SSRMS SETUP (00:30)

IV/SSRMS	EV1 – Kopra (SSRMS)
<p>1. Verify SSRMS at APFR Setup position</p> <p>SSRMS: Maneuver to APFR and WIF Adapter Install position</p> <p>SSRMS: GCA to APFR and WIF Adapter Install position (if required)</p> <p>SSRMS: <b>On EV1 GO</b> to APFR Ingress position</p> <p>SSRMS: GCA to APFR Ingress (if required)</p>	<p><u>SSRMS SETUP (00:30)</u></p> <p>1. Retrieve PM Cap bag from ESP-2 HR 8003; stow on BRT</p> <div style="border: 3px double black; padding: 5px; text-align: center;"> <p><b>WARNING</b> ESP-2 HR 8012 has potential sharp edge (MMOD Strike) on label</p> </div> <p>2. Stow PM Cap bag on PM FRAM HR and DCSU HR</p> <p>3. Retrieve WIF Adapter and 55-ft ST</p> <p>4. Attach 55-ft ST to L D-ring ext</p> <p>5. Retrieve Rd Scoop and Socket Caddy; stow on MWS</p> <p>6. <b>Give SSRMS GO</b> to maneuver to APFR and WIF Adapter Install position</p> <p>7. Translate to ESP-2 WIF 5 APFR [12,FF,F,12]</p> <p>8. GCA SSRMS to APFR and WIF Adapter Install position (if required)</p> <p>9. Install WIF Adapter onto SSRMS LEE (Tether point toward EE)</p> <p><input type="checkbox"/> PIP Pin installed</p> <p><input type="checkbox"/> Pull test</p> <p>10. Install APFR [12,FF,F,12] into WIF Adapter</p> <p><input type="checkbox"/> √Bik-Bik</p> <p><input type="checkbox"/> Pull/Twist test</p> <p>11. Perform tether swap to 55-ft ST on SSRMS LEE HR tether point (left of bootplate)</p> <p><input type="checkbox"/> √Gate closed (both hooks)</p> <p><input type="checkbox"/> √Hook locked (both hooks)</p> <p><input type="checkbox"/> √Reel unlocked (55-ft ST)</p> <p>12. Extend Ingress Aid</p> <p>13. Temp stow Red 85-ft ST on ESP-2 HR _____ (HR 8011)</p> <p>14. <b>Give SSRMS GO</b> to APFR Ingress position</p> <p>15. GCA SSRMS for APFR Ingress (if required)</p> <p>16. Attach Waist Tether to Ingress Aid</p> <p>17. Ingress APFR</p> <p>18. CHECK GLOVES</p>

EV1

**VENT TOOL EXTENSION BAG/APFR TO ESP-2 (00:30)**

IV/SSRMS	EV2 – Drew (FF)
	<p><u>VENT TOOL EXTENSION BAG/APFR TO ESP-2 (00:30)</u></p> <ol style="list-style-type: none"> <li>1. Translate to port CETA cart</li> <li>2. Configure CETA Cart WIF 1 APFR [ ,QQ,F,12]</li> <li>3. Retrieve the PM Jumper bag (VTE bag #2) and Vent Tool Extension bag (VTE bag #1), strap together with bag #1 accessible</li> <li>4. Verify Lg-sm adjustable on bags</li> <li>5. Stow bags #1/#2 on APFR in WIF 1</li> <li>6. Stow APFR on BRT</li> <li>7. Translate to ESP-2</li> <li>8. Install APFR [3,QQ,F,12] ESP-2 WIF 8               <ul style="list-style-type: none"> <li><input type="checkbox"/> √Blk-Blk</li> <li><input type="checkbox"/> Pull/Twist test</li> </ul> </li> <li>9. Retrieve VTE bags #1/#2; stow on BRT</li> <li>10. CHECK GLOVES</li> </ol>

EV2

## VENT TOOL SETUP (00:25)

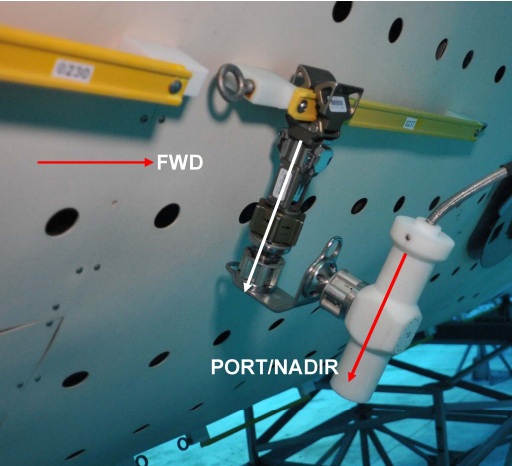
IV/SSRMS	EV2 – Drew (FF)
	<p><u>VENT TOOL SETUP (00:25)</u></p> <ol style="list-style-type: none"><li>1. Translate to Lab HR 0230/0237; temp stow bags</li><li>2. Open VTE bag #1</li><li>3. Attach VTE nozzle to MUT EE clocking = nozzle points port/nadir</li><li>4. Move Lg-sm adjustable to MWS</li></ol> <div data-bbox="701 513 1596 643" style="border: 1px solid black; padding: 5px;"><p style="text-align: center;"><u>CAUTION</u></p><ul style="list-style-type: none"><li>• 20-min cumulative QD exposure to direct sun can cause seal damage. The vent tool QD can remain uncovered for no more than 90 min (1 orbit)</li><li>• Avoid bend radius &lt; 2 in for vent tool and vent tool extension hoses</li></ul></div> <ol style="list-style-type: none"><li>5. Prior to attaching 1.5" vent tool to VTE, perform visual check that vent tool nozzle will protrude past VTE internal seals:<ul style="list-style-type: none"><li><input type="checkbox"/> Hold vent tool nozzle against VTE external alignment groove. (Vent tool hook should contact VTE connector)</li><li><input type="checkbox"/> ✓ Nozzle tip is past thin black alignment line</li></ul></li><li>6. Install 1.5" vent tool nozzle into VTE connector:<ul style="list-style-type: none"><li><input type="checkbox"/> Rotate lock lever to unlock (hard stop detent – very loose)</li><li><input type="checkbox"/> Depress lever to hard stop (2-10 lb)</li><li><input type="checkbox"/> Insert vent tool nozzle into connector tube (vent tool hook will contact front of connector, go to hard stop)</li><li><input type="checkbox"/> Release lever and rotate to lock</li></ul></li></ol> <div data-bbox="701 1013 1516 1094" style="border: 3px double black; padding: 5px;"><p style="text-align: center;"><u>WARNING</u> ESP-2 HR 8012 has potential sharp edge (MMOD Strike) on label</p></div> <ol style="list-style-type: none"><li>7. Stow vent tool QD on ESP-2 HR 8013 with wire tie</li></ol>

EV2

**FAILED PM RETRIEVE FROM POA (00:30)**

<b>IV/SSRMS</b>	<b>EV1 – Kopra (SSRMS)</b>
<p>SSRMS: <b>On EV1 GO</b> to Backoff position</p> <p>SSRMS: JOCAS to PM Retrieve Setup position (04:00)</p> <p>SSRMS: Maneuver to PM Retrieve position</p> <p>SSRMS: GCA for Rd Scoop install</p> <p>SSRMS/POA: <b>On EV1 GO</b>, release PM</p> <p>SSRMS: <b>On EV1 GO</b> to Backoff position</p> <p>SSRMS: JOCAS to ESP-2 Setup position (03:00)</p>	<p><u>FAILED PM RTRV FROM POA (00:30)</u></p> <ol style="list-style-type: none"> <li>1. <b>Give SSRMS GO</b> for mnvr to Backoff position (failed PM retrieve on POA)</li> <li>2. Perform socket swap 5/8" 7.8 ext socket; stow on PGT               <ul style="list-style-type: none"> <li><input type="checkbox"/> Perform pull test</li> </ul> </li> <li>3. Prep PGT for PM bolts, <b>PGT [B7, CW2]</b></li> <li>4. GCA for Rd Scoop install</li> <li>5. Install Rd Scoop on Bolt #3 clocking = 10</li> <li>6. Verify following in good config prior to PM removal               <ul style="list-style-type: none"> <li><input type="checkbox"/> Cooling</li> <li><input type="checkbox"/> APFR Ingress Aid</li> <li><input type="checkbox"/> Visors</li> <li><input type="checkbox"/> Glove heaters</li> <li><input type="checkbox"/> Helmet lights</li> <li><input type="checkbox"/> Keep heels out</li> <li><input type="checkbox"/> Tethers clear</li> </ul> </li> <li>7. <b>Give SSRMS/POA GO</b> to release PM</li> <li>8. <b>On SSRMS GO</b>, remove PM from POA</li> <li>9. <b>Give SSRMS GO</b> to Backoff position</li> <li>10. Re-orient PM at Backoff position</li> </ol>

EV1

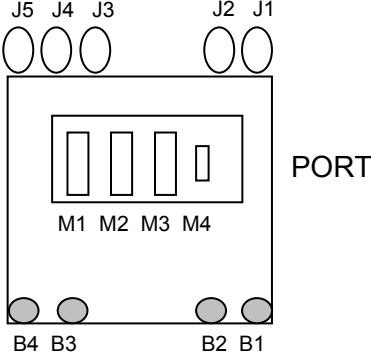

## FAILED PM INSTALL ON ESP-2 (01:30)

IV/SSRMS	EV1 – Kopra (SSRMS)	EV2 – Drew (FF)																				
<p>SSRMS: Maneuver to PM pre-install position                      SSRMS: GCA to AGB Removal position</p>  <p>SSRMS: GCA for full PM Install</p> <p>PM Bolt Data:</p> <table border="1" data-bbox="111 1149 640 1412"> <thead> <tr> <th>Bolt</th> <th>Torque (ft-lb)</th> <th>Turns</th> <th>Green Light</th> </tr> </thead> <tbody> <tr> <td>1</td> <td></td> <td></td> <td></td> </tr> <tr> <td>4</td> <td></td> <td></td> <td></td> </tr> <tr> <td>3</td> <td></td> <td></td> <td></td> </tr> <tr> <td>2</td> <td></td> <td></td> <td></td> </tr> </tbody> </table>	Bolt	Torque (ft-lb)	Turns	Green Light	1				4				3				2				<p><u>FAILED PM INSTALL ON ESP-2 (01:30)</u></p> <ol style="list-style-type: none"> <li>GCA SSRMS to AGB Removal position                             <ul style="list-style-type: none"> <li><input type="checkbox"/> Align aft pins and alignment guides to truss guide rails</li> </ul> </li> <li>Partially install PM into FSE</li> <li>Assist EV2 with rotating AGB, single pin side</li> <li>Verify electrical cables clear</li> <li><b>Give SSRMS GO</b> to GCA to fully install PM</li> <li><b>PGT: B7,CW2</b> (25.5 ft-lb, 30 RPM, 30.5) <b>7.8-ext, 5/8"</b></li> <li>Drive PM bolts 1, 4, 3, 2 in that order, 14.5-17 turns to torque                             <ul style="list-style-type: none"> <li><input type="checkbox"/> PM Bolt 1</li> <li><input type="checkbox"/> Remove Rd Scoop; stow on MWS</li> <li><input type="checkbox"/> PM Bolt 4</li> <li><input type="checkbox"/> PM Bolt 3</li> <li><input type="checkbox"/> PM Bolt 2</li> </ul> </li> </ol>	<p><u>FAILED PM INSTALL ON ESP-2 (01:15)</u></p> <ol style="list-style-type: none"> <li>Translate to ESP-2 PM FSE</li> <li>Retrieve electrical cables from inside PM MLI tent and stow clear of PM install</li> <li>Assist with GCA to PM FSE (on stbd side)</li> <li>Attach BRT RET to FHRC port/zenith HR, attach other end to AGB stbd HR</li> <li>Attach MWS Lg-sm adj tether to single pin side (AGB port)</li> <li><b>PGT: A2, CCW2</b> (3.8 ft-lb, 30 RPM, MTL 30.5) <b>2-in ext 7/16</b></li> <li>Release AGB bolt, 2-4 turns (preps for release)</li> <li>Pull T-handle out to unlock (two white lines visible)</li> <li>Slide two pin end of AGB from receptacles (GP5 and GP6/stbd)</li> <li>Remove single pin end out of receptacle (GP7/port)</li> <li>Temp stow AGB; Lg-sm adj tether to stbd FHRC HR (rotate 180)</li> <li>Assist EV1 with installing PM</li> <li>Retrieve Fish Stringer with PM caps and electrical cables; stow on PM handrails (zenith)</li> </ol>
Bolt	Torque (ft-lb)	Turns	Green Light																			
1																						
4																						
3																						
2																						

EV1 & EV2

**FAILED PM INSTALL ON ESP-2 (01:30) (Cont)**

IV/SSRMS	EV1 – Kopra (SSRMS)	EV2 – Drew (FF)						
<p>SSRMS: GCA to Vent Tool Install position</p> <p>1. <b>IV give SSRMS GO</b> to maneuver to AGB Install position</p> <p>SSRMS: GCA to AGB Install position AGB Bolt Data:</p> <table border="1" data-bbox="109 527 489 646"> <thead> <tr> <th>Torque (ft-lb)</th> <th>Turns</th> <th>Green Light</th> </tr> </thead> <tbody> <tr> <td> </td> <td> </td> <td> </td> </tr> </tbody> </table> <p>SSRMS: <b>On EV1 GO</b>, maneuver to Backoff position SSRMS: GCA to Connector/Cap Install as required</p> <div style="border: 1px solid black; background-color: yellow; padding: 5px;"> <p><b>BLOCK B – MATE QD</b></p> <ol style="list-style-type: none"> <li>Remove QD caps as required</li> <li>Inspect male and female QD for debris or damage</li> <li>Verify female QD ready to mate √Detent button – up √Fwd white band – not visible</li> <li>Assess side load potential prior to mate</li> <li>Mate QD √Fwd white band – visible</li> <li>Perform snapback test √Fwd white band visible</li> <li>Perform pull test (Stay clear of button, release ring, and bail trigger)</li> <li>Perform visual gap test</li> </ol> </div>	Torque (ft-lb)	Turns	Green Light				<ol style="list-style-type: none"> <li>Retrieve Vent Tool QD</li> <li>GCA SSRMS to Vent Tool Install position</li> <li>Pull back on release ring (bail trigger); remove 1.5" vent tool plug</li> <li>Mate vent tool to M2; perform <b>Block B</b></li> <li>Secure plug with wire tie as required</li> <li>GCA SSRMS to AGB install</li> <li>Install two pin end of AGB into receptacles (GP5 and GP6/port)</li> <li><b>Give SSRMS GO</b> to maneuver to Backoff position</li> <li>GCA SSRMS to Connector/Cap Install as required</li> <li>Connect electrical connector to PM                     <ul style="list-style-type: none"> <li><input type="checkbox"/> J1 (port-most)</li> <li><input type="checkbox"/> J4</li> <li><input type="checkbox"/> J5</li> </ul> </li> <li>Retrieve electrical caps J2, J3</li> <li>Install caps                     <ul style="list-style-type: none"> <li><input type="checkbox"/> J2 (size 15)</li> <li><input type="checkbox"/> J3 (size 21)</li> </ul> </li> <li>Retrieve QD caps</li> <li>Install QD caps                     <ul style="list-style-type: none"> <li><input type="checkbox"/> M1</li> <li><input type="checkbox"/> M3</li> <li><input type="checkbox"/> M4</li> </ul> </li> <li>Wire tie M2 cap to port PM Handrail</li> <li>Wire tie vent tool extension as required</li> <li>Retrieve fish stringer; stow on MWS</li> </ol>	<ol style="list-style-type: none"> <li>Route port electrical cable to port PM HR</li> <li>Retrieve ratchet from PM cap bag; stow on MWS</li> <li>Translate to FHRC</li> <li>Open FHRC AGB MLI flaps (3)</li> <li>Retrieve AGB</li> <li>Retract AGB to FHRC position and slide single pin end into receptacle (GP7/stbd)</li> <li>Push T-handle to lock position (no white lines visible)</li> <li>Drive AGB bolt cw with ratchet palm wheel until running torque increases (DO NOT reach hard stop)</li> <li><b>PGT: A2, CW2</b> (3.8 ft-lb, 30 RPM, MTL 30.5) <b>2-in ext 7/16</b></li> <li>Drive AGB bolt to hard stop</li> <li>Retrieve RET and adj tether from AGB; stow on BRT and MWS</li> <li>Stow ratchet and Lg-sm adj tether in PM Cap bag</li> <li>Translate to APFR ESP-2 WIF 8</li> <li>CHECK GLOVES</li> </ol>
Torque (ft-lb)	Turns	Green Light						

EV1 & EV2

**FAILED PM INSTALL ON ESP-2 (01:30) (Cont)**

IV/SSRMS	EV1 – Kopra (SSRMS)	EV2 – Drew (FF)
<p>2. Notify <b>MCC-H</b> when MLI flap closed</p> <p>SSRMS: <b>On EV1 GO</b>, maneuver to Backoff position</p> <p>SSRMS: FOR OCAS to APFR Egress Setup position (01:00)</p> <p>SSRMS: Maneuver to APFR Egress position</p> <p>SSRMS: GCA to APFR Egress (if required)</p>	<p>25. Fold front MLI flap over PM; secure as required (covering vent tool QD)</p> <p>26. <b>Give SSRMS GO</b> to maneuver to Backoff position</p> <p>27. Perform socket swap 7/16" 6 ext socket; stow on PGT  <input type="checkbox"/> Perform pull test</p> <p>28. GCA SSRMS as required for APFR egress (if required)</p> <p>29. CHECK GLOVES</p>	

**EV1 & EV2**

# APFR RETRIEVE/TOOL STANCHION RELOCATE (00:50)

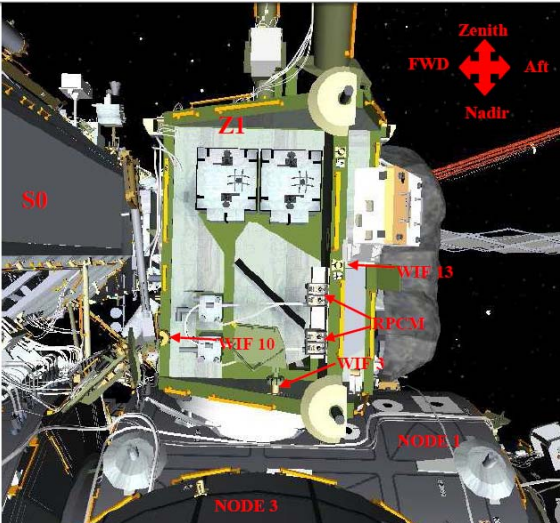
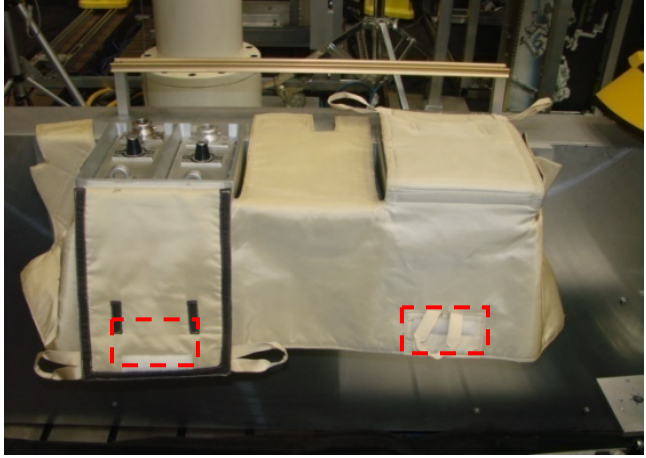
IV/SSRMS	EV2 – Drew (FF)						
	<p><b>EV2 – Drew (FF)</b></p> <p><u>APFR STOW</u> (00:15)</p> <ol style="list-style-type: none"> <li>1. Retrieve APFR ESP-2 WIF 8; stow on BRT</li> <li>2. Translate to Z1 WIF 13 (via aft route)</li> <li>3. Stow APFR1 in WIF 13 (3,QQ,F,12) <ul style="list-style-type: none"> <li><input type="checkbox"/> √BIK-BIK</li> <li><input type="checkbox"/> Pull/Twist test</li> </ul> </li> </ol> <p><u>Z1 RPCM MLI RECONFIG</u> (00:10)</p> <ol style="list-style-type: none"> <li>4. Fold back two RPCM flaps; secure w/Velcro flap</li> </ol> <p><u>RELOCATE TOOL STANCHION</u> (00:10)</p> <ol style="list-style-type: none"> <li>5. Translate to Z1 WIF 10</li> <li>6. Retrieve TS; place on BRT</li> <li>7. Translate to Z1 WIF 13</li> <li>8. Stow TS in APFR – pointing zenith (TS head parallel to port Z1 truss) <ul style="list-style-type: none"> <li><input type="checkbox"/> Pull Test</li> </ul> </li> </ol> <p><u>APFR RETRIEVE</u> (00:15)</p> <ol style="list-style-type: none"> <li>9. Translate to Z1 WIF 10</li> <li>10. Configure APFR 4 in low profile config for ingress [_, ZZ, A, 6]</li> <li>11. Retrieve APFR4; place on BRT</li> <li>12. Translate to A/L</li> <li>13. Open hatch thermal cover</li> <li>14. Stow APFR in A/L</li> <li>15. Close thermal cover</li> <li>16. Retrieve Stub bag; place on BRT</li> </ol> <p>17. GLOVE CHECK</p> <ol style="list-style-type: none"> <li>18. Check SAFER handles <ul style="list-style-type: none"> <li><input type="checkbox"/> √L handle down (MAN ISO Vlv – Open)</li> <li><input type="checkbox"/> √R handle down, door closed (HCM – Closed)</li> </ul> </li> <li>19. Translate to S1 CP3 via nadir route (inboard of ELC4; EV1 leads)</li> </ol>						
<ol style="list-style-type: none"> <li>1. Start hatch thermal cover clock PET (30 min) ___ : ___</li> <li>2. Stop hatch thermal cover clock PET (30 min) ___ : ___</li> <li>3. √MCC-H: EV1/EV2 Consumable status</li> </ol> <table border="1" data-bbox="130 1247 609 1364"> <tr> <td>Consumable limit</td> <td></td> </tr> <tr> <td>Cleanup time</td> <td></td> </tr> <tr> <td>On SCU time</td> <td></td> </tr> </table>	Consumable limit		Cleanup time		On SCU time		
Consumable limit							
Cleanup time							
On SCU time							

EV2

## SSRMS CLEANUP (00:30)

IV/SSRMS	EV1 – Kopra (SSRMS)						
<p>SSRMS: Maneuver to APFR Egress position</p> <p>SSRMS: <b>On EV1 GO</b>, maneuver to APFR Removal position</p> <p>SSRMS: GCA to APFR Removal position (if required)</p> <p>SSRMS: GCA to WIF adapter Removal position (if required)</p> <p>SSRMS: <b>On EV1 GO</b>, maneuver to APFR Backoff position</p> <p>1. <input checked="" type="checkbox"/> <b>MCC-H:</b> EV1/EV2 Consumable status</p>	<p><u>SSRMS CLEANUP</u> (00:30)</p> <ol style="list-style-type: none"> <li>1. Egress APFR</li> <li>2. Perform tether swap to STP on ESP-2 HR _____ (HR 8011)               <ul style="list-style-type: none"> <li><input type="checkbox"/> <input checked="" type="checkbox"/> <math>\sqrt</math>Red suit hook is on L D-ring ext (gate closed, hook locked)</li> <li><input type="checkbox"/> <math>\sqrt</math>Reel unlocked</li> </ul> </li> <li>3. <b>Give SSRMS GO</b> to maneuver to APFR Removal position</li> <li>4. GCA SSRMS for APFR Removal (if required)</li> <li>5. Retrieve SSRMS LEE 55-ft ST; stow on MWS</li> <li>6. Retract and lock ingress aid; fold to boot plate [ __,OO,B,1]</li> <li>7. Remove APFR from WIF adapter</li> <li>8. Install APFR [10,OO,B,1] ESP-2 WIF 6               <ul style="list-style-type: none"> <li><input type="checkbox"/> <math>\sqrt</math>Bik-Bik</li> <li><input type="checkbox"/> Pull/Twist test</li> <li><input type="checkbox"/> <math>\sqrt</math>AIA retracted and locked, folded to boot plate</li> </ul> </li> <li>9. GCA SSRMS for WIF adapter removal (if required)</li> <li>10. Retrieve WIF adapter</li> <li>11. Verify tools and tethers clear of SSRMS</li> <li>12. <b>Give SSRMS GO</b> to maneuver to APFR Backoff position</li> <li>13. Stow in PM Cap bag:               <ul style="list-style-type: none"> <li><input type="checkbox"/> 55-ft ST (outside)</li> <li><input type="checkbox"/> WIF adapter</li> <li><input type="checkbox"/> Rd Scoop</li> <li><input type="checkbox"/> Socket Caddy</li> <li><input type="checkbox"/> Fish Stringer</li> </ul> </li> <li>14. Perform PM bag Inventory</li> <li>15. BRT to PM bag</li> <li>16. Stow PM bag outside of A/L</li> <li>17. GLOVE CHECK</li> <li>18. Translate to S1 CP3 via face 1 (inboard of ELC4; EV1 leads)</li> </ol>						
<table border="1" style="width: 100%;"> <tr> <td style="background-color: #cccccc;">Consumable limit</td> <td></td> </tr> <tr> <td>Cleanup time</td> <td></td> </tr> <tr> <td>On SCU time</td> <td></td> </tr> </table>	Consumable limit		Cleanup time		On SCU time		
Consumable limit							
Cleanup time							
On SCU time							

EV1

**CP3 CAMERA WEDGE INSTALL (01:00)**

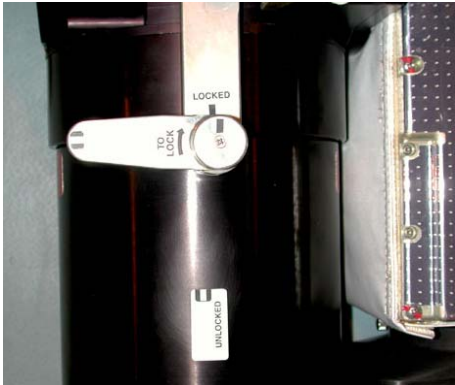
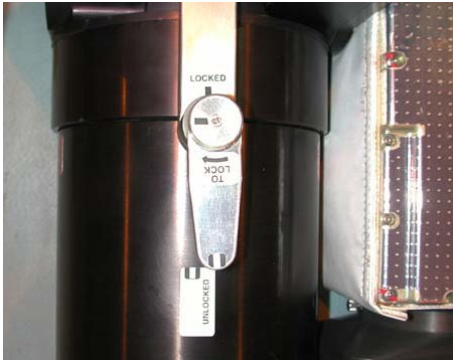
IV/SSRMS	EV1 – Kopra (FF)	EV2 – Drew (FF)												
<p>1. <b>MCC-H:</b> Inhibits in place                      ✓S1 TRRJ locked at -15°                      ✓ETVCG inhibits                      ✓Camera stowed</p>	<p><u>CP3 CAMERA WEDGE INSTALL (01:00)</u>                      1. Drop green fairlead hook at S1 HR 3247 (Bay 11)</p>	<p><u>CP3 CAMERA WEDGE INSTALL (01:00)</u>                      1. Drop green fairlead hook at S1 HR 3238 (Bay 13)                      2. Temp stow Stub bag at S1 HR _____ (HR 3246)                      3. Retrieve camera wedge from bag; stow on MWS                      4. Secure bag to structure with RET</p>												
<p><b>CAUTION</b>                      Avoid kicking S1 radiator beam. If this occurs, wait 2 to 5 min to allow structural response to dissipate</p>														
	<p>2. Push in and rotate pan/tilt lever on camera to LOCK position                      3. BRT to S3 HR 3010 (Head Fwd)                      4. Attach RET to stanchion tether point                      5. Release TA-clamps as required</p>	<p>5. BRT to S1 HR 3214 (left side Zenith, Head Aft)                      6. Perform socket swap to 7/16" 6 ext socket; stow on PGT  <input type="checkbox"/> Stow 7/16" 2 ext in trash bag on RET  <input type="checkbox"/> Perform pull test</p>												
	<p>6. Receive stanchion from EV2; stabilize (without pulling on electrical cables)</p> <p style="text-align: center;"><u>NOTE</u>                      Camera will be canted inboard/forward once wedge is installed</p>	<p>7. <b>PGT [B7, CCW2]</b>                      (25.5 ft-lb, 30 RPM, MTL 30.5) 6-ext 7/16                      8. Release stanchion bolt, 16.5 turns                      9. ✓Spring tension on bolt. (Launch Lock threads are not engaged)</p>												
<p>2. Notify <b>MCC-H</b> when CP3 Wedge Install complete</p> <p>CP3 Bolt Data:</p>	<p>7. Assist EV2 with stanchion installation                      8. UNLOCK pan/tilt lever on camera; retrieve RET                      9. GLOVE CHECK                      10. Translate to airlock or perform get-ahead per <b>MCC-H</b> direction</p>	<p>10. Remove stanchion from receptacle; hand off to EV1                      11. Soft dock wedge onto truss; ✓flat against surface                      12. <b>PGT [B3, CW2]</b>                      (18.4 ft-lb, 30 RPM, MTL 30.5) 6-ext 7/16                      13. Drive wedge bolt, 16.5 turns to hard stop (pushing in while driving to overcome spring force)                      14. Remove RET from wedge                      15. Soft dock stanchion onto wedge; ✓flat against surface                      16. <b>PGT [B3, CW2]</b>                      (18.4 ft-lb, 30 RPM, MTL 30.5) 6-ext 7/16                      17. Drive stanchion bolt, 16.5 turns to hard stop (pushing in while driving to overcome spring force)                      18. GLOVE CHECK                      19. Retrieve Stub bag; stow on BRT                      20. Translate to airlock or perform get-ahead per <b>MCC-H</b> direction</p>												
<table border="1" style="width: 100%; border-collapse: collapse;"> <thead> <tr> <th style="width: 25%;">Bolt</th> <th style="width: 25%;">Torque (ft-lb)</th> <th style="width: 25%;">Turns</th> <th style="width: 25%;">Green Light</th> </tr> </thead> <tbody> <tr> <td>Wedge</td> <td></td> <td></td> <td></td> </tr> <tr> <td>Stanchion</td> <td></td> <td></td> <td></td> </tr> </tbody> </table>	Bolt	Torque (ft-lb)	Turns	Green Light	Wedge				Stanchion					
Bolt	Torque (ft-lb)	Turns	Green Light											
Wedge														
Stanchion														

**EV1 & EV2**

**GET-AHEAD – STBD CETA RAIL STUB INSTALL (01:00)**

IV/SSRMS	EV1 – Kopra (FF)	EV2 – Drew (FF)																								
<p>1. <b>MCC-H:</b> Inhibits in place √Stbd SARJ locked at 345°</p> <p>Nadir Clam Shell Bolt Data:</p> <table border="1" data-bbox="109 516 604 685"> <thead> <tr> <th>Bolt</th> <th>Torque (ft-lb)</th> <th>Turns</th> <th>Green Light</th> </tr> </thead> <tbody> <tr> <td>Fwd</td> <td></td> <td></td> <td></td> </tr> <tr> <td>Aft</td> <td></td> <td></td> <td></td> </tr> </tbody> </table> <p>Zenith Clam Shell Bolt Data:</p> <table border="1" data-bbox="109 1112 604 1281"> <thead> <tr> <th>Bolt</th> <th>Torque (ft-lb)</th> <th>Turns</th> <th>Green Light</th> </tr> </thead> <tbody> <tr> <td>Fwd</td> <td></td> <td></td> <td></td> </tr> <tr> <td>Aft</td> <td></td> <td></td> <td></td> </tr> </tbody> </table> <p>2. Perform Stub bag inventory</p>	Bolt	Torque (ft-lb)	Turns	Green Light	Fwd				Aft				Bolt	Torque (ft-lb)	Turns	Green Light	Fwd				Aft				<p><u>NADIR RAIL STUB INSTALL (00:30)</u></p> <ol style="list-style-type: none"> <li>Translate to S3 SARJ interface (Face 1, Nadir Rail)</li> <li>Retrieve nadir rail stub with ETRS from Stub bag</li> <li>BRT to S3 HR _____ (3062)</li> <li>Position and hold rail stub on end of CETA rail (“mushroom head to mushroom head”)</li> <li>Assist EV2 with clam shell install</li> </ol> <p>6. <b>PGT [A3, CW2]</b> (4.8 ft-lb, 30 RPM, MTL 30.5) 7/16 x 6-in ext</p> <ol style="list-style-type: none"> <li>Engage <b>fwd</b> retaining bolt 2 turns</li> <li>Engage <b>aft</b> retaining bolt to hard stop, ~16 turns</li> <li>Engage <b>fwd</b> retaining bolt to hard stop, ~14 turns</li> <li>Remove RET from rail stub</li> </ol> <p><u>ZENITH RAIL STUB INSTALL (00:30)</u></p> <ol style="list-style-type: none"> <li>Retrieve zenith rail stub from Stub bag</li> <li>Translate to zenith rail stub worksite</li> <li>BRT to S3 HR _____ (3064)</li> <li>Position and hold rail stub on end of CETA rail (“mushroom head to mushroom head”)</li> <li>Assist EV2 with clam shell install</li> </ol> <p>16. <b>PGT [A3, CW2]</b> (4.8 ft-lb, 30 RPM, MTL 30.5) 7/16 x 6-in ext</p> <ol style="list-style-type: none"> <li>Engage <b>fwd</b> retaining bolt 2 turns</li> <li>Engage <b>aft</b> retaining bolt to hard stop, ~16 turns</li> <li>Engage <b>fwd</b> retaining bolt to hard stop, ~14 turns</li> <li>Remove and stow adj equip tether in Stub bag</li> <li>GLOVE CHECK</li> </ol>	<p><u>NADIR RAIL STUB INSTALL (00:30)</u></p> <ol style="list-style-type: none"> <li>Translate to S3 SARJ interface (Face 1, Nadir Rail)</li> <li>Temp stow Stub bag on SARJ Covers _____ (1, 2)</li> <li>Retrieve clam shell (6A) from Stub bag</li> <li>BRT to S3 HR _____ (3061)</li> <li>Install clam shell with bolt heads pointing nadir and tether point facing aft</li> <li>Verify clam shell tether cable is clear from clam shell-mushroom head interface</li> <li>Squeeze clam shells together around mushroom heads and hold</li> <li>Watch for clam shell tether cable clearance and alignment while EV1 engages bolts</li> </ol> <p>9. Remove RET from clam shell</p> <p><u>ZENITH RAIL STUB INSTALL (00:30)</u></p> <ol style="list-style-type: none"> <li>Retrieve zenith clam shell (1A) from Stub bag</li> <li>Translate to zenith rail stub worksite</li> <li>BRT to S3 HR _____ (3046)</li> <li>Install clam shell with bolt heads pointing zenith and tether point facing aft</li> <li>Verify clam shell tether cable is clear from clam shell-mushroom head interface</li> <li>Squeeze clam shells together around mushroom heads and hold</li> <li>Watch for clam shell tether cable clearance and alignment while EV1 engages bolts</li> <li>Remove and stow RET from clam shell</li> </ol> <p>18. GLOVE CHECK</p>
Bolt	Torque (ft-lb)	Turns	Green Light																							
Fwd																										
Aft																										
Bolt	Torque (ft-lb)	Turns	Green Light																							
Fwd																										
Aft																										

EV1 & EV2

**GET-AHEAD – STOW TETHER SHUTTLE STOP AND S3 MT STOP (00:15)**

IV/SSRMS	EV1 – Kopra (FF)	EV2 – Drew (FF)
	<p><u>TS STOP STOW</u> (00:15)</p> <ol style="list-style-type: none"> <li>1. Translate to S3 bay 19 Face 1, TS stop</li> <li>2. Pull TS stop inboard, rotate 90 deg Nadir and then push outboard</li> <li>3. Translate to A/L</li> </ol> <div data-bbox="783 418 1228 1026" data-label="Image"> <p>A photograph showing a close-up of a mechanical assembly, likely the TS stop, being stowed. A person's hands in blue gloves are visible, interacting with the mechanism. A white rectangular label with the text "TS Stop Stowed" is centered over the image.</p> </div>	<p><u>MT STOP STOW</u> (00:15)</p> <ol style="list-style-type: none"> <li>1. Translate to S3 bay 19/17 interface Face 1</li> <li>2. Pull MT stop ~1/4" inboard out of spring loaded detents</li> <li>3. Rotate MT stop ~45 deg</li> <li>4. Push MT stop flush back into detents</li> <li>5. Translate to Stub bag; stow on BRT (S3 mile marker 5310)</li> <li>6. Translate to A/L</li> </ol> <div data-bbox="1341 602 1896 1060" data-label="Image"> <p>A photograph showing a close-up of a mechanical assembly, likely the MT stop, being stowed. The mechanism is mounted on a metal structure. A white rectangular label with the text "MT Stop Stowed" is centered over the image.</p> </div>

**EV1 & EV2**



**MESSAGE IN A BOTTLE (00:15)**

IV/SSRMS	EV1 – Kopra (FF)	EV2 – Drew (FF)
<p>1. Start hatch thermal cover clock PET (30 min) __ : __</p>	<p><u>MESSAGE IN A BOTTLE</u> (00:15)</p> <ol style="list-style-type: none"> <li>1. Translate to Airlock</li> <li>2. Receive camera from EV2</li> <li>3.  Photograph EV2 and Message in Bottle</li> <li>4. Transfer camera to EV2</li> </ol>	<p><u>MESSAGE IN A BOTTLE</u> (00:15)</p> <div style="border: 1px solid black; padding: 5px; margin: 10px 0;"> <p style="text-align: center;"><u>CAUTION</u></p> <p>Avoid impact on Space Bottle (cover and valve). Sharp edges exist under Kapton tape at wire's edge</p> </div> <ol style="list-style-type: none"> <li>1. Open Airlock thermal cover</li> <li>2. Stow Stub bag in Airlock</li> <li>3. Retrieve bottle and camera from Get-ahead bag</li> <li>4. Transfer camera to EV1</li> <li>5. Rotate knob cw until resistance felt, about 2 turns √Red markings aligned</li> <li>6. Receive camera from EV1</li> <li>7. Stow bottle and camera in Get-ahead bag</li> </ol>

EV1 & EV2

**CLEANUP/INGRESS (00:30)**

IV/SSRMS	EV1 – Kopra (FF)	EV2 – Drew (FF)
<ol style="list-style-type: none"> <li>1. Stop hatch thermal cover clock PET (30 min) __ : __</li> <li>2. Perform WVS PWRDN (PHOTO/TV, <u>WVS CUE CARD</u>)</li> </ol>	<p><u>INGRESS AND PRE-REPRESS</u> (00:30)</p> <ol style="list-style-type: none"> <li>1. Transfer bags to EV2, as required               <ul style="list-style-type: none"> <li><input type="checkbox"/> Stub bag</li> <li><input type="checkbox"/> PM bag</li> <li><input type="checkbox"/> Get-ahead bag</li> <li><input type="checkbox"/> APFR</li> </ul> </li> <li>2. Attach R Waist Tether to Internal A/L D-ring ext               <ul style="list-style-type: none"> <li><input type="checkbox"/> √Gate closed, hook locked</li> </ul> </li> <li>3. <b>On EV2 GO:</b> Release EV2 anchor from aft ext D-ring</li> <li>4. Release EV1 anchor from fwd ext D-ring</li> <li>5. Ingress A/L</li> <li>6. Close hatch thermal cover; attach Velcro strap</li> <li>7. Remove SCU from stowage pouch</li> <li>8. Remove DCM cover; Velcro to DCM</li> <li>9. Connect SCU to DCM               <ul style="list-style-type: none"> <li>√SCU locked</li> </ul> </li> </ol> <p style="text-align: center;"><u>NOTE</u> A TCV setting 8 – Max C Minimizes time for SCU cooling</p> <ol style="list-style-type: none"> <li>10. WATER – OFF (fwd), expect H2O IS OFF msg</li> </ol> <div style="border: 1px solid black; padding: 5px; margin: 10px auto; width: fit-content;"> <p style="text-align: center;"><u>CAUTION</u> Do not close hatch until EMU Water OFF for 2 min. Verify outer hatch clear of hardware</p> </div> <ol style="list-style-type: none"> <li>11. Verify outer hatch clear of hardware</li> <li>12. Verify handle position per hatch decal</li> <li>13. Close and lock hatch</li> </ol> <p>Go to PRE-REPRESS (<u>DEPRESS/REPRESS</u> Cue Card)</p>	<p><u>INGRESS AND PRE-REPRESS</u> (00:30)</p> <ol style="list-style-type: none"> <li>1. Ingress A/L</li> <li>2. Receive bags from EV1; stow in A/L</li> <li>3. Attach R Waist Tether to A/L int UIA D-ring               <ul style="list-style-type: none"> <li><input type="checkbox"/> √Gate closed, hook locked</li> </ul> </li> <li>4. Give <b>EV1 GO</b> to release EV2 anchor from ext D-ring</li> <li>5. Remove SCU from stowage pouch</li> <li>6. Remove DCM cover; Velcro to DCM</li> <li>7. Connect SCU to DCM               <ul style="list-style-type: none"> <li>√SCU locked</li> </ul> </li> </ol> <p style="text-align: center;"><u>NOTE</u> A TCV setting 8 – Max C Minimizes time for SCU cooling</p> <ol style="list-style-type: none"> <li>8. WATER – OFF (fwd), expect H2O IS OFF msg</li> </ol> <p>Go to PRE-REPRESS (<u>DEPRESS/REPRESS</u> Cue Card)</p>

EV1 & EV2

## J612 EXTENSION CABLE – TASK DATA

### Estimated Task Duration:

	With SSRMS	Without SSRMS
One EV Crew	N/A	N/A
Two EV Crew	N/A	00:30

### Tools:

EV1	EV2
Wire ties	N/A
Adj equip tether (for caps)	

### EVA Connectors:

Harness	From	To	Inhibits	Conn Size	Function	Length
Nod1 J612 Pwr Ext Cable W5107	Node 1 J612	A/L cable P1		21	Heater power	133-in

### NOTE

Avoid inadvertent contact with the NPV on the Lab and the fluid line jumpers from Node 3

### Timeline Considerations:

1. If there is not enough slack in the airlock cable to meet the extension cable, there are several options to gain slack, although the exact config of the airlock cable is unknown beyond the wire tie. First, the wire tie at Node 1 HR EH 1 can be released. Second, the cable may be able to be re-routed from underneath one or multiple cables in the area



Figure 1.- J612 Extension Cable – Caps Removed.



Figure 2.- J612 Extension Cable – Caps Installed.

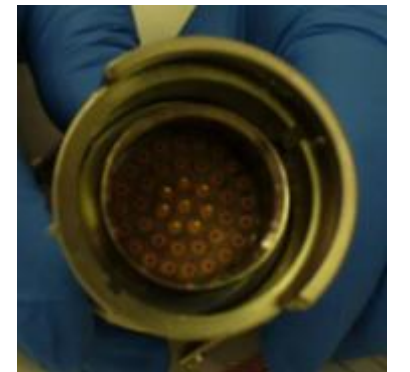
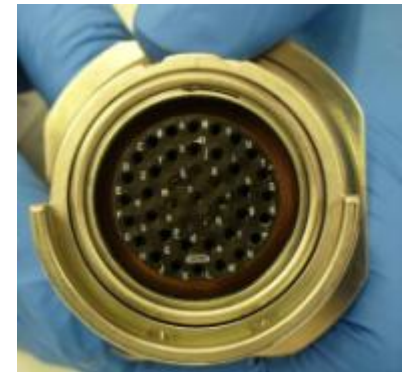

Figure 3.- Internal View of Extension Cable Connectors.

## J612 EXTENSION CABLE – TASK DATA (Cont)

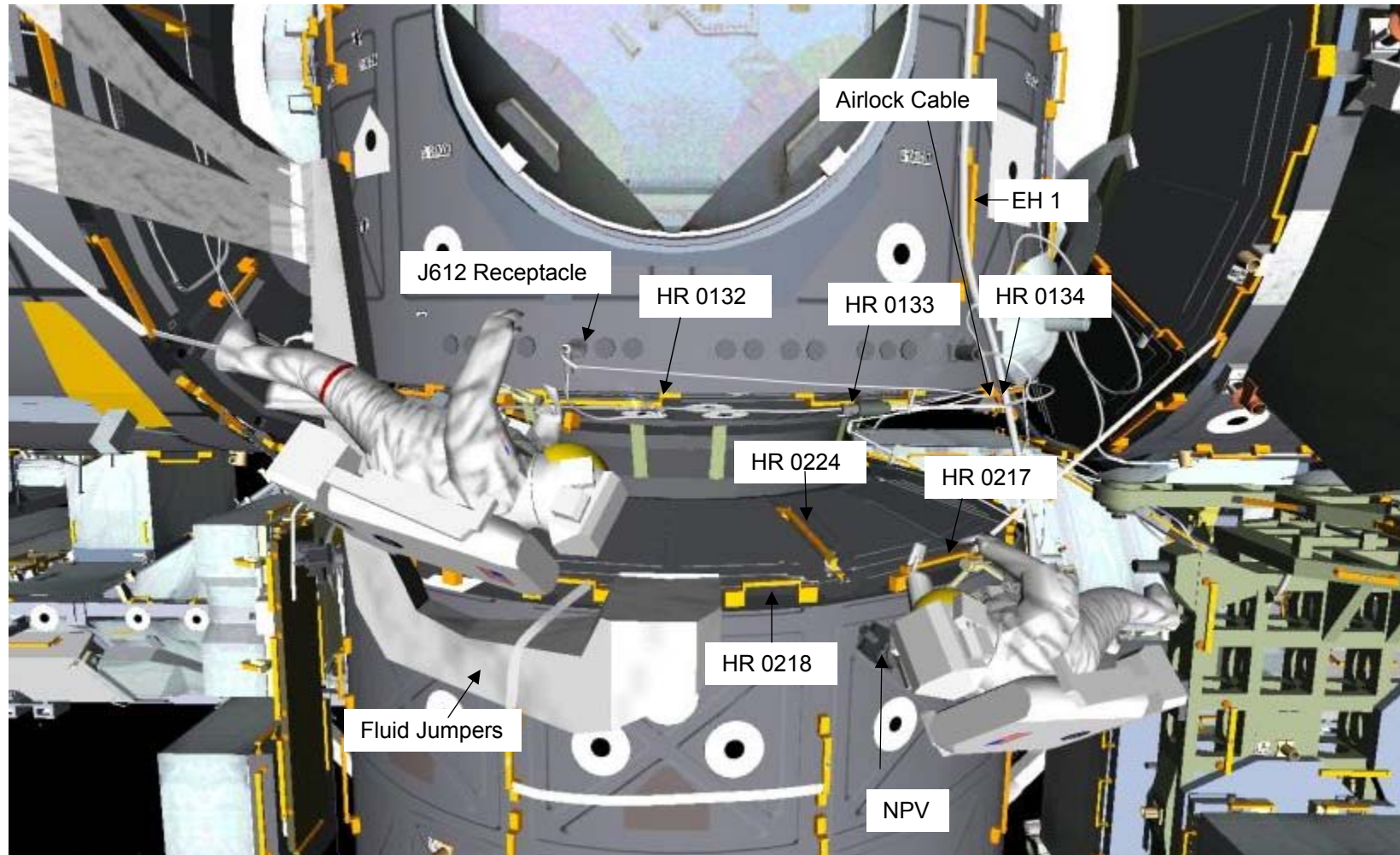

Figure 4.- DOUG View of J612 Extension Cable Installed.

## PMA REMOVE AND REPLACE – TASK DATA

### Estimated Task Duration:

	With SSRMS	Without SSRMS
One EV Crew	N/A	N/A
Two EV Crew	01:30	N/A

### Electrical Connectors:

From	To	Clamps	Conn Size	Function
ESP-2 M/W J5 (P11)	PM J5	Tape	NZGL-17	PM Heater Data
ESP-2 M/W J4 (P10)	PM J4	Tape	NZGL-21	PM ORU Htr Power
ESP-2 M/W J1 (P12)	PM J1	Tape	NZGL-25	Fault Bond

### Fluid Connectors:

Harness	From	To	Size	SPD	Function
Fluid QD	S1 F44	M1	1.5"	Yes	Bypass outlet (does not go through radiators)
Fluid QD	S1 F45	M2	1.5"	Yes	Radiator return NH3 to PM inlet
Fluid QD	S1 F48	M3	1.5"	Yes	Connects outlet of PM to EATCS system (iso valve)
Fluid QD	S1 F49	M4	0.5"	Yes	Connects NH3 tank and NH3 supply to inlet side of PM (downstream of mixing valve) – venting QD

### EVA Fasteners:

Fastener Name	Label	Size	Qty	Install Torque (ft-lb)	Release Torque (ft-lb)	Failure Install Torque (ft-lb)	Failure Release Torque (ft-lb)	Turns	RPM
AGB-PM Center Bolt		7/16"	1	3.8	3.8	5.7	116.8	2-4	30
FGB-PM Mounting Bolt	GP1, GP2, GP3, GP4	7/16"	4	9.2	25.5	16.1	47.4	17-20	30
FGB-PM Bolt w/o FGB present	GP1, GP2, GP3, GP4	7/16"	4	2.5	25.5	16.1	47.4	8-11	30
PM Attach Bolt (ESP-2)	Bolt 1, 2, 3, 4	5/8"	4	25.5*	24.0	44.6	168.0	14.5-17.0	30
PM Attach Bolt (S1)	Bolt 1, 2, 3, 4	5/8"	4	18.4	24.0	45.2	168.0	14.5-17.0	30
P-Clamp Bolt	N/A	7/16"	4	6.3	8.3	10.75	13.7	12-14	30

\*18.4 ft-lb and 2 of 4 bolts (one bolt must be #1 or #4) is sufficient for on-orbit loads

### Foot Restraints:

Task	WIF	Y/P Setting	APFR Setting
P1 PM	CETA Cart-01	12,GG	5, PP, J, 12
CETA Cart Batman Handoff	CETA Cart-01	12,GG	5, PP, B, 12
ESP-2 Temp Stow	ESP-2 5	N/A	12, PP, K, 12
ESP-2 Spare PM	ESP-2 5	N/A	12, PP, B, 12

## PMA REMOVE AND REPLACE – TASK DATA (Cont)

### Required Tools:

Item		
PGT (2)	APFR (2)	VTEB
6" ext 7/16" wobble socket (2)	OTSD	Vent Tool Extender + MUT EE (VTEB bag)
Crewlock Bag (2)	CETA Cart	Adjustable Tether (for MUT EE OCAD)
Socket Caddy (2)	Lg-sm RET (for PM)	1.5" NH3/N2 Vent Tool (Female) (QD Bag #1 or #2)
7.8" ext 5/8" socket (2)	Wire Ties	PM Jumper
Round Torque Multiplier + 5/8" proud socket (2)	EVA Camera	

### Contingency Tools:

Item
1.5" QRT & FID Gauge (QD Bag #1)
1.5" Bail Drive Lever (QD Bag #1)
0.5" Cap Tool (QD Bag #1 or #2)

### ORUs:

Item	Mass (lb)	Dimensions (in)
Pump Module (w/10 lb of NH3)	804	60 x 49 x 31
AGB	75	45-53 x 27 x 22

## PMA REMOVE AND REPLACE – TASK DATA (Cont)

### **BLOCK A – Close Valve**

1. √Aft white band visible
2. √Detent button fully installed
3. √Detent button up
4. Rotate locking collar to unlocked position (not on 1.5")
5. √Detent button can be depressed
6. Assess side loads prior to bail movement
7. Push bail toward open position with significant force while depressing detent button (unstick male sleeve seals)
8. Depress detent button, move bail aft (close valve)
9. √Fwd white band visible
10. √Detent button up
11. Rotate locking collar to locked position (not on 1.5")

### **BLOCK C – Open Valve**

1. Assess and counteract side loads (do not move bail if QD under significant side-loading)
2. Rotate locking collar to unlocked position (not on 1.5")
3. Depress detent button
4. Push bail to forward position
5. √Aft white band visible
6. √Detent button – up
7. Rotate locking collar to locked position (not on 1.5")

### **BLOCK B – MATE QD**

1. Remove QD caps as required
2. Inspect male and female QD for debris or damage
3. Verify female QD ready to mate
  - √Detent button – up
  - √Locking collar – locked position
  - √Fwd white band – not visible
4. Assess side load potential prior to mate
5. Mate QD
  - √Fwd white band – visible
6. Perform snapback test
  - √Fwd white band – visible
7. Perform pull test (Stay clear of button, release ring, and bail trigger)
8. Perform visual gap test

### **BLOCK D – Demate QD**

1. Assess side loads prior to demate
2. Demate QD
  - a. For 0.5" QD, pull back on release ring
  - b. For 1.5" QD, use QRT (or squeeze trigger)
3. √Release ring retracted
  - √Fwd white band not visible (FID check)
4. Inspect male and female QD for debris, damage, or anomalous conditions (ammonia crystals)
5. Install QD caps as required; verify lock tab engaged

## **PMA REMOVE AND REPLACE – TASK DATA (Cont)**

### **Notes:**

1. Check connectors for damage, FOD, bent pins, EMI band, and cable bend radii
2. On ammonia QDs, check for ammonia crystals
3. Route vent tools with nozzles away from structure and crew
4. If EMU is contaminated with ammonia (during venting), use ISS EVA Decontamination procedure

### **Cautions:**

1. Minimize loads into PM MLI handholds. It is possible that handholds may tear off
2. Fluid QDs exposed to direct sun without thermal covers can overtemp in a matter of minutes (impacts QD seal integrity)
3. Use caution when manipulating fluid QDs; minimize loads input into fluid QDs and lines
4. When operating QDs, assess sideloads and flexhose alignment prior to mating/demating and valve opening/closing
5. PM installation bolts (for initial torque) must be installed in the following order: Bolt 1 first, then bolts 4, 3, 2 (due to nut plate tolerances)

### **Warnings:**

1. Do not open Vent Tool valve until nozzle is routed and EV crew is clear of vent region

### **Timeline Considerations:**



**PMA REMOVE AND REPLACE – TASK DATA (Cont)**

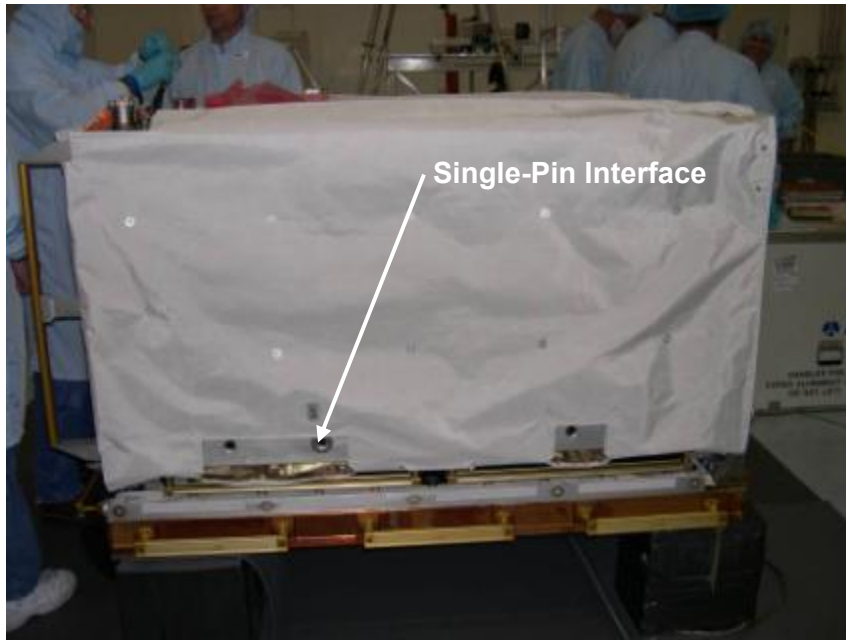

Figure 1.- Pump Module – Single-Pin Interface.

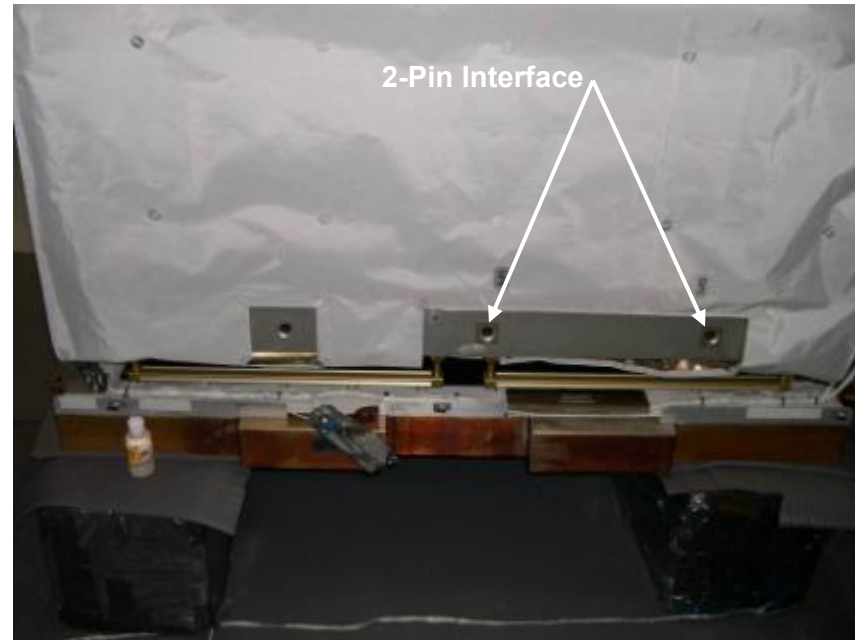

Figure 2.- Pump Module – 2-Pin Interface.



Figure 3.- Pump Module – NZGL.

**PMA REMOVE AND REPLACE – TASK DATA (Cont)**

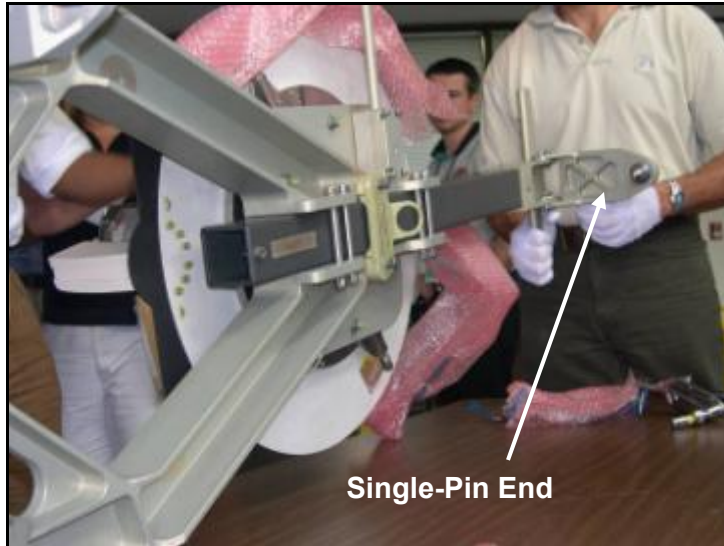

Figure 4.- Adjustable Grapple Bar.



Figure 5.- ORU Sizing Indication Lines.

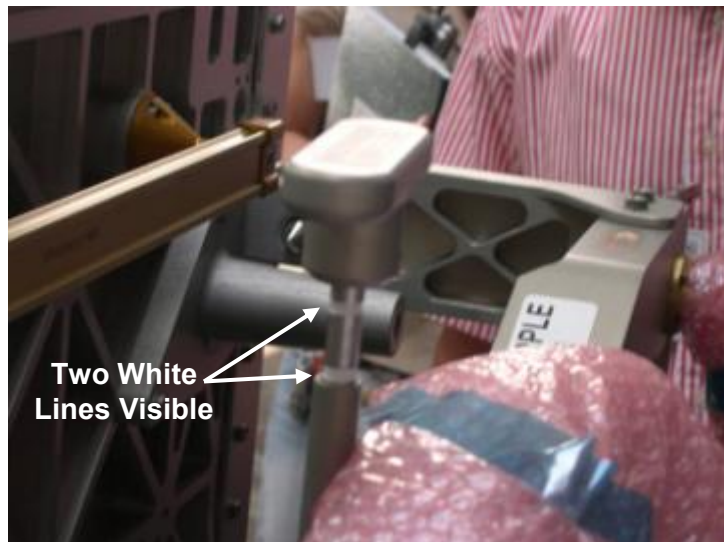

Figure 6.- T-Handle In Unlock Position.



Figure 7.- T-Handle In Lock Position.

## CP3 CAMERA WEDGE INSTALL – TASK DATA

### Estimated Task Duration:

	With SSRMS	Without SSRMS
One EV Crew	N/A	N/A
Two EV Crew	N/A	01:00

### Tools:

EV1 (SSRMS)	EV2 (FF)
	PGT 6" ext 7/16
	ETVCG Wedge

### EVA Fasteners:

Fastener Name	Head Size	Qty	Install Torque (ft-lb)	Release Torque (ft-lb)	Failure Torque (ft-lb)	Max Break-away (ft-lb)	Turns	RPM
VSSA Bolt	7/16	1	18.4 (B7)	25.5	77.5	42.2	16.5	30
Wedge Bolt	7/16	1	18.4 (B7)	25.5	77.5	42.2	16.5	30

### EVA Connectors:

Harness	From	To	Clamps (#)	Conn Size	Function
(W8200)	J2	P2 (S1 pnl A101)	4	15	ETVCG Ops, Light Ops, Sync, and Video
(W8200)	J3	P3 (S1 pnl A101)	4	15	ETVCG Htr, Light Htr
(W8200)	J4	P4 (S1 pnl A101)	4	15	Identification Cable

### Thermal Clock:

Item	Time (min)
CP3 Light	109

### ORUs/Loose items:

ORU/Item	Qty	Part Number, ID	Mass (lb)	Dimensions (in)
ETVCG Wedge	1	1F81835-501	16	9 x 8.21 x 6.15

### Notes:

- If stanchion bolt is driven more than 17 turns, it will engage in the launch lock threads and will not move freely as expected

### Cautions:

- Avoid kicking P1 radiator beam. If this occurs, wait 2 to 5 min to allow structure response to dissipate

### Timeline Considerations:

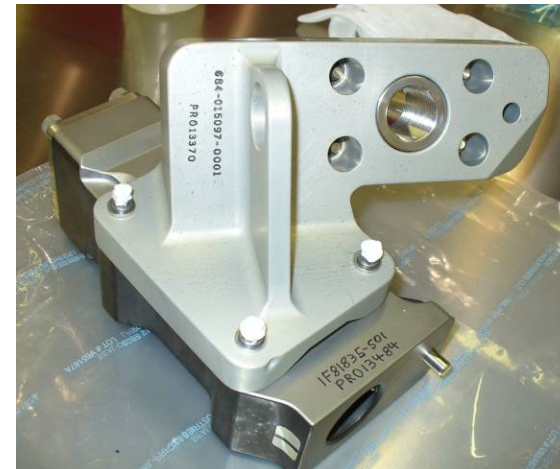

## CP3 CAMERA WEDGE INSTALL – TASK DATA (Cont)



S126E008810



Camera Pan/Tilt Lock (shown in the locked position)

## STBD CETA RAIL STUB INSTALL – TASK DATA

### Estimated Task Duration:

	With SSRMS	Without SSRMS
Two EV Crew	N/A	01:30

### Tools:

EV1	EV2
PGT w/7/16-6" ext	Medium ORU Bag
	Rail Stub (Zenith)
	Rail Stub w/ETRS (Nadir)
	Clam Shell (2)

### EVA Fasteners:

Fastener Name	Head Size	Qty	Install Torque (ft-lb)	Release Torque (ft-lb)	Failure Torque (ft-lb)	Turns
Clam Shell Bolts	7/16	2 per	4.8	12	39.25	15.6-17.4

### Mass & Dimensions:

ORU/Item	Qty	Part Number, ID	Mass (lb)	Dimensions (in)
Rail Stub	2		26	13.5 x 6.5 x 6.5
Clam Shell (two halves)	2	1F83193-1	5.5 w/Jack Bolt	5 x 5 x 2.5

### Foot Restraints:

Task	WIF	APFR Setting
Nadir Rail Stub	S3 WIF 31	4, QQ, B, 12
Zenith Rail Stub	S4 WIF 1	8, QQ, D, 10 (Stbd SARJ at 340 deg)
Zenith Rail Stub	S4 WIF 1	11, SS, J, 10 (Stbd SARJ at 345 deg)

### Notes:

1.

### Cautions:

1.

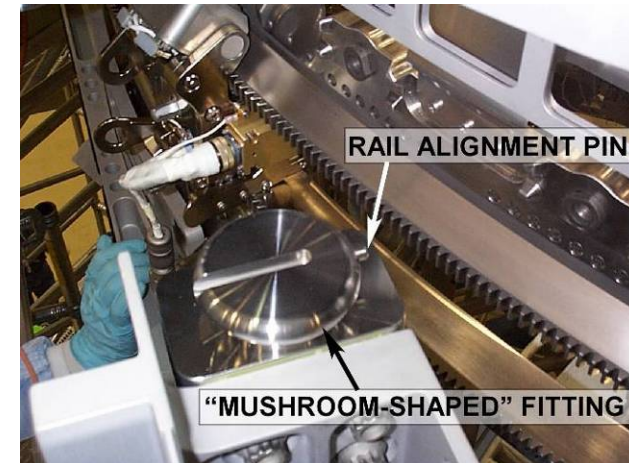
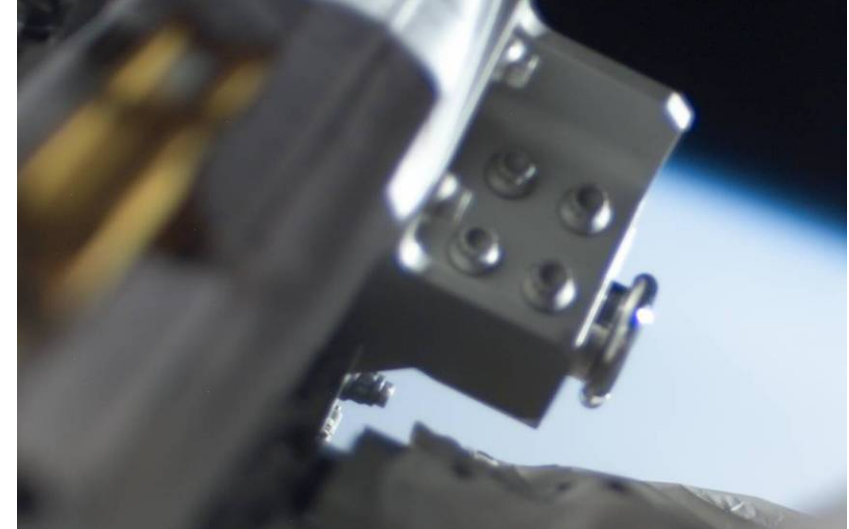

STBD CETA RAIL STUB INSTALL – TASK DATA (Cont)

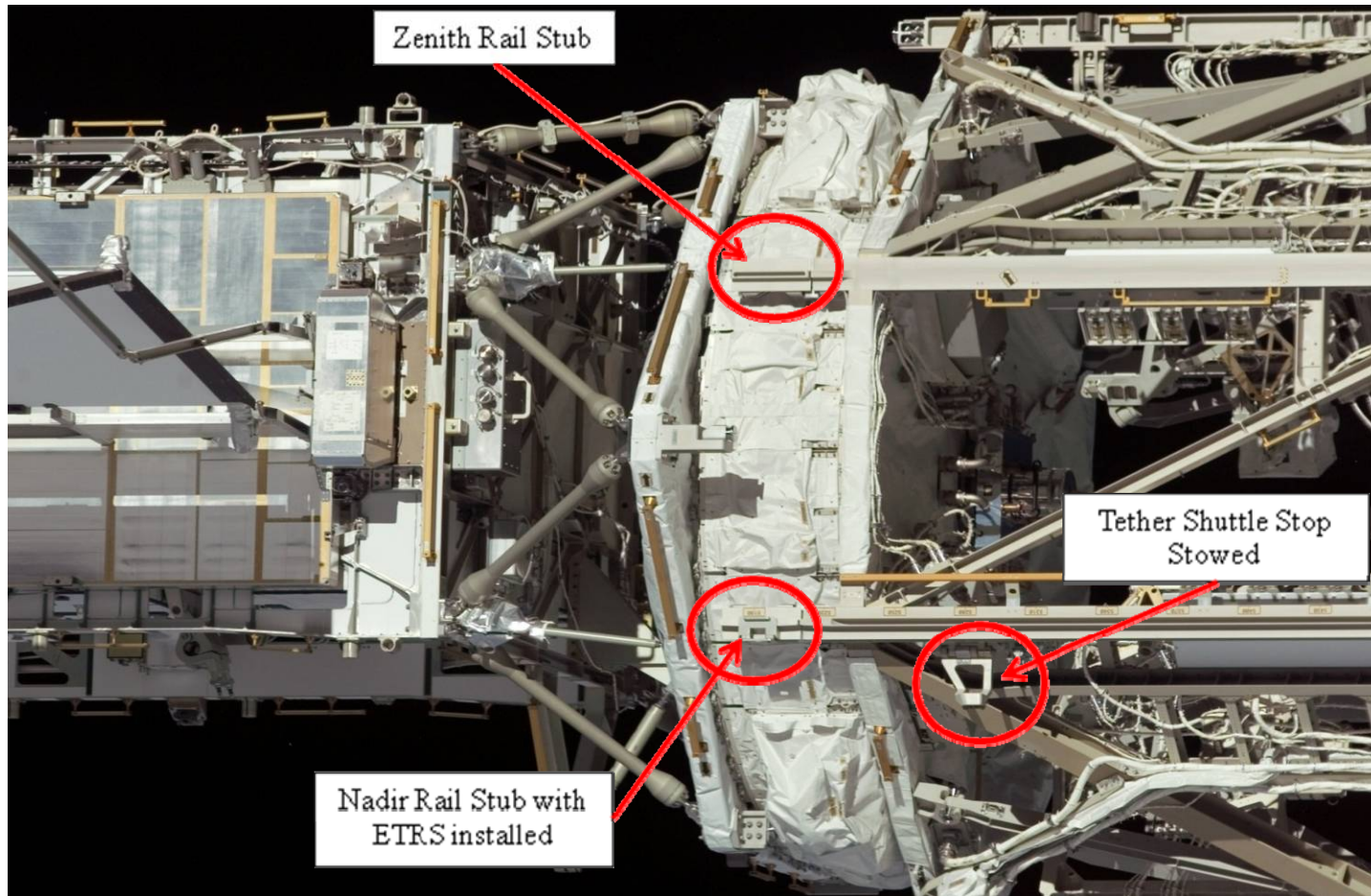

# SPDM CLPA AND POA CLA LENS COVER INSTALL – TASK DATA

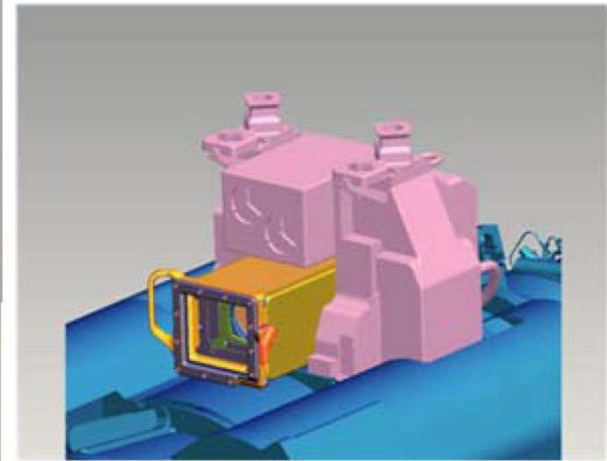

Cover on CLA



MSS Camera Cover  
(Shown in Unlocked Position)



Latch Pin

FS 7-47

EVA/133/FIN

# EVA 2

## EVA 2 SUMMARY TIMELINE

PET	IV/SSRMS	EV1 – Kopra (SSRMS/FF)	EV2 – Drew (FF)	
00:00		POST DEPRESS (00:05)	POST DEPRESS (00:05)	00:00
		EGRESS/SETUP (00:25)	EGRESS/SETUP (00:25)	
		<ul style="list-style-type: none"> <li>APFR stow</li> </ul>		
	SSRMS: SETUP POS SSRMS: APFR INGRESS POS	SSRMS SETUP (01:00)	VENT OPS AND QD BAG CLEANUP (01:00)	
01:00	<ul style="list-style-type: none"> <li>VERIFY LWAPA INHIBITS</li> </ul>	<ul style="list-style-type: none"> <li>Translate to Columbus</li> <li>Install APFR on SSRMS</li> </ul>		01:00
	SSRMS: LWAPA RETRIEVE POS			
		LWAPA RETRIEVE (00:30)	ELC4 ExPCA MLI REMOVE (00:30)	
		<ul style="list-style-type: none"> <li>Remove LWAPA</li> </ul>		
02:00	SSRMS: LWAPA INSTALL POS	LWAPA INSTALL (00:30)	JETTISON STOWAGE BAG PICKUP (00:20)	02:00
	<ul style="list-style-type: none"> <li>VERIFY SPDM INHIBITS</li> </ul>		P3 CETA LIGHT INSTALL (01:00)	
	SSRMS: CLPA 1 INSTALL POS	SPDM CLPA 1 INSTALL (00:35)		
03:00	SSRMS: SPDM EP 1 MLI REMOVAL POS	SPDM EP 1 MLI REMOVAL (00:25)	P1 RBVM MLI REPAIR (00:20)	03:00
		SSRMS CLEANUP (01:00)	P1 GRAPPLE BEAM TROUBLESHOOT (01:10)	
04:00	SSRMS: CLEANUP POS			04:00
	<ul style="list-style-type: none"> <li>EVA CONSUMABLE STATUS</li> </ul>	SSRMS ELBOW CLPA COVER INSTALL (00:20)		
	<ul style="list-style-type: none"> <li>VERIFY SSRMS CLPA INHIBITS</li> </ul>	P1 GRAPPLE BEAM TROUBLESHOOT/GET-AHEAD (00:35)	NODE 3 MLI REMOVAL (00:35)	
05:00	SSRMS: ELBOW CLPA COVER INSTALL POS			05:00
		SPDM CLPA COVER (00:20)	POA CLA COVER (00:20)	
		GET-AHEAD (00:15)	GET-AHEAD (00:15)	
06:00		CLEANUP & INGRESS (00:30)	CLEANUP & INGRESS (00:30)	06:00
06:30	PET 6:30			06:30



# EVA 2 TOOL CONFIGURATION

## EV1

- MWS
  - BRT (L)
    - RET (sm-sm) (both hooks to front loop)
    - Wire Tie (1 Long, 1 Short)
  - T-Bar
    - RET (sm-sm)
    - RET w/PIP Pin
    - Adj Equip Tether (2) (inside)
    - Small ISS Trash Bag w/wire tie (R outside)
    - Wire Tie (2) – bunny ears (w/tape)
  - Swing Arm (R)
    - RET (sm-sm)
      - PGT [A4 6.3 ft-lb, CAL, MTL 30.5] s/n \_\_\_\_\_
      - PGT Battery s/n \_\_\_\_\_
      - 7/16 (wobble) Socket-6 ext
  - D-ring Extender (2, R & L D-ring)
    - Safety Tether Pack (L D-ring ext)
    - Waist Tether (1, R on D-ring ext)

## EV2

- MWS
  - BRT (L)
    - RET (sm-sm) (both hooks to front loop)
    - Wire Tie (1 Long, 2 Short)
  - T-Bar
    - RET (sm-sm)
    - RET w/PIP Pin
    - Adj Equip Tether
    - Wire Tie (2) – bunny ears (w/tape)
    - Small ISS Trash Bag w/wire tie (R inside)
      - Adj Equip Tether (clove hitched to trash bag)
      - Long Wire Tie (2) (inside trash bag)
  - Swing Arm (R)
    - RET (sm-sm) (to camera)
      - Camera w/Bracket (integral hook free)
      - PGT [A7] s/n \_\_\_\_\_ (outside under strap)
      - PGT Battery s/n \_\_\_\_\_
      - 7/16 (wobble) Socket-6 ext
  - D-ring Extender (2, R & L D-ring)
    - Safety Tether Pack (L D-ring ext)
    - Waist Tether (1, R on D-ring ext)

NOTE: Prior to use, inspect the following hardware:

- All RET cords for fraying
- Inspect Load Alleviating Straps and D-ring Extenders; ref CREW TETHER INSPECTIONS, ISS EVA Tasks Checklist:
  1. MMOD/general damage
  2. Discoloration
  3. Tack Stitching
  4. Red Band
- ISS Trash Bag: √Bristle deformation/damage, after having stowed tools in trash bag. √Zipper closed, √bag empty
- BRT joint screws not loose

## CREWLOCK

- RET (Lg-Sm)
  - Medium ORU Bag** (SPDM Bag)
    - Adj tether (2) (outside – tie down)
    - SSRMS Safety Tether – 55-ft ST (outside)
    - RET (sm-sm)
      - Sq Scoop
        - SPDM CLPA 1
          - RET (sm-sm) – to sq scoop
          - Lens Cover (installed)
  - RET (sm-sm)
    - CLPA Lens Cover MLI Case
    - CLPA Lens Cover (Elbow)
  - RET (sm-sm)
    - Long Wire Tie
      - SPDM EP1 MLI
    - Adj tether (clover tether to bag side strap)
      - Sq Scoop
      - WIF Adapter
  - RET (sm-sm)
    - Camera w/Bracket
- RET (Lg-Sm)
  - Medium ORU Bag** (Light Bag)
    - Adj tether (1) (outside – tie down)
    - RET (sm-sm) (outside – tie down)
      - PGT [A7] s/n \_\_\_\_\_ (outside under strap)
        - PGT Battery s/n \_\_\_\_\_
        - 7/16 (wobble) Socket-6 ext
    - RET (sm-sm)
      - P3 CETA Light
      - Node3 MLI
    - RET (sm-sm)
      - Round Scoop
    - RET w/PIP Pin
      - Socket Caddy
        - 5/8-7.8-in Socket (2)
    - Adj tether (clover tether)
      - P1 Grapple Fix Beams (2) (if removed)

Tether Counts:

Red RETs (sm-sm) = 15      RETs (PIP Pin) = 4  
 Green RETs (sm-sm) = 5      Adj Equip Tether = 10  
 RETs (Lg-sm) = 4              Shuttle Adj Equip Tether = 5

## CREWLOCK (Cont)

- RET (Lg-Sm)
  - APFR [\_\_, XX, F, 12]**
    - Small ORU Bag** (secured to APFR)
      - RET (sm-sm) (outside – tie down)
      - Adj tether (outside – tie down)
      - RET (sm-sm)
        - Long wire tie
          - ELC MLI ExPCA
        - Adj tether (clover tether, hooks to outside of bag)
          - Jettison Stowage Bag #1
          - Jettison Stowage Bag #2
        - RET (sm-sm) (hook to outside of bag)
          - Jettison Stowage Bag #3
      - Camera w/Bracket (int hook to bag)
- RET (Lg-Sm)
  - Crewlock Bag** (Get-ahead Bag)
    - Adj tether (outside)
    - RET (sm-sm) (outside)
    - Adj tether (Integral RET to D-ring)
      - CLA Lens Cover MLI Case
        - CLA Lens Cover (POA)
        - CLPA 2 Lens Cover MLI Case
          - CLPA 2 Lens Cover (SPDM)
      - S0 Cable Grounding Bootie
      - Sq Scoop
      - Wire Tie Caddy
        - 5 long, 4 short wire ties
      - RET w/PIP Pin
        - 7/16 Socket – 18-in
      - RET (sm-sm)
        - Ratchet Wrench w/PW and
          - 7/16 Socket-2 ext
      - RET (sm-sm)
        - Prybar
  - RET (Lg-Sm)
    - Crewlock Bag 2** (tool relocations)
      - Adj Equip Tether (on outside)
      - Vise Grips (stbd toolbox) (Int RET 1)
      - Probe (stbd toolbox) (Int RET 2)
      - Pin Straightener Assy (port toolbox) (Int RET 3)
      - Adj Equip Tether (Int RET 4)
        - Short MMOD T-Handle Tool (port toolbox)
        - Short MMOD T-Handle Tool (port toolbox)

## EVA 2 TOOL CONFIGURATION (Cont)

### STAGING BAG

- Fish Stringer #1 (outside tether)
  - Velcro/Tape Caddy (hook #2)
  - PGT (hook #3) s/n 1006
    - PGT Battery s/n 1004
    - 7/16 (wobble) Socket-6 ext
  - Ratchet Wrench (hook #5)
    - 7/16 (rigid) Socket-9 ext
  - 2 – Long duration tie-down tether (hook #6)
  - Spare WIF Adapter (hook #7)
  - Spare 55-ft Safety Tether
- Fish Stringer #2 (inside tether)
  - ERAD (hook #1) s/n \_\_\_\_\_
  - Connector Cleaner Tool Kit (hook #2)
  - Needle nose Pliers (hook #6)
  - MWS Key Strap Assy (on wire tie, to strap)

### IV Bag

- Ammonia Contamination Cue Card
- 2 – Towels (wrapped with short wire tie)
- Contamination Detection Kit
- RET (sm-sm) (Black)
  - 2 – DCM Plug (SAFER Hardmount)
- RET (sm-sm) (Black)
  - 2 – GP Caddy
    - 2 – Thermal Mitten (pair)
- RET (sm-sm) (Black)
  - Socket Caddy
    - 1/2-in (wobble) Socket – 8 ext
    - 7/16-in (wobble) Socket – 6 ext

### EVA 1 Deconfig – Config for EVA 2

Items (to be removed)	Stow Location
<u>EV2 MWS</u>	
PGT	Medium ORU Bag (Light Bag)
Red RET w/PIP Pin	Medium ORU Bag (SPDM Bag)
<u>Small ORU Bag (Stub Bag)</u>	
Prybar	Crewlock Bag (Get-aheads)
Red RET (sm-sm)	
Red RET (sm-sm)	Medium ORU Bag (SPDM Bag)
Red RET (sm-sm)	EV2 MWS
<u>Crewlock Bag (PM Cap Bag)</u>	
Adj Tether	EV2 MWS
55-ft ST (outside)	Medium ORU Bag (SPDM Bag)
Adj Tether	
Red RET (sm-sm)	
WIF Adapter	
Socket Caddy	Medium ORU Bag (Light Bag)
5/8 Socket-7.8-in ext	
Fish Stringer	EVA Done Mesh Bag
Adj Tether (Lg-sm)	
Rd Scoop	
Ratchet Wrench w/2"	Crewlock Bag (Get-aheads)
<u>Crewlock Bag (Get-ahead Bag)</u>	
Camera w/Bracket	Medium ORU Bag (SPDM Bag)
JAXA: Msg-in-a-Bottle	EVA Done Mesh Bag
CLA Lens Cover MLI (2) (if completed)	
<u>A/L Floor Bag</u>	
CLPA Lens Covers (2)	Medium ORU Bag (SPDM Bag) (1 MLI Case goes in Done Bag)
Green RET (sm-sm) (5)	Medium ORU Bag (Light Bag) (3)
(S/Ns: 4397, 4398, 4399, 4400, 4401)	Medium ORU Bag (SPDM Bag) (2)
Adj Tether (5)	Medium ORU Bag (Light Bag) (2)
	Medium ORU Bag (SPDM Bag) (3)

\* All Tethers Stow in Tether Staging Area

\*\* All EVA Cameras perform appropriate photo/TV procedures prior to use

# EVA 2 TOOL CONFIGURATION (Cont)

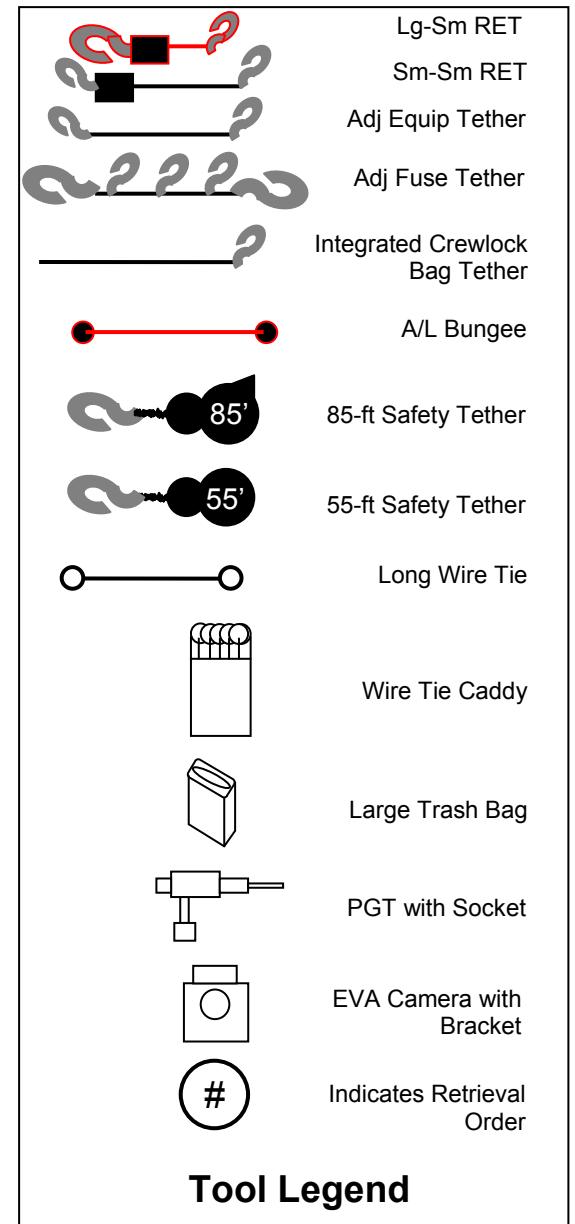
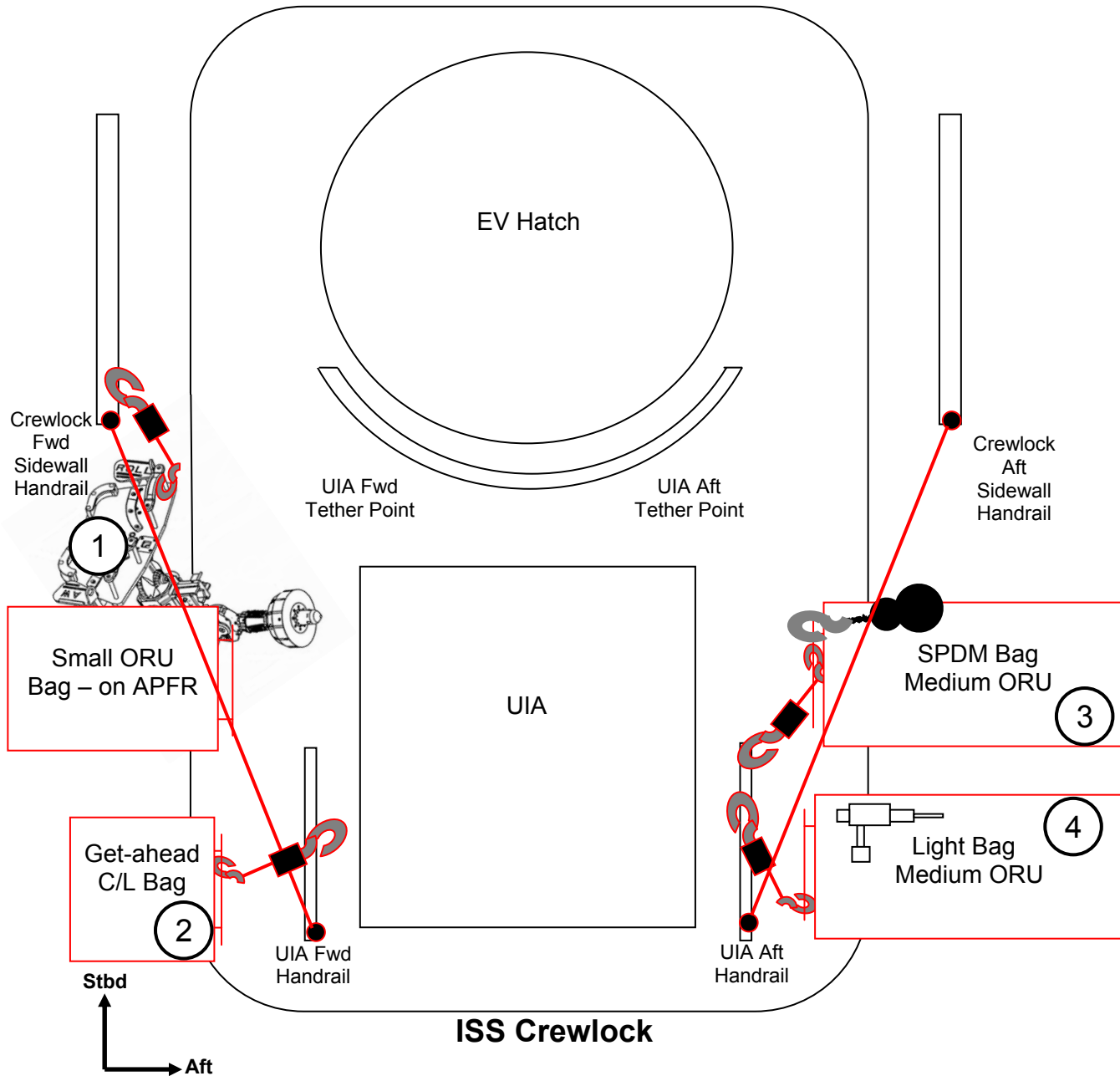

## EVA 2 BRIEFING CARD

### Flight Day Prior to EVA

1. EVA Prep
  - ❑ Campout – overnight bag checklist, EMU equipment bag – EV1
  - ❑ Get-up plan – target to wake up 20 minutes early (egress on time), bio-med attached prior to opening hatch – EV1
  - ❑ Prebreathe protocol review (Notes and Warnings) – Suit-up IV
  - ❑ Task IV verifies tools on suits per timeline – Task IV
  - ❑ Suit-up IV verifies bag/tool configuration within crewlock – Suit-up IV
  - ❑ Suit donning plan – special requests – EV's, IV's
  - ❑ Airlock depress review – Suit-up IV
2. EV Crew Procedure Review
  - ❑ Summary timeline + get-ahead tasks – Task IV
  - ❑ Notes, Cautions, and Warnings review – Task IV
  - ❑ Contingency procedures – cribsheet – Task IV
  - ❑ First actions – EV1, EV2
  - ❑ EVA-specific concerns – ammonia contamination – EV1 and all
3. Communications – EV1
  - ❑ Airlock – Hardline, transition to Big Loop, EV1/EV2 calls in sequence
  - ❑ Task – Big loop, A/G2 (Discovery), S/G2 if robo-specific
  - ❑ Robotics – coordinate frames (Columbus, payload bay, SPDM), GCA protocol (EV, IV, M1)
4. Emergencies Review – EV1
  - ❑ Loss of comm – confirm config (pri, low, volume), clear obstructions, alt, frequency change (hand signals)
  - ❑ EMU malfunctions – read DCM message, say page number, IV runs it – say if “Terminate” or “Abort”
  - ❑ Lost tools – velocity and direction estimate, when last seen
  - ❑ Rapid return to airlock, incapacitated crewmember (drop the green hook, yellow structure hook on ICM)
5. Lessons Learned – EV1 and all

## EVA 2 INHIBIT PAD

### Orbiter

<b>ALL EVAs</b>	
Ku-Band Antenna (Prior to Egress)	
<b>MCC-H (INCO)</b>	1. √KU-BAND Mask – active 2. √KU-BAND EVA Protect Box – active
RCS (Prior to Egress)	
EV crew < 27 feet from FRCS	
IV	1. √DAP: VERN, FREE, LO Z
O14,15,16	2. √RJDF F1, F2, F3, F4 MANF DRIVER (four) – OFF LOGIC (four) – OFF
<b>MCC-H (Prop)</b>	3. √Above RCS config
IV	4. √RCS F – ITEM 1 EXEC (*) √JET DES F1U – ITEM 17 (*) F3U – ITEM 19 (*) F2U – ITEM 21 (*)
<b>LOCATION DEPENDENT INHIBITS</b>	
Payload Bay Camera B (LWAPA Install) (Prior to Task)	
<b>IV</b>	1. Camera pointed orbiter zenith (Pan = 0, Tilt = +90)
Payload Bay Camera B, C (Pump Module Venting) (Prior to Egress)	
<b>IV</b>	1. Camera pointed into PLB (Pan = 0, Tilt = 0)

### Ground

<b>ALL EVAs</b>	
Ground Radar (Prior to Egress)	
<b>MCC-H (TOPO)</b>	1. √TOPO console, ground radar restrictions in place for EVA

### USOS (1)

<b>LOCATION DEPENDENT INHIBITS</b>	
Cupola Windows (Not expected)	
IV	If EV crew less than 10 feet from window or in window FOV, coordinate shutter opening/closing with EV crew and minimize time shutter is open
Mobile Transporter (Prior to Egress)	
<b>MCC-H (ROBO)</b>	EV crew expected <1.5 meters from MT
	1. √MT latched

### USOS (2)

<b>ALL EVAs</b>	
PCU (Prior to Egress)	
<b>NOTE</b>	
PCUs may require up to a 1-hour warmup period before they are operational.	
<b>MCC-H (PHALCON)</b>	
	1. √PCUs (two) operational in discharge mode and one of the following:
a.	CCS PCU EVA hazard control FDIR enabled.
b.	No more than two arrays unshunted and oriented <105° from velocity vector.
If one or both PCUs failed	
	2. No more than two arrays unshunted and oriented <105° from velocity vector.
<b>ALL EVAs</b>	
CUCU (Prior to Egress)	
IV (LAB104)	1. √cb POWER A, B [two] – OPEN
	2. √cb LINK 1,2 [two] – OPEN
And One of the following Inhibit pairs:	
<b>MSFC / PRO</b>	
	3a. Express Rack 2 Locker 6 – Power Removed
	3b. Express Rack 6 Locker 7 – Power Removed
<b>OR</b>	
<b>IV</b>	4a. Express Rack 2 Locker 6 – OFF
	4b. Express Rack 6 Locker 7 – OFF
<b>LOCATION DEPENDENT INHIBITS</b>	
LAB Window (SPDM tasks) (Prior to Egress)	
IV	EV crew expected < 10 feet from window or in window FOV, close window shutter
P1 TRRJ (RBVM bootie, P1 Rad Beam, Node 3 MLI removal) (Prior to Egress)	
<b>MCC-H (THOR)</b>	EV crew working within 2 feet of P1 TRRJ rotation envelope
	1. √DLA (1) – LOCKED at 0
FPMU (RBVM Bootie) (Prior to egress)	
<b>MCC-H</b>	If EV crew on Port truss (P1 - P6) or working within 5 feet of Floating Potential Measurement Unit
	1. RPCM P11A_B RPC 13 Open/Close Cmd Inhibit

## EVA 2 INHIBIT PAD (Cont)

### USOS (3)

LOCATION DEPENDENT INHIBITS	
Starboard SARJ (ExPCA MLI removal task) (Prior to egress)	
<b>MCC-H</b>	S3 SARJ locked (any angle)
	1. √DLA (1) – LOCKED
	2. All motor setpoints set to zero
	3. All motors deselected
SPDM (CLPA 1 Install) (30 min prior to task)	
<b>MCC-H</b>	1. SPDM PSU Output Bank #1, Port #3, OFF
(ROBO)	2. SPDM PSU Output Bank #2, Port #3, OFF
	3. Verify inhibits for (1) and (2) are OFF
SPDM (EP Blanket, CLPA 2 lens cover install) (Prior to Egress)	
<b>MCC-H</b>	1. √SPDM in Keep Alive configuration
(ROBO)	2. √PSU – Operational
	3. √SACU1(2) – Keep Alive
	4. √Body Prime(Redundant) – Keep Alive
	5. √SPDM Arm 1(2) – Keep Alive
<b>NOTE:</b> CLPA 1 inhibits will also meet inhibit requirements for EP blanket removal and CLPA 2 lens cover install	
P3 CETA LIGHT (Prior to Egress)	
<b>MCC-H</b>	Verify RPC Position – Op and
	Close command inhibited
	√P3-1A_A RPC 3
	√P3-2B_A RPC 2
SPDM CLPA 2 (lens cover install) (Prior to Egress)	
<b>MCC-H</b>	1. CLPA 2 pointed at SPDM input drive (pan = -168, tilt = -63)
((ROBO)	2. CLPA 2 in Keep Alive configuration
SSPTS ( <i>not expected</i> )	
<b>MCC-H</b>	(PHALCON)
	If EV crew working within 2 feet of SSPTS cables
	1. RPCM LA2A3B D RPC 1 – Open, Close Cmd Inhibit
	2. RPCM Z14B A RPC 2 – Open, Close Cmd Inhibit
	3. RPCM Z13B A RPC 2 – Open, Close Cmd Inhibit
SSRMS (Tip Elbow CLPA cover) (Prior to Task)	
<b>MCC-H</b>	1. Tip Elbow Camera: Pan = +70, Tilt = +20
(ROBO)	2. Tip Elbow camera in Keep Alive configuration

### JEM

ALL EVAs	
ICS-EF Antenna (Prior to Egress)	
<b>SSIPC</b>	1. ICS MOD – OFF
	2. ICS UPC – OFF
	3. ICS HPA – OFF
	4. “HPA ON” and “UPC ON” commands are cleared (not present) in the ICS stored command queue

### RSOS

ALL EVAs	
SM Antennas (Prior to Egress)	
<b>IV</b>	1. GTS – Deactivate
	2. ARISS (Ham Radio) – Deactivate
IMPULSE (Prior to Egress)	
<b>MCC-M</b>	1. IMPULSE (ИПИ-100) – Is not activated

### COL

TASK SPECIFIC INHIBITS	
COLUMBUS EPF (LWAPA Retrieve)	
(Prior to Egress)	
<b>IV</b>	COL1SC 1. √PPSB PL DN 1, 2 (two) sw – DISCHARGE
<b>NOTE:</b> Payload Power Switch Boxes (PPSB) located under cover on COL stbd endcone	
(20 min prior to LWAPA Removal)	
<b>COL-CC</b>	1. √PDU2 Outlet 3 SSPC 1, 2, 3, 4 (four) Pwr – OFF
	Verify Current < 0.1A
	2. √SSPC 1, 2, 3, 4 (four) Sys Bus Cntl Stat – DISABLED

## EVA 2 NOTES, CAUTIONS, WARNINGS

### NOTES

1. Bolt install: Report torque and turns
2. Bolt release: Report torque and turns if different from published range
3. EVA connectors: After disconnection and prior to connection; verify pin and EMI band integrity; verify connector free of FOD
4. Inspect QDs for damage prior to mating
5. Toolbox doors must be closed with one latch per door when EV crew not in immediate vicinity
6. 85-ft safety tether retract force may affect body positioning
7. CETA Cart brake handle wire ties must be replaced after crew loading

### CAUTION

#### ISS Generic Constraints

- A. Avoid inadvertent contact with
1. Grapple fixture shafts (drylube)
  2. PIP Pins
  3. Passive UMAs
  4. MBS/SSRMS/SPDM taped radiative surfaces: VDU, ACU, JEU, LEU, MCU, CRPCMs, and Cameras
  5. SPDM SJEU, EP, OTCM, LEU, and LEE VDU radiator surfaces
  6. OTSD
- B. Electrical cables
1. Avoid bend radii < 10 times cable diameter
- C. Fiber optic cables
1. Avoid bend radii < 10 times cable diameter
  2. Avoid pulling on cable during mate/demate
- D. Fluid line flex hoses and QDs
1. Avoid bend radii < 14 in for hoses with a diameter  $\geq 1$  in
  2. Additional care should be taken to not exceed bend radii when applying loads at the flexible hose to rigid tube stub interfaces
  3. Ensure fluid QD booties are fully closed prior to leaving worksite; wire tie if required
  4. Avoid bend radii < 5 in for hoses with diameter < 1 in on LAB, S0, S1, P1, and 10 in for hoses with diameter < 1 in on all other elements

### CAUTION

#### ISS Generic Constraints (Cont)

- E. For structural reasons
1. Avoid vigorous body motions, quick grabs and kickoffs against tether restraints
  2. Avoid performing shaking motions (sinusoidal functions) more than four cycles
- F. Other
1. ITT Cannon connector: On demated connectors, do not rotate collar or manipulate cable/connector using collar or connector tool
  2. MLI handholds are not rated for crewmember translation loads

## EVA 2 NOTES, CAUTIONS, WARNINGS (Cont)

### CAUTION

#### ISS Truss Constraints

##### A. Avoid inadvertent contact with

1. CETA lights (Z-93 paint)  
[LAB,S1,NODE 1]
2. Deployed TUS cable [Zenith and Nadir CETA rails]
3. S0 aft face radiator
4. GPS antennas (S13 paint) [S0,JLP]
5. UHF antennas [LAB,P1]
6. ETCS radiator flexhoses and panels [S1,P1]
7. EETCS/PV radiator flexhoses, bellows and panels [P6,P4,S4,S6]
8. SASA RF group [S1,P1]
9. Heat pipe radiators [Z1]
10. PCU cathode and HCA ports [Z1]
11. Ku-Band antenna (SGANT) dish [Z1]
12. CMG cover/shells [Z1]
13. FPMU [P1]
14. SASA high and low gain antennas and radiator surfaces [Z1]
15. Deployed MISSEs
16. OTP on HAB Tray [S0]

##### B. For structural reasons

1. Avoid kicking S1/P1 radiator beam.  
If any of these occur, wait 2 to 5 min to allow structural response to dissipate

### CAUTION

#### ISS Truss Constraints (Cont)

##### C. Other

1. WIS antennas: Do not use as handholds [NODE 1,LAB,P6,Z1]
2. Lubricant from Ku-Band SGANT gimbals [Z1], CMGs [Z1], and RTAS ground strap fasteners [P6,P4,S4,S6] can contaminate EMU
3. Prevent inadvertent contact of the tether shuttle with ETRS when the P3 tether shuttle stop is raised away from the rail

### CAUTION

#### ISS U.S. Pressurized Elements Constraints

##### A. Avoid inadvertent contact with

1. EVA crane [PMA1]
2. TCS reflectors [PMA2,PMA3]
3. APAS hardware [PMA2,PMA3]
4. CETA lights (Z-93 paint)  
[LAB,S1,NODE 1]
5. UHF antennas [LAB,P1]
6. Open CBM petal covers, LAB and Cupola window shutters
7. S0/NODE 2 fluid tray hardlines at NODE 2 end, which are limited to 25 lb

##### B. Other

1. WIS antennas: Do not use as handholds [NODE 1,LAB,P6,Z1]
2. CBM petal covers may not be used as handholds unless both launch restraint pins are engaged



## EVA 2 NOTES, CAUTIONS, WARNINGS (Cont)

### CAUTION

#### ISS I.P. Elements Constraints

##### COL

- A. Avoid inadvertent contact with
1. COL ARISS and AIS antennas [COL-Nadir]

##### JEM

- A. Avoid inadvertent contact with
1. GPS antennas (S13 paint) [S0,JLP]
  2. Open JPM window shutter
  3. JTVE, WVE/EVE, JEF VE cameras
  4. JEMRMS taped radiative surfaces [JEU,EE,Cameras]
  5. JEM A/L target and pins
  6. JEF ORUs and EFUs (paint and lubricant)
  7. MAXI front and top panel (paint)
  8. SEDA-AP sensors (HIT, SDOM, and AOM) and MPAC & SEED
  9. Trunnions and UCMs (paint and lubricant) [JEF Payloads]
  10. RAIDS covers on end of HREP
  11. ICS-EF Ka-Band antenna dish
  12. Small Fine Arm (SFA) (paint, coating and lubricant)
- B. For structural reasons
1. Avoid kicking MMOD shields between JLP and JPM
  2. Avoid tool impact on ICS-EF sensor

### CAUTION

#### Shuttle Constraints

- A. Avoid inadvertent contact with
1. OBSS and SRMS composite sections joint torque arms, grapple fixture shafts, and cable harnesses
  2. LCS (silver Teflon) and LDRI (silver Teflon) and ITVC (gold foil) [OBSS]
  3. WVS antenna [ODS truss and PLB sill]
  4. Payload bay and camera wire harnesses, cables, cable guides, and connectors
  5. OBSS striker bars (drylube)
- B. No touch
1. LDRI diffuser [OBSS]
  2. OBSS saddle contacts (when OBSS unberthed) [OBSS]
  3. Monkey fur [PLB]
  4. Cameras: Metallic surfaces [PLB]
  5. Ku-Band antenna black dish and gold thermal blankets [PLB]

## EVA 2 NOTES, CAUTIONS, WARNINGS (Cont)

### WARNING

#### ISS Generic Constraints

- A. Avoid inadvertent contact with
1. Grapple fixture targets and target pins
- B. Pinch
1. NZGL connector linkage. Use caution when mating/locking
  2. ITT Cannon connector rotating housing
  3. PDGF connector doors
- C. QDs
1. If QD is in FID when valve is opened (bail fwd), QD will leak and fluid line may whip
  2. Do not rotate if in mated/valve open configuration
  3. Bail may kick back suddenly when detent button is depressed if pressure has built up in spring cavity
- D. Sharp Edges
1. Inner edges of WIF sockets
  2. APFR active WIF probes
  3. Mating surfaces of EVA connectors  
Avoid side loads during connector mating
  4. Back side of MMOD shield fasteners
  5. Spring loaded captive EVA fasteners (e.g., 6B-boxes, BMRRM, RTAS, SARJ Covers); the end of the spring may protrude
  6. SPDM OTCM gripper jaws
  7. Keep hands away from SSRMS LEE/POA/SPDM LEE opening, snares, and PDGF curvic coupling (teeth)
  8. MMOD strikes on ISS exterior

### WARNING

#### ISS Generic Constraints (Cont)

- E. Thermal
1. EVA connectors with booties may become hot if left uncovered. Handling may need to be limited
  2. Turn off glove heaters when comfortable temperature reached to prevent bladder damage. Do not pull fingers out of gloves when heaters are on
  3. Uncovered trunnion pins may be hot
  4. SSRMS/MBS/SPDM operating cameras and lights may radiate large amounts of heat
  5. Do not touch EMU protective visor if temperature has been  $< -134$  degF for  $> 15$  min
  6. No EMU boot contact with foot restraint when temperature  $< -120$  degF or  $> 200$  degF
  7. PDGF surfaces may not meet touch temperature requirements for unlimited contact when  $\beta \leq -70$  or  $\beta \geq 70$
- F. Electrical Shock
1. Do not touch SPDM CLPA 1 electrical connector prior to camera installation

### WARNING

#### ISS Truss Constraints

- A. Avoid inadvertent contact
1. SSU, ECU, beta gimbal platform, mast canister, SAW blanket boxes unless the beta gimbal is locked and the motor is turned off
  2. Stay inboard of SARJ when active
  3. Stay 2 ft from S1/P1 radiator beam rotational envelope when beam is free to rotate
  4. Stay 5 ft from moving MT on face 1
  5. Stay 3.3 ft from Ku-Band (SGANT antenna) when powered
- B. RF radiation exposure
1. Stay 3.6 ft from S-Band (SASA) high gain antenna when powered [S1,P1]
  2. Stay 1.3 ft from S-Band (SASA) low gain antenna when powered [S1,P1]
  3. Stay 3 ft from UHF antenna when powered [LAB,P1]
- C. Sharp Edges
1. Solar array blanket box [P6,S6]
  2. Fastener threads on back of Z1 U-jumper male FQD panel, if nutplate cap missing
  3. Outboard MT rail attachment lug near P6 handrail 5333 and gap spanner
  4. P2 connector on EWIS box TAA-06 [Zenith/Forward Corner 1 of P5 – SARJ at 0 deg]
  5. Nickel coated braided copper ground straps may contain frayed wires [P6,P4,S4,S6]
  6. MMOD strikes on Z1 toolboxes

## EVA 2 NOTES, CAUTIONS, WARNINGS (Cont)

### WARNING

#### ISS Truss Constraints (Cont)

##### D. Electrical Shock

1. Stay  $\geq 2$  ft from ungrounded floating connectors if powered  
S0 EVA power cables (inside S0 Bay 00 Face 4, Bay 01 Face 3)  
ESP-2 jumper (inside S0 Bay 03 Face 4)

##### E. Thermal

1. ELC may exceed touch temperatures when  $\beta > 75$  deg

### WARNING

#### ISS U.S. Pressurized Elements Constraints

##### A. Handrails

1. Handrails previously used for MISSE attachment may not be used as a safety tether point [A/L endcone 564 and 566, A/L Tank 2 Nad/Fwd and Port/Fwd, P6 5389]

##### B. Pinch

1. EV side of IV Hatch during Hatch operation (also snag hazard) [A/L]
2. LAB/Cupola window shutter and CBM petal cover linkages during operation

##### C. RF radiation exposure

1. Stay 1 ft from UHF antenna when powered [LAB, P1]

##### D. Sharp Edges

1. PMA umbilical launch restraints - exposed bolt threads
2. Adjustable fuse tether (Fish Stringer) buckles stowed in Node Bag
3. Port/Aft portion of A/L circular HR [HR 0506]
4. A/L HR 0537 (Eq Lock Zenith)
5. PMM ROEU and ROFU panels (zenith endcone)

### WARNING

#### ISS U.S. Pressurized Elements Constraints (Cont)

##### E. Thermal

1. PMA handrails may be hot. Handling may need to be limited
2. Stay  $\geq 1$  ft away from PMAs and MMOD shields  $> 270$  degF if EMU sun visor up; limit time to 15 min or less if  $> 300$  degF
3. Stay at least 0.5 ft away from PMA and MMOD shields  $> 325$  degF
4. No EMU TMG contact with PMAs and MMOD shields  $> 320$  degF

##### F. Electrical Shock

1. Stay  $\geq 2$  ft from ungrounded floating connectors if powered. SSPTS connectors include NOD1 Stbd/Fwd HR 0130, LAB Stbd/Fwd HR 0273, PMA2 Stbd

##### G. Fluid QDs

1. Do not translate on gap spanners restraining NODE 3 – LAB NH3 jumpers

## EVA 2 NOTES, CAUTIONS, WARNINGS (Cont)

### WARNING

#### ISS I.P. Elements Constraints

##### COL

- A. Avoid inadvertent contact with
1. SOLAR [COL Zenith EPF]

##### B. Thermal

1. Columbus end cones may violate touch temperature constraints when  $-75 \leq \beta \leq -60$  or  $60 \leq \beta \leq 75$

##### C. Sharp Edges

1. LWAPA PIP pins [COL EPF]

##### JEM

- A. Avoid inadvertent contact with

1. ICS-EF sensors

##### B. Pinch

1. JPM window shutter linkages during operation
2. JEM cameras (JVTEs, EVE, WVE, and JEF VEs)
3. JEM EFU latching arms
4. JEF SSE latch
5. ICS-EF antenna boom
6. SEDA-AP mast
7. SMILES antenna rotating area
8. HREP hinge sides and RAIDS pinch areas
9. JEMRMS EE
10. JEMRMS Small Fine Arm (SFA) joints and booms

### WARNING

#### ISS I.P. Elements Constraints (Cont)

##### JEM (Cont)

##### C. Sharp Edges

1. Interior of JEMRMS HRMs
2. JEMRMS EE opening and snares
3. JEM A/L hatch corners
4. ICS-EF AHM gears
5. MAXI visual star camera
6. SMILES baffles (two), baffle base bare bolts, and Cold Sky Terminator (CST)
7. HREP baffles (four) [Star tracker aperture Zenith and three instrument baffles Aft]
8. SFAs Electro-Mechanical GF (EMGF)

##### D. RF radiation exposure

1. Stay 0.3 ft from Fwd/Aft JPM PROX antenna

##### E. Thermal

1. JPM Port End Cones and JLP Port Nadir may violate touch temperature constraints when  $\beta > 60$  deg
2. JEMRMS/JTVE/JEFVE operating cameras and lights may radiate large amounts of heat

### WARNING

#### Shuttle Constraints

##### A. Arcing/Molten Debris

1. Stay  $\geq 2$  ft from exposed EFGF connector when OBSS berthed, powered, and EFGF not grappled [PLB]
2. Stay  $\geq 2$  ft from exposed Stbd Fwd MPM contacts [PLB]
3. Stay above PLB sill when within 1 ft of powered ROEU connector [PLB]

##### B. Pinch

1. PRLA operation [PLB]

##### C. RF radiation exposure

1. Stay 3.28 ft from S-Band antenna when powered
2. Stay 1 ft from top and side of UHF PLB antenna radome surface when in high powered mode [ODS truss]
3. Stay 0.33 ft from top and side of UHF PLB antenna radome surface when in low powered mode [ODS truss]
4. Remain below the level of the PLB door mold line for first 20 in Aft of Fwd bulkhead when S-Band antenna powered [PLB]
5. Remain on the inboard side of the Stbd slidewire (sill handrails if slidewire not installed) for first 20 ft Aft of Fwd bulkhead when Ku-Band antenna powered [PLB]

## EVA 2 NOTES, CAUTIONS, WARNINGS (Cont)

### WARNING

#### **Shuttle Constraints (Cont)**

##### D. Sharp Edges

1. PRLA grounding wipers [PLB]
2. LDRI baffles (also an entrapment hazard) [OBSS]
3. Keep hands away from SRMS EE opening and snares
4. TCS connector backshells have exposed threads [ODS]

##### E. Thermal

1. Illuminated PLB lights; do not touch
2. OBSS grapple fixture shafts/cams may be hot. Limit handling if required
3. Stay 27 ft from PRCS when powered
4. Stay 3 ft from VRCS when powered
5. Stay 3 ft from APU when operating

##### F. Contamination

1. Stay out of the immediate vicinity of leaking jet or APU.

##### G. Lasers

1. Do not look at LDRI diffuser or LCS laser aperture window

# EGRESS/SETUP (00:25)

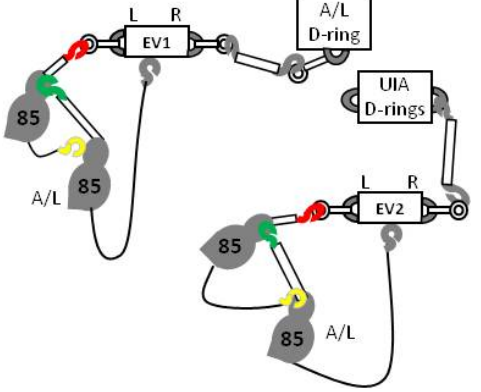
IV/SSRMS	EV1 – Kopra (FF)	EV2 – Drew (FF)
 <p>1. Start hatch thermal cover clock PET (30 min) ___ : ___</p> <p>2. <b>Give EV1 GO</b> to release Waist Tether</p> <p>3. <b>Give EV2 GO</b> to release EV2 Waist Tether</p>	<p><b>Initial Configuration:</b></p> <ol style="list-style-type: none"> <li>√All gates closed &amp; hooks locked <ul style="list-style-type: none"> <li><input type="checkbox"/> R Waist Tether to R D-ring extender</li> <li><input type="checkbox"/> R Waist Tether to A/L internal D-ring extender</li> <li><input type="checkbox"/> Red suit hook to L D-ring extender</li> <li><input type="checkbox"/> Green fairlead hook to crew ERCM</li> <li><input type="checkbox"/> Yellow anchor hook to fairlead ERCM</li> <li><input type="checkbox"/> Structure anchor hook to MWS</li> <li><input type="checkbox"/> ERCM reels unlocked</li> </ul> </li> </ol> <p><u>EGRESS/SETUP (00:25)</u></p> <ol style="list-style-type: none"> <li>← Open hatch thermal cover</li> <li>Egress A/L</li> <li>EV1 structure anchor to aft external D-ring <ul style="list-style-type: none"> <li><input type="checkbox"/> √Gate closed, hook locked, reel unlocked</li> </ul> </li> <li><b>On IV GO</b>, release EV1 Waist Tether from A/L internal D-ring extender</li> <li>Receive APFR/Small ORU bag; translate to stbd A/L tool box</li> <li>Install APFR [6,XX,F,12] into stbd A/L tool box (WIF Zenith [12,AA], boot plate outboard) <ul style="list-style-type: none"> <li><input type="checkbox"/> √Blk-Blk</li> <li><input type="checkbox"/> Pull/Twist test</li> </ul> </li> <li>Receive Get-ahead bag; stow outside A/L HR 0550</li> <li>Receive SPDM bag; stow on BRT</li> <li>Receive EV2 structure anchor; attach to fwd external D-ring <ul style="list-style-type: none"> <li><input type="checkbox"/> √Gate closed, hook locked</li> </ul> </li> </ol>	<p><b>Initial Configuration:</b></p> <ol style="list-style-type: none"> <li>√All gates closed &amp; hooks locked <ul style="list-style-type: none"> <li><input type="checkbox"/> R Waist Tether to R D-ring extender</li> <li><input type="checkbox"/> R Waist Tether to A/L UIA</li> <li><input type="checkbox"/> Red suit hook to L D-ring extender</li> <li><input type="checkbox"/> Green fairlead hook to crew ERCM</li> <li><input type="checkbox"/> Yellow anchor hook to fairlead ERCM</li> <li><input type="checkbox"/> Structure anchor hook to MWS</li> <li><input type="checkbox"/> ERCM reels unlocked</li> </ul> </li> </ol> <p><u>EGRESS/SETUP (00:25)</u></p> <ol style="list-style-type: none"> <li>Transfer APFR/Small ORU bag to EV1</li> <li>Transfer Get-ahead bag to EV1</li> <li>Transfer SPDM bag to EV1 (stow Lg-sm on D-ring ext)</li> <li>Transfer EV2 structure anchor to EV1</li> <li><b>On IV GO</b>, release Waist Tether from A/L UIA D-ring</li> <li>Egress A/L</li> </ol>

EV1 & EV2

**EGRESS/SETUP (00:25) (Cont)**

IV/SSRMS	EV1 – Kopra (FF)	EV2 – Drew (FF)
<p>4. Stop hatch thermal cover clock PET (30 min) ___ : ___</p> <p>5. Post crew egress: WVS Software:     Select page – RF camera     Sel ‘Advanced Controls’     S-Band Level (two) – Max</p> <p>6. <b>Give MCC-H GO</b> to implement remaining LWAPA inhibits</p>	<p>11. √WVS – green LED</p> <p>12. √MWS tabs up, tethers clear, visors/lights</p> <p>13. Verify SAFER config  <input type="checkbox"/> √L handle down (MAN ISO Vlv – Open)  <input type="checkbox"/> √R handle down, door closed (HCM – Closed)</p> <p>14. Fairlead at A/L – 2 o’clock position</p> <p>15. Translate to APFR on NOD2 WIF 7</p>	<p>8. √WVS – green LED</p> <p>9. √MWS tabs up, tethers clear, visors/lights</p> <p>10. Verify SAFER config  <input type="checkbox"/> √L handle down (MAN ISO Vlv – Open)  <input type="checkbox"/> √R handle down, door closed (HCM – Closed)</p> <p>11. ← Close hatch thermal cover</p> <p>12. Translate to ESP-2 fwd face via FHRC (nadir)</p> <div data-bbox="1388 732 1919 846" style="border: 3px double black; padding: 5px; margin: 10px auto; width: fit-content;"> <p style="text-align: center;"><u>WARNING</u>  ESP-2 HR 8012 has potential sharp edge  (MMOD Strike) on label</p> </div>

EV1 & EV2



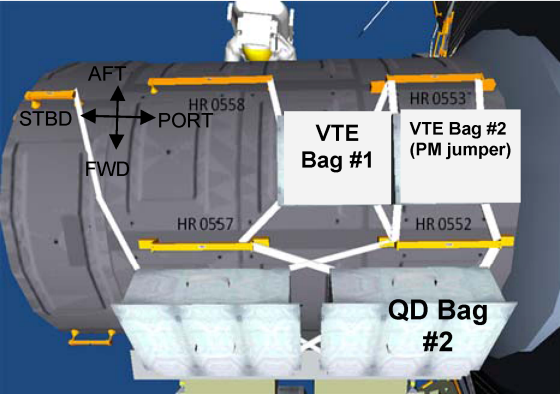

## VENT OPS AND QD BAG CLEANUP (01:00)

IV/SSRMS	EV2 – Drew (FF)
<ol style="list-style-type: none"> <li>Get <b>GO</b> from <b>MCC-H</b> for venting <ul style="list-style-type: none"> <li>√EVs clear of venting path</li> <li>√SRMS/OBSS in sensor clear position</li> <li>√Cameras B, C pointed into Payload Bay</li> </ul> </li> <li>Notify <b>MCC-H</b> when venting complete</li> <li>√<b>MCC-H</b> for <b>GO</b> to proceed with VTE cleanup</li> </ol> 	<p><u>PM VENTING</u> (00:45)</p> <ol style="list-style-type: none"> <li>Open front flap of ESP-2 PM; secure with Velcro tabs as required</li> <li>Translate to ESP-2 WIF 6 APFR [10,00,B,1]</li> <li>Ingress APFR; rotate T-Bar down, as required</li> <li><b>On MCC GO:</b> Vent PM – M2 <ul style="list-style-type: none"> <li><input type="checkbox"/> Open vent tool per <b>BLOCK C</b></li> <li><input type="checkbox"/> Wait ~2 min for venting</li> </ul> </li> </ol> <ul style="list-style-type: none"> <li><input type="checkbox"/> <b>On MCC GO</b>, close vent tool per <b>BLOCK A</b></li> <li><input type="checkbox"/> Demate vent tool per <b>BLOCK D</b></li> <li><input type="checkbox"/> Wave QD away from EMU to liberate ammonia crystals if present</li> <li><input type="checkbox"/> Install vent tool plug</li> </ul> <div style="border: 1px solid black; padding: 5px; margin: 10px 0;"> <p style="text-align: center;"><b>CAUTION</b></p> <p>20-min cumulative QD exposure to direct sun can cause seal damage. The vent tool QD can remain uncovered for no more than 90 min (1 orbit)</p> </div> <ol style="list-style-type: none"> <li>Temp stow vent tool</li> <li>Release cap from HR; install on to M2</li> <li>Egress APFR; rotate T-Bar up as required <ul style="list-style-type: none"> <li><input type="checkbox"/> Retract ingress aid</li> <li><input type="checkbox"/> Stow ingress aid flat against boot plate</li> </ul> </li> <li>Temp stow vent tool clear of PM flap</li> <li>Close front flap of PM</li> <li>Secure front flap with Velcro on each side (port and starboard) and one strap that goes nadir</li> <li>Inspect VTE for ammonia prior to contacting it; report to <b>MCC-H</b></li> <li><b>On IV GO</b>, retrieve vent tool and VTE from Lab HR 0237; leave MUT EE attached to nozzle</li> <li>Wave nozzle away from EMU to liberate ammonia crystals if present</li> <li>Stow vent tool and VTE in VTE bag #1 (Lab HR 0230); close bag</li> <li>Retrieve VTE bags #1/#2; stow on BRT</li> </ol> <p><u>VTE/PM JUMPER BAGS STOW</u> (00:15)</p> <ol style="list-style-type: none"> <li>Translate to Airlock zenith</li> <li>Stow VTE #2 (PM Jumper bag) on Airlock port (hinge aft) using HRs 0553 and 0552 (see photo)</li> <li>Stow VTE #1 bag on Airlock stbd (hinge aft) using HRs 0552, 0553, 0557, 0558</li> </ol> <ol style="list-style-type: none"> <li>CHECK GLOVES</li> </ol>

EV2

## VENT OPS AND QD BAG CLEANUP (01:00) (Cont)

### **BLOCK A – Close Valve**

1. ✓Aft white band visible
2. ✓Detent button fully installed
3. ✓Detent button up
4. ✓Detent button can be depressed
5. Assess side loads prior to bail movement
6. Push bail toward open position with significant force while depressing detent button (unstick male sleeve seals)
7. Depress detent button, move bail aft (close valve)
8. ✓Fwd white band visible
9. ✓Detent button up

### **BLOCK C – Open Valve**

1. Assess and counteract side loads (do not move bail if QD under significant side-loading)
2. Depress detent button
3. Push bail to forward position
4. ✓Aft white band visible
5. ✓Detent button – up

### **BLOCK B – MATE QD**

1. Remove QD caps as required
2. Inspect male and female QD for debris or damage
3. Verify female QD ready to mate
  - ✓Detent button – up
  - ✓Fwd white band – not visible
4. Assess side load potential prior to mate
5. Mate QD
  - ✓Fwd white band – visible
6. Perform snapback test
  - ✓Fwd white band – visible
7. Perform pull test (Stay clear of button, release ring, and bail trigger)
8. Perform visual gap test

### **BLOCK D – Demate QD**

1. Assess side loads prior to demate
2. Demate QD – 1.5" QD, squeeze trigger (or use QRT)
3. ✓Release ring retracted
  - ✓Fwd white band not visible (FID check)
4. Inspect male and female QD for debris, damage, or anomalous conditions (ammonia crystals)
5. Install QD caps as required; verify lock tab engaged

EV2

## LWAPA RETRIEVE (00:30)

IV/SSRMS	EV1 – Kopra (SSRMS)
<p>1. √<b>MCC-H</b>: LWAPA inhibits and PM venting complete</p> <p>2. √Payload Bay Camera B pointed orbiter zenith (Pan = 0, Tilt = +90)</p> <p>3. Verify EV1 config prior to LWAPA bolt removal</p> <p>4. <b>Give EV1 GO</b> for LWAPA FRAM Bolt release</p> <p>SSRMS: <b>On EV1 GO</b>, GCA for access to FRAM bolt (if required)</p> <p>SSRMS: <b>On EV1 GO</b>, maneuver to COL Backoff position</p> <p>SSRMS: Joint OCAS to Payload Bay Clearance position (4:00)</p> <p>SSRMS: Single Joint – LWAPA Approach</p>	<p><u>LWAPA REMOVAL AND TRANSFER TO PLB (00:30)</u></p> <p>1. √MWS RET to Sq Scoop</p> <p>2. Verify following in good config prior to LWAPA removal</p> <ul style="list-style-type: none"> <li><input type="checkbox"/> Cooling</li> <li><input type="checkbox"/> APFR ingress aid</li> <li><input type="checkbox"/> Visors</li> <li><input type="checkbox"/> Glove heaters</li> <li><input type="checkbox"/> Helmet lights</li> <li><input type="checkbox"/> Keep heels out</li> <li><input type="checkbox"/> Tethers clear</li> </ul> <p>3. CHECK GLOVES</p> <p>4. <b>PGT [A4, CCW2]</b> (6.3 ft-lb, 30 RPM, MTL 30.5); 6-in ext 7/16</p> <p>5. GCA SSRMS for access to FRAM bolt (if required)</p> <p>6. <b>On IV GO:</b></p> <ul style="list-style-type: none"> <li><input type="checkbox"/> Release primary FRAM bolt ~11 turns to hard stop. (Push ~10 lb to release bolt locking tabs)</li> <li><input type="checkbox"/> √Status Indicator “In”</li> </ul> <p>7. <b>PGT [A4, CW2]</b>; stow PGT</p> <p>8. Lift LWAPA from PFRAM</p> <p>9. <b>Give SSRMS GO</b>: Maneuver to COL Backoff position</p> <p>10. Rotate LWAPA 180° (once Backoff complete)</p>

EV1

## ELC4 ExPCA MLI REMOVAL/JSB RETRIEVE (00:50)

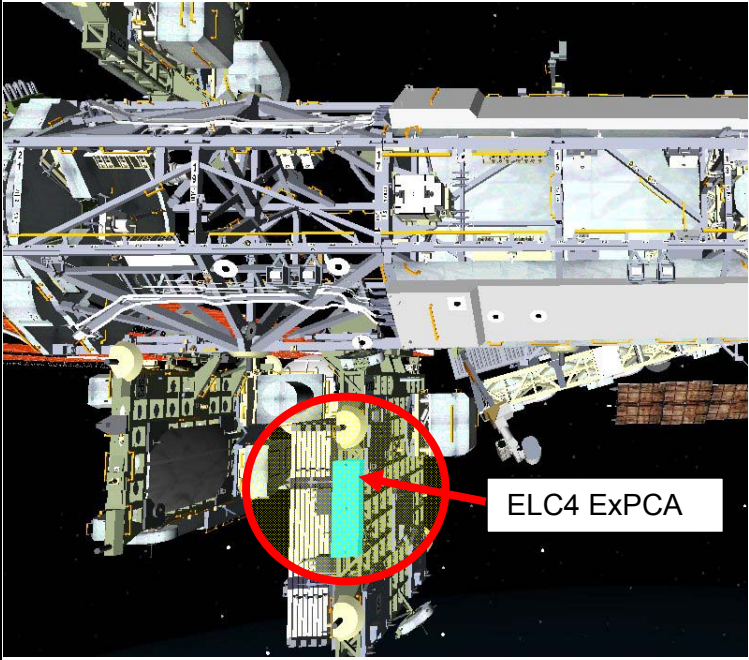
IV/SSRMS	EV2 – Drew (FF)
<p>1. ✓MCC-H: Stbd SARJ locked</p> 	<p><u>ELC4 ExPCA MLI REMOVAL</u> (00:30)</p> <ol style="list-style-type: none"> <li>1. Retrieve Small ORU bag from APFR in stbd A/L tool box WIF; stow on BRT</li> <li>2. Translate to S3 via nadir route; drop Green fairlead hook at HR_____ (Mile Marker 5790)</li> <li>3. Translate onto ELC4 forward edge</li> <li>4. Stow Small ORU bag on ELC4 HR_____ (HR 8809 or 8804)</li> <li>5. Tether to ExPCA MLI with bag RET</li> <li>6. Remove ELC4 ExPCA MLI (4 straps and 1 grounding strap)</li> <li>7. Fold the structure Velcro straps (2 Stbd, 2 Port, 1 grounding strap) back to itself</li> <li>8. Stow MLI in Small ORU bag; use long wire tie, as required</li> <li>9. Stow Small ORU bag on BRT</li> <li>10. GLOVE CHECK</li> </ol> <p><u>JETTISON STOWAGE BAG RETRIEVE</u> (00:20)</p> <ol style="list-style-type: none"> <li>11. Translate to port CETA Cart</li> <li>12. Temp stow small ORU bag on CETA cart</li> <li>13. Retrieve Jettison Stowage bags (3 sets); stow in Small ORU bag</li> <li>14. Retrieve small ORU bag; stow on BRT</li> </ol>
<p>2. ✓MCC-H for Port CETA Cart get-aheads</p>	

EV2

**LWAPA INSTALL (00:30)**

IV/SSRMS	EV1 – Kopra (SSRMS)	EV2 – Drew (FF) (if required)						
<p>SSRMS: <b>On EV1 GO</b>, GCA for LWAPA Install position</p> <p>SSRMS: <b>On EV1 GO</b>, GCA to <b>PGT</b> position</p> <p>1. Record LWAPA bolt data</p> <table border="1" data-bbox="163 589 617 727"> <thead> <tr> <th>Torque (ft-lb)</th> <th>Turns</th> <th>Green Light</th> </tr> </thead> <tbody> <tr> <td> </td> <td> </td> <td> </td> </tr> </tbody> </table> <p>SSRMS: <b>On EV1 GO</b>, maneuver to LWAPA Backoff position</p> <p>SSRMS: Joint OCAS SPDM Intermediate position (03:00)</p> <p>SSRMS: Single Joint to SPDM CLPA 1 Setup position</p>	Torque (ft-lb)	Turns	Green Light				<p><u>LWAPA INSTALL ON SIDEWALL CARRIER</u> (00:30)</p> <ol style="list-style-type: none"> <li>GCA SSRMS to LWAPA Install position</li> <li>Position LWAPA on PFRAM using FRAM alignment stripes</li> <li>GCA SSRMS to PGT position</li> <li><b>PGT [A4, CW2]</b> (6.3 ft-lb, 30 RPM, MTL 30.5); 6-in ext 7/16</li> <li>Engage primary FRAM bolt ~11 turns to hard stop (Push ~10 lb to release bolt locking tabs) <input type="checkbox"/> √Status indicator 'out'</li> <li>Release Sq Scoop from LWAPA</li> <li>Stow Sq Scoop on MWS</li> <li>Verify worksite is clear</li> <li><b>Give SSRMS GO:</b> Maneuver to LWAPA Backoff position</li> <li>GLOVE CHECK</li> <li>Stow Sq Scoop in SPDM bag</li> </ol>	<p><u>LWAPA INSTALL ON SIDEWALL CARRIER</u> (00:30)</p> <ol style="list-style-type: none"> <li>Translate to NOD 2</li> <li>Translate to PLDB; drop Green fairlead hook on NOD 2 HR_____ (HR: 0318)</li> <li>Translate to fwd side of sidewall carrier</li> <li>Provide SSRMS clearance views as required</li> <li>Assist EV1 with LWAPA install as required</li> <li>Translate to NOD 2; retrieve Green fairlead hook from NOD 2 HR 0318; stow on crew ERCM</li> <li>√<b>MCC-H</b> for next worksite</li> </ol>
Torque (ft-lb)	Turns	Green Light						

**EV1 & EV2**

# SPDM CLPA 1 INSTALL, EP 1 COVER REMOVAL (01:00)

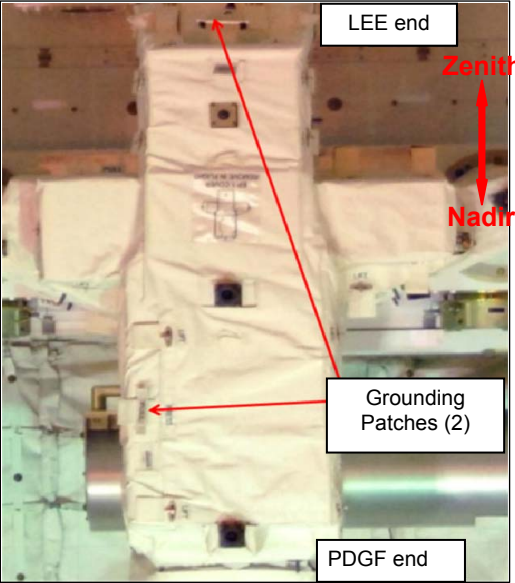
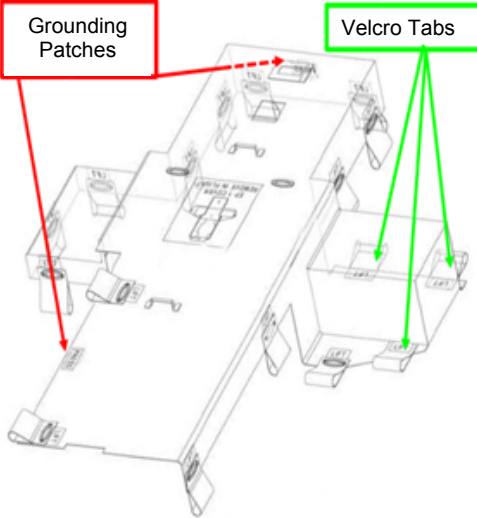
IV/SSRMS	EV1 – Kopra (SSRMS)							
<p>1. ✓ <b>MCC-H</b> CLPA 1 inhibits in place</p> <p>SSRMS: GCA CLPA 1 Install</p> <p>2. <b>Give GO</b> for connector cover removal</p> <p>CLPA 1 Bolt Data</p> <table border="1" data-bbox="163 440 617 576"> <thead> <tr> <th>Torque (ft-lb)</th> <th>Turns</th> <th>Green Light</th> </tr> </thead> <tbody> <tr> <td> </td> <td> </td> <td> </td> </tr> </tbody> </table> <p>3. <b>Give MCC-H GO</b> for CLPA 1 Keep Alive power</p> <p>SSRMS: <b>On EV1 GO</b>, maneuver to CLPA 1 Backoff position</p> <p>SSRMS: For OCAS EP 1 Setup (01:30)</p> <p>4. ✓ <b>MCC-H</b> EP 1 inhibits in place</p> <p>SSRMS: <b>On EV1 GO</b>, GCA as reqd for EP 1 Thermal Cover Removal positions</p> <p>SSRMS: <b>On EV1 GO</b>, maneuver to EP 1 Backoff position</p> <p>5. <b>Give MCC-H GO</b> to take SPDM to operational</p>	Torque (ft-lb)	Turns	Green Light				<p><u>SPDM CLPA 1 INSTALL</u> (00:35)</p> <ol style="list-style-type: none"> <li>GCA SSRMS to CLPA 1 Install position</li> <li><b>On IV GO</b>: Remove connector cover on SPDM; mate Velcro tab and cover exposed Velcro with flap</li> <li>Retrieve CLPA on bag RET</li> <li>Install CLPA on SPDM; magnetic soft dock</li> <li><b>PGT [B2, CW2]</b> (16.0 ft-lb, 30 RPM, MTL 30.5); 6-in ext 7/16</li> <li>Drive tie-down bolt, 22-23 turns to hard stop</li> <li>Verify lens cover is fully installed; release RET from lens cover</li> <li>Remove sq scoop; stow in SPDM bag (lens cover RET to bag side strap)</li> <li>Verify primary bolt indicator is fully 'IN' (indicator only visible without scoop installed)</li> <li>Perform SPDM bag inventory</li> <li><b>Give SSRMS GO</b>: Maneuver to CLPA 1 Backoff position</li> </ol> <p><u>SPDM EP 1 THERMAL COVER REMOVAL</u> (00:25)</p> <ol style="list-style-type: none"> <li>GCA SSRMS to EP 1 Cover Removal position</li> <li>GCA SSRMS as reqd (monitor bag clearance)</li> <li>Attach RET from SPDM bag to EP 1 cover tether loop</li> <li>Release quarter turn fasteners (14 total) and lift corresponding tabs (Zenith to Nadir)</li> <li>Wire tie through quarter turn fastener grommet</li> <li>On SPDM, starting with Zenith (roll up cover), fold over Velcro flaps to cover thermal cover grounding patches (2) and Velcro patches (3)</li> <li>Remove cover from EP 1; stow inside SPDM bag</li> <li>GLOVE CHECK</li> <li><b>Give SSRMS GO</b>: Maneuver to EP 1 Backoff position</li> <li>Wait for CLPA powerup, per <b>MCC-H</b> direction</li> </ol>	 
Torque (ft-lb)	Turns	Green Light						

EV1

## SSRMS CLEANUP (01:00)

IV/SSRMS	EV1 – Kopra (SSRMS)						
<p>SSRMS: Joint OCAS (2) to COL (07:30)</p> <p>SSRMS: <b>On EV1 GO</b>, GCA to APFR Egress position</p> <p>SSRMS: <b>On EV1 GO</b>, maneuver to APFR Backoff position</p> <p>SSRMS: <b>On EV1 GO</b>, GCA to APFR/WIF Adapter Removal position (if required)</p> <p>SSRMS: <b>On EV1 GO</b>, GCA to WIF Adapter Removal position (if required)</p> <p>SSRMS: <b>On EV1 GO</b>, maneuver to APFR Backoff position</p> <p>1. <input checked="" type="checkbox"/> <b>MCC-H</b>: EV1/EV2 Consumable status and get-ahead plan</p> <table border="1" style="width: 100%; border-collapse: collapse;"> <tr style="background-color: #cccccc;"> <td style="width: 50%;">Consumable limit</td> <td></td> </tr> <tr> <td>Cleanup time</td> <td></td> </tr> <tr> <td>On SCU time</td> <td></td> </tr> </table>	Consumable limit		Cleanup time		On SCU time		<p><u>SSRMS CLEANUP</u> (01:00)</p> <ol style="list-style-type: none"> <li>1. GCA SSRMS for APFR Egress</li> <li>2. Egress APFR</li> <li>3. <b>Give SSRMS GO</b> to maneuver to APFR Backoff position</li> <li>4. Temp stow SPDM bag on COL HR _____ (HR 0940, 0939)</li> <li>5. Perform tether swap to STP on HR _____ (HR 0956)               <ul style="list-style-type: none"> <li><input checked="" type="checkbox"/> <input checked="" type="checkbox"/> <input checked="" type="checkbox"/> Red suit hook is on L D-ring ext (gate closed, hook locked)</li> <li><input type="checkbox"/> <input checked="" type="checkbox"/> Reel unlocked</li> </ul> </li> <li>6. GCA SSRMS for APFR/WIF adapter removal if required</li> <li>7. Retract and lock ingress aid; fold to boot plate</li> <li>8. Remove APFR from WIF adapter</li> <li>9. Place APFR on BRT</li> <li>10. GCA SSRMS for WIF adapter removal if required</li> <li>11. Retrieve WIF adapter</li> <li>12. Retrieve SSRMS LEE 55-ft ST</li> <li>13. Verify tools and tethers clear of SSRMS</li> <li>14. <b>Give SSRMS GO</b> to maneuver to APFR Backoff position</li> <li>15. Stow WIF adapter in SPDM bag on girth hitch</li> <li>16. Stow 55-ft ST on outside of SPDM bag</li> <li>17. Translate to COL WIF 3</li> <li>18. Install APFR [<b>6,NN,F,6</b>]               <ul style="list-style-type: none"> <li><input type="checkbox"/> <input checked="" type="checkbox"/> BiK-BiK</li> <li><input type="checkbox"/> Pull/Twist test</li> <li><input type="checkbox"/> <input checked="" type="checkbox"/> AIA retracted and locked, folded to boot plate</li> </ul> </li> <li>19. Translate to SPDM bag on COL HR _____ (HR 0940)</li> </ol>
Consumable limit							
Cleanup time							
On SCU time							

EV1

**SSRMS ELBOW CLPA COVER INSTALL (00:20)**

<b>IV/SSRMS</b>	<b>EV1 – Kopra (FF)</b>
<p>SSRMS: Joint OCAS to SSRM Elbow CLPA Cover Setup position (01:30)</p> <p>1. Verify SSRMS inhibits in place            √Tip Elbow Camera: Pan = +70,            Tilt = +20            √Tip Elbow camera in Keep Alive configuration</p> <p>SSRMS: <b>On EV1 GO</b>, GCA to CLPA Cover Install position</p> <p>SSRMS: <b>On EV1 GO</b>, maneuver to CLPA Backoff position</p>	<p><u>SSRMS ELBOW CLPA COVER INSTALL (00:20)</u></p> <ol style="list-style-type: none"> <li>1. Stow PGT in SPDM bag (based on get-ahead plan)</li> <li>2. Retrieve camera from SPDM bag; stow on swing arm</li> <li>3. Retrieve CLPA lens cover from SPDM bag; MLI case remains in SPDM bag</li> <li>4. Reconfirm bag configuration and perform tool inventory</li> <li>5. GCA SSRMS for CLPA Cover Install position (align cover slot to CLPA slot)</li> <li>6. Rotate locking lever to open/unlocked position (lever perpendicular to plane of lens)</li> <li>7. Install CLPA cover on SSRMS elbow CLPA by inserting spring loaded flange to depress spring</li> <li>8. Rotate locking lever to closed/locked position (lever parallel to plane of lens)</li> <li>9. Perform pull test</li> <li>10. Remove RET</li> <li>11. Give <b>SSRMS GO</b> to maneuver to CLPA Backoff position</li> <li>12. Retrieve SPDM bag; place on BRT</li> <li>13. GLOVE CHECK</li> <li>14. Translate to A/L retrieve green fairlead hook; stow on crew ERCM</li> <li>15. Stow SPDM bag at A/L</li> </ol>

EV1



**P3 CETA LIGHT INSTALL (01:00)**

IV/SSRMS	EV2 – Drew (FF)								
<p>1. <b>IV:</b> √P3 CETA Light inhibits in place</p> <p>2. Start hatch thermal cover clock PET (30 min) ___ : ___</p> <p>3. Stop hatch thermal cover clock PET (30 min) ___ : ___</p> <p>4. Record CETA light bolt data:</p> <table border="1" data-bbox="109 1062 617 1198"> <thead> <tr> <th>Bolt</th> <th>Turns</th> <th>Torque (ft-lb)</th> <th>Green Light</th> </tr> </thead> <tbody> <tr> <td>CETA Light</td> <td></td> <td></td> <td></td> </tr> </tbody> </table> <p>5. <b>IV: Give MCC-H GO</b> for CETA light powerup</p>	Bolt	Turns	Torque (ft-lb)	Green Light	CETA Light				<p><u>P3 CETA LIGHT INSTALL (01:00)</u></p> <div style="border: 1px solid black; padding: 5px; margin: 10px 0;"> <p style="text-align: center;"><b>CAUTION</b></p> <p>CETA Lights are covered with Z-93 paint (White), avoid impact/inadvertent contact</p> </div> <ol style="list-style-type: none"> <li>1. Translate to A/L</li> <li>2. Open hatch thermal cover</li> <li>3. Stow Small ORU bag in A/L</li> <li>4. Swap PGT (Light bag) and camera (Swing arm); stow camera in A/L on Small ORU bag</li> <li>5. Stow Light bag on BRT</li> <li>6. Close thermal cover</li> <li>7. Check SAFER config               <ul style="list-style-type: none"> <li><input type="checkbox"/> √L handle down (MAN ISO Vlv – Open)</li> <li><input type="checkbox"/> √R handle down, door closed (HCM – Closed)</li> </ul> </li> <li>8. Translate to P3 Bay 20 (Face 1)               <ul style="list-style-type: none"> <li><input type="checkbox"/> Fairlead at top of CETA Spur/Face 6 (S0 HR 3413)</li> <li><input type="checkbox"/> Drop Green fairlead hook at P1 Mile Marker 9110</li> </ul> </li> <li>9. Stow Light bag on P3 Face 1 HR _____ (Mile Marker 10170)</li> <li>10. <b>On IV GO:</b> Demate P170 ← → J1 on stanchion panel A92</li> <li>11. Demate dust cap ← → J1 on CETA light</li> <li>12. Install dust cap → ← J1 on stanchion panel A92</li> <li>13. Retrieve CETA light from bag</li> <li>14. Soft dock light onto empty (inner) light bracket (A92)</li> <li>15. Perform CETA light connector ops               <ul style="list-style-type: none"> <li><input type="checkbox"/> √Good pins &amp; EMI band; no FOD</li> <li><input type="checkbox"/> Mate connector P170 → ← J1 on CETA light</li> </ul> </li> <li>16. <b>PGT [B1, CW2]</b> (12.0 ft-lb, 30 RPM, MTL 30.5); 6-in ext 7/16</li> <li>17. Drive bolt while pushing in, expect 11-15 turns</li> <li>18. Retrieve socket caddy with 7.8 in ext 5/8 socket; stow on MWS</li> <li>19. Notify IV, worksite clear</li> <li>20. GLOVE CHECK</li> <li>21. Check SAFER handles               <ul style="list-style-type: none"> <li><input type="checkbox"/> √L handle down (MAN ISO Vlv – Open)</li> <li><input type="checkbox"/> √R handle down, door closed (HCM – Closed)</li> </ul> </li> </ol>
Bolt	Turns	Torque (ft-lb)	Green Light						
CETA Light									

EV2

# P1 RBVM MLI REPAIR (00:20)

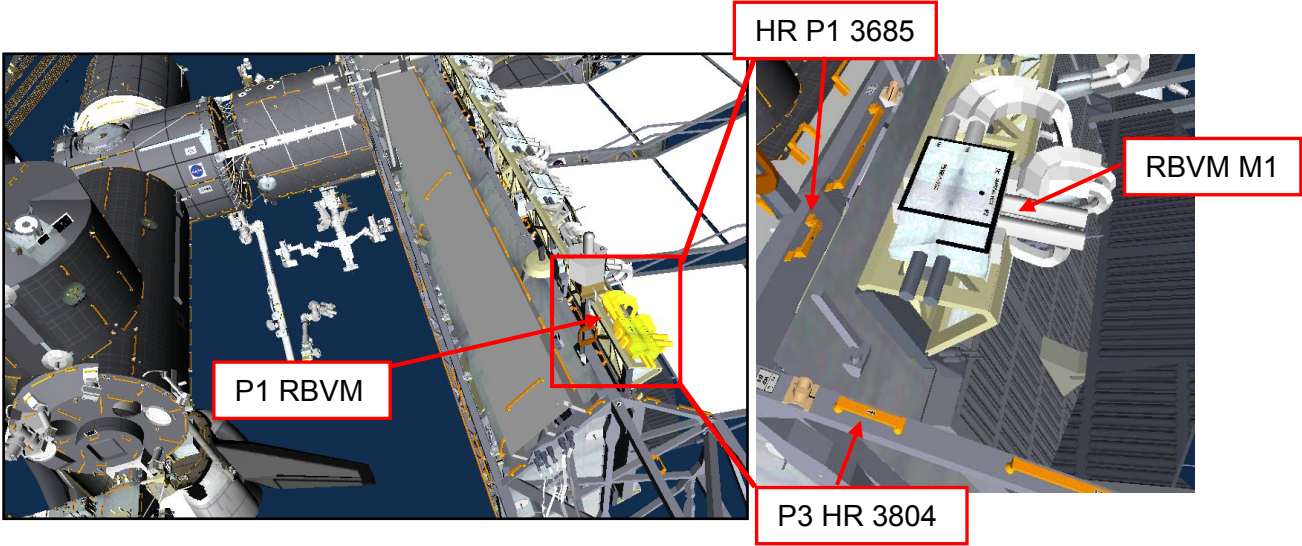
IV/SSRMS	EV2 – Drew (FF)						
<p>1. Verify <b>MCC-H</b> that P1 TRRJ is locked at 0 deg</p> <p>2. <math>\sqrt{\text{MCC-H}}</math>: EV1/EV2 Consumable status</p> <table border="1" data-bbox="130 760 606 873"> <tr> <td>Consumable limit</td> <td></td> </tr> <tr> <td>Cleanup time</td> <td></td> </tr> <tr> <td>On SCU time</td> <td></td> </tr> </table>	Consumable limit		Cleanup time		On SCU time		<p>P1 RBVM MLI REPAIR (00:20)</p> <div data-bbox="688 302 1325 427" style="border: 1px solid black; padding: 5px; margin-bottom: 10px;"> <p style="text-align: center;"><b>CAUTION</b></p> <p>Do not impart loads into radiator. If inadvertent kick load is applied anywhere along the radiator beam, wait 2 min to allow the response to dissipate</p> </div> <ol style="list-style-type: none"> <li>1. Translate to P1 Outboard Zenith RBVM worksite</li> <li>2. BRT to P3 HR 3804 or P1 HR 3685</li> <li>3. Reinstall Fluid QD MLI on M1/F151</li> <li>4. Install wire tie around Fluid QD MLI</li> <li>5. Perform WVS survey of RBVM </li> <li>6. Verify Radiator Beam Launch Locks are disengaged (pointing zenith)</li> <li>7. GLOVE CHECK</li> </ol> <div data-bbox="701 721 1995 1263" style="text-align: center; margin-top: 20px;">  </div>
Consumable limit							
Cleanup time							
On SCU time							

EV2

## P1 GRAPPLE FIXTURE BEAM TROUBLESHOOT (01:10)

IV/SSRMS	EV1	EV2
		<p><b>P1 RADIATOR GF STOWAGE BEAM TROUBLESHOOTING (01:10)</b></p> <ol style="list-style-type: none"> <li>Translate nadir to P1 HR 3650 (via P1 FHRC)</li> </ol> <div data-bbox="1054 329 1776 423" style="border: 1px solid black; padding: 5px; margin: 10px 0;"> <p style="text-align: center;"><u>CAUTION</u></p> <p style="text-align: center;">Avoid kicking P1 radiator beam. If this occurs, wait 2-5 min to allow structural response to dissipate</p> </div> <ol style="list-style-type: none"> <li>Perform socket swap to 7.8 in ext 5/8           <ul style="list-style-type: none"> <li><input type="checkbox"/> Perform pull test</li> </ul> </li> <li>Locate Inboard Stowage Beam and BRT to P1 HR 3649</li> <li>Gently wiggle stowage beam and both bolts. (Wiggling bolts may eliminate potential cross-thread due to zip nut design.) Report beam/fastener tightness, gaps to <b>MCC</b></li> </ol> <p style="text-align: center;"><u>NOTE</u></p> <p style="text-align: center;">Avoid side-loads when pushing or driving bolts into zip nuts. Do not push in while driving bolts</p> <p style="text-align: center;"><u>Troubleshooting: Loosen Beam, Index Aft Bolt, and Re-engage</u></p> <ol style="list-style-type: none"> <li><b>PGT [B3, CCW2]</b>, (18.4 ft-lb, 30 RPM, MTL 30.5); 7.8 in ext 5/8</li> <li>Bolt drive:           <ul style="list-style-type: none"> <li><input type="checkbox"/> RET to beam</li> <li><input type="checkbox"/> Release bolts (2), 6 turns</li> </ul> </li> <li>√Gap between truss and beam; position beam if required</li> <li>Fully depress ISS Fwd bolt with PGT or hand to engage zip nut to hard stop</li> <li>Fully depress ISS Aft bolt with PGT or hand to engage zip nut to hard stop while indexing beam:           <ul style="list-style-type: none"> <li><input type="checkbox"/> Push Aft end of beam away from other beam while zipping ISS Aft bolt to hard stop. (This should center (aka "index") Aft bolt to aid in alignment)</li> </ul> </li> <li>√Beam fully seated on truss</li> </ol>

EV2 & EV1

# P1 GRAPPLE FIXTURE BEAM TROUBLESHOOT (01:10) (Cont)

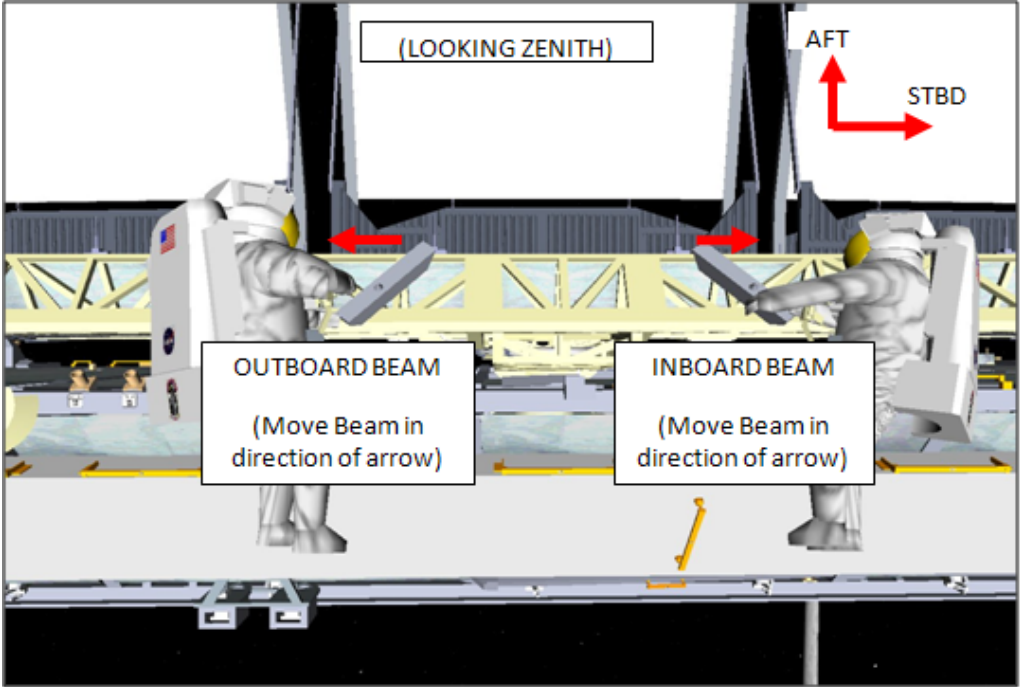
IV/SSRMS	EV1	EV2												
<p>P1 <b>Inboard</b> Stowage Beam Bolts</p> <table border="1" data-bbox="130 360 583 451"> <thead> <tr> <th></th> <th>Torque</th> <th>Green Light</th> </tr> </thead> <tbody> <tr> <td>Fwd</td> <td></td> <td></td> </tr> </tbody> </table> <p>P1 <b>Outboard</b> Stowage Beam Bolts</p> <table border="1" data-bbox="130 513 583 604"> <thead> <tr> <th></th> <th>Torque</th> <th>Green Light</th> </tr> </thead> <tbody> <tr> <td>Fwd</td> <td></td> <td></td> </tr> </tbody> </table>		Torque	Green Light	Fwd				Torque	Green Light	Fwd			<p>1. Assist EV2 as required</p>	<p>11. <b>PGT [A3, CW1]</b>, (4.8 ft-lb, 10 RPM, MTL 30.5); 7.8 in ext 5/8</p> <p>12. Engage ISS Fwd bolt to hard stop</p> <p>13. Engage ISS Aft bolt to hard stop while indexing beam:  <input type="checkbox"/> Push Aft end of beam away from other beam while driving ISS Aft bolt to hard stop. (This should center (aka "index") Aft bolt to aid in alignment)</p> 
	Torque	Green Light												
Fwd														
	Torque	Green Light												
Fwd														

EV2 & EV1

**P1 GRAPPLE FIXTURE BEAM TROUBLESHOOT (01:10) (Cont)**

IV/SSRMS			EV1	EV2									
<b>P1 Inboard Stowage Beam Bolts</b> <table border="1"> <tr> <td></td> <td>Torque</td> <td>Green Light</td> </tr> <tr> <td>Fwd</td> <td></td> <td></td> </tr> <tr> <td>Aft</td> <td></td> <td></td> </tr> </table>				Torque	Green Light	Fwd			Aft				<p>14. <b>PGT [B3, CW1]</b>, (18.4 ft-lb, 10 RPM, MTL 30.5); 7.8 in ext 5/8</p> <p>15. Drive ISS Fwd bolt to required torque</p> <p>16. Drive ISS Aft bolt to required torque</p> <p>17. Check bolts and inboard beam for movement; report to <b>MCC</b></p> <ul style="list-style-type: none"> <li><input type="checkbox"/> If bolts or beam moves, go to step 18</li> <li><input type="checkbox"/> Else, go to step 42 (go to step 43 if working on outboard bolt)</li> </ul> <p><u>Continued Troubleshooting: Remove Beams &amp; Re-install:</u></p> <p>18. RET to beam</p> <p>19. <b>PGT [B3, CCW2]</b> (18.4 ft-lb, 30 RPM, MTL 30.5); 7.8 in ext 5/8</p> <p>20. Release bolts (2) of inboard stowage beam, 21-23 turns</p> <p>21. Remove beam from structure</p> <p>22. ✓Truss and stowage beam for FOD or damage. ✓Beam lies flat against truss</p> <p>23. Depress each bolt; ✓above threads for damage or galling on smooth bolt shank</p> <p>24. Place beam on radiator beam w/tether point facing ISS Fwd (away from radiator)</p> <p>25. Fully depress ISS Fwd bolt with PGT or hand to engage zip nut to hard stop</p> <p>26. Fully depress ISS Aft bolt with PGT or hand to engage zip nut to hard stop while indexing beam:</p> <ul style="list-style-type: none"> <li><input type="checkbox"/> Push Aft end of beam away from other beam while zipping ISS Aft bolt to hard stop. (This should center (aka "index") Aft bolt to aid in alignment)</li> </ul> <p>27. ✓Beam fully seated on truss</p> <p>28. <b>PGT [A3, CW1]</b>, (4.8 ft-lb, 10 RPM, MTL 30.5); 7.8 in ext 5/8</p> <p>29. Engage ISS Fwd bolt to hard stop</p> <p>30. Engage ISS Aft bolt to hard stop while indexing beam:</p> <ul style="list-style-type: none"> <li><input type="checkbox"/> Push Aft end of beam away from other beam while driving ISS Aft bolt to hard stop. (This should center (aka "index") Aft bolt to aid in alignment)</li> </ul> <p>31. <b>PGT [B3, CW1]</b>, (18.4 ft-lb, 10 RPM, MTL 30.5); 7.8 in ext 5/8</p> <p>32. Drive ISS Fwd bolt to required torque</p>
	Torque	Green Light											
Fwd													
Aft													
<b>P1 Outboard Stowage Beam Bolts</b> <table border="1"> <tr> <td></td> <td>Torque</td> <td>Green Light</td> </tr> <tr> <td>Fwd</td> <td></td> <td></td> </tr> <tr> <td>Aft</td> <td></td> <td></td> </tr> </table>				Torque	Green Light	Fwd			Aft				
	Torque	Green Light											
Fwd													
Aft													
<b>P1 Inboard Stowage Beam Bolts</b> <table border="1"> <tr> <td></td> <td>Torque</td> <td>Green Light</td> </tr> <tr> <td>Fwd</td> <td></td> <td></td> </tr> </table>				Torque	Green Light	Fwd							
	Torque	Green Light											
Fwd													
<b>P1 Outboard Stowage Beam Bolts</b> <table border="1"> <tr> <td></td> <td>Torque</td> <td>Green Light</td> </tr> <tr> <td>Fwd</td> <td></td> <td></td> </tr> </table>				Torque	Green Light	Fwd							
	Torque	Green Light											
Fwd													
<b>P1 Inboard Stowage Beam Bolts</b> <table border="1"> <tr> <td></td> <td>Torque</td> <td>Green Light</td> </tr> <tr> <td>Fwd</td> <td></td> <td></td> </tr> <tr> <td>Aft</td> <td></td> <td></td> </tr> </table>				Torque	Green Light	Fwd			Aft				
	Torque	Green Light											
Fwd													
Aft													
<b>P1 Outboard Stowage Beam Bolts</b> <table border="1"> <tr> <td></td> <td>Torque</td> <td>Green Light</td> </tr> <tr> <td>Fwd</td> <td></td> <td></td> </tr> <tr> <td>Aft</td> <td></td> <td></td> </tr> </table>				Torque	Green Light	Fwd			Aft				
	Torque	Green Light											
Fwd													
Aft													

EV2 & EV1

# P1 GRAPPLE FIXTURE BEAM TROUBLESHOOT (01:10) (Cont)

IV/SSRMS			EV1	EV2									
<b>P1 Inboard Stowage Beam Bolts</b> <table border="1"> <thead> <tr> <th></th> <th>Torque</th> <th>Green Light</th> </tr> </thead> <tbody> <tr> <td>Fwd</td> <td></td> <td></td> </tr> <tr> <td>Aft</td> <td></td> <td></td> </tr> </tbody> </table>				Torque	Green Light	Fwd			Aft				<p>33. Drive ISS Aft bolt to required torque</p> <p>34. Check bolts and beam for movement; report to <b>MCC</b></p> <ul style="list-style-type: none"> <li><input type="checkbox"/> If bolts or beam moves, go to step 35</li> <li><input type="checkbox"/> Else, go to step 42 (go to step 43 if working on outboard bolt)</li> </ul> <p><u>Re-torque Beam to Max Torque</u></p> <p>35. If bolts or beam moves</p> <ul style="list-style-type: none"> <li>• PGT [B7, CW1], (25.5 ft-lb, 10 RPM, MTL 30.5); 7.8 in ext 5/8</li> <li>• Drive ISS Fwd then Aft bolt to torque</li> </ul> <p>36. Check bolts and beam for movement; report to <b>MCC</b></p> <ul style="list-style-type: none"> <li><input type="checkbox"/> If bolts or beam moves, go to step 37 or 41 per <b>MCC-H</b> direction</li> <li><input type="checkbox"/> Else, go to step 42 (go to step 43 if working on outboard bolt)</li> </ul> <p><u>Beam Remove or Tiedown</u></p> <p><b>On MCC GO</b>, perform either Beam Remove or Beam Tiedown</p> <p>Beam Remove:</p> <p>37. <b>PGT [B7, CCW2, 30.5]</b> (25.5 ft-lb, 30 RPM, MTL 30.5); 7.8 in ext 5/8</p> <p>38. Tether to beam</p> <p>39. Release bolts (2) of inboard stowage beam, 21-23 turns</p> <p>40. Remove beam from structure; stow in Med ORU bag</p> <p>Beam Tiedown:</p> <p>41. Use AET from beam tether point, around structure, and back to beam tether point (see Task Data for diagrams)</p> <p>42. Translate to outboard stowage beam, BRT to P1 HR 3666 and return to step 4</p> <p><u>Troubleshooting Completed</u></p> <p>43. Perform socket swap back to 6 in on PGT; 5/8 7.8-ext onto socket caddy</p> <ul style="list-style-type: none"> <li><input type="checkbox"/> Perform pull test</li> </ul> <p>44. Verify TRRJ Launch Lock in stowed position (see Task Data)</p> <p>45. GLOVE CHECK</p> <p>46. Translate to Light bag at P1 HR 3800; perform bag inventory</p> <p>47. Stow socket caddy with 7.8 in ext 5/8 socket on RET w/PIP Pin in Light bag</p> <p>48. Stow Light bag on BRT</p> <p>49. Retrieve green fairlead from P1 mile marker 9110; stow on crew ERCM</p>
	Torque	Green Light											
Fwd													
Aft													
<b>P1 Outboard Stowage Beam Bolts</b> <table border="1"> <thead> <tr> <th></th> <th>Torque</th> <th>Green Light</th> </tr> </thead> <tbody> <tr> <td>Fwd</td> <td></td> <td></td> </tr> <tr> <td>Aft</td> <td></td> <td></td> </tr> </tbody> </table>				Torque	Green Light	Fwd			Aft				
	Torque	Green Light											
Fwd													
Aft													
<p>2. <b>Give EV1 GO</b> for either beam remove or tiedown</p>													
<p>3. Light Bag Inventory:</p>													

EV2 & EV1

## NODE 3 MLI REMOVAL (00:35)

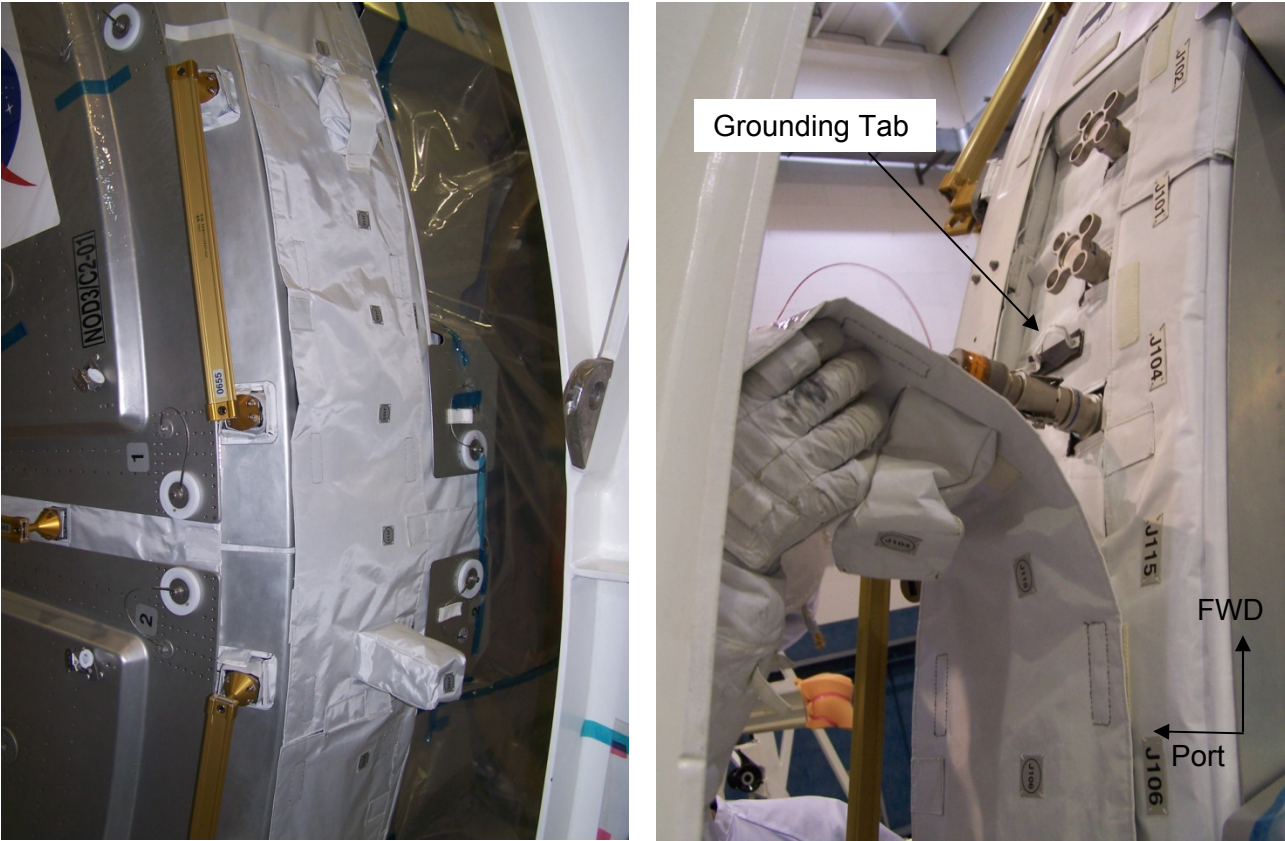
IV/SSRMS	EV2 – Drew (FF)
<p>1. Verify Port TRRJ locked at 0 deg</p>	<p><u>NODE 3 MLI REMOVAL (00:35)</u></p> <ol style="list-style-type: none"><li>1. Translate to Zenith side of Node 3 port endcone via fwd/zenith translation path</li><li>2. Remove Connector MLI (covers connectors J102, J101, J104, J115, J106, J103, J117, J105)</li><li>3. Release grounding tab lanyards (2) from Node 3 (conductive Velcro)</li><li>4. Stow MLI in Light bag</li><li>5. Stow Light bag on BRT</li></ol>  <p>The left photograph shows a close-up of the Node 3 port endcone with white MLI covering several connectors. Labels 'NOD3/C2-01' and '0655' are visible. The right photograph shows a hand holding the MLI, with a 'Grounding Tab' label pointing to a tab on the MLI. A diagram in the bottom right of the right photo shows 'FWD' and 'Port' directions.</p>

EV2

**POA CLA AND SPDM CLPA LENS COVER INSTALL (00:20)**

<b>IV/SSRMS</b>	<b>EV1 – Kopra (FF)</b>	<b>EV2 – Drew (FF)</b>
<p>1. ✓ <b>MCC-H</b> SPDM CLPA 2: Pan = -168 Tilt = -63</p>	<p><u>SPDM CLPA 2 COVER INSTALL (00:20)</u></p> <div style="border: 1px solid black; padding: 5px; margin: 10px auto; width: fit-content;"> <p style="text-align: center;"><b>CAUTION</b> Avoid contact with CLA cover lens</p> </div> <ol style="list-style-type: none"> <li>1. Translate to A/L</li> <li>2. Retrieve Sq Scoop from SPDM bag</li> <li>3. Retrieve CLPA cover in MLI from Get-ahead bag</li> <li>4. Translate to SPDM via nadir route</li> <li>5. Use EOTP input drive to access CLPA</li> <li>6. Install Sq Scoop on CLPA</li> <li>7. Tether to cover and MLI (adjustable tether or BRT RET reqd)</li> <li>8. Remove cover from MLI case</li> <li>9. Rotate locking lever to the open/unlocked position (lever perpendicular to plane of lens)</li> <li>10. Install CLPA 2 cover on SPDM CLPA by inserting spring loaded flange to depress spring</li> <li>11. Rotate locking lever to the closed/locked position (lever parallel to plane of lens)</li> <li>12. Perform pull test</li> <li>13. Remove RET</li> <li>14. Remove Sq Scoop; stow on MWS</li> <li>15. <input type="checkbox"/> Perform WVS survey</li> <li>16. Translate to A/L</li> <li>17. Stow Sq Scoop in SPDM bag, if desired</li> <li>18. Stow lens cover MLI in Get-ahead bag, if desired</li> </ol>	<p><u>POA CLA COVER INSTALL (00:20)</u></p> <div style="border: 1px solid black; padding: 5px; margin: 10px auto; width: fit-content;"> <p style="text-align: center;"><b>CAUTION</b> Avoid contact with CLA cover lens</p> </div> <ol style="list-style-type: none"> <li>1. Translate to A/L</li> <li>2. Retrieve Get-ahead bag; stow on BRT</li> <li>3. Translate to POA</li> <li>4. Install Sq Scoop on micro fixture on POA CLA</li> <li>5. RET to cover and MLI, remove from MLI case</li> <li>6. Rotate locking lever to the open/unlocked position (lever perpendicular to plane of lens)</li> <li>7. Install CLA cover on POA CLA by inserting spring loaded flange to depress spring</li> <li>8. Rotate cover to seat against camera bracket for full installation</li> <li>9. Rotate locking lever to the closed/locked position (lever parallel to plane of lens)</li> <li>10. Perform pull test</li> <li>11. Remove RET</li> <li>12. <input type="checkbox"/> Perform WVS survey</li> <li>13. Stow Sq Scoop and MLI case in Get-ahead bag</li> <li>14. Translate to A/L</li> </ol>

**EV1 & EV2**



**CLEANUP/INGRESS (00:30)**

IV/SSRMS	EV1 – Kopra (FF)	EV2 – Drew (FF)
<p>1. Stop hatch thermal cover clock PET (30 min) __ : __</p> <p>2. Perform WVS PWRDN (PHOTO/TV, <u>WVS CUE CARD</u>)</p>	<p><u>CLEANUP AND INGRESS</u> (00:30)</p> <ol style="list-style-type: none"> <li>Translate to A/L</li> <li>Transfer bags to EV2, as required               <ul style="list-style-type: none"> <li><input type="checkbox"/> SPDM Bag</li> <li><input type="checkbox"/> Small ORU</li> <li><input type="checkbox"/> Get-ahead Bag</li> <li><input type="checkbox"/> Light Bag</li> </ul> </li> <li>Attach R Waist Tether to Internal A/L D-ring ext               <ul style="list-style-type: none"> <li><input type="checkbox"/> √Gate closed, hook locked</li> </ul> </li> <li><b>ON EV2 GO:</b> Release EV2 anchor from fwd ext D-ring</li> <li>Release EV1 anchor from aft ext D-ring</li> <li>Ingress A/L</li> <li>Close hatch thermal cover; attach Velcro strap</li> <li>Remove SCU from stowage pouch</li> <li>Remove DCM cover; Velcro to DCM</li> <li>Connect SCU to DCM               <ul style="list-style-type: none"> <li>√SCU locked</li> </ul> </li> </ol> <p style="text-align: center;"><u>NOTE</u> A TCV setting 8 – Max C Minimizes time for SCU cooling</p> <ol style="list-style-type: none"> <li>WATER – OFF (fwd), expect H2O IS OFF msg</li> </ol> <div style="border: 1px solid black; padding: 5px; margin: 10px auto; width: fit-content;"> <p style="text-align: center;"><u>CAUTION</u> Do not close hatch until EMU Water OFF for 2 min. Verify outer hatch clear of hardware</p> </div> <ol style="list-style-type: none"> <li>Verify outer hatch clear of hardware</li> <li>Verify handle position per hatch decal</li> <li>Close and lock hatch</li> </ol> <p>Go to PRE-REPRESS (<u>DEPRESS/REPRESS</u> Cue Card)</p>	<p><u>CLEANUP AND INGRESS</u> (00:30)</p> <ol style="list-style-type: none"> <li>Ingress A/L</li> <li>Receive bags from EV1; stow in A/L</li> <li>Attach R Waist Tether to A/L int UIA D-ring               <ul style="list-style-type: none"> <li><input type="checkbox"/> √Gate closed, hook locked</li> </ul> </li> <li>Give <b>EV1 GO</b> to release EV2 anchor from ext D-ring</li> <li>Remove SCU from stowage pouch</li> <li>Remove DCM cover; Velcro to DCM</li> <li>Connect SCU to DCM               <ul style="list-style-type: none"> <li>√SCU locked</li> </ul> </li> </ol> <p style="text-align: center;"><u>NOTE</u> A TCV setting 8 – Max C Minimizes time for SCU cooling</p> <ol style="list-style-type: none"> <li>WATER – OFF (fwd), expect H2O IS OFF msg</li> </ol> <p>Go to PRE-REPRESS (<u>DEPRESS/REPRESS</u> Cue Card)</p>

EV1 & EV2

## LWAPA RETRIEVE AND INSTALL – TASK DATA

### Estimated Task Duration:

	With SSRMS	Without SSRMS
One EV Crew	01:00	N/A
Two EV Crew	N/A	N/A

### Tools:

EV1 (SSRMS)	EV2 (FF)
WIF adapter	
APFR	
PGT 6-in ext 7/16	

### EVA Fasteners:

Fastener Name	Label	Head Size	Qty	Install Torque (ft-lb)	Release Torque (ft-lb)	Failure Torque (ft-lb)	Turns	RPM
LWAPA FRAM PRIMARY BOLT		7/16	1	6.3	6.3		11	30

### EVA Connectors:

Harness	From	To	Clamps (#)	Conn Size	Function
P6A	LWAPA	J6A (PEC 6A)	2		PEC power
P6B	LWAPA	J6B (PEC 6B)	3		PEC power

### Foot Restraints:

Task	WIF	APFR Setting
MISSE 6 INSTALL	SSRMS	(12,PP,F,6)

### ORUs/Loose items:

ORU/Item	Qty	Part Number, ID	Mass (lb)	Dimensions (in)
LWAPA and FSE	1	SEG33120158-301	257.8	47.99 x 46.05 x 15.77

### Notes:

### Cautions:

### Warnings:

1. Sidewall carrier clamp are a pinch point. Use caution during actuation
2. Avoid contact with SSPTS cable connectors (2-ft Keep-out Zone)

# SPDM CLPA 1 INSTALL – TASK DATA

**Estimated Task Duration:**

	With SSRMS	Without SSRMS
One EV Crew	00:45	N/A

**Tools:**

EV2
PGT w/7/16 6-in ext
ORU Bag
Sq Scoop
CLPA

**EVA Fasteners:**

Fastener Name	Head Size	Qty	Install Torque (ft-lb)	Release Torque (ft-lb)	Failure Torque (ft-lb)	Turns
CLPA Bolt	7/16	1	16.0 (B2)	N/A	30.5	22-23

**Mass & Dimensions:**

ORU	Mass (lb)	Dimensions (in)
CLPA	50.59	22.5 x 17.0 x 16.8
EP1 Cover	1.8	32.2 x 44.1 x 8.1

**Notes:**

1. There is a magnetics soft dock for the CLPA
2. The status indicator may only be visible once sq scoop removed

**Cautions:**

1. Avoid contact with SPDM CLPA connections if powered

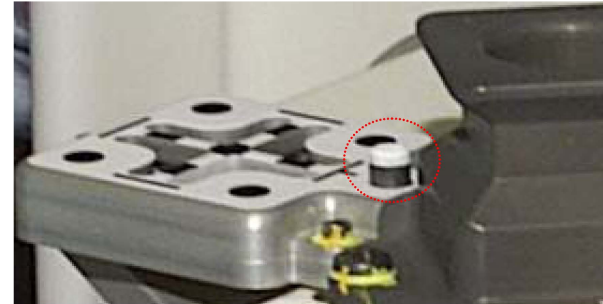

CLPA status indicator (top – indicator shows CLPA not installed, bottom – shows CLPA installed)

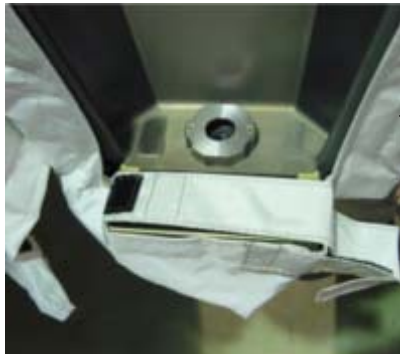

CLPA Connector Cover (Launch)



CLPA Connector Cover (Stowed)

## CLPA LENS COVER – TASK DATA

ORU	Mass (lb)	Dimensions (in)
Lens Cover	1.1	2.4 x 5.0 x 7.2
MLI Case	TBD	2.3 x 5.9 x 7.5

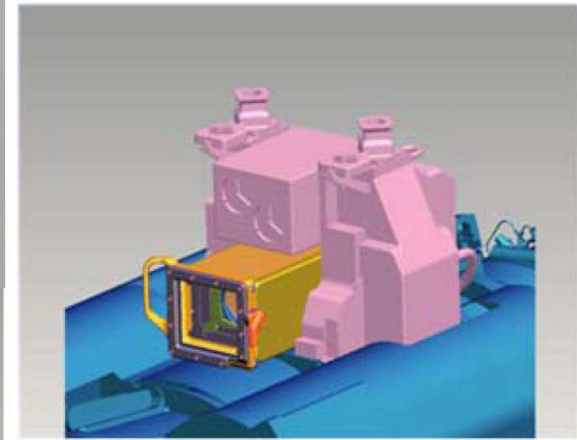

Cover on CLA



MSS Camera Cover  
(Shown in Unlocked Position)

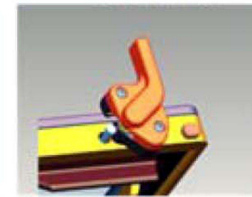

Latch Pin

## P3 CETA LIGHT INSTALL – TASK DATA

### Estimated Task Duration:

	With SSRMS	Without SSRMS
One EV Crew	N/A	00:30
Two EV Crew	N/A	N/A

### Tools:

EV1
PGT w/7/16 6-in ext
Rd Scoop
Med ORU bag

### EVA Fasteners:

Fastener Name	Label	Head Size	Qty	Install Torque (ft-lb)	Release Torque (ft-lb)	Failure Torque (ft-lb)	Turns
CETA Light Bolt		7/16	1	12.0	24.0	56.2	11-15

### EVA Connectors:

Harness	From	To	Clamps (#)	Conn Size	Function
A29	P401	J1	1	15	Power



### Notes:

1. CETA Lights covered with Z-93 paint; avoid impact/inadvertent contact
2. If light turned on during EVA, do not touch (possible hot touch temp violation)
3. EVA connectors present a pinch hazard. Caution should be used when mating/locking connectors

### Timeline Considerations:

1. CETA light has a thermal clock of 3.5 hr from removal from Airlock



### P3 CETA LIGHT INSTALL – TASK DATA (Cont)

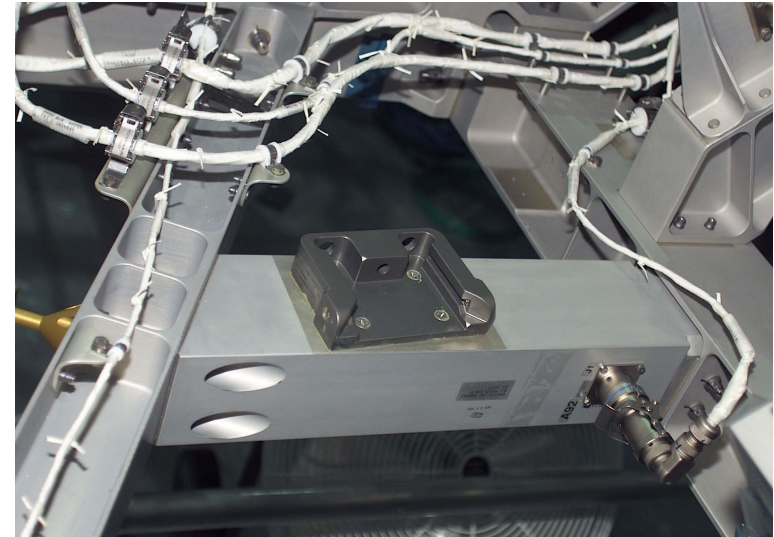
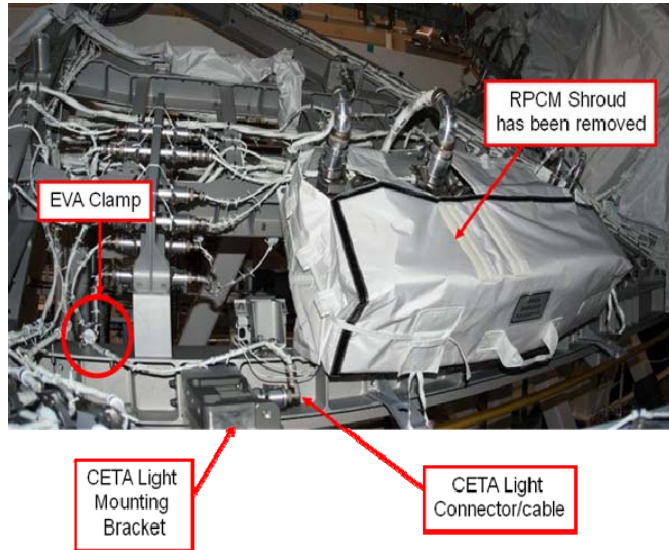

Bracket, connector mated to dummy panel, TA-clamp

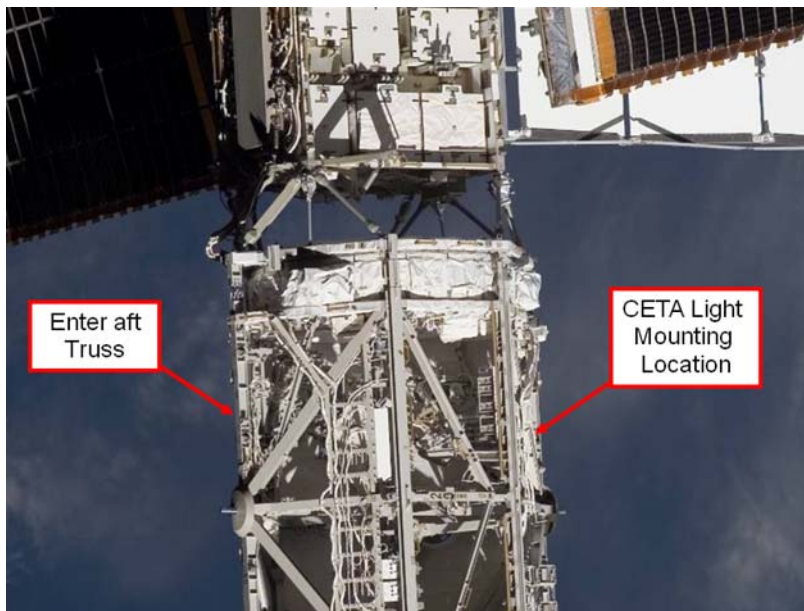

MT at WS8, port CETA cart will be over worksite

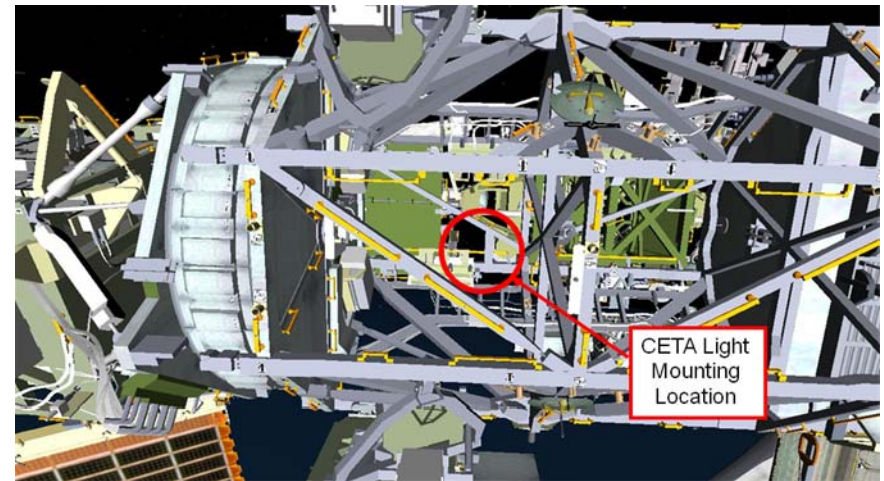

Through Face 4

# P1 RADIATOR GRAPPLE STOW BEAM – TASK DATA

**Estimated Task Duration:**

	With SSRMS	Without SSRMS
One EV Crew	N/A	00:45
Two EV Crew	N/A	00:30

**Tools:**

EV1	EV2
ORU Bag	PGT
Stow Beams (2)	Socket Caddy
	5/8 x 7.8-in Socket

**EVA Fasteners:**

Head Size	Qty	Install Torque (ft-lb)	Release Torque (ft-lb)	Failure Torque (ft-lb)	Turns	RPM
5/8	4	12.0	25.5	77.0	21-23	30

**Notes:**

1. Stow beams are attached to truss with zip nuts

**Cautions:**

1. Avoid kicking P1 radiator beam. If this occurs, wait 2 to 5 min to allow structural response to dissipate

**Timeline Considerations:**

1. Task is being used to fill time while SSRMS is retrieving ATA from POA





## GET-AHEADS

### STS-133/ULF5 GET-AHEADS

<b>Task (in priority order)</b>	<b>EV – Time (hr:min) Required</b>	<b>EVA Applicable</b>
Port CETA Cart Reconfig	1 EV – 00:30	2
SPDM CLPA 2 Lens Cover Install	1 EV – 00:30	1
POA CLA Lens Cover Install	1 EV – 00:30	1
Strela Adapter Relocate	1 EV – 00:45	1, 2
CP13 Light R&R	2 EV – 01:00	1, 2
Release S1 FHRC P-Clamps Release	1 EV – 00:45	2
S0 Connector Grounding Bootie Install (ESP-2 J57A)	1 EV – 00:30 (00:45 on EVA 2)	1, 2 (MT at WS 3)
Tool Reconfiguration	1 EV – 00:30	1, 2

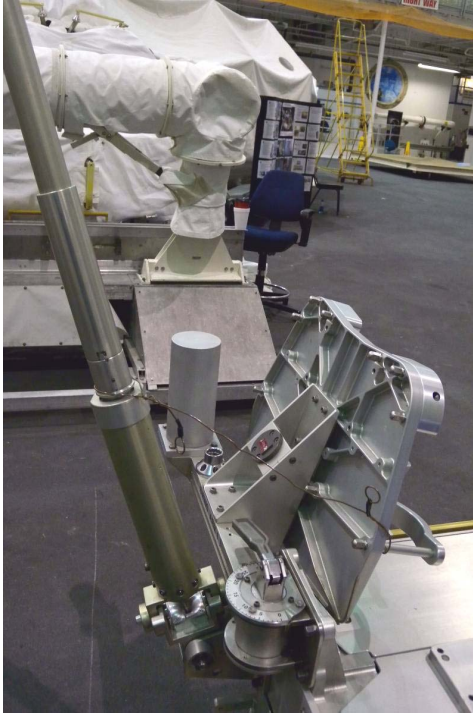

## PORT CETA CART RECONFIG (00:30)

IV/SSRMS	EV1
<p>√Inhibits in place:</p> <p>Mobile Transporter  <b>MCC-H</b> EV crew expected &lt; 1.5 meters from MT            (ROBO) 1. √MT latched</p>	<p><u>PORT CETA CART RECONFIG (00:30)</u></p> <ol style="list-style-type: none"> <li>1. Retrieve at least two long wire tires (from BRT or Get-ahead bag)</li> <li>2. Translate to Port CETA Cart</li> <li>3. Release Port nadir TFR swing arm</li> <li>4. √TFR nadir 180 deg full nadir (position 30)</li> <li>5. Lock TFR swing arm</li> <li>6. √WIF 4 and WIF 5 pitch to inboard 45 deg minimum (JJ)</li> <li>7. Rotate Port brake handles forward and tie down (one long wire tie per handle)               <ul style="list-style-type: none"> <li><input type="checkbox"/> Nadir brake handle to zenith TFR Toe Clip</li> <li><input type="checkbox"/> Zenith brake handle to Sq Grid H (port/nadir corner)</li> <li><input type="checkbox"/> √Three twists at each end of wire ties</li> <li><input type="checkbox"/> √Brake handles bent at elbow and secured together with wire tie</li> </ul> </li> <li>8. Perform WVS survey of CETA Cart <input type="checkbox"/></li> <li>9. GLOVE CHECK</li> </ol> <div style="display: flex; justify-content: space-around; margin-top: 20px;">   </div>

## SPDM CLPA 2 COVER INSTALL (00:30)

IV/SSRMS	EV1
<p>√Inhibits in place:</p> <p>LAB Window (SPDM tasks)</p> <p><b>IV</b> EV crew expected &lt; 10 ft from window or in window FOV, close window shutter</p> <p><b>MCC-H</b></p> <ol style="list-style-type: none"> <li>1. √SPDM in Keep Alive configuration</li> <li>2. √PSU – Operational</li> <li>3. √Body Prime(Redundant) – Keep Alive</li> <li>4. √SPDM Arm 1(2) – Keep Alive</li> <li>5. CLPA 2 pointed at SPDM input drive (pan = -168, tilt = -63)</li> <li>6. CLPA 2 in Keep Alive configuration</li> </ol>	<p><u>SPDM CLPA 2 COVER INSTALL (00:30)</u></p> <div style="border: 1px solid black; padding: 5px; margin: 10px auto; width: fit-content;"> <p style="text-align: center;"><b>CAUTION</b></p> <p style="text-align: center;">Avoid contact with CLA cover lens</p> </div> <ol style="list-style-type: none"> <li>1. Retrieve CLPA cover in MLI from Get-ahead bag</li> <li>2. Retrieve Sq Scoop from Get-ahead bag</li> <li>3. Translate to SPDM via nadir route</li> <li>4. Use EOTP input drive to access CLPA</li> <li>5. Install Sq Scoop</li> <li>6. Tether to cover and MLI (BRT RET or adjustable tether required)</li> <li>7. Rotate locking lever to the open/unlocked position (lever perpendicular to plane of lens)</li> <li>8. Install CLPA 2 cover on SPDM CLPA by inserting spring loaded flange to depress spring</li> <li>9. Rotate locking lever to the closed/locked position (lever parallel to plane of lens)</li> <li>10. Perform pull test</li> <li>11. Remove RET</li> <li>12. Remove Sq Scoop; stow on MWS</li> <li>13. <input type="checkbox"/> Perform WVS survey</li> <li>14. Translate to A/L</li> <li>15. Stow Sq Scoop and MLI case in Get-ahead bag</li> </ol>

**POA CLA LENS COVER INSTALL (00:30)**

IV/SSRMS	EV1
<p>√Inhibits in place:</p> <p>Mobile Transporter  <b>MCC-H</b> EV crew expected &lt; 1.5 meters from MT            (ROBO) 1. √MT latched</p>	<p><u>POA CLA COVER INSTALL (00:30)</u></p> <div style="border: 1px solid black; padding: 5px; margin: 10px auto; width: fit-content;"> <p style="text-align: center;"><b>CAUTION</b> Avoid contact with CLA cover lens</p> </div> <ol style="list-style-type: none"> <li>1. Retrieve Get-ahead bag; stow on BRT</li> <li>2. Translate to POA</li> <li>3. Install Sq Scoop on micro fixture on POA CLA</li> <li>4. RET to cover and MLI, remove from MLI case</li> <li>5. Rotate locking lever to the open/unlocked position (lever perpendicular to plane of lens)</li> <li>6. Install CLA cover on POA CLA by inserting spring loaded flange to depress spring</li> <li>7. Rotate cover to seat against camera bracket for full installation</li> <li>8. Rotate locking lever to the closed/locked position (lever parallel to plane of lens)</li> <li>9. Perform pull test</li> <li>10. Remove RET</li> <li>11. <input type="checkbox"/> Perform WVS survey</li> <li>12. Stow Sq Scoop and MLI cover in Get-ahead bag</li> <li>13. Translate to A/L</li> </ol>

## S1 FHRC P-CLAMPS (00:45)

IV/SSRMS	EV2
<p>√Inhibits in place:</p> <p>1. √<b>MCC-H</b>: Stbd TRRJ locked at 0 deg</p>	<p><u>S1 FHRC P-CLAMPS – BAY 13 (00:20)</u></p> <ol style="list-style-type: none"> <li>Translate to S1 FHRC Bay 13 with Get-ahead bag</li> <li>Retrieve Ratchet Wrench from Get-ahead bag</li> </ol> <div style="border: 1px solid black; padding: 5px; margin: 10px 0;"> <p style="text-align: center;"><b>CAUTION</b></p> <p style="text-align: center;">Do not impart loads greater than 15 lb into FHRC Hose Box fluid lines</p> </div> <ol style="list-style-type: none"> <li><b>PGT [A7, CCW2]</b> (9.2 ft-lb, 30 RPM, MTL 30.5); 6-in ext</li> <li>Release Hose Box P-clamps (4) ~6-12.5 turns</li> <li>Egress Bay 13</li> <li>Verify SAFER handles:               <ul style="list-style-type: none"> <li><input type="checkbox"/> √R Handle down (HCM door – Closed)</li> <li><input type="checkbox"/> √L Handle down (MAN ISO Valve – Open)</li> </ul> </li> </ol>

	P-clamp	Tool	Socket
<input type="checkbox"/>	<b>1 (N)</b>	PGT	6-in ext
<input type="checkbox"/>	<b>2 (N)</b>	PGT	6-in ext
<input type="checkbox"/>	<b>3 (N)</b>	Ratchet	2-in ext
<input type="checkbox"/>	<b>1 (Z)</b>	PGT	6-in ext
√	<b>2 (Z)</b>	PGT	6-in ext
√	<b>3 (Z)</b>	Ratchet	2-in ext

**S1 FHRC P-CLAMPS (00:45) (Cont)**

IV/SSRMS	EV2
<p>√Inhibits in place:                      1. √<b>MCC-H</b>: Stbd TRRJ locked at 0 deg</p>	<p><b>S1 FHRC P-CLAMPS – BAY 11 (00:25)</b></p> <ol style="list-style-type: none"> <li>1. Translate S1 FHRC Bay 11 with Get-ahead bag</li> <li>2. Retrieve Ratchet Wrench from Get-ahead bag</li> <li>3. Retrieve 18 in ext from Get-ahead bag</li> <li>4. Translate to Bay 11</li> <li>5. <b>PGT [A7, CCW2]</b> (9.2 ft-lb, 30 RPM, MTL 30.5); 6-in ext/18-in ext</li> <li>6. Release Stinger P-clamps (6) [P-clamp #2 requires 18 in ext] ~7-12.5 turns Do not release P-clamp on hardline P-clamps are not numbered Release 3 P-clamps closest to QD</li> <li>7. Egress Bay 11</li> <li>8. Verify SAFER handles:                             <ul style="list-style-type: none"> <li><input type="checkbox"/> √R Handle down (HCM door – Closed)</li> <li><input type="checkbox"/> √L Handle down (MAN ISO Valve – Open)</li> </ul> </li> <li>9. GLOVE CHECK</li> <li>10. Stow 18-in ext in Get-ahead bag</li> <li>11. Stow Get-ahead bag on BRT</li> <li>12. Stow Get-ahead bag at A/L</li> </ol>

	P-clamp	Tool	Socket
<input type="checkbox"/>	1	PGT	6- or 18-in ext
<input type="checkbox"/>	2	PGT	18-in ext
<input type="checkbox"/>	3	PGT	6-in ext
<input type="checkbox"/>	4	PGT	6- or 18-in ext
<input type="checkbox"/>	5	PGT	6- or 18-in ext
<input type="checkbox"/>	6	PGT	6* or 18-in ext

\* wobble reqd w/6-in

# S1 FHRC P-CLAMP RELEASE – TASK DATA

## FHRC P-clamps – Hose Box (Outboard)

**Legend:**  
 ○ = P-clamp Location  
 ⊗ = TA-clamp (not released)

**Hose Box S1 Bay 13**

	P-clamp	Tool	Socket
<input type="checkbox"/>	1 (N)	PGT	6-in ext
<input type="checkbox"/>	2 (N)	PGT	6-in ext
<input type="checkbox"/>	3 (N)	Ratchet	2-in ext
<input type="checkbox"/>	1 (Z)	PGT	6-in ext
<input checked="" type="checkbox"/>	2 (Z)	PGT	6-in ext
<input checked="" type="checkbox"/>	3 (Z)	Ratchet	2-in ext

Additional labels: Nadir, Aft, Zenith Tray, TA, HR 3230, HR 3229, Forward, QD: M3/F40, QD: M4/F41, QD: M5/F42, QD: M6/F43.

## FHRC P-clamps – Stinger (Inboard)

**Legend:**  
 ○ = P-clamp Location  
 ⊗ = P-clamp (not released)

**Stinger S1 Bay 11**

	P-clamp	Tool	Socket
<input type="checkbox"/>	1	PGT	6- or 18-in ext
<input type="checkbox"/>	2	PGT	18-in ext
<input type="checkbox"/>	3	PGT	6-in ext
<input type="checkbox"/>	4	PGT	6- or 18-in ext
<input type="checkbox"/>	5	PGT	6- or 18-in ext
<input type="checkbox"/>	6	PGT	6* or 18-in ext

\* wobble reqd w/6-in

Additional labels: Nadir, Zenith Tray, QD: M1, QD: M2, Torque Box Assy, AVIONICS WIRE HARNESS, VIEW M-M, SCALE 1/4.

## S1 FHRC P-CLAMP RELEASE – TASK DATA (Cont)

### Estimated Task Duration:

	With SSRMS	Without SSRMS
One EV Crew	N/A	N/A
Two EV Crew	N/A	00:45

### Tools:

EV1
PGT w/7/16 (wobble) Socket-6 ext
Ratchet wrench w/7/16-2 in ext
PGT w/7/16 Socket-18 in ext

### EVA Fasteners:

Fastener Name	Label	Head Size	Qty	Install Torque (ft-lb)	Release Torque (ft-lb)	Failure Torque (ft-lb)	Turns	RPM
Hosebox P-clamp bolts	1,2,3	7/16	6	N/A	6.0	12.6	6-12.5	30
Stinger P-clamp bolts	Arrow	7/16	6	N/A	6.0	12.6	7-12.5	30

### Inhibits:

ORU/Task	Location	Inhibit
S1 P-clamps	Prior to translation to S1	Stbd TRRJ √DLA (1) – LOCKED (0 deg)



Hose box P-clamps have labels with bolt numbers

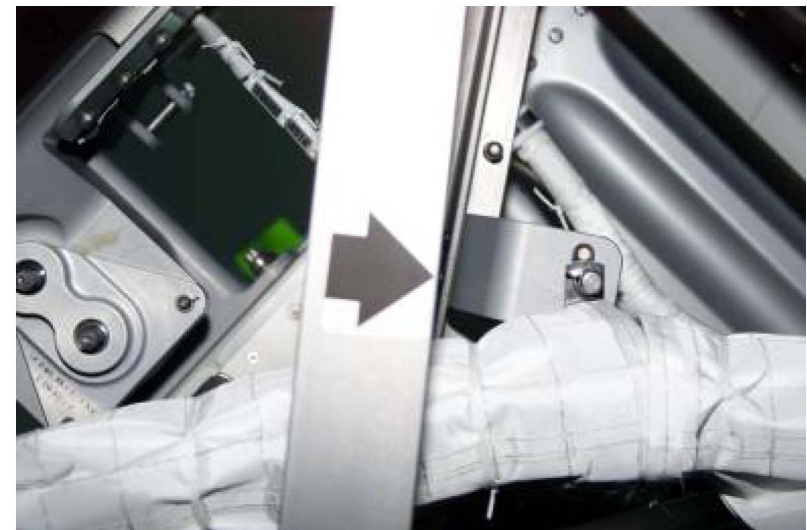

Torque box P-clamps have arrow labels for bolts

## STRELA ADAPTER RELOCATE (00:30)

IV/SSRMS	EV1
<p>√Inhibits in place:</p> <p>1. √<b>MCC-H</b>: Russian inhibits in place:</p> <ul style="list-style-type: none"> <li><input type="checkbox"/> Soyuz (docked to MRM-1) Thrusters – Inhibited</li> <li><input type="checkbox"/> RSOS and RSOS Visiting Vehicle Antennas (includes FGB, MRM-1, and Soyuz (docked to MRM-1)):               <ol style="list-style-type: none"> <li>1. √KURS P [KYPC P] – Deactivated</li> <li>2. √KURS A [KYPC A] – Deactivated</li> </ol> </li> <li><input type="checkbox"/> FGB Antennas:               <ol style="list-style-type: none"> <li>1. √TORU [TOPY] – Deactivated</li> <li>2. √TV System [TBC] – Deactivated</li> <li>3. √TV System [КЛ-108А] – Deactivated</li> </ol> </li> </ul>	<p><u>STRELA REMOVAL</u></p> <ol style="list-style-type: none"> <li>1. Translate to PMA3 aft FRGF via nadir route</li> </ol> <div style="border: 3px double black; padding: 5px; margin: 10px 0;"> <p style="text-align: center;"><u>WARNING</u></p> <p style="text-align: center;">Port TRRJ is not locked for EVA 1. Stay at least 2 ft from TRRJ at all times</p> </div> <ol style="list-style-type: none"> <li>2. Preposition BRT RET to adjustable tether</li> <li>3. BRT to PMA3 HR 1604</li> <li>4. Loop adjustable tether around Strela Adapter handhold back to D-ring</li> <li>5. Open three paddles (lift up)</li> </ol> <p style="text-align: center;"><u>NOTE</u></p> <p style="text-align: center;">Gap between adapter latch and FRGF pin head enables release of adapter latch</p> <ol style="list-style-type: none"> <li>6. Rotate paddles ccw 6.5-7 turns           <ul style="list-style-type: none"> <li><input type="checkbox"/> Check for gap between adapter latch and FRGF pin head</li> </ul> </li> <li>7. Rotate adapter latch to open position</li> <li>8. Remove adapter from FRGF</li> <li>9. BRT to Strela Adapter</li> <li>10. Translate to Node 3 endcone</li> </ol>

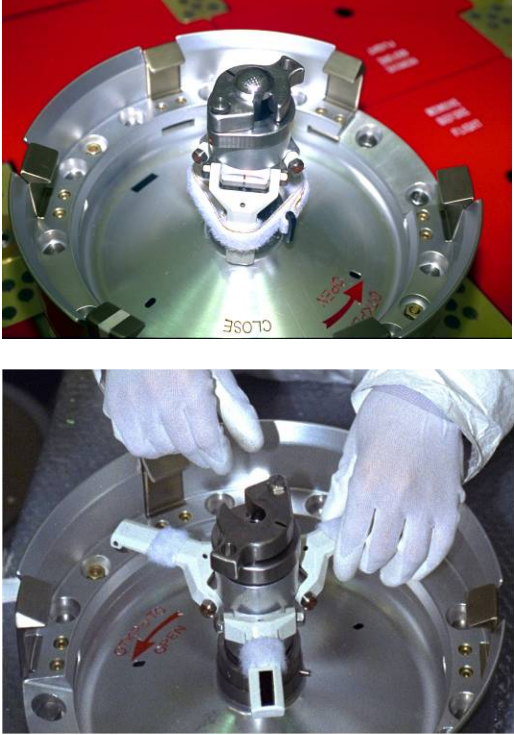

## STRELA ADAPTER RELOCATE (00:30) (Cont)

IV/SSRMS	EV1
	<p><u>STRELA INSTALL</u></p> <ol style="list-style-type: none"><li>1. Translate to FGB stbd/zenith EFGF</li><li>2. Align white stripe on adapter with EFGF target pin<ul style="list-style-type: none"><li><input type="checkbox"/> Check adapter latch is open</li></ul></li><li>3. Verify safety tether clear of EFGF and Strela Adapter interface</li><li>4. Install adapter on EFGF</li><li>5. Rotate adapter latch to the close position<ul style="list-style-type: none"><li><input type="checkbox"/> Verify adapter latch black stripe aligns with one of three screws on EFGF pin head</li></ul></li><li>6. Rotate paddles cw 6.5-7 turns</li><li>7. Align paddle with black stripe with the black stripe on adapter housing</li><li>8. Close three paddles (push down)<ul style="list-style-type: none"><li><input type="checkbox"/> Verify no gap between adapter latch and EFGF pin head</li><li><input type="checkbox"/> Verify paddles are flush and do not interfere with retainer pin at base of adapter shaft</li></ul></li><li>9. Stow adjustable tether on MWS</li></ol>

## STRELA ADAPTER RELOCATION – TASK DATA

### Estimated Task Duration:

	With SSRMS	Without SSRMS
One EV Crew	N/A	00:45
Two EV Crew	N/A	N/A

### Tools:

<b>EV1</b>
BRT
Adjustable Tether
RET
Strela Adapter Extender (contingency)

### Notes:

1. Gap between adapter latch and FRGF pin head enables release of adapter latch
2. White stripe on adapter used to align adapter with grapple fixture target pin may not be easy to see. Before removing adapter, take note of where white stripe is located on adapter plate
3. Retainer pin at base of the adapter shaft provides a hard stop for closed paddles in event Strela Adapter begins to back out from installed position

STRELA ADAPTER RELOCATION – TASK DATA (Cont)

White Velcro strap is a ground only item

Adapter Latch

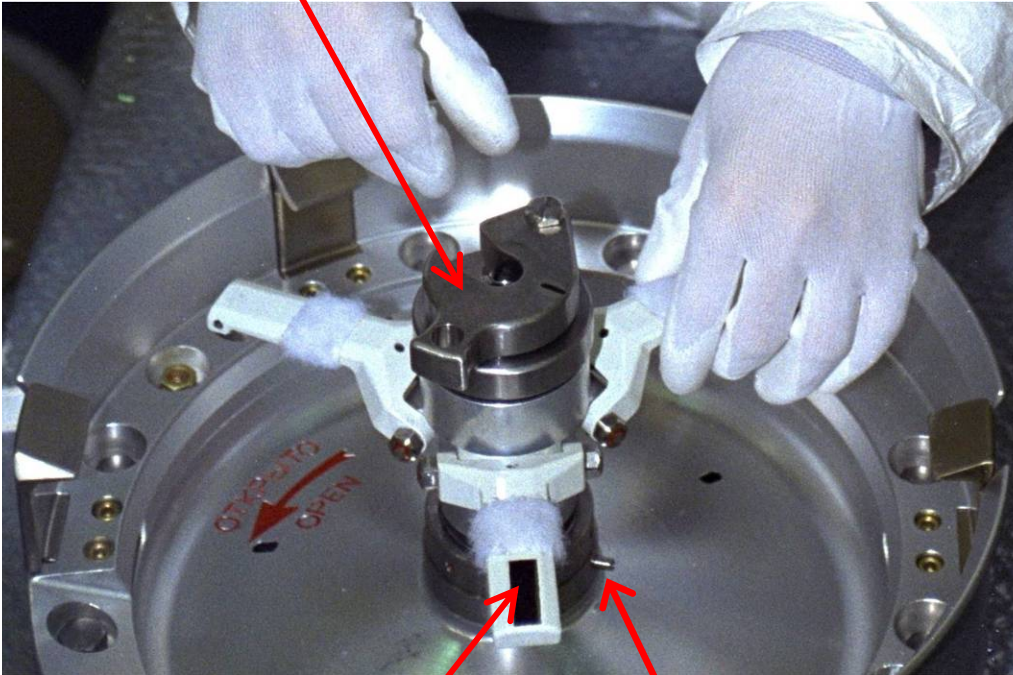
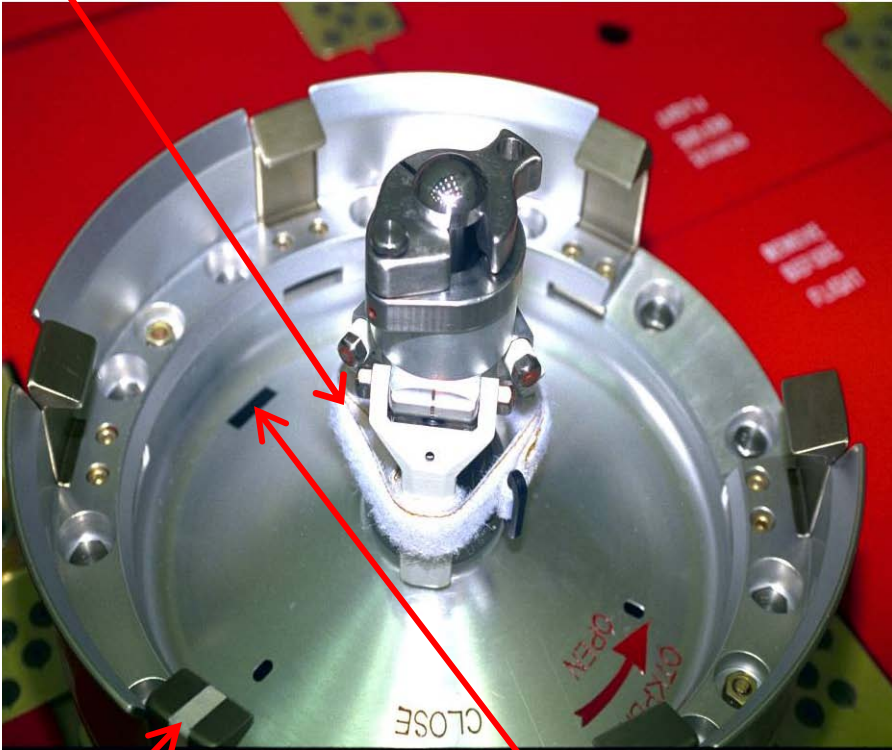

White Stripe

Housing Black Stripe

Paddle Black Stripe

Retainer Pin

# STRELA ADAPTER RELOCATION – TASK DATA (Cont)

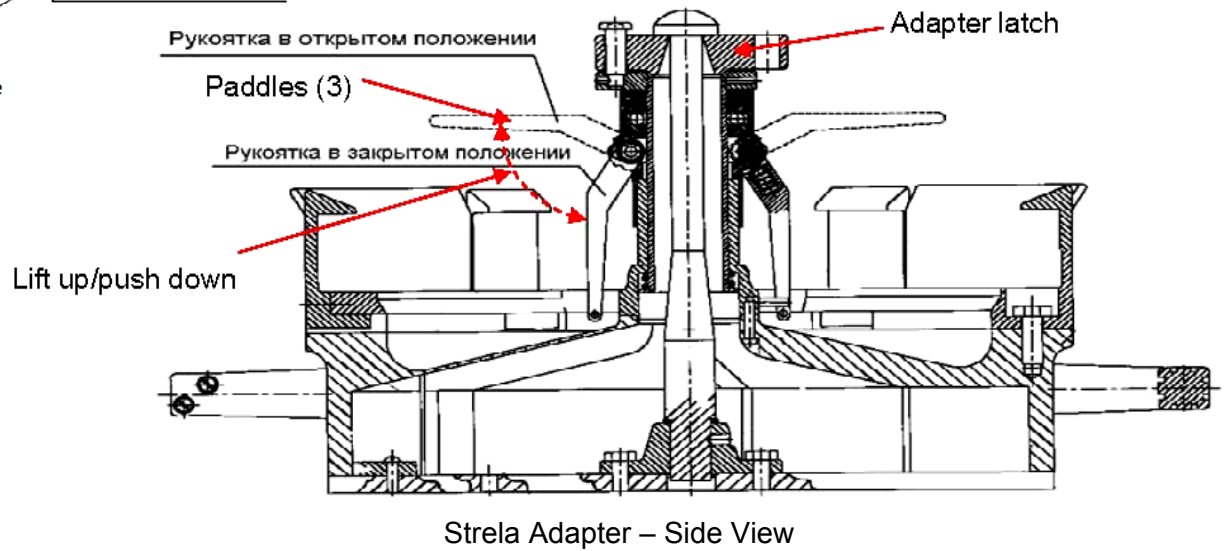
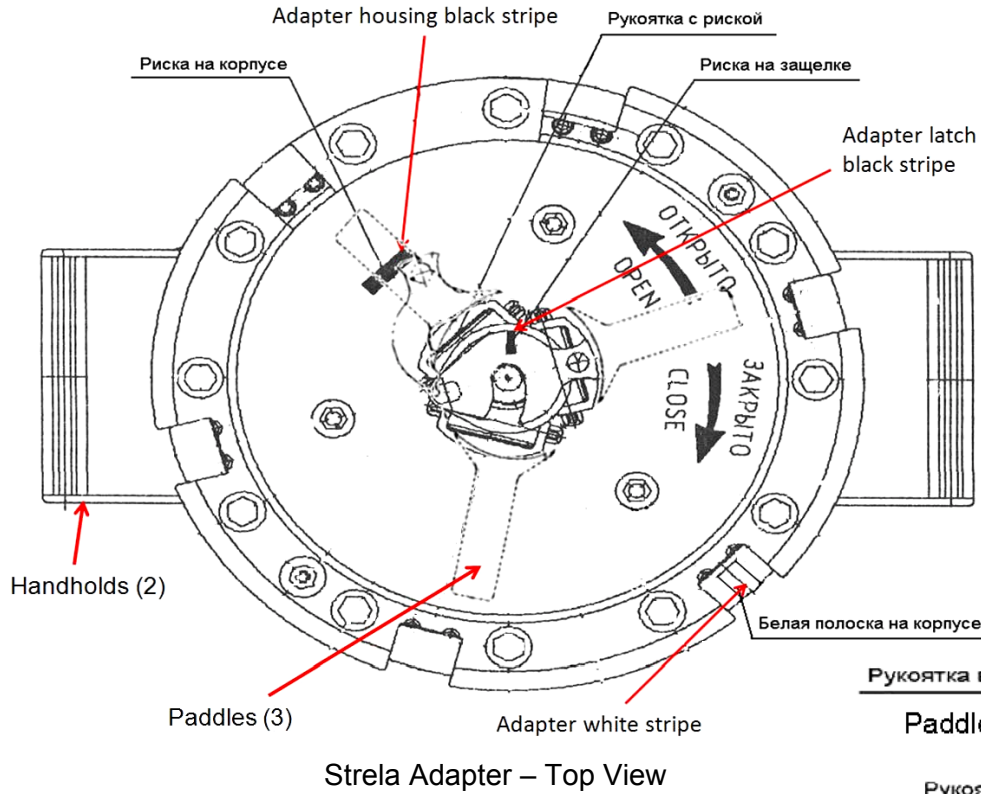

## S0 GROUNDING BOOTIE INSTALL (00:45)

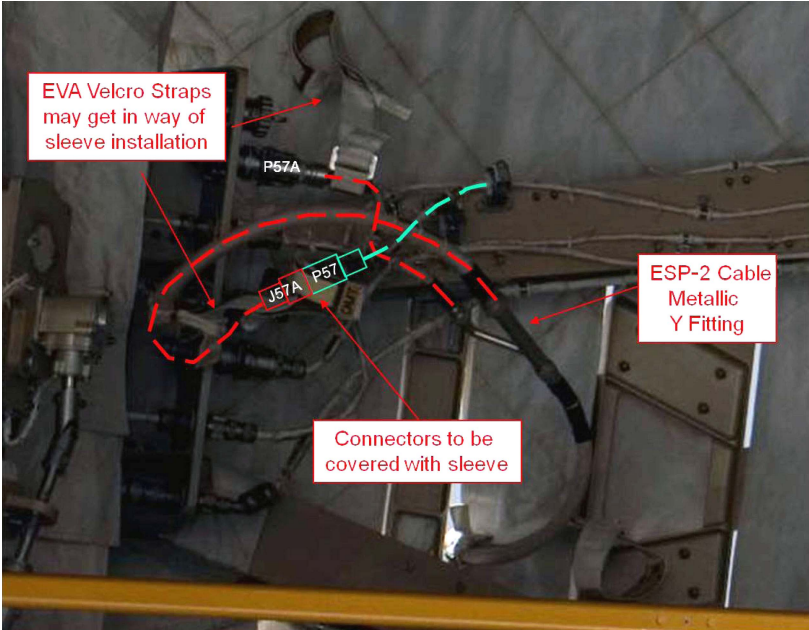
IV/SSRMS	EV1
<p>1. <b>IV/MCC-H:</b> Verify Inhibits are in place:</p> <ul style="list-style-type: none"><li><input type="checkbox"/> RPCM S04B F RPCS 10 – Open, Close Cmd Inhibit</li><li><input type="checkbox"/> RPCM S04B F RPCS 11 – Open, Close Cmd Inhibit</li><li><input type="checkbox"/> RPCM S04B F RPCS 12 – Open, Close Cmd Inhibit</li><li><input type="checkbox"/> RPCM S04B F RPCS 13 – Open, Close Cmd Inhibit</li></ul>	<p><b>FPP SLEEVES: S0 BAY3</b></p> <ol style="list-style-type: none"><li>1. Retrieve sleeve (sz 15/17) from Get-ahead bag</li><li>2. <b>On IV GO</b> (inhibits complete)</li><li>3. Translate to S0 Bay 3</li><li>4. Install sleeve<ul style="list-style-type: none"><li><input type="checkbox"/> P57/J57A</li></ul></li><li>5. WVS Survey </li></ol> <div data-bbox="909 513 1713 1138"><p>The photograph shows the interior of the S0 bay with various cables and connectors. Red dashed lines and arrows point to specific areas:</p><ul style="list-style-type: none"><li><b>EVA Velcro Straps may get in way of sleeve installation:</b> Points to a strap on the left side of the bay.</li><li><b>P57A:</b> Points to a connector on the top left.</li><li><b>J57A P57:</b> Points to a connector in the center, which is highlighted with a green box.</li><li><b>Connectors to be covered with sleeve:</b> Points to the central connector area.</li><li><b>ESP-2 Cable Metallic Y Fitting:</b> Points to a fitting on the right side.</li></ul></div>

## TOOL RECONFIG (00:30)

IV/SSRMS	EV1
	<ol style="list-style-type: none"><li>1. Retrieve Tool Relocate bag from A/L Staging bag</li><li>2. Translate to A/L Toolboxes</li></ol> <p style="text-align: center;"><u>NOTE</u> Tether to toolboard prior to removal for tool stow</p> <ol style="list-style-type: none"><li>3. Stow following tools in the Port A/L Toolbox (figure 2):<ul style="list-style-type: none"><li><input type="checkbox"/> Behind Zenith Door – Slot 1 (figure 3)<ul style="list-style-type: none"><li><input type="checkbox"/> Pin Straightener</li></ul></li><li><input type="checkbox"/> Behind Nadir Door – Slot 5 (figures 4-7)<ul style="list-style-type: none"><li><input type="checkbox"/> Short MMOD T-handle tool (tether point aligned with angled slot)</li><li><input type="checkbox"/> Short MMOD T-handle tool (tether point aligned with angled slot)</li></ul></li></ul></li><li>4. Close both doors<ul style="list-style-type: none"><li><input type="checkbox"/> Verify at least one lever in lock position for each door</li></ul></li><li>5. Stow following tools in Starboard A/L Toolbox (figure 8):<ul style="list-style-type: none"><li><input type="checkbox"/> Inside Zenith Door – Panel 9 (figure 9)<ul style="list-style-type: none"><li><input type="checkbox"/> Probe</li></ul></li><li><input type="checkbox"/> Behind Zenith Door – Slot 5 (figure 10)<ul style="list-style-type: none"><li><input type="checkbox"/> Vise Grips</li></ul></li></ul></li><li>6. Close both doors<ul style="list-style-type: none"><li><input type="checkbox"/> Verify at least one lever in lock position for each door</li></ul></li><li>7. Retrieve Tool Relocate bag; stow in A/L</li></ol>

TOOL RECONFIG (00:30) (Cont)

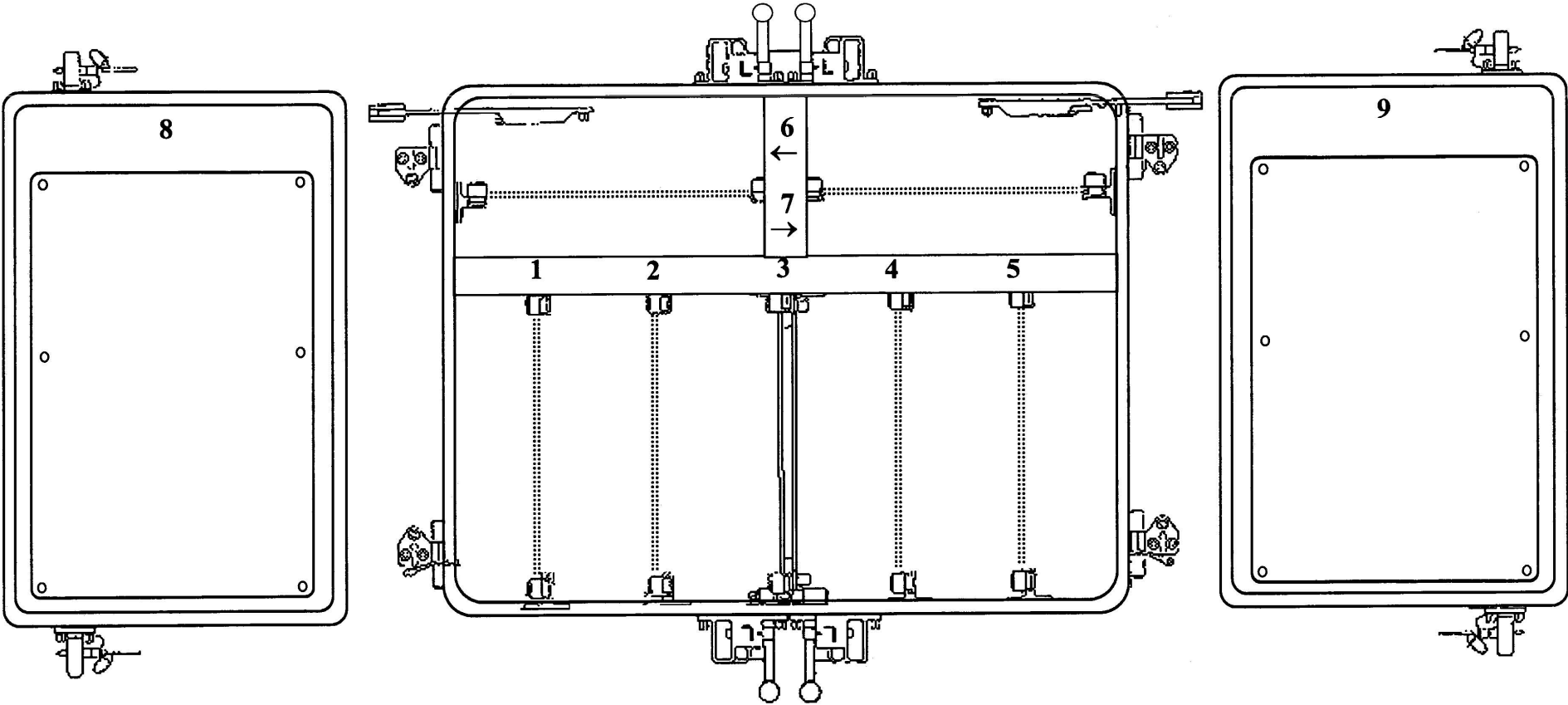

Figure 1.- A/L Toolbox Panel and Slot Labels.

TOOL RECONFIG (00:30) (Cont)

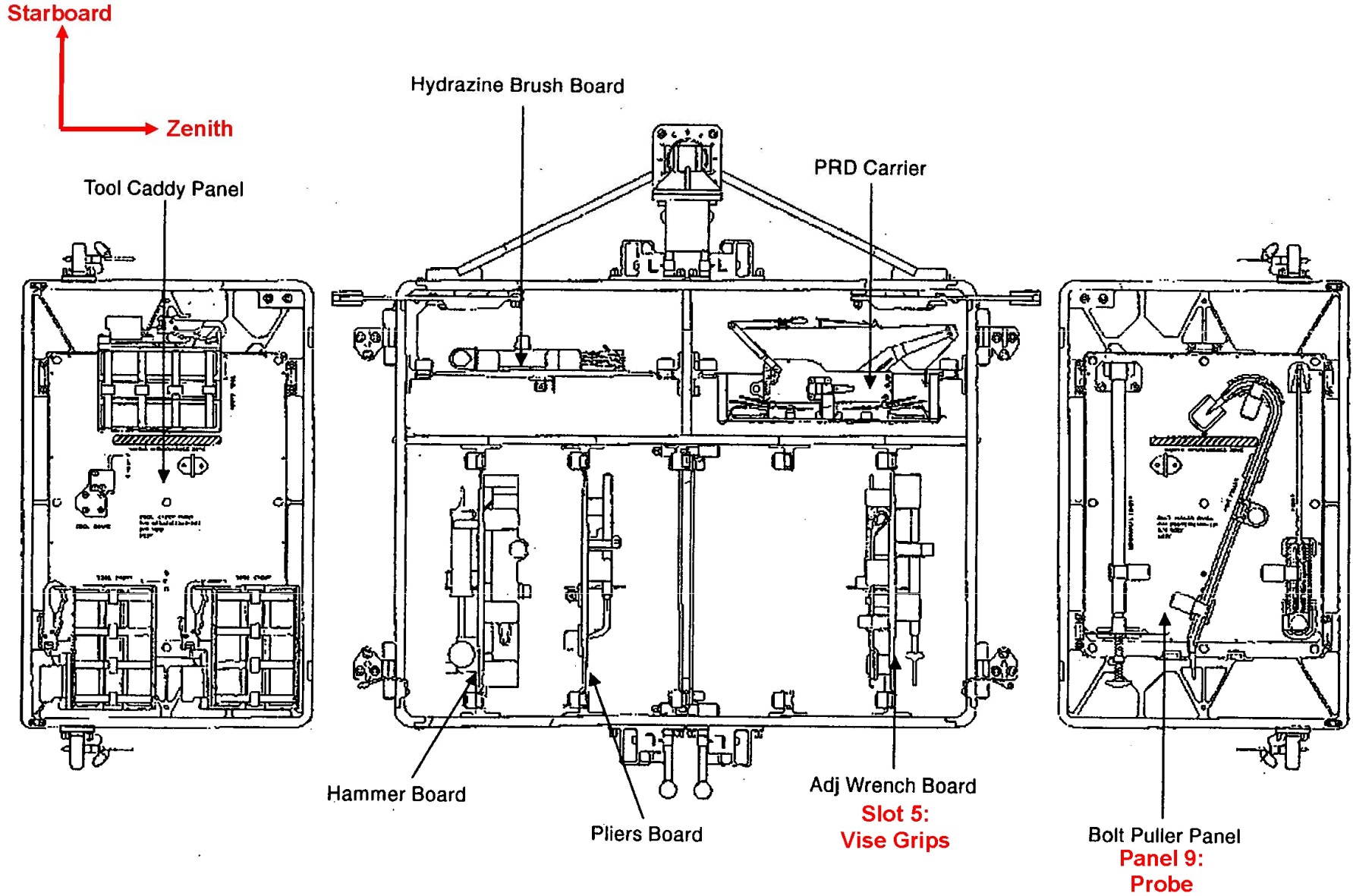

Figure 2.- A/L Toolbox 1 Stbd.



TOOL RECONFIG (00:30) (Cont)

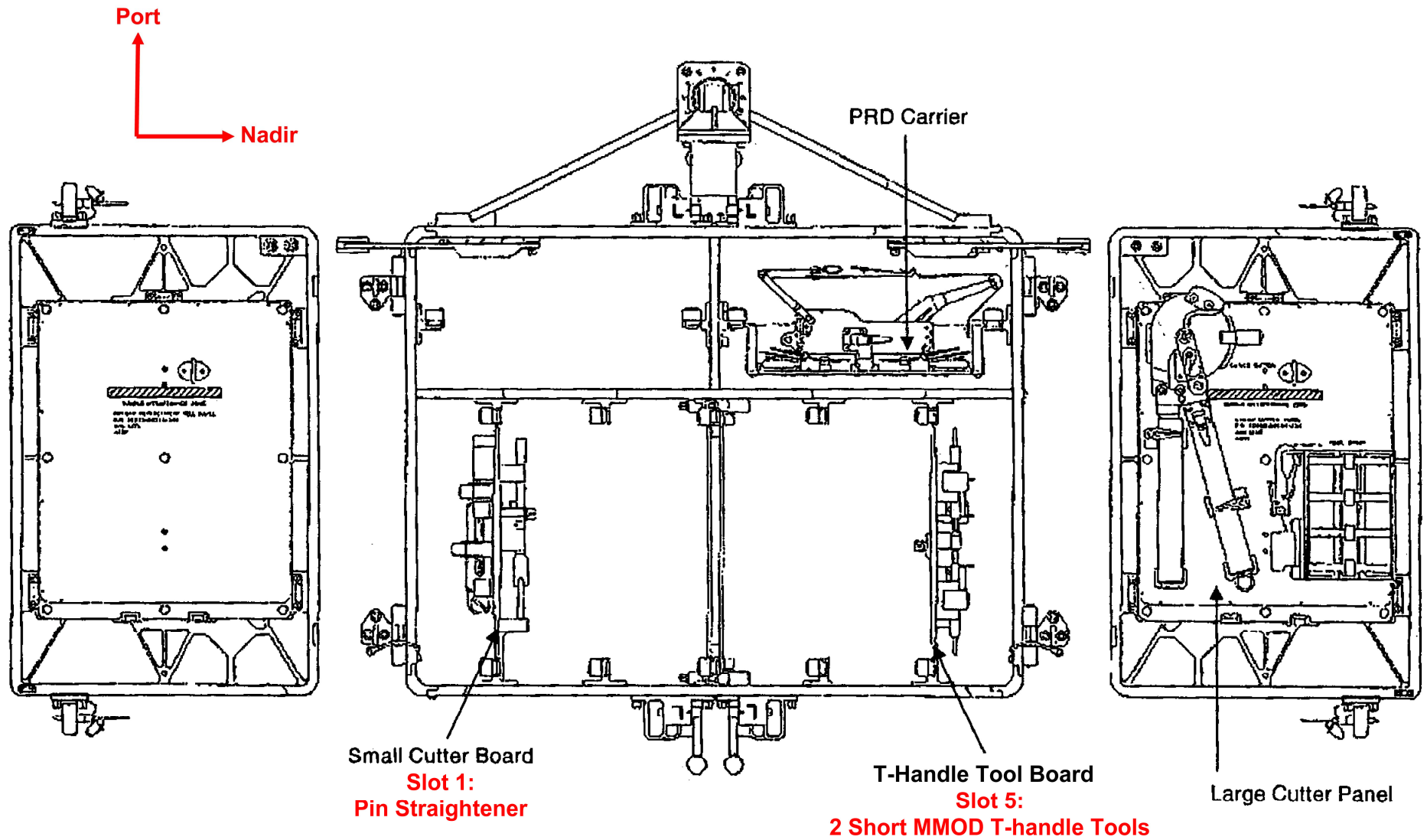
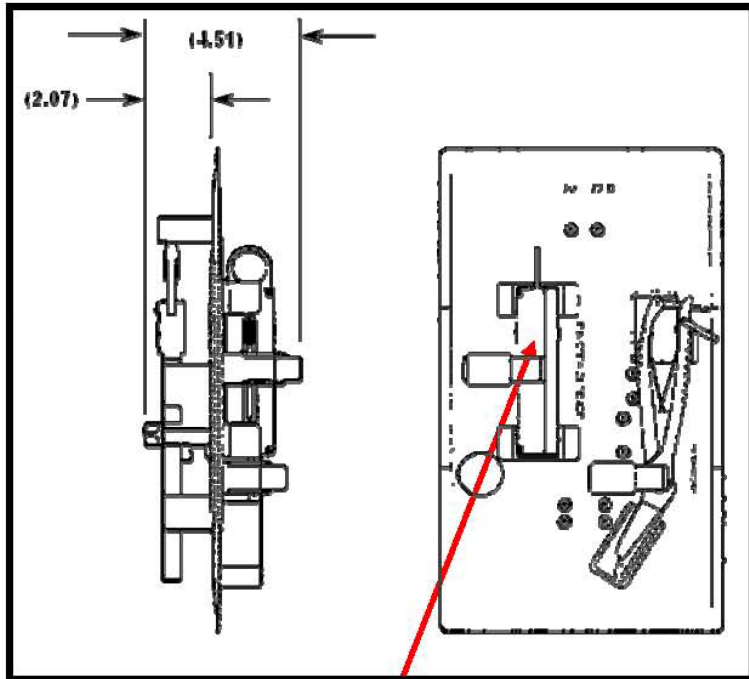

Figure 3.- AL Toolbox 2 Port.

TOOL RECONFIG (00:30) (Cont)



Pin Straightener Tool

Figure 4.- Small Cutter Board.

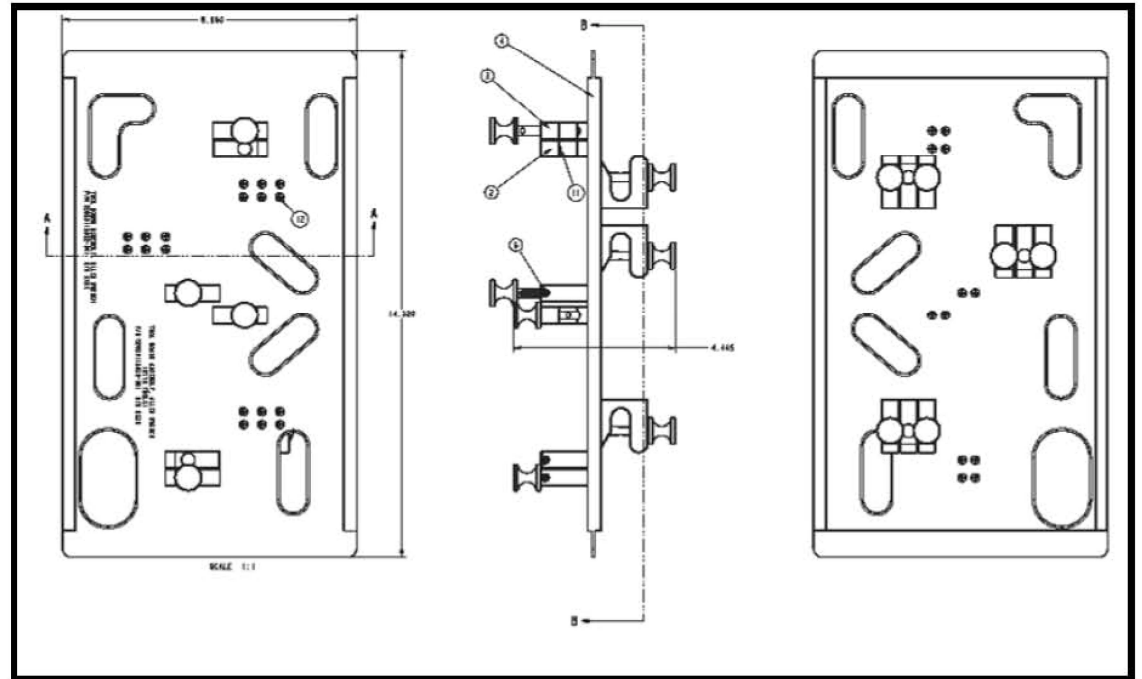
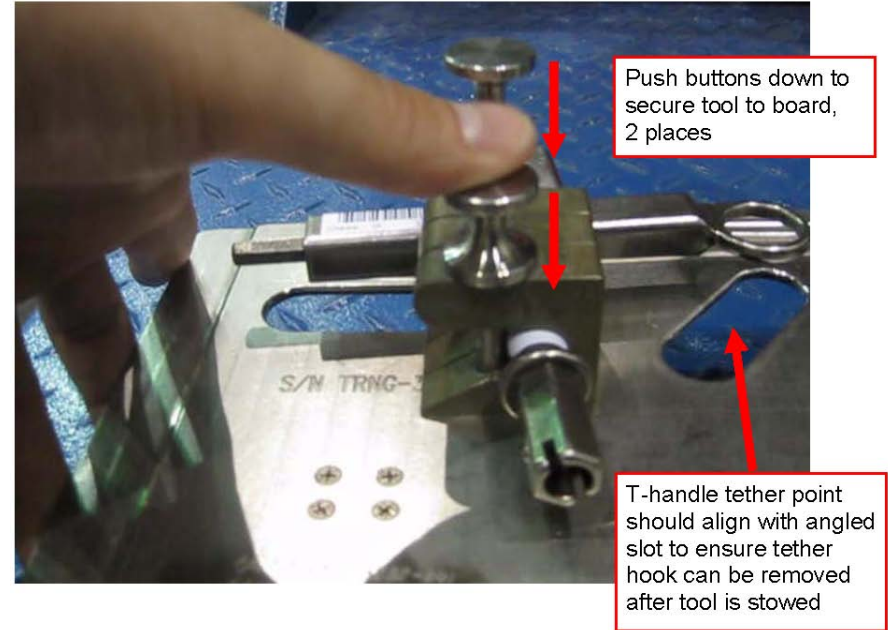
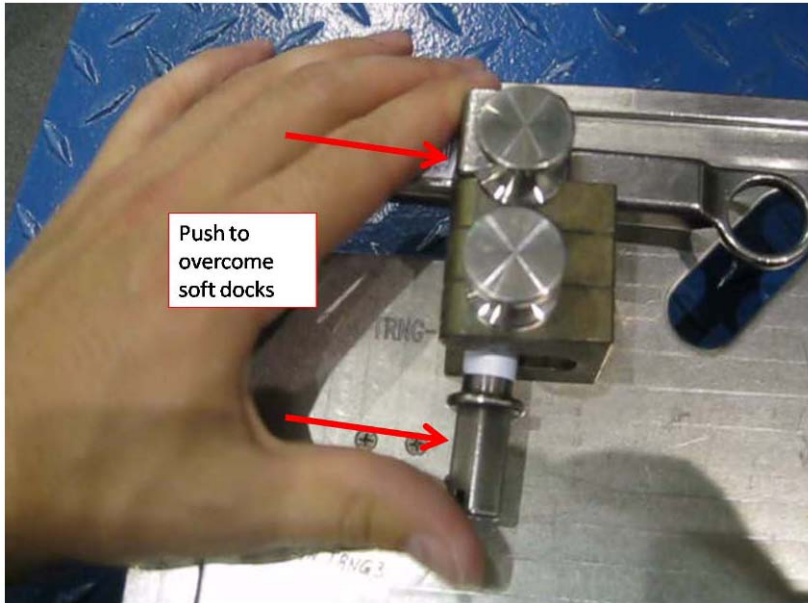

Figure 5.- T-Handle Tool Board.

TOOL RECONFIG (00:30) (Cont)



Figures 6-7.- T-Handle Tool Board Operation.

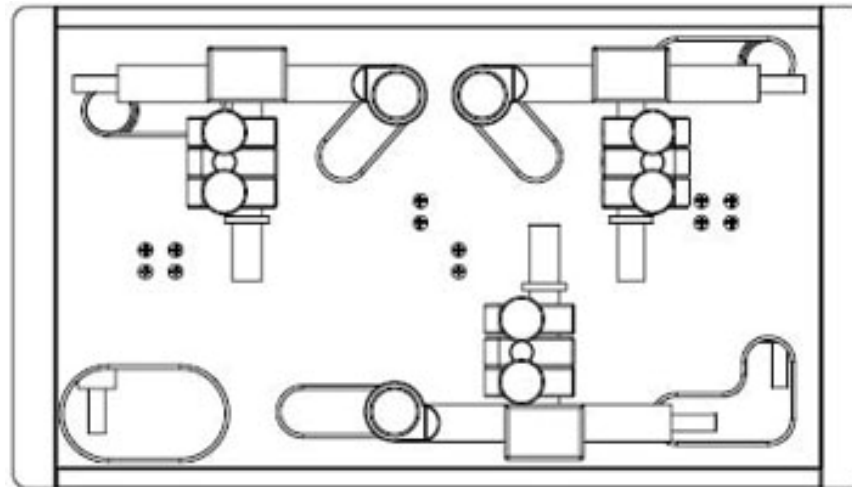
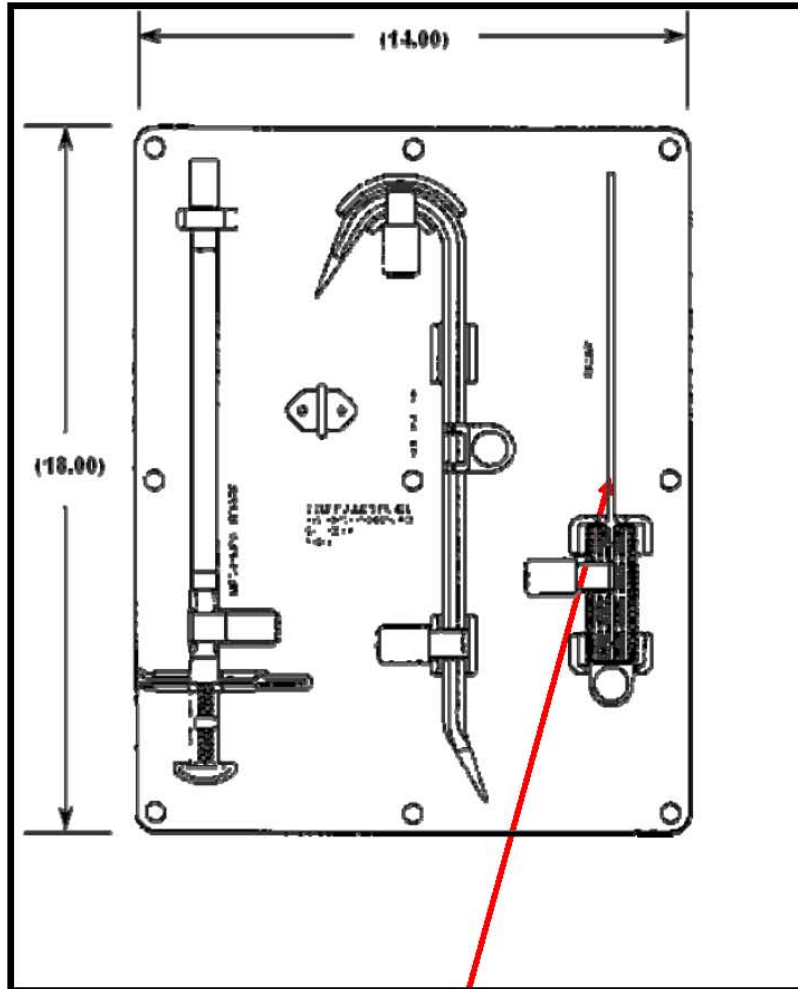

Figure 8.- T-Handle Tools Stowed on Tool Board.

TOOL RECONFIG (00:30) (Cont)



Probe

Figure 9.- Bolt Puller Panel.

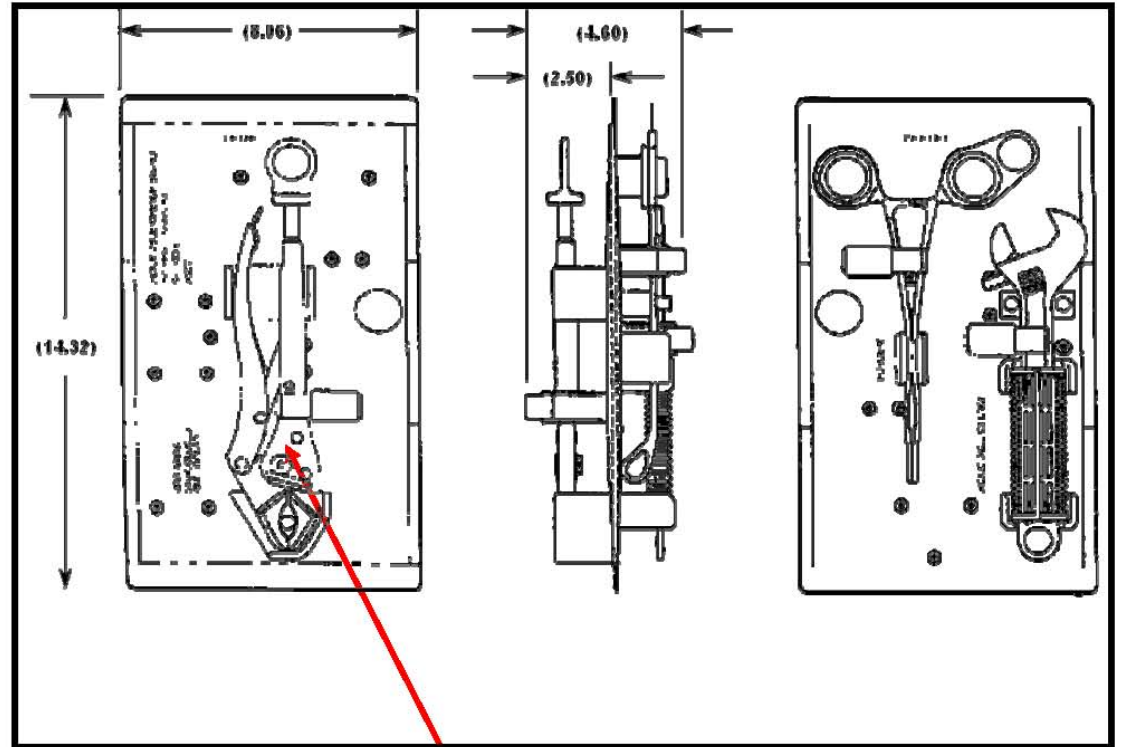

Vise Grips

Figure 10.- Adjustable Wrench Board.

**CP13 LIGHT R&R (01:00)**

IV/SSRMS	EV1	EV2								
<p>1. <input checked="" type="checkbox"/> <b>MCC-H</b> CP13 Light inhibits in place</p> <p>SSPTS  <b>MCC-H</b> (PHALCON)                      EV crew working within 2 ft of Lab SSPTS cables</p> <ul style="list-style-type: none"> <li><input type="checkbox"/> RPCM Z14B A RPC 2 – Open, Close Cmd Inhibit</li> <li><input type="checkbox"/> RPCM Z13B A RPC 2 – Open, Close Cmd Inhibit</li> </ul> <p>CP13 light  <b>MCC-H</b> (PHALCON)                      One (1) hr prior to EV crew working on CP13 Light</p> <ul style="list-style-type: none"> <li><input type="checkbox"/> RPCM S01A C RPC 12 (Light Ops PWR) – Open, Close Cmd Inhibit</li> </ul> <p>At start of crew translation to worksite:</p> <ul style="list-style-type: none"> <li><input type="checkbox"/> Stow camera</li> <li><input type="checkbox"/> RPCM S01A C RPC 13 (Ops PWR) – Open, Close Cmd Inhibit</li> <li><input type="checkbox"/> RPCM S02B C RPC 12 (Light HTR PWR) – Open, Close Cmd Inhibit</li> </ul> <p>2. Record Lab Light Bolt Data:</p> <table border="1" data-bbox="109 1214 573 1349"> <thead> <tr> <th>Bolt</th> <th>Torque (ft-lb)</th> <th>Turns</th> <th>Green Light</th> </tr> </thead> <tbody> <tr> <td>Lab Light</td> <td></td> <td></td> <td></td> </tr> </tbody> </table>	Bolt	Torque (ft-lb)	Turns	Green Light	Lab Light				<p><u>CP13 (LAB) LIGHT R&amp;R (01:00)</u></p> <ol style="list-style-type: none"> <li>1. Translate to S1 CP13</li> <li>2. Stow Crewlock bag on HR____(0260)</li> </ol> <div style="border: 1px solid black; padding: 5px; margin: 10px 0;"> <p style="text-align: center;"><b>CAUTION</b></p> <p>Avoid contact with Lab light cover glass. Reflective coating may be damaged. Contact with other surfaces of Lab light should be minimized to avoid damaging thermal coating</p> <p>Avoid contact with Lab light silver tape</p> </div> <ol style="list-style-type: none"> <li>3. Receive Rd Scoop from EV2</li> <li>4. Install Rd Scoop on camera base (aft)</li> <li>5. Move RET from Rd Scoop to old Lab light</li> <li>6. Verify that camera is in stowed position</li> <li>7. <b>On IV GO:</b> Place Pan/Tilt mechanism in <b>LOCKED</b> position. (Push and turn lever)</li> <li>8. Receive Rd Scoop from EV2; install on old Lab light</li> <li>9. Open TA-clamp</li> <li>10. Disconnect connector; restrain cable as reqd</li> <li>11. <b>PGT [B6, CCW2]</b> (24.0 ft-lb, 30 RPM, MTL 30.5) 7/16 x 6-in ext</li> <li>12. Release bolt 11-15 turns, remove old Lab light and transfer to EV2</li> <li>13. Receive new Lab light install on BRT</li> <li>14. Connect connector on Lab light                             <ul style="list-style-type: none"> <li><input type="checkbox"/> <input checked="" type="checkbox"/> Pins</li> <li><input type="checkbox"/> <input checked="" type="checkbox"/> Good EMI band</li> <li><input type="checkbox"/> <input checked="" type="checkbox"/> No FOD</li> </ul> </li> <li>15. Install new Lab light in soft dock</li> <li>16. <b>PGT [B1, CW2]</b> (12.0 ft-lb, 30 RPM, MTL 30.5) 7/16 x 6-in ext</li> <li>17. Drive bolt 11-15 turns to hardstop</li> <li>18. Remove Rd Scoop from VSSA; transfer to EV2</li> </ol>	<p><u>CP13 (LAB) LIGHT R&amp;R (01:00)</u></p> <ol style="list-style-type: none"> <li>1. Retrieve CP13 Light bag</li> <li>2. Translate to S1 CP13</li> <li>3. Temp stow Light bag on Lab HR 0294 &amp; 0295</li> <li>4. Transfer Rd Scoop (VSSA Base) to EV1</li> <li>5. Transfer Rd Scoop (Light) to EV1</li> <li>6. Receive old Lab light from EV1 and temp stow</li> <li>7. Transfer new Lab light to EV1</li> <li>8. Stow failed Lab into Light bag</li> </ol>
Bolt	Torque (ft-lb)	Turns	Green Light							
Lab Light										

CP13 LIGHT R&R (01:00) (Cont)

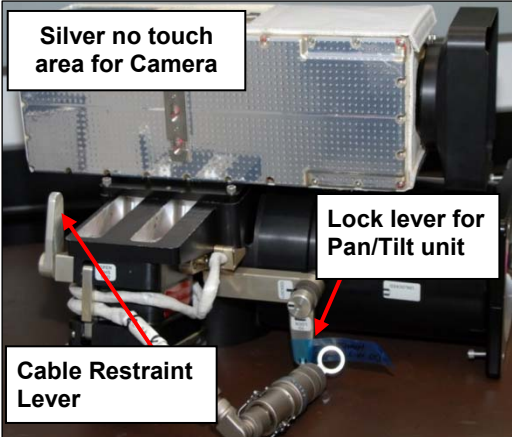
IV/SSRMS	EV1	EV2
 <p>3. Verify bag inventory</p> 	<p>19. Close TA-clamp around cable</p> <p>20. ✓Cable under cable restraint on Lab light pan/tilt unit</p> <p>21. If cable not under restraint, push and rotate cable restraint lever. Lift cable restraint bar. Place cable under restraint and close restraint</p> <p>22. Remove Round Scoop from new Lab light; transfer to EV2</p> <p>23. While holding restraint closed, push and rotate cable restraint lever to LOCKED position</p> <p>24. Place Pan/Tilt mechanism in <b>UNLOCKED</b> position</p> <p>25. Translate clear of camera worksite</p> <p>26. Give <b>MCC-H GO</b> to pan/tilt camera/light</p> <p>27. Perform tool inventory</p> <p>28. Retrieve Get-ahead bag on HR____(0260); stow on BRT</p> <p>29. GLOVE CHECK</p>	<p>9. Receive Round Scoop from EV1; stow in Light bag</p> <p>10. Perform Light bag inventory</p> <p>11. Retrieve Light bag; stow on BRT</p> <p>12. GLOVE CHECK</p>

TOOLS AND STOWAGE

STARBOARD LIGHTWEIGHT TOOL STOWAGE ASSEMBLY (TSA).....	TEMP FS 8-2
PGT CHECKOUT .....	8-3
PGSC-PGT CONNECTION (A31P AND 760XD) .....	8-4
PROGRAM PGT SETTINGS .....	8-5
DOWNLOAD/ERASE EVENT LOG .....	8-5
PGT CONTINGENCIES.....	8-6
PGT STANDARD SETTINGS.....	8-7
SAFETY TETHERS POST STS-133/ULF5 .....	FS 8-9
APFR MANAGEMENT – STS-133 (ULF5) .....	FS 8-10
TOOLBOX STOWAGE – STS-133 (ULF5).....	FS 8-11
TOOLBOX PANEL AND SLOT LABELS .....	FS 8-12
Z1 TOOLBOX INTERNAL LAYOUT .....	FS 8-13
AIRLOCK TOOLBOX INTERNAL LAYOUT .....	FS 8-14
FLUID QD BAG LAYOUT .....	FS 8-15
VENT TOOL EXTENSION BAG LAYOUT – STOWED ON PORT CETA CART ....	FS 8-17
PUMP MODULE JUMPER BAG – STOWED ON PORT CETA CART .....	FS 8-17
CREW TETHER INSPECTIONS .....	FS 8-18
CLPA IVA UNPACKING .....	FS 8-25
APFR THERMAL SHIELD REMOVAL.....	FS 8-28

TOOLS AND  
STOWAGE

# STARBOARD LIGHTWEIGHT TOOL STORAGE ASSEMBLY (TSA)

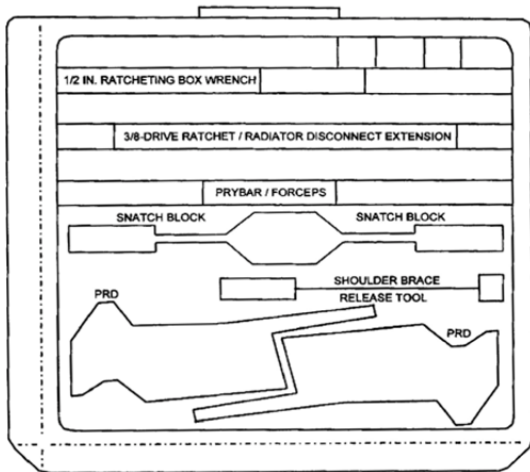

Aft Tray Layout and Labels

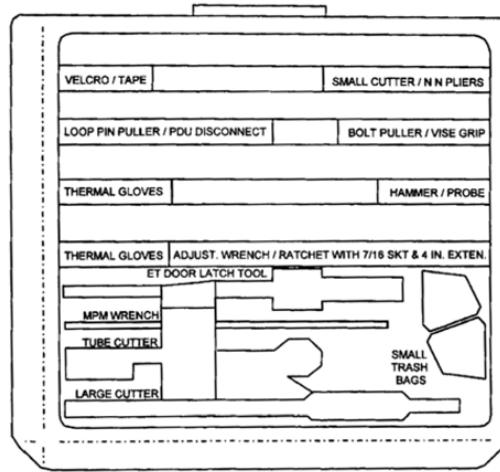

Forward Tray Layout and Labels

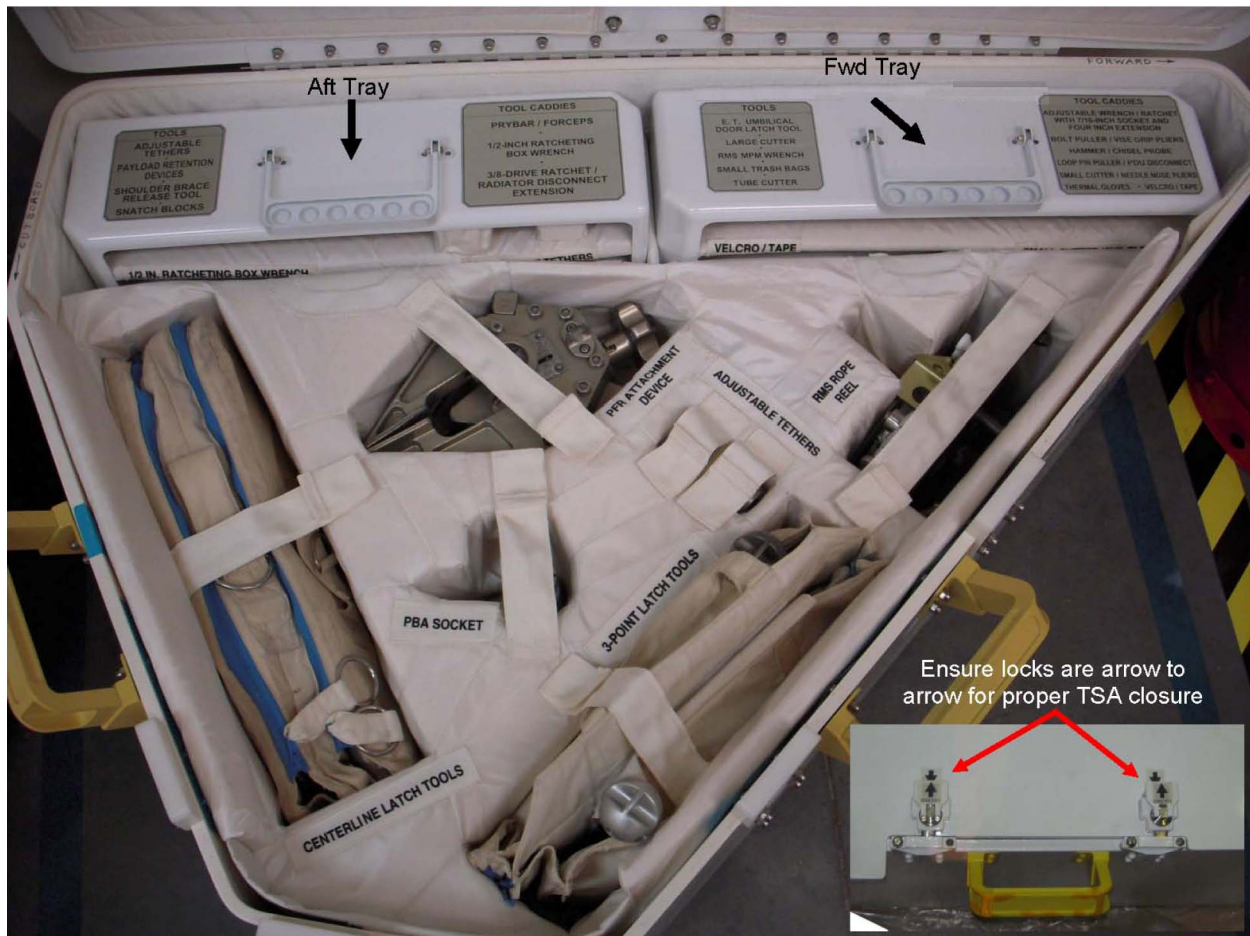

TOOLS AND STOWAGE



## SAFETY TETHERS POST STS-133/ULF5

### 55-FT SAFETY TETHERS

	#67 s/n 1017 Lg-sm	#68 s/n 1018 Lg-sm  (retracting issues – ULF4)	#69 s/n 1019 Lg-sm	#72 s/n 1022 Lg-sm
ULF4 Stage	INSIDE: Tether staging area	INSIDE: Tether staging area	INSIDE: Tether staging area	INSIDE: Tether staging area
Post EVA 1	INSIDE: Tether staging area	INSIDE: Tether staging area	INSIDE: Tether staging area	INSIDE: C/L deployed in STP
Post EVA 2	INSIDE: Tether staging area	INSIDE: Tether staging area	INSIDE: Tether staging area	INSIDE: C/L deployed in STP

### 85-FT SAFETY TETHERS

	#22 s/n 1002 Lg-sm  (2 J/A – retracting issue)	#21 s/n 1001 Lg-sm  (GMT201 Tether Inspect – only 1 through tack stitch)	#24 s/n 1004 Lg-sm	#29 s/n 1009 Lg-sm  (Up on ULF3)	#25 s/n 1005 Lg-sm	#27 s/n 1007 Lg-sm
ULF4 Stage	INSIDE: Tether staging area	INSIDE: Tether staging area	INSIDE: Tether staging area	INSIDE: Tether staging area	<b>STS-133/ULF5 Middeck</b>	<b>STS-133/ULF5 Middeck</b>
Post EVA 1	INSIDE: C/L deployed in STP	INSIDE: C/L deployed in STP	INSIDE: C/L deployed in STP	INSIDE: C/L deployed in STP	<b>STS-133/ULF5 Middeck</b>	<b>STS-132/ULF5 Middeck</b>
Post EVA 2	INSIDE: C/L deployed in STP	INSIDE: C/L deployed in STP	INSIDE: C/L deployed in STP	INSIDE: C/L deployed in STP	<b>STS-133/ULF5 Middeck</b>	<b>STS-133/ULF5 Middeck</b>

## APFR MANAGEMENT – STS-133 (ULF5)

APFR DESIGNATOR	APFR 1 s/n 1004 (sticky pitch knob – 8A, 13A.1, 1JA)	APFR 2 s/n 1006 (sticky pitch knob – US 7 & 9, sticky locking collar – 10A)	APFR 3 s/n 1005 (suspected sharp edge on locking collar and possible sticky locking collar – US 7)	APFR 4 s/n 1002 (heat shield)	APFR 5 s/n 1003 (sticky pitch knob – ULF4)	APFR 6 s/n 1007 (sticky pitch knob – 20A)	APFR 7 s/n 1008 (possible sticky locking collar – ULF4)	IAPFR 1	IAPFR 2	OTSD	WIF Extender
Post US EVA 17	Port CETA Cart WIF 1 (1, LL) [12,SS,F,3]	P1 WIF 3 [6,PP,F,11] TS	ESP-2 WIF 05 [12,FF,F,12] Ingress Aid	Z1 WIF 10 [3,LL,B,6] TS	Stbd CETA Cart WIF 1 [12,GG] [6,OO,E,6]	NODE 2 WIF 7 [12,NN,F,6] Ingress Aid	P6 WIF 12 [3,OO,F,12] Ingress Aid	Z1 WIF 5 [12,PP,F,12]	Z1 WIF 3 [6,PP,F,12]	S0 WIF 7 CL=7	MBS WIF 12 [2,A,1]
Post EVA 1	Z1 WIF 13 [3,QQ,F,12] TS	P1 WIF 3 [6,PP,F,11] TS	ESP-2 WIF 06 [10,OO,B,1] Ingress Aid	AL	Stbd CETA Cart WIF 1 [12,GG] [6,OO,E,6]	NODE 2 WIF 7 [12,NN,F,6] Ingress Aid	P6 WIF 12 [3,OO,F,12] Ingress Aid	Z1 WIF 5 [12,PP,F,12]	Z1 WIF 3 [6,PP,F,12]	S0 WIF 7 CL=7	MBS WIF 12 [2,A,1]
Post EVA 2	Z1 WIF 13 [3,QQ,F,12] TS	P1 WIF 3 [6,PP,F,11] TS	ESP-2 WIF 06 [10,OO,B,1] Ingress Aid	A/L Toolbox 1 [6,XX,F,12] (heat shield removed)	Stbd CETA Cart WIF 1 [12,GG] [6,OO,E,6]	COL WIF 3 [6,NN,F,6] Ingress Aid	P6 WIF 12 [3,OO,F,12] Ingress Aid	Z1 WIF 5 [12,PP,F,12]	Z1 WIF 3 [6,PP,F,12]	S0 WIF 7 CL=7	MBS WIF 12 [2,A,1]

Crane (old ORU tether)	ORU Stanchion/TERA Headless	APFR 2 Tool Stanchion	APFR 4 Tool Stanchion	Tool Stanchion
PMA1 WIF 5	S0 port wedge face	Hex pointed ISS zenith, tool head pointed ISS stbd, and oriented ISS Zenith/Nadir	Tool stanchion aft pointed zenith (Moving to APFR 1 Post EVA 1)	S0 port wedge face

## TOOLBOX STOWAGE – STS-133 (ULF5)

	Z1 PORT TOOLBOX (MMOD Damage – potential sharp edges) {all slots have sliders}	Z1 STBD TOOLBOX (MMOD Damage – potential sharp edges) {all slots have sliders}	A/L TOOLBOX 1 (STBD)	A/L TOOLBOX 2 (PORT)
<b>SLOT # 1</b>	SQUARE TM BOARD {stbd door} SQ TORQUE MULTIPLIER 7/16" FLUSH SQ SOCKET 7/16" PROUD SQ SOCKET 7/16" RECESSED SQ SOCKET		HAMMER BOARD {nadir door} HAMMER	CABLE CUTTER BOARD {zenith door} COMPOUND CUTTERS (SM) SCISSORS
<b>SLOT # 2</b>		QD BAIL TOOL BOARD {stbd door} BMRRM LATCH TOOL QD BAIL DRIVE TOOL (1")	PLIERS BOARD {nadir door} NEEDLE NOSE PLIERS	
<b>SLOT # 3</b>	RATCHET BOARD {middle} 7/16" X 12" WOBBLE SOCKET 7/16" X 2" RIGID SOCKET	RATCHET BOARD {middle} 7/16" X 6" WOBBLE SOCKET 7/16" X 12" WOBBLE SOCKET RATCHET WRENCH RIGHT ANGLE DRIVE	{only slot with slider}	{only slot with slider}
<b>SLOT # 4</b>				
<b>SLOT # 5</b>	ROUND TM BOARD {port door} RND TORQUE MULTIPLIER 5/8" PROUD RND SOCKET 7/16" FLUSH RND SOCKET 7/16" PROUD RND SOCKET		ADJ WRENCH BOARD {zenith door} FORCEPS WRENCH, ADJ	T-HANDLE TOOL BOARD {nadir door} 1-8" T-TOOLS
<b>SLOT # 6</b>	TRASH BAG BOARD {stbd door} SMALL TRASH BAG	TRASH BAG BOARD {stbd door}	HYDRAZINE BRUSH BOARD {nadir door} HYDRAZINE BRUSH	
<b>SLOT # 7</b>	SOCKET BOARD {port door} 5/32" BALL END ALLEN DR 1/2" X 8" WOBBLE SOCKET 5/16" X 7" RIGID SOCKET	SOCKET BOARD {port door} 5/32" BALL END ALLEN DR 1/2" X 8" WOBBLE SOCKET 5/16" X 7" RIGID SOCKET	PRD (Toolboard) {zenith door} PRD	PRD (Toolboard) {nadir door} PRD
<b>PANEL # 8</b>	CHEATER BAR PANEL {stbd door} CHEATER BAR GP CADDY CANNON CONNECTOR TOOLS (2)	CHEATER BAR PANEL {stbd door} CHEATER BAR ADJ EQUIP TETHER	TOOL CADDY PANEL {nadir door}	
<b>PANEL # 9</b>	18" SOCKET PANEL {port door} 7/16" X 18" WOBBLE SOCKET	18" SOCKET PANEL {port door} 7/16" X 18" WOBBLE SOCKET	BOLT PULLER PANEL {zenith door} BOLT PULLER MECHANICAL FINGER	LARGE CUTTER PANEL {nadir door} LARGE CUTTERS (-303)
<b>EXTERNAL</b>	1 ROUND SCOOP w/D-HANDLE (on zenith micro) (D-handle taped over repaired MMOD damage) D-HANDLE on port side of toolbox	<u>NOTE</u> D-Handle will not stow on the side of this toolbox due to an interference with the CMG MLI		

# TOOLBOX PANEL AND SLOT LABELS

### NOTE

- A/L Toolbox: Slider feature located in center slot only (#3)
- Z1/CETA Toolbox: Slider feature located in all slots

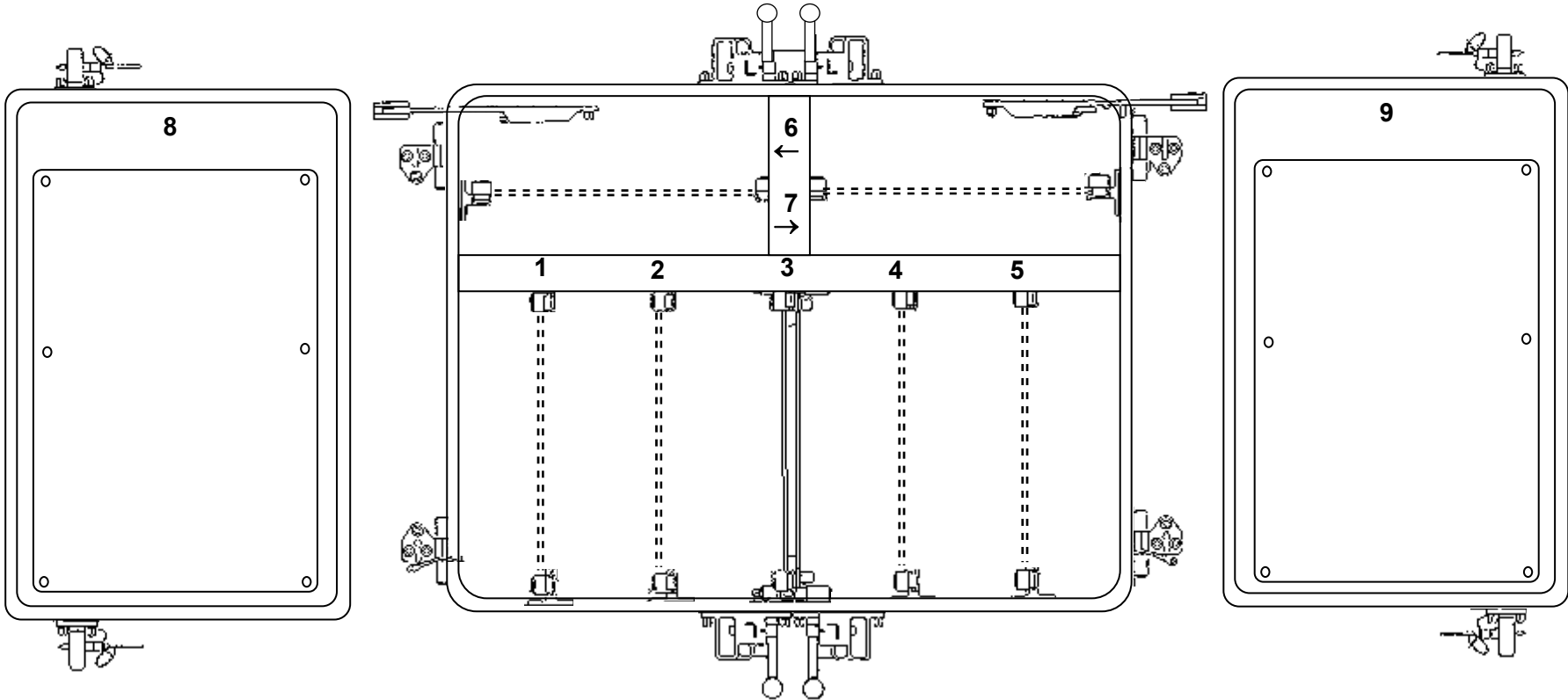

# Z1 TOOLBOX INTERNAL LAYOUT

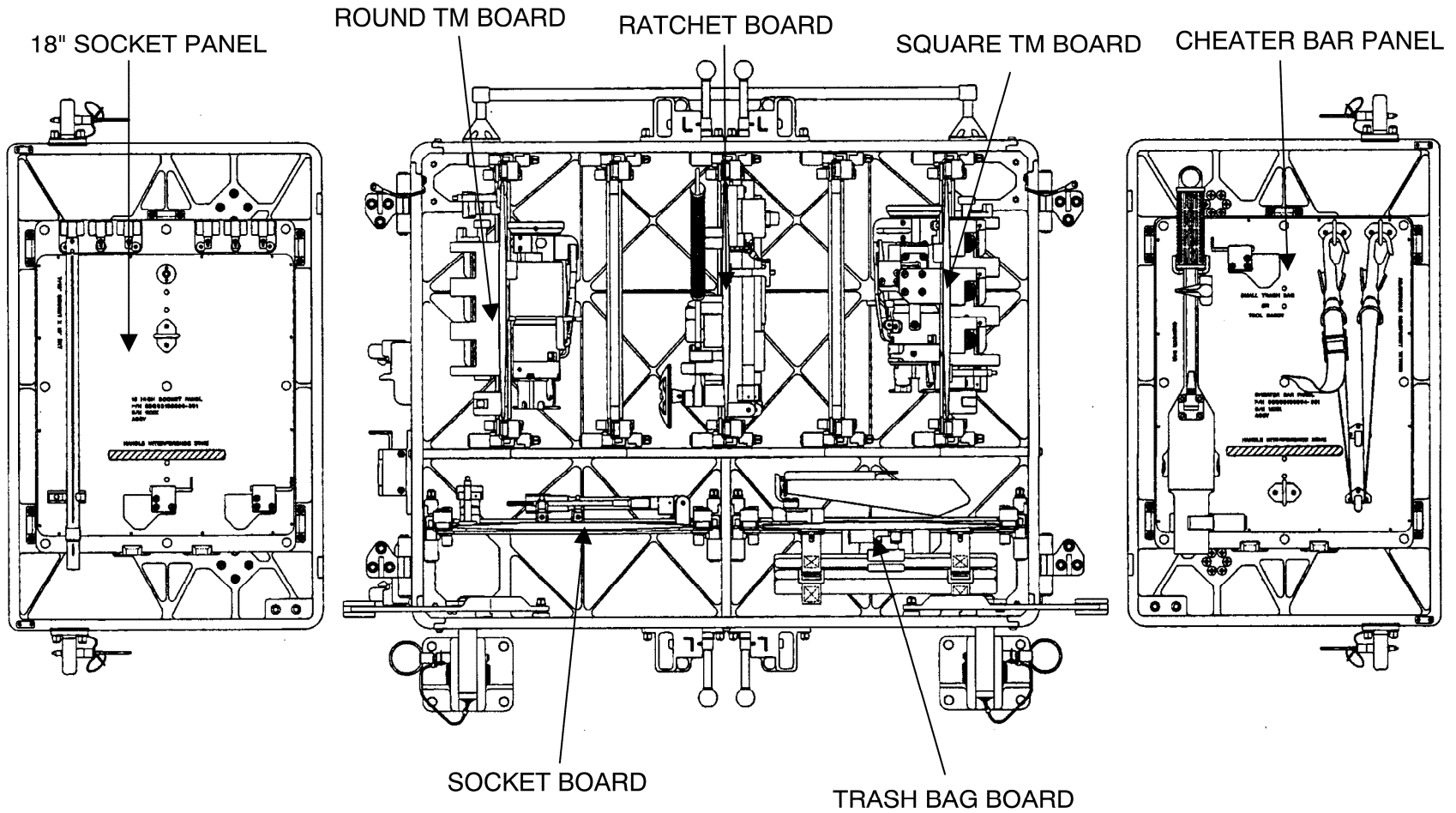

DOORS SHOWN REMOVED AND ROTATED 180°  
FROM CLOSED POSITION FOR CLARITY.

# AIRLOCK TOOLBOX INTERNAL LAYOUT

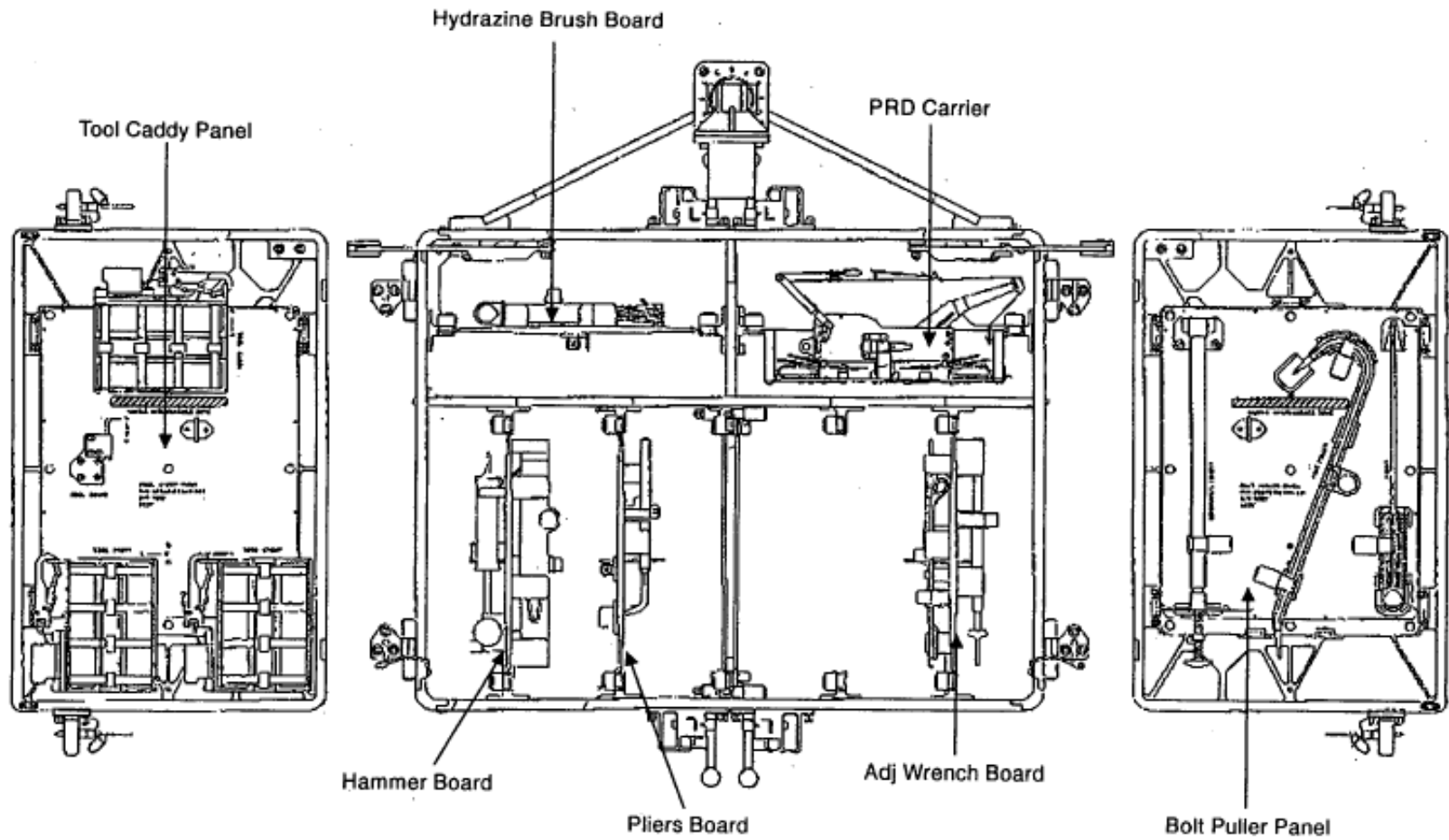

## FLUID QD BAG LAYOUT

QD TOOL BAG #1, STBD (SEG33114667-301/1001)			
#	TOOL	PART#/SERIAL #	LOCATION IN BAG
1.	1/4" CAP TOOL	GD2043725	<input type="checkbox"/> 1/4" CAP TOOL POCKET
2.	1/2" CAP TOOL	GD2043730	<input type="checkbox"/> 1/2" CAP TOOL POCKET
3.	1" CAP TOOL	GD2043325	<input type="checkbox"/> 1" CAP TOOL POCKET
4.	3/4" & 1' QD BAIL DRIVE LEVER	SDG33113838-703	<input type="checkbox"/> 3/4" & 1' QD BAIL DRIVE LEVER POUCH ON LID
5.	1.5" QD BAIL DRIVE LEVER	SDG33113837-701	<input type="checkbox"/> 1.5" QD BAIL DRIVE LEVER POUCH ON LID
6.	1.5" NH3/N2 VENT TOOL – F	1F9859-1/01	<input type="checkbox"/> 1.5" NH3/N2 VENT TOOL – F POCKET
7.	1" H20/N2 VENT TOOL – F	1F98593-1/01	<input type="checkbox"/> 1" H20/N2 VENT TOOL – F POCKET
8.	3/4" NH3/N2 VENT TOOL – F	1F98597-1/01	<input type="checkbox"/> 3/4" NH3/N2 VENT TOOL – F POCKET
9.	1" NH3/N2 VENT TOOL – F	1F98589-1/T	<input type="checkbox"/> 1" NH3/N2 VENT TOOL – F POCKET
10.	1" NH3/N2 VENT TOOL – M	1F98596-1/01	<input type="checkbox"/> 1" NH3/N2 VENT TOOL – M POCKET
11.	1/4" NH3/N2 VENT TOOL – F	1F98592-1/01	<input type="checkbox"/> 1/4" NH3/N2 VENT TOOL – F POCKET
12.	1.5" QRT & FID GAUGE	SEG33114617-701	<input type="checkbox"/> 1.5" QRT & FID GAUGE POCKET
13.	3/4" & 1" QRT & FID GAUGE	SEG33114616-701	<input type="checkbox"/> 3/4" & 1" QRT & FID GAUGE POCKET

- Ensure cap tools (3) are friction fitted

- Close all QRT tool flaps (2)

- Close all vent tool flaps (6)

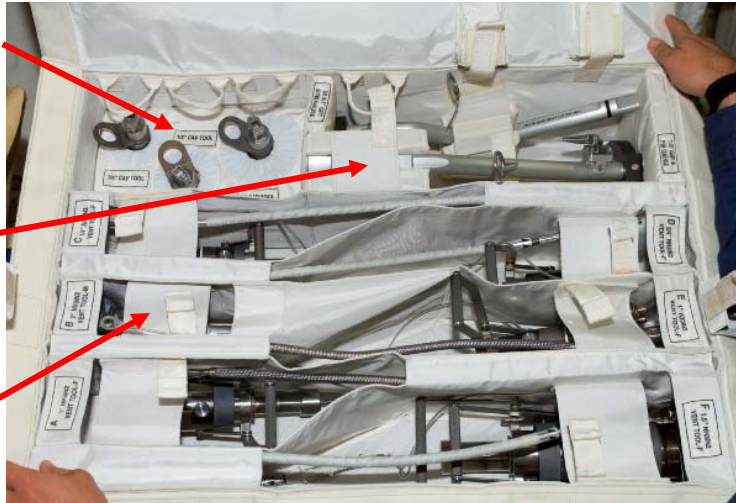

- Close bail drive lever flaps (2)

- Internal bag straps (2) should be stowed in pouches

**FLUID QD BAG LAYOUT (Cont)**

<b>QD TOOL BAG #2, PORT (SEG33114667-301/1002)</b>			
<b>#</b>	<b>TOOL</b>	<b>PART #/SERIAL #</b>	<b>LOCATION IN BAG</b>
1.	1/4" CAP TOOL	GD2043725	<input type="checkbox"/> 1/4" CAP TOOL POCKET
2.	1/2" CAP TOOL	GD2043730	<input type="checkbox"/> 1/2" CAP TOOL POCKET
3.	1" NH3/N2 VENT TOOL – F	1F98589-1	<input type="checkbox"/> MOVED FROM VTEB ON US EVA 16 <input type="checkbox"/> POCKET A
4.	VENT TOOL ADAPTER	SEG33119079-301	<input type="checkbox"/> MOVED FROM VTEB ON US EVA 16 <input type="checkbox"/> QRT AND FID GAUGE POCKET
5.	1" H2O/N2 VENT TOOL – F	1F98593-1/02	<input type="checkbox"/> STILL IN RAT'S NEST (EXTERNAL FROM 5A)
6.	3/4" NH3/N2 VENT TOOL – F	1F98597-1/02	<input type="checkbox"/> 3/4" NH3/N2 VENT TOOL – F POCKET
7.	1/4" NH3/N2 VENT TOOL – F	1F98592-1/02	<input type="checkbox"/> 1/4" NH3/N2 VENT TOOL – F POCKET
8.	1/4" BDT	SEG33114984-301/001	<input type="checkbox"/> STOWED ON TOP OF 1/4" VENT TOOL <input type="checkbox"/> MUST BE TETHERED TO INSIDE OF BAG USING 1 ADJ
9.	3/4" BDT	SEG33114986-301/001	<input type="checkbox"/> STOWED ON TOP OF 1/4" VENT TOOL, TETHERS TO BAG INTERNAL LOOPS USING BDT INTEGRAL TETHER
10.	3/4" AKT	SEG33114983-301/1001	<input type="checkbox"/> STOWED WITH VENT TOOL ADAPTERS IN QRT & FID POUCHES <input type="checkbox"/> MUST BE TETHERED TO INSIDE OF BAG USING 1 ADJ
11.	VENT TOOL ADAPTER (1)	SEG33119079-301	<input type="checkbox"/> ONE VTA EITHER IN THE 3/4" & 1" QRT & FID GAUGE POUCH OR 1.5" QRT & FID GAUGE POUCH <input type="checkbox"/> EACH VTA MUST BE TETHERED INSIDE THE BAG USING 1 ADJ TETHER FOR EACH <input type="checkbox"/> 1 VTA TRANSFERRED TO VTEB ON STS-120

3/4" BDT is tethered to internal bag loop using integral tool tether

3/4" AKT stowed with VTAs in QRT/FID pouch

1/4" and 3/4" BDTs are stowed on top of 1/4" vent tool

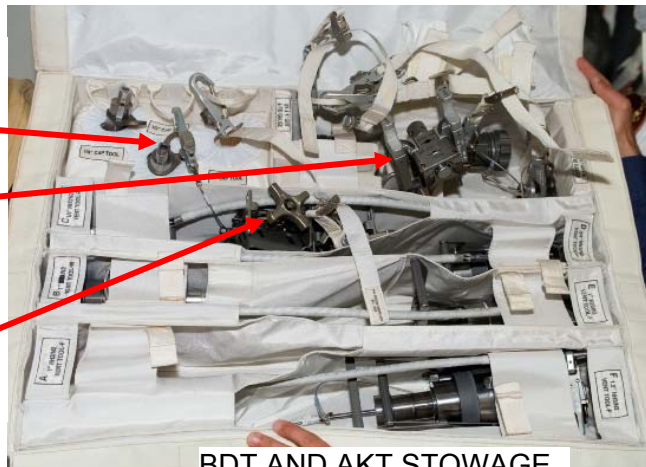

**BDT AND AKT STOWAGE**

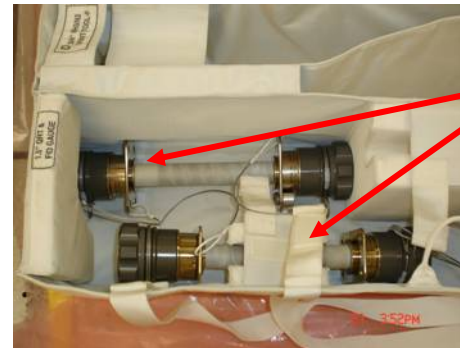

**VENT TOOL ADAPTER STOWAGE**

Vent Tool Adapters (2) are stowed in QRT/FID gauge pockets and need adj tethers

Only 1 currently in QD bag



**VENT TOOL EXTENSION BAG LAYOUT – STOWED ON PORT CETA CART**

<b>VENT TOOL EXTENSION BAG (SEG33119100-301/1001)</b>			
<b>#</b>	<b>TOOL</b>	<b>PART #</b>	<b>LOCATION IN BAG</b>
1.	VENT TOOL EXTENSION	SEG33119090-301	<input type="checkbox"/> VTE AND VENT TOOL NOT MATED TOGETHER <input type="checkbox"/> TETHER USING INTERNAL TETHER
2.	1.5" NH3/N2 VENT TOOL – F	1F9859-1/02	<input type="checkbox"/> NOT MATED TO VTE



S116E06137

**PUMP MODULE JUMPER BAG – STOWED ON PORT CETA CART**

<b>PUMP MODULE JUMPER BAG (SEG33119100-301)</b>			
<b>#</b>	<b>TOOL</b>	<b>PART #</b>	<b>LOCATION IN BAG</b>
1.	PUMP MODULE JUMPER ASSY	1F15818	<input type="checkbox"/> BAG HAS LG-SM AET ATTACHED TO OUTSIDE <input type="checkbox"/> TETHERED BY 1 INTEGRAL TETHER TO HR ON JUMPER

## CREW TETHER INSPECTIONS

### OBJECTIVE:

Inspect Load Alleviating Strap (LAS) on Safety Tethers, Waist Tethers and soft strap on D-Ring extenders. Prior to each set of EVAs (shuttle or ISS), all on-board tethers are to be inspected. Between each EVA, only those tethers used during the previous EVA require inspection.

### DURATION:

1 hour 30 minutes (Parts 1 and 2 on six waist tethers, six D-Ring extenders, and eight safety tethers)

Additional 30 minutes required to perform Part 3 on two tethers.

### NOTE

Standard tool config prep times only protect for performing Part 1 between EVAs on tethers used during the previous EVA.

### ITEMS REQUIRED (PART 2 OR 3):

#### MATERIALS:

Sharpie

Ziplock Bag

#### TOOLS:

Camera

#### IS IVA Toolbox:

Drawer 5:

    Tape Measure

#### Tape Pantry

EVA Tape (1" Permacel Glass Cloth Tape) P/N P-213

### PART 1: PRIOR TO EACH EVA

1. Prior to EVA use, soft goods on each safety tether (LAS), waist tether (LAS) and D-Ring extender (strap) for that EVA must be inspected.
  - 1.1 MMOD Inspection

Inspect the soft goods (LAS) of the Waist Tether and ERCM/Safety Tether and soft strap of the D-Ring extender for MMOD damage and discoloration, manipulating the sheath as needed to inspect between folds. The damage may appear as small or large holes in the LAS or as a tear/rip in the sheath. The MMOD damage may also appear in small concentrated areas of excessive fraying (as would be expected to be found in the vicinity of a hole). Soft goods should be white to yellow or tan in appearance. Soft goods showing a burnt brown or black discoloration should not be used. Refer to Figures 1, 2, 3.

## CREW TETHER INSPECTIONS (Cont)

### 1.2 D-Ring Extender

Inspect the soft strap of the D-Ring extender for MMOD damage, excessive wear and fraying.  
Refer to Figures 1, 2, 3.

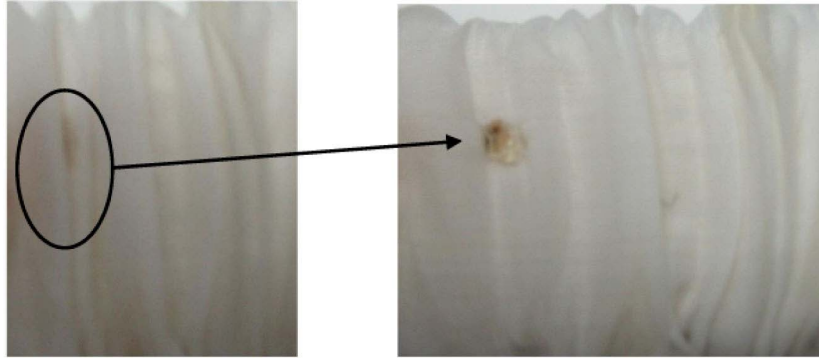

Figure 1. Damage Masked by Folds in LAS Sheath Exposed When Unbunched. (Note: Photo of ground-created damage.)

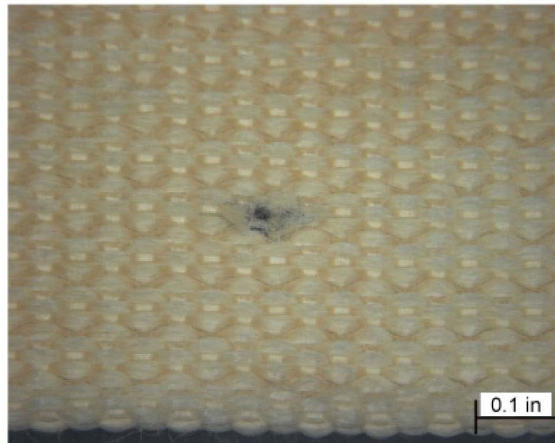

Figure 2. Picture Showing MMOD Damage Found in Flight AET.



Figure 3. Frayed D-Ring Extender; No-GO for Use.

### 1.3 LAS Base Inspection

Inspect base of LAS where strap attaches to ERCM D-Ring for any damage.  
Refer to Figure 4.

1.3.1 Smudging is acceptable.

## CREW TETHER INSPECTIONS (Cont)

- 1.3.2 If safety tether anchor hook is taped, inspect tape for wear or damage.



Figure 4. LAS Attachment to ERCM D-Ring.

### 1.4 Tack Stitching Inspection

Verify two surface and two through tack stitches still present on each LAS (waist tether and safety tether).

- 1.4.1 Verify through stitches still intact by gently moving sheath away from hook to expose threads through Nomex. Refer to Figures 5 and 6. Once verified, gently replace sheath over red indicator.

- 1.4.2 Visually verify surface stitches on nonseam side of tether

### 1.5 Red Indicator Inspection

If red showing and all tack stitches present

- 1.5.1 Gently pull the sheath back to cover red indicator. Due to tolerances, some red may still show (tether is GO as long as tack stitching still present.)
- 1.5.2 Note width of any remaining red showing.
- 1.5.3 Report S/N of any tethers with red still showing to **MCC-H**.

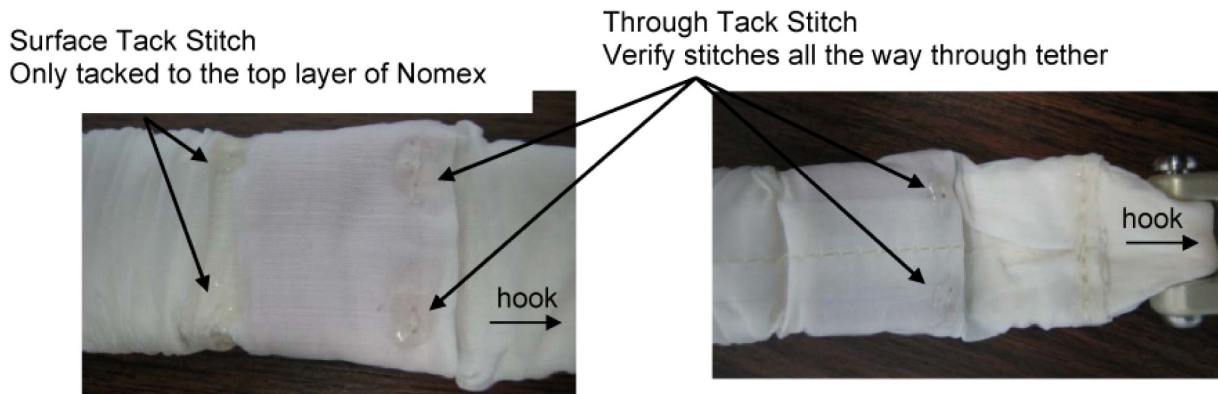

Figure 5. Top View (Non-Seam Side) and Bottom View (Seam Side).

## CREW TETHER INSPECTIONS (Cont)

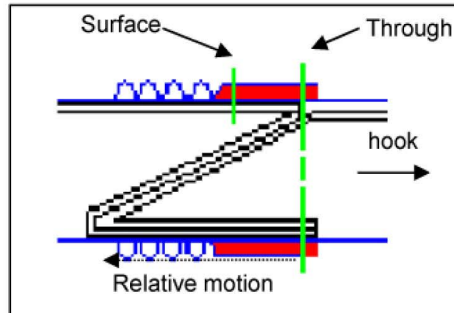

Figure 6. Cross-Section of Tack Stitching.

2. Report serial numbers to **MCC-H** with inspection results.
3. For any tethers with MMOD/other damage, fraying or missing tack stitching, proceed to Part 2.
4. Restow remaining tethers.

### PART 2: MMOD DAMAGE/MISSING TACK STITCHING EVALUATION

5. Retrieve Camera and Ziplock Bag(s).
6. If MMOD damage is found on LAS
  - 6.1 Smooth out the sheath at the damage location and take detailed photos of damage (with serial number in photo if possible). Refer to Figures 7 and 8. Note if any damage to the underlying Nomex strap is visible.
  - 6.2 Remove tether from usable inventory. Place tether in Ziplock Bag labeled, "No-GO for use". Report location and S/N to **MCC-H**.
  - 6.3 Report results to **MCC-H**.



Refer to Figure 8 for correct label location. For Waist Tethers, ensure label says Waist Tether Assy.

Figure 7. Photo of Partial Red Indicator Showing with Serial Number.

## CREW TETHER INSPECTIONS (Cont)

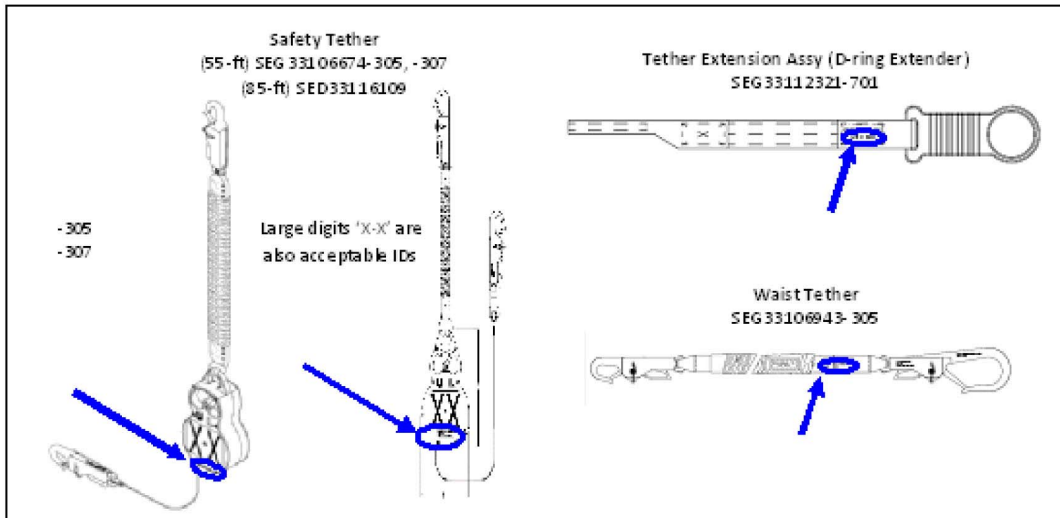

Figure 8. Serial Number References.

7. If tack stitches are broken
  - 7.1 Take detailed photos of tack stitches (with serial number in photo) for further engineering evaluation. Refer to Figure 7.
  - 7.2 Stow tethers per Table 1.

Table 1. Tether GO/No-GO Criteria

Broken Stitch	Action
One or both surface stitches broken	Gently smooth sheath away from hook so only a single layer covers the red indicator area. Return tether to usable inventory.
One through stitch broken, one through stitch intact and zero to two surface tack stitches intact	Return tether to usable inventory.
Two through stitches broken	Remove tether from usable inventory. Place tether in Ziplock Bag labeled "No-GO for use." Report location to <b>MCC-H</b> .

- 7.3 Report results to **MCC-H**.
8. If fraying or MMOD damage is found on D-Ring extender
  - 8.1 Take detailed photos of damage showing S/N of extender (if possible). Refer to Figure 9.
  - 8.2 Remove tether from usable inventory. Place tether in Ziplock Bag labeled "No-GO for use." Report location and S/N to **MCC-H**.

~

## CREW TETHER INSPECTIONS (Cont)

- 8.3 Report results to **MCC-H**.



Figure 9. D-Ring Extender Showing Serial Number.

9. If damage found on LAS base
  - 9.1 Take detailed photos of damage with at least one photo showing tether number.
  - 9.2 Swap tether for spare.
  - 9.3 Remove tether from usable inventory. Place tether in Ziplock Bag labeled "No-GO for use." Report location and S/N to **MCC-H**.
  - 9.4 If tape damaged/worn on anchor hook, take detailed photos. Replace tape as necessary using EVA tape.
  - 9.5 Report results to **MCC-H**.

### PART 3: MEASURE LAS LENGTH (ON MCC-H GO)

10. Retrieve quarantined tethers, tape measure, Sharpie, and Camera.
11. Mark the desired length on a stable surface. Refer to Figures 10 and 11 for required lengths.
12. Measure quarantined tether against markings. Photograph results.
13. Report findings to **MCC-H**.
14. Stow tethers per **MCC-H** direction.

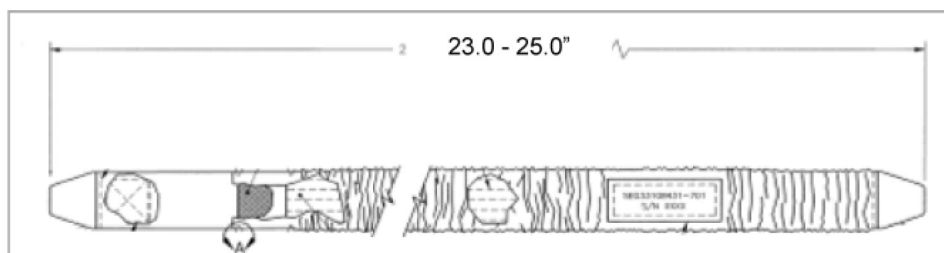
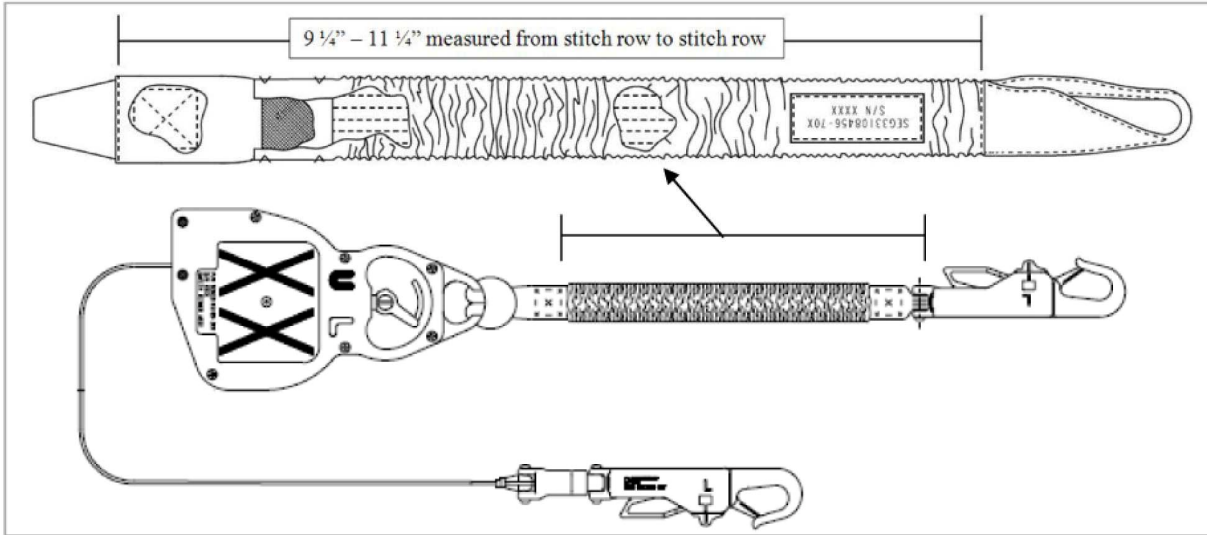

Figure 10. Waist Tether.

**CREW TETHER INSPECTIONS (Cont)**



**Figure 11. Safety Tether.**

**Table 2. Inspection Results**

Tether Type	Tether S/N	Damage Description	Tether Location
_____	_____	_____	_____
_____	_____	_____	_____
_____	_____	_____	_____
_____	_____	_____	_____
_____	_____	_____	_____
_____	_____	_____	_____
_____	_____	_____	_____
_____	_____	_____	_____
_____	_____	_____	_____
_____	_____	_____	_____
_____	_____	_____	_____
_____	_____	_____	_____
_____	_____	_____	_____
_____	_____	_____	_____



## CLPA IVA UNPACKING

### CAUTION

Extreme care should be exercised to avoid touching the white thermal paint on the camera, as it is easily removed. Scuffing the paint may reduce the CLPA life due to overheating, or it may reduce the allowed operational timelines to prevent overheating

The electrical grounding tabs and the connectors at the base of the unit should not be touched

The unit has an awkward center of mass, making it uncomfortable to handle. When possible, it is recommended to hold the unit from the tether point and micro fixture

1. Retrieve CLPA Protective Case
2. Release belts, pull-tabs, and beta cloth cover (in order); fold beta cloth cover on itself
3. Open two shells to expose mounted CLPA on base plate and ORU interface (figure 1)
4. Using a ratchet wrench w/7/16-in socket, drive EVA bolt ccw, ~22-23 turns  
NOTE: Running torque should not exceed 75 in-lb (figure 2)
5. Verify EVA bolt driven out to hard stop
6. CLPA should slide freely from the base plate. It may be necessary to loosen four nuts on top of alignment guides (figure 3)
7. Visually verify blindmate connector cover removed
8. Install Sq scoop and place CLPA in ORU bag per tool config
9. Close shells on base. Secure Velcro straps, belts, and beta cloth cover
10. Stow CLPA Protective Case

**CLPA IVA UNPACKING (Cont)**

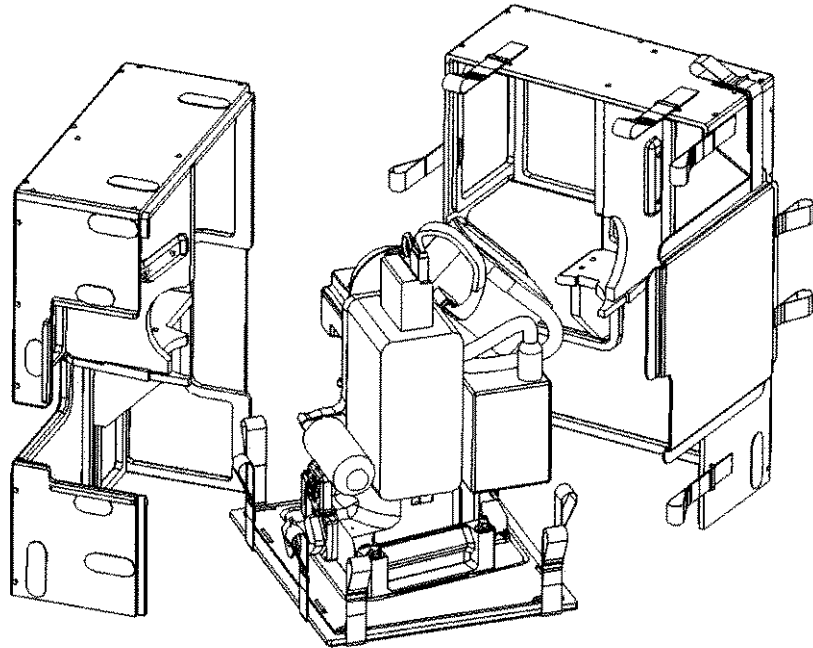

Figure 1

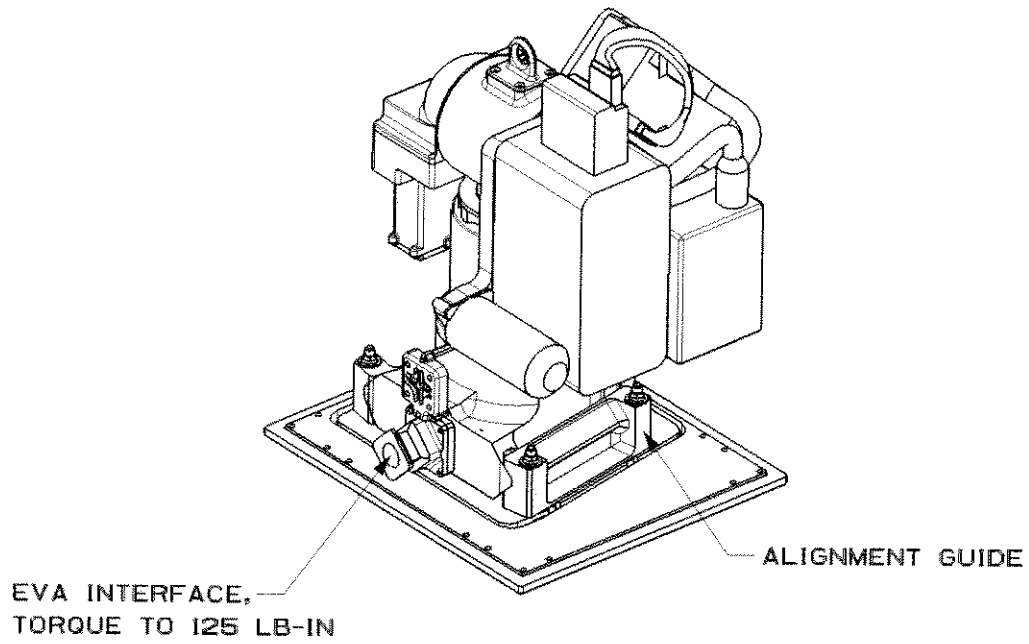

Figure 2

# CLPA IVA UNPACKING (Cont)

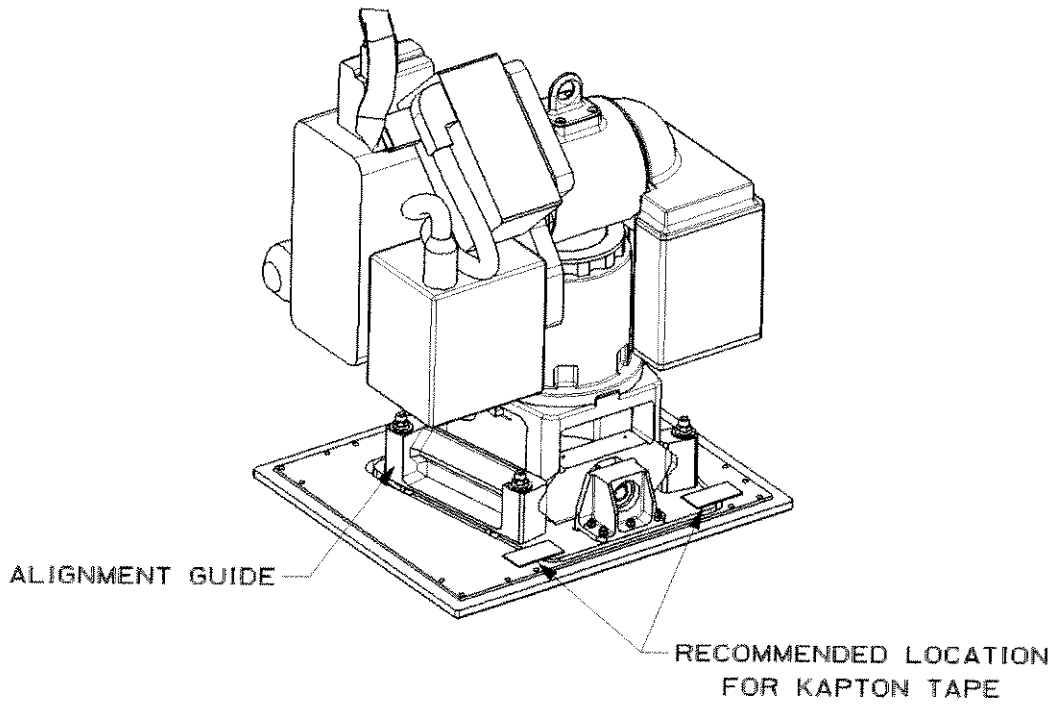

Figure 3

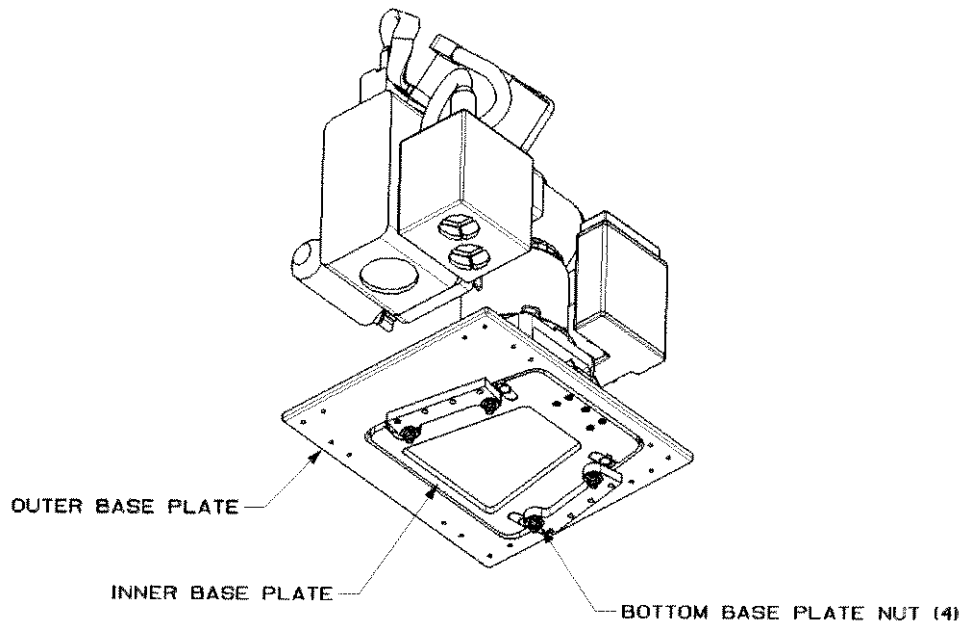

Figure 4

## APFR THERMAL SHIELD REMOVAL

1. Retrieve the following:
  - APFR
  - Dry Wipes
  - Ziplock Bag
  - Sharpie
  - Driver Handle, 3/8-in Drive – Drawer 2
  - #8 Long Torq Driver, 3/8-in Drive – Drawer 3

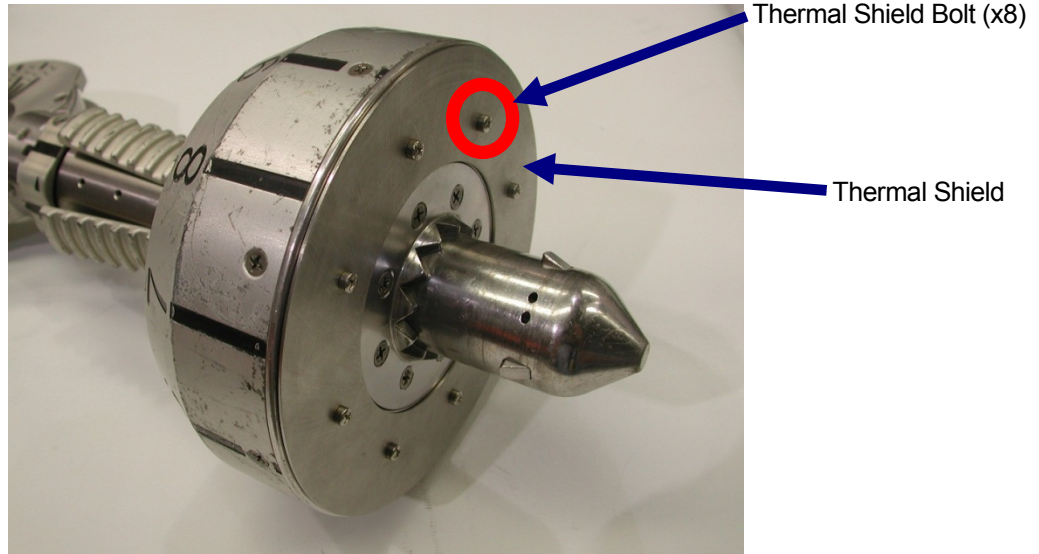

Figure 1.- Thermal Shield Location on APFR.

2. Remove APFR thermal shield non-captive screws (eight) (Driver, Handle, 3/8-in Drive; #8 Long Torq Driver, 3/8-in Drive). Expect a breaking torque of 10-30 in-lb  
Refer to figure 1  
Stow screws in Ziplock Bag

**CAUTION**

Do not pry Thermal Shield off, damage could occur

3. Remove Thermal Shield; light tapping applied from side of Thermal Shield may be required (Driver Handle, 3/8-in Drive, blunt end)  
Temp stow thermal shield in Ziplock Bag
4. Inspect bottom of APFR Load Limiter for sharp edges
5. Wipe off Vibratite from bottom of Load Limiter (Dry Wipes). Vibratite may not come completely off; it is not essential to remove all residue
6. Label Ziplock Bag "ULF5 APFR Thermal Shield, GMT 2010/XXX" and stow in Done bag

EMU MAINT/RECHARGE

WATER RECHARGE.....	TEMP FS 10-2
EMU POWERUP.....	TEMP FS 10-2
WATER FILL.....	TEMP FS 10-2
WATER FILL VERIFICATION.....	TEMP FS 10-2
EMU LiOH CHANGEOUT.....	10-4
MIDDECK EMU BATTERY RECHARGE (STAND-ALONE).....	10-4a
MIDDECK EMU BATTERY RECHARGE/LiOH REPLACEMENT.....	10-5
INITIATE.....	10-5
TERMINATE.....	10-6
IN-SUIT EMU BATTERY RECHARGE/CHARGE VERIFICATION.....	10-7
INITIATE.....	10-7
TERMINATE.....	10-7
EMU POWERDOWN.....	10-7
HELMET LIGHT/PGT BATTERY RECHARGE.....	10-8
INITIATE.....	10-8
TERMINATE.....	10-9
REBA BATTERY INSTALLATION.....	10-9
EMU BATTERY REMOVAL/INSTALL.....	10-10
HELMET LIGHT BULB CHANGEOUT.....	10-11
REBA BATTERY RECHARGE.....	10-12
INITIATE.....	10-12
TERMINATE.....	10-13
STS-133 CONSUMABLES TRACKING CUE CARD.....	FS CC 10-15
STS-133 EVA BATTERY RECHARGE PLAN CUE CARD.....	FS CC 10-16

## WATER RECHARGE

### IF EMU NOT ALREADY POWERED UP:

#### EMU POWERUP

- BOTH DCM 1. Retrieve, position SCUs; remove DCM covers  
 2. Connect SCUs to DCM, √locked  
 3. PWR – BATT

#### CAUTION

EMU must be on BATT pwr when  
 airlock pwr supply is turned on

- AW18H 4. PWR/BATT CHGR EMU 1,2 MODE (two) – PWR  
 BUS SEL (two) – MNA(MNB)  
 MD(flr) 5. √EMU O2 ISOL VLV – OP  
 AW82B 6. EV1,2 O2 vlv (two) – OP  
 DCM 7. PWR – SCU

#### WATER FILL

- MO13Q 8. √ARLK H2O S/O VLV – OPEN (tb-OP)  
 R11L 9. √SPLY H2O TKA OUTLET – CL (tb-CL)

#### SM 60 TABLE MAINT

- CRT 10. Use TKB quantity:  
 PARAM ID – ITEM 1 +0 6 2 0 4 2 0 EXEC  
 11. Log value before recharge

Recharge #	H2O TKB %
1	
2	
3	
4	
5	

- AW82D 12. √EMU 1,2 H2O WASTE tb (two) – CL  
 SPLY (two) – OP (tb-OP)  
 13. √H2O TKB quantity decreasing

#### NOTE

Full charge requires ~15 min

#### WATER FILL VERIFICATION

- DCM 14. √STATUS: **H2O WP** 8-15 psi and stable for ~30 sec (indicates charging complete)

#### SM 60 TABLE MAINT

- CRT 15. Use TKB quantity:  
 PARAM ID – ITEM 1 +0 6 2 0 4 2 0 EXEC  
 16. Log value after recharge

Recharge #	H2O TKB %
1	
2	
3	
4	
5	

EMU MAINT/  
 RECHARGE

Cont next page

TEMP FS 10-2

TOP

**HOOK  
VELCRO**

**STS-133 CONSUMABLES TRACKING CUE CARD**

		<b>EVA 1</b>	<b>EVA 2</b>
<b>Metox for Campout &amp; 10.2 ops</b>	<b>Serial Numbers</b>	05, 07	11, 13

**PWR Usage:** Use 1003, 1007, in that order until drained

**Dump CWC:** 1059

	<b>EV</b>	<b>EMU</b>	<b>LiOH (s/n)</b>	<b>EMU Batt (s/n)</b>	<b>REBA (s/n)</b>	<b>EHIP (HL) Batts (s/n)</b>	<b>ERCA (address)</b>	<b>SAFER (s/n)</b>	<b>PGT Batt (s/n)</b>	<b>PGT Batt Spare (s/n)</b>
<b>EVA 1</b>	EV1 KO	3008	2023	2089	1008	1022 1025	16	1005	1005	1004
	EV2 DR	3004	2006	2090	1012	1026 1028	18	1006	1006	
<b>EVA 2</b>	EV1 KO	3008	2017	2091	1008	1029 1030	16	1005	1008	1004
	EV2 DR	3004	2014	2086	1012	1031 1035	18	1006	1009	
<b>Return Config</b>	EV1 KO	3008	2017	2087	N/A	N/A	N/A	N/A	N/A	N/A
	EV2 DR	3004	2014	2088	N/A	N/A	N/A	N/A	N/A	N/A

EVA-4a/133/O/A

(reduced copy)

TOP  
 BACK OF 'STS-133 CONSUMABLES TRACKING CUE CARD'

HOOK  
 VELCRO

STS-133 EVA BATTERY RECHARGE PLAN CUE CARD

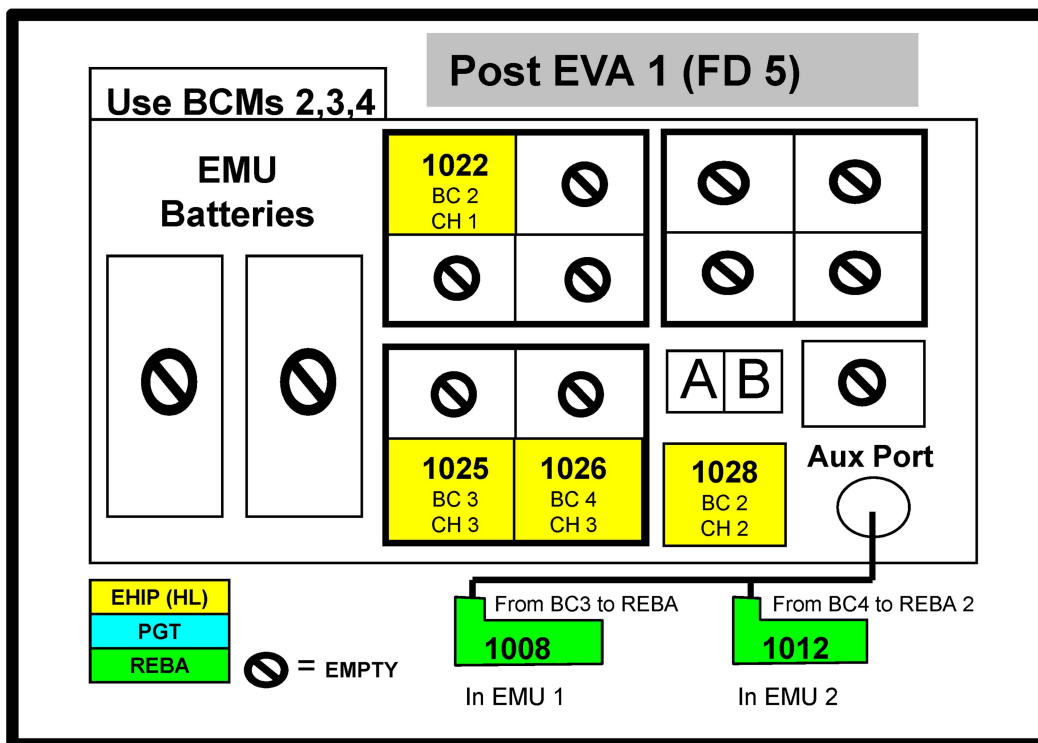

EVA-4b/133/O/A

(reduced copy)



EMU CONTINGENCY PROCS

DISPLAY LOSS DURING POWER TRANSFER (WARM RESTART)..... TEMP FS 12-2  
VACUUM H2O RECHARGE (MANNED)..... TEMP FS 12-2  
LiOH REPLACEMENT (MANNED)..... 12-3  
BATTERY REPLACEMENT (MANNED) ..... 12-4  
WATER DUMP ..... 12-6  
SCU SWAP (UNMANNED)..... 12-7  
SCU SWAP (MANNED)..... 12-7  
EMU COLD RESTART (MANNED) ..... 12-7  
12.1 STS EVA DECONTAMINATION..... 12-8  
CONTAMINATION TEST..... 12-15  
SAFER BATTERY CHANGEOUT ..... 12-18  
BENDS TREATMENT ADAPTER (BTA) INSTALLATION (IN-SUIT) ..... 12-19  
    BTA PREP ..... 12-19  
    BTA TREATMENT ..... 12-20  
BENDS TREATMENT ADAPTER (BTA) INSTALLATION (POST SUIT DOFFING) ..... 12-21  
    BTA PREP ..... 12-21  
    BTA TREATMENT ..... 12-22  
EMU RESIZE ..... 12-25  
EMERGENCY UNDOCKING EVA TRANSFER ..... FS CC 12-27  
EXPEDITED SUIT DOFFING CUE CARD ..... FS CC 12-28  
STS-133 NOMINAL EMU SIZING ..... FS 12-29  
EMU CONTINGENCY RESIZE MATRIX (STS-133/ULF5) ..... FS 12-30  
EVA PREBREATHE CUE CARD SUPPLEMENT (EXERCISE PROTOCOL).... FS CC 12-31

## DISPLAY LOSS DURING POWER TRANSFER (WARM RESTART)

- DCM If PWR – BATT and SCU connected:  
 AW18H 1. √PWR/BATT CHGR EMU 1(2) BUS SEL – OFF  
 DCM If PWR – SCU:  
 2. PWR – BATT  
 AW18H 3. PWR/BATT CHGR EMU 1(2) BUS SEL – OFF

**WARNING**  
 Fan will be off from steps 4 to 9 during  
 which time CO2 buildup is a concern

### NOTE

Affected EMU will be without comm after step 6. Steps 6 and 7 should be read together before step 6 is performed

- DCM 4. FAN – OFF (expect FAN SW OFF msg, DISP – PRO)  
 IV 5. Inform affected EV crewmember of impending comm loss  
 DCM 6. PWR – SCU (7 sec)  
 7. PWR – BATT  
 When power restart complete:  
 8. √Display – O2 POS XX, expect FAN SW OFF msg, DISP – PRO  
 9. As reqd, FAN – ON  
 If display blank or locked up:  
 10. Contact MCC  
 If SCU power desired:  
 11. √SCU connected to DCM  
 AW18H 12. PWR/BATT CHGR EMU 1(2) MODE – PWR  
BUS SEL – MNA(MNB)  
 13. √EMU INPUT 1(2) Volts = 18.0 – 20.0  
 DCM 14. PWR – SCU  
 DCM 15. √Display – O2 POS XX

## VACUUM H2O RECHARGE (MANNED)

**WARNING**  
 Procedure should be used only if performing a contingency EVA

- EV 1. Perform AIRLOCK INGRESS, Cuff C/L, 30 (Close hatch, partially engage latches)  
 2. √Helmet purge vlv – cl, locked  
 DCM 3. √PURGE vlv – cl (dn)  
 4. √WATER – OFF  
 IV MO13Q 5. √ARLK H2O S/O VLV – OPEN (tb-OP)  
 MD(flr) 6. √EMU O2 ISOL VLV – OP  
 ML86B:C 7. √cb MNC EXT ARLK HTR LINE ZN 1,2 (two) – op  
 AW82B 8. √EV-1(EV-2) O2 vlv – OP  
 EV AW18H 9. PWR/BATT CHGR EMU 1(2) BUS SEL – MNA(MNB)  
 DCM 10. PWR – SCU (fwd), WARN TONE  
 IV R11L If SPLY H2O XOVR VLV closed (tb-CL or bp) (water transfer config):  
 | 11. SPLY H2O TKA OUTLET – CL (tb-CL)  
 If SPLY H2O XOVR VLV open (tb-OP) (nominal config):  
 L1 12. √RAD CNTLR OUT TEMP – NORM  
 13. √FLASH EVAP CNTLR PRI A,B (two) – OFF  
 ML31C 14. SPLY H2O TKD OUTLET – CL (tb-CL)  
 R11L 15. SPLY H2O TKB OUTLET – CL (tb-CL)  
√TKA OUTLET – CL (tb-CL)  
TKC INLET – CL (tb-CL)  
TKC OUTLET – OP (tb-OP)

TOP

HOOK  
VELCRO

## EMERGENCY UNDOCKING EVA TRANSFER

### Critical

- A/L Floor Bag
    - MWS baseplate and T-Bar (2)  
[prefer baseplates 1005 and 1009  
w/T-Bars 1002 and 1006]
    - BTA s/n 1003
    - RETs (11) [prefer Red RETs]
  - Systems Transfer Bag
    - EHIP Light [prefer 1011]
  - EMU Batteries (2) [prefer 2087 and 2088]
- Ko & Dr
- EMUs
  - CCAs
  - Gloves
  - LCVGs

### Desired

- ECOKs (Ko/Dr)
- EMU Servicing Kit [in System Transfer Bag,  
prefer s/n 5004]
- Adj Eq Tethers (6) [in A/L Floor Bag]
- Remove the following from EMUs and  
leave on ISS
  - Helmet lights
  - EMU TV
  - REBA
  - ISS Tethers/Tools

EVA-5a/133/O/A

(reduced copy)

TOP  
BACK OF 'EMERGENCY UNDOCKING EVA TRANSFER'

HOOK  
VELCRO

## EXPEDITED SUIT DOFFING CUE CARD

### CAUTION

Verify EV crew is clear of hatch mechanism

- IV When equalization complete:  
1. Open IV Hatch per decal
- DCM SUIT DOFFING  
2. O2 ACT → OFF  
3. PURGE vlv → op (up)  
4. sw REBA → OFF (toward left arm of suit)  
5. EMU TV Power Cable ←|→ EMU TV  
6. √STATUS: **SUIT P** < 0.4 (compare with gauge)  
7. Glove ←|→ EMU (leave donned, disconnected)  
8. Helmet ←|→ EMU
- DCM 9. sw FAN → OFF
- SAFER SAFER DOFFING  
10. Latch → ENG  
11. Latch ↷ until release (~90 deg)  
12. PLSS ←|→ Thruster Towers
- PLSS SUIT DOFFING (Cont)  
13. Engage EMU in EDDA  
14. Lower Arm Cables ←|→ Gloves  
15. Gloves ←|→ EMU  
16. Comm Mode → OFF  
17. Disconnect CCA, MWC, and Biomed  
18. Doff EMU
- UIA If taking EMUs to shuttle:  
19. sw PWR EV-1,2 (two) → OFF  
√PWR EV-1,2 LEDs (four) – Off
- DCM 20. SCU ←|→ DCM  
21. LTA →|← HUT  
22. Gloves →|← EMU  
23. Helmet →|← EMU  
24. Go to **EMERGENCY UNDOCKING  
EVA TRANSFER** on reverse side

EVA-5b/133/O/A

(reduced copy)

# STS-133 NOMINAL EMU SIZING

## Kopra (Ko) – Up/Dn

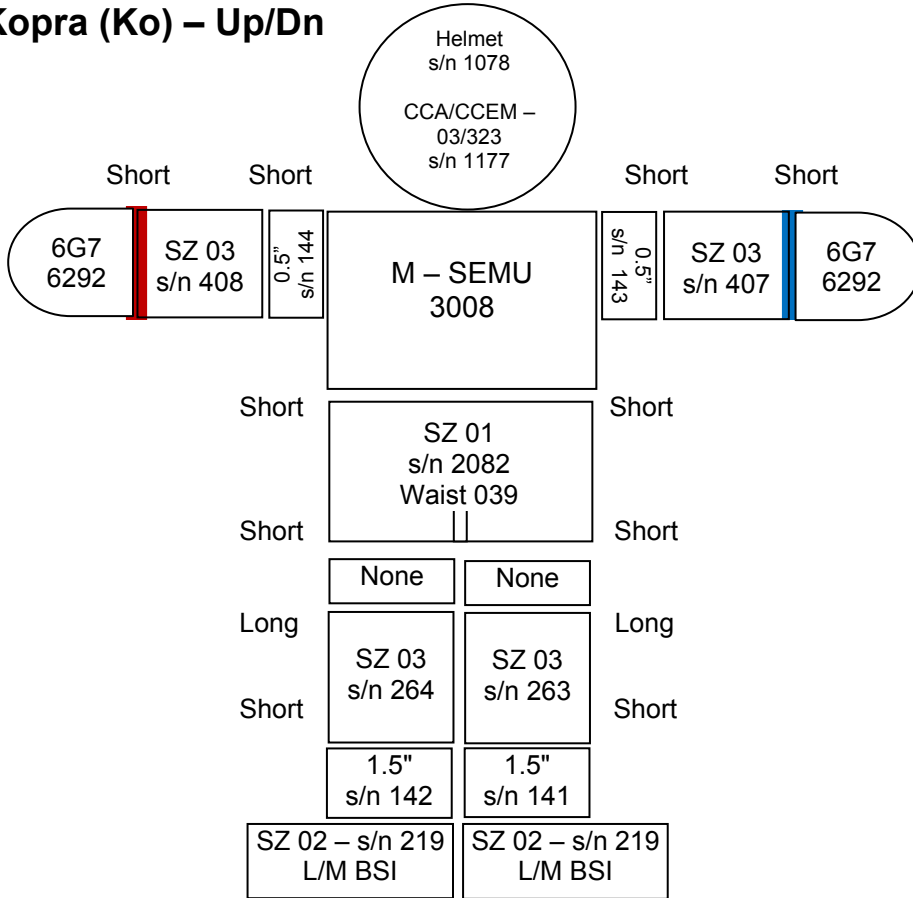

## Drew (Dr) – Up/Dn

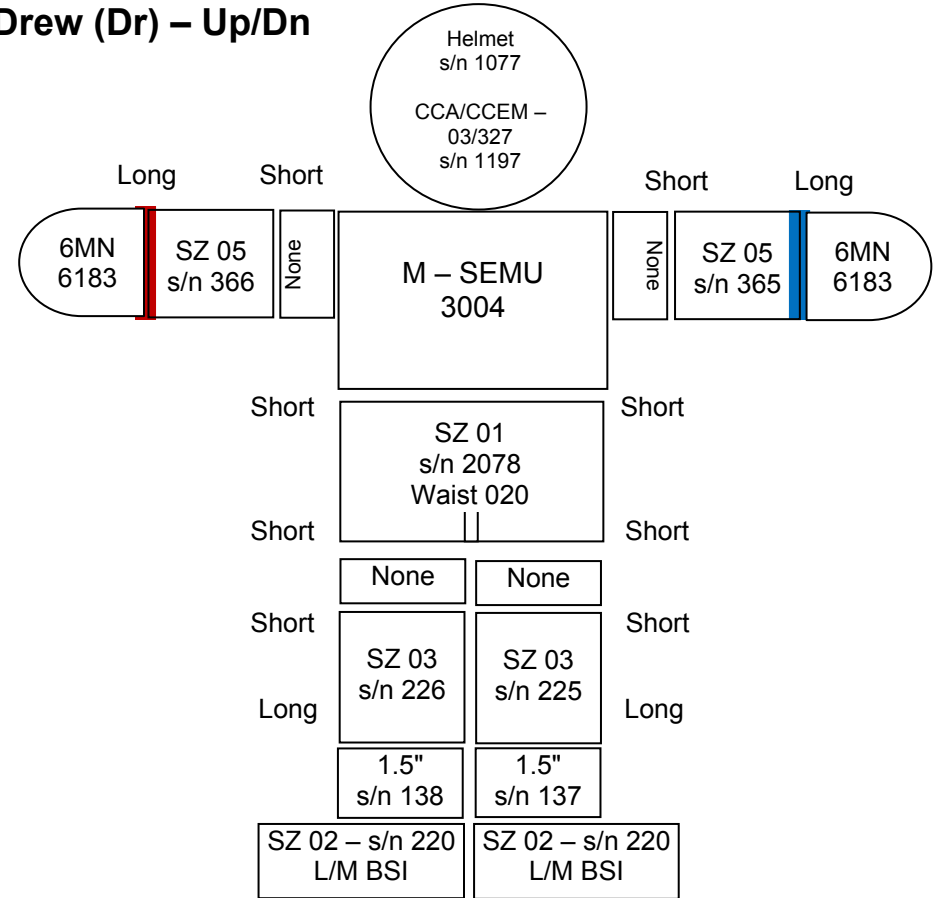

	Croakie	Fresnel	Valsalva	LCVG/BLVD	MAG	TCU Top	TCU Bottom	Comfort Gloves	Socks
<b>Ko</b>	N/A	N/A	309	3202/319		L	S	Spectra LG Thin	L Poly Liners
<b>Dr</b>	Mod M	N/A	308	3220/310		S	M	Spectra L Thick	Crew 10-13

## EMU CONTINGENCY RESIZE MATRIX (STS-133/ULF5)

FOR LOSS OF:	EV1 – Kopra	EV2 – Drew
<b>HUT/PLSS</b>	EMU 3011, M 1. Remove glove/arm assys 2. Use primary arms, gloves 3. √Arm red connects to right, √locks, √cams 4. Use primary LTA 5. Swap EMU PLSS identifier stripes, national flag 6. Swap helmet, comm cap, LiOH/Metox, EMU battery, REBA	EMU 3011, M 1. Remove ring/glove/arm assys 2. Use primary ring, arms, gloves 3. √Arm red connects to right, √locks, √cams 4. Use primary LTA 5. Swap EMU PLSS identifier stripes, national flag 6. Swap helmet, comm cap, LiOH/Metox, EMU battery, REBA
<b>CCA</b>	Size 03/323 s/n 1179/5017 Location: ECOK (Ko)	Size 03/327 CCA s/n 1203/1067 Location: ECOK (Dr)
<b>Lower Arm Segment</b>	Size 03 arm s/n 422/421 Location: A/L1D2 CTB 1078. Cams S/S (red = right, blue = left) 1. √Locks, √cams	Size 05 arm s/n 411/412 Location: A/L1O1 M-02 Bag 1010. Cams S/L (red = right, blue = left) 1. √Locks, √cams
<b>Gloves</b>	6G7 gloves s/n 6305 Location: ECOK (Ko) Swap Arm Cams to S/L	6MN gloves s/n 6184 Location: ECOK (Dr) Arm Cams remain S/L
<b>Waist Brief</b>	Size 01 waist brief s/n 2076/045 from EMU 3010. Cams S/S 1. Use prime legs, leg rings, and boots 2. √Locks, √cams 3. Swap EMU brief identifier stripes	Size 01 waist brief s/n 2076/045 from EMU 3010. Cams S/S 1. Use prime legs, leg rings, and boots 2. √Locks, √cams 3. Swap EMU brief identifier stripes
<b>Leg Segment</b>	Use size 03 leg s/n 251/252 Location: NOD1D2 CTB 1076 Cams L/S 1. √Locks, √cams	Use size 03 leg s/n 251/252 Location: NOD1D2 CTB 1076 Cams S/L 1. √Locks, √cams
<b>Boot</b>	Use size 02 boots s/n 232 from EMU 3010 1. 02 L/M BSI & Toe Cap 2. √Locks	Use size 02 boots s/n 232 EMU 3010 1. 02 L/M BSI & Toe Cap 2. √Locks
<b>Sizing Rings</b>	<ul style="list-style-type: none"> <li>• 0.5" Arm: Use s/n 145/146 from EMU 3005</li> <li>• 1.5" Leg: Use s/n 121/122 Location: A/L1O1 M-02 1010</li> </ul>	1.5" Leg: Use s/n 121/122 Location: A/L1O1 M-02 1010
<b>LCVG</b>	(04/05) 1. Use s/n 3195 Location: Bag "C" 2. Transfer biomed and dosimeter	(04/05) 1. Use s/n 3195 Location: Bag "C" 2. Transfer biomed and dosimeter

TOP

HOOK  
VELCRO

### EVA PREBREATHE CUE CARD SUPPLEMENT (EXERCISE PROTOCOL)

Cue Card Block	Step	EV1		EV2	
		GMT	PET	GMT	PET
A	Mask Prebreathe Init (PET = 0)				
	Exercise Init				
B	Exercise Terminate				
C	AL Depress Init				
	AL Intermed Depress, 11.8 psi (PET = 15 min)				
	AL Depress Complete, 10.2 psi				
D	Mask Prebreathe Terminate (stop PET)				
	<p style="text-align: center;"><u>WARNING</u></p> <p>Do not terminate mask prebreathe until:</p> <ul style="list-style-type: none"> <li>• Airlock at 10.2 psia (527mmHg)</li> <li>• P/B PET &gt; 1:20</li> <li>• 45 min since Block B</li> <li>• Airlock O2 concentration between 24.2 and 28.2</li> </ul>				
E	EMU Purge Start				
	EMU Purge Restart				
F	EMU Prebreathe Init (PET = 0)				
G	CL Depress Init (after P/B Term)				

WARNING

Duration of interruption in protocol must be recorded. Interruptions other than during exercise will use PHA or EMU for O2 buy-back. **√MCC-H** for buy-back duration and location

NOTE

This cue card supplement allows sequential timekeeping for exercise Prebreathe protocol, and will be used in conjunction with side 2 of the cue card

EVA-6a/133/O/A

(reduced copy)

TOP  
BACK OF 'EVA PREBREATHE CUE CARD SUPPLEMENT (EXERCISE PROTOCOL)'

HOOK  
VELCRO

EVA-6b/133/O/A

(reduced copy)

FS CC 12-32

EVA/133/FIN



## TPS REPAIR

The TPS Repair procedures listed below are not published in the hardcopy EVA Flight Supplement. These procedures will be uplinked realtime if they are required.

A PDF and a WORD version of the procedures can be found at:  
<http://mod.jsc.nasa.gov/do3/FDF/FDFBooks/Status%20Sheets/index.html>.

Select the "As Flown" Status sheet for STS-133 and the link to the procedures can be found with the link to the EVA FS. The procedures can also be found on the FDF Books CD provided to the FAO console

<b>BOOM TPS INSPECTION</b>	
BOOM POINT INSPECTION SUMMARY TIMELINE .....	FS 13-3
BOOM POINT INSPECTION TOOL CONFIG.....	FS 13-4
BOOM POINT INSPECTION .....	FS 13-5
BOOM WLE MAPPING SUMMARY TIMELINE .....	FS 13-15
BOOM WLE MAPPING TOOL CONFIG .....	FS 13-17
BOOM WLE MAPPING .....	FS 13-18
EVA WLE MAPPING INSPECTION.....	FS 13-24
<b>BOOM CONTINGENCY</b>	
BOOM FRGF SHAFT RELEASE .....	FS 13-29
BOOM FRGF SHAFT INSTALLATION .....	FS 13-30
BOOM EFGF SHAFT RELEASE .....	FS 13-32
BOOM MPM STOW/DEPLOY.....	FS 13-34
BOOM ASSISTED LATCHING .....	FS 13-35
<b>TILE REPAIR</b>	
EMU PREP FOR TPS REPAIR.....	FS 13-36
POST TPS REPAIR DOFFING .....	FS 13-37
EWA MATERIAL MIXING .....	FS 13-38
EWA REF DATA .....	FS 13-39
EWA TILE REPAIR – DOCKED/ORM SUMMARY TIMELINE .....	FS 13-40
EWA TILE REPAIR – DOCKED/ORM TOOL CONFIG.....	FS 13-41
EWA TILE REPAIR – DOCKED/ORM .....	FS 13-42
SSRMS GAP FILLER REMOVAL SUMMARY TIMELINE .....	FS 13-50
BOOM GAP FILLER REMOVAL SUMMARY TIMELINE .....	FS 13-51
GAP FILLER REMOVAL .....	FS 13-52
<b>RCC REPAIR</b>	
RCC CRACK REPAIR BAG ASSEMBLY.....	FS 13-57
TEMP SENSOR DISASSEMBLY POST-EVA.....	FS 13-60
RCC CRACK REPAIR BAG DISASSEMBLY POST-EVA .....	FS 13-61
TEMPERATURE PROBE ASSEMBLY .....	FS 13-63
CRM APPLICATOR ASSEMBLY .....	FS 13-63
CRM APPLICATOR NOZZLE INSTALLATION (DAY OF EVA).....	FS 13-64
RCC CRACK REPAIR.....	FS 13-65
RCC PLUG TRANSFER BAG ASSEMBLY .....	FS 13-77
RCC UNDOCKED CRACK REPAIR .....	FS 13-89
RULER PROTUBERANCE GAUGE TAPING.....	FS 13-120
<b>NOTES, CAUTIONS, WARNINGS</b>	
EVA TPS INSPECTION/REPAIR INHIBIT PAD.....	FS 13-122
TPS REPAIR CAUTIONS AND WARNINGS .....	FS 13-125
TPS REPAIR NOTES.....	FS 13-126
BOOM OPERATIONAL WARNINGS .....	FS 13-127
BOOM OPERATIONAL NOTES .....	FS 13-128

TPS REF DATA	
PREFERRED EMU POSITIONING FOR TPS REPAIR.....	FS 13-129
EVA TPS REACH AND ACCESS .....	FS 13-130
POINT INSPECTION REACH AND ACCESS WHILE DOCKED.....	FS 13-131
WLE MAPPING INSPECTION WHILE DOCKED .....	FS 13-133
TILE LAYUP .....	FS 13-134
85-FOOT SAFETY TETHER.....	FS 13-135
PFR ATTACHMENT DEVICE (PAD) .....	FS 13-136
WIF EXTENDER .....	FS 13-137
EVA DIGITAL CAMERA.....	FS 13-138
EVA IR CAMERA .....	FS 13-140
OVERLAY TILE REPAIR SYSTEM (OTRS) .....	FS 13-142
OTRS MARKING TEMPLATE AND INSULATION BAGS .....	FS 13-143
AUGER HOUSING.....	FS 13-144
OTRS RELEASED CONFIGURATION .....	FS 13-145
ORU BAG INSERT FOR OTRS .....	FS 13-146
RCC NOAX REPAIR REFERENCE.....	FS 13-147
BOOM REF DATA	
RTF BOOM OVERVIEW .....	FS 13-176
BOOM TRANSITIONS WITH MLI .....	FS 13-177
BOOM BASE END AND MODIFIED EFGF .....	FS 13-178
BOOM BASE END EFGF ADAPTER PLATE .....	FS 13-179
EVA-ASSISTED EFGF CONNECTOR DEMATE .....	FS 13-180
BOOM BASE END SADDLE AND MPM.....	FS 13-181
BOOM MID SECTION AND MODIFIED FRGF .....	FS 13-182
BOOM MID SECTION FRGF ADAPTER PLATE.....	FS 13-183
BOOM TIP END AND SENSORS .....	FS 13-184
BOOM SENSOR DETAILS .....	FS 13-186
SENSOR PACKAGE 1 (SP1): LDRI/ITVC .....	FS 13-188
SENSOR PACKAGE 2 (SP2): LCS.....	FS 13-190
POSSIBLE PRD ROUTING FOR EVA ASSISTED LATCHING	
OF BOOM IN MPMS.....	FS 13-192
BOOM CONTINGENCIES .....	FS 13-193
GRAPPLE SHAFTS .....	FS 13-194
PDGF GRAPPLE SHAFT COVER.....	FS 13-195
BOOM FRGF FSE.....	FS 13-196

UNSCHEDULED/CONTINGENCY EVA TASKS

STS-133/ULF5 WORKAROUNDS CRIBSHEET .....	TEMP FS 16-2
EVA 1 CONTINGENCIES .....	TEMP FS 16-2
EVA 2 CONTINGENCIES .....	FS 16-6
GET-AHEAD CONTINGENCIES .....	FS 16-10
GENERIC CONTINGENCIES .....	FS 16-12
RELEASE ROEU LATCHES .....	FS 16-34
LATCH ROEU LATCHES .....	FS 16-37
STOW ROEU ARM.....	FS 16-40
MATE ROEU ARM.....	FS 16-43
ROEU OVERVIEW .....	FS 16-45
RADIATOR GRAPPLE FIXTURE STOWAGE BEAM TIEDOWNS .....	FS 16-46
CAMERA PORT 13 TIEDOWN.....	FS 16-49
S3 FORWARD-NADIR CLAM SHELL AND STUB TIEDOWN .....	FS 16-50
S3 FORWARD-ZENITH CLAM SHELL AND STUB TIEDOWN .....	FS 16-51
ETRS TIEDOWN .....	FS 16-52
SPDM CLPA1 TIEDOWN .....	FS 16-53
CP3 STANCHION TIEDOWN .....	FS 16-54
CP3 WEDGE TIEDOWN .....	FS 16-56
CP3 STANCHION/WEDGE TIEDOWN .....	FS 16-57
P3 CETA LIGHT TIEDOWN .....	FS 16-58
PUMP MODULE TIEDOWN (ESP-2) .....	FS 16-59
AGB TIEDOWN .....	FS 16-60

UNSCH/CONT  
EVA TASKS

# STS-133/ULF5 WORKAROUNDS CRIBSHEET

## EVA 1 Contingencies

TASK	FAILURE	ACTION
I. 612 Extension Cable Install	A. NZGL Connectors	Reference Generic section below: <b>NZGL Connectors</b>
	B. Cannot access Node 3 P612 LTA cable TA clamps to release slack	<ol style="list-style-type: none"> <li>1. Release Node 3 P612 Cable from Node 3 HR 0681 and Node 1 HR 0142</li> <li>2. Verify sufficient slack for Node 3 P612 cable to reach Node 1 HR 0133 (stbd end)</li> <li>3. If NO joy, move Node 3 P612 connector to Node 3 HR 0668</li> </ol>
II. SSRMS Setup	A. APFR	Reference Generic section below: <b>APFR/IAPFR</b>
III. Failed PM Install on ESP-2	A. PM fails to install fully into FSE	<ol style="list-style-type: none"> <li>1. Check for FOD, and verify no induced side loads</li> <li>2. Increase force</li> </ol>
	B. Bolts 1, 2, or 4 will not install	<ol style="list-style-type: none"> <li>1. Verify PM fully seated</li> <li>2. Verify axial force on bolts</li> <li>3. Increase torque PGT Manual Ratchet until running torque decreases, return to <b>PGT: [B7 (25.5), CW2, 30.5]</b> for rest of turns</li> <li>4. Notify <b>MCC-H</b>, and if bolt 1 is partially engaged, proceed to next bolt (any 2 of 4 bolts 1, 2, and 4 required for ISS only)</li> </ol>
	C. Bolt 3 will not install	<ol style="list-style-type: none"> <li>1. Verify axial force on bolts</li> <li>2. If still no joy, re-attempt bolt 3 at nominal settings after bolt 2 install</li> <li>3. Increase torque PGT Manual Ratchet until running torque decreases, return to <b>PGT: [B7 (25.5), CW2, 30.5]</b> for rest of turns</li> </ol>
IV. AGB Release	A. Bolt fails to release	<ol style="list-style-type: none"> <li>1. Increase torque <b>PGT: [B1 (12.0), CCW2, 30.5]</b></li> <li>2. If NO joy, increase torque <b>PGT: [B7 (25.5), CCW2, 30.5]</b></li> </ol>
	B. Bolt jams due to PGT dimensions	<ol style="list-style-type: none"> <li>1. Drive bolt back in <b>PGT: [A2 (3.8), CW2, 30.5]</b></li> <li>2. Retrieve ratchet wrench to perform release</li> </ol>
	C. T-handle fails to unlock (release)	<ol style="list-style-type: none"> <li>1. Check interface for FOD or damage</li> <li>2. Increase force and reattempt</li> <li>3. Use prybar as lever to release T-handle</li> </ol>
	D. AGB fails to release from soft dock	Use bolt puller (A/L Toolbox) or prybar to pry the AGB from the PM near sticky plungers

UNSC/CONT  
EVA TASKS

# STS-133/ULF5 WORKAROUNDS CRIBSHEET (Cont)

## EVA 1 Contingencies (Cont)

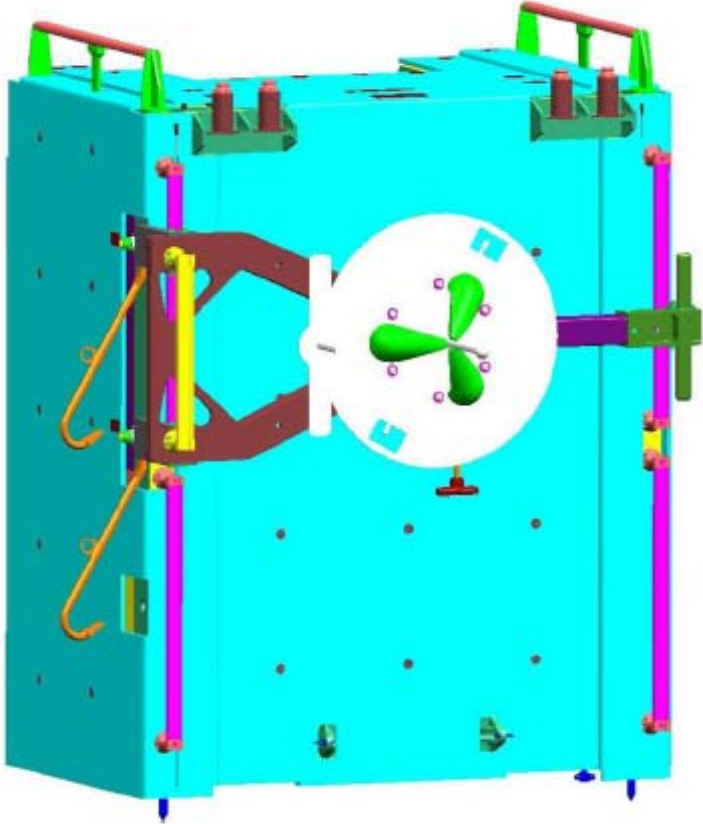
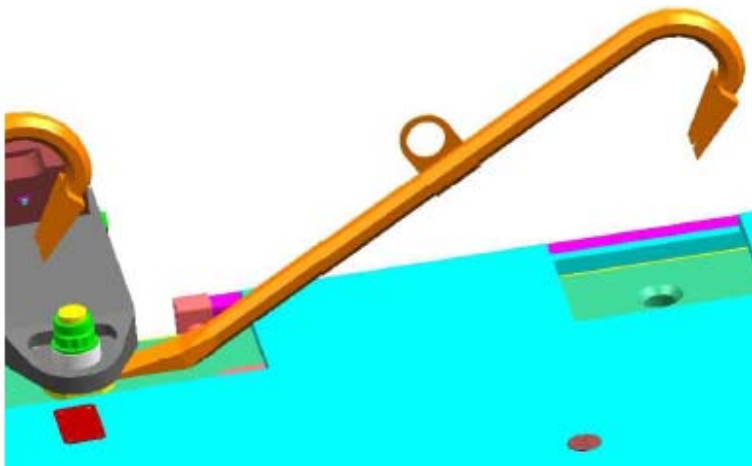
TASK	FAILURE	ACTION
	 	
	E. T-handle fails to engage into alignment hole	Slide AGB single pin side in and out a few inches while tapping T-handle into position
<b>V. AGB Install</b>	A. T-handle fails to unlock (release)	<ol style="list-style-type: none"> <li>1. Check interface for FOD or damage</li> <li>2. Increase force and reattempt</li> </ol>
	B. AGB fails to soft dock	<ol style="list-style-type: none"> <li>1. Check for FOD</li> <li>2. Exercise plungers with bolt puller or prybar</li> </ol>
	C. Slider mechanism overcomes soft dock	<ol style="list-style-type: none"> <li>1. Verify T-handle fully out – 2 white lines</li> <li>2. Install tether to hold 2 pin side to restraint engaged on ORU and push in single pin side. Then slide AGB single pin side in and out a few inches while tapping T-handle into position</li> </ol>

## STS-133/ULF5 WORKAROUNDS CRIBSHEET (Cont)

### EVA 1 Contingencies (Cont)

TASK	FAILURE	ACTION
	D. T-handle fails to engage into alignment hole	<ol style="list-style-type: none"> <li>Slide AGB single pin side in and out a few inches while tapping T-handle into position</li> <li>Install tether to hold 2 pin side to restraint engaged on ORU and push in single pin side. Then reattempt step 1</li> </ol>
	E. Bolt fails to engage fully	<ol style="list-style-type: none"> <li>Check interface for FOD or damage</li> <li>Back out bolt <b>PGT: [A2 (3.8), CCW2, 30.5]</b> and reattempt installation at nominal setting <b>[A2 (3.8), CW2, 30.5]</b></li> <li>If green light achieved, check with <b>MCC-H</b> if turn count is acceptable</li> </ol>
	F. PGT Interferes when engaging bolt	Attempt turns by hand or with ratchet wrench palm wheel cw until bolt seated; do not put preload on bolt
<b>VI. Fluid QD &amp; Vent Tool Ops</b>	<b>NOTE</b> If troubleshooting requires the crew to leave the worksite, verify that QDs are covered to prevent exposure to direct sunlight	
	<b>Mating Ops</b>	
	A. QD fails to mate	<ol style="list-style-type: none"> <li>Check alignment and verify side loads are counteracted</li> <li>Verify fwd white band is not visible (release ring is retracted)</li> <li>Inspect male and female QD for debris, damage, or NH3</li> <li>Leave female QD engaged with male (NH3 may sublimate between QDs)</li> <li>Change body orientation for better access</li> </ol>
	B. Release ring snap back test fails	<ol style="list-style-type: none"> <li>Push release ring forward (release ring will not slide fwd if QD is in FID)</li> <li>QD is in FID                             <ol style="list-style-type: none"> <li>Demate QD</li> <li>Pull back on release ring</li> <li>Verify fwd white band not visible</li> </ol> </li> <li>Remate QD</li> </ol>
	C. Gap check fails (visual)	<ol style="list-style-type: none"> <li>Demate and Remate QD                             <ol style="list-style-type: none"> <li>Retract release ring</li> <li>Demate QD</li> <li>Verify fwd white band not visible</li> </ol> </li> <li>Remate QD</li> </ol>
	D. Pull test fails	<ol style="list-style-type: none"> <li>Verify fwd white band is not visible (release ring is retracted)</li> <li>Assess and counteract sideloads and mate QD</li> </ol>
	<b>Vent Tool</b>	
	E. Tip of vent tool does not pass black mark during alignment check	Slide the equipment hook further away from vent tool nozzle end
	F. Vent tool cannot be mated to Vent Tool Extender	Hold VTE adapter in sunlight to warm it up (known tolerance issue between cold VTE adapter and vent tool nozzle)
	<b>VII. CP3 Camera Wedge Install</b>	A. Stanchion bolt does not release
B. Stanchion fails to release from soft dock		<ol style="list-style-type: none"> <li>Rock stanchion back and forth to overcome spring plungers</li> <li>If sufficient gap is present, use prybar</li> </ol>

## STS-133/ULF5 WORKAROUNDS CRIBSHEET (Cont)

### EVA 1 Contingencies (Cont)

TASK	FAILURE	ACTION
	C. Spring plungers seize or fail to depress	<ol style="list-style-type: none"> <li>1. Attempt soft-dock installation slightly tilted - Start with stanchion at ~30 deg angle off-vertical and apply downward pressure as stanchion is rotated toward vertical</li> <li>2. Use EVA probe tool (or similar metal object) to depress plunger</li> <li>3. Attempt full installation without soft dock engaged</li> </ol>
	D. Stanchion/wedge bolt does not fully engage	<ol style="list-style-type: none"> <li>1. Release stanchion bolt, verify alignment and reattempt <b>PGT [B3, CW2, 30.5]-6 ext 7/16</b></li> <li>2. <b>PGT [B7, CW2, 30.5]-6 ext 7/16</b>: Reattempt stanchion bolt engage</li> <li>3. Remove stanchion, inspect bolt and truss interface, report to <b>MCC-H</b></li> <li>4. 1 of 1 bolt is required, if &lt; 1 bolt engaged, refer to tie-down plan</li> </ol>
	E. Cannot engage PGT socket on stanchion bolt	<ol style="list-style-type: none"> <li>1. Attempt to reengage bolt</li> <li>2. Remove socket from PGT; engage socket on stanchion bolt, then put back on PGT</li> <li>3. Use ERAD, torque wrench, or ratchet wrench (for release). (For install, <b>ERAD w/PGT [A7, CW2, 30.5]</b>. For release, <b>ERAD w/PGT [B3, CCW2, 30.5]</b>)</li> </ol>
<b>VIII. CETA Rail Install</b>	A. Primary Bolts fail to engage (2)	<ol style="list-style-type: none"> <li>1. Check for FOD in mechanism</li> <li>2. Check alignment and Clam Shell is installed correctly</li> <li>3. Attempt to engage other bolt If neither bolt will engage: <ol style="list-style-type: none"> <li>a. Take Clam Shell off</li> <li>b. Check for FOD and galling</li> <li>c. Engage bolts into Clam Shell by hand. Report to <b>MCC-H</b></li> </ol> </li> <li>4. Reattempt to install Clam Shell and drive bolts</li> </ol>
<b>IX. Message in a Bottle</b>	A. Knob does not rotate to close	<ol style="list-style-type: none"> <li>1. Re-open the knob ccw, then attempt to close it again (approx 2 turns) (Bottle may contain 1 atmospheric-pressure air if the knob is fully closed and forgotten to open before EVA. Even so, induced force from nozzle is less than 4 lbf in an instant)</li> <li>2. If NO joy and red marking does not match up for close, open the knob 2 turns and temp stow into Airlock for IVA troubleshooting</li> </ol>
	B. Tether point (wire) torn off	<ol style="list-style-type: none"> <li>1. Attach wire tie to the base of valve (nozzle) as a tether point</li> <li>2. Stow the failed wire into trash bag</li> </ol>
	C. Kapton tape came off wire tether point (sharp edge)	<ol style="list-style-type: none"> <li>1. Avoid contact with wire</li> <li>2. If unsafe to use as tether point, attach wire tie to the base of valve (nozzle) as a new tether point</li> </ol>

# STS-133/ULF5 WORKAROUNDS CRIBSHEET (Cont)

## EVA 2 Contingencies

TASK	FAILURE	ACTION
I. Fluid QD & Vent Tool Ops		<u>NOTE</u> If troubleshooting requires the crew to leave the worksite, verify that QDs are covered to prevent exposure to direct sunlight
	<b>Mating Ops</b>	
	A. QD fails to mate	<ol style="list-style-type: none"> <li>1. Check alignment and verify side loads are counteracted</li> <li>2. Verify fwd white band is not visible (release ring is retracted)</li> <li>3. Inspect male and female QD for debris, damage, or NH3</li> <li>4. Leave female QD engaged with male (NH3 may sublimate between QDs)</li> <li>5. Change body orientation for better access</li> </ol>
	B. Release ring snap back test fails	<ol style="list-style-type: none"> <li>1. Push release ring forward (release ring will not slide fwd if QD is in FID)</li> <li>2. QD is in FID                             <ol style="list-style-type: none"> <li>a. Demate QD</li> <li>b. Pull back on release ring</li> <li>c. Verify fwd white band not visible</li> <li>d. Remate QD</li> </ol> </li> </ol>
	C. Gap check fails (visual or FID gauge)	Demate and Remate QD <ol style="list-style-type: none"> <li>a. Retract release ring</li> <li>b. Demate QD</li> <li>c. Verify fwd white band not visible</li> <li>d. Remate QD</li> </ol>
	D. Pull test fails	<ol style="list-style-type: none"> <li>1. Verify fwd white band is not visible (release ring is retracted)</li> <li>2. Assess and counteract sideloads and mate QD</li> </ol>
	<b>Valve Ops</b>	
	A. Detent button is partially unthreaded	Rethread detent button <ol style="list-style-type: none"> <li>a. Load bail handle (button will free spin if not loaded)                             <ul style="list-style-type: none"> <li>- If valve is open, pull bail handle aft</li> <li>- If valve is closed, push bail handle fwd</li> </ul> </li> <li>b. Rotate button cw (8 turns max)</li> </ol>
	B. Detent button is missing	<ol style="list-style-type: none"> <li>1. Use equipment hook to depress detent button shaft</li> <li>2. Or use tether strap around gloved finger to depress detent button shaft</li> <li>3. Or retrieve and use Beta Gimbal Antirotation Latch Tool to depress detent button shaft</li> <li>4. On <b>MCC-H GO</b>: Install spare detent button. (Buttons are stowed IVA and must be configured prior to EVA use)</li> </ol>
	C. Bail fails to travel to fwd (valve open) position (button does not pop up if attempting to go to full fwd)	<ol style="list-style-type: none"> <li>1. Neutralize sideloads</li> <li>2. If NO joy: Apply greater opening force to QD bail handle</li> <li>3. If NO joy: Retrieve and use QD bail drive lever (3/4, 1, &amp; 1-1/2 in only)</li> <li>4. If applicable, retrieve and install SPD; notify <b>MCC-H</b></li> </ol>



# STS-133/ULF5 WORKAROUNDS CRIBSHEET (Cont)

## EVA 2 Contingencies (Cont)

TASK	FAILURE	ACTION
	<p>D. Detent button fails to depress during valve closing</p> <div style="border: 2px solid black; padding: 5px; margin: 10px 0;"> <p style="text-align: center;"><b>WARNING</b></p> <p>Bail may kick back and contact crew when button is depressed if a leaking primary seal allowed pressure build-up in spring cavity</p> </div>	<ol style="list-style-type: none"> <li>1. Verify locking collar unlocked (1/2, 3/4, &amp; 1 in only)</li> <li>2. Push and hold bail handle fwd (to open) with significant force to relieve load on button while simultaneously depressing the detent button - If button depresses, vent by pulling bail aft until aft white band no longer visible</li> <li>3. If NO joy: Rock QD from side-to-side and up/down while depressing button</li> <li>4. If NO joy: Retrieve QD bail drive lever and repeat step 2 (3/4, 1, &amp; 1-1/2 in only)</li> <li>5. If NO joy: Contact <b>MCC</b> to reduce NH3 pressure, if possible</li> <li>6. If NO joy: On <b>MCC-H GO</b>: Retrieve and install QD button depress tool (BDT) (1/4, 3/4, &amp; 1 in only)</li> <li>7. If NO joy: On <b>MCC-H GO</b>: Retrieve hammer and tap center of button. (Use plastic side of hammer.) (Inspect tool and QD)</li> </ol>
	<p>E. Bail fails to travel to full aft (valve closed) position (button does not pop up)</p>	<ol style="list-style-type: none"> <li>1. Neutralize possible side loading</li> <li>2. Increase force on bail</li> <li>3. If NO joy: Retrieve and use QD bail drive lever (3/4, 1, &amp; 1-1/2 in only)</li> <li>4. If NO joy: Inspect QD for retaining wire protrusion</li> </ol>
<b>Demating Ops</b>		
	<p>A. Female QD fails to demate</p>	<ol style="list-style-type: none"> <li>1. Neutralize sideloads or manipulate flexhose to relieve mating forces on female QD</li> <li>2. If NO joy: Verify release ring is fully retracted while attempting to demate</li> <li>3. If NO joy: Verify TA or P clamps are released</li> <li>4. If NO joy: Verify detent button is up (locking collar can be rotated under button)</li> <li>5. If NO joy: Verify trigger linkage is still attached to release ring (1-1/2 in only)</li> <li>6. If NO joy: Apply greater force to release ring and female QD</li> <li>7. If NO joy: Retrieve and use QD release tool (QRT) to apply greater force; (3/4, 1, &amp; 1-1/2 in only)</li> <li>8. If NO joy: Shake QD vigorously while attempting to demate</li> </ol>
	<p>B. Thermal bootie fails to remain securely closed</p>	<p>Install wire tie around bootie to keep QD fully covered</p>
	<p>C. Cap will not demate</p>	<ol style="list-style-type: none"> <li>1. Verify pulling out on cap before rotating to ensure locking tab is disengaged</li> <li>2. If NO joy: Wait for opposite thermal conditions if possible and reattempt cap removal</li> <li>3. If NO joy: Retrieve QD cap tool (1/4, 1/2, &amp; 1 in only) <ol style="list-style-type: none"> <li>a. <b>PGT: [A4 (6.3), CCW1, 30.5]</b> with QD cap tool to turn stuck cap a maximum of 2 turns (cap vents at ~2 turns)</li> <li>b. Once venting is complete, finish removal of cap by hand (~1 additional turn) <ul style="list-style-type: none"> <li>- If venting does not stop or cap cannot be removed by hand, notify <b>MCC-H</b>. (Male QD may be leaking)</li> </ul> </li> </ol> </li> </ol>

## STS-133/ULF5 WORKAROUNDS CRIBSHEET (Cont)

### EVA 2 Contingencies (Cont)

TASK	FAILURE	ACTION
	<b>Vent Tools</b>	
	A. Frozen NH3 present on female or male QD	<ol style="list-style-type: none"> <li>1. Leave QD exposed to vacuum; wait maximum of 5 min for sublimation (check periodically)</li> <li>2. On <b>MCC-H GO</b>: Continue QD ops</li> </ol>
	B. Tip of vent tool does not pass black mark during alignment check	Slide the equipment hook further away from vent tool nozzle end
	C. Vent tool cannot be mated to Vent Tool Extender	Hold VTE adapter in sunlight to warm it up (known tolerance issue between cold VTE adapter and vent tool nozzle)
<b>II. LWAPA Retrieve</b>	A. Primary FRAM bolt fails to release	<ol style="list-style-type: none"> <li>1. Confirm socket fully engaged to release anti-rotation mechanism</li> <li>2. Increase PGT setting: <b>PGT: [A7 (9.2), CCW2, 30.5], 7/16-6-ext</b> 1 turn only to break torque; reset PGT to <b>A4 (6.3)</b> for full run-out of bolt</li> <li>3. If NO joy, check <b>MCC-H</b> for re-securing LWAPA</li> </ol>
<b>III. LWAPA Install</b>	A. Active FRAM fails to seat on passive FRAM	<ol style="list-style-type: none"> <li>1. Check for FOD in mechanism</li> <li>2. Check alignment</li> </ol>
	B. Primary FRAM bolt fails to engage	<ol style="list-style-type: none"> <li>1. Verify FRAM seated</li> <li>2. Check for FOD</li> <li>3. Back out primary bolt fully: <b>PGT: [A4 (6.3), CCW2, 30.5], 7/16-6-ext</b> If no joy backing bolt out, see Block A</li> <li>4. Reattempt engagement <b>PGT: [A4 (6.3), CW2, 30.5], 7/16-6-ext</b></li> <li>5. Increase PGT setting: <b>PGT: [A7 (9.2), CW2, 30.5], 7/16-6-ext</b></li> <li>6. Consider hold for thermal stabilization between active and passive FRAM</li> <li>7. Engage contingency locking pins (aft pins not required if primary bolt turn count &gt; 6.5):</li> </ol> <p style="text-align: center;"><u>NOTE</u></p> <p>4 of 4 contingency pins required for PLB; 3 of 4 contingency pins required for Columbus EPF</p> <p>- Front pins <b>PGT: [A4 (6.3), CW2, 30.5], 7/16-6-ext</b> 14.1 – (1.25 * turns on Primary Bolt) turns</p> <p style="text-align: center;"><u>NOTE</u></p> <p>Aft contingency pins can only be installed if the primary bolt turn count is 6.5 turns or less. With greater than 6.5 turns on the primary bolt, the aft contingency pins are not needed and, in some cases where the primary bolt is mostly installed, cannot be installed</p> <p>- Aft pins for reinstallation on</p> <ul style="list-style-type: none"> <li>• Remove bolt from STOW location and engage in INSTALL location</li> <li>• Manually turn bolt as far as possible <b>PGT: [B1 (12.0), CW2, 30.5], 7/16-6-ext</b></li> </ul> <p>16.9 – (1.25 * turns on Primary Bolt) turns</p>

## STS-133/ULF5 WORKAROUNDS CRIBSHEET (Cont)

### EVA 2 Contingencies (Cont)

TASK	FAILURE	ACTION
IV. SPDM CLPA2 Install	A. Connector cover will not stay clear of CLPA during install	Cut connector cover blanket off of SPDM
	B. CLPA fails to soft dock	1. Inspect for FOD or damage 2. Wiggle CLPA into V-guide
	C. Bolt fails to engage fully	Increase torque PGT: <b>[B7 (25.5), CW2, 30.5]</b> for 1 turn only
V. SPDM EP1 Cover Remove	A. 1/4-turn fastener fails to rotate	Use equipment hook for additional leverage
VI. CETA Light Install	A. Light fails to engage into soft dock	1. Check for FOD 2. Exercise plungers with bolt puller or prybar
	B. Primary bolt fails to engage	Increase torque PGT: <b>[B7 (25.5), CW2, 30.5]</b> for 1 turn and then return to nominal install PGT: <b>[B1 (12.0), CW2, 30.5]</b>
	C. NZGLs	Reference Generic section below: <b>NZGL Connectors</b>

## STS-133/ULF5 WORKAROUNDS CRIBSHEET (Cont)

### Get-Ahead Contingencies

TASK	FAILURE	ACTION
<b>I. FHRC P-Clamp Release</b>	A. Bolt fails to release	Increase torque <b>PGT: [B1 (12.0), CCW2, 30.5]</b> for 1 turn then return to nominal setting <b>PGT: [A7 (9.2), CCW2, 30.5]</b>
<b>II. CP13 ETVCG Light R&amp;R</b>	A. ETVCG is not oriented correctly (Lens should be pointed to structure)	On <b>MCC-H GO</b> : Manually align camera
	B. PTU lock lever fails to engage	1. Check for FOD 2. Wiggle ETVCG while locking PTU 3. Increase force
	C. NZGLs	See Generic section of cribsheet
	D. Primary bolt fails to release	Increase torque <b>PGT: [B7 (25.5), CCW2, 30.5]</b>
	E. Light fails to engage into soft dock	1. Check for FOD 2. Exercise plungers with bolt puller or prybar
	F. Primary bolt fails to engage	Increase torque <b>PGT: [B7 (25.5), CW2, 30.5]</b> for 1 turn and then return to nominal install <b>PGT: [B1 (12.0), CW2, 30.5]</b>
	G. PTU lock lever fails to release	1. Check for FOD 2. Increase force
<b>III. Strela Adapter Relocate</b>	<b>Release</b>	
	A. Paddles will not open (lift up)	1. Verify no FOD in paddles 2. Use large tether hook to pry open faulty paddle 3. Retrieve pry bar from staging bag, attempt to pry open faulty paddle
	B. Paddles will not rotate full turn count	1. Retrieve Strela Adapter extender from Staging Bag. Engage extender on one paddle (slide on) and reattempt full release 2. If gap present between adapter latch and FRGF pin head: a. Attempt to rotate adapter latch to open position and remove adapter from FRGF b. Confirm with <b>MCC-M</b> : Continue with install or return Strela Adapter to A/L for IVA troubleshooting 3. Tighten Strela Adapter back down to FRGF
	C. Adapter latch will not rotate to open position	1. If gap present between adapter latch and FRGF pinhead, use equipment hook to apply extra force on adapter latch extension (opposite of pivot point) 2. Confirm with <b>MCC-M</b> : Continue with install or return Strela Adapter to A/L for IVA troubleshooting
	<b>Install</b>	
A. Adapter latch will not rotate to close position	1. Verify Strela Adapter is fully seated on FGB EFGF 2. Check for FOD or interference between EFGF and Strela Adapter 3. Remove Strela Adapter from EFGF and cycle adapter latch 4. If NO joy, return Strela Adapter to Airlock for IVA inspection	

## STS-133/ULF5 WORKAROUNDS CRIBSHEET (Cont)

### Get-Ahead Contingencies (Cont)

TASK	FAILURE	ACTION
	B. Paddles will not rotate full turn count	<ol style="list-style-type: none"> <li>1. Back out Strela Adapter (rotate paddles ccw) and reattempt full turn count into install position (rotate paddles cw)</li> <li>2. Release Strela Adapter from EFGF (rotate paddles ccw, rotate adapter latch to open position), remove adapter from EFGF, and inspect for FOD or interference between EFGF and adapter</li> <li>3. Retrieve Strela Adapter extender from staging bag. Engage extender on one paddle (slide on), and reattempt turn count</li> </ol>
	C. Paddles will not close (push down)	<ol style="list-style-type: none"> <li>1. Verify no FOD in paddles</li> <li>2. Release Strela Adapter from EFGF and return to Airlock</li> </ol>
<b>IV. Tool Relocations</b>	A. Toolbox door will not open	<ol style="list-style-type: none"> <li>1. Verify both door locks are in open position (on either side of door panel) <ol style="list-style-type: none"> <li>a. If necessary, remove launch restraint pip pin, place in stowage bracket, and open lock</li> </ol> </li> <li>2. Ingress APFR/IAPFR for better worksite access</li> </ol>
	B. Toolbox door will not close	<ol style="list-style-type: none"> <li>1. Verify no FOD or interference in door hinge</li> <li>2. Verify door hinge in travel in groove</li> </ol>
	C. Toolbox door lock stuck	<ol style="list-style-type: none"> <li>1. Verify no FOD or interference</li> <li>2. Use crew hook to apply additional force in desired direction</li> <li>3. If door lock is stuck open, leave in open position and close the door lock on the other side of door panel</li> </ol>
	D. Toolboard tab will not open	<ol style="list-style-type: none"> <li>1. Verify no FOD or interference in tab</li> <li>2. Use equipment hook to tap toolboard tab into open position</li> <li>3. If appropriate, utilize alternate tab (TB vs SL) to gain access to toolboard</li> </ol>
	E. Toolboard tab will not close	<ol style="list-style-type: none"> <li>1. Verify toolboard is fully seated in guide rail, reattempt</li> <li>2. Verify no FOD or interference in tab</li> <li>3. Stow toolboard in alternate location (mission specific): <ol style="list-style-type: none"> <li>a. Alternate slot in same toolbox</li> <li>b. Alternate slot in alternate toolbox</li> <li>c. Return toolboard to Airlock for internal stowage</li> </ol> </li> </ol>

## STS-133/ULF5 WORKAROUNDS CRIBSHEET (Cont)

### Generic Contingencies

TASK	FAILURE	ACTION	
I. Generic	<b>APFR/IAPFR</b>		
	A. APFR/IAPFR fails to install into WIF	<ol style="list-style-type: none"> <li>1. Verify APFR collar in install position (black-on-black)</li> <li>2. Check for FOD in WIF or structural interference</li> <li>3. Attempt APFR install in alternate clocking</li> <li>4. If NO joy, attempt APFR install in alternate WIF</li> <li>5. If NO joy, APFR failure - Use another APFR</li> </ol>	
	B. Joint fails to actuate	<ol style="list-style-type: none"> <li>1. Verify no load is applied to joint and/or jiggle APFR joint while actuating knob - For pitch joint, push knob in during rotation (Class I pitch joints known to be stiff)</li> <li>2. Increase force applied in order to free joint</li> </ol>	
	C. Boot becomes stuck in APFR boot plate	<ol style="list-style-type: none"> <li>1. Have other EV crewmember assist with getting boot out</li> <li>2. Loosen 7/16-in EVA bolts (3) on heel clip using EVA ratchet or PGT: <b>PGT: [B1 (12.0), CCW2, 30.5], 7/16-6-ext</b></li> <li>3. Remove 7/16-in EVA bolts (3 – captive) on heel clip (non captive) using EVA ratchet or PGT: <b>PGT: [B1 (12.0), CCW2, 30.5], 7/16-6-ext</b> 5 turns</li> </ol>	
	D. Boot becomes stuck in IAPFR boot plate	<ol style="list-style-type: none"> <li>1. Have other EV crewmember assist with getting boot out</li> <li>2. If wearing Small EMU boot, have other EV crewmember adjust boot sizing to Large</li> <li>3. Loosen 7/16-in EVA bolts (2) on heel clip using EVA ratchet or PGT: <b>PGT: [B2 (16.0), CCW2, 30.5], 7/16-6-ext</b></li> <li>4. Remove 7/16-in EVA bolts (2) on heel clip using EVA ratchet or PGT: <b>PGT: [B2 (16.0), CCW2, 30.5], 7/16-6-ext</b> 4 turns</li> </ol>	
	<b>Ballstack</b>		
	A. ECOM fails to release from ISS Structure	On <b>MCC-H GO</b> : Tether ballstack to handrail and leave outside	
	B. ECOM fails to release from MUT EE	Leave together and return inside	
	C. Ballstack fails to rigidize	On <b>MCC-H GO</b> : Use secondary tethers to assist in restraining payload	
	<b>BRT</b>		
	A. BRT jaws fail to release	<ol style="list-style-type: none"> <li>1. Loosen rigidizing collar to relieve sideloads</li> <li>2. Shake BRT while depressing paddles to alleviate sideloads from handrail</li> <li>3. Detach BRT from suit and tether to structure</li> </ol>	
	<b>Cannon Connector</b>		
	A. Connector fails to release	<ol style="list-style-type: none"> <li>1. Check for FOD, damage, or misalignment</li> <li>2. Verify cable routing is not impeding connector rotation. (Release TA-clamps as required)</li> <li>3. Use cannon connector tool for more leverage</li> </ol>	
B. Connector/Cap fails to soft dock	<ol style="list-style-type: none"> <li>1. Verify collar unlocked. (White on connector shell tip should align with white on receptacle backplate)</li> <li>2. Check for FOD or damage</li> </ol>		

## STS-133/ULF5 WORKAROUNDS CRIBSHEET (Cont)

### Generic Contingencies (Cont)

TASK	FAILURE	ACTION
	C. Connector/Cap fails to lock	<ol style="list-style-type: none"> <li>1. Remove connector/cap, check for FOD or damage</li> <li>2. Check alignment, remate, rock connector back and forth as required. (Once locked, white on connector shell tip should align with black on receptacle backplate)</li> <li>3. Use cannon connector tool for more leverage</li> </ol>
	D. High cable stiffness prevents mating	<ol style="list-style-type: none"> <li>1. Verify all TA-clamps are released</li> <li>2. Use second crewmember</li> <li>3. Use APFR</li> </ol>
	E. Connector/Jack pin bent	<ol style="list-style-type: none"> <li>1. Describe pin location and condition - Obtain WVS view of interface if possible</li> <li>2. On <b>MCC-H GO</b>: For 16, 20, or 22 gauge pins only, retrieve pin straightener and attempt pin repair</li> <li>3. On <b>MCC-H GO</b>: Retrieve needle nose pliers and attempt pin repair - <b>MCC-H</b> will verify pin size prior to retrieving tools</li> </ol>
	F. Connector/Jack FOD	On <b>MCC-H GO</b> : Obtain connector cleaner tool to remove FOD
	G. Connector EMI band bent	On <b>MCC-H GO</b> : Obtain needle nose pliers or forceps to remove band
<b>CETA Cart</b>		
	A. Wheel bogie fails to release from truss	<ol style="list-style-type: none"> <li>1. Verify brakes are fully released</li> <li>2. Ensure trigger is being depressed while attempting to rotate handle</li> <li>3. On <b>MCC-H GO</b>: Perform {6.100.125 CETA Cart Wheel Bogie R&amp;R} - There is no spare wheel bogie on-orbit, so after the CETA cart is relocated the failed wheel bogie will be reinstalled</li> </ol>
	B. Wheel bogie fails to install on truss	There is no spare wheel bogie on-orbit. 4 of 4 bogies are required. Real time call on whether MT couple or CETA cart tiedown required. For tiedown see block G
	C. Parking brake fails to engage	<ol style="list-style-type: none"> <li>1. Use parking brake handle on other side of CETA cart</li> <li>2. Couple CETA cart to MT and utilize other WIF if possible</li> </ol>
	D. Parking brake fails to disengage	<ol style="list-style-type: none"> <li>1. Hold pedal down for brake release</li> <li>2. Use pedal on other side of CETA cart to release parking brake</li> </ol>
	E. Dynamic brake fails to engage	Limit translation rates to allow manual stopping
	F. CETA active coupler fails to capture or lock	<ol style="list-style-type: none"> <li>1. Cycle active coupler</li> <li>2. On <b>MCC-H GO</b>: Swap active couplers. (Port CETA Cart has short coupler)</li> <li>3. On <b>MCC-H GO</b>: Tie down CETA cart. See block G</li> </ol>

## STS-133/ULF5 WORKAROUNDS CRIBSHEET (Cont)

### Generic Contingencies (Cont)

TASK	FAILURE	ACTION
	G. CETA cart tiedown	<p>On <b>MCC-H GO</b>: Perform the following tie-down procedure (see figure 1)</p> <ol style="list-style-type: none"> <li>a. Translate CETA cart to TBD location (not over truss segment joint)</li> <li>b. Engage parking brake</li> <li>c. Retrieve 2 Long Duration TieDown (LDTD) tethers from P6 AUX Bag (fwd face of Z1)</li> <li>d. Route 1 LDTD tether on stbd side of CETA cart as follows:               <ol style="list-style-type: none"> <li>1. Attach 1 hook to zenith brake handle support tether point</li> <li>2. Loop tether strap around CETA rail HR standoff</li> <li>3. Attach second hook to nadir brake handle support tether point</li> <li>4. Lightly cinch tether and close buckle</li> <li>5. Close MLI flap over buckle and any excess strap</li> </ol> </li> <li>e. Repeat on port side of CETA cart</li> </ol>
	H. Coupler knob fails to unlock	<ol style="list-style-type: none"> <li>1. On <b>MCC-H GO</b>: Release active coupler by removing wire ties (2) (reinstall of wire ties not required) and PIP pins (2)</li> <li>2. On <b>MCC-H GO</b>: Release passive coupler via EVA bolt:  <b>PGT: [B7 (25.5), CCW2, 30.5], 7/16-6-ext</b>            9 turns            - Bolt is attached by lanyard</li> </ol>
	I. Swing arm fails to deploy	Use alternate swing arm or WIF
	J. Swing arm fails to stow	On <b>MCC-H GO</b> : Remove swing arm via EVA bolts (4): <b>PGT: [B7 (25.5), CCW2, 30.5], 7/16-6-ext</b>
	K. Swing arm fails to lock	Restrain in stowed position with wire ties



**STS-133/ULF5 WORKAROUNDS CRIBSHEET (Cont)**

**Generic Contingencies (Cont)**

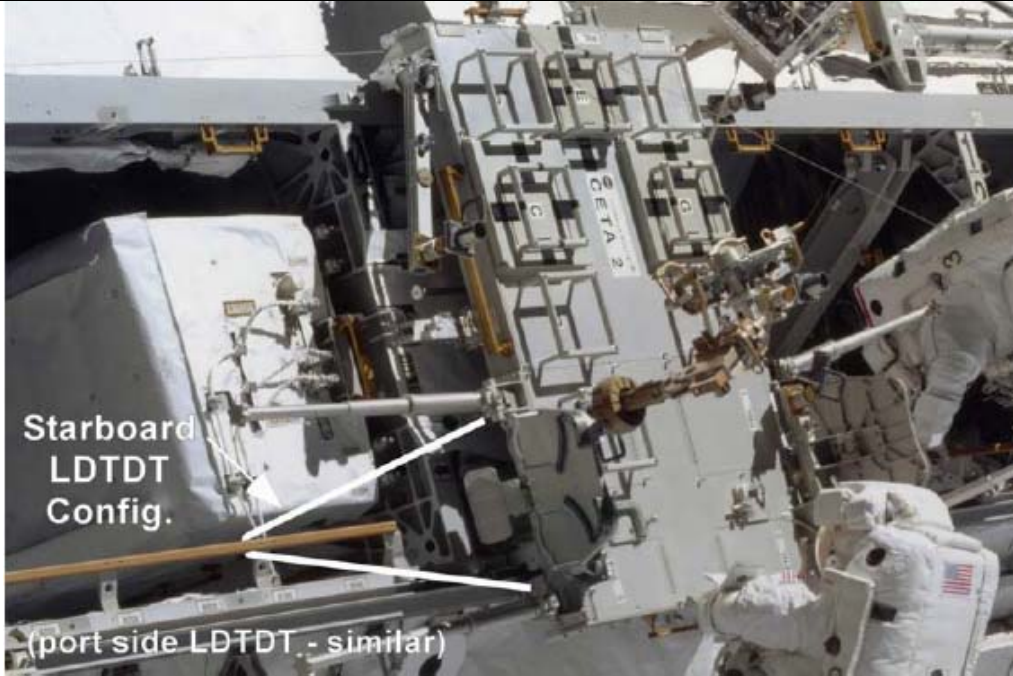
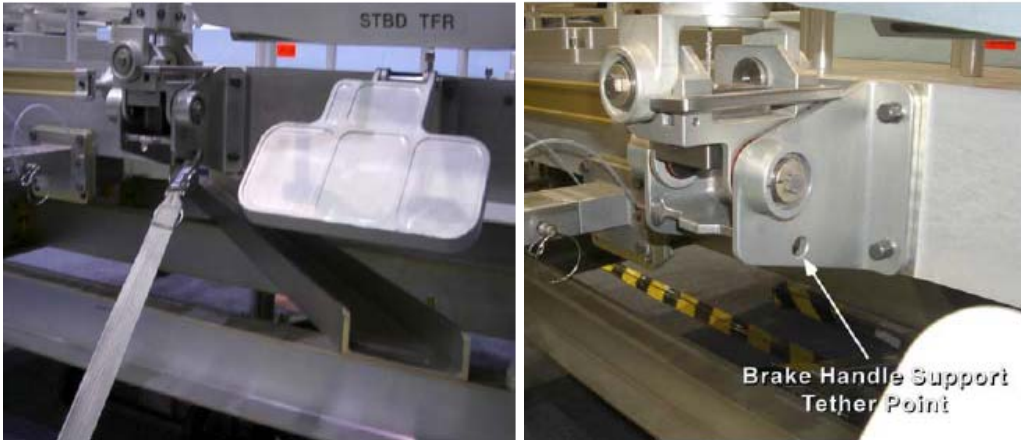
TASK	FAILURE	ACTION
	 <p>Starboard LDTDT Config. (port side LDTDT - similar)</p>	 <p>STBD TFR</p> <p>Brake Handle Support Tether Point</p> <p>Figure 1 - CETA Cart Tiedown</p>

## STS-133/ULF5 WORKAROUNDS CRIBSHEET (Cont)

### Generic Contingencies (Cont)

TASK	FAILURE	ACTION
	<b>EVA Wrench (Torque &amp; Ratchet)</b>	
	A. Ratchet teeth slip	Ratchet to new set of teeth and reapply torque
	B. Wrench does not ratchet	Hold the ratchet selector and socket in opposite hands and rotate in opposite directions
	<b>Expandable Diameter Fasteners (EDFs)</b>	
	A. EDF does not release with recommended torque	<ol style="list-style-type: none"> <li>1. Increase torque to <b>PGT: [B7 (25.5), CCW2, 30.5]</b> for one turn only. Continue release at nominal setting</li> <li>2. Increase torque to <b>PGT: [RCCW, 30.5]</b> for one turn only. Continue release at nominal setting</li> <li>3. Use Ratchet Wrench (ccw)</li> <li>4. Remove EDF with prybar (only if head not free spinning)</li> </ol>
	B. EDF cannot be removed from lug/clevis after untorqued	<ol style="list-style-type: none"> <li>1. Twist outer washer (lanyard washer) back and forth while pulling outward</li> <li>2. Verify lanyard not snagged</li> <li>3. Drive EDF ccw 2 turns (start EDF by hand when re-installing)</li> <li>4. Gently tap along EDF major axis with back of equipment hook or hammer (EDF head must not be free spinning), and pull outward with lanyards</li> <li>5. Use equipment hook over EDF bolt head to remove. (EDF head must not be free spinning)</li> <li>6. Use EVA prybar (EDF head must not be free spinning)</li> </ol>
	C. Cannot insert EDF into lug/clevis interface	<ol style="list-style-type: none"> <li>1. Verify lug/clevis fully seated</li> <li>2. Twist EDF bolt head by hand to seat on tip hex head</li> <li>3. Drive EDF 2 addl turns ccw, retry insertion, verify head not free spinning</li> <li>4. Remove EDF and verify collets not expanded</li> <li>5. Cut EDF lanyards and replace failed EDF with spare EDF</li> </ol>
	D. EDF is not captive after all EDFs at final torque	<ol style="list-style-type: none"> <li>1. Increase torque to <b>PGT: [B7 (25.5), CW2, 30.5]</b>, ensure fully seated</li> <li>2. Increase torque to <b>PGT: [RCW, 30.5]</b>, ensure fully seated</li> <li>3. Pull EDF and re-insert (loosen collets as reqd), ensure fully seated, retry</li> <li>4. Increase torque on all EDFs to <b>PGT: [RCW, 30.5]</b>, ensure fully seated</li> <li>5. Cut EDF lanyards and replace failed EDF with spare EDF</li> </ol>
	<b>Fluid QD Ops</b>	
	<b>NOTE</b>	
	<p>Troubleshooting steps outlined in this cribsheet are a generic starting point. Flight specific situations may require different actions.</p> <p>If troubleshooting requires the crew to leave the worksite, verify that female QDs are covered to prevent exposure to direct sunlight. For thermal clocks refer to Flight Rules</p>	

## STS-133/ULF5 WORKAROUNDS CRIBSHEET (Cont)

### Generic Contingencies (Cont)

TASK	FAILURE	ACTION
	<b>Mating Ops</b>	
	A. QD fails to mate	<ol style="list-style-type: none"> <li>1. Check alignment and verify side loads are counteracted</li> <li>2. Verify fwd white band is not visible (release ring is retracted)</li> <li>3. Inspect male and female QD for debris, damage, or NH3</li> <li>4. Leave female QD engaged with male. (NH3 may sublimate between QDs)</li> <li>5. Change body orientation for better access</li> </ol>
	B. Release ring snap back test fails	<ol style="list-style-type: none"> <li>1. Push release ring forward. (Release ring will not slide fwd if QD is in FID)</li> <li>2. QD is in FID               <ol style="list-style-type: none"> <li>a. Demate QD</li> <li>b. Pull back on release ring</li> <li>c. Verify fwd white band not visible</li> <li>d. Remate QD</li> </ol> </li> </ol>
	C. Gap check fails (visual or FID gauge)	Demate and Remate QD <ol style="list-style-type: none"> <li>a. Retract release ring</li> <li>b. Demate QD</li> <li>c. Verify fwd white band not visible</li> <li>d. Remate QD</li> </ol>
	D. Pull test fails	<ol style="list-style-type: none"> <li>1. Verify fwd white band is not visible (release ring is retracted)</li> <li>2. Assess and counteract sideloads and mate QD</li> </ol>
	<b>Valve Ops</b>	
	A. Detent button is partially unthreaded	Rethread detent button <ol style="list-style-type: none"> <li>a. Load bail handle. (Button will free spin if not loaded)               <ul style="list-style-type: none"> <li>- If valve is open, pull bail handle aft</li> <li>- If valve is closed, push bail handle fwd</li> </ul> </li> <li>b. Rotate button cw (8 turns max)</li> </ol>
	B. Detent button is missing  <u>NOTE</u> Detent button is only required for BDT ops and 1 in SPD ops	<ol style="list-style-type: none"> <li>1. Use equipment hook to depress detent button shaft</li> <li>2. Or, use tether strap around gloved finger to depress detent button shaft</li> <li>3. Or, retrieve and use Beta Gimbal Antirotation Latch Tool to depress detent button shaft</li> <li>4. On <b>MCC-H GO</b>: Install spare detent button. (Buttons are stowed IVA and must be configured prior to EVA use)</li> </ol>
	C. Bail fails to travel to fwd (valve open) position (button does not pop up if attempting to go to full fwd)	<ol style="list-style-type: none"> <li>1. Neutralize sideloads</li> <li>2. If NO joy: Apply greater opening force to QD bail handle</li> <li>3. If NO joy: Retrieve and use QD bail drive lever (3/4, 1, &amp; 1-1/2 in only)</li> <li>4. If applicable, retrieve and install SPD; notify <b>MCC-H</b></li> </ol>

# STS-133/ULF5 WORKAROUNDS CRIBSHEET (Cont)

## Generic Contingencies (Cont)

TASK	FAILURE	ACTION
	<p>D. Detent button fails to depress during valve closing</p> <div style="border: 1px solid black; padding: 5px; width: fit-content; margin: 10px auto;"> <p style="text-align: center;"><b>WARNING</b></p> <p>Bail may kick back and contact crew when button is depressed if a leaking primary seal allowed pressure build-up in spring cavity</p> </div>	<ol style="list-style-type: none"> <li>1. Verify locking collar unlocked (1/2, 3/4, &amp; 1 in only)</li> <li>2. Push and hold bail handle fwd (to open) with significant force to relieve load on button while simultaneously depressing the detent button - If button depresses, vent by pulling bail aft until aft white band no longer visible</li> <li>3. If NO joy: Rock QD from side-to-side and up/down while depressing button</li> <li>4. If NO joy: Retrieve QD bail drive lever and repeat step 2 (3/4, 1, &amp; 1-1/2 in only)</li> <li>5. If NO joy: Contact <b>MCC</b> to reduce NH3 pressure, if possible</li> <li>6. If NO joy: On <b>MCC-H GO</b>: Retrieve and install QD button depress tool (BDT) (1/4, 3/4, &amp; 1 in only)</li> <li>7. If NO joy: On <b>MCC-H GO</b>: Retrieve hammer and tap center of button. (Use plastic side of hammer.) (Inspect tool and QD)</li> </ol>
	<p>E. Bail fails to travel to full aft (valve closed) position (button does not pop up)</p>	<ol style="list-style-type: none"> <li>1. Neutralize possible side loading</li> <li>2. Increase force on bail</li> <li>3. If NO joy: Retrieve and use QD bail drive lever (3/4, 1, &amp; 1-1/2 in only)</li> <li>4. If NO joy: Inspect QD for retaining wire protrusion</li> </ol>
<b>Demating Ops</b>		
	<p>A. Female QD fails to demate</p>	<ol style="list-style-type: none"> <li>1. Neutralize sideloads or manipulate flexhose to relieve mating forces on female QD</li> <li>2. If NO joy: Verify release ring is fully retracted while attempting to demate</li> <li>3. If NO joy: Verify TA or P clamps are released</li> <li>4. If NO joy: Verify detent button is up. (Locking collar can be rotated under button)</li> <li>5. If NO joy: Verify trigger linkage is still attached to release ring (1-1/2 in only)</li> <li>6. If NO joy: Apply greater force to release ring and female QD</li> <li>7. If NO joy: Retrieve and use QD release tool (QRT) to apply greater force; (3/4, 1, &amp; 1-1/2 in only)</li> <li>8. If NO joy: Shake QD vigorously while attempting to demate</li> </ol>
	<p>B. Thermal bootie fails to remain securely closed</p>	<p>Install wire tie around bootie to keep QD fully covered</p>
	<p>C. Cap will not demate</p>	<ol style="list-style-type: none"> <li>1. Verify pulling out on cap before rotating to ensure locking tab is disengaged</li> <li>2. If NO joy: Wait for opposite thermal conditions if possible and reattempt cap removal</li> <li>3. If NO joy: Retrieve QD cap tool (1/4, 1/2, &amp; 1 in only) <ol style="list-style-type: none"> <li>a. <b>PGT: [A4 (6.3), CCW1, 30.5]</b> with QD cap tool to turn stuck cap a maximum of 2 turns (cap vents at ~2 turns)</li> <li>b. Once venting is complete, finish removal of cap by hand (~1 additional turn) <ul style="list-style-type: none"> <li>- If venting does not stop or cap cannot be removed by hand, notify <b>MCC-H</b>. (Male QD may be leaking)</li> </ul> </li> </ol> </li> </ol>

## STS-133/ULF5 WORKAROUNDS CRIBSHEET (Cont)

### Generic Contingencies (Cont)

TASK	FAILURE	ACTION
	D. Partial fwd white band visible after QD demate	<ol style="list-style-type: none"> <li>1. Pull back on release ring to verify QD is not in FID</li> <li>2. Verify detent button is up</li> <li>3. If fwd white band is still partially visible this is likely a tolerance stackup and has been seen before; notify <b>MCC-H</b> and press with QD ops</li> </ol>
	<b>Leaks</b>	
		<p style="text-align: center;"><u>CAUTION</u></p> <p>Do not fully open a leaking QD. Fully opening a leaking QD could trap NH3 and prevent future valve closure. For 1.5 in QDs, insert fwd SPD spacer prior to opening valve</p>
	A. Mated QD leaks in valve open position (bail fwd)	<ol style="list-style-type: none"> <li>1. Remove SPD if present (aft spacer only for 1-1/2 in) and fully close valve (bail aft)</li> <li>2. Open valve (bail fwd). (For 1-1/2, install SPD prior to fully opening valve)</li> <li>3. If NO joy: Repeat steps 1 and 2</li> <li>4. If NO joy, on <b>MCC-H GO</b>: Remove SPD, push bail full fwd to engage secondary seal, verify detent button is up and aft white line is visible</li> <li>5. If NO joy: Close valve; notify <b>MCC-H</b></li> <li>6. If applicable, close valve of appropriate QD in flowpath, verify detent button is up, and fwd white line is visible</li> </ol>
	B. Male QD leaks after cap removal	<ol style="list-style-type: none"> <li>1. If crystals minimal and dissipating; continue</li> <li>2. Else: Reinstall cap; notify <b>MCC-H</b></li> </ol>
	C. Female QD leaks due to FID	<ol style="list-style-type: none"> <li>1. Return bail to aft position (valve closed)</li> <li>2. Perform release ring snap back test               <ul style="list-style-type: none"> <li>- If FID is observed, demate and remate QD</li> <li>- If no FID, neutralize sideloads and cycle bail to fwd position (valve open). (For 1/2 and 1-1/2, install SPD prior to fully opening valve)</li> </ul> </li> </ol>
	D. QD leaks during valve close operation  <div style="border: 2px solid black; padding: 5px; width: fit-content; margin: 10px auto;"> <p style="text-align: center;"><u>WARNING</u></p> <p>Bail may kick back and contact crew when button is depressed if a leaking primary seal allowed pressure build-up in spring cavity</p> </div>	<ol style="list-style-type: none"> <li>1. Open valve (bail fwd). (For 1/2 and 1-1/2, install SPD prior to fully opening valve)</li> <li>2. Contact <b>MCC-H</b>; quantify leak</li> <li>3. On <b>MCC-H GO</b>, re-close QD; inform <b>MCC-H</b> if leak still present and quantify leak</li> <li>4. If still leaking, contact <b>MCC-H</b> to determine if male leaking. (THOR will monitor pressure drop)</li> <li>5. On <b>MCC-H GO</b>, demate QD and inspect</li> <li>6. If still leaking, contact <b>MCC-H</b> for direction</li> </ol>
	E. Female QD leaks after demate	<ol style="list-style-type: none"> <li>1. Contact <b>MCC-H</b>; quantify leak</li> <li>2. On <b>MCC-H GO</b>: Fully mate to destination male as quickly as possible</li> </ol>

## STS-133/ULF5 WORKAROUNDS CRIBSHEET (Cont)

### Generic Contingencies (Cont)

TASK	FAILURE	ACTION
	F. Male QD leaks after demate (male sleeve may be visibly stuck open)	<ol style="list-style-type: none"> <li>Contact <b>MCC-H</b>; quantify leak</li> <li>If leak is small and does not interfere with EVA: Press with operations on <b>MCC-H GO</b></li> <li>If leak is large: Remate female QD and open valve (bail fwd). (For 1/2 and 1-1/2, install SPD prior to fully opening valve) <ol style="list-style-type: none"> <li>Depress button and use significant force to push bail forward; release button</li> <li>With QD in open position (bail fwd) apply significant force to aft end of the female QD in back and forth, up and down directions</li> <li>Attempt to close valve (bail aft)</li> <li>Demate QD and inspect</li> </ol> </li> <li>If applicable, close valve of appropriate QD in flowpath, verify detent button is up, and fwd white line is visible</li> <li>On <b>MCC-H GO</b>: Install cap</li> </ol>
	G. Frozen NH3 present on female or male QD	<ol style="list-style-type: none"> <li>Leave QD exposed to vacuum; wait maximum of 5 min for sublimation (check periodically)</li> <li>On <b>MCC-H GO</b>: Continue QD ops. (NH3 may sublimate during QD mating)</li> </ol>
<b>SPD</b>		
A.	1/2-in SPD cannot be installed	<ol style="list-style-type: none"> <li>If aft portion of SPD not fully seated, move bail fwd slightly to allow SPD to fully seat</li> <li>After bail secured in slot on slider, wire tie in place</li> </ol>
B.	1/2-in SPD cannot be removed	1/2-in SPD sliders can be sticky. Increase force on SPD slider
C.	1.5-in aft SPD spacer cannot be installed	<ol style="list-style-type: none"> <li>Install fwd SPD spacer; ensure bail against fwd SPD</li> <li>Wire tie bail to keep it against SPD; restrain aft SPD with wire tie, if reqd</li> </ol>
D.	1.5-in fwd SPD spacer cannot be installed	<ol style="list-style-type: none"> <li>Install aft SPD spacer; ensure bail against aft SPD</li> <li>Wire tie bail to keep it against SPD; restrain fwd SPD with wire tie, if reqd</li> </ol>
<b>Vent Tool</b>		
A.	Tip of vent tool does not pass black mark during alignment check	Slide the equipment hook further away from vent tool nozzle end
B.	Vent tool cannot be mated to Vent Tool Extender	Hold VTE adapter in sunlight to warm it up (known tolerance issue between cold VTE adapter and vent tool nozzle)

## STS-133/ULF5 WORKAROUNDS CRIBSHEET (Cont)

### Generic Contingencies (Cont)

TASK	FAILURE	ACTION
<p><b><u>Mate QD</u></b></p> <ol style="list-style-type: none"> <li>1. Remove QD caps as required</li> <li>2. Inspect male and female QD for debris or damage</li> <li>3. Verify female QD ready to mate               <ul style="list-style-type: none"> <li>√Detent button – up</li> <li>√Locking collar – locked position</li> <li>√Fwd white band – not visible</li> </ul> </li> <li>4. Assess and relieve side loads prior to mate</li> <li>5. Mate QD               <ul style="list-style-type: none"> <li>√Fwd white band – visible</li> </ul> </li> <li>6. Perform snapback test               <ul style="list-style-type: none"> <li>√Fwd white band visible</li> </ul> </li> <li>7. Perform pull test. (Stay clear of button and release ring)</li> <li>8. Perform visual gap test</li> </ol>		<p><b><u>Demate QD</u></b></p> <ol style="list-style-type: none"> <li>1. Assess and relieve side loads prior to demate</li> <li>2. Pull back on release ring and demate QD</li> <li>3. √Release ring – retracted (FWD white band not visible)</li> <li>4. Inspect male and female QD for debris, damage, or anomalous conditions (ammonia crystals)</li> <li>5. If complete with QD ops: Rotate locking collar to locked position (1/2, 3/4, &amp; 1 in only)</li> <li>6. Install QD caps as required; verify lock tab engaged</li> </ol>
<p><b><u>Open Valve (1/4 inch)</u></b></p> <ol style="list-style-type: none"> <li>1. Prior and during bail movement relieve and react high forces (side loads)</li> <li>2. Depress detent button</li> <li>3. Push bail to forward position</li> <li>4. √Aft white band visible</li> <li>5. √Detent button – up</li> </ol>		<p><b><u>Close Valve</u></b></p> <ol style="list-style-type: none"> <li>1. If present, remove SPD</li> <li>2. Rotate locking collar to unlocked position (1/2, 3/4, &amp; 1 in only)</li> <li>3. Push bail toward open position with significant force while depressing detent button (unstick male sleeve seals)</li> <li>4. √Aft white band visible</li> <li>5. √Detent button fully installed</li> <li>6. √Detent button up</li> <li>7. √Detent button can be depressed</li> <li>8. Prior and during bail movement relieve and react high forces (side loads)</li> <li>9. Depress detent button, move bail aft (close valve)</li> <li>10. √Fwd white band visible</li> <li>11. √Detent button up</li> <li>12. If complete with QD ops: Rotate locking collar to locked position (1/2, 3/4, &amp; 1 in only)</li> </ol>
<p><b><u>Open Valve (1/2 inch)</u></b></p> <ol style="list-style-type: none"> <li>1. Prior and during bail movement relieve and react high forces (side loads)</li> <li>2. Rotate locking collar to unlocked position</li> <li>3. Depress detent button</li> <li>4. Push bail fwd, so aft white band just begins to show</li> <li>5. Pull lock knob up on SPD</li> <li>6. Slide slider aft</li> <li>7. Install SPD</li> <li>8. Slide slider fwd to engage bail handle</li> <li>9. Push bail toward closed position up against slider</li> <li>10. Push lock knob down on SPD</li> </ol>		<p><b><u>Open Valve (3/4 inch)</u></b></p> <ol style="list-style-type: none"> <li>1. Prior and during bail movement relieve and react high forces (side loads)</li> <li>2. Rotate locking collar to unlocked position</li> <li>3. Depress detent button</li> <li>4. Push bail to forward position</li> <li>5. √Aft white band visible</li> <li>6. √Detent button – up</li> <li>7. Rotate locking collar to locked position</li> </ol>
<p><b><u>Open Valve (1 inch)</u></b></p> <ol style="list-style-type: none"> <li>1. Prior and during bail movement relieve and react high forces (side loads)</li> <li>2. Rotate locking collar to unlocked position</li> <li>3. Depress detent button</li> <li>4. Push bail to forward position</li> <li>5. √Aft white band visible</li> <li>6. √Detent button – up</li> <li>7. Install 1 in SPD if present; verify locking tabs engage; perform pull test</li> <li>8. Rotate locking collar to locked position, if present and no SPD</li> </ol>		<p><b><u>Open Valve (1-1/2 inch)</u></b></p> <ol style="list-style-type: none"> <li>1. Install forward SPD spacer aft of release ring</li> <li>2. Prior and during bail movement relieve and react high forces (side loads)</li> <li>3. Depress detent button</li> <li>4. Push bail against fwd SPD spacer</li> <li>5. Install aft SPD spacer</li> </ol>

# STS-133/ULF5 WORKAROUNDS CRIBSHEET (Cont)

## Generic Contingencies (Cont)

TASK	FAILURE	ACTION
	<b>MMOD Shield</b>	
	A. MMOD shield Dzus fastener fails to release  <div style="border: 2px solid black; padding: 5px; width: fit-content; margin: 10px auto;"> <p style="text-align: center; margin: 0;"><b>WARNING</b></p> <p style="margin: 0;">Do not touch back side of MMOD shield or handle fastener fragments due to sharp edges</p> <p style="margin: 0;">Fastener and shield/tool interface must be covered to avoid potential projectiles</p> </div>	<ol style="list-style-type: none"> <li>1. On <b>MCC-H GO</b>: Retrieve pry bar and emptied med ORU bag</li> <li>2. Release other Dzus fasteners</li> <li>3. Assess clearance between MMOD shield and tools</li> <li>4. If possible, rotate fastener to position tangs off of tools</li> <li>5. Place med ORU bag over failed fastener</li> <li>6. Insert pry bar under MMOD shield by failed fastener and pry shield away from structure</li> </ol>
	B. MMOD shield Dzus fastener fails to engage	<ol style="list-style-type: none"> <li>1. Verify center fastener is engaged first</li> <li>2. Check Dzus fastener aligned with bracket (floating receptacles on endcones)</li> <li>3. Verify fastener clocking correct per alignment mark</li> <li>4. Push firmly and rotate</li> <li>5. Engage other fasteners: 2 out of 3 required</li> <li>6. If 2 of 3 not achieved:                             <ul style="list-style-type: none"> <li>- Option 1 (Wire Tie) (See figures 2-4): 1 properly secured wire tie = 1 Dzus fastener; using a long wire tie, squish the loop on one end, feed it through the bracket on structure (may need to push floating receptacle inboard to get it out of way), secure wire tie w/3 twists. Feed one end of wire tie around Dzus head (on outside of shield) and secure with 3 twists. If HR nearby can also secure wire tie to HR. (Goal is for the wire tie to push shield in toward body of structure and toward center if endcone shield)</li> <li>- Option 2 (LDTDT): Use 1 adj (attach to tether point on T tool and to structure HR) and 1 LDTDT across shield to hold shield in position</li> </ul> </li> </ol>
	C. T-handle tool fails to engage shield	Remove adjacent fasteners and attempt reinstallation
	D. MLI grounding strap Dzus fails to release	On <b>MCC-H GO</b> : Cut ground wire near Dzus fastener



# STS-133/ULF5 WORKAROUNDS CRIBSHEET (Cont)

## Generic Contingencies (Cont)

TASK	FAILURE	ACTION
		<p data-bbox="1214 348 1429 499">Will "squish" loop together a little Pre-EVA for easier access through nutplate</p> <p data-bbox="1175 653 1429 737">Floating receptacle shifted toward center of Shield</p> <p data-bbox="1138 905 1429 989">Wire tie inserted thru "Window" on receptacle bracket</p> <div data-bbox="618 1570 1214 1625" style="border: 1px solid black; padding: 5px; text-align: center;">Figure 2 - MMOD Shield Wire Tie Option</div>

# STS-133/ULF5 WORKAROUNDS CRIBSHEET (Cont)

## Generic Contingencies (Cont)

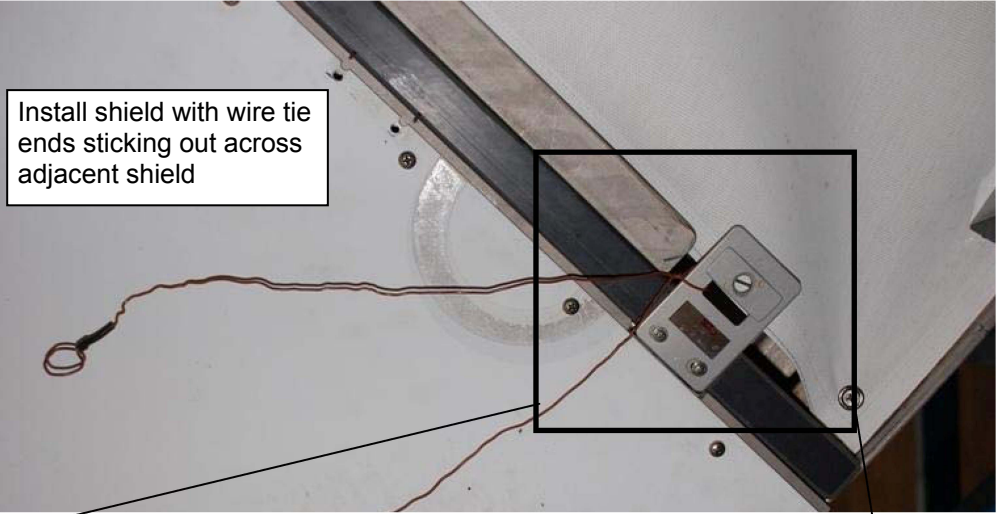
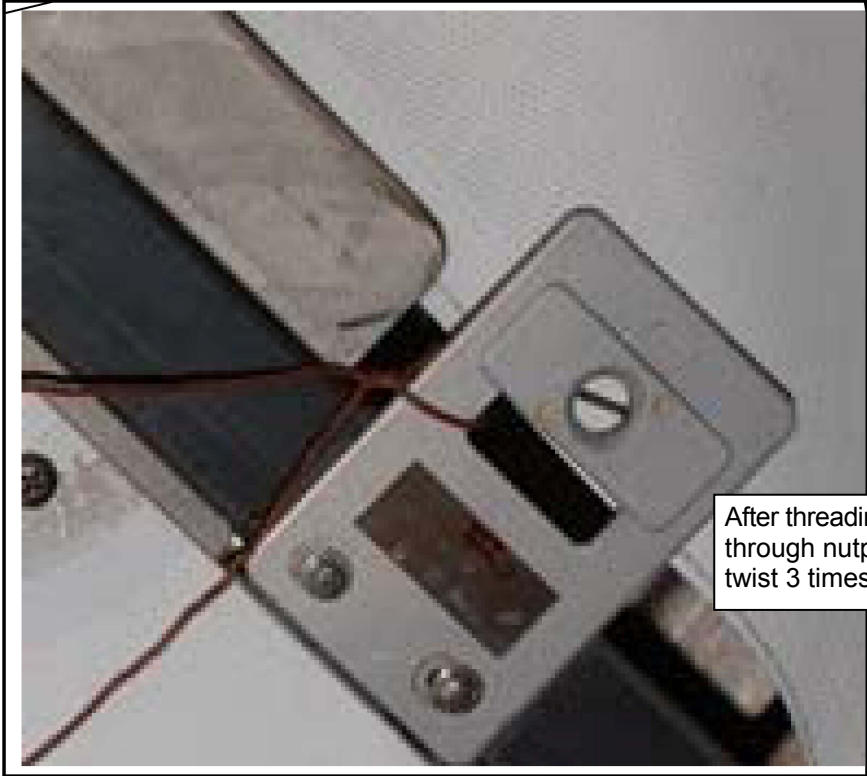
TASK	FAILURE	ACTION
	 <p data-bbox="415 344 732 457">Install shield with wire tie ends sticking out across adjacent shield</p>	 <p data-bbox="1125 1262 1414 1375">After threading wire tie through nutplate; twist 3 times</p> <p data-bbox="618 1583 1216 1640">Figure 3 - MMOD Shield Wire Tie Option (Cont)</p>

# STS-133/ULF5 WORKAROUNDS CRIBSHEET (Cont)

## Generic Contingencies (Cont)

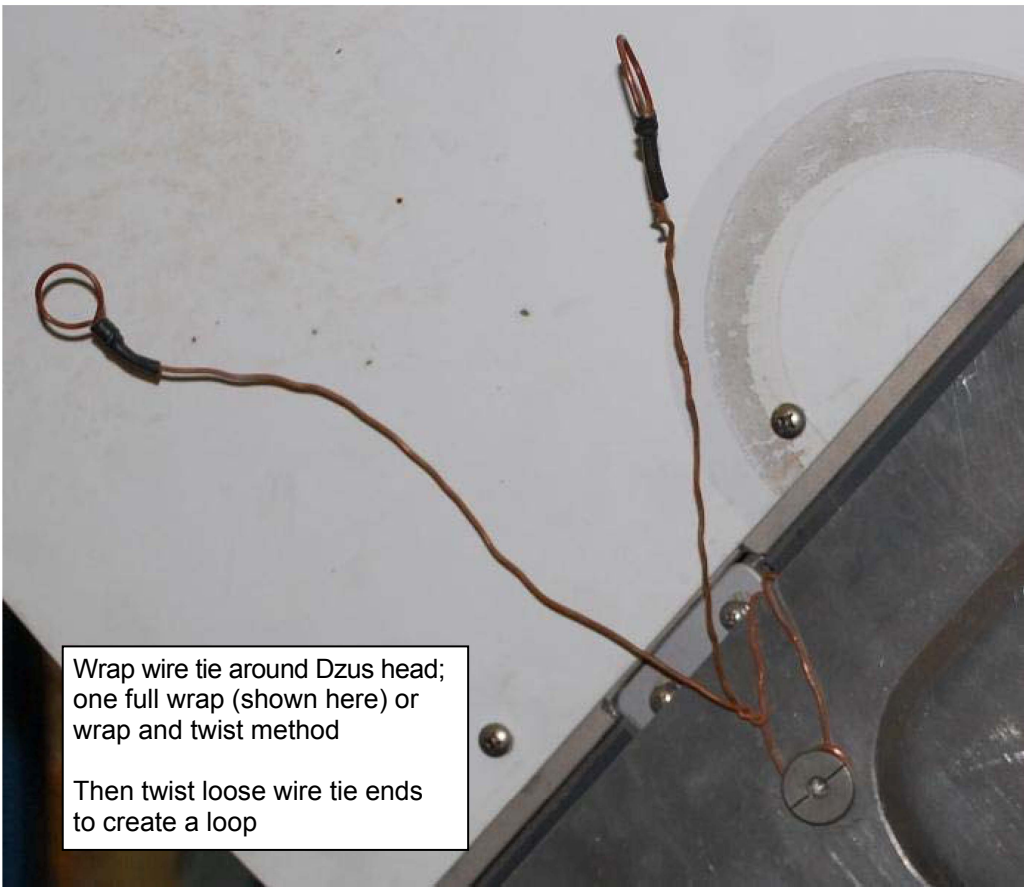
TASK	FAILURE	ACTION
<div style="text-align: center;">  <p data-bbox="472 890 867 1087">Wrap wire tie around Dzus head; one full wrap (shown here) or wrap and twist method Then twist loose wire tie ends to create a loop</p> <p data-bbox="618 1163 1214 1220">Figure 4 - MMOD Shield Wire Tie Option (Cont)</p> </div>		
<b>MUT EE</b>		
A. MUT EE jaws fail to release	<ol style="list-style-type: none"> <li>1. Verify locking collar fully released</li> <li>2. Shake MUT EE while depressing paddles to alleviate sideloads from handrail</li> <li>3. Release MUT EE ECOM socket and tether MUT EE to structure</li> </ol>	
<b>MWS</b>		
A. MWS EE is sticky	Known problem. Report degree of stickiness to <b>MCC-H</b> and any noted correlation with thermal environment. Post EVA, report s/n of affected unit (s/n located on "stem" of T-bar)	
B. MWS EE cord fails to retract	<ol style="list-style-type: none"> <li>1. Verify MWS EE tether lock in unlock position</li> <li>2. Cycle MWS EE tether lock</li> <li>3. Check tether reel opening for FOD</li> <li>4. Pull out small amount of tether and allow reel to retract while holding light tension on the tether</li> </ol>	
C. MWS T-bar fails to pivot	<ol style="list-style-type: none"> <li>1. Check sideloads on T-bar while depressing button</li> <li>2. Slip T-bar clutch (40-60 lb force required)</li> </ol>	

## STS-133/ULF5 WORKAROUNDS CRIBSHEET (Cont)

### Generic Contingencies (Cont)

TASK	FAILURE	ACTION
	<b>NZGL Connectors</b>	
	A. Bail bar fails to slide over-center	<ol style="list-style-type: none"> <li>1. Inspect bail for FOD</li> <li>2. Inspect bail linkage for damage and report to <b>MCC-H</b></li> <li>3. Check alignment and sideloads</li> <li>4. Verify sufficient TA-clamps are open</li> <li>5. Increase force on bail</li> <li>6. Attach 2 hooks from adj tether to connector bail and use adj strap to pull bail into demated position</li> <li>7. On <b>MCC-H GO</b>: Retrieve vise grips to help increase force on bail</li> </ol>
	B. Backshell fails to slide (after over-center mechanism has been overcome)	<ol style="list-style-type: none"> <li>1. Verify sufficient TA-clamps are open</li> <li>2. Check for cable harness and hardware interference</li> <li>3. Check alignment and sideloads</li> <li>4. Inspect bail and connector for FOD</li> <li>5. Inspect bail linkage for damage and report to <b>MCC-H</b></li> <li>6. Wiggle/jiggle connector while pushing or pulling on backshell</li> <li>7. Attach 2 hooks from adj tether to connector bail and use adj strap to pull bail into demated position</li> <li>8. On <b>MCC-H GO</b>: Retrieve vise grips to help increase force on bail</li> </ol>
	C. Connector fails to release from soft dock	<ol style="list-style-type: none"> <li>1. Verify bail fully thrown, undamaged, and backshell fully aft</li> <li>2. If backshell springs forward, pull and hold in fully aft position (will have to overcome spring force, approx 5-10 lb) while attempting to demate connector</li> <li>3. Verify sufficient TA-clamps are open</li> <li>4. Check for cable harness and hardware interference</li> <li>5. Check alignment and sideloads</li> <li>6. Relieve compression on connector interface due to cable loads by pulling backshell away from jack</li> <li>7. Push the plug towards the jack to compress the soft dock</li> <li>8. Wiggle/jiggle connector. (Use slight rolling motion)</li> </ol>
	D. Connector fails to soft dock	<ol style="list-style-type: none"> <li>1. Verify correct plug and jack</li> <li>2. Verify bail fully aft</li> <li>3. Verify backshell fully aft and remains fully aft. If backshell not fully aft, pull and hold in fully aft position while attempting to soft dock connector</li> <li>4. Inspect the following: <ul style="list-style-type: none"> <li>- O-ring seal</li> <li>- FOD</li> <li>- Bend radius</li> <li>- Soft dock springs</li> <li>- Connector keying feature</li> </ul> </li> <li>5. Verify alignment (avoid excessive rolling or rocking the plug as this could unseat soft dock springs) <ul style="list-style-type: none"> <li>- Connector should snap into soft dock with little force once half shells are aligned</li> </ul> </li> </ol>

## STS-133/ULF5 WORKAROUNDS CRIBSHEET (Cont)

### Generic Contingencies (Cont)

TASK	FAILURE	ACTION
	E. Connector fails to mate	<ol style="list-style-type: none"> <li>1. Verify half-shells are fully seated on both sides</li> <li>2. Verify cable and backshell free to move (no clamps)</li> <li>3. Push forward on connector backshell while actuating bail</li> <li>4. Detach from soft dock and inspect: <ul style="list-style-type: none"> <li>- Pins</li> <li>- FOD</li> <li>- EMI band</li> <li>- Bend radius</li> <li>- TA clamps</li> <li>- P clamps</li> <li>- Bail linkages and rivets</li> <li>- Soft dock springs</li> <li>- O-ring seal and main joint gasket</li> <li>- Connector keying feature</li> </ul> </li> <li>5. Cycle bail while disconnected (push forward on connector backshell for additional leverage)</li> </ol>
	F. Connector pin bent	<ol style="list-style-type: none"> <li>1. Rotate connector to bail up position and describe pin location and condition <ul style="list-style-type: none"> <li>- Obtain WVS view of interface if possible</li> </ul> </li> <li>2. On <b>MCC-H GO</b>: For 16, 20, or 22 gauge pins only, retrieve pin straightener and attempt pin repair</li> <li>3. On <b>MCC-H GO</b>: Retrieve needle nose pliers and attempt pin repair <ul style="list-style-type: none"> <li>- <b>MCC-H</b> will verify pin size prior to retrieving tools</li> </ul> </li> <li>4. Inspect plug and jack prior to re-mating</li> </ol>
	G. Connector FOD	<ol style="list-style-type: none"> <li>1. On <b>MCC-H GO</b>: Retrieve connector cleaner tool <p style="text-align: center;"><u>NOTE</u></p> <p>One N2 cartridge is already captured in the tool (the other is lanyarded inside the caddy). In order to puncture the cartridge, it must be threaded into the tool until the indicator line passes out of sight under the collar of the tool.</p> <p>Puncture connector cleaner cartridge only when ready to perform actual cleaning.</p> <p>Use entire N2 cartridge prior to reentering airlock</p> </li> <li>2. Attempt cleaning</li> </ol>
	H. Connector EMI band bent	<p>On <b>MCC-H GO</b>: Retrieve needle nose pliers or forceps to remove band</p> <ul style="list-style-type: none"> <li>- Bail may need to be pushed forward while demated to expose EMI band for removal</li> </ul>
	I. Connector bail linkage failure	<ol style="list-style-type: none"> <li>1. On <b>MCC-H GO</b>: Re-attempt connector mate/demate with broken bail <ul style="list-style-type: none"> <li>- Impart load through undamaged side of bail linkage</li> <li>- Assist bail motion with hand on backshell once bail linkage has passed over-center</li> <li>- May take multiple pushes on the bail to mate/demate connector</li> </ul> </li> <li>2. Tether hook or vise grips may be used for additional leverage</li> </ol>

## STS-133/ULF5 WORKAROUNDS CRIBSHEET (Cont)

### Generic Contingencies (Cont)

TASK	FAILURE	ACTION
	J. Connector soft dock spring bent	On <b>MCC-H GO</b> : Retrieve needle nose pliers and remove bent spring
	K. Connector O-ring or main joint gasket seal loose (seal and O-ring required in 1-G only)	1. Remove seal with tether hook 2. On <b>MCC-H GO</b> : Retrieve additional tools to remove seal (ex., wire tie, needle nose pliers, probe, loop pin puller)
	L. Connector cap (Twist) will not release	1. Increase force 2. Use tether hook for additional leverage 3. On <b>MCC-H GO</b> : Attach equip hook to cap tether point and use strap of adj tether to release cap
<b>On-Orbit Installed HR</b>		
	A. HR will not install in seat track or fails to soft dock	1. Verify HR installed in correct direction per arrow on underside of HR 2. Verify HR shoes are completely released and soft dock armed 3. Check for FOD on HR and seat track 4. Verify HR bolt completely released: <b>PGT [A1 (2.5), CCW2, 30.5], 7/16-6-ext</b> 5. If HR in seat track but soft dock will not engage, attempt to drive HR bolts 6. On <b>MCC-H GO</b> : Depending on HR priority, attempt to install 180 out or a different HR at this location
	B. HR bolt fails to fully engage	1. If torqued, remove HR: <b>PGT [A2 (3.8), CCW2, 30.5], 7/16-6-ext</b> - To break torque: <b>PGT [A1 (2.5), CCW2, 30.5], 7/16-6-ext</b> - For removal - Check for FOD on HR and seat track and reinstall using original torque 2. Increase PGT setting: <b>PGT [A3 (4.8), CW2, 30.5], 7/16-6-ext</b> 3. On <b>MCC-H GO</b> : Depending on HR priority, attempt to install 180 out or a different HR at this location
<b>On-Orbit Installed WIF</b>		
	A. WIF fails to soft dock	1. Check for FOD and structural interference, cycle soft dock pins; reattempt installation 2. Verify WIF is co-planar 3. Install a different WIF at this location 4. On <b>MCC-H GO</b> : Attempt installation of WIF in a different location 5. Return WIF inside
<b>PAD</b>		
	A. Release knob fails to rotate open	1. Verify knob in release position. (J-hook not locked) 2. Attempt to rotate knob using ratchet on knob 7/16-in hex stud 3. Release contingency release bar captive bolts (2) <b>PGT [A6 (8.3), CCW2, 30.5], 7/16-6 ext</b> 5 turns (Verify hook released from striker bar)
<b>PGT</b>		
	A. No LEDs	1. Perform LED test 2. Use display torque
	B. LEDs and torque messages do not agree	Use torque message and notify <b>MCC-H</b>
	C. Mode switch breaks	Retrieve spare PGT

## STS-133/ULF5 WORKAROUNDS CRIBSHEET (Cont)

### Generic Contingencies (Cont)

TASK	FAILURE	ACTION
	<b>LCD Messages</b>	
	A. BATTERY HITEMP	<ol style="list-style-type: none"> <li>1. Power off PGT</li> <li>2. If alternate battery available; change battery</li> <li>3. Retrieve spare PGT</li> <li>4. Switch to ratchet mode</li> </ol>
	B. BATTERY LOTEMP (blinking)	<ol style="list-style-type: none"> <li>1. Drive tool with no load to increase battery temperature</li> <li>2. If alternate battery available; power off and change battery</li> <li>3. Retrieve spare PGT</li> <li>4. Power off and switch to ratchet mode</li> </ol>
	C. BATTERY LOVOLT (blinking)	<ol style="list-style-type: none"> <li>1. Continue using tool until unable to deliver sufficient torque</li> <li>2. Retrieve spare PGT</li> <li>3. Power off and switch to ratchet mode</li> </ol>
	D. CAL FAILED	<ol style="list-style-type: none"> <li>1. Press, release trigger to repeat calibration</li> <li>2. Power cycle and calibrate</li> <li>3. Retrieve spare PGT</li> <li>4. Power off and switch to ratchet mode</li> </ol>
	E. COLLAR ERROR	<ol style="list-style-type: none"> <li>1. Cycle torque and speed collars to clear error</li> <li>2. Power cycle and calibrate</li> <li>3. Retrieve spare PGT</li> <li>4. Power off and switch to ratchet mode</li> </ol>
	F. COMPAR ERROR	<ol style="list-style-type: none"> <li>1. Cycle torque collar and A/B mode switch</li> <li>2. Power cycle and calibrate</li> <li>3. Retrieve spare PGT</li> <li>4. Power off and switch to ratchet mode</li> </ol>
	G. EEPROM WR ERR (blinking) HYBRID HITEMP OVER CURR SLFTST FAIL X	<ol style="list-style-type: none"> <li>1. Power cycle and calibrate</li> <li>2. Retrieve spare PGT</li> <li>3. Power off and switch to ratchet mode</li> </ol>
	H. HI TORQ	<ol style="list-style-type: none"> <li>1. Contact <b>MCC-H</b> and report torque (Real time engineering assessment required)</li> <li>2. On <b>MCC-H GO</b>: Power cycle and calibrate</li> <li>3. Retrieve spare PGT</li> <li>4. Power off and switch to ratchet mode</li> </ol>
	I. HICURR	<ol style="list-style-type: none"> <li>1. Reattempt operation - Can be caused by excessive rotation of the PGT body while torquing</li> <li>2. Power cycle and calibrate</li> <li>3. Retrieve spare PGT</li> <li>4. Power off and switch to ratchet mode</li> </ol>
	J. LO TORQ (Expected during bolt release)	<ol style="list-style-type: none"> <li>1. Reattempt operation until desired torque is reached</li> <li>2. Power cycle and calibrate</li> <li>3. Retrieve spare PGT</li> <li>4. Power off and switch to ratchet mode</li> </ol>
	K. LOCURR	<ol style="list-style-type: none"> <li>1. Reattempt operation</li> <li>2. Power cycle and calibrate</li> <li>3. Retrieve spare PGT</li> <li>4. Power off and switch to ratchet mode</li> </ol>
	L. LOG IS FULL (blinking)	<ol style="list-style-type: none"> <li>1. Cycle torque and speed collars to clear message</li> <li>2. Continue operation</li> </ol>
	M. MOTOR HITEMP	<ol style="list-style-type: none"> <li>1. Power off PGT</li> <li>2. Retrieve spare PGT</li> <li>3. Switch to ratchet mode</li> </ol>

## STS-133/ULF5 WORKAROUNDS CRIBSHEET (Cont)

### Generic Contingencies (Cont)

TASK	FAILURE	ACTION
	<b>Safety Tether</b>	
	A. Safety tether fails to retract/tend	<ol style="list-style-type: none"> <li>1. Verify reel is unlocked</li> <li>2. Verify tether reel and/or cable guide (for 85-ft tethers) is clear of FOD</li> <li>3. Pull out small amount of cable and allow reel to retract while holding light tension on the cable</li> <li>4. Tap side of reel housing during retraction</li> <li>5. Report ID # of faulty tether to <b>MCC-H</b> and use alternate safety tether</li> <li>6. Coil safety tether to bring inside</li> <li>7. For 85-ft tether: On <b>MCC-H GO</b>, if coiling tether is not practical, release level wind mechanism bypass on back of safety tether. (Red indicator will show around edge of bypass once released)</li> </ol> <p style="text-align: center;"><b>NOTE</b></p> <p>Once level wind has been released cable guide will likely be frozen in place. This will limit the amount of tether that can be successfully retracted into the tether housing and may require coiling of excess tether.</p> <p>Level wind release will require safety tether be returned for ground servicing.</p> <p>If tether fails to retract due to thermal issue, normal tether function may return after tether brought IVA</p>
	B. Safety tether red stripe showing (any length)	<ol style="list-style-type: none"> <li>1. Use alternate safety tether</li> <li>2. Connect waist tether to ERCM body as alternative load alleviation (Double Tether)</li> <li>3. Inspect "Through" tack stitches. Tether NO-GO until tack stitching inspected. (Reference Crew Tether Inspection procedure) <ol style="list-style-type: none"> <li>a. 1 of 2 stitches is required for tether to be GO for use</li> <li>b. If both "Through" stitches are broken, Safety tether NO-GO for use <ul style="list-style-type: none"> <li>- Report ID # of faulty tether to <b>MCC-H</b></li> <li>- Use alternate safety tether</li> </ul> </li> </ol> </li> </ol>
	C. Crew hook fails	<ol style="list-style-type: none"> <li>1. On load alleviating end: Use waist tether to replace alleviating strap <ul style="list-style-type: none"> <li>- Report ID # of faulty tether to <b>MCC-H</b></li> <li>- Retrieve replacement safety tether</li> </ul> </li> <li>2. On anchor end: Report ID # of faulty tether to <b>MCC-H</b> and use an alternate safety tether</li> </ol>
	<b>Scoops</b>	
	A. Scoop will not release from fitting	<ol style="list-style-type: none"> <li>1. If actuator will not pull back while in locked position, tap actuator with tool to release</li> <li>2. On <b>MCC-H GO</b>: Leave scoop in place</li> <li>3. On <b>MCC-H GO</b>: Remove non-captive contingency screws; 5 turns. Stow in trash bag <b>PGT [A1 (2.5), CCW2, 30.5], 5/32 Allen Drive</b> <ul style="list-style-type: none"> <li>- Square Scoop: 4 screws (figure 5)</li> <li>- Round Scoop: 7 screws (figure 6)</li> </ul> </li> </ol>



**STS-133/ULF5 WORKAROUNDS CRIBSHEET (Cont)**

**Generic Contingencies (Cont)**

TASK	FAILURE	ACTION
		<p data-bbox="760 804 1081 850">Figure 5 - Square Scoop</p> <p data-bbox="760 1581 1081 1627">Figure 6 - Round Scoop</p>

# STS-133/ULF5 WORKAROUNDS CRIBSHEET (Cont)

## Generic Contingencies (Cont)

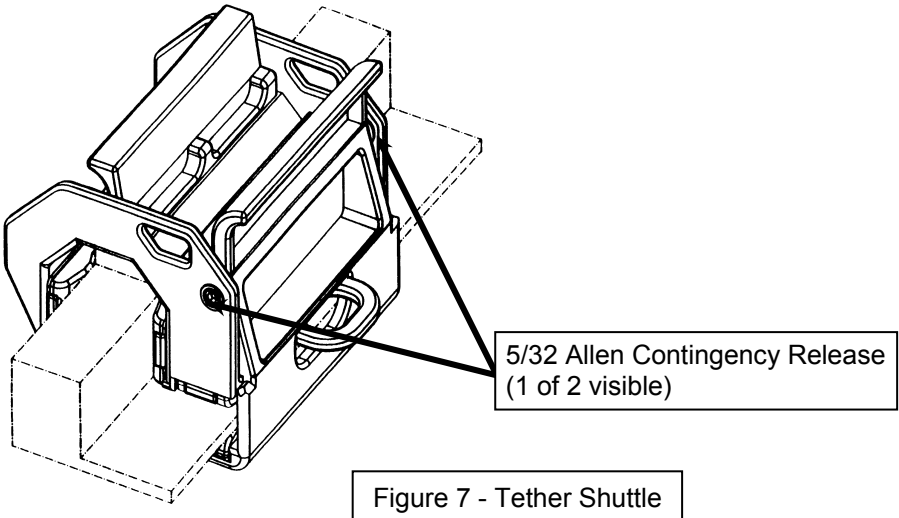
TASK	FAILURE	ACTION
	<b>Socket Caddy</b>	
	A. Socket fails to release from socket caddy	<ol style="list-style-type: none"> <li>1. Verify PIP pin fully inserted into drop proof tether interface on socket</li> <li>2. Reattempt using a different PIP pin</li> </ol>
	<b>TA Clamp</b>	
	A. TA clamp fails to release	<ol style="list-style-type: none"> <li>1. With handle up, press down on top of rounded clamp</li> <li>2. With handle up, use tether hook to pry drawhook from capture pin</li> </ol>
	<b>Tether Shuttle</b>	
	A. Tether shuttle will not release from CETA/MT rail	<ol style="list-style-type: none"> <li>1. Verify slider in unlock and no obstructions to paddle actuation</li> <li>2. Verify safety tethered to structure and safety tether removed from tether shuttle anchor point</li> <li>3. On <b>MCC-H GO</b>: Remove non-captive screws (2) at hingeline to release nadir section with slide lock (not captive) (figure 7). TBD turns. Stow screws in trash bag <b>PGT [A1 (2.5), CCW1, 30.5], 5/32 Allen Drive</b></li> </ol>
		
	<b>Torque Multiplier</b>	
	A. TM will not release from fitting	<ol style="list-style-type: none"> <li>1. Place TM anti-backlash in neutral, if unable: <b>PGT [RCW, 30.5]</b> - Apply cw torque while pushing anti-backlash button to neutral. Reattempt removal</li> <li>2. If able to lift TM off of bolt, attempt to rock off of fitting (Square TM only)</li> <li>3. On <b>MCC-H GO</b>: Release TM contingency release band pin 20 turns (do not exceed 28 turns) (figure 8): <b>PGT [A1 (2.5), CCW2, 30.5], 5/32 ball end driver</b> - When band springs open, remove TM</li> </ol>

# STS-133/ULF5 WORKAROUNDS CRIBSHEET (Cont)



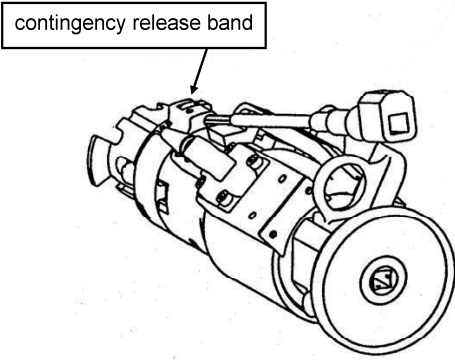
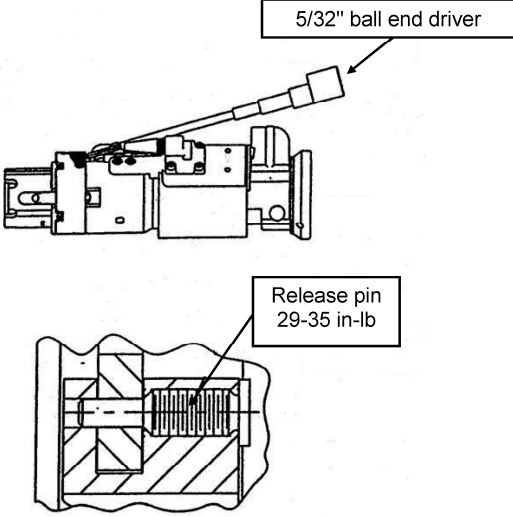





## Generic Contingencies (Cont)

TASK	FAILURE	ACTION
	 <p>contingency release band</p>	 <p>5/32" ball end driver</p> <p>Release pin 29-35 in-lb</p> <p>Figure 8 - Torque Multiplier</p>
<b>TSA</b>		
A. Latch fails to open		Release 7/16 EVA bolt on latch bracket; rotate bracket clear of latch <b>PGT [A2 (3.8), CCW2, 30.5], 7/16-6 ext 1-2 turns</b>
B. Latch fails to close		Close remaining latches arrow to arrow (3 of 4 required for landing)

## RELEASE ROEU LATCHES

IV	EV
<div data-bbox="296 345 827 410" style="border: 1px solid black; padding: 5px; margin-bottom: 10px;"> <p style="text-align: center;"><b>CAUTION</b> After step 1, 2 hr LCS Thermal Clock starts</p> </div> <p>SSP1 1. <u>Deadface ROEU</u>            √MPLM CH 1,2 HTR PWR – OFF (tb-bp)            APCU 1,2 CONV – OFF (tb-bp)                √1 OUTPUT RLY – OP (tb-bp)</p> <p>R1 PRI PL MNC – OFF (tb-OFF)</p> <p>R13L 2. <u>ROEU SAFING</u>            A6U √PL BAY MECH PWR SYS 1,2 (two) – OFF                √RETEN LOGIC PWR SYS 1,SYS 2 (two) – OFF                PL SEL – 1</p> <p style="margin-top: 20px;">Give EV GO to release ROEU</p>	<p>Tools reqd: Ratchet with 3-in Ext (Airlock)</p> <div data-bbox="1094 407 1749 521" style="border: 3px double black; padding: 10px; margin: 10px auto; width: fit-content;"> <p style="text-align: center;"><b>WARNING</b> For release, do not close access cover until ROEU stowed. Latches may not snap back to closed posn</p> </div> <p>1. On IV GO, open latch drive access cover:            Break safety cord, release access cover (3/4 turn ccw)            Open access cover (~120°)          Manual drive to RELEASE:            Rotate control lever to RELEASE            Rotate latch drive cw (~9 ft-lb) to hard stop (~3/4 turn)            Remove drive ratchet, clear worksite</p>

## RELEASE ROEU LATCHES (Cont)

IV	EV
<p>A6U 3. <u>VERIFY TALKBACKS</u> Install ROEU A6U PANEL OVERLAY</p> <p>PL RETEN PL SEL – 2</p> <div style="text-align: center;"> <p>ELEC CONT</p> <p>✓ </p> <p>RELAX DEMATE RELEASE</p> <p>✓   </p> <p>MATE LATCH</p> </div> <p>R13L PL BAY MECH PWR SYS 1,2 (two) – ON A6U PL RETEN LOGIC PWR SYS 1,SYS 2 (two) – ON</p> <p>Note single motor time (&gt; 18 sec)</p> <p>DEMATE/MATE – DEMATE (tb-REL), 36 sec max – OFF</p> <div style="text-align: center;"> <p>ELEC CONT</p> <p></p> <p>RELAX DEMATE RELEASE</p> <p>✓   </p> <p>MATE LATCH</p> </div> <p>PL RETEN LOGIC PWR SYS 1, SYS 2 (two) – OFF PL SEL – 1</p> <p>R13L PL BAY MECH PWR SYS 1,2 (two) – OFF</p>	<div style="border: 3px double black; padding: 10px; text-align: center;"> <p><b>WARNING</b></p> <p>For release, remain clear of latches during access cover closing. Latches may snap back to closed posn</p> </div>

**RELEASE ROEU LATCHES (Cont)**

<b>IV</b>	<b>EV</b>
<p>R1 SSP1</p> <p>4. <u>ENABLE POWER</u>            PRI PL MNC – ON (tb-ON)            APCU 2 OUTPUT RLY – CL                CONV – ON (tb-gray)            √APCU 2 OUTPUT RLY tb – gray</p> <p>5. End Thermal Clock ____:____</p>	<p>2. Reengage latch actuator:            Rotate control lever to neutral posn            Close, secure access cover (3/4 turn cw)            Clear worksite</p>

# LATCH ROEU LATCHES

IV		EV
A6U	1. <u>CONFIGURE FOR ROEU MATE</u> Install ROEU A6U PANEL OVERLAY	Tools reqd: Ratchet with 3-in Ext (Airlock)
R13L A6U	√PL BAY MECH PWR SYS 1,2 (two) – OFF RETEN LOGIC PWR SYS 1, SYS 2 (two) – OFF PL RETEN PL SEL – 2  <div style="border: 1px solid black; padding: 2px; width: fit-content; margin: 10px auto;">SM 97 PL RETENTION</div>	
CRT	√LAT 1,2,3 (six): 0  * If LATCH 2,3 LAT msw shows 1, drive latch for * * single motor time *	
A6U	<p style="text-align: center;">ELEC CONT  <input checked="" type="checkbox"/> </p> <p>RELAX REL    DEMATE REL MATE    RELEASE REL LATCH</p> <p>✓ <input type="checkbox"/>    <input type="checkbox"/>    <input type="checkbox"/></p>	
SSP1	√MPLM CH 1,2 HTR PWR – OFF (tb-bp) APCU 1,2 CONV – OFF (tb-bp) √1 OUTPUT RLY – OP (tb-bp)	
R1	PRI PL MNC – OFF (tb-OFF)	

## LATCH ROEU LATCHES (Cont)

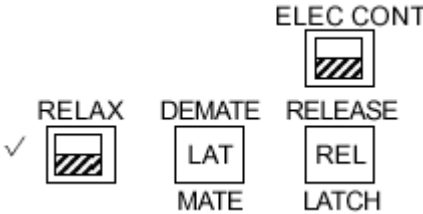
IV	EV
<p>A6U R13L</p> <p>2. <u>MATE ROEU</u>            PL RETEN LOGIC PWR SYS 1,2 (two) – ON            BAY MECH PWR SYS 1,2 (two) – ON</p> <p>Note single motor time (&gt; 30 sec)</p> <p>A6U</p> <p>DEMATE/MATE – MATE (tb-LAT), 60 sec max            – OFF</p> <div style="text-align: center;"> <p>ELEC CONT</p>  </div> <p>3. <u>ROEU SAFING</u>            PL BAY MECH PWR SYS 1,2 (two) – OFF            RETEN LOGIC PWR SYS 1, SYS 2 (two) – OFF            PL SEL – 1</p> <p>Give EV GO to latch ROEU</p>	<p>1. On IV GO, open latch drive access cover:            Break safety cord, release access cover (3/4 turn ccw)            Open access cover (~120°)            Manual drive to LATCH:            Rotate control lever to LATCH            Rotate latch drive ccw (~9 ft-lb) to hard stop (~3/4 turn)            Remove drive ratchet, clear worksite</p>







## LATCH ROEU LATCHES (Cont)

IV	EV
<p>A6U</p> <p>4. <u>VERIFY TALKBACKS</u> PL RETEN PL SEL – 2</p> <div style="text-align: center;"> <p>ELEC CONT</p> <p>✓ <input type="checkbox"/></p> <p>RELAX    DEMATE    RELEASE</p> <p>✓ <input checked="" type="checkbox"/>    <input type="checkbox"/>    <input type="checkbox"/></p> <p>          MATE        LATCH</p> </div> <p>R13L A6U</p> <p>5. <u>RELAX ROEU</u> PL BAY MECH PWR SYS 1,2 (two) – ON RETEN LOGIC PWR SYS 1,SYS 2 (two) – ON</p> <p style="text-align: center;"><u>NOTE</u> Monitor PL SEL 2 LATCH 1 REL SYS msws on SPEC 97</p> <p>Note single motor time (&gt; 12 sec)</p> <p>RELAX – RELAX (tb-REL), 24 sec max</p> <p>When LATCH 1 REL A(B) msw changes to 1: RELAX – OFF</p> <div style="text-align: center;"> <p>ELEC CONT</p> <p><input type="checkbox"/></p> <p>RELAX    DEMATE    RELEASE</p> <p>✓ <input type="checkbox"/>    <input checked="" type="checkbox"/>    <input type="checkbox"/></p> <p>          MATE        LATCH</p> </div> <p>R13L</p> <p>PL RETEN LOGIC PWR SYS 1,2 (two) – OFF BAY MECH PWR SYS 1,2 (two) – OFF</p>	<p>2. Reengage latch actuator: Rotate control lever to neutral posn Close, secure access cover (3/4 turn cw) Clear worksite</p>

## STOW ROEU ARM

IV	EV
<div style="border: 1px solid black; padding: 5px; margin: 10px auto; width: fit-content;"> <p style="text-align: center;"><u>CAUTION</u> After step 1, 2 hr LCS Thermal Clock starts</p> </div> <p>1. <u>RELEASE ROEU LATCHES</u></p> <p>SSP 1   √MPLM CHAN 1,2 HTR PWR – OFF (tb-bp)           APCU 1,2 CONV – OFF (tb-bp)           √1 OUTPUT RLY – OP (tb-bp)</p> <p>R1       PRI PL MNC – OFF (tb-OFF)</p> <p>A6U       Install ROEU A6U PANEL OVERLAY</p> <p>          √PL RETEN LAT (five) – OFF           PL SEL – 2</p> <div style="border: 1px solid black; padding: 2px; margin: 10px auto; width: fit-content;"> <p style="text-align: center;"><u>SM 97 PL RETENTION</u></p> </div> <p>√REL 2,3 (four) – 0</p> <p style="margin-left: 40px;">* If LATCH 2,3 REL msw shows 1, drive latch for * * single motor time *</p> <div style="margin-top: 20px;"> <div style="display: flex; justify-content: space-around; align-items: flex-start;"> <div style="text-align: center;"> <p>RELAX</p> <input checked="" type="checkbox"/> REL         </div> <div style="text-align: center;"> <p>DEMATE</p> <input type="checkbox"/> MATE         </div> <div style="text-align: center;"> <p>RELEASE</p> <input type="checkbox"/> LAT LATCH         </div> </div> <div style="text-align: center; margin-top: 10px;"> <p>ELEC CONT</p> <input checked="" type="checkbox"/> </div> </div>	<p>Tools reqd: Ratchet with 3-in Ext (Airlock)</p>

## STOW ROEU ARM (Cont)

IV	EV
<p>R13L</p> <p>2. <u>RELEASE LATCHES</u>            PL RETEN LOGIC PWR SYS 1,2 (two) – ON            BAY MECH PWR SYS 1,2 (two) – ON</p> <p>Note single motor time (&gt; 20 sec)</p> <p>RELEASE/LATCH – REL (tb-REL), 40 sec max            – OFF</p> <div style="text-align: center;"> <p>ELEC CONT</p> <p>✓ </p> <p>RELAX    DEMATE    RELEASE</p> <p>✓         </p> <p>MATE    LATCH</p> </div> <p>3. <u>ROEU SAFING</u>            PL BAY MECH PWR SYS 1,2 (two) – OFF            RETEN LOGIC PWR SYS 1, SYS 2 (two) – OFF            PL SEL – 1</p> <p>Give EV GO to stow ROEU</p>	<p>1. On IV GO, open latch drive access cover:            Break safety cord, release access cover (3/4 turn ccw)            Open access cover (~120°)            Manual drive to STOW:            Rotate control lever to STOW            Rotate arm drive ccw (~23 ft-lb) to hard stop and pull arm inboard to verify            Remove drive ratchet</p>

## STOW ROEU ARM (Cont)

IV	EV
<p>A6U</p> <p>4. <u>VERIFY TALKBACKS</u> PL RETEN PL SEL – 2</p> <div style="text-align: center;"> <p>ELEC CONT</p>  </div> <div style="display: flex; justify-content: space-around; align-items: center;"> <div style="text-align: center;"> <p>RELAX</p> <p>✓ <span style="border: 1px solid black; padding: 2px;">REL</span></p> </div> <div style="text-align: center;"> <p>DEMATE</p> <p><span style="border: 1px solid black; padding: 2px;">REL</span> MATE</p> </div> <div style="text-align: center;"> <p>RELEASE</p> <p><span style="border: 1px solid black; padding: 2px;">REL</span> LATCH</p> </div> </div> <p>R1 SSP 1</p> <p>5. <u>ENABLE POWER</u> PRI PL MNC – ON (tb-ON) APCU 2 OUTPUT RLY – CL CONV – ON (tb-gray) √OUTPUT RLY tb – gray</p> <p>6. End Thermal Clock ____:____</p>	<p>2. Reengage arm actuator: Rotate control lever to neutral posn Close, secure access cover (3/4 turn cw) Clear worksite</p>

# MATE ROEU ARM

IV		EV
A6U	1. <u>CONFIGURE ROEU</u> Install <u>ROEU A6U PANEL OVERLAY</u>	Tools reqd: Ratchet with 3-in Ext (Airlock)
R13L A6U	2. <u>ROEU SAFING</u> √PL BAY MECH PWR SYS 1,2 (two) – OFF √RETEN LOGIC PWR SYS 1,SYS 2 (two) – OFF PL SEL – 1	
SSP 1 R1	√MPLM CH 1,2 HTR PWR – OFF (tb-bp) APCU 1,2 CONV – OFF (tb-bp) √1 OUTPUT RLY – OP (tb-bp) PRI PL MNC – OFF (tb-OFF)	
	Give EV GO to mate ROEU	
A6U	3. <u>VERIFY TALKBACKS</u> PL RETEN PL SEL – 2	1. On IV GO, open arm drive access cover: Break safety cord, release access cover (3/4 turn ccw) Open access cover (~120°) Manual drive to MATE: Rotate control lever to MATE Ratchet arm drive cw (~25 ft-lb) until “READY TO LATCH” posn indicated on interface guide Remove drive ratchet Clear worksite (for latching)
	<p style="text-align: center;">ELEC CONT</p> <p style="text-align: center;">RELAX    DEMATE    RELEASE</p> <p style="text-align: center;">✓         </p> <p style="text-align: center;">MATE                  LATCH</p>	

## MATE ROEU ARM (Cont)

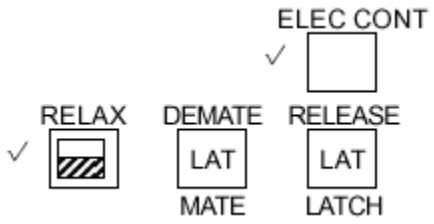
IV	EV
<p>R13L A6U</p> <p>4. <u>LATCH LATCHES</u>            PL BAY MECH PWR SYS 1,2 (two) – ON            RETEN LOGIC PWR SYS 1,SYS 2 (two) – ON</p> <p>Note single motor time (&gt; 20 sec)</p> <p>RELEASE/LATCH – LATCH (tb-LAT), 40 sec max            – OFF</p> <div style="text-align: center;">  <p>The diagram shows a control panel with several buttons. At the top is 'ELEC CONT' with a checkmark to its left. Below it are three buttons: 'RELAX' (with a checkmark and a hatched square icon), 'DEMATE', and 'RELEASE'. Below 'DEMATE' is a button labeled 'LAT' with 'MATE' underneath it. Below 'RELEASE' is a button labeled 'LAT' with 'LATCH' underneath it.</p> </div> <p>R13L</p> <p>PL RETEN LOGIC PWR SYS 1,SYS 2 (two) – OFF            BAY MECH PWR SYS 1,2 (two) – OFF</p> <p>5. <u>RELAX ROEU (EVA)</u>            Monitor PL RETEN LAT 1 tb</p> <p>Give EV GO to STOW arm, halt once RELAX tb – REL</p>	<p>2. <u>RELAX ROEU (EVA)</u>            On IV GO, rotate control lever to STOW:            Ratchet arm drive ccw until IV receives RELAX 1 tb – REL. Remove drive ratchet</p> <p>3. Reengage arm actuator:            Rotate control lever to neutral posn            Close, secure access cover (3/4 turn cw)            Clear worksite</p>

**ROEU OVERVIEW**

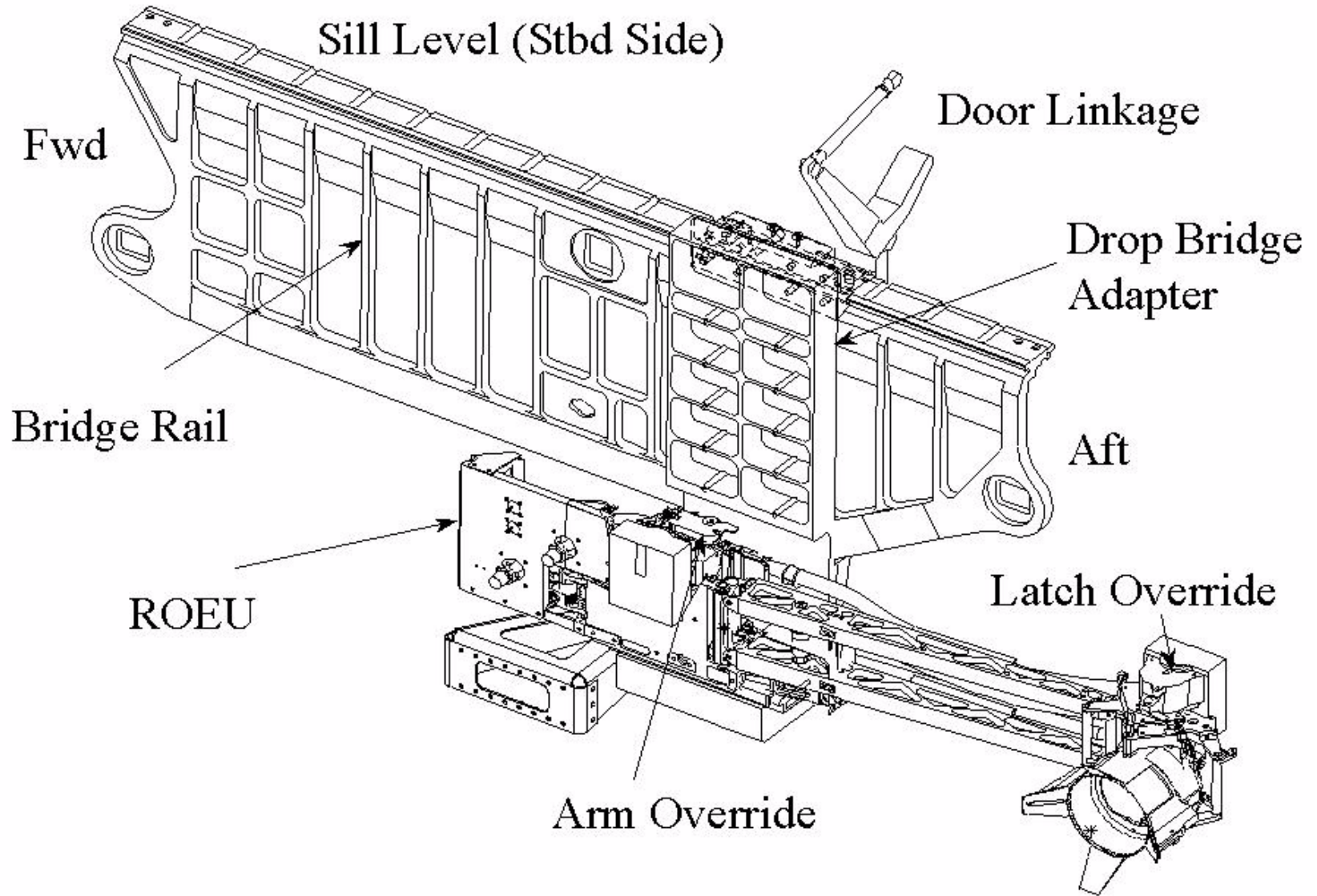

## RADIATOR GRAPPLE FIXTURE STOWAGE BEAM TIEDOWNS

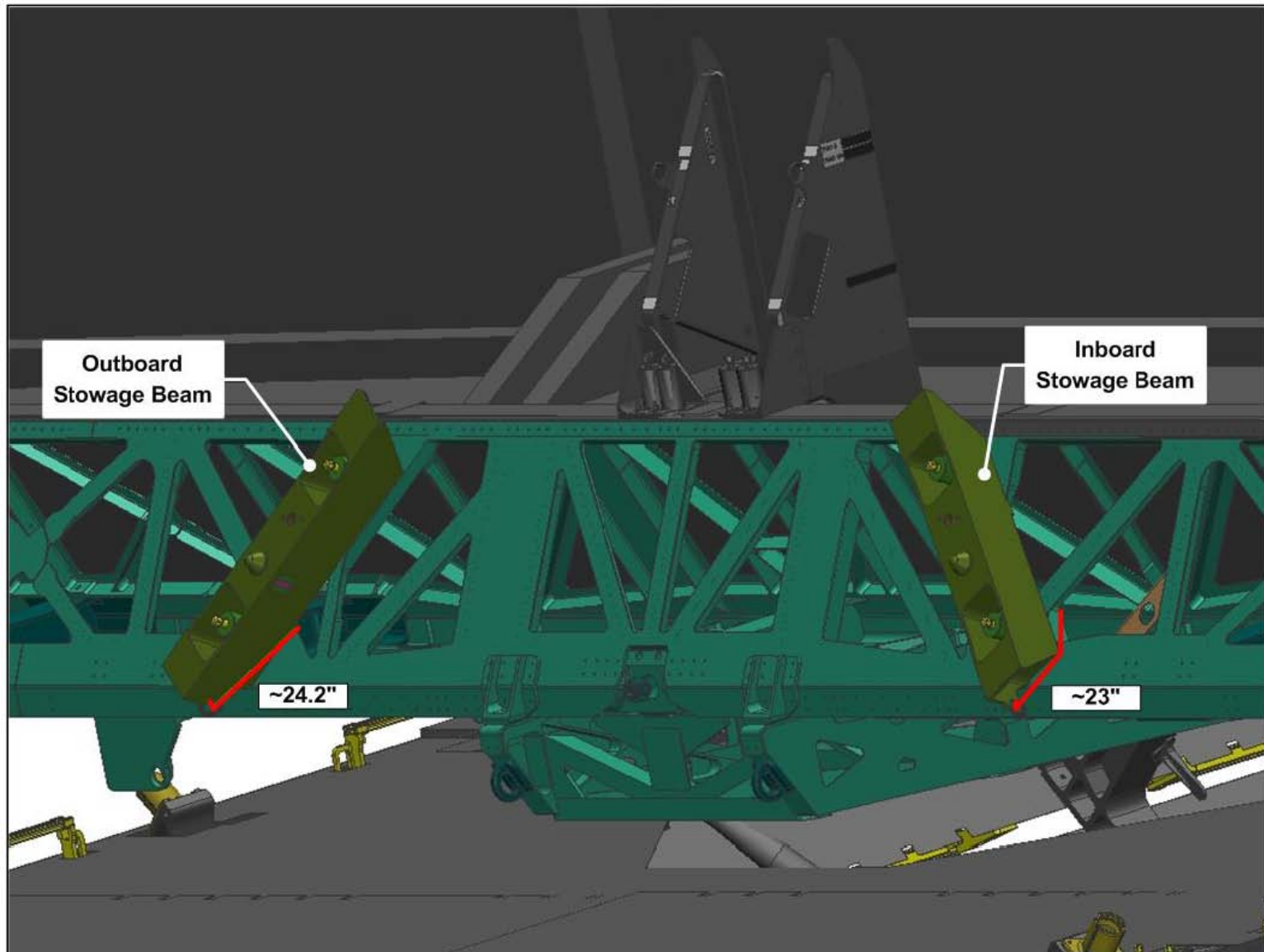



**RADIATOR GRAPPLE FIXTURE STOWAGE BEAM TIEDOWNS (Cont)**

**Outboard Radiator Grapple Bar Beam**

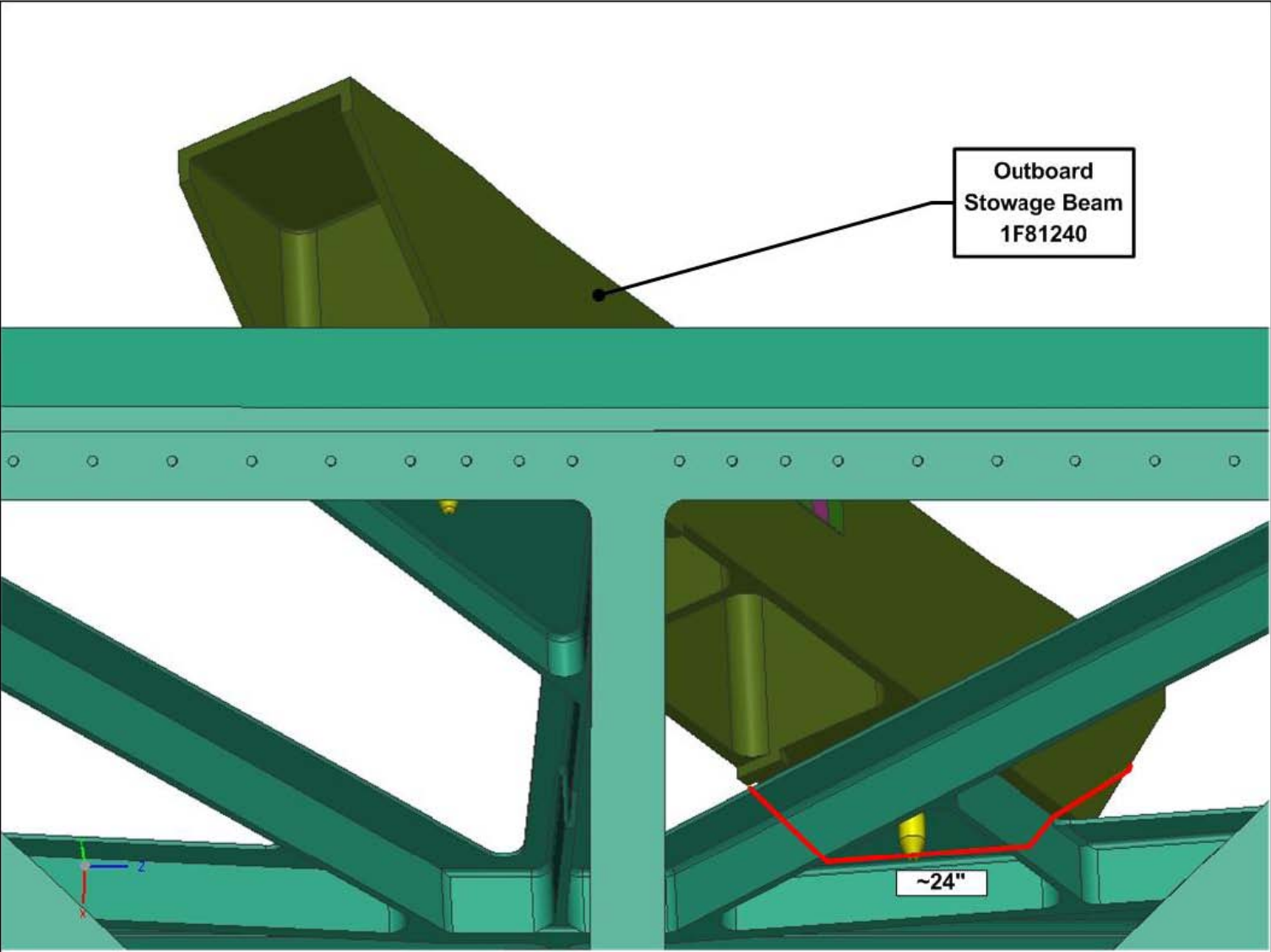

**RADIATOR GRAPPLE FIXTURE STOWAGE BEAM TIEDOWNS (Cont)**

**Inboard Radiator Grapple Bar Beam**

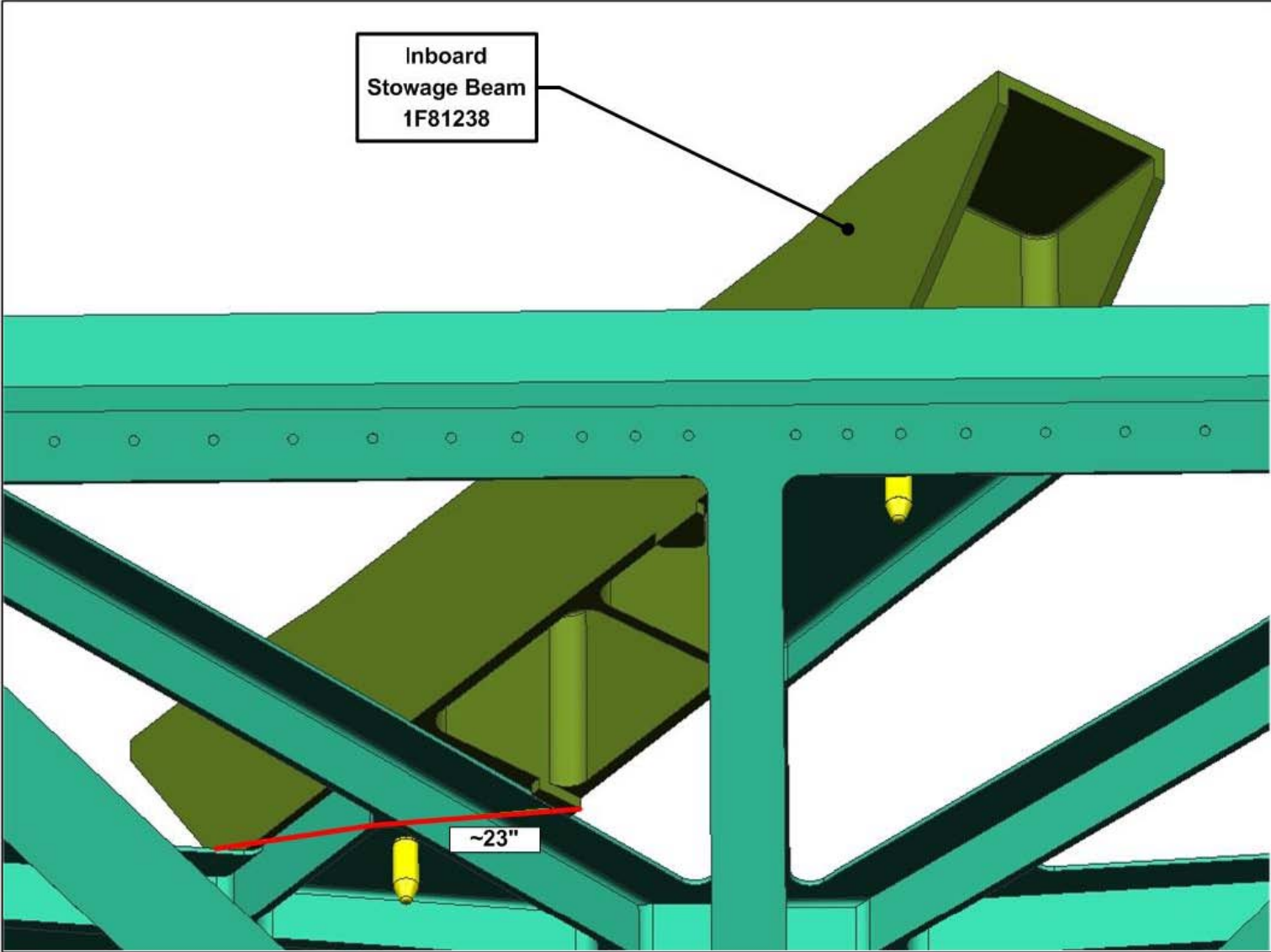

# CAMERA PORT 13 TIEDOWN

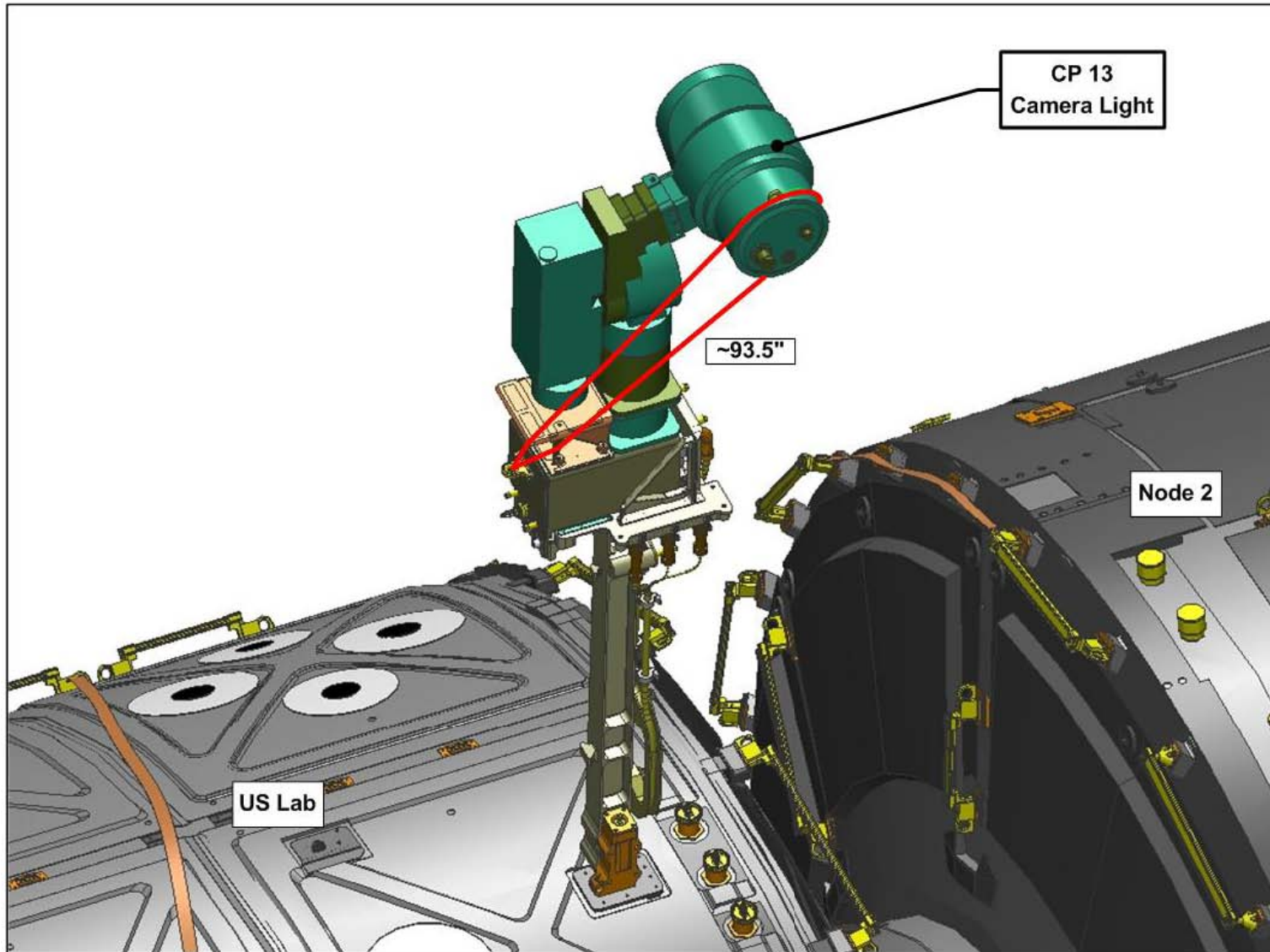

## S3 FORWARD-NADIR CLAM SHELL AND STUB TIEDOWN

NOTE: SARJ MLI Covers not depicted, but do not impose restrictions to tethers

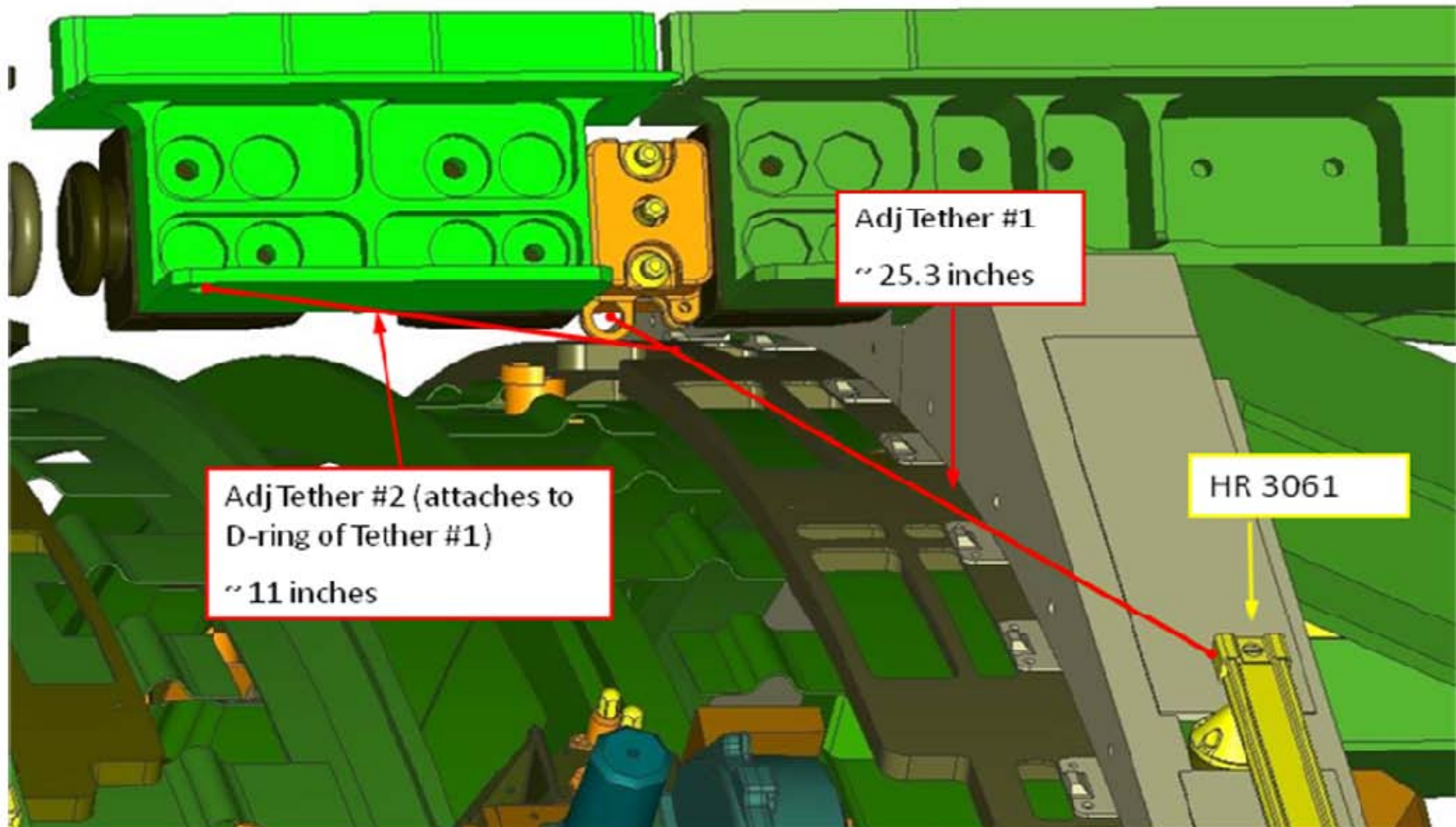

### S3 FORWARD-ZENITH CLAM SHELL AND STUB TIEDOWN

NOTE: SARJ MLI Covers not depicted, but do not impose restrictions to tethers

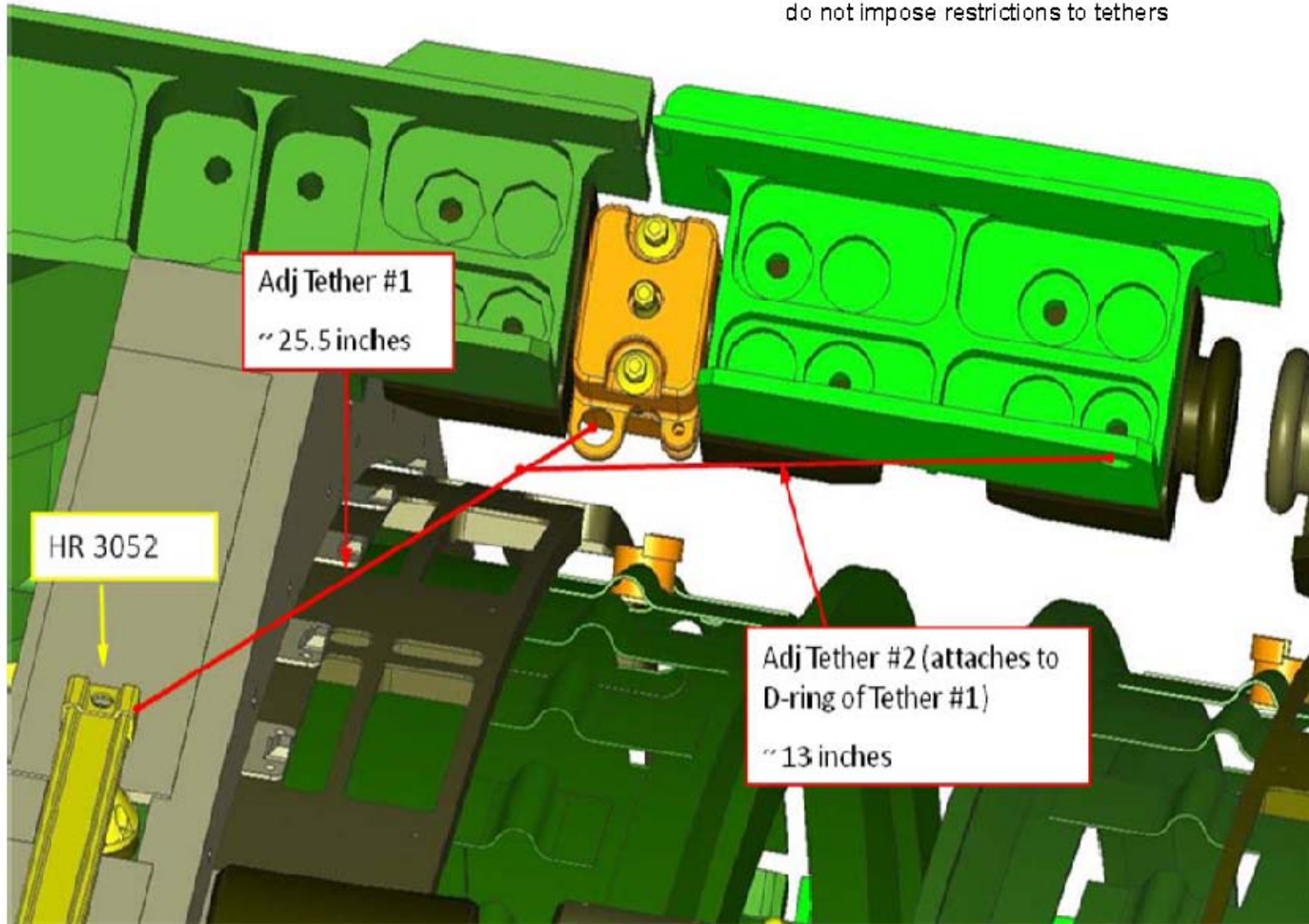

## ETRS TIEDOWN

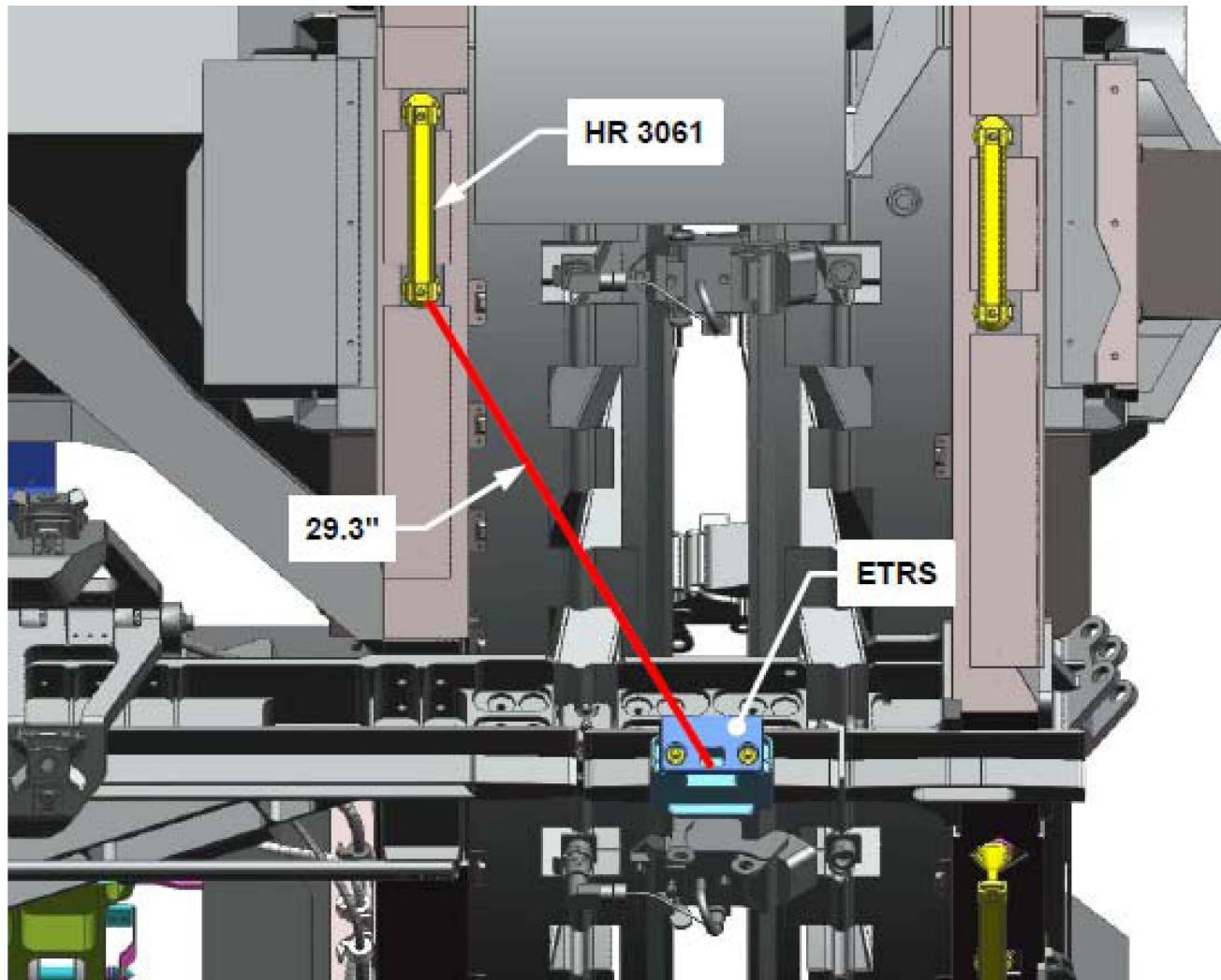

This tether is a long duration tether. Total length is approx 29.3". It goes from the tether loop on the ETRS to HR3061. The buckles are not a concern

## SPDM CLPA1 TIEDOWN

The CLPA slides into a V-guide groove and is held in place with a magnetic soft-dock. The tie-down bolt is then driven to secure the CLPA. In the event that the CLPA bolt is partially driven in the CLPA will already be held in one axis by the V-guide. If it can still slide out, however, the bolt would have to break and the load in that direction would need to be greater than the magnetic soft-dock. A tethering plan with 2 tethers attached to one another and cinched around Pan/Tilt Unit base of the CLPA and then tethered to a tether point on the SPDM will sufficiently hold the CLPA from sliding out in that axis. The V-guide holds the other axis and prevents the CLPA from coming loose and being held only by the tether.

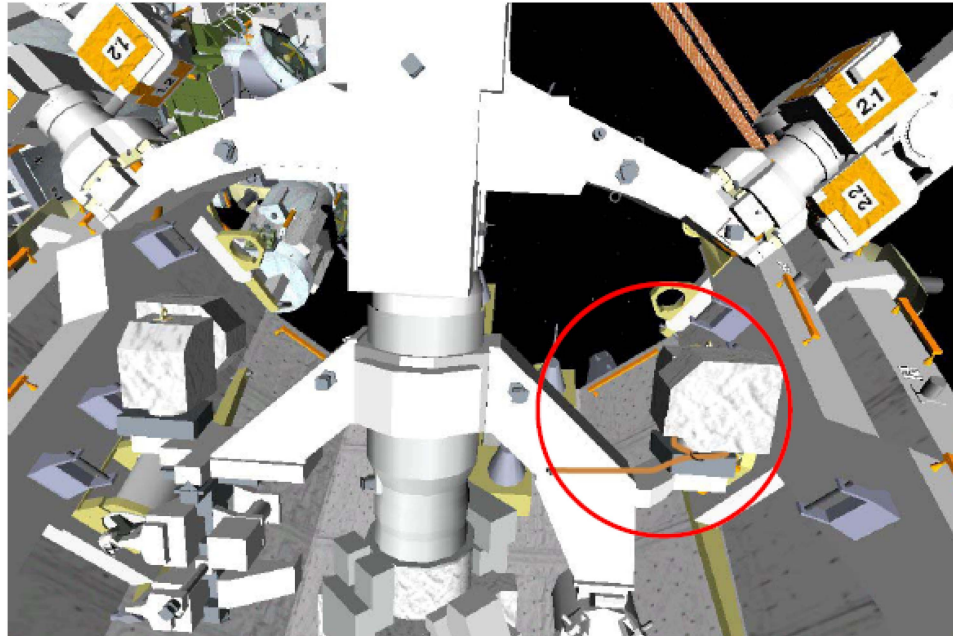

CLPA tie-down to SPDM

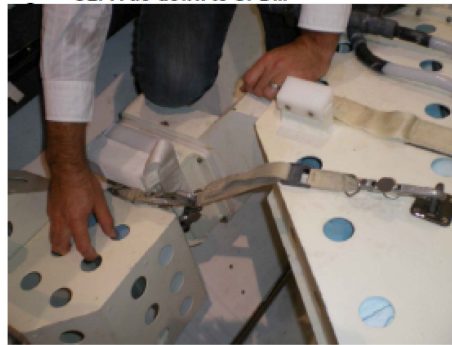

# CP3 STANCHION TIEDOWN

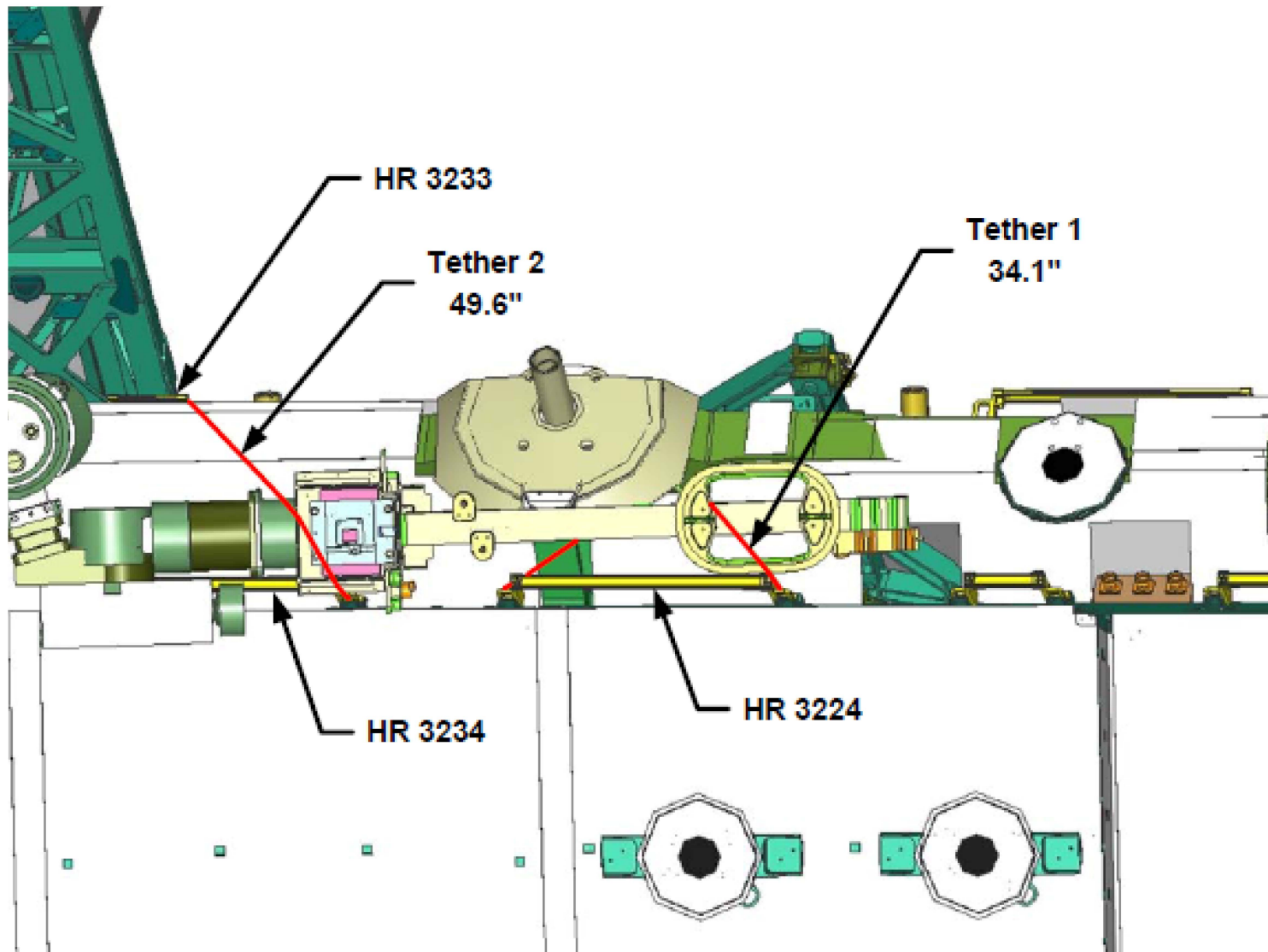



CP3 STANCHION TIEDOWN (Cont)

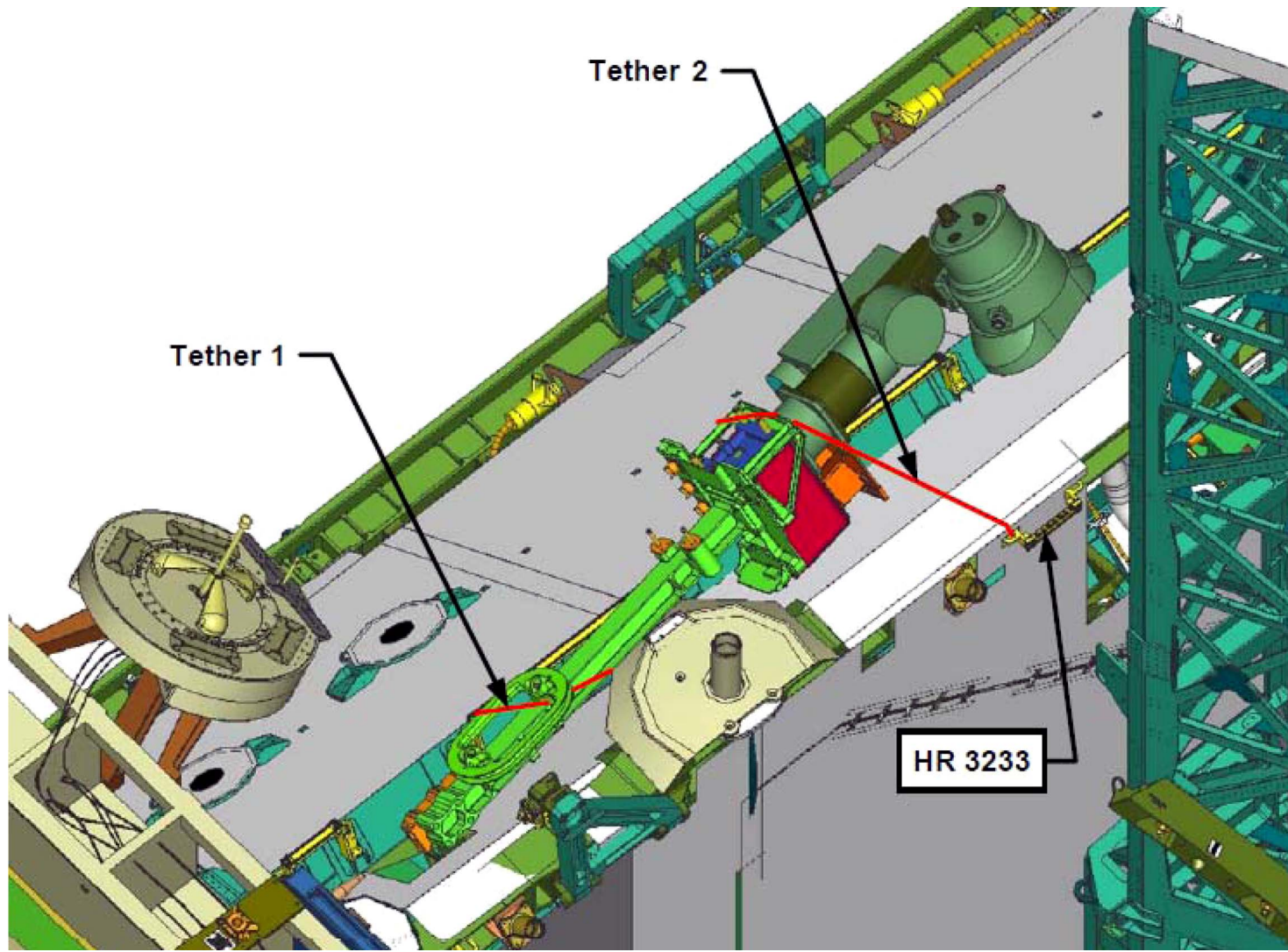

# CP3 WEDGE TIEDOWN

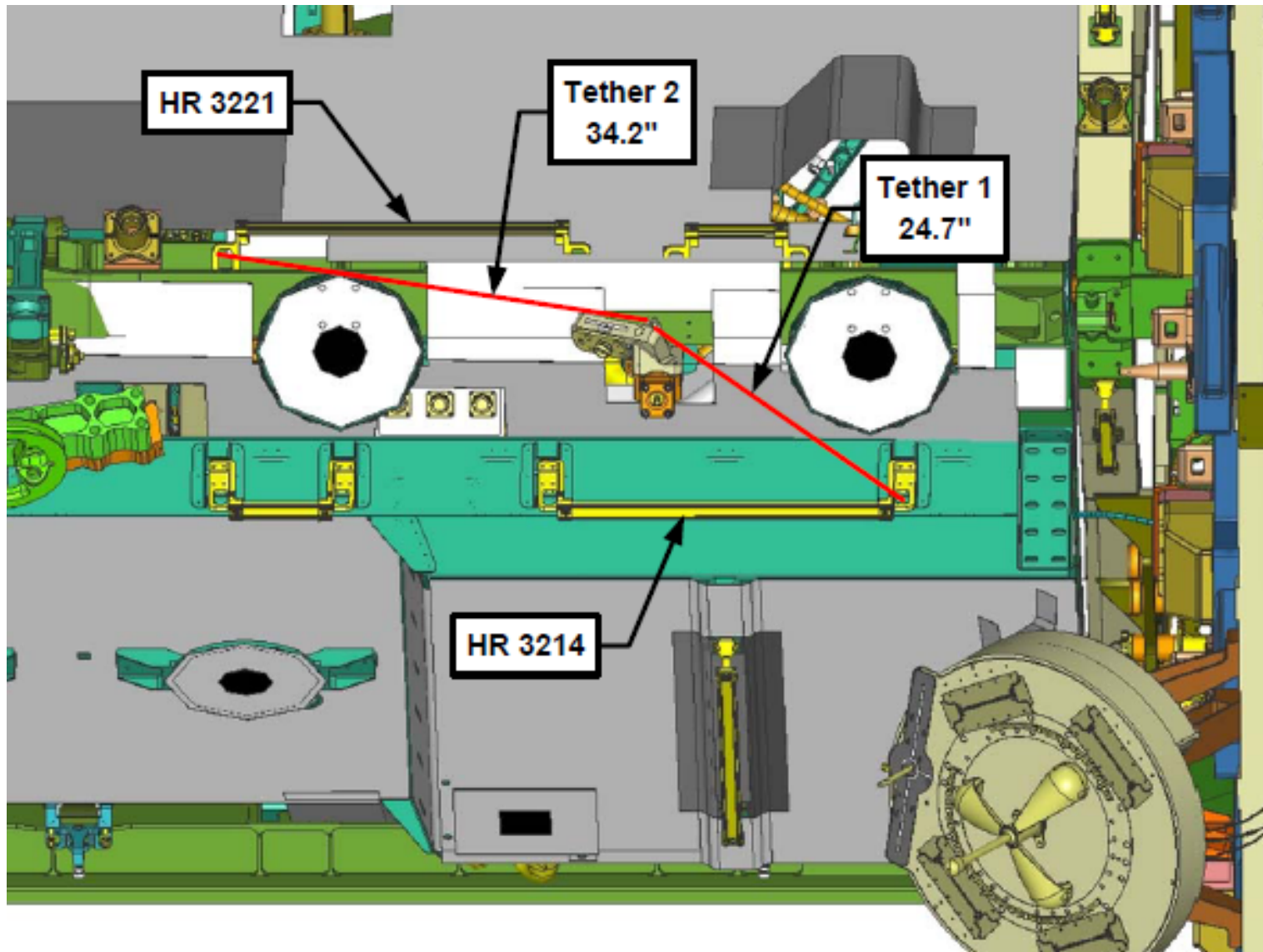

# CP3 STANCHION/WEDGE TIEDOWN

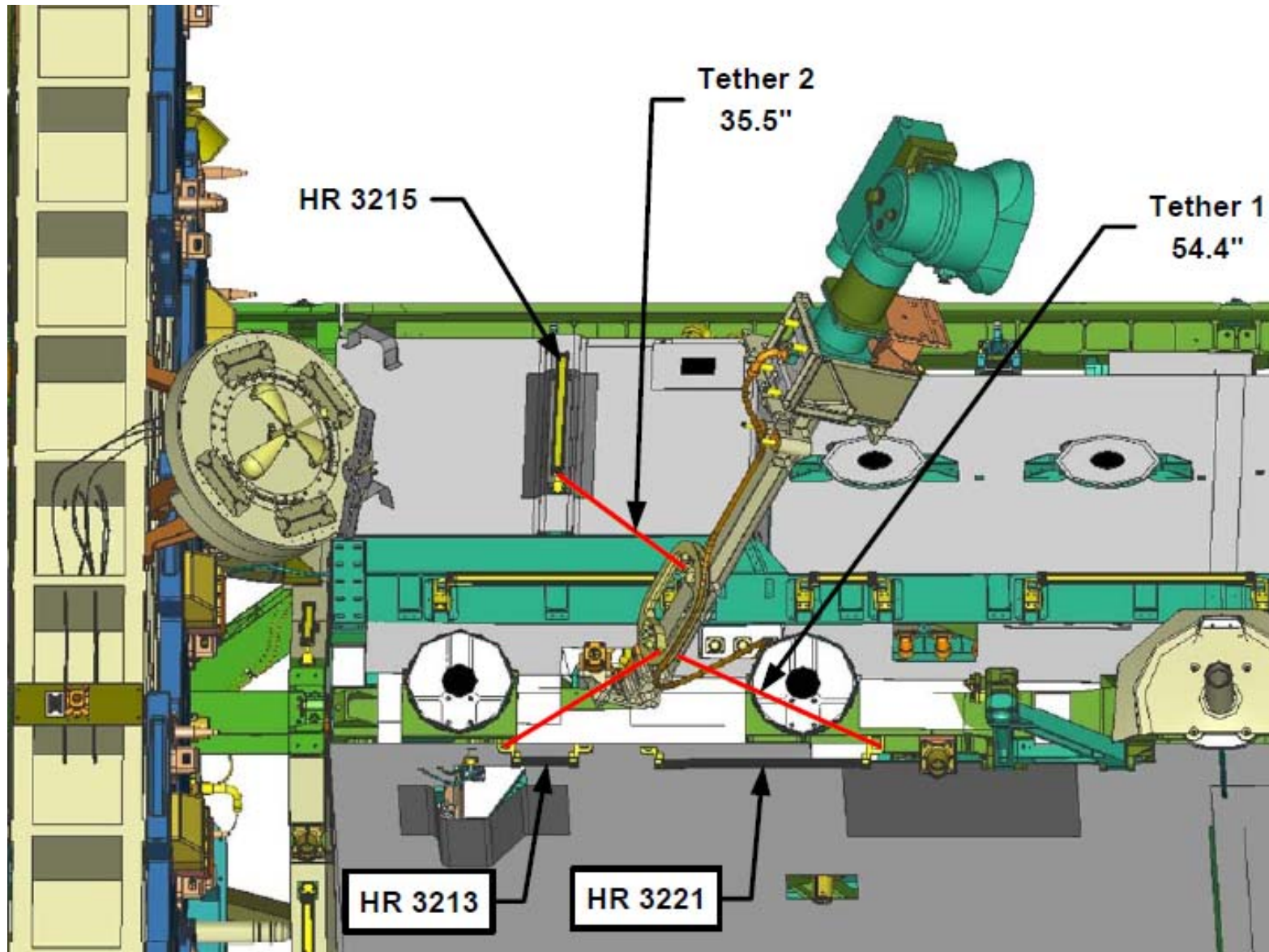

P3 CETA LIGHT TIEDOWN

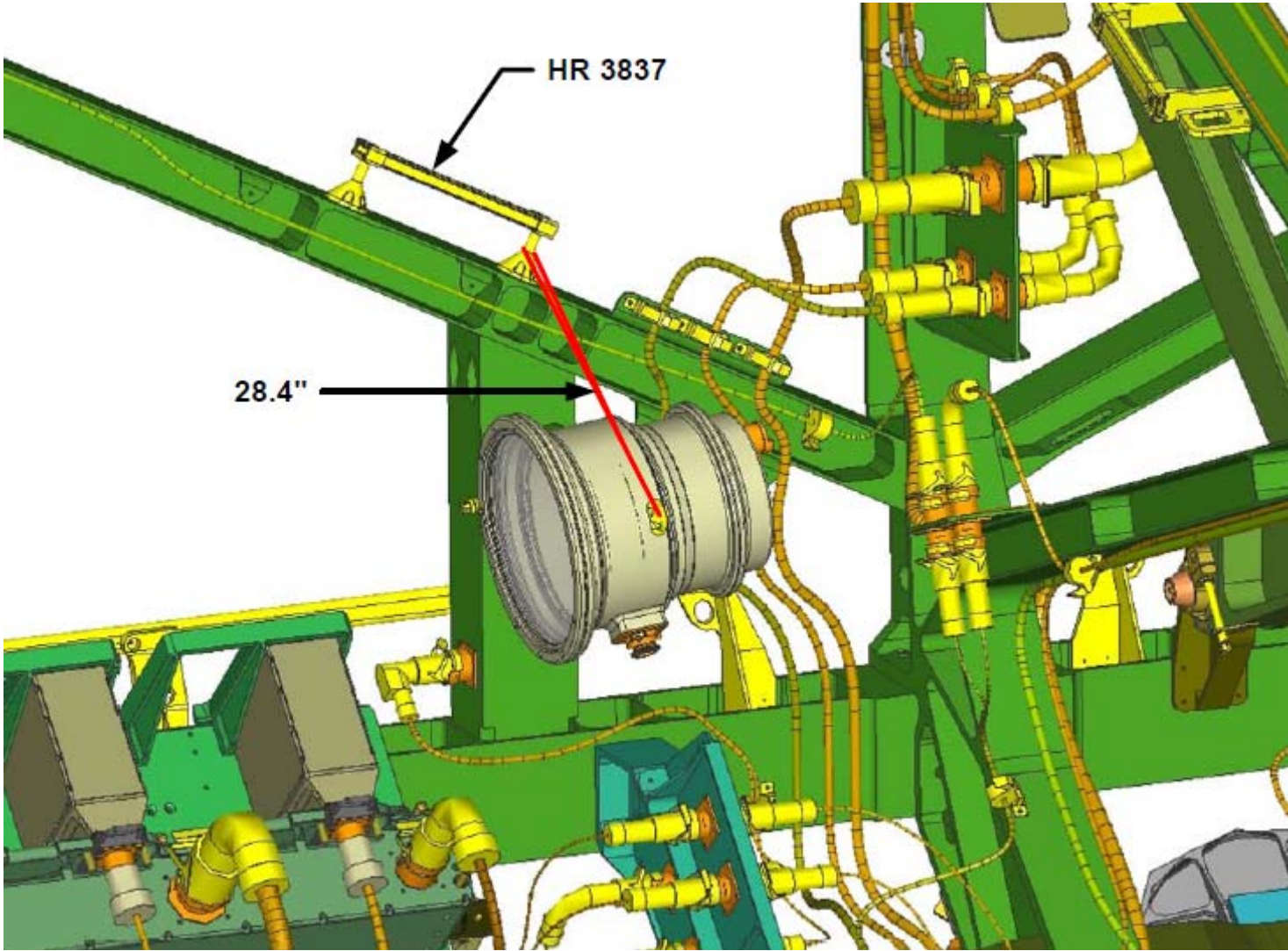

PUMP MODULE TIEDOWN (ESP-2)

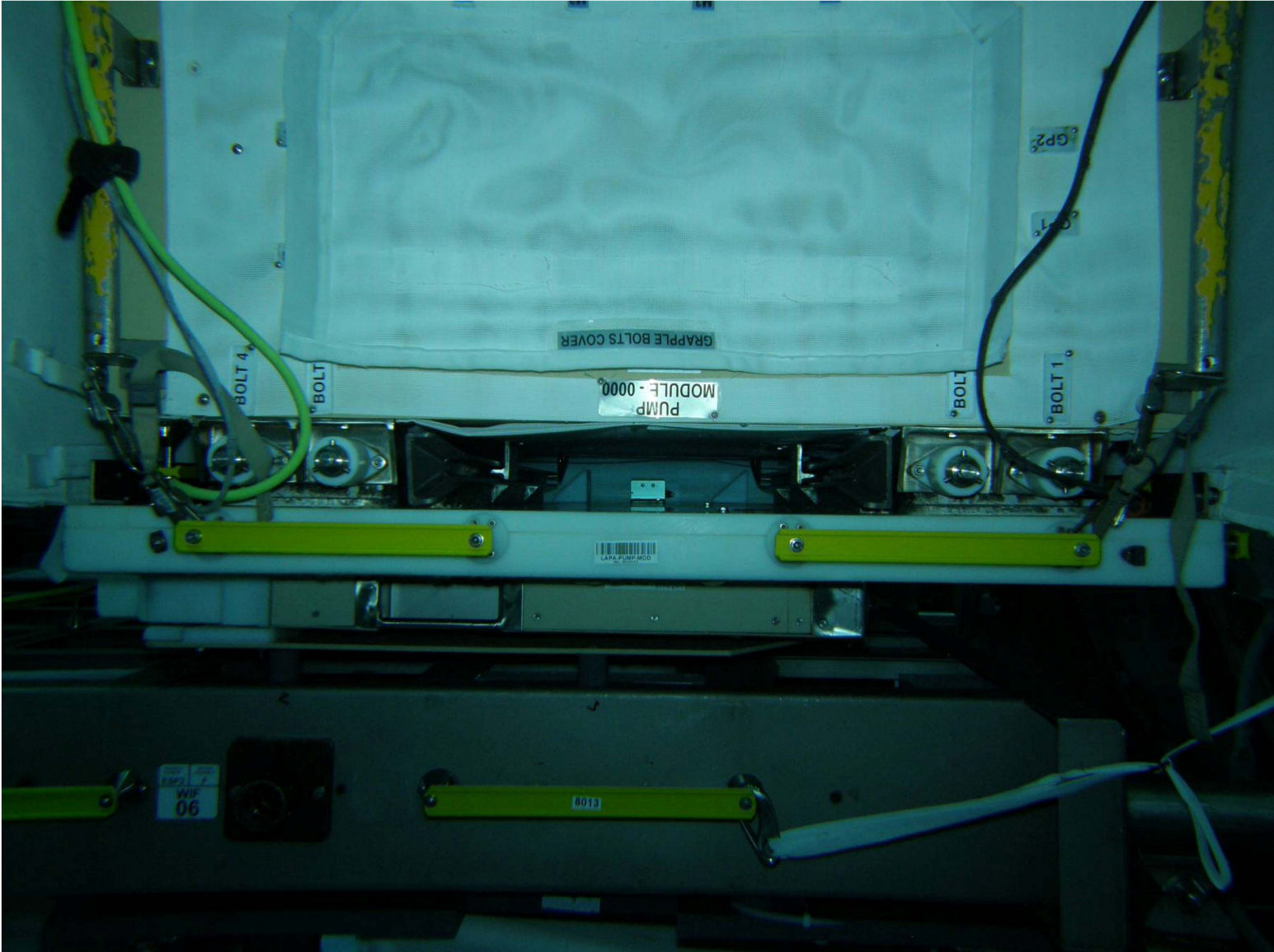

AGB TIEDOWN

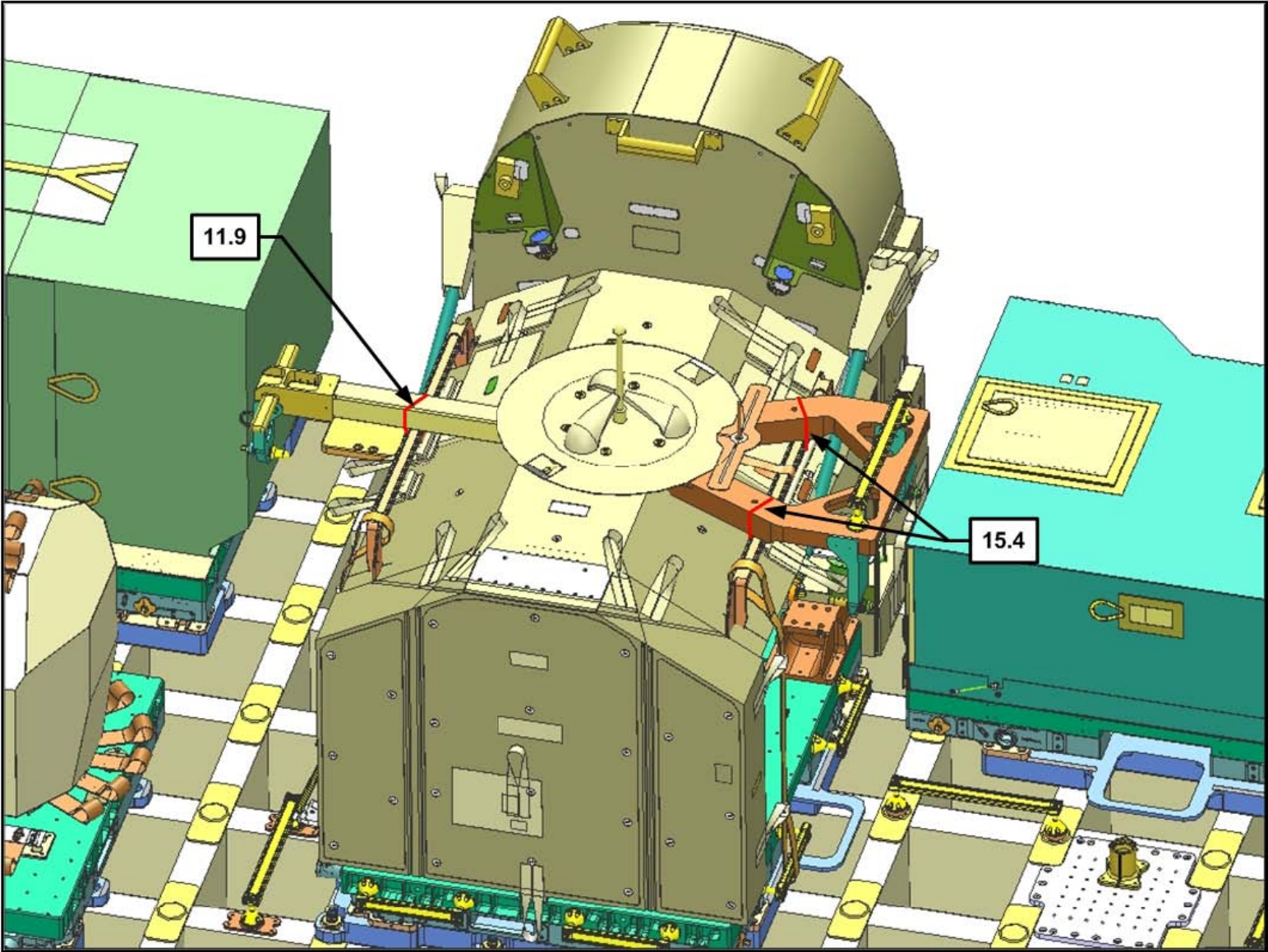

## AGB TIEDOWN (Cont)

AGB fully extended, centered between MBSU and UTA (AGB Pins 5 and 6 not in receptacles)

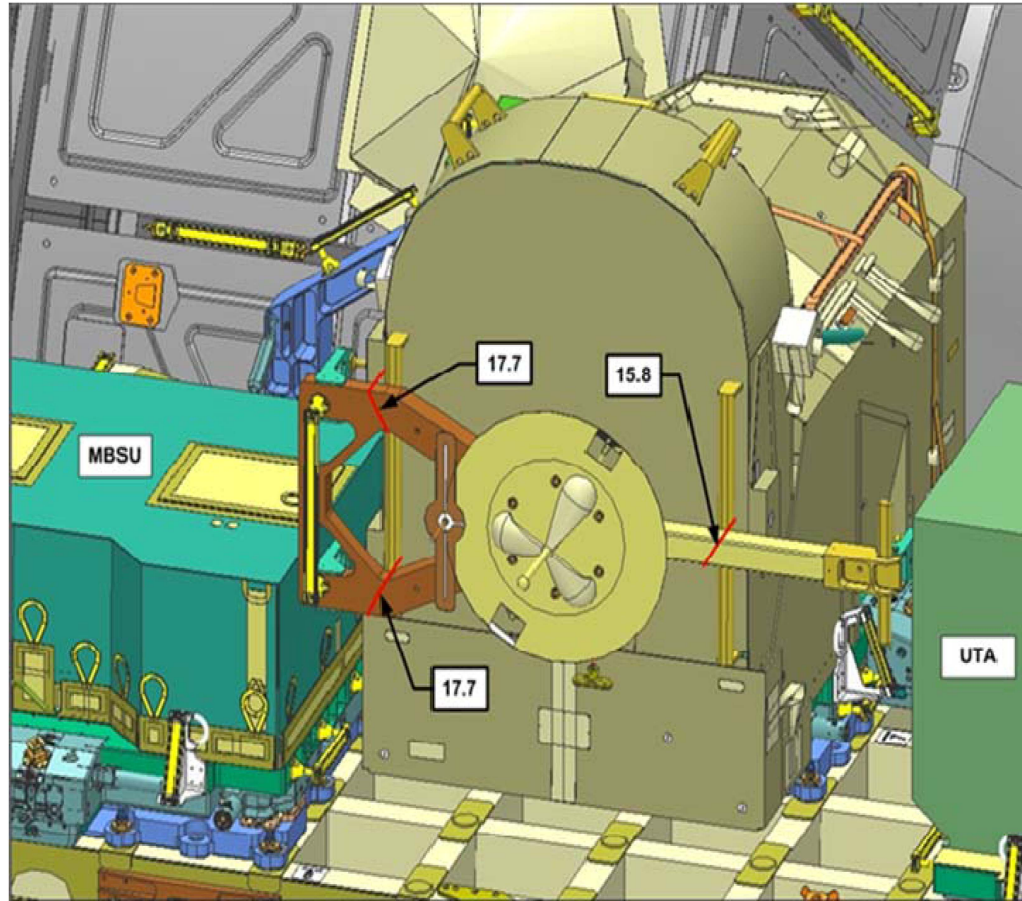

Distance between MBSU MLI and UTA MLI = 62.7

Distance between MNSU FSE and UTA FSE (no MLI) = 63.6

AGB overall length when fully extended 62.0

NOTE: All dimensions measured in CAD are approximate and might not reflect the actual hardware configuration

**AGB TIEDOWN (Cont)**

**Hard Interference between AGB and UTA**

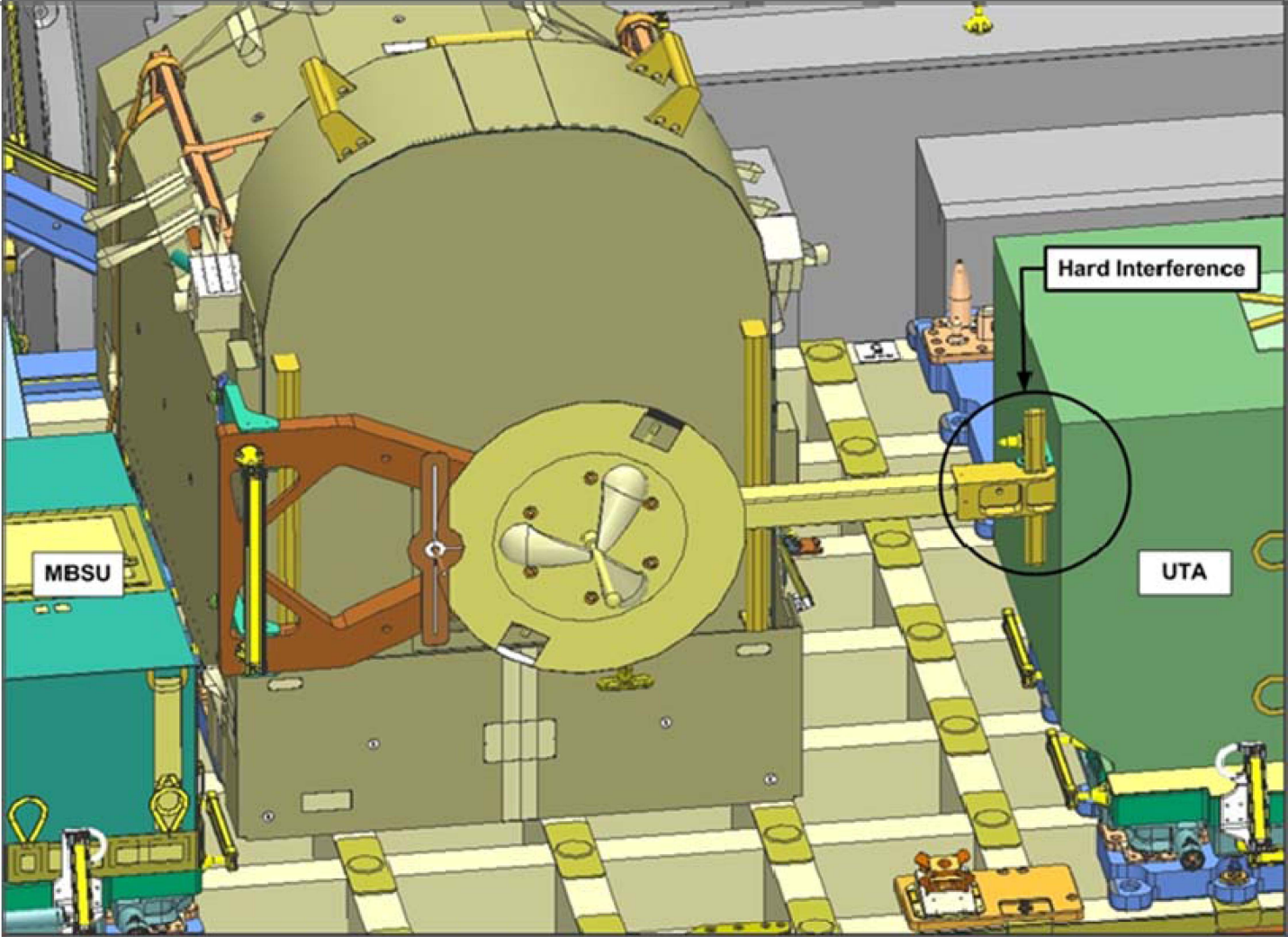



FLIGHT SPECIFIC EVA REFERENCE

PAYLOAD BAY LAYOUT .....	FS 18-2
ELC 4 .....	FS 18-4
PMM.....	FS 18-8
ROEU.....	FS 18-10
PRLA.....	FS 18-12
EVA 1	
J612 EXT AND NODE 3 CABLE .....	FS 18-16
PUMP MODULE.....	FS 18-18
VENT TOOL.....	FS 18-22
Z1 RPCM MLI.....	FS 18-24
CP3 CAMERA WEDGE .....	FS 18-25
CP3 CAMERA AND VSSA.....	FS 18-28
STBD CETA RAIL STUB.....	FS 18-30
TETHER SHUTTLE STOP .....	FS 18-35
S3 MT STOP .....	FS 18-36
JAXA MESSAGE IN A BOTTLE.....	FS 18-37
EVA 2	
LWAPA.....	FS 18-38
ELC4 ExPCA MLI.....	FS 18-45
SPDM CLPA 1.....	FS 18-48
SPDM EP 1 .....	FS 18-53
P3 CETA LIGHT.....	FS 18-57
P1 RBVM BOOTIE .....	FS 18-59
P1 RADIATOR GRAPPLE STOW BEAMS .....	FS 18-61
NODE 3 MLI.....	FS 18-64
CLA/CLPA LENS COVER.....	FS 18-65
GET-AHEADS	
LAB CP13 LIGHT .....	FS 18-66
S1 FHRC P-CLAMP RELEASE .....	FS 18-69
STRELA ADAPTER .....	FS 18-70
PORT CETA CART RECONFIG .....	FS 18-72

**FLIGHT SPECIFIC  
EVA REFERENCE**

# FLIGHT SPECIFIC EVA REFERENCE

## PAYLOAD BAY LAYOUT

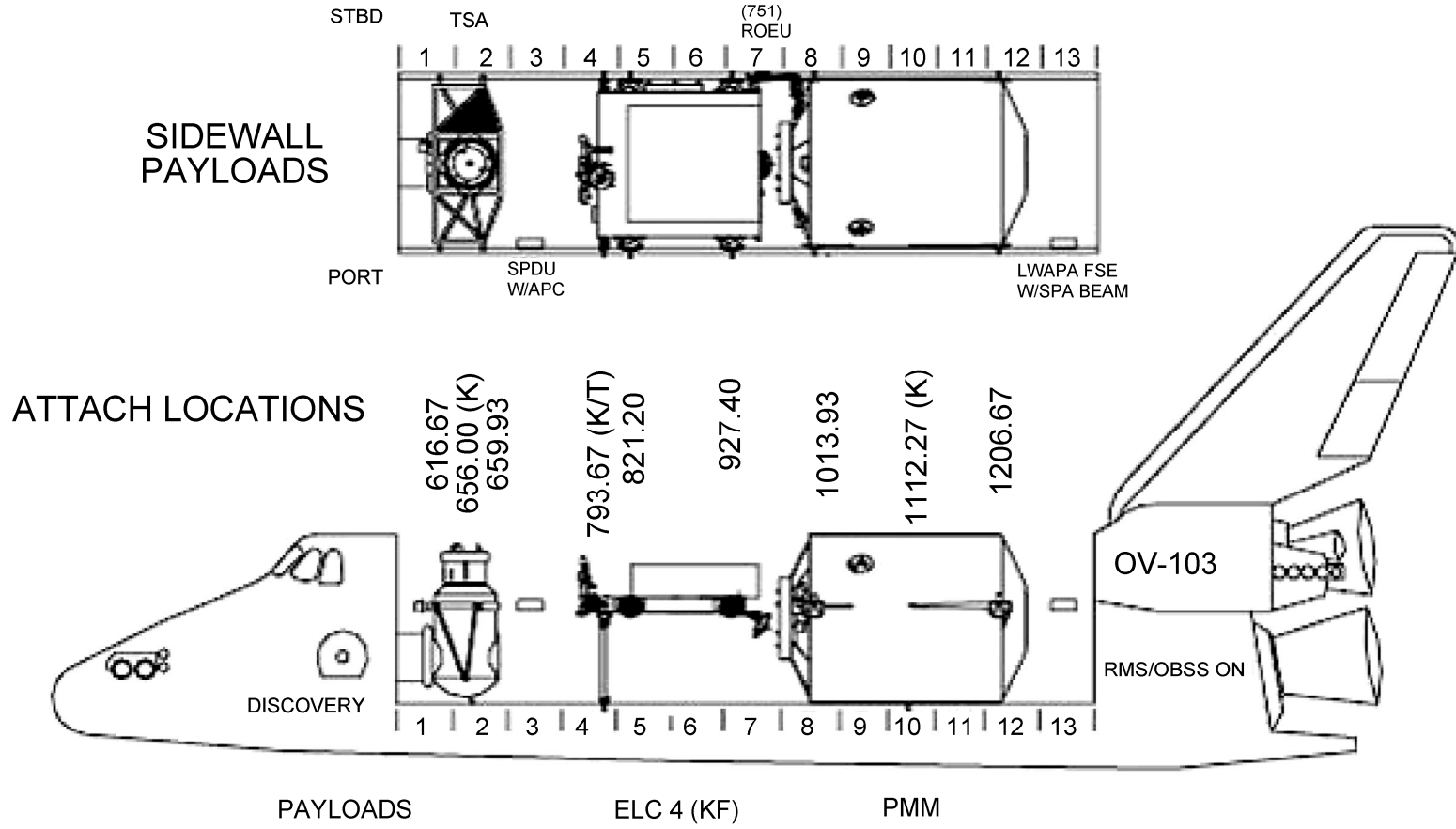

## CARGO ARRANGEMENT

# STS-133 (ISS-ULF5) OV-103/Discovery

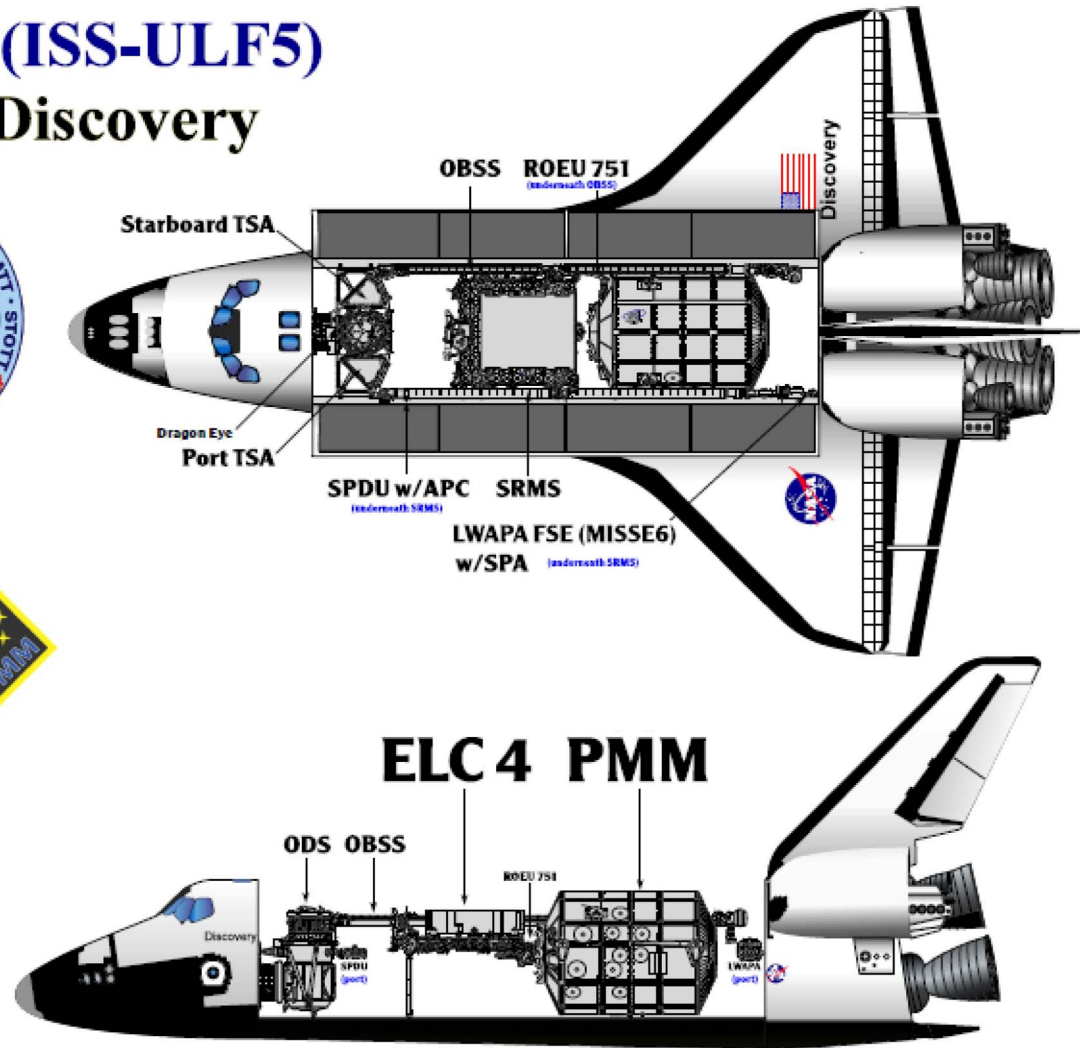

ELC 4

OUTBOARD FACE

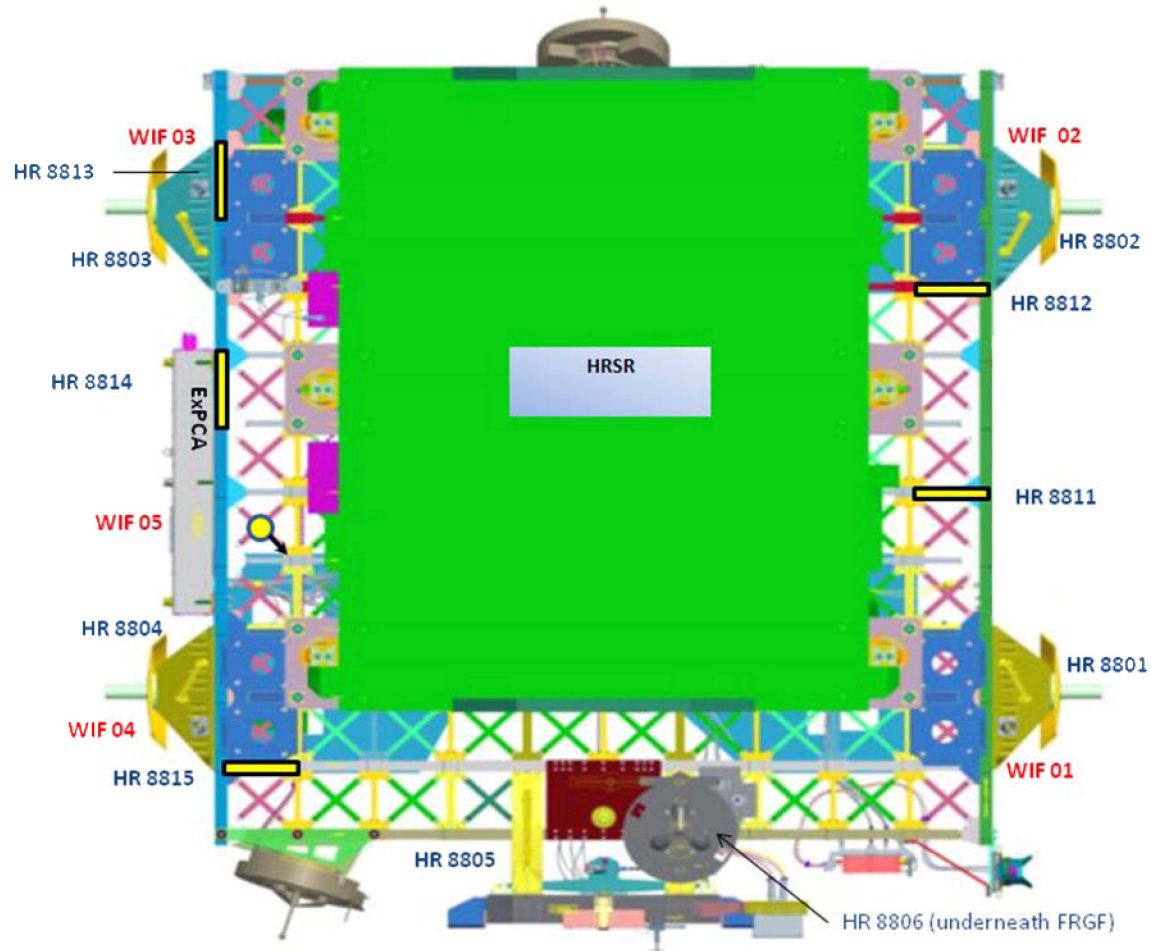

ELC 4 Top Deck

# INBOARD FACE

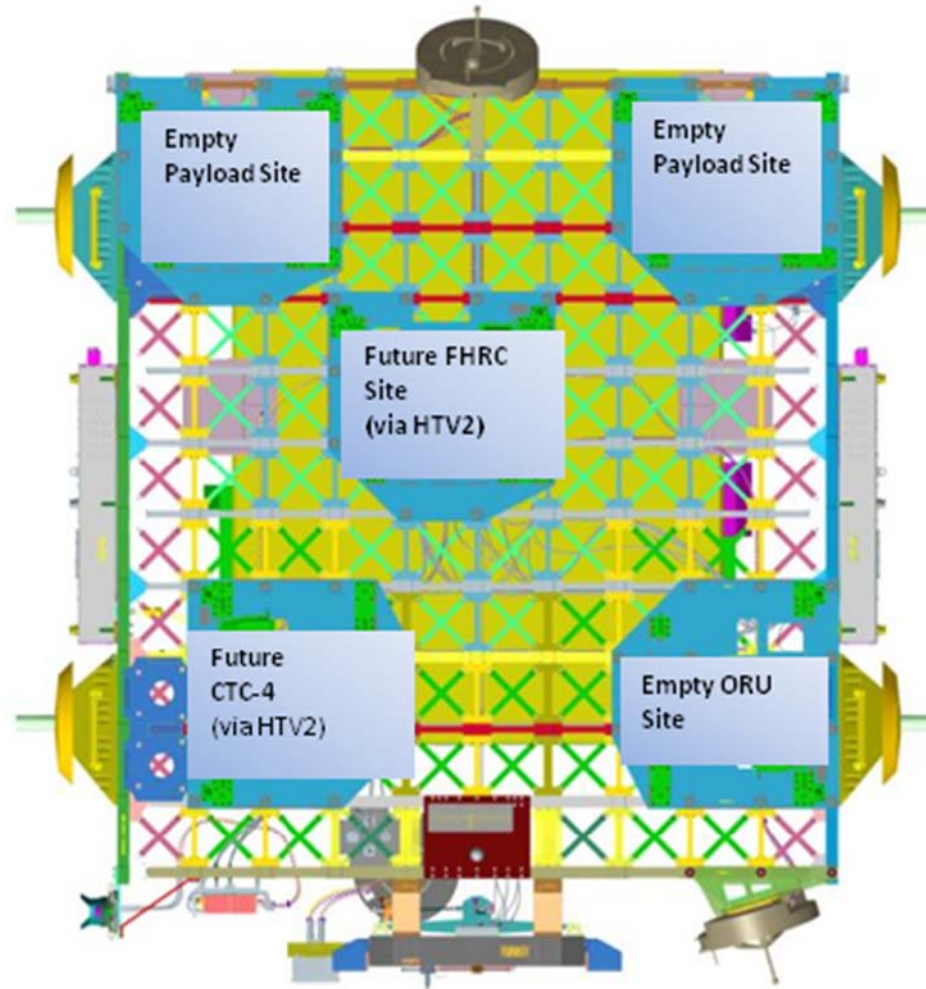

**ELC 4 (Cont)**

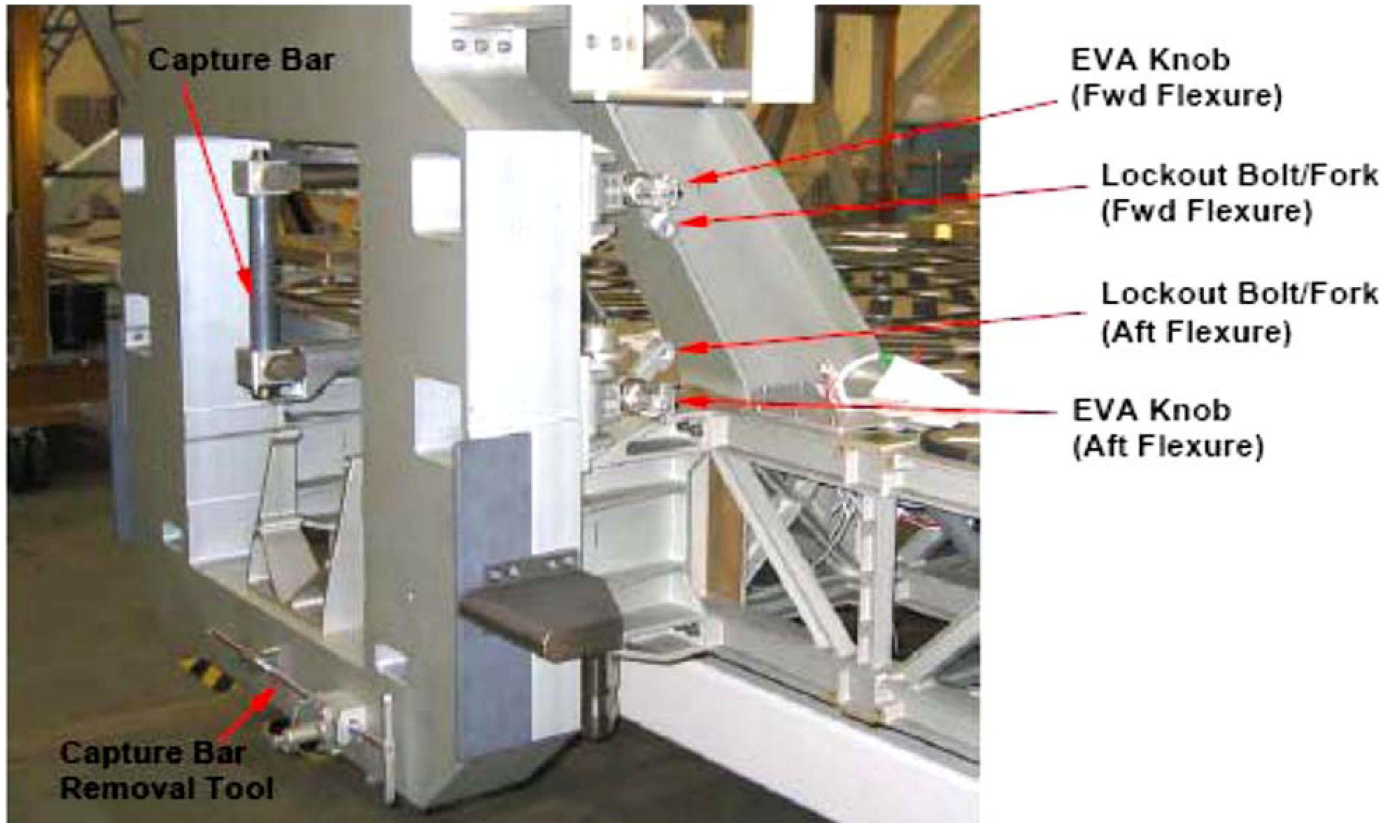

**ELC – Attach points/EVA Interfaces**

**ELC 4 (Cont)**

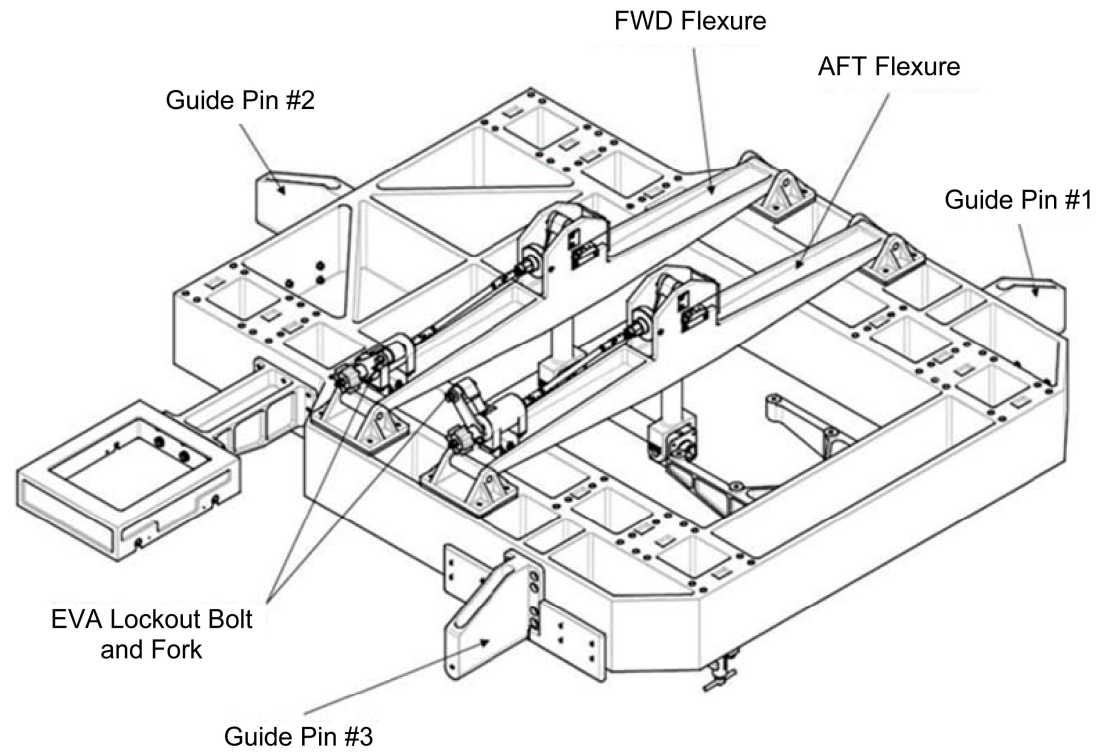

# ELEC Diagram/EVA Interfaces

PMM

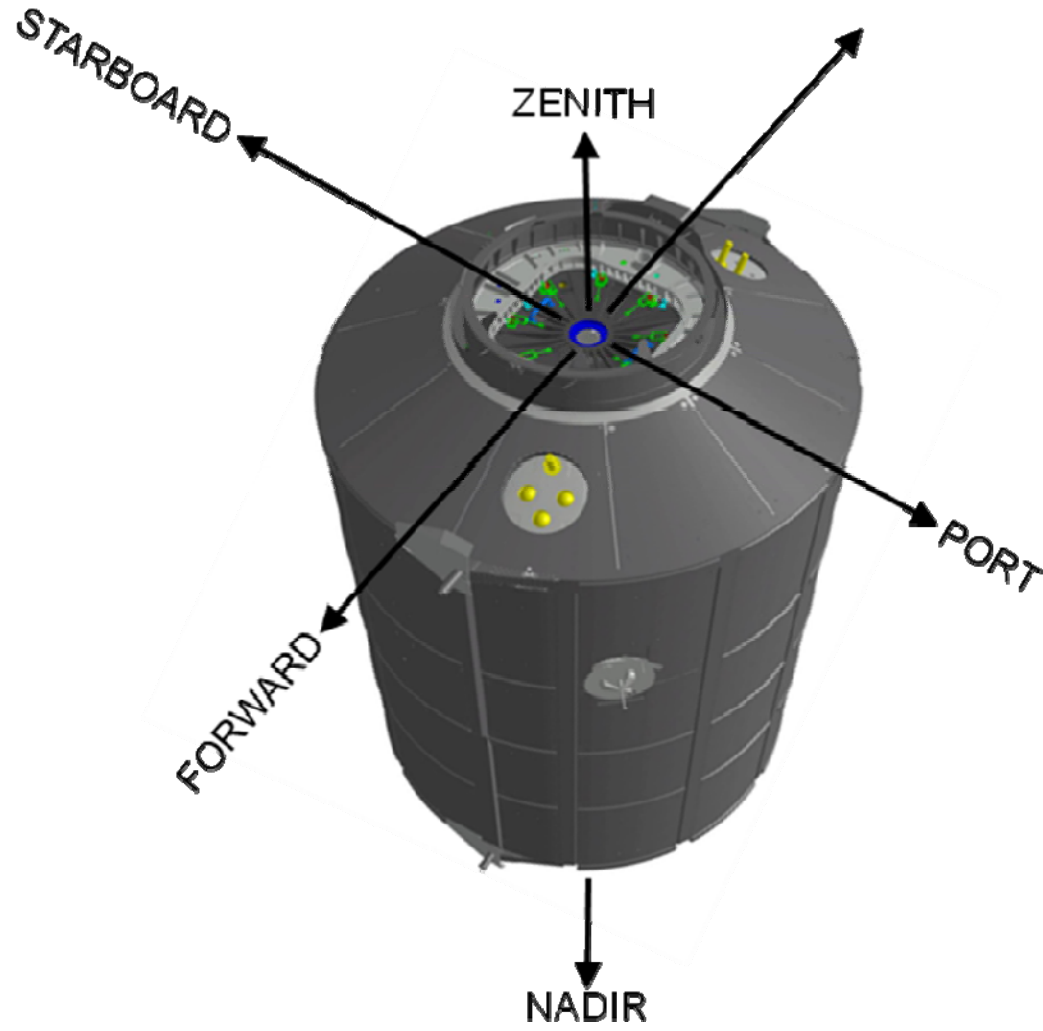

PMM Installed Configuration



PMM (Cont)

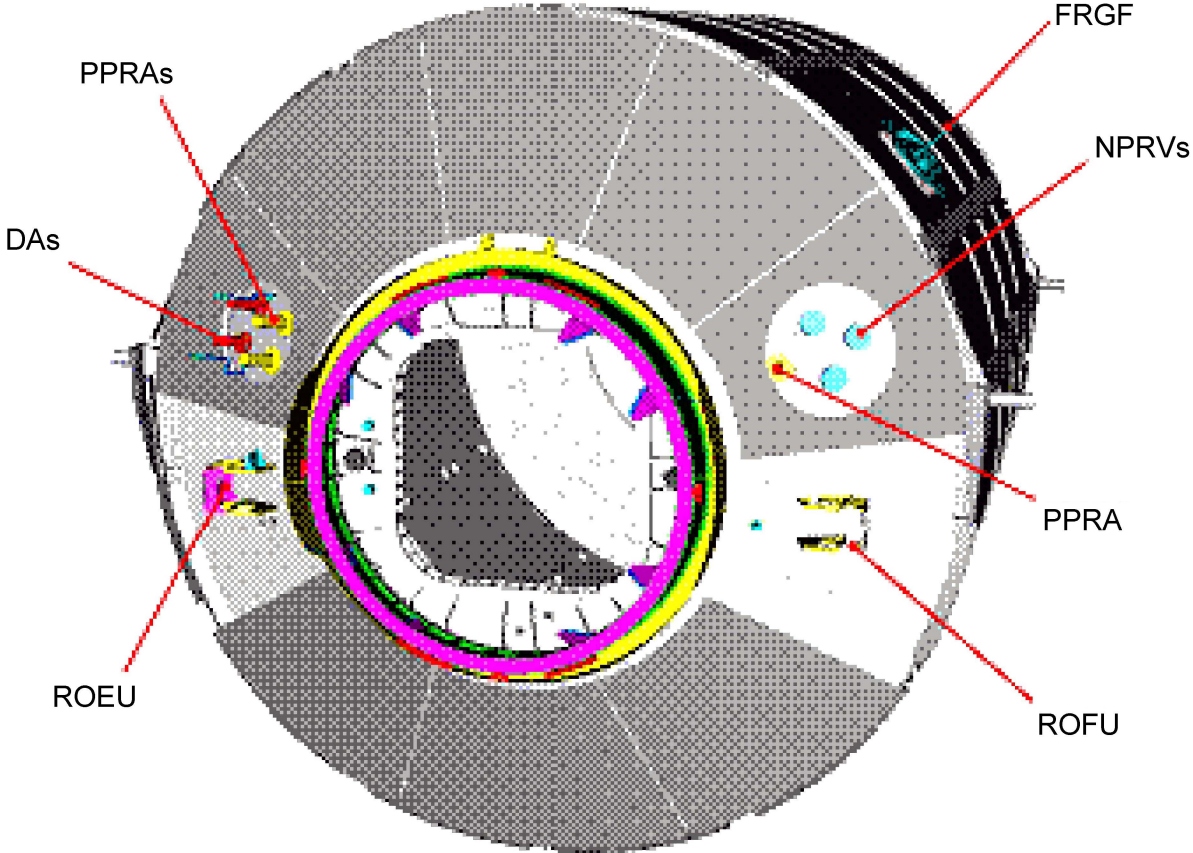

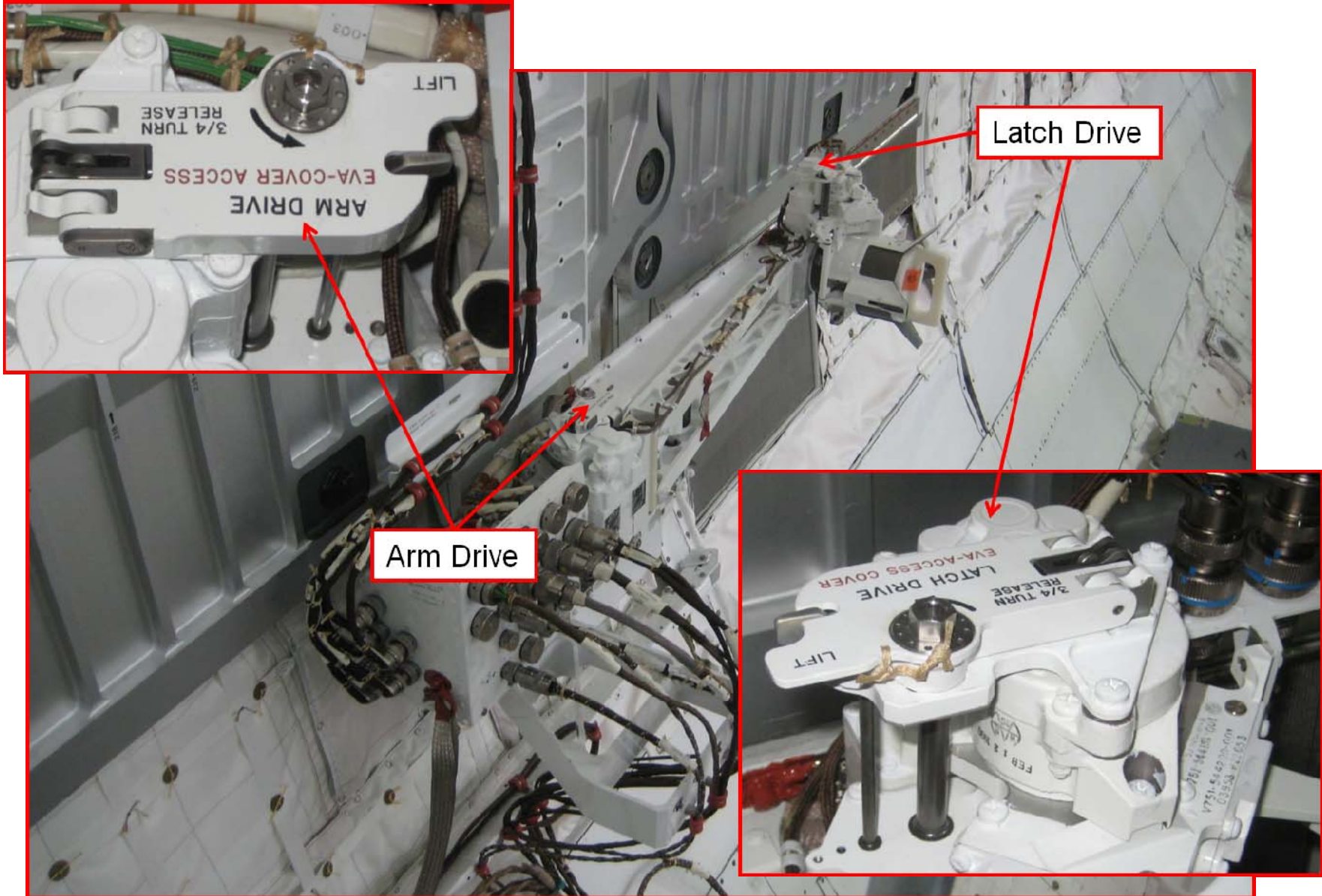

ROEU (Cont)



# PRLA

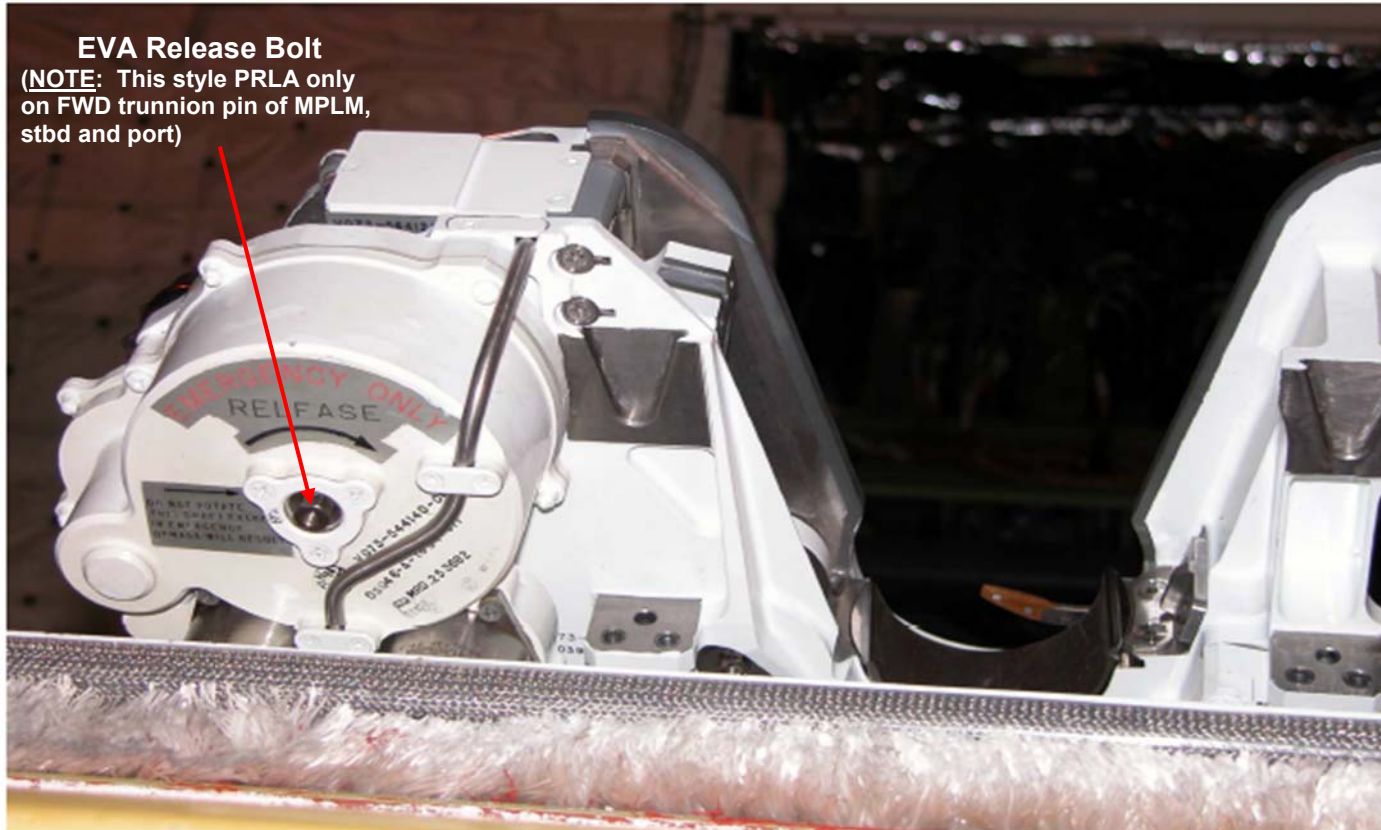

**LIGHT/MIDDLE WEIGHT PRLA**  
(MRM AND AFT PALLET TRUNNIONS)

PRLA (Cont)

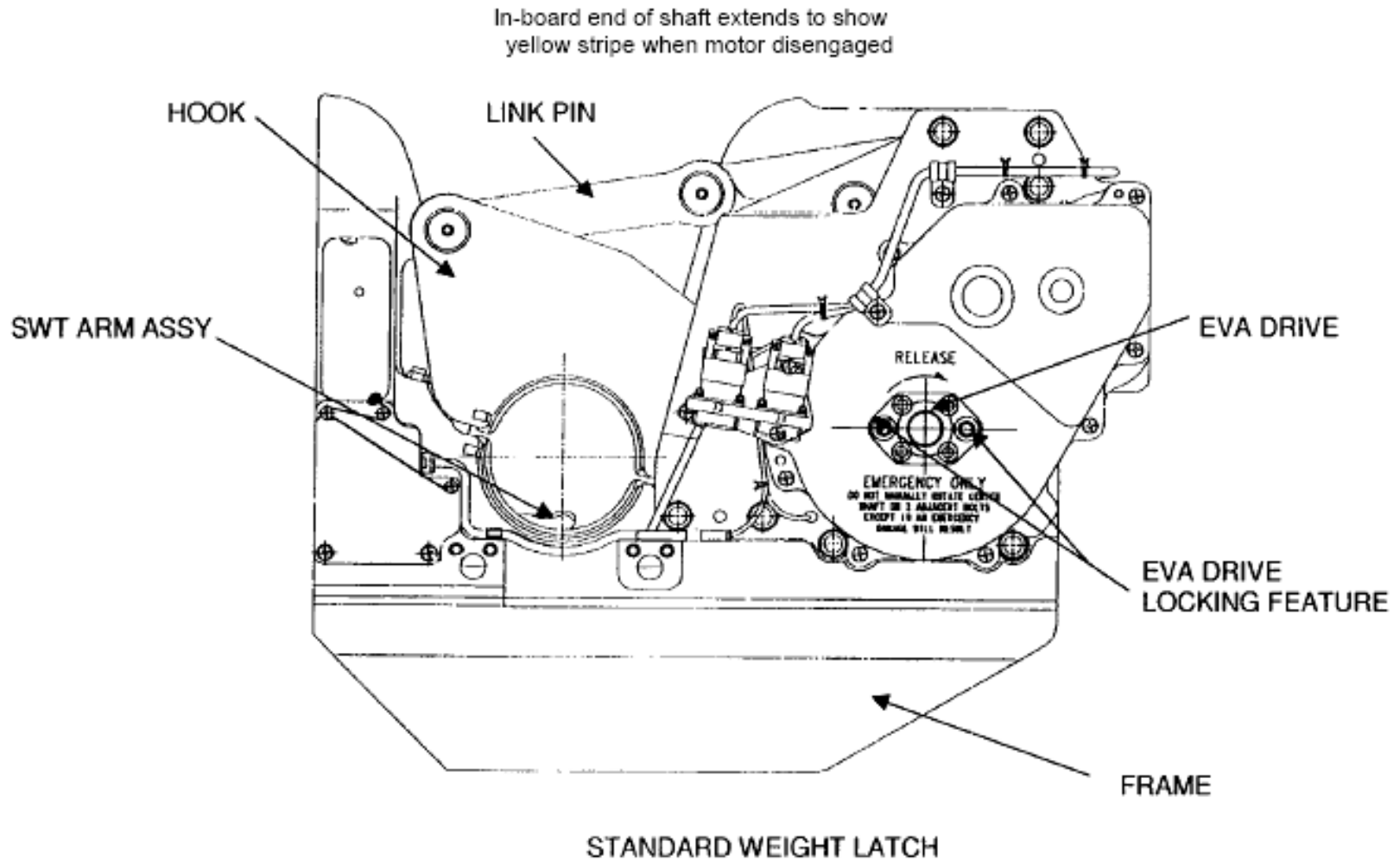

EVA RELEASABLE PAYLOAD RETENTION LATCHES (Cont)

**STANDARD WEIGHT PRLA**  
(FWD Pallet trunnions)

**PRLA (Cont)**

**PRLA EVA Release Bolt (Clearance is tight; avoid the monkey fur)**

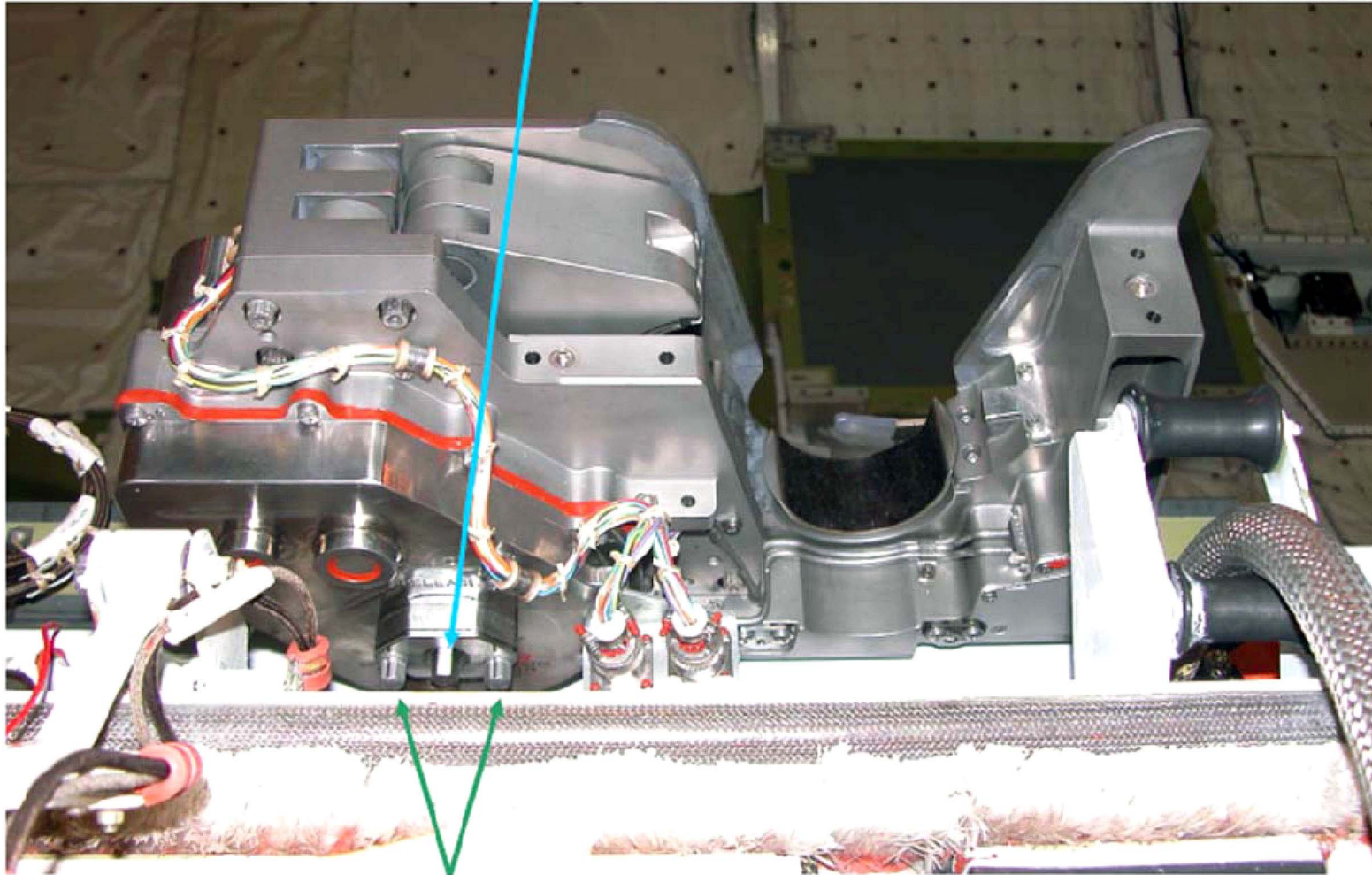

**Locking Bolts (2)**

**Standard Weight PRLA**



PRLA Grounding Wiper: Listed as a sharp edge warning in Notes/Cautions/Warnings

They are installed as needed based on testing after payload installation. They have passed swatch tests, but EV crew should be aware and take precaution

EVA 1

J612 EXT AND NODE 3 CABLE

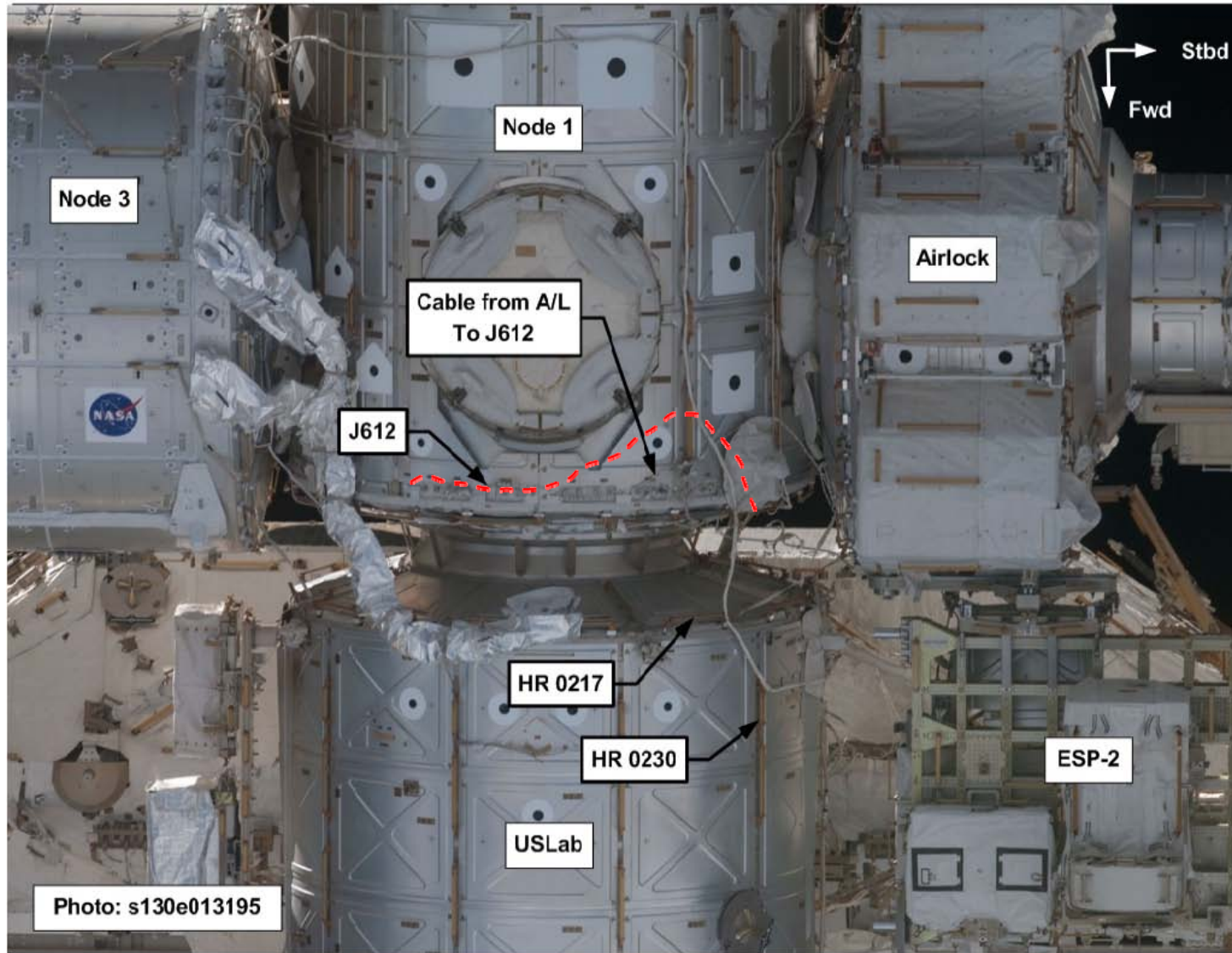



J612 EXT AND NODE 3 CABLE (Cont)



# PUMP MODULE

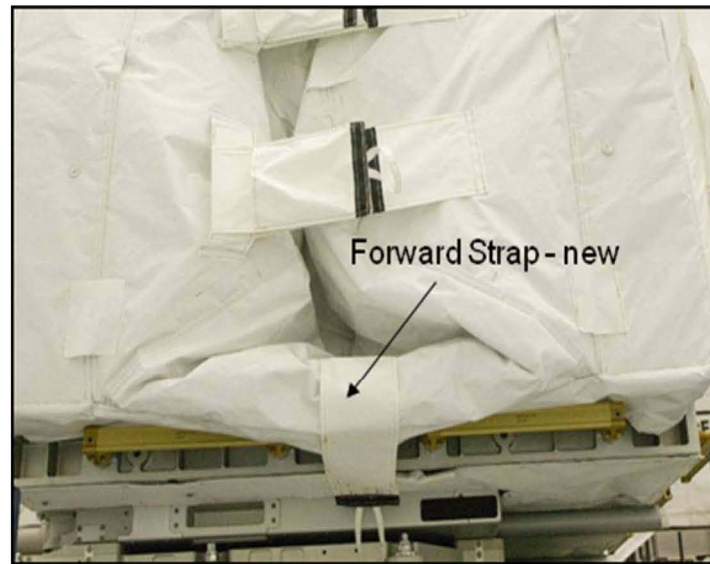
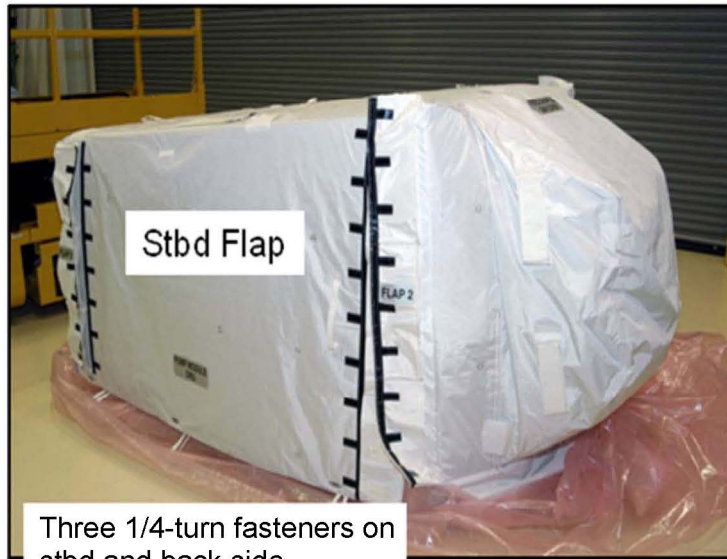
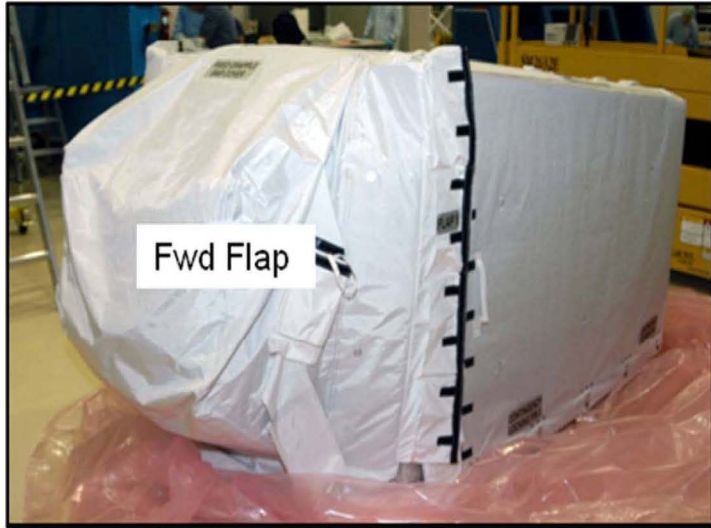

## PUMP MODULE (Cont)

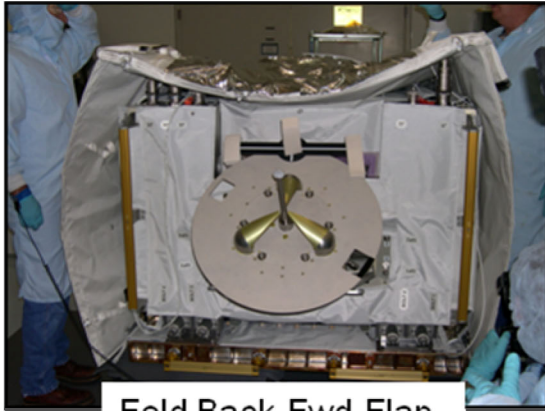

Fold Back Fwd Flap



Attach Fwd Flap to Top



Fold Back Stbd Flap,  
attach to top

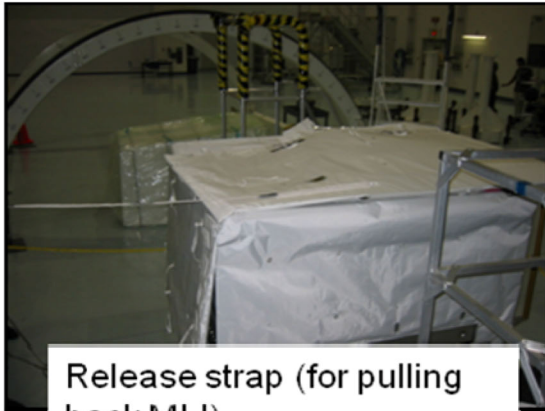

Release strap (for pulling  
back MLI)

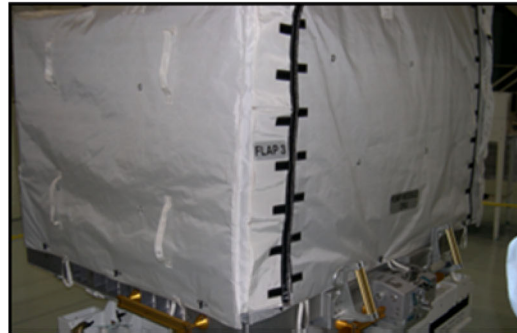

Release aft ¼-turn fasteners  
(3)



Pull tent away from ESP-2 (stays  
attached to FSE on port side)

## PUMP MODULE (Cont)

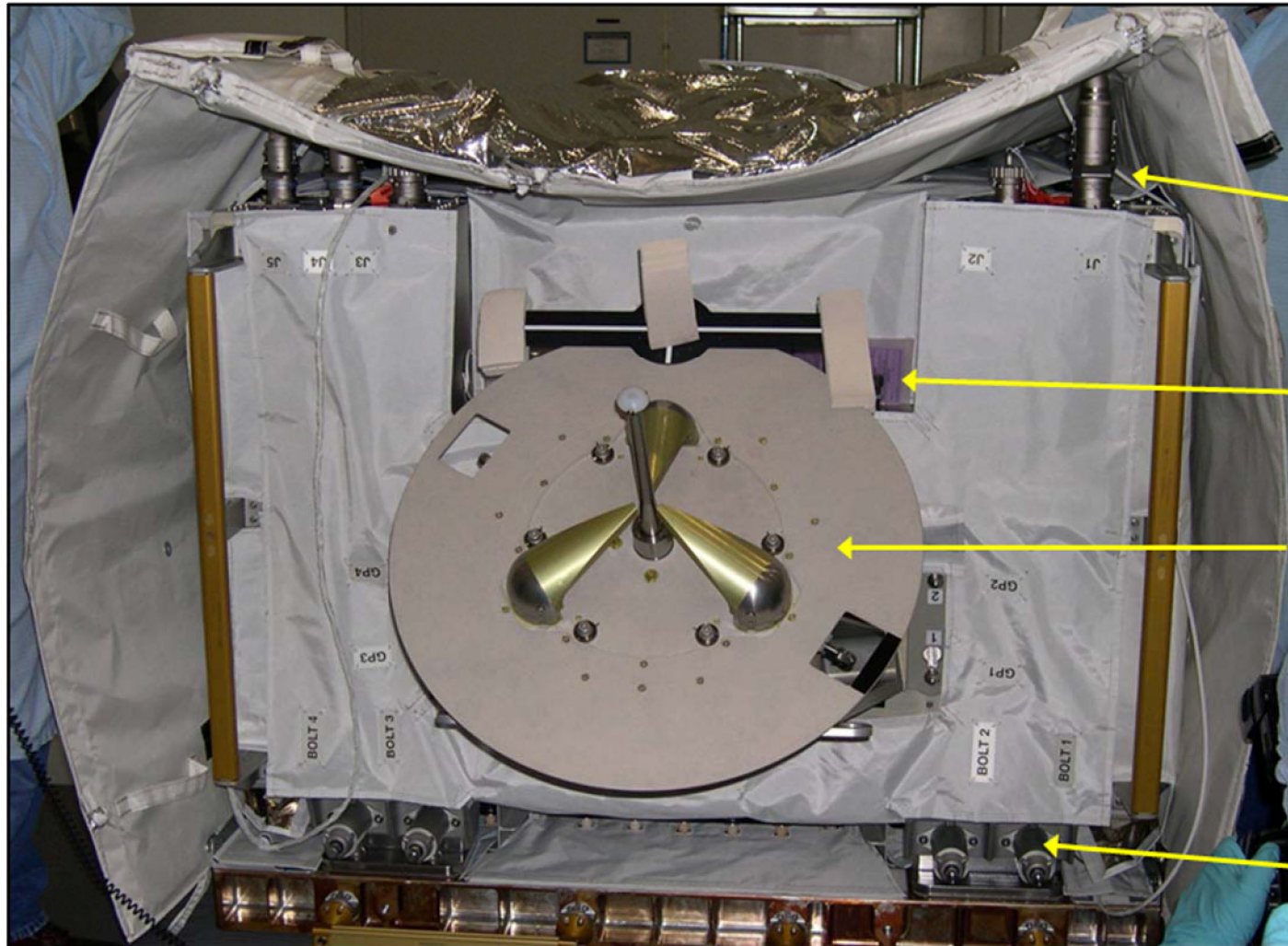

Electrical  
Connectors  
(5 jacks,  
3 connectors)

Fluid QDs  
(4)  
(blocked)

FGB

FSE Bolts  
(4)

# PUMP MODULE (Cont)

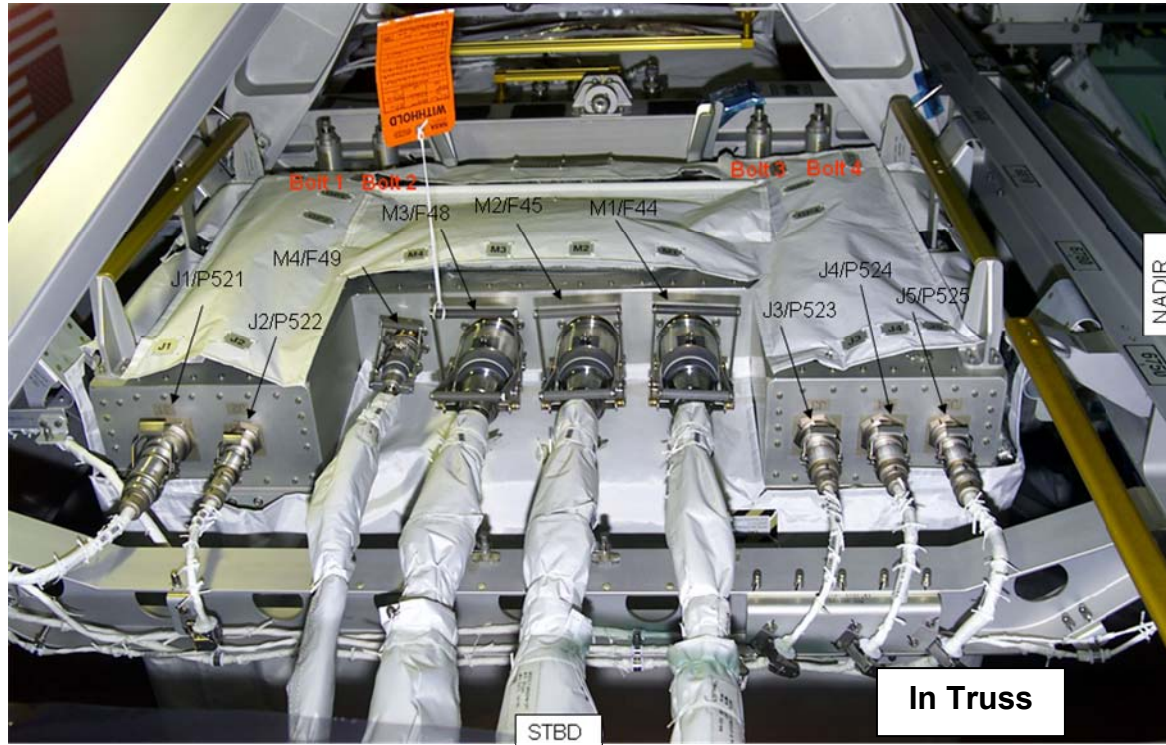

Port Connector – M/W J1



Stbd Connector – M/W J4 and J5

VENT TOOL



Has equipment hook on 1/4-in nozzle



**VENT TOOL (Cont)**

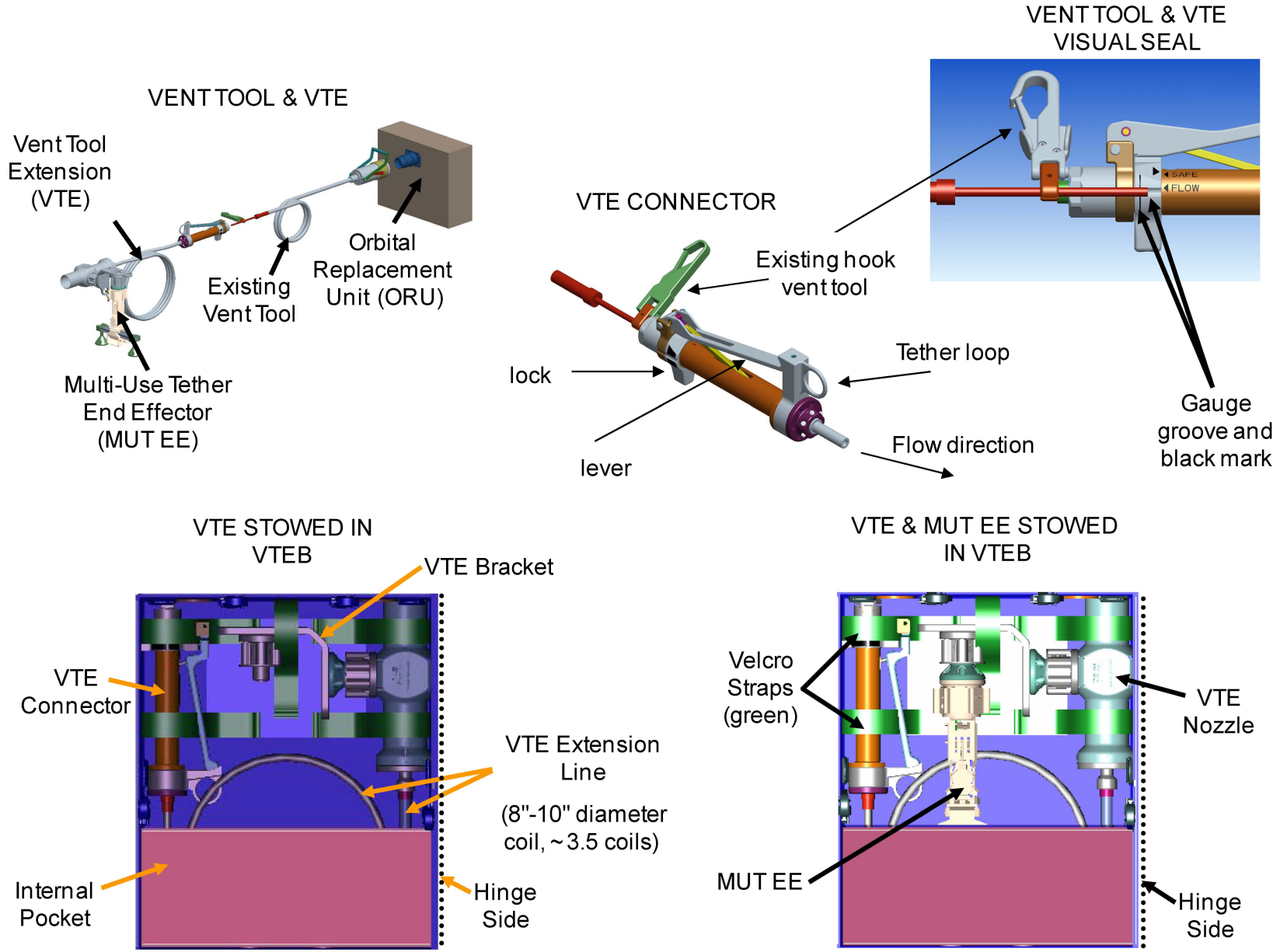

Z1 RPCM MLI

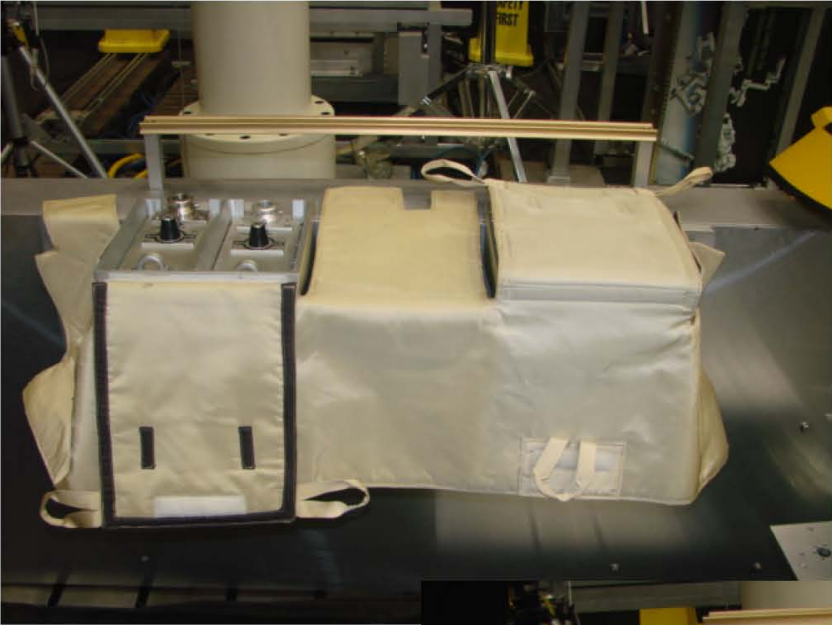



# CP3 CAMERA WEDGE

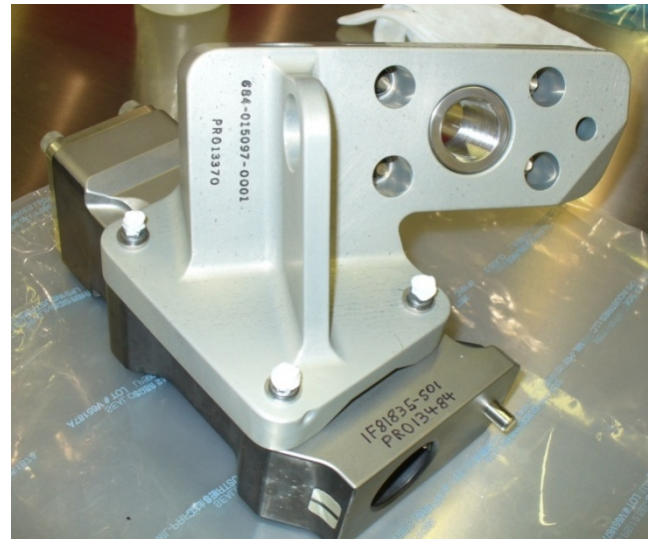
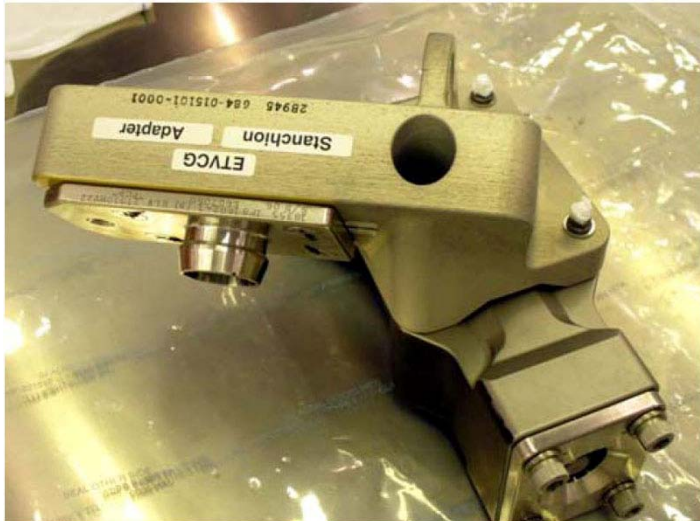
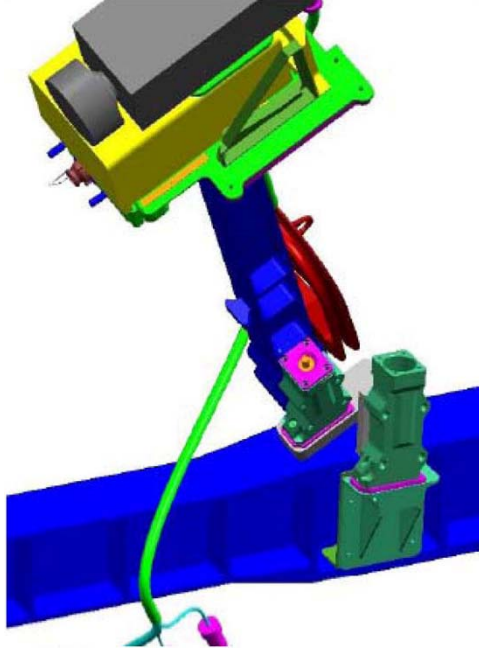

# CP3 CAMERA WEDGE (Cont)

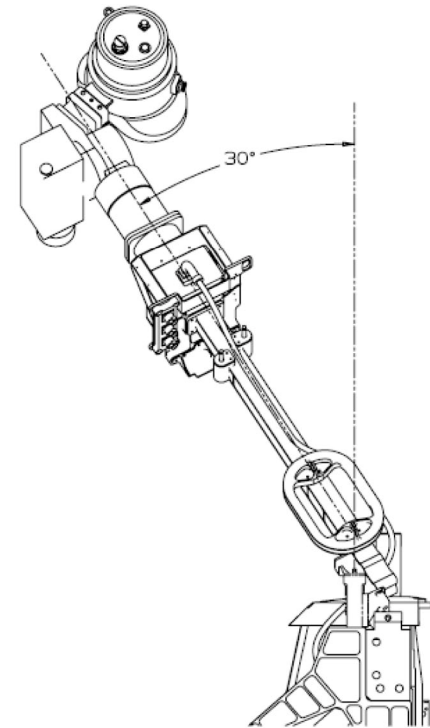
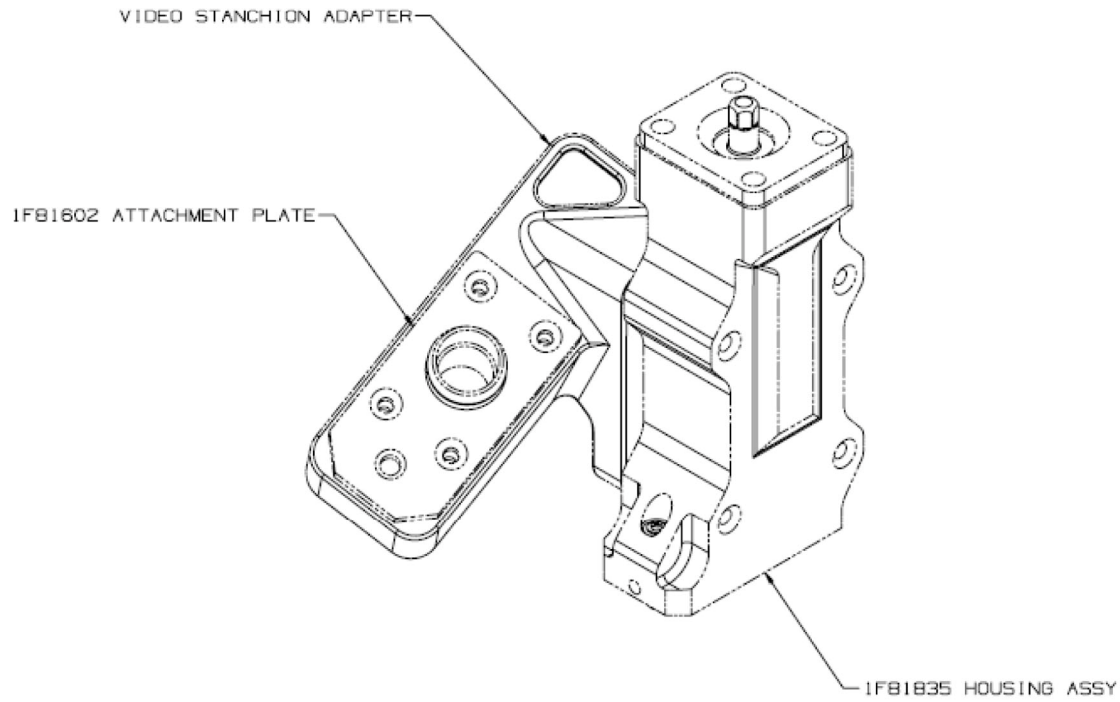

SCALE: 2/1  
VCSA INSTALLED ON  
THE ADAPTER ASSY  
(LOOKING TOWARD PORT)

**CP3 CAMERA WEDGE (Cont)**

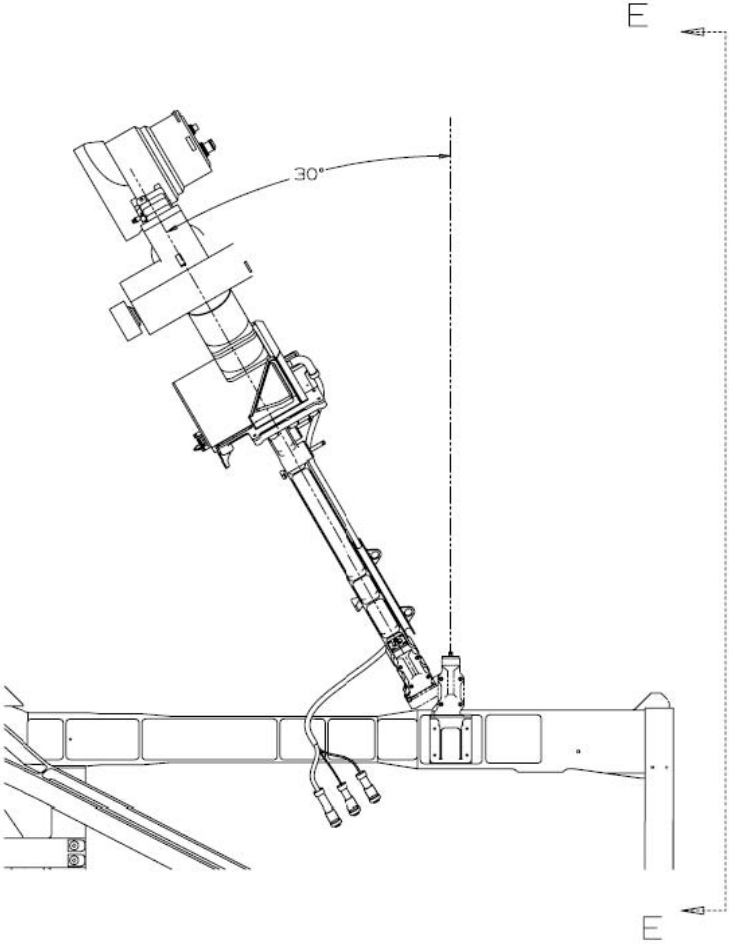

SCALE: 2/1  
VCSA INSTALLED ON  
THE ADAPTER ASSY  
(LOOKING AFT)

## CP3 CAMERA AND VSSA



Camera Pan/Tilt Lock (shown in locked position)



CP3 CAMERA AND VSSA (Cont)

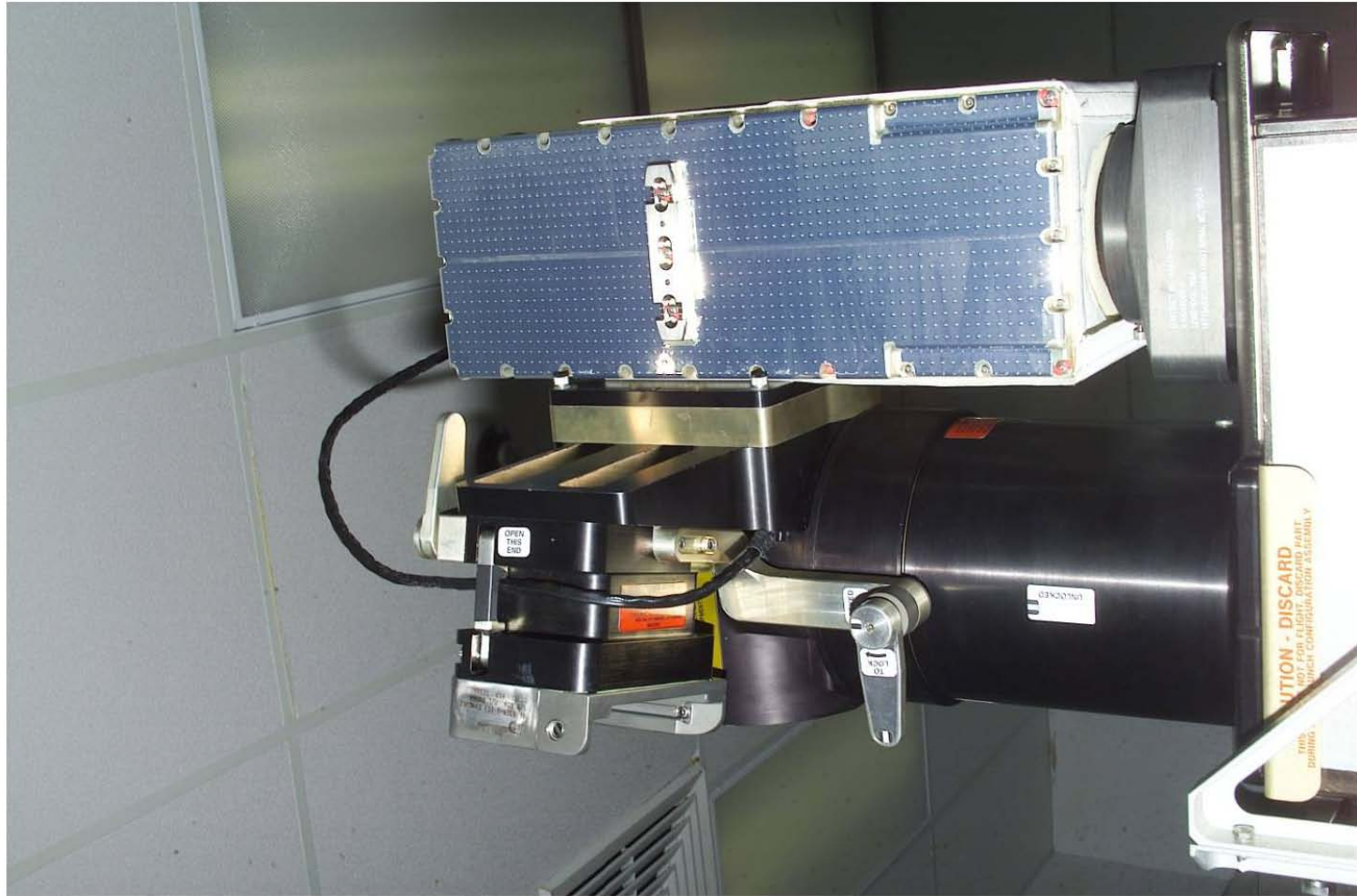

STBD CETA RAIL STUB

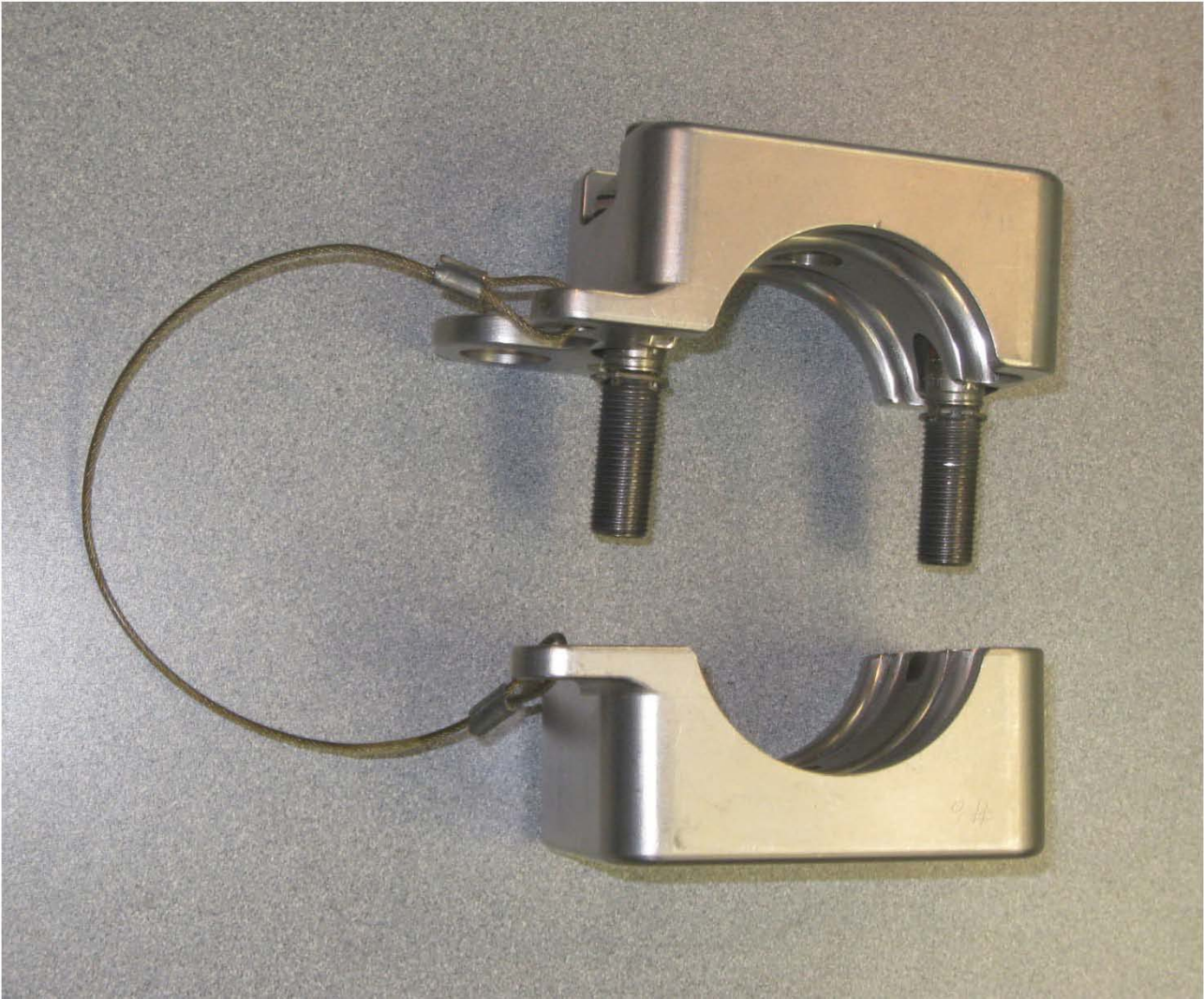

STBD CETA RAIL STUB (Cont)

6A LAUNCH RESTRAINT – LAUNCH CONFIG



## STBD CETA RAIL STUB (Cont)

### 6A LAUNCH RESTRAINT – LAUNCH CONFIG (BACK SIDE)





STBD CETA RAIL STUB (Cont)

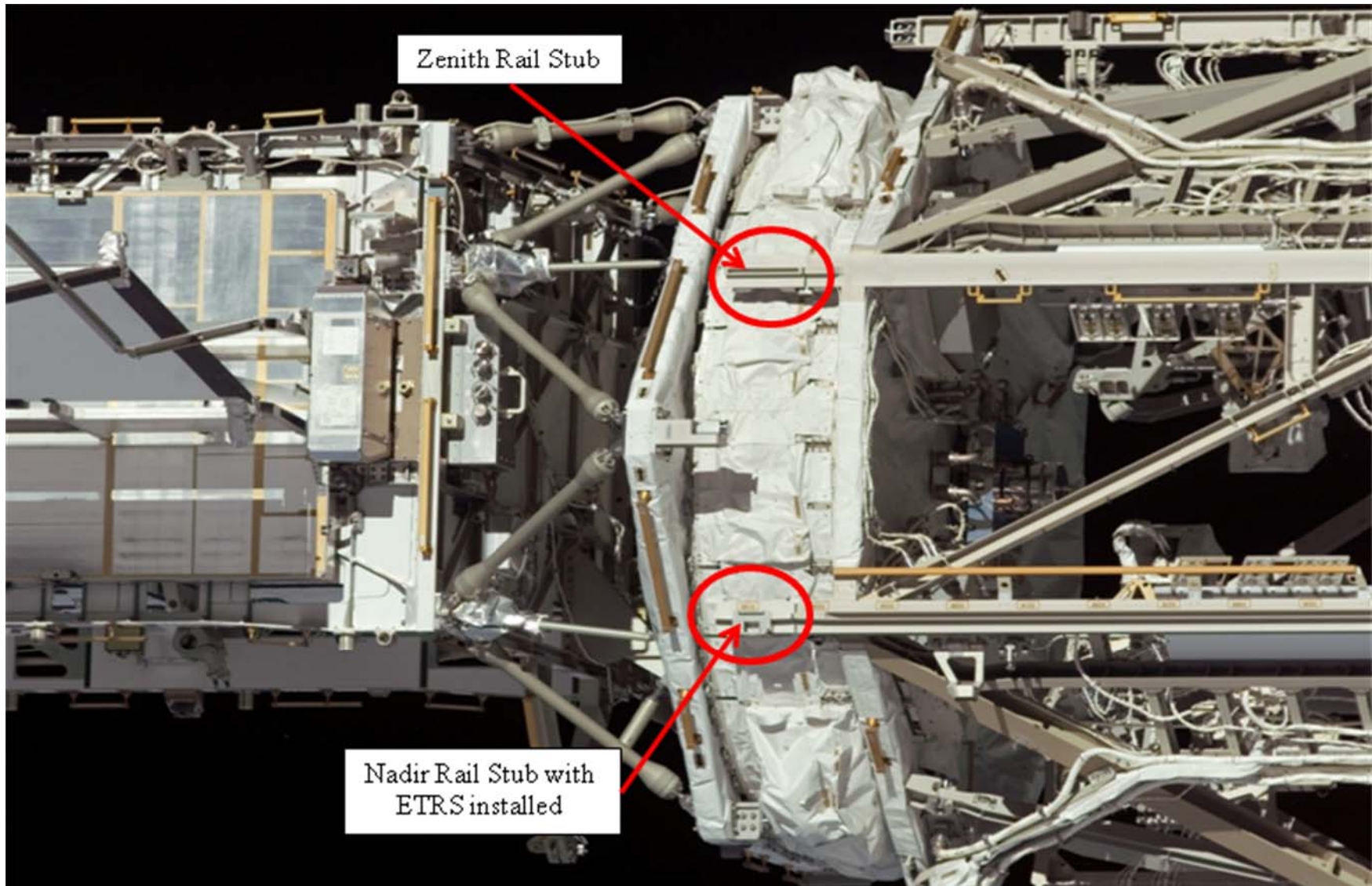

STBD CETA RAIL STUB (Cont)

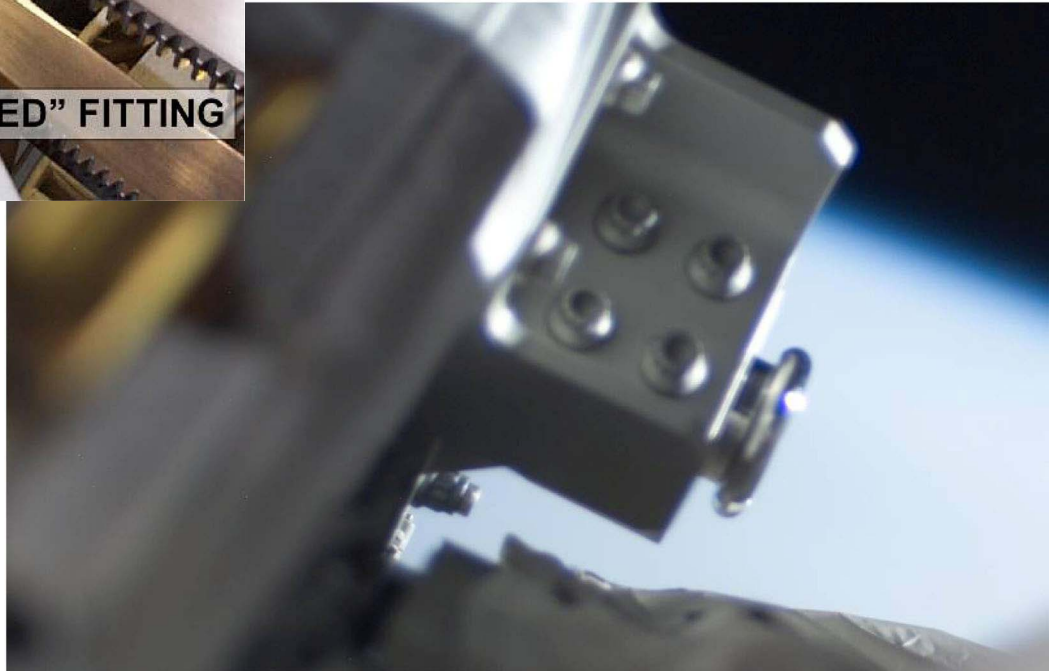

## TETHER SHUTTLE STOP



Deployed



Stowed

S3 MT STOP

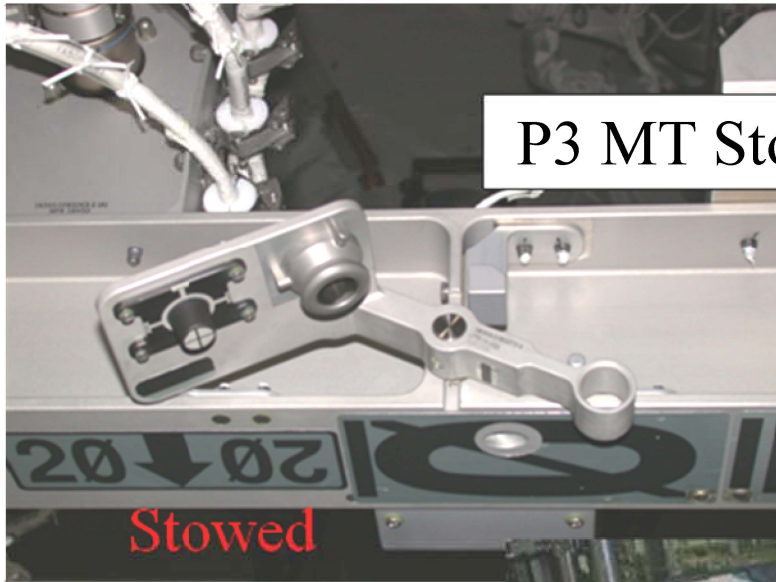

Stowed

P3 MT Stop shown here

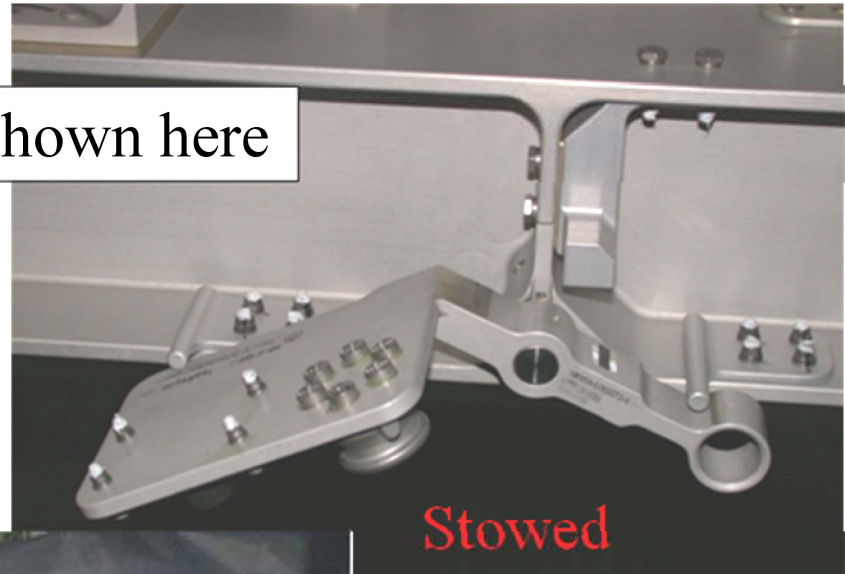

Stowed

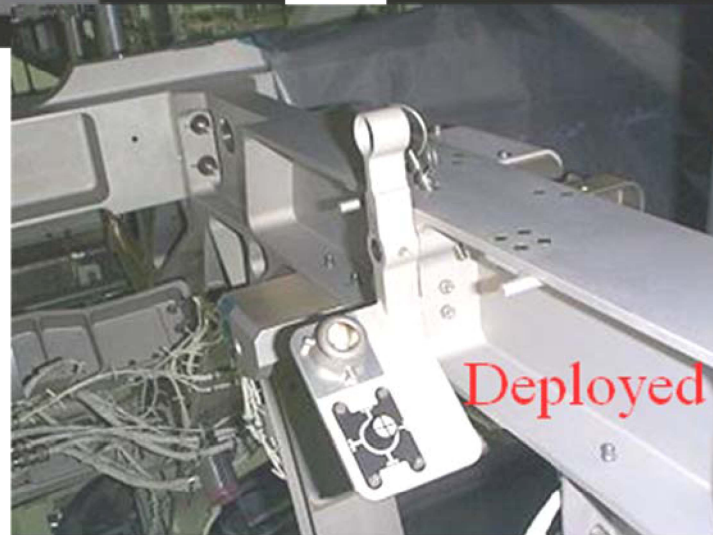

Deployed

## JAXA MESSAGE IN A BOTTLE

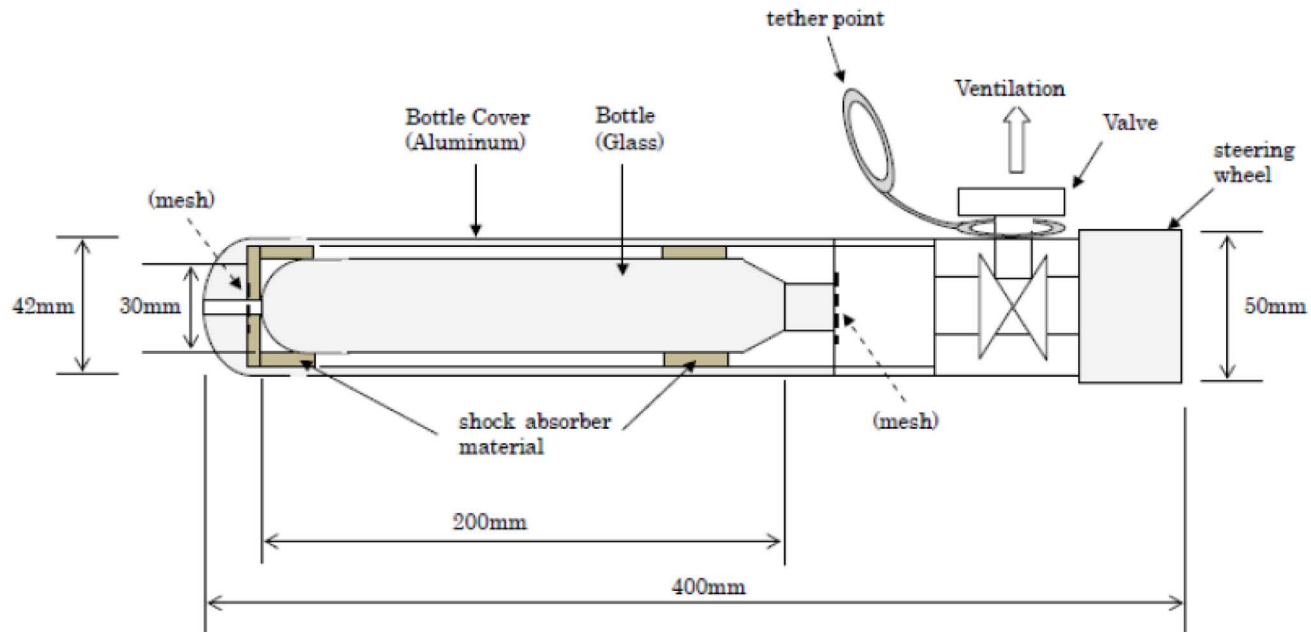

(size, configuration)

- Material
- bottle···kovar
  - cover, steering wheel···aluminum
  - valve, wire···SUS
  - shock absorber Material···silicone rubber

To use, put out the air in the glass by rotating steering wheel



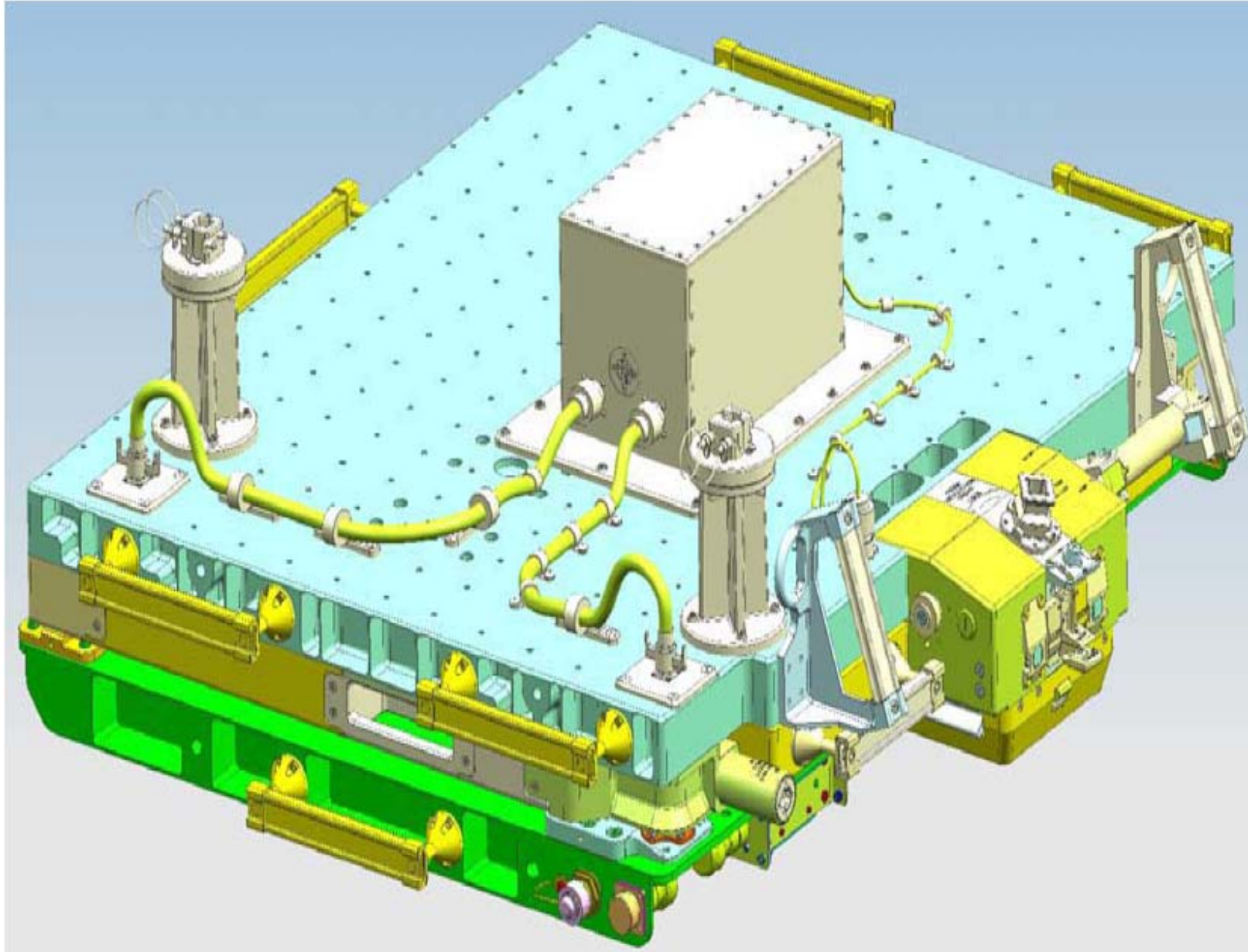

LWAPA (Cont)

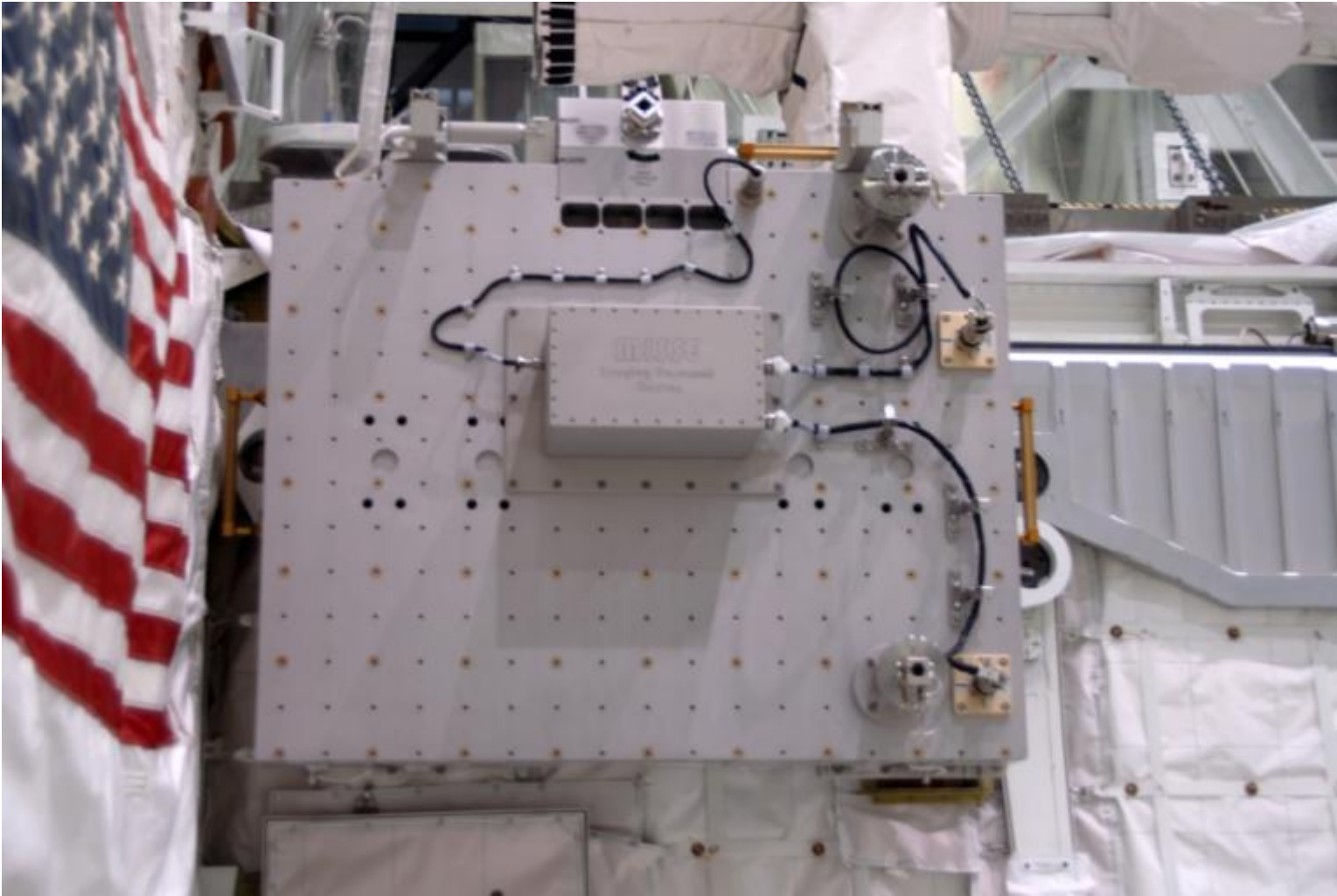

LWAPA (Cont)





LWAPA (Cont)

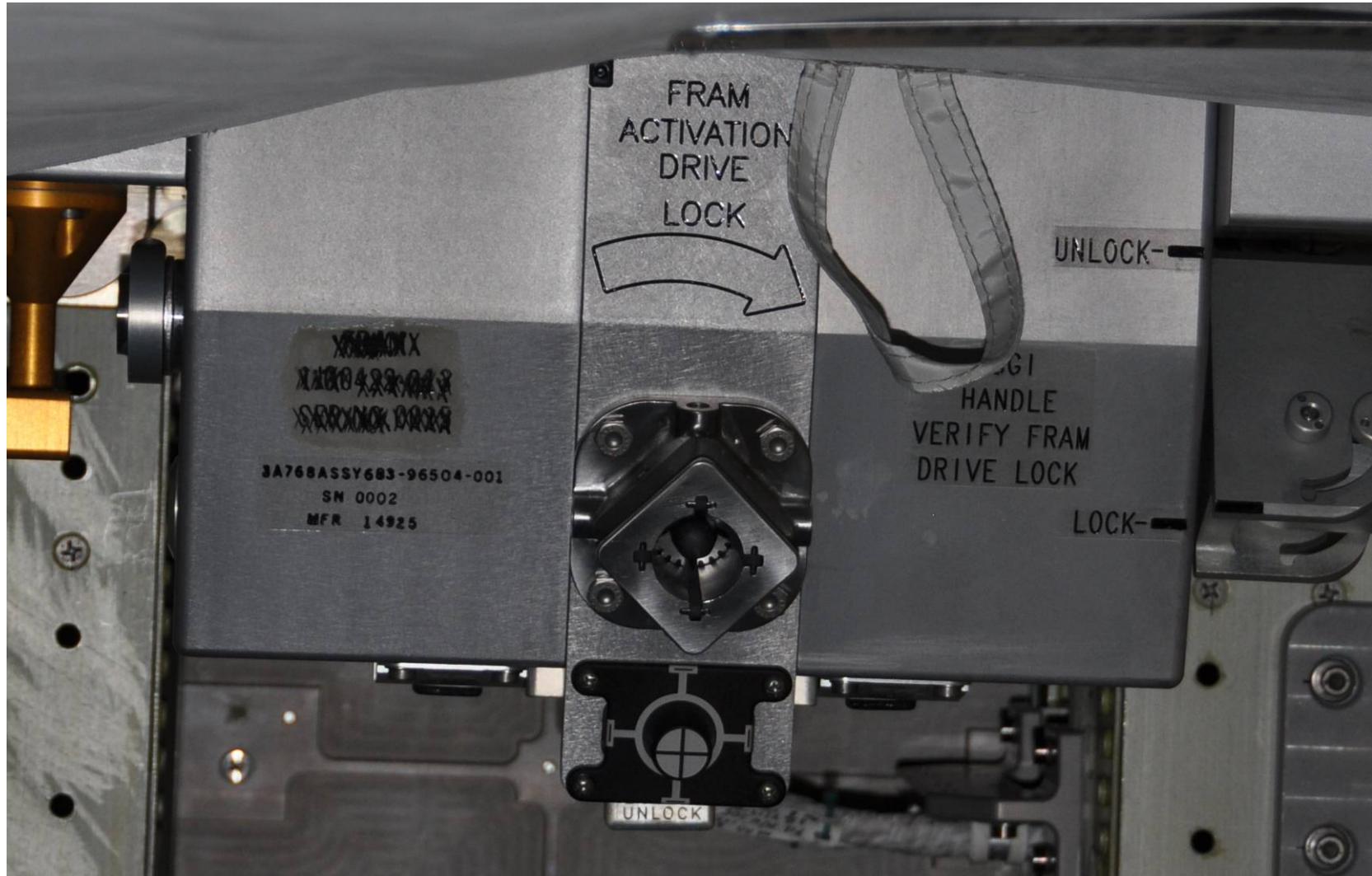

LWAPA (Cont)



LWAPA (Cont)

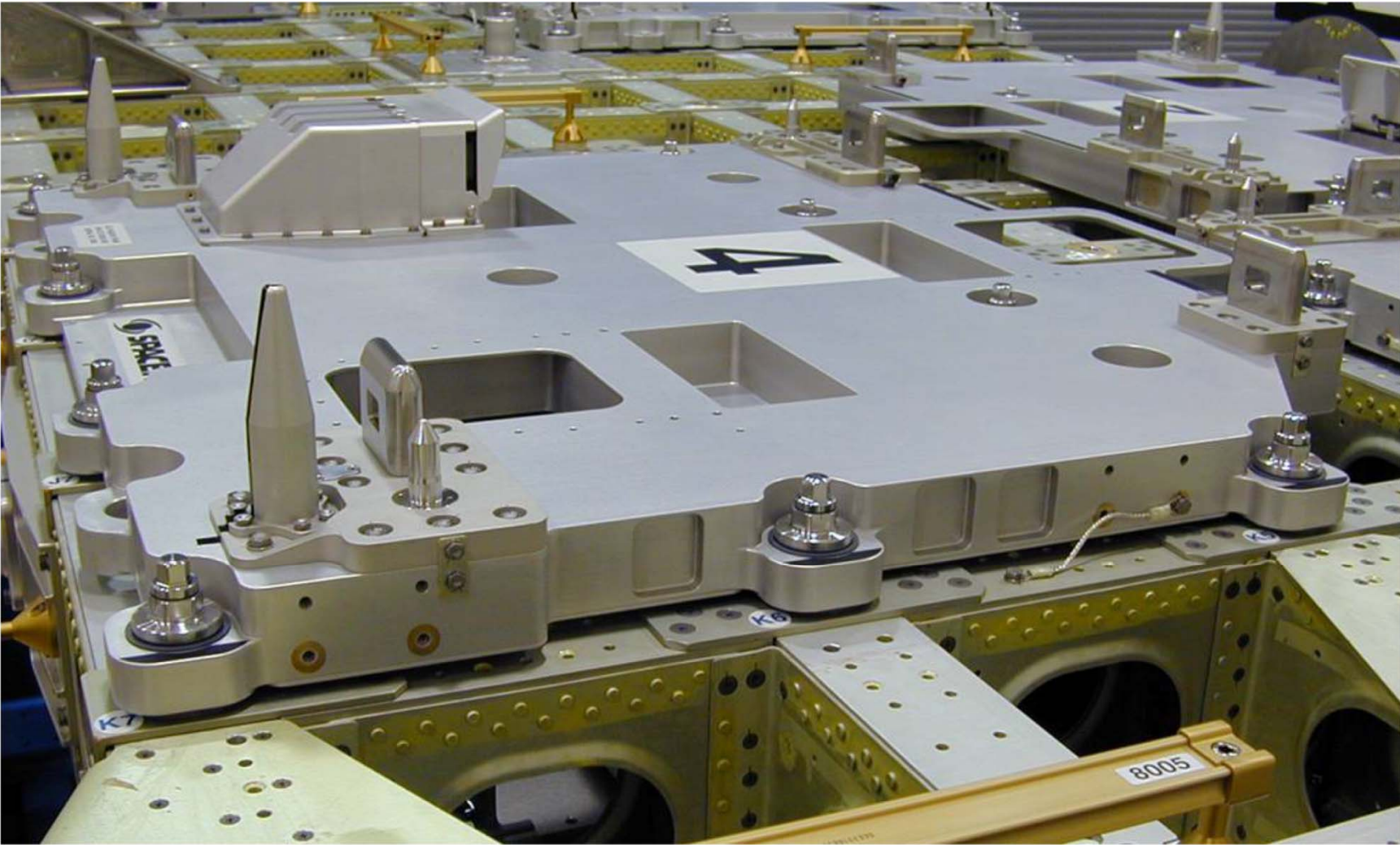

LWAPA (Cont)



ELC4 ExPCA MLI

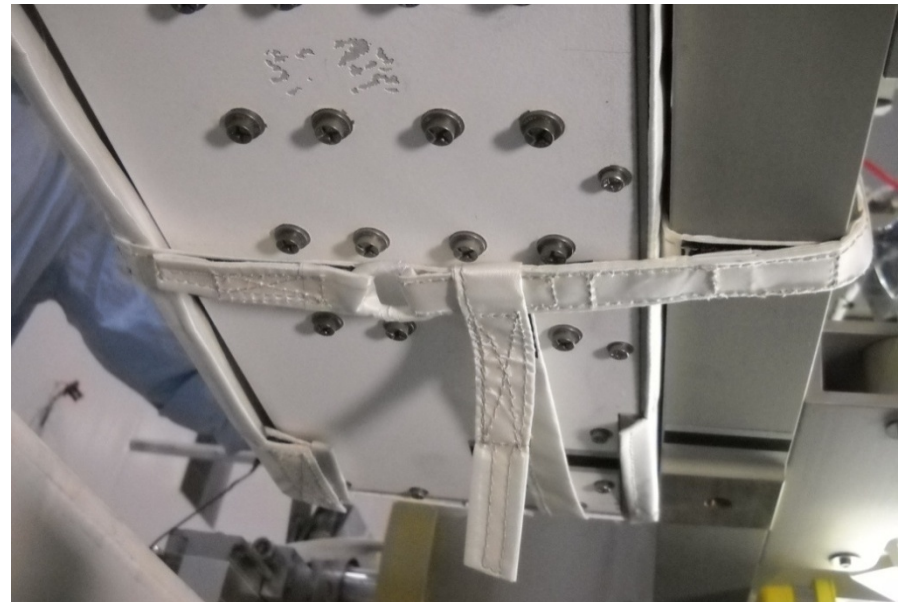

FS 18-45

EVA/133/FIN

## ELC4 ExPCA MLI (Cont)

Step	Description
1	Ground strap from deck Velcro patch
2	Lower Fwd blanket strap & end strap from deck tie-down ring
3	Lower Aft blanket strap & end strap from deck tie-down ring
4	Upper Fwd blanket strap from deck tie-down ring
5	Upper Aft blanket strap from deck tie-down ring

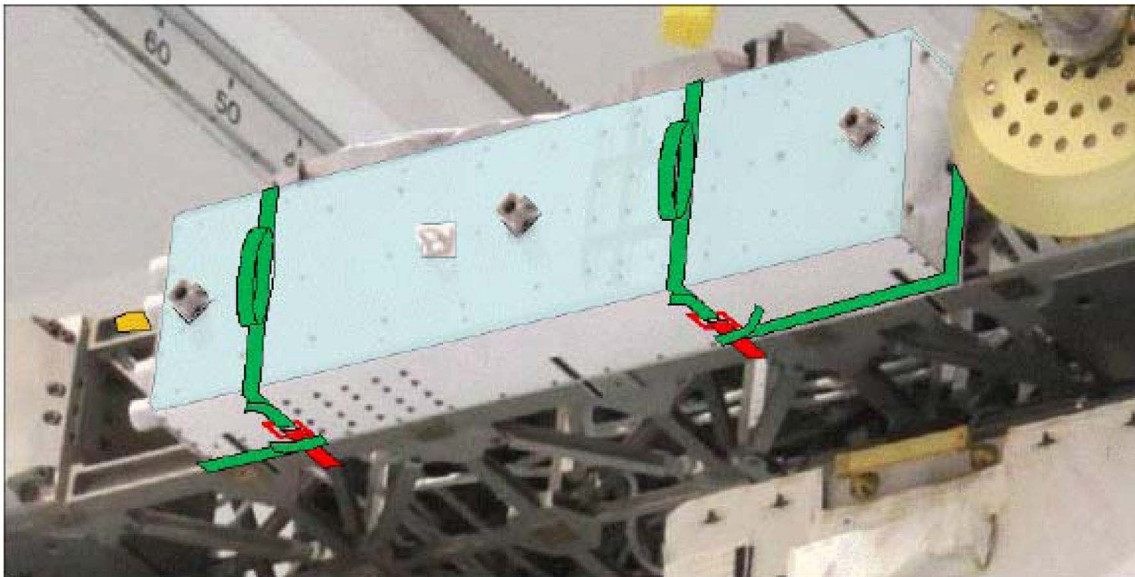
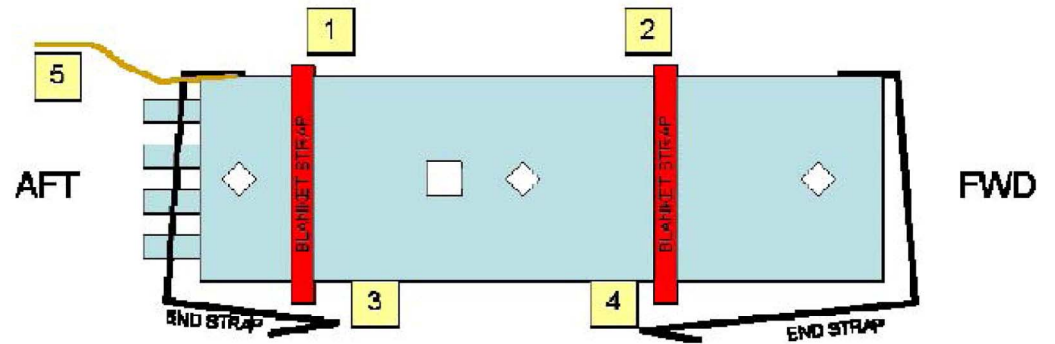

ELC4 ExPCA MLI (Cont)

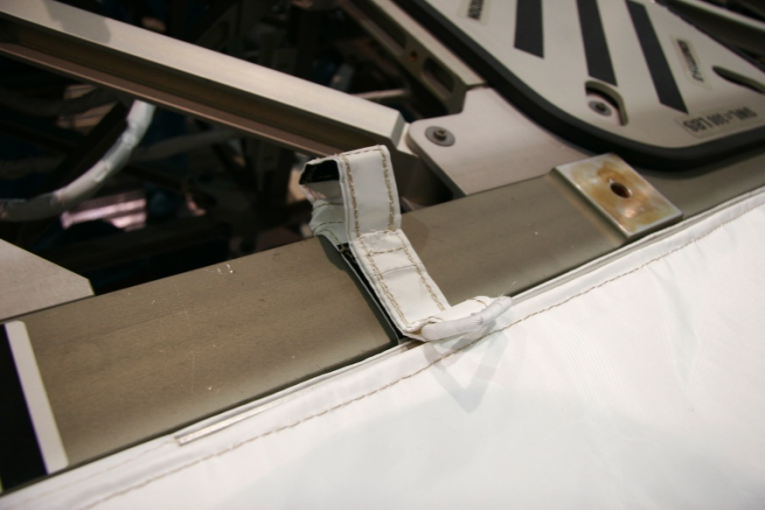
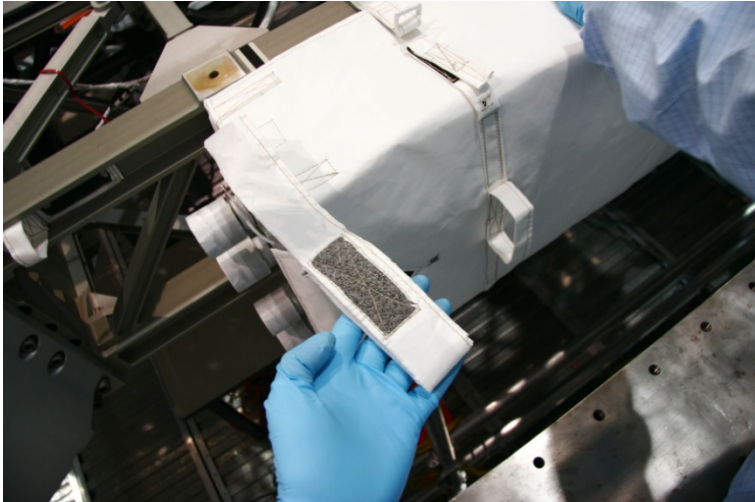
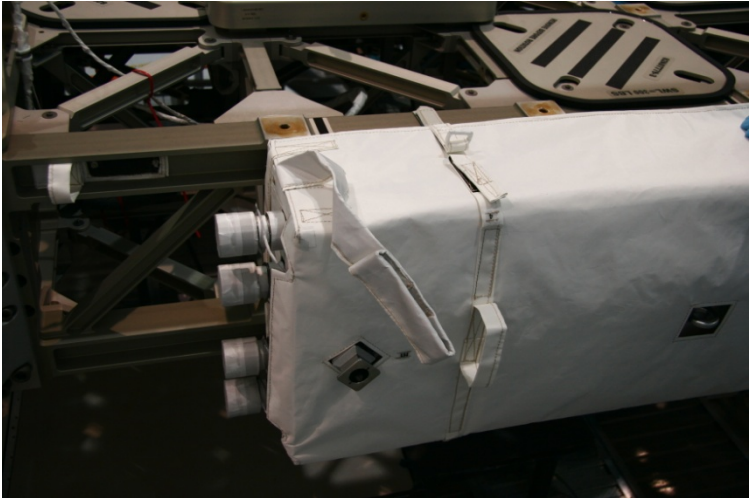

SPDM CLPA 1

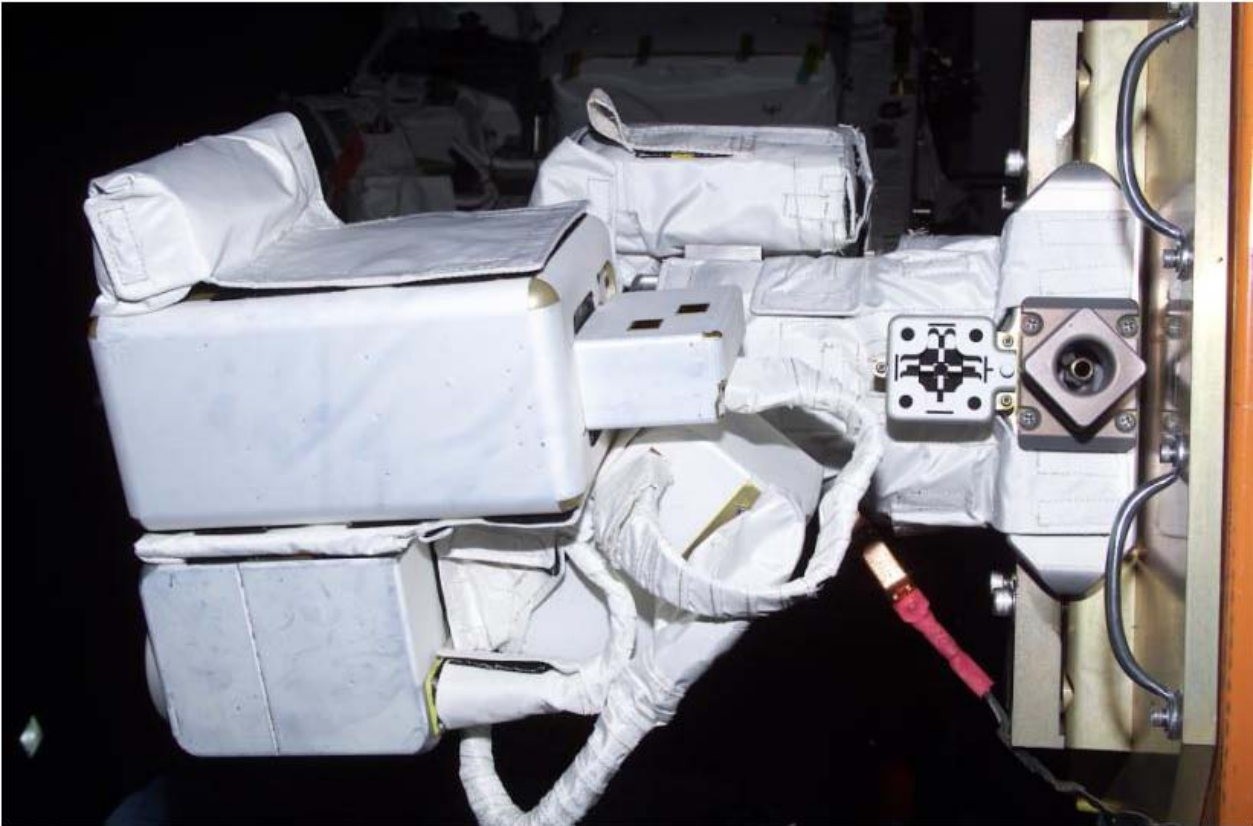



# SPDM CLPA 1 (Cont)

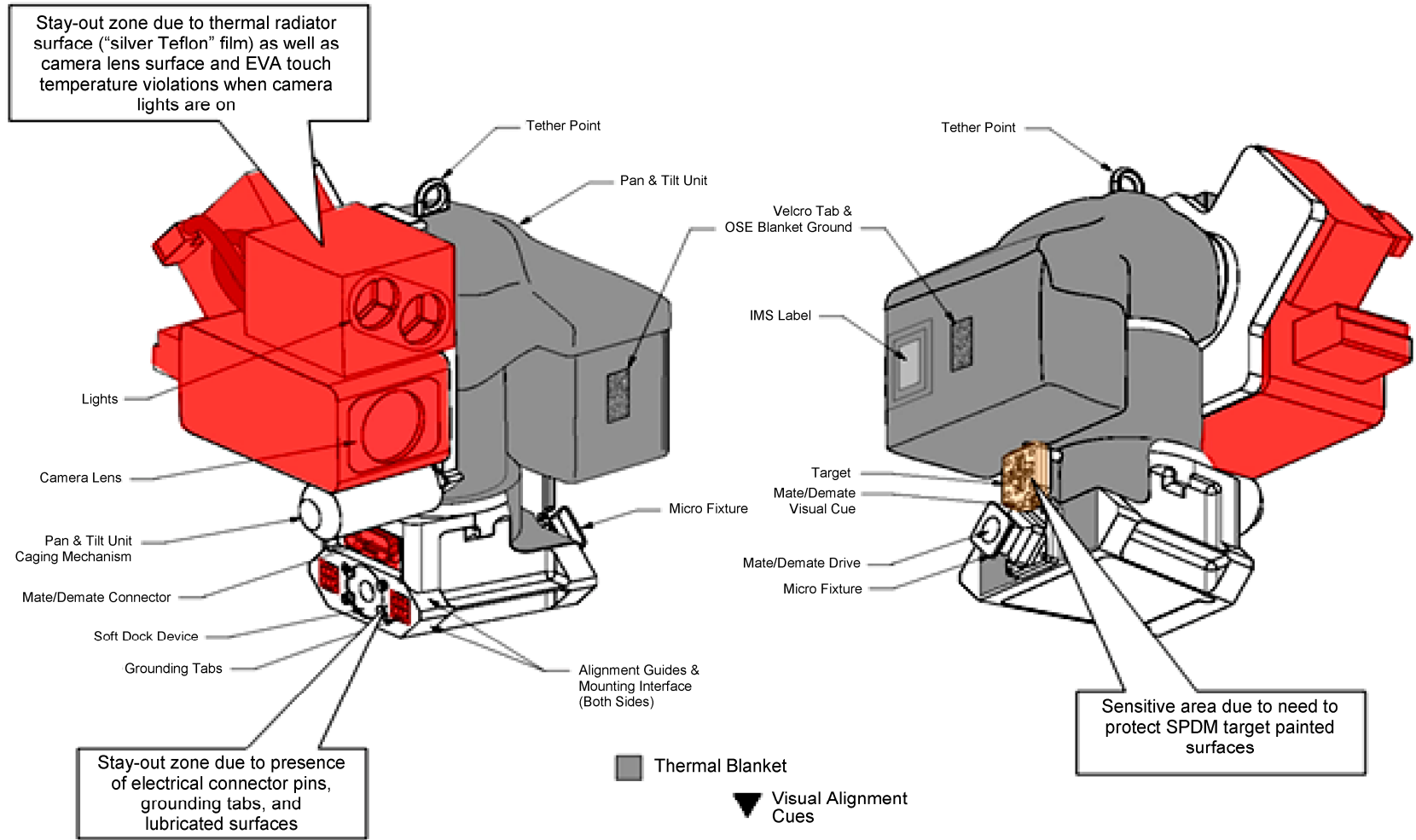

SPDM CLPA 1 (Cont)

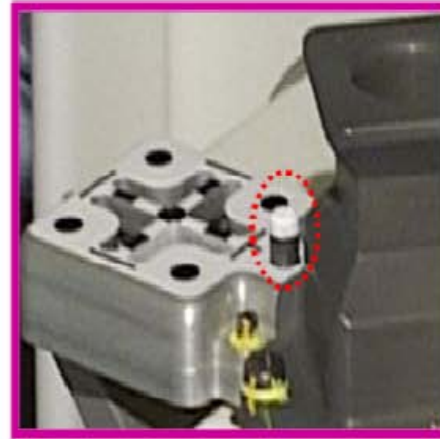
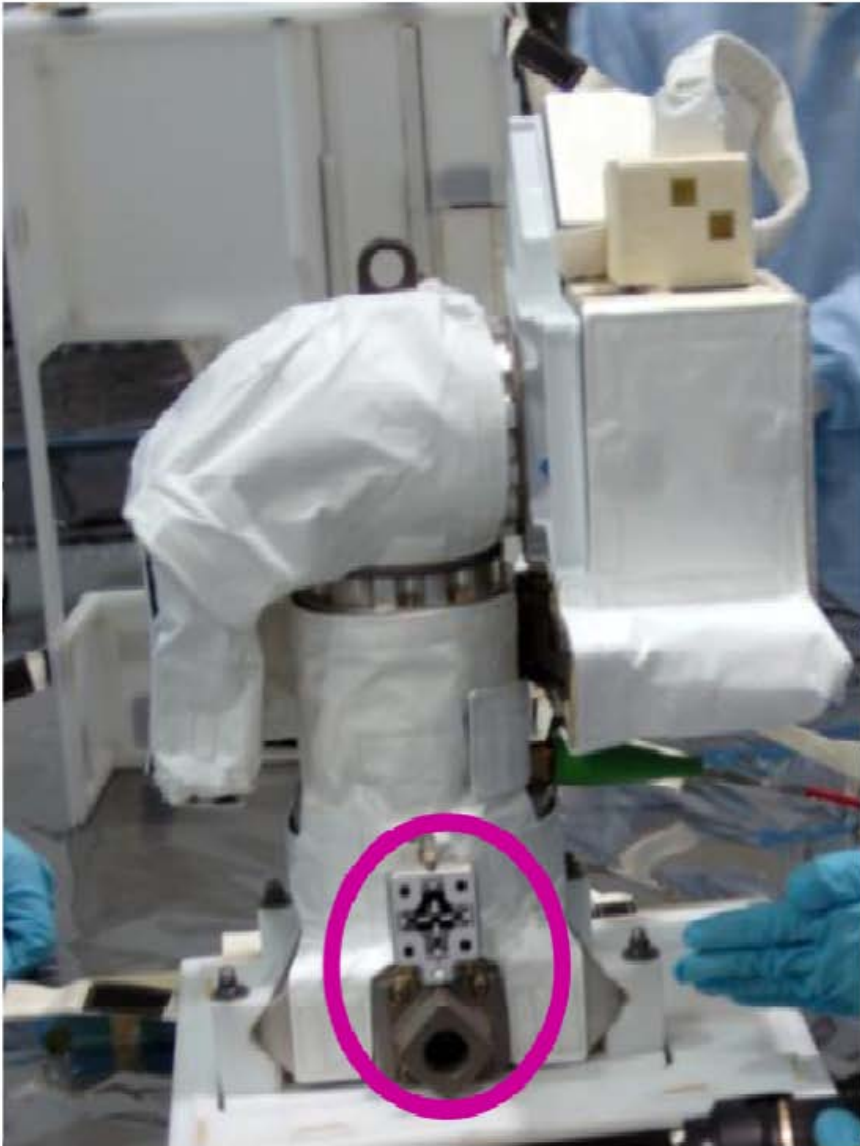

Uninstalled



Installed (only white tip visible)

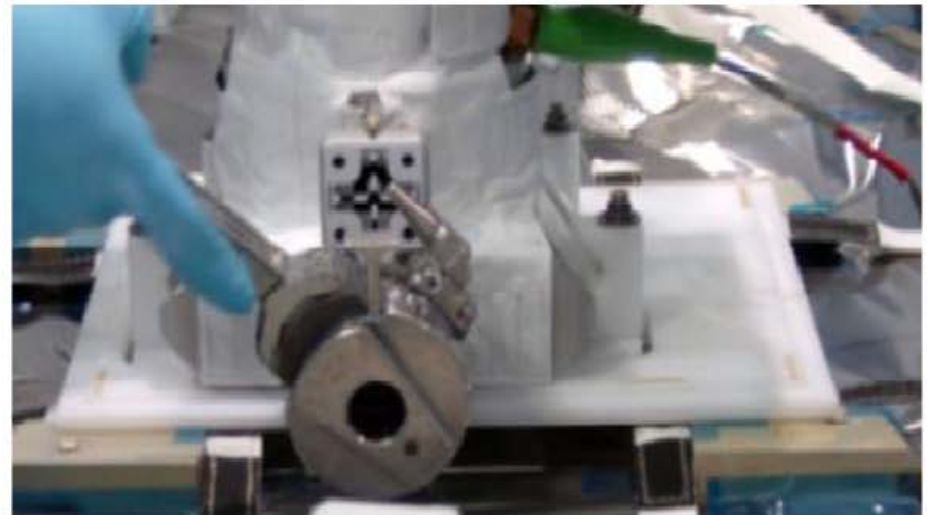

SPDM CLPA 1 (Cont)



Bolt interface

Pins

Track CLPA slides in



SPDM CLPA 1 (Cont)

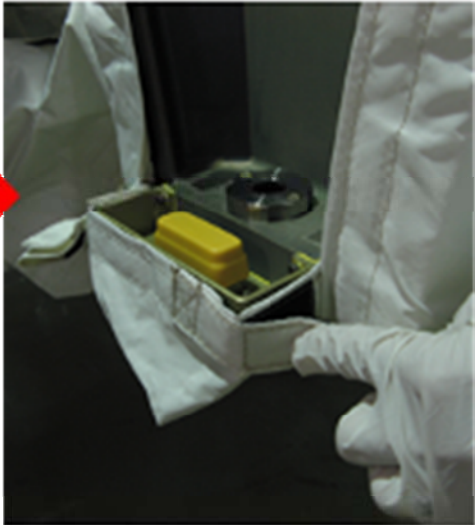
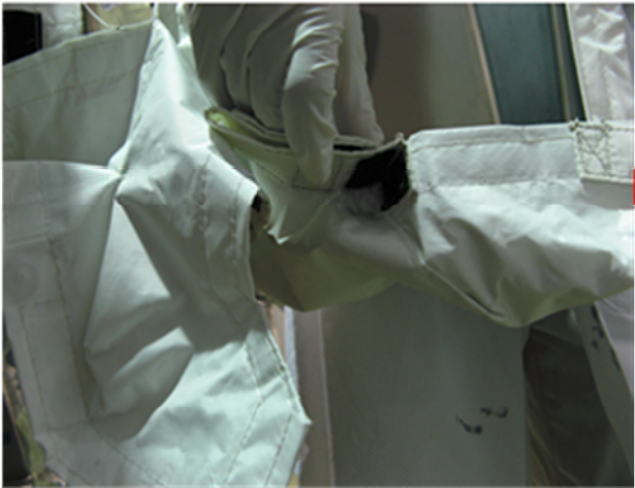
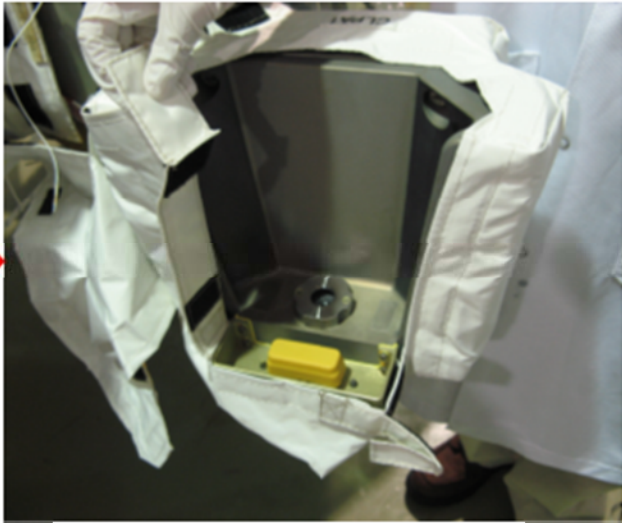
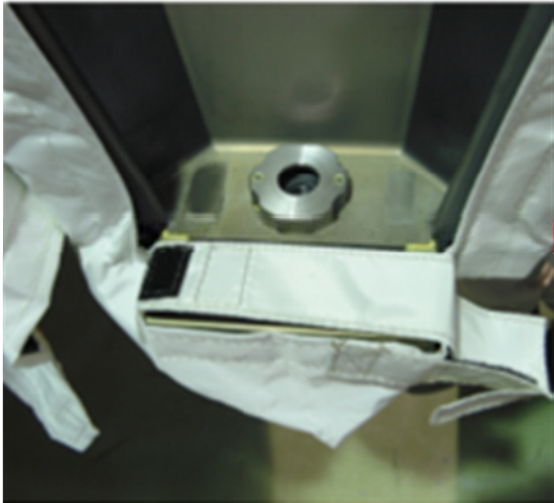

SPDM EP 1



SPDM EP 1 (Cont)

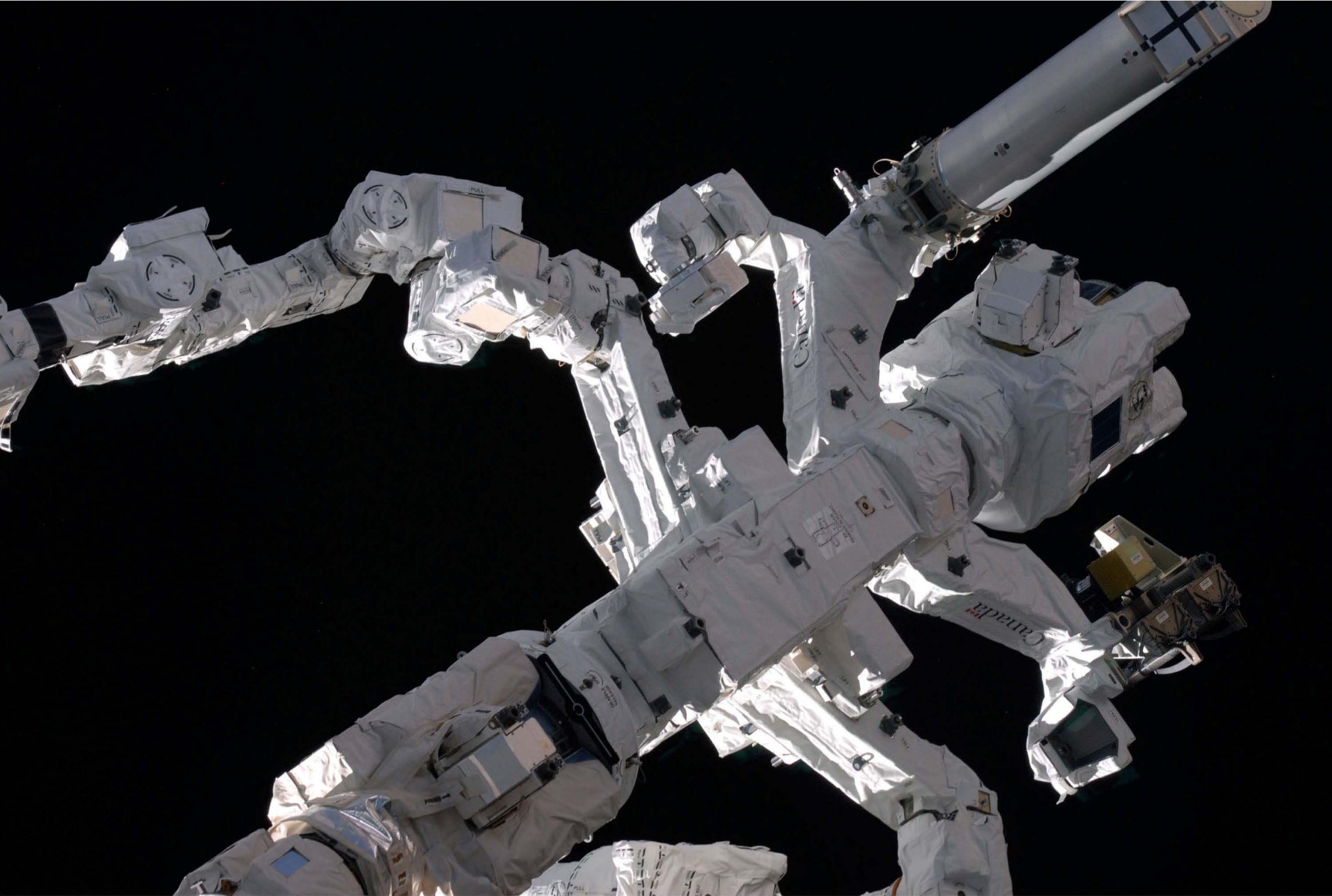

SPDM EP 1 (Cont)



SPDM EP 1 (Cont)

- 14 – Quarter-turn Fasteners
- 3 – Velcro Tabs
- 2 – Grounding Patches

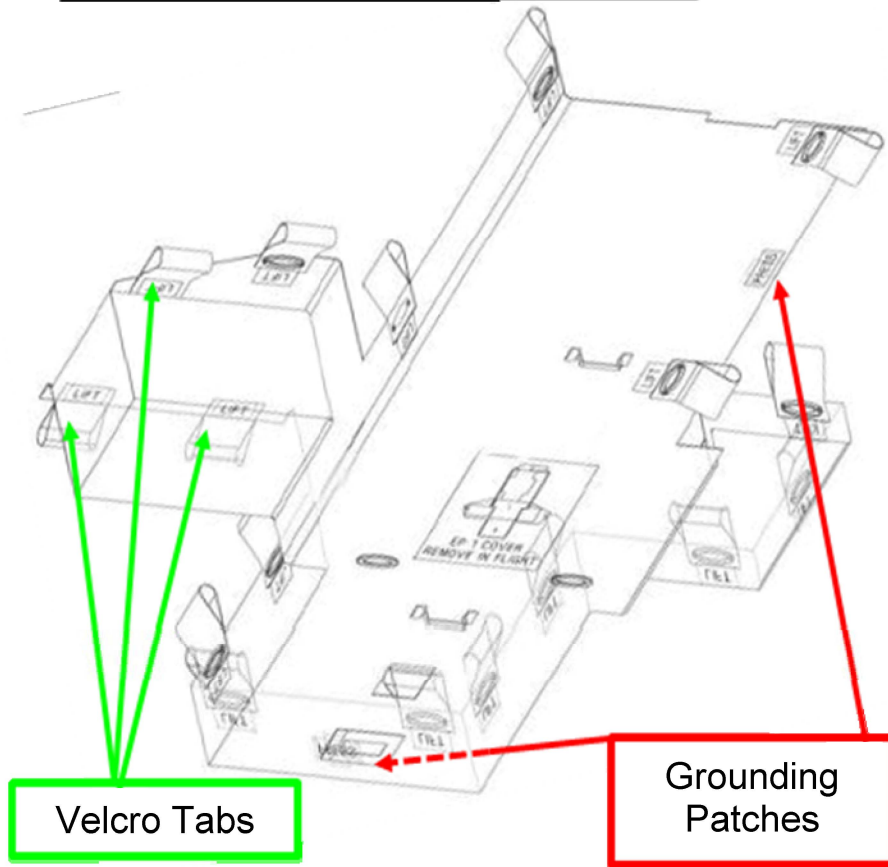



P3 CETA LIGHT

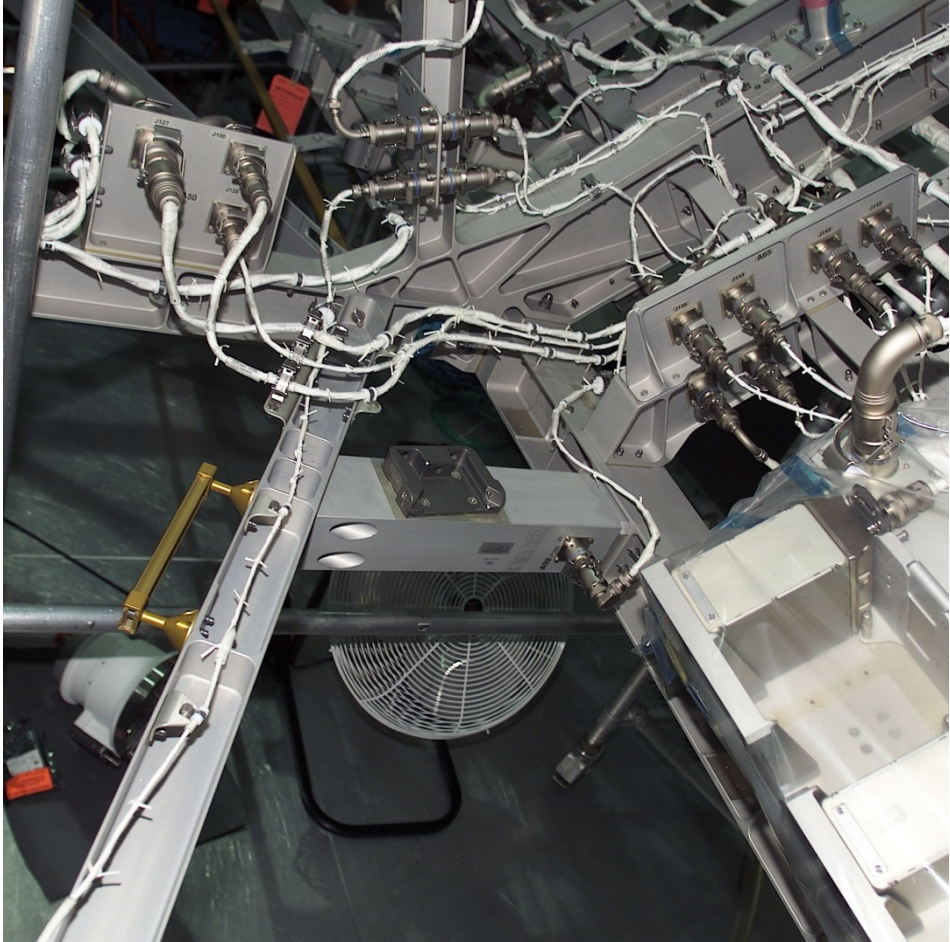

**P3 CETA LIGHT (Cont)**

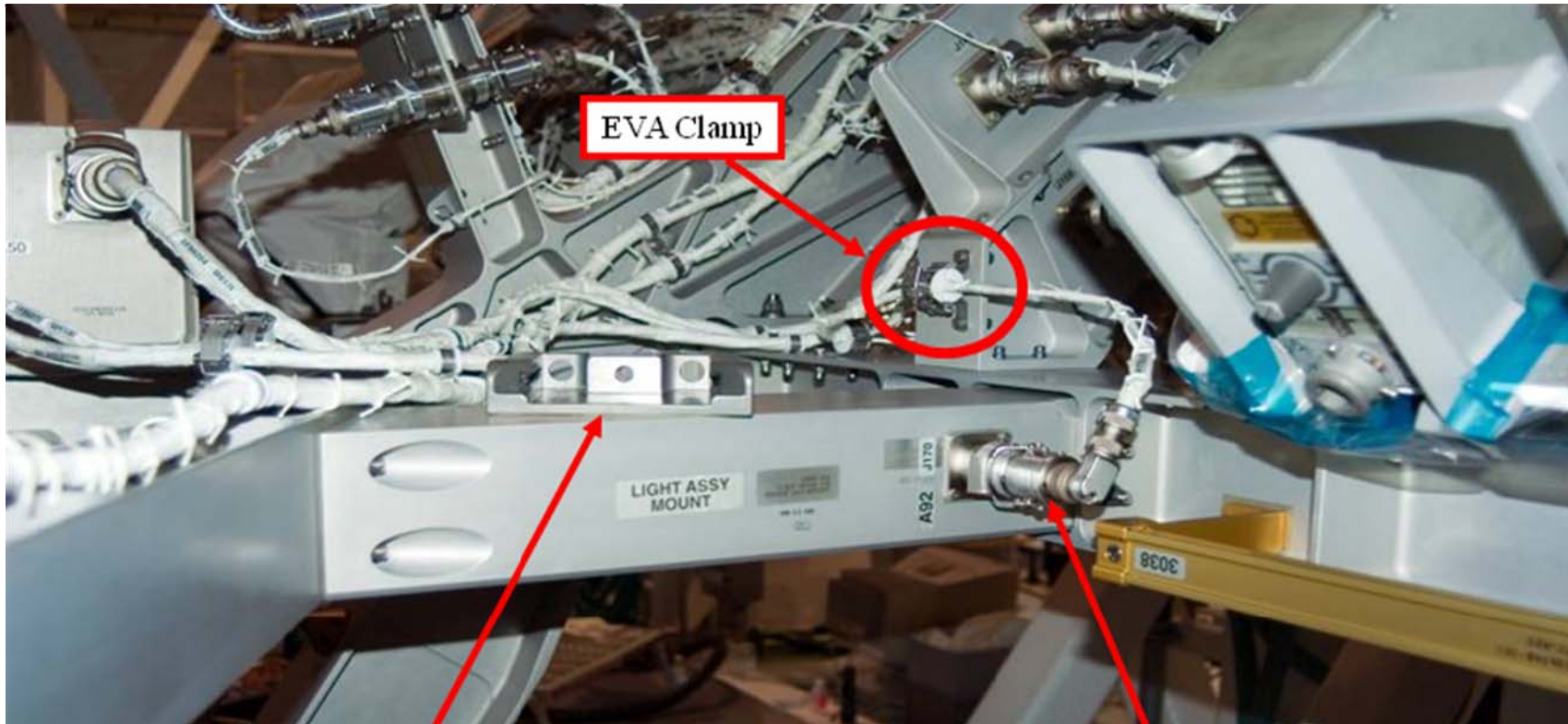

**CETA Light  
Mounting  
Bracket**

**CETA Light  
Connector/cable**

P1 RBVM BOOTIE



P1 RBVM BOOTIE (Cont)

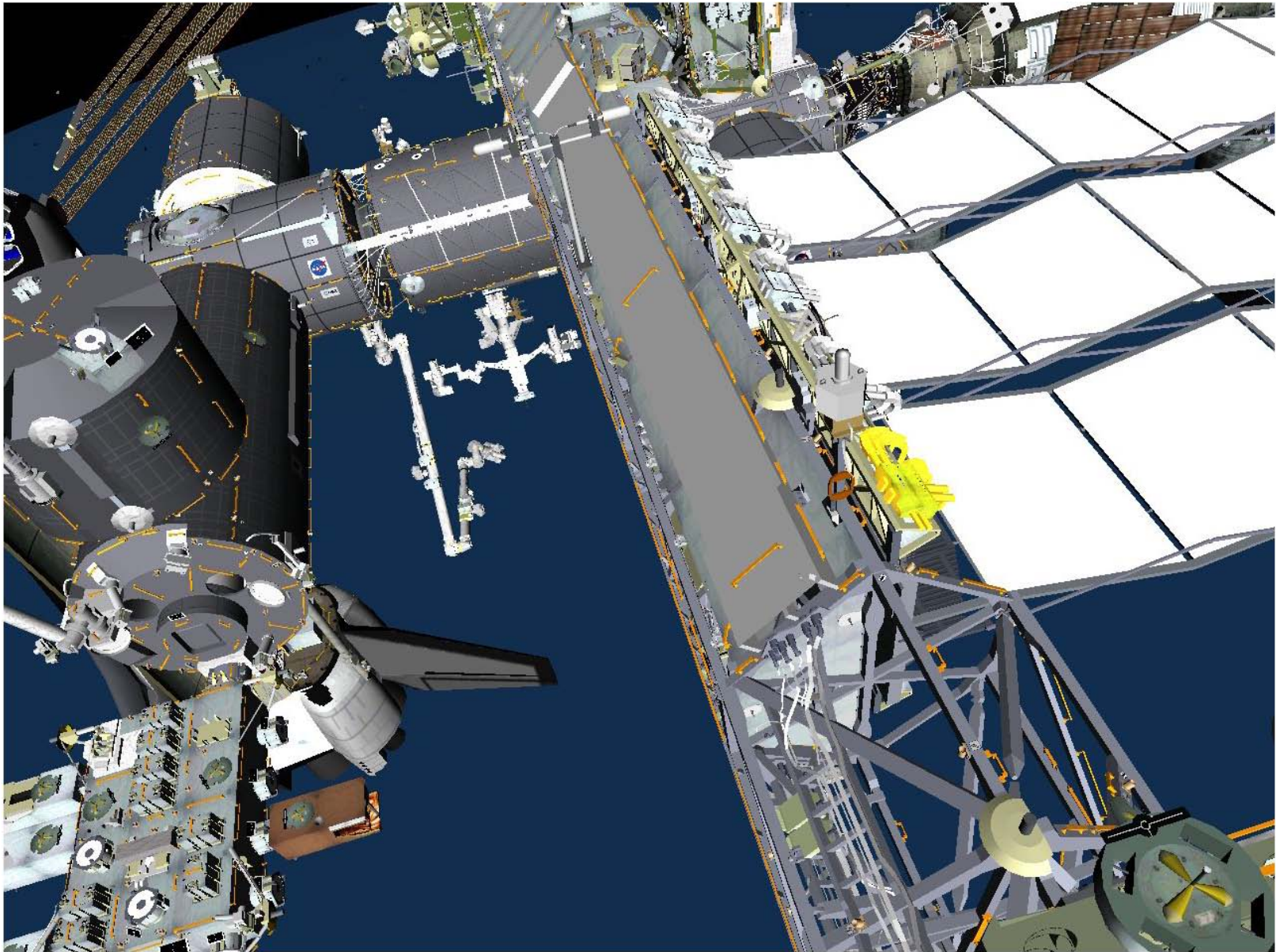

## P1 RADIATOR GRAPPLE STOW BEAMS

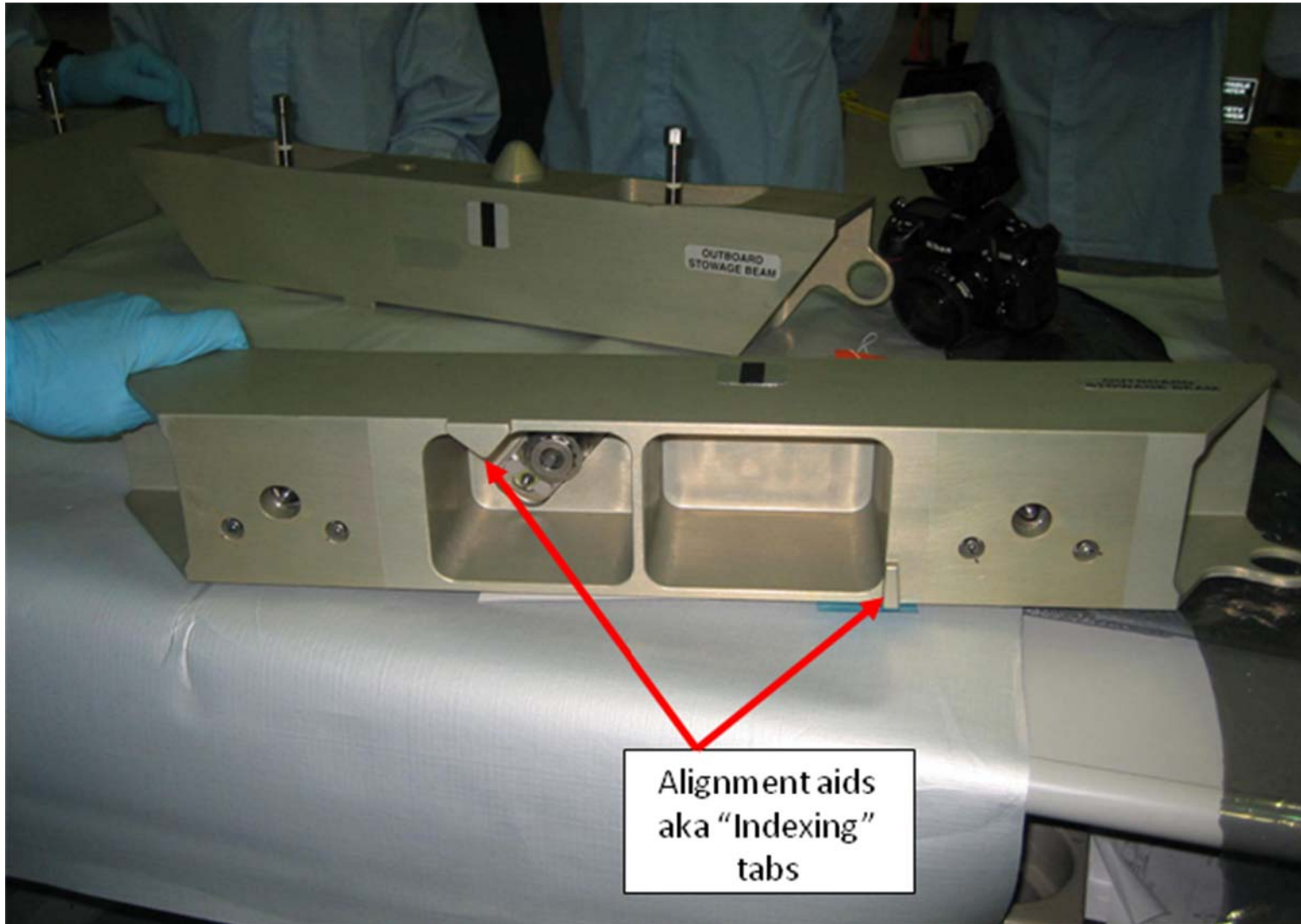

**P1 RADIATOR GRAPPLE STOW BEAMS (Cont)**



P1 RADIATOR GRAPPLE STOW BEAMS (Cont)

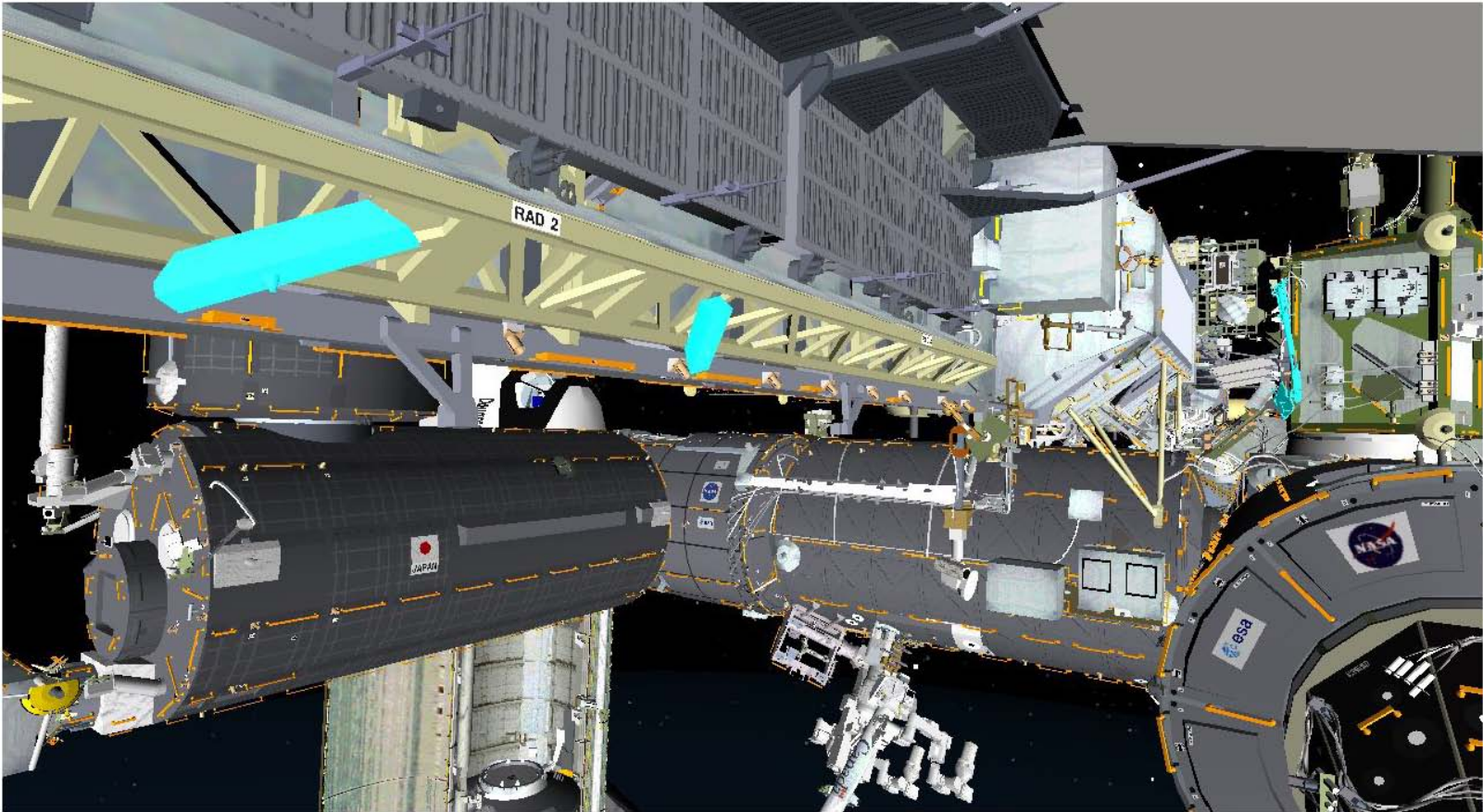

NODE 3 MLI

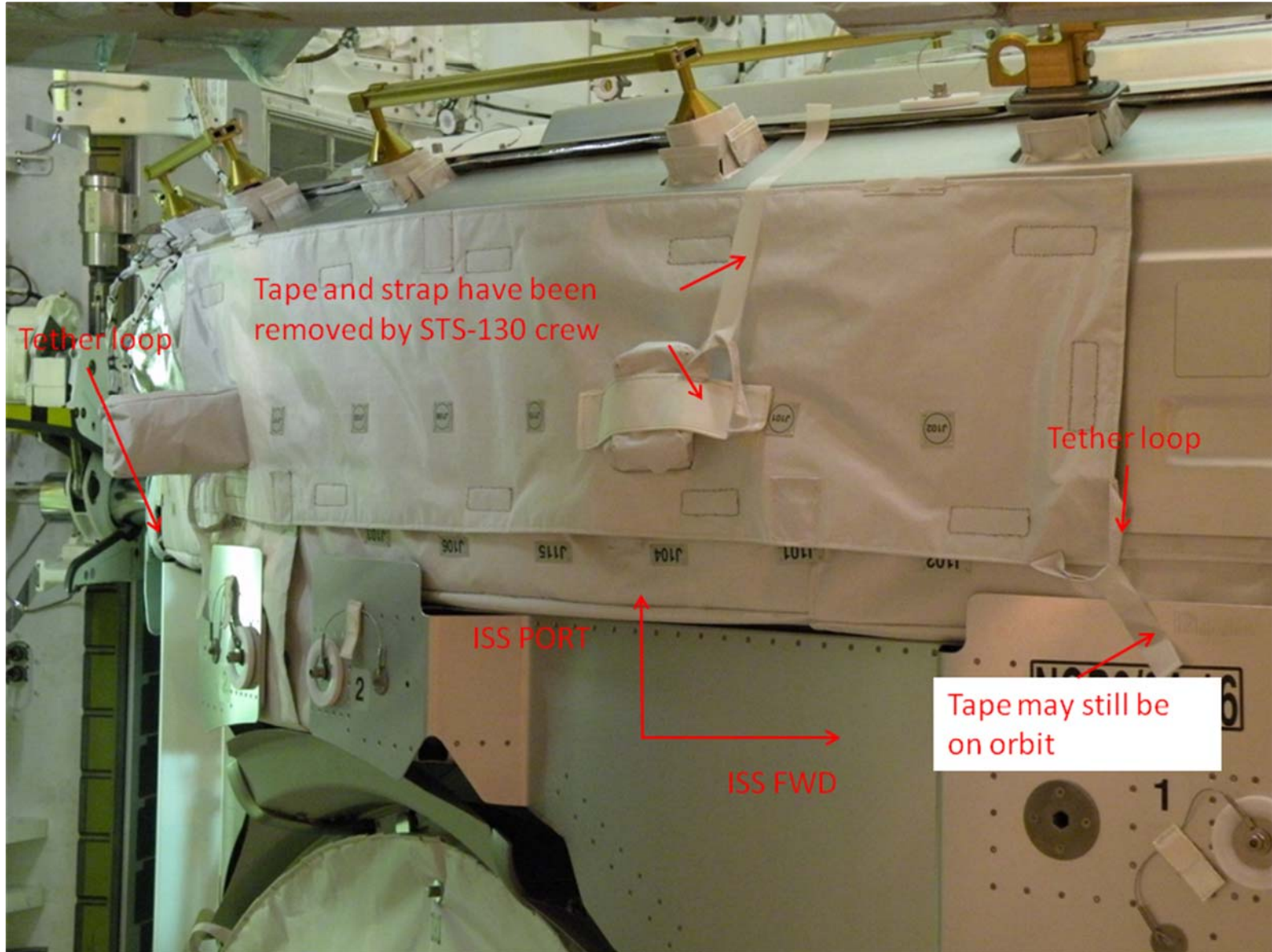



# CLA/CLPA LENS COVER



MSS Camera Cover  
(Shown in Unlocked Position)

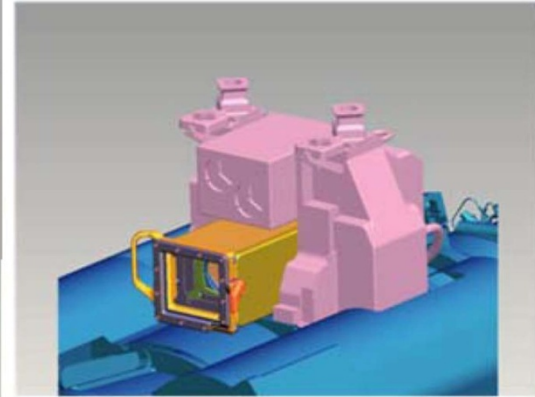

Cover on CLA



Latch Pin

LAB CP13 LIGHT



LAB CP13 LIGHT (Cont)

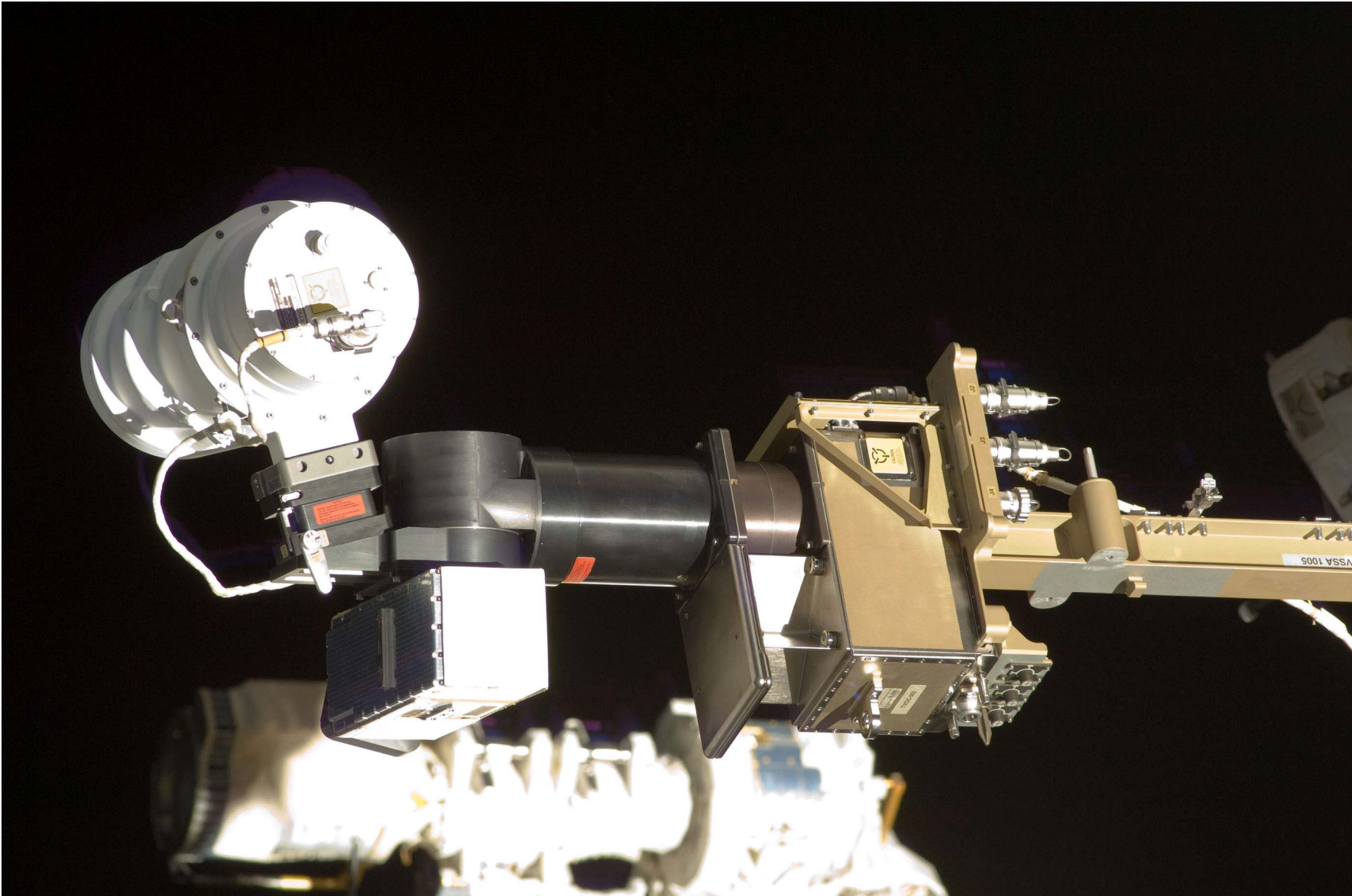

LAB CP13 LIGHT (Cont)



# S1 FHRC P-CLAMP RELEASE

## FHRC P-clamps – Hose Box (Outboard)

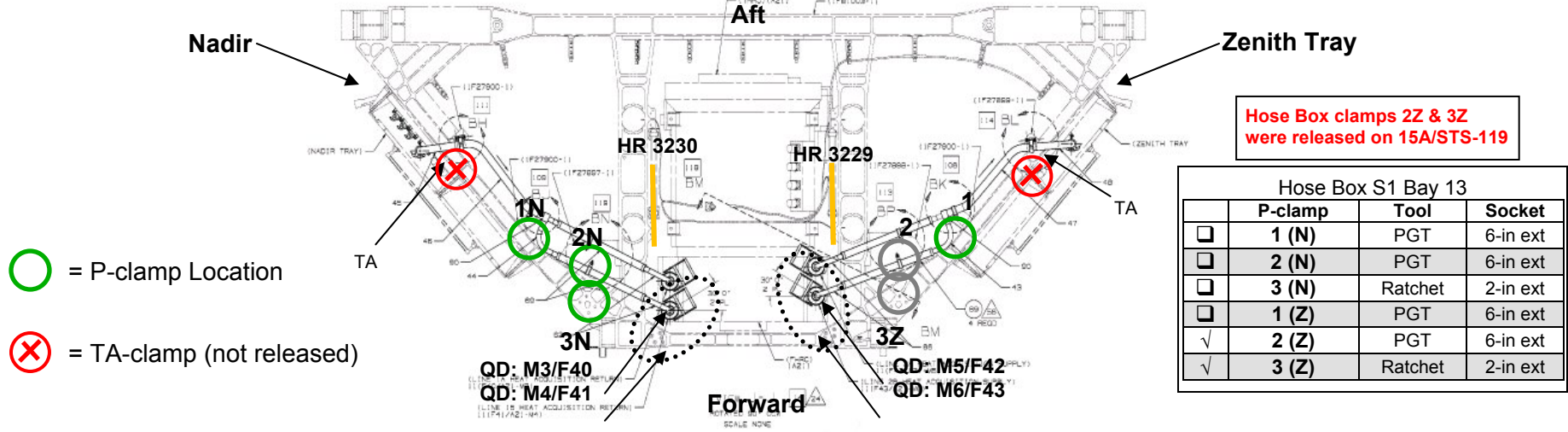

## FHRC P-clamps – Stinger (Inboard)

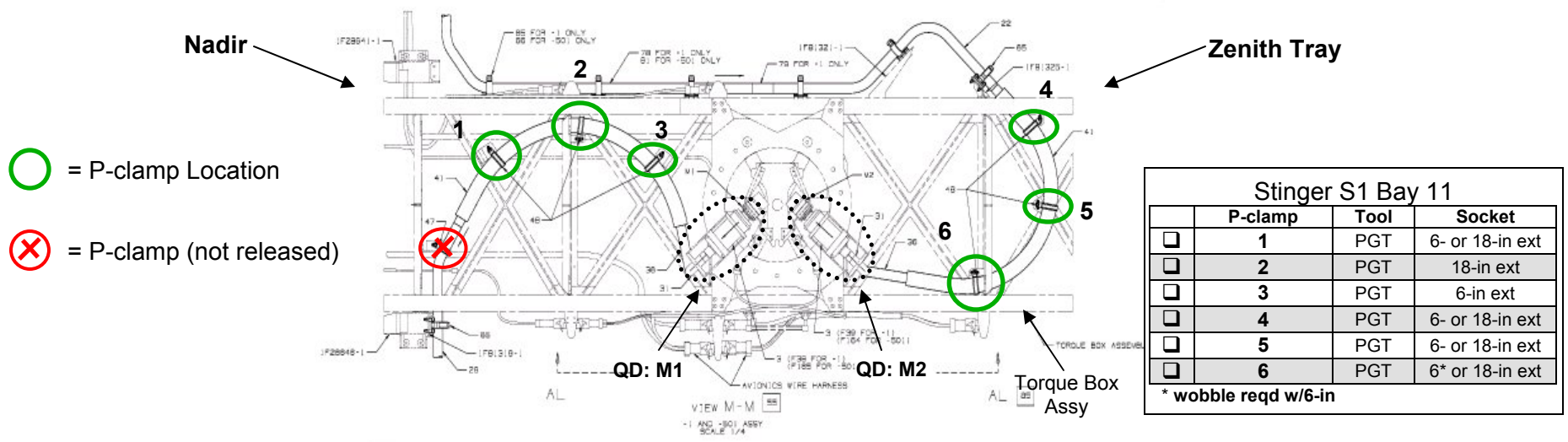

# STRELA ADAPTER

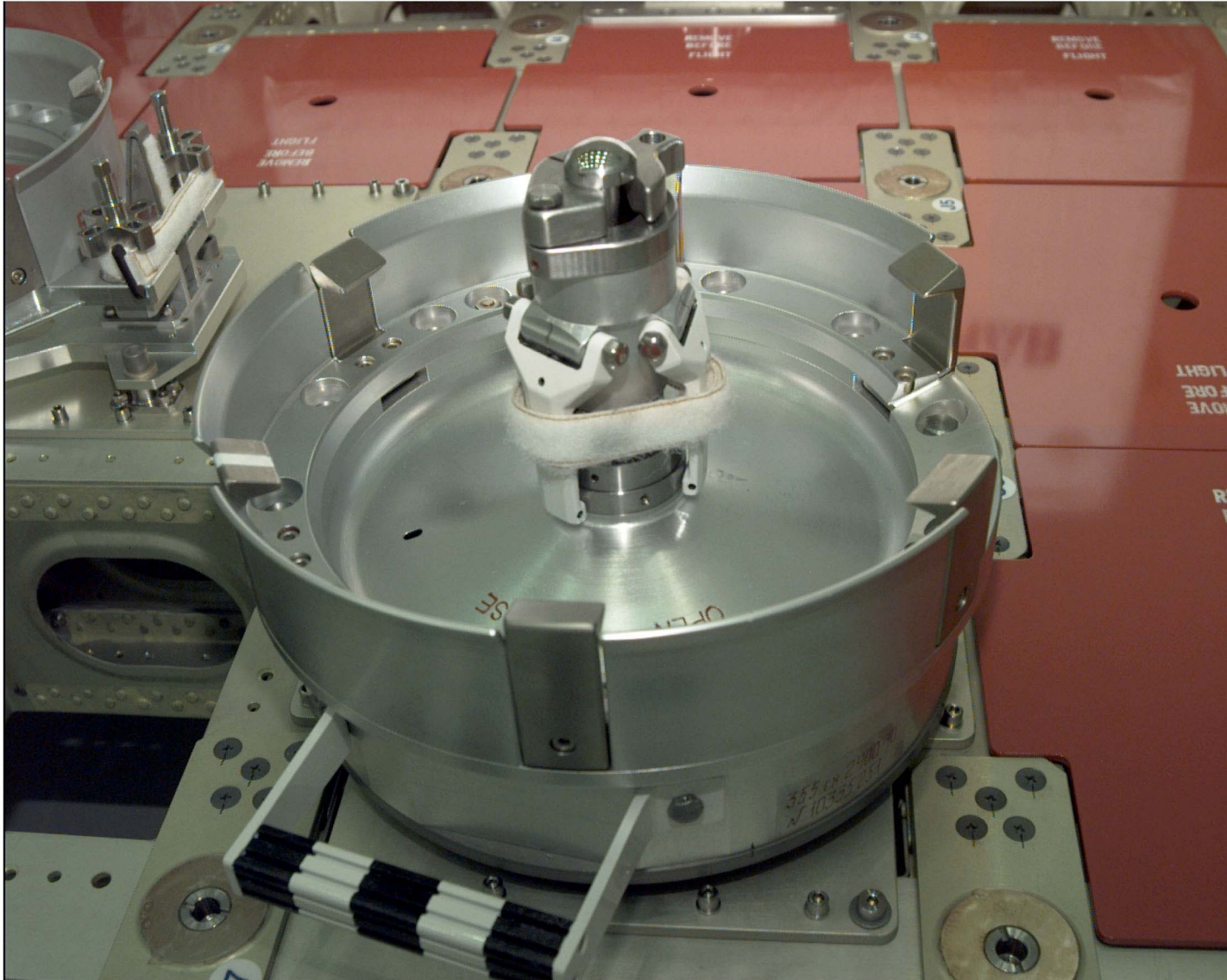

99E03369 1999-03-25 12:09:39  
Serial : 4153602 Firmware : 031997  
Frame : 91 Shtr : 60 Exp : P Exp Comp : -13 Dist : 1.0m  
ISO : 200 Lens : 24 Prog : Po Mtr Area : Mtrx  
Div Mode : S F Sync : Norm F Mode : C F Area : Wide

FS 18-70

EVA/133/FIN

STRELA ADAPTER (Cont)



FS 18-71

EVA/133/FIN

# PORT CETA CART RECONFIG

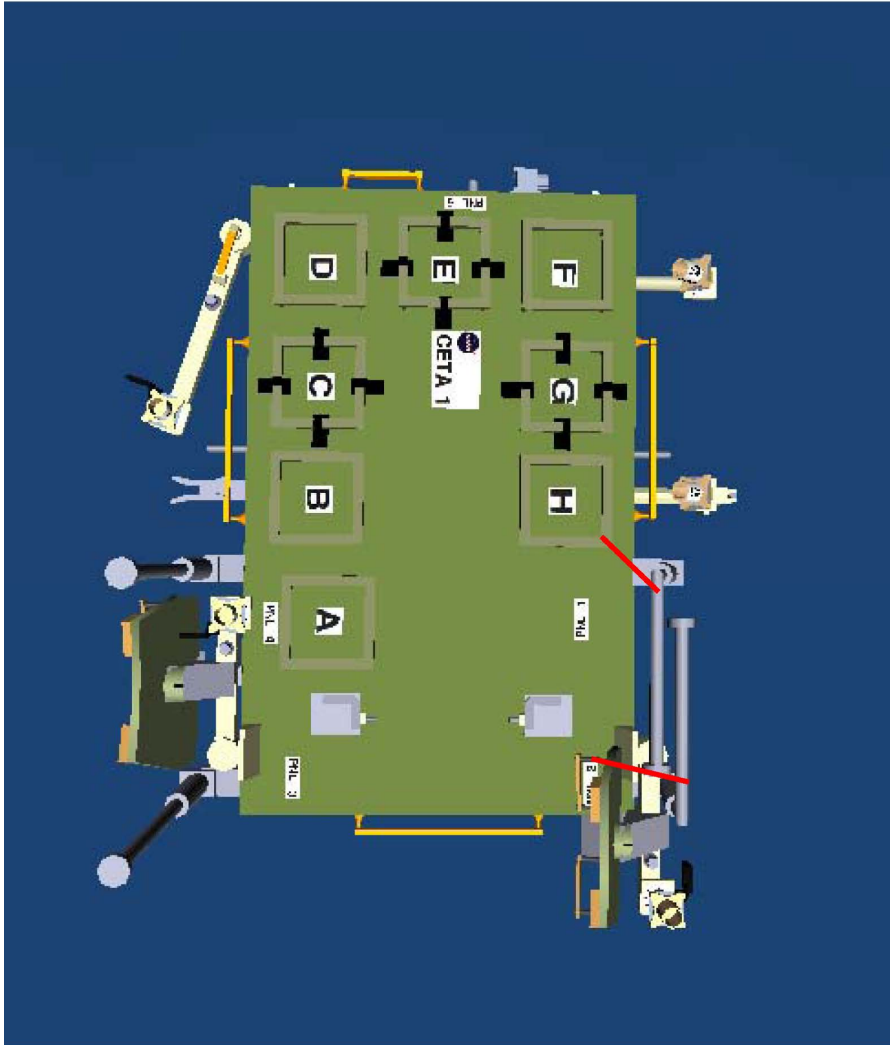





# EVA CHECKLIST

STS  
133