

# EVA Checklist

## STS-134 Flight Supplement

---

**Mission Operations Directorate  
EVA, Robotics, and Crew Systems  
Operations Division**

**Final, Rev A  
April 1, 2011**

### **NOTE**

This supplement is to be integrated into the generic edition to provide a complete document for the specific flight. Some pages in the generic edition may be replaced with supplemental pages identified as 'TEMP'. These generic pages, if any, must be retained for use on future flights.

National Aeronautics and  
Space Administration

**Lyndon B. Johnson Space Center**  
Houston, Texas

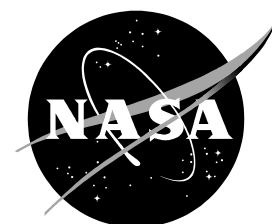





MISSION OPERATIONS DIRECTORATE

**EVA CHECKLIST  
STS-134 FLIGHT SUPPLEMENT**

FINAL, REVISION A  
April 1, 2011

PREPARED BY:



Vickie R. Otto  
Book Manager

APPROVED BY:



Tomas L. Gonzalez-Torres  
Lead, EVA Systems Group

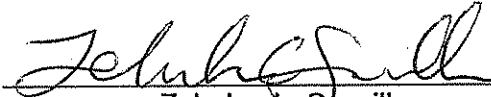

Zebulon L. Scoville  
Lead, EVA Task Group



Munish P. Patel  
Chief, EVA Operations Branch

This document is under the configuration control of the Crew Procedures Control Board (CPCB). All proposed changes must be submitted via Change Request Workflow (CRW) to DO3/FDF Manager.

Additional distribution of this book, for official use only, may be requested in writing to DO3/PMO Administrator. The request must include justification and requester's name, organization, position, and phone number. Contractor requests are made through the NASA or DOD organization supported. Deletions, reduction in quantity, or change of address may be submitted to DO3/FDF Management Office, 281-244-1184.

Incorporates the following:		
482#:	EVA FS-00395	EVA FS-00401
	EVA FS-00396	EVA FS-00402A
	EVA FS-00397	EVA FS-00403A
	EVA FS-00398	EVA FS-00404
	EVA FS-00399	EVA FS-00405B
	EVA FS-00400	

AREAS OF TECHNICAL RESPONSIBILITY

Book Manager

DX32/V. Otto

281-483-2981

EVA CHECKLIST  
STS-134 FLIGHT SUPPLEMENT

**LIST OF EFFECTIVE PAGES**

FINAL 04/21/10  
REV A 04/01/11

Sign Off .....	*	134/FIN A	3-1 .....	generic
FS ii .....	*	134/FIN A	3-2 .....	generic
iii .....	*	generic	3-3 .....	generic
iv .....	*	generic	3-4 .....	generic
FS v .....	*	134/FIN A	3-5 .....	generic
FS vi .....	*	134/FIN A	3-6 .....	generic
FS vii .....	*	134/FIN A	3-7 .....	generic
FS viii .....	*	134/FIN A	3-8 .....	generic
FS ix .....	*	134/FIN A	3-8a .....	generic
FS x .....	*	134/FIN A	3-8b .....	generic
FS xi .....		134/FIN A	3-9 .....	generic
FS xii .....		134/FIN A	CC 3-10 .....	generic
FS xiii .....		134/FIN A	CC 3-11 .....	generic
FS xiv .....		134/FIN A	3-12 .....	generic
FS xv .....		134/FIN A	4-1 .....	generic
FS xvi .....		134/FIN A	4-2 .....	generic
FS xvii .....		134/FIN A	4-3 .....	generic
FS xviii .....		134/FIN A	4-4 .....	generic
1-1 .....		generic	4-5 .....	generic
1-2 .....		generic	4-6 .....	generic
1-3 .....		generic	4-7 .....	generic
1-4 .....		generic	4-8 .....	generic
1-5 .....		generic	4-9 .....	generic
1-6 .....		generic	4-10 .....	generic
1-7 .....		generic	4-11 .....	generic
1-8 .....		generic	4-12 .....	generic
1-9 .....		generic	5-1 .....	generic
1-10 .....		generic	5-2 .....	generic
TEMP FS 2-1 .....		134/FIN A	5-3 .....	generic
TEMP FS 2-2 .....		ALL/FIN A	5-4 .....	generic
TEMP FS 2-3 .....		ALL/FIN A	A6-1 .....	generic
TEMP FS 2-4 .....		134/FIN A	CC A6-2 .....	generic
TEMP FS 2-5 .....		134/FIN A	6-3 .....	generic
TEMP FS 2-6 .....		ALL/FIN A	CC 6-4 .....	generic
FS 2-7 .....		134/FIN A	FS 7-1 .....	134/FIN A
FS 2-8 .....		134/FIN A	FS 7-2 .....	134/FIN A
FS 2-9 .....		134/FIN A	FS 7-3 .....	⊗ 134/FIN A
FS 2-10 .....		134/FIN A	FS 7-4 .....	134/FIN A
FS 2-11 .....		134/FIN A	FS 7-5 .....	134/FIN A
FS 2-12 .....		134/FIN A	FS 7-6 .....	⊗ 134/FIN A
FS 2-13 .....		134/FIN A	FS 7-7 .....	⊗ 134/FIN A
FS 2-14 .....	⊗	134/FIN A	FS 7-8 .....	⊗ 134/FIN A
FS 2-15 .....		134/FIN A	FS 7-9 .....	⊗ 134/FIN A
FS 2-16 .....		134/FIN A	FS 7-10 .....	134/FIN A
FS 2-17 .....		134/FIN A	FS 7-11 .....	134/FIN A
FS 2-18 .....		134/FIN A	FS 7-12 .....	134/FIN A
FS 2-19 .....		134/FIN A	FS 7-13 .....	⊗ 134/FIN A
FS 2-20 .....		134/FIN A	FS 7-14 .....	⊗ 134/FIN A

\* – Omit from flight book

⊗ – Flight copies of this page contain color

FS 7-15	⊗	134/FIN A	FS 7-71	⊗	134/FIN A
FS 7-16	⊗	134/FIN A	FS 7-72	⊗	134/FIN A
FS 7-17	⊗	134/FIN A	FS 7-73	⊗	134/FIN A
FS 7-18	⊗	134/FIN A	FS 7-74	⊗	134/FIN A
FS 7-19		134/FIN A	FS 7-75	⊗	134/FIN A
FS 7-20		134/FIN A	FS 7-76	⊗	134/FIN A
FS 7-21		134/FIN A	FS 7-77	⊗	134/FIN A
FS 7-22	⊗	134/FIN A	FS 7-78	⊗	134/FIN A
FS 7-23	⊗	134/FIN A	FS 7-79	⊗	134/FIN A
FS 7-24	⊗	134/FIN A	FS 7-80	⊗	134/FIN A
FS 7-25	⊗	134/FIN A	FS 7-81		134/FIN A
FS 7-26	⊗	134/FIN A	FS 7-82	⊗	134/FIN A
FS 7-27	⊗	134/FIN A	FS 7-83		134/FIN A
FS 7-28	⊗	134/FIN A	FS 7-84	⊗	134/FIN A
FS 7-29	⊗	134/FIN A	FS 7-85	⊗	134/FIN A
FS 7-30	⊗	134/FIN A	FS 7-86		134/FIN A
FS 7-31	⊗	134/FIN A	FS 7-87		134/FIN A
FS 7-32		134/FIN A	FS 7-88		134/FIN A
FS 7-33	⊗	134/FIN A	FS 7-89	⊗	134/FIN A
FS 7-34		134/FIN A	FS 7-90	⊗	134/FIN A
FS 7-35	⊗	134/FIN A	FS 7-91	⊗	134/FIN A
FS 7-36		134/FIN A	FS 7-92	⊗	134/FIN A
FS 7-37	⊗	134/FIN A	FS 7-93		134/FIN A
FS 7-38		134/FIN A	FS 7-94		134/FIN A
FS 7-39		134/FIN A	FS 7-95		134/FIN A
FS 7-40		134/FIN A	FS 7-96	⊗	134/FIN A
FS 7-41	⊗	134/FIN A	FS 7-97	⊗	134/FIN A
FS 7-42	⊗	134/FIN A	FS 7-98	⊗	134/FIN A
FS 7-43	⊗	134/FIN A	FS 7-99	⊗	134/FIN A
FS 7-44	⊗	134/FIN A	FS 7-100	⊗	134/FIN A
FS 7-45	⊗	134/FIN A	FS 7-101	⊗	134/FIN A
FS 7-46	⊗	134/FIN A	FS 7-102	⊗	134/FIN A
FS 7-47		134/FIN A	FS 7-103	⊗	134/FIN A
FS 7-48	⊗	134/FIN A	FS 7-104	⊗	134/FIN A
FS 7-49	⊗	134/FIN A	FS 7-105	⊗	134/FIN A
FS 7-50	⊗	134/FIN A	FS 7-106	⊗	134/FIN A
FS 7-51	⊗	134/FIN A	FS 7-107	⊗	134/FIN A
FS 7-52	⊗	134/FIN A	FS 7-108	⊗	134/FIN A
FS 7-53	⊗	134/FIN A	FS 7-109		134/FIN A
FS 7-54		134/FIN A	FS 7-110	⊗	134/FIN A
FS 7-55		134/FIN A	FS 7-111	⊗	134/FIN A
FS 7-56	⊗	134/FIN A	FS 7-112	⊗	134/FIN A
FS 7-57	⊗	134/FIN A	FS 7-113	⊗	134/FIN A
FS 7-58		134/FIN A	FS 7-114		134/FIN A
FS 7-59		134/FIN A	FS 7-115		134/FIN A
FS 7-60		134/FIN A	FS 7-116		134/FIN A
FS 7-61	⊗	134/FIN A	FS 7-117		134/FIN A
FS 7-62	⊗	134/FIN A	FS 7-118	⊗	134/FIN A
FS 7-63		134/FIN A	FS 7-119	⊗	134/FIN A
FS 7-64	⊗	134/FIN A	FS 7-120		134/FIN A
FS 7-65	⊗	134/FIN A	FS 7-121	⊗	134/FIN A
FS 7-66		134/FIN A	FS 7-122	⊗	134/FIN A
FS 7-67		134/FIN A	FS 7-123		134/FIN A
FS 7-68		134/FIN A	FS 7-124		134/FIN A
FS 7-69		134/FIN A	FS 7-125		134/FIN A
FS 7-70	⊗	134/FIN A	FS 7-126		134/FIN A

⊗ – Flight copies of this page contain color

FS 7-127	.....	134/FIN A	FS 7-183	.....	⊗	134/FIN A	
FS 7-128	.....	134/FIN A	FS 7-184	.....		134/FIN A	
FS 7-129	.....	⊗	134/FIN A	FS 7-185	.....	134/FIN A	
FS 7-130	.....	⊗	134/FIN A	FS 7-186	.....	134/FIN A	
FS 7-131	.....	⊗	134/FIN A	FS 7-187	.....	134/FIN A	
FS 7-132	.....	⊗	134/FIN A	FS 7-188	.....	⊗	134/FIN A
FS 7-133	.....	⊗	134/FIN A	FS 7-189	.....		134/FIN A
FS 7-134	.....		134/FIN A	FS 7-190	.....		134/FIN A
FS 7-135	.....	⊗	134/FIN A	FS 7-191	.....		134/FIN A
FS 7-136	.....	⊗	134/FIN A	FS 7-192	.....	⊗	134/FIN A
FS 7-137	.....	⊗	134/FIN A	FS 7-193	.....		134/FIN A
FS 7-138	.....		134/FIN A	FS 7-194	.....	⊗	134/FIN A
FS 7-139	.....		134/FIN A	FS 7-195	.....	⊗	134/FIN A
FS 7-140	.....		134/FIN A	FS 7-196	.....	⊗	134/FIN A
FS 7-141	.....		134/FIN A	FS 7-197	.....		134/FIN A
FS 7-142	.....	⊗	134/FIN A	FS 7-198	.....		134/FIN A
FS 7-143	.....	⊗	134/FIN A	FS 7-199	.....		134/FIN A
FS 7-144	.....	⊗	134/FIN A	FS 7-200	.....		134/FIN A
FS 7-145	.....	⊗	134/FIN A	FS 7-201	.....	⊗	134/FIN A
FS 7-146	.....	⊗	134/FIN A	FS 7-202	.....	⊗	134/FIN A
FS 7-147	.....		134/FIN A	FS 7-203	.....	⊗	134/FIN A
FS 7-148	.....	⊗	134/FIN A	FS 7-204	.....	⊗	134/FIN A
FS 7-149	.....		134/FIN A	FS 7-205	.....	⊗	134/FIN A
FS 7-150	.....	⊗	134/FIN A	FS 7-206	.....	⊗	134/FIN A
FS 7-151	.....	⊗	134/FIN A	FS 7-207	.....	⊗	134/FIN A
FS 7-152	.....	⊗	134/FIN A	FS 7-208	.....		134/FIN A
FS 7-153	.....		134/FIN A	FS 7-209	.....	⊗	134/FIN A
FS 7-154	.....	⊗	134/FIN A	FS 7-210	.....	⊗	134/FIN A
FS 7-155	.....	⊗	134/FIN A	FS 7-211	.....	⊗	134/FIN A
FS 7-156	.....	⊗	134/FIN A	FS 7-212	.....	⊗	134/FIN A
FS 7-157	.....	⊗	134/FIN A	FS 7-213	.....	⊗	134/FIN A
FS 7-158	.....		134/FIN A	FS 7-214	.....	⊗	134/FIN A
FS 7-159	.....	⊗	134/FIN A	FS 7-215	.....	⊗	134/FIN A
FS 7-160	.....	⊗	134/FIN A	FS CC 7-216	.....	⊗	134/FIN A
FS 7-161	.....	⊗	134/FIN A	FS CC 7-217	.....	⊗	134/FIN A
FS 7-162	.....	⊗	134/FIN A	FS CC 7-218	.....	⊗	134/FIN A
FS 7-163	.....	⊗	134/FIN A	FS CC 7-219	.....	⊗	134/FIN A
FS 7-164	.....	⊗	134/FIN A	FS 7-220	.....		134/FIN A
FS 7-165	.....	⊗	134/FIN A	FS 7-221	.....	⊗	134/FIN A
FS 7-166	.....	⊗	134/FIN A	FS 7-222	.....	⊗	134/FIN A
FS 7-167	.....	⊗	134/FIN A	FS 7-223	.....	⊗	134/FIN A
FS 7-168	.....	⊗	134/FIN A	FS 7-224	.....	⊗	134/FIN A
FS 7-169	.....	⊗	134/FIN A	FS 7-225	.....		134/FIN A
FS 7-170	.....	⊗	134/FIN A	FS 7-226	.....	⊗	134/FIN A
FS 7-171	.....		134/FIN A	FS 7-227	.....	⊗	134/FIN A
FS 7-172	.....	⊗	134/FIN A	FS 7-228	.....		134/FIN A
FS 7-173	.....	⊗	134/FIN A	TEMP FS 8-1	.....		134/FIN A
FS 7-174	.....		134/FIN A	TEMP FS 8-2	.....	⊗	134/FIN A
FS 7-175	.....		134/FIN A	8-3	.....		generic
FS 7-176	.....		134/FIN A	8-4	.....		generic
FS 7-177	.....	⊗	134/FIN A	8-5	.....		generic
FS 7-178	.....	⊗	134/FIN A	8-6	.....		generic
FS 7-179	.....	⊗	134/FIN A	8-7	.....		generic
FS 7-180	.....	⊗	134/FIN A	8-8	.....		generic
FS 7-181	.....	⊗	134/FIN A	FS 8-9	.....		134/FIN A
FS 7-182	.....		134/FIN A	FS 8-10	.....	⊗	134/FIN A

⊗ – Flight copies of this page contain color

FS 8-11	⊗	134/FIN A	12-11	generic
FS 8-12		134/FIN A	12-12	generic
FS 8-13		134/FIN A	12-13	generic
FS 8-14		134/FIN A	12-14	generic
FS 8-15		134/FIN A	12-15	generic
FS 8-16	⊗	134/FIN A	12-16	generic
FS 8-17	⊗	134/FIN A	12-17	generic
FS 8-18	⊗	134/FIN A	12-18	generic
FS 8-19		134/FIN A	12-19	generic
FS 8-20		134/FIN A	12-20	generic
FS 8-21	⊗	134/FIN A	12-21	generic
FS 8-22	⊗	134/FIN A	12-22	generic
FS 8-23	⊗	134/FIN A	12-23	generic
FS 8-24	⊗	134/FIN A	12-24	generic
FS 8-25	⊗	134/FIN A	12-24a	generic
FS 8-26		134/FIN A	12-24b	generic
9-1		generic	12-25	generic
9-2		generic	12-26	generic
9-3		generic	FS 12-27	⊗ 134/FIN A
9-4		generic	FS 12-28	⊗ 134/FIN A
9-5		generic	FS 12-29	⊗ 134/FIN A
9-6		generic	FS 12-30	134/FIN A
TEMP FS 10-1		134/FIN A	FS CC 12-31	⊗ 134/FIN A
TEMP FS 10-2		ALL/FIN A	FS CC 12-32	⊗ 134/FIN A
10-3		generic	FS 13-1	134/FIN A
10-4		generic	FS 13-2	134/FIN A
10-4a		generic	14-1	generic
10-4b		generic	14-2	generic
10-5		generic	14-3	generic
10-6		generic	14-4	generic
10-7		generic	14-5	generic
10-8		generic	14-6	generic
10-9		generic	14-7	generic
10-10		generic	14-8	generic
10-11		generic	14-9	generic
10-12		generic	14-10	generic
10-13		generic	14-11	generic
10-14		generic	14-12	generic
FS CC 10-15		134/FIN A	14-13	generic
FS CC 10-16	⊗	134/FIN A	14-14	generic
11-1		generic	14-15	generic
11-2		generic	14-16	generic
11-3		generic	14-17	generic
11-4		generic	14-18	generic
12-i		generic	14-19	generic
12-ii		generic	14-20	generic
TEMP FS 12-1		134/FIN A	14-21	generic
TEMP FS 12-2		ALL/FIN A	14-22	generic
12-3		generic	15-1	generic
12-4		generic	15-2	generic
12-5		generic	15-3	generic
12-6		generic	15-4	generic
12-7		generic	15-5	generic
12-8		generic	15-6	generic
12-9		generic	15-7	generic
12-10		generic	15-8	generic

⊗ – Flight copies of this page contain color

15-9	generic	FS 16-49	134/FIN A
15-10	generic	FS 16-50	134/FIN A
15-11	generic	FS 16-51	⊗ 134/FIN A
15-12	generic	FS 16-52	⊗ 134/FIN A
15-13	generic	FS 16-53	⊗ 134/FIN A
15-14	generic	FS 16-54	⊗ 134/FIN A
16-i	generic	FS 16-55	⊗ 134/FIN A
16-ii	generic	FS 16-56	⊗ 134/FIN A
TEMP FS 16-1	134/FIN A	FS 16-57	134/FIN A
TEMP FS 16-2	134/FIN A	FS 16-58	134/FIN A
FS 16-3	134/FIN A	FS 16-59	134/FIN A
FS 16-4	134/FIN A	FS 16-60	⊗ 134/FIN A
FS 16-5	⊗ 134/FIN A	FS 16-61	134/FIN A
FS 16-6	⊗ 134/FIN A	FS 16-62	134/FIN A
FS 16-7	⊗ 134/FIN A	FS 16-63	134/FIN A
FS 16-8	134/FIN A	FS 16-64	134/FIN A
FS 16-9	134/FIN A	FS 16-65	134/FIN A
FS 16-10	134/FIN A	FS 16-66	134/FIN A
FS 16-11	134/FIN A	FS 16-67	134/FIN A
FS 16-12	134/FIN A	FS 16-68	134/FIN A
FS 16-13	134/FIN A	FS 16-69	134/FIN A
FS 16-14	⊗ 134/FIN A	FS 16-70	134/FIN A
FS 16-15	134/FIN A	FS 16-71	134/FIN A
FS 16-16	134/FIN A	FS 16-72	134/FIN A
FS 16-17	⊗ 134/FIN A	FS 16-73	134/FIN A
FS 16-18	⊗ 134/FIN A	FS 16-74	134/FIN A
FS 16-19	⊗ 134/FIN A	FS 16-75	⊗ 134/FIN A
FS 16-20	134/FIN A	FS 16-76	134/FIN A
FS 16-21	134/FIN A	FS 16-77	134/FIN A
FS 16-22	134/FIN A	FS 16-78	⊗ 134/FIN A
FS 16-23	134/FIN A	FS 16-79	134/FIN A
FS 16-24	134/FIN A	FS 16-80	⊗ 134/FIN A
FS 16-25	134/FIN A	FS 16-81	134/FIN A
FS 16-26	134/FIN A	FS 16-82	134/FIN A
FS 16-27	134/FIN A	FS 16-83	134/FIN A
FS 16-28	134/FIN A	FS 16-84	⊗ 134/FIN A
FS 16-29	⊗ 134/FIN A	FS 16-85	⊗ 134/FIN A
FS 16-30	134/FIN A	FS 16-86	134/FIN A
FS 16-31	134/FIN A	FS 16-87	134/FIN A
FS 16-32	⊗ 134/FIN A	FS 16-88	⊗ 134/FIN A
FS 16-33	134/FIN A	FS 16-89	⊗ 134/FIN A
FS 16-34	⊗ 134/FIN A	FS 16-90	⊗ 134/FIN A
FS 16-35	134/FIN A	FS 16-91	⊗ 134/FIN A
FS 16-36	134/FIN A	FS 16-92	⊗ 134/FIN A
FS 16-37	134/FIN A	FS 16-93	⊗ 134/FIN A
FS 16-38	⊗ 134/FIN A	FS 16-94	⊗ 134/FIN A
FS 16-39	⊗ 134/FIN A	FS 16-95	⊗ 134/FIN A
FS 16-40	⊗ 134/FIN A	FS 16-96	⊗ 134/FIN A
FS 16-41	134/FIN A	FS 16-97	⊗ 134/FIN A
FS 16-42	⊗ 134/FIN A	FS 16-98	⊗ 134/FIN A
FS 16-43	⊗ 134/FIN A	FS 16-99	⊗ 134/FIN A
FS 16-44	134/FIN A	FS 16-100	⊗ 134/FIN A
FS 16-45	134/FIN A	FS 16-101	⊗ 134/FIN A
FS 16-46	134/FIN A	FS 16-102	⊗ 134/FIN A
FS 16-47	134/FIN A	17-1	* generic
FS 16-48	134/FIN A	17-2	* generic

⊗ – Flight copies of this page contain color

\* – Omit from flight book

FS 18-1 .....	134/FIN A	FS 18-33.....	⊗	134/FIN A
FS 18-2 .....	134/FIN A	FS 18-34.....	⊗	134/FIN A
FS 18-3 .....	⊗ 134/FIN A	FS 18-35.....	⊗	134/FIN A
FS 18-4 .....	⊗ 134/FIN A	FS 18-36.....	⊗	134/FIN A
FS 18-5 .....	⊗ 134/FIN A	FS 18-37.....	⊗	134/FIN A
FS 18-6 .....	⊗ 134/FIN A	FS 18-38.....	⊗	134/FIN A
FS 18-7 .....	⊗ 134/FIN A	FS 18-39.....	⊗	134/FIN A
FS 18-8 .....	⊗ 134/FIN A	FS 18-40.....	⊗	134/FIN A
FS 18-9 .....	⊗ 134/FIN A	FS 18-41.....	⊗	134/FIN A
FS 18-10 .....	⊗ 134/FIN A	FS 18-42.....	⊗	134/FIN A
FS 18-11 .....	⊗ 134/FIN A	FS 18-43.....	⊗	134/FIN A
FS 18-12 .....	⊗ 134/FIN A	FS 18-44.....	⊗	134/FIN A
FS 18-13 .....	⊗ 134/FIN A	FS 18-45.....	⊗	134/FIN A
FS 18-14 .....	⊗ 134/FIN A	FS 18-46.....	⊗	134/FIN A
FS 18-15 .....	⊗ 134/FIN A	19-i.....		generic
FS 18-16 .....	⊗ 134/FIN A	19-ii.....		generic
FS 18-17 .....	⊗ 134/FIN A	TEMP FS 19-1 .....		134/FIN A
FS 18-18 .....	⊗ 134/FIN A	TEMP FS 19-2 .....		ALL/FIN A
FS 18-19 .....	⊗ 134/FIN A	19-3 .....		generic
FS 18-20 .....	⊗ 134/FIN A	19-4 .....		generic
FS 18-21 .....	⊗ 134/FIN A	19-5 .....		generic
FS 18-22 .....	⊗ 134/FIN A	19-6 .....		generic
FS 18-23 .....	⊗ 134/FIN A	19-7 .....		generic
FS 18-24 .....	⊗ 134/FIN A	19-8 .....		generic
FS 18-25 .....	⊗ 134/FIN A	19-9 .....		generic
FS 18-26 .....	⊗ 134/FIN A	19-10 .....		generic
FS 18-27 .....	⊗ 134/FIN A	19-11 .....		generic
FS 18-28 .....	⊗ 134/FIN A	19-12 .....		generic
FS 18-29 .....	⊗ 134/FIN A	TEMP FS 19-13 .....		134/FIN A
FS 18-30 .....	⊗ 134/FIN A	TEMP FS 19-14 .....		134/FIN A
FS 18-31 .....	⊗ 134/FIN A	20-1 .....	*	generic
FS 18-32 .....	⊗ 134/FIN A	20-2 .....	*	generic

#### EVA CUE CARDS

<u>Title</u>	<u>Ref. Page</u>	<u>Card No.</u>
SAFER CHECKOUT RESULTS (Front).....	CC 3-10	generic
SAFER STATUS TROUBLESHOOTING (Back) .....	CC 3-11	generic
DEPRESS/REPRESS (NOM A/L) (Front).....	CC A6-2	generic
FAILED LEAK CHECK		
(Back of DEPRESS/REPRESS) .....	CC 6-4	generic
EVA FLUID QD/SARJ CUE CARD (Front) .....	FS CC 7-216	EVA-4a/134/O/B
(Back).....	FS CC 7-217	EVA-4b/134/O/B
EVA 3 CABLE ROUTING CUE CARD (Front).....	FS CC 7-218	EVA-7a/134/O/A
(Back).....	FS CC 7-219	EVA-7b/134/O/A
STS-134 CONSUMABLES TRACKING CUE CARD		
(Front) .....	FS CC 10-15	EVA-5a/134/O/B
STS-134 EVA BATTERY RECHARGE PLAN		
(Back).....	FS CC 10-16	EVA-5b/134/O/B
EXPEDITED SUIT DOFFING CUE CARD (Front).....	FS CC 12-31	EVA-6a/134/O/A
EMERGENCY UNDOCKING EVA TRANSFER (Back)...	FS CC 12-32	EVA-6b/134/O/B

⊗ – Flight copies of this page contain color

\* – Omit from flight book



CONTENTS

PAGE

10.2 PSI CABIN ..... 1-1  
    MASK PREBREATHE INITIATE ..... 1-2  
    PREP FOR 10.2 PSI CABIN ..... 1-3  
    CABIN DEPRESS TO 10.2 PSI..... 1-4  
    10.2 PSIA DEPRESS CHART ..... 1-5  
    10.2 PSI CABIN CONFIG..... 1-6  
    MASK PREBREATHE TERMINATE ..... 1-6  
    10.2 PSI MAINTENANCE..... 1-7  
    CABIN REPRESS TO 14.7 PSI..... 1-8  
    14.7 PSI CABIN CONFIG..... 1-9

AIRLOCK CONFIG..... TEMP FS 2-1  
    AIRLOCK PREP ..... TEMP FS 2-2  
    EMU SWAP ..... TEMP FS 2-3  
    BOOSTER FAN DEACTIVATION/REMOVAL..... TEMP FS 2-4  
    BOOSTER FAN INSTALLATION/ACTIVATION..... TEMP FS 2-4  
    EMU REMOVAL ..... TEMP FS 2-4  
    EMU INSTALLATION ..... TEMP FS 2-4  
    EMU CHECKOUT PREP..... TEMP FS 2-5  
    LTA RESTRAINT STRAP REMOVAL ..... TEMP FS 2-6  
    LTA RESTRAINT STRAP INSTALLATION ..... TEMP FS 2-6  
    EVA PREP FOR ISS TRANSFER..... FS 2-7  
    POST-DOCKING EVA TRANSFER AND RECONFIG..... FS 2-9  
    EMU SWAP FOR EVA 2 ..... FS 2-11  
    EMU SWAP FOR EVA 4 ..... FS 2-12  
    POST EVA EMU RECONFIGURATION ..... FS 2-13  
    EVA TRANSFER TO SHUTTLE..... FS 2-18  
    EVA UNPACK AND STOW ..... FS 2-19

CHECKOUTS..... 3-1  
    EMU CHECKOUT ..... 3-2  
        EMU POWERUP AND COMM CHECK..... 3-2  
        PRIMARY REGULATOR/FAN/PUMP CHECK..... 3-4  
        SOP CHECK..... 3-5  
        BATTERY CHARGE CHECK INIT..... 3-6  
        BATTERY CHARGE CHECK TERM ..... 3-6  
        EMU SWAP DURING CHECKOUT ..... 3-7  
        POST EMU C/O RECONFIG..... 3-7  
    SAFER CHECKOUT ..... 3-8  
    SELF TEST SEQUENCE ..... 3-9  
    SAFER CHECKOUT RESULTS..... CC 3-10  
    SAFER STATUS TROUBLESHOOTING ..... CC 3-11  
    REBA POWERED HARDWARE CHECKOUT ..... 3-12

EVA PREP ..... 4-1  
    MIDDECK PREP ..... 4-2  
    EVA PREP..... 4-3  
        PREP FOR DORNING..... 4-3  
        EMU DORNING..... 4-5  
        EMU CHECK ..... 4-7  
    EMU PURGE..... 4-7  
    EMU PREBREATHE ..... 4-8  
        SAFER DORNING..... 4-8  
    EVA COMM CONFIG..... 4-10  
    EVA COMM DECONFIG ..... 4-10  
    APPROVED NON-EMU HARDWARE MATRIX..... 4-11

EMU STATUS .....	5-1
EMU STATUS .....	5-2
DEPRESS/REPRESS .....	A6-1
DEPRESS/REPRESS (NOM A/L) .....	CC A6-2
FAILED LEAK CHECK .....	6-3
FAILED LEAK CHECK (5 PSI) .....	CC 6-4
FAILED LEAK CHECK (14.7/10.2 PSI) .....	CC 6-4
TIMELINES .....	FS 7-1
STS-134 (ULF6) EVA TIMELINE OVERVIEW .....	FS 7-3
EVA 1	
EVA 1 SUMMARY TIMELINE .....	FS 7-5
EVA 1 TOOL CONFIG .....	FS 7-6
EVA 1 BRIEFING CARD .....	FS 7-10
EVA 1 INHIBIT PAD .....	FS 7-11
EVA 1 NOTES/CAUTIONS/WARNINGS .....	FS 7-13
EVA 1 EGRESS/SETUP .....	FS 7-20
MISSE 7 RETRIEVE .....	FS 7-22
MISSE 8 INSTALL .....	FS 7-24
S3 CETA LIGHT INSTALL .....	FS 7-26
STBD SARJ COVER 7 INSTALL .....	FS 7-27
P3/P4 NH3 JUMPER INSTALL .....	FS 7-28
NH3 JUMPERS N2 VENT/P3/P4 JUMPER TEMP STOW .....	FS 7-29
EWC ANTENNA INSTALL .....	FS 7-31
VTEB RECONFIG .....	FS 7-37
EVA 1 CLEANUP/INGRESS .....	FS 7-39
EVA 2	
EVA 2 SUMMARY TIMELINE .....	FS 7-55
EVA 2 TOOL CONFIG .....	FS 7-56
EVA 2 BRIEFING CARD .....	FS 7-58
EVA 2 INHIBIT PAD .....	FS 7-59
EVA 2 NOTES/CAUTIONS/WARNINGS .....	FS 7-61
EVA 2 EGRESS/SETUP .....	FS 7-68
P3/P4 NH3 JUMPER RE-ROUTE .....	FS 7-70
PVTCS NH3 FILL/CONFIGURE ATA .....	FS 7-71
EAS JUMPER SETUP/VENT .....	FS 7-76
NH3 VENT TOOL CLEANUP .....	FS 7-78
PSARJ COVER REMOVAL .....	FS 7-79
PSARJ FIRST LUBE .....	FS 7-81
P3/P4 JUMPER STOW .....	FS 7-82
CONFIGURE ATA TO VENT .....	FS 7-84
SPDM CLA COVER INSTALL .....	FS 7-85
SPDM LEE LUBE .....	FS 7-86
S1 RAD GB STOW BEAM INSTALL .....	FS 7-89
PSARJ SECOND LUBE .....	FS 7-91
PSARJ REINSTALL COVERS .....	FS 7-92
EVA 2 CLEANUP/INGRESS .....	FS 7-93
EVA 3	
EVA 3 SUMMARY TIMELINE .....	FS 7-109
EVA 3 TOOL CONFIG .....	FS 7-110
EVA 3 BRIEFING CARD .....	FS 7-114
EVA 3 INHIBIT PAD .....	FS 7-115
EVA 3 NOTES/CAUTIONS/WARNINGS .....	FS 7-118
EVA 3 EGRESS/SETUP .....	FS 7-125
PDGF SETUP .....	FS 7-127
RETRIEVE PAMA/PDGF .....	FS 7-128
PAMA/PDGF INSTALL .....	FS 7-129
VSC INSTALL .....	FS 7-130
NOD1/FGB CH 1/4 CABLE INSTALL (PORT) .....	FS 7-132

1553 DATA CABLE INSTALL.....	FS 7-135
NOD1/FGB CH 2/3 CABLE INSTALL (STBD).....	FS 7-136
FGB AND PDGF PHOTOS/CLEANUP.....	FS 7-139
A/L TOOLBOX TOOL STOW.....	FS 7-140
HPGT FRGF MLI INSTALL.....	FS 7-147
STP-H3 PHOTOS.....	FS 7-148
EVA 3 CLEANUP/INGRESS.....	FS 7-149
EVA 4	
EVA 4 SUMMARY TIMELINE.....	FS 7-171
EVA 4 TOOL CONFIG.....	FS 7-172
EVA 4 BRIEFING CARD.....	FS 7-174
EVA 4 INHIBIT PAD.....	FS 7-175
EVA 4 NOTES/CAUTIONS/WARNINGS.....	FS 7-177
EVA 4 EGRESS/SETUP.....	FS 7-184
OBSS STOW.....	FS 7-186
P6 PDGF RETRIEVE.....	FS 7-188
OBSS EFGF/PDGF SWAP.....	FS 7-190
EFGF STOWAGE IN TSA.....	FS 7-194
OTP LDTD TETHER CINCH.....	FS 7-195
SPDM EDF RELEASE.....	FS 7-196
CLEANUP/INGRESS.....	FS 7-198
CUE CARDS	
EVA FLUID QD/SARJ CUE CARD.....	FS CC 7-216
EVA 3 CABLE ROUTING CUE CARD.....	FS CC 7-218
GET-AHEADS	
STS-134 GET-AHEADS.....	FS 7-220
OTP LDTD TETHER CINCH.....	FS 7-221
STP-H3 PHOTOS.....	FS 7-223
PORT CETA CART RECONFIG.....	FS 7-224
S1 FHRC P-CLAMP RELEASE.....	FS 7-225
TOOLS AND STOWAGE.....	
PORT LIGHTWEIGHT TOOL STOWAGE ASSEMBLY (TSA).....	TEMP FS 8-1
PGT CHECKOUT.....	TEMP FS 8-2
PGSC-PGT CONNECTION (A31P AND 760XD).....	8-3
PROGRAM PGT SETTINGS.....	8-4
DOWNLOAD/ERASE EVENT LOG.....	8-5
PGT CONTINGENCIES.....	8-5
PGT STANDARD SETTINGS.....	8-6
APFR MANAGEMENT – STS-134 (ULF6).....	8-7
CETA CART WIF AND SWINGARM MANAGEMENT TABLE – STS-134/ULF6 ...	FS 8-9
SAFETY TETHERS STS-134/ULF6.....	FS 8-10
TOOLBOX STOWAGE – STS-134 (ULF6).....	FS 8-11
TOOLBOX PANEL AND SLOT LABELS.....	FS 8-12
Z1 TOOLBOX INTERNAL LAYOUT.....	FS 8-13
AIRLOCK TOOLBOX INTERNAL LAYOUT.....	FS 8-14
FLUID QD BAG LAYOUT.....	FS 8-15
CETA CART CONFIG.....	FS 8-16
CREW TETHER INSPECTIONS.....	FS 8-19
POST EVA.....	FS 8-20
POST EVA.....	
SUIT DOFFING.....	9-1
SAFER DOFFING.....	9-2
EMU WATER RECHARGE.....	9-2
SAFER STOW.....	9-3
SUIT DRYING/SEAL WIPE.....	9-3
OXYGEN RECHARGE VERIFICATION.....	9-4
WATER FILL VERIFICATION.....	9-4
EMU POWERDOWN/OVERNIGHT STOW.....	9-5

EMU MAINT/RECHARGE.....	TEMP FS	10-1
WATER RECHARGE .....	TEMP FS	10-2
EMU POWERUP .....	TEMP FS	10-2
WATER FILL.....	TEMP FS	10-2
WATER FILL VERIFICATION.....	TEMP FS	10-2
EMU LiOH CHANGEOUT .....		10-4
MIDDECK EMU BATTERY RECHARGE (STAND-ALONE) .....		10-4a
MIDDECK EMU BATTERY RECHARGE/LiOH REPLACEMENT .....		10-5
INITIATE .....		10-5
TERMINATE .....		10-6
IN-SUIT EMU BATTERY RECHARGE/CHARGE VERIFICATION .....		10-7
INITIATE .....		10-7
TERMINATE .....		10-7
EMU POWERDOWN.....		10-7
HELMET LIGHT/PGT BATTERY RECHARGE .....		10-8
INITIATE .....		10-8
TERMINATE .....		10-9
REBA BATTERY INSTALLATION.....		10-9
EMU BATTERY REMOVAL/INSTALL.....		10-10
HELMET LIGHT BULB CHANGEOUT .....		10-11
REBA BATTERY RECHARGE .....		10-12
INITIATE .....		10-12
TERMINATE .....		10-13
STS-134 CONSUMABLES TRACKING CUE CARD .....	FS CC	10-15
STS-134 EVA BATTERY RECHARGE PLAN.....	FS CC	10-16
POST EVA ENTRY PREP .....		11-1
POST EVA ENTRY PREP.....		11-2
SAFER ENTRY STOW .....		11-2
POST ISS EVA ENTRY PREP .....		11-3
<u>OFF-NOMINAL PROCEDURES</u> .....		12-i
EMU CONTINGENCY PROCS .....	TEMP FS	12-1
DISPLAY LOSS DURING POWER TRANSFER (WARM RESTART)..	TEMP FS	12-2
VACUUM H2O RECHARGE (MANNED) .....	TEMP FS	12-2
LiOH REPLACEMENT (MANNED) .....		12-3
BATTERY REPLACEMENT (MANNED) .....		12-4
WATER DUMP .....		12-6
SCU SWAP (UNMANNED) .....		12-7
SCU SWAP (MANNED) .....		12-7
EMU COLD RESTART (MANNED).....		12-7
12.1 STS EVA DECONTAMINATION .....		12-8
CONTAMINATION TEST .....		12-15
SAFER BATTERY CHANGEOUT .....		12-18
BENDS TREATMENT ADAPTER (BTA) INSTALLATION (IN-SUIT).....		12-19
BTA PREP .....		12-19
BTA TREATMENT .....		12-20
BENDS TREATMENT ADAPTER (BTA) INSTALLATION (POST SUIT DOFFING)...		12-21
BTA PREP .....		12-21
BTA TREATMENT .....		12-22
EMU RESIZE.....		12-25
STS-134 NOMINAL EMU SIZING .....	FS	12-27
EMU CONTINGENCY RESIZE MATRIX (STS-134/ULF6) .....	FS	12-30
EXPEDITED SUIT DOFFING CUE CARD .....	FS CC	12-31
EMERGENCY UNDOCKING EVA TRANSFER.....	FS CC	12-32

TPS REPAIR.....	FS 13-1
ORBITER CONTINGENCY EVA.....	14-1
PAYLOAD BAY EVA NOMENCLATURE.....	14-2
RMS/PRLA CONTINGENCY EVA.....	14-3
96 BOLT PRE-EVA TOOL CONFIG.....	14-13
96 BOLT EVA TIMELINE.....	14-14
CAPTURE LATCH MANUAL RELEASE (ODS/PMA).....	14-19
96 BOLT EVA LAYOUT.....	14-21
PLBD LATCH TOOL PLACEMENT WITH DUAL LATCH GANG FAILURES.....	14-22
EVA CUFF CHECKLIST (CIL).....	15-1
NORMAL EVA STATUS.....	15-2
DCM CONFIGURATION.....	15-2
EMU MALFUNCTION INDEX.....	15-2
DECOMPRESSION SICKNESS (DCS).....	15-3
DECOMPRESSION SICKNESS (DCS) (CONT).....	15-3
ABORT EVA.....	15-3
TERMINATE EVA.....	15-3
SUIT P EMERG.....	15-4
SOP O2 ON.....	15-4
BATT AMPS HIGH.....	15-4
BATT V DECAY OR BATT VDC LOW.....	15-4
SUIT P LOW.....	15-5
SUIT P HIGH.....	15-5
SOP P LOW.....	15-5
O2 USE HIGH.....	15-5
SUBLM PRESS.....	15-6
H2O GP LOW.....	15-6
RESRV H2O ON.....	15-6
H2O WP HIGH.....	15-6
NO VENT FLOW.....	15-7
CO2 HIGH OR MONITOR CO2.....	15-7
CO2 SNSR BAD.....	15-7
COMM FAILURE.....	15-7
AIR FLOW CONTAMINATION.....	15-8
LOSS OF COOLING.....	15-8
RLF V FAIL.....	15-8
MISC MSGS 1.....	15-8
MISC MSGS (CONT)/TIME LF.....	15-9
AIRLOCK LATCH DISCONNECT.....	15-9
AIRLOCK INGRESS.....	15-9

FOLLOWING PAGES NOT IN EV CUFF

RADIATOR ACTUATOR DISCONNECT.....	15-9
PLBD DRIVE CUT.....	15-10
DOOR DRIVE RESTRAINT.....	15-10
DOOR DRIVE DISCONNECT.....	15-10
WINCH OPERATIONS.....	15-10
WINCH OPERATIONS (CONT).....	15-11
3-PT TOOL INSTALLATION.....	15-11
CL LATCH TOOL.....	15-11
RMS JOINT ALIGN.....	15-11
MPM STOW/DEPLOY.....	15-12
RMS TIEDOWN.....	15-12
RMS FLIGHT RELEASABLE GRAPPLE FIXTURE RELEASE.....	15-12
PRLA OPEN/CLOSE.....	15-12
PRLA OPEN/CLOSE (CONT).....	15-13
KU ANTENNA STOW.....	15-13
KU ANTENNA STOW (CONT).....	15-13
AIRLOCK EGRESS.....	15-13

<u>FLIGHT SPECIFIC REFERENCE</u> .....	16-i
UNSCHEDULED/CONTINGENCY EVA TASKS .....	TEMP FS 16-1
STS 134/ULF6 WORKAROUNDS CRIBSHEET .....	TEMP FS 16-2
EVA 1 CONTINGENCIES .....	TEMP FS 16-2
P6 PVTCS FILL CONTINGENCIES .....	FS 16-8
EVA 2 CONTINGENCIES .....	FS 16-14
EVA 3 CONTINGENCIES .....	FS 16-15
EVA 4 CONTINGENCIES .....	FS 16-20
GET-AHEAD CONTINGENCIES .....	FS 16-25
GENERIC CONTINGENCIES .....	FS 16-26
AGB .....	FS 16-26
APFR/IAPFR .....	FS 16-26
BALLSTACK .....	FS 16-27
BRT .....	FS 16-27
CANNON CONNECTOR .....	FS 16-27
CETA CART .....	FS 16-28
EVA WRENCH (TORQUE AND RATCHET) .....	FS 16-30
EXPANDABLE DIAMETER FASTENERS (EDFs) .....	FS 16-30
FLUID QD OPS .....	FS 16-30
FRAM .....	FS 16-36
MMOD SHIELD .....	FS 16-37
MUT EE .....	FS 16-40
MWS .....	FS 16-40
NZGL CONNECTORS .....	FS 16-41
ON-ORBIT INSTALLED HR .....	FS 16-43
ON-ORBIT INSTALLED WIF .....	FS 16-44
PAD .....	FS 16-44
PGT .....	FS 16-44
SAFETY TETHER .....	FS 16-46
SCOOPS .....	FS 16-46
SOCKET CADDY .....	FS 16-48
TA CLAMP .....	FS 16-48
TETHER SHUTTLE .....	FS 16-48
TORQUE MULTIPLIER .....	FS 16-48
TSA .....	FS 16-49
P6 PVTCS LEAK DETECTION .....	FS 16-50
P6 PVTCS FILL FAILURE MATRIX .....	FS 16-55
ROEU CONTINGENCIES	
ROEU OVERVIEW .....	FS 16-61
RELEASE ELC(AMS) ROEU LATCHES .....	FS 16-62
LATCH ELC(AMS) ROEU LATCHES .....	FS 16-65
STOW ELC(AMS) ROEU ARM .....	FS 16-69
MATE ROEU ARM .....	FS 16-72
ELC3/AMS CONTINGENCIES	
UCCAS/PAS UMBILICAL MATING ASSEMBLY (UMA)	
MANUAL DRIVE .....	FS 16-75
EXPCA R&R PROCEDURES .....	FS 16-79
AMS CAPTURE BAR MANUAL RELEASE/INSTALL .....	FS 16-85
MANUALLY SWITCH AMS DATA CHANNELS .....	FS 16-89
TIEDOWN PLANS	
MISSE 8 AND ORMATE-III TIEDOWNS .....	FS 16-91
S3 CETA LIGHT TIEDOWN .....	FS 16-92
EWC ANTENNA HANDRAILS TIEDOWN .....	FS 16-93
EAS JUMPER TIEDOWN .....	FS 16-94
SARJ COVERS TIEDOWN .....	FS 16-95
S1 RADIATOR GB STOW BEAMS TIEDOWN .....	FS 16-96
PAMA/PDGF TIEDOWN .....	FS 16-97
OBSS (IBA) TIEDOWN IN OSE .....	FS 16-102

GENERIC EVA REFERENCE.....	17-1
FLIGHT SPECIFIC EVA REFERENCE.....	FS 18-1
PAYLOAD BAY LAYOUT .....	FS 18-2
ELC3.....	FS 18-4
AMS.....	FS 18-7
ROEU .....	FS 18-13
PRLA .....	FS 18-15
EVA 1	
ELC2 ExPA.....	FS 18-16
MISSE 7.....	FS 18-17
MISSE 8.....	FS 18-19
LAB EWC ANTENNAS .....	FS 18-21
MMOD SHIELD DZUS FASTENERS .....	FS 18-25
P6 PVTCS FILL .....	FS 18-27
EVA 2	
PORT SARJ LUBE .....	FS 18-28
SPDM LEE LUBE .....	FS 18-29
S1 RADIATOR GRAPPLE BAR STOWAGE BEAMS.....	FS 18-30
EVA 3	
FGB PAMA/PDGF .....	FS 18-32
VSC .....	FS 18-34
NOD1/FGB CH1/4 AND CH2/3 CABLES .....	FS 18-35
EVA 4	
OBSS.....	FS 18-38
PDGF.....	FS 18-41
EFGF/PAA .....	FS 18-43
PORT TSA.....	FS 18-44
SPARE SPDM .....	FS 18-45
<u>EVA EMERGENCY</u> .....	19-i
EMERGENCY PROCEDURES.....	TEMP FS 19-1
EMERGENCY AIRLOCK REPRESS .....	19-3
EMERGENCY AIRLOCK REPRESS.....	19-4
POST EMERGENCY AIRLOCK REPRESS .....	19-4
SAFER RESCUE.....	19-5
SAFER RESCUE .....	19-6
DAP/EVA RESCUE/RETRIEVE .....	19-7
EVA ORBITER CONFIG.....	19-7
EVA RESCUE/RETRIEVE.....	19-9
19.1 DCS TREATMENT .....	19-10
CONTINGENCY SHUTTLE AIRLOCK INGRESS FROM ISS .....	TEMP FS 19-13
CUE CARD CONFIGURATION .....	20-1

This Page Intentionally Blank



AIRLOCK CONFIG

AIRLOCK PREP .....	TEMP FS 2-2
EMU SWAP .....	TEMP FS 2-3
BOOSTER FAN DEACTIVATION/REMOVAL .....	TEMP FS 2-4
BOOSTER FAN INSTALLATION/ACTIVATION .....	TEMP FS 2-4
EMU REMOVAL .....	TEMP FS 2-4
EMU INSTALLATION .....	TEMP FS 2-4
EMU CHECKOUT PREP .....	TEMP FS 2-5
LTA RESTRAINT STRAP REMOVAL .....	TEMP FS 2-6
LTA RESTRAINT STRAP INSTALLATION .....	TEMP FS 2-6
EVA PREP FOR ISS TRANSFER .....	FS 2-7
POST-DOCKING EVA TRANSFER AND RECONFIG .....	FS 2-9
EMU SWAP FOR EVA 2.....	FS 2-11
EMU SWAP FOR EVA 4.....	FS 2-12
POST EVA EMU RECONFIGURATION .....	FS 2-13
EVA TRANSFER TO SHUTTLE .....	FS 2-18
EVA UNPACK AND STOW .....	FS 2-19

AIRLOCK  
CONFIG

## AIRLOCK PREP (50 min)

	Retrieve or unstow following equipment:
MF28G	3/8-in breaker bar, 4-in ext w/3/8-in drive
IFM Tool Kit	1/2-in socket w/3/8-in drive
Vol H	EMU Equipment Bag – attach to middeck wall
	Helmet Lights
	EVA Bag
	Contamination Detection Kit (location flight specific)
FDF Locker	Cuff Checklists (2) – stow in EMU Equipment Bag
	<u>DEPRESS/REPRESS</u> Cue Card

- AW18A
1. ✓ Inner hatch Equal vlv (two) – OFF
  2. LTG FLOOD (four) – ON
  3. Remove from airlock, as reqd:
    - Airlock Stowage Bag
    - Airlock Floor Pallet using 3/8-in breaker bar, 4-in ext w/3/8-in drive, and 1/2-in socket w/3/8-in drive
  4. Stow Vol H Bags in Vol H
  5. Transfer to airlock:
    - EVA Bag – install on airlock wall
    - DEPRESS/REPRESS Cue Card
    - Helmet Lights
    - Contamination Detection Kit – install on airlock wall
  6. Install IVA foot restraint, as reqd
  7. Unbuckle SCU straps, Velcro SCU to wall
  8. Install EMU lights on helmets (EMU 1, EMU 2); perform pull test
  9. Disconnect helmets from Airlock EMUs, temp stow
  10. Remove comm caps from LTA Restraint Bags and connect to electrical harnesses
  11. Install helmets (not reqd if proceeding directly to EMU Checkout)
  12. Remove LTA Restraint Bags
  13. Disconnect waist rings; remove and stow any equipment stowed in HUT/LTA
  14. Stow LTA Restraint Bags on AAPs
  15. ✓ Thermal cover clear of waist ring
  16. Waist ring – engage posn
  17. Connect LTA to HUT, lock
  18. Remove 20-g Crash Bag from middeck EMU, as reqd

## EMU SWAP (30 min)

### NOTE

EMU X is to be removed and EMU Y is to be installed

- |       |                                                                                                                                                                                                                                                                                                                                                                                                                                                                    |
|-------|--------------------------------------------------------------------------------------------------------------------------------------------------------------------------------------------------------------------------------------------------------------------------------------------------------------------------------------------------------------------------------------------------------------------------------------------------------------------|
| EMU X | 1. Install gloves                                                                                                                                                                                                                                                                                                                                                                                                                                                  |
| AW18H | 2. √PWR/BATT CHGR EMU 1,2 BUS SEL (two) – OFF<br>√MODE (two) – OFF                                                                                                                                                                                                                                                                                                                                                                                                 |
| DCM   | 3. Disconnect SCU, install DCM cover<br>4. Stow SCU on AAP, Velcro to wall<br>5. Connect LTA to HUT, lock (if reqd)<br>6. Disconnect helmet with sunshades down and helmet cover installed; stow<br>7. Release EMU from AAP, transfer EMU to middeck<br>8. Install helmet<br>9. Remove 20-g Crash Bag on middeck EMUs (if flown)                                                                                                                                   |
| EMU Y | 10. Disconnect helmet, temp stow<br>11. Remove comm cap from LTA Restraint Bag and connect to electrical harness (if reqd)<br>12. Remove LTA Restraint Bag<br>13. Release EMU from middeck AAP, transfer to airlock<br>14. Mount EMU on AAP<br>15. Install helmets (not reqd if proceeding directly to EMU Checkout)<br>16. Disconnect waist ring; remove and stow any equipment stowed in HUT/LTA<br>17. Waist ring – engage posn<br>18. Connect LTA to HUT, lock |

### NOTE

O2 vlv for SCU connected to EMU Y must be closed prior to checkout of EMU Y

- |       |                                                                    |
|-------|--------------------------------------------------------------------|
| AW82B | 19. If performing EMU CHECKOUT of EMU Y:<br>EV-1(EV-2) O2 vlv – CL |
| EMU X | 20. Attach EMU to middeck AAP<br>21. Attach LTA Restraint Bag      |

## **BOOSTER FAN DEACTIVATION/REMOVAL (15 min)**

- MO13Q 1. ARLK FAN A,B (two) – OFF  
MA73C:G 2. cb AC1,2 ARLK TNL FAN A,B (six) – op  
EXT A/L 3. Disconnect flex duct from booster fan muffler inlet, direct airflow into airlock, temp secure  
4. Disconnect vent duct from booster fan outlet and external airlock duct inlet; temp stow in middeck  
If booster fan to be removed:  
5. Disconnect flex duct from booster fan inlet; rotate and stow in launch bracket  
6. Demate booster fan electrical connectors from J1,J2 (two) on tunnel extension wall; loosen cable harnesses (two) from Velcro strips (four)  
7. Stow electrical connectors (two) on booster fan dummy fittings, secure cable harnesses with Velcro strips  
8. Loosen booster fan fasteners (four)  
9. Remove booster fan assy, temp stow in middeck

## **BOOSTER FAN INSTALLATION/ACTIVATION (15 min)**

- If booster fan to be installed:  
MA73C:G 1. √cb AC1,2 ARLK TNL FAN A,B (six) – op  
MO13Q 2. √ARLK FAN A,B (two) – OFF  
EXT A/L 3. Install booster fan assy, secure fasteners (four)  
4. Demate electrical connectors (two) from booster fan dummy fittings and Velcro strips  
5. Mate booster fan electrical connectors J1,J2 (two) on tunnel extension wall; secure cable harnesses (two) with Velcro strips (four)  
6. Unstow/connect flex duct from launch bracket to booster fan inlet  
7. Unstow/connect vent duct to external airlock duct inlet and booster fan outlet  
8. Unstow/connect flex duct from middeck to fan muffler inlet  
MA73C:G 9. cb AC1,2 ARLK TNL FAN A,B (six) – cl  
MO13Q 10. ARLK FAN A(B) – ON  
11. Check for airflow at top of external airlock halo

## **EMU REMOVAL (15 min)**

1. As reqd, install gloves
2. As reqd, perform LTA RESTRAINT STRAP INSTALLATION (AIRLOCK CONFIG)
3. As reqd, relocate LTA spring hooks (four) from AAP rings to SAFER mount brackets
4. Disconnect EMUs from AAPs, stow in middeck
5. Remove ICB EMU Batteries from EMUs, temp stow in Post Insertion locker MF43H

## **EMU INSTALLATION (15 min)**

1. Transfer EMUs to A/L, connect to AAPs
2. As reqd for EVA, perform LTA RESTRAINT STRAP REMOVAL (AIRLOCK CONFIG)
3. As reqd, relocate LTA spring hooks (four) from SAFER mount brackets to AAP rings

## EMU CHECKOUT PREP (30 min)

1. LTG FLOOD (four) – ON
  2. Remove Ext A/L Floor Bag (Bag I) from Airlock, secure bag straps with gray tape or Velcro
  3. Unbuckle SCU straps as needed for EMU Checkout, Velcro SCU to wall
  4. Disconnect helmets from EMUs, temp stow
  5. ✓DIDB restraint bags installed
  6. Remove comm caps (4) from LTA Restraint Bag kangaroo pouches; temp stow FT2 and FN2 (for respective ECOKs, step 10)
  7. Connect comm caps FT1 and FN1 to electrical harnesses
  8. Remove LTA Restraint Bags
  9. Disconnect waist rings; remove ECOKs/LCVGs – temp stow LCVGs for EMU Checkout
  10. Stow comm caps FT2 and FN2 in respective ECOKs
  11. Temp stow ECOKs for EVA Prep for ISS Transfer
  12. Stow LTA Restraint Bags on AAPs
  13. ✓Thermal cover clear of waist rings
  14. Waist rings – engage position
  15. Connect LTAs to HUTs, lock
  16. Remove SCOFs (2) from EMU Equipment Bag for EMU Checkout
  17. Stow Vol H Bags in Vol H (SCOFs (2) will be stowed back in EMU Equipment Bag after EMU Checkout)
- Airlock
- IFM Tool Locker (tray 1)
- Middeck Vol H INBD

## LTA RESTRAINT STRAP REMOVAL (15 min)

### NOTE

May be performed on EMU 1 and 2 simultaneously.  
Perform steps as reqd for current EMU config

1. As reqd, remove comm cap from LTA Restraint Bag; temp stow
2. Remove EMU from AAP
3. Disconnect all restraint attachments from SAFER mount brackets (two)
4. Loosen cinch strap mechanism, remove SAFER mount brackets
5. Remove strap from PLSS
6. Stow strap in LTA Restraint Bag Pouch with D-rings (three) connected
7. Engage EMU in AAP
8. Stow LTA Restraint Bag/strap

## LTA RESTRAINT STRAP INSTALLATION (15 min)

### NOTE

May be performed on EMU 1 and 2 simultaneously. Perform steps as reqd for current EMU config. Procedure written to install in Launch/Landing config shown below

1. Unstow LTA Restraint Bag/strap
2. Remove EMU from AAP
3. Install SAFER mount brackets (two)
4. Install elastic band of strap around SOP
5. Tighten cinch strap mechanism
6. Attach strap French hooks (two) to SAFER mount brackets
7. Engage EMU in AAP
8. Stow LTA, suit arms inside LTA Restraint Bag
9. Connect upper spring hooks (two) over suit shoulders to upper AAP attachment rings (two)
10. Connect lower spring hooks (two) around suit arms to SAFER mount brackets (two)
11. Tighten all LTA bag straps with bag as high as possible on EMU

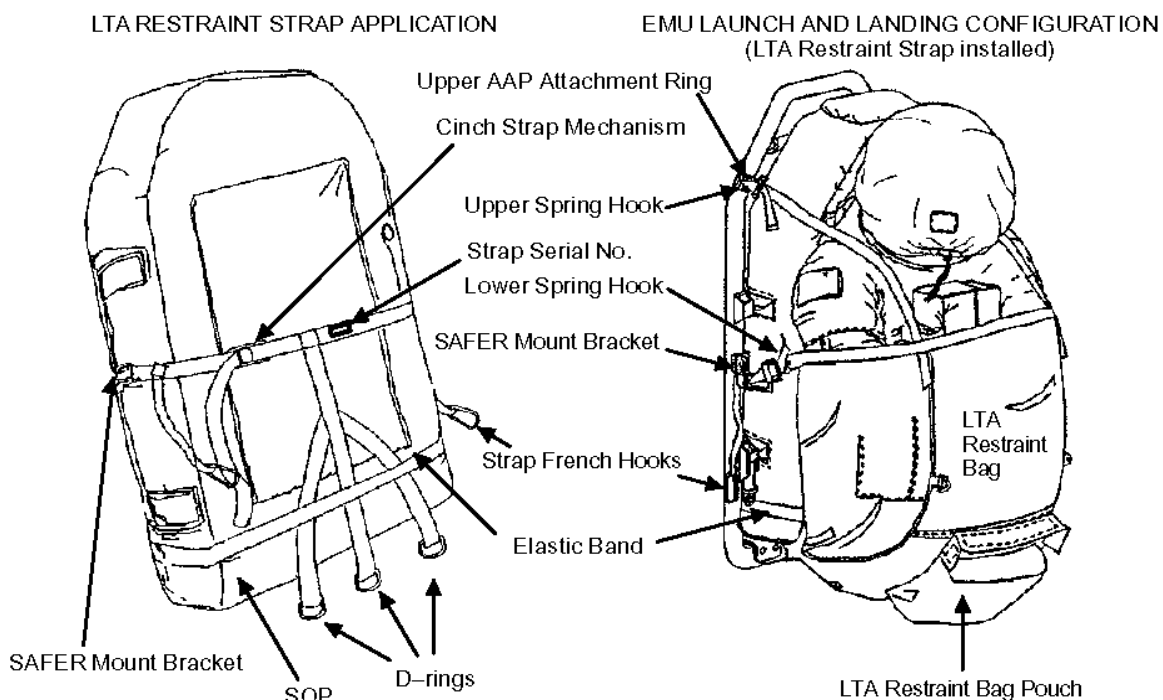

### NOTE

French hooks should be attached to SAFER mount brackets for launch and landing

**EVA PREP FOR ISS TRANSFER (90 min)**

|

- BOTH
- EMUs
1. √PWR – SCU
  2. √PURGE vlv – op (up)
  3. √O2 ACT – OFF
  4. √WATER – OFF, switch guard installed
  5. √Helmet sunshades down, cover installed
  6. Retrieve B/U gloves (FT2 and FN2) from Bag E and stow in respective ECOKs
  7. Retrieve FT EVA 3 Ziplock bag and FN EVA 4 Ziplock bag from CF ECOK and stow in respective ECOKs
  8. Configure/verify items stowed in tables below

<b><u>EMU 3004 (L) (FT)</u></b>	<b><u>EMU 3018 (L) (FN)</u></b>
<input type="checkbox"/> Helmet s/n 1084 <input type="checkbox"/> Valsalva <input type="checkbox"/> LTA FT (attached) <input type="checkbox"/> EMU gloves FT1 s/n 6248 <input type="checkbox"/> Wrist Mirrors (2)	<input type="checkbox"/> Helmet s/n 1072 <input type="checkbox"/> Valsalva <input type="checkbox"/> LTA FN (attached) <input type="checkbox"/> EMU gloves FN1 s/n 6276 <input type="checkbox"/> Wrist Mirrors (2)
<b><u>EMU Crew Options Kit (ECOK) (FT)</u></b>	<b><u>EMU Crew Options Kit (ECOK) (FN)</u></b>
<input type="checkbox"/> LCVG FT1 <input type="checkbox"/> Comm cap FT2 <input type="checkbox"/> EMU Gloves FT2 <input type="checkbox"/> FT EVA 1, 2, & 3 Ziplock Bags <ul style="list-style-type: none"> <li><input type="checkbox"/> 2 MAGs</li> <li><input type="checkbox"/> TCUs (top, bottom)</li> <li><input type="checkbox"/> Socks</li> <li><input type="checkbox"/> Wristlets</li> <li><input type="checkbox"/> Comfort Gloves</li> <li><input type="checkbox"/> Moleskin</li> <li>X <input type="checkbox"/> Patch, Stripes, American Flag</li> </ul>	<input type="checkbox"/> LCVG FN1 <input type="checkbox"/> Comm cap FN2 <input type="checkbox"/> EMU Gloves FN2 <input type="checkbox"/> FN EVA 2, 3 & 4 Ziplock Bags <ul style="list-style-type: none"> <li><input type="checkbox"/> 2 MAGs</li> <li><input type="checkbox"/> TCUs (top, bottom)</li> <li><input type="checkbox"/> Socks</li> <li><input type="checkbox"/> Wristlets</li> <li><input type="checkbox"/> Comfort Gloves</li> <li>X <input type="checkbox"/> Patch, Stripes, American Flag</li> </ul>

## EVA PREP FOR ISS TRANSFER (90 min) (Cont)

<p>From Bag E (Middeck Ceiling Port 1)  <b>EMU Crew Options Kit (ECOK) (CF)</b></p> <p><input type="checkbox"/> LCVG CF1  <input type="checkbox"/> Comm cap CF1 &amp; CF2  <input type="checkbox"/> CF EVA 1 &amp; 4 Ziplock Bags              <input type="checkbox"/> 2 MAGs              <input type="checkbox"/> TCUs (top, bottom)              <input type="checkbox"/> Socks              <input type="checkbox"/> Wristlets              <input type="checkbox"/> Comfort Gloves              <input type="checkbox"/> Patch, Stripes, American Flag              <input type="checkbox"/> Mole Skin              <input type="checkbox"/> X Valsalva/Lens Template              <input type="checkbox"/> X 2 Fresnel Lenses</p> <p><input type="checkbox"/> EMU gloves CF1 &amp; CF2  <input type="checkbox"/> 2 Mesh Bags              SYSTEMS TRANSFER Bag              TOOLS TRANSFER Bag</p>	
-----------------------------------------------------------------------------------------------------------------------------------------------------------------------------------------------------------------------------------------------------------------------------------------------------------------------------------------------------------------------------------------------------------------------------------------------------------------------------------------------------------------------------------------------------------------------------------------------------------------------------------------------------------------------------------------------------------------------------------------------------------------------------------------------------------------------------------------------------------------------------------------------------------------------------------------------------------------------	--

<b>SYSTEMS TRANSFER Bag (from CF ECOK)</b>	
Current Location	Item
FDF Locker (MF71G)	<input type="checkbox"/> <u>STS-134 CONSUMABLES TRACKING/BATTERY RECHARGE</u> Cue Card <input type="checkbox"/> <u>EMERGENCY UNDOCKING/EVA TRANSFER</u> Cue Card <input type="checkbox"/> STS-134 EVA Checklist (SPARE)
SODF Locker (MF71G)	<input type="checkbox"/> STS-134 ISS EVA Systems Checklist (Brown stripe) <input type="checkbox"/> 'EVA Transfer' Ziplock Bag <input type="checkbox"/> <u>JOINT EMERGENCY EGRESS</u> Cue Card <input type="checkbox"/> <u>ISLE PREBREATHE</u> Cue Cards (2) <input type="checkbox"/> <u>CREWLOCK DEPRESS/REPRESS</u> Cue Cards (3) <input type="checkbox"/> ISS EVA Cuff Checklist (3)
Bag E (Middeck Ceiling Port 1)	<input type="checkbox"/> 8 DIDBs <input type="checkbox"/> 6 LiOH canisters

<b>TOOLS TRANSFER Bag (from CF ECOK)</b>	
Current Location	Item
Bag E (Middeck Ceiling Port 1)	<input type="checkbox"/> 85-ft Safety Tethers (#28 and #30) (2) (EVA 1) <input type="checkbox"/> Vent Tool Extension Plug (EVA 1) <input type="checkbox"/> 90 deg Connector Tool (EVA 1) <input type="checkbox"/> HPGT MLI (EVA 3)
Bag D (Middeck Floor Starboard 2)	<input type="checkbox"/> "EVA Handrail Assy" – EWC Antennas/Handrails (2) (EVA 1) <input type="checkbox"/> "Antenna Cable Assy" – EWC Cables (EVA 1)
Seat 7 Bag	<input type="checkbox"/> "FGB Cables" – FGB Y-Jumpers (2) (EVA 1)



# POST-DOCKING EVA TRANSFER AND RECONFIG (60 min)

I

## NOTE

This procedure assumes that transfer items were preconfigured per EVA PREP FOR ISS TRANSFER

1. Transfer items in table below to ISS; report status to **MCC-H** when complete:

Item	Destination
EMU 3004 (FT)	E-Lk, Aft EDDA
EMU 3018 (FN)	Node 1
ECOK (FT)	E-Lk
ECOK (FN)	Node 1
ECOK (CF)	E-Lk
SYSTEMS TRANSFER Bag	E-Lk
TOOLS TRANSFER Bag	E-Lk

SYSTEMS  
TRANSFER Bag

2. Unstow following items and position in E-Lk, unless otherwise specified:
  - STS-134 EVA CHECKLIST (SPARE)
  - STS-134 ISS EVA Systems Checklist (Brown stripe)
  - STS-134 CONSUMABLES TRACKING/BATTERY RECHARGE CUE CARD
  - EMERGENCY UNDOCKING/EVA TRANSFER CUE CARD
  - 'EVA Transfer' Ziplock Bag
    - JOINT EMERGENCY EGRESS Cue Card
    - ISLE PREBREATHE Cue Card in Node 1 in EVA #3 Systems Bag
    - ISS EVA Cuff Checklists (3) as follows:
      - Install EV1 on EMU 3004
      - Install EV2 on EMU 3018 in Node 1
      - Install EV3 on EMU 3005
    - CREWLOCK DEPRESS/REPRESS Cue Cards as follows:
      - Tether to Crewlock Wall
      - Stow on Equipment Lock Wall
      - Stow on Equipment Lock Wall per CDR

Temp stow old CREWLOCK DEPRESS/REPRESS Cue Cards (2) for step 7

3. Unstow following items and position in EVA #1 Systems Bag:
  - LiOH canister
  - DIDBs (2)
4. Unstow following items and position in EVA #2 Systems Bag:
  - LiOH canister
  - DIDBs (2)
5. Unstow following items and position in EVA #3 Systems Bag:
  - LiOH canisters (2)
  - DIDBs (2)
6. Unstow following items and position in EVA #4 Systems Bag:
  - LiOH canisters (2)
  - DIDBs (2)

## POST-DOCKING EVA TRANSFER AND RECONFIG (60 min) (Cont)

7. Stow following items in SYSTEMS TRANSFER Bag:
- CREWLOCK DEPRESS/REPRESS Cue Cards (old) – temp stowed
  - ISS EVA Cuff Checklists (3) (old) from EMU Equipment Bag
  - STS-133 ISS EVA Systems Checklist (old)
- TOOLS TRANSFER Bag
8. Unstow following items and position in EVA #1 Tools Bag:
- 85-ft Safety Tethers (28 and 30) (2)
  - 90 deg Connector Tool
  - Vent Tool Extension Plug
  - “FGB Cables” – FGB Y-Jumpers (2)
  - “EVA Handrail Assy” – EWC Antennas/Handrails (2)
  - “Antenna Cable Assy” – EWC Cables
9. Unstow following items and position in EVA #3 Tools Bag:
- HPGT MLI

### CONFIGURE EMUs

- EMU 3005 (CF)
10.  Installed on fwd EDDA
11. Install following items from EVA #1 Ziplock bag in CF ECOK:
- STS-134 Mission Patch on DCM
  - Stripes as follows:
    - Upper PLSS (left, right) (2)
    - Leg lower Velcro (left, right) (2)
  - American Flag:
12. Remove protective arm covers and stow in EMU Equipment Bag
13. From CF ECOK, remove protective glove covers from Gloves CF1 and install gloves
14. Stow glove covers in CF ECOK
15. Disconnect/Reconnect Helmet to install:
- Comm cap CF1 from CF ECOK
- Wrap 3-in length of Kapton tape, with 1/2-in courtesy tab, around joined LEMO connector between EMU electrical harness and comm cap (Kapton tape in EVA #1 Systems Bag)
- EMU 3004
16. Install Helmet Light Assembly (HLA) without ERCA or EHIP batteries onto helmet
17. Perform finger pull test on all four white buttons to ensure buttons fully out
18. Perform pull test to verify all HLA latches fully seated in helmet brackets
19. Install ERCA per ERCA Address in STS-134 CONSUMABLES TRACKING CUE CARD (EMU MAINT/RECHARGE)
- Refer to Figure 1 ERCA Cable Routing:

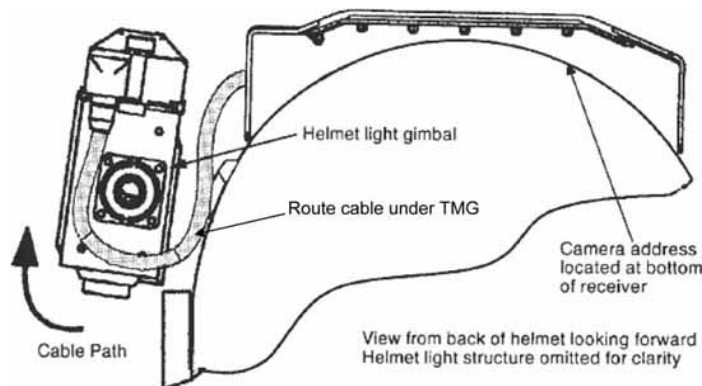

Figure 1.- ERCA Cable Routing.

20. Perform pull test of HLA/ERCA
21. Confirm sizing cam configuration per STS-134 NOMINAL EMU SIZING (EMU CONTINGENCY PROCS)
- ECOKs (FT, CF)
22. Populate ISS EMU Equipment Bag crew specific compartments, as desired
- Wristlets
  - Comfort Gloves
  - Moleskin/mosite
  - Nasal Spray

## EMU SWAP FOR EVA 2 (CF → FN) (45 min)

### NOTE

This procedure assumes the following procedures have been completed following EVA 1:  
{1.240 POST EVA} (SODF: ISS EVA SYS: EVA PREP/POST)  
{1.605 BSA BATTERY RECHARGE - init} (SODF: ISS EVA SYS: BATTERY OPS)  
{1.605 BSA BATTERY RECHARGE - term} (SODF: ISS EVA SYS: BATTERY OPS)

- EMUs 3004,3005
1. Connect waist ring to HUT
  2. Reconnect gloves and boots
- EMU 3005 (CF)
3. Remove ERCA assembly from Helmet Light Assembly and temp stow
  4. ✓Helmet installed, sun shades down, cover installed
  5. Remove EMU from fwd EDDA, temp stow in Node 1
  6. Remove CF items ISS EMU Equipment Bag crew specific compartments and stow in ECOK
    - Wristlets
    - Comfort Gloves
    - Moleskin/mosite
    - Nasal Spray
  7. Remove CF ECOK from E-Lk, temp stow in Node 1
- EMU 3018 (FN)
8. Transfer EMU and FN ECOK to E-Lk
  9. Install EMU on fwd EDDA
  10. Install Helmet Light Assembly (HLA) without ERCA or EHIP batteries onto helmet
  11. Perform finger pull test on all four white buttons to ensure buttons fully out
  12. Perform pull test to verify all HLA latches fully seated in helmet brackets
  13. Install ERCA per ERCA Address in STS-134 CONSUMABLES TRACKING CUE CARD (EMU MAINT/RECHARGE)
- Refer to Figure 1 ERCA Cable Routing:

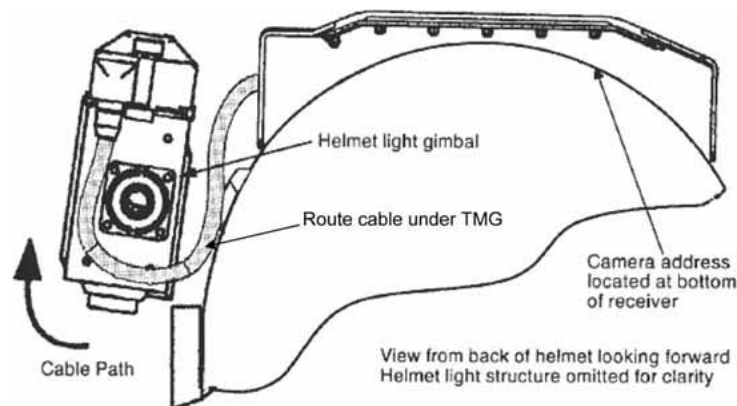

Figure 1.- ERCA Cable Routing.

14. Perform pull test of HLA/ERCA
  15. Helmet sunshades down, install cover
  16. Confirm sizing cam configuration per STS-134 NOMINAL EMU SIZING (EMU CONTINGENCY PROCS)
- FT, FN ECOK
17. Populate ISS EMU Equipment Bag crew specific compartments, as desired
    - Wristlets
    - Comfort Gloves
    - Moleskin/mosite
    - Nasal Spray

## EMU SWAP FOR EVA 4 (FT → CF) (CF AFT, FN FWD) (30 min)

### NOTE

This procedure assumes the following procedures have been completed following EVA 3:  
{1.240 POST EVA} (SODF: ISS EVA SYS: EVA PREP/POST)  
{1.605 BSA BATTERY RECHARGE - init} (SODF: ISS EVA SYS: BATTERY OPS)  
{1.605 BSA BATTERY RECHARGE - term} (SODF: ISS EVA SYS: BATTERY OPS)  
{1.506 EMU WATER RECHARGE} (SODF: ISS EVA SYS: EMU MAINTENANCE)

- EMUs 3004,3018
1. Connect waist ring to HUT
  2. Reconnect gloves and boots
- EMU 3004 (FT)
3. Remove ERCA assembly and temp stow
  4. ✓Helmet installed, sun shades down, cover installed
  5. Remove EMU from fwd EDDA, temp stow on Node 1
  6. Remove CF items ISS EMU Equipment Bag crew specific compartments and stow in ECOK
    - Wristlets
    - Comfort Gloves
    - Moleskin/mosite
    - Nasal Spray
- EMU 3005 (CF)
7. Remove CF ECOK from E-Lk, temp stow in Node 1
  8. Transfer EMU and FN ECOK to E-Lk
  9. Install EMU on fwd EDDA
  10. Install ERCA on Helmet Light Assembly per ERCA Address in STS-134 CONSUMABLES TRACKING CUE CARD (EMU MAINT/RECHARGE)  
Refer to Figure 1 ERCA Cable Routing:

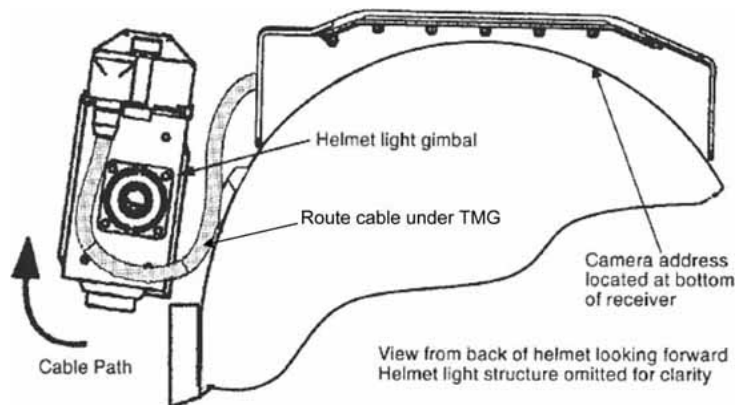

Figure 1.- ERCA Cable Routing.

11. Perform pull test of HLA/ERCA
- FT, FN ECOK
12. ✓Helmet installed, sunshades down, install cover
  13. Populate ISS EMU Equipment Bag crew specific compartments, as desired
    - Wristlets
    - Comfort Gloves
    - Moleskin/mosite
    - Nasal Spray

## POST EVA EMU RECONFIGURATION (180 min)

### NOTE

This procedure assumes the following procedures have been completed following EVA 4:  
{1.240 POST EVA} (SODF: ISS EVA SYS: EVA PREP/POST)

### CONFIGURE EMU 3005 TO STAY ON ISS

- EMU 3005
1. Remove following:
    - HL Batteries, stow in MO-2 Bag s/n 1038
    - REBAs, stow in MO-2 Bag s/n 1038
    - LiOH, install caps and stow in SYSTEMS TRANSFER Bag
    - Li-Ion EMU Battery, stow in MO-2 Bag s/n 1038
    - EV3 ISS Cuff C/L (cut out FS pages),  
stow in EMU Equipment Bag
    - Patches, Stripes, American Flag, stow in CF ECOK
    - Comm cap CF1, stow in CF ECOK
    - Fresnel Lenses (2), stow in CF ECOK
    - EMU Gloves CF1, install protective caps and stow in CF ECOK
  2. Install protective arm covers from EMU Equipment Bag
  3. Remove from Aft EDDA and temp stow

### CONFIGURE EMUs 3004, 3018 FOR RETURN

- EMU 3004
- EMUs 3004/3018
4. Install in Aft EDDA
  5. Remove following:
    - HL Batteries, stow in MO-2 Bag s/n 1038
    - REBAs, stow in MO-2 Bag s/n 1038
    - Li-Ion EMU Batteries, stow in MO-2 Bag s/n 1038
    - EV1, EV2 ISS Cuff C/Ls (cut out FS pages),  
stow in EMU Equipment Bag
    - Remove ISS tethers and tools, and temp stow
    - Patches, Stripes, American Flags, stow in respective ECOKs
    - Remove comm caps FT1, FN1, stow in respective ECOKs
    - Remove Helmet Lights Assemblies, ERCA assembly,  
stow in E-Lk

- EMU 3010
6. Retrieve and stow in Airlock
  7. As reqd, reference STS-134 NOMINAL EMU SIZING  
(EMU CONTINGENCY PROCS), fig 1, EMU 3010 – Initial Configuration  
and fig 2, EMU 3010 – Final Configuration

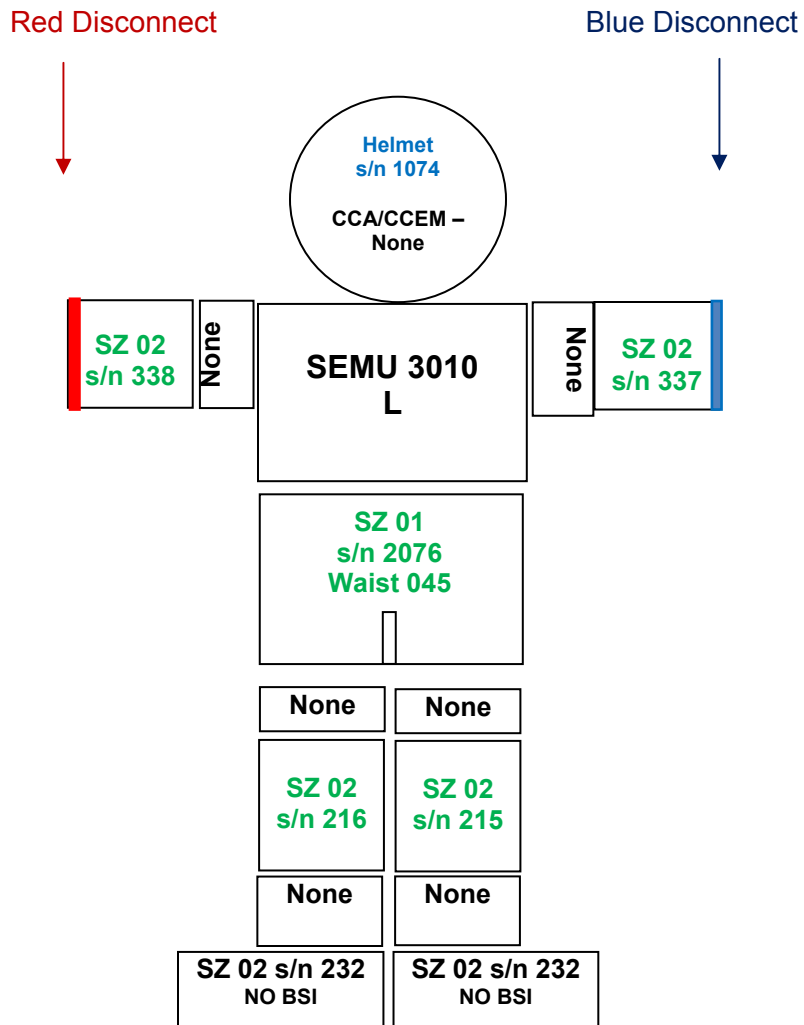

Figure 1 – EMU 3010 – Initial Configuration

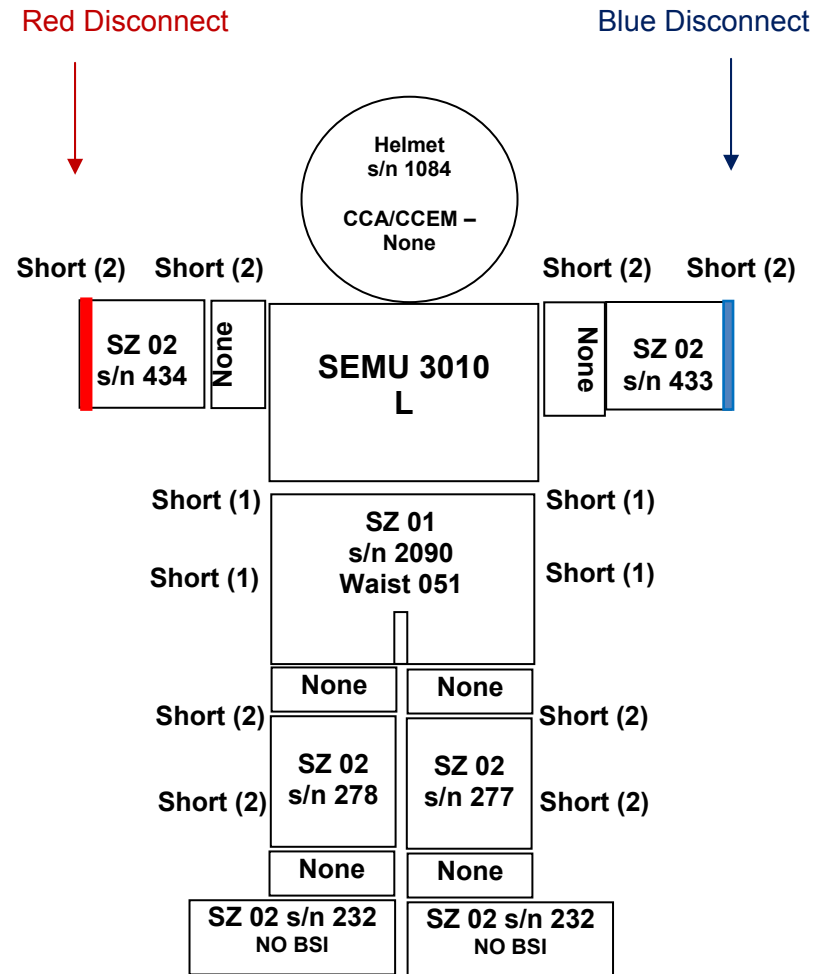

Figure 2 – EMU 3010 – Final Configuration

**Blue Font** – Indicates component to be swapped with EMU 3004  
**Green Font** – Indicates components to be swapped with EMU 3018  
**Black Font** – Indicates hardware remaining on EMU 3010

## POST EVA EMU RECONFIGURATION (180 min) (Cont)

- EMUs 3004/3010 8. Swap helmets
- Remove valsalva, use gray tape to remove adhesive
  - As required, remove any Fresnel lenses from helmet 1074, stow in EMU Equipment Bag (Miscellaneous)
  - Verify sunshades down, cover installed
- A/L1O1 MO-2 Bag s/n 1010 9. Retrieve Size 01 Waist Brief 029, s/n 2075  
Remove protective covers and temp stow
- EMU 3004 10. Remove [Leg Assembly/Leg Sizing Ring/Boots] and temp stow
11. Remove Size 01 Waist Brief 052, s/n 2094 and install protective covers temp stowed in step 8
12. Install Size 01 Waist Brief 029, s/n 2075 and set waist sizing cams (4) to Short/Short
13. Re-install [Leg Assemblies/Leg Sizing Rings/Boots]
14. Remove from Aft EDDA and temp stow in Node 1 for transfer to Shuttle
- EMU 3010 15. Install on Aft EDDA
16. Remove Boots s/n 232 and temp stow
- EMU 3018 17. Remove [0.5" Leg Sizing Rings s/n 132,133/Boots s/n 240] and install on EMU 3010
18. Remove [Waist Brief s/n 051/Leg Assembly s/n 277,278] and temp stow
- EMU 3010 19. Remove [Waist Brief s/n 045/Leg Assembly s/n 215,216/ 0.5" Leg Sizing Rings s/n 132,133/Boots s/n 240] and install on EMU 3018
20. Install [Waist Brief s/n 051/Leg Assembly s/n 277,278] from step 18
21. Re-install Boots s/n 232, temp stowed in step 16
22. Remove Lower Arm protective covers and temp stow
23. Remove Lower Arms s/n 337,338 and temp stow
- EMU 3018 24. Remove EMU Gloves FN1 and temp stow
25. Install Lower Arm protective covers temp stowed in step 22
26. Remove Lower Arms s/n 433, 434 with protective covers and install on EMU 3010
27. Install Lower Arms s/n 337,338  
Set sizing cams (8) to Short/Long
28. Install EMU Gloves FN1
29. Verify waist cams (4) are Short/Short and leg sizing cams (8) are Short/Short
- DCM 30.  O2 ACT – OFF  
 PWR – SCU  
 DCM Purge vlv – Op (up)  
 WATER – OFF, Switch Guard installed

**POST EVA EMU RECONFIGURATION (180 min) (Cont)**

31. Verify/reconfigure EMUs and ECOK per the following table:

<p style="text-align: center;"><b>EMU 3004 (FT↓)</b></p> <ul style="list-style-type: none"> <li><input type="checkbox"/> LiOH (any used)</li> <li><input type="checkbox"/> Helmet, sunshades down, cover installed</li> <li><input type="checkbox"/> FT ECOK</li> <li><input type="checkbox"/> LTA</li> <li><input type="checkbox"/> EMU Gloves FT1</li> <li><input type="checkbox"/> Wrist Mirrors (2) [swap to worst]</li> </ul>	<p style="text-align: center;"><b>EMU 3018 (FN↓)</b></p> <ul style="list-style-type: none"> <li><input type="checkbox"/> LiOH (any used)</li> <li><input type="checkbox"/> Helmet, sunshades down, cover installed</li> <li><input type="checkbox"/> FN ECOK</li> <li><input type="checkbox"/> LTA</li> <li><input type="checkbox"/> EMU Gloves FN1</li> <li><input type="checkbox"/> Wrist Mirrors (2) [swap to worst]</li> </ul>
<p style="text-align: center;"><b>EMU Crew Options Kit (ECOK) (FT)</b></p> <ul style="list-style-type: none"> <li><input type="checkbox"/> FT EVA 1, 2, &amp; 3 Ziplock Bags             <ul style="list-style-type: none"> <li><input type="checkbox"/><input type="checkbox"/><input type="checkbox"/> TCUs (top, bottom)</li> <li><input type="checkbox"/><input type="checkbox"/><input type="checkbox"/> Socks</li> <li><input type="checkbox"/><input type="checkbox"/><input type="checkbox"/> Wristlets</li> <li><input type="checkbox"/><input type="checkbox"/><input type="checkbox"/> Comfort Gloves</li> <li><input type="checkbox"/><input type="checkbox"/><input type="checkbox"/> Moleskin</li> <li>X <input type="checkbox"/><input type="checkbox"/><input type="checkbox"/> Patch, Stripes, American Flag</li> </ul> </li> <li><input type="checkbox"/> LCVG FT1 (w/biomed sternal harness and signal conditioner)</li> <li><input type="checkbox"/> EMU Gloves FT2</li> <li><input type="checkbox"/><input type="checkbox"/> Comm caps FT1 &amp; FT2</li> </ul>	<p style="text-align: center;"><b>EMU Crew Options Kit (ECOK) (FN)</b></p> <ul style="list-style-type: none"> <li><input type="checkbox"/> FN EVA 2, 3 &amp; 4 Ziplock Bags             <ul style="list-style-type: none"> <li><input type="checkbox"/><input type="checkbox"/><input type="checkbox"/> TCUs (top, bottom)</li> <li><input type="checkbox"/><input type="checkbox"/><input type="checkbox"/> Socks</li> <li><input type="checkbox"/><input type="checkbox"/><input type="checkbox"/> Wristlets</li> <li><input type="checkbox"/><input type="checkbox"/><input type="checkbox"/> Comfort Gloves</li> <li>X <input type="checkbox"/><input type="checkbox"/><input type="checkbox"/> Patch, Stripes, American Flag</li> </ul> </li> <li><input type="checkbox"/> LCVG FN1 (w/biomed sternal harness and signal conditioner)</li> <li><input type="checkbox"/> EMU Gloves FN2</li> <li><input type="checkbox"/><input type="checkbox"/> Comm caps FN1 &amp; FN2</li> </ul>
<p style="text-align: center;"><b>EMU Crew Options Kit (ECOK) (CF)</b></p> <ul style="list-style-type: none"> <li><input type="checkbox"/> CF EVA 1 &amp; 3 Ziplock Bags             <ul style="list-style-type: none"> <li><input type="checkbox"/><input type="checkbox"/> TCUs (top, bottom)</li> <li><input type="checkbox"/><input type="checkbox"/> Socks</li> <li><input type="checkbox"/><input type="checkbox"/> Wristlets</li> <li><input type="checkbox"/><input type="checkbox"/> Comfort Gloves</li> <li><input type="checkbox"/><input type="checkbox"/> Patch, Stripes, American Flag</li> <li><input type="checkbox"/><input type="checkbox"/> Mole Skin</li> <li><input type="checkbox"/> X Valsalva/Lens Template</li> <li><input type="checkbox"/><input type="checkbox"/> Fresnel Lenses (2)</li> </ul> </li> <li><input type="checkbox"/> LCVG CF1 (w/biomed sternal harness and signal conditioner)</li> <li><input type="checkbox"/><input type="checkbox"/> EMU Gloves CF1 &amp; CF2</li> <li><input type="checkbox"/><input type="checkbox"/> Comm caps CF1 &amp; CF2</li> </ul>	

32. Retrieve new ISS EVA Systems Checklist (white) from STS; deploy in C-Lk



## POST EVA EMU RECONFIGURATION (180 min) (Cont)

SYSTEMS TRANSFER Bag 33. Configure/verify contents of SYSTEMS TRANSFER Bag per following table:

### SYSTEMS TRANSFER Bag

Verify already in Bag:

- ISS Cuff Checklists (3) (old)
- CREWLOCK DEPRESS/REPRESS Cue Card (2) old
- STS-133 ISS EVA Systems Checklist (old)

Configure:

- STS-134 CONSUMABLES TRACKING/BATTERY RECHARGE PLAN CUE CARD
- EMERGENCY UNDOCKING/EVA TRANSFER CUE CARD
- CREWLOCK DEPRESS/REPRESS CUE CARD – Mark's
- ISLE PREBREATHE Cue Card
- STS-134 ISS EVA Systems Checklist (Brown stripe)  
(Brown stripe copy bring back to STS; leave white copy)
- STS-134 EVA CHECKLIST (2) (SPARE and MASTER)
- EMU LiOH (6) (used)

## EVA TRANSFER TO SHUTTLE (15 min)

I

1. Configure/verify contents of TOOLS TRANSFER Bag per following table

<b>TOOLS TRANSFER Bag</b>
<input type="checkbox"/> <input type="checkbox"/> 85-ft Safety tethers (#28 and #30) (2)
<input type="checkbox"/> 90 deg Connector Tool
<input type="checkbox"/> "Sample Wipes" Ziplock Bag

2. Transfer items in table below to Shuttle; report status to **MCC-H** when complete

<b>Item</b>	<b>Destination</b>
EMU 3004 (FT↓)	Temp stow Middeck
EMU 3018 (FN↓)	Temp stow Middeck
FT ECOK	Temp stow Middeck
FN ECOK	Temp stow Middeck
CF ECOK	Temp stow Middeck
SYSTEMS TRANSFER Bag	Temp stow Middeck
TOOLS TRANSFER Bag	Temp stow Middeck

## EVA UNPACK AND STOW (90 min)

1. Retrieve 2 ICB EMU Batteries from Post Insertion locker (MF43H) and install in s/n 2089 in EMU 3004 and s/n 2090 in EMU 3018
2. Unpack and stow items per table below:

### EMU SYSTEMS UNPACK AND STOW

Item	Final Location
EMU 3004 (FT)	Ext A/L (Stbd AAP)
EMU 3018 (FN)	Ext A/L (Port AAP)
FT ECOK <input type="checkbox"/> <input type="checkbox"/> Comm cap FT1 & FT2 <input type="checkbox"/> EMU Gloves FT2 <input type="checkbox"/> FT EVA #3 Bag	Temp stow for LTA pouch Bag E CF ECOK
FN ECOK <input type="checkbox"/> <input type="checkbox"/> Comm cap FN1 & FN2 <input type="checkbox"/> EMU Gloves FN2 <input type="checkbox"/> FN EVA #4 Bag	Temp stow for LTA pouch Bag E CF ECOK
CF ECOK; unpack to fit <input type="checkbox"/> ECOK <input type="checkbox"/> LCVG CF1 <input type="checkbox"/> <input type="checkbox"/> EMU Gloves CF1 & CF2 <input type="checkbox"/> <input type="checkbox"/> Comm caps CF1 & CF2	Bag E

### SYSTEMS TRANSFER BAG UNPACK AND STOW

Item	Final Location
<input type="checkbox"/> <u>STS-134 CONSUMABLES TRACKING CUE CARD</u> <input type="checkbox"/> <u>EMERGENCY UNDOCKING EVA TRANSFER CUE CARD</u> <input type="checkbox"/> <input type="checkbox"/> STS-134 EVA Checklist (SPARE and MASTER)	FDF Locker (MF71G)
<input type="checkbox"/> STS-134 ISS EVA Systems Checklists (Brown stripe) <input type="checkbox"/> STS-133 ISS EVA Systems Checklist (old) <input type="checkbox"/> <input type="checkbox"/> <input type="checkbox"/> ISS Cuff Checklist (3) (old) <input type="checkbox"/> <input type="checkbox"/> <u>CREWLOCK DEPRESS/REPRESS</u> (2) Cue Card (old) <input type="checkbox"/> <u>CREWLOCK DEPRESS/REPRESS</u> Cue Card (Mark) <input type="checkbox"/> <u>ISLE PREBREATHE</u> Cue Card	SODF Locker (MF71G)
<input type="checkbox"/> <input type="checkbox"/> <input type="checkbox"/> <input type="checkbox"/> <input type="checkbox"/> EMU LiOH (6) (used)	Bag E

### TOOLS TRANSFER BAG UNPACK AND STOW

Item	Final Location
<input type="checkbox"/> <input type="checkbox"/> 85-ft Safety tethers (28 and 30)	Bag E
<input type="checkbox"/> 90 deg Connector Tool	Bag E
<input type="checkbox"/> "Sample Wipes" Ziplock Bag	TBD

3. Stow empty SYSTEMS, TOOLS TRANSFER Bags (2) in Bag E
4. Report status to **MCC-H** when complete

This Page Intentionally Blank

TIMELINES

I

STS-134 (ULF6) EVA TIMELINE OVERVIEW ..... FS 7-3

EVA 1

- EVA 1 SUMMARY TIMELINE ..... FS 7-5
- EVA 1 TOOL CONFIG ..... FS 7-6
- EVA 1 BRIEFING CARD ..... FS 7-10
- EVA 1 INHIBIT PAD ..... FS 7-11
- EVA 1 NOTES/CAUTIONS/WARNINGS ..... FS 7-13
- EVA 1 EGRESS/SETUP ..... FS 7-20
- MISSE 7 RETRIEVE ..... FS 7-22
- MISSE 8 INSTALL..... FS 7-24
- S3 CETA LIGHT INSTALL ..... FS 7-26
- STBD SARJ COVER 7 INSTALL ..... FS 7-27
- P3/P4 NH3 JUMPER INSTALL ..... FS 7-28
- NH3 JUMPERS N2 VENT/P3/P4 JUMPER TEMP STOW ..... FS 7-29
- EWC ANTENNA INSTALL ..... FS 7-31
- VTEB RECONFIG..... FS 7-37
- EVA 1 CLEANUP/INGRESS ..... FS 7-39

EVA 2

- EVA 2 SUMMARY TIMELINE ..... FS 7-55
- EVA 2 TOOL CONFIG ..... FS 7-56
- EVA 2 BRIEFING CARD ..... FS 7-58
- EVA 2 INHIBIT PAD ..... FS 7-59
- EVA 2 NOTES/CAUTIONS/WARNINGS ..... FS 7-61
- EVA 2 EGRESS/SETUP ..... FS 7-68
- P3/P4 NH3 JUMPER RE-ROUTE ..... FS 7-70
- PVTCS NH3 FILL/CONFIGURE ATA ..... FS 7-71
- EAS JUMPER SETUP/VENT..... FS 7-76
- NH3 VENT TOOL CLEANUP..... FS 7-78
- PSARJ COVER REMOVAL ..... FS 7-79
- PSARJ FIRST LUBE ..... FS 7-81
- P3/P4 JUMPER STOW ..... FS 7-82
- CONFIGURE ATA TO VENT ..... FS 7-84
- SPDM CLA COVER INSTALL..... FS 7-85
- SPDM LEE LUBE..... FS 7-86
- S1 RAD GB STOW BEAM INSTALL..... FS 7-89
- PSARJ SECOND LUBE ..... FS 7-91
- PSARJ REINSTALL COVERS ..... FS 7-92
- EVA 2 CLEANUP/INGRESS ..... FS 7-93

EVA 3

- EVA 3 SUMMARY TIMELINE ..... FS 7-109
- EVA 3 TOOL CONFIG ..... FS 7-110
- EVA 3 BRIEFING CARD ..... FS 7-114
- EVA 3 INHIBIT PAD ..... FS 7-115
- EVA 3 NOTES/CAUTIONS/WARNINGS ..... FS 7-118
- EVA 3 EGRESS/SETUP ..... FS 7-125
- PDGF SETUP ..... FS 7-127
- RETRIEVE PAMA/PDGF ..... FS 7-128
- PAMA/PDGF INSTALL..... FS 7-129
- VSC INSTALL ..... FS 7-130
- NOD1/FGB CH 1/4 CABLE INSTALL (PORT) ..... FS 7-132
- 1553 DATA CABLE INSTALL ..... FS 7-135
- NOD1/FGB CH 2/3 CABLE INSTALL (STBD) ..... FS 7-136
- FGB AND PDGF PHOTOS/CLEANUP ..... FS 7-139
- A/L TOOLBOX TOOL STOW ..... FS 7-140
- HPGT FRGF MLI INSTALL ..... FS 7-147
- STP-H3 PHOTOS ..... FS 7-148
- EVA 3 CLEANUP/INGRESS ..... FS 7-149

TIMELINES

EVA 4	
EVA 4 SUMMARY TIMELINE .....	FS 7-171
EVA 4 TOOL CONFIG .....	FS 7-172
EVA 4 BRIEFING CARD .....	FS 7-174
EVA 4 INHIBIT PAD .....	FS 7-175
EVA 4 NOTES/CAUTIONS/WARNINGS .....	FS 7-177
EVA 4 EGRESS/SETUP .....	FS 7-184
OBSS STOW.....	FS 7-186
P6 PDGF RETRIEVE .....	FS 7-188
OBSS EFGF/PDGF SWAP .....	FS 7-190
EFGF STOWAGE IN TSA.....	FS 7-194
OTP LDTD TETHER CINCH.....	FS 7-195
SPDM EDF RELEASE .....	FS 7-196
CLEANUP/INGRESS .....	FS 7-198
CUE CARDS	
EVA FLUID QD/SARJ CUE CARD .....	FS CC 7-216
EVA 3 CABLE ROUTING CUE CARD .....	FS CC 7-218
GET-AHEADS	
STS-134 GET-AHEADS.....	FS 7-220
OTP LDTD TETHER CINCH.....	FS 7-221
STP-H3 PHOTOS .....	FS 7-223
PORT CETA CART RECONFIG .....	FS 7-224
S1 FHRC P-CLAMP RELEASE .....	FS 7-225

# STS-134 (ULF6) EVA TIMELINE OVERVIEW

FD 3 ELC3 install, MT: WS 7, SSRMS: MBS PDGF 3, OBSS: PLB

FD 4 AMS install, MT: WS 2, SSRMS: MBS PDGF 3, OBSS: PLB

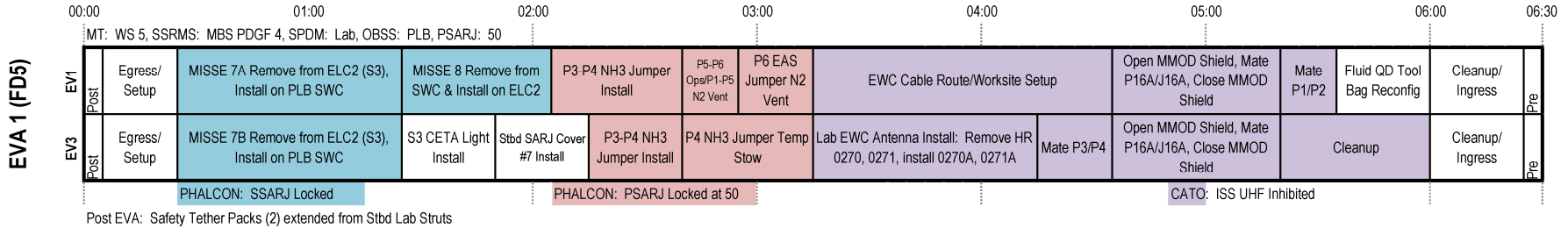

FD 6 OBSS H/O, MT: WS 5, SSRMS: Node 2, SPDM: Lab, OBSS: SSRMS @ beginning, SRMS @ end

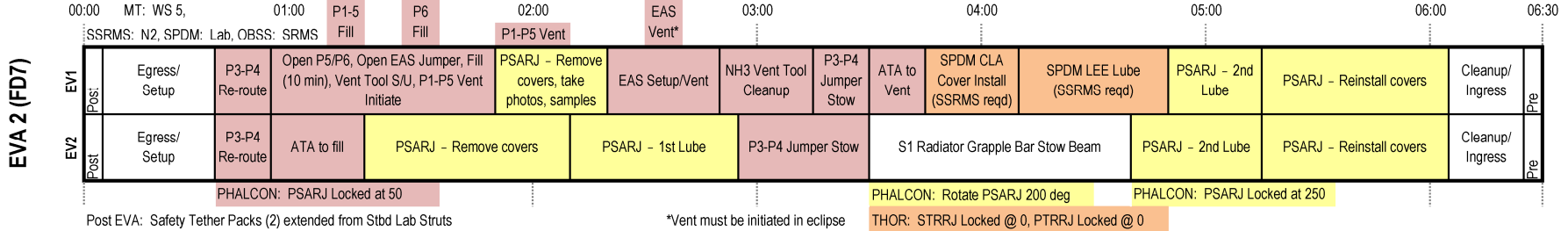

FD 8

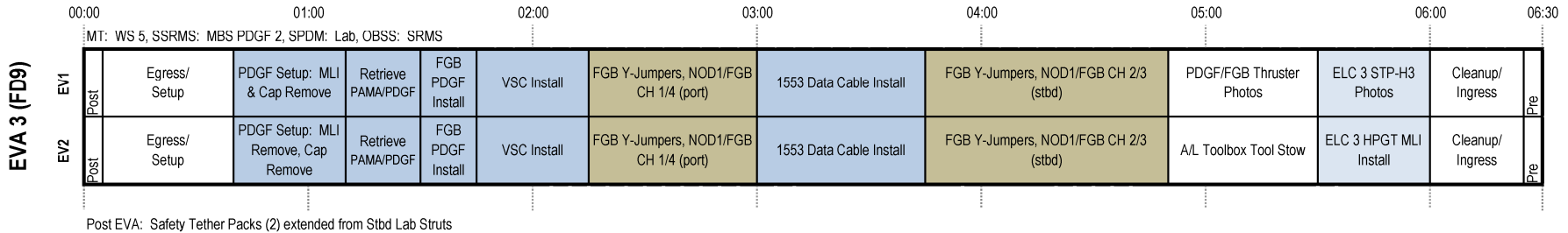

FD 10 Late Inspection, MT: WS 5, SSRMS: MBS PDGF 2, OBSS: SRMS

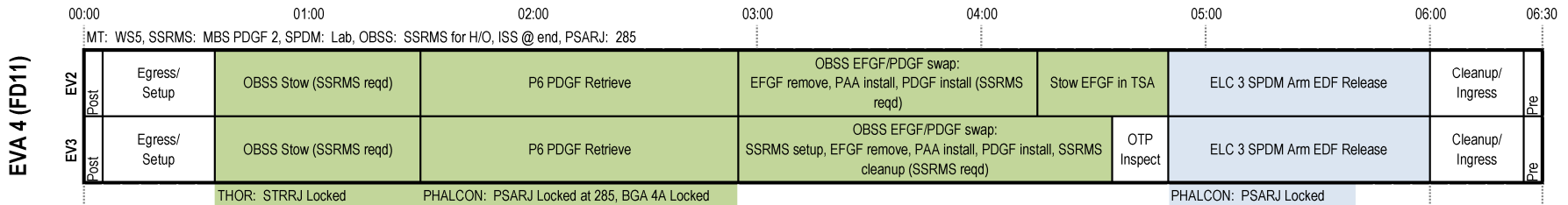

This Page Intentionally Blank



# EVA 1 SUMMARY TIMELINE

PET HR : MIN	IV/SSRMS	EV1 (Ft)	EV3 (Cf)	
00:00		<u>EGRESS/SETUP</u> (00:25) • Post Depress and Egress (00:15) • Setup (00:10)	<u>EGRESS/SETUP</u> (00:25) • Post Depress and Egress (00:15) • Setup (00:10)	00:00
01:00		<u>MISSE 7 RETRIEVE</u> (01:00) • Retrieve PEC 7A (00:50) • Stow PEC 7A (00:10)	<u>MISSE 7 RETRIEVE</u> (01:00) • Retrieve PEC 7B (00:45) • Stow PEC 7B (00:15)	01:00
02:00		<u>MISSE 8 INSTALL</u> (00:40) • Retrieve MISSE 8 (00:15) • Install MISSE 8 (00:25)	<u>S3 CETA LIGHT INSTALL</u> (00:25)	
			<u>STBD SARJ COVER 7 INSTALL</u> (00:25)	02:00
		<u>P3/P4 NH3 JUMPER INSTALL</u> (00:35)	<u>P3/P4 NH3 JUMPER INSTALL</u> (00:25)	
03:00		<u>P5/P6 NH3 JUMPER INSTALL/N2 VENT</u> (00:35) • Vent P1-P5 Jumpers (00:15) • Vent P6 EAS Jumper (00:20)	<u>P3/P4 NH3 JUMPER TEMP STOW</u> (00:35)	03:00
04:00		<u>EWC ANTENNA INSTALL</u> (02:20) • Setup/Worksite Prep (01:20)	<u>EWC ANTENNA INSTALL</u> (02:45) • Setup/EWC Antenna Install (01:00)	04:00
05:00		• Open MMOD Shield C2-01 (00:15) • Mate P16A/J16A (00:15) • Close MMOD Shield C2-01 (00:15) • Mate P1/P2 (00:15)	• P3/P4 Mate (00:20) • Open MMOD Shield C2-01 (00:15) • Mate P16A/J16A (00:15) • Close MMOD Shield C2-01 (00:15) • Cleanup (00:40)	05:00
06:00		<u>VTEB RECONFIG</u> (00:25)		
06:30		<u>CLEANUP/INGRESS</u> (00:30) • Cleanup (00:10) • Ingress and Pre-Repress (00:20)	<u>CLEANUP/INGRESS</u> (00:30) • Cleanup (00:10) • Ingress and Pre-Repress (00:20)	06:00
				06:30

# EVA 1

## EVA 1 TOOL CONFIG

### ISS Configuration:

MT @ WS5: CETA Carts Port/Stbd  
 SSRMS on MBS PDGF  
 SPDM on Lab PDGF  
 PSARJ @ 50°  
 SSARJ @ 295°

Post EVA STP Config:

EV1 STP: S0 port, outbd Strut → A/L Curved HR, fwd Stanchion

EV3 STP: S0 port, inbd Strut → A/L aft D-ring

**NOTE:** Prior to use, inspect the following hardware:

- RET cords for fraying
- Inspect Load Alleviating Straps and D-ring Extenders; ref 2.230.100 CREW TETHER INSPECTIONS (SODF: ISS EVA TASKS):
  1. MMOD/general damage
  2. Discoloration
  3. Tack Stitching
  4. Red Band
- ISS Trash Bag: Bristle deformation/damage, after having stowed tools in trash bag
  - √Empty √Zipper Closed
- BRT joint screws not loose
- Swing arm stiffness

Tether Counts: (Green RETs – Do NOT use ones in Ziplock bag labeled “ULF6 EVA 2 RETs”)

RETs (sm-sm) = 11/11	RETs (PIP Pin) = 5/5
RETs (Lg-sm) = 7/8	Adj Equip Tethers = 9/10
Adj Equip Tethers (Lg-sm) = 1/2	

### EV1

- MWS
  - BRT (L)
    - RET (sm-sm)
    - Wire Tie (3 short)
  - T-Bar
    - RET (Lg-sm) (R)
    - RET (Lg-sm) (L)
    - Adj Equip Tether (R)
      - 1" QD Cap Removal Tool **2**
    - Adj Equip Tether (L to TB)
    - Small ISS Trash Bag (R, inbd)
  - Swing Arm (R)
    - RET w/PIP Pin
    - EVA Camera w/bracket (int RET – morning of)
- D-ring Extender (L D-ring)
  - ST Pack (85-ft + 85-ft to L D-ring Ext) (see fig 1)
- Waist Tether (1, R on D-ring)

### EV3

- MWS
  - BRT (L)
    - RET (sm-sm)
    - Wire Tie (3 short)
  - T-Bar
    - RET (sm-sm) (L)
    - RET w/PIP Pin (R)
    - Adj Equip Tether (L to TB)
    - Wire Tie (2)
    - Small ISS Trash Bag (R, inbd)
  - Adj Equip Tether (R Wrist)
  - Swing Arm (R)
    - RET w/PIP Pin
      - PGT [A7, CAL, MTL 30.5] s/n \_\_\_\_\_
      - PGT Battery s/n \_\_\_\_\_
      - 7/16 (wobble) Socket-6 ext
- D-ring Extender (2, R & L D-ring)
  - Waist Tether (R on D-ring Ext)
  - Waist Tether (L on D-ring Ext)
  - ST Pack (85-ft + 85-ft to L D-ring Ext) (see fig 1)

### A/L

- RET (Lg-Sm) (to HR Stanchion)
    - EWC Med ORU Bag **2** (bottom to top)
      - Adj Equip Tether (ext – RF soft tether pt)
      - Adj Equip Tether (ext – LF soft tether pt)
      - Fish Stringer (RB, LB)
        - Hook 1: RET (sm-sm)
          - Long T-Handle Tool
            - Adj Equip Tether (Lg-sm) (sm hook to T-handle tool, Lg hook to D-ring)
        - Hook 2: RET (sm-sm)
          - Short T-Handle Tool
        - Hook 3: Loop Pin Puller
        - Hook 4: Wire Tie Caddy **3** (2 long, 7 short)
        - Hook 5: Wire Tie
          - P1 Cap
          - P2 Cap
          - J16A Cap
          - P16A Cap
      - Adj Equip Tether (RF) (replaces long wire tie)
        - EWC Cable (see fig 3)
        - EWIS Cable
    - Zenith Fish Stringer (fully extended; tape hook near hook #1; stow on left bag side tether; non-tape hook stow on LF soft tether pt)
      - Hook 1: RET (sm-sm) to Antenna side
        - EWC HR 0271A
        - EWC Antenna Cap
      - Hook 2: RET (sm-sm) to 0271A Antenna side
        - P4 Cap
      - Hook 3: RET (sm-sm)
        - HR 0271
      - Hook 4: 1" N2 Vent Tool **2**
      - Hook 5: RET (sm-sm)
        - HR 0270
      - Hook 6: RET (sm-sm) to 0270A Antenna side
        - P3 Cap
      - Hook 7: RET (sm-sm) to Antenna side
        - EWC HR 0270A
        - EWC Antenna Cap
- RET (Lg-Sm)
  - FGB Y-Cable bag (Node 3 Avionics bag) (back tether across to HR stanchion) (see fig 2)
    - Ch 2/3 (stbd) Cables (bottom/back) (see fig 4)
    - Ch 1/4 (port) Cables (top/front) (see fig 5)

## EVA 1 TOOL CONFIG (Cont)

### A/L (Cont)

- RET (Lg-sm) (to HR Stanchion)
  - CETA Med ORU Bag 2**
    - Adj Equip Tether (ext – LF soft tether pt)
    - Adj Equip Tether (ext – RB soft tether pt)
    - RET w/PIP Pin (RF)
      - 1" N2 Vent Tool
    - RET w/PIP Pin (RB)
      - SARJ Cover 7 (external MLI toward light)
    - RET (Lg-sm) (LF)
      - CETA Light
- RET (Lg-sm)
  - VTE Plug
- Staging Bag**
  - Fish Stringer Tether
    - Wire Tie Caddy (hook 1) (5 short, 4 long)
    - Velcro/Tape Caddy (hook 2)
    - PGT (hook 3) s/n \_\_\_\_\_
      - PGT Battery s/n \_\_\_\_\_
      - 7/16 (wobble) Socket-6 ext
    - Vise Grips (hook 4)
    - Ratchet Wrench (hook 5)
      - 7/16 (rigid) Socket-2 ext
    - Long Duration Tie Down Tethers (2) (hook 6)
    - Hubble Connector Tool (90 deg) 4** (hook 7)
    - Spare Safety Tether Pack (85-ft + 85-ft) (to strap)
  - Fish Stringer Tether
    - Pin Straightener Assy (hook 1)
    - Connector Cleaner Tool Kit (hook 2)
    - Probe (hook 3)
    - Pry Bar (hook 4)
    - Needle Nose Pliers **2** (hook 6)
    - MWS Key Strap Assy (on wire tie, to strap)
    - EVA Camera w/bracket 2** (hook 7 – morning of)
- IV Bag**
  - Towels (2)
  - Contamination Detection Kit
  - GP Caddy (2)
    - Adjustable Thermal Mittens (2)
  - Socket Caddy (hatch cont) w/RET (sm-sm) (Black)
    - 1/2 Socket-8 ext
    - 7/16 (wobble) Socket-6 ext (spare)
  - DCM Plug (SAFER Hardmount) (2)
  - RET (sm-sm, Black) (2)

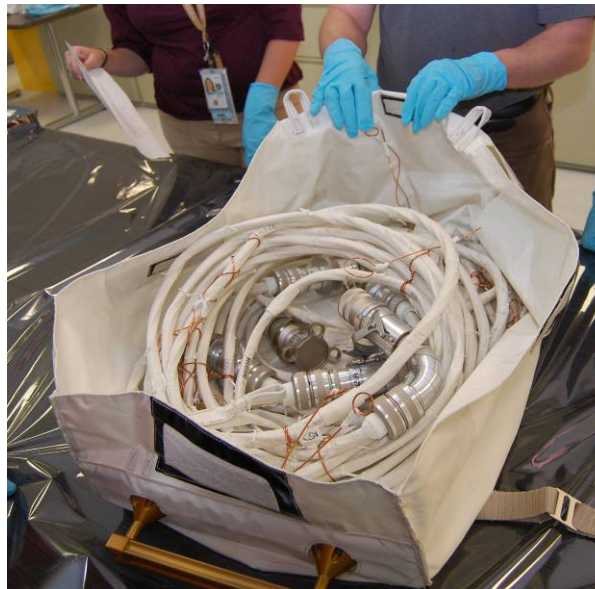
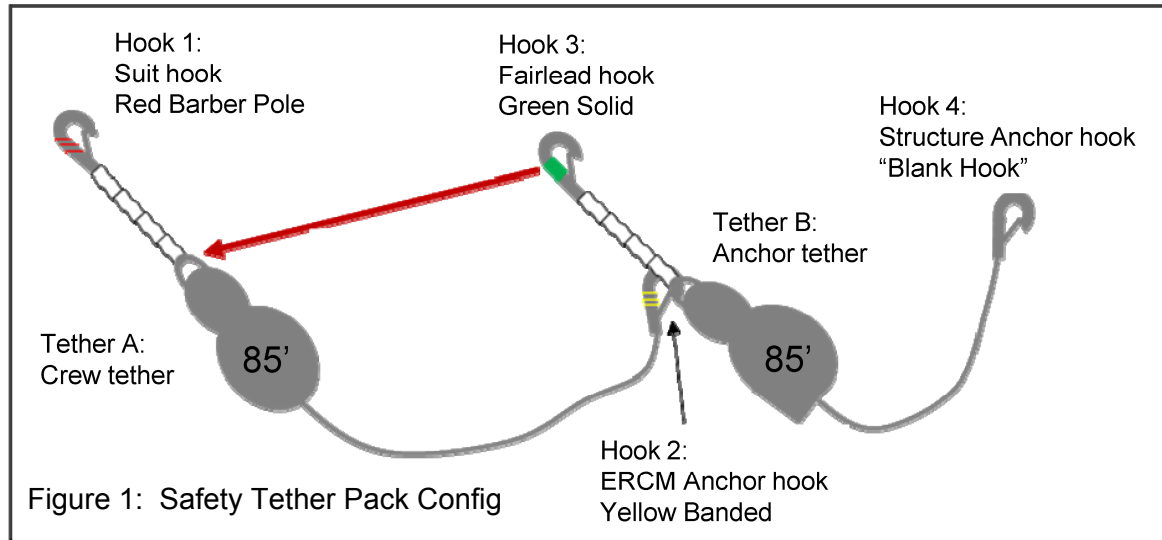
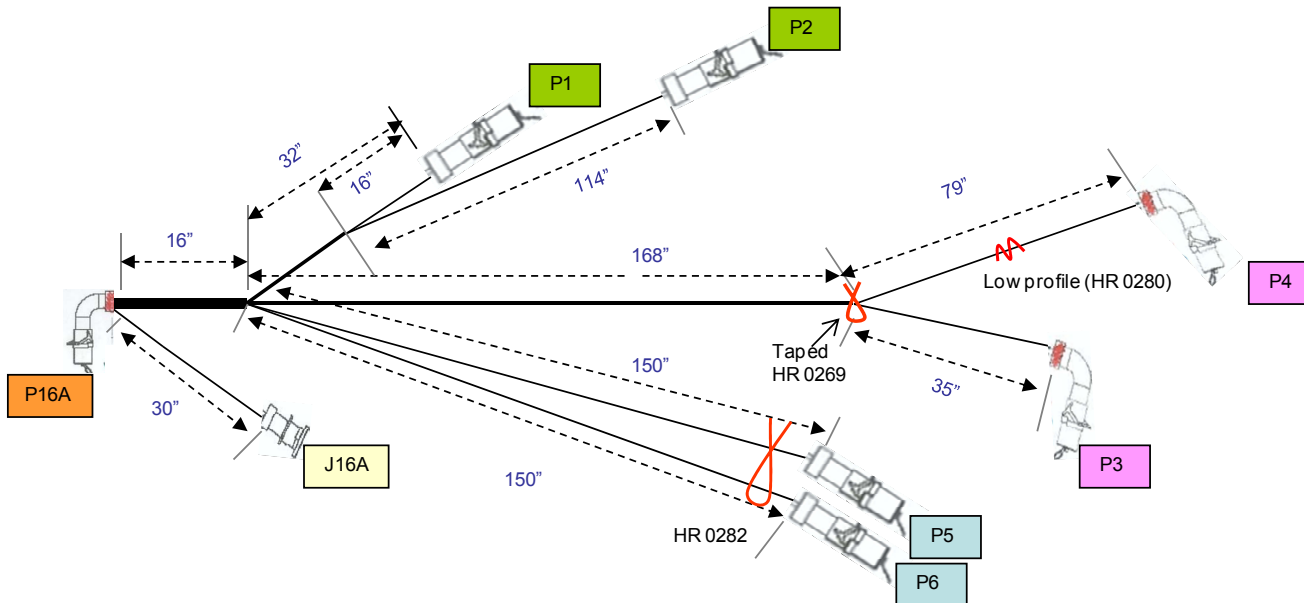

Figure 2: FGB Y-Cable Bag Config  
 Tether through cable, through both D-rings, through bag tether, onto itself

## EVA 1 TOOL CONFIG (Cont)

### EWC Cable



#### Actions:

- Replace long wire tie with Adj Equip Tether – goes around P1/P2/J16A/P16A only; hook back on D-ring
- Place smushed end of taped wire tie (from P3/P4) through unused D-ring of AET

#### Current Config:

- All wire ties (3) are short
- P3/P4 coiled together up to taped wire tie. Coiled up to Big Y with twist of taped wire tie
- P1/P2/J16A/P16A coiled together with long wire tie around coils
- P3/P4 bundle on top of P1/P2/J16A/P16A bundle – smushed end of taped wire tie through “D-ring” of long wire tie
- P5/P6 coiled together 5 coils with a twist of P5/P6 wire tie – 1 more coil to Big Y with a twist of P5/P6 wire tie around additional coil and AET bundle

Figure 3: EWC Cable Coiled Configuration

## EVA 1 TOOL CONFIG (Cont)

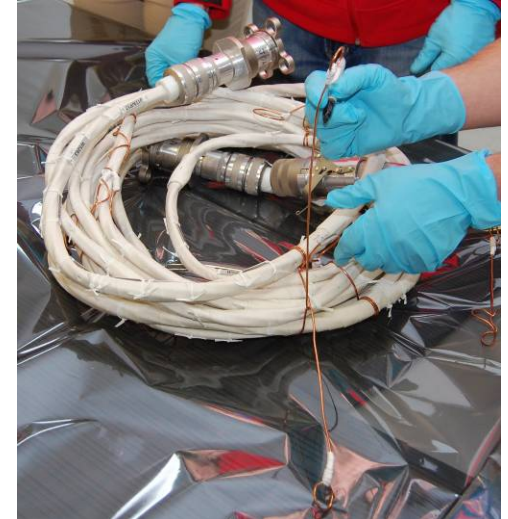
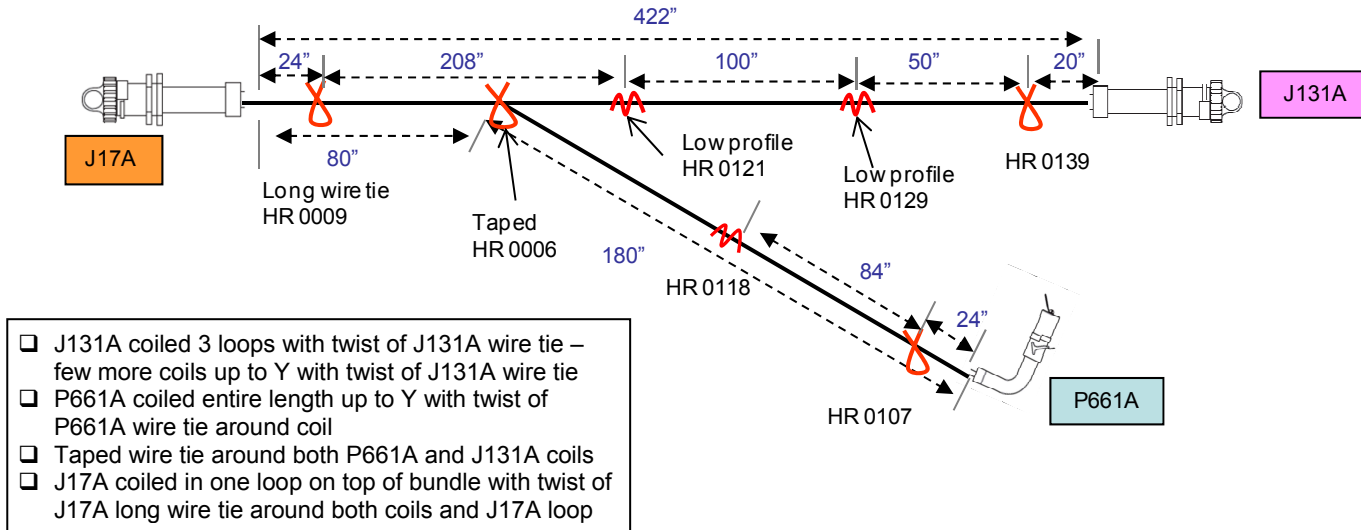

Figure 4: Ch 1/4 FGB Y-Cable (port)

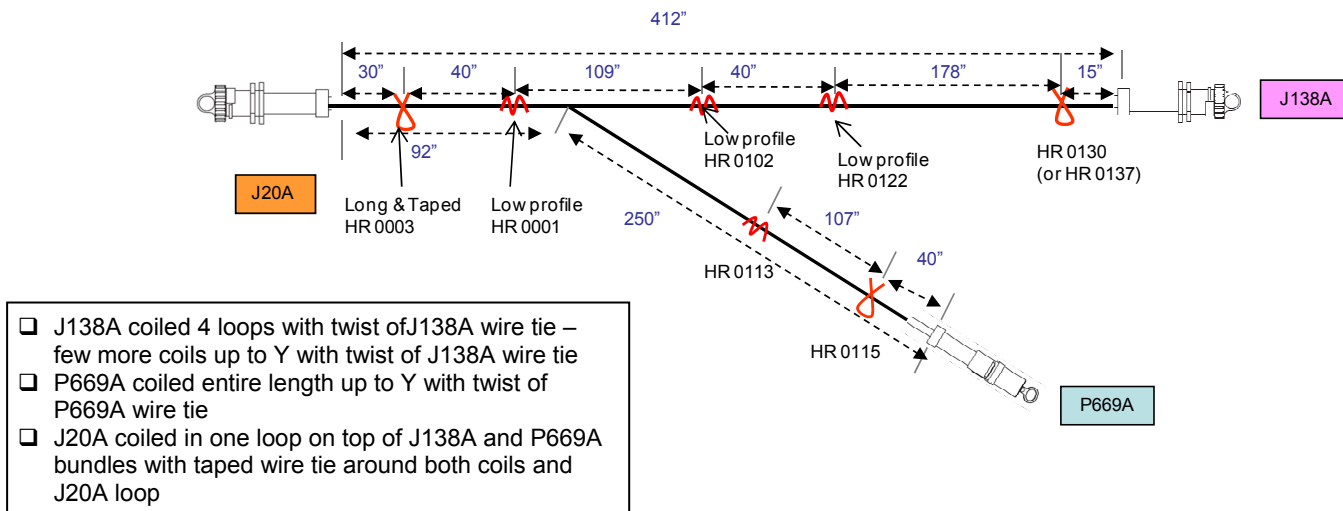

Figure 5: Ch 2/3 FGB Y-Cable (stbd)

## EVA 1 BRIEFING CARD

### EVA Prep

- Review Morning Timeline/Plan/Tethers
- Work With a Purpose
- Pure O2 Protocol
- Suit Donning Plan – special requests, boot bladder manipulation
- Safer, MWS, Tools, CL, Bag Stowage in A/L
- Airlock Depress Review

### Procedure Review

- Egress Plan (tethers)
- Order of Tasks (summary timeline)
- Translation Paths, Fairleads
- Hazards (no touch, no damage, keep outs, notes, cautions, warnings)
  - Opened MISSE PECs – no touch; PEC hinges – pinch point
  - CETA Light – no touch
  - Backside of Dzus fastener – sharp edge
- Contingencies – section 16
- Task Constraints, Potential Get-aheads
- Ingress Plan

### Post EVA

- Suit Doffing
- Tool Reconfig Plan

### Emergencies

- Comm Fail (hand signals, Term EVA, Abort EVA)
  - EWC Task: Loss of comm plan/signals
- EMU Malfunctions
- Lost Tools/Crewmember (velocity and direction)
- DCS
- Safer Ops
- Crew Rescue

### Reminders/Top Ten

- Gate Closed, Slider Locked, Tether Reel Unlocked
- Pins Straight, No FOD, Good EMI
- PGT Read-back, Turns and Torque with light
- Worksite Departure – tethers and tools clear
- Move Slow – no hopping (slower is faster)
- Body Position is Everything (use space)
- Tether Awareness – all of them
- Suit/Tool Awareness – BRT/PGT/ORU Stowage
- Suit MAL – read down DCM messages
- Discipline and Attention to detail until the end
- Day/Night Checks (Settings, tools, tethers)

### Contingency

- MISSE 7B
- Loss of Comm during Lab EWC Antenna task



# EVA 1 INHIBIT PAD

## Orbiter

<b>ALL EVAs</b>	
TCS ( <i>Crew: Prior to Egress</i> )	
IV L12	1. √TCS POWER – OFF Install Switch Guard to remain in place through EVA 4
Ku-Band Antenna ( <i>INCO: Prior to Egress</i> )	
<b>MCC-H</b>	1. √KU-BAND Mask – active 2. √KU-BAND EVA Protect Box – active
RCS ( <i>GNC/PROP: Prior to Egress</i> )	
If EV crew < 27 ft from FRCS	
IV	1. √DAP: VERN, FREE, LO Z
O14,15,16	2. √RJDF F1, F2, F3, F4 MANF DRIVER (four) – OFF LOGIC (four) – OFF
<b>MCC-H</b>	3. √Above RCS config
IV	4. √RCS F – ITEM 1 EXEC (*) √JET DES F1U – ITEM 17 (*) F3U – ITEM 19 (*) F2U – ITEM 21 (*)

## Ground

<b>ALL EVAs</b>	
Ground Radar ( <i>TOPO: Prior to Egress</i> )	
<b>MCC-H</b>	1. √TOPO console, ground radar restrictions in place for EVA

## USOS (1)

<b>ALL EVAs</b>	
PCU ( <i>PHALCON: Prior to Egress</i> )	
<b>NOTE</b>	
PCUs may require up to a 1-hr warmup period before they are operational	
<b>MCC-H</b>	1. √PCUs (two) operational in discharge mode and one of the following: a. CCS PCU EVA hazard control FDIR enabled b. No more than two arrays unshunted and oriented < 105° from velocity vector If one or both PCUs failed
	2. No more than two arrays unshunted and oriented < 105° from velocity vector
CUCU ( <i>Crew: Prior to Egress</i> )	
IV – (LAB104)	
	1. √cb POWER A, B [two] – OPEN
	2. √cb LINK 1,2 [two] – OPEN
And one of the following inhibit pairs:	
<b>POIC</b>	3a. Express Rack 2 Locker 6 – Power Removed 3b. Express Rack 6 Locker 7 – Power Removed
<b>OR</b>	
IV	4a. Express Rack 2 Locker 6 – OFF 4b. Express Rack 6 Locker 7 – OFF
<b>LOCATION DEPENDENT INHIBITS</b>	
Lab Window ( <i>Not expected</i> )	
IV	If EV crew less than 10 ft from window or in window FOV, close window shutter
Cupola Windows ( <i>Not expected</i> )	
IV	If EV crew less than 10 ft from window, coordinate shutter opening/closing with EV crew and minimize time shutter is open
Mobile Transporter ( <i>ROBO: Prior to Egress</i> )	
<b>MCC-H</b>	If EV crew < 1.5 meters from MT 1. √MT latched
SPDM ( <i>ROBO: Prior to Egress</i> )	
<b>MCC-H</b>	If EV crew translating or working on SPDM 1. √SPDM in Keep Alive configuration or Safed

## EVA 1 INHIBIT PAD (Cont)

### TASK SPECIFIC INHIBITS

MISSE 7/8 on ELC2 (*POD: During Egress*)

**POIC** ELC-2 ECM EXPA-2 120V OPEN  
 ELC-2 ECM EXPA-2 28V OPEN  
 ELC-2 EXPA-2 OP PWR OPEN  
 RPCM S34B E RPC 1 – Open, Close Command Inhibited  
 RPCM S33A E RPC 1 – Open, Close Command Inhibited

S3 CETA Light (*PHALCON: Prior to Egress*)

**MCC-H** 1. RPC S31A A 03 – Open, Close Command Inhibited  
 2. RPC S32B A 02 – Open, Close Command Inhibited

Lab EWIS Antennas (*CATO: During Task – EWC Antenna Install*)

**MCC-H** Deactivate SSSR (UHF)

### JEM (1)

ALL EVAs

ICS-EF Antenna (*Prior to Egress*)

**SSIPC** 1. ICS MOD – OFF  
 2. ICS UPC – OFF  
 3. ICS HPA – OFF  
 4. HPA ON and UPC ON commands are cleared (not present) in the ICS stored command queue

### COL (1)

ALL EVAs

HAM Radio

IV 1. HAM Radio – Deactivate

### RSOS (1)

ALL EVAs

SM Antennas (*RIO: Prior to Egress*)

IV 1. ARISS (Ham Radio) – Deactivate  
**MCC-M** 2. GTS – Deactivate  
 3. Napor (PCПИ) – Deactivate

### USOS (2)

#### LOCATION DEPENDENT INHIBITS

Stbd SARJ (*PHALCON: Prior to Egress – MISSE, SARJ Cover*)

**MCC-H** If EV crew working within 2 ft, outboard of SARJ or reqd per loads FR  
 1. √DLA (1) – LOCKED at +60 thru +180, +220 thru +350  
 2. All motor setpoints set to zero  
 3. All motors deselected

Port SARJ (*PHALCON: During Egress – PVTCS Fill Prep*)

**MCC-H** If EV crew working within 2 ft, outboard of SARJ or reqd per loads FR  
 1. √DLA (1) – LOCKED at 50°  
 2. All motor setpoints set to zero  
 3. All motors deselected

FPMU (*PHALCON: Prior to Egress – PVTCS Fill Prep*)

**MCC-H** If EV crew on Port truss (P1-P6) or working within 5 ft of Floating Potential Measurement Unit  
 1. RPCM P11A\_B RPC 13 Open/Close Cmd Inhibit

SSPTS (*PHALCON: Prior to Egress – MISSEs, EWC Antennas*)

*Inhibit 1 egress until MISSE 8, inhibits 2 and 3 entire EVA*

**MCC-H** If EV crew working within 2 ft of SSPTS cables  
 1. RPCM LA2A3B D RPC 1 – Open, Close Cmd Inhibit  
 2. RPCM Z14B A RPC 2 – Open, Close Cmd Inhibit  
 3. RPCM Z13B A RPC 2 – Open, Close Cmd Inhibit



## EVA 1 NOTES/CAUTIONS/WARNINGS

### NOTES

1. Bolt install: Report torque and turns
2. Bolt release: Report torque and turns if different from published range
3. EVA connectors: After disconnection and prior to connection; verify pin and EMI band integrity; verify connector free of FOD
4. Inspect QDs for damage prior to mating
5. Toolbox doors must be closed with one latch per door when EV crew not in immediate vicinity
6. 85-ft safety tether retract force may affect body positioning
7. CETA Cart brake handle wire ties must be replaced after crew loading

### CAUTION

#### **ISS Generic Constraints**

- A. Avoid inadvertent contact with
1. Grapple fixture shafts (dry lube)
  2. PIP pins
  3. Passive UMAs
  4. MBS/SSRMS/SPDM taped radiative surfaces: VDU, ACU, JEU, LEU, MCU, CRPCMs, and Cameras
  5. SPDM SJEU, EP, OTCM, LEU, and LEE VDU radiator surfaces
  6. OTSD
- B. Electrical cables
1. Avoid bend radii < 10 times cable diameter
- C. Fiber optic cables
1. Avoid bend radii < 10 times cable diameter
  2. Avoid pulling on cable during mate/demate
- D. Fluid line flex hoses and QDs
1. Avoid bend radii < 14 in for hoses with a diameter  $\geq$  1 in
  2. Additional care should be taken to not exceed bend radii when applying loads at the flexible hose to rigid tube stub interfaces
  3. Ensure fluid QD booties are fully closed prior to leaving worksite; wire tie if required
  4. Avoid bend radii < 5 in for hoses with diameter < 1 in on LAB, S0, S1, P1, and 10 in for hoses with diameter < 1 in on all other elements

### CAUTION

#### **ISS Generic Constraints (Cont)**

- E. For structural reasons
1. Avoid vigorous body motions, quick grabs and kickoffs against tether restraints
  2. Avoid performing shaking motions (sinusoidal functions) more than four cycles
- F. Other
1. ITT Cannon connector: On demated connectors, do not rotate collar or manipulate cable/connector using collar or connector tool
  2. MLI handholds are not rated for crewmember translation loads

## EVA 1 NOTES/CAUTIONS/WARNINGS (Cont)

### CAUTION

#### ISS Truss Constraints

##### A. Avoid inadvertent contact with

1. CETA lights (Z-93 paint)  
[LAB,S1,NODE 1,P3]
2. Deployed TUS cable [Zenith and Nadir CETA rails]
3. S0 aft face radiator
4. GPS antennas (S13 paint) [S0,JLP]
5. UHF antennas [LAB,P1]
6. ETCS radiator flexhoses and panels [S1,P1]
7. EETCS/PV radiator flexhoses, bellows and panels [P6,P4,S4,S6]
8. SASA RF group [S1,P1]
9. Heat pipe radiators [Z1]
10. PCU cathode and HCA ports [Z1]
11. Ku-Band antenna (SGANT) dish [Z1]
12. CMG cover/shells [Z1]
13. FPMU [P1]
14. SASA high and low gain antennas and radiator surfaces [Z1]
15. Deployed MISSEs
16. OTP on HAB Tray [S0]

##### B. For structural reasons

1. Avoid kicking S1/P1 radiator beam.  
If any of these occur, wait 2 to 5 min to allow structural response to dissipate

### CAUTION

#### ISS Truss Constraints (Cont)

##### C. Other

1. EWIS antennas: Do not use as handholds [NODE 1,LAB,P6,Z1]
2. Lubricant from Ku-Band SGANT gimbals [Z1], CMGs [Z1], and RTAS ground strap fasteners [P6,P4,S4,S6] can contaminate EMU
3. Prevent inadvertent contact of the tether shuttle with ETRS when the P3 tether shuttle stop is raised away from the rail

### CAUTION

#### ISS U.S. Pressurized Elements Constraints

##### A. Avoid inadvertent contact with

1. EVA crane [PMA1]
2. TCS reflectors [PMA2,PMA3]
3. APAS hardware [PMA2,PMA3]
4. CETA lights (Z-93 paint)  
[LAB,S1,NODE 1,P3]
5. UHF antennas [LAB,P1]
6. Open CBM petal covers, LAB and Cupola window shutters
7. S0/NODE 2 fluid tray hardlines at NODE 2 end, which are limited to 25 lb

##### B. Other

1. EWIS antennas: Do not use as handholds [NODE 1,LAB,P6,Z1]
2. CBM petal covers may not be used as handholds unless both launch restraint pins are engaged

## EVA 1 NOTES/CAUTIONS/WARNINGS (Cont)

### CAUTION

#### **ISS I.P. Elements Constraints**

##### COL

- A. Avoid inadvertent contact with
1. COL ARISS and AIS antennas [COL-Nadir]

##### JEM

- A. Avoid inadvertent contact with
1. GPS antennas (S13 paint) [S0,JLP]
  2. Open JPM window shutter
  3. JTVE, WVE/EVE, JEF VE cameras
  4. JEMRMS taped radiative surfaces [JEU,EE,Cameras]
  5. JEM A/L target and pins
  6. JEF ORUs and EFUs (paint and lubricant)
  7. MAXI front and top panel (paint)
  8. SEDA-AP sensors (HIT, SDOM, and AOM)
  9. Trunnions and UCMs (paint and lubricant) [JEF Payloads]
  10. RAIDS covers on end of HREP
  11. ICS-EF Ka-Band antenna dish
  12. Small Fine Arm (SFA) (paint, coating and lubricant)
- B. For structural reasons
1. Avoid kicking MMOD shields between JLP and JPM
  2. Avoid tool impact on ICS-EF sensor

### CAUTION

#### **Shuttle Constraints**

- A. Avoid inadvertent contact with
1. OBSS and SRMS composite sections joint torque arms, grapple fixture shafts, and cable harnesses
  2. LCS (silver Teflon) and LDRI (silver Teflon) and ITVC (gold foil) [OBSS]
  3. WVS antenna [ODS truss and PLB sill]
  4. Payload bay and camera wire harnesses, cables, cable guides, and connectors
  5. OBSS striker bars (drylube)
- B. No touch
1. LDRI diffuser [OBSS]
  2. OBSS saddle contacts (when OBSS unberthed) [OBSS]
  3. Monkey fur [PLB]
  4. Cameras: Metallic surfaces [PLB]
  5. Ku-Band antenna black dish and gold thermal blankets [PLB]

## EVA 1 NOTES/CAUTIONS/WARNINGS (Cont)

### WARNING

#### ISS Generic Constraints

- A. Avoid inadvertent contact with
1. Grapple fixture targets and target pins
- B. Pinch
1. NZGL connector linkage. Use caution when mating/locking
  2. ITT Cannon connector rotating housing
  3. PDGF connector doors
- C. QDs
1. If QD is in FID when valve is opened (bail fwd), QD will leak and fluid line may whip
  2. Do not rotate if in mated/valve open configuration
  3. Bail may kick back suddenly when detent button is depressed if pressure has built up in spring cavity
- D. Sharp Edges
1. Inner edges of WIF sockets
  2. APFR active WIF probes
  3. Mating surfaces of EVA connectors  
Avoid side loads during connector mating
  4. Back side of MMOD shield fasteners
  5. Spring loaded captive EVA fasteners (e.g., 6B-boxes, BMRRM, RTAs, SARJ Covers); the end of the spring may protrude
  6. SPDM OTCM gripper jaws
  7. Keep hands away from SSRMS LEE/POA/SPDM LEE opening, snares, and PDGF curvic coupling (teeth)
  8. MMOD strikes on ISS exterior

### WARNING

#### ISS Generic Constraints (Cont)

- E. Thermal
1. EVA connectors with booties may become hot if left uncovered. Handling may need to be limited
  2. Turn off glove heaters when comfortable temperature reached to prevent bladder damage. Do not pull fingers out of gloves when heaters are on
  3. Uncovered trunnion pins may be hot
  4. SSRMS/MBS/SPDM operating cameras and lights may radiate large amounts of heat
  5. Do not touch EMU protective visor if temperature has been  $< -134$  degF for  $> 15$  min
  6. No EMU boot contact with foot restraint when temperature  $< -120$  degF or  $> 200$  degF
  7. PDGF surfaces may not meet touch temperature requirements for unlimited contact when  $\beta \leq -70$  or  $\beta \geq 70$

### WARNING

#### ISS Truss Constraints

- A. Avoid inadvertent contact
1. SSU, ECU, beta gimbal platform, mast canister, SAW blanket boxes unless the beta gimbal is locked and the motor is turned off
  2. Stay inboard of SARJ when active
  3. Stay 2 ft from S1/P1 radiator beam rotational envelope when beam is free to rotate
  4. Stay 5 ft from moving MT on face 1
  5. Stay 3.3 ft from Ku-Band (SGANT antenna) when powered
  6. Stay 1 ft from top of STP-H3 (ELC3)
  7. Deployed MISSEs and ORMATE-III R/W
- B. RF radiation exposure
1. Stay 3.8 ft from S-Band (SASA) high gain antenna when powered [S1,P1]
  2. Stay 1.3 ft from S-Band (SASA) low gain antenna when powered [S1,P1]
  3. Stay 1 ft from UHF antenna when powered [LAB,P1]
- C. Sharp Edges
1. Solar array blanket box [P6,S6]
  2. Fastener threads on back of Z1 U-jumper male FQD panel, if nutplate cap missing
  3. Outboard MT rail attachment lug near P6 handrail 5333 and gap spanner
  4. P2 connector on EWIS box TAA-06 [Zenith/Forward Corner 1 of P5 – SARJ at 0 deg]
  5. Nickel coated braided copper ground straps may contain frayed wires [P6,P4,S4,S6]
  6. MMOD strikes on Z1 toolboxes
  7. POA FSE (CSA logo below MBS mast camera)
  8. AMS Star Trackers Baffles (2)

## EVA 1 NOTES/CAUTIONS/WARNINGS (Cont)

### WARNING

#### ISS Truss Constraints (Cont)

##### D. Electrical Shock

1. Stay  $\geq 2$  ft from ungrounded floating connectors if powered  
S0 EVA power cables (inside S0 Bay 00 Face 4, Bay 01 Face 3)  
ESP-2 jumper (inside S0 Bay 03 Face 4)

##### E. Thermal

1. ELC may exceed touch temperatures when  $\beta > 75$  deg

### WARNING

#### ISS U.S. Pressurized Elements Constraints

##### A. Handrails

1. Handrails previously used for MISSE attachment may not be used as a safety tether point [A/L endcone 564 and 566, A/L Tank 2 Nad/Fwd and Port/Fwd, P6 5389]

##### B. Pinch

1. EV side of IV Hatch during Hatch operation (also snag hazard) [A/L]
2. LAB and Cupola window shutters and CBM petal cover linkages during operation

##### C. RF radiation exposure

1. Stay 1 ft from UHF antenna when powered [LAB,P1]

##### D. Sharp Edges

1. PMA umbilical launch restraints - exposed bolt threads
2. Adjustable fuse tether (Fish Stringer) buckles stowed in Node bag
3. Port/Aft portion of A/L circular HR [HR 0506]
4. A/L HR 0537 (Eq Lock Zenith)
5. ESP-2 HR 8012
6. PMM ROEU and ROFU panels (zenith endcone)

### WARNING

#### ISS U.S. Pressurized Elements Constraints (Cont)

##### E. Thermal

1. PMA handrails may be hot. Handling may need to be limited
2. Stay  $\geq 1$  ft away from PMAs and MMOD shields  $> 270$  degF if EMU sun visor up; limit time to 15 min or less if  $> 300$  degF
3. Stay at least 0.5 ft away from PMA and MMOD shields  $> 325$  degF
4. No EMU TMG contact with PMAs and MMOD shields  $> 320$  degF

##### F. Electrical Shock

1. Stay  $\geq 2$  ft from ungrounded floating connectors if powered  
SSPTS connectors include NOD1 Stbd/Fwd HR 0130, LAB Stbd/Fwd HR 0273, PMA2 Stbd

##### G. Fluid QDs

1. Do not translate on gap spanners restraining NODE 3 – LAB NH3 jumpers

## EVA 1 NOTES/CAUTIONS/WARNINGS (Cont)

### WARNING

#### ISS I.P. Elements Constraints

##### COL

- A. Avoid inadvertent contact with
  - 1. SOLAR [COL EPF]
- B. Thermal
  - 1. Columbus end cones may violate touch temperature constraints when  $-75 \leq \beta \leq -60$  or  $60 \leq \beta \leq 75$

##### JEM

- A. Avoid inadvertent contact with
  - 1. ICS-EF sensors
- B. Pinch
  - 1. JPM window shutter linkages during operation
  - 2. JEM cameras (JVTEs, EVE, WVE, and JEF VEs)
  - 3. JEM EFU latching arms
  - 4. JEF SSE latch
  - 5. ICS-EF antenna boom
  - 6. SEDA-AP mast
  - 7. SMILES antenna rotating area
  - 8. HREP hinge sides and RAIDS pinch areas
  - 9. JEMRMS EE
  - 10. JEMRMS Small Fine Arm (SFA) joints and booms

### WARNING

#### ISS I.P. Elements Constraints (Cont)

##### JEM (Cont)

- C. Sharp Edges
  - 1. Interior of JEMRMS HRMs
  - 2. JEMRMS EE opening and snares
  - 3. JEM A/L hatch corners
  - 4. ICS-EF AHM gears
  - 5. MAXI visual star camera
  - 6. SMILES baffles (two), baffle base bare bolts, and Cold Sky Terminator (CST)
  - 7. HREP baffles (four) [Star tracker aperture Zenith and three instrument baffles Aft]
  - 8. SFA Electro-Mechanical GF (EMGF)
- D. RF radiation exposure
  - 1. Stay 0.3 ft from Fwd/Aft JPM PROX antenna
- E. Thermal
  - 1. JPM Port End Cones and JLP Port Nadir may violate touch temperature constraints when  $\beta > 60$  deg
  - 2. JEMRMS/JTVE/JEFVE operating cameras and lights may radiate large amounts of heat

### WARNING

#### Shuttle Constraints

- A. Arcing/Molten Debris
  - 1. Stay  $\geq 2$  ft from exposed EFGF connector when OBSS berthed, powered, and EFGF not grappled [PLB]
  - 2. Stay  $\geq 2$  ft from exposed Stbd Fwd MPM contacts [PLB]
  - 3. Stay above PLB sill when within 1 ft of powered ROEU connector [PLB]
- B. Pinch
  - 1. PRLA operation [PLB]
- C. RF radiation exposure
  - 1. Stay 3.28 ft from S-Band antenna when powered
  - 2. Stay 1 ft from top and side of UHF PLB antenna radome surface when in high powered mode [ODS truss]
  - 3. Stay 0.33 ft from top and side of UHF PLB antenna radome surface when in low powered mode [ODS truss]
  - 4. Remain below the level of the PLB door mold line for first 20 in Aft of Fwd bulkhead when S-Band antenna powered [PLB]
  - 5. Remain on the inboard side of the Stbd slidewire (sill handrails if slidewire not installed) for first 20 ft Aft of Fwd bulkhead when Ku-Band antenna powered [PLB]

## EVA 1 NOTES/CAUTIONS/WARNINGS (Cont)

### WARNING

#### **Shuttle Constraints (Cont)**

##### D. Sharp Edges

1. PRLA grounding wipers [PLB]
2. LDRI baffles (also an entrapment hazard) [OBSS]
3. Keep hands away from SRMS EE opening and snares
4. TCS connector backshells have exposed threads [ODS]

##### E. Thermal

1. Illuminated PLB lights; do not touch
2. OBSS grapple fixture shafts/cams may be hot. Limit handling if required
3. Stay 27 ft from PRCS when powered
4. Stay 3 ft from VRCS when powered
5. Stay 3 ft from APU when operating

##### F. Contamination

1. Stay out of the immediate vicinity of leaking jet or APU

##### G. Lasers

1. Do not look at LDRI diffuser or LCS laser aperture window

## EVA 1 EGRESS/SETUP (00:25)

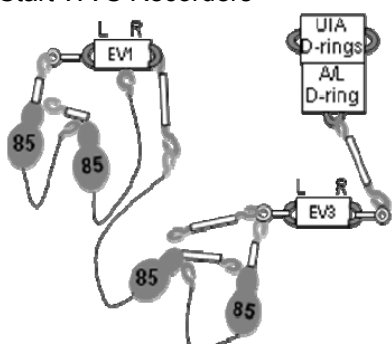

IV/SSRMS	EV1 (Drew)	EV3 (Taz)
<p>1. Record PET Start Time ___ : ___ (Pwr to Batt)</p> <p>2. Start WVS Recorders</p>  <p>3. Start Hatch Thermal Cover clock PET (30 min) ___ : ___</p> <p>4. Post crew egress: WVS Software:   Select page – RF camera   Sel 'Advanced Controls'   S-Band Level (two) – Max</p> <p>5. Stop Hatch Thermal Cover clock PET (30 min) ___ : ___</p>	<p><b>Initial Configuration:</b></p> <ol style="list-style-type: none"> <li>√All gates closed &amp; hooks locked <ul style="list-style-type: none"> <li><input type="checkbox"/> R Waist Tether to EV3 Blank hook</li> <li><input type="checkbox"/> Red hook on L D-ring ext</li> <li><input type="checkbox"/> Yellow hook on Green ERCM</li> <li><input type="checkbox"/> Green hook on Red ERCM</li> <li><input type="checkbox"/> Blank hook on MWS</li> </ul> </li> </ol> <p><u>EGRESS/SETUP</u> (00:25)</p> <ol style="list-style-type: none"> <li>Open hatch thermal cover</li> <li>Egress A/L</li> <li>Receive EWC ORU bag from EV3, stow on BRT w/RET</li> <li>Perform buddy checks √MWS tabs up, BRT tabs up, tether configs</li> <li>Verify SAFER config <ul style="list-style-type: none"> <li><input type="checkbox"/> √L handle down (MAN ISOL Vlv – Open)</li> <li><input type="checkbox"/> √R handle down (HCM – Closed)</li> </ul> </li> <li>√WVS – green LED</li> <li>Translate to S0 Port Struts</li> <li>Attach EV1 <b>BLANK</b> hook to Port, outbd Strut <ul style="list-style-type: none"> <li><input type="checkbox"/> √Gate closed, hook locked, reels unlocked, release RET</li> </ul> </li> <li>Attach EV3 <b>BLANK</b> hook to Port, inbd Strut <ul style="list-style-type: none"> <li><input type="checkbox"/> √Gate closed, hook locked</li> </ul> </li> <li>Release EV1 R Waist Tether from EV3 <b>BLANK</b> hook</li> <li>Give <b>EV3 GO</b> to release Waist Tether</li> <li>Translate fwd along Lab</li> </ol>	<p><b>Initial Configuration:</b></p> <ol style="list-style-type: none"> <li>√All gates closed &amp; hooks locked <ul style="list-style-type: none"> <li><input type="checkbox"/> R Waist Tether to A/L D-ring ext</li> <li><input type="checkbox"/> Red hook on L D-ring ext</li> <li><input type="checkbox"/> Yellow hook on Green ERCM</li> <li><input type="checkbox"/> Green hook on Red ERCM</li> <li><input type="checkbox"/> Blank hook to EV1 R Waist Tether</li> </ul> </li> </ol> <p><u>EGRESS/SETUP</u> (00:25)</p> <ol style="list-style-type: none"> <li>Transfer EWC ORU bag to EV1 <ul style="list-style-type: none"> <li><input type="checkbox"/> Position CETA ORU bag near hatch</li> </ul> </li> <li>Egress A/L</li> <li>Perform buddy checks √MWS tabs up, BRT tabs up, tether configs</li> <li>Verify SAFER config <ul style="list-style-type: none"> <li><input type="checkbox"/> √L handle down (MAN ISOL Vlv – Open)</li> <li><input type="checkbox"/> √R handle down (HCM – Closed)</li> </ul> </li> <li>√WVS – green LED</li> <li>Retrieve CETA ORU bag, stow on BRT w/RET</li> <li>On <b>EV1 GO</b>, release R Waist Tether from A/L int D-ring</li> <li>Close hatch thermal cover</li> </ol>



**EVA 1 EGRESS/SETUP (00:25) (Cont)**

<b>IV/SSRMS</b>	<b>EV1 (Drew)</b>	<b>EV3 (Taz)</b>
	14. Stow EWC ORU bag on Lab HR 0260, 0259 with hinge ISS aft  (Translate to S1 Face 1, zenith – MISSE 7 Retrieve)	10. Perform translation adaptation  (Translate to S1 Face 1, nadir – MISSE 7 Retrieve)

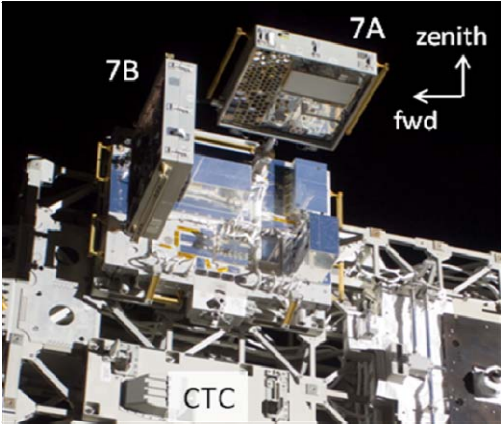
# MISSE 7 RETRIEVE (01:00)

IV/SSRMS	EV1 (Drew)	EV3 (Taz)
<p>Planned PET 00:25</p> <ol style="list-style-type: none"> <li>Verify inhibits in place               <ul style="list-style-type: none"> <li>√Stbd SARJ Locked</li> <li>√MISSE/ELC-2 Inhibits</li> </ul> </li> </ol> 	<div style="border: 3px double black; padding: 5px; text-align: center; margin-bottom: 10px;"> <p><b>WARNING</b></p> <p>Do not touch the hinged side while closing the MISSE PECs (Pinch Point)</p> </div> <div style="border: 1px solid black; padding: 5px; text-align: center; margin-bottom: 10px;"> <p><b>CAUTION</b></p> <p>Avoid inadvertent contact with deployed MISSE PECs, which have shatterable materials, and the silver avionics boxes atop the ExPA</p> </div> <p><u>RETRIEVE PEC 7A (00:50)</u></p> <ol style="list-style-type: none"> <li>Translate to S1 Face 2, zenith route               <ul style="list-style-type: none"> <li><input type="checkbox"/> Fairlead on S0 HR 3467 (bay 1)</li> </ul> </li> <li>Attach <b>GREEN</b> hook on S1 HR 3208 (bay 17)               <ul style="list-style-type: none"> <li><input type="checkbox"/> √Gate closed, hook locked, reels unlocked, release RET</li> </ul> </li> <li>Translate zenith to ELC2               <ul style="list-style-type: none"> <li><input type="checkbox"/> Fairlead on S3 HR 3052 (face 1)</li> </ul> </li> <li> Photograph deployed PECs               <ul style="list-style-type: none"> <li>PEC 7B (<input type="checkbox"/> Ram/Fwd side, <input type="checkbox"/> Aft side)</li> <li>PEC 7A (<input type="checkbox"/> Zenith side, <input type="checkbox"/> Nadir side)</li> <li><input type="checkbox"/> Overall View (2 angles)</li> </ul> </li> <li>Close PEC 7A               <ul style="list-style-type: none"> <li><input type="checkbox"/> √All 4 PIP pins are re-installed</li> </ul> </li> </ol>	<p><u>RETRIEVE PEC 7B (00:45)</u></p> <ol style="list-style-type: none"> <li>Translate to S1 Face 6, nadir route</li> <li>Attach <b>GREEN</b> hook on S1 HR 3217 or Xo 5790 (bay 17)               <ul style="list-style-type: none"> <li><input type="checkbox"/> √Gate closed, hook locked, reels unlocked, release RET</li> </ul> </li> <li>Translate outbd to bay 19</li> <li>Stow CETA ORU bag on S3 HRs 3046, 3038</li> <li>Translate zenith to ELC2</li> <li>If EV1 complete with photos of PEC 7B, close PEC 7B               <ul style="list-style-type: none"> <li><input type="checkbox"/> √All 4 PIP pins are re-installed</li> </ul> </li> <li>Disconnect connector from PEC 7B               <ul style="list-style-type: none"> <li><input type="checkbox"/> RET, remove cap from dummy connector J7B</li> <li><input type="checkbox"/> Demate connector from PEC</li> <li><input type="checkbox"/> Mate connector to dummy connector J7B (√no FOD, pins)</li> <li><input type="checkbox"/> Install cap onto PEC 7B</li> </ul> </li> <li>Disconnect connector from PEC 7A               <ul style="list-style-type: none"> <li><input type="checkbox"/> RET, remove cap from dummy connector J7A</li> <li><input type="checkbox"/> Demate connector from PEC</li> <li><input type="checkbox"/> Mate connector to dummy connector J7A (√no FOD, pins)</li> <li><input type="checkbox"/> Install cap onto PEC 7A</li> </ul> </li> </ol>

**MISSE 7 RETRIEVE (01:00) (Cont)**

IV/SSRMS	EV1 (Drew)	EV3 (Taz)
	<p>6. Release PEC 7A (release 2 PIP pins), stow on BRT w/RET (RAM HR)  <input type="checkbox"/> Reinstall Socket PIP pins (2)</p> <div style="border: 1px solid black; padding: 5px; text-align: center;"> <p><b>CAUTION</b>                      When translating around fwd edge of Node 2 and PMA2, avoid contact with Shuttle</p> </div> <p>7. Retrieve <b>GREEN</b> hook from S1 HR 3208  <input type="checkbox"/> <math>\checkmark</math>Gate closed, hook locked, reels unlocked, release RET</p> <p>8. Translate to Node 2, along port/zenith</p> <p>9. Attach <b>GREEN</b> hook on Node 2 HR 0344  <input type="checkbox"/> <math>\checkmark</math>Gate closed, hook locked, reels unlocked, release RET</p> <p><u>STOW MISSE 7A IN PLB (00:10)</u></p> <p>10. Translate to Orbiter, port, bay 4</p> <p>11. Remove SWC latch PIP pins (2)</p> <p>12. Release latch (2) from stow position</p> <p>13. Stow PEC 7A in carrier (HRs out, Probe up)</p> <p>14. Lock fwd latch in landing config  <input type="checkbox"/> Install PIP pin</p> <p>15. Retrieve RET</p> <p>16. Lock aft latch in landing config  <input type="checkbox"/> Install PIP pin</p> <p>17. Glove and Gauntlet Check                      (Translate aft to Bay 9 – MISSE 8 Retrieve)</p>	<p>9. Release PEC 7B (2 PIP pins), stow on BRT w/RET (nadir HR)  <input type="checkbox"/> Reinstall Socket PIP pins (2)</p> <div style="border: 1px solid black; padding: 5px; text-align: center;"> <p><b>CAUTION</b>                      When translating around fwd edge of Node 2 and PMA2, avoid contact with Shuttle</p> </div> <p>10. Retrieve <b>GREEN</b> hook from S1 HR 3217 or Xo 5790  <input type="checkbox"/> <math>\checkmark</math>Gate closed, hook locked, reels unlocked, release RET</p> <p>11. Translate to Node 2, stbd/zenith route  <input type="checkbox"/> Fairlead on Lab HR 0247 with wrist Adj  <input type="checkbox"/> Fairlead on Node 2 HR 0314  <input type="checkbox"/> Face toward Col and Node 2</p> <div style="border: 3px double black; padding: 5px; text-align: center;"> <p><b>WARNING</b>                      Stay <math>\geq</math> 2 ft from exposed EFGF connector when OBSS berthed, powered, and EFGF not grappled</p> </div> <p><u>STOW MISSE 7B IN PLB (00:15)</u></p> <p>12. Translate to Orbiter, stbd, bay 4</p> <p>13. Remove SWC latch PIP pins (2)</p> <p>14. Release latch (2) from stow position</p> <p>15. Stow PEC 7B in carrier (HRs out, Probe up)</p> <p>16. Lock aft latch in landing config  <input type="checkbox"/> Install PIP pin</p> <p>17. Retrieve RET</p> <p>18. Lock fwd latch in landing config  <input type="checkbox"/> Install PIP pin</p> <p>19. Glove and Gauntlet Check                      (Translate to S3 Face 1 – S3 CETA Light Install)</p>

## MISSE 8 INSTALL (00:40)

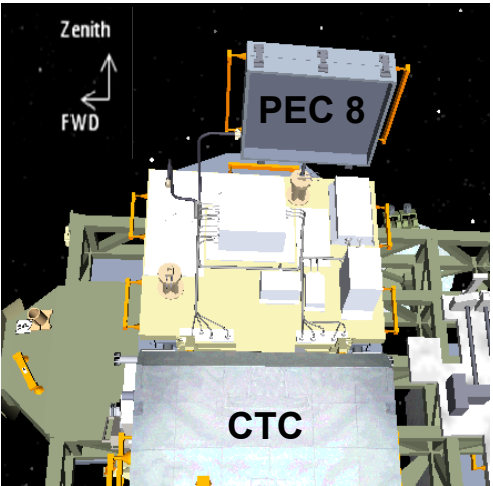
IV/SSRMS	EV1 (Drew)
<p>Planned PET 01:25</p>  <p>1. When EV1 is clear of PMA2, give <b>MCC-H GO</b> to release SSPTS Inhibit 1</p>	<p><u>MISSE 8 RETRIEVE</u> (00:15)</p> <ol style="list-style-type: none"> <li>1. Translate aft to bay 9, MISSE 8 Side Wall Carrier</li> <li>2. Release aft latch from launch config</li> <li>3. RET to PEC 8 (fwd HR)</li> <li>4. Release fwd latch to release PEC 8 from carrier</li> <li>5. Stow PEC 8 on BRT w/RET (fwd HR)</li> <li>6. Lock latches (2) into stow position               <ul style="list-style-type: none"> <li><input type="checkbox"/> Aft <input type="checkbox"/> Fwd</li> </ul> </li> <li>7. Install PIP pins (2)</li> <li>8. Retrieve <b>GREEN</b> hook from Node 2 HR 0344               <ul style="list-style-type: none"> <li><input type="checkbox"/> <input checked="" type="checkbox"/> Gate closed, hook locked, reels unlocked, release RET</li> </ul> </li> <li>9. Translate to S1 Face 2, zenith route               <ul style="list-style-type: none"> <li><input type="checkbox"/> Fairlead on S0 HR 3467 (Bay 1)</li> </ul> </li> <li>10. Attach <b>GREEN</b> hook to S1 HR 3208               <ul style="list-style-type: none"> <li><input type="checkbox"/> <input checked="" type="checkbox"/> Gate closed, hook locked, reels unlocked, release RET</li> </ul> </li> </ol> <div style="border: 2px solid black; padding: 5px; text-align: center; margin: 10px 0;"> <p><b>WARNING</b></p> <p>Do not touch the hinged side while opening the MISSE PEC</p> </div> <div style="border: 1px solid black; padding: 5px; text-align: center; margin: 10px 0;"> <p><b>CAUTION</b></p> <p>Avoid inadvertent contact with deployed MISSE PECs, which have shatterable materials, and the silver avionics boxes atop the ExPA</p> </div> <p><u>MISSE 8 INSTALL</u> (00:25)</p> <ol style="list-style-type: none"> <li>11. Translate zenith to ELC2 at trunnion</li> <li>12. Release PIP pins (2) on zenith ExPA socket</li> <li>13. Install PEC 8 into socket (HRs inbd, connectors ISS fwd)               <ul style="list-style-type: none"> <li><input type="checkbox"/> <input checked="" type="checkbox"/> Alignment marks match up</li> </ul> </li> <li>14. Install PIP pins (2)</li> </ol>

## MISSE 8 INSTALL (00:40) (Cont)

IV/SSRMS	EV1 (Drew)
<div data-bbox="121 245 562 906" data-label="Image"> </div> <p data-bbox="210 852 493 885">MISSE 8 Side View</p> <ol style="list-style-type: none"> <li data-bbox="100 917 625 1006">2. When EV1 is clear of ELC2, give <b>MCC-H GO</b> to power up ELC2 (except for MISSE 8 WVS Inhibit)</li> <li data-bbox="100 1039 625 1234">3. Perform CETA ORU bag inventory: <ul style="list-style-type: none"> <li><input type="checkbox"/> CETA Med ORU bag <ul style="list-style-type: none"> <li><input type="checkbox"/> Adj Equip Tether (ext)</li> <li><input type="checkbox"/> Adj Equip Tether (ext)</li> <li><input type="checkbox"/> RET (sm-sm)</li> <li><input type="checkbox"/> RET (sm-sm)</li> <li><input type="checkbox"/> RET (sm-sm)</li> </ul> </li> </ul> </li> </ol>	<ol style="list-style-type: none"> <li data-bbox="625 235 1999 397">15. Mate MISSE 8 Connector 7A: <ul style="list-style-type: none"> <li><input type="checkbox"/> Remove 7A cap (lower/red connector)</li> <li><input type="checkbox"/> Demate 7A connector from dummy panel J7A</li> <li><input type="checkbox"/> Mate J7A connector to J7A (lower connector) (√no FOD, pins)</li> <li><input type="checkbox"/> Install 7A cap onto dummy connector J7A</li> </ul> </li> <li data-bbox="625 422 1999 576">16. Mate MISSE 8 Connector 7B: <ul style="list-style-type: none"> <li><input type="checkbox"/> Remove 7B cap (upper/green connector)</li> <li><input type="checkbox"/> Demate 7B connector from dummy panel J7B</li> <li><input type="checkbox"/> Mate J7B connector to J7B (upper connector) (√no FOD, pins)</li> <li><input type="checkbox"/> Install 7B cap onto dummy connector J7B</li> </ul> </li> <li data-bbox="625 609 1999 673">17. Open PEC 8 <ul style="list-style-type: none"> <li><input type="checkbox"/> √All 4 PIP pins are re-installed</li> </ul> </li> <li data-bbox="625 763 1999 860">18.  Photograph deployed PEC PEC 8 (<input type="checkbox"/> Nadir, <input type="checkbox"/> Zenith) <input type="checkbox"/> Overall View (2 angles)</li> <li data-bbox="625 917 1999 950">19. Translate to CETA ORU bag on S3 HR 3046</li> <li data-bbox="625 950 1999 982">20. When clear of ELC2, give <b>IV GO</b> for ELC2 power up</li> <li data-bbox="625 1006 1999 1039">21. Retrieve N2 vent tool from CETA ORU bag, leave RET in bag</li> <li data-bbox="625 1039 1999 1071">22. If EV3 complete with CETA ORU bag, perform bag inventory</li> <li data-bbox="625 1071 1999 1104">23. Stow CETA ORU bag on BRT w/RET</li> <li data-bbox="625 1128 1999 1193">24. Retrieve <b>GREEN</b> hook S1 HR 3208 <ul style="list-style-type: none"> <li><input type="checkbox"/> √Gate closed, hook locked, reels unlocked, release RET</li> </ul> </li> <li data-bbox="625 1193 1999 1291">25. Translate to CETA Spur <ul style="list-style-type: none"> <li><input type="checkbox"/> Retrieve fairlead at Bay 1</li> <li><input type="checkbox"/> Translate nadir at Bay 5 (watch for EV3's tether)</li> </ul> </li> <li data-bbox="625 1291 1999 1323">26. Stow CETA ORU bag on S0 HR 3413, 3412 (Face 6)</li> <li data-bbox="625 1323 1999 1356">27. Glove and Gauntlet Check</li> </ol> <p data-bbox="955 1372 1669 1404" style="text-align: center;">(Translate to P3 Face 1, nadir route – P3/P4 Jumper Install)</p>

### S3 CETA LIGHT INSTALL (00:25)

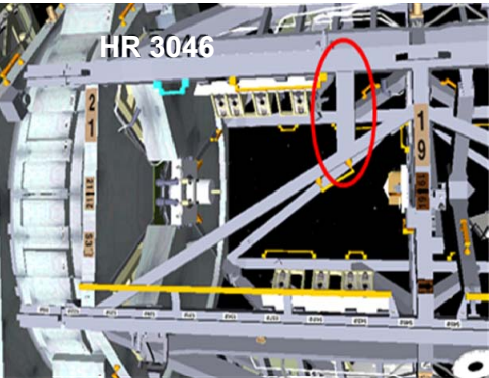
IV/SSRMS	EV3 (Taz)									
<p>Planned PET 01:25</p>  <p>1. Record CETA light bolt data:</p> <table border="1" data-bbox="107 1109 615 1203"> <thead> <tr> <th>Bolt</th> <th>Turns</th> <th>Torque (ft-lb)</th> </tr> </thead> <tbody> <tr> <td>CETA Light</td> <td>(11-15)</td> <td>(12.0)</td> </tr> </tbody> </table> <p>2. Give <b>MCC-H GO</b> for CETA light heater power</p>	Bolt	Turns	Torque (ft-lb)	CETA Light	(11-15)	(12.0)	<table border="1" data-bbox="701 240 1610 342"> <tr> <td style="text-align: center;"><b>CAUTION</b></td> </tr> <tr> <td>CETA Lights are covered with Z-93 paint, avoid impact/inadvertent contact</td> </tr> <tr> <td>CETA Light grid could be a finger entrapment, do not stick finger in grid</td> </tr> </table> <p><b>S3 CETA LIGHT INSTALL (00:25)</b></p> <ol style="list-style-type: none"> <li>1. Translate to S1 Face 1 (stbd/zenith, then nadir route) <ul style="list-style-type: none"> <li><input type="checkbox"/> Retrieve fairlead on Node 2 HR 0314</li> </ul> </li> <li>2. Attach <b>GREEN</b> hook on S1 HR 3217 or Xo 5790 (bay 17) <ul style="list-style-type: none"> <li><input type="checkbox"/> √Gate closed, hook locked, reels unlocked, release RET</li> </ul> </li> <li>3. Translate to S3 Face 1 (bay 19)</li> <li>4. BRT to S3 HR 3037</li> <li>5. Release TA clamp</li> <li>6. Demate connector P170 from J1 on stanchion pnl A92 <ul style="list-style-type: none"> <li><input type="checkbox"/> Close TA clamp, if able</li> </ul> </li> <li>7. RET, remove dust cap from J1 on CETA light</li> <li>8. Retrieve CETA light from CETA ORU bag</li> <li>9. Mate connector P170 to J1 on CETA light <ul style="list-style-type: none"> <li><input type="checkbox"/> √Good pins &amp; EMI band; no FOD</li> </ul> </li> <li>10. Retrieve RET</li> <li>11. Soft dock light onto empty (inner) light bracket</li> <li>12. Install dust cap on J1 on stanchion pnl A92</li> <li>13. Configure PGT: <ul style="list-style-type: none"> <li><b>[B1 (12.0), CW2, 30.5]</b> 6-Ext 7/16</li> </ul> </li> <li>14. ←Drive bolt while pushing in, <b>11-15 turns</b></li> <li>15. Glove and Gauntlet Check</li> <li>16. <b>Notify IV</b> when clear of worksite</li> </ol> <p style="text-align: right;">(Retrieve SARJ Cover – SARJ Cover Install)</p>	<b>CAUTION</b>	CETA Lights are covered with Z-93 paint, avoid impact/inadvertent contact	CETA Light grid could be a finger entrapment, do not stick finger in grid
Bolt	Turns	Torque (ft-lb)								
CETA Light	(11-15)	(12.0)								
<b>CAUTION</b>										
CETA Lights are covered with Z-93 paint, avoid impact/inadvertent contact										
CETA Light grid could be a finger entrapment, do not stick finger in grid										

# STBD SARJ COVER 7 INSTALL (00:25)

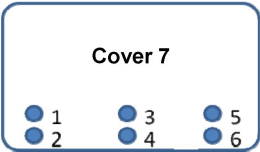
IV/SSRMS	EV3 (Taz)														
<p>Planned PET 01:50</p> <div style="text-align: center;">  <p>Cover 7</p> </div> <p>1. Record SARJ Cover bolt:</p> <table border="1" data-bbox="107 764 611 829"> <thead> <tr> <th>Cover</th> <th>1</th> <th>2</th> <th>3</th> <th>4</th> <th>5</th> <th>6</th> </tr> </thead> <tbody> <tr> <td>Cover 7</td> <td></td> <td></td> <td></td> <td></td> <td></td> <td></td> </tr> </tbody> </table>	Cover	1	2	3	4	5	6	Cover 7							<div style="border: 1px solid black; padding: 5px; margin-bottom: 10px;"> <p style="text-align: center;"><u>CAUTION</u></p> <p>Minimize side loading bolt head</p> <p>Maintain axial force on fastener to compress spring during rotation</p> </div> <div style="border: 3px double black; padding: 5px; margin-bottom: 10px;"> <p style="text-align: center;"><u>WARNING</u></p> <p>End of spring on EVA fasteners may protrude – sharp edge</p> </div> <p><u>S3 SARJ COVER 7 INSTALL (00:25)</u></p> <ol style="list-style-type: none"> <li>1. Retrieve SARJ Cover 7 from CETA ORU bag</li> <li>2. Translate zenith at SARJ to Face 3</li> <li>3. Report any off-nominal findings under Cover 7</li> <li>4. Configure PGT:  <b>[A1 (2.5), CW2, 30.5]</b> 6-Ext 7/16</li> <li>5. ←Engage MLI cover fasteners, <b>9 turns</b>  <input checked="" type="checkbox"/> Green light and bolt seated for all bolts</li> <li>6. Retrieve <b>GREEN</b> hook from S1 HR 3217 or Xo 5790  <input type="checkbox"/> <input checked="" type="checkbox"/> Gate closed, hook locked, reels unlocked, release RET</li> </ol> <p style="text-align: right;">(Translate to P3 Face 1, zenith – P3/P4 Jumper Install)</p>
Cover	1	2	3	4	5	6									
Cover 7															

## P3/P4 NH3 JUMPER INSTALL (00:35/00:25)

IV/SSRMS	EV1 (Drew)	EV3 (Taz)
<p>Planned PET 02:05 (EV1) 02:15 (EV3)</p> <p>1. Verify inhibits in place  <input checked="" type="checkbox"/> Port SARJ locked at 50°            (No inhibit required for P4 EWIS)</p>	<div style="border: 1px solid black; padding: 5px; margin-bottom: 10px;"> <p style="text-align: center;"><u>CAUTION</u></p> <p>QDs exposed to direct sun can overtemp in 20 min. Shading by EMU or thermal shrouds can lengthen acceptable time with bootie removed</p> </div> <p style="text-align: center;"><u>NOTE</u></p> <p style="text-align: center;">Mind your safety tethers.            Do not route P3/P4 Jumper over your safety tether</p> <p><u>P3/P4 NH3 JUMPER INSTALL (00:35)</u></p> <ol style="list-style-type: none"> <li>1. Translate to P3 Face 6, nadir route</li> <li>2. Attach <b>GREEN</b> hook to P3 HR 3861 (bay 22)               <ul style="list-style-type: none"> <li><input type="checkbox"/> <input checked="" type="checkbox"/> Gate closed, hook locked, reels unlocked, release RET</li> </ul> </li> <li>3. Attach RET to P3 HR 3860 _____</li> <li>4. RET, remove cap from QD M2</li> <li>5. Translate nadir/aft to P4 bulkhead</li> <li>6. Demate EWIS Connectors (2)               <ul style="list-style-type: none"> <li><input type="checkbox"/> J1 <input type="checkbox"/> J2</li> </ul> </li> <li>7. Release jumper and mate EWIS Connectors               <ul style="list-style-type: none"> <li><input checked="" type="checkbox"/> Good pins &amp; EMI band; no FOD</li> <li><input type="checkbox"/> J1 <input type="checkbox"/> J2</li> </ul> </li> <li>8. Release TA Clamps (10)</li> <li>9. Retrieve QD F2 from EV3 w/tether</li> <li>10. Translate to P3 M2 with QD F2</li> <li>11. Route jumper as required</li> <li>12. Mate and open QD F2 to M2 per <b>BLOCK B</b> and <b>BLOCK C</b></li> <li>13. <input type="checkbox"/> <input checked="" type="checkbox"/> Visually inspect jumper connections</li> </ol> <p style="text-align: center;">(Translate to P5/P6 Jumper)</p>	<p><u>P3/P4 NH3 JUMPER INSTALL (00:25)</u></p> <ol style="list-style-type: none"> <li>1. Translate to P3 Face 2, zenith route           <ul style="list-style-type: none"> <li><input type="checkbox"/> Watch for EV1's ST</li> <li><input type="checkbox"/> Fairlead zenith after MT</li> </ul> </li> <li>2. Attach <b>GREEN</b> hook to P3 HR 3852 (bay 22)           <ul style="list-style-type: none"> <li><input type="checkbox"/> <input checked="" type="checkbox"/> Gate closed, hook locked, reels unlocked, release RET</li> </ul> </li> <li>3. Translate zenith/aft to P4 inbd bulkhead</li> <li>4. Open thermal bootie on QD F2 (1/4")           <ul style="list-style-type: none"> <li><input type="checkbox"/> <input checked="" type="checkbox"/> Detent button fully installed</li> </ul> </li> <li>5. Demate QD F2 per <b>BLOCK A</b></li> <li>6. Transfer QD F2 to EV1</li> <li>7. Open thermal bootie on QD F15 (1")           <ul style="list-style-type: none"> <li><input type="checkbox"/> <input checked="" type="checkbox"/> Detent button fully installed</li> </ul> </li> <li>8. Demate QD F15 per <b>BLOCK A</b></li> <li>9. Translate to P4 M15 with QD F15</li> <li>10. Remove cap from P4 M15 (lanyarded)</li> <li>11. Mate and open QD F15 to M15 per <b>BLOCK B</b> and <b>BLOCK C</b></li> <li>12. <input type="checkbox"/> <input checked="" type="checkbox"/> Visually inspect jumper connections</li> </ol> <p style="text-align: center;">(Translate to P3 Face 6)</p>

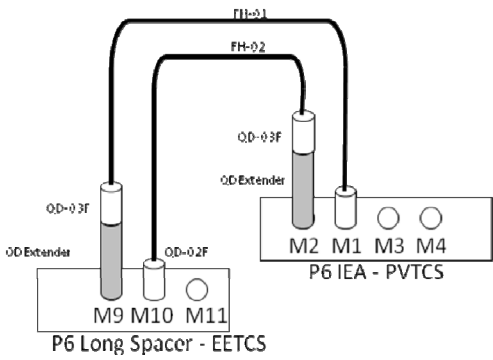

## NH3 JUMPERS N2 VENT/P3/P4 JUMPER TEMP STOW (00:35)

IV/SSRMS	EV1 (Drew)	EV3 (Taz)
<p>Planned PET 02:40</p> <p>1. When EV1 complete with P1-P5 venting ops, give <b>EV3 GO</b> for P3/P4 Jumper temp stow</p> 	<p><u>P1-P5 JUMPER VENT (00:15)</u></p> <ol style="list-style-type: none"> <li>Translate to P5 dummy panel M14</li> <li>Remove cap from N2 vent tool</li> <li>Release TA Clamp (1)</li> <li>Open thermal bootie on QD F14 <ul style="list-style-type: none"> <li><input type="checkbox"/> ✓ Detent button fully installed</li> </ul> </li> <li>Demate QD F14 per <b>BLOCK A</b></li> <li>Mate QD F14 to N2 vent tool per <b>BLOCK B</b> (1")</li> <li>Open QD F14 per <b>BLOCK C</b> to allow venting</li> <li>After 45 sec, close QD F14 per <b>BLOCK D</b>; notify IV when complete (<b>EV3 GO</b> for P3/P4 temp stow)</li> <li>Demate QD F14 from N2 vent tool per <b>BLOCK A</b></li> </ol> <p style="text-align: center;"><u>NOTE</u> Do not touch P6 M14 Cap</p> <ol style="list-style-type: none"> <li>Mate QD F14 to P5 dummy panel M14 (original location) per <b>BLOCK B</b>; do not open QD</li> <li>Install cap on vent tool</li> </ol> <p><u>EAS JUMPER VENT (00:20)</u></p> <ol style="list-style-type: none"> <li>Translate to EAS Jumpers, fairlead as reqd</li> <li>Remove cap from vent tool</li> <li>Open thermal bootie on QD-03F (jumper side of QD at M2) <ul style="list-style-type: none"> <li><input type="checkbox"/> ✓ Detent button fully installed</li> </ul> </li> <li>Open QD-03F to QD extender (jumper side QD) per <b>BLOCK C</b></li> <li>Open thermal bootie on QD Extender at M2 <ul style="list-style-type: none"> <li><input type="checkbox"/> ✓ Detent button fully installed</li> </ul> </li> <li>Demate QD Extender from M2 per <b>BLOCK A</b></li> <li>Mate and open QD Extender to N2 vent tool per <b>BLOCK B</b> and <b>BLOCK C</b></li> <li>After 5 sec, close and demate QD Extender from N2 vent tool per <b>BLOCK D</b> and <b>BLOCK A</b></li> </ol>	<p><u>P3/P4 NH3 JUMPER TEMP STOW (00:35)</u></p> <ol style="list-style-type: none"> <li>Translate to P3 pnl A502 (face 6)</li> <li>On <b>IV GO</b>, close and demate QD F2 at M2 per <b>BLOCK D</b> and <b>BLOCK A</b></li> <li>Install cap on M2, leave EV1 RET there</li> <li>Translate to P4 inbd bulkhead with QD F2</li> <li>Mate QD F2 to dummy male M2 per <b>BLOCK B</b> <ul style="list-style-type: none"> <li><input type="checkbox"/> Close nearest TA Clamp</li> </ul> </li> <li>Install wire tie around jumper on P4 HR 5123</li> <li>Glove and Gauntlet Check</li> <li>Retrieve <b>GREEN</b> hook from P3 HR 3852 (bay 22) <ul style="list-style-type: none"> <li><input type="checkbox"/> ✓ Gate closed, hook locked, reels unlocked, release RET</li> </ul> <p style="text-align: center;">(Translate to Lab fwd – EWC Antenna Install)</p> </li> </ol>

**NH3 JUMPERS N2 VENT/P3/P4 JUMPER TEMP STOW (00:35) (Cont)**

<b>IV/SSRMS</b>	<b>EV1 (Drew)</b>	<b>EV3 (Taz)</b>
<p>2. Consumable tag up with <b>MCC-H</b></p>	<p>20. Mate QD Extender to M2 per <b>BLOCK B</b>; do not open QD</p> <p>21. Install cap on N2 vent tool; stow behind MWS</p> <p>22. Glove and Gauntlet Check</p> <p>23. Translate to P3 HR 3860 (face 6)</p> <p>24. Retrieve RET</p> <p>25. Retrieve <b>GREEN</b> hook from P3 HR 3861 (bay 22)</p> <p><input type="checkbox"/> √Gate closed, hook locked, reels unlocked, release RET</p> <p>(Translate to Lab fwd – EWC Antenna Install)</p>	

## EWC ANTENNA INSTALL (02:20/02:45)

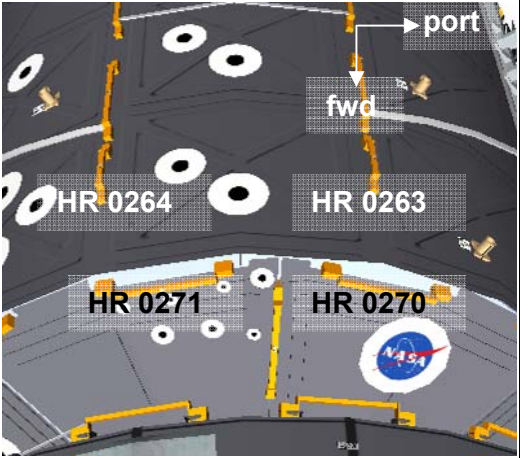
IV/SSRMS	EV1 (Drew)	EV3 (Taz)
<p>Planned PET 03:15</p> 	<div style="border: 1px solid black; padding: 5px; margin-bottom: 10px;"> <p style="text-align: center;"><b>CAUTION</b></p> <p>Avoid inadvertent contact with S0/Node 2 fluid tray hardlines at Node 2 end, which are limited to 25 lb</p> </div> <p style="text-align: center;"><b>NOTE</b></p> <p>MMOD Shield C2-03 (with NASA Meatball) is wire tied closed on port-most Dzus fastener</p> <p><u>SETUP/WORKSITE PREP (01:20)</u></p> <ol style="list-style-type: none"> <li>1. Translate to Lab fwd, zenith/port route</li> <li>2. Open EWC ORU bag</li> <li>3. Deploy zenith Fish Stringer on LAB HRs 0264 and 0263 on the fwd stanchions (taped hook on HR 0264/stbd) <ul style="list-style-type: none"> <li><input type="checkbox"/> Tighten Fish Stringer as necessary</li> </ul> </li> <li>4. Stow N2 Vent tool on middle hook of zenith Fish Stringer w/o RET</li> <li>5. Close and stow EWC ORU bag on BRT w/RET</li> <li>6. Translate port/nadir using gap spanner to Node 2 HR 0300</li> </ol>	<p><u>SETUP/EWC ANTENNA INSTALL (01:00)</u></p> <ol style="list-style-type: none"> <li>1. Translate to Lab fwd, zenith/stbd route</li> <li>2. Assist with Fish Stringer deploy</li>   <li>3. Relocate LTA Connector from Lab HR 0270 to HR 0269, old wire tie stays on HR</li> <li>4. Retrieve RETs from zenith Fish Stringer, attach to <ul style="list-style-type: none"> <li><input type="checkbox"/> HR 0270</li> <li><input type="checkbox"/> HR 0271</li> </ul> </li> <li>5. Locate EWC Handrails 0270A and 0271A so reachable at BRT worksite</li>   <li>6. Attach R Waist Tether to HR 0369</li> <li>7. BRT to Lab HR 0263 for HR 0270</li> <li>8. Configure PGT: <ul style="list-style-type: none"> <li><b>[B1 (12.0), CCW2, 30.5]</b> 6-ext 7/16</li> </ul> </li> <li>9. Break torque on HR 0270 bolts, <b>1 turn only</b> <ul style="list-style-type: none"> <li><input type="checkbox"/> Port bolt <input type="checkbox"/> Stbd bolt</li> </ul> </li> <li>10. Configure PGT: <ul style="list-style-type: none"> <li><b>[A1 (2.5), CCW2, 30.5]</b> 6-ext 7/16</li> </ul> </li> <li>11. Release HR 0270, <b>7 turns</b> <ul style="list-style-type: none"> <li><input type="checkbox"/> Port bolt <input type="checkbox"/> Stbd bolt</li> </ul> </li> <li>12. Push OIH release buttons and remove HR</li> </ol>



## EWC ANTENNA INSTALL (02:20/02:45) (Cont)

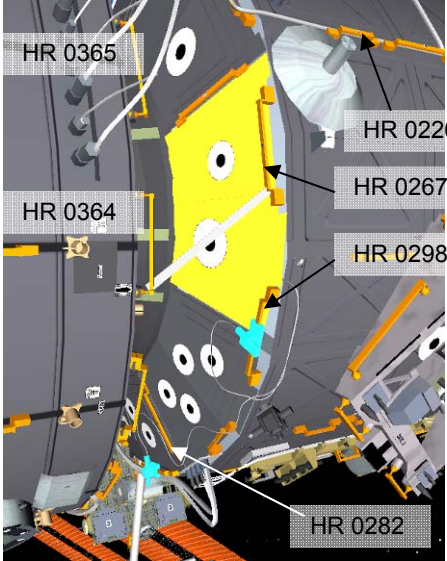

IV/SSRMS	EV1 (Drew)	EV3 (Taz)
	<ol style="list-style-type: none"> <li>19. Install long T-handle tool into MMOD shield C2-01  <input type="checkbox"/> √Pull test</li> <li>20. Attach Lg hook of adj equip tether from long T-handle to Node 2 HR 0364</li> <li>21. Stow short T-handle tool on EOTP HR using attached RET</li> <li>22. Remove gap spanner from Lab HR 0267; stow hook on Node 2 HR 0365 or HR 0364</li> <li>23. Release trunnion MLI from MMOD Shield C2-01</li> <li>24. As time allows, perform get-ahead tasks (on previous page)</li> <li>25. Demate P1 from EWIS Antenna 11 (port) HR 0298</li> </ol> <p><u>OPEN MMOD SHIELD C2-01 (00:15)</u></p> <ol style="list-style-type: none"> <li>26. Assess MMOD shield alignment and body positioning (Lab HR 0298 potential BRT)</li> <li>27. Release Dzus fasteners, in any order <ul style="list-style-type: none"> <li><input type="checkbox"/> Zenith</li> <li><input type="checkbox"/> Center</li> <li><input type="checkbox"/> Nadir</li> </ul> </li> <li>28. Give <b>EV3 GO</b>, open shield (clamshell)</li> <li>29. Release nadir MLI Dzus fastener and peel back MLI to expose electrical connectors (attached w/Velcro)</li> </ol>	<ol style="list-style-type: none"> <li>33. Receive P3/P4 bundle from EV1 or Lab 0269</li> <li>34. Wire tie cables to HR 0269 using integrated wire tie</li> <li>35. Transfer RET from EWC HR 0270A to P3 connector cap, remove cap</li> <li>36. Mate connector P3 to Ant 1 J3 on EWC HR 0270A (port) <ul style="list-style-type: none"> <li><input type="checkbox"/> √Good pins &amp; EMI band; no FOD</li> </ul> </li> <li>37. Transfer RET from EWC HR 0271A to P4 connector cap, remove cap</li> <li>38. Mate connector P4 to Ant 2 J4 on EWC HR 0271A (stbd) <ul style="list-style-type: none"> <li><input type="checkbox"/> √Good pins &amp; EMI band; no FOD</li> </ul> </li> <li>39. Wire tie P4 cable to Lab HR 0280 (low profile wire tie)</li> <li>40. Translate nadir/port to MMOD shield C2-01 using JEM HRs <ul style="list-style-type: none"> <li><input type="checkbox"/> Fairlead on JEM or Node 2</li> </ul> </li> </ol> <p><u>OPEN MMOD SHIELD C2-01 (00:15)</u></p> <ol style="list-style-type: none"> <li>41. Assess MMOD shield alignment and body positioning (Lab HR 0267 potential BRT) <ul style="list-style-type: none"> <li><input type="checkbox"/> Look at MMOD alignment landmarks</li> </ul> </li> <li>42. On <b>EV1 GO</b>, open shield (clamshell) while maintaining pressure into flanges to keep shield hinged</li> </ol>



## EWC ANTENNA INSTALL (02:20/02:45) (Cont)

IV/SSRMS	EV1 (Drew)	EV3 (Taz)
<p>BINGO time for Drew to go to A/L: PET 05:35 (00:55 to SCU)</p> 	<p><u>CLOSE MMOD SHIELD C2-01</u> (00:15)</p> <p>38. Reinstall MLI Dzus fastener</p> <ul style="list-style-type: none"> <li>√Dzus alignment <ul style="list-style-type: none"> <li><input type="checkbox"/> Rotate ccw until Dzus drops down onto spring</li> <li><input type="checkbox"/> Rotate Dzus to locked position cw, quarter turn</li> <li><input type="checkbox"/> Verify all MLI is beneath Dzus fastener plates</li> </ul> </li> </ul> <p>39. Install MMOD shield C2-01</p> <p>40. Engage Center Dzus fastener</p> <ul style="list-style-type: none"> <li>√Dzus alignment <ul style="list-style-type: none"> <li><input type="checkbox"/> Rotate ccw until Dzus drops down onto spring</li> <li><input type="checkbox"/> Rotate Dzus to locked position cw, quarter turn</li> </ul> </li> </ul> <p>41. Engage Dzus fasteners (<input type="checkbox"/> Zenith, <input type="checkbox"/> Nadir)</p> <ul style="list-style-type: none"> <li>√Dzus alignment <ul style="list-style-type: none"> <li><input type="checkbox"/> Rotate ccw until Dzus drops down onto spring</li> <li><input type="checkbox"/> Rotate Dzus to locked position cw, quarter turn</li> </ul> </li> </ul> <p><u>MATE EWC P1/P2 CONNECTORS</u> (00:15)</p> <p>42. Mate new connector P1 to EWIS Ant 11</p> <ul style="list-style-type: none"> <li><input type="checkbox"/> √Good pins &amp; EMI band; no FOD</li> </ul> <p>43. Route P2 cable stbd to EWIS Ant 12, wire tie on Lab HR 0297 (get-ahead task)</p> <p>44. RET to old EWIS cable</p> <p>45. Demate P2 from EWIS Ant 12</p> <p>46. Mate EWC connector P2 to EWIS Ant 12</p> <ul style="list-style-type: none"> <li><input type="checkbox"/> √Good pins &amp; EMI band; no FOD</li> </ul> <p>47. Wire tie new P2 cable and P5/P6 cable to Lab HR 0277 (BRT wire tie)</p> <p>48. Release all wire ties from old EWIS cable</p>	<p><u>CLOSE MMOD SHIELD C2-01</u> (00:15)</p> <p>44. Assist EV1 as reqd</p> <p><u>CLEANUP</u> (00:40)</p> <p>45. Wire tie P3/P4 cable to Lab HR 0268 and/or HR 0267 (BRT wire tie)</p> <p>46. Retrieve long T-handle tool/Lg-sm Adj/RET from shield</p> <p>47. Retrieve short T-handle tool from EOTP</p> <p>48. Stow T-handles (2) in EWC ORU bag on Fish Stringer</p> <ul style="list-style-type: none"> <li><input type="checkbox"/> Short <input type="checkbox"/> Long</li> </ul> <p>49. Re-install gap spanner from Node 2 HR 0365 to Lab HR 0267 (nadir stanchion)</p> <p>50. Install trunnion MLI over MMOD shield</p> <p>51. Config P5/P6 cable bundle for long-term stowage on Lab HR 0282 (get-ahead task)</p>

**EWC ANTENNA INSTALL (02:20/02:45) (Cont)**

IV/SSRMS	EV1 (Drew)	EV3 (Taz)
<p>EWC Med ORU Bag:</p> <ul style="list-style-type: none"> <li><input type="checkbox"/> Adj Equip Tether (ext)</li> <li><input type="checkbox"/> Adj Equip Tether (ext)</li> <li><input type="checkbox"/> Adj Equip Tether or Wire Tie               <ul style="list-style-type: none"> <li><input type="checkbox"/> EWIS Cable</li> </ul> </li> <li><input type="checkbox"/> Fish Stringer #1               <ul style="list-style-type: none"> <li><input type="checkbox"/> Hook 1: RET (sm-sm)                   <ul style="list-style-type: none"> <li><input type="checkbox"/> Long T-Handle Tool                       <ul style="list-style-type: none"> <li><input type="checkbox"/> Adj Equip Tether (Lg-sm)</li> </ul> </li> </ul> </li> <li><input type="checkbox"/> Hook 2: RET (sm-sm)                   <ul style="list-style-type: none"> <li><input type="checkbox"/> Short T-Handle Tool</li> </ul> </li> <li><input type="checkbox"/> Hook 3: Loop Pin Puller</li> <li><input type="checkbox"/> Hook 4: Wire Tie Caddy</li> <li><input type="checkbox"/> Hook 5: Wire tie                   <ul style="list-style-type: none"> <li><input type="checkbox"/> P1 Cap</li> <li><input type="checkbox"/> P2 Cap</li> <li><input type="checkbox"/> J16A Cap</li> <li><input type="checkbox"/> P16A Cap</li> </ul> </li> </ul> </li> <li><input type="checkbox"/> Zenith Fish Stringer               <ul style="list-style-type: none"> <li><input type="checkbox"/> Hook 1: RET (sm-sm)                   <ul style="list-style-type: none"> <li><input type="checkbox"/> EWC Antenna Cap</li> </ul> </li> <li><input type="checkbox"/> Hook 2: RET (sm-sm)                   <ul style="list-style-type: none"> <li><input type="checkbox"/> P4 Cap</li> </ul> </li> <li><input type="checkbox"/> Hook 3: RET (sm-sm)                   <ul style="list-style-type: none"> <li><input type="checkbox"/> HR 0271</li> </ul> </li> <li><input type="checkbox"/> Hook 4: N2 Vent Tool</li> <li><input type="checkbox"/> Hook 5: RET (sm-sm)                   <ul style="list-style-type: none"> <li><input type="checkbox"/> HR 0270</li> </ul> </li> <li><input type="checkbox"/> Hook 6: RET (sm-sm)                   <ul style="list-style-type: none"> <li><input type="checkbox"/> P3 Cap</li> </ul> </li> <li><input type="checkbox"/> Hook 7: RET (sm-sm)                   <ul style="list-style-type: none"> <li><input type="checkbox"/> EWC Antenna Cap</li> </ul> </li> </ul> </li> </ul>	<p>49. Assist EV3 with coiling old EWIS cable</p> <p>50.  WVS Survey</p> <p>51. Translate fwd/zenith using port gap spanner</p> <p>52. Translate to CETA Spur</p> <p>53. Retrieve CETA ORU bag from S1 HR 3413, stow on BRT w/RET</p> <p>54. Glove Check (Translate to A/L)</p>	<p>52. Retrieve adj tether from Lab HR 0298 (from new EWC cable)</p> <p>53. Retrieve EWIS cable</p> <p>54. Coil cable and wrap long wire tie or adj tether around bundle, as reqd</p> <p>55. Stow EWIS cable in EWC ORU bag</p> <p>56. Perform EWC ORU bag inventory</p> <p>57. Verify all cables are appropriately routed and wire tied to structure</p> <p>58.  WVS Survey</p> <p>59. Stow EWC ORU Bag on BRT w/RET</p> <p>60. Translate zenith around JEM</p> <p>61. If not completed, wire tie P4 cable to Lab HR 0280 (low profile wire tie)</p> <p>62. Retrieve <b>GREEN</b> hook from Lab HR 0272 <input type="checkbox"/> <math>\sqrt</math>Gate closed, hook locked, reels unlocked, release RET</p> <p>63. Perform inventory of zenith Fish Stringer</p> <p>64. Stow Fish Stringer into EWC ORU bag</p> <p>65. Perform MWS tool inventory (Reference Final Tool Configs FS 7- )</p> <p>66. Glove Check  (Translate to A/L)</p>

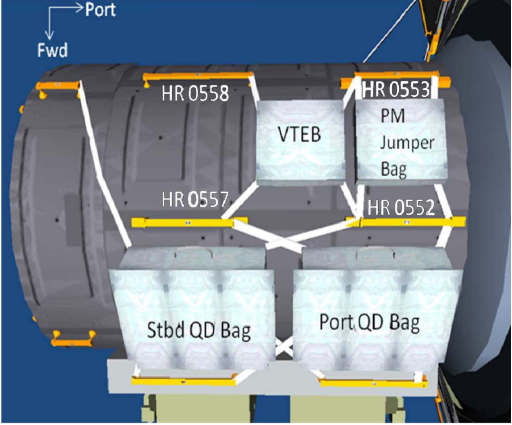

## VTEB RECONFIG (00:25)

IV/SSRMS	EV1 (Drew)
<p>Planned PET 05:35</p> <p><i>Fluid QD Bag info in section 8</i></p> 	<p><u>VTEB RECONFIG (00:20)</u></p> <ol style="list-style-type: none"> <li>1. Translate to A/L</li> <li>2. Open hatch thermal cover</li> <li>3. Stow CETA ORU bag in A/L</li> <li>4. Retrieve VTE plug</li> <li>5. Close hatch thermal cover</li> <li>6. Translate zenith to VTEB</li> <li>7. Open VTEB</li> <li>8. Disconnect 1.5" Vent tool from vent tool extension <ul style="list-style-type: none"> <li><input type="checkbox"/> Rotate indicator to Unlock</li> <li><input type="checkbox"/> Squeeze trigger and pull vent tool out</li> </ul> </li> <li>9. Install VTE plug into VTE connector: <ul style="list-style-type: none"> <li><input type="checkbox"/> Rotate lock lever to unlock (hard stop detent – very loose)</li> <li><input type="checkbox"/> Depress lever to hard stop (2-10 lb)</li> <li><input type="checkbox"/> Insert VTE plug into connector tube</li> <li><input type="checkbox"/> Release lever and rotate to lock</li> <li><input type="checkbox"/> Perform pull test</li> </ul> </li> <li>10. Wrap long wire tie around VTE nozzle (disconnect from L-bracket if needed)</li> <li>11. Coil VTE using wire tie and velcro strap and temp stow</li> <li>12. Translate to Fluid QD Tool Bag #2 (port) with 1.5" Vent Tool</li> <li>13. Open fwd/port corner of bag</li> <li>14. Stow 1.5" Vent tool in Pocket F of Fluid QD Tool Bag #2</li> <li>15. Retrieve vent tool adapter from QRT &amp; FID Gauge pocket (leave Adj tether in QD bag)</li> <li>16. Close QD bag, open fwd/stbd corner of QD bag</li> <li>17. Retrieve 1.0" Vent tool from Pocket A</li> <li>18. Close QD bag</li> <li>19. Coil and stow following in VTEB (using internal tethers): <ul style="list-style-type: none"> <li><input type="checkbox"/> MUT EE (already in VTEB)</li> <li><input type="checkbox"/> Vent Tool Adapter</li> <li><input type="checkbox"/> 1.0" Vent tool</li> <li><input type="checkbox"/> Vent Tool Extension w/plug</li> </ul> </li> <li>20. Relocate french hook of VTE plug to VTEB D-ring</li> <li>21. Close VTE bag <ul style="list-style-type: none"> <li><input type="checkbox"/> <input checked="" type="checkbox"/> All Velcro secure</li> </ul> </li> </ol>

**VTEB RECONFIG (00:25) (Cont)**

<b>IV/SSRMS</b>	<b>EV1 (Drew)</b>
	<p><u>QD CONTINGENCY TOOL GATHER</u> (00:05)</p> <p>22. Open Fluid QD Bag #1 (stbd)</p> <p>23. Retrieve the 1" Cap Tool (aft/stbd corner); stow on MWS adj equip tether</p> <p>24. √1" QD Bail Drive Lever stowed in bag lid</p> <p>25. Close Fluid QD Bag #1</p> <p>26. Perform MWS tool inventory (Reference Final Tool Configs FS 7- )</p>

## EVA 1 CLEANUP/INGRESS (00:30)

IV/SSRMS	EV1 (Drew)	EV3 (Taz)
<p>Planned PET 06:00</p> <p>1. Start Hatch Thermal Cover clock PET (30 min) __ : __</p> <p>2. Prior to hatch closure, perform WVS PWRDN (PHOTO/TV, <u>WVS</u> Cue Card)</p> <p>3. Stop Hatch Thermal Cover clock PET (30 min) __ : __</p>	<p><u>CLEANUP</u> (00:10)</p> <p>1. Translate nadir to A/L</p> <p><u>INGRESS/PRE-REPRESS</u> (00:20)</p> <p>2. Receive Node 3 Avionics bag from EV3</p> <p>3. Translate aft/zenith on C/L</p> <p>4. Stow bag on C/L HRs 0513 and 0559 using integrated tethers</p> <p>5. Translate nadir to A/L</p> <p>6. On <b>EV3 GO</b>, RET to EV3 STP, release <b>RED</b> hook and attach to aft ext D-ring  <input type="checkbox"/> √Gate closed, hook locked, reels unlocked, release RET</p> <p>7. Attach R Waist Tether to A/L int D-ring extender  <input type="checkbox"/> √Gate closed, hook locked</p> <p>8. RET to STP, release <b>RED</b> hook and attach to curved HR, fwd/stbd stanchion  <input type="checkbox"/> √Gate closed, hook locked, reels unlocked, release RET</p> <p>9. Ingress A/L</p> <p>10. Close hatch thermal cover; attach Velcro strap</p> <p>11. Remove SCU from stowage pouch</p> <p>12. Remove DCM cover; Velcro to DCM</p> <p>13. Connect SCU to DCM            √SCU locked</p> <p style="text-align: center;"><u>NOTE</u>            A TCV setting 8 – Max C            minimizes time for SCU cooling</p>	<p><u>CLEANUP</u> (00:10)</p> <p>1. Translate to A/L  <input type="checkbox"/> Retrieve fairlead and Adj Equip Tether from Lab HR 0247  <input type="checkbox"/> Fairlead on Equip Lock HR 0500</p> <p><u>INGRESS/PRE-REPRESS</u> (00:20)</p> <p>2. Open hatch thermal cover</p> <p>3. Retrieve Node 3 Avionics bag from A/L (FGB Y-Cables)</p> <p>4. Transfer Node 3 Avionics bag to EV1</p> <p>5. Stow EWC ORU bag in A/L</p> <p>6. Attach R Waist Tether to UIA D-ring  <input type="checkbox"/> √Gate closed, hook locked</p> <p>7. Give <b>EV1 GO</b> to release EV3 <b>RED</b> hook</p> <p>8. Ingress A/L</p> <p>9. Remove SCU from stowage pouch</p> <p>10. Remove DCM cover; Velcro to DCM</p> <p>11. Connect SCU to DCM            √SCU locked</p> <p style="text-align: center;"><u>NOTE</u>            A TCV setting 8 – Max C            minimizes time for SCU cooling</p>

**EVA 1 CLEANUP/INGRESS (00:30) (Cont)**

<b>IV/SSRMS</b>	<b>EV1 (Drew)</b>	<b>EV3 (Taz)</b>
	<p>14. WATER – OFF (fwd), expect <span style="border: 1px solid black; padding: 2px;">H2O IS OFF</span> msg</p> <div style="border: 1px solid black; padding: 5px; margin: 10px auto; width: fit-content;"> <p style="text-align: center;"><b>CAUTION</b></p> <p style="text-align: center;">Do not close hatch until EMU Water OFF for 2 min. Verify outer hatch clear of hardware</p> </div> <p>15. Verify outer hatch clear of hardware            16. Verify handle position per hatch decal            17. Close and lock hatch</p> <p>Go to PRE-REPRESS (<u>DEPRESS/REPRESS</u> Cue Card)</p>	<p>12. WATER – OFF (fwd), expect <span style="border: 1px solid black; padding: 2px;">H2O IS OFF</span> msg</p> <p>Go to PRE-REPRESS (<u>DEPRESS/REPRESS</u> Cue Card)</p>

## MISSE 7 RETRIEVE – TASK DATA

### Estimated Task Duration:

	With RMS	Without RMS
One EV Crew	N/A	02:00
Two EV Crew	N/A	01:00

### Tools:

EV1
Camera

### EVA Fasteners:

Fastener Name	Head Size	Qty	Install Torque (ft-lb)	Release Torque (ft-lb)	Failure Torque (ft-lb)	Turns
PEC Probe EVA Bolt	7/16	2/probe	N/A	123 in-lb	260 in-lb	11.5
SWC Latch Plate Pin	7/16	2/SWC	N/A	128 in-lb	260 in-lb	11.1

### EVA Connectors:

Harness	From	To	Clamps (#)	Function
P7A	PEC J7A	J7A Dummy	1	Data
P7B	PEC J7B	J7B Dummy	1	Data + Heater

### ORU Details:

ORU	Part Number	Mass
MISSE 7A	FT-TA-5142	75.4 lb
MISSE 7B	PW-7B-0012	82.67 lb

### Notes:

1. Red cap goes to PEC 7A; green cap goes to PEC 7B
2. Caps are not required to be installed on PECs for landing
3. Do not touch avionics boxes (shiny) on the ExPA
4. Alignment markings on the PECs connectors are no longer visible
5. Avoid inadvertent touch to ELC2 ExPCA when translating to MISSE ExPA

### Timeline Considerations:

1. Thermal clock on MISSE 7 PECs is 120 min from ELC power off to PEC close
2. Thermal clock on ELC2 is 6 hr

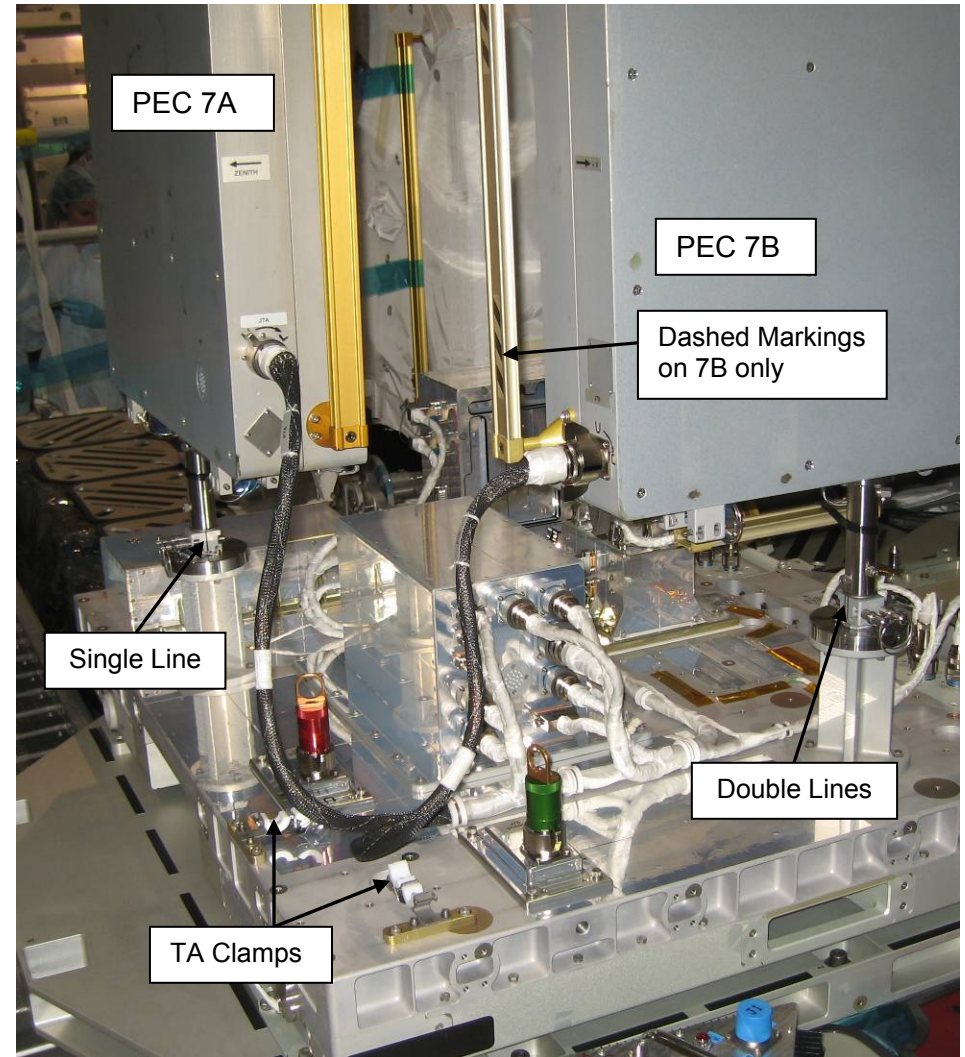



MISSE 7 RETRIEVE – TASK DATA (Cont)

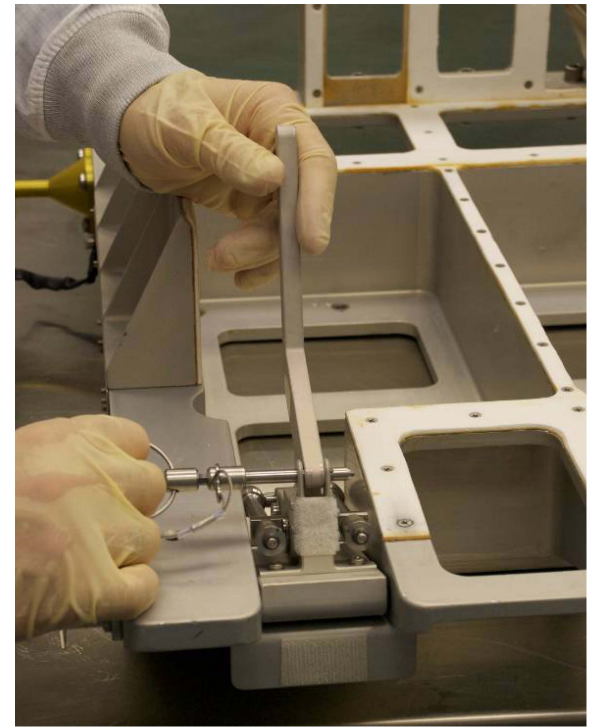
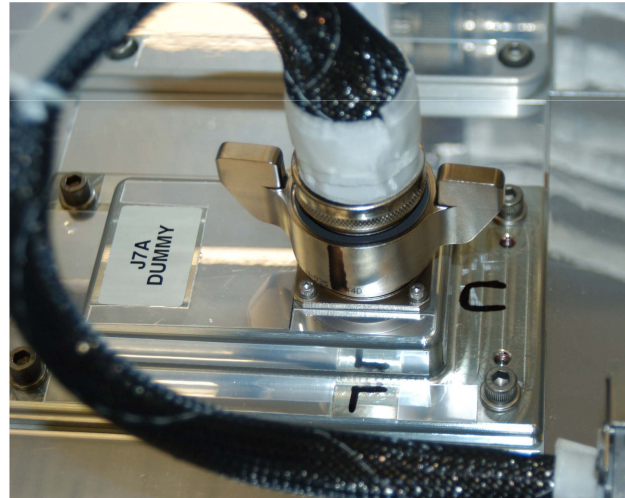
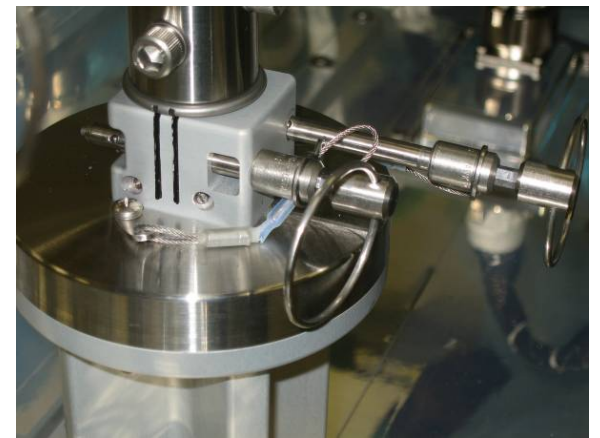
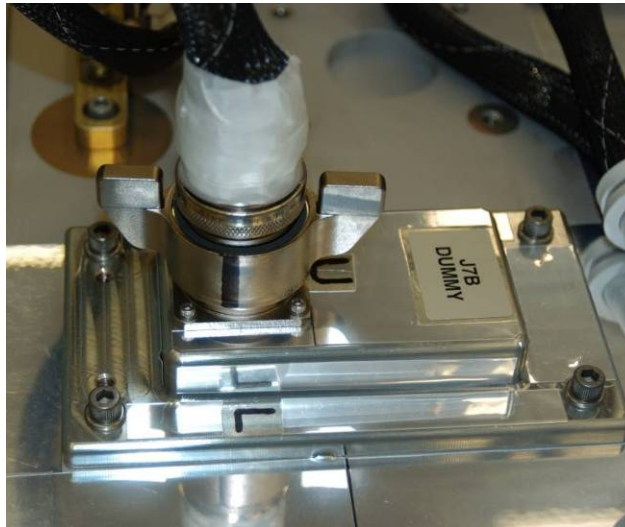

## MISSE 8 INSTALL – TASK DATA

### Estimated Task Duration:

	With RMS	Without RMS
One EV Crew	N/A	00:40
Two EV Crew	N/A	N/A

### Tools:

EV1
MISSE 8 PEC

### EVA Fasteners:

Fastener Name	Head Size	Qty	Install Torque (ft-lb)	Release Torque (ft-lb)	Failure Torque (ft-lb)	Turns
PEC Probe EVA Bolt	7/16	2	N/A	78 in-lb	260 in-lb	11.5
SWC Latch Plate Pin	7/16	2	N/A	128 in-lb	260 in-lb	11.1

### EVA Connectors:

Harness	From	To	Clamps (#)	Function
P7A	J7A Dummy	PEC 8/J7A	1	Data
P7B	J7B Dummy	PEC 8/J7B	1	Data + Heater

### ORU Details:

ORU	Part Number	Mass
MISSE 8 PEC	FT-TA-8010	80.2 lb

### Notes:

- 7A Connector provides data for 4 experiments, no heaters
- 7B Connector provides data for 1 experiment, heaters
- Connector Pins are on the PEC side
- For connector install, line up one of the wing tabs to the black alignment mark, then rotate cw 90 deg
- MISSE 8 install orientation is with HRs nadir (single alignment mark ISS fwd)

### Timeline Considerations:

- Thermal clock on MISSE 8 is 120 min from PEC open to ELC power on
- ELC2 thermal clock is 6 hr



Connectors shown in Lock position

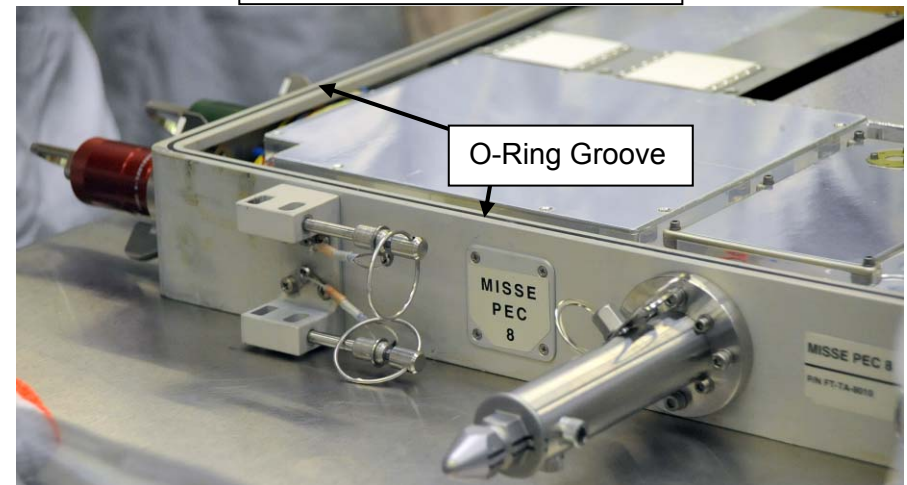



## S3 CETA LIGHT INSTALL – TASK DATA

### Estimated Task Duration:

	With RMS	Without RMS
One EV Crew	N/A	00:30
Two EV Crew	N/A	N/A

### Tools:

EV3
PGT w/7/16 – 6" ext
Medium ORU bag

### EVA Fasteners:

Fastener Name	Head Size	Qty	Install Torque (ft-lb)	Release Torque (ft-lb)	Failure Torque (ft-lb)	Turns
CETA Light Bolt	7/16	1	12.0	24.0	73.4	11-15

### EVA Connectors:

Harness	From	To	Clamps (#)	Conn Size	Function
A92	S3 J170	CETA Light J1	1 TA	15	Power

### ORU Details:

ORU	Part Number	Mass
CETA Light	1F03046-1	24.0 lb

### Notes:

1. Heaters will be applied after install
2. Cap goes to connector dummy panel
3. Must push bracket past soft dock in order to engage bolt

### Caution:

1. CETA Lights are covered with Z-93 paint, avoid impact/inadvertent contact
2. If light turned on during EVA, do not touch (possible hot touch temp violation)

### Timeline Considerations:

1. CETA light has a thermal clock of 3 hr. Refer to table below for more information

Translation time to wkst (in MLI)	Install time (outside MLI)
2 hr	1 hr
3 hr	0.6 hr
3.5 hr	0.5 hr
4 hr	0.3 hr

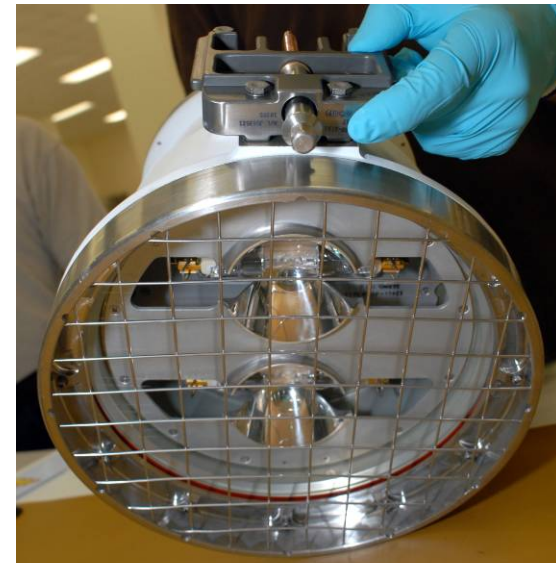



### S3 CETA LIGHT INSTALL – TASK DATA (Cont)

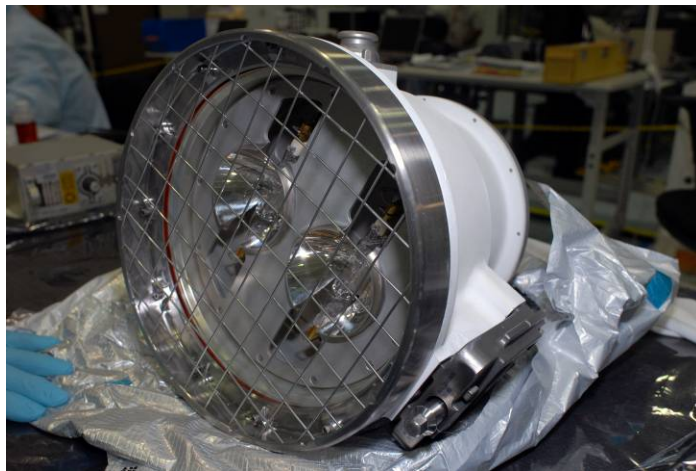
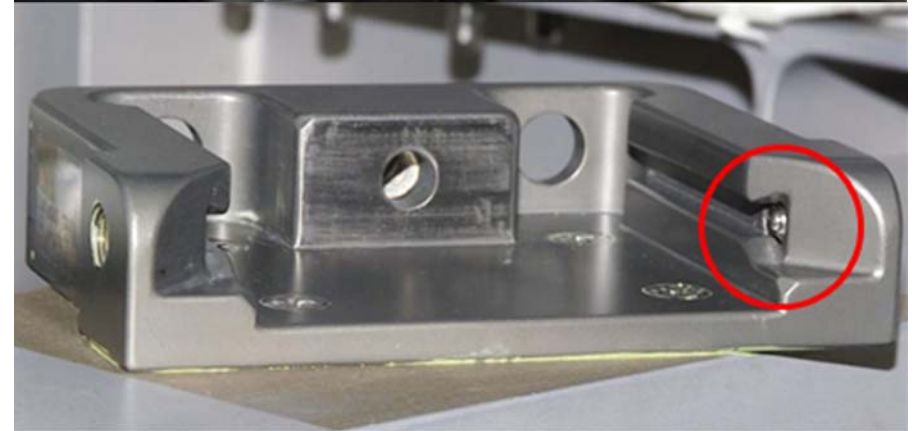
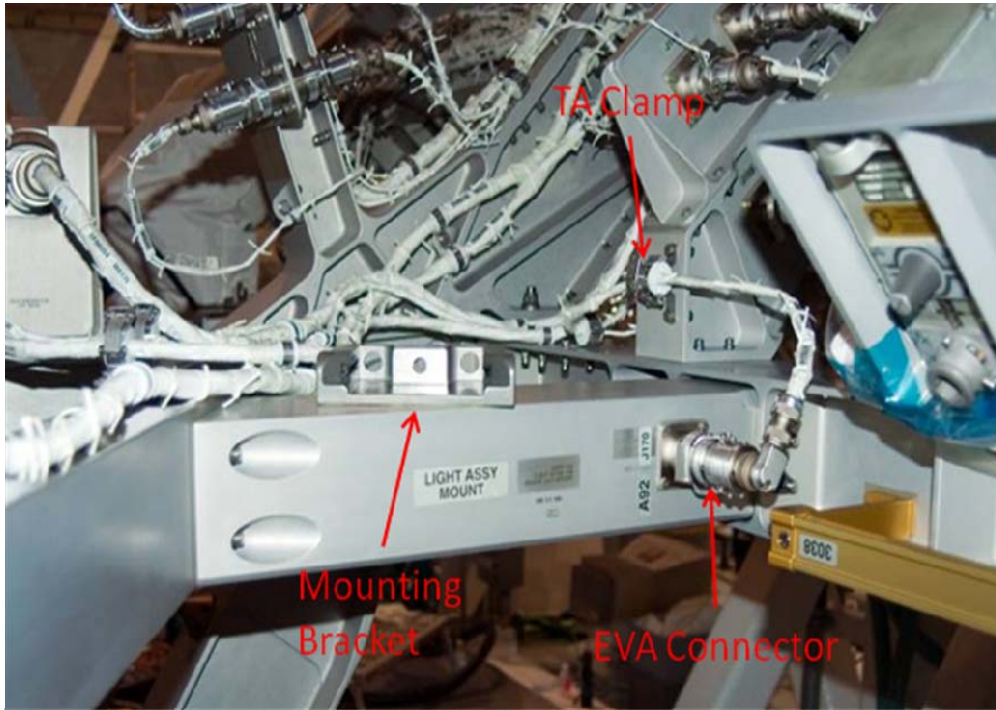

# STBD SARJ COVER 7 INSTALL – TASK DATA

## Estimated Task Duration:

	With RMS	Without RMS
One EV Crew	N/A	00:15
Two EV Crew	N/A	N/A

## Tools:

EV3
PGT w/7/16 x 6" socket

## EVA Fasteners:

Fastener Name	Head Size	Qty	Install Torque (ft-lb)	Release Torque (ft-lb)	Failure Torque (ft-lb)	Turns
SARJ Cover bolt	7/16	6	2.5	4.8	3.8	7-9

## ORU Details:

ORU	Part Number	Mass
SARJ Cover 7 – Double	1F26519	5.63 lb

## Notes:

1. EVA preferred stbd SARJ angles are 90°-165°, 220°-295°
2. Minimize side loading bolt head
3. Maintain axial force on fastener to compress spring during rotation
4. Limit turns if have to release



6 Bolts per Double Wide Cover

## P6 PVTCS FILL SETUP – TASK DATA

### Estimated Task Duration:

	With RMS	Without RMS
One EV Crew	N/A	02:00
Two EV Crew	N/A	01:10

### Tools:

EV1	EV3
1" N2 Vent Tool	Wire Tie

### EVA Fluid QDs:

Jumper	QD#	Line #	QD Size	Pre EVA1	Post EVA1
ATA Vent Pnl	F184	N/A	1/4"	P1 Pnl A500 M2 – open	P1 Pnl A500 M2 – open
ATA Vent Pnl	F185	N/A	1/4"	P1 Pnl A500 M3 – open	P1 Pnl A500 M3 – open
P1/P3	F186	N/A	1/4"	P1 Pnl A503 M3 – open	P1 Pnl A503 M3 – open
P1/P3	F187	N/A	1/4"	P3 Pnl A503 M1 – open	P3 Pnl A503 M1 – open
P3/P4	F2	FH-03	1/4"	P4 Stowage QD – closed	P4 Stowage QD – closed
P3/P4	F15	FH-03	1"	P4 Stowage QD – closed	<b>P4 QD M15 – closed</b>
P4/P5	F16	FH-05	1"	P4 QD M16 – open	P4 QD M16 – open
P5/P6	F14	FH-06	1"	P5 Stowage QD – closed	P5 Stowage QD – closed
EAS Jumpers	02F	FH-02	1"	P6 QD M10 – closed	P6 QD M10 – closed
EAS Jumpers	03F	FH-02	1"	Extender – closed	<b>Extender – open</b>
EAS Jumpers	Ext	FH-02	1"	P6 QD M2 – closed	P6 QD M2 – closed

### EVA Connectors:

Harness	Function
EWIS Connectors J1 and J2	Data

### ORU Details:

Name	Part Number	Mass
EAS Jumper	R081351	21.07 lb
EAS Jumper Assy	R081697	23.5 lb
EAS Extender	RH000054	5 lb
P3/P4 Jumper	RH000138-1	8.34 lb
1" N2 Vent Tool	1F98596-1	5.36 lb
P1 ATA Jumper "homeplate"	1F78113-5	3.3 lb

### Notes:

1. Port SARJ must be locked between -78° through +170° for P3/P4 Jumper to reach
2. S3/S4 jumper is 27 in longer than P3/P4 jumper
3. EAS Jumper is 102" long not including QD Extender
4. P3/P4 Jumper is 214.5" long, after thermal reduction factor it is 209.4". S3/S4 Jumper is 243.48" long, after thermal reduction factor it is 237.7" long (back-up jumper)
5. IFI 7792 contains information on a kink in the vent tool extension



P6 PVTCS FILL SETUP – TASK DATA (Cont)

P3/P4 Fluid Jumper

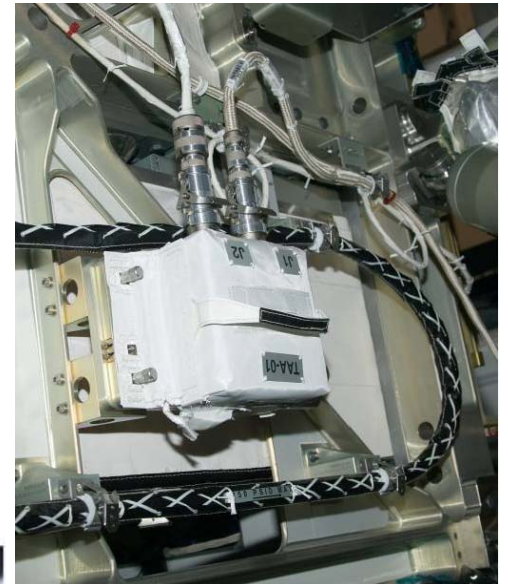

## P6 PVTCS FILL SETUP – TASK DATA (Cont)

### P5/P6 Fluid Jumper



### P3/P4 Fluid Jumper in Temp Stow Config

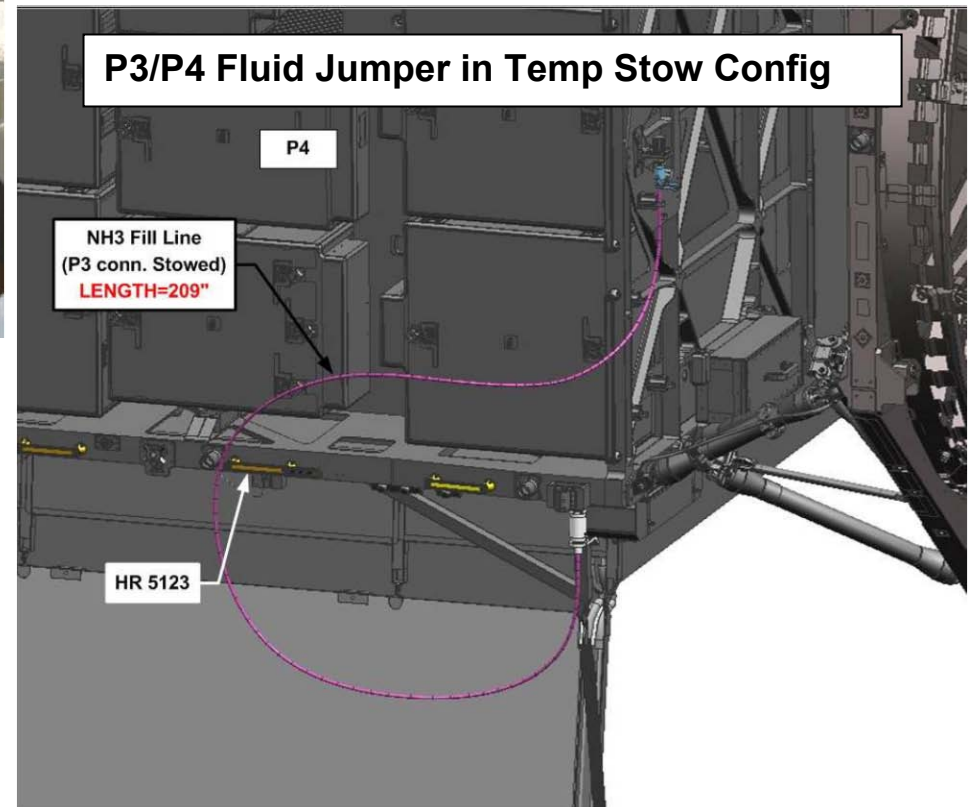



# P6 PVTCS FILL SETUP – TASK DATA (Cont)

## EAS Fluid Jumpers

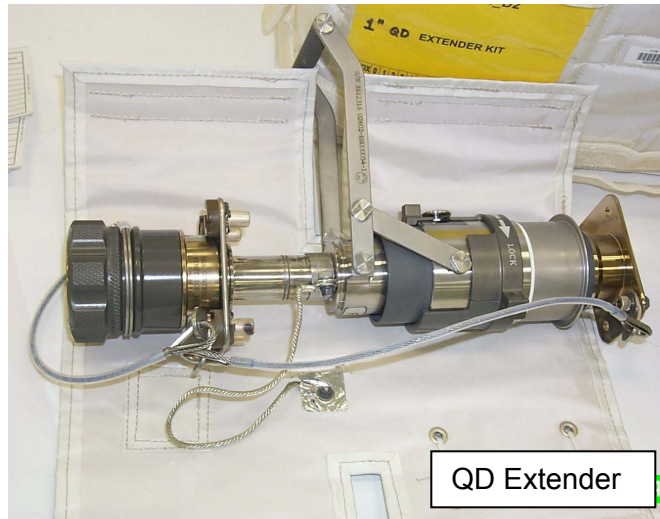
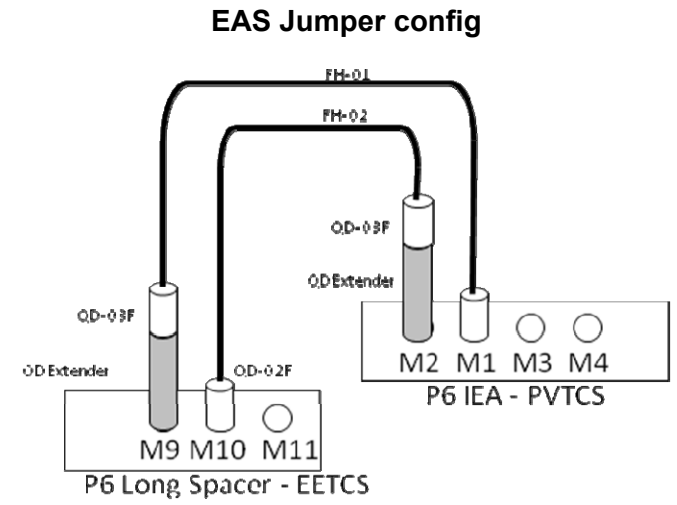
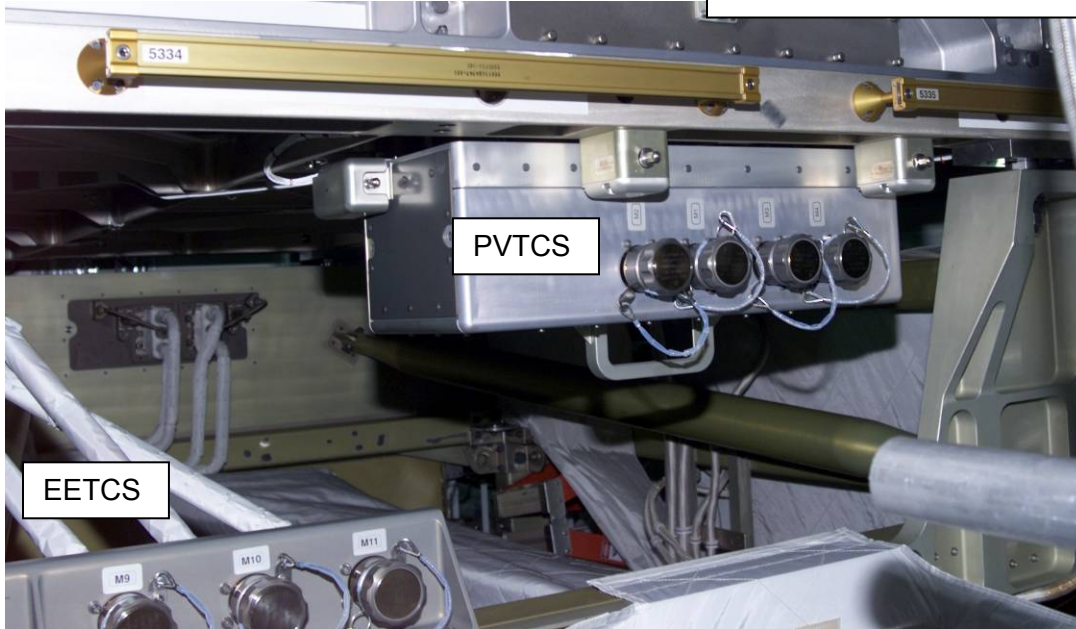

## EWC ANTENNA INSTALL – TASK DATA

### Estimated Task Duration:

	With RMS	Without RMS
One EV Crew	N/A	N/A
Two EV Crew	N/A	02:30

### Tools:

EV1	EV3
Short, Long MMOD T-handle Tools	PGT w/7/16 – 6" ext
Loop Pin Puller (Contingency)	
Wire ties for cable tie down	

### EVA Fasteners:

Fastener Name	Head Size	Qty	Install Torque (ft-lb)	Release Torque (ft-lb)	Failure Torque (ft-lb)	Turns
Antenna Mount OIH EVA bolt	7/16	2/each	3.8	8.3	12.33	0.5-23.5
OIH bolt	7/16	2/each	3.8	8.3	25.5	9-9.5

### EVA Connectors:

EWC Cable (W5255)	To	Label	Conn Size	Function
P1	EWIS Ant 11 (port)	J1	21	RF
P2	EWIS Ant 12 (stbd)	J1	21	RF
P3	EWC Ant 1 – 0270A (port)	J3	21	RF
P4	EWC Ant 2 – 0271A (stbd)	J4	21	RF
P5	Coil and stow	N/A	21	RF
P6	Coil and stow	N/A	21	RF
P16A	Lab	J16	25	ISS UHF
J16A	Lab free-float cable	P16	25	ISS UHF

EWIS Cable (W5448)	From	Label	Conn Size	Function
P1	EWIS Ant 11 (port)	J1	21	RF
P2	EWIS Ant 12 (stbd)	J1	21	RF
P16A	Lab	J16	25	ISS UHF
J16A	Lab free-float cable	P16	25	ISS UHF

### ORU Details:

ORU	Part Number	Mass
HR 0270, 0271	SEG33106351-301	1.87 lb
EWC Ant HR 0270A	684-015274-0001	10.01 lb
EWC Ant HR 0271A	684-015274-0501	10.01 lb
EWC Cable	684-015255-0001	8.0 lb
EWIS Cable	1F15448-1	2.69 lb
EWIS Ant 11 HR	1F15742-1	9.69 lb
EWIS Ant 12 HR	1F15742-501	9.69 lb

### Notes:

1. EWIS Connector P1 must be removed before C2-01 MMOD shield can be opened
2. EWIS Connector P1 is routed under HR 0298
3. EWC Antenna Handrails do have a direction arrow
4. EWC Ant 1 is on HR 0270A (J3), EWC Ant 2 is on HR 0271A (J4)
5. Caps have the "vent holes" or open keying grooves
6. Lab MMOD Shield C2-03 (NASA meatball) is secured with wire tie on port most Dzus fastener

### Timeline Considerations:

1. Loss of comm is possible during connector inhibits (inhibits ISS UHF). Want to get J16A and P16A connectors mated as soon as possible to limit UHF down time
2. Need 2 crew members to open MMOD shield



# EWC ANTENNA INSTALL – TASK DATA (Cont)

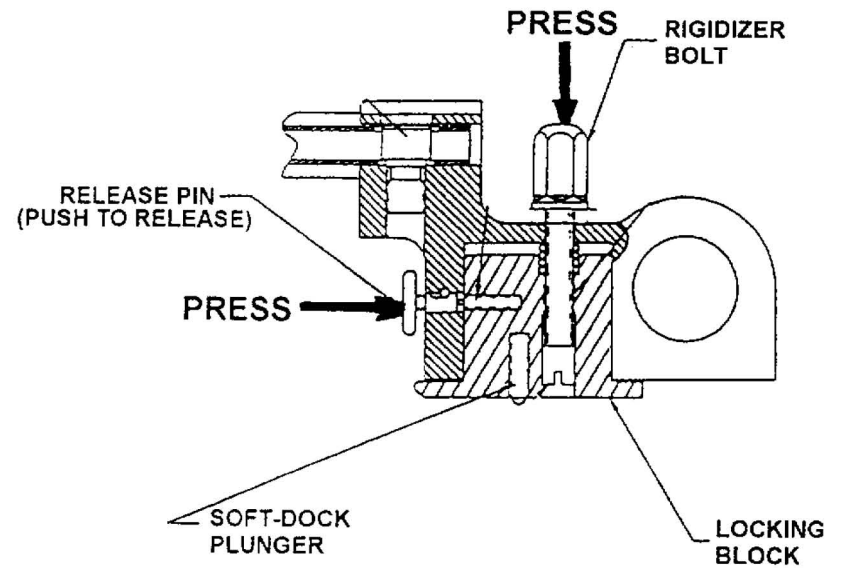
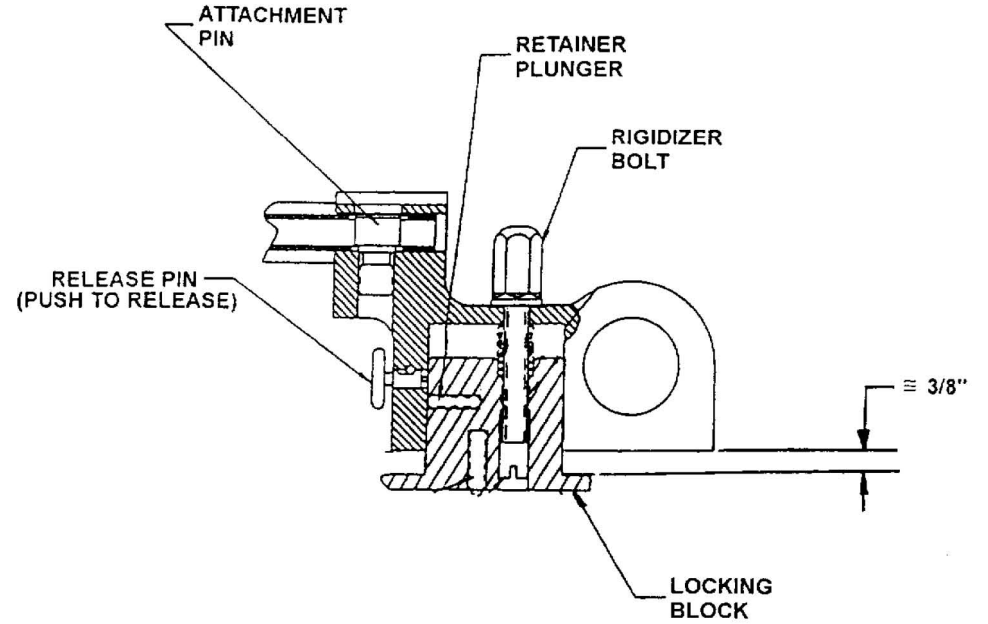
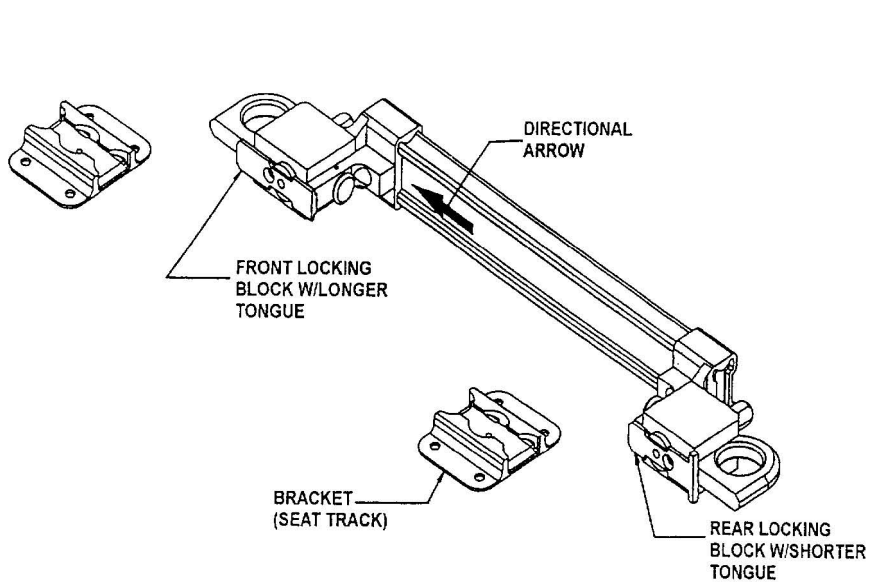



## EWC ANTENNA INSTALL – TASK DATA (Cont)

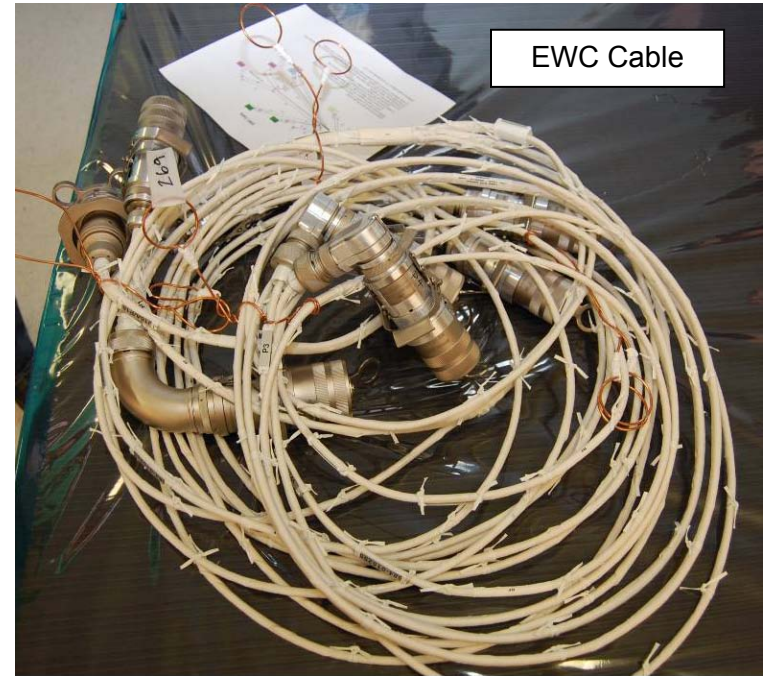

Dzus Fastener similar to MMOD  
Shield Fastener



This Page Intentionally Blank

# EVA 2 SUMMARY TIMELINE

PET HR : MIN	IV/SSRMS	EV1 (Ft)	EV2 (Fn)	
00:00		<u>EGRESS/SETUP</u> (00:35) • Post Depress and Egress (00:25) • Setup (00:10)	<u>EGRESS/SETUP</u> (00:35) • Post Depress and Egress (00:25) • Setup (00:10)	00:00
		<u>P3/P4 NH3 JUMPER RE-ROUTE</u> (00:15)	<u>P3/P4 NH3 JUMPER RE-ROUTE</u> (00:15)	
01:00	Leak Check in P1-P5 Jumpers Fill P6 PVTCS (10 min) Vent P1-P5 Jumper (17 min)	<u>PVTCS NH3 FILL</u> (01:00) • Leak Check; Open P5/P6 (00:15) • Open EAS Jumper/Fill PVTCS (00:15) • Vent tool Setup (00:20) • Initiate P1-P5 vent (00:10)	<u>CONFIGURE ATA FOR NH3 FILL</u> (00:25)	01:00
		<u>PSARJ OPS</u> (00:30) • Remove Covers (00:20) • Inspection (photos/samples) (00:10)	<u>PSARJ COVER REMOVAL</u> (00:55) • Setup (00:20) • Remove Covers (00:35)	
02:00	Vent EAS Jumpers (3.5 min)	<u>EAS JUMPER SETUP/VENT</u> (00:30) • Vent Tool Reconfig (00:10) • Vent EAS Jumpers (00:10) • EAS Jumper Reconfig (00:10)	<u>PSARJ FIRST LUBE</u> (00:45)	02:00
		<u>NH3 VENT TOOL CLEANUP</u> (00:25)		
03:00		<u>P3/P4 JUMPER STOW</u> (00:15)	<u>P3/P4 JUMPER STOW</u> (00:35)	03:00
	MCC-H: Rotate Port SARJ	<u>CONFIGURE ATA FOR VENT</u> (00:15)	<u>S1 RAD GB STOW BEAM INSTALL</u> (01:10)	
04:00	SSRMS: SPDM in APFR Ingress posn Mnvr to LEE Lube posn	<u>SPDM CLA COVER INSTALL</u> (00:25) • SPDM Setup (00:20) • CLA Cover Install (00:05)		04:00
		<u>SPDM LEE LUBE</u> (00:40) • SPDM LEE Lube (00:20) • Cleanup (00:20)	<u>PSARJ SECOND LUBE</u> (00:35)	
05:00	SSRMS: Mnvr SPDM to APFR Egress posn	<u>PSARJ SECOND LUBE</u> (00:25)		05:00
		<u>PSARJ REINSTALL COVERS</u> (00:50) • Install SARJ Covers (00:35) • Cleanup (00:15)	<u>PSARJ REINSTALL COVERS</u> (00:50) • Install SARJ Covers (00:35) • Cleanup (00:15)	
06:00		<u>CLEANUP/INGRESS</u> (00:25) • Cleanup (00:10) • Ingress and Pre-Repress (00:15)	<u>CLEANUP/INGRESS</u> (00:25) • Cleanup (00:10) • Ingress and Pre-Repress (00:15)	06:00
06:30				06:30

# EVA 2

## EVA 2 TOOL CONFIG

### ISS Configuration:

MT @ WS5; CETA Carts Port/Stbd  
 SSRMS on Node 2 PDGF  
 SPDM on SSRMS  
 PSARJ @ 50 deg

EV1 STP: S0 Port, inbd Strut → A/L aft D-ring  
 EV2 STP: S0 Port, outbd Strut → A/L Curved HR, fwd Stanchion

**NOTE:** Prior to use, inspect the following hardware:

- RET cords for fraying
- Inspect Load Alleviating Straps and D-ring Extenders; ref 2.230.100 CREW TETHER INSPECTIONS (SODF: ISS EVA TASKS):
  1. MMOD/general damage
  2. Discoloration
  3. Tack Stitching
  4. Red Band
- ISS Trash Bag: Bristle deformation/damage, after having stowed tools in trash bag
  - √Empty
  - √Zipper Closed
- BRT joint screws not loose
- Swing arm stiffness

Tether Counts: (Green RETs)  
 RETs (sm-sm) = 16/16      RETs (PIP Pin) = 5/5  
 RETs (Lg-sm) = 5/8      Adj Equip Tethers = 10/10  
 Adj Equip Tether (Lg-sm) = 2/2

### EV1

- MWS
    - BRT (L)
      - RET (sm-sm)
      - Wire Tie (2 short)
    - T-Bar
      - RET (Lg-sm) (R)
      - RET (Lg-sm) (L)
      - Adj Equip Tether (R)
      - Adj Equip Tether (L to TB)
      - Small ISS Trash Bag (R, inbd)
    - Swing Arm (R)
      - EVA Camera w/bracket (int RET – morning of)
      - RET w/PIP Pin
  - D-ring Extender (1, L D-ring)
  - Waist Tether (1, R on D-ring)
- 
- ### EV2
- MWS
    - BRT (L)
      - RET (sm-sm)
      - Wire Tie (2 short)
    - T-Bar
      - RET (sm-sm) (L)
      - RET w/PIP Pin (R)
      - Adj Equip Tether (R)
      - Wire Tie (2 short)
      - Small ISS Trash Bag (R, inbd)
        - Wire Tie (from P3/P4 Jumper)
    - Swing Arm (R)
      - RET (sm-sm)
        - PGT [A6, CAL, 30.5] s/n \_\_\_\_\_
        - PGT Battery s/n \_\_\_\_\_
        - 7/16 (wobble) Socket-6 ext
  - D-ring Extender (2, R & L D-ring)
    - Waist Tether (1, R on D-ring Ext)
    - Waist Tether (1, L on D-ring Ext)

### A/L

- RET (Lg-Sm) to HR stanchion
  - SARJ Medium ORU Bag (bottom to top)
    - Adj Equip Tether (ext – LF bottom)
    - Adj Equip Tether (ext – RF bottom)
    - Fish Stringer (Lg hook RF, all 7 sm hooks to free Lg hook)
    - RET (sm-sm) (RB)
      - Large Trash Bag
    - Fish Stringer (Tape near hook #1 – non-tape hook inside bag LB, taped hook on L bag side tether)
      - Hook #7: 1" QD Bail Drive Lever
      - Hook #6: 1" QD Cap Removal Tool **3**
      - Hook #5: EVA Camera w/Flash (int RET free – morning of)
      - Hook #4: RET (sm-sm) (to hinge side tether)
        - EVA Wipe Caddy
          - EVA Wipes (6) (dry – numbered 6-11) (wipe w/RED #6 inside-out)
    - Hook #3: RET (sm-sm) to shaft
      - J-Hook Nozzle Grease Gun w/zip tie tether pt
    - Hook #2: RET (sm-sm) to shaft
      - Straight-Nozzle Grease Gun w/zip tie tether pt
    - Hook #1: Adj Equip Tether (2) (covers)
    - Hook #1: Adj Equip Tether (Lg-sm) (2) (covers)
  - RET w/PIP Pin
    - PGT
      - 7/16 (wobble) Socket-6 ext
- RET (sm-sm) (ORU bag LF top to C/L bag R HR stanchion)
- EV1 Lube Crewlock Bag **3** (inside ORU bag) (integral tether to C/L bag lid handle)
  - External:
    - RET w/PIP Pin (C/L bag L D-ring) (PGT beneath C/L bag)
      - PGT [A6, CAL, 30.5] s/n \_\_\_\_\_
      - PGT Battery (Systems bag) s/n \_\_\_\_\_
      - 7/16 (wobble) Socket-6 ext
    - Adj Equip Tether (L HR stanchion) (covers)
    - Adj Equip Tether (L HR stanchion) (covers)
    - Wire Ties (2 – long) (for grease gun) (see fig 1)
    - RET (sm-sm) (ext)
      - Straight-Nozzle Grease Gun (L)
    - RET (sm-sm) (external)
      - J-Hook Nozzle Grease Gun (R)
  - Side 1 of divider:
    - EVA Gap Gauge "LEE" (int RET)
    - Taped Needle-Nose Pliers **3** (int RET)
    - RET (sm-sm)
      - CLA Cover MLI
        - CLA Cover

## EVA 2 TOOL CONFIG (Cont)

### A/L (Cont)

Side 2 of divider:

- RET (sm-sm) (3) + (2 int RET)
- EVA Wipes (5) (dry) (number 1-5)

- RET (Lg-Sm)  
(for SARJ C/L Bag return)

- RET (Lg-Sm)
  - Beam Med ORU Bag 3**
    - Adj Equip Tether (external) (L HR Stanchion)
    - RET w/PIP Pin (RF)
      - Inbd Rad GB Stow Beam (front in bag)
    - RET w/PIP Pin (LB)
      - Outbd Rad GB Stow Beam
    - RET (sm-sm) (LF)
      - Socket Caddy
        - 5/8 socket-7.8 ext

### Staging Bag

- Fish Stringer Tether
  - Wire Tie Caddy (hook 1) (5 short, 4 long)
  - Velcro/Tape Caddy (hook 2)
  - PGT (hook 3) s/n \_\_\_\_\_
    - PGT Battery s/n \_\_\_\_\_
    - 7/16 (wobble) Socket-6 ext
  - Vise Grips 3 (hook 4)
  - Ratchet Wrench (hook 5)
    - 7/16 (rigid) Socket-2 ext
  - Long Duration Tie-Down Tethers (2) (hook 6)
  - Spare MUT EE D (hook 7)
  - Spare Safety Tether Pack (85-ft + 85-ft) (to strap)
- Fish Stringer Tether
  - Pin Straightener Assy 3 (hook 1)
  - Connector Cleaner Tool Kit (hook 2)
  - Probe 3 (hook 3)
  - Pry Bar (hook 4)
  - Socket Caddy D** (hook 5)
    - 5/8 socket-7.8 ext D
  - 1" **Button Depress Tool (BDT) D** (hook 6)
    - 1" **Anti Kickback Tool (AKT) D**
  - MWS Key Strap Assy (on wire tie, to strap)
  - 1" **N2 Vent Tool** (hook 7) D

- IV Bag**
  - Towels (2)
  - Contamination Detection Kit
  - GP Caddy (2)
    - Adjustable Thermal Mittens (2)
  - Socket Caddy (hatch cont) w/RET (sm-sm) (Black)
    - 1/2 Socket-8 ext
    - 7/16 (wobble) Socket-6 ext (spare)
  - DCM Plug (SAFER Hardmount) (2)
  - RET (sm-sm, Black) (2)



Figure 1: EV1 Grease Gun Wire Tie Config

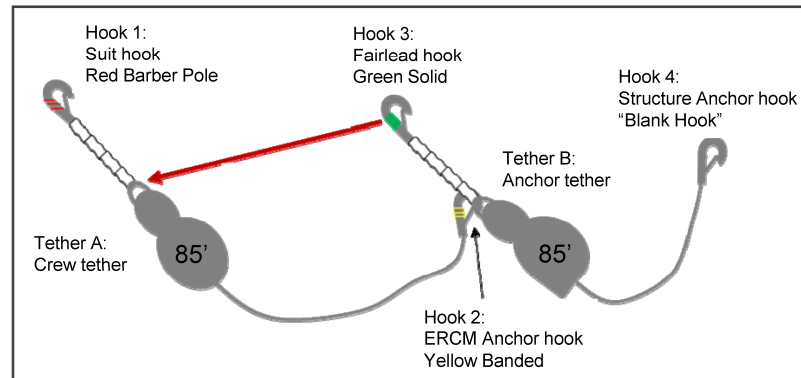

Figure 2: EV2 Grease Gun Wire Tie Config

### Post EVA 2

1. Stow sample wipes in labeled Ziplock bag and place in "EVA Tools Transfer" bag
2. Stow all other used wipes in labeled Ziplock bag and place in "Done" mesh bag

## EVA 2 BRIEFING CARD

### EVA Prep

- Review Morning Timeline/Plan
- Work With a Purpose
- Pure O2 Protocol
- Suit Donning Plan – special requests, boot bladder manipulation
- Safer, MWS, Tools, CL, Bag Stowage in A/L
- Airlock Depress Review

### Procedure Review

- Egress Plan (tethers) – Spanky then Drew, make good tether calls
- Order of Tasks (summary timeline)
- Translation Paths, Fairleads
- Hazards (no touch, no damage, keep outs, notes, cautions, warnings)
  - Stbd/Port TRRJ (Rad beam stow; LEE Lube)
  - SARJ ring/grease
  - Sharp edge: MT Lug near EAS Jumpers
  - Sharp edge: A/L Curved HR
- Contingencies – section 16 (NH3 QD ops, SARJ ops, Beam install)
- Task Constraints
  - NH3 Leak check choreography
  - EAS vent – night pass
  - P1-P5 vent – IV coordination (see P1-P5 Jumper Vent warning)
  - SARJ rotation – P3/P4 jumper
  - Drew's PGT – move before SARJ rotation
  - SARJ bolts turn count limited
  - Wipe numbering
  - Indexing for Grapple Bar Beam – Aft Bolt
  - LEE Lube – Drew inbd of APFR
- Ingress Plan

### Robotics – SPDM LEE Lube

- Coordinate Frames
- GCA – clear and concise, direction and distance
- Clearance Concerns
- GCA Complete

### Post EVA

- Suit Doffing
- Tool Reconfig Plan

### Emergencies

- Comm Fail (hand signals), Term EVA, Abort EVA
- EMU Malfunctions
- Lost Tools/Crew Member (velocity and direction)
- DCS – Cuff Classes
- Safer Ops
- Crew Rescue

### Reminders/Top Ten

- Gate Closed, Slider Locked, Tether Reel Unlocked
- QD Discipline – Read Blocks, verify actions (min Block interruptions)
- PGT Read-back, Turns and Torque with light
- Worksite Departure – tethers and tools clear
- Move Slow – no hopping (slower is faster)
- Body Position is Everything (use space)
- Tether Awareness – (special attn: egress, initial xlation, SARJ area, P3/P4 Jumper)
- Suit/Tool Awareness – BRT/PGT/ORU Stowage
- Suit MAL – read down DCM messages
- Discipline and Attention to detail until the end
- Day/Night Cycle Checks (settings, tools, tethers)

### Contingency

- Retrieve and pre-stage appropriate books (FDF, SODF) for NH3 decontam and EMU suit contingencies
- Suspected NH3 Contamination
  - Describe leak
  - EMU Inspection
  - Priorities/Replan (consumables vs EVA objectives)
- Confirmed NH3 Contamination
  - EMU Inspection
  - Priorities/Replan (consumables vs EVA objectives)
- EVA NH3 Ingress

## EVA 2 INHIBIT PAD

### Orbiter

ALL EVAs	
TCS ( <i>Not required, switch guard installed on EVA 1</i> )	
IV L12	1. √TCS POWER – OFF
Ku-Band Antenna ( <i>INCO: Prior to Egress</i> )	
<b>MCC-H</b>	1. √KU-BAND Mask – active 2. √KU-BAND EVA Protect Box – active
RCS ( <i>Not expected since not translating to Payload Bay</i> )	
If EV crew < 27 ft from FRCS	
IV	1. √DAP: VERN, FREE, LO Z
O14,15,16	2. √RJDF F1, F2, F3, F4 MANF DRIVER (four) – OFF LOGIC (four) – OFF
<b>MCC-H</b>	3. √Above RCS config
IV	4. √RCS F – ITEM 1 EXEC (*) √JET DES F1U – ITEM 17 (*) F3U – ITEM 19 (*) F2U – ITEM 21 (*)

### Ground

ALL EVAs	
Ground Radar ( <i>TOPO: Prior to Egress</i> )	
<b>MCC-H</b>	1. √TOPO console, ground radar restrictions in place for EVA

### USOS (1)

ALL EVAs	
PCU ( <i>PHALCON: Prior to Egress</i> )	
<u>NOTE</u>	
PCUs may require up to a 1-hr warmup period before they are operational	
<b>MCC-H</b>	1. √PCUs (two) operational in discharge mode and one of the following: a. CCS PCU EVA hazard control FDIR enabled b. No more than two arrays unshunted and oriented < 105° from velocity vector
	If one or both PCUs failed
	2. No more than two arrays unshunted and oriented < 105° from velocity vector
CUCU ( <i>Crew: Prior to Egress</i> )	
IV – (LAB1O4)	
	1. √cb POWER A, B [two] – OPEN
	2. √cb LINK 1,2 [two] – OPEN
And one of the following inhibit pairs:	
<b>POIC</b>	3a. Express Rack 2 Locker 6 – Power Removed 3b. Express Rack 6 Locker 7 – Power Removed
<b>OR</b>	
IV	4a. Express Rack 2 Locker 6 – OFF 4b. Express Rack 6 Locker 7 – OFF
MISSE 8 ( <i>POD: Prior to Egress</i> )	
<b>POIC</b>	Prior to EV Hatch Open 1. ELC-2 ExPA-2 Discrete Channel 6 – Disabled

## EVA 2 INHIBIT PAD (Cont)

### USOS (2)

#### LOCATION DEPENDENT INHIBITS

Lab Window (*Not expected*)

IV If EV crew less than 10 ft from window or in window FOV, close window shutter

Cupola Windows (*Not expected*)

IV If EV crew less than 10 ft from window, coordinate shutter opening/closing with EV crew and minimize time shutter is open

Mobile Transporter (*ROBO: Prior to Egress*)

**MCC-H** If EV crew < 1.5 meters from MT  
1. √MT latched

#### TASK DEPENDENT INHIBITS

P6 PVTCS Fill (*THOR: Prior to Egress*)

**MCC-H**  
1. Configure Loop for PVTCS Fill  
2. √Final PVTCS Pressure  
3. Provide ATA quantity to IV

### JEM (1)

#### ALL EVAs

ICS-EF Antenna (*Prior to Egress*)

**SSIPC**  
1. ICS MOD – OFF  
2. ICS UPC – OFF  
3. ICS HPA – OFF  
4. HPA ON and UPC ON commands are cleared (not present) in the ICS stored command queue

### COL (1)

#### ALL EVAs

HAM Radio

IV 1. HAM Radio – Deactivate

### RSOS (1)

#### ALL EVAs

SM Antennas (*RIO: Prior to Egress*)

IV 1. ARISS (Ham Radio) – Deactivate  
**MCC-M** 2. GTS – Deactivate  
3. Napor (PCПИ) – Deactivate

### USOS (3)

#### LOCATION DEPENDENT INHIBITS

Port SARJ (*PHALCON: Prior to Egress – will rotate to 250° after first lube*)

**MCC-H** If EV crew working within 2 ft, outboard of SARJ or reqd per loads  
FR  
1. √DLA (1) – LOCKED at 50°  
2. All motor setpoints set to zero  
3. All motors deselected

Port TRRJ (*THOR: Prior to Egress – SPDM LEE Lube*)

**MCC-H** If EV crew working within 2 ft of P1 TRRJ rotation envelope (Includes Node 3 Port Endcone and PMA3)  
1. √DLA 1(2) – LOCKED at 0°  
2. √DLA 2(1) – ENGAGED

Stbd TRRJ (*THOR: Prior to Egress – Radiator Grapple Bar Stow Beams*)

**MCC-H** If EV crew working within 2 ft of S1 TRRJ rotation envelope  
1. √DLA 1(2) – LOCKED at 0°  
2. √DLA 2(1) – ENGAGED

FPMU (*PHALCON: Prior to Egress*)

**MCC-H** If EV crew on Port truss (P1-P6) or working within 5 ft of Floating Potential Measurement Unit  
1. RPCM P11A\_B RPC 13 Open/Close Cmd Inhibit

SSPTS (*Not expected*)

**MCC-H** If EV crew working within 2 ft of SSPTS cables  
1. RPCM LA2A3B D RPC 1 – Open, Close Cmd Inhibit  
2. RPCM Z14B A RPC 2 – Open, Close Cmd Inhibit  
3. RPCM Z13B A RPC 2 – Open, Close Cmd Inhibit



## EVA 2 NOTES/CAUTIONS/WARNINGS

### NOTES

1. Bolt install: Report torque and turns
2. Bolt release: Report torque and turns if different from published range
3. EVA connectors: After disconnection and prior to connection; verify pin and EMI band integrity; verify connector free of FOD
4. Inspect QDs for damage prior to mating
5. Toolbox doors must be closed with one latch per door when EV crew not in immediate vicinity
6. 85-ft safety tether retract force may affect body positioning
7. CETA Cart brake handle wire ties must be replaced after crew loading

### CAUTION

#### ISS Generic Constraints

- A. Avoid inadvertent contact with
1. Grapple fixture shafts (dry lube)
  2. PIP pins
  3. Passive UMAs
  4. MBS/SSRMS/SPDM taped radiative surfaces: VDU, ACU, JEU, LEU, MCU, CRPCMs, and Cameras
  5. SPDM SJEU, EP, OTCM, LEU, and LEE VDU radiator surfaces
  6. OTSD
- B. Electrical cables
1. Avoid bend radii < 10 times cable diameter
- C. Fiber optic cables
1. Avoid bend radii < 10 times cable diameter
  2. Avoid pulling on cable during mate/demate
- D. Fluid line flex hoses and QDs
1. Avoid bend radii < 14 in for hoses with a diameter  $\geq$  1 in
  2. Additional care should be taken to not exceed bend radii when applying loads at the flexible hose to rigid tube stub interfaces
  3. Ensure fluid QD booties are fully closed prior to leaving worksite; wire tie if required
  4. Avoid bend radii < 5 in for hoses with diameter < 1 in on LAB, S0, S1, P1, and 10 in for hoses with diameter < 1 in on all other elements

### CAUTION

#### ISS Generic Constraints (Cont)

- E. For structural reasons
1. Avoid vigorous body motions, quick grabs and kickoffs against tether restraints
  2. Avoid performing shaking motions (sinusoidal functions) more than four cycles
- F. Other
1. ITT Cannon connector: On demated connectors, do not rotate collar or manipulate cable/connector using collar or connector tool
  2. MLI handholds are not rated for crewmember translation loads

## EVA 2 NOTES/CAUTIONS/WARNINGS (Cont)

### CAUTION

#### ISS Truss Constraints

- A. Avoid inadvertent contact with
1. CETA lights (Z-93 paint) [LAB,S1,NODE 1,P3,S3]
  2. Deployed TUS cable [Zenith and Nadir CETA rails]
  3. S0 aft face radiator
  4. GPS antennas (S13 paint) [S0,JLP]
  5. UHF antennas [LAB,P1]
  6. ETCS radiator flexhoses and panels [S1,P1]
  7. EETCS/PV radiator flexhoses, bellows and panels [P6,P4,S4,S6]
  8. SASA RF group [S1,P1]
  9. Heat pipe radiators [Z1]
  10. PCU cathode and HCA ports [Z1]
  11. Ku-Band antenna (SGANT) dish [Z1]
  12. CMG cover/shells [Z1]
  13. FPMU [P1]
  14. SASA high and low gain antennas and radiator surfaces [Z1]
  15. Deployed MISSEs
  16. OTP on HAB Tray [S0]
- B. For structural reasons
1. Avoid kicking S1/P1 radiator beam. If any of these occur, wait 2 to 5 min to allow structural response to dissipate

### CAUTION

#### ISS Truss Constraints (Cont)

- C. Other
1. EWIS antennas: Do not use as handholds [NODE 1,LAB,P6,Z1]
  2. Lubricant from Ku-Band SGANT gimbals [Z1], CMGs [Z1], and RTAS ground strap fasteners [P6,P4,S4,S6] can contaminate EMU
  3. Prevent inadvertent contact of the tether shuttle with ETRS when the P3 tether shuttle stop is raised away from the rail

### CAUTION

#### ISS U.S. Pressurized Elements Constraints

- A. Avoid inadvertent contact with
1. EVA crane [PMA1]
  2. TCS reflectors [PMA2,PMA3]
  3. APAS hardware [PMA2,PMA3]
  4. CETA lights (Z-93 paint) [LAB,S1,NODE 1,P3,S3]
  5. UHF antennas [LAB,P1]
  6. Open CBM petal covers, LAB and Cupola window shutters
  7. S0/NODE 2 fluid tray hardlines at NODE 2 end, which are limited to 25 lb
- B. Other
1. EWIS antennas: Do not use as handholds [NODE 1,LAB,P6,Z1]
  2. CBM petal covers may not be used as handholds unless both launch restraint pins are engaged

## EVA 2 NOTES/CAUTIONS/WARNINGS (Cont)

### CAUTION

#### **ISS I.P. Elements Constraints**

##### COL

- A. Avoid inadvertent contact with
1. COL ARISS and AIS antennas [COL-Nadir]

##### JEM

- A. Avoid inadvertent contact with
1. GPS antennas (S13 paint) [S0,JLP]
  2. Open JPM window shutter
  3. JTVE, WVE/EVE, JEF VE cameras
  4. JEMRMS taped radiative surfaces [JEU,EE,Cameras]
  5. JEM A/L target and pins
  6. JEF ORUs and EFUs (paint and lubricant)
  7. MAXI front and top panel (paint)
  8. SEDA-AP sensors (HIT, SDOM, and AOM)
  9. Trunnions and UCMs (paint and lubricant) [JEF Payloads]
  10. RAIDS covers on end of HREP
  11. ICS-EF Ka-Band antenna dish
  12. Small Fine Arm (SFA) (paint, coating and lubricant)
- B. For structural reasons
1. Avoid kicking MMOD shields between JLP and JPM
  2. Avoid tool impact on ICS-EF sensor

### CAUTION

#### **Shuttle Constraints**

- A. Avoid inadvertent contact with
1. OBSS and SRMS composite sections joint torque arms, grapple fixture shafts, and cable harnesses
  2. LCS (silver Teflon) and LDRI (silver Teflon) and ITVC (gold foil) [OBSS]
  3. WVS antenna [ODS truss and PLB sill]
  4. Payload bay and camera wire harnesses, cables, cable guides, and connectors
  5. OBSS striker bars (drylube)
- B. No touch
1. LDRI diffuser [OBSS]
  2. OBSS saddle contacts (when OBSS unberthed) [OBSS]
  3. Monkey fur [PLB]
  4. Cameras: Metallic surfaces [PLB]
  5. Ku-Band antenna black dish and gold thermal blankets [PLB]

## EVA 2 NOTES/CAUTIONS/WARNINGS (Cont)

### WARNING

#### ISS Generic Constraints

- A. Avoid inadvertent contact with
1. Grapple fixture targets and target pins
- B. Pinch
1. NZGL connector linkage. Use caution when mating/locking
  2. ITT Cannon connector rotating housing
  3. PDGF connector doors
- C. QDs
1. If QD is in FID when valve is opened (bail fwd), QD will leak and fluid line may whip
  2. Do not rotate if in mated/valve open configuration
  3. Bail may kick back suddenly when detent button is depressed if pressure has built up in spring cavity
- D. Sharp Edges
1. Inner edges of WIF sockets
  2. APFR active WIF probes
  3. Mating surfaces of EVA connectors  
Avoid side loads during connector mating
  4. Back side of MMOD shield fasteners
  5. Spring loaded captive EVA fasteners (e.g., 6B-boxes, BMRRM, RTAs, SARJ Covers); the end of the spring may protrude
  6. SPDM OTCM gripper jaws
  7. Keep hands away from SSRMS LEE/POA/SPDM LEE opening, snares, and PDGF curvic coupling (teeth)
  8. MMOD strikes on ISS exterior

### WARNING

#### ISS Generic Constraints (Cont)

- E. Thermal
1. EVA connectors with booties may become hot if left uncovered. Handling may need to be limited
  2. Turn off glove heaters when comfortable temperature reached to prevent bladder damage. Do not pull fingers out of gloves when heaters are on
  3. Uncovered trunnion pins may be hot
  4. SSRMS/MBS/SPDM operating cameras and lights may radiate large amounts of heat
  5. Do not touch EMU protective visor if temperature has been  $< -134$  degF for  $> 15$  min
  6. No EMU boot contact with foot restraint when temperature  $< -120$  degF or  $> 200$  degF
  7. PDGF surfaces may not meet touch temperature requirements for unlimited contact when  $\beta \leq -70$  or  $\beta \geq 70$

### WARNING

#### ISS Truss Constraints

- A. Avoid inadvertent contact
1. SSU, ECU, beta gimbal platform, mast canister, SAW blanket boxes unless the beta gimbal is locked and the motor is turned off
  2. Stay inboard of SARJ when active
  3. Stay 2 ft from S1/P1 radiator beam rotational envelope when beam is free to rotate
  4. Stay 5 ft from moving MT on face 1
  5. Stay 3.3 ft from Ku-Band (SGANT antenna) when powered
  6. Stay 1 ft from top of STP-H3 (ELC3)
  7. Deployed MISSEs and ORMATE-III R/W
- B. RF radiation exposure
1. Stay 3.8 ft from S-Band (SASA) high gain antenna when powered [S1,P1]
  2. Stay 1.3 ft from S-Band (SASA) low gain antenna when powered [S1,P1]
  3. Stay 1 ft from UHF antenna when powered [LAB,P1]
- C. Sharp Edges
1. Solar array blanket box [P6,S6]
  2. Fastener threads on back of Z1 U-jumper male FQD panel, if nutplate cap missing
  3. Outboard MT rail attachment lug near P6 handrail 5333 and gap spanner
  4. P2 connector on EWIS box TAA-06 [Zenith/Forward Corner 1 of P5 – SARJ at 0 deg]
  5. Nickel coated braided copper ground straps may contain frayed wires [P6,P4,S4,S6]
  6. MMOD strikes on Z1 toolboxes
  7. POA FSE (CSA logo below MBS mast camera)
  8. AMS Star Trackers Baffles (2)

## EVA 2 NOTES/CAUTIONS/WARNINGS (Cont)

### WARNING

#### ISS Truss Constraints (Cont)

##### D. Electrical Shock

1. Stay  $\geq$  2 ft from ungrounded floating connectors if powered  
S0 EVA power cables (inside S0 Bay 00 Face 4, Bay 01 Face 3)  
ESP-2 jumper (inside S0 Bay 03 Face 4)

##### E. Thermal

1. ELC may exceed touch temperatures when  $\beta > 75$  deg

### WARNING

#### ISS U.S. Pressurized Elements Constraints

##### A. Handrails

1. Handrails previously used for MISSE attachment may not be used as a safety tether point [A/L endcone 564 and 566, A/L Tank 2 Nad/Fwd and Port/Fwd, P6 5389]

##### B. Pinch

1. EV side of IV Hatch during Hatch operation (also snag hazard) [A/L]
2. LAB and Cupola window shutters and CBM petal cover linkages during operation

##### C. RF radiation exposure

1. Stay 1 ft from UHF antenna when powered [LAB,P1]

##### D. Sharp Edges

1. PMA umbilical launch restraints - exposed bolt threads
2. Adjustable fuse tether (Fish Stringer) buckles stowed in Node bag
3. Port/Aft portion of A/L circular HR [HR 0506]
4. A/L HR 0537 (Eq Lock Zenith)
5. ESP-2 HR 8012
6. PMM ROEU and ROFU panels (zenith endcone)

### WARNING

#### ISS U.S. Pressurized Elements Constraints (Cont)

##### E. Thermal

1. PMA handrails may be hot. Handling may need to be limited
2. Stay  $\geq$  1 ft away from PMAs and MMOD shields  $> 270$  degF if EMU sun visor up; limit time to 15 min or less if  $> 300$  degF
3. Stay at least 0.5 ft away from PMA and MMOD shields  $> 325$  degF
4. No EMU TMG contact with PMAs and MMOD shields  $> 320$  degF

##### F. Electrical Shock

1. Stay  $\geq$  2 ft from ungrounded floating connectors if powered  
SSPTS connectors include NOD1 Stbd/Fwd HR 0130, LAB Stbd/Fwd HR 0273, PMA2 Stbd

##### G. Fluid QDs

1. Do not translate on gap spanners restraining NODE 3 – LAB NH3 jumpers

## EVA 2 NOTES/CAUTIONS/WARNINGS (Cont)

### WARNING

#### ISS I.P. Elements Constraints

##### COL

- A. Avoid inadvertent contact with
  - 1. SOLAR [COL EPF]
- B. Thermal
  - 1. Columbus end cones may violate touch temperature constraints when  $-75 \leq \beta \leq -60$  or  $60 \leq \beta \leq 75$

##### JEM

- A. Avoid inadvertent contact with
  - 1. ICS-EF sensors
- B. Pinch
  - 1. JPM window shutter linkages during operation
  - 2. JEM cameras (JVTEs, EVE, WVE, and JEF VEs)
  - 3. JEM EFU latching arms
  - 4. JEF SSE latch
  - 5. ICS-EF antenna boom
  - 6. SEDA-AP mast
  - 7. SMILES antenna rotating area
  - 8. HREP hinge sides and RAIDS pinch areas
  - 9. JEMRMS EE
  - 10. JEMRMS Small Fine Arm (SFA) joints and booms

### WARNING

#### ISS I.P. Elements Constraints (Cont)

##### JEM (Cont)

- C. Sharp Edges
  - 1. Interior of JEMRMS HRMs
  - 2. JEMRMS EE opening and snares
  - 3. JEM A/L hatch corners
  - 4. ICS-EF AHM gears
  - 5. MAXI visual star camera
  - 6. SMILES baffles (two), baffle base bare bolts, and Cold Sky Terminator (CST)
  - 7. HREP baffles (four) [Star tracker aperture Zenith and three instrument baffles Aft]
  - 8. SFA Electro-Mechanical GF (EMGF)
- D. RF radiation exposure
  - 1. Stay 0.3 ft from Fwd/Aft JPM PROX antenna
- E. Thermal
  - 1. JPM Port End Cones and JLP Port Nadir may violate touch temperature constraints when  $\beta > 60$  deg
  - 2. JEMRMS/JTVE/JEFVE operating cameras and lights may radiate large amounts of heat

### WARNING

#### Shuttle Constraints

- A. Arcing/Molten Debris
  - 1. Stay  $\geq 2$  ft from exposed EFGF connector when OBSS berthed, powered, and EFGF not grappled [PLB]
  - 2. Stay  $\geq 2$  ft from exposed Stbd Fwd MPM contacts [PLB]
  - 3. Stay above PLB sill when within 1 ft of powered ROEU connector [PLB]
- B. Pinch
  - 1. PRLA operation [PLB]
- C. RF radiation exposure
  - 1. Stay 3.28 ft from S-Band antenna when powered
  - 2. Stay 1 ft from top and side of UHF PLB antenna radome surface when in high powered mode [ODS truss]
  - 3. Stay 0.33 ft from top and side of UHF PLB antenna radome surface when in low powered mode [ODS truss]
  - 4. Remain below the level of the PLB door mold line for first 20 in Aft of Fwd bulkhead when S-Band antenna powered [PLB]
  - 5. Remain on the inboard side of the Stbd slidewire (sill handrails if slidewire not installed) for first 20 ft Aft of Fwd bulkhead when Ku-Band antenna powered [PLB]

## EVA 2 NOTES/CAUTIONS/WARNINGS (Cont)

### WARNING

#### **Shuttle Constraints (Cont)**

##### D. Sharp Edges

1. PRLA grounding wipers [PLB]
2. LDRI baffles (also an entrapment hazard) [OBSS]
3. Keep hands away from SRMS EE opening and snares
4. TCS connector backshells have exposed threads [ODS]

##### E. Thermal

1. Illuminated PLB lights; do not touch
2. OBSS grapple fixture shafts/cams may be hot. Limit handling if required
3. Stay 27 ft from PRCS when powered
4. Stay 3 ft from VRCS when powered
5. Stay 3 ft from APU when operating

##### F. Contamination

1. Stay out of the immediate vicinity of leaking jet or APU

##### G. Lasers

1. Do not look at LDRI diffuser or LCS laser aperture window

## EVA 2 EGRESS/SETUP (00:35)

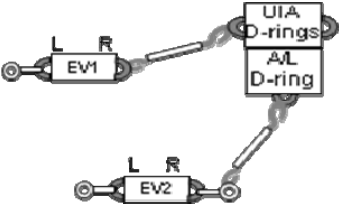
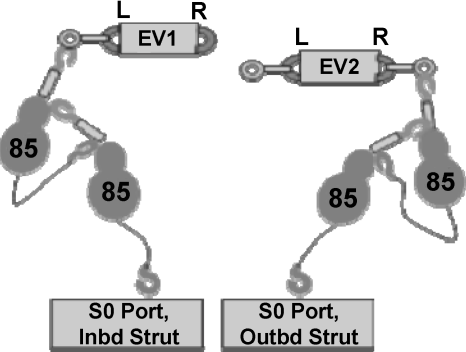

IV/SSRMS	EV1 (Drew)	EV2 (Spanky)
<ol style="list-style-type: none"> <li>Record PET Start time __ : __ (Pwr to Batt)</li> <li>DAY/NIGHT Cycles _____</li> </ol>  <ol style="list-style-type: none"> <li>Start WVS Recorders</li> <li>Start Hatch Thermal Cover clock PET (30 min) __ : __</li> <li>Inspect Load Alleviating Straps for: <ol style="list-style-type: none"> <li>MMOD/general damage</li> <li>Discoloration</li> <li>Tack Stitching</li> <li>Red Band</li> </ol> </li> </ol> 	<p><b>Initial Configuration:</b></p> <ol style="list-style-type: none"> <li>√All gates closed &amp; sliders locked  <input type="checkbox"/> R Waist Tether to UIA D-ring</li> </ol> <p><u>EGRESS</u> (00:25)</p> <ol style="list-style-type: none"> <li>Partially egress A/L hatch to allow EV2 to attach the <b>RED</b> hook to L D-ring ext</li> <li>On <b>EV2 GO</b>, release Waist Tether from UIA D-ring</li> <li>Transfer Beam ORU bag to EV2</li> <li>Transfer SARJ bag bundle to EV2</li> <li>Pre-stage empty Lg-sm RETs on A/L int D-ring ext</li> <li>Egress A/L</li> </ol>	<p><b>Initial Configuration:</b></p> <ol style="list-style-type: none"> <li>√All gates closed &amp; sliders locked  <input type="checkbox"/> R Waist Tether to A/L int D-Ring ext</li> </ol> <p><u>EGRESS</u> (00:25)</p> <ol style="list-style-type: none"> <li>Open hatch thermal cover</li> <li>Egress A/L</li> <li>Perform LAS inspection on EV1 ST Pack (aft D-ring)  <input type="checkbox"/> LAS; <input type="checkbox"/> √Yellow hook on Green ERCM  <input type="checkbox"/> LAS; <input type="checkbox"/> √Green hook on Red ERCM</li> <li>RET to ST Pack on aft D-ring</li> <li>Attach <b>RED</b> hook to EV1 L D-ring ext  <input type="checkbox"/> √Gate closed, slider locked, reels unlocked, release RET</li> <li>Give <b>EV1 GO</b> to release Waist Tether</li> <li>Perform LAS inspection on EV2 ST Pack  <input type="checkbox"/> LAS; <input type="checkbox"/> √Yellow hook on Green ERCM  <input type="checkbox"/> LAS; <input type="checkbox"/> √Green hook on Red ERCM</li> <li>RET to ST Pack on fwd curved HR stanchion</li> <li>Attach <b>RED</b> hook to R D-ring ext  <input type="checkbox"/> √Tether routing in front (right side)  <input type="checkbox"/> √Gate closed, slider locked, reels unlocked, release RET</li> <li>Release Waist tether from A/L int D-ring ext</li> <li>Receive and temp stow Beam ORU bag on HR_____</li> <li>Receive SARJ bag bundle, stow on BRT w/RET</li> </ol>



**EVA 2 EGRESS/SETUP (00:35) (Cont)**

IV/SSRMS	EV1 (Drew)	EV2 (Spanky)
<p>6. Post crew egress: WVS Software:   Select page – RF camera   Sel 'Advanced Controls'   S-Band Level (two) – Max</p> <p>7. Stop Hatch Thermal Cover clock PET (30 min) __ : __</p>	<p>8. Perform buddy checks   √MWS tabs up, BRT tab up, tether configs</p> <p>9. Verify SAFER config   <input type="checkbox"/> √L handle down (MAN ISOL Vlv – Open)   <input type="checkbox"/> √R handle down (HCM – Closed)</p> <p>10. √WVS – green LED</p> <p>11. Close hatch thermal cover</p> <p><u>SETUP</u> (00:10)</p> <p>12. Translate zenith on A/L to Vent Tool Extension Bag (VTEB)</p> <p>13. Attach VTEB to BRT w/RET</p> <p>14. Translate to P3 Face 6, nadir route</p> <p>15. Attach <b>GREEN</b> hook to P3 HR 3861 (bay 22)   <input type="checkbox"/> √Gate closed, slider locked, reels unlocked, release RET</p> <p>(Translate to P3 QD M2 – P3/P4 Jumper)</p>	<p>14. Perform buddy checks   √MWS tabs up, BRT tab up, tether configs</p> <p>15. Verify SAFER config   <input type="checkbox"/> √L handle down (MAN ISOL Vlv – Open)   <input type="checkbox"/> √R handle down (HCM – Closed)</p> <p>16. √WVS – green LED</p> <p><u>SETUP</u> (00:10)</p> <p>17. Translate to P3 Face 2, zenith route   <input type="checkbox"/> √Lab strut ST anchor hooks   <input type="checkbox"/> Start zenith Bay 10 (fairlead tether)</p> <p>18. Attach <b>GREEN</b> hook to P3 HR 3852 (bay 22)   <input type="checkbox"/> √Gate closed, slider locked, reels unlocked, release RET</p> <p>19. Translate zenith/aft to Face 4</p> <p>20. Stow SARJ bag bundle on P3 HR 3842 and HR 3849 (Diag Strut Face 4)</p> <p>(Translate to P4 HR 5123 – P3/P4 Jumper)</p>

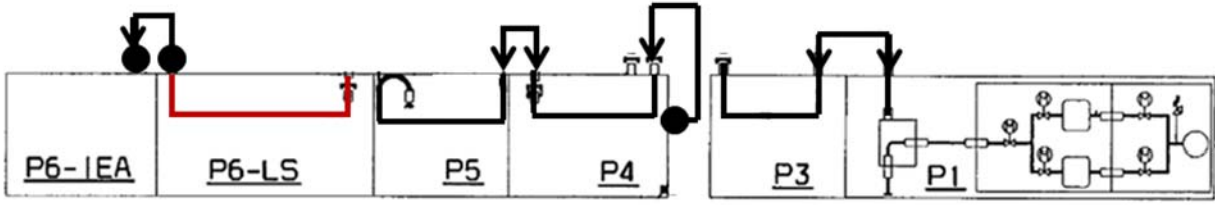
## P3/P4 NH3 JUMPER RE-ROUTE (00:15)

IV/SSRMS	EV1 (Drew)	EV2 (Spanky)
<p>Planned PET 00:35</p>	<p><b>Post EVA 1 Jumper Config:</b></p>  <div data-bbox="787 544 1848 706" style="border: 1px solid black; padding: 5px;"> <p style="text-align: center;"><b>CAUTION</b></p> <ul style="list-style-type: none"> <li>• QDs exposed to direct sun can overtemp in 20 min. Shading by EMU or thermal shrouds can lengthen acceptable time with bootie removed</li> <li>• P3/P4 Jumper exposed to sun can become dangerously hot, use caution</li> <li>• P3/P4 Jumper QD stems can break with excessive force; use caution when handling</li> </ul> </div> <p style="text-align: center;"><b>NOTE</b></p> <p style="text-align: center;">Do not route safety tether underneath P3/P4 jumper connector</p> <div style="display: flex; justify-content: space-between;"> <div data-bbox="619 828 1312 1404" style="width: 48%;"> <p><u>P3/P4 NH3 JUMPER RE-ROUTE (00:15)</u></p> <ol style="list-style-type: none"> <li>1. Translate nadir to QD M2 on P3 outbd panel A502 (face 6)</li> <li>2. Attach RET to P3 HR 3860 (notify IV _____)</li> <li>3. RET, remove cap from QD M2</li> <li>4. Translate nadir/aft to P4 inbd bulkhead M2 dummy male</li> <li>5. RET, receive QD F2 from EV2</li> <li>6. Translate to QD M2 on P3 panel A502 (face 6)</li> <li>7. Mate and open QD F2 to M2 on panel A502 per <b>BLOCK B</b> and <b>BLOCK C</b> (HR 3860 if BRT reqd) (1/4")</li> <li>8.  Visually inspect jumper connections</li> <li>9. Glove and Gauntlet Check</li> </ol> <p style="text-align: center;">(Translate to P6 Long Spacer – Stow VTEB)</p> </div> <div data-bbox="1312 828 2005 1404" style="width: 48%;"> <p><u>P3/P4 NH3 JUMPER RE-ROUTE (00:15)</u></p> <ol style="list-style-type: none"> <li>1. Translate to P4 HR 5123 (IEA Radiator sidewall)</li> <li>2. Remove wire tie from P3/P4 jumper line, stow in trash bag</li> <li>3. Translate to P4 inbd bulkhead M2 dummy male</li> <li>4. Open TA clamp</li> <li>5. Demate QD F2 per <b>BLOCK A</b> (HR 5110 if BRT reqd) (1/4")</li> <li>6. Transfer QD F2 to EV1; watch jumper line as it is routed</li> <li>7. Glove and Gauntlet Check</li> </ol> <p style="text-align: center;">(Translate to P3 face 2 – ATA Fill Config)</p> </div> </div>	

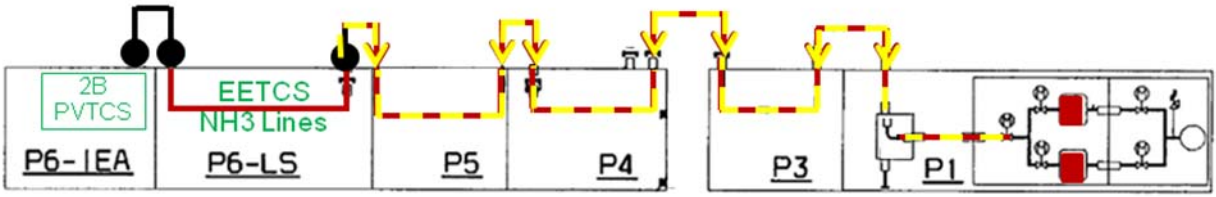

PVTCS NH3 FILL (01:00)/CONFIGURE ATA (00:25) (Cont)

IV/SSRMS	EV1 (Drew)	EV2 (Spanky)
<p>EV1: Cribsheet EVA 2: Blocks J, K  <b>MCC-H:</b> Report EV2 is GO to leave worksite (~2.5 min)</p> <p>2. Give <b>EV2 GO</b> to leave from P1 ATA worksite</p> <p><b>MCC-H:</b> Report leak check complete (~5 min)</p> <p>3. Give <b>EV1 GO</b> to open P5/P6 Jumper</p>	<p style="text-align: center;"><b>Current Jumper Config During Leak Check</b></p>  <p>4. Remove cap from P6 M14 (HR 5309 if BRT reqd)  5. Demate QD F14 from dummy M14 per <b>BLOCK A</b> (1")  6. Mate QD F14 to P6 M14 per <b>BLOCK B (DO NOT OPEN)</b></p> <p>7. On <b>IV GO</b>, open QD F14 to P6 M14 per <b>BLOCK C</b>  (Translate to P6 EAS Jumper FH-02)</p>	<p>11. If observe any leaks or on <b>MCC-H GO</b>, perform the following close valve steps on QD F185/M1:  a. Press detent button, move bail aft  b. √Fwd white band visible; √detent button up  c. Contact <b>MCC-H</b></p> <p>12. On <b>IV GO</b>, close bootie on QD F185 at M1</p> <p>13. Translate to P3 Face 2, zenith route  14. Attach <b>GREEN</b> hook to P3 HR 3852 (bay 22)  <input type="checkbox"/> √Gate closed, slider locked, reels unlocked, release RET</p> <p>(Translate to P3 SARJ, Face 4 – SARJ Cover Removal)</p>

PVTCS NH3 FILL (01:00)/CONFIGURE ATA (00:25) (Cont)

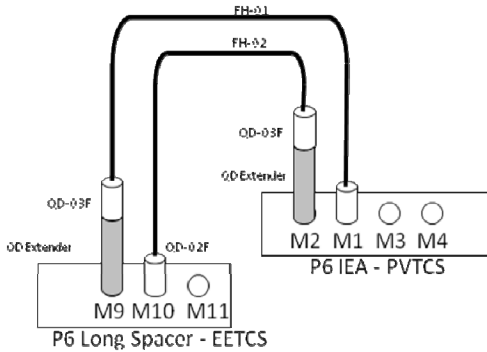
IV/SSRMS	EV1 (Drew)	EV2 (Spanky)
<p>EV1: Cribsheet EVA 2: Blocks L, M, &amp; N</p> <p><b>EAS Jumper Diagram</b></p>  <p>The diagram illustrates the EAS Jumper configuration. It shows two main sections: 'P6 Long Spacer - EETCS' and 'P6 IEA - PVTCS'. The EETCS section contains ports M9, M10, and M11, with a 'QD-02F' and 'QD Extender' connected to M10. The PVTCS section contains ports M2, M1, M3, and M4, with a 'QD-02F' and 'QD Extender' connected to M2. Two jumper cables, FH-01 and FH-02, connect the QD-02F ports between the two sections. FH-01 connects the PVTCS QD-02F to the EETCS QD-02F. FH-02 connects the EETCS QD-02F to the PVTCS QD-02F.</p>	<div style="border: 2px solid black; padding: 5px; text-align: center;"> <p><b>WARNING</b> Sharp Edge on P6 MT Lug Near EAS Jumpers (near P6 HR 5333)</p> </div> <p><u>OPEN EAS JUMPER/FILL PVTCS (00:15)</u></p> <ol style="list-style-type: none"> <li>8. Translate to P6 EAS Jumper FH-02</li> <li>9. Open thermal bootie on QD-02F at M10 <ul style="list-style-type: none"> <li><input type="checkbox"/> <input checked="" type="checkbox"/> Detent button fully installed</li> </ul> </li> <li>10. Open QD-02F at M10 per <b>BLOCK C</b> (HR 5327 if BRT reqd) (1")</li> <li>11. Open QD Extender at M2 per <b>BLOCK C</b></li> </ol> <p>ATA fills P6 PVTCS (~10 min)</p> <p><u>NH3 VENT TOOL SETUP (00:20)</u></p> <ol style="list-style-type: none"> <li>12. Translate to VTEB on P6 HR 5322</li> <li>13. Retrieve and attach MUT EE to P6 HR 5321 (straight on HR) <ul style="list-style-type: none"> <li><input type="checkbox"/> <input checked="" type="checkbox"/> Locked</li> <li><input type="checkbox"/> Clock L-bracket so it is parallel to HR</li> </ul> </li> <li>14. Attach vent tool extension (VTE) to L-bracket <ul style="list-style-type: none"> <li><input type="checkbox"/> <input checked="" type="checkbox"/> French hook attached to bracket</li> <li><input type="checkbox"/> <input checked="" type="checkbox"/> VTE inbd of MUT EE</li> <li><input type="checkbox"/> Clock nozzle such that it points ISS Zenith/Fwd and away from all structure and solar arrays</li> </ul> </li> <li>15. Remove plug from VTE (stays in VTEB) <ul style="list-style-type: none"> <li><input type="checkbox"/> Rotate lock lever to unlock (hard stop detent – very loose)</li> <li><input type="checkbox"/> Depress lever to hard stop (2-10 lb)</li> </ul> </li> <li>16. Prior to attaching 1.0" Vent Tool to VTE, perform visual check that vent tool nozzle will protrude past VTE internal seals: <ul style="list-style-type: none"> <li><input type="checkbox"/> Hold vent tool nozzle against VTE external alignment groove (vent tool hook should contact VTE connector)</li> <li><input type="checkbox"/> <input checked="" type="checkbox"/> Nozzle tip is past thin black alignment line</li> </ul> </li> </ol>	

PVTCS NH3 FILL (01:00)/CONFIGURE ATA (00:25) (Cont)

IV/SSRMS	EV1 (Drew)	EV2 (Spanky)
<p><i>MCC-H: Report when fill complete</i></p> <p>EV1: Cribsheet EVA 2: Blocks O, P, Q, R</p> <p>4. On <b>MCC-H GO</b>, give <b>EV1 GO</b> to close QD Extender at M2</p>	<p>17. Install vent tool nozzle into VTE connector:</p> <ul style="list-style-type: none"> <li><input type="checkbox"/> Rotate lock lever to unlock (hard stop detent – very loose)</li> <li><input type="checkbox"/> Depress lever to hard stop (2-10 lb)</li> <li><input type="checkbox"/> Insert vent tool nozzle into connector tube (vent tool hook will contact front of connector; go to hard stop)</li> <li><input type="checkbox"/> Release lever and rotate to lock</li> </ul> <p>18. Retrieve vent tool adapter from VTEB</p> <p>19. Remove 1 cap from vent tool adapter</p> <p>20. Remove plug from vent tool QD (1", no collar)</p> <p>21. Mate vent tool adapter to vent tool QD per <b>BLOCK B</b></p> <p>22. Open vent tool QD valve per <b>BLOCK C</b></p> <p>23. Temp stow vent tool adapter at VTEB worksite</p> <p>24. Translate to P6 EAS Jumper at M2</p> <p>25. On <b>IV GO</b>, close and demate QD Extender at M2 per <b>BLOCK D</b> and <b>BLOCK A</b> (1")</p> <p>26. <input type="checkbox"/> Perform visual inspection of QD; report if leaking</p> <p>27. Install plug on QD Extender</p> <p>28. Tether QD Extender bail to M1 bail w/Adj tether</p> <p>29. Install cap on M2</p> <ul style="list-style-type: none"> <li><input type="checkbox"/> <input checked="" type="checkbox"/> All booties installed before leaving workstation</li> </ul> <p><u>INITIATE P1-P5 JUMPER VENT</u> (00:10) (HR 5309 if BRT reqd)</p> <p style="text-align: center;"><u>NOTE</u></p> <p>Big picture: IV closing ATA valve for P1-P5 vent. Minimize comm during operations</p> <div style="border: 3px double black; padding: 5px; margin-top: 10px;"> <p style="text-align: center;"><b>WARNING</b></p> <p>When P1-P5 line is isolated from accumulator during a day pass, NH3 in line can overtemp in 2.5 min. If there is difficulty opening QD valve, IV re-open ATA valve. (ref. <u>1.106 P1-P5 JUMPER VENT ECLIPSE CONSTRAINT WORKAROUND</u>) (SODF: ASSY OPS)</p> </div>	

PVTCS NH3 FILL (01:00)/CONFIGURE ATA (00:25) (Cont)

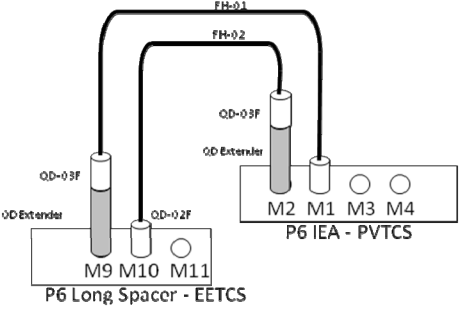

IV/SSRMS	EV1 (Drew)	EV2 (Spanky)
<p>EV1: Cribsheet EVA 2: Block S, T, U</p> <p>5. When QD F14 mated to vent tool adapter (not open), close ATA valve (ref. <u>1.106 P1-P5 JUMPER VENT ECLIPSE CONSTRAINT WORKAROUND</u>) (SODF: ASSY OPS)</p> <p>6. Give <b>EV1 GO</b> to open QD F14 valve</p> <p><i>Jumper line vents (~17 min)</i></p>	<p>30. Translate to VTEB, retrieve vent tool adapter w/Adj tether</p> <p>31. Translate inbd to P6-LS QD F14 at M14, tending vent lines</p> <p>32. Stow vent tool adapter with adj tether on HR 5309</p> <p>33. Remove cap from vent tool adapter</p> <p>34. Close and demate P6 QD F14 per <b>BLOCK D</b> and <b>BLOCK A</b> (1")</p> <p>35. Mate QD F14 to vent tool adapter per <b>BLOCK B</b>, adjust adj equip tether as reqd (<b>DO NOT OPEN</b>)</p> <p>36. On <b>IV GO</b>, open valve on QD F14 per <b>BLOCK C</b></p> <p>37. Reinstall cap on P6 M14</p> <p>38. Attempt to shade QD F14/vent tool as much as possible during vent with bootie and structure</p> <p>39. Translate inbd to assist EV2 with SARJ Lube as reqd (FS 7-__)</p>	

## EAS JUMPER SETUP/VENT (00:30)

IV/SSRMS	EV1 (Drew)
<p>Planned PET 02:20  <b>MCC-H: Report when vent complete</b></p> <ol style="list-style-type: none"> <li>On <b>MCC-H GO</b>, give <b>EV GO</b> to close QD</li> </ol> <p>EV1: Cribsheet EVA 2: Block V</p> <ol style="list-style-type: none"> <li>If eclipse, give <b>EV1 GO</b> to vent</li> </ol>  <p>The diagram shows two panels: 'P6 Long Spacer - EETCS' on the left and 'P6 IEA - PVTCS' on the right. The left panel has ports M9, M10, and M11. The right panel has ports M2, M1, M3, and M4. Two QD Extenders are shown: one connected to M9 and another to M10. Two hoses, FH-01 and FH-02, connect the QD Extenders to the right panel. FH-01 connects to M2, and FH-02 connects to M1. A QD-03F is also shown connected to M2.</p> <p>EV1: Cribsheet EVA 2: Block Y</p>	<p><b>VENT TOOL RECONFIG (00:10)</b></p> <ol style="list-style-type: none"> <li>Glove and Gauntlet check</li> <li>Translate to P5 QD F14 near P6 Long Spacer</li> <li>On <b>IV GO</b>, close QD F14 per <b>BLOCK D</b></li> <li>Demate QD F14 from vent tool adapter per <b>BLOCK A</b></li> <li>Mate QD F14 to P5 dummy panel M14 per <b>BLOCK B (DO NOT OPEN)</b></li> <li>Install cap on vent tool adapter</li> </ol> <div style="border: 1px solid black; padding: 5px; margin: 10px 0;"> <p style="text-align: center;"><u>CAUTION</u></p> <p>Initiate EAS Jumper vent only during eclipse to prevent trapping NH3 in jumper lines at high temperatures. Use caution when rotating EAS QD to vent position</p> </div> <p style="text-align: center;"><u>NOTE</u></p> <p style="text-align: center;">Check bail handle clocking for each QD on EAS jumper before manipulation</p> <p><b>EAS JUMPER VENT (00:10)</b> (HR 5334 if BRT reqd)</p> <ol style="list-style-type: none"> <li>Translate to P6 EAS Jumpers with vent tool adapter <ul style="list-style-type: none"> <li><input type="checkbox"/> √Vent line as translating</li> </ul> </li> <li>Stow vent tool adapter to HR 5327 using adj tether; adjust as reqd</li> <li>Remove cap from vent tool adapter</li> </ol> <ol style="list-style-type: none"> <li>On <b>IV GO</b>, close QD-02F at M10 per <b>BLOCK D</b></li> <li>Remove plug from QD Extender on QD-03F by pulling back on release ring <ul style="list-style-type: none"> <li>√Fwd white band not visible</li> </ul> </li> <li>Mate QD Extender to vent tool adapter per <b>BLOCK B</b>; adjust adj tether as reqd</li> <li>Open valve on QD Extender per <b>BLOCK C</b></li> </ol> <p style="text-align: center;"><i>Jumper line vents (~3.5 min)</i></p> <ol style="list-style-type: none"> <li>Remove cap from M3</li> <li>Remove cap from M11</li> </ol>

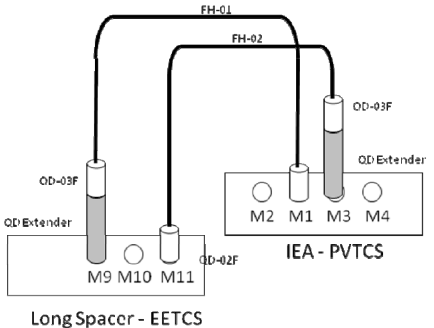

## EAS JUMPER SETUP/VENT (00:30) (Cont)

IV/SSRMS	EV1 (Drew)
<p><b>MCC-H:</b> Report when vent complete</p> <p>3. On <b>MCC-H GO</b>, give <b>EV1 GO</b> to close QD</p> <p>EV1: Cribsheet EVA 2: Blocks W, X</p> <p><b>Final EAS Jumper Config</b></p>  <p>The diagram illustrates the final EAS Jumper configuration. It shows two main components: a 'Long Spacer - EETCS' and an 'IEA - PVTCs'. The Long Spacer has three ports labeled M9, M10, and M11. The IEA has four ports labeled M2, M1, M3, and M4. Two 'QD Extender' units are connected to the Long Spacer: one to M9 and M11, and another to M1 and M3. Two hoses, labeled FH-01 and FH-02, connect the QD Extenders to the IEA ports. FH-01 connects the top of the first QD Extender to M2 on the IEA. FH-02 connects the top of the second QD Extender to M4 on the IEA. There are also two 'OD-03F' ports on the QD Extenders.</p>	<p><b>EAS JUMPER RECONFIG (00:10)</b></p> <ol style="list-style-type: none"> <li>16. On <b>IV GO</b>, close QD Extender per <b>BLOCK D</b></li> <li>17. Demate QD Extender from vent tool adapter per <b>BLOCK A</b></li> <li>18. Mate QD Extender to M3 per <b>BLOCK B (DO NOT OPEN)</b></li> <li>19. Retrieve Adj tether from QD Extender</li> <li>20. Demate QD-02F at M10 per <b>BLOCK A</b></li> <li>21. Mate QD-02F to M11 per <b>BLOCK B (DO NOT OPEN)</b></li> <li>22. Install cap on M10</li> <li>23. Install cap on vent tool adapter</li> <li>24.  Visually inspect jumper connections</li> </ol> <p style="text-align: right;">(Translate to VTEB – Vent Tool Bag Cleanup)</p>

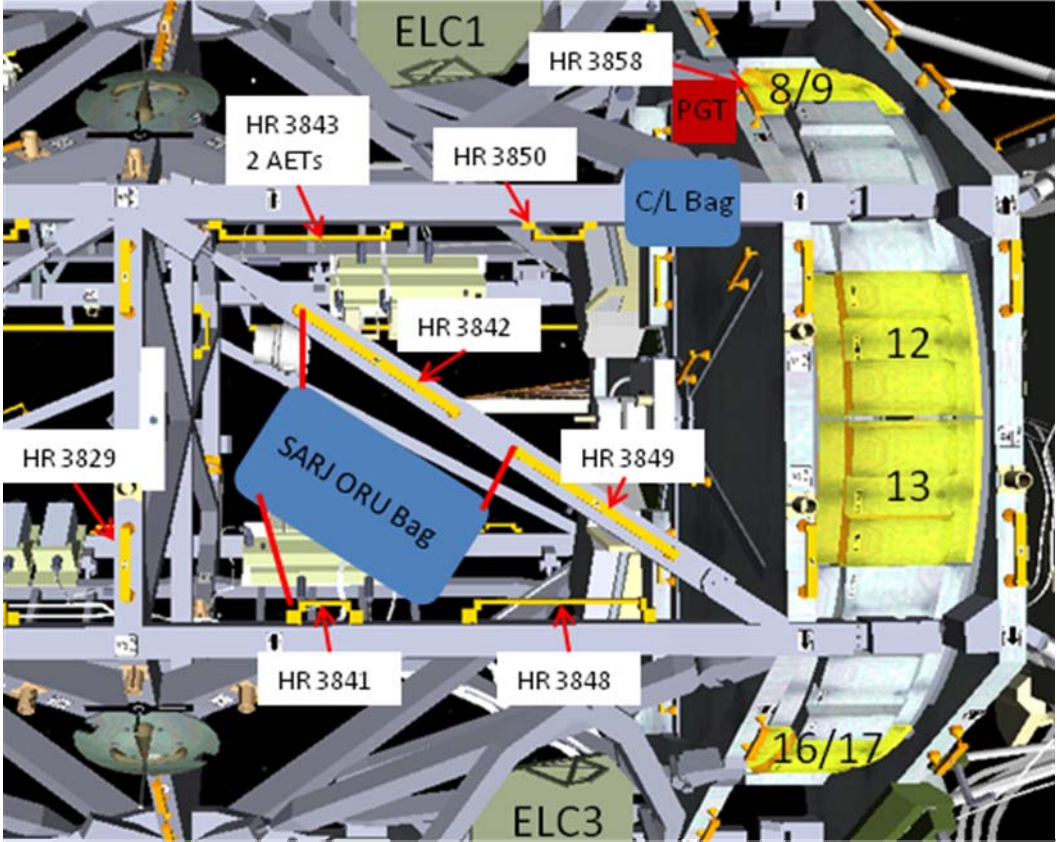

## PSARJ COVER REMOVAL (00:55)

IV/SSRMS	EV2 (Spanky)
Planned PET 01:15	 <p>The diagram shows the interior of the EV2 (Spanky) module. A blue SARJ ORU Bag is suspended from the structure. A blue C/L Bag is attached to HR 3850. A red PGT is attached to HR 3858. Yellow panels are labeled 8/9, 12, 13, and 16/17. Green panels are labeled ELC1 and ELC3. Red arrows point to various hardware locations: HR 3843 (2 AETs), HR 3850, HR 3842, HR 3849, HR 3841, HR 3848, and HR 3829.</p> <p><b>SETUP (00:20)</b></p> <ol style="list-style-type: none"><li>1. Translate to SARJ bag on P3, face 4</li><li>2. Tether lid of SARJ ORU bag open to HR 3841 (using lid hook)</li><li>3. Remove Lube C/L bag from ORU bag and stow on P3 HR 3850 (use integral bag hook on HR, keep RET with ORU bag)</li><li>4. Remove external adj tethers from Lube C/L bag and attach to HR 3843</li><li>5. Stow EV1 PGT from Lube C/L bag on HR 3858 (using RET between PGT and C/L bag)</li><li>6. Attach taped fish stringer hook to P3 HR 3841</li></ol>

# PSARJ COVER REMOVAL (00:55) (Cont)

### EV2 (Spanky)

**CAUTION**

To prevent loss of inboard MLI cover fasteners during removal:  
 Limit turn count to minimum required for fastener release  
 Minimize side loading bolt head  
 Maintain axial force on fastener to compress spring during rotation

**NOTE**

EV1 will nominally remove covers 8 & 9 while waiting for P1-P5 to vent.  
 Bolt 2 is missing from cover 8; does not meet kick loads

EAS jumper must be vented during Eclipse:  
 EV1 returns to FS 7-\_\_ step 1 (EAS JUMPER SETUP/VENT)

### PSARJ COVER REMOVAL (00:35)

7. Attach RET to cover
8. Configure PGT: (BRT as reqd)  
**[A6 (8.3), CCW2, 30.5]** 6-Ext 7/16
9. ←Release inboard MLI cover fasteners, **9 turns**:
  - Covers 8, 9, 16, 17 are singles
  - Covers 12, 13 are doubles
10. Stow covers on fish stringer hook #1 adj tethers near HR 3841
  - Cover 12
  - Cover 13
  - Cover 16
  - Cover 17
11. Stow covers on adj tethers on HR 3843
  - Cover 8
  - Cover 9

### 2. SARJ Cover removal & temp stow table

Cover	1	2	3	4	5	6
Cover 8		X				
Cover 9						
Cover 12						
Cover 13						
Cover 16						
Cover 17						

**PSARJ FIRST LUBE (00:45)**

IV/SSRMS	EV2 (Spanky)																																																													
<p>Planned PET 02:10</p> <p>1. Table for photos, record Cover #</p> <table border="1" style="width:100%; border-collapse: collapse;"> <thead> <tr> <th style="width:33%;">Cover</th> <th style="width:33%;">Datum A</th> <th style="width:33%;">Outer Canted</th> </tr> </thead> <tbody> <tr><td>Cover _____</td><td></td><td></td></tr> <tr><td>Cover _____</td><td></td><td></td></tr> <tr><td>Cover _____</td><td></td><td></td></tr> <tr><td>Cover _____</td><td></td><td></td></tr> </tbody> </table> <p>2. SARJ Table for samples, record cover # and sample wipe #</p> <table border="1" style="width:100%; border-collapse: collapse;"> <thead> <tr> <th style="width:25%;">Cover</th> <th style="width:15%;">Datum A</th> <th style="width:15%;">Outer Canted</th> <th style="width:15%;">Inner Canted</th> </tr> </thead> <tbody> <tr> <td>Cover _____</td> <td># _____</td> <td># _____</td> <td># _____</td> </tr> <tr> <td>Cover _____</td> <td># _____</td> <td># _____</td> <td># _____</td> </tr> </tbody> </table> <p>3. SARJ Lube Table</p> <table border="1" style="width:100%; border-collapse: collapse;"> <thead> <tr> <th style="width:15%;">Cover</th> <th style="width:15%;">Inner Canted</th> <th style="width:15%;">Datum A</th> <th style="width:15%;">Outer Canted</th> </tr> </thead> <tbody> <tr><td>Cover 8</td><td></td><td></td><td></td></tr> <tr><td>Cover 9</td><td></td><td></td><td></td></tr> <tr><td>Cover 12</td><td></td><td></td><td></td></tr> <tr><td>Cover 13</td><td></td><td></td><td></td></tr> <tr><td>Cover 16</td><td></td><td></td><td></td></tr> <tr><td>Cover 17</td><td></td><td></td><td></td></tr> </tbody> </table> <p>4. EVA wipe(s) used for cleaning:</p> <table border="1" style="width:100%; border-collapse: collapse;"> <thead> <tr> <th style="width:15%;">Wipe #</th> <th style="width:15%;"># _____</th> <th style="width:15%;"># _____</th> </tr> </thead> <tbody> <tr> <td></td> <td></td> <td></td> </tr> </tbody> </table>	Cover	Datum A	Outer Canted	Cover _____			Cover _____			Cover _____			Cover _____			Cover	Datum A	Outer Canted	Inner Canted	Cover _____	# _____	# _____	# _____	Cover _____	# _____	# _____	# _____	Cover	Inner Canted	Datum A	Outer Canted	Cover 8				Cover 9				Cover 12				Cover 13				Cover 16				Cover 17				Wipe #	# _____	# _____				<p style="text-align: center;"><u>NOTE</u></p> <p>Inspection:</p> <ul style="list-style-type: none"> <li><input type="checkbox"/> Inspection/Sample steps are only required for race ring under one cover or any areas of interest at worksite</li> </ul> <p>Lube:</p> <ul style="list-style-type: none"> <li><input type="checkbox"/> When lubing Inner Canted surface: no pitch, no roll (if moving away – handle toward you; if moving toward you – handle away)</li> <li><input type="checkbox"/> Surfaces to be lubed: Outboard Ring – Inner Canted, Datum A, and Outer Canted surfaces</li> </ul> <ol style="list-style-type: none"> <li>RET and stow EVA wipe on MWS as reqd (EV2 – red #6 is terrycloth inside)</li> </ol> <p><u>INSPECTION AND SAMPLE</u> (photos &amp; inspection under same cover)</p> <ol style="list-style-type: none"> <li>If reqd, retrieve camera/flash from SARJ ORU bag</li> <li><input checked="" type="checkbox"/> Take photos of outboard Outer Canted surface and Datum A surface; <b>notify IV</b> under which covers</li> <li>Retrieve 3 numbered EVA wipes</li> <li>Using wiping motion, obtain sample from Datum A surface</li> <li>Report wipe number and invert wipe, securing with Velcro</li> <li>Repeat steps 5-6 for Outer Canted surface and Inner Canted surfaces</li> <li>Stow sample wipes</li> </ol> <p><u>LUBE INNER CANTED SURFACES (DATUM A/OUTER CANTED SURFACES) ON OUTBD RING</u></p> <ol style="list-style-type: none"> <li>Retrieve J-hook nozzle gun (straight nozzle gun)</li> <li>Prep J-hook nozzle gun (straight nozzle gun):             <ol style="list-style-type: none"> <li>Remove tip cover</li> <li>Push plunger in</li> <li>Black triangle up</li> <li>Rotate restraint ring to open</li> <li>Open shut off knob</li> </ol> </li> <li>Lube Inner Canted surface (Datum A/Outer Canted surface)</li> <li>Safe J-hook nozzle gun (straight nozzle gun):             <ol style="list-style-type: none"> <li>Close shut off knob</li> <li>Rotate restraint ring to lock</li> <li>Black triangle down</li> <li>Wipe nozzle</li> <li>Install tip cover</li> </ol> </li> <li>Repeat for all covers</li> <li>Repeat steps 9-13 with straight nozzle gun for Datum A and Outer Canted surfaces</li> <li>Stow grease guns on fish stringer</li> <li>Report any wipe numbers used for cleaning (Translate to P3/P4 Jumper)</li> </ol> <div style="text-align: right;"> <p style="text-align: center;">SARJ TERMINOLOGY</p> <p style="text-align: center;">← A/JIS Struts OUTBOARD → INBOARD RING</p> </div>
Cover	Datum A	Outer Canted																																																												
Cover _____																																																														
Cover _____																																																														
Cover _____																																																														
Cover _____																																																														
Cover	Datum A	Outer Canted	Inner Canted																																																											
Cover _____	# _____	# _____	# _____																																																											
Cover _____	# _____	# _____	# _____																																																											
Cover	Inner Canted	Datum A	Outer Canted																																																											
Cover 8																																																														
Cover 9																																																														
Cover 12																																																														
Cover 13																																																														
Cover 16																																																														
Cover 17																																																														
Wipe #	# _____	# _____																																																												

**P3/P4 JUMPER STOW (00:15/00:35)**

IV/SSRMS	EV1 (Drew)	EV2 (Spanky)
<p>Planned PET 03:15 (EV1), 02:55 (EV2)</p> <p><b>MCC-H:</b> Report if NH3 Inspection reqd</p> <p>1. EV1 Tool Inventory:</p> <ul style="list-style-type: none"> <li><input type="checkbox"/> MWS               <ul style="list-style-type: none"> <li><input type="checkbox"/> BRT (L)                   <ul style="list-style-type: none"> <li><input type="checkbox"/> RET (sm-sm)</li> <li><input type="checkbox"/> Wire Tie (2 short)</li> </ul> </li> <li><input type="checkbox"/> T-Bar                   <ul style="list-style-type: none"> <li><input type="checkbox"/> RET (Lg-sm) (R)</li> <li><input type="checkbox"/> RET (Lg-sm) (L)</li> <li><input type="checkbox"/> Adj Equip Tether (R)</li> <li><input type="checkbox"/> Adj Equip Tether (L to TB)</li> <li><input type="checkbox"/> Small ISS Trash Bag (R, inbd)</li> </ul> </li> <li><input type="checkbox"/> Swing Arm (R)                   <ul style="list-style-type: none"> <li><input type="checkbox"/> EVA Camera w/bracket (int RET)</li> <li><input type="checkbox"/> RET w/PIP pin</li> </ul> </li> </ul> </li> </ul> <p>2. EV2 Tool Inventory:</p> <ul style="list-style-type: none"> <li><input type="checkbox"/> MWS               <ul style="list-style-type: none"> <li><input type="checkbox"/> BRT (L)                   <ul style="list-style-type: none"> <li><input type="checkbox"/> RET (sm-sm)</li> <li><input type="checkbox"/> Wire Tie (2 short)</li> </ul> </li> <li><input type="checkbox"/> T-Bar                   <ul style="list-style-type: none"> <li><input type="checkbox"/> RET (sm-sm) (L)</li> <li><input type="checkbox"/> RET w/PIP pin (R)</li> <li><input type="checkbox"/> Wire Tie (2 short)</li> <li><input type="checkbox"/> Adj Equip Tether (R)</li> <li><input type="checkbox"/> Small ISS Trash Bag (R, inbd)                       <ul style="list-style-type: none"> <li><input type="checkbox"/> Wire Tie (from P3/P4 temp stow)</li> </ul> </li> </ul> </li> <li><input type="checkbox"/> Swing Arm (R)                   <ul style="list-style-type: none"> <li><input type="checkbox"/> RET (sm-sm)                       <ul style="list-style-type: none"> <li><input type="checkbox"/> PGT w/7/16 socket 6" ext</li> </ul> </li> </ul> </li> </ul> </li> </ul>	<div style="border: 1px solid black; padding: 5px; text-align: center;"> <p><b>CAUTION</b></p> <p>Use caution when translating near SARJ ring with open covers</p> </div> <p style="text-align: center;"><b>NOTE</b></p> <p>On <b>MCC-H GO:</b> Perform NH3 Inspection of EMU at earliest convenient opportunity, shade as reqd during day (For inspection description see <u>4.141 ISS EVA AMMONIA DECONTAMINATION</u>, note 2 (SODF: ISS EVA SYS))</p> <p><u>P3/P4 JUMPER STOW (00:15)</u></p> <ol style="list-style-type: none"> <li>1. Temp stow VTEB as reqd on HR_____</li> <li>2. Assist EV2 as reqd</li> <li>3. Retrieve RET from P3 HR 3860</li> </ol> <p><u>CLEANUP (00:05)</u></p> <ol style="list-style-type: none"> <li>4. Retrieve and stow Lube C/L bag on BRT w/RET</li> <li>5. Verify Port SARJ interface is clear of all tethers and tools</li> <li>6. Perform MWS tool inventory</li> <li>7. Glove and Gauntlet Check</li> </ol>	<p><u>P3/P4 JUMPER STOW (00:30)</u></p> <ol style="list-style-type: none"> <li>1. Translate to QD M2 on P3 outbd panel A502 (face 6)</li> <li>2. Close and demate QD F2 at M2 per <b>BLOCK D</b> and <b>BLOCK A</b></li> <li>3. Install cap on M2</li> <li>4. Close MLI on pnl A502</li> <li>5. Translate to P4 inbd bulkhead with QD F2, tend line</li> <li>6. Mate QD F2 to dummy male M2 per <b>BLOCK B</b></li> <li>7. Translate to P4 QD M15</li> <li>8. Close and demate QD F15 per <b>BLOCK D</b> and <b>BLOCK A</b></li> <li>9. Install cap on M15</li> <li>10. Translate to inbd bulkhead with QD F15</li> <li>11. Mate QD F15 to dummy male M15 per <b>BLOCK B</b></li> <li>12. Stow jumper cable (close line in all outbd TA clamps and, as reqd, inbd TA clamps to ensure line is fully clear of SARJ)</li> <li>13.  WVS survey</li> </ol> <p><u>CLEANUP (00:05)</u></p> <ol style="list-style-type: none"> <li>14. Retrieve and stow VTEB on BRT w/RET</li> <li>15. Verify Port SARJ interface is clear of all tethers and tools</li> <li>16. Perform MWS tool inventory</li> <li>17. Glove and Gauntlet Check</li> </ol>

**P3/P4 JUMPER STOW (00:15/00:35) (Cont)**

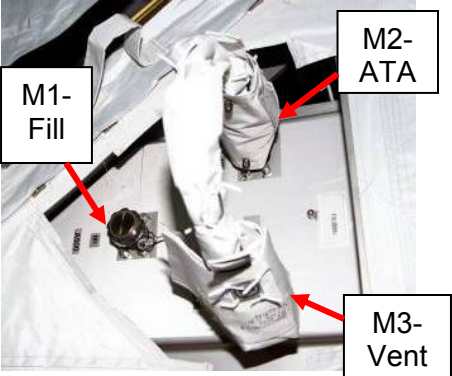

<b>IV/SSRMS</b>	<b>EV1 (Drew)</b>	<b>EV2 (Spanky)</b>
<p>3. On <b>EV1 and EV2 GO</b>, give <b>MCC-H GO</b> to rotate Port SARJ</p> <p>4. Consumable tag up with <b>MCC-H</b></p>	<p>8. Retrieve <b>GREEN</b> hook from P3 HR 3861  <input type="checkbox"/> √Gate closed, slider locked, both reels unlocked, release RET</p> <p>9. When clear of worksite, <b>notify IV</b> for Port SARJ rotation</p> <p>(Translate to P1 ATA Config ATA to Vent)</p>	<p>18. Retrieve <b>GREEN</b> hook from P3 HR 3852  <input type="checkbox"/> √Gate closed, slider locked, both reels unlocked, release RET</p> <p>19. When clear of worksite, <b>notify IV</b> for Port SARJ rotation</p> <p>(Translate to A/L – S1 Rad GB Beam Install)</p>

## CONFIGURE ATA TO VENT (00:15)

IV/SSRMS	EV1 (Drew)
<p>Planned PET 03:30</p>  <p>M1-Fill</p> <p>M2-ATA</p> <p>M3-Vent</p>	<p><u>CONFIGURE P1 ATA TO VENT</u> (00:15)</p> <ol style="list-style-type: none"><li>1. Translate to P1 WIF 16<ul style="list-style-type: none"><li>☐ At bay 14, translate nadir to P1 HR 3651</li></ul></li><li>2. Stow Lube C/L bag on HR 3649</li><li>3. Translate to P1 ATA panel A500</li><li>4. Remove cap from M3</li><li>5. Close and demate QD F185 on M1 per <b>BLOCK D</b> and <b>BLOCK A</b></li><li>6. Mate and open QD F185 to M3 per <b>BLOCK B</b> and <b>BLOCK C</b></li><li>7. Reinstall cap on M1</li></ol> <p>(Translate to Port CETA cart – SPDM LEE Lube)</p>

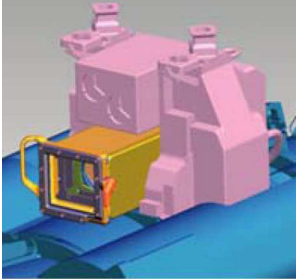

## SPDM CLA COVER INSTALL (00:25)

IV/SSRMS	EV1 (Drew)
<p>Planned PET 03:45</p> <p>1. ICOM with Box</p> <p><b>SSRMS:</b> <i>In EVA Setup posn; SPDM LEE snares fully opened</i></p> <p><b>SSRMS:</b> <i>Box Brief</i></p> <p><b>SSRMS:</b> <i>Mnvr to APFR Ingress posn</i>  <input type="checkbox"/> √Brakes on before ingress</p> 	<p><b>SPDM SETUP (00:20)</b></p> <ol style="list-style-type: none"> <li>Translate to Port CETA cart</li> <li>Remove APFR from WIF 2, stow on BRT w/RET</li> <li>Translate to P1 nadir Bay 12</li> <li>Install APFR in P1 WIF 16 [9, TT, F, 6] (3 o'clock = double black lines)  <input type="checkbox"/> √Black-on-black, pull/twist test</li> <li>Retrieve SARJ C/L bag; stow on BRT w/RET</li> </ol> <div style="border: 2px solid black; padding: 5px; text-align: center;"> <p><b>WARNING</b></p> <p>Avoid touching curvic coupling, grounding springs, snares, internal mechanisms, cable-return springs, latch covers, shrouds, and camera with gloved hand</p> </div> <p style="text-align: center;"><b>NOTE</b></p> <p style="text-align: center;">Drew ingress position is Stbd/Inbd of APFR. Brakes ON reqd for APFR ingress/egress</p> <ol style="list-style-type: none"> <li>Give <b>SSRMS GO</b> to mnvr to APFR Ingress position, GCA as reqd</li> <li>If reqd for ingress, attach Waist tether to SPDM LEE HR</li> <li>Ingress APFR</li> <li>If reqd, remove Waist tether from SPDM LEE HR</li> </ol> <p><b>CLA COVER INSTALL ON SPDM LEE CAMERA (00:05)</b></p> <div style="border: 1px solid black; padding: 5px; text-align: center;"> <p><b>CAUTION</b></p> <p>Avoid contact with CLA cover lens</p> </div> <ol style="list-style-type: none"> <li>RET, retrieve CLA cover frame from C/L bag; MLI case remains in C/L bag</li> <li>Rotate locking lever to the open/unlocked position (lever perpendicular to plane of lens)</li> <li>GCA SSRMS to CLA cover install position</li> <li>Install CLA cover frame on SPDM LEE CLA by inserting spring loaded flange to depress spring</li> <li>Push cover to seat against camera bracket for full installation</li> <li>Rotate locking lever to the closed/locked position (lever parallel to plane of lens)</li> <li>Perform pull test</li> <li>Retrieve RET</li> <li><input type="checkbox"/> √ Perform WVS survey</li> </ol>  <p style="text-align: center;">Cover on CLA</p>  <p style="text-align: center;">Latch Pin</p>

**SPDM LEE LUBE (00:40)**

IV/SSRMS	EV1 (Drew)
<p>Planned PET 04:10</p> <p><b>SSRMS:</b> GCA to LEE Lube position</p> <p>○ Inner bearing (moving) ⊕ Outer bearing (fixed)</p> <p><b>SSRMS:</b> On EV1 GO, rotate SPDM LEE as reqd</p> <p><b>SSRMS:</b> On EV1 GO, fully close snares</p>	<p><b>SPDM SNARE LUBE (00:20)</b></p> <ol style="list-style-type: none"> <li>1. GCA SSRMS as required for SPDM lube</li> <li>2. Verify camera &amp; handrail orientation</li> <li>3. <input checked="" type="checkbox"/> Take photos of SPDM LEE <ul style="list-style-type: none"> <li><input type="checkbox"/> Overall view of LEE</li> <li><input type="checkbox"/> Bearings 1 &amp; 2</li> <li><input type="checkbox"/> Bearings 3 &amp; 4</li> <li><input type="checkbox"/> Bearings 5 &amp; 6</li> </ul> </li> <li>4. Stow camera</li> <li>5. Retrieve unused wipe and stow on MWS</li> <li>6. ✓ Snares fully open</li> <li>7. Prep straight nozzle gun: <ol style="list-style-type: none"> <li>a. Remove tip cover</li> <li>b. Push plunger in</li> <li>c. Black triangle up</li> <li>d. Rotate restraint ring to open</li> <li>e. Open shut off knob</li> </ol> </li> </ol> <p style="text-align: center;"><u>NOTE</u> Grease should not extend more than 1/4 inch from bearing</p> <ol style="list-style-type: none"> <li>8. Apply grease to all bearings (6) in any order <ul style="list-style-type: none"> <li><input type="checkbox"/> Use box pattern, apply to innermost side of bearing first</li> <li><input type="checkbox"/> Rotate SPDM LEE as reqd to reach all bearings <ul style="list-style-type: none"> <li><input type="checkbox"/> 1    <input type="checkbox"/> 3    <input type="checkbox"/> 5</li> <li><input type="checkbox"/> 2    <input type="checkbox"/> 4    <input type="checkbox"/> 6</li> </ul> </li> </ul> </li> <li>9. ✓ Worksite clear and give <b>SPDM GO</b> to fully close snares</li> </ol>

**SPDM LEE LUBE (00:40) (Cont)**

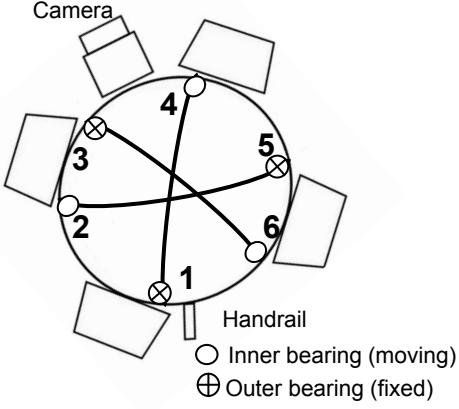
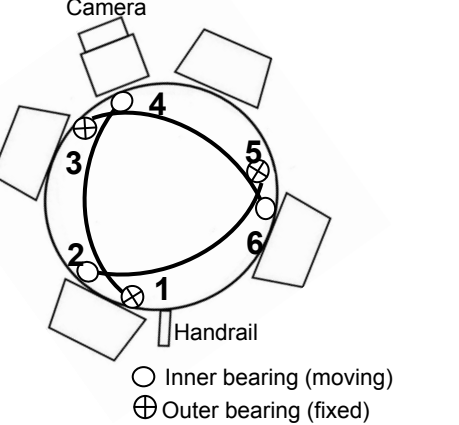
IV/SSRMS	EV1 (Drew)
<p><b>SSRMS:</b> On <b>EV1 GO</b>, rotate SPDM LEE as reqd</p>  <p><b>SSRMS:</b> On <b>EV1 GO</b>, partially open snares</p>	<p>10. Apply grease to rod end &amp; fork interface of all bearings (6) in any order</p> <ul style="list-style-type: none"> <li><input type="checkbox"/> Rotate SPDM LEE as reqd to reach all bearings             <ul style="list-style-type: none"> <li><input type="checkbox"/> 1    <input type="checkbox"/> 3    <input type="checkbox"/> 5</li> <li><input type="checkbox"/> 2    <input type="checkbox"/> 4    <input type="checkbox"/> 6</li> </ul> </li> </ul> <p>11. Safe and stow straight nozzle gun:</p> <ol style="list-style-type: none"> <li>a. Close shut off knob</li> <li>b. Rotate restraint ring to lock</li> <li>c. Black triangle down</li> <li>d. Wipe nozzle</li> <li>e. Install tip cover</li> </ol> <p>12. Retrieve needle nose pliers from C/L bag</p> <p>13. ✓ Worksite clear and give <b>SPDM GO</b> to partially open snares (inner bearings within cam cutouts)</p> <div style="border: 1px solid black; padding: 5px; text-align: center; margin: 10px 0;"> <p><b>CAUTION</b></p> <p>When exercising bearing, do not extend cable-return spring more than 90 deg (rod end perpendicular to housing)</p> </div> <p style="text-align: center;"><b>NOTE</b></p> <p style="text-align: center;">If bearings overshoot cam cutouts, use gap gauge to expose snares</p>
<p><b>SSRMS:</b> On <b>EV1 GO</b>, rotate SPDM LEE as reqd</p> 	<p>14. Exercise all bearings (6) in any order</p> <ul style="list-style-type: none"> <li><input type="checkbox"/> Bring rod end to 90 deg with needle nose pliers and exercise bearing in x axis (in/out of LEE) (1 min/40 cycles)</li> <li><input type="checkbox"/> Report bearing mobility to <b>MCC-H</b></li> <li><input type="checkbox"/> Rotate SPDM LEE as reqd to reach all bearings             <ul style="list-style-type: none"> <li><input type="checkbox"/> 1    <input type="checkbox"/> 3    <input type="checkbox"/> 5</li> <li><input type="checkbox"/> 2    <input type="checkbox"/> 4    <input type="checkbox"/> 6</li> </ul> </li> </ul> <p>15. If required, retrieve gap gauge from C/L bag and pack grease as required</p>

**SPDM LEE LUBE (00:40) (Cont)**

IV/SSRMS	EV1 (Drew)			
<p><b>SSRMS:</b> On <b>EV1 GO</b>, perform snare checkout</p> <p>1. EVA wipe(s) used for cleaning:  <table border="1" data-bbox="107 358 510 396"> <tr> <td data-bbox="107 358 226 396">Wipe #</td> <td data-bbox="226 358 365 396"># _____</td> <td data-bbox="365 358 510 396"># _____</td> </tr> </table> </p> <p>2. Receive EV1 snare report</p> <p><b>SSRMS:</b> GCA for APFR Egress  <input type="checkbox"/> √Brakes on before egress</p> <p><b>SSRMS:</b> Mnvrr to SPDM stow posn</p>	Wipe #	# _____	# _____	<p><u>SPDM LUBE CLEANUP (00:20)</u></p> <p>16. √Worksite clear and give <b>SPDM GO</b> for snare checkout (open/close/open snares)</p> <p>17. Clean tools as necessary with EVA wipe</p> <p>18. Stow used wipe and report #</p> <p>19. Report to <b>IV/MCC-H:</b> Snare condition (in or out of groove)</p> <p>20. <input checked="" type="checkbox"/> Take photos of SPDM  <input type="checkbox"/> Overall view of SPDM  <input type="checkbox"/> Bearings 1 &amp; 2  <input type="checkbox"/> Bearings 3 &amp; 4  <input type="checkbox"/> Bearings 5 &amp; 6</p> <p>21. Stow camera</p> <p>22. √Tools and tethers clear from SPDM LEE</p> <p>23. GCA SSRMS for APFR Egress</p> <p>24. Egress APFR</p> <p>25. Give <b>SSRMS GO</b> to stow SPDM</p> <p>26. Stow Lube C/L bag on HR 3651</p> <p>27. Remove APFR, stow on BRT w/RET</p> <p>28. Translate to Port CETA cart</p> <p>29. Install APFR into WIF 2 [6,GG] [<b>12,TT,F,6</b>] (boot plate toward nadir/port) (same position as removal)  <input type="checkbox"/> √Black-on-black, pull/twist test</p> <p>30. Translate to HR 3651; retrieve and stow Lube C/L bag on BRT w/RET</p> <p>31. Glove and Gauntlet check</p> <p style="text-align: right;">(Translate to Port SARJ – 2<sup>nd</sup> Lube)</p>
Wipe #	# _____	# _____		

## S1 RAD GB STOW BEAM INSTALL (01:10)

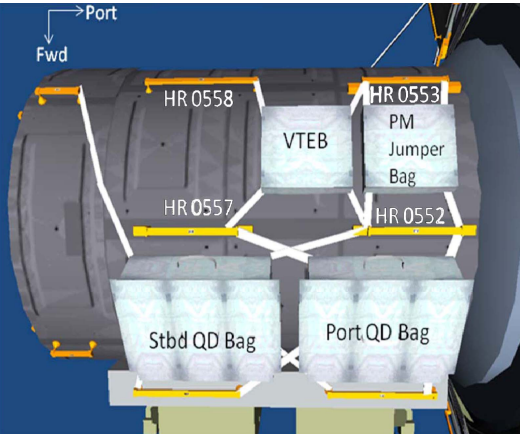
IV/SSRMS	EV2 (Spanky)									
<p>Planned PET 03:30</p>  <p>1. Record Inbd Beam Bolt data (1<sup>st</sup> trq):</p> <table border="1" data-bbox="109 1120 615 1218"> <thead> <tr> <th>Bolt</th> <th>Turns</th> <th>Torque (ft-lb)</th> </tr> </thead> <tbody> <tr> <td>fwd</td> <td></td> <td>(4.8)</td> </tr> <tr> <td>aft</td> <td></td> <td></td> </tr> </tbody> </table>	Bolt	Turns	Torque (ft-lb)	fwd		(4.8)	aft			<p><u>S1 RAD GB STOW BEAM INSTALL (01:10)</u></p> <ol style="list-style-type: none"> <li>Translate to A/L zenith <ul style="list-style-type: none"> <li><input type="checkbox"/> √Clear of EV1 safety tether under MT</li> </ul> </li> <li>Stow VTEB onto A/L via crewlock handrails 0552, 0553, 0557, and 0558 (hinge toward aft side of A/L)</li> <li>Translate nadir to A/L</li> <li>Retrieve Beam ORU bag; stow on BRT w/RET</li> <li>Translate to S1 <ul style="list-style-type: none"> <li><input type="checkbox"/> Translate zenith at S1 FHRC to S1 HR 3250 (Bay 13)</li> </ul> </li> <li>Temp stow Beam ORU bag on S1 HR 3251 (zenith edge of S1)</li> <li>Perform socket swap to 5/8 x 7.8-in socket <ul style="list-style-type: none"> <li><input type="checkbox"/> Pull test</li> </ul> </li> <li>Retrieve inbd stowage beam from ORU bag</li> <li>Translate to S1 HR 3252 inboard</li> <li>BRT to S1 HR 3252, as reqd</li> <li>Place inboard stowage beam on radiator beam per picture with tether point facing ISS fwd (away from radiator)</li> </ol> <p style="text-align: center;"><u>NOTE</u></p> <p>Indexing the beam is defined as:</p> <ul style="list-style-type: none"> <li><input type="checkbox"/> Push AFT end of beam away from other beam while engaging ISS AFT bolt (This should center (aka "index") AFT bolt to aid in alignment)</li> </ul> <ol style="list-style-type: none"> <li>Fully depress ISS FWD bolt with the PGT or hand to engage zip nut to hard stop</li> <li>While indexing beam, fully depress ISS AFT bolt with PGT or hand to engage zip nut to hard stop</li> <li>√Beam fully seated on truss</li> <li>Configure PGT: <ul style="list-style-type: none"> <li><b>[A3 (4.8), CW1, 30.5]</b> 5/8 x 7.8-in ext</li> </ul> </li> <li>←Drive ISS FWD bolt to hard stop</li> <li>←While indexing beam, drive ISS AFT bolt to hard stop <ul style="list-style-type: none"> <li><input type="checkbox"/> √No white lines visible on FWD and AFT bolts</li> </ul> </li> <li>Configure PGT: <ul style="list-style-type: none"> <li><b>[B3 (18.4), CW1, 30.5]</b> 5/8 x 7.8-in ext</li> </ul> </li> </ol>
Bolt	Turns	Torque (ft-lb)								
fwd		(4.8)								
aft										

## S1 RAD GB STOW BEAM INSTALL (01:10) (Cont)

IV/SSRMS	EV2 (Spanky)									
<p>2. Record Inbd Beam Bolt data (2<sup>nd</sup> trq):</p> <table border="1" data-bbox="109 267 613 365"> <thead> <tr> <th>Bolt</th> <th>Turns</th> <th>Torque (ft-lb)</th> </tr> </thead> <tbody> <tr> <td>fwd</td> <td></td> <td>(18.4)</td> </tr> <tr> <td>aft</td> <td></td> <td></td> </tr> </tbody> </table>	Bolt	Turns	Torque (ft-lb)	fwd		(18.4)	aft			<p>19. ←Drive ISS FWD bolt to required torque            20. ←Drive ISS AFT bolt to required torque            21. Verify both bolts and beam secure (wiggle)</p>
Bolt	Turns	Torque (ft-lb)								
fwd		(18.4)								
aft										
<p>3. Record Outbd Beam Bolt data (1<sup>st</sup> trq):</p> <table border="1" data-bbox="109 641 613 738"> <thead> <tr> <th>Bolt</th> <th>Turns</th> <th>Torque (ft-lb)</th> </tr> </thead> <tbody> <tr> <td>fwd</td> <td></td> <td>(4.8)</td> </tr> <tr> <td>aft</td> <td></td> <td></td> </tr> </tbody> </table>	Bolt	Turns	Torque (ft-lb)	fwd		(4.8)	aft			<p>22. Retrieve outbd stowage beam from ORU bag            23. Translate outboard to S1 HR 3236            24. BRT to S1 HR 3236, as reqd            25. Place outboard stowage beam on radiator beam per picture with tether point facing ISS fwd             26. Fully depress ISS FWD bolt with the PGT or hand to engage zip nut to hard stop            27. While indexing beam, fully depress ISS AFT bolt with the PGT or hand to engage zip nut to hard stop            28. ✓Beam fully seated on truss</p>
Bolt	Turns	Torque (ft-lb)								
fwd		(4.8)								
aft										
<p>4. Record Outbd Beam Bolt data (2<sup>nd</sup> trq):</p> <table border="1" data-bbox="109 828 613 925"> <thead> <tr> <th>Bolt</th> <th>Turns</th> <th>Torque (ft-lb)</th> </tr> </thead> <tbody> <tr> <td>fwd</td> <td></td> <td>(18.4)</td> </tr> <tr> <td>aft</td> <td></td> <td></td> </tr> </tbody> </table>	Bolt	Turns	Torque (ft-lb)	fwd		(18.4)	aft			<p>29. Configure PGT:  <b>[A3 (4.8), CW1, 30.5]</b> 5/8 x 7.8-in ext            30. ←Drive ISS FWD bolt to hard stop            31. ←While indexing beam, drive ISS AFT bolt to hard stop  <input type="checkbox"/> ✓No white lines visible on FWD and AFT bolts</p>
Bolt	Turns	Torque (ft-lb)								
fwd		(18.4)								
aft										
<p>5. Perform Bag Inventory:            Beam ORU Bag:</p> <ul style="list-style-type: none"> <li><input type="checkbox"/> Adj Equip Tether (external)</li> <li><input type="checkbox"/> RET w/PIP Pin</li> <li><input type="checkbox"/> RET w/PIP Pin</li> <li><input type="checkbox"/> RET (sm-sm)               <ul style="list-style-type: none"> <li><input type="checkbox"/> Socket Caddy                   <ul style="list-style-type: none"> <li><input type="checkbox"/> 5/8 socket-7.8 ext</li> </ul> </li> </ul> </li> </ul>	<p>32. Configure PGT:  <b>[B3 (18.4), CW1, 30.5]</b> 5/8 x 7.8-in ext            33. ←Drive ISS FWD bolt to required torque            34. ←Drive ISS AFT bolt to required torque            35. Verify both bolts and beam secure (wiggle)             36. Perform socket swap to 7/16 x 6-in  <input type="checkbox"/> Stow 5/8" on socket caddy  <input type="checkbox"/> Pull test            37. Stow socket caddy in ORU bag            38. Perform bag inventory            39. Stow ORU bag on BRT w/RET             40. Translate to A/L            41. Stow Beam ORU bag on curved HR             42. Glove and Gauntlet Check</p> <div data-bbox="1155 893 1995 1364"> <p style="text-align: center;"><b>(Looking Nadir)</b></p> <p style="text-align: right;"><b>AFT</b>    <b>PORT</b>  </p> <p><b>OUTBOARD BEAM</b>            (Move Beam in direction of arrow)</p> <p><b>INBOARD BEAM</b>            (Move Beam in direction of arrow)</p> </div> <p style="text-align: center;">(Translate to Port SARJ – 2<sup>nd</sup> Lube)</p>									

# PSARJ SECOND LUBE (00:25/00:35)

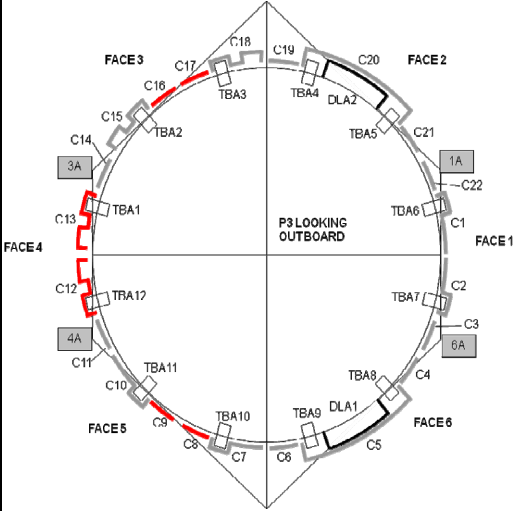
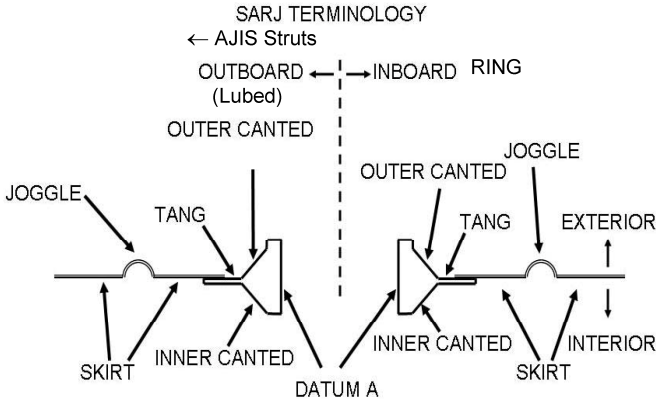
IV/SSRMS	EV1 (Drew)	EV2 (Spanky)																																		
<p>Planned PET 04:50 (EV1) 04:40 (EV2)</p> <p>1. Verify inhibits in place:  <input checked="" type="checkbox"/> PSARJ locked at 250°</p>  <p>2. SARJ Lube Table</p> <table border="1" style="width:100%; border-collapse: collapse; text-align: center;"> <thead> <tr> <th>Cover</th> <th>Inner Canted</th> <th>Datum A</th> <th>Outer Canted</th> </tr> </thead> <tbody> <tr><td>Cover 8</td><td></td><td></td><td></td></tr> <tr><td>Cover 9</td><td></td><td></td><td></td></tr> <tr><td>Cover 12</td><td></td><td></td><td></td></tr> <tr><td>Cover 13</td><td></td><td></td><td></td></tr> <tr><td>Cover 16</td><td></td><td></td><td></td></tr> <tr><td>Cover 17</td><td></td><td></td><td></td></tr> </tbody> </table> <p>3. EVA wipe(s) used for cleaning:</p> <table border="1" style="width:100%; border-collapse: collapse; text-align: center;"> <thead> <tr> <th>Wipe #</th> <th># _____</th> <th># _____</th> </tr> </thead> <tbody> <tr> <td> </td> <td> </td> <td> </td> </tr> </tbody> </table>	Cover	Inner Canted	Datum A	Outer Canted	Cover 8				Cover 9				Cover 12				Cover 13				Cover 16				Cover 17				Wipe #	# _____	# _____				<p style="text-align: center;"><u>NOTE</u></p> <ul style="list-style-type: none"> <li><input type="checkbox"/> When lubing the Inner Canted surface: No pitch, no roll (if moving away – handle toward you; if moving toward you – handle away)</li> <li><input type="checkbox"/> Surfaces to be lubed: Outboard Ring – Inner Canted, Datum A, and Outer Canted surfaces</li> </ul> <ol style="list-style-type: none"> <li>1. Translate to Port SARJ</li> <li>2. Attach <b>GREEN</b> hook to P3 HR 3861             <ul style="list-style-type: none"> <li><input type="checkbox"/> <input checked="" type="checkbox"/> Gate closed, slider locked, reels unlocked, release RET</li> </ul> </li> <li>3. Perform second SARJ Lube per procedures below:             <ul style="list-style-type: none"> <li><input type="checkbox"/> Stow Lube C/L Bag on HR _____</li> </ul> </li> </ol> <p><u>LUBE INNER CANTED SURFACES (DATUM A/OUTER CANTED SURFACES) ON OUTBD RING</u></p> <ol style="list-style-type: none"> <li>4. Retrieve unused wipe, report #</li> <li>5. Retrieve J-hook nozzle gun (straight nozzle gun)</li> <li>6. Prep J-hook nozzle gun (straight nozzle gun):             <ol style="list-style-type: none"> <li>a. Remove tip cover</li> <li>b. Push plunger in</li> <li>c. Black triangle up</li> <li>d. Rotate hinged restraint ring to open</li> <li>e. Open shut off knob</li> </ol> </li> <li>7. Grease Inner Canted surface (Datum A/Outer Canter surface)</li> <li>8. Safe J-hook nozzle gun (straight nozzle gun):             <ol style="list-style-type: none"> <li>a. Close shut off knob</li> <li>b. Rotate hinged restraint ring to lock</li> <li>c. Black triangle down</li> <li>d. Wipe nozzle</li> <li>e. Install tip cover</li> </ol> </li> <li>9. Repeat for all covers</li> <li>10. Repeat steps 5-9 with straight nozzle gun for Datum A and Outer Canted surfaces</li> <li>11. Stow Straight Nozzle and J-Hook grease guns             <ul style="list-style-type: none"> <li><input type="checkbox"/> EV2, fish stringer hooks #2 and 3</li> <li><input type="checkbox"/> EV1, C/L bag</li> </ul> </li> <li>12. Report wipe #s if used for cleaning</li> </ol>	<ol style="list-style-type: none"> <li>1. Translate to Port SARJ (<input checked="" type="checkbox"/> clear of EV1 safety tether)</li> <li>2. Attach <b>GREEN</b> hook to P3 HR 3852             <ul style="list-style-type: none"> <li><input type="checkbox"/> <input checked="" type="checkbox"/> Gate closed, slider locked, reels unlocked, release RET</li> </ul> </li> <li>3. Perform second SARJ Lube per procedures below:</li> </ol> 
Cover	Inner Canted	Datum A	Outer Canted																																	
Cover 8																																				
Cover 9																																				
Cover 12																																				
Cover 13																																				
Cover 16																																				
Cover 17																																				
Wipe #	# _____	# _____																																		

# PSARJ REINSTALL COVERS (00:50)

IV/SSRMS	EV1 (Drew)	EV2 (Spanky)																																																	
<p>Planned PET 05:15</p> <p>1. SARJ Cover Bolts Table</p> <div data-bbox="218 302 516 448" style="border: 1px solid black; padding: 5px; margin: 10px 0;"> <p style="text-align: center;">Cover X</p> </div> <table border="1" data-bbox="107 480 611 704"> <thead> <tr> <th>Cover</th> <th>1</th> <th>2</th> <th>3</th> <th>4</th> <th>5</th> <th>6</th> </tr> </thead> <tbody> <tr> <td>Cover 8</td> <td></td> <td>X</td> <td></td> <td></td> <td></td> <td></td> </tr> <tr> <td>Cover 9</td> <td></td> <td></td> <td></td> <td></td> <td></td> <td></td> </tr> <tr> <td>Cover 12</td> <td></td> <td></td> <td></td> <td></td> <td></td> <td></td> </tr> <tr> <td>Cover 13</td> <td></td> <td></td> <td></td> <td></td> <td></td> <td></td> </tr> <tr> <td>Cover 16</td> <td></td> <td></td> <td></td> <td></td> <td></td> <td></td> </tr> <tr> <td>Cover 17</td> <td></td> <td></td> <td></td> <td></td> <td></td> <td></td> </tr> </tbody> </table> <p>2. Final tool and bag inventory (reference Tool Config FS 7-__)</p>	Cover	1	2	3	4	5	6	Cover 8		X					Cover 9							Cover 12							Cover 13							Cover 16							Cover 17							<div data-bbox="848 246 1629 342" style="border: 1px solid black; padding: 5px; margin-bottom: 10px;"> <p style="text-align: center;"><b>CAUTION</b></p> <p>Minimize side loading bolt head. Maintain axial force on fastener to compress spring during rotation</p> </div> <div data-bbox="848 375 1583 456" style="border: 3px double black; padding: 5px; margin-bottom: 10px;"> <p style="text-align: center;"><b>WARNING</b></p> <p>End of spring on EVA fasteners may protrude – sharp edge</p> </div> <p><u>INSTALL SARJ COVERS</u> (00:35)</p> <p>1. Assist EV2 as reqd</p> <p><u>CLEANUP</u> (00:15)</p> <p>2. Stow adj tethers (2) from HR 3843; stow in C/L bag</p> <p>3. Perform final MWS tool and bag inventory</p> <p>4. Stow Lube C/L bag on BRT w/RET</p> <p>5. Glove Check</p> <p>6.  WVS Survey of PSARJ</p>	<p><u>INSTALL SARJ COVERS</u> (00:35)</p> <p>1. Configure PGT: <b>[A1 (2.5), CW2, 30.5]</b> 6-Ext 7/16</p> <p>2. ←Engage MLI cover fasteners, 9 turns: Covers <input type="checkbox"/>8, <input type="checkbox"/>9, <input type="checkbox"/> 12, <input type="checkbox"/> 13, <input type="checkbox"/> 16, <input type="checkbox"/> 17 √Green light and bolt seated for all bolts</p> <p><u>CLEANUP</u> (00:15)</p> <p>3. Stow fish stringer in SARJ ORU bag</p> <p>4. Stow EV1 PGT in SARJ ORU bag</p> <p>5. Stow all used wipes in large trash bag as reqd</p> <p>6. Perform final MWS tool and bag inventory</p> <p>7. Stow SARJ ORU bag on BRT w/RET</p> <p>8. Glove Check</p> <p>9.  WVS Survey of PSARJ</p>
Cover	1	2	3	4	5	6																																													
Cover 8		X																																																	
Cover 9																																																			
Cover 12																																																			
Cover 13																																																			
Cover 16																																																			
Cover 17																																																			



**EVA 2 CLEANUP/INGRESS (00:25)**

<b>IV/SSRMS</b>	<b>EV1 (Drew)</b>	<b>EV2 (Spanky)</b>
<p>Planned PET 06:05</p> <p>1. Start Hatch Thermal Cover clock PET (30 min) __ : __</p> <p>2. Prior to hatch closure, perform WVS PWRDN (PHOTO/TV, <u>WVS</u> Cue Card)</p> <p>3. Stop Hatch Thermal Cover clock PET (30 min) __ : __</p>	<p><u>CLEANUP</u> (00:10)</p> <p>1. Retrieve <b>GREEN</b> hook from P3 HR 3861  <input type="checkbox"/> √Gate closed, slider locked, reels unlocked, release RET</p> <p>2. Translate to A/L  <input type="checkbox"/> Fairlead on Equip Lock HR 0500</p> <p><u>INGRESS/PRE-REPRESS</u> (00:15)</p> <p>3. Open hatch thermal cover</p> <p>4. Stow bags in A/L  <input type="checkbox"/> Lube C/L bag  <input type="checkbox"/> Beam ORU bag  <input type="checkbox"/> SARJ ORU bag from EV2</p> <p>5. Attach R Waist Tether to UIA D-ring  <input type="checkbox"/> √Gate closed, hook locked</p> <p>6. Give <b>EV2 GO</b> to release EV1 <b>RED</b> hook</p> <p>7. Ingress A/L</p> <p>8. Remove SCU from stowage pouch</p> <p>9. Remove DCM cover; Velcro to DCM</p> <p>10. Connect SCU to DCM</p> <p>11. √SCU locked</p>	<p><u>CLEANUP</u> (00:10)</p> <p>1. Retrieve <b>GREEN</b> hook from P3 HR 3852  <input type="checkbox"/> √Gate closed, slider locked, reels unlocked, release RET</p> <p>2. Translate to A/L</p> <p><u>INGRESS/PRE-REPRESS</u> (00:15)</p> <p>3. Transfer SARJ ORU bag to EV1</p> <p>4. On <b>EV1 GO</b>, RET to EV1 ST Pack and release EV1 <b>RED</b> hook</p> <p>5. Attach EV1 <b>RED</b> hook to aft ext D-ring  <input type="checkbox"/> √Gate closed, slider locked, reels unlocked, release RET</p> <p>6. Attach R Waist Tether to A/L int D-ring ext  <input type="checkbox"/> √Gate closed, hook locked</p> <p>7. RET to ST Pack and release <b>RED</b> hook</p> <p>8. Attach <b>RED</b> hook to curved HR, fwd/stbd stanchion  <input type="checkbox"/> √Gate closed, slider locked, reels unlocked, release RET</p> <p>9. Ingress A/L</p> <p>10. Close hatch thermal cover; attach Velcro strap</p> <p>11. Remove SCU from stowage pouch</p> <p>12. Remove DCM cover; Velcro to DCM</p> <p>13. Connect SCU to DCM</p> <p>14. √SCU locked</p>

**EVA 2 CLEANUP/INGRESS (00:25) (Cont)**

IV/SSRMS	EV1 (Drew)	EV2 (Spanky)
	<p style="text-align: center;"><u>NOTE</u> A TCV setting 8 – Max C minimizes time for SCU cooling</p> <p>12. WATER – OFF (fwd), expect <span style="border: 1px solid black; padding: 2px;">H2O IS OFF</span> msg</p> <p style="text-align: center;">Go to PRE-REPRESS (<u>DEPRESS/REPRESS</u> Cue Card)</p>	<p style="text-align: center;"><u>NOTE</u> A TCV setting 8 – Max C minimizes time for SCU cooling</p> <p>15. WATER – OFF (fwd), expect <span style="border: 1px solid black; padding: 2px;">H2O IS OFF</span> msg</p> <div style="border: 1px solid black; padding: 5px; margin: 10px 0;"> <p style="text-align: center;"><u>CAUTION</u> Do not close hatch until EMU Water OFF for 2 min. Verify outer hatch clear of hardware</p> </div> <p>16. Verify outer hatch clear of hardware 17. Verify handle position per hatch decal 18. Close and lock hatch</p> <p style="text-align: center;">Go to PRE-REPRESS (<u>DEPRESS/REPRESS</u> Cue Card)</p>

## P6 PVTCS FILL AND VENT – TASK DATA

### Estimated Task Duration:

	With RMS	Without RMS
One EV Crew	N/A	03:30
Two EV Crew	N/A	03:00

### Tools:

EV1	Contingency Tools
1" NH3 Vent Tool	1" Bail Drive Lever
1" NH3 Vent Tool Adapter	1" Cap Removal Tool
1" NH3 Vent Tool Extension	
MUT EE	
Vent Tool Extender Plug	

### EVA Fluid QDs:

Jumper	QD#	Line #	QD Size	Pre EVA2	Rad Fill Config	Post EVA2
ATA Vent Pnl	F184	N/A	1/4"	P1 Pnl A500 M2 – open	P1 Pnl A500 M2 – open	P1 Pnl A500 M2 – open
ATA Vent Pnl	F185	N/A	1/4"	P1 Pnl A500 M3 – open	<b>P1 Pnl A500 M1 – open</b>	<b>P1 Pnl A500 M3 – open</b>
P1/P3	F186	N/A	1/4"	P1 Pnl A503 M3 – open	P1 Pnl A503 M3 – open	P1 Pnl A503 M3 – open
P1/P3	F187	N/A	1/4"	P3 Pnl A503 M1 – open	P3 Pnl A503 M1 – open	P3 Pnl A503 M1 – open
P3/P4	F2	FH-03	1/4"	P4 Stowage QD – closed	<b>P3 Pnl A502 M2 – open</b>	<b>P4 Stowage QD – closed</b>
P3/P4	F15	FH-03	1"	P4 QD M15 – closed	P4 QD M15 – open	<b>P4 Stowage QD – closed</b>
P4/P5	F16	FH-05	1"	P4 QD M16 – open	P4 QD M16 – open	P4 QD M16 – open
P5/P6	F14	FH-06	1"	P5 Stowage QD – closed	<b>P6 QD M14 – open</b>	<b>P5 Stowage QD – closed</b>
EAS Jumper	02F	FH-02	1"	P6 QD M10 – closed	P6 QD M10 – open	<b>P6 QD M11 – closed</b>
EAS Jumper	03F	FH-02	1"	Extender – open	Extender – open	Extender – open
EAS Jumper	Ext	FH-02	1"	P6 QD M2 – closed	P6 QD M2 – open	<b>P6 QD M3 – closed</b>

### ORU Details:

Name	Part Number	Mass
EAS Jumper	R081351	21.07 lb
EAS Jumper Assy	R081697	23.5 lb
EAS Extender	RH000054	5 lb
P3/P4 Jumper	RH000138-1	8.34 lb
S3/S4 Jumper	RH000138-21	9.09 lb
P1/P3 Jumper	1F78113-3	3.51 lb
P1 ATA Jumper "homeplate"	1F78113-5	3.3 lb
1" NH3 Vent Tool	1F98589-1	5.36 lb
1" Vent Tool Adapter	SEG33119079-301	10 lb
1" Vent Tool Extension	SEG33119090-301	15 lb
MUT EE	SEG33106890-303	3.5 lb
1" Vent Tool Extension Plug	SED33123116-301	.25 lb

## P6 PVTCS FILL AND VENT – TASK DATA (Cont)

### Notes:

1. AR2180 documents difficulty that US EVA 6 crew had with removing cap from EETCS QD male M9. NH3 was noticed leaking from male. This QD is currently connected to PVTCS M1 through FH-01 line. It is not nominally planned for use during EVA 2; however, this line is a backup for the FH-02 line
2. EAS Jumpers have directional flow paths, must vent from the proper direction. Flow direction for both EAS jumper lines is toward QD Extenders
3. 6-8 lb of NH3 will be filled into 2B P6 PVTCS
4. Amount of NH3 venting from both Jumpers
  - P1-P5 Vent = 6 lb
  - EAS Jumper = 3 lb
5. QD Extenders have a lanyarded plug and cap attached
6. EAS Jumper is 102" long, not including QD Extender
7. P3/P4 Jumper is 214.5" long, after thermal reduction factor it is 209.4". S3/S4 Jumper is 243.48" long, after thermal reduction factor it is 237.7" long (back-up jumper)
8. IFI 7792 contains information on a kink in the vent tool extension

### Timeline Considerations:

1. P1-P5 NH3 Vent must be coordinated with IV; IV will close ATA valve directly before vent
  - a. IV to use Assy Ops Procedure 1.106 P1-P5 JUMPER VENT ECLIPSE CONSTRAINT WORKAROUND
2. EAS NH3 Vent must begin during a night pass
3. P6 M14 QD cap could be potential contamination point (QD cap on wet QD) similar situation on STS-130
4. Leak Check, checks the path from ATA to P5 QD F14. Can fail if NH3 is seen by crew or if THOR ATA quantity value drops below a predetermined level
5. PVTCS fill may require multiple iterations if the initial mark is not met; EV1 would assist with SARJ lube while waiting for fill completion



P6 PVTCS FILL AND VENT – TASK DATA (Cont)

ATA “Homeplate” Jumper

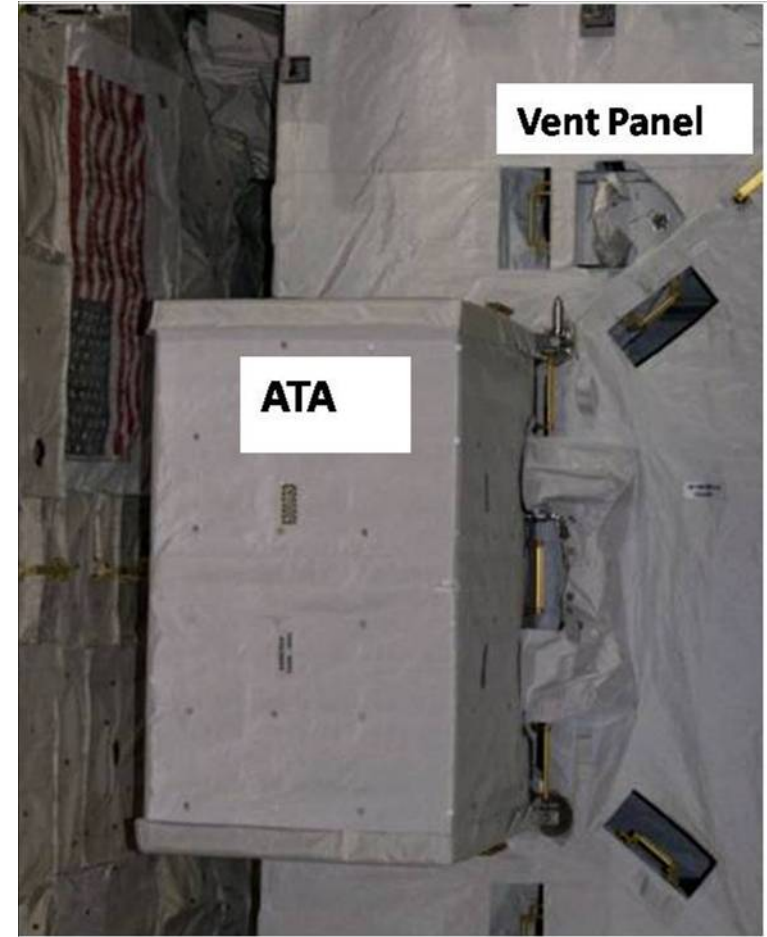
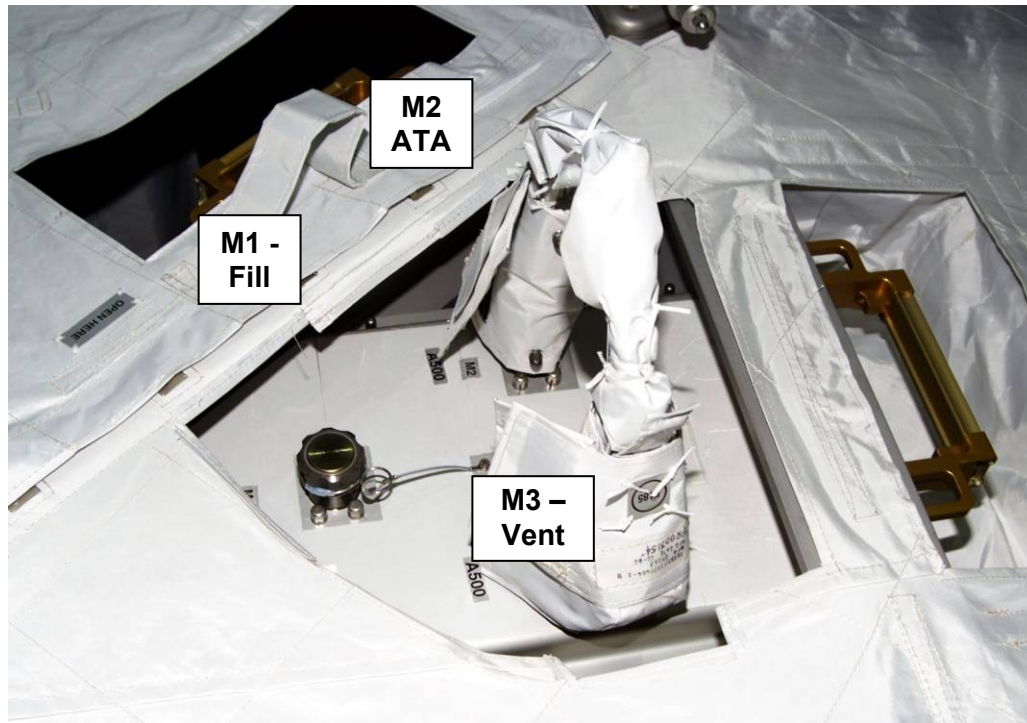



P6 PVTCS FILL AND VENT – TASK DATA (Cont)

P3/P4 Fluid Jumper



P6 PVTCS FILL AND VENT – TASK DATA (Cont)

P4/P5 Fluid Jumper

P5/P6 Fluid Jumper

P4



P5

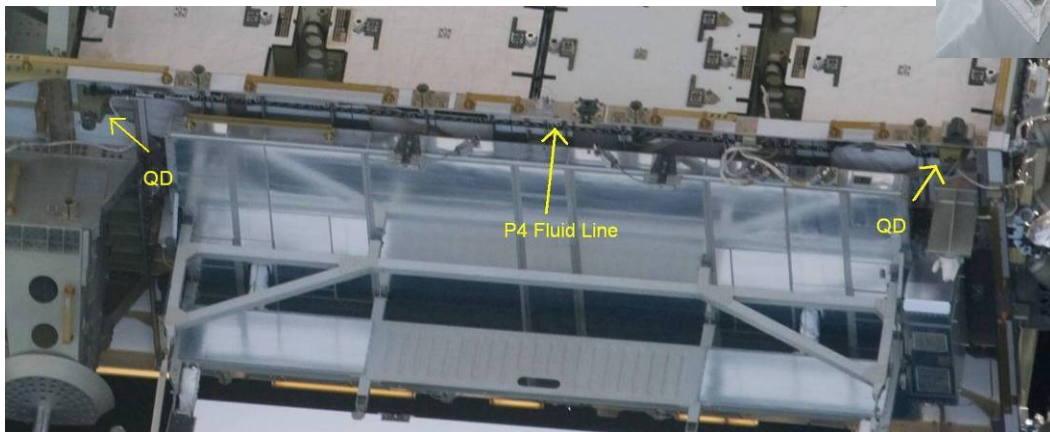
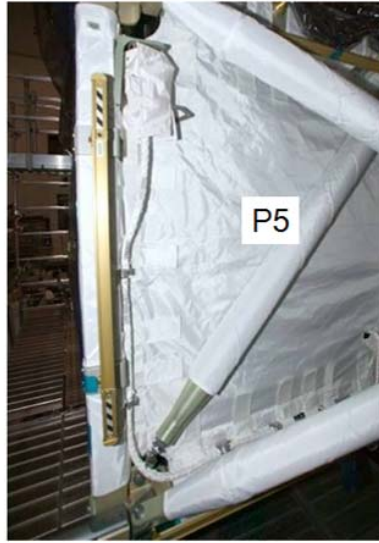



P6 PVTCS FILL AND VENT – TASK DATA (Cont)

EAS Fluid Jumpers

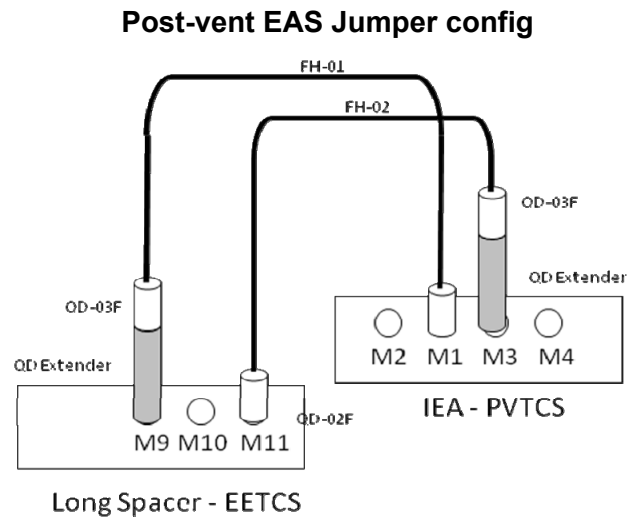
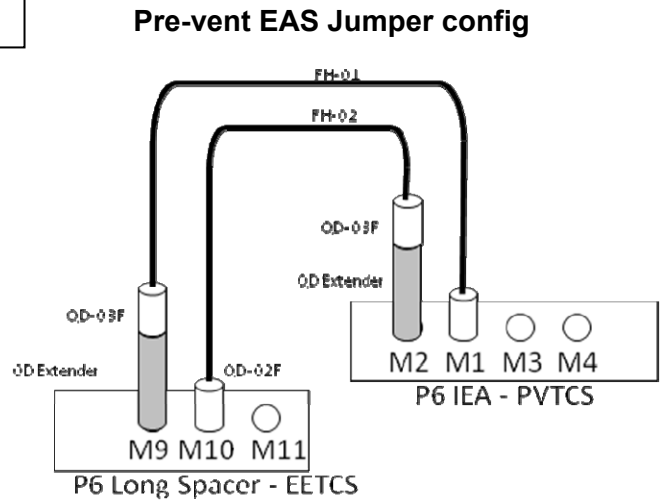
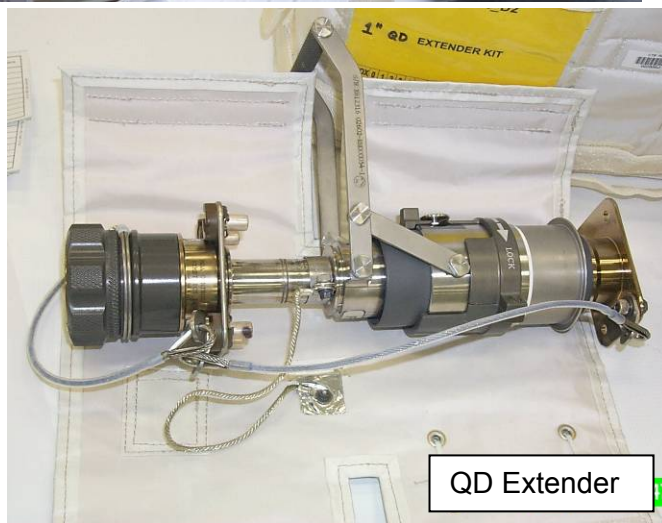



## PORT SARJ LUBE – TASK DATA

### Estimated Task Duration:

	With RMS	Without RMS
One EV Crew	N/A	04:00
Two EV Crew	N/A	02:30

### Tools:

EV1	EV2
J-hook Nozzle Grease Gun	J-hook Nozzle Grease Gun
Straight Nozzle Grease Gun	Straight Nozzle Grease Gun
EVA wipes	Wipe Caddy with EVA wipes
Camera	Camera w/flash
	Large Trash bag
	PGT w/7/16 Socket 6"

### EVA Fasteners:

Fastener Name	Head Size	Qty	Install Torque (ft-lb)	Release Torque (ft-lb)	Failure Torque (ft-lb)	Turns
SARJ Cover bolt	7/16	4 or 6	2.5	4.8	3.8 for install 13.7 for removal	7-9

### ORU Details:

Name	Part Number	Mass
J-hook grease gun	SEG33120797-304	1.94 lb
Straight grease gun	SEG33120797-303	1.78 lb
EVA Wipes	SED33116397-701	0.3 lb
Single cover	1F26520-1	3.488 lb
Double cover	1F26517-1	5.568 lb

### Notes:

1. Do not reengage outboard MLI cover spring clamps during re-installation of cover. Spring clamp engagement will preclude future SARJ rotation
2. SARJ cover 8 missing bolt #2 (see bolt diagram below)
3. Samples and photos are reqd on one segment of ring before new grease is applied (can be under any cover)

### Caution:

1. SARJ Race Ring not tolerant to nicks and scratches. Exercise care within vicinity of Race Ring while handling components

### Timeline Considerations:

1. If photos are taken during night pass, camera w/flash is reqd
2. SARJ rotation between 1<sup>st</sup> and 2<sup>nd</sup> lube will be 200 deg, can take up to 1 hr. 250° is crew preference over 230° (180° rotation)

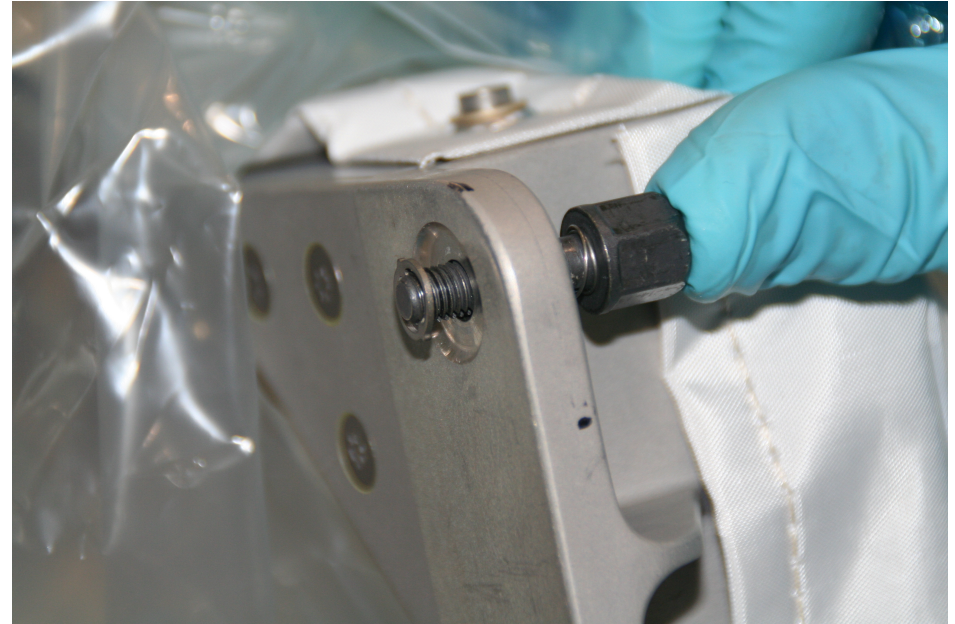

PORT SARJ LUBE – TASK DATA (Cont)



6 Bolts per Double Wide Cover



**SARJ Cover Bolt nomenclature:**  
 Single covers are bolts 1-4  
 Double covers are bolt 1-6

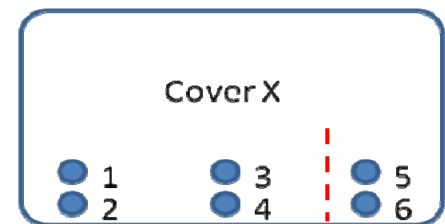

# PORT SARJ LUBE – TASK DATA (Cont)





# SPDM CLA COVER – TASK DATA

## Estimated Task Duration:

	With RMS	Without RMS
One EV Crew	N/A	00:10
Two EV Crew	N/A	N/A

## ORU Details:

ORU	Part Number	Mass (lb)	Dimensions (in)
Lens Cover	51612-4968-551	1.1	2.4 x 5.0 x 7.2
MLI Case	51612-5016-551	< 1.0	2.3 x 5.9 x 7.5

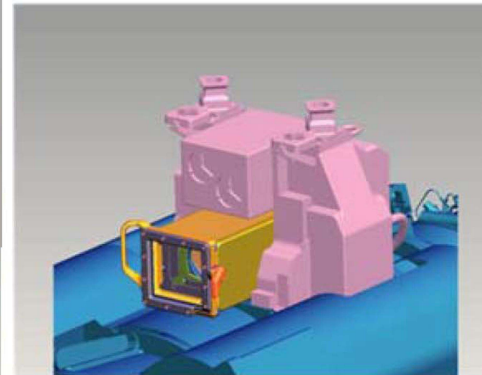

Cover on CLA



MSS Camera Cover  
(Shown in Unlocked Position)



Latch Pin

# SPDM LEE LUBE – TASK DATA

## Estimated Task Duration:

	With RMS	Without RMS
One EV Crew	00:40	N/A
Two EV Crew	N/A	N/A

## Tools:

EV1
Straight Nozzle Grease Gun
EVA Wipes
Gap Gauge
Needle Nose Pliers
EVA Camera

## Foot Restraints:

Task	WIF	APFR Setting
SPDM LEE Lube	P1 WIF 16	[9,TT,F,6]

## Notes:

1. Crew member will use SSRMS handrail to ingress ISS-based APFR in P1 WIF 16
2. Grease should not extend more than 1/4 inch from bearing

## Cautions:

1. Avoid contact with grounding springs, cable-return springs, latch covers, shrouds, and camera
2. When exercising bearing, do not extend cable-return spring more than 90 deg (rod end perpendicular to housing)
3. Avoid contact with SPDM arms during APFR ingress/egress

## Warnings:

1. Avoid touching curvic coupling, grounding springs, snares, and internal mechanisms with gloved hand

## Timeline Considerations:

1. Photos shall be taken as best effort, noting that it is possible may be in eclipse
2. Inhibits for SSRMS brakes and trigger-safe are controlled in Robotics procedures. SSRMS will give EV1 GO when inhibits are in place and ready for EVA work

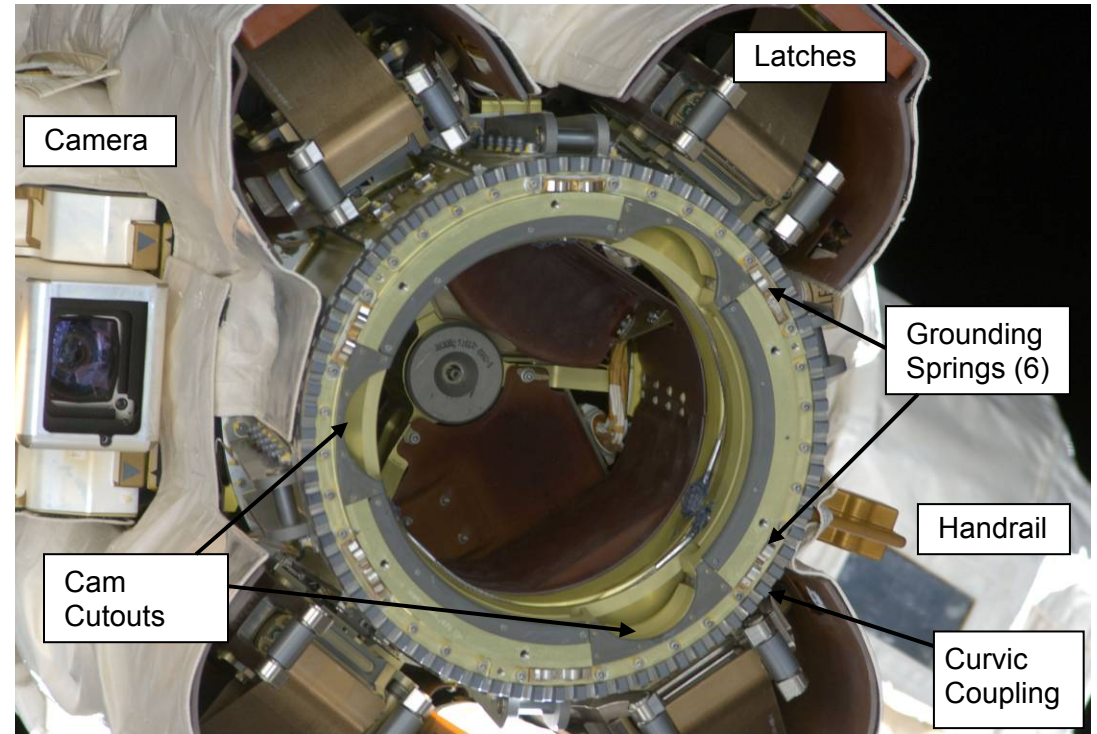

## Spherical Bearing

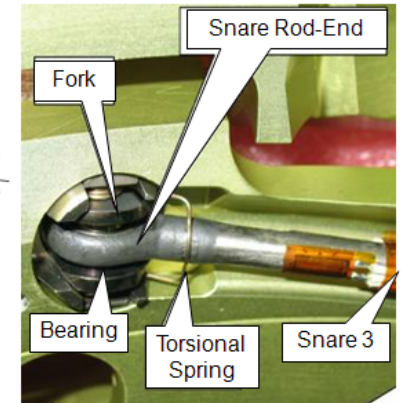
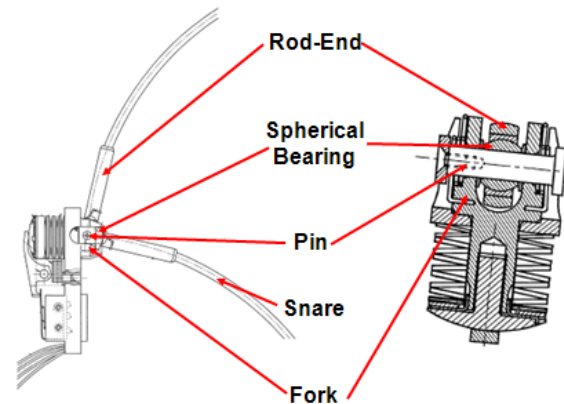

# SPDM LEE LUBE – TASK DATA (Cont)

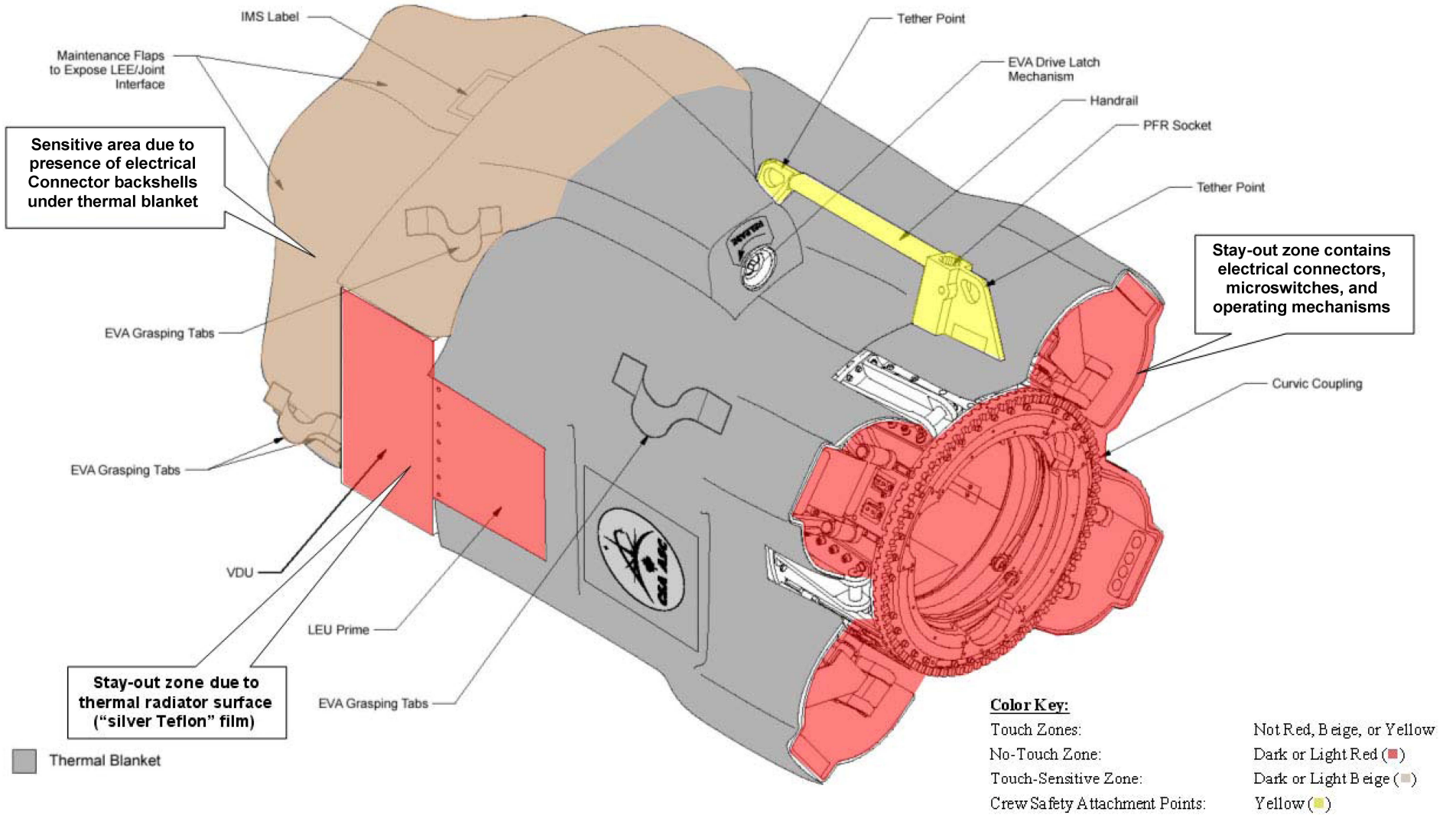



## S1 RAD GB STOW BEAM INSTALL – TASK DATA

### Estimated Task Duration:

	With RMS	Without RMS
One EV Crew	N/A	01:00
Two EV Crew	N/A	00:30

### Tools:

EV2
PGT
Socket Caddy
5/8 x 7.8-in Socket
Medium ORU Bag

### EVA Fasteners:

Fastener Name	Head Size	Qty	Install Torque (ft-lb)	Release Torque (ft-lb)	Failure Torque (ft-lb)	Turns	RPM
Rad GB Stow Beam Zip Nuts	5/8	2/each	18.4	25.5	77.0	21-23	30

### Notes:

1. Rad GB Stow beams have zip nuts
2. Index (push beam away from center) when zipping or engaging aft bolt

### Cautions:

1. Avoid kicking S1 radiator beam. If this occurs, wait 2 to 5 min to allow structural response to dissipate

### Timeline Considerations:

1. Task is being used to fill time while Port SARJ is rotating for SARJ Lube

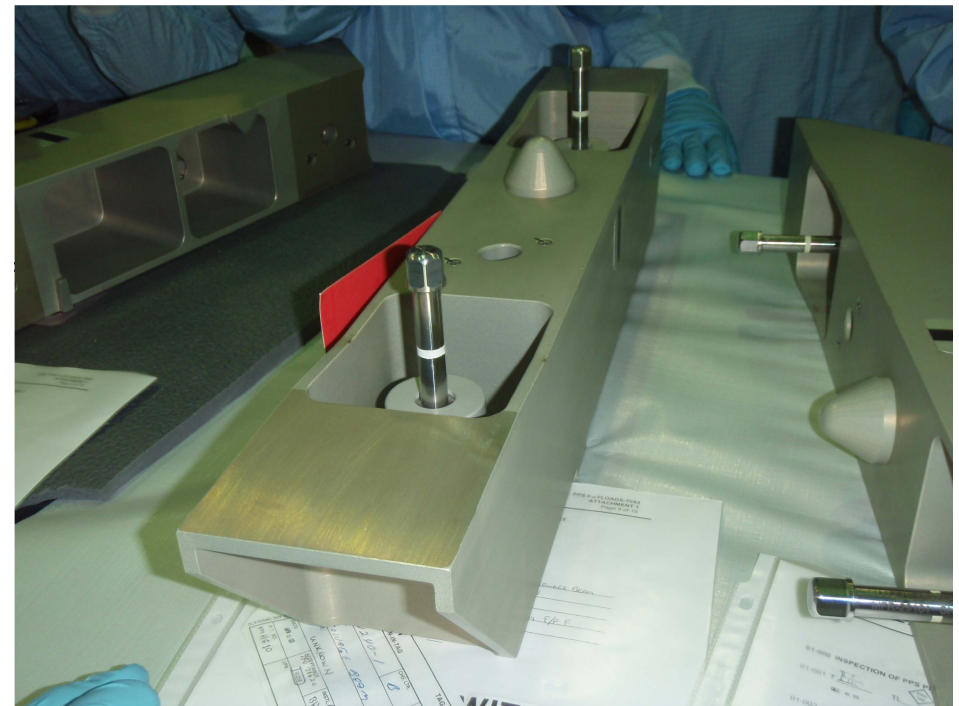
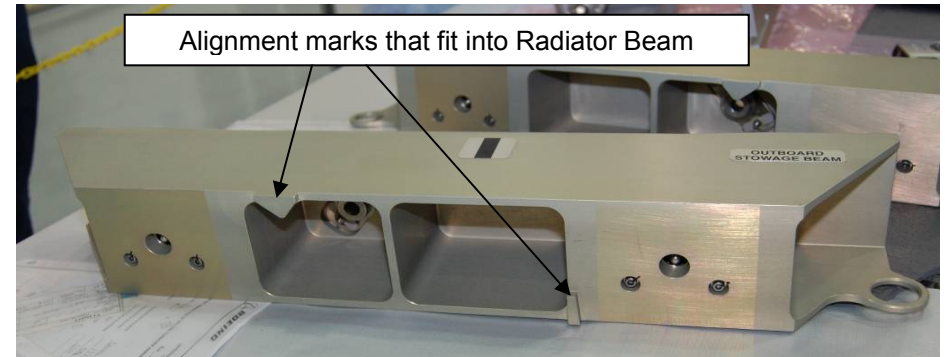

S1 RAD GB STOW BEAM INSTALL – TASK DATA (Cont)

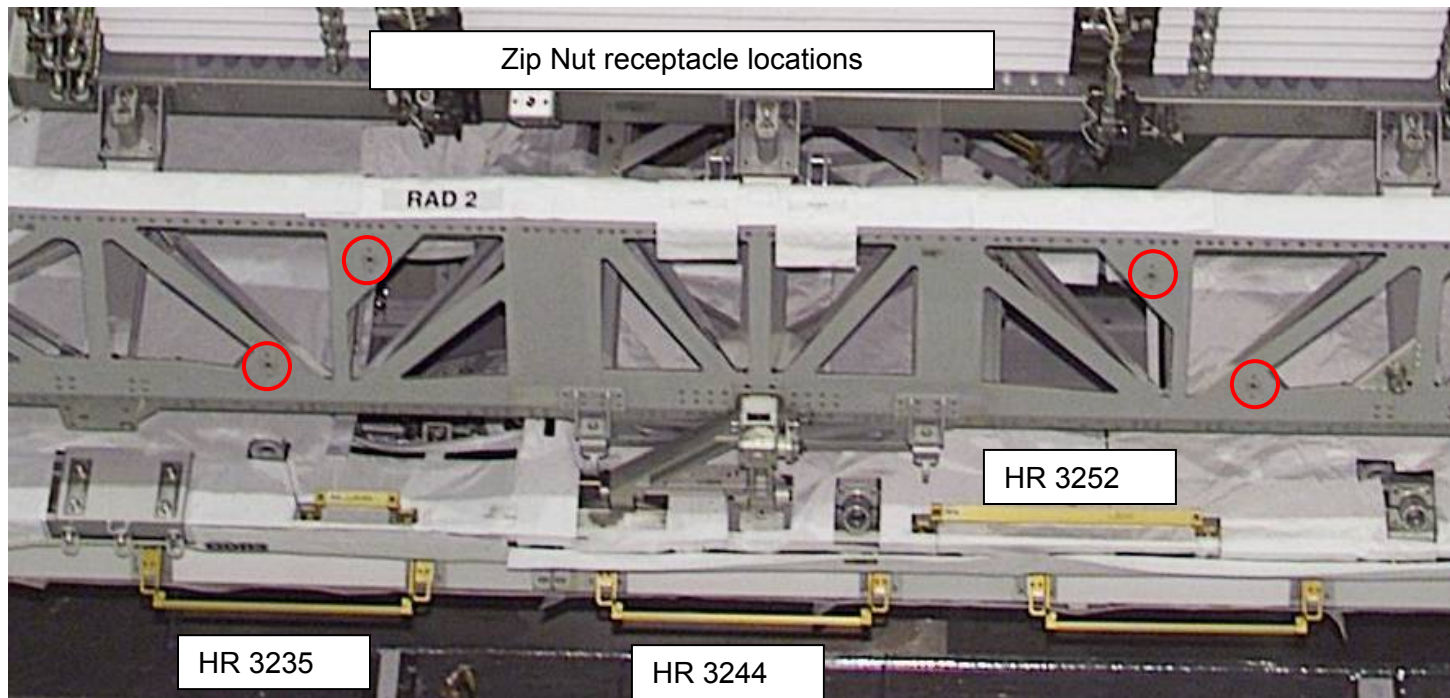



# EVA 3 SUMMARY TIMELINE

PET HR : MIN	IV/SSRMS	EV1 (Ft)	EV2 (Fn)	
00:00		<u>EGRESS/SETUP</u> (00:40) <ul style="list-style-type: none"> <li>• Post Depress and Egress (00:15)</li> <li>• Setup (00:25)</li> </ul>	<u>EGRESS/SETUP</u> (00:40) <ul style="list-style-type: none"> <li>• Post Depress and Egress (00:15)</li> <li>• Setup (00:25)</li> </ul>	00:00
		<u>PDGF SETUP</u> (00:30)	<u>PDGF SETUP</u> (00:30)	
01:00		<u>RETRIEVE PAMA/PDGF</u> (00:20)	<u>RETRIEVE PAMA/PDGF</u> (00:20)	01:00
		<u>PAMA/PDGF INSTALL</u> (00:15)	<u>PAMA/PDGF INSTALL</u> (00:15)	
		<u>VSC INSTALL</u> (00:30)	<u>VSC INSTALL</u> (00:30)	
02:00		<u>NOD1/FGB CH 1/4 CABLE INSTALL</u> (00:45)	<u>NOD1/FGB CH 1/4 CABLE INSTALL</u> (00:45)	02:00
03:00		<u>1553 DATA CABLE</u> (00:45)	<u>1553 DATA CABLE</u> (00:45)	03:00
		<u>NOD1/FGB CH 2/3 CABLE INSTALL</u> (01:05)	<u>NOD1/FGB CH 2/3 CABLE INSTALL</u> (01:05)	
04:00				04:00
		<u>PDGF AND FGB THRUSTER PHOTOS</u> (00:40)	<u>A/L TOOLBOX TOOL STOW</u> (00:40)	
05:00				05:00
		<u>STP-H3 PHOTOS</u> (00:30)	<u>HPGT FRGF MLI INSTALL</u> (00:30)	
06:00		<u>CLEANUP/INGRESS</u> (00:30) <ul style="list-style-type: none"> <li>• Cleanup (00:15)</li> <li>• Ingress and Pre-Repress (00:15)</li> </ul>	<u>CLEANUP/INGRESS</u> (00:30) <ul style="list-style-type: none"> <li>• Cleanup (00:15)</li> <li>• Ingress and Pre-Repress (00:15)</li> </ul>	06:00
06:30				06:30

# EVA 3

## EVA 3 TOOL CONFIG

### ISS Configuration:

MT @ WS5; CETA Carts Port/Stbd

SSRMS on MBS PDGF 2

SPDM on Lab

EV1 STP: S0 Port, outbd Strut → A/L Curved HR, fwd Stanchion

EV2 STP: S0 Port, inbd Strut → A/L aft D-ring

**NOTE:** Prior to use, inspect the following hardware:

- RET cords for fraying
- Inspect Load Alleviating Straps and D-ring Extenders; ref 2.230.100 CREW TETHER INSPECTIONS (SODF: ISS EVA TASKS):
  1. MMOD/general damage      3. Tack Stitching
  2. Discoloration              4. Red Band
- ISS Trash Bag: Bristle deformation/damage, after having stowed tools in trash bag
  - √Empty    √Zipper Closed
- BRT joint screws not loose
- Swing arm stiffness
- Remove PUMAA from PDGF
 

PGT [B7 (25.5),CCW2,30.5] 11 turns  
Stow in EVA 4 Tools Mesh Bag
- Check alignment of Russian connector pins IVA (use cap tool) on both PDGF harness and 1553 cables

Tether Counts: (Green RETs)

RETs (sm-sm) = 16/16

RETs (PIP Pin) = 2/5

RETs (Lg-sm) = 6/8

Adj Equip Tethers = 7/10

Adj Equip Tethers (Lg-sm) = 1/2

### EV1

- MWS
  - BRT (L)
    - RET (sm-sm)
    - Wire Tie (2 long, 2 short)
  - T-Bar
    - RET (Lg-sm) (L)
    - RET (Lg-sm) (R)
    - Adj Equip Tether (R)
    - Adj Equip Tether (L to TB)
    - Small ISS Trash Bag (R, inbd)
  - Swing Arm (R)
    - RET w/PIP Pin
    - EVA Camera w/bracket (int RET – morning of)
- D-ring Extender (1, L D-ring)
- Waist Tether (1, R on D-ring)

### EV2

- MWS
  - BRT (L)
    - RET (sm-sm)
    - Wire Tie (4 short)
  - T-Bar
    - RET (sm-sm) (L)
    - RET w/PIP Pin (R)
    - Adj Equip Tether (R)
    - Adj Equip Tether (L)
    - Wire Tie (2, 1 around TB)
    - Small ISS Trash Bag (R, outbd)
      - PAMA 1 cap
      - PAMA 2 cap
      - PAMA 3 cap
  - Swing Arm (R)
    - EVA Camera w/bracket (int RET – morning of)
- D-ring Extender (2, R & L D-ring)
  - Waist Tether (R on D-ring Ext)
  - Waist Tether (L on D-ring Ext)

### A/L

- RET (Lg-Sm)
  - Med ORU Bag 4** (bottom to top)
    - External:
      - Adj Equip Tether (RF soft tether pt to C/L bag door handle – taped hook)
      - Adj Equip Tether (LB soft tether pt to C/L bag door handle – taped hook)
      - 72" Gap Spanner fully extended (RB, RF soft tether pts with tether inside bag)
    - Internal:
      - RET (sm-sm) (RB to Cable)
        - 1553 Cable (see fig 2)
          - 2 FPP Booties
      - Fish Stringer (RB – other hook outside of bag)
        - Hook 1: FO video cable cap
        - Hook 2: Node 3 Terminator MLI
        - Hook 3: Node 3 Terminator MLI
        - Hook 4: Node 3 Terminator Cap
        - Hook 5: Node 3 Terminator Cap
        - Hook 6: 1553 P1 cap
        - Hook 7: 1553 P2 cap
      - RET (Lg-sm) (LF)
        - VSC thermal cover (hard) (Velcro flaps folded up)
          - Russian Fixed tether (hooks thru tether, around VSC handle)
      - RET (sm-sm) (LB)
        - VSC MLI (soft)
      - RET (sm-sm) (LB)
        - VSC (inside VSC MLI)
      - RET (sm-sm) (RF)
        - PGT [A7, CAL,30.5] s/n \_\_\_\_\_
          - PGT Battery s/n \_\_\_\_\_
          - 7/16 (wobble) Socket-6 ext
      - RET (sm-sm) (from PDGF)
        - Grapple shaft cover
          - Wire Tie
    - Crewlock Bag 4** (divider snapped up – attached to underside of Med ORU bag)
      - Adj Equip Tether (Lg-sm) (ext – sm hook on R HR stanchion, Lg hook (taped) on Med bag)
  - Side 1 of divider:
    - Wire Tie Caddy 4 (Int RET) (2 long, 7 short)
    - RET (sm-sm)
      - PAMA Cheater Bar
    - Russian Ratchet Wrench (Int RET)

# EVA 3 TOOL CONFIG (Cont)

## A/L (Cont)

- Side 2 of divider:
  - RET (sm-sm)
  - Long Wire Tie – preconfigured for MLI
  - Dust cap P18 – size 25 (Int RET)
  - Dust cap P19 – size 25 (Int RET)
- RET (Lg-sm) (near Staging Bag)
- Tool Stow C/L bag** (divider snapped up)
- Adj Equip Tether (external)
- Side 1 of divider:
  - Fish Stringer
    - Hook 1: RET (sm-sm)
    - Pin Straightener Assy
    - Hook 2: RET (sm-sm)
    - Short MMOD T-handle
    - Hook 3: RET (sm-sm)
    - Short MMOD T-handle
    - Hook 4: RET (sm-sm)
    - Probe
    - Hook 5: RET (sm-sm)
    - Vise Grips
    - Hook 6: RET (sm-sm)
    - 1" QD Cap Removal Tool
- Side 2 of divider:
  - HPGT FRGF MLI (Int RET – to MLI tether w/"T")
  - Long Wire Tie (around MLI – smushed loop around MLI tether)
- RET (Lg-sm) (foot 1 – Airlock D-ring ext)
- PAMA/PDGF/Harness** (see fig 3)
  - RET (sm-sm)
  - Grapple shaft cover
  - Long Wire Tie
  - Dust Cover 1 (pre-installed on power cables)
  - Dust Cover 2 (pre-installed on power cables)
  - Node 3 Cable Bag (FGB Y-Cables)

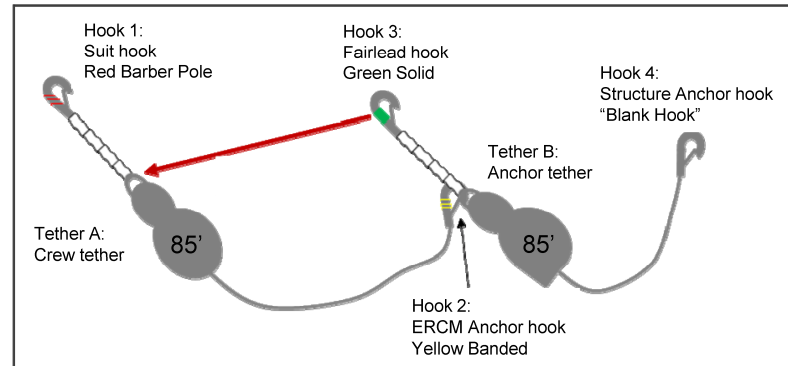

Figure 1: Safety Tether Pack Config

## A/L (Cont)

- Staging Bag**
  - Fish Stringer Tether
    - Wire Tie Caddy (hook 1) (5 short, 4 long)
    - Velcro/Tape Caddy (hook 2)
    - PGT (hook 3) s/n \_\_\_\_\_
    - PGT Battery s/n \_\_\_\_\_
    - 7/16 (wobble) Socket-6 ext
    - Ratchet Wrench (hook 5)
    - 7/16 (rigid) Socket-2 ext
    - Long Duration Tie-Down Tethers (2) (hook 6)
    - Russian Ratchet Wrench D** (hook 7)
    - Spare Safety Tether Pack (85-ft + 85-ft) (to strap)
  - Fish Stringer Tether
    - Connector Cleaner Tool Kit (hook 2)
    - Pry Bar (hook 4)
    - Needle Nose Pliers** (hook 6)
    - Russian Adjustable Tether (2)** (for tie down) **D**
    - Russian Fixed Tether** (for tie down) **D**
    - MWS Key Strap Assy (on wire tie, to strap)

## A/L (Cont)

- IV Bag**
  - Towels (2)
  - Contamination Detection Kit
  - GP Caddy (2)
    - Adjustable Thermal Mittens (2)
  - Socket Caddy (hatch cont) w/RET (sm-sm) (Black)
    - 1/2 Socket-8 ext
    - 7/16 (wobble) Socket-6 ext (spare)
  - DCM Plug (SAFER Hardmount) (2)
  - RET (sm-sm, Black) (2)

## ISS External:

- Node 3 Cable Bag (FGB Y-Cables)**
  - NOD1/FGB Ch 1/4 Cables (see fig 4)
  - NOD1/FGB Ch 2/3 Cables (see fig 5)

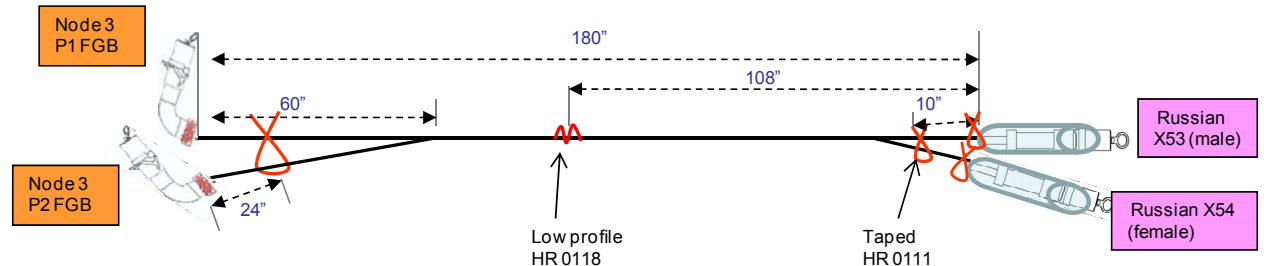

- Attach short wire tie at low profile location
  - Attach short wire tie on X53 cable/connector
    - Twist one remaining end of wire tie around cap tether point
    - Twist other end of wire tie around bootie tether point
  - Attach short wire tie on X54 cable/connector
    - Twist one remaining end of wire tie around cap tether point
    - Twist other end of wire tie around bootie tether point
- Attach taped short wire tie around both Russian cables
- Attach short wire tie around both Node 3 cables
- Coil Node 3 end toward Russian end 3 loops – twist Node 3 wire tie around coils
  - Continue coiling Node 3 end – twist taped wire tie (Russian) around whole bundle

Figure 2: 1553 PDGF Cable

## EVA 3 TOOL CONFIG (Cont)

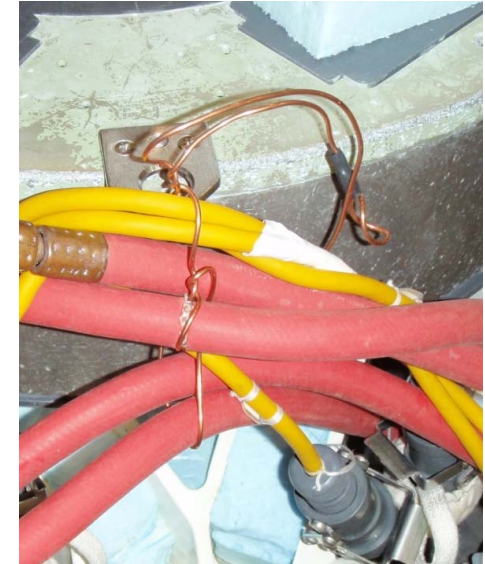
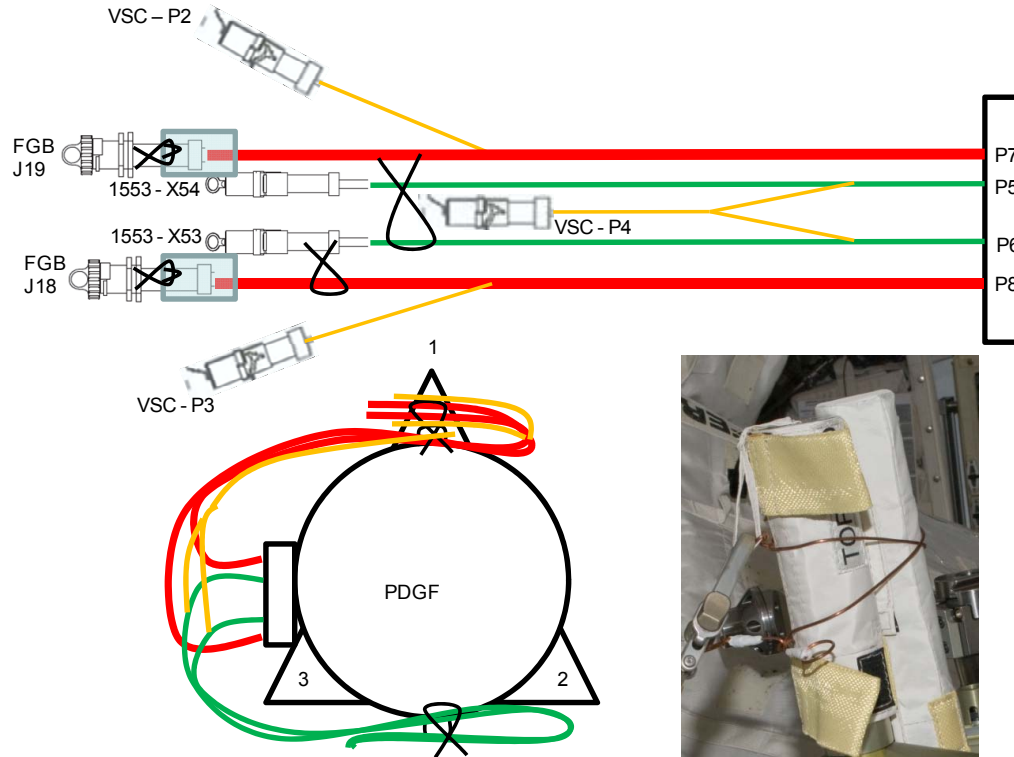

- Attach long wire tie (both ends smushed) on J18
- Attach long wire tie (both ends smushed) around both X53 and X54
- Attach short wire tie to dust cover tether pt, then wrap around J18 connector
- Attach short wire tie to dust cover tether pt, then wrap around J19 connector
- Coil cables as shown/described:
  - Wrap J18 wire tie around all VSC and Power cables – one end of wire tie through PDGF tether point, then twist with other end of wire tie
  - Wrap 1553 wire tie around both cables – one end of wire tie through PDGF tether point, then twist with other end of wire tie
    - Twist end not going through PDGF tether point through both cap tether points of Russian connectors
- Attach long wire tie to grapple shaft cover tether point, then around both covers (should already be configured)

Figure 3: FGB PDGF Harness

## EVA 3 TOOL CONFIG (Cont)

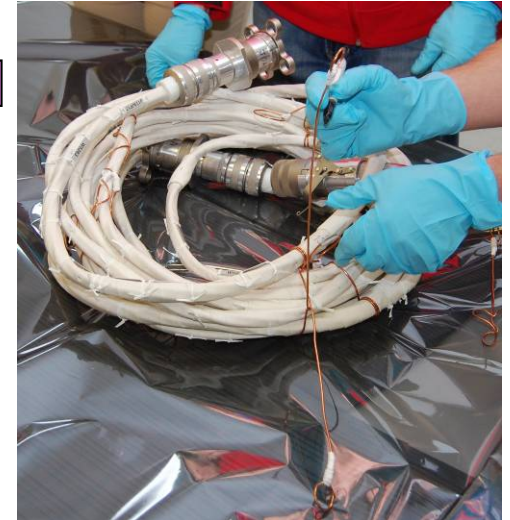
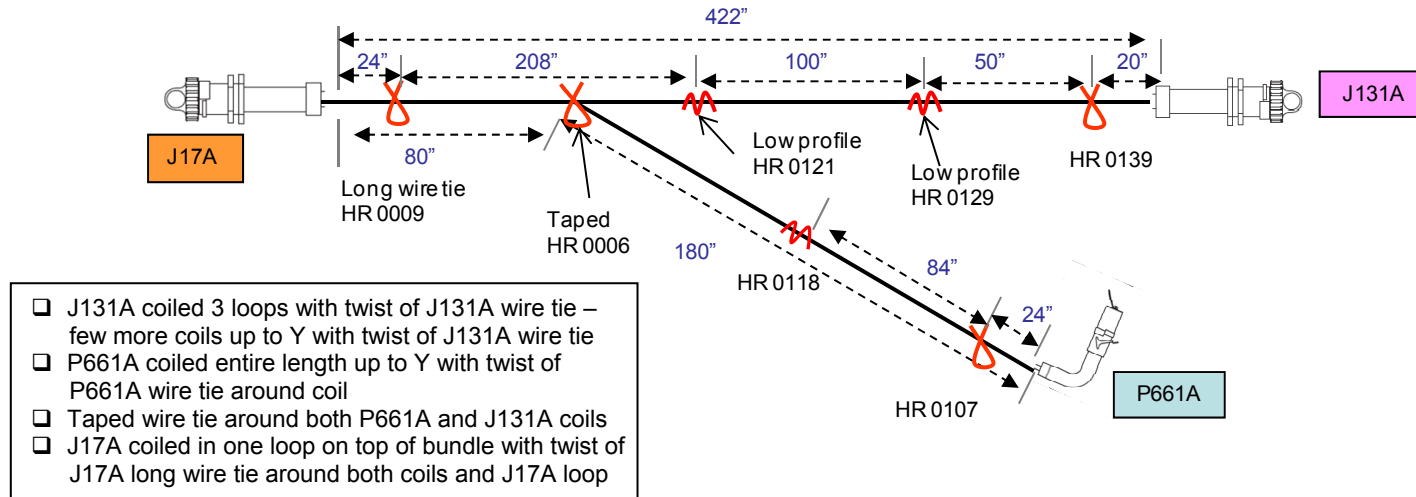

Figure 4: Ch 1/4 FGB Y-Cable (port)

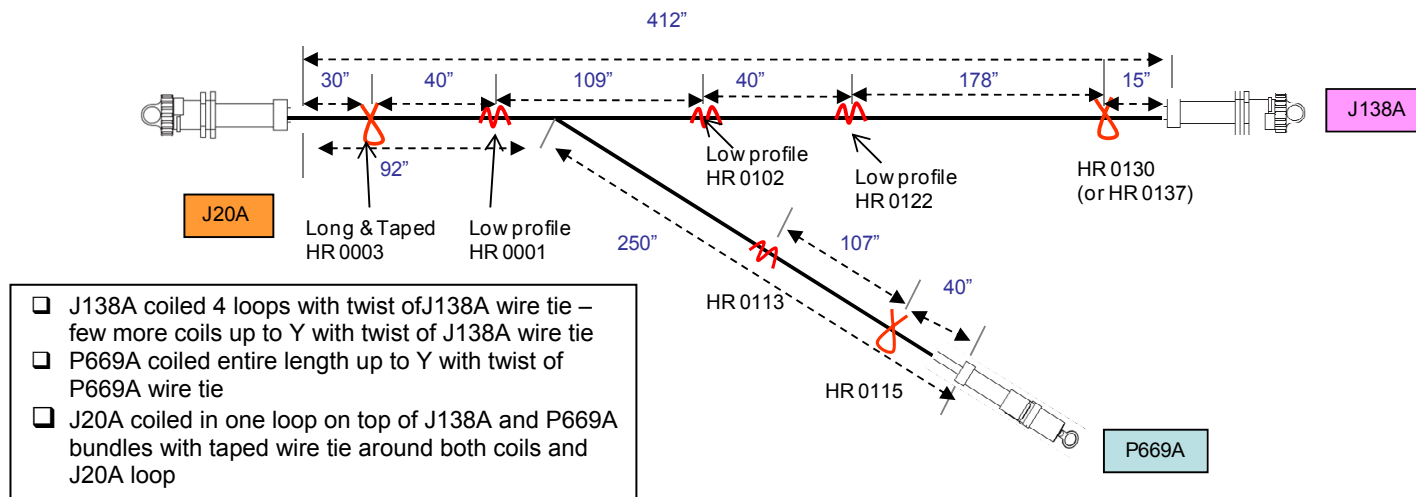

Figure 5: Ch 2/3 FGB Y-Cable (stbd)

## EVA 3 BRIEFING CARD

### EVA Prep

- Review Morning Timeline/Plan
- Work With a Purpose
- Pure O2 Protocol
- Suit Donning Plan – special requests, boot bladder manipulation
- Safer, MWS, Tools, CL, Bag Stowage in A/L
- Airlock Depress Review

### Procedure Review

- Egress Plan (tethers)
- Order of Tasks (summary timeline)
- Translation Paths, Fairleads
  - Inch-worm comm with PAMA/PDGF
- Hazards (no touch, no damage, keep outs, notes, cautions, warnings)
  - Sun sensors, FGB thrusters, CETA light, WETA, SASA, EVA crane
- Contingencies – section 16
  - NZGLs, PAMA feet
- Task Constraints, Potential Get-aheads
  - FGB Y-cable order
- Ingress Plan

### Post EVA

- Suit Doffing
- Tool Reconfig Plan

### Emergencies

- Comm Fail (hand signals), Term EVA, Abort EVA
- EMU Malfunctions
- Lost Tools/Crewmember (velocity and direction)
- DCS
- Safer Ops
- Crew Rescue

### Reminders/Top Ten

- Gate Closed, Slider Locked, Tether Reel Unlocked
- Pins Straight, No FOD, Good EMI
- PGT Read-back, Turns and Torque with light
- Worksite Departure – tethers and tools clear
- Move Slowly – no hopping (slower is faster)
- Body Position is Everything (use space)
- Tether Awareness – all of them
- Suit/Tool Awareness – BRT/PGT/ORU Stowage
- Suit MAL – read down DCM messages
- Discipline and Attention to detail until the end
- Day/Night Checks (tethers, tools, visors)

### Contingency

- Coordinate with **MCC-H** on following connector demate ops
  - Rats Nest connectors
    - P132
    - P140
    - P141
  - PMA1 power connectors
    - FGB J16/P16
    - FGB J21/P21



## EVA 3 INHIBIT PAD

### Orbiter

ALL EVAs	
TCS ( <i>Not required, switch guard installed on EVA 1</i> )	
IV L12	1. √TCS POWER – OFF
Ku-Band Antenna ( <i>INCO: Prior to Egress</i> )	
<b>MCC-H</b>	1. √KU-BAND Mask – active 2. √KU-BAND EVA Protect Box – active
RCS ( <i>Not expected since not translating to Payload Bay</i> )	
If EV crew < 27 ft from FRCS	
IV	1. √DAP: VERN, FREE, LO Z
O14,15,16	2. √RJDF F1, F2, F3, F4 MANF DRIVER (four) – OFF LOGIC (four) – OFF
<b>MCC-H</b>	3. √Above RCS config
IV	4. √RCS F – ITEM 1 EXEC (*) √JET DES F1U – ITEM 17 (*) F3U – ITEM 19 (*) F2U – ITEM 21 (*)

### Ground

ALL EVAs	
Ground Radar ( <i>TOPO: Prior to Egress</i> )	
<b>MCC-H</b>	1. √TOPO console, ground radar restrictions in place for EVA

### USOS (1)

ALL EVAs	
PCU ( <i>PHALCON: Prior to Egress</i> )	
<u>NOTE</u>	
PCUs may require up to a 1-hr warmup period before they are operational	
<b>MCC-H</b>	1. √PCUs (two) operational in discharge mode and one of the following: a. CCS PCU EVA hazard control FDIR enabled b. No more than two arrays unshunted and oriented < 105° from velocity vector
	If one or both PCUs failed
	2. No more than two arrays unshunted and oriented < 105° from velocity vector
CUCU ( <i>Crew: Prior to Egress</i> )	
IV – (LAB104)	
	1. √cb POWER A, B [two] – OPEN
	2. √cb LINK 1,2 [two] – OPEN
And one of the following inhibit pairs:	
<b>POIC</b>	3a. Express Rack 2 Locker 6 – Power Removed 3b. Express Rack 6 Locker 7 – Power Removed
<b>OR</b>	
IV	4a. Express Rack 2 Locker 6 – OFF 4b. Express Rack 6 Locker 7 – OFF
MISSE 8 ( <i>POD: Prior to Egress</i> )	
<b>POIC</b>	Prior to EV Hatch Open
	1. ELC-2 ExPA-2 Discrete Channel 6 – Disabled

### JEM (1)

ALL EVAs	
ICS-EF Antenna ( <i>Prior to Egress</i> )	
<b>SSIPC</b>	1. ICS MOD – OFF 2. ICS UPC – OFF 3. ICS HPA – OFF 4. HPA ON and UPC ON commands are cleared (not present) in the ICS stored command queue

## EVA 3 INHIBIT PAD (Cont)

### LOCATION DEPENDENT INHIBITS

Lab Window (*Not expected*)  
 IV If EV crew less than 10 ft from window or in window FOV,  
 close window shutter

Cupola Windows (*Not expected*)  
 IV If EV crew less than 10 ft from window, coordinate shutter  
 opening/closing with EV crew and minimize time shutter is open

Mobile Transporter (*ROBO: Prior to Egress*)  
**MCC-H** If EV crew < 1.5 meters from MT  
 1. √MT latched

Port SARJ (*PHALCON: Prior to Task – STP-H3 and HPGT MLI*)  
**MCC-H** If EV crew working within 2 ft, outboard of SARJ or reqd per loads FR  
 1. √DLA (1) – LOCKED  
 2. All motor setpoints set to zero  
 3. All motors deselected

SSPTS (*PHALCON: Prior to Task – FGB stbd Y-jumper install*  
*Inhibit 1 not required, inhibits 2 and 3 from ~3:45 – ingress*)  
**MCC-H** If EV crew working within 2 ft of SSPTS cables  
 1. RPCM LA2A3B D RPC 1 – Open, Close Cmd Inhibit  
 2. RPCM Z14B A RPC 2 – Open, Close Cmd Inhibit  
 3. RPCM Z13B A RPC 2 – Open, Close Cmd Inhibit

### COL (1)

ALL EVAs  
 HAM Radio (*Crew: Prior to Egress*)  
 IV 1. HAM Radio – Deactivate

### USOS (2)

#### TASK SPECIFIC

Ch 1/4 FGB Power Cable (*PHALCON: Prior to Egress for RACU*)  
**MCC-H** 1. √RACU-6 – OFF  
 2. √RACU-5 – OFF  
 P17 (port Y-jumper, CH 1/4) – *prior to task*  
 1. ARCU 51 – ON  
 2. ARCU 52, 53 and 54 – OFF  
 3. CHT 21 and 22 – OFF  
 4. CHT 23 and 24 – ON  
 5. RPCM Z14B\_A RPC1 – Open, Close Cmd Inhibit  
 P16 – *prior to task*  
 1. MBSU-2, RBI-5 – Open, Close Cmd Inhibit

Ch 2/3 FGB Power Cable (*PHALCON: Prior to Egress for RACU*)  
**MCC-H** 1. √RACU-6 – OFF  
 2. √RACU-5 – OFF  
 P20 (stbd Y-jumper, CH 2/3) – *prior to task*  
 1. ARCU 53 – ON  
 2. ARCU 51, 52 and 54 – OFF  
 3. CHT 21 and 22 – ON  
 4. CHT 23 and 24 – OFF  
 5. RPCM Z13B\_A RPC1 – Open, Close Cmd Inhibit  
 P21 – *prior to task*  
 1. MBSU-4, RBI-5 – Open, Close Cmd Inhibit

Node 3 J1 FGB and J2 FGB 1553 (*ROBO: Prior to Egress*)  
**MCC-H** If any RWS active, cmd 'Active Assert Backup'



## EVA 3 INHIBIT PAD (Cont)

### RSOS (1)

#### ALL EVAs

SM Antennas (*RIO: Prior to Egress*)

- |              |                                   |
|--------------|-----------------------------------|
| IV           | 1. ARISS (Ham Radio) – Deactivate |
| <b>MCC-M</b> | 2. GTS – Deactivate               |
|              | 3. Napor (PCПИ) – Deactivate      |

#### EVAs ON PMA1 OR RSOS (LOCATION DEPENDENT)

Soyuz TMA-20 (25S, No. 230) Thrusters

- |              |              |
|--------------|--------------|
| <b>MCC-M</b> | 1. Inhibited |
|--------------|--------------|

RSOS and RSOS Visiting Vehicle Antennas (Includes FGB, SM, DC-1, MRM-1, MRM-2, Soyuz TMA-20 (25S, No. 230) Progress)

- |              |                                   |
|--------------|-----------------------------------|
| <b>MCC-M</b> | 1. √KURS P [КУРС P] – Deactivated |
|              | 2. √KURS A [КУРС A] – Deactivated |

#### ADDITIONAL ANTENNA INHIBITS FOR EVAs ON RSOS (LOCATION DEPENDENT)

##### FGB Antennas

- |              |                              |               |
|--------------|------------------------------|---------------|
| <b>MCC-M</b> | 1. √TORU [ТОРУ]              | – Deactivated |
|              | 2. √TV System [ТВС]          | – Deactivated |
|              | 3. Radiotelemetry [БР-9ЦУ-8] | – Deactivate  |
|              | 4. √TV System [КЛ-108А]      | – Deactivated |
|              | 5. √CNPMS [СИТНП]            | – Deactivated |
|              | 6. √KOMPARUS [КИС]           | – Deactivated |

## EVA 3 NOTES/CAUTIONS/WARNINGS

### NOTES

1. Bolt install: Report torque and turns
2. Bolt release: Report torque and turns if different from published range
3. EVA connectors: After disconnection and prior to connection; verify pin and EMI band integrity; verify connector free of FOD
4. Inspect QDs for damage prior to mating
5. Toolbox doors must be closed with one latch per door when EV crew not in immediate vicinity
6. 85-ft safety tether retract force may affect body positioning
7. CETA Cart brake handle wire ties must be replaced after crew loading

### CAUTION

#### **ISS Generic Constraints**

- A. Avoid inadvertent contact with
1. Grapple fixture shafts (dry lube)
  2. PIP pins
  3. Passive UMAs
  4. MBS/SSRMS/SPDM taped radiative surfaces: VDU, ACU, JEU, LEU, MCU, CRPCMs, and Cameras
  5. SPDM SJEU, EP, OTCM, LEU, and LEE VDU radiator surfaces
  6. OTSD
- B. Electrical cables
1. Avoid bend radii < 10 times cable diameter
- C. Fiber optic cables
1. Avoid bend radii < 10 times cable diameter
  2. Avoid pulling on cable during mate/demate
- D. Fluid line flex hoses and QDs
1. Avoid bend radii < 14 in for hoses with a diameter  $\geq$  1 in
  2. Additional care should be taken to not exceed bend radii when applying loads at the flexible hose to rigid tube stub interfaces
  3. Ensure fluid QD booties are fully closed prior to leaving worksite; wire tie if required
  4. Avoid bend radii < 5 in for hoses with diameter < 1 in on LAB, S0, S1, P1, and 10 in for hoses with diameter < 1 in on all other elements

### CAUTION

#### **ISS Generic Constraints (Cont)**

- E. For structural reasons
1. Avoid vigorous body motions, quick grabs and kickoffs against tether restraints
  2. Avoid performing shaking motions (sinusoidal functions) more than four cycles
- F. Other
1. ITT Cannon connector: On demated connectors, do not rotate collar or manipulate cable/connector using collar or connector tool
  2. MLI handholds are not rated for crewmember translation loads

## EVA 3 NOTES/CAUTIONS/WARNINGS (Cont)

### CAUTION

#### ISS Truss Constraints

##### A. Avoid inadvertent contact with

1. CETA lights (Z-93 paint)  
[LAB,S1,NODE 1,P3,S3]
2. Deployed TUS cable [Zenith and Nadir CETA rails]
3. S0 aft face radiator
4. GPS antennas (S13 paint) [S0,JLP]
5. UHF antennas [LAB,P1]
6. ETCS radiator flexhoses and panels [S1,P1]
7. EETCS/PV radiator flexhoses, bellows and panels [P6,P4,S4,S6]
8. SASA RF group [S1,P1]
9. Heat pipe radiators [Z1]
10. PCU cathode and HCA ports [Z1]
11. Ku-Band antenna (SGANT) dish [Z1]
12. CMG cover/shells [Z1]
13. FPMU [P1]
14. SASA high and low gain antennas and radiator surfaces [Z1]
15. Deployed MISSEs
16. OTP on HAB Tray [S0]

##### B. For structural reasons

1. Avoid kicking S1/P1 radiator beam.  
If any of these occur, wait 2 to 5 min to allow structural response to dissipate

### CAUTION

#### ISS Truss Constraints (Cont)

##### C. Other

1. EWIS antennas: Do not use as handholds [NODE 1,LAB,P6,Z1]
2. Lubricant from Ku-Band SGANT gimbals [Z1], CMGs [Z1], and RTAS ground strap fasteners [P6,P4,S4,S6] can contaminate EMU
3. Prevent inadvertent contact of the tether shuttle with ETRS when the P3 tether shuttle stop is raised away from the rail

### CAUTION

#### ISS U.S. Pressurized Elements Constraints

##### A. Avoid inadvertent contact with

1. EVA crane [PMA1]
2. TCS reflectors [PMA2,PMA3]
3. APAS hardware [PMA2,PMA3]
4. CETA lights (Z-93 paint)  
[LAB,S1,NODE 1,P3,S3]
5. UHF antennas [LAB,P1]
6. Open CBM petal covers, LAB and Cupola window shutters
7. S0/NODE 2 fluid tray hardlines at NODE 2 end, which are limited to 25 lb

##### B. Other

1. EWIS antennas: Do not use as handholds [NODE 1,LAB,P6,Z1]
2. CBM petal covers may not be used as handholds unless both launch restraint pins are engaged

## EVA 3 NOTES/CAUTIONS/WARNINGS (Cont)

### CAUTION

#### **ISS I.P. Elements Constraints**

##### COL

- A. Avoid inadvertent contact with
1. COL ARISS and AIS antennas [COL-Nadir]

##### JEM

- A. Avoid inadvertent contact with
1. GPS antennas (S13 paint) [S0,JLP]
  2. Open JPM window shutter
  3. JTVE, WVE/EVE, JEF VE cameras
  4. JEMRMS taped radiative surfaces [JEU,EE,Cameras]
  5. JEM A/L target and pins
  6. JEF ORUs and EFUs (paint and lubricant)
  7. MAXI front and top panel (paint)
  8. SEDA-AP sensors (HIT, SDOM, and AOM)
  9. Trunnions and UCMs (paint and lubricant) [JEF Payloads]
  10. RAIDS covers on end of HREP
  11. ICS-EF Ka-Band antenna dish
  12. Small Fine Arm (SFA) (paint, coating and lubricant)
- B. For structural reasons
1. Avoid kicking MMOD shields between JLP and JPM
  2. Avoid tool impact on ICS-EF sensor

### CAUTION

#### **Shuttle Constraints**

- A. Avoid inadvertent contact with
1. OBSS and SRMS composite sections joint torque arms, grapple fixture shafts, and cable harnesses
  2. LCS (silver Teflon) and LDRI (silver Teflon) and ITVC (gold foil) [OBSS]
  3. WVS antenna [ODS truss and PLB sill]
  4. Payload bay and camera wire harnesses, cables, cable guides, and connectors
  5. OBSS striker bars (drylube)
- B. No touch
1. LDRI diffuser [OBSS]
  2. OBSS saddle contacts (when OBSS unberthed) [OBSS]
  3. Monkey fur [PLB]
  4. Cameras: Metallic surfaces [PLB]
  5. Ku-Band antenna black dish and gold thermal blankets [PLB]

## EVA 3 NOTES/CAUTIONS/WARNINGS (Cont)

### WARNING

#### ISS Generic Constraints

- A. Avoid inadvertent contact with
1. Grapple fixture targets and target pins
- B. Pinch
1. NZGL connector linkage. Use caution when mating/locking
  2. ITT Cannon connector rotating housing
  3. PDGF connector doors
- C. QDs
1. If QD is in FID when valve is opened (bail fwd), QD will leak and fluid line may whip
  2. Do not rotate if in mated/valve open configuration
  3. Bail may kick back suddenly when detent button is depressed if pressure has built up in spring cavity
- D. Sharp Edges
1. Inner edges of WIF sockets
  2. APFR active WIF probes
  3. Mating surfaces of EVA connectors  
Avoid side loads during connector mating
  4. Back side of MMOD shield fasteners
  5. Spring loaded captive EVA fasteners (e.g., 6B-boxes, BMRRM, RTAs, SARJ Covers); the end of the spring may protrude
  6. SPDM OTCM gripper jaws
  7. Keep hands away from SSRMS LEE/POA/SPDM LEE opening, snares, and PDGF curvic coupling (teeth)
  8. MMOD strikes on ISS exterior

### WARNING

#### ISS Generic Constraints (Cont)

- E. Thermal
1. EVA connectors with booties may become hot if left uncovered. Handling may need to be limited
  2. Turn off glove heaters when comfortable temperature reached to prevent bladder damage. Do not pull fingers out of gloves when heaters are on
  3. Uncovered trunnion pins may be hot
  4. SSRMS/MBS/SPDM operating cameras and lights may radiate large amounts of heat
  5. Do not touch EMU protective visor if temperature has been  $< -134$  degF for  $> 15$  min
  6. No EMU boot contact with foot restraint when temperature  $< -120$  degF or  $> 200$  degF
  7. PDGF surfaces may not meet touch temperature requirements for unlimited contact when  $\beta \leq -70$  or  $\beta \geq 70$

### WARNING

#### ISS Truss Constraints

- A. Avoid inadvertent contact
1. SSU, ECU, beta gimbal platform, mast canister, SAW blanket boxes unless the beta gimbal is locked and the motor is turned off
  2. Stay inboard of SARJ when active
  3. Stay 2 ft from S1/P1 radiator beam rotational envelope when beam is free to rotate
  4. Stay 5 ft from moving MT on face 1
  5. Stay 3.3 ft from Ku-Band (SGANT antenna) when powered
  6. Stay 1 ft from top of STP-H3 (ELC3)
  7. Deployed MISSEs and ORMATE-III R/W
- B. RF radiation exposure
1. Stay 3.6 ft from S-Band (SASA) high gain antenna when powered [S1,P1]
  2. Stay 1.3 ft from S-Band (SASA) low gain antenna when powered [S1,P1]
  3. Stay 1 ft from UHF antenna when powered [LAB,P1]
- C. Sharp Edges
1. Solar array blanket box [P6,S6]
  2. Fastener threads on back of Z1 U-jumper male FQD panel, if nutplate cap missing
  3. Outboard MT rail attachment lug near P6 handrail 5333 and gap spanner
  4. P2 connector on EWIS box TAA-06 [Zenith/Forward Corner 1 of P5 – SARJ at 0 deg]
  5. Nickel coated braided copper ground straps may contain frayed wires [P6,P4,S4,S6]
  6. MMOD strikes on Z1 toolboxes
  7. POA FSE (CSA logo below MBS mast camera)
  8. AMS Star Trackers Baffles (2)

## EVA 3 NOTES/CAUTIONS/WARNINGS (Cont)

### WARNING

#### ISS Truss Constraints (Cont)

##### D. Electrical Shock

1. Stay  $\geq$  2 ft from ungrounded floating connectors if powered  
S0 EVA power cables (inside S0 Bay 00 Face 4, Bay 01 Face 3)  
ESP-2 jumper (inside S0 Bay 03 Face 4)

##### E. Thermal

1. ELC may exceed touch temperatures when  $\beta > 75$  deg

### WARNING

#### ISS U.S. Pressurized Elements Constraints

##### A. Handrails

1. Handrails previously used for MISSE attachment may not be used as a safety tether point [A/L endcone 564 and 566, A/L Tank 2 Nad/Fwd and Port/Fwd, P6 5389]

##### B. Pinch

1. EV side of IV Hatch during Hatch operation (also snag hazard) [A/L]
2. LAB and Cupola window shutters and CBM petal cover linkages during operation

##### C. RF radiation exposure

1. Stay 1 ft from UHF antenna when powered [LAB,P1]

##### D. Sharp Edges

1. PMA umbilical launch restraints - exposed bolt threads
2. Adjustable fuse tether (Fish Stringer) buckles stowed in Node bag
3. Port/Aft portion of A/L circular HR [HR 0506]
4. A/L HR 0537 (Eq Lock Zenith)
5. ESP-2 HR 8012
6. PMM ROEU and ROFU panels (zenith endcone)

### WARNING

#### ISS U.S. Pressurized Elements Constraints (Cont)

##### E. Thermal

1. PMA handrails may be hot. Handling may need to be limited
2. Stay  $\geq$  1 ft away from PMAs and MMOD shields  $>$  270 degF if EMU sun visor up; limit time to 15 min or less if  $>$  300 degF
3. Stay at least 0.5 ft away from PMA and MMOD shields  $>$  325 degF
4. No EMU TMG contact with PMAs and MMOD shields  $>$  320 degF

##### F. Electrical Shock

1. Stay  $\geq$  2 ft from ungrounded floating connectors if powered  
SSPTS connectors include NOD1 Stbd/Fwd HR 0130, LAB Stbd/Fwd HR 0273, PMA2 Stbd

##### G. Fluid QDs

1. Do not translate on gap spanners restraining NODE 3 – LAB NH3 jumpers

## EVA 3 NOTES/CAUTIONS/WARNINGS (Cont)

### WARNING

#### ISS I.P. Elements Constraints

##### COL

- A. Avoid inadvertent contact with
  - 1. SOLAR [COL EPF]
- B. Thermal
  - 1. Columbus end cones may violate touch temperature constraints when  $-75 \leq \beta \leq -60$  or  $60 \leq \beta \leq 75$

##### JEM

- A. Avoid inadvertent contact with
  - 1. ICS-EF sensors
- B. Pinch
  - 1. JPM window shutter linkages during operation
  - 2. JEM cameras (JVTEs, EVE, WVE, and JEF VEs)
  - 3. JEM EFU latching arms
  - 4. JEF SSE latch
  - 5. ICS-EF antenna boom
  - 6. SEDA-AP mast
  - 7. SMILES antenna rotating area
  - 8. HREP hinge sides and RAIDS pinch areas
  - 9. JEMRMS EE
  - 10. JEMRMS Small Fine Arm (SFA) joints and booms

### WARNING

#### ISS I.P. Elements Constraints (Cont)

##### JEM (Cont)

- C. Sharp Edges
  - 1. Interior of JEMRMS HRMs
  - 2. JEMRMS EE opening and snares
  - 3. JEM A/L hatch corners
  - 4. ICS-EF AHM gears
  - 5. MAXI visual star camera
  - 6. SMILES baffles (two), baffle base bare bolts, and Cold Sky Terminator (CST)
  - 7. HREP baffles (four) [Star tracker aperture Zenith and three instrument baffles Aft]
  - 8. SFA Electro-Mechanical GF (EMGF)
- D. RF radiation exposure
  - 1. Stay 0.3 ft from Fwd/Aft JPM PROX antenna
- E. Thermal
  - 1. JPM Port End Cones and JLP Port Nadir may violate touch temperature constraints when  $\beta > 60$  deg
  - 2. JEMRMS/JTVE/JEFVE operating cameras and lights may radiate large amounts of heat

### WARNING

#### Shuttle Constraints

- A. Arcing/Molten Debris
  - 1. Stay  $\geq 2$  ft from exposed EFGF connector when OBSS berthed, powered, and EFGF not grappled [PLB]
  - 2. Stay  $\geq 2$  ft from exposed Stbd Fwd MPM contacts [PLB]
  - 3. Stay above PLB sill when within 1 ft of powered ROEU connector [PLB]
- B. Pinch
  - 1. PRLA operation [PLB]
- C. RF radiation exposure
  - 1. Stay 3.28 ft from S-Band antenna when powered
  - 2. Stay 1 ft from top and side of UHF PLB antenna radome surface when in high powered mode [ODS truss]
  - 3. Stay 0.33 ft from top and side of UHF PLB antenna radome surface when in low powered mode [ODS truss]
  - 4. Remain below the level of the PLB door mold line for first 20 in Aft of Fwd bulkhead when S-Band antenna powered [PLB]
  - 5. Remain on the inboard side of the Stbd slidewire (sill handrails if slidewire not installed) for first 20 ft Aft of Fwd bulkhead when Ku-Band antenna powered [PLB]

## EVA 3 NOTES/CAUTIONS/WARNINGS (Cont)

### WARNING

#### **Shuttle Constraints (Cont)**

##### D. Sharp Edges

1. PRLA grounding wipers [PLB]
2. LDRI baffles (also an entrapment hazard) [OBSS]
3. Keep hands away from SRMS EE opening and snares
4. TCS connector backshells have exposed threads [ODS]

##### E. Thermal

1. Illuminated PLB lights; do not touch
2. OBSS grapple fixture shafts/cams may be hot. Limit handling if required
3. Stay 27 ft from PRCS when powered
4. Stay 3 ft from VRCS when powered
5. Stay 3 ft from APU when operating

##### F. Contamination

1. Stay out of the immediate vicinity of leaking jet or APU

##### G. Lasers

1. Do not look at LDRI diffuser or LCS laser aperture window

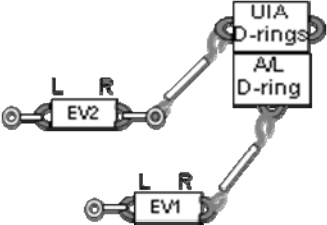
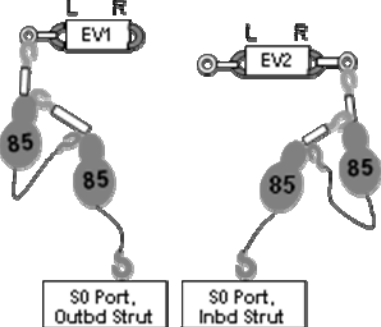

## EVA 3 EGRESS/SETUP (00:40)

IV/SSRMS	EV1 (Drew)	EV2 (Spanky)
<p>1. Record PET Start time ___:___</p> <p>2. Day/Night Cycles _____</p>  <p>3. Start WVS Recorders</p> <p>4. Start Hatch Thermal Cover clock PET (30 min) ___ : ___</p> <p>5. Inspect Load Alleviating Straps for:</p> <ol style="list-style-type: none"> <li>1. MMOD/general damage</li> <li>2. Discoloration</li> <li>3. Tack Stitching</li> <li>4. Red Band</li> </ol> 	<p><b>Initial Configuration:</b></p> <ol style="list-style-type: none"> <li>1. <input checked="" type="checkbox"/> All gates closed &amp; hooks locked <ul style="list-style-type: none"> <li><input type="checkbox"/> R Waist Tether to A/L int D-ring ext</li> </ul> </li> </ol> <div style="border: 1px solid black; padding: 5px; text-align: center; margin: 10px 0;"> <p><b>WARNING</b></p> <p>Avoid inadvertent contact with grapple fixture target, target pin, connector doors, and PDGF curvic coupling (teeth)</p> </div> <p><u>EGRESS</u> (00:15)</p> <ol style="list-style-type: none"> <li>2. Open hatch thermal cover</li> <li>3. Egress A/L (toward fwd curved HR)</li> <li>4. Perform LAS inspection on EV2 ST Pack (aft D-ring) <ul style="list-style-type: none"> <li><input type="checkbox"/> LAS; <input type="checkbox"/> <input checked="" type="checkbox"/> Yellow hook on Green ERCM</li> <li><input type="checkbox"/> LAS; <input type="checkbox"/> <input checked="" type="checkbox"/> Green hook on Red ERCM</li> </ul> </li> <li>5. RET to ST Pack</li> <li>6. Attach <b>RED</b> hook to EV2 R D-ring ext <ul style="list-style-type: none"> <li><input type="checkbox"/> <input checked="" type="checkbox"/> Gate closed, hook locked, reels unlocked, release RET</li> </ul> </li> <li>7. Give <b>EV2 GO</b> to release Waist Tether</li> <li>8. Perform LAS inspection on EV1 ST Pack <ul style="list-style-type: none"> <li><input type="checkbox"/> LAS; <input type="checkbox"/> <input checked="" type="checkbox"/> Yellow hook on Green ERCM</li> <li><input type="checkbox"/> LAS; <input type="checkbox"/> <input checked="" type="checkbox"/> Green hook on Red ERCM</li> </ul> </li> <li>9. RET to ST Pack on fwd/stbd curved HR stanchion</li> <li>10. Attach <b>RED</b> hook to L D-ring ext <ul style="list-style-type: none"> <li><input type="checkbox"/> <input checked="" type="checkbox"/> Gate closed, hook locked, reels unlocked, release RET</li> </ul> </li> <li>11. Release R Waist Tether from A/L int D-ring ext</li> </ol>	<p><b>Initial Configuration:</b></p> <ol style="list-style-type: none"> <li>1. <input checked="" type="checkbox"/> All gates closed &amp; hooks locked <ul style="list-style-type: none"> <li><input type="checkbox"/> R Waist Tether to UIA D-ring</li> </ul> </li> </ol> <p><u>EGRESS</u> (00:15)</p> <ol style="list-style-type: none"> <li>2. Partially egress A/L hatch to allow EV1 to attach <b>RED</b> hook to R D-ring ext</li> <li>3. On <b>EV1 GO</b>, release Waist Tether from UIA D-ring</li> <li>4. Relocate sm hook of Lg-sm RET to UIA D-rings</li> <li>5. Egress A/L with ORU+C/L bag bundle</li> <li>6. Attach ORU+C/L bag bundle on BRT w/RET</li> </ol>

**EVA 3 EGRESS/SETUP (00:40) (Cont)**

IV/SSRMS	EV1 (Drew)	EV2 (Spanky)
<p>6. Post crew egress: WVS Software:     Select page – RF camera     Sel 'Advanced Controls'     S-Band Level (two) – Max</p> <p>7. Stop Hatch Thermal Cover clock PET (30 min) __ : __</p>	<p>12. Perform buddy checks     √MWS tabs up, BRT tab up, tether configs</p> <p>13. Verify SAFER config     <input type="checkbox"/> √L handle down (MAN ISOL Vlv – Open)     <input type="checkbox"/> √R handle down (HCM – Closed)</p> <p>14. √WVS – green LED</p> <p>15. Close hatch thermal cover</p> <div data-bbox="846 521 1787 586" style="border: 1px solid black; padding: 5px; text-align: center;"> <p><b>CAUTION</b> Avoid inadvertent contact with zenith PMA1 MDM and above 22" of EVA crane</p> </div> <div data-bbox="942 618 1688 699" style="border: 3px double black; padding: 5px; text-align: center;"> <p><b>WARNING</b> Avoid contact with FGB sun sensors (possible sharp edges)</p> </div> <p><u>SETUP</u> (00:25)</p> <p>16. EV2 translate first, then translate aft/zenith on Crewlock to the Cable bag</p> <p>17. Retrieve Cable bag, stow on BRT w/RET</p> <p>18. Translate to FGB zenith/aft</p> <p>19. Stow Cable bag across FGB HRs 1037 and 1032 (handle port)</p> <p style="text-align: center;">(Translate to PDGF worksite – PDGF Setup)</p>	<p>7. Perform buddy checks     √MWS tabs up, BRT tab up, tether configs</p> <p>8. Verify SAFER config     <input type="checkbox"/> √L handle down (MAN ISOL Vlv – Open)     <input type="checkbox"/> √R handle down (HCM – Closed)</p> <p>9. √WVS – green LED</p> <p><u>SETUP</u> (00:25)</p> <p>10. Translate to FGB/MRM1 interface     <input type="checkbox"/> Fairlead on E/L HR 0510 (zenith of trunnion pins)     <input type="checkbox"/> Fairlead on NOD1 HR 0119 (end cone radial HR)     <input type="checkbox"/> Translate nadir/port on PMA1</p> <p>11. Attach <b>GREEN</b> hook to PMA1 HR 0013     <input type="checkbox"/> √Gate closed, hook locked, reels unlocked, release RET</p> <p>12. Release ORU bag taped hooks from C/L bag</p> <p>13. Stow Medium ORU bag on PMA1 HRs 0011 and 0012 (hinge ISS fwd)</p> <p>14. Install gap spanner on PMA1 HR 0010 and FGB vertical HR 1050</p> <p>15. Remove C/L bag from ORU bag by releasing C/L bag taped hook from ORU bag</p> <p>16. Stow C/L bag on MRM1 curved HR     (Retrieve long wire tie – PDGF Setup)</p>

**PDGF SETUP (00:30)**

IV/SSRMS	EV1 (Drew)	EV2 (Spanky)
<p>Planned PET 00:40</p>	<p><u>PDGF SETUP (00:30)</u></p> <ol style="list-style-type: none"> <li>1. Translate to PDGF worksite</li>   <li>2. Receive MLI and wire tie from EV2</li> <li>3. Remove remaining PAMA and VSC MLI from FGB and stow on EV2 wire tie; twist wire tie to ensure each MLI is captured (3 twists after last MLI)               <ul style="list-style-type: none"> <li><input type="checkbox"/> PAMA 1      <input checked="" type="checkbox"/> PAMA 2      <input checked="" type="checkbox"/> PAMA 3</li> <li><input type="checkbox"/> VSC (small)      <input type="checkbox"/> VSC (large – Ushape)</li> </ul> </li> <li>4. Translate zenith on FGB to FGB bracket</li> <li>5. Bundle/stow MLI on FGB bracket               <ul style="list-style-type: none"> <li><input type="checkbox"/> 1 long wire tie to MLI tether point, around bundle and bracket (as tight as possible)</li> <li><input type="checkbox"/> 1 long wire tie to bracket, around bundle and through MLI tether loop (as tight as possible)</li> <li><input type="checkbox"/> Stow MLI under bracket</li> </ul> </li> <li>6.  WVS of the temp stow config</li> </ol> <p style="text-align: center;">(Translate to A/L – Retrieve PAMA/PDGF)</p>	<p><u>PDGF SETUP (00:30)</u></p> <ol style="list-style-type: none"> <li>1. Retrieve pre-configured long wire tie from C/L bag</li> <li>2. Translate to PDGF worksite</li>   <li>3. Remove PAMA and VSC MLI from FGB and stow on wire tie; twist wire tie to ensure each MLI is captured               <ul style="list-style-type: none"> <li><input checked="" type="checkbox"/> PAMA 1      <input type="checkbox"/> PAMA 2      <input type="checkbox"/> PAMA 3</li> <li><input checked="" type="checkbox"/> VSC (small)      <input checked="" type="checkbox"/> VSC (large)</li> </ul> </li> <li>4. Transfer MLI and wire tie to EV1</li>   <li>5. Retrieve Russian ratchet from C/L bag               <ul style="list-style-type: none"> <li><input type="checkbox"/> √Ratchet in Open</li> </ul> </li> <li>6. Remove PAMA caps (3 total):               <ul style="list-style-type: none"> <li><input type="checkbox"/> Pull and rotate T-handle (release secondary lock)</li> <li><input type="checkbox"/> Engage ratchet to cap; pull test</li> <li><input type="checkbox"/> Remove cap (ccw) and stow in trash bag (pull ratchet release tab)</li> <li><input type="checkbox"/> PAMA 1      <input type="checkbox"/> PAMA 2      <input type="checkbox"/> PAMA 3</li> </ul> </li> <li>7. Visually inspect PAMA mating surfaces (3)               <ul style="list-style-type: none"> <li><input type="checkbox"/> PAMA 1      <input type="checkbox"/> PAMA 2      <input type="checkbox"/> PAMA 3</li> </ul> </li> <li>8. Stow Russian ratchet in C/L bag</li> </ol> <p style="text-align: center;">(Translate to A/L – Retrieve PAMA/PDGF)</p>

## RETRIEVE PAMA/PDGF (00:20)

IV/SSRMS	EV1 (Drew)	EV2 (Spanky)
<p>Planned PET 01:10</p> <ol style="list-style-type: none"> <li>Start Hatch Thermal Cover clock PET (30 min) __ : __</li> <li>Stop Hatch Thermal Cover clock PET (30 min) __ : __</li> </ol>	<p><u>RETRIEVE PAMA/PDGF (00:20)</u></p> <ol style="list-style-type: none"> <li>Translate to A/L, go first</li> <li>Glove Check</li> <li>Open hatch thermal cover</li> <li>Attach Lg-sm RET to PAMA handhold at foot 1</li> <li>Retrieve the PAMA/PDGF</li> <li>Close thermal cover</li> </ol> <div data-bbox="829 581 1801 760" style="border: 3px double black; padding: 5px; margin: 10px auto; width: fit-content;"> <p style="text-align: center;"><b>WARNING</b></p> <p>During translation, PDGF surfaces may not meet touch temp requirements for incidental or unlimited contact</p> <p>Avoid inadvertent contact with grapple fixture target, target pin, connector doors, and PDGF curvic coupling (teeth)</p> </div> <ol style="list-style-type: none"> <li>Inch worm PAMA/PDGF toward Node 1               <ul style="list-style-type: none"> <li><input type="checkbox"/> EV2 leads translation</li> <li><input type="checkbox"/> Fairlead EV2's tether on E/L HR 0510</li> </ul> </li> <li>Attach <b>GREEN</b> hook to Node 1 HR 0119, inbd stanchion               <ul style="list-style-type: none"> <li><input type="checkbox"/> √Gate closed, hook locked, reels unlocked, release RET</li> </ul> </li> <li>Inch worm PAMA/PDGF to PDGF Worksite               <ul style="list-style-type: none"> <li><input type="checkbox"/> Fairlead on PMA1 HR 0005</li> </ul> </li> </ol> <p style="text-align: center;">(EV1 is at zenith worksite)</p>	<p><u>RETRIEVE PAMA/PDGF (00:20)</u></p> <ol style="list-style-type: none"> <li>Translate zenith/stbd over PMA1 to A/L, EV1 goes first</li> <li>Glove Check</li> <li>Attach R Waist Tether to PAMA handhold at foot 3</li> <li>Verify EV1 SAFER configuration               <ul style="list-style-type: none"> <li><input type="checkbox"/> √R Handle down (HCM door – Closed)</li> <li><input type="checkbox"/> √L Handle down (MAN ISO Valve – Open)</li> </ul> </li> </ol> <ol style="list-style-type: none"> <li>Inch worm PAMA/PDGF toward Node 1               <ul style="list-style-type: none"> <li><input type="checkbox"/> Verify grapple shaft away from structure</li> <li><input type="checkbox"/> Lead translation</li> </ul> </li> <li>Maintain control while EV1 drops his GREEN</li> <li>Inch worm PAMA/PDGF to PDGF Worksite               <ul style="list-style-type: none"> <li><input type="checkbox"/> Translate zenith over FGB, then nadir/port to worksite</li> </ul> </li> </ol> <p style="text-align: center;">(EV2 is at nadir worksite)</p>

## PAMA/PDGF INSTALL (00:15)

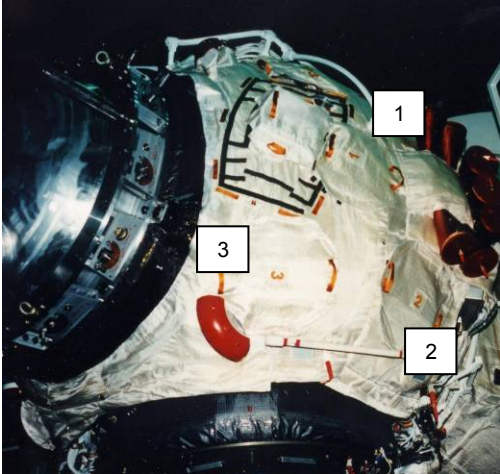
IV/SSRMS	EV1 (Drew)	EV2 (Spanky)
<p>Planned PET 01:30</p>  <p>PAMA/PDGF Alignment:  Foot 1: Zenith  Foot 2: Nadir/Aft  Foot 3: Nadir/Fwd  Target Pin: Aft  Horseshoe/PDGF Harness: Fwd  EV1: Zenith  EV2: Nadir</p>	<p><u>PAMA/PDGF INSTALL (00:15)</u></p> <ol style="list-style-type: none"> <li>Align PAMA/PDGF for install <ul style="list-style-type: none"> <li><input type="checkbox"/> Foot 1 zenith</li> <li><input type="checkbox"/> Target pin aft</li> <li><input type="checkbox"/> Harness fwd</li> </ul> </li> <li>Verify ST clear of PAMA install</li> <li>Install PAMA foot 1 to soft dock</li> <li>Hand tighten PAMA foot 1, ~3-4 turns to hardstop, back off ½ turn <ul style="list-style-type: none"> <li><input type="checkbox"/> PAMA Foot 1 ____</li> </ul> </li> <li>Receive PAMA cheater bar from EV2</li> <li>Place final torque on PAMA foot 1 <ul style="list-style-type: none"> <li><input type="checkbox"/> √Black-on black</li> </ul> </li> <li>Engage secondary lock on PAMA foot 1 <ul style="list-style-type: none"> <li><input type="checkbox"/> Pull and rotate T-handle 90°</li> <li><input type="checkbox"/> Confirm T-handle pin on knurled portion of foot</li> </ul> </li> <li>Transfer PAMA cheater bar to EV2</li> </ol> <p>(Release VSC/Power Cables from PDGF – VSC Install)</p>	<p><u>PAMA/PDGF INSTALL (00:15)</u></p> <ol style="list-style-type: none"> <li>Align PAMA/PDGF for install <ul style="list-style-type: none"> <li><input type="checkbox"/> Foot 2 nadir/aft</li> <li><input type="checkbox"/> Target pin aft</li> <li><input type="checkbox"/> Harness fwd</li> </ul> </li> <li>Verify ST clear of PAMA install</li> </ol> <p><u>NOTE</u>  Soft dock in any order; hand tighten feet in desired 1-2-3 order</p> <ol style="list-style-type: none"> <li>Install PAMA foot 3 to soft dock</li> <li>Install PAMA foot 2 to soft dock</li> <li>Hand tighten PAMA foot 2, ~3-4 turns to hardstop, back off ½ turn <ul style="list-style-type: none"> <li><input type="checkbox"/> PAMA Foot 2 ____</li> </ul> </li> <li>Hand tighten PAMA foot 3, ~3-4 turns to hardstop, back off ½ turn <ul style="list-style-type: none"> <li><input type="checkbox"/> PAMA Foot 3 ____</li> </ul> </li> <li>Retrieve PAMA cheater bar from C/L bag</li> <li>Place final torque on PAMA feet 2 and 3, in any order <ul style="list-style-type: none"> <li><input type="checkbox"/> Foot 2 √black-on black</li> <li><input type="checkbox"/> Foot 3 √black-on black</li> </ul> </li> <li>Engage secondary lock on PAMA feet 2 and 3 <ul style="list-style-type: none"> <li><input type="checkbox"/> Pull and rotate T-handle 90°</li> <li><input type="checkbox"/> Confirm T-handle pin on knurled portion of foot</li> </ul> </li> <li>Transfer PAMA cheater bar to EV1</li> <li>Receive PAMA cheater bar from EV1, stow in C/L bag</li> </ol> <p>(Retrieve VSC – VSC Install)</p>

## VSC INSTALL (00:30)

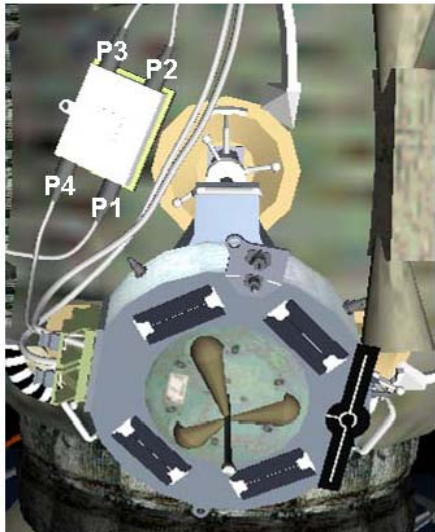
IV/SSRMS	EV1 (Drew)	EV2 (Spanky)						
<p>Planned PET 01:45</p> <p>1. Record VSC bolt data:</p> <table border="1" data-bbox="100 792 583 857"> <thead> <tr> <th>Bolt</th> <th>Turns</th> <th>Torque (ft-lb)</th> </tr> </thead> <tbody> <tr> <td>VSC</td> <td>(11)</td> <td>(12.0)</td> </tr> </tbody> </table> 	Bolt	Turns	Torque (ft-lb)	VSC	(11)	(12.0)	<p><u>VSC INSTALL</u> (00:30)</p> <ol style="list-style-type: none"> <li>Release wire tie from PDGF above foot 1 for VSC/J18/J19 cables</li> <li>Route VSC/J18/J19 cables zenith; temp stow cables on FGB HR 1050 using J18 wire tie</li> <li>Assist EV2 with VSC install as reqd</li> <li>Retrieve VSC connectors from FGB HR 1050</li> <li>Remove MLI caps from PDGF harness connectors P2, P3, and P4 (lanyarded)</li> <li>Mate PDGF harness connectors P2, P3, and P4 to VSC (√Good pins &amp; EMI band; no FOD) <ul style="list-style-type: none"> <li><input type="checkbox"/> PDGF harness P2 → ← VSC J2</li> <li><input type="checkbox"/> PDGF harness P3 → ← VSC J3</li> <li><input type="checkbox"/> PDGF harness P4 → ← VSC J4</li> </ul> </li> <li>Assist EV2 with VSC thermal cover install</li> </ol>	<p><u>VSC INSTALL</u> (00:30)</p> <ol style="list-style-type: none"> <li>Translate to Med ORU bag</li> </ol> <div style="border: 2px solid black; padding: 5px; text-align: center;"> <p><b>WARNING</b></p> <p>Avoid contact with exposed VSC surfaces: Grounding tabs, seals, bolt threads and connectors</p> </div> <ol style="list-style-type: none"> <li>Retrieve VSC and PGT from Med ORU bag</li> <li>Remove MLI from VSC; let MLI RET retract back into ORU bag</li> <li>Inspect following for FOD or damage: <ul style="list-style-type: none"> <li><input type="checkbox"/> VSC mounting bracket</li> <li><input type="checkbox"/> VSC bottom and connectors</li> </ul> </li> <li>Install VSC into bracket with tether point ISS fwd (J2 &amp; J3 connectors are zenith)</li> <li>Configure PGT: <p><b>[B1 (12.0), CW2, 30.5]</b> 6-in ext 7/16</p> </li> <li>←Engage VSC bolt to hard stop, <b>11 turns</b></li> <li>Retrieve FO video cable from PMA1 HR 0006 (fwd/port) <ul style="list-style-type: none"> <li><input type="checkbox"/> Route FO video cable nadir of crane</li> </ul> </li> <li>RET, remove FO video cable cap</li> <li>Mate FO video cable connector P1 to VSC J1 <ul style="list-style-type: none"> <li><input type="checkbox"/> √Safety Tether clear</li> <li><input type="checkbox"/> √Good pins &amp; EMI band; no FOD</li> </ul> </li> <li>Stow FO cap on Fish Stringer and PGT in Med ORU bag</li> <li>Retrieve VSC thermal cover (hard) from Med ORU bag</li> <li>Unfold thermal cover MLI flaps</li> </ol> <p style="text-align: center;"><b>NOTE</b></p> <p style="text-align: center;">Verify connector MLI caps do not interfere with VSC thermal cover install</p> <ol style="list-style-type: none"> <li>Install VSC thermal cover on VSC (handle single stripe zenith, double stripe nadir)</li> </ol>
Bolt	Turns	Torque (ft-lb)						
VSC	(11)	(12.0)						

**VSC INSTALL (00:30) (Cont)**

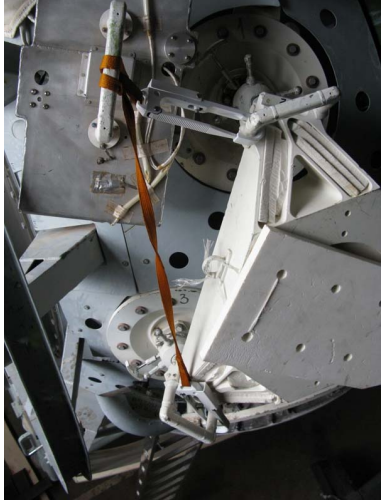
IV/SSRMS	EV1 (Drew)	EV2 (Spanky)
	<p>8. Glove Check (Translate to FGB zenith – Port FGB Y-Cable Install)</p>	<p>15. Attach VSC thermal cover Velcro to FGB MLI            16. Attach Russian tether to PAMA foot 1 and foot 3 handholds             17. Wire tie slack in FO video cable to PMA1 HR 0006  <input type="checkbox"/> Verify wire tie accommodates multiple cables             18. Glove Check (Translate to FGB zenith – Port FGB Y-Cable Install)</p>

# NOD1/FGB CH 1/4 CABLE INSTALL (PORT) (00:45)

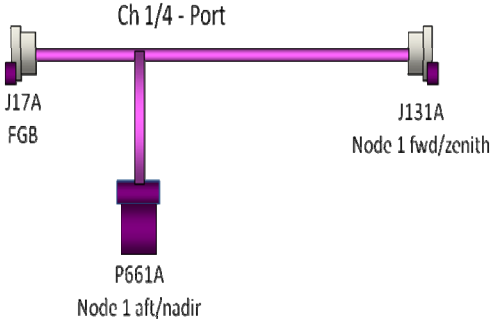
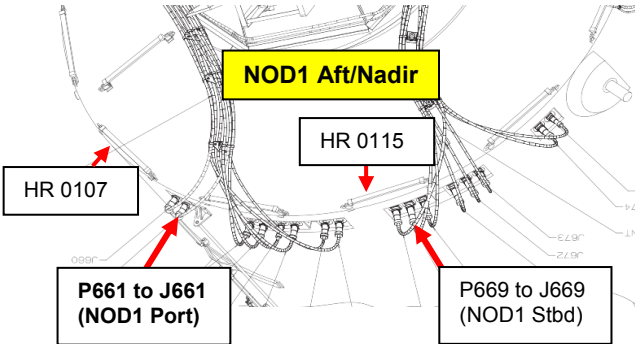
IV/SSRMS	EV1 (Drew)	EV2 (Spanky)
<p>Planned PET 02:15</p> <p>1. Verify inhibits in place: √P16/P17/P18 Inhibited</p> 	<div style="border: 1px solid black; padding: 5px; text-align: center;"> <p><b>CAUTION</b></p> <p>Avoid inadvertent contact with PMA1 MDM, FGB Sun sensors, and above 22" of EVA crane</p> </div> <p style="text-align: center;"><b>NOTE</b></p> <p style="text-align: center;">Ensure Safety Tethers are routed above all electrical connections</p> <p><b>CH 1/4 CABLE INSTALL (PORT) (00:45)</b></p> <ol style="list-style-type: none"> <li>1. Translate to FGB zenith, Node 3 Cable bag</li> <li>2. Retrieve Port FGB cable from bag (J17A), nearest to bag HR <ul style="list-style-type: none"> <li><input type="checkbox"/> RET to cable before releasing Velcro strap</li> </ul> </li> <li>3. Wire tie J17A connector to PMA1 HR 0009</li> <li>4. Transfer rest of cable to EV2</li> <li>5. Assist EV2 with clearances</li> <li>6. Untwist P661A wire tie to retrieve nadir cable coil (P661A)</li> <li>7. Translate nadir to Node 1 aft endcone while routing cable</li> <li>8. Wire tie cable to HR 0118</li> <li>9. Demate P661 from Node 1 J661; do not mate P661A <ul style="list-style-type: none"> <li><input type="checkbox"/> P661 ← → NOD1 J661</li> </ul> </li> <li>10. Wire tie P661 and P661A connectors to Node 1 HR 0107</li> </ol> 	<p><b>CH 1/4 CABLE INSTALL (PORT) (00:45)</b></p> <ol style="list-style-type: none"> <li>1. Translate to FGB zenith</li> <li>2. Retrieve cable from EV1</li> <li>3. Attach taped wire tie to PMA1 HR 0006</li> <li>4. Retrieve fwd cable coil (J131A)</li> </ol> <div style="border: 1px solid black; padding: 5px; text-align: center;"> <p><b>CAUTION</b></p> <p>Avoid inadvertent contact with Node 1 aft CETA Light</p> </div> <ol style="list-style-type: none"> <li>5. Translate to Node 1 fwd endcone under Rat's nest while routing cable <ul style="list-style-type: none"> <li><input type="checkbox"/> Fwd/port to Node 1</li> <li><input type="checkbox"/> Fwd along Node 3 stbd endcone</li> <li><input type="checkbox"/> Stbd onto Node 1 fwd endcone</li> </ul> </li> </ol>

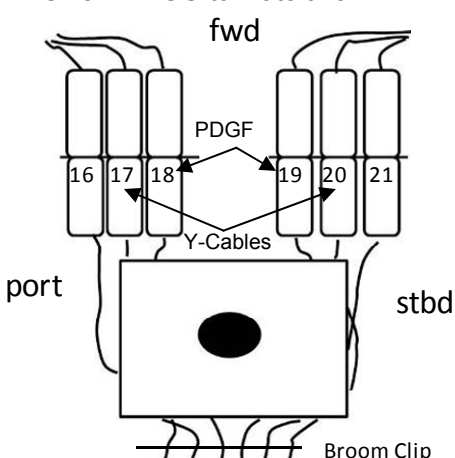
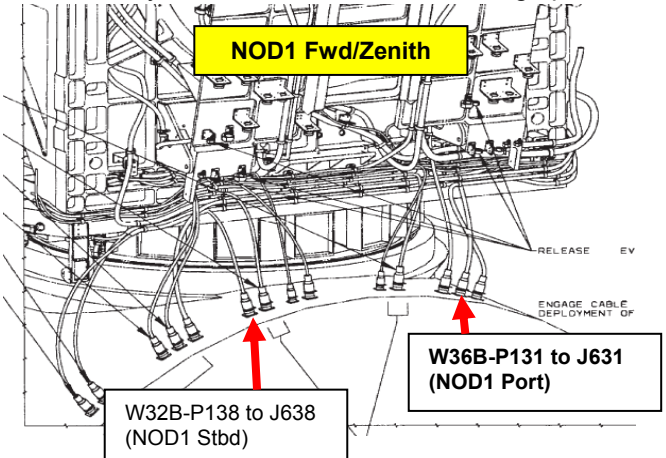

## NOD1/FGB CH 1/4 CABLE INSTALL (PORT) (00:45) (Cont)

IV/SSRMS	EV1 (Drew)	EV2 (Spanky)
<p>2. <input type="checkbox"/> P661 demated  <input type="checkbox"/> P131 demated            Give <b>EV1 GO</b> for demate of P17 and P18</p> <p>3. <input type="checkbox"/> J17A mated            Give <b>EV2 GO</b> to mate J131A</p> 	<p>11. Translate to PMA1/FGB zenith connector panel</p> <p>12. On <b>IV GO</b>: Demate FGB P17 and P18 connectors from PMA1/FGB panel (zenith)  <input type="checkbox"/> FGB P17 ← → PMA1 J17  <input type="checkbox"/> FGB P18 ← → PMA1 J18</p> <p>13. Pull FGB P18 cable out from under SVS target  <input type="checkbox"/> Release cables (P16/P17) as reqd from broom clip to provide additional slack  <input type="checkbox"/> If need to demate P16, contact <b>MCC-H</b></p> <p>14. Remove cap from FGB Y-cable connector J17A</p> <p>15. Mate FGB Y-cable J17A connector to FGB P17  <input checked="" type="checkbox"/> Good pins &amp; EMI band; no FOD  <input type="checkbox"/> FGB J17A → ← FGB P17</p> <p>16. Install cap on FGB J17</p> <p>17. Route P18 cable port under FGB HR toward PDGF (HR 1030)</p> <p>18. Remove MLI cap from PDGF harness connector J18 (lanyarded)</p> <p>19. Mate FGB P18 to PDGF harness J18  <input type="checkbox"/> Verify all ST routed over the cables  <input type="checkbox"/> Good pins &amp; EMI band; no FOD  <input type="checkbox"/> PDGF J18 → ← FGB P18</p> <p>20. Move dust cover in place around mated connector; adjust wire tie as reqd  <input type="checkbox"/> Verify no metal portion of connectors is exposed</p>	<p>6. Demate W36B cable connector P131 from Node 1 J631; do not mate P131A  <input type="checkbox"/> P131 ← → NOD1 J631</p> <p>7. Remove cap from FGB cable connector J131A</p> <p>8. Install cap on Node 1 J631</p> <p>9. Stand by for <b>IV GO</b> on connector mating ops</p>  <p>10. On <b>IV GO</b>, mate FGB cable connector J131A to floating cable P131  <input type="checkbox"/> Good pins &amp; EMI band; no FOD  <input type="checkbox"/> FGB J131A → ← P131</p> <p>11. Wire tie cable at following HRs as translate back to PMA1:  <input type="checkbox"/> Node 1 HR 0139 (fwd/port endcone – J131A wire tie)  <input type="checkbox"/> Node 1 HR 0129 (fwd/port near trunnion – low profile wire tie)  <input type="checkbox"/> Node 1 HR 0121 (aft/port base of CETA light – low profile wire tie)            Position the cable so that it is as flush as possible to Node 1 port  <input type="checkbox"/> PMA1 HR 0006 – any excess slack</p>

**NOD1/FGB CH 1/4 CABLE INSTALL (PORT) (00:45) (Cont)**

IV/SSRMS	EV1 (Drew)	EV2 (Spanky)
<p>4. On <b>EV1 GO</b>, give <b>MCC-H GO</b> to power up FGB Ch 1/4 and P18</p>	<p>21. Translate nadir to Node 1 aft endcone                  22. Remove cap from FGB cable connector P661A                  23. Mate port FGB cable connector P661A to Node 1 J661                      <input type="checkbox"/> ✓ Good pins &amp; EMI band; no FOD                      <input type="checkbox"/> FGB P661A → ← NOD1 J661                  24. Install cap on floating cable connector P661                  25. <b>Notify IV</b> complete with Ch 1/4 connector ops                  26. Wire tie cable at following HRs as translate back to PMA1:                      <input type="checkbox"/> Node 1 HR 0107 (P661 wire tie)                      <input type="checkbox"/> Node 1 HR 0118 (aft/port endcone – low profile wire tie)                  27. Glove Check                  (Translate to PMA1 HR 0011 – 1553 Data Cable Install)</p>	<p>12. Glove Check                  (Retrieve 1553 cable – 1553 Data Cable Install)</p>

# 1553 DATA CABLE INSTALL (00:45)

IV/SSRMS	EV1 (Drew)	EV2 (Spanky)
<p>Planned PET 03:00</p>  <p>Demated</p> <p>Mated</p> <ol style="list-style-type: none"> <li>1. Give <b>MCC-H GO</b> to check both data channels</li> <li>2. Consumable tag up with <b>MCC-H</b></li> </ol>	<p><u>1553 DATA CABLE INSTALL (00:45)</u></p> <ol style="list-style-type: none"> <li>1. Translate to PAMA/PDGF between foot 2 and 3</li> <li>2. Release wire tie from PDGF for the 1553 cables</li> <li>3. Route PDGF harness cables toward PMA1 HR 0011 <ul style="list-style-type: none"> <li><input type="checkbox"/> Verify ST routed over the cables</li> </ul> </li> <li>4. Remove caps (4); verify caps are securely wire tied to cables</li> <li>5. Mate 1553 cable connectors to PDGF harness and lock connector: <ul style="list-style-type: none"> <li><input type="checkbox"/> √Good pins; no FOD</li> <li><input type="checkbox"/> PDGF harness 1800-X54 → ← J54 (Bus A)</li> <li><input type="checkbox"/> PDGF harness 1800-X53 → ← J53 (Bus B)</li> </ul> <p style="text-align: center;"><u>NOTE</u></p> <p>Russian connectors reminder:</p> <ul style="list-style-type: none"> <li>- Verify lock is in Open position</li> <li>- Align arrows on connector shells</li> <li>- Push connectors together</li> <li>- Rotate connectors ~1/4 turn</li> <li>- Verify arrow on plug points to white mark on socket</li> <li>- Slide lock closed</li> </ul> </li> <li>6. Secure FPP booties around 1553/PDGF harness connections; adjust wire ties as reqd</li> <li>7. Wire tie any slack to PMA1 HR 0011 using integrated PDGF harness wire tie</li> <li>8. Relocate C/L bag to FGB zenith HR</li> <li>9. Glove Check</li> </ol> <p>(Translate to Node 3 Cable bag – Stbd FGB Cable Install)</p>	<p><u>1553 DATA CABLE INSTALL (00:45)</u></p> <ol style="list-style-type: none"> <li>1. Retrieve 1553 cable and fish stringer from Med ORU bag <ul style="list-style-type: none"> <li><input type="checkbox"/> RET to connector bail or cable</li> </ul> </li> <li>2. Untwist taped wire tie to release Node 3 end</li> <li>3. Attach taped wire tie (FGB end) to PMA1 HR 0011</li> <li>4. Translate nadir/port to Node 3 connector panel (along Node 1 HR 0118), reel out 1553 cable as reqd</li> <li>5. Temp stow fish stringer</li> <li>6. Remove Node 3 terminator MLI (2); stow on fish stringer <ul style="list-style-type: none"> <li><input type="checkbox"/> J1 FGB    <input type="checkbox"/> J2 FGB</li> </ul> </li> <li>7. Remove Node 3 terminator caps (2) from aft avionics panel; stow on fish stringer <ul style="list-style-type: none"> <li><input type="checkbox"/> Terminator cap ← → Node 3 J1 FGB</li> <li><input type="checkbox"/> Terminator cap ← → Node 3 J2 FGB</li> </ul> </li> <li>8. Remove cap from 1553 P1 cable; stow on fish stringer</li> <li>9. Mate 1553 cable P1 to Node 3 J1 FGB <ul style="list-style-type: none"> <li><input type="checkbox"/> √Good pins &amp; EMI band; no FOD</li> <li><input type="checkbox"/> 1553 cable P1 → ← J1 FGB (Node 3)</li> </ul> </li> <li>10. Remove cap from 1553 P2 cable; stow on fish stringer</li> <li>11. Mate 1553 cable P2 to Node 3 J2 FGB <ul style="list-style-type: none"> <li><input type="checkbox"/> √Good pins &amp; EMI band; no FOD</li> <li><input type="checkbox"/> 1553 cable P2 → ← J2 FGB (Node 3)</li> </ul> </li> <li>12. Retrieve fish stringer</li> <li>13. Wire tie 1553 cable and any slack to Node 1 HR 0118 (low profile wire tie) and PMA1 HR 0006</li> <li>14. Translate to Med ORU bag; stow fish stringer in Med ORU bag</li> <li>15. Glove Check</li> </ol> <p>(Translate to FGB zenith – Stbd FGB Cable Install)</p>

# NOD1/FGB CH 2/3 CABLE INSTALL (STBD) (01:05)

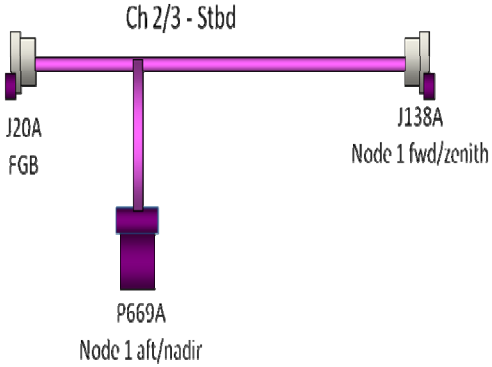
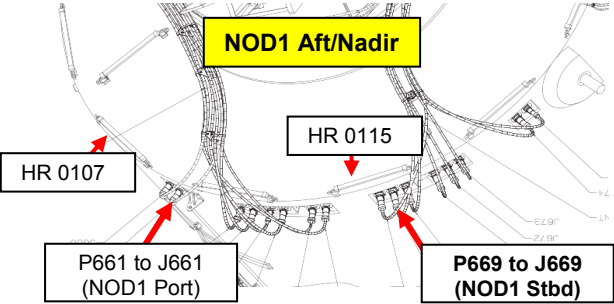
IV/SSRMS	EV1 (Drew)	EV2 (Spanky)
<p>Planned PET 03:45</p> <ol style="list-style-type: none"> <li>Verify inhibits in place: <ul style="list-style-type: none"> <li>√SSPTS Inhibited</li> <li>√P19/P20/P21 Inhibited</li> </ul> </li> </ol> 	<div style="border: 1px solid black; padding: 5px; text-align: center;"> <p><b>CAUTION</b></p> <p>Avoid inadvertent contact with PMA1 MDM and FGB Sun sensors. Ensure Safety Tethers are routed above all electrical connections</p> </div> <p><b>CH 2/3 CABLE INSTALL (STBD) (01:05)</b></p> <ol style="list-style-type: none"> <li>Translate to Node 1 stbd</li> <li>Retrieve <b>GREEN</b> hook from Node 1 HR 0119 <ul style="list-style-type: none"> <li>☐ √Gate closed, hook locked, reels unlocked, release RET</li> </ul> </li> <li>Translate to FGB zenith, Node 3 Cable bag</li> <li>Retrieve Stbd FGB Y-cable from bag (J20A) <ul style="list-style-type: none"> <li>☐ RET to cable before releasing Velcro strap</li> </ul> </li> <li>Untwist taped wire tie to release cable bundles</li> <li>Transfer Node 1 fwd bundle (J138A) to EV2</li> <li>Attach taped wire tie to PMA1 HR 0003</li> <li>Retrieve nadir cable bundle (P669A)</li> <li>Attach low profile wire tie to PMA1 HR 0001</li> <li>Translate to Node 1 aft/nadir while routing cable <ul style="list-style-type: none"> <li>☐ Fwd to Node 1 aft endcone</li> <li>☐ Nadir using aft endcone HRs</li> </ul> </li> <li>Wire tie cable to Node 1 HR 0113</li> <li>Demate P669 from Node 1 J669; do not mate P669A <ul style="list-style-type: none"> <li>☐ P669 ← → NOD1 J669</li> </ul> </li> <li>Wire tie P669 and P669A connectors to Node 1 HR 0115</li> </ol> 	<p><b>CH 2/3 CABLE INSTALL (STBD) (01:05)</b></p> <ol style="list-style-type: none"> <li>Translate to PMA1 nadir</li> <li>Retrieve <b>GREEN</b> hook from PMA1 HR 0013 <ul style="list-style-type: none"> <li>☐ √Gate closed, hook locked, reels unlocked, release RET</li> </ul> </li> <li>Translate to FGB zenith from stbd side</li> <li>Retrieve Node 1 fwd bundle (J138A) from EV1 <div style="border: 1px solid black; padding: 5px; text-align: center;"> <p><b>CAUTION</b></p> <p>Avoid inadvertent contact with WETA antenna on NOD1 and spare SASA hi-gain and lo-gain antennas on Z1 stbd</p> </div> <div style="border: 3px double black; padding: 5px; text-align: center;"> <p><b>WARNING</b></p> <p>E/L HR 0537 has MMOD strike</p> </div> </li> <li>Translate to Node 1 fwd endcone under Rat's nest while routing cable <ul style="list-style-type: none"> <li>☐ Fwd/stbd to Node 1</li> <li>☐ Fwd along E/L, over HPGTs</li> <li>☐ Port onto Node 1 fwd endcone</li> </ul> </li> </ol>

# NOD1/FGB CH 2/3 CABLE INSTALL (STBD) (01:05) (Cont)

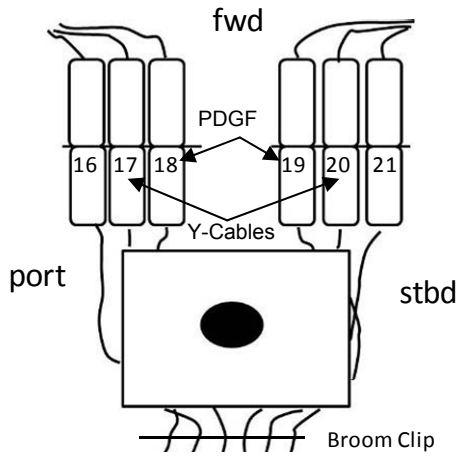
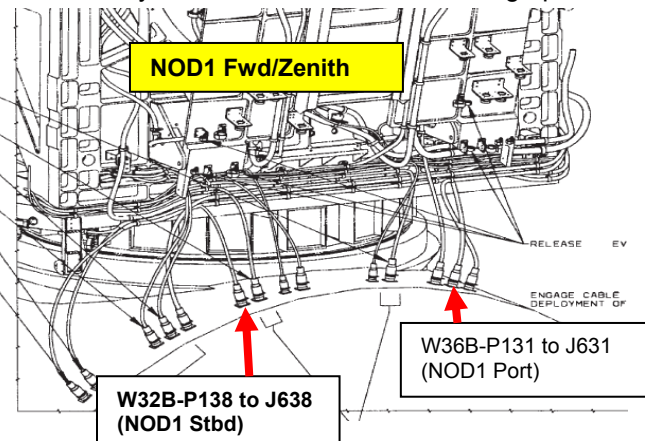
IV/SSRMS	EV1 (Drew)	EV2 (Spanky)
<p>2. <input type="checkbox"/> P669 demated  <input type="checkbox"/> P138 demated            Give <b>EV1 GO</b> for demate of P19 and 20</p>  <p>3. <input type="checkbox"/> P20A mated            Give <b>EV2 GO</b> to mate J138A</p>	<p>14. Translate to PMA1/FGB zenith connector panel</p> <p>15. On <b>IV GO</b>: Demate FGB P19 and P20 connectors from PMA1/FGB panel (zenith)  <input type="checkbox"/> FGB P19 ← → PMA1 J19  <input type="checkbox"/> FGB P20 ← → PMA1 J20</p> <p>16. Pull FGB P19 cable out from under SVS target  <input type="checkbox"/> Release cable (P21/P20) as reqd from broom clip to provide additional slack  <input type="checkbox"/> If need to demate P21, contact <b>MCC-H</b></p> <p>17. Remove cap from FGB Y-cable connector J20A            18. Mate stbd FGB cable connector J20A to FGB P20  <input type="checkbox"/> √Good pins &amp; EMI band; no FOD  <input type="checkbox"/> FGB J20A → ← FGB P20</p> <p>19. Install cap on FGB J20</p> <p>20. Route P19 cable port under FGB HR toward PDGF (HR 1030)</p> <p>21. Remove MLI cap from PDGF harness connector J19 (lanyarded)            22. Mate PDGF harness J19 to FGB P19  <input type="checkbox"/> √Good pins &amp; EMI band; no FOD  <input type="checkbox"/> PDGF J19 → ← FGB P19            23. Move dust cover in place around mated connector; adjust wire tie as reqd  <input type="checkbox"/> Verify no metal portion of connectors is exposed</p>	<p><u>NOTE</u>            Best worksite position is inverted;            Right hand on connector, Left hand on tray</p> <p>6. Demate W32B cable connector P138 from Node 1 J638; do not mate P138A  <input type="checkbox"/> W32B P138 ← → NOD1 J638</p> <p>7. Remove cap from FGB cable connector J138A            8. Install cap on Node 1 J638            9. Stand by for <b>IV GO</b> on connector mating ops</p>  <p>10. On <b>IV GO</b>: Mate FGB cable connector J138A to floating cable connector P138  <input type="checkbox"/> √Good pins &amp; EMI band; no FOD  <input type="checkbox"/> FGB J138A → ← P138</p> <p>11. Wire tie cable at following HRs as translate back to PMA1:  <input type="checkbox"/> Node 1 HR 0130 (fwd/stbd – J138A wire tie)  <input type="checkbox"/> Node 1 HR 0122 (aft/stbd – low profile wire tie) (near Z1 pool handle)            Position cable so that it is as flush as possible to Node 1 stbd  <input type="checkbox"/> Node 1 HR 0102 (low profile wire tie)  <input type="checkbox"/> PMA1 HR 0001 – any excess slack</p>

**NOD1/FGB CH 2/3 CABLE INSTALL (STBD) (01:05) (Cont)**

IV/SSRMS	EV1 (Drew)	EV2 (Spanky)
<p>4. On <b>EV1 GO</b>, give <b>MCC-H GO</b> to power up FGB Ch 2/3 and P19</p>	<p>24. Retrieve caps from C/L bag                  25. Install caps on FGB J18 and J19</p> <p>26. Translate nadir to Node 1 aft/nadir                  27. Remove cap from FGB cable connector P669A                  28. Install cap on floating cable connector P669</p> <p>29. Mate FGB cable connector P669A to Node 1 J669  <input type="checkbox"/> ✓ Good pins &amp; EMI band; no FOD  <input type="checkbox"/> FGB P669A → ← NOD1 J669</p> <p>30. <b>Notify IV</b>, complete with Ch 2/3 and FGB P19 connector ops                  31. Wire tie cable at following HRs as translate back to PMA1:  <input type="checkbox"/> Node 1 HR 0113 (low profile wire tie)                  32. Glove Check</p> <p>(Translate to PAMA/PDGF – Cleanup and Photos)</p>	<p>12. Glove Check</p> <p>(Translate to A/L – Tool Stow)</p>



## A/L TOOLBOX TOOL STOW (00:40)

IV/SSRMS	EV2 (Spanky)
Planned PET 04:50	<p><u>A/L TOOLBOX TOOL STOW (00:40)</u></p> <ol style="list-style-type: none"> <li>1. Translate to A/L, watch for EV1 ST</li> <li>2. Open hatch thermal cover</li> <li>3. Retrieve Tool Stow C/L bag</li> <li>4. Close hatch thermal cover</li> <li>5. Translate to A/L Toolboxes</li> </ol> <p style="text-align: center;"><u>NOTE</u> Tether to toolboard prior to removal</p> <ol style="list-style-type: none"> <li>6. Stow C/L bag on stbd/nadir door</li> <li>7. Retrieve and temp stow fish stringer</li> <li>8. Stow following tools in the Port A/L Toolbox (figs 1-2):               <ul style="list-style-type: none"> <li><input type="checkbox"/> Behind Zenith Door – Slot 1 (fig 3)                   <ul style="list-style-type: none"> <li><input type="checkbox"/> Pin Straightener</li> </ul> </li> <li><input type="checkbox"/> Behind Nadir Door – Slot 5 (figs 4-7)                   <ul style="list-style-type: none"> <li><input type="checkbox"/> Short MMOD T-handle tool (tether point aligned with angled slot)</li> <li><input type="checkbox"/> Short MMOD T-handle tool (tether point aligned with angled slot)</li> </ul> </li> </ul> </li> <li>9. Close both doors               <ul style="list-style-type: none"> <li><input type="checkbox"/> Verify at least one lever in lock position for each door</li> </ul> </li> </ol> <p style="text-align: center;"><u>NOTE</u> Tether to toolboard prior to removal</p> <ol style="list-style-type: none"> <li>10. Stow following tools in Starboard A/L Toolbox (fig 8):               <ul style="list-style-type: none"> <li><input type="checkbox"/> Inside Zenith Door – Panel 9 (fig 9)                   <ul style="list-style-type: none"> <li><input type="checkbox"/> Probe</li> </ul> </li> <li><input type="checkbox"/> Behind Zenith Door – Slot 5 (fig 10)                   <ul style="list-style-type: none"> <li><input type="checkbox"/> Vise Grips</li> </ul> </li> </ul> </li> <li>11. Close door               <ul style="list-style-type: none"> <li><input type="checkbox"/> Verify at least one lever in lock position</li> </ul> </li> <li>12. Stow fish stringer in C/L bag</li> <li>13. Translate zenith to stbd FQD bag</li> <li>14. Open stbd Fluid QD bag (stbd/aft corner)</li> <li>15. Stow 1" QD cap tool in FQD bag</li> <li>16. Close Fluid QD bag               <ul style="list-style-type: none"> <li>√Velcro secure</li> </ul> </li> <li>17. Stow Tool Stow C/L bag on BRT w/RET (Translate to ELC3 – HPGT MLI Install)</li> </ol>



A/L TOOLBOX TOOL STOW (00:40) (Cont)

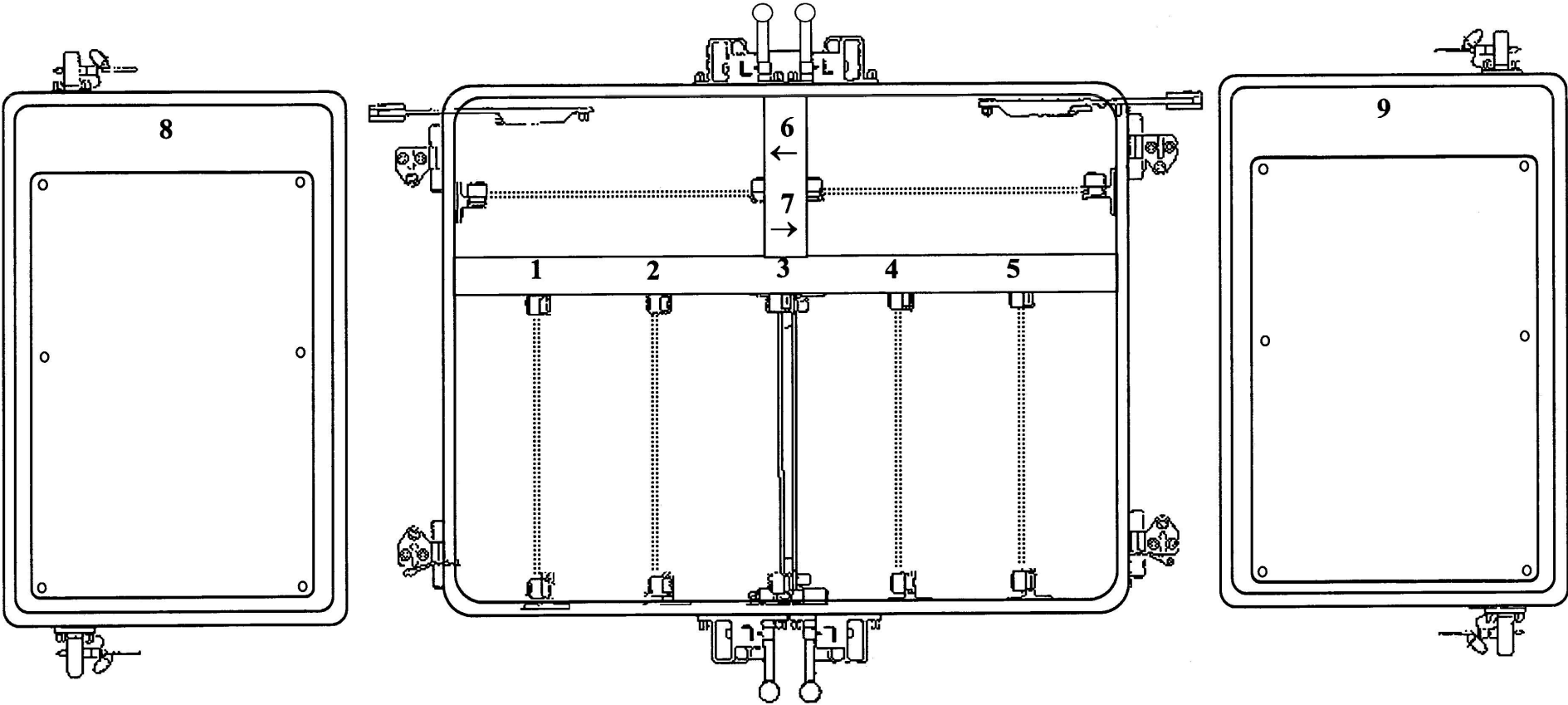

Figure 1.- A/L Toolbox Panel and Slot Labels.

A/L TOOLBOX TOOL STOW (00:40) (Cont)

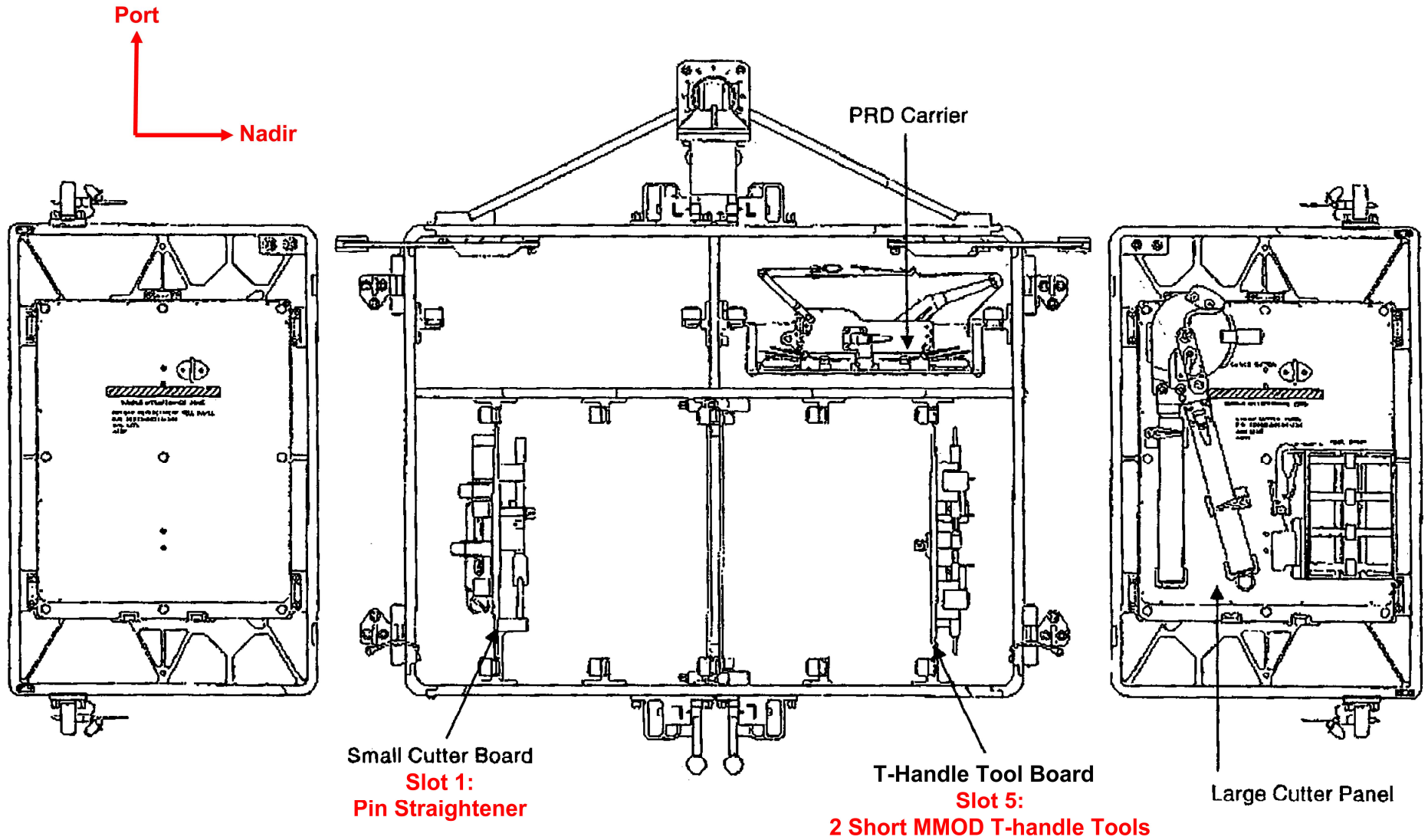
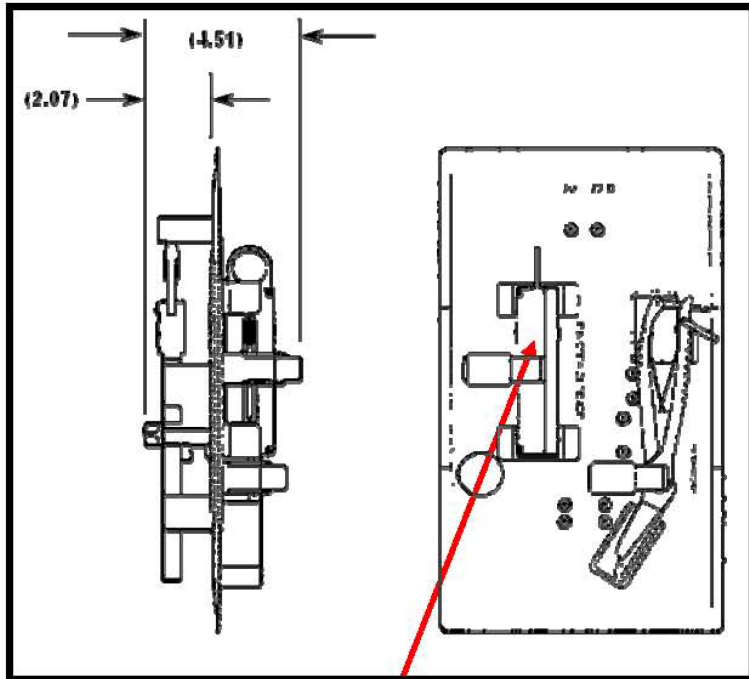

Figure 2.- A/L Toolbox 2 Port.

A/L TOOLBOX TOOL STOW (00:40) (Cont)



Pin Straightener Tool

Figure 3.- Small Cutter Board.

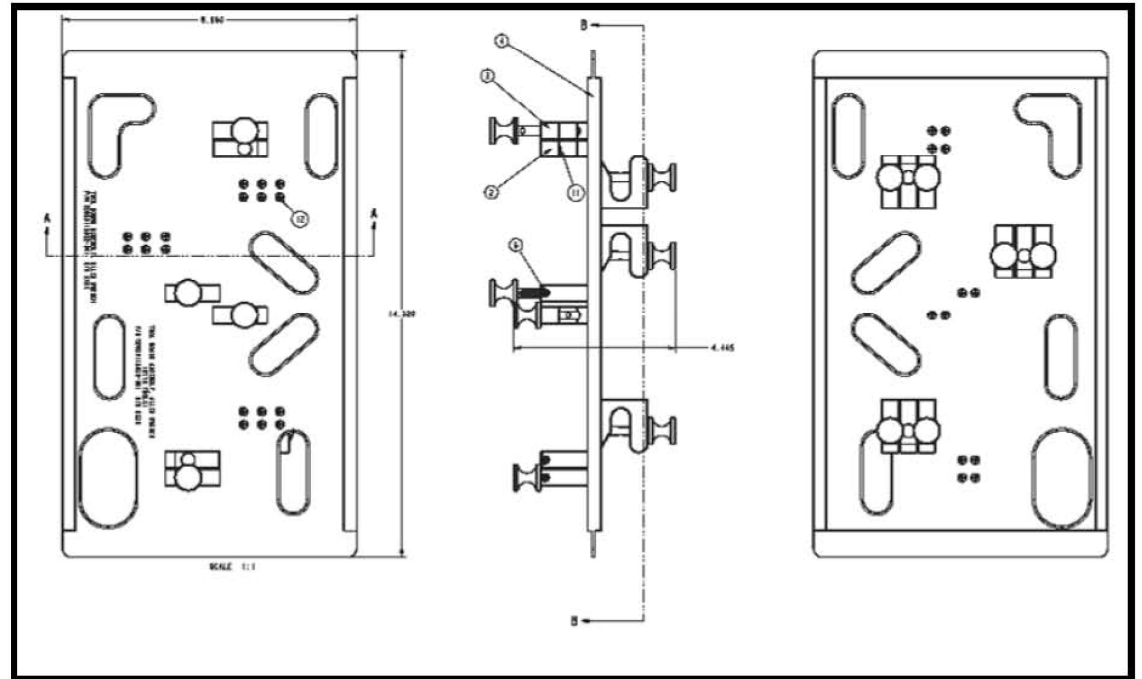
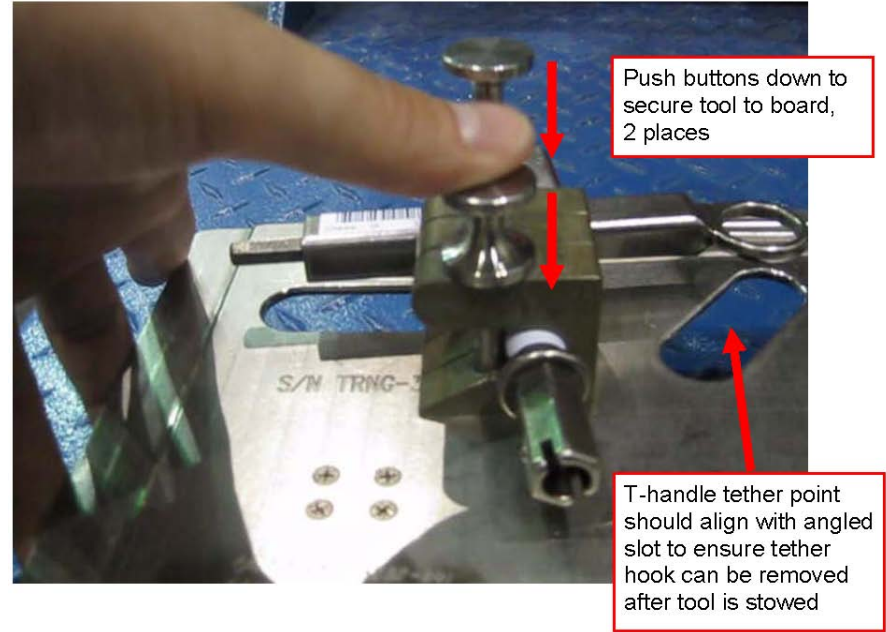
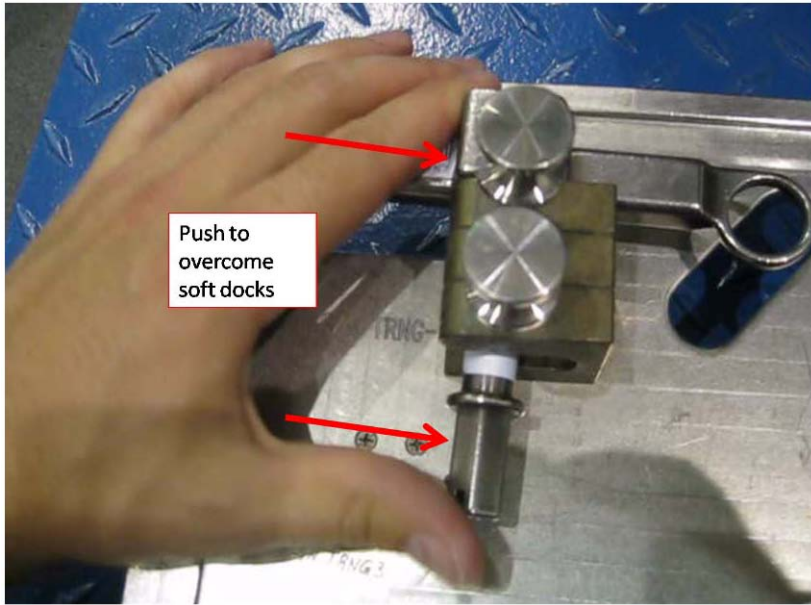

Figure 4.- T-Handle Tool Board.

A/L TOOLBOX TOOL STOW (00:40) (Cont)



Figures 5-6.- T-Handle Tool Board Operation.

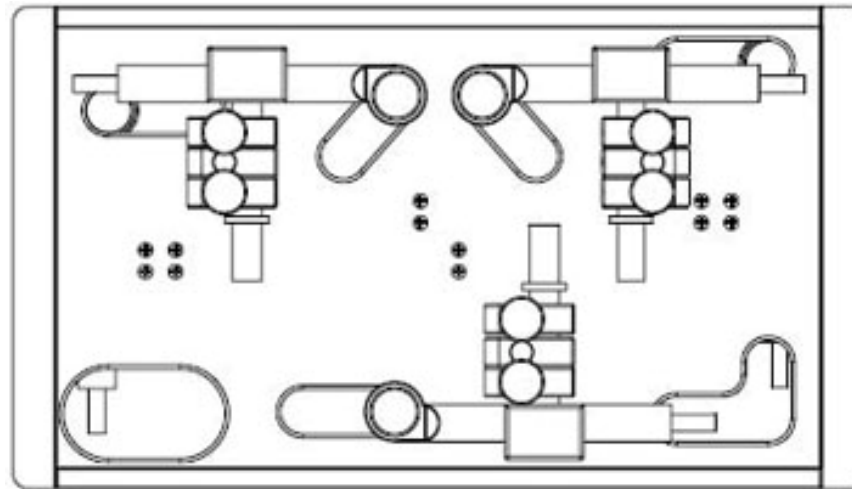

Figure 7.- T-Handle Tools Stowed on Tool Board.

A/L TOOLBOX TOOL STOW (00:40) (Cont)

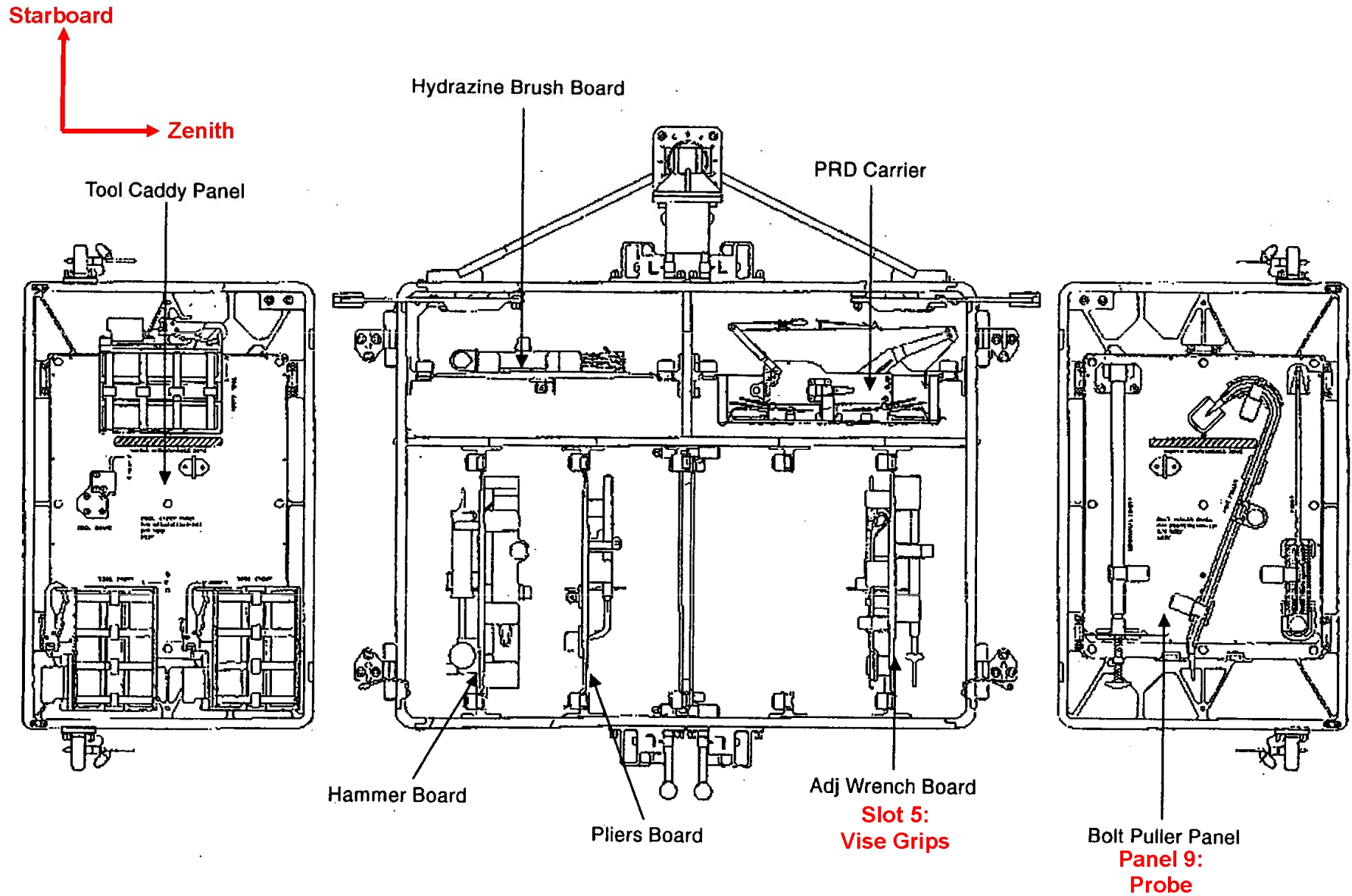

Figure 8.- A/L Toolbox 1 Stbd.

A/L TOOLBOX TOOL STOW (00:40) (Cont)

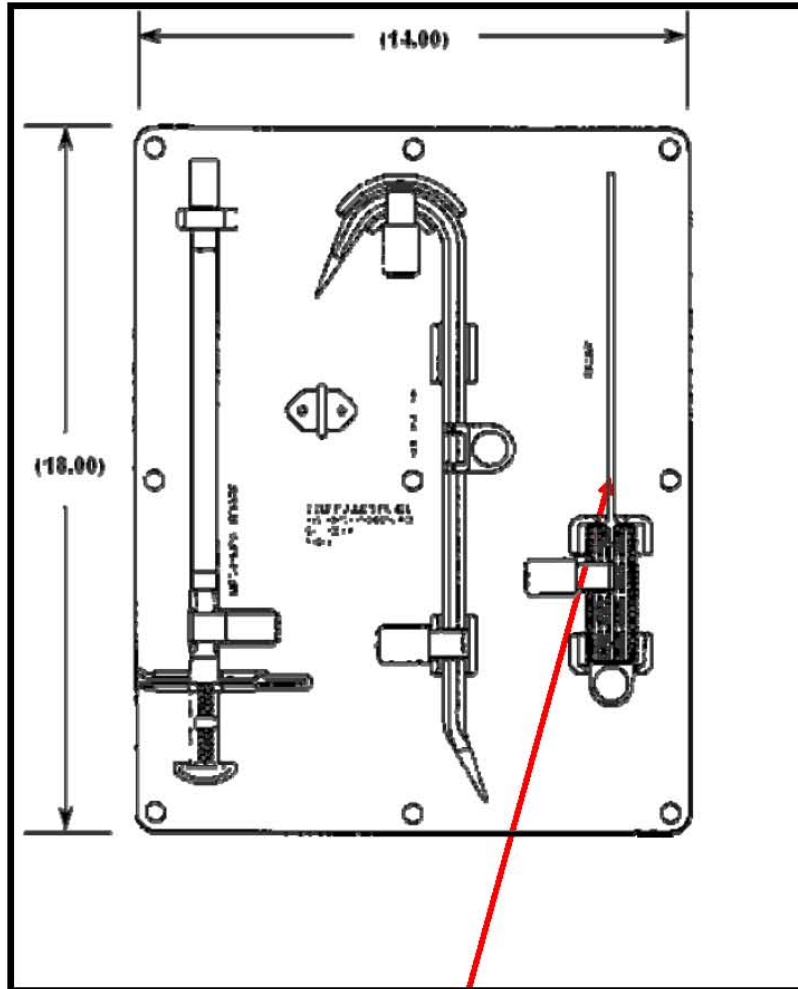

Figure 9.- Bolt Puller Panel.

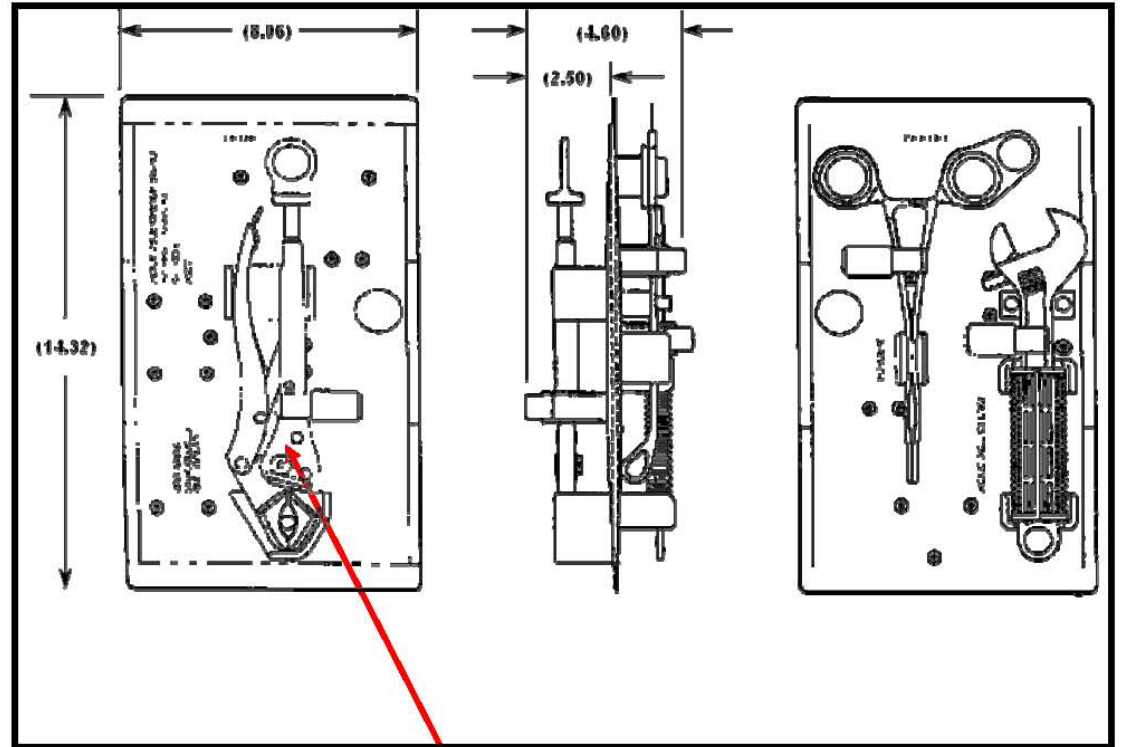

Figure 10.- Adjustable Wrench Board.

## HPGT FRGF MLI INSTALL (00:30)

IV/SSRMS	EV2
<p>Planned PET 05:30</p> <p>1. Verify inhibits in place √PSARJ locked</p>	<div style="border: 1px solid black; padding: 5px; text-align: center;"> <p><b>CAUTION</b> Avoid inadvertent contact with SASA's hi-gain and lo-gain Antennas</p> </div> <p><u>HPGT FRGF MLI INSTALL (00:30)</u></p> <ol style="list-style-type: none"> <li>1. Translate to P3, Bay 20 – nadir route</li> <li>2. Attach <b>GREEN</b> hook to CETA rail Xo 10230  <input type="checkbox"/> √Gate closed, hook locked, reels unlocked, release RET</li> <li>3. Translate to HPGT (outbd, fwd on ELC3)</li> <li>4. Retrieve MLI from C/L bag</li> <li>5. Install MLI on HPGT FRGF (T at 1 o'clock)</li> <li>6. Stow wire tie in trash bag or C/L bag</li> <li>7. Glove Check</li> <li>8. Retrieve <b>GREEN</b> hook from Xo 10230  <input type="checkbox"/> √Gate closed, hook locked, reels unlocked, release RET</li> </ol> <p style="text-align: right;">(Translate to A/L)</p>



## STP-H3 PHOTOS (00:30)

IV/SSRMS	EV1
<p>Planned PET 05:30</p> <p>1. Verify inhibits in place √PSARJ locked</p>	<div data-bbox="913 245 1623 354" style="border: 1px solid black; padding: 5px; margin-bottom: 10px;"> <p style="text-align: center;"><b>CAUTION</b></p> <p>Top of STP-H3 is a KOZ</p> <p>Avoid inadvertent contact with MHTEX radiator – Z93 paint</p> </div> <p>STP-H3 PHOTOS (00:30)</p> <ol style="list-style-type: none"> <li>1. Translate to P1 Bay 18 – zenith route</li> <li>2. Attach <b>GREEN</b> hook to P1 HR 3681               <ul style="list-style-type: none"> <li><input type="checkbox"/> √Gate closed, hook locked, reels unlocked, release RET</li> </ul> </li> <li>3. Translate to STP-H3 (outbd aft, zenith on ELC3)</li> <li>4. <input checked="" type="checkbox"/> Take photos of STP-H3               <ul style="list-style-type: none"> <li><input type="checkbox"/> VADER back side (nadir)</li> <li><input type="checkbox"/> Canary Face (aft)</li> <li><input type="checkbox"/> MHTEX Radiator Surface (aft)</li> </ul> </li> <li>5. If additional time allows, also take photos of:               <ul style="list-style-type: none"> <li><input type="checkbox"/> Front of VADER</li> <li><input type="checkbox"/> DISC lens</li> </ul> </li> <li>6. Retrieve <b>GREEN</b> hook from P1 HR 3681               <ul style="list-style-type: none"> <li><input type="checkbox"/> √Gate closed, hook locked, reels unlocked, release RET</li> </ul> </li> <li>7. Glove Check</li> </ol> <p style="text-align: center;">(Translate to A/L)</p> <div data-bbox="1041 727 1982 1370" style="text-align: center;"> </div>



## EVA 3 CLEANUP/INGRESS (00:30)

IV/SSRMS	EV1 (Drew)	EV2 (Spanky)
<p>Planned PET 06:00</p> <ol style="list-style-type: none"> <li>Perform Tool and Bag Inventories: (Ref FS 7-__ for Final Inventories)</li> <li>Start Hatch Thermal Cover clock PET (30 min) __ : __</li> <li>Prior to hatch closure, perform WVS PWRDN (PHOTO/TV, <u>WVS</u> Cue Card)</li> <li>Stop Hatch Thermal Cover clock PET (30 min) __ : __</li> </ol>	<p><u>CLEANUP</u> (00:15)</p> <ol style="list-style-type: none"> <li>Translate to A/L</li> <li>Perform MWS tool inventory</li> </ol> <p><u>INGRESS</u> (00:15)</p> <ol style="list-style-type: none"> <li>On <b>EV2 GO</b>, RET to EV2 STP, release <b>RED</b> hook and attach to aft ext D-ring <input type="checkbox"/> <math>\sqrt</math>Gate closed, hook locked, reels unlocked, release RET</li> <li>Attach R Waist Tether to A/L int D-ring ext <input type="checkbox"/> <math>\sqrt</math>Gate closed, hook locked</li> <li>RET to STP, release <b>RED</b> hook and attach to curved HR, fwd/stbd stanchion <input type="checkbox"/> <math>\sqrt</math>Gate closed, hook locked, reels unlocked, release RET</li> <li>Ingress A/L</li> <li>Close thermal cover; attach Velcro strap</li> <li>Remove SCU from stowage pouch</li> <li>Remove DCM cover; Velcro to DCM</li> <li>Connect SCU to DCM; <math>\sqrt</math>SCU locked</li> </ol> <p style="text-align: center;"><u>NOTE</u> A TCV setting 8 – Max C minimizes time for SCU cooling</p> <ol style="list-style-type: none"> <li>WATER – OFF (fwd), expect <span style="border: 1px solid black; padding: 2px;">H2O IS OFF</span> msg</li> </ol> <div style="border: 1px solid black; padding: 5px; margin: 10px 0;"> <p style="text-align: center;"><u>CAUTION</u> Do not close hatch until EMU Water OFF for 2 min. Verify outer hatch clear of hardware</p> </div> <ol style="list-style-type: none"> <li>Verify outer hatch clear of hardware</li> <li>Verify handle position per hatch decal</li> <li>Close and lock hatch</li> </ol> <p>Go to PRE-REPRESS (<u>DEPRESS/REPRESS</u> Cue Card)</p>	<p><u>CLEANUP</u> (00:15)</p> <ol style="list-style-type: none"> <li>Translate to A/L <input type="checkbox"/> Fairlead on Equip Lock HR 0500</li> <li>Perform MWS tool inventory</li> </ol> <p><u>INGRESS</u> (00:15)</p> <ol style="list-style-type: none"> <li>Open hatch thermal cover</li> <li>Stow Tool Stow C/L bag in A/L</li> <li>Attach R Waist Tether to UIA D-ring <input type="checkbox"/> <math>\sqrt</math>Gate closed, hook locked</li> <li>Ingress A/L</li> <li>Give <b>EV1 GO</b> to release EV2 <b>RED</b> hook</li> <li>Remove SCU from stowage pouch</li> <li>Remove DCM cover; Velcro to DCM</li> <li>Connect SCU to DCM; <math>\sqrt</math>SCU locked</li> </ol> <p style="text-align: center;"><u>NOTE</u> A TCV setting 8 – Max C minimizes time for SCU cooling</p> <ol style="list-style-type: none"> <li>WATER – OFF (fwd), expect <span style="border: 1px solid black; padding: 2px;">H2O IS OFF</span> msg</li> </ol> <p>Go to PRE-REPRESS (<u>DEPRESS/REPRESS</u> Cue Card)</p>

## PDGF SETUP – TASK DATA

### Estimated Task Duration:

	With RMS	Without RMS
One EV Crew	N/A	00:45
Two EV Crew	N/A	00:25

### Tools:

EV1	EV2
2 Long Wire Ties	Russian Ratchet Wrench
ISS Small Trash Bag	ISS Small Trash Bag
	Pre-configured Long Wire Tie
	72" Gap Spanner

### Notes:

1. If PAMA does not get installed, will need to reinstall MLI
2. Gap Spanner will go around Russian HR and back onto its strap

### Caution:

1. OTD (Crane) can handle EVA translation loads up to 22" from WIF

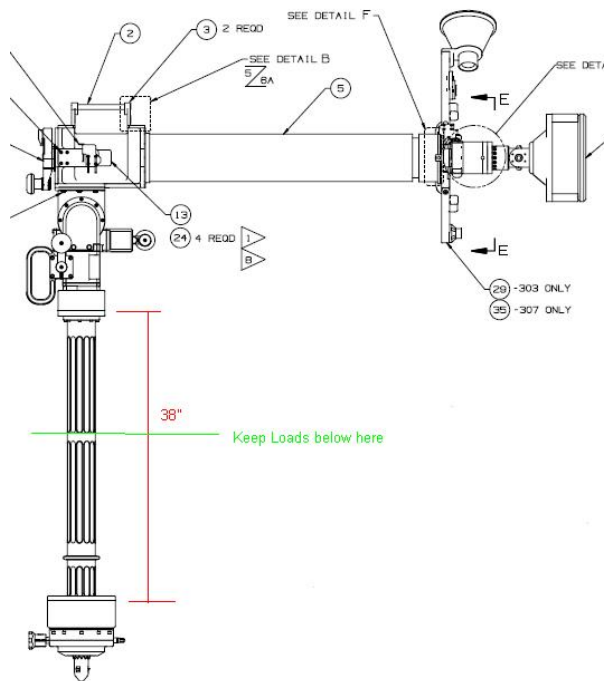

# PDGF SETUP – TASK DATA (Cont)

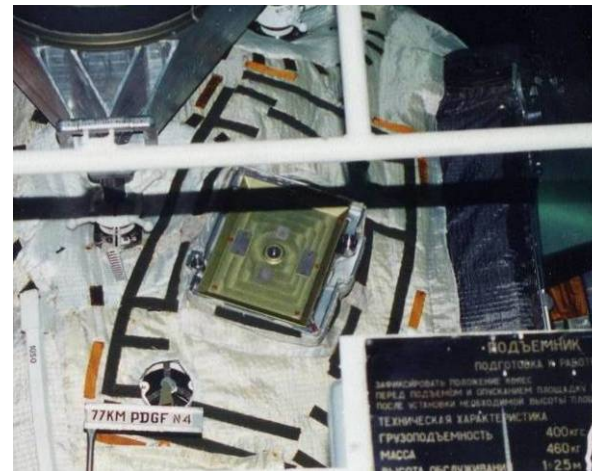
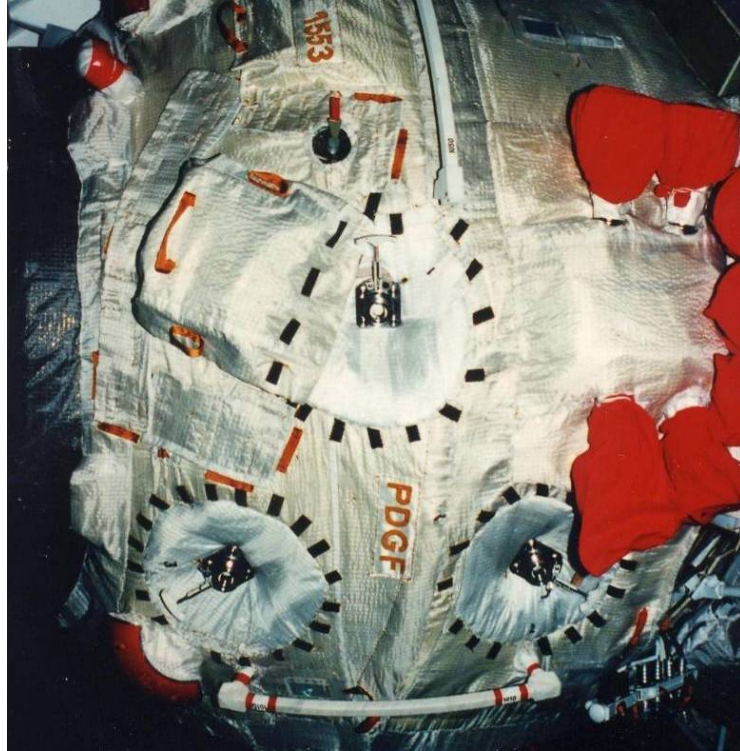



PDGF SETUP – TASK DATA (Cont)

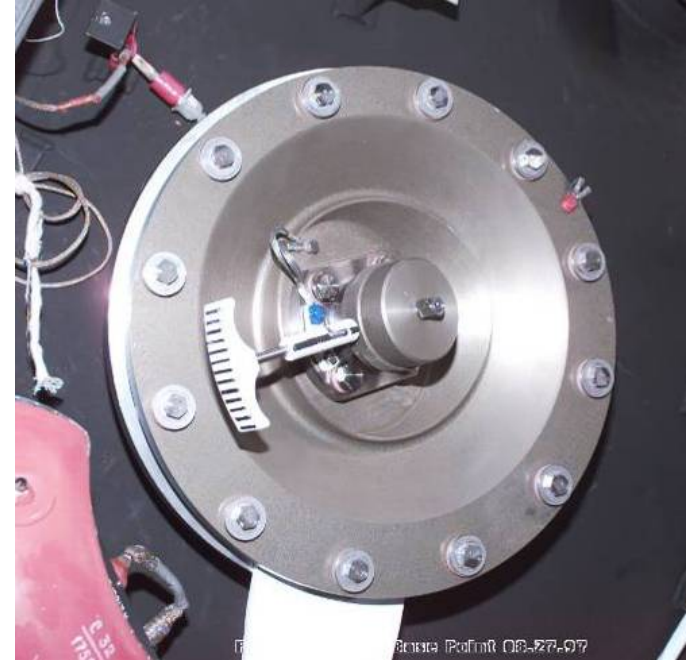

## FGB PAMA/PDGF INSTALL – TASK DATA

### Estimated Task Duration:

	With RMS	Without RMS
One EV Crew	N/A	N/A
Two EV Crew	N/A	00:35

### Tools:

EV2
Russian Cheater Bar

### EVA Fasteners:

Fastener Name	Label	Head Size	Qty	Install Torque (ft-lb)	Release Torque (ft-lb)	Failure Torque (ft-lb)	Turns	RPM
PAMA Foot	1/2/3	N/A	3	N/A	N/A	N/A	3-4	N/A

### EVA Connectors:

Connector	To	Size	Function
P2	VSC J2	15	VSC Pri Power
P3	VSC J3	15	VSC Alt Power
P4	VSC J4	15	VSC Coax
P5	PDGF		PDGF Pri Video/Data
P6	PDGF		PDGF Alt Video/Data
P7	PDGF		PDGF Pri Power
P8	PDGF		PDGF Alt Power
J18	FGB P18	25	FGB Alt Power
J19	FGB P19	25	FGB Pri Power
1800-X53	1553 J53		FGB Alt Data
1800-X54	1553 J54		FGB Prime Data

### Notes:

- Crew will soft dock feet in 1-3-2 order. They will hand tighten feet in desired order of 1-2-3. If reqd, order of 1-3-2 is also acceptable
- PAMA feet engage with double threads. 3-4 turns should bring the foot to a hardstop
- Crane loads:
  - 125 lbf inadvertent kick load no higher than 33" up the OTD mast
  - 187 lbf translation load no higher than 22" up on the OTD mast
  - Stanchion portion is 38" so keep translation on the lower half of stanchion

# FGB PAMA/PDGF INSTALL – TASK DATA (Cont)





FGB PAMA/PDGF INSTALL – TASK DATA (Cont)

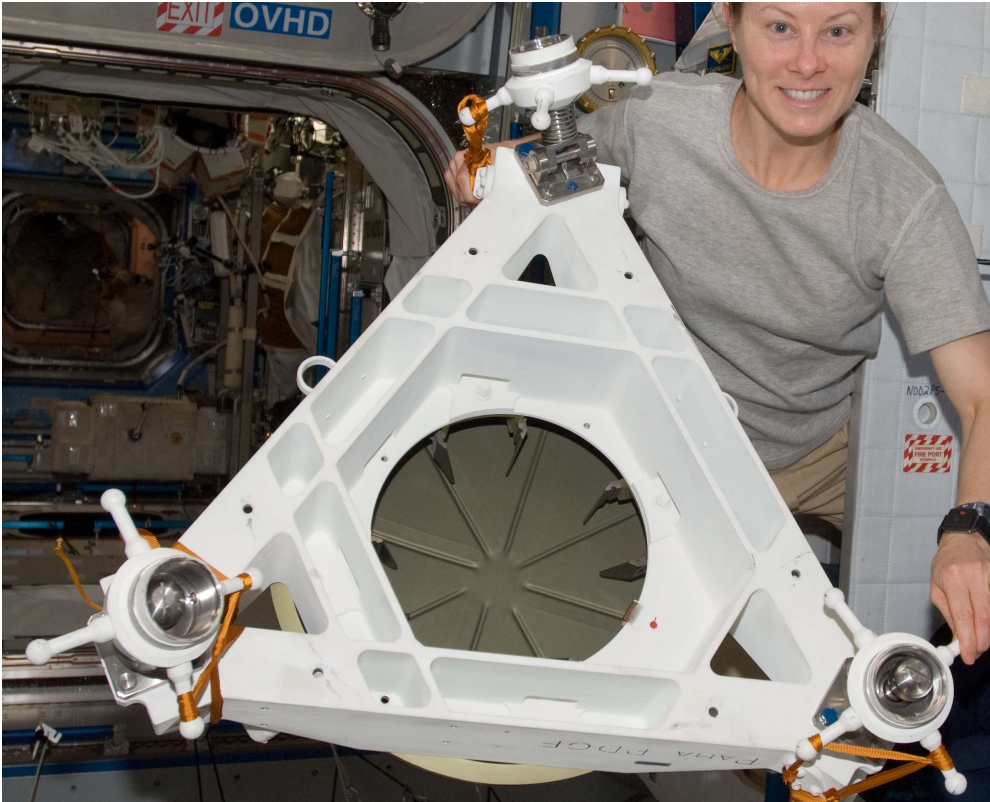
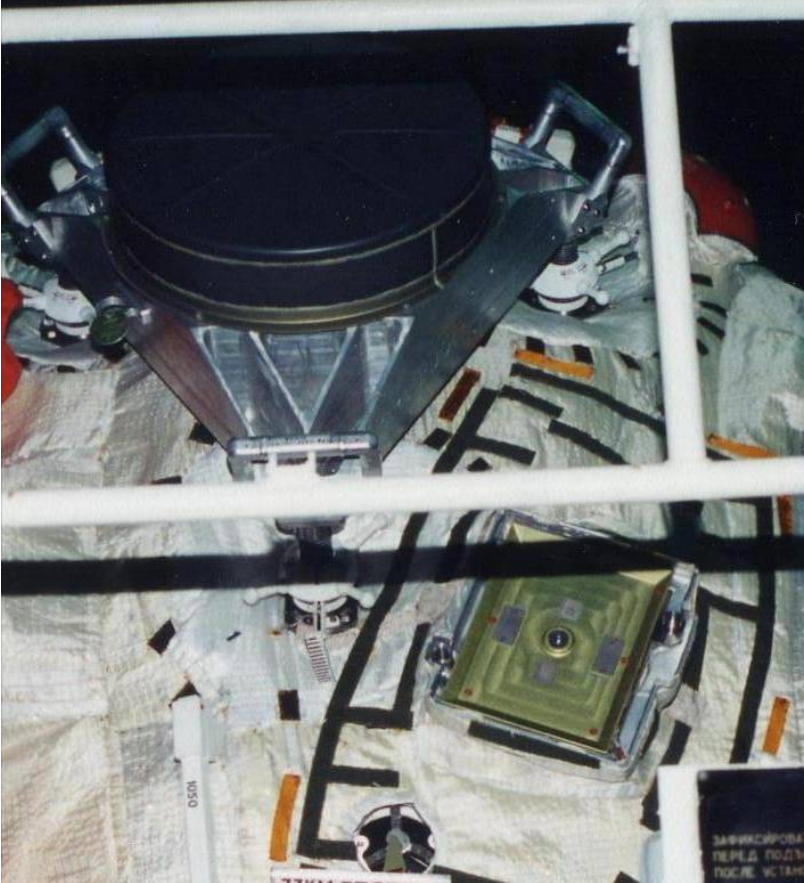

# FGB PAMA/PDGF INSTALL – TASK DATA (Cont)

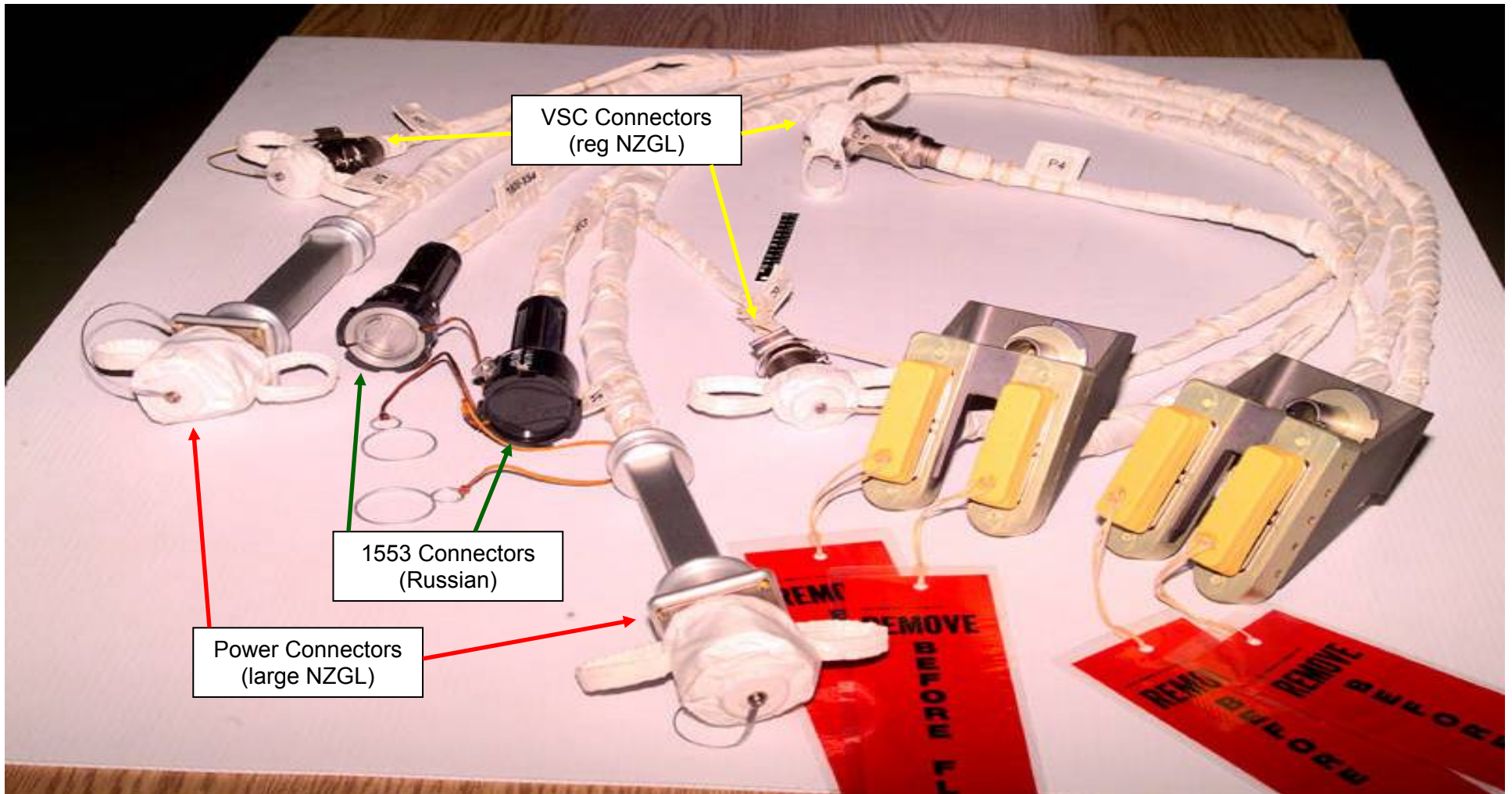



FGB PAMA/PDGF INSTALL – TASK DATA (Cont)

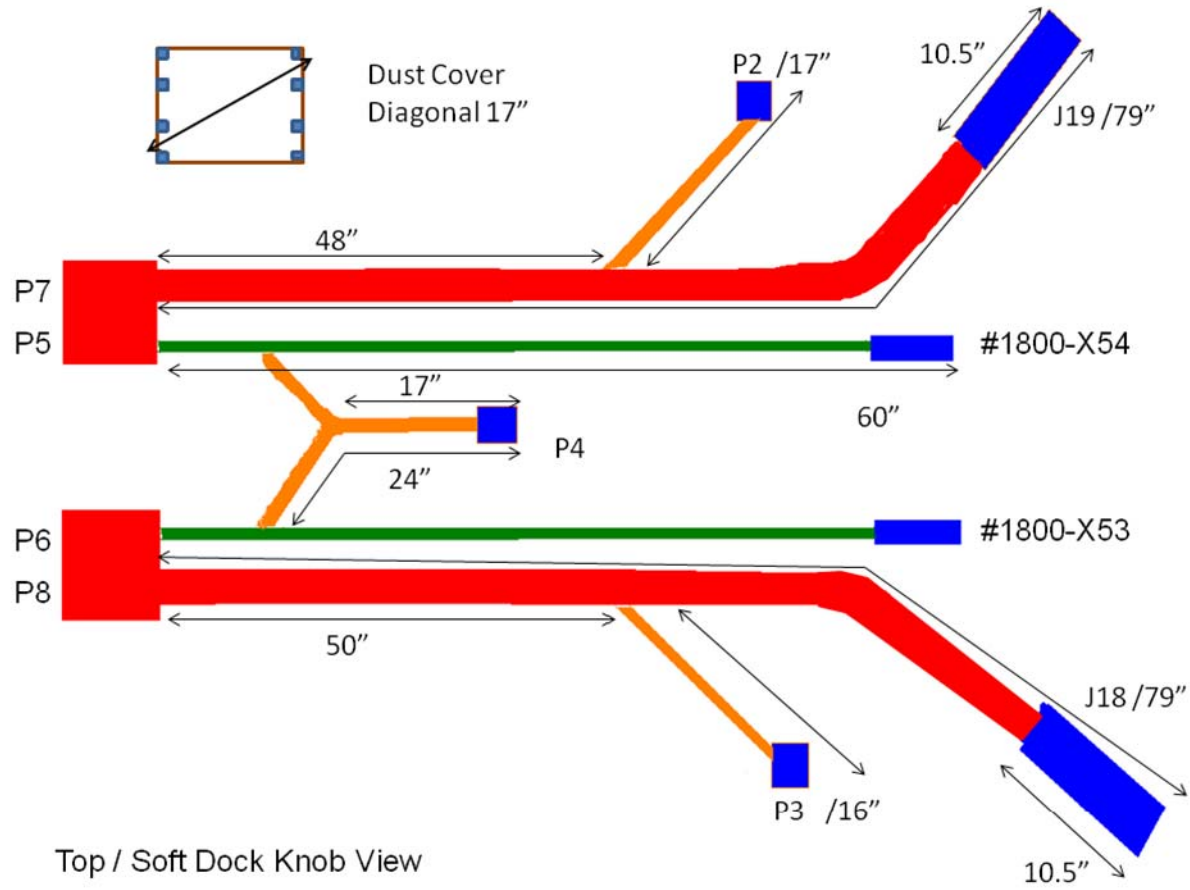

## VSC INSTALL – TASK DATA

### Estimated Task Duration:

	With SSRMS	Without SSRMS
One EV Crew	N/A	00:45
Two EV Crew	N/A	00:30

### Tools:

EV1/2
PGT 6-ext 7/16
VSC Thermal Cover
Russian Tether

### EVA Fasteners:

Fastener Name	Head Size	Qty	Install Torque (ft-lb)	Release Torque (ft-lb)	Failure Torque (ft-lb)	Turns
VSC Bolt	7/16	1	9.0	13.0	19.9	11

### EVA Connectors:

Connector	To	Size	Function
FO Cable P1	VSC J1	15	VSC Fiber Optic
PDGF P2	VSC J2	15	VSC Pri Power
PDGF P3	VSC J3	15	VSC Alt Power
PDGF P4	VSC J4	15	VSC Coax
P1	VSC J1	15	VSC Fiber Optic
P184	S0 J184	15	VSC Fiber Optic
P187	S0 J187	15	VSC Fiber Optic
P191	S0 J191	15	VSC Fiber Optic

### Notes:

1. VSC soft dock feature is magnetic
2. VSC installs with tether point ISS fwd
3. VSC thermal cover installs with double lines nadir, single line zenith

# VSC INSTALL – TASK DATA (Cont)

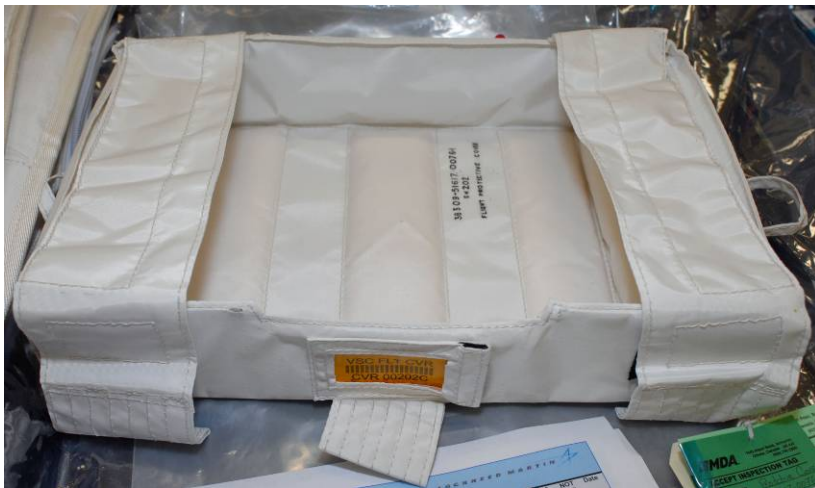
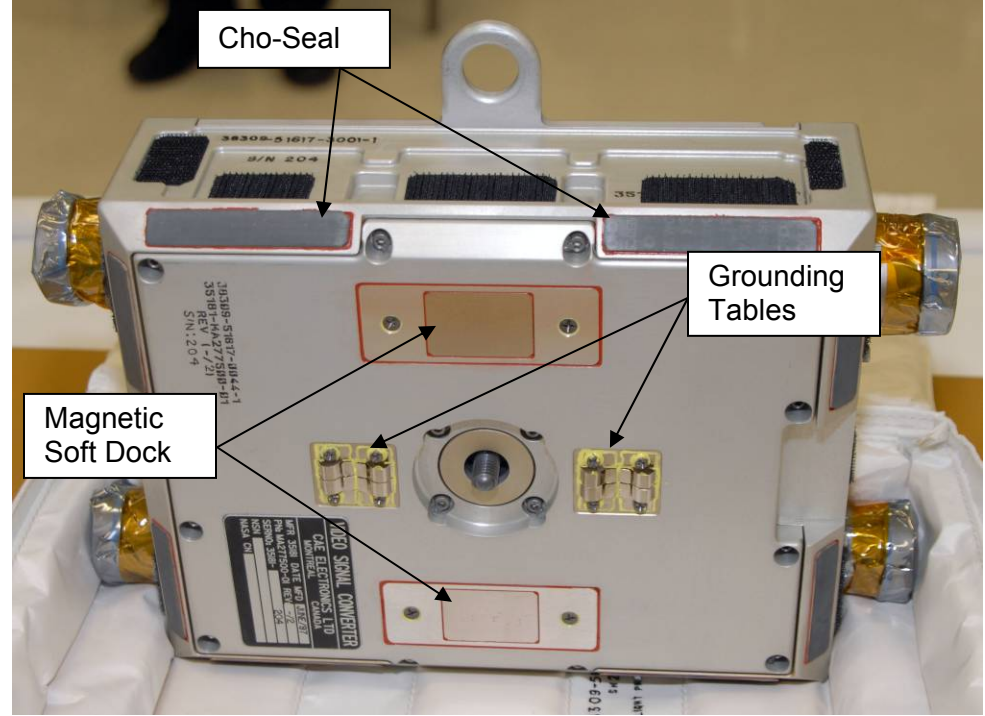



VSC INSTALL – TASK DATA (Cont)

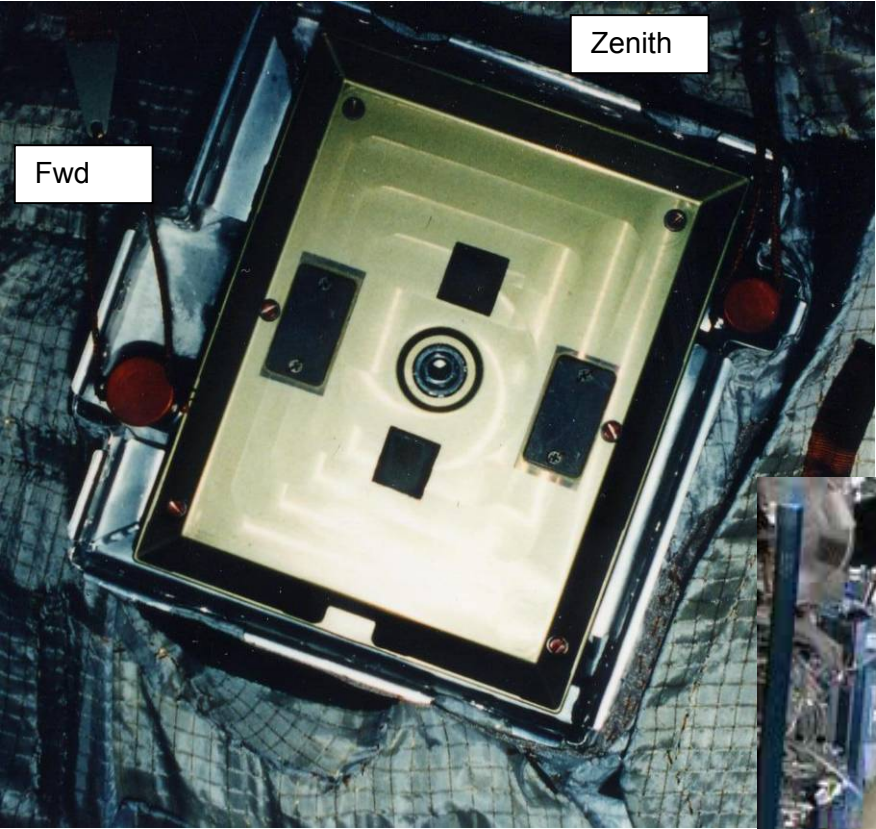

## POWER CABLES – TASK DATA

### Estimated Task Duration:

	With RMS	Without RMS
One EV Crew	N/A	00:30
Two EV Crew	N/A	N/A

### Tools:

EV2
Dust covers (2 – pre-installed on harness)
Dust caps (2) size 25

### EVA Connectors:

Connector	To	Size	Function
FGB P16	PMA1 J16	25	
FGB P18	PMA1 J18	25	
FGB P19	PMA1 J19	25	
FGB P21	PMA1 J21	25	
PDGF Harness			
J18	FGB P18	25	FGB Alt Power
J19	FGB P19	25	FGB Pri Power

### Notes:

1. Dust covers pre-installed over harness power cables
2. If there is not enough slack to route P18 or P19 from under the SVS target, use P18 Routing Contingency or P19 Routing Contingency pages to temporarily demate additional cables for increased access to P18 or P19 cables
3. If dust covers do not fully cover all metal portions of connectors, dust covers should be placed in series per cribsheet steps and cables remated with both P18 and P19 connections stowed inside single longer dust cover

### Timeline Considerations:

1. Wire tie power cables to FGB handrail after both VSC and power cable connections complete

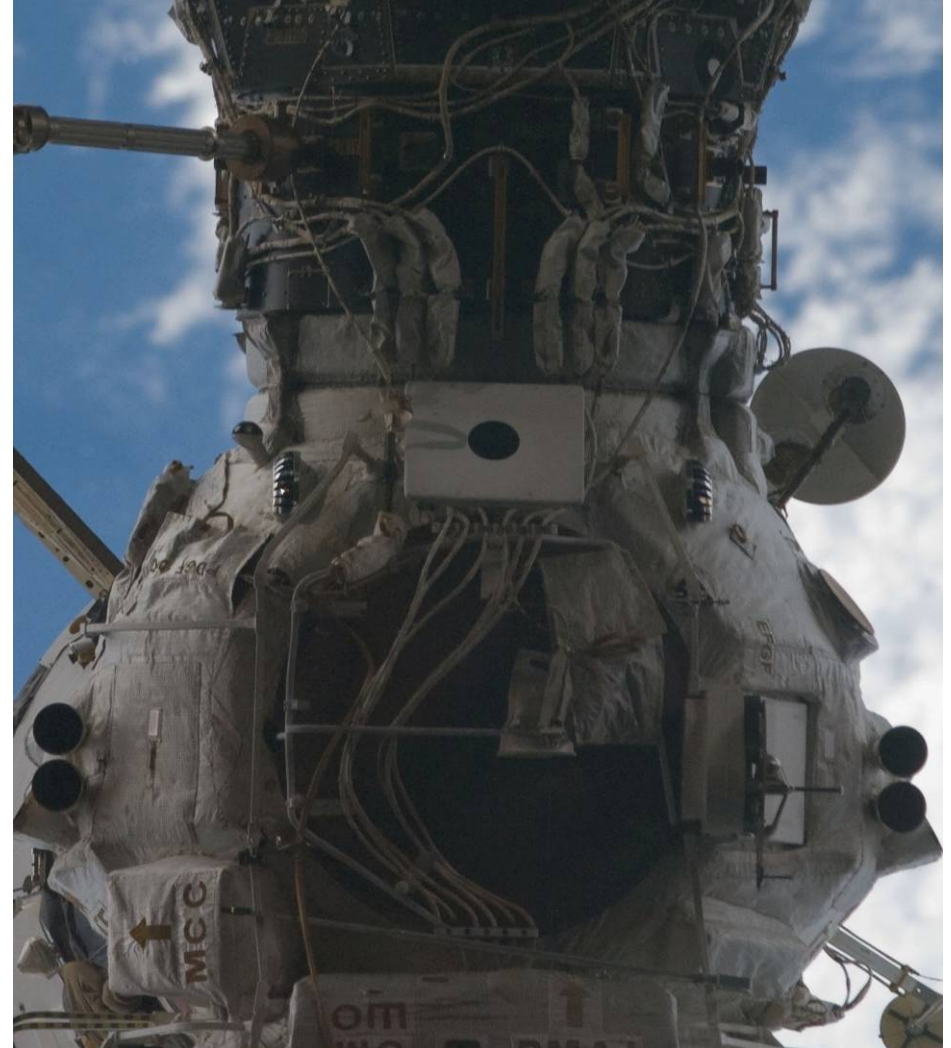



## POWER CABLES – TASK DATA (Cont)

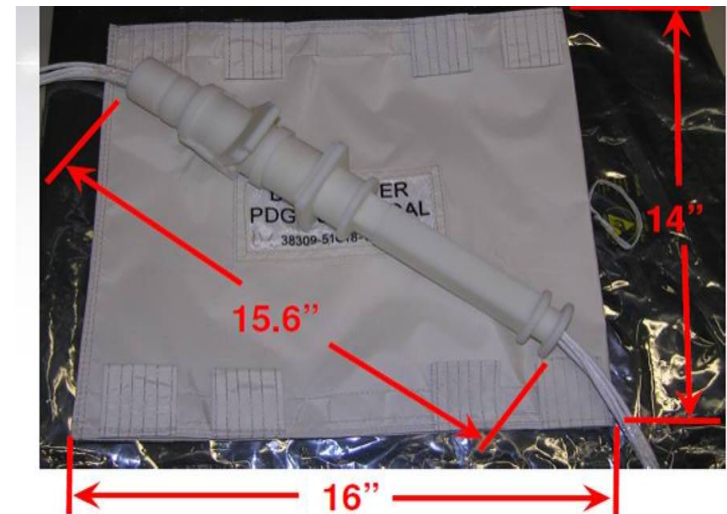

## 1553 DATA CABLE – TASK DATA

### Estimated Task Duration:

	With RMS	Without RMS
One EV Crew	N/A	01:30
Two EV Crew	N/A	00:45

### Tools:

EV1	EV2
FPP thermal booties (2)	Fish stringer
Wire ties	

### EVA Connectors:

Connector	To	Size	Function
<b>1553 Cables</b>			
P1	J1 FGB	15	Bus A
P2	J2 FGB	15	Bus B
J53	1800-X53	male	Bus B
J54	1800-X54	female	Bus A
<b>PDGF Harness</b>			
1800-X53	1553 J53	female	FGB Alt Data
1800-X54	1553 J54	male	FGB Prime Data

### Notes:

1. 1553 cables were taped together into a single bundle along middle of cable length  
First tape location on Russian connector side is located approximately 2 ft from connector; first tape location on NZGL connector side is located approximately 5 ft from connector

### Timeline Considerations:

1. Although nominal timeline has extra 1553 cable slack stowed on PAMA HR 0006 and Node 1 HR 0118, Node 1 HR 0106 as well as Node 3 HR 0673 are acceptable tie-down points as well





1553 DATA CABLE – TASK DATA (Cont)

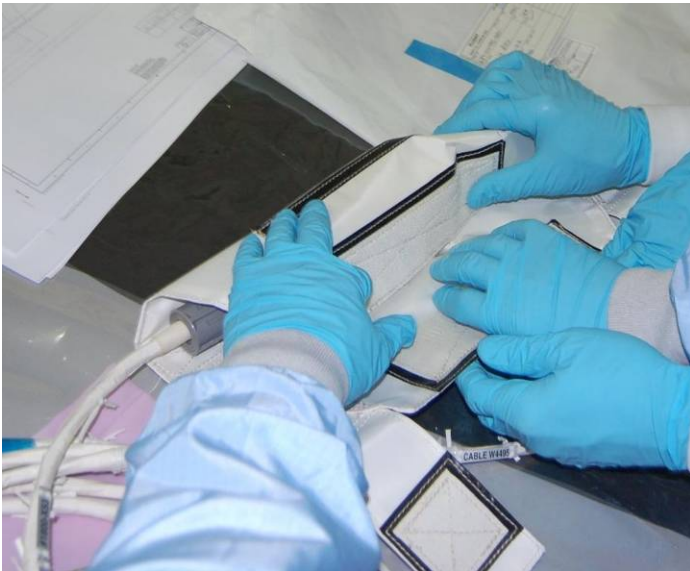
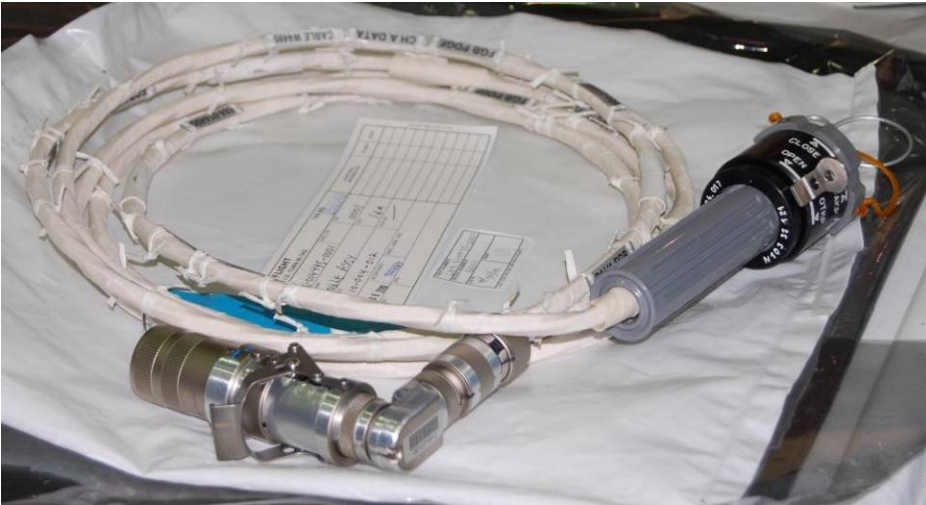

# 1553 DATA CABLE – TASK DATA (Cont)

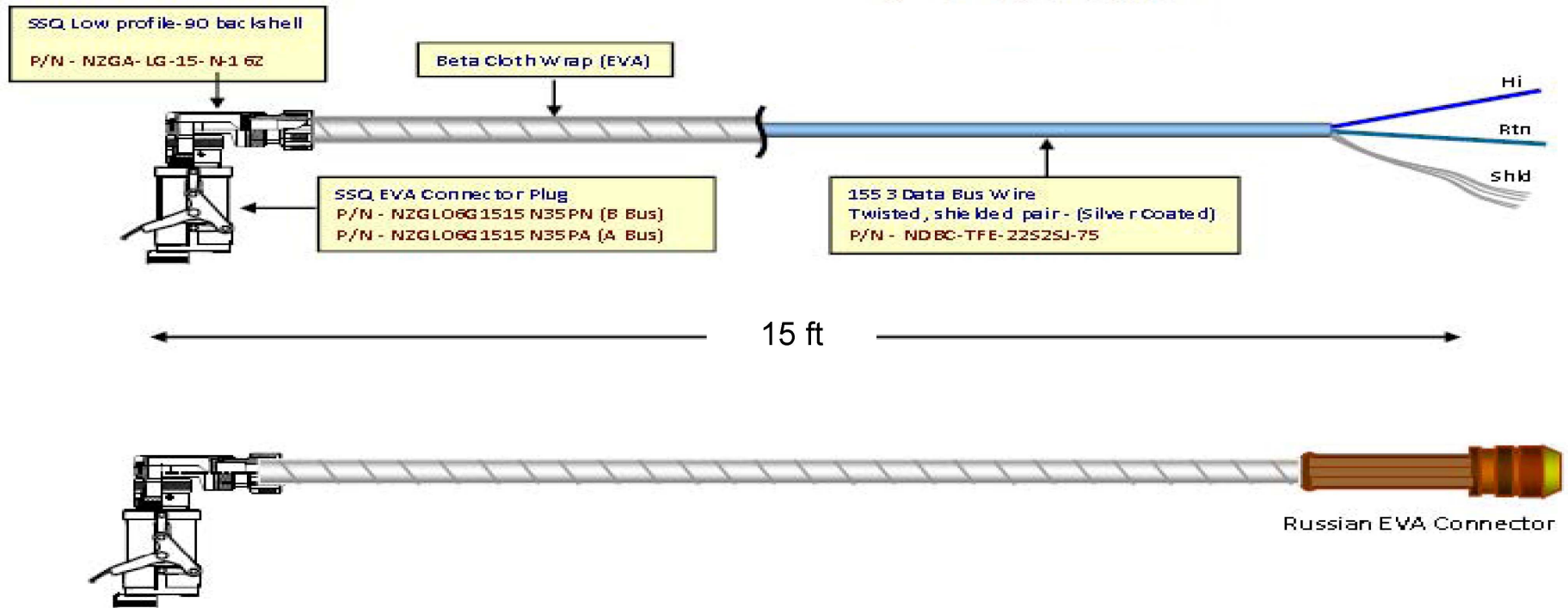

## NOD1/FGB CH 1/4 AND CH 2/3 CABLES INSTALL – TASK DATA

### Estimated Task Duration:

	With RMS	Without RMS
One EV Crew	N/A	04:00
Two EV Crew	N/A	02:00

### EVA Connectors:

Harness	From	To	Conn Size	Function
<b>Ch 1/4 Cable (port)</b>				
J17A	Cap	FGB P17	25	
P661A	Cap	NOD1 J661	25	
J131A	Cap	W36B-P131	25	
<b>Existing Cables</b>				
FGB P17	PMA P17	Ch 1/4 J17A	25	
W36B-P131	NOD1 J631	Ch 1/4 J131A	25	
PMA1 W1101 P661	NOD1 J661	Cap	25	
<b>Ch 2/3 Cable (stbd)</b>				
J20A	Cap	FGB P20	25	
P669A	Cap	NOD1 J669	25	
J138A	Cap	W32B-P138	25	
<b>Existing Cables</b>				
FGB P20	PMA P20	Ch 2/3 J20A	25	
W32B-P138	NOD1 J638	Ch 2/3 J138A	25	
PMA1 W1102 P669	NOD1 J669	Cap	25	

### ORU Details:

	Part Number	Mass
Ch 1/4 Cable	684-015283	25.13 lb
Ch 2/3 Cable	684-015284	25.13 lb

### Notes:

1. Cables have minimum bend radius of 4.9" for J17A/J20A and 4.0" for others

### Timeline Considerations:

1. Ch 1/4 Inhibits will be removed after Ch 1/4 cable (port) is installed to check connections  
The check will take approximately 45-60 min. During this time, power to both channels will be enabled  
Then Ch 2/3 inhibits will be put in place for Ch 2/3 cable (stbd)





# NOD1/FGB CH 1/4 AND CH 2/3 CABLES INSTALL – TASK DATA (Cont)

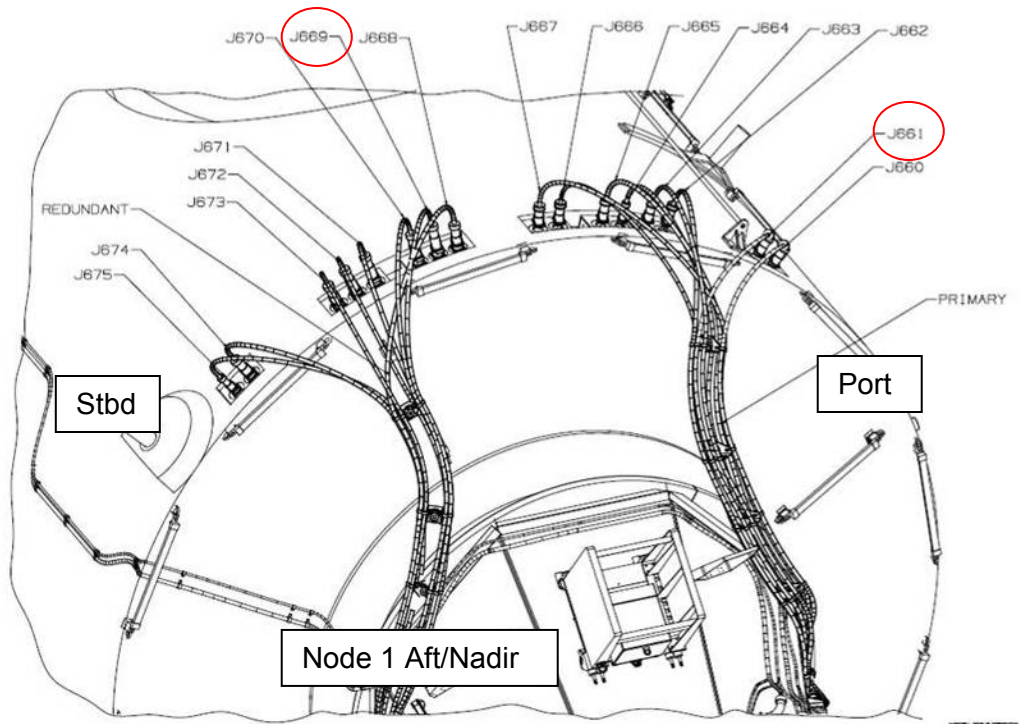

# NOD1/FGB CH 1/4 AND CH 2/3 CABLES INSTALL – TASK DATA (Cont)

## FINAL Z1 UMBILICALS

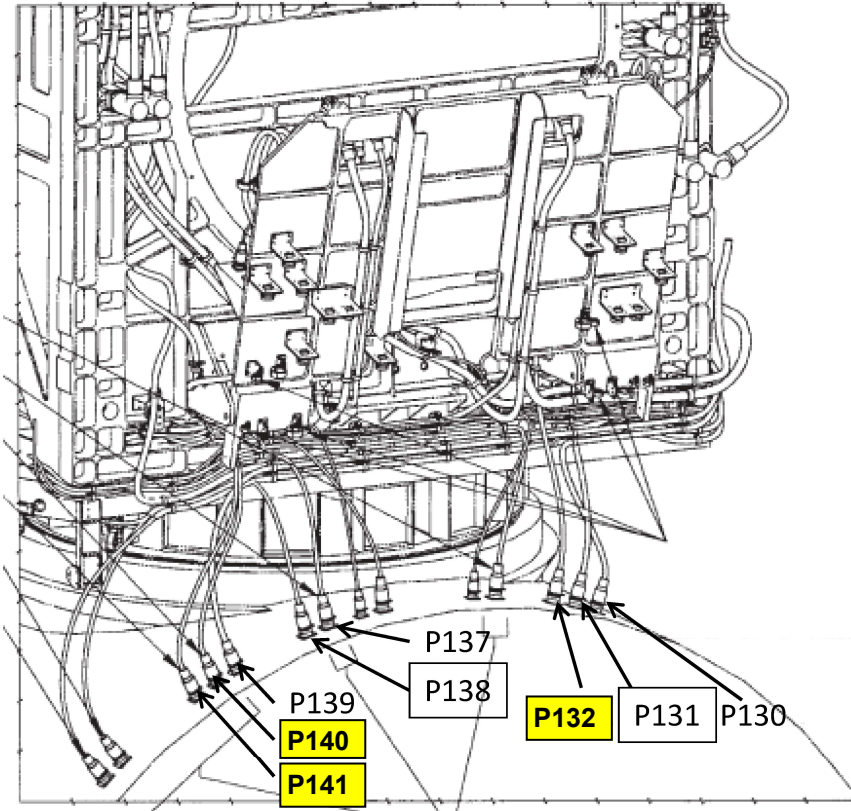

Connector	Shut Down reqd	Real time?
P130/J630	DDCU Z1-4B	No
P132/J632	RPCM N1 RS1-A 5 and 6	Yes
P137/J637	DDCU Z1-3B	No
P139/J639	DDCU Z1-3B	No
P140/J640	None	Yes
P141/J641	None	Yes



## STP-H3 PHOTOS – TASK DATA

### Estimated Task Duration:

	With RMS	Without RMS
One EV Crew	N/A	00:20
Two EV Crew	N/A	00:20

### Tools:

EV2
EVA Camera

### Notes:

1. EVA Camera during EVA4 has a fish eye lens.  
This is acceptable for DoD

### Cautions:

1. Top of STP-H3 is a KOZ
2. MHTEX Radiator has Z93 paint – avoid inadvertent contact

### Timeline Considerations:

1. The following are required by EVA photos:
  - Canary Face and FOV
  - Back of VADER
  - MHTEX Radiator
2. If additional time allows, also take photos of:
  - Front of VADER
  - DISC lens

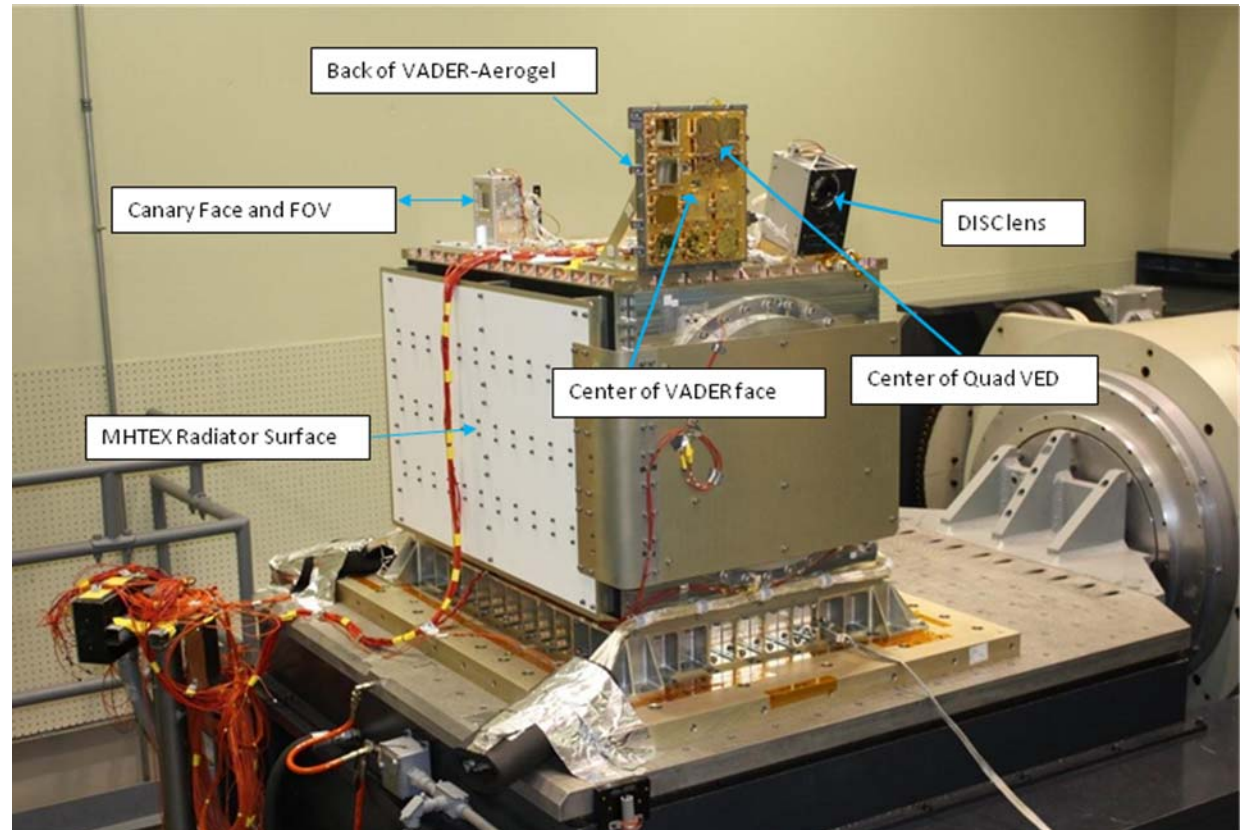

# HPGT FRGF MLI INSTALL – TASK DATA

**Estimated Task Duration:**

	With RMS	Without RMS
One EV Crew	N/A	00:15
Two EV Crew	N/A	N/A

**Tools:**

EV3
MLI

**Notes:**

1. Velcro is outlined with black sharpie
2. "T" located on MLI at the 1 o'clock position
3. MLI helps control ORU temperature

**Cautions:**

1. Avoid inadvertent contact with the SASA hi-gain and lo-gain antennas

**Timeline Considerations:**

1. MLI must be installed prior to end of ULF6 mission

**ORU Details:**

ORU	Part Number	Mass (lb)
HPGT FRGF MLI	683-52338-8	1.59

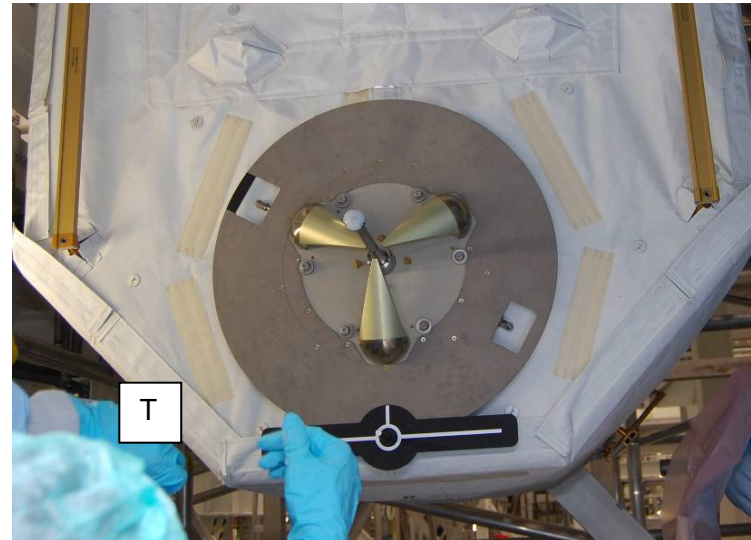



# EVA 4 SUMMARY TIMELINE

PET HR : MIN	IV/SSRMS	EV2 (Fn)	EV3 (Cf)	
00:00	SSRMS: Mnvtr to OBSS Stow Setup posn	<u>EGRESS/SETUP</u> (00:35) <ul style="list-style-type: none"> <li>• Post Depress and Egress (00:20)</li> <li>• Setup (00:15)</li> </ul>	<u>EGRESS/SETUP</u> (00:35) <ul style="list-style-type: none"> <li>• Post Depress and Egress (00:20)</li> <li>• Setup (00:15)</li> </ul>	00:00
01:00	SSRMS: Mnvtr to Stow GCA Start posn	<u>OBSS STOW</u> (00:55) <ul style="list-style-type: none"> <li>• OBSS Capture (00:35)</li> <li>• Grounding Connectors Install (00:20)</li> </ul>	<u>OBSS STOW</u> (00:55) <ul style="list-style-type: none"> <li>• OBSS Capture (00:35)</li> <li>• Cleanup (00:20)</li> </ul>	01:00
02:00	SSRMS: Mnvtr to Ingress posn	<u>P6 PDGF RETRIEVE</u> (01:25)	<u>P6 PDGF RETRIEVE</u> (01:25) <ul style="list-style-type: none"> <li>• PDGF Retrieve (01:15)</li> <li>• APFR Relocate (00:10)</li> </ul>	02:00
03:00	SSRMS: Mnvtr to GF Setup posn	<u>OBSS EFGF/PDGF SWAP</u> (01:20) <ul style="list-style-type: none"> <li>• PDGF Handoff (00:20)</li> <li>• EFGF Removal/PDGF Adapter Assy Install (00:25)</li> <li>• PDGF Install (00:25)</li> <li>• Cleanup (00:10)</li> </ul>	<u>OBSS EFGF/PDGF SWAP</u> (01:40) <ul style="list-style-type: none"> <li>• APFR Ingress (00:20)</li> <li>• EFGF Removal/PDGF Adapter Assy Install (00:25)</li> <li>• PDGF Install (00:25)</li> <li>• SSRMS Cleanup (00:30)</li> </ul>	03:00
04:00	SSRMS: Mnvtr to Egress posn SSRMS: Mnvtr to APFR Removal Setup posn	<u>STOW EFGF IN TSA</u> (00:35)	<u>OTP LDTD TETHER CINCH</u> (00:15)	04:00
05:00		<u>SPDM EDF RELEASE</u> (01:10)	<u>SPDM EDF RELEASE</u> (01:10)	05:00
06:00		<u>CLEANUP/INGRESS</u> (00:30) <ul style="list-style-type: none"> <li>• Cleanup (00:15)</li> <li>• Ingress and Pre-Repress (00:15)</li> </ul>	<u>CLEANUP/INGRESS</u> (00:30) <ul style="list-style-type: none"> <li>• Cleanup (00:15)</li> <li>• Ingress and Pre-Repress (00:15)</li> </ul>	06:00
06:30				06:30

## EVA 4 TOOL CONFIG

### ISS Configuration:

MT @ WS5 CETA Port/Stbd  
 SSRMS on MBS PDGF 2  
 SPDM on Lab  
 PSARJ @ 285°

EV2 STP: S0 port, inbd Strut → A/L aft D-ring  
 EV3 STP: S0 port, outbd Strut → A/L Curved HR, fwd Stanchion

- NOTE:** Prior to use, inspect the following hardware:
- RET cords for fraying
  - Inspect Load Alleviating Straps and D-ring Extenders; ref 2.230.100 CREW TETHER INSPECTIONS (SODF: ISS EVA TASKS):
    1. MMOD/general damage
    2. Discoloration
    3. Tack Stitching
    4. Red Band
  - ISS Trash Bag: Bristle deformation/damage, after having stowed tools in trash bag
    - √Empty √Zipper Closed
  - BRT joint screws not loose
  - Swing arm stiffness

- Tether Counts: (Green RETs)
- |                                 |                          |
|---------------------------------|--------------------------|
| RETs (sm-sm) = 9/16             | RETs (PIP Pin) = 2/5     |
| RETs (Lg-sm) = 2/8              | Adj Equip Tethers = 9/10 |
| Adj Equip Tethers (Lg-sm) = 0/2 |                          |

### EV2

- MWS
  - BRT (L)
    - RET (sm-sm)
    - Wire Ties (2 short – smushed ends)
  - T-Bar
    - RET (sm-sm) (L)
    - RET w/PIP Pin (R)
    - Adj Equip Tether (R)
    - Adj Equip Tether (L)
    - Wire Tie (2)
    - Small ISS Trash Bag (L, inbd)
  - Swing Arm (R)
    - RET (sm-sm)
      - PGT s/n \_\_\_\_\_
      - PGT Battery s/n \_\_\_\_\_
      - 7/16 (wobble) Socket-6 ext
- D-ring Extender (2, R & L D-ring)
  - Waist Tether (R on D-ring Ext)
  - Waist Tether (L on D-ring Ext)
  - ST Pack (85-ft+ 85-ft to R D-ring Ext) **SHUTTLE**

### EV3

- MWS
  - BRT (L)
    - RET (sm-sm)
    - Wire Tie (1 short, 1 long)
  - T-Bar
    - RET w/PIP Pin (R)
      - WIF Adapter
    - RET (sm-sm) (L) (hold WIF Adapter to bunny ear)
    - Adj Equip Tether (L to TB)
    - Adj Equip Tether (L to TB)
    - Wire Tie (2)
    - Small ISS Trash Bag (R, inbd)
  - Swing Arm (R)
    - EVA Camera w/bracket** (int RET – morning of)
- D-ring Extender (2, R & L D-ring)
  - Waist Tether (1, R on D-ring Ext)
  - Waist Tether (1, L on D-ring Ext)
  - ST Pack (85-ft + 85-ft to L D-ring Ext) **SHUTTLE**

### A/L

- RET (Lg-sm) (to bag aft soft tether pt)
  - OBSS Medium ORU Bag** (aft/port corner of A/L)
    - External:
      - Adj Equip Tether (aft tether pt)
      - Adj Equip Tether (aft tether pt)
      - Torque Wrench Bag (see fig 2)
        - Long Wire Tie (around bag tether pts and HR)
        - Short Wire Tie (around bag tether pts)
        - Adj Equip Tether (b/Pry Rod and HR stanchion)
          - Pry Rod
    - Internal:
      - RET (sm-sm) (RF to T-handle b/Bolts 5 & 6)
        - PAA
      - RET (sm-sm) (LB)
        - Scissors (keep on top of bag)
      - RET (sm-sm) (RB to L HR stanchion)
        - OBSS Crewlock Bag** (divider snapped up)
          - Adj Equip Tether (ext – R D-ring)
    - Side 1 of divider:
      - Wire tie caddy (5 short, 4 long) (int RET)
      - Hubble Connector Tool (90 deg) **SHUTTLE** (int RET)
      - Round Scoop (int RET)
        - PUMAA (Rd Scp straight out, opposite bolt)
        - RET (sm-sm) (both hooks on PUMAA)
    - Side 2 of divider:
      - J601/J602 Grounding Connectors (int RET) (on PIP pin tether loops) (see fig 1)
      - Adj Equip Tether (around Grounding Connectors and back onto own D-ring)
      - WIF Adapter (int RET)
- RET (Lg-sm) (for OBSS Crewlock Bag)

## EVA 4 TOOL CONFIG (Cont)

### A/L (Cont)

#### Staging Bag

- Fish Stringer Tether
  - Wire Tie Caddy (hook 1) (5 short, 4 long)
  - Velcro/Tape Caddy (hook 2)
  - PGT (hook 3) s/n \_\_\_\_\_
  - PGT Battery s/n \_\_\_\_\_
  - 7/16 (wobble) Socket-6 ext
  - Ratchet Wrench (hook 5)
  - 7/16 (rigid) Socket-2 ext
  - Long Duration Tie-Down Tethers (2) (hook 6)
  - Spare WIF Adapter (hook 7)
  - Spare Safety Tether Pack (85-ft + 85-ft) (to strap)
- Fish Stringer Tether
  - Connector Cleaner Tool Kit (hook 2)
  - Pry Bar (hook 4)
  - Needle Nose Pliers (hook 6)
  - MWS Key Strap Assy (on wire tie, to strap)
  - EVA Camera w/bracket (hook 7- morning of)

#### IV Bag

- Towels (2)
- Contamination Detection Kit
- GP Caddy (2)
  - Adjustable Thermal Mittens (2)
- Socket Caddy (hatch cont) w/RET (sm-sm) (Black)
  - 1/2 Socket-8 ext
  - 7/16 (wobble) Socket-6 ext (spare)
- DCM Plug (SAFER Hardmount) (2)
- RET (sm-sm, Black) (2)



Figure 1: OBSS Grounding Connectors



Figure 2: Torque Wrench Bag Config

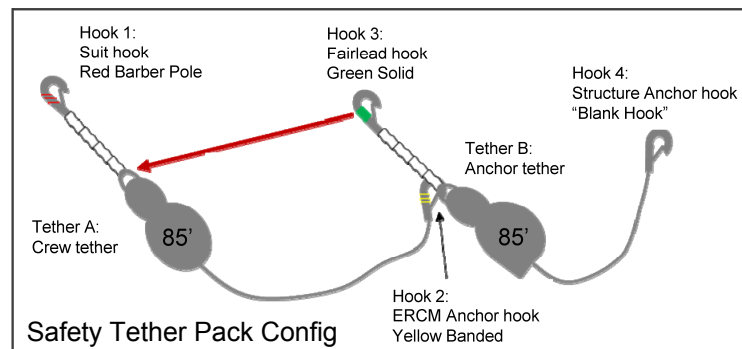

## EVA 4 BRIEFING CARD

### EVA Prep

- Review Morning Timeline/Plan
  - From Wake to Egress
- Suit Donning Plan
  - Boot bladder manipulation – 2 people check, 3 locks in place
  - Verify comm-cap connection, bite valve
- Checks – SAFER, MWS Tools, CL Config, Bag Stowage
- Airlock Depress Review (Suit IV protocol)

### Procedure Review

- EVA Summary/Sequence
- Egress Plan – Greg 1st, Mike 2nd
  - LAS and tether config inspections, RETs on STPs
  - Watch EV2 tether under A/L, EV3 tether near CETA spur
- Translation Paths/Fairleads
  - OBSS – EV2 fwd/zenith, EV3 aft/zenith
  - PDGF – EV2 low, EV3 high and 1st (frld on P4 not P6)
  - SPDM – EV2 high, EV3 low
- Hazards/Task Constraints (no touch, no damage, keep outs, notes, cautions, warnings)
  - WIF probes and sockets
  - OBSS striker bars, composite, MPM contacts, S1 Radiator Beam
  - PDGF doors, shaft, curvic coupling (especially during EV2 APFR ingress)
  - EFGF underside, open scissors
  - SPDM radiator areas, SASAs on ELC3
- Contingencies – section 16
- Potential Get-aheads
- Ingress Plan
  - EV2 secure – EV3 waist tether to EV2 anchor hook, take STPs inside
  - EV2 w/CL bag, EV3 w/OBSS ORU bag

### Robotics (Box)

- Coordinate Frames
- GCA – clear and concise, direction and distance
- Clearance Concerns
- GCA Complete

### Post EVA

- Suit Doffing
- Tool Reconfig Plan – section 2 procedures for xfer to Shuttle

### Emergencies

- Comm Fail (hand signals), Term EVA, Abort EVA
- EMU Malfunctions – verbalize DCM messages
- Lost Tools/Crew Member (velocity and direction)
- DCS – note symptoms/changes during ingress
- Safer Ops – right handle controller – both down = ready
- Crew Rescue – approach from desired side, waist tether together + on STP

### Reminders/Top Ten

- Slow is Fast – no hopping
- Discipline and Attention to Detail until the End (Flight not over until parked)
- BRT/ORU/Swing Arm/Tether Awareness
- Body Position is Everything (think 3D + zero-G, use BRT)
- Day/Night Checks – Visor (glove heaters, lights, tools, tethers)
- STs – Gate Closed, Slider Locked, 2 Reels Unlocked, remove RET
- Connectors – Check Pins Straight, No FOD, Red Band
- PGT – ON-Torque, Turns & Green Light, OFF (only if different than expected)
- Worksite Departure – check tools/tethers clear
- Glove & gauntlet check crossing SARJ
- Robotics – GCA complete and Brakes On
- Suit MAL – read down DCM messages
- Robotics – GCA complete and Bakes On (distance + observe in same call)

### Contingency

- OBSS Stow – outbd reach
- SPDM EDF Release communication

## EVA 4 INHIBIT PAD

### Orbiter

ALL EVAs	
TCS ( <i>Not required, switch guard installed on EVA1</i> )	
IV L12	1. √TCS POWER – OFF
KU-Band Antenna ( <i>INCO: Prior to Egress</i> )	
<b>MCC-H</b>	1. √KU-BAND Mask – active
	2. √KU-BAND EVA Protect Box – active
RCS ( <i>GNC/PROP: Prior to Egress</i> )	
If EV crew < 27 ft from FRCS	
IV	1. √DAP: VERN, FREE, LO Z
O14,15,16	2. √RJDF F1, F2, F3, F4 MANF DRIVER (four) – OFF
	LOGIC (four) – OFF
<b>MCC-H</b>	3. √Above RCS config
IV	4. √RCS F – ITEM 1 EXEC (*)
	√JET DES F1U – ITEM 17 (*)
	F3U – ITEM 19 (*)
	F2U – ITEM 21 (*)

### Ground

ALL EVAs	
Ground Radar ( <i>TOPO: Prior to Egress</i> )	
<b>MCC-H</b>	1. √TOPO console, ground radar restrictions in place for EVA

### USOS (1)

ALL EVAs	
PCU ( <i>PHALCON: Prior to Egress</i> )	
<u>NOTE</u>	
PCUs may require up to a 1-hr warmup period before they are operational	
<b>MCC-H</b>	1. √PCUs (two) operational in discharge mode and one of the following:
	a. CCS PCU EVA hazard control FDIR enabled
	b. No more than two arrays unshunted and oriented < 105° from velocity vector
	If one or both PCUs failed
	2. No more than two arrays unshunted and oriented < 105° from velocity vector
CUCU ( <i>Crew: Prior to Egress</i> )	
IV – (LAB104)	
	1. √cb POWER A, B [two] – OPEN
	2. √cb LINK 1,2 [two] – OPEN
And one of the following inhibit pairs:	
<b>POIC</b>	3a. Express Rack 2 Locker 6 – Power Removed
	3b. Express Rack 6 Locker 7 – Power Removed
<b>OR</b>	
IV	4a. Express Rack 2 Locker 6 – OFF
	4b. Express Rack 6 Locker 7 – OFF
MISSE 8 ( <i>POD: Prior to Egress</i> )	
<b>POIC</b>	Prior to EV Hatch Open
	1. ELC-2 ExPA-2 Discrete Channel 6 – Disabled

## EVA 4 INHIBIT PAD (Cont)

LOCATION DEPENDENT INHIBITS	
Lab Window ( <i>Not expected</i> ) IV	If EV crew less than 10 ft from window or in window FOV, close window shutter
Cupola Windows ( <i>Not expected</i> ) IV	If EV crew less than 10 ft from window, coordinate shutter opening/closing with EV crew and minimize time shutter is open
S-Band (SASA) Antennas ( <i>CATO: Prior to Egress – OBSS Stow</i> ) <b>MCC-H</b>	If EV crew < 3.8 ft from S1 SASA <ol style="list-style-type: none"> <li>1. P1 SASA – Active</li> <li>2. S1 SASA – Powered down and unavailable to FDIR</li> </ol>
Mobile Transporter ( <i>ROBO: Prior to Egress</i> ) <b>MCC-H</b>	If EV crew < 1.5 meters from MT <ol style="list-style-type: none"> <li>1. √MT latched</li> </ol>
Port SARJ ( <i>PHALCON: During Egress – PDGF Retrieve</i> ) <b>MCC-H</b>	If EV crew working within 2 ft, outboard of SARJ or reqd per loads FR <ol style="list-style-type: none"> <li>1. √DLA (1) – LOCKED at 285°</li> <li>2. All motor setpoints set to zero</li> <li>3. All motors deselected</li> </ol>
TRRJ ( <i>THOR: Prior to Egress – OBSS Stow</i> ) <b>MCC-H</b>	If EV crew working within 2 ft of S1 TRRJ rotation envelope <ol style="list-style-type: none"> <li>1. √DLA 1(2) – LOCKED within 65° to 90°</li> <li>2. √DLA 2(1) – ENGAGED</li> </ol>
FPMU ( <i>PHALCON: Prior to Egress – PDGF Retrieve, SPDM EDF Release</i> ) <b>MCC-H</b>	If EV crew on Port truss (P1-P6) or working within 5 ft of Floating Potential Measurement Unit <ol style="list-style-type: none"> <li>1. RPCM P11A_B RPC 13 Open/Close Cmd Inhibit</li> </ol>
SSPTS ( <i>PHALCON: Prior to Task – EFGF Stow in TSA</i> <i>Inhibits 1, 2 and 3 from ~4:00-5:15</i> ) <b>MCC-H</b>	If EV crew working within 2 ft of SSPTS cables <ol style="list-style-type: none"> <li>1. RPCM LA2A3B D RPC 1 – Open, Close Cmd Inhibit</li> <li>2. RPCM Z14B A RPC 2 – Open, Close Cmd Inhibit</li> <li>3. RPCM Z13B A RPC 2 – Open, Close Cmd Inhibit</li> </ol>

TASK DEPENDENT INHIBITS	
BGA 4A ( <i>PHALCON: Prior to Egress – PDGF Retrieve</i> ) <b>MCC-H</b>	If EV crew working within rotation plane of BGA <ol style="list-style-type: none"> <li>1. Lock BGA 4A between 50°-180° (160° preferred) with motor turned off</li> </ol>
MISSE 8 ( <i>POD: Prior to Egress – SPDM EDF Release</i> ) <b>POIC</b>	If EV crew working zenith of plane of MISSE 8 <ol style="list-style-type: none"> <li>1. MISSE-8 PASCAL solar cells – Zero voltage bias</li> <li>2. ELC-2 ExPA-2 Discrete Channel 1 – Disabled</li> <li>3. ELC-2 ExPA-2 28V Operational Power – Disabled</li> </ol>

### JEM (1)

ALL EVAs	
ICS-EF Antenna <b>SSIPC</b>	<ol style="list-style-type: none"> <li>1. ICS MOD – OFF</li> <li>2. ICS UPC – OFF</li> <li>3. ICS HPA – OFF</li> <li>4. HPA ON and UPC ON commands are cleared (not present) in the ICS stored command queue</li> </ol>

### COL (1)

ALL EVAs	
HAM Radio ( <i>Crew: Prior to Egress</i> ) IV	<ol style="list-style-type: none"> <li>1. HAM Radio – Deactivate</li> </ol>

### RSOS (1)

ALL EVAs	
SM Antennas ( <i>RIO: Prior to Egress</i> ) IV <b>MCC-M</b>	<ol style="list-style-type: none"> <li>1. ARISS (Ham Radio) – Deactivate</li> <li>2. GTS – Deactivate</li> <li>3. Napor (PCПИ) – Deactivate</li> </ol>

## EVA 4 NOTES/CAUTIONS/WARNINGS

### NOTES

1. Bolt install: Report torque and turns
2. Bolt release: Report torque and turns if different from published range
3. EVA connectors: After disconnection and prior to connection; verify pin and EMI band integrity; verify connector free of FOD
4. Inspect QDs for damage prior to mating
5. Toolbox doors must be closed with one latch per door when EV crew not in immediate vicinity
6. 85-ft safety tether retract force may affect body positioning
7. CETA Cart brake handle wire ties must be replaced after crew loading

### CAUTION

#### ISS Generic Constraints

- A. Avoid inadvertent contact with
1. Grapple fixture shafts (dry lube)
  2. PIP pins
  3. Passive UMAs
  4. MBS/SSRMS/SPDM taped radiative surfaces: VDU, ACU, JEU, LEU, MCU, CRPCMs, and Cameras
  5. SPDM SJEU, EP, OTCM, LEU, and LEE VDU radiator surfaces
  6. OTSD
- B. Electrical cables
1. Avoid bend radii  $< 10$  times cable diameter
- C. Fiber optic cables
1. Avoid bend radii  $< 10$  times cable diameter
  2. Avoid pulling on cable during mate/demate
- D. Fluid line flex hoses and QDs
1. Avoid bend radii  $< 14$  in for hoses with a diameter  $\geq 1$  in
  2. Additional care should be taken to not exceed bend radii when applying loads at the flexible hose to rigid tube stub interfaces
  3. Ensure fluid QD booties are fully closed prior to leaving worksite; wire tie if required
  4. Avoid bend radii  $< 5$  in for hoses with diameter  $< 1$  in on LAB, S0, S1, P1, and 10 in for hoses with diameter  $< 1$  in on all other elements

### CAUTION

#### ISS Generic Constraints (Cont)

- E. For structural reasons
1. Avoid vigorous body motions, quick grabs and kickoffs against tether restraints
  2. Avoid performing shaking motions (sinusoidal functions) more than four cycles
- F. Other
1. ITT Cannon connector: On demated connectors, do not rotate collar or manipulate cable/connector using collar or connector tool
  2. MLI handholds are not rated for crewmember translation loads



## EVA 4 NOTES/CAUTIONS/WARNINGS (Cont)

### CAUTION

#### ISS Truss Constraints

- A. Avoid inadvertent contact with
1. CETA lights (Z-93 paint) [LAB,S1,NODE 1,P3,S3]
  2. Deployed TUS cable [Zenith and Nadir CETA rails]
  3. S0 aft face radiator
  4. GPS antennas (S13 paint) [S0,JLP]
  5. UHF antennas [LAB,P1]
  6. ETCS radiator flexhoses and panels [S1,P1]
  7. EETCS/PV radiator flexhoses, bellows and panels [P6,P4,S4,S6]
  8. SASA RF group [S1,P1]
  9. Heat pipe radiators [Z1]
  10. PCU cathode and HCA ports [Z1]
  11. Ku-Band antenna (SGANT) dish [Z1]
  12. CMG cover/shells [Z1]
  13. FPMU [P1]
  14. SASA high and low gain antennas and radiator surfaces [Z1]
  15. Deployed MISSEs
  16. OTP on HAB Tray [S0]
  17. OBSS composite sections, striker bars, grapple fixture shafts, and cable harnesses
- B. For structural reasons
1. Avoid kicking S1/P1 radiator beam. If any of these occur, wait 2 to 5 min to allow structural response to dissipate

### CAUTION

#### ISS Truss Constraints (Cont)

- C. Other
1. EWIS antennas: Do not use as handholds [NODE 1,LAB,P6,Z1]
  2. Lubricant from Ku-Band SGANT gimbals [Z1], CMGs [Z1], and RTAS ground strap fasteners [P6,P4,S4,S6] can contaminate EMU
  3. Prevent inadvertent contact of the tether shuttle with ETRS when the P3 tether shuttle stop is raised away from the rail

### CAUTION

#### ISS U.S. Pressurized Elements Constraints

- A. Avoid inadvertent contact with
1. EVA crane [PMA1]
  2. TCS reflectors [PMA2,PMA3]
  3. APAS hardware [PMA2,PMA3]
  4. CETA lights (Z-93 paint) [LAB,S1,NODE 1,P3,S3]
  5. UHF antennas [LAB,P1]
  6. Open CBM petal covers, LAB and Cupola window shutters
  7. S0/NODE 2 fluid tray hardlines at NODE 2 end, which are limited to 25 lb
- B. Other
1. EWIS antennas: Do not use as handholds [NODE 1,LAB,P6,Z1]
  2. CBM petal covers may not be used as handholds unless both launch restraint pins are engaged

## EVA 4 NOTES/CAUTIONS/WARNINGS (Cont)

### CAUTION

#### ISS I.P. Elements Constraints

##### COL

- A. Avoid inadvertent contact with
1. COL ARISS and AIS antennas [COL-Nadir]

##### JEM

- A. Avoid inadvertent contact with
1. GPS antennas (S13 paint) [S0,JLP]
  2. Open JPM window shutter
  3. JTVE, WVE/EVE, JEF VE cameras
  4. JEMRMS taped radiative surfaces [JEU,EE,Cameras]
  5. JEM A/L target and pins
  6. JEF ORUs and EFUs (paint and lubricant)
  7. MAXI front and top panel (paint)
  8. SEDA-AP sensors (HIT, SDOM, and AOM)
  9. Trunnions and UCMs (paint and lubricant) [JEF Payloads]
  10. RAIDS covers on end of HREP
  11. ICS-EF Ka-Band antenna dish
  12. Small Fine Arm (SFA) (paint, coating and lubricant)
- B. For structural reasons
1. Avoid kicking MMOD shields between JLP and JPM
  2. Avoid tool impact on ICS-EF sensor

### CAUTION

#### Shuttle Constraints

- A. Avoid inadvertent contact with
1. OBSS and SRMS composite sections joint torque arms, grapple fixture shafts, and cable harnesses
  2. LCS (silver Teflon) and LDRI (silver Teflon) and ITVC (gold foil) [OBSS]
  3. WVS antenna [ODS truss and PLB sill]
  4. Payload bay and camera wire harnesses, cables, cable guides, and connectors
  5. OBSS striker bars (drylube)
- B. No touch
1. LDRI diffuser [OBSS]
  2. OBSS saddle contacts (when OBSS unberthed) [OBSS]
  3. Monkey fur [PLB]
  4. Cameras: Metallic surfaces [PLB]
  5. Ku-Band antenna black dish and gold thermal blankets [PLB]

## EVA 4 NOTES/CAUTIONS/WARNINGS (Cont)

### WARNING

#### ISS Generic Constraints

- A. Avoid inadvertent contact with
1. Grapple fixture targets and target pins
- B. Pinch
1. NZGL connector linkage. Use caution when mating/locking
  2. ITT Cannon connector rotating housing
  3. PDGF connector doors
- C. QDs
1. If QD is in FID when valve is opened (bail fwd), QD will leak and fluid line may whip
  2. Do not rotate if in mated/valve open configuration
  3. Bail may kick back suddenly when detent button is depressed if pressure has built up in spring cavity
- D. Sharp Edges
1. Inner edges of WIF sockets
  2. APFR active WIF probes
  3. Mating surfaces of EVA connectors  
Avoid side loads during connector mating
  4. Back side of MMOD shield fasteners
  5. Spring loaded captive EVA fasteners (e.g., 6B-boxes, BMRRM, RTAs, SARJ Covers); the end of the spring may protrude
  6. SPDM OTCM gripper jaws
  7. Keep hands away from SSRMS LEE/POA/SPDM LEE opening, snares, and PDGF curvic coupling (teeth)
  8. MMOD strikes on ISS exterior

### WARNING

#### ISS Generic Constraints (Cont)

- E. Thermal
1. EVA connectors with booties may become hot if left uncovered. Handling may need to be limited
  2. Turn off glove heaters when comfortable temperature reached to prevent bladder damage. Do not pull fingers out of gloves when heaters are on
  3. Uncovered trunnion pins may be hot
  4. SSRMS/MBS/SPDM operating cameras and lights may radiate large amounts of heat
  5. Do not touch EMU protective visor if temperature has been  $< -134$  degF for  $> 15$  min
  6. No EMU boot contact with foot restraint when temperature  $< -120$  degF or  $> 200$  degF
  7. PDGF surfaces may not meet touch temperature requirements for unlimited contact when  $\beta \leq -70$  or  $\beta \geq 70$

### WARNING

#### ISS Truss Constraints

- A. Avoid inadvertent contact
1. SSU, ECU, beta gimbal platform, mast canister, SAW blanket boxes unless the beta gimbal is locked and the motor is turned off
  2. Stay inboard of SARJ when active
  3. Stay 2 ft from S1/P1 radiator beam rotational envelope when beam is free to rotate
  4. Stay 5 ft from moving MT on face 1
  5. Stay 3.3 ft from Ku-Band (SGANT antenna) when powered
  6. Stay 1 ft from top of STP-H3 (ELC3)
  7. Deployed MISSEs and ORMATE-III R/W
- B. RF radiation exposure
1. Stay 3.8 ft from S-Band (SASA) high gain antenna when powered [S1,P1]
  2. Stay 1.3 ft from S-Band (SASA) low gain antenna when powered [S1,P1]
  3. Stay 1 ft from UHF antenna when powered [LAB,P1]
- C. Sharp Edges
1. Solar array blanket box [P6,S6]
  2. Fastener threads on back of Z1 U-jumper male FQD panel, if nutplate cap missing
  3. Outboard MT rail attachment lug near P6 handrail 5333 and gap spanner
  4. P2 connector on EWIS box TAA-06 [Zenith/Forward Corner 1 of P5 – SARJ at 0 deg]
  5. Nickel coated braided copper ground straps may contain frayed wires [P6,P4,S4,S6]
  6. MMOD strikes on Z1 toolboxes
  7. POA FSE (CSA logo below MBS mast camera)
  8. AMS Star Trackers Baffles (2)

## EVA 4 NOTES/CAUTIONS/WARNINGS (Cont)

### WARNING

#### ISS Truss Constraints (Cont)

##### D. Electrical Shock

1. Stay  $\geq 2$  ft from ungrounded floating connectors if powered  
S0 EVA power cables (inside S0 Bay 00 Face 4, Bay 01 Face 3)  
ESP-2 jumper (inside S0 Bay 03 Face 4)

##### E. Thermal

1. ELC may exceed touch temperatures when  $\beta > 75$  deg

### WARNING

#### ISS U.S. Pressurized Elements Constraints

##### A. Handrails

1. Handrails previously used for MISSE attachment may not be used as a safety tether point [A/L endcone 564 and 566, A/L Tank 2 Nad/Fwd and Port/Fwd, P6 5389]

##### B. Pinch

1. EV side of IV Hatch during Hatch operation (also snag hazard) [A/L]
2. LAB and Cupola window shutters and CBM petal cover linkages during operation

##### C. RF radiation exposure

1. Stay 1 ft from UHF antenna when powered [LAB,P1]

##### D. Sharp Edges

1. PMA umbilical launch restraints - exposed bolt threads
2. Adjustable fuse tether (Fish Stringer) buckles stowed in Node bag
3. Port/Aft portion of A/L circular HR [HR 0506]
4. A/L HR 0537 (Eq Lock Zenith)

##### E. Thermal

1. PMA handrails may be hot. Handling may need to be limited
2. Stay  $\geq 1$  ft away from PMAs and MMOD shields  $> 270$  degF if EMU sun visor up; limit time to 15 min or less if  $> 300$  degF
3. Stay at least 0.5 ft away from PMA and MMOD shields  $> 325$  degF
4. No EMU TMG contact with PMAs and MMOD shields  $> 320$  degF

### WARNING

#### ISS U.S. Pressurized Elements Constraints (Cont)

##### F. Electrical Shock

1. Stay  $\geq 2$  ft from ungrounded floating connectors if powered  
SSPTS connectors include NOD1 Stbd/Fwd HR 0130, LAB Stbd/Fwd HR 0273, PMA2 Stbd

##### G. Fluid QDs

1. Do not translate on gap spanners restraining NODE 3 – LAB NH3 jumpers

## EVA 4 NOTES/CAUTIONS/WARNINGS (Cont)

### WARNING

#### ISS I.P. Elements Constraints

##### COL

- A. Avoid inadvertent contact with
  - 1. SOLAR [COL EPF]
- B. Thermal
  - 1. Columbus end cones may violate touch temperature constraints when  $-75 \leq \beta \leq -60$  or  $60 \leq \beta \leq 75$
- C. Sharp Edges
  - 1. LWAPA PIP pins [COL EPF]

##### JEM

- A. Avoid inadvertent contact with
  - 1. ICS-EF sensors
- B. Pinch
  - 1. JPM window shutter linkages during operation
  - 2. JEM cameras (JVTEs, EVE, WVE, and JEF VEs)
  - 3. JEM EFU latching arms
  - 4. JEF SSE latch
  - 5. ICS-EF antenna boom
  - 6. SEDA-AP mast
  - 7. SMILES antenna rotating area
  - 8. HREP hinge sides and RAIDS pinch areas
  - 9. JEMRMS EE
  - 10. JEMRMS Small Fine Arm (SFA) joints and booms

### WARNING

#### ISS I.P. Elements Constraints (Cont)

##### JEM (Cont)

- C. Sharp Edges
  - 1. Interior of JEMRMS HRMs
  - 2. JEMRMS EE opening and snares
  - 3. JEM A/L hatch corners
  - 4. ICS-EF AHM gears
  - 5. MAXI visual star camera
  - 6. SMILES baffles (two), baffle base bare bolts, and Cold Sky Terminator (CST)
  - 7. HREP baffles (four) [Star tracker aperture Zenith and three instrument baffles Aft]
  - 8. SFA Electro-Mechanical GF (EMGF)
- D. RF radiation exposure
  - 1. Stay 0.3 ft from Fwd/Aft JPM PROX antenna
- E. Thermal
  - 1. JPM Port End Cones and JLP Port Nadir may violate touch temperature constraints when  $\beta > 60$  deg
  - 2. JEMRMS/JTVE/JEFVE operating cameras and lights may radiate large amounts of heat

### WARNING

#### Shuttle Constraints

- A. Arcing/Molten Debris
  - 1. Stay  $\geq 2$  ft from exposed EFGF connector when OBSS berthed, powered, and EFGF not grappled [PLB]
  - 2. Stay  $\geq 2$  ft from exposed Stbd Fwd MPM contacts [PLB]
  - 3. Stay above PLB sill when within 1 ft of powered ROEU connector [PLB]
- B. Pinch
  - 1. PRLA operation [PLB]
- C. RF radiation exposure
  - 1. Stay 3.28 ft from S-Band antenna when powered
  - 2. Stay 1 ft from top and side of UHF PLB antenna radome surface when in high powered mode [ODS truss]
  - 3. Stay 0.33 ft from top and side of UHF PLB antenna radome surface when in low powered mode [ODS truss]
  - 4. Remain below the level of the PLB door mold line for first 20 in Aft of Fwd bulkhead when S-Band antenna powered [PLB]
  - 5. Remain on the inboard side of the Stbd slidewire (sill handrails if slidewire not installed) for first 20 ft Aft of Fwd bulkhead when Ku-Band antenna powered [PLB]

## EVA 4 NOTES/CAUTIONS/WARNINGS (Cont)

### WARNING

#### **Shuttle Constraints (Cont)**

##### D. Sharp Edges

1. PRLA grounding wipers [PLB]
2. LDRI baffles (also an entrapment hazard) [OBSS]
3. Keep hands away from SRMS EE opening and snares
4. TCS connector backshells have exposed threads [ODS]

##### E. Thermal

1. Illuminated PLB lights; do not touch
2. OBSS grapple fixture shafts/cams may be hot. Limit handling if required
3. Stay 27 ft from PRCS when powered
4. Stay 3 ft from VRCS when powered
5. Stay 3 ft from APU when operating

##### F. Contamination

1. Stay out of the immediate vicinity of leaking jet or APU

##### G. Lasers

1. Do not look at LDRI diffuser or LCS laser aperture window

## EVA 4 EGRESS/SETUP (00:35)

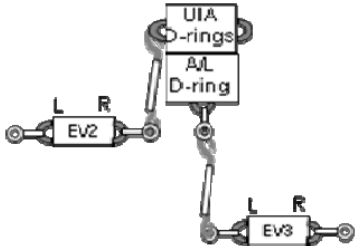
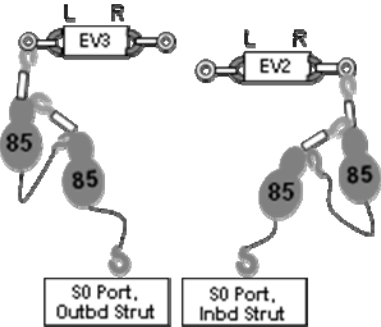
IV/SSRMS	EV2 (Spanky)	EV3 (Taz)
<ol style="list-style-type: none"> <li>Record PET Start time ___:___</li> <li>Day/Night Cycles _____</li> </ol>  <ol style="list-style-type: none"> <li>Start WVS Recorders</li> <li>Start Hatch Thermal Cover clock PET (30 min) ___ : ___</li> <li>Inspect Load Alleviating Straps for: <ol style="list-style-type: none"> <li>MMOD/general damage</li> <li>Discoloration</li> <li>Tack Stitching</li> <li>Red Band</li> </ol> </li> </ol>  <ol style="list-style-type: none"> <li>Post crew egress: WVS Software: Select page – RF camera Sel 'Advanced Controls' S-Band Level (two) – Max</li> </ol>	<p><b>Initial Configuration:</b></p> <ol style="list-style-type: none"> <li>√All gates closed &amp; hooks locked <ul style="list-style-type: none"> <li><input type="checkbox"/> R Waist Tether to UIA D-ring</li> </ul> </li> </ol> <p><u>EGRESS</u> (00:20)</p> <ol style="list-style-type: none"> <li>Partially egress A/L hatch to allow EV3 to attach <b>RED</b> hook to R D-ring ext</li> <li>On <b>EV3 GO</b>, release R Waist Tether from UIA D-ring</li> <li>Relocate sm hooks on Lg-sm (2) to UIA D-rings</li> <li>Egress A/L with OBSS ORU bag</li> <li>Stow OBSS ORU bag on BRT w/RET</li> <li>Perform buddy checks √MWS tabs up, BRT tabs up, tether configs</li> <li>Verify SAFER config <ul style="list-style-type: none"> <li><input type="checkbox"/> √L handle down (MAN ISOL Vlv – Open)</li> <li><input type="checkbox"/> √R handle down (HCM – Closed)</li> </ul> </li> <li>√WVS – green LED</li> </ol>	<p><b>Initial Configuration:</b></p> <ol style="list-style-type: none"> <li>√All gates closed &amp; hooks locked <ul style="list-style-type: none"> <li><input type="checkbox"/> L Waist Tether to A/L int D-ring Ext</li> </ul> </li> </ol> <p><u>EGRESS</u> (00:20)</p> <ol style="list-style-type: none"> <li>Open hatch thermal cover</li> <li>Egress A/L</li> <li>Perform LAS inspection on EV2 ST Pack (aft D-ring) <ul style="list-style-type: none"> <li><input type="checkbox"/> LAS, <input type="checkbox"/> √Yellow hook on Green ERCM</li> <li><input type="checkbox"/> LAS, <input type="checkbox"/> √Green hook on Red ERCM</li> </ul> </li> <li>RET to ST Pack on aft D-ring</li> <li>Attach <b>RED</b> hook to EV2 R D-ring ext <ul style="list-style-type: none"> <li><input type="checkbox"/> √Gate closed, hook locked, reels unlocked, release RET</li> </ul> </li> <li>Give <b>EV2 GO</b> to release Waist Tether</li> <li>Perform LAS inspection on EV3 ST Pack <ul style="list-style-type: none"> <li><input type="checkbox"/> LAS, <input type="checkbox"/> √Yellow hook on Green ERCM</li> <li><input type="checkbox"/> LAS, <input type="checkbox"/> √Green hook on Red ERCM</li> </ul> </li> <li>RET to ST Pack on fwd/stbd curved HR stanchion</li> <li>Attach <b>RED</b> hook to L D-ring ext <ul style="list-style-type: none"> <li><input type="checkbox"/> √Gate closed, hook locked, reels unlocked, release RET</li> </ul> </li> <li>Release L Waist Tether from A/L int D-ring Ext</li> <li>Perform buddy checks √MWS tabs up, BRT tabs up, tether configs</li> <li>Verify SAFER config <ul style="list-style-type: none"> <li><input type="checkbox"/> √L handle down (MAN ISOL Vlv – Open)</li> <li><input type="checkbox"/> √R handle down (HCM – Closed)</li> </ul> </li> <li>√WVS – green LED</li> </ol>



**EVA 4 EGRESS/SETUP (00:35) (Cont)**

<b>IV/SSRMS</b>	<b>EV2 (Spanky)</b>	<b>EV3 (Taz)</b>
<p>7. Stop Hatch Thermal Cover clock PET (30 min) __ : __</p>	<p>10. Close hatch thermal cover</p> <p><u>SETUP</u> (00:15)</p> <p>11. Translate to S0 Face 2 <input type="checkbox"/> Watch for EV3 ST</p> <p>12. Stow ORU bag on S0 HR 3458</p> <p>13. Retrieve C/L bag from OBSS ORU bag, stow on BRT w/RET <input type="checkbox"/> Remove RET from C/L bag and attach to HR 3458 to help secure ORU bag</p> <p>14. Close OBSS ORU bag</p> <p>(Translate to S1 outbd OSE)</p>	<p><u>SETUP</u> (00:15)</p> <p>15. Translate to A/L stbd Toolbox <input type="checkbox"/> Clear ST for EV2</p> <p>16. Reconfig APFR to [x,FF,J,1]</p> <p>17. Retrieve APFR; stow on BRT w/RET</p> <p>(Translate to S1 inbd OSE)</p>



**OBSS STOW (00:55) (Cont)**

IV/SSRMS	EV2 (Spanky)	EV3 (Taz)						
<p>3. Record Bolt 1 data:</p> <table border="1" data-bbox="107 264 611 334"> <thead> <tr> <th>Bolt</th> <th>Turns</th> <th>Torque (ft-lb)</th> </tr> </thead> <tbody> <tr> <td>#1</td> <td>(11.5-13)</td> <td>(18.4)</td> </tr> </tbody> </table> <p>4. Give <b>SSRMS GO</b> for mnvr to APFR Install GCA Start posn <b>SSRMS: Mnvr to APFR Install posn</b></p> <p>5. Give <b>SSRMS GO</b> to mnvr to APFR Ingress Clearance posn <b>SSRMS: Mnvr to APFR Ingress Clearance posn</b></p>	Bolt	Turns	Torque (ft-lb)	#1	(11.5-13)	(18.4)	<p>14. Translate aft to Bolt 1 of outboard OSE</p> <p>15. Configure PGT: <b>[B3 (18.4), CW2, 30.5]</b> 6-Ext 7/16</p> <p>16. ←Drive clamp 'bolt 1' to torque, max 13 turns</p> <p>17. Verify OBSS stand fully clamped to trunnion (view clamping mechanism through OSE cover slot)</p> <p>18. Release Y-slider PIP pin #1 and stow in any black ring stowage location</p> <p><u>GROUNDING CONNECTORS INSTALL</u> (00:20)</p> <p>19. Retrieve grounding connectors from OBSS C/L bag</p> <p>20. Disconnect connectors <input type="checkbox"/> P601 (outbd) <input type="checkbox"/> P602 (inbd)</p> <p>21. Mate grounding connectors to: (Align red wing with arrow, turn cw 1/4 turn) <input type="checkbox"/> J601 <input type="checkbox"/> J602 √Red band on connector is not visible</p> <p>22. Wire tie OBSS connectors to OBSS tether points <input type="checkbox"/> P601 (outbd) <input type="checkbox"/> P602 (inbd)</p> <p>23. Install PIP pins into OSE HR (pull test) <input type="checkbox"/> <input type="checkbox"/> √Orient so cable is inline with HR</p> <p>24. Stow adj equip tether in C/L bag</p> <p>25. Translate to stbd CETA cart</p> <p>26. Stow C/L bag on upper/left grid (D)</p> <p>27. Retrieve PUMAA/Rd Scoop/RET from C/L bag, stow on BRT w/RET <input type="checkbox"/> Attach C/L bag RET to door handle</p> <p>28. Glove and Gauntlet Check (Translate to P6, nadir route – PDGF Retrieve)</p>	<p><u>CLEANUP</u> (00:20)</p> <p>12. Egress APFR</p> <p>13. Reconfigure APFR to <b>[10,FF,F,6]</b></p> <p>14. <b>Notify IV</b> ready for mnvr to APFR Install posn</p> <p>15. GCA SSRMS as reqd for APFR install</p> <p>16. Install WIF Adapter into SSRMS, tether point away from HR (PIP pin required; not hitch pin)</p> <p>17. Install APFR in WIF Adapter <b>[12,PP,F,6]</b> <input type="checkbox"/> √Locking collar black-on-black, pull/twist test</p> <p>18. <b>Notify IV</b> ready for mnvr APFR Ingress Clearance posn</p> <p>19. Glove and Gauntlet Check</p> <p>(Translate to P6, zenith route – PDGF Retrieve)</p>
Bolt	Turns	Torque (ft-lb)						
#1	(11.5-13)	(18.4)						

## P6 PDGF RETRIEVE (01:25)

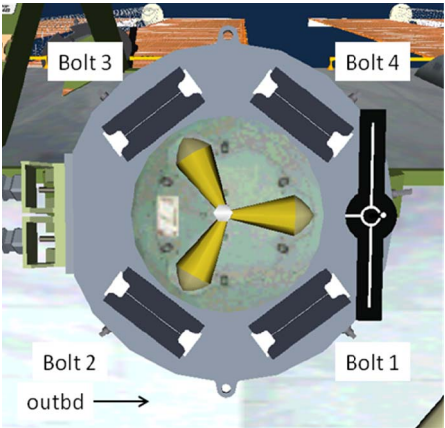
IV/SSRMS	EV2 (Spanky)	EV3 (Taz)						
<p>Planned PET 01:30</p> <ol style="list-style-type: none"> <li>Verify inhibits in place  <input checked="" type="checkbox"/> Port SARJ locked at 285°</li> </ol> <ol style="list-style-type: none"> <li>Record PUMAA bolt data:</li> </ol> <table border="1" data-bbox="107 833 615 898"> <thead> <tr> <th>Bolt</th> <th>Turns</th> <th>Torque (ft-lb)</th> </tr> </thead> <tbody> <tr> <td>PUMAA</td> <td>(10)</td> <td>(18.4)</td> </tr> </tbody> </table> 	Bolt	Turns	Torque (ft-lb)	PUMAA	(10)	(18.4)	<div style="border: 2px solid black; padding: 5px; text-align: center; margin-bottom: 10px;"> <p><b>WARNING</b></p> <p>Avoid touching curvic coupling due to potential sharp edges</p> </div> <div style="border: 1px solid black; padding: 5px; text-align: center; margin-bottom: 10px;"> <p><b>CAUTION</b></p> <p>Avoid touching grapple pin, target and underside of PDGF</p> </div> <p><u>P6 PDGF RETRIEVE (01:25)</u></p> <ol style="list-style-type: none"> <li>Translate to P3 Face 6, nadir route</li> <li>Attach <b>GREEN</b> hook to P3 HR 3861  <input type="checkbox"/> <input checked="" type="checkbox"/> Gate closed, hook locked, reels unlocked, release RET</li> <li>Translate to P6 PDGF  <input type="checkbox"/> EV3 leads, take same route</li> <li>Ingress APFR  <input type="checkbox"/> Only extend ingress aid if reqd</li> <li>Configure PGT:  <b>[B3 (18.4), CW2, 30.5]</b> 6-Ext 7/16</li> <li>←Install PUMAA onto PDGF between Bolts 1 and 2, expect 10 turns</li> <li>Configure PGT:  <b>[B7 (25.5), CCW2, 30.5]</b> 6-Ext 7/16</li> <li>Swap PGT and EVA camera with EV3</li> <li>After EV3, release EDF bolts (2), 5 turns  <input type="checkbox"/> Bolt 1  <input type="checkbox"/> Bolt 4</li> <li><input checked="" type="checkbox"/> All EDFs fully extended  Remove PDGF from mounting ring</li> <li>Push in all EDFs into PDGF; stow PDGF on BRT w/RET  <input type="checkbox"/> Stow with grapple shaft toward PLSS/fwd</li> </ol>	<p><u>P6 PDGF RETRIEVE (01:15)</u></p> <ol style="list-style-type: none"> <li>Translate to P3 Face 2, zenith route  <input type="checkbox"/> Go zenith after CETA Cart, fairlead ST</li> <li>Attach <b>GREEN</b> hook to P3 HR 3852  <input type="checkbox"/> <input checked="" type="checkbox"/> Gate closed, hook locked, reels unlocked, release RET</li> <li>Translate to P6 PDGF (Taz leads)  <input type="checkbox"/> Zenith corner of P4, fairlead after P4 radiator on trunnion pin  <input type="checkbox"/> Photo Ops  <input type="checkbox"/> Use gap spanner with no fairlead on P6</li> <li>Verify APFR config in P6 WIF 12 [3,OO,F,12]  <input type="checkbox"/> Rotate ingress aid</li> <li>Attach PUMAA RET to PDGF tether pt</li> <li><input checked="" type="checkbox"/> EV2 BRT RET attached to Rd Scoop or PUMAA</li> <li>Swap PGT and EVA camera with EV2</li> <li>Release EDF bolts (2), 5 turns  <input type="checkbox"/> Bolt 2  <input type="checkbox"/> Bolt 3</li> <li>Assist EV2 with release of PDGF and attach to EV2's BRT</li> </ol>
Bolt	Turns	Torque (ft-lb)						
PUMAA	(10)	(18.4)						

**P6 PDGF RETRIEVE (01:25) (Cont)**

IV/SSRMS	EV2 (Spanky)	EV3 (Taz)
	<p>12. Egress APFR</p> <p>13. Translate to P3 Face 6 (Spanky leads)  <input type="checkbox"/> Photo ops</p> <p>14. Retrieve <b>GREEN</b> hook from P3 HR 3861 (face 6)  <input type="checkbox"/> √Gate closed, hook locked, reels unlocked, release RET</p> <p>15. Glove Check</p> <p>(Translate to Face 2, Bay 03 – PDGF Handoff)</p>	<p>10. Rotate ingress aid against boot plate</p> <p>11. Retrieve APFR; stow on BRT w/RET</p> <p>12. Translate to P3 Face 2</p> <p>13. Retrieve <b>GREEN</b> hook from P3 HR 3852 (face 2)  <input type="checkbox"/> √Gate closed, hook locked, reels unlocked, release RET</p> <p><u>APFR RELOCATE</u> (00:10)</p> <p>14. Translate to port CETA cart</p> <p>15. Install APFR in WIF 4 (zenith/port) [12,DD]  <b>[12,OO,F,12]</b>  <input type="checkbox"/> √Locking collar black-on-black, pull/twist test</p> <p>16. Glove Check</p> <p>(Translate to Face 2, Bay 00 – APFR Ingress)</p>

**OBSS EFGF/PDGF SWAP (01:20/01:40)**

IV/SSRMS	EV2 (Spanky)	EV3 (Taz)	
<p>Planned PET 02:55</p> <p><b>SSRMS:</b> <i>In APFR Ingress Clearance posn</i></p> <p>1. Give <b>SSRMS GO</b> for mnvr to PDGF Handoff Clearance posn and mnvr to GF Swap posn</p> <p><b>SSRMS:</b> <i>Mnvr to PDGF Handoff Clearance posn and GF Swap posn</i></p>	<p><u>PDGF HANDOFF</u> (00:20)</p> <ol style="list-style-type: none"> <li>Translate to Face 2, Bay 3</li> <li>Open/prep OBSS ORU bag</li> <li>Assist EV3 as required</li> <li>Transfer PDGF to EV3, retrieve RET</li> <li>Retrieve EVA scissors from OBSS ORU bag</li> <li>Retrieve RET from HR 3458 for EFGF</li> </ol>	<p><u>APFR INGRESS</u> (00:20)</p> <ol style="list-style-type: none"> <li>Translate to Face 2, Bay 0</li> <li>GCA SSRMS as reqd for APFR Ingress</li> <li>Ingress APFR</li> <li>GCA SSRMS as reqd for PDGF Handoff</li> <li>RET, retrieve PDGF from EV2; stow on BRT w/RET</li> <li><b>Notify IV</b> ready for mnvr to PDGF Handoff Clearance posn and GF Swap posn</li> <li>GCA SSRMS as reqd for GF Swap</li> </ol>	
	<p><u>EFGF REMOVAL/PAA INSTALL</u> (00:25)</p>	<p><u>EFGF REMOVAL/PAA INSTALL</u> (00:25)</p>	
<table border="2"> <tr> <td> <p><b>WARNING</b></p> <p>Avoid touching underside of EFGF, mounting location on OBSS, or cut EFGF cable due to potential sharp edges</p> </td> </tr> </table>			<p><b>WARNING</b></p> <p>Avoid touching underside of EFGF, mounting location on OBSS, or cut EFGF cable due to potential sharp edges</p>
<p><b>WARNING</b></p> <p>Avoid touching underside of EFGF, mounting location on OBSS, or cut EFGF cable due to potential sharp edges</p>			
	<ol style="list-style-type: none"> <li>Attach RET to EFGF</li> <li>Transfer scissors to EV3</li> <li>Tilt EFGF inbd and stabilize</li> <li>Stow scissors and transfer EFGF near OBSS ORU bag</li> </ol>	<ol style="list-style-type: none"> <li>Configure PGT: <b>[B2 (16.0), CCW2, 30.5]</b> 6-Ext 7/16</li> <li>Release EFGF bolts (6) in any order, expect 8 turns <ul style="list-style-type: none"> <li><input type="checkbox"/> Bolt #1</li> <li><input type="checkbox"/> Bolt #2</li> <li><input type="checkbox"/> Bolt #3</li> <li><input type="checkbox"/> Bolt #4</li> <li><input type="checkbox"/> Bolt #5</li> <li><input type="checkbox"/> Bolt #6</li> </ul> </li> <li>Retrieve scissors from EV2</li> <li>Cut EFGF cable in blue area</li> <li>Transfer scissors to EV2</li> <li>Verify all (6) washers installed on OBSS mounting ring</li> </ol>	

**OBSS EFGF/PDGF SWAP (01:20/01:40) (Cont)**

IV/SSRMS	EV2 (Spanky)	EV3 (Taz)																					
<p>2. Record PAA Bolt data:</p> <table border="1" data-bbox="107 722 596 971"> <thead> <tr> <th>Bolt</th> <th>Turns</th> <th>Torque (ft-lb)</th> </tr> </thead> <tbody> <tr> <td>#1</td> <td>(5.5)</td> <td>(22.0)</td> </tr> <tr> <td>#4</td> <td></td> <td></td> </tr> <tr> <td>#2</td> <td></td> <td></td> </tr> <tr> <td>#5</td> <td></td> <td></td> </tr> <tr> <td>#3</td> <td></td> <td></td> </tr> <tr> <td>#6</td> <td></td> <td></td> </tr> </tbody> </table>	Bolt	Turns	Torque (ft-lb)	#1	(5.5)	(22.0)	#4			#2			#5			#3			#6			<p>11. Retrieve PDGF Adapter Assy (PAA) from OBSS ORU bag; transfer to EV3</p> <p>12. Take photos of PAA/PDGF as time allows</p> <p>13. Release RET from PAA; stow in OBSS ORU bag</p> <p>14. Stow EFGF in OBSS ORU bag</p>	<p>14. Retrieve PDGF Adapter Assy (PAA) from EV2</p> <p>15. Align PAA on OBSS (Bolt 1 at 1 o'clock, black T handle to black line)                      ✓No interference with cut cable                      ✓No interference with OBSS MLI</p> <p>16. Configure PGT:  <b>[A3 (4.8), CW2, 30.5]</b> 6-Ext 7/16</p> <p>17. Drive PAA bolts in star pattern for only 3 turns  <input type="checkbox"/> Bolt #1  <input type="checkbox"/> Bolt #4  <input type="checkbox"/> Bolt #2  <input type="checkbox"/> Bolt #5  <input type="checkbox"/> Bolt #3  <input type="checkbox"/> Bolt #6</p> <p>18. Configure PGT:  <b>[B5 (22.0), CW2, 30.5]</b> 6-Ext 7/16</p> <p>19. ←Drive PAA bolts in star pattern to torque, expect 5.5 turns, 8.5 turns total, ✓bolts fully seated  <input type="checkbox"/> Bolt #1  <input type="checkbox"/> Bolt #4  <input type="checkbox"/> Bolt #2  <input type="checkbox"/> Bolt #5  <input type="checkbox"/> Bolt #3  <input type="checkbox"/> Bolt #6</p> <p>20. Perform pull test on PAA</p>
Bolt	Turns	Torque (ft-lb)																					
#1	(5.5)	(22.0)																					
#4																							
#2																							
#5																							
#3																							
#6																							
<p><b>CAUTION</b>                      Avoid applying off-axis loads to EDFs when the EDF is not engaged</p>																							
	<p><u>PDGF INSTALL</u> (00:25)</p> <p>15. Assist EV3 with alignment and soft dock of PDGF</p> <p>16. Engage zenith EDFs (2), may need to rotate EDF to catch hex key                      ✓Lanyard washer is flush to retaining ring</p>	<p><u>PDGF INSTALL</u> (00:25)</p> <p>21. Extend all EDFs                      ✓Verify all EDF lanyards clear of interface</p> <p>22. Align and soft dock PDGF onto PAA (target aligns with arrow on PAA; EDFs at 12, 3, 6, 9 o'clock posns)</p> <p>23. Engage nadir EDFs (2), may need to rotate EDF to catch hex key                      ✓Lanyard washer is flush to retaining ring</p>																					



**OBSS EFGF/PDGF SWAP (01:20/01:40) (Cont)**

IV/SSRMS	EV2 (Spanky)	EV3 (Taz)																														
<p>3. Record Initial PDGF Bolt data:</p> <table border="1" data-bbox="142 272 592 446"> <thead> <tr> <th>Bolt</th> <th>Turns</th> <th>Torque (ft-lb)</th> </tr> </thead> <tbody> <tr> <td>3</td> <td>(5)</td> <td>(12.0)</td> </tr> <tr> <td>6</td> <td></td> <td></td> </tr> <tr> <td>9</td> <td></td> <td></td> </tr> <tr> <td>12</td> <td></td> <td></td> </tr> </tbody> </table> <p>4. Record Final PDGF Bolt data:</p> <table border="1" data-bbox="142 474 592 649"> <thead> <tr> <th>Bolt</th> <th>Turns</th> <th>Torque (ft-lb)</th> </tr> </thead> <tbody> <tr> <td>3</td> <td>(&lt; 1)</td> <td>(25.5)</td> </tr> <tr> <td>6</td> <td></td> <td></td> </tr> <tr> <td>9</td> <td></td> <td></td> </tr> <tr> <td>12</td> <td></td> <td></td> </tr> </tbody> </table>	Bolt	Turns	Torque (ft-lb)	3	(5)	(12.0)	6			9			12			Bolt	Turns	Torque (ft-lb)	3	(< 1)	(25.5)	6			9			12			<p><b>NOTE</b> EDFs must be driven in a cross pattern (order not critical). Maintain axial force on EDF bolt to ensure hex key remains engaged</p> <p>17. Assist EV3 as reqd</p> <p><b>NOTE</b> Tighten EDFs until repeatable torque reached and less than a 1/4 turn before reaching torque</p> <p>18. Assist EV3 as reqd</p> <p><u>CLEANUP (00:10)</u> 19. Stow EFGF and EVA scissors in OBSS ORU bag, if not completed 20. Stow OBSS ORU bag on BRT w/RET 21. Glove Check 22. Move nadir to clear EV3 tether</p> <p>(Translate to Node 2 – Stow EFGF in TSA)</p>	<p><b>NOTE</b> EDFs must be driven in a cross pattern (order not critical). Maintain axial force on EDF bolt to ensure hex key remains engaged</p> <p>24. Configure PGT: <b>[B1 (12.0), CW2, 30.5]</b> 6-Ext 7/16</p> <p>25. ←Drive EDF bolt to torque, expect 5 turns Continue drive bolt until less than 1/4 turn of motion</p> <ul style="list-style-type: none"> <li><input type="checkbox"/> Bolt at 3 o'clock</li> <li><input type="checkbox"/> Bolt at 6 o'clock</li> <li><input type="checkbox"/> Bolt at 9 o'clock</li> <li><input type="checkbox"/> Bolt at 12 o'clock</li> </ul> <p><b>NOTE</b> Tighten EDFs until repeatable torque reached and less than a 1/4 turn before reaching torque</p> <p>26. Configure PGT: <b>[B7 (25.5), CW2, 30.5]</b> 6-Ext 7/16</p> <p>27. ←Drive EDF bolt to torque, expect no more than 1 turn Continue drive bolt until less than 1/4 turn of motion</p> <ul style="list-style-type: none"> <li><input type="checkbox"/> Bolt at 3 o'clock</li> <li><input type="checkbox"/> Bolt at 6 o'clock</li> <li><input type="checkbox"/> Bolt at 9 o'clock</li> <li><input type="checkbox"/> Bolt at 12 o'clock</li> </ul> <p>28. Perform pull test on all EDFs 29. Retrieve RET from PDGF, stow on PUMAA 30. Configure PGT: <b>[B7 (25.5), CCW2, 30.5]</b> 6-Ext 7/16 31. Release PUMAA bolt, expect 11 turns 32. Stow PUMAA/rd scoop on BRT w/RET</p> <p><u>SSRMS CLEANUP (00:30)</u> 33. <b>Notify IV</b> ready for SSRMS mnvr to APFR Egress posn, GCA as reqd 34. Egress APFR 35. <b>Notify IV</b> ready for SSRMS mnvr to APFR Removal Setup posn 36. Ride/GCA SSRMS to stbd CETA Cart for APFR Removal 37. RET, release APFR from SSRMS</p>
Bolt	Turns	Torque (ft-lb)																														
3	(5)	(12.0)																														
6																																
9																																
12																																
Bolt	Turns	Torque (ft-lb)																														
3	(< 1)	(25.5)																														
6																																
9																																
12																																
 <p>5. Give <b>SSRMS GO</b> to mnvr to APFR Egress posn <b>SSRMS:</b> Mnvr to APFR Egress posn</p> <p>6. Give <b>SSRMS GO</b> to mnvr to APFR Removal Setup posn <b>SSRMS:</b> Mnvr to APFR Removal Setup posn</p>																																

**OBSS EFGF/PDGF SWAP (01:20/01:40) (Cont)**

IV/SSRMS	EV2 (Spanky)	EV3 (Taz)
<p>7. Give <b>SSRMS GO</b> for mnvr to Stage Park posn  <b>SSRMS: Mnvr to Stage Park posn</b></p> <p>8. Perform C/L bag Inventory:  OBSS Crewlock Bag:  <input type="checkbox"/> Adj Equip Tether (ext)  <input type="checkbox"/> Wire tie caddy (int RET)  <input type="checkbox"/> Hubble Connector Tool (90 deg) (int RET)  <input type="checkbox"/> Round Scoop (int RET)  <input type="checkbox"/> PUMAA  <input type="checkbox"/> RET (sm-sm)  <input type="checkbox"/> Adj Equip Tether  <input type="checkbox"/> WIF Adapter (int RET)</p> <p>9. Consumables tag up with <b>MCC-H</b></p>		<p>38. Stow APFR in stbd CETA cart WIF 4 (zenith/port) [12,GG] [9,PP,F,6]  <input type="checkbox"/> √Locking collar black-on-black, pull/twist test</p> <p>39. Retrieve WIF adapter</p> <p>40. <b>Notify IV</b> ready for mnvr to Stage Park posn</p> <p>41. Stow PUMAA/rd scoop/RET and WIF adapter in OBSS C/L bag</p> <p>42. Perform OBSS C/L bag Inventory</p> <p>43. Glove Check</p> <p>(Translate Zenith to OTP – OTP Inspection)</p>

## EFGF STOWAGE IN TSA (00:35)

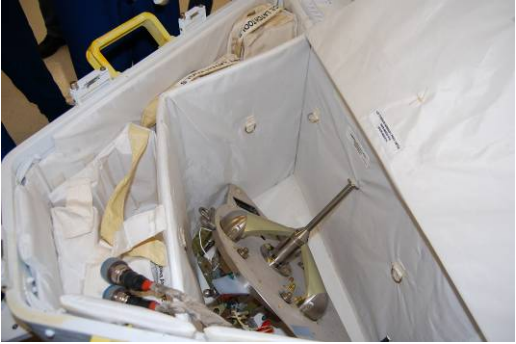
IV/SSRMS	EV2 (Spanky)
<p>Planned PET 04:15</p> <p>1. Verify inhibits in place √SSPTS inhibited</p>  <p>2. Perform bag Inventory: OBSS Med ORU Bag:</p> <p>External:</p> <ul style="list-style-type: none"> <li><input type="checkbox"/> Adj Equip Tethers (2) (soft tether loops)</li> <li><input type="checkbox"/> Torque Wrench Bag <ul style="list-style-type: none"> <li><input type="checkbox"/> Long Wire Tie</li> <li><input type="checkbox"/> Short Wire Tie</li> </ul> </li> <li><input type="checkbox"/> Adj Equip Tether (between Pry Rod and HR) <ul style="list-style-type: none"> <li><input type="checkbox"/> Pry Rod</li> </ul> </li> </ul> <p>Internal:</p> <ul style="list-style-type: none"> <li><input type="checkbox"/> RET (sm-sm) (RF)</li> <li><input type="checkbox"/> RET (sm-sm) (LB) <ul style="list-style-type: none"> <li><input type="checkbox"/> Scissors</li> </ul> </li> <li><input type="checkbox"/> RET (sm-sm) (RB)</li> </ul> <p>3. When EV2 is clear of PMA2 and Lab fwd, give <b>MCC-H GO</b> to release SSPTS Inhibits</p>	<div style="border: 1px solid black; padding: 5px; margin-bottom: 10px;"> <p style="text-align: center;"><b>CAUTION</b></p> <p style="text-align: center;">When translating around fwd edge of Node 2 and PMA2, avoid contact with Shuttle</p> </div> <p><u>EFGF STOWAGE IN TSA (00:35)</u></p> <ol style="list-style-type: none"> <li>1. Translate to Node 2, zenith/port route</li> <li>2. Attach <b>GREEN</b> hook to Node 2 HR 0344 <ul style="list-style-type: none"> <li><input type="checkbox"/> √Gate closed, hook locked, reels unlocked, release RET</li> </ul> </li> <li>3. Translate to Orbiter, port TSA</li> <li>4. Open port TSA <ul style="list-style-type: none"> <li><input type="checkbox"/> √Adj equip tether config – pull out of pocket</li> </ul> </li> <li>5. Open flight specific compartment</li> <li>6. Remove cushion</li> <li>7. Open OBSS ORU bag</li> <li>8. Retrieve EFGF from ORU bag</li> <li>9. Remove adj equip tether hook from D-ring, attach to EFGF <ul style="list-style-type: none"> <li><input type="checkbox"/> Release RET</li> </ul> </li> <li>10. Remove Tee Pull from EFGF</li> <li>11. Stow EFGF in TSA; grapple shaft toward ODS, Tee bolt out</li> <li>12. Install cushion and close flight specific compartment √Velcro strap closed</li> <li>13. Close port TSA <ul style="list-style-type: none"> <li><input type="checkbox"/> <input type="checkbox"/> <input type="checkbox"/> <input type="checkbox"/> √Latches closed</li> </ul> </li> <li>14. Perform OBSS ORU bag Inventory</li> <li>15. Close OBSS ORU bag; stow on BRT w/RET</li> <li>16. Translate to Node 2</li> <li>17. Retrieve <b>GREEN</b> hook from Node 2 HR 0344 <ul style="list-style-type: none"> <li><input type="checkbox"/> √Gate closed, hook locked, reels unlocked, release RET</li> </ul> </li> </ol> <p style="text-align: right;">(Translate to P3 (ELC3), zenith route – SPDM EDF Release)</p>

## OTP LDTD TETHER CINCH (00:15)

IV/SSRMS	EV3 (Taz)
<p>Planned PET 04:35</p> 	<div data-bbox="701 266 1614 331" style="border: 1px solid black; padding: 5px; text-align: center;"><p><u>CAUTION</u> Avoid inadvertent contact with the OTP and RPCM radiator panel on Face 3</p></div> <p><u>OTP LDTD TETHER CINCH (00:15)</u></p> <ol style="list-style-type: none"><li>1. Translate zenith to OTP<ul style="list-style-type: none"><li><input type="checkbox"/> Use HR stanchion for local tether</li></ul></li><li>2. Route wire tie under buckle</li><li>3. Cinch down LDTD Tether</li><li>4. Close MLI over buckle<ul style="list-style-type: none"><li>√No metal is showing</li></ul></li><li>5. Install wire tie around MLI, closer to buckle end<ul style="list-style-type: none"><li><input type="checkbox"/> 3 twists</li></ul></li><li>6. If possible, wrap wire tie under and around MLI a 2nd time<ul style="list-style-type: none"><li><input type="checkbox"/> 3 twists</li></ul></li><li>7. Gather excess tether on top of MLI<ul style="list-style-type: none"><li><input type="checkbox"/> Close tabs</li></ul></li></ol> <p style="text-align: right;">(Translate to P3 (ELC3), nadir route – SPDM EDF Release)</p>

# SPDM EDF RELEASE (01:10)

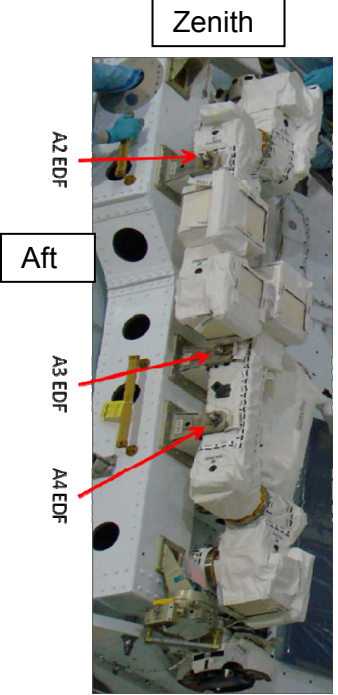
IV/SSRMS	EV2 (Spanky)	EV3 (Taz)									
<p>Planned PET 04:50</p> <div style="text-align: center;"> <div style="border: 1px solid black; padding: 2px; display: inline-block;">Zenith</div>   </div> <p>1. Record EDF Bolt data:</p> <table border="1" data-bbox="142 1128 592 1234"> <thead> <tr> <th>EDF</th> <th>Turns</th> <th>Torque (ft-lb)</th> </tr> </thead> <tbody> <tr> <td>A3</td> <td>(5)</td> <td>(12.0)</td> </tr> <tr> <td>A2</td> <td></td> <td></td> </tr> </tbody> </table>	EDF	Turns	Torque (ft-lb)	A3	(5)	(12.0)	A2			<div style="border: 1px solid black; padding: 5px; text-align: center;"> <p><u>CAUTION</u>                      Avoid inadvertent contact with ELC3 PVGF, SASA Antennas and SPDM Radiators</p> <p>Limit pry rod impulses to 5, then wait 60 sec to let load dissipate</p> </div> <p><u>SPDM EDFS RELEASE (01:10)</u></p> <ol style="list-style-type: none"> <li>Translate to P1 Face 2, zenith route</li> <li>Attach <b>GREEN</b> hook to P1 HR 3681 (bay 18)                             <ul style="list-style-type: none"> <li><input type="checkbox"/> √Gate closed, hook locked, reels unlocked, release RET</li> </ul> </li> <li>Translate to ELC3; cross at trunnion</li> <li>Stow OBSS ORU bag on ELC3 HR 8704; retrieve pry rod</li> <li>Translate to SPDM SAPH middle EDF (A3)</li> <li>Retrieve PGT from EV3</li> <li>Configure PGT:  <b>[B5 (22.0), CCW2, 30.5]</b> 6-Ext 7/16</li> <li>Release middle EDF bolt (A3), 5 turns</li> <li>Remove EDF using lanyard; place in stowage location</li> <li>Configure PGT:  <b>[B1 (12.0), CW2, 30.5]</b> 6-Ext 7/16</li> <li>←Drive middle EDF bolt (A3), 5 turns</li> <li>Transfer PGT to EV3</li> <li>Place pry rod in EDF A3 bolt location up to black line</li> <li>If A2 EDF does not release nominally, apply force on pry rod and give <b>EV3 GO</b> to release EDF</li> <li>Swap PGT and EVA Camera with EV3</li> </ol>	<div style="border: 1px solid black; padding: 5px; text-align: center;"> <p><u>CAUTION</u>                      Avoid inadvertent contact with STP-H3 top experiments, STP-H3 Radiator, and SPDM Radiators</p> <p>Limit pry rod impulses to 5, then wait 60 sec to let load dissipate</p> </div> <p><u>SPDM EDFS RELEASE (01:10)</u></p> <ol style="list-style-type: none"> <li>Translate to P3 Face 1, nadir route</li> <li>Attach <b>GREEN</b> hook to P3 CETA rail at Xo 10230                             <ul style="list-style-type: none"> <li><input type="checkbox"/> √Gate closed, hook locked, reels unlocked, release RET</li> </ul> </li> <li>Translate zenith ELC3</li> <li>Translate around edge of ELC3 to SPDM SAPH shoulder EDF (A2)</li> <li>Transfer PGT to EV2</li> <li>Retrieve PGT from EV2</li> <li>Configure PGT:  <b>[B5 (22.0), CCW2, 30.5]</b> 6-Ext 7/16</li> <li>Release shoulder EDF bolt (A2), 5 turns</li> <li>Remove EDF using lanyard. Do not continue if observe resistance</li> <li>On <b>EV2 GO</b>, remove EDF using lanyard</li> <li>Place EDF in stowage location</li> <li>Configure PGT:  <b>[B1 (12.0), CW2, 30.5]</b> 6-Ext 7/16</li> <li>←Drive shoulder EDF bolt (A2), 5 turns</li> <li>Swap PGT and EVA Camera with EV2</li> </ol>
EDF	Turns	Torque (ft-lb)									
A3	(5)	(12.0)									
A2											

**SPDM EDF RELEASE (01:10) (Cont)**

IV/SSRMS	EV2 (Spanky)	EV3 (Taz)						
<p>2. Record EDF Bolt data:</p> <table border="1" data-bbox="138 508 592 578"> <thead> <tr> <th>EDF</th> <th>Turns</th> <th>Torque (ft-lb)</th> </tr> </thead> <tbody> <tr> <td>A4</td> <td>(5)</td> <td>(12.0)</td> </tr> </tbody> </table> <p>3. Perform EV Final Tool Inventory (Refer to Tool Config FS 7-__)</p>	EDF	Turns	Torque (ft-lb)	A4	(5)	(12.0)	<p>16. Transfer pry rod to EV3            17. Configure PGT:  <b>[B5 (22.0), CCW2, 30.5]</b> 6-Ext 7/16            18. Release wrist EDF bolt (A4), 5 turns            19. Remove EDF using lanyard. Do not continue if observe resistance            20. On <b>EV3 GO</b>, remove EDF using lanyard            21. Place EDF in stowage location            22. Configure PGT:  <b>[B1 (12.0), CW2, 30.5]</b> 6-Ext 7/16            23. ←Drive wrist EDF bolt (A4), 5 turns            24. Retrieve pry rod from EV3            25. Stow pry rod on OBSS ORU bag</p> <p>26. Perform MWS Tool Inventory            27. Stow OBSS ORU bag on BRT w/RET            28. Glove Check</p> <p>29. Retrieve <b>GREEN</b> hook from P1 HR 3681  <input type="checkbox"/> √Gate closed, hook locked, reels unlocked, release RET</p> <p style="text-align: center;">(Translate to A/L)</p>	<p>15. Retrieve pry rod from EV2</p> <p>16. Place pry rod in EDF A3 bolt position up to black line            17. If EDF does not release nominally, apply force on pry rod and give <b>EV2 GO</b> to release EDF</p> <p>18. Transfer pry rod to EV2            19. Perform MWS Tool Inventory            20. Glove Check            21. Retrieve <b>GREEN</b> hook from P3 CETA rail at Xo 10230  <input type="checkbox"/> √Gate closed, hook locked, reels unlocked, release RET            22. Translate to stbd CETA Cart            23. Retrieve C/L bag, stow on BRT w/RET</p> <p style="text-align: center;">(Translate to S0 Port Struts)</p>
EDF	Turns	Torque (ft-lb)						
A4	(5)	(12.0)						

## CLEANUP/INGRESS (00:30)

IV/SSRMS	EV2 (Spanky)	EV3 (Taz)
<p>Planned PET 06:00</p> <ol style="list-style-type: none"> <li>1. Start Hatch Thermal Cover clock PET (30 min) __ : __</li> <li>2. Prior to hatch closure, perform WVS PWRDN (PHOTO/TV, <u>WVS</u> Cue Card)</li> <li>3. Stop Hatch Thermal Cover clock PET (30 min) __ : __</li> </ol>	<p><u>CLEANUP</u> (00:15)</p> <ol style="list-style-type: none"> <li>1. Translate to A/L</li> </ol> <p><u>INGRESS</u> (00:15)</p> <ol style="list-style-type: none"> <li>2. Open hatch thermal cover</li> <li>3. Attach R Waist Tether to A/L int D-ring ext <input type="checkbox"/> √Gate closed, hook locked</li> <li>4. Give <b>EV3 GO</b> to attach R WT and release EV2 <b>BLANK</b> hook</li> <li>5. Stow OBSS ORU bag in A/L</li> <li>6. Retrieve OBSS C/L bag from EV3; stow in A/L</li> <li>7. Ingress A/L</li> <li>8. Remove SCU from stowage pouch</li> <li>9. Remove DCM cover; Velcro to DCM</li> <li>10. Connect SCU to DCM √SCU locked</li> </ol> <p style="text-align: center;"><u>NOTE</u> A TCV setting 8 – Max C minimizes time for SCU cooling</p> <ol style="list-style-type: none"> <li>11. WATER – OFF (fwd), expect <span style="border: 1px solid black; padding: 2px;">H2O IS OFF</span> msg</li> </ol>	<p><u>CLEANUP</u> (00:15)</p> <ol style="list-style-type: none"> <li>1. Translate to S0 Port Struts</li> </ol> <p><u>INGRESS</u> (00:15)</p> <ol style="list-style-type: none"> <li>2. On <b>EV2 GO</b>, attach L Waist Tether to EV2 <b>BLANK</b> hook (inbd strut) <input type="checkbox"/> √Gate closed, hook locked</li> <li>3. Release EV2 <b>BLANK</b> hook from inbd strut <input type="checkbox"/> √Gate closed, hook locked</li> <li>4. Retrieve EV3 <b>BLANK</b> hook from outbd strut; attach to MWS</li> <li>5. Translate to A/L</li> <li>6. Transfer OBSS C/L bag to EV2</li> <li>7. Ingress A/L</li> <li>8. Close hatch thermal cover; attach Velcro strap</li> <li>9. Remove SCU from stowage pouch</li> <li>10. Remove DCM cover; Velcro to DCM</li> <li>11. Connect SCU to DCM √SCU locked</li> </ol> <p style="text-align: center;"><u>NOTE</u> A TCV setting 8 – Max C minimizes time for SCU cooling</p> <ol style="list-style-type: none"> <li>12. WATER – OFF (fwd), expect <span style="border: 1px solid black; padding: 2px;">H2O IS OFF</span> msg</li> </ol> <div style="border: 1px solid black; padding: 5px; text-align: center; margin: 10px 0;"> <p><b>CAUTION</b> Do not close hatch until EMU Water OFF for 2 min. Verify outer hatch clear of hardware</p> </div> <ol style="list-style-type: none"> <li>13. Verify outer hatch clear of hardware</li> </ol>



**CLEANUP/INGRESS (00:30) (Cont)**

<b>IV/SSRMS</b>	<b>EV2 (Spanky)</b>	<b>EV3 (Taz)</b>
	Go to PRE-REPRESS ( <u>DEPRESS/REPRESS</u> Cue Card)	14. Verify handle position per hatch decal 15. Close and lock hatch Go to PRE-REPRESS ( <u>DEPRESS/REPRESS</u> Cue Card)

## OBSS STOW – TASK DATA

### Estimated Task Duration:

	With RMS	Without RMS
One EV Crew	N/A	N/A
Two EV Crew	00:55	N/A

### Tools:

EV2	EV3
J601/J602 Grounding Connectors	APFR
90 deg Connector Tool (Contingency)	SSBAD/OSE
SSBAD/OSE	

### EVA Fasteners (Contingency):

Fastener Name	Head Size	Qty	Install Torque (ft-lb)	Release Torque (ft-lb)	Failure Torque (ft-lb)	Turns
SSBAD Knob	7/16	1	3.8	12.0	12.3 <sup>1</sup>	SD-CL 3.5-7.5 OP-CL 10.5-11.0
SSBAD Release Bolts	7/16	2	2.5	12.0	17.4	4-6
OSE Bolt 1	7/16	1	18.4	25.5	82.6	11.5-13

<sup>1</sup>Do not drive the SSBAD Knob bolt past the 'OP' indicator and to hard stop.  
Failure torque is 7.3 ft-lb if hard stop reached

### EVA Connectors:

Harness	From	To	Clamps (#)	Conn Size	Function
ISA1	P601	OSE HR (PIP pins)			Ground
ISA2	P602	OSE HR (PIP pins)			Ground
W1-3					

### Foot Restraints:

Task	WIF	APFR Setting
OBSS Stow at Inbd OSE	S1 WIF 5	[10,TT,J,1]

### ORU Details:

ORU	Part Number	Mass
IBA	Serial # 202	547.36 lb (IBA)
J601/J602 Connectors	260213-206938-553	1.72 lb

### Notes:

1. If outbd striker bar lines up with outbd OSE, EV2 can soft dock simultaneously with EV3 (inbd OSE capture)
2. To disconnect P601/P602 connector, rotate wing-tabbed connector 1/4 turn ccw, then lift straight up
3. To install J601/J602 grounding connectors, align red stripped backshell wing with arrow on ISA plate, mate connector and rotate 1/4 turn cw
4. After grounding connectors are installed, verify red band on connector not visible
5. J601/J602 Grounding connectors are tied together to form one cable assembly. Connector end of cable has ~28 inches free and PIP pin end has ~35 inches free
6. Inbd OSE does not have 3rd joint release. Positions 3 and 4 are same
7. Once OBSS is fully secured to both OSEs, handrails on OBSS can be used for translation and BRT
8. OBSS is 597 inches long

### Caution:

1. Must be cautious when moving SSRMS to clear FRGF grapple shaft of OBSS. Inadvertent oscillations can cause damage to LEE on SSRMS. If oscillations do occur, plan is to continue to move LEE away from OBSS at a constant rate while EV crewmembers try to maintain current positions. If significant oscillation occurs, SSMRS will stop motion and wait for oscillations to dampen before resuming motion

### Timeline Considerations:

1. Sensors have a thermal clock of 90 min starting at SRMS/SSRMS handoff. Not applicable during OBSS stow since plan is to let sensors decay

# OBSS STOW – TASK DATA (Cont)

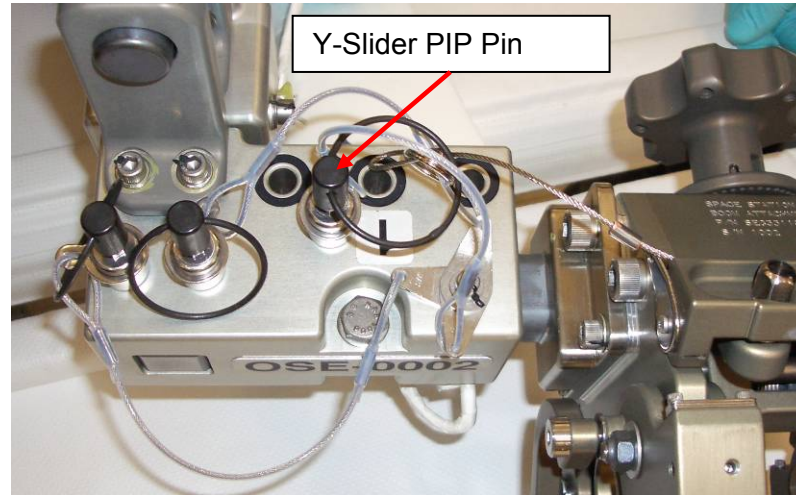
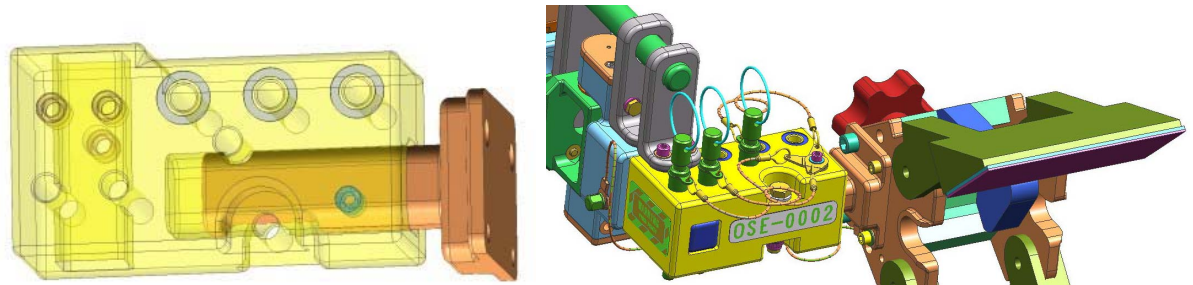
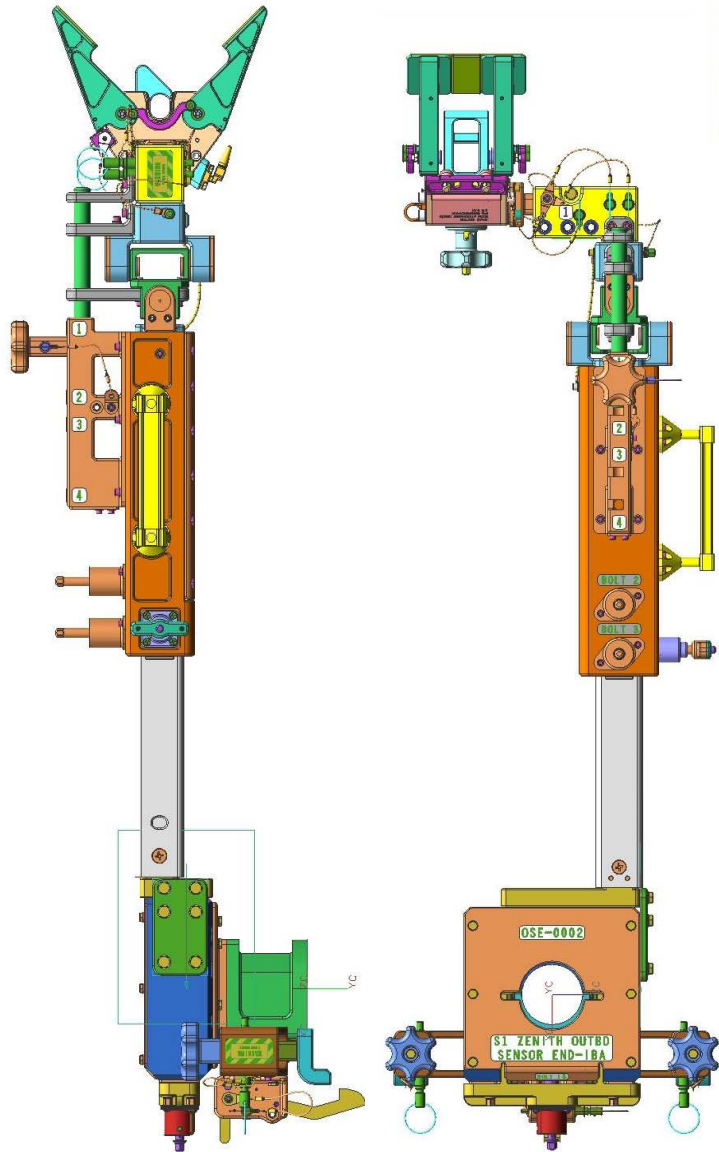

# OBSS STOW – TASK DATA (Cont)

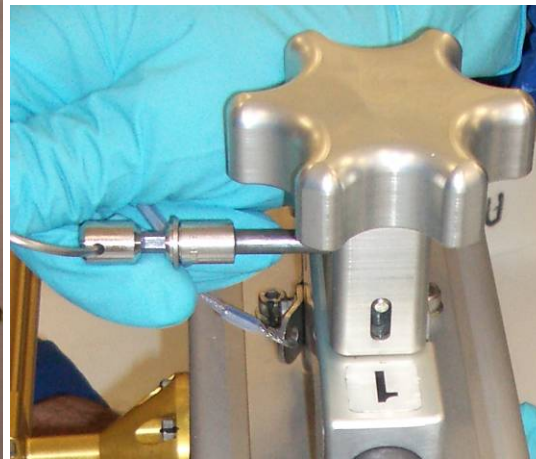
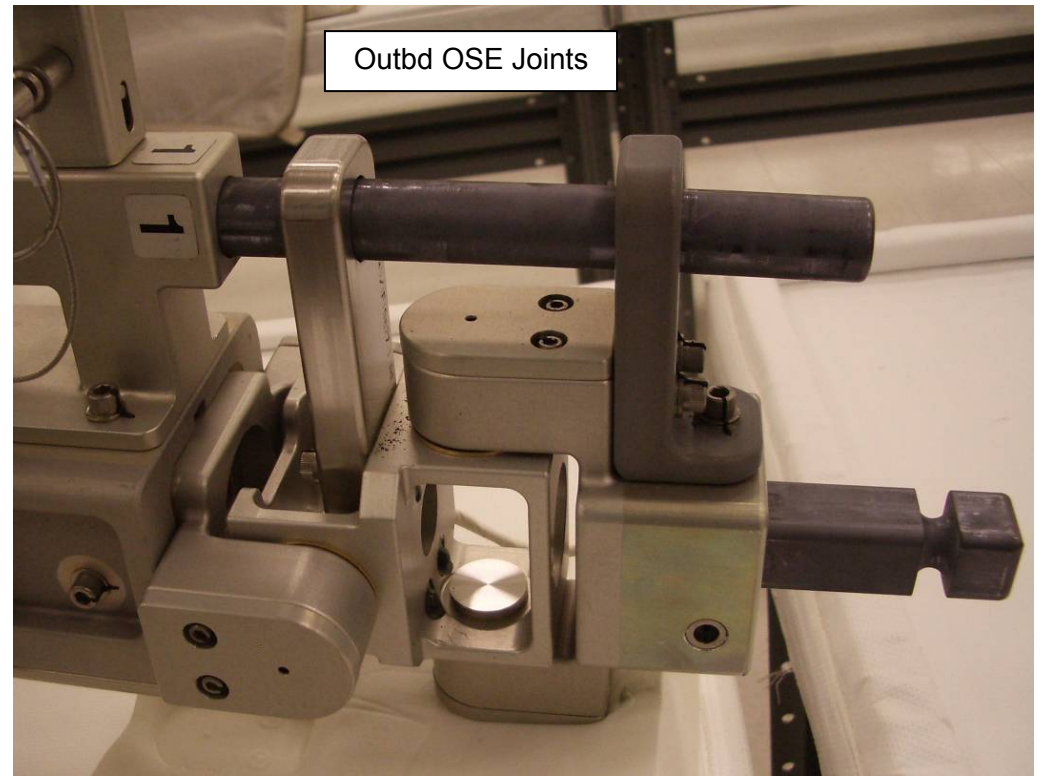
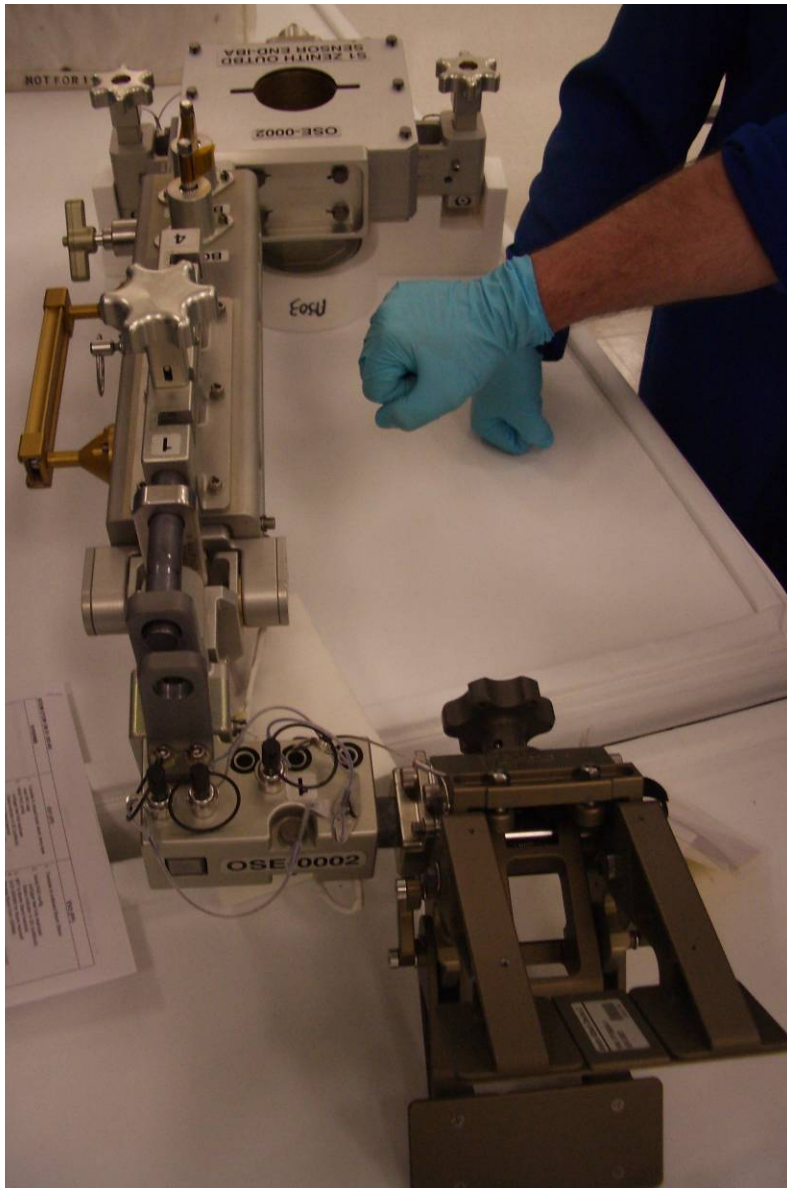



## OBSS STOW – TASK DATA (Cont)

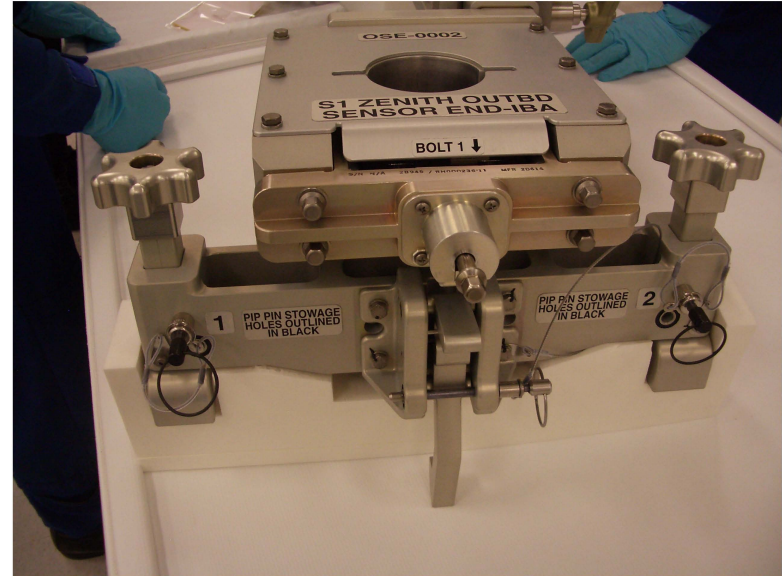

# OBSS STOW – TASK DATA (Cont)

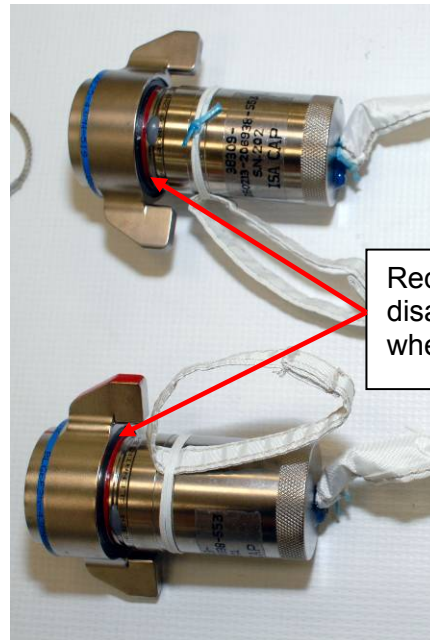
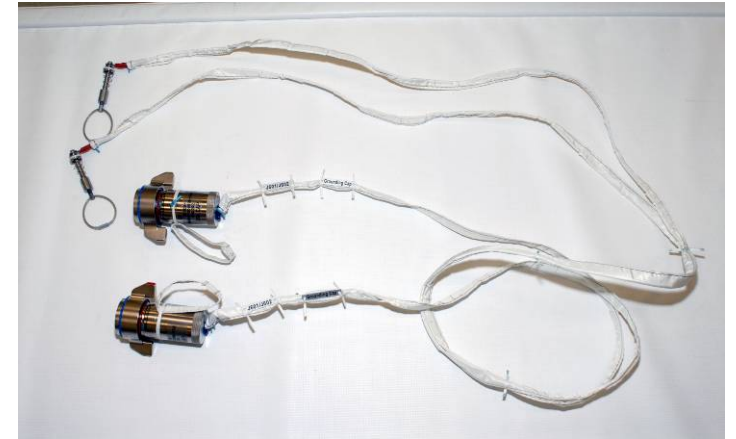
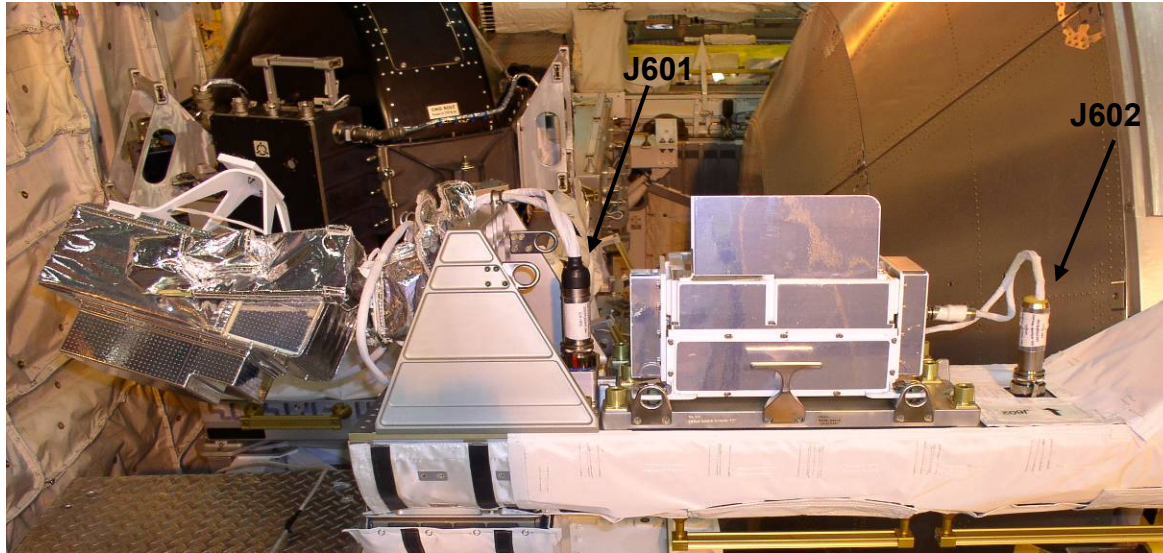

Red line disappears when mated

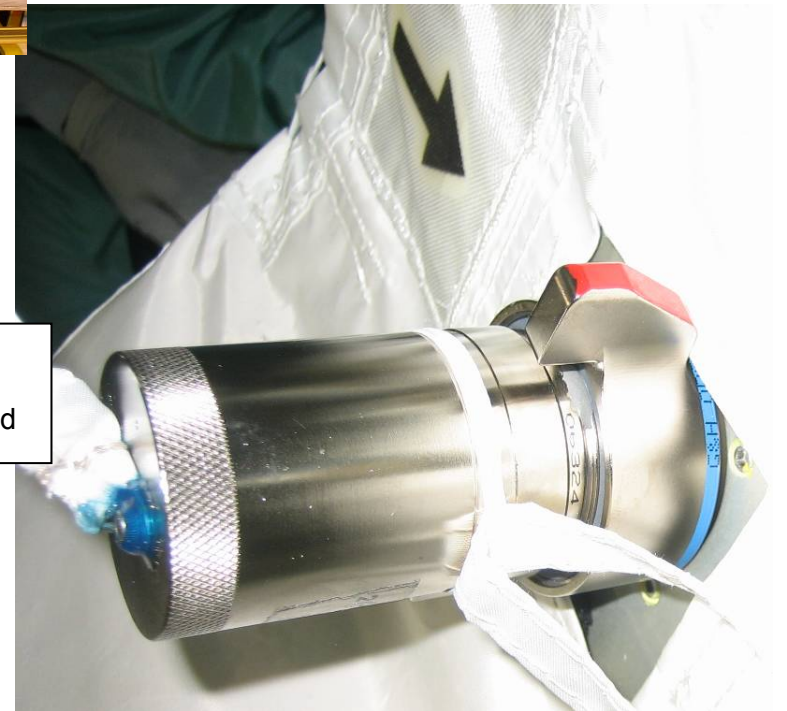



## P6 PDGF RETRIEVE – TASK DATA

### Estimated Task Duration:

	With RMS	Without RMS
One EV Crew	N/A	N/A
Two EV Crew	N/A	01:25

### Tools:

EV2	EV3
PUMAA	PGT w/7/16 Socket – 6 ext
Round Scoop	

### EVA Fasteners:

Fastener Name	Head Size	Qty	Install Torque (ft-lb)	Release Torque (ft-lb)	Failure Torque (ft-lb)	Turns
PDGF EDFs	7/16	4	25.8	25.8	33.0	4-6
PUMAA Bolt	7/16	1	18.4	25.5 <sup>1</sup> for 2 turns, 9.2 for 8 turns	27.3	10

<sup>1</sup>Per MDA coordination, PUMAA bolt can be released at B7 for all turns

### Foot Restraints:

Task	WIF	APFR Setting
PDGF Retrieve	P6 WIF 12	[3,00,F,12]

### Notes:

1. PUMAA could exceed touch temperatures in 4.5 min
2. RET must be directly applied to both PDGF and PUMAA (or round scoop if attached to PUMAA)
3. The number of cycles on PUMAA bolt needs to be tracked

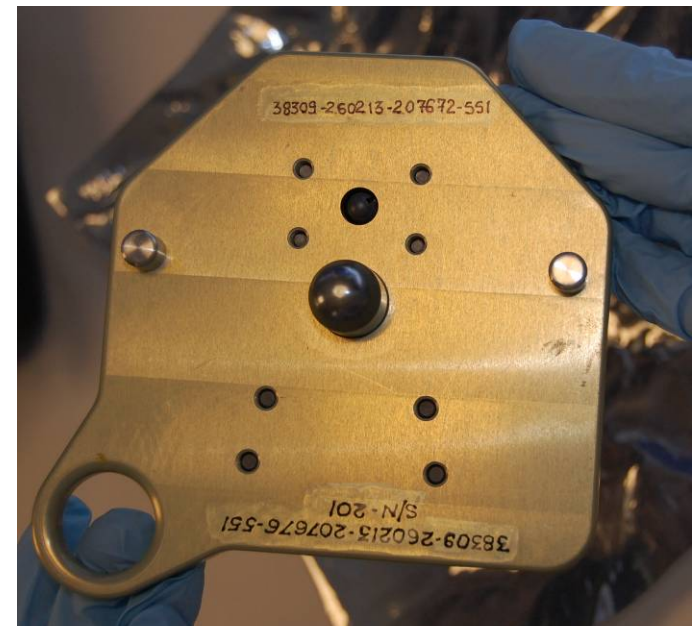



## P6 PDGF RETRIEVE – TASK DATA (Cont)

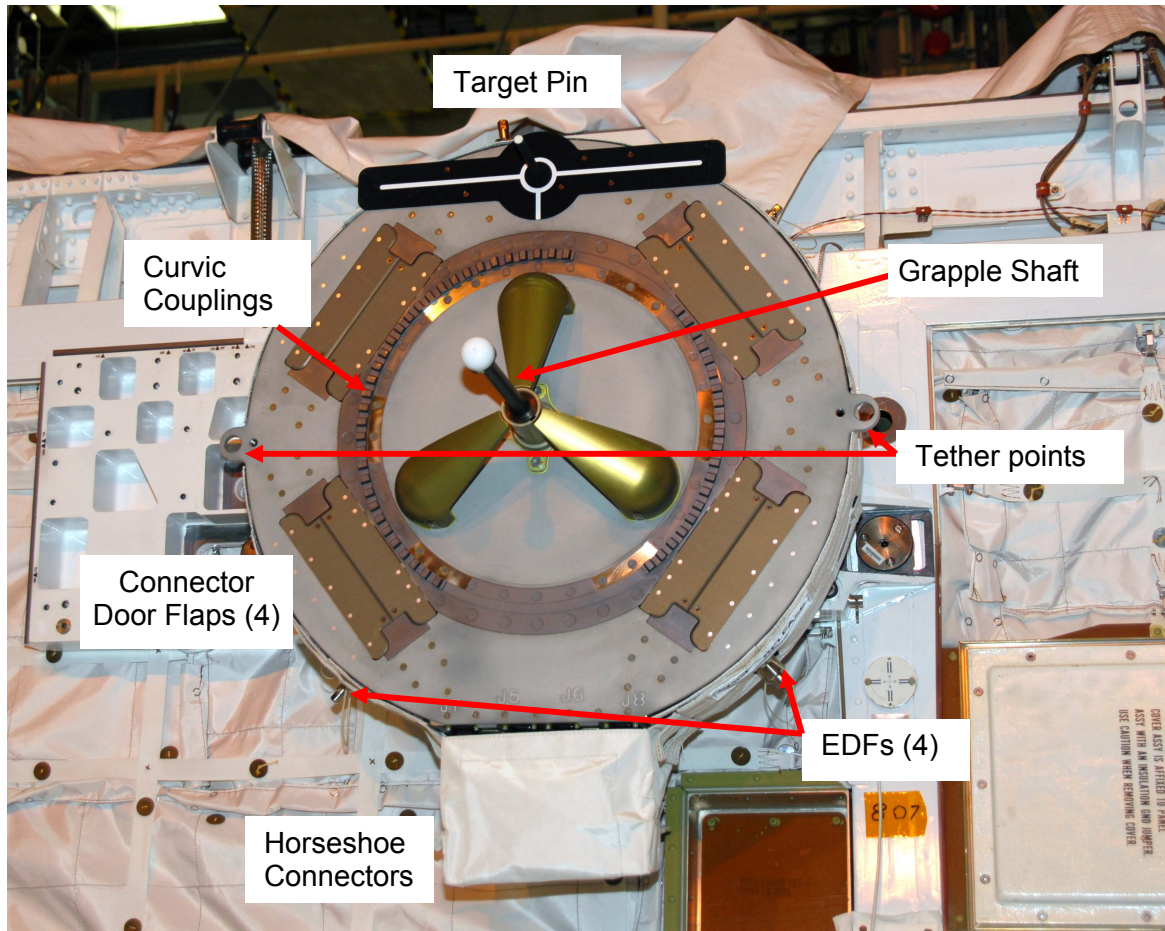

P6 PDGF RETRIEVE – TASK DATA (Cont)

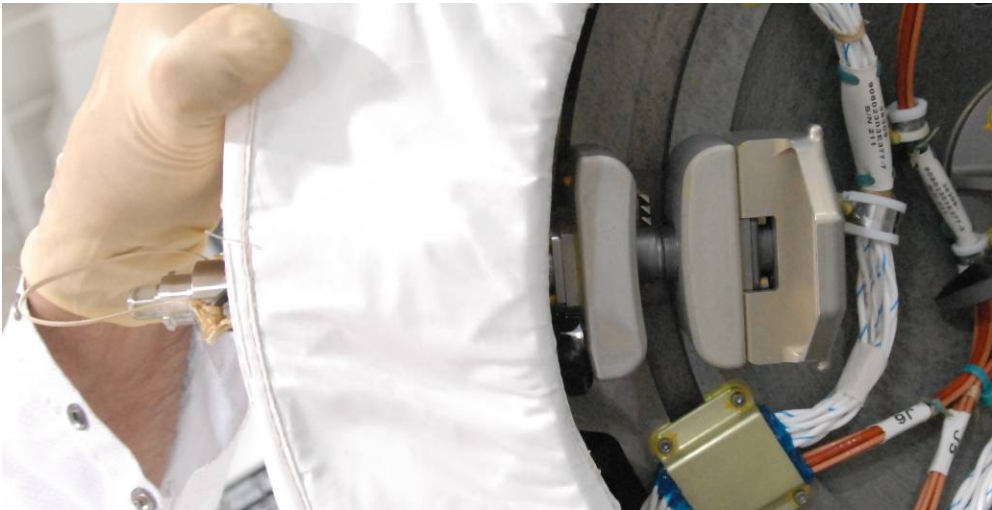

## OBSS EFGF/PDGF SWAP – TASK DATA

### Estimated Task Duration:

	With RMS	Without RMS
One EV Crew	N/A	N/A
Two EV Crew	01:30	N/A

### Tools:

EV2	EV3
EVA Scissors	PGT w/7/16 Socket – 6 ext
	WIF Adapter
	APFR

### EVA Fasteners:

Fastener Name	Head Size	Qty	Install Torque (ft-lb)	Release Torque (ft-lb)	Failure Torque (ft-lb)	Turns
EFGF Bolts	7/16	6	16.0	25.5 2 turns, 9.2 remaining <sup>1</sup>	40.4	8
PAA Bolts	7/16	6	4.8 (3 turns), 22.0 (5.5 turns)	25.5 2 turns, 9.2 remaining	40.4	8.5
PDGF EDFs	7/16	4	12.0, then 25.5	25.5	33	4-6
PUMAA Bolt	7/16	1	18.4	25.5 2 turns, 9.2 remaining <sup>2</sup>	27.3	10

<sup>1</sup>Per MDA coordination, EFGF bolts can be released at B2 for all turns

<sup>2</sup>Per MDA coordination, PUMAA bolt can be released at B7 for all turns

### ORU Details:

ORU	Part Number	Mass (lb)
EFGF	260213-204662-557	33.3
PAA	260213-207629-551	29.1
PDGF	51618-0002-1	70.7
PUMAA	260213-207676-551	1.7
EIBA	Serial # 202	621.32

### Foot Restraints:

Task	WIF	APFR Setting
EFGF/PDGF Swap	SSRMS	[12,PP,F,6]

### Notes:

#### EFGF

1. Bolts will disengage prior to visible white line
2. As the 6th EFGF bolt removed, EFGF can float concealing the white lines

#### PAA

3. 6 bolts on PAA and IBA standoff are numbered for alignment
4. No soft dock on PAA; must be held in place until at least 1 bolt
5. There are 4 T-handles, 1 black for alignment with IBA. Matches black line on IBA
6. Washers on IBA may become dislodged if struck. Refer to contingency procedures if this occurs

#### PDGF

7. 1 o'clock orientation is only physically possible orientation for PDGF install on PAA
8. Target rod on PDGF will align with arrow on PAA
9. PDGF has soft dock
10. Crew should avoid off-axis loads on EDFs

### Warnings:

#### EFGF

1. Six captive EVA 7/16" bolts, non-spring retracted resulting in exposed threads (sharp edge concerns)
2. Bottom of 6 standoff blocks no-touch due to surface material (dry lube: Tungsten Disulphide)
3. Grapple shaft no-touch due to surface material (dry lube: Tungsten Disulphide)
4. Potential sharp edges after cutting EFGF harness cable



OBSS EFGF/PDGF SWAP – TASK DATA (Cont)

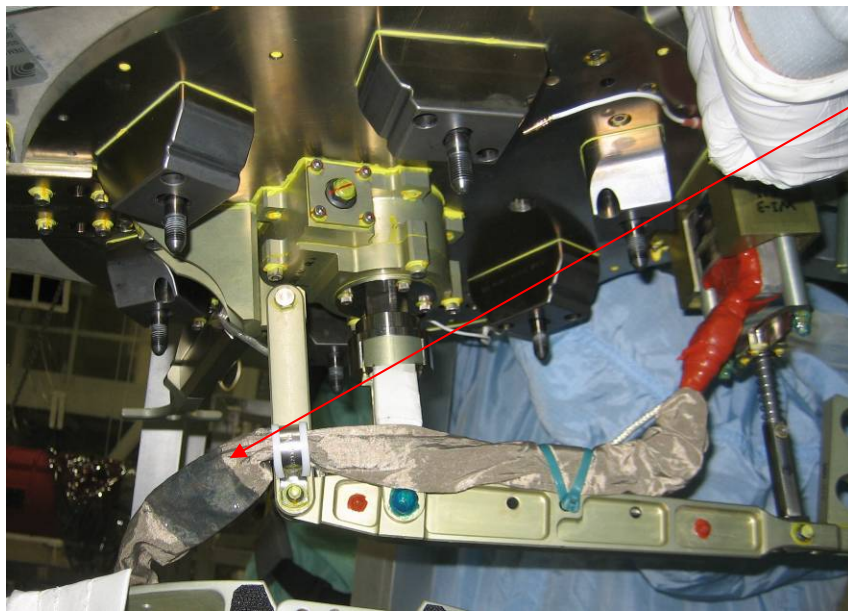
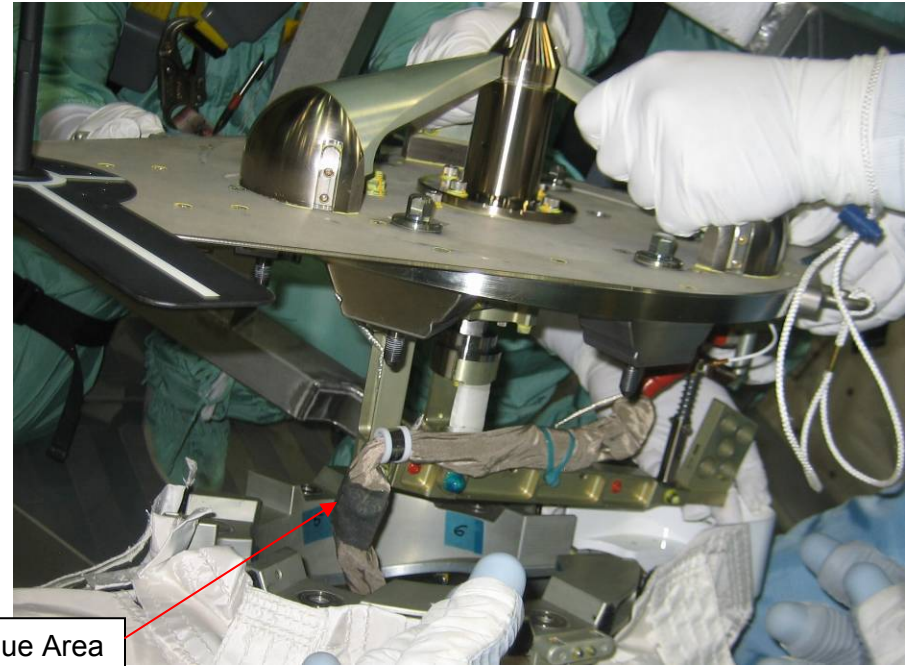
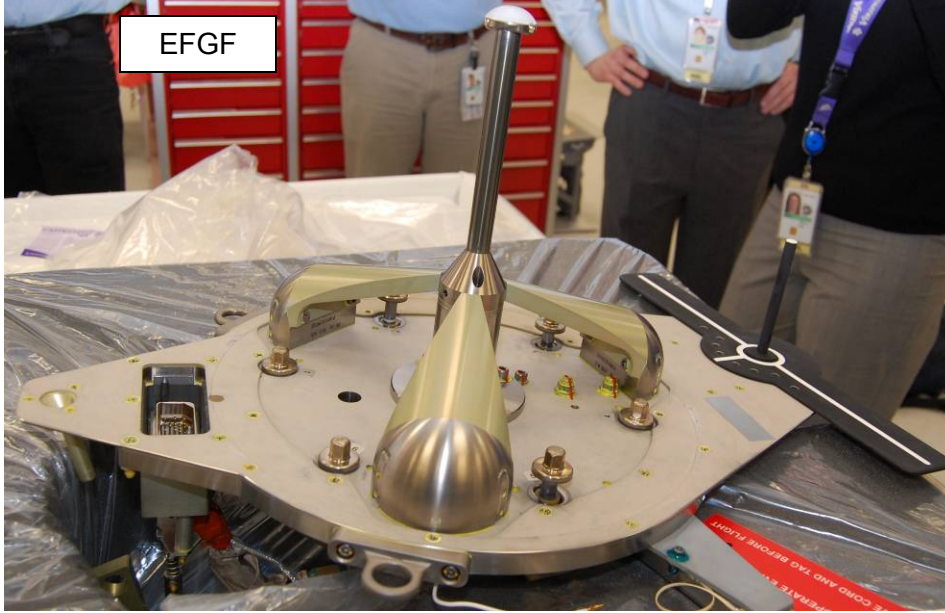

Blue Area  
to Cut



Releasable TA Clamp



OBSS EFGF/PDGF SWAP – TASK DATA (Cont)

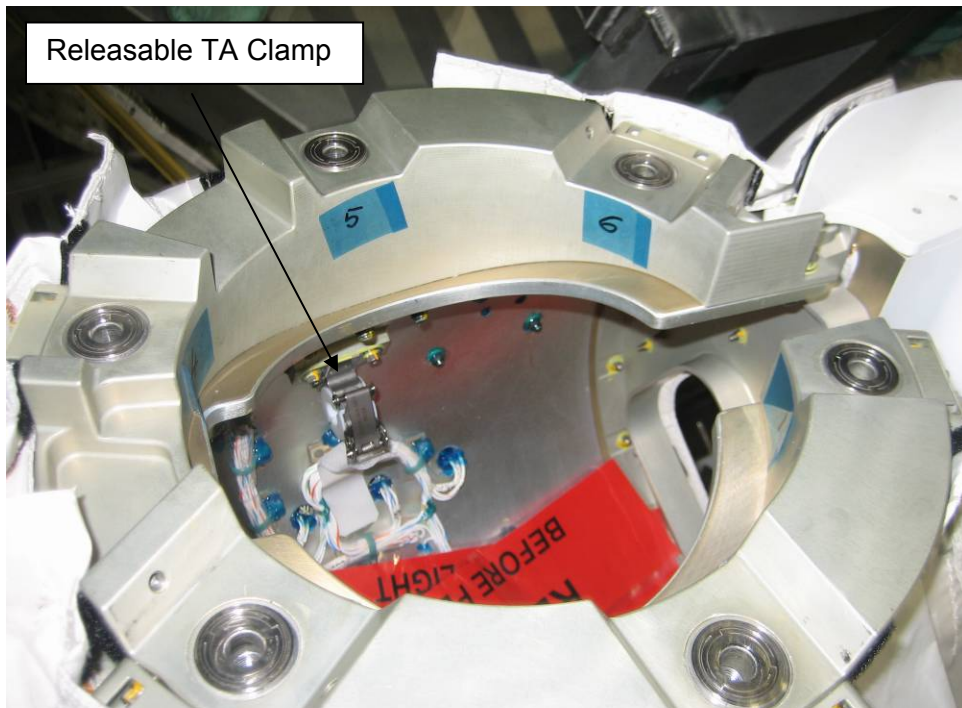
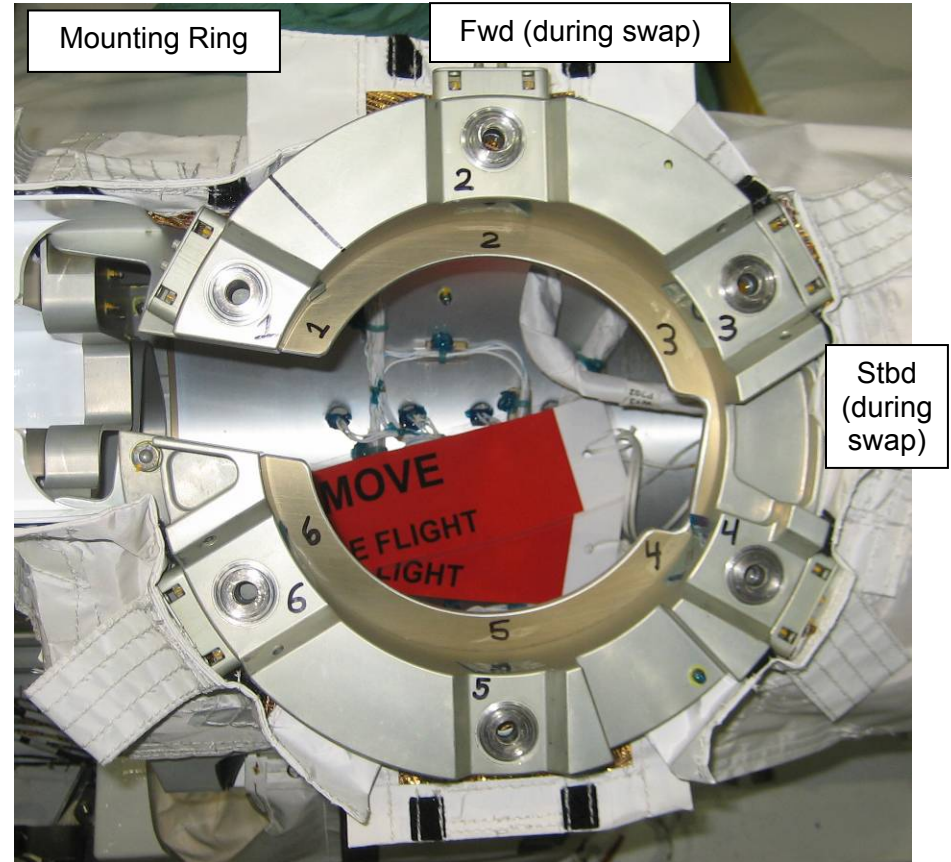
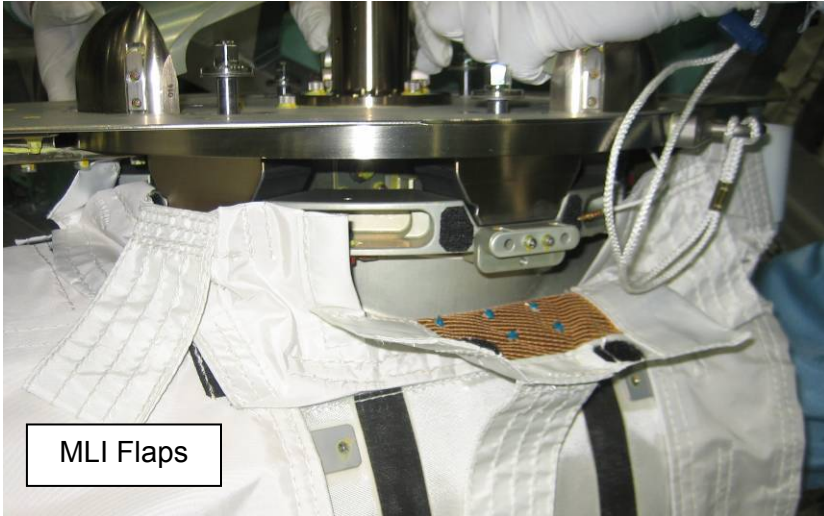



OBSS EFGF/PDGF SWAP – TASK DATA (Cont)

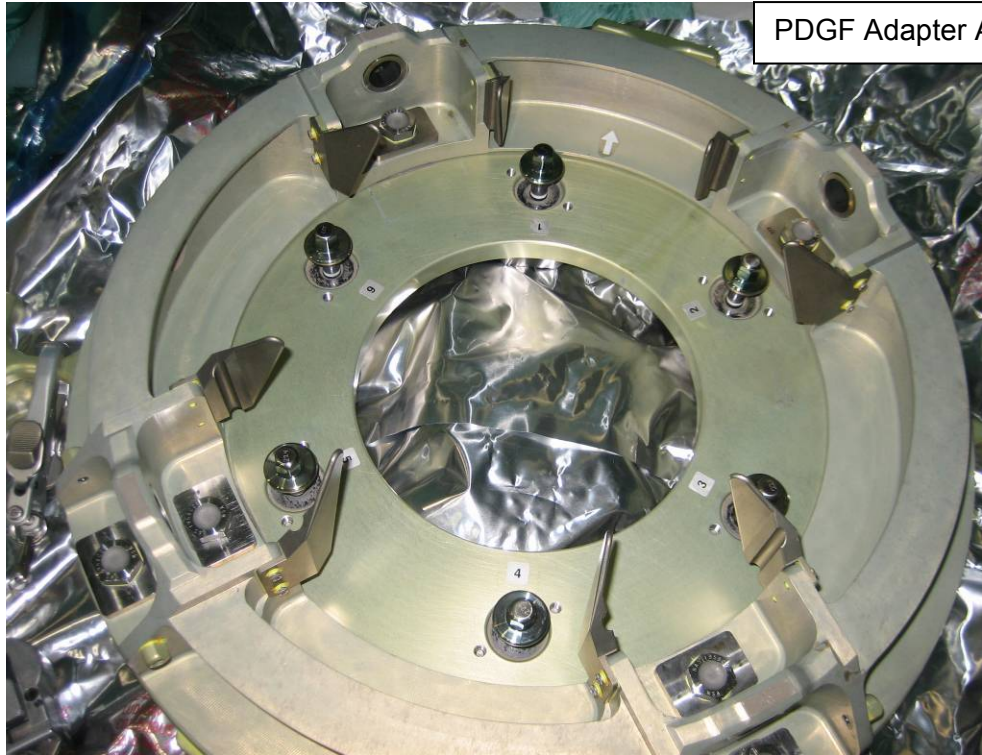

PDGF Adapter Assembly (PAA)

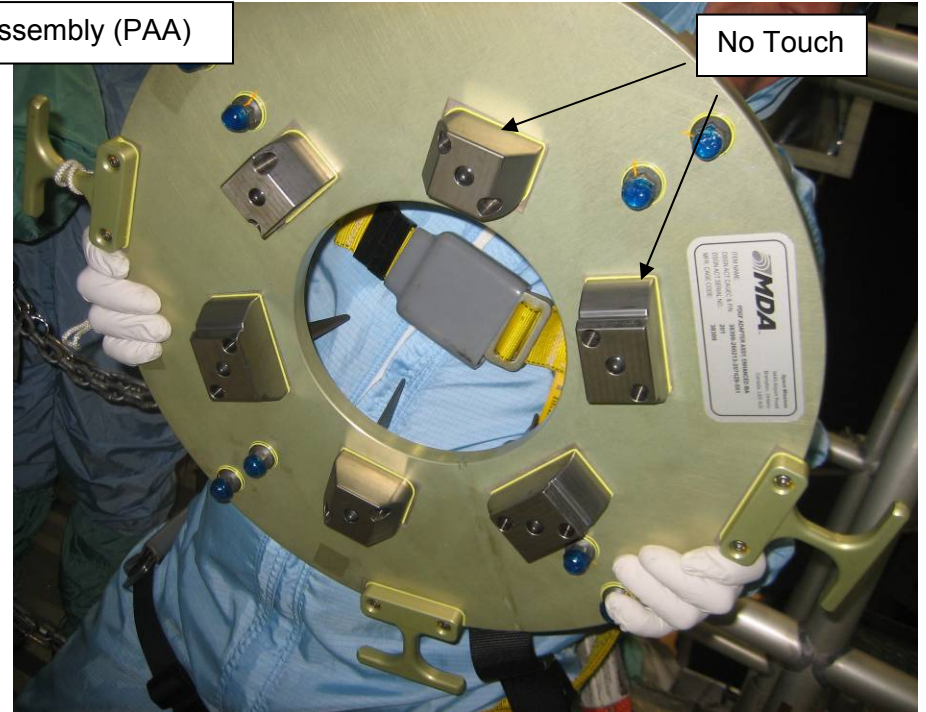

No Touch

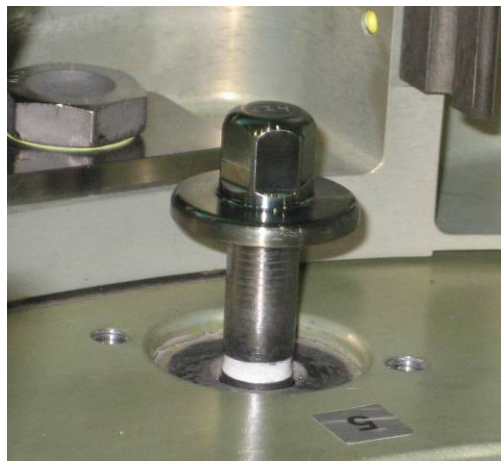

Near Bolt 1



## EFGF STOW IN TSA – TASK DATA

### Estimated Task Duration:

	With RMS	Without RMS
One EV Crew	N/A	00:35
Two EV Crew	N/A	N/A

### Tools:

EV2
EFGF
1/2" Box End Ratchet (Contingency)

### Notes:

1. EFGF is requested to be brought home mainly for the bolts
2. T-handle must be removed for EFGF to fit





## OTP LDTD TETHER CINCH – TASK DATA

### Estimated Task Duration:

	With RMS	Without RMS
One EV Crew	N/A	00:15
Two EV Crew	N/A	N/A

### Tools:

EV3
Long Wire Tie

### Notes:

1. 2 wraps of the wire tie around LDTD is requested, but understand it is best effort

### Caution:

1. Avoid inadvertent contact with RPCM Radiator Panel and OTP surfaces

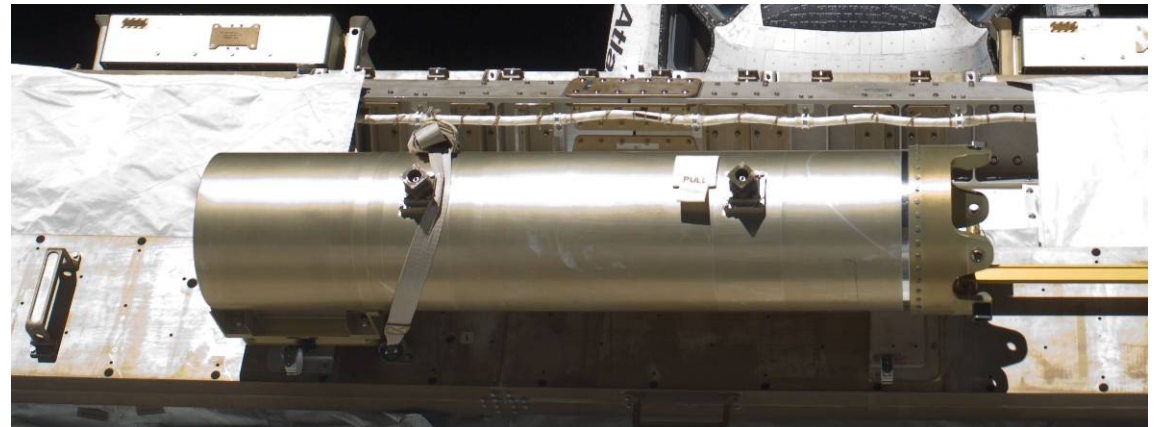
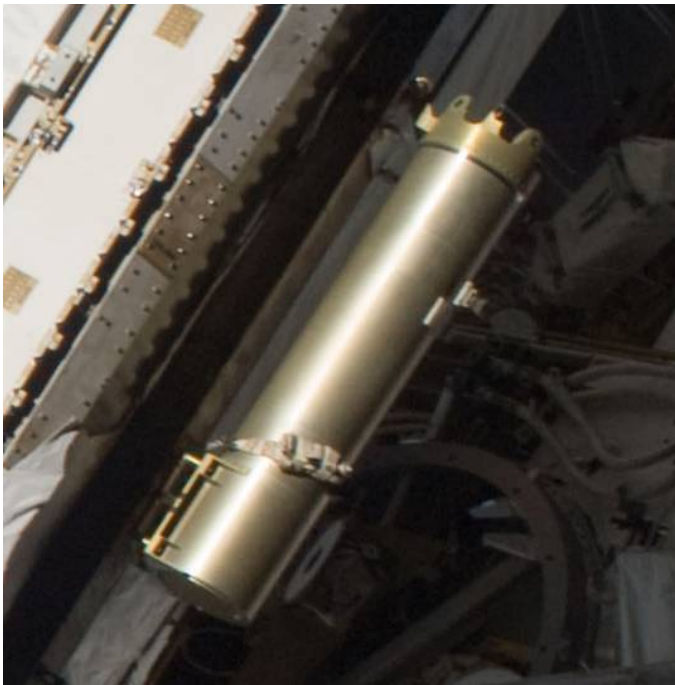

## SPDM EDF RELEASE – TASK DATA

### Estimated Task Duration:

	With RMS	Without RMS
One EV Crew	N/A	N/A
Two EV Crew	N/A	01:00

### Tools:

EV2/EV3
PGT w/7/16 Socket – 6 ext
SPDM Pry Rod

### EVA Fasteners:

Fastener Name	Head Size	Qty	Install Torque (ft-lb)	Release Torque (ft-lb)	Failure Torque (ft-lb)	Turns	RPM
SPDM EDFs	7/16	3	12.0	22.0	19.9	5	30

### Foot Restraints:

Task	WIF	APFR Setting
Release A4 EDF – Contingency	ELC3 WIF 3	[9,FF,A,12]
Release A2 EDF – Contingency	ELC3 WIF 4	[3,VV,A,1]

### ORU Details:

ORU	Part Number	Mass (lb)
Pry Rod	51602-9315-551	3.53



### Notes:

1. EDFs are only required for launch
2. Crew will attempt to release EDFs without use of pry rod
3. SPDM pry rod is 40" long
4. Estimated force on SPDM pry rod at end is 50 lb. Max is 67 lb
5. EV will insert SPDM pry rod into EDF hole up to black line
6. Limit pry rod impulses to 5, then wait 60 sec to let load dissipate

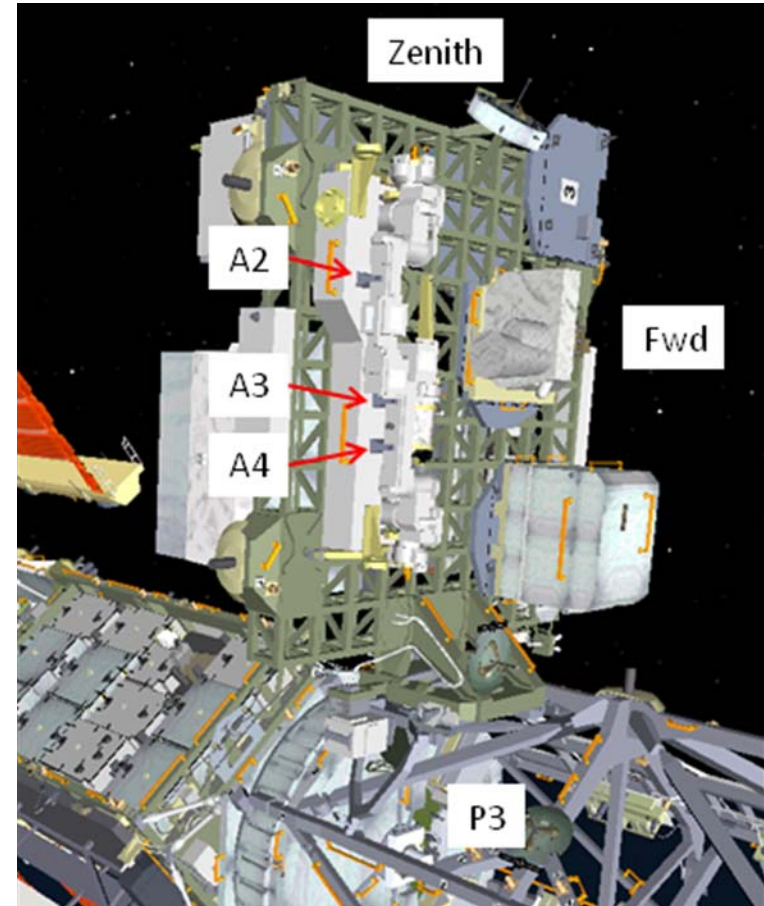

## SPDM EDF RELEASE – TASK DATA (Cont)



FS 7-215

EVA/134/FIN A

CUE CARDS



# CUE CARDS

TOP

## HOOK VELCRO

### EVA FLUID QD/SARJ CUE CARD

#### BLOCK A – DEMATE QD

1. ✓Side-loads
2. Pull back release ring – demate
3. ✓Fwd band not visible
4. ✓FOD – both sides

#### BLOCK B – MATE QD

1. ✓FOD – both sides
2. ✓Button up, collar locked (1" only)
3. ✓Fwd band not visible
4. ✓Side-loads
5. Mate QD
6. ✓Fwd band visible
7. Snapback, Pull, Gap checks
8. Close bootie (as reqd)

#### BLOCK C – OPEN VALVE

1. ✓Side-loads
2. Unlock collar (1" only)
3. Depress button, move bail fwd
4. ✓Aft band visible  
✓Button up
5. Lock collar (1" only)
6. Close bootie (as reqd)

#### BLOCK D – CLOSE VALVE

1. ✓Aft band visible
2. Unlock collar (1" only)
3. ✓Detent button up & depressible
4. ✓Side-loads
5. Move bail fwd forcefully; while depressing button, move bail aft
6. ✓Fwd band visible
7. ✓Detent button up
8. Lock collar (1" only)
9. Close bootie (as reqd)

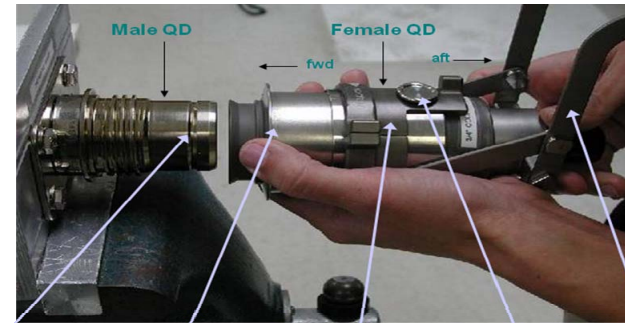
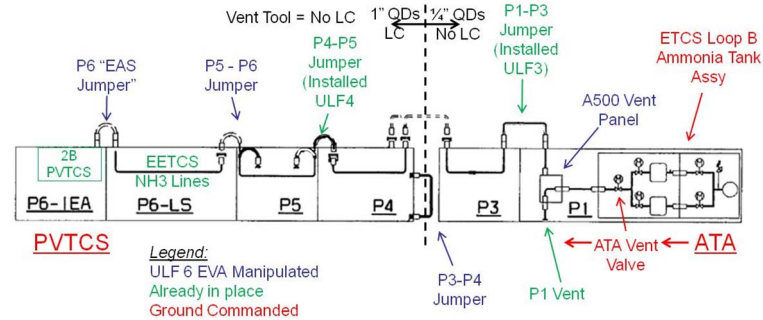
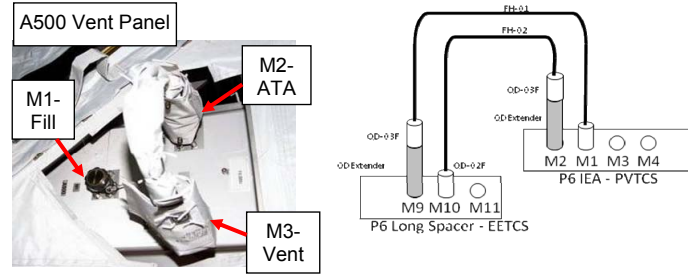

Male Groove Release Ring Locking Collar Detent Button Ball

EVA-4a/134/O/B

(reduced copy)

TOP  
BACK OF 'EVA FLUID QD/SARJ CUE CARD'

HOOK  
VELCRO

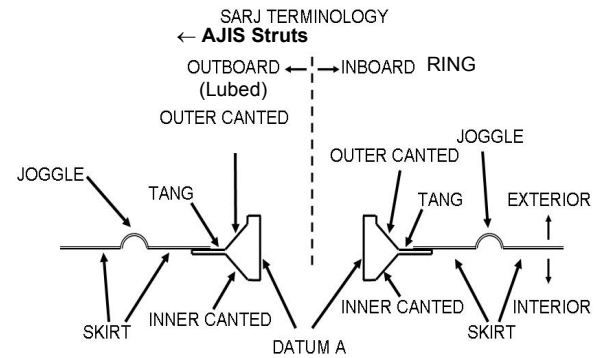
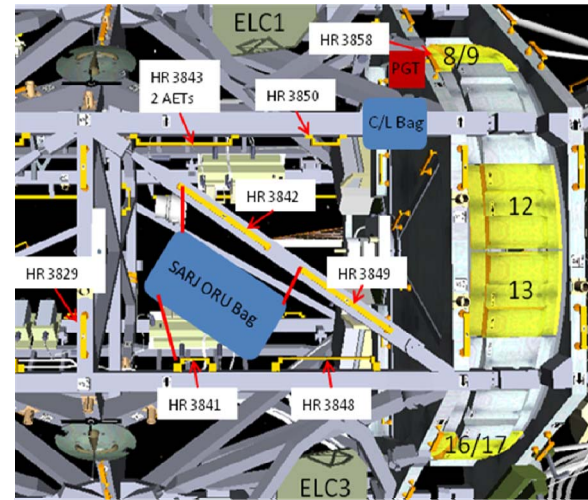
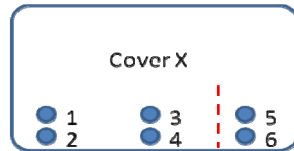
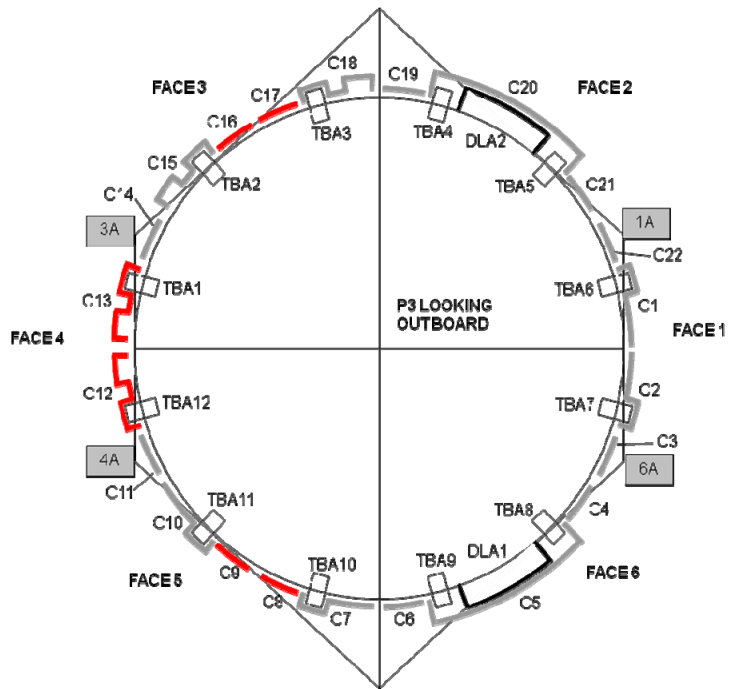

EVA-4b/134/O/B

(reduced copy)

FS CC 7-217

EVA/134/FIN A

TOP

HOOK  
VELCRO

**EVA 3 CABLE ROUTING CUE CARD**  
**Ch 1/4 FGB Y-Cable (port)**

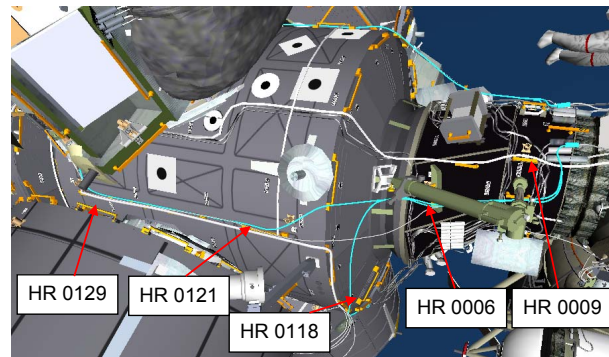
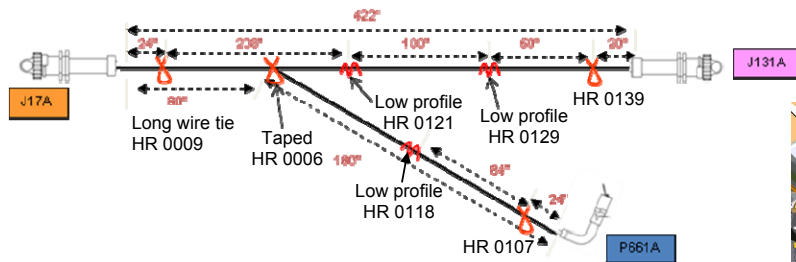

**Ch 2/3 FGB Y-Cable (stbd)**

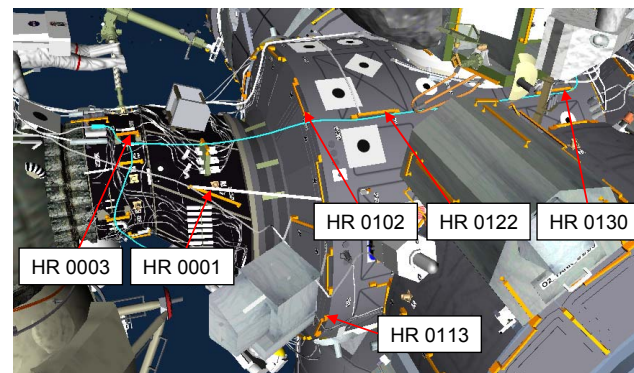
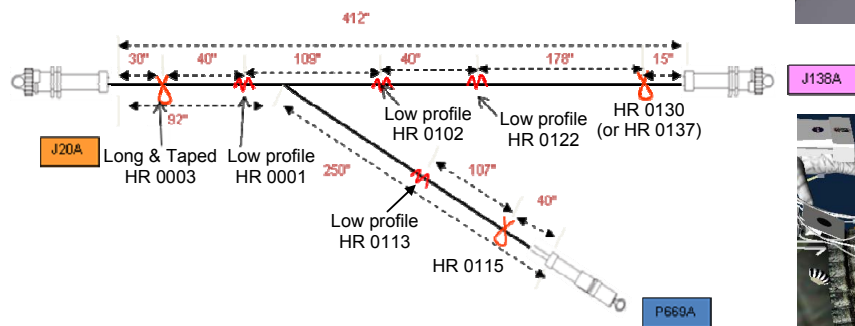

EVA-7a/134/O/A

(reduced copy)



TOP  
BACK OF 'EVA 3 CABLE ROUTING CUE CARD'

HOOK  
VELCRO

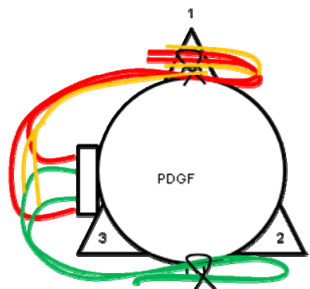

FGF PDGF Cables

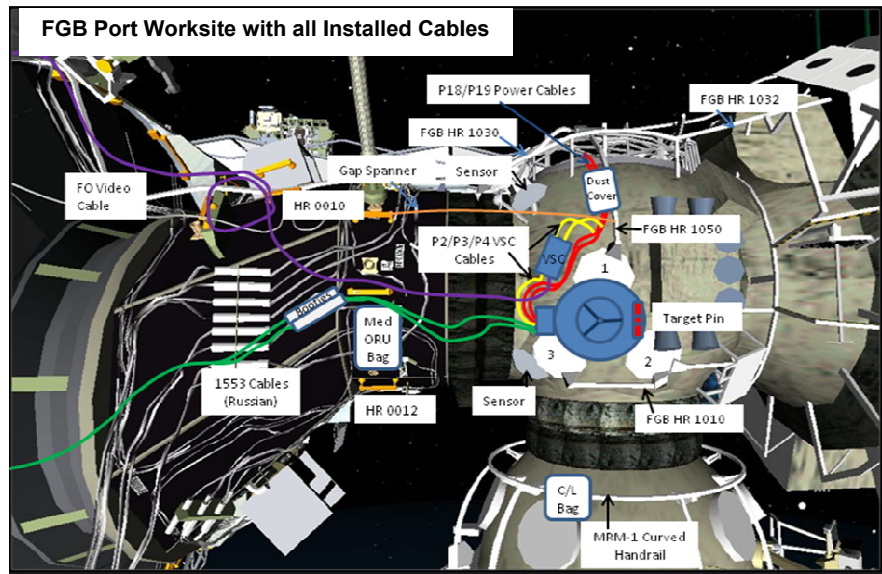
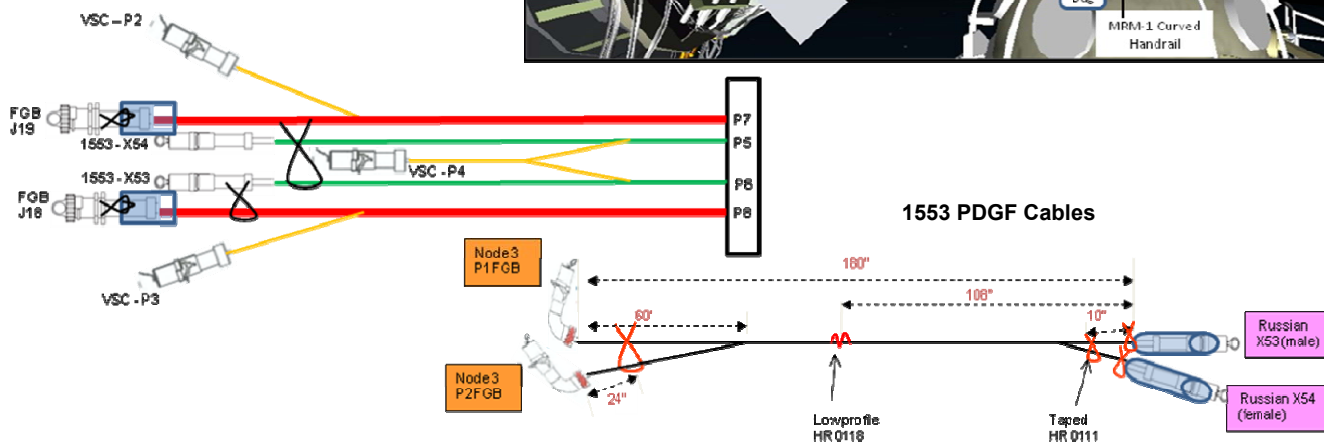

EVA-7b/134/O/A

(reduced copy)

FS CC 7-219

GET-AHEADS

EVA/134/FIN A

## GET-AHEADS

### STS-134 GET-AHEADS

EVA Get-ahead Tasks (Order indicates priority)	Duration	EVA to Perform Task	Inhibits
OTP LDTD Tether Cinch	00:15	EVA 1, 2, 3	None
STP-H3 Photos	00:15	EVA 1, 2	PSARJ Locked
Port CETA Cart Reconfig	00:30	EVA 4	MT Latched
S1 FHRC P-Clamp Release	00:45	EVA 1, 2, 3, 4	Stbd TRRJ Locked at 0°

## OTP LDTD TETHER CINCH (00:15)

IV/SSRMS	EV
<p>Tools Required:</p> <ul style="list-style-type: none"><li><input type="checkbox"/> 1 Long Wire Tie</li></ul> <p>Inhibits Required: None</p> 	<div style="border: 1px solid black; padding: 5px; text-align: center;"><p><b>CAUTION</b> Avoid inadvertent contact with the OTP and RPCM radiator panel on Face 3</p></div> <p><u>OTP LDTD TETHER CINCH (00:15)</u></p> <ol style="list-style-type: none"><li>1. Translate to OTP<ul style="list-style-type: none"><li><input type="checkbox"/> Use HR stanchion for local tether</li></ul></li><li>2. Route wire tie under buckle</li><li>3. Cinch down the LDTD Tether</li><li>4. Close the MLI over the buckle<ul style="list-style-type: none"><li>√No metal showing</li></ul></li><li>5. Install wire tie around MLI, closer to buckle end<ul style="list-style-type: none"><li><input type="checkbox"/> 3 twists</li></ul></li><li>6. If possible, wrap wire tie under and around MLI a second time<ul style="list-style-type: none"><li><input type="checkbox"/> 3 twists</li></ul></li><li>7. Gather excess tether on top of MLI<ul style="list-style-type: none"><li><input type="checkbox"/> Close tabs</li></ul></li><li>8. Glove Check</li></ol>

## OTP LDTD TETHER CINCH – TASK DATA

### Estimated Task Duration:

	With RMS	Without RMS
One EV Crew	N/A	00:15
Two EV Crew	N/A	N/A

### Tools:

EV
Long Wire Tie

### Notes:

1. Two wraps of the wire tie around the LDTD is requested, but understand it is best effort

### Caution:

1. Avoid inadvertent contact with RPCM Radiator Panel and OTP surfaces

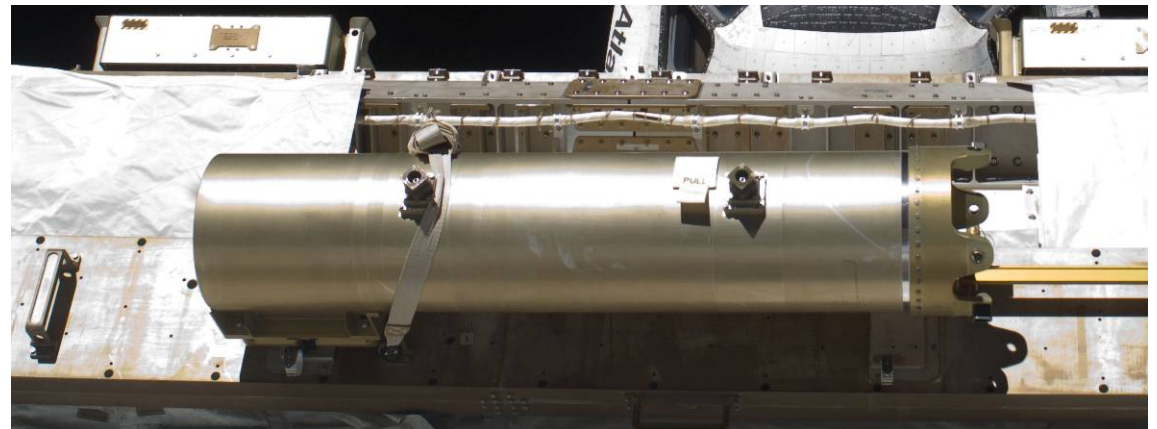
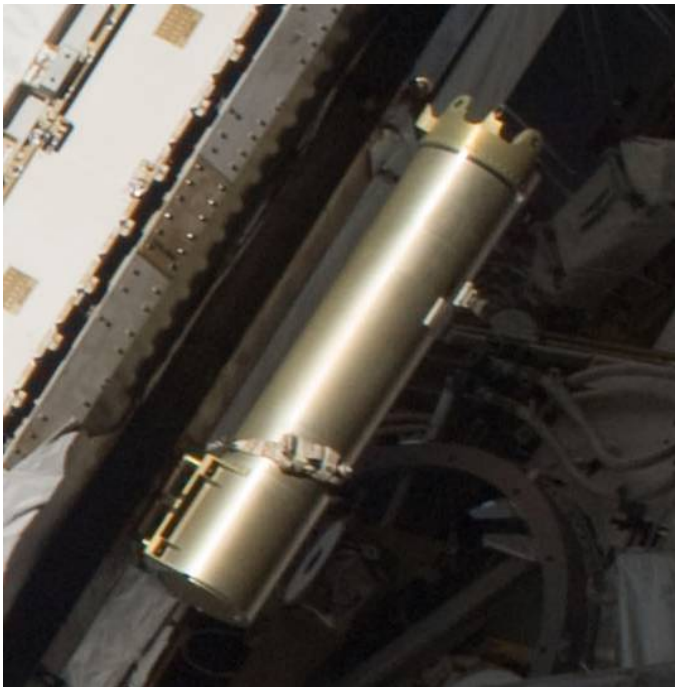



## STP-H3 PHOTOS (00:15)

IV/SSRMS	EV
<p>Tools Required:</p> <ul style="list-style-type: none"><li><input type="checkbox"/> EVA Camera</li></ul> <p>Inhibits Required: PSARJ locked</p>	<div data-bbox="913 243 1627 349" style="border: 1px solid black; padding: 5px;"><p style="text-align: center;"><b>CAUTION</b></p><p>Top of STP-H3 is a KOZ</p><p>Avoid inadvertent contact with MHTEX radiator – Z93 paint</p></div> <p>STP-H3 PHOTOS (00:15)</p> <ol style="list-style-type: none"><li>1. Translate to P3 Bay 20</li><li>2. Attach <b>GREEN</b> hook to P3 HR 3852<ul style="list-style-type: none"><li><input type="checkbox"/> Gate closed, hook locked, reels unlocked, release RET</li></ul></li><li>3. Translate to STP-H3 (outbd aft zenith on ELC3)</li><li>4. <input checked="" type="checkbox"/> Take photos of STP-H3<ul style="list-style-type: none"><li><input type="checkbox"/> VADER back side (nadir)</li><li><input type="checkbox"/> Canary Face (aft)</li><li><input type="checkbox"/> MHTEX Radiator Surface (aft)</li></ul></li><li>5. If additional time allows, also take photos of:<ul style="list-style-type: none"><li><input type="checkbox"/> Front of VADER</li><li><input type="checkbox"/> DISC lens</li></ul></li></ol> <div data-bbox="951 727 1892 1370"><p>The photograph shows the STP-H3 payload assembly mounted on a metal structure. Several components are labeled with white boxes and blue arrows pointing to them: 'Back of VADER-Aerogel' points to a gold-colored rectangular component; 'Canary Face and FOV' points to a smaller component on the left; 'DISC lens' points to a black lens-like component on the right; 'Center of VADER face' points to the front of the gold component; 'Center of Quad VED' points to a component on the right side of the assembly; 'MHTEX Radiator Surface' points to a large, flat, metallic surface; 'ISS Aft side' points to the lower part of the assembly; and 'ISS Zenith side' points to the bottom of the assembly.</p></div>

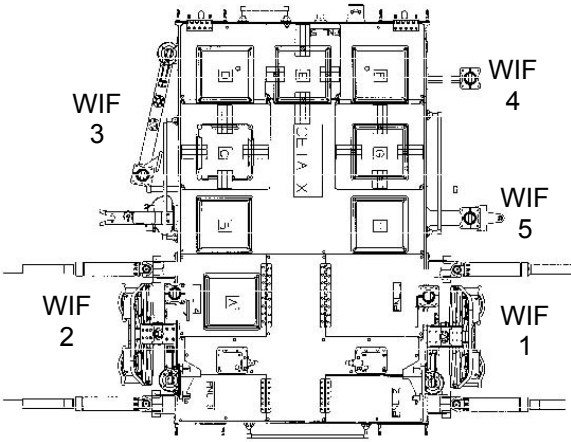

## PORT CETA CART RECONFIG (00:30)

IV/SSRMS	EV1
<p>Tools Required:</p> <ul style="list-style-type: none"> <li><input type="checkbox"/> 2 long wire ties, 1 short (optional)</li> </ul> <p>Inhibits Required: Mobile Transporter</p> <p><b>MCC-H</b> EV crew expected &lt; 1.5 meters from MT (ROBO) 1. <input checked="" type="checkbox"/> MT latched</p> 	<p><b>PORT CETA CART RECONFIG (00:30)</b></p> <ol style="list-style-type: none"> <li>1. Retrieve at least two long wire ties</li> <li>2. Translate to Port CETA Cart</li> <li>3. <input checked="" type="checkbox"/> TFR nadir 180 deg full nadir (position 30)</li> <li>4. If not             <ul style="list-style-type: none"> <li><input type="checkbox"/> Release Port nadir TFR swing arm, move to position 30</li> <li><input type="checkbox"/> Lock TFR swing arm</li> </ul> </li> <li>5. Attach Waist Tether to WIF 1 tether pt</li> <li>6. Rotate Port brake handles forward and tie down (one long wire tie per handle)             <ul style="list-style-type: none"> <li><input type="checkbox"/> Nadir brake handle to zenith TFR Toe Clip</li> <li><input type="checkbox"/> Zenith brake handle to Sq Grid H (port/nadir corner)</li> <li><input type="checkbox"/> <input checked="" type="checkbox"/> Three twists at each end of wire ties</li> <li><input type="checkbox"/> <input checked="" type="checkbox"/> Brake handles bent at elbow and secured together with wire tie</li> </ul> </li> <li>7. <input checked="" type="checkbox"/> Perform WVS survey of CETA Cart</li> <li>8. Glove Check</li> </ol>  



# S1 FHRC P-CLAMP RELEASE (00:45)

IV/SSRMS	EV																																																																
<p>1. Record P-clamps:</p> <table border="1" style="margin-left: 20px;"> <thead> <tr> <th colspan="4" style="text-align: center;">Hose Box S1 Bay 13</th> </tr> <tr> <th></th> <th style="text-align: center;">P-clamp</th> <th style="text-align: center;">Tool</th> <th style="text-align: center;">Socket</th> </tr> </thead> <tbody> <tr> <td style="text-align: center;"><input type="checkbox"/></td> <td style="text-align: center;"><b>1 (N)</b></td> <td style="text-align: center;">PGT</td> <td style="text-align: center;">6-in ext</td> </tr> <tr> <td style="text-align: center;"><input type="checkbox"/></td> <td style="text-align: center;"><b>2 (N)</b></td> <td style="text-align: center;">PGT</td> <td style="text-align: center;">6-in ext</td> </tr> <tr> <td style="text-align: center;"><input type="checkbox"/></td> <td style="text-align: center;"><b>3 (N)</b></td> <td style="text-align: center;">Ratchet</td> <td style="text-align: center;">2-in ext</td> </tr> <tr> <td style="text-align: center;"><input type="checkbox"/></td> <td style="text-align: center;"><b>1 (Z)</b></td> <td style="text-align: center;">PGT</td> <td style="text-align: center;">6-in ext</td> </tr> <tr> <td style="text-align: center;"><input checked="" type="checkbox"/></td> <td style="text-align: center;"><b>2 (Z)</b></td> <td style="text-align: center;">PGT</td> <td style="text-align: center;">6-in ext</td> </tr> <tr> <td style="text-align: center;"><input checked="" type="checkbox"/></td> <td style="text-align: center;"><b>3 (Z)</b></td> <td style="text-align: center;">Ratchet</td> <td style="text-align: center;">2-in ext</td> </tr> </tbody> </table> <p>2. Verify inhibits in place: √Stbd TRRJ locked at 0 deg</p> <p>3. Record P-clamps:</p> <table border="1" style="margin-left: 20px;"> <thead> <tr> <th colspan="4" style="text-align: center;">Stinger S1 Bay 11</th> </tr> <tr> <th></th> <th style="text-align: center;">P-clamp</th> <th style="text-align: center;">Tool</th> <th style="text-align: center;">Socket</th> </tr> </thead> <tbody> <tr> <td style="text-align: center;"><input type="checkbox"/></td> <td style="text-align: center;"><b>1</b></td> <td style="text-align: center;">PGT</td> <td style="text-align: center;">6- or 18-in ext</td> </tr> <tr> <td style="text-align: center;"><input type="checkbox"/></td> <td style="text-align: center;"><b>2</b></td> <td style="text-align: center;">PGT</td> <td style="text-align: center;">18-in ext</td> </tr> <tr> <td style="text-align: center;"><input type="checkbox"/></td> <td style="text-align: center;"><b>3</b></td> <td style="text-align: center;">PGT</td> <td style="text-align: center;">6-in ext</td> </tr> <tr> <td style="text-align: center;"><input type="checkbox"/></td> <td style="text-align: center;"><b>4</b></td> <td style="text-align: center;">PGT</td> <td style="text-align: center;">6- or 18-in ext</td> </tr> <tr> <td style="text-align: center;"><input type="checkbox"/></td> <td style="text-align: center;"><b>5</b></td> <td style="text-align: center;">PGT</td> <td style="text-align: center;">6- or 18-in ext</td> </tr> <tr> <td style="text-align: center;"><input type="checkbox"/></td> <td style="text-align: center;"><b>6</b></td> <td style="text-align: center;">PGT</td> <td style="text-align: center;">6* or 18-in ext</td> </tr> </tbody> </table> <p>* wobble reqd w/6-in</p>	Hose Box S1 Bay 13					P-clamp	Tool	Socket	<input type="checkbox"/>	<b>1 (N)</b>	PGT	6-in ext	<input type="checkbox"/>	<b>2 (N)</b>	PGT	6-in ext	<input type="checkbox"/>	<b>3 (N)</b>	Ratchet	2-in ext	<input type="checkbox"/>	<b>1 (Z)</b>	PGT	6-in ext	<input checked="" type="checkbox"/>	<b>2 (Z)</b>	PGT	6-in ext	<input checked="" type="checkbox"/>	<b>3 (Z)</b>	Ratchet	2-in ext	Stinger S1 Bay 11					P-clamp	Tool	Socket	<input type="checkbox"/>	<b>1</b>	PGT	6- or 18-in ext	<input type="checkbox"/>	<b>2</b>	PGT	18-in ext	<input type="checkbox"/>	<b>3</b>	PGT	6-in ext	<input type="checkbox"/>	<b>4</b>	PGT	6- or 18-in ext	<input type="checkbox"/>	<b>5</b>	PGT	6- or 18-in ext	<input type="checkbox"/>	<b>6</b>	PGT	6* or 18-in ext	<p><b>S1 FHRC HOSE BOX P-CLAMP RELEASE – BAY 13 (00:20)</b></p> <ol style="list-style-type: none"> <li>Translate to A/L</li> <li>Open hatch thermal cover</li> <li>Retrieve ratchet wrench with 2" ext from Staging Bag</li> <li>Close hatch thermal cover</li> <li>Translate to S1 FHRC Bay 13</li> </ol> <div style="border: 1px solid black; padding: 5px; margin: 10px 0;"> <p style="text-align: center;"><b>CAUTION</b></p> <p style="text-align: center;">Do not impart loads greater than 15 lb into FHRC Hose Box fluid lines</p> </div> <ol style="list-style-type: none"> <li>Configure PGT: <b>[A7 (9.2), CCW2, 30.5]</b></li> <li>Release Hose Box P-clamps (4) [P-clamp #3N requires ratchet] ~6-12.5 turns</li> <li>Egress Bay 13</li> <li>Verify SAFER handles: <ul style="list-style-type: none"> <li><input type="checkbox"/> √R Handle down (HCM door – Closed)</li> <li><input type="checkbox"/> √L Handle down (MAN ISO Valve – Open)</li> </ul> </li> </ol> <p><b>S1 FHRC STINGER P-CLAMPS – BAY 11 (00:25)</b></p> <ol style="list-style-type: none"> <li>Translate S1 FHRC Bay 11</li> <li>Configure <b>PGT</b> <b>[A7 (9.2), CCW2, 30.5]</b> 7/16 socket 6 ext</li> <li>Release Stinger P-clamps (5) [P-clamp #2 requires 18 in ext] ~7-12.5 turns Do not release P-clamp on hardline P-clamps are not numbered Release 3 P-clamps closest to QD</li> <li>Egress Bay 11</li> <li>Verify SAFER handles: <ul style="list-style-type: none"> <li><input type="checkbox"/> √R Handle down (HCM door – Closed)</li> <li><input type="checkbox"/> √L Handle down (MAN ISO Valve – Open)</li> </ul> </li> <li>Glove Check</li> </ol>
Hose Box S1 Bay 13																																																																	
	P-clamp	Tool	Socket																																																														
<input type="checkbox"/>	<b>1 (N)</b>	PGT	6-in ext																																																														
<input type="checkbox"/>	<b>2 (N)</b>	PGT	6-in ext																																																														
<input type="checkbox"/>	<b>3 (N)</b>	Ratchet	2-in ext																																																														
<input type="checkbox"/>	<b>1 (Z)</b>	PGT	6-in ext																																																														
<input checked="" type="checkbox"/>	<b>2 (Z)</b>	PGT	6-in ext																																																														
<input checked="" type="checkbox"/>	<b>3 (Z)</b>	Ratchet	2-in ext																																																														
Stinger S1 Bay 11																																																																	
	P-clamp	Tool	Socket																																																														
<input type="checkbox"/>	<b>1</b>	PGT	6- or 18-in ext																																																														
<input type="checkbox"/>	<b>2</b>	PGT	18-in ext																																																														
<input type="checkbox"/>	<b>3</b>	PGT	6-in ext																																																														
<input type="checkbox"/>	<b>4</b>	PGT	6- or 18-in ext																																																														
<input type="checkbox"/>	<b>5</b>	PGT	6- or 18-in ext																																																														
<input type="checkbox"/>	<b>6</b>	PGT	6* or 18-in ext																																																														

# S1 FHRC P-CLAMP RELEASE – TASK DATA

## FHRC P-clamps – Hose Box (Outboard)

**Legend:**  
 ○ = P-clamp Location  
 ⊗ = TA-clamp (not released)

**Hose Box S1 Bay 13**

	P-clamp	Tool	Socket
<input type="checkbox"/>	1 (N)	PGT	6-in ext
<input type="checkbox"/>	2 (N)	PGT	6-in ext
<input type="checkbox"/>	3 (N)	Ratchet	2-in ext
<input type="checkbox"/>	1 (Z)	PGT	6-in ext
<input checked="" type="checkbox"/>	2 (Z)	PGT	6-in ext
<input checked="" type="checkbox"/>	3 (Z)	Ratchet	2-in ext

**Notes:**  
 HR 3230, HR 3229  
 QD: M3/F40, QD: M4/F41  
 QD: M5/F42, QD: M6/F43  
 TA (Nadir Tray)  
 Zenith Tray  
 Aft, Forward

## FHRC P-clamps – Stinger (Inboard)

**Legend:**  
 ○ = P-clamp Location  
 ⊗ = P-clamp (not released)

**Stinger S1 Bay 11**

	P-clamp	Tool	Socket
<input type="checkbox"/>	1	PGT	6- or 18-in ext
<input type="checkbox"/>	2	PGT	18-in ext
<input type="checkbox"/>	3	PGT	6-in ext
<input type="checkbox"/>	4	PGT	6- or 18-in ext
<input type="checkbox"/>	5	PGT	6- or 18-in ext
<input type="checkbox"/>	6	PGT	6* or 18-in ext

**Notes:**  
 Nadir, Zenith Tray  
 QD: M1, QD: M2  
 Torque Box Assy  
 AVIONICS WIRE HARNESS  
 VIEW M-M  
 SCALE 1/4

## S1 FHRC P-CLAMP RELEASE – TASK DATA (Cont)

### Estimated Task Duration:

	With SSRMS	Without SSRMS
One EV Crew	N/A	N/A
Two EV Crew	N/A	00:45

### Tools:

EV1
PGT w/7/16 (wobble) Socket-6 ext
Ratchet wrench w/7/16-2 in ext

### EVA Fasteners:

Fastener Name	Label	Head Size	Qty	Install Torque (ft-lb)	Release Torque (ft-lb)	Failure Torque (ft-lb)	Turns	RPM
Hosebox P-clamp bolts	1,2,3	7/16	6	N/A	6.0	12.6	6-12.5	30
Stinger P-clamp bolts	Arrow	7/16	6	N/A	6.0	12.6	7-12.5	30

### Inhibits:

ORU/Task	Location	Inhibit
S1 P-clamps	Prior to translation to S1	Stbd TRRJ √DLA (1) – LOCKED (0 deg)

### Caution:

- Do not impart more than 15 lbf load into the hose box fluid lines

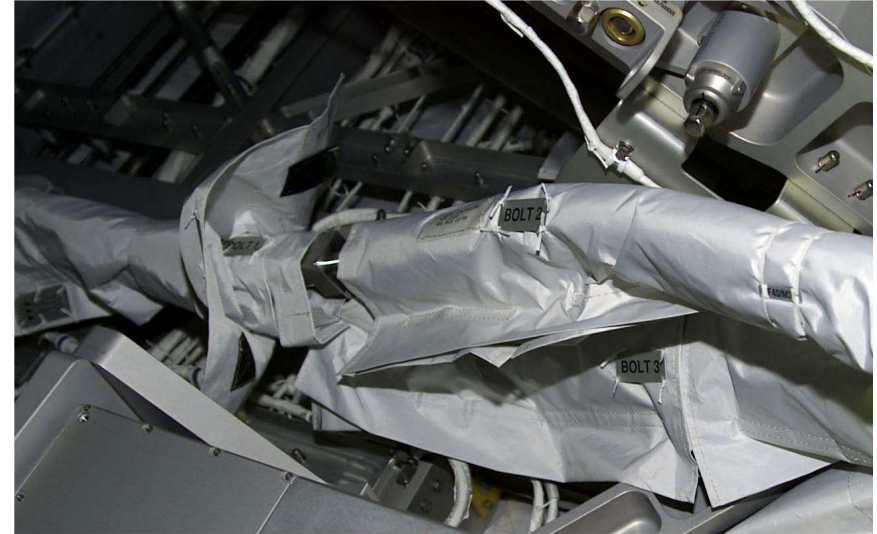

Hose box P-clamps have labels with bolt numbers

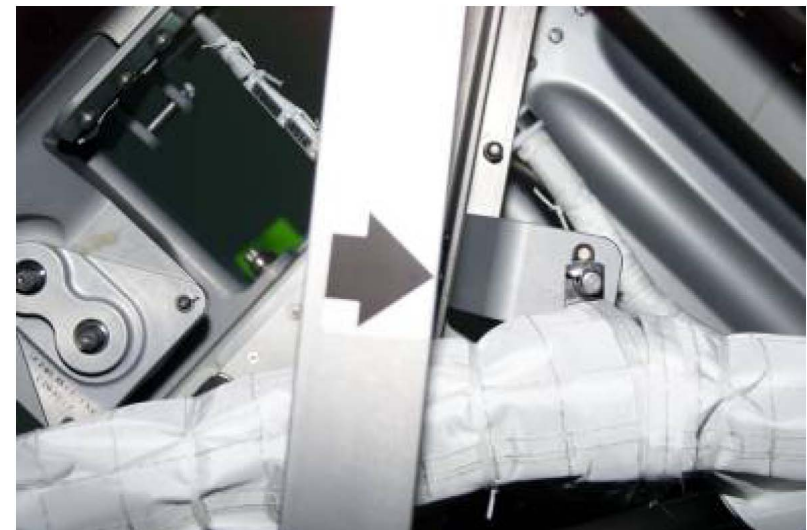

Stinger P-clamps have arrow labels for bolts

This Page Intentionally Blank

TOOLS AND STOWAGE

PORT LIGHTWEIGHT TOOL STOWAGE ASSEMBLY (TSA) ..... TEMP FS 8-2  
PGT CHECKOUT ..... 8-3  
PGSC-PGT CONNECTION (A31P AND 760XD) ..... 8-4  
PROGRAM PGT SETTINGS ..... 8-5  
DOWNLOAD/ERASE EVENT LOG ..... 8-5  
PGT CONTINGENCIES..... 8-6  
PGT STANDARD SETTINGS..... 8-7  
APFR MANAGEMENT – STS-134 (ULF6) ..... FS 8-9  
CETA CART WIF AND SWINGARM MANAGEMENT TABLE – STS-134/ULF6 ..... FS 8-10  
SAFETY TETHERS STS-134/ULF6 ..... FS 8-11  
TOOLBOX STOWAGE – STS-134 (ULF6)..... FS 8-12  
TOOLBOX PANEL AND SLOT LABELS ..... FS 8-13  
Z1 TOOLBOX INTERNAL LAYOUT ..... FS 8-14  
AIRLOCK TOOLBOX INTERNAL LAYOUT ..... FS 8-15  
FLUID QD BAG LAYOUT ..... FS 8-16  
CETA CART CONFIG..... FS 8-19  
CREW TETHER INSPECTIONS ..... FS 8-20

TOOLS AND  
STOWAGE

# PORT LIGHTWEIGHT TOOL STORAGE ASSEMBLY (TSA)

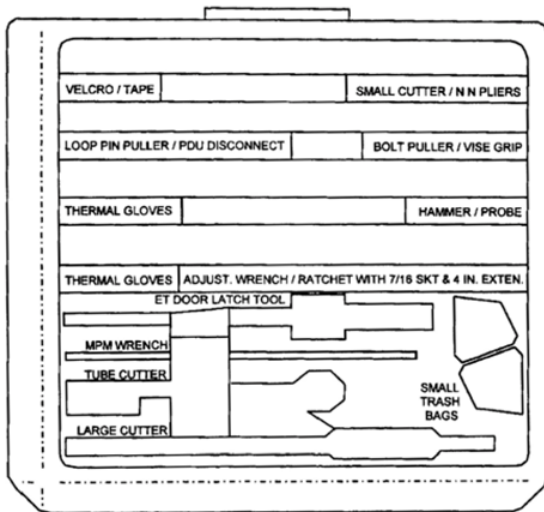
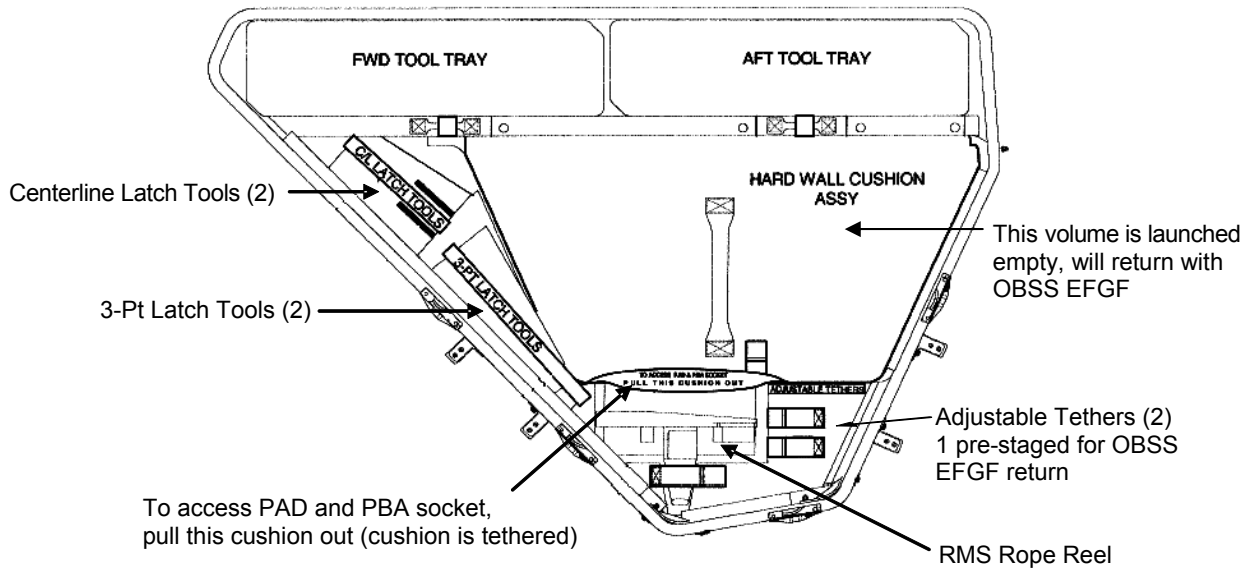

Forward Tray Layout and Labels

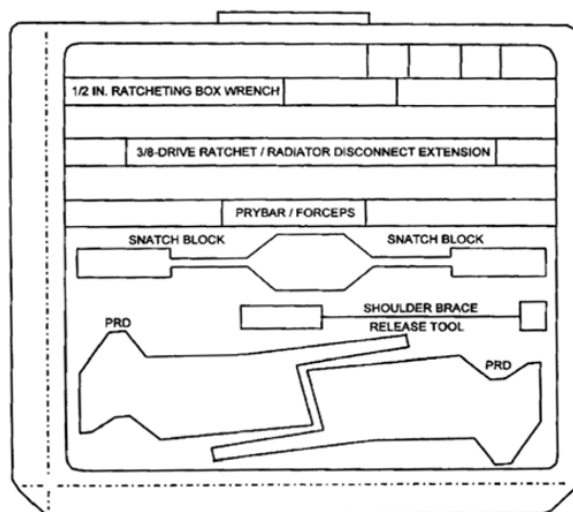

Aft Tray Layout and Labels



When closing TSA doors, ensure locking tabs on latches are closed "Arrow to Arrow"

TOOLS AND STOWAGE



## APFR MANAGEMENT – STS-134 (ULF6)

APFR DESIGNATOR	APFR 1 s/n 1004 (8A, 13A.1 Pitch knob problem)	APFR 2 s/n 1006 (US EVA 9 Pitch knob problem, 10A sticky locking collar)	APFR 3 s/n 1005 (no pitch knob prob 9A-inc12 suspected sharp edge on locking collar and possible sticky locking collar)	APFR 4 s/n 1002 (Heat shield removed on ULF5)	APFR 5 s/n 1003 (Heat shield removed on ULF3)	APFR 6 s/n 1007 (Heat shield removed on 12A.1 stage)	APFR 7 s/n 1008	IAPFR 1	IAPFR 2	OTSD	WIF Extender
<b>Post STS-133</b>	Z1 WIF 13 [3,QQ,F,12] TS	P1 WIF 3 [6,PP,F,11] TS	ESP-2 WIF 06 [10,FF,A,3] Ingress Aid	A/L Toolbox1 [12,AA] [6,XX,F,12]	Port CETA Cart WIF 2 [6,GG] [12,TT,F,6]	COL WIF 3 [6,NN,F,6] Ingress Aid	P6 WIF 12 [3,OO,F,12] Ingress Aid	Z1 WIF 5 [12,PP,F,12]	Z1 WIF 3 [6,PP,F,12]	S0 WIF 7 CL=7	ESP-2 WIF 3 [3,A,1]
<b>Post EVA 1</b>	Z1 WIF 13 [3,QQ,F,12] TS	P1 WIF 3 [6,PP,F,11] TS	ESP-2 WIF 06 [10,FF,A,3] Ingress Aid	A/L Toolbox1 [12,AA] [6,XX,F,12]	Port CETA Cart WIF 2 [6,GG] [12,TT,F,6]	COL WIF 3 [6,NN,F,6] Ingress Aid	P6 WIF 12 [3,OO,F,12] Ingress Aid	Z1 WIF 5 [12,PP,F,12]	Z1 WIF 3 [6,PP,F,12]	S0 WIF 7 CL=7	ESP-2 WIF 3 [3,A,1]
<b>Post EVA 2</b>	Z1 WIF 13 [3,QQ,F,12] TS	P1 WIF 3 [6,PP,F,11] TS	ESP-2 WIF 06 [10,FF,A,3] Ingress Aid	A/L Toolbox1 [12,AA] [6,XX,F,12]	Port CETA Cart WIF 2 [6,GG] [12,TT,F,6]	COL WIF 3 [6,NN,F,6] Ingress Aid	P6 WIF 12 [3,OO,F,12] Ingress Aid	Z1 WIF 5 [12,PP,F,12]	Z1 WIF 3 [6,PP,F,12]	S0 WIF 7 CL=7	ESP-2 WIF 3 [3,A,1]
<b>Post EVA 3</b>	Z1 WIF 13 [3,QQ,F,12] TS	P1 WIF 3 [6,PP,F,11] TS	ESP-2 WIF 06 [10,FF,A,3] Ingress Aid	A/L Toolbox1 [12,AA] [6,XX,F,12]	Port CETA Cart WIF 2 [6,GG] [12,TT,F,6]	COL WIF 3 [6,NN,F,6] Ingress Aid	P6 WIF 12 [3,OO,F,12] Ingress Aid	Z1 WIF 5 [12,PP,F,12]	Z1 WIF 3 [6,PP,F,12]	S0 WIF 7 CL=7	ESP-2 WIF 3 [3,A,1]
<b>Post EVA 4</b>	Z1 WIF 13 [3,QQ,F,12] TS	P1 WIF 3 [6,PP,F,11] TS	ESP-2 WIF 06 [10,FF,A,3] Ingress Aid	<b>Stbd CETA Cart WIF 4 [12,GG] [4,PP,F,6]</b>	Port CETA Cart WIF 2 [6,GG] [12,TT,F,6]	COL WIF 3 [6,NN,F,6] Ingress Aid	<b>Port CETA Cart WIF 4 [12,DD] [7,OO,F,12] Ingress Aid</b>	Z1 WIF 5 [12,PP,F,12]	Z1 WIF 3 [6,PP,F,12]	S0 WIF 7 CL=7	ESP-2 WIF 3 [3,A,1]

Crane (old ORU tether)	ORU Stanchion/TERA Headless	APFR 2 Tool Stanchion	APFR 1 Tool Stanchion	Tool Stanchion
PMA1 WIF 5	S0 port wedge face	Hex pointed ISS zenith, tool head pointed ISS stbd, and oriented ISS Zenith/Nadir	Tool stanchion port, pointed zenith	S0 port wedge face

## CETA CART WIF AND SWINGARM MANAGEMENT TABLE – STS-134/ULF6

WIF Designator	CETA 1 (port) WIF 1 Port-nadir	CETA 1 (port) WIF 2 Stbd-nadir	CETA 1 (port) WIF 3 Stbd-zenith	CETA 1 (port) WIF 4 Port-zenith	CETA 1 (port) WIF 5 Port-middle	CETA 2 (stbd) WIF 1 Port-nadir	CETA 2 (stbd) WIF 2 Stbd-nadir  ULF4: Pitch setting stuck in FF	CETA 2 (stbd) WIF 3 Stbd-zenith	CETA 2 (stbd) WIF 4 Port-zenith	CETA 2 (stbd) WIF 5 Port-middle
Post STS 133	[30,1,LL]	[0,6,GG]	[1,12,GG]	[12,DD]	[12,DD]	[0,12,GG]	[0,12,FF]	[1,12,GG]	[12,GG]	[12,GG]
Post EVA 1	...	...	...	...	...	...	...	...	...	...
Post EVA 2	...	...	...	...	...	...	...	...	...	...
Post EVA 3	...	...	...	...	...	...	...	...	...	...
Post EVA 4	...	...	...	...	...	...	...	...	...	...

CETA 1 (port) Port Brake Handles	CETA 1 (port) Stbd Brake Handles	CETA 2 (Stbd) Port Brake Handles	CETA 2 (Stbd) Stbd Brake Handles
Folded over and wiretied to each other Handles FWD and NOT wiretied to cart	Straight and Locked No Wireties	Straight and Locked No Wireties	Straight and Locked No Wireties

### NOTE

- Settings highlighted red are unconfirmed. This table was created during STS-132/ULF4. All WIFs and swingarms not used on ULF4 are assumed unconfirmed
- PORT CETA cart is NOT configured for translation to WS 8 unless the SARJ is parked for the duration
- STBD CETA cart is NOT configured for translation to WS 1 unless the SARJ is parked for the duration

## SAFETY TETHERS STS-134/ULF6

### 55-FT SAFETY TETHERS

	#67 s/n 1017 Lg-sm	#68 s/n 1018 Lg-sm  (retracting issues – ULF4)	#69 s/n 1019 Lg-sm	#72 s/n 1022 Lg-sm
ULF5 Stage	INSIDE: Tether staging area	INSIDE: Tether staging area	INSIDE: Tether staging area	INSIDE: Tether staging area
Post EVAs 1, 2, 3	INSIDE: Tether staging area	INSIDE: Tether staging area	INSIDE: Tether staging area	INSIDE: C/L deployed in STP
Post EVA 4	INSIDE: Tether staging area	INSIDE: Tether staging area	INSIDE: Tether staging area	INSIDE: C/L deployed in STP

### 85-FT SAFETY TETHERS

	#22 s/n 1002 Lg-sm  (2 J/A – retracting issue)	#21 s/n 1001 Lg-sm  (GMT201 Tether Inspect – only 1 through tack stitch)	#24 s/n 1004 Lg-sm	#29 s/n 1009 Lg-sm	#26 s/n 1006 Lg-sm	#23 s/n 1003 Lg-sm	#28 s/n 1008 Lg-sm	#30 s/n 1010 Lg-sm
ULF5 Stage	INSIDE: Tether staging area	INSIDE: Tether staging area	INSIDE: Tether staging area	INSIDE: Tether staging area	INSIDE: Tether staging area	INSIDE: Tether staging area	<b>STS-134/ULF6 Middeck</b>	<b>STS-134/ULF6 Middeck</b>
Post EVAs 1, 2, 3	INSIDE: C/L Deployed in STP	INSIDE: Tether staging area	INSIDE: C/L Deployed in STP	INSIDE: Tether staging area	<b>External: Deployed in STP</b>	<b>External: Deployed in STP</b>	<b>External: Deployed in STP</b>	<b>External: Deployed in STP</b>
Post EVA 4	INSIDE: C/L deployed in STP	INSIDE: Tether staging area	INSIDE: C/L deployed in STP	INSIDE: Tether staging area	<b>INSIDE: C/L deployed in STP</b>	<b>INSIDE: C/L deployed in STP</b>	<b>STS-134/ULF6 Middeck</b>	<b>STS-134/ULF6 Middeck</b>

## TOOLBOX STOWAGE – STS-134 (ULF6)

	Z1 PORT TOOLBOX (MMOD Damage – potential sharp edges) {all slots have sliders}	Z1 STBD TOOLBOX (MMOD Damage – potential sharp edges) {all slots have sliders}	A/L TOOLBOX 1 (STBD)	A/L TOOLBOX 2 (PORT)
<b>SLOT # 1</b>	SQUARE TM BOARD {stbd door} SQ TORQUE MULTIPLIER 7/16" FLUSH SQ SOCKET 7/16" PROUD SQ SOCKET 7/16" RECESSED SQ SOCKET		HAMMER BOARD {nadir door} HAMMER	CABLE CUTTER BOARD {zenith door} COMPOUND CUTTERS (SM) SCISSORS
<b>SLOT # 2</b>		QD BAIL TOOL BOARD {stbd door} BMRRM LATCH TOOL QD BAIL DRIVE TOOL (1")	PLIERS BOARD {nadir door} NEEDLE NOSE PLIERS	
<b>SLOT # 3</b>	RATCHET BOARD {middle} 7/16" X 12" WOBBLE SOCKET 7/16" X 2" RIGID SOCKET	RATCHET BOARD {middle} 7/16" X 6" WOBBLE SOCKET 7/16" X 12" WOBBLE SOCKET RATCHET WRENCH RIGHT ANGLE DRIVE	{only slot with slider}	{only slot with slider}
<b>SLOT # 4</b>				
<b>SLOT # 5</b>	ROUND TM BOARD {port door} RND TORQUE MULTIPLIER 5/8" PROUD RND SOCKET 7/16" FLUSH RND SOCKET 7/16" PROUD RND SOCKET		ADJ WRENCH BOARD {zenith door} FORCEPS WRENCH, ADJ	T-HANDLE TOOL BOARD {nadir door} 1-8" T-TOOLS
<b>SLOT # 6</b>	TRASH BAG BOARD {stbd door} SMALL TRASH BAG	TRASH BAG BOARD {stbd door}	HYDRAZINE BRUSH BOARD {nadir door} HYDRAZINE BRUSH	
<b>SLOT # 7</b>	SOCKET BOARD {port door} 5/32" BALL END ALLEN DR 1/2" X 8" WOBBLE SOCKET 5/16" X 7" RIGID SOCKET	SOCKET BOARD {port door} 5/32" BALL END ALLEN DR 1/2" X 8" WOBBLE SOCKET 5/16" X 7" RIGID SOCKET	PRD (Toolboard) {zenith door} PRD	PRD (Toolboard) {nadir door} PRD
<b>PANEL # 8</b>	CHEATER BAR PANEL {stbd door} CHEATER BAR GP CADDY CANNON CONNECTOR TOOLS (2)	CHEATER BAR PANEL {stbd door} CHEATER BAR ADJ EQUIP TETHER	TOOL CADDY PANEL {nadir door}	
<b>PANEL # 9</b>	18" SOCKET PANEL {port door} 7/16" X 18" WOBBLE SOCKET	18" SOCKET PANEL {port door} 7/16" X 18" WOBBLE SOCKET	BOLT PULLER PANEL {zenith door} BOLT PULLER MECHANICAL FINGER	LARGE CUTTER PANEL {nadir door} LARGE CUTTERS (-303)
<b>EXTERNAL</b>	1 ROUND SCOOP w/D-HANDLE (on zenith micro) (D-handle taped over repaired MMOD damage) D-HANDLE on port side of toolbox	<u>NOTE</u> D-Handle will not stow on the side of this toolbox due to an interference with the CMG MLI		

## TOOLBOX PANEL AND SLOT LABELS

### NOTE

- A/L Toolbox: Slider feature located in center slot only (#3)
- Z1/CETA Toolbox: Slider feature located in all slots

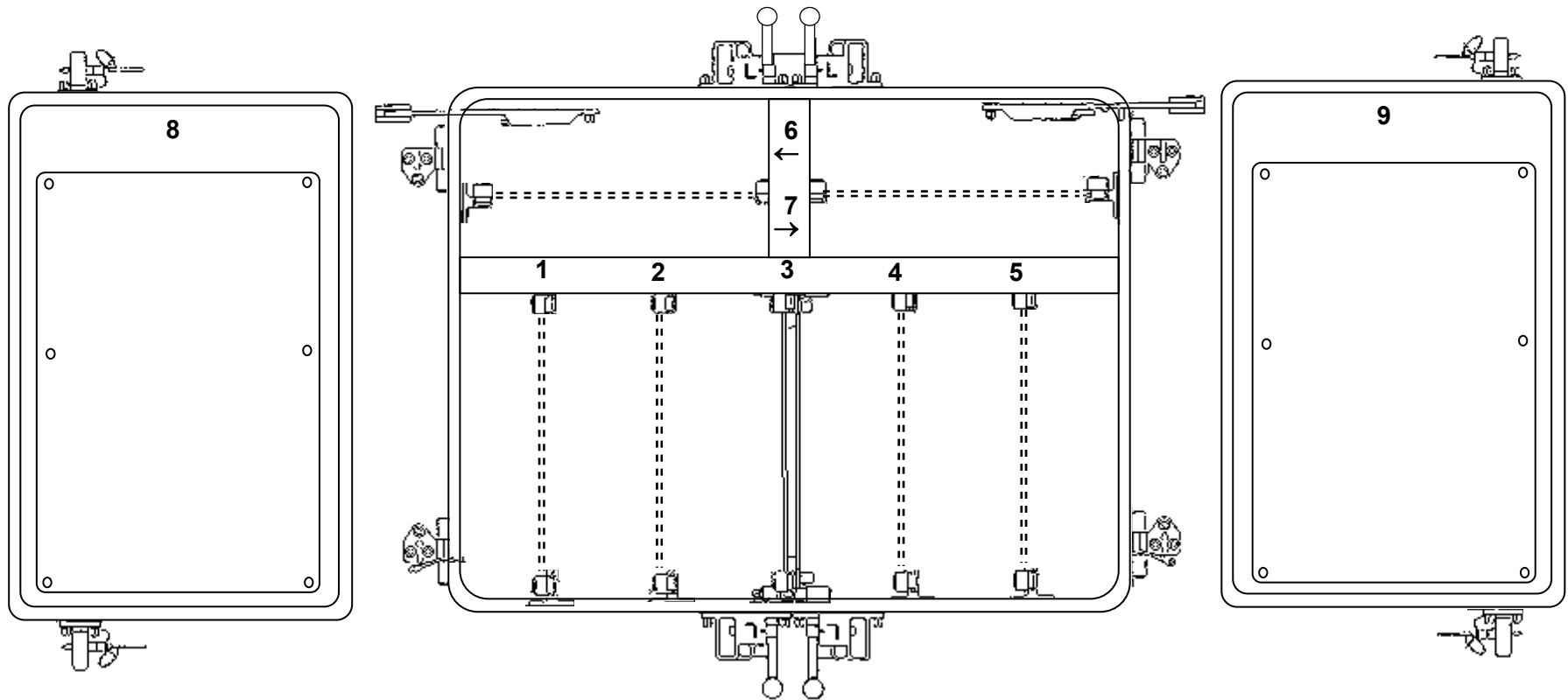

# Z1 TOOLBOX INTERNAL LAYOUT

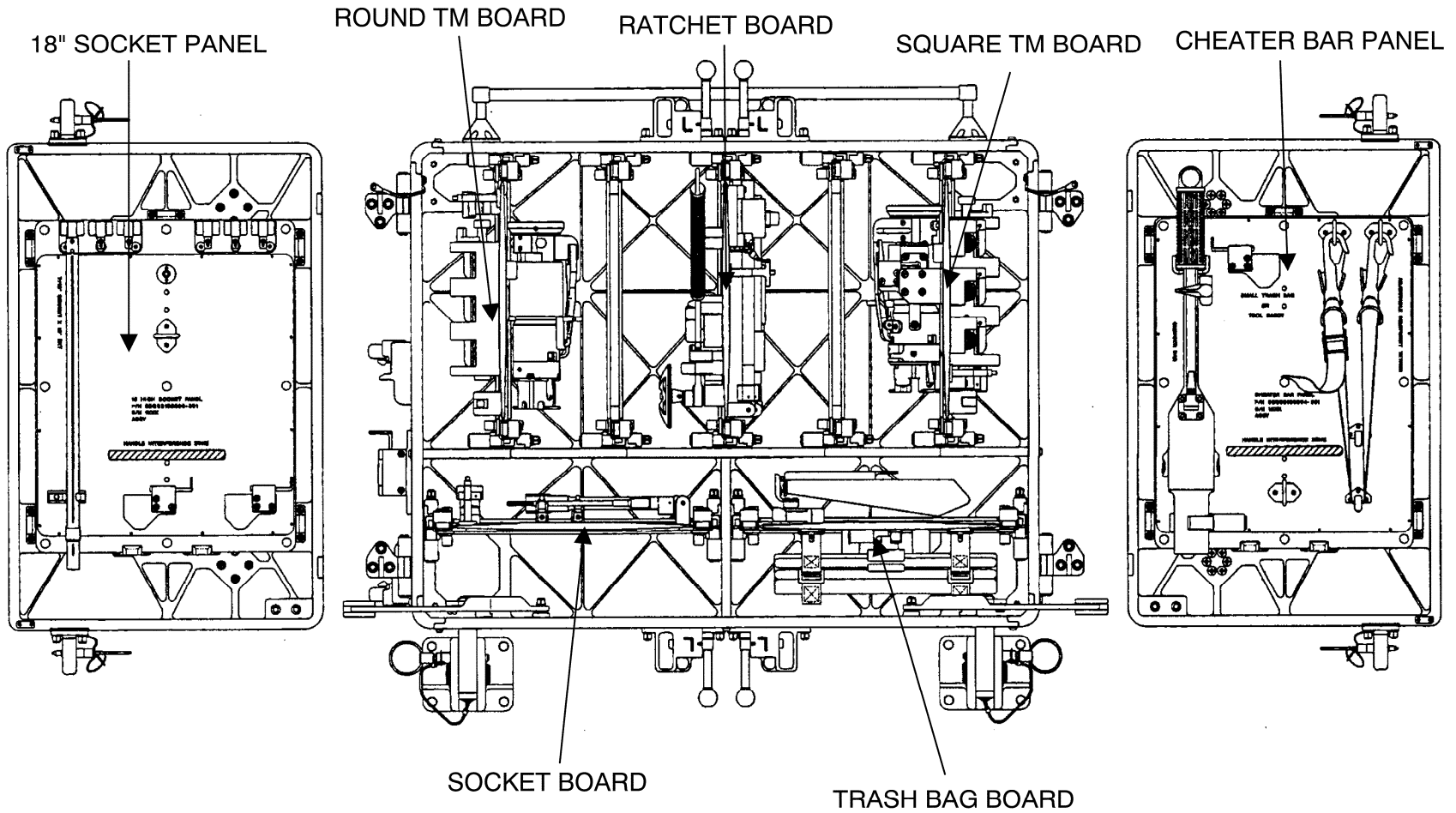



AIRLOCK TOOLBOX INTERNAL LAYOUT

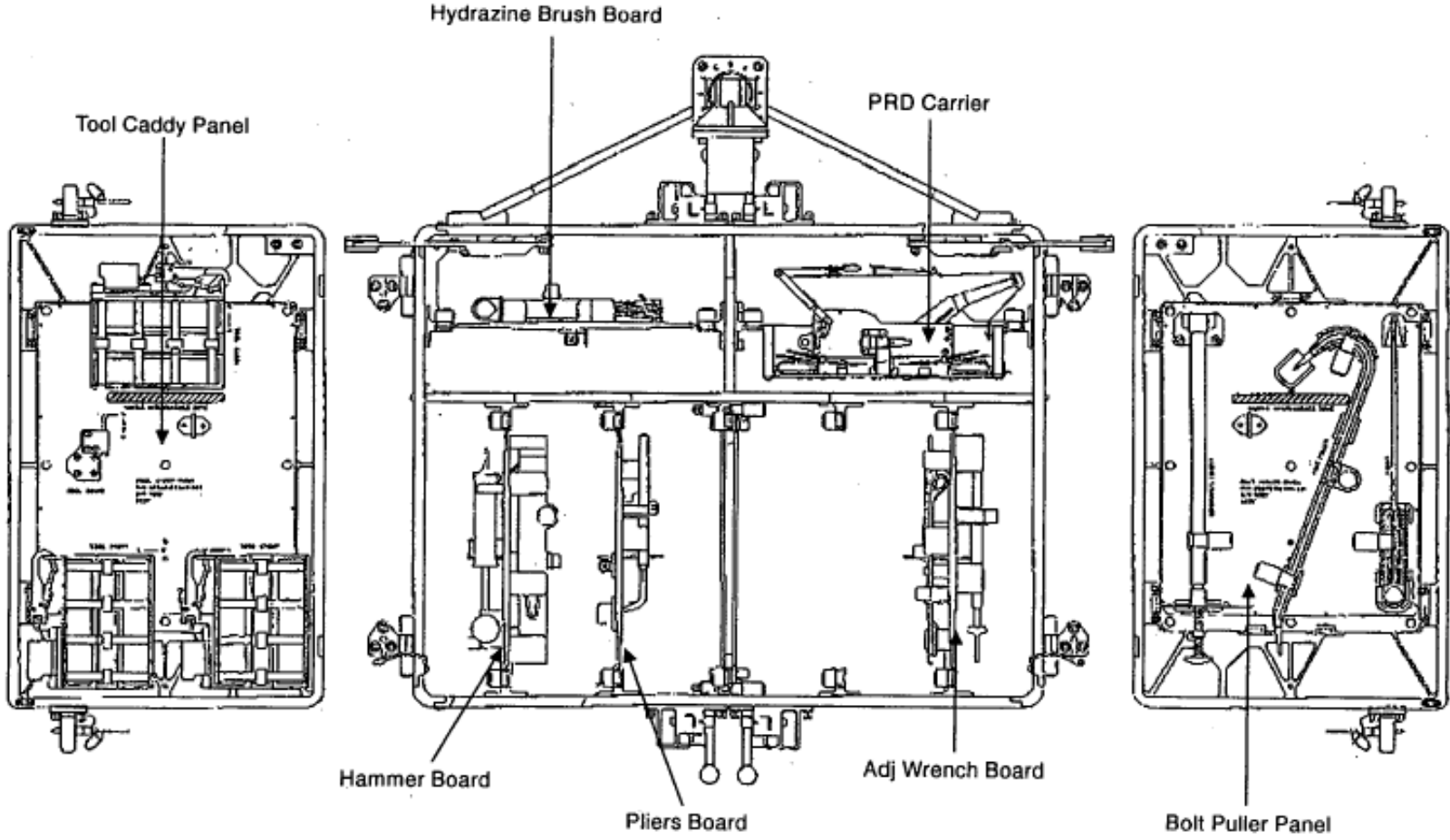

## FLUID QD BAG LAYOUT

QD TOOL BAG #1, STBD (SEG33114667-301/1001)							
	TOOL	PART#	LOCATION POST ULF5	LOCATION POST EVA 1	LOCATION POST EVA 2	LOCATION POST EVA 3	LOCATION POST EVA 4
1	1/4" Cap Tool	GD2043725	1/4" Cap Tool Pkt				1/4" Cap Tool Pkt
2	1/2" Cap Tool	GD2043730	1/2" Cap Tool Pkt				1/2" Cap Tool Pkt
3	1" Cap Tool	GD2043325	1" Cap Tool Pkt	ISS A/L internal	ISS A/L internal (EV2 ORU bag during EVA)	1" Cap Tool Pkt	1" Cap Tool Pkt
4	3/4" & 1" QD Bail Drive lever	SDG33113838-703	3/4" & 1" QD Bail Drive Lever pouch on Lid				3/4" & 1" QD Bail Drive Lever pouch on Lid
5	1.5" QD Bail Drive Lever	SDG33113837-701	1.5" QD Bail drive lever pouch on lid				1.5" QD Bail drive lever pouch on lid
6	1.5" NH3/N2 Vent Tool – F	1F9859-1/01	Pkt F: 1.5" NH3/N2				Pkt F: 1.5" NH3/N2
7	1" H2O/N2 Vent Tool – F	1F98593-1/01	Pkt E: 1" H2O/N2				Pkt E: 1" H2O/N2
8	3/4" NH3/N2 Vent Tool – F	1F98597-1/01	Pkt D: 3/4" NH3/N2				Pkt D: 3/4" NH3/N2
9	1" NH3/N2 Vent Tool – F	1F98589-1/T	Pkt A: 1" NH3/N2				Pkt A: 1" NH3/N2
10	1" N2 Vent Tool – M	1F98596-1/01	Pkt B: 1" NH3/N2 (male tool)				Pkt B: 1" NH3/N2 (male tool)
11	1/4" NH3/N2 Vent Tool – F	1F98592-1/01	Pkt C: 1/4" NH3/N2				Pkt C: 1/4" NH3/N2
12	1.5" QRT & FID Gauge	SEG33114617-701	Pkt FID/Gauge				Pkt FID/Gauge
13	3/4" & 1" QRT & FID Gauge	SEG33114616-701	Pkt FID/Gauge				Pkt FID/Gauge

☐→Ensure cap  
tools (3) are  
friction fitted

☐→Close all  
QRT tool  
flaps (2)

☐→Close all  
vent tool  
flaps (6)

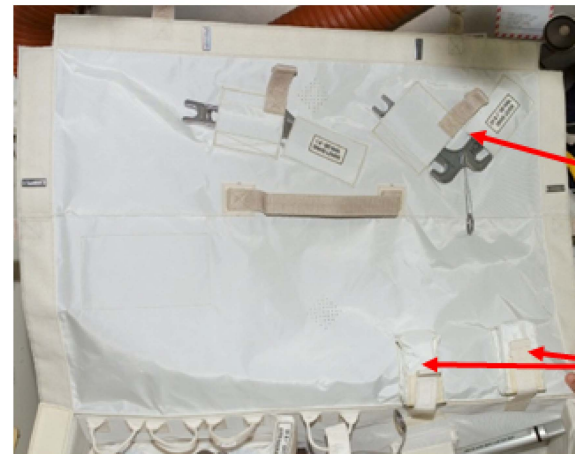
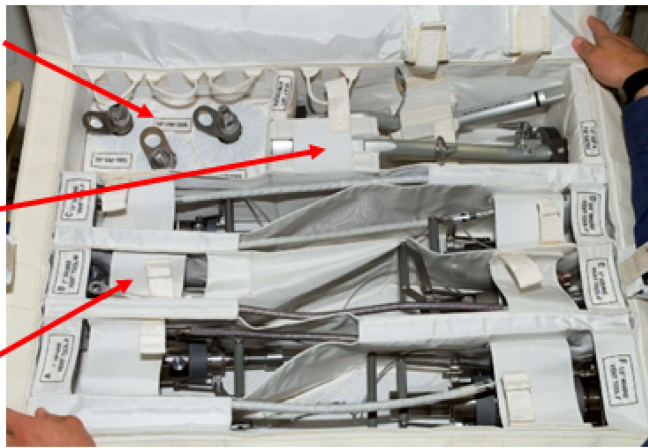

☐→Close bail  
drive lever  
flaps (2)

☐→Internal bag  
straps (2)  
should be  
stowed in  
pouches

## FLUID QD BAG LAYOUT (Cont)

### QD TOOL BAG #2, PORT (SEG33114667-301/1002)

	TOOL	PART#	LOCATION POST ULF5	LOCATION POST EVA 1	LOCATION POST EVA 2	LOCATION POST EVA3	LOCATION POST EVA 4
1	1/4" Cap Tool	GD2043725	1/4" Cap Tool Pkt				1/4" Cap Tool Pkt
2	1/2" Cap Tool	GD2043730	1/2" Cap Tool Pkt				1/2" Cap Tool Pkt
3	1" NH3/N2 Vent Tool – F	1F98589-1	Pkt A: 1" NH3/N2	<b>VTEB</b>	VTEB	VTEB	VTEB
4	1.5" NH3/N2 Vent Tool – F	1F9859-1/02	VTEB	<b>Pkt F: 1.5" NH3/N2</b>	Pkt F: 1.5" NH3/N2	Pkt F: 1.5" NH3/N2	Pkt F: 1.5" NH3/N2
5	1" H2O/N2 Vent Tool – F	1F98593-1/02	Pkt E: H2O/N2				Pkt E: H2O/N2
6	3/4" NH3/N2 Vent Tool – F	1F98597-1/02	Pkt D: 3/4" NH3/N2				Pkt D: 3/4" NH3/N2
7	1/4" NH3/N2 Vent Tool – F	1F98592-1/02	Pkt C: 1/4" NH3/N2				Pkt C: 1/4" NH3/N2
8	1/4" BDT	SEG33114984-301/001	Pkt C: 1/4" NH3/N2 w/adj tether				Pkt C: 1/4" NH3/N2 w/adj tether
9	3/4" BDT	SEG33114986-301/001	Pkt C: 1/4" NH3/N2 w/adj tether				Pkt C: 1/4" NH3/N2 w/adj tether
10	3/4" AKT	SEG33114983-301/1001	Pkt FID/Gauge: Stowed w/Adj tether to int loop				Pkt FID/Gauge: Stowed w/Adj tether to int loop
11	Vent Tool Adapter	SEG33119079-301	Pkt FID/Gauge: Stowed w/Adj tether to int loop				Pkt FID/Gauge: Stowed w/Adj tether to int loop
12	Vent Tool Adapter	SEG33119079-301	Pkt FID/Gauge: Stowed w/Adj tether to int loop	<b>VTEB</b>	VTEB	VTEB	VTEB

3/4" BDT is tethered to internal bag loop using integral tool tether

3/4" AKT stowed with VTAs in QRT/FID pouch

1/4" and 3/4" BDTs are stowed on top of 1/4" vent tool

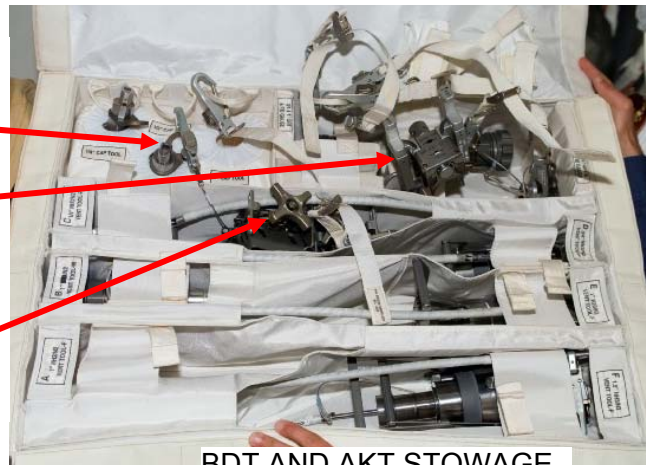

BDT AND AKT STOWAGE

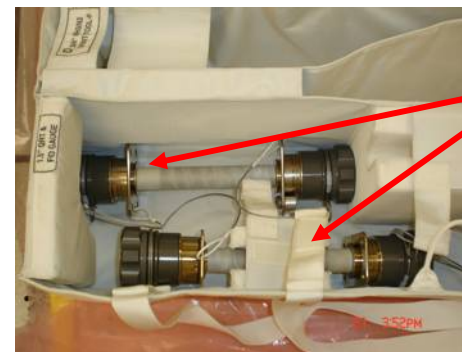

VENT TOOL ADAPTER STOWAGE

Vent Tool Adapters (2) are stowed in QRT/FID gauge pockets and need adj tethers

**FLUID QD BAG LAYOUT (Cont)**

<b>VENT TOOL EXTENSION BAG (SEG33119100-301/1001)</b>							
	<b>TOOL</b>	<b>PART#</b>	<b>LOCATION POST ULF5</b>	<b>LOCATION POST EVA 1</b>	<b>LOCATION POST EVA 2</b>	<b>LOCATION POST EVA 3</b>	<b>LOCATION POST EVA 4</b>
1	Vent Tool Extension	SEG33119090-301	Mated to 1.5" Vent tool	<b>VTEB with VTE plug</b>			VTEB with VTE plug
2	1.5" NH3/N2 Vent Tool – F	1F9859-1/02	Mated to VTE	<b>QD Bag 2, Pkt F</b>			QD Bag 2, Pkt F: 1.5" NH3/N2
3	MUT EE		Connected to VTE L-bracket				VTEB Connected to VTE L-bracket
4	Vent Tool Adapter	SEG33119079-301	QD Bag 2, Pkt FID/ Gauge	<b>VTEB</b>			VTEB
5	1" NH3/N2 Vent Tool – F	1F98589-1	Pkt A: 1" NH3/N2	<b>VTEB</b>			VTEB
6	Vent Tool Extension Plug		-	<b>VTEB mated to VTE</b>			VTEB Mated to VTE



S116E06137

<b>PUMP MODULE JUMPER BAG (SEG33119100-301)</b>			
<b>#</b>	<b>TOOL</b>	<b>PART #</b>	<b>LOCATION IN BAG</b>
1.	PUMP MODULE JUMPER ASSY	1F15818	<input type="checkbox"/> TETHERED BY 1 INTEGRAL TETHER TO HR ON JUMPER

# CETA CART CONFIG

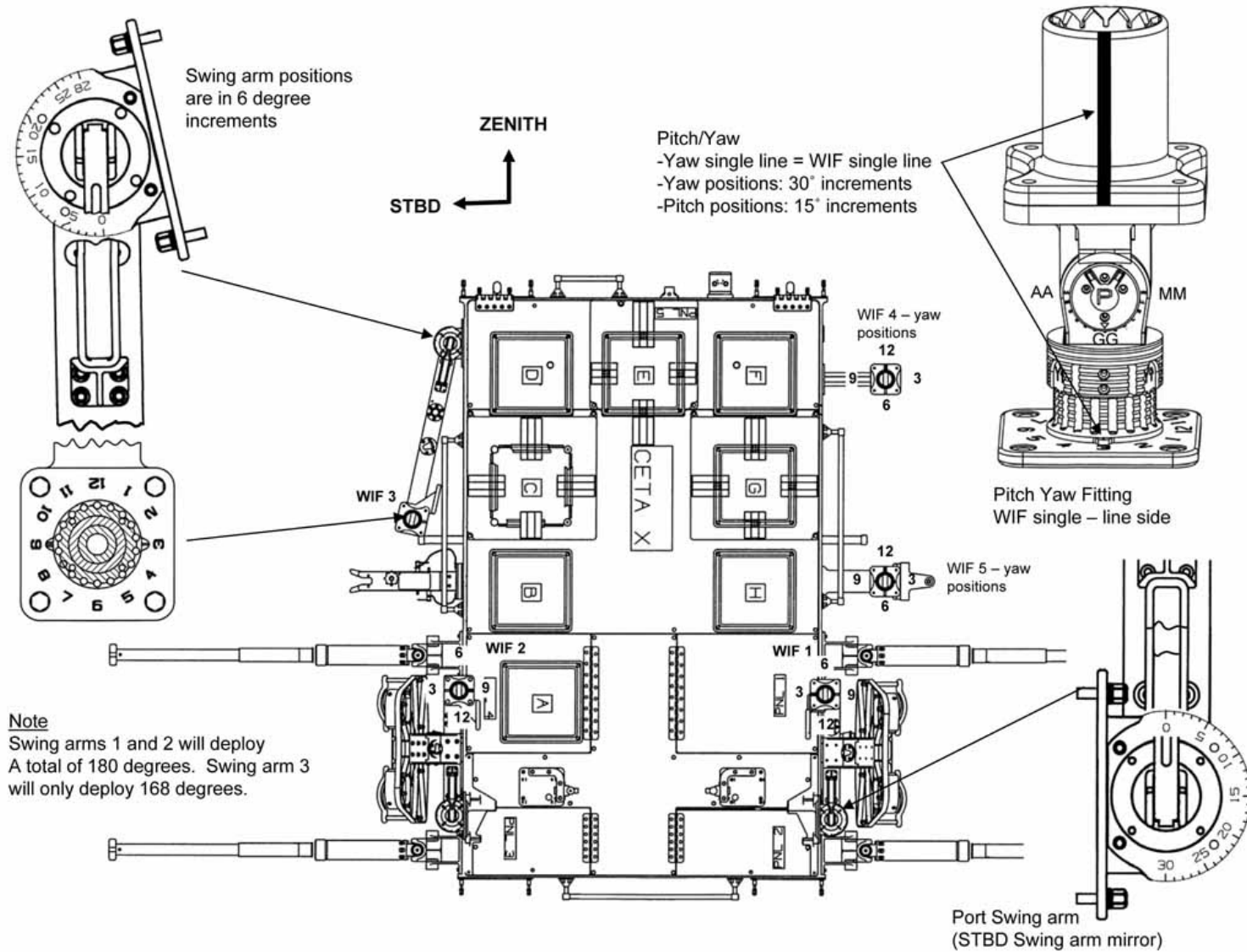



# CREW TETHER INSPECTIONS

## OBJECTIVE:

Inspect Load Alleviating Strap (LAS) on Safety Tethers, Waist Tethers and soft strap on D-Ring extenders. Prior to each set of EVAs (shuttle or ISS), all on-board tethers are to be inspected. Between each EVA, only those tethers used during the previous EVA require inspection.

## DURATION:

1 hour 30 minutes (Parts 1 and 2 on six waist tethers, six D-Ring extenders, and eight safety tethers)

Additional 30 minutes required to perform Part 3 on two tethers.

### NOTE

Standard tool config prep times only protect for performing Part 1 between EVAs on tethers used during the previous EVA.

## ITEMS REQUIRED (PART 2 OR 3):

### MATERIALS:

Sharpie

Ziplock Bag

### TOOLS:

Camera

### IS IVA Toolbox:

Drawer 5:

Tape Measure

### Tape Pantry

EVA Tape (1" Permacel Glass Cloth Tape) P/N P-213

## PART 1: PRIOR TO EACH EVA

1. Prior to EVA use, soft goods on each safety tether (LAS), waist tether (LAS) and D-Ring extender (strap) for that EVA must be inspected.

### 1.1 MMOD Inspection

Inspect the soft goods (LAS) of the Waist Tether and ERCM/Safety Tether and soft strap of the D-Ring extender for MMOD damage and discoloration, manipulating the sheath as needed to inspect between folds. The damage may appear as small or large holes in the LAS or as a tear/rip in the sheath. The MMOD damage may also appear in small concentrated areas of excessive fraying (as would be expected to be found in the vicinity of a hole). Soft goods should be white to yellow or tan in appearance. Soft goods showing a burnt brown or black discoloration should not be used. Refer to Figures 1, 2, 3.



## CREW TETHER INSPECTIONS (Cont)

### 1.2 D-Ring Extender

Inspect the soft strap of the D-Ring extender for MMOD damage, excessive wear and fraying.  
Refer to Figures 1, 2, 3.

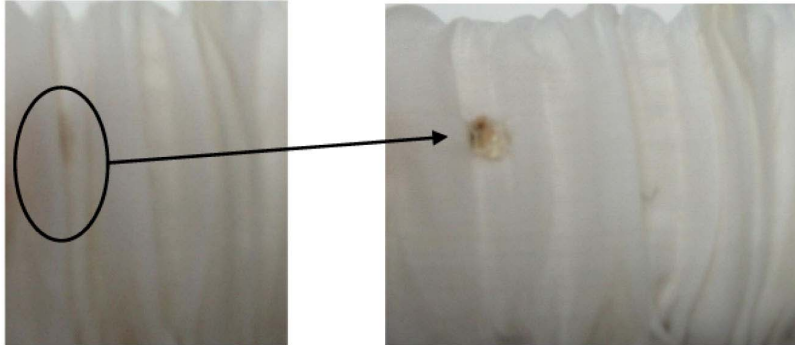

Figure 1. Damage Masked by Folds in LAS Sheath Exposed When Unbunched. (Note: Photo of ground-created damage.)

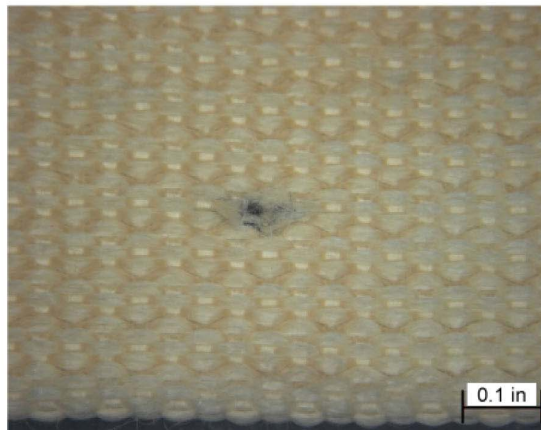

Figure 2. Picture Showing MMOD Damage Found in Flight AET.



Figure 3. Frayed D-Ring Extender; No-GO for Use.

### 1.3 LAS Base Inspection

Inspect base of LAS where strap attaches to ERCM D-Ring for any damage.  
Refer to Figure 4.

1.3.1 Smudging is acceptable.

## CREW TETHER INSPECTIONS (Cont)

- 1.3.2 If safety tether anchor hook is taped, inspect tape for wear or damage.



Figure 4. LAS Attachment to ERCM D-Ring.

### 1.4 Tack Stitching Inspection

Verify two surface and two through tack stitches still present on each LAS (waist tether and safety tether).

- 1.4.1 Verify through stitches still intact by gently moving sheath away from hook to expose threads through Nomex. Refer to Figures 5 and 6. Once verified, gently replace sheath over red indicator.

- 1.4.2 Visually verify surface stitches on nonseam side of tether

### 1.5 Red Indicator Inspection

If red showing and all tack stitches present

- 1.5.1 Gently pull the sheath back to cover red indicator. Due to tolerances, some red may still show (tether is GO as long as tack stitching still present.)
- 1.5.2 Note width of any remaining red showing.
- 1.5.3 Report S/N of any tethers with red still showing to **MCC-H**.

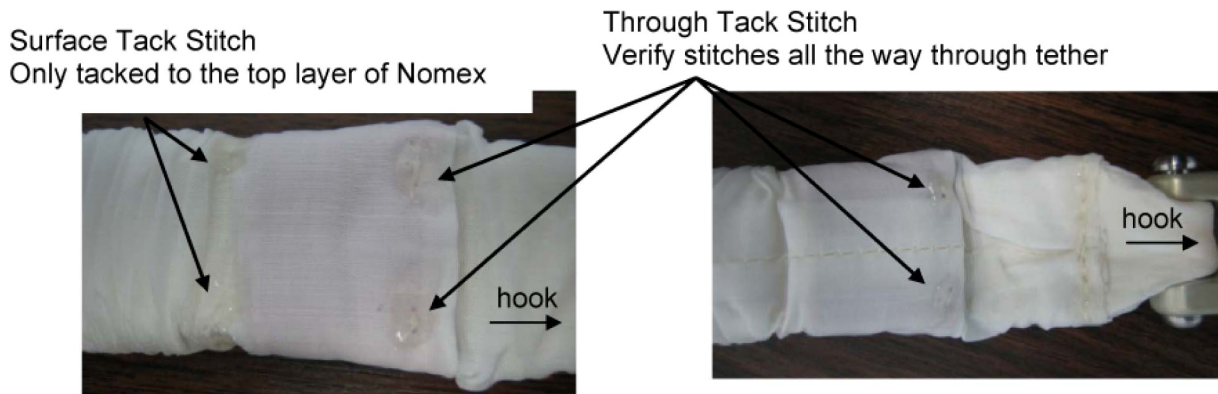

Figure 5. Top View (Non-Seam Side) and Bottom View (Seam Side).

## CREW TETHER INSPECTIONS (Cont)

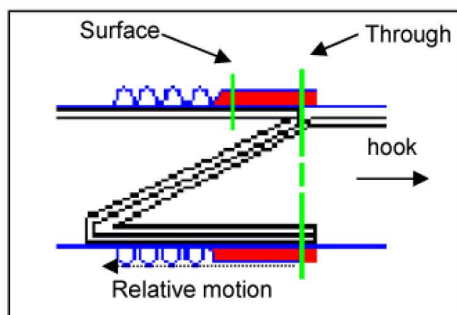

Figure 6. Cross-Section of Tack Stitching.

2. Report serial numbers to **MCC-H** with inspection results.
3. For any tethers with MMOD/other damage, fraying or missing tack stitching, proceed to Part 2.
4. Restow remaining tethers.

### PART 2: MMOD DAMAGE/MISSING TACK STITCHING EVALUATION

5. Retrieve Camera and Ziplock Bag(s).
6. If MMOD damage is found on LAS
  - 6.1 Smooth out the sheath at the damage location and take detailed photos of damage (with serial number in photo if possible). Refer to Figures 7 and 8. Note if any damage to the underlying Nomex strap is visible.
  - 6.2 Remove tether from usable inventory. Place tether in Ziplock Bag labeled, "No-GO for use". Report location and S/N to **MCC-H**.
  - 6.3 Report results to **MCC-H**.



Refer to Figure 8 for correct label location. For Waist Tethers, ensure label says Waist Tether Assy.

Figure 7. Photo of Partial Red Indicator Showing with Serial Number.

## CREW TETHER INSPECTIONS (Cont)

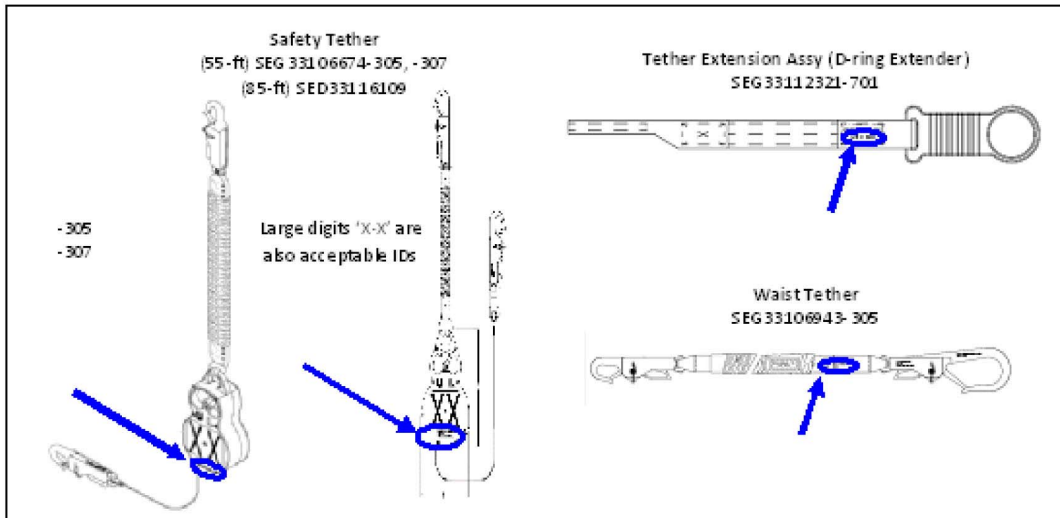

Figure 8. Serial Number References.

7. If tack stitches are broken
  - 7.1 Take detailed photos of tack stitches (with serial number in photo) for further engineering evaluation. Refer to Figure 7.
  - 7.2 Stow tethers per Table 1.

Table 1. Tether GO/No-GO Criteria

Broken Stitch	Action
One or both surface stitches broken	Gently smooth sheath away from hook so only a single layer covers the red indicator area. Return tether to usable inventory.
One through stitch broken, one through stitch intact and zero to two surface tack stitches intact	Return tether to usable inventory.
Two through stitches broken	Remove tether from usable inventory. Place tether in Ziplock Bag labeled "No-GO for use." Report location to <b>MCC-H</b> .

- 7.3 Report results to **MCC-H**.
8. If fraying or MMOD damage is found on D-Ring extender
  - 8.1 Take detailed photos of damage showing S/N of extender (if possible). Refer to Figure 9.
  - 8.2 Remove tether from usable inventory. Place tether in Ziplock Bag labeled "No-GO for use." Report location and S/N to **MCC-H**.

## CREW TETHER INSPECTIONS (Cont)

- 8.3 Report results to **MCC-H**.



Figure 9. D-Ring Extender Showing Serial Number.

9. If damage found on LAS base
- 9.1 Take detailed photos of damage with at least one photo showing tether number.
  - 9.2 Swap tether for spare.
  - 9.3 Remove tether from usable inventory. Place tether in Ziplock Bag labeled "No-GO for use." Report location and S/N to **MCC-H**.
  - 9.4 If tape damaged/worn on anchor hook, take detailed photos. Replace tape as necessary using EVA tape.
  - 9.5 Report results to **MCC-H**.

### PART 3: MEASURE LAS LENGTH (ON MCC-H GO)

- 10. Retrieve quarantined tethers, tape measure, Sharpie, and Camera.
- 11. Mark the desired length on a stable surface. Refer to Figures 10 and 11 for required lengths.
- 12. Measure quarantined tether against markings. Photograph results.
- 13. Report findings to **MCC-H**.
- 14. Stow tethers per **MCC-H** direction.

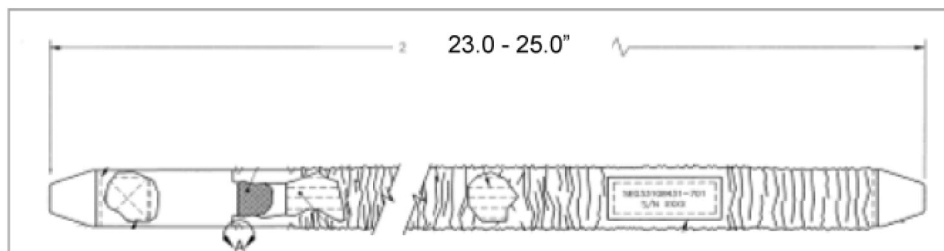

Figure 10. Waist Tether.







EMU MAINT/RECHARGE

WATER RECHARGE.....	TEMP FS 10-2
EMU POWERUP.....	TEMP FS 10-2
WATER FILL .....	TEMP FS 10-2
WATER FILL VERIFICATION .....	TEMP FS 10-2
EMU LiOH CHANGEOUT .....	10-4
MIDDECK EMU BATTERY RECHARGE (STAND-ALONE).....	10-4a
MIDDECK EMU BATTERY RECHARGE/LiOH REPLACEMENT .....	10-5
INITIATE .....	10-5
TERMINATE.....	10-6
IN-SUIT EMU BATTERY RECHARGE/CHARGE VERIFICATION.....	10-7
INITIATE .....	10-7
TERMINATE.....	10-7
EMU POWERDOWN .....	10-7
HELMET LIGHT/PGT BATTERY RECHARGE .....	10-8
INITIATE .....	10-8
TERMINATE.....	10-9
REBA BATTERY INSTALLATION .....	10-9
EMU BATTERY REMOVAL/INSTALL .....	10-10
HELMET LIGHT BULB CHANGEOUT .....	10-11
REBA BATTERY RECHARGE .....	10-12
INITIATE .....	10-12
TERMINATE.....	10-13
STS-134 CONSUMABLES TRACKING CUE CARD .....	FS CC 10-15
STS-134 EVA BATTERY RECHARGE PLAN .....	FS CC 10-16

## WATER RECHARGE

### IF EMU NOT ALREADY POWERED UP:

#### EMU POWERUP

- BOTH DCM
1. Retrieve, position SCUs; remove DCM covers
  2. Connect SCUs to DCM, √locked
  3. PWR – BATT

#### CAUTION

EMU must be on BATT pwr when  
airlock pwr supply is turned on

- AW18H
4. PWR/BATT CHGR EMU 1,2 MODE (two) – PWR  
BUS SEL (two) – MNA(MNB)
- MD(flr)
5. √EMU O2 ISOL VLV – OP
- AW82B
6. EV1,2 O2 vlv (two) – OP
- DCM
7. PWR – SCU

#### WATER FILL

- MO13Q
8. √ARLK H2O S/O VLV – OPEN (tb-OP)
- R11L
9. √SPLY H2O TKA OUTLET – CL (tb-CL)

#### SM 60 TABLE MAINT

- CRT
10. Use TKB quantity:  
PARAM ID – ITEM 1 +0 6 2 0 4 2 0 EXEC
  11. Log value before recharge

Recharge #	H2O TKB %
1	
2	
3	
4	
5	

- AW82D
12. √EMU 1,2 H2O WASTE tb (two) – CL  
SPLY (two) – OP (tb-OP)
  13. √H2O TKB quantity decreasing

#### NOTE

Full charge requires ~15 min

#### WATER FILL VERIFICATION

- DCM
14. √STATUS: **H2O WP** 8-15 psi and stable for ~30 sec (indicates charging complete)

#### SM 60 TABLE MAINT

- CRT
15. Use TKB quantity:  
PARAM ID – ITEM 1 +0 6 2 0 4 2 0 EXEC
  16. Log value after recharge

Recharge #	H2O TKB %
1	
2	
3	
4	
5	

EMU MAINT/  
RECHARGE

Cont next page

TEMP FS 10-2

134

EVA/ALL/FIN A

TOP

HOOK  
VELCRO

**STS-134 CONSUMABLES TRACKING CUE CARD**

		EV1	EV2	EV3	EV3
<b>Metox for Campout</b>	<b>S/N</b>	5 & 22	7 & 11	15 & 16	13 & 21

**PWR Usage:** Use 1026, 1005, 1007 in that order until drained

**Dump CWC:** 1059

	EV	EDDA SCU	EMU	LiOH (s/n)	EMU Batt (s/n)	REBA (s/n)	EHIP (HL) Batts (s/n)	ERCA (address)	SAFER (s/n)	PGT Batt (s/n)	PGT Batt Spare (s/n)
<b>EVA 1</b>	EV1 FT	AFT SCU1	3004	2012	3004	1007	1022 1025	18	1003		1005
	EV3 CF	FWD SCU2	3005	20__	3005	1012	1026 1028	20	1007	1011	
<b>Batt Post EVA</b>					X	X	X			X	X
<b>EVA 2</b>	EV1 FT	AFT SCU2	3004	2030	3006	1007	1029 1030	18	1003	1006	1009
	EV2 FN	FWD SCU1	3018	20__	3007	1009	1031 1035	20	1007	1008	
<b>Batt Post EVA</b>					X	X	X				
<b>EVA 3</b>	EV1 FT	AFT SCU1	3004	20__	3004	1007	1022 1025	18	1003		1011
	EV2 FN	FWD SCU2	3018	20__	3005	1009	1026 1028	20	1007	1009	
<b>Batt Post EVA</b>						X	X				
<b>EVA 4</b>	EV2 FN	FWD SCU2	3018	20__	3006	1009	1029 1030	20	1003		1011
	EV3 CF	AFT SCU1	3005	20__	3007	1012	1031 1035	18	1007	1005	
<b>Return Config</b>	EV1 FT	STBD SCU1	3004	20__	2089	N/A	N/A	N/A	N/A	N/A	N/A
	EV2 FN	PORT SCU2	3018	20__	2090	N/A	N/A	N/A	N/A	N/A	N/A

**NOTE:** SCU1 = double red, SCU2 = green; EMU Battery s/ns 20xx are ICB and 30XX are Li-Ion

(reduced copy)

EVA-5a/134/O/B I

FS CC 10-15

EVA/134/FIN A

TOP  
BACK OF 'STS-134 CONSUMABLES TRACKING CUE CARD'

HOOK  
VELCRO

STS-134 EVA BATTERY RECHARGE PLAN

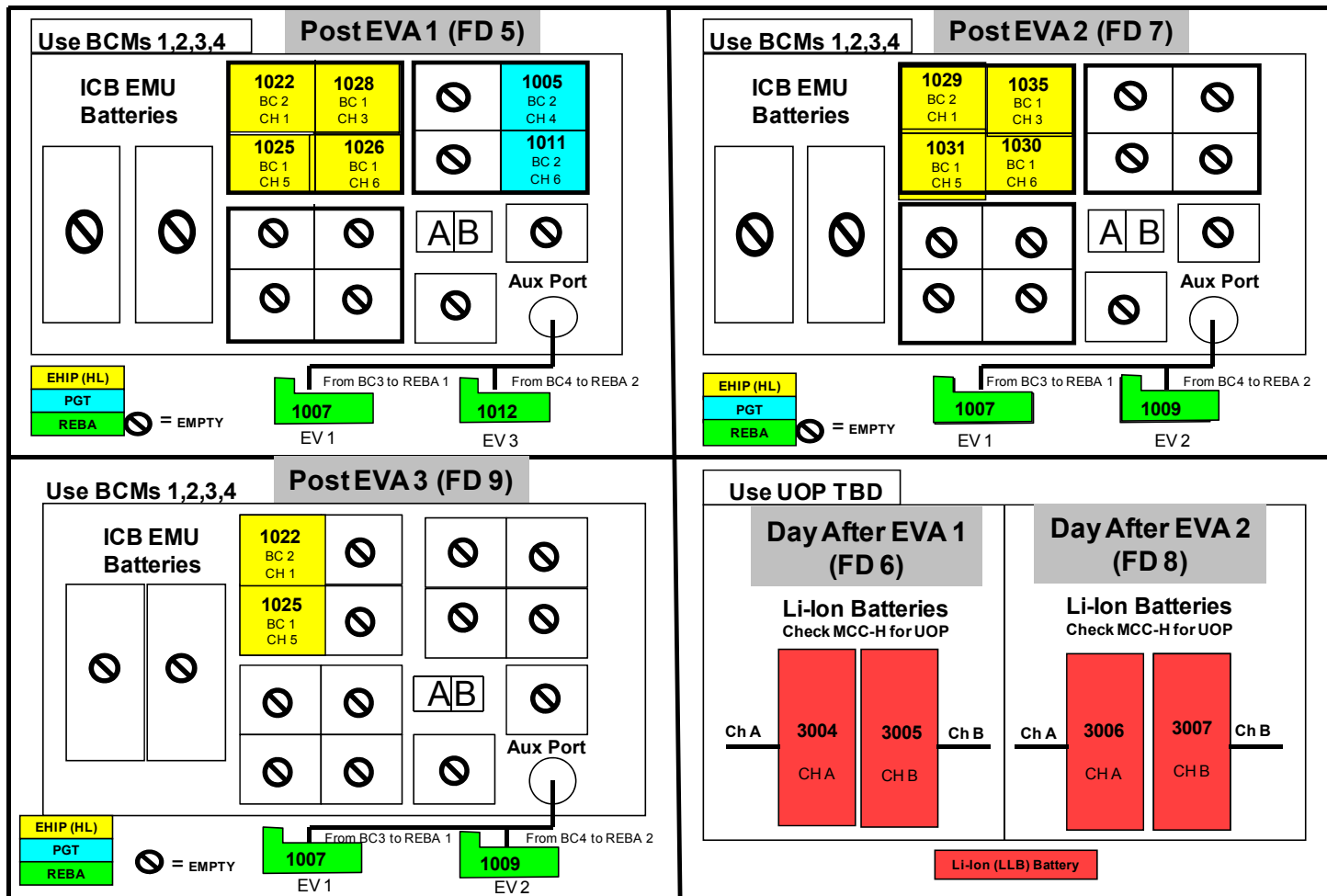

(reduced copy)

EVA-5b/134/O/B |

EMU CONTINGENCY PROCS

DISPLAY LOSS DURING POWER TRANSFER (WARM RESTART)..... TEMP FS 12-2  
VACUUM H2O RECHARGE (MANNED)..... TEMP FS 12-2  
LiOH REPLACEMENT (MANNED)..... 12-3  
BATTERY REPLACEMENT (MANNED) ..... 12-4  
WATER DUMP ..... 12-6  
SCU SWAP (UNMANNED)..... 12-7  
SCU SWAP (MANNED)..... 12-7  
EMU COLD RESTART (MANNED) ..... 12-7  
12.1 STS EVA DECONTAMINATION..... 12-8  
CONTAMINATION TEST..... 12-15  
SAFER BATTERY CHANGEOUT ..... 12-18  
BENDS TREATMENT ADAPTER (BTA) INSTALLATION (IN-SUIT) ..... 12-19  
    BTA PREP ..... 12-19  
    BTA TREATMENT ..... 12-20  
BENDS TREATMENT ADAPTER (BTA) INSTALLATION (POST SUIT DOFFING) ..... 12-21  
    BTA PREP ..... 12-21  
    BTA TREATMENT ..... 12-22  
EMU RESIZE ..... 12-25  
STS-134 NOMINAL EMU SIZING ..... FS 12-27  
EMU CONTINGENCY RESIZE MATRIX (STS-134/ULF6) ..... FS 12-30  
EXPEDITED SUIT DOFFING CUE CARD ..... FS CC 12-31  
EMERGENCY UNDOCKING EVA TRANSFER ..... FS CC 12-32





# STS-134 NOMINAL EMU SIZING

I

## Feustel (FT) – Up

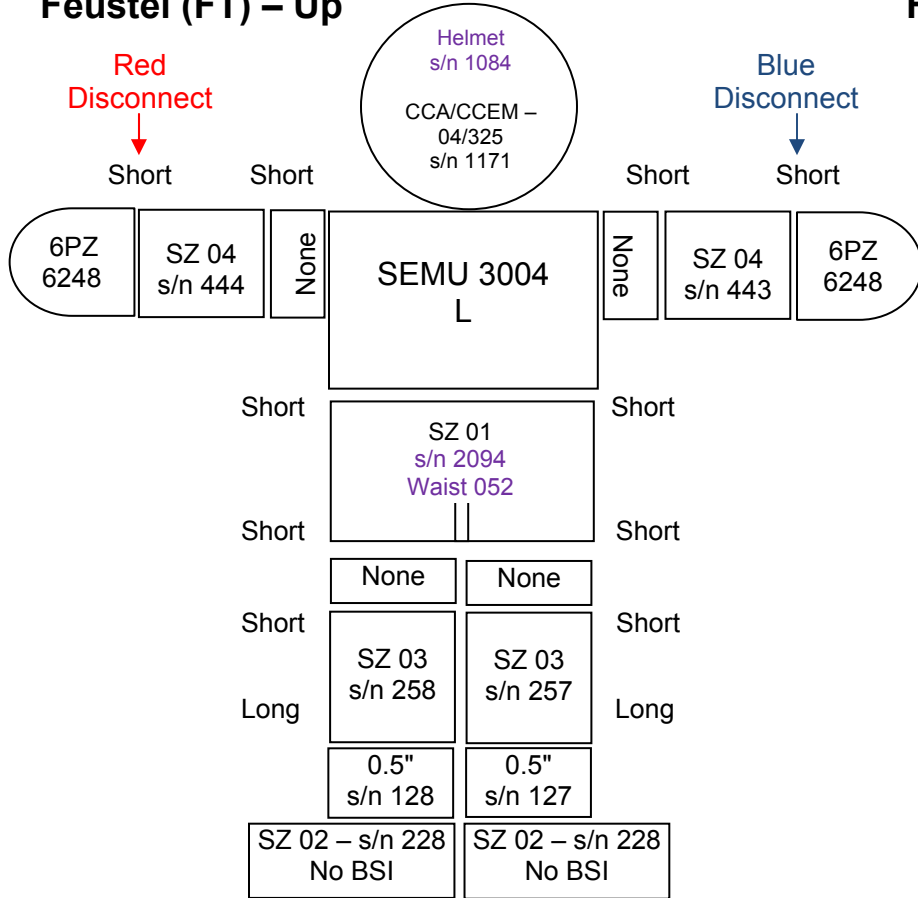

## Feustel (FT) – Dn

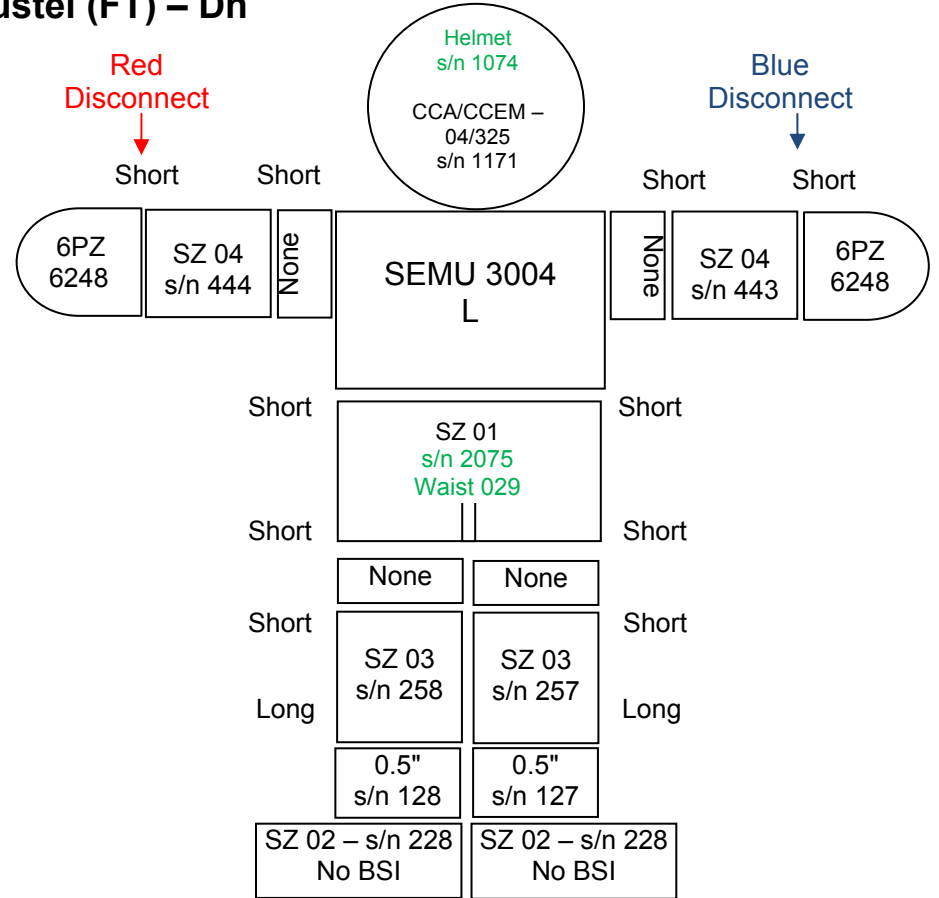

	Croakie	Fresnel	Valsalva	LCVG/BLVD	MAG	TCU Top	TCU Bottom	Comfort Gloves	Socks
FT	None	None	-308	04/05	709	M	S	Large, Thin	Tube

# STS-134 NOMINAL EMU SIZING (Cont)

## Fincke (FN) – Up

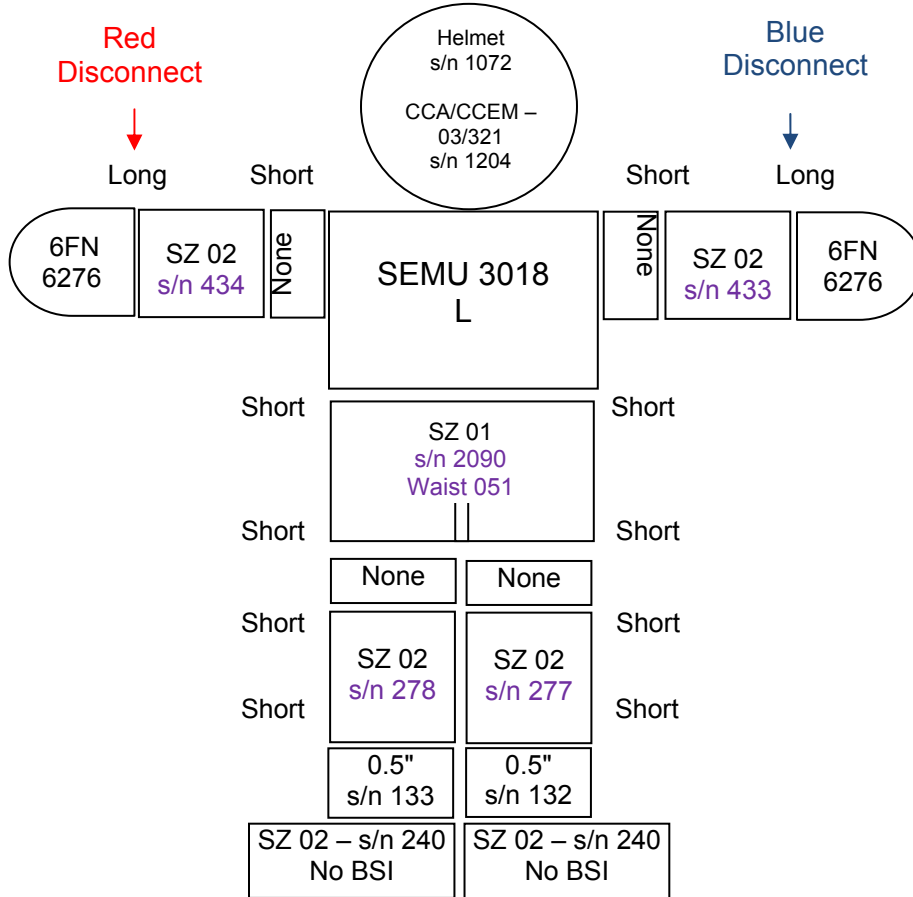

## Fincke (FN) – Down

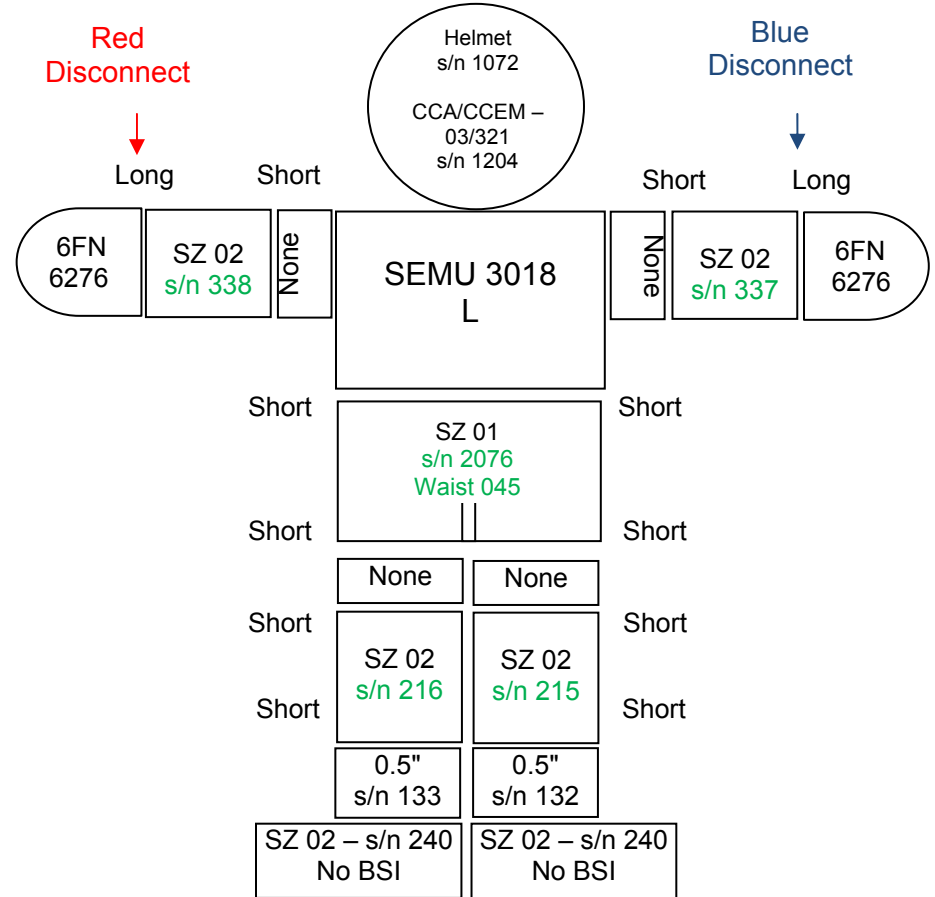

	Croakie	Fresnel	Valsalva	LCVG/BLVD	MAG	TCU Top	TCU Bottom	Comfort Gloves	Socks
FN	None	None	-309	03/04	709	M	S	Medium, Thick	Crew (10-13)

**STS-134 NOMINAL EMU SIZING (Cont)**

**Chamitoff (CF)**

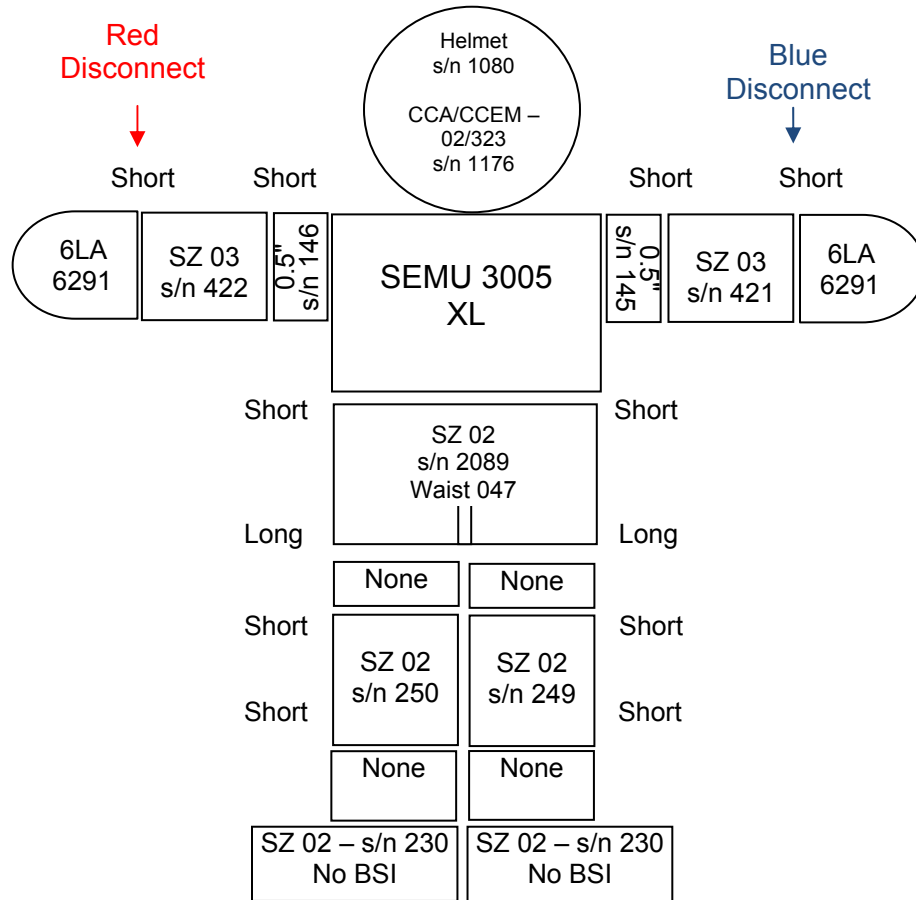

	Croakie	Fresnel	Valsalva	LCVG/BLVD	MAG	TCU Top	TCU Bottom	Comfort Gloves	Socks
CF	None	-019 -007	-308	05/05	711	XL	L	Custom Spectra [CF]	Poly Liner (L)

## EMU CONTINGENCY RESIZE MATRIX (STS-134/ULF6)

FOR LOSS OF:	EV1 – Feustel	EV2 – Fincke	EV3 – Chamitoff
<b>HUT/PLSS</b>	Use EMU 3010, Large 1. Remove arm assys/gloves 2. Use primary arms, FT gloves 3. ✓Arm red connects to right, ✓locks, ✓cams 4. Use primary LTA 5. Swap EMU PLSS identifier stripes, American flag 6. Swap helmet, CCA, LiOH, Li-Ion EMU battery, REBA, DIDB	Use EMU 3010, Large 1. Remove arm assys/gloves 2. Use primary arms, FN gloves 3. ✓Arm red connects to right, ✓locks, ✓cams 4. Use primary LTA 5. Swap EMU PLSS identifier stripes, American flag 6. Swap helmet, CCA, LiOH, Li-Ion EMU battery, REBA, DIDB	<u>INFO ONLY*</u> : Use HUT ORU 2026, XL 1. Use primary rings, arms, CF gloves 2. ✓Arm red connects to right, ✓locks, ✓cams 3. Use primary LTA 4. Swap EMU PLSS identifier stripes, American flag 5. Swap helmet, CCA, LiOH, Li-Ion EMU battery, REBA, DIDB
<b>CCA</b>	Use size 04/325 s/n 1172 Location FT ECOK	Use size 03/321 CCA s/n 1207 Location FN ECOK	Use size 02/323 CCA s/n 1210 Location CF ECOK
<b>Lower Arm Segment</b>	Use size 04 arm s/n 379 or 380 from ISS. Cams S/S (red = right, blue = left) 1. ✓Locks, ✓cams	Use size 02 arm s/n 337 or 338 from ISS. Cams S/L (red = right, blue = left) 1. ✓Locks, ✓cams	Use size 03 arm s/n 377 or 378 from ISS. Cams S/S (red = right, blue = left) 1. ✓Locks, ✓cams
<b>Gloves</b>	Back-up (FT2) in FT ECOK: 1. Use 6PZ gloves s/n 6268 2. ✓Locks, ✓cams	Back-up (FN2) in FN ECOK: 1. Use 6FN gloves s/n 6241 2. Cams L/L 3. ✓Locks, ✓cams	Back-up (CF2) in CF ECOK: 1. Use 6LA gloves s/n 6194 2. ✓Locks, ✓cams
<b>Waist Brief</b>	Use size 01 waist brief s/n 2075 (029) from ISS. Cams S/S 1. Use FT prime 03 legs, 0.5" leg rings, and 02 boots 2. ✓Locks, ✓cams 3. Swap EMU brief identifier stripes	Use size 01 waist brief s/n 2076 (045) from ISS. Cams S/S 1. Use prime FN 02 legs and 02 boots/No BSI 2. ✓Locks, ✓cams 3. Swap EMU brief identifier stripes	Use size 02 waist brief s/n 2092 (053) from ISS. Cams S/L 1. Use prime CF 02 legs and 02 boots/No BSI 2. ✓Locks, ✓cams 3. Swap EMU brief identifier stripes
<b>Leg Segment</b>	Use size 03 leg s/n 251 or 252 from ISS. Cams S/L 1. Use FT prime 0.5" leg rings 2. ✓Locks, ✓cams	Use size 02 leg s/n 215 or 216 from ISS. Cams S/S 1. ✓Locks, ✓cams	Use size 02 leg s/n 215 or 216 from ISS. Cams S/S 1. ✓Locks, ✓cams
<b>Boot</b>	Use size 02 boots s/n 234 from ISS 1. No BSI 2. ✓Locks	Use size 02 boots s/n 234 from ISS 1. No BSI 2. ✓Locks	Use size 02 boots s/n 234 from ISS 1. No BSI 2. ✓Locks
<b>Sizing Rings</b>	• <u>0.5" Leg</u> : Use s/n 115 or 116 from ISS	• <u>0.5" Leg</u> : Use s/n 115 or 116 from ISS	• <u>0.5" Arm</u> : Use s/n 171 or 172 from ISS
<b>Signal Conditioner</b>	Use s/n 117 from OBS IVA kit	Use s/n 117 from OBS IVA kit	Use s/n 123 from ISS
<b>LCVG</b>	Use s/n 3226 (FT 2) from Shuttle 1. Transfer biomed, dosimeter	Use s/n 3199 (FN 2) from Shuttle 1. Transfer biomed, dosimeter	Use s/n 3239 (CF 2) from Shuttle 1. Transfer biomed, dosimeter

\*If EMU 3005 is no go, the pre-flight agreement is that Feustel and Fincke would become the EV crew, and Chamitoff would become Task IV

TOP

HOOK  
VELCRO

## EXPEDITED SUIT DOFFING CUE CARD

### CAUTION

Verify EV crew is clear of hatch mechanism.

- IV When equalization complete:  
1. Open IV Hatch per decal
- SUIT DOFFING
- DCM 2. O2 ACT → OFF  
3. PURGE vlv → op (up)  
4. sw REBA → OFF (toward left arm of suit)  
5. EMU TV Power Cable ←|→ EMU TV  
6. √STATUS: [SUIT P] < 0.4 (compare with gauge)  
7. Glove ←|→ EMU (leave donned, disconnected)  
8. Helmet ←|→ EMU
- DCM 9. sw FAN → OFF
- SAFER DOFFING
- SAFER 10. Latch → ENG  
11. Latch ↷ until release (~90 deg)  
12. PLSS ←|→ Thruster Towers
- SAFER DOFFING cont.
- PLSS 13. Engage EMU in EDDA.  
14. Lower Arm Cables ←|→ Gloves  
15. Gloves ←|→ EMU  
16. Comm Mode → OFF  
17. Doff EMU.
- If taking EMUs to shuttle:
- UJA 18. sw PWR EV-1,2 (two) → OFF  
√PWR EV-1,2 LEDs (four) – Off
- DCM 19. SCU ←|→ DCM  
20. LTA →|← HUT  
21. Gloves →|← EMU  
22. Helmet →|← EMU  
23. Go to **EMERGENCY UNDOCKING EVA TRANSFER** on reverse side

EVA-6a/134/O/A

TOP  
BACK OF 'EXPEDITED SUIT DOFFING CUE CARD'

HOOK  
VELCRO

## EMERGENCY UNDOCKING EVA TRANSFER

### Critical

#### Take

- EMUs (FT & FN)
- Comm caps (FT & FN)
- Gloves (FT & FN)
- 85-ft Safety Tethers (2) (*prefer 28 and 30*)
- Shuttle EVA Checklist

#### Remove from EMUs, if time permitting

- *Helmet Lights/ERCA*
- *Li-Ion EMU Batteries*
- *REBAs*
- *ISS Tethers and Tools*
- *Biomed Pigtaills*

### Desired

- LCVGs (FT & FN)
- ECOKs (FT, FN, & CF)
- CF Comm cap, Gloves, LCVG

EVA-6b/134/O/B I



## TPS REPAIR

The TPS Repair procedures listed below are not published in the hardcopy EVA Flight Supplement. These procedures will be uplinked realtime if they are required.

A PDF and a WORD version of the procedures can be found at:  
<http://mod.jsc.nasa.gov/do3/FDF/FDFBooks/Status%20Sheets/index.html>.

Select the "As Flown" Status sheet for STS-134 and the link to the procedures can be found with the link to the EVA FS. The procedures can also be found on the FDF Books CD provided to the FAO console

<b>BOOM TPS INSPECTION</b>	
BOOM POINT INSPECTION SUMMARY TIMELINE .....	FS 13-3
BOOM POINT INSPECTION TOOL CONFIG.....	FS 13-4
BOOM POINT INSPECTION .....	FS 13-5
BOOM WLE MAPPING SUMMARY TIMELINE .....	FS 13-15
BOOM WLE MAPPING TOOL CONFIG .....	FS 13-17
BOOM WLE MAPPING.....	FS 13-18
EVA WLE MAPPING INSPECTION.....	FS 13-24
<b>BOOM CONTINGENCY</b>	
BOOM FRGF SHAFT RELEASE .....	FS 13-29
BOOM FRGF SHAFT INSTALLATION .....	FS 13-30
BOOM EFGF SHAFT RELEASE .....	FS 13-32
BOOM MPM STOW/DEPLOY.....	FS 13-34
BOOM ASSISTED LATCHING .....	FS 13-35
<b>TILE REPAIR</b>	
EMU PREP FOR TPS REPAIR.....	FS 13-36
POST TPS REPAIR DOFFING .....	FS 13-37
EWA MATERIAL MIXING .....	FS 13-38
EWA REF DATA .....	FS 13-39
EWA TILE REPAIR – DOCKED/ORM SUMMARY TIMELINE .....	FS 13-40
EWA TILE REPAIR – DOCKED/ORM TOOL CONFIG.....	FS 13-41
EWA TILE REPAIR – DOCKED/ORM .....	FS 13-42
SSRMS GAP FILLER REMOVAL SUMMARY TIMELINE .....	FS 13-50
BOOM GAP FILLER REMOVAL SUMMARY TIMELINE .....	FS 13-51
GAP FILLER REMOVAL.....	FS 13-52
<b>RCC REPAIR</b>	
RCC CRACK REPAIR BAG ASSEMBLY.....	FS 13-57
TEMP SENSOR DISASSEMBLY POST-EVA.....	FS 13-60
RCC CRACK REPAIR BAG DISASSEMBLY POST-EVA .....	FS 13-61
TEMPERATURE PROBE ASSEMBLY .....	FS 13-63
CRM APPLICATOR ASSEMBLY .....	FS 13-63
CRM APPLICATOR NOZZLE INSTALLATION (DAY OF EVA).....	FS 13-64
RCC CRACK REPAIR.....	FS 13-65
RCC PLUG TRANSFER BAG ASSEMBLY .....	FS 13-77
RCC UNDOCKED CRACK REPAIR.....	FS 13-89
RULER PROTUBERANCE GAUGE TAPING.....	FS 13-120
<b>NOTES, CAUTIONS, WARNINGS</b>	
EVA TPS INSPECTION/REPAIR INHIBIT PAD.....	FS 13-122
TPS REPAIR CAUTIONS AND WARNINGS .....	FS 13-125
TPS REPAIR NOTES.....	FS 13-126
BOOM OPERATIONAL WARNINGS .....	FS 13-127
BOOM OPERATIONAL NOTES .....	FS 13-128

TPS REF DATA	
PREFERRED EMU POSITIONING FOR TPS REPAIR.....	FS 13-129
EVA TPS REACH AND ACCESS .....	FS 13-130
POINT INSPECTION REACH AND ACCESS WHILE DOCKED.....	FS 13-131
WLE MAPPING INSPECTION WHILE DOCKED .....	FS 13-133
TILE LAYUP.....	FS 13-134
85-FOOT SAFETY TETHER.....	FS 13-135
PFR ATTACHMENT DEVICE (PAD) .....	FS 13-136
WIF EXTENDER .....	FS 13-137
EVA DIGITAL CAMERA.....	FS 13-138
EVA IR CAMERA .....	FS 13-140
OVERLAY TILE REPAIR SYSTEM (OTRS) .....	FS 13-142
OTRS MARKING TEMPLATE AND INSULATION BAGS .....	FS 13-143
AUGER HOUSING.....	FS 13-144
OTRS RELEASED CONFIGURATION .....	FS 13-145
ORU BAG INSERT FOR OTRS .....	FS 13-146
RCC NOAX REPAIR REFERENCE.....	FS 13-147
BOOM REF DATA	
RTF BOOM OVERVIEW .....	FS 13-176
BOOM TRANSITIONS WITH MLI .....	FS 13-177
BOOM BASE END AND MODIFIED EFGF .....	FS 13-178
BOOM BASE END EFGF ADAPTER PLATE .....	FS 13-179
EVA-ASSISTED EFGF CONNECTOR DEMATE .....	FS 13-180
BOOM BASE END SADDLE AND MPM.....	FS 13-181
BOOM MID SECTION AND MODIFIED FRGF .....	FS 13-182
BOOM MID SECTION FRGF ADAPTER PLATE.....	FS 13-183
BOOM TIP END AND SENSORS .....	FS 13-184
BOOM SENSOR DETAILS .....	FS 13-186
SENSOR PACKAGE 1 (SP1): LDRI/ITVC .....	FS 13-188
SENSOR PACKAGE 2 (SP2): LCS.....	FS 13-190
POSSIBLE PRD ROUTING FOR EVA ASSISTED LATCHING	
OF BOOM IN MPMS.....	FS 13-192
BOOM CONTINGENCIES .....	FS 13-193
GRAPPLE SHAFTS .....	FS 13-194
PDGF GRAPPLE SHAFT COVER.....	FS 13-195
BOOM FRGF FSE.....	FS 13-196

UNSCHEDULED/CONTINGENCY EVA TASKS

UNSCH/CONT  
EVA TASKS

STS 134/ULF6 WORKAROUNDS CRIBSHEET .....	TEMP FS 16-2
EVA 1 CONTINGENCIES .....	TEMP FS 16-2
P6 PVTCS FILL CONTINGENCIES .....	FS 16-8
EVA 2 CONTINGENCIES .....	FS 16-14
EVA 3 CONTINGENCIES .....	FS 16-15
EVA 4 CONTINGENCIES .....	FS 16-20
GET-AHEAD CONTINGENCIES .....	FS 16-25
GENERIC CONTINGENCIES .....	FS 16-26
AGB .....	FS 16-26
APFR/IAPFR .....	FS 16-26
BALLSTACK .....	FS 16-27
BRT .....	FS 16-27
CANNON CONNECTOR .....	FS 16-27
CETA CART .....	FS 16-28
EVA WRENCH (TORQUE AND RATCHET) .....	FS 16-30
EXPANDABLE DIAMETER FASTENERS (EDFs) .....	FS 16-30
FLUID QD OPS .....	FS 16-30
FRAM .....	FS 16-36
MMOD SHIELD .....	FS 16-37
MUT EE .....	FS 16-40
MWS .....	FS 16-40
NZGL CONNECTORS .....	FS 16-41
ON-ORBIT INSTALLED HR .....	FS 16-43
ON-ORBIT INSTALLED WIF .....	FS 16-44
PAD .....	FS 16-44
PGT .....	FS 16-44
SAFETY TETHER .....	FS 16-46
SCOOPS .....	FS 16-46
SOCKET CADDY .....	FS 16-48
TA CLAMP .....	FS 16-48
TETHER SHUTTLE .....	FS 16-48
TORQUE MULTIPLIER .....	FS 16-48
TSA .....	FS 16-49
P6 PVTCS LEAK DETECTION .....	FS 16-50
P6 PVTCS FILL FAILURE MATRIX .....	FS 16-55
ROEU CONTINGENCIES	
ROEU OVERVIEW .....	FS 16-61
RELEASE ELC(AMS) ROEU LATCHES .....	FS 16-62
LATCH ELC(AMS) ROEU LATCHES .....	FS 16-65
STOW ELC(AMS) ROEU ARM .....	FS 16-69
MATE ROEU ARM .....	FS 16-72
ELC3/AMS CONTINGENCIES	
UCCAS/PAS UMBILICAL MATING ASSEMBLY (UMA) MANUAL DRIVE .....	FS 16-75
EXPCA R&R PROCEDURES .....	FS 16-79
AMS CAPTURE BAR MANUAL RELEASE/INSTALL .....	FS 16-85
MANUALLY SWITCH AMS DATA CHANNELS .....	FS 16-89
TIEDOWN PLANS	
MISSE 8 AND ORMATE-III TIEDOWNS .....	FS 16-91
S3 CETA LIGHT TIEDOWN .....	FS 16-92
EWC ANTENNA HANDRAILS TIEDOWN .....	FS 16-93
EAS JUMPER TIEDOWN .....	FS 16-94
SARJ COVERS TIEDOWN .....	FS 16-95
S1 RADIATOR GB STOW BEAMS TIEDOWN .....	FS 16-96
PAMA/PDGF TIEDOWN .....	FS 16-97
OBSS (IBA) TIEDOWN IN OSE .....	FS 16-102

# STS-134/ULF6 WORKAROUNDS CRIBSHEET

## EVA 1 CONTINGENCIES

TASK	FAILURE	ACTION
I. MISSE 7 Retrieve and MISSE 8 Install	A. PEC door PIP pin will not release	Tap detent end of PIP pin (end opposite pull ring) with hammer or other tool; 6" max stroke; use metal side of hammer (Stbd A/L toolbox)
	B. PEC door PIP pin will not engage	<ol style="list-style-type: none"> <li>1. Verify ball detents can be depressed</li> <li>2. Check alignment and reattempt</li> <li>3. If no joy, install other door PIP pin</li> <li>4. If no joy, wire-tie door open/closed</li> <li>5. For PEC 7s, if neither PIP pin installs and more than 1/4" gap exists, bring PEC inside A/L</li> </ol> <p><b>**One PIP pin is sufficient to restrain the PEC open/closed</b></p>
	C. ExPA Socket PIP pin will not release	<ol style="list-style-type: none"> <li>1. Push PIP pin button and increase force on pull ring; stop if deformation occurs</li> <li>2. If no joy, offload any misalignments on the PEC while releasing PIP pin</li> <li>3. If no joy, tap detent end of PIP pin with hook</li> <li>4. If no joy, retrieve hammer (stbd A/L toolbox), pry bar (Staging Bag), and BMRRM tool (stbd Z1 toolbox, slot 2)</li> <li>5. Tap detent end of PIP pin with hammer; 6" max stroke; use metal side of hammer; reattempt step 1</li> <li>6. If no joy, place edge of pry bar along the detent end of PIP pins, tap with hammer; 6" max stroke; use metal side of hammer; reattempt step 1</li> <li>7. If no joy, insert BMRRM tool axially into detent end of PIP pin, tap with hammer; 4" max stroke; use metal side of hammer; reattempt step 1</li> <li>8. If no joy, release probe contingency bolts (2) to release PEC; RET to bolt tether pt <b>PGT [A7 (9.2), CCW2, 30.5], 11.5 turns</b></li> </ol>
	D. ExPA Socket PIP pin will not engage	<ol style="list-style-type: none"> <li>1. Verify ball detents can be depressed</li> <li>2. Check alignment of PEC</li> <li>3. Wiggle PEC to offload any misalignments while installing PIP pin</li> <li>4. Install other PIP pin, if not already, and reattempt</li> </ol> <p><b>**One PIP pin is sufficient to hold PEC in ExPA socket</b></p>
	E. PEC 8 will not freely open	<ol style="list-style-type: none"> <li>1. Verify both door PIP pins fully released</li> <li>2. Increase force to pull open the door. Use other hand to stabilize on the PEC probe. It may require a constant force up to 25 lb, then a quick drop to no resistance</li> <li>3. If O-ring comes out of groove on probe side of PEC, attach RET around O-ring. Remove and stow in trash bag or CETA ORU bag</li> <li>4. If no joy, use pry bar (Staging Bag) between the doors, start from probe side and move up toward hinge</li> </ol>
	F. Wing tab connector fails to release	<ol style="list-style-type: none"> <li>1. Use tether hook for leverage</li> <li>2. If no joy, use Hubble connector tool (90 deg) (Staging Bag)</li> </ol>
	G. Wing tab connector fails to install	<ol style="list-style-type: none"> <li>1. Check for FOD/damage</li> <li>2. Verify connector is matched to correct jack and fully seated</li> <li>3. Verify alignment/keying (line up wing with black line on PEC, rotate cw 90°)</li> <li>4. Reattempt with lining up other wing with black line on PEC</li> </ol>

UNSC/CONT  
EVA TASKS

## STS-134/ULF6 WORKAROUNDS CRIBSHEET (Cont)

### EVA 1 CONTINGENCIES (Cont)

TASK	FAILURE	ACTION
		<ol style="list-style-type: none"> <li>If no joy, use tether hook or Hubble connector tool (90 deg) (Staging Bag)</li> <li>If no joy on 7B connector, bring PEC inside A/L **7B connector is required – provides heater power</li> </ol>
	H. Side Wall Carrier Latch PIP pin will not release	<ol style="list-style-type: none"> <li>Push PIP pin button and increase force on pull ring; stop if deformation occurs</li> <li>If no joy, tap detent end of PIP pin with hook</li> <li>If no joy, perform steps 2-3 in Block I</li> </ol>
	I. Side Wall Carrier Latch will not release from launch config	<ol style="list-style-type: none"> <li>Verify PIP pin fully released</li> <li>Tether to both clamp and contingency bolt; release contingency bolt <b>PGT [A7 (9.2), CCW2, 30.5]</b>, 11 turns</li> <li>Stow bolt and latch assembly in trash bag</li> </ol>
	J. Side Wall Carrier Latch does not latch into landing config	<ol style="list-style-type: none"> <li>Check for interference (PIP pin, MISSE flush to SWC, etc) and reattempt</li> <li>If no joy, wire tie latch to Side Wall Carrier</li> <li>If no joy and on <b>MCC-H GO</b>, tether to both clamp and contingency bolt; release contingency bolt: <b>PGT [A7 (9.2), CCW2, 30.5]</b> (11 turns)</li> <li>Stow bolt and latch assembly in trash bag **One latch required for landing</li> </ol>
	K. Side Wall Carrier Latch PIP pin will not install	Tap PIP pin with hook **PIP pin not required for landing
<b>II. SARJ Cover Install</b>	A. SARJ MLI Cover bolt will not fully install	<ol style="list-style-type: none"> <li>Check alignment of cover</li> <li>Loosen installed bolts for only a few turns (do not release more turns than performed to engage)</li> <li>Re-attempt starting with problem bolt. Verify all bolts are engaged before final torque</li> <li>If no joy, install other bolts to achieve minimum reqd</li> <li>If less than minimum bolts, bring cover inside A/L **Minimum number of bolts is any 4 of 6 per cover. For 6 fasteners, 3 of 6 is min if one fastener in each pair</li> </ol> <div style="border: 1px solid black; padding: 5px; margin-top: 10px; text-align: center;"> <p><b>CAUTION</b>              If cover has less than 4/4 or 6/6 bolts, it does not meet EVA kickloads.              Avoid inadvertent contact with cover</p> </div>
<b>III. CETA Light Install</b>	A. CETA light fails to soft dock	<ol style="list-style-type: none"> <li>Check for FOD/damage</li> <li>Verify ball detents/plunger can be depressed, reattempt</li> </ol>
	B. NZGL Connectors	See Generic Section of cribsheet
	C. Bolt fails to engage	<ol style="list-style-type: none"> <li>Verify pushing in on bolt. Will need to push mounting bracket past soft dock to engage bolt; reattempt</li> <li>If no joy, verify electrical cable clear or not interfering with install; reattempt</li> <li>If no joy, remove CETA light and check for FOD/damage</li> </ol>
	D. CETA light bolt fails to fully install	Increase torque <b>PGT [B7 (25.5), CW2, 30.5]</b> for 1 turn; then nominal settings for remainder turns
<b>IV. EWC Install</b>	A. HR bolt fails to break torque	<ol style="list-style-type: none"> <li>Increase torque to <b>PGT [B7 (25.5), CW2, 30.5]</b> for 1 turn only</li> <li>If no joy, use manual ratchet on PGT for 1 turn only</li> </ol>
	B. HR bolt fails to release	<ol style="list-style-type: none"> <li>Increase torque to <b>PGT [B5 (22.0), CCW2, 30.5]</b></li> <li>If no joy, re-install at <b>PGT [A2 (3.8), CW2, 30.5]</b> and reattempt bolt release</li> </ol>

# STS-134/ULF6 WORKAROUNDS CRIBSHEET (Cont)

## EVA 1 CONTINGENCIES (Cont)

TASK	FAILURE	ACTION
	C. HR will not install in seat track or fails to soft dock	<ol style="list-style-type: none"> <li>1. Verify HR installed in correct direction per arrow on underside of HR</li> <li>2. Verify HR shoes are completely released and soft dock armed</li> <li>3. Verify pitch of feet is parallel to seat track</li> <li>4. Check for FOD on HR and seat track; reattempt</li> <li>5. If no joy, verify HR bolt completely released: <b>PGT [A1 (2.5), CCW2, 30.5]</b></li> <li>6. If HR in seat track but soft dock will not engage, attempt to drive HR bolts</li> </ol> <p>**1 bolt is required</p> <div style="border: 1px solid black; padding: 5px; text-align: center;"> <p><b>CAUTION</b></p> <p>If less than 2 bolts fully installed, do not use for translation</p> </div>
	D. T-handle tool fails to engage shield	<ol style="list-style-type: none"> <li>1. Remove adjacent fasteners and reattempt</li> <li>2. If no joy, try other T-handle tool</li> </ol>
	E. MMOD shield Dzus fastener fails to release	<ol style="list-style-type: none"> <li>1. Release other Dzus fasteners and reattempt</li> <li>2. On <b>MCC-H GO</b>, retrieve pry bar (Staging Bag) and CETA ORU bag</li> <li>3. Assess clearance between MMOD shield and tools</li> <li>4. If possible, rotate fastener to position tangs off of tools</li> <li>5. Place ORU bag over failed fastener</li> <li>6. Insert pry bar under MMOD shield by failed fastener and pry shield away from structure</li> </ol>
	<p style="text-align: center;"><b>WARNING</b></p> <p>Do not touch back side of MMOD shield or handle fastener fragments due to sharp edges</p> <p>Fastener and shield/tool interface must be covered to avoid potential projectiles</p>	
	F. MLI grounding strap Dzus fails to release	On <b>MCC-H GO</b> , cut ground wire near Dzus fastener
	G. MLI grounding strap Dzus fails to engage	<ol style="list-style-type: none"> <li>1. Verify alignment, push firmly and reattempt</li> <li>2. If no joy, push MLI under bracket and install MMOD shield</li> </ol>
	H. Access to P16 difficult	On <b>MCC-H GO</b> , disconnect P15 for more clearance. Mate P15 once P16 is mated
	I. MMOD shield Dzus fastener fails to engage	<ol style="list-style-type: none"> <li>1. Verify center fastener is engaged first</li> <li>2. Check Dzus fastener aligned with bracket (floating receptacles on endcones). Use loop pin puller to help with receptacle alignment if reqd</li> <li>3. Verify fastener clocking correct per alignment mark</li> <li>4. Push firmly to rotate; reattempt</li> <li>5. If no joy, engage other fasteners</li> </ol> <p>**2 out of 3 Dzus fasteners required</p> <ol style="list-style-type: none"> <li>6. If 2 of 3 not achieved: <ul style="list-style-type: none"> <li>-Wire Tie Shield (See figs 1-3): 1 properly secured wire tie = 1 Dzus fastener; using a long wire tie, squish the loop on one end, feed it through the bracket on structure (may need to push floating receptacle inboard to get it out of way), secure wire tie w/3 twists. Feed one end of wire tie around Dzus head (on outside of shield) and secure with 3 twists. If HR nearby can also secure wire tie to HR. (Goal is for the wire tie to push shield in toward body of structure and toward center if endcone shield)</li> </ul> </li> </ol>



**STS-134/ULF6 WORKAROUNDS CRIBSHEET (Cont)**

**EVA 1 CONTINGENCIES (Cont)**

TASK	FAILURE	ACTION
		<p data-bbox="824 216 1421 300">- Option 2 (LDTDT): Use 1 adj (attach to tether point on T-tool and to structure HR) and 1 LDTDT across shield to hold shield in position</p> <div data-bbox="418 306 1412 1423">  <p data-bbox="1174 464 1393 604">Will "squish" loop together a little Pre-EVA for easier access through nutplate</p> <p data-bbox="1154 709 1409 793">Floating receptacle shifted towards center of Shield</p> <p data-bbox="1174 1031 1393 1115">Wire Tie Inserted Thru "Window" on receptacle bracket</p> </div> <p data-bbox="678 1482 1166 1514">Figure 1.- MMOD Shield Wire Tie Option.</p>

# STS-134/ULF6 WORKAROUNDS CRIBSHEET (Cont)

## EVA 1 CONTINGENCIES (Cont)

TASK	FAILURE	ACTION
	 <p data-bbox="446 325 717 430">Install shield with wire tie ends sticking out across adjacent shield</p>	 <p data-bbox="1144 1333 1396 1438">After threading wire tie through nutplate, twist 3 times</p>

Figure 2.- MMOD Shield Wire Tie Option. (Cont)

**STS-134/ULF6 WORKAROUNDS CRIBSHEET (Cont)**

**EVA 1 CONTINGENCIES (Cont)**

TASK	FAILURE	ACTION
		 <p data-bbox="513 831 867 1079">Wrap wire tie around Dzus head; one full wrap (shown here) or wrap and twist method</p> <p data-bbox="529 999 829 1062">Then twist loose wire tie ends to create a loop</p> <p data-bbox="638 1129 1208 1161">Figure 3.- MMOD Shield Wire Tie Option. (Cont)</p>

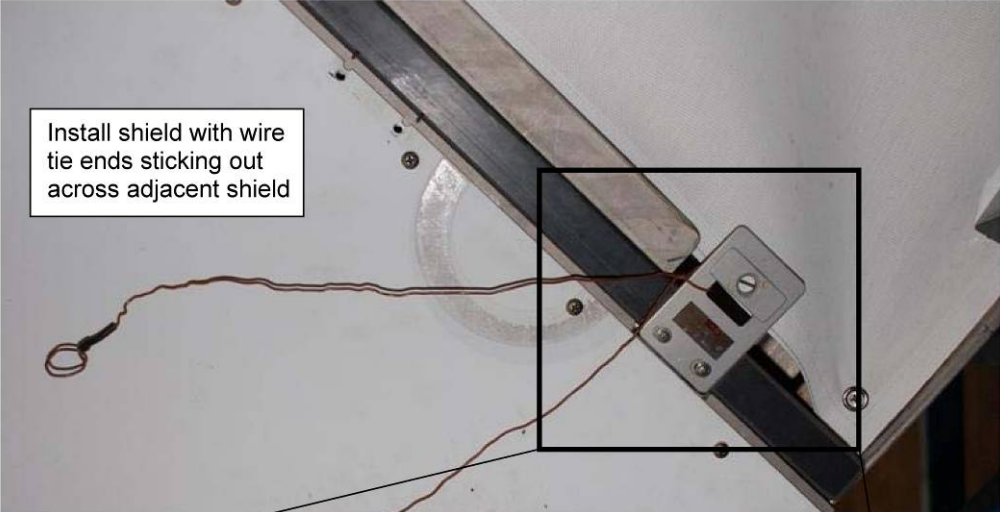
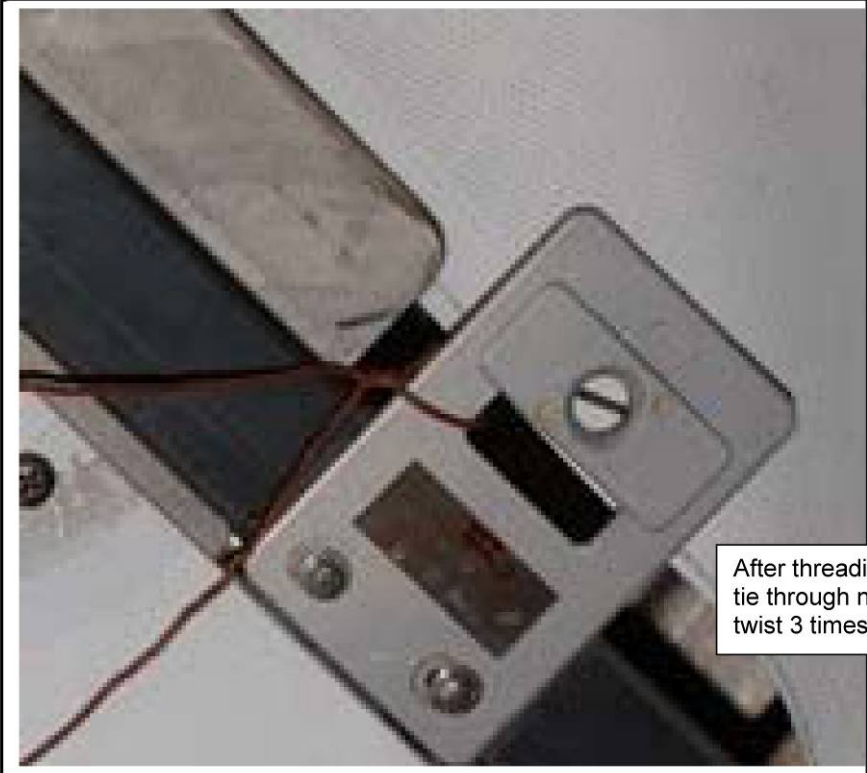
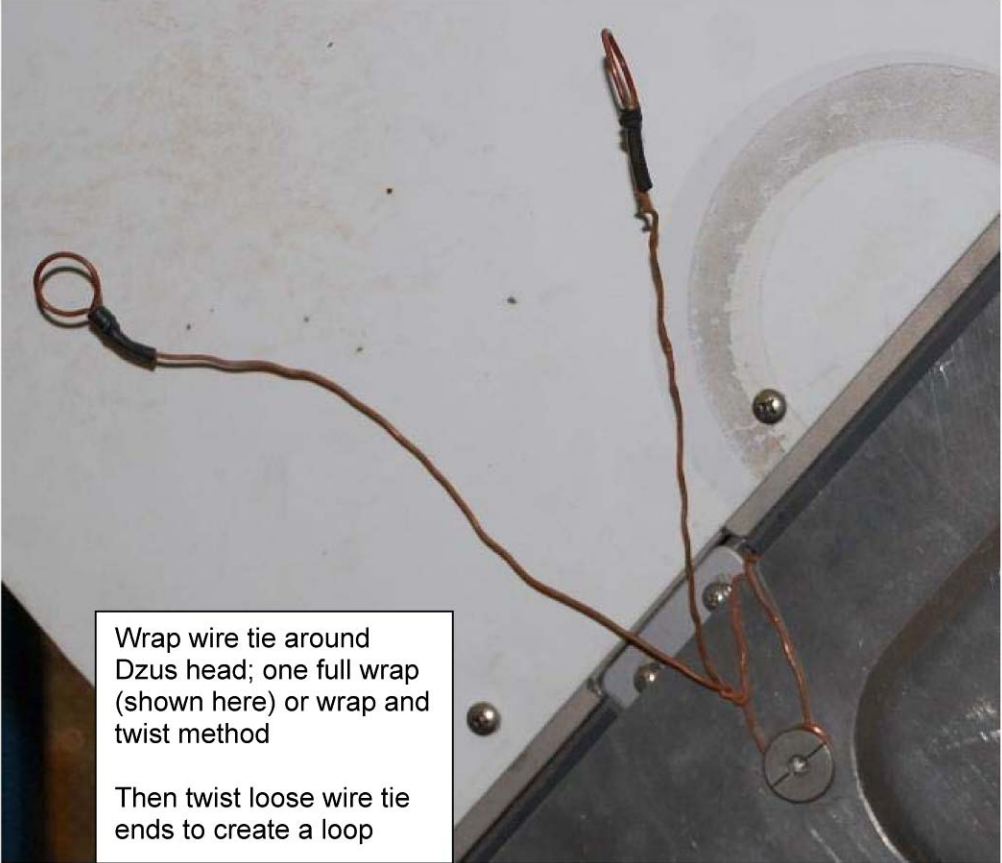
# STS-134/ULF6 WORKAROUNDS CRIBSHEET (Cont)

## P6 PVTCS FILL CONTINGENCIES

TASK	FAILURE	ACTION
	<b>Fluid QD Ops</b>	
	<u>NOTE</u>	
	Troubleshooting steps outlined in this section are for the Flight Specific task of refilling the P6 PVTCS. For any other QD items, use the QD steps in the generic section of the cribsheet.	
	If troubleshooting requires the crew to leave the worksite, verify that female QDs are covered to prevent exposure to direct sunlight. For thermal clocks refer to flight rules	
	<b>Mating Ops</b>	
A. QD fails to mate		<ol style="list-style-type: none"> <li>1. Check alignment and verify side loads are counteracted</li> <li>2. Verify fwd white band is not visible (release ring is retracted)</li> <li>3. Inspect male and female QD for debris, damage, or NH3 <ul style="list-style-type: none"> <li>• If NH3 present, leave female QD engaged with male (NH3 may sublime between QDs)</li> </ul> </li> <li>4. Change body orientation for better access and reattempt</li> </ol>
B. Release ring snap back test fails		<ol style="list-style-type: none"> <li>1. Push release ring forward. (Release ring will not slide fwd if QD is in FID)</li> <li>2. If no joy, QD is in FID <ol style="list-style-type: none"> <li>a. Pull back on release ring</li> <li>b. Demate QD</li> <li>c. Verify fwd white band not visible</li> <li>d. Remate QD</li> </ol> </li> </ol>
C. Gap check fails (visual or FID gauge)		Demate and Remate QD <ol style="list-style-type: none"> <li>a. Retract release ring</li> <li>b. Demate QD</li> <li>c. Verify fwd white band not visible</li> <li>d. Remate QD</li> </ol>
D. Pull test fails		<ol style="list-style-type: none"> <li>1. Verify fwd white band is not visible. (If visible, retract release ring)</li> <li>2. Assess and counteract sideloads and mate QD</li> </ol>
	<b>Valve Ops</b>	
A. Detent button is partially unthreaded		Rethread detent button <ol style="list-style-type: none"> <li>a. Load bail handle towards the button (button will free spin if not loaded) <ul style="list-style-type: none"> <li>• If valve is open, pull bail handle aft</li> <li>• If valve is closed, push bail handle fwd</li> </ul> </li> <li>b. Rotate button cw (8 turns max)</li> </ol>
B. Detent button is missing		<ol style="list-style-type: none"> <li>1. Use equipment hook to depress detent button shaft</li> <li>2. Or, use tether strap around gloved finger to depress detent button shaft</li> <li>3. Or, retrieve and use BMRRM Tool (stbd Z1 Toolbox, slot 2) to depress detent button shaft</li> </ol>
C. Bail fails to travel to fwd (valve open) position (button does not pop up if attempting to go to full fwd)		<ol style="list-style-type: none"> <li>1. Neutralize sideloads</li> <li>2. If no joy, apply greater opening force to QD bail handle</li> <li>3. If no joy, use QD bail drive lever (1-in only, SARJ Med ORU bag)</li> </ol>

# STS-134/ULF6 WORKAROUNDS CRIBSHEET (Cont)

## P6 PVTCS FILL CONTINGENCIES (Cont)

TASK	FAILURE	ACTION
	<p>D. Detent button fails to depress in preparation for valve closing</p> <div style="border: 3px double black; padding: 5px; width: fit-content; margin: 10px auto;"> <p style="text-align: center;"><b>WARNING</b></p> <p style="text-align: center;">Bail may kick back and contact crew when a stuck button is depressed due to pressure build-up in spring cavity</p> </div>	<ol style="list-style-type: none"> <li>1. Verify locking collar unlocked (for 1-in)</li> <li>2. Push and hold bail handle fwd (to open) with significant force to relieve load on button while simultaneously depressing detent button <ul style="list-style-type: none"> <li>• If button depresses, vent by pulling bail aft until aft white band no longer visible</li> </ul> </li> <li>3. If no joy: <ol style="list-style-type: none"> <li>a. Rock bail handle from side-to-side while depressing button</li> <li>b. Rock QD at QD stub up-down and side to side while depressing button</li> </ol> </li> <li>4. If no joy, retrieve QD bail drive lever and repeat step 2 (1-in only, SARJ Med ORU bag)</li> <li>5. If no joy, on <b>MCC-H GO</b>, retrieve and install QD button depress tool (BDT) (1/4-in – Fluid QD Bag #2, port; 1-in Staging Bag)</li> <li>6. If no joy, on <b>MCC-H GO</b>, retrieve hammer (stbd A/L Toolbox, nadir door) and tap center of button. (Use fiberglass side of hammer.) (Inspect tool and QD)</li> </ol>
	<p>E. Bail fails to travel to full aft (valve closed) position (button does not pop up)</p>	<ol style="list-style-type: none"> <li>1. Neutralize possible side loading</li> <li>2. Increase force on bail</li> <li>3. If no joy, use QD bail drive lever (1-in only – SARJ Med ORU bag)</li> <li>4. If no joy, inspect QD for retaining wire protrusion</li> </ol>
<b>Demating Ops</b>		
	<p>A. Female QD fails to demate</p>	<ol style="list-style-type: none"> <li>1. Neutralize sideloads or manipulate flexhose to relieve mating forces on female QD</li> <li>2. Verify release ring is fully retracted while attempting to demate</li> <li>3. Verify TA clamps are released</li> <li>4. Verify detent button is up. (Locking collar can be rotated under button)</li> <li>5. If no joy, apply greater force to release ring and female QD</li> <li>6. If no joy, retrieve and use QD release tool (QRT) to apply greater force (1-in only – Fluid QD Bag #1, stbd)</li> <li>7. If no joy, shake QD vigorously while attempting to demate</li> </ol>
	<p>B. Thermal bootie fails to remain securely closed</p>	<p>Install wire tie around bootie to keep QD fully covered</p>
	<p>C. Cap will not demate</p>	<ol style="list-style-type: none"> <li>1. Verify pulling out on cap before rotating to ensure locking tab is disengaged</li> <li>2. If no joy, wait for opposite thermal conditions if possible and reattempt cap removal</li> <li>3. If no joy, retrieve QD cap tool (1/4-in – Fluid QD Bag #1 &amp; 1-in located in SARJ Med ORU bag) <ol style="list-style-type: none"> <li>a. Verify pull out on the cap before turning</li> <li>b. <b>PGT: [A4 (6.3), CCW1, 30.5]</b> with QD cap tool to turn stuck cap a maximum of 2 turns (cap vents at ~2 turns)</li> <li>c. Once venting is complete, finish removal of cap by hand (~1 additional turn) <ul style="list-style-type: none"> <li>• If venting does not stop or cap cannot be removed by hand, notify <b>MCC-H</b>. (Male QD may be leaking)</li> </ul> </li> </ol> </li> </ol>

# STS-134/ULF6 WORKAROUNDS CRIBSHEET (Cont)

## P6 PVTCS FILL CONTINGENCIES (Cont)

TASK	FAILURE	ACTION
	D. Partial fwd white band visible after QD demate	<ol style="list-style-type: none"> <li>Pull back on release ring to verify QD is not in FID</li> <li>Verify detent button is up</li> <li>If fwd white band is still partially visible this is likely a tolerance stackup and has been seen before; notify <b>MCC-H</b> and press with QD ops</li> </ol>
<b>Vent Tool Reconfig Ops</b>		
	A. Tip of vent tool does not pass black mark during alignment check	Slide the equipment hook further away from vent tool nozzle end
	B. Vent tool/VTE plug cannot be fully mated to Vent Tool Extender	Hold VTE adapter in sunlight to warm it up (known tolerance issue between cold VTE adapter & vent tool nozzle)
<b>Leaks</b>		
<b>CAUTION</b> Do not fully open a leaking QD. Fully opening a leaking 1-in QD could trap NH3 and prevent future valve closure		
<b>I. General</b>	A. Female QD leaks due to FID	<ol style="list-style-type: none"> <li>Close valve (bail aft)</li> <li>Perform release ring snap back test                             <ul style="list-style-type: none"> <li>If FID observed, demate and remate QD</li> </ul> </li> </ol>
	B. Frozen NH3 present on female or male QD	<ol style="list-style-type: none"> <li>Leave QD exposed to vacuum; wait maximum of 5 min for sublimation (check periodically)</li> <li>On <b>MCC-H GO</b>, continue QD ops (NH3 may sublimate during QD mating)</li> </ol>
<b>II. EVA 1</b>	C. Problems with P3/P4 jumper (hole, QD won't demate/mate, etc)	<ol style="list-style-type: none"> <li>Close and demate QDs at P3 M2 and P4 M15</li> <li>Stow P3/P4 jumper back in launch config</li> <li>Use S3/S4 jumper:                             <ol style="list-style-type: none"> <li>Retrieve S3/S4 Jumper from S4 bulkhead</li> <li>Mate and open S3 QD F2 to P3 M2</li> <li>Mate and open S4 QD F15 to P4 M15</li> </ol> </li> </ol> <p><b>NOTE:</b> S3/S4 jumper is 28-in longer than P3/P4 jumper</p>
	D. P3/P4 Jumper cannot reach P3 QD M2 (length too short)	<ol style="list-style-type: none"> <li>Route jumper through AJIS struts</li> <li>If no joy and on <b>MCC-H GO</b>, retrieve S3/S4 jumper (Reference Block C) or <b>MCC</b> will rotate SARJ</li> </ol>
	E. Problems with FH-02 EAS Jumper	<ol style="list-style-type: none"> <li>Close and demate QDs at M2 and M10</li> <li>Use FH-01 Jumper:                             <ol style="list-style-type: none"> <li>Demate QDs at M9 and M1</li> <li>Mate QD-02F to M10</li> <li>Open QD-03F at QD Extender</li> <li>Vent N2 from jumper at QD Extender QD</li> <li>Mate QD Extender to M2</li> </ol> </li> <li>Wire tie FH-02 to FH-01 per tiedown</li> <li>If APFR is required for EAS Jumper QD ops in P6 WIF 11, inspect WIF adapter plate prior to using:                             <ul style="list-style-type: none"> <li>Verify 4 bolts present</li> <li>Verify bolt/washers flush to plate</li> <li>Verify lock collar black on black</li> <li>Perform pull/twist test, verify no WIF motion</li> </ul> </li> </ol>
	F. Male QD M2 leaks when QD is demated (P6 PVTCS)	<ol style="list-style-type: none"> <li>Install cap on M2</li> <li>Wire tie QD Extender to FH-01 jumper (2 wire ties)</li> </ol>
<b>III. EVA 2</b>	G. Loss of Comm during Leak Check	<ol style="list-style-type: none"> <li>Monitor ATA Tank quantity Nav Display: P1: TCS: ATA: Loop B ATA Valves <u>Loop B ATA Valves</u> 'Telemetry'</li> <li>If ATA Tank _____ quantity &lt; _____ (values to be provided by THOR on morning of EVA), IV send commands on display: <u>Loop B ATA Valves</u> 'Commands' <b>cmd</b> Tank (1 or 2, same as above) Isol Valve Close - Arm (√-√) <b>cmd</b> Tank (1 or 2, same as above) Isol Valve Close - Close (√ - Closed)</li> <li>Contact <b>MCC-H</b> for further actions</li> </ol>



# STS-134/ULF6 WORKAROUNDS CRIBSHEET (Cont)

## P6 PVTCS FILL CONTINGENCIES (Cont)

TASK	FAILURE	ACTION
<b>Leaks</b>		
<div style="border: 1px solid black; padding: 5px; margin: 0 auto; width: fit-content;"> <p style="text-align: center;"><u>CAUTION</u></p> <p style="text-align: center;">Do not fully open a leaking QD. Fully opening a leaking 1-in QD could trap NH3 and prevent future valve closure</p> </div>		
H. Leak Check fails		<ol style="list-style-type: none"> <li>1. If Large Leak:               <ol style="list-style-type: none"> <li>a. EV2 close ATA QD M1</li> <li>b. <b>MCC-H</b> (THOR) closes ATA valve</li> <li>c. On <b>MCC-H GO</b>, EV1/EV2 perform P6 PVTCS Leak Detection Procedure FS 16-_____</li> <li>d. Contact <b>MCC-H</b> for further actions</li> </ol> </li> <li>2. If Medium Leak:               <ol style="list-style-type: none"> <li>a. <b>MCC-H</b> (THOR) closes ATA valve</li> <li>b. On <b>MCC-H GO</b>, EV1/EV2 perform P6 PVTCS Leak Detection Procedure FS 16-_____ (Including P1-P5 Vent)</li> <li>c. Contact <b>MCC-H</b> for further actions</li> </ol> </li> <li>3. If Small Leak, continue with nominal procedures (P6 QD F14 open)</li> </ol>
I. A500 pnl QD leaks during Leak Check		<ol style="list-style-type: none"> <li>1. If F185 on M1, fully open valve (bail fwd)</li> <li>2. If F184 on M2:               <ol style="list-style-type: none"> <li>a. Fully close valve (bail aft)</li> <li>b. Fully open valve (bail fwd)</li> </ol> </li> <li>3. If leak stopped, proceed with Leak Check</li> <li>4. If leak persists, close QD, contact <b>MCC-H</b></li> </ol>
J. Male QD M14 (P5/P6) leaks when cap removed		<ol style="list-style-type: none"> <li>1. If leak is small and dissipating, continue with nominal procedures (Mate and open F14 to M14)</li> <li>2. If large leak, install cap and contact <b>MCC-H</b>; quantify leak</li> </ol>
K. Female QD F14 (P5/P6) leaks before mate to P6 (valve in closed position)		<ol style="list-style-type: none"> <li>1. Mate QD F14 to P6 male QD M14</li> <li>2. Partially open valve (bail fwd ~halfway/50%) without popping up detent button</li> <li>3. Return QD to closed position (bail aft)</li> <li>4. If leak stopped, fully open QD F14, continue nominal plan</li> <li>5. If leak persists, partially open valve (bail fwd ~halfway/50%) without popping up detent button</li> </ol>
L. Mated QD-02F leaks in valve open position at M10 (EAS Jumper)		<ol style="list-style-type: none"> <li>1. Fully close valve (bail aft)</li> <li>2. Partially open valve (bail fwd ~halfway/50%) without popping up detent button</li> <li>3. If leak persists, use FH-01 jumper (see block E for steps). Contact <b>MCC-H</b> if need to vent FH-02 Jumper</li> </ol>
M. Leak in FH-02 Jumper		Use FH-01 Jumper (see block E for steps). Do not need to vent FH-02 Jumper
N. Mated QD Extender leaks in valve open position at M2 (EAS Jumper)		<ol style="list-style-type: none"> <li>1. Fully close valve (bail aft)</li> <li>2. Partially open valve (bail fwd ~halfway/50%) without popping up detent button</li> <li>3. If no joy, remove QD Extender from jumper:               <ol style="list-style-type: none"> <li>a. Fully close valve on QD Extender (bail aft)</li> <li>b. Fully close and demate QD-03F at QD Extender</li> <li>c. Demate QD Extender and temp stow</li> <li>d. Mate QD-03F to M2 and fully open valve. May need to demate QD at M1 if bail interference</li> </ol> </li> </ol>

# STS-134/ULF6 WORKAROUNDS CRIBSHEET (Cont)

## P6 PVTCS FILL CONTINGENCIES (Cont)

TASK	FAILURE	ACTION
<b>Leaks</b>		
<div style="border: 1px solid black; padding: 5px; margin: 0 auto; width: fit-content;"> <p style="text-align: center;"><u>CAUTION</u></p> <p style="text-align: center;">Do not fully open a leaking QD. Fully opening a leaking 1-in QD could trap NH3 and prevent future valve closure</p> </div>		
O. PVTCS overfilled (P1 NTA Isol Valve fail close)		<ol style="list-style-type: none"> <li>1. On <b>MCC-H GO</b>, keep EAS QD Extender at M2 open, continue to P1-P5 vent</li> <li>2. Or, vent additional NH3 from PVTCS using whole EAS Jumper               <ol style="list-style-type: none"> <li>a. Vent EAS jumper per nominal plan</li> <li>b. Mate and open QD Extender at M2</li> <li>c. On <b>MCC-H GO</b>, close QD extender at M2</li> <li>d. Vent FH-02 jumper</li> <li>e. On <b>MCC-H GO</b>, repeat steps b-d</li> </ol> </li> <li>3. Or, vent additional NH3 from PVTCS using EAS QD Extender               <ol style="list-style-type: none"> <li>a. Vent EAS jumper per nominal plan</li> <li>b. Mate QD Extender to M2</li> <li>c. Fully close valve on QD-03F into QD Extender</li> <li>d. Open QD Extender at M2</li> <li>e. On <b>MCC-H GO</b>, close QD extender at M2</li> <li>f. Vent FH-02 jumper (Extender only)</li> <li>g. On <b>MCC-H GO</b>, repeat steps b-f</li> </ol> </li> </ol>
P. QD Extender leaks after valve close operation at M2 (EAS Jumper)		<ol style="list-style-type: none"> <li>1. Partially open valve (bail fwd ~halfway/50%) without popping up detent button</li> <li>2. Wait while ice crystals on QD dissipate</li> <li>3. Return QD to closed position (bail aft)</li> <li>4. On <b>MCC-H GO</b>, demate QD and inspect</li> <li>5. If leak persists:               <ol style="list-style-type: none"> <li>a. If male QD F14, reference Block Q</li> <li>b. If female QD F14, reference Block R</li> </ol> </li> </ol>
Q. Male QD M2 leaks after demate (P6 PVTCS)		<ol style="list-style-type: none"> <li>1. Contact <b>MCC-H</b>, quantify leak</li> <li>2. If leak small and dissipating, continue with nominal procedures (install cap on M2)</li> <li>3. Else, leave QD Extender attached to P6 PVTCS               <ol style="list-style-type: none"> <li>a. Mate QD Extender to M2 and fully open valve (bail fwd)</li> <li>b. Fully close and demate QD-03F at QD Extender</li> <li>c. Install cap on QD Extender</li> </ol> </li> </ol>
R. Female QD Extender leaks after demate from M2 (EAS Jumper)		<ol style="list-style-type: none"> <li>1. Contact <b>MCC-H</b>, quantify leak</li> <li>2. If leak small and dissipating, continue with nominal procedures (install plug on QD Extender)</li> <li>3. Else:               <ol style="list-style-type: none"> <li>a. On <b>MCC-H GO</b>, close and demate QD-02F at M10</li> <li>b. Wire tie QD Ext to FH-01 jumper; allow to leak</li> </ol> </li> </ol>
S. QD pair F14/M14 leaks during valve close operation (P5/P6)		<ol style="list-style-type: none"> <li>1. Partially open valve (bail fwd ~halfway/50%) without popping up detent button</li> <li>2. Contact <b>MCC-H</b>, quantify leak</li> <li>3. On <b>MCC-H GO</b> and after NH3 crystals have dissipated, re-close QD</li> <li>4. If still leaking, contact <b>MCC-H</b> to determine if male leaking. (THOR will monitor pressure drop)</li> <li>5. On <b>MCC-H GO</b>, demate QD and inspect</li> <li>6. If still leaking:               <ol style="list-style-type: none"> <li>a. If female QD F14, reference Block T</li> <li>b. If male QD M14, reference Block U</li> </ol> </li> </ol>

# STS-134/ULF6 WORKAROUNDS CRIBSHEET (Cont)

## P6 PVTCS FILL CONTINGENCIES (Cont)

TASK	FAILURE	ACTION
<b>Leaks</b>		
<div style="border: 1px solid black; padding: 5px; margin: 0 auto; width: fit-content;"> <p style="text-align: center;"><u>CAUTION</u></p> <p style="text-align: center;">Do not fully open a leaking QD. Fully opening a leaking 1-in QD could trap NH3 and prevent future valve closure</p> </div>		
T. Female QD F14 leaks after demate (P5/P6)		<ol style="list-style-type: none"> <li>1. Contact <b>MCC-H</b>; quantify leak</li> <li>2. Mate QD F14 to Vent tool adapter as quickly as possible</li> </ol>
U. Male QD M14 leaks after demate (male sleeve may be visibly stuck open) (P6 EETCS)		<ol style="list-style-type: none"> <li>1. Contact <b>MCC-H</b>; quantify leak</li> <li>2. Attempt to install cap on M14</li> <li>3. If no joy, vent from P4:               <ol style="list-style-type: none"> <li>a. Mate QD F14 to M14 and fully open valve (bail fwd)</li> <li>b. Remove MUT EE/nozzle from P6 HR 5321</li> <li>c. Translate to P4 HR 5131 with vent lines and MUT EE, attach MUT EE</li> <li>d. Translate to P4/P5 Jumper, tend vent lines</li> <li>e. Close and demate QD F16</li> <li>f. Mate QD F16 to dummy male P5 M16</li> <li>g. Remove vent tool adapter from Vent Tool</li> <li>h. Mate Vent Tool to P4 male QD M14</li> <li>i. On <b>MCC-H GO</b>, open vent tool female QD to vent P1-P4 (eclipse constraint or IV close ATA)</li> </ol> </li> </ol>
V. QD-02F leaks during valve close operation at M10 (EAS Jumper)		<ol style="list-style-type: none"> <li>1. Small Leak: Demate QD and install cap on M10</li> <li>2. Large Leak:               <ol style="list-style-type: none"> <li>a. Partially open valve (bail fwd ~halfway/50%) without popping up detent button</li> <li>b. Contact <b>MCC-H</b>; quantify leak</li> <li>c. On <b>MCC-H GO</b>, re-close QD</li> <li>d. If still leaking, contact <b>MCC-H</b> to determine if male leaking. (THOR will monitor pressure drop)</li> <li>e. On <b>MCC-H GO</b>, demate QD and inspect</li> <li>f. If still leaking:                   <ul style="list-style-type: none"> <li>• If female QD, reference Block W</li> <li>• If male QD, reference Block X</li> </ul> </li> </ol> </li> </ol>
W. Female QD-02F leaks after demate from M10 (EAS Jumper)		<ol style="list-style-type: none"> <li>1. Contact <b>MCC-H</b>; quantify leak</li> <li>2. Wire tie FH-02 to FH-01 jumper per tiedown; allow to leak</li> </ol>
X. Male QD M10 leaks after demate		<ol style="list-style-type: none"> <li>1. Contact <b>MCC-H</b>; quantify leak</li> <li>2. Attempt to install cap on M10</li> <li>3. If no joy, mate QD-02F to M10 and fully open valve (bail fwd). Do not vent Jumper</li> </ol>
Y. Male QD M3 (M11) leaks when cap removed		<ol style="list-style-type: none"> <li>1. Reinstall cap on M3 (M11); notify <b>MCC-H</b></li> <li>2. Wire tie FH-02 to FH-01 jumper per tiedown</li> </ol>
Z. Leak occurs in vent tools during venting ops		<ol style="list-style-type: none"> <li>1. Continue venting</li> <li>2. Keep crew away from leak until vent is complete</li> </ol>

## STS-134/ULF6 WORKAROUNDS CRIBSHEET (Cont)

### EVA 2 CONTINGENCIES

TASK	FAILURE	ACTION
I. SARJ Covers	A. SARJ MLI Cover bolt will not release	<ol style="list-style-type: none"> <li>1. Release other bolts, reattempt problem bolt</li> <li>2. Increase torque to <b>PGT [B7 (25.5), CCW2, 30.5]-6 ext 7/16</b> for 1 turn only</li> <li>3. If free spinning nut plate suspected:               <ol style="list-style-type: none"> <li>a. Retrieve vise grips (Staging Bag)</li> <li>b. Attach vise grips to bolt head</li> <li>c. Turn bolt ccw while applying gentle pull force (do not fail bolt)</li> </ol> </li> <li>4. If no joy, re-install all released bolts and remove nearby cover</li> </ol>
	B. SARJ MLI Cover bolt does not fully install	<ol style="list-style-type: none"> <li>1. Check alignment of cover</li> <li>2. Loosen installed bolts for only a few turns. (Do not release more turns than performed to engage)</li> <li>3. Re-attempt starting with problem bolt. Verify all bolts are engaged before final torque</li> <li>4. If no joy, install other bolts to achieve minimum reqd</li> <li>5. If less than minimum bolts, bring cover inside A/L</li> </ol> <p><b>**Minimum number of bolts that must be re-installed is any 2 of 4 or any 4 of 6 per cover panel. For 6 fasteners, 3 of 6 is min if one fastener in each pair</b></p> <div style="border: 1px solid black; padding: 5px; margin-top: 10px;"> <p style="text-align: center;"><b>CAUTION</b></p> <p>If cover has less than 4/4 or 6/6 bolts, it does not meet EVA kickloads. Avoid inadvertent contact with cover</p> </div>
II. Grease Guns	A. Hinged Restraint Ring gets stuck in closed posn	<p>Use PIP pin to release ring, stow ring in trash bag</p> <p style="text-align: center;"><b>NOTE</b></p> <p>Hinged Restraint Ring does not have a tether point</p>
	B. Grease gun trigger jams	<ol style="list-style-type: none"> <li>1. Inspect trigger for FOD, look to see if zip tie is broken</li> <li>2. If trigger is depressed, use tool or hook to pry trigger open. Re-examine for FOD</li> <li>3. Use other grease gun OR manually use grease gun by depress plunger slowly and gently with hand (black triangle down)</li> </ol>
		
C. No resistance felt from grease gun trigger	<p>Trigger spring probably broken. Use other grease gun or manually use grease gun by depressing plunger slowly and gently with hand (black triangle down)</p>	
III. S1 Radiator Grapple Bar Stowage Beams	A. Beam still loose after install procedures	<ol style="list-style-type: none"> <li>1. Gently wiggle stowage beam and both bolts (may eliminate potential cross-thread). Report beam/fastener tightness and gaps to <b>MCC-H</b></li> <li>2. Release bolts 6 turns at <b>PGT [B3 (18.4), CCW2, 30.5] 7.8in ext 5/8</b></li> <li>3. Re-attempt install per nominal procedures</li> <li>4. If no joy, perform tiedown</li> </ol>

## STS-134/ULF6 WORKAROUNDS CRIBSHEET (Cont)

### EVA 3 CONTINGENCIES

TASK	FAILURE	ACTION
<b>I. FGB PDGF Setup</b>	A. T-handle lock will not disengage from cap	<ol style="list-style-type: none"> <li>1. Wiggle T-handle as attempt to pull and rotate into unlock position</li> <li>2. If no joy, use equipment tether hook or adjustable tether strap to apply additional force to pull out T-handle</li> </ol>
	B. Russian ratchet will not engage PAMA cap	<ol style="list-style-type: none"> <li>1. Inspect ratchet and cap for FOD or damage</li> <li>2. Cycle release tab, reattempt</li> <li>3. If no joy, use other Russian ratchet (Staging Bag), reattempt</li> </ol>
	C. PAMA cap will not release	<ol style="list-style-type: none"> <li>1. Verify T-handle is in released position</li> <li>2. Extend ratchet handle to apply more torque and reattempt</li> </ol>
	D. Russian ratchet will not release from PAMA cap	<ol style="list-style-type: none"> <li>1. Attempt to wiggle cap, inside trash bag, while pulling the release tab on the ratchet</li> <li>2. If no joy, perform tug test on cap, leave cap attached to Russian ratchet and stow</li> <li>3. Retrieve other Russian ratchet from Staging Bag if more caps need to be released</li> </ol>
	E. MLI flaking or disintegrating	<ol style="list-style-type: none"> <li>1. Attempt to put degraded MLI piece into middle of MLI bundle when stowing</li> <li>2. If any fiberglass is present on EMU, use hydrazine brush (stbd A/L Toolbox – slot 6) to brush off flakes</li> </ol>
<b>II. PAMA/ PDGF Install</b>	A. PAMA foot will not initially engage	<ol style="list-style-type: none"> <li>1. Lift PAMA foot away from receptacle, verify no FOD or other interference in receptacle or on foot; verify soft dock mechanism clear; reattempt to hand-tighten foot</li> <li>2. If PAMA foot does not engage soft dock, use equipment hook to verify soft dock plungers are functional</li> <li>3. Back out or release previously installed PAMA feet, reattempt soft dock PAMA in 1-2-3 foot order</li> <li>4. If no joy and at least one foot installed, implement PAMA tie-down plan</li> <li>5. If no joy on any feet, return PAMA to A/L and reinstall PAMA MLI</li> </ol> <p>**3 of 3 feet with black-on-black required</p>
	B. PAMA foot will not fully engage (after all feet are in soft dock)	<ol style="list-style-type: none"> <li>1. Back out PAMA feet 2 turns and reattempt</li> <li>2. If no joy, back out other PAMA feet 2 turns, reattempt to hand tighten PAMA foot, and retighten any PAMA feet loosened</li> <li>3. If no joy, fully release PAMA feet and inspect for FOD or other interference in receptacle or on foot; verify soft dock mechanism clear, reattempt PAMA install in 1-2-3 foot order</li> <li>4. If no joy, use PAMA cheater bar to tighten PAMA foot to 3-4 turns and black on black</li> <li>5. If no joy and at least one foot installed, implement PAMA tie-down plan</li> <li>6. If no joy on any feet, return PAMA to A/L and reinstall PAMA MLI</li> </ol> <p>**3 of 3 feet with black-on-black required</p>



## STS-134/ULF6 WORKAROUNDS CRIBSHEET (Cont)

### EVA 3 CONTINGENCIES (Cont)

TASK	FAILURE	ACTION
	C. Cheater bar will not engage	<ol style="list-style-type: none"> <li>1. Cycle release button on cheater bar handle, reattempt</li> <li>2. If no joy, attempt to engage cheater bar on different PAMA foot handle</li> <li>3. If no joy, engage cheater bar on PAMA foot handle as far as possible, attempt to turn PAMA foot to black-on-black</li> <li>4. If no joy, hand-tighten PAMA foot handle to black-on-black, use adj tether strap or tether hook as reqd</li> </ol>
	D. PAMA foot will not engage to black-on-black	<ol style="list-style-type: none"> <li>1. Loosen PAMA foot handle ½ turn, reattempt to engage with cheater bar to black-on-black</li> <li>2. If no joy, implement PAMA tie-down plan **3 of 3 feet with black-on-black required</li> </ol>
	E. Cheater bar will not release	<ol style="list-style-type: none"> <li>1. Cycle release button on cheater bar handle, reattempt</li> <li>2. If release button will not depress, use equipment hook or hammer (stbd A/L toolbox) to lightly tap release button; reattempt</li> <li>3. If no joy, wiggle cheater bar handle; reattempt</li> <li>4. Retrieve tool to provide additional force to remove cheater bar: <ol style="list-style-type: none"> <li>a. Vise grips (Staging Bag) to pull the cheater bar handle out</li> <li>b. Pry bar (Staging Bag) to pry the cheater bar free from PAMA handle</li> </ol> </li> <li>5. If no joy, tie down cheater bar</li> </ol>
	F. T-handle lock will not engage	<ol style="list-style-type: none"> <li>1. Wiggle T-handle while attempting to pull and rotate into lock position</li> <li>2. If no joy, implement PAMA tie-down plan using the option that that foot is not engaged **3 of 3 T-handles engaged required</li> </ol>
<b>III. FGB VSC Install</b>	A. VSC fails to install in FGB bracket	<ol style="list-style-type: none"> <li>1. Check VSC oriented correctly (tether point is station forward)</li> <li>2. Check for FOD or MLI interference in FGB bracket</li> </ol>
	B. VSC bolt fails to engage	<ol style="list-style-type: none"> <li>1. Verify VSC is seated properly in bracket and reattempt</li> <li>2. If no joy, increase torque to <b>PGT [B3 (18.4), CW2, 30.5]</b></li> <li>3. If no joy or bolt stuck, install hard thermal cover and Russian tether to PAMA foot 1</li> </ol>
	C. NZGL Connectors	See Generic Section of Cribsheet
	D. Thermal cover will not engage detent	<ol style="list-style-type: none"> <li>1. Attempt to reinstall thermal cover in opposite orientation</li> <li>2. Verify ball detents on large probe are depressible</li> <li>3. Verify no FOD or interference in the receptacles in the bracket; reattempt</li> <li>4. If no joy, install thermal cover using Velcro and Russian tether attachments only</li> </ol>

# STS-134/ULF6 WORKAROUNDS CRIBSHEET (Cont)



## EVA 3 CONTINGENCIES (Cont)

TASK	FAILURE	ACTION
<b>IV. PDGF/FGB Power Connections</b>	A. NZGL Connectors	See Generic Section of Cribsheet
	B. Dust cover does not fully cover all metal surfaces of power connectors	<p>Redo power connections using dust covers in series:</p> <ol style="list-style-type: none"> <li>Tether to dust covers</li> <li>Demate connectors</li> <li>Using "H" hook labels, Velcro dust covers together</li> </ol>  <p>Figure 4.- PDGF Dust Covers.</p> <ol style="list-style-type: none"> <li>Place dust covers over both sets of connectors</li> <li>Mate connectors (follow checks, etc)</li> <li>Use dust covers to cover both sets of connectors</li> <li>If P18 or P19 booties are not fully under the dust covers, pull them back on the cables so none of the booties are touching the connectors</li> <li>Wire tie dust covers in place, then wire tie connectors to handrail</li> </ol>
<b>V. 1553 Cable Install</b>	A. NZGL Connectors	See Generic Section of Cribsheet
	B. Russian connectors will not mate	<ol style="list-style-type: none"> <li>Verify connector alignment: Wide keypin should align with ball on the exterior housing of the connector housing</li> </ol>  <p>Figure 5.- Russian connector socket.</p>

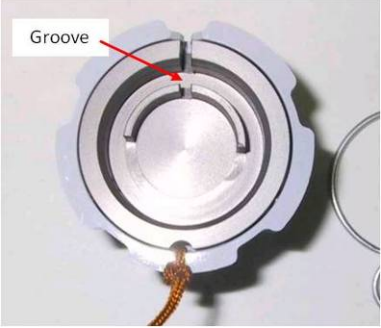

# STS-134/ULF6 WORKAROUNDS CRIBSHEET (Cont)

## EVA 3 CONTINGENCIES (Cont)

TASK	FAILURE	ACTION
		<p>2. If connector not aligned:</p> <ol style="list-style-type: none"> <li>Turn connector cap around to use keypin groove</li> </ol>  <p>Figure 6.- Russian connector cap.</p> <ol style="list-style-type: none"> <li>Place cap on connector so keypin enters groove on cap</li> </ol>  <p>Figure 7.- Russian socket and cap.</p> <ol style="list-style-type: none"> <li>Rotate cap until ball on connector housing aligns with groove on cap (may feel "detent" in rotation)</li> </ol>  <p>Figure 8.- Russian connector properly aligned.</p> <ol style="list-style-type: none"> <li>Remove cap and verify keypin aligns with ball on connector housing</li> <li>Reattempt connector mate</li> </ol>

# STS-134/ULF6 WORKAROUNDS CRIBSHEET (Cont)

## EVA 3 CONTINGENCIES (Cont)

TASK	FAILURE	ACTION																				
VI. FGB Y-Cables	A. NZGL Connectors	See Generic Section of Cribsheet																				
	B. Access to Connector difficult	<ol style="list-style-type: none"> <li>1. Notify <b>MCC-H</b> which connector needs to be removed</li> <li>2. On <b>MCC-H GO</b>, demate connector. Need to mate connector once Y-cable mated</li> </ol> <p>**The following table summarizes the inhibits per connector:</p> <table border="1"> <thead> <tr> <th>Connector</th> <th>Shut Down reqd</th> <th>Real time?</th> </tr> </thead> <tbody> <tr> <td>P130/J630</td> <td>DDCU Z1-4B</td> <td>No</td> </tr> <tr> <td>P132/J632</td> <td>RPCM N1 RS1-A 5 and 6</td> <td>Yes</td> </tr> <tr> <td>P137/J637</td> <td>DDCU Z1-3B</td> <td>No</td> </tr> <tr> <td>P139/J639</td> <td>DDCU Z1-3B</td> <td>No</td> </tr> <tr> <td>P140/J640</td> <td>None</td> <td>Yes</td> </tr> <tr> <td>P141/J641</td> <td>None</td> <td>Yes</td> </tr> </tbody> </table>	Connector	Shut Down reqd	Real time?	P130/J630	DDCU Z1-4B	No	P132/J632	RPCM N1 RS1-A 5 and 6	Yes	P137/J637	DDCU Z1-3B	No	P139/J639	DDCU Z1-3B	No	P140/J640	None	Yes	P141/J641	None
Connector	Shut Down reqd	Real time?																				
P130/J630	DDCU Z1-4B	No																				
P132/J632	RPCM N1 RS1-A 5 and 6	Yes																				
P137/J637	DDCU Z1-3B	No																				
P139/J639	DDCU Z1-3B	No																				
P140/J640	None	Yes																				
P141/J641	None	Yes																				
<p>FINAL Z1 UMBILICALS</p>																						
VII. Tool Relocations	A. Toolbox door will not open	<ol style="list-style-type: none"> <li>1. Verify both door locks are in open position (on either side of door panel) <ul style="list-style-type: none"> <li>• If necessary, remove launch restraint PIP pin, place in stowage bracket, and open lock</li> </ul> </li> <li>2. Ingress APFR/IAPFR for better worksite access</li> </ol>																				
	B. Toolbox door will not close	<ol style="list-style-type: none"> <li>1. Verify no FOD or interference in door hinge</li> <li>2. Verify door hinge in travel in groove</li> </ol>																				
	C. Toolbox door lock stuck	<ol style="list-style-type: none"> <li>1. Verify no FOD or interference</li> <li>2. Use crew hook to apply additional force in desired direction</li> <li>3. If door lock is stuck open, leave in open position and close door lock on the other side of door panel</li> </ol>																				
	D. Toolboard tab will not open	<ol style="list-style-type: none"> <li>1. Verify no FOD or interference in tab</li> <li>2. Use equipment hook to tap toolboard tab into open position</li> <li>3. If appropriate, utilize alternate tab (TB vs SL) to gain access to toolboard</li> </ol>																				
	E. Toolboard tab will not close	<ol style="list-style-type: none"> <li>1. Verify toolboard is fully seated in guide rail, reattempt</li> <li>2. Verify no FOD or interference in tab</li> <li>3. Stow toolboard in alternate location (mission specific): <ol style="list-style-type: none"> <li>a. Alternate slot in same toolbox</li> <li>b. Alternate slot in alternate toolbox</li> <li>c. Return toolboard to Airlock for internal stowage</li> </ol> </li> </ol>																				

# STS-134/ULF6 WORKAROUNDS CRIBSHEET (Cont)

## EVA 4 CONTINGENCIES

TASK	FAILURE	ACTION
I. <b>OBSS Stow</b>	A. OBSS fails to soft dock to SSBAD	<ol style="list-style-type: none"> <li>1. Verify SSBAD in SD, knob J-lock not engaged</li> <li>2. Verify SSBAD centered between striker bar stand-offs</li> <li>3. Inspect for FOD and reattempt</li> <li>4. If no joy, rotate SSBAD knob ccw to OP; insert OBSS striker bar, rotate SSBAD knob cw to CL</li> <li>5. If no joy, SSRMS re-grapple OBSS</li> </ol>
	B. SSBAD fails to go to "CL"	<ol style="list-style-type: none"> <li>1. Verify knob in release position (J-hook not locked)</li> <li>2. Verify SSBAD centered between striker bar standoffs</li> <li>3. Pull OBSS into SSBAD and reattempt</li> <li>4. If no joy, <b>PGT [A6, CW1, 30.5]</b> on knob's 7/16-in hex stud until in CL</li> <li>5. If no joy and at least in soft dock, perform OBSS tiedown</li> </ol>
	C. OBSS striker bar does not align with outbd SSBAD	<ol style="list-style-type: none"> <li>1. Verify outbd OSE is fully rotated in the direction towards the striker bar</li> <li>2. If EV2 not able to get full rotation, EV3 translate over to outbd OSE and help rotate about the trunnion pin</li> <li>3. If no joy and if less than .5" required for alignment, EV2 release Y-slider and continue with nominal capture steps</li> <li>4. Once U-joints released on outbd OSE, release clamp 'bolt 1' of inbd OSE <b>PGT [B7 (25.5), CCW2, 30.5]</b> 6 ext 7/16, max 13 turns</li> <li>5. Rotate inbd OSE stbd to provide enough slack to be able to lock Y-slider on outbd OSE</li> <li>6. Once in acceptable configuration, drive clamp 'bolt 1' of both OSEs <b>PGT [B3 (18.4), CW2, 30.5]</b> 6 ext 7/16; max 13 turns</li> <li>7. Verify OBSS stand fully clamped to trunnion (view clamping mechanism through OSE cover slot)</li> </ol>
	D. OSE slider knob stuck	<ol style="list-style-type: none"> <li>1. Verify PIP pin fully released and pulling up on knob</li> <li>2. Try to off-load SSBAD and reattempt</li> </ol>
	E. Wing-tabbed Connectors fail to disconnect	Use Hubble Connector Tool (90 deg in C/L bag)
	F. Wing-tabbed Connectors fail to connect	<ol style="list-style-type: none"> <li>1. Verify alignment/keying and reattempt (red wing line up with arrow, then rotate cw 90°)</li> <li>2. Reattempt using the Hubble connector tool (90 deg in C/L bag)</li> <li>3. If no joy, swap connectors and reattempt</li> </ol> <p>**1 of 2 required</p>
	G. Grounding PIP pins fail to install in OSE HR	<ol style="list-style-type: none"> <li>1. Verify ball detents are depressible</li> <li>2. Attempt in other OSE HR stanchion</li> <li>3. Verify slack in line and reattempt on another HR stanchion (S1 HR 3223)</li> <li>4. If no joy, lightly tap PIP pin with hook</li> </ol> <p>**1 of 2 required</p>

# STS-134/ULF6 WORKAROUNDS CRIBSHEET (Cont)

## EVA 4 CONTINGENCIES (Cont)

TASK	FAILURE	ACTION
II. PDGF Retrieve	A. PUMAA bolt does not fully install	<ol style="list-style-type: none"> <li>1. Back out bolt at <b>PGT [B7 (25.5), CCW2, 30.5]</b></li> <li>2. Verify PUMAA flat against PDGF and no rocking motion. Check FOD at bolt and tether hole. Check for MLI interference</li> <li>3. Reattempt with positive force on bolt at <b>PGT [A1 (2.5), CCW2, 30.5]</b> for 2 turns, then <b>PGT [B3 (18.4), CCW2, 30.5]</b> for remainder turns (8)</li> <li>4. If no joy, reattempt on other PDGF tether point</li> <li>5. If no joy, use inchworm technique with PDGF</li> </ol>
	B. Both EDF retaining lanyards missing/broken	<ol style="list-style-type: none"> <li>1. Contact <b>MCC-H</b> if continue with release</li> <li>2. On <b>MCC-H GO</b>, tether to pull lanyard of EDF and release EDF</li> <li>3. Fully remove EDF and stow in trash bag (keep attached to RET)</li> <li>4. Contact <b>MCC-H</b> if continue with PDGF install or bring inside A/L</li> </ol>
	C. Torque cannot be broken on EDF	<ol style="list-style-type: none"> <li>1. Re-torque EDF at <b>PGT [B7 (25.5), CW2,30.5]</b></li> <li>2. Reattempt release at <b>PGT [B7 (25.5), CCW2,30.5]</b></li> <li>3. If no joy, use manual ratchet on PGT for 1 turn only</li> <li>4. If no joy, release other EDFs and reattempt</li> <li>5. If no joy, retrieve ratchet wrench (Staging Bag) and reattempt</li> <li>6. If no joy, retrieve pry bar (Staging Bag) and reattempt (only if head not free spinning)</li> </ol>
	D. Once 5 turns achieved, EDF will not retract from PDGF	<ol style="list-style-type: none"> <li>1. Twist outer washer (lanyard washer) back and forth while pulling outward and reattempt</li> <li>2. If no joy, use hook to lightly tap bolt head and reattempt</li> <li>3. If no joy, release EDF two more turns at <b>PGT [B5 (22.0), CCW2,30.5]</b> and reattempt</li> <li>4. If no joy, release other EDFs and reattempt</li> <li>5. If no joy, rock the PDGF while pulling outward on EDF</li> <li>6. If no joy, use equipment hook to attempt to pry around bolt head/under retaining washer to release</li> <li>7. If no joy and on <b>MCC-H GO</b>, use pry bar (Staging Bag) between the washers to pry EDF out. (EDF head must not be free spinning)</li> <li>8. If no joy, on <b>MCC-H GO</b>, reinstall all 4 EDFs: <ul style="list-style-type: none"> <li>• Torque in a star pattern</li> <li>• Initial torque <b>PGT [B1 (12.0), CW2, 30.5]</b> 5 turns</li> <li>• Final torque <b>PGT [B7 (25.5), CW2, 30.5]</b> ~1/4 turn repeatable</li> </ul> </li> </ol> <p><b>**2 of 4 EDFs fully installed required</b></p>
	E. PDGF cannot be removed from mounting ring	<ol style="list-style-type: none"> <li>1. Ensure all 4 EDFs are released and retracted, twist PDGF while pulling to work it off, avoiding curvic coupling and reattempt</li> <li>2. If no joy and on <b>MCC-H GO</b>, retrieve pry bar (Staging Bag) and reattempt</li> <li>3. If no joy and on <b>MCC-H GO</b>, reinstall all 4 EDFs: <ul style="list-style-type: none"> <li>• Torque in a star pattern</li> <li>• Initial torque <b>PGT [B1 (12.0), CW2, 30.5]</b> 5 turns</li> <li>• Final torque <b>PGT [B7 (25.5), CW2, 30.5]</b> ~1/4 turn repeatable</li> </ul> </li> </ol> <p><b>**2 of 4 EDFs fully installed required</b></p>

## STS-134/ULF6 WORKAROUNDS CRIBSHEET (Cont)

### EVA 4 CONTINGENCIES (Cont)

TASK	FAILURE	ACTION
<b>III. EFGF Removal</b>	A. EFGF bolt fails to break torque	<ol style="list-style-type: none"> <li>Increase torque <b>PGT [B7 (25.5), CCW2, 30.5]</b> for 2 turns</li> <li>If no joy, use manual ratchet mode on PGT</li> <li>If no joy, release other bolts and reattempt</li> <li>If no joy, reinstall all bolts at <b>PGT [B2 (16.0), CW2, 30.5]</b>, 7 turns in star pattern</li> </ol> <p>**4 of 6 bolts required</p>
	B. EFGF bolt fails to release	<ol style="list-style-type: none"> <li>Verify no preload/twist on EFGF</li> <li>Release other bolts and reattempt</li> <li>If no joy, increase torque to <b>PGT [B7 (25.5), CCW2, 30.5]</b></li> <li>If no joy, use manual ratchet mode on PGT</li> <li>If no joy, reinstall all bolts at <b>PGT [B2 (16.0), CW2, 30.5]</b>, 7 turns in star pattern</li> </ol> <p>**4 of 6 bolts required</p>
	C. EVA Scissors fail to cut through EFGF cable	<ol style="list-style-type: none"> <li>Release TA Clamp to gain more leverage and reattempt</li> <li>If no joy, use general purpose cutters (port A/L Toolbox) or EMU scissors</li> <li>If no joy, reinstall EFGF in star pattern at <b>PGT [B2 (16.0), CW2, 30.5]</b>, 7 turns</li> </ol> <p>**4 of 6 bolts required</p>
	D. If pop off OBSS thermal washer	<ol style="list-style-type: none"> <li>Try to capture washer, put in trash bag</li> <li>Notify <b>MCC-H</b> bolt location</li> <li>For PAA install, drive associated bolt as last installed bolt and at reduced torque <b>PGT [A1 (2.5), CW2, 30.5]</b>, then ccw half a turn</li> </ol> <p>**5 of 6 washers required</p>
<b>IV. PAA Install</b>	A. PAA bolt fails to fully install	<ol style="list-style-type: none"> <li>Verify PAA alignment (can only fit in 1 orientation)</li> <li>Verify PAA fully seated (no soft dock) and no MLI or other interference; reattempt</li> <li>If no joy, release other bolts at <b>PGT [B7 (25.5), CCW2, 30.5]</b> 2 turns</li> <li>Reinstall all bolts at <b>PGT [B5 (22.0), CCW2, 30.5]</b> in star pattern starting with problem bolt</li> </ol> <p>**5 of 6 required, bolts 2/5 must be seated within last two turns or will have interference issues with PDGF EDFs</p>
	B. PAA Bolt 2 or 5 fails to fully install	<ol style="list-style-type: none"> <li>If installed within 2 turns, install PAA and start with corresponding EDF</li> <li>If not within 2 turns, PDGF will not seat properly on PAA. Bring PDGF inside A/L</li> </ol>
<b>V. PDGF Install</b>	A. PDGF will not soft dock on to PAA	<ol style="list-style-type: none"> <li>Verify all 4 EDFs are fully retracted</li> <li>Verify PDGF orientation (can only fit in 1 o'clock posn)</li> <li>Check for MLI and other interference</li> <li>Verify PDGF is fully seated on PAA. If rocking motion observed, remove PDGF (PAA bolt not fully seated)</li> </ol>

# STS-134/ULF6 WORKAROUNDS CRIBSHEET (Cont)

## EVA 4 CONTINGENCIES (Cont)

TASK	FAILURE	ACTION
	B. EDF will not insert (greater than 1/4" gap between washers, but appears to be through all clevis/lug holes)	<ol style="list-style-type: none"> <li>1. Ensure lanyards are not snagged between washers</li> <li>2. Verify EDF fully seated on internal hex head and aligned by pushing in and rotating the EDF. May require up to 60 deg of rotation</li> <li>3. Retract EDF, wiggle PDGF/EDF and reattempt</li> <li>4. If no joy, release other EDFs at <b>PGT [B7 (25.5), CCW2, 30.5]</b>, reattempt</li> <li>5. If no joy and for EDFs 3, 9 o'clock, remove PDGF, check PAA Bolt 2 or 5 if fully installed</li> </ol> <p>**4 of 4 EDFs required for SSRMS grapple, 2 of 4 required for structural integrity</p>
	C. After 5-7 cycles, unable to torque EDF to final torque	<ol style="list-style-type: none"> <li>1. Verify EDF fully seated on internal hex head and aligned by pushing in and rotating the EDF. May require up to 60 deg of rotation</li> <li>2. Verify maintaining axial force into EDF to keep engaged on hex head while driving EDF; reattempt</li> <li>3. If no joy, release all EDFs at <b>PGT [B7 (25.5), CCW2, 30.5]</b>, reinstall per nominal procedures starting with problem EDF</li> </ol> <p>**4 of 4 EDFs required for SSRMS grapple, 2 of 4 required for structural integrity</p>
	D. PUMAA bolt fails to break torque	<ol style="list-style-type: none"> <li>1. Use manual ratchet on PGT for 1 turn</li> <li>2. If no joy, leave installed on PDGF</li> </ol>
<b>VI. EFGF Stow in TSA</b>	A. TSA	See Generic Cribsheet Procedures
	B. EFGF does not fit in TSA	<ol style="list-style-type: none"> <li>1. Verify Grapple Shaft towards ODS</li> <li>2. Verify Tee Pull is released</li> <li>3. Check for interference (Tee pull, cushion, Adj tether hook, etc)</li> <li>4. If no joy and on <b>MCC-H GO</b>, release Grapple Shaft               <ol style="list-style-type: none"> <li>a. Retrieve 1/2" Box Ratchet from TSA (Aft tray)</li> <li>b. Add wire tie just under head for tether point</li> <li>c. Rotate release rod cw 19-23 turns to hard stop with 1/2" box ratchet (&lt; 20 ft-lb)</li> <li>d. Stow shaft in ORU bag or in TSA</li> </ol> </li> <li>5. Or on <b>MCC-H GO</b>, bring EFGF into A/L</li> </ol>

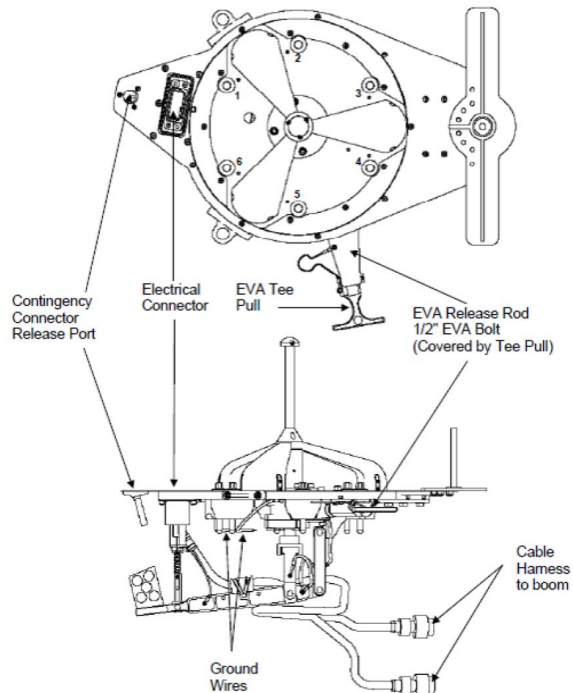

# STS-134/ULF6 WORKAROUNDS CRIBSHEET (Cont)

## EVA 4 CONTINGENCIES (Cont)

TASK	FAILURE	ACTION
VII. OTP Cinch	A. Cannot get wire tie under buckle for 2nd loop	Verify 1st loop around end of buckle. Do not require 2nd loop – best effort
VIII.SPDM EDF Release	A. Both EDF retaining lanyards missing/broken	<ol style="list-style-type: none"> <li>1. Contact <b>MCC-H</b> to continue with release</li> <li>2. On <b>MCC-H GO</b>, tether to pull lanyard of EDF and release EDF</li> <li>3. Fully remove EDF and stow in trash bag</li> </ol>
	B. Torque cannot be broken on EDF	<ol style="list-style-type: none"> <li>1. Use manual ratchet on PGT for 1 turn</li> <li>2. If no joy and on <b>MCC-H GO</b>, retrieve ratchet wrench (Staging Bag) and reattempt</li> </ol>
	C. Once 5 turns achieved, EDF will not release from lug/clevis (A3 EDF only)	<ol style="list-style-type: none"> <li>1. Use hook to lightly tap bolt head and reattempt</li> <li>2. If no joy, twist outer washer (lanyard washer) back and forth while pulling outward and reattempt</li> <li>3. If no joy, release EDF two more turns at <b>PGT [B5 (22.0), CCW2,30.5]</b> and reattempt</li> <li>4. If no joy, use equipment hook to attempt to pry around bolt head/under retaining washer to release</li> <li>5. If no joy, release A2 or A4 EDF and use pryrod from that location, reattempt A3 EDF release</li> <li>6. If no joy, use prybar (from Staging Bag) between the washers to pry EDF out</li> </ol>
	D. EDF fail to release after pry rod (A2 and A4 EDFs)	<ol style="list-style-type: none"> <li>1. Verify location of pry rod, no more than up to black line on pry rod showing</li> <li>2. Reattempt with impulse loads</li> <li>3. If no joy, retrieve APFR: <ul style="list-style-type: none"> <li>• For A4 EDF, use ELC3 WIF 3 [9,FF,A,12]</li> <li>• For A2 EDF, use ELC3 WIF 4 [3,VV,A,1]</li> </ul> </li> </ol> <p style="text-align: center;"><u>NOTE</u></p> <p>While one EV crew is in the APFR, he must maintain a hand-hold on approved ELC3 structure while free float EV crew is translating.</p> <p>Limit pry rod impulses to 5, then wait 60 sec to let loads dissipate</p>
	E. EDF fails to install in Stowage location	<ol style="list-style-type: none"> <li>1. Ensure lanyards are not snagged between washers</li> <li>2. Verify EDF fully seated on internal hex and aligned by pushing in and rotating the EDF. May require up to 60 deg of rotation</li> <li>3. Verify maintaining axial force into EDF to keep engaged on hex head while driving EDF</li> <li>4. If no joy, drive EDF 2 turns ccw, reattempt; verify head not free spinning</li> <li>5. If no joy, wire tie EDF around FSE or cut lanyard with EVA scissors and stow in trash bag</li> </ol>



## STS-134/ULF6 WORKAROUNDS CRIBSHEET (Cont)

### GET-AHEAD CONTINGENCIES

TASK	FAILURE	ACTION
I. <b>FHRC P-Clamp Release</b>	A. Bolt fails to release	Increase torque <b>PGT: [B1 (12.0), CCW2, 30.5]</b> for 1 turn then return to nominal setting <b>PGT: [A7 (9.2), CCW2, 30.5]</b>

## STS-134/ULF6 WORKAROUNDS CRIBSHEET (Cont)

### GENERIC CONTINGENCIES

TASK	FAILURE	ACTION	
I. Generic	<b>AGB</b>		
	A. Bolt fails to release	<ol style="list-style-type: none"> <li>Increase torque PGT: <b>[B1 (12.0), CCW2, 30.5], 7/16 - 6-ext (2-in required for ESP-2 FHRC)</b></li> <li>If no joy, increase torque PGT: <b>[B7 (25.5), CCW2, 30.5], 7/16 - 6-ext (2-in required for ESP-2 FHRC)</b></li> </ol>	
	B. Bolt jams during AGB release due to PGT dimensions (on ESP-2 FHRC)	<p>Use ratchet wrench</p> <ol style="list-style-type: none"> <li>Drive bolt back in PGT: <b>[A2 (3.8), CW2, 30.5], 7/16 - 2-ext</b></li> <li>Retrieve ratchet wrench to perform release</li> </ol>	
	C. T-handle fails to unlock (release)	<ol style="list-style-type: none"> <li>Check interface for FOD or damage</li> <li>Increase force and reattempt</li> <li>Use pry bar as lever to release T-handle</li> </ol>	
	D. AGB fails to release from soft dock	Use bolt puller or pry bar to pry the AGB from the PM near sticky plungers	
	E. T-handle fails to engage into alignment hole	<ol style="list-style-type: none"> <li>Slide AGB single pin side in and out a few inches while tapping T-handle into position</li> <li>Install tether to hold 2 pin side to restraint engaged on ORU and push in single pin side. Then reattempt step 1</li> </ol>	
	F. AGB fails to soft dock	<ol style="list-style-type: none"> <li>Check for FOD</li> <li>Exercise plungers with bolt puller or prybar</li> </ol>	
	G. Slider mechanism overcomes soft dock	<ol style="list-style-type: none"> <li>Verify T-handle fully out – 2 white lines</li> <li>Install tether to hold 2 pin side to restraint engaged on ORU and push in single pin side. Then slide AGB single pin side in and out a few inches while tapping T-handle into position</li> </ol>	
	H. Bolt fails to engage fully	<ol style="list-style-type: none"> <li>Check interface for FOD or damage</li> <li>Back out bolt PGT: <b>[A2 (3.8), CCW2, 30.5], 7/16 - 6-ext (2-in required for ESP-2 FHRC)</b> and reattempt installation at nominal setting <b>[A2 (3.8), CW2, 30.5], 7/16 - 6-ext (2-in required for ESP-2 FHRC)</b></li> <li>If green light achieved, check with <b>MCC-H</b> if turn count is acceptable</li> </ol>	
	I. PGT interferes during AGB install (on ESP-2 FHRC)	Attempt turns by hand or with ratchet wrench palm wheel cw until bolt seated; do not put preload on bolt with ratchet	
	<b>APFR/IAPFR</b>		
	A. APFR/IAPFR fails to install into WIF	<ol style="list-style-type: none"> <li>Verify APFR collar in install position (black-on-black)</li> <li>Check for FOD in WIF or structural interference</li> <li>Attempt APFR install in alternate clocking</li> <li>Attempt APFR install in alternate WIF</li> <li>APFR failure <ul style="list-style-type: none"> <li>Use another APFR</li> </ul> </li> </ol>	
	B. Joint fails to actuate	<ol style="list-style-type: none"> <li>Verify no load is applied to joint and/or jiggle APFR joint while actuating <ul style="list-style-type: none"> <li>For pitch joint, push knob in during rotation. (Class I pitch joints known to be stiff)</li> </ul> </li> <li>Increase force applied in order to free joint</li> </ol>	
C. Boot becomes stuck in APFR boot plate	<ol style="list-style-type: none"> <li>Have other EV crewmember assist with getting boot out</li> <li>Loosen 7/16-in EVA bolts (3) on heel clip using EVA ratchet or PGT: <b>PGT: [B1 (12.0), CCW2, 30.5], 7/16 - 6-ext</b></li> <li>Remove 7/16-in EVA bolts (3 – captive) on heel clip (non captive) using EVA ratchet or PGT: <b>PGT: [B1 (12.0), CCW2, 30.5], 7/16 - 6-ext</b> 5 turns total</li> </ol>		

## STS-134/ULF6 WORKAROUNDS CRIBSHEET (Cont)

### GENERIC CONTINGENCIES (Cont)

TASK	FAILURE	ACTION
	D. Boot becomes stuck in IAPFR boot plate	<ol style="list-style-type: none"> <li>1. Have other EV crewmember assist with getting boot out</li> <li>2. If wearing Small EMU boot, have other EV crewmember adjust boot sizing to Large</li> <li>3. Loosen 7/16-in EVA bolts (2) on heel clip using EVA ratchet or PGT: <b>PGT: [B2 (16.0), CCW2, 30.5], 7/16 - 6-ext</b></li> <li>4. Remove 7/16-in EVA bolts (2) on heel clip using EVA ratchet or PGT: <b>PGT: [B2 (16.0), CCW2, 30.5], 7/16 - 6-ext</b> 4 turns total</li> </ol>
<b>Ballstack</b>		
	A. ECOM fails to release from ISS Structure	On <b>MCC-H GO</b> : Tether ballstack to handrail and leave outside
	B. ECOM fails to release from MUT EE	Leave together and return inside
	C. Ballstack fails to rigidize	On <b>MCC-H GO</b> : Use secondary tethers to assist in restraining payload
<b>BRT</b>		
	A. BRT jaws fail to release	<ol style="list-style-type: none"> <li>1. Loosen rigidizing collar to relieve sideloads</li> <li>2. Shake BRT while depressing paddles to alleviate sideloads from handrail</li> <li>3. Detach BRT from suit and tether to structure</li> </ol>
<b>Cannon Connector</b>		
	A. Connector fails to release	<ol style="list-style-type: none"> <li>1. Check for FOD, damage or misalignment</li> <li>2. Verify cable routing is not impeding connector rotation (Release TA-clamps as required)</li> <li>3. Use cannon connector tool for more leverage</li> </ol>
	B. Connector/Cap fails to soft dock	<ol style="list-style-type: none"> <li>1. Verify collar unlocked (White on connector shell tip should align with white on receptacle backplate)</li> <li>2. Check for FOD or damage</li> </ol>
	C. Connector/Cap fails to lock	<ol style="list-style-type: none"> <li>1. Remove connector/cap, check for FOD or damage</li> <li>2. Check alignment, remate, rock connector back and forth as required. (Once locked, white on connector shell tip should align with black on receptacle backplate)</li> <li>3. Use cannon connector tool for more leverage</li> </ol>
	D. High cable stiffness prevents mating	<ol style="list-style-type: none"> <li>1. Verify all TA-clamps are released</li> <li>2. Use second crewmember</li> <li>3. Use APFR</li> </ol>
	E. Connector/Jack pin bent	<ol style="list-style-type: none"> <li>1. Describe pin location and condition <ul style="list-style-type: none"> <li>• Obtain WVS view of interface if possible</li> </ul> </li> <li>2. On <b>MCC-H GO</b>: For 16, 20, or 22 gauge pins only, retrieve pin straightener and attempt pin repair</li> <li>3. On <b>MCC-H GO</b>: Retrieve needle nose pliers and attempt pin repair <ul style="list-style-type: none"> <li>• <b>MCC-H</b> will verify pin size prior to retrieving tools</li> </ul> </li> </ol>
	F. Connector/Jack FOD	On <b>MCC-H GO</b> : Obtain connector cleaner tool to remove FOD
	G. Connector EMI band bent	On <b>MCC-H GO</b> : Obtain needle nose pliers or forceps to remove band

## STS-134/ULF6 WORKAROUNDS CRIBSHEET (Cont)

### GENERIC CONTINGENCIES (Cont)

TASK	FAILURE	ACTION
	<b>CETA Cart</b>	
	A. Wheel bogie fails to release from truss	<ol style="list-style-type: none"> <li>1. Verify brakes are fully released</li> <li>2. Ensure trigger is being depressed while attempting to rotate handle</li> <li>3. On <b>MCC-H GO</b>: Perform <u>6.100.125 CETA CART WHEEL BOGIE R&amp;R</u> <ul style="list-style-type: none"> <li>• There is no spare wheel bogie on-orbit, so after CETA cart is relocated, the failed wheel bogie will be reinstalled</li> </ul> </li> </ol>
	B. Wheel bogie fails to install on truss	There is no spare wheel bogie on-orbit. 4 of 4 bogies are required. Real time call on whether MT couple or CETA cart tie down required. For tie down see block G
	C. Parking brake fails to engage	<ol style="list-style-type: none"> <li>1. Use parking brake handle on other side of CETA cart</li> <li>2. Couple CETA cart to MT and utilize other WIF if possible</li> </ol>
	D. Parking brake fails to disengage	<ol style="list-style-type: none"> <li>1. Hold pedal down for brake release</li> <li>2. Use pedal on other side of CETA cart to release parking brake</li> </ol>
	E. Dynamic brake fails to engage	Limit translation rates to allow manual stopping
	F. CETA active coupler fails to capture or lock	<ol style="list-style-type: none"> <li>1. Cycle active coupler</li> <li>2. On <b>MCC-H GO</b>: Swap active couplers by removing PIP pins (2 on each coupler). (Port CETA Cart has short coupler) (MT Coupler PIP pins restrained by lanyard which must be cut to remove PIP pins) (Stbd Cart Coupler PIP pins restrained by wire tie. Wire tie does not need to be reinstalled)</li> <li>3. On <b>MCC-H GO</b>: Tie down CETA cart. See block G</li> </ol>
	G. CETA cart tiedown	<p>On <b>MCC-H GO</b>: Perform following tie-down procedure (see fig 1)</p> <ol style="list-style-type: none"> <li>a. Translate CETA cart to TBD location (not over truss segment joint)</li> <li>b. Engage parking brake</li> <li>c. Retrieve 2 Long Duration Tie-Down (LDTD) tethers</li> <li>d. Route 1 LDTD tether on stbd side of CETA cart as follows: <ol style="list-style-type: none"> <li>1. Attach 1 hook to zenith brake handle support tether point</li> <li>2. Loop tether strap around CETA rail HR standoff</li> <li>3. Attach second hook to nadir brake handle support tether point</li> <li>4. Lightly cinch tether and close buckle</li> <li>5. Close MLI flap over buckle and any excess strap</li> </ol> </li> <li>e. Repeat on port side of CETA cart</li> </ol>

# STS-134/ULF6 WORKAROUNDS CRIBSHEET (Cont)

## GENERIC CONTINGENCIES (Cont)

TASK	FAILURE	ACTION
	H. Coupler knob fails to unlock	<ol style="list-style-type: none"> <li>On <b>MCC-H GO</b>: Release active coupler by removing PIP pins (2) (MT Coupler PIP pins restrained by lanyard which must be cut to remove PIP pins Stbd Cart Coupler PIP pins restrained by wire tie. Wire tie does not need to be reinstalled)</li> <li>On <b>MCC-H GO</b>: Release passive coupler via EVA bolt: <b>PGT: [B7 (25.5), CCW2, 30.5], 7/16 - 6-ext 9 turns</b> <ul style="list-style-type: none"> <li>Bolt is attached by lanyard</li> </ul> </li> </ol>
	I. Swing arm fails to deploy	Use alternate swing arm or WIF
	J. Swing arm fails to stow	On <b>MCC-H GO</b> : Remove swing arm via EVA bolts (4): <b>PGT: [B7 (25.5), CCW2, 30.5], 7/16 - 6-ext TBD turns (Captive bolts?)</b>
	K. Swing arm fails to lock	Restrain in stowed position with wire ties

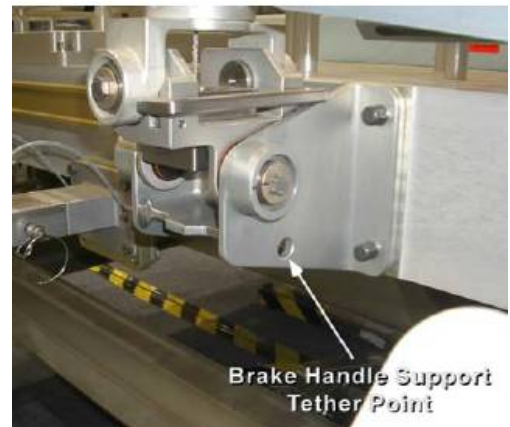
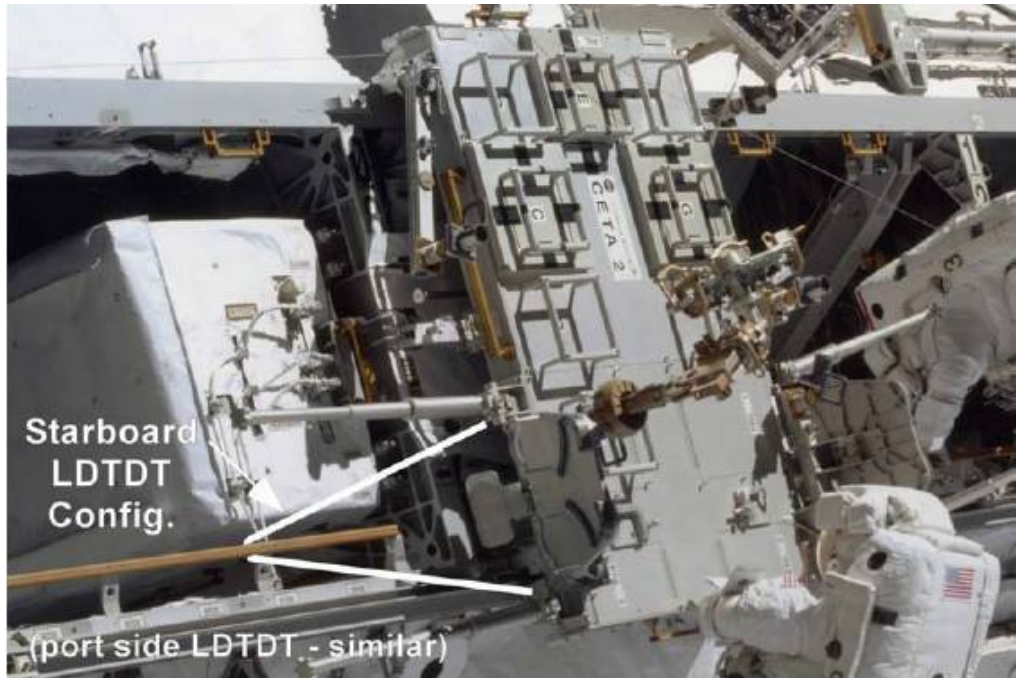

Figure 1.- CETA Cart Tiedown.

# STS-134/ULF6 WORKAROUNDS CRIBSHEET (Cont)

## GENERIC CONTINGENCIES (Cont)

TASK	FAILURE	ACTION
	<b>EVA Wrench (Torque and Ratchet)</b>	
	A. Ratchet teeth slip	Ratchet to new set of teeth and reapply torque
	B. Wrench does not ratchet	Hold the ratchet selector and socket in opposite hands and rotate in opposite directions
	<b>Expandable Diameter Fasteners (EDFs)</b>	
	A. EDF does not release with recommended torque	<ol style="list-style-type: none"> <li>Increase torque to <b>PGT: [B7 (25.5), CCW2, 30.5]</b> for one turn only. Continue release at nominal setting</li> <li>Increase torque to <b>PGT: [RCCW, 30.5]</b> for one turn only. Continue release at nominal setting</li> <li>Use Ratchet Wrench (ccw)</li> <li>Remove EDF with pry bar (only if head not free spinning)</li> </ol>
	B. EDF cannot be removed from lug/clevis after untorqued	<ol style="list-style-type: none"> <li>Twist outer washer (lanyard washer) back and forth while pulling outward</li> <li>Verify lanyard not snagged</li> <li>Drive EDF ccw 2 turns (start EDF by hand when re-installing)</li> <li>Gently tap along EDF major axis with back of equipment hook or hammer (EDF head must not be free spinning), and pull outward with lanyards</li> <li>Use equipment hook over EDF bolt head to remove (EDF head must not be free spinning)</li> <li>Use EVA pry bar (EDF head must not be free spinning)</li> </ol>
	C. Cannot insert EDF into lug/clevis interface	<ol style="list-style-type: none"> <li>Verify lug/clevis fully seated</li> <li>Twist EDF bolt head by hand to seat on tip hex head</li> <li>Drive EDF 2 addl turns ccw, retry insertion, verify head not free spinning</li> <li>Remove EDF and verify collets not expanded</li> <li>Cut EDF lanyards and replace failed EDF with spare EDF</li> </ol>
	D. EDF is not captive after all EDFs at final torque	<ol style="list-style-type: none"> <li>Increase torque to <b>PGT: [B7 (25.5), CW2, 30.5]</b>, ensure fully seated</li> <li>Increase torque to <b>PGT: [RCW, 30.5]</b>, ensure fully seated</li> <li>Pull EDF and re-insert (loosen collets as reqd), ensure fully seated, retry</li> <li>Increase torque on all EDFs to <b>PGT: [RCW, 30.5]</b>, ensure fully seated</li> <li>Cut EDF lanyards and replace failed EDF with spare EDF</li> </ol>
	<b>Fluid QD Ops</b>	
	<b>NOTE</b>	
	<p>Troubleshooting steps outlined in this cribsheet are a generic starting point. Flight specific situations may require different actions.</p> <p>If troubleshooting requires the crew to leave the worksite, verify that female QDs are covered to prevent exposure to direct sunlight. For thermal clocks refer to flight rules</p>	

# STS-134/ULF6 WORKAROUNDS CRIBSHEET (Cont)

## GENERIC CONTINGENCIES (Cont)

TASK	FAILURE	ACTION
	<b>Mating Ops</b>	
	A. QD fails to mate	<ol style="list-style-type: none"> <li>1. Check alignment and verify side loads are counteracted</li> <li>2. Verify fwd white band is not visible. (Release ring is retracted)</li> <li>3. Inspect male and female QD for debris, damage, or NH3</li> <li>4. Leave female QD engaged with male. (NH3 may sublimate between QDs)</li> <li>5. Change body orientation for better access</li> </ol>
	B. Release ring snap back test fails	<ol style="list-style-type: none"> <li>1. Push release ring forward. (Release ring will not slide fwd if QD is in FID)</li> <li>2. QD is in FID               <ol style="list-style-type: none"> <li>a. Demate QD</li> <li>b. Pull back on release ring</li> <li>c. Verify fwd white band not visible. (Release ring is retracted)</li> <li>d. Assess and counteract sideloads and remate QD</li> </ol> </li> </ol>
	C. Gap check fails (visual or FID gauge)	QD is in FID <ol style="list-style-type: none"> <li>a. Demate QD</li> <li>b. Pull back on release ring</li> <li>c. Verify fwd white band not visible. (Release ring is retracted)</li> <li>d. Assess and counteract sideloads and remate QD</li> </ol>
	D. Pull test fails	<ol style="list-style-type: none"> <li>1. Verify fwd white band is not visible. (Release ring is retracted)</li> <li>2. Assess and counteract sideloads and mate QD</li> </ol>
	<b>Valve Ops</b>	
	A. Detent button is partially unthreaded	Rethread detent button <ol style="list-style-type: none"> <li>a. Load bail handle. (Button will free spin if not loaded)               <ul style="list-style-type: none"> <li>• If valve is open (bail fwd), pull bail handle aft</li> <li>• If valve is closed (bail aft), push bail handle fwd</li> </ul> </li> <li>b. Rotate button cw to hardstop (8 turns max)</li> </ol>
	B. Detent button is missing  <u>NOTE</u> Detent button is only required for BDT ops and 1 in SPD ops	<ol style="list-style-type: none"> <li>1. Use equipment hook to depress detent button shaft</li> <li>2. Use tether strap around gloved finger to depress detent button shaft</li> <li>3. Retrieve and use Beta Gimbal Antirotation Latch Tool to depress detent button shaft</li> <li>4. On <b>MCC-H GO</b>: Install spare detent button. (Buttons are stowed IVA and must be configured prior to EVA use)</li> </ol>
	C. Bail fails to travel to fwd (valve open) position (button does not pop up if attempting to go to full fwd)	<ol style="list-style-type: none"> <li>1. Assess and counteract sideloads</li> <li>2. Apply greater opening force to QD bail handle in fwd direction</li> <li>3. Retrieve and use QD bail drive lever (3/4, 1, &amp; 1.5 in only)</li> <li>4. If applicable, retrieve and install SPD; notify <b>MCC-H</b></li> </ol>



# STS-134/ULF6 WORKAROUNDS CRIBSHEET (Cont)

## GENERIC CONTINGENCIES (Cont)

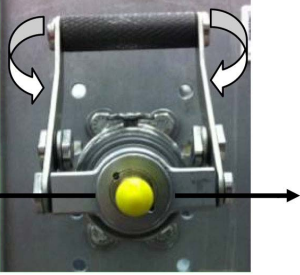
TASK	FAILURE	ACTION
	<p>D. Detent button fails to depress in preparation for valve closing</p> <div data-bbox="462 325 734 590" style="border: 2px solid black; padding: 5px; margin: 10px 0;"> <p style="text-align: center;"><b>WARNING</b></p> <p>Bail may kick back and contact crew when a stuck button is forcibly depressed due to pressure build-up in spring cavity</p> </div> 	<ol style="list-style-type: none"> <li>1. Verify locking collar unlocked (1/2, 3/4, &amp; 1 in only)</li> <li>2. Push and hold bail handle fwd (to open) with significant force to relieve load on button while simultaneously depressing the detent button <ul style="list-style-type: none"> <li>• If button depresses, vent by allowing bail aft until aft white band no longer visible</li> </ul> </li> <li>3. Twist bail handle/Rock QD from side-to-side and fwd/aft while depressing button to allow internal QD components to align</li> <li>4. Retrieve QD bail drive lever and repeat step 2 (3/4, 1, &amp; 1.5 in only)</li> <li>5. Contact <b>MCC</b> to reduce NH3 pressure, if possible</li> <li>6. On <b>MCC-H GO</b>: Retrieve and install QD button depress tool (BDT) (1/4, 3/4, &amp; 1 in only)</li> <li>7. On <b>MCC-H GO</b>: Retrieve hammer and tap center of button. (Use plastic side of hammer.) (Inspect tool and QD)</li> </ol>
	<p>E. Bail fails to travel to full aft (valve closed) position (button does not pop up)</p>	<ol style="list-style-type: none"> <li>1. Assess and counteract sideloads</li> <li>2. Increase force on bail while depressing button</li> <li>3. Retrieve and use QD bail drive lever (3/4, 1, &amp; 1.5 in only)</li> <li>4. Inspect QD for retaining wire protrusion</li> </ol>
<b>Demating Ops</b>		
	<p>A. Female QD fails to demate</p>	<ol style="list-style-type: none"> <li>1. Assess and counteract sideloads or manipulate flexhose to relieve mating forces on female QD</li> <li>2. Verify release ring is fully retracted while attempting to demate</li> <li>3. Verify TA or P clamps are released</li> <li>4. Verify detent button is up (locking collar can be rotated under button)</li> <li>5. Verify trigger linkage is still attached to release ring (1.5 in only)</li> <li>6. Apply greater force to release ring and female QD</li> <li>7. Retrieve and use QD release tool (QRT) to apply greater force (3/4, 1, &amp; 1.5 in only)</li> <li>8. On <b>MCC-H GO</b>: Shake QD vigorously while attempting to demate</li> </ol>
	<p>B. Thermal bootie fails to remain securely closed</p>	<p>Install wire tie around bootie to keep QD fully covered</p>
	<p>C. Cap will not demate</p>	<ol style="list-style-type: none"> <li>1. Verify pulling out on cap before rotating to ensure locking tab is disengaged</li> <li>2. Wait for opposite thermal conditions if possible and reattempt cap removal</li> <li>3. Retrieve QD cap tool (1/4, 1/2, &amp; 1 in only) <ol style="list-style-type: none"> <li>a. <b>PGT: [A4 (6.3), CCW1, 30.5]</b> with QD cap tool to turn stuck cap a maximum of 2 turns (cap vents at ~2 turns)</li> <li>b. Once venting is complete, finish removal of cap by hand (~1 additional turn) <ul style="list-style-type: none"> <li>• If venting does not stop or cap cannot be removed by hand, notify <b>MCC-H</b>. (Male QD may be leaking)</li> </ul> </li> </ol> </li> </ol>

# STS-134/ULF6 WORKAROUNDS CRIBSHEET (Cont)

## GENERIC CONTINGENCIES (Cont)

TASK	FAILURE	ACTION
	D. Partial fwd white band visible after QD demate	<ol style="list-style-type: none"> <li>1. Pull back on release ring to verify QD is not in FID</li> <li>2. Verify detent button is up</li> <li>3. If fwd white band is still partially visible this is likely a tolerance stackup; notify <b>MCC-H</b> and press with QD ops</li> </ol>
		<p style="text-align: center;"><b>CAUTION</b></p> <p>Do not fully open a leaking QD. Fully opening a leaking QD could trap NH3 and prevent depressing the button in the future. For 1.5 in QDs, insert fwd SPD spacer prior to opening valve</p>
<b>Leaks</b>		
	A. Mated QD leaks in valve open position (bail fwd)	<ol style="list-style-type: none"> <li>1. Cycle valve               <ol style="list-style-type: none"> <li>a. Remove SPD if present (aft spacer only for 1.5 in) and fully close valve (bail aft); wait for ice crystals to dissipate</li> <li>b. Open valve halfway (bail fwd). (For 1.5 in, verify fwd SPD spacer installed prior to opening valve)</li> <li>c. Describe leak size and if leak rate is changing</li> </ol> </li> <li>2. If leak has stopped, on <b>MCC-H GO</b>: Complete valve open steps; else; repeat step 1</li> <li>3. On <b>MCC-H GO</b>: Remove SPD if in place; push bail full fwd to engage secondary seal, verify detent button is up and aft white band is visible</li> <li>4. Close valve; notify <b>MCC-H</b></li> <li>5. If applicable, close valve of appropriate QD in flowpath, verify detent button is up, and fwd white band is visible</li> </ol>
	B. Female QD leaks due to FID	<ol style="list-style-type: none"> <li>1. Return bail to aft position (valve closed)</li> <li>2. Perform release ring snap back test               <ul style="list-style-type: none"> <li>• If FID is observed, demate and remate QD</li> </ul> </li> </ol>
	C. Male QD leaks after cap removal	<ol style="list-style-type: none"> <li>1. If leak small, mate female QD; continue ops</li> <li>2. Reinstall cap; notify <b>MCC-H</b></li> </ol>
	D. QD leaks after valve close operation  <div style="border: 2px solid black; padding: 5px; width: fit-content;"> <p style="text-align: center;"><b>WARNING</b></p> <p>Bail may kick back and contact crew when a stuck button is forcibly depressed due to pressure build-up in spring cavity</p> </div>	<ol style="list-style-type: none"> <li>1. Cycle Valve               <ol style="list-style-type: none"> <li>a. Open valve halfway (bail fwd). (For 1.5-in, install fwd SPD spacer prior to opening valve)</li> <li>b. Contact <b>MCC-H</b>; describe leak size and if leak rate is changing; wait for ice crystals to dissipate</li> <li>c. On <b>MCC-H GO</b>, re-close QD; inform <b>MCC-H</b> if leak still present and quantify leak</li> </ol> </li> <li>2. If still leaking, contact <b>MCC-H</b> to determine if male leaking. (THOR will monitor pressure drop)</li> <li>3. On <b>MCC-H GO</b>, demate QD and inspect</li> <li>4. If still leaking, contact <b>MCC-H</b> for direction. Depending on the situation further direction could include: Living with leak, using a QD extender, additional cycles of QD, applying radial force to tube stub with valve open or other real-time decisions</li> </ol>

# STS-134/ULF6 WORKAROUNDS CRIBSHEET (Cont)

## GENERIC CONTINGENCIES (Cont)

TASK	FAILURE	ACTION
		<p align="center"><b>CAUTION</b></p> <p>Do not fully open a leaking QD. Fully opening a leaking QD could trap NH3 and prevent depressing the button in the future. For 1.5-in QDs, insert fwd SPD spacer prior to opening valve</p>
	E. Female QD leaks after demate	<ol style="list-style-type: none"> <li>Contact <b>MCC-H</b>: Describe leak size and if leak rate is changing</li> <li>Depending on situation, <b>MCC-H</b> could recommend the following actions: Continuing ops, using a QD extender, or other real-time decisions</li> </ol>
	F. Male QD leaks after demate. (Male sleeve may be visibly stuck open)	<ol style="list-style-type: none"> <li>Contact <b>MCC-H</b>: Describe leak size and if leak rate is changing</li> <li>If leak is small and dissipating and does not interfere with EVA: Press with operations on <b>MCC-H GO</b></li> <li>If leak is large: Remate female QD and open valve (bail fwd)               <ol style="list-style-type: none"> <li>Depress button and use significant force to push bail forward; release button</li> <li>With QD in open position (bail fwd), apply significant force to aft end of female QD in side-to-side &amp; up and down directions (radially from tube stub)</li> <li>Attempt to close valve (bail aft)</li> <li>Demate QD and inspect</li> </ol> </li> <li>If applicable, close valve of appropriate QD in flowpath, verify detent button is up, and fwd white line is visible</li> <li>On <b>MCC-H GO</b>: Install cap</li> </ol>
	G. Frozen NH3 present on female or male QD	<ol style="list-style-type: none"> <li>Leave QD exposed to vacuum; wait maximum of 5 min for sublimation (check periodically)</li> <li>On <b>MCC-H GO</b>: Continue QD ops. (NH3 may sublimate during QD mating)</li> </ol>
	<b>SPD</b>	
	A. 1/2-in SPD cannot be installed	<ol style="list-style-type: none"> <li>If aft portion of SPD not fully seated, move bail fwd slightly to allow SPD to fully seat</li> <li>After bail secured in slot on slider, wire tie in place</li> </ol>
	B. 1/2-in SPD cannot be removed	Increase force on SPD slider (1/2-in SPD sliders can be sticky)
	C. 1.5-in aft SPD spacer cannot be installed	<ol style="list-style-type: none"> <li>Install fwd SPD spacer; ensure bail against fwd SPD</li> <li>Wire tie bail to keep it against SPD; restrain aft SPD with wire tie, if reqd</li> </ol>
	D. 1.5-in fwd SPD spacer cannot be installed	<ol style="list-style-type: none"> <li>Install aft SPD spacer; ensure bail against aft SPD</li> <li>Wire tie bail to keep it against SPD; restrain fwd SPD with wire tie, if reqd</li> </ol>
	<b>Vent Tool</b>	
	A. Tip of vent tool does not pass black mark during alignment check	Slide the equipment hook further away from vent tool nozzle end
	B. Vent tool cannot be mated to Vent Tool Extender	Hold VTE adapter in sunlight to warm it up (known tolerance issue between cold VTE adapter & vent tool nozzle)

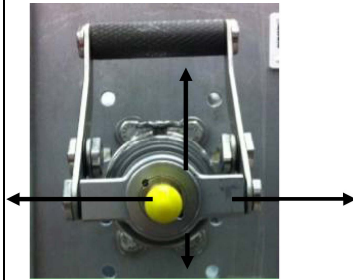

# STS-134/ULF6 WORKAROUNDS CRIBSHEET (Cont)

## GENERIC CONTINGENCIES (Cont)

TASK	FAILURE	ACTION
<p><b><u>Mate QD</u></b></p> <ol style="list-style-type: none"> <li>1. Remove QD caps as required</li> <li>2. Inspect male and female QD for debris or damage</li> <li>3. Verify female QD ready to mate               <ul style="list-style-type: none"> <li>√Detent button – up</li> <li>√Locking collar – locked position</li> <li>√Fwd white band – not visible</li> </ul> </li> <li>4. Assess and counteract side loads prior to mate</li> <li>5. Mate QD               <ul style="list-style-type: none"> <li>√Fwd white band – visible</li> </ul> </li> <li>6. Perform snapback test               <ul style="list-style-type: none"> <li>√Fwd white band visible</li> </ul> </li> <li>7. Perform pull test. (Stay clear of button and release ring)</li> <li>8. Perform visual gap test</li> </ol>	<p><b><u>Demate QD</u></b></p> <ol style="list-style-type: none"> <li>1. Assess and counteract side loads prior to demate</li> <li>2. Pull back on release ring and demate QD</li> <li>3. √Release ring – retracted (FWD white band not visible)</li> <li>4. Inspect male and female QD for debris, damage, or anomalous conditions (ammonia crystals)</li> <li>5. If complete with QD ops: Rotate locking collar to locked position (1/2, 3/4, &amp; 1 in only)</li> <li>6. Install QD caps as required; verify lock tab engaged</li> </ol>	
<p><b><u>Open Valve (1/4 inch)</u></b></p> <ol style="list-style-type: none"> <li>1. Prior and during bail movement assess and counteract side loads</li> <li>2. Depress detent button</li> <li>3. Push bail to forward position</li> <li>4. √Aft white band visible</li> <li>5. √Detent button – up</li> </ol>	<p><b><u>Close Valve</u></b></p> <div style="border: 1px solid black; padding: 5px; margin: 5px 0;"> <p style="text-align: center;"><b><u>CAUTION</u></b></p> <p>Do not fully open a leaking QD. Fully opening a leaking QD could trap NH3 and prevent depressing the button in the future. For 1.5-in QDs, insert fwd SPD spacer prior to opening valve</p> </div> <ol style="list-style-type: none"> <li>1. If present, remove SPD</li> <li>2. Rotate locking collar to unlocked position (1/2, 3/4, &amp; 1 in only)</li> <li>3. √Aft white band visible</li> <li>4. √Detent button fully installed</li> <li>5. √Detent button up</li> <li>6. √Detent button can be depressed</li> <li>7. Prior and during bail movement assess and counteract side loads</li> <li>8. Push bail toward open position with significant force while depressing detent button (unstick male sleeve seals)</li> <li>9. Depress detent button, move bail aft (close valve)</li> <li>10. √Fwd white band visible</li> <li>11. √Detent button up</li> <li>12. If complete with QD ops: Rotate locking collar to locked position (1/2, 3/4, &amp; 1 in only)</li> </ol>	
<p><b><u>Open Valve (1/2 inch)</u></b></p> <ol style="list-style-type: none"> <li>1. Prior and during bail movement assess and counteract side loads</li> <li>2. Rotate locking collar to unlocked position</li> <li>3. Depress detent button</li> <li>4. Push bail fwd, so aft white band just begins to show</li> <li>5. Pull lock knob up on SPD</li> <li>6. Slide SPD slider aft</li> <li>7. Install SPD</li> <li>8. Slide SPD slider fwd to engage bail handle</li> <li>9. Push bail toward closed position up against slider</li> <li>10. Push lock knob down on SPD; perform pull test on SPD</li> </ol>	<p><b><u>Open Valve (3/4 inch)</u></b></p> <ol style="list-style-type: none"> <li>1. Prior and during bail movement assess and counteract side loads</li> <li>2. Rotate locking collar to unlocked position</li> <li>3. Depress detent button</li> <li>4. Push bail to forward position</li> <li>5. √Aft white band visible</li> <li>6. √Detent button – up</li> <li>7. Rotate locking collar to locked position</li> </ol>	
<p><b><u>Open Valve (1 inch)</u></b></p> <ol style="list-style-type: none"> <li>1. Prior and during bail movement assess and counteract side loads</li> <li>2. Rotate locking collar to unlocked position</li> <li>3. Depress detent button</li> <li>4. Push bail to forward position</li> <li>5. √Aft white band visible</li> <li>6. √Detent button – up</li> <li>7. Install 1-in SPD if present; verify locking tabs engage; perform pull test</li> <li>8. Rotate locking collar to locked position, if present and no SPD</li> </ol>	<p><b><u>Open Valve (1.5 inch)</u></b></p> <ol style="list-style-type: none"> <li>1. Install forward SPD spacer aft of release ring</li> <li>2. Prior and during bail movement assess and counteract side loads</li> <li>3. Depress detent button</li> <li>4. Push bail against fwd SPD spacer</li> <li>5. Install aft SPD spacer</li> </ol>	

# STS-134/ULF6 WORKAROUNDS CRIBSHEET (Cont)

## GENERIC CONTINGENCIES (Cont)

TASK	FAILURE	ACTION
	<b>FRAM</b>	
	A. Primary FRAM bolt fails to release	<ol style="list-style-type: none"> <li>1. Confirm socket fully engaged to release anti-rotation mechanism</li> <li>2. Increase PGT setting for 1 turn only (except CEPA): <b>PGT: [A7 (9.2), CCW2, 30.5], 7/16 - 6-ext</b></li> <li>3. Increase PGT setting for 1 turn only: <b>PGT: [B2 (16.0), CCW2, 30.5], 7/16 - 6-ext</b></li> <li>4. On <b>MCC-H GO</b>: Increase PGT setting for 1 turn only: <b>PGT: [B4 (19.4), CCW2, 30.5], 7/16 - 6-ext</b></li> </ol>
	B. Active FRAM fails to seat on passive FRAM	<ol style="list-style-type: none"> <li>1. Check alignment. (Engage 2 forward shear pins first to ensure connector door is not jamming)</li> <li>2. Check for FOD in mechanism</li> </ol>
	C. Primary FRAM bolt fails to engage required number of turns  <u>NOTE</u> 4 of 4 pins required in Shuttle PLB. 3 of 4 pins required for ISS Stowage	<ol style="list-style-type: none"> <li>1. Verify active FRAM fully seated</li> <li>2. Check for FOD</li> <li>3. Cycle FRAM bolt               <ol style="list-style-type: none"> <li>a. Fully release primary FRAM bolt</li> <li>b. Reattempt engagement at nominal setting</li> </ol> </li> <li>4. Increase PGT setting (except CEPA): <b>PGT: [A7 (9.2), CW2, 30.5], 7/16 - 6-ext</b></li> <li>5. Increase PGT setting: <b>PGT: [B2 (12.0), CW2, 30.5], 7/16 - 6-ext</b></li> <li>6. On <b>MCC-H GO</b>: Increase PGT setting: <b>PGT: [B4 (16.0), CW2, 30.5], 7/16 - 6-ext</b></li> <li>7. Hold for thermal stabilization between active and passive FRAM</li> <li>8. Engage contingency pins:               <ul style="list-style-type: none"> <li>• Front pins (all FRAMs) <b>PGT: [A4 (6.3), CW2, 30.5], 7/16 - 6-ext</b> 14.11 – (1.25 * Turns on Primary Bolt) turns</li> </ul> </li> </ol> <p style="text-align: center;"><u>NOTE</u></p> <p>Aft contingency pins can only be installed if the primary bolt turn count is 6.5 turns or less</p> <ol style="list-style-type: none"> <li>a. Aft pins for LWAPA, SAPA, CEPA, and ExPA               <ol style="list-style-type: none"> <li>1. Remove bolt from STOW location and engage in INSTALL location</li> <li>2. Manually turn bolt as far as possible</li> <li>3. <b>PGT: [B1 (12.0), CW2, 30.5], 7/16 - 6-ext</b> ~3.5 turns</li> </ol> </li> <li>b. Aft pins for MAPA and LAPA               <ol style="list-style-type: none"> <li>1. <b>PGT: [A4 (6.3), CW2, 30.5], 7/16 - 6-ext</b> 16.858 – (1.25*Turns on Primary Bolt) turns</li> </ol> </li> <li>c. Aft pins for LMC FRAM               <ol style="list-style-type: none"> <li>1. Prep CPK by disengaging J-hook on locking mechanism; ensure J-hook fully seated in unlock position</li> <li>2. Slide T-handle until contingency pin contacts primary FRAM pin (# on locking mechanism counter = # of turns on primary FRAM bolt)</li> <li>3. Disengage J-hook from unlock position. J-hook is spring loaded and will “pop” into place if not precisely aligned with numbered slot. Fully seat J-hook in lock position</li> </ol> </li> </ol>

# STS-134/ULF6 WORKAROUNDS CRIBSHEET (Cont)

## GENERIC CONTINGENCIES (Cont)

TASK	FAILURE	ACTION
	D. Latch dogs fail to retract during FRAM removal from Square Grid Interface	<ol style="list-style-type: none"> <li>Lift FRAM so that latch dogs contact square grid</li> <li>Cycle primary drive bolt</li> </ol>
	E. Latch dogs not retracted prior to installation onto Square Grid Interface	Push latch dogs to retracted position with tool or tether hook
<b>MMOD Shield</b>		
	A. MMOD shield Dzus fastener fails to release  <div style="border: 2px solid black; padding: 5px; width: fit-content; margin: 10px auto;"> <p style="text-align: center;"><b>WARNING</b></p> <p style="text-align: center;">Do not touch back side of MMOD shield or handle fastener fragments due to sharp edges</p> <p style="text-align: center;">Fastener and shield/tool interface must be covered to avoid potential projectiles</p> </div>	On <b>MCC-H GO</b> : Use pry bar to release <ol style="list-style-type: none"> <li>Retrieve pry bar and emptied med ORU bag</li> <li>Release other Dzus fasteners</li> <li>Assess clearance between MMOD shield and tools</li> <li>If possible, rotate fastener to position tangs off of tools</li> <li>Place med ORU bag over failed fastener</li> <li>Insert pry bar under MMOD shield by failed fastener and pry shield away from structure</li> </ol>
	B. MMOD shield Dzus fastener fails to engage	<ol style="list-style-type: none"> <li>Verify center fastener is engaged first</li> <li>Check Dzus fastener aligned with bracket (floating receptacles on endcones)</li> <li>Verify fastener clocking correct per alignment mark</li> <li>Push firmly and rotate</li> <li>Engage other fasteners: 2 out of 3 required</li> <li>If 2 of 3 not achieved:               <ul style="list-style-type: none"> <li>Option 1 (Wire Tie) (See figs 2-4): 1 properly secured wire tie = 1 Dzus fastener; using a long wire tie, squish the loop on one end, feed it through the bracket on structure (may need to push floating receptacle inboard to get it out of way), secure wire tie w/3 twists. Feed one end of wire tie around Dzus head (on outside of shield) and secure with 3 twists. If HR nearby can also secure wire tie to HR. (Goal is for the wire tie to push shield in toward body of structure and toward center if endcone shield)</li> <li>Option 2 (LDTDT): Use 1 adj (attach to tether point on T tool and to structure HR) and 1 LDTDT across shield to hold shield in position</li> </ul> </li> </ol>
	C. T-handle tool fails to engage shield	Remove adjacent fasteners and attempt reinstallation
	D. MLI grounding strap Dzus fails to release	On <b>MCC-H GO</b> : Cut ground wire near Dzus fastener

# STS-134/ULF6 WORKAROUNDS CRIBSHEET (Cont)

## GENERIC CONTINGENCIES (Cont)

TASK	FAILURE	ACTION
		

Figure 2.- MMOD Shield Wire Tie Option.



# STS-134/ULF6 WORKAROUNDS CRIBSHEET (Cont)

## GENERIC CONTINGENCIES (Cont)

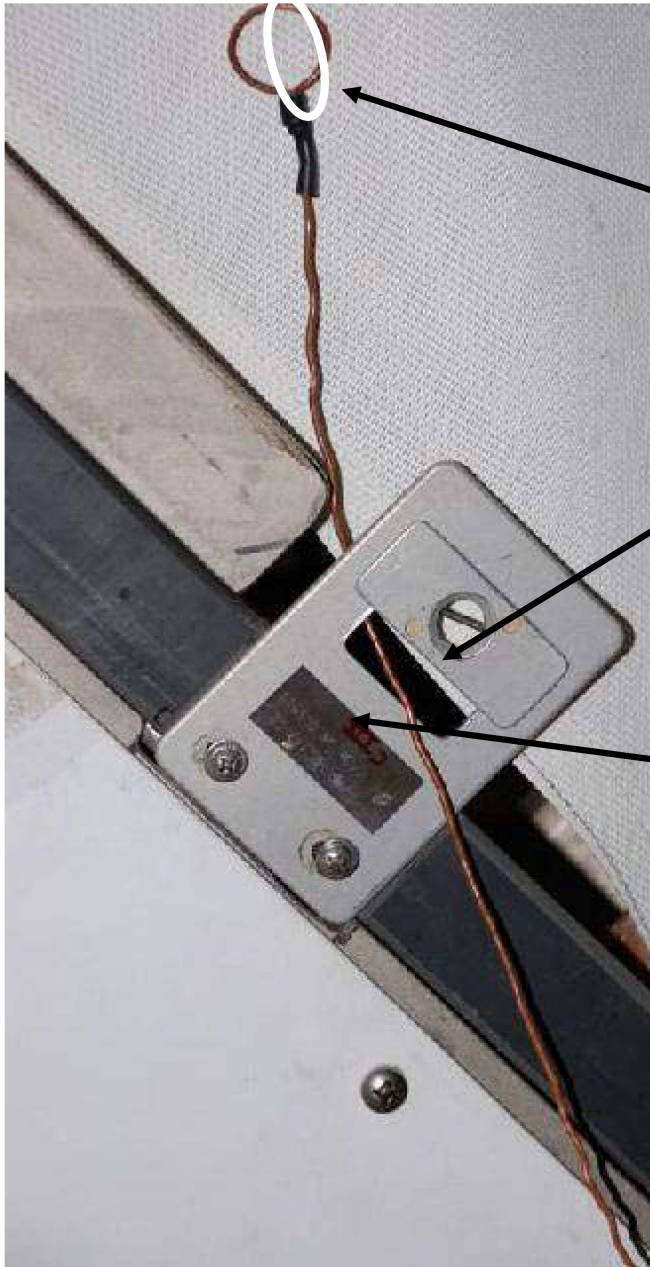
TASK	FAILURE	ACTION
	 <p data-bbox="438 325 714 430">Install shield with wire tie ends sticking out across adjacent shield</p>	 <p data-bbox="1153 1270 1404 1375">After threading wire tie through nutplate, twist 3 times</p>

Figure 3.- MMOD Shield Wire Tie Option (Cont).

# STS-134/ULF6 WORKAROUNDS CRIBSHEET (Cont)

## GENERIC CONTINGENCIES (Cont)

TASK	FAILURE	ACTION
	 <div data-bbox="470 829 860 1029" style="border: 1px solid black; padding: 5px;"> <p>Wrap wire tie around Dzus head; one full wrap (shown here) or wrap &amp; twist method</p> <p>Then twist loose wire tie ends to create a loop</p> </div>	<p style="text-align: center;">Figure 4.- MMOD Shield Wire Tie Option (Cont).</p>
	<p><b>MUT EE</b></p>	
<p>A. MUT EE jaws fail to release</p>		<ol style="list-style-type: none"> <li>1. Verify locking collar fully released</li> <li>2. Shake MUT EE while depressing paddles to alleviate sideloads from handrail</li> <li>3. Release MUT EE ECOM socket and tether MUT EE to structure</li> </ol>
	<p><b>MWS</b></p>	
<p>A. MWS EE is sticky</p>		<p>Known problem. Report degree of stickiness to <b>MCC-H</b> and any noted correlation with thermal environment. Post EVA, report s/n of affected unit (s/n located on "stem" of T-bar)</p>
<p>B. MWS EE cord fails to retract</p>		<ol style="list-style-type: none"> <li>1. Verify MWS EE tether lock in unlock position</li> <li>2. Cycle MWS EE tether lock</li> <li>3. Check tether reel opening for FOD</li> <li>4. Pull out small amount of tether and allow reel to retract while holding light tension on the tether</li> </ol>
<p>C. MWS T-bar fails to pivot</p>		<ol style="list-style-type: none"> <li>1. Check sideloads on T-bar while depressing button</li> <li>2. Slip T-bar clutch (40-60 lb force required)</li> </ol>

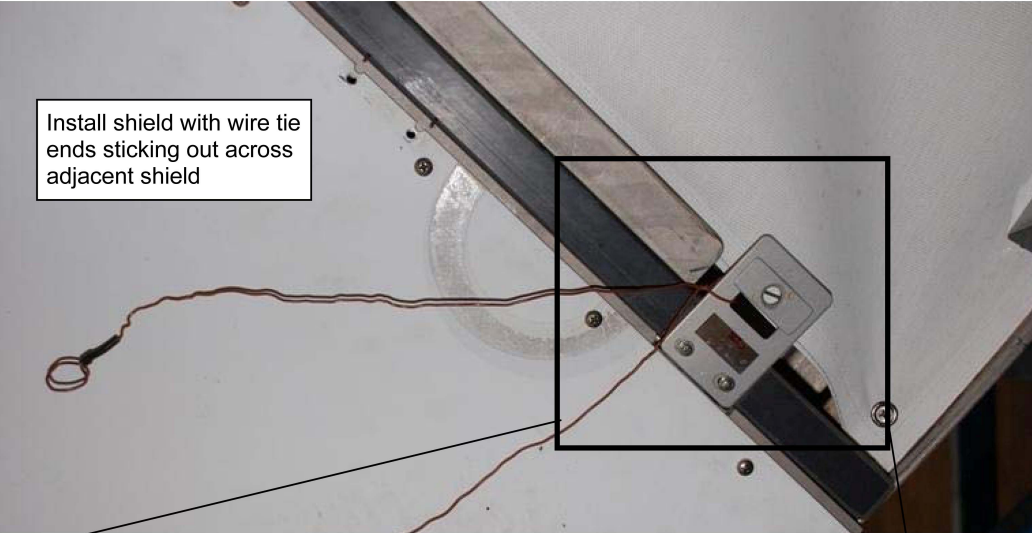
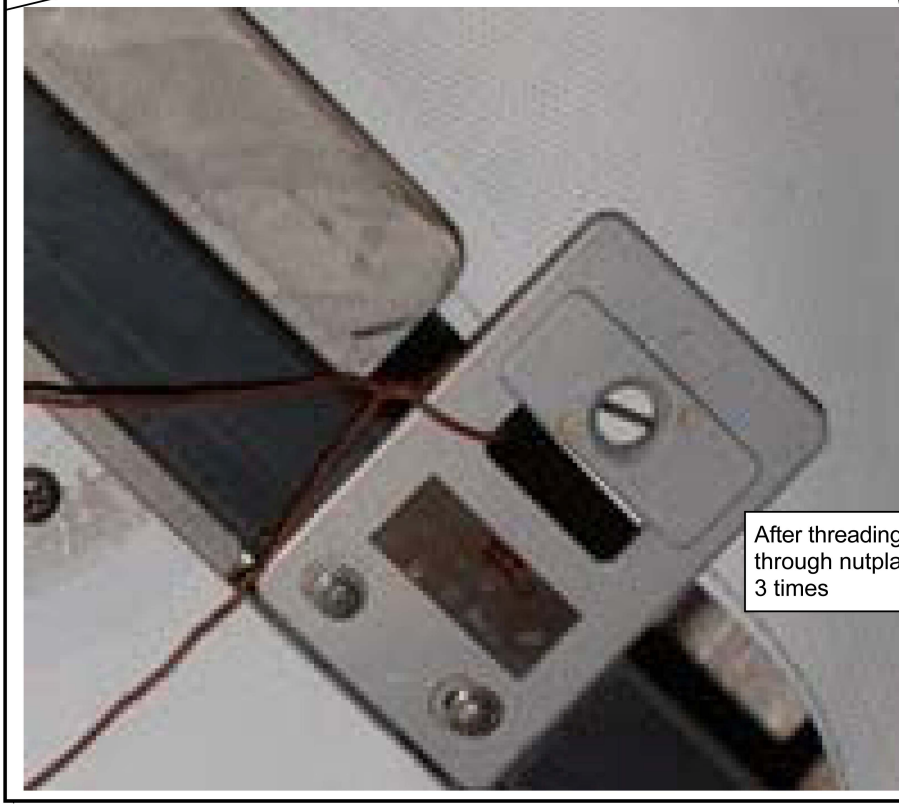
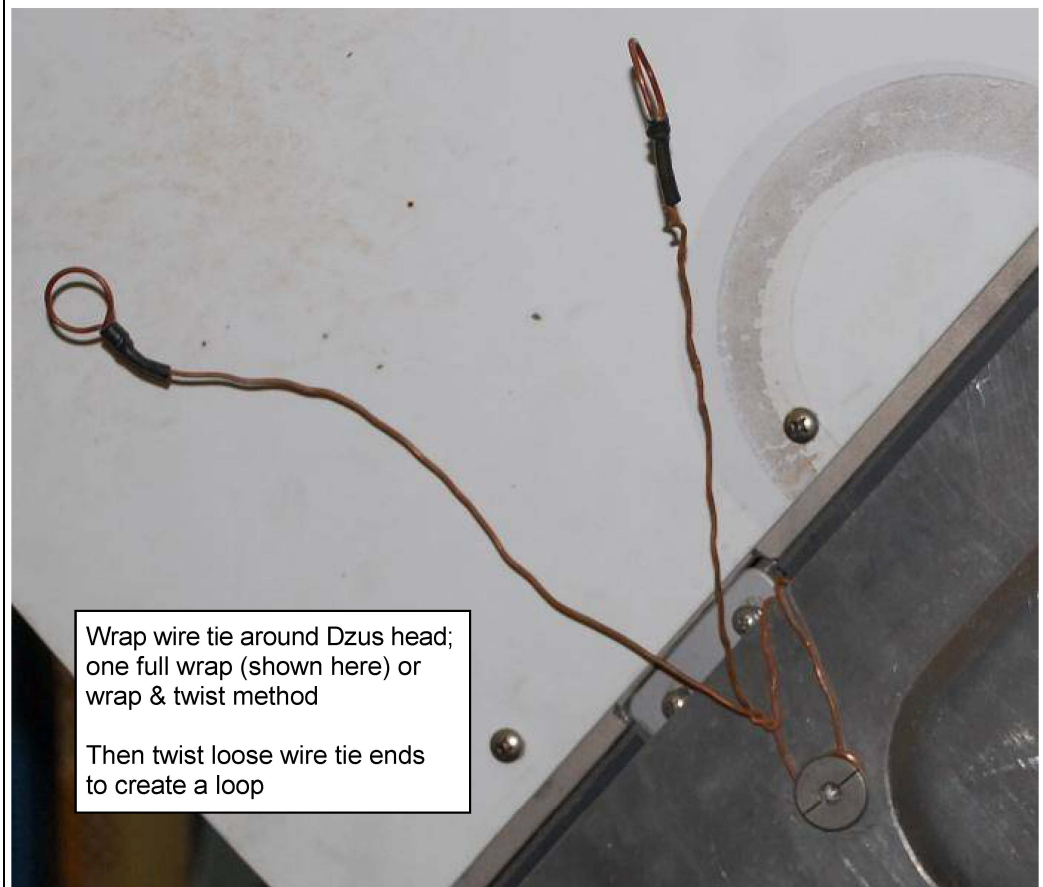
## STS-134/ULF6 WORKAROUNDS CRIBSHEET (Cont)

### GENERIC CONTINGENCIES (Cont)

TASK	FAILURE	ACTION
	<b>NZGL Connectors</b>	
	A. Bail bar fails to slide over-center	<ol style="list-style-type: none"> <li>1. Inspect bail for FOD</li> <li>2. Inspect bail linkage for damage and report to <b>MCC-H</b></li> <li>3. Check alignment and sideloads</li> <li>4. Verify sufficient TA-clamps are open</li> <li>5. Increase force on bail</li> <li>6. Attach 2 hooks from adj tether to connector bail and use adj strap to pull bail into demated position</li> <li>7. On <b>MCC-H GO</b>: Retrieve vise grips to help increase force on bail</li> </ol>
	B. Backshell fails to slide (after over-center mechanism has been overcome)	<ol style="list-style-type: none"> <li>1. Verify sufficient TA-clamps are open</li> <li>2. Check for cable harness and hardware interference</li> <li>3. Check alignment and sideloads</li> <li>4. Inspect bail and connector for FOD</li> <li>5. Inspect bail linkage for damage and report to <b>MCC-H</b></li> <li>6. Wiggle/jiggle connector while pushing or pulling on backshell</li> <li>7. Attach 2 hooks from adj tether to connector bail and use adj strap to pull bail into demated position</li> <li>8. On <b>MCC-H GO</b>: Retrieve vise grips to help increase force on bail</li> </ol>
	C. Connector fails to release from soft dock	<ol style="list-style-type: none"> <li>1. Verify bail fully thrown, undamaged, and backshell fully aft</li> <li>2. If backshell springs forward, pull and hold in fully aft position (will have to overcome spring force, approx 5-10 lb) while attempting to demate connector</li> <li>3. Verify sufficient TA-clamps are open</li> <li>4. Check for cable harness and hardware interference</li> <li>5. Check alignment and sideloads</li> <li>6. Relieve compression on connector interface due to cable loads by pulling backshell away from jack</li> <li>7. Push the plug towards the jack to compress the soft dock</li> <li>8. Wiggle/jiggle connector. (Use slight rolling motion)</li> </ol>
	D. Connector fails to soft dock	<ol style="list-style-type: none"> <li>1. Verify correct plug and jack</li> <li>2. Verify bail fully aft</li> <li>3. Verify backshell fully aft and remains fully aft. If backshell not fully aft, pull and hold in fully aft position while attempting to soft dock connector</li> <li>4. Inspect the following: <ul style="list-style-type: none"> <li>• O-ring seal</li> <li>• FOD</li> <li>• Bend radius</li> <li>• Soft dock springs</li> <li>• Connector keying feature</li> </ul> </li> <li>5. Verify alignment (avoid excessive rolling or rocking the plug as this could unseat soft dock springs) <ul style="list-style-type: none"> <li>• Connector should snap into soft dock with little force once half shells are aligned</li> </ul> </li> </ol>

# STS-134/ULF6 WORKAROUNDS CRIBSHEET (Cont)

## GENERIC CONTINGENCIES (Cont)

TASK	FAILURE	ACTION
	E. Connector fails to mate	<ol style="list-style-type: none"> <li>1. Verify half-shells are fully seated on both sides</li> <li>2. Verify cable and backshell free to move (no clamps)</li> <li>3. Push forward on connector backshell while actuating bail</li> <li>4. Detach from soft dock and inspect: <ul style="list-style-type: none"> <li>• Pins</li> <li>• FOD</li> <li>• EMI band</li> <li>• Bend radius</li> <li>• TA clamps</li> <li>• P clamps</li> <li>• Bail linkages and rivets</li> <li>• Soft dock springs</li> <li>• O-ring seal and main joint gasket</li> <li>• Connector keying feature</li> </ul> </li> <li>5. Cycle bail while disconnected. (Push forward on connector backshell for additional leverage)</li> </ol>
	F. Connector pin bent	<ol style="list-style-type: none"> <li>1. Rotate connector to bail up position and describe pin location and condition <ul style="list-style-type: none"> <li>• Obtain WVS view of interface if possible</li> </ul> </li> <li>2. On <b>MCC-H GO</b>: For 16, 20, or 22 gauge pins only, retrieve pin straightener and attempt pin repair <ul style="list-style-type: none"> <li>• <b>MCC-H</b> will verify pin size prior to retrieving tools</li> </ul> </li> <li>3. On <b>MCC-H GO</b>: Retrieve needle nose pliers and attempt pin repair</li> <li>4. Inspect plug and jack prior to re-mating</li> </ol>
	G. Connector FOD	<p>On <b>MCC-H GO</b>: Remove FOD with connector cleaner tool</p> <ol style="list-style-type: none"> <li>a. Retrieve connector cleaner tool</li> </ol> <p style="text-align: center;"><u>NOTE</u></p> <p>One N2 cartridge is already captured in the tool (the other is lanyarded inside the caddy). In order to puncture the cartridge, it must be threaded into the tool until the indicator line passes out of sight under the collar of the tool.</p> <p>Puncture connector cleaner cartridge only when ready to perform actual cleaning.</p> <p>Use entire N2 cartridge prior to reentering airlock</p> <ol style="list-style-type: none"> <li>b. Attempt cleaning</li> </ol>
	H. Connector EMI band bent 	<p>On <b>MCC-H GO</b>: Retrieve needle nose pliers or forceps to remove band</p> <ul style="list-style-type: none"> <li>• Bail may need to be pushed forward while demated to expose EMI band for removal</li> </ul>

# STS-134/ULF6 WORKAROUNDS CRIBSHEET (Cont)

## GENERIC CONTINGENCIES (Cont)

TASK	FAILURE	ACTION
	I. Connector bail linkage failure	1. On <b>MCC-H GO</b> : Re-attempt connector mate/demate with broken bail <ul style="list-style-type: none"> <li>• Impart load through undamaged side of bail linkage</li> <li>• Assist bail motion with hand on backshell once bail linkage has passed over-center</li> <li>• May take multiple pushes on the bail to mate/demate connector</li> </ul> 2. Tether hook or vise grips may be used for additional leverage
	J. Connector soft dock spring bent 	On <b>MCC-H GO</b> : Retrieve needle nose pliers and remove bent spring
	K. Connector O-ring or main joint gasket seal loose (seal and O-ring required in 1-G only)	1. Remove seal with tether hook 2. On <b>MCC-H GO</b> : Retrieve additional tools to remove seal (Ex: wire tie, needle nose pliers, probe, loop pin puller)
	L. Connector cap (Twist) will not release	1. Increase force 2. Use tether hook for additional leverage 3. On <b>MCC-H GO</b> : Attach equip hook to cap tether point and use strap of adj tether to release cap
<b>On-Orbit Installed HR</b>		
	A. HR will not install in seat track or fails to soft dock	1. Verify HR installed in correct direction per arrow on underside of HR 2. Verify HR shoes are completely released and soft dock armed 3. Check for FOD on HR and seat track 4. Verify HR bolt completely released: <b>PGT [A1 (2.5), CCW2, 30.5], 7/16 - 6-ext</b> 5. If HR in seat track but soft dock will not engage, attempt to drive HR bolts 6. On <b>MCC-H GO</b> : Depending on HR priority, attempt to install 180 out or a different HR at this location
	B. HR bolt fails to fully engage	1. If torqued, remove HR: <b>PGT [A2 (3.8), CCW2, 30.5], 7/16 - 6-ext</b> <ul style="list-style-type: none"> <li>• To break torque</li> </ul> <b>PGT [A1 (2.5), CCW2, 30.5], 7/16 - 6-ext</b> <ul style="list-style-type: none"> <li>• For removal</li> </ul> Check for FOD on HR and seat track and reinstall using original torque 2. Increase PGT setting: <b>PGT [A3 (4.8), CW2, 30.5], 7/16 - 6-ext</b> 3. On <b>MCC-H GO</b> : Depending on HR priority, attempt to install 180 out or a different HR at this location

## STS-134/ULF6 WORKAROUNDS CRIBSHEET (Cont)

### GENERIC CONTINGENCIES (Cont)

TASK	FAILURE	ACTION
	<b>On-Orbit Installed WIF</b>	
	A. WIF fails to soft dock	<ol style="list-style-type: none"> <li>1. Check for FOD and structural interference, cycle soft dock pins; reattempt installation</li> <li>2. Verify WIF is co-planar to structure</li> <li>3. Install a different WIF at this location</li> <li>4. On <b>MCC-H GO</b>: Attempt installation of WIF in a different location</li> <li>5. Return WIF inside</li> </ol>
	<b>PAD</b>	
	A. Release knob fails to rotate open	<ol style="list-style-type: none"> <li>1. Verify knob in release position (J-hook not locked)</li> <li>2. Attempt to rotate knob using ratchet on knob's 7/16 in hex stud</li> <li>3. Release contingency release bar captive bolts (2) <b>PGT [A6 (8.3), CCW2, 30.5], 7/16 - 6 ext 5 turns</b> (Verify hook released from striker bar)</li> </ol>
	<b>PGT</b>	
	A. No LEDs	<ol style="list-style-type: none"> <li>1. Perform LED test</li> <li>2. Use display torque</li> </ol>
	B. LEDs and torque messages do not agree	Use torque message and notify <b>MCC-H</b>
	C. Mode switch breaks	Retrieve spare PGT
	D. NEED TO CAL displayed during PGT operation after calibration complete	<ol style="list-style-type: none"> <li>1. Power cycle and calibrate</li> <li>2. Retrieve spare PGT</li> <li>3. Power off and switch to ratchet mode</li> </ol>
	E. TRIG TO CAL displayed with Mode collar set to MTR. (Display should nominally read NEED TO CAL)	<ol style="list-style-type: none"> <li>1. <ol style="list-style-type: none"> <li>a. Set Mode collar to RCW or RCCW</li> <li>b. Depress Trigger; verify CAL PASSED</li> <li>c. Set Mode collar to MTR</li> <li>d. Verify good LED Test</li> </ol> </li> <li>2. <ol style="list-style-type: none"> <li>a. Power Off</li> <li>b. Set Mode collar to RCW or RCCW</li> <li>c. Verify Speed collar in CAL</li> <li>d. Power On</li> <li>e. Verify TRIG TO CAL on display</li> <li>f. Complete calibration; continue ops</li> </ol> </li> <li>3. Retrieve spare PGT</li> <li>4. Power off and switch to ratchet mode</li> </ol>
	F. PGT fails to drive with Mode collar set to MTR	<ol style="list-style-type: none"> <li>1. Power cycle and calibrate</li> <li>2. <ol style="list-style-type: none"> <li>a. Set Mode collar to RCW or RCCW</li> <li>b. Depress Trigger; verify CAL PASSED</li> <li>c. Set Mode collar to MTR</li> <li>d. Verify good LED Test</li> </ol> </li> <li>3. <ol style="list-style-type: none"> <li>a. Power Off</li> <li>b. Set Mode collar to RCW or RCCW</li> <li>c. Verify Speed collar in CAL</li> <li>d. Power On</li> <li>e. Verify TRIG TO CAL on display</li> <li>f. Complete calibration; continue ops</li> </ol> </li> <li>4. Retrieve spare PGT</li> <li>5. Power off and switch to ratchet mode</li> </ol>

## STS-134/ULF6 WORKAROUNDS CRIBSHEET (Cont)

### GENERIC CONTINGENCIES (Cont)

TASK	FAILURE	ACTION
	<b>LCD Messages</b>	
A.	BATTERY HITEMP	<ol style="list-style-type: none"> <li>1. Power off PGT</li> <li>2. If alternate battery available; change battery</li> <li>3. Retrieve spare PGT</li> <li>4. Switch to ratchet mode</li> </ol>
B.	BATTERY LOTEMP (blinking)	<ol style="list-style-type: none"> <li>1. Drive tool with no load to increase battery temperature</li> <li>2. If alternate battery available; power off and change battery</li> <li>3. Retrieve spare PGT</li> <li>4. Power off and switch to ratchet mode</li> </ol>
C.	BATTERY LOVOLT (blinking)	<ol style="list-style-type: none"> <li>1. Continue using tool until unable to deliver sufficient torque</li> <li>2. Retrieve spare PGT</li> <li>3. Power off and switch to ratchet mode</li> </ol>
D.	CAL FAILED	<ol style="list-style-type: none"> <li>1. Press, release trigger to repeat calibration</li> <li>2. Power cycle and calibrate</li> <li>3. Retrieve spare PGT</li> <li>4. Power off and switch to ratchet mode</li> </ol>
E.	COLLAR ERROR	<ol style="list-style-type: none"> <li>1. Cycle torque and speed collars to clear error</li> <li>2. Power cycle and calibrate</li> <li>3. Retrieve spare PGT</li> <li>4. Power off and switch to ratchet mode</li> </ol>
F.	COMPAR ERROR	<ol style="list-style-type: none"> <li>1. Cycle torque collar and A/B mode switch</li> <li>2. Power cycle and calibrate</li> <li>3. Retrieve spare PGT</li> <li>4. Power off and switch to ratchet mode</li> </ol>
G.	EEPROM WR ERR (blinking) HYBRID HITEMP OVER CURR SLFTST FAIL X	<ol style="list-style-type: none"> <li>1. Power cycle and calibrate</li> <li>2. Retrieve spare PGT</li> <li>3. Power off and switch to ratchet mode</li> </ol>
H.	HI TORQ	<ol style="list-style-type: none"> <li>1. Contact <b>MCC-H</b> and report torque. (Real time engineering assessment required)</li> <li>2. On <b>MCC-H GO</b>: Power cycle and calibrate</li> <li>3. Retrieve spare PGT</li> <li>4. Power off and switch to ratchet mode</li> </ol>
I.	HICURR	<ol style="list-style-type: none"> <li>1. Reattempt operation <ul style="list-style-type: none"> <li>• Can be caused by excessive rotation of the PGT body while torquing</li> </ul> </li> <li>2. Power cycle and calibrate</li> <li>3. Retrieve spare PGT</li> <li>4. Power off and switch to ratchet mode</li> </ol>
J.	LO TORQ (Expected during bolt release)	<ol style="list-style-type: none"> <li>1. Reattempt operation until desired torque is reached</li> <li>2. Power cycle and calibrate</li> <li>3. Retrieve spare PGT</li> <li>4. Power off and switch to ratchet mode</li> </ol>
K.	LOCURR	<ol style="list-style-type: none"> <li>1. Reattempt operation</li> <li>2. Power cycle and calibrate</li> <li>3. Retrieve spare PGT</li> <li>4. Power off and switch to ratchet mode</li> </ol>
L.	LOG IS FULL (blinking)	<ol style="list-style-type: none"> <li>1. Cycle torque and speed collars to clear message</li> <li>2. Continue operation</li> </ol>
M.	MOTOR HITEMP	<ol style="list-style-type: none"> <li>1. Power off PGT</li> <li>2. Retrieve spare PGT</li> <li>3. Switch to ratchet mode</li> </ol>



# STS-134/ULF6 WORKAROUNDS CRIBSHEET (Cont)

## GENERIC CONTINGENCIES (Cont)

TASK	FAILURE	ACTION
	<b>Safety Tether</b>	
	A. Safety tether fails to retract/tend	<ol style="list-style-type: none"> <li>1. Verify reel is unlocked and cycle the lock</li> <li>2. Verify tether reel and/or cable guide (for 85-ft tethers) is clear of FOD</li> <li>3. Pull out small amount of cable and allow reel to retract while holding light tension on the cable</li> <li>4. Tap side of reel housing during retraction</li> <li>5. Report ID # of faulty tether to <b>MCC-H</b> and use alternate safety tether</li> <li>6. Coil safety tether to bring inside</li> <li>7. For 85-ft tether, on <b>MCC-H GO</b>: If coiling tether is not practical, release level wind mechanism bypass on back of safety tether. (Red indicator will show around edge of bypass once released)</li> </ol> <p style="text-align: center;"><u>NOTE</u></p> <p>Once level wind has been released cable guide will likely be frozen in place. This will limit the amount of tether that can be successfully retracted into the tether housing and may require coiling of excess tether.</p> <p>Level wind release will require safety tether be returned for ground servicing.</p> <p>If tether fails to retract due to thermal issue, normal tether function may return after tether brought IVA</p>
	B. Safety tether red stripe showing (any length)	<ol style="list-style-type: none"> <li>1. Use alternate safety tether</li> <li>2. Connect waist tether to ERCM body as alternative load alleviation (Double Tether)</li> <li>3. Inspect "Through" tack stitches. Tether NO-GO until tack stitching inspected. (Reference Crew tether inspection procedure) <ol style="list-style-type: none"> <li>a. 1 of 2 stitches is required for tether to be GO for use</li> <li>b. If both "Through" stitches are broken, safety tether NO-GO for use <ul style="list-style-type: none"> <li>• Report ID # of faulty tether to <b>MCC-H</b></li> <li>• Use alternate safety tether</li> </ul> </li> </ol> </li> </ol>
	C. Crew hook fails	<ol style="list-style-type: none"> <li>1. On load alleviating end: Use waist tether to replace alleviating strap <ul style="list-style-type: none"> <li>• Report ID # of faulty tether to <b>MCC-H</b></li> <li>• Retrieve replacement safety tether</li> </ul> </li> <li>2. On anchor end: Report ID # of faulty tether to <b>MCC-H</b> and use an alternate safety tether</li> </ol>
	<b>Scoops</b>	
	A. Scoop will not release from fitting	<ol style="list-style-type: none"> <li>1. If actuator will not pull back while in locked position, tap actuator with tool to release</li> <li>2. On <b>MCC-H GO</b>: Leave scoop in place</li> <li>3. On <b>MCC-H GO</b>: Remove non-captive contingency screws; 5 turns. Stow in trash bag <b>PGT [A1 (2.5), CCW2, 30.5], 5/32 allen drive</b> <ul style="list-style-type: none"> <li>• Square Scoop: 4 screws (fig 5)</li> <li>• Round Scoop: 7 screws (fig 6)</li> </ul> </li> </ol>

**STS-134/ULF6 WORKAROUNDS CRIBSHEET (Cont)**

**GENERIC CONTINGENCIES (Cont)**

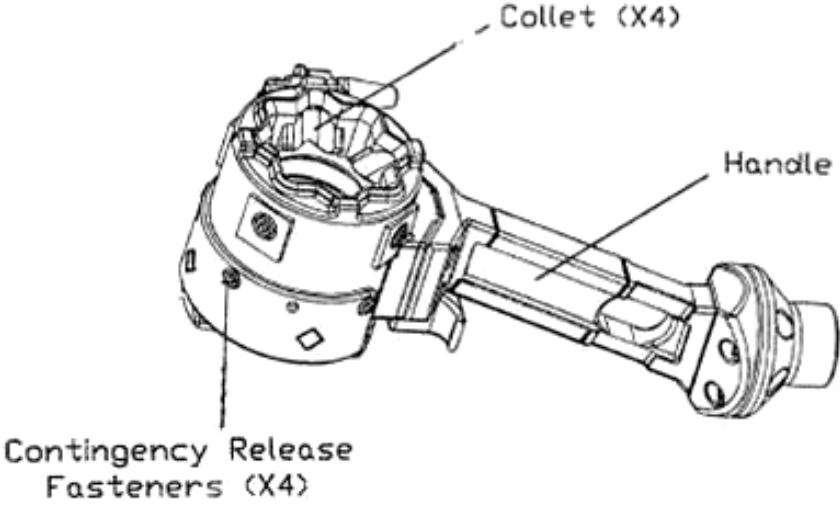
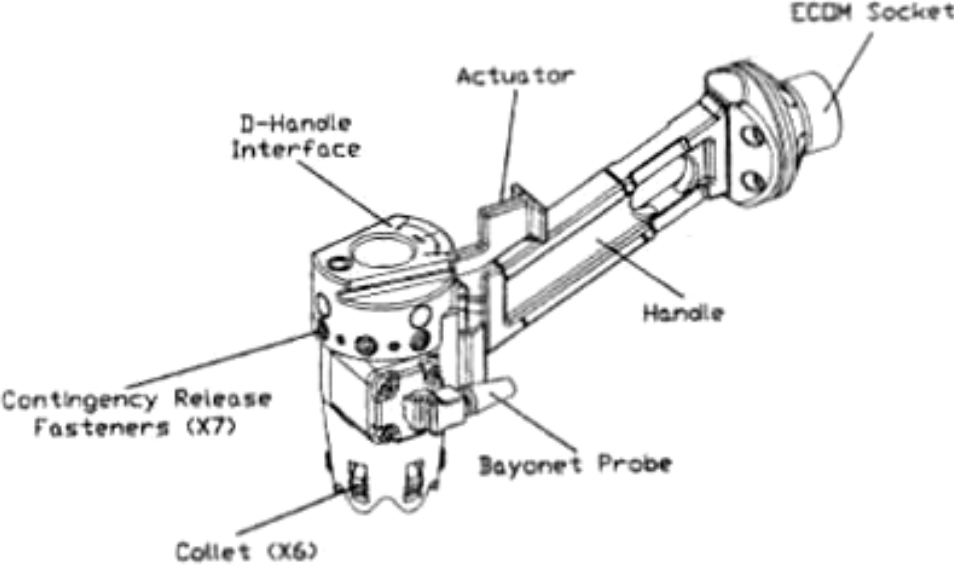
TASK	FAILURE	ACTION
		 <p data-bbox="766 760 1068 793">Figure 5.- Square Scoop.</p>
		 <p data-bbox="766 1537 1068 1570">Figure 6.- Round Scoop.</p>

# STS-134/ULF6 WORKAROUNDS CRIBSHEET (Cont)

## GENERIC CONTINGENCIES (Cont)

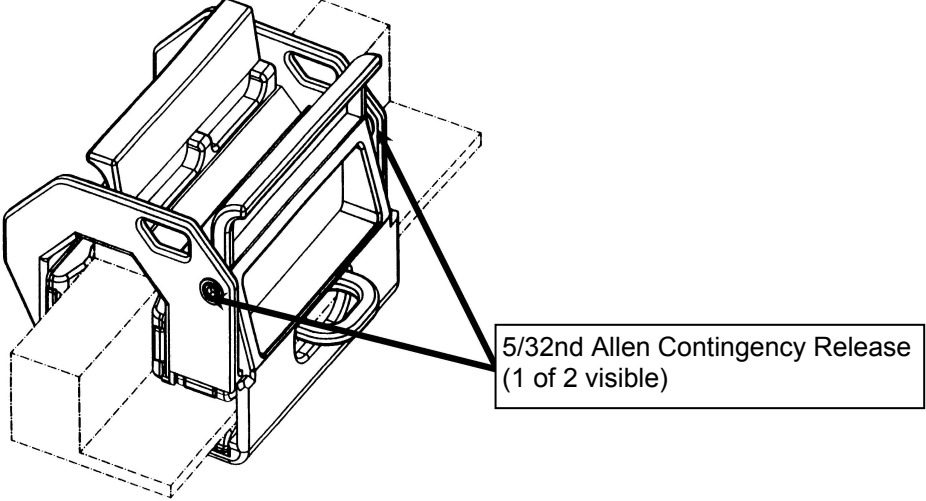
TASK	FAILURE	ACTION
	<b>Socket Caddy</b>	
	A. Socket fails to release from socket caddy	<ol style="list-style-type: none"> <li>1. Verify PIP pin fully inserted into drop proof tether interface on socket</li> <li>2. Reattempt using a different PIP pin</li> </ol>
	<b>TA Clamp</b>	
	A. TA clamp fails to release	<ol style="list-style-type: none"> <li>1. With handle up, press down on top of rounded clamp</li> <li>2. With handle up, use tether hook to pry drawhook from capture pin</li> </ol>
	<b>Tether Shuttle</b>	
	A. Tether shuttle will not release from CET/MT rail	<ol style="list-style-type: none"> <li>1. Verify slider in unlock and no obstructions to paddle actuation</li> <li>2. Verify safety tethered to structure and safety tether removed from tether shuttle anchor point</li> <li>3. On <b>MCC-H GO</b>: Remove non-captive screws (2) at hingeline to release nadir section with slide lock (not captive) (fig 7). TBD turns. Stow screws in trash bag <b>PGT [A1 (2.5), CCW1, 30.5], 5/32 allen drive</b></li> </ol>
 <p style="text-align: center;">Figure 7.- Tether Shuttle.</p>		
	<b>Torque Multiplier</b>	
	A. TM will not release from fitting	<ol style="list-style-type: none"> <li>1. Place TM anti-backlash in neutral, if unable: <b>PGT [RCW, 30.5]</b> <ul style="list-style-type: none"> <li>• Apply cw torque while pushing anti-backlash button to neutral. Reattempt removal</li> </ul> </li> <li>2. If able to lift TM off of bolt, attempt to rock off of fitting (Square TM only)</li> <li>3. On <b>MCC-H GO</b>: Release TM contingency release band pin 20 turns (do not exceed 28 turns) (fig 8): <b>PGT [A1 (2.5), CCW2, 30.5], 5/32 ball end driver</b> <ul style="list-style-type: none"> <li>• When band springs open remove TM</li> </ul> </li> </ol>

# STS-134/ULF6 WORKAROUNDS CRIBSHEET (Cont)

## GENERIC CONTINGENCIES (Cont)

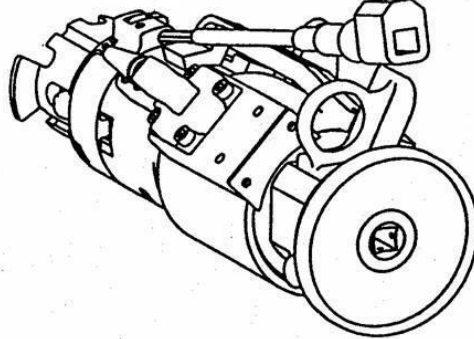
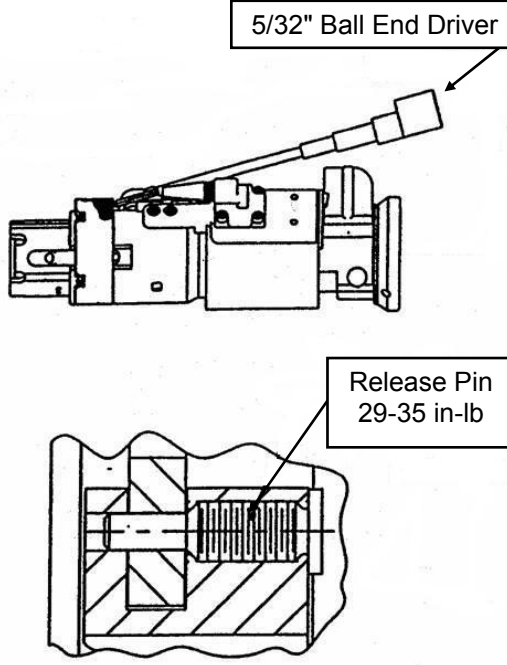
TASK	FAILURE	ACTION
		
Figure 8.- Torque Multiplier.		
<b>TSA</b>		
A. Latch fails to open		Release 7/16 EVA bolt on latch bracket; rotate bracket clear of latch <b>PGT [A2 (3.8), CCW2, 30.5], 7/16 - 6 ext 1-2 turns</b>
B. Latch fails to close		Close remaining latches arrow to arrow (3 of 4 required for landing)

## P6 PVTCS LEAK DETECTION

### OBJECTIVE

To find a leak in the P1-P5 NH3 lines after PVTCS fill leak check has failed and the location of the leak is unknown.

Big Picture: Crew will translate toward P3/P4 interface looking for any NH3 leaks. The crew will close the jumper QDs. **MCC-H** will restart the fill and the EV crew will open the QDs one at a time. IV and **MCC-H** will coordinate whether to close the QD (if leak found) or to continue to next QD. Keep comm to minimum

IV/SSRMS	EV1 (Drew)	EV2 (Spanky)
<p><b>MCC-H:</b> Report if Large or Medium leak</p> <p style="text-align: center;"><b><u>NOTE</u></b></p> <p>If Medium leak, have EV2 perform all Inspection steps and EV1 do Venting steps</p> <p>1. For Medium Leak, give <b>EV1 GO</b> for P1-P5 Jumper Venting ops</p>	<p><u>P1-P5 JUMPER INSPECTION</u></p> <ol style="list-style-type: none"> <li>1. Translate to P5 M14 dummy panel               <ul style="list-style-type: none"> <li><input type="checkbox"/> √QD F14 is mated, valve closed</li> </ul> </li> <li>2. Open bootie and inspect P5 QD F14 for any signs of leak</li> <li>3. Peel back P5 Truss MLI as much as possible to view inside truss element</li> <li>4. Translate to P4 QD M16 (P4/P5 Jumper)               <ul style="list-style-type: none"> <li><input type="checkbox"/> Look inside truss along NH3 lines for any signs of a leak</li> </ul> </li> <li>5. Open bootie and inspect P5 QD F16 and P4/P5 jumper for any signs of leak</li> <li>6. Translate to P4 QD F15 (P3/P4 Jumper)               <ul style="list-style-type: none"> <li><input type="checkbox"/> Trace external NH3 line along P4 radiator for any signs of a leak</li> </ul> </li> <li>7. Open bootie and inspect P4 QD F15 for any signs of leak</li> <li>8. Check P3/P4 Jumper for leaks</li> </ol> <p><u>P1-P5 JUMPER VENT (for Medium Leak)</u></p> <ol style="list-style-type: none"> <li>9. On <b>IV/MCC-H GO</b>, perform Vent Tool Setup</li> <li>10. Perform P1-P5 Jumper Vent (~17 min)</li> </ol>	<p><u>P1-P5 JUMPER INSPECTION</u></p> <ol style="list-style-type: none"> <li>1. Open bootie and inspect ATA QD F184 at M2 and ATA jumper for any signs of leak</li> <li>2. For Medium Leak, verify ATA QD F185 at M1 is open</li> <li>3. Translate to P1 face 1               <ul style="list-style-type: none"> <li><input type="checkbox"/> Look inside truss along NH3 lines and on MLI for any signs of a leak</li> </ul> </li> <li>4. Translate to P1/P3 Jumper, face 6</li> <li>5. Open shroud on P1 nadir umbilical tray</li> <li>6. Look for any signs of leak               <ul style="list-style-type: none"> <li><input type="checkbox"/> Pnl A503 (P1), open bootie and inspect QD F186 at M3</li> <li><input type="checkbox"/> Pnl A501 (P3), open bootie and inspect QD F187 at M1</li> </ul> </li> <li>7. Close shroud on umbilical tray before leaving wkst</li> <li>8. Translate to P3 face 6</li> <li>9. Open bootie and inspect P3 QD F2 for any signs of leak</li> <li>10. Check P3/P4 Jumper for leaks</li> </ol> <p><u>P1-P5 JUMPER VENT (for Medium Leak)</u></p>

## P6 PVTCS LEAK DETECTION (Cont)

IV/SSRMS	EV1 (Drew)	EV2 (Spanky)
<p>2. Verify following QDs are closed:</p> <ul style="list-style-type: none"> <li><input type="checkbox"/> P3/P4 Jumper at M2 pnl A502</li> <li><input type="checkbox"/> P3/P4 Jumper at P4 M15</li> <li><input type="checkbox"/> P1/P3 Jumper at M1 pnl A503</li> <li><input type="checkbox"/> P1/P3 Jumper at M3 pnl A503</li> <li><input type="checkbox"/> ATA Jumper at M1 pnl A500</li> </ul> <p>3. On <b>MCC-H GO</b>, give EV2 GO to open ATA QD F185 on M1 <b>MCC-H: Report leak or continue</b></p> <p>4. On <b>MCC-H GO</b>, give EV2 GO to open P1 QD F186 on M3 <b>MCC-H: Report leak or continue</b></p> <p>5. On <b>MCC-H GO</b>, give EV2 GO to open P3 QD F187 on M1 <b>MCC-H: Report leak or continue</b></p> <p>6. On <b>MCC-H GO</b>, give EV1 GO to open P3 QD F2 on M2 <b>MCC-H: Report leak or continue</b></p> <p>7. On <b>MCC-H GO</b>, give EV1 GO to open P4 QD F15 on M15 <b>MCC-H: Report leak or continue</b></p> <p>8. Contact <b>MCC-H</b> for further actions</p>	<p><b>NH3 LEAK ISOLATION</b></p> <p>11. Close QD F15 at P4 M15, per <b>BLOCK D</b></p> <p>12. Translate to P3 side of P3/P4 Jumper pnl A502 <i>Stand by for IV</i></p> <p>13. On <b>IV GO</b>, open P3 QD F2 at M2 per <b>BLOCK C</b></p> <p>14. If no leak, translate to P4 QD F15 of P3/P4 Jumper</p> <p>15. On <b>IV GO</b>, open P4 QD F15 at M15 per <b>BLOCK C</b></p>	<p><b>NH3 LEAK ISOLATION</b></p> <p>11. Close P3 QD F2 per <b>BLOCK D</b></p> <p>12. Translate to P1 face 6, P1/P3 Jumper</p> <p>13. Open shroud on P1 nadir umbilical tray</p> <p>14. Close QD F187 on pnl A501 (P3) M1 per <b>BLOCK D</b></p> <p>15. Close QD F186 on pnl A503 (P1) M3 per <b>BLOCK D</b></p> <p>16. Translate to P1 ATA pnl A500</p> <p>17. Close QD F185 on M1 per <b>BLOCK D</b>, if not already</p> <p>18. On <b>IV GO</b>, open QD F185 on M1 per <b>BLOCK C</b></p> <p>19. If no leak, translate to P1/P3 Jumper Face 6, pnl A503</p> <p>20. On <b>IV GO</b>, open P1 QD F186 on M3 per <b>BLOCK C</b></p> <p>21. On <b>IV GO</b>, open P3 QD F187 on M1 per <b>BLOCK C</b></p> <p>22. Close shroud on P1 nadir umbilical tray</p>

# P6 PVTCS LEAK DETECTION (Cont)

P1 to P3 Fluid Line – Stowed Config

↑ FACE 1

FACE 6

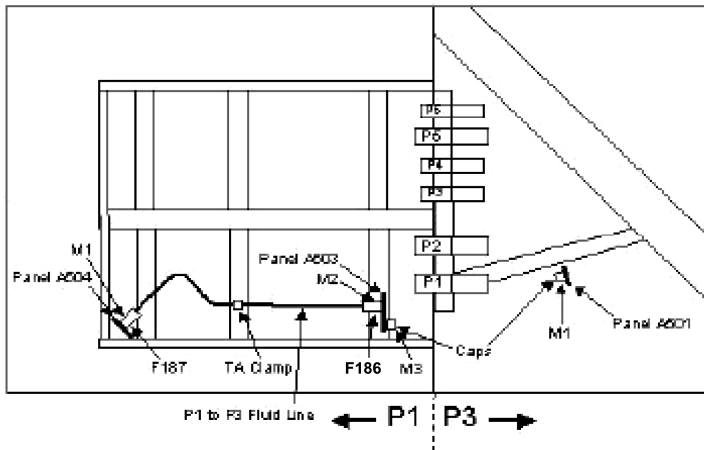

P1 to P3 Fluid Line – Deployed Config

↑ FACE 1

FACE 6

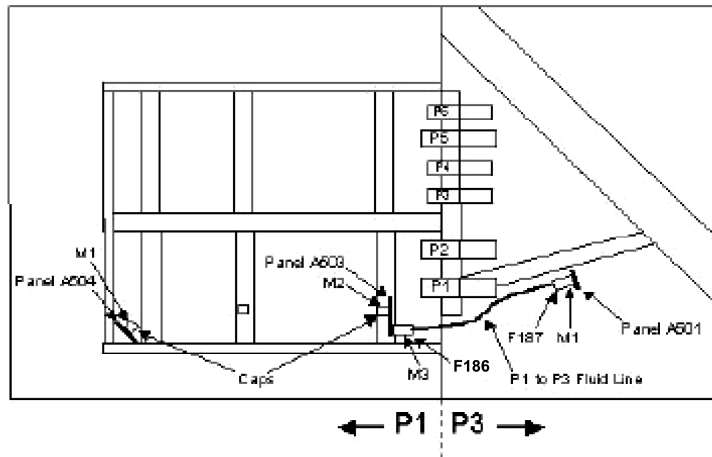

**Notes:**

1. Jumper QDs are 1/4-in
- 2.

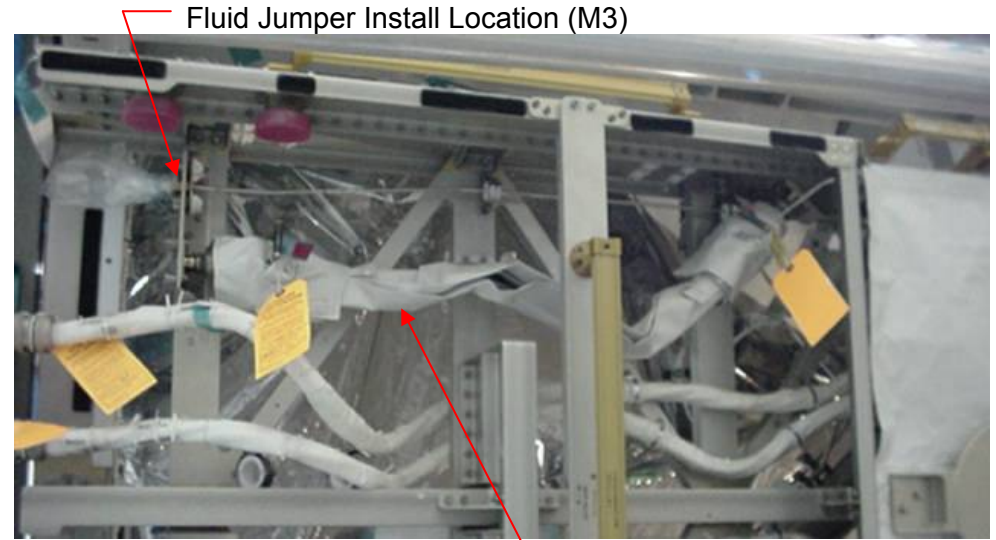

Fluid Jumper Stowed

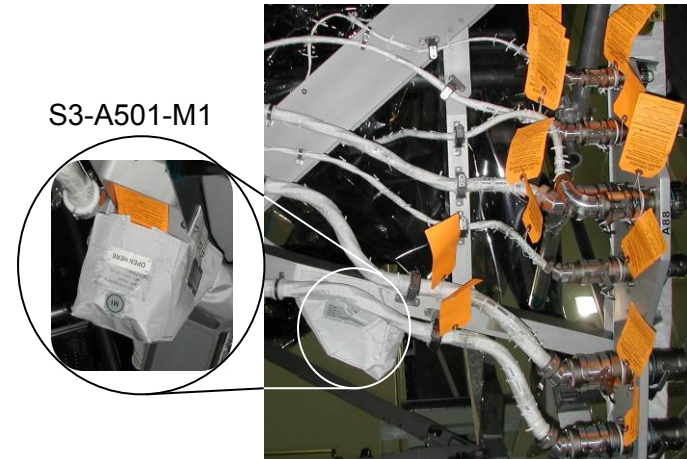

Ammonia Jumper Connection (S3-A501-M1)

P1/P3 Worksite Photos



**P6 PVTCS LEAK DETECTION (Cont)**

**Line connected with SARJ at 50°**

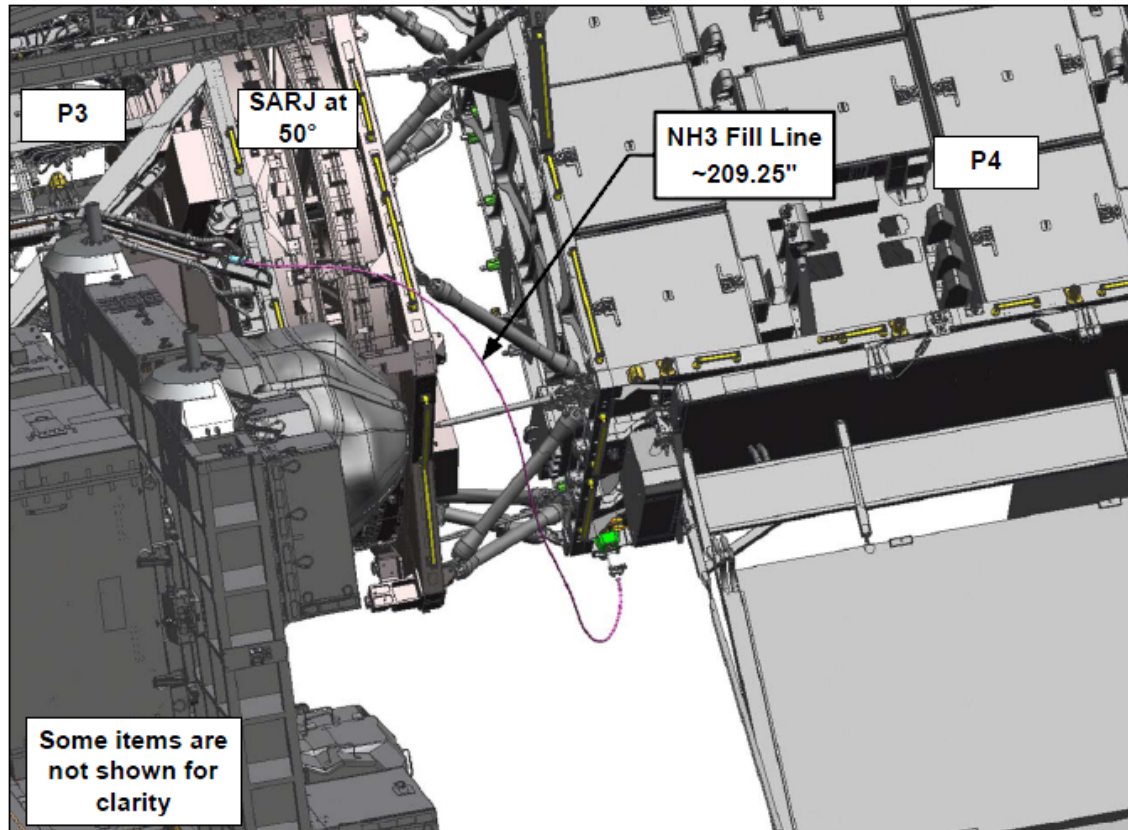



## P6 PVTCS FILL FAILURE MATRIX

	Procedure Task	First Failure	Response/Control	Second Failure	Response/Control	Notes
1a	Remove P3/P4 jumper from P3 dummy, install on P3, open valve	Jumper fails to remove/install/open	Either utilize the S3/S4 Jumper or do not proceed with the fill and return the system to its nominal configuration (including venting if needed)	S3/S4 fails to remove/install/open	Do not proceed with the fill and return the system to its nominal configuration	Cap failures could also prevent proper installation of the jumper, preventing the fill
1b				Won't reattach to dummy	Tie down out of SARJ rotation plane or remove completely	The SARJ rotation plane must be clear of obstructions before the SARJ can be allowed to rotate
1c				Won't remove from P4	Remove at P3 and tie down	
2	Close and demate A500 panel jumper QD from vent position (M3)	Fails to close/remove	Remove jumper from ATA side and use S1 A500 jumper or No fill, return to nominal configuration	QD valve won't reopen	Can't vent ATA using A500 panel	Cap failures could also prevent proper installation of the jumper, preventing the fill or a return to a nominal configuration
3	Install and open A500 jumper to P1/P3 jumper position (M1)	Fails to install/open	No fill, return to nominal configuration or remove jumper from ATA side and use S1 A500 jumper	Won't remove or install at M3/S1 jumper fails to install/open	Install at M1; can't vent ATA using A500 panel without S1 A500 jumper	
4a1	Open ATA Vent Valve (this step pressurizes the segment from the ATA to P5/P6 jumper)	Large leak between P5 and A500 (greater than 6% ATA drop over 90 sec)	Close M1 jumper QD at A500 (this isolates the A500 to P5 line)	M1 fails to close	No overpress hazard immediately as there is no isolated segment; however, closing an alternate QD valve will ultimately result in an isolated segment – see NCR-ISS-259 for acceptance of this risk	For steps 4a1-4a3: With this very large leak rate, the segment that is isolated is losing 1.5 times its fluid mass per minute, while (for the entire volume) it takes at least 2.5 min of insulation to overpress. Ultimately, if the leak can't be isolated and/or repaired, the segment will be vented

## P6 PVTCS FILL FAILURE MATRIX (Cont)

	Procedure Task	First Failure	Response/Control	Second Failure	Response/Control	Notes
4a2			Perform leak identification steps (closing nearest QD valve inboard of leak, reopen M1 once the leak has been isolated to a smaller segment) – see NCR-ISS-259 for acceptance of this risk	M1 fails to reopen	NCR-259, reopen valve that isolated the smaller segment, replace P1 A500 jumper with S1	For steps 4a1-4a3: With this very large leak rate, the segment that is isolated is losing 1.5 times its fluid mass per minute, while (for the entire volume) it takes at least 2.5 min of insolation to overpress. Ultimately, if the leak can't be isolated and/or repaired, the segment will be vented
4a3			Perform leak identification and isolation steps (closing and incrementally reopening QD valves, reopen M1 once the leak has been isolated to a smaller segment) – see NCR-ISS-259 for acceptance of this risk	Other valves fail to close/open; jumper replacement fails (QDs fail to release/attach/open/close)	Close ATA VV; NCR-259	For steps 4a1-4a3: With this very large leak rate, the segment that is isolated is losing 1.5 times its fluid mass per minute, while (for the entire volume) it takes at least 2.5 min of insolation to overpress. Ultimately, if the leak can't be isolated and/or repaired, the segment will be vented
4b1		Large leak (greater than 6% ATA drop over 90 sec) that is actually between A500 and ATA VV	Close M1 jumper QD at A500 (this isolates the A500 to P5 line); upon determining that the leak has not stopped, reopen M1 – see NCR-ISS-259 for acceptance of this risk	M1 fails to open	Close ATA Isolation Valve or ATA VV, NCR-259; vent the P5-A500 segment or integrate with the EEATCS	The P5-A500 line segment is isolated with no pressure relief and is *not* leaking, the A500-ATA line is isolated with pressure relief, and leaking 1.5 times its fluid mass per minute, while (for the entire volume) it takes at least 2.5 min of insolation to overpress
4c		Medium leak (ATA-P5 pressure decay > (1551-PVPFINAL/20) kPa per minute) between P5 and VV	Close ATA Isolation Valve, attempt to locate and isolate leak, vent lines if not located; NCR-259	Isolation Valve fails to close	Close Vent Valve, vent lines; NCR-259	The P5-VV line segment is isolated with no pressure relief, but leaking – this configuration has *not* been shown good for over pressure protection
4d				Isolation Valve fails to relieve overpressure	NCR-259	The ATA Isolation Valve can be reopened if an overpressure condition is detected

## P6 PVTCS FILL FAILURE MATRIX (Cont)

	Procedure Task	First Failure	Response/Control	Second Failure	Response/Control	Notes
5a	Remove P5/P6 jumper from P5 dummy, install on P6, open valve	Fails to remove/install/open	No fill, return to nominal configuration	Won't attach to dummy	Tie down or return to P6	Same for cap failures
5b				Won't remove from P6	Leave in place	
6	Open EAS jumper QD valve (M10)	Fails to open or leaks excessively	Use second EAS jumper	Second EAS jumper fails	Do not proceed with PVTCS fill, vent all lines that have been filled	
7a	Open EAS jumper QD extender valve (M2) (PVTCS fill begins)	Fails to open	Use second EAS jumper	Second EAS jumper fails	No fill, vent lines	EAS jumper partially filled – vent or stow away from EVA
7b				EAS jumper can't be removed	No fill, vent lines	
8a	Correct PVTCS overfill using GPRV	GPRV fails to correct PVTCS overfill	Close/demate EAS QD extender at M2 (begin manual EAS jumper vent to correct overfill)	Fails to close/can't remove	Close/demate EAS jumper QD (next to QD extender)	Manual EAS jumper isolation and venting (steps 8a-8e) must be in eclipse; the EAS jumper (or just the extender) will be repeatedly filled and vented to correct the overfill; a smaller volume of ammonia can be vented with each iteration if the extender must be left in place at M2 due to failures
8b			Close M10 QD valve	Fails to close	Use second EAS jumper to attach to M2 and vent PVTCS overfill	
8c			Mate Extender to vent tool	Fails to mate to vent tool	Use second EAS jumper or second vent tool	
8d			Open EAS jumper to vent tool	Fails to open	Use second EAS jumper	
8e			Repeat 8a through 8d until PVTCS overfill is corrected	Same as above. If either valve fails to open or close, or the jumper or vent tool extender QDs fail to mate or demate, use the second EAS jumper and/or vent tool		

**P6 PVTCS FILL FAILURE MATRIX (Cont)**

	<b>Procedure Task</b>	<b>First Failure</b>	<b>Response/Control</b>	<b>Second Failure</b>	<b>Response/Control</b>	<b>Notes</b>
9	Close and remove EAS jumper QD extender (M2) (PVTCS fill complete)	Fails to close/remove	Close and remove QD-03F/leave extender open with PVTCS	Fails to close/can't remove	Close M10/leave EAS open with PVTCS	
10a	Close and demate P5/P6 jumper QD from P6 (M14)	Fails to close/remove	Use P4/P5 jumper (reopen P5/P6 jumper and P5 becomes part of EETCS)	Fails to close/can't remove	Use P3/P4 jumper and P4 becomes part of EETCS	NOTE (steps 10a-10c4): Once the P5/P6 jumper is isolated, vent must be started in eclipse or within 2.5 min of isolation during day pass; however, the time to overpress was based on the total volume and NH3 qty in the entire P1/P5 line, since the time to overpress is unknown if venting from P4/P5 or P3/P4, these contingencies should be conducted in eclipse
10b1	Mate P5/P6 jumper (F14) to vent tool adapter	Fails to mate	Use second vent tool or P4/P5 jumper (reattach and open P5/P6 to EETCS)	Second vent tool or P4/P5 jumper fails to mate/open	Reattach and open P4/P5 jumper to EETCS, use P3/P4 jumper	The outboard line segments would be provided over pressure protection by the EETCS. Those segments could be subsequently reisolated and vented during eclipse.
10b2				P5/P6 jumper fails to reattach/open	Isolate and vent P5 segment separately from P4/P5	No analysis for separately isolated P5 segment exists – eclipse only constraint required
10c1	Open P5/P6 jumper to vent tool adapter (Vent P6-ATA VV line segment)	Fails to open	Use P4/P5 jumper (reattach and open P5/P6 jumper to the EETCS)	P4/P5 jumper fails to connect/open	Reattach and open P4/P5 jumper to EETCS, use P3/P4 jumper	The outboard line segments would be provided over pressure protection by the EETCS. Those segments could be subsequently reisolated and vented during eclipse
10c2				P5/P6 jumper fails to reattach/open	Isolate and vent P5 segment separately from P4/P5	No analysis for separately isolated P5 segment exists – eclipse only constraint required

## P6 PVTCS FILL FAILURE MATRIX (Cont)

	Procedure Task	First Failure	Response/Control	Second Failure	Response/Control	Notes
10c3	Close and demate P5/P6 jumper (F14) (End P6-ATA VV vent)	Fails to close/demate	Leave in place, use alternate vent tool adapter for EAS venting	2nd vent tool adapter fails to mate/EAS jumper fails to open	Remove unvented EAS jumper, stow away from EVA or open QD Extender to M2 (integrate into PVTCS), attempt vent from QD-03F or open QD at M10 and integrate into EETCS	
11a	Close EAS QD (02F) at M10 (Isolates EAS jumper)	Fails to close	Leave in place, EAS jumper becomes part of EETCS			<u>NOTE</u> (steps 11a to 11c2): EAS jumper isolation and venting must be in eclipse
11b	Remove plug/Mate QD extender to vent tool	Fails to remove/mate	Leave in place (open QD at M10), EAS jumper becomes part of EETCS or use alternate vent tool	QD fails to reopen to integrate with EETCS or alternate vent tool fails to mate	Remove unvented EAS jumper, stow away from EVA or attempt to vent from QD 02F or reintegrate into PVTCS	
11c1	Open QD extender valve (EAS vent)	Fails to open	Leave in place, reopen M10, EAS jumper becomes part of EETCS	M10 fails to open	Remove unvented EAS jumper, stow away from EVA or attempt to vent from QD 02F or reintegrate into PVTCS	
12a	Close QD extender valve (EAS vent complete)	Fails to close	Stow EAS jumper and vent tool adapter together			
12b	Demate EAS jumper from vent tool	Fails to demate	Stow EAS jumper and vent tool adapter together			
13	Mate EAS jumper QD extender to M3	Fails to mate	Tie down			
14	Demate/Mate EAS jumper from M10/to M11	Fails to demate/mate	Leave in place or Tie down			
15	Similar controls for vent tool disassembly and stowage					



## P6 PVTCS FILL FAILURE MATRIX (Cont)

	Procedure Task	First Failure	Response/Control	Second Failure	Response/Control	Notes
16a	Close and demate P3/P4 jumper (M2) from P3	Fails to close/demate	Close & demate from P4	Fails to close/can't remove	Leave in place; Port SARJ cannot be rotated	
16b	Mate P3/P4 jumper to dummy	Fails to mate	Tie down out of SARJ rotation plane or remove jumper			
17a	Close/demate A500 QD valve (M1)	Fails to close/demate	Leave as is; can't use A500 to vent ATA without S1 A500 jumper			
17b	Mate/open A500 jumper to M3	Fails to mate/open	Return to M1, tie down, or leave as is		Can't use A500 to vent ATA without S1 A500 jumper	

**NOTE:** The hazard being protected for with these operational controls is EVA exposure to an isolated, liquid-locked line segment overpressurizing due to a temperature increase. Except where specifically noted, the isolation and venting of portions of the TCS system must occur in eclipse. In addition, utilizing alternate jumpers or means of venting, providing overpressurization protection, or limiting EVA exposure are all acceptable controls, so long as they provide similar fault-tolerance to the nominal or contingency operations provided below. While all possible failures have not been explicitly detailed, this matrix can be used as a guide to bring the system to a safe state following similar response controls for similar failures

 Indicates Accepted Risk

 Indicates not a listed hazard control

## ROEU CONTINGENCIES

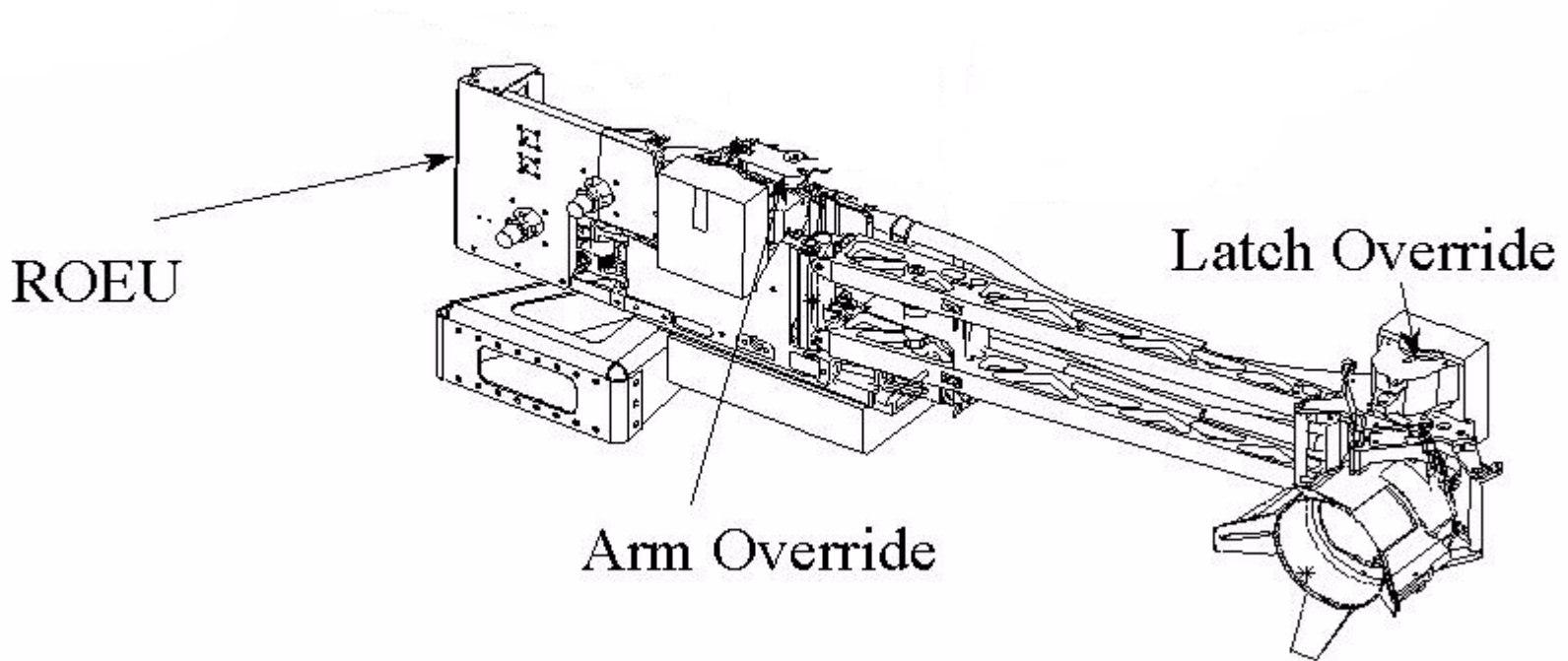

ROEU OVERVIEW







## ROEU CONTINGENCIES (Cont)

### RELEASE ELC(AMS) ROEU LATCHES

IV	EV
<p>1. <u>DEADFACE ROEU</u>            If ELC:            L12L ELC3 PWR – OFF            SSP2     √BUS 2/3 tb – bp                      √BUS 1 tb – bp                      cb SW PWR 4 – op</p> <p>R1           PL PRI MNC – OFF (tb-OFF)                      √MNB,FC3 (two) – ctr (tb-OFF)</p> <p>If AMS:            L12L       √cb SW PWR 4 – op            SSP2            A15        √APCU 1,2 CONV (two) – OFF                      1 OUTPUT – OFF</p> <p>2. <u>ROEU SAFING</u>            R13L       √PL BAY MECH PWR SYS 1,2 (two) – OFF            A6U        √RETEN LOGIC PWR SYS 1,SYS 2 (two) – OFF                      PL SEL – MON</p> <p>Give EV GO to release ROEU</p>	<p>Tools reqd:            Ratchet with 7/16-in Socket</p> <div data-bbox="1178 407 1833 518" style="border: 3px double black; padding: 5px; text-align: center;"> <p><b>WARNING</b>              For release, do not close access cover until ROEU stowed. Latches may not snap back to closed posn</p> </div> <p>1. On IV GO, open latch drive access cover:                Break safety cord, release access cover (3/4 turn ccw)                Open access cover (~120°)            Manual drive to RELEASE:                Rotate control lever to RELEASE                Rotate latch drive cw (~9 ft-lb) to hard stop (~3/4 turn)                Remove drive ratchet, clear worksite</p>

## ROEU CONTINGENCIES (Cont)

### RELEASE ELC(AMS) ROEU LATCHES (Cont)

IV	EV
<p>A6U</p> <p>3. <u>VERIFY TALKBACKS</u> Install ROEU A6U PANEL OVERLAY PL RETEN PL SEL – 2</p> <p>ELEC CONT              ✓            RELEASE      DEMATE                    ✓      ✓            LATCH      MATE</p> <p>4. <u>DEMATE ROEU</u></p> <p style="text-align: center;"><u>NOTE</u> When LOGIC switches taken OFF, KU will mode to standby. MPM and MRL tbs – bp</p> <p>MA73C:A      MCA LOGIC MNC MID 2 – OFF :B                      MNB MID 4 – OFF</p> <p>R13L      PL BAY MECH PWR SYS 1,2 (two) – ON A6U      RETEN LOGIC PWR SYS 1,SYS 2 (two) – ON</p> <p>Note single motor time (&gt; 18 sec)</p> <p>ELC (AMS) DEMATE/MATE – DEMATE (tb-REL), 36 sec max – OFF</p> <p>ELEC CONT              RELEASE      DEMATE        ✓             LATCH      MATE</p>	<div style="border: 3px double black; padding: 10px; text-align: center;"> <p><b>WARNING</b></p> <p>For release, remain clear of latches during access cover closing. Latches may snap back to closed posn</p> </div>



# ROEU CONTINGENCIES (Cont)

## LATCH ELC(AMS) ROEU LATCHES

IV		EV
A6U	<p>1. <u>CONFIGURE FOR ROEU MATE</u>  <u>Install ROEU A6U PANEL OVERLAY</u></p>	<p>Tools reqd:  Ratchet with 7/16-in Socket</p>
R13L	<p>√PL RETEN LOGIC PWR SYS 1,2 (two) – OFF  PL SEL – 2</p> <p>√PL BAY MECH PWR SYS 1,2 (two) – OFF</p> <div style="border: 1px solid black; padding: 2px; width: fit-content; margin: 5px auto;">SM 97 PL RETENTION</div>	
CRT	<p>√PL SEL 2 LAT 1,2 (3,4) (four): 0</p> <p style="margin-left: 40px;">* If LATCH 1,2 (3,4) LAT msw shows 1, *</p> <p style="margin-left: 40px;">* drive latch for single motor time *</p>	
A6U	<p>ELEC CONT</p> 	
L12L SSP2	<p>If ELC:</p> <p>√ELC3 PWR – OFF</p> <p style="margin-left: 40px;">√BUS 2/3 tb – bp</p> <p style="margin-left: 40px;">√BUS 1 tb – bp</p> <p>√cb SW PWR 4 – op</p>	
R1	<p>√PL PRI MNB,FC3,MNC (three) – ctr (tb-OFF)</p>	

**ROEU CONTINGENCIES (Cont)**

**LATCH ELC(AMS) ROEU LATCHES (Cont)**

IV	EV
<p>L12L SSP2 A15</p> <p>If AMS: √cb SW PWR 4 – op</p> <p>√APCU 1,2 CONV (two) – OFF √1 OUTPUT – OFF</p> <p>2. <u>MATE ROEU</u></p> <p style="text-align: center;"><u>NOTE</u> When LOGIC switches taken OFF, KU will mode to standby. MPM and MRL tbs – bp</p> <p>MA73C:A :B</p> <p>MCA LOGIC MNC MID 2 – OFF MNB MID 4 – OFF</p> <p>R13L A6U</p> <p>PL BAY MECH PWR SYS 1,2 (two) – ON RETEN LOGIC PWR SYS 1,2 (two) – ON</p> <p>Note single motor time (&gt; 30 sec)</p> <p>ELC (AMS) DEMATE/MATE – MATE (tb-LAT), 60 sec max – OFF</p> <p>ELEC CONT</p> <div style="display: flex; justify-content: space-around; align-items: center;"> <div style="text-align: center;">  <p>RELEASE</p> <div style="border: 1px solid black; padding: 2px; display: inline-block;">REL</div> LATCH         </div> <div style="text-align: center;"> <p>DEMATE</p> <div style="display: flex; align-items: center;"> <div style="margin-right: 5px;">✓</div> <div style="border: 1px solid black; padding: 2px; display: inline-block;">LAT</div> </div> MATE         </div> </div>	



## ROEU CONTINGENCIES (Cont)

### LATCH ELC(AMS) ROEU LATCHES (Cont)

	IV	EV
<p>R13L A6U</p> <p>3. <u>ROEU SAFING</u>            PL BAY MECH PWR SYS 1,2 (two) – OFF            RETEN LOGIC PWR SYS 1,2 (two) – OFF            PL SEL – MON</p> <p>Give EV GO to latch ROEU</p> <p>A6U</p> <p>4. <u>VERIFY TALKBACKS</u>            PL RETEN PL SEL – 2</p> <p style="text-align: center;">ELEC CONT</p> <p>✓ <input type="checkbox"/></p> <p style="text-align: center;">RELEASE      DEMATE</p> <p>✓ <input type="checkbox"/> LAT      <input type="checkbox"/> LAT</p> <p style="text-align: center;">LATCH      MATE</p> <p>A6U</p> <p>5. <u>RELAX ROEU</u>            If ELC:            PL RETEN PL SEL – 1</p> <p>R13L A6U</p> <p>PL BAY MECH PWR SYS 1,2 (two) – ON            RETEN LOGIC PWR SYS 1,SYS 2 (two) – ON</p> <p style="text-align: center;"><u>NOTE</u></p> <p>Monitor PL SEL 1(2) LATCH 5 msw status on SPEC 97</p> <p>Note single motor time (&gt; 12 sec)</p> <p>RELAX – RELAX (tb-REL), 24 sec max</p> <p>When PL SEL 1(2) LATCH 5 REL A(B) msw changes to 1:            RELAX – OFF</p> <p>✓ <input type="checkbox"/> RELAX  <input type="checkbox"/> REL</p>	<p>1. On IV GO, open latch drive access cover:            Break safety cord, release access cover            (3/4 turn ccw)            Open access cover (~120°)            Manual drive to LATCH:            Rotate control lever to LATCH            Rotate latch drive ccw (~9 ft-lb) to hard stop            (~3/4 turn)            Remove drive ratchet, clear worksite</p>	

**ROEU CONTINGENCIES (Cont)**

**LATCH ELC(AMS) ROEU LATCHES (Cont)**

<b>IV</b>		<b>EV</b>
R13L	PL RETEN LOGIC PWR SYS 1,2 (two) – OFF PL SEL – MON BAY MECH PWR SYS 1,2 (two) – OFF	2. Reengage latch actuator: Rotate control lever to neutral posn Close, secure access cover (3/4 turn cw) Clear worksite
R1 L12L SSP2	6. <u>ENABLE POWER</u> If ELC: PL PRI MNC – ON (tb-ON) cb SW PWR 4 – cl ELC3 PWR – ON √BUS 2/3 tb – UP √BUS 1 tb – UP	
A15	If AMS: On MCC GO: APCU 1 OUTPUT – ON	
	<u>NOTE</u> The APCU CONV switches need to be thrown simo due to AMS startup loads	
	APCU 1,2 CONV (two simo) – ON	
MA73C:A :B	MCA LOGIC MNC MID 2 – ON MNB MID 4 – ON	

**ROEU CONTINGENCIES (Cont)**

**STOW ELC(AMS) ROEU ARM**

<b>IV</b>	<b>EV</b>
<p>1. <u>VERIFY ROEU DEADFACED</u>                      If ELC:                      L12L      √ELC3 PWR – OFF                      SSP2          √BUS 2/3 tb – bp                                  √BUS 1 tb – bp                                  √cb SW PWR 4 – op</p> <p>R1            √PL PRI MNB,FC3,MNC (three) – ctr (tb-OFF)</p> <p>If AMS:                      L12L      √cb SW PWR 4 – op                      SSP2</p> <p>A15            √APCU 1,2 CONV (two) – OFF                                      √1 OUTPUT – OFF</p> <p>2. <u>CONFIGURE FOR ROEU LATCH</u>                      A6U        Install ROEU A6U PANEL OVERLAY</p> <p style="text-align: center;"><u>NOTE</u>                      When LOGIC switches taken OFF, KU will                      mode to standby. MPM and MRL tbs – bp</p> <p>MA73C:A    MCA LOGIC MNC MID 2 – OFF                      :B            MNB MID 4 – OFF</p> <p>√PL RETEN LAT (five) – OFF                                      LAT PL SEL – 2</p> <p style="border: 1px solid black; padding: 2px; display: inline-block;">SM 97 PL RETENTION</p> <p>√PL SEL 2 REL 1,2 (3,4) (four) – 0</p>	<p>Tools reqd:                      Ratchet with 7/16-in Socket</p>

## ROEU CONTINGENCIES (Cont)

### STOW ELC(AMS) ROEU ARM (Cont)

IV	EV
<p>* If LATCH 1,2 (3,4) REL msw shows 1, *</p> <p>* drive latch for single motor time *</p> <p>ELEC CONT</p> <p>✓ <input type="checkbox"/></p> <p>RELEASE      DEMATE</p> <p><input type="checkbox"/> LAT      <input checked="" type="checkbox"/> MATE</p> <p>LATCH      MATE</p> <p>2. <u>RELEASE LATCHES</u></p> <p>R13L PL BAY MECH PWR SYS 1,2 (two) – ON</p> <p>A6U RETEN LOGIC PWR SYS 1,2 (two) – ON</p> <p>Note single motor time (&gt; 20 sec)</p> <p>ELC (AMS) RELEASE/LATCH – REL (tb-REL), 40 sec max</p> <p>– OFF</p> <p>ELEC CONT</p> <p>✓ <input checked="" type="checkbox"/></p> <p>RELEASE      DEMATE</p> <p>✓ <input type="checkbox"/> REL      <input checked="" type="checkbox"/> MATE</p> <p>LATCH      MATE</p>	

## ROEU CONTINGENCIES (Cont)

### STOW ELC(AMS) ROEU ARM (Cont)

IV	EV
<p>R13L A6U</p> <p>3. <u>ROEU SAFING</u> PL BAY MECH PWR SYS 1,2 (two) – OFF RETEN LOGIC PWR SYS 1,2 (two) – OFF PL SEL – MON</p> <p>Give EV GO to stow ROEU</p> <p>A6U</p> <p>4. <u>VERIFY TALKBACKS</u> PL RETEN PL SEL – 2</p> <p>ELEC CONT</p>  <p>MA73C:A :B</p> <p>5. <u>ENABLE POWER</u> MCA LOGIC MNC MID 2 – ON MNB MID 4 – ON</p>	<p>1. On IV GO, open arm drive access cover: Break safety cord, release access cover (3/4 turn ccw) Open access cover (~120°) Manual drive to STOW: Rotate control lever to STOW Rotate arm drive ccw (~23 ft-lb) to hard stop (~3/4 turn) and pull arm inboard to verify Remove drive ratchet, clear worksite</p> <p>2. Reengage arm actuator: Rotate control lever to neutral posn Close, secure access cover (3/4 turn cw) Clear worksite</p>







## ROEU CONTINGENCIES (Cont)

### MATE ELC(AMS) ROEU ARM

IV		EV
<p>A6U</p> <p>R13L A6U</p> <p>L12L SSP2</p> <p>R1</p> <p>L12L SSP2</p> <p>A15</p>	<p>1. <u>CONFIGURE ROEU</u> Install <u>ROEU A6U PANEL OVERLAY</u></p> <p>2. <u>ROEU SAFING</u> √PL BAY MECH PWR SYS 1,2 (two) – OFF √RETN LOGIC PWR SYS 1,SYS 2 (two) – OFF PL SEL – MON</p> <p>If ELC: √ELC3 PWR – OFF √BUS 2/3 tb – bp √BUS 1 tb – bp √cb SW PWR 4 – op</p> <p>√PL PRI MNB,FC3,MNC (three) – ctr (tb-OFF)</p> <p>If AMS: √cb SW PWR 4 – op</p> <p>√APCU 1,2 CONV (two) – OFF √1 OUTPUT – OFF</p> <p>Give EV GO to mate ROEU</p>	<p>Tools reqd: Ratchet with 7/16-in Socket</p> <p>1. On IV GO, open arm drive access cover: Break safety cord, release access cover (3/4 turn ccw) Open access cover (~120°) Manual drive to MATE: Rotate control lever to MATE Ratchet arm drive cw (~25 ft-lb) until “READY TO LATCH” posn indicated on interface guide Remove drive ratchet Clear worksite (for latching)</p>

**ROEU CONTINGENCIES (Cont)**

**MATE ELC(AMS) ROEU ARM (Cont)**

<b>IV</b>	<b>EV</b>
<p>A6U 3. <u>VERIFY TALKBACKS</u> PL RETEN PL SEL – 2</p> <p style="margin-left: 40px;">ELEC CONT              RELEASE DEMATE      ✓ </p> <p>4. <u>LATCH LATCHES</u></p> <p style="margin-left: 80px;"><u>NOTE</u> When LOGIC switches taken OFF, KU will mode to standby. MPM and MRL tbs – bp</p> <p>MA73C:A MCA LOGIC MNC MID 2 – OFF :B MNB MID 4 – OFF</p> <p>R13L PL BAY MECH PWR SYS 1,2 (two) – ON A6U RETEN LOGIC PWR SYS 1,SYS 2 (two) – ON</p> <p>Note single motor time (&gt; 20 sec)</p> <p>ELC (AMS) RELEASE/LATCH – LATCH (tb-LAT), 40 sec max – OFF</p> <p style="margin-left: 40px;">ELEC CONT ✓             RELEASE DEMATE            ✓     </p> <p>R13L PL RETEN LOGIC PWR SYS 1,SYS 2 (two) – OFF BAY MECH PWR SYS 1,2 (two) – OFF</p>	



## ROEU CONTINGENCIES (Cont)

### MATE ELC(AMS) ROEU ARM (Cont)

IV	EV
<p>5. <u>RELAX ROEU (EVA)</u>            If ELC:            A6U PL RETEN PL SEL – 1            A6U Monitor RELAX tb            Give EV GO to STOW arm, halt once RELAX tb – REL</p> <div style="text-align: center;">  </div> <p>6. <u>ENABLE POWER</u>            MA73C:A MCA LOGIC MNC MID 2 – ON            :B MNB MID 4 – ON</p> <p>If ELC:            R1 PL PRI MNC – ON (tb-ON)            L12L cb SW PWR 4 – cl            SSP2 ELC3 PWR – ON                  √BUS 2/3 tb – UP                  √BUS 1 tb – UP</p> <p>If AMS:            On MCC GO:            A15 APCU 1 OUTPUT – ON</p> <p style="text-align: center;"><u>NOTE</u>            The APCU CONV switches need to be thrown simo due to AMS startup loads</p> <p style="text-align: center;">APCU 1,2 CONV (two simo) – ON</p>	<p>2. <u>RELAX ROEU (EVA)</u>            On IV GO, rotate control lever to STOW:            Ratchet arm drive ccw until IV receives RELAX tb – REL.            Remove drive ratchet</p> <p>3. Reengage arm actuator:            Rotate control lever to neutral posn            Close, secure access cover (3/4 turn cw)            Clear worksite</p>



## UCCAS/PAS UMBILICAL MATING ASSEMBLY (UMA) MANUAL DRIVE (00:20) (Cont)

### TASK DATA

Table 1: Estimated Task Duration

	Without SSRMS
One EV Crew	0:20
Two EV Crew	N/A

Table 2: Tools

EV1 (RMS)
PGT
7/16 (wobble) Socket-6 ext

Table 3: EVA Fasteners

Fastener Name	Label	Head Size (in)	Qty	Drive Torque (ft-lb)	Failure Torque (ft-lb)	Turns	RPM
UMA EVA Override	EVA Override	7/16	1 ea	2.5	3.83	85 Refer to Note 1	30 10 for last four to five turns

Table 4: EVA ORU Lables

EVA Label	Location	Functional Designation
UMA ACTIVE – 0101	P3 Zenith UCCAS	UCCAS-1 UMA
UMA ACTIVE – 0102	P3 Nadir UCCAS	UCCAS-2 UMA
UMA ACTIVE – 0101	S3 Zenith Outboard PAS	PAS-1 UMA
UMA ACTIVE – 0102	S3 Zenith Inboard PAS	PAS-2 UMA
UMA ACTIVE – 0103	S3 Nadir Outboard PAS	PAS-3 UMA
UMA ACTIVE – 0104	S3 Nadir Inboard PAS	PAS-4 UMA

## UCCAS/PAS UMBILICAL MATING ASSEMBLY (UMA) MANUAL DRIVE (00:20) (Cont)

Table 5: EVA ORU Inhibits

Location	UMA	RPCM
P3 Zenith	UCCAS-1 UMA (P3 Zenith)	P34B E RPC 01 – Open; Close command Inhibit
		P33A E RPC 01 – Open; Close command Inhibit
P3 Nadir	UCCAS-2 UMA (P3 Nadir)	P34B E RPC 02 – Open; Close command Inhibit
		P33A E RPC 02 – Open; Close command Inhibit
S3 Zenith Outboard	PAS-1 UMA (S3 Zenith Outboard)	S34BE RPC 01 – Open; Close command Inhibit
		S33A E RPC 01 – Open; Close command Inhibit
S3 Zenith Inboard	PAS-2 UMA (S3 Zenith Inboard)	S34B E RPC 02 – Open; Close command Inhibit
		S33A E RPC 02 – Open; Close command Inhibit
S3 Nadir Outboard	PAS-3 UMA (S3 Nadir Outboard)	S34BE RPC 03 – Open; Close command Inhibit
		S33A E RPC 03 – Open; Close command Inhibit
S3 Nadir Inboard	PAS-4 UMA (S3 Nadir Inboard)	S34BE RPC 04 – Open; Close command Inhibit
		S33A E RPC 04 – Open; Close command Inhibit

## UCCAS/PAS UMBILICAL MATING ASSEMBLY (UMA) MANUAL DRIVE (00:20) (Cont)

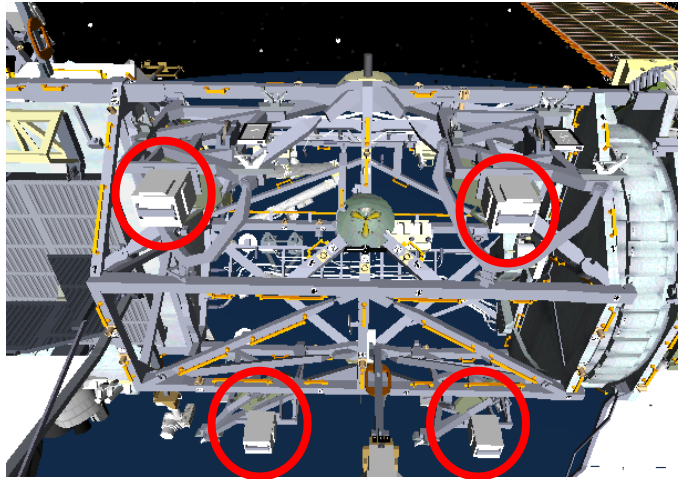

Figure 1.- S3 UMA Locations

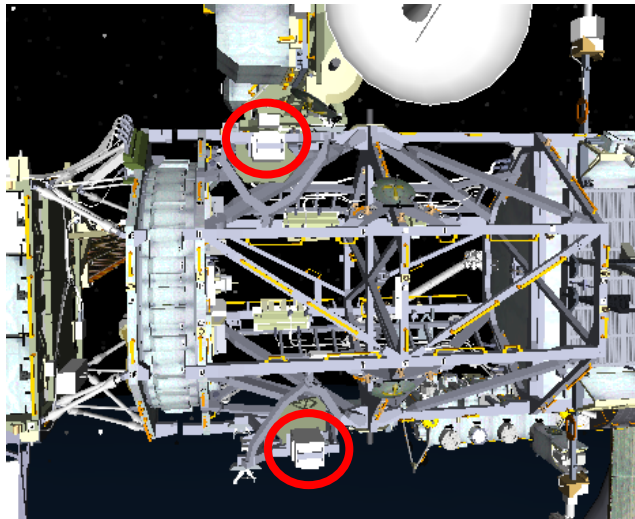

Figure 2.- P3 UMA Locations



Figure 3.- EVA Override Bolt

## EXPCA R&R PROCEDURES (03:40)

ESTIMATED TASK DURATION: 03:40

### CAUTION

Avoid inadvertent contact with ExPCA – Z93 paint

### NOTE

- ELCs have thermal clocks, need to do worksite specific analysis to determine
- ELC4 and ELC3 aft ExPCA locations have Velcro tabs on the ELCs for the ExPCA MLI. ELC4s ExPCA MLI was removed during STS-133
- H3 is an empty microconical – no bolt inside
- H2 is primary jacking bolt, H1 is secondary bolt
- H2 is nearest to the blind mate connectors
- Active UMA must be demated from ELC in addition to the inhibit
- ExPCA MLI may be required on failed ExPCA after the R&R

## EXPCA R&R PROCEDURES (03:40) (Cont)

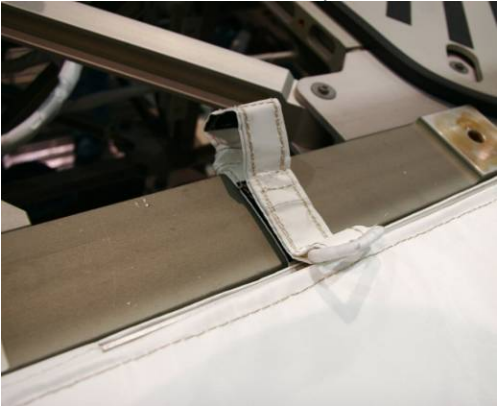
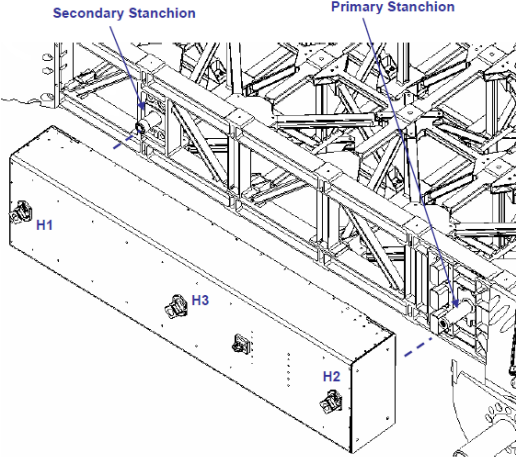
IV/SSRMS	EV1	EV2
<p>1. Verify inhibits in place            ✓Port SARJ locked (ELC3)            ✓UMA demated</p> <p>SSRMS: On <b>EV1 GO</b>, mnvr to Failed ExPCA Removal position</p>  	<p><u>SSRMS SETUP (00:20)</u></p> <ol style="list-style-type: none"> <li>1. Retrieve APFR</li> <li>2. GCA SSRMS for APFR Install/Ingress</li> <li>3. Install WIF adapter (tether point forward)</li> <li>4. Install APFR [<b>TBD</b>] in WIF adapter</li> <li>5. Perform Safety Tether swap to SSRMS</li> <li>6. Ingress APFR</li> <li>7. Give <b>SSRMS GO</b> to mnvr to Failed ExPCA Removal posn</li> </ol> <p><u>EXPCA REMOVAL (00:45)</u></p> <ol style="list-style-type: none"> <li>8. Install scoop on H3 and tether to ExPCA</li> <li>9. Install TM on H1</li> <li>10. Configure PGT: [<b>A7 (9.2), CCW1, 30.5</b>]</li> <li>11. Release H1 bolt 1 turn, 5 turns on PGT</li> <li>12. Relocate TM from H1 to H2, GCA SSRMS as reqd</li> <li>13. Configure PGT: [<b>A7 (9.2), CCW1, 30.5</b>]</li> <li>14. Release H2 bolt 1 turn, 5 turns on PGT</li> <li>15. Remove TM and stow or transfer to EV2</li> <li>16. Install scoop on H2</li> </ol>	<p><u>SPARE EXPCA SETUP (00:20)</u></p> <ol style="list-style-type: none"> <li>1. Translate to aft side of ELC3 (spare ExPCA)</li> <li>2. Tether to ExPCA MLI</li> <li>3. Remove ELC2 ExPCA MLI (4 straps, 1 grounding strap)</li> <li>4. Fold the structure Velcro straps (2 Stbd, 2 Port, 1 grounding strap) back to itself</li> <li>5. Stow MLI in bag; use long wire tie, as required</li> <li>6. Install scoop on H3</li> <li>7. Install TM on H1</li> <li>8. Configure PGT: [<b>A7 (9.2), CCW1, 30.5</b>]</li> <li>9. Release H1 bolt 1 turn, 5 turns on PGT</li> <li>10. Relocate TM from H1 to H2</li> <li>11. Configure PGT: [<b>A7 (9.2), CCW1, 30.5</b>]</li> <li>12. Release H2 bolt 1 turn, 5 turns on PGT</li> <li>13. Remove TM and stow</li> <li>14. Install scoop on H2</li> </ol> <p><u>EXPCA REMOVAL (00:45)</u></p> <ol style="list-style-type: none"> <li>15. Translate to failed ExPCA</li> <li>16. Assist EV1 as required</li> </ol>



**EXPCA R&R PROCEDURES (03:40) (Cont)**

IV/SSRMS	EV1	EV2									
<p>SSRMS: On <b>EV1 GO</b>, mnvr to Spare ExPCA Retrieve position</p> <p>SSRMS: On <b>EV1 GO</b>, mnvr to Spare ExPCA Install position</p> <p>2. Record bolt data:</p> <table border="1" data-bbox="121 992 613 1117"> <thead> <tr> <th>Bolt</th> <th>Torque</th> <th>Turns</th> </tr> </thead> <tbody> <tr> <td>H2</td> <td></td> <td></td> </tr> <tr> <td>H1</td> <td></td> <td></td> </tr> </tbody> </table> <p>SSRMS: On <b>EV1 GO</b>, mnvr to Failed ExPCA Install position</p>	Bolt	Torque	Turns	H2			H1			<p>17. Configure PGT:  <b>[A7 (9.2), CCW2, 30.5]</b> 6-in ext 7/16</p> <p>18. Release H1 bolt ~ 4 turns</p> <p>19. Release H2 bolt ~15 turns</p> <p>20. Remove failed ExPCA from stanchions and temp stow with EV2 assistance</p> <p><u>SPARE EXPCA REMOVAL (00:45)</u></p> <p>21. Give <b>SSRMS GO</b> to mnvr to Spare ExPCA Retrieve posn</p> <p>22. Tether to ExPCA</p> <p>23. Configure PGT:  <b>[A7 (9.2), CCW2, 30.5]</b> 6-in ext 7/16</p> <p>24. Release H1 bolt ~ 4 turns</p> <p>25. Release H2 bolt ~15 turns</p> <p>26. Remove spare ExPCA from stanchions</p> <p>27. Give <b>SSRMS GO</b> to mnvr to Spare ExPCA Install posn</p> <p><u>SPARE EXPCA INSTALL (00:45)</u></p> <p>28. Install spare ExPCA; align on stanchions, GCA as reqd (ball plunger on H2 ~5 lb soft dock)</p> <p>29. Configure PGT:  <b>[B7 (25.5), CW2, 30.5]</b> 6-in ext 7/16</p> <p>30. Drive H2 bolt 14-16 turns</p> <p>31. Drive H1 bolt 4-5 turns</p> <p>32. Release scoops from H3 and H2 and stow</p> <p>33. Release RET</p> <p><u>FAILED EXPCA INSTALL (00:45)</u></p> <p>34. Retrieve failed ExPCA from temp stow location, GCA SSRMS as reqd</p> <p>35. Give <b>SSRMS GO</b> to mnvr to Failed ExPCA Install posn (ELC3 aft side)</p>	<p><u>EXPCA REMOVAL (00:45)</u></p> <p>17. Assist EV1 as required</p> <p><u>SPARE EXPCA INSTALL (00:45)</u></p> <p>18. For ELC4 site, verify MLI velcro tabs clear of interface</p> <p>19. Assist EV1 as required</p> <p><u>FAILED EXPCA INSTALL (00:45)</u></p> <p>20. At ELC3 aft site, verify MLI Velcro tabs clear of interface</p> <p>21. Assist EV1 as required</p>
Bolt	Torque	Turns									
H2											
H1											

**EXPCA R&R PROCEDURES (03:40) (Cont)**

IV/SSRMS	EV1	EV2									
<p>3. Record bolt data:</p> <table border="1" data-bbox="117 321 611 446"> <thead> <tr> <th>Bolt</th> <th>Torque</th> <th>Turns</th> </tr> </thead> <tbody> <tr> <td>H2</td> <td></td> <td></td> </tr> <tr> <td>H1</td> <td></td> <td></td> </tr> </tbody> </table> <p>SSRMS: On <b>EV1 GO</b>, mnvr to APFR Egress position</p>	Bolt	Torque	Turns	H2			H1			<p>36. Install failed ExPCA; align on stanchions (ball plunger on H2 ~5 lb soft dock)</p> <p>37. Configure PGT:  <b>[B7 (25.5), CW2, 30.5]</b> 6-in ext 7/16</p> <p>38. Drive H2 bolt 14-16 turns</p> <p>39. Drive H1 bolt 4-5 turns</p> <p>40. Release scoops from H3 and H2 and stow</p> <p>41. Release RET</p> <p><u>SSRMS CLEANUP (00:20)</u></p> <p>42. Give <b>SSRMS GO</b> to mnvr to APFR egress position</p> <p>43. Egress APFR</p> <p>44. Retrieve and stow APFR</p> <p>45. Retrieve WIF adapter</p> <p>46. Perform tether swap back to A/L tether</p> <p>47. Glove Check</p>	
Bolt	Torque	Turns									
H2											
H1											

## EXPCA R&R PROCEDURES (03:40) (Cont)

### TASK DATA

Table 1: Estimated Task Duration

	Without SSRMS	With SSRMS
One EV Crew	N/A	04:00
Two EV Crew	N/A	03:40

Table 2: Tools

EV1 (RMS)	EV2 (FF)
PGT	PGT
7/16 (wobble) Socket-6 ext	7/16 (wobble) Socket-6 ext
2 Square Scoops	2 Square Scoops
Square TM w/Recessed 7/16 bolt	Square TM w/Recessed 7/16 bolt

Table 3: EVA Fasteners

Fastener Name	Label	Head Size (in)	Qty	Install Torque (ft-lb)	Removal Torque (ft-lb)	Failure Torque (ft-lb)	Turns	RPM
Primary bolt	H2	7/16	1	9.2	9.2	104.4	14-16	10 w/TM; 30 w/out
Secondary bolt	H1	7/16	1	9.2	9.2	104.4	4-6	10 w/TM; 30 w/out

Table 4: ORU Details

ORU	Part Number	Mass (lb)
ExPCA	2091750	197 lb

Table 5: EVA ORU Inhibits – Active UMA must also be demated from the ELCs in addition to the inhibits below:

Failed ExPCA Location	Inhibit
ELC1	TBD
ELC2	TBD
ELC3	TBD
ELC4	TBD
Spare ExPCA – ELC3	TBD

EXPCA R&R PROCEDURES (03:40) (Cont)

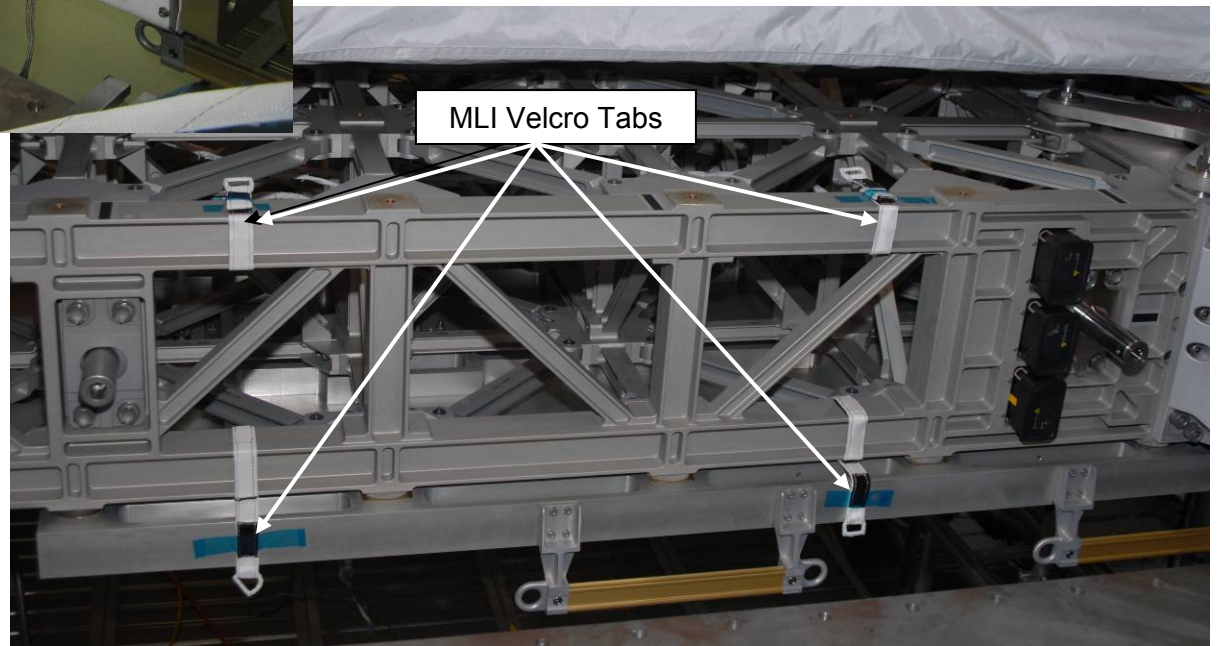

## AMS CAPTURE BAR MANUAL RELEASE/INSTALL (01:00)

ESTIMATED TASK DURATION: 01:00

### CAUTION

Do not exceed 60 RPM and 5 ft-lb when driving interface knob.

Avoid AMS Star Trackers Baffles - possible sharp edge.

### NOTE

1. The ELC Capture Bar Manual Release procedure is performed only if release is not achieved by CLA Manual Drive procedure.
2. The anti-rotation mechanisms on the Load Release bolts may be stiff and require additional force on socket to disengage.

## AMS CAPTURE BAR MANUAL RELEASE/INSTALL (01:00) (Cont)

IV	EV1 (FF)	EV2 (FF)
<p>1. Verify CLA power off, UMA disconnected, and SSRMS grappled to AMS in Limp mode.</p> <p>2. Give <b>SSRMS GO</b> for AMS removal.</p> <p>Prior to remating AMS to a CAS, perform capture bar restow.</p>	<p><a href="#">AMS CAPTURE BAR MANUAL RELEASE (00:30)</a></p> <ol style="list-style-type: none"> <li>1. <b>PGT [A5 (7.0 ft-lb), CW2 (30 RPM), 30.5]-6" Ext-7/16:</b> Drive Load Release Bolt #1, 20 turns.</li> <li>2. <b>PGT [A5 (7.0 ft-lb), CW2 (30 RPM), 30.5]-6" Ext-7/16:</b> Drive Load Release Bolt #2, 40 turns.</li> <li>3. <b>PGT [A5 (7.0 ft-lb), CW2 (30 RPM), 30.5]-6" Ext-7/16:</b> Drive Load Release Bolt #1, 40 turns.</li> <li>4. <b>PGT [A5 (7.0 ft-lb), CW2 (30 RPM), 30.5]-6" Ext-7/16:</b> Drive Load Release Bolt #2, 40 turns.</li> <li>5. <b>PGT [A5 (7.0 ft-lb), CW2 (30 RPM), 30.5]-6" Ext-7/16:</b> Drive Load Release Bolt #1, 20 turns.</li> <li>6. Verify capture bar clear of CLA.</li> <li>7. On <b>EV2 GO</b>, give <b>IV GO</b> for AMS removal.</li> </ol> <p><a href="#">AMS CAPTURE BAR RESTOW (00:30)</a></p> <div style="border: 1px solid black; padding: 5px; margin: 10px 0;"> <p style="text-align: center;"><u>NOTE</u></p> <p>The following steps are required to restow AMS on a CAS site.</p> </div> <ol style="list-style-type: none"> <li>8. <b>PGT [A3 (4.8 ft-lb), CCW2 (30 RPM), 30.5]-6" Ext-7/16:</b> Drive Load Release Bolt #1, 20 turns.</li> <li>8. <b>PGT [A3 (4.8 ft-lb), CCW2 (30 RPM), 30.5]-6" Ext-7/16:</b> Drive Load Release Bolt #2, 40 turns.</li> <li>9. <b>PGT [A3 (4.8 ft-lb), CCW2 (30 RPM), 30.5]-6" Ext-7/16:</b> Drive Load Release Bolt #1, 40 turns.</li> <li>10. <b>PGT [A3 (4.8 ft-lb), CCW2 (30 RPM), 30.5]-6" Ext-7/16:</b> Drive Load Release Bolt #2 to torque stall, expect 40 turns.</li> <li>11. <b>PGT [A3 (4.8 ft-lb), CCW2 (30 RPM), 30.5]-6" Ext-7/16:</b> Drive Load Release Bolt #1 to torque stall, expect 20 turns.</li> <li>12. Inspect EMU gloves.</li> </ol>	<p><a href="#">AMS CAPTURE BAR MANUAL RELEASE (00:30)</a></p> <ol style="list-style-type: none"> <li>1. Assist EV1 as reqd.</li> <li>2. Translate to aft side of PCAS.</li> <li>3. Pull Capture Bar out and rotate up/out through the Keel</li> <li>4. Give <b>EV1 GO</b> for AMS removal when clear.</li> </ol> <p><a href="#">AMS CAPTURE BAR RESTOW (00:30)</a></p> <div style="border: 1px solid black; padding: 5px; margin: 10px 0;"> <p style="text-align: center;"><u>NOTE</u></p> <p>The following steps are required to restow AMS on a CAS site.</p> </div> <ol style="list-style-type: none"> <li>5. Push capture bar in/down into the locking slot, then into the installed position</li> <li>6. Visually inspect capture bar to ensure it is fully seated in the installed position.</li> <li>7. Inspect EMU gloves</li> </ol>

## AMS CAPTURE BAR MANUAL RELEASE/INSTALL (01:00) (Cont)

### TASK DATA

Table 1: Estimated Task Duration

	Without SSRMS	With SSRMS
One EV Crew	N/A	N/A
Two EV Crew	N/A	01:00

Table 2: Tools

EV1
PGT
7/16 (wobble) Socket-6 ext

Table 3: EVA Fasteners

Fastener Name	Label	Head Size (in)	Qty	Install Torque (ft-lb)	Removal Torque (ft-lb)	Failure Torque (ft-lb)	Turns	RPM
Capture Bar Release Bolt	Bolt 1	7/16	1	4.8	7.0	19.4	81	30
Capture Bar Release Bolt	Bolt 2	7/16	1	4.8	7.0	19.4	81	30



AMS CAPTURE BAR MANUAL RELEASE/INSTALL (01:00) (Cont)

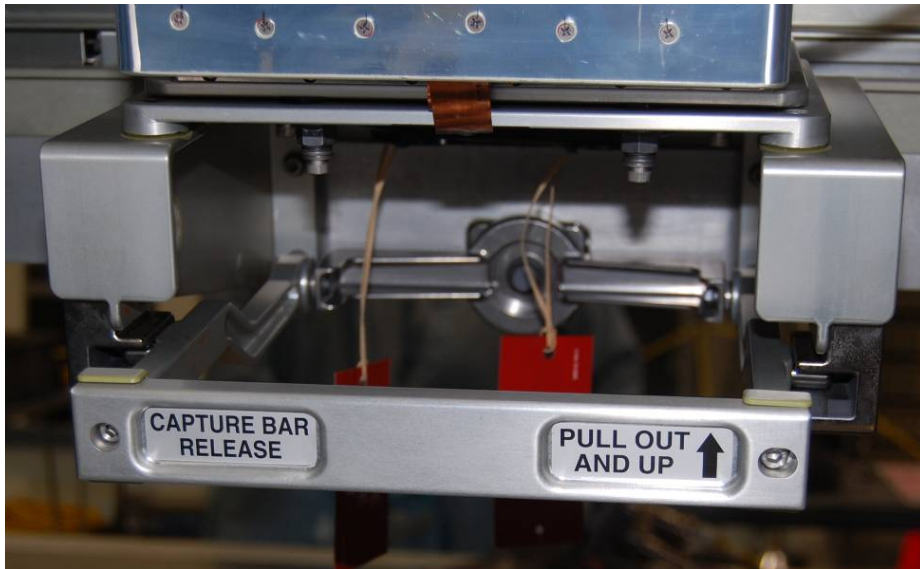
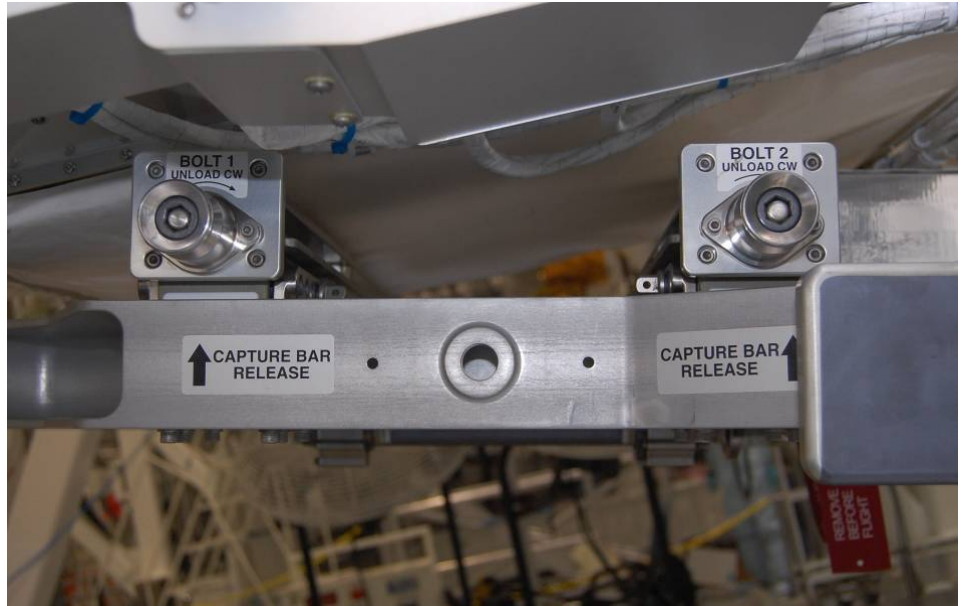

## MANUALLY SWITCH AMS DATA CHANNELS

ESTIMATED TASK DURATION: 00:30

IV	EV1/EV2
<p>1. Verify Inhibits. RPCMs Demate UMA</p>	<p><u>MANUALLY SWITCH AMS DATA CHANNELS</u></p> <ol style="list-style-type: none"><li>1. Translate to EVA Interface Panel</li><li>2. Remove cap from J104</li><li>3. Disconnect connector P103</li><li>4. Mate connector to J104</li><li>5. Install cap on J103</li><li>6. Remove cap from J101B</li><li>7. Disconnect connector P101A</li><li>8. Mate connector to J101B</li><li>9. Install cap on J101A</li></ol>

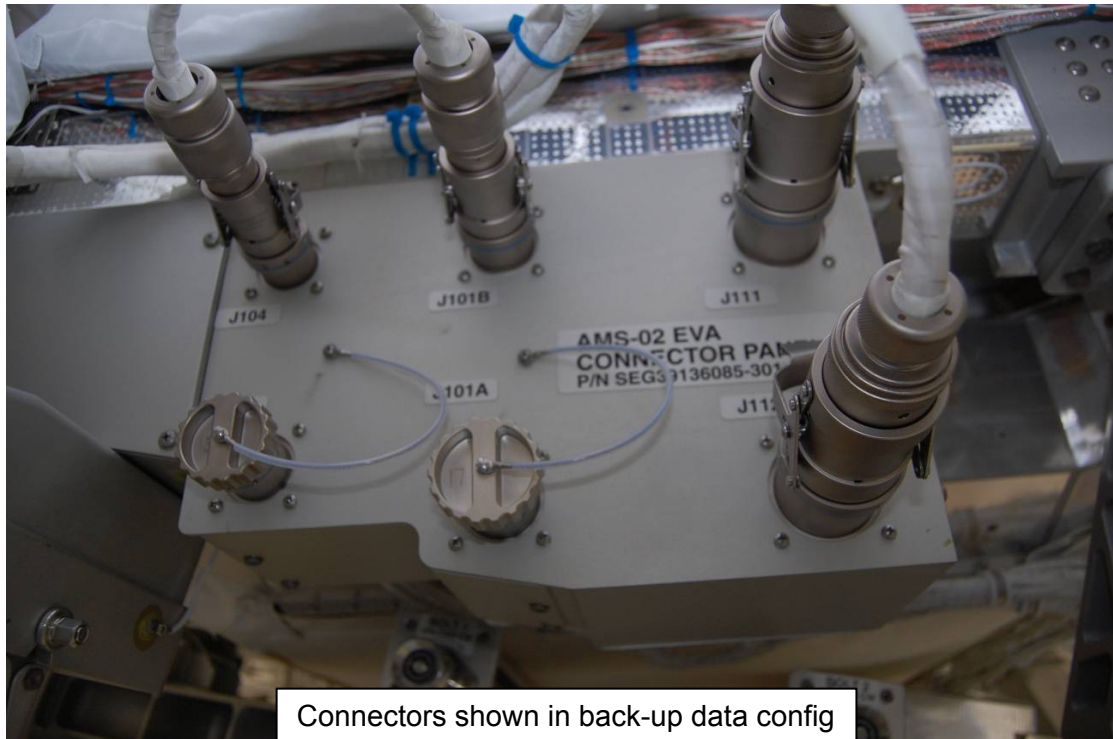

Connectors shown in back-up data config

## MANUALLY SWITCH AMS DATA CHANNELS (Cont)

### TASK DATA

Table 1: Estimated Task Duration

	Without SSRMS	With SSRMS
One EV Crew	00:30	N/A
Two EV Crew	N/A	N/A

Table 2: EVA Connectors

Connector	From	To	Conn Size	Function
P103	J103	J104	15	Data
P101	J101A	J101	15	Data
P111	J111	-	25	Power
P112	J112	-	25	Power

# MISSE 8 AND ORMATE-III TIEDOWNS

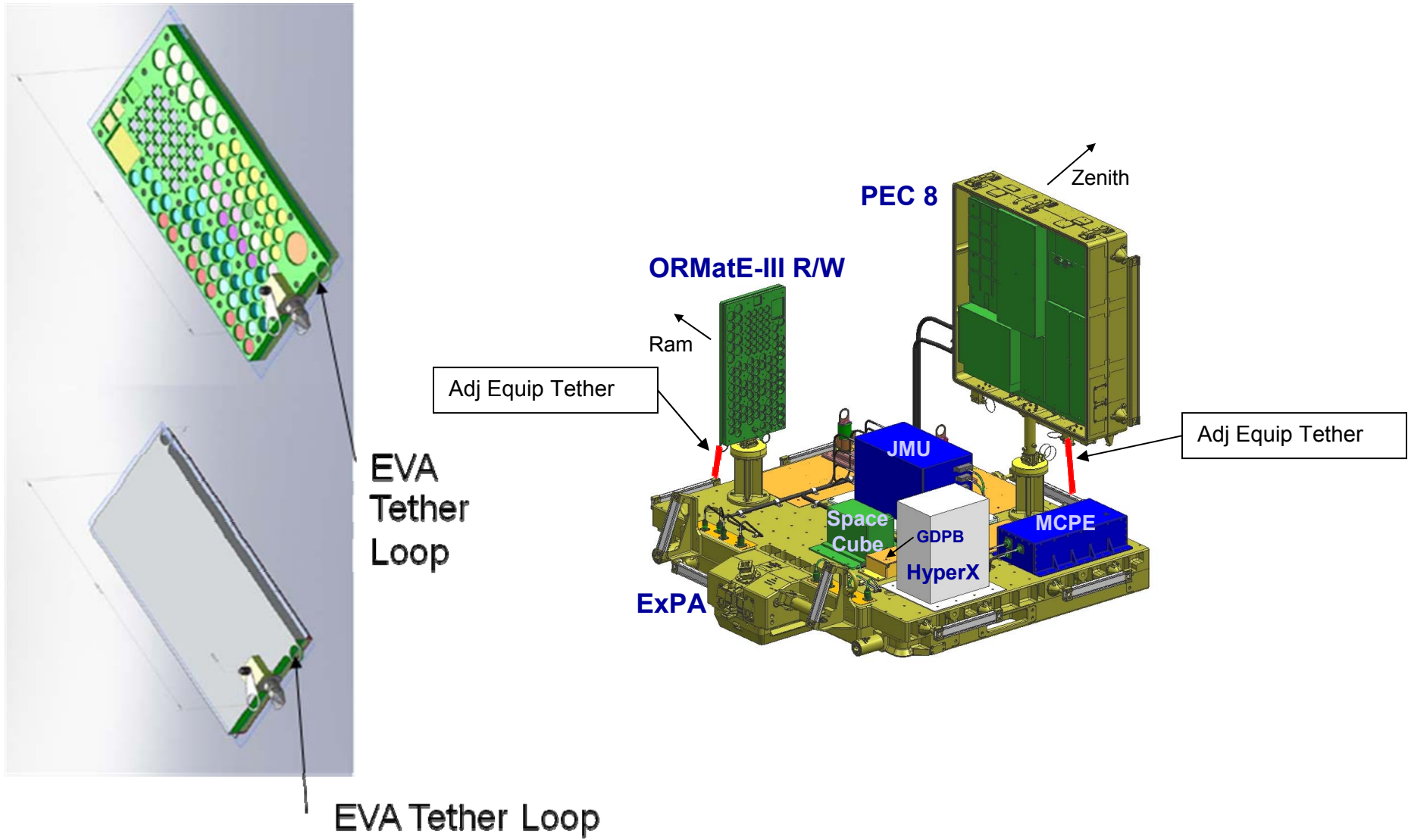



# S3 CETA LIGHT TIEDOWN

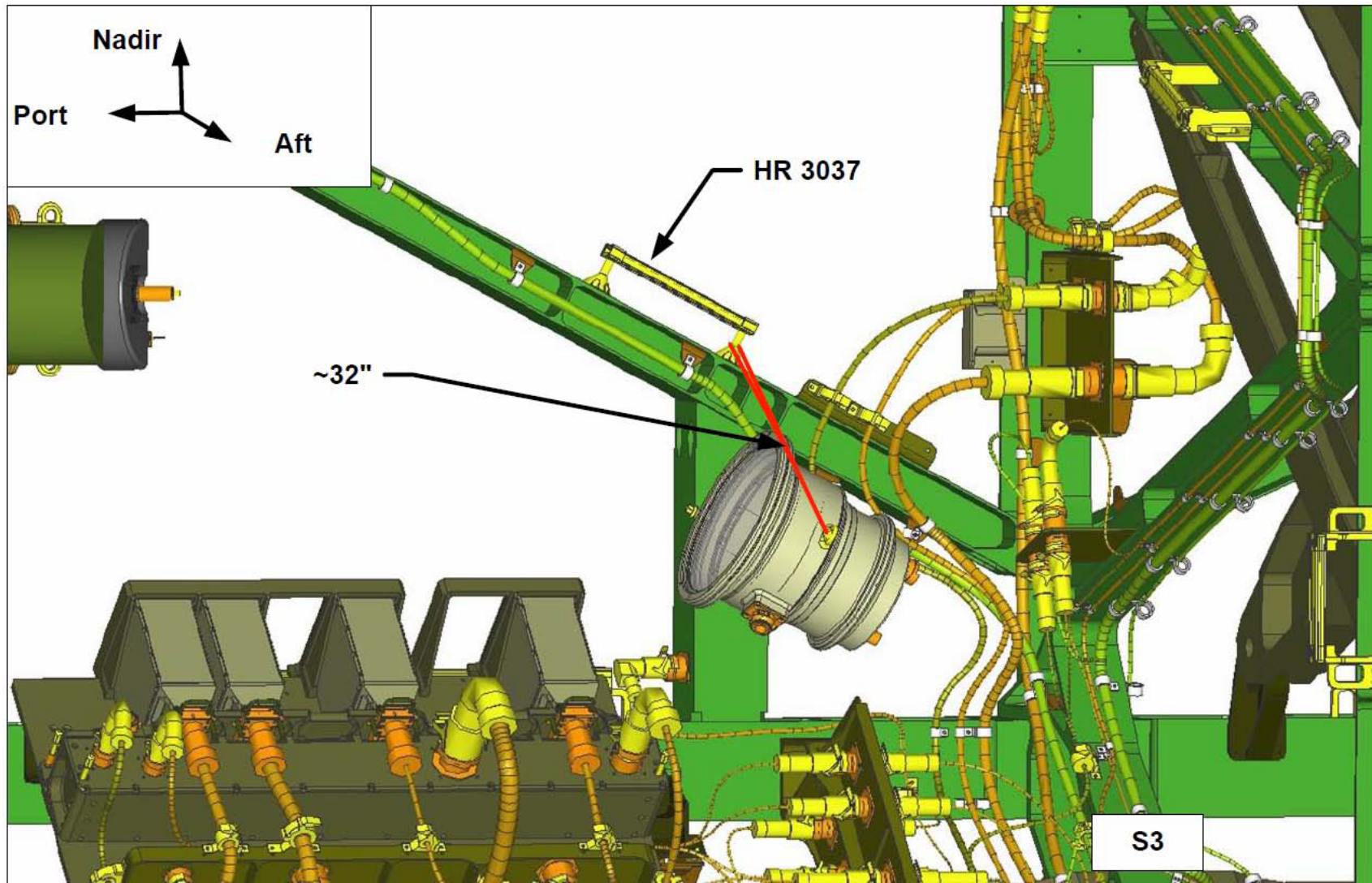

# EWC ANTENNA HANDRAILS TIEDOWN

ANT-1 TO HR 0264 (Option 1)

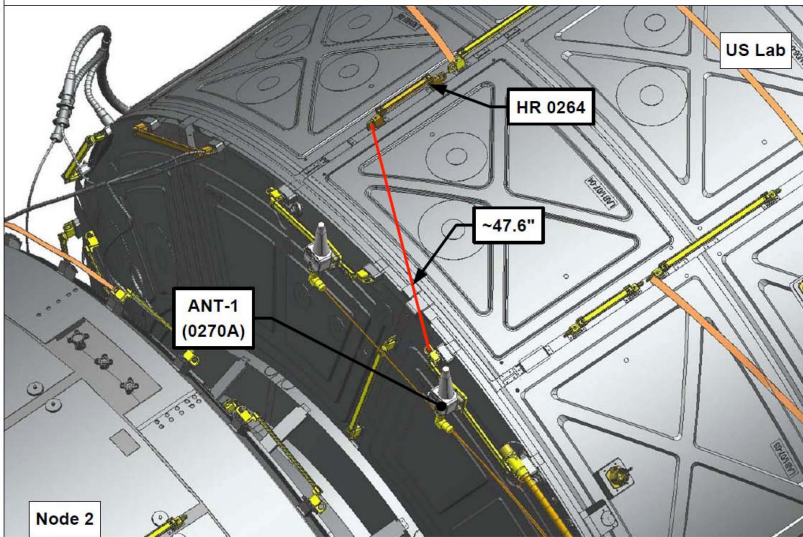

Option 1 is only if there is no Handrail fully installed in HR 0271 position  
 2 AETs will be used in series for the 47" span

ANT-1 TO ANT-2 (Option 2)

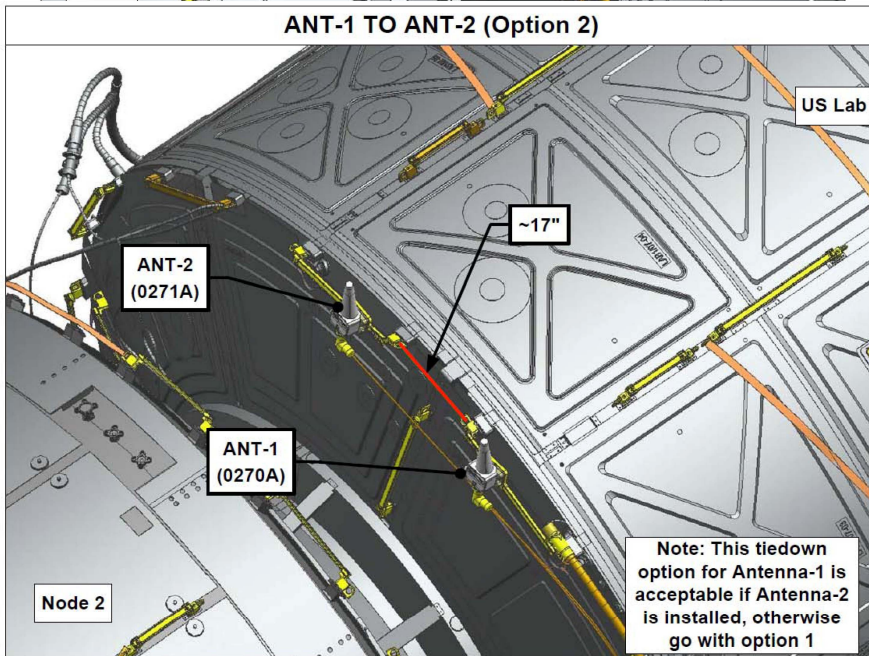

ANT-2 TO HR 0272

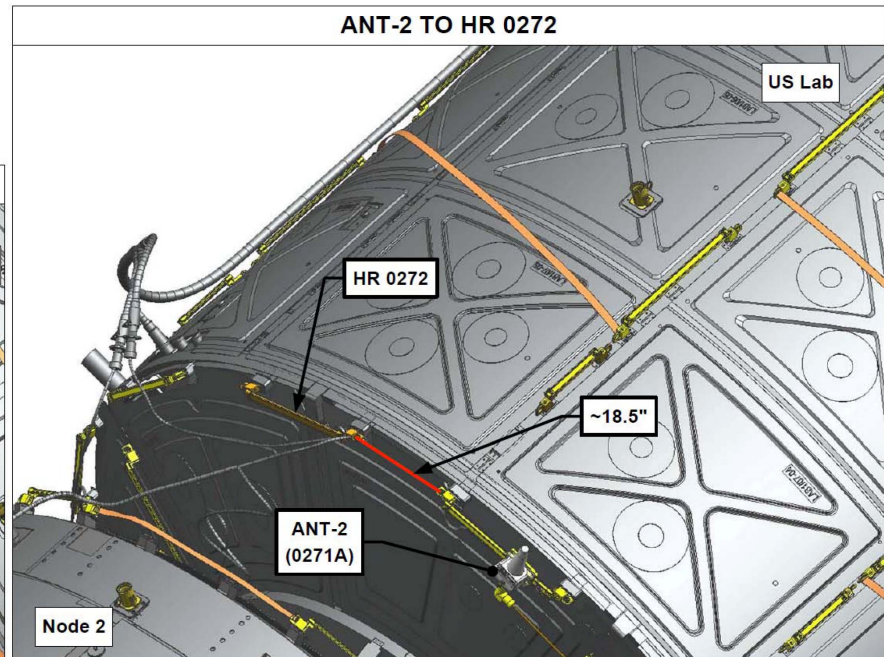



## EAS JUMPER TIEDOWN

### Approximate Wire Tie Locations (Qty 4)

- Lower Wire Ties should be located ~1 ft from connectors
- Upper Wire Ties should be located ~1.5 ft from lower ties (as shown)

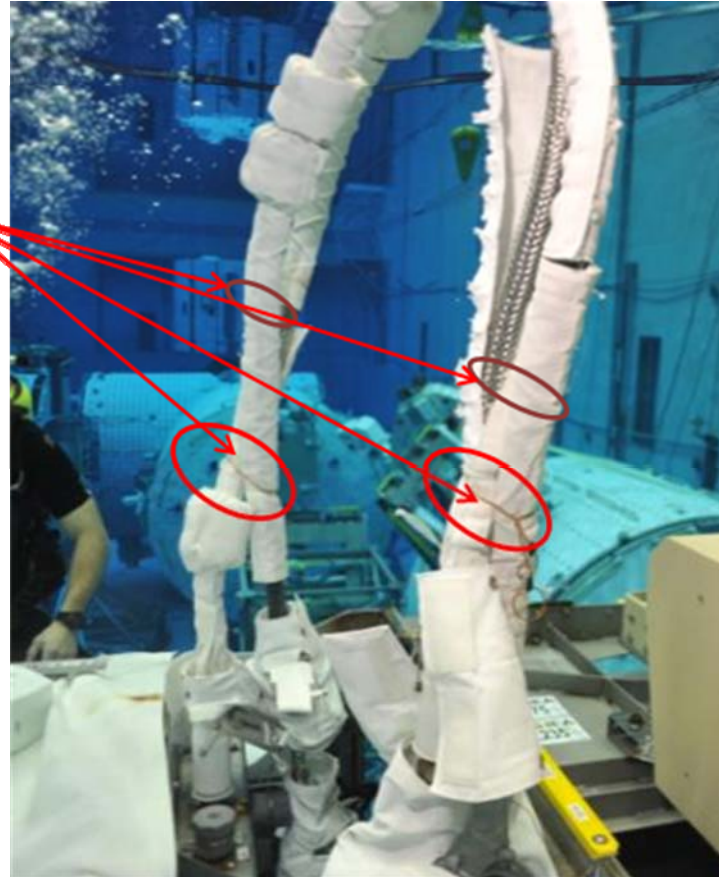



# SARJ COVERS TIEDOWN

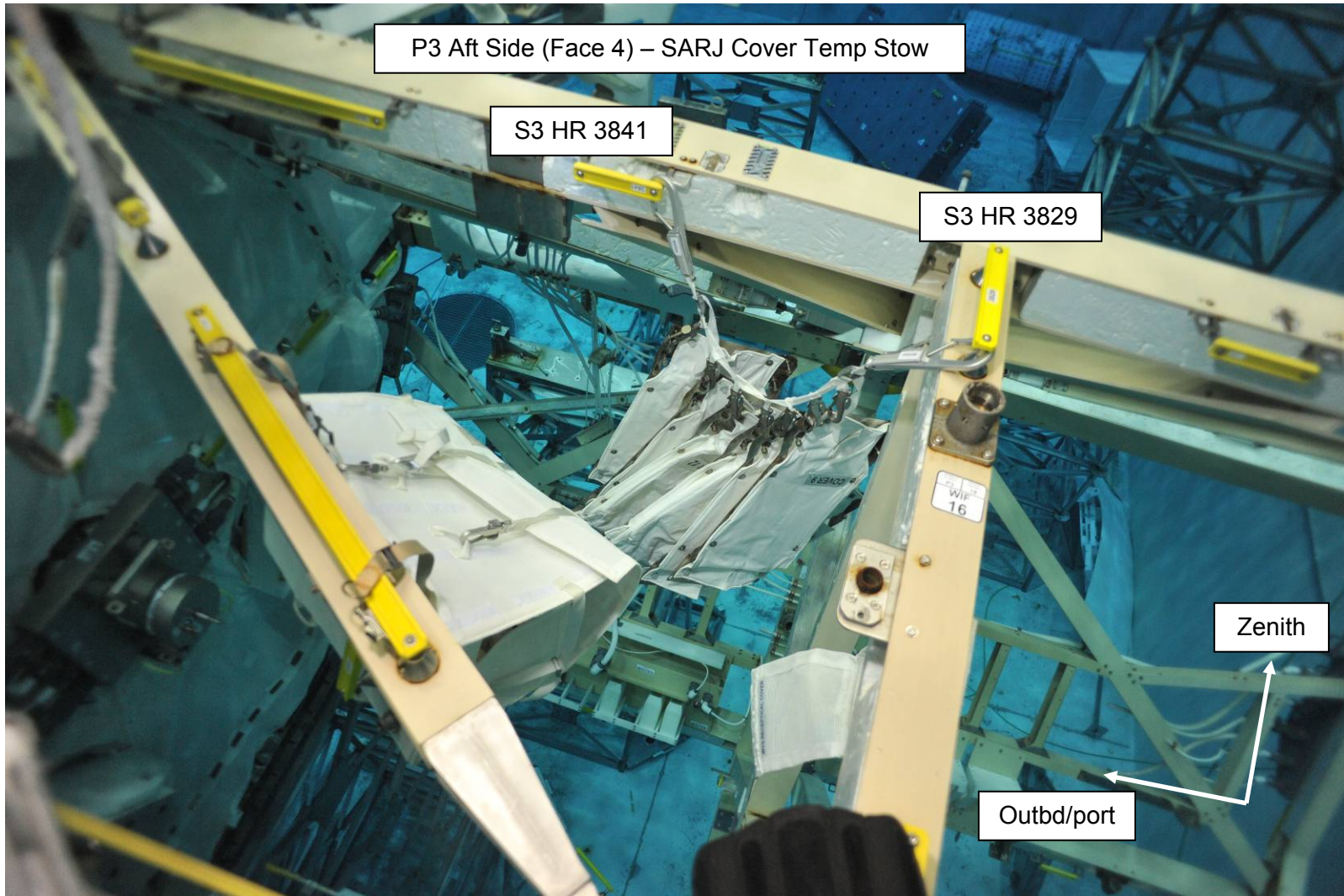

# S1 RADIATOR GB STOW BEAMS TIEDOWN

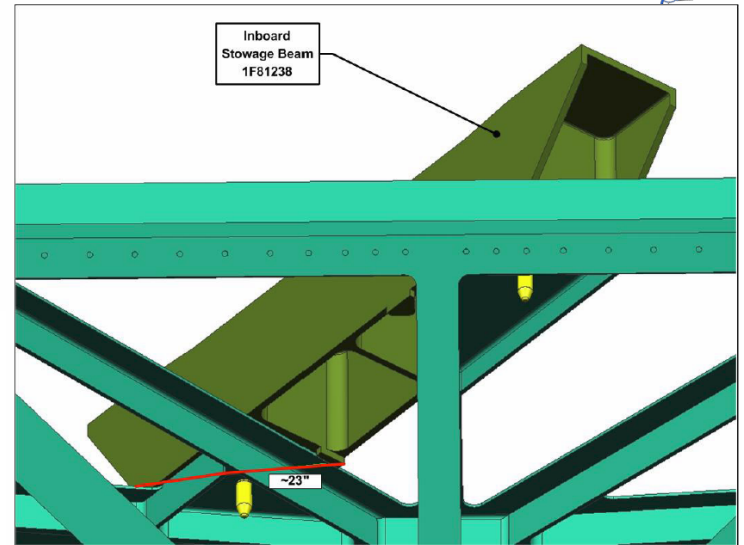
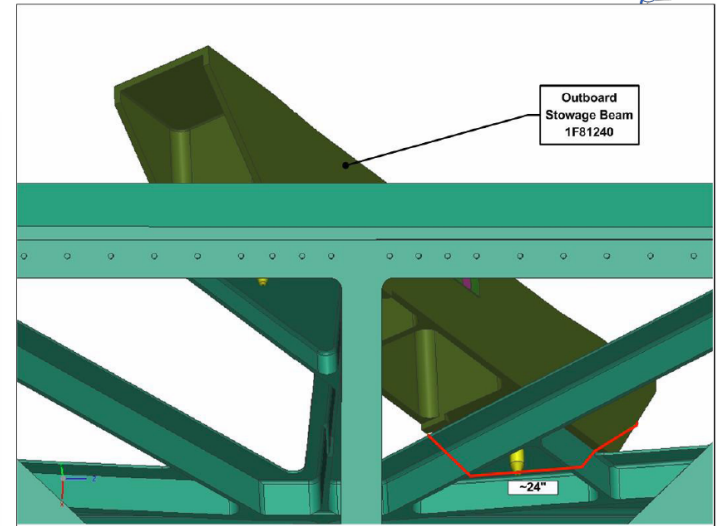
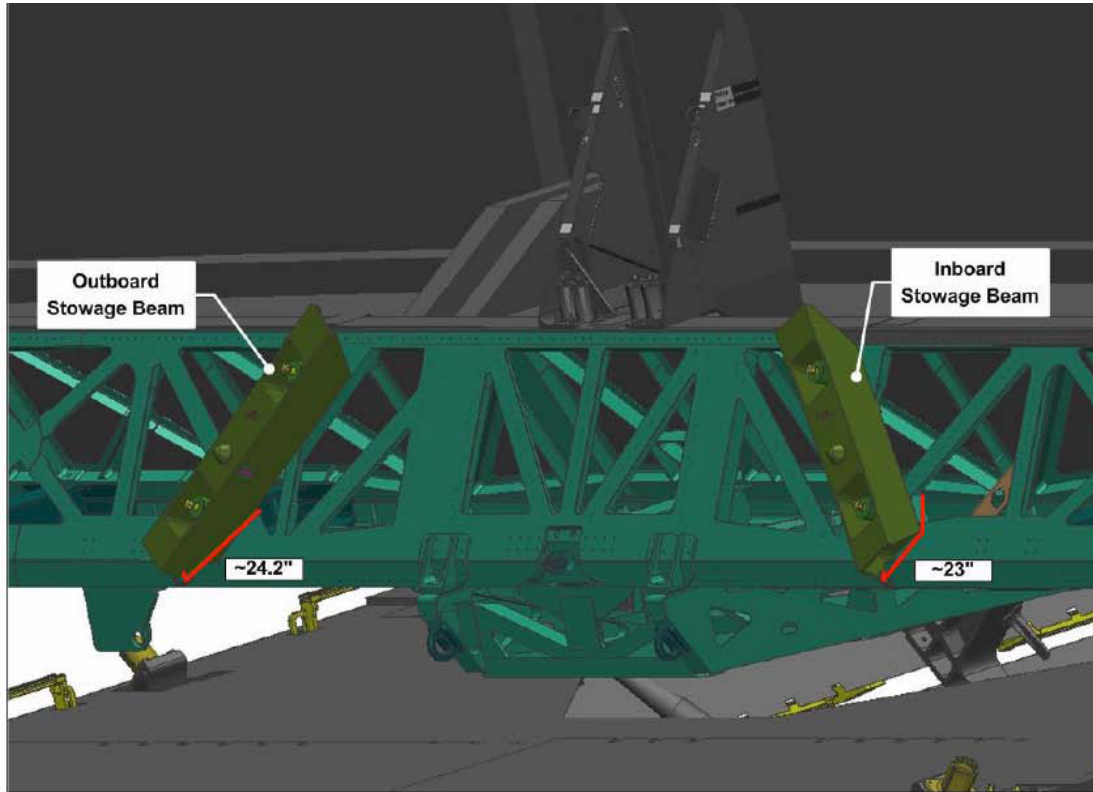

## PAMA/PDGF TIEDOWN

IV	EV1/EV2
<b>Lock 1 installed</b>	<ol style="list-style-type: none"><li data-bbox="478 256 1228 284">1. Retrieve Russian tethers (2 Adj, 1 Fixed) from Staging Bag</li><li data-bbox="478 316 1780 376">2. If only one PAMA foot fully engaged, T-handle locked: Use 2 Russian adjustable tethers in criss cross pattern from PAMA handholds 2 and 3 to FGB HR 1010</li></ol> 





## PAMA/PDGF TIEDOWN (Cont)

IV	EV1/EV2
<b>Locks 1 and 2 installed</b>	<p>3. If two PAMA feet fully engaged, T-handles locked: Use 1 Russian adjustable tether from PAMA handhold 3 diagonally to FBG HR 1010</p> 

## PAMA/PDGF TIEDOWN (Cont)

IV	EV1/EV2
<p><b>Locks 1 and 3 installed</b></p>	<p>Use 1 Russian adjustable tether from PAMA handhold 2 diagonally to FGB HR 1010</p> 

## PAMA/PDGF TIEDOWN (Cont)

IV	EV1/EV2
<b>Locks 2 and 3 installed</b>	<p>Use 1 Russian adjustable tether and 1 Russian fixed length tether in series from PAMA handhold 1 to FGB HR 1030</p> <ol style="list-style-type: none"><li>Fixed tether – both hooks to PAMA handhold 1</li><li>Adjustable tether – one hook to fixed tether strap, one hook to FGB HR 1010</li></ol> <div data-bbox="478 375 1180 1141">A wide-angle photograph showing the interior of a spacecraft module. A large, light-colored, perforated metal structure (PAMA handhold 1) is visible. Two orange tethers are attached to it. One tether is connected to a fixed length tether, and the other is connected to a Russian adjustable tether. The background shows various structural elements and equipment.</div> <div data-bbox="1348 480 1738 995">A close-up photograph of a tether attachment point. An orange tether is connected to a metal hook or bracket. The background shows a circular structure with several small, circular openings, likely a handhold or a specific attachment point on the FGB.</div>

**PAMA/PDGF TIEDOWN (Cont)**

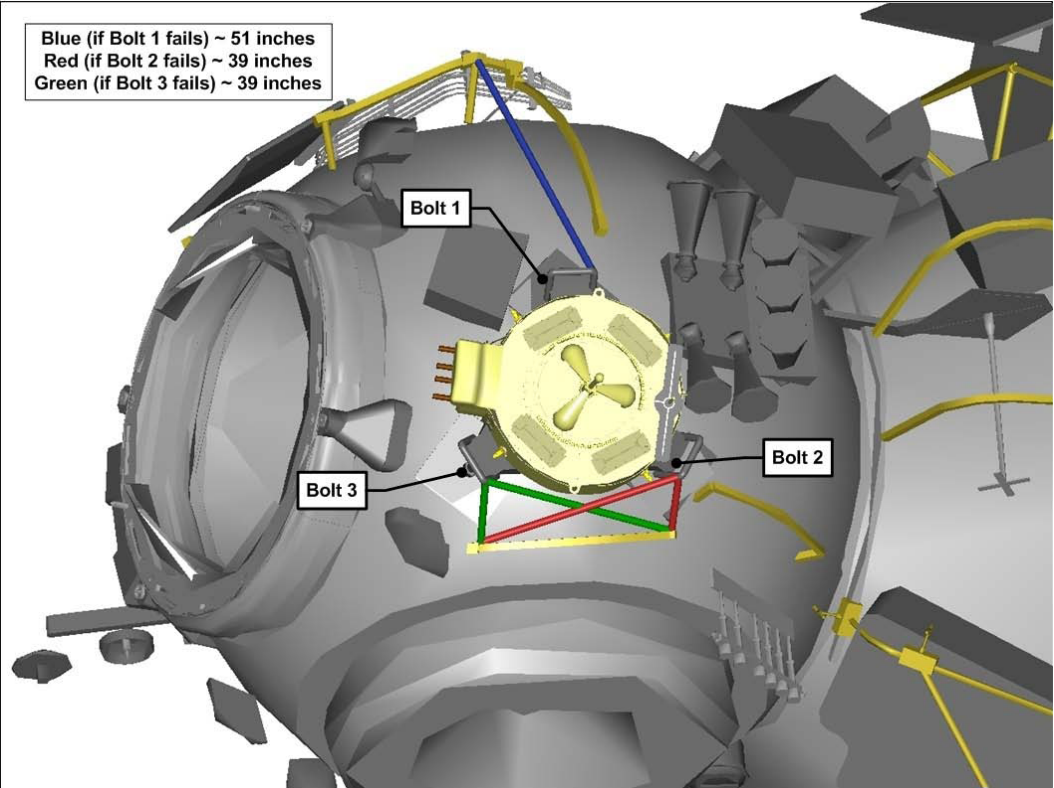



# OBSS (IBA) TIEDOWN IN OSE

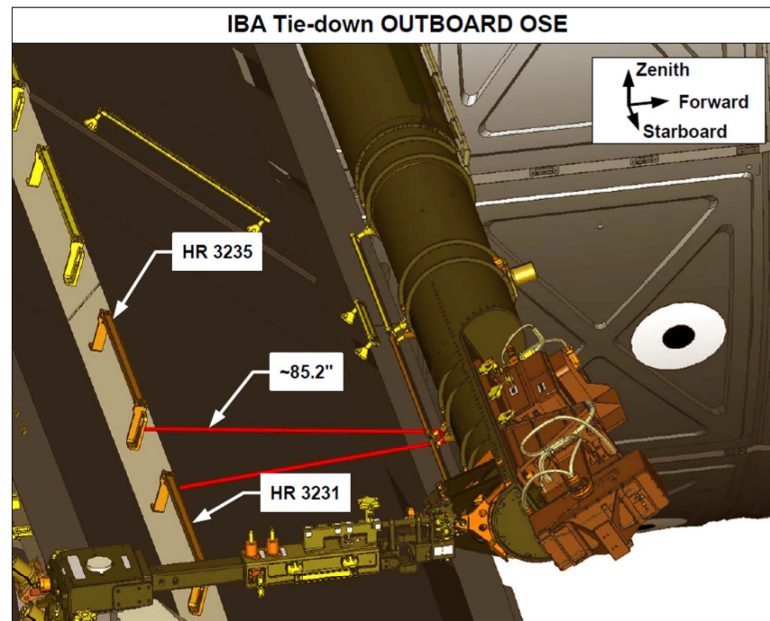
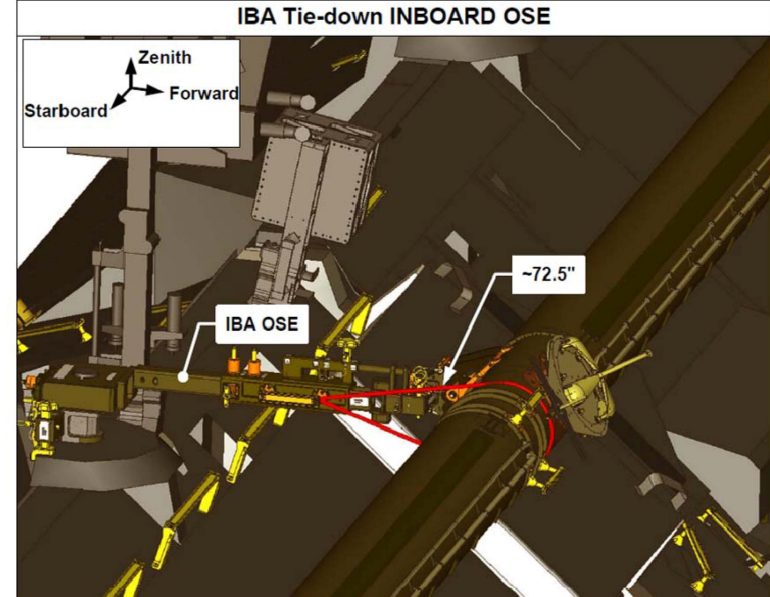
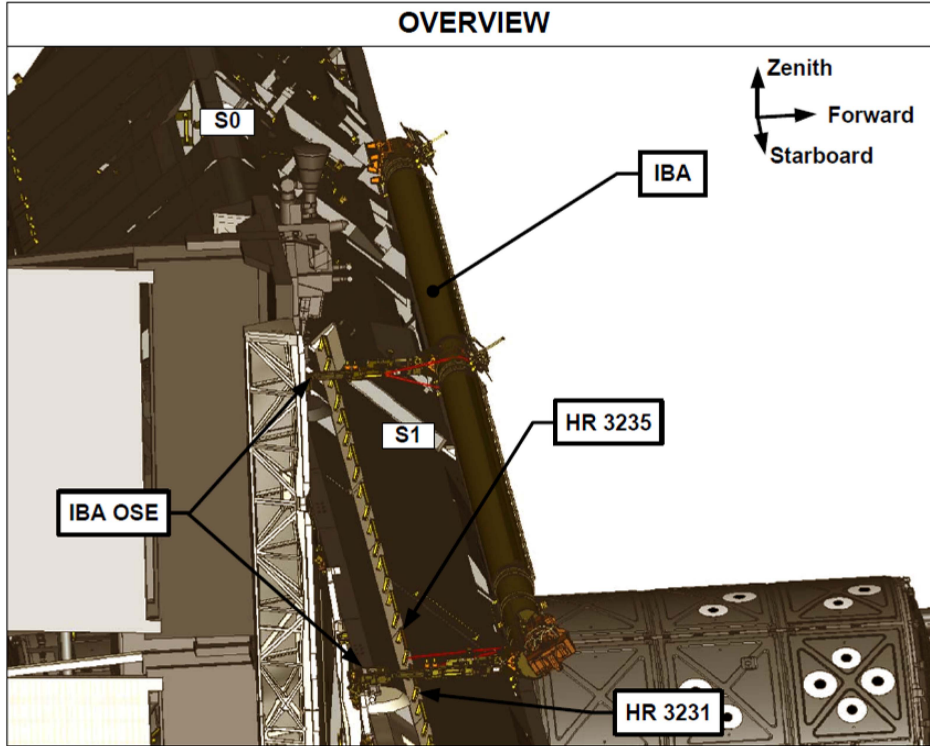

FLIGHT SPECIFIC EVA REFERENCE

I

PAYLOAD BAY LAYOUT ..... FS 18-2  
ELC3 ..... FS 18-4  
AMS ..... FS 18-7  
ROEU ..... FS 18-13  
PRLA ..... FS 18-15  
EVA 1  
    ELC2 ExPA ..... FS 18-16  
    MISSE 7 ..... FS 18-17  
    MISSE 8 ..... FS 18-19  
    LAB EWC ANTENNAS ..... FS 18-21  
    MMOD SHIELD DZUS FASTENERS ..... FS 18-25  
    P6 PVTCS FILL ..... FS 18-27  
EVA 2  
    PORT SARJ LUBE ..... FS 18-28  
    SPDM LEE LUBE ..... FS 18-29  
    S1 RADIATOR GRAPPLE BAR STOWAGE BEAMS ..... FS 18-30  
EVA 3  
    FGB PAMA/PDGF ..... FS 18-32  
    VSC ..... FS 18-34  
    NOD1/FGB CH1/4 AND CH2/3 CABLES ..... FS 18-35  
EVA 4  
    OBSS ..... FS 18-38  
    PDGF ..... FS 18-41  
    EFGF/PAA ..... FS 18-43  
    PORT TSA ..... FS 18-44  
    SPARE SPDM ..... FS 18-45

**FLIGHT SPECIFIC  
EVA REFERENCE**

# FLIGHT SPECIFIC EVA REFERENCE

## PAYLOAD BAY LAYOUT

- ODS
- STORMM
- MISSEs
- ELC3
- AMS

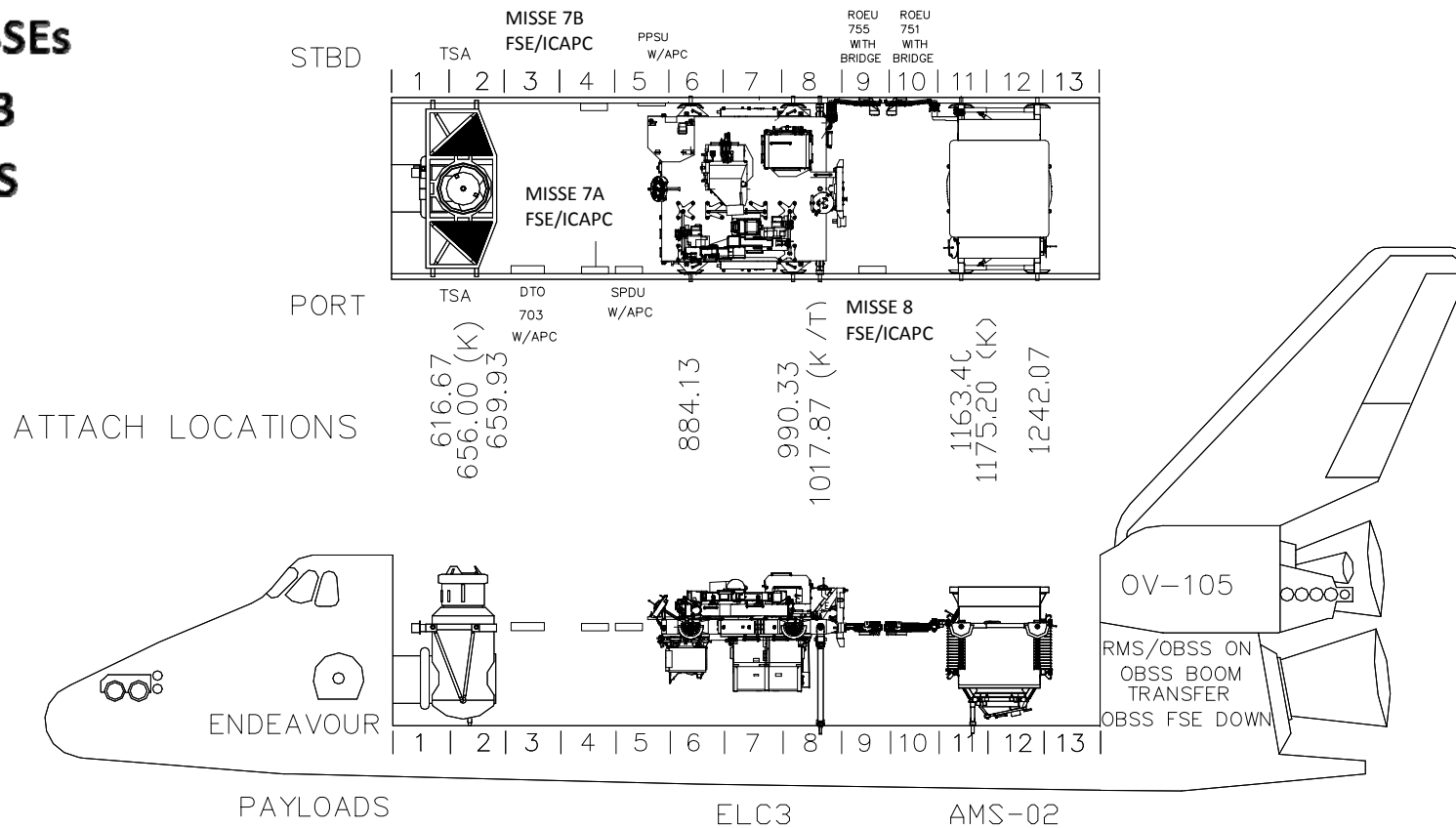

PAYLOAD BAY LAYOUT (Cont)

**STS-134, ULF6  
LAUNCH CONFIGURATION**

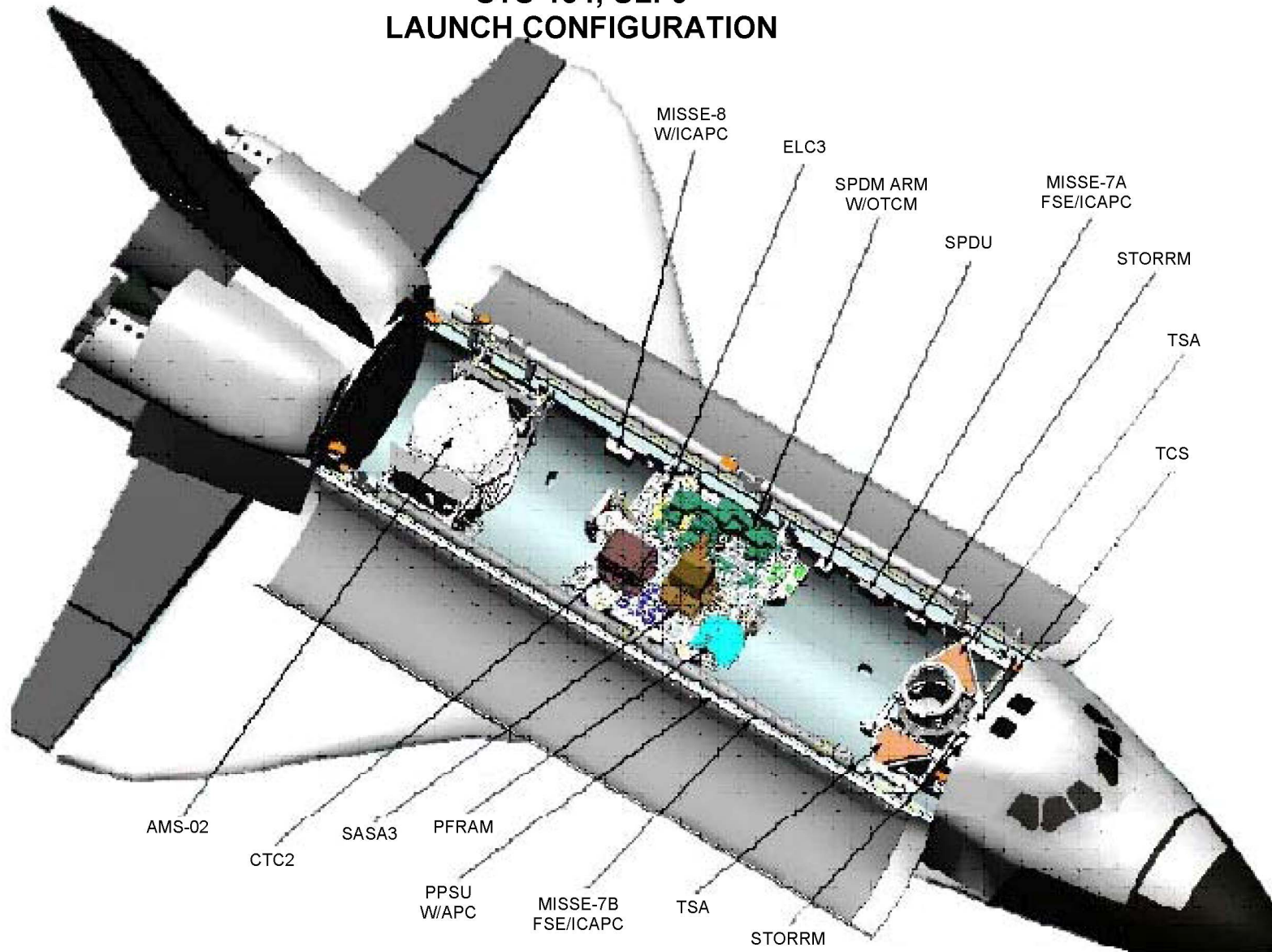

# ELC3

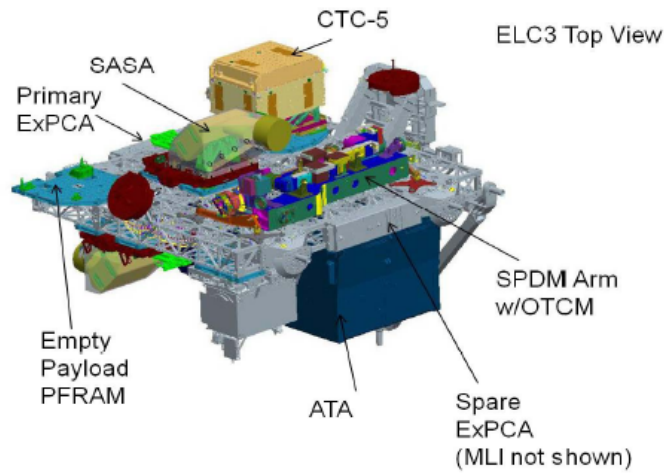
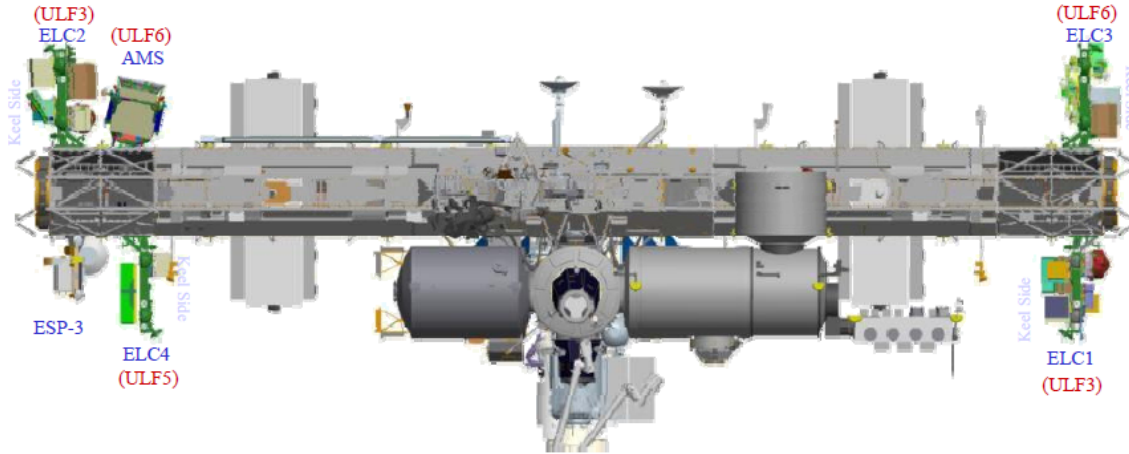

ELC3 Top View

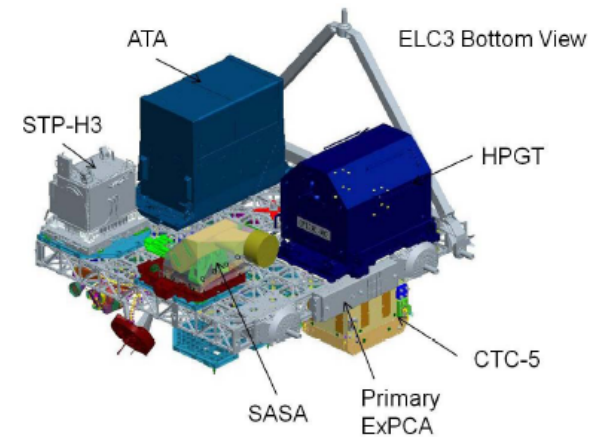

ELC3 Bottom View

**Pre-Positioned Spares:**  
 SPDM ARM with Direct Mount FSE  
 HPGT with Direct Mount FSE  
 ATA with Direct Mount FSE  
 2 SASAs with SAPA FSE  
 CTC with 10 RPCMs, ACU

**Utilization:**  
 STP-H3 with EXPA FSE (returning on SpaceX)  
 Empty Payload PFAP site for future SCAN payload (HTV3)



# ELC3 (Cont)

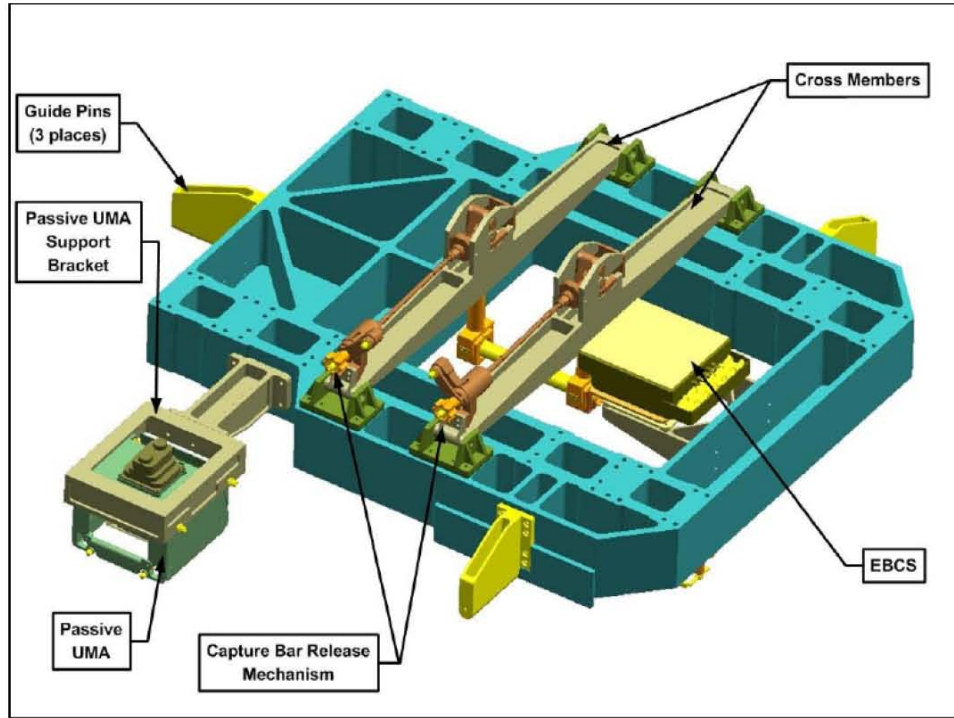

ELC3 (Cont)

Taped Electrical Connectors

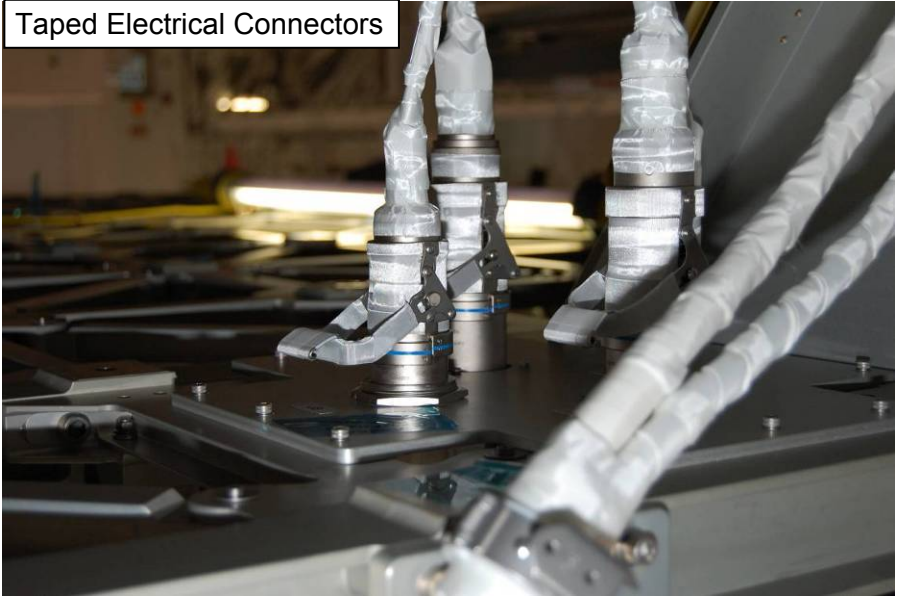



AMS

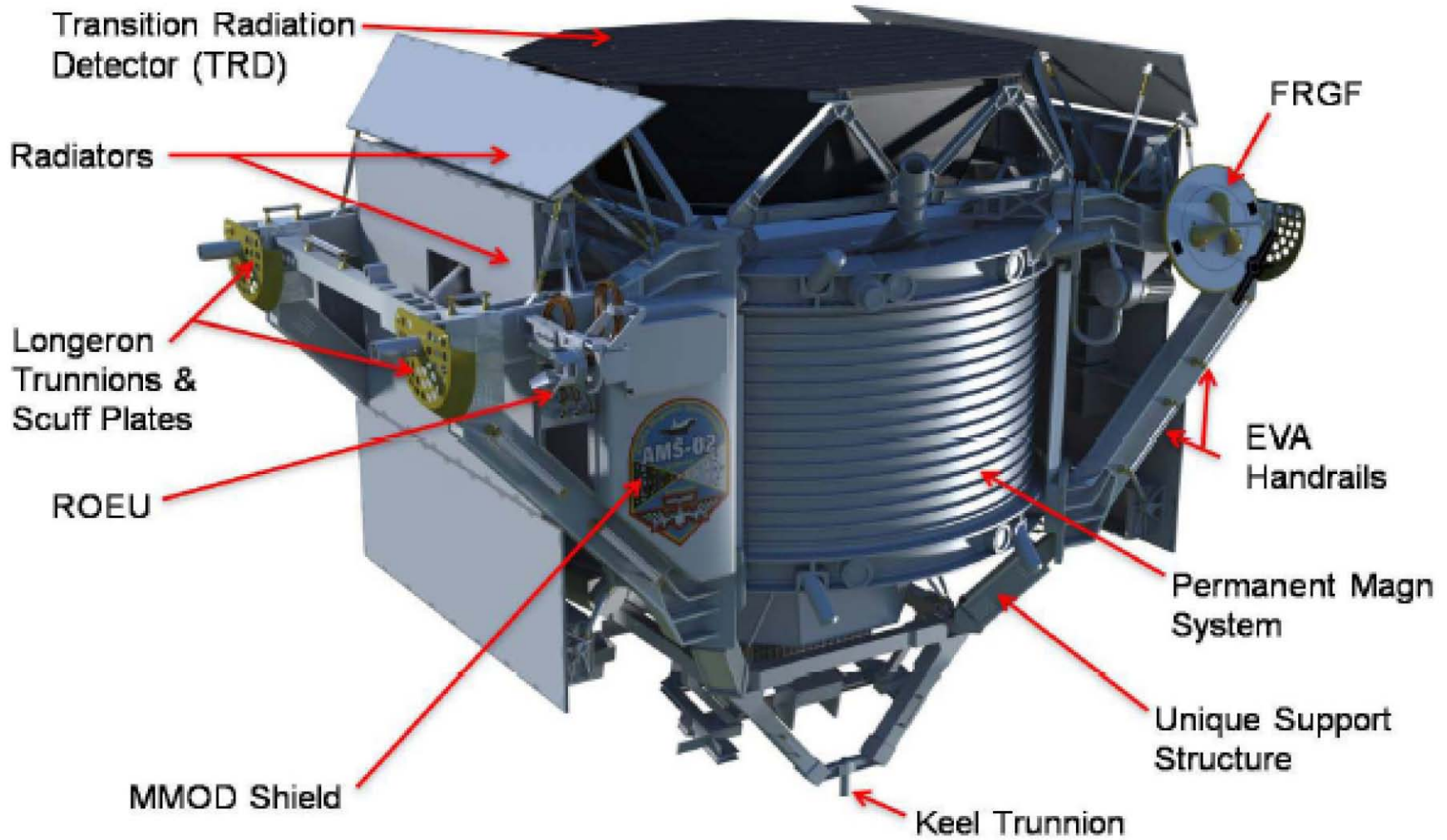

AMS (Cont)





AMS (Cont)

STAR TRACKER BAFFLE – EVA No Touch Area

STAR Tracker Location,  
EVA No Touch Area

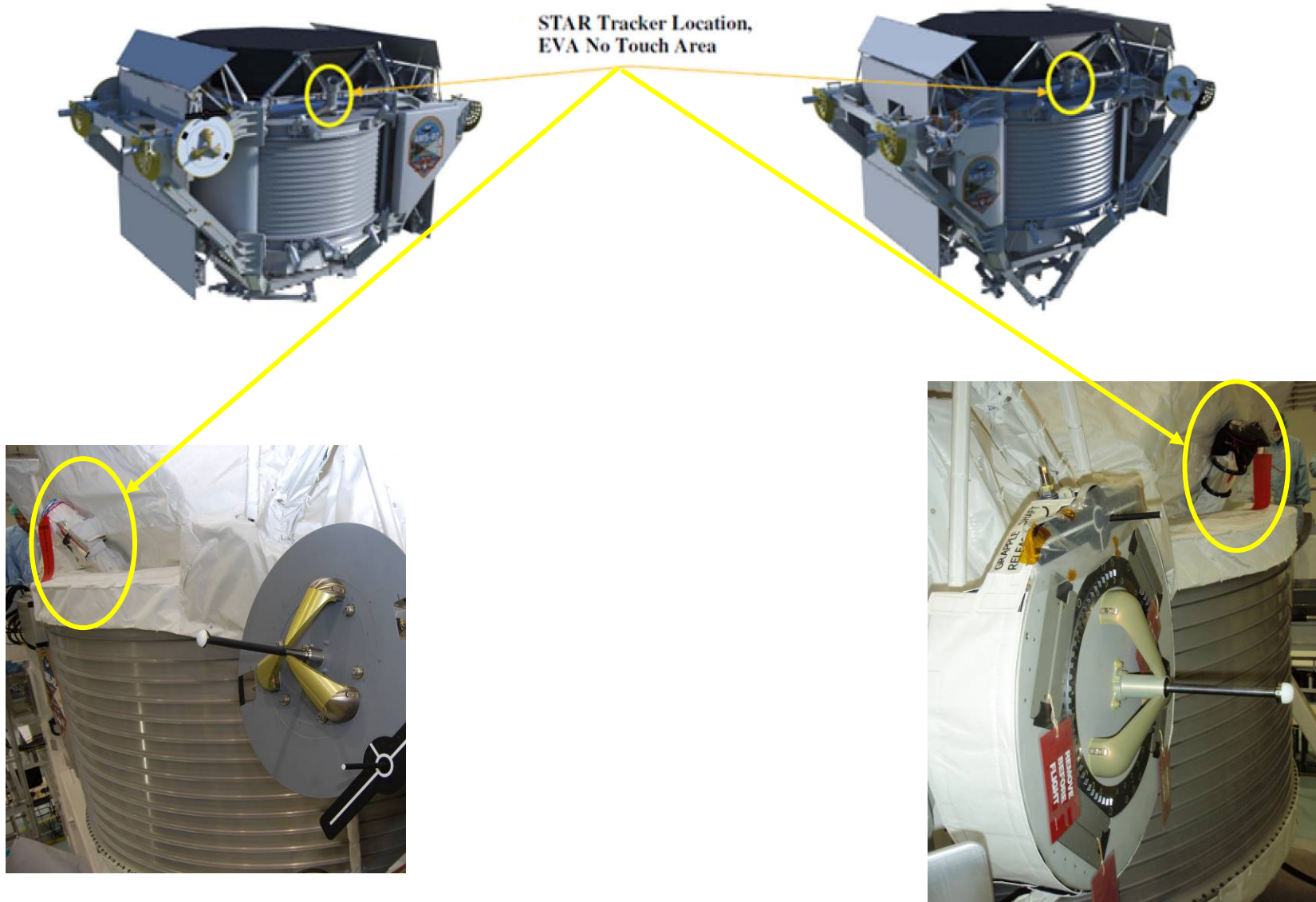

AMS (Cont)

UMA Passive Connector and Electrical Pins

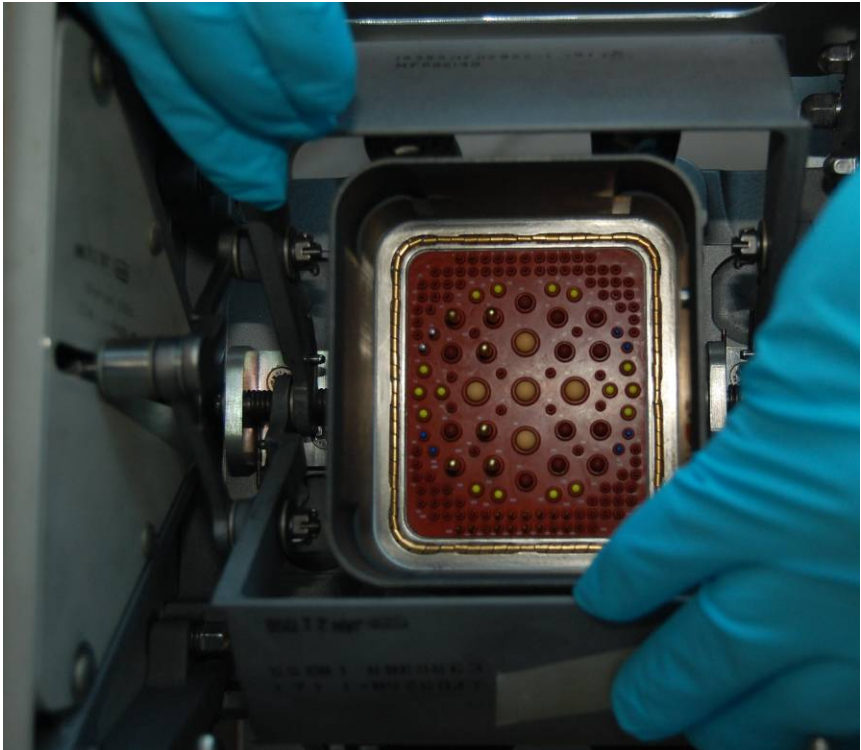

AMS (Cont)

ROEU and Electrical Pins

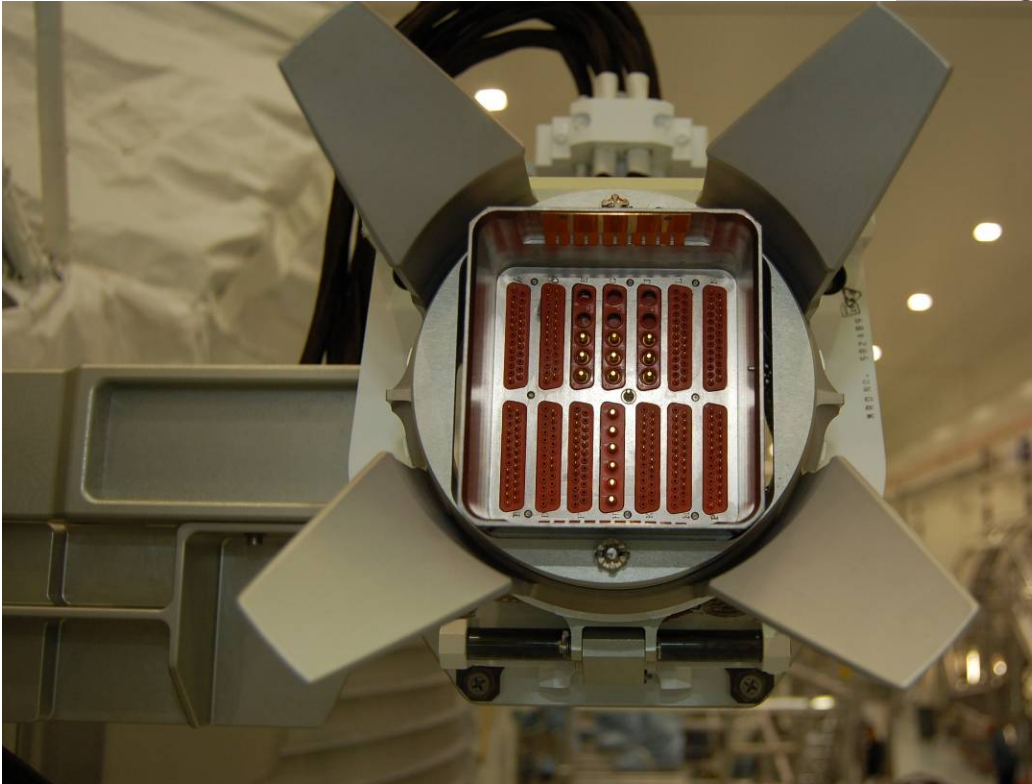
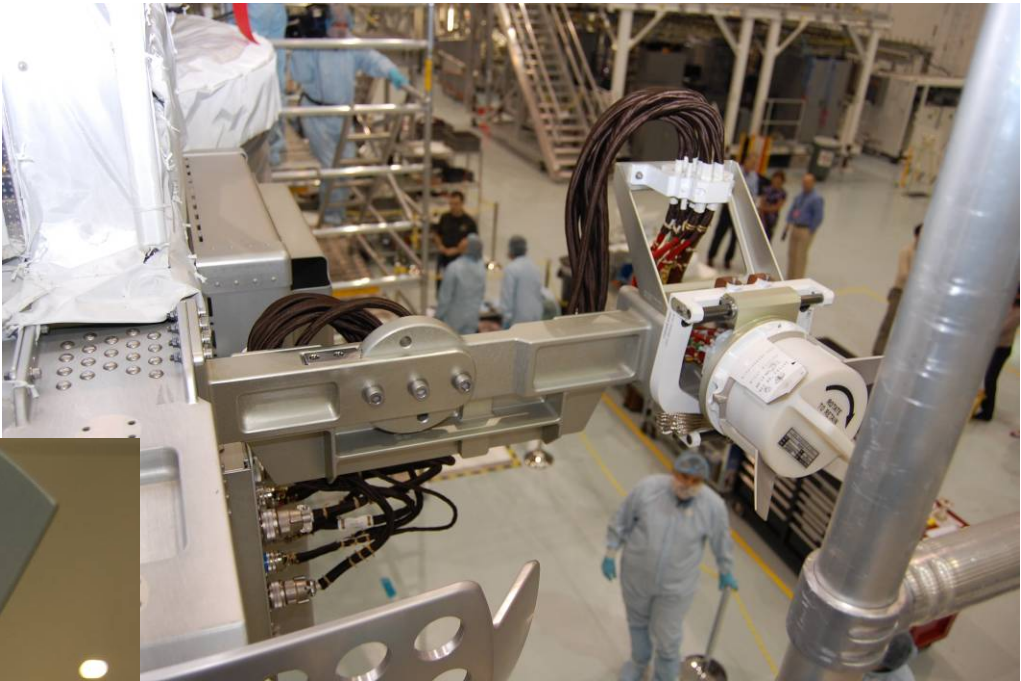



AMS (Cont)



# ROEU

ROEUs on stbd PLB sill

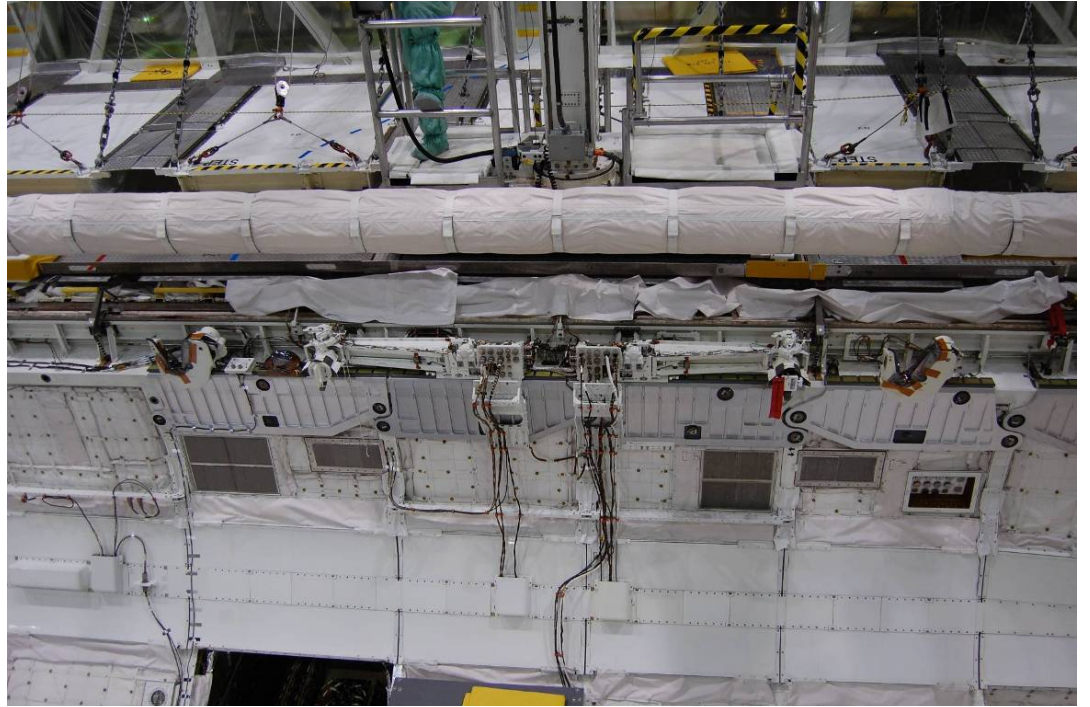



ROEU (Cont)

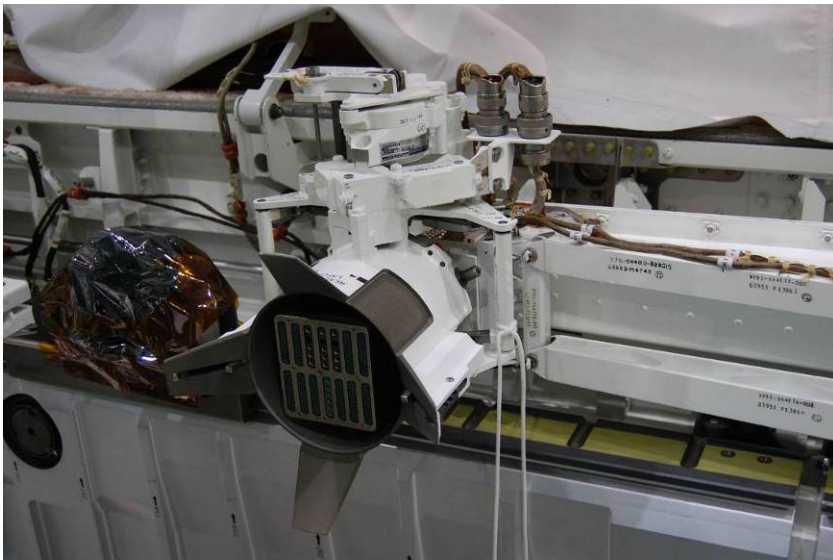
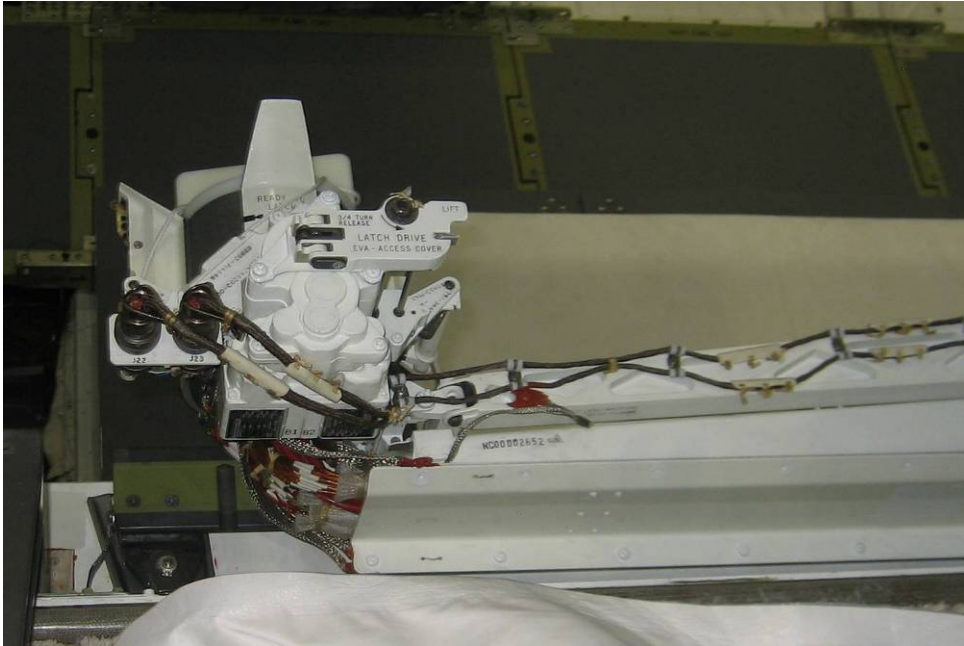

PRLA

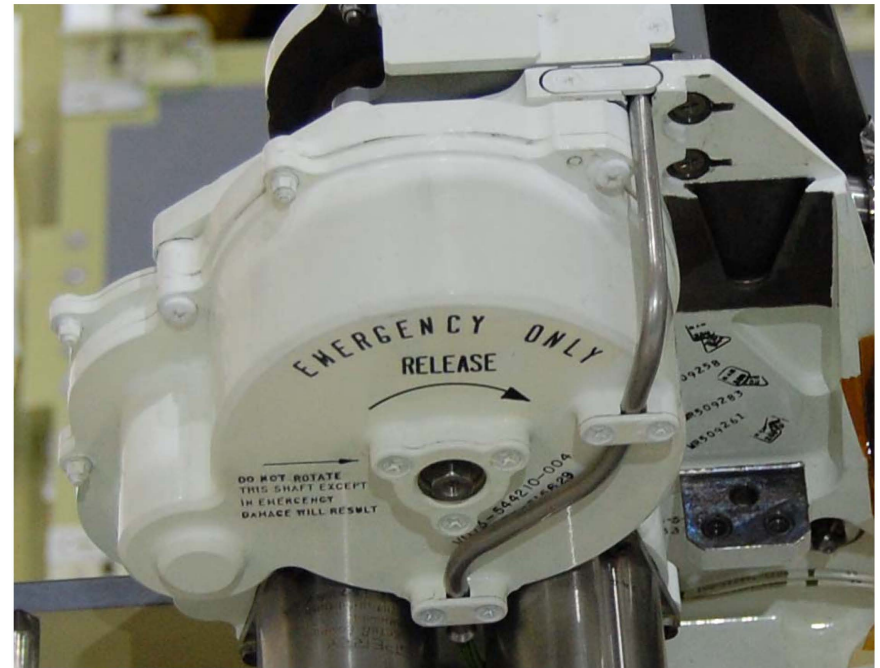
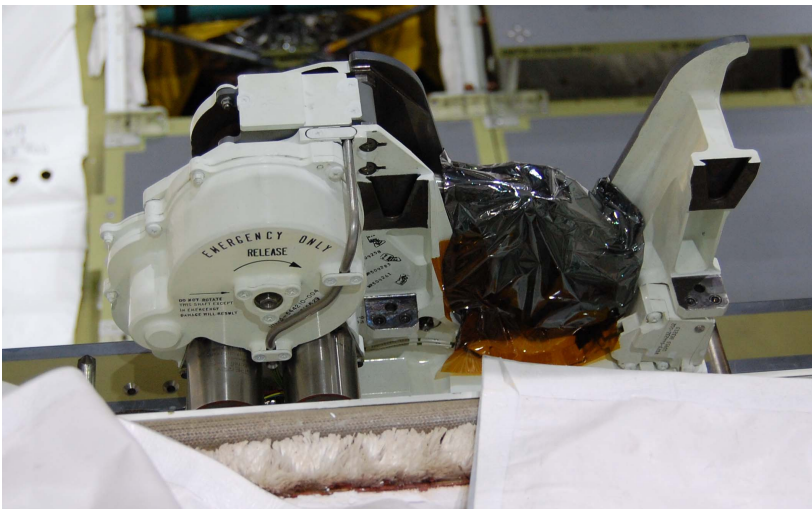
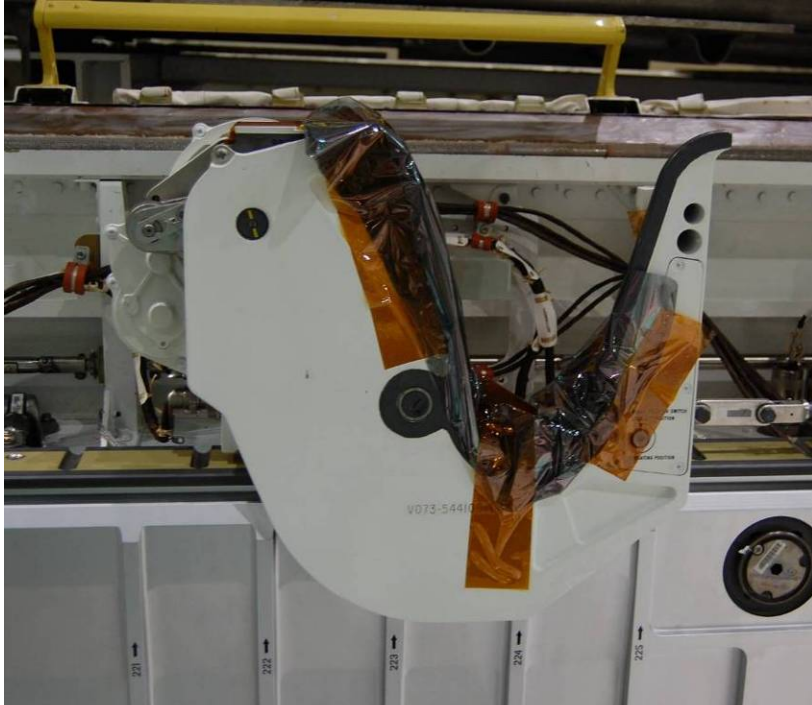



ELC2 ExPA

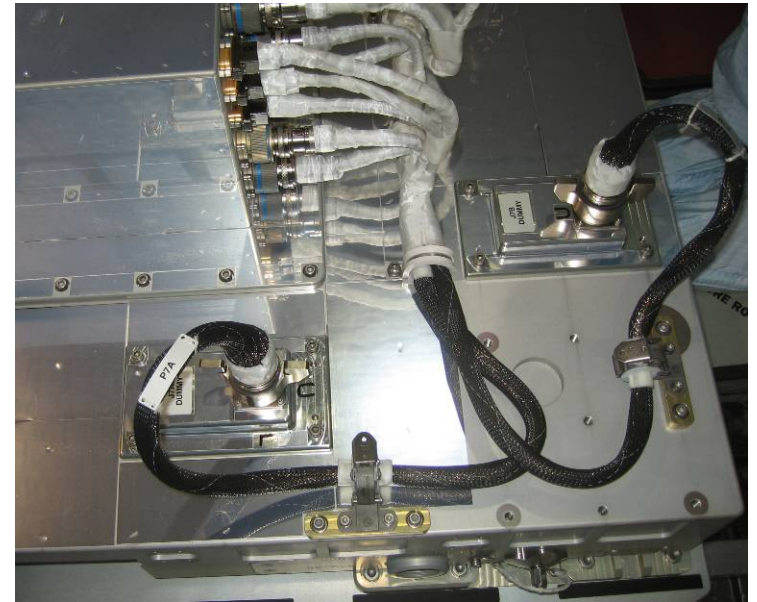

FS 18-16

EVA/134/FIN A



MISSE 7

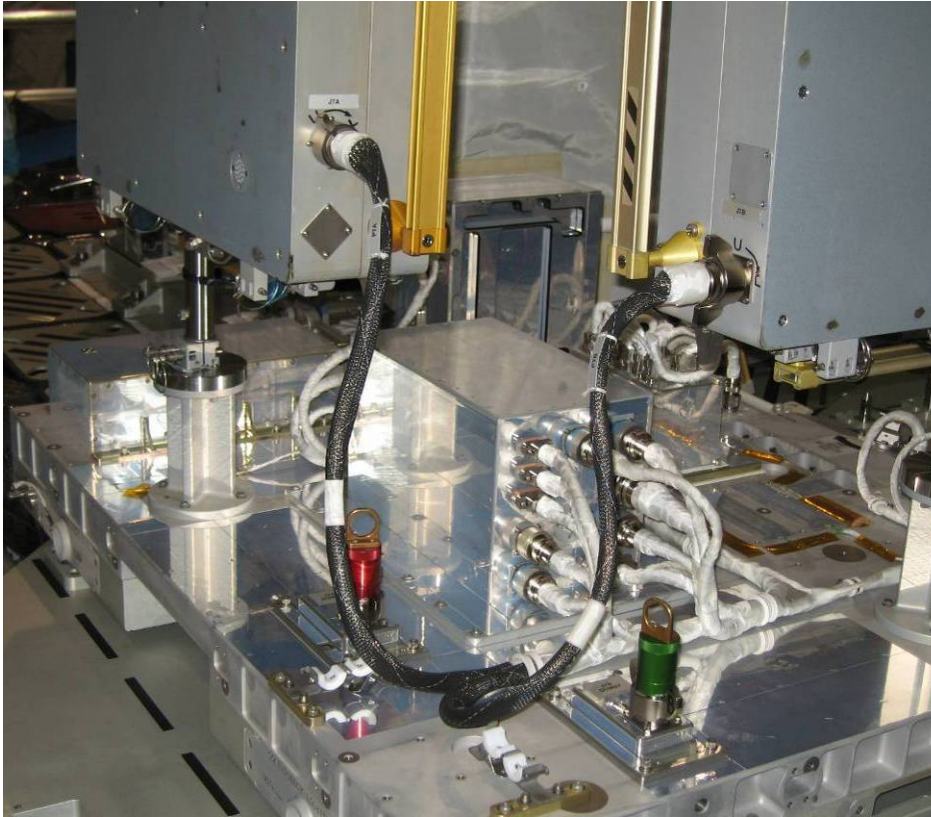



MISSE 7 (Cont)



Translation path to stbd MISSE 7B SWC

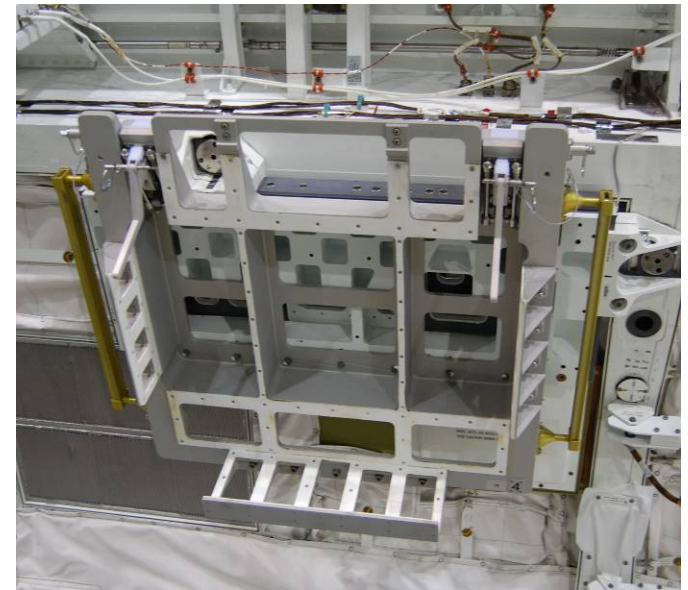

Translation path to port MISSE 7A SWC



MISSE 8

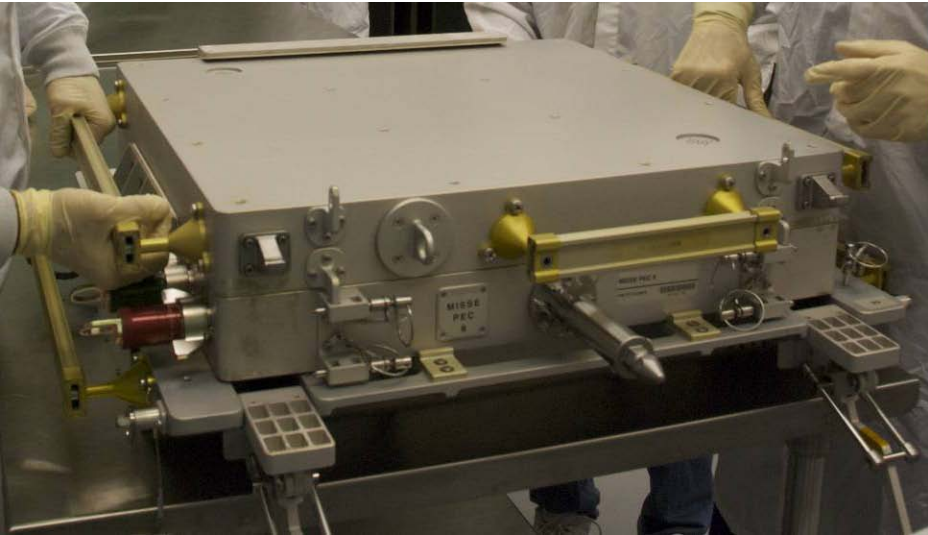
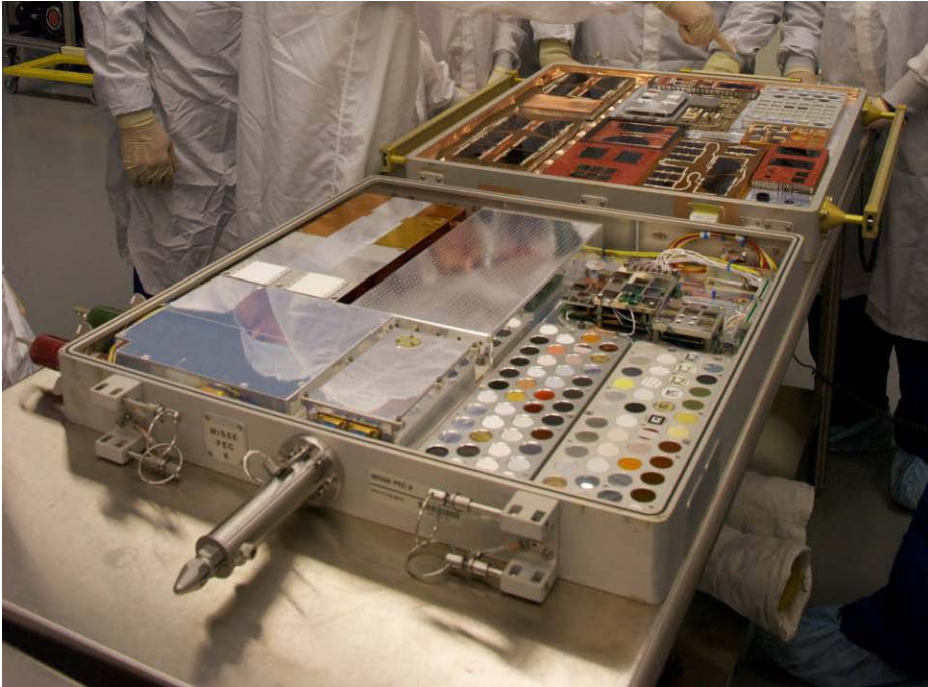

MISSE 8 (Cont)

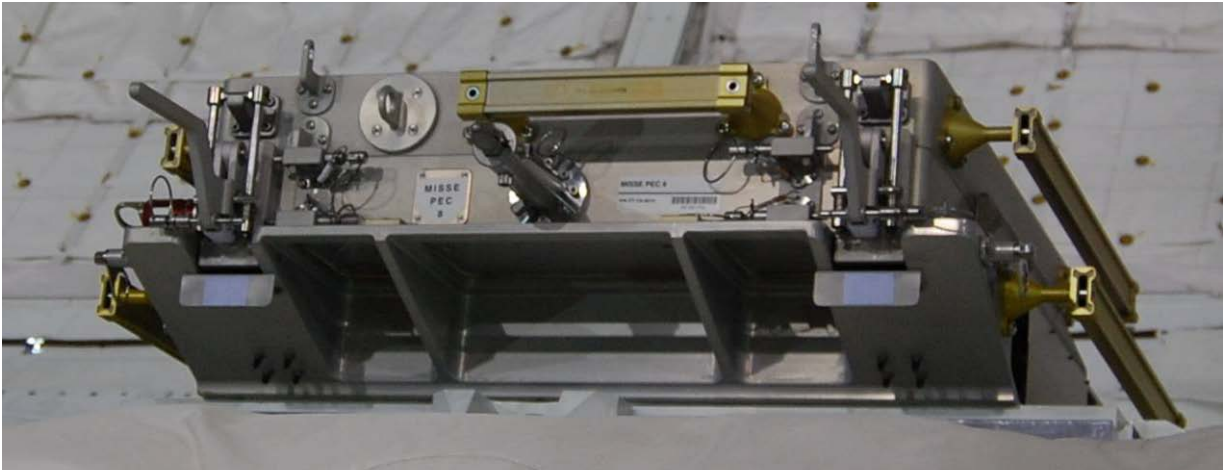
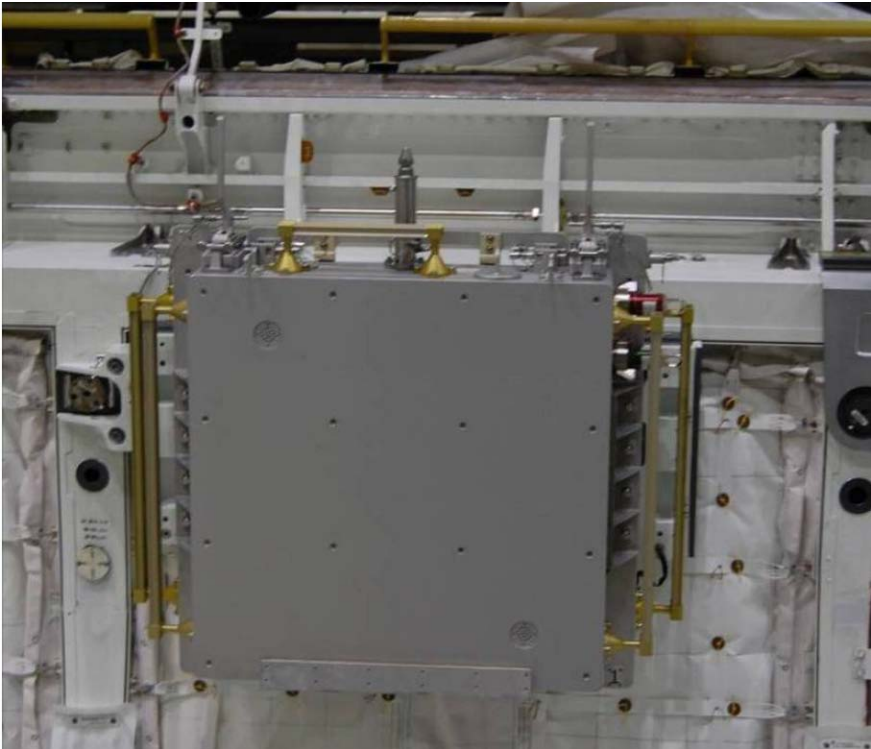



LAB EWC ANTENNAS

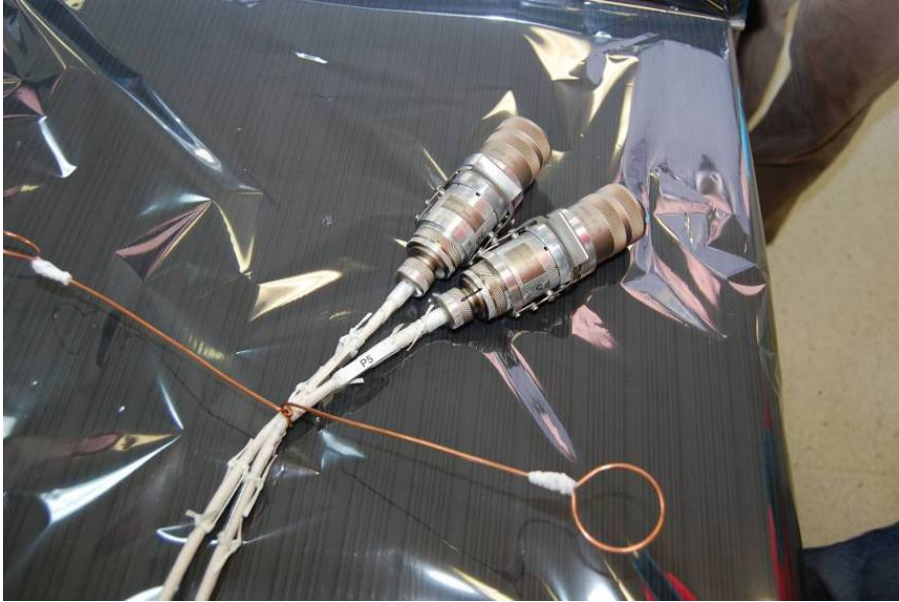

## LAB EWC ANTENNAS (Cont)



Wire tie to be replaced by  
Adj Equip Tether

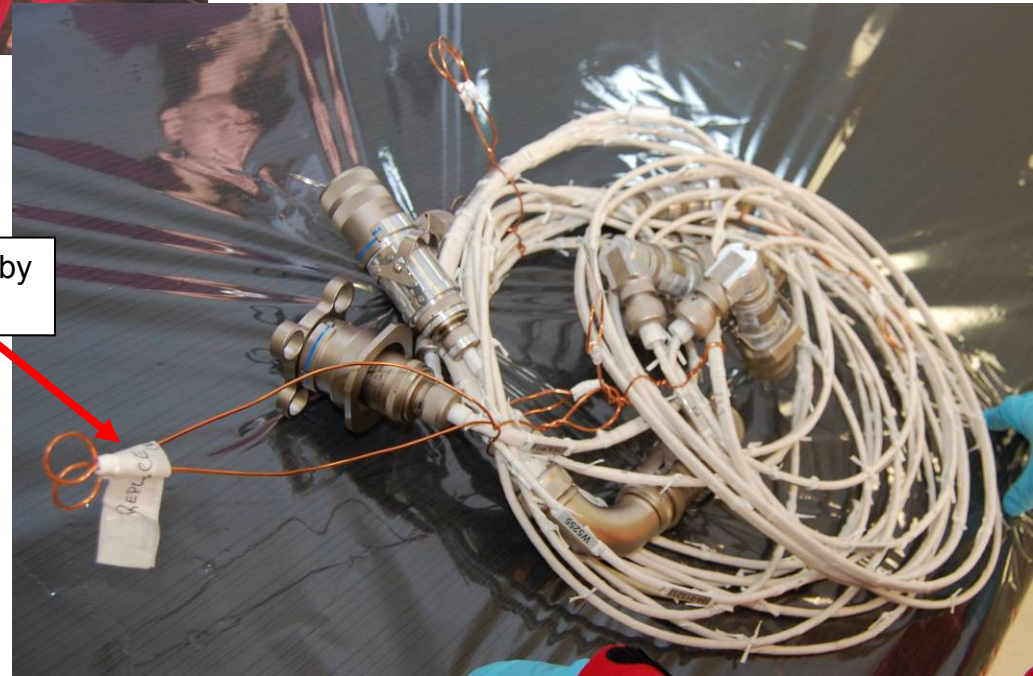



**LAB EWC ANTENNAS (Cont)**

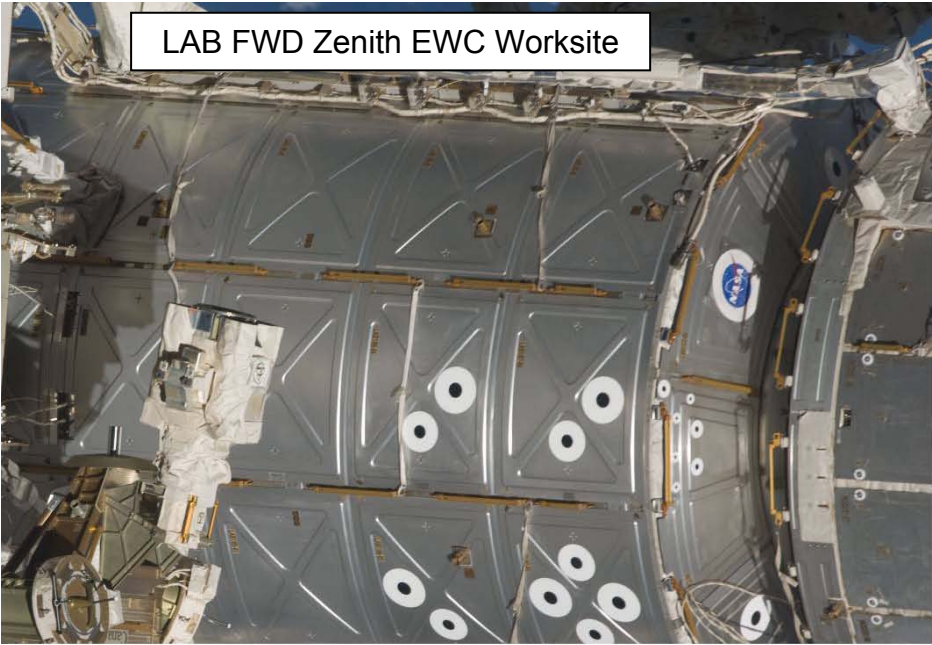

LAB FWD Zenith EWC Worksite

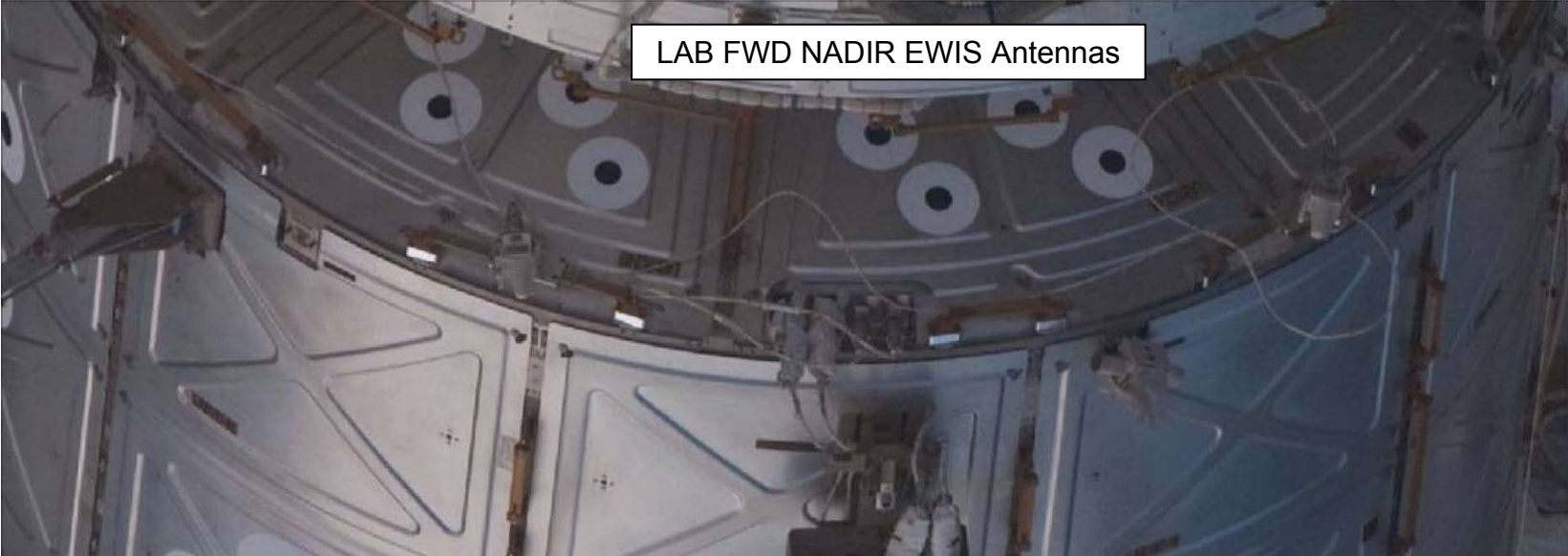

LAB FWD NADIR EWIS Antennas

LAB EWC ANTENNAS (Cont)

J16 Electrical Connector for EWC install  
Located underneath MMOD Shield C2-01

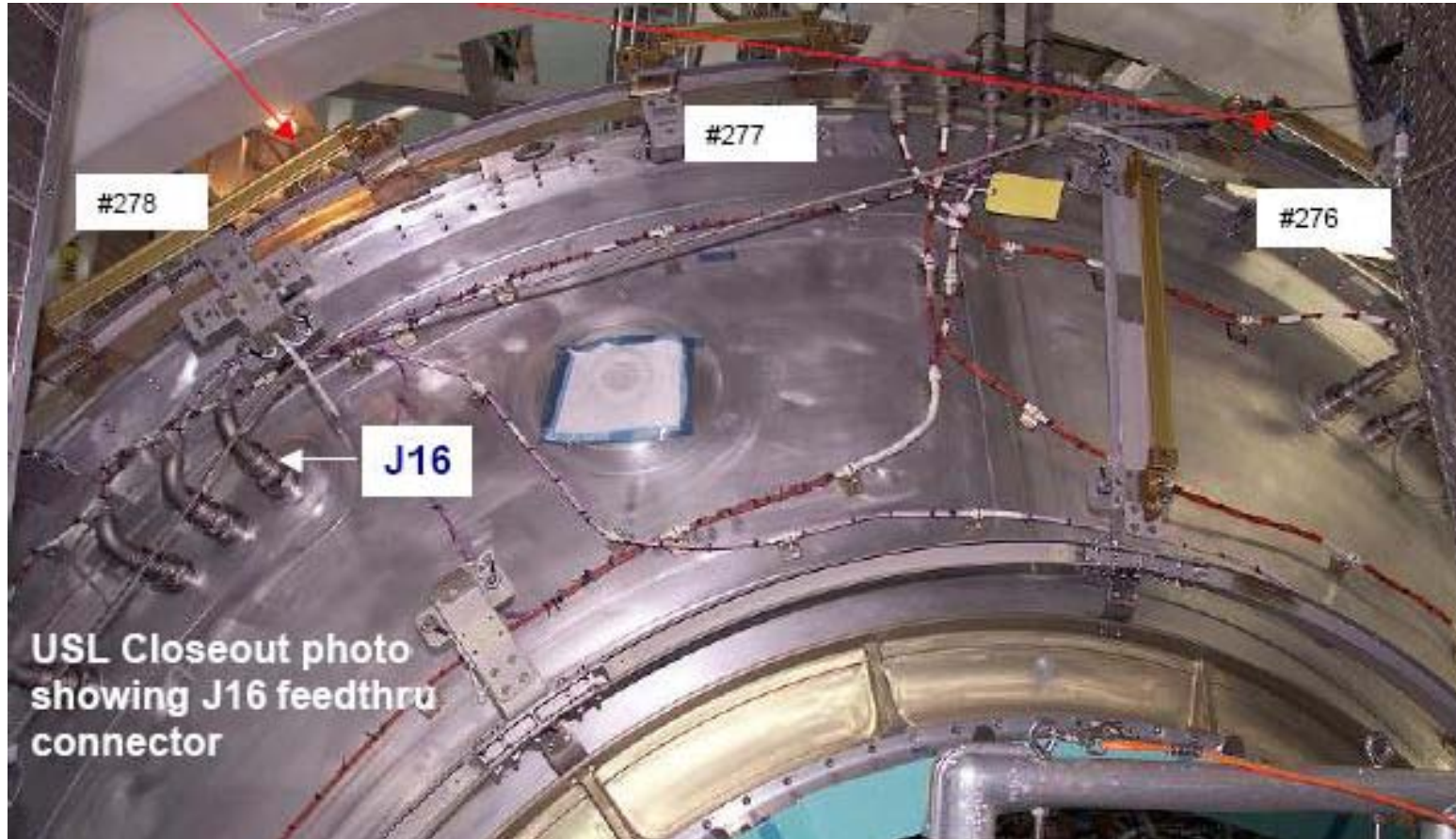



## MMOD SHIELD DZUS FASTENERS

MMOD Shield Fastener Receptacles



## MMOD SHIELD DZUS FASTENERS (Cont)



MMOD Shield DZUS Fasteners





# P6 PVTCS FILL

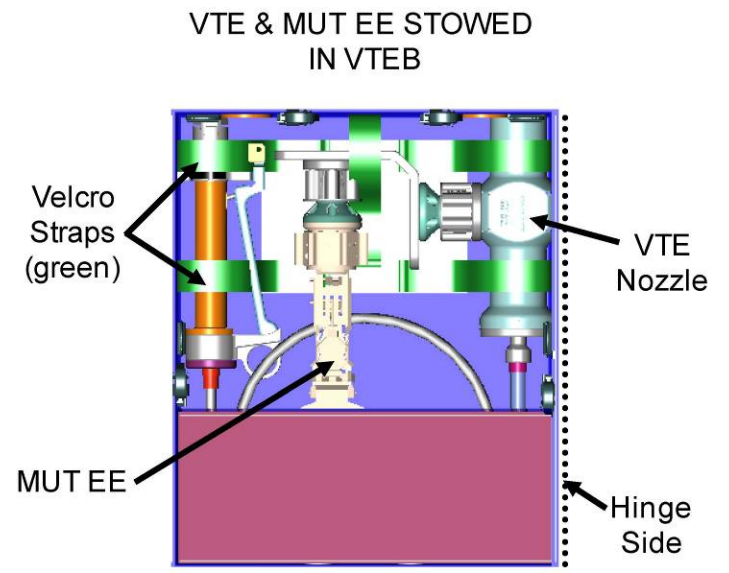
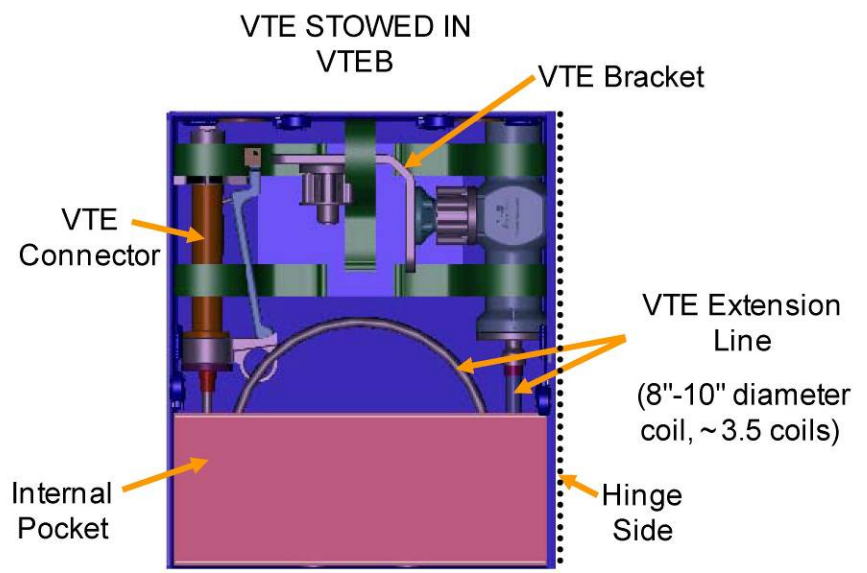
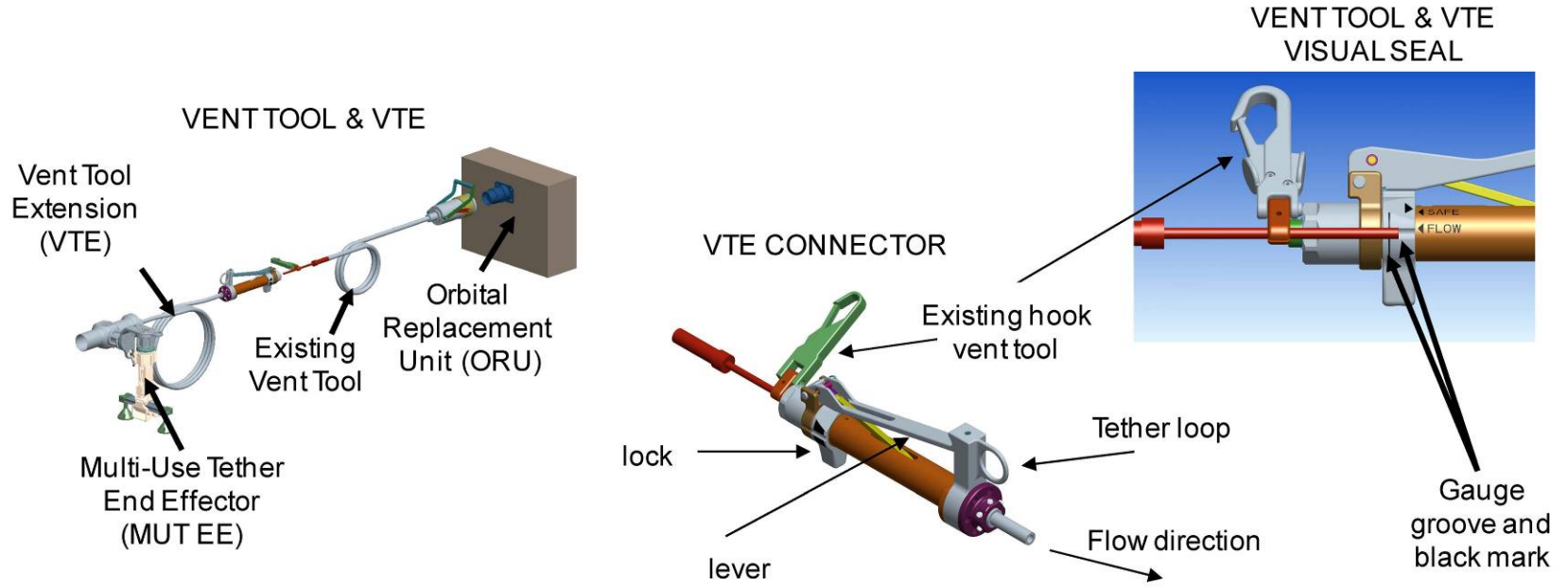

## PORT SARJ LUBE

Zip Tie Tether point for Grease Gun



# SPDM LEE LUBE

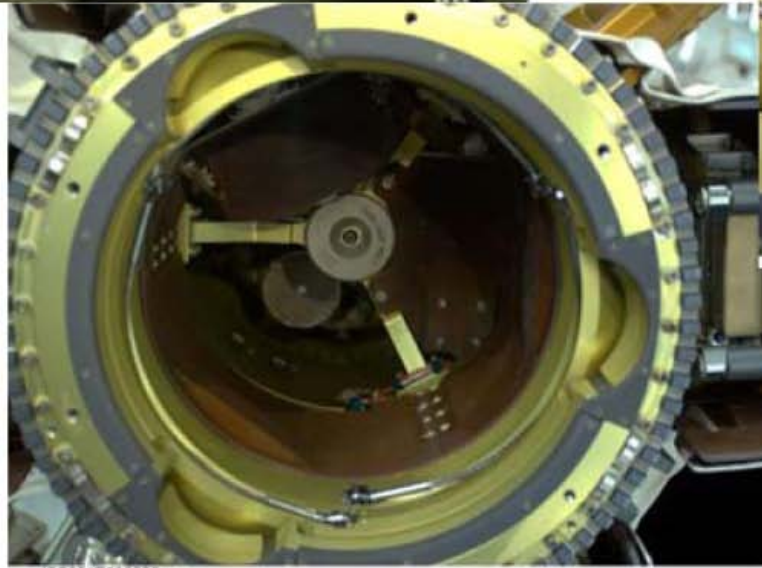
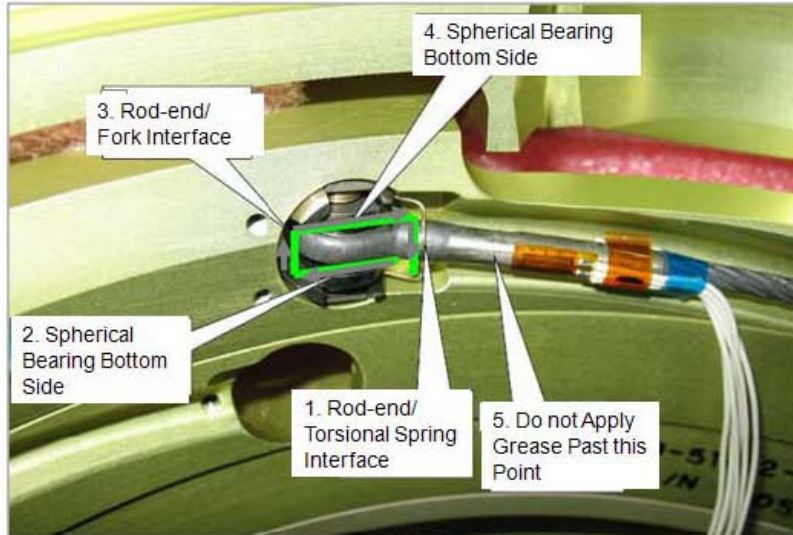



## S1 RADIATOR GRAPPLE BAR STOWAGE BEAMS

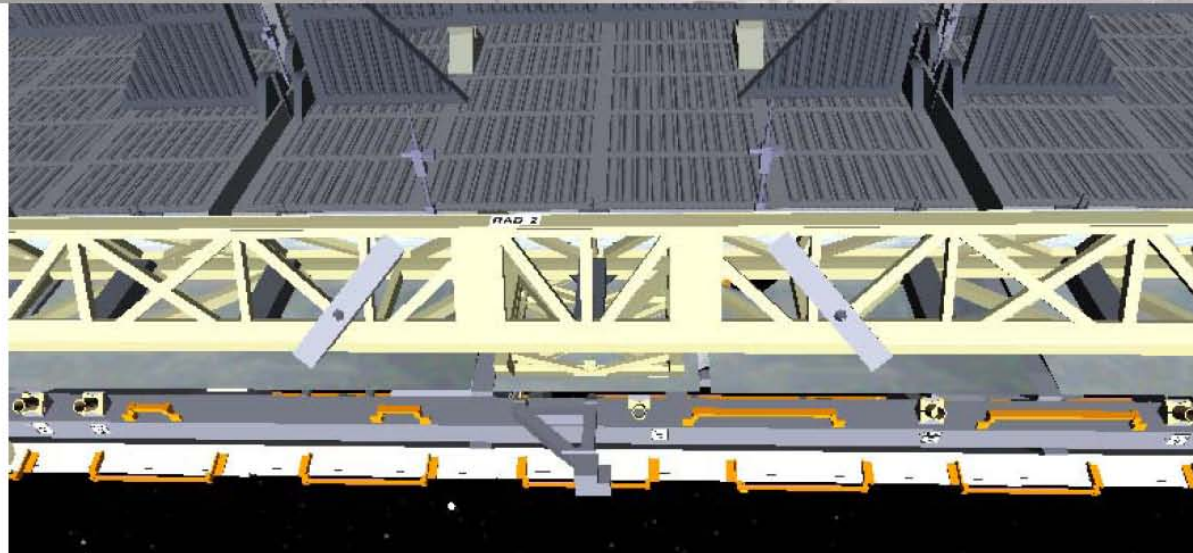
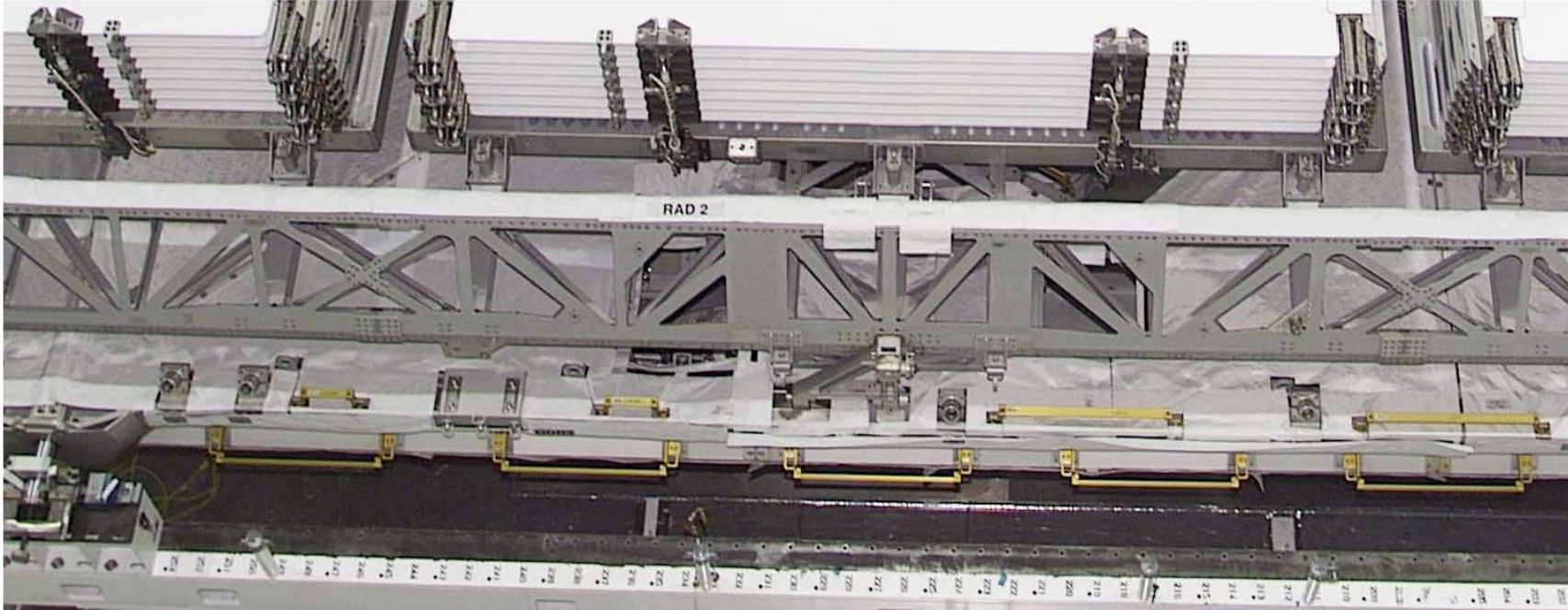

## S1 RADIATOR GRAPPLE BAR STOWAGE BEAMS (Cont)

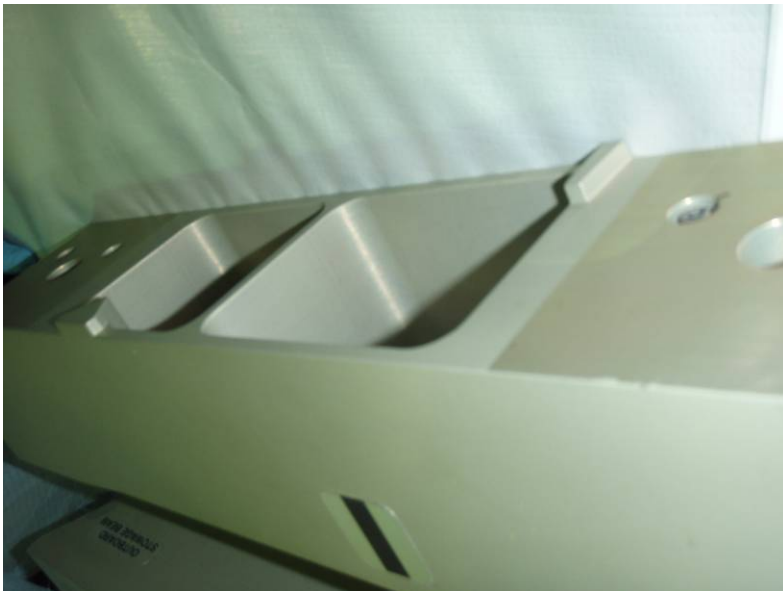
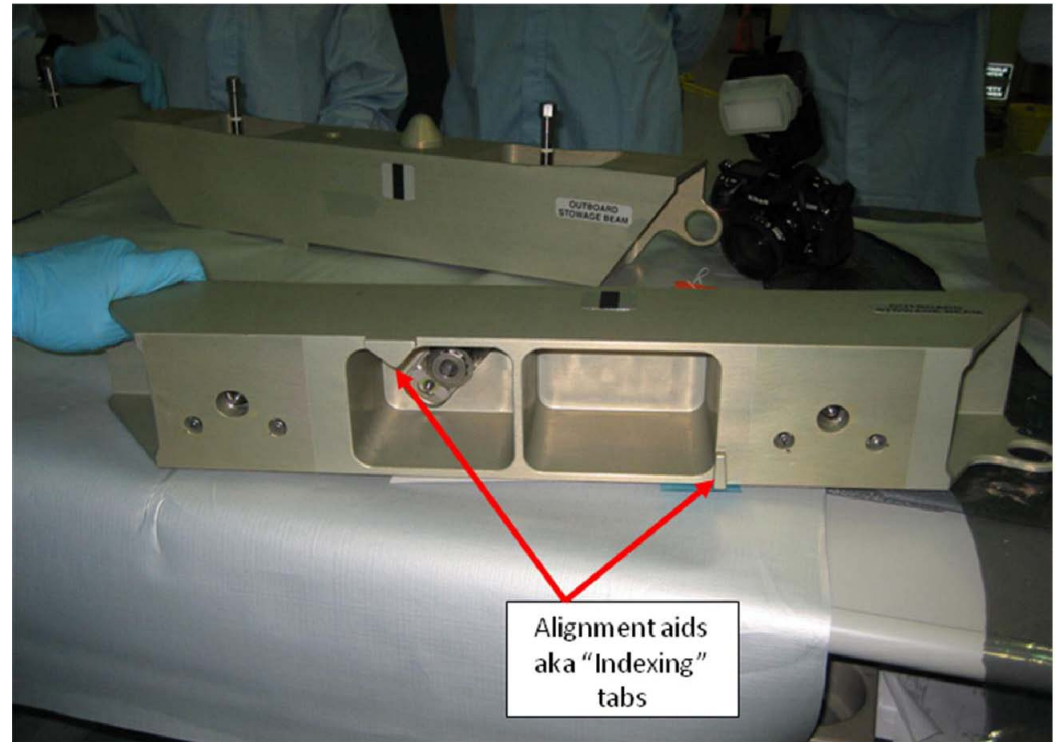
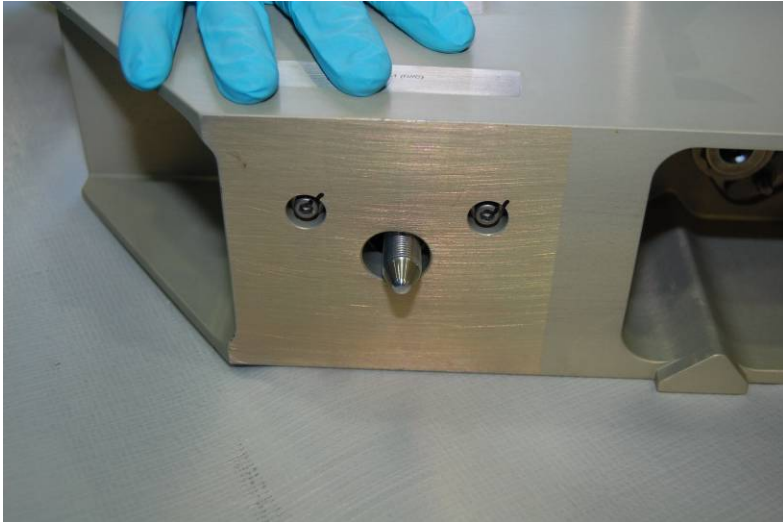



FGB PAMA/PDGF

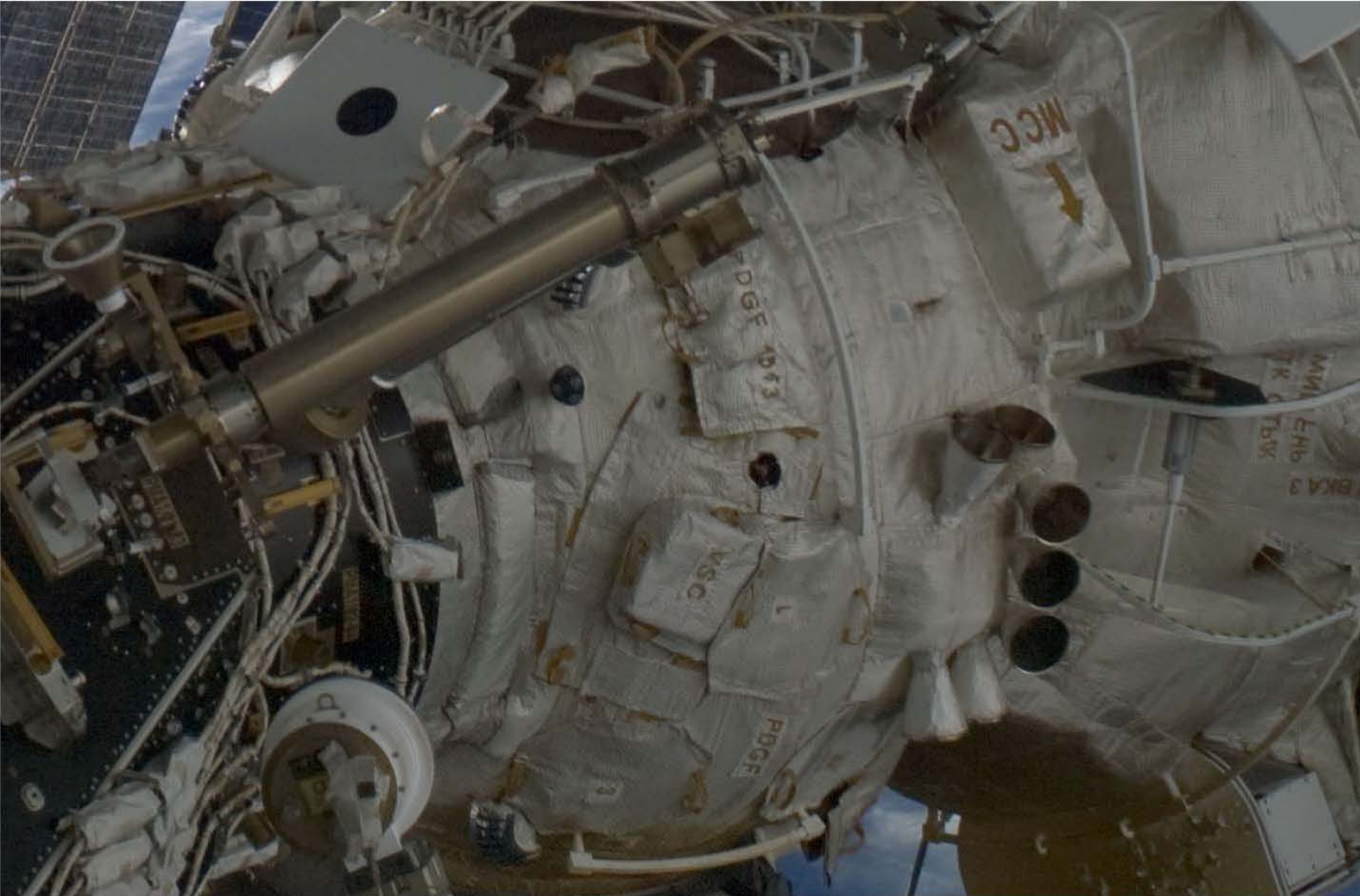



FGB PAMA/PDGF (Cont)



Russian Ratchet Wrench with PAMA Cap

VSC

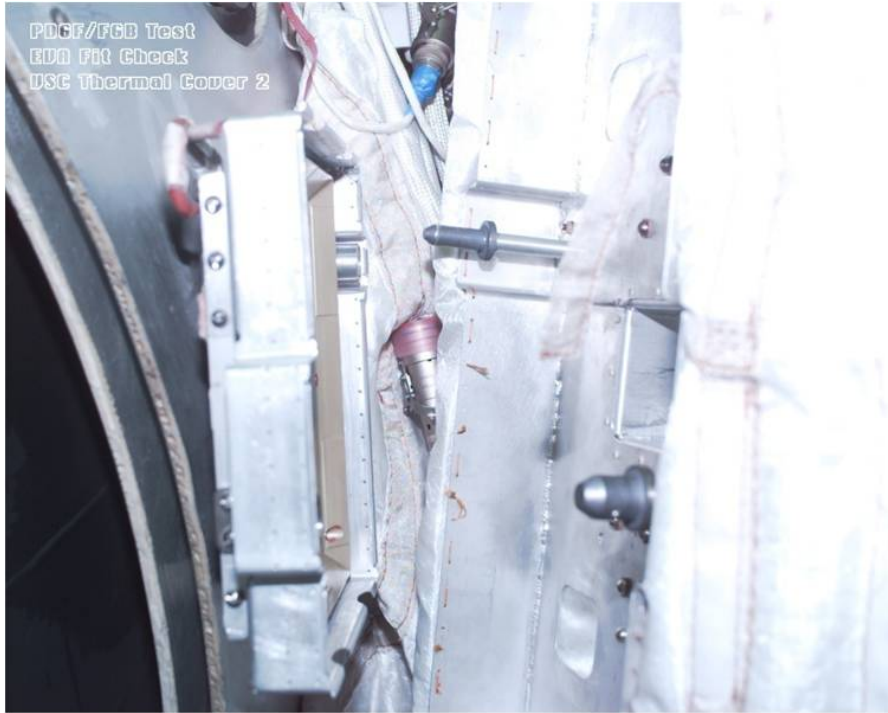

VSC Thermal Cover mating to FGB



VSC with MLI Protective Cover



VSC Thermal Cover

# NOD1/FGB CH1/4 AND CH2/3 CABLES

## EVA Cables Ch 1/4 – J17A to J131A

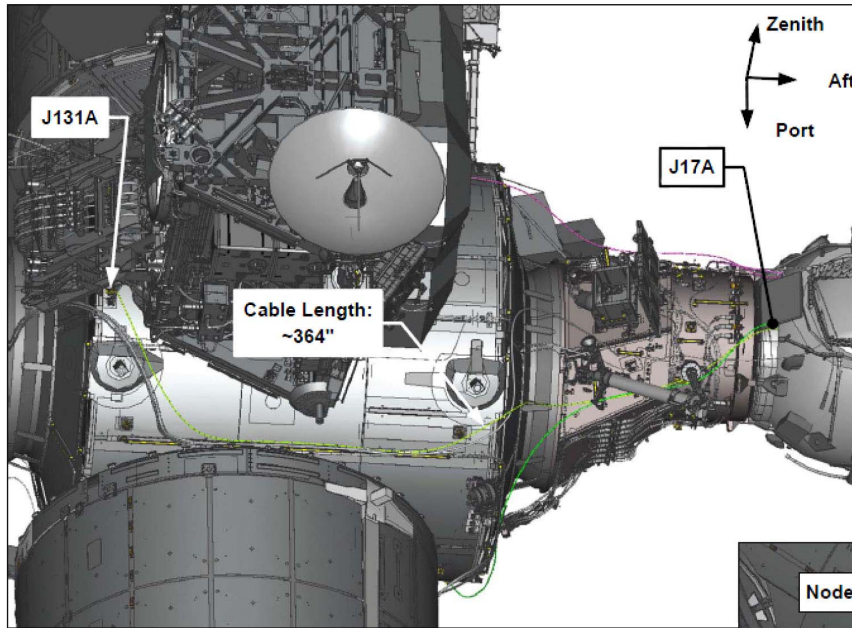

## EVA Cables Ch 2/3 – Overview

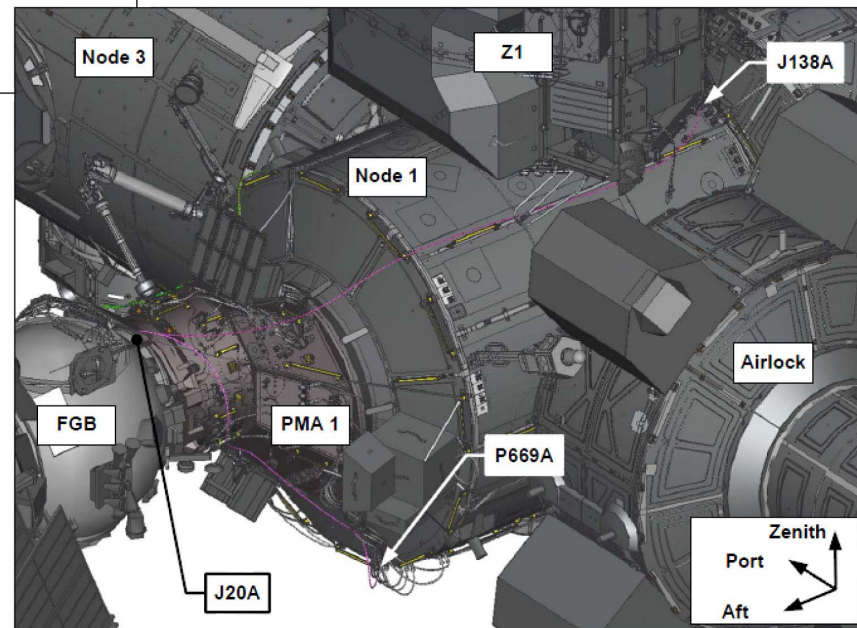



# NOD1/FGB CH1/4 AND CH2/3 CABLES (Cont)

## Node 1 Zenith Forward Endcone

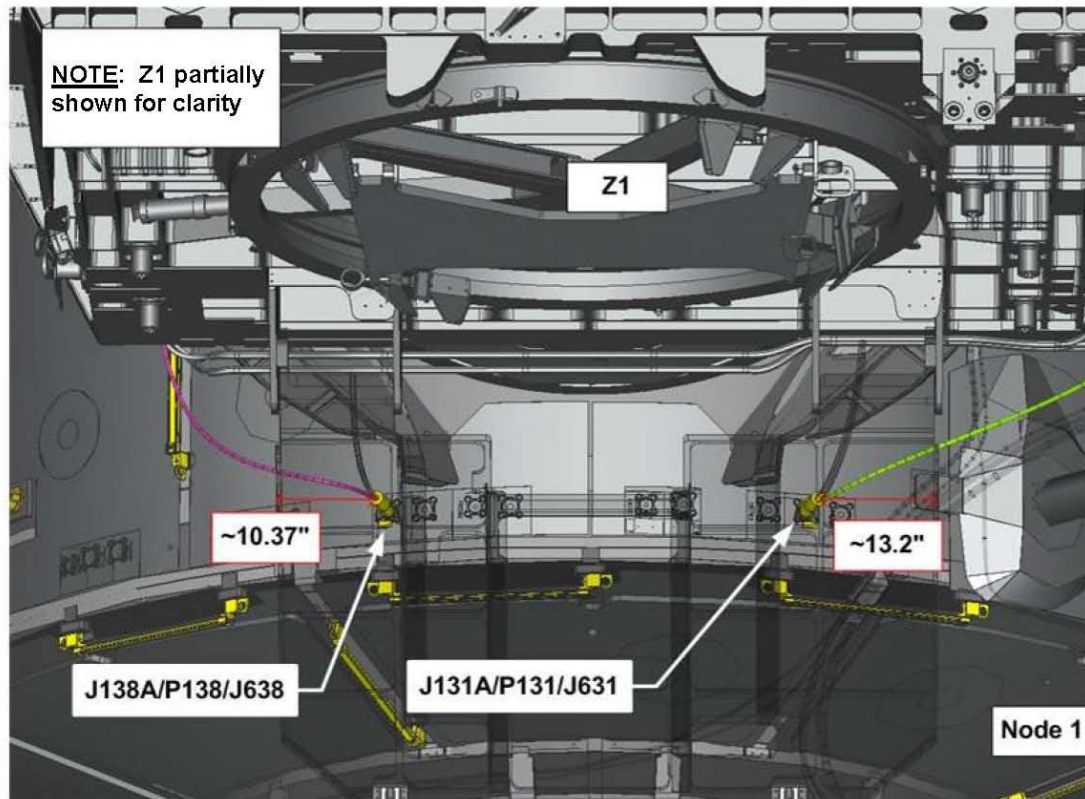

**NOTE:** Z1 partially shown for clarity

**NOTE:** NOD1/FGB Cable connectors are Jacks that mate to the cables shown mated to Node 1. They do not connect into Node 1 jacks

### Measurement from Z1 tray to J138A

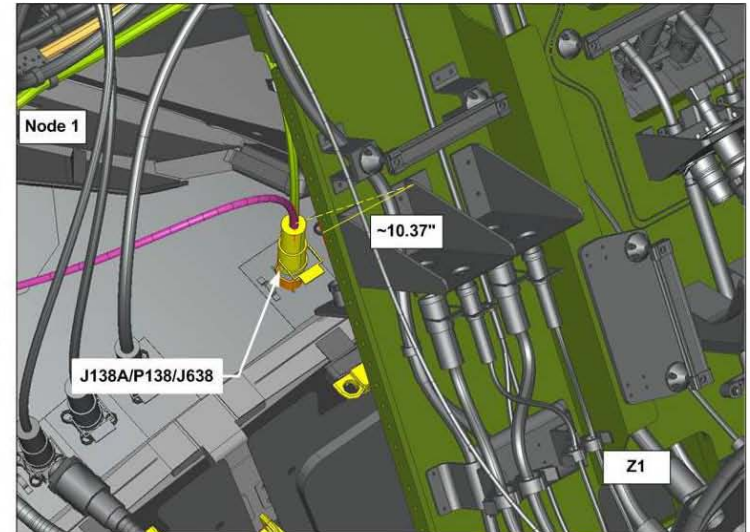

### Measurement from Z1 tray to J131A

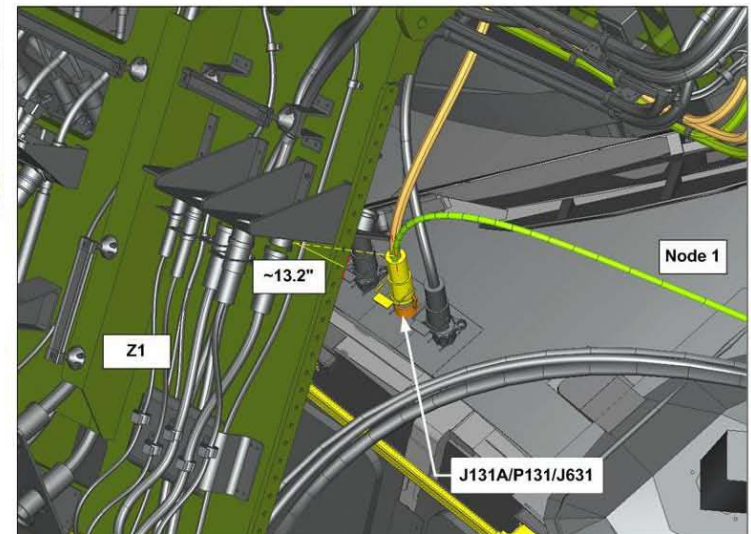

NOD1/FGB CH1/4 AND CH2/3 CABLES (Cont)

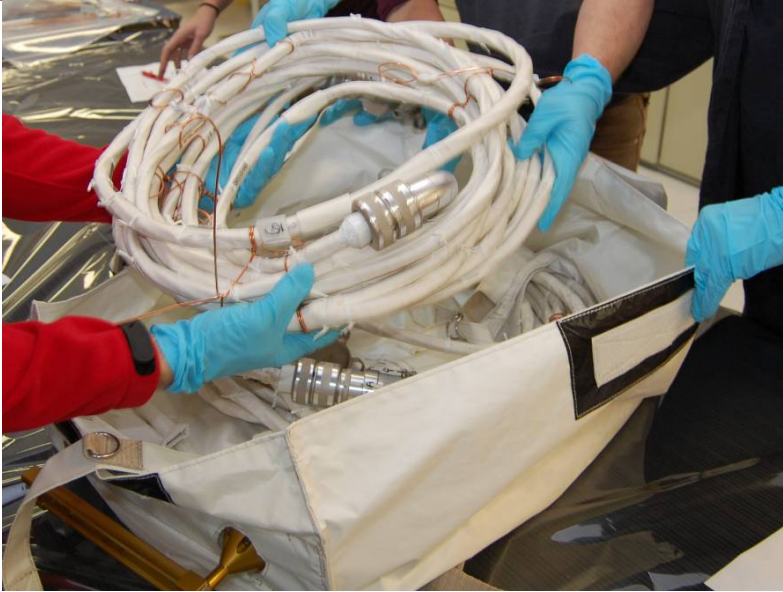



OBSS



S1 OSEs

FS 18-38

EVA/134/FIN A



OBSS (Cont)



J601/602 Connector Cap Assembly

OBSS (Cont)

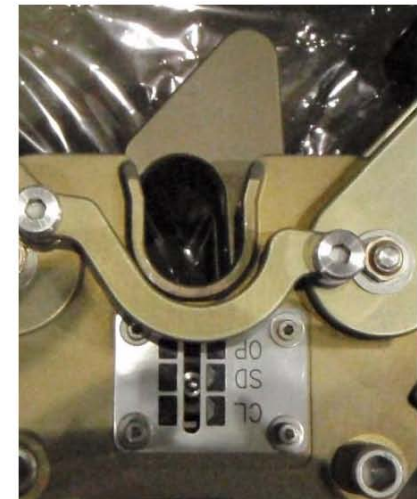
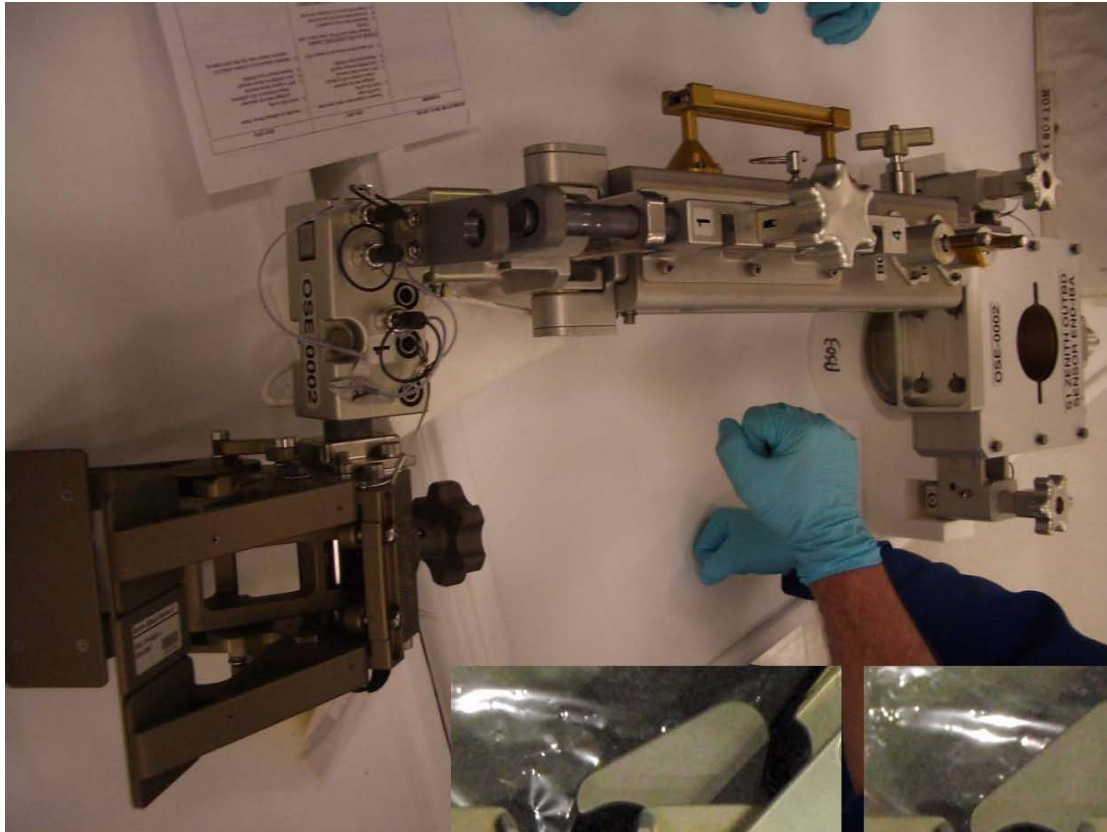

SSBAD – Space Station Boom Attachment Device



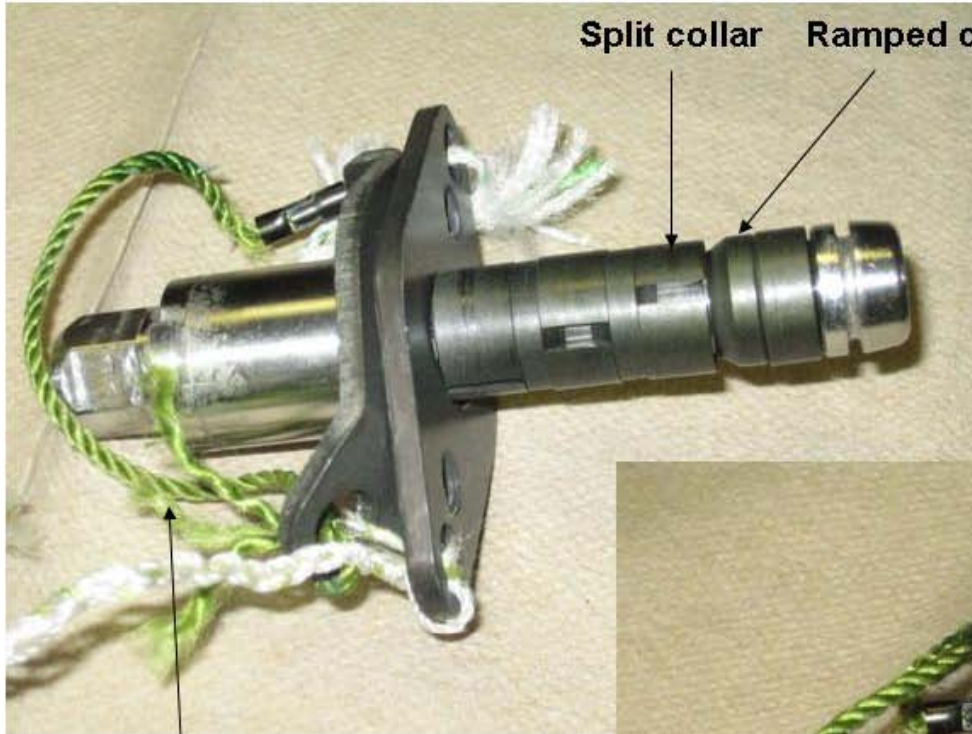

### EDF Bolt

When bolt is driven, this distance is shortened. The ramped collars are driven under the split collars, forcing them to expand. The bolt can no longer be pulled free

The lanyards restrain the bolt from coming free when the bolt is driven out and the collars will slip through the bolt hole



PDGF (Cont)



PUMAA – PDGF  
Universal Microconical  
Adapter Assembly

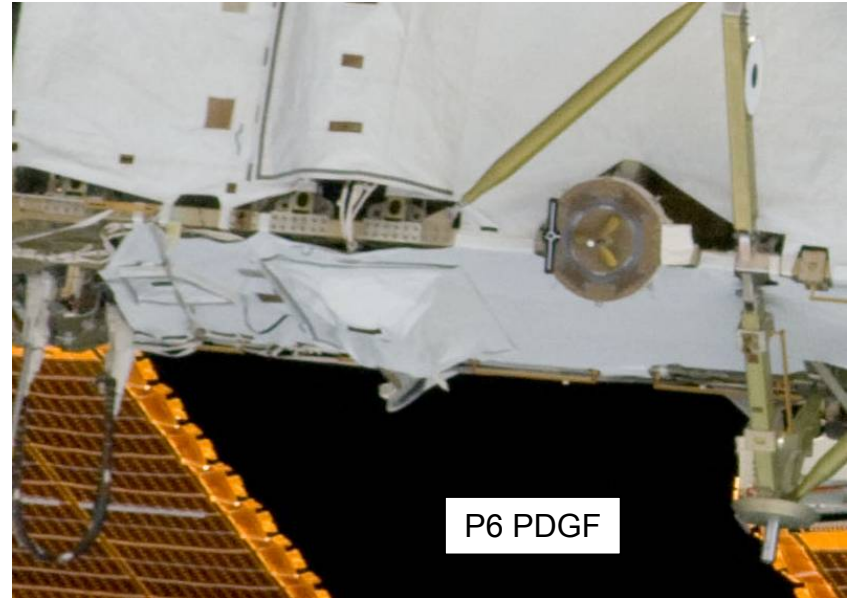

P6 PDGF



Mounting Ring Soft Docks



EFGF/PAA

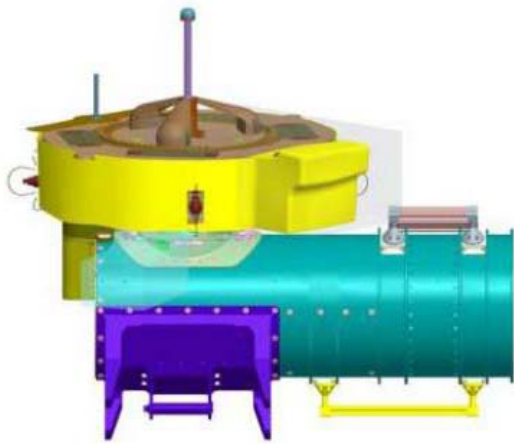

EIBA Complete Assembly (Fwd Transition)

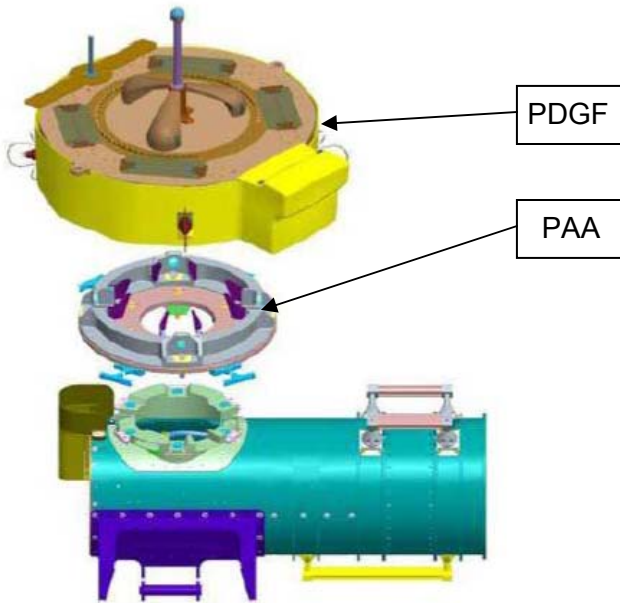

Exploded view of EIBA (Fwd Transition)

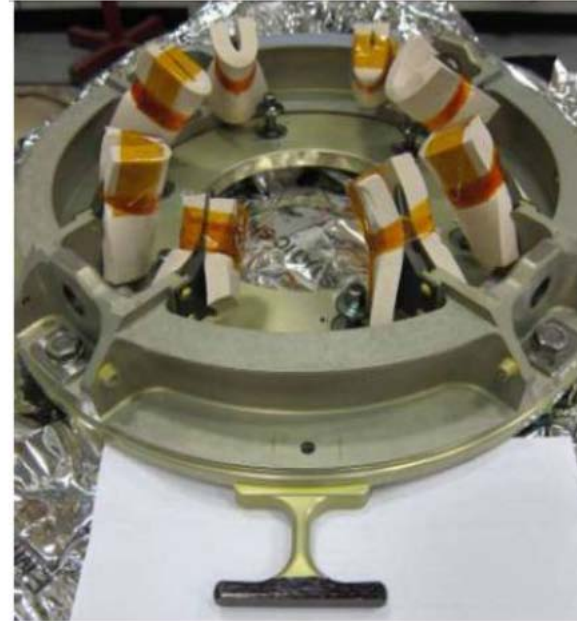

PAA - PDGF Adapter Assembly  
Black mark at 1 o'clock







## SPARE SPDM



EDF Installed, Stowage Hole Below



Pry Rod in EDF Receptacle

SPARE SPDM (Cont)

No-Touch (■)

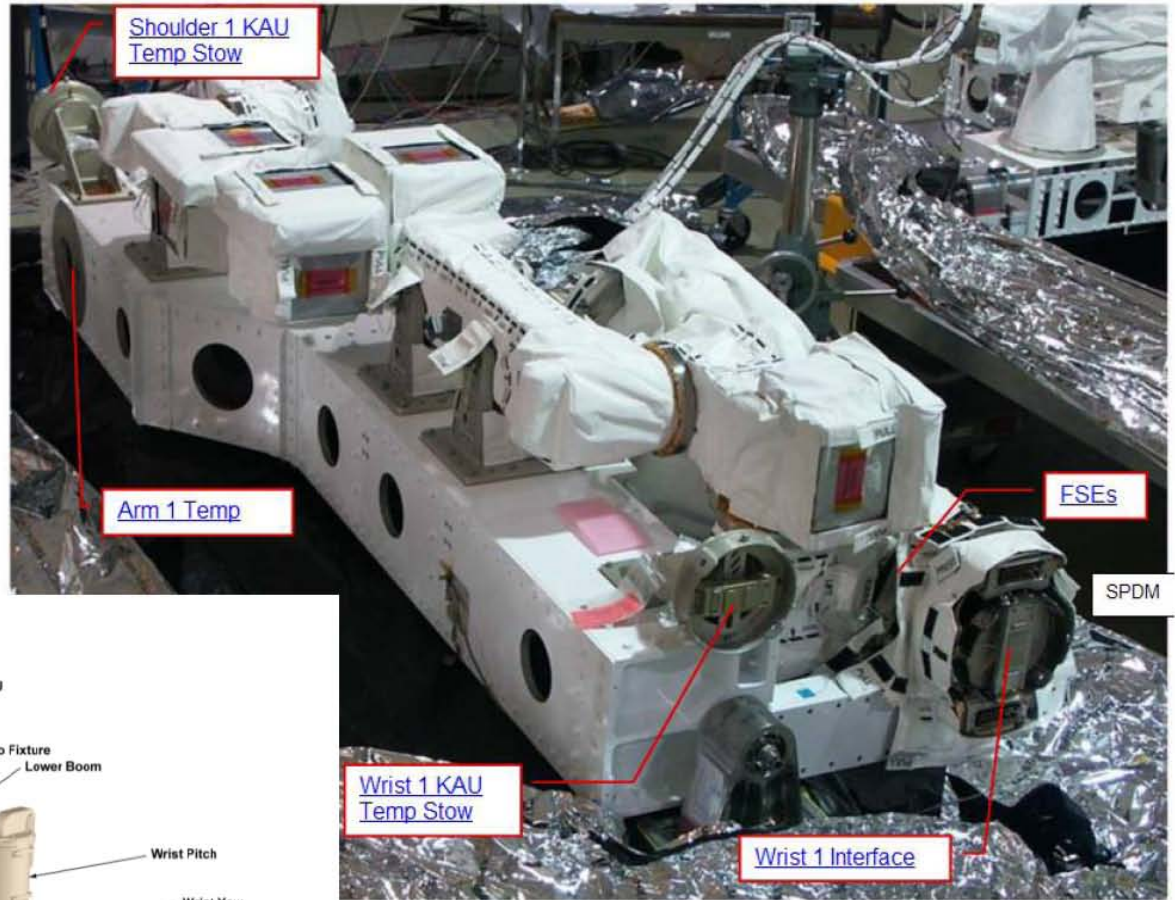
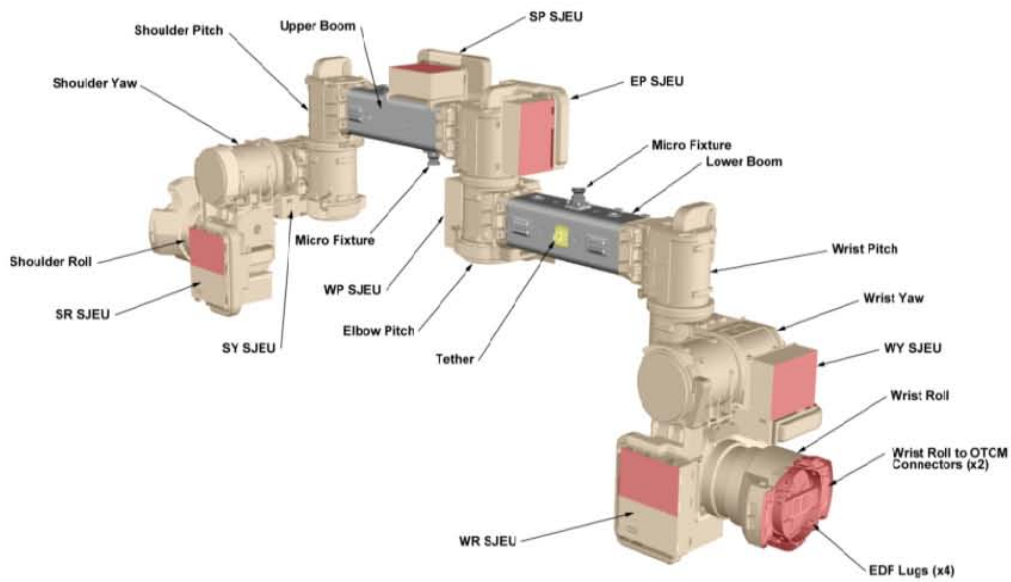

EMERGENCY PROCEDURES

EMERGENCY AIRLOCK REPRESS ..... 19-3  
    EMERGENCY AIRLOCK REPRESS ..... 19-4  
    POST EMERGENCY AIRLOCK REPRESS ..... 19-4  
SAFER RESCUE ..... 19-5  
    SAFER RESCUE ..... 19-6  
DAP/EVA RESCUE/RETRIEVE ..... 19-7  
    EVA ORBITER CONFIG ..... 19-7  
    RESCUE/RETRIEVE ..... 19-9  
19.1 DCS TREATMENT ..... 19-10  
CONTINGENCY SHUTTLE AIRLOCK INGRESS FROM ISS..... TEMP FS 19-13

EMER PROCS

This Page Intentionally Blank

# CONTINGENCY SHUTTLE AIRLOCK INGRESS FROM ISS

I

CONT  
A/L INGRESS

## CREWLOCK EGRESS

- If ISS crewlock EV hatch closed and  $\Delta P < 0.5$  psi:
- EV 1.  $\checkmark$ Tethers connected to crewlock D-ring, open EV hatch, stow
  - 2. Perform POST DEPRESS steps as reqd on CREWLOCK DEPRESS/REPRESS CUE CARD (SODF: ISS EVA SYS: EVA PREP/POST)
  - EV1 3. Open thermal cover, egress crewlock
  - EV2 4. Configure safety tethers for EV1 and EV2,  $\checkmark$ locked
  - 5. Egress crewlock, close thermal cover

## SHUTTLE AIRLOCK PREP

### NOTE

EV1 will translate to prep and open shuttle airlock hatch while EV2 remains to close ISS crewlock hatch after shuttle hatch is open

- EV1 6. Translate to shuttle airlock
- IV Aft Hatch MDK 7. Ext A/L Aft Hatch Equal vlv caps (two) – vent, remove caps, stow
- 8. Close Inner Hatch:  
Position handle to preclosing position per decal  
Hatch – rotate about hinge and push  
Handle – ccw to LATCH  
Lock lever to LOCKED
- EV1 9.  $\checkmark$ Inner Hatch Equal vlvs (two) – OFF, caps removed
- EV1 10. Open Ext A/L Aft Hatch thermal cover
- IV 11.  $\checkmark$ MCC for attitude control in preparation for Shuttle airlock depress
- EV1 12. On IV GO: Ext A/L Aft Hatch Equal vlvs (two) – EMER

**IF CABIN DP/DT OR O<sub>2</sub>(N<sub>2</sub>) FLOW HI ALARM DURING AIRLOCK DEPRESS**  
EV crew: Ext A/L Aft Hatch Equal vlvs (two) – OFF  
IV crew: Verify Inner Hatch closed and Inner Hatch Equal vlvs (two) – OFF

- EV1 13. Monitor Ext A/L Aft Hatch  $\Delta P$  gauge  
When  $\Delta P < 0.5$  psi (~2 min), open hatch and ingress A/L, connect waist tether to A/L D-ring,  $\checkmark$ locked
- EV1 14. Give EV2 GO for closing ISS crewlock EV Hatch

## SHUTTLE AIRLOCK INGRESS

- EV2 15. Open ISS crewlock thermal cover
- 16. As required,  
OXYGEN EMU 1,2 vlvs (two) – CLOSED
- UIA 17. On EV1 GO, close ISS crewlock EV Hatch:  
Verify hatch clear of FOD and obstructions  
EV hatch handle – preclose  
Hatch – rotate around hinge and pull  
Handle – cw to LATCH  
Lock lever to LOCKED  
Close thermal cover

- 18. Translate to Port Lab Struts
- 19. Attach waist tether to EV1 safety tether anchor hook, √locked
- 20. Release EV1 & EV2 safety tether anchor hooks from Port Lab Struts,  
attach EV2 safety tether anchor hook to mini-workstation
- 21. Translate to shuttle airlock, ingress
- 22. Close thermal cover
- BOTH 23. Retrieve, position SCU; remove DCM cover
- 24. Connect SCU to DCM, √locked
- AW82B 25. EV-1, EV-2 O2 vlv (two) – OP
- AW18H 26. PWR/BATT CHGR EMU 1,2 MODE (two) – PWR
- BOTH 27. WATER – OFF (fwd)

**CAUTION**  
Do not close hatch until EMU WATER – OFF for 2 min

- 28. √Ext A/L Aft Hatch clear of FOD and obstructions, close hatch:  
Position handle to preclosing position per decal  
Hatch – rotate about hinge and push  
Handle – ccw to LATCH  
Lock lever to LOCKED
- IV 29. Ext A/L Aft Hatch Equal vlvs (two) – OFF, install caps
- 30. Go to PRE-REPRESS/REPRESS (DEPRESS/REPRESS Cue Card)  
with the following delta:  
In REPRESS, skip step 2



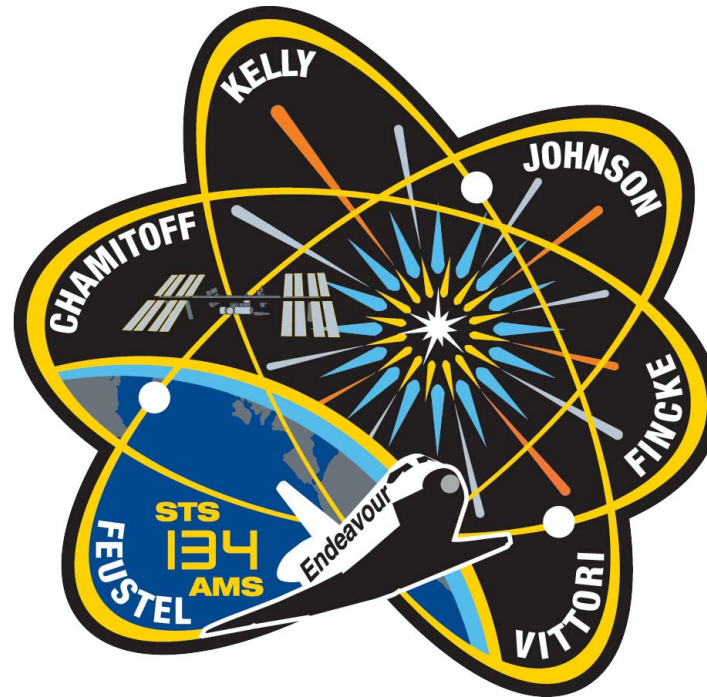

# EVA CHECKLIST

STS  
134