

# EVA Checklist

## STS-129 Flight Supplement

**Mission Operations Directorate  
EVA, Robotics, and Crew Systems  
Operations Division**

**Final  
October 30, 2009**

### **NOTE**

This supplement is to be integrated into the generic edition to provide a complete document for the specific flight. Some pages in the generic edition may be replaced with supplemental pages identified as 'TEMP'. These generic pages, if any, must be retained for use on future flights.

National Aeronautics and  
Space Administration

**Lyndon B. Johnson Space Center**  
Houston, Texas

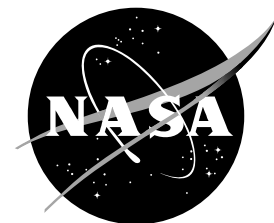



MISSION OPERATIONS DIRECTORATE

**EVA CHECKLIST  
STS-129 FLIGHT SUPPLEMENT**

FINAL  
October 30, 2009

PREPARED BY:

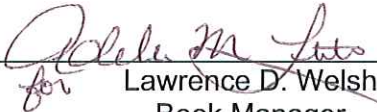
  
for Lawrence D. Welsh  
Book Manager

APPROVED BY:

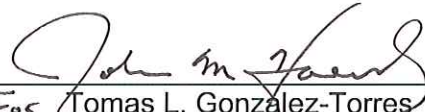
  
for Tomas L. Gonzalez-Torres  
Lead, EVA Systems Group

  
for Zebulon L. Scoville  
Lead, EVA Task Group

  
for Angela R. Prince  
Chief, EVA Operations Branch

This document is under the configuration control of the Crew Procedures Control Board (CPCB). All proposed changes must be submitted via Change Request Workflow (CRW) to DO3/FDF Manager.

Additional distribution of this book, for official use only, may be requested in writing to DO3/PMO Administrator. The request must include justification and requester's name, organization, position, and phone number. Contractor requests are made through the NASA or DOD organization supported. Deletions, reduction in quantity, or change of address may be submitted to DO3/FDF Management Office, 281-244-1184.

Incorporates the following:		
482#:	EVA FS-00316	EVA FS-00321
	EVA FS-00317	EVA FS-00322
	EVA FS-00318	EVA FS-00323
	EVA FS-00319	EVA FS-00324
	EVA FS-00320	EVA FS-00325

AREAS OF TECHNICAL RESPONSIBILITY

Book Manager

DX3/L. Welsh

281-244-1058

EVA CHECKLIST  
STS-129 FLIGHT SUPPLEMENT

**LIST OF EFFECTIVE PAGES**

FINAL      10/30/09

Sign Off .....	* 129/FIN	3-3 .....	generic
FS ii .....	* 129/FIN	3-4 .....	generic
iii .....	* generic	3-5 .....	generic
iv .....	* generic	3-6 .....	generic
FS v .....	* 129/FIN	3-7 .....	generic
FS vi .....	* 129/FIN	3-8 .....	generic
FS vii .....	* 129/FIN	3-9 .....	generic
FS viii .....	* 129/FIN	CC 3-10 .....	generic
FS ix .....	* 129/FIN	CC 3-11 .....	generic
FS x .....	* 129/FIN	3-12 .....	generic
FS xi .....	129/FIN	4-1 .....	generic
FS xii .....	129/FIN	4-2 .....	generic
FS xiii .....	129/FIN	4-3 .....	generic
FS xiv .....	129/FIN	4-4 .....	generic
FS xv .....	129/FIN	4-5 .....	generic
FS xvi .....	129/FIN	4-6 .....	generic
FS xvii .....	129/FIN	4-7 .....	generic
FS xviii .....	129/FIN	4-8 .....	generic
1-1 .....	generic	4-9 .....	generic
1-2 .....	generic	4-10 .....	generic
1-3 .....	generic	4-11 .....	generic
1-4 .....	generic	4-12 .....	generic
1-5 .....	generic	5-1 .....	generic
1-6 .....	generic	5-2 .....	generic
1-7 .....	generic	5-3 .....	generic
1-8 .....	generic	5-4 .....	generic
1-9 .....	generic	A6-1 .....	generic
1-10 .....	generic	CC A6-2 .....	generic
TEMP FS 2-1 .....	129/FIN	6-3 .....	generic
TEMP FS 2-2 .....	ALL/FIN	CC 6-4 .....	generic
2-3 .....	generic	FS 7-1 .....	129/FIN
2-4 .....	generic	FS 7-2 .....	129/FIN
TEMP FS 2-5 .....	129/FIN	FS 7-3 .....	129/FIN
TEMP FS 2-6 .....	ALL/FIN	FS 7-4 .....	129/FIN
FS 2-7 .....	129/FIN	FS 7-5 .....	⊗ 129/FIN
FS 2-8 .....	129/FIN	FS 7-6 .....	129/FIN
FS 2-9 .....	129/FIN	FS 7-7 .....	129/FIN
FS 2-10 .....	129/FIN	FS 7-8 .....	129/FIN
FS 2-11 .....	129/FIN	FS 7-9 .....	⊗ 129/FIN
FS 2-12 .....	129/FIN	FS 7-10 .....	⊗ 129/FIN
FS 2-13 .....	129/FIN	FS 7-11 .....	⊗ 129/FIN
FS 2-14 .....	129/FIN	FS 7-12 .....	⊗ 129/FIN
FS 2-15 .....	129/FIN	FS 7-13 .....	⊗ 129/FIN
FS 2-16 .....	129/FIN	FS 7-14 .....	⊗ 129/FIN
FS 2-17 .....	129/FIN	FS 7-15 .....	⊗ 129/FIN
FS 2-18 .....	129/FIN	FS 7-16 .....	129/FIN
3-1 .....	generic	FS 7-17 .....	129/FIN
3-2 .....	generic	FS 7-18 .....	129/FIN

\* – Omit from flight book

⊗ – Flight copies of this page contain color

FS 7-19 .....	129/FIN	FS 7-75.....	129/FIN
FS 7-20 .....	129/FIN	FS 7-76.....⊗	129/FIN
FS 7-21 .....	129/FIN	FS 7-77.....	129/FIN
FS 7-22 .....	129/FIN	FS 7-78.....	129/FIN
FS 7-23 .....	129/FIN	FS 7-79.....	129/FIN
FS 7-24 .....	129/FIN	FS 7-80.....	129/FIN
FS 7-25 .....	129/FIN	FS 7-81.....	129/FIN
FS 7-26 .....	129/FIN	FS 7-82.....	129/FIN
FS 7-27 .....	129/FIN	FS 7-83.....	129/FIN
FS 7-28 .....	129/FIN	FS 7-84.....	129/FIN
FS 7-29 .....⊗	129/FIN	FS 7-85.....⊗	129/FIN
FS 7-30 .....⊗	129/FIN	FS 7-86.....⊗	129/FIN
FS 7-31 .....⊗	129/FIN	FS 7-87.....⊗	129/FIN
FS 7-32 .....⊗	129/FIN	FS 7-88.....	129/FIN
FS 7-33 .....	129/FIN	FS 7-89.....⊗	129/FIN
FS 7-34 .....	129/FIN	FS 7-90.....⊗	129/FIN
FS 7-35 .....⊗	129/FIN	FS 7-91.....⊗	129/FIN
FS 7-36 .....	129/FIN	FS 7-92.....	129/FIN
FS 7-37 .....	129/FIN	FS 7-93.....⊗	129/FIN
FS 7-38 .....	129/FIN	FS 7-94.....⊗	129/FIN
FS 7-39 .....	129/FIN	FS 7-95.....⊗	129/FIN
FS 7-40 .....⊗	129/FIN	FS 7-96.....⊗	129/FIN
FS 7-41 .....⊗	129/FIN	FS 7-97.....	129/FIN
FS 7-42 .....	129/FIN	FS 7-98.....⊗	129/FIN
FS 7-43 .....⊗	129/FIN	FS 7-99.....	129/FIN
FS 7-44 .....⊗	129/FIN	FS 7-100.....	129/FIN
FS 7-45 .....⊗	129/FIN	FS 7-101.....	129/FIN
FS 7-46 .....	129/FIN	FS 7-102.....	129/FIN
FS 7-47 .....⊗	129/FIN	FS 7-103.....	129/FIN
FS 7-48 .....⊗	129/FIN	FS 7-104.....	129/FIN
FS 7-49 .....⊗	129/FIN	FS 7-105.....⊗	129/FIN
FS 7-50 .....⊗	129/FIN	FS 7-106.....⊗	129/FIN
FS 7-51 .....	129/FIN	FS 7-107.....⊗	129/FIN
FS 7-52 .....⊗	129/FIN	FS 7-108.....⊗	129/FIN
FS 7-53 .....⊗	129/FIN	FS 7-109.....⊗	129/FIN
FS 7-54 .....	129/FIN	FS 7-110.....⊗	129/FIN
FS 7-55 .....⊗	129/FIN	FS 7-111.....⊗	129/FIN
FS 7-56 .....⊗	129/FIN	FS 7-112.....	129/FIN
FS 7-57 .....⊗	129/FIN	FS 7-113.....⊗	129/FIN
FS 7-58 .....⊗	129/FIN	FS 7-114.....⊗	129/FIN
FS 7-59 .....	129/FIN	FS 7-115.....⊗	129/FIN
FS 7-60 .....	129/FIN	FS 7-116.....	129/FIN
FS 7-61 .....	129/FIN	FS 7-117.....	129/FIN
FS 7-62 .....	129/FIN	FS 7-118.....⊗	129/FIN
FS 7-63 .....	129/FIN	FS 7-119.....	129/FIN
FS 7-64 .....	129/FIN	FS 7-120.....	129/FIN
FS 7-65 .....⊗	129/FIN	FS 7-121.....	129/FIN
FS 7-66 .....⊗	129/FIN	FS 7-122.....	129/FIN
FS 7-67 .....⊗	129/FIN	FS 7-123.....	129/FIN
FS 7-68 .....⊗	129/FIN	FS 7-124.....	129/FIN
FS 7-69 .....⊗	129/FIN	FS 7-125.....⊗	129/FIN
FS 7-70 .....⊗	129/FIN	FS 7-126.....⊗	129/FIN
FS 7-71 .....⊗	129/FIN	FS 7-127.....⊗	129/FIN
FS 7-72 .....	129/FIN	FS 7-128.....⊗	129/FIN
FS 7-73 .....⊗	129/FIN	FS 7-129.....	129/FIN
FS 7-74 .....	129/FIN	FS 7-130.....⊗	129/FIN

⊗ – Flight copies of this page contain color

FS 7-131 .....	⊗	129/FIN	FS 8-17 .....	⊗	129/FIN
FS 7-132 .....	⊗	129/FIN	FS 8-18 .....	⊗	129/FIN
FS 7-133 .....	⊗	129/FIN	FS 8-19 .....	⊗	129/FIN
FS 7-134 .....		129/FIN	FS 8-20 .....		129/FIN
FS 7-135 .....	⊗	129/FIN	9-1 .....		generic
FS 7-136 .....	⊗	129/FIN	9-2 .....		generic
FS 7-137 .....	⊗	129/FIN	9-3 .....		generic
FS 7-138 .....	⊗	129/FIN	9-4 .....		generic
FS 7-139 .....		129/FIN	9-5 .....		generic
FS 7-140 .....		129/FIN	9-6 .....		generic
FS 7-141 .....	⊗	129/FIN	TEMP FS 10-1 .....		129/FIN
FS 7-142 .....	⊗	129/FIN	TEMP FS 10-2 .....		ALL/FIN
FS 7-143 .....	⊗	129/FIN	10-3 .....		generic
FS 7-144 .....		129/FIN	10-4 .....		generic
FS 7-145 .....		129/FIN	10-4a .....		generic
FS 7-146 .....		129/FIN	10-4b .....		generic
FS 7-147 .....		129/FIN	10-5 .....		generic
FS 7-148 .....	⊗	129/FIN	10-6 .....		generic
FS 7-149 .....	⊗	129/FIN	10-7 .....		generic
FS 7-150 .....	⊗	129/FIN	10-8 .....		generic
FS 7-151 .....	⊗	129/FIN	10-9 .....		generic
FS 7-152 .....		129/FIN	10-10 .....		generic
FS 7-153 .....	⊗	129/FIN	10-11 .....		generic
FS 7-154 .....		129/FIN	10-12 .....		generic
FS 7-155 .....	⊗	129/FIN	10-13 .....		generic
FS 7-156 .....		129/FIN	10-14 .....		generic
FS 7-157 .....	⊗	129/FIN	FS CC 10-15 .....		129/FIN
FS 7-158 .....	⊗	129/FIN	FS CC 10-16 .....	⊗	129/FIN
FS 7-159 .....		129/FIN	11-1 .....		generic
FS 7-160 .....	⊗	129/FIN	11-2 .....		generic
FS 7-161 .....	⊗	129/FIN	11-3 .....		generic
FS 7-162 .....	⊗	129/FIN	11-4 .....		generic
TEMP FS 8-1 .....		129/FIN	12-i .....		generic
TEMP FS 8-2 .....	⊗	129/FIN	12-ii .....		generic
TEMP FS 8-2a .....	⊗	129/FIN	TEMP FS 12-1 .....		129/FIN
TEMP FS 8-2b .....	⊗	129/FIN	TEMP FS 12-2 .....		ALL/FIN
TEMP FS 8-2c .....		129/FIN	12-3 .....		generic
TEMP FS 8-2d .....	⊗	129/FIN	12-4 .....		generic
TEMP FS 8-2e .....		129/FIN	12-5 .....		generic
TEMP FS 8-2f .....	⊗	129/FIN	12-6 .....		generic
TEMP FS 8-2g .....	⊗	129/FIN	12-7 .....		generic
TEMP FS 8-2h .....	⊗	129/FIN	12-8 .....		generic
8-3 .....		generic	12-9 .....		generic
8-4 .....		generic	12-10 .....		generic
8-5 .....		generic	12-11 .....		generic
8-6 .....		generic	12-12 .....		generic
8-7 .....		generic	12-13 .....		generic
8-8 .....		generic	12-14 .....		generic
FS 8-9 .....		129/FIN	12-15 .....		generic
FS 8-10 .....		129/FIN	12-16 .....		generic
FS 8-11 .....		129/FIN	12-17 .....		generic
FS 8-12 .....		129/FIN	12-18 .....		generic
FS 8-13 .....		129/FIN	12-19 .....		generic
FS 8-14 .....		129/FIN	12-20 .....		generic
FS 8-15 .....		129/FIN	12-21 .....		generic
FS 8-16 .....	⊗	129/FIN	12-22 .....		generic

⊗ – Flight copies of this page contain color

12-23.....	generic	FS 16-7.....	129/FIN
12-24.....	generic	FS 16-8.....	129/FIN
12-25.....	generic	FS 16-9.....	129/FIN
12-26.....	generic	FS 16-10.....	129/FIN
FS 12-27..... ⊗	129/FIN	FS 16-11.....	129/FIN
FS 12-28..... ⊗	129/FIN	FS 16-12.....	129/FIN
FS 12-29.....	129/FIN	FS 16-13..... ⊗	129/FIN
FS CC 12-30..... ⊗	129/FIN	FS 16-14.....	129/FIN
FS CC 12-31..... ⊗	129/FIN	FS 16-15.....	129/FIN
FS 12-32.....	129/FIN	FS 16-16.....	129/FIN
FS 13-1.....	129/FIN	FS 16-17.....	129/FIN
FS 13-2.....	129/FIN	FS 16-18.....	129/FIN
14-1.....	generic	FS 16-19..... ⊗	129/FIN
14-2.....	generic	FS 16-20..... ⊗	129/FIN
14-3.....	generic	FS 16-21..... ⊗	129/FIN
14-4.....	generic	FS 16-22.....	129/FIN
14-5.....	generic	FS 16-23.....	129/FIN
14-6.....	generic	FS 16-24.....	129/FIN
14-7.....	generic	FS 16-25.....	129/FIN
14-8.....	generic	FS 16-26.....	129/FIN
14-9.....	generic	FS 16-27.....	129/FIN
14-10.....	generic	FS 16-28.....	129/FIN
14-11.....	generic	FS 16-29.....	129/FIN
14-12.....	generic	FS 16-30..... ⊗	129/FIN
14-13.....	generic	FS 16-31.....	129/FIN
14-14.....	generic	FS 16-32.....	129/FIN
14-15.....	generic	FS 16-33.....	129/FIN
14-16.....	generic	FS 16-34.....	129/FIN
14-17.....	generic	FS 16-35.....	129/FIN
14-18.....	generic	FS 16-36.....	129/FIN
14-19.....	generic	FS 16-37.....	129/FIN
14-20.....	generic	FS 16-38.....	129/FIN
14-21.....	generic	FS 16-39.....	129/FIN
14-22.....	generic	FS 16-40.....	129/FIN
15-1.....	generic	FS 16-41.....	129/FIN
15-2.....	generic	FS 16-42.....	129/FIN
15-3.....	generic	FS 16-43..... ⊗	129/FIN
15-4.....	generic	FS 16-44..... ⊗	129/FIN
15-5.....	generic	FS 16-45.....	129/FIN
15-6.....	generic	FS 16-46.....	129/FIN
15-7.....	generic	FS 16-47..... ⊗	129/FIN
15-8.....	generic	FS 16-48..... ⊗	129/FIN
15-9.....	generic	FS 16-49..... ⊗	129/FIN
15-10.....	generic	FS 16-50..... ⊗	129/FIN
15-11.....	generic	FS 16-51..... ⊗	129/FIN
15-12.....	generic	FS 16-52..... ⊗	129/FIN
15-13.....	generic	FS 16-53..... ⊗	129/FIN
15-14.....	generic	FS 16-54.....	129/FIN
16-i.....	generic	FS 16-55..... ⊗	129/FIN
16-ii.....	generic	FS 16-56..... ⊗	129/FIN
TEMP FS 16-1.....	129/FIN	FS 16-57..... ⊗	129/FIN
TEMP FS 16-2.....	129/FIN	FS 16-58.....	129/FIN
FS 16-3.....	129/FIN	FS 16-59.....	129/FIN
FS 16-4.....	129/FIN	FS 16-60.....	129/FIN
FS 16-5.....	129/FIN	FS 16-61..... ⊗	129/FIN
FS 16-6.....	129/FIN	FS 16-62.....	129/FIN

⊗ – Flight copies of this page contain color



FS 16-63 .....	129/FIN	FS 18-41.....	⊗	129/FIN
FS 16-64 .....	129/FIN	FS 18-42.....	⊗	129/FIN
FS 16-65 .....	129/FIN	FS 18-43.....	⊗	129/FIN
FS 16-66 .....	129/FIN	FS 18-44.....	⊗	129/FIN
FS 16-67 .....	⊗ 129/FIN	FS 18-45.....	⊗	129/FIN
FS 16-68 .....	⊗ 129/FIN	FS 18-46.....	⊗	129/FIN
FS 16-69 .....	129/FIN	FS 18-47.....	⊗	129/FIN
FS 16-70 .....	⊗ 129/FIN	FS 18-48.....	⊗	129/FIN
FS 16-71 .....	⊗ 129/FIN	FS 18-49.....		129/FIN
FS 16-72 .....	⊗ 129/FIN	FS 18-50.....	⊗	129/FIN
FS 16-73 .....	⊗ 129/FIN	FS 18-51.....		129/FIN
FS 16-74 .....	⊗ 129/FIN	FS 18-52.....		129/FIN
FS 16-75 .....	⊗ 129/FIN	FS 18-53.....	⊗	129/FIN
FS 16-76 .....	129/FIN	FS 18-54.....		129/FIN
17-1 .....	generic	FS 18-55.....	⊗	129/FIN
17-2 .....	generic	FS 18-56.....	⊗	129/FIN
FS 18-1 .....	129/FIN	FS 18-57.....	⊗	129/FIN
FS 18-2 .....	129/FIN	FS 18-58.....	⊗	129/FIN
FS 18-3 .....	⊗ 129/FIN	FS 18-59.....	⊗	129/FIN
FS 18-4 .....	⊗ 129/FIN	FS 18-60.....	⊗	129/FIN
FS 18-5 .....	⊗ 129/FIN	19-i.....		generic
FS 18-6 .....	⊗ 129/FIN	19-ii.....		generic
FS 18-7 .....	⊗ 129/FIN	19-1 .....		generic
FS 18-8 .....	⊗ 129/FIN	19-2 .....		generic
FS 18-9 .....	⊗ 129/FIN	19-3 .....		generic
FS 18-10 .....	⊗ 129/FIN	19-4 .....		generic
FS 18-11 .....	⊗ 129/FIN	19-5 .....		generic
FS 18-12 .....	⊗ 129/FIN	19-6 .....		generic
FS 18-13 .....	⊗ 129/FIN	19-7 .....		generic
FS 18-14 .....	⊗ 129/FIN	19-8 .....		generic
FS 18-15 .....	129/FIN	19-9 .....		generic
FS 18-16 .....	⊗ 129/FIN	19-10 .....		generic
FS 18-17 .....	⊗ 129/FIN	19-11 .....		generic
FS 18-18 .....	⊗ 129/FIN	19-12 .....		generic
FS 18-19 .....	⊗ 129/FIN	19-13 .....		generic
FS 18-20 .....	⊗ 129/FIN	19-14 .....		generic
FS 18-21 .....	⊗ 129/FIN	20-1 .....	*	generic
FS 18-22 .....	⊗ 129/FIN	20-2 .....	*	generic
FS 18-23 .....	⊗ 129/FIN			
FS 18-24 .....	⊗ 129/FIN			
FS 18-25 .....	⊗ 129/FIN			
FS 18-26 .....	⊗ 129/FIN			
FS 18-27 .....	⊗ 129/FIN			
FS 18-28 .....	⊗ 129/FIN			
FS 18-29 .....	⊗ 129/FIN			
FS 18-30 .....	⊗ 129/FIN			
FS 18-31 .....	⊗ 129/FIN			
FS 18-32 .....	⊗ 129/FIN			
FS 18-33 .....	⊗ 129/FIN			
FS 18-34 .....	⊗ 129/FIN			
FS 18-35 .....	⊗ 129/FIN			
FS 18-36 .....	⊗ 129/FIN			
FS 18-37 .....	⊗ 129/FIN			
FS 18-38 .....	⊗ 129/FIN			
FS 18-39 .....	129/FIN			
FS 18-40 .....	⊗ 129/FIN			

⊗ – Flight copies of this page contain color

\* – Omit from flight book

## EVA CUE CARDS

<u>Title</u>	<u>Ref. Page</u>	<u>Card No.</u>
SAFER CHECKOUT RESULTS (Front).....	CC 3-10	generic
SAFER STATUS TROUBLESHOOTING (Back) .....	CC 3-11	generic
DEPRESS/REPRESS (NOM A/L) (Front).....	CC A6-2	generic
FAILED LEAK CHECK (Back of DEPRESS/REPRESS) .....	CC 6-4	generic
STS-129 CONSUMABLES TRACKING CUE CARD (Front).....	FS CC 10-15	EVA-5a/129/O/A
STS-129 EVA BATTERY RECHARGE PLAN (Back) ..	FS CC 10-16	EVA-5b/129/O/A
EMERGENCY UNDOCKING EXPEDITED SUIT DOFFING CUE CARD (Front).....	FS CC 12-30	EVA-6a/129/O/A
EVA TRANSFER (Back).....	FS CC 12-31	EVA-6b/129/O/A

## CONTENTS

## PAGE

10.2 PSI CABIN .....	1-1
MASK PREBREATHE INITIATE .....	1-2
PREP FOR 10.2 PSI CABIN .....	1-3
CABIN DEPRESS TO 10.2 PSI.....	1-4
10.2 PSIA DEPRESS CHART .....	1-5
10.2 PSI CABIN CONFIG.....	1-6
MASK PREBREATHE TERMINATE .....	1-6
10.2 PSI MAINTENANCE.....	1-7
CABIN REPRESS TO 14.7 PSI.....	1-8
14.7 PSI CABIN CONFIG.....	1-9
AIRLOCK CONFIG.....	TEMP FS 2-1
AIRLOCK PREP .....	TEMP FS 2-2
EMU SWAP .....	2-3
BOOSTER FAN DEACTIVATION/REMOVAL.....	2-4
BOOSTER FAN INSTALLATION/ACTIVATION.....	2-4
EMU REMOVAL .....	2-4
EMU INSTALLATION .....	2-4
EMU CHECKOUT PREP.....	TEMP FS 2-5
LTA RESTRAINT STRAP REMOVAL .....	TEMP FS 2-6
LTA RESTRAINT STRAP INSTALLATION .....	TEMP FS 2-6
EMU PREP FOR ISS TRANSFER .....	FS 2-7
POST-DOCKING EVA TRANSFER AND RECONFIG.....	FS 2-9
EMU SWAP FOR EVA 2 .....	FS 2-10
EMU SWAP FOR EVA 3 .....	FS 2-11
POST EVA EMU RECONFIGURATION .....	FS 2-12
EVA TRANSFER TO SHUTTLE.....	FS 2-16
EVA UNPACK AND STOW .....	FS 2-17
CHECKOUTS.....	3-1
EMU CHECKOUT .....	3-2
EMU POWERUP AND COMM CHECK.....	3-2
PRIMARY REGULATOR/FAN/PUMP CHECK.....	3-4
SOP CHECK.....	3-5
BATTERY CHARGE CHECK INIT.....	3-6
BATTERY CHARGE CHECK TERM .....	3-6
EMU SWAP DURING CHECKOUT .....	3-7
POST EMU C/O RECONFIG.....	3-7
SAFER CHECKOUT .....	3-8
SELF TEST SEQUENCE .....	3-9
SAFER CHECKOUT RESULTS.....	CC 3-10
SAFER STATUS TROUBLESHOOTING .....	CC 3-11
REBA POWERED HARDWARE CHECKOUT .....	3-12
EVA PREP .....	4-1
MIDDECK PREP .....	4-2
EVA PREP.....	4-3
PREP FOR DONNING.....	4-3
EMU DONNING.....	4-5
EMU CHECK .....	4-7
EMU PURGE.....	4-7
EMU PREBREATHE .....	4-8
SAFER DONNING.....	4-8
EVA COMM CONFIG.....	4-10
EVA COMM DECONFIG .....	4-10
APPROVED NON-EMU HARDWARE MATRIX.....	4-11

EMU STATUS .....	5-1
EMU STATUS .....	5-2
DEPRESS/REPRESS .....	A6-1
DEPRESS/REPRESS (NOM A/L) .....	CC A6-2
FAILED LEAK CHECK .....	6-3
FAILED LEAK CHECK (5 PSI) .....	CC 6-4
FAILED LEAK CHECK (14.7/10.2 PSI) .....	CC 6-4
TIMELINES .....	FS 7-1
ULF3 EVA SUMMARY TIMELINE .....	FS 7-2
EVA 1	
EVA 1 SUMMARY TIMELINE .....	FS 7-3
EVA 1 TOOL CONFIG .....	FS 7-4
EVA 1 BRIEFING CARD .....	FS 7-6
EVA 1 INHIBIT PAD .....	FS 7-7
EVA 1 NOTES/CAUTIONS/WARNINGS .....	FS 7-9
EVA 1 EGRESS/SETUP .....	FS 7-16
SPARE SASA INSTALL .....	FS 7-17
POA LUBE .....	FS 7-20
JEM RMS EE LUBE .....	FS 7-23
SGANT CABLE INSTALL .....	FS 7-26
INSTALL NODE 1 NH3 BRACKET .....	FS 7-27
NOD1 FGB LAN CABLE/MMOD SHIELD .....	FS 7-28
S0 PANEL A145 CONNECTOR TROUBLESHOOTING .....	FS 7-34
EVA 1 CLEANUP/INGRESS .....	FS 7-36
EVA 1 TASK DATA .....	FS 7-38
EVA 2	
EVA 2 SUMMARY TIMELINE .....	FS 7-59
EVA 2 TOOL CONFIG .....	FS 7-60
EVA 2 BRIEFING CARD .....	FS 7-62
EVA 2 INHIBIT PAD .....	FS 7-63
EVA 2 NOTES/CAUTIONS/WARNINGS .....	FS 7-65
EVA 2 EGRESS/SETUP .....	FS 7-72
GATOR ASSEMBLY INSTALL .....	FS 7-73
FPMU RELOCATE .....	FS 7-75
S3 NADIR/OUTBD PAS DEPLOY .....	FS 7-77
CP1 WETA INSTALL .....	FS 7-81
EVA 2 CLEANUP/INGRESS .....	FS 7-83
EVA 2 TASK DATA .....	FS 7-84
EVA 3	
EVA 3 SUMMARY TIMELINE .....	FS 7-99
EVA 3 TOOL CONFIG .....	FS 7-100
EVA 3 BRIEFING CARD .....	FS 7-102
EVA 3 INHIBIT PAD .....	FS 7-103
EVA 3 NOTES/CAUTIONS/WARNINGS .....	FS 7-105
EGRESS/SETUP .....	FS 7-112
HPGT TRANSFER & MISSE 7 INSTALL .....	FS 7-113
A/L MMOD SHIELDS .....	FS 7-118
S3 ZENITH/INBD PAS DEPLOY .....	FS 7-119
CLEANUP/INGRESS .....	FS 7-123
EVA 3 TASK DATA .....	FS 7-124
GET-AHEADS	
TIMELINE GET-AHEADS – STS-129 .....	FS 7-139
MT/MBS CONNECTOR INSULATING SLEEVE INSTALL .....	FS 7-140
S1 ATA BOLT 1 RELEASE/CHEATER BAR STOW .....	FS 7-142
S3 NADIR/INBD PAS DEPLOY .....	FS 7-144
P1/P3 FLUID JUMPER INSTALL .....	FS 7-150
APFR 3 RELOCATION FOR 20A .....	FS 7-152
APFR 2 RELOCATION FOR ULF4 .....	FS 7-154

APFR 5/TOOL STANCHION RELOCATION .....	FS 7-156
S1/S3 FLUID JUMPER INSTALL .....	FS 7-158
MSS CAMERA COVER INSTALL ON LEE A TIP AND MBS CAMERAS ...	FS 7-159
A/L HANDRAIL 0537 PHOTOGRAPH.....	FS 7-161
NODE 2 NADIR CBM PHOTOGRAPH.....	FS 7-162
TOOLS AND STOWAGE .....	TEMP FS 8-1
PORT LIGHTWEIGHT TOOL STOWAGE ASSEMBLY (TSA).....	TEMP FS 8-2
STARBOARD LIGHTWEIGHT TOOL STOWAGE ASSEMBLY (TSA).....	TEMP FS 8-2h
PGT CHECKOUT .....	8-3
PGSC-PGT CONNECTION (A31P AND 760XD).....	8-4
PROGRAM PGT SETTINGS.....	8-5
DOWNLOAD/ERASE EVENT LOG.....	8-5
PGT CONTINGENCIES .....	8-6
PGT STANDARD SETTINGS .....	8-7
SAFETY TETHERS – STS-129 (ULF3) .....	FS 8-9
APFR MANAGEMENT – STS-129 (ULF3).....	FS 8-11
TOOLBOX STOWAGE – STS-129 (ULF3) .....	FS 8-12
TOOLBOX PANEL AND SLOT LABELS.....	FS 8-13
Z1 TOOLBOX INTERNAL LAYOUT .....	FS 8-14
AIRLOCK TOOLBOX INTERNAL LAYOUT .....	FS 8-15
APFR THERMAL SHIELD REMOVAL .....	FS 8-16
GREASE GUN PREP.....	FS 8-17
GREASE GUN CLEANUP.....	FS 8-19
POST EVA .....	9-1
POST EVA.....	9-2
SUIT DOFFING.....	9-2
SAFER DOFFING.....	9-2
EMU WATER RECHARGE.....	9-3
SAFER STOW .....	9-3
SUIT DRYING/SEAL WIPE .....	9-4
OXYGEN RECHARGE VERIFICATION .....	9-4
WATER FILL VERIFICATION.....	9-4
EMU POWERDOWN/OVERNIGHT STOW.....	9-5
EMU MAINT/RECHARGE.....	TEMP FS 10-1
WATER RECHARGE .....	TEMP FS 10-2
EMU POWERUP .....	TEMP FS 10-2
WATER FILL.....	TEMP FS 10-2
WATER FILL VERIFICATION.....	TEMP FS 10-2
EMU LiOH CHANGEOUT .....	10-4
MIDDECK EMU BATTERY RECHARGE (STAND-ALONE) .....	10-4a
MIDDECK EMU BATTERY RECHARGE/LiOH REPLACEMENT .....	10-5
INITIATE .....	10-5
TERMINATE .....	10-6
IN-SUIT EMU BATTERY RECHARGE/CHARGE VERIFICATION .....	10-7
INITIATE .....	10-7
TERMINATE .....	10-7
EMU POWERDOWN.....	10-7
HELMET LIGHT/PGT BATTERY RECHARGE .....	10-8
INITIATE .....	10-8
TERMINATE .....	10-9
REBA BATTERY INSTALLATION.....	10-9
EMU BATTERY REMOVAL/INSTALL.....	10-10
HELMET LIGHT BULB CHANGEOUT .....	10-11
REBA BATTERY RECHARGE .....	10-12
INITIATE .....	10-12
TERMINATE .....	10-13
STS-129 CONSUMABLES TRACKING CUE CARD .....	FS CC 10-15
STS-129 EVA BATTERY RECHARGE PLAN.....	FS CC 10-16

POST EVA ENTRY PREP .....	11-1
POST EVA ENTRY PREP .....	11-2
SAFER ENTRY STOW .....	11-2
POST ISS EVA ENTRY PREP .....	11-3
<u>OFF-NOMINAL PROCEDURES</u> .....	12-i
DISPLAY LOSS DURING POWER TRANSFER (WARM RESTART) .....	TEMP FS 12-2
VACUUM H2O RECHARGE (MANNED) .....	TEMP FS 12-2
LIOH REPLACEMENT (MANNED) .....	12-3
BATTERY REPLACEMENT (MANNED) .....	12-4
WATER DUMP .....	12-6
SCU SWAP (UNMANNED) .....	12-7
SCU SWAP (MANNED) .....	12-7
EMU COLD RESTART (MANNED) .....	12-7
12.1 STS EVA DECONTAMINATION .....	12-8
CONTAMINATION TEST .....	12-15
SAFER BATTERY CHANGEOUT .....	12-18
BENDS TREATMENT ADAPTER (BTA) INSTALLATION (IN-SUIT) .....	12-19
BTA PREP .....	12-19
BTA TREATMENT .....	12-19
BENDS TREATMENT ADAPTER (BTA) INSTALLATION (POST SUIT DOFFING) .....	12-21
BTA PREP .....	12-21
BTA TREATMENT .....	12-21
EMU RESIZE .....	12-24
STS-129 NOMINAL EMU SIZING .....	FS 12-27
EMU CONTINGENCY RESIZE MATRIX (STS-129/ULF3) .....	FS 12-29
EXPEDITED SUIT DOFFING CUE CARD .....	FS CC 12-30
EMERGENCY UNDOCKING EVA TRANSFER .....	FS CC 12-31
 TPS REPAIR .....	 FS 13-1
 ORBITER CONTINGENCY EVA .....	 14-1
PAYLOAD BAY EVA NOMENCLATURE .....	14-2
RMS/PRLA CONTINGENCY EVA .....	14-3
96 BOLT PRE-EVA TOOL CONFIG .....	14-13
96 BOLT EVA TIMELINE .....	14-14
CAPTURE LATCH MANUAL RELEASE (ODS/PMA) .....	14-19
96 BOLT EVA LAYOUT .....	14-21
PLBD LATCH TOOL PLACEMENT WITH DUAL LATCH GANG FAILURES .....	14-22
 EVA CUFF CHECKLIST (CIL) .....	 15-1
NORMAL EVA STATUS .....	15-2
DCM CONFIGURATION .....	15-2
EMU MALFUNCTION INDEX .....	15-2
DECOMPRESSION SICKNESS (DCS) .....	15-3
DECOMPRESSION SICKNESS (DCS) (CONT) .....	15-3
ABORT EVA .....	15-3
TERMINATE EVA .....	15-3
SUIT P EMERG .....	15-4
SOP O2 ON .....	15-4
BATT AMPS HIGH .....	15-4
BATT V DECAY OR BATT VDC LOW .....	15-4
SUIT P LOW .....	15-5
SUIT P HIGH .....	15-5
SOP P LOW .....	15-5
O2 USE HIGH .....	15-5
SUBLM PRESS .....	15-6

H2O GP LOW .....	15-6
RESRV H2O ON .....	15-6
H2O WP HIGH .....	15-6
NO VENT FLOW .....	15-7
CO2 HIGH OR MONITOR CO2 .....	15-7
CO2 SNSR BAD.....	15-7
COMM FAILURE .....	15-7
AIR FLOW CONTAMINATION .....	15-8
LOSS OF COOLING .....	15-8
RLF V FAIL.....	15-8
MISC MSGS 1 .....	15-8
MISC MSGS (CONT)/TIME LF.....	15-9
AIRLOCK LATCH DISCONNECT .....	15-9
AIRLOCK INGRESS.....	15-9

FOLLOWING PAGES NOT IN EV CUFF

RADIATOR ACTUATOR DISCONNECT .....	15-9
PLBD DRIVE CUT .....	15-10
DOOR DRIVE RESTRAINT .....	15-10
DOOR DRIVE DISCONNECT .....	15-10
WINCH OPERATIONS.....	15-10
WINCH OPERATIONS (CONT) .....	15-11
3-PT TOOL INSTALLATION .....	15-11
CL LATCH TOOL .....	15-11
RMS JOINT ALIGN .....	15-11
MPM STOW/DEPLOY .....	15-12
RMS TIEDOWN.....	15-12
RMS FLIGHT RELEASABLE GRAPPLE FIXTURE RELEASE .....	15-12
PRLA OPEN/CLOSE.....	15-12
PRLA OPEN/CLOSE (CONT) .....	15-13
KU ANTENNA STOW.....	15-13
KU ANTENNA STOW (CONT) .....	15-13
AIRLOCK EGRESS.....	15-13

<u>FLIGHT SPECIFIC REFERENCE .....</u>	16-i
UNSCHEDULED/CONTINGENCY EVA TASKS .....	TEMP FS 16-1
STS-129/ULF3 WORKAROUNDS CRIBSHEET .....	TEMP FS 16-2
EVA 1 CONTINGENCIES.....	TEMP FS 16-2
EVA 2 CONTINGENCIES.....	FS 16-3
EVA 3 CONTINGENCIES.....	FS 16-7
CONTINGENCY/GET-AHEAD TASKS.....	FS 16-9
GENERIC CONTINGENCIES.....	FS 16-10
APFR/IAPFR .....	FS 16-10
BALLSTACK .....	FS 16-10
BRT .....	FS 16-10
CANNON CONNECTOR .....	FS 16-11
CETA CART.....	FS 16-11
EVA WRENCH (TORQUE AND RATCHET) .....	FS 16-13
FLUID QD OPS.....	FS 16-14
MMOD SHIELD.....	FS 16-18
MUT EE.....	FS 16-22
MWS .....	FS 16-22
NZGL CONNECTORS .....	FS 16-22
ON-ORBIT INSTALLED HANDRAILS .....	FS 16-25
ON-ORBIT INSTALLED WIFs.....	FS 16-25

PAD.....	FS 16-25
PGT.....	FS 16-25
SAFETY TETHER.....	FS 16-27
SCOOPS.....	FS 16-27
SOCKET CADDY.....	FS 16-29
TA CLAMP.....	FS 16-29
TETHER SHUTTLE.....	FS 16-29
TORQUE MULTIPLIER.....	FS 16-29
TSA.....	FS 16-30
RELEASE ELC1 (ELC2) ROEU LATCHES.....	FS 16-31
LATCH ELC1 (ELC2) ROEU LATCHES.....	FS 16-34
STOW ELC1 (ELC2) ROEU ARM.....	FS 16-37
MATE ELC1 (ELC2) ROEU ARM.....	FS 16-40
ROEU OVERVIEW.....	FS 16-42
ELC CAPTURE BAR MANUAL RELEASE/INSTALL.....	FS 16-43
CAS CAPTURE LATCH ASSY (CLA) MANUAL DRIVE.....	FS 16-54
UCCAS/PAS UMBILICAL MATING ASSEMBLY (UMA) MANUAL DRIVE...	FS 16-57
TEMP STOW WETA/VSSA.....	FS 16-62
RE-INSTALL WETA/VSSA.....	FS 16-64
RELOCATE WETA/VSSA.....	FS 16-66
LONG DURATION TIE-DOWN TETHER.....	FS 16-68
SASA TIE DOWN AT Z1.....	FS 16-70
FPMU TIE DOWN AT CP2 (S1).....	FS 16-72
FPMU TIE DOWN AT CP6 (P1).....	FS 16-73
PAS CLEVIS BRACKET TIEDOWN.....	FS 16-74
WETA DUMMY BOX TIEDOWN.....	FS 16-75
GENERIC EVA REFERENCE.....	17-1
FLIGHT SPECIFIC EVA REFERENCE.....	FS 18-1
EVA 1	
SASA.....	FS 18-3
POA.....	FS 18-9
JEM RMS.....	FS 18-11
SGANT CABLE.....	FS 18-12
NH3 BRACKET.....	FS 18-15
S0 ¼ AVIONICS CABLE.....	FS 18-18
EVA 2	
GATOR ASSEMBLY.....	FS 18-21
AIS ANTENNA.....	FS 18-27
ARISS ANTENNA.....	FS 18-28
FPMU.....	FS 18-29
PAS.....	FS 18-30
WETA.....	FS 18-33
EVA 3	
HPGT.....	FS 18-35
MMOD SHIELD.....	FS 18-40
MISSE 7.....	FS 18-41
GET-AHEADS	
GET-AHEADS: P1-P3 UMBILICALS.....	FS 18-47
GET-AHEADS: CLA.....	FS 18-49
ELC	
ELC 1 AND 2.....	FS 18-50
MISC	
ROEU.....	FS 18-56
PRLA.....	FS 18-60



<u>EVA EMERGENCY</u> .....	19-i
EMERGENCY PROCEDURES.....	19-1
EMERGENCY AIRLOCK REPRESS .....	19-3
EMERGENCY AIRLOCK REPRESS.....	19-4
POST EMERGENCY AIRLOCK REPRESS .....	19-4
SAFER RESCUE.....	19-5
SAFER RESCUE.....	19-6
DAP/EVA RESCUE/RETRIEVE .....	19-7
EVA ORBITER CONFIG.....	19-7
EVA RESCUE/RETRIEVE.....	19-9
19.1 DCS TREATMENT .....	19-10
CONTINGENCY SHUTTLE AIRLOCK INGRESS FROM ISS .....	19-13
 CUE CARD CONFIGURATION .....	 20-1

This Page Intentionally Blank

AIRLOCK CONFIG

AIRLOCK PREP .....	TEMP FS 2-2
EMU SWAP .....	2-3
BOOSTER FAN DEACTIVATION/REMOVAL .....	2-4
BOOSTER FAN INSTALLATION/ACTIVATION .....	2-4
EMU REMOVAL .....	2-4
EMU INSTALLATION .....	2-4
EMU CHECKOUT PREP .....	TEMP FS 2-5
LTA RESTRAINT STRAP REMOVAL .....	TEMP FS 2-6
LTA RESTRAINT STRAP INSTALLATION .....	TEMP FS 2-6
EMU PREP FOR ISS TRANSFER .....	FS 2-7
POST-DOCKING EVA TRANSFER AND RECONFIG .....	FS 2-9
EMU SWAP FOR EVA 2.....	FS 2-10
EMU SWAP FOR EVA 3.....	FS 2-11
POST EVA EMU RECONFIGURATION.....	FS 2-12
EVA TRANSFER TO SHUTTLE .....	FS 2-16
EVA UNPACK AND STOW .....	FS 2-17

AIRLOCK  
CONFIG

## AIRLOCK PREP (50 min)

	Retrieve or unstow following equipment:
MF28G	3/8-in breaker bar, 4-in ext w/3/8-in drive
IFM Tool Kit	1/2-in socket w/3/8-in drive
Vol H	EMU Equipment Bag – attach to middeck wall
	Helmet Lights
	EVA Bag
	Contamination Detection Kit (location flight specific)
FDF Locker	Cuff Checklists (2) – stow in EMU Equipment Bag
	<u>DEPRESS/REPRESS</u> Cue Card

- AW18A
1. ✓ Inner hatch Equal vlv (two) – OFF
  2. LTG FLOOD (four) – ON
  3. Remove from airlock, as reqd:
    - Airlock Stowage Bag
    - Airlock Floor Pallet using 3/8-in breaker bar, 4-in ext w/3/8-in drive, and 1/2-in socket w/3/8-in drive
  4. Stow Vol H Bags in Vol H
  5. Transfer to airlock:
    - EVA Bag – install on airlock wall
    - DEPRESS/REPRESS Cue Card
    - Helmet Lights
    - Contamination Detection Kit – install on airlock wall
  6. Install IVA foot restraint, as reqd
  7. Unbuckle SCU straps, Velcro SCU to wall
  8. Install EMU lights on helmets (EMU 1, EMU 2)
  9. Disconnect helmets from Airlock EMUs, temp stow
  10. Remove comm caps from LTA Restraint Bags and connect to electrical harnesses
  11. Install helmets (not reqd if proceeding directly to EMU Checkout)
  12. Remove LTA Restraint Bags
  13. Disconnect waist rings; remove and stow any equipment stowed in HUT/LTA
  14. Stow LTA Restraint Bags on AAPs
  15. ✓ Thermal cover clear of waist ring
  16. Waist ring – engage posn
  17. Connect LTA to HUT, lock
  18. Remove 20-g Crash Bag from middeck EMU, as reqd

## EMU CHECKOUT PREP (30 min)

- Airlock
  - 1. LTG FLOOD (four) → on
  - 2. Remove External Airlock Floor Bag from Airlock
  - 3. Unbuckle SCU straps, Velcro SCU to wall
  - 4. Disconnect helmets from EMUs, temp stow
  - 5. √DIDB restraint bags installed
  - 6. Remove comm caps (3) from LTA Restraint Bag kangaroo pouches; temp stow FM2
  - 7. Connect comm caps FM1 and SA1 to electrical harnesses
  - 8. Remove LTA Restraint Bags (reference LTA Restraint Strap Removal, next page, as reqd); stow LTA Restraint Bags and Straps on AAPs
  - 9. Disconnect waist rings; remove ECOKs/LCVGs – temp stow LCVGs for EMU Checkout
  - 10. Stow CCA FM2 in ECOK
  - 11. Temp stow ECOKs for EVA PREP FOR TRANSFER TO ISS (AIRLOCK CONFIG)
  - 12. √Thermal cover clear of waist rings
  - 13. Waist rings – engage position
  - 14. Connect LTAs to HUTs, lock
- Middeck
  - 15. Unpack and temp stow for EVA Prep for Transfer to ISS:
    - EMU Servicing Kit s/n 5004 (Yellow Tag)
    - Helmet Light Assembly s/n 1003 (no batteries)
- MD23R
- Vol H
- INBD EV1
  - 16. Remove SCOFs (2) from EMU Equipment Bag for EMU Checkout
  - 17. Stow Vol H Bags in Vol H  
(SCOFs (2) will be stowed back in EMU Equipment Bag after EMU Checkout)

## LTA RESTRAINT STRAP REMOVAL (15 min)

### NOTE

May be performed on EMU 1 and 2 simultaneously.  
Perform steps as reqd for current EMU config

1. As reqd, remove comm cap from LTA Restraint Bag; temp stow
2. Remove EMU from AAP
3. Disconnect all restraint attachments from SAFER mount brackets (two)
4. Loosen cinch strap mechanism, remove SAFER mount brackets
5. Remove strap from PLSS
6. Stow strap in LTA Restraint Bag Pouch with D-rings (three) connected
7. Engage EMU in AAP
8. Stow LTA Restraint Bag/strap

## LTA RESTRAINT STRAP INSTALLATION (15 min)

### NOTE

May be performed on EMU 1 and 2 simultaneously. Perform steps as reqd for current EMU config. Procedure written to install in Launch/Landing config shown below

1. Unstow LTA Restraint Bag/strap
2. Remove EMU from AAP
3. Install SAFER mount brackets (two)
4. Install elastic band of strap around SOP
5. Tighten cinch strap mechanism
6. Attach strap French hooks (two) to SAFER mount brackets
7. Engage EMU in AAP
8. Stow LTA, suit arms inside LTA Restraint Bag
9. Connect upper spring hooks (two) over suit shoulders to upper AAP attachment rings (two)
10. Connect lower spring hooks (two) around suit arms to SAFER mount brackets (two)
11. Tighten all LTA bag straps with bag as high as possible on EMU

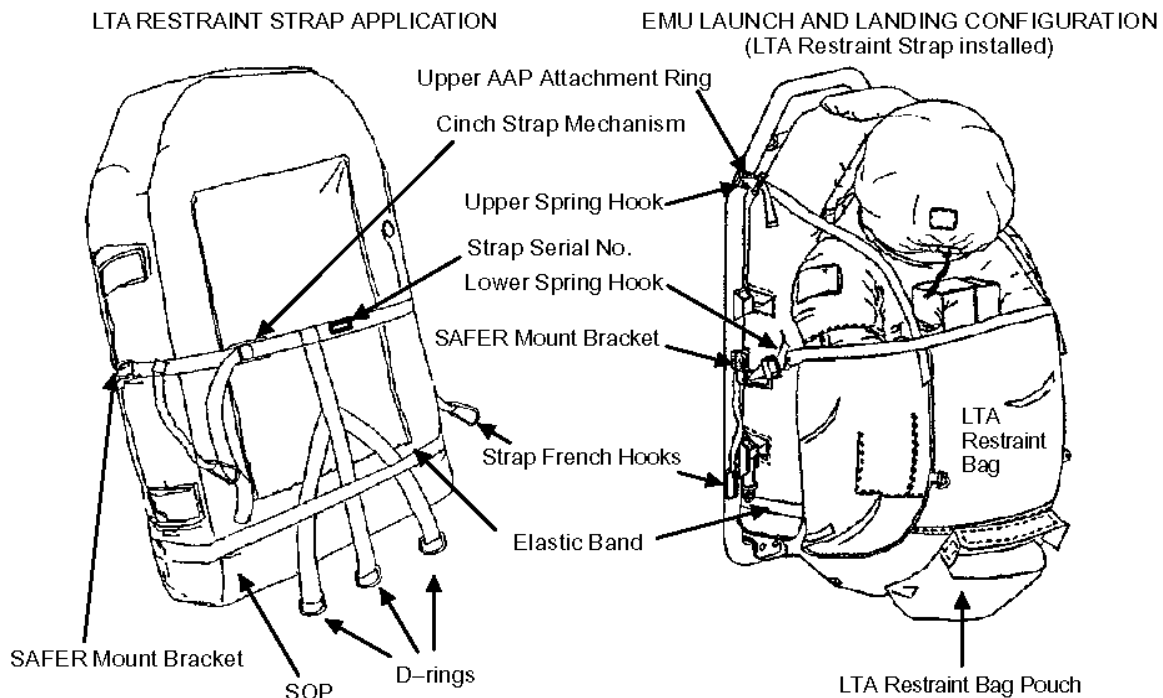

### NOTE

French hooks should be attached to SAFER mount brackets for launch and landing

## EMU PREP FOR ISS TRANSFER (90 min)

- BOTH
- EMUs
1. √PWR – SCU
  2. √PURGE vlv – op (up)
  3. √O2 ACT – OFF
  4. √WATER – OFF, switch guard installed
  5. Helmet ←|→ HUT
  6. Apply antifog (EMU Servicing Kit s/n 5004) to the helmet  
Thoroughly wipe off antifog. Seal used antifog wipes and packages in containment bag and dispose of in wet trash
  7. Helmet →|← HUT  
√Helmet sunshades down, cover installed
  8. Configure/verify items stowed in tables below

<b><u>EMU 3018 (XL) (FM)</u></b>	<b><u>EMU 3010 (L) (SA)</u></b>
<input type="checkbox"/> Helmet (FM) <input type="checkbox"/> Valsalva <input type="checkbox"/> LTA FM (attached) <input type="checkbox"/> FM1 gloves <input type="checkbox"/> Wrist Mirrors (2)	<input type="checkbox"/> Helmet (SA) <input type="checkbox"/> Valsalva <input type="checkbox"/> LTA SA (attached) <input type="checkbox"/> SA1 gloves <input type="checkbox"/> Wrist Mirrors (2)
<b>EMU Crew Options Kit (FM ECOK)</b>	<b>EMU Crew Options Kit (SA ECOK)</b>
<input type="checkbox"/> LCVG FM1 <input type="checkbox"/> FM EVA 1 & 2 Ziplock Bags <input type="checkbox"/> 3 MAGs <input type="checkbox"/> TCUs (top, bottom) <input type="checkbox"/> Socks <input type="checkbox"/> Wristlets <input type="checkbox"/> Comfort Gloves <input type="checkbox"/> Moleskin <input checked="" type="checkbox"/> Patch, Stripes, National Flag <input type="checkbox"/> CCA FM2 <input type="checkbox"/> LiOH Canister from MD Bag C	<input type="checkbox"/> LCVG SA1 <input type="checkbox"/> SA EVA 1 & 3 Ziplock Bags <input type="checkbox"/> 3 MAGs <input type="checkbox"/> TCUs (top, bottom) <input type="checkbox"/> Socks <input type="checkbox"/> Wristlets <input type="checkbox"/> Comfort Gloves <input type="checkbox"/> Moleskin <input checked="" type="checkbox"/> Patch, Stripes, National Flag <input type="checkbox"/> LiOH Canister from MD Bag C

**EMU PREP FOR ISS TRANSFER (90 min) (Cont)**

<p>From MD Bag D <b>EMU Crew Options Kit (BR ECOK)</b></p> <p><input type="checkbox"/> LCVG BR1</p> <p><input type="checkbox"/> BR EVA 2 &amp; 3 Ziplock Bags</p> <p style="padding-left: 20px;"><input type="checkbox"/> 3 MAGs</p> <p style="padding-left: 20px;"><input type="checkbox"/> TCUs (top, bottom)</p> <p style="padding-left: 20px;"><input type="checkbox"/> Socks (2 pairs)</p> <p style="padding-left: 20px;"><input type="checkbox"/> Wristlets</p> <p style="padding-left: 20px;"><input type="checkbox"/> Comfort Gloves (2 pairs)</p> <p style="padding-left: 20px;"><input type="checkbox"/> Patch, Stripes, National Flag</p> <p style="padding-left: 20px;"><input type="checkbox"/> Mole Skin</p> <p style="padding-left: 20px;">X <input type="checkbox"/> Back-up Finger Crotch Pads (for BR2 gloves)</p> <p><input type="checkbox"/> Mesh Transfer Bags (2) Labeled "EVA Systems Transfer" bag "EVA Tools Transfer" bag</p> <p><input type="checkbox"/> CCA BR1</p> <p><input type="checkbox"/> BR1 gloves s/n 6169</p> <p><input type="checkbox"/> LiOH Canisters (2) from MD Bag C</p>	<p>From MD Bag C <b>LiOH Canisters (4)</b></p> <p>Add LiOH Canister(s) to the following:</p> <p style="padding-left: 20px;"><input type="checkbox"/> 1 – FM ECOK</p> <p style="padding-left: 20px;"><input type="checkbox"/> 1 – SA ECOK</p> <p style="padding-left: 20px;"><input type="checkbox"/> 2 – BR ECOK</p>
--	--

<b>EVA Systems Transfer Bag (from BR ECOK)</b>	
Current Location	Item
Vol H (INBD EV1) – Previously gathered on FD2	<input type="checkbox"/> EMU Servicing Kit s/n 5004 (Yellow Tag) <input type="checkbox"/> Helmet Light Assembly s/n 1003
FDF Locker	<input type="checkbox"/> <u>STS-129 CONSUMABLES TRACKING CUE CARD</u> <input type="checkbox"/> <u>EMERGENCY UNDOCKING EVA TRANSFER CUE CARD</u> <input type="checkbox"/> STS-129 EVA Checklist
SODF Locker	<input type="checkbox"/> STS-129 ISS EVA Systems Checklists (green) <input type="checkbox"/> ISS EVA Cuff Checklist (3) <input type="checkbox"/> <u>Joint Emergency Egress CC</u> <input type="checkbox"/> <u>Ammonia Contamination CC</u>
MF71M	<input type="checkbox"/> CWC s/n 5096
MF71O	<input type="checkbox"/> Bends Treatment Adapter (BTA) s/n 1008
MD Bag D	<input type="checkbox"/> EMU Comfort Patch Kit <input type="checkbox"/> EMU Battery s/n 2083 <input type="checkbox"/> 2 Adjustable Tethers – Labeled "FOR SCU ONLY" s/n 1006, 1010

<b>EVA Tools Transfer Bag (from BR ECOK)</b>	
Current Location	Item
MD Bag D	<input type="checkbox"/> 85-ft Safety Tether s/n 1009 (# 29) <input type="checkbox"/> Hi Press N2/O2 EVA QD Tool <input type="checkbox"/> HPGT FRGF MLI (P/N 683-52338-8) <input type="checkbox"/> Wire Ties Short (20) Long (20)
MD Bag H	<input type="checkbox"/> NH3 Line Bracket <input type="checkbox"/> S0 Connector Adapter with wire tie <input type="checkbox"/> MSS Camr Cover and Bag (2)



## POST-DOCKING EVA TRANSFER AND RECONFIG (60 min)

### NOTE

This procedure assumes that transfer items were preconfigured per EMU PREP FOR TRANSFER TO ISS

1. Transfer following EVA equipment to ISS and update transfer list:

Item	Destination	Transfer Status
EMU 3018 (FM↑)	E-LK	
EMU 3010 (SA↑)	E-LK	
ECOK (FM)	E-Lk	
ECOK (SA)	E-Lk	
ECOK (BR)	Node 1	
EVA Systems Transfer Bag	E-Lk	
EVA Tools Transfer Bag	E-Lk	

EVA Systems  
Transfer Bag

2. Unstow following items and position in E-Lk:
  - STS-129 CONSUMABLES TRACKING CUE CARD
  - EMERGENCY UNDOCKING EVA TRANSFER CUE CARD
  - STS-129 EVA Checklist
  - STS-129 ISS EVA Systems Checklist (green)
  - Joint Emergency Egress CC
  - Ammonia Contamination CC → C-lk in endcone, IV Bag, Ammonia Contamination Kit swap with old card
  - Comfort Patch Kit → EVA Soft Goods, 0.5 CBT (s/n 1006), A/L1D0 behind closeout
  - BTA s/n 1008 → MO-2 (s/n 1038), side pocket, A/L 1O1
  - EMU Battery s/n 2083 → MO-2 (s/n 1038)
  - 2 Adjustable Tethers – Labeled FOR SCU ONLY s/n 1006, 1010 → MO-2 (s/n 1038)
  - Helmet Light Assembly s/n 1003 → MO-2 (s/n 1010)

### CONFIGURE STS EMUs

- |                 |  |
|-----------------|--|
| EMU 3018 (FM)   | 3. Install on aft EDDA   |
| EMU 3010 (SA)   | 4. Install on fwd EDDA   |
| Both EMUs       | 5. Install Helmet Lights/EMU TV assembly, perform pull test to verify all latches fully seated                     |
|                 | 6. Confirm EMU Battery and LiOH per <u>STS-129 CONSUMABLES TRACKING CUE CARD</u> ; report LiOH s/n to <b>MCC-H</b> |
|                 | 7. Confirm cam configuration per STS-129 NOMINAL EMU SIZING ( <u>EMU CONTINGENCY PROCS</u> )                       |
|                 | 8. Install respective EVA Cuff Checklists from EVA Systems Transfer Bag  |
| ECOKs (FM & SA) | 9. Populate ISS EMU Equipment Bag crew specific compartments, as desired   |

## EMU SWAP FOR EVA 2 (SA → BR) (45 min)

### NOTE

This procedure assumes the following procedures have been completed following EVA 1:  
{1.240 POST EVA} (SODF: ISS EVA SYS: EVA PREP/POST)  
{1.605 BSA BATTERY RECHARGE - term} (SODF: ISS EVA SYS: BATTERY OPS)  
{1.605 BSA BATTERY RECHARGE - init} (SODF: ISS EVA SYS: BATTERY OPS)

- |                |                          |  |
|----------------|--------------------------|--|
| EMUs 3010/3018 | <input type="checkbox"/> | 1. Connect waist ring to HUT   |
|                | <input type="checkbox"/> | 2. Reconnect gloves and boots  |
| EMU 3010 (SA)  | <input type="checkbox"/> | 3. Remove Helmet Lights/EMU TV assembly, temp stow   |
|                | <input type="checkbox"/> | 4. √Helmet installed, sun shades down, cover installed   |
|                | <input type="checkbox"/> | 5. Remove EMU from fwd EDDA, temp stow on ISS  |
|                | <input type="checkbox"/> | 6. Remove SA ECOK from Airlock, temp stow on ISS   |
| EMU 3006 (BR)  | <input type="checkbox"/> | 7. Transfer EMU and BR ECOK to E-Lk  |
|                |                          | Install EMU on fwd EDDA  |
|                | <input type="checkbox"/> | 8. Install Helmet Lights/EMU TV assembly, perform pull test to verify all latches fully seated   |
|                | <input type="checkbox"/> | 9. Install EV3 cuff checklist (from EVA Systems Transfer Bag)                                    |
|                | <input type="checkbox"/> | 10. Install following items from BR ECOK:  |
|                |                          | <input type="checkbox"/> STS-129 Mission Patch, Stripes, National Flag                           |
|                |                          | <input type="checkbox"/> Gloves BR1  |
|                | <input type="checkbox"/> | 11. Install (2) Wrist Mirrors from EMU Equipment Bag   |
|                | <input type="checkbox"/> | 12. Disconnect/Reconnect Helmet to install:  |
|                |                          | <input type="checkbox"/> CCA BR1 from BR ECOK  |
|                |                          | <input type="checkbox"/> Valsalva from EMU Servicing Kit s/n 5002                                |
|                | <input type="checkbox"/> | 13. √Helmet sunshades down, cover installed  |
|                | <input type="checkbox"/> | 14. Confirm cam configuration per STS-129 NOMINAL EMU SIZING<br>( <u>EMU CONTINGENCY PROCS</u> ) |

### HEATED GLOVE CHECKOUT (10 min)

- |               |  |
|---------------|--|
| EMU 3006 (BR) | 15. √Upper arm connections mated (located under TMG covering; unzip shoulder TMG as reqd for access, then reconfigure) |
|               | 16. √Glove heater sw – OFF   |
|               | 17. Connect lower arm pwr harness to gloves (remove Kapton tape as reqd)   |

### NOTE

To avoid excessive battery consumption and heat buildup, deactivate heaters once heat detected at fingertips

18. REBA sw – ON, pull tab toward right arm of suit
  19. Glove heater sw (one per glove) – ON
- When heat detected on all outside fingertips:
20. Glove heater sw (one per glove) – OFF
  21. REBA sw – OFF, pull tab toward left arm of suit
  22. Disconnect lower arm pwr harness from gloves
  23. Stow lower arm and glove pwr harness connectors under TMG

## EMU SWAP FOR EVA 3 (FM → SA) (SA AFT, BR FWD) (30 min)

### NOTE

This procedure assumes the following procedures have been completed following EVA 2:  
{1.240 POST EVA} (SODF: ISS EVA SYS: EVA PREP/POST)  
{1.605 BSA BATTERY RECHARGE - term} (SODF: ISS EVA SYS: BATTERY OPS)

- |                |                          |   |
|----------------|--------------------------|---|
| EMUs 3018/3006 | <input type="checkbox"/> | 1. Connect waist ring to HUT  |
|                | <input type="checkbox"/> | 2. Reconnect gloves and boots   |
| EMU 3018 (FM)  | <input type="checkbox"/> | 3. Remove Helmet Lights/EMU TV assembly, temp stow  |
|                | <input type="checkbox"/> | 4. ✓Helmet installed, sunshades down, cover installed   |
|                | <input type="checkbox"/> | 5. Remove EMU from aft EDDA, temp stow on ISS   |
|                | <input type="checkbox"/> | 6. Remove CCA FM2 from ECOK, stow in SA ECOK  |
|                | <input type="checkbox"/> | 7. Remove FM ECOK from Airlock, temp stow on ISS  |
| EMU 3010 (SA)  | <input type="checkbox"/> | 8. Transfer EMU and SA ECOK to E-Lk<br>Install EMU on aft EDDA                                    |
|                | <input type="checkbox"/> | 9. Install Helmet Lights/EMU TV assembly, perform pull test to verify<br>all latches fully seated |
|                | <input type="checkbox"/> | 10. ✓Helmet sunshades down, cover installed   |

## POST EVA EMU RECONFIGURATION (150 min)

### NOTE

Part I assumes the following procedures have been completed for EVA 3:  
{Post Depress, Depress/Repress CC} (SODF: ISS EVA SYS: EVA PREP/POST).

Part II assumes the following procedures have been completed following EVA 3:  
{1.240 POST EVA} (SODF: ISS EVA SYS: EVA PREP/POST)

### Part I (60 min)

### NOTE

EMUs will be installed in EDDAs during an EVA. If EVA, ISS, or STS, emergency immediately remove EMUs from EDDA and airlock in preparation for EVA terminate/abort

### CONFIGURE EMU (3011) FOR RETURN

1. As reqd, reference STS-129 NOMINAL EMU SIZING  
(EMU CONTINGENCY PROCS)
- EMU 3018/3011 2. Retrieve and stow in EDDAs
- FM ECOK 3. Retrieve and stow in airlock
- EMU 3018 4. Remove helmet, temp stow
5. Remove CCA FM1 stow in EVA Systems Transfer Bag
6. Install helmet
- Both EMUs 7. Remove gloves, swap, and connect
8. Remove LTA, swap, and connect
9. Remove lower legs (only), swap, and connect
- EMU 3018 10. Remove following:
  - REBA, stow in MO-2 (s/n 1038)
  - Battery, stow in MO-2 (s/n 1038)
  - Cuff C/L (cut out FS pages), stow in EMU Equipment Bag
  - Patches, Stripes, National Flag, stow in FM ECOK
  - LiOH, stow in EVA Systems Transfer Bag
11. Install vent port plugs from EMU Equipment Bag
- EMU 3011 12. Install following
  - LiOH (any used), from EVA Systems Transfer Bag
  - Battery s/n 2082 from MO-2 (s/n 1038)
- EMU 3011 13. Adjust Foreman (FM)- DN cam configuration and confirm serial numbers  
per STS-129 NOMINAL EMU SIZING (EMU CONTINGENCY PROCS)
- Both EMUs 14.  $\sqrt{\text{O}_2}$  ACT – OFF
- DCM  $\sqrt{\text{PWR}}$  – SCU
- $\sqrt{\text{DCM}}$  Purge vlv – Op (up)
- $\sqrt{\text{WATER}}$  – OFF, Switch Guard installed
- Both EMUs 15. Remove from EDDAs and return to previous stowed locations
- FM ECOK 16. Remove from airlock

## POST EVA EMU RECONFIGURATION (150 min) (Cont)

### Part II (90 min)

#### CONFIGURE EMUs (3006) FOR RETURN

17. As reqd, reference STS-129 NOMINAL EMU SIZING (EMU CONTINGENCY PROCS)
- EMU 3010/3006 18. Remove arms and LTAs, swap, and connect
- EMU 3010 19. Remove helmet, temp stow
20. Remove CCA SA1 stow in EVA Systems Transfer Bag
21. Install helmet
- Both EMUs 22. Remove following
  - REBAs and stow in MO-2 (s/n 1038)
  - HL Batteries and stow in MO-2 (s/n 1038)
  - EMU Batteries and stow in MO-2 (s/n 1038)
  - Cuff C/Ls (cut out FS pages), stow in EMU Equipment Bag
  - Patches, Stripes, National Flag, stow in respective ECOKs
- EMU 3010 23. Remove LiOH, stow in EVA Systems Transfer Bag
24. Install vent port plugs from EMU Equipment Bag
- EMU 3006 25. Install EMU battery s/n 2081 from MO-2 (s/n 1038)
26. Remove Helmet Lights/EMU TV assembly, and temp stow
27. Check Satcher (SA) cam configuration and confirm serial numbers per STS-129 NOMINAL EMU SIZING (EMU CONTINGENCY PROCS)
- Both EMUs 28.  O2 ACT – OFF
- DCM  PWR – SCU
- DCM Purge vlv – Op (up)
- WATER – OFF, Switch Guard installed
29. Verify/reconfigure EMUs and ECOK per the following table

**POST EVA EMU RECONFIGURATION (150 min) (Cont)**

<p style="text-align: center;"><b>EMU 3011 (FM↓)</b></p> <ul style="list-style-type: none"> <li><input type="checkbox"/> EMU Battery s/n 2082</li> <li><input type="checkbox"/> LiOH (used)</li> <li><input type="checkbox"/> Helmet, cover installed</li> <li><input type="checkbox"/> FM ECOK</li> <li><input type="checkbox"/> LTA</li> <li><input type="checkbox"/> Gloves (FM)</li> <li><input type="checkbox"/> Wrist Mirrors (2) [swap to old]</li> </ul>	<p style="text-align: center;"><b>EMU 3006 (SA↓)</b></p> <ul style="list-style-type: none"> <li><input type="checkbox"/> EMU Battery s/n 2081</li> <li><input type="checkbox"/> LiOH (used)</li> <li><input type="checkbox"/> Helmet, cover installed</li> <li><input type="checkbox"/> SA ECOK</li> <li><input type="checkbox"/> LTA</li> <li><input type="checkbox"/> Gloves (SA)</li> <li><input type="checkbox"/> Wrist Mirrors (2) [swap to old]</li> </ul>
<p style="text-align: center;"><b>EMU Crew Options Kit (FM)</b></p> <ul style="list-style-type: none"> <li><input type="checkbox"/> FM EVA 1 &amp; 2 Ziplock Bags <ul style="list-style-type: none"> <li><input type="checkbox"/> MAGs</li> <li><input type="checkbox"/> TCUs (top, bottom)</li> <li><input type="checkbox"/> Socks</li> <li><input type="checkbox"/> Wristlets</li> <li><input type="checkbox"/> Comfort Gloves</li> <li><input type="checkbox"/> Moleskin</li> <li><input type="checkbox"/> Patch, Stripes, National Flag</li> </ul> </li> <li><input type="checkbox"/> LCVG FM1 (w/biomed sternal harness and signal conditioner)</li> </ul>	<p style="text-align: center;"><b>EMU Crew Options Kit (SA)</b></p> <ul style="list-style-type: none"> <li><input type="checkbox"/> SA EVA 1 &amp; 3 Ziplock Bags <ul style="list-style-type: none"> <li><input type="checkbox"/> MAGs</li> <li><input type="checkbox"/> TCUs (top, bottom)</li> <li><input type="checkbox"/> Socks</li> <li><input type="checkbox"/> Wristlets</li> <li><input type="checkbox"/> Comfort Gloves</li> <li><input type="checkbox"/> Moleskin</li> <li><input type="checkbox"/> Patch, Stripes, National Flag</li> </ul> </li> <li><input type="checkbox"/> LCVG SA1 (w/biomed sternal harness and signal conditioner)</li> </ul>
<p style="text-align: center;"><b>EMU Crew Options Kit (BR)</b></p> <ul style="list-style-type: none"> <li><input type="checkbox"/> BR EVA 2 &amp; 3 Ziplock Bags <ul style="list-style-type: none"> <li><input type="checkbox"/> MAGs</li> <li><input type="checkbox"/> TCUs (top, bottom)</li> <li><input type="checkbox"/> Socks</li> <li><input type="checkbox"/> Wristlets</li> <li><input type="checkbox"/> Comfort Gloves</li> <li><input type="checkbox"/> Patch, Stripes, National Flag</li> <li><input type="checkbox"/> Mole Skin</li> </ul> </li> <li><input type="checkbox"/> CCA BR1</li> <li><input type="checkbox"/> LCVG BR1 (w/biomed sternal harness and signal conditioner)</li> <li><input type="checkbox"/> BR Gloves</li> </ul>	

- EVA Systems Transfer Bag
30. Retrieve new ISS EVA Systems Checklist (white) from STS; deploy in C-Lk
  31. Stow EMU Servicing Kit s/n 5004 (Yellow Tag) on E-Lk Wall  
Retrieve EMU Servicing Kit s/n 5002 for return  
Confirm signal conditioners (4) s/n 118, 122, 123, & 125
  32. Configure/verify contents of EVA Systems Transfer Bag per following table (next page)

## POST EVA EMU RECONFIGURATION (150 min) (Cont)

### EVA Systems Transfer Bag

#### Pre-Gathered

- Bends Treatment Adapter (BTA) s/n 1004
- BTA s/n 1004
- Helmet Light Assembly s/n 1007
- ISS Cuff Checklist (3 of 3) (old)
- ISS EVA Systems Checklist (20 JULY 09, old)

#### Configure

- EMU Servicing Kit s/n 5002
- STS-129 CONSUMABLES TRACKING CUE CARD
- EMERGENCY UNDOCKING EVA TRANSFER CUE CARD
- Joint Emergency Egress CC
- Ammonia Contamination CC (old)
- STS-129 ISS EVA Systems Checklist (green)  
(Green copy, bring back to STS; leave white copy)
- STS-129 EVA Checklist
- CWC s/n 5096
- EMU LiOH (4)
- CCA FM1

## EVA TRANSFER TO SHUTTLE (15 min)

1. Configure/verify contents of EVA Tools Transfer Bag per following table

### EVA Tools Transfer Bag

- 85-ft Safety Tether s/n 1008 (#28)
- Adjustable Equipment Tethers (3) s/n 1009, 1032, 1034
- Blue RETs
  - sm-sm (16)
  - Lg-sm (8)
  - w/PIP pin (5)

2. Transfer items in table below to Shuttle; report status to **MCC-H** when complete

### TRANSFER TO SHUTTLE

Item	Destination	Transfer Status
EMU 3011 (FM↓) with ECOK	Temp stow Middeck	
EMU 3006 (SA↓) with ECOK	Temp stow Middeck	
BR ECOK	Temp stow Middeck	
EVA Systems Transfer Bag	Temp stow Middeck	
EVA Tools Transfer Bag	Temp stow Middeck	



## EVA UNPACK AND STOW (90 min)

1. Unpack and stow items per table below; report status to **MCC-H** when complete

### EVA SYSTEMS TRANSFER BAG UNPACK AND STOW

Item	Final Location
EMU 3011 (FM↓)	Ext A/L (Stbd AAP)
EMU 3006 (SA↓)	Ext A/L (Port AAP)
BR ECOK; unpack to fit <input type="checkbox"/> ECOK <input type="checkbox"/> CCA BR1 <input type="checkbox"/> LCVG BR1 <input type="checkbox"/> BR Gloves	MD Bag D
<b>EVA Systems Transfer Bag</b>	
<input type="checkbox"/> <u>STS-129 CONSUMABLES TRACKING CUE CARD</u> <input type="checkbox"/> <u>EMERGENCY UNDOCKING EVA TRANSFER CUE CARD</u> <input type="checkbox"/> STS-129 EVA Checklist	FDF Locker
<input type="checkbox"/> STS-129 ISS EVA Systems Checklists (green) <input type="checkbox"/> ISS EVA Systems Checklists (20 JULY 09, old) <input type="checkbox"/> ISS Cuff Checklist (3) (old) <input type="checkbox"/> <u>Joint Emergency Egress CC</u> <input type="checkbox"/> <u>Ammonia Decontamination CC</u> (old)	SODF Locker
<input type="checkbox"/> CWC s/n 5096	MF71M
<input type="checkbox"/> Bends Treatment Adapter (BTA) s/n 1004	MF71O
<input type="checkbox"/> EMU LiOH (4)	MD Bag C
<input type="checkbox"/> EMU Servicing Kit s/n 5002 <input type="checkbox"/> Helmet Light Assembly s/n 1007	Vol H (INBD EV1)

### EVA TOOLS TRANSFER BAG UNPACK AND STOW

Item	Final Location
<input type="checkbox"/> 85-ft Safety Tether s/n 1008 (#28) <input type="checkbox"/> Adjustable Equipment Tethers (3) s/n 1009, 1032, 1034	MD Bag D
<input type="checkbox"/> Blue RETs <input type="checkbox"/> sm-sm (16) <input type="checkbox"/> Lg-sm (8) <input type="checkbox"/> w/PIP pin (5)	MD Bag C

- EVA Systems Transfer Bag      2. Remove CCAs install in respective LTA Restraint Bag Pouches

This Page Intentionally Blank

TIMELINES

ULF3 EVA SUMMARY TIMELINE .....	FS 7-2
EVA 1	
EVA 1 SUMMARY TIMELINE .....	FS 7-3
EVA 1 TOOL CONFIG .....	FS 7-4
EVA 1 BRIEFING CARD .....	FS 7-6
EVA 1 INHIBIT PAD .....	FS 7-7
EVA 1 NOTES/CAUTIONS/WARNINGS .....	FS 7-9
EVA 1 EGRESS/SETUP .....	FS 7-16
SPARE SASA INSTALL .....	FS 7-17
POA LUBE .....	FS 7-20
JEM RMS EE LUBE .....	FS 7-23
SGANT CABLE INSTALL .....	FS 7-26
INSTALL NODE 1 NH3 BRACKET .....	FS 7-27
NOD1 FGB LAN CABLE/MMOD SHIELD .....	FS 7-28
S0 PANEL A145 CONNECTOR TROUBLESHOOTING .....	FS 7-34
EVA 1 CLEANUP/INGRESS .....	FS 7-36
EVA 1 TASK DATA .....	FS 7-38
EVA 2	
EVA 2 SUMMARY TIMELINE .....	FS 7-59
EVA 2 TOOL CONFIG .....	FS 7-60
EVA 2 BRIEFING CARD .....	FS 7-62
EVA 2 INHIBIT PAD .....	FS 7-63
EVA 2 NOTES/CAUTIONS/WARNINGS .....	FS 7-65
EVA 2 EGRESS/SETUP .....	FS 7-72
GATOR ASSEMBLY INSTALL .....	FS 7-73
FPMU RELOCATE .....	FS 7-75
S3 NADIR/OUTBD PAS DEPLOY .....	FS 7-77
CP1 WETA INSTALL .....	FS 7-81
EVA 2 CLEANUP/INGRESS .....	FS 7-83
EVA 2 TASK DATA .....	FS 7-84
EVA 3	
EVA 3 SUMMARY TIMELINE .....	FS 7-99
EVA 3 TOOL CONFIG .....	FS 7-100
EVA 3 BRIEFING CARD .....	FS 7-102
EVA 3 INHIBIT PAD .....	FS 7-103
EVA 3 NOTES/CAUTIONS/WARNINGS .....	FS 7-105
EGRESS/SETUP .....	FS 7-112
HPGT TRANSFER & MISSE 7 INSTALL .....	FS 7-113
A/L MMOD SHIELDS .....	FS 7-118
S3 ZENITH/INBD PAS DEPLOY .....	FS 7-119
CLEANUP/INGRESS .....	FS 7-123
EVA 3 TASK DATA .....	FS 7-124
GET-AHEADS	
TIMELINE GET-AHEADS – STS-129 .....	FS 7-139
MT/MBS CONNECTOR INSULATING SLEEVE INSTALL .....	FS 7-140
S1 ATA BOLT 1 RELEASE/CHEATER BAR STOW .....	FS 7-142
S3 NADIR/INBD PAS DEPLOY .....	FS 7-144
P1/P3 FLUID JUMPER INSTALL .....	FS 7-150
APFR 3 RELOCATION FOR 20A .....	FS 7-152
APFR 2 RELOCATION FOR ULF4 .....	FS 7-154
APFR 5/TOOL STANCHION RELOCATION .....	FS 7-156
S1/S3 FLUID JUMPER INSTALL .....	FS 7-158
MSS CAMERA COVER INSTALL ON LEE A TIP AND MBS CAMERAS .....	FS 7-159
A/L HANDRAIL 0537 PHOTOGRAPH .....	FS 7-161
NODE 2 NADIR CBM PHOTOGRAPH .....	FS 7-162

TIMELINES

# TIMELINES

## ULF3 EVA SUMMARY TIMELINE

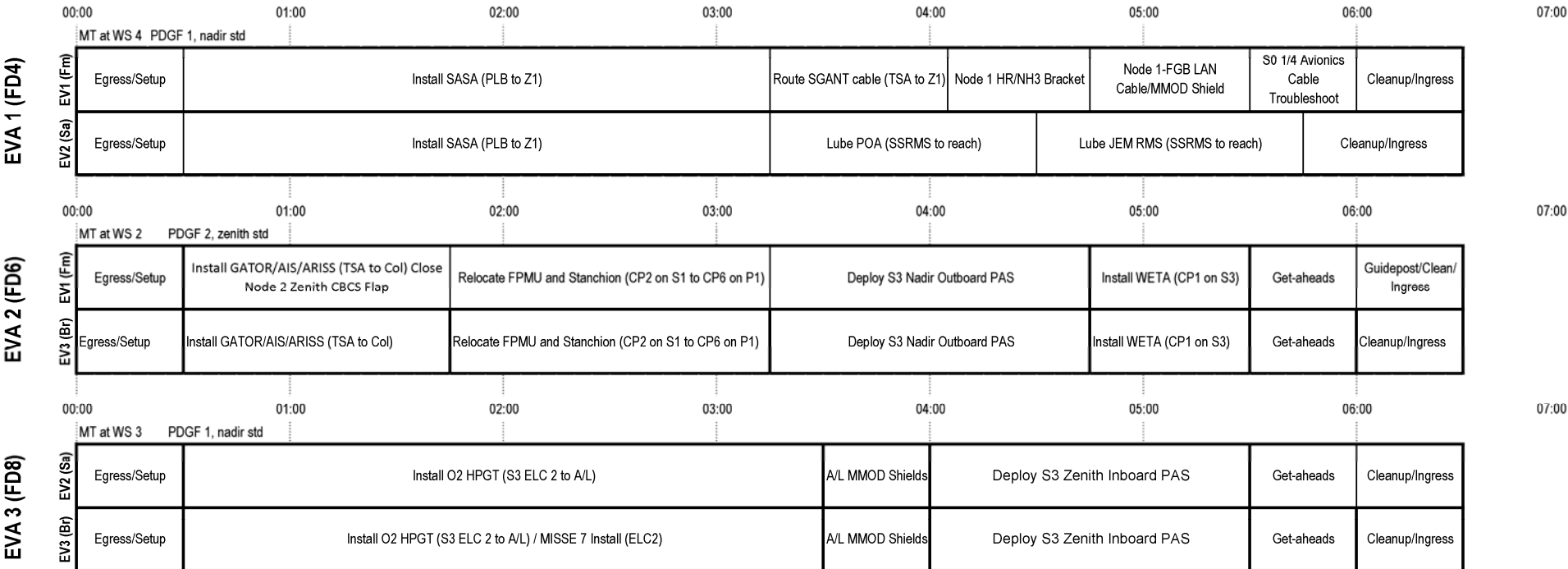

# EVA 1 SUMMARY TIMELINE

PET HR : MIN	IV/SSRMS	EV1 (Fm)	EV2 (Sa)	
00:00		<u>EGRESS/SETUP (00:30)</u> <ul style="list-style-type: none"> <li>Post Depress and Egress (00:15)</li> <li>Setup (00:15)</li> </ul>	<u>EGRESS/SETUP (00:30)</u> <ul style="list-style-type: none"> <li>Post Depress and Egress (00:15)</li> <li>Setup (00:15)</li> </ul>	00:00
01:00		<u>SPARE SASA INSTALL (02:45)</u> <ul style="list-style-type: none"> <li>Release Spare SASA (01:30)</li> </ul>	<u>SPARE SASA INSTALL (02:45)</u> <ul style="list-style-type: none"> <li>SSRMS Setup/Ingress on S1 (00:50)</li> </ul>	01:00
	<ul style="list-style-type: none"> <li>SSRMS Maneuver to PLB (00:30)</li> </ul>		<ul style="list-style-type: none"> <li>SSRMS Maneuver to PLB (00:30)</li> </ul>	
02:00		<ul style="list-style-type: none"> <li>Retrieve AIA and SGANT Cable from TSA (00:45)</li> </ul>	<ul style="list-style-type: none"> <li>Spare SASA Retrieval in PLB (00:10)</li> <li>SSRMS Maneuver to Z1 (00:45)</li> </ul>	02:00
	<ul style="list-style-type: none"> <li>SSRMS Maneuver to Z1 (00:45)</li> </ul>	<ul style="list-style-type: none"> <li>Install Spare SASA on Z1 (00:30)</li> </ul>	<ul style="list-style-type: none"> <li>Install Spare SASA on Z1 (00:30)</li> </ul>	
03:00				03:00
	<ul style="list-style-type: none"> <li>SSRMS Maneuver to POA (00:20)</li> </ul>	<u>SGANT CABLE INSTALL (00:50)</u>	<u>POA LUBE (01:15)</u>	
04:00				04:00
	<ul style="list-style-type: none"> <li>SSRMS Maneuver to JEM RMS EE (00:10)</li> </ul>	<u>INSTALL NODE 1 NH3 BRACKET (00:40)</u>	<u>JEM RMS EE LUBE (01:15)</u>	
05:00		<u>NOD1 FGB LAN CABLE/MMOD SHIELD (00:45)</u>		05:00
	<ul style="list-style-type: none"> <li>SSRMS Maneuver to S1 Egress Position (00:10)</li> </ul>	<u>S0 PANEL A145 CONNECTOR TROUBLESHOOTING (00:30)</u>	<u>CLEANUP/INGRESS (00:45)</u> <ul style="list-style-type: none"> <li>Cleanup (00:30)</li> </ul>	
06:00		<u>CLEANUP/INGRESS (00:30)</u> <ul style="list-style-type: none"> <li>Cleanup (00:15)</li> <li>Ingress and Pre-Repress (00:15)</li> </ul>	<ul style="list-style-type: none"> <li>Ingress and Pre-Repress (00:15)</li> </ul>	06:00
06:30				06:30

# EVA 1

## EVA 1 TOOL CONFIG

### EV1

- MWS
  - BRT (L)
    - RET (sm-sm)
    - RET (sm-sm)
    - Wire Ties (2 short, 3 long)
  - T-Bar
    - RET (sm-sm)
      - Adj Equip Tether (clove hitch)
    - RET (sm-sm)
    - RET w/PIP Pin
    - Adj Equip Tether (for AIA)
    - Adj Equip Tether
    - Wire Ties (2)
    - Small ISS Trash Bag (right/inboard)
      - SGANT Connector Caps (2)
      - Velcro Strap from SGANT
      - Adj Equip Tether (from NOD1 shield)
      - Adj Equip Tether (from NOD1 shield)
      - Adj Equip Tether (from NOD1 shield)
  - Swing Arm (R)
    - RET (sm-sm)
      - PGT [B2 16.0 ft-lb, CAL, MTL 30.5] s/n \_\_\_\_\_
      - PGT Battery s/n \_\_\_\_\_
      - 7/16 Socket-2 ext
- D-ring Extender (2, R & L D-ring)
  - ST Pack (85-ft + 85-ft to L D-ring Ext) (A/L & Second)
- Waist Tether (2, L on D-ring, R on D-ring Ext)
- SAFER
- WVS
- RET (Lg-sm)
- Adj Equip Tether
  - Crewlock Bag (NOD1 Bag)**
    - Loop Pin Puller (on int RET)
    - Internal RET to door handle
    - Wire Ties (2) (external for bracket)
      - Node 1 NH3 Bracket (on int RET) (wire tied to outside of bag)
      - Node 1 HR 0111 (wire tied to outside of bag)
    - Wire Tie Caddy (on int RET) (9 short)
    - RET (sm-sm) to door handle
      - MMOD Shield T-Tool (from NOD1 shield)
    - RET (sm-sm)
      - Connector Adapter
      - MBS Booty (-0501; size 21/25)
    - RET (sm-sm)
      - S0 Connector Booty (-0503; size 33/37)

### EV2

- MWS
  - BRT (L)
    - RET (sm-sm)
    - Wire Ties (2 short, 1 long)
  - T-Bar
    - RET (sm-sm)
      - WIF Adapter w/PIP Pin
      - RET w/PIP Pin
      - Adj Equip Tether (for AIA)
      - Adj Equip Tether
      - Adj Equip Tether
      - Wire Ties (2)
      - Small ISS Trash Bag (left/inside)
    - Swing Arm (R)
      - RET (sm-sm)
        - EVA Camera w/bracket (use int RET)
        - Long Wire Tie (grease gun holster)
  - D-ring Extender (2, R & L D-ring)
    - 85-ft Safety Tether (L D-ring Ext) (A/L)
    - 85-ft Safety Tether (L D-ring Ext) (Arm)
  - Waist Tether (2, L on D-ring, R on D-ring Ext)
  - SAFER
  - WVS
  - RET (Lg-sm)
  - Adj Equip Tether
    - Crewlock Bag (Lube Bag)**
      - EVA Gap Gauge (labeled "LEE") (on int RET)
      - Taped Needle-Nose Pliers (on int RET)
      - Wire Ties (2) (external for grease gun)
      - RET (sm-sm)
        - Straight-Nozzle Grease Gun (in wipe)
          - EVA Wipe (dry) (on int RET)
            - Wire Tie (to hold wipe around grease gun)
        - EVA Wipe (dry) (on int RET)
        - RET (sm-sm)
          - EVA Wipe (dry)

### A/L

- RET (Lg-sm)
  - PGT [X X ft-lb, CAL, MTL 30.5] s/n \_\_\_\_\_
  - PGT Battery s/n \_\_\_\_\_
    - 7/16 (wobble) Socket-6 ext
- RET (Lg-sm)
- Adj Equip Tether
  - Crewlock Bag (Get-ahead Bag)**
    - EVA Ratchet Palm Wheel (on int RET)
    - EVA Ratchet w/2" socket (on int RET) (use middle tether point)
    - Wire Ties (2) (external)
      - Cheater Bar (on int RET) (wire tied to outside of bag)
- RET (Lg-sm)
- Adj Equip Tether
- Lg-sm Adj Equip Tether
- Crewlock Bag (PAS Bag)**
  - Internal RET to door handle
  - DRT (on int RET)
  - DRT (on int RET)
  - Hammer (on int RET)
  - Wire Ties (2) (ext, loops squished for bracket)
  - RET (sm-sm)
    - PAS Stow Clevis Bracket

**NOTE** – Prior to use, inspect the following hardware:

- RET cords for fraying
- Safety Tether/Waist Tether LAS: No Red Visible
- ISS Trash Bag: Bristle deformation/damage, after having stowed tools in trash bag
- BRT joint screws not loose
- Empty trash bags and verify zipper closed

## EVA 1 TOOL CONFIG (Cont)

### IV Bag

- Towels (2)
- Contamination Detection Kit
- GP Caddy (2)
  - Adjustable Thermal Mittens (2)
- Socket Caddy (hatch cont) w/RET (sm-sm) (Black)
  - 1/2 Socket-8 ext
  - 7/16 (wobble) Socket-6 ext (spare)
- DCM Plug (SAFER Hardmount) (2)
- RET (sm-sm, Black) (2)

### Staging Bag

- Fish Stringer Tether
  - Long Duration Tie Down Tether
  - Velcro/Tape Caddy
  - PGT s/n \_\_\_\_\_
  - PGT Battery s/n \_\_\_\_\_
  - 7/16 (wobble) Socket-6 ext
  - Vise Grips
  - Ratchet Wrench
    - 7/16 (rigid) Socket-9 ext
  - Spare 85-ft Safety Tether
  - Spare WIF Adapter
- Fish Stringer Tether
  - Connector Cleaner Tool Kit
  - Pin Straightener Assy
  - Probe
  - Pry Bar
  - Long Duration Tie Down Tether
  - Torque Wrench Bag
    - Torque Wrench (set to 20 ft-lb; on hook)
  - MWS Key Strap Assy (wire-tied to strap)

Tether Counts: <b>BLUE RETS</b>	
RETs (sm-sm) = 14	Adj Equip Tethers
RETs (Lg-sm) = 5	(sm-sm) = 8 of 10
RETs (PIP Pin) = 2	(Lg-sm) = 1 of 2



# EVA 1 BRIEFING CARD

EV1 \_\_\_\_\_ EV2 \_\_\_\_\_ IV1 \_\_\_\_\_ IV2 \_\_\_\_\_

EVA Prep start (GMT) \_\_\_\_ / \_\_\_\_ : \_\_\_\_  
Depress to 10.2 \_\_\_\_\_ : \_\_\_\_\_  
Start purge \_\_\_\_\_ : \_\_\_\_\_  
PET 00:00 \_\_\_\_\_ : \_\_\_\_\_

## EVA Prep

- Get-up plan – clothing and EMU equipment bag
- Equipment lock activities – IV responsibilities
- Suit donning plan – special requests
- SAFER, MWS, tools, CL positions and bag stowage
- Airlock depress review
- EV/IV comm protocol
- SRMS/SSRMS initial position

## EV Crew Procedure Review

- Egress Plan
- Translations – tether swaps
- Order of tasks
- Ingress Plan

## General Procedure Review

- Hazards
- Get ahead tasks
- Constraints – ground and flight
- Cautions and warnings review
- SSRMS and RMS operations – comm protocol/clearances and coordinate systems
- Contingency procedures – crib sheet
- Inspect gloves after each task or if high loading event happens
- Anticipated hazards

## Emergencies review

- Lost comm
- EMU malfunctions
- Rescue of Incapacitated Crewmember – retreat, tethers, A/L, MCC for SCU
- Lost tools
- Lost crewmember
- DCS
- SAFER Ops

## 1<sup>st</sup> Steps today

- A/L Egress and ST config
- Thermal cover
- Translation paths

## Post EVA

- Post EVA plan

## Lessons learned from previous EVAs



# EVA 1 INHIBIT PAD

## Orbiter

ALL EVAs	
TCS ( <i>Prior to Egress</i> ) L12	1. √TCS POWER – OFF
KU-Band Antenna ( <i>Prior to Egress</i> ) MCC-H	
	1. √KU-BAND Mask – active 2. √KU-BAND EVA Protect Box – active
RCS ( <i>Prior to Egress</i> )	
	If EV crew < 27 feet from FRCS
IV O14,15,16	1. √DAP: VERN, FREE, LO Z 2. √RJDF F1, F2, F3, F4 MANF DRIVER (four) – OFF LOGIC (four) – OFF
MCC-H IV	3. √Above RCS config 4. √RCS F – ITEM 1 EXEC (*) √JET DES F1U – ITEM 17 (*) F3U – ITEM 19 (*) F2U – ITEM 21 (*)
SASA ( <i>Prior to Egress</i> ) IV	
	R1 PL AFT MNC – OFF (to remove SASA Heater Power)

## Ground

ALL EVAs	
Ground Radar ( <i>Prior to Egress</i> ) MCC-H	
	1. √TOPO console, ground radar restrictions in place for EVA

## USOS

ALL EVAs	
PCU ( <i>Prior to Egress</i> )	
<b>NOTE</b> PCUs may require up to a 1-hour warmup period before they are operational.	
MCC-H	1. √PCUs (two) operational in discharge mode and one of the following: a. CCS PCU EVA hazard control FDIR enabled. b. No more than two arrays unshunted and oriented < 105° from velocity vector. If one or both PCUs failed 2. No more than two arrays unshunted and oriented < 105° from velocity vector.
LOCATION DEPENDENT INHIBITS	
Lab Window ( <i>Prior to Egress, for crew in Payload Bay</i> ) IV	
	If EV crew less than 10 feet from window or in window FOV, close window shutter
Mobile Transporter ( <i>Prior to Egress</i> ) MCC-H	
	If EV crew < 1.5 meters from MT 1. √MT latched
S-Band (SASA) Antennas ( <i>Prior to Egress, release after SASA install on Z1</i> ) MCC-H	
	If EV crew < 3.6 feet from S1 SASA 1. P1 SASA (String 2) – Active 2. S1 SASA (String 1) – Powered down, FDIR unavailable for String 1
SASA (SASA) Z1 Location ( <i>Prior to Egress, release after SASA install on Z1</i> ) MCC-H	
	RPCM Z13B-B RPC 1 open and close command inhibited RPCM Z14B-B RPC 1 open and close command inhibited
SGANT Cable Connector ( <i>Prior to connector operations</i> ) MCC-H	
	RPCM LAD52B A RPC 8 – Open, Close Command Inhibited RPCM LA1B H RPC 4 – Open, Close Command Inhibited
NOD3 CH 1/4 Cable Connector P181 ( <i>Prior to Egress</i> ) MCC-H	
	MBSU 4 RBI 4 – Open, Close Command Inhibited
TRRJ ( <i>Prior to Egress</i> ) MCC-H	
	If EV crew working within 2 feet of S1 TRRJ rotation envelope 1. √DLA (1) – LOCKED at 0 degrees

## EVA 1 INHIBIT PAD (Cont)

### JEM

#### ALL EVAs

ICS-EF Antenna (*Prior to Egress*)

- SSIPC**
1. ICS MOD Off
  2. ICS UPC Off
  3. ICS HPA Off

#### LOCATION DEPENDENT INHIBITS (*JEM RMS EE Lube*)

JEMRMS (*Prior to Egress*)

- SSIPC** If EV crew working within vicinity (5 ft) of JEMRMS
1. RIP MA Brake – ON
  2. MDP Main Mode – Stby Mode
- or
1. JEMRMS Rack – OFF

JEMRMS EE & WVE

- SSIPC** EE Enable 1 – Off (*Prior to Egress*)  
EE Enable 2 – Off (*Prior to Egress*)
- IV** VLU EE Pwr – Off (*Prior to maneuver from POA to JEM RMS EE*)

### RSOS

#### ALL EVAs

SM Antennas (*Prior to Egress*)

- IV**
1. GTS – Deactivate
  2. ARISS (Ham Radio) – Deactivate or VHF (144-146 MHz) TX only

IMPULSE (*Prior to Egress*)

- MCC-M** 1. IMPULSE (ИПИ-100) – Is not activated

### GET-AHEADS

#### EVAs ON PMA1 OR RSOS (*APFR 5 Retrieval*)

FGB Antennas

- MCC-M** 1. √FGB KURS P [KYPC P] – Deactivated

FGB Thrusters

- MCC-M**
1. √FGB MCS unpowered
  2. √All FGB Attitude Control Thruster Valves (eighty) – closed
  3. √FGB Attitude Control Manifold Valves – closed  
КШК1, КШК2, КШК4, КШК5, КШК9, ОКО3, ОКГ3, ОКО6, ОКГ6,  
ОКО7, ОКГ7, ОКО8, ОКГ8

Nadir/Outboard PAS Deploy (PAS 3) (*Prior to Egress*)

- MCC-H** 1. RPCM S32B A RPC 13 Open, Closed Command Inhibited

Zenith/Inboard PAS Deploy (PAS 2) (*Prior to Egress*)

- MCC-H** 1. RPCM S32B A RPC 12 Open, Closed Command Inhibited

Nadir/Inboard PAS Deploy (PAS 4) (*Prior to Egress*)

- MCC-H** 1. RPCM S31A A RPC 13 Open, Closed Command Inhibited

## EVA 1 NOTES/CAUTIONS/WARNINGS

### NOTES

1. Bolt install: Report torque and turns
2. Bolt release: Report torque and turns if different from published range
3. EVA connectors: After disconnection and prior to connection; verify pin and EMI band integrity; verify connector free of FOD
4. Inspect QDs for damage prior to mating
5. Toolbox doors must be closed with one latch per door when EV crew not in immediate vicinity
6. Avoid contact with OBSS striker bars (Vitrolube coating)
7. 85-ft safety tether retract force may affect body positioning

### CAUTION

#### ISS Generic Constraints

- A. Avoid inadvertent contact with
1. Grapple fixture shafts (drylube)
  2. PIP pins
  3. Passive UMAs
  4. MBS/SSRMS/SPDM taped radiative surfaces: VDU, ACU, JEU, LEU, MCU, CRPCMs, and Cameras
  5. SPDM SJEU, EP, OTCM, LEU, and LEE VDU radiator surfaces
  6. OTSD
- B. Electrical cables
1. Avoid bend radii < 10 times cable diameter
- C. Fiber optic cables
1. Avoid bend radii < 10 times cable diameter
  2. Avoid pulling on cable during mate/demate
- D. Fluid line flex hoses and QDs
1. Avoid bend radii < 14 in for hoses with a diameter  $\geq$  1 in
  2. Additional care should be taken to not exceed bend radii when applying loads at the flexible hose to rigid tube stub interfaces
  3. Ensure fluid QD booties are fully closed prior to leaving worksite; wire tie if reqd
  4. Avoid bend radii < 5 in for hoses with diameter < 1 in on Lab, S0, S1, P1, and 10 in for hoses with diameter < 1 in on all other elements

### CAUTION

#### ISS Generic Constraints (Cont)

- E. For structural reasons
1. Avoid vigorous body motions, quick grabs and kickoffs against tether restraints
  2. Avoid performing shaking motions (sinusoidal functions) more than four cycles
- F. Other
1. ITT Cannon connector: On demated connectors, do not rotate collar or manipulate cable/connector using collar or connector tool
  2. MLI handholds are not rated for crewmember translation loads

## EVA 1 NOTES/CAUTIONS/WARNINGS (Cont)

### CAUTION

#### ISS Truss Constraints

##### A. Avoid inadvertent contact with (Cont)

1. CETA lights (Z-93 paint) [Lab,S1, Node 1]
2. Deployed TUS cable [Nadir CETA rail]
3. S0 aft face radiator
4. GPS antennas (S13 paint) [S0,JLP]
5. UHF antennas [Lab,P1]
6. ETCS radiator flexhoses and panels [S1,P1]
7. EETCS/PV radiator flexhoses, bellows and panels [P6,P4,S4,S6]
8. SASA RF group [S1,P1]
9. Heat pipe radiators [Z1]
10. PCU cathode and HCA ports [Z1]
11. Ku-Band antenna (SGANT) dish [Z1]
12. CMG cover/shells [Z1]
13. FPMU [S1]
14. SASA high & low gain antennas and radiator surfaces [Z1]
15. Deployed MISSEs

##### B. For structural reasons

1. Avoid kicking S1/P1 radiator beam.  
If any of these occur, wait 2 to 5 min to allow structural response to dissipate

### CAUTION

#### ISS Truss Constraints (Cont)

##### C. Other

1. WIS Antennas: Do not use as handholds [Node 1,Lab,P6,Z1]
2. Lubricant from Ku-Band SGANT gimbals [Z1], CMGs [Z1], and RTAS ground strap fasteners [P6,P4,S4,S6] can contaminate EMU
3. Prevent inadvertent contact of the tether shuttle with ETRS when the P3 tether shuttle stop is raised away from the rail

### CAUTION

#### ISS U.S. Pressurized Elements Constraints

##### A. Avoid inadvertent contact with

1. EVA crane [PMA1]
2. TCS reflectors [PMA2,PMA3]
3. APAS hardware [PMA2,PMA3]
4. CETA lights (Z-93 paint) [Lab,S1, Node 1]
5. UHF antennas [Lab,P1]
6. Open CBM petal covers and Lab window shutter
7. S0/Node 2 fluid tray hardlines at Node 2 end are limited to 25 lb

##### B. Other

1. WIS antennas: Do not use as handholds [Node 1,Lab,P6,Z1]
2. CBM petal covers may not be used as handholds unless both launch restraint pins are engaged

## EVA 1 NOTES/CAUTIONS/WARNINGS (Cont)

### CAUTION

#### ISS I.P. Elements Constraints

##### COL:

- A. Avoid inadvertent contact with
1. COL ARISS & AIS antennas [COL-Nadir]

##### JEM:

- A. Avoid inadvertent contact with
1. GPS antennas (S13 paint) [S0,JLP]
  2. Open JPM window shutter
  3. JTVE, WVE/EVE, JEF VE cameras
  4. JEMRMS taped radiative surfaces (JEU, End Effector, Cameras)
  5. JEM A/L target and pins
  6. JEF ORUs and EFUs (paint & lubricant)
  7. MAXI front and top panel (paint)
  8. SEDA-AP sensors (HIT, SDOM, & AOM) and MPAC & SEED
  9. Trunnions and UCMs (paint & lubricant) [JEF Payloads]
  10. RAIDS covers on end of HREP
  11. ICS-EF Ku-Band antenna dish
- B. For structural reasons
1. Avoid kicking MMOD shields between JLP and JPM
  2. Avoid tool impact on ICS-EF sensor

### CAUTION

#### Shuttle Constraints

- A. Avoid inadvertent contact with
1. OBSS and SRMS composite sections joint torque arms, grapple fixture shafts, and cable harnesses
  2. LCS (silver Teflon) and LDRI (silver Teflon) and ITVC (gold foil) [OBSS]
  3. WVS antenna [ODS truss & PLB sill]
  4. Payload bay and camera wire harnesses, cables, cable guides, and connectors
- B. No touch
1. LDRI diffuser [OBSS]
  2. OBSS saddle contacts (when OBSS unberthed) [OBSS]
  3. Monkey fur [PLB]
  4. Cameras: Metallic surfaces [PLB]
  5. Ku-Band antenna black dish and gold thermal blankets [PLB]

## EVA 1 NOTES/CAUTIONS/WARNINGS (Cont)

### WARNING

#### ISS Generic Constraints

- A. Avoid inadvertent contact with
1. Grapple fixture targets and target pins
- B. Pinch
1. NZGL connector linkage. Use caution when mating/locking
  2. ITT Cannon connector rotating housing
- C. QDs
1. If QD is in FID when valve is opened (bail fwd), QD will leak and fluid line may whip
  2. Do not rotate if in mated/valve open config
- D. Sharp Edges
1. Inner edges of WIF sockets
  2. APFR active WIF probes
  3. Mating surfaces of EVA connectors  
Avoid side loads during connector mating
  4. Back side of MMOD shield fasteners
  5. Spring loaded captive EVA fasteners (e.g., 6B-boxes, BMRRM, RTAS, SARJ Covers); the end of the spring may protrude
  6. SPDM OTCM gripper jaws
  7. Keep hands away from SSRMS LEE/POA/SPDM LEE opening, snares, and PDGF curvic coupling (teeth)
  8. MMOD strikes on ISS exterior

### WARNING

#### ISS Generic Constraints (Cont)

- E. Thermal
1. EVA connectors with booties may become hot if left uncovered. Handling may need to be limited
  2. Turn off glove heaters when comfortable temp reached to prevent bladder damage. Do not pull fingers out of gloves when heaters are on
  3. Uncovered trunnion pins may be hot
  4. SSRMS/MBS/SPDM/JEMRMS/JTVE/JEF VE operating cameras and lights may radiate large amounts of heat
  5. Do not touch EMU protective visor if temp has been < -134 degF for > 15 min
  6. No EMU boot contact with foot restraint when temp < -120 degF or > 200 degF
  7. PDGF surfaces may not meet touch temperature requirements for unlimited contact when  $\beta \leq -70$  or  $\beta \geq 70$
- F. Electrical Shock
1. Do not touch SPDM CLPA 1 electrical connector prior to camera installation

### WARNING

#### ISS Truss Constraints

- A. Avoid inadvertent contact with
1. SSU, ECU, beta gimbal platform, mast canister, SAW blanket boxes unless the beta gimbal is locked and the motor is turned off
  2. Stay inboard of SARJ when active
  3. Stay 2 ft from S1/P1 radiator beam rotational envelope when beam is free to rotate
  4. Stay 5 ft from moving MT on face 1
- B. RF radiation exposure
1. Stay 3.6 ft from S-Band (SASA) high gain Antenna when powered [S1,P1]
  2. Stay 1.3 ft from S-Band (SASA) low gain Antenna when powered [S1,P1]
  3. Stay 1 ft from UHF Antenna when powered [Lab,P1]
- C. Sharp Edges
1. Solar array blanket box [P6,S6]
  2. Fastener threads on back of Z1 U-jumper male FQD panel, if nutplate cap missing
  3. Outboard MT rail attachment lug near P6 handrail 5333 and gap spanner
  4. P2 connector on EWIS box TAA-06 [Zenith/Forward Corner 1 of P5 – SARJ at 0 deg]
  5. Nickel coated braided copper ground straps may contain frayed wires [P6,P4,S4,S6]
  6. MMOD strikes on Z1 toolboxes

## EVA 1 NOTES/CAUTIONS/WARNINGS (Cont)

### WARNING

#### ISS Truss Constraints (Cont)

##### D. Electrical Shock

1. Stay  $\geq$  2 ft from ungrounded floating connectors if powered
  - MBS cross-connect jumpers (translate past these using UMA handrails)
  - S0 EVA power cables (inside S0 Bay 00 Face 4, Bay 01 Face 3)
  - ESP-2 jumper (inside S0 Bay 03 Face 4)

##### E. Thermal

1. ELC may exceed touch temperatures when  $\beta > 75$  deg

### WARNING

#### ISS U.S. Pressurized Elements Constraints

##### A. Handrails

1. Handrails previously used for MISSE attachment may not be used as a safety tether point [A/L endcone 564 & 566, A/L Tank 2 nad/fwd & port/fwd, P6 5389]

##### B. Pinch

1. EV side of IV Hatch during Hatch operation (also snag hazard) [A/L]
2. Lab window shutter and CBM petal cover linkages during operation

##### C. RF radiation exposure

1. Stay 1 ft from UHF antenna when powered [Lab,P1]

##### D. Sharp Edges

1. PMA umbilical launch restraints-exposed bolt threads
2. Adjustable fuse tether (Fish Stringer) buckles stowed in Node bag
3. Port/Aft portion of A/L circular HR [HR 0506]
4. A/L HR 0537 (Eq Lock Zenith)

##### E. Thermal

1. PMA handrails may be hot. Handling may need to be limited
2. Stay  $\geq$  1 ft away from PMAs and MMOD shields  $> 270$  degF if EMU sun visor up; limit time to 15 min or less if  $> 300$  degF
3. Stay at least 0.5 ft away from PMA and MMOD shields  $> 325$  degF
4. No EMU TMG contact with PMAs and MMOD shields  $> 320$  degF

### WARNING

#### ISS U.S. Pressurized Elements Constraints (Cont)

##### F. Electrical Shock

1. Stay  $\geq$  2 ft from ungrounded floating connectors if powered
  - SSPTS connectors include NOD1 Stbd/Fwd HR 0130, Lab Stbd/Fwd HR 0273, PMA2 Stbd and Port

## EVA 1 NOTES/CAUTIONS/WARNINGS (Cont)

### WARNING

#### ISS I.P. Elements Constraints

##### COL:

- A. Avoid inadvertent contact with
  - 1. SOLAR [COL EPF]
- B. Thermal
  - 1. Columbus end cones may violate touch temperature constraints when  $-75 \leq \beta \leq -60$  or  $60 \leq \beta \leq 75$

##### JEM:

- A. Avoid inadvertent contact with
  - 1. ICS-EF sensors
- B. Pinch
  - 1. JPM window shutter linkages during operation
  - 2. JEM cameras (JVTEs, EVE, WVE, & JEF VEs)
  - 3. JEM EFU latching arms
  - 4. JEF SSE latch
  - 5. ICS-EF antenna boom
  - 6. SEDA-AP mast
  - 7. SMILES antenna rotating area
  - 8. HREP hinge sides and RAIDS pinch areas
  - 9. JEMRMS EE snares

### WARNING

#### ISS I.P. Elements Constraints (Cont)

##### JEM (Cont):

- C. Sharp Edges
  - 1. Interior of JEMRMS HRMs
  - 2. JEMRMS EE opening and snares
  - 3. JEM A/L hatch corners
  - 4. ICS-EF AHM gears
  - 5. MAXI visual star camera
  - 6. SMILES baffles (2), baffle base bare bolts, and cold sky terminator (CST)
  - 7. HREP baffles (4) [Star tracker aperture Zenith and three instrument baffles aft]
  - 8. PIU springs [ICS-EF, MAXI, SEDA-AP, SMILES, HREP]
- D. RF radiation exposure
  - 1. Stay 0.3 ft from fwd/aft JPM PROX antenna
- E. Thermal
  - 1. JPM port end cones and JLP port nadir may violate touch temperature constraints when  $\beta > 60$  deg
  - 2. JEMRMS/JTVE/JEFVE operating cameras and lights may radiate large amounts of heat

### WARNING

#### Shuttle Constraints

- A. Arcing/Molten Debris
  - 1. Stay  $\geq 2$  ft from exposed EFGF connector when OBSS berthed, powered, and EFGF not grappled [PLB]
  - 2. Stay  $\geq 2$  ft from exposed Stbd Fwd MPM contacts [PLB]
  - 3. Stay above PLB sill when within 1 ft of powered ROEU connector [PLB]
- B. Pinch
  - 1. PRLA operation [PLB]
- C. RF radiation exposure
  - 1. Stay 3.28 ft from S-Band Antenna when powered
  - 2. Stay 1 ft from top and side of UHF PLB Antenna radome surface when in high powered mode [ODS truss]
  - 3. Stay 0.33 ft from top and side of UHF PLB Antenna radome surface when in low powered mode [ODS truss]
  - 4. Remain below the level of the PLB door mold line for first 20 in Aft of Fwd bulkhead when S-Band Antenna powered [PLB]
  - 5. Remain on the inboard side of the Stbd slidewire (sill handrails if slidewire not installed) for first 20 ft Aft of Fwd bulkhead when Ku-Band Antenna powered [PLB]



## EVA 1 NOTES/CAUTIONS/WARNINGS (Cont)

### WARNING

#### **Shuttle Constraints (Cont)**

##### D. Sharp Edges

1. PRLA grounding wipers [PLB]
2. LDRI baffles (also an entrapment hazard) [OBSS]
3. Keep hands away from SRMS EE opening and snares
4. TCS connector backshells have exposed threads [ODS]

##### E. Thermal

1. Illuminated PLB lights; do not touch
2. OBSS grapple fixture shafts/cams may be hot. Limit handling if required
3. Stay 27 ft from PRCS when powered
4. Stay 3 ft from VRCS when powered
5. Stay 3 ft from APU when operating

##### F. Contamination

1. Stay out of the immediate vicinity of leaking jet or APU

##### G. Lasers

1. Do not look at LDRI diffuser or LCS laser aperture window

## EVA 1 EGRESS/SETUP (00:30)

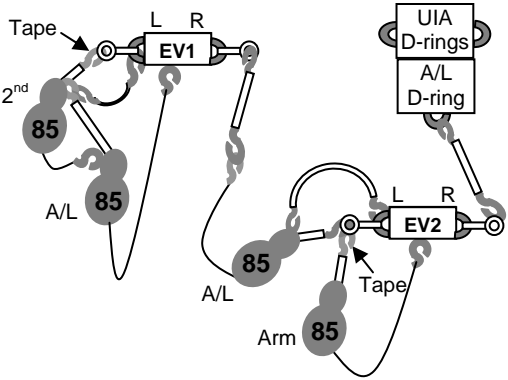
IV/SSRMS	EV1	EV2
 <p>The diagram illustrates the initial configuration for EV1 and EV2. EV1 is connected to the IV/SSRMS via a Tape and A/L 85-ft ST. EV2 is connected via a Tape and A/L 85-ft ST. Various tethers (R, L) and anchors (2nd 85-ft ST, MWS) are shown. Labels include Tape, 2nd, A/L, 85, L, R, EV1, EV2, Arm, and UIA D-rings.</p> <ol style="list-style-type: none"> <li>1. Start Hatch Thermal Cover clock PET (30 min) ___ : ___</li> <li>2. Stop Hatch Thermal Cover clock PET (30 min) ___ : ___</li> <li>3. Post crew egress: WVS Software: Select page – RF camera Sel 'Advanced Controls' S-Band Level (two) – Max</li> </ol>	<p><b>Initial Configuration:</b></p> <ol style="list-style-type: none"> <li>1. <input checked="" type="checkbox"/> All gates closed &amp; hooks locked <ul style="list-style-type: none"> <li><input type="checkbox"/> R Waist Tether to EV2 A/L 85-ft ST anchor</li> <li><input type="checkbox"/> A/L 85-ft ST LAS to 2<sup>nd</sup> ST reel</li> <li><input type="checkbox"/> A/L 85-ft ST anchor to MWS</li> <li><input type="checkbox"/> L Waist Tether to 2<sup>nd</sup> 85-ft ST reel</li> <li><input type="checkbox"/> 2<sup>nd</sup> 85-ft ST LAS to L D-ring extender</li> <li><input type="checkbox"/> 2<sup>nd</sup> 85-ft ST anchor to A/L 85-ft ST reel</li> </ul> </li> </ol> <p><u>EGRESS/SETUP</u> (00:30)</p> <ol style="list-style-type: none"> <li>2. ← Open hatch thermal cover</li> <li>3. Egress A/L</li> <li>4. Anchor EV1 A/L 85-ft ST to fwd external D-ring <ul style="list-style-type: none"> <li><input type="checkbox"/> <input checked="" type="checkbox"/> Gate closed, hook locked, reel unlocked</li> </ul> </li> <li>5. Anchor EV2 A/L 85-ft ST to aft external D-ring <ul style="list-style-type: none"> <li><input type="checkbox"/> <input checked="" type="checkbox"/> Gate closed, hook locked, reel unlocked</li> </ul> </li> <li>6. <b>Give EV2 GO</b> to release Waist Tether from A/L internal D-ring</li> <li>7. Adj Tether temp stow NOD1 Crewlock bag on A/L port toolbox door HR _____</li> <li>8. RET, receive Lube Crewlock Bag from EV2</li> <li>9. Verify SAFER config <ul style="list-style-type: none"> <li><input type="checkbox"/> <input checked="" type="checkbox"/> L handle down (MAN ISOL Vlv – Open)</li> <li><input type="checkbox"/> <input checked="" type="checkbox"/> R handle down, door closed (HCM – Closed)</li> </ul> </li> <li>10. <input checked="" type="checkbox"/> WVS – green LED</li> <li>11. Perform translation adaptation</li> <li>12. Fairlead on A/L HR 0554 _____</li> <li>13. Stow Lube Crewlock Bag on stbd/aft HR of zenith HPGT _____</li> </ol> <p>(Translate to Node 2)</p>	<p><b>Initial Configuration:</b></p> <ol style="list-style-type: none"> <li>1. <input checked="" type="checkbox"/> All gates closed &amp; hooks locked <ul style="list-style-type: none"> <li><input type="checkbox"/> R Waist Tether to A/L internal D-ring extender</li> <li><input type="checkbox"/> A/L 85-ft ST LAS to L D-ring extender</li> <li><input type="checkbox"/> A/L 85-ft ST anchor to EV1 R Waist Tether</li> <li><input type="checkbox"/> L Waist Tether to A/L 85-ft ST reel</li> <li><input type="checkbox"/> Arm 85-ft ST LAS to L D-ring extender</li> <li><input type="checkbox"/> Arm 85-ft ST anchor to MWS</li> </ul> </li> </ol> <p><u>EGRESS/SETUP</u> (00:30)</p> <ol style="list-style-type: none"> <li>2. <b>On EV1 GO</b> release Waist Tether from A/L internal D-ring</li> <li>3. Transfer NOD1 Crewlock Bag to EV1</li> <li>4. Transfer Lube Crewlock Bag to EV1</li> <li>5. Egress A/L</li> <li>6. Verify SAFER config <ul style="list-style-type: none"> <li><input type="checkbox"/> <input checked="" type="checkbox"/> L handle down (MAN ISOL Vlv – Open)</li> <li><input type="checkbox"/> <input checked="" type="checkbox"/> R handle down, door closed (HCM – Closed)</li> </ul> </li> <li>7. <input checked="" type="checkbox"/> WVS – green LED</li> <li>8. ← Close hatch thermal cover</li> <li>9. Perform translation adaptation</li> </ol> <p>(Translate aft/over A/L to S1 zenith, fairlead along CETA spur)</p>



## SPARE SASA INSTALL (02:45)

IV/SSRMS	EV1	EV2
<p>1. <input checked="" type="checkbox"/> <b>MCC-H</b> – SASA inhibits in place  <input type="checkbox"/> ISS  <input type="checkbox"/> Shuttle</p> <p>Planned PET 0:30</p> <p>2. EV2 A/L ST LAS _____</p> <p>3. <b>SSRMS:</b> Maneuver from S1 to PLB (00:30)</p>	<div style="border: 1px solid black; padding: 5px; text-align: center;"> <p><b>CAUTION</b>  High gain antenna, low gain antenna and radiator surfaces are sensitive to contact</p> </div> <p><u>RELEASE SPARE SASA (01:30)</u></p> <ol style="list-style-type: none"> <li>1. Translate to Node 2</li> <li>2. Attach A/L tether on Lab HR 0264 _____  <input type="checkbox"/> <input checked="" type="checkbox"/> Gate closed, hook locked, reel unlocked</li> <li>3. Translate to Orbiter port TSA</li> <li>4. RET, retrieve ERAD (not with PIP pin RET)</li> <li>5. Close port TSA  <input type="checkbox"/></li> <li>6. BRT to SASA FSE fwd HR</li> <li>7. Configure PGT  <input type="checkbox"/> <b>[B7, CCW3, 30.5]</b>, ERAD + 2" ext 7/16"</li> <li>8. Release fwd launch restraints (2), expect 12 turns at bolt  <input type="checkbox"/><input type="checkbox"/></li> <li>9. BRT to SASA FSE aft HR</li> <li>10. Release aft launch restraints (2), expect 12 turns at bolt  <input type="checkbox"/><input type="checkbox"/></li> <li>11. Configure PGT – remove ERAD  <input type="checkbox"/> <b>[B7, CCW2, 30.5]</b>, 2" ext 7/16"</li> <li>12. Break torque on mast bolts (2), 1 turn  <input type="checkbox"/><input type="checkbox"/></li> <li>13. Stow ERAD in port TSA, <input checked="" type="checkbox"/> Velcro secure</li> <li>14. Close port TSA  <input type="checkbox"/><input type="checkbox"/><input type="checkbox"/><input type="checkbox"/></li> <li>15. Remove caps from SASA, temp stow  <input type="checkbox"/> P3  <input type="checkbox"/> P4</li> </ol>	<div style="border: 1px solid black; padding: 5px; text-align: center;"> <p><b>CAUTION</b>  High gain antenna, low gain antenna and radiator surfaces are sensitive to contact</p> </div> <p><u>SSRMS SETUP/INGRESS ON S1 (00:50)</u></p> <ol style="list-style-type: none"> <li>1. Translate aft/over A/L to S1 zenith, fairlead along CETA spur</li> <li>2. RET, retrieve APFR from S1 WIF 1 (near SASA)</li> <li>3. Translate to S1 bay 11 (Y<sub>0</sub> 6273)</li> <li>4. GCA SSRMS as required for setup</li> <li>5. Install WIF Adapter into SSRMS PFR socket with tether point toward LEE (PIP pin required; not hitch pin)</li> <li>6. Install APFR in WIF Adapter <b>[12, PP, F, 6]</b>  <input type="checkbox"/> <input checked="" type="checkbox"/> Locking collar black-on-black, pull test</li> <li>7. Safety Tether swap to SSRMS LEE handrail (black end)  <input type="checkbox"/> <input checked="" type="checkbox"/> Gate closed, hook locked, reel unlocked</li> <li>8. Attach A/L tether on S1 HR 3247</li> <li>9. GCA SSRMS as required for ingress</li> <li>10. Ingress SSRMS APFR; attach Waist Tether to APFR boot plate</li> <li>11. <b>Give SSRMS GO</b> for maneuver to payload bay (00:30)</li> </ol>

**SPARE SASA INSTALL (02:45) (Cont)**

IV/SSRMS	EV1	EV2									
<p>4. Record SASA bolt data:</p> <table border="1" data-bbox="109 391 617 488"> <thead> <tr> <th>Bolt</th> <th>Turns</th> <th>Torque (ft-lb)</th> </tr> </thead> <tbody> <tr> <td>Zenith</td> <td>(8)</td> <td>N/A</td> </tr> <tr> <td>Nadir</td> <td>(8)</td> <td>N/A</td> </tr> </tbody> </table> <p>5. <b>SSRMS:</b> Maneuver from PLB to Z1 (00:45)</p> <p>6. EV1 Tool Inventory:  <input type="checkbox"/> SASA Caps  <input type="checkbox"/> PGT + 2" socket  <input type="checkbox"/> SGANT bundles (2)  <input type="checkbox"/> Ingress Aids (2)</p>	Bolt	Turns	Torque (ft-lb)	Zenith	(8)	N/A	Nadir	(8)	N/A	<p>16. ← <b>On EV2 GO</b>, release mast bolts (2), expect 8 turns  <input type="checkbox"/><input type="checkbox"/></p> <p>17. Assist EV2 with SASA removal from FSE</p> <p><u>RETRIEVE AIA &amp; SGANT CABLE FROM TSA (00:45)</u>            18. Open stbd TSA (4 latches)            19. RET SGANT cables and lasso around BRT (cable first, then bracket; use MWS EE to restrain)            20. RET both Ingress Aids and stow in MWS            21. Close stbd TSA  <input type="checkbox"/><input type="checkbox"/><input type="checkbox"/><input type="checkbox"/>            22. ← Tool inventory            23. <b>Glove check, Payload Bay check</b>            24. Pick up A/L tether; attach to 2<sup>nd</sup> reel  <input type="checkbox"/> √Gate closed, hook locked, reel unlocked            25. Translate to stbd CETA Cart, stow one Ingress Aid with adj tether onto grid E            26. Translate to A/L WIF 10, install 2<sup>nd</sup> Ingress Aid onto APFR  <input type="checkbox"/> √Locking collar black-on-black, pull test            27. Temp stow SGANT bracket bundle on top of Z1, HR 6053 _____            28. Temp stow SGANT Y-cable bundle at Z1 base HR 6006 _____</p> <p><u>INSTALL SPARE SASA ON Z1 (00:30)</u></p> <div style="border: 1px solid black; padding: 5px; text-align: center;"> <p><b>CAUTION</b>              Avoid contact with S0 and Z1 radiators              Avoid inadvertent PLSS contact with HPGT</p> </div>	<p><u>SPARE SASA RETRIEVAL IN PLB (00:10)</u>            12. GCA SSRMS as required for SASA retrieval            13. RET to SASA            14. Hold SASA for release from sidewall carrier            15. <b>Give EV1 GO</b> to release SASA</p> <p>16. Remove SASA from FSE            17. GCA SSRMS as required for maneuver from payload bay            18. <b>Give SSRMS GO</b> for maneuver to Z1 (00:45)</p> <p>19. Rotate SASA to hand off with stanchion toward EV1</p> <p><u>INSTALL SPARE SASA ON Z1 (00:30)</u></p>
Bolt	Turns	Torque (ft-lb)									
Zenith	(8)	N/A									
Nadir	(8)	N/A									

**SPARE SASA INSTALL (02:45) (Cont)**

IV/SSRMS	EV1	EV2									
<p>7. Record SASA bolt data:</p> <table border="1" data-bbox="109 760 615 857"> <thead> <tr> <th>Bolt</th> <th>Turns</th> <th>Torque (ft-lb)</th> </tr> </thead> <tbody> <tr> <td>Zenith</td> <td>(8)</td> <td>(9.2)</td> </tr> <tr> <td>Nadir</td> <td>(8)</td> <td>(9.2)</td> </tr> </tbody> </table> <p>8. <b>IV:</b> Notify MCC-H SASA connections complete</p> <p>9.  WVS close-out video</p> <p>10. <b>SSRMS:</b> Maneuver to POA (00:20)</p>	Bolt	Turns	Torque (ft-lb)	Zenith	(8)	(9.2)	Nadir	(8)	(9.2)	<p>29. Release SASA cabling from TA clamp (connector end); close clamp</p> <p>30. Disconnect connectors from Z1 dummy panel; temp stow  <input checked="" type="checkbox"/> Good pins &amp; EMI band, no FOD  <input type="checkbox"/> P3  <input type="checkbox"/> P4</p> <p>31. Install SASA caps onto Z1 dummy panel  <input type="checkbox"/> P3  <input type="checkbox"/> P4</p> <p>32. <b>Get-ahead:</b> SGANT Cable Install</p> <p>33. Mate Z1 cables to SASA connectors  <input type="checkbox"/> J3/P3  <input type="checkbox"/> J4/P4</p> <p>34. Maneuver SASA into soft dock</p> <p>35. Configure PGT  <input type="checkbox"/> [A7, CW2, 30.5], 2" ext 7/16"</p> <p>36. ← Drive nadir mast bolt, stop at 4 turns</p> <p>37. ← Drive zenith mast bolt to torque, expect 8 turns</p> <p>38. ← Drive nadir mast bolt to torque, expect 4 turns</p> <p>39. <b>Give MCC-H GO</b> for SASA powerup</p> <p>40.  WVS close-out video</p> <p>41. <b>Glove check</b></p> <p>(Retrieve SGANT cables and translate to Z1 zenith)</p>	<p>20. GCA SSRMS as required for SASA handoff</p> <p>21. Hold SASA in position for EV1 to connect cables</p> <p>22. Assist EV1 with SASA install</p> <p>23. Retrieve RET from SASA</p> <p>24. Take photos of A/L HR 0537</p> <p>25. GCA SSRMS and RET, retrieve Lube Crewlock Bag</p> <p>26. <b>Give SSRMS GO</b> for maneuver to POA Lube (00:20)</p> <p>27. <b>Glove check</b></p> <p>28. Adjust MWS T-bar down as required to provide workspace</p> <p>29. Configure holster and crewlock bag for use</p>
Bolt	Turns	Torque (ft-lb)									
Zenith	(8)	(9.2)									
Nadir	(8)	(9.2)									

## POA LUBE (01:15)

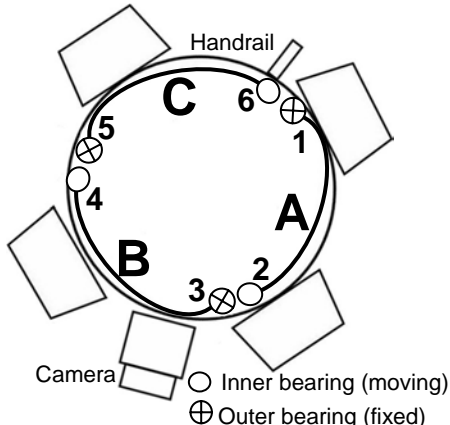
IV/SSRMS	EV2
<p>1. <b>SSRMS:</b> Fully open POA snares</p> <p>Planned PET 3:15</p>  <p>The diagram shows a circular POA snare mechanism with six bearings labeled 1 through 6. Bearings 1 and 6 are at the 2 o'clock position, 2 and 3 at 5 o'clock, 3 and 4 at 10 o'clock, and 4 and 5 at 10 o'clock. A handrail is at the top, and a camera is at the bottom. A legend indicates that a circle with a cross represents an inner bearing (moving) and a circle with a dot represents an outer bearing (fixed).</p>	<p><b>POA LUBE SETUP (00:15)</b></p> <div style="border: 2px solid black; padding: 5px; text-align: center;"> <p><b>WARNING</b></p> <p>Avoid touching curvic coupling, grounding springs, snares, and internal mechanisms with gloved hand</p> </div> <div style="border: 1px solid black; padding: 5px; text-align: center;"> <p><b>CAUTION</b></p> <p>Avoid contact with grounding springs, cable-return springs, latch covers, shrouds, and camera</p> <p>When exercising bearing, do not extend cable-return spring more than 90 deg (rod end perpendicular to housing)</p> </div> <p style="text-align: center;"><b>NOTE</b></p> <p>Grease should not extend more than 1/4 inch from bearing</p> <ol style="list-style-type: none"> <li>1. GCA SSRMS as required for POA lubrication</li> <li>2. Verify camera &amp; handrail orientation</li> <li>3. <input checked="" type="checkbox"/> Take photos of POA <ul style="list-style-type: none"> <li><input type="checkbox"/> Overall view of POA</li> <li><input type="checkbox"/> Bearings 1 &amp; 6 (2 o'clock)</li> <li><input type="checkbox"/> Bearings 2 &amp; 3 (5 o'clock)</li> <li><input type="checkbox"/> Bearings 4 &amp; 5 (10 o'clock)</li> </ul> </li> <li>4. Stow camera</li> </ol> <p><b>POA SNARE LUBE (00:45)</b></p> <ol style="list-style-type: none"> <li>5. ✓ Snares fully open</li> <li>6. Prep grease gun: Engage teeth by rotating plunger (black triangle UP)</li> <li>7. Remove MLI tip cover and stow</li> <li>8. Aim tip away from hardware</li> <li>9. Open shutoff knob (FLOW ⇒ nozzle)</li> <li>10. Apply grease to all bearings (6) in any order <ul style="list-style-type: none"> <li>Use box pattern, apply to innermost side of bearing first</li> <li><input type="checkbox"/> 1 (2 o'clock outer)</li> <li><input type="checkbox"/> 2 (5 o'clock inner)</li> <li><input type="checkbox"/> 3 (5 o'clock outer)</li> <li><input type="checkbox"/> 4 (10 o'clock inner)</li> <li><input type="checkbox"/> 5 (10 o'clock outer)</li> <li><input type="checkbox"/> 6 (2 o'clock inner)</li> </ul> </li> </ol>

POA LUBE (01:15) (Cont)

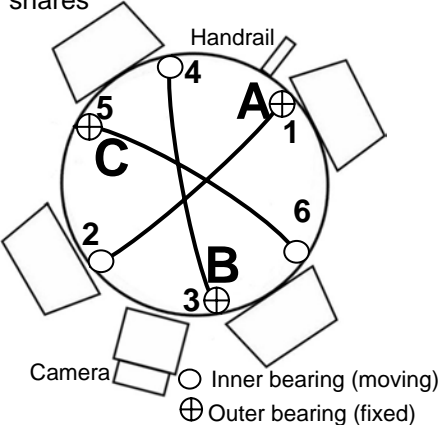
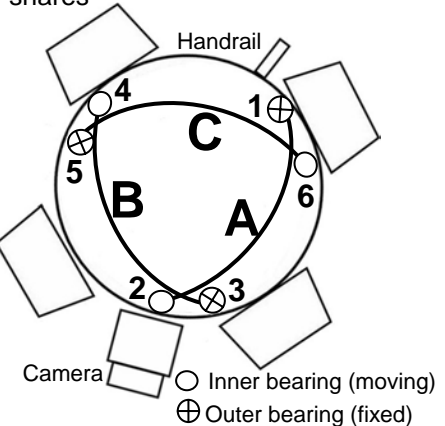
IV/SSRMS	EV2
<p>2. <b>SSRMS: On EV2 GO</b>, fully close snares</p>  <p>3. <b>SSRMS: On EV2 GO</b>, partially open snares</p> 	<p>11. ✓ Worksite clear and <b>give SSRMS GO</b> to fully close snares</p> <p>12. Apply grease to rod end &amp; fork interface of all bearings (6) in any order</p> <ul style="list-style-type: none"> <li><input type="checkbox"/> 1 (2 o'clock outer)</li> <li><input type="checkbox"/> 2 (8 o'clock inner)</li> <li><input type="checkbox"/> 3 (5 o'clock outer)</li> <li><input type="checkbox"/> 4 (11 o'clock inner)</li> <li><input type="checkbox"/> 5 (10 o'clock outer)</li> <li><input type="checkbox"/> 6 (4 o'clock inner)</li> </ul> <p>13. Disengage teeth by rotating plunger (black triangle DOWN)</p> <p>14. Close shutoff knob (FLOW ↑ nozzle)</p> <p>15. Install MLI tip cover</p> <p>16. Stow grease gun in holster</p> <p>17. ✓ Worksite clear and <b>give SSRMS GO</b> to partially open snares (inner bearings within cam cutouts)</p> <p style="text-align: center;"><u>NOTE</u></p> <p style="text-align: center;">If bearings overshoot cam cutouts, use gap gauge to expose the snares</p> <p>18. Exercise all bearings (6) in any order Bring rod end to 90 deg with needle nose pliers and exercise bearing in x axis (in/out of EE) (1 min/40 cycles) Report bearing mobility to <b>MCC-H</b></p> <ul style="list-style-type: none"> <li><input type="checkbox"/> 1 (2 o'clock outer)</li> <li><input type="checkbox"/> 2 (7 o'clock inner)</li> <li><input type="checkbox"/> 3 (5 o'clock outer)</li> <li><input type="checkbox"/> 4 (11 o'clock inner)</li> <li><input type="checkbox"/> 5 (10 o'clock outer)</li> <li><input type="checkbox"/> 6 (3 o'clock inner)</li> </ul> <p>19. Pack grease using gap gauge as required</p>

**POA LUBE (01:15) (Cont)**

<b>IV/SSRMS</b>	<b>EV2</b>
<p>4. <b>SSRMS: On EV2 GO</b>, snare checkout</p> <p>5. <b>IV/MCC-H:</b> Receive EV2 snare report</p> <p>6. <b>IV:</b> Turn JEM RMS lights off: J1: JEM RMS VLU EE Pwr – Off</p> <p>7. <b>SSRMS:</b> Maneuver to JEM RMS EE (00:10)</p>	<p><u>POA LUBE CLEANUP (00:15)</u></p> <p>20. ✓ Worksite clear and <b>give SSRMS GO</b> for snare checkout (close and open snares)</p> <p>21. Clean tools as necessary with EVA wipe</p> <p>22. Report to <b>IV/MCC-H:</b> Snare condition (in or out of groove)</p> <p>23. <input checked="" type="checkbox"/> Take photos of POA  <input type="checkbox"/> Overall view of POA  <input type="checkbox"/> Bearings 1 &amp; 6 (5 o'clock)  <input type="checkbox"/> Bearings 2 &amp; 3 (10 o'clock)  <input type="checkbox"/> Bearings 4 &amp; 5 (2 o'clock)</p> <p>24. Stow camera</p> <p>25. ✓ Tools and tethers clear from POA</p> <p>26. <b>Give SSRMS GO</b> for maneuver to JEM RMS EE Lube</p> <p>27. <b>Glove check</b></p>



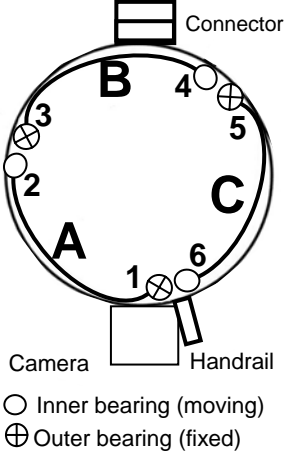

## JEM RMS EE LUBE (01:15)

IV/SSRMS	EV2
<p>1. <b>JEM RMS:</b> Fully open JEM RMS EE snares</p> <p>Planned PET 4:30</p>  <p>Connector</p> <p>Camera Handrail</p> <p>○ Inner bearing (moving) ⊕ Outer bearing (fixed)</p>	<p><u>JEM RMS EE LUBE SETUP (00:15)</u></p> <div style="border: 3px double black; padding: 5px; text-align: center;"> <p><u>WARNING</u></p> <p>Avoid touching snares and internal mechanisms with gloved hand. Keep away from JEM RMS MA EE camera</p> </div> <div style="border: 1px solid black; padding: 5px; text-align: center; margin-top: 10px;"> <p><u>CAUTION</u></p> <p>Avoid contact with cable-return springs, SPEE cover, EE exterior silver Teflon coating, and camera When exercising bearing, do not extend cable-return spring more than 90 deg (rod end perpendicular to housing)</p> </div> <p style="text-align: center;"><u>NOTE</u></p> <p style="text-align: center;">Grease should not extend more than 1/4 inch from bearing</p> <ol style="list-style-type: none"> <li>1. GCA SSRMS as required for JEM RMS EE lubrication</li> <li>2. Verify camera &amp; handrail orientation</li> <li>3.  Take photos of EE             <ul style="list-style-type: none"> <li><input type="checkbox"/> Overall view of JEM RMS EE</li> <li><input type="checkbox"/> Bearings 1 &amp; 6 (5 o'clock)</li> <li><input type="checkbox"/> Bearings 2 &amp; 3 (10 o'clock)</li> <li><input type="checkbox"/> Bearings 4 &amp; 5 (2 o'clock)</li> </ul> </li> <li>4. Stow camera</li> </ol> <p><u>JEM RMS EE SNARE LUBE (00:45)</u></p> <ol style="list-style-type: none"> <li>5. ✓ Snares fully open</li> <li>6. Prep grease gun: Engage teeth by rotating plunger (black triangle UP)</li> <li>7. Remove MLI tip cover and stow</li> <li>8. Aim tip away from hardware</li> <li>9. Open shutoff knob (FLOW ⇒ nozzle)</li> <li>10. Apply grease to all bearings (6) in any order Use box pattern, apply to innermost side of bearing first             <ul style="list-style-type: none"> <li><input type="checkbox"/> 1 (5 o'clock outer)</li> <li><input type="checkbox"/> 2 (10 o'clock inner)</li> <li><input type="checkbox"/> 3 (10 o'clock outer)</li> <li><input type="checkbox"/> 4 (2 o'clock inner)</li> <li><input type="checkbox"/> 5 (2 o'clock outer)</li> <li><input type="checkbox"/> 6 (5 o'clock inner)</li> </ul> </li> </ol>

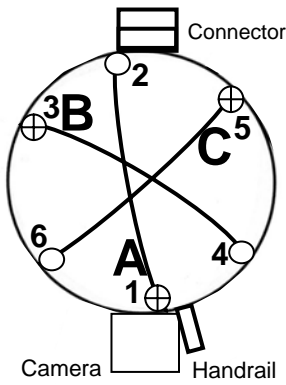
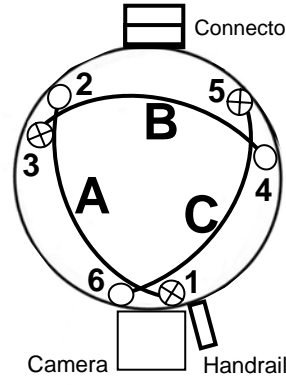
## JEM RMS EE LUBE (01:15) (Cont)

IV/SSRMS	EV2
<p>2. <b>JEM RMS: On EV2 GO</b>, fully close snares</p> <p>3. <b>JEM RMS: Give EV2 GO</b> to continue</p>  <p>○ Inner bearing (moving) ⊕ Outer bearing (fixed)</p>	<p>11. ✓ Worksite clear and <b>give JEM RMS GO</b> to fully close snares</p> <p>12. <b>On JEM RMS GO</b> Apply grease to rod end &amp; fork interface of all bearings (6) in any order</p> <ul style="list-style-type: none"> <li><input type="checkbox"/> 1 (6 o'clock outer)</li> <li><input type="checkbox"/> 2 (12 o'clock inner)</li> <li><input type="checkbox"/> 3 (10 o'clock outer)</li> <li><input type="checkbox"/> 4 (4 o'clock inner)</li> <li><input type="checkbox"/> 5 (2 o'clock outer)</li> <li><input type="checkbox"/> 6 (8 o'clock inner)</li> </ul> <p>13. Disengage teeth by rotating plunger (black triangle DOWN)</p> <p>14. Close shutoff knob (FLOW ↑ nozzle)</p> <p>15. Install MLI tip cover</p> <p>16. Stow grease gun in holster</p> <p>17. ✓ Worksite clear and <b>give JEM RMS GO</b> to partially open snares (inner bearings within cam cutouts)</p> <p style="text-align: center;"><u>NOTE</u></p> <p style="text-align: center;">If bearings overshoot cam cutouts, use gap gauge to expose the snares</p>
<p>4. <b>JEM RMS: On EV2 GO</b>, partially open snares</p> <p>5. <b>JEM RMS: Give EV2 GO</b> to continue</p>  <p>○ Inner bearing (moving) ⊕ Outer bearing (fixed)</p>	<p>18. <b>On JEM RMS GO</b>, Exercise all bearings (6) in any order Bring rod end to 90 deg with needle nose pliers and exercise bearing in x axis (in/out of EE) (1 min/40 cycles) Report bearing mobility to <b>MCC-H</b></p> <ul style="list-style-type: none"> <li><input type="checkbox"/> 1 (6 o'clock outer)</li> <li><input type="checkbox"/> 2 (10 o'clock inner)</li> <li><input type="checkbox"/> 3 (10 o'clock outer)</li> <li><input type="checkbox"/> 4 (2 o'clock inner)</li> <li><input type="checkbox"/> 5 (2 o'clock outer)</li> <li><input type="checkbox"/> 6 (6 o'clock inner)</li> </ul> <p>19. Pack grease using gap gauge as required</p>

## JEM RMS EE LUBE (01:15) (Cont)

IV/SSRMS	EV2
<p>6. <b>JEM RMS: On EV2 GO</b>, snare checkout</p> <p>7. <b>IV:</b> Receive EV2 snare checkout video</p> <p>8. <b>IV/MCC-H:</b> Receive EV2 snare report</p> <p>EV2 Tool Inventory:</p> <ul style="list-style-type: none"> <li><input type="checkbox"/> Adj Equip Tether <ul style="list-style-type: none"> <li><input type="checkbox"/> <b>Crewlock Bag (Lube Bag)</b> <ul style="list-style-type: none"> <li><input type="checkbox"/> EVA Gap Gauge (on int RET)</li> <li><input type="checkbox"/> Taped Needle-Nose Pliers (on int RET)</li> <li><input type="checkbox"/> RET (sm-sm) <ul style="list-style-type: none"> <li><input type="checkbox"/> Grease Gun (in wipe) <ul style="list-style-type: none"> <li><input type="checkbox"/> EVA Wipe (dry) (on int RET) <ul style="list-style-type: none"> <li><input type="checkbox"/> Wire Tie (on int RET) (to hold wipe around grease gun)</li> </ul> </li> </ul> </li> </ul> </li> <li><input type="checkbox"/> EVA Wipe (dry) (on int RET)</li> <li><input type="checkbox"/> RET (sm-sm) <ul style="list-style-type: none"> <li><input type="checkbox"/> EVA Wipe (dry)</li> </ul> </li> </ul> </li> <li><input type="checkbox"/> Camera</li> </ul> </li> </ul> <p>9. <b>SSRMS:</b> Maneuver to S1 Egress position (00:10)</p>	<p><b>JEM RMS EE LUBE CLEANUP (00:15)</b></p> <p>20. ✓ Worksite clear and <b>give JEM RMS GO</b> for snare checkout (close and open snares)</p> <p>21.  WVS of snare checkout</p> <p>22. Report to IV/<b>MCC-H:</b> Snare condition (in or out of groove)</p> <p>23.  Take photos of JEM RMS EE <ul style="list-style-type: none"> <li><input type="checkbox"/> Overall view of JEM RMS EE</li> <li><input type="checkbox"/> Bearings 1 &amp; 6 (5 o'clock)</li> <li><input type="checkbox"/> Bearings 2 &amp; 3 (10 o'clock)</li> <li><input type="checkbox"/> Bearings 4 &amp; 5 (2 o'clock)</li> </ul> </p> <p>24. Stow camera</p> <p>25. Clean tools as necessary with EVA wipe</p> <p>26. Place EVA wipe over end of grease gun and secure with wire tie</p> <p>27. Stow grease gun in Crewlock Bag</p> <p>28. ⇐ Tool inventory</p> <p>29. ✓ Tools and tethers clear from JEM RMS</p> <p>30. <b>Give SSRMS GO</b> for maneuver to Egress position</p> <p>31. <b>Glove check</b></p>



## SGANT CABLE INSTALL (00:50)

IV/SSRMS	EV1
<p>Planned PET 3:15</p> <p>1. <input checked="" type="checkbox"/> <b>MCC-H</b> – SGANT inhibits in place (ISS UHF radios off – potential loss of comm)</p> <p>2. <b>IV:</b> Notify MCC-H SGANT connections complete</p> <p>3. <b>IV:</b> <input type="checkbox"/> WVS close-out video</p> <p>4. <b>IV:</b> <input type="checkbox"/> WVS close-out video</p>	<div style="border: 1px solid black; padding: 5px; margin-bottom: 10px; text-align: center;"> <p><b>CAUTION</b> Avoid contact with S0 and Z1 radiators</p> </div> <p style="text-align: center;"><u>NOTE</u> Do not remove connector caps on unmated connectors</p> <p><u>INSTALL SGANT CABLES (00:50)</u></p> <ol style="list-style-type: none"> <li>1. Retrieve SGANT cables and translate to Z1 zenith</li> <li>2. Wire tie connector panel to HR 6053</li> <li>3. Wire tie free end of cable bundle to HR 6054</li> <li>4. Translate to Rats' Nest</li> <li>5. ← Demate Lab P212 from J212</li> <li>6. RET to caps and remove</li> <li>7. Stow caps in trash bag (2)</li> <li>8. Mate cable connectors:               <ul style="list-style-type: none"> <li><input checked="" type="checkbox"/> Good pins &amp; EMI band, no FOD</li> <li><input type="checkbox"/> Lab P212A to Lab J212</li> <li><input type="checkbox"/> Lab J212A to Lab P212</li> </ul> </li> <li>9. <input type="checkbox"/> WVS close-out video</li> <li>10. Route cable and secure with wire ties:               <ul style="list-style-type: none"> <li><input type="checkbox"/> HR 6006</li> <li><input type="checkbox"/> HR 6017</li> <li><input type="checkbox"/> HR 6024</li> <li><input type="checkbox"/> HR 6031 (optional)</li> <li><input type="checkbox"/> HR 6039</li> </ul> </li> <li>11. Wire tie free end of cable on HR 6052</li> <li>12. RET, retrieve Velcro strap; stow in trash bag</li> <li>13. <input type="checkbox"/> WVS close-out video</li> <li>14. <b>Glove check</b></li> </ol>

## INSTALL NODE 1 NH3 BRACKET (00:40)

IV/SSRMS	EV1									
<p>Planned PET 4:05</p> <p>1. Record Node 1 NH3 bracket bolt data</p> <table border="1" data-bbox="109 789 596 886"> <thead> <tr> <th>Bolt</th> <th>Turns</th> <th>Torque (ft-lb)</th> </tr> </thead> <tbody> <tr> <td>Fwd</td> <td>(11)</td> <td>(2.5)</td> </tr> <tr> <td>Aft</td> <td>(11)</td> <td>(2.5)</td> </tr> </tbody> </table>	Bolt	Turns	Torque (ft-lb)	Fwd	(11)	(2.5)	Aft	(11)	(2.5)	<p><u>INSTALL NODE 1 NH3 BRACKET (00:40)</u></p> <ol style="list-style-type: none"> <li>1. Translate to Stbd A/L Toolbox</li> <li>2. RET, retrieve NOD1 Crewlock Bag</li> <li>3. Translate to Node 1 HR 0128, temp stow Crewlock Bag on HR 0128</li> <li>4. BRT to Node 1 HR 0128</li> <li>5. Crewlock Bag internal RET HR 0111</li> <li>6. Configure PGT               <ul style="list-style-type: none"> <li>☐ [A2, CCW2, 30.5], 2" ext 7/16"</li> </ul> </li> <li>7. Release HR 0111 bolts (2), in any order, expect 8 turns</li> <li>8. Depress buttons to release soft dock (2)</li> <li>9. Remove HR 0111 and temp stow</li> <li>10. Retrieve NH3 bracket</li> <li>11. Depress buttons to extend feet (2)</li> <li>12. Install NH3 bracket from ISS forward to aft (M3 oriented ISS forward)               <ul style="list-style-type: none"> <li>√RET clear for removal</li> </ul> </li> <li>13. Configure PGT               <ul style="list-style-type: none"> <li>☐ [A1, CW2, 30.5], 2" ext 7/16"</li> </ul> </li> <li>14. Drive NH3 bracket bolts (2), in any order to torque; expect 11 turns</li> <li>15. Scorch HR 0111 on Crewlock Bag</li> <li>16. <b>Glove check</b></li> </ol>
Bolt	Turns	Torque (ft-lb)								
Fwd	(11)	(2.5)								
Aft	(11)	(2.5)								

## NOD1 FGB LAN CABLE/MMOD SHIELD (00:45)

IV/SSRMS	EV1
<p>Planned PET 4:45</p> <p>1. <b>IV:</b>  WVS close-out video</p>	<p><u>NOD-FGB LAN CABLE REPOSITION</u></p> <ol style="list-style-type: none"> <li>1. Translate to Node 1 MMOD shield C2-02 (Node 1 fwd port endcone)</li> <li>2. BRT to Lab HR 0209</li> <li>3. Assess alignment of shield; may need to loosen adj equipment tethers</li> <li>4. Reposition FGB LAN cable connector cable, small wire tie to NOD1 HR 0141 (and HR 0145 as reqd)</li> <li>5.  Perform WVS survey</li> </ol> <p><u>WIRE TIE SHIELD</u></p> <p style="text-align: center;"><u>NOTE</u></p> <p>Wire tie must positively capture the Dzus fastener (either 2 wraps around or 1 wrap and a double twist) and positively capture structure on the Node.</p> <p>Wire tie must pull shield flat against structure and in toward centerline of module.</p> <p>Verify both ends of wire tie attached securely so that if wire tie breaks, each end will still be attached</p>

# NOD1 FGB LAN CABLE/MMOD SHIELD (00:45) (Cont)

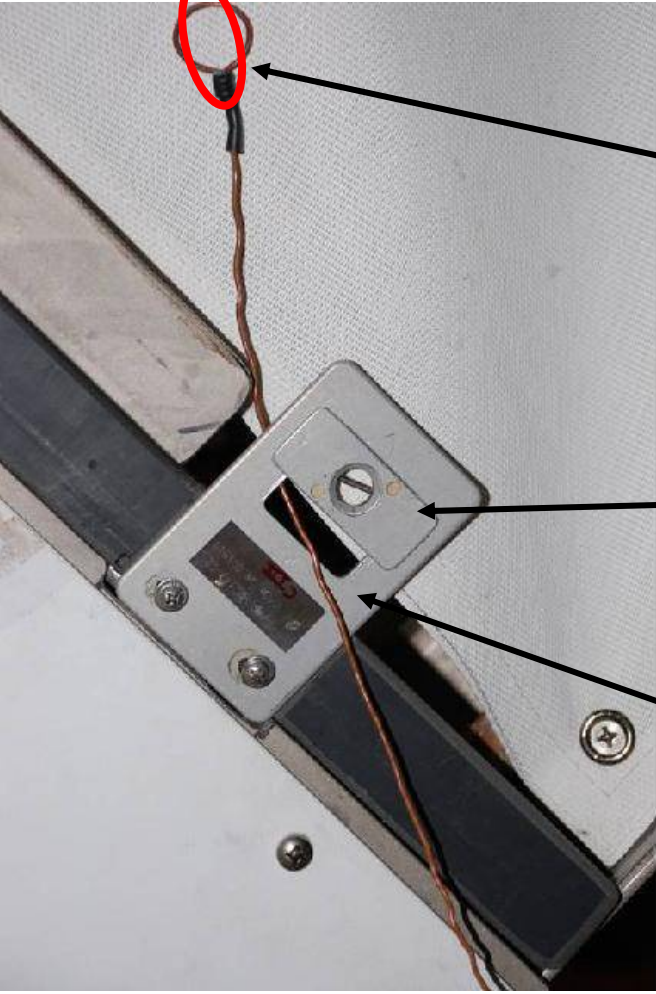
IV/SSRMS	EV1
	<p data-bbox="634 240 1990 272">6. Shift floating receptacle toward center of shield and insert long wire tie through 'window' in receptacle bracket</p>  <p data-bbox="1495 483 1789 571">Use crimped-loop end of long wire tie for easier access through nutplate</p> <p data-bbox="1495 776 1864 831">Floating receptacle shifted toward the center of the shield</p> <p data-bbox="1516 1058 1885 1117">Long wire tie inserted thru 'window' in receptacle bracket</p>

**NOD1 FGB LAN CABLE/MMOD SHIELD (00:45) (Cont)**

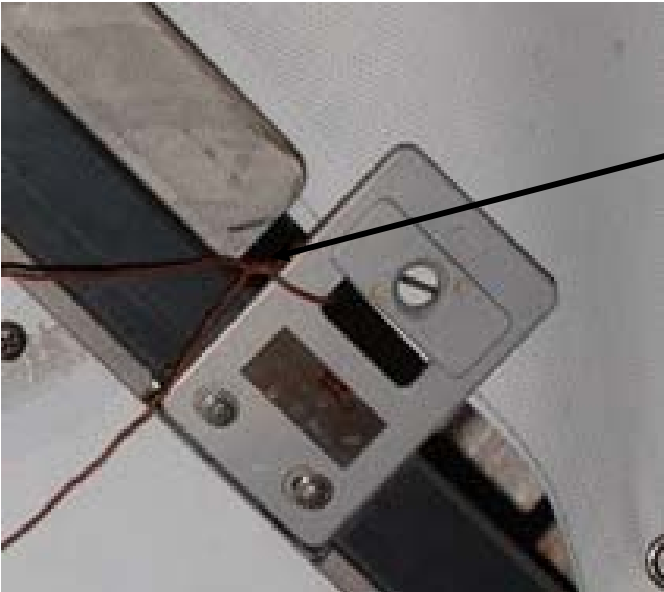
<b>IV/SSRMS</b>	<b>EV1</b>
	<p>7. After threading wire tie through receptacle bracket, twist 3 times</p>  <p>Twist wire tie 3 times</p>

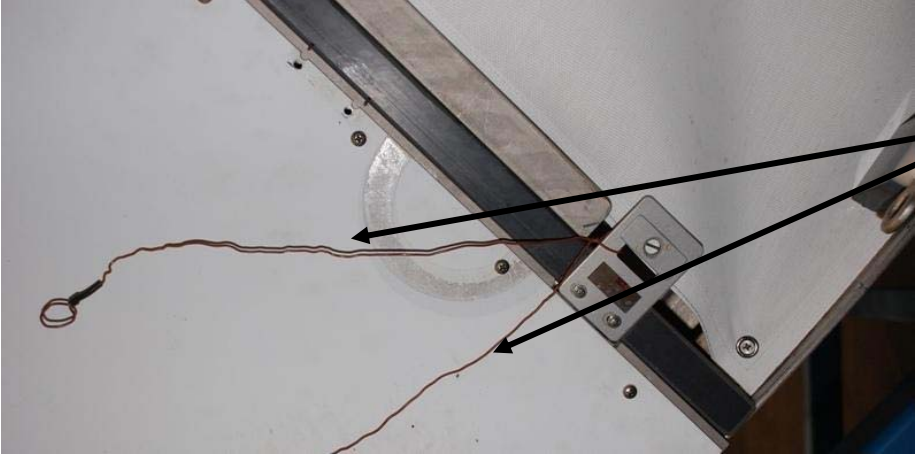

**NOD1 FGB LAN CABLE/MMOD SHIELD (00:45) (Cont)**

<b>IV/SSRMS</b>	<b>EV1</b>
	<p>8. Install long wire tie on two remaining receptacle brackets</p> <p>9. Install MMOD shield C2-02 with wire ties (3) sticking out across adjacent shield</p>  <p>Wire tie ends stretched out across adjacent shield</p>

## NOD1 FGB LAN CABLE/MMOD SHIELD (00:45) (Cont)

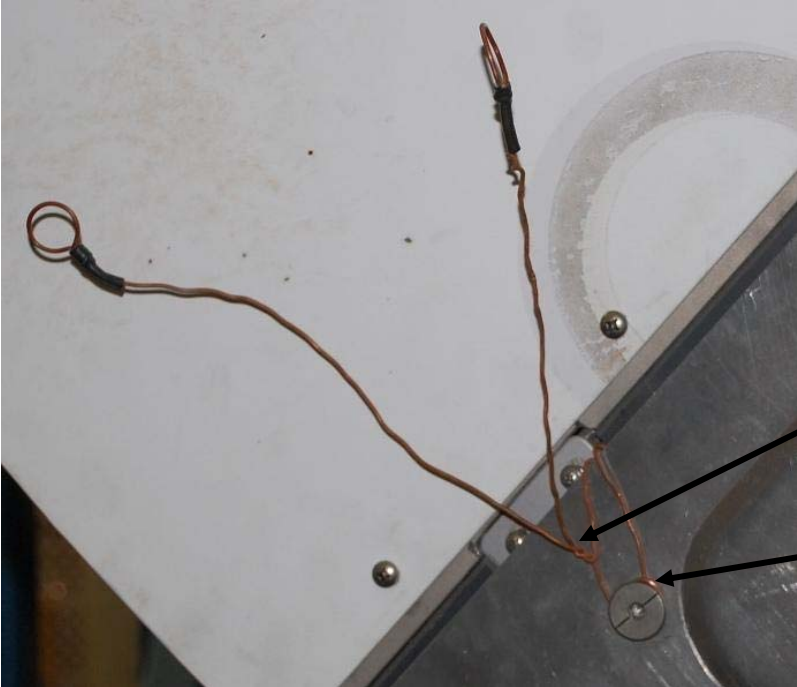
IV/SSRMS	EV1
<p>2. <b>IV:</b> <input type="checkbox"/> WVS close-out video</p>	<p>10. Wrap wire tie around Dzus fastener (either two wraps or one wrap and a double twist) 11. Twist loose wire tie ends together to form a loop</p>  <p>Loose wire tie ends twisted together</p> <p>Wire tie wrapped around Dzus fastener (two wraps or one wrap and a double twist)</p> <p>12. Repeat for remaining Dzus fasteners on MMOD Shield C2-02 (2 of 3 minimum required) 13. If there is a HR nearby, the loose ends of the wire tie can be wrapped around the HR (not required) 14. <input type="checkbox"/> Perform WVS survey</p>

## NOD1 FGB LAN CABLE/MMOD SHIELD (00:45) (Cont)

IV/SSRMS	EV1
<p>EV1 Tool Inventory:</p> <ul style="list-style-type: none"> <li><input type="checkbox"/> Adj Equip Tether           <ul style="list-style-type: none"> <li><input type="checkbox"/> <b>Crewlock Bag (NOD1 Bag)</b> <ul style="list-style-type: none"> <li><input type="checkbox"/> Loop Pin Puller (on int RET)</li> <li><input type="checkbox"/> Wire Ties (2) (external for bracket)               <ul style="list-style-type: none"> <li><input type="checkbox"/> NOD1 HR 0111 (wire tied to bag)</li> </ul> </li> <li><input type="checkbox"/> Wire Tie Caddy (on int RET) (9 short)</li> <li><input type="checkbox"/> RET (sm-sm)               <ul style="list-style-type: none"> <li><input type="checkbox"/> MMOD Shield T-Tool (from shield)</li> </ul> </li> <li><input type="checkbox"/> RET (sm-sm)               <ul style="list-style-type: none"> <li><input type="checkbox"/> S0 Connector Adapter</li> </ul> </li> <li><input type="checkbox"/> RET (sm-sm)               <ul style="list-style-type: none"> <li><input type="checkbox"/> S0 Connector Booty</li> </ul> </li> </ul> </li> </ul> </li> <li><input type="checkbox"/> Small ISS Trash Bag (right/inboard)           <ul style="list-style-type: none"> <li><input type="checkbox"/> SGANT Connector Caps (2)</li> <li><input type="checkbox"/> Adj Equip Tether (from NOD1 shield)</li> <li><input type="checkbox"/> Adj Equip Tether (from NOD1 shield)</li> <li><input type="checkbox"/> Adj Equip Tether (from NOD1 shield)</li> </ul> </li> </ul>	<p><u>CLEANUP</u></p> <ol style="list-style-type: none"> <li>15. Retrieve adj equipment tethers (3) that were installed on shield; stow in trash bag (not usable)</li> <li>16. RET, retrieve MMOD Shield Handling Tool from shield; stow in Crewlock Bag</li> <li>17. ← Perform tool inventory of Crewlock Bag</li> <li>18. Retrieve C/L bag</li> <li>19. <b>Glove check</b></li> </ol>

## S0 PANEL A145 CONNECTOR TROUBLESHOOTING (00:30)

IV/SSRMS	EV1
<p>1. <input type="checkbox"/> <input checked="" type="checkbox"/> <b>MCC-H</b> – S0 panel A145 inhibits in place</p> <p>Planned PET 5:30</p>	<p><u>S0 PANEL A145 CONNECTOR TROUBLESHOOTING (00:30)</u></p> <ol style="list-style-type: none"> <li>1. Translate to S0 starboard strut with NOD1 Crewlock Bag</li> <li>2. Temp stow Crewlock Bag on S0 HR _____</li> <li>3. RET, retrieve connector adapter from Crewlock Bag</li> <li>4. RET, retrieve wire tie and 21/25 booty from P181 connector</li> <li>5. Stow 21/25 booty in Crewlock Bag; stow wire tie in trash bag</li> <li>6. Attempt to soft dock and mate P181 to J181 on connector panel A145 (If successful, skip ahead to Crewlock Bag retrieval)</li> <li>7. Soft dock cable connector P181 to connector adapter (do not throw bale) √Good pins &amp; EMI band, no FOD</li> <li>8. After verifying cable connector P181 will soft dock to connector adapter, retrieve and temp stow connector adapter</li> <li>9. Open S0 MLI door</li> <li>10. Release TA clamp on J181 back side cable (inside truss)</li> <li>11. Demate back side J181 connector from A145 panel √Good pins &amp; EMI band, no FOD</li> <li>12. Mate back side J181 connector to connector adapter</li> <li>13. Mate cable connector P181 to connector adapter</li> <li>14. Install 33/37 booty over both connectors and adapter √All metallic surfaces covered by connector insulating sleeve</li> <li>15. Close S0 MLI door; ensure all Velcro fully mated</li> <li>16. RET, retrieve Crewlock Bag</li> <li>17. <b>Glove check</b></li> </ol>

## S0 PANEL A145 CONNECTOR TROUBLESHOOTING (00:30) (Cont)

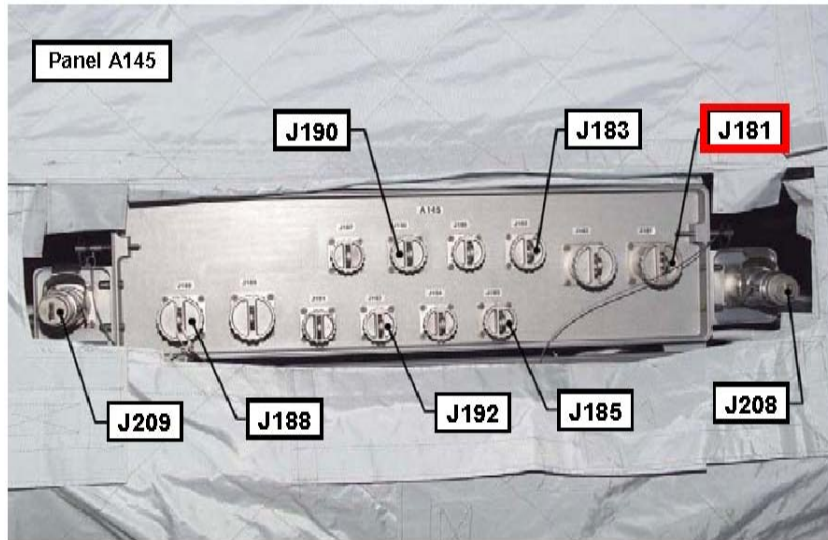

Figure 22: S0 Panel A145

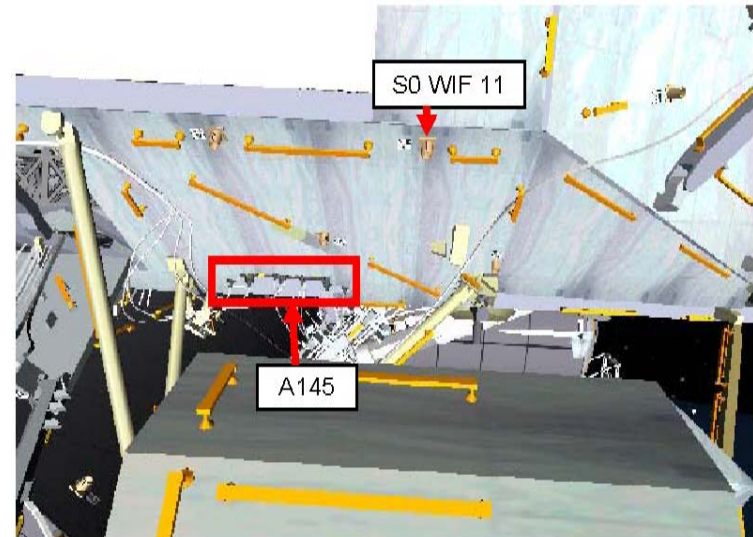

Figure 23: S0 Panel A145 Location (S0 aft, looking fwd)

## EVA 1 CLEANUP/INGRESS (00:45)

IV/SSRMS	EV1	EV2
<p>1. <b>IV:</b> Perform WVS PWRDWN (PHOTO/TV, <u>WVS CUE CARD</u>)</p> <p>2. <b>SSRMS:</b> Maneuver to park position</p> <p>3. Start Hatch Thermal Cover clock PET (30 min) ____ : ____</p>	<p><u>CLEANUP (00:15)</u></p> <ol style="list-style-type: none"> <li>1. Final Tool Inventory</li> <li>2. Translate to A/L</li> </ol> <p><u>INGRESS AND PRE-REPRESS (00:15)</u></p> <ol style="list-style-type: none"> <li>3. Transfer bags to EV2               <ul style="list-style-type: none"> <li><input type="checkbox"/> Node 1 Crewlock Bag</li> <li><input type="checkbox"/> Lube Crewlock Bag</li> </ul> </li> <li>4. <b>On EV2 GO</b>, release EV2 ST anchor, attach to R Waist Tether               <ul style="list-style-type: none"> <li><input type="checkbox"/> <math>\sqrt</math>Gate closed, hook locked</li> </ul> </li> <li>5. Retrieve EV1 ST anchor hook</li> <li>6. Ingress Airlock</li> <li>7. Remove SCU from stowage pouch</li> <li>8. Remove DCM cover; Velcro to DCM</li> <li>9. Connect SCU to DCM               <ul style="list-style-type: none"> <li><math>\sqrt</math>SCU locked</li> </ul> </li> </ol>	<p><u>CLEANUP (00:30)</u></p> <ol style="list-style-type: none"> <li>1. GCA SSRMS as required for egress</li> <li>2. Egress SSRMS, locate A/L ST on S1 HR 3247</li> <li>3. Tether swap onto A/L ST, retrieve Arm ST               <ul style="list-style-type: none"> <li><input type="checkbox"/> <math>\sqrt</math>Gate closed, hook locked, reel unlocked</li> </ul> </li> <li>4. Temp stow Lube Crewlock Bag on APFR</li> <li>5. RET, retrieve APFR; stow on BRT</li> <li>6. RET, retrieve WIF Adapter, stow on MWS</li> <li>7. <b>Give SSRMS GO</b> for maneuver to park position</li> <li>8. Stow APFR in stbd CETA Cart WIF 3 [<b>9, PP, F, 6</b>] (inboard and deconflict TFR and brake handles)               <ul style="list-style-type: none"> <li><math>\sqrt</math>Locking collar black-on-black, pull test</li> </ul> </li> <li>9. RET and BRT to Lube Crewlock Bag</li> <li>10. Install Ingress Aid and remove Adjustable Tether               <ul style="list-style-type: none"> <li><math>\sqrt</math>Locking collar black-on-black, pull test</li> </ul> </li> <li>11. Final Tool Inventory</li> <li>12. Translate to A/L</li> </ol> <p><u>INGRESS AND PRE-REPRESS (00:15)</u></p> <ol style="list-style-type: none"> <li>13. ← Open hatch thermal cover</li> <li>14. Ingress Airlock</li> <li>15. RET, receive and stow bags in A/L               <ul style="list-style-type: none"> <li><input type="checkbox"/> Node 1 Crewlock Bag</li> <li><input type="checkbox"/> Lube Crewlock Bag</li> </ul> </li> <li>16. Attach R Waist Tether to A/L internal D-ring extender               <ul style="list-style-type: none"> <li><input type="checkbox"/> <math>\sqrt</math>Gate closed, hook locked</li> </ul> </li> <li>17. <b>Give EV1 GO</b> to release EV2 ST anchor</li> </ol> <ol style="list-style-type: none"> <li>18. Remove SCU from stowage pouch</li> <li>19. Remove DCM cover; Velcro to DCM</li> <li>20. Connect SCU to DCM               <ul style="list-style-type: none"> <li><math>\sqrt</math>SCU locked</li> </ul> </li> </ol>

**EVA 1 CLEANUP/INGRESS (00:45) (Cont)**

IV/SSRMS	EV1	EV2
<p>4. Stop Hatch Thermal Cover clock PET (30 min) ___ : ___</p>	<p style="text-align: center;"><u>NOTE</u> A TCV setting 8 – Max C minimizes time for SCU cooling</p> <p>10. WATER – OFF (fwd), expect H2O IS OFF msg 11. ← Close hatch thermal cover; attach Velcro strap</p> <div style="border: 1px solid black; padding: 5px; margin: 10px auto; width: fit-content;"> <p style="text-align: center;"><u>CAUTION</u> Do not close hatch until EMU Water OFF for 2 min. Verify outer hatch clear of hardware</p> </div> <p>12. Verify outer hatch clear of hardware 13. Verify handle position per hatch decal 14. Close and lock hatch</p> <p>Go to PRE-REPRESS (<u>DEPRESS/REPRESS</u> Cue Card)</p>	<p style="text-align: center;"><u>NOTE</u> A TCV setting 8 – Max C minimizes time for SCU cooling</p> <p>21. WATER – OFF (fwd), expect H2O IS OFF msg</p> <p>Go to PRE-REPRESS (<u>DEPRESS/REPRESS</u> Cue Card)</p>

# EVA 1 TASK DATA

## SPARE SASA INSTALL – TASK DATA

### Estimated Task Duration:

	With RMS	Without RMS
One EV Crew	N/A	N/A
Two EV Crew	02:45	03:00

### ORU Identification:

ORU	Part Number	Serial Number	Mass
S-Band Antenna Support Assy (SASA)	830699-551	002	228 lbs

### Tools:

EV1	EV2
PGT	
ERAD + 2" ext 7/16"	

### EVA Fasteners:

Fastener Name	Head Size	Qty	Install Torque (ft-lb)	Release Torque (ft-lb)	Failure Torque (ft-lb)	Turns	RPM
Mast Bolts	7/16"	2	9.2	25.5	13.25 (Z1 install) 15.42 (SWC install) 57.57 (release)	9	30
Launch Restraints	7/16"	4	12.0	25.5	15.58 (install) 57.6 (release)	12	30

### EVA Connectors:

Harness	From	To	Clamps (#)	Conn Size	Function
		SASA J2		21	Not used at Z1
W07S	Z1 J3	SASA J3	2	17	Heater power/Data Ch B
W34A	Z1 J4	SASA J4	2	15	Operational power/Data Ch A

### Foot Restraints:

Task	WIF	APFR Setting
SASA Transfer	SSRMS LEE	12, PP, F, 6
SASA Install on Z1	Z1 WIF 11	12, UU, H, 12
Alternate SASA Install on A/L	HPGT #5 Dovetail	3, QQ, F, 11

### Inhibits:

ORU/Task	Location	Inhibit
SASA Retrieval	Payload Bay	R1 PL AFT MNC – OFF (SASA Heater Power)
SASA Install	Z1	RPCM Z13B-B RPC 1 – Open RPCM Z14B-B RPC 1 – Open

### Notes:

1. Sidewall Carrier heater mat is covered with MLI

### Cautions:

1. High gain antenna, low gain antenna and radiator surfaces are sensitive to contact
2. Avoid contact with S0 and Z1 radiators
3. Avoid inadvertent PLSS contact with HPGT while in APFR

### Warnings:

- 1.

### Timeline Considerations:

1. 11 hour thermal clock from PLB inhibit to Z1 powerup



# SPARE SASA INSTALL – TASK DATA (Cont)

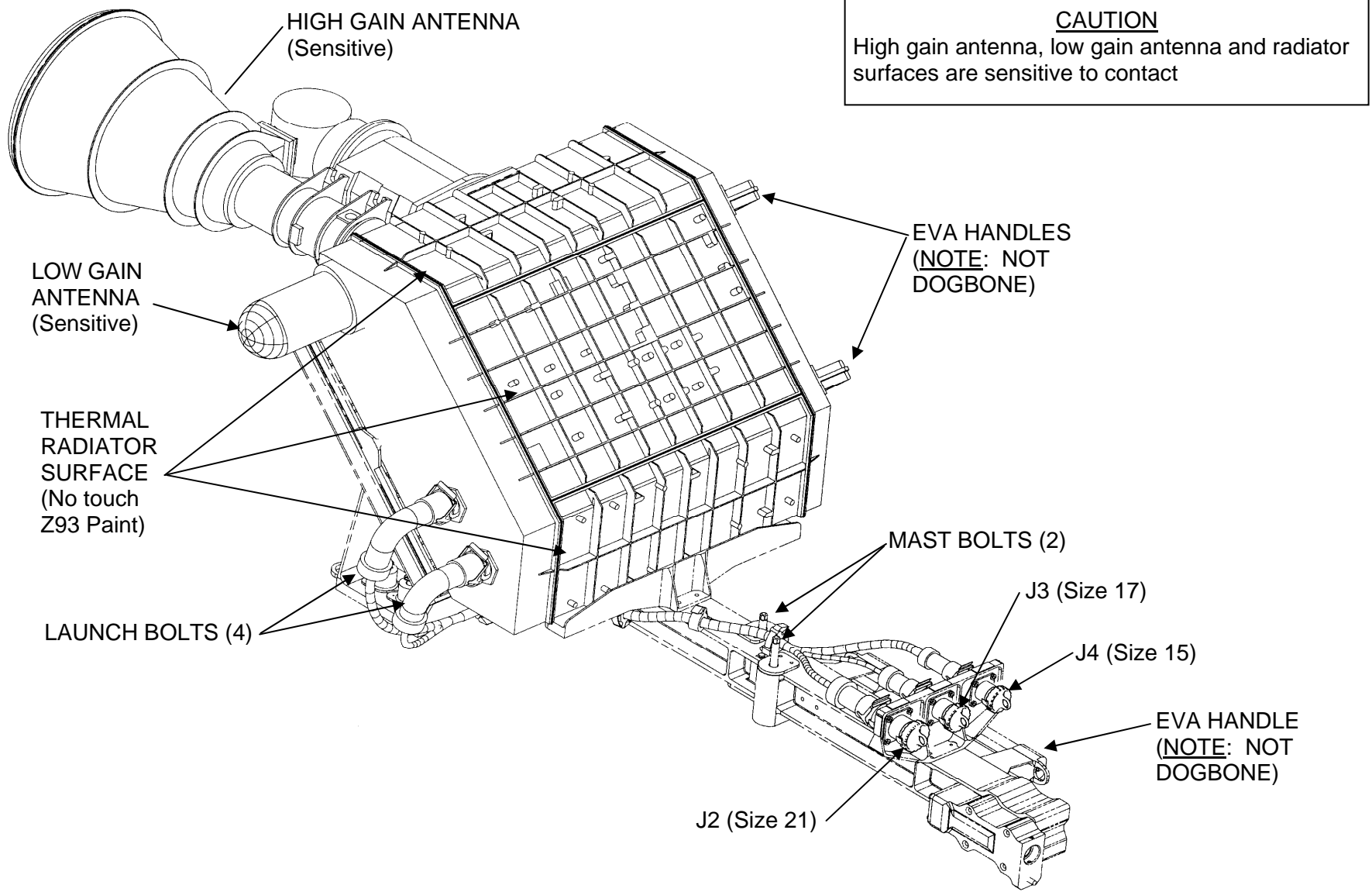
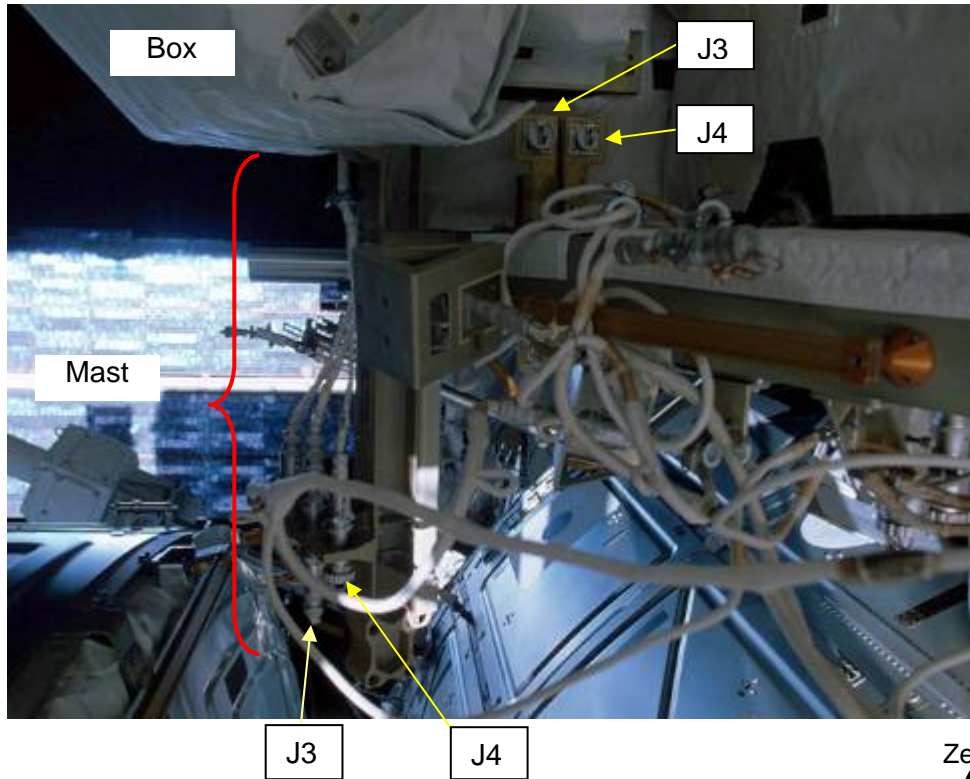
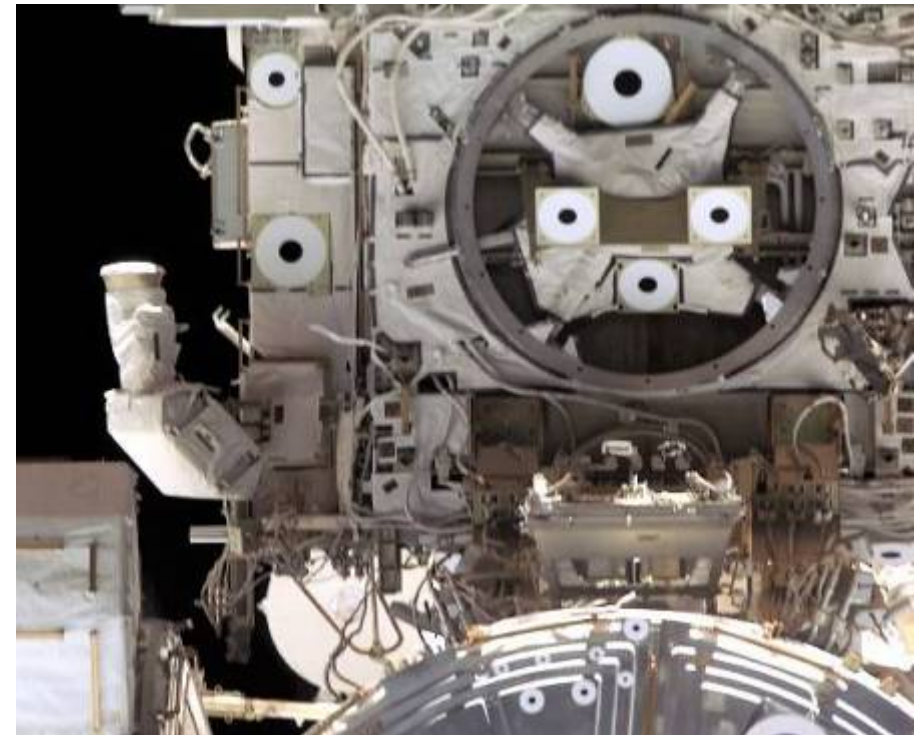

Figure 1: S-Band Antenna Support Assembly (SASA)

SPARE SASA INSTALL – TASK DATA (Cont)



SASA STOWAGE ON Z1 – looking ISS aft



SASA STOWAGE ON Z1 – looking ISS aft  
NOTE: S0 not installed yet

Figure 2: Z1 SASA Worksite

SPARE SASA INSTALL – TASK DATA (Cont)



SASA SIDE VIEW

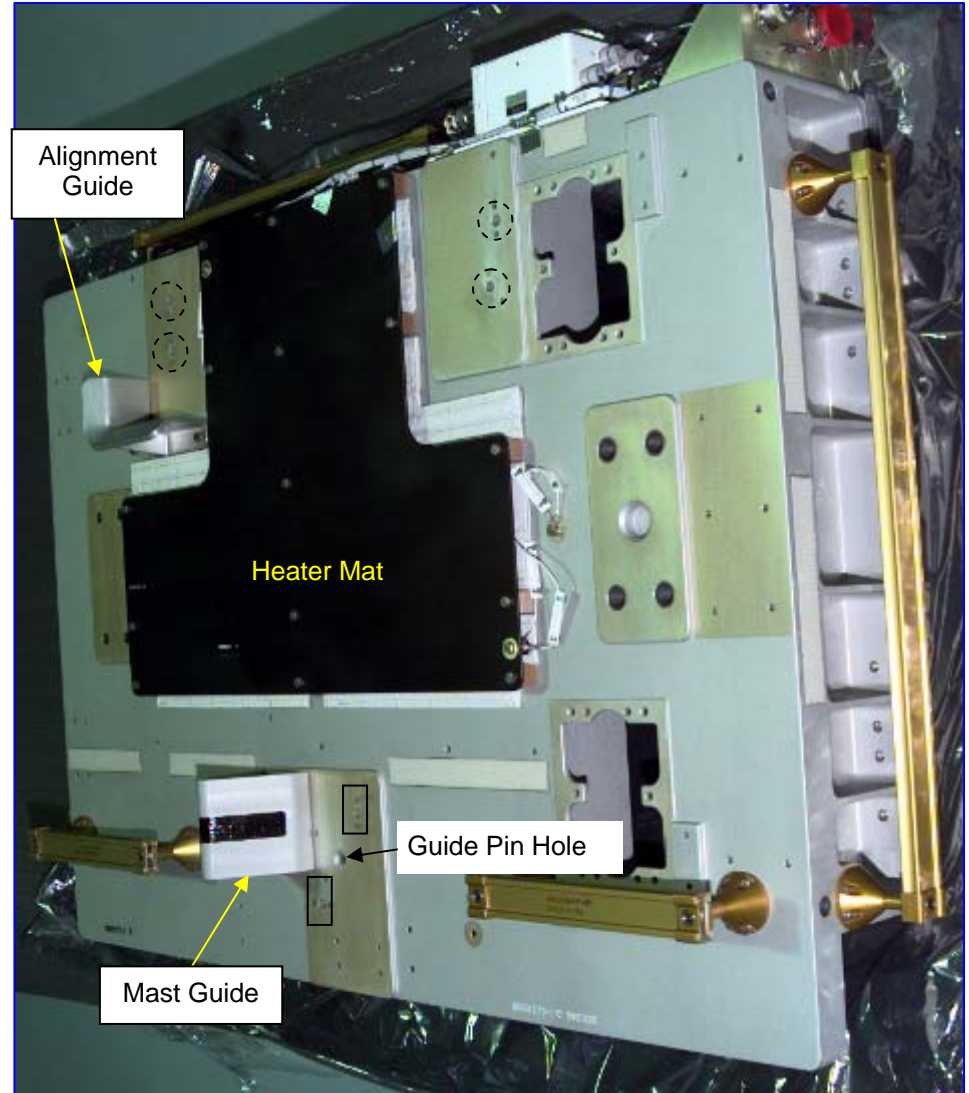
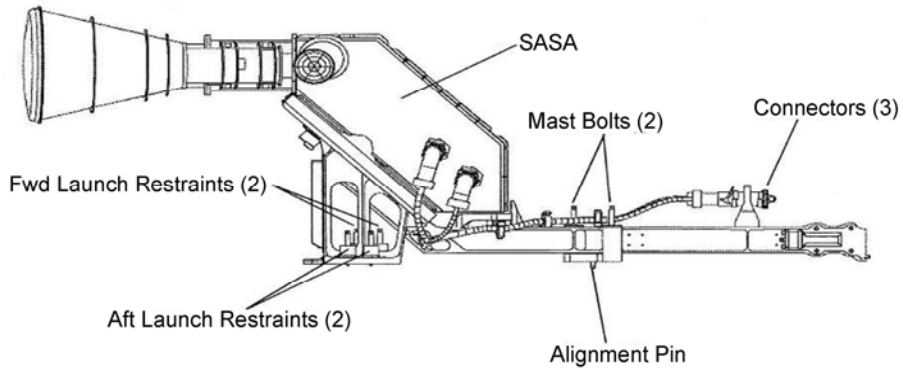

SASA Sidewall Carrier



-  Launch Bolt holes
-  Mast Bolt Holes

Figure 3: SASA Sidewall Carrier

# POA LUBE – TASK DATA

## Estimated Task Duration:

	With RMS	Without RMS
One EV Crew	01:15	02:00
Two EV Crew	N/A	N/A

## Tools:

EV1	
Crewlock Bag	EVA Camera
Gap Gauge ("LEE")	Straight Nozzle Grease Gun
Needle Nose Pliers (taped)	EVA Wipes

## Foot Restraints:

Task	WIF	APFR Setting
POA Lube	SSRMS LEE	12, PP, F, 6
POA Lube (alt)	Port CETA Cart (uncoupled from MT) WIF 2	[12,GG] [12,JJ,F,10]

## Notes:

- Grease should not extend more than 1/4 inch from bearing

## Cautions:

- Avoid contact with grounding springs, cable-return springs, latch covers, shrouds, and camera
- When exercising bearing, do not extend cable-return spring more than 90 deg (rod end perpendicular to housing)

## Warnings:

- Avoid touching curvic coupling, grounding springs, snares, and internal mechanisms with gloved hand

## Timeline Considerations:

- Photos shall be taken as best effort, noting that it is possible that the POA may be in eclipse
- Inhibits for SSRMS brakes and trigger-safe are controlled in Robotics procedures. SSRMS will give EV2 GO when inhibits are in place and ready for EVA work
- Time permitting, **MCC-H** may request additional cycles for sticky bearings

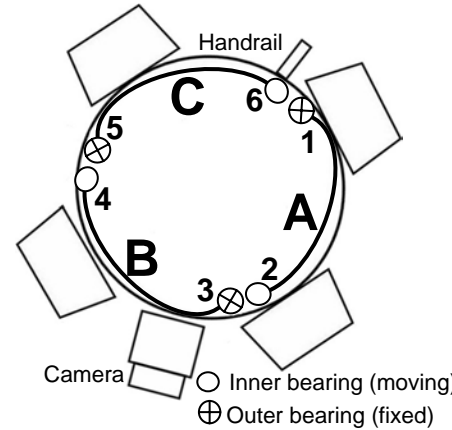

Figure 4: Snares Fully Open

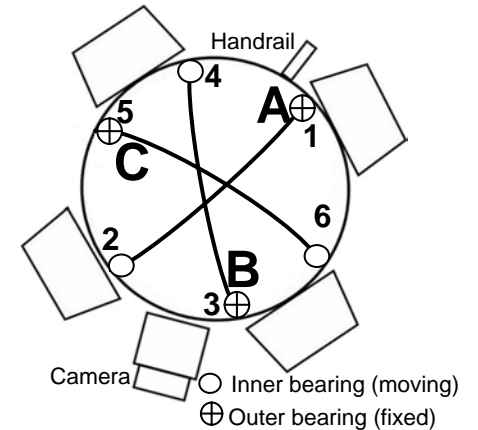

Figure 5: Snares Fully Closed

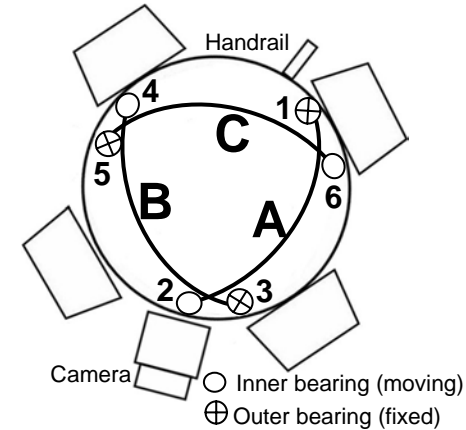

Figure 6: Snares Partially Open

POA LUBE – TASK DATA (Cont)

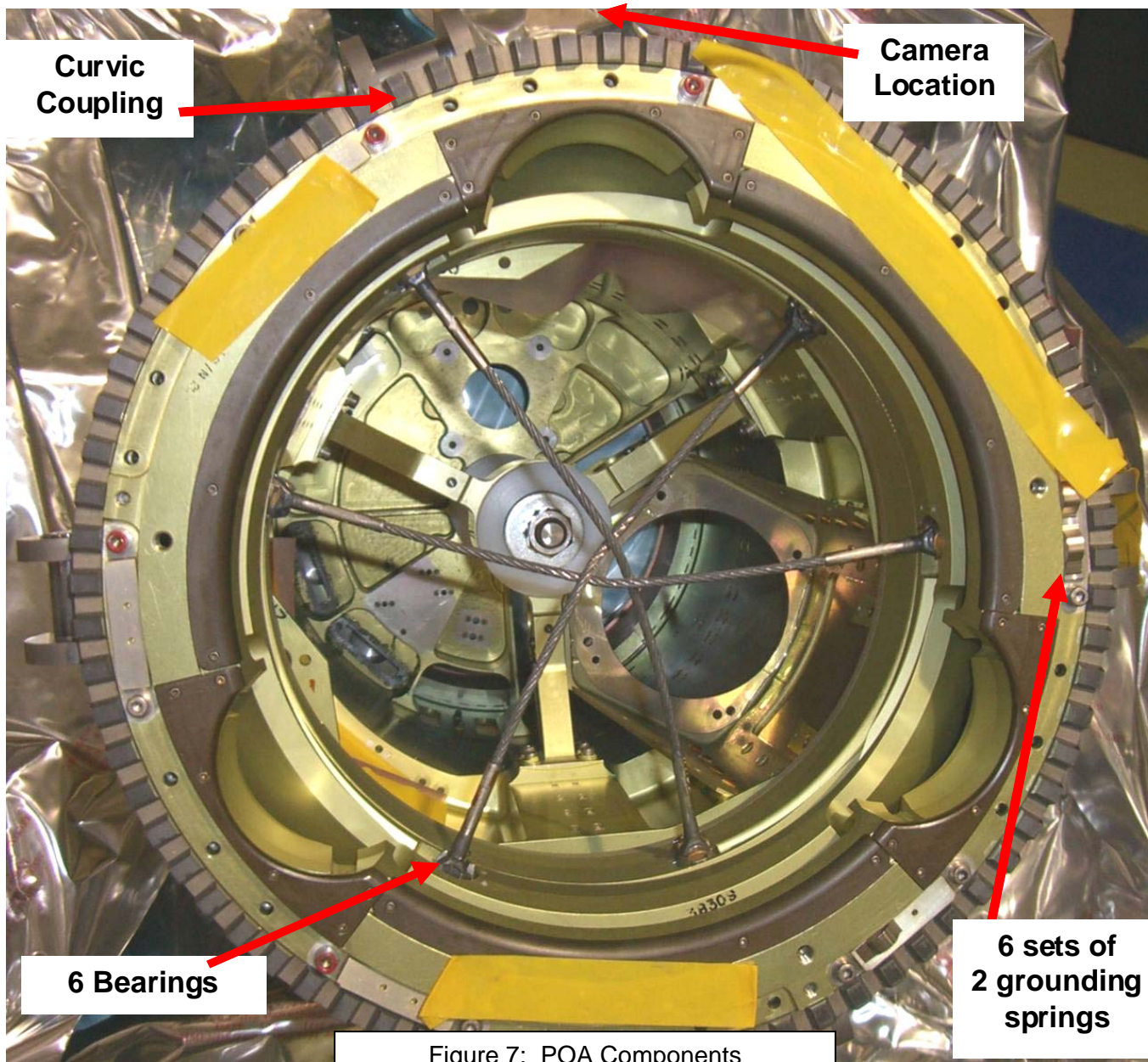

Figure 7: POA Components

POA LUBE – TASK DATA (Cont)

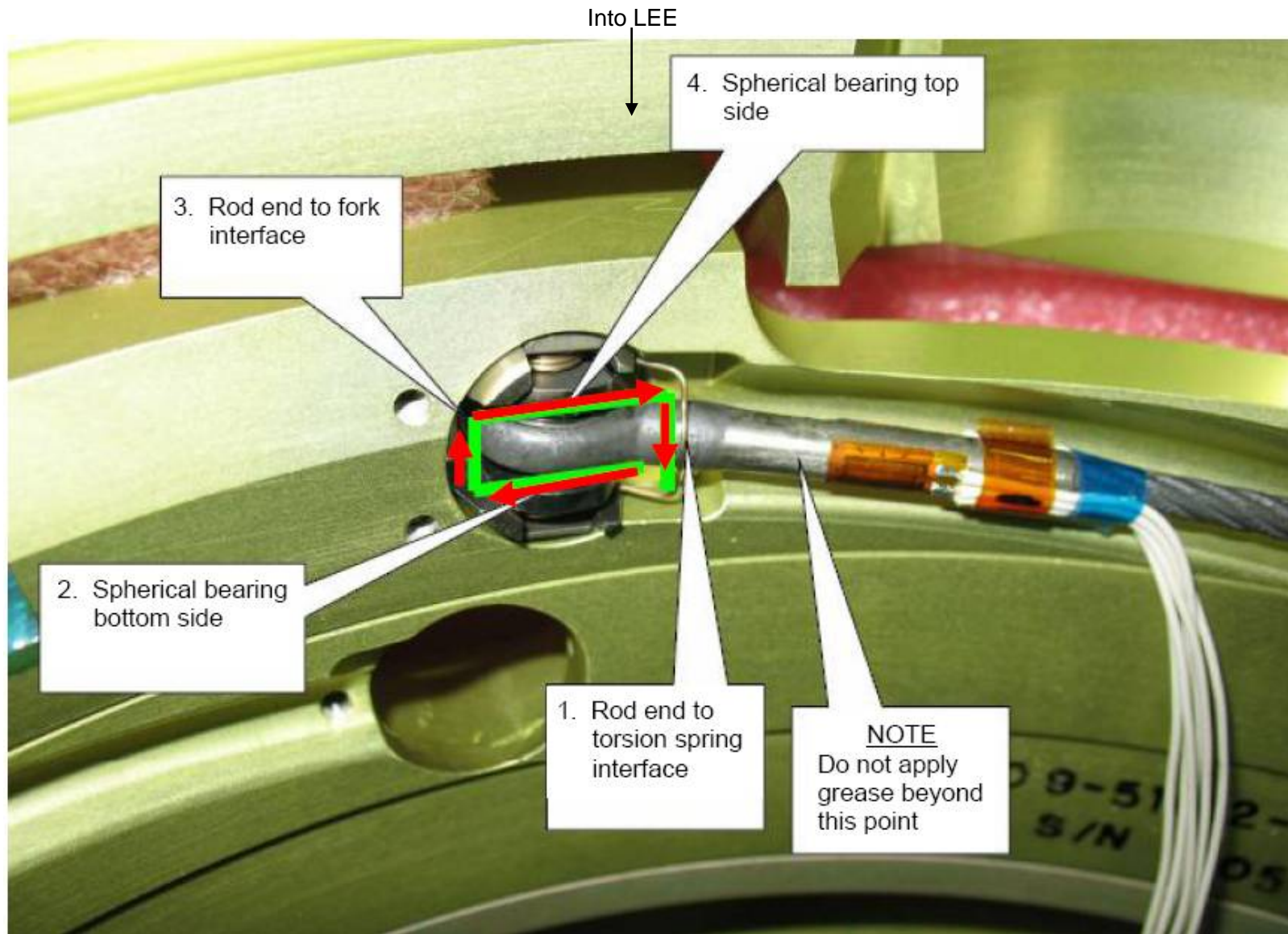
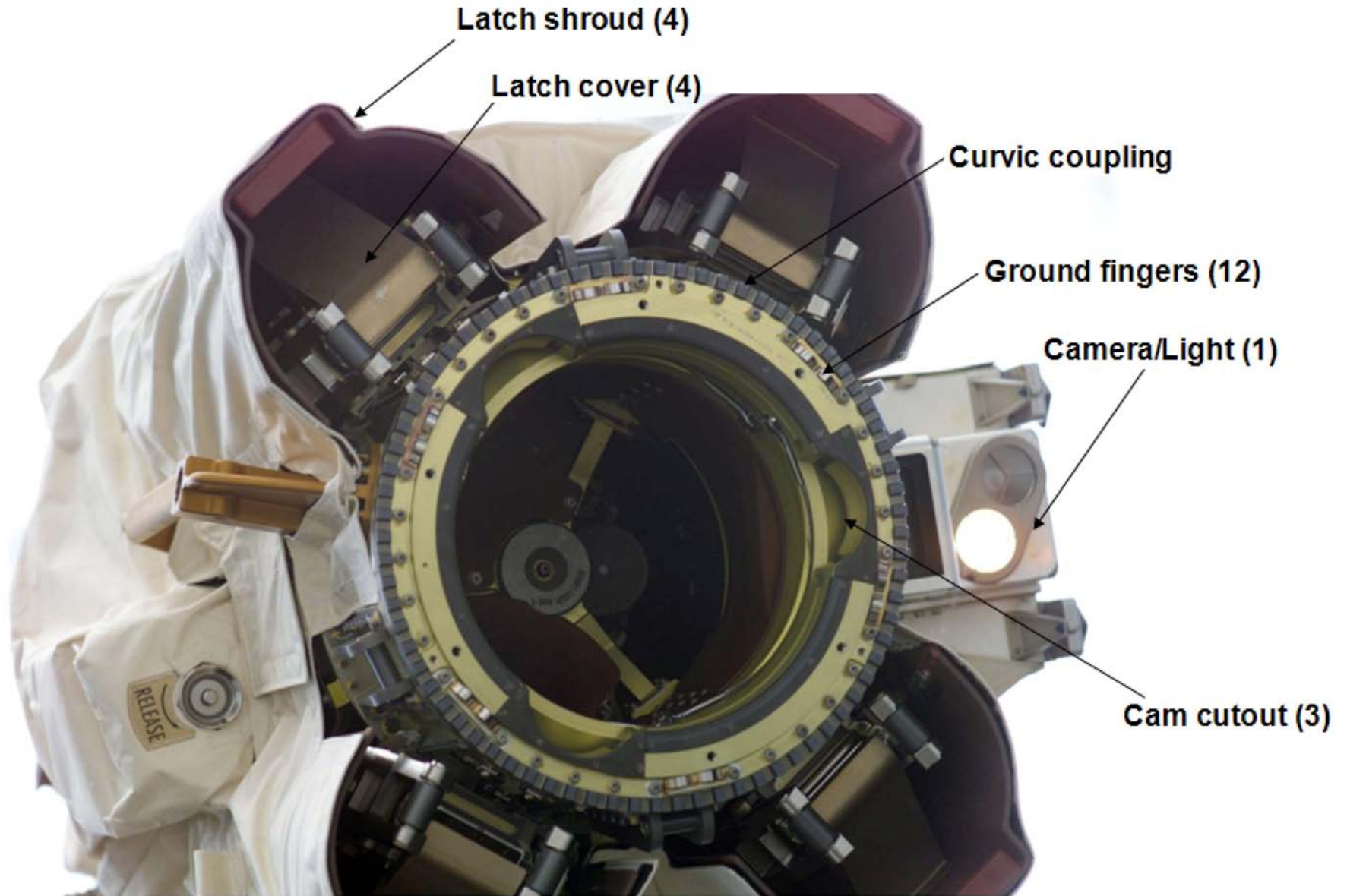

Figure 8: POA Bearing and Snare

POA LUBE – TASK DATA (Cont)



ISS006E19806

Figure 9: POA External Components

# JEM RMS EE LUBE – TASK DATA

## Estimated Task Duration:

	With RMS	Without RMS
One EV Crew	01:15	TBD
Two EV Crew	N/A	N/A

## Tools:

EV2	
Crewlock Bag	EVA Camera
Gap Gauge ("LEE")	Straight Nozzle Grease Gun
Needle Nose Pliers (taped)	EVA Wipes

## Foot Restraints:

Task	WIF	APFR Setting
JEM RMS EE Lube	TBD	TBD

## Notes:

- Grease should not extend more than 1/4 inch from bearing

## Cautions:

- Avoid contact with cable-return springs, SPEE cover, EE exterior silver Teflon coating, and camera
- When exercising bearing, do not extend cable-return spring more than 90 deg (rod end perpendicular to housing)

## Warnings:

- Avoid touching snares and internal mechanisms with gloved hand. Keep away from JEM RMS MA EE camera

## Timeline Considerations:

- Photos shall be taken as best effort, noting that it is possible that the JEM RMS EE may be in eclipse
- Inhibits for JEM RMS brakes and trigger-safe are controlled in Robotics procedures. JEM RMS will give EV2 GO when inhibits are in place and ready for EVA work
- Time permitting, **MCC-H** may request additional cycles for sticky bearings

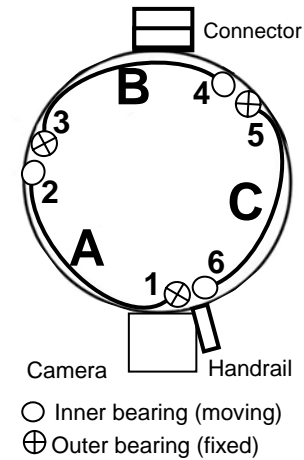

Figure 10: Snares Fully Open

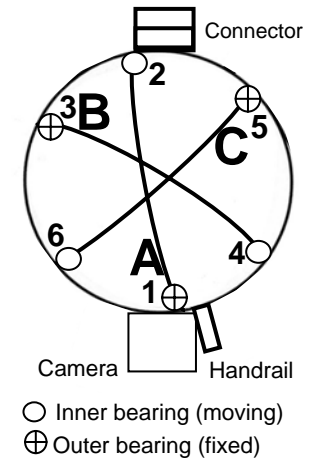

Figure 11: Snares Fully Closed

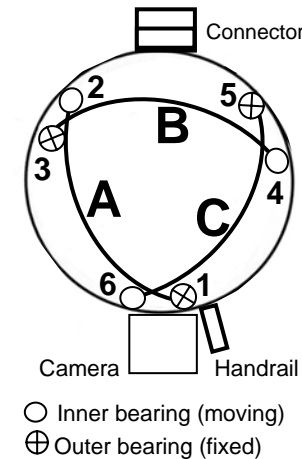

Figure 12: Snares Partially Open



JEM RMS EE LUBE – TASK DATA (Cont)  
SPEE  
(cover closed)

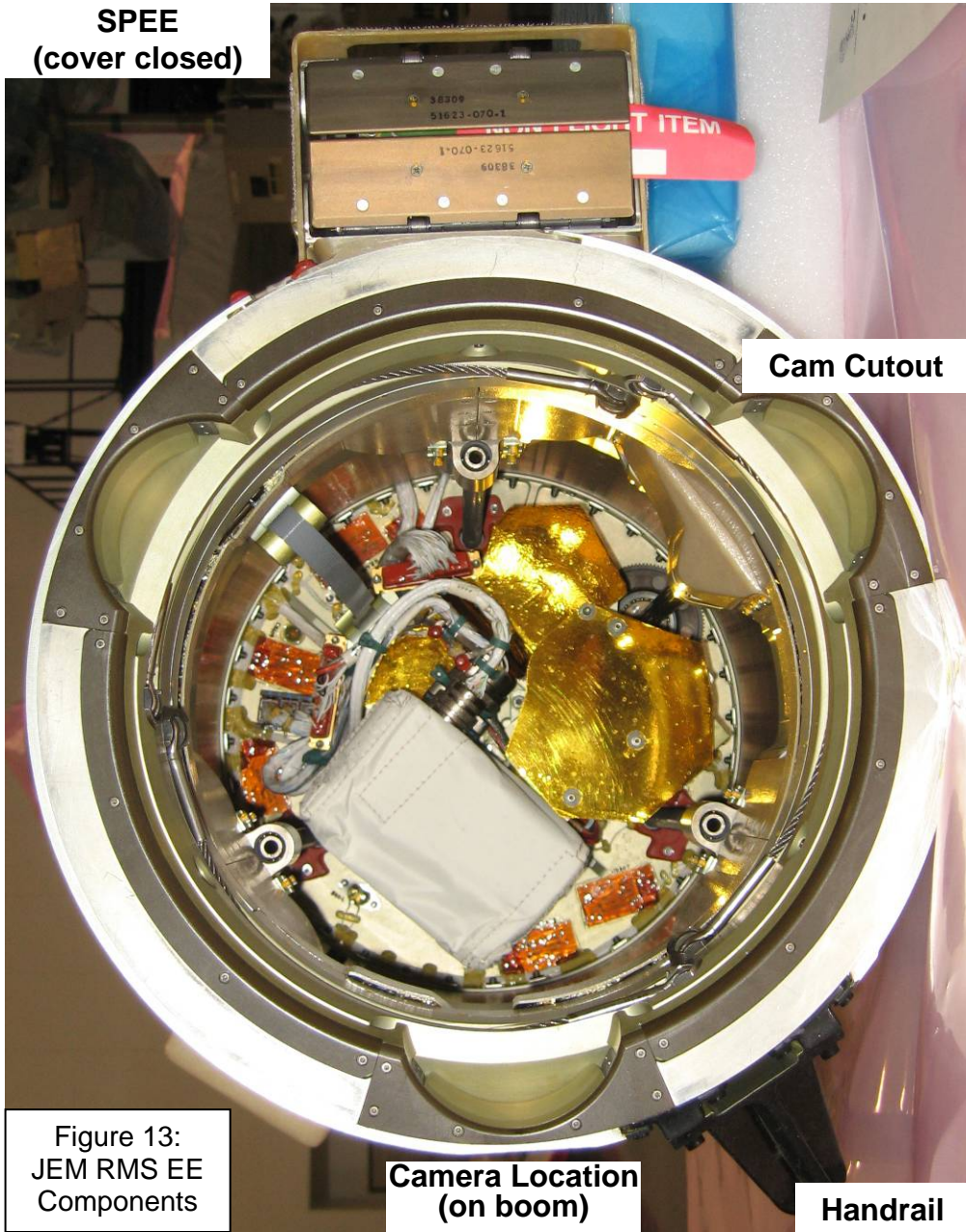

Figure 13:  
JEM RMS EE  
Components

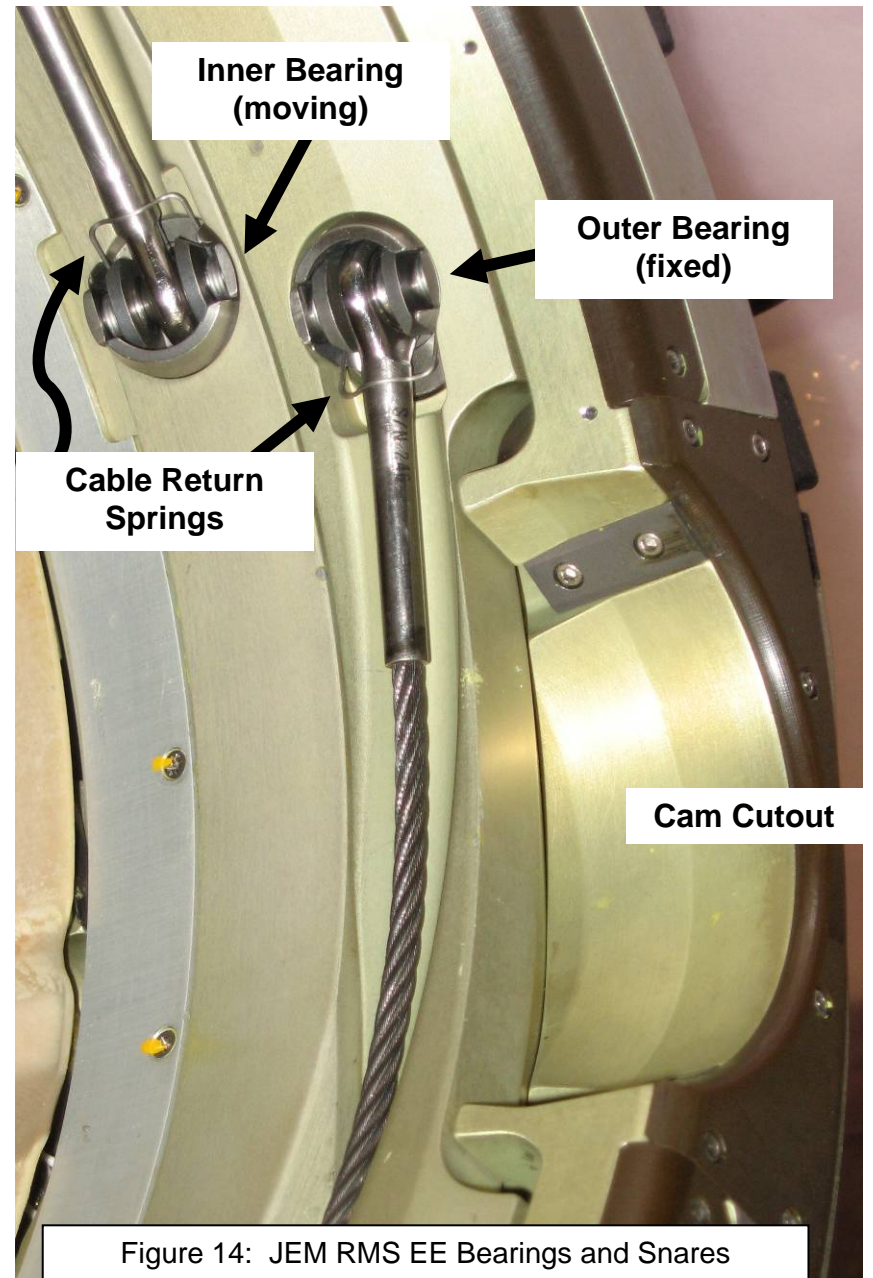

Figure 14: JEM RMS EE Bearings and Snares

# SGANT CABLE INSTALL – TASK DATA

## Estimated Task Duration:

	With RMS	Without RMS
One EV Crew	N/A	00:45
Two EV Crew	N/A	00:30

## Tools:

EV1
Wire ties

## EVA Connectors:

Harness	From	To	Clamps (#)	Conn Size	Function
W2069 W4052	W2069- J212	W4052- P212A			COAX
W4504 W4052	W4052- J212A	W4504- P212			COAX

## Notes:

- Do not remove connector caps
- The connection made in the Rats' Nest is data, not power, so inhibits are not required
- Cable has HR numbers sharpie on sheath
- 5 wire ties are pre-installed on the long cable
- 2 wire ties are pre-installed on the bracket bundle (one on the bracket; one bundling it all together)
- The two SGANT cable bundles are stowed in the starboard TSA

## Timeline Considerations:

- This task may be deferred to a later EVA if more time is deemed necessary for the S0 connector troubleshooting

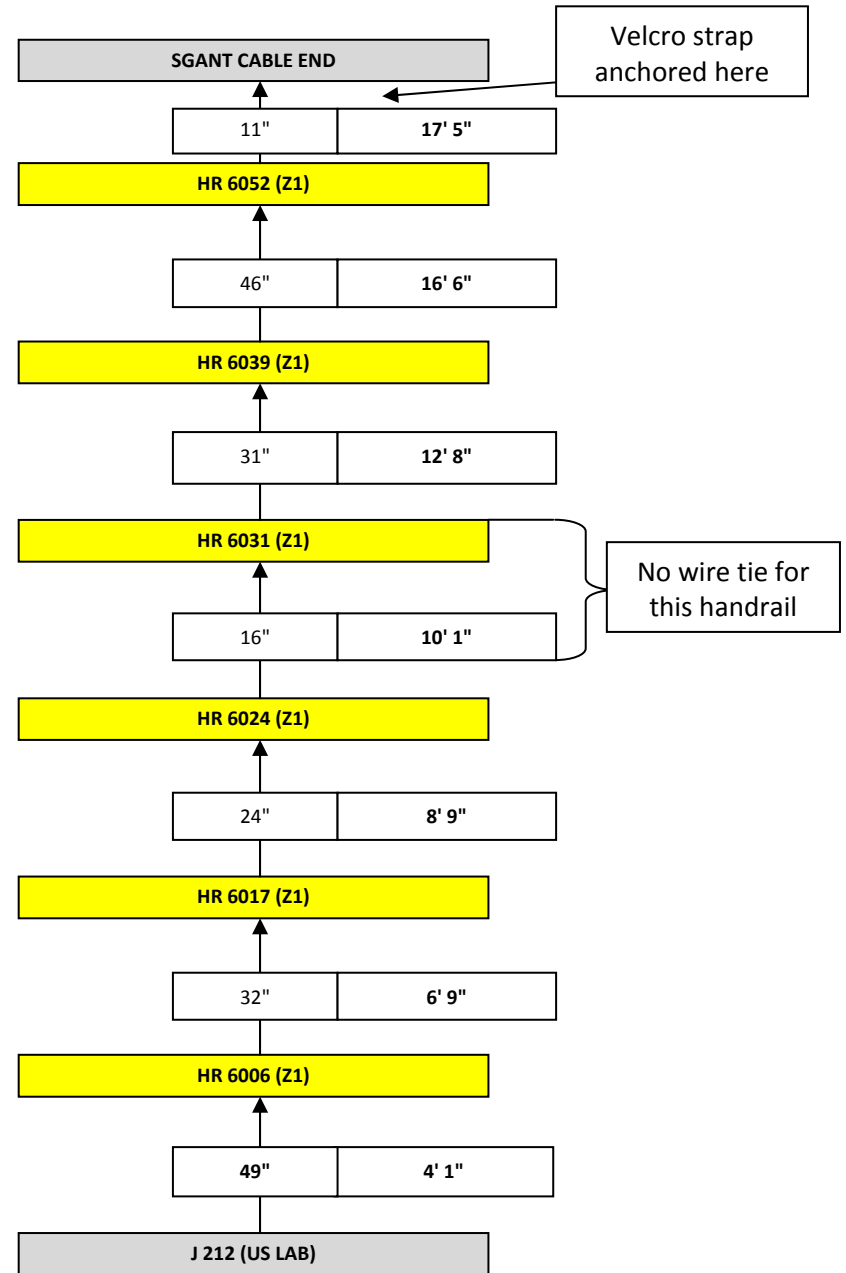

# SGANT CABLE INSTALL – TASK DATA (Cont)

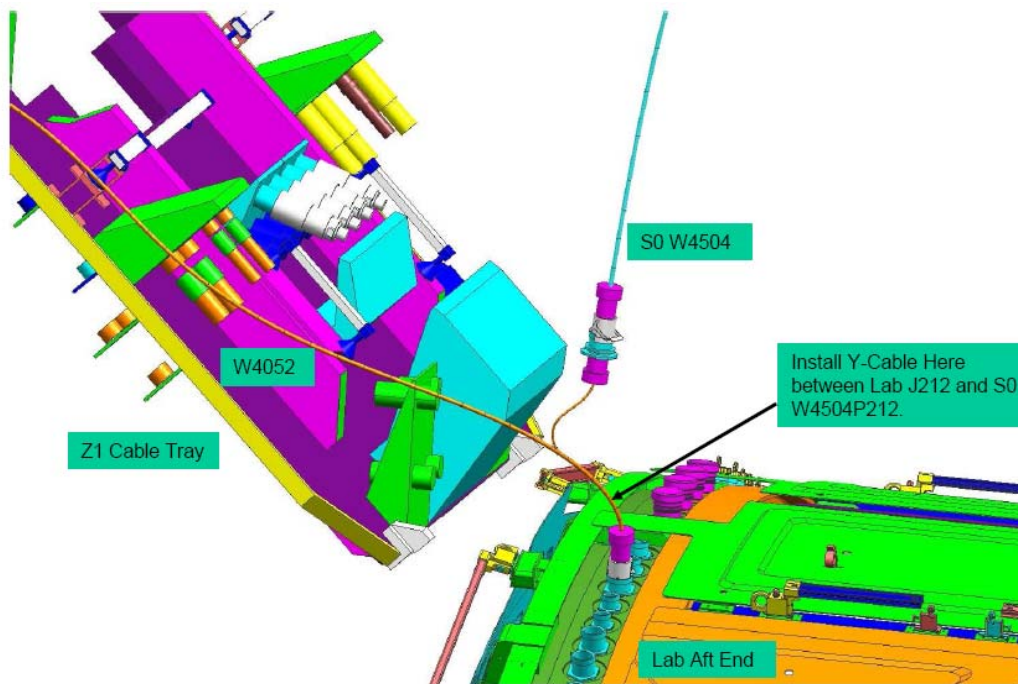

Figure 15: SGANT Connections in Rats' Nest



Figure 16: SGANT Cable Routing on Z1

# INSTALL NODE 1 NH3 BRACKET – TASK DATA

**Estimated Task Duration:**

	With RMS	Without RMS
One EV Crew	N/A	00:30
Two EV Crew	N/A	N/A

**Tools:**

<b>EV1</b>
PGT w/2" ext 7/16" socket

**EVA Fasteners:**

Fastener Name	Head Size	Qty	Install Torque (ft-lb)	Release Torque (ft-lb)	Failure Torque (ft-lb)	Turns	RPM
OIH Bolt	7/16"	2	3.8	3.8		8	30
NH3 Bracket Bolt	7/16"	2	2.5	N/A	4.17	11	30

**Notes:**

- 1.
- 2.
- 3.
- 4.
- 5.

**Timeline Considerations:**

- 1.
- 2.
- 3.
- 4.
- 5.

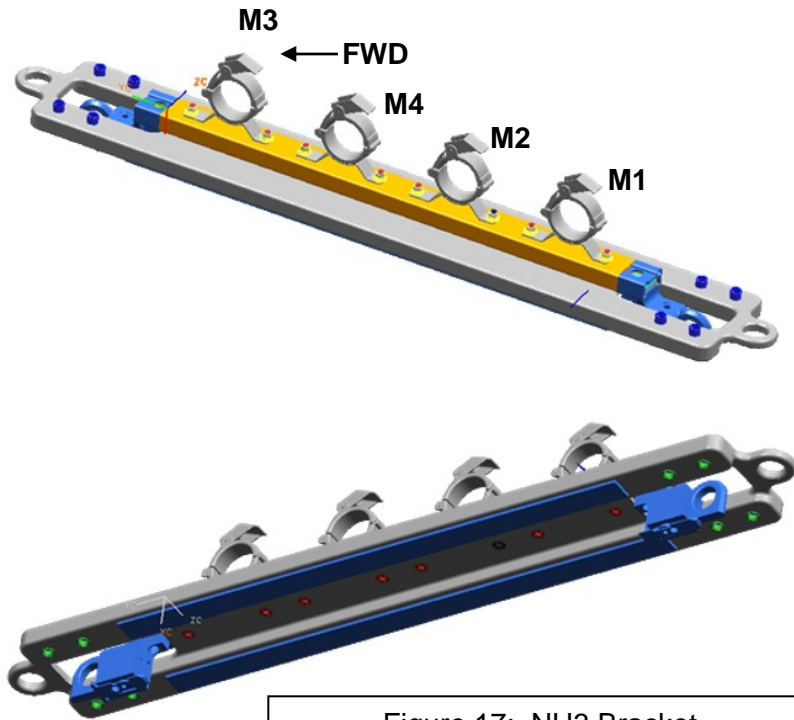

Figure 17: NH3 Bracket

## NOD1 FGB LAN CABLE/MMOD SHIELD – TASK DATA

### Estimated Task Duration:

	With RMS	Without RMS
One EV Crew	N/A	00:45
Two EV Crew	N/A	00:30

### Tools:

	EV1	EV2
1 Short Wire Tie		
3 Long Wire Ties		

### Notes:

- 1.
- 2.
- 3.
- 4.
- 5.

### Timeline Considerations:

- 1.
- 2.
- 3.
- 4.
- 5.

**NOD1 FGB LAN CABLE/MMOD SHIELD – TASK DATA (Cont)**

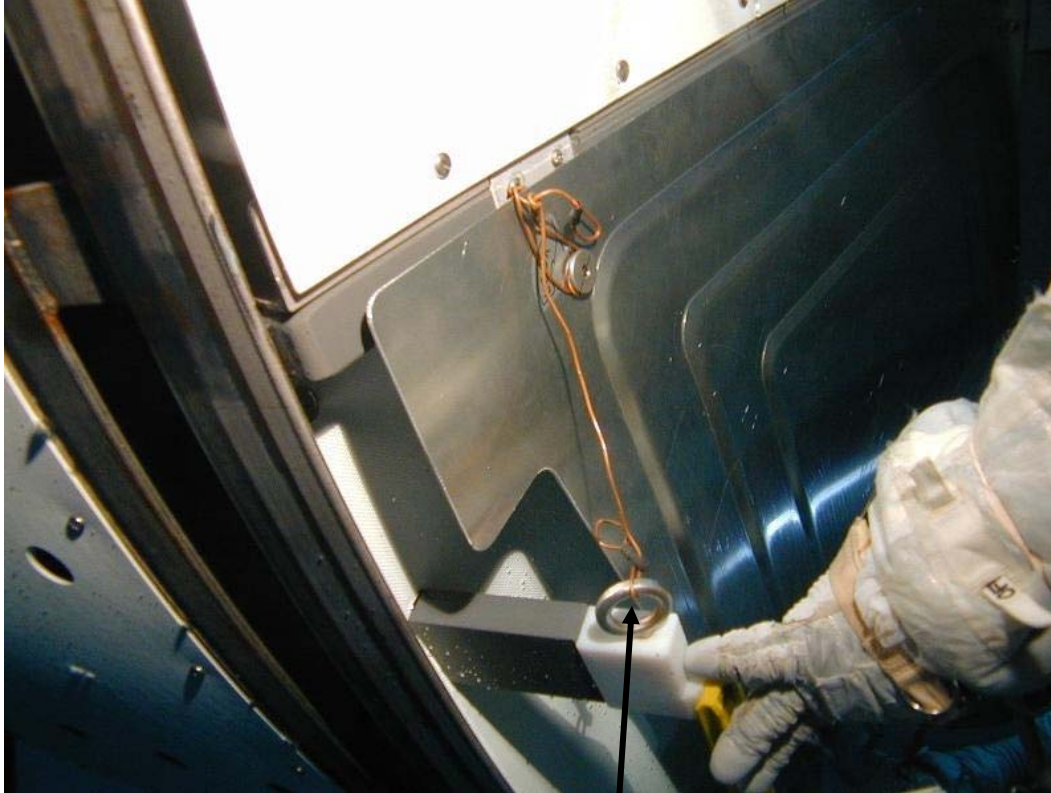

Wire tie attached to a HR (not required)

Figure 18: NOD1 MMOD Shield Wire Tie to Handrail

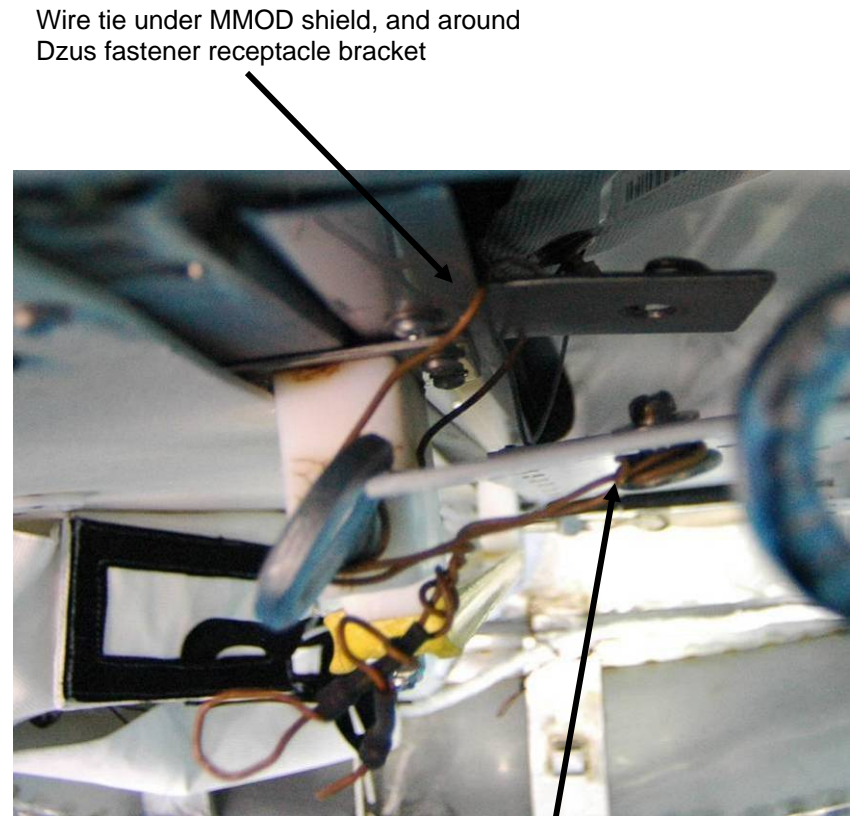

Wire tie under MMOD shield, and around Dzus fastener receptacle bracket

Wire tie around Dzus fastener

Figure 19: NOD1 MMOD Shield Wire Tie around Dzus fastener

# NOD1 FGB LAN CABLE/MMOD SHIELD – TASK DATA (Cont)

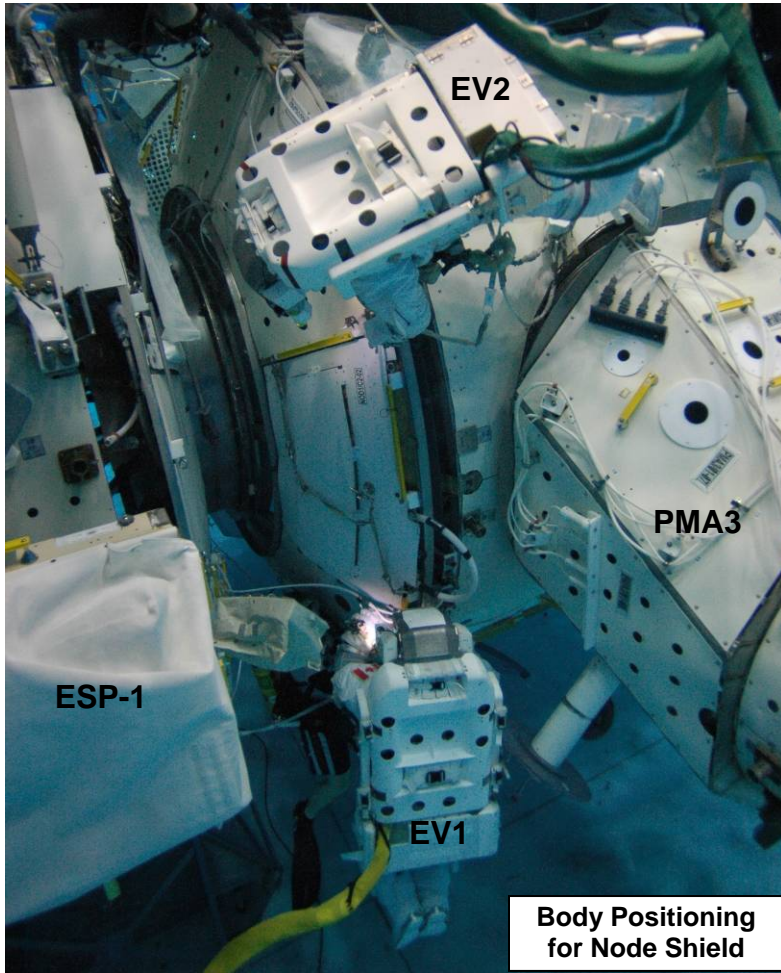

Figure 20: NOD1 MMOD Shield Body Positioning

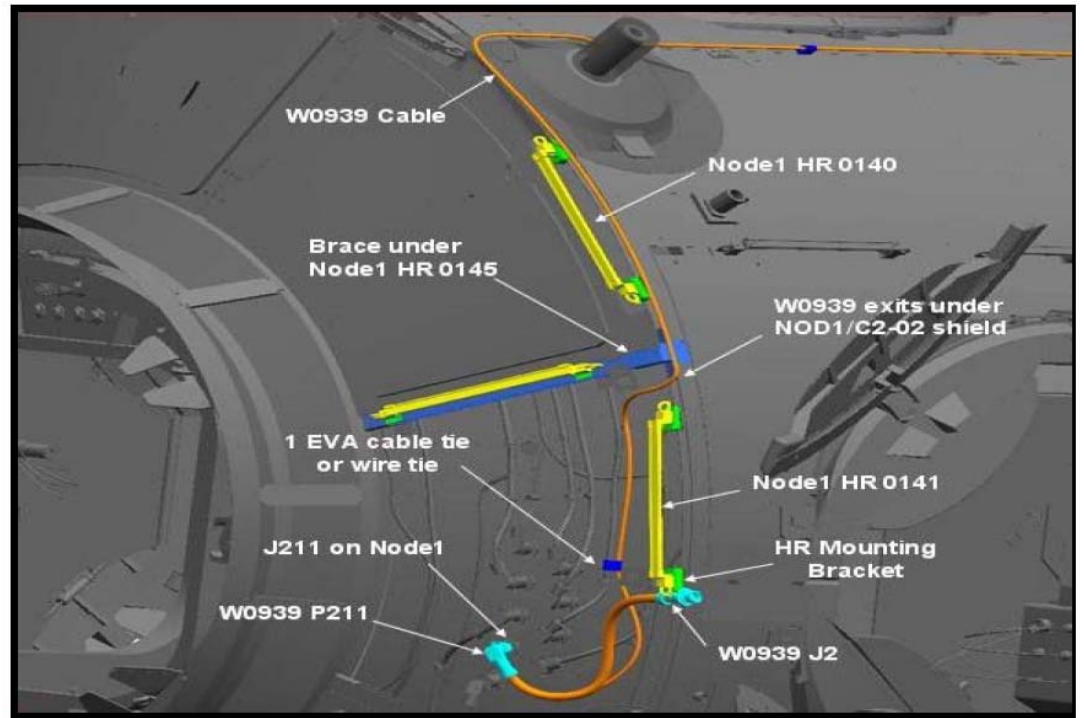

Figure 21: FGB LAN Cable Routing

## S0 PANEL A145 CONNECTOR TROUBLESHOOTING – TASK DATA

### Estimated Task Duration:

	With RMS	Without RMS
One EV Crew	N/A	00:30
Two EV Crew	N/A	N/A

### ORU Identification:

ORU	Part Number	Dimensions	Mass
Ch 1/4 Cable	684-014123-0001	~675"	60.5 lbs

### Tools:

EV1
Connector Adapter

### EVA Connector:

Harness	Connector	Conn Size	S0 Panel A145 Connector	Function
W9025	P181	25L	J181	Pri 4A Power

### Foot Restraints:

Task	WIF	APFR Setting
S0 A145 Conn	S0 WIF 11	1, QQ, F, 12
Alternate for S0 A145 Conn	S0 WIF 14	10, QQ, C 12

### Notes:

1. S0 HR 3450 is good for BRT restraint inside the truss
2. Direct access via face 1 is likely blocked by the MT when at worksite 4, but access may be possible via one bay starboard

### Cautions:

- 1.

### Warnings:

1. Verify electrical inhibits for S0 Panel A145 in place prior to electrical mate/demate



# S0 PANEL A145 CONNECTOR TROUBLESHOOTING – TASK DATA (Cont)

## S0 Bay 01, Face 5



Shroud hinge line

J181

Shroud handling aid

Approximate EVA access created by opening Face 5 shroud

Connector Panel A145

NOTE: The S0 Face 5 shroud (1F77052) is designed to peel back to create access for the Crewmember while working on the connector panel. It may be possible to access the connector on the back side of J181 from outside the truss

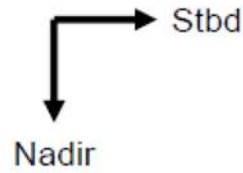

S0 PANEL A145 CONNECTOR TROUBLESHOOTING – TASK DATA (Cont)

# S0 Bay 01, Face 1

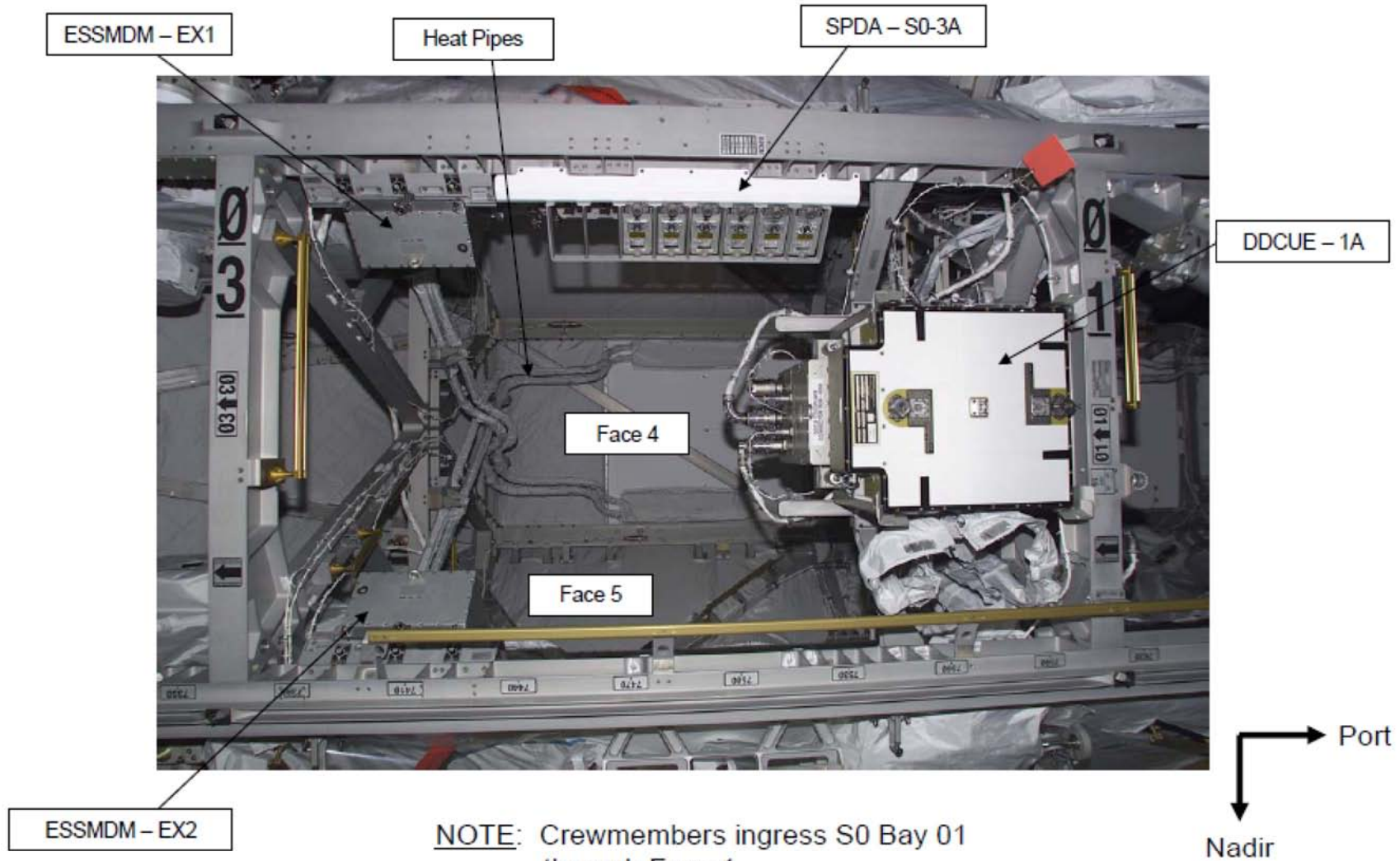

## S0 PANEL A145 CONNECTOR TROUBLESHOOTING – TASK DATA (Cont)

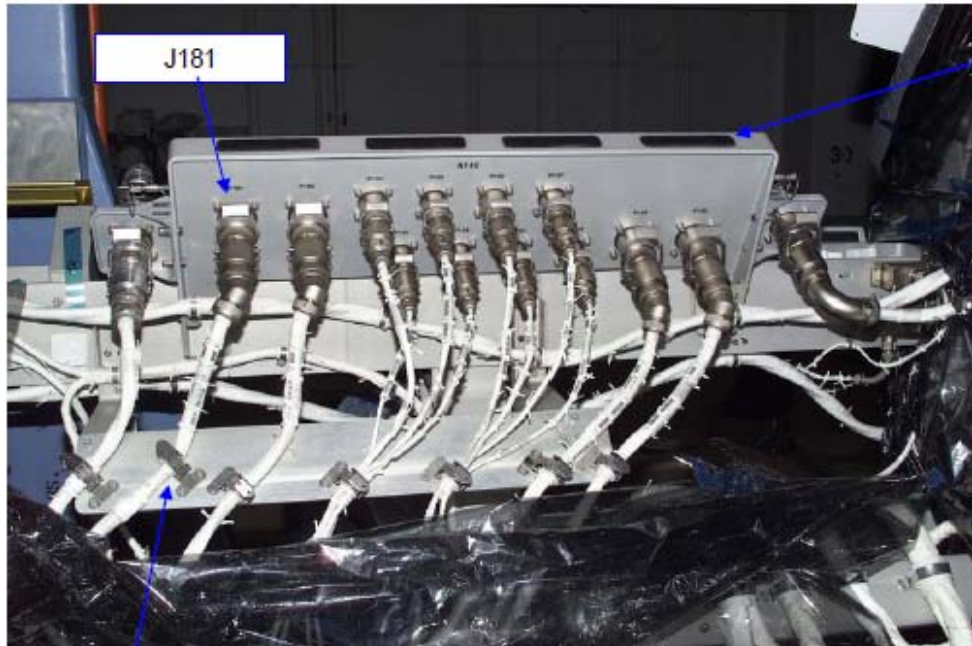

Velcro on top edge of A145 Panel  
to secure Face 5 shroud

### Back Side of A145 Connector Panel

TA Clamp & Support  
Structure



**S0 PANEL A145 CONNECTOR TROUBLESHOOTING – TASK DATA (Cont)**



# EVA 2 SUMMARY TIMELINE

PET HR : MIN	IV/SSRMS	EV1 (Fm)	EV3 (Br)	
00:00		<u>EGRESS/SETUP (00:30)</u> <ul style="list-style-type: none"> <li>Post Depress and Egress (00:15)</li> <li>Setup (00:15)</li> </ul>	<u>EGRESS/SETUP (00:30)</u> <ul style="list-style-type: none"> <li>Post Depress and Egress (00:15)</li> <li>Setup (00:15)</li> </ul>	00:00
01:00		<u>GATOR ASSEMBLY INSTALL (01:15)</u> <ul style="list-style-type: none"> <li>Retrieve TSA Contents (00:30)</li> <li>Mate Connector and Secure Harness (00:40)</li> <li>Close Node 2 Zenith CBCS Flap (00:05)</li> </ul>	<u>GATOR ASSEMBLY INSTALL (01:15)</u> <ul style="list-style-type: none"> <li>Retrieve GATOR Assembly (00:20)</li> <li>Install AIS &amp; ARISS Antennas (00:55)</li> </ul>	01:00
02:00		<u>FPMU RELOCATE (01:30)</u> <ul style="list-style-type: none"> <li>Remove &amp; Relocate FPMU from CP2 (01:00)</li> <li>Install FPMU in CP6 (00:30)</li> </ul>	<u>FPMU RELOCATE (01:30)</u> <ul style="list-style-type: none"> <li>Remove &amp; Relocate FPMU from CP2 (01:00)</li> <li>Install FPMU in CP6 (00:30)</li> </ul>	02:00
03:00		<u>S3 NADIR/OUTBD PAS DEPLOY (01:30)</u> <ul style="list-style-type: none"> <li>Hinge Line Prep</li> <li>Remove SARJ Brace</li> <li>Remove Diagonal Brace</li> <li>Deploy Platform</li> <li>Reinstall Diagonal Brace</li> <li>Reinstall SARJ Brace</li> <li>Prep UMA</li> </ul>	<u>S3 NADIR/OUTBD PAS DEPLOY (01:30)</u> <ul style="list-style-type: none"> <li>Swivel Deploy Clevis Bracket</li> <li>Release Yoke ADP and PIP Pin</li> <li>Remove Stow Clevis Bracket</li> <li>Deploy Platform</li> <li>Reinstall Diagonal Brace</li> <li>Reinstall Deploy Clevis Bracket</li> <li>Install Yoke</li> <li>RTL Checkout</li> <li>EBCS Target Prep</li> </ul>	03:00
04:00		<u>CP1 WETA INSTALL (00:45)</u>	<u>CP1 WETA INSTALL (00:45)</u>	04:00
05:00		<u>GET-AHEADS (00:30)</u>	<u>GET-AHEADS (00:30)</u>	05:00
06:00		<u>CLEANUP/INGRESS (00:30)</u> <ul style="list-style-type: none"> <li>Cleanup (00:15)</li> <li>Ingress and Pre-Repress (00:15)</li> </ul>	<u>CLEANUP/INGRESS (00:30)</u> <ul style="list-style-type: none"> <li>Install HPGT Guide Post (00:05)</li> <li>Cleanup (00:10)</li> <li>Ingress and Pre-Repress (00:15)</li> </ul>	06:00
06:30				06:30

# EVA 2

## EVA 2 TOOL CONFIG

### EV1

- MWS
  - BRT (L)
    - RET (sm-sm)
    - Wire Tie (2 short)
  - T-Bar
    - RET (sm-sm)
    - RET w/PIP Pin
    - Adj Equip Tether
    - Adj Equip Tether (left side for FPMU)
    - Wire Tie (2)
    - Small ISS Trash Bag (right/inboard)
      - GATOR Cap
      - GATOR Velcro Strap
      - PAS UMA Anti-rotation cap w/hitch pin
  - Swing Arm (R)
    - RET (sm-sm)
      - Wire Tie Caddy (9 short)
      - PGT [A7 ft-lb, CAL, MTL 30.5]
        - PGT Battery
        - 7/16 (wobble) Socket-6 ext
    - EVA Camera w/bracket (use int RET)
  - D-ring Extender (2, R&L D-ring)
    - ST Pack (85-ft + 85-ft to L D-ring) (A/L & Second)
  - Waist Tether (2, L on D-ring, R on D-ring Ext)
  - SAFER
  - WVS

- RET (Lg-sm)
- Adj Equip Tether
  - Crewlock Bag (NOD1 Bag)**
    - int RET (attached to door handle)
      - ERAD
    - int RET (attached to door handle)
      - ERAD
    - int RET (attached to door handle)
      - HPGT Guide Post (get-ahead install)
    - Int RET to door handle

### EV3

- MWS
  - BRT (L)
    - RET (sm-sm)
    - Wire Tie (3 long, 1 short)
  - T-Bar
    - RET (sm-sm)
    - RET w/PIP Pin
    - Adj Equip Tether
    - Adj Equip Tether
    - Wire Tie (2)
    - Small ISS Trash Bag (right/inboard)
      - PAS RTL PIP Pins (3)
      - GATOR Velcro Strap
  - Swing Arm (R)
    - RET (sm-sm)
      - PGT [A2 ft-lb, CAL, MTL 30.5] s/n \_\_\_\_\_
      - PGT Battery s/n \_\_\_\_\_
      - 7/16 (wobble) Socket-6 ext
  - D-ring Extender
    - ST Pack (85-ft + 85-ft to L D-ring ext) (A/L & Second)
  - Waist Tether (2, L on D-ring, R on D-ring Ext)
  - SAFER
  - WVS

- RET (Lg-sm)
- Adj Equip Tether
- Lg-sm Adj Equip Tether
  - Crewlock Bag (PAS Bag)**
    - DRT (on int RET)
    - DRT (on int RET)
    - Hammer (on int RET)
    - Wire Ties (2) (ext, loops squished for bracket)
    - RET (sm-sm) (to door handle)
      - PAS Stow Clevis Bracket
      - Round Scoop (on int RET)
    - RET (sm-sm) (to door handle)
      - Dummy Box (Scorched)
    - RET (sm-sm) (to door handle)
      - WETA MLI

### A/L

- RET (Lg-sm)
  - PGT [B6 ft-lb, CAL, MTL 30.5] s/n \_\_\_\_\_
  - PGT Battery s/n \_\_\_\_\_
    - 7/16 (wobble) Socket-6 ext
  - Round Scoop
- RET (Lg-sm)
  - Round Scoop (handle up)
  - WETA (EV MLI installed; IV MLI & conn cap off)
  - Wire Tie Caddy
- RET (Lg-sm)
- Adj Equip Tether
  - Crewlock Bag (Get-ahead Bag)**
    - EVA Ratchet Palm Wheel (on int RET)
    - EVA Ratchet w/2" socket (on int RET) (use middle tether point)
    - Wire Tie (2) (external)
      - Cheater Bar (on int RET) (wire tied to outside of bag)
    - Int RET to door handle

**NOTE** – Prior to use, inspect the following hardware:

- RET cords for fraying
- Safety Tether/Waist Tether LAS: No Red Visible
- ISS Trash Bag: Bristle deformation/damage, after having stowed tools in trash bag
- BRT joint screws not loose
- Empty trash bags and verify zipper closed

## EVA 2 TOOL CONFIG (Cont)

### IV Bag

- Towels (2)
- Contamination Detection Kit
- GP Caddy (2)
  - Adjustable Thermal Mittens (2)
- Socket Caddy (hatch cont) w/RET (sm-sm) (Black)
  - 1/2 Socket-8 ext
  - 7/16 (wobble) Socket-6 ext (spare)
- DCM Plug (SAFER Hardmount) (2)
- RET (sm-sm, Black) (2)

### Staging Bag

- Fish Stringer Tether
  - Long Duration Tie Down Tether
  - Velcro/Tape Caddy
  - PGT s/n \_\_\_\_\_
  - PGT Battery s/n \_\_\_\_\_
  - 7/16 (wobble) Socket-6 ext
  - Vise Grips
  - Ratchet Wrench
    - 7/16 (rigid) Socket-9 ext
  - Spare 85-ft Safety Tether
  - Spare WIF Adapter
- Fish Stringer Tether
  - Connector Cleaner Tool Kit
  - Pin Straightener Assy
  - Probe
  - Pry Bar
  - Long Duration Tie Down Tether
  - Torque Wrench Bag
    - Torque Wrench (set to 20 ft-lb; on hook)
  - MWS Key Strap Assy (wire-tied to strap)

Tether Counts: <b>BLUE RETs</b>	
RETs (sm-sm) = 9	Adj Equip Tethers (sm-sm) = 7 of 10
RETs (Lg-sm) = 5	(Lg-sm) = 1 of 2
RETs (PIP Pin) = 2	

## EVA 2 BRIEFING CARD

EV1 \_\_\_\_\_ EV2 \_\_\_\_\_ IV1 \_\_\_\_\_ IV2 \_\_\_\_\_

EVA Prep start (GMT) \_\_\_\_ / \_\_\_\_ : \_\_\_\_  
Depress to 10.2 \_\_\_\_\_ : \_\_\_\_\_  
Start purge \_\_\_\_\_ : \_\_\_\_\_  
PET 00:00 \_\_\_\_\_ : \_\_\_\_\_

### EVA Prep

- Get-up plan – clothing and EMU equipment bag
- Equipment lock activities – IV responsibilities
- Suit donning plan – special requests
- SAFER, MWS, tools, CL positions and bag stowage
- Airlock depress review
- EV/IV comm protocol
- SRMS/SSRMS initial position

### EV Crew Procedure Review

- Egress Plan
- Translations – tether swaps
- Order of tasks
- Ingress Plan

### General Procedure Review

- Hazards
- Get ahead tasks
- Constraints – ground and flight
- Cautions and warnings review
- SSRMS and RMS operations – comm protocol/clearances and coordinate systems
- Contingency procedures – crib sheet
- Inspect gloves after each task or if high loading event happens
- Anticipated hazards

### Emergencies review

- Lost comm
- EMU malfunctions
- Rescue of Incapacitated Crewmember – retreat, tethers, A/L, MCC for SCU
- Lost tools
- Lost crewmember
- DCS
- SAFER Ops

### 1<sup>st</sup> Steps today

- A/L Egress and ST config
- Thermal cover
- Translation paths

### Post EVA

- Post EVA plan

Lessons learned from previous EVAs



## EVA 2 INHIBIT PAD

### Orbiter (1)

ALL EVAs	
TCS ( <i>Prior to Egress</i> ) L12	1. √TCS POWER – OFF
KU-Band Antenna ( <i>Prior to Egress</i> )	
MCC-H	1. √KU-BAND Mask – active 2. √KU-BAND EVA Protect Box – active
RCS ( <i>Prior to Egress</i> )	
	If EV crew < 27 feet from FRCS
IV O14,15,16	1. √DAP: VERN, FREE, LO Z 2. √RJDF F1, F2, F3, F4 MANF DRIVER (four) – OFF LOGIC (four) – OFF
MCC-H	3. √Above RCS config
IV	4. √RCS F – ITEM 1 EXEC (*) √JET DES F1U – ITEM 17 (*) F3U – ITEM 19 (*) F2U – ITEM 21 (*)

### Ground

ALL EVAs	
Ground Radar ( <i>Prior to Egress</i> )	
MCC-H	1. √TOPO console, ground radar restrictions in place for EVA

### USOS (1)

ALL EVAs	
PCU ( <i>Prior to Egress</i> )	
<u>NOTE</u> PCUs may require up to a 1-hour warmup period before they are operational.	
MCC-H	1. √PCUs (two) operational in discharge mode and one of the following: a. CCS PCU EVA hazard control FDIR enabled. b. No more than two arrays unshunted and oriented < 105° from velocity vector. If one or both PCUs failed 2. No more than two arrays unshunted and oriented < 105° from velocity vector.
JEM	
ICS-EF Antenna ( <i>Prior to Egress</i> )	
SSIPC	1. ICS MOD Off 2. ICS UPC Off 3. ICS HPA Off
LOCATION DEPENDENT INHIBITS	
Lab Window ( <i>Prior to Egress, for crew in Payload Bay</i> )	
IV	If EV crew less than 10 feet from window or in window FOV, close window shutter
S-Band (SASA) Antennas ( <i>Prior to FPMU Relocate, release after FPMU Relocate</i> )	
MCC-H	If EV crew < 3.6 feet from P1 SASA 1. S1 SASA (String 1) – Active 2. P1 SASA (String 2) – Powered down, FDIR unavailable for String 2
Mobile Transporter ( <i>Prior to Egress</i> )	
MCC-H	If EV crew < 1.5 meters from MT 1. √MT latched

## EVA 2 INHIBIT PAD (Cont)

### USOS (2)

#### LOCATION DEPENDENT INHIBITS

##### SARJ (*S3 at egress, P3 not expected*)

MCC-H If EV crew working within 2 feet or outboard of SARJ

1. √DLA (1) – LOCKED at 330 degrees
2. All motor setpoints set to zero.
3. All motors deselected.

##### TRRJ (*S1 at egress, P1 not expected*)

MCC-H If EV crew working within 2 feet of P1 TRRJ rotation envelope

1. √DLA (1) – LOCKED at 0 degrees

MCC-H If EV crew working within 2 feet of S1 TRRJ rotation envelope

1. √DLA (1) – LOCKED at 0 degrees

##### FPMU (*Prior to Egress*)

MCC-H If EV crew working within 5 feet of Floating Potential Measurement Unit

1. FPMU power – Off

##### S3 Nadir Outboard (PAS 3) (*at Egress*)

MCC-H IMCA PWR: RPCM S32B A RPC 13 – Open, Close Cmd Inhibit

##### S3 Zenith Inboard (PAS 2) (*on call*)

MCC-H IMCA PWR: RPCM S32B A RPC 12 – Open, Close Cmd Inhibit

##### CP1 WETA INSTALL (*Prior to Egress*)

MCC-H RPCM S31A\_A RPC 15 – Open, Close Cmd inhibit  
 RPC 16 – Open, Close Cmd Inhibit  
 RPCM S32B\_A RPC 15 – Open, Close Cmd Inhibit  
 RPC 16 – Open, Close Cmd Inhibit

##### FPMU Relocate (*Prior to FPMU – 4.5 hour thermal clock*)

MCC-H RPCM S12B-A(CP2) RPC 1 – Open, Close Cmd Inhibit  
 RPC 15 – Open, Close Cmd Inhibit  
 RPCM S11A-A(CP2) RPC 2 – Open, Close Cmd Inhibit  
 RPC 16 – Open, Close Cmd Inhibit  
 RPCM P12B-B(CP6) RPC 3 – Open, Close Cmd Inhibit  
 RPC 14 – Open, Close Cmd Inhibit  
 RPCM P11A-B(CP6) RPC 1 – Open, Close Cmd Inhibit  
 RPC 13 – Open, Close Cmd Inhibit

### COL (1)

#### ALL EVAs

##### GATOR (*Prior to Egress*)

IV 1. Verify COL100 J02 ACES connector capped.

### RSOS (1)

#### ALL EVAs

##### SM Antennas (*Prior to Egress*)

IV 1. GTS – Deactivate  
 2. ARISS (Ham Radio) – Deactivate or VHF (144-146 MHz) TX only

##### IMPULSE (*Prior to Egress*)

MCC-M 1. IMPULSE (ИПИ-100) – Is not activated

### GET-AHEADS

#### EVAs ON PMA 1 OR RSOS (*APFR 5 Retrieval*)

##### FGB Antennas

MCC-M 1. √FGB KURS P [КУРС P] – Deactivated

##### FGB Thrusters

MCC-M 1. √FGB MCS unpowered  
 2. √All FGB Attitude Control Thruster Valves (eighty) – closed  
 3. √FGB Attitude Control Manifold Valves – closed  
 КШК1, КШК2, КШК4, КШК5, КШК9, ОКО3, ОКГ3, ОКО6, ОКГ6,  
 ОКО7, ОКГ7, ОКО8, ОКГ8

## EVA 2 NOTES/CAUTIONS/WARNINGS

### NOTES

1. Bolt install: Report torque and turns
2. Bolt release: Report torque and turns if different from published range
3. EVA connectors: After disconnection and prior to connection; verify pin and EMI band integrity; verify connector free of FOD
4. Inspect QDs for damage prior to mating
5. Toolbox doors must be closed with one latch per door when EV crew not in immediate vicinity
6. Avoid contact with OBSS striker bars (Vitrolube coating)
7. 85-ft safety tether retract force may affect body positioning

### CAUTION

#### ISS Generic Constraints

- A. Avoid inadvertent contact with
1. Grapple fixture shafts (drylube)
  2. PIP pins
  3. Passive UMAs
  4. MBS/SSRMS/SPDM taped radiative surfaces: VDU, ACU, JEU, LEU, MCU, CRPCMs, and Cameras
  5. SPDM SJEU, EP, OTCM, LEU, and LEE VDU radiator surfaces
  6. OTSD
- B. Electrical cables
1. Avoid bend radii < 10 times cable diameter
- C. Fiber optic cables
1. Avoid bend radii < 10 times cable diameter
  2. Avoid pulling on cable during mate/demate
- D. Fluid line flex hoses and QDs
1. Avoid bend radii < 14 in for hoses with a diameter  $\geq$  1 in
  2. Additional care should be taken to not exceed bend radii when applying loads at the flexible hose to rigid tube stub interfaces
  3. Ensure fluid QD booties are fully closed prior to leaving worksite; wire tie if reqd
  4. Avoid bend radii < 5 in for hoses with diameter < 1 in on Lab, S0, S1, P1, and 10 in for hoses with diameter < 1 in on all other elements

### CAUTION

#### ISS Generic Constraints (Cont)

- E. For structural reasons
1. Avoid vigorous body motions, quick grabs and kickoffs against tether restraints
  2. Avoid performing shaking motions (sinusoidal functions) more than four cycles
- F. Other
1. ITT Cannon connector: On demated connectors, do not rotate collar or manipulate cable/connector using collar or connector tool
  2. MLI handholds are not rated for crewmember translation loads

## EVA 2 NOTES/CAUTIONS/WARNINGS (Cont)

### CAUTION

#### ISS Truss Constraints

##### A. Avoid inadvertent contact with

1. CETA lights (Z-93 paint) [Lab,S1,Node 1]
2. Deployed TUS cable [Nadir CETA rail]
3. S0 aft face radiator
4. GPS antennas (S13 paint) [S0,JLP]
5. UHF antennas [Lab,P1]
6. ETCS radiator flexhoses and panels [S1,P1]
7. EETCS/PV radiator flexhoses, bellows and panels [P6,P4,S4,S6]
8. SASA RF group [S1,P1]
9. Heat pipe radiators [Z1]
10. PCU cathode and HCA ports [Z1]
11. Ku-Band antenna (SGANT) dish [Z1]
12. CMG cover/shells [Z1]
13. FPMU [S1]
14. SASA high & low gain antennas and radiator surfaces [Z1]
15. Deployed MISSEs

##### B. For structural reasons

1. Avoid kicking S1/P1 radiator beam.  
If any of these occur, wait 2 to 5 min to allow structural response to dissipate

### CAUTION

#### ISS Truss Constraints (Cont)

##### D. Other

1. WIS Antennas: Do not use as handholds [Node 1,Lab,P6,Z1]
2. Lubricant from Ku-Band SGANT gimbals [Z1], CMGs [Z1], and RTAS ground strap fasteners [P6,P4,S4,S6] can contaminate EMU
3. Prevent inadvertent contact of the tether shuttle with ETRS when the P3 tether shuttle stop is raised away from the rail

### CAUTION

#### ISS U.S. Pressurized Elements Constraints

##### A. Avoid inadvertent contact with

1. EVA crane [PMA1]
2. TCS reflectors [PMA2,PMA3]
3. APAS hardware [PMA2,PMA3]
4. CETA lights (Z-93 paint) [Lab,S1,Node 1]
5. UHF antennas [Lab,P1]
6. Open CBM petal covers and Lab window shutter
7. S0/Node 2 fluid tray hardlines at Node 2 end are limited to 25 lb

##### B. Other

1. WIS antennas: Do not use as handholds [Node 1,Lab,P6,Z1]
2. CBM petal covers may not be used as handholds unless both launch restraint pins are engaged

## EVA 2 NOTES/CAUTIONS/WARNINGS (Cont)

### CAUTION

#### ISS I.P. Elements Constraints

##### COL:

##### A. Avoid inadvertent contact with

1. COL ARISS & AIS antennas [COL-Nadir]

##### JEM:

##### A. Avoid inadvertent contact with

1. GPS antennas (S13 paint) [S0,JLP]
2. Open JPM window shutter
3. JTVE, WVE/EVE, JEF VE cameras [JEM]
4. JEMRMS taped radiative surfaces
5. JEM A/L target and pins
6. JEF ORUs and EFUs (paint & lubricant)
7. MAXI front and top panel (paint)
8. SEDA-AP sensors (HIT, SDOM, & AOM) and MPAC & SEED
9. Trunnions and UCMS (paint & lubricant) [JEF Payloads]
10. RAIDS covers on end of HREP
11. ICS-EF Ku-Band antenna dish

##### B. For structural reasons

1. Avoid kicking MMOD shields between JLP and JPM
2. Avoid tool impact on ICS-EF sensor

### CAUTION

#### Shuttle Constraints

##### A. Avoid inadvertent contact with

1. OBSS and SRMS composite sections joint torque arms, grapple fixture shafts, and cable harnesses
2. LCS (silver Teflon) and LDRI (silver Teflon) and ITVC (gold foil) [OBSS]
3. WVS antenna [ODS truss & PLB sill]
4. Payload bay and camera wire harnesses, cables, cable guides, and connectors

##### B. No touch

1. LDRI diffuser [OBSS]
2. OBSS saddle contacts (when OBSS unberthed) [OBSS]
3. Monkey fur [PLB]
4. Cameras: Metallic surfaces [PLB]
5. Ku-Band antenna black dish and gold thermal blankets [PLB]

## EVA 2 NOTES/CAUTIONS/WARNINGS (Cont)

### WARNING

#### ISS Generic Constraints

- A. Avoid inadvertent contact with
1. Grapple fixture targets and target pins
- B. Pinch
1. NZGL connector linkage. Use caution when mating/locking
  2. ITT Cannon connector rotating housing
- C. QDs
1. If QD is in FID when valve is opened (bail fwd), QD will leak and fluid line may whip
  2. Do not rotate if in mated/valve open config
- D. Sharp Edges
1. Inner edges of WIF sockets
  2. APFR active WIF probes
  3. Mating surfaces of EVA connectors  
Avoid side loads during connector mating
  4. Back side of MMOD shield fasteners
  5. Spring loaded captive EVA fasteners (e.g., 6B-boxes, BMRRM, RTAS, SARJ Covers); the end of the spring may protrude
  6. SPDM OTCM gripper jaws
  7. Keep hands away from SSRMS LEE/POA/SPDM LEE opening, snares, and PDGF curvic coupling (teeth)
  8. MMOD strikes on ISS exterior

### WARNING

#### ISS Generic Constraints (Cont)

- E. Thermal
1. EVA connectors with booties may become hot if left uncovered. Handling may need to be limited
  2. Turn off glove heaters when comfortable temp reached to prevent bladder damage. Do not pull fingers out of gloves when heaters are on
  3. Uncovered trunnion pins may be hot
  4. SSRMS/MBS/SPDM/JEMRMS/JTVE/JEF VE operating cameras and lights may radiate large amounts of heat
  5. Do not touch EMU protective visor if temp has been < -134 degF for > 15 min
  6. No EMU boot contact with foot restraint when temp < -120 degF or > 200 degF
  7. PDGF surfaces may not meet touch temperature requirements for unlimited contact when  $\beta \leq -70$  or  $\beta \geq 70$
- F. Electrical Shock
1. Do not touch SPDM CLPA 1 electrical connector prior to camera installation

### WARNING

#### ISS Truss Constraints

- A. Avoid inadvertent contact with
1. SSU, ECU, beta gimbal platform, mast canister, SAW blanket boxes unless the beta gimbal is locked and the motor is turned off
  2. Stay inboard of SARJ when active
  3. Stay 2 ft from S1/P1 radiator beam rotational envelope when beam is free to rotate
  4. Stay 5 ft from moving MT on face 1
- B. RF radiation exposure
1. Stay 3.6 ft from S-Band (SASA) high gain Antenna when powered [S1,P1]
  2. Stay 1.3 ft from S-Band (SASA) low gain Antenna when powered [S1,P1]
  3. Stay 1 ft from UHF Antenna when powered [Lab,P1]
- C. Sharp Edges
1. Solar array blanket box [P6,S6]
  2. Fastener threads on back of Z1 U-jumper male FQD panel, if nutplate cap missing
  3. Outboard MT rail attachment lug near P6 handrail 5333 and gap spanner
  4. P2 connector on EWIS box TAA-06 [Zenith/Forward Corner 1 of P5 – SARJ at 0 deg]
  5. Nickel coated braided copper ground straps may contain frayed wires [P6,P4,S4,S6]
  6. MMOD strikes on Z1 toolboxes

## EVA 2 NOTES/CAUTIONS/WARNINGS (Cont)

### WARNING

#### ISS Truss Constraints (Cont)

##### D. Electrical Shock

1. Stay  $\geq 2$  ft from ungrounded floating connectors if powered
  - MBS cross-connect jumpers (translate past these using UMA handrails)
  - S0 EVA power cables (inside S0 Bay 00 Face 4, Bay 01 Face 3)
  - ESP-2 jumper (inside S0 Bay 03 Face 4)

##### E. Thermal

1. ELC may exceed touch temperatures when  $\beta > 75$  deg

### WARNING

#### ISS U.S. Pressurized Elements Constraints

##### A. Handrails

1. Handrails previously used for MISSE attachment may not be used as a safety tether point [A/L endcone 564 & 566, A/L Tank 2 nad/fwd & port/fwd, P6 5389]

##### B. Pinch

1. EV side of IV Hatch during Hatch operation (also snag hazard) [A/L]
2. LAB window shutter and CBM petal cover linkages during operation

##### C. RF radiation exposure

1. Stay 1 ft from UHF antenna when powered [Lab,P1]

##### D. Sharp Edges

1. PMA umbilical launch restraints-exposed bolt threads
2. Adjustable fuse tether (Fish Stringer) buckles stowed in Node bag
3. Port/Aft portion of A/L circular HR [HR 0506]
4. A/L HR 0537 (Eq Lock Zenith)

##### E. Thermal

1. PMA handrails may be hot. Handling may need to be limited
2. Stay  $\geq 1$  ft away from PMAs and MMOD shields  $> 270$  degF if EMU sun visor up; limit time to 15 min or less if  $> 300$  degF
3. Stay at least 0.5 ft away from PMA and MMOD shields  $> 325$  degF
4. No EMU TMG contact with PMAs and MMOD shields  $> 320$  degF

### WARNING

#### ISS U.S. Pressurized Elements Constraints (Cont)

##### F. Electrical Shock

1. Stay  $\geq 2$  ft from ungrounded floating connectors if powered
  - SSPTS connectors include NOD1 Stbd/Fwd HR 0130, Lab Stbd/Fwd HR 0273, PMA 2 Stbd and Port

## EVA 2 NOTES/CAUTIONS/WARNINGS (Cont)

### WARNING

#### ISS I.P. Elements Constraints

##### COL:

##### A. Avoid inadvertent contact with

1. SOLAR [COL EPF]

##### B. Thermal

1. Columbus end cones may violate touch temperature constraints when  $-75 \leq \beta \leq -60$  or  $60 \leq \beta \leq 75$

##### JEM:

##### A. Avoid inadvertent contact with

1. ICS-EF sensors

##### B. Pinch

1. JPM window shutter linkages during operation
2. JEMRMS HRM capture latches
3. JEM cameras (JVTEs, EVE, WVE, & JEF VEs)
4. JEM EFBM capture latches
5. JEM EFU latching arms
6. JEF SSE latch
7. ICS-EF antenna boom
8. SEDA-AP mast
9. SMILES antenna rotating area
10. HREP hinge sides and RAIDS pinch areas

### WARNING

#### ISS I.P. Elements Constraints (Cont)

##### JEM (Cont):

##### C. Sharp Edges

1. Interior of JEMRMS HRMs
2. JEMRMS EE opening and snares
3. JEM A/L hatch corners
4. ICS-EF AHM gears
5. MAXI visual star camera
6. SMILES baffles (2), baffle base bare bolts, and cold sky terminator (CST)
7. HREP baffles (4) [Star tracker aperture Zenith and three instrument baffles aft]
8. PIU springs [ICS-EF, MAXI, SEDA-AP, SMILES, HREP]

##### D. RF radiation exposure

1. Stay 0.3 ft from fwd/aft JPM PROX antenna

##### E. Thermal

1. JPM port end cones and JLP port nadir may violate touch temperature constraints when  $\beta > 60$  deg
2. JEMRMS/JTVE/JEFVE operating cameras and lights may radiate large amounts of heat

### WARNING

#### Shuttle Constraints

##### A. Arcing/Molten Debris

1. Stay  $\geq 2$  ft from exposed EFGF connector when OBSS berthed, powered, and EFGF not grappled [PLB]
2. Stay  $\geq 2$  ft from exposed Stbd Fwd MPM contacts [PLB]
3. Stay above PLB sill when within 1 ft of powered ROEU connector [PLB]

##### B. Pinch

1. PRLA operation [PLB]

##### C. RF radiation exposure

1. Stay 3.28 ft from S-Band Antenna when powered
2. Stay 1 ft from top and side of UHF PLB Antenna radome surface when in high powered mode [ODS truss]
3. Stay 0.33 ft from top and side of UHF PLB Antenna radome surface when in low powered mode [ODS truss]
4. Remain below the level of the PLB door mold line for first 20 in Aft of Fwd bulkhead when S-Band Antenna powered [PLB]
5. Remain on the inboard side of the Stbd slidewire (sill handrails if slidewire not installed) for first 20 ft Aft of Fwd bulkhead when Ku-Band Antenna powered [PLB]



## EVA 2 NOTES/CAUTIONS/WARNINGS (Cont)

### WARNING

#### Shuttle Constraints (Cont)

##### D. Sharp Edges

1. PRLA grounding wipers [PLB]
2. LDRI baffles (also an entrapment hazard) [OBSS]
3. Keep hands away from SRMS EE opening and snares
4. TCS connector backshells have exposed threads [ODS]

##### E. Thermal

1. Illuminated PLB lights; do not touch
2. OBSS grapple fixture shafts/cams may be hot. Limit handling if required
3. Stay 27 ft from PRCS when powered
4. Stay 3 ft from VRCS when powered
5. Stay 3 ft from APU when operating

##### F. Contamination

1. Stay out of the immediate vicinity of leaking jet or APU

##### G. Lasers

1. Do not look at LDRI diffuser or LCS laser aperture window

## EVA 2 EGRESS/SETUP (00:30)

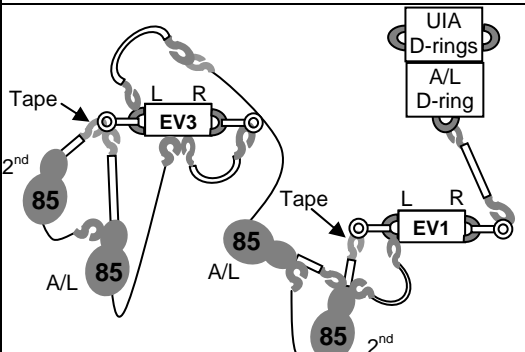
IV/SSRMS	EV1	EV3
 <p>The diagram illustrates the initial configuration for EVA 2. It shows two Extravehicular Modules (EV1 and EV3) connected to the International Space Station (ISS) structure. EV1 and EV3 are both equipped with Left (L) and Right (R) tethers. EV1 has an A/L (Anterior/Lateral) tether and a 2nd tether. EV3 has an A/L tether and a 2nd tether. The diagram also shows the UIA (Universal Interface Assembly) D-rings and A/L D-rings. Tapes are used to secure the tethers to the D-rings. The 85-foot ST (Space Tether) reels are also shown, with their respective anchors and LAS (Locking and Attaching System) components.</p> <ol style="list-style-type: none"> <li>1. Start Hatch Thermal Cover clock PET (30 min) __: __</li> <li>2. Stop Hatch Thermal Cover clock PET (30 min) __: __</li> <li>3. <b>IV:</b> Post crew egress: WVS Software: Select page – RF camera Sel ‘Advanced Controls’ S-Band Level (two) – Max</li> </ol>	<p><b>Initial Configuration:</b></p> <ol style="list-style-type: none"> <li>1. <input checked="" type="checkbox"/> All gates closed &amp; hooks locked <ul style="list-style-type: none"> <li><input type="checkbox"/> R Waist Tether to A/L Internal D-ring</li> <li><input type="checkbox"/> 2<sup>nd</sup> 85-ft ST LAS to L D-ring Extender</li> <li><input type="checkbox"/> 2<sup>nd</sup> 85-ft ST anchor to 85-ft A/L ST reel</li> <li><input type="checkbox"/> L Waist Tether to 2<sup>nd</sup> 85-ft ST reel</li> <li><input type="checkbox"/> A/L 85-ft ST LAS to 2<sup>nd</sup> 85-ft ST reel</li> <li><input type="checkbox"/> A/L 85-ft ST anchor to EV3 L Waist Tether</li> </ul> </li> </ol> <p><u>EGRESS/SETUP (00:30)</u></p> <ol style="list-style-type: none"> <li>1. BRT RET to NOD1 Crewlock Bag</li> <li>2. <b>On EV3 GO</b>, release Waist Tether from A/L internal D-ring</li> <li>3. Transfer PAS Crewlock Bag to EV3</li> <li>4. Egress A/L</li> <li>5. Attach NOD1 Crewlock Bag to BRT</li> <li>6. RET to PAS Crewlock Bag; configure for short translation</li> <li>7. Verify SAFER config <ul style="list-style-type: none"> <li><input type="checkbox"/> <input checked="" type="checkbox"/> L handle down (MAN ISOL Vlv – Open)</li> <li><input type="checkbox"/> <input checked="" type="checkbox"/> R handle down, door closed (HCM – Closed)</li> </ul> </li> <li>8. <input checked="" type="checkbox"/> ERCA – green LED</li> </ol>	<p><b>Initial Configuration:</b></p> <ol style="list-style-type: none"> <li>1. <input checked="" type="checkbox"/> All gates closed &amp; hooks locked <ul style="list-style-type: none"> <li><input type="checkbox"/> L Waist Tether to EV1 A/L 85-ft ST anchor</li> <li><input type="checkbox"/> A/L 85-ft ST LAS to L D-ring extender</li> <li><input type="checkbox"/> A/L 85-ft ST anchor to MWS</li> <li><input type="checkbox"/> 2<sup>nd</sup> 85-ft ST LAS to L D-ring extender</li> <li><input type="checkbox"/> 2<sup>nd</sup> 85-ft ST anchor to A/L 85-ft ST reel</li> <li><input type="checkbox"/> R Waist Tether to MWS</li> </ul> </li> </ol> <p><u>EGRESS/SETUP (00:30)</u></p> <ol style="list-style-type: none"> <li>2. ← Open hatch thermal cover</li> <li>3. Egress A/L</li> <li>4. Anchor EV3 A/L 85-ft ST to fwd external D-ring <ul style="list-style-type: none"> <li><input type="checkbox"/> <input checked="" type="checkbox"/> Gate closed, hook locked, reel unlocked</li> </ul> </li> <li>5. Anchor EV1 A/L 85-ft ST to aft external D-ring <ul style="list-style-type: none"> <li><input type="checkbox"/> <input checked="" type="checkbox"/> Gate closed, hook locked, reel unlocked</li> </ul> </li> <li>6. <b>Give EV1 GO</b> to release Waist Tether from A/L internal D-ring</li> <li>7. RET to PAS Crewlock Bag from EV1; hold for EV1 egress</li> <li>8. ← Close hatch thermal cover</li> <li>9. Verify SAFER config <ul style="list-style-type: none"> <li><input type="checkbox"/> <input checked="" type="checkbox"/> L handle down (MAN ISOL Vlv – Open)</li> <li><input type="checkbox"/> <input checked="" type="checkbox"/> R handle down, door closed (HCM – Closed)</li> </ul> </li> <li>10. <input checked="" type="checkbox"/> ERCA – green LED</li> <li>11. Perform translation adaptation</li> </ol>

# GATOR ASSEMBLY INSTALL (01:15)

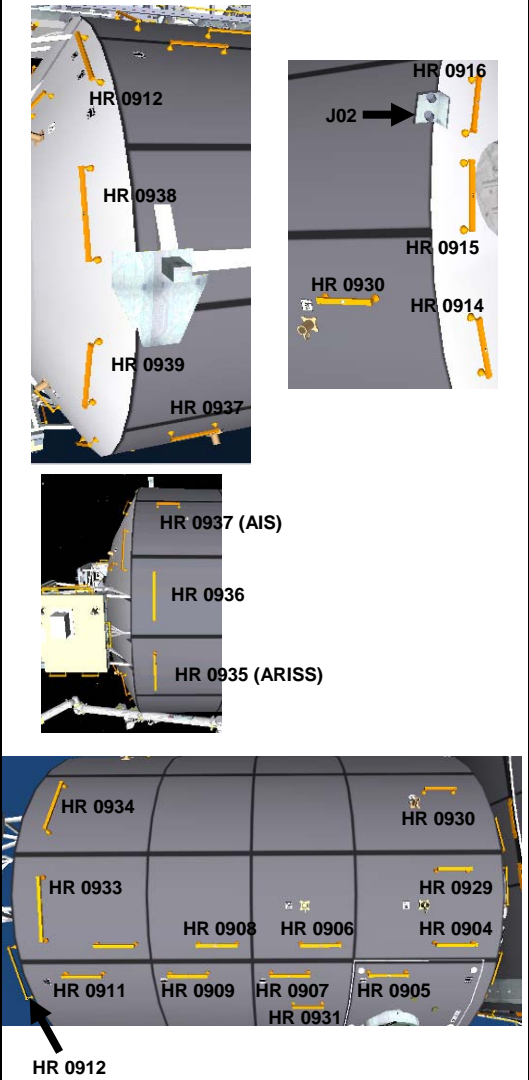
IV/SSRMS	EV1	EV3
<p>1. IV: <input type="checkbox"/> <input checked="" type="checkbox"/> MCC-H GATOR inhibits in place</p> <p>Planned PET 0:30</p>  <p>The diagram shows the GATOR assembly being installed on the ISS. It includes several views: a top-down view of the assembly with hardware labels HR 0912, HR 0938, HR 0939, and HR 0937; a side view showing the assembly's profile with labels HR 0916, HR 0915, HR 0914, and HR 0930; a view of the assembly's base with labels HR 0937 (AIS), HR 0936, and HR 0935 (ARISS); and a large grid view of the assembly's surface with labels HR 0934, HR 0933, HR 0908, HR 0906, HR 0929, HR 0904, HR 0911, HR 0909, HR 0907, HR 0905, HR 0931, and HR 0912.</p>	<p><b>RETRIEVE TSA CONTENTS (00:30)</b></p> <ol style="list-style-type: none"> <li>Translate to top of CETA spur <input type="checkbox"/> Fairlead along CETA spur &amp; Equipment Lock</li> <li>Temp stow PAS Crewlock Bag on S0 HR 3414 ____</li> <li>Translate to orbiter, port TSA <input type="checkbox"/> Translate zenith, port</li> <li>Attach A/L tether at Lab HR 0263 _____ <input type="checkbox"/> <input checked="" type="checkbox"/> Gate closed, hook locked, reel unlocked</li> <li>Open port TSA</li> <li>RET, retrieve ERADs (2); stow in NOD1 Crewlock Bag <input type="checkbox"/> <input type="checkbox"/></li> <li>RET, retrieve HPGT Guide Post; stow in NOD1 Crewlock Bag</li> <li>Close port TSA <input type="checkbox"/> <input type="checkbox"/> <input type="checkbox"/> <input type="checkbox"/> <input checked="" type="checkbox"/> Latches closed</li> <li><b>Payload Bay check</b>; translate to COL</li> </ol> <p><b>MATE CONNECTOR &amp; SECURE HARNESS (00:40)</b></p> <ol style="list-style-type: none"> <li>Translate to HR 0938; retrieve harness bundle</li> <li>Translate zenith/port to APCU Bracket</li> <li>RET cap; remove from APCU connector J02 (fwd); stow in trash bag</li> <li>Mate J02 to P02 <input checked="" type="checkbox"/> Good pins &amp; EMI band; no FOD</li> <li>Route harness and secure with wire ties along: <ul style="list-style-type: none"> <li><input type="checkbox"/> HR 0930</li> <li><input type="checkbox"/> HR 0929</li> <li><input type="checkbox"/> HR 0904</li> <li><input type="checkbox"/> HR 0906</li> <li><input type="checkbox"/> HR 0908</li> <li><input type="checkbox"/> HR 0910</li> <li><input type="checkbox"/> HR 0912</li> <li><input type="checkbox"/> HR 0938 – wire tie any extra cabling</li> </ul> </li> <li>RET, retrieve Velcro strap, stow in trash bag</li> </ol>	<p><b>RETRIEVE GATOR ASSEMBLY (00:20)</b></p> <ol style="list-style-type: none"> <li>Translate to orbiter, port TSA <input type="checkbox"/> Translate zenith, stbd (clotheslining)</li> <li>Attach A/L tether at Lab HR 0264 ____ <input type="checkbox"/> <input checked="" type="checkbox"/> Gate closed, hook locked, reel unlocked</li> <li>Open port TSA</li> <li>RET, retrieve GATOR Assembly and open clamp bolts; lasso around BRT</li> <li>Temporarily close TSA (if EV1 is not there yet) <input type="checkbox"/> <input checked="" type="checkbox"/> Latch closed</li> <li>Translate to COL</li> </ol> <p><b>INSTALL AIS &amp; ARISS ANTENNAS (00:55)</b></p> <ol style="list-style-type: none"> <li>Temp stow harness bundle on HR 0938 (nadir stanchion)</li> <li>Translate nadir to HR 0937</li> <li>Soft dock AIS Antenna (3 arms) on HR 0937 (Antenna on nadir side of HR, bracket flush with stbd edge of HR) <input type="checkbox"/> Visually verify proper seating of clamp (arrow points toward ISS port)</li> <li>Translate nadir/aft to HR 0935</li> </ol>



**GATOR ASSEMBLY INSTALL (01:15) (Cont)**

IV/SSRMS	EV1	EV3																		
<p>2. <b>IV:</b> Record ARISS bolt data:</p> <table border="1" data-bbox="107 483 615 581"> <thead> <tr> <th>Bolt</th> <th>Turns</th> <th>Torque (ft-lb)</th> </tr> </thead> <tbody> <tr> <td>Aft</td> <td>(6)</td> <td>(3.8)</td> </tr> <tr> <td>Fwd</td> <td>(6)</td> <td>(3.8)</td> </tr> </tbody> </table> <p>3. <b>IV:</b> Record AIS bolt data:</p> <table border="1" data-bbox="107 695 615 792"> <thead> <tr> <th>Bolt</th> <th>Turns</th> <th>Torque (ft-lb)</th> </tr> </thead> <tbody> <tr> <td>Port</td> <td>(6)</td> <td>(3.8)</td> </tr> <tr> <td>Stbd</td> <td>(6)</td> <td>(3.8)</td> </tr> </tbody> </table>	Bolt	Turns	Torque (ft-lb)	Aft	(6)	(3.8)	Fwd	(6)	(3.8)	Bolt	Turns	Torque (ft-lb)	Port	(6)	(3.8)	Stbd	(6)	(3.8)	<div data-bbox="701 787 1215 880" style="border: 1px solid black; padding: 5px; text-align: center;"> <p><b>CAUTION</b> Both petal launch locks must be engaged to allow for translation on a petal</p> </div> <p><u>CLOSE NODE 2 ZENITH CBCS FLAP (00:05)</u></p> <ol style="list-style-type: none"> <li>16. Translate to Node 2 zenith CBM</li> <li>17. Release flap from Velcro cover</li> <li>18. Close Velcro cover</li> <li>19. Close flap</li> <li>20. Secure flap fastener</li> <li>21. Check worksite clear of tethers and tools</li> <li>22. <b>Glove check</b></li> <li>23. Retrieve A/L tether; attach to 2nd reel</li> </ol> <ol style="list-style-type: none"> <li>24. Translate to top of CETA spur</li> <li>25. Temp stow NOD1 Crewlock Bag; retrieve PAS Crewlock Bag from HR 3414 and stow on BRT</li> </ol>	<ol style="list-style-type: none"> <li>11. Soft dock ARISS Antenna (5 arms) on HR 0935 (Antenna on stbd side of HR, bracket flush with aft edge of HR)             <ul style="list-style-type: none"> <li><input type="checkbox"/> Visually verify proper seating of clamp (arrow points toward ISS port)</li> </ul> </li> <li>12. Configure PGT             <ul style="list-style-type: none"> <li><input type="checkbox"/> <b>[A2, CW1, 30.5]</b>, 6" ext 7/16" wobble</li> </ul> </li> <li>13. ← Drive ARISS Clamping Bolts (2), aft bolt first; expect 6 turns</li> <li>14. Deploy antenna arms</li> <li>15. Translate fwd to HR 0937</li> <li>16. Configure PGT             <ul style="list-style-type: none"> <li><input type="checkbox"/> <b>[A2, CW1, 30.5]</b>, 6" ext 7/16" wobble</li> </ul> </li> <li>17. ← Drive AIS Clamping Bolts (2), port bolt first; expect 6 turns</li> <li>18. Deploy antenna arms</li> <li>19. Secure extra cable with wire tie on HR 0938</li> <li>20. RET, retrieve Velcro strap, stow in trash bag</li> <li>21. Check worksite clear of tethers and tools</li> <li>22. <b>Glove check</b></li> <li>23. Retrieve A/L tether; attach to D-ring ext</li> </ol>
Bolt	Turns	Torque (ft-lb)																		
Aft	(6)	(3.8)																		
Fwd	(6)	(3.8)																		
Bolt	Turns	Torque (ft-lb)																		
Port	(6)	(3.8)																		
Stbd	(6)	(3.8)																		

## FPMU RELOCATE (01:30)

IV/SSRMS	EV1	EV3
<p>1. IV: <input type="checkbox"/> <input checked="" type="checkbox"/> MCC-H FPMU inhibits in place</p> <p>Planned PET 1:45</p>	<div style="border: 1px solid black; padding: 5px; margin-bottom: 10px;"> <p style="text-align: center;"><u>CAUTION</u></p> <p>Do not touch gold or white thermal control paint. Gold surfaces of FPMU may be hot</p> <p>Do not touch the hinged areas around the FPMU</p> <p>Do not bend stanchion cables to &lt; 10 cable radii to avoid possible damage to fiber optic cable</p> <p>The FPMU does not meet kick loads</p> </div> <p><u>REMOVE &amp; RELOCATE FPMU FROM CP2 (01:00)</u></p> <ol style="list-style-type: none"> <li>1. Translate to S1 FPMU, high on Face 1</li> <li>2. Attach A/L tether at S0 HR 3424_____ (Face 2)               <ul style="list-style-type: none"> <li><input type="checkbox"/> <input checked="" type="checkbox"/> Gate closed, hook locked, reel unlocked</li> </ul> </li> <li>3. Temp Stow PAS Crewlock Bag on S3 HR 3003</li> <li>4. _____</li> <li>4. Install Round Scoop onto FPMU (handle at 9-10 position)</li> <li>5. Attach RET to FPMU Stanchion</li> <li>6. Demate connectors (3) from S1 pnl A100:               <ul style="list-style-type: none"> <li><input checked="" type="checkbox"/> Good pins &amp; EMI band; no FOD</li> <li><input type="checkbox"/> P2 from J2</li> <li><input type="checkbox"/> P3 from J3</li> <li><input type="checkbox"/> P4 from J4</li> </ul> </li> <li>7. Route cable around racetrack and hand off to EV3</li> <li>8. Receive dustcap/deadface connectors from EV3 and mate to S1 pnl A100               <ul style="list-style-type: none"> <li><input type="checkbox"/> J2 – Deadface connector</li> <li><input type="checkbox"/> J3 – Deadface connector</li> <li><input type="checkbox"/> J4 – Dustcap</li> </ul> </li> </ol>	<div style="border: 1px solid black; padding: 5px; margin-bottom: 10px;"> <p style="text-align: center;"><u>CAUTION</u></p> <p>Do not touch gold or white thermal control paint. Gold surfaces of FPMU may be hot</p> <p>Do not touch the hinged areas around the FPMU</p> <p>Do not bend stanchion cables to &lt; 10 cable radii to avoid possible damage to fiber optic cable</p> <p>The FPMU does not meet kick loads</p> </div> <p><u>REMOVE &amp; RELOCATE FPMU FROM CP2 (01:00)</u></p> <ol style="list-style-type: none"> <li>1. Translate to S1 FPMU, low on Face 1</li> <li>2. Attach A/L tether at S0 Yo 6930_____ (stbd of CETA Spur)               <ul style="list-style-type: none"> <li><input type="checkbox"/> <input checked="" type="checkbox"/> Gate closed, hook locked, reel unlocked</li> </ul> </li> <li>3. Open TA Clamps on Stanchion (2), if required</li> <li>4. Demate the following from stanchion pnl A296, and transfer to EV1:               <ul style="list-style-type: none"> <li><input type="checkbox"/> P2 – Deadface connector</li> <li><input type="checkbox"/> P3 – Deadface connector</li> <li><input type="checkbox"/> P4 – Dustcap</li> </ul> </li> <li>5. Mate connectors (3) to stanchion pnl A296:               <ul style="list-style-type: none"> <li><input type="checkbox"/> P2 to J2</li> <li><input type="checkbox"/> P3 to J3</li> <li><input type="checkbox"/> P4 to J4</li> </ul> </li> <li>6. Close top TA clamp on stanchion</li> </ol>

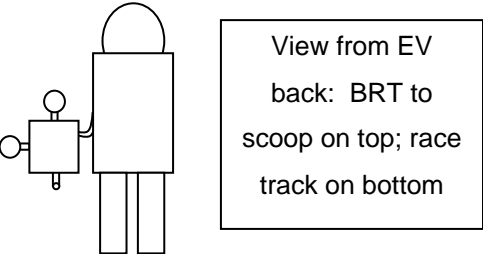
## FPMU RELOCATE (01:30) (Cont)

IV/SSRMS	EV1	EV3										
<p>2. <b>IV:</b> Record stanchion bolt release data:</p> <table border="1" data-bbox="109 446 415 511"> <thead> <tr> <th>Bolt</th> <th>Turns</th> </tr> </thead> <tbody> <tr> <td>Stanchion</td> <td>(17)</td> </tr> </tbody> </table>  <p>View from EV back: BRT to scoop on top; race track on bottom</p> <p>3. <b>IV:</b> Record stanchion bolt install data:</p> <table border="1" data-bbox="109 917 613 982"> <thead> <tr> <th>Bolt</th> <th>Turns</th> <th>Torque (ft-lb)</th> </tr> </thead> <tbody> <tr> <td>Stanchion</td> <td>(17)</td> <td>(18.4)</td> </tr> </tbody> </table>  <p>4. <b>IV:</b> <input type="checkbox"/> Give MCC-H GO for FPMU power up</p>	Bolt	Turns	Stanchion	(17)	Bolt	Turns	Torque (ft-lb)	Stanchion	(17)	(18.4)	<p>9. √RET to FPMU stanchion</p> <p>10. Position FPMU and stanchion parallel to truss</p> <p>11. Attach BRT to Round Scoop; add Adj tether</p> <p>12. Translate along Face 1 to P1:</p> <ul style="list-style-type: none"> <li><input type="checkbox"/> Worksite outbd of port MBSU</li> </ul> <div style="border: 1px solid black; padding: 5px; text-align: center;"> <p><b>CAUTION</b> Avoid inadvertent contact with GPS Antenna (Z-93 paint)</p> </div> <p><b>INSTALL FPMU IN P1/CP6 (00:30)</b></p> <div style="border: 1px solid black; padding: 5px; text-align: center;"> <p><b>CAUTION</b> Avoid inadvertent contact with SASA Antenna</p> </div> <p>13. Release BRT and guide stanchion into soft dock on CP6 (racetrack outboard)</p> <p>14. Receive PGT from EV3</p> <p>15. ← Tighten stanchion bolt, ~17 turns</p> <p>16. Release connectors from stanchion pnl A296:</p> <ul style="list-style-type: none"> <li><input type="checkbox"/> P2 from J2</li> <li><input type="checkbox"/> P3 from J3</li> <li><input type="checkbox"/> P4 from J4</li> </ul> <p>17. Demate the following from P1 pnl A115, and install on stanchion pnl A296:</p> <ul style="list-style-type: none"> <li><input type="checkbox"/> P2 – Deadface connector</li> <li><input type="checkbox"/> P3 – Deadface connector</li> <li><input type="checkbox"/> P4 – Dustcap</li> </ul> <p>18. Mate connectors (3) to P1 pnl A115:</p> <ul style="list-style-type: none"> <li>√ Good pins &amp; EMI band; no FOD</li> <li><input type="checkbox"/> P2 to J2</li> <li><input type="checkbox"/> P3 to J3</li> <li><input type="checkbox"/> P4 to J4</li> </ul> <p>19. RET, retrieve round scoop and adj tether; stow on MWS</p> <p>20. Retrieve RET from stanchion</p> <p>21. <b>Give IV GO</b> for FPMU power up</p> <p>22. <b>Glove check</b></p>	<p>7. Slide locking collar away from latch handle; rotate probe into stow position</p> <ul style="list-style-type: none"> <li><input type="checkbox"/> <input type="checkbox"/> <input type="checkbox"/></li> </ul> <p>8. Install wire tie around probes</p> <p>9. Configure PGT:</p> <ul style="list-style-type: none"> <li><input type="checkbox"/> [B7, CCW2, 30.5], 6" ext 7/16" wobble</li> </ul> <p>10. Release stanchion bolt, 17 turns</p> <p>11. Assist EV1 with positioning FPMU</p> <p>12. Translate along Face 1 to P1:</p> <ul style="list-style-type: none"> <li><input type="checkbox"/> Worksite outbd of port MBSU</li> </ul> <div style="border: 1px solid black; padding: 5px; text-align: center;"> <p><b>CAUTION</b> Avoid inadvertent contact with GPS Antenna (Z-93 paint)</p> </div> <p><b>INSTALL FPMU IN P1/CP6 (00:30)</b></p> <div style="border: 1px solid black; padding: 5px; text-align: center;"> <p><b>CAUTION</b> Avoid inadvertent contact with SASA Antenna</p> </div> <p>13. Guide stanchion into soft dock on CP6 (race track outboard)</p> <p>14. Configure PGT:</p> <ul style="list-style-type: none"> <li><input type="checkbox"/> [B3, CW2, 30.5], 6" ext 7/16" wobble</li> </ul> <p>15. Pass PGT to EV1</p> <p>16. Remove wire tie from probes; stow in trash bag</p> <p>17. Rotate probe into deploy position; slide locking collar to latch handle</p> <ul style="list-style-type: none"> <li><input type="checkbox"/> <input type="checkbox"/> <input type="checkbox"/></li> </ul> <p>18. Receive camera from EV1</p> <p>19. <b>Glove check</b></p>
Bolt	Turns											
Stanchion	(17)											
Bolt	Turns	Torque (ft-lb)										
Stanchion	(17)	(18.4)										

### S3 NADIR/OUTBD PAS DEPLOY (01:30)

IV/SSRMS	EV1	EV3										
<p>1. <u>NOTE:</u> These steps can be done at any time on any PAS</p> <ul style="list-style-type: none"> <li><input type="checkbox"/> Hingeline ADPs</li> <li><input type="checkbox"/> RTL PIP Pins</li> <li><input type="checkbox"/> EVA override cap removal</li> </ul> <p>Planned PET 3:15</p> <p>2. <b>IV:</b> <input checked="" type="checkbox"/>MCC-H PAS inhibits in place</p> <p>3. Start Hatch Thermal Cover clock PET (30 min) ____ : ____</p> <p>4. Stop Hatch Thermal Cover clock PET ____ : ____</p> <p>5. <b>IV:</b> Record Deploy Clevis bolt data:</p> <table border="1" data-bbox="109 1144 430 1307"> <thead> <tr> <th>Bolt</th> <th>Turns</th> </tr> </thead> <tbody> <tr> <td>Bolt 1</td> <td>(10)</td> </tr> <tr> <td>Bolt 2</td> <td>(10)</td> </tr> <tr> <td>Bolt 4</td> <td>(10)</td> </tr> <tr> <td>Bolt 3</td> <td>(8)</td> </tr> </tbody> </table>	Bolt	Turns	Bolt 1	(10)	Bolt 2	(10)	Bolt 4	(10)	Bolt 3	(8)	<div style="border: 1px solid black; padding: 5px; margin-bottom: 10px;"> <p style="text-align: center;"><u>CAUTION</u></p> <ol style="list-style-type: none"> <li>1. When attempting to remove or install the Yoke PIP pin and ADP, do not impart more than 10 lbf</li> <li>2. Yoke ADP does not have a stowage hole. Do not close ADP lock bracket when ADP is not inserted in a stowage/clevis hole</li> <li>3. Do not exceed 30" between the yoke ADP and Deploy Clevis Bracket. Exceeding this could allow platform to enter detent position</li> <li>4. Do not lift diagonal brace more than ~7 deg out of rotation plane to prevent damage to hinge end</li> <li>5. Avoid inadvertent contact with grapple fixture shafts and target pins</li> <li>6. EBCS target has finished surface that is susceptible to damage by contact. Do not remove MLI until all work inside truss is complete</li> </ol> </div> <ol style="list-style-type: none"> <li>1. Retrieve A/L tether from HR 3424, translate to A/L</li> <li>2. ← Open hatch thermal cover</li> <li>3. Retrieve PGT and WETA</li> <li>4. Stow round scoop and wire tie caddy in A/L</li> <li>5. ← Close hatch thermal cover <ul style="list-style-type: none"> <li><input type="checkbox"/> √L handle down (MAN ISOL Vlv – Open)</li> <li><input type="checkbox"/> √R handle down, door closed (HCM – Closed)</li> </ul> </li> <li>6. Translate to S3, high on Face 1</li> <li>7. Attach A/L tether at S3 HR 3003 ____ (zenith) <ul style="list-style-type: none"> <li><input type="checkbox"/> √Gate closed, hook locked, reel unlocked</li> </ul> </li> <li>8. Translate zenith/aft to PAS</li> <li>9. Temp stow WETA on S3 HR 3029 _____</li> </ol> <p><u>HINGE LINE PREP</u></p> <ol style="list-style-type: none"> <li>10. Remove hinge line ADPs (2)</li> <li>11. Insert in stowage hole (pin station fwd, handle inside platform) <ul style="list-style-type: none"> <li><input type="checkbox"/> √ADP closed: Inboard</li> <li><input type="checkbox"/> √ADP closed: Outboard</li> </ul> </li> </ol>	<ol style="list-style-type: none"> <li>1. Retrieve A/L tether, translate to S3</li> <li>2. Attach A/L tether at S1 HR 3215 ____ (face 6) <ul style="list-style-type: none"> <li><input type="checkbox"/> √Gate closed, hook locked, reel unlocked</li> </ul> </li> <li>3. Retrieve PAS Crewlock Bag from HR 3003</li> </ol> <ol style="list-style-type: none"> <li>4. Translate fwd/nadir to PAS</li> <li>5. Temp stow PAS Crewlock Bag on S3 HR 3042/3043 ____</li> </ol> <p><u>SWIVEL DEPLOY CLEVIS BRACKET</u></p> <ol style="list-style-type: none"> <li>6. MWS RET to Deploy Clevis Bracket</li> <li>7. Relocate MWS RET to HR 3057</li> <li>8. Configure PGT: <ul style="list-style-type: none"> <li><input type="checkbox"/> [RCCW, 30.5], 6" ext 7/16" wobble</li> </ul> </li> <li>9. Break torque on all bolts (4) in Ratchet Mode <ul style="list-style-type: none"> <li><input type="checkbox"/><input type="checkbox"/><input type="checkbox"/><input type="checkbox"/></li> </ul> </li> <li>10. Configure PGT: <ul style="list-style-type: none"> <li><input type="checkbox"/> [B7, CCW2, 30.5], 6" ext 7/16" wobble</li> </ul> </li> <li>11. Release bolts (4); 10 turns (bolts 1, 2, 4), 8 turns (bolt 3)</li> <li>12. Swivel Deploy Clevis Bracket</li> </ol>
Bolt	Turns											
Bolt 1	(10)											
Bolt 2	(10)											
Bolt 4	(10)											
Bolt 3	(8)											

### S3 NADIR/OUTBD PAS DEPLOY (01:30) (Cont)

IV/SSRMS	EV1	EV3						
<p>6. <b>IV:</b> Record Brace bolt data:</p> <table border="1" data-bbox="107 1304 611 1369"> <thead> <tr> <th>Bolt</th> <th>Turns</th> <th>Torque (ft-lb)</th> </tr> </thead> <tbody> <tr> <td>Diagonal</td> <td>(35)</td> <td>(16.0)</td> </tr> </tbody> </table>	Bolt	Turns	Torque (ft-lb)	Diagonal	(35)	(16.0)	<p><u>REMOVE SARJ BRACE</u></p> <p>12. Release SARJ Launch Bolt by hand; ~3 turns ccw</p> <p>13. Configure PGT:  <input type="checkbox"/> [B6, CCW3, 30.5], 6" ext 7/16" wobble</p> <p>14. Release SARJ Brace (cup-cone bolt), stop on 35 turns (do not exceed 37 turns)</p> <p><u>REMOVE DIAGONAL BRACE (Caution #4)</u></p> <p>15. Attach SARJ Brace to Diagonal Strut, hand tighten SARJ Launch Bolt 1 turn cw</p> <p>16. Configure PGT:  <input type="checkbox"/> [B6, CCW3, 30.5], 6" ext 7/16" wobble</p> <p>17. Release Diagonal Brace (cup-cone bolt), stop on 35 turns (do not exceed 37 turns)</p> <p>18. Guide Diagonal Brace to EV3</p> <p><u>DEPLOY PLATFORM (Caution #3)</u></p> <p>19. Monitor UMA to longeron clearance</p> <p>20. Inform EV3 when UMA just clears the longeron</p> <p>21. Assist EV3 as needed with yoke</p> <p><u>REINSTALL DIAGONAL BRACE (Caution #4)</u></p> <p>22. Tend platform</p> <p>23. Configure PGT:  <input type="checkbox"/> [B2, CW2, 30.5], 6" ext 7/16" wobble</p> <p>24. ← Engage Diagonal Brace (Cup-cone bolt) to hard stop; ~35 turns</p>	<p><u>RELEASE YOKE ADP AND PIP PIN (Caution #1, #2)</u></p> <p>13. Attach Sm hook of AET to S3 HR 3050</p> <p>14. Release yoke PIP pin</p> <p>15. Release yoke ADP (do not close ADP)</p> <p>16. Attach Lg hook of AET to ADP hole</p> <p>17. Tend platform "into" truss</p> <p><u>REMOVE STOW CLEVIS BRACKET</u></p> <p>18. Crewlock Bag RET to Stow Clevis Bracket</p> <p>19. Configure PGT:  <input type="checkbox"/> [RCCW, 30.5], 6" ext 7/16" wobble</p> <p>20. Break torque on all bolts (4) in Ratchet Mode  <input type="checkbox"/><input type="checkbox"/><input type="checkbox"/><input type="checkbox"/></p> <p>21. Configure PGT:  <input type="checkbox"/> [B7, CCW2, 30.5], 6" ext 7/16" wobble</p> <p>22. Release bolts (4); 10 turns  <input type="checkbox"/><input type="checkbox"/><input type="checkbox"/><input type="checkbox"/></p> <p>23. Stow Stow Clevis Bracket in PAS Crewlock Bag</p> <p>24. Receive Diagonal Brace from EV1; restrain with MWS EE</p> <p><u>DEPLOY PLATFORM (Caution #3)</u></p> <p>25. Deploy platform out until UMA clears longeron</p> <p>26. Release AET as needed for brace clearance</p> <p><u>REINSTALL DIAGONAL BRACE (Caution #4)</u></p> <p>27. Move Diagonal Brace into position for re-installation</p> <p>28. On EV1 GO, rotate yoke from in to out</p> <p>29. Swivel clevis bracket out</p> <p>30. Reinstall AET once brace is clear</p> <p>31. Retrieve tether from brace temp stow location</p>
Bolt	Turns	Torque (ft-lb)						
Diagonal	(35)	(16.0)						



### S3 NADIR/OUTBD PAS DEPLOY (01:30) (Cont)

IV/SSRMS	EV1	EV3																																	
<p>7. <b>IV:</b> Record Brace bolt data:</p> <table border="1" data-bbox="109 461 613 526"> <thead> <tr> <th>Bolt</th> <th>Turns</th> <th>Torque (ft-lb)</th> </tr> </thead> <tbody> <tr> <td>SARJ</td> <td>(35)</td> <td>(16.0)</td> </tr> </tbody> </table> <p>8. <b>IV:</b> Record Deploy Clevis bolt data:</p> <table border="1" data-bbox="109 600 613 760"> <thead> <tr> <th>Bolt</th> <th>Turns</th> <th>Torque (ft-lb)</th> </tr> </thead> <tbody> <tr> <td>Bolt 1</td> <td>(10)</td> <td>(22.0)</td> </tr> <tr> <td>Bolt 2</td> <td>(10)</td> <td>(22.0)</td> </tr> <tr> <td>Bolt 3</td> <td>(8)</td> <td>(22.0)</td> </tr> <tr> <td>Bolt 4</td> <td>(10)</td> <td>(22.0)</td> </tr> </tbody> </table> <p>9. <b>IV:</b> Give <b>MCC-H GO</b> to power up IMCA            ✓All tasks inside truss prior to UMA prep complete            ✓Tools cleared from inside truss</p> <p>10. <b>IV:</b> Obtain <b>MCC-H GO</b> for RTL Checkout</p> <table border="1" data-bbox="109 1247 613 1377"> <thead> <tr> <th>RTL</th> <th>PIP Pin</th> <th>Test Pass</th> </tr> </thead> <tbody> <tr> <td>1</td> <td></td> <td></td> </tr> <tr> <td>2</td> <td></td> <td></td> </tr> <tr> <td>3</td> <td></td> <td></td> </tr> </tbody> </table>	Bolt	Turns	Torque (ft-lb)	SARJ	(35)	(16.0)	Bolt	Turns	Torque (ft-lb)	Bolt 1	(10)	(22.0)	Bolt 2	(10)	(22.0)	Bolt 3	(8)	(22.0)	Bolt 4	(10)	(22.0)	RTL	PIP Pin	Test Pass	1			2			3			<p><b>REINSTALL SARJ BRACE</b></p> <p>25. Release SARJ Brace via SARJ Launch Bolt by hand, ~1 turn ccw</p> <p>26. Configure PGT:  <input type="checkbox"/> <b>[B2, CW2, 30.5]</b>, 6" ext 7/16" wobble</p> <p>27. ← Engage SARJ Brace (Cup-cone bolt) to hard stop; ~35 turns</p> <p>28. Re-engage SARJ Launch Bolt for temp stow; hand tighten cw 2-3 turns</p> <p>29. Assist EV3 with yoke installation while keeping platform out of detents</p> <p><b>PREP UMA</b></p> <p>30. Translate under PAS UMA</p> <p>31. RET, retrieve hitch pin from EVA OVERRIDE anti-rotation cap</p> <p>32. Retrieve anti-rotation cap; stow in trash bag</p> <p>33. <b>Glove check</b></p>	<p><b>REINSTALL DEPLOY CLEVIS BRACKET</b></p> <p style="text-align: center;"><u>NOTE</u></p> <p>Make sure yoke is outside the Deploy Clevis Bracket</p> <p>32. Finger start Deploy Clevis Bracket bolts (4), approx 1-2 turns</p> <p>33. Configure PGT:  <input type="checkbox"/> <b>[B5, CW2, 30.5]</b>, 6" ext 7/16" wobble</p> <p>34. ← Engage bolts (4) to hard stop, expect 10 turns on bolts 1, 2, 4 and 8 turns on bolt 3</p> <p>35. Configure PGT:  <input type="checkbox"/> <b>[RCW, 30.5]</b>, 6" ext 7/16" wobble</p> <p>36. Apply final torque to bolts (4) in Ratchet Mode, 2 clicks each bolt  <input type="checkbox"/><input type="checkbox"/><input type="checkbox"/><input type="checkbox"/></p> <p>37. Retrieve RET</p> <p><b>INSTALL YOKE</b> (Caution #1)</p> <p>38. Disconnect Adj Tether</p> <p>39. Install yoke in Deploy Clevis Bracket  <input type="checkbox"/> Install yoke ADP, ✓lock bracket engaged  <input type="checkbox"/> Install yoke PIP pin</p> <p>40. Retrieve Adj Tether</p> <p><b>RTL CHECKOUT</b></p> <p>41. Translate to each Guide Vane (3) and perform:  <input type="checkbox"/><input type="checkbox"/><input type="checkbox"/> RET to launch restraint PIP pin; remove from guide vane and stow in trash bag  <input type="checkbox"/><input type="checkbox"/><input type="checkbox"/> On <b>MCC-H GO</b>, depress and hold RTL lever for 15 sec, then release  <input type="checkbox"/><input type="checkbox"/><input type="checkbox"/> Verify with <b>MCC-H</b> good checkout, move to next guide vane</p>
Bolt	Turns	Torque (ft-lb)																																	
SARJ	(35)	(16.0)																																	
Bolt	Turns	Torque (ft-lb)																																	
Bolt 1	(10)	(22.0)																																	
Bolt 2	(10)	(22.0)																																	
Bolt 3	(8)	(22.0)																																	
Bolt 4	(10)	(22.0)																																	
RTL	PIP Pin	Test Pass																																	
1																																			
2																																			
3																																			

**S3 NADIR/OUTBD PAS DEPLOY (01:30) (Cont)**

IV/SSRMS	EV1	EV3
<p>11. <b>IV:</b> Tool Inventory:</p> <ul style="list-style-type: none"> <li><input type="checkbox"/> <b>Crewlock Bag (PAS Bag)</b> <ul style="list-style-type: none"> <li><input type="checkbox"/> DRT (on int RET)</li> <li><input type="checkbox"/> DRT (on int RET)</li> <li><input type="checkbox"/> Lg-sm Adj Equip Tether (on int RET)</li> <li><input type="checkbox"/> Hammer (on int RET)</li> <li><input type="checkbox"/> Wire Ties (2) (ext, loops squished for bracket)                             <ul style="list-style-type: none"> <li><input type="checkbox"/> RET (sm-sm)                                     <ul style="list-style-type: none"> <li><input type="checkbox"/> PAS Stow Clevis Bracket</li> </ul> </li> <li><input type="checkbox"/> RET (sm-sm)</li> <li><input type="checkbox"/> RET (sm-sm)</li> <li><input type="checkbox"/> RET (sm-sm)</li> </ul> </li> </ul> </li> <li><input type="checkbox"/> Trash Bag                             <ul style="list-style-type: none"> <li><input type="checkbox"/><input type="checkbox"/><input type="checkbox"/> RTL PIP Pins (3) (EV3)</li> <li><input type="checkbox"/> Anti-rotation cap w/hitch pin (EV1)</li> </ul> </li> </ul>		<p><u>EBCS TARGET PREP</u> (Caution #6)</p> <p>42. Translate to EBCS target and perform:</p> <ul style="list-style-type: none"> <li><input type="checkbox"/> Verify both EV clear of target area</li> <li><input type="checkbox"/> Remove target cover; stow on backside of target assy</li> </ul> <p>43. <b>Glove check</b></p>

## CP1 WETA INSTALL (00:45)

IV/SSRMS	EV1	EV3												
<p>Planned PET 4:45</p> <p>1. <b>IV:</b> <input type="checkbox"/> <input checked="" type="checkbox"/> <b>MCC-H</b> WETA inhibits in place  RPCM S31A_A RPC 15 – Open,  Close Cmd Inh  RPCM S31A_A RPC 16 – Open,  Close Cmd Inh  RPCM S32B_A RPC 15 – Open,  Close Cmd Inh  RPCM S32B_A RPC 16 – Open,  Close Cmd Inh</p> <p>2. <b>IV:</b> Record WETA bolt data:</p> <table border="1" data-bbox="109 755 613 885"> <thead> <tr> <th>Bolt</th> <th>Turns</th> <th>Torque (ft-lb)</th> </tr> </thead> <tbody> <tr> <td>Center</td> <td>(24)</td> <td>(9.2)</td> </tr> <tr> <td>Outbd</td> <td>(7)</td> <td>(9.2)</td> </tr> <tr> <td>Inbd</td> <td>(7)</td> <td>(9.2)</td> </tr> </tbody> </table>	Bolt	Turns	Torque (ft-lb)	Center	(24)	(9.2)	Outbd	(7)	(9.2)	Inbd	(7)	(9.2)	<p><u>INSTALL CP1 WETA (00:45)</u></p> <ol style="list-style-type: none"> <li>RET, retrieve WETA from HR 3029</li> <li>Tether to dummy box with PAS Crewlock Bag RET</li> <li>Configure PGT: <input type="checkbox"/> <b>[A5, CCW2, 30.5]</b>, 6" ext 7/16" wobble</li> <li>Release captive fasteners (2 outer), 7-12 turns (bolt will pop out) <input type="checkbox"/><input type="checkbox"/></li> <li>Release center jack screw, 24-30 turns</li> <li>Remove dummy box; scorch on PAS Crewlock Bag</li> <li>Install WETA onto stanchion by sliding it along guide pins into soft dock position</li> <li>RET, retrieve round scoop and stow in PAS Crewlock Bag</li> <li>Configure PGT: <input type="checkbox"/> <b>[A7, CW2, 30.5]</b>, 6" ext 7/16" wobble</li> <li>← Push in and engage WETA center jack bolt to hard stop, 24-30 turns</li> <li>Visually verify contact between WETA front edge and support structure</li> </ol> <p style="text-align: center;"><u>NOTE</u></p> <p>Start BOTH side fasteners before going to hardstop</p> <ol style="list-style-type: none"> <li>← Push in and engage WETA outer bolts to hard stop, 7-12 turns</li> <li>Remove WETA RET</li> <li>Release TA clamps on stanchion</li> <li>Demate W8200 cable connectors (3) from stanchion pnl A296: <input type="checkbox"/> P2 from J2 <input type="checkbox"/> P3 from J3 <input type="checkbox"/> P4 from J4</li> <li>Receive dustcap/deadface connectors from EV3 and mate to stanchion pnl A296 <input type="checkbox"/> P2 – Deadface connector (size 15) <input type="checkbox"/> P3 – Deadface connector (size 13) <input type="checkbox"/> P4 – Dustcap</li> </ol>	<p><u>INSTALL CP1 WETA (00:45)</u></p> <ol style="list-style-type: none"> <li>Assist EV1 with dummy box, connectors, and MLI</li> </ol> <ol style="list-style-type: none"> <li>Demate the following from S3 pnl A78, and transfer to EV1: <input type="checkbox"/> J2 – Deadface connector <input type="checkbox"/> J3 – Deadface connector <input type="checkbox"/> J4 – Dustcap</li> <li>Mate W8200 cable connectors (3) to S3 pnl A78: √Good pins &amp; EMI band, no FOD <input type="checkbox"/> P2 to J2 <input type="checkbox"/> P3 to J3 <input type="checkbox"/> P4 to J4</li> </ol>
Bolt	Turns	Torque (ft-lb)												
Center	(24)	(9.2)												
Outbd	(7)	(9.2)												
Inbd	(7)	(9.2)												

**CP1 WETA INSTALL (00:45) (Cont)**

<b>IV/SSRMS</b>	<b>EV1</b>	<b>EV3</b>
<p>3. <b>IV: Give MCC-H GO</b> to power up WETA</p> <p>4. <b>IV: Tool inventory</b></p> <ul style="list-style-type: none"> <li><input type="checkbox"/> Dummy Box</li> <li><input type="checkbox"/> WETA MLI</li> <li><input type="checkbox"/> Round Scoop</li> </ul>	<p>17. RET to MLI</p> <p>18. Remove and stow MLI in PAS Crewlock Bag</p> <p>19. Close TA clamps or wire tie cables as required</p> <p>20. Tool inventory</p> <p>21. <b>Glove check</b></p> <p>22. Retrieve PAS Crewlock Bag</p>	<p>4. Tool inventory</p> <p>5. <b>Glove check</b></p>

## EVA 2 CLEANUP/INGRESS (00:30)

IV/SSRMS	EV1	EV3
<p>Planned PET 6:00</p> <p>1. <b>IV:</b> Perform WVS PWRDWN (PHOTO/TV, <u>WVS CUE CARD</u>)</p> <p>2. Start Hatch Thermal Cover clock PET (30 min) __:__</p> <p>3. Stop Hatch Thermal Cover clock PET __:__</p>	<p><u>CLEANUP</u> (00:15)</p> <ol style="list-style-type: none"> <li>Retrieve A/L tether from S3 HR 3003</li> <li>Final Tool Inventory</li> <li>Translate to A/</li> </ol> <p><u>INGRESS AND PRE-REPRESS</u> (00:15)</p> <ol style="list-style-type: none"> <li>← Open hatch thermal cover</li> <li>Retrieve NOD1 Crewlock Bag from EV3; stow in A/L</li> <li>Ingress A/L with PAS Crewlock Bag</li> <li>Attach R Waist Tether to A/L internal D-ring               <ul style="list-style-type: none"> <li><input type="checkbox"/> √Gate closed, hook locked</li> </ul> </li> <li><b>Give EV3 GO</b> to release ST anchor</li> </ol> <p>9. Remove SCU from stowage pouch</p> <p>10. Remove DCM cover, Velcro to DCM</p> <p>11. Connect SCU to DCM √SCU locked</p> <p style="text-align: center;"><u>NOTE</u> A TCV setting 8 – Max C minimizes time for SCU cooling</p> <p>12. Water – OFF (fwd), expect H2O IS OFF message</p> <p>Go to PRE-REPRESS (<u>DEPRESS/REPRESS</u> Cue Card)</p>	<p><u>CLEANUP</u> (00:15)</p> <ol style="list-style-type: none"> <li>Retrieve A/L tether from S1 HR 3215</li> <li>Translate to top of CETA spur; retrieve NOD1 Crewlock Bag from HR _____</li> <li>Translate to A/L HPGT #5 worksite</li> <li>Install HPGT guide post               <ul style="list-style-type: none"> <li><input type="checkbox"/> Pull test</li> </ul> </li> <li>Final Tool Inventory</li> </ol> <p><u>INGRESS AND PRE-REPRESS</u> (00:15)</p> <p>6. Transfer NOD1 Crewlock Bag to EV1</p> <p>7. <b>On EV1 GO</b>, release EV1 ST anchor, attach to L Waist Tether         <ul style="list-style-type: none"> <li><input type="checkbox"/> √Gate closed, hook locked</li> </ul> </p> <p>8. Retrieve EV3 ST anchor hook</p> <p>9. Ingress A/L</p> <p>10. Remove SCU from stowage pouch</p> <p>11. Remove DCM cover, Velcro to DCM</p> <p>12. Connect SCU to DCM √SCU locked</p> <p style="text-align: center;"><u>NOTE</u> A TCV setting 8 – Max C minimizes time for SCU cooling</p> <p>13. Water – OFF (fwd), expect H2O IS OFF message</p> <p>14. ← Close hatch thermal cover; attach Velcro strap</p> <div style="border: 1px solid black; padding: 5px; text-align: center;"> <p><b>CAUTION</b> Do not close hatch until EMU Water OFF for 2 min. Verify outer hatch clear of hardware</p> </div> <p>15. Verify outer hatch clear of hardware</p> <p>16. Verify handle position per hatch decal, close and lock hatch</p> <p>Go to PRE-REPRESS (<u>DEPRESS/REPRESS</u> Cue Card)</p>

**GATOR ASSEMBLY INSTALL – TASK DATA**

**Estimated Task Duration:**

	<b>With RMS</b>	<b>Without RMS</b>
One EV Crew	N/A	02:00
Two EV Crew	N/A	01:15

**Tools:**

<b>EV1</b>	<b>EV3</b>
PGT w/7/16 6-in ext	Wire Ties (6)
Wire Ties (2)	

**EVA Fasteners:**

<b>Fastener Name</b>	<b>Head Size</b>	<b>Qty</b>	<b>Install Torque (ft-lb)</b>	<b>Upper Bound Torque (ft-lb)</b>	<b>Failure Torque (ft-lb)</b>	<b>Release Torque (ft-lb)</b>	<b>Turns</b>	<b>RPM</b>
GATOR Clamping Bolt	7/16"	4	3.8	4.8	7.13	TBD	6	20

**EVA Connectors:**

<b>Harness</b>	<b>From</b>	<b>To</b>	<b>Clamps (#)</b>	<b>Conn Size</b>	<b>Function</b>
895	J02	APCU P02	N/A	25	

**Foot Restraints:**

<b>Task</b>	<b>WIF</b>	<b>APFR Setting</b>
N/A	N/A	N/A

**Notes:**

1. ESA recommends driving the left bolt first since the clockwise torque will keep the clamp firm against the handrail, whereas driving the right bolt first could torque the clamp away from the handrail
- 2.
- 3.
- 4.
- 5.

**Timeline Considerations:**

- 1.
- 2.
- 3.
- 4.
- 5.

# GATOR ASSEMBLY INSTALL – TASK DATA (Cont)

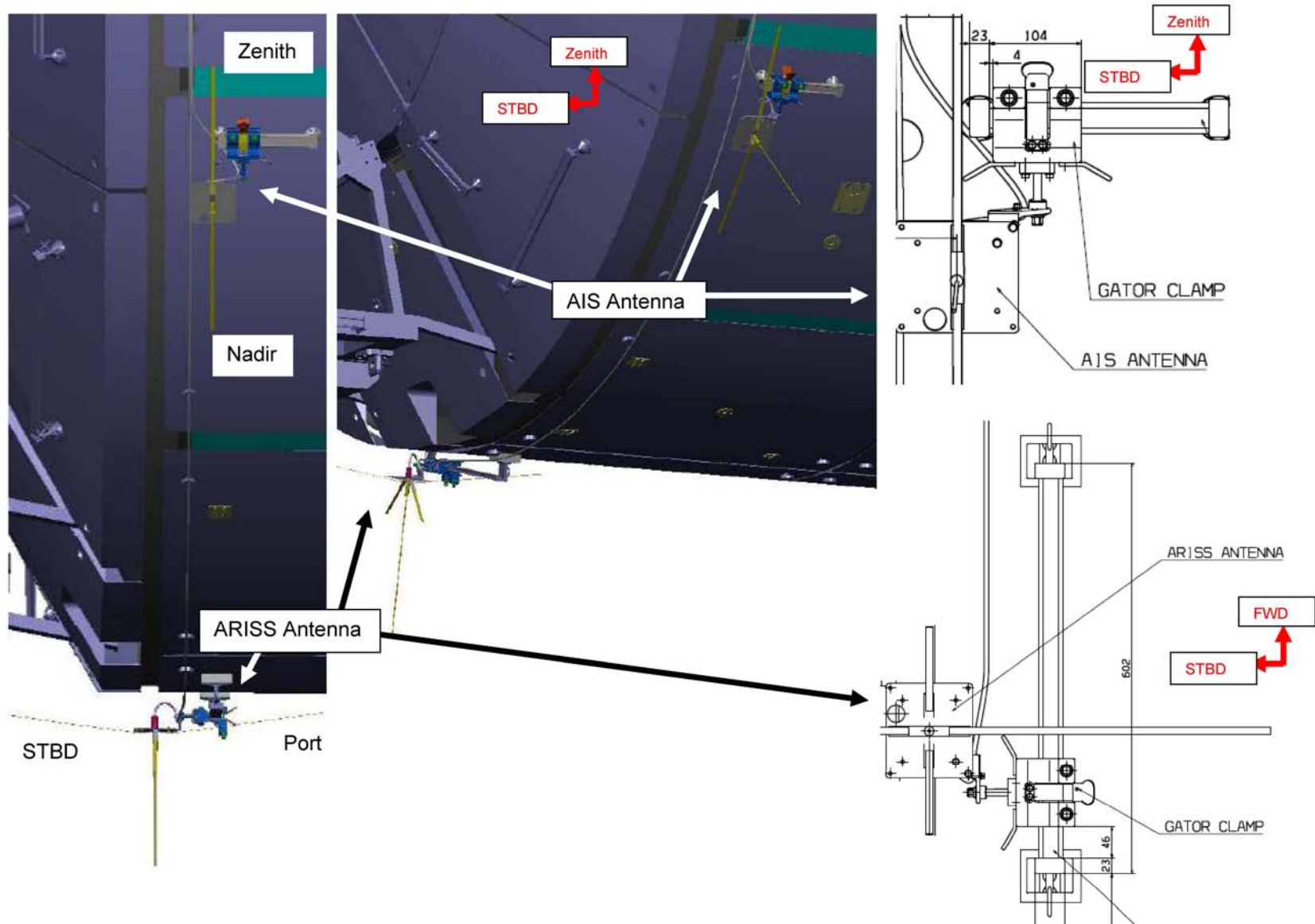

Figure 1: GATOR Installation Orientation

# GATOR ASSEMBLY INSTALL – TASK DATA (Cont)

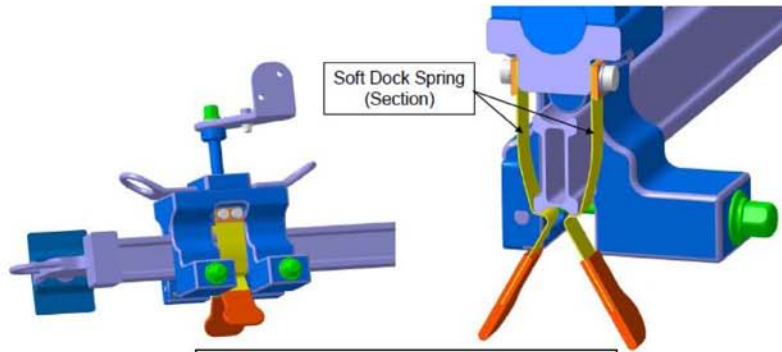

Figure 2: GATOR Clamp Model



Figure 3: GATOR Clamp

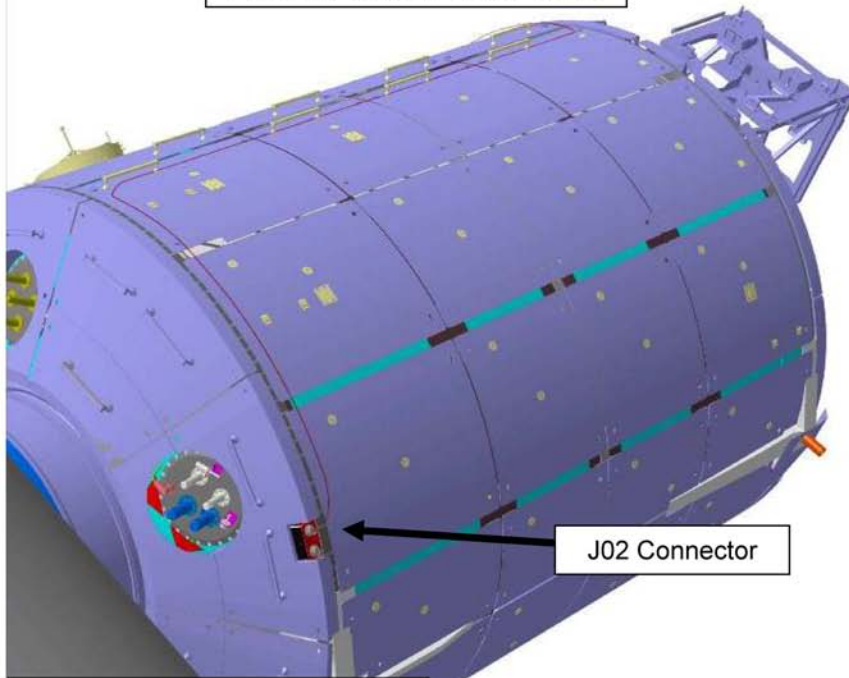

Figure 4: GATOR Cable Routing

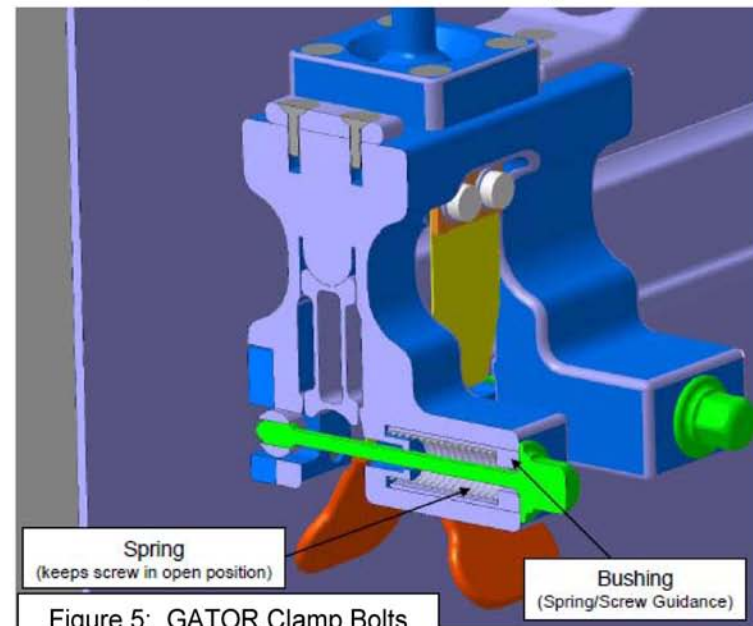

Figure 5: GATOR Clamp Bolts



**GATOR ASSEMBLY INSTALL – TASK DATA (Cont)**



## FPMU RELOCATE – TASK DATA

Estimated Task Duration:

	With RMS	Without RMS
One EV Crew	N/A	N/A
Two EV Crew	N/A	01:30

Tools:

EV1	EV3
Adj Tether	PGAT w/7/16-6-in ext
	Rd Scoop

EVA Fasteners:

Fastener Name	Head Size	Qty	Install Torque (ft-lb)	Release Torque (ft-lb)	Failure Torque (ft-lb)	Turns	RPM
Stanchion Bolt	7/16"	1	18.4	25.5	62	16.5	30
FPMU Center Bolt	7/16"	1	9.2	12.0	13.2 (install) 14.7 (release)	24.4- 30.4	30
FPMU Outer Bolt	7/16"	2	9.2	12.0	13.2 (install) 14.7 (release)	6.8-15	30

EVA Connectors:

Connector	From	To	Conn Size	Function
P2	S1 PNL A100 – J2	P1 PNL A115 – J2	15	Video, ETVCG Power, luminaire power
P3	S1 PNL A100 – J3	P1 PNL A115 – J3	13	ETVCG heater power, luminaire heater power
P4	S1 PNL A100 – J4	P1 PNL A115 – J4	15	Data

Inhibits:

ORU/Task	Location	Inhibit
FPMU Removal	S1 CP2	RPCM S12B-A RPCs 1, 15 open and close command inhibited RPCM S11A-A RPCs 2, 16 open and close command inhibited
FPMU Install	P1 CP6	RPCM S12B-B RPCs 3, 14 open and close command inhibited RPCM S11A-B RPCs 1, 13 open and close command inhibited

**Notes:**

1. Small equipment hook will not fit onto FPMU tether point. Plan to use scoop
2. FPMU Relocate is required prior to HPGT retrieval or significant impact to robotics access to ELC2
- 3.
- 4.
- 5.

**Timeline Considerations:**

- 1.
- 2.
- 3.
- 4.
- 5.

## FPMU RELOCATE – TASK DATA (Cont)

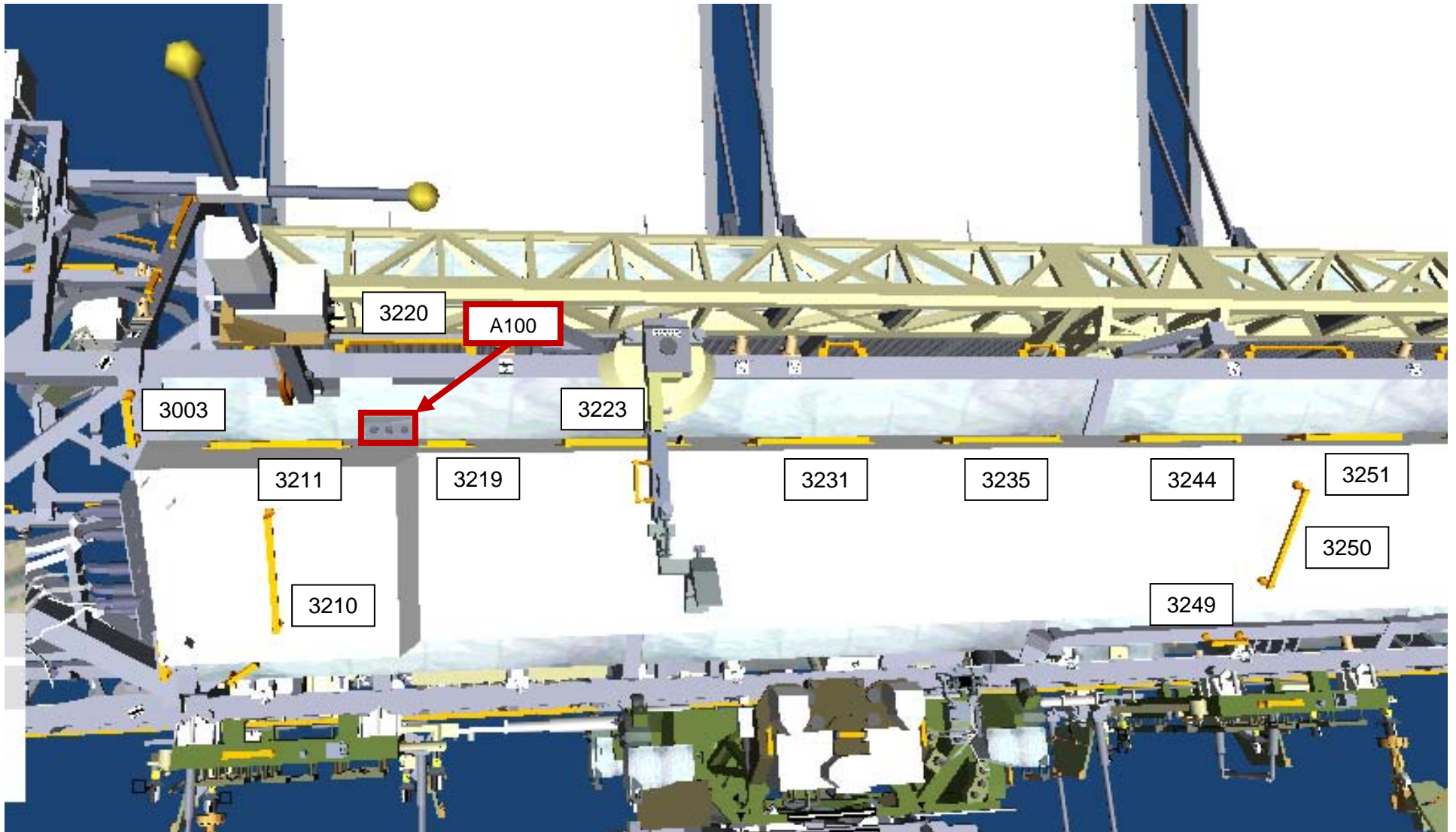

Figure 8: S1 CP2 FPMU Worksite

FPMU RELOCATE – TASK DATA (Cont)

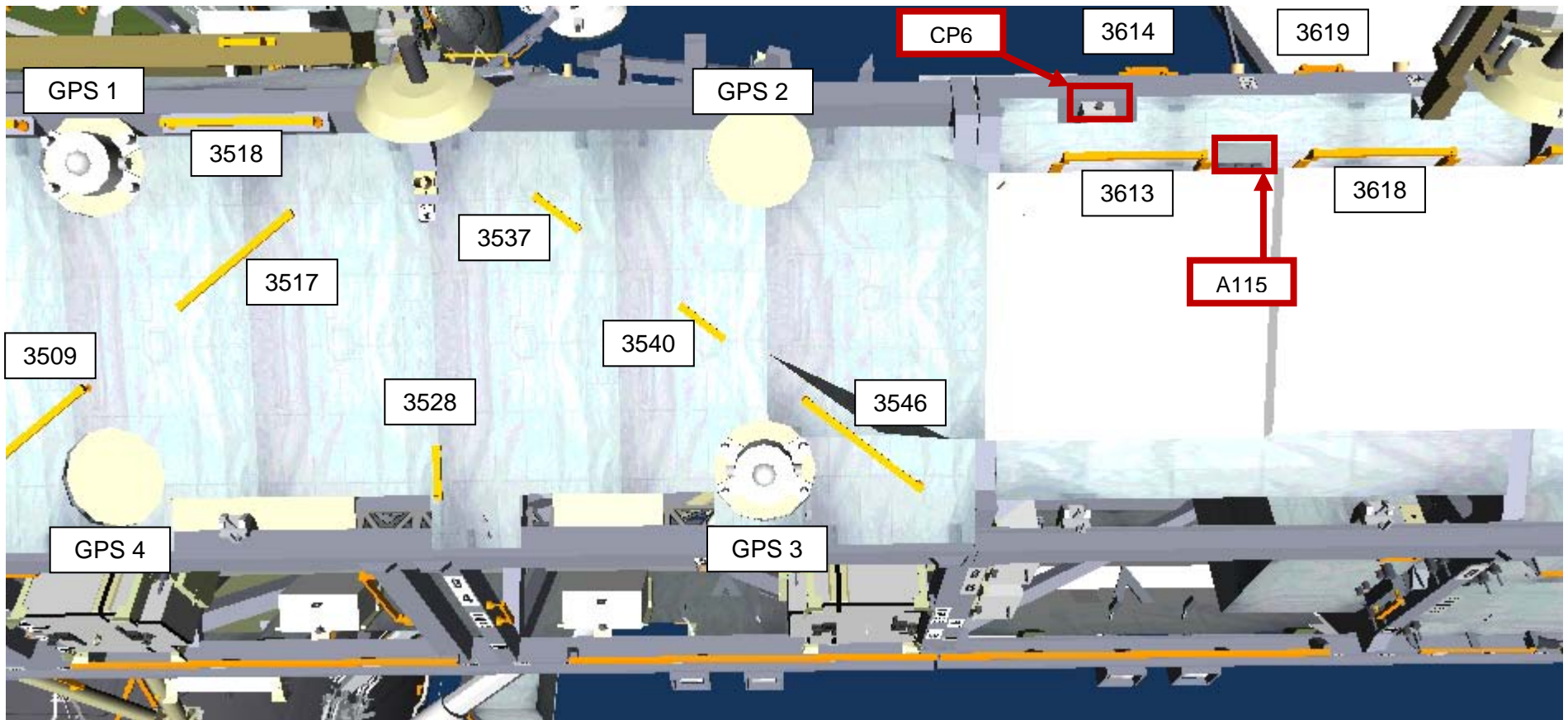
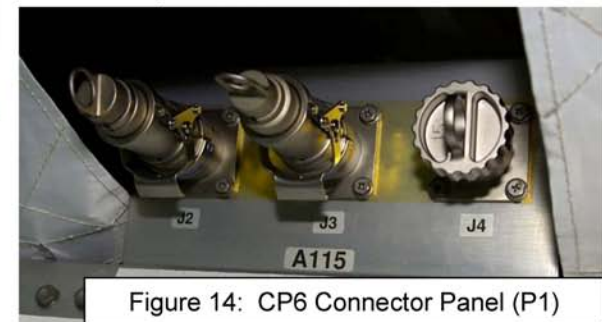
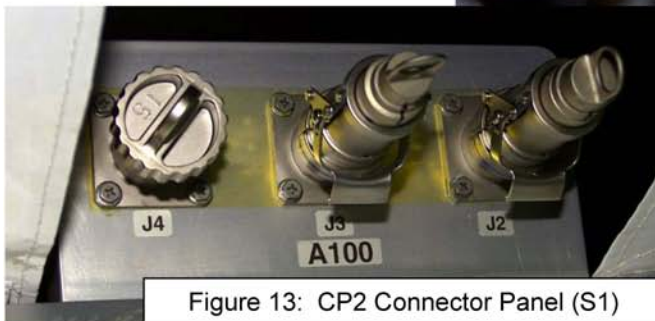
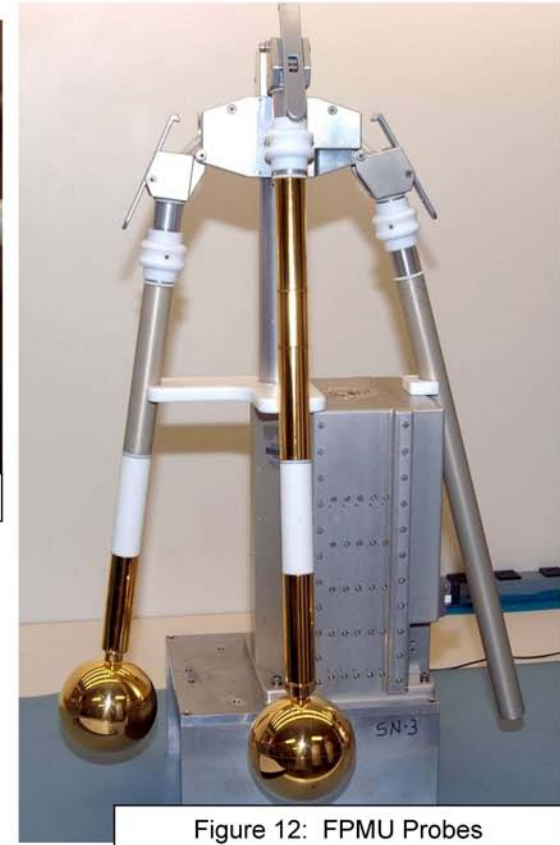
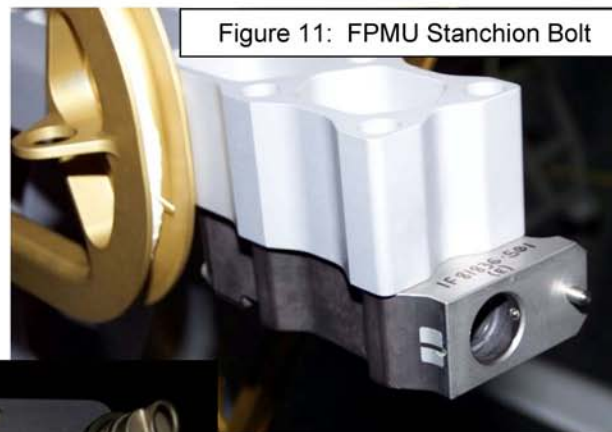
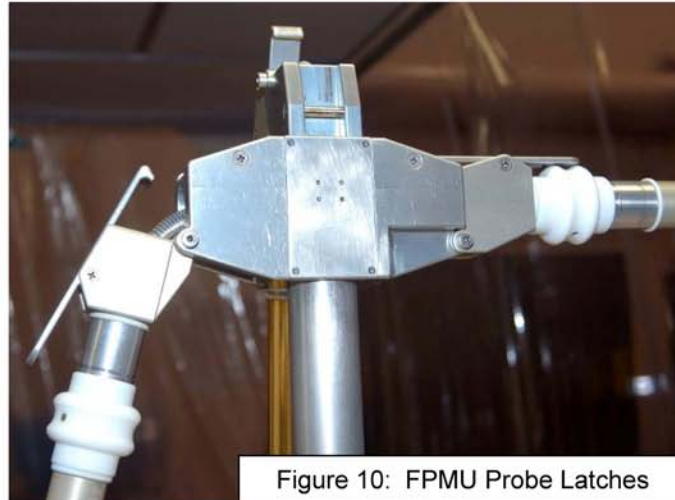

Figure 9: P1 CP6 FPMU Worksite

## FPMU RELOCATE – TASK DATA (Cont)



### S3 NADIR/OUTBD PAS DEPLOY – TASK DATA

**Estimated Task Duration:**

	Without RMS
One EV Crew	N/A
Two EV Crew	01:30

**Tools:**

EV1	EV3
PGT	PGT
7/16-6-in socket ext	7/16-6-in socket ext
	Adj (Lg-sm)

**EVA Fasteners:**

Fastener Name	Head Size	Qty	Install Torque (ft-lb)	Release Torque (ft-lb)	Failure Torque (ft-lb)	Turns
SARJ Brace Launch Lock Bolt	7/16	1	16.0	24.0	32.3	8.5-13.5
SARJ Brace cup/cone Bolt	7/16	1	16.0	24.0	14.0 and 31.6	35-37
Diagonal cup/cone Bolt	7/16	1	16.0	24.0	14.0 and 31.6	35-37
Stow Clevis	7/16	4	16.0	25.5	46.7	9-16.5
Deploy Clevis	7/16	4	30.5	25.5	106.6 (remove) or 44.7 (install)	7-10.5

**Notes:**

1. UMA EVA Override anti-rotation cap must be removed prior to first use of UMA on PAS
2. EBCS target cover must be removed prior to cargo attachment to PAS. Protects target from MMOD and inadvertent contact. Remove as last activity
3. RAD may be needed for re-install of deployed clevis bracket. It will likely exceed RAD limits and need to be returned for refurb

**Timeline Considerations:**

- 1.
- 2.
- 3.
- 4.
- 5.

S3 NADIR/OUTBD PAS DEPLOY – TASK DATA (Cont)

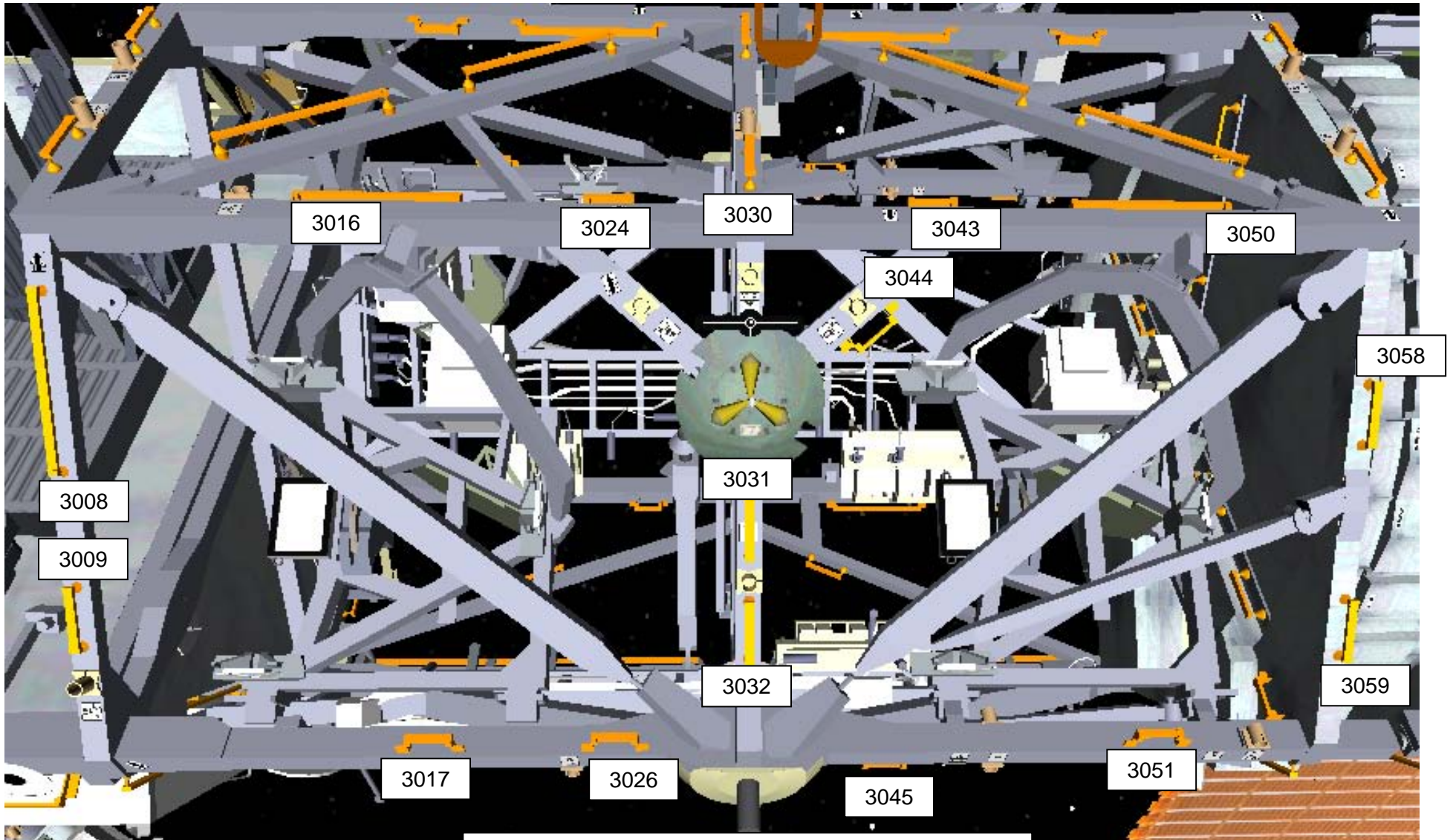

Figure 15: S3 Nadir PAS Stowed (Handrail Numbers)

### S3 NADIR/OUTBD PAS DEPLOY – TASK DATA (Cont)

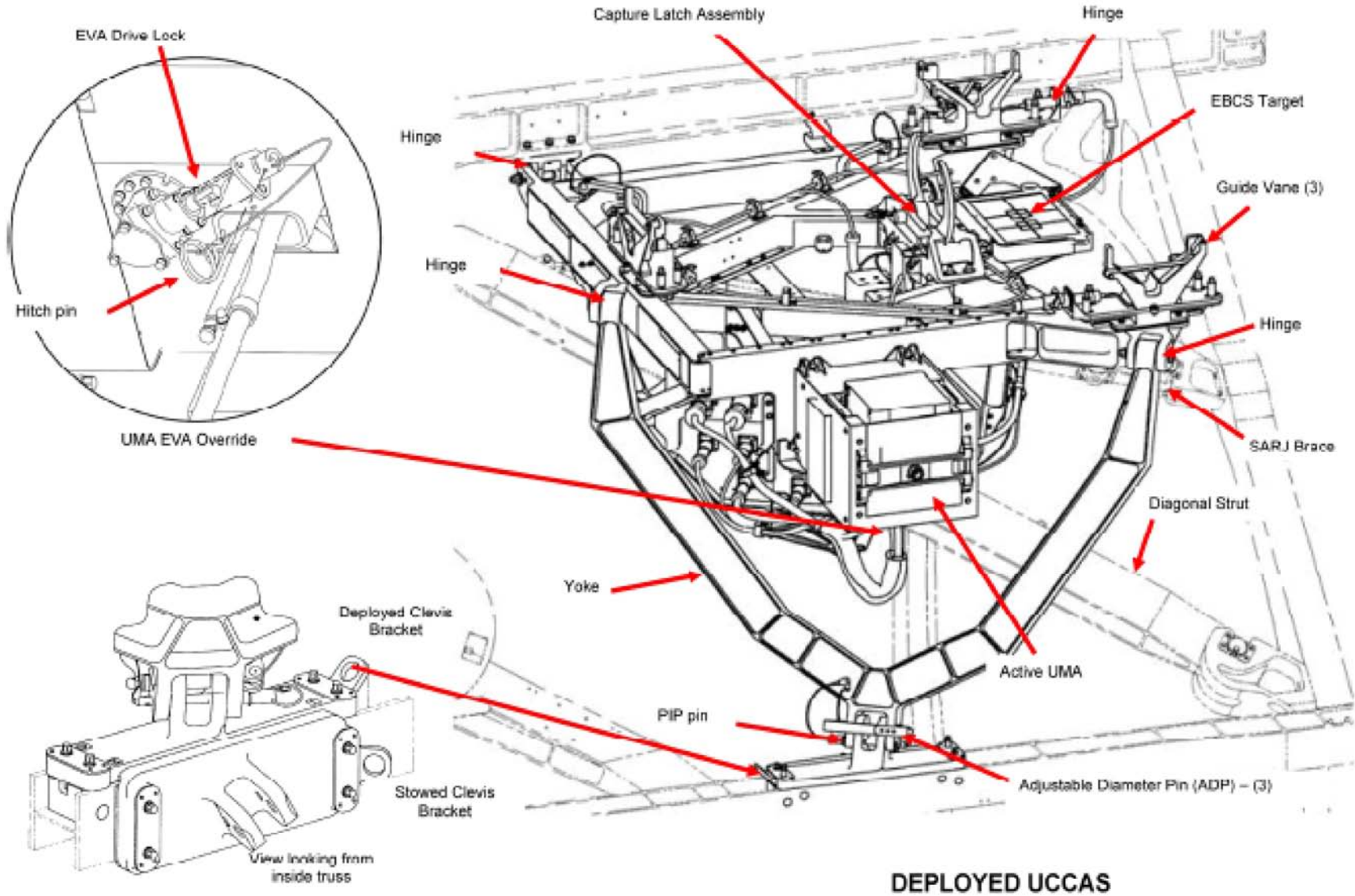

Figure 16: PAS Hardware



S3 NADIR/OUTBD PAS DEPLOY – TASK DATA (Cont)



Figure 17: PAS Hinge Line ADP Orientation

S3 NADIR/OUTBD PAS DEPLOY – TASK DATA (Cont)

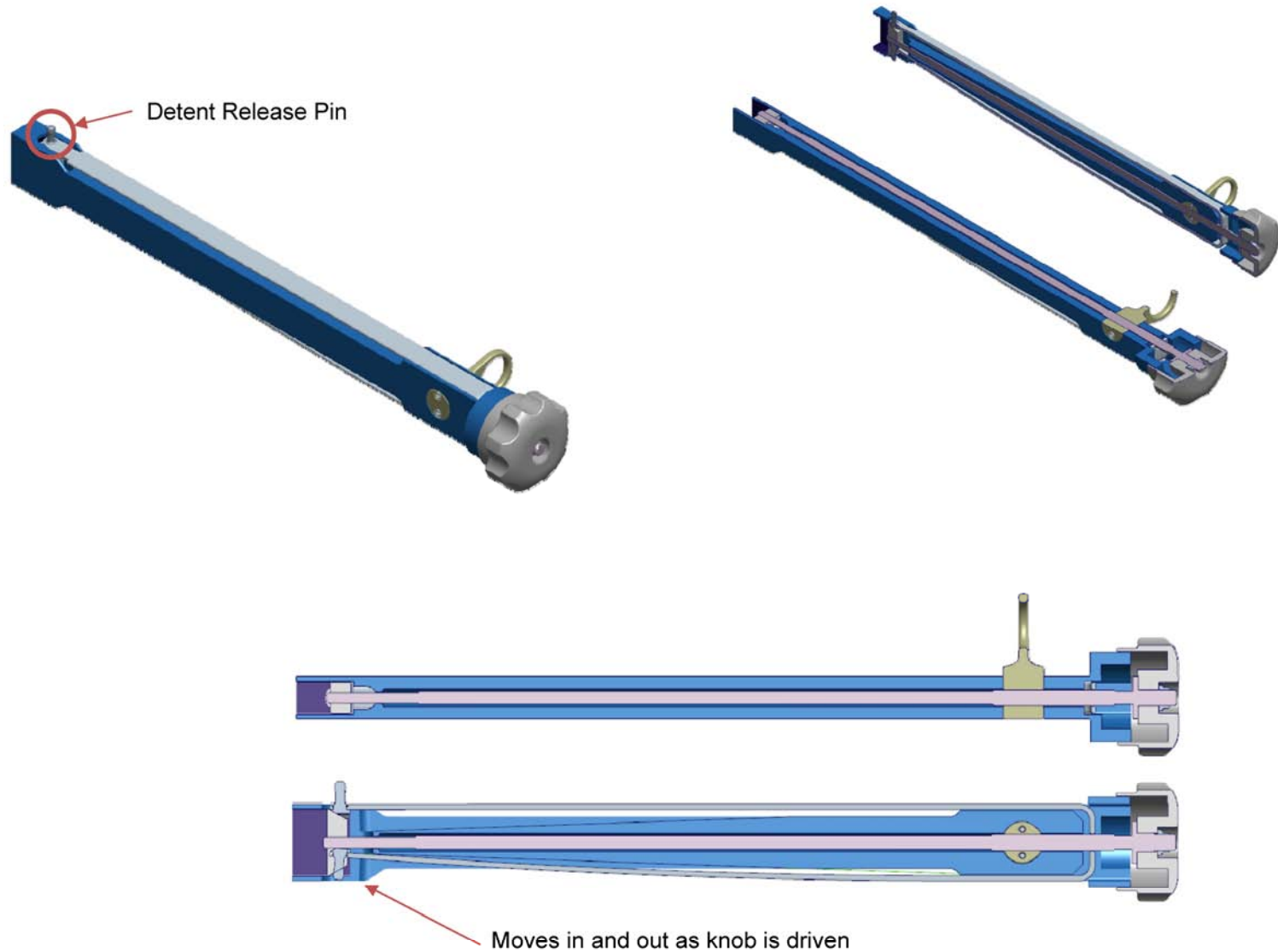

Figure 18: Detent Release Tool (DRT)

## INSTALL CP1 WETA – TASK DATA

### Estimated Task Duration:

	With RMS	Without RMS
One EV Crew	N/A	01:00
Two EV Crew	N/A	00:45

### Tools:

EV1	EV2
PGT	PGT
7/16-6-in wobble	7/16-6-in wobble
Round Scoop (on WETA in A/L)	

### ORU Identification:

ORU	Part number	Serial Number
WETA	16103320-301	1003

### ORU Specs:

ORU	Dimensions (in)	Mass (lb)
WETA	34x18x18	105.8

### EVA Fasteners:

Fastener Name	Head Size	Qty	Install Torque (ft-lb)	Release Torque (ft-lb)	Failure Torque (ft-lb)	Turns	RPM
Dummy Box (Outer)	7/16	2	N/A	7.0	17.1	6.8-11.8	30
Dummy Box (Center)	7/16	1	N/A	7.0	17.1	24.4-30.4	30
WETA (Outer)	7/16	2	9.2	N/A	13.2	6.8-12.8	30
WETA (Center)	7/16	1	9.2	N/A	13.2	24.4-30.4	30

### Electrical Connectors:

Harness	From	To	Size
Dead Face Connector	S3 PNL A78 – J2	VSSA PNL A296 – J2	15
Dead Face Connector	S3 PNL A78 – J3	VSSA PNL A296 – J3	13
Connector Cap	S3 PNL A78 – J4	VSSA PNL A296 – J4	15
W8200-P2	VSSA PNL A296 – J2	S3 PNL A78 – J2	15
W8200-P3	VSSA PNL A296 – J3	S3 PNL A78 – J3	13
W8200-P4	VSSA PNL A296 – J4	S3 PNL A78 – J4	15

### Connector Inhibits:

1. RPCM S31A\_A RPC 15 – Open, Close Cmd Inhibit
2. RPCM S31A\_A RPC 16 – Open, Close Cmd Inhibit
3. RPCM S32B\_A RPC 15 – Open, Close Cmd Inhibit
4. RPCM S32B\_A RPC 16 – Open, Close Cmd Inhibit

### Timeline Considerations:

WETA thermal clock is 9 hr with thermal cover and 4 hr with no thermal cover  
WETA thermal cover must be removed before WETA heater activation

### Notes:

1. Dummy panel A296 is on bottom of VSSA mounting plate ~4 ft from S3 face 4; S3 A78 is just inside S3 face 4

### Cautions:

N/A

### Warnings:

N/A

# INSTALL CP1 WETA – TASK DATA

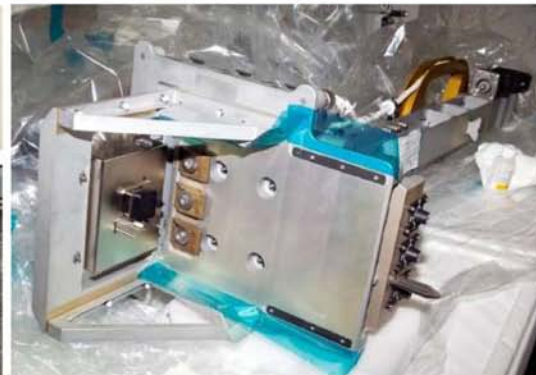
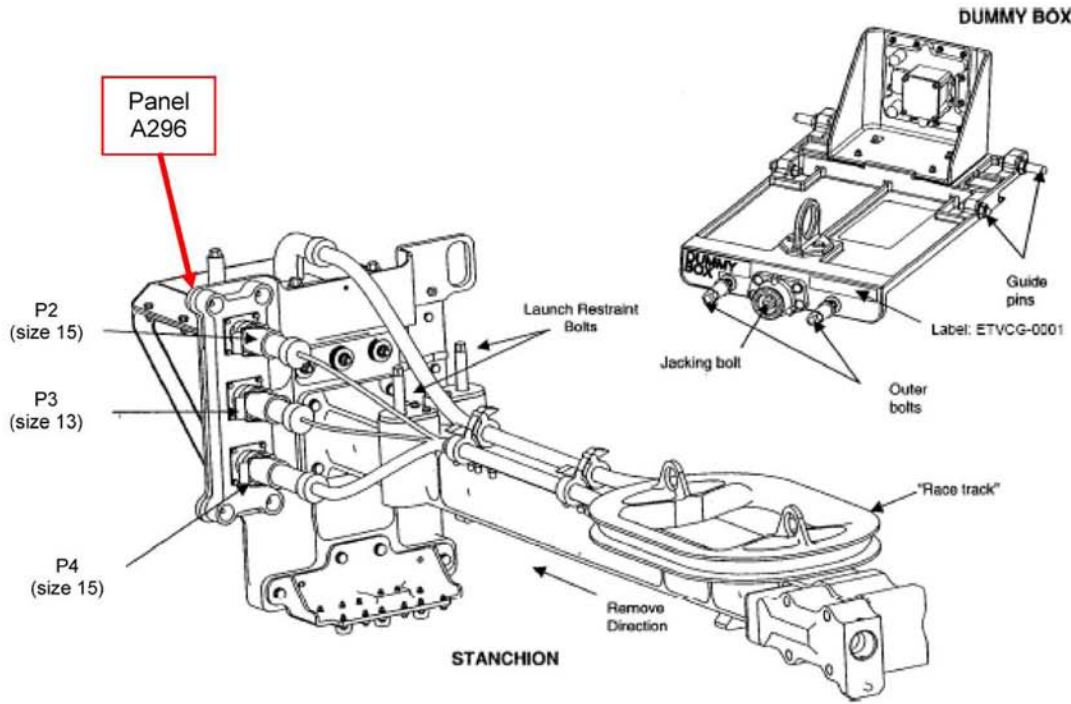

Figure 19: VSSA, WETA, and Dummy Box

# EVA 3 SUMMARY TIMELINE

PET HR : MIN	IV/SSRMS	EV2 (Sa)	EV3 (Br)	
00:00		<u>EGRESS/SETUP</u> (00:30) • Post Depress and Egress (00:15) • Setup (00:15)	<u>EGRESS/SETUP</u> (00:30) • Post Depress and Egress (00:15) • Setup (00:15)	00:00
01:00	• Maneuver HPGT to A/L (00:45)	<u>HPGT TRANSFER &amp; MISSE 7 INSTALL</u> (03:00) • HPGT Setup (01:00)  • Hand off HPGT to SSRMS (00:15)  • Prepare A/L (00:30)  • Install HPGT (01:15)	<u>HPGT TRANSFER &amp; MISSE 7 INSTALL</u> (03:00) • Retrieve MISSE PECs (00:45)  • Install MISSE PEC Bundle (00:15) • Hand off HPGT to SSRMS (00:15)  • Install & Deploy MISSE PECs (00:30)  • Install HPGT (01:15)	01:00
02:00				02:00
03:00				03:00
04:00		<u>A/L MMOD SHIELDS</u> (00:30) • Open HPGT 1 & 5	<u>A/L MMOD SHIELDS</u> (00:30) • Open HPGT 1 & 5	04:00
05:00		<u>S3 ZENITH/INBD PAS DEPLOY</u> (01:30)	<u>S3 ZENITH/INBD PAS DEPLOY</u> (01:30)	05:00
06:00		<u>GET-AHEADS</u> (00:30)	<u>GET-AHEADS</u> (00:30)	06:00
06:30		<u>CLEANUP/INGRESS</u> (00:30) • Cleanup (00:15)  • Ingress and Pre-Repress (00:15)	<u>CLEANUP/INGRESS</u> (00:30) • Cleanup (00:15)  • Ingress and Pre-Repress (00:15)	06:30

EVA 3 TOOL CONFIG

EV 2

- MWS
  - BRT (L)
    - RET (sm-sm)
    - Wire Ties (2 long)
  - T-Bar
    - RET (sm-sm)
    - RET w/PIP Pin
    - Adj Equip Tether (for HPGT handling)
    - Adj Equip Tether (for HPGT handling)
    - Wire Ties (2)
    - Empty Small ISS Trash Bag (left/inboard)
      - A/L Towel Bar Strap
      - A/L QD MLI
  - Swing Arm (R)
    - RET (sm-sm)
      - PGT [B7 25.5ft-lb, CAL, MTL 30.5] s/n \_\_\_\_\_
      - PGT Battery s/n \_\_\_\_\_
      - 7/16 (wobble) Socket-6 ext
- D-ring Extenders (2, R & L D-ring)
  - ST Pack (85-ft + 85-ft to L D-ring Ext) (A/L & Second)
- Waist Tethers (2, L on D-ring, R on D-ring Ext)
- SAFER
- WVS
  
- RET (Lg-sm)
- Adj Equip Tether
  - Crewlock Bag (HPGT Bag)**
    - HPGT Guide Post (on int RET)
    - QD Tool (on int RET)
    - RET (sm-sm)
      - RET (sm-sm)
        - Short MMOD Shield T-Tool
    - Wire Tie Caddy (9 short) (on int RET)
    - RET (sm-sm)
      - RET (Lg-sm) (Lg hook to RET; sm to T-Tool)
      - Long MMOD Shield T-Tool (long for BRT)
    - RET (sm-sm)
      - RET (sm-sm)
        - Short MMOD Shield T-Tool
    - HPGT FRGF Cover (on int RET)
    - Long Duration Tie-Down Tether
    - Long Duration Tie-Down Tether

EV 3

- MWS
  - BRT (R)
    - RET (sm-sm)
    - Wire Ties (2 short, 2 long)
  - T-Bar
    - RET (sm-sm)
    - RET w/PIP Pin
    - Adj Equip Tether
    - Adj Equip Tether (for MISSE bundle)
    - Adj Equip Tether (for MISSE bundle)
    - Wire Ties (2)
    - Empty Small ISS Trash Bag (right/inboard)
      - PAS UMA EVA Bolt Cover w/hitch pin
      - PAS RTL PIP Pins (3)
  - Swing Arm (L)
    - RET (sm-sm)
      - EVA Camera w/bracket
- D-ring Extenders (2, R & L D-ring)
  - ST Pack (85-ft + 85-ft to L D-ring Ext) (A/L & Second)
- Waist Tethers (2, L on D-ring, R on D-ring Ext)
- SAFER
- WVS
  
- RET (Lg-sm)
- Adj Equip Tether
- Lg-sm Adj Equip Tether
  - Crewlock Bag (PAS Bag)**
    - Internal RET to door handle
    - DRT (on int RET)
    - DRT (on int RET)
    - Hammer (on int RET)
    - Wire Ties (2) (external)
    - RET (sm-sm) (to door handle)
      - PAS Stow Clevis Bracket

A/L

- RET (Lg-sm)
  - MUT EE + Ballstack + Round Scoop
  
- RET (Lg-sm)
  - PGT [X Xft-lb, CAL, MTL 30.5] s/n \_\_\_\_\_
  - PGT Battery s/n \_\_\_\_\_
    - 7/16 (wobble) Socket-6 ext
  
- RET (Lg-sm)
- Adj Equip Tether
  - Crewlock Bag (Get-ahead Bag)**
    - EVA Ratchet Palm Wheel (on int RET)
    - EVA Ratchet w/2" socket (on int RET) (use middle tether point)
    - Wire Ties (2) (external)
      - Cheater Bar (on int RET) (wire tied to outside of bag)
    - MBS Booty (-0501; size 21/25) (on int RET)
    - RET w/PIP Pin
      - MBS Booty (-0501; size 21/25)
    - RET (sm-sm)
      - MSS Camr Cover Bag
    - RET (sm-sm)
      - MSS Camr Cover (in bag)
    - RET (sm-sm)
      - MSS Camr Cover Bag
    - RET (sm-sm)
      - MSS Camr Cover (in bag)

**NOTE** – Prior to use, inspect the following hardware:

- RET cords for fraying
- Safety Tether/Waist Tether LAS: No Red Visible
- ISS Trash Bag: Bristle deformation/damage, after having stowed tools in trash bag
- BRT joint screws not loose
- Empty trash bags and verify zipper closed

## EVA 3 TOOL CONFIG (Cont)

### IV Bag

- Towels (2)
- Contamination Detection Kit
- GP Caddy (2)
  - Adjustable Thermal Mittens (2)
- Socket Caddy (hatch cont) w/RET (sm-sm) (Black)
  - 1/2 Socket-8 ext
  - 7/16 (wobble) Socket-6 ext (spare)
- DCM Plug (SAFER Hardmount) (2)
- RET (sm-sm, Black) (2)

### Staging Bag

- Fish Stringer Tether
  - Long Duration Tie-Down Tether
  - Velcro/Tape Caddy
  - PGT s/n \_\_\_\_\_
    - PGT Battery s/n \_\_\_\_\_
    - 7/16 (wobble) Socket-6 ext
  - Vise Grips
  - Ratchet Wrench
    - 7/16 (rigid) Socket-9 ext
  - Spare 85-ft Safety Tether
  - Spare WIF Adapter
- Fish Stringer Tether
  - Connector Cleaner Tool Kit
  - Pin Straightener Assy
  - Probe
  - Pry Bar
  - Long Duration Tie-Down Tether
  - Torque Wrench Bag
    - Torque Wrench (set to 20 ft-lb; on hook)
  - MWS Key Strap Assy (wire-tied to strap)

Tether Counts: <b>BLUE RETS</b>	
RETs (sm-sm) = 16	Adj Equip Tethers
RETs (Lg-sm) = 6	Sm-sm = 8 of 10
RETs (PIP Pin) = 3	Lg-sm = 1 of 2

## EVA 3 BRIEFING CARD

EV1 \_\_\_\_\_ EV2 \_\_\_\_\_ IV1 \_\_\_\_\_ IV2 \_\_\_\_\_

EVA Prep start (GMT) \_\_\_\_ / \_\_\_\_ : \_\_\_\_  
Depress to 10.2 \_\_\_\_\_ : \_\_\_\_\_  
Start purge \_\_\_\_\_ : \_\_\_\_\_  
PET 00:00 \_\_\_\_\_ : \_\_\_\_\_

### EVA Prep

- Get-up plan – clothing and EMU equipment bag
- Equipment lock activities – IV responsibilities
- Suit donning plan – special requests
- SAFER, MWS, tools, CL positions and bag stowage
- Airlock depress review
- EV/IV comm protocol
- SRMS/SSRMS initial position

### EV Crew Procedure Review

- Egress Plan
- Translations – tether swaps
- Order of tasks
- Ingress Plan

### General Procedure Review

- Hazards
- Get ahead tasks
- Constraints – ground and flight
- Cautions and warnings review
- SSRMS and RMS operations – comm protocol/clearances and coordinate systems
- Contingency procedures – crib sheet
- Inspect gloves after each task or if high loading event happens
- Anticipated hazards

### Emergencies review

- Lost comm
- EMU malfunctions
- Rescue of Incapacitated Crewmember – retreat, tethers, A/L, MCC for SCU
- Lost tools
- Lost crewmember
- DCS
- SAFER Ops

### 1<sup>st</sup> Steps today

- A/L Egress and ST config
- Thermal cover
- Translation paths

### Post EVA

- Post EVA plan

Lessons learned from previous EVAs



## EVA 3 INHIBIT PAD

### Orbiter

ALL EVAs	
TCS ( <i>Prior to Egress</i> )	
L12	1. √TCS POWER – OFF
KU-Band Antenna ( <i>Prior to Egress</i> )	
MCC-H	1. √KU-BAND Mask – active
	2. √KU-BAND EVA Protect Box – active
RCS ( <i>Prior to Egress</i> )	
	If EV crew < 27 feet from FRCS
IV	1. √DAP: VERN, FREE, LO Z
O14,15,16	2. √RJDF F1, F2, F3, F4 MANF DRIVER (four) – OFF
	LOGIC (four) – OFF
MCC-H	3. √Above RCS config
IV	4. √RCS F – ITEM 1 EXEC (*)
	√JET DES F1U – ITEM 17 (*)
	F3U – ITEM 19 (*)
	F2U – ITEM 21 (*)

### Ground

ALL EVAs	
Ground Radar ( <i>Prior to Egress</i> )	
MCC-H	1. √TOPO console, ground radar restrictions in place for EVA

### RSOS

ALL EVAs	
SM Antennas ( <i>Prior to Egress</i> )	
IV	1. GTS – Deactivate
	2. ARISS (Ham Radio) – Deactivate or VHF (144-146 MHz) TX only
IMPULSE ( <i>Prior to Egress</i> )	
MCC-M	1. IMPULSE (ИПИ-100) – Is not activated

### USOS

ALL EVAs	
PCU ( <i>Prior to Egress</i> )	
<u>NOTE</u>	
PCUs may require up to a 1-hour warmup period before they are operational.	
MCC-H	1. √PCUs (two) operational in discharge mode and one of the following:
	a. CCS PCU EVA hazard control FDIR enabled.
	b. No more than two arrays unshunted and oriented <105° from velocity vector.
	If one or both PCUs failed
	2. No more than two arrays unshunted and oriented <105° from velocity vector.
JEM	
ICS-EF Antenna ( <i>Prior to Egress</i> )	
SSIPC	1. ICS MOD Off
	2. ICS UPC Off
	3. ICS HPA Off

## EVA 3 INHIBIT PAD (Cont)

### USOS

#### LOCATION DEPENDENT INHIBITS

Zenith/Inboard PAS Deploy (PAS 2) *(Prior to Egress)*  
MCC-H 1. RPCM S32B A RPC 12 Open, Closed Command Inhibited

Lab Window *(Prior to Egress, for crew in Payload Bay)*  
IV If EV crew less than 10 feet from window or in window FOV, close window shutter

Mobile Transporter *(Prior to Egress)*  
MCC-H If EV crew <1.5 meters from MT  
1. √MT latched

Stbd SARJ *(S3 at egress, P3 not expected)*  
MCC-H If EV crew working within 2 feet or outboard of SARJ  
1. √DLA (1) – LOCKED at 330 degrees  
2. All motor setpoints set to zero.  
3. All motors deselected.

TRRJ *(S1 at egress, P1 not expected)*  
MCC-H If EV crew working within 2 feet of P1 TRRJ rotation envelope  
1. √DLA (1) – LOCKED at 0 degrees  
If EV crew working within 2 feet of S1 TRRJ rotation envelope  
1. √DLA (1) – LOCKED at 0 degrees

MISSE 7 *(Prior to connector operations)*  
POIC ELC-2 ECM EXPA-2 120V OPEN  
ELC-2 ECM EXPA-2 28V OPEN  
ELC-2 EXPA-2 OP PWR OPEN  
RPCM S34B E RPC 1 – Open, Close Command Inhibited  
RPCM S33A E RPC 1 – Open, Close Command Inhibited

### GET-AHEADS

#### USOS

MBS Booty Installation *(Prior to connector operations)*  
MCC-H  
1. J35/P35 (Prime Power)  
RPCM S14B F RPC 1 – Open, Close Command Inhibited  
2. J37/P37 (Redundant Power)  
RPCM S13A F RPC 1 – Open, Close Command Inhibited  
3. Demate MT UMAs

Nadir/Outboard PAS Deploy (PAS 3) *(Prior to Egress)*  
MCC-H 1. RPCM S32B A RPC 13 Open, Closed Command Inhibited

Nadir/Inboard PAS Deploy (PAS 4) *(Prior to Egress)*  
MCC-H 1. RPCM S31A A RPC 13 Open, Closed Command Inhibited

#### EVAs ON PMA1 OR RSOS *(APFR 5 Stowage)*

FGB Antennas  
MCC-M 1. √FGB KURS P [KYPC P] – Deactivated

FGB Thrusters  
MCC-M 1. √FGB MCS unpowered  
2. √All FGB Attitude Control Thruster Valves (eighty) – closed  
3. √FGB Attitude Control Manifold Valves – closed  
KШK1, KШK2, KШK4, KШK5, KШK9, OKO3, OKГ3, OKO6, OKГ6, OKO7, OKГ7, OKO8, OKГ8

#### CONTINGENCIES

##### *(Node 1 WETA Temp Stow & Relocation)*

Node 1 WETA (CP 12)  
MCC-H 1. RPCM N13B A RPC 14 Open, Closed Command Inhibited  
2. RPCM N13B A RPC 15 Open, Closed Command Inhibited  
3. RPCM N1RS1 A RPC 8 Open, Closed Command Inhibited  
4. RPCM N1RS1 A RPC 7 Open, Closed Command Inhibited

P3 WETA (CP 10)  
MCC-H 1. RPCM P31A A RPC 15 Open, Closed Command Inhibited  
2. RPCM P31A A RPC 16 Open, Closed Command Inhibited  
3. RPCM P32B A RPC 15 Open, Closed Command Inhibited  
4. RPCM P32B A RPC 16 Open, Closed Command Inhibited

## EVA 3 NOTES/CAUTIONS/WARNINGS

### NOTES

1. Bolt install: Report torque and turns
2. Bolt release: Report torque and turns if different from published range
3. EVA connectors: After disconnection and prior to connection; verify pin and EMI band integrity; verify connector free of FOD
4. Inspect QDs for damage prior to mating
5. Toolbox doors must be closed with one latch per door when EV crew not in immediate vicinity
6. Avoid contact with OBSS striker bars (Vitrolube coating)
7. 85-ft safety tether retract force may affect body positioning

### CAUTION

#### ISS Generic Constraints

- A. Avoid inadvertent contact with
  1. Grapple fixture shafts (drylube)
  2. PIP pins
  3. Passive UMAs
  4. MBS/SSRMS/SPDM taped radiative surfaces: VDU, ACU, JEU, LEU, MCU, CRPCMs, and Cameras
  5. SPDM SJEU, EP, OTCM, LEU, and LEE VDU radiator surfaces
  6. OTSD
- B. Electrical cables
  1. Avoid bend radii < 10 times cable diameter
- C. Fiber optic cables
  1. Avoid bend radii < 10 times cable diameter
  2. Avoid pulling on cable during mate/demate
- D. Fluid line flex hoses and QDs
  1. Avoid bend radii < 14 in for hoses with a diameter  $\geq 1$  in
  2. Additional care should be taken to not exceed bend radii when applying loads at the flexible hose to rigid tube stub interfaces
  3. Ensure fluid QD booties are fully closed prior to leaving worksite; wire tie if reqd
  4. Avoid bend radii < 5 in for hoses with diameter < 1 in on Lab, S0, S1, P1, and 10 in for hoses with diameter < 1 in on all other elements

### CAUTION

#### ISS Generic Constraints (Cont)

- E. For structural reasons
  1. Avoid vigorous body motions, quick grabs and kickoffs against tether restraints
  2. Avoid performing shaking motions (sinusoidal functions) more than four cycles
- F. Other
  1. ITT Cannon connector: On demated connectors, do not rotate collar or manipulate cable/connector using collar or connector tool
  2. MLI handholds are not rated for crewmember translation loads

## EVA 3 NOTES/CAUTIONS/WARNINGS (Cont)

### CAUTION

#### ISS Truss Constraints

##### A. Avoid inadvertent contact with (Cont)

1. CETA lights (Z-93 paint) [Lab,S1, Node 1]
2. Deployed TUS cable [Nadir CETA rail]
3. S0 aft face radiator
4. GPS antennas (S13 paint) [S0,JLP]
5. UHF antennas [Lab,P1]
6. ETCS radiator flexhoses and panels [S1,P1]
7. EETCS/PV radiator flexhoses, bellows and panels [P6,P4,S4,S6]
8. SASA RF group [S1,P1]
9. Heat pipe radiators [Z1]
10. PCU cathode and HCA ports [Z1]
11. Ku-Band antenna (SGANT) dish [Z1]
12. CMG cover/shells [Z1]
13. FPMU [P1]
14. SASA high & low gain antennas and radiator surfaces [Z1]
15. Deployed MISSEs

##### B. For structural reasons

1. Avoid kicking S1/P1 radiator beam.  
If any of these occur, wait 2 to 5 min to allow structural response to dissipate

### CAUTION

#### ISS Truss Constraints (Cont)

##### C. Other

1. WIS Antennas: Do not use as handholds [Node 1,Lab,P6,Z1]
2. Lubricant from Ku-Band SGANT gimbals [Z1], CMGs [Z1], and RTAS ground strap fasteners [P6,P4,S4,S6] can contaminate EMU
3. Prevent inadvertent contact of the tether shuttle with ETRS when the P3 tether shuttle stop is raised away from the rail

### CAUTION

#### ISS U.S. Pressurized Elements Constraints

##### A. Avoid inadvertent contact with

1. EVA crane [PMA1]
2. TCS reflectors [PMA2,PMA3]
3. APAS hardware [PMA2,PMA3]
4. CETA lights (Z-93 paint) [Lab,S1, Node 1]
5. UHF antennas [Lab,P1]
6. Open CBM petal covers and Lab window shutter
7. S0/Node 2 fluid tray hardlines at Node 2 end are limited to 25 lb

##### B. Other

1. WIS antennas: Do not use as handholds [Node 1,Lab,P6,Z1]
2. CBM petal covers may not be used as handholds unless both launch restraint pins are engaged

## EVA 3 NOTES/CAUTIONS/WARNINGS (Cont)

### CAUTION

#### **ISS I.P. Elements Constraints**

##### **COL:**

- A. Avoid inadvertent contact with
1. COL ARISS & AIS antennas [COL-Nadir]

##### **JEM:**

- A. Avoid inadvertent contact with
1. GPS antennas (S13 paint) [S0,JLP]
  2. Open JPM window shutter
  3. JTVE, WVE/EVE, JEF VE cameras [JEM]
  4. JEMRMS taped radiative surfaces
  5. JEM A/L target and pins
  6. JEF ORUs and EFUs (paint & lubricant)
  7. MAXI front and top panel (paint)
  8. SEDA-AP sensors (HIT, SDOM, & AOM) and MPAC & SEED
  9. Trunnions and UCMs (paint & lubricant) [JEF Payloads]
  10. RAIDS covers on end of HREP
  11. ICS-EF Ku-Band antenna dish
- B. For structural reasons
1. Avoid kicking MMOD shields between JLP and JPM
  2. Avoid tool impact on ICS-EF sensor

### CAUTION

#### **Shuttle Constraints**

- A. Avoid inadvertent contact with
1. OBSS and SRMS composite sections joint torque arms, grapple fixture shafts, and cable harnesses
  2. LCS (silver Teflon) and LDRI (silver Teflon) and ITVC (gold foil) [OBSS]
  3. WVS antenna [ODS truss & PLB sill]
  4. Payload bay and camera wire harnesses, cables, cable guides, and connectors
- B. No touch
1. LDRI diffuser [OBSS]
  2. OBSS saddle contacts (when OBSS unberthed) [OBSS]
  3. Monkey fur [PLB]
  4. Cameras: Metallic surfaces [PLB]
  5. Ku-Band antenna black dish and gold thermal blankets [PLB]

## EVA 3 NOTES/CAUTIONS/WARNINGS (Cont)

### WARNING

#### ISS Generic Constraints

- A. Avoid inadvertent contact with
1. Grapple fixture targets and target pins
- B. Pinch
1. NZGL connector linkage. Use caution when mating/locking
  2. ITT Cannon connector rotating housing
- C. QDs
1. If QD is in FID when valve is opened (bail fwd), QD will leak and fluid line may whip
  2. Do not rotate if in mated/valve open config
- D. Sharp Edges
1. Inner edges of WIF sockets
  2. APFR active WIF probes
  3. Mating surfaces of EVA connectors  
Avoid side loads during connector mating
  4. Back side of MMOD shield fasteners
  5. Spring loaded captive EVA fasteners (e.g., 6B-boxes, BMRRM, RTAS, SARJ Covers); the end of the spring may protrude
  6. SPDM OTCM gripper jaws
  7. Keep hands away from SSRMS LEE/POA/SPDM LEE opening, snares, and PDGF curvic coupling (teeth)
  8. MMOD strikes on ISS exterior

### WARNING

#### ISS Generic Constraints (Cont)

- E. Thermal
1. EVA connectors with booties may become hot if left uncovered. Handling may need to be limited
  2. Turn off glove heaters when comfortable temp reached to prevent bladder damage. Do not pull fingers out of gloves when heaters are on
  3. Uncovered trunnion pins may be hot
  4. SSRMS/MBS/SPDM/JEMRMS/JTVE/JEF VE operating cameras and lights may radiate large amounts of heat
  5. Do not touch EMU protective visor if temp has been < -134 degF for > 15 min
  6. No EMU boot contact with foot restraint when temp < -120 degF or > 200 degF
  7. PDGF surfaces may not meet touch temperature requirements for unlimited contact when  $\beta \leq -70$  or  $\beta \geq 70$
- F. Electrical Shock
1. Do not touch SPDM CLPA 1 electrical connector prior to camera installation

### WARNING

#### ISS Truss Constraints

- A. Avoid inadvertent contact with
1. SSU, ECU, beta gimbal platform, mast canister, SAW blanket boxes unless the beta gimbal is locked and the motor is turned off
  2. Stay inboard of SARJ when active
  3. Stay 2 ft from S1/P1 radiator beam rotational envelope when beam is free to rotate
  4. Stay 5 ft from moving MT on face 1
- B. RF radiation exposure
1. Stay 3.6 ft from S-Band (SASA) high gain Antenna when powered [S1,P1]
  2. Stay 1.3 ft from S-Band (SASA) low gain Antenna when powered [S1,P1]
  3. Stay 1 ft from UHF Antenna when powered [Lab,P1]
- C. Sharp Edges
1. Solar array blanket box [P6,S6]
  2. Fastener threads on back of Z1 U-jumper male FQD panel, if nutplate cap missing
  3. Outboard MT rail attachment lug near P6 handrail 5333 and gap spanner
  4. P2 connector on EWIS box TAA-06 [Zenith/Forward Corner 1 of P5 – SARJ at 0 deg]
  5. Nickel coated braided copper ground straps may contain frayed wires [P6,P4,S4,S6]
  6. MMOD strikes on Z1 toolboxes

## EVA 3 NOTES/CAUTIONS/WARNINGS (Cont)

### WARNING

#### ISS Truss Constraints (Cont)

##### D. Electrical Shock

1. Stay  $\geq 2$  ft from ungrounded floating connectors if powered
  - MBS cross-connect jumpers (translate past these using UMA handrails)
  - S0 EVA power cables (inside S0 Bay 00 Face 4, Bay 01 Face 3)
  - ESP-2 jumper (inside S0 Bay 03 Face 4)

##### E. Thermal

1. ELC may exceed touch temperatures when  $\beta > 75$  deg

### WARNING

#### ISS U.S. Pressurized Elements Constraints

##### A. Handrails

1. Handrails previously used for MISSE attachment may not be used as a safety tether point [A/L endcone 564 & 566, A/L Tank 2 nad/fwd & port/fwd, P6 5389]

##### B. Pinch

1. EV side of IV Hatch during Hatch operation (also snag hazard) [A/L]
2. Lab window shutter and CBM petal cover linkages during operation

##### C. RF radiation exposure

1. Stay 1 ft from UHF antenna when powered [Lab,P1]

##### D. Sharp Edges

1. PMA umbilical launch restraints-exposed bolt threads
2. Adjustable fuse tether (Fish Stringer) buckles stowed in Node bag
3. Port/Aft portion of A/L circular HR [HR 0506]
4. A/L HR 0537 (Eq Lock Zenith)

##### E. Thermal

1. PMA handrails may be hot. Handling may need to be limited
2. Stay  $\geq 1$  ft away from PMAs and MMOD shields  $> 270$  degF if EMU sun visor up; limit time to 15 min or less if  $> 300$  degF
3. Stay at least 0.5 ft away from PMA and MMOD shields  $> 325$  degF
4. No EMU TMG contact with PMAs and MMOD shields  $> 320$  degF

### WARNING

#### ISS U.S. Pressurized Elements Constraints (Cont)

##### F. Electrical Shock

1. Stay  $\geq 2$  ft from ungrounded floating connectors if powered
  - SSPTS connectors include NOD1 Stbd/Fwd HR 0130, Lab Stbd/Fwd HR 0273, PMA2 Stbd and Port

## EVA 3 NOTES/CAUTIONS/WARNINGS (Cont)

### WARNING

#### ISS I.P. Elements Constraints

##### COL:

- A. Avoid inadvertent contact with
  - 1. SOLAR [COL EPF]
- B. Thermal
  - 1. Columbus end cones may violate touch temperature constraints when  $-75 \leq \beta \leq -60$  or  $60 \leq \beta \leq 75$

##### JEM:

- A. Avoid inadvertent contact with
  - 1. ICS-EF sensors
- B. Pinch
  - 1. JPM window shutter linkages during operation
  - 2. JEMRMS HRM capture latches
  - 3. JEM cameras (JVTEs, EVE, WVE, & JEF VEs)
  - 4. JEM EFBM capture latches
  - 5. JEM EFU latching arms
  - 6. JEF SSE latch
  - 7. ICS-EF antenna boom
  - 8. SEDA-AP mast
  - 9. SMILES antenna rotating area
  - 10. HREP hinge sides and RAIDS pinch areas

### WARNING

#### ISS I.P. Elements Constraints (Cont)

##### JEM (Cont):

- C. Sharp Edges
  - 1. Interior of JEMRMS HRMs
  - 2. JEMRMS EE opening and snares
  - 3. JEM A/L hatch corners
  - 4. ICS-EF AHM gears
  - 5. MAXI visual star camera
  - 6. SMILES baffles (2), baffle base bare bolts, and cold sky terminator (CST)
  - 7. HREP baffles (4) [Star tracker aperture Zenith and three instrument baffles aft]
  - 8. PIU springs [ICS-EF, MAXI, SEDA-AP, SMILES, HREP]
- D. RF radiation exposure
  - 1. Stay 0.3 ft from fwd/aft JPM PROX antenna
- E. Thermal
  - 1. JPM port end cones and JLP port nadir may violate touch temperature constraints when  $\beta > 60$  deg
  - 2. JEMRMS/JTVE/JEFVE operating cameras and lights may radiate large amounts of heat

### WARNING

#### Shuttle Constraints

- A. Arcing/Molten Debris
  - 1. Stay  $\geq 2$  ft from exposed EFGF connector when OBSS berthed, powered, and EFGF not grappled [PLB]
  - 2. Stay  $\geq 2$  ft from exposed Stbd Fwd MPM contacts [PLB]
  - 3. Stay above PLB sill when within 1 ft of powered ROEU connector [PLB]
- B. Pinch
  - 1. PRLA operation [PLB]
- C. RF radiation exposure
  - 1. Stay 3.28 ft from S-Band Antenna when powered
  - 2. Stay 1 ft from top and side of UHF PLB Antenna radome surface when in high powered mode [ODS truss]
  - 3. Stay 0.33 ft from top and side of UHF PLB Antenna radome surface when in low powered mode [ODS truss]
  - 4. Remain below the level of the PLB door mold line for first 20 in Aft of Fwd bulkhead when S-Band Antenna powered [PLB]
  - 5. Remain on the inboard side of the Stbd slidewire (sill handrails if slidewire not installed) for first 20 ft Aft of Fwd bulkhead when Ku-Band Antenna powered [PLB]



## EVA 3 NOTES/CAUTIONS/WARNINGS (Cont)

### WARNING

#### Shuttle Constraints (Cont)

##### D. Sharp Edges

1. PRLA grounding wipers [PLB]
2. LDRI baffles (also an entrapment hazard) [OBSS]
3. Keep hands away from SRMS EE opening and snares
4. TCS connector backshells have exposed threads [ODS]

##### E. Thermal

1. Illuminated PLB lights; do not touch
2. OBSS grapple fixture shafts/cams may be hot. Limit handling if required
3. Stay 27 ft from PRCS when powered
4. Stay 3 ft from VRCS when powered
5. Stay 3 ft from APU when operating

##### F. Contamination

1. Stay out of the immediate vicinity of leaking jet or APU

##### G. Lasers

1. Do not look at LDRI diffuser or LCS laser aperture window

## EGRESS/SETUP (00:30)

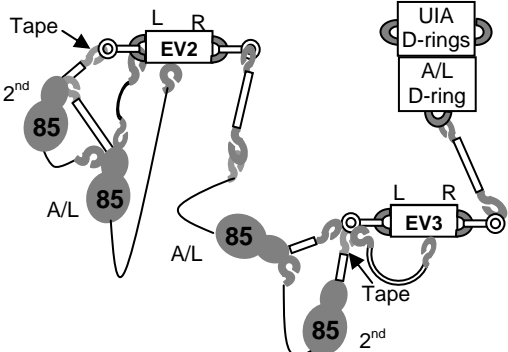
IV/SSRMS	EV2	EV3
 <p>The diagram illustrates the egress setup for the IV/SSRMS. It shows two external D-rings, labeled EV2 and EV3, each with Left (L) and Right (R) sides. EV2 is connected to a 2nd 85-foot ST reel and an A/L 85-foot ST reel. EV3 is connected to a 2nd 85-foot ST reel and an A/L 85-foot ST reel. A UIA D-ring is attached to the A/L D-ring of EV2. Tapes are attached to the D-rings. The setup is used for egress from the hatch thermal cover.</p> <ol style="list-style-type: none"> <li>1. Start Hatch Thermal Cover clock PET (30 min) ____:____</li> <li>2. Stop Hatch Thermal Cover clock PET (30 min) ____:____</li> <li>3. <b>IV:</b> Post crew egress: WVS Software: Select page – RF camera Sel 'Advanced Controls' S-Band Level (two) – Max</li> </ol>	<p><b>Initial Configuration:</b></p> <ol style="list-style-type: none"> <li>1. <input checked="" type="checkbox"/> All gates closed &amp; hooks locked <ul style="list-style-type: none"> <li><input type="checkbox"/> R Waist Tether to EV3 A/L 85-ft ST anchor</li> <li><input type="checkbox"/> A/L 85-ft ST LAS to 2<sup>nd</sup> 85-ft ST reel</li> <li><input type="checkbox"/> A/L 85-ft ST anchor to MWS</li> <li><input type="checkbox"/> L Waist Tether to A/L 85-ft ST reel</li> <li><input type="checkbox"/> 2<sup>nd</sup> 85-ft ST LAS to L D-ring extender</li> <li><input type="checkbox"/> 2<sup>nd</sup> 85-ft ST anchor to A/L 85-ft ST reel</li> </ul> </li> </ol> <p><b>EGRESS/SETUP (00:30)</b></p> <ol style="list-style-type: none"> <li>2. ← Open hatch thermal cover</li> <li>3. Egress A/L</li> <li>4. Anchor EV2 A/L 85-ft ST to aft external D-ring <ul style="list-style-type: none"> <li><input type="checkbox"/> <input checked="" type="checkbox"/> Gate closed, hook locked, reel unlocked</li> </ul> </li> <li>5. Anchor EV3 A/L 85-ft ST to fwd external D-ring <ul style="list-style-type: none"> <li><input type="checkbox"/> <input checked="" type="checkbox"/> Gate closed, hook locked, reel unlocked</li> </ul> </li> <li>6. <b>Give EV3 GO</b> to release Waist Tether from A/L internal D-ring</li> <li>7. BRT RET to HPGT Crewlock Bag from EV3; stow on BRT</li> <li>8. Verify SAFER config <ul style="list-style-type: none"> <li><input type="checkbox"/> <input checked="" type="checkbox"/> L handle down (MAN ISOL Vlv – Open)</li> <li><input type="checkbox"/> <input checked="" type="checkbox"/> R handle down, door closed (HCM – Closed)</li> </ul> </li> <li>9. <input type="checkbox"/> <input checked="" type="checkbox"/> WVS – green LED</li> <li>10. ← Close hatch thermal cover</li> </ol> <p>(Translate to HPGT 1, A/L aft/nadir)</p>	<p><b>Initial Configuration:</b></p> <ol style="list-style-type: none"> <li>1. <input checked="" type="checkbox"/> All gates closed &amp; hooks locked <ul style="list-style-type: none"> <li><input type="checkbox"/> R Waist Tether to A/L internal D-ring</li> <li><input type="checkbox"/> A/L 85-ft ST LAS to R D-ring extender</li> <li><input type="checkbox"/> A/L 85-ft ST anchor to EV2 R Waist Tether</li> <li><input type="checkbox"/> L Waist Tether to MWS</li> <li><input type="checkbox"/> 2<sup>nd</sup> 85-ft ST LAS to L D-ring extender</li> <li><input type="checkbox"/> 2<sup>nd</sup> 85-ft ST anchor to A/L 85-ft ST reel</li> </ul> </li> </ol> <p><b>EGRESS/SETUP (00:30)</b></p> <ol style="list-style-type: none"> <li>2. <b>On EV2 GO</b>, release Waist Tether from A/L internal D-ring</li> <li>3. Transfer HPGT Crewlock Bag to EV2</li> <li>4. RET to PAS Crewlock Bag</li> <li>5. Egress A/L with PAS Crewlock Bag</li> <li>6. Verify SAFER config <ul style="list-style-type: none"> <li><input type="checkbox"/> <input checked="" type="checkbox"/> L handle down (MAN ISOL Vlv – Open)</li> <li><input type="checkbox"/> <input checked="" type="checkbox"/> R handle down, door closed (HCM – Closed)</li> </ul> </li> <li>7. <input type="checkbox"/> <input checked="" type="checkbox"/> WVS – green LED</li> <li>8. Stow PAS Crewlock Bag on port A/L Toolbox HR</li> </ol> <p>(Translate to Payload Bay)</p>

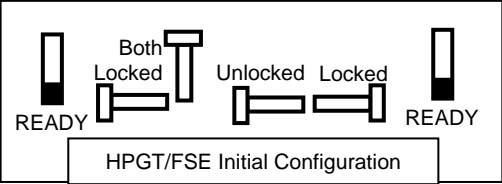
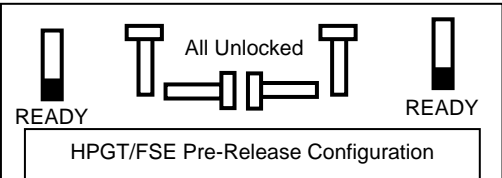

## HPGT TRANSFER & MISSE 7 INSTALL (03:00)

IV/SSRMS	EV2	EV3
<p>Planned PET 0:30</p> <ol style="list-style-type: none"> <li>IV: <input type="checkbox"/> <input checked="" type="checkbox"/> <b>MCC-H</b> – Give EV GO to close HPGT #1 isolation valve</li> <li>IV: <input type="checkbox"/> <input checked="" type="checkbox"/> <b>MCC-H</b> – Start Hi P O2 line vent</li> <li>IV: <input type="checkbox"/> <input checked="" type="checkbox"/> <b>MCC-H</b> Stbd SARJ locked IV: <input type="checkbox"/> <input checked="" type="checkbox"/> <b>MCC-H</b> Stbd TRRJ locked</li> </ol>  <div data-bbox="113 1026 611 1208">  <p>HPGT/FSE Initial Configuration</p> </div> <div data-bbox="113 1219 611 1396">  <p>HPGT/FSE Pre-Release Configuration</p> </div>	<p><b>EV2</b></p> <p><u>HPGT SETUP (01:00)</u></p> <ol style="list-style-type: none"> <li>← Translate to A/L HPGT #1 (aft/nadir)</li> <li>Open HPGT #1 door</li> <li><b>On IV GO</b>, CLOSE HPGT #1 isolation valve (right)</li> <li>Close HPGT #1 door and engage ¼-turn fastener</li> <li>Translate aft/over A/L to zenith HPGT</li> <li>Stow HPGT Crewlock Bag on aft/port HR of zenith HPGT (#4)</li> <li>Translate to Z1 WIF 1 (stbd IAPFR)</li> <li>RET, remove IAPFR; temp stow in Z1 WIF 14 √Locking collar black-on-black, pull test</li> <li>← Translate to stbd CETA Cart WIF 3, RET, retrieve APFR</li> <li>Translate nadir to S1 outboard, bay 15, face 6</li> <li>Attach A/L tether to S1 HR 3217 _____ <input type="checkbox"/> √Gate closed, hook locked, reel unlocked</li> </ol> <div data-bbox="701 802 1079 896" style="border: 1px solid black; padding: 5px; text-align: center;"> <p><b>CAUTION</b> Avoid inadvertent contact with grapple fixture shaft (drylube)</p> </div> <ol style="list-style-type: none"> <li>Translate nadir/aft S3 to ELC2</li> <li>Install APFR in ELC2 WIF 6 [<b>6,SS,F,12</b>] √Locking collar black-on-black, pull test</li> <li>Configure Adjustable Tethers on HPGT</li> <li>√Left tank handle in READY position (vertical) √Right tank handle in READY position (vertical)</li> <li>Remove PIP Pins, rotate adapter plate release handles to UNLOCK, reinstall PIP Pins (3) <input type="checkbox"/><input type="checkbox"/><input type="checkbox"/></li> </ol>	<p><b>EV3</b></p> <p><u>RETRIEVE MISSE PECs (00:45)</u></p> <ol style="list-style-type: none"> <li>Translate to Node 2 along stbd/zenith <input type="checkbox"/> Fairlead along Equip. Lock and CETA Spur</li> <li>Attach A/L tether to Lab HR 0264 _____ <input type="checkbox"/> √Gate closed, hook locked, reel unlocked</li> <li>Translate to orbiter, bay 4, stbd</li> <li>RET to PEC 7B</li> <li>Remove PEC 7B restraint PIP Pins (2)</li> <li>Pull levers (2) to release PEC 7B from carrier</li> <li>Stow PEC on BRT</li> <li>Lock levers (2) into stow position</li> <li>Install PIP Pins (2)</li> <li>Translate to orbiter, bay 4, port</li> <li>Remove PEC 7B from BRT; bundle PEC 7B to PEC 7A with Adj Equip Tethers (2)</li> <li>Remove PEC 7A restraint PIP Pins (2)</li> <li>Pull levers (2) to release PEC 7A from carrier</li> <li>Attach PEC bundle on BRT</li> <li>Lock levers (2) into stow position</li> <li>Install PIP Pins (2)</li> <li><b>Glove check, Payload Bay check</b></li> <li>Retrieve A/L tether <input type="checkbox"/> √Gate closed, hook locked, reel unlocked</li> <li>Translate to S3 inboard, bay 17, face 2</li> <li>Attach A/L tether to S3 HR 3002 _____ <input type="checkbox"/> √Gate closed, hook locked, reel unlocked</li> </ol> <p><u>INSTALL MISSE PEC BUNDLE (00:15)</u></p> <div data-bbox="1388 1133 1766 1227" style="border: 1px solid black; padding: 5px; text-align: center;"> <p><b>CAUTION</b> Avoid inadvertent contact with grapple fixture shaft (drylube)</p> </div> <ol style="list-style-type: none"> <li>Translate fwd/zenith S3 to ELC2 zenith</li> <li>Remove PIP Pins (2) from ExPA fwd socket</li> <li>BRT to ExPA HR</li> </ol>

# HPGT TRANSFER & MISSE 7 INSTALL (03:00) (Cont)

IV/SSRMS	EV2	EV3
<p>HPGT/FSE Release Configuration</p>		
<p>4. <b>SSRMS:</b> Once HPGT grappled, <b>give EV crew GO</b> to release</p> <p>5. <b>SSRMS:</b> <b>On EV crew GO</b>, maneuver HPGT to A/L (00:45)</p> <p>Planned PET 1:45</p> <p>6. <b>IV:</b> <input type="checkbox"/> <b>√MCC-H MISSE</b> inhibits in place</p>	<p><u>HANDOFF HPGT TO SSRMS (00:15)</u></p> <p>17. Attach Waist Tether to APFR 18. Ingress APFR 19. Deploy MWS T-bar down, if required 20. Tether HPGT and hold handrails</p> <p>21. <b>Give EV3 GO</b> to release HPGT from FSE</p> <p>22. Perform Mass Handling Adaptation 23. Rotate HPGT to orient grapple fixture for SSRMS grapple 24. <b>Give SSRMS GO</b> to capture and rigidize</p> <p>25. <b>On SSRMS GO</b>, release RET from HPGT 26. Retrieve HPGT Adjustable Tethers and verify HPGT clear for maneuver</p> <p>27. <b>Give SSRMS GO</b> for HPGT maneuver to A/L 28. <b>Glove check</b></p> <p><u>PREPARE A/L (00:30)</u> 29. RET, retrieve APFR 30. Translate to S1 (bay 15) HR 3217 _____; retrieve A/L tether</p>	<p>24. Slide PEC 7B probe into forward ExPA socket <input type="checkbox"/> <b>√Alignment marks match up</b></p> <p>25. Install PIP Pins (2) <input type="checkbox"/> <b>√Ball detents on PIP Pins visible on back side of socket</b></p> <p>26. Retrieve BRT RET</p> <p><u>HANDOFF HPGT TO SSRMS (00:15)</u></p> <p>27. Evaluate BRT and foot wedge configuration for HPGT release</p> <p>28. <b>√Tethers and worksite clear for HPGT release</b> 29. Configure BRT and foot wedge 30. <b>On EV2 GO</b>, release HPGT from FSE 31. Rotate right tank handle to OPEN position (horizontal, black mark inboard) 32. Perform Mass Handling Adaptation 33. Rotate right tank handle to READY position (vertical); assist EV2 with HPGT rotation 34. GCA SSRMS, as required</p> <p>35. <b>On SSRMS GO</b>, release HPGT and verify HPGT clear for maneuver</p>
		<p><u>INSTALL &amp; DEPLOY MISSE PECS (00:30)</u></p> <p>36. Remove PIP Pins (2) from ExPA zenith socket 37. RET to PEC 7A; release PEC 7A from PEC 7B 38. Retrieve adjustable tethers 39. Slide PEC A probe into ExPA socket <input type="checkbox"/> <b>√Alignment marks match up</b></p> <p>40. Install PIP Pins (2) <input type="checkbox"/> <b>√Ball detents on PIP Pins visible on back side of socket</b></p> <p>41. ← Release TA Clamps (2)</p>

## HPGT TRANSFER & MISSE 7 INSTALL (03:00) (Cont)

IV/SSRMS	EV2	EV3
<div style="display: flex; justify-content: space-between;"> <span>7a</span> <span>7b</span> </div> 	<ol style="list-style-type: none"> <li>31. Translate zenith/over A/L, under WETA, up to Z1</li> <li>32. Install APFR in Z1 WIF 1 [4,GG,F,12] √Locking collar black-on-black, pull test</li> <li>33. √HPGT guide post is installed</li>   <li>34. RET, remove stbd/aft towel bar strap; stow in trash bag</li> <li>35. Install MMOD Shield T-handle tools into shields (with RET routed to C/L bag); long T-Tool in stbd shield</li> <li>36. Using short MMOD Shield T-handle tool, release Dzus fasteners on both MMOD shields and stow shields near zenith HPGT</li>   <li>37. <b>Get-ahead:</b> Bundle MMOD Shields with wire ties</li> <li>38. √APFR settings in A/L WIF 10 [4, PP, F, 12]</li> <li>39. √HPGT install worksite clear</li> </ol>	<ol style="list-style-type: none"> <li>42. RET to PEC 7A cap; remove cap</li> <li>43. Demate connector from dummy panel</li> <li>44. Mate connector to PEC 7A √Good pins &amp; EMI band; no FOD</li> <li>45. Install connector cap onto dummy connector</li> <li>46. RET to PEC 7B cap; remove cap</li> <li>47. Demate connector from dummy panel</li> <li>48. Mate connector to PEC 7B √Good pins &amp; EMI band; no FOD</li> <li>49. Install connector cap onto dummy connector</li>   <div style="border: 2px solid black; padding: 5px; text-align: center; margin: 10px 0;"> <p><b>WARNING</b></p> <p>Do not touch the hinged side while opening the MISSE PEC (Pinch Point)</p> </div>   <div style="border: 1px solid black; padding: 5px; text-align: center; margin: 10px 0;"> <p><b>CAUTION</b></p> <p>Avoid inadvertent contact with deployed MISSE PECs, which have shatterable materials</p> </div>   <li>50. Remove PEC 7B PIP Pins (4)</li> <li>51. Open PEC 7B</li> <li>52. Install PIP Pins (4)</li> <li>53. Remove PEC 7A PIP Pins (4)</li> <li>54. Open PEC 7A</li> <li>55. Install PIP Pins (4)</li> <li>56.  Photograph deployed PECs  <input type="checkbox"/> PEC 7A both sides  <input type="checkbox"/> PEC 7B both sides  <input type="checkbox"/> Overall View (2 angles)</li> <li>57. <b>Glove check</b></li> <li>58. Translate to S3 (inboard bay 17, face 2) HR 3002 _____; retrieve A/L tether</li> <li>59. Translate to A/L zenith √APFR Ingress Aid clear of HPGT install</li> </ol>

## HPGT TRANSFER & MISSE 7 INSTALL (03:00) (Cont)

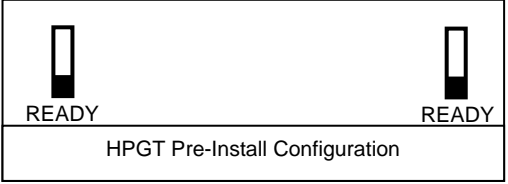
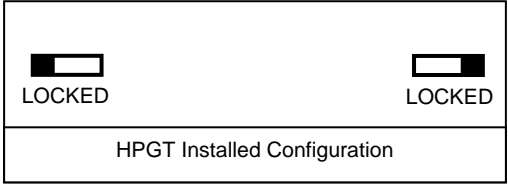
IV/SSRMS	EV2	EV3
<p>Planned PET 2:15</p> <p>7. <b>SSRMS:</b> Maneuver HPGT for handoff to EV crew</p> <div data-bbox="109 431 613 613"><p>READY READY</p><p>HPGT Pre-Install Configuration</p></div> <p>8. <b>SSRMS:</b> On EV crew GO, un-grapple HPGT and back away</p> <div data-bbox="109 865 613 1047"><p>LOCKED LOCKED</p><p>HPGT Installed Configuration</p></div>	<p><u>INSTALL HPGT (01:15)</u></p> <p>40. Ingress Z1 APFR, keep Ingress Aid close to body</p> <p>41. GCA SSRMS for handoff</p> <p>42. ✓HPGT install worksite clear</p> <p>43. Hold HPGT for un-grapple</p> <p>44. Once SSRMS clear of FRGF, soft dock tank to A/L</p> <p>45. ✓Latches soft docked</p> <p>46. Hold HPGT for EV3 to operate latches</p> <p>47. <b>Glove check</b></p> <p>48. RET, retrieve APFR; stow on BRT</p>	<p><u>INSTALL HPGT (01:15)</u></p> <p>60. Left MWS RET, retrieve FRGF MLI from C/L bag; stow on MWS</p> <p>61. Provide clearance calls for HPGT and WETA</p> <p>62. ✓Both tank handles in READY position (vertical)</p> <p>63. Ingress A/L APFR</p> <p>64. Determine if enough clearance exists between HPGT and WETA for installation; → If there is not enough clearance to install HPGT, <u>TEMP STOW WETA/VSSA (section 16)</u></p> <p>65. ✓HPGT install worksite clear</p> <p>66. RET to HPGT</p> <p>67. Hold HPGT for ungrapple</p> <p>68. <b>Give SSRMS GO</b> for ungrapple</p> <p>69. Once SSRMS clear of FRGF, soft dock tank to A/L</p> <p>70. ✓Latches soft docked</p> <p>71. Rotate right tank handle to LOCKED position (horizontal, black mark outboard)</p> <p>72. Install handle lock PIP Pin</p> <p>73. Rotate left tank handle to LOCKED position (horizontal, black mark outboard)</p> <p>74. Install handle lock PIP Pin</p> <p>75. Retrieve RET from HPGT</p> <p>76. Wire tie handles to tank handrails to prevent rotation <input type="checkbox"/> Left Handle (Aft) <input type="checkbox"/> Right Handle (Fwd)</p> <p>77. Install FRGF cover; ✓Velcro fully mated, Sharpie lines zenith</p> <p>78. Open HPGT #5 door</p> <p>79. ✓Isolation valve CLOSED (right)</p> <p>80. Release and stow access panel MLI</p> <p>81. Remove cap from A/L O2 QD024 (has lanyard)</p> <p>82. Depress button and rotate QD (cw) to open/vent position (black/black), wait 5 sec</p>

**HPGT TRANSFER & MISSE 7 INSTALL (03:00) (Cont)**

IV/SSRMS	EV2	EV3
<p>9. <b>IV:</b> <input type="checkbox"/> <b>√MCC-H</b> – Hi P O2 line vent complete; <b>GO</b> for <b>QD mate</b></p> <p>10. <b>IV:</b> <input type="checkbox"/> <b>√MCC-H</b> – <b>Give EV GO</b> to open HPGT #5 isolation valve</p> <p>11. <b>IV:</b> <input type="checkbox"/> <b>√MCC-H</b> – Verify Supply P and UIA Supply P</p> <p>12. <b>IV:</b> <input type="checkbox"/> <b>√MCC-H</b> – <b>Give EV GO</b> to close HPGT #5 isolation valve</p> <p>13. <b>IV:</b> <input type="checkbox"/> <b>√MCC-H</b> – Start HPGT leak check (~0:30)</p>	<p>49. RET, relocate IAPFR to Z1 WIF 1 <b>[12, PP, F, 12]</b>  <b>√Locking collar black-on-black, pull test</b></p> <p>50. Translate nadir/under WETA and A/L to stbd CETA Cart</p> <p>51. Stow APFR in stbd CETA Cart WIF 1 <b>[12,GG] [6, OO, E, 6]</b>  <b>√Locking collar black-on-black, pull test</b></p> <p>52. → If WETA/VSSA was temp stowed, <b>RE-INSTALL WETA/VSSA</b> (section 16)</p> <p>(A/L MMOD Shields)</p>	<p>83. Depress button and rotate QD (ccw) to closed position (white/white)  <b>√Gap visible between collar black line and barrel line</b></p> <p>84. ← Demate QD from dummy panel  <b>√Soft dock collar fully retracted – <u>NO</u> gap visible between collar black line and barrel line</b></p> <p>85. <b>On IV GO</b>, mate QD to A/L (white/white) –  Do not grasp near soft dock ring or depress button  <b>√Gap visible between collar black line and barrel line</b>  <b>√Good soft dock (pull test)</b></p> <p>86. Depress button and rotate QD (cw) to open position (black/black)  Do not depress button past 10 degrees  <b>√Button pops out</b>  <b>Give IV GO</b> that QD is mated and valve open</p> <p>87. <b>On IV GO</b>, OPEN HPGT #5 isolation valve (left)</p> <p>88. <b>On IV GO</b>, CLOSE HPGT #5 isolation valve (right)</p> <p>89. Close HPGT #5 door and engage ¼-turn fastener</p> <p>90. <b>Give IV GO</b> for tank pressure integrity verification</p> <p>91. <b>Glove check</b></p> <p>92. → If WETA/VSSA was temp stowed, <b>RE-INSTALL WETA/VSSA</b> (section 16)</p> <p>(A/L MMOD Shields)</p>

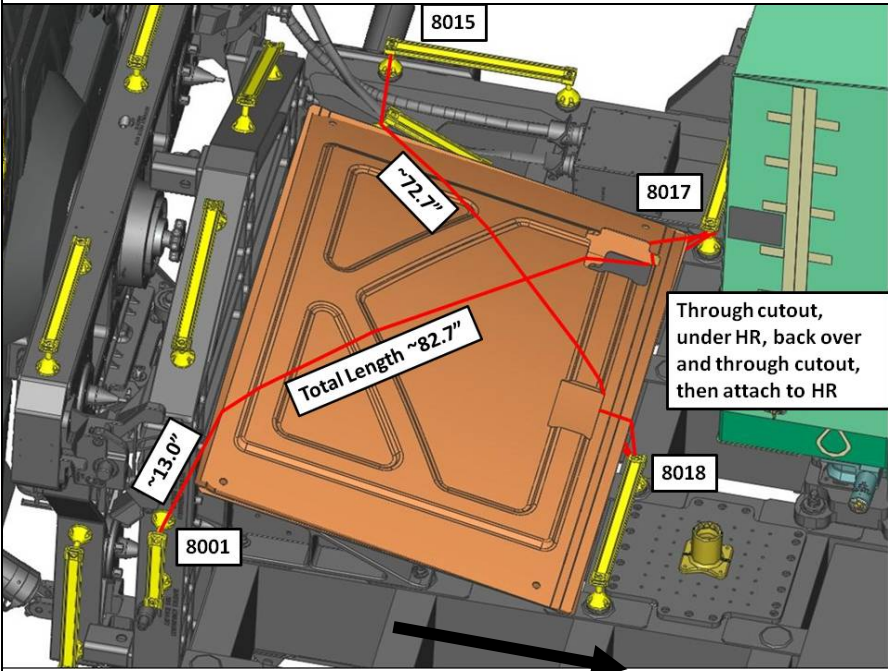
IV/SSRMS	EV2	EV3
	<p>A/L MMOD SHIELDS (00:30)</p> <ol style="list-style-type: none"> <li>1. Translate to A/L zenith</li> <li>2. Retrieve 2 LDTDTs from HPGT Crewlock Bag</li> <li>3. Translate to ESP-2</li> <li>4. Hand one LDTDT to EV3</li> <li>5. Route non-buckle end of LDTDT through stbd cutout in shield, under HR 8018, back over and through cutout, then attach to HR 8018 port stanchion with hook tether point oriented nadir</li> <li>6. Adjust LDTDT to max length</li> <li>7. Route buckle end of LDTDT across bundle to HR 8001 zenith stanchion</li> <li>8. Take up slack in LDTDT, tighten shields against ESP-2, and stow LDTDT remainder in buckle (cover metal buckle and close all Velcro)</li> </ol> <p style="text-align: center;"><b>CAUTION</b> Do not kick tied down MMOD shields</p>	<p>A/L MMOD SHIELDS (00:30)</p> <ol style="list-style-type: none"> <li>1. Translate to A/L zenith</li> <li>2. Bundle MMOD shields, if not complete</li> <li>3. RET to long T-Tool, release long T-Tool RET; disengage short T-Tool; allow short T-Tool to retract to C/L bag</li> <li>4. RET to wire tie on shield bundle</li> <li>5. Translate to ESP-2; position shield bundle with double cutouts forward/zenith</li> <li>6. Route non-buckle end of LDTDT through port cutout in shields, under HR 8017, back over and through cutout, then attach to HR 8017 stbd stanchion with hook tether point oriented nadir</li> <li>7. Adjust LDTDT length and route across bundle to HR 8015 aft stanchion</li> <li>8. Take up slack in LDTDT, tighten shields against ESP-2, and stow LDTDT remainder in buckle (cover metal buckle and close all Velcro)</li> </ol> <p style="text-align: center;"><b>CAUTION</b> Do not kick tied down MMOD shields</p>
<p style="text-align: center;">Forward</p> <ol style="list-style-type: none"> <li>1. <b>IV:</b> <input type="checkbox"/> <math>\sqrt{\text{MCC-H}}</math> – HPGT leak check complete; <b>GO</b> to open HPGT 1</li> <li>2. <b>IV:</b> <input type="checkbox"/> <math>\sqrt{\text{MCC-H}}</math> – <b>GO</b> to open HPGT 5</li> </ol>	<ol style="list-style-type: none"> <li>9. <b>Glove check</b></li> <li>10. RET, retrieve T-Tool from shield</li> <li>11. Translate to A/L</li> <li>12. Stow T-Tool in HPGT Crewlock Bag</li> <li>13. RET, retrieve HPGT Crewlock Bag and stow on port A/L Toolbox HR</li> </ol>	<ol style="list-style-type: none"> <li>9. <b>Glove check</b></li> <li>10. <b>OPEN HPGT 1 AND 5</b></li> <li>11. Translate to A/L HPGT #1 (aft/zenith)</li> <li>11. Open HPGT #1 door</li> <li>12. <b>On IV GO</b>, OPEN HPGT #1 isolation valve (left)</li> <li>13. Close HPGT #1 door; engage ¼-turn fasteners (2)</li> <li>14. Translate to A/L HPGT #5 (aft/nadir)</li> <li>15. Open HPGT #5 door</li> <li>16. <b>On IV GO</b>, OPEN HPGT #5 isolation valve (left)</li> <li>17. Close HPGT #5 door; engage ¼-turn fasteners (2)</li> <li>18. RET, retrieve PAS Crewlock Bag; stow on BRT</li> </ol>



### S3 ZENITH/INBD PAS DEPLOY (01:30)

IV/SSRMS	EV2	EV3										
<p>1. <b>NOTE:</b> These steps can be done at any time on any PAS</p> <ul style="list-style-type: none"> <li><input type="checkbox"/> Hingeline ADPs</li> <li><input type="checkbox"/> RTL PIP Pins</li> <li><input type="checkbox"/> EVA override cap removal</li> </ul> <p>Planned PET 4:00</p> <p>2. <b>IV:</b> <input checked="" type="checkbox"/> <b>MCC-H</b> PAS inhibits in place</p> <p>3. <b>IV:</b> Record Deploy Clevis bolt data:</p> <table border="1" data-bbox="109 820 430 982"> <thead> <tr> <th>Bolt</th> <th>Turns</th> </tr> </thead> <tbody> <tr> <td>Bolt 1</td> <td>(10)</td> </tr> <tr> <td>Bolt 2</td> <td>(10)</td> </tr> <tr> <td>Bolt 4</td> <td>(10)</td> </tr> <tr> <td>Bolt 3</td> <td>(8)</td> </tr> </tbody> </table>	Bolt	Turns	Bolt 1	(10)	Bolt 2	(10)	Bolt 4	(10)	Bolt 3	(8)	<div data-bbox="703 267 1953 584" style="border: 1px solid black; padding: 5px;"> <p style="text-align: center;"><u>CAUTION</u></p> <ol style="list-style-type: none"> <li>1. When attempting to remove or install the Yoke PIP pin and ADP, do not impart more than 10 lbf</li> <li>2. Yoke ADP does not have a stowage hole. Do not close ADP lock bracket when ADP is not inserted in a stowage/clevis hole</li> <li>3. Do not exceed 30" between the yoke ADP and Deploy Clevis Bracket. Exceeding this could allow platform to enter detent position</li> <li>4. Do not lift diagonal brace more than ~7 deg out of rotation plane to prevent damage to hinge end</li> <li>5. Avoid inadvertent contact with grapple fixture shafts and target pins</li> <li>6. EBCS target has finished surface that is susceptible to damage by contact. Do not remove MLI until all work inside truss is complete</li> </ol> </div> <ol style="list-style-type: none"> <li>1. Translate to S3 (nadir path)</li> <li>2. Attach A/L tether to S1 HR 3005 _____  <input type="checkbox"/> <input checked="" type="checkbox"/> Gate closed, hook locked, reel unlocked</li> </ol> <p><u>SWIVEL DEPLOY CLEVIS BRACKET</u></p> <ol style="list-style-type: none"> <li>3. MWS RET to Deploy Clevis Bracket</li> <li>4. Relocate MWS RET to HR 3005 _____</li> <li>5. Configure PGT:  <input type="checkbox"/> <b>[RCCW, 30.5]</b>, 6" ext 7/16" wobble</li> <li>6. Break torque on bracket bolts (4) in Ratchet Mode  <input type="checkbox"/><input type="checkbox"/><input type="checkbox"/><input type="checkbox"/></li> <li>7. Configure PGT:  <input type="checkbox"/> <b>[B7, CCW2, 30.5]</b>, 6" ext 7/16" wobble</li> <li>8. Release bolts (4); 10 turns (bolts 1, 2, 4), 8 turns (bolt 3)</li> <li>9. Swivel Deploy Clevis Bracket</li> </ol> <p><u>REMOVE DIAGONAL BRACE</u> (Caution #4)</p> <ol style="list-style-type: none"> <li>10. Configure PGT:  <input type="checkbox"/> <b>[B6, CCW3, 30.5]</b>, 6" ext 7/16" wobble</li> <li>11. Release Diagonal Brace (cup-cone bolt), stop on turns 35 (do not exceed 37 turns)</li> <li>12. Guide Diagonal Brace and temp stow with RET to HR 3023 _____</li> </ol>	<ol style="list-style-type: none"> <li>1. Translate to S3 (zenith path)</li> <li>2. Attach A/L tether to S1 HR 3217 _____  <input type="checkbox"/> <input checked="" type="checkbox"/> Gate closed, hook locked, reel unlocked</li> <li>3. Temp Stow PAS Crewlock Bag on face 4 HR 3014 &amp; 3015 _____</li> </ol> <p><u>HINGE LINE PREP</u></p> <ol style="list-style-type: none"> <li>4. Remove hinge line ADPs (2)</li> <li>5. Insert in stowage hole (pin station fwd, handle inside platform)  <input type="checkbox"/> <input checked="" type="checkbox"/> ADP closed: Inboard  <input type="checkbox"/> <input checked="" type="checkbox"/> ADP closed: Outboard</li> </ol> <p><u>DEPLOY LG-SM AET</u></p> <ol style="list-style-type: none"> <li>6. Attach small hook of Lg-sm AET to S3 HR 3014            _____</li> </ol>
Bolt	Turns											
Bolt 1	(10)											
Bolt 2	(10)											
Bolt 4	(10)											
Bolt 3	(8)											

**S3 ZENITH/INBD PAS DEPLOY (01:30) (Cont)**

IV/SSRMS	EV2	EV3
	<p><u>RELEASE YOKE ADP AND PIP PIN</u> (Caution #1, #2)</p> <p>13. Release yoke PIP Pin            14. Release yoke ADP (do not close ADP)            15. Attach Lg hook of AET to ADP hole            16. Tend platform "into" truss</p> <p><u>REMOVE STOW CLEVIS BRACKET</u></p> <p>17. Crewlock Bag RET to Stow Clevis Bracket            18. Configure PGT:  <input type="checkbox"/> [RCCW, 30.5], 6" ext 7/16" wobble            19. Break torque on bracket bolts (4) in Ratchet Mode  <input type="checkbox"/><input type="checkbox"/><input type="checkbox"/><input type="checkbox"/>            20. Configure PGT:  <input type="checkbox"/> [B7, CCW2, 30.5], 6" ext 7/16" wobble            21. Release bolts (4); 10 turns  <input type="checkbox"/><input type="checkbox"/><input type="checkbox"/><input type="checkbox"/></p> <p><u>DEPLOY PLATFORM</u> (Caution #3)</p> <p>22. Deploy platform out until UMA clears longeron            23. On EV3 GO, rotate yoke from in to out</p> <p><u>REINSTALL DIAGONAL BRACE</u> (Caution #4)</p> <p>24. Move Diagonal Brace into position for re-installation            25. Release AET as needed for brace clearance            26. Reinstall AET once brace is clear</p> <p><u>REINSTALL DEPLOY CLEVIS BRACKET</u></p> <p style="text-align: center;"><u>NOTE</u>            Make sure yoke is outside            the Deploy Clevis Bracket</p> <p>27. Finger start Deploy Clevis Bracket bolts (4), approx            1-2 turns            28. Configure PGT:  <input type="checkbox"/> [B5, CW2, 30.5], 6" ext 7/16" wobble</p>	<p>7. <b>Get-ahead:</b> Stow the Stow Clevis Bracket in PAS            Crewlock Bag</p> <p><u>DEPLOY PLATFORM</u> (Caution #3)</p> <p>8. Monitor UMA to longeron clearance            9. Inform EV2 when UMA just clears the longeron            10. Assist EV2 as needed with yoke</p> <p><u>REINSTALL DIAGONAL BRACE</u> (Caution #4)</p> <p>11. Tend platform            12. Retrieve tether from brace (HR 3023)</p>

**S3 ZENITH/INBD PAS DEPLOY (01:30) (Cont)**

IV/SSRMS			EV2	EV3															
4. <b>IV:</b> Record Deploy Clevis bolt data: <table border="1"> <thead> <tr> <th>Bolt</th> <th>Turns</th> <th>Torque (ft-lb)</th> </tr> </thead> <tbody> <tr> <td>Bolt 1</td> <td>(10)</td> <td>(22.0)</td> </tr> <tr> <td>Bolt 2</td> <td>(10)</td> <td>(22.0)</td> </tr> <tr> <td>Bolt 3</td> <td>(8)</td> <td>(22.0)</td> </tr> <tr> <td>Bolt 4</td> <td>(10)</td> <td>(22.0)</td> </tr> </tbody> </table>			Bolt	Turns	Torque (ft-lb)	Bolt 1	(10)	(22.0)	Bolt 2	(10)	(22.0)	Bolt 3	(8)	(22.0)	Bolt 4	(10)	(22.0)	29. ← Engage bolts (4) to hard stop, 10 turns 30. Configure PGT: <input type="checkbox"/> [RCW, 30.5], 6" ext 7/16" wobble 31. Apply final torque to bolts (4) in Ratchet Mode; 2 clicks each bolt <input type="checkbox"/> <input type="checkbox"/> <input type="checkbox"/> 32. Retrieve RET from Deploy Clevis Bracket  <u>INSTALL YOKE (Caution #1)</u> 33. Disconnect Adj Tether 34. Install yoke in Deploy Clevis Bracket <input type="checkbox"/> Install yoke ADP, √lock bracket engaged <input type="checkbox"/> Install yoke PIP pin 35. Retrieve Adj Tether  <u>BOLT DIAGONAL BRACE</u> 36. Configure PGT: <input type="checkbox"/> [B2, CW2, 30.5], 6" ext 7/16" wobble 37. ← Engage Diagonal Brace (Cup-cone bolt) to hard stop; ~35 turns	13. Assist EV2 with yoke installation while keeping platform out of detents  14. Stow the Stow Clevis Bracket in PAS Crewlock Bag 15. Retrieve PAS Crewlock Bag  16. Tool Inventory 17. <b>Glove check</b>
Bolt	Turns	Torque (ft-lb)																	
Bolt 1	(10)	(22.0)																	
Bolt 2	(10)	(22.0)																	
Bolt 3	(8)	(22.0)																	
Bolt 4	(10)	(22.0)																	
5. <b>IV:</b> Record Brace bolt data: <table border="1"> <thead> <tr> <th>Bolt</th> <th>Turns</th> <th>Torque (ft-lb)</th> </tr> </thead> <tbody> <tr> <td>Diagonal</td> <td>(35)</td> <td>(16.0)</td> </tr> </tbody> </table>			Bolt	Turns	Torque (ft-lb)	Diagonal	(35)	(16.0)	<u>PREP UMA</u> 38. Translate under PAS UMA 39. RET, retrieve hitch pin from EVA OVERRIDE anti-rotation cap 40. Retrieve anti-rotation cap; stow in trash bag  <u>RTL CHECKOUT</u> 41. Translate to each Guide Vane (3) and perform: <input type="checkbox"/> <input type="checkbox"/> <input type="checkbox"/> RET to launch restraint PIP Pin; remove from guide vane and stow in trash bag <input type="checkbox"/> <input type="checkbox"/> <input type="checkbox"/> On <b>MCC-H GO</b> , depress and hold RTL lever for 15 sec, then release <input type="checkbox"/> <input type="checkbox"/> <input type="checkbox"/> Verify with <b>MCC-H</b> good checkout, move to next guide vane										
Bolt	Turns	Torque (ft-lb)																	
Diagonal	(35)	(16.0)																	
6. <b>IV:</b> Give <b>MCC-H GO</b> to power up IMCA √All tasks inside truss prior to UMA prep complete √Tools cleared from inside truss																			
7. <b>IV:</b> Obtain <b>MCC-H GO</b> for RTL Checkout <table border="1"> <thead> <tr> <th>RTL</th> <th>PIP Pin</th> <th>Test Pass</th> </tr> </thead> <tbody> <tr> <td>1</td> <td></td> <td></td> </tr> <tr> <td>2</td> <td></td> <td></td> </tr> <tr> <td>3</td> <td></td> <td></td> </tr> </tbody> </table>			RTL	PIP Pin	Test Pass	1			2			3							
RTL	PIP Pin	Test Pass																	
1																			
2																			
3																			

**S3 ZENITH/INBD PAS DEPLOY (01:30) (Cont)**

<b>IV/SSRMS</b>	<b>EV2</b>	<b>EV3</b>
	<p><u>EBCS TARGET PREP</u> (Caution #6)</p> <p>42. Translate to EBSC target and perform:</p> <ul style="list-style-type: none"><li><input type="checkbox"/> Verify both EV clear of target area</li><li><input type="checkbox"/> Remove target cover; stow on backside of target assy</li></ul> <p>43. Retrieve PAS C/L bag from face 4</p> <p>44. Tool Inventory</p> <p>45. <b>Glove check</b></p>	

## CLEANUP/INGRESS (00:30)

IV/SSRMS	EV2	EV3
<p>1. <b>IV:</b> Perform WVS PWRDWN (PHOTO/TV, <u>WVS CUE CARD</u>)</p> <p>2. Start Hatch Thermal Cover clock PET (30 min) ___ : ___</p> <p>3. Stop Hatch Thermal Cover clock PET ___ : ___</p>	<p><u>CLEANUP</u> (00:15)</p> <ol style="list-style-type: none"> <li>Final Tool Inventory</li> <li>Retrieve A/L tether; translate to A/L</li> </ol> <p><u>INGRESS AND PRE-REPRESS</u> (00:15)</p> <ol style="list-style-type: none"> <li><b>On EV3 GO</b>, release EV3 ST anchor, attach to R Waist Tether <ul style="list-style-type: none"> <li><input type="checkbox"/> <input checked="" type="checkbox"/> Gate closed, hook locked</li> </ul> </li> <li>Retrieve EV2 ST anchor hook</li> <li>Transfer HPGT Crewlock Bag to EV3</li> <li>Ingress A/L</li> <li>Remove SCU from stowage pouch</li> <li>Remove DCM cover, velcro to DCM</li> <li>Connect SCU to DCM <ul style="list-style-type: none"> <li><input checked="" type="checkbox"/> SCU locked</li> </ul> </li> </ol> <p style="text-align: center;"><u>NOTE</u> A TCV setting 8 – Max C minimizes time for SCU cooling</p> <ol style="list-style-type: none"> <li>Water – OFF (fwd), expect H2O IS OFF message</li> <li>← Close hatch thermal cover; attach Velcro strap</li> </ol> <div style="border: 1px solid black; padding: 5px; text-align: center;"> <p><u>CAUTION</u> Do not close hatch until EMU Water OFF for 2 min. Verify outer hatch clear of hardware</p> </div> <ol style="list-style-type: none"> <li>Verify outer hatch clear of hardware</li> <li>Verify handle position per hatch decal, close and lock hatch</li> </ol> <p>Go to PRE-REPRESS (<u>DEPRESS/REPRESS</u> Cue Card)</p>	<p><u>CLEANUP</u> (00:15)</p> <ol style="list-style-type: none"> <li>Final Tool Inventory</li> <li>Retrieve A/L tether; translate to A/L</li> </ol> <p><u>INGRESS AND PRE-REPRESS</u> (00:15)</p> <ol style="list-style-type: none"> <li>← Open hatch thermal cover</li> <li><input checked="" type="checkbox"/> Get-Ahead Bag stowed in A/L</li> <li>Ingress A/L with PAS Crewlock Bag</li> <li>Attach R Waist Tether to A/L internal D-ring <ul style="list-style-type: none"> <li><input type="checkbox"/> <input checked="" type="checkbox"/> Gate closed, hook locked</li> </ul> </li> <li><b>Give EV2 GO</b> to release ST anchor</li> </ol> <ol style="list-style-type: none"> <li>RET to HPGT Crewlock Bag and stow for EV2 ingress</li> <li>Remove SCU from stowage pouch</li> <li>Remove DCM cover, velcro to DCM</li> <li>Connect SCU to DCM <ul style="list-style-type: none"> <li><input checked="" type="checkbox"/> SCU locked</li> </ul> </li> </ol> <p style="text-align: center;"><u>NOTE</u> A TCV setting 8 – Max C minimizes time for SCU cooling</p> <ol style="list-style-type: none"> <li>Water – OFF (fwd), expect H2O IS OFF message</li> </ol> <p>Go to PRE-REPRESS (<u>DEPRESS/REPRESS</u> Cue Card)</p>

# EVA 3 TASK DATA

## HPGT TRANSFER – TASK DATA

**Estimated Task Duration:**

	With RMS	Without RMS
One EV Crew	03:00	N/A
Two EV Crew	03:00	N/A

**Tools:**

EV1	EV2
QD Tool	2 Long Wire Ties
(3) MMOD Shield T-Tools	

**Foot Restraints:**

Task	WIF	APFR Setting
Handoff HPGT to SSRMS	ELC 2 WIF 6	[6, SS, F, 12]
Install HPGT	Z1 WIF 1	[4, GG, F, 12]
Install HPGT	A/L WIF 10	[4, PP, F, 12]
Alternate Install HPGT (if NOD1 WETA removed)	A/L WIF 6	[9, PP, F, 12]

**Notes:**

1. The ONTO EVA power connector is for contingency use
2. If the HPGT is likely to contact the WETA, temp stow WETA/VSSA ("Plan B")
3. If the WETA/VSSA cannot be reinstalled due to lack of clearance, relocate WETA/VSSA to P3 aft ("Plan C")

**Timeline Considerations:**

1. Robotics access will be impacted if the FPMU is not relocated from S1

HPGT TRANSFER – TASK DATA (Cont)

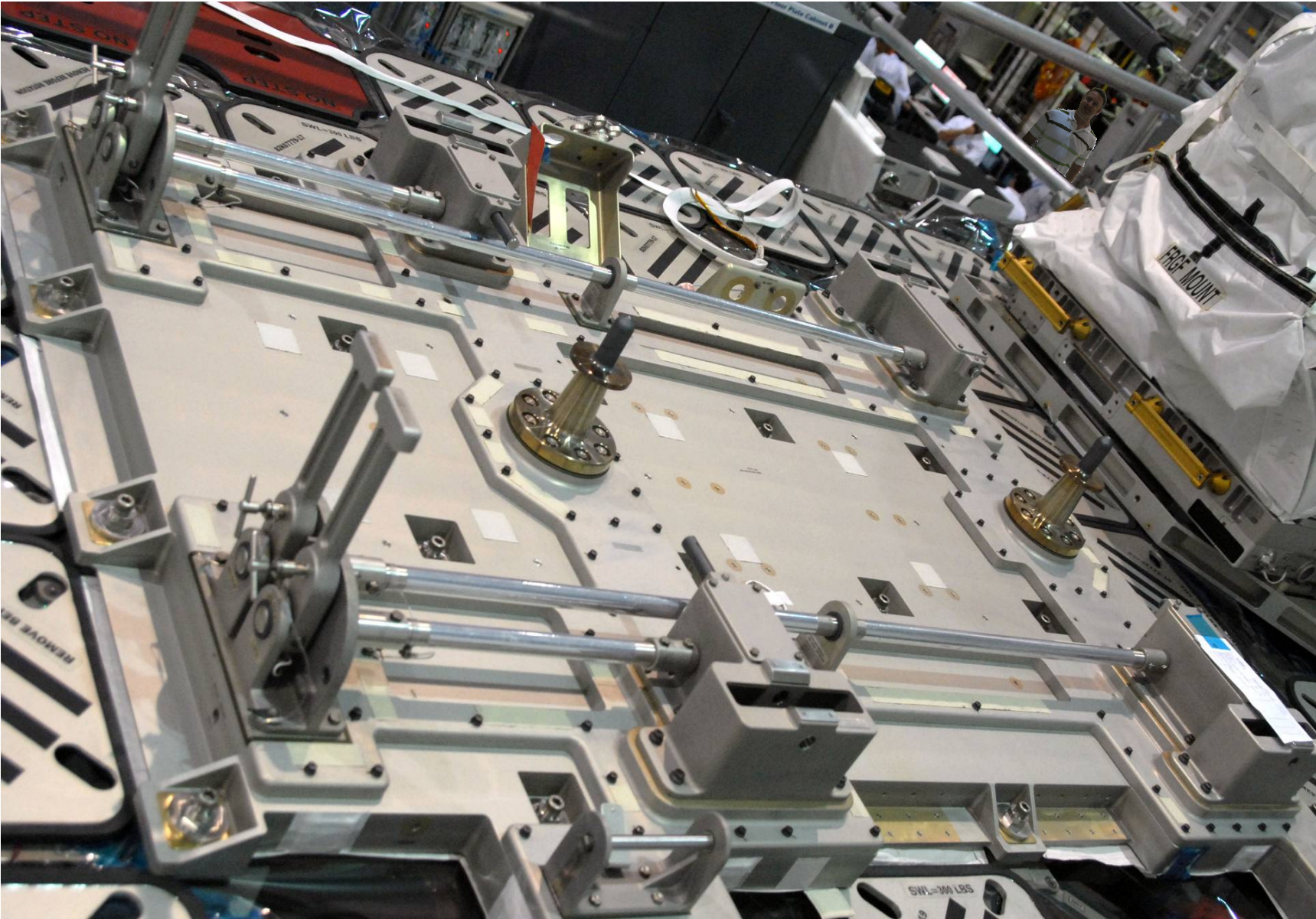

Figure 1: HPGT ONTO Adapter FSE

HPGT TRANSFER – TASK DATA (Cont)

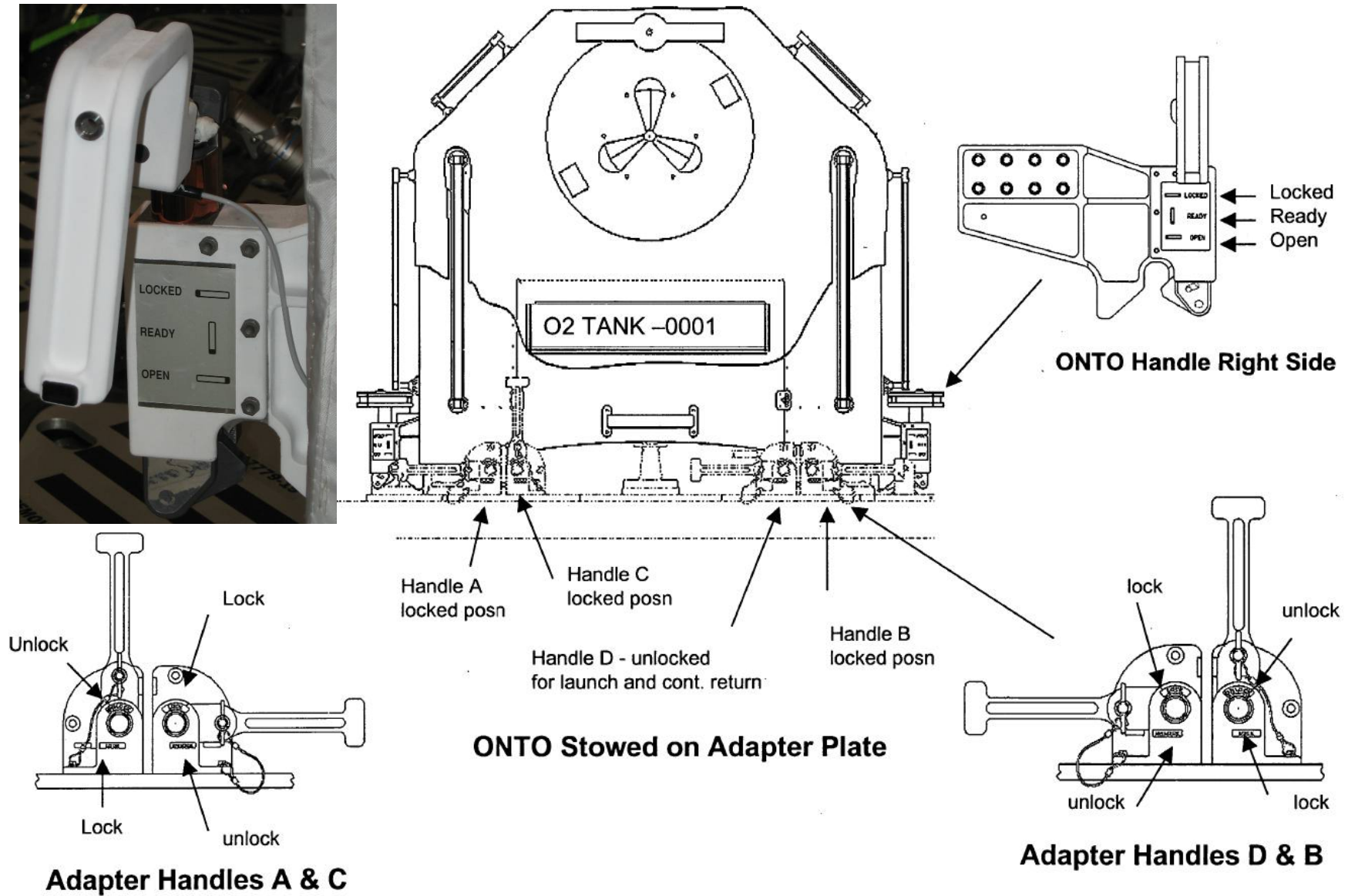

Figure 2: HPGT & FSE Latches



## HPGT TRANSFER – TASK DATA (Cont)



Figure 3: HPGT Guide Post

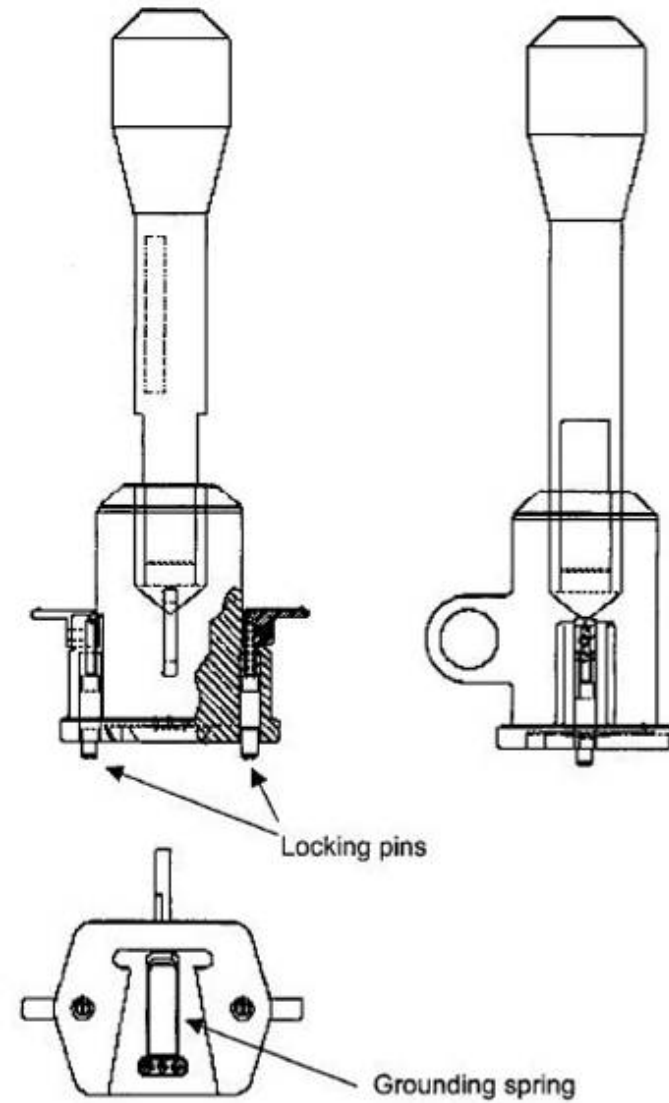

Figure 4: HPGT Guide Post Drawing

# HPGT TRANSFER – TASK DATA (Cont)

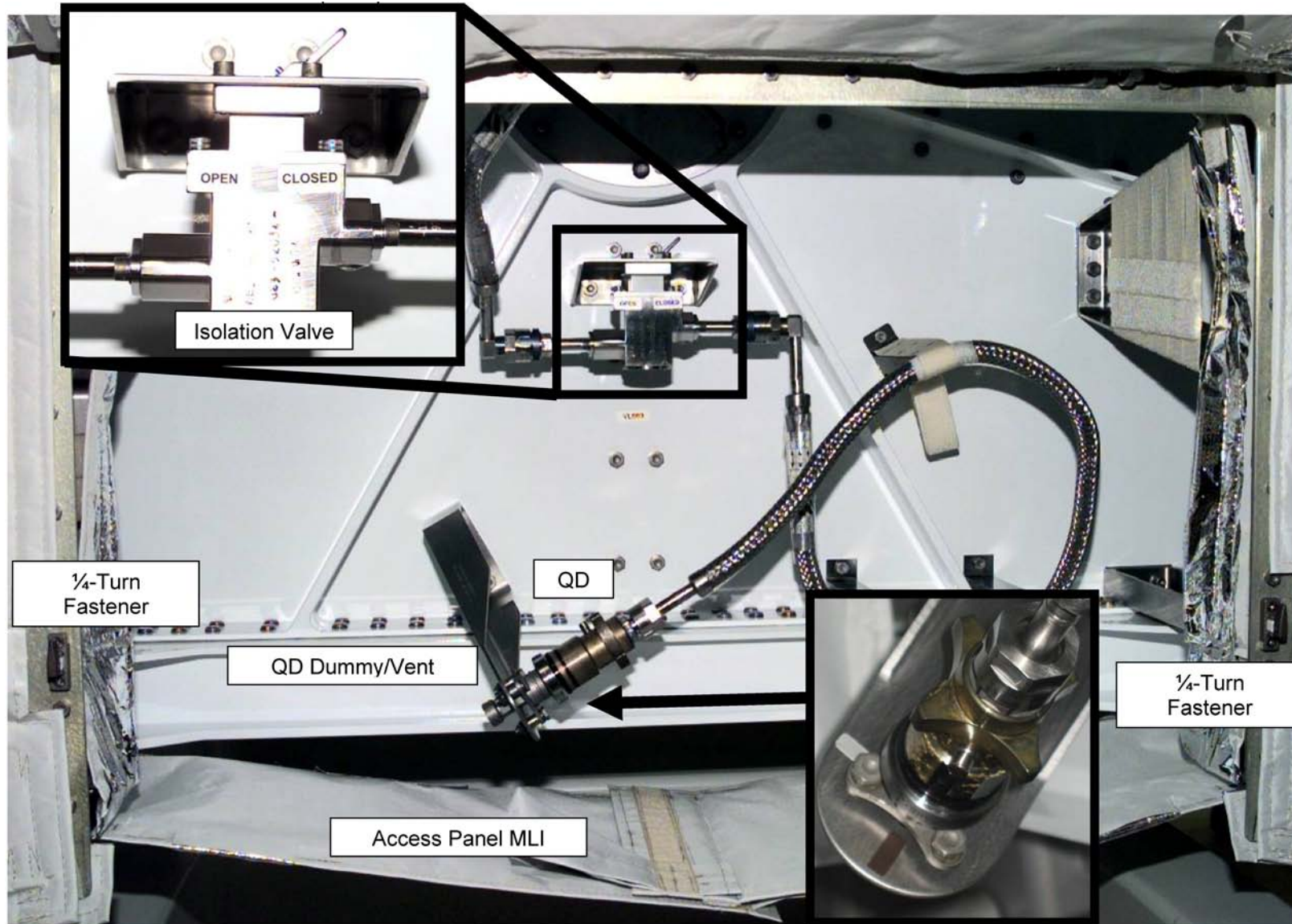

Figure 5: Inside HPGT Access Door

# HPGT TRANSFER – TASK DATA (Cont)

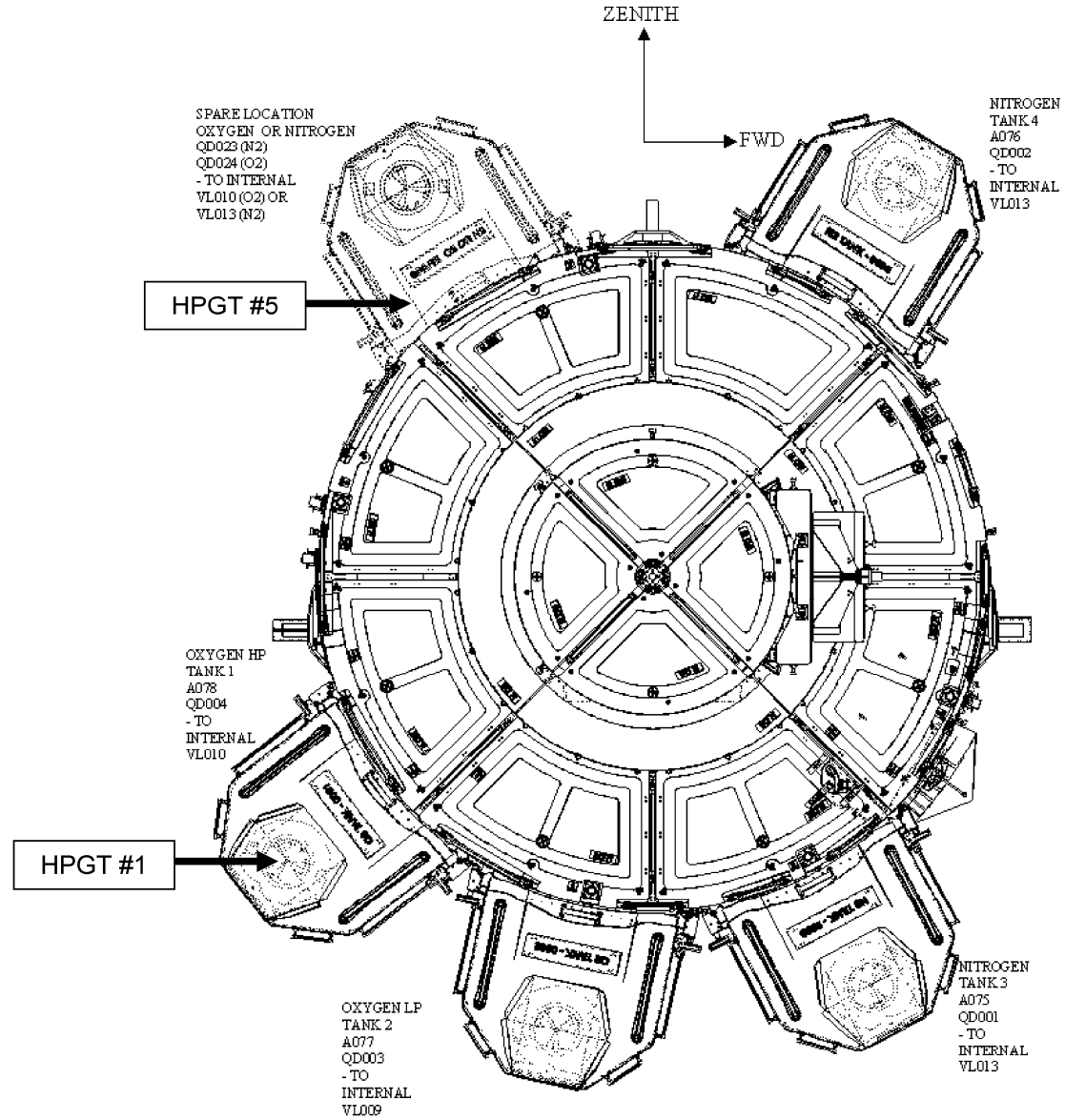

Figure 6: A/L HPGTs

## HPGT TRANSFER – TASK DATA (Cont)



Figure 7: A/L HPGT #5 QDs (under MLI)



Figure 8: A/L HPGT #5 QDs – QD024 is O2

# MISSE 7 INSTALL – TASK DATA

**Estimated Task Duration:**

	With RMS	Without RMS
One EV Crew	N/A	01:15
Two EV Crew	N/A	01:00

**Tools:**

EV1

**EVA Connectors:**

Connector	From	To	Clamps (#)	Conn Size	Function
P7A	J7A Dummy	PEC J7A	1		
P7B	J7B Dummy	PEC J7B	1		

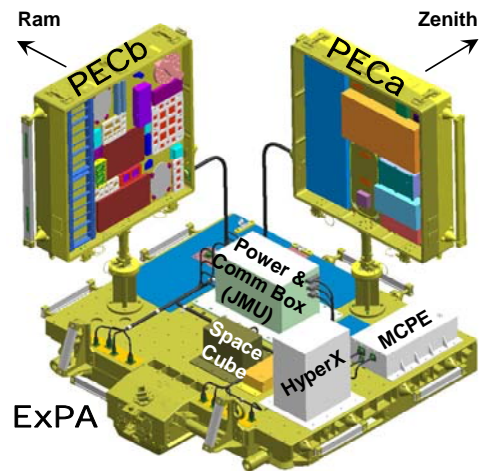

Figure 9: MISSE 7 Layout

**Notes:**

1. PEC A has a red cap; PEC B has a green cap
2. PEC A requires heater power

**Timeline Considerations:**

1. This can be done as a standalone task, but it is more efficient to combine with the HPGT task to minimize translation time
2. MISSEs must be installed after ELC 2 has been installed on S3. Analysis has not been done to support installation in the Payload Bay

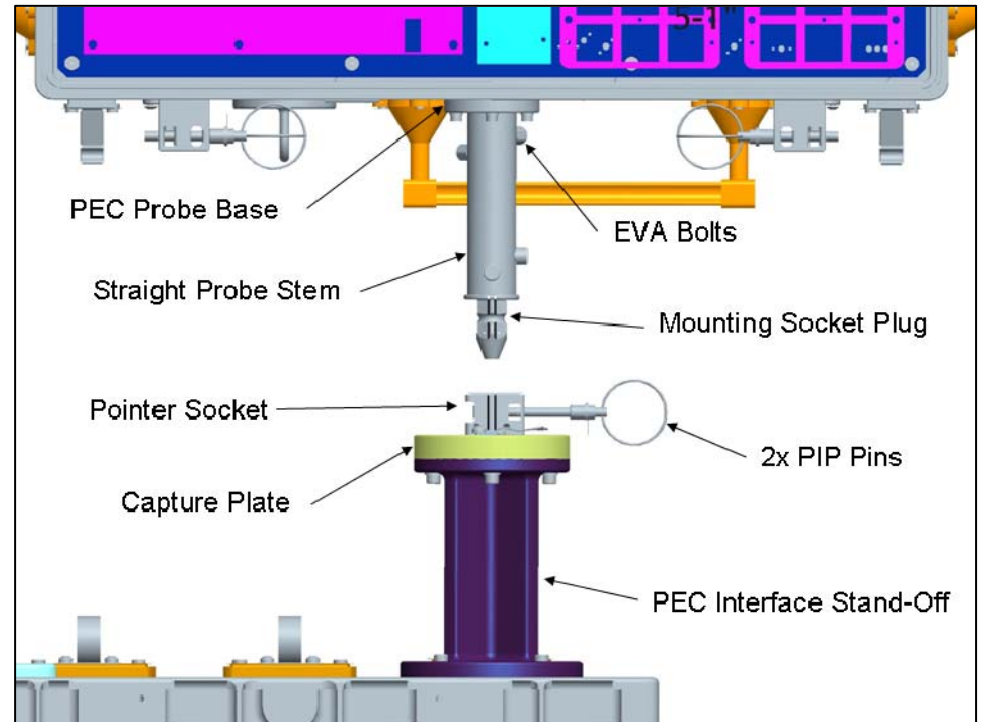

Figure 10: MISSE Interfaces

MISSE 7 INSTALL – TASK DATA (Cont)

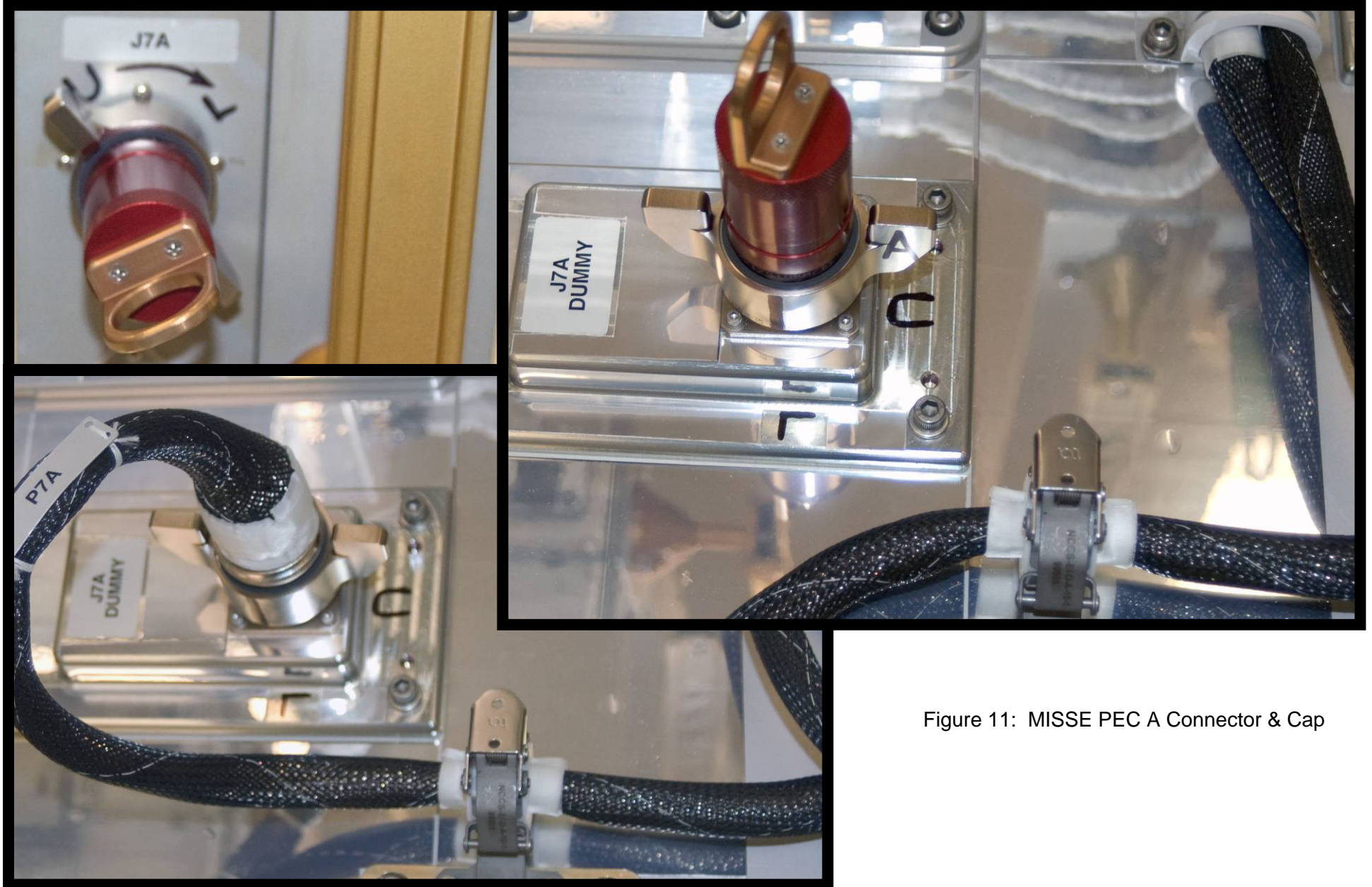
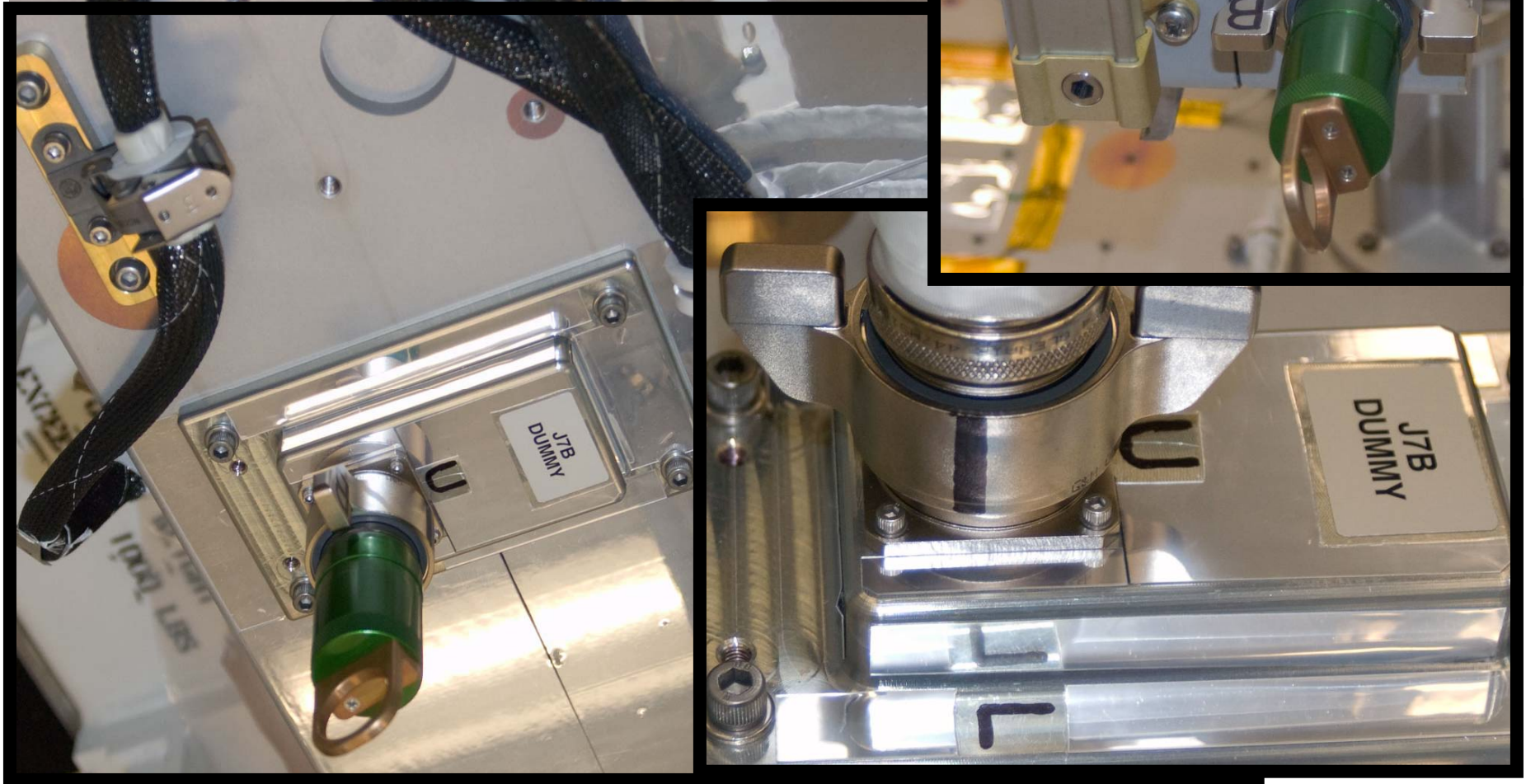

Figure 11: MISSE PEC A Connector & Cap

MISSE 7 INSTALL – TASK DATA (Cont)

Figure 12: MISSE PEC B Connector & Cap



### S3 ZENITH/INBD PAS DEPLOY – TASK DATA

**Estimated Task Duration:**

	With RMS
One EV Crew	N/A
Two EV Crew	01:30

**Tools:**

EV2	EV3
PGT	Adj (lg-sm)
7/16-6-in socket ext	

**EVA Fasteners:**

Fastener Name	Head Size	Qty	Install Torque (ft-lb)	Release Torque (ft-lb)	Failure Torque (ft-lb)	Turns
Diagonal cup/cone Bolt	7/16	1	16.0	24.0	14.0 and 31.6	35-37
Stow Clevis	7/16	4	16.0	25.5	46.7	9-16.5
Deploy Clevis	7/16	4	30.5	25.5	106.6 (remove) or 44.7 (install)	7-10.5

**Notes:**

1. UMA EVA Override anti-rotation cap must be removed prior to first use of UMA on PAS
2. EBCS target cover must be removed prior to cargo attachment to PAS. Protects target from MMOD and inadvertent contact. Remove as last activity
3. RAD may be needed for re-install of deployed clevis bracket. It will likely exceed RAD limits and need to be returned for refurb

**Timeline Considerations:**

- 1.



S3 ZENITH/INBD PAS DEPLOY – TASK DATA (Cont)

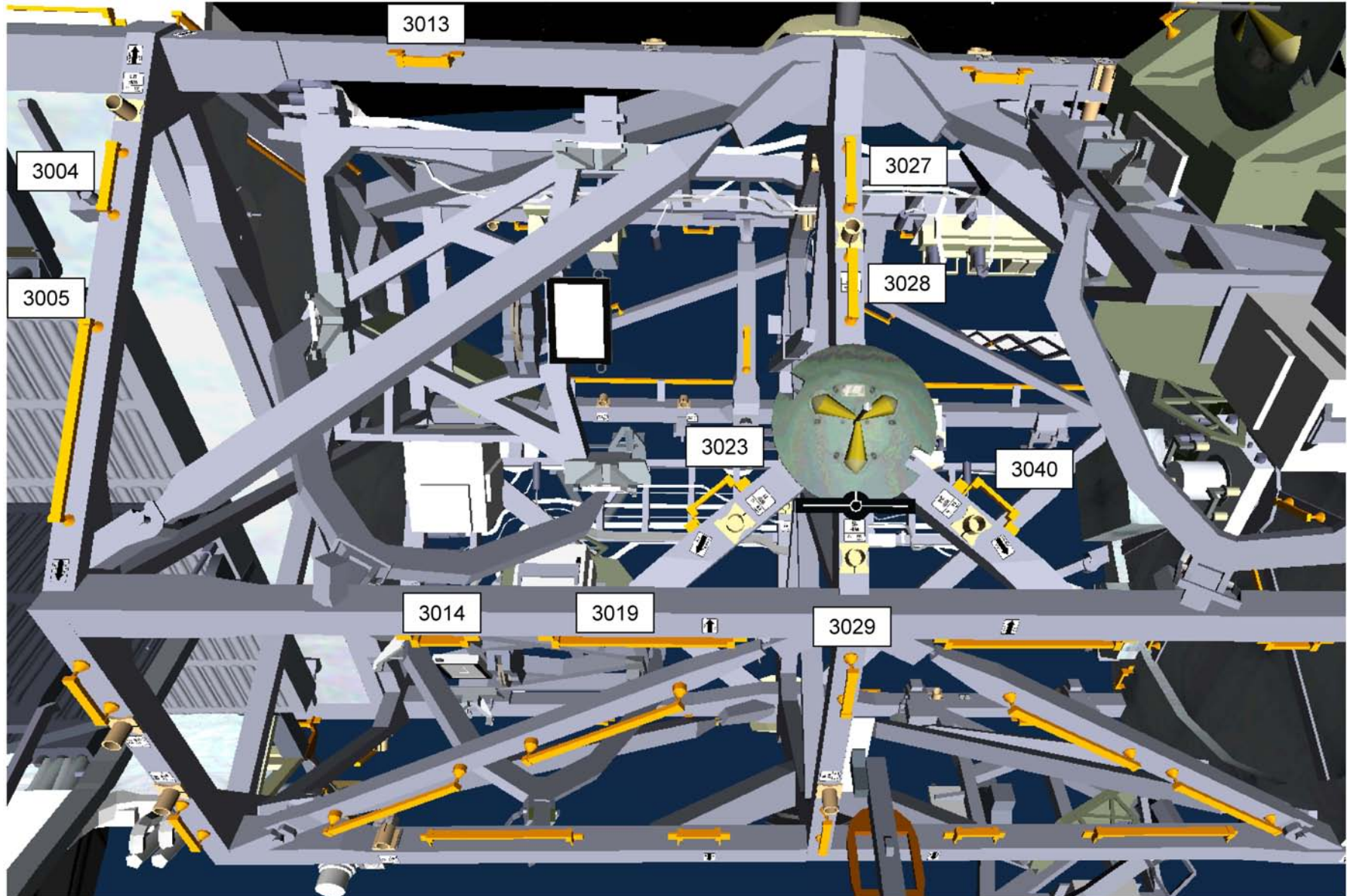

Figure 13: S3 Zenith/Inboard PAS Stowed (Handrail Numbers)

### S3 ZENITH/INBD PAS DEPLOY – TASK DATA (Cont)

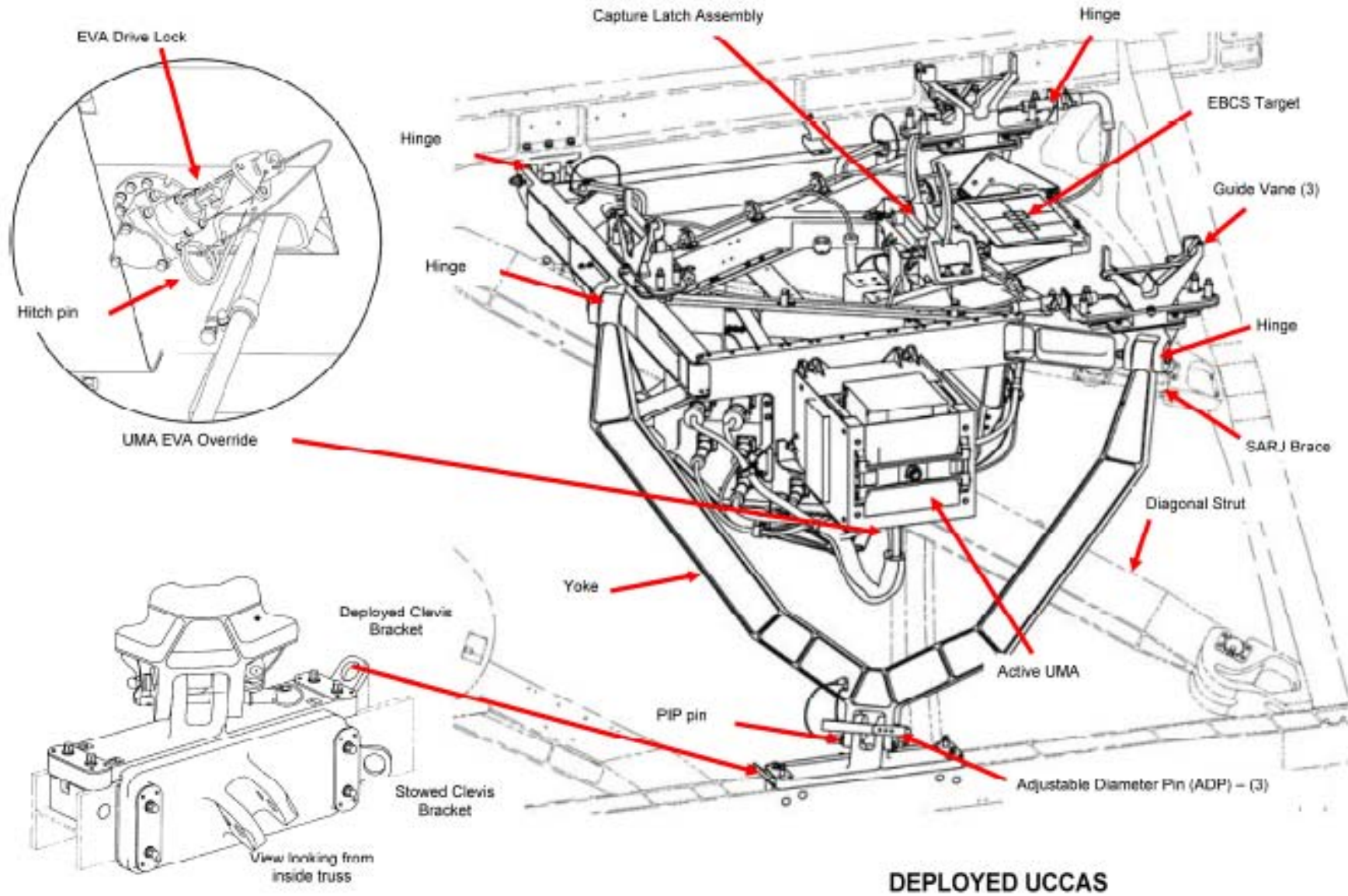

Figure 14: PAS Hardware

S3 ZENITH/INBD PAS DEPLOY – TASK DATA (Cont)



Figure 15: PAS Hinge Line ADP Orientation

### S3 ZENITH/INBD PAS DEPLOY – TASK DATA (Cont)

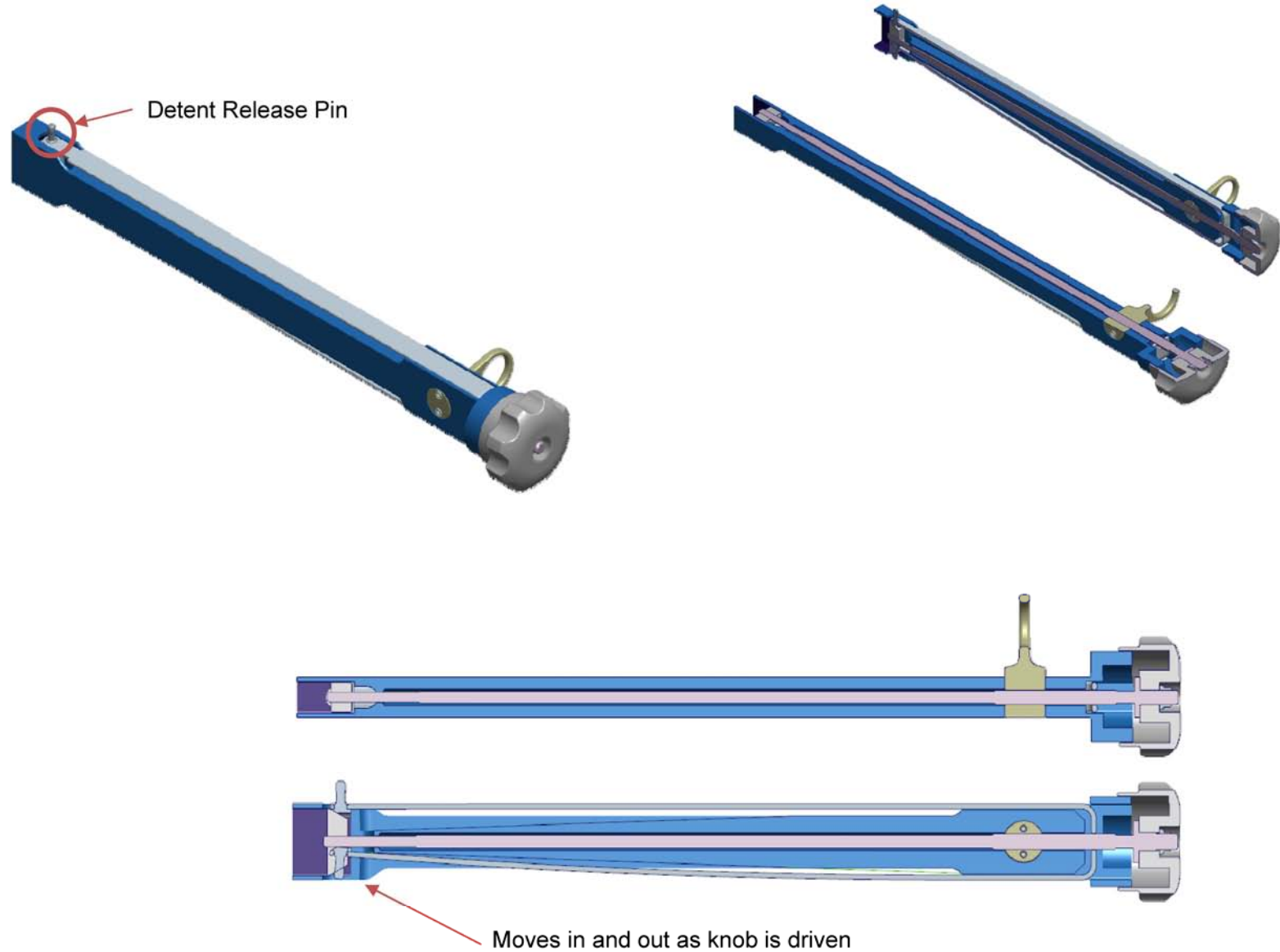

Figure 16: Detent Release Tool (DRT)

## TIMELINE GET-AHEADS – STS-129

EVA Get-ahead Task (Order indicates priority)	Duration	EVA to Perform Task
MT/MBS Connector Insulating Sleeve Install	00:20	EVA 3
S1 ATA Bolt #1 Release/Cheater Bar Stow	00:20 (ATA bolt); 00:15 (Cheater bar)	EVA 1, 2, 3
S3 Nadir/Outbd PAS Deploy (Ref. EVA 2)	01:30 (2 EV)	EVA 1
S3 Zenith/Inbd PAS Deploy (Ref. EVA 3)	01:30 (2 EV)	EVA 1, 2
S3 Nadir/Inbd PAS Deploy	01:30 (2 EV)	EVA 3
P1/P3 Fluid Jumper Install	00:30	EVA 1, 2, 3
APFR 3 Relocation for 20A	00:15	EVA 3
APFR 2 Relocation for ULF4	00:15	EVA 3
APFR 5/TS Relocation	00:20	EVA 1, 2
S1/S3 Fluid Jumper Install	00:30	EVA 1, 2, 3
MSS Camera Cover Install on LEE A Tip and MBS Cameras	00:20	EVA 3
A/L Handrail 0537 Photograph	00:05	EVA 1, 2, 3
Node 2 Nadir CBM Photograph	00:15	EVA 1, 2, 3

## GET-AHEADS

### MT/MBS CONNECTOR INSULATING SLEEVE INSTALL (00:20)

IV/SSRMS	EV1
<p>1. Verify inhibits in place:                      RPCM S14B_F RPC 1 – open,                      close cmd inhibit                      RPCM S13A_F RPC 1 – open,                      close cmd inhibit                      Demate MT UMAs</p>	<p><u>MT/MBS CONNECTOR INSULATING SLEEVE INSTALLATION (00:20)</u></p> <ol style="list-style-type: none"> <li>1. <b>On IV/MCC-H GO:</b> Translate to nadir side of MT/MBS</li> <li>2. On UMA1 J1 connector, adjust pre-existing MLI to fully uncover connector</li> <li>3. Retrieve connector insulating sleeve size 21/25 from Crewlock Bag</li> <li>4. Install connector insulating sleeve on UMA1 J1 connector</li> <li>√All metallic surfaces covered by connector insulating sleeve</li> <li>5. <input type="checkbox"/> Perform WVS survey</li> <li>6. On UMA1 J2 connector, adjust pre-existing MLI to fully uncover connector</li> <li>7. Retrieve connector insulating sleeve size 21/25 from Crewlock Bag</li> <li>8. Install connector insulating sleeve on UMA1 J2 connector</li> <li>√All metallic surfaces covered by connector insulating sleeve</li> <li>9. <input type="checkbox"/> Perform WVS survey</li> </ol>

MT/MBS CONNECTOR INSULATING SLEEVE INSTALL – TASK DATA

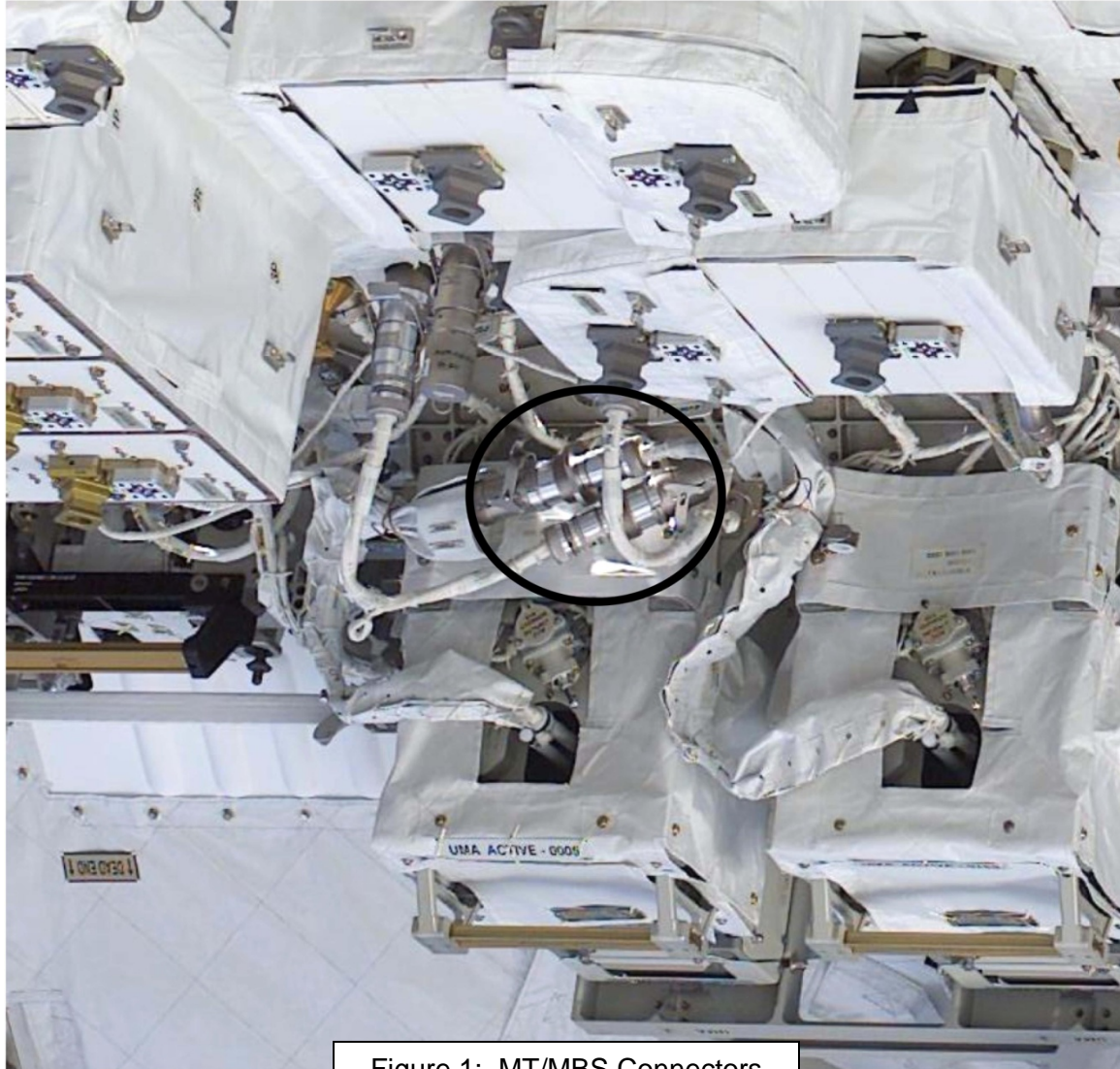

Figure 1: MT/MBS Connectors

## S1 ATA BOLT 1 RELEASE/CHEATER BAR STOW (00:35)

IV/SSRMS



EV1

### WARNING

Stay 3.6 ft from S-Band (SASA) high gain Antenna on S1

### S1 ATA BOLT 1 RELEASE (00:20)

1. Retrieve Get-Ahead Crewlock Bag from A/L
2. Translate to S1 aft/zenith
3. BRT to S1 HR 3418
4. Install cheater bar on ratchet wrench
5. Break torque on S1 ATA Bolt 1
6. RET ratchet wrench
7. Remove cheater bar and scorch to Crewlock Bag
8. Stow ratchet wrench in Crewlock Bag
9. Release S1 ATA Bolt 1 by hand, expect 16 turns
10. ✓Two white lines are visible

### WARNING

There may be MMOD strikes on Z1 Stbd Toolbox

### CHEATER BAR STOW (00:15)

11. Translate to Z1 Stbd Toolbox
12. Open stbd door
13. Stow cheater bar on stbd door panel
14. Close Toolbox door and close at least one lock
15. Tool Inventory
16. **Glove check**



# S1 ATA BOLT 1 RELEASE/CHEATER BAR STOW – TASK DATA

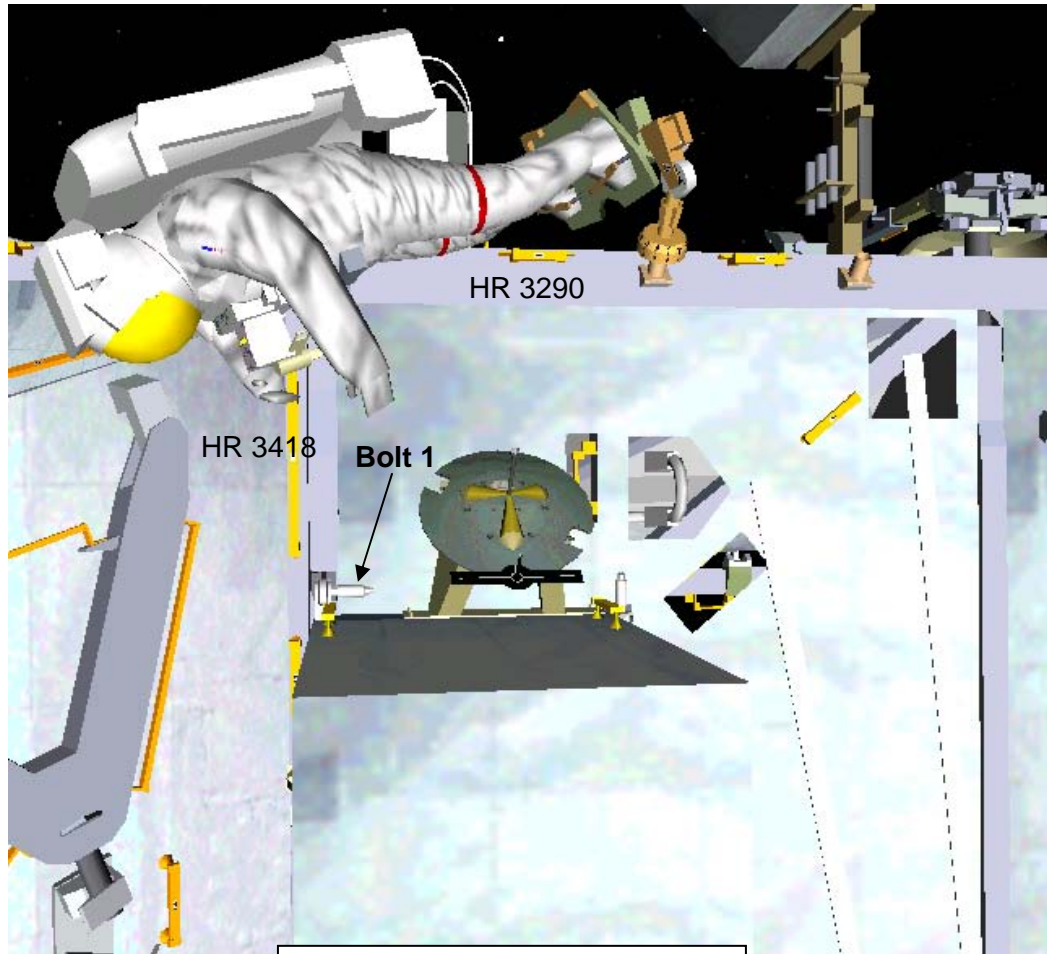

Figure 2: S1 ATA Worksite



Figure 3: Cheater Bar Panel

### S3 NADIR/INBD PAS DEPLOY (01:30)

IV/SSRMS	EV2	EV3										
<p>1. <b>NOTE:</b> These steps can be done at any time on any PAS</p> <ul style="list-style-type: none"> <li><input type="checkbox"/> Hingeline ADPs</li> <li><input type="checkbox"/> RTL PIP Pins</li> <li><input type="checkbox"/> EVA override cap removal</li> </ul> <p>2. Verify inhibit in place: √RPCM S31A A RPC 13 – Open, Close Cmd Inhibit</p> <p>3. Record Deploy Clevis bolt data:</p> <table border="1" data-bbox="109 922 430 1084"> <thead> <tr> <th>Bolt</th> <th>Turns</th> </tr> </thead> <tbody> <tr> <td>Bolt 1</td> <td>(10)</td> </tr> <tr> <td>Bolt 2</td> <td>(10)</td> </tr> <tr> <td>Bolt 3</td> <td>(10)</td> </tr> <tr> <td>Bolt 4</td> <td>(8)</td> </tr> </tbody> </table>	Bolt	Turns	Bolt 1	(10)	Bolt 2	(10)	Bolt 3	(10)	Bolt 4	(8)	<div style="border: 1px solid black; padding: 5px; margin-bottom: 10px;"> <p style="text-align: center;"><b>CAUTION</b></p> <ol style="list-style-type: none"> <li>1) When attempting to remove or install the Yoke PIP pin and ADP, do not impart more than 10 lbf</li> <li>2) Yoke ADP does not have a stowage hole. Do not close ADP lock bracket when ADP is not inserted in a stowage/clevis hole</li> <li>3) Do not exceed 30" between the yoke ADP and Deploy Clevis Bracket. Exceeding this could allow platform to enter detent position</li> <li>4) Do not lift diagonal brace more than ~7 deg out of rotation plane to prevent damage to hinge end</li> <li>5) Avoid inadvertent contact with grapple fixture shafts and target pins</li> <li>6) EBCS target has finished surface that is susceptible to damage by contact. Do not remove MLI until all work inside truss is complete</li> </ol> </div> <p><b>SWIVEL DEPLOY CLEVIS BRACKET</b></p> <ol style="list-style-type: none"> <li>1. MWS RET to Deploy Clevis Bracket</li> <li>2. Relocate MWS RET to HR 3007</li> <li>3. Configure PGT: <ul style="list-style-type: none"> <li><input type="checkbox"/> [RCCW, 30.5], 6" ext 7/16" wobble</li> </ul> </li> <li>4. Break torque on all bolts (4) <input type="checkbox"/><input type="checkbox"/><input type="checkbox"/><input type="checkbox"/></li> <li>5. Configure PGT: <ul style="list-style-type: none"> <li><input type="checkbox"/> [B7, CCW2, 30.5], 6" ext 7/16" wobble</li> </ul> </li> <li>6. ← Release bolts (4); 10 turns (bolts 1, 2, 3), 8 turns (bolt 4)</li> <li>7. Swivel Deploy Clevis Bracket</li> </ol> <p><b>REMOVE DIAGONAL BRACE (Caution #4)</b></p> <ol style="list-style-type: none"> <li>8. Configure PGT: <ul style="list-style-type: none"> <li><input type="checkbox"/> [B6, CCW3, 30.5], 6" ext 7/16" wobble</li> </ul> </li> <li>9. Release Diagonal Brace (cup-cone bolt), stop on 35 turns (do not exceed 37 turns)</li> <li>10. Guide Diagonal Brace and temp stow with tether on HR 3024</li> </ol> <p><b>RELEASE YOKE ADP AND PIP PIN (Caution #1, #2)</b></p> <ol style="list-style-type: none"> <li>11. Attach Sm hook of AET to S3 HR 3016</li> <li>12. Release yoke PIP pin</li> <li>13. Release yoke ADP (do not close ADP)</li> <li>14. Attach Lg hook of AET to ADP hole</li> <li>15. Tend platform "into" truss</li> </ol>	<ol style="list-style-type: none"> <li>1. Stow PAS Crewlock Bag on HR 3020/3024_____</li> </ol> <p><b>HINGE LINE PREP</b></p> <ol style="list-style-type: none"> <li>2. Remove hinge line ADPs (2)</li> <li>3. Insert in stowage hole (pin station fwd, handle inside platform) <ul style="list-style-type: none"> <li><input type="checkbox"/> √ADP closed: Inboard</li> <li><input type="checkbox"/> √ADP closed: Outboard</li> </ul> </li> </ol> <p><b>DEPLOY LG-SM AET</b></p> <ol style="list-style-type: none"> <li>4. Attach small hook of Lg-sm AET to S3 HR 3016</li> </ol>
Bolt	Turns											
Bolt 1	(10)											
Bolt 2	(10)											
Bolt 3	(10)											
Bolt 4	(8)											

**S3 NADIR/INBD PAS DEPLOY (01:30) (Cont)**

IV/SSRMS	EV2	EV3						
<p>4. <b>IV:</b> Record Brace bolt data:</p> <table border="1" data-bbox="109 1032 613 1097"> <thead> <tr> <th>Bolt</th> <th>Turns</th> <th>Torque (ft-lb)</th> </tr> </thead> <tbody> <tr> <td>Diagonal</td> <td>(35)</td> <td>(16.0)</td> </tr> </tbody> </table>	Bolt	Turns	Torque (ft-lb)	Diagonal	(35)	(16.0)	<p><u>REMOVE STOW CLEVIS BRACKET</u></p> <p>16. RET to Stow Clevis Bracket</p> <p>17. Configure PGT:  <input type="checkbox"/> <b>[RCCW, 30.5]</b>, 6" ext 7/16" wobble</p> <p>18. Break torque on all bolts (4)  <input type="checkbox"/><input type="checkbox"/><input type="checkbox"/><input type="checkbox"/></p> <p>19. Configure PGT:  <input type="checkbox"/> <b>[B7, CCW2, 30.5]</b>, 6" ext 7/16" wobble</p> <p>20. Release bolts (4); 10 turns  <input type="checkbox"/><input type="checkbox"/><input type="checkbox"/><input type="checkbox"/></p> <p><u>DEPLOY PLATFORM (Caution #3)</u></p> <p>21. Deploy platform out until UMA clears longeron</p> <p>22. On EV3 GO; rotate yoke from in to out</p> <p><u>REINSTALL DIAGONAL BRACE (Caution #4)</u></p> <p>23. Move Diagonal Brace into position for re-installation</p> <p>24. Release AET as needed for brace clearance</p> <p>25. Reinstall AET once brace is clear</p> <p>26. Configure PGT (can wait until after clevis and ADP are re-installed):  <input type="checkbox"/> <b>[B2, CW2, 30.5]</b>, 6" ext 7/16" wobble</p> <p>27. ← Engage Diagonal Brace (Cup-cone bolt) to hard stop; ~35 turns</p> <p><u>REINSTALL DEPLOY CLEVIS BRACKET</u></p> <p style="text-align: center;"><u>NOTE</u>            Make sure yoke is outside the Deploy Clevis Bracket</p> <p>28. Finger start Deploy Clevis Bracket bolts (4), approx 1-2 turns</p> <p>29. Configure PGT:  <input type="checkbox"/> <b>[B5, CW2, 30.5]</b>, 6" ext 7/16" wobble</p>	<p>5. Stow the Stow Clevis Bracket in Crewlock Bag</p> <p><u>DEPLOY PLATFORM (Caution #3)</u></p> <p>6. Monitor UMA to longeron clearance</p> <p>7. Inform EV2 when UMA just clears the longeron</p> <p>8. Assist EV2 as needed with yoke</p> <p><u>REINSTALL DIAGONAL BRACE (Caution #4)</u></p> <p>9. Tend Platform</p> <p>10. Retrieve tether from brace temp stow location</p>
Bolt	Turns	Torque (ft-lb)						
Diagonal	(35)	(16.0)						

### S3 NADIR/INBD PAS DEPLOY (01:30) (Cont)

IV/SSRMS	EV2	EV3															
<p>5. <b>IV:</b> Record Deploy Clevis bolt data:</p> <table border="1"> <thead> <tr> <th>Bolt</th> <th>Turns</th> <th>Torque (ft-lb)</th> </tr> </thead> <tbody> <tr> <td>Bolt 1</td> <td>(10)</td> <td>(22.0)</td> </tr> <tr> <td>Bolt 2</td> <td>(10)</td> <td>(22.0)</td> </tr> <tr> <td>Bolt 3</td> <td>(10)</td> <td>(22.0)</td> </tr> <tr> <td>Bolt 4</td> <td>(8)</td> <td>(22.0)</td> </tr> </tbody> </table>	Bolt	Turns	Torque (ft-lb)	Bolt 1	(10)	(22.0)	Bolt 2	(10)	(22.0)	Bolt 3	(10)	(22.0)	Bolt 4	(8)	(22.0)	<p>30. ← Engage bolts (4) to hard stop, 10 turns</p> <p>31. Configure PGT:  <input type="checkbox"/> [RCW, 30.5], 6" ext 7/16" wobble</p> <p>32. Apply final torque to bolts (4) in Ratchet Mode;                  2 clicks each bolt  <input type="checkbox"/><input type="checkbox"/><input type="checkbox"/></p> <p>33. Retrieve RET</p> <p><u>INSTALL YOKE (Caution #1)</u></p> <p>34. Disconnect Adj Tether</p> <p>35. Install yoke in Deploy Clevis Bracket  <input type="checkbox"/> Install yoke ADP, √lock bracket engaged  <input type="checkbox"/> Install yoke PIP pin</p> <p>36. Retrieve Adj Tether</p> <p><u>PREP UMA</u></p> <p>37. Translate under PAS UMA</p> <p>38. RET, retrieve hitch pin from EVA OVERRIDE anti-rotation cap; stow in trash bag</p> <p>39. RET, retrieve anti-rotation cap; stow in trash bag</p> <p>40. Tool Inventory</p> <p>41. <b>Glove check</b></p>	<p>11. Assist EV2 with yoke installation while keeping platform out of detents</p> <p><u>RTL CHECKOUT</u></p> <p>12. Translate to each Guide Vane (3) and perform:  <input type="checkbox"/><input type="checkbox"/><input type="checkbox"/> RET to launch restraint PIP Pin; remove from guide vane and stow in trash bag  <input type="checkbox"/><input type="checkbox"/><input type="checkbox"/> On <b>MCC-H GO</b>, depress and hold RTL lever for 15 sec, then release  <input type="checkbox"/><input type="checkbox"/><input type="checkbox"/> Verify with MCC-H good checkout, move to next guide vane</p> <p><u>EBCS TARGET PREP (Caution #6)</u></p> <p>13. Translate to EBCS target and perform:  <input type="checkbox"/> Verify both EV clear of target area  <input type="checkbox"/> Remove target cover; stow on backside of target assy</p> <p>14. Tool Inventory</p> <p>15. <b>Glove check</b></p>
Bolt	Turns	Torque (ft-lb)															
Bolt 1	(10)	(22.0)															
Bolt 2	(10)	(22.0)															
Bolt 3	(10)	(22.0)															
Bolt 4	(8)	(22.0)															
<p>6. <b>IV:</b> Give <b>MCC-H GO</b> to power up IMCA                  √All tasks inside truss prior to UMA prep complete                  √Tools cleared from inside truss</p> <p>7. <b>IV:</b> Obtain <b>MCC-H GO</b> for RTL Checkout</p> <table border="1"> <thead> <tr> <th>RTL</th> <th>PIP Pin</th> <th>Test Pass</th> </tr> </thead> <tbody> <tr> <td>1</td> <td></td> <td></td> </tr> <tr> <td>2</td> <td></td> <td></td> </tr> <tr> <td>3</td> <td></td> <td></td> </tr> </tbody> </table>	RTL	PIP Pin	Test Pass	1			2			3							
RTL	PIP Pin	Test Pass															
1																	
2																	
3																	
<p>8. <b>IV:</b> Tool Inventory:  <input type="checkbox"/> UMA Override Cap  <input type="checkbox"/><input type="checkbox"/><input type="checkbox"/> RTL PIP Pins  <input type="checkbox"/> Stow Clevis Bracket  <input type="checkbox"/> Adj Tether (Lg-Sm)  <input type="checkbox"/> Hammer  <input type="checkbox"/><input type="checkbox"/> DRTs</p>																	

### S3 NADIR/INBD PAS DEPLOY – TASK DATA

**Estimated Task Duration:**

	Without RMS
One EV Crew	N/A
Two EV Crew	01:30

**Tools:**

EV1	EV2
PGT	PGT
7/16-6-in socket ext	7/16-6-in socket ext
	Adj (Lg-sm)

**EVA Fasteners:**

Fastener Name	Head Size	Qty	Install Torque (ft-lb)	Release Torque (ft-lb)	Failure Torque (ft-lb)	Turns
Diagonal cup/cone Bolt	7/16	1	16.0	24.0	14.0 and 31.6	35-37
Stow Clevis	7/16	4	16.0	25.5	46.7	9-16.5
Deploy Clevis	7/16	4	30.5	25.5	106.6 (remove) or 44.7 (install)	7-10.5

**Notes:**

1. UMA EVA Override anti-rotation cap must be removed prior to first use of UMA on PAS
2. EBCS target cover must be removed prior to cargo attachment to PAS. Protects target from MMOD and inadvertent contact. Remove as last activity
3. RAD may be needed for re-install of deployed clevis bracket. It will likely exceed RAD limits and need to be returned for refurb

**Timeline Considerations:**

- 1.

S3 NADIR/INBD PAS DEPLOY – TASK DATA (Cont)

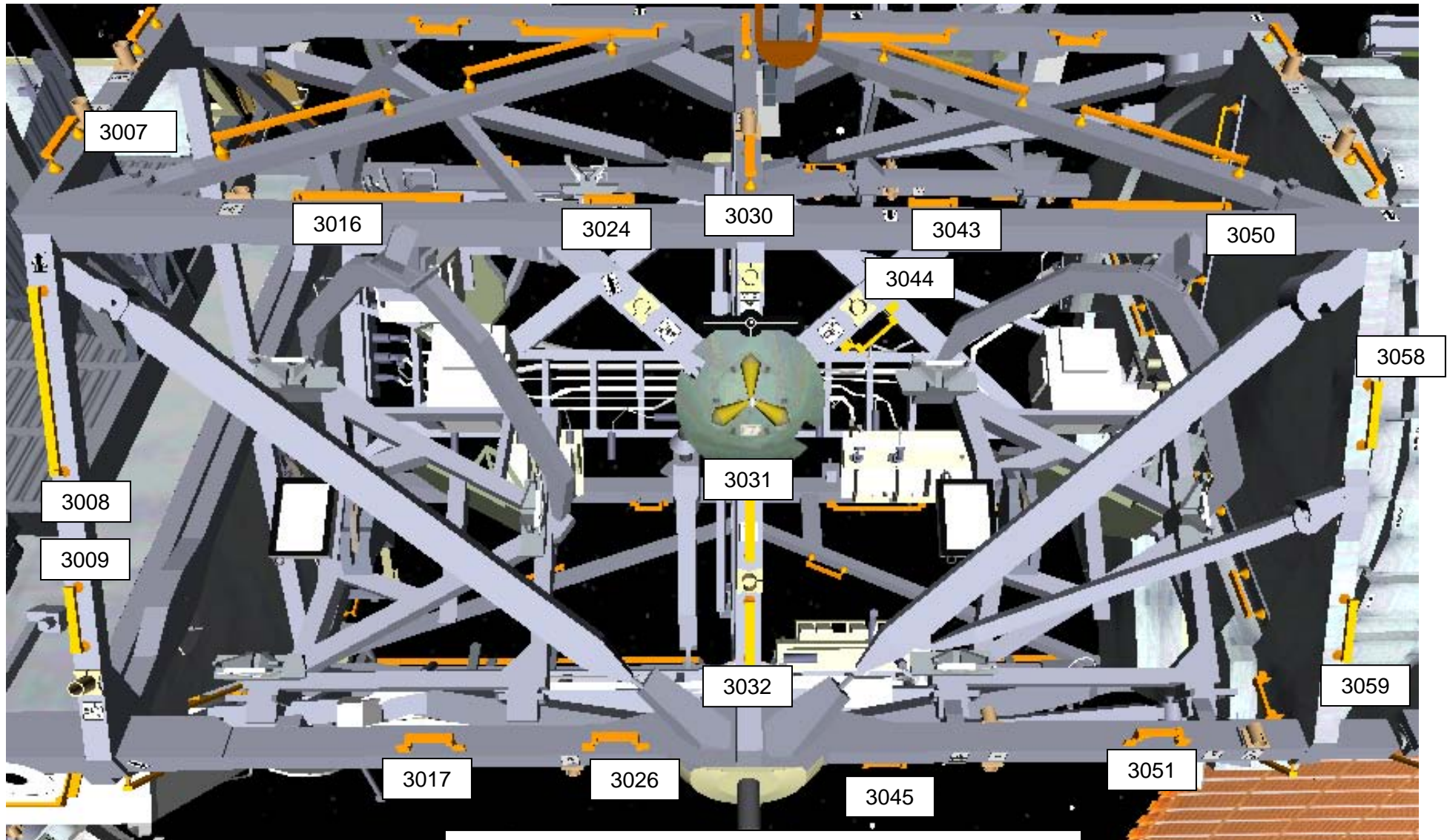

Figure 6: S3 Nadir/Inboard PAS Stowed (Handrail Numbers)

### S3 NADIR/INBD PAS DEPLOY – TASK DATA (Cont)

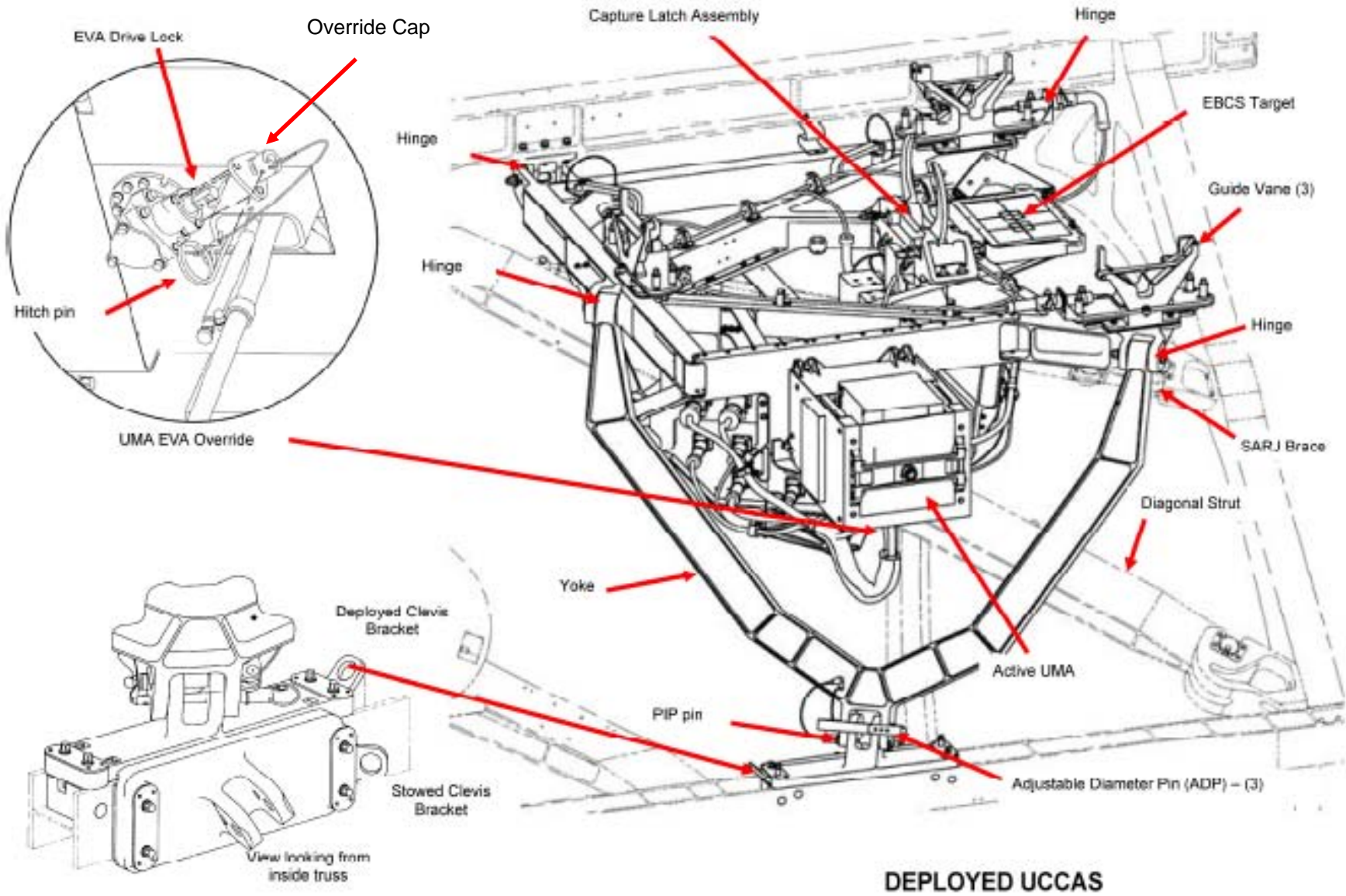



Figure 7: PAS Hardware

## P1/P3 FLUID JUMPER INSTALL (00:30)

IV/SSRMS	EV1
<p>1. Verify inhibits in place: √P1 TRRJ locked</p> <div data-bbox="105 344 667 560" style="border: 1px solid black; padding: 5px; margin: 5px 0;"> <p><b>BLOCK A – DEMATE QD</b></p> <ol style="list-style-type: none"> <li>√Detent button – up</li> <li>Assess &amp; counteract side loads</li> <li>Pull back on release ring</li> <li>Demate QD</li> <li>√Fwd white band not visible (√release ring – retracted)</li> </ol> </div> <div data-bbox="105 609 667 977" style="border: 1px solid black; padding: 5px; margin: 5px 0;"> <p><b>BLOCK B – MATE QD</b></p> <ol style="list-style-type: none"> <li>Inspect QDs for FOD or damage</li> <li>√Detent button – up</li> <li>√Fwd white band – not visible</li> <li>Assess &amp; counteract side loads</li> <li>Mate QD</li> <li>√Fwd white band – visible</li> <li>Snapback test (√Fwd white band still visible)</li> <li>Pull test</li> <li>Visual gap test</li> <li>Assess Side loads before Valve Open</li> </ol> </div> <div data-bbox="105 1058 667 1205" style="border: 1px solid black; padding: 5px; margin: 5px 0;"> <p><b>BLOCK C – Open Valve</b></p> <ol style="list-style-type: none"> <li>Press detent button – down, move bail fwd</li> <li>√Aft white band visible; √Detent button – up</li> <li>Verify detent button can be depressed</li> </ol> </div>	<div data-bbox="756 246 1738 357" style="border: 3px double black; padding: 10px; margin: 10px 0;"> <p style="text-align: center;"><u>WARNING</u></p> <p>The 2 ft KOZ for the P1 Radiator Beam begins just nadir of the umbilical tray. If TRRJ can not be locked, then body position must be maintained on tray or zenith</p> </div> <div data-bbox="756 389 1621 487" style="border: 1px solid black; padding: 10px; margin: 10px 0;"> <p style="text-align: center;"><u>CAUTION</u></p> <p>QDs exposed to direct sun can overtemp in 6 minutes. Shading by EMU or thermal shrouds can lengthen acceptable time with bootie removed</p> </div> <p>P1/P3 FLUID JUMPER INSTALL (00:30)</p> <ol style="list-style-type: none"> <li>Translate to P1/P3 Face 6 (nadir) interface</li> <li>Open shroud on P1 nadir umbilical tray</li> <li>Open TA clamp</li> <li>BRT to P1 HR 3688, RET to FQD jumper</li> <li>For QDs F186 &amp; F187, open thermal booties (check detent button is installed) and perform <b>BLOCK A</b> steps in IV column (removes Fluid Jumper from P1) F186 is on M2 Panel A503; F187 is on M1 Panel A504</li> <li>Open thermal bootie and remove QD cap from M3 on P1 panel A503; stow in trash bag</li> <li>Perform <b>BLOCK B</b> steps (IV column) to mate QD F186 to M3 on P1 panel A503</li> <li>For QD F186, perform <b>BLOCK C</b> steps (IV column)</li> <li>Reinstall thermal booties</li> <li>BRT to P1 HR 3810</li> <li>Open thermal bootie and remove QD cap from M1 on P3 panel A501; stow in trash bag</li> <li>Perform <b>BLOCK B</b> steps (IV column) to mate QD F187 to M1 on P3 panel A501</li> <li>For QD F187, perform <b>BLOCK C</b> steps (IV column)</li> <li>Reinstall thermal booties</li> <li> Visually inspect jumper connections</li> <li>Close TA clamp</li> <li>Replace P1 nadir umbilical tray shroud</li> <li><b>Glove check</b></li> </ol>



# P1/P3 FLUID JUMPER INSTALL – TASK DATA

**Notes:**

1. No ammonia in jumper or behind any males; lines contain nitrogen only – no risk of contamination
2. Jumper QDs are 1/4-in

P1 to P3 Fluid Line – Stowed Config

↑ FACE 1

FACE 6

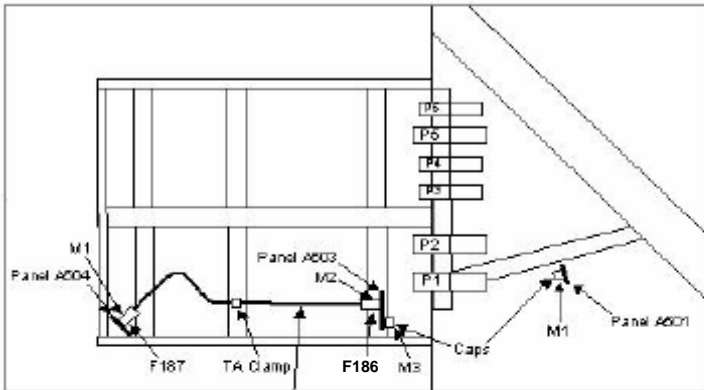

P1 to P3 Fluid Line – Deployed Config

↑ FACE 1

FACE 6

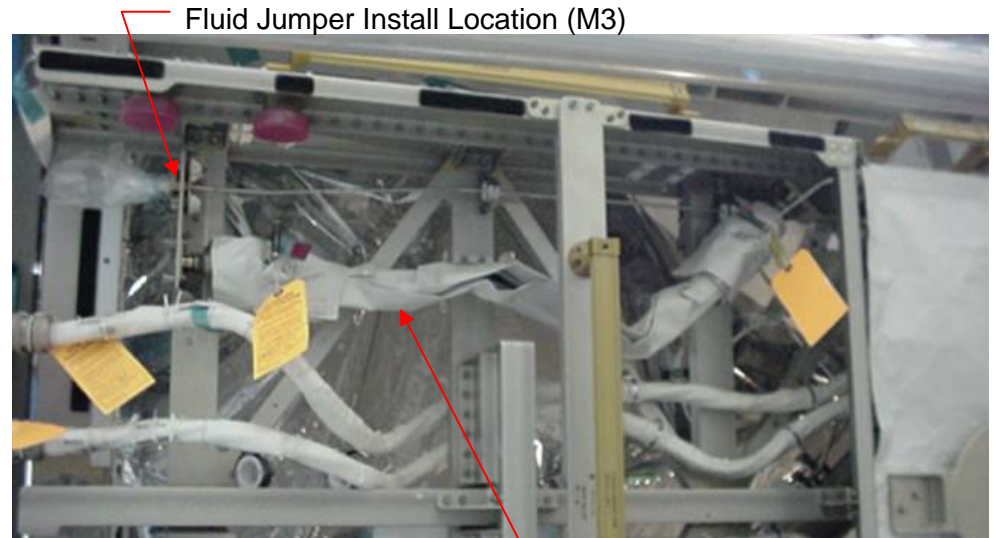
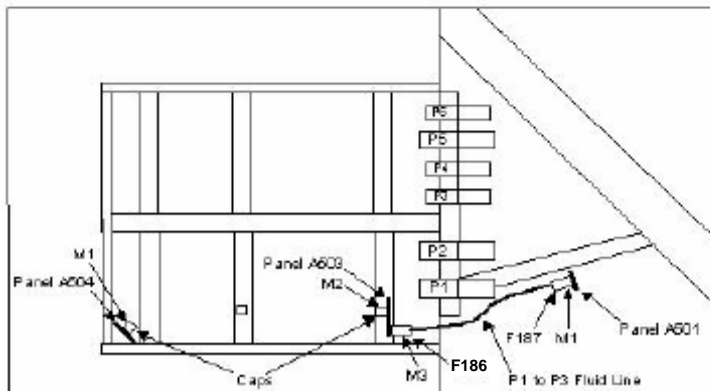

Fluid Jumper Stowed

S3-A501-M1

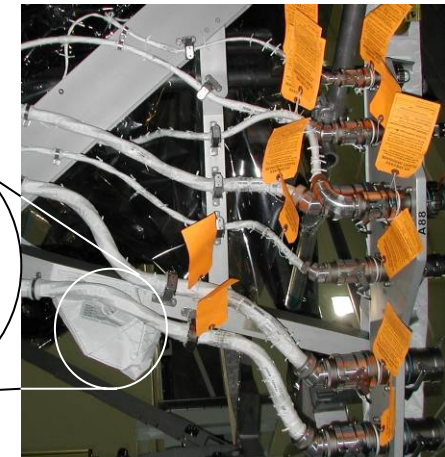

Ammonia Jumper Connection (S3-A501-M1)

Figure 8: P1/P3 Worksite Photos

**APFR 3 RELOCATION FOR 20A (00:15)**

<b>IV/SSRMS</b>	<b>EV1</b>
	<p><u>APFR 3 RELOCATE FOR 20A (00:15)</u></p> <ol style="list-style-type: none"><li>1. Translate to A/L WIF 10</li><li>2. RET, retrieve APFR; stow on BRT</li><li>3. Translate to Lab WIF 4 (nadir/aft of Lab)</li><li>4. Install APFR in Lab WIF 4 [1,RR,F,12] <input type="checkbox"/> √Locking collar black-on-black, pull test</li><li>5. Fold AIA toward Lab (not flat on boot plate)</li></ol>

# APFR 3 RELOCATION FOR 20A (00:15) (Cont)

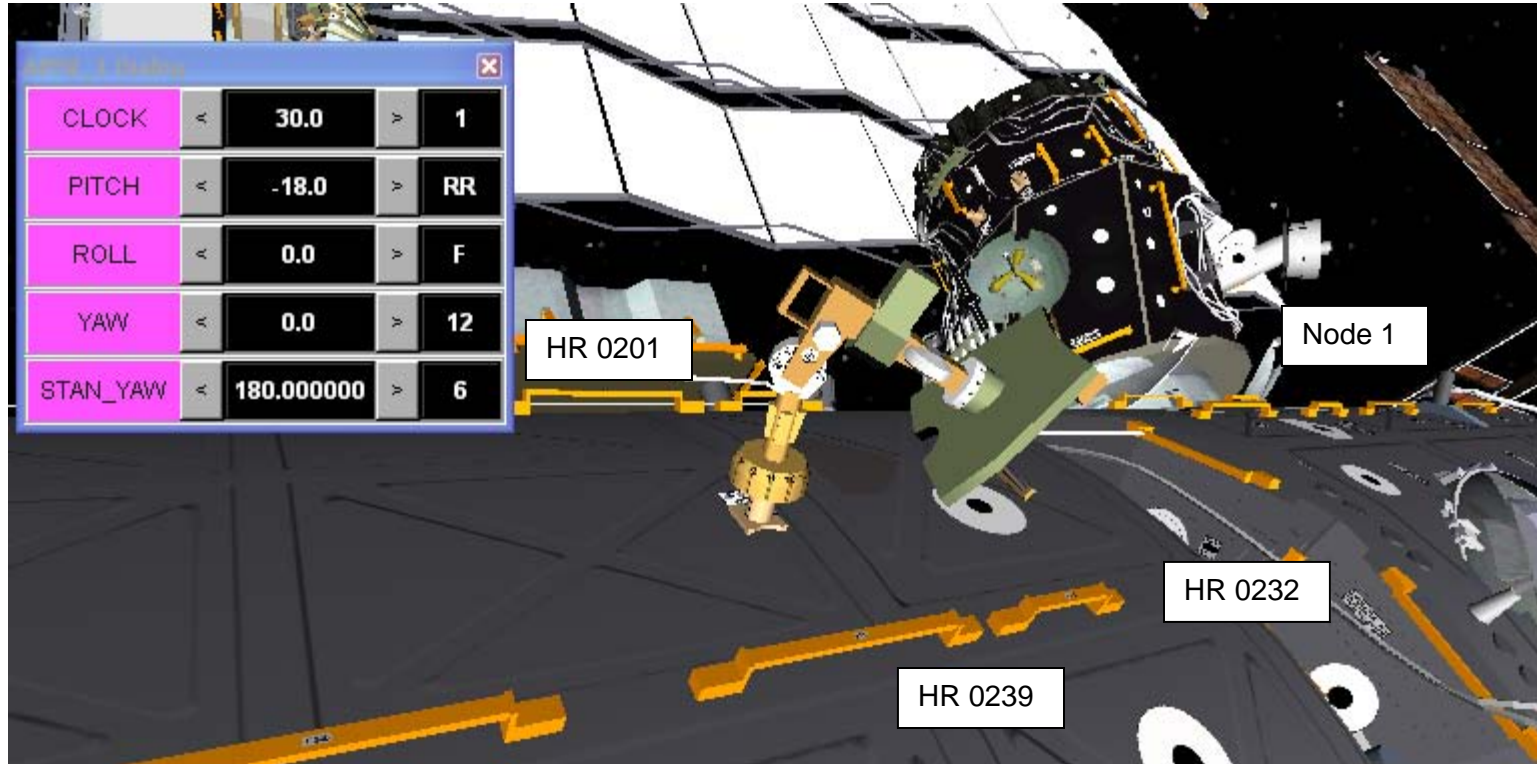

Figure 9: APFR Relocate to Lab WIF 4

## APFR 2 RELOCATION FOR ULF4 (00:15)

IV/SSRMS	EV1
<p>(NOTE: This is only a get-ahead if the P1 WIF 3 APFR is not used for stowage of the Tool Stanchion. In that case, the APFR brought inside would be brought back outside on EVA 2 or 3 and taken to A/L WIF 9)</p>	<p>APFR 2 RELOCATION FOR ULF4 (00:15)</p> <div data-bbox="703 302 1451 443" style="border: 3px double black; padding: 5px;"><p style="text-align: center;"><u>WARNING</u></p><p>The 2 ft KOZ for the P1 Radiator Beam begins just outboard of P1 WIF 3. If TRRJ can not be locked, then body position must be maintained inboard of WIF</p></div> <div data-bbox="703 477 1262 540" style="border: 1px solid black; padding: 5px;"><p style="text-align: center;"><u>CAUTION</u></p><p>Avoid contact with the P1 Lower/Inbd Camera</p></div> <ol style="list-style-type: none"><li>1. Translate to P1 WIF 3 (P1 nadir/inboard)</li><li>2. RET, retrieve APFR; stow on BRT</li><li>3. Translate to A/L WIF 9 (between two zenith tanks)</li><li>4. Install APFR in A/L WIF 9 [12,PP,F,12]<ul style="list-style-type: none"><li><input type="checkbox"/> √Locking collar black-on-black, pull test</li></ul></li></ol>

APFR 2 RELOCATION FOR ULF4 (00:15) (Cont)

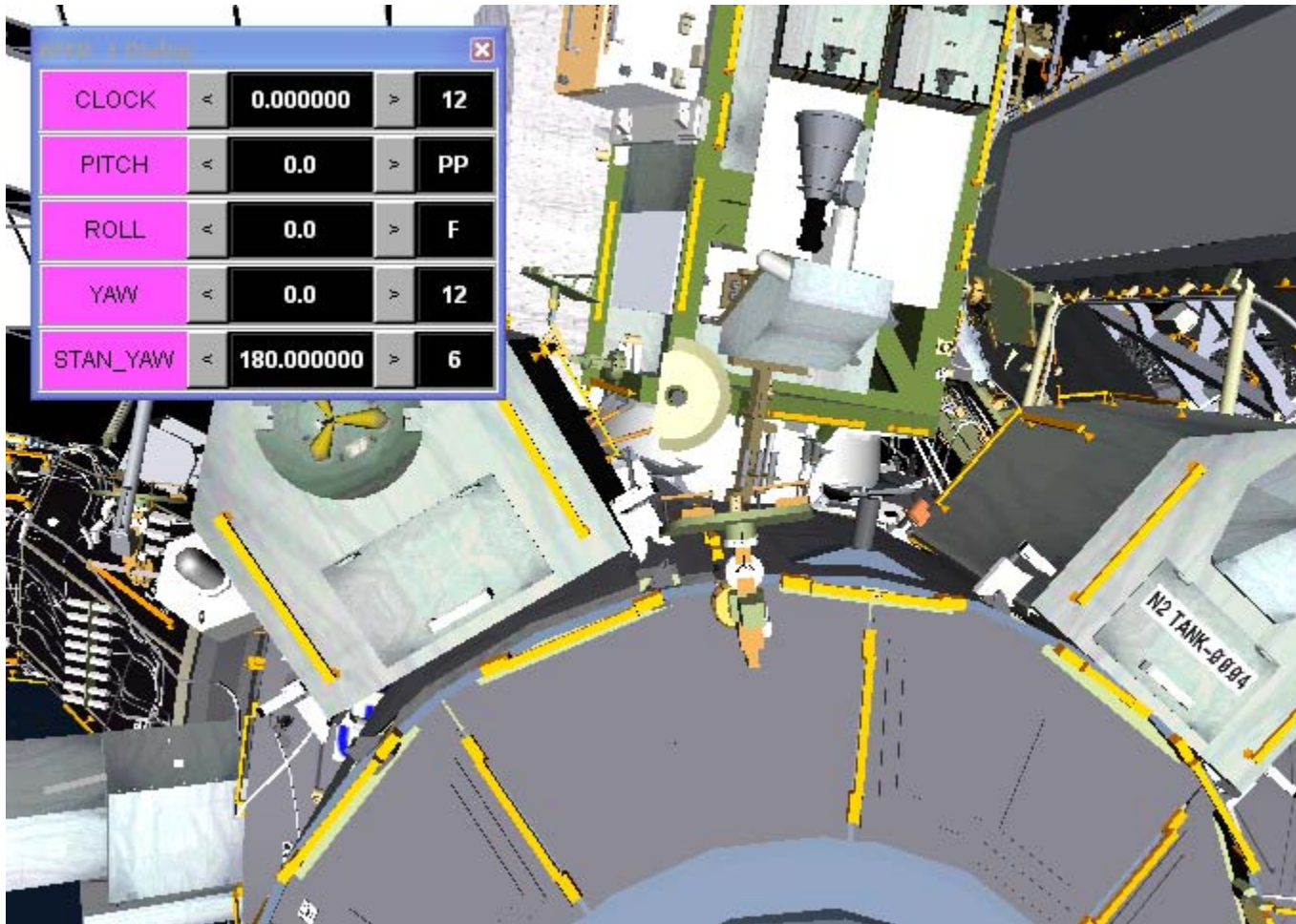

Figure 10: APFR Relocate to A/L WIF 4

## APFR 5/TOOL STANCHION RELOCATION (00:20)

IV/SSRMS	EV1	EV2
<p>1. Verify inhibits in place:</p> <ul style="list-style-type: none"> <li>√FGB KURS P [KYPC P] – Deactivated</li> <li>√FGB MCS unpowered</li> <li>√All FGB Attitude Control Thruster Valves (eighty) – closed</li> <li>√FGB Attitude Control Manifold Valves – closed</li> <li>KШK1, KШK2, KШK4, KШK5, KШK9, OKO3, OKГ3, OKO6, OKГ6, OKO7, OKГ 7, OKO8, OKГ8</li> </ul>	<p><u>RELOCATE TOOL STANCHION</u></p> <ol style="list-style-type: none"> <li>1. Translate to PMA1 stbd</li> <li>2. RET, retrieve Tool Stanchion; stow on BRT</li> <li>3. Translate to P1 WIF 3 (P1 nadir/inboard) Translate along NOD1 zenith/aft/port to Port S0 strut, then along nadir HR path</li> </ol> <div data-bbox="703 454 1291 625" style="border: 2px solid black; padding: 5px; margin: 10px 0;"> <p style="text-align: center;"><u>WARNING</u></p> <p>The 2 ft KOZ for the P1 Radiator Beam begins just outboard of P1 WIF 3. If TRRJ can not be locked, then body position must be maintained inboard of WIF</p> </div> <div data-bbox="703 657 1260 787" style="border: 1px solid black; padding: 5px; margin: 10px 0;"> <p style="text-align: center;"><u>CAUTION</u></p> <p>Avoid contact with the P1 Lower/Inbd Camera</p> <p>Avoid inadvertent contact with grapple fixture shaft (drylube)</p> </div> <ol style="list-style-type: none"> <li>4. Configure APFR [6, PP, F, 11]</li> <li>5. Install Tool Stanchion on APFR with low-profile settings close to structure: Tool Stanchion hex socket pointing ISS zenith Tool Stanchion oriented from APFR toward ISS stbd Tool Head yaw orientation zenith/nadir <input type="checkbox"/> Pull test</li> </ol>	<p><u>RETRIEVE APFR</u></p> <ol style="list-style-type: none"> <li>1. Translate to PMA1 stbd</li> <li>2. RET, retrieve APFR; stow on BRT</li> <li>3. Translate to A/L</li> <li>4. Stow APFR in A/L; configure low profile for ingress</li> </ol>

# APFR 5/TOOL STANCHION RELOCATION (00:20) (Cont)

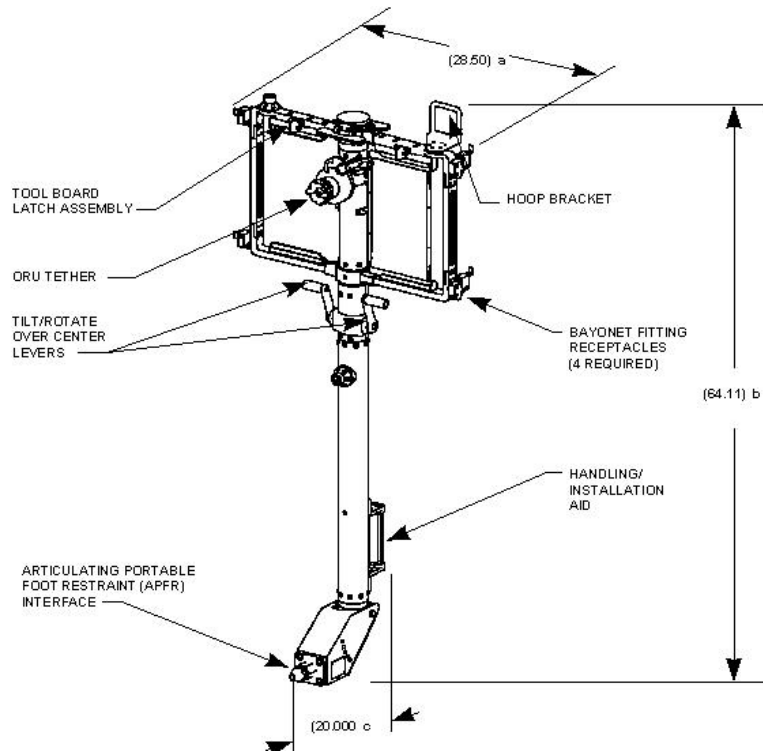

Figure 11: Tool Stanchion

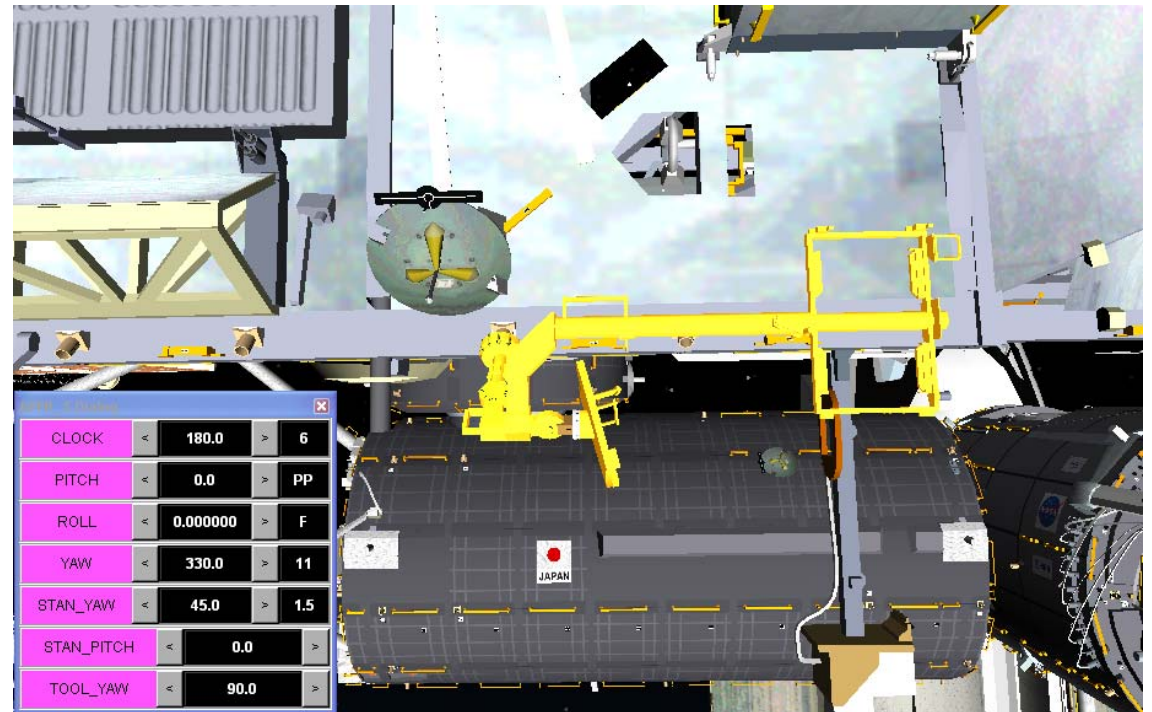



Figure 12: Tool Stanchion Relocation to P1 WIF 3

## S1/S3 FLUID JUMPER INSTALL (00:30)

IV/SSRMS	EV1
<p>1. Verify Inhibits in place: √S1 TRRJ locked</p> <div data-bbox="107 324 667 540" style="border: 1px solid black; background-color: #e0f7fa; padding: 5px;"> <p><b>BLOCK A – DEMATE QD</b></p> <ol style="list-style-type: none"> <li>√Detent button – up</li> <li>Assess &amp; counteract side loads</li> <li>Pull back on release ring</li> <li>Demate QD</li> <li>√Fwd white band not visible (√release ring – retracted)</li> </ol> </div> <div data-bbox="107 597 667 971" style="border: 1px solid black; background-color: #fff9c4; padding: 5px;"> <p><b>BLOCK B – MATE QD</b></p> <ol style="list-style-type: none"> <li>Inspect QDs for FOD or damage</li> <li>√Detent button – up</li> <li>√Fwd white band – not visible</li> <li>Assess &amp; counteract side loads</li> <li>Mate QD</li> <li>√Fwd white band – visible</li> <li>Snapback test (√Fwd white band still visible)</li> <li>Pull test</li> <li>Visual gap test</li> <li>Assess Side loads before Valve Open</li> </ol> </div> <div data-bbox="107 1044 667 1190" style="border: 1px solid black; background-color: #e8f5e9; padding: 5px;"> <p><b>BLOCK C – Open Valve</b></p> <ol style="list-style-type: none"> <li>Press detent button – down, move bail fwd</li> <li>√Aft white band visible; √Detent button – up</li> <li>Verify detent button can be depressed</li> </ol> </div>	<div data-bbox="758 245 1745 358" style="border: 3px double black; padding: 10px; text-align: center;"> <p><b>WARNING</b></p> <p>The 2 ft KOZ for the S1 Radiator Beam begins just nadir of the umbilical tray. If TRRJ can not be locked, then body position must be maintained on tray or zenith</p> </div> <div data-bbox="758 391 1633 488" style="border: 1px solid black; padding: 10px; text-align: center;"> <p><b>CAUTION</b></p> <p>QDs exposed to direct sun can overtemp in 6 minutes. Shading by EMU or thermal shrouds can lengthen acceptable time with bootie removed</p> </div> <p>S1/S3 FLUID JUMPER INSTALL (00:30)</p> <ol style="list-style-type: none"> <li>Translate to S1/S3 Face 6 (nadir) interface</li> <li>Open shroud on S1 nadir umbilical tray</li> <li>Open TA clamp</li> <li>BRT to S1 HR 3215, RET to FQD jumper</li> <li>For QDs F56 &amp; F57, open thermal booties (check detent button is installed) and perform <b>BLOCK A</b> steps in IV column (removes Fluid Jumper from P1) F576 is on M2 Panel A503; F56 is on M1 Panel A504</li> <li>Open thermal bootie and remove QD cap from M3 on S1 panel A503; stow in trash bag</li> <li>Perform <b>BLOCK B</b> steps (IV column) to mate QD F57 to M3 on S1 panel A503</li> <li>For QD F57, perform <b>BLOCK C</b> steps (IV column)</li> <li>Reinstall thermal booties</li> <li>BRT to S1 HR 3010</li> <li>Open thermal bootie and remove QD cap from M1 on S3 panel A501; stow in trash bag</li> <li>Perform <b>BLOCK B</b> steps (IV column) to mate QD F56 to M1 on S3 panel A501</li> <li>For QD F56, perform <b>BLOCK C</b> steps (IV column)</li> <li>Reinstall thermal booties</li> <li> Visually inspect jumper connections</li> <li>Close TA clamp</li> <li>Replace S1 nadir umbilical tray shroud</li> <li><b>Glove check</b></li> </ol>



## MSS CAMERA COVER INSTALL ON LEE A TIP AND MBS CAMERAS (00:20)

IV/SSRMS	EV1
<p>1. Verify inhibits in place: SSRMS brakes engaged</p>	<p><u>MSS CAMERA COVER INSTALL ON LEE A TIP CAMERA</u> (00:10)</p> <div style="border: 1px solid black; padding: 5px; margin: 10px auto; width: fit-content;"> <p style="text-align: center;"><b>CAUTION</b> Avoid contact with MSS camera cover lens</p> </div> <ol style="list-style-type: none"> <li>1. Translate to MT/MBS stbd (SSRMS base LEE)</li> <li>2. Retrieve MSS camera cover from Get-Ahead Crewlock Bag; MLI case remains in Crewlock Bag</li> <li>3. Rotate locking lever to the open/unlocked position (lever perpendicular to plane of lens)</li> <li>4. Install MSS camera cover on SSRMS LEE A Tip CLA by inserting spring loaded flange to depress spring</li> <li>5. Rotate cover to seat against camera bracket for full installation</li> <li>6. Rotate locking lever to the closed/locked position (lever parallel to plane of lens)</li> <li>7. Perform pull test</li> <li>8. Retrieve RET</li> <li>9. <input type="checkbox"/> Perform WVS survey</li> </ol> <p><u>MSS CAMERA COVER INSTALL ON MBS CAMERA</u> (00:10)</p> <ol style="list-style-type: none"> <li>10. Translate to MT/MBS Camera (MBS fwd)</li> <li>11. Retrieve MSS camera cover from Get-Ahead Crewlock Bag; MLI case remains in Crewlock Bag</li> <li>12. Rotate locking lever to the open/unlocked position (lever perpendicular to plane of lens)</li> <li>13. Install MSS camera cover on MBS CLA by inserting spring loaded flange to depress spring</li> <li>14. Rotate cover to seat against camera bracket for full installation</li> <li>15. Rotate locking lever to the closed/locked position (lever parallel to plane of lens)</li> <li>16. Perform pull test</li> <li>17. Retrieve RET</li> <li>18. <input type="checkbox"/> Perform WVS survey</li> </ol>

# MSS CAMERA COVER INSTALL ON LEE A TIP AND MBS CAMERAS – TASK DATA

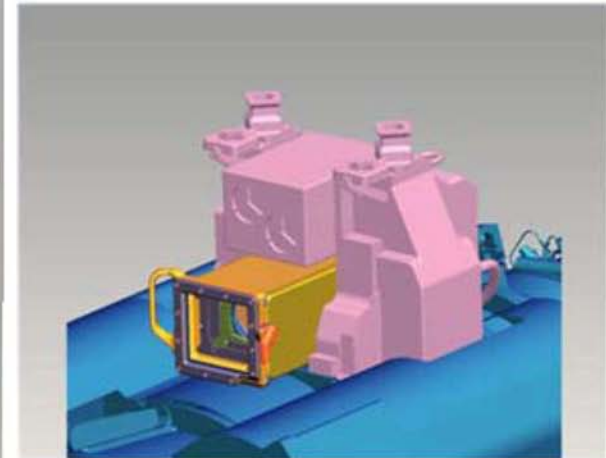

Cover on CLA



MSS Camera Cover  
(Shown in Unlocked Position)



Latch Pin

Figure 13: MSS Camera Cover Diagrams

## A/L HANDRAIL 0537 PHOTOGRAPH

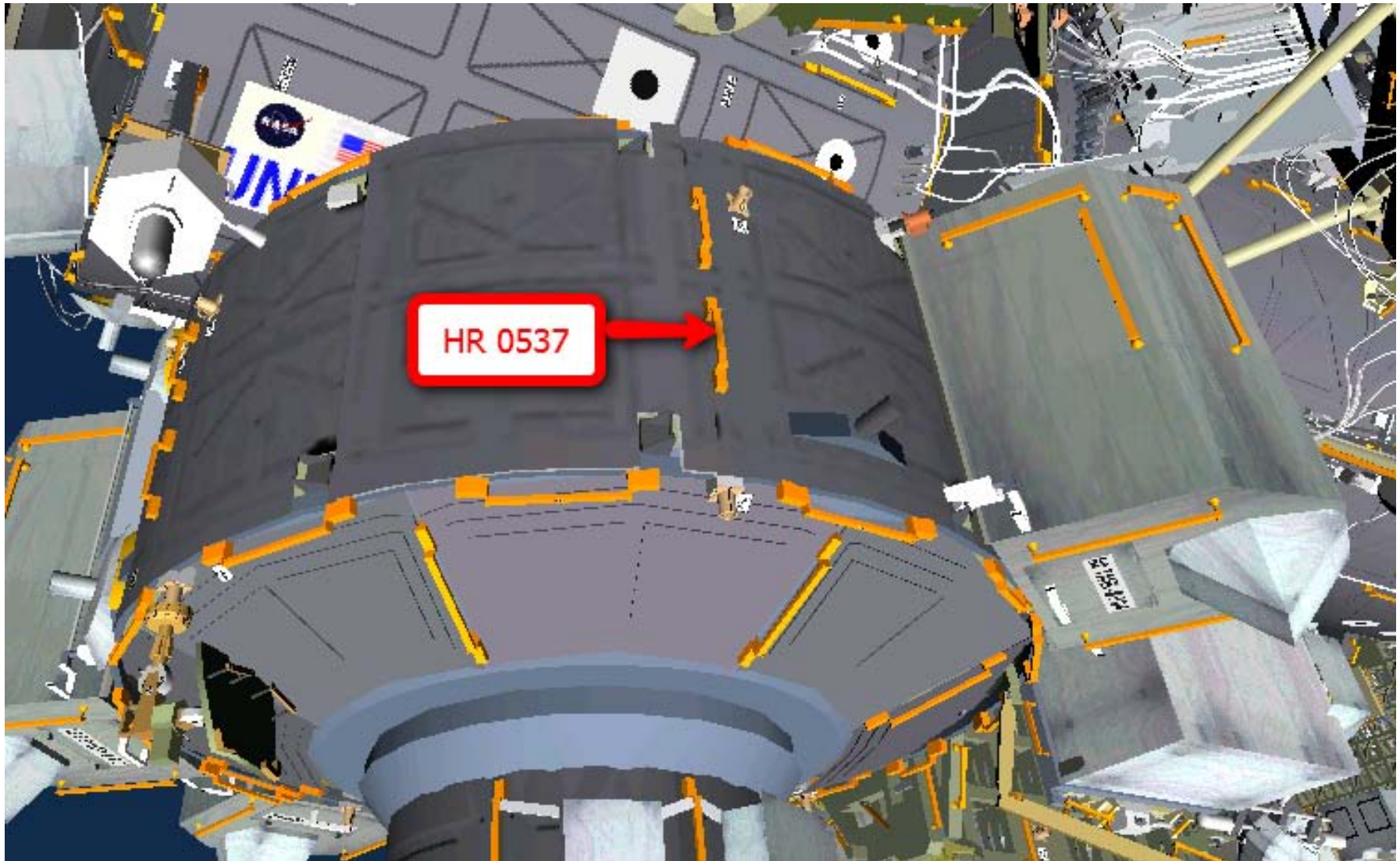

Figure 14: Location of A/L Handrail 0537

## NODE 2 NADIR CBM PHOTOGRAPH

IV/SSRMS	EV1
<p>1. IV: Verify Starboard-Aft quadrant CBM petal (Latch 1) is open</p>	<p><u>NODE 2 NADIR CBM PHOTOGRAPH (00:15)</u></p> <p><u>NOTE</u> Pictures must be taken during daylight</p> <ol style="list-style-type: none"> <li>1. Translate to Node 2 nadir CBM, starboard aft, latch 1</li> <li>2. Take at least 2 laterally offset photos (~0.5 ft -1.5 ft apart) of area of concern, forward of the adjacent bolt area</li> </ol>

Petal will be open, shown in gray for clarity

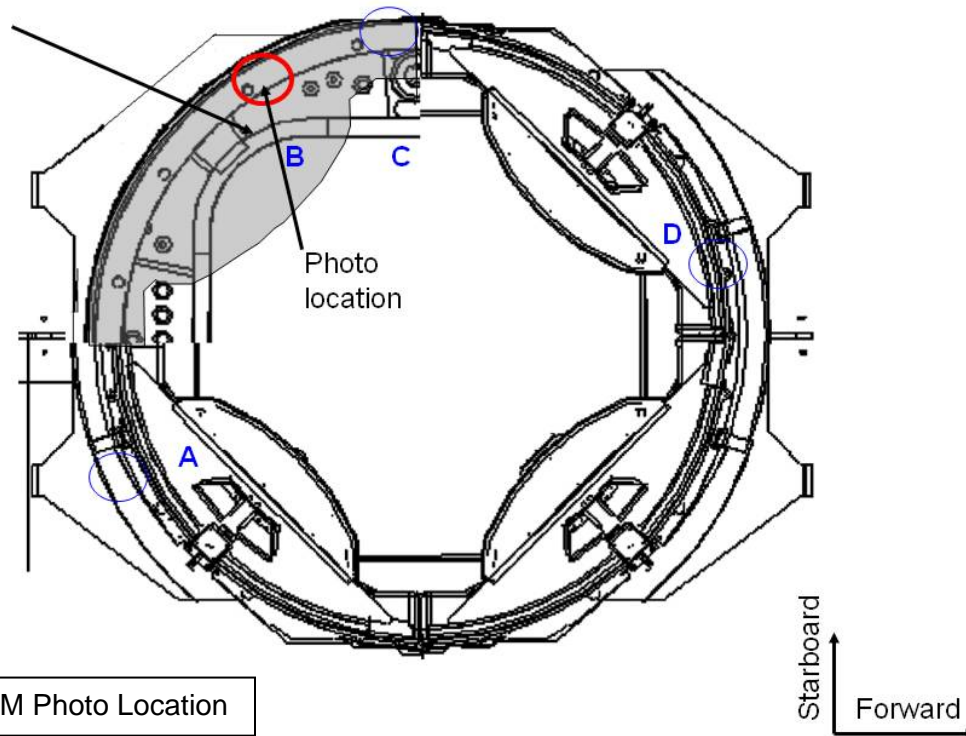
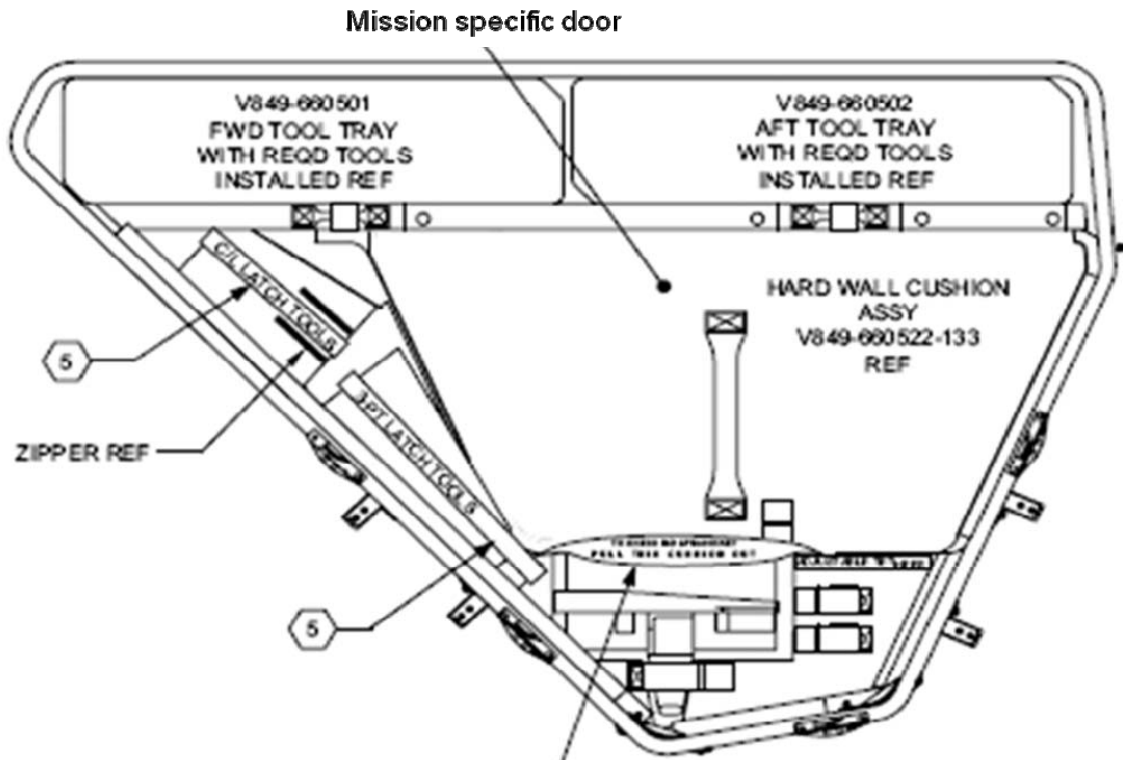

Figure 15: Node 2 Nadir CBM Photo Location

## TOOLS AND STOWAGE

PORT LIGHTWEIGHT TOOL STOWAGE ASSEMBLY (TSA) .....	TEMP FS 8-2
STARBOARD LIGHTWEIGHT TOOL STOWAGE ASSEMBLY (TSA).....	TEMP FS 8-2h
PGT CHECKOUT .....	8-3
PGSC-PGT CONNECTION (A31P AND 760XD) .....	8-4
PROGRAM PGT SETTINGS .....	8-5
DOWNLOAD/ERASE EVENT LOG .....	8-5
PGT CONTINGENCIES.....	8-6
PGT STANDARD SETTINGS.....	8-7
SAFETY TETHERS – STS-129 (ULF3).....	FS 8-9
APFR MANAGEMENT – STS-129 (ULF3) .....	FS 8-11
TOOLBOX STOWAGE – STS-129 (ULF3).....	FS 8-12
TOOLBOX PANEL AND SLOT LABELS .....	FS 8-13
Z1 TOOLBOX INTERNAL LAYOUT .....	FS 8-14
AIRLOCK TOOLBOX INTERNAL LAYOUT .....	FS 8-15
APFR THERMAL SHIELD REMOVAL.....	FS 8-16
GREASE GUN PREP .....	FS 8-17
GREASE GUN CLEANUP .....	FS 8-19

# PORT LIGHTWEIGHT TOOL STOWAGE ASSEMBLY (TSA)



Removal handle for rope reel / adj tether cushion to access PAD and push-button articulating socket



TOOLS AND  
STOWAGE

# PORT LIGHTWEIGHT TOOL STOWAGE ASSEMBLY (TSA) (Cont)

Mission Specific Area



# PORT LIGHTWEIGHT TOOL STOWAGE ASSEMBLY (TSA) (Cont)

Forward Tray





# PORT LIGHTWEIGHT TOOL STORAGE ASSEMBLY (TSA) (Cont)

## Forward Tray

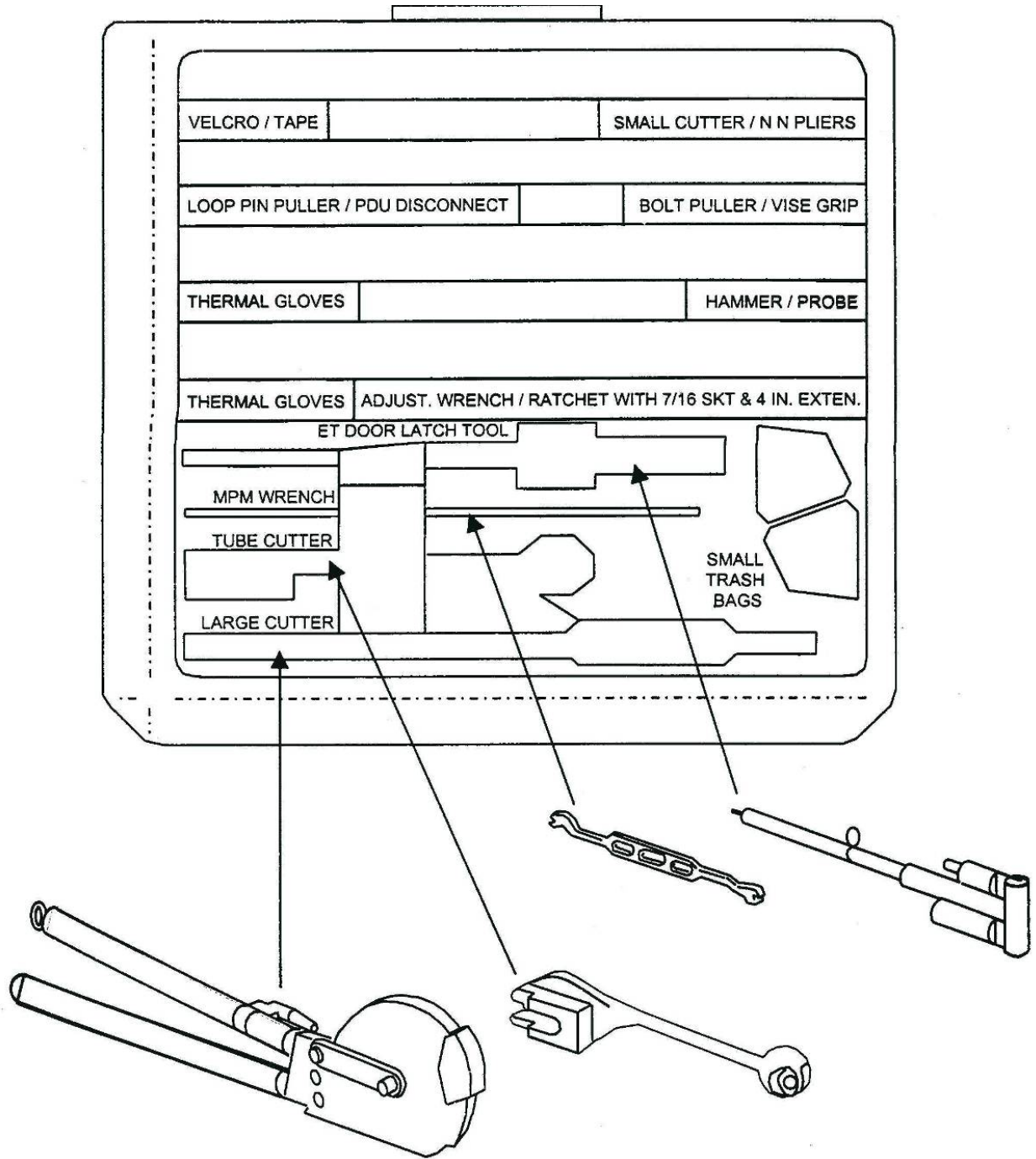

**PORT LIGHTWEIGHT TOOL STOWAGE ASSEMBLY (TSA) (Cont)**

Aft Tray



# PORT LIGHTWEIGHT TOOL STORAGE ASSEMBLY (TSA) (Cont)

Aft Tray

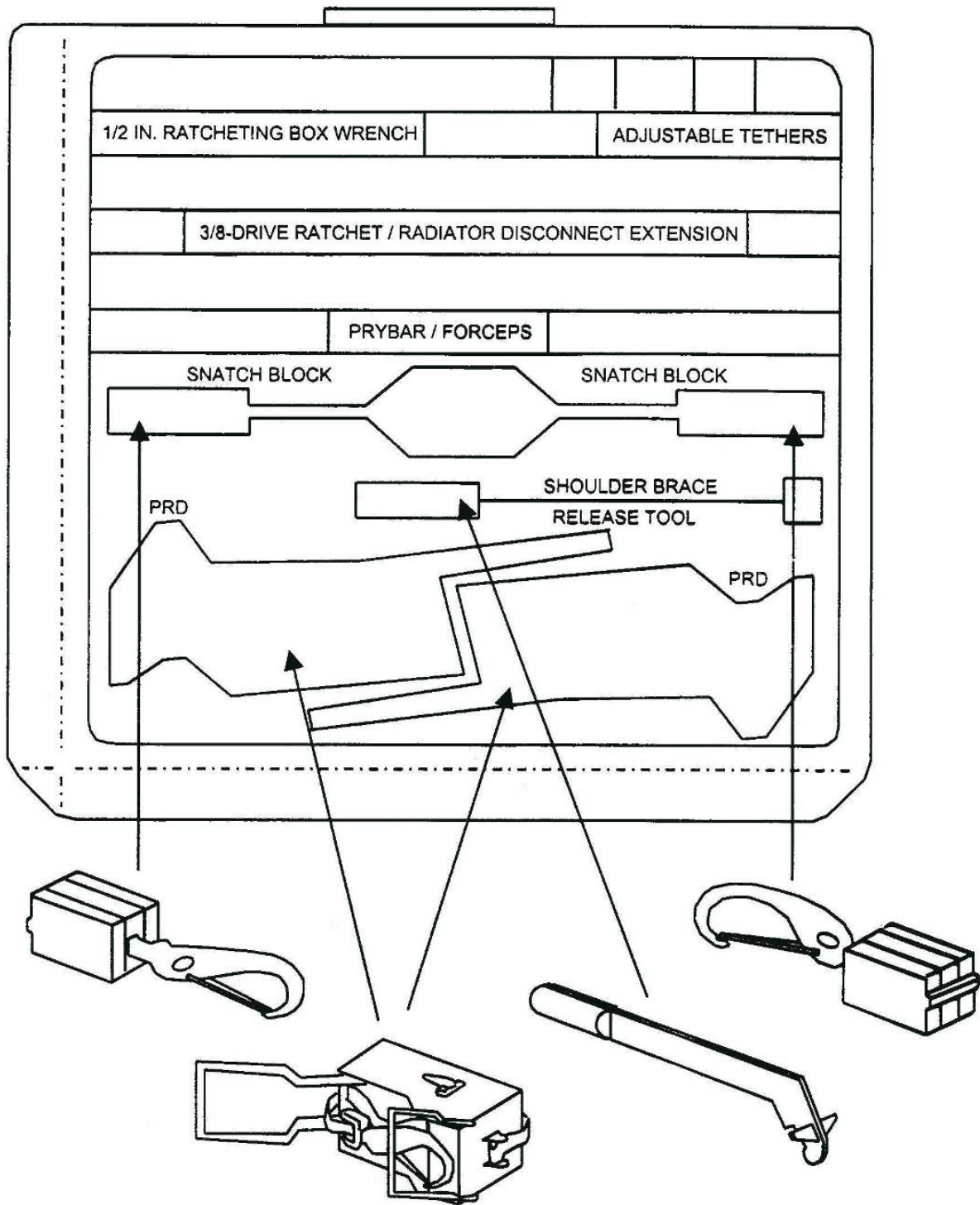

**PORT LIGHTWEIGHT TOOL STOWAGE ASSEMBLY (TSA) (Cont)**

RMS Rope Reel, PFR Attachment Device, and Push Button Articulating Socket



**PORT LIGHTWEIGHT TOOL STOWAGE ASSEMBLY (TSA) (Cont)**

Centerline and 3-Point Latch Tools



# STARBOARD LIGHTWEIGHT TOOL STOWAGE ASSEMBLY (TSA)



### SAFETY TETHERS – STS-129 (ULF3)

	55-ft tethers								
	#71 s/n 1021 Lg-sm (has retracting issues – AR written-2J/A) (2J/A saw kink in braided cable)	#73 s/n 1023 has retracting issues – ARs 1J, 2J/A) (2J/A saw kink in braided cable & noted brown smudges on the LAT)	#60 s/n 1008 Lg-sm (has retracting issues) (2J/A – LATs are pretty brown & may need inspection before use)	#70 s/n 1020 Lg-sm  (2J/A – LATs are pretty brown & may need inspection before use)	#66 s/n 1016 Sm-sm  2J/A noted brown smudges on the LAT-GO for EVA	#67 s/n 1017 Lg-sm	#68 s/n 1018 Lg-sm	#69 s/n 1019 Lg-sm	#72 s/n 1022 Lg-sm
17A Stage	<b>RETURNED: STS 128/17A</b>	<b>RETURNED: STS 128/17A</b>	<b>RETURNED: STS 128/17A</b>	<b>RETURNED: STS 128/17A</b>	<b>RETURNED: STS 128/17A</b>	INSIDE: tether staging area	INSIDE: tether staging area	INSIDE: tether staging area	INSIDE: tether staging area
Post EVA 1						INSIDE: tether staging area	INSIDE: tether staging area	INSIDE: tether staging area	INSIDE: tether staging area
Post EVA 2						INSIDE: tether staging area	INSIDE: tether staging area	INSIDE: tether staging area	INSIDE: tether staging area
Post EVA 3						INSIDE: tether staging area	INSIDE: tether staging area	INSIDE: tether staging area	INSIDE: tether staging area

**SAFETY TETHERS – STS-129 (ULF3) (Cont)**

<b>85-ft tethers</b>								
	#22 s/n 1002 Lg-sm  (2 J/A – retracting issue)	#28 s/n 1008 Lg-sm	#21 s/n 1001 Lg-sm	#24 s/n 1004 Lg-sm	#29 s/n 1009 Lg-sm	#30 s/n 1010 Lg-sm	#23 s/n 1003 (Shuttle safety tethers)	#26 s/n 1006 (Shuttle safety tethers)
17A Stage	INSIDE: tether staging area	INSIDE: tether staging area	INSIDE: tether staging area	INSIDE: tether staging area	<b>Arrives on STS 129/ULF3</b>	<b>STS-129/ULF3 Middeck</b>	<b>RETURNED: STS 128/17A</b>	<b>RETURNED: STS 128/17A</b>
Post EVA 1	INSIDE: tether staging area	INSIDE: tether staging area	INSIDE: tether staging area	INSIDE: tether staging area	INSIDE: tether staging area	<b>STS-129/ULF3 Middeck</b>		
Post EVA 2	INSIDE: tether staging area	INSIDE: tether staging area	INSIDE: tether staging area	INSIDE: tether staging area	INSIDE: tether staging area	<b>STS-129/ULF3 Middeck</b>		
Post EVA 3	INSIDE: tether staging area	<b>RETURNED: STS 129/ULF3</b>	INSIDE: tether staging area	INSIDE: tether staging area	INSIDE: tether staging area	<b>STS-129/ULF3 Middeck</b>		



## APFR MANAGEMENT – STS-129 (ULF3)

APFR DESIGNATOR	APFR 1 (8A, 13A.1 Pitch knob problem)	APFR 2 (US EVA 9 Pitch knob problem, 10A sticky locking collar)	APFR 3 s/n 1005 (no pitch knob prob 9A-inc12 suspected sharp edge on locking collar and possible sticky locking collar)	APFR 4 (TS, old ORU tether, heat shield)	APFR 5 (TS, old ORU tether, heat shield)	APFR 6 (heat shield removed on 12A.1 stage)	APFR 7 s/n 1008	IAPFR 1	IAPFR 2	CRANE (old ORU tether)	TS (from APFR 5)	TS	ORU stanchion/ TERA headless	OTSD
<b>Post STS-128</b>	P6 WIF 22 [12,QQ,C,1] Yaw & Roll Settings are Approximate	P1 WIF 3 [3,HH,G,6]	A/L WIF 10 [4,PP,F,12]	Z1 WIF 10 [3,LL,B,6] TS at 4 o'clock	PMA1 WIF 2 TS/HS [6,KK,F,12] Tool Head Zenith on Fwd side of APFR	S1 WIF 1 [10,TT,L,12]	P6 WIF 10 [12,GG,E,6] Ingress Aid	Z1 WIF 1 [12,PP,F,12]	Z1 WIF 3 [6,PP,F,12]	PMA1 WIF 5	TBD	S0 port wedge face	S0 port wedge face	S0 WIF 7 CL=7
<b>Post EVA 1</b>	P6 WIF 22 [12,QQ,C,1] Yaw & Roll Settings are Approximate	P1 WIF 3 [3,HH,G,6]	A/L WIF 10 [4,PP,F,12] Ingress Aid	Z1 WIF 10 [3,LL,B,6] TS at 4 o'clock	PMA1 WIF 2 TS/HS [6,KK,F,12]	Stbd CETA cart WIF 3 [9,PP,F,6] Ingress Aid	P6 WIF 10 [12,GG,E,6] Ingress Aid	Z1 WIF 1 [12,PP,F,12]	Z1 WIF 3 [6,PP,F,12]	PMA1 WIF 5	TBD	S0 port wedge face	S0 port wedge face	S0 WIF 7 CL=7
<b>Post EVA 2</b>	P6 WIF 22 [12,QQ,C,1] Yaw & Roll Settings are Approximate	P1 WIF 3 [3,HH,G,6]	A/L WIF 10 [4,PP,F,12] Ingress Aid	Z1 WIF 10 [3,LL,B,6] TS at 4 o'clock	PMA1 WIF 2 TS/HS [6,KK,F,12]	Stbd CETA cart WIF 3 [9,PP,F,6] Ingress Aid	P6 WIF 10 [12,GG,E,6] Ingress Aid	Z1 WIF 1 [12,PP,F,12]	Z1 WIF 3 [6,PP,F,12]	PMA1 WIF 5	TBD	S0 port wedge face	S0 port wedge face	S0 WIF 7 CL=7
<b>Post EVA 3</b>	P6 WIF 22 [12,QQ,C,1] Yaw & Roll Settings are Approximate	P1 WIF 3 [3,HH,G,6]	A/L WIF 10 [4,PP,F,12] Ingress Aid	Z1 WIF 10 [3,LL,B,6] TS at 4 o'clock	PMA1 WIF 2 TS/HS [6,KK,F,12]	Stbd CETA cart WIF 1 [6,OO,E,6] Ingress Aid	P6 WIF 10 [12,GG,E,6] Ingress Aid	Z1 WIF 1 [12,PP,F,12]	Z1 WIF 3 [6,PP,F,12]	PMA1 WIF 5	TBD	S0 port wedge face	S0 port wedge face	S0 WIF 7 CL=7
<b>Get-ahead</b>		A/L WIF 9 [12,PP,F,12]	Lab WIF 4 [1,RR,F,12] Ingress Aid toward LAB (not against boot plate)											

## TOOLBOX STOWAGE – STS-129 (ULF3)

	Z1 PORT TOOLBOX (MMOD Damage – potential sharp edges) {all slots have sliders}	Z1 STBD TOOLBOX (MMOD Damage – potential sharp edges) {all slots have sliders}	A/L TOOLBOX 1 (STBD)	A/L TOOLBOX 2 (PORT)
<b>SLOT # 1</b>	SQUARE TM BOARD {stbd door} SQ TORQUE MULTIPLIER 7/16" FLUSH SQ SOCKET 7/16" PROUD SQ SOCKET 7/16" RECESSED SQ SOCKET	SQUARE TM BOARD {stbd door} 7/16" FLUSH SQ SOCKET 7/16" PROUD SQ SOCKET	HAMMER BOARD {nadir door}	CABLE CUTTER BOARD COMPOUND CUTTERS (SM) SCISSORS {zenith door}
<b>SLOT # 2</b>		QD BAIL TOOL BOARD {stbd door} BMRRM LATCH TOOL QD BAIL DRIVE TOOL (1")	PLIERS BOARD {nadir door} NEEDLE NOSE PLIERS	
<b>SLOT # 3</b>	RATCHET BOARD {middle} 7/16" X 12" WOBBLE SOCKET 7/16" X 2" RIGID SOCKET	RATCHET BOARD {middle} 7/16" X 6" WOBBLE SOCKET	{only slot with slider}	{only slot with slider}
<b>SLOT # 4</b>				
<b>SLOT # 5</b>	ROUND TM BOARD {port door} RND TORQUE MULTIPLIER 5/8" PROUD RND SOCKET 7/16" FLUSH RND SOCKET 7/16" PROUD RND SOCKET		ADJ WRENCH BOARD FORCEPS WRENCH, ADJ {zenith door}	T-HANDLE TOOL BOARD 1-8" T-TOOLS {nadir door}
<b>SLOT # 6</b>	TRASH BAG BOARD {stbd door} SMALL TRASH BAG	TRASH BAG BOARD {stbd door}	HYDRAZINE BRUSH BOARD HYDRAZINE BRUSH {nadir door}	
<b>SLOT # 7</b>	SOCKET BOARD {port door} 5/32" BALL END ALLEN DR 1/2" X 8" WOBBLE SOCKET 5/16" X 7" RIGID SOCKET	SOCKET BOARD {port door} 5/32" BALL END ALLEN DR 1/2" X 8" WOBBLE SOCKET 5/16" X 7" RIGID SOCKET	PRD (Toolboard) {zenith door} PRD	PRD (Toolboard) {nadir door} PRD
<b>PANEL # 8</b>	CHEATER BAR PANEL {stbd door}	CHEATER BAR PANEL {stbd door} ADJ EQUIP TETHER	TOOL CADDY PANEL {nadir door}	
<b>PANEL # 9</b>	18" SOCKET PANEL {port door} 7/16" X 18" WOBBLE SOCKET	18" SOCKET PANEL {port door}	BOLT PULLER PANEL BOLT PULLER MECHANICAL FINGER {zenith door}	LARGE CUTTER PANEL {nadir door} Large Cutters (-303)
<b>EXTERNAL</b>	1 ROUND SCOOP w/D-HANDLE (on zenith micro) (D-handle taped over repaired MMOD damage) D-HANDLE on port side of toolbox	<u>NOTE</u> D-Handle will not stow on the side of this toolbox due to an interference with the CMG MLI		

## TOOLBOX PANEL AND SLOT LABELS

### NOTE

- A/L Toolbox: Slider feature located in center slot only (#3)
- Z1/CETA Toolbox: Slider feature located in all slots

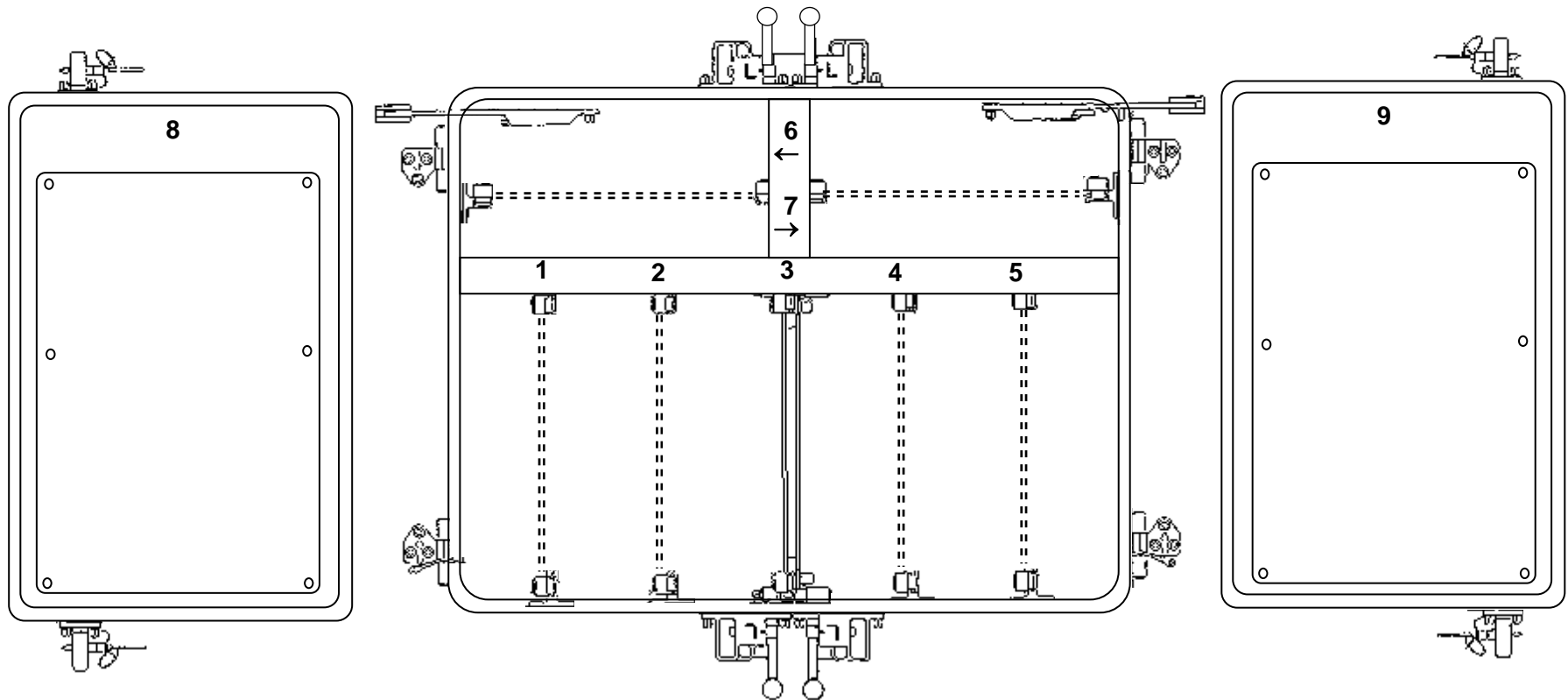

# Z1 TOOLBOX INTERNAL LAYOUT

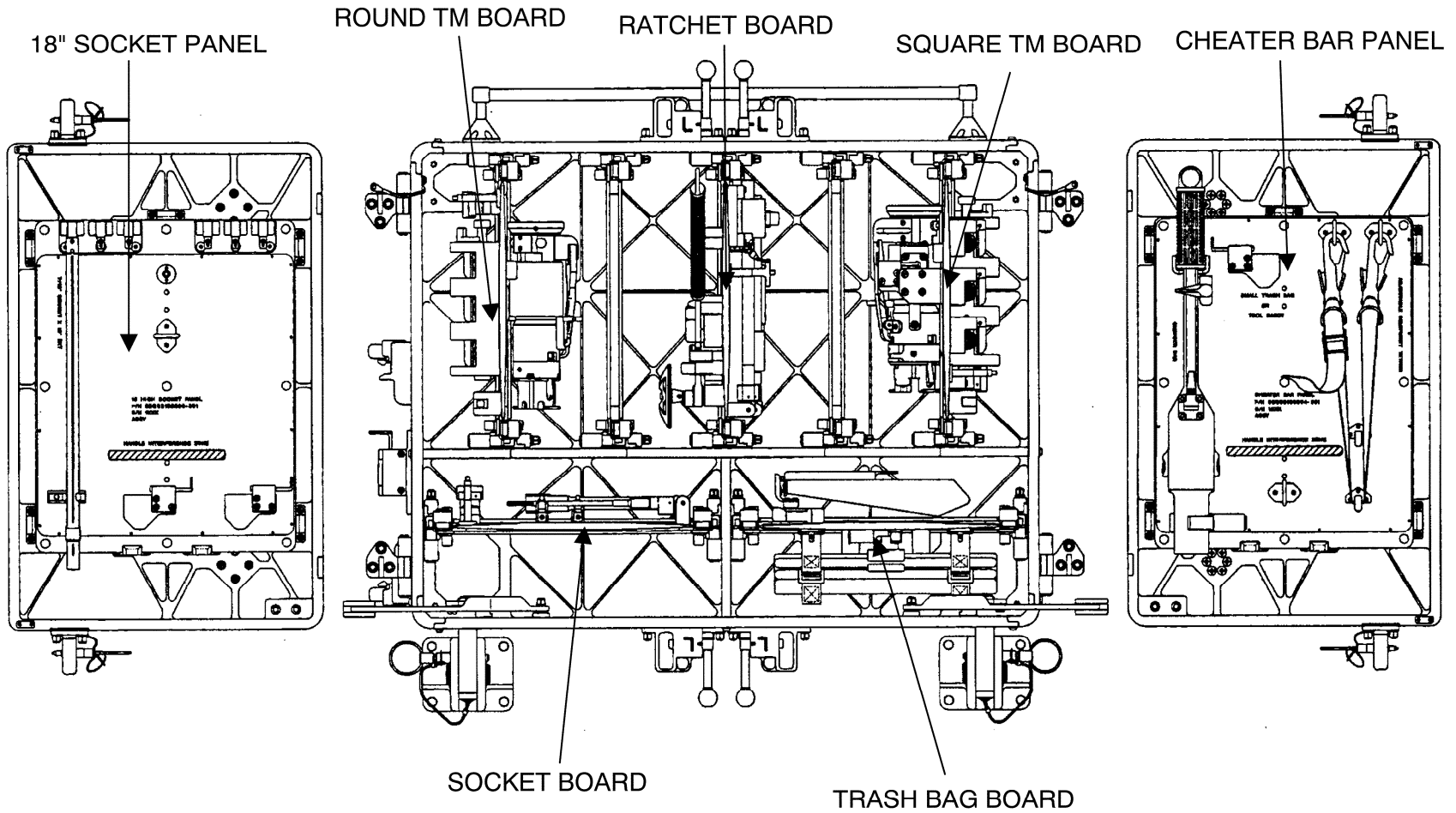

DOORS SHOWN REMOVED AND ROTATED 180°  
FROM CLOSED POSITION FOR CLARITY.

# AIRLOCK TOOLBOX INTERNAL LAYOUT

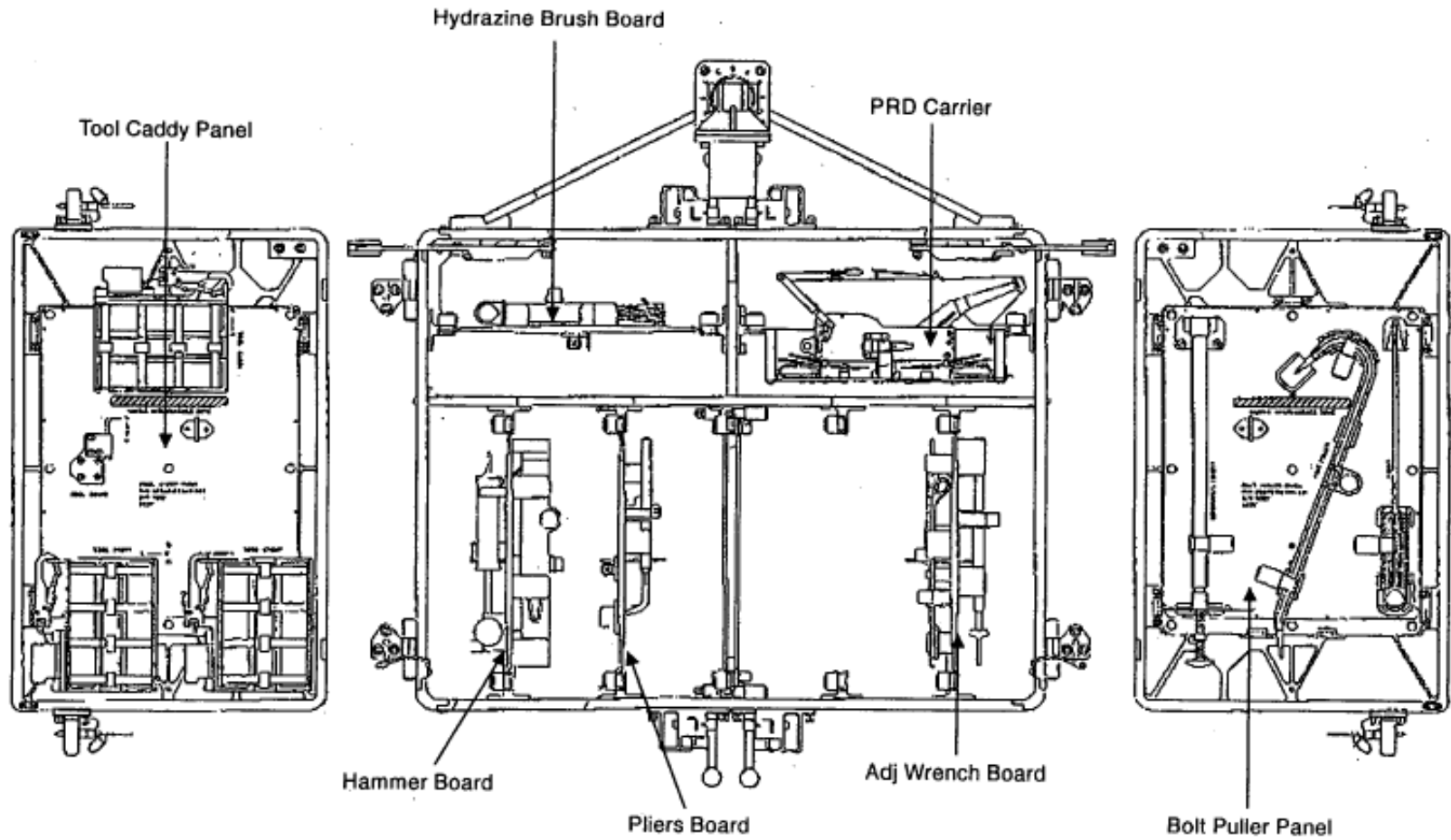

## APFR THERMAL SHIELD REMOVAL

1. Retrieve the following:
  - APFR
  - Dry Wipes
  - Ziplock Bag
  - Sharpie
  - Driver Handle, 3/8-in Drive – Drawer 2
  - #8 Long Torq Driver, 3/8-in Drive – Drawer 3

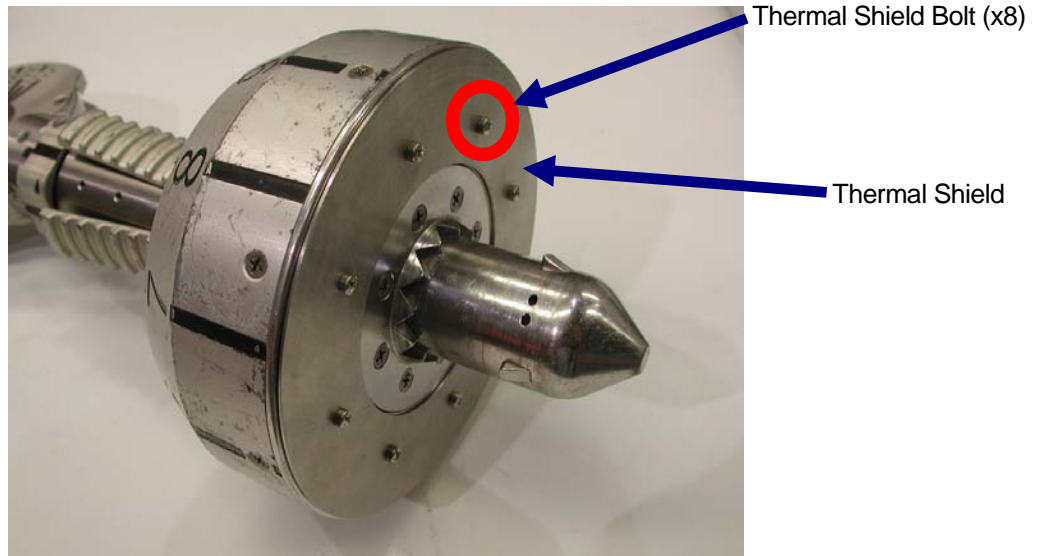

Figure 1.- Thermal Shield Location on APFR.

2. Remove APFR thermal shield non-captive screws (eight) (Driver, Handle, 3/8-in Drive; #8 Long Torq Driver, 3/8-in Drive). Expect a breaking torque of 10-30 in-lb  
Refer to figure 1  
Stow screws in Ziplock Bag

**CAUTION**

Do not pry Thermal Shield off, damage could occur

3. Remove Thermal Shield; light tapping applied from side of Thermal Shield may be required (Driver Handle, 3/8-in Drive, blunt end)  
Temp stow thermal shield in Ziplock Bag
4. Inspect bottom of APFR Load Limiter for sharp edges
5. Wipe off Vibratite from bottom of Load Limiter (Dry Wipes). Vibratite may not come completely off; it is not essential to remove all residue
6. Label Ziplock Bag "ULF3 APFR Thermal Shield, GMT 2009/XXX" and stow (Sharpie)

## GREASE GUN PREP

### OBJECTIVE:

Load a grease gun for use on STS-129/ULF3

### DURATION:

30 minutes

### PARTS:

Straight Nozzle Gun (Grease)  
Grease Cartridge  
EVA Wipe  
EVA Wire Tie (short)

### MATERIALS:

Dry towel  
Nitrile gloves  
Ziplock bag

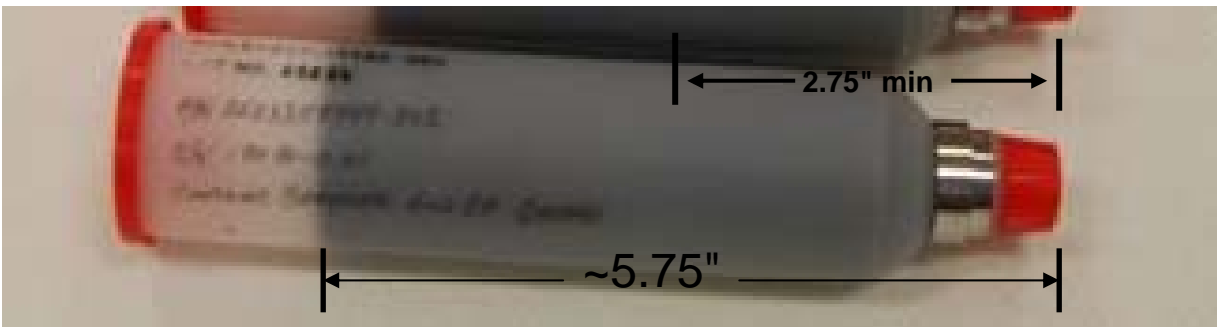

Figure 1.- Grease Gun Measurement (Full Cartridge shown).

1. Retrieve grease cartridges
2. Measure grease in a cartridge. Minimum of 2.75" of grease needed. [Measured from red tip cap to end of grease]. Refer to figure 1 for measurement location
3. Retrieve
  - a. Dry towel
  - b. Ziplock bag
  - c. Nitrile gloves
4. Verify plunger disengaged (black triangle down)
5. Verify valve closed (shutoff knob perpendicular to nozzle)
6. Remove MLI cover from grease gun
7. Fully retract plunger
8. Remove nozzle/shutoff valve, temp stow in Ziplock
9. Remove red flange cap from grease cartridge; stow in Ziplock
10. Install grease cartridge into grease cartridge housing, leaving red tip cap on cartridge
11. Screw trigger assembly onto grease gun housing (cw at least 1.5 turns)
12. Verify plunger disengaged (black triangle down)
13. Remove red tip cap (ccw, use Allen wrench if reqd from NOD1D4\_G2 in Drawer 4); stow in Ziplock
14. Retrieve nozzle/shutoff valve from Ziplock
15. Install nozzle/shutoff valve (cw), attempt to install so nozzle is straight vertical on grease gun
16. Verify valve closed (shutoff knob perpendicular to nozzle)

## GREASE GUN PREP (Cont)

17. Install MLI cover on grease gun
18. Install MLI tip cover



Good Config

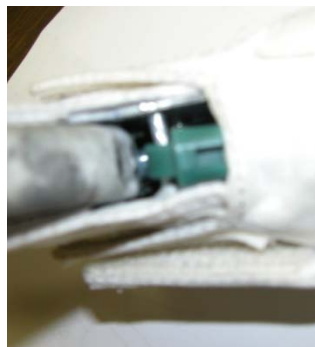

Bad Config (too much zip tie visible)

Figure 2.- Zip-tie Configuration.

19. Verify zip tie not visible (MLI should cover zip tie head). Refer to figure 2
20. Prime grease gun by disengaging plunger and gently pushing fwd on back of triangle until resistance met
21. Secure EVA Wipe over nozzle with wire tie aft of shutoff valve to secure valve in off position
22. Stow towel (if used) in Ziplock
23. If not already completed, configure Green Mesh Bag (label "ISS Temp Stow")
24. Stow Ziplock in "ISS Temp Stow" Mesh Bag
25. Stow grease gun in Crewlock Bag "Lube Bag"



## GREASE GUN CLEANUP

### PARTS:

Straight Nozzle Gun (Grease)  
Grease Cartridge Ziplock  
EVA Wipe  
Ziplock w/Red Grease Cartridge Caps

### MATERIALS:

Dry towel  
Nitrile gloves  
Ziplock bags

1. Retrieve the following hardware:
  - a. Dry towel
  - b. Ziplock bags (2); label Ziplock bags "Trash" and "ISS"
  - c. Nitrile gloves
  - d. Grease Cartridge Ziplock
2. Don Nitrile gloves
3. Retrieve Ziplock bag w/grease gun cartridge caps
4. Retrieve EVA wipes
5. Stow used wipes in Ziplock "Trash" and stow clean wipes in SARJ Hardware, 3.0 CTB 1061
6. Verify plunger disengaged (black triangle down)
7. Verify valve closed (shutoff knob perpendicular to nozzle)
8. Remove MLI cover from grease gun
9. Fully extend plunger
10. Remove nozzle/shutoff valve from used cartridge (ccw); note valve will be full of grease
11. Wipe any excess grease around nozzle using towel; stow towel in Ziplock "Trash"
12. Temp stow nozzle/shutoff valve in Ziplock "ISS"
13. Unscrew grease cartridge housing from trigger assembly (ccw)
14. Remove used cartridge from grease gun housing
15. Attach red caps to used grease cartridge
16. Estimate if cartridge is > 1/4 full (~1.5" of grease)

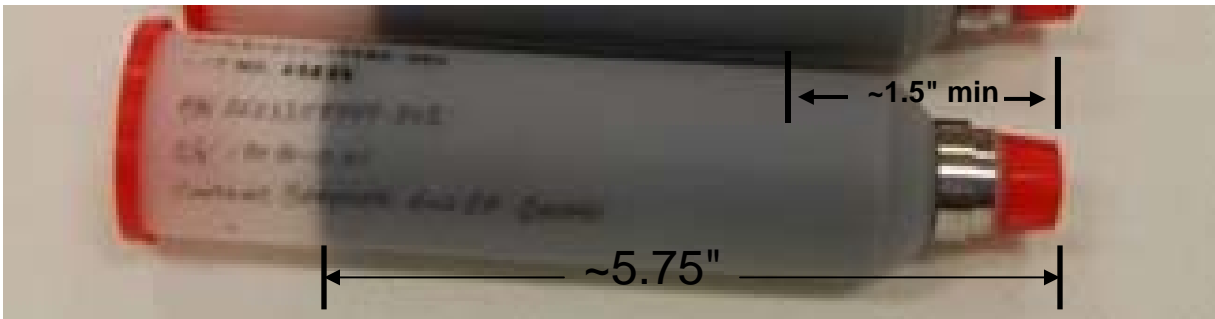

Figure 1.- Grease Cartridge Measurement (Full Cartridge Shown).

17. Stow used grease cartridge in Ziplock "Trash" if < 1/4 full, and in Ziplock with other cartridges if > 1/4 full
18. Screw trigger assembly onto grease gun housing
19. Install MLI cover on grease gun
20. Install MLI tip cover
21. Stow grease gun in Ziplock "ISS"
22. Doff Nitrile gloves; stow in Ziplock "Trash"
23. Inform MCC-H: Number of wipes, towels, and grease cartridges in "Trash" Ziplock
24. Stow Ziplock "Trash" in dry trash
25. Stow Ziplock "ISS" and grease cartridge Ziplock in SARJ Hardware, 3.0 CTB 1061

This Page Intentionally Blank

EMU MAINT/RECHARGE

WATER RECHARGE.....	TEMP FS 10-2
EMU POWERUP.....	TEMP FS 10-2
WATER FILL.....	TEMP FS 10-2
WATER FILL VERIFICATION.....	TEMP FS 10-2
EMU LiOH CHANGEOUT.....	10-4
MIDDECK EMU BATTERY RECHARGE (STAND-ALONE).....	10-4a
MIDDECK EMU BATTERY RECHARGE/LiOH REPLACEMENT.....	10-5
INITIATE.....	10-5
TERMINATE.....	10-6
IN-SUIT EMU BATTERY RECHARGE/CHARGE VERIFICATION.....	10-7
INITIATE.....	10-7
TERMINATE.....	10-7
EMU POWERDOWN.....	10-7
HELMET LIGHT/PGT BATTERY RECHARGE.....	10-8
INITIATE.....	10-8
TERMINATE.....	10-9
REBA BATTERY INSTALLATION.....	10-9
EMU BATTERY REMOVAL/INSTALL.....	10-10
HELMET LIGHT BULB CHANGEOUT.....	10-11
REBA BATTERY RECHARGE.....	10-12
INITIATE.....	10-12
TERMINATE.....	10-13
STS-129 CONSUMABLES TRACKING CUE CARD.....	FS CC 10-15
STS-129 EVA BATTERY RECHARGE PLAN.....	FS CC 10-16

## WATER RECHARGE

### IF EMU NOT ALREADY POWERED UP:

#### EMU POWERUP

- BOTH DCM 1. Retrieve, position SCUs; remove DCM covers  
 2. Connect SCUs to DCM, √locked  
 3. PWR – BATT

#### CAUTION

EMU must be on BATT pwr when  
 airlock pwr supply is turned on

- AW18H 4. PWR/BATT CHGR EMU 1,2 MODE (two) – PWR  
 BUS SEL (two) – MNA(MNB)  
 MD(flir) 5. √EMU O2 ISOL VLV – OP  
 AW82B 6. EV1,2 O2 vlv (two) – OP  
 DCM 7. PWR – SCU

#### WATER FILL

- MO13Q 8. √ARLK H2O S/O VLV – OPEN (tb-OP)  
 R11L 9. √SPLY H2O TKA OUTLET – CL (tb-CL)

#### SM 60 TABLE MAINT

- CRT 10. Use TKB quantity:  
 PARAM ID – ITEM 1 +0 6 2 0 4 2 0 EXEC  
 11. Log value before recharge

Recharge #	H2O TKB %
1	
2	
3	
4	
5	

- AW82D 12. √EMU 1,2 H2O WASTE tb (two) – CL  
 SPLY (two) – OP (tb-OP)  
 13. √H2O TKB quantity decreasing

#### NOTE

Full charge requires ~15 min

#### WATER FILL VERIFICATION

- DCM 14. √STATUS: **H2O WP** 8-15 psi and stable for ~30 sec (indicates charging complete)

#### SM 60 TABLE MAINT

- CRT 15. Use TKB quantity:  
 PARAM ID – ITEM 1 +0 6 2 0 4 2 0 EXEC  
 16. Log value after recharge

Recharge #	H2O TKB %
1	
2	
3	
4	
5	

EMU MAINT/  
 RECHARGE

Cont next page

TEMP FS 10-2

TOP

**HOOK  
VELCRO**

**STS-129 CONSUMABLES TRACKING CUE CARD**

		EVA 1	EVA 2	EVA 3
<b>METOX for Campout &amp; 10.2 Ops</b>	<b>Serial Numbers</b>	07 & 11	15 & 16	19 & 20

**PWR Usage:** Use 1007, 1026, in that order until drained

**Dump CWC:** 5096 from MF71M

	EV	EMU	LiOH (s/n)	Metox (s/n)	EMU Batt (s/n)	REBA (s/n)	EHIP (HL) Batts (s/n)	ERCA (address)	SAFER (s/n)	PGT Batt (s/n)	PGT Batt Spare (s/n)
<b>EVA 1</b>	EV1 FM	3018	s/n 20__	N/A	2085	1006	1022 1025	16	1006	1005	1008
	EV2 SA	3010	s/n 20__	N/A	2084	1008	1026 1028	18	1003	1006	
<b>Battery Post EVA</b>						X	X			X	X
<b>Battery Day After</b>					X						
<b>EVA 2</b>	EV1 FM	3018	s/n 20__	N/A	2080	1006	1029 1030	16	1006	1004	1008
	EV3 BR	3006	s/n 20__	N/A	2083	1009	1031 1035	18	1003	1009	
<b>Battery Post EVA</b>						X	X			X	X
<b>EVA 3</b>	EV2 SA	3010	s/n 20__	N/A	2079	1008	1022 1025	16	1006	1005	1008
	EV3 BR	3006	s/n 20__	N/A	2084	1009	1026 1028	18	1003	1006	
<b>Return Config</b>	EV1 FM	3011	s/n 20__	N/A	2082	N/A	N/A	N/A	N/A	N/A	N/A
	EV2 SA	3006	s/n 2019	N/A	2081	N/A	N/A	N/A	N/A	N/A	N/A

EVA-5a/129/O/X

(reduced copy)

FS CC 10-15

EVA/129/FIN X

TOP  
BACK OF 'STS-129 CONSUMABLES TRACKING CUE CARD'

HOOK  
VELCRO

STS-129 EVA BATTERY RECHARGE PLAN

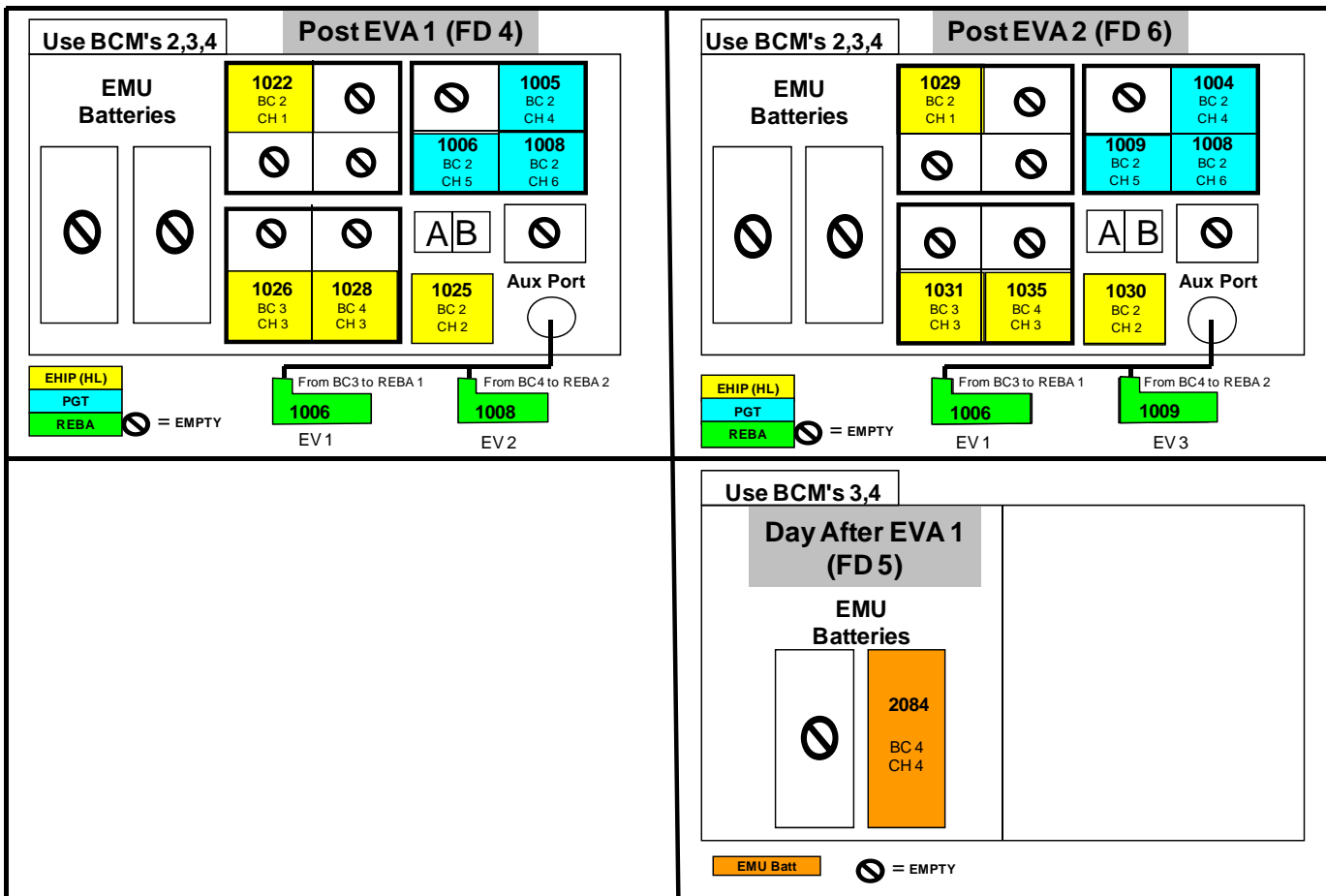

EVA-5b/129/O/X

(reduced copy)

EMU CONTINGENCY PROCS

DISPLAY LOSS DURING POWER TRANSFER (WARM RESTART).....	TEMP FS	12-2
VACUUM H2O RECHARGE (MANNED).....	TEMP FS	12-2
LiOH REPLACEMENT (MANNED).....		12-3
BATTERY REPLACEMENT (MANNED) .....		12-4
WATER DUMP .....		12-6
SCU SWAP (UNMANNED).....		12-7
SCU SWAP (MANNED).....		12-7
EMU COLD RESTART (MANNED) .....		12-7
12.1 STS EVA DECONTAMINATION.....		12-8
CONTAMINATION TEST.....		12-15
SAFER BATTERY CHANGEOUT .....		12-18
BENDS TREATMENT ADAPTER (BTA) INSTALLATION (IN-SUIT) .....		12-19
BTA PREP .....		12-19
BTA TREATMENT .....		12-19
BENDS TREATMENT ADAPTER (BTA) INSTALLATION (POST SUIT DOFFING) .....		12-21
BTA PREP .....		12-21
BTA TREATMENT .....		12-21
EMU RESIZE .....		12-24
STS-129 NOMINAL EMU SIZING .....	FS	12-27
EMU CONTINGENCY RESIZE MATRIX (STS-129/ULF3) .....	FS	12-29
EXPEDITED SUIT DOFFING CUE CARD .....	FS CC	12-30
EMERGENCY UNDOCKING EVA TRANSFER .....	FS CC	12-31

**DISPLAY LOSS DURING POWER TRANSFER (WARM RESTART)**

- DCM If PWR – BATT and SCU connected:
- AW18H 1. √PWR/BATT CHGR EMU 1(2) BUS SEL – OFF
- DCM If PWR – SCU:
- 2. PWR – BATT
- AW18H 3. PWR/BATT CHGR EMU 1(2) BUS SEL – OFF

WARNING  
Fan will be off from steps 4 to 9 during which time CO2 buildup is a concern

NOTE

Affected EMU will be without comm after step 6. Steps 6 and 7 should be read together before step 6 is performed

- DCM 4. FAN – OFF (expect FAN SW OFF msg, DISP – PRO)
- IV 5. Inform affected EV crewmember of impending comm loss
- DCM 6. PWR – SCU (7 sec)
- 7. PWR – BATT
- When power restart complete:
- 8. √Display – O2 POS XX, expect FAN SW OFF msg, DISP – PRO
- 9. As reqd, FAN – ON
- If display blank or locked up:
- 10. Contact MCC
- If SCU power desired:
- 11. √SCU connected to DCM
- AW18H 12. PWR/BATT CHGR EMU 1(2) MODE – PWR  
BUS SEL – MNA(MNB)
- 13. √EMU INPUT 1(2) Volts = 18.0 – 20.0
- DCM 14. PWR – SCU
- DCM 15. √Display – O2 POS XX

**VACUUM H2O RECHARGE (MANNED)**

WARNING  
Procedure should be used only if performing a contingency EVA

- EV 1. Perform AIRLOCK INGRESS, Cuff C/L, 30 (Close hatch, partially engage latches)
- 2. √Helmet purge vlv – cl, locked
- DCM 3. √PURGE vlv – cl (dn)
- 4. √WATER – OFF
- IV MO13Q 5. √ARLK H2O S/O VLV – OPEN (tb-OP)
- MD(flr) 6. √EMU O2 ISOL VLV – OP
- ML86B:C 7. √cb MNC EXT ARLK HTR LINE ZN 1,2 (two) – op
- AW82B 8. √EV-1(EV-2) O2 vlv – OP
- EV AW18H 9. PWR/BATT CHGR EMU 1(2) BUS SEL – MNA(MNB)
- DCM 10. PWR – SCU (fwd), WARN TONE
- IV R11L If SPLY H2O XOVR VLV closed (tb-CL or bp) (water transfer config):
- 11. SPLY H2O TKA OUTLET – CL (tb-CL)
- If SPLY H2O XOVR VLV open (tb-OP) (nominal config):
- L1 12. √RAD CNTLR OUT TEMP – NORM
- 13. √FLASH EVAP CNTLR PRI A,B (two) – OFF
- ML31C 14. SPLY H2O TKD OUTLET – CL (tb-CL)
- R11L 15. SPLY H2O TKB OUTLET – CL (tb-CL)
- √TKA OUTLET – CL (tb-CL)
- TKC INLET – CL (tb-CL)
- TKC OUTLET – OP (tb-OP)



# STS-129 NOMINAL EMU SIZING

## Foreman (FM) – Up

## Foreman (FM) – Dn

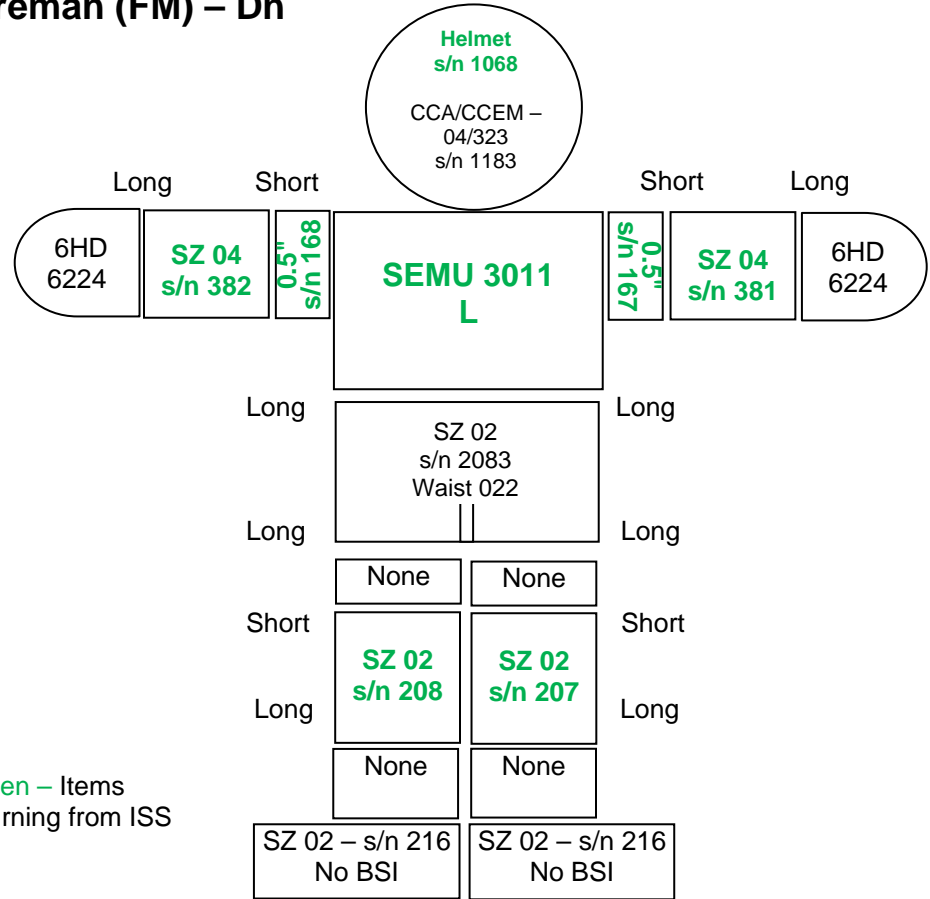
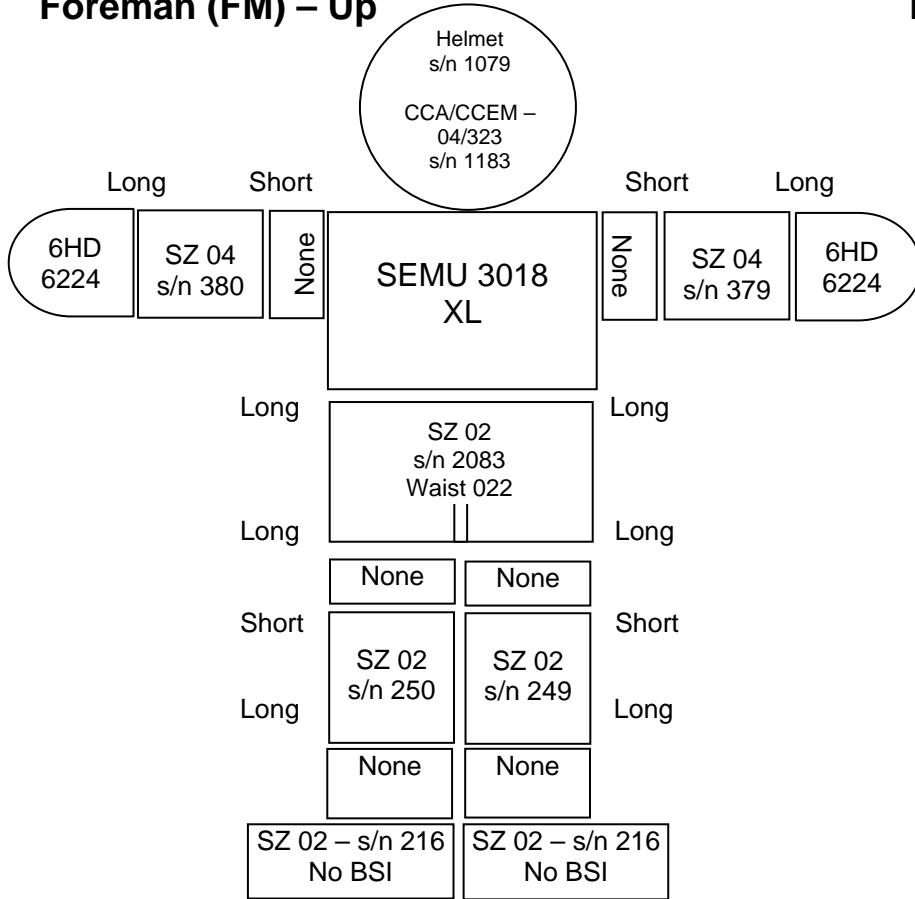

	Croakie	Fresnel	Valsalva	LCVG/BLVD	MAG	TCU Top	TCU Bottom	Comfort Gloves	Socks
FM	None	None	-309	06/05	711	L	L	Spectra	Poly Liner (L)

**STS-129 NOMINAL EMU SIZING (Cont)**

**Satcher (SA)**

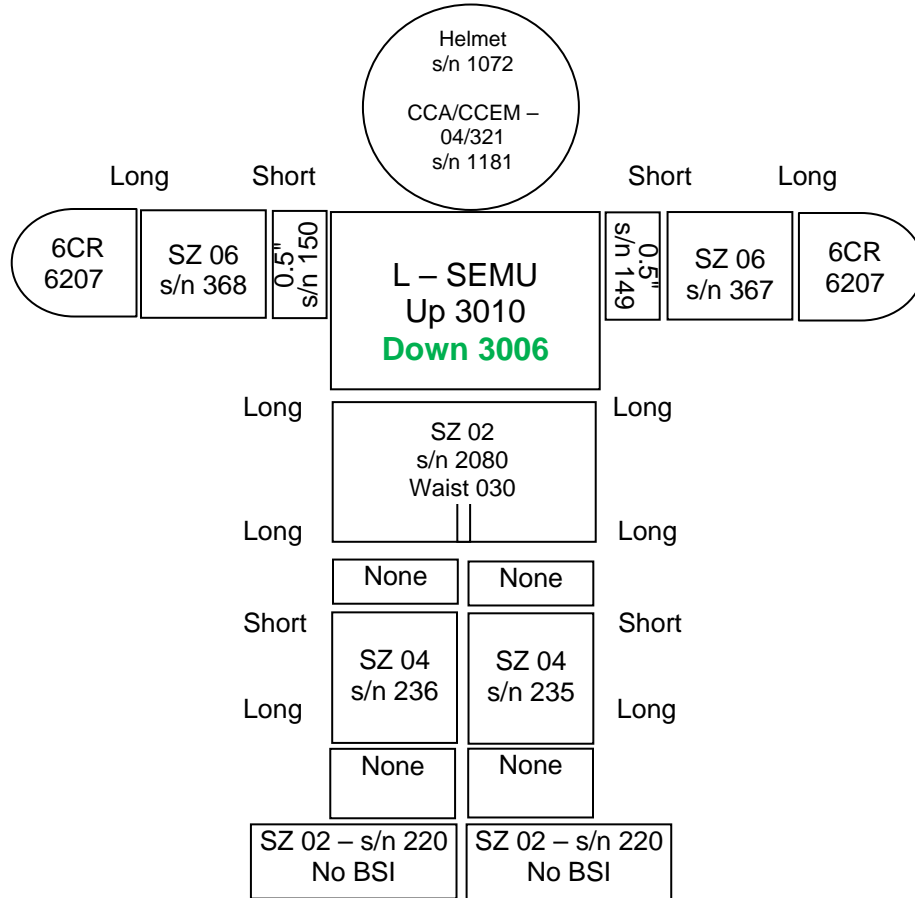

**Bresnik (BR)**

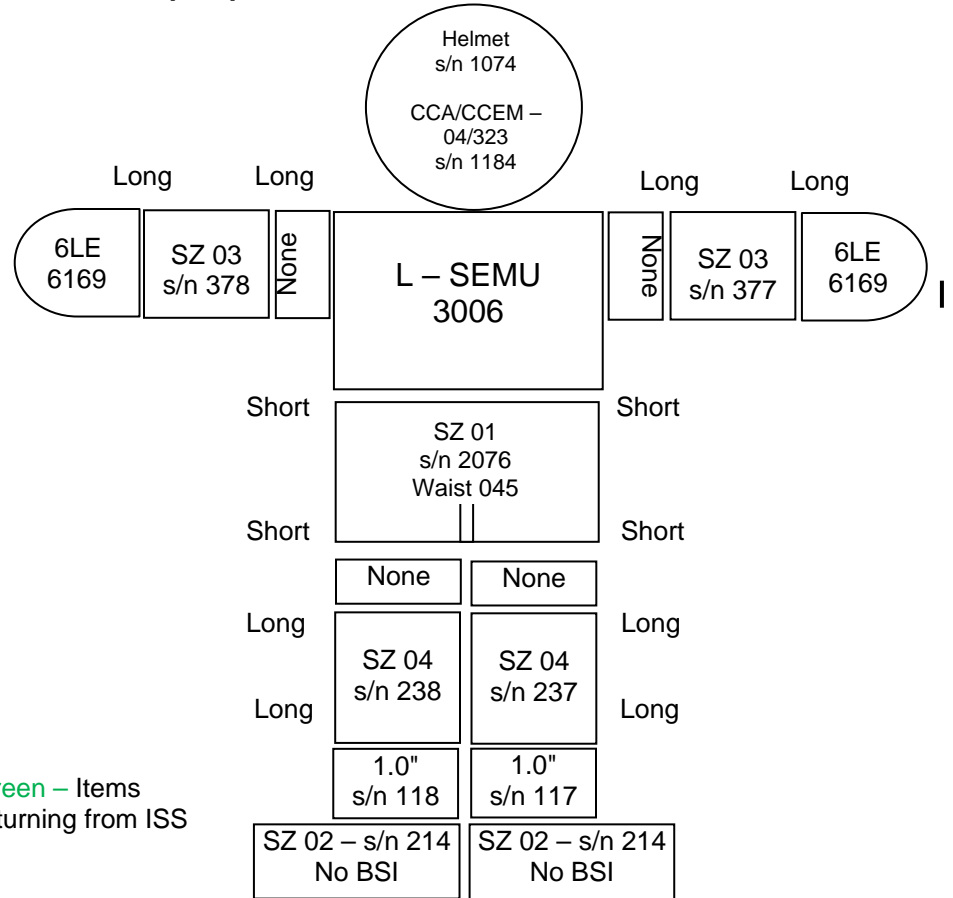

Green – Items returning from ISS

	Croakie	Fresnel	Valsalva	LCVG/BLVD	MAG	TCU Top	TCU Bottom	Comfort Gloves	Socks
<b>SA</b>	None	None	-308	06/06	711	XXL	L	Custom NG	Poly Liner (XL)
<b>BR</b>	None	None	-309	04/07	709	M	M	Custom & Spectra	Tube & Poly Liner (L)

## EMU CONTINGENCY RESIZE MATRIX (STS-129/ULF3)

FOR LOSS OF:	EV1 – Foreman	EV2 – Satcher	EV3 – Bresnik
<b>HUT/PLSS</b>	Use EMU 3011, Large 1. Remove arm assys/gloves 2. Install 0.5 arm sizing rings, s/n 167/168 3. Use primary arms, Fm gloves 4. √Arm red connects to right, √locks, √cams 5. Use primary LTA 6. Swap EMU PLSS identifier stripes, national flag 7. Swap helmet, CCA, LiOH, EMU battery, REBA, DIDB	Use EMU 3011, Large 1. Remove rings/arm assys/gloves 2. Use primary rings, arms, Sa gloves 3. √Arm red connects to right, √locks, √cams 4. Use primary LTA 5. Swap EMU PLSS identifier stripes, national flag 6. Swap helmet, CCA, LiOH, EMU battery, REBA, DIDB	Use EMU 3011, Large 1. Remove rings/arm assys/gloves 2. Use primary rings, arms, Br gloves 3. √Arm red connects to right, √locks 4. Use primary LTA 5. Swap EMU PLSS identifier stripes, national flag 6. Swap helmet, CCA, LiOH, EMU battery, REBA, DIDB
<b>CCA</b>	Use size 04/323 FM2 s/n 1182 EVA1,2 – Location FM ECOK EVA3 – SA ECOK	Use size 04/323 FM02 s/n 1182 EVA1,2 – Location FM ECOK EVA3 – SA ECOK	Use size 04/323 FM02 s/n 1182 EVA1,2 – Location FM ECOK EVA3 – SA ECOK
<b>Lower Arm Segment</b>	Use size 04 arm s/n 347/348 from ISS. Cams S/L (red = right, blue = left) 1. √Locks, √cams <ul style="list-style-type: none"> <li>• If use both, cams need to be L/L</li> <li>• If use single, cams kept S/L</li> </ul>	Use size 06 arm s/n 369/370 from shuttle. Cams S/L (red = right, blue = left) 1. √Locks, √cams	Use size 03 arm s/n 421/422 from shuttle. Cams L/L (red = right, blue = left) 1. √Locks, √cams
<b>Gloves</b>	Back-up (FM2): Use 6HD gloves s/n 6280	Back-up (SA2): 1. Use 6CR gloves s/n 6187 2. Cams L/L	Back-up (BR2): 1. Use 6LE gloves s/n 6179 2. Cams S/L
<b>Waist Brief</b>	Use size 02 waist brief s/n 2074 (031) from ISS. Cams L/L 1. Use FR prime legs, and boots 2. √Locks, √cams 3. Swap EMU brief identifier stripes	Use size 02 waist brief s/n 2074 (031) from ISS. Cams L/L 1. Use prime SA legs and boots 2. √Locks, √cams 3. Swap EMU brief identifier stripes	Use size 01 waist brief s/n 2075 (029) from ISS. Cams S/S 1. Use prime BR legs, rings, and boots 2. √Locks, √cams 3. Swap EMU brief identifier stripes
<b>Leg Segment</b>	Use size 02 leg from ISS s/n 215. Cams S/L 1. √Locks, √cams	Use size 04 leg from ISS s/n 212. Cams S/L 1. √Locks, √cams	Use size 04 leg from ISS s/n 212. Cams S/L 1. √Locks, √cams
<b>Boot</b>	Use size 02 boots s/n 227 from ISS 1. No BSI 2. √Locks	Use size 02 boots s/n 227 from ISS 1. No BSI 2. √Locks	Use size 02 boots s/n 227 from ISS 1. No BSI 2. √Locks
<b>Sizing Rings</b>	• N/A	• 0.5" Arm: Use s/n 145 or 146 from ISS	• 1.0" Leg: Use s/n 144 or 145 from ISS
<b>Signal Conditioner</b>	Use s/n 101 from Servicing Kit s/n 5004 (Yellow Tag)	Use s/n 112 from OBS Kit on shuttle	Use s/n 101 from Servicing Kit s/n 5004 (Yellow Tag)
<b>LCVG</b>	Use s/n 3224 (FM B/U) on shuttle, filled 1. Transfer biomed, dosimeter	Use s/n 3230 (SA/BR B/U) on shuttle, filled 1. Transfer biomed, dosimeter 2. Remove ¼" mosite heel pads	Use s/n 3230 (SA/BR B/U) on shuttle, filled 1. Transfer biomed, signal conditioner, and dosimeter <b>NOTE:</b> Keep all pads

TOP

HOOK  
VELCRO

## EXPEDITED SUIT DOFFING CUE CARD

### CAUTION

Verify EV crew is clear of hatch mechanism

- IV                    When equalization complete:  
1. Open IV Hatch per decal
- DCM                    SUIT DOFFING  
2. O2 ACT → OFF  
3. PURGE vlv → op (up)  
4. sw REBA → OFF (toward left arm of suit)  
5. EMU TV Power Cable ←|→ EMU TV  
6. √STATUS: **SUIT P** < 0.4 (compare with gauge)  
7. Glove ←|→ EMU (leave donned, disconnected)  
8. Helmet ←|→ EMU
- DCM                    9. sw FAN → OFF
- SAFER                    SAFER DOFFING  
10. Latch → ENG  
11. Latch ↷ until release (~90 deg)  
12. PLSS ←|→ Thruster Towers
- PLSS                    SUIT DOFFING (Cont)  
13. Engage EMU in EDDA  
14. Lower Arm Cables ←|→ Gloves  
15. Gloves ←|→ EMU  
16. Comm Mode → OFF  
17. Doff EMU
- UIA                    If taking EMUs to shuttle:  
18. sw PWR EV-1,2 (two) → OFF  
    √PWR EV-1,2 LEDs (four) – Off
- DCM                    19. SCU ←|→ DCM  
20. LTA →|← HUT  
21. Gloves →|← EMU  
22. Helmet →|← EMU  
23. Go to **EMERGENCY UNDOCKING CUE CARD**  
    on reverse side

EVA-6a/129/O/A

TOP  
BACK OF 'EXPEDITED SUIT DOFFING CUE CARD'

HOOK  
VELCRO

## EMERGENCY UNDOCKING EVA TRANSFER

### Critical

- EMUs (FM & SA)
  - *Remove: Helmet Lights, TV, REBA, ISS Tethers, and Tools*
- CCAs (FM & SA)
- Gloves (FM & SA)
- LCVG (FM & SA)
- EMU Batteries (2), (s/n 2081 & 2082, preferred)
- 85' Safety Tether (s/n 1008, #28, preferred)

### Desired

- ECOKS (FM, SA, & BR)
- EMU Servicing Kit s/n 5002 (Use and Return on 129)
- BR CCA, Gloves, LCVG
- EMU Battery (s/n 2080)

EVA-6b/129/O/A

This Page Intentionally Blank

## TPS REPAIR

The TPS Repair procedures listed below are not published in the hardcopy EVA Flight Supplement. These procedures will be uplinked realtime if they are required.

A PDF and a WORD version of the procedures can be found at:  
<http://mod.jsc.nasa.gov/do3/FDF/FDFBooks/Status%20Sheets/index.html>.

Select the "As Flown" Status sheet for STS-129 and the link to the procedures can be found with the link to the EVA FS. The procedures can also be found on the FDF Books CD provided to the FAO console

<b>BOOM TPS INSPECTION</b>	
BOOM POINT INSPECTION SUMMARY TIMELINE .....	FS 13-3
BOOM POINT INSPECTION TOOL CONFIG.....	FS 13-4
BOOM POINT INSPECTION .....	FS 13-5
BOOM WLE MAPPING SUMMARY TIMELINE .....	FS 13-15
BOOM WLE MAPPING TOOL CONFIG .....	FS 13-17
BOOM WLE MAPPING .....	FS 13-18
EVA WLE MAPPING INSPECTION.....	FS 13-24
<b>BOOM CONTINGENCY</b>	
BOOM FRGF SHAFT RELEASE .....	FS 13-29
BOOM FRGF SHAFT INSTALLATION .....	FS 13-30
BOOM EFGF SHAFT RELEASE .....	FS 13-32
BOOM MPM STOW/DEPLOY.....	FS 13-34
BOOM ASSISTED LATCHING .....	FS 13-35
<b>TILE REPAIR</b>	
EMU PREP FOR TPS REPAIR.....	FS 13-36
POST TPS REPAIR DOFFING .....	FS 13-37
EWA MATERIAL MIXING .....	FS 13-38
EWA REF DATA .....	FS 13-39
EWA TILE REPAIR – DOCKED/ORM SUMMARY TIMELINE .....	FS 13-40
EWA TILE REPAIR – DOCKED/ORM TOOL CONFIG.....	FS 13-41
EWA TILE REPAIR – DOCKED/ORM .....	FS 13-42
SSRMS GAP FILLER REMOVAL SUMMARY TIMELINE .....	FS 13-50
BOOM GAP FILLER REMOVAL SUMMARY TIMELINE .....	FS 13-51
GAP FILLER REMOVAL.....	FS 13-52
<b>RCC REPAIR</b>	
RCC CRACK REPAIR BAG ASSEMBLY.....	FS 13-57
TEMP SENSOR DISASSEMBLY POST-EVA.....	FS 13-60
RCC CRACK REPAIR BAG DISASSEMBLY POST-EVA .....	FS 13-61
TEMPERATURE PROBE ASSEMBLY .....	FS 13-63
CRM APPLICATOR ASSEMBLY .....	FS 13-63
CRM APPLICATOR NOZZLE INSTALLATION (DAY OF EVA).....	FS 13-64
RCC CRACK REPAIR.....	FS 13-65
RCC PLUG TRANSFER BAG ASSEMBLY .....	FS 13-77
<b>NOTES, CAUTIONS, WARNINGS</b>	
EVA TPS INSPECTION/REPAIR INHIBIT PAD.....	FS 13-89
TPS REPAIR CAUTIONS AND WARNINGS .....	FS 13-92
TPS REPAIR NOTES.....	FS 13-93
BOOM OPERATIONAL WARNINGS .....	FS 13-94
BOOM OPERATIONAL NOTES .....	FS 13-95

TPS REF DATA	
PREFERRED EMU POSITIONING FOR TPS REPAIR.....	FS 13-96
EVA TPS REACH AND ACCESS .....	FS 13-97
POINT INSPECTION REACH AND ACCESS WHILE DOCKED.....	FS 13-98
WLE MAPPING INSPECTION WHILE DOCKED .....	FS 13-100
TILE LAYUP .....	FS 13-101
85-FOOT SAFETY TETHER.....	FS 13-102
PFR ATTACHMENT DEVICE (PAD) .....	FS 13-103
WIF EXTENDER .....	FS 13-104
EVA DIGITAL CAMERA.....	FS 13-105
EVA IR CAMERA .....	FS 13-107
OVERLAY TILE REPAIR SYSTEM (OTRS) .....	FS 13-109
OTRS MARKING TEMPLATE AND INSULATION BAGS .....	FS 13-110
AUGER HOUSING.....	FS 13-111
OTRS RELEASED CONFIGURATION .....	FS 13-112
ORU BAG INSERT FOR OTRS .....	FS 13-113
BOOM REF DATA	
RTF BOOM OVERVIEW .....	FS 13-114
BOOM TRANSITIONS WITH MLI .....	FS 13-115
BOOM BASE END AND MODIFIED EFGF .....	FS 13-116
BOOM BASE END EFGF ADAPTER PLATE .....	FS 13-117
EVA-ASSISTED EFGF CONNECTOR DEMATE .....	FS 13-118
BOOM BASE END SADDLE AND MPM.....	FS 13-119
BOOM MID SECTION AND MODIFIED FRGF .....	FS 13-120
BOOM MID SECTION FRGF ADAPTER PLATE.....	FS 13-121
BOOM TIP END AND SENSORS .....	FS 13-122
BOOM SENSOR DETAILS .....	FS 13-124
SENSOR PACKAGE 1 (SP1): LDRI/ITVC .....	FS 13-126
SENSOR PACKAGE 2 (SP2): LCS.....	FS 13-128
POSSIBLE PRD ROUTING FOR EVA ASSISTED LATCHING	
OF BOOM IN MPMS .....	FS 13-130
BOOM CONTINGENCIES .....	FS 13-131
GRAPPLE SHAFTS .....	FS 13-132
PDGF GRAPPLE SHAFT COVER.....	FS 13-133
BOOM FRGF FSE.....	FS 13-134



UNSCHEDULED/CONTINGENCY EVA TASKS

STS-129/ULF3 WORKAROUNDS CRIBSHEET .....	TEMP FS 16-2
EVA 1 CONTINGENCIES .....	TEMP FS 16-2
EVA 2 CONTINGENCIES .....	FS 16-3
EVA 3 CONTINGENCIES .....	FS 16-7
CONTINGENCY/GET-AHEAD TASKS .....	FS 16-9
GENERIC CONTINGENCIES .....	FS 16-10
APFR/IAPFR .....	FS 16-10
BALLSTACK .....	FS 16-10
BRT .....	FS 16-10
CANNON CONNECTOR .....	FS 16-11
CETA CART .....	FS 16-11
EVA WRENCH (TORQUE AND RATCHET) .....	FS 16-13
FLUID QD OPS .....	FS 16-14
MMOD SHIELD .....	FS 16-18
MUT EE .....	FS 16-22
MWS .....	FS 16-22
NZGL CONNECTORS .....	FS 16-22
ON-ORBIT INSTALLED HANDRAILS .....	FS 16-25
ON-ORBIT INSTALLED WIFs .....	FS 16-25
PAD .....	FS 16-25
PGT .....	FS 16-25
SAFETY TETHER .....	FS 16-27
SCOOPS .....	FS 16-27
SOCKET CADDY .....	FS 16-29
TA CLAMP .....	FS 16-29
TETHER SHUTTLE .....	FS 16-29
TORQUE MULTIPLIER .....	FS 16-29
TSA .....	FS 16-30
RELEASE ELC1 (ELC2) ROEU LATCHES .....	FS 16-31
LATCH ELC1 (ELC2) ROEU LATCHES .....	FS 16-34
STOW ELC1 (ELC2) ROEU ARM .....	FS 16-37
MATE ELC1 (ELC2) ROEU ARM .....	FS 16-40
ROEU OVERVIEW .....	FS 16-42
ELC CAPTURE BAR MANUAL RELEASE/INSTALL .....	FS 16-43
CAS CAPTURE LATCH ASSY (CLA) MANUAL DRIVE .....	FS 16-54
UCCAS/PAS UMBILICAL MATING ASSEMBLY (UMA) MANUAL DRIVE .....	FS 16-57
TEMP STOW WETA/VSSA .....	FS 16-62
RE-INSTALL WETA/VSSA .....	FS 16-64
RELOCATE WETA/VSSA .....	FS 16-66
LONG DURATION TIE-DOWN TETHER .....	FS 16-68
SASA TIE DOWN AT Z1 .....	FS 16-70
FPMU TIE DOWN AT CP2 (S1) .....	FS 16-72
FPMU TIE DOWN AT CP6 (P1) .....	FS 16-73
PAS CLEVIS BRACKET TIEDOWN .....	FS 16-74
WETA DUMMY BOX TIEDOWN .....	FS 16-75

UNSCH/CONT  
EVA TASKS

# STS-129/ULF3 WORKAROUNDS CRIBSHEET

## EVA 1 CONTINGENCIES

UNSCH/CONT  
EVA TASKS

TASK	FAILURE	ACTION
<b>SASA</b>	A. SASA launch bolts do not release from side wall carrier	Attempt with ratchet wrench
	B. SASA mast bolts do not release from side wall carrier	1. Use PGT in ratchet mode <b>PGT [RCCW, 30.5]</b> 2. Attempt with ratchet wrench
	C. SASA mast fasteners do not engage Z1 truss	1. Increase to <b>[B1 (12.0), CW2, 30.5]</b> 2. Release bolt <b>[A7 (9.2), CCW2, 30.5]</b> , check for FOD, and reattempt install with nominal torque 3. 2 of 2 bolts required; if < 2 bolts engaged, refer to tie-down plan
<b>NOD1 HR</b>	A. HR will not release	Contact <b>MCC-H</b> before attempting higher torque
<b>NH3 Bracket</b>	A. Bracket will not install in seat track or fails to soft dock	1. Verify bracket installed in correct direction 2. Verify bracket shoes are completely released and soft dock armed 3. Verify pitch of feet is parallel to seat track 4. Check for FOD on bracket and seat track 5. Verify bracket bolt completely released: <b>PGT [A1, CCW2, 30.5]</b> 6. If bracket in seat track but soft dock will not engage, attempt to drive HR bolts
	B. Bracket bolt fails to fully engage	1. If torqued, remove bracket: <b>PGT [A2, CCW2, 30.5], 7/16 - 6-ext</b> – To break torque <b>PGT [A1, CCW2, 30.5], 7/16 - 6-ext</b> – For removal – Check FOD and reinstall using original torque 2. Contact <b>MCC-H</b> before attempting higher torque 3. Soft dock is sufficient to secure bracket in place, no tie down required
	C. Bracket bolt jammed and can be neither installed nor removed	<div style="border: 3px double black; padding: 5px; text-align: center;"> <p><b>WARNING</b> Do not use failed OIH for any translation</p> </div> <p>2 of 2 bolts required for translation. Softdock is sufficient to secure bracket in place, no tie down required</p>
<b>Lan_Cable Reposition</b>	A. Cable has insufficient slack	Place inside MMOD shield

**STS-129/ULF3 WORKAROUNDS CRIBSHEET (Cont)**

**EVA 2 CONTINGENCIES**

<b>TASK</b>	<b>FAILURE</b>	<b>ACTION</b>
<b>GATOR Assembly</b>	A. Gator fails to soft dock to handrail	<ol style="list-style-type: none"> <li>1. Verify EVA Clamp bolt fully retracted and are no other obstructions in clamp opening</li> <li>2. Verify alignment on handrail; check for FOD on handrail or handrail deformation</li> </ol>
	B. EVA bolts do not engage	<ol style="list-style-type: none"> <li>1. Back bolt out <b>PGT [A2, CCW2, 30.5]</b>; check for FOD; reattempt installation <b>PGT [A2, CW2, 30.5]</b></li> <li>2. Increase torque for 1 turn <b>PGT [A4, CCW2, 30.5]</b>. Return to nominal setting <b>PGT [A2, CW2, 30.5]</b></li> <li>3. 1 of 2 EVA bolts required (If 0 of 2 bolts, soft dock will keep GATOR Assembly in place, no-touch area)</li> </ol>
	C. EVA bolt fails to achieve full torque and turns	<ol style="list-style-type: none"> <li>1. Back bolt out <b>PGT [A2, CCW2, 30.5]</b>; check for FOD; reattempt installation <b>PGT [A2, CW2, 30.5]</b></li> <li>2. Increase torque to <b>PGT [A4, CW2, 30.5]</b></li> <li>3. 1 of 2 EVA bolts required (If 0 of 2 bolts, soft dock will keep GATOR Assembly in place, no-touch area)</li> </ol>
	D. EVA bolt suffers high running torque	1 of 2 EVA bolts required (If 0 of 2 bolts, soft dock will keep GATOR Assembly in place, no-touch area)
	E. EVA bolt fails to release	Increase torque for 1 turn to break torque <b>PGT [A3,CW2,30.5]</b> . Reset <b>PGT [A2, CW2, 30.5]</b> to fully release bolt
	F. Contingency removal of antenna from GATOR clamp	Release captive EVA bolt <b>PGT [A3, CCW2, 30.5]</b> to remove antenna from GATOR clamp
<b>FPMU</b>	A. Stanchion bolt does not release	<ol style="list-style-type: none"> <li>1. Use PGT in ratchet mode <b>PGT [RCCW, 30.5]</b></li> <li>2. If no joy, contact <b>MCC-H</b> for ratchet wrench use</li> </ol>
	B. Spring plungers seize or fail to depress	<ol style="list-style-type: none"> <li>1. Attempt soft-dock installation slightly tilted – Start with stanchion at ~30 degree angle off-vertical and apply downward pressure as stanchion is rotated toward vertical</li> <li>2. Use EVA probe tool (or similar metal object) to depress plunger</li> <li>3. Attempt installation without soft dock engaged</li> </ol>
	C. PGT socket comes off stanchion bolt	<ol style="list-style-type: none"> <li>1. Attempt to reengage bolt</li> <li>2. Remove socket from PGT; engage socket on stanchion bolt, then put back on PGT</li> <li>3. Use ERAD, torque wrench, or ratchet wrench (for release). (For Install <b>ERAD w/PGT [A7, CW2, 30.5]</b>. For release <b>ERAD w/PGT [B3, CCW2, 30.5]</b>)</li> </ol>
	D. Stanchion bolt does not fully engage	<ol style="list-style-type: none"> <li>1. Release stanchion bolt, verify alignment and reattempt <b>PGT [B3, CW2, 30.5]</b></li> <li>2. <b>PGT [B7, CW2, 30.5]-6 ext 7/16</b>: Reattempt stanchion bolt engage</li> <li>3. Remove stanchion, inspect bolt and truss interface, report to <b>MCC-H</b></li> <li>4. 1 of 1 bolt is required, if &lt; 1 bolt engaged, refer to tie-down plan</li> </ol>

**STS-129/ULF3 WORKAROUNDS CRIBSHEET (Cont)**

<b>TASK</b>	<b>FAILURE</b>	<b>ACTION</b>
<b>PAS Deploy</b>	A. Deploy/Stow clevis bracket bolt fails to break torque	1. Use PGT in manual ratchet mode <b>[RCCW, 30.5]</b> 2. Retrieve torque wrench from A/L staging bag. Set to 41 ft-lb and reattempt release
	B. ADP/PIP pin does not release	Retrieve hammer from PAS Crewlock Bag and with ADP in full open position, tap it in farther to relax collets. Reattempt removal
	C. Yoke PIP pin does not release after loosening clevis bolts	1. Loosen Stow Clevis Bracket bolts (4) <b>PGT [B7 (25.5), CCW2, 30.5]-7/16-6-in ext</b> , approx 4 turns each 2. Re-attempt removal of yoke PIP pin and/or yoke ADP, secure using pre-installed wire tie 3. If does not release after loosening bolts; retrieve hammer from PAS Crewlock and tap out PIP pin
	D. SARJ launch bolt fails to break torque	Increase to <b>PGT [B7 (25.5), CCW2, 30.5]</b> for 1 turn, then return to original setting
	E. Cup-cone bolt fails to break torque	Increase to <b>PGT [B7 (25.5), CCW2, 30.5]</b> . (Do not go to hard stop at this setting)
	F. Strut cone cannot be removed from cup interface	1. Inspect for clearance between cup and cone, if reqd, <b>PGT [A7 (9.2), CCW2, 30.5]-6 ext 7/16</b> : Release bolt to hardstop 2. Wiggle brace 3. Consider hold for thermal stabilization. Check <b>MCC-H</b> before proceeding to hammer 4. Retrieve hammer and tap brace with plastic end of hammer
	G. Clevis bracket bolt fails to achieve full torque and turns	1. Back out the bolts fully and reattempt installation 2. If reattempt of bolt installation is not successful with 4 of 4 fully installed bolts, refer to tie-down plan
	H. Yoke PIP pin does not install	1. Open handle of Yoke ADP and reattempt installation. If joy, close ADP handle 2. If no joy, manipulate yoke to align PIP pin holes. If joy, close ADP handle
	I. Yoke will not install in Deploy Clevis Bracket	1. Loosen Deploy Clevis Bracket bolts (4), approx 4-6 turns, <b>PGT [RCW, 30.5]-7/16-6-in ext</b> 2. Re-attempt yoke installation, wiggle brace/yoke 3. If joy, remove yoke, re-tighten Deploy Clevis Bracket bolts (4) <b>PGT [B5 (22.0), CW2, 30.5]-6 ext 7/16</b> , to hard stop, approx 4-6 turns 4. Apply final torque, <b>PGT [RCW, 30.5]-7/16-6-in ext</b> , 2 clicks
	J. ADP will not install in Deploy Clevis Bracket	1. Loosen Deploy Clevis Bracket bolts (4), approx 4-6 turns a. Some bolts will require Torque Wrench 2-in ext at 31 ft-lb b. Remaining bolts, <b>PGT [RCW, 30.5]-7/16-6-in ext</b> 2. Re-attempt ADP installation 3. Re-attempt PIP pin installation

**STS-129/ULF3 WORKAROUNDS CRIBSHEET (Cont)**

TASK	FAILURE	ACTION
		<ol style="list-style-type: none"> <li>4. Engage Deploy Clevis Bracket bolts (4) to hard stop, approx 4-6 turns                             <ul style="list-style-type: none"> <li><input type="checkbox"/> Some bolts will require RAD (attempt w/fingers first)</li> <li><input type="checkbox"/> <b>PGT [A7 (9.2), CW2, 30.5]-RAD w/7/16-2-in ext</b> (count turns at bolt head)</li> <li><input type="checkbox"/> Remaining bolts, <b>PGT [B5 (22.0), CW2, 30.5]-6 ext 7/16</b></li> </ul> </li> <li>5. Apply Final Torque                             <ul style="list-style-type: none"> <li><input type="checkbox"/> Torque wrench 2-in ext at 31 ft-lb</li> <li><input type="checkbox"/> Remaining bolts, <b>PGT [RCW, 30.5]-6 ext 7/16</b></li> </ul> </li> </ol>
	K. Platform enters detents	<ol style="list-style-type: none"> <li>1. Apply steady force 1-2 times to attempt to release platform from detents</li> <li>2. Retrieve and install Detent Release Tools</li> </ol> <div style="border: 3px double black; padding: 5px; margin: 10px 0;"> <p style="text-align: center;"><b>WARNING</b></p> <p style="text-align: center;">Do not exceed 4.1 ft-lb on DRT knob</p> <p style="text-align: center;">Avoid inadvertent contact with spring arm pins prior to DRT install</p> <p style="text-align: center;">Avoid inadvertent contact with DRT once installed</p> </div>
<b>Detent Release Tool</b>	A. Unable to install DRT in softdock position	<ol style="list-style-type: none"> <li>1. Verify DRT knob fully driven in release direction (cw)</li> <li>2. Check hinge interface for FOD or other interference</li> <li>3. Squeeze DRT tongs and verify pins are fully recessed inside DRT housing</li> <li>4. Inspect DRT for FOD or other interference</li> <li>5. Attempt to install tool at different angle relative to hinge</li> <li>6. Attempt install with second DRT if not yet installed</li> </ol>
	B. Unable to achieve 7 turns or points of silver markings not visible	<ol style="list-style-type: none"> <li>1. Inspect tool/hinge area to verify both DRT pins engaged in hinge holes, no FOD or other interference</li> <li>2. Remove DRT, inspect for damage</li> <li>3. Cycle uninstalled DRT, verify knob turns 7 revs ccw, points of silver markings exposed and pins locked in extended position</li> <li>4. If uninstalled DRT functional, reattempt DRT installation</li> <li>5. If only 1 DRT operational, install functional DRT in both hinges, one at a time, to cycle all detent plungers. Leave DRT installed in second hinge</li> <li>6. Attempt PAS deploy. Do not exceed 3 pulls, ~1 pull/sec, max force of 314 lbs/pull. Wait &gt; 30 sec between each set of 3 pulls for structural motion to dampen</li> </ol>

**STS-129/ULF3 WORKAROUNDS CRIBSHEET (Cont)**

<b>TASK</b>	<b>FAILURE</b>	<b>ACTION</b>
	C. Unable to release/remove DRT from hinge	<ol style="list-style-type: none"> <li>1. If knob not fully flush with top of DRT housing               <ol style="list-style-type: none"> <li>a. Cycle DRT knob to full install position (ccw), then full release (cw)</li> <li>b. <b>PGT [A1 (2.5), CW2, 30.5]</b>: Drive knob in release direction till flush with top of DRT housing</li> <li>c. Secure DRT with wire tie through hinge ADP hole and leave in place</li> </ol> </li> <li>2. If knob flush with top of DRT housing               <ol style="list-style-type: none"> <li>a. Apply additional force to retract pins using equipment hooks or tether wrapped around lever arms</li> <li>b. Re-engage DRT to fully driven position until points of silver markings visible, ~7 ccw</li> <li>c. Secure DRT with wire tie through hinge ADP hole and leave in place</li> </ol> </li> </ol>
<b>WETA Install</b>	A. Dummy box outer bolt does not release	<ol style="list-style-type: none"> <li>1. Increase torque to <b>PGT [B7 25.5 ft-lb, CCW2 30 RPM, 30.5]</b> for 1 turn, then return to original setting</li> <li>2. 2 of 3 bolts required, if &lt; 2 bolts released, refer to tie-down plan</li> </ol>
	B. Dummy box center jacking bolt does not release	<ol style="list-style-type: none"> <li>1. Verify outer bolts (2) are released</li> <li>2. Increase torque to <b>PGT [B7 25.5 ft-lb, CCW2 30 RPM, 30.5]</b> for 1 turn, the return to original setting</li> <li>3. 2 of 3 bolts required, if &lt; 2 bolts released, refer to tie-down plan</li> </ol>
	C. WETA center bolt does not engage	<ol style="list-style-type: none"> <li>1. Remove WETA; inspect stanchion interface for FOD or damage; reattempt installation</li> <li>2. 2 of 3 bolts required, if &lt; 2 bolts engaged, refer to tie-down plan</li> </ol>
	D. WETA center bolt does not achieve minimum turn count (24 turns)	<ol style="list-style-type: none"> <li>1. Increase torque to <b>PGT [B1 12 ft-lb, CCW2 30 RPM, 30.5]</b></li> <li>2. 2 of 3 bolts required, if &lt; 2 bolts engaged, refer to tie-down plan</li> </ol>
	E. WETA outer bolt does not engage	<ol style="list-style-type: none"> <li>1. Engage opposite outer bolt; reattempt installation of failed bolt</li> <li>2. Increase torque to <b>PGT [B1 12 ft-lb, CCW2 30 RPM, 30.5]</b></li> <li>3. 2 of 3 bolts required, if &lt; 2 bolts engaged, refer to tie-down plan</li> </ol>

## STS-129/ULF3 WORKAROUNDS CRIBSHEET (Cont)

### EVA 3 CONTINGENCIES

TASK	FAILURE	ACTION
HPGT	A. Tank latch fails to soft dock	<ol style="list-style-type: none"> <li>1. If at least one latch soft docked, inspect failed latch for FOD; attempt to soft dock by applying direct force</li> <li>2. Reset and retry. 3 of 3 latches and guide post are required</li> </ol>
	B. 3 of 3 latches cannot be engaged	Long Duration Tie-down Tethers – 4 stowed in Aux Bag on Z1 (Rats' Nest), 4 come from inside, refer to tie-down plan
	C. QD will not rotate completely to open position	<ol style="list-style-type: none"> <li>1. Verify detent button is depressed to initiate rotation</li> <li>2. Use QD Persuader – max force 6 lb (stowed in HPGT Bag)</li> </ol>
	D. Unable to install guide post	Check for FOD and structural interference, cycle soft dock pins; re-attempt
	E. Tank door latch will not release	Remove or shear quarter turn fastener
	F. Gross leak detected (first response)	<ol style="list-style-type: none"> <li>1. Verify HPGT 1 and 5 isolation valves are CLOSED (right)</li> <li>2. (IV) Reduce ISS O2 System P to Ambient, refer to New HI Pressure O2 Tank Leak Check procedure in ASSY OPS</li> <li>3. Depress button and rotate QD (ccw) to closed position (white/white)</li> <li>4. Check gap visible between collar black line and barrel line</li> <li>5. Demate QD from A/L; check for FOD or damage</li> <li>6. Mate QD to A/L (white/white) – do not grasp near soft dock ring or depress ring</li> <li>7. Check gap visible between collar black line and barrel line</li> <li>8. Check good pull test</li> <li>9. Depress button and rotate QD (cw) to open position (black/black). Do not depress button past 10 degrees</li> <li>10. Check button pops out</li> <li>11. OPEN HPGT #5 isolation valve (left)</li> <li>12. Contact <b>MCC-H</b> for further direction</li> </ol>
	G. Gross leak detected (second response)	<ol style="list-style-type: none"> <li>1. CLOSE HPGT 1 and 5 isolation valves (right)</li> <li>2. (IV) Reduce ISS O2 System P to Ambient, refer to New HI Pressure O2 Tank Leak Check procedure in ASSY OPS</li> <li>3. Depress button and rotate QD (ccw) to closed position (white/white)</li> <li>4. Check gap visible between collar black line and barrel line</li> <li>5. Demate QD from A/L; check for FOD or damage</li> <li>6. Mate QD to tank dummy panel (white/white) – do not grasp near soft dock ring or depress ring</li> </ol>

**STS-129/ULF3 WORKAROUNDS CRIBSHEET (Cont)**

<b>TASK</b>	<b>FAILURE</b>	<b>ACTION</b>
		<ol style="list-style-type: none"> <li>7. Check gap visible between collar black line and barrel line</li> <li>8. Check good pull test</li> <li>9. Reinstall cap on A/L QD (cw)</li> <li>10. OPEN HPGT #1 isolation valve (left)</li> </ol>
	H. Tank door latch will not engage	<ol style="list-style-type: none"> <li>1. 1 of 2 required</li> <li>2. If neither fastener will engage, attempt to restrain with wire tie</li> </ol>
<b>MISSE 7</b>	A. Latch assembly PIP pin will not release	<ol style="list-style-type: none"> <li>1. Increase force on pull ring, stop if deformation occurs</li> <li>2. Lightly tap detent end of PIP pin with hammer</li> </ol>
	B. Latch assembly does not release	<ol style="list-style-type: none"> <li>1. Tether to both clamp and contingency bolt; release contingency bolt. <b>PGT [B1 (12.0), CCW2, 30.5]</b> (96 turns)</li> <li>2. Stow bolt and latch assembly in trash bag</li> </ol>
	C. Latch assembly does not go in stow position	<ol style="list-style-type: none"> <li>1. Tether to both clamp and contingency bolt; release contingency bolt. <b>PGT [B1 (12.0), CCW2, 30.5]</b> (96 turns)</li> <li>2. Stow bolt and latch assembly in trash bag</li> </ol>
	D. Latch assembly PIP pin will not install	<ol style="list-style-type: none"> <li>1. Lightly tap PIP pin with hammer</li> <li>2. PIP pin not required for landing</li> </ol>
	E. ExPA Socket PIP pins will not release	<ol style="list-style-type: none"> <li>1. Increase force on pull ring, stop if deformation occurs</li> <li>2. Strike detent end of PIP pin (end opposite pull ring) with hammer (6" max stroke, use metal side of hammer); reattempt step 1</li> </ol>
	F. ExPA Socket PIP pin will not engage	One PIP pin is sufficient to hold PEC in ExPA socket
	G. Wing tab connector fails to release	Use tether hook for leverage
	H. Wing tab connector fails to install	<ol style="list-style-type: none"> <li>1. Verify connector is matched to correct PEC</li> <li>2. Check for FOD/damage</li> <li>3. Verify alignment/keying</li> <li>4. Verify connector fully seated</li> <li>5. Use tether hook for leverage</li> </ol>
	I. PEC PIP pin used to restrain PEC open will not release	Lightly tap detent end of PIP pin (end opposite pull ring) with hammer (6" max stroke, use metal side of hammer)
	J. PEC PIP pin used to restrain PEC open will not engage	One PIP pin is sufficient to restrain the PEC open



**STS-129/ULF3 WORKAROUNDS CRIBSHEET (Cont)**

**CONTINGENCY/GET-AHEAD TASKS**

<b>TASK</b>	<b>FAILURE</b>	<b>ACTION</b>
<b>WETA</b>	A. Stanchion bolt does not release	<ol style="list-style-type: none"> <li>1. Use PGT in ratchet mode <b>PGT [RCCW, 30.5]</b></li> <li>2. If no joy, contact <b>MCC-H</b> for ratchet wrench use</li> </ol>
	B. Spring Plungers seize or fail to depress	<ol style="list-style-type: none"> <li>1. Attempt soft-dock installation slightly tilted – Start with stanchion at ~30 degree angle off-vertical and apply downward pressure as stanchion is rotated toward vertical</li> <li>2. Use EVA probe tool (or similar metal object) to depress plunger</li> <li>3. Attempt full installation without soft dock engaged</li> </ol>
	C. PGT socket comes off stanchion bolt	<ol style="list-style-type: none"> <li>1. Attempt to reengage bolt</li> <li>2. Remove socket from PGT; engage socket on stanchion bolt, then put back on PGT</li> <li>3. Use ratchet wrench or torque wrench</li> </ol>
	D. Stanchion bolt does not fully engage	<ol style="list-style-type: none"> <li>1. Release stanchion bolt, verify alignment and reattempt</li> <li>2. <b>PGT [B7 25.5 ft-lb, CW2 30 RPM, MTL 30.5]-6 ext 7/16:</b> Reattempt stanchion bolt engage</li> <li>3. Remove stanchion, inspect bolt and truss interface, report to <b>MCC</b></li> </ol>

## STS-129/ULF3 WORKAROUNDS CRIBSHEET (Cont)

### GENERIC CONTINGENCIES

TASK	FAILURE	ACTION
I. Generic	<b>APFR/IAPFR</b>	
	A. APFR/IAPFR fails to install into WIF	<ol style="list-style-type: none"> <li>1. Verify APFR collar in install position (black-on-black)</li> <li>2. Check for FOD in WIF or structural interference</li> <li>3. Attempt APFR install in alternate clocking</li> <li>4. If no joy, attempt APFR install in alternate WIF</li> <li>5. If no joy, APFR failure – Use another APFR</li> </ol>
	B. Joint fails to actuate	<ol style="list-style-type: none"> <li>1. Verify no load is applied to joint and/or jiggle APFR joint while actuating knob – For pitch joint, push knob in during rotation (Class I pitch joints known to be stiff)</li> <li>2. Increase force applied in order to free joint</li> </ol>
	C. Boot becomes stuck in APFR boot plate	<ol style="list-style-type: none"> <li>1. Have other EV crewmember assist with getting boot out</li> <li>2. Loosen 7/16-in EVA bolts (3) on heel clip using EVA ratchet or PGT: <b>PGT: [B1 (12.0), CCW2, 30.5], 7/16 - 6-ext</b></li> <li>3. Remove 7/16-in EVA bolts (3 – captive) on heel clip (non captive) using EVA ratchet or PGT: <b>PGT: [B1 (12.0), CCW2, 30.5], 7/16 - 6-ext 5 turns</b></li> </ol>
	D. Boot becomes stuck in IAPFR boot plate	<ol style="list-style-type: none"> <li>1. Have other EV crewmember assist with getting boot out</li> <li>2. If wearing Small EMU boot, have other EV crewmember adjust boot sizing to Large</li> <li>3. Loosen 7/16-in EVA bolts (2) on heel clip using EVA ratchet or PGT: <b>PGT: [B2 (16.0), CCW2, 30.5], 7/16 - 6-ext</b></li> <li>4. Remove 7/16-in EVA bolts (2) on heel clip using EVA ratchet or PGT: <b>PGT: [B2 (16.0), CCW2, 30.5], 7/16 - 6-ext 4 turns</b></li> </ol>
	<b>Ballstack</b>	
	A. ECOM fails to release from ISS Structure	<b>On MCC-H GO:</b> Tether ballstack to handrail and leave outside
	B. ECOM fails to release from MUT EE	Leave together and return inside
	C. Ballstack fails to rigidize	<b>On MCC-H GO:</b> Use secondary tethers to assist in restraining payload
	<b>BRT</b>	
A. BRT jaws fail to release	<ol style="list-style-type: none"> <li>1. Loosen rigidizing collar to relieve sideloads</li> <li>2. Shake BRT while depressing paddles to alleviate sideloads from handrail</li> <li>3. Detach BRT from suit and tether to structure</li> </ol>	



**STS-129/ULF3 WORKAROUNDS CRIBSHEET (Cont)**

<b>TASK</b>	<b>FAILURE</b>	<b>ACTION</b>
	<b>Cannon Connector</b>	
	A. Connector fails to release	<ol style="list-style-type: none"> <li>1. Check for FOD, damage or misalignment</li> <li>2. Verify cable routing is not impeding connector rotation. (Release TA-clamps as required)</li> <li>3. Use cannon connector tool for more leverage</li> </ol>
	B. Connector/Cap fails to softdock	<ol style="list-style-type: none"> <li>1. Verify collar unlocked. (White on connector shell tip should align with white on receptacle backplate)</li> <li>2. Check for FOD or damage</li> </ol>
	C. Connector/Cap fails to lock	<ol style="list-style-type: none"> <li>1. Remove connector/cap, check for FOD or damage</li> <li>2. Check alignment, remate, rock connector back and forth as required. (Once locked, white on connector shell tip should align with black on receptacle backplate)</li> <li>3. Use cannon connector tool for more leverage</li> </ol>
	D. High cable stiffness prevents mating	<ol style="list-style-type: none"> <li>1. Verify all TA-clamps are released</li> <li>2. Use second crewmember</li> <li>3. Use APFR</li> </ol>
	E. Connector/Jack pin bent	<ol style="list-style-type: none"> <li>1. Describe pin location and condition – Obtain WVS view of interface if possible</li> <li>2. <b>On MCC-H GO:</b> For 16, 20, or 22 gauge pins only, retrieve pin straightener and attempt pin repair</li> <li>3. <b>On MCC-H GO:</b> Retrieve needle nose pliers and attempt pin repair – <b>MCC-H</b> will verify pin size prior to retrieving tools</li> </ol>
	F. Connector/Jack FOD	<b>On MCC-H GO:</b> Obtain connector cleaner tool to remove FOD
	G. Connector EMI band bent	<b>On MCC-H GO:</b> Obtain needle nose pliers or forceps to remove band
	<b>CETA Cart</b>	
	A. Wheel bogie fails to release from truss	<ol style="list-style-type: none"> <li>1. Verify brakes are fully released</li> <li>2. Ensure trigger is being depressed while attempting to rotate handle</li> <li>3. <b>On MCC-H GO:</b> Perform {6.100.125 CETA Cart Wheel Bogie R&amp;R} – There is no spare wheel bogie on-orbit, so after the CETA cart is relocated, the failed wheel bogie will be reinstalled</li> </ol>
	B. Wheel bogie fails to install on truss	There is no spare wheel bogie on-orbit. 4 of 4 bogies are required. Real time call on whether MT couple or CETA cart tie down required. For tie down see block G
	C. Parking brake fails to engage	<ol style="list-style-type: none"> <li>1. Use parking brake handle on other side of CETA cart</li> <li>2. Couple CETA cart to MT and utilize other WIF if possible</li> </ol>
	D. Parking brake fails to disengage	<ol style="list-style-type: none"> <li>1. Hold pedal down for brake release</li> <li>2. Use pedal on other side of CETA cart to release parking brake</li> </ol>

**STS-129/ULF3 WORKAROUNDS CRIBSHEET (Cont)**

<b>TASK</b>	<b>FAILURE</b>	<b>ACTION</b>
	E. Dynamic brake fails to engage	Limit translation rates to allow manual stopping
	F. CETA active coupler fails to capture or lock	<ol style="list-style-type: none"> <li>1. Cycle active coupler</li> <li>2. If at least 1 CETA cart is stbd of the MT, swap active couplers</li> <li>3. <b>On MCC-H GO:</b> Tie down CETA cart. See block G</li> </ol>
	G. CETA cart tie down	<ol style="list-style-type: none"> <li>1. <b>On MCC-H GO:</b> Perform the following tie down procedure (see figure 1) <ol style="list-style-type: none"> <li>a. Translate CETA cart to TBD location (not over truss segment joint)</li> <li>b. Engage parking brake</li> <li>c. Retrieve 2 Long Duration Tie Down (LDTD) tethers from P6 AUX Bag (fwd face of Z1)</li> <li>d. Route 1 LDTD tether on stbd side of CETA cart as follows: <ol style="list-style-type: none"> <li>1) Attach 1 hook to zenith brake handle support tether point</li> <li>2) Loop tether strap around CETA rail HR standoff</li> <li>3) Attach second hook to nadir brake handle support tether point</li> <li>4) Lightly cinch tether and close buckle</li> <li>5) Close MLI flap over buckle and any excess strap</li> </ol> </li> <li>e. Repeat on port side of CETA cart</li> </ol> </li> </ol>
	H. Coupler knob fails to unlock	<ol style="list-style-type: none"> <li>1. <b>On MCC-H GO:</b> Release active coupler by removing wire ties (2) (reinstall of wire ties not required) and PIP pins (2)</li> <li>2. <b>On MCC-H GO:</b> Release passive coupler via EVA bolt:  <b>PGT: [B7 (25.5), CCW2, 30.5], 7/16 - 6-ext TBD turns</b>                      – Bolt is attached by lanyard</li> </ol>
	I. Swing arm fails to deploy	Use alternate swing arm or WIF
	J. Swing arm fails to stow	<b>On MCC-H GO:</b> Remove swing arm via EVA bolts (4): <b>PGT: [B7 (25.5), CCW2, 30.5], 7/16 - 6-ext TBD turns (Captive bolts?)</b>
	K. Swing arm fails to lock	Restrain in stowed position with wire ties

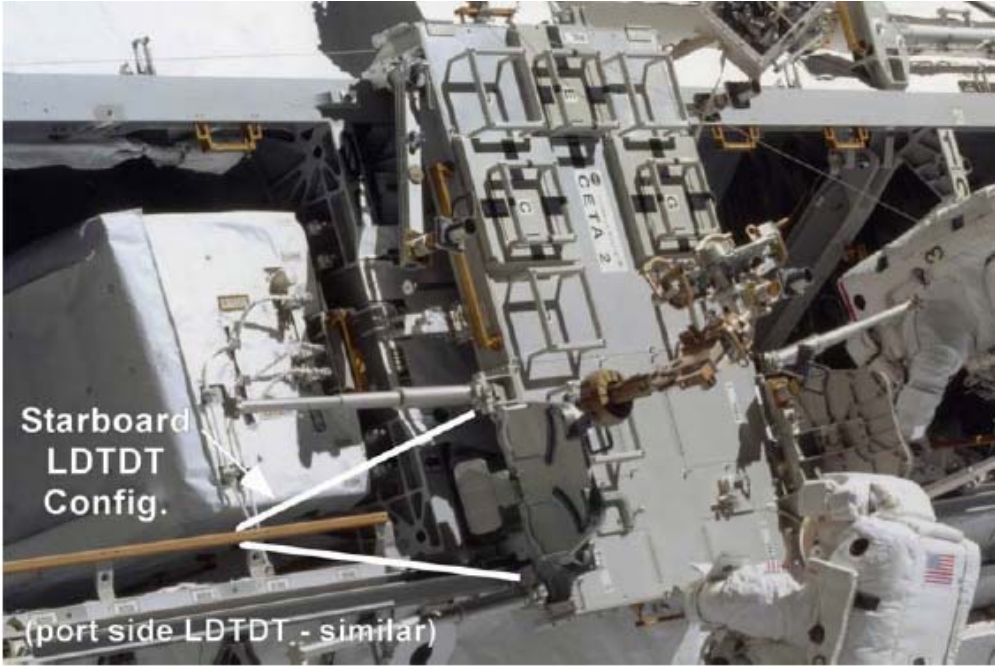
**STS-129/ULF3 WORKAROUNDS CRIBSHEET (Cont)**

TASK	FAILURE	ACTION
	 <p>Starboard LDTDT Config. (port side LDTDT - similar)</p>  	<p style="text-align: center; border: 1px solid black; padding: 5px;">Figure 1.- CETA Cart Tie-down.</p>
	<p><b>EVA Wrench (Torque and Ratchet)</b></p>	
	<p>A. Ratchet teeth slip</p>	<p>Ratchet to new set of teeth and reapply torque</p>
	<p>B. Wrench does not ratchet</p>	<p>Hold the ratchet selector and socket in opposite hands and rotate in opposite directions</p>

## STS-129/ULF3 WORKAROUNDS CRIBSHEET (Cont)

TASK	FAILURE	ACTION
	<b>Fluid QD Ops</b>	
<u>NOTE</u>		
Troubleshooting steps outlined in this cribsheet are a generic starting point. Flight specific situations may require different actions.		
If troubleshooting requires the crew to leave the worksite, verify that female QDs are covered to prevent exposure to direct sunlight. For thermal clocks refer to flight rules		
	<b>Mating Ops</b>	
A. QD fails to mate		<ol style="list-style-type: none"> <li>1. Check for debris, damage, or crystals</li> <li>2. Verify release ring is retracted. (Fwd white band is not visible)</li> <li>3. Check alignment and verify no side loads</li> </ol>
B. Release ring snap back test fails		<ol style="list-style-type: none"> <li>1. Push release ring forward. (Release ring will not slide fwd if QD is in FID)</li> <li>2. QD is in FID; demate QD, verify fwd white band not visible, and remate QD</li> </ol>
C. Gap check fails (visual or FID gauge)		Retract release ring, demate QD, verify fwd white band not visible, and remate QD
	<b>Valve Ops</b>	
D. Detent button is partially unthreaded		Rethread detent button <ol style="list-style-type: none"> <li>a. Load bail handle (button will free spin if not loaded)               <ul style="list-style-type: none"> <li>– If valve is open, pull bail handle aft</li> <li>– If valve is closed, push bail handle fwd</li> </ul> </li> <li>b. Rotate button cw (8 turns max)</li> </ol>
E. Detent button is missing	<p style="text-align: center;"><u>NOTE</u> Detent button is only required for BDT ops and 1 in SPD ops</p>	<ol style="list-style-type: none"> <li>1. Use equipment hook to depress detent button shaft</li> <li>2. Use tether strap around gloved finger to depress detent button shaft</li> <li>3. Retrieve and use Beta Gimbal Antirotation Latch Tool to depress detent button shaft</li> <li>4. <b>On MCC-H GO:</b> Install spare detent button (Buttons are stowed IVA and must be configured prior to EVA use)</li> </ol>
F. Bail fails to travel fwd		<ol style="list-style-type: none"> <li>1. Check for debris, damage, or crystals</li> <li>2. Retrieve and use QD bail drive lever (3/4, 1, &amp; 1-1/2 in only); notify <b>MCC-H</b></li> </ol>
G. Bail fails to travel to full fwd (valve open) position (button does not pop up)		<ol style="list-style-type: none"> <li>1. Neutralize sideloads</li> <li>2. Apply greater opening force to QD bail handle</li> <li>3. Retrieve and use QD bail drive lever (3/4, 1, &amp; 1-1/2 in only); notify <b>MCC-H</b></li> <li>4. If applicable, retrieve and install SPD; notify <b>MCC-H</b></li> </ol>

**STS-129/ULF3 WORKAROUNDS CRIBSHEET (Cont)**

TASK	FAILURE	ACTION
	<p>H. Detent button fails to depress during valve closing</p> <div style="border: 3px double black; padding: 5px; margin: 10px 0;"> <p style="text-align: center;"><b>WARNING</b></p> <p>Bail may kick back and contact crew when button is depressed if a leaking primary seal allowed pressure build-up in spring cavity</p> </div>	<ol style="list-style-type: none"> <li>1. Verify locking collar fully rotated (1/2, 3/4, &amp; 1 in only)</li> <li>2. Push and hold bail handle fwd (to open) with significant force to relieve load on button while simultaneously depressing the detent button               <ul style="list-style-type: none"> <li>– If button depresses, vent by pulling bail aft until release ring covers aft white band</li> <li>– Push bail fwd to valve open and check button depresses</li> </ul> </li> <li>3. Retrieve QD bail drive lever and repeat step 2 (3/4, 1, &amp; 1-1/2 in only); notify <b>MCC-H</b></li> <li>4. Contact <b>MCC</b> to reduce NH3 temperature if possible</li> <li>5. <b>On MCC-H GO:</b> Retrieve and install QD button depress tool (BDT) (1/4, 3/4, &amp; 1 in only)</li> </ol>
	<p>I. Bail fails to travel to full aft (valve closed) position (button does not pop up)</p>	<ol style="list-style-type: none"> <li>1. Inspect QD for retaining wire protrusion</li> <li>2. Neutralize possible side loading</li> <li>3. Depress button and increase force on bail</li> <li>4. Retrieve and use QD bail drive lever (3/4, 1, &amp; 1-1/2 in only); notify <b>MCC-H</b></li> </ol>
<b>Demating Ops</b>		
	<p>J. Female QD fails to demate</p>	<ol style="list-style-type: none"> <li>1. Verify release ring is fully retracted while attempting to demate</li> <li>2. Verify TA or P clamps are released</li> <li>3. Verify detent button is up (locking collar can be rotated under button)</li> <li>4. Verify trigger linkage is still attached to release ring (1-1/2 in only)</li> <li>5. Neutralize sideloads or manipulate flexhose to relieve mating forces on female QD</li> <li>6. Apply greater force to release ring and female QD</li> <li>7. Retrieve and use QD release tool (QRT) to apply greater force; notify <b>MCC-H</b></li> </ol>
	<p>K. Thermal bootie fails to remain securely closed</p>	<p>Install wire tie around bootie to keep QD fully covered</p>
	<p>L. Cap will not demate</p>	<ol style="list-style-type: none"> <li>1. Verify pulling out on cap before rotating to ensure locking tab is disengaged</li> <li>2. Wait for day pass if possible and reattempt cap removal</li> <li>3. If force is too great for hand actuation or crystals visible around the QD, male may be leaking; notify <b>MCC-H</b> <ul style="list-style-type: none"> <li>– Prepare for quick mate on <b>MCC-H GO</b></li> </ul> </li> <li>4. Retrieve QD cap tool (1/4, 1/2, &amp; 1 in only)               <ul style="list-style-type: none"> <li>– Use QD cap tool to turn stuck cap a maximum of 2 turns (cap vents at ~ 2 turns). Finish removal of cap by hand (~ 1 additional turn)</li> </ul> </li> </ol>

**STS-129/ULF3 WORKAROUNDS CRIBSHEET (Cont)**

<b>TASK</b>	<b>FAILURE</b>	<b>ACTION</b>
	<b>Leaks</b>	
	M. Mated QD leaks in valve open position (bail fwd)	<ol style="list-style-type: none"> <li>1. Remove SPD and fully open valve (bail fwd)</li> <li>2. If leak continues close valve (bail aft)</li> </ol>
	N. Male QD leaks after cap removal	Reinstall cap; notify <b>MCC-H</b> – Prepare for quick QD mate on <b>MCC-H GO</b>
	O. Female QD leaks during or after bail actuation to fwd position (valve open)	<ol style="list-style-type: none"> <li>1. Return bail to aft position (valve closed)</li> <li>2. Perform release ring snap back test                             <ul style="list-style-type: none"> <li>– If FID is observed, demate and remate QD</li> <li>– If no FID, neutralize sideloads and cycle bail to fwd position (valve open)</li> </ul> </li> </ol>
	P. Leaking QD after SPD install	<ol style="list-style-type: none"> <li>1. Remove SPD, open valve fully (bail fwd), verify detent button is up, and aft white line is visible                             <ul style="list-style-type: none"> <li>– If leak stops rotate locking collar to lock</li> </ul> </li> <li>2. Close valve (bail aft), verify detent button is up, fwd white line is visible, and rotate locking collar to lock</li> <li>3. If applicable, close valve of appropriate QD in flowpath, verify detent button is up, and fwd white line is visible</li> </ol>
	Q. Female QD leaks after demate	Fully mate to destination male as quickly as possible
	R. Male QD leaks after demate (male sleeve may be visibly stuck open)	<ol style="list-style-type: none"> <li>1. Remate female QD and open valve (bail fwd)                             <ol style="list-style-type: none"> <li>a. Depress button and use significant force to push bail forward; Release button</li> <li>b. With QD in open position (bail fwd) apply significant force to aft end of the female QD in back and forth, up and down directions</li> <li>c. Attempt to close valve (bail aft)</li> <li>d. Demate QD and inspect</li> </ol> </li> <li>2. If applicable, close valve of appropriate QD in flowpath, verify detent button is up, and fwd white line is visible</li> <li>3. Install cap (1/4, 1/2, &amp; 1 in only)</li> </ol>
	S. Leak detected by <b>MCC-H</b> after valve ops (possible male sleeve stuck open)	<ol style="list-style-type: none"> <li>1. Cycle QD to open position (bail fwd)                             <ol style="list-style-type: none"> <li>a. Depress button and use significant force to push bail forward; release button</li> <li>b. With QD in valve open (bail fwd) position apply significant force to aft end of the female QD in back and forth, up and down directions</li> <li>c. Attempt to close valve (bail aft)</li> <li>d. Demate QD and inspect</li> </ol> </li> <li>2. If applicable, close valve of appropriate QD in flowpath, verify detent button is up, and fwd white line is visible</li> </ol>
	T. Frozen NH3 present on female or male QD	<ol style="list-style-type: none"> <li>1. Leave QD exposed to vacuum; wait maximum of 5 min for sublimation (check periodically)</li> <li>2. <b>On MCC-H GO:</b> Continue QD ops</li> </ol>



**STS-129/ULF3 WORKAROUNDS CRIBSHEET (Cont)**

TASK	FAILURE	ACTION
		<div data-bbox="488 233 1349 737" style="border: 1px solid black; padding: 5px;"> <p><b><u>MATE QD</u></b></p> <ol style="list-style-type: none"> <li>1. Remove QD caps as required</li> <li>2. Inspect male and female QD for debris or damage</li> <li>3. Verify female QD ready to mate               <ul style="list-style-type: none"> <li>√Detent button – up</li> <li>√Locking collar – locked position</li> <li>√Fwd white band – not visible</li> </ul> </li> <li>4. Assess side load potential prior to mate</li> <li>5. Mate QD               <ul style="list-style-type: none"> <li>√Fwd white band – visible</li> </ul> </li> <li>6. Perform snapback test               <ul style="list-style-type: none"> <li>√Fwd white band visible</li> </ul> </li> <li>7. Perform pull test (Stay clear of button and release ring)</li> <li>8. Perform visual gap test               <ul style="list-style-type: none"> <li>√For FID</li> </ul> </li> </ol> </div> <div data-bbox="488 772 1349 1045" style="border: 1px solid black; padding: 5px; margin-top: 10px;"> <p><b><u>Open Valve</u></b></p> <ol style="list-style-type: none"> <li>1. Assess side loads</li> <li>2. Rotate locking collar to unlocked position</li> <li>3. Depress detent button</li> <li>4. Push bail to forward position</li> <li>5. √Aft white band visible</li> <li>6. √Detent button – up</li> <li>7. Rotate locking collar to locked position</li> </ol> </div> <div data-bbox="488 1081 1349 1724" style="border: 1px solid black; padding: 5px; margin-top: 10px;"> <p><b><u>Close Valve, Demate QD</u></b></p> <ol style="list-style-type: none"> <li>1. √Aft white band visible</li> <li>2. √Detent button fully installed</li> <li>3. √Detent button up</li> <li>4. Rotate locking collar to unlocked position</li> <li>5. √Detent button can be depressed</li> <li>6. Assess side loads prior to bail movement</li> <li>7. Push bail toward open position with significant force while depressing detent button (unstick male sleeve seals)</li> <li>8. Depress detent button, move bail aft (close valve)</li> <li>9. √Fwd white band visible</li> <li>10. √Detent button up</li> <li>11. Rotate locking collar to locked position</li> <li>12. Assess side loads prior to demate</li> <li>13. Pull back on release ring and demate QD</li> <li>14. √Release ring – retracted (FWD white band not visible)</li> <li>15. Inspect male and female QD for debris, damage, or anomalous conditions (ammonia crystals)</li> <li>16. Install QD caps as required; verify lock tab engaged</li> </ol> </div>

**STS-129/ULF3 WORKAROUNDS CRIBSHEET (Cont)**

TASK	FAILURE	ACTION
	<p><b>MMOD Shield</b></p> <p>A. MMOD shield Dzus fastener fails to release</p> <div style="border: 3px double black; padding: 5px; margin: 10px 0;"> <p style="text-align: center;"><b>WARNING</b></p> <p>Do not touch back side of MMOD shield or handle fastener fragments due to sharp edges</p> <p>Fastener and shield/tool interface must be covered to avoid potential projectiles</p> </div>	<ol style="list-style-type: none"> <li>1. <b>On MCC-H GO:</b> Retrieve pry bar and emptied med ORU bag</li> <li>2. Release other Dzus fasteners</li> <li>3. Assess clearance between MMOD shield and tools</li> <li>4. If possible, rotate fastener to position tangs off of tools</li> <li>5. Place med ORU bag over failed fastener</li> <li>6. Insert pry bar under MMOD shield by failed fastener and pry shield away from structure</li> </ol>
	<p>B. MMOD shield Dzus fastener fails to engage</p>	<ol style="list-style-type: none"> <li>1. Verify center fastener is engaged first</li> <li>2. Check Dzus fastener aligned with bracket (floating receptacles on endcones)</li> <li>3. Verify fastener clocking correct per alignment mark</li> <li>4. Push firmly and rotate</li> <li>5. Engage other fasteners: 2 out of 3 required</li> <li>6. If 2 of 3 not achieved: <ul style="list-style-type: none"> <li>– Option 1 (Wire Tie) (See figures 2-4): 1 properly secured wire tie = 1 Dzus fastener; Using a long wire tie, squish the loop on one end, feed it through the bracket on structure (may need to push floating receptacle inboard to get it out of way), secure wire tie w/3 twists. Feed one end of wire tie around Dzus head (on outside of shield) and secure with 3 twists. If HR nearby can also secure wire tie to HR. (Goal is for the wire tie to push shield in toward body of structure and toward center if endcone shield)</li> <li>– Option 2 (LDTDT): Use 1 adj (attach to tether point on T tool and to structure HR) and 1 LDTDT across shield to hold shield in position</li> </ul> </li> </ol>
	<p>C. T-handle tool fails to engage shield</p>	<p>Remove adjacent fasteners and attempt reinstallation</p>
	<p>D. MLI grounding strap Dzus fails to release</p>	<p><b>On MCC-H GO:</b> Cut ground wire near Dzus fastener</p>

STS-129/ULF3 WORKAROUNDS CRIBSHEET (Cont)

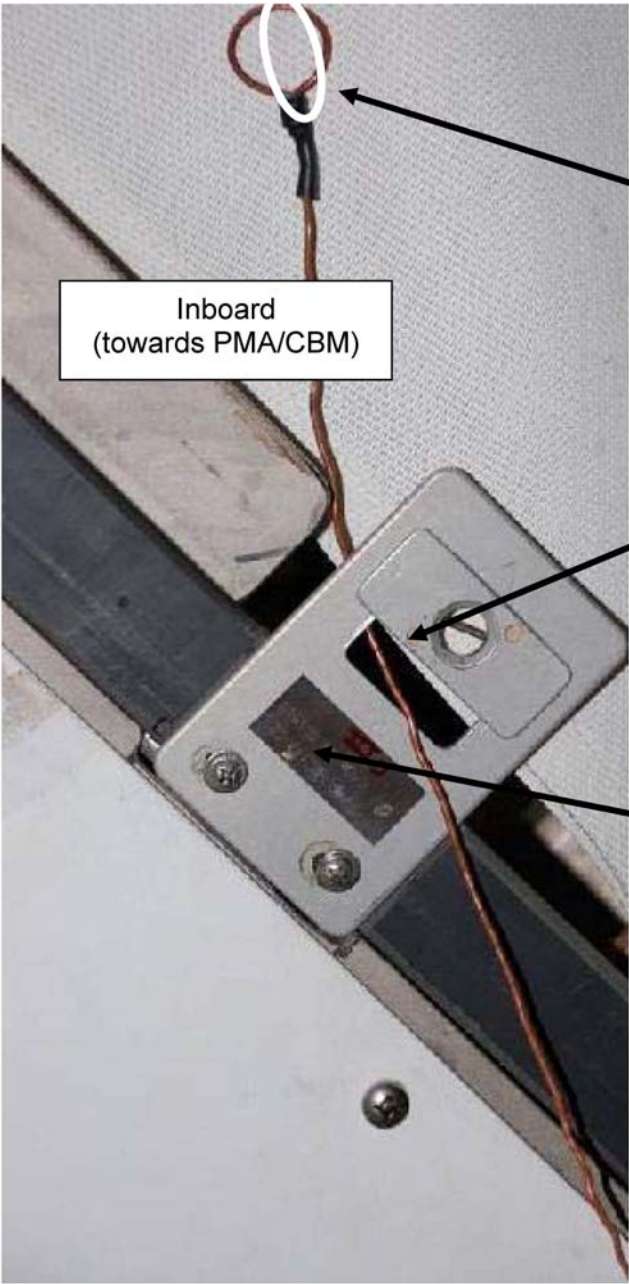
TASK	FAILURE	ACTION
		<p>Will "squish" loop together a little Pre-EVA for easier access through nutplate</p> <p>Inboard (towards PMA/CBM)</p> <p>Floating receptacle shifted towards center of Shield</p> <p>Wire Tie Inserted Thru "Window" on receptacle bracket</p> <p>Figure 3.- MMOD Shield Wire Tie Option.</p>

STS-129/ULF3 WORKAROUNDS CRIBSHEET (Cont)

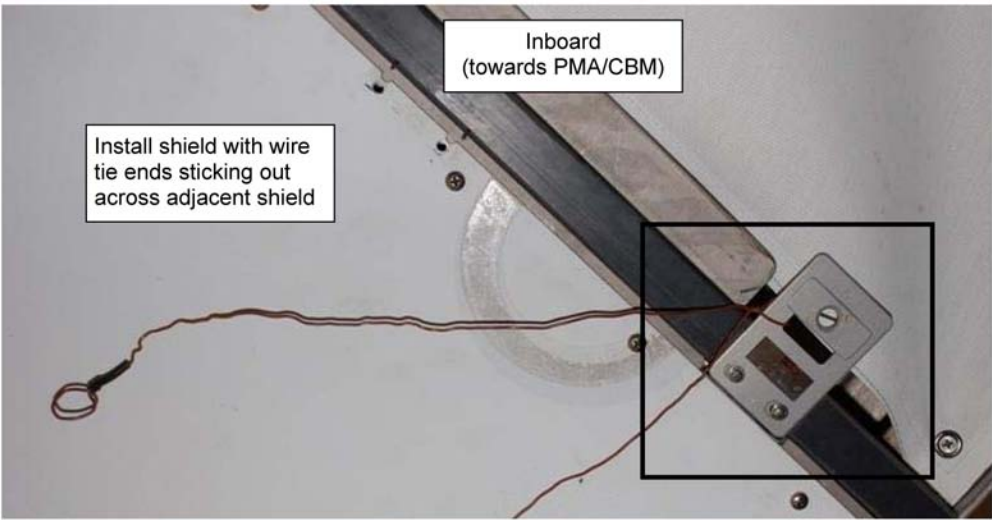
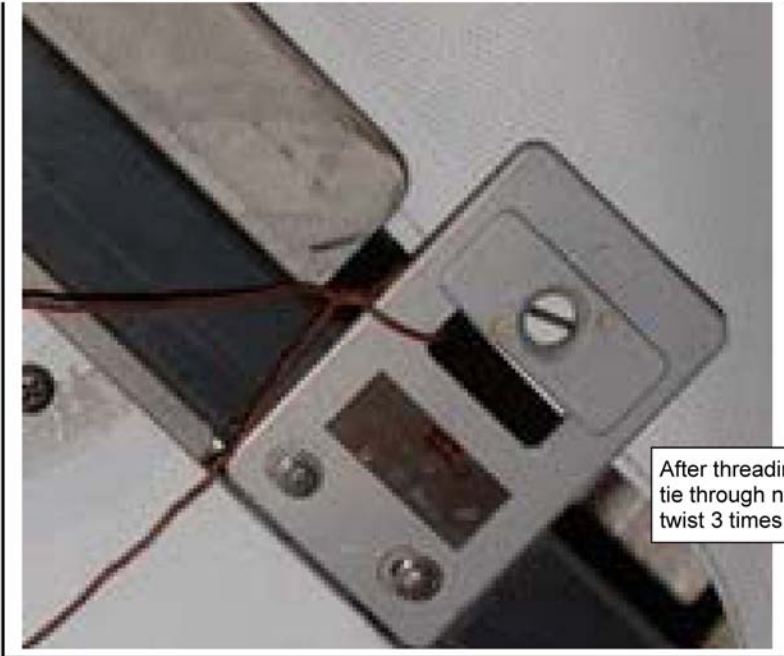
TASK	FAILURE	ACTION
		 <p data-bbox="592 1449 1242 1501">Figure 3.- MMOD Shield Wire Tie Option. (Cont)</p>

STS-129/ULF3 WORKAROUNDS CRIBSHEET (Cont)

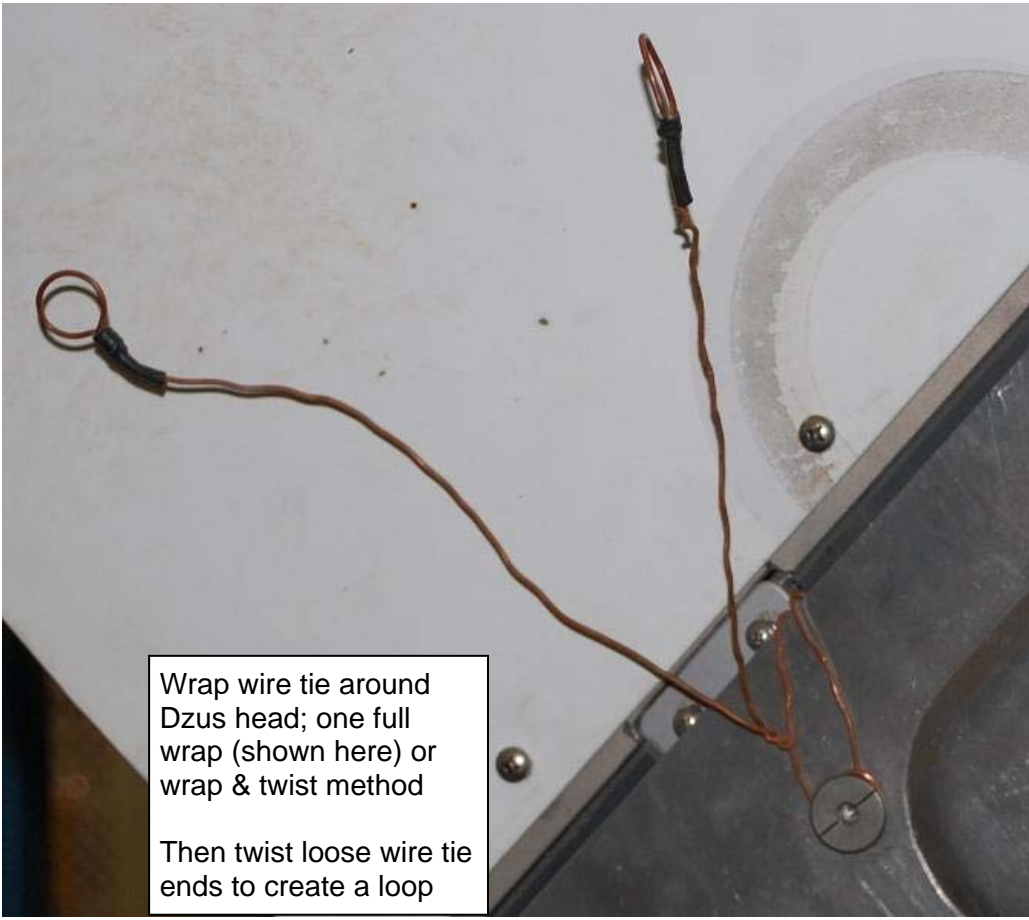
TASK	FAILURE	ACTION
		 <p data-bbox="560 884 894 1136">Wrap wire tie around Dzus head; one full wrap (shown here) or wrap &amp; twist method Then twist loose wire tie ends to create a loop</p> <p data-bbox="583 1178 1255 1234">Figure 3.- MMOD Shield Wire Tie Option. (Cont)</p>

**STS-129/ULF3 WORKAROUNDS CRIBSHEET (Cont)**

<b>TASK</b>	<b>FAILURE</b>	<b>ACTION</b>
	<b>MUT EE</b>	
	A. MUT EE jaws fail to release	<ol style="list-style-type: none"> <li>1. Verify locking collar fully released</li> <li>2. Shake MUT EE while depressing paddles to alleviate sideloads from handrail</li> <li>3. Release MUT EE ECOM socket and tether MUT EE to structure</li> </ol>
	<b>MWS</b>	
	A. MWS EE is sticky	Known problem. Report degree of stickiness to <b>MCC-H</b> and any noted correlation with thermal environment. Post EVA, report s/n of affected unit (s/n located on "stem" of T-bar)
	B. MWS EE cord fails to retract	<ol style="list-style-type: none"> <li>1. Verify MWS EE tether lock in unlock position</li> <li>2. Cycle MWS EE tether lock</li> <li>3. Check tether reel opening for FOD</li> <li>4. Pull out small amount of tether and allow reel to retract while holding light tension on the tether</li> </ol>
	C. MWS T-bar fails to pivot	<ol style="list-style-type: none"> <li>1. Check sideloads on T-bar while depressing button</li> <li>2. Slip T-bar clutch (40-60 lb force required)</li> </ol>
	<b>NZGL Connectors</b>	
	A. Bail bar fails to slide over-center	<ol style="list-style-type: none"> <li>1. Inspect bail for FOD</li> <li>2. Inspect bail linkage for damage and report to <b>MCC-H</b></li> <li>3. Check alignment and sideloads</li> <li>4. Verify sufficient TA-clamps are open</li> <li>5. Increase force on bail</li> <li>6. Attach 2 hooks from adj tether to connector bail and use adj strap to pull bail into demated position</li> <li>7. <b>On MCC-H GO:</b> Retrieve vise grips to help increase force on bail</li> </ol>
	B. Backshell fails to slide (after over-center mechanism has been overcome)	<ol style="list-style-type: none"> <li>1. Verify sufficient TA-clamps are open</li> <li>2. Check for cable harness and hardware interference</li> <li>3. Check alignment and sideloads</li> <li>4. Inspect bail and connector for FOD</li> <li>5. Inspect bail linkage for damage and report to <b>MCC-H</b></li> <li>6. Wiggle/jiggle connector while pushing or pulling on backshell</li> <li>7. Attach 2 hooks from adj tether to connector bail and use adj strap to pull bail into demated position</li> <li>8. <b>On MCC-H GO:</b> Retrieve vise grips to help increase force on bail</li> </ol>

## STS-129/ULF3 WORKAROUNDS CRIBSHEET (Cont)

TASK	FAILURE	ACTION
	C. Connector fails to release from soft dock	<ol style="list-style-type: none"> <li>1. Verify bail fully thrown, undamaged, and backshell fully aft</li> <li>2. If backshell springs forward, pull and hold in fully aft position (will have to overcome spring force, approx 5-10 lb) while attempting to demate connector</li> <li>3. Verify sufficient TA-clamps are open</li> <li>4. Check for cable harness and hardware interference</li> <li>5. Check alignment and sideloads</li> <li>6. Relieve compression on connector interface due to cable loads by pulling backshell away from jack</li> <li>7. Push the plug towards the jack to compress the soft dock</li> <li>8. Wiggle/jiggle connector (Use slight rolling motion)</li> </ol>
	D. Connector fails to soft dock	<ol style="list-style-type: none"> <li>1. Verify correct plug and jack</li> <li>2. Verify bail fully aft</li> <li>3. Verify backshell fully aft and remains fully aft. If backshell not fully aft, pull and hold in fully aft position while attempting to soft dock connector</li> <li>4. Inspect the following: <ul style="list-style-type: none"> <li>- O-ring seal</li> <li>- FOD</li> <li>- Bend radius</li> <li>- Soft dock springs</li> <li>- Connector keying feature</li> </ul> </li> <li>5. Verify alignment (avoid excessive rolling or rocking the plug as this could unseat soft dock springs) <ul style="list-style-type: none"> <li>- Connector should snap into soft dock with little force once half shells are aligned</li> </ul> </li> </ol>
	E. Connector fails to mate	<ol style="list-style-type: none"> <li>1. Verify half-shells are fully seated on both sides</li> <li>2. Verify cable and backshell free to move (no clamps)</li> <li>3. Push forward on connector backshell while actuating bail</li> <li>4. Detach from soft dock and inspect: <ul style="list-style-type: none"> <li>- Pins</li> <li>- FOD</li> <li>- EMI band</li> <li>- Bend radius</li> <li>- TA clamps</li> <li>- P clamps</li> <li>- Bail linkages and rivets</li> <li>- Soft dock springs</li> <li>- O-ring seal and main joint gasket</li> <li>- Connector keying feature</li> </ul> </li> <li>5. Cycle bail while disconnected (push forward on connector backshell for additional leverage)</li> </ol>

**STS-129/ULF3 WORKAROUNDS CRIBSHEET (Cont)**

TASK	FAILURE	ACTION
	F. Connector pin bent	<ol style="list-style-type: none"> <li>1. Rotate connector to bail up position and describe pin location and condition                             <ul style="list-style-type: none"> <li>– Obtain WVS view of interface if possible</li> </ul> </li> <li>2. <b>On MCC-H GO:</b> For 16, 20, or 22 gauge pins only, retrieve pin straightener and attempt pin repair</li> <li>3. <b>On MCC-H GO:</b> Retrieve needle nose pliers and attempt pin repair                             <ul style="list-style-type: none"> <li>– <b>MCC-H</b> will verify pin size prior to retrieving tools</li> </ul> </li> <li>4. Inspect plug and jack prior to re-mating</li> </ol>
	G. Connector FOD	<ol style="list-style-type: none"> <li>1. <b>On MCC-H GO:</b> Retrieve connector cleaner tool                             <p style="text-align: center;"><u>NOTE</u></p> <p>One N2 cartridge is already captured in the tool (the other is lanyarded inside the caddy). In order to puncture the cartridge, it must be threaded into the tool until the indicator line passes out of sight under the collar of the tool.</p> <p>Puncture connector cleaner cartridge only when ready to perform actual cleaning.</p> <p>Use entire N2 cartridge prior to reentering airlock</p> </li> <li>2. Attempt cleaning</li> </ol>
	H. Connector EMI band bent	<p><b>On MCC-H GO:</b> Retrieve needle nose pliers or forceps to remove band</p> <ul style="list-style-type: none"> <li>– Bail may need to be pushed forward while demated to expose EMI band for removal</li> </ul>
	I. Connector bail linkage failure	<ol style="list-style-type: none"> <li>1. <b>On MCC-H GO:</b> Re-attempt connector mate/demate with broken bail                             <ul style="list-style-type: none"> <li>– Impart load through undamaged side of bail linkage</li> <li>– Assist bail motion with hand on backshell once bail linkage has passed over-center</li> <li>– May take multiple pushes on the bail to mate/demate connector</li> </ul> </li> <li>2. Tether hook or vise grips may be used for additional leverage</li> </ol>
	J. Connector soft dock spring bent	<p><b>On MCC-H GO:</b> Retrieve needle nose pliers and remove bent spring</p>
	K. Connector O-ring or main joint gasket seal loose (seal and O-ring required in 1-G only)	<ol style="list-style-type: none"> <li>1. Remove seal with tether hook</li> <li>2. <b>On MCC-H GO:</b> Retrieve additional tools to remove seal (Ex: wire tie, needle nose pliers, probe, loop pin puller)</li> </ol>
	L. Connector cap (Twist) will not release	<ol style="list-style-type: none"> <li>1. Increase force</li> <li>2. Use tether hook for additional leverage</li> </ol>



**STS-129/ULF3 WORKAROUNDS CRIBSHEET (Cont)**

<b>TASK</b>	<b>FAILURE</b>	<b>ACTION</b>
	<b>On-Orbit Installed HR</b>	
	A. HR will not install in seat track or fails to soft dock	<ol style="list-style-type: none"> <li>1. Verify HR installed in correct direction per arrow on underside of HR</li> <li>2. Verify HR shoes are completely released and soft dock armed</li> <li>3. Check for FOD on HR and seat track</li> <li>4. Verify HR bolt completely released: <b>PGT [A1 (2.5), CCW2, 30.5], 7/16 - 6-ext</b></li> <li>5. If HR in seat track but soft dock will not engage, attempt to drive HR bolts</li> <li>6. <b>On MCC-H GO:</b> Depending on HR priority, attempt to install 180 out or a different HR at this location</li> </ol>
	B. HR bolt fails to fully engage	<ol style="list-style-type: none"> <li>1. If torqued, remove HR: <b>PGT [A2 (3.8), CCW2, 30.5], 7/16 - 6-ext</b> – To break torque <b>PGT [A1 (2.5), CCW2, 30.5], 7/16 - 6-ext</b> – For removal – Check for FOD on HR and seat track and reinstall using original torque</li> <li>2. Increase PGT setting: <b>PGT [A3 (4.8), CW2, 30.5], 7/16 - 6-ext</b></li> <li>3. <b>On MCC-H GO:</b> Depending on HR priority, attempt to install 180 out or a different HR at this location</li> </ol>
	<b>On-Orbit Installed WIF</b>	
	A. WIF fails to soft dock	<ol style="list-style-type: none"> <li>1. Check for FOD and structural interference, cycle soft dock pins; reattempt installation</li> <li>2. Verify WIF is co-planar</li> <li>3. Install a different WIF at this location</li> <li>4. <b>On MCC-H GO:</b> Attempt installation of WIF in a different location</li> <li>5. Return WIF inside</li> </ol>
	<b>PAD</b>	
	A. Release knob fails to rotate open	<ol style="list-style-type: none"> <li>1. Verify knob in release position (J-hook not locked)</li> <li>2. Attempt to rotate knob using ratchet on knob's 7/16 in hex stud</li> <li>3. Release contingency release bar captive bolts (2) <b>PGT [A6 (8.3), CCW2, 30.5], 7/16 - 6 ext</b> 5 turns (Verify hook released from striker bar)</li> </ol>
	<b>PGT</b>	
	A. No LEDs	<ol style="list-style-type: none"> <li>1. Perform LED test</li> <li>2. Use display torque</li> </ol>
	B. LEDs and torque messages do not agree	Use torque message and notify <b>MCC-H</b>
	C. Mode switch breaks	Retrieve spare PGT
	<b>LCD Messages</b>	
	D. BATTERY HITEMP	<ol style="list-style-type: none"> <li>1. Power off PGT</li> <li>2. If alternate battery available; change battery</li> <li>3. Retrieve spare PGT</li> <li>4. Switch to ratchet mode</li> </ol>

**STS-129/ULF3 WORKAROUNDS CRIBSHEET (Cont)**

<b>TASK</b>	<b>FAILURE</b>	<b>ACTION</b>
	E. BATTERY LOTEMP (blinking)	<ol style="list-style-type: none"> <li>1. Drive tool with no load to increase battery temperature</li> <li>2. If alternate battery available; power off and change battery</li> <li>3. Retrieve spare PGT</li> <li>4. Power off and switch to ratchet mode</li> </ol>
	F. BATTERY LOVOLT (blinking)	<ol style="list-style-type: none"> <li>1. Continue using tool until unable to deliver sufficient torque</li> <li>2. Retrieve spare PGT</li> <li>3. Power off and switch to ratchet mode</li> </ol>
	G. CAL FAILED	<ol style="list-style-type: none"> <li>1. Press, release trigger to repeat calibration</li> <li>2. Power cycle and calibrate</li> <li>3. Retrieve spare PGT</li> <li>4. Power off and switch to ratchet mode</li> </ol>
	H. COLLAR ERROR	<ol style="list-style-type: none"> <li>1. Cycle torque and speed collars to clear error</li> <li>2. Power cycle and calibrate</li> <li>3. Retrieve spare PGT</li> <li>4. Power off and switch to ratchet mode</li> </ol>
	I. COMPAR ERROR	<ol style="list-style-type: none"> <li>1. Cycle torque collar and A/B mode switch</li> <li>2. Power cycle and calibrate</li> <li>3. Retrieve spare PGT</li> <li>4. Power off and switch to ratchet mode</li> </ol>
	J. EEPROM WR ERR (blinking) HYBRID HITEMP OVER CURR SLFTST FAIL X	<ol style="list-style-type: none"> <li>1. Power cycle and calibrate</li> <li>2. Retrieve spare PGT</li> <li>3. Power off and switch to ratchet mode</li> </ol>
	K. HI TORQ	<ol style="list-style-type: none"> <li>1. Contact <b>MCC-H</b> and report torque (Real time engineering assessment required)</li> <li>2. <b>On MCC-H GO:</b> Power cycle and calibrate</li> <li>3. Retrieve spare PGT</li> <li>4. Power off and switch to ratchet mode</li> </ol>
	L. HICURR	<ol style="list-style-type: none"> <li>1. Reattempt operation – Can be caused by excessive rotation of the PGT body while torquing</li> <li>2. Power cycle and calibrate</li> <li>3. Retrieve spare PGT</li> <li>4. Power off and switch to ratchet mode</li> </ol>
	M. LO TORQ (Expected during bolt release)	<ol style="list-style-type: none"> <li>1. Reattempt operation until desired torque is reached</li> <li>2. Power cycle and calibrate</li> <li>3. Retrieve spare PGT</li> <li>4. Power off and switch to ratchet mode</li> </ol>
	N. LOCURR	<ol style="list-style-type: none"> <li>1. Reattempt operation</li> <li>2. Power cycle and calibrate</li> <li>3. Retrieve spare PGT</li> <li>4. Power off and switch to ratchet mode</li> </ol>
	O. LOG IS FULL (blinking)	<ol style="list-style-type: none"> <li>1. Cycle torque and speed collars to clear message</li> <li>2. Continue operation</li> </ol>
	P. MOTOR HITEMP	<ol style="list-style-type: none"> <li>1. Power off PGT</li> <li>2. Retrieve spare PGT</li> <li>3. Switch to ratchet mode</li> </ol>

**STS-129/ULF3 WORKAROUNDS CRIBSHEET (Cont)**

TASK	FAILURE	ACTION
	<p><b>Safety Tether</b></p> <p>A. Safety tether fails to retract/tend</p>	<ol style="list-style-type: none"> <li>1. Verify reel is unlocked</li> <li>2. Verify tether reel and/or cable guide (for 85-ft tethers) is clear of FOD</li> <li>3. Pull out small amount of cable and allow reel to retract while holding light tension on the cable</li> <li>4. Tap side of reel housing during retraction</li> <li>5. Report ID # of faulty tether to <b>MCC-H</b> and use alternate safety tether</li> <li>6. Coil safety tether to bring inside</li> <li>7. For 85-ft tether. <b>On MCC-H GO:</b> If coiling tether is not practical, release level wind mechanism bypass on back of safety tether. (Red indicator will show around edge of bypass once released)</li> </ol> <p style="text-align: center;"><u>NOTE</u></p> <p>Once level wind has been released cable guide will likely be frozen in place. This will limit the amount of tether that can be successfully retracted into the tether housing and may require coiling of excess tether.</p> <p>Level wind release will require safety tether be returned for ground servicing.</p> <p>If tether fails to retract due to thermal issue, normal tether function may return after tether brought IVA</p>
	<p>B. Safety tether red stripe showing (any length)</p>	<p>Safety tether cannot be used</p> <ul style="list-style-type: none"> <li>– Report ID # of faulty tether to <b>MCC-H</b></li> <li>– Use alternate safety tether</li> </ul>
	<p>C. Crew hook fails</p>	<ol style="list-style-type: none"> <li>1. On load alleviating end: Use waist tether to replace alleviating strap <ul style="list-style-type: none"> <li>– Report ID # of faulty tether to <b>MCC-H</b></li> <li>– Retrieve replacement safety tether</li> </ul> </li> <li>2. On anchor end: Report ID # of faulty tether to <b>MCC-H</b> and use an alternate safety tether</li> </ol>
	<p><b>Scoops</b></p>	
	<p>A. Scoop will not release from fitting</p>	<ol style="list-style-type: none"> <li>1. If actuator will not pull back while in locked position, tap actuator with tool to release</li> <li>2. <b>On MCC-H GO:</b> Leave scoop in place</li> <li>3. <b>On MCC-H GO:</b> Remove non-captive contingency screws; 5 turns. Stow in trash bag. <b>PGT [A1 (2.5), CCW2, 30.5], 5/32 allen drive</b> <ul style="list-style-type: none"> <li>– Square Scoop: 4 screws (Figure 5)</li> <li>– Round Scoop: 7 screws (Figure 6)</li> </ul> </li> </ol>

STS-129/ULF3 WORKAROUNDS CRIBSHEET (Cont)

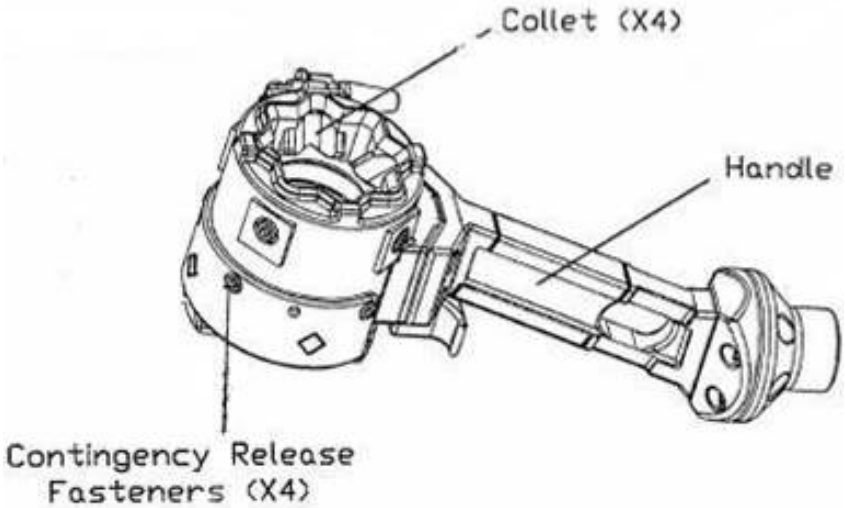
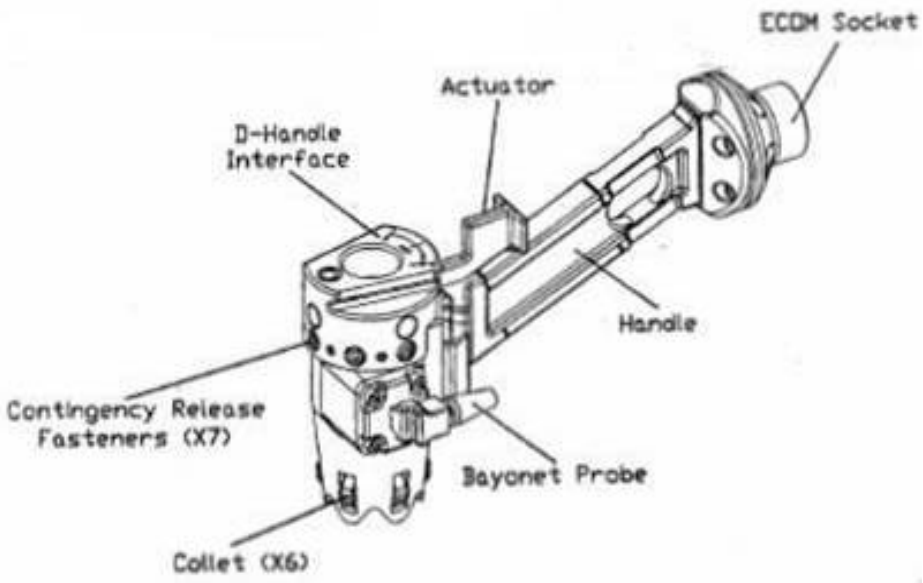
TASK	FAILURE	ACTION
		 <p data-bbox="730 787 1112 850">Figure 5.- Square Scoop.</p>  <p data-bbox="738 1575 1104 1638">Figure 6.- Round Scoop.</p>

**STS-129/ULF3 WORKAROUNDS CRIBSHEET (Cont)**

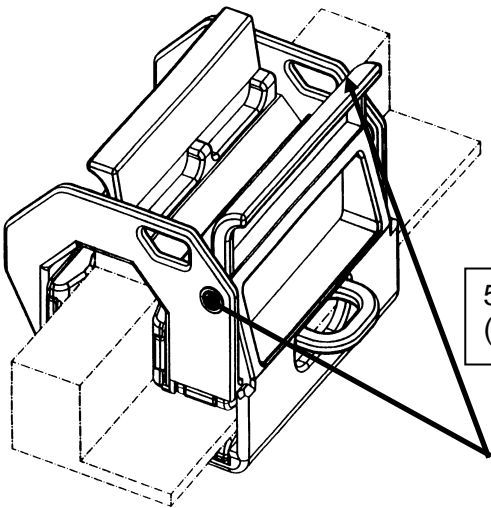
TASK	FAILURE	ACTION
<b>Socket Caddy</b>		
	A. Socket fails to release from socket caddy	<ol style="list-style-type: none"> <li>1. Verify PIP pin fully inserted into drop proof tether interface on socket</li> <li>2. Reattempt using a different PIP pin</li> </ol>
<b>TA Clamp</b>		
	A. TA clamp fails to release	<ol style="list-style-type: none"> <li>1. With handle up, press down on top of rounded clamp</li> <li>2. With handle up, use tether hook to pry drawhook from capture pin</li> </ol>
<b>Tether Shuttle</b>		
	A. Tether shuttle will not release from CETA/ MT rail	<ol style="list-style-type: none"> <li>1. Verify slider in unlock and no obstructions to paddle actuation</li> <li>2. Verify safety tethered to structure and safety tether removed from tether shuttle anchor point</li> <li>3. <b>On MCC-H GO:</b> Remove non-captive screws (2) at hingeline to release nadir section with slide lock (not captive) (figure 7). TBD turns. Stow screws in trash bag <b>PGT [A1 (2.5), CCW1, 30.5], 5/32 allen drive</b></li> </ol>
 <div data-bbox="906 1136 1404 1234" style="border: 1px solid black; padding: 5px;"> <p>5/32nd Allen Contingency Release (1 of 2 visible)</p> </div> <div data-bbox="730 1417 1107 1476" style="border: 1px solid black; padding: 5px; margin-top: 10px;"> <p>Figure 7.- Tether Shuttle.</p> </div>		
<b>Torque Multiplier</b>		
	A. TM will not release from fitting	<ol style="list-style-type: none"> <li>1. Place TM anti-backlash in neutral, if unable: <b>PGT [RCW, 30.5]</b> – Apply cw torque while pushing anti-backlash button to neutral. Reattempt removal</li> <li>2. If able to lift TM off of bolt, attempt to rock off of fitting (Square TM only)</li> <li>3. <b>On MCC-H GO:</b> Release TM contingency release band pin 20 turns (do not exceed 28 turns) (figure 8): <b>PGT [A1 (2.5), CCW2, 30.5], 5/32 ball end driver</b> – When band springs open, remove TM</li> </ol>



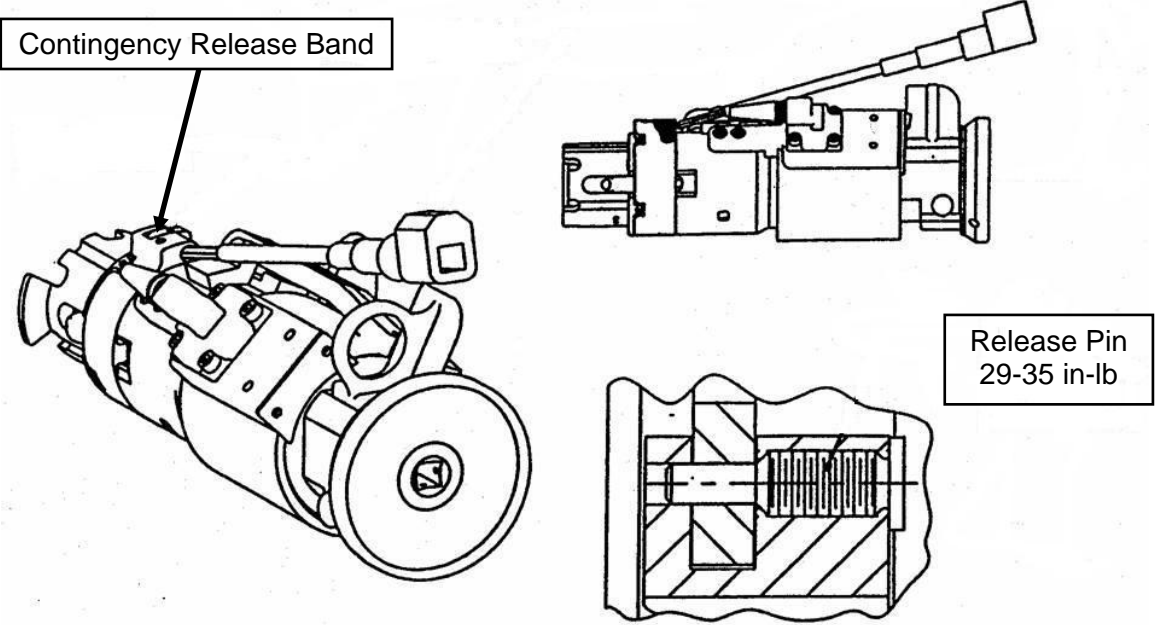
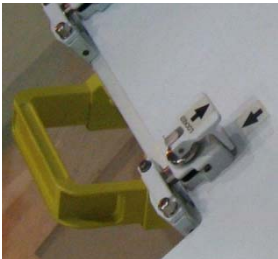



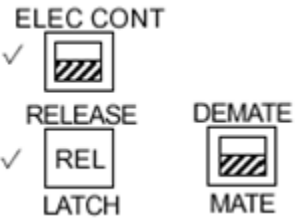

**STS-129/ULF3 WORKAROUNDS CRIBSHEET (Cont)**

TASK	FAILURE	ACTION
		
<p><b>TSA</b></p>		
<p>A. Latch fails to open</p>	<p>Release 7/16 EVA bolt on latch bracket; rotate bracket clear of latch  <b>PGT [A2 (3.8), CCW2, 30.5], 7/16 - 6 ext</b>                      1-2 turns</p>	
<p>B. Latch fails to close</p>	<p>Close remaining latches (3 of 4 required for landing).                      Latch is closed arrow to arrow</p>	
		

## RELEASE ELC1 (ELC2) ROEU LATCHES

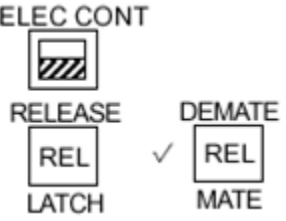
IV		EV
<p>R1</p> <p>O13:C :E</p> <p>O14:B</p> <p>O16:B</p> <p>MA73C:A :B</p> <p>R13L A6U</p>	<p>1. <u>DEADFACE ROEU</u>            PL PRI MNC – OFF (tb-OFF)              √MNB,FC3 (two) – ctr (tb-OFF)</p> <p>cb ESS 2CA MNB CONTR – op              3AB MNC CONTR – op</p> <p>MNA MNC CONTR – op</p> <p>MNC MNB CONTR – op</p> <p>2. <u>ROEU SAFING</u></p> <p style="text-align: center;"><u>NOTE</u></p> <p style="text-align: center;">When LOGIC switches taken OFF, KU will            mode to standby. MPM and MRL tbs – bp</p> <p>MCA LOGIC MNC MID 2 – OFF              MNB MID 4 – OFF</p> <p>√PL BAY MECH PWR SYS 1,2 (two) – OFF            √RETEN LOGIC PWR SYS 1,2 (two) – OFF              PL SEL – MON</p> <p>Give EV GO to release ROEU</p>	<p>Tools reqd:            Ratchet with 3-in Ext (Airlock)</p> <div style="border: 3px double black; padding: 5px; text-align: center; margin: 10px 0;"> <p><u>WARNING</u></p> <p>For release, do not close access cover until ROEU            stowed. Latches may not snap back to closed posn</p> </div> <p>1. On IV GO, open latch drive access cover:              Break safety cord, release access cover (3/4 turn ccw)              Open access cover (~120°)            Manual drive to RELEASE:              Rotate control lever to RELEASE              Rotate latch drive cw (~9 ft-lb) to hard stop (~3/4 turn)              Remove drive ratchet, clear worksite</p>

## RELEASE ELC1 (ELC2) ROEU LATCHES (Cont)

IV	EV
<p>A6U 3. <u>VERIFY TALKBACKS</u> Install <u>ROEU A6U PANEL OVERLAY</u></p> <p>PL RETEN PL SEL – 2</p> <div style="text-align: center;">  <p>ELEC CONT ✓  RELEASE REL LATCH ✓  DEMATE MATE </p> </div> <p>R13L A6U 4. <u>DEMATE ROEU</u> PL BAY MECH PWR SYS 1,2 (two) – ON RETEN LOGIC PWR SYS 1,2 (two) – ON</p> <p>Note single motor time (&gt; 18 sec)</p> <p>ELC1 (ELC2) DEMATE/MATE – DEMATE (tb-REL), 36 sec max – OFF</p> <div style="text-align: center;">  <p>ELEC CONT  RELEASE REL LATCH  DEMATE REL MATE ✓ </p> </div> <p>PL RETEN LOGIC PWR SYS 1,2 (two) – OFF PL SEL – MON</p> <p>R13L PL BAY MECH PWR SYS 1,2 (two) – OFF</p>	<div style="border: 3px double black; padding: 10px; text-align: center;"> <p><b>WARNING</b></p> <p>For release, remain clear of latches during access cover closing. Latches may snap back to closed posn</p> </div>



**RELEASE ELC1 (ELC2) ROEU LATCHES (Cont)**

<b>IV</b>	<b>EV</b>
<p>5. <u>ENABLE POWER</u></p> <p>O13:C      cb ESS 2CA MNB CONTR – cl            :E            3AB MNC CONTR – cl</p> <p>O14:B            MNA MNC CONTR – cl  O16:B            MNC MNB CONTR – cl</p> <p>R1            PL PRI MNC – ON (tb-ON)</p> <p>MA73C:A      MCA LOGIC MNC MID 2 – ON            :B                    MNB MID 4 – ON</p>	<p>2. Reengage latch actuator:            Rotate control lever to neutral posn            Close, secure access cover (3/4 turn cw)            Clear worksite</p>

# LATCH ELC1 (ELC2) ROEU LATCHES

IV	EV
<p>R1            1. <u>DEADFACE ROEU</u>            PL PRI MNC – OFF (tb-OFF)                √MNB,FC3 (two) – ctr (tb-OFF)</p> <p>O13:C        cb ESS 2CA MNB CONTR – op                  :E            3AB MNC CONTR – op</p> <p>O14:B        MNA MNC CONTR – op</p> <p>O16:B        MNC MNB CONTR – op</p> <p>A6U           2. <u>CONFIGURE FOR ROEU MATE</u>            Install <u>ROEU A6U PANEL OVERLAY</u></p> <p style="text-align: center;"><u>NOTE</u>            When LOGIC switches taken OFF, KU will            mode to standby. MPM and MRL tbs – bp</p> <p>MA73C:A     MCA LOGIC MNC MID 2 – OFF                  :B            MNB MID 4 – OFF</p> <p>R13L        √PL BAY MECH PWR SYS 1,2 (two) – OFF            A6U           RETEN LOGIC PWR SYS 1,2 (two) – OFF                             PL SEL – 2</p> <p style="text-align: center;"><span style="border: 1px solid black; padding: 2px;">SM 97 PL RETENTION</span></p> <p>CRT         √LAT 1,2 (3,4) (four): 0</p> <p style="text-align: center;">* If LATCH 1,2 (3,4) LAT msw shows 1, drive *            * latch for single motor time                    *</p> <p style="text-align: center;">ELEC CONT</p> <div style="display: flex; justify-content: space-around; align-items: center;"> <div style="text-align: center;">  <p>RELEASE</p> <div style="border: 1px solid black; padding: 2px; width: 30px; margin: 0 auto;">REL</div> <p>LATCH</p> </div> <div style="text-align: center;"> <p>DEMATE</p> <div style="border: 1px solid black; padding: 2px; width: 30px; margin: 0 auto;">REL</div> <p>MATE</p> </div> </div>	<p>Tools reqd:            Ratchet with 3-in Ext (Airlock)</p>

## LATCH ELC1 (ELC2) ROEU LATCHES (Cont)

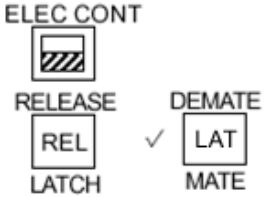
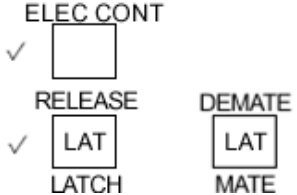
IV	EV
<p>A6U R13L 3. <u>MATE ROEU</u>            PL RETEN LOGIC PWR SYS 1,2 (two) – ON            BAY MECH PWR SYS 1,2 (two) – ON</p> <p>Note single motor time (&gt; 30 sec)</p> <p>A6U ELC1 (ELC2) DEMATE/MATE – MATE (tb-LAT), 60 sec max            – OFF</p> <div style="text-align: center;"> <p>ELEC CONT</p>  </div>	<p>1. On IV GO, open latch drive access cover:            Break safety cord, release access cover (3/4 turn ccw)            Open access cover (~120°)            Manual drive to LATCH:            Rotate control lever to LATCH            Rotate latch drive ccw (~9 ft-lb) to hard stop (~3/4 turn)            Remove drive ratchet, clear worksite</p>
<p>R13L A6U 4. <u>ROEU SAFING</u>            PL BAY MECH PWR SYS 1,2 (two) – OFF            RETEN LOGIC PWR SYS 1,2 (two) – OFF            PL SEL – MON</p> <p>Give EV GO to latch ROEU</p>	
<p>A6U 5. <u>VERIFY TALKBACKS</u>            PL RETEN PL SEL – 2</p> <div style="text-align: center;"> <p>ELEC CONT</p>  </div>	



## LATCH ELC1 (ELC2) ROEU LATCHES (Cont)

IV	EV
<p>R13L A6U</p> <p>6. <u>RELAX ROEU</u>            PL BAY MECH PWR SYS 1,2 (two) – ON            RETEN LOGIC PWR SYS 1,2 (two) – ON            PL SEL – 1 (3)</p> <p style="text-align: center;"><u>NOTE</u>            Monitor PL SEL 1 (3) LATCH 5 REL SYS msws on SPEC 97</p> <p>Note single motor time (&gt; 12 sec)</p> <p>RELAX – RELAX (tb-REL), 24 sec max</p> <p>When LATCH 5 REL A(B) msw changes to 1:            RELAX – OFF</p> <div style="text-align: center;">  <p>A diagram of a control button. The word "RELAX" is written above a square button. Inside the square button, the word "REL" is written. A checkmark is positioned to the left of the button.</p> </div> <p>R13L</p> <p>PL RETEN LOGIC PWR SYS 1,2 (two) – OFF            PL SEL – MON            PL BAY MECH PWR SYS 1,2 (two) – OFF</p>	<p>2. Reengage latch actuator:            Rotate control lever to neutral posn            Close, secure access cover (3/4 turn cw)            Clear worksite</p>
<p>O13:C :E</p> <p>O14:B O16:B</p> <p>7. <u>ENABLE POWER</u>            cb ESS 2CA MNB CONTR – cl            3AB MNC CONTR – cl            MNA MNC CONTR – cl            MNC MNB CONTR – cl</p> <p>R1</p> <p>PL PRI MNC – ON (tb-ON)</p> <p>MA73C:A :B</p> <p>MCA LOGIC MNC MID 2 – ON            MNB MID 4 – ON</p>	

# STOW ELC1 (ELC2) ROEU ARM

IV	EV
<p>R1 1. <u>DEADFACE ROEU</u>            PL PRI MNC – OFF (tb-OFF)                √MNB,FC3 (two) – ctr (tb-OFF)</p> <p>O13:C      cb ESS 2CA MNB CONTR – op              :E            3AB MNC CONTR – op            O14:B      MNA MNC CONTR – op            O16:B      MNC MNB CONTR – op</p> <p>2. <u>CONFIGURE FOR ROEU LATCH</u></p> <p style="text-align: center;"><u>NOTE</u></p> <p style="text-align: center;">When LOGIC switches taken OFF, KU will mode to standby.            MPM and MRL tbs – bp</p> <p>MA73C:A    MCA LOGIC MNC MID 2 – OFF              :B            MNB MID 4 – OFF</p> <p>A6U        Install ROEU A6U PANEL OVERLAY</p> <p>    √PL RETEN LAT (five) – OFF                PL SEL – 2</p> <p style="border: 1px solid black; display: inline-block; padding: 2px;">SM 97 PL RETENTION</p> <p>    √REL 1,2 (3,4) (four): 0</p> <p style="margin-left: 40px;">* If LATCH 1,2 (3,4) REL msw shows 1, drive *              * latch for single motor time                    *</p> <div style="margin-left: 40px;"> <p>ELEC CONT</p> <p>✓ <input type="checkbox"/></p> <p>RELEASE      DEMATE</p> <p><input type="checkbox"/> LAT      <input checked="" type="checkbox"/> MATE</p> <p>LATCH        MATE</p> </div>	<p>Tools reqd:            Ratchet with 30-in Ext (Airlock)</p>



## STOW ELC1 (ELC2) ROEU ARM (Cont)

IV	EV
<p>R13L</p> <p>3. <u>RELEASE LATCHES</u>            PL RETEN LOGIC PWR SYS 1,2 (two) – ON            BAY MECH PWR SYS 1,2 (two) – ON</p> <p>Note single motor time (&gt; 20 sec)</p> <p>ELC1 (ELC2) RELEASE/LATCH – REL (tb-rel), 40 sec max            – OFF</p> <div style="text-align: center;"> <p>ELEC CONT</p> <p>✓ </p> <p>RELEASE      DEMATE</p> <p>✓       </p> <p>LATCH      MATE</p> </div> <p>4. <u>ROEU SAFING</u>            PL BAY MECH PWR SYS 1,2 (two) – OFF            RETEN LOGIC PWR SYS 1,2 (two) – OFF            PL SEL – MON</p> <p>Give EV GO to stow ROEU</p>	<p>1. On IV GO, open arm drive access cover:            Break safety cord, release access cover (3/4 turn ccw)            Open access cover (~120°)            Manual drive to STOW:            Rotate control lever to STOW            Rotate arm drive ccw (~23 ft-lb) to hard stop (~3/4 turn) and pull arm inboard to verify            Remove drive ratchet, clear worksite</p> <p>2. Reengage arm actuator:            Rotate control lever to neutral posn            Close, secure access cover (3/4 turn cw)            Clear worksite</p>

**STOW ELC1 (ELC2) ROEU ARM (Cont)**

IV	EV
<p>A6U 5. <u>VERIFY TALKBACKS</u> PL RETEN PL SEL – 2</p> <p style="text-align: center;">ELEC CONT</p> <div style="text-align: center;">  </div> <div style="display: flex; justify-content: space-around; align-items: center;"> <div style="text-align: center;"> <p>RELEASE</p> <div style="border: 1px solid black; padding: 2px;">REL</div> <p>LATCH</p> </div> <div style="text-align: center;"> <p>DEMATE</p> <div style="display: flex; align-items: center;"> <span style="font-size: 1.2em; margin-right: 5px;">✓</span> <div style="border: 1px solid black; padding: 2px;">REL</div> </div> <p>MATE</p> </div> </div> <p>O13:C 6. <u>ENABLE POWER</u> cb ESS 2CA MNB CONTR – cl :E 3AB MNC CONTR – cl O14:B MNA MNC CONTR – cl O16:B MNC MNB CONTR – cl</p> <p>R1 PL PRI MNC – ON (tb-ON)</p> <p>MA73C:A MCA LOGIC MNC MID 2 – ON :B MNB MID 4 – ON</p>	

## MATE ELC1 (ELC2) ROEU ARM

IV		EV
A6U	<p>1. <u>CONFIGURE ROEU</u> Install <u>ROEU A6U PANEL OVERLAY</u></p> <p>2. <u>ROEU SAFING</u></p> <p style="text-align: center;"><u>NOTE</u> When LOGIC switches taken OFF, KU will mode to standby. MPM and MRL tbs – bp</p> <p>MA73C:A MCA LOGIC MNC MID 2 – OFF :B MNB MID 4 – OFF</p> <p>R13L √PL BAY MECH PWR SYS 1,2 (two) – OFF A6U √RETEN LOGIC PWR SYS 1,2 (two) – OFF PL RETEN PL SEL – MON R1 PL PRI MNC – OFF (tb-OFF) √MNB,FC3 (two) – ctr (tb-OFF)</p> <p>O13:C cb ESS 2CA MNB CONTR – op :E 3AB MNC CONTR – op O14:B MNA MNC CONTR – op O16:B MNC MNB CONTR – op</p> <p>Give EV GO to mate ROEU</p>	<p>Tools reqd: Ratchet with 3-in Ext (Airlock)</p>
A6U	<p>3. <u>VERIFY TALKBACKS</u> PL RETEN PL SEL – 2</p> <p>ELEC CONT</p> <div style="display: flex; justify-content: space-around; align-items: center;"> <div style="text-align: center;">               RELEASE                LATCH         </div> <div style="text-align: center;">             DEMATE                MATE         </div> </div>	<p>1. On IV GO, open arm drive access cover: Break safety cord, release access cover (3/4 turn ccw) Open access cover (~120°) Manual drive to MATE: Rotate control lever to MATE Ratchet arm drive cw (~25 ft-lb) until “READY TO LATCH” posn indicated on interface guide Remove drive ratchet Clear worksite (for latching)</p>



## MATE ELC1 (ELC2) ROEU ARM (Cont)

	IV	EV
<p>R13L A6U</p> <p>4. <u>LATCH LATCHES</u>            PL BAY MECH PWR SYS 1,2 (two) – ON            RETEN LOGIC PWR SYS 1,2 (two) – ON</p> <p>Note single motor time (&gt; 20 sec)</p> <p>ELC1 (ELC2) RELEASE/LATCH – LATCH (tb-LAT), 40 sec max            – OFF</p> <div style="text-align: center;"> <p>ELEC CONT</p> <p>✓ <input type="checkbox"/></p> <p>RELEASE      DEMATE</p> <p>✓ <input type="checkbox"/> LAT      <input type="checkbox"/> LAT</p> <p>LATCH          MATE</p> </div>		
<p>R13L A6U</p> <p>5. <u>RELAX ROEU (EVA)</u>            PL RETEN PL SEL – 1(3)            Monitor PL RETEN LAT 1 tb</p> <p>Give EV GO to STOW arm,            halt once RELAX tb – REL</p>		<p>2. <u>RELAX ROEU (EVA)</u>            On IV GO, rotate control lever to STOW:            Ratchet arm drive ccw until IV receives RELAX 1 tb – REL.            Remove drive ratchet</p> <p>3. Reengage arm actuator:            Rotate control lever to neutral posn            Close, secure access cover (3/4 turn cw)            Clear worksite</p>
<p>O13:C      6. <u>ENABLE POWER</u>                  :E      cb ESS 2CA MNB CONTR – cl                  O14:B      3AB MNC CONTR – cl                  O16:B      MNA MNC CONTR – cl                          MNC MNB CONTR – cl</p> <p>R1            PL PRI MNC – ON (tb-ON)</p> <p>MA73C:A    MCA LOGIC MNC MID 2 – ON                  :B            MNB MID 4 – ON</p>		

ROEU OVERVIEW

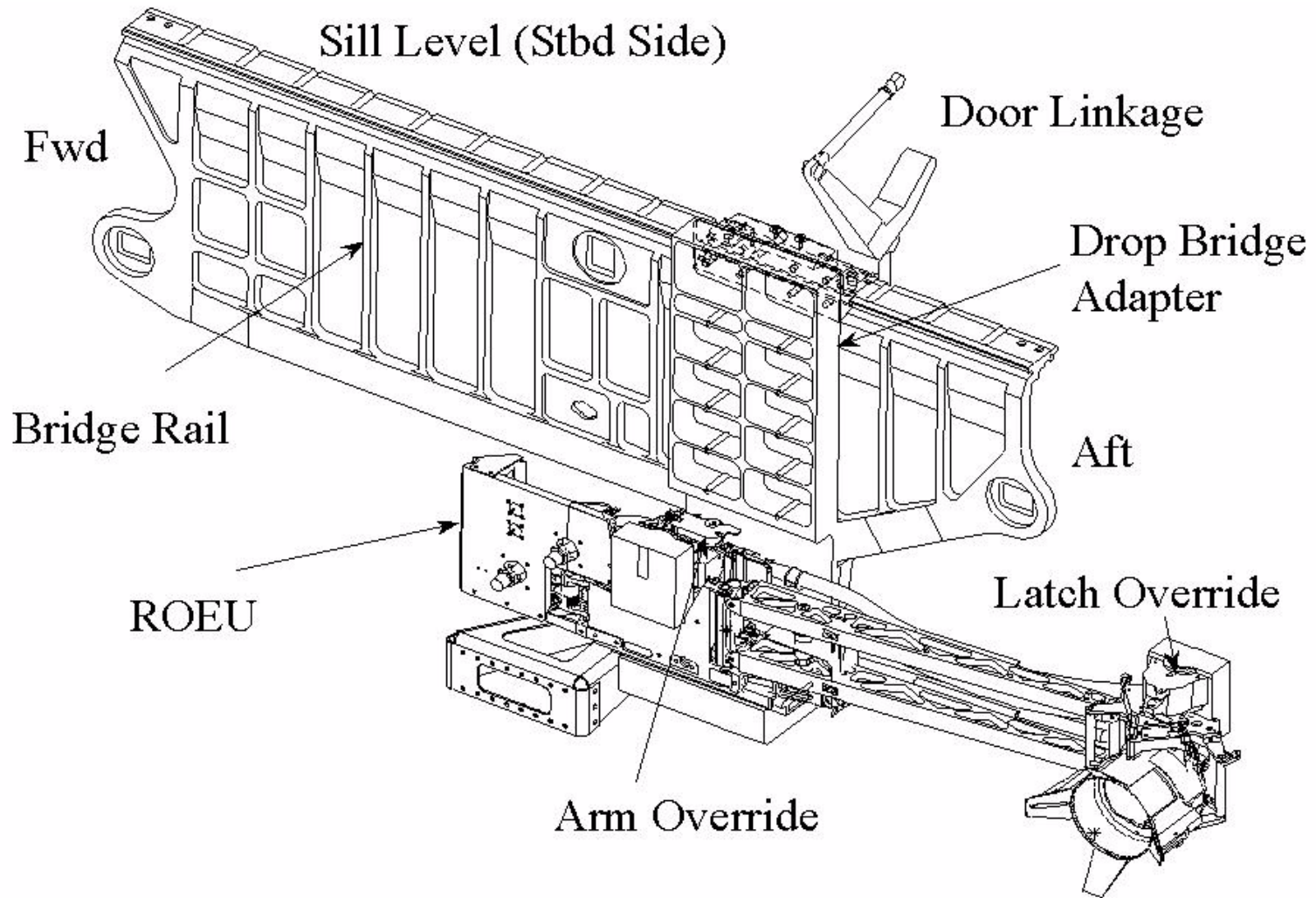

## ELC CAPTURE BAR MANUAL RELEASE/INSTALL (01:30)

ESTIMATED TASK DURATION: 01:30

### CAUTION

Do not exceed 60 rpm or 60 in-lb of running torque while exercising preload release mechanism (EVA knobs). If torque is reached before required number of turns, try other knob and alternate to reduced loading.

### NOTE

1. The connector panels on the attach structures have been modified to add two cut-outs, allowing the crewmember to see through the panel and increasing visual access to the manual release bolt head.
2. P3 and S3: Manual operation of the CLA requires that the EVA crewmember turn a bolt located underneath the CLA. The bolt is accessed via a hole in the connector panel beneath the UMA. The EVA bolt requires 7/16" x 18" extension.
3. CLA drive 37 turns to topological capture from open, 125 turns to fully closed, 127 turns to hard stop.
4. Alternating turns on EVA knobs prevents the capture bar from releasing at an excessive angle, thus preventing any side-loading of the CLA jaws and mechanism. EVA knobs are turn critical vs. torque and have hard stops.
5. CLA Contingency release PIP-Pins are not accessible with ELC installed.

## ELC CAPTURE BAR MANUAL RELEASE/INSTALL (01:30) (Cont)

IV	EV1 (FF)	EV2 (FF)
<p>IV: Verify CLA power off, UMA disconnected, and SSRMS grappled to ELC in TBD mode.</p> <p>IV: Give SSRMS GO for ELC removal.</p> <p>If no joy for CLA release, perform capture bar release.</p>	<p><a href="#">ELC UCCAS/PAS CLA MANUAL RELEASE (0:30)</a></p> <ol style="list-style-type: none"> <li>1. Translate to worksite.</li> <li>2. <b>PGT[A6 (8.3ft-lb), CCW2 (30 RPM), 30.5]-18" Ext-7/16:</b> 125 turns. Perform CLA manual drive to release CLA loading.</li> <li>3. On EV GO, confirm CLA is open and ELC clear for removal and EVA crew GO for SSRMS ops.</li> </ol> <p><a href="#">ELC UCCAS/PAS CAPTURE BAR MANUAL RELEASE (0:30)</a></p> <div data-bbox="594 578 1127 662" style="border: 1px solid black; padding: 5px;"> <p style="text-align: center;"><u>NOTE</u></p> <p>The following steps are performed only if release is not achieved by the CLA drive.</p> </div> <ol style="list-style-type: none"> <li>4. <b>PGT[B2 (16.0ft-lb), CCW2 (30 RPM), 30.5]-6" Ext-7/16"</b> Drive EVA Interface Knob #1 lockout fork bolt one turn to break torque, then A4 until hard stop, five turns. Drive EVA Interface Knob #2 lockout fork bolt one turn to break torque, then A4 until hard stop, five turns.</li> <li>5. Pull EVA Interface Knob #1 out (up to 26 lbs force) by hand to enable release mechanism. Pull EVA Interface Knob #2 out (up to 26 lbs force) by hand to enable release mechanism.</li> </ol> <div data-bbox="594 992 1127 1096" style="border: 2px solid black; background-color: yellow; padding: 5px;"> <p style="text-align: center;"><b>CAUTION</b></p> <p>Do not exceed 60 RPM and 5 ft-lb when driving interface knob.</p> </div> <div data-bbox="594 1127 1127 1292" style="border: 1px solid black; padding: 5px;"> <p style="text-align: center;"><u>NOTE</u></p> <p>EVA Interface Knob torque will initially increase and then decrease during release sequence.</p> <p>Steps 6-9 may be performed with PGT or by hand.</p> </div>	<p><a href="#">ELC UCCAS/PAS CLA MANUAL RELEASE (0:30)</a></p> <ol style="list-style-type: none"> <li>1. Translate to worksite.</li> <li>2. Assist with CLA manual drive to release CLA loading.</li> </ol> <p><a href="#">ELC UCCAS/PAS CAPTURE BAR MANUAL RELEASE (0:30)</a></p> <div data-bbox="1289 578 1822 662" style="border: 1px solid black; padding: 5px;"> <p style="text-align: center;"><u>NOTE</u></p> <p>The following steps are performed only if release is not achieved by the CLA drive.</p> </div> <ol style="list-style-type: none"> <li>3. Assist EV1 as reqd.</li> </ol>

## ELC CAPTURE BAR MANUAL RELEASE/INSTALL (01:30) (Cont)

IV	EV1 (FF)	EV2 (FF)
<p>IV: Give SSRMS GO for ELC removal.</p> <p>Prior to remating ELC to a CAS, perform capture bar restow.</p>	<ol style="list-style-type: none"> <li>6. <b>PGT[A3 (4.8 ft-lb), CCW2 (30 RPM), 30.5]-6" Ext-7/16:</b> Drive EVA Interface Knob #1, 8 turns.</li> <li>7. <b>PGT[A3 (4.8 ft-lb), CCW2 (30 RPM), 30.5]-6" Ext-7/16:</b> Drive EVA Interface Knob #2, 12 turns.</li> <li>8. <b>PGT[A3 (4.8 ft-lb), CCW2 (30 RPM), 30.5]-6" Ext-7/16:</b> Drive EVA Interface Knob #1, 6 turns.</li> <li>9. <b>PGT[A3 (4.8 ft-lb), CCW2 (30 RPM), 30.5]-6" Ext-7/16:</b> Drive EVA Interface Knob #2, 3 turns.</li> <li>10. Drive EVA Interface Knob #1, 2.5 turns CCW by hand.</li> <li>11. Drive EVA Interface Knob #2, 1.5 turns CCW by hand.</li> <li>12. Verify capture bar clear of CLA.</li> <li>13. On EV2 GO, give IV GO for ELC removal.</li> </ol> <p><a href="#">ELC UCCAS/PAS CAPTURE BAR RESTOW (0:30)</a></p> <div style="border: 1px solid black; padding: 5px; text-align: center;"> <p><b>NOTE</b></p> <p>The following steps are required to restow ELC on a CAS site.</p> </div>	<ol style="list-style-type: none"> <li>4. Translate to aft side of PCAS.</li> <li>5. Remove hitch-pin from captive lock-pin.</li> <li>6. Push in on captive lock-pin and rotate CCW 1/4 turn.</li> <li>7. Pull T-Handle capture bar removal tool from stowage block.</li> <li>8. Rotate T-handle capture bar removal tool 90 deg.</li> <li>9. Insert into capture bar keyway, then CW 45 deg.</li> <li>10. Pull capture bar removal tool to disengage capture bar (15 lbs force).</li> <li>11. Soft dock capture bar in removed position (15 lbs force).</li> <li>12. Give EV1 GO for ELC removal when clear.</li> </ol> <p><a href="#">ELC UCCAS/PAS CAPTURE BAR RESTOW (0:30)</a></p> <div style="border: 1px solid black; padding: 5px; text-align: center;"> <p><b>NOTE</b></p> <p>The following steps are required to restow ELC on a CAS site.</p> </div> <ol style="list-style-type: none"> <li>13. Push capture bar removal tool to move capture bar out of the removal position soft dock (15 lbs force) and into the installed position soft dock (15 lbs force).</li> <li>14. Remove T-Handle capture bar tool from capture bar.</li> <li>15. Stow in stowage block.</li> <li>16. Reinstall captive lock-pin (hitch pin not required).</li> <li>17. Visually inspect capture bar to ensure it is fully seated in the installed position.</li> </ol>

## ELC CAPTURE BAR MANUAL RELEASE/INSTALL (01:30) (Cont)

IV				EV1 (FF)	EV2 (FF)
Step	# of Turns CW		Method	<p>14. <b>PGT[A3 (4.8 ft-lb), CW2 (30 RPM), 30.5]-6" Ext-7/16:</b> Drive EVA Interface Knob #2, 1.5 turns.</p> <p>15. <b>PGT[A3 (4.8 ft-lb), CW2 (30 RPM), 30.5]-6" Ext-7/16:</b> Drive EVA Interface Knob #1, 2.5 turns.</p> <p>16. <b>PGT[A3 (4.8 ft-lb), CW2 (30 RPM), 30.5]-6" Ext-7/16:</b> Drive EVA Interface Knob #2, 3 turns.</p> <p>17. <b>PGT[A3 (4.8 ft-lb), CW2 (30 RPM), 30.5]-6" Ext-7/16:</b> Drive EVA Interface Knob #1, 6 turns.</p> <p>18. <b>PGT[A3 (4.8 ft-lb), CW2 (30 RPM), 30.5]-6" Ext-7/16:</b> Drive EVA Interface Knob #1, 10 turns.</p> <p>19. <b>PGT[A3 (4.8 ft-lb), CW2 (30 RPM), 30.5]-6" Ext-7/16:</b> Drive EVA Interface Knob #1, 6 turns.</p> <p>20. Drive EVA Interface Knob #2, 2 turns CW by hand.</p> <p>21. Turn EVA Interface Knob #2 CCW to align the black stripe on the knob perimeter so it faces up toward the ELC Deck.</p> <p>22. Push in EVA Interface Knob #2 and ensure it is fully seated in square cutout (26 lbs).</p> <p>23. Drive EVA Interface Knob #1, 2 turns CW by hand.</p> <p>24. Turn EVA Interface Knob #1 CCW to align the black stripe on the knob perimeter so it faces up toward the ELC Deck.</p> <p>25. Push in EVA Interface Knob #1 and ensure it is fully seated in square cutout (26 lbs).</p> <p>26. <b>PGT[A3 (4.8 ft-lb), CW2 (30 RPM), 30.5]-6" Ext-7/16:</b> Drive lockout fork bolt, five turns.  <input type="checkbox"/>Knob #1 (first)  <input type="checkbox"/>Knob #2</p> <p>27. Inspect EMU gloves.</p>	<p>18. Inspect EMU gloves</p>
	Knob 1	Knob 2			
1	2.5	1.5	PGT or Hand		
2	6	3	PGT or Hand		
3	6	10	PGT or Hand		
4	2	2	Hand only to hard stop		

# ELC CAPTURE BAR MANUAL RELEASE/INSTALL – TASK DATA

## TASK DATA

Table 1. Tools

EV1 (FF)	EV2 (FF)
PGT	PGT
7/16 Socket – 18 inch	7/16 socket - 6 inch
BRT	BRT
APFR & APFR WIF Ext (optional)	

Table 2. EVA Fasteners

Fastener Name	Label	Head Size	Qty	Install Torque (ft-lb)	Release Torque (ft-lb)	Failure Torque (ft-lb)	Turns	RPM
CLA Manual Drive		7/16	1	8.3	8.3	11.9	127 total	60
Lockout Fork bolt		7/16	2	6.7+running Ground 6.0 On-orbit	6.7	13.7	5	30
EVA knob		7/16	2	N/A	5.0 max	11.1	16.5	30



Figure 1.

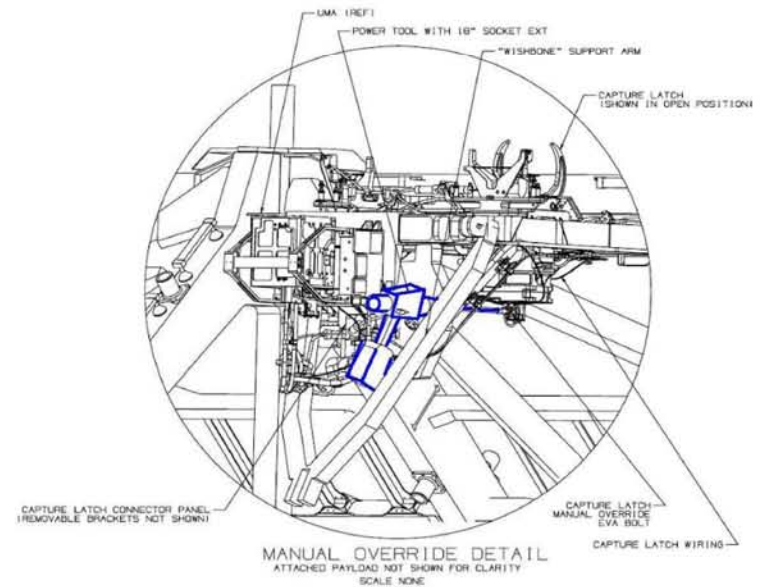

Figure 2.

# ELC CAPTURE BAR MANUAL RELEASE/INSTALL – TASK DATA (Cont)

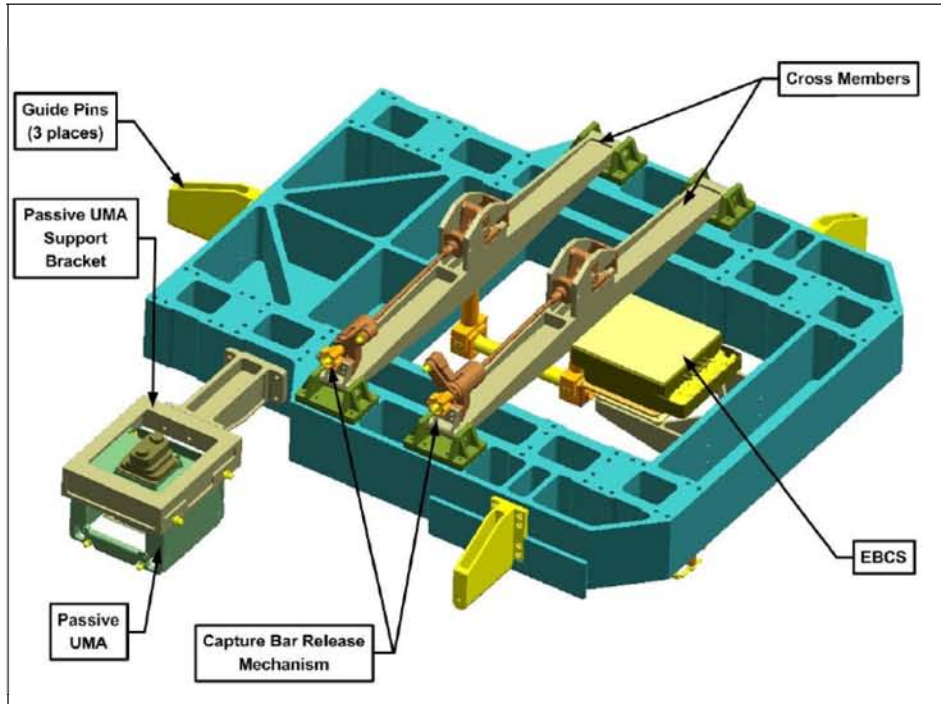

Figure 3.- (Top View).

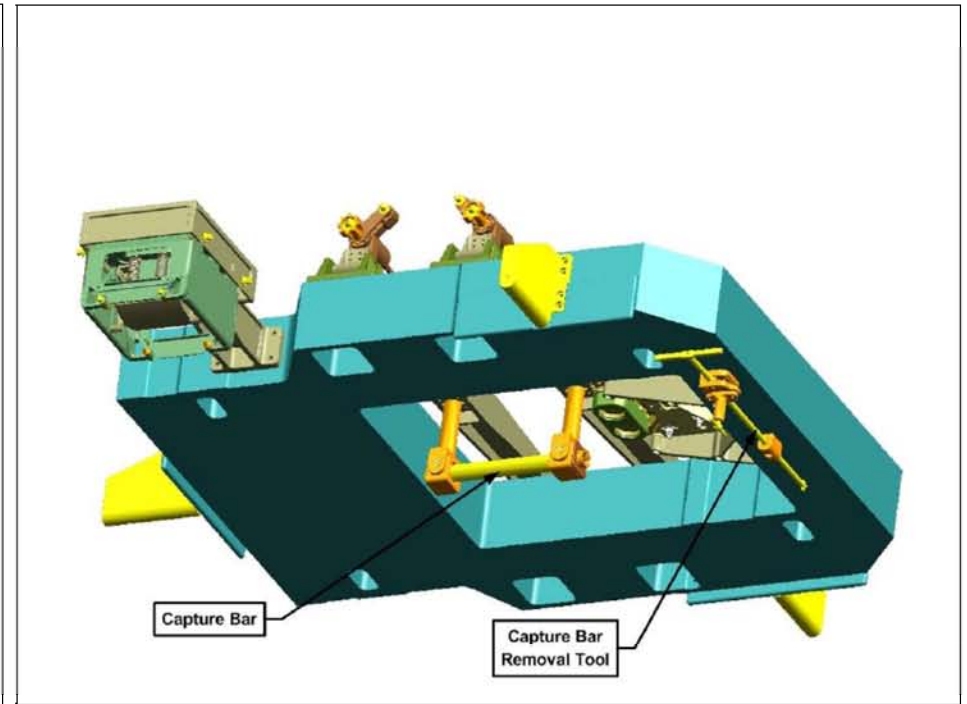

Figure 4.- (Bottom View).



ELC CAPTURE BAR MANUAL RELEASE/INSTALL – TASK DATA (Cont)

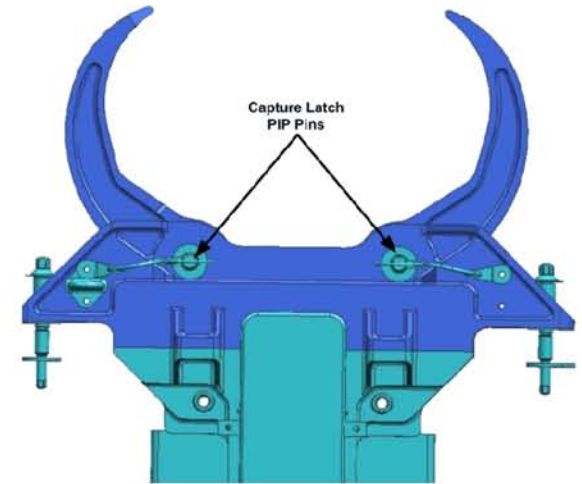
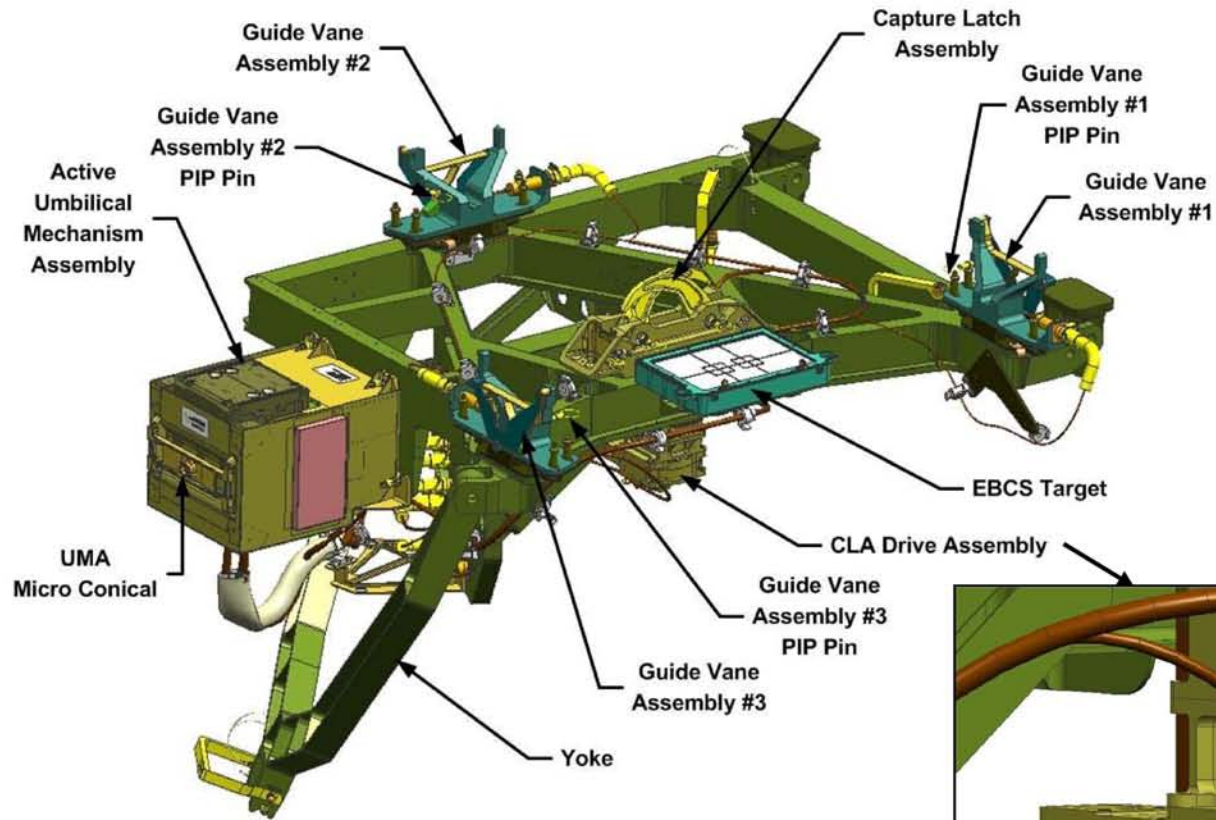

Figure 7 – (CLA).

Note: Guide Vane Assembly PIP Pins are removed upon CAS deploy

Figure 5 (PAS/UCCAS).

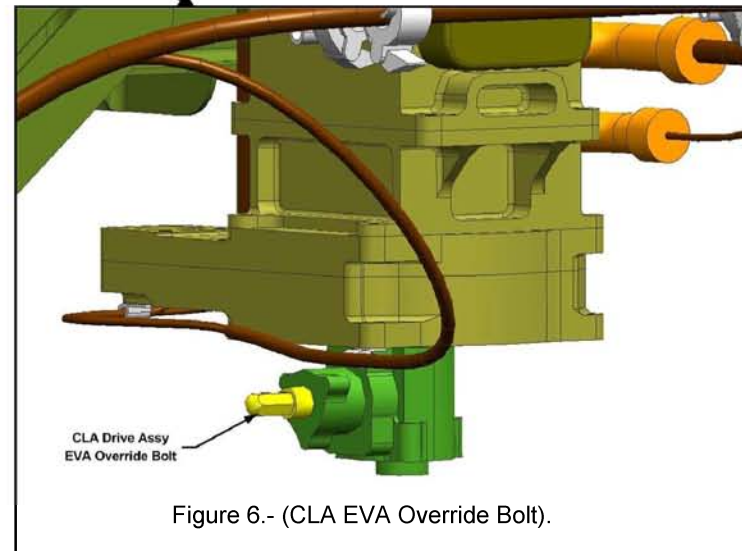

Figure 6.- (CLA EVA Override Bolt).

**ELC CAPTURE BAR MANUAL RELEASE/INSTALL – TASK DATA (Cont)**

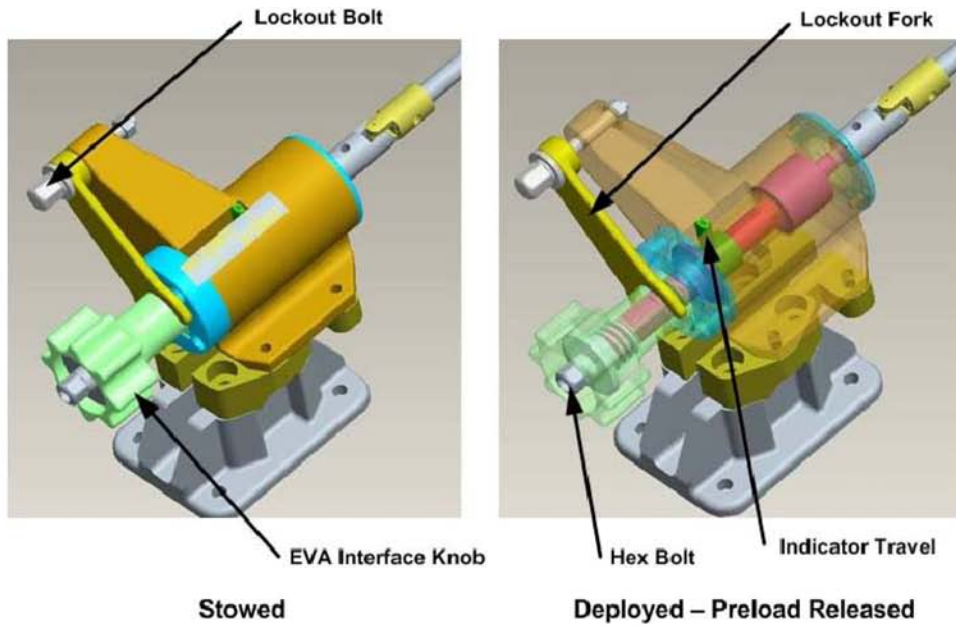

Figure 10.

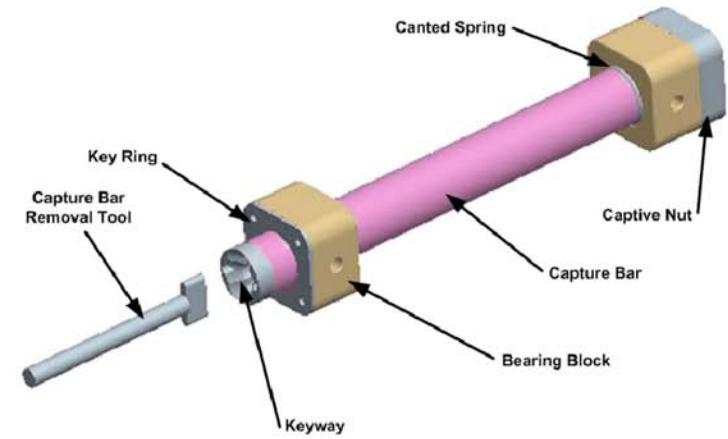

Figure 11.

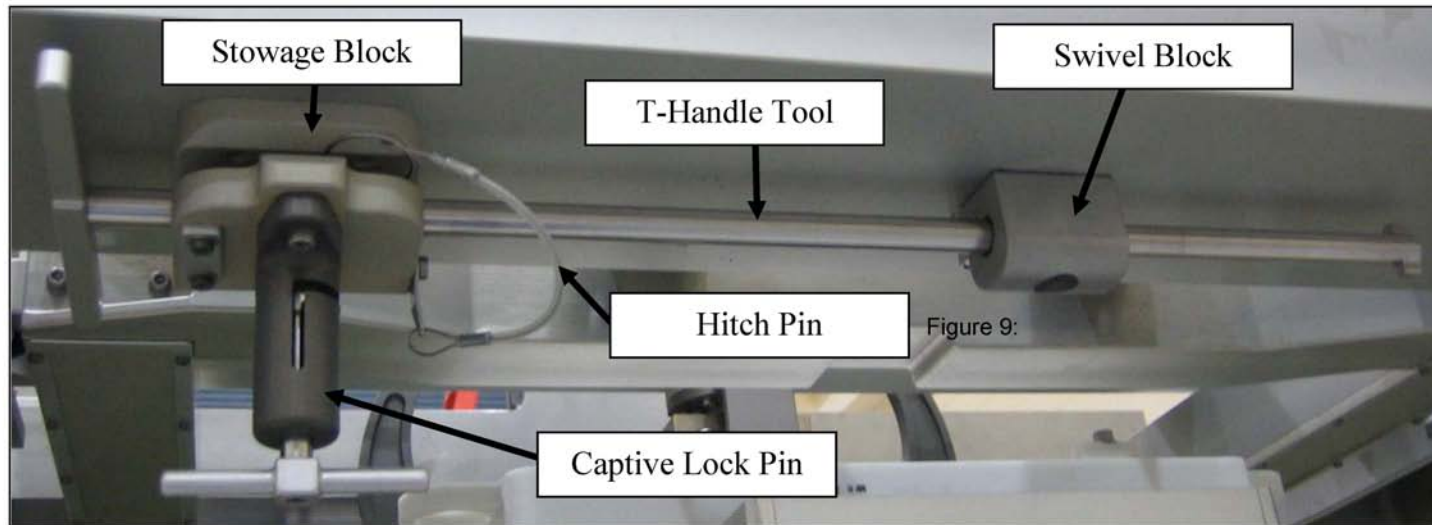
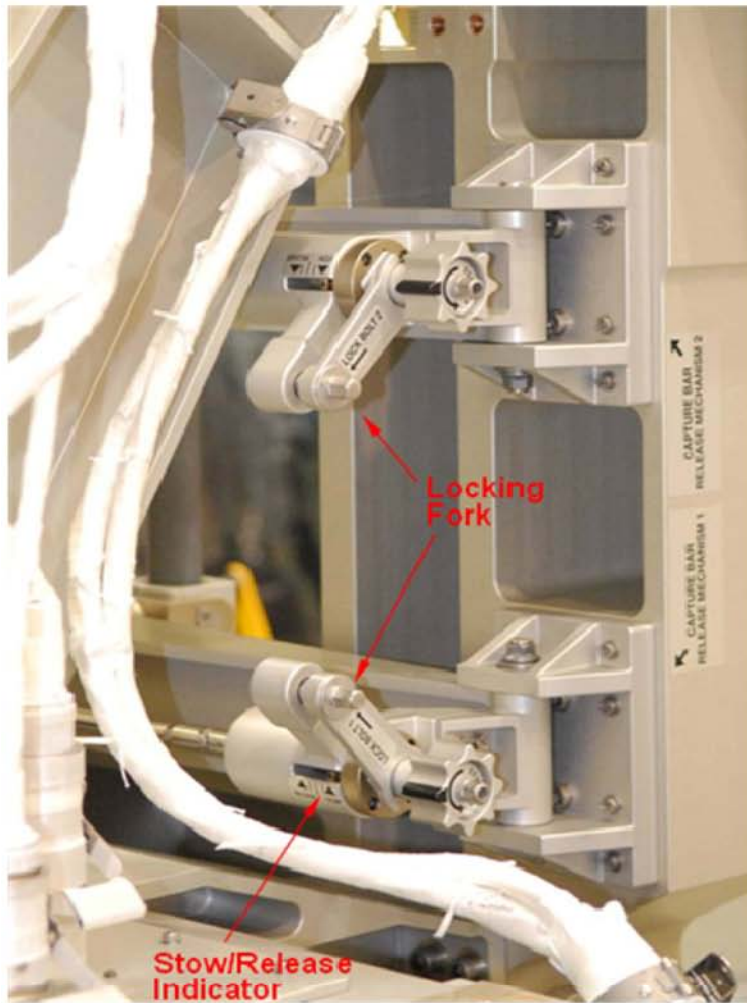

Figure 8:

Figure 12.

# ELC CAPTURE BAR MANUAL RELEASE/INSTALL – TASK DATA (Cont)



**Knob Interfaces on ELC1**

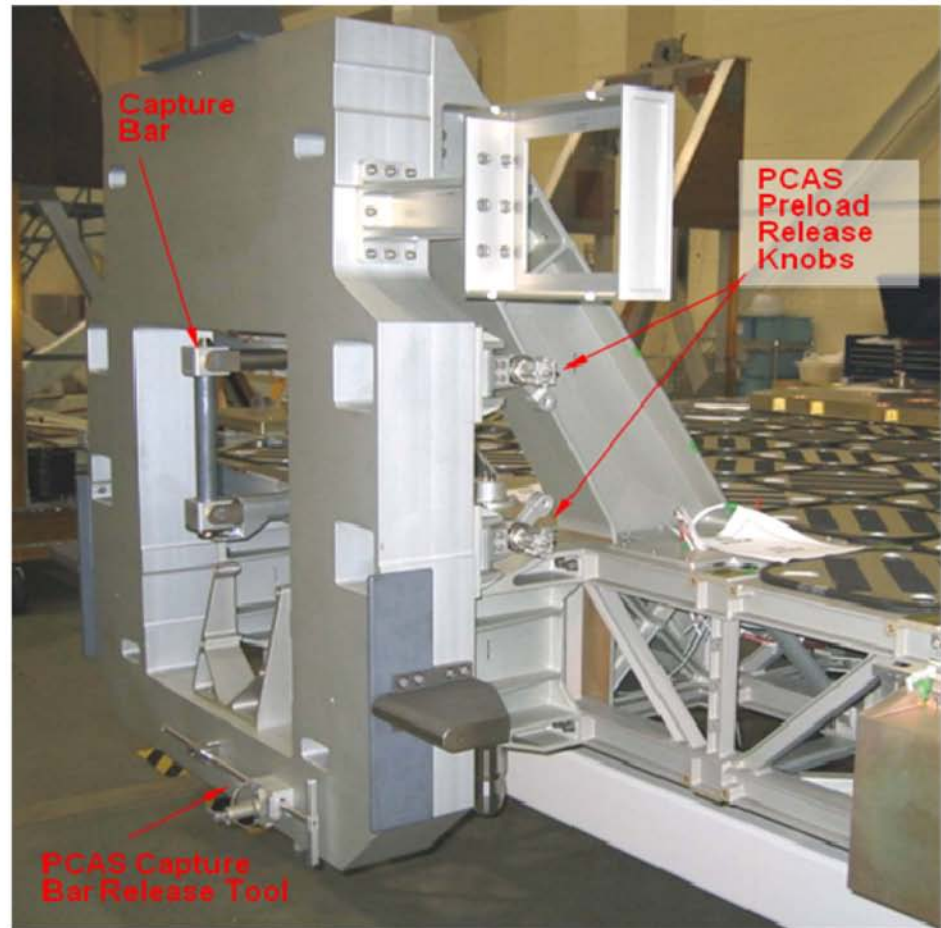

**PCAS on ELC2**

## ELC CAPTURE BAR MANUAL RELEASE/INSTALL – TASK DATA (Cont)



Figure 13.- Capture Bar in Preload Position Before Driving EVA Interface Knobs.



Figure 14.- Capture Bar (Lowered) in Unloaded Position After Driving EVA Interface Knobs.



Figure 15.- Capture Bar in Normal Position.

## ELC CAPTURE BAR MANUAL RELEASE/INSTALL – TASK DATA (Cont)

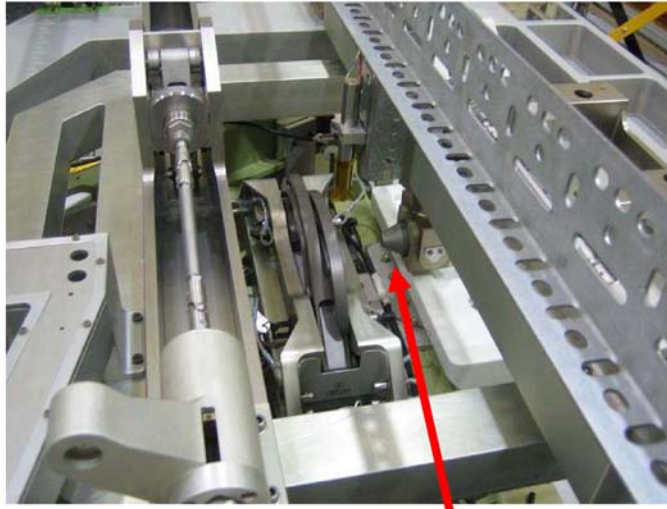

Figure 16.- Capture Bar in Removed Position Using T-Handle Tool.



Figure 17. T-Handle Tool Engaged in Removed Capture Bar

## CAS CAPTURE LATCH ASSY (CLA) MANUAL DRIVE

### NOTE

1. The connector panels on the attach structures have been modified to add two cut-outs, allowing the crewmember to see through the panel and increase visual access to the manual release bolt head.
2. P3 and S3: Manual operation of the CL requires that the EVA crewmember turn a bolt located underneath the CL. The bolt is accessed via a hole in the connector panel beneath the UMA. The EVA bolt requires the power tools with 7/16" x 18" extension.
3. APFR settings for reference; may not be required.
4. PGT settings should be verified with 1819 data and EBIT analysis.

## CAS CAPTURE LATCH ASSY (CLA) MANUAL DRIVE (Cont)

IV/RMS	EV1 (FF)	EV2 (FF)
<p>1. IV: First stage capture complete. Go to limp SSRMS.</p> <p>2. <b>MCC-H:</b> Inhibit mechanism autosafing.</p> <div data-bbox="132 386 657 431" style="background-color: yellow; border: 1px solid black; text-align: center; padding: 2px;"><b>CAUTION</b></div> <div data-bbox="132 431 657 605" style="border: 1px solid black; padding: 2px;"> <p>1. Verify and maintain good communication with EV crew during manual override drive.</p> <p>2. If SSRMS safing occurs during EVA manual drive of CLA, IV must notify EV crew to stop driving the manual override immediately to prevent SSRMS damage.</p> </div> <p>3. IV: Give EV GO to continue latch closure.</p>	<p><u>CAS CAPTURE LATCH ASSY MANUAL DRIVE</u></p> <p>1. <b>PGT [A6, CW3, 30.5]-18" Ext-7/16":</b> Rotate CLA drive 37 turns to topological capture.</p> <p>2. On IV GO, rotate drive to hard stop ~ 91 additional turns (~127 turns total).</p> <div data-bbox="751 431 1287 516" style="border: 1px solid black; padding: 2px; text-align: center;"> <p><u>NOTE</u></p> <p>If less than 68 additional turns (105 total) before hard stop, capture latch closure not complete.</p> </div> <p>3. <b>PGT [A6, CCW2, 30.5]-18" Ext-7/16":</b> Rotate drive two turns to final close position.</p>	

# CAS CAPTURE LATCH ASSY (CLA) MANUAL DRIVE (Cont)

## TASK DATA

Table 1. Tools

EV1 (FF)	EV2 (FF)
PGT	
7/16 Socket - 18 inch	
BRT	

Table 2. EVA Fasteners

Fastener Name	Label	Head Size	Qty	Install Torque (ft-lb)	Release Torque (ft-lb)	Failure Torque (ft-lb)	Turns	RPM
CLA Manual Drive		7/16	1	8.3	8.3	11.9	127 total	60

Table 3. APFR Positions

Task	WIF	APFR Setting
CLA Manual Drive (P3 zenith)	P3 WIF36	[12,Q,Q,H,11]

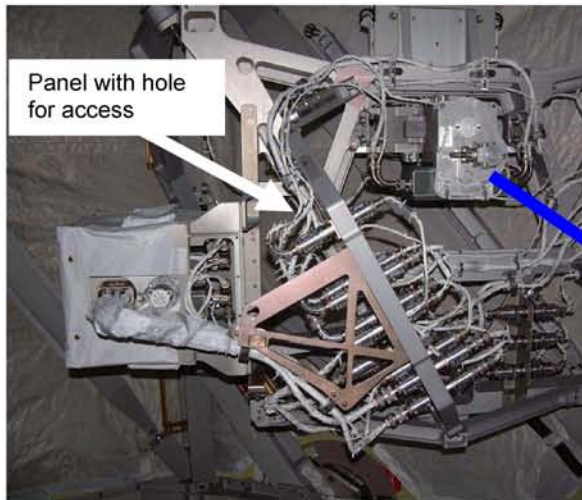

Figure.1.

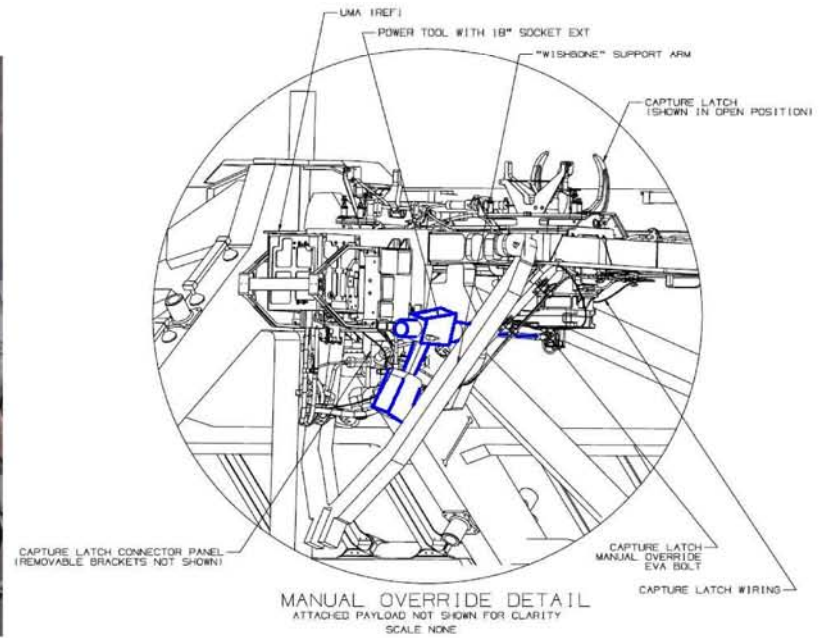
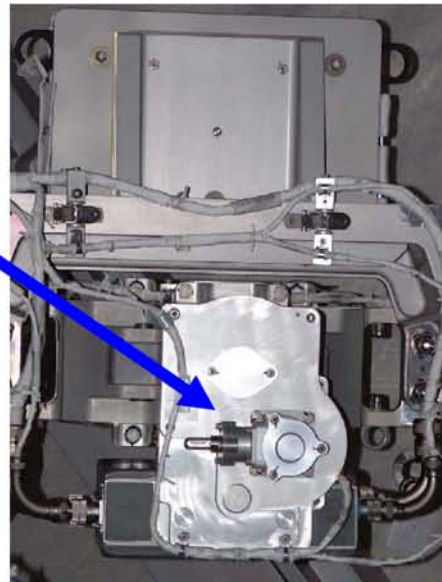

Figure.2.



## UCCAS/PAS UMBILICAL MATING ASSEMBLY (UMA) MANUAL DRIVE (00:20) (Cont)

ESTIMATED TASK DURATION: 00:20

### CAUTION

1. EVA override uses the same mechanism as the nominal drive - it does not bypass a jam and should not be used in a jammed case.

### NOTE

1. If UMA drives part-way before failure, turn count must be obtained from OSO console. 6.053 IMCA turns = 1 EVA bolt turn. Full travel is 516 IMCA turns = ~ 85 EVA bolt turns.

**UCCAS/PAS UMBILICAL MATING ASSEMBLY (UMA) MANUAL DRIVE (00:20) (Cont)**

IV/RMS	EV1/EV2
<p>IV 1. Verify Inhibits.</p> <p>IV: 2. Check <b>MCC-H</b> for required turn count.</p>	<div data-bbox="877 329 1745 548" style="border: 1px solid black; padding: 5px;"> <p style="text-align: right;"><u>NOTE</u></p> <p>Zenith UCCAS UMA is labeled: UMA ACTIVE-101.            Nadir UCCAS UMA is labeled: UMA ACTIVE-102.            Zenith Outboard PAS UMA is labeled: UMA ACTIVE-101.            Zenith Inboard PAS UMA is labeled: UMA ACTIVE-102.            Nadir Outboard PAS UMA is labeled: UMA ACTIVE-103.            Nadir Inboard PAS UMA is labeled: UMA ACTIVE-104.</p> </div> <p><a href="#"><u>MANUALLY RETRACT UMA CONNECTOR</u></a></p> <ol style="list-style-type: none"> <li>1. <b>PGT[A1, CCW2, MTL 30.5]-6 ext-7/16</b></li> <li>2. Engage EVA Override bolt on failed UMA _____ turns to turn count.</li> <li>3. <b>PGT[A1, CCW1, MTL 30.5]-6 ext-7/16</b></li> <li>4. Engage EVA Override bolt on failed UMA four to five turns to torque stall.</li> </ol> <p><a href="#"><u>MANUALLY MATE UMA CONNECTOR</u></a></p> <ol style="list-style-type: none"> <li>1. <b>PGT[A1, CW2, MTL 30.5]-6 ext-7/16</b></li> <li>2. Engage EVA Override bolt on failed UMA _____ turns to torque stall.</li> <li>3. <b>PGT[A1, CW1, MTL 30.5]-6 ext-7/16</b></li> <li>4. Engage EVA Override bolt on failed UMA four to five turns to torque stall.</li> </ol>

## UCCAS/PAS UMBILICAL MATING ASSEMBLY (UMA) MANUAL DRIVE (00:20) (Cont)

### TASK DATA

Table 1. Estimated Task Duration

	Without SSRMS
One EV Crew	0:20
Two EV Crew	N/A

Table 2. Tools

EV1 (RMS)
PGT
7/16 (wobble) Socket-6 ext

Table 3. EVA Fasteners

Fastener Name	Label	Head Size (in)	Qty	Drive Torque (ft-lb)	Failure Torque (ft-lb)	Turns	RPM
UMA EVA Override	EVA Override	7/16	1 ea	2.5	3.83	85 Refer to Note 1	30 10 for last four to five turns

Table 4. EVA ORU Labels

EVA Label	Location	Functional Designation
UMA ACTIVE – 0101	P3 Zenith UCCAS	UCCAS-1 UMA
UMA ACTIVE – 0102	P3 Nadir UCCAS	UCCAS-2 UMA
UMA ACTIVE – 0101	S3 Zenith Outboard PAS	PAS-1 UMA
UMA ACTIVE – 0102	S3 Zenith Inboard PAS	PAS-2 UMA
UMA ACTIVE – 0103	S3 Nadir Outboard PAS	PAS-3 UMA
UMA ACTIVE – 0104	S3 Nadir Inboard PAS	PAS-4 UMA

**UCCAS/PAS UMBILICAL MATING ASSEMBLY (UMA) MANUAL DRIVE (00:20) (Cont)**

Table 5. EVA ORU Inhibits

Location	UMA	RPCM
P3 Zenith	UCCAS-1 UMA (P3 Zenith)	P34B E RPC 01 – Open; Close command Inhibit
		P33A E RPC 01 – Open; Close command Inhibit
P3 Nadir	UCCAS-2 UMA (P3 Nadir)	P34B E RPC 02 – Open; Close command Inhibit
		P33A E RPC 02 – Open, Close command Inhibit
S3 Zenith Outboard	PAS-1 UMA (S3 Zenith Outboard)	S34BE RPC 01 – Open; Close command Inhibit
		S33A E RPC 01 – Open; Close command Inhibit
S3 Zenith Inboard	PAS-2 UMA (S3 Zenith Inboard)	S34B E RPC 02 – Open; Close command Inhibit
		S33A E RPC 02 – Open; Close command Inhibit
S3 Nadir Outboard	PAS-3 UMA (S3 Nadir Outboard)	S34BE RPC 03 – Open; Close command Inhibit
		S33A E RPC 03 – Open; Close command Inhibit
S3 Nadir Inboard	PAS-4 UMA (S3 Nadir Inboard)	S34BE RPC 04 – Open; Close command Inhibit
		S33A E RPC 04 – Open; Close command Inhibit

EVA Connectors: None

Foot Restraints: None

UCCAS/PAS UMBILICAL MATING ASSEMBLY (UMA) MANUAL DRIVE (00:20) (Cont)

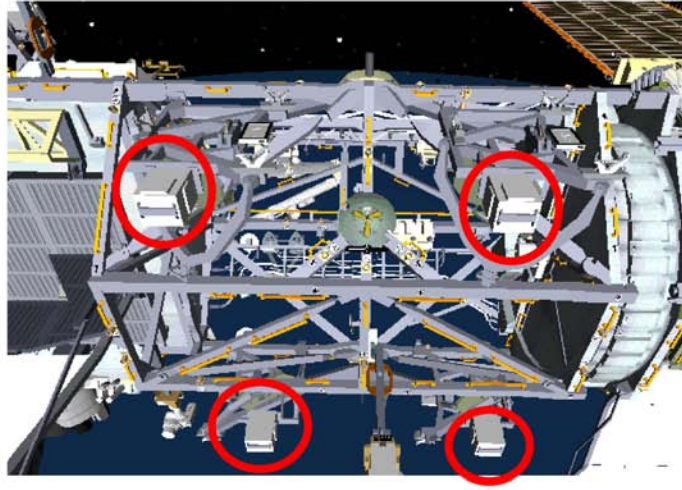

Figure 1.- S3 UMA Locations.

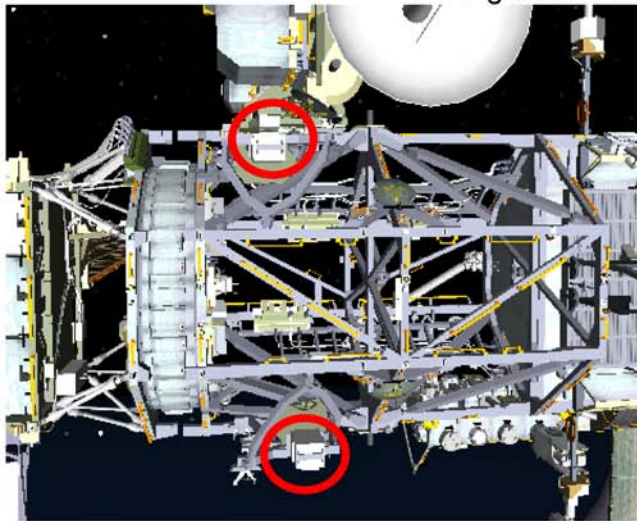

Figure 2.- P3 UMA Locations.



Figure 3.- EVA Override Bolt.

**TEMP STOW WETA/VSSA (00:30)**

<b>IV/SSRMS</b>	<b>EV2</b>	<b>EV3</b>
<p>1. SSRMS: Maneuver as required for EV crew clearance</p>	<p><u>TEMP STOW WETA/VSSA (00:30)</u></p> <p>1. GCA SSRMS as required for clearance</p> <div data-bbox="701 326 1085 423" style="border: 1px solid black; padding: 5px; margin: 10px 0;"> <p style="text-align: center;"><u>CAUTION</u> Do not touch WETA antennas, keep slack in cables</p> </div> <p>2. Tether WETA stanchion to Node 1 HR 0101 _____</p> <p>3. Configure PGT (6" ext wobble 7/16" installed) □ [B7, CCW2, 30.5]</p> <p>4. Release WETA stanchion bolt, expect 16.5 turns</p> <p>5. Stow WETA stanchion on NOD1 HR 0122 with MUT EE + Ballstack + Round Scoop</p>	<p><u>TEMP STOW WETA/VSSA (00:30)</u></p> <p>1. Retrieve MUT EE + Ballstack + Round Scoop from Airlock</p> <div data-bbox="1388 358 1772 456" style="border: 1px solid black; padding: 5px; margin: 10px 0;"> <p style="text-align: center;"><u>CAUTION</u> Do not touch WETA antennas, keep slack in cables</p> </div> <p>2. Install MUT EE on Node 1</p> <p>3. Assist EV2 with WETA temp stow onto Round Scoop</p>

## TEMP STOW WETA/VSSA – TASK DATA

### Estimated Task Duration:

	With RMS	Without RMS
One EV Crew	N/A	00:45
Two EV Crew	N/A	00:30

### Tools:

EV1	EV2
MUT EE	
Ballstack	
Round Scoop	

### EVA Fasteners:

Fastener Name	Head Size	Qty	Install Torque (ft-lb)	Release Torque (ft-lb)	Failure Torque (ft-lb)	Turns	RPM
VSSA Bolt	7/16"	1	18.4	25.5	62.0	16.5	30

### Notes:

1. The WETA remains powered during temp stow

### Timeline Considerations:

1. The addition of temp-stowing and re-installing the WETA/VSSA adds 01:00 to the timeline

## RE-INSTALL WETA/VSSA (00:30)

IV/SSRMS	EV2	EV3						
<p>1. Record WETA stanchion bolt data</p> <table border="1" data-bbox="109 516 617 587"> <thead> <tr> <th>Bolt</th> <th>Turns</th> <th>Torque (ft-lb)</th> </tr> </thead> <tbody> <tr> <td>Stanchion</td> <td>(16.5)</td> <td>(18.4)</td> </tr> </tbody> </table>	Bolt	Turns	Torque (ft-lb)	Stanchion	(16.5)	(18.4)	<p><u>REINSTALL WETA (00:30)</u></p> <div data-bbox="701 300 1083 393" style="border: 1px solid black; padding: 5px; margin: 10px 0;"> <p style="text-align: center;"><b>CAUTION</b></p> <p style="text-align: center;">Do not touch WETA antennas, keep slack in cables</p> </div> <ol style="list-style-type: none"> <li>1. Release WETA from Round Scoop</li> <li>2. Align stanchion for installation</li> <li>3. Configure <b>PGT [B3, CW2, 30.5]</b></li> <li>4. Engage stanchion bolt to torque, expect 16.5 turns</li> <li>5. → If WETA/VSSA cannot be re-installed due to lack of clearance, <u>RELOCATE WETA/VSSA</u> (section 16)</li> <li>6. Retrieve tethers and tools</li> </ol>	<p><u>REINSTALL WETA (00:30)</u></p> <div data-bbox="1388 300 1770 393" style="border: 1px solid black; padding: 5px; margin: 10px 0;"> <p style="text-align: center;"><b>CAUTION</b></p> <p style="text-align: center;">Do not touch WETA antennas, keep slack in cables</p> </div> <ol style="list-style-type: none"> <li>1. Assist EV2 with WETA stanchion alignment</li> <li>2. Stow MUT EE + Ballstack + Round Scoop in Airlock</li> </ol>
Bolt	Turns	Torque (ft-lb)						
Stanchion	(16.5)	(18.4)						



## RE-INSTALL WETA/VSSA – TASK DATA

### Estimated Task Duration:

	With RMS	Without RMS
One EV Crew	N/A	00:45
Two EV Crew	N/A	00:30

### Tools:

EV1	EV2
MUT EE	
Ballstack	
Round Scoop	

### EVA Fasteners:

Fastener Name	Head Size	Qty	Install Torque (ft-lb)	Release Torque (ft-lb)	Failure Torque (ft-lb)	Turns	RPM
VSSA Bolt	7/16"	1	18.4	25.5	62.0	16.5	30

### Notes:

1. The WETA remains powered during temp stow

### Timeline Considerations:

1. The addition of temp-stowing and re-installing the WETA/VSSA adds 01:00 to the timeline

## RELOCATE WETA/VSSA (00:45)

IV/SSRMS	EV2	EV3						
<p>1. <input type="checkbox"/> <b>√MCC-H</b> – Inhibits for P3 (CP 10)  RPCM P31A A RPC 15 OPEN, CL INH  RPCM P31A A RPC 16 OPEN, CL INH  RPCM P32B A RPC 15 OPEN, CL INH  RPCM P32B A PRC 16 OPEN, CL INH</p> <p>2. Record WETA stanchion bolt data</p> <table border="1" data-bbox="109 755 617 824"> <thead> <tr> <th>Bolt</th> <th>Turns</th> <th>Torque (ft-lb)</th> </tr> </thead> <tbody> <tr> <td>Stanchion</td> <td>(16.5)</td> <td>(18.4)</td> </tr> </tbody> </table> <p>3. Notify <b>MCC-H</b> – WETA/VSSA connections complete</p>	Bolt	Turns	Torque (ft-lb)	Stanchion	(16.5)	(18.4)	<p><u>RELOCATE WETA/VSSA (00:45)</u></p> <ol style="list-style-type: none"> <li>1. Attach Round Scoop to WETA</li> <li>2. Demate VSSA connectors from NOD1 panel A11 <ul style="list-style-type: none"> <li><input type="checkbox"/> P2 from J677</li> <li><input type="checkbox"/> P3 from J678</li> <li><input type="checkbox"/> P4 from J679</li> </ul> </li> <li>3. Demate caps from VSSA dummy panel and install on NOD1 panel A11 <ul style="list-style-type: none"> <li><input type="checkbox"/><input type="checkbox"/><input type="checkbox"/></li> </ul> </li> <li>4. Route cable around VSSA race track and mate connectors to VSSA dummy panel <ul style="list-style-type: none"> <li><input type="checkbox"/><input type="checkbox"/><input type="checkbox"/></li> </ul> </li> <li>5. Attach WETA/VSSA to BRT</li> <li>6. Translate to CP 10 (P3 aft)</li> <li>7. Align stanchion for installation</li> <li>8. Configure <b>PGT [B3, CW2, 30.5]</b></li> <li>9. Engage stanchion bolt to torque, expect 16.5 turns</li> <li>10. Demate VSSA connectors from dummy panel</li> <li>11. Demate caps from P3 A78 panel and install on VSSA dummy panel <ul style="list-style-type: none"> <li><input type="checkbox"/><input type="checkbox"/><input type="checkbox"/></li> </ul> </li> <li>12. Mate VSSA connectors to P3 A78 <ul style="list-style-type: none"> <li><input type="checkbox"/> P2 to J2</li> <li><input type="checkbox"/> P3 to J3</li> <li><input type="checkbox"/> P4 to J4</li> </ul> </li> <li>13. <b>Glove check</b></li> <li>14. Translate to A/L</li> </ol>	<p><u>RELOCATE WETA/VSSA (00:45)</u></p> <ol style="list-style-type: none"> <li>1. Stow MUT EE + Ballstack in Airlock</li> <li>2. Assist EV2 with WETA/VSSA relocation</li> <li>3. Assist EV2 with WETA stanchion alignment</li> <li>4. Retrieve Round Scoop and tethers</li> <li>5. <b>Glove check</b></li> <li>6. Translate to A/L</li> </ol>
Bolt	Turns	Torque (ft-lb)						
Stanchion	(16.5)	(18.4)						

## RELOCATE WETA/VSSA – TASK DATA

### Estimated Task Duration:

	With RMS	Without RMS
One EV Crew	N/A	01:00
Two EV Crew	N/A	00:45

### Tools:

EV1	EV2
PGT w/6" wobble 7/16" ext	Round Scoop

### EVA Fasteners:

Fastener Name	Head Size	Qty	Install Torque (ft-lb)	Release Torque (ft-lb)	Failure Torque (ft-lb)	Turns	RPM
VSSA Bolt	7/16"	1	18.4	25.5	62.0	16.5	30

### EVA Connectors:

Harness	From	To	Conn Size	Function
A11 (NOD1)	P2	J677	15	
A11 (NOD1)	P3	J678	15	
A11 (NOD1)	P4	J679	15	
A78 (P3)	P2	J2	15	
A78 (P3)	P3	J3	15	
A78 (P3)	P4	J4	15	

### Notes:

1. Ref. dwg. 1F90951 for Stanchion Instl, video camera – TVCIC
2. Ref. dwg. 1F90951-555 for VCP 12 on Node 1
3. Ref. dwg. 1F90951-575 for VCP 10 on P3
4. Ref. dwg. 1F91504 for Electrical Instl, video camera – TVCIC
5. Ref. dwg. 1F91504-527 for VCP 12 on Node 1
6. Ref. dwg. 1F91504-547 for VCP 10 on P3
7. VSSA harness is W8200
8. Caps from VSSA dummy panel are 1F00920 (size 15 clover leaf with four tether points)
9. Caps/Deadface connectors P3:  
 J2 = 1F76637-1 = size 15 dead face connector  
 J3 = 1F76638-1 = size 15 dead face connector  
 J4 = NZGL-RPC-N-15-0-MS = size 15 scalloped electrical cap w/tether loop

### Timeline Considerations:

1. WETA thermal clock without MLI cover is 04:00

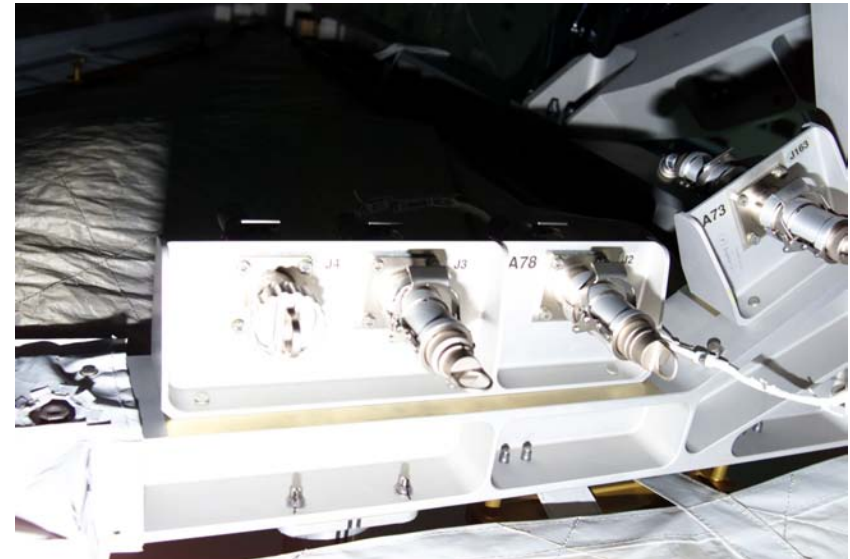

# LONG DURATION TIE-DOWN TETHER

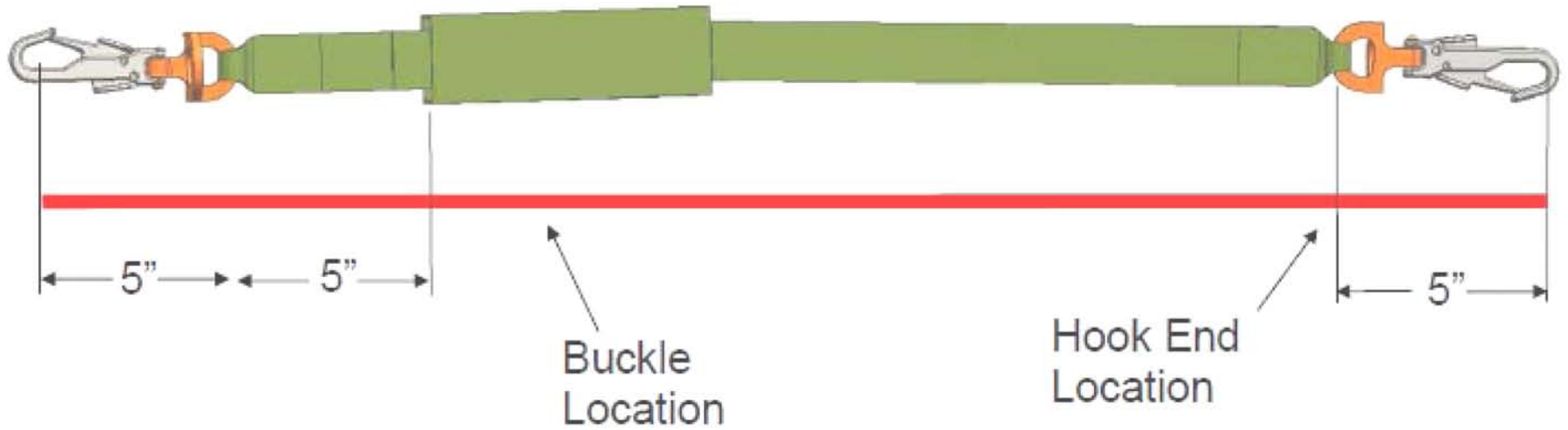

## Long Duration Tie-Down Tether End To End Configuration (48-168")

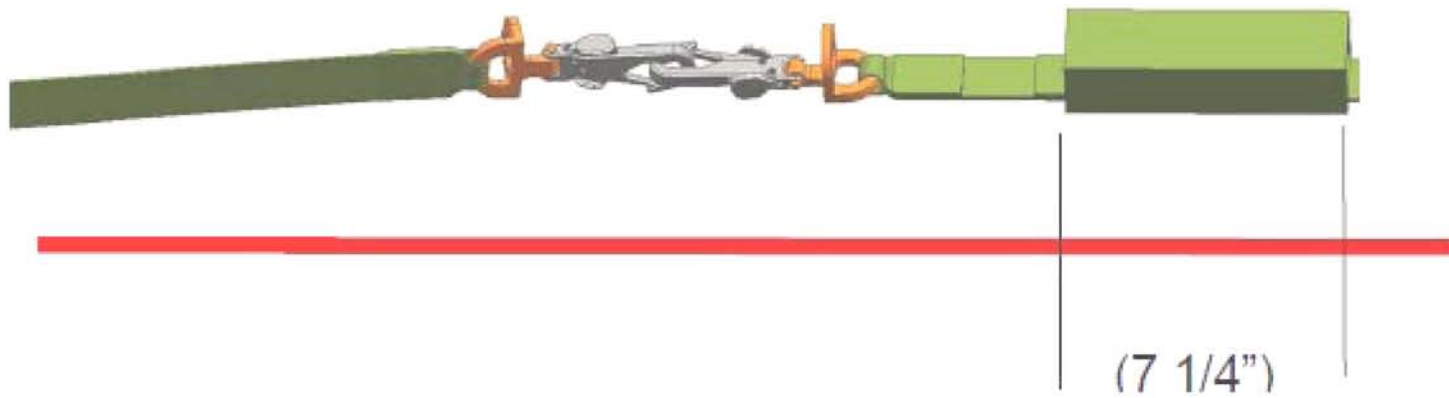

**LONG DURATION TIE-DOWN TETHER (Cont)**

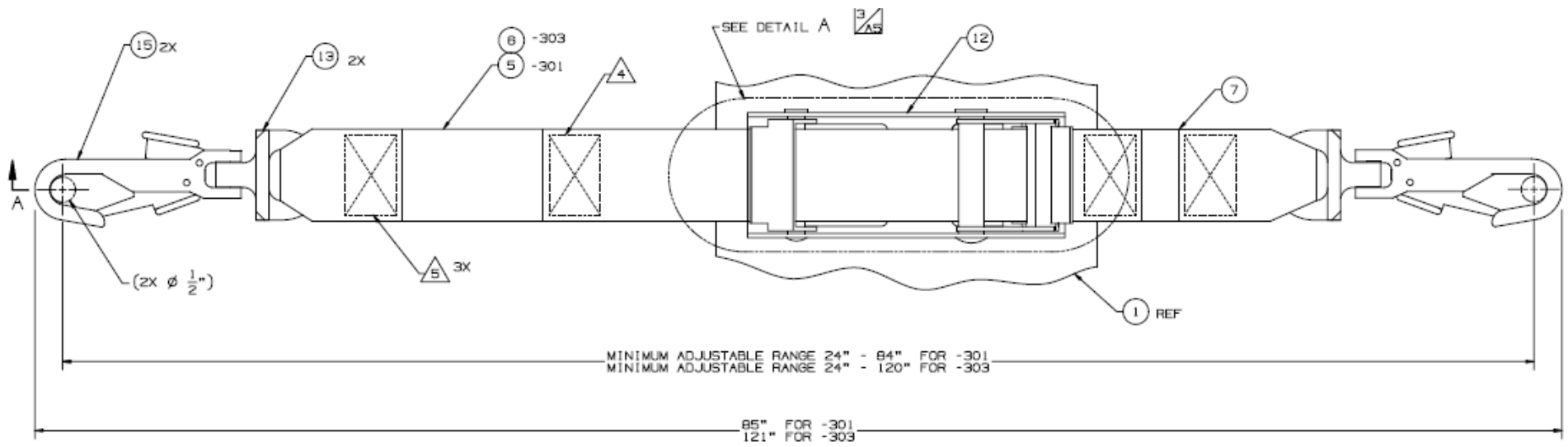

-301  
-303

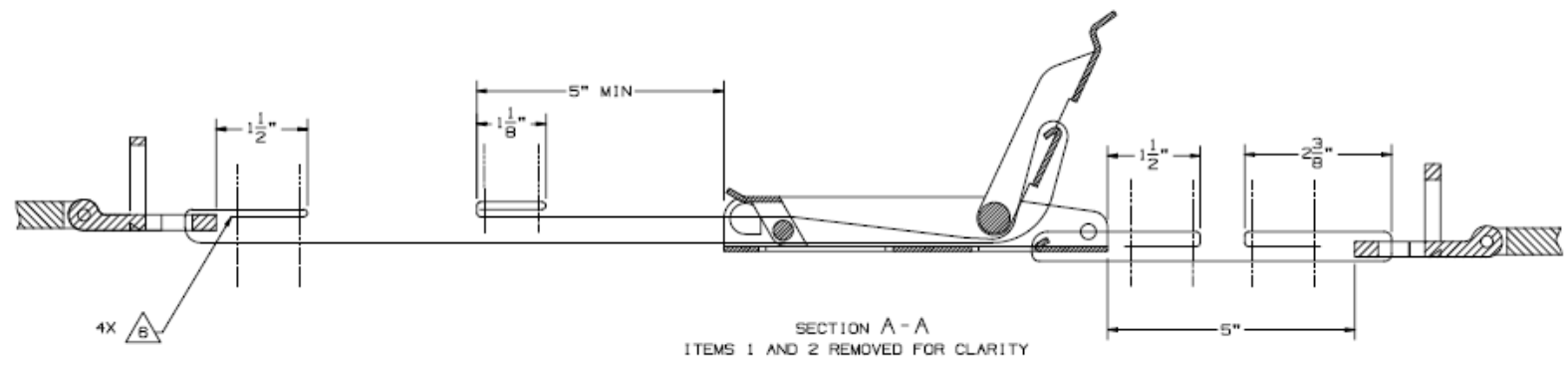

# SASA TIE DOWN AT Z1

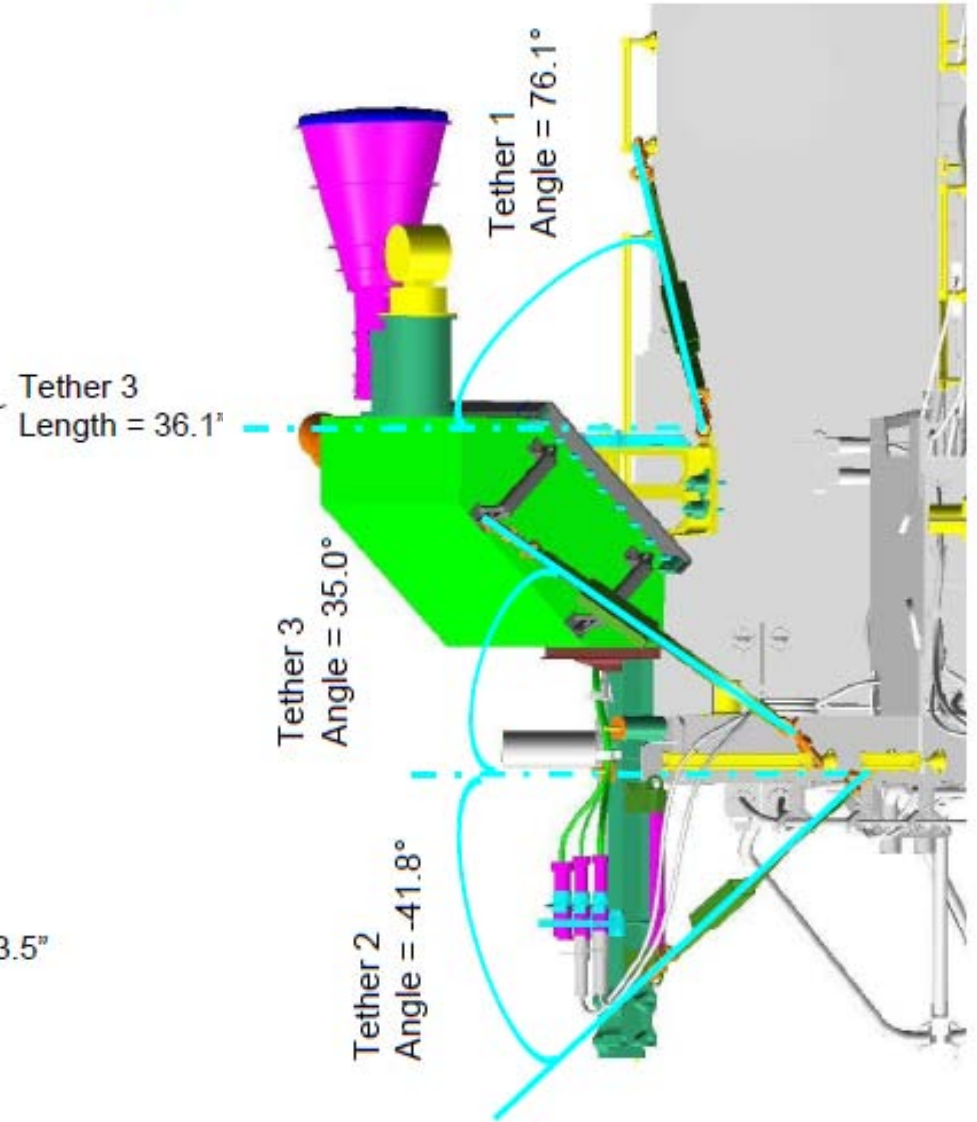
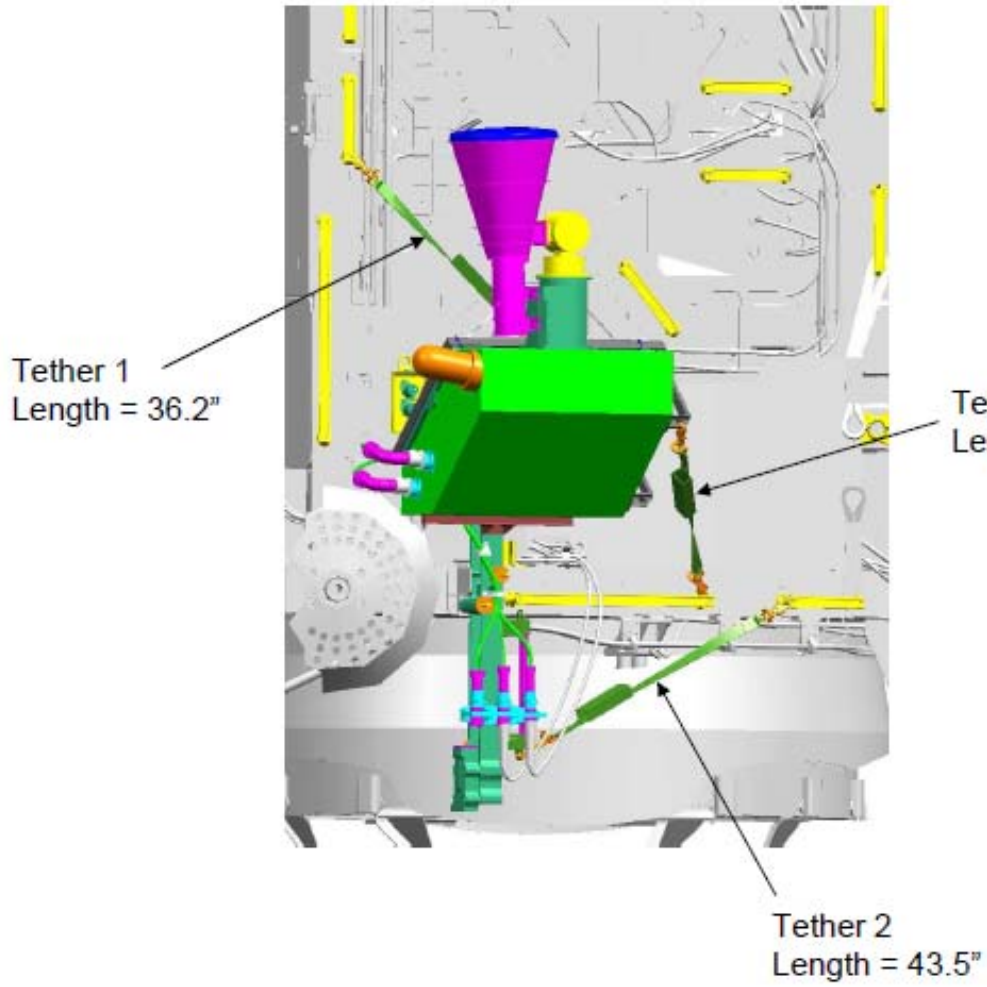

# SASA TIE DOWN AT Z1 (Cont)

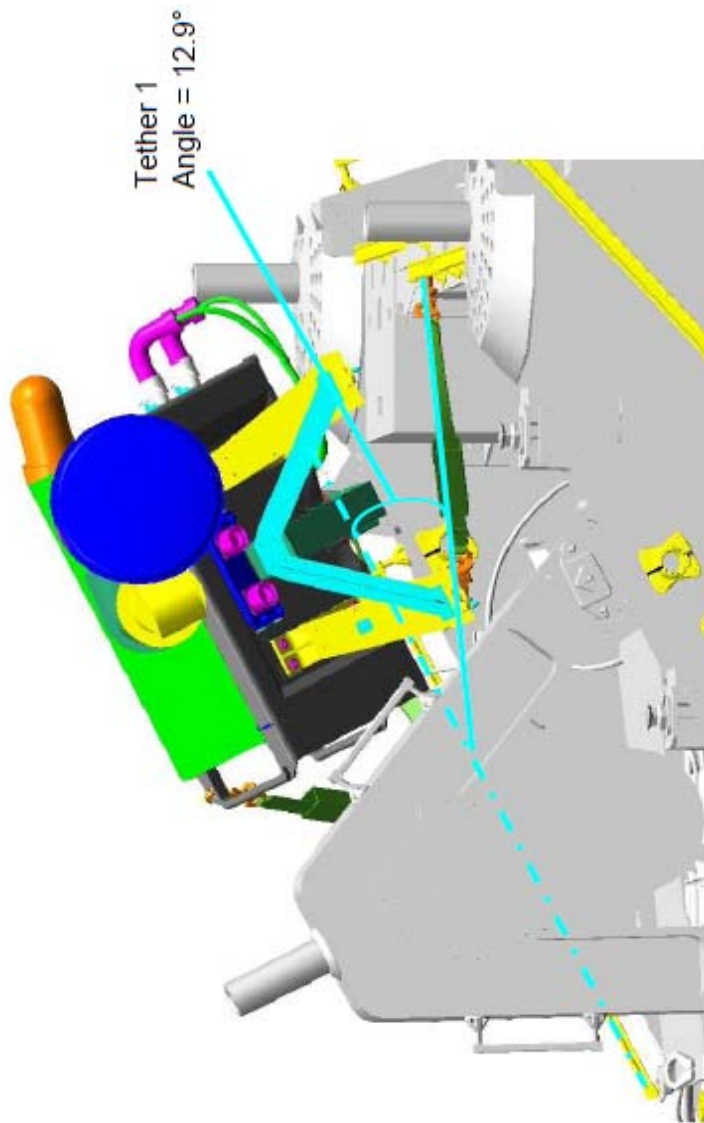

Tether 2  
Angle = 6.9°

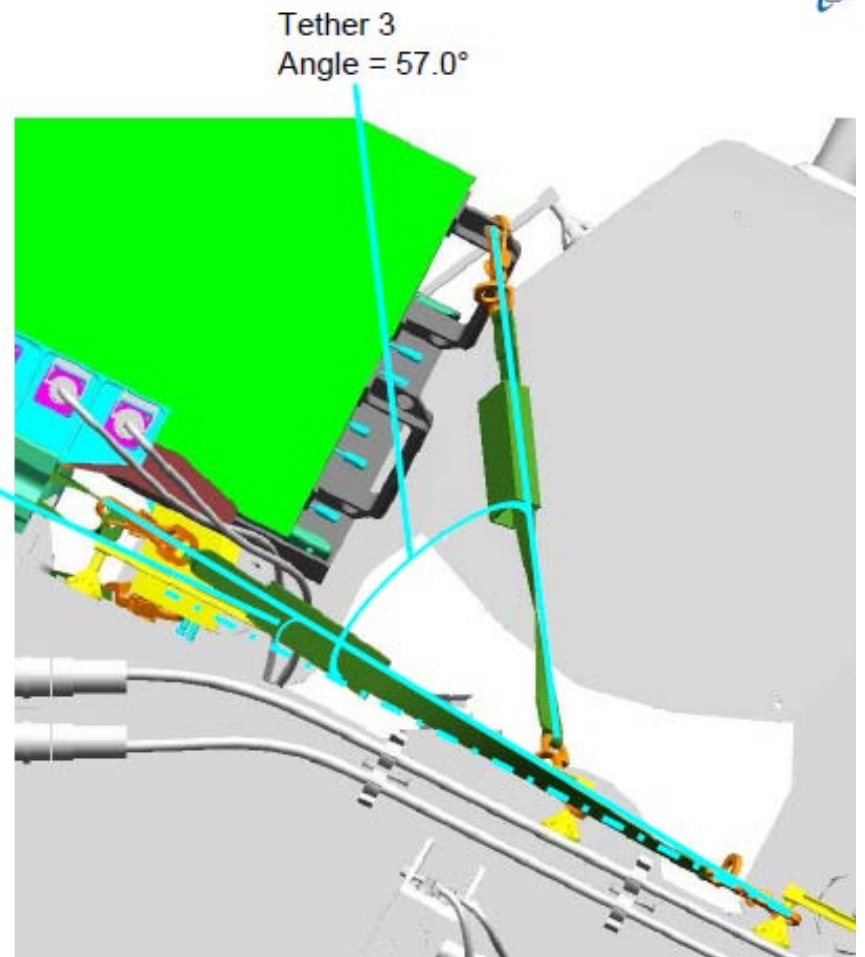

# FPMU TIE DOWN AT CP2 (S1)

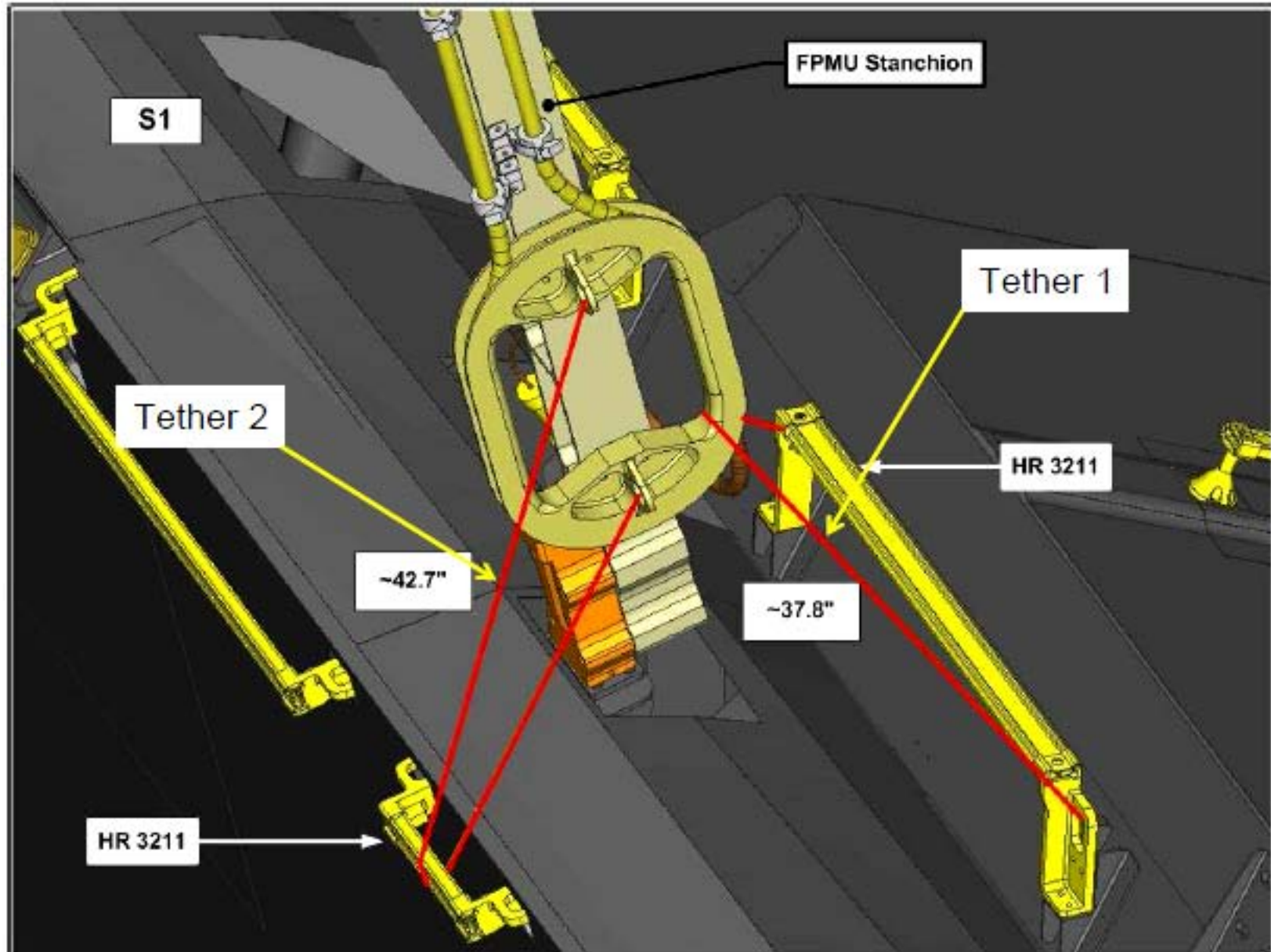



# FPMU TIE DOWN AT CP6 (P1)

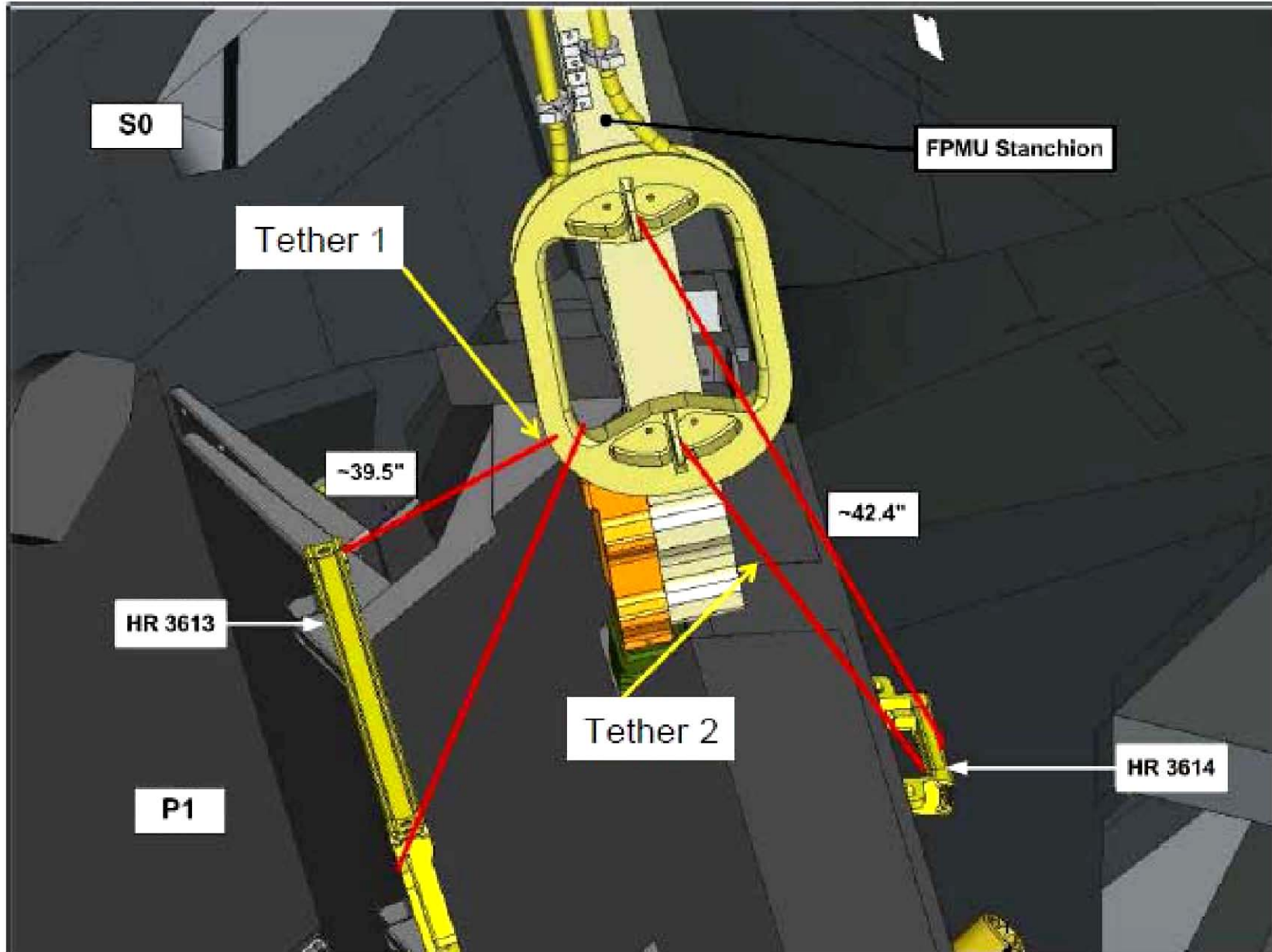

## PAS CLEVIS BRACKET TIEDOWN

Wire ties shown in this view are not allowed per EVA tools. Crew should use AET and wrap to fit

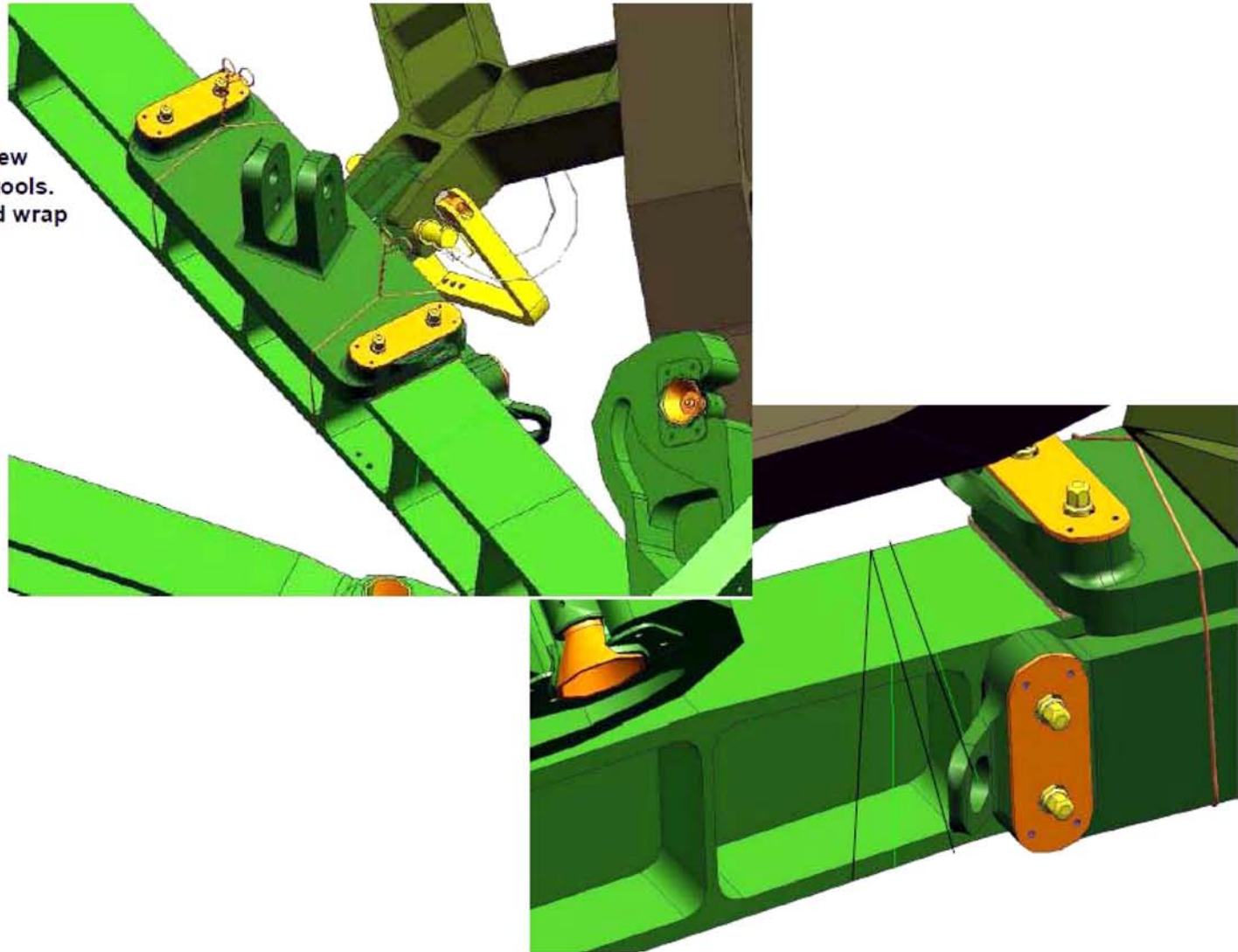

This tether is an adjustable equipment tether (small/small hooks). Total length is approx. 22.5". It goes from the tether loop on the Deployed Bracket around P3 or S3 Structure and hooks back onto its own D-Ring

# WETA DUMMY BOX TIEDOWN

Two 5m-5m Adjustable Tethers

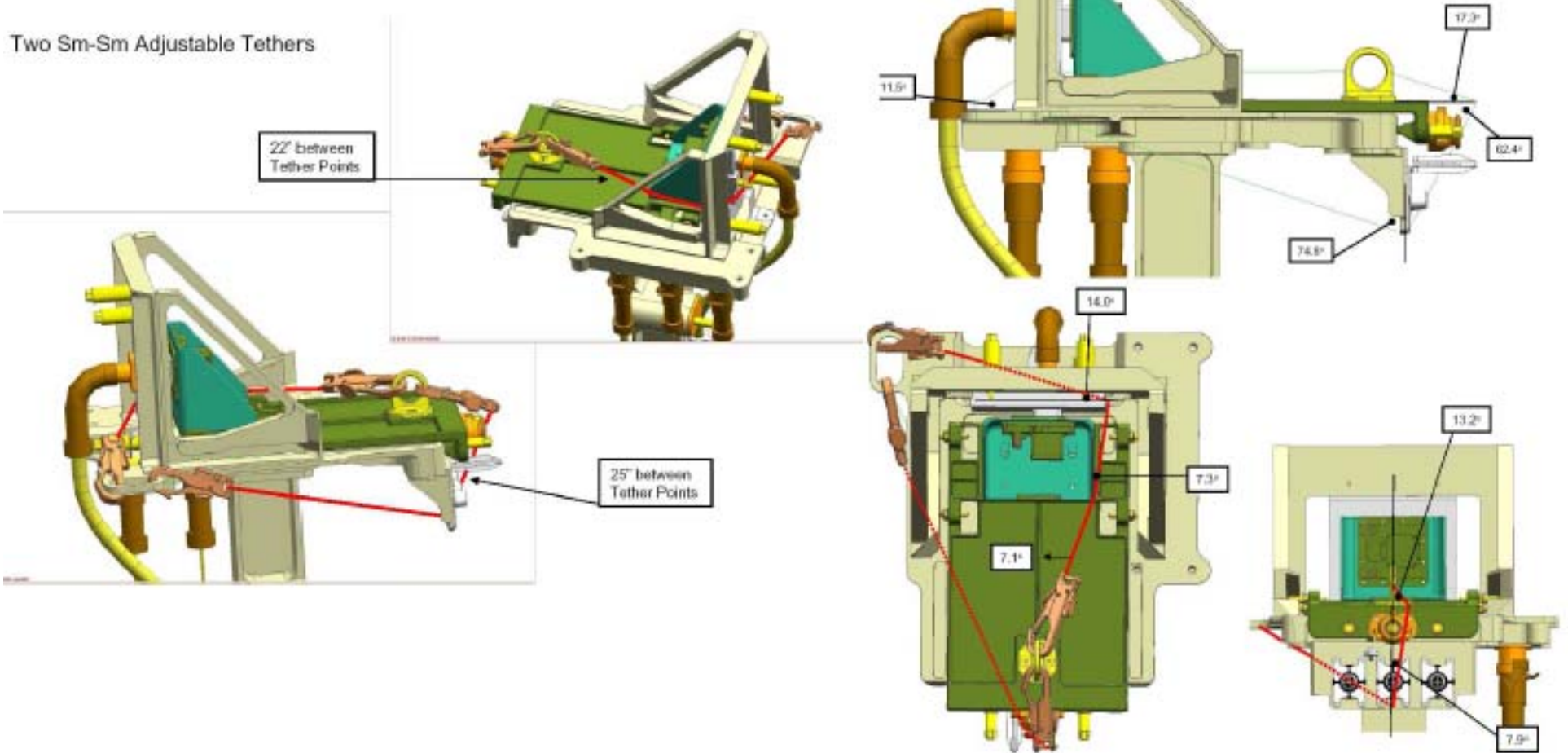

This Page Intentionally Blank

FLIGHT SPECIFIC EVA REFERENCE

EVA 1	
SASA.....	FS 18-3
POA.....	FS 18-9
JEM RMS.....	FS 18-11
SGANT CABLE.....	FS 18-12
NH3 BRACKET.....	FS 18-15
S0 ¼ AVIONICS CABLE.....	FS 18-18
EVA 2	
GATOR ASSEMBLY.....	FS 18-21
AIS ANTENNA.....	FS 18-27
ARISS ANTENNA.....	FS 18-28
FPMU.....	FS 18-29
PAS.....	FS 18-30
WETA.....	FS 18-33
EVA 3	
HPGT.....	FS 18-35
MMOD SHIELD.....	FS 18-40
MISSE 7.....	FS 18-41
GET-AHEADS	
GET-AHEADS: P1-P3 UMBILICALS.....	FS 18-47
GET-AHEADS: CLA.....	FS 18-49
ELC	
ELC 1 AND 2.....	FS 18-50
MISC	
ROEU.....	FS 18-56
PRLA.....	FS 18-60

FLIGHT SPECIFIC  
EVA REFERENCE

This Page Intentionally Blank

SASA

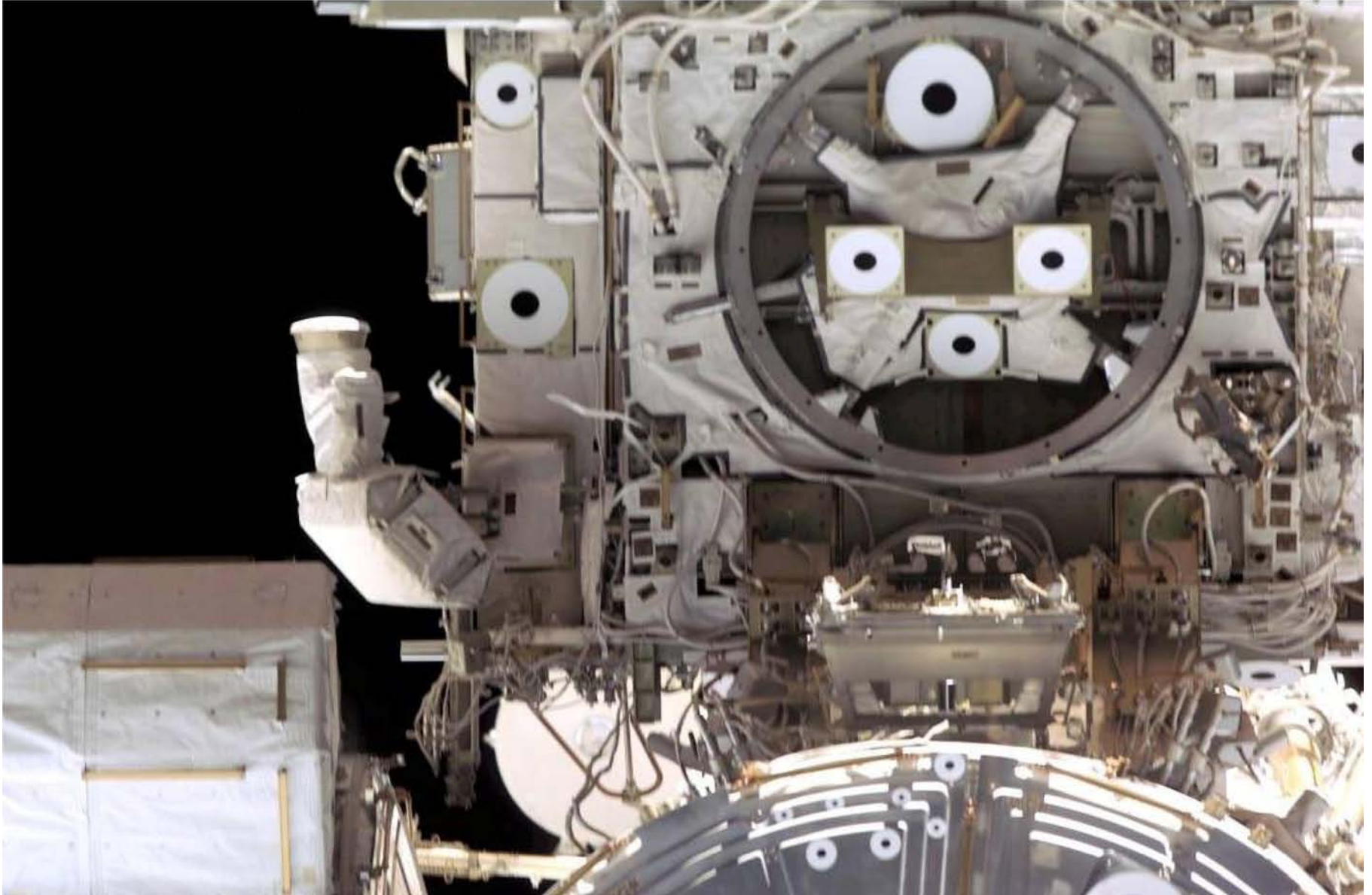

FS 18-3

EVA/129/FIN

EVA 1

SASA (Cont)





SASA (Cont)

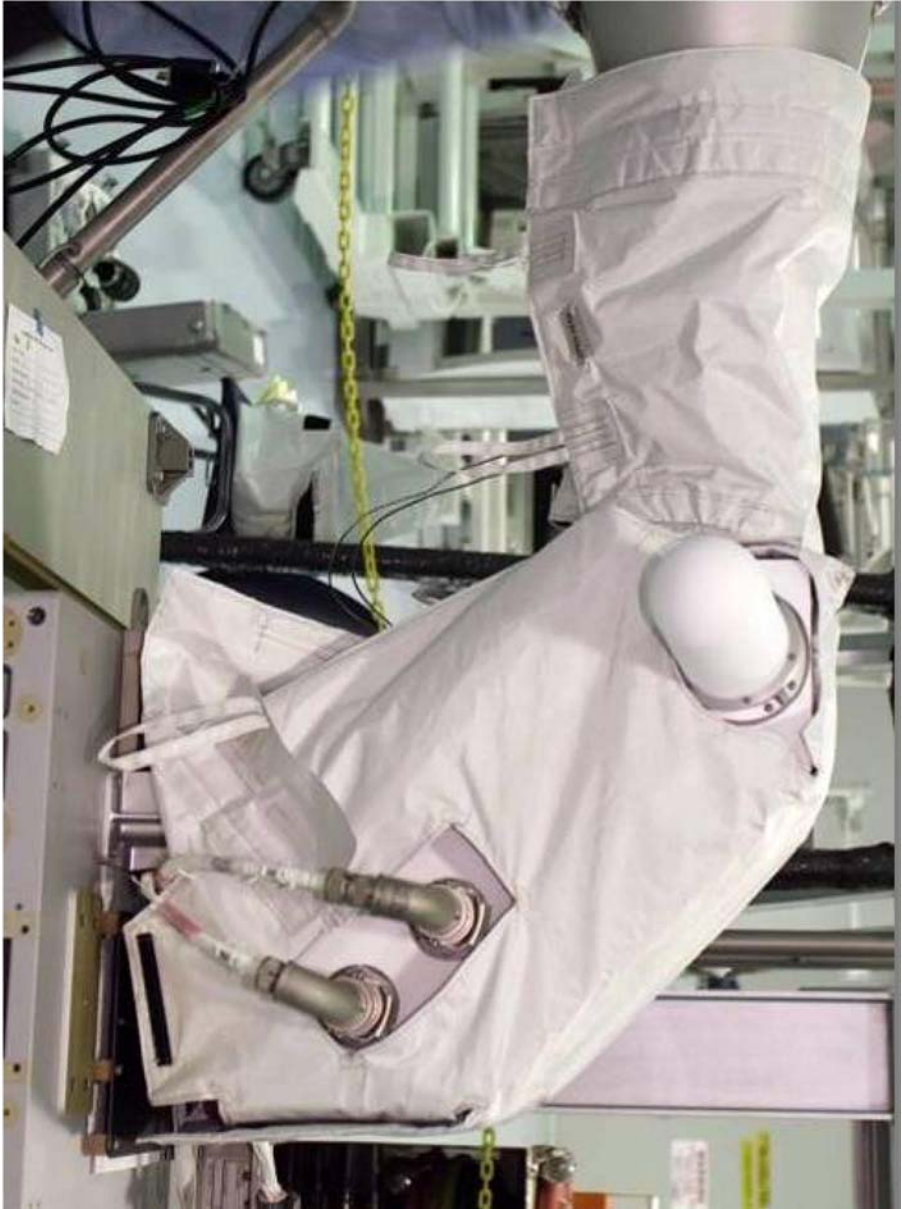

## SASA (Cont)

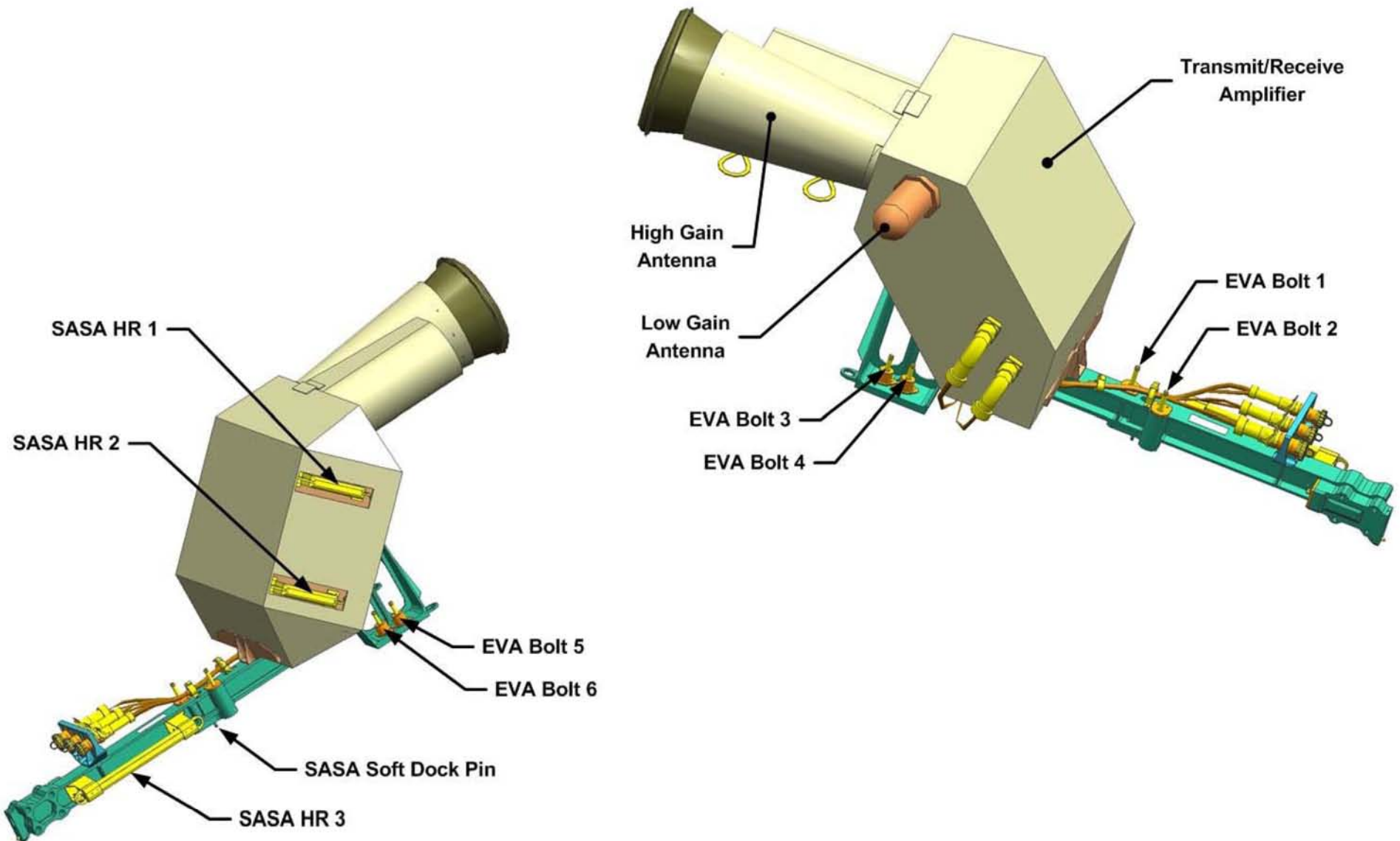

SASA (Cont)

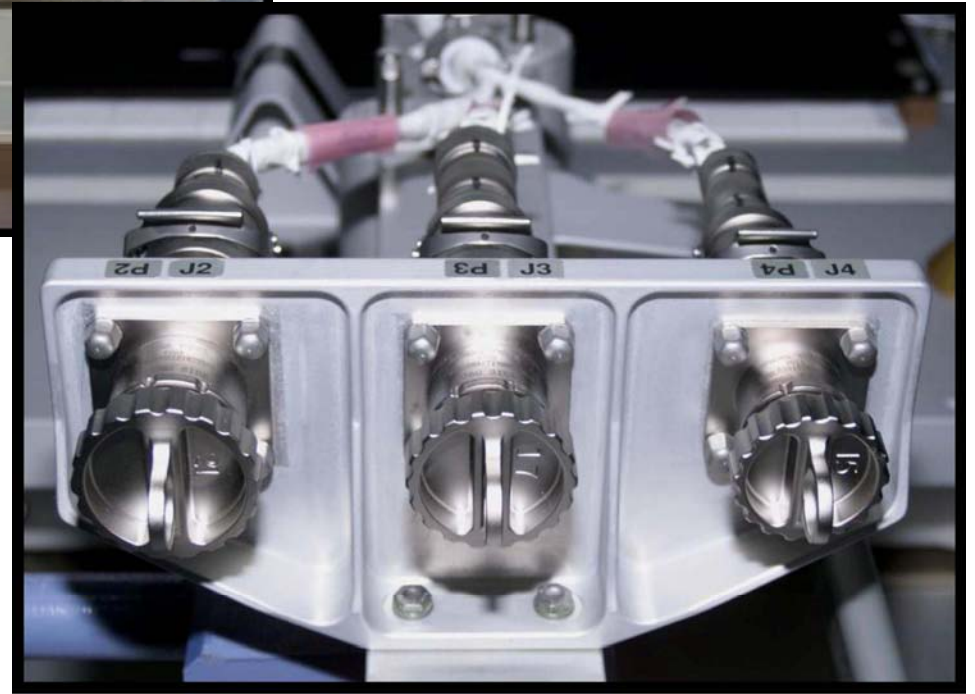
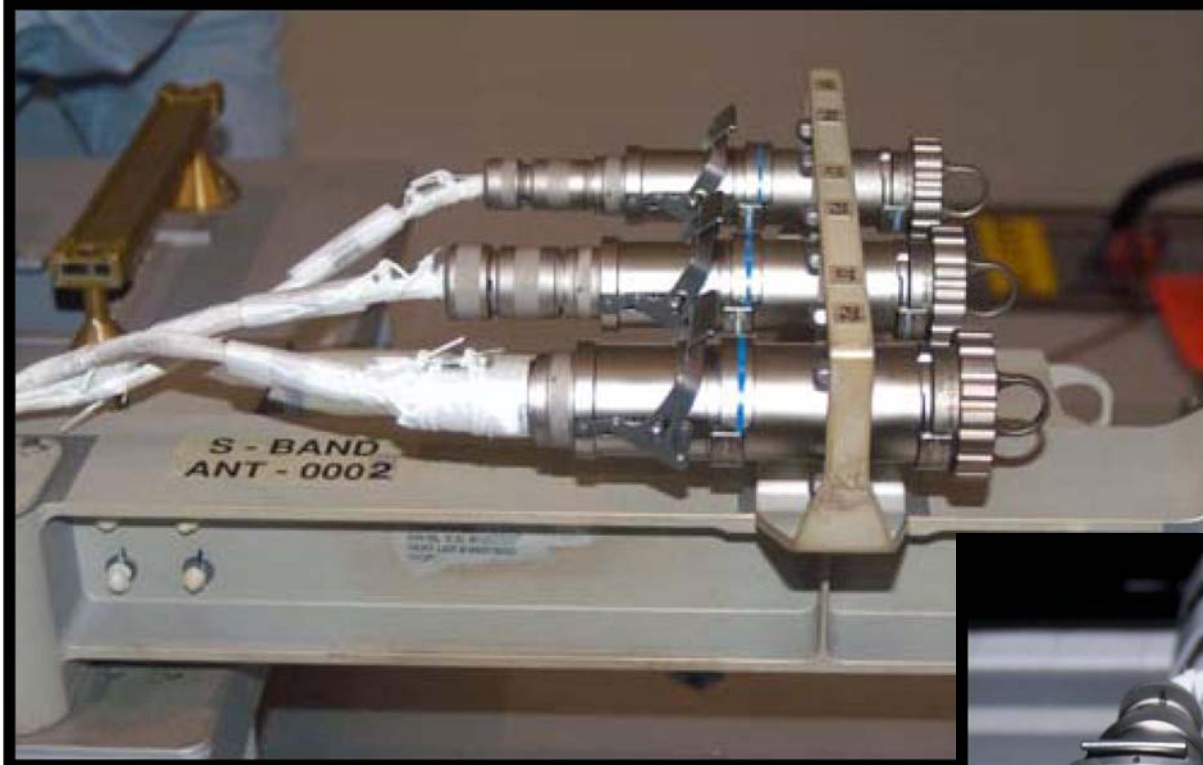

SASA (Cont)



POA



FS 18-9

EVA/129/FIN

POA (Cont)

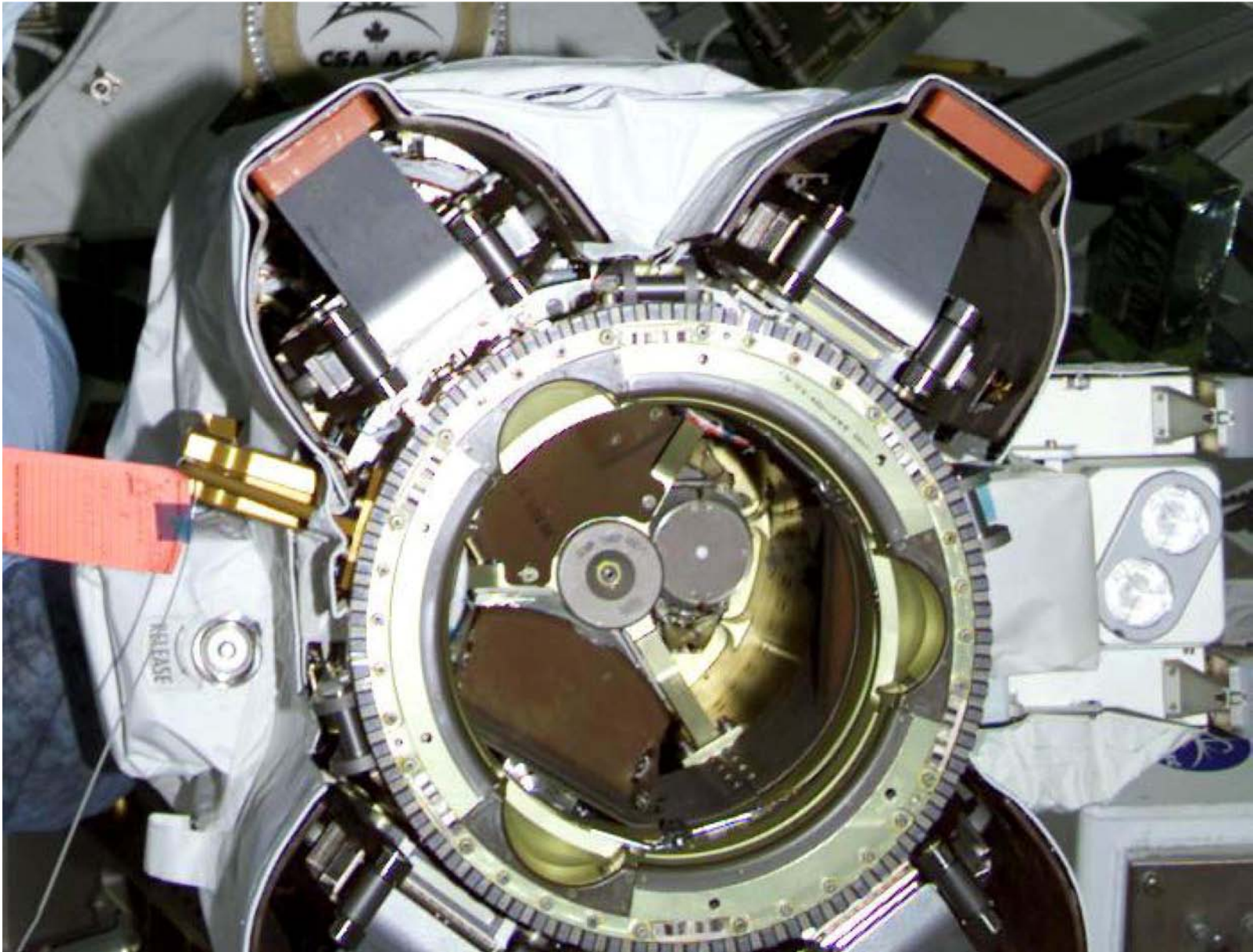

JEM RMS



# SGANT CABLE





**SGANT CABLE (Cont)**



SGANT CABLE (Cont)



# NH3 BRACKET

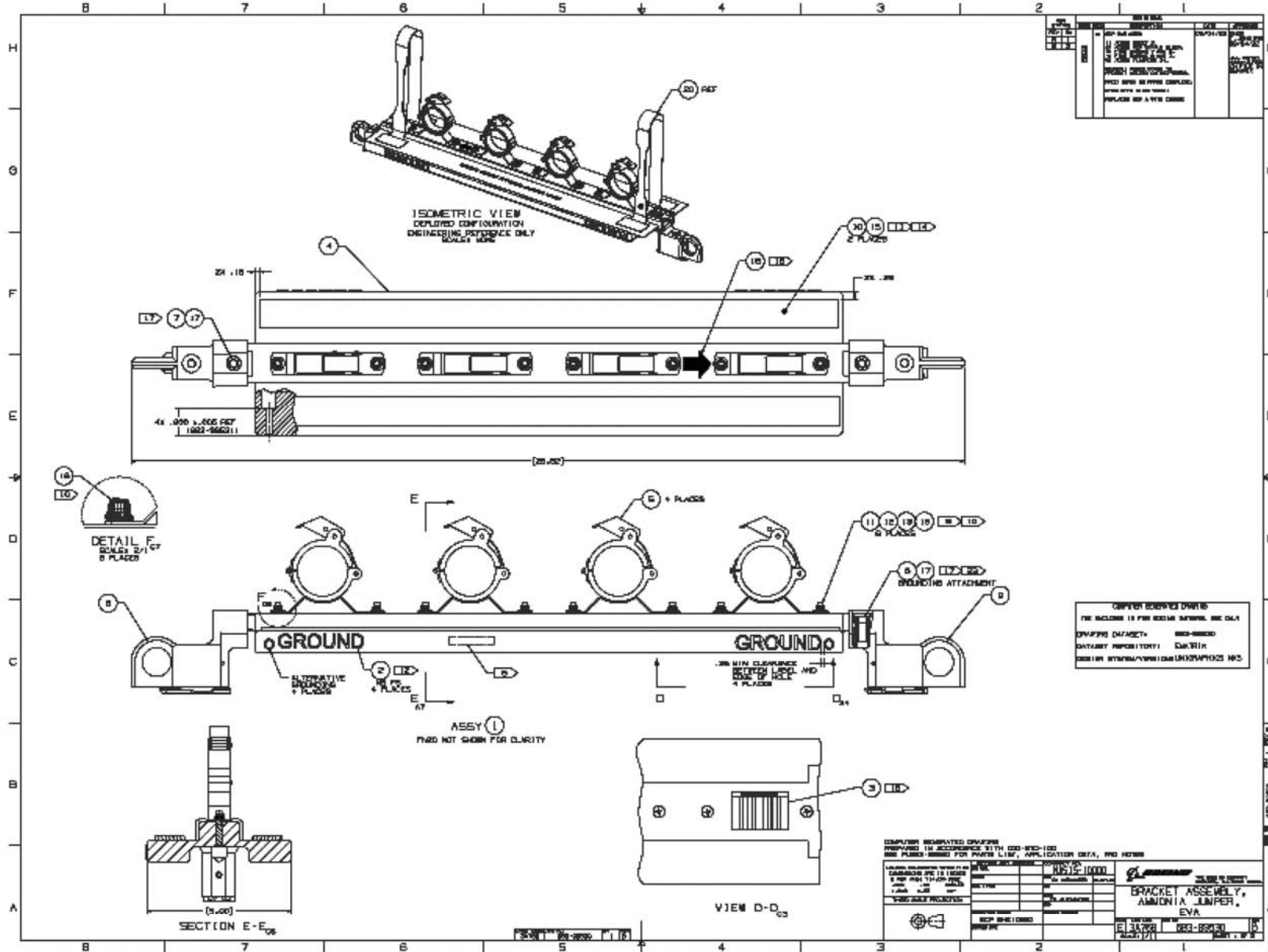

NH3 BRACKET (Cont)

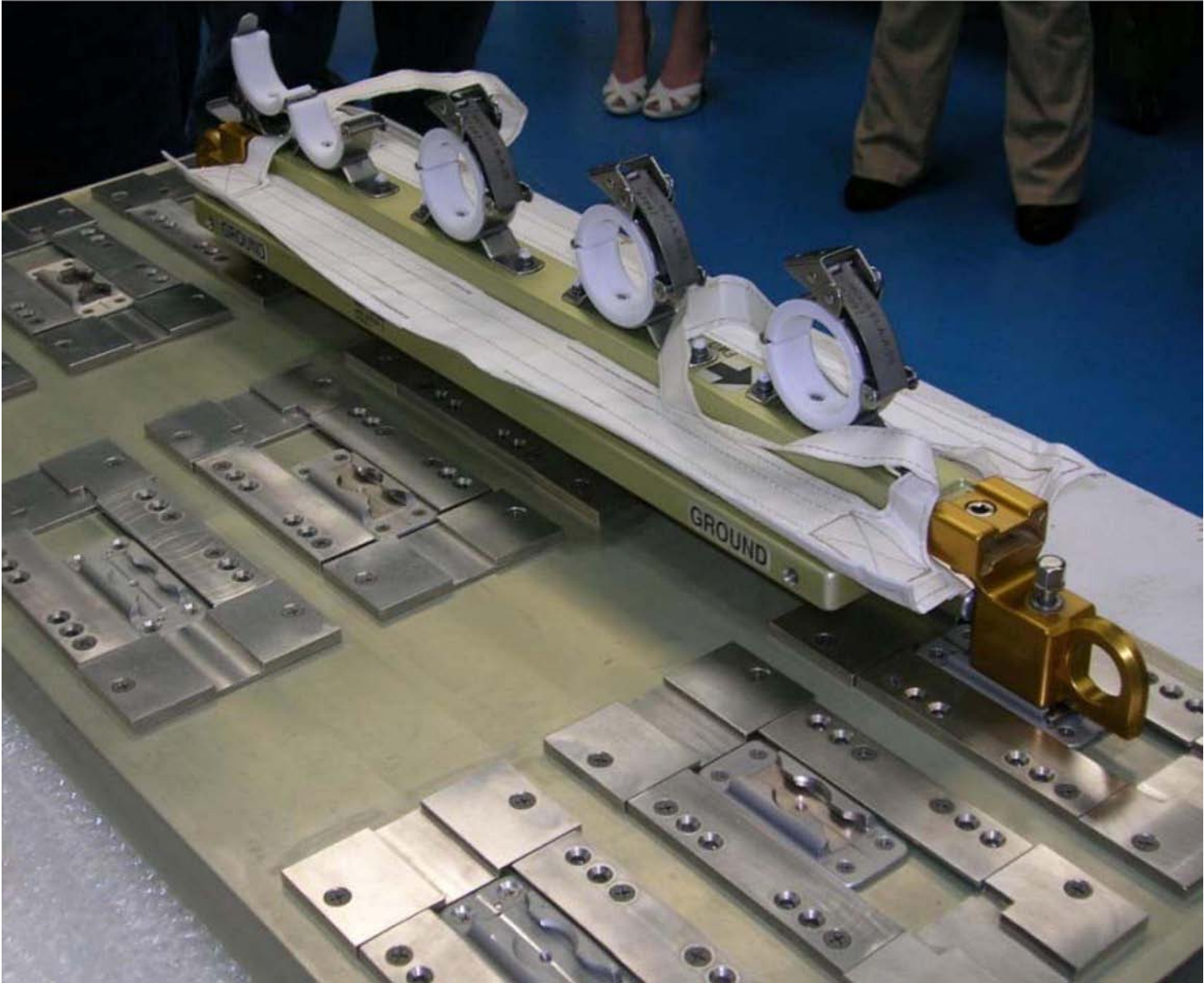

NH3 BRACKET (Cont)

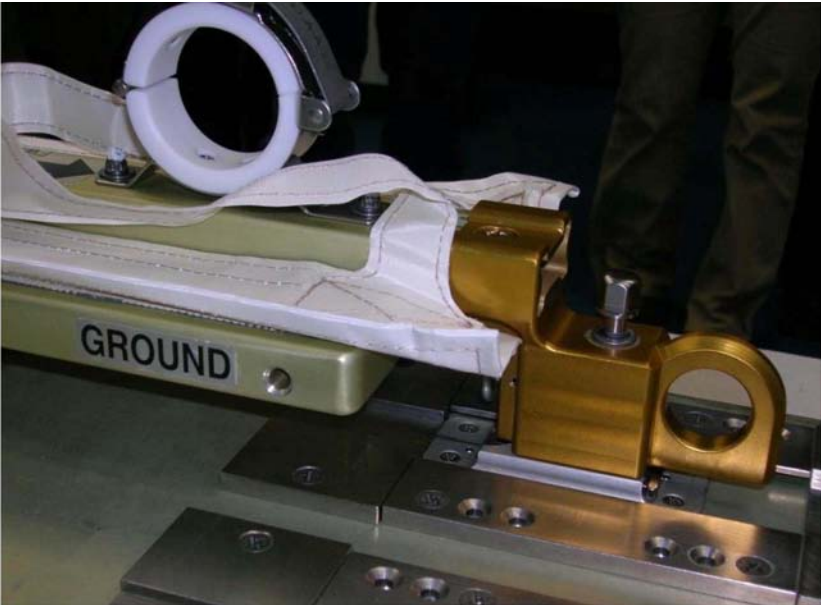

# S0 ¼ AVIONICS CABLE

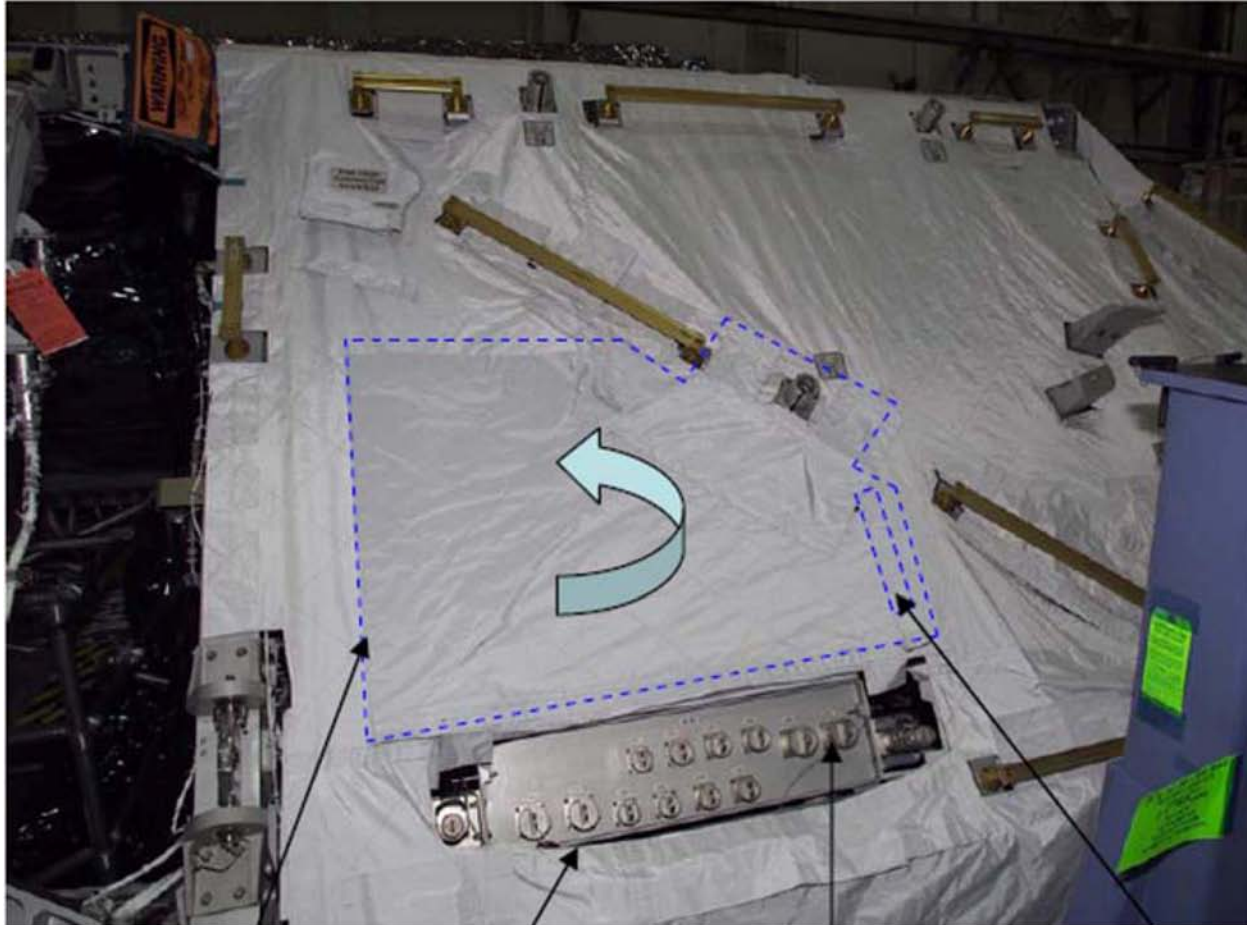

Shroud hinge line

Connector Panel A145

J181

Shroud handling aid

## S0 ¼ AVIONICS CABLE (Cont)

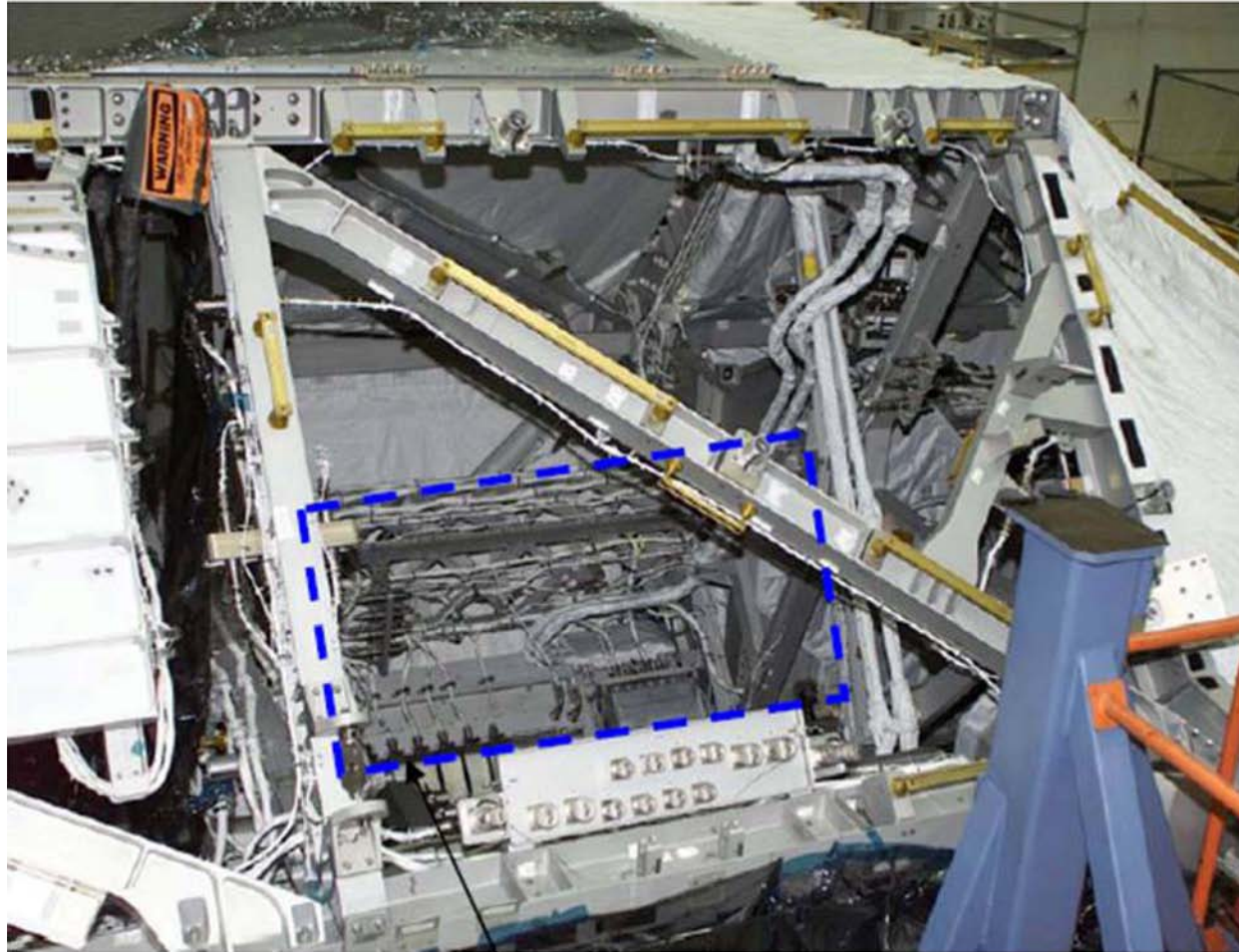

Approximate EVA access  
created by opening Face 5  
shroud

S0 ¼ AVIONICS CABLE (Cont)

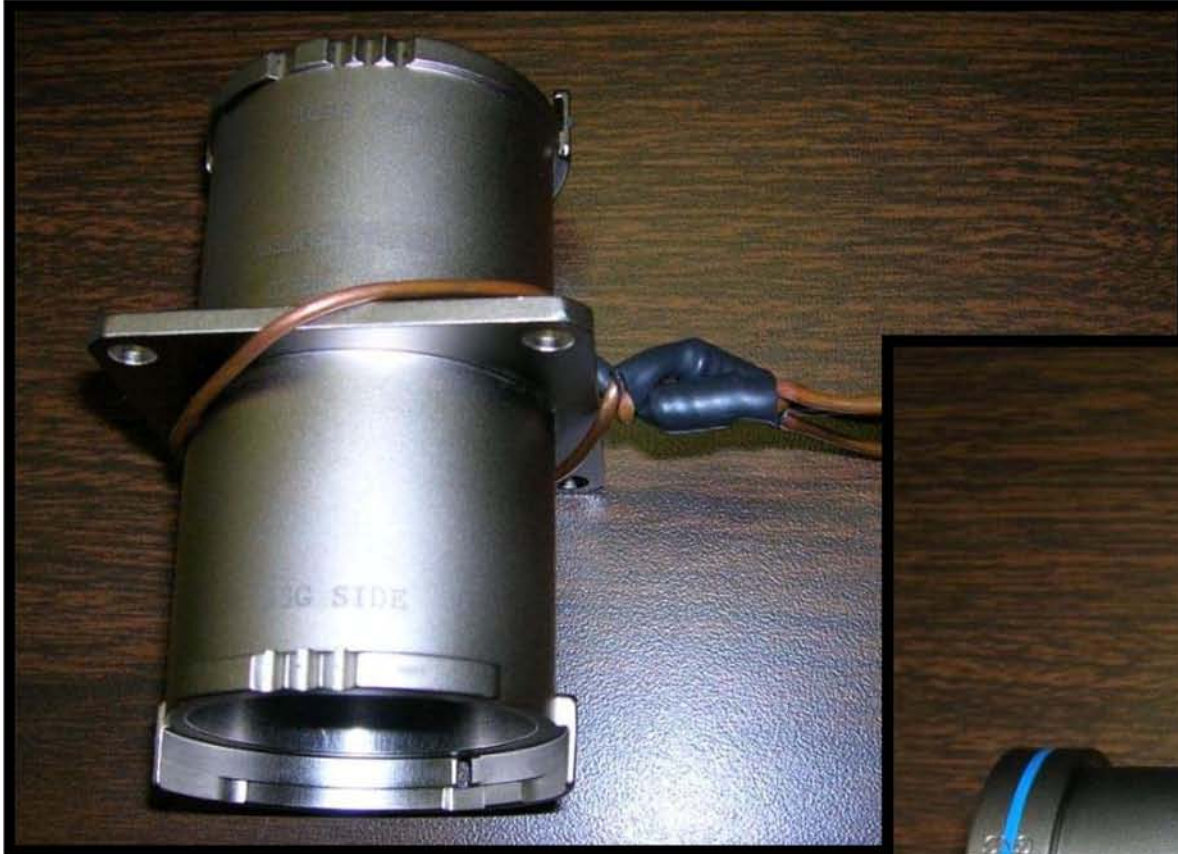



## GATOR ASSEMBLY

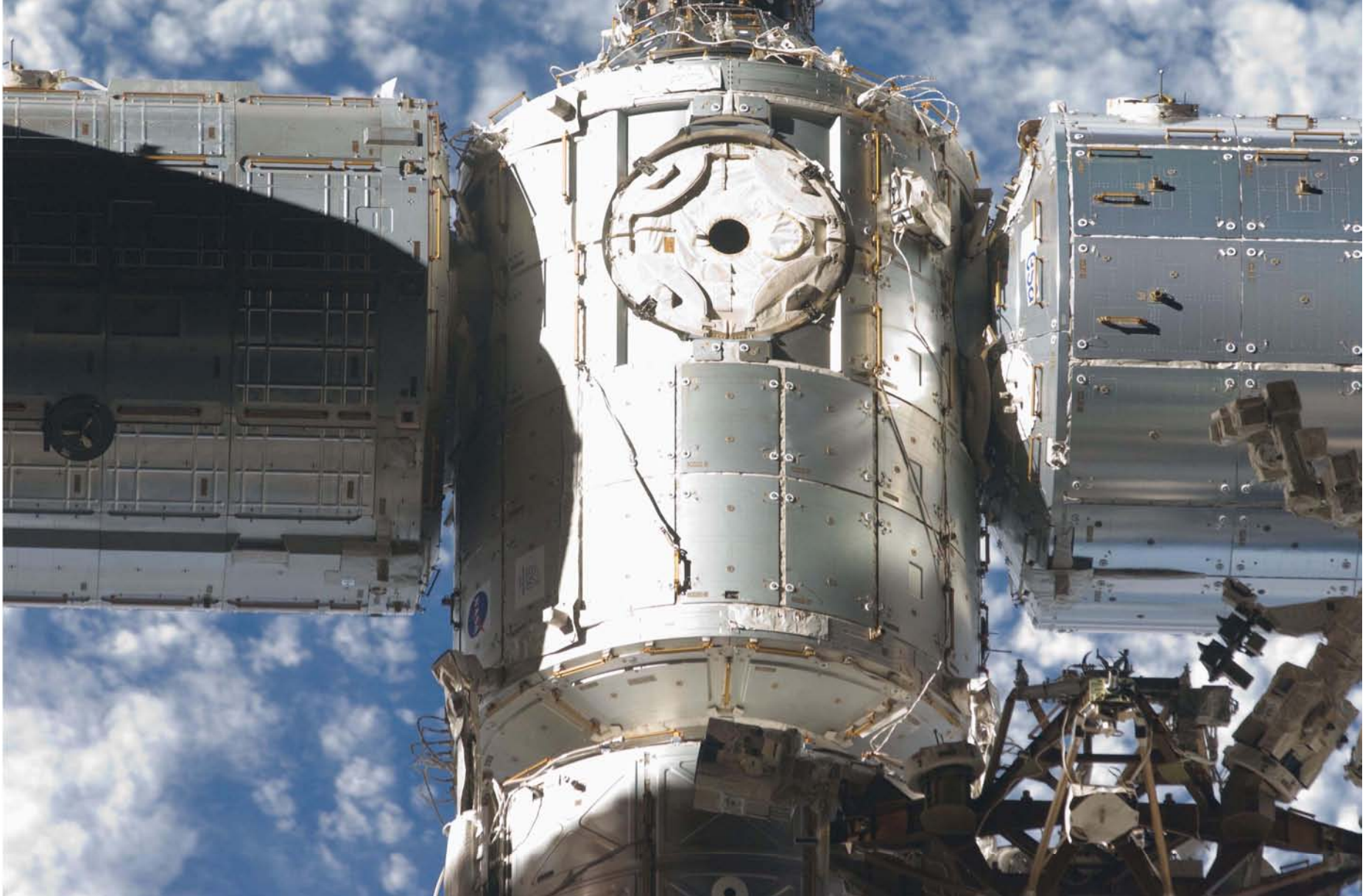

FS 18-21

EVA/129/FIN

EVA 2

GATOR ASSEMBLY (Cont)

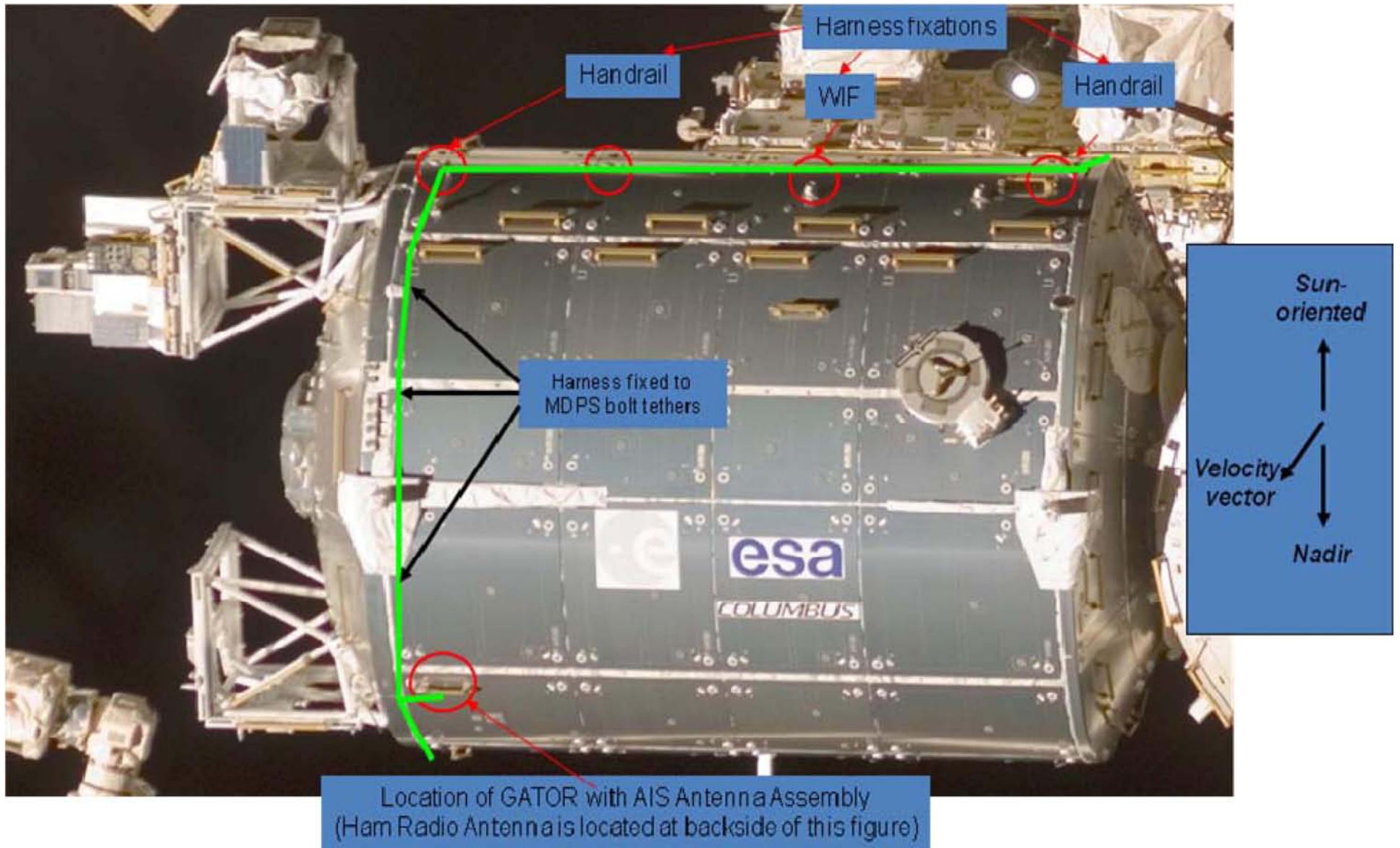

GATOR ASSEMBLY (Cont)



**GATOR ASSEMBLY (Cont)**

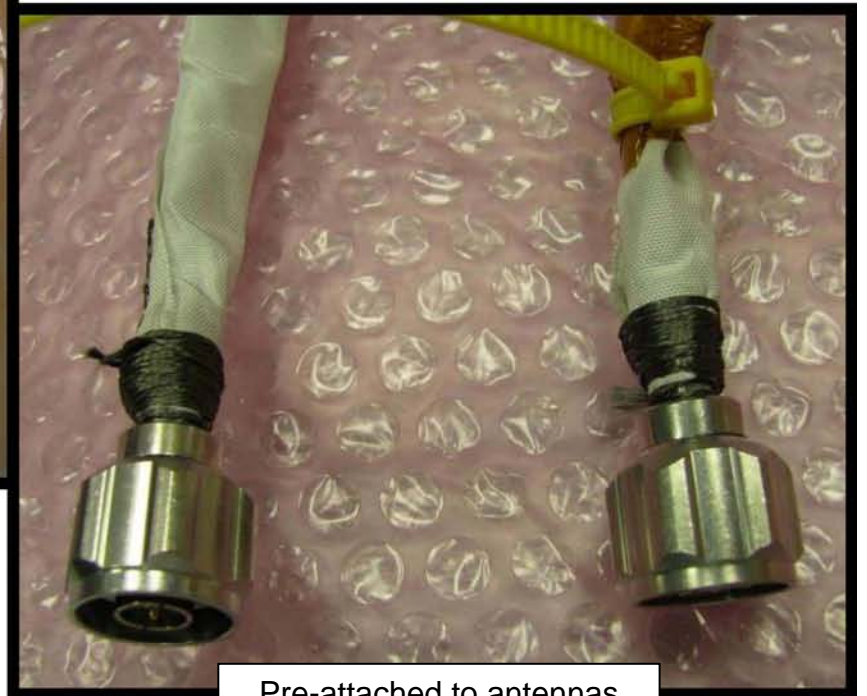

Pre-attached to antennas

GATOR ASSEMBLY (Cont)

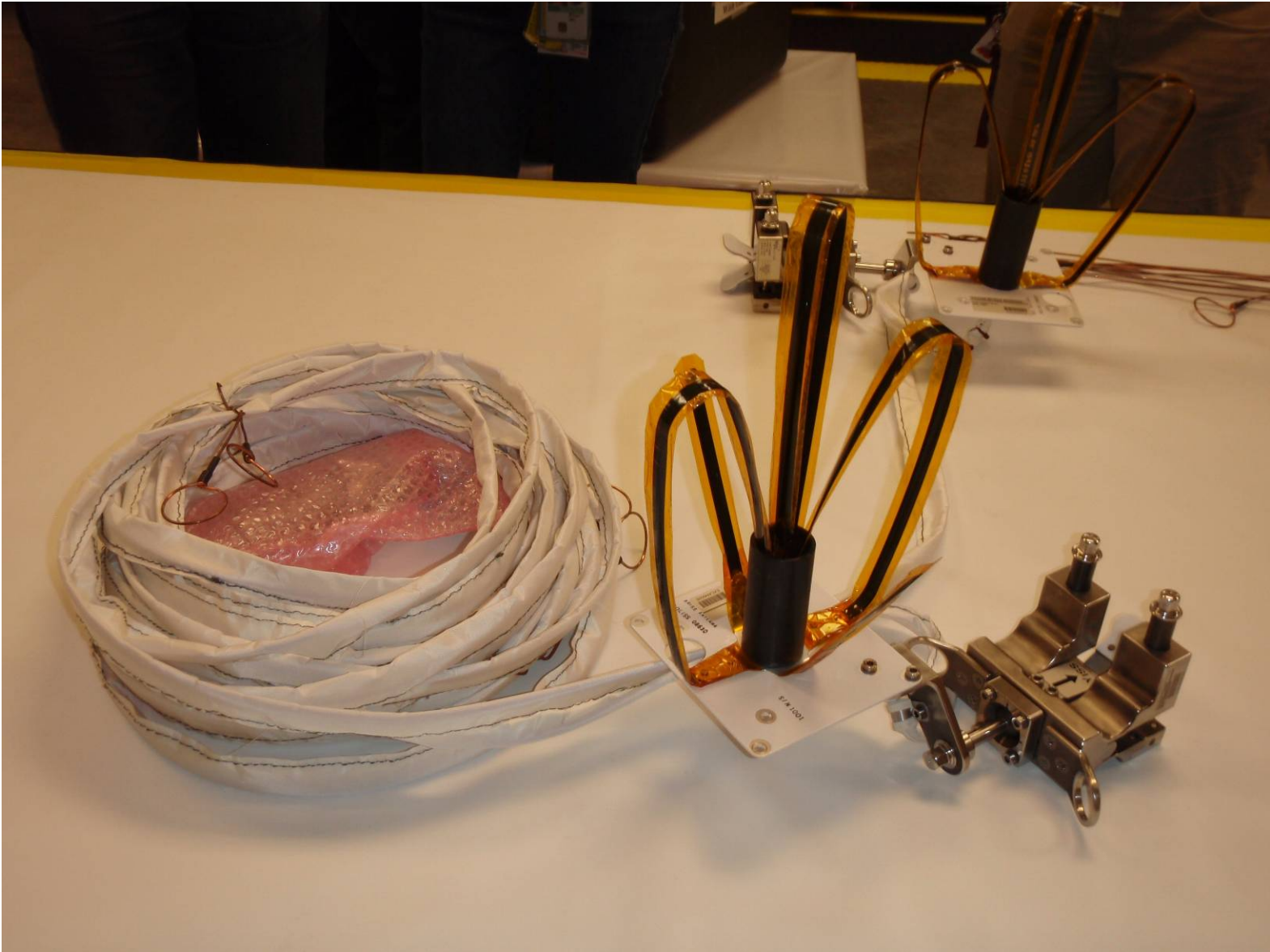

GATOR ASSEMBLY (Cont)

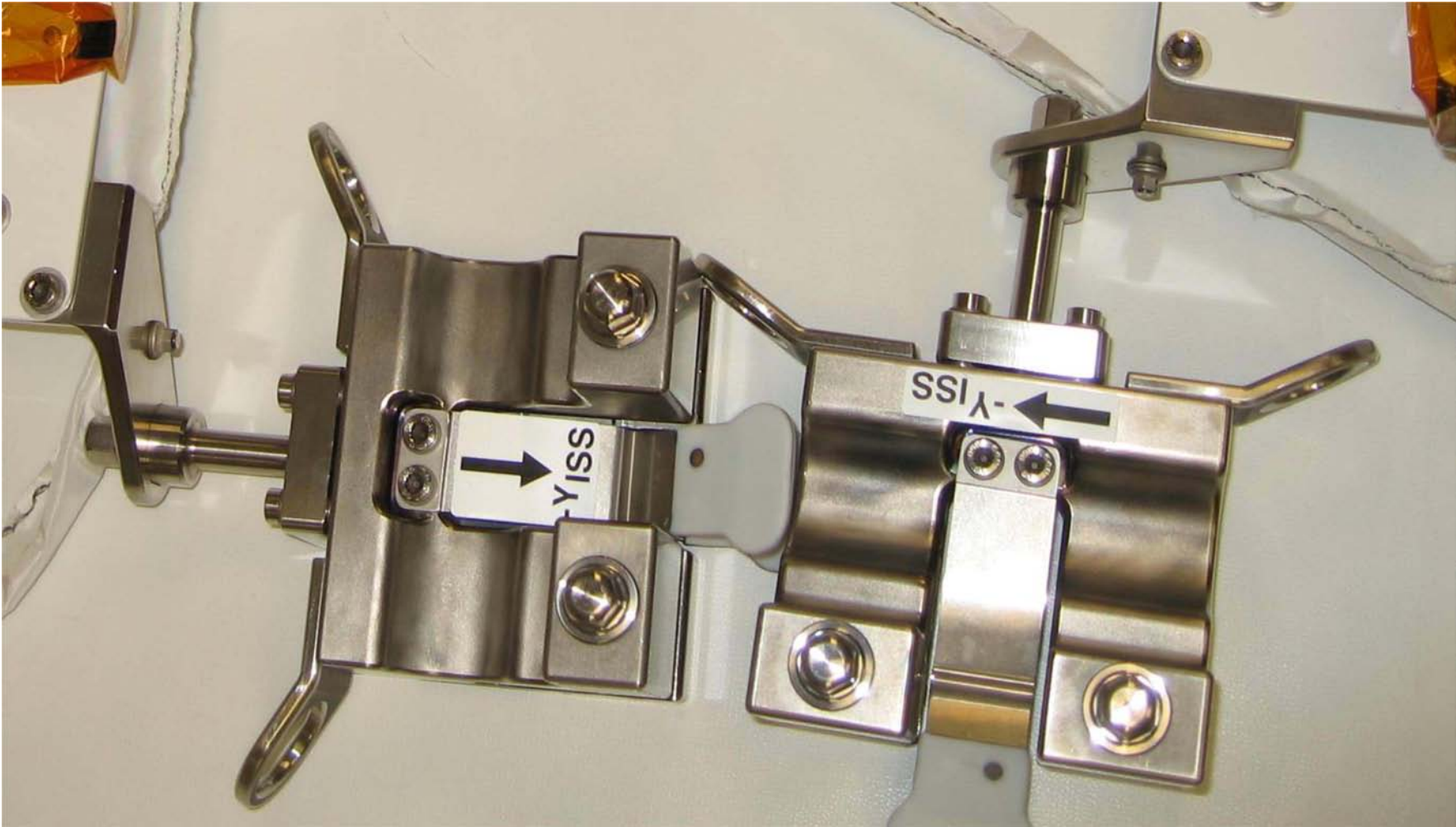

AIS ANTENNA

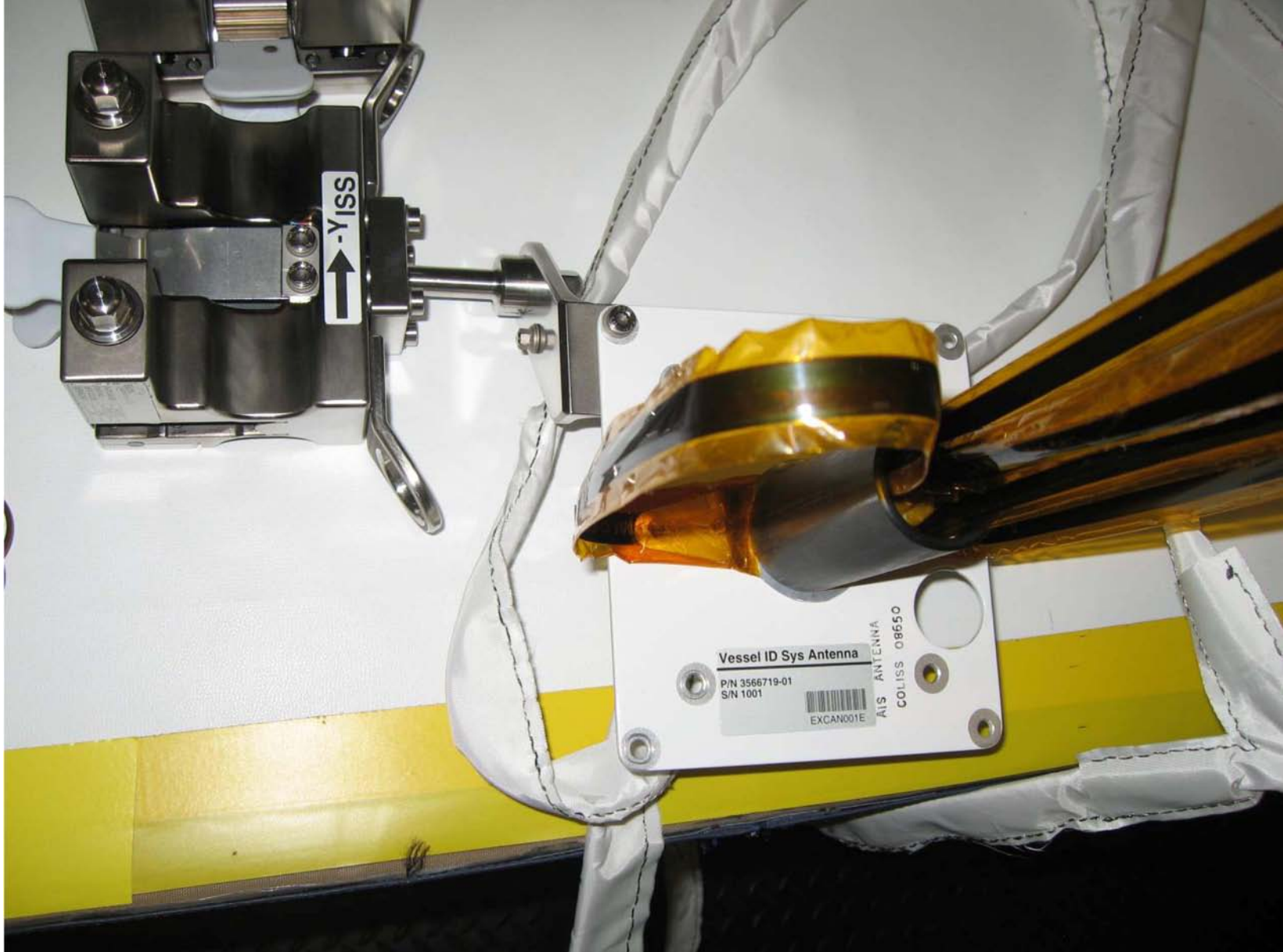

# ARISS ANTENNA





FPMU

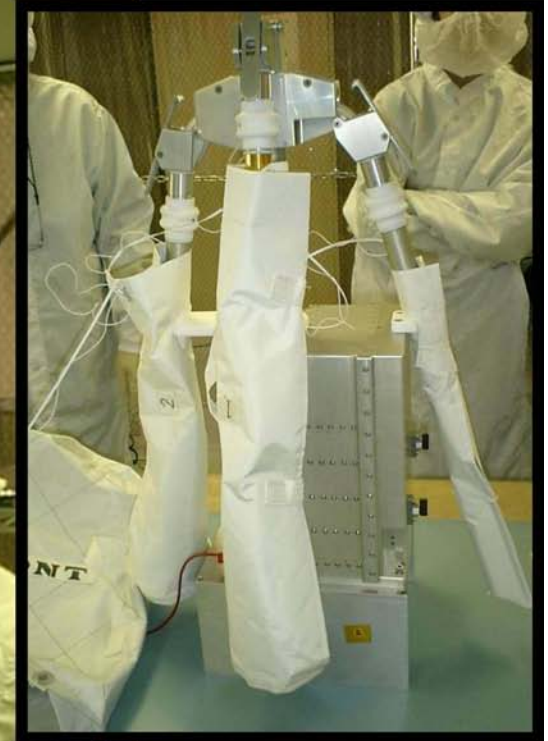

FS 18-29

EVA/129/FIN

PAS



FS 18-30

EVA/129/FIN

PAS (Cont)

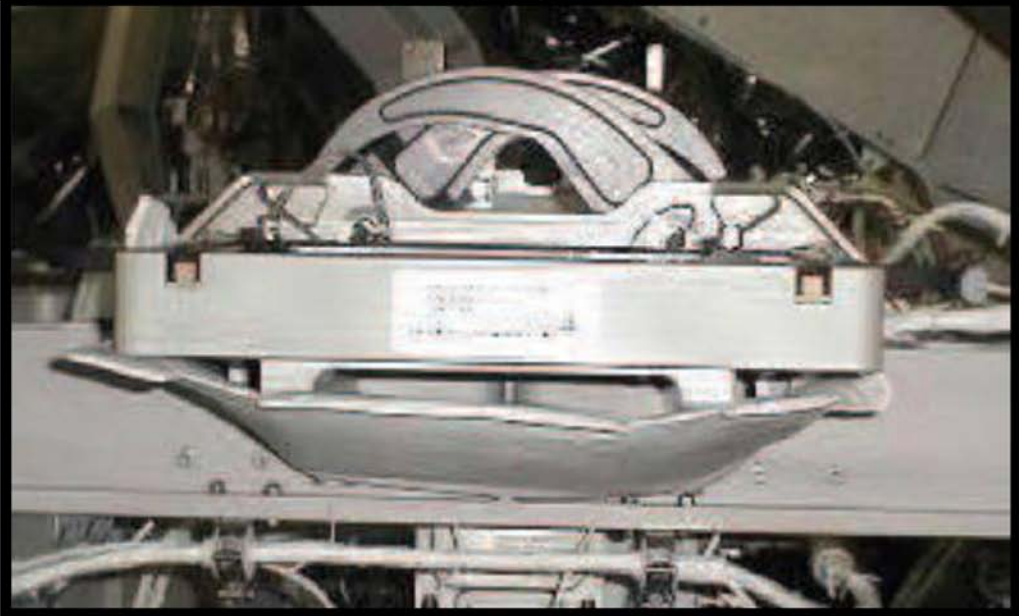
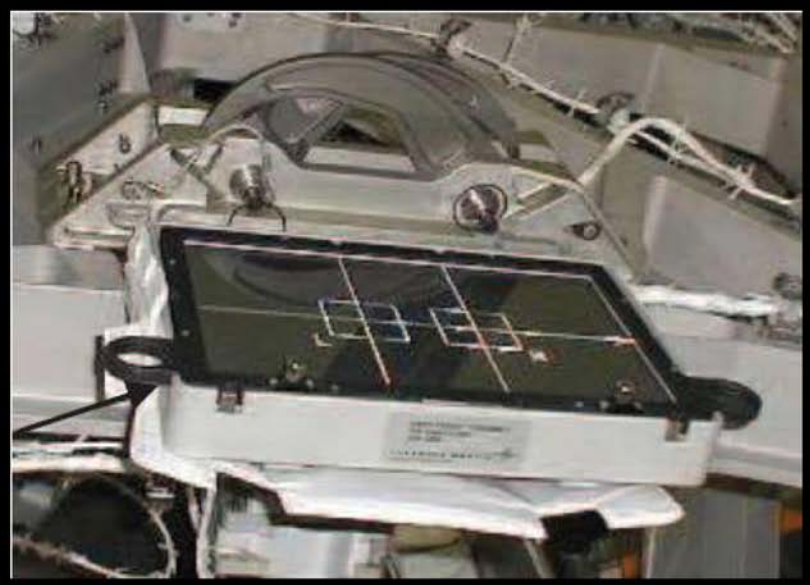
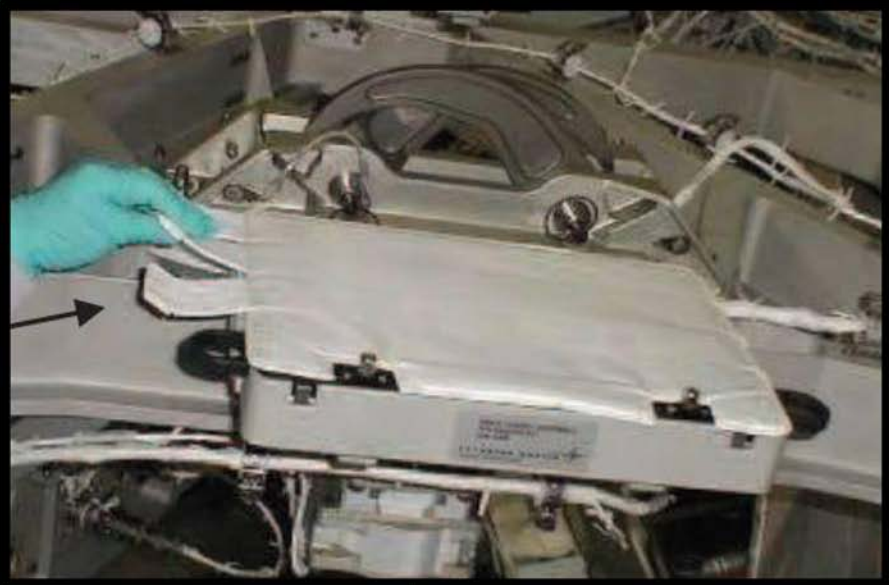

PAS (Cont)

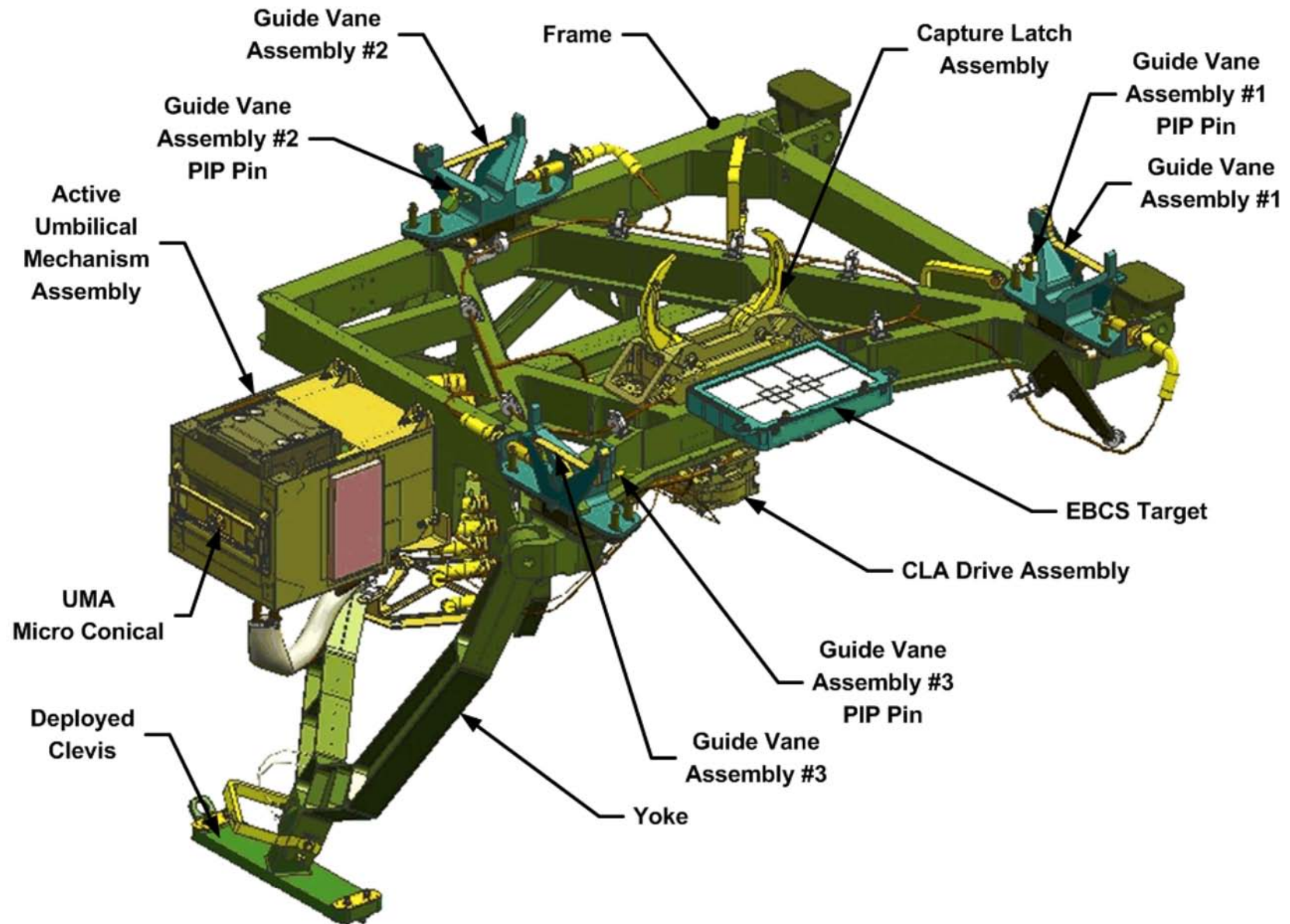

WETA

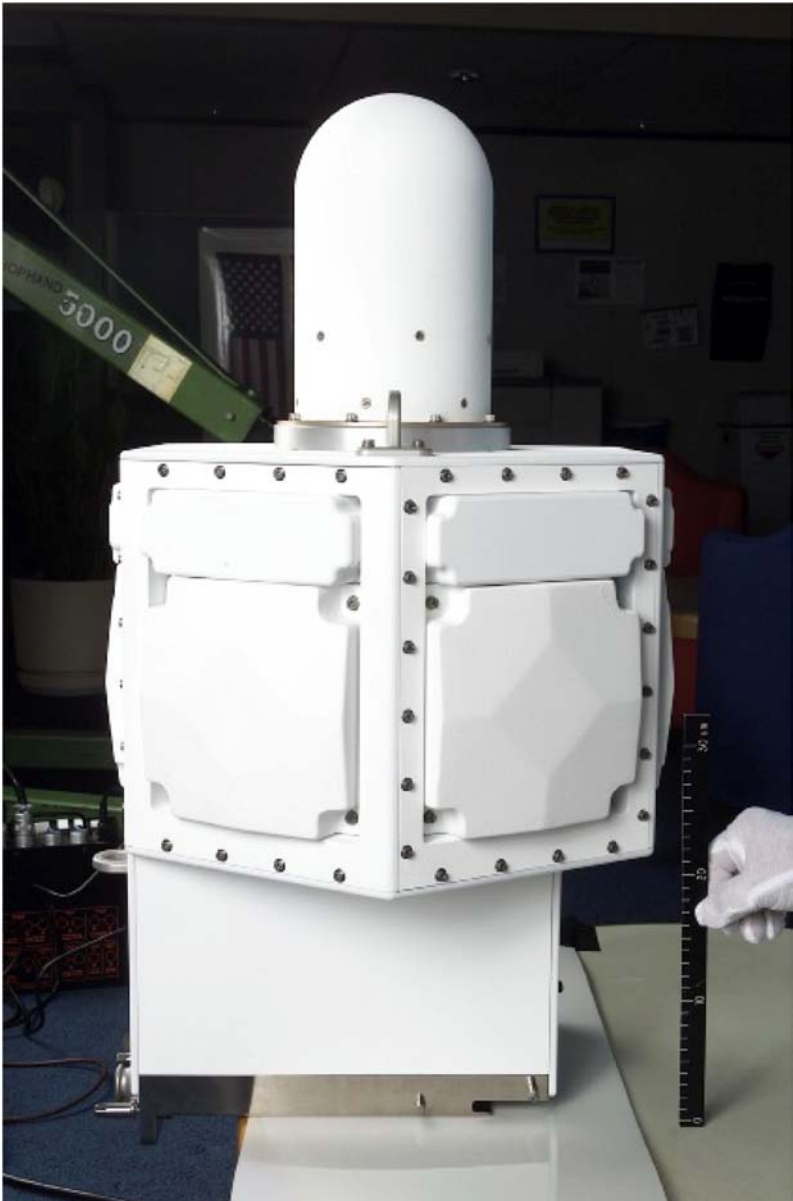

FS 18-33



EVA/129/FIN

WETA (Cont)

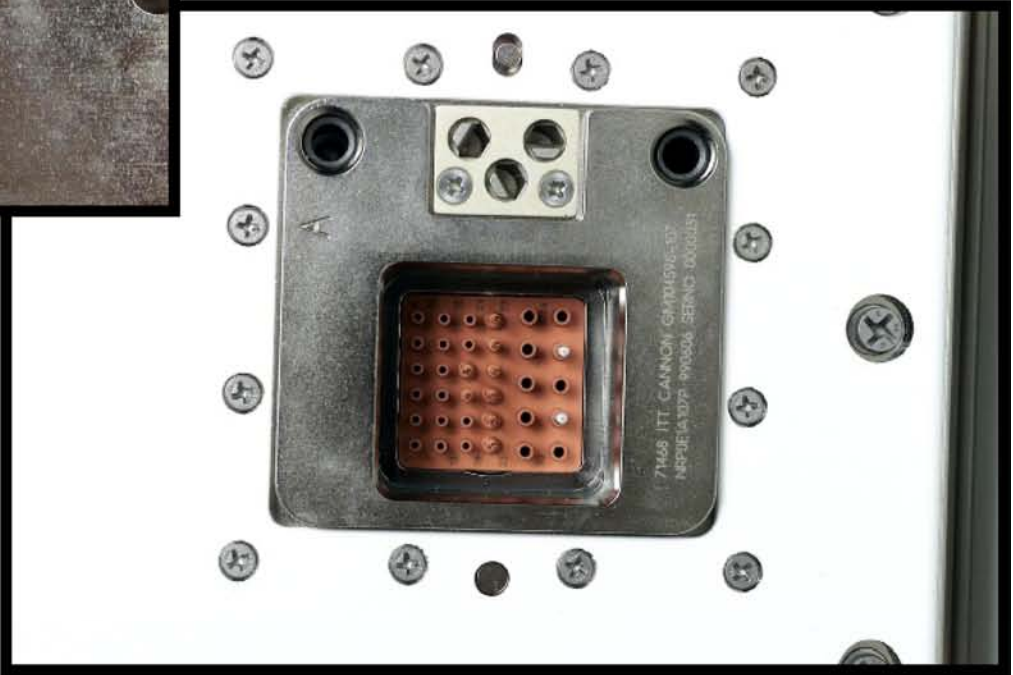
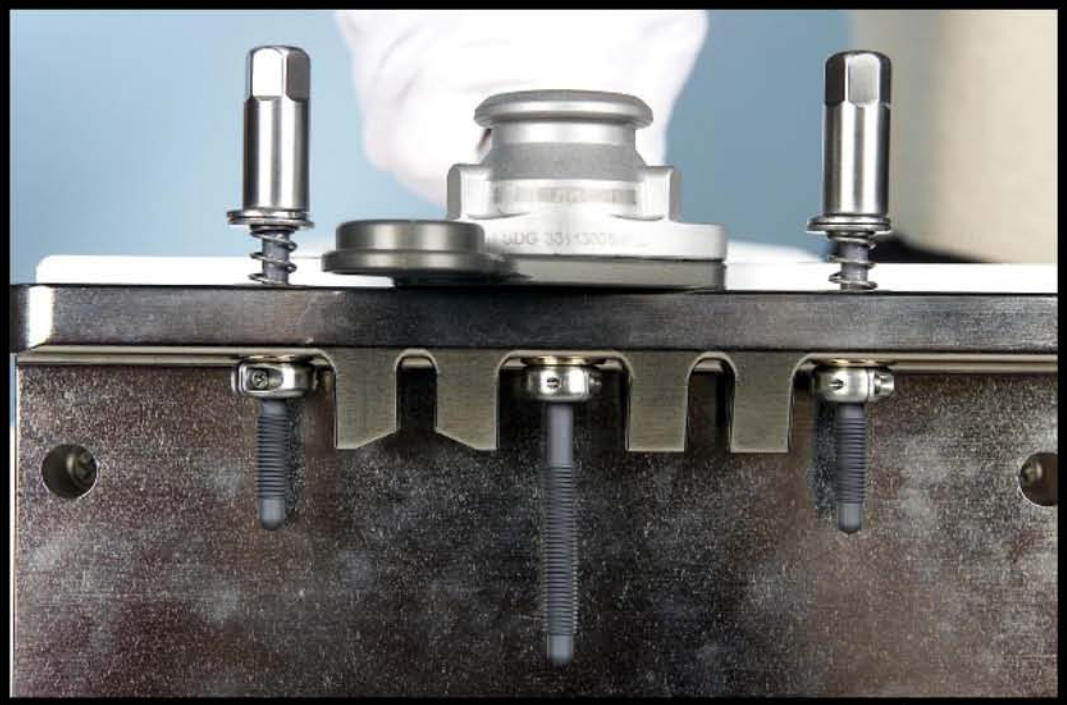

HPGT

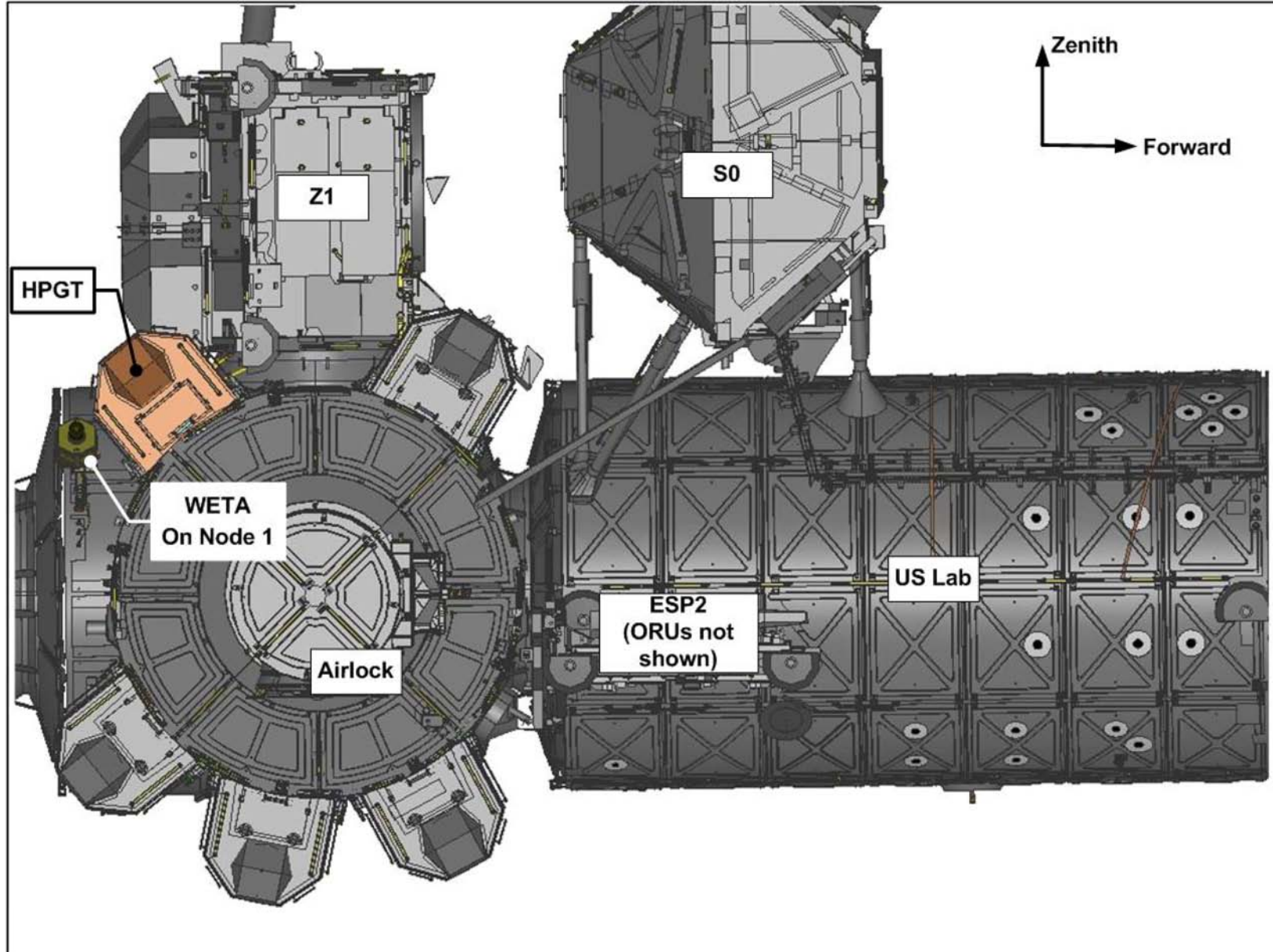

HPGT (Cont)





## HPGT (Cont)



NOTE: Middle handrail is not being flown in the picture above

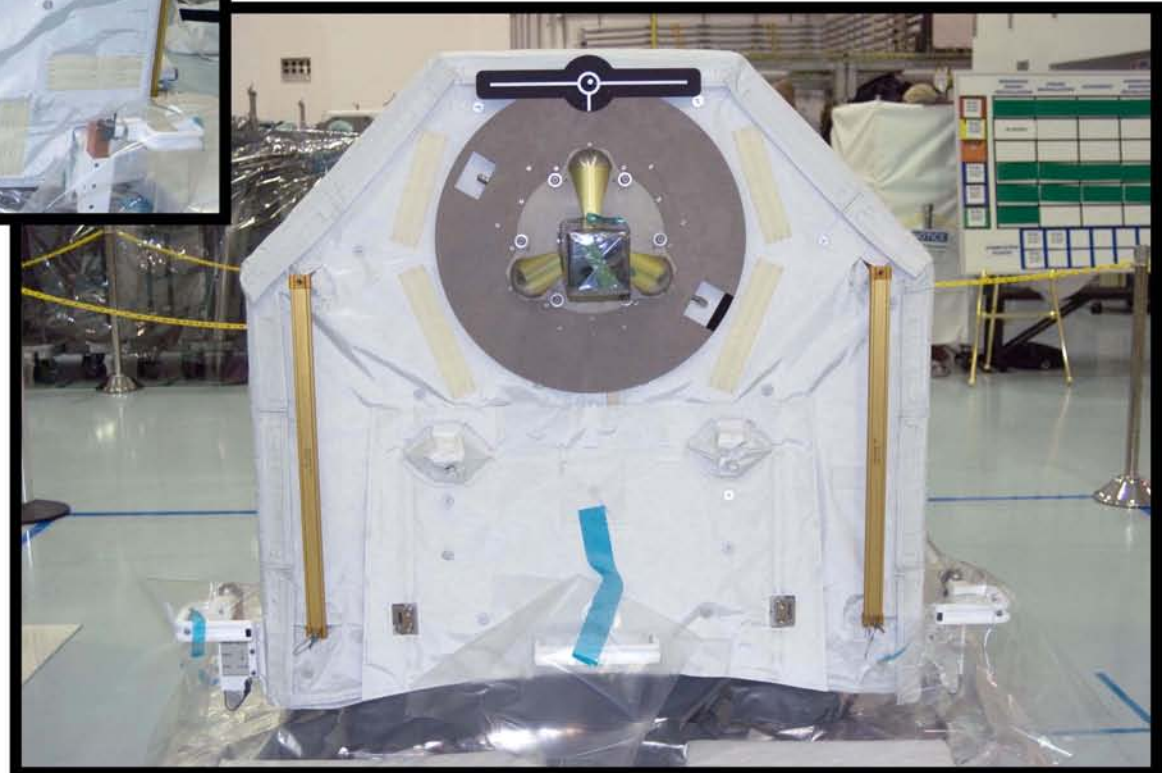

HPGT (Cont)

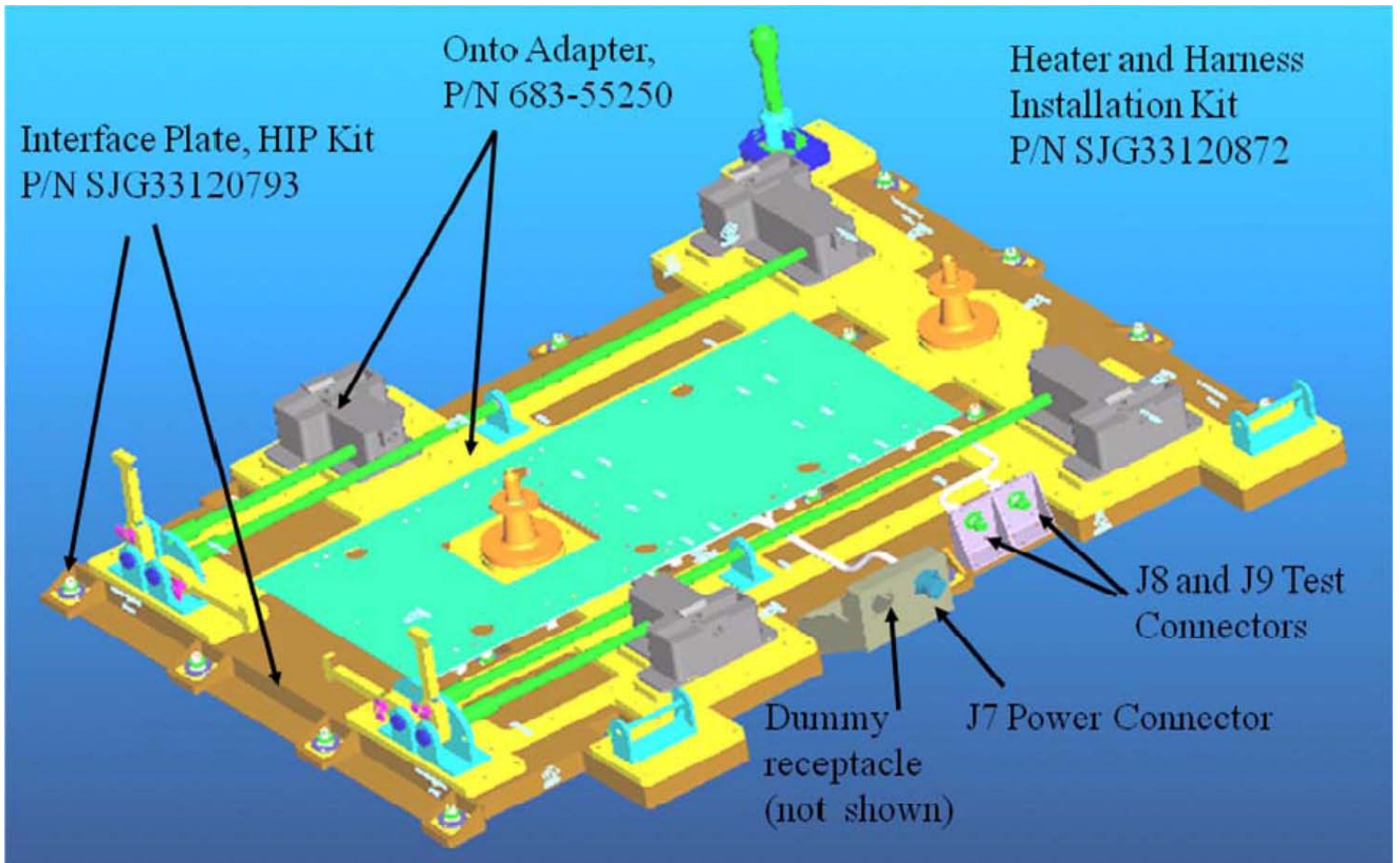

## HPGT (Cont)

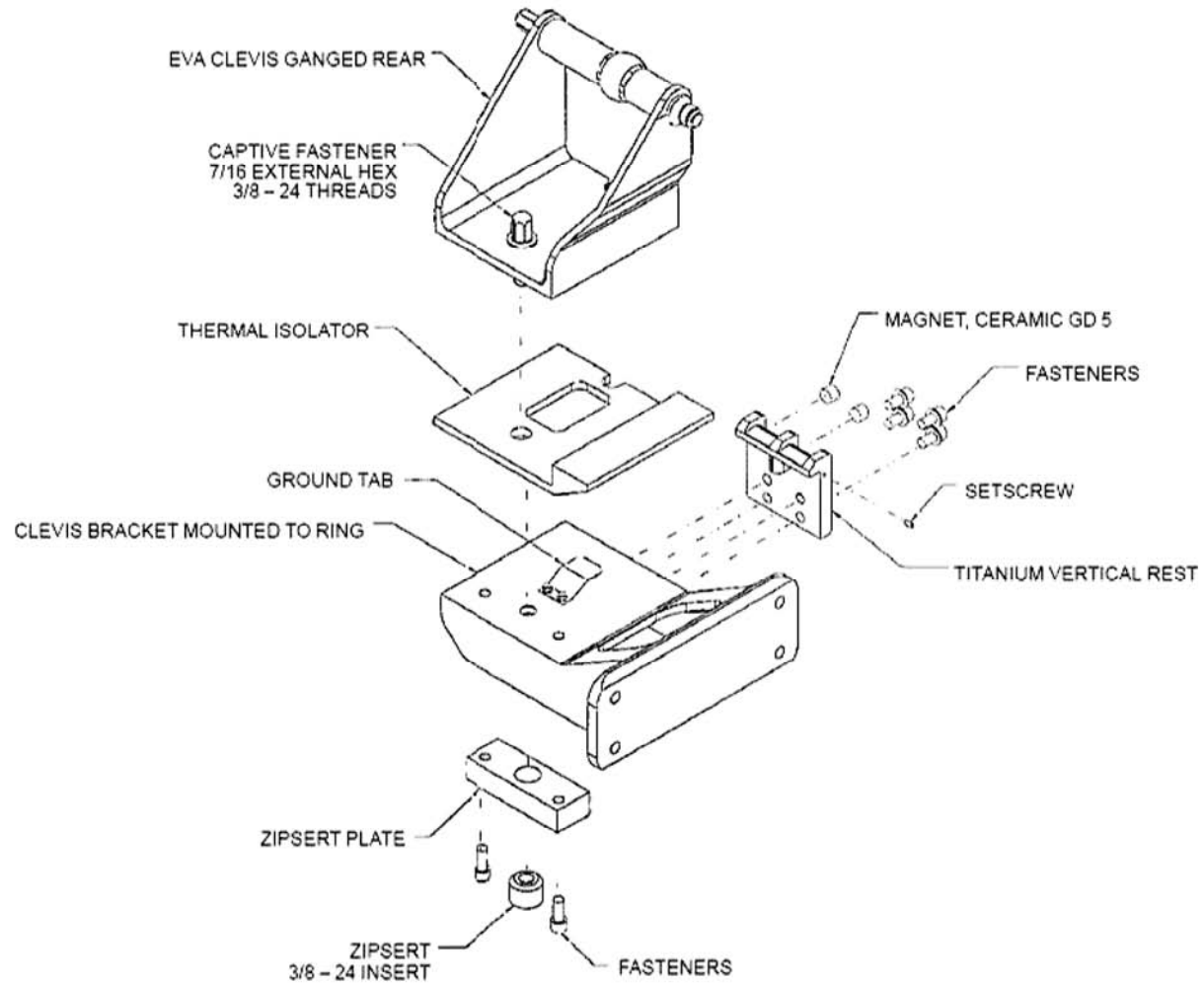

There are 3 towel bars on A/L #5 position

MMOD SHIELD

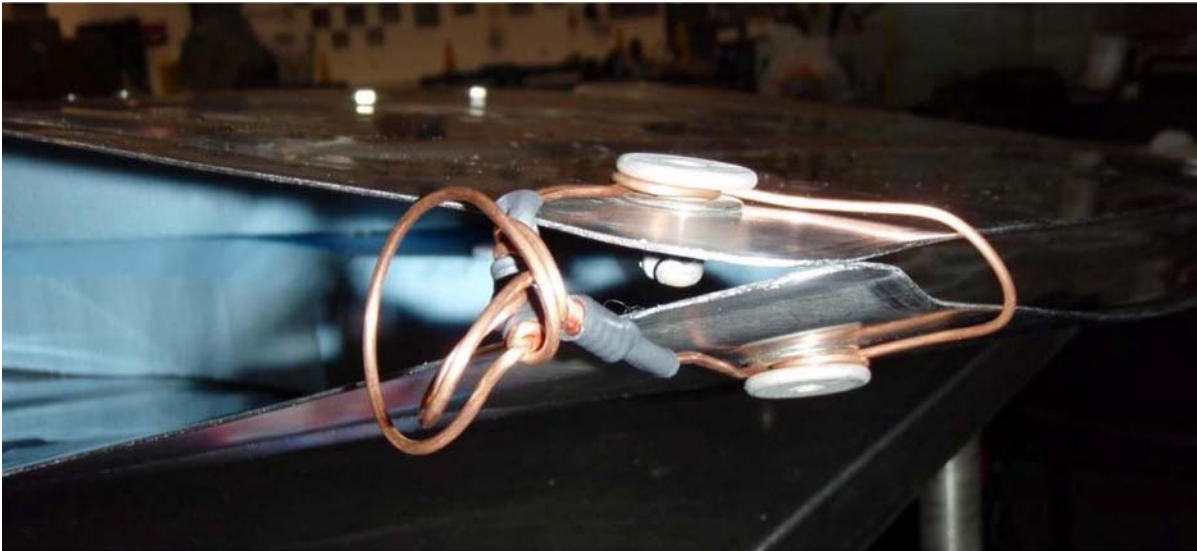

MISSE 7

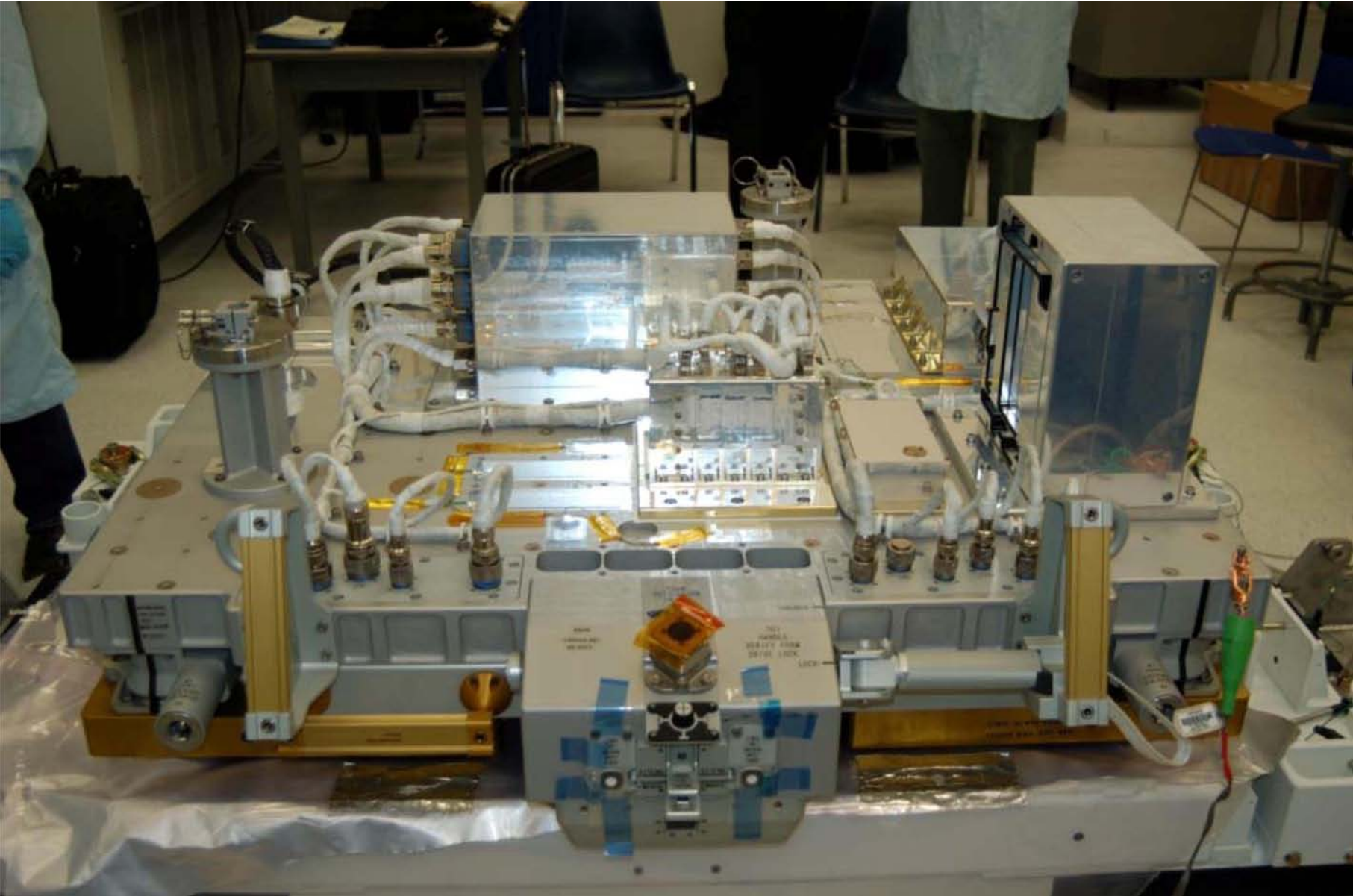

MISSE 7 (Cont)



MISSE 7 (Cont)

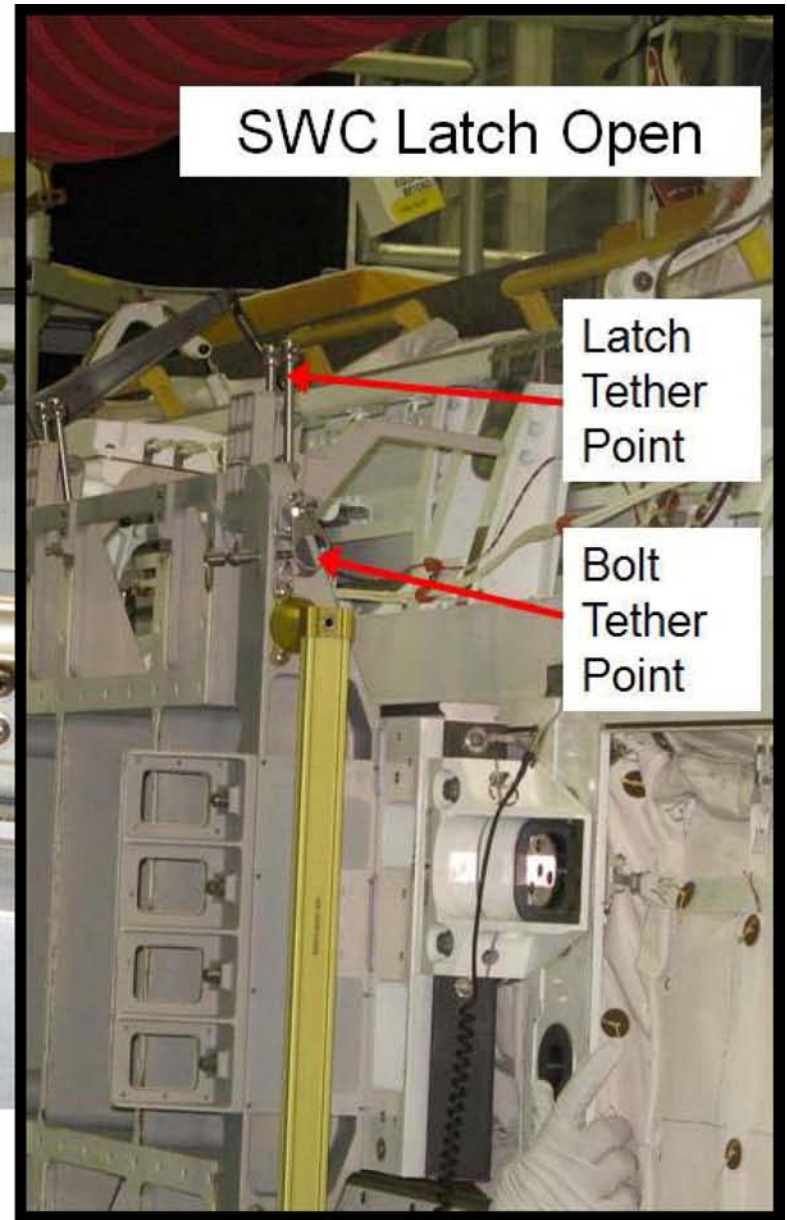
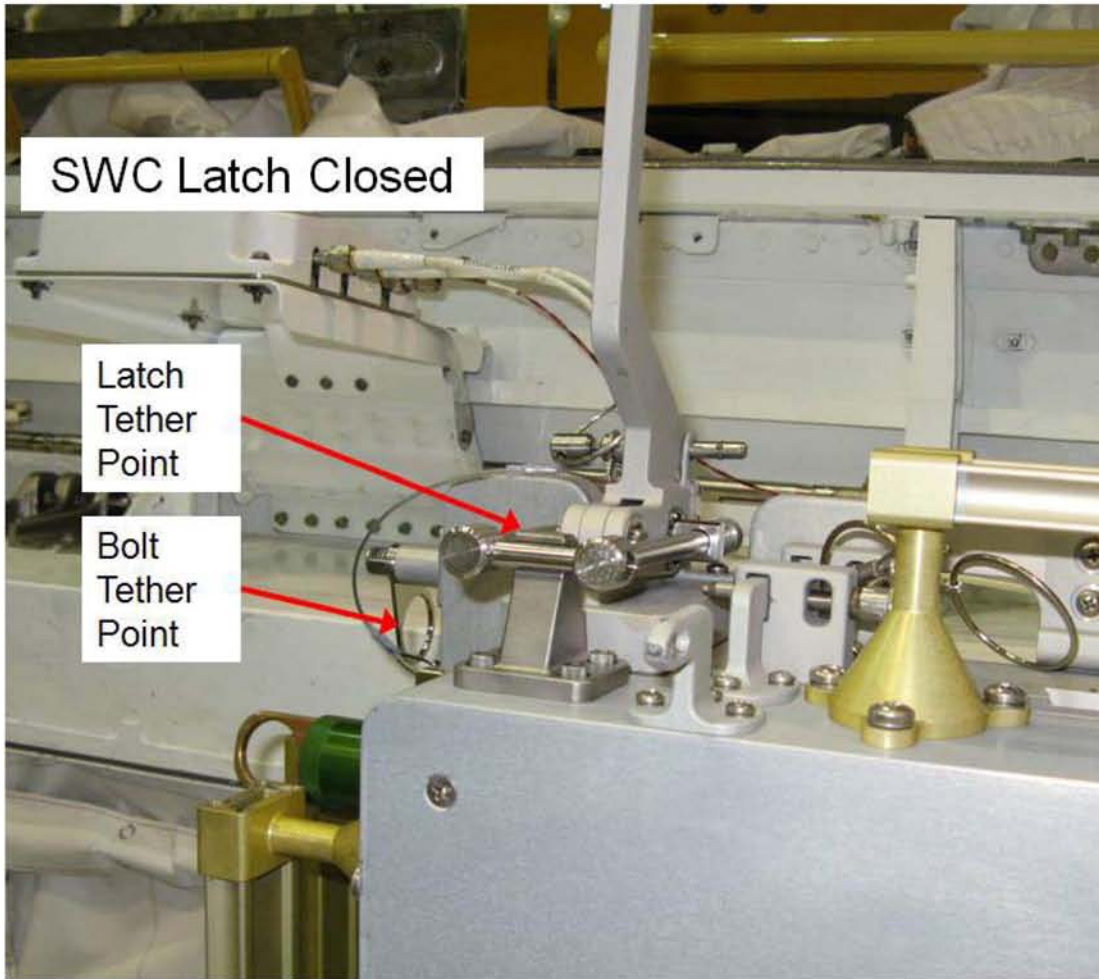

MISSE 7 (Cont)

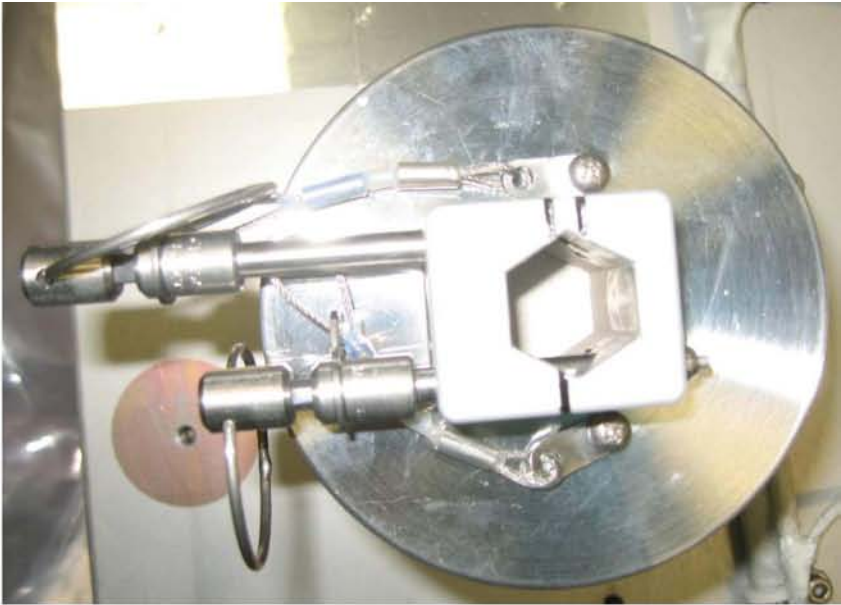



MISSE 7 (Cont)

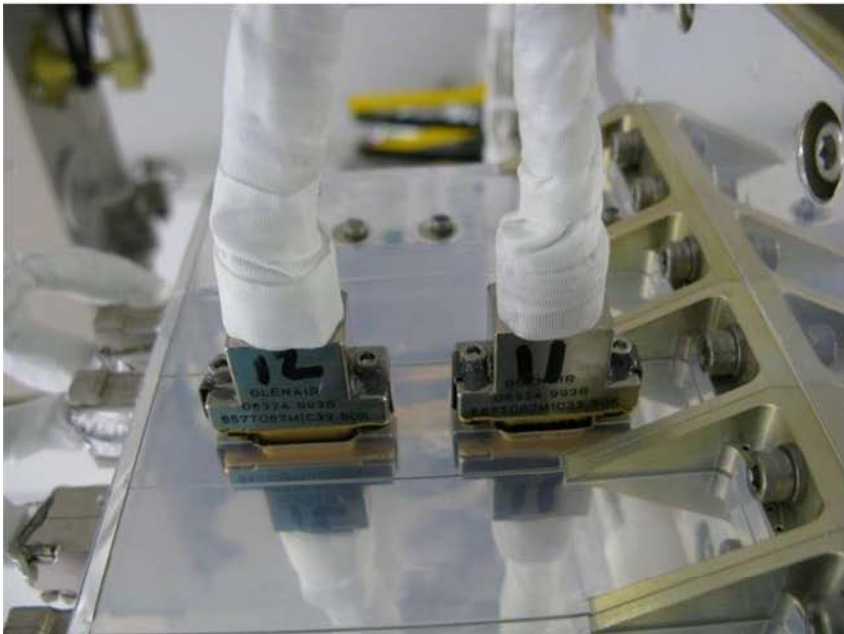

MISSE 7 (Cont)



**GET-AHEADS: P1-P3 UMBILICALS**



FS 18-47

EVA/129/FIN

**GET-AHEADS**

GET-AHEADS: P1-P3 UMBILICALS (Cont)

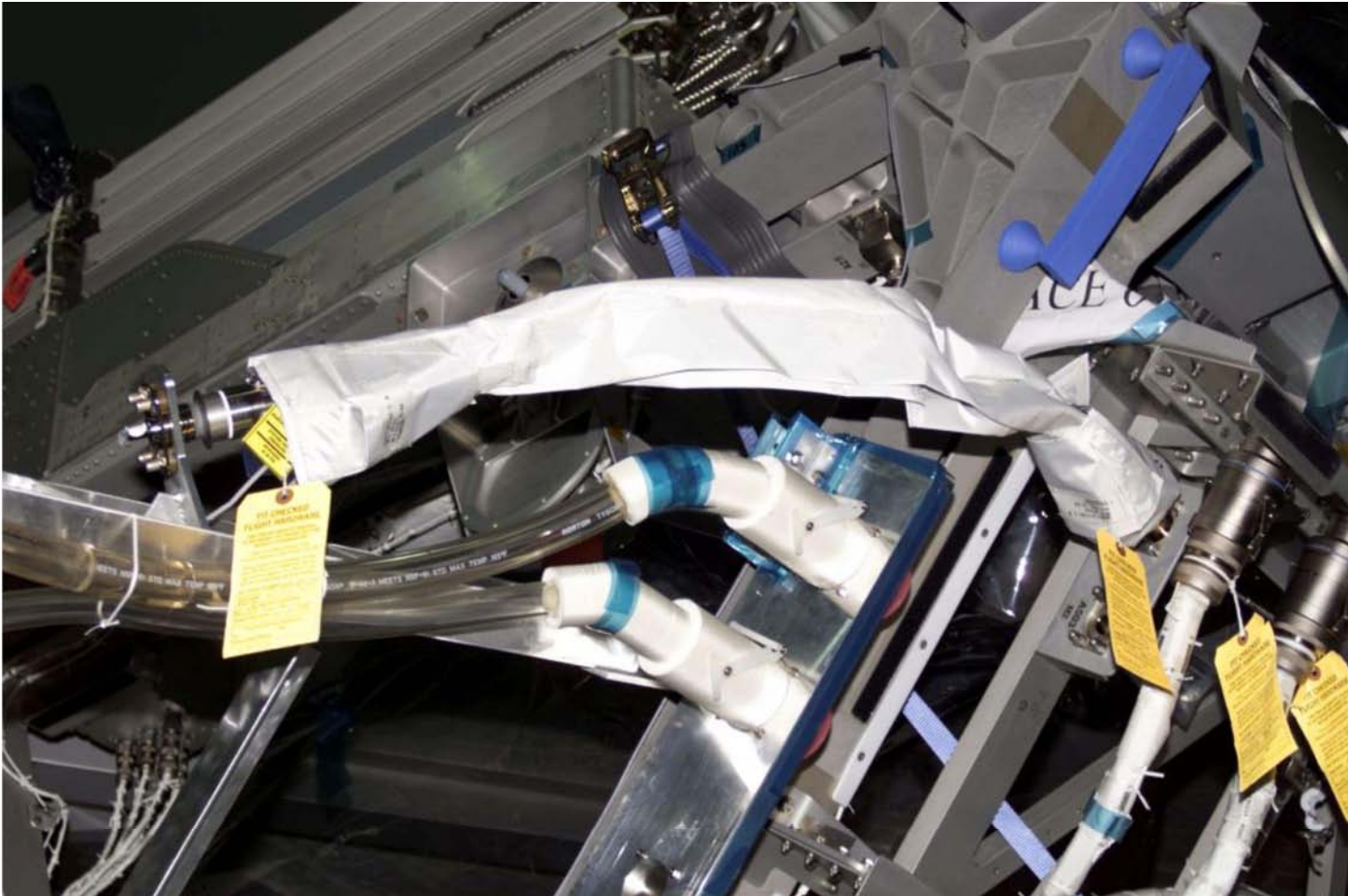

# GET-AHEADS: CLA

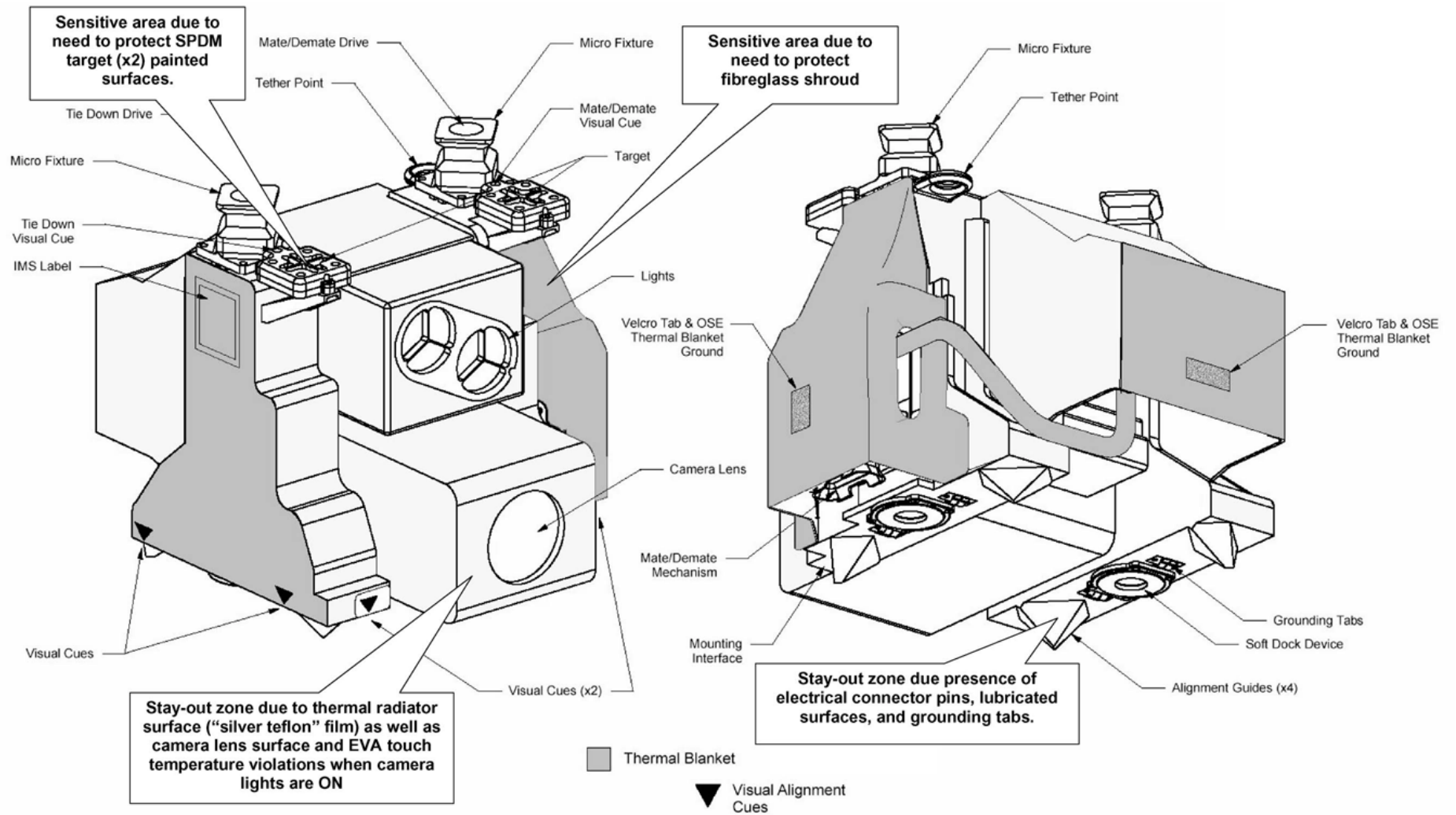

# ELC

## ELC 1 AND 2

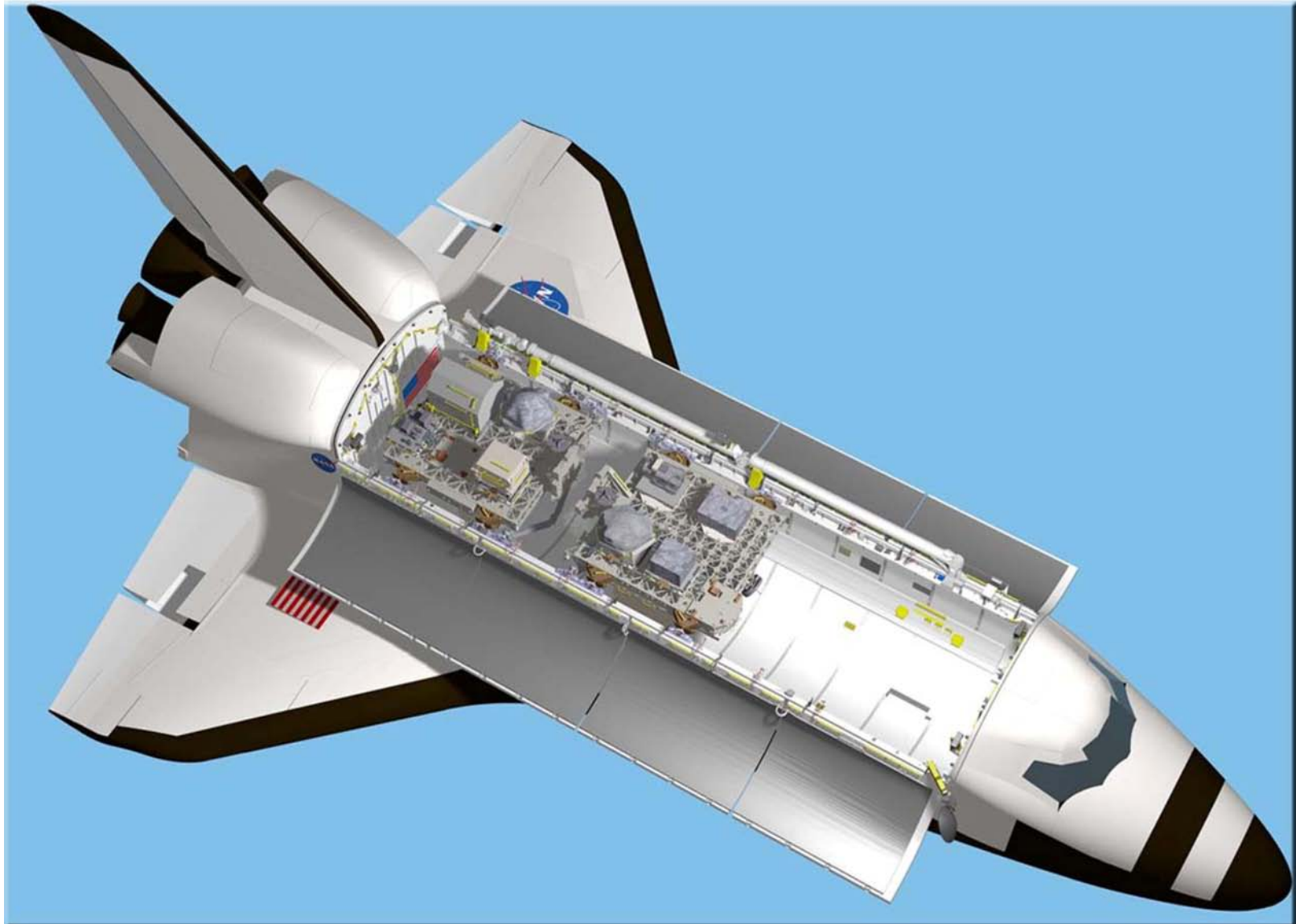

ELC 1 AND 2 (Cont)

ELC 1

Top Deck

Keel Deck

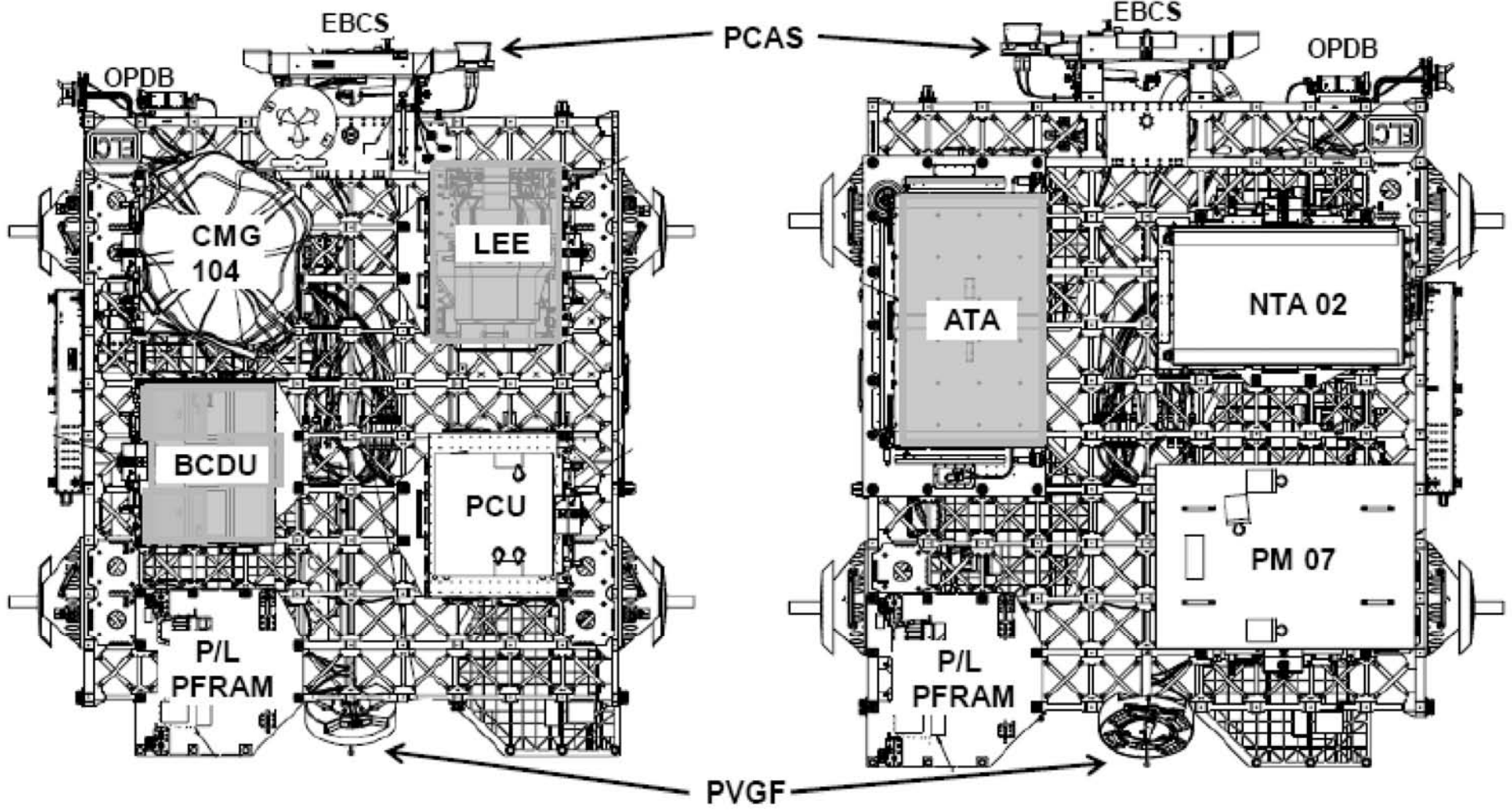

ELC 1 AND 2 (Cont)

ELC 2

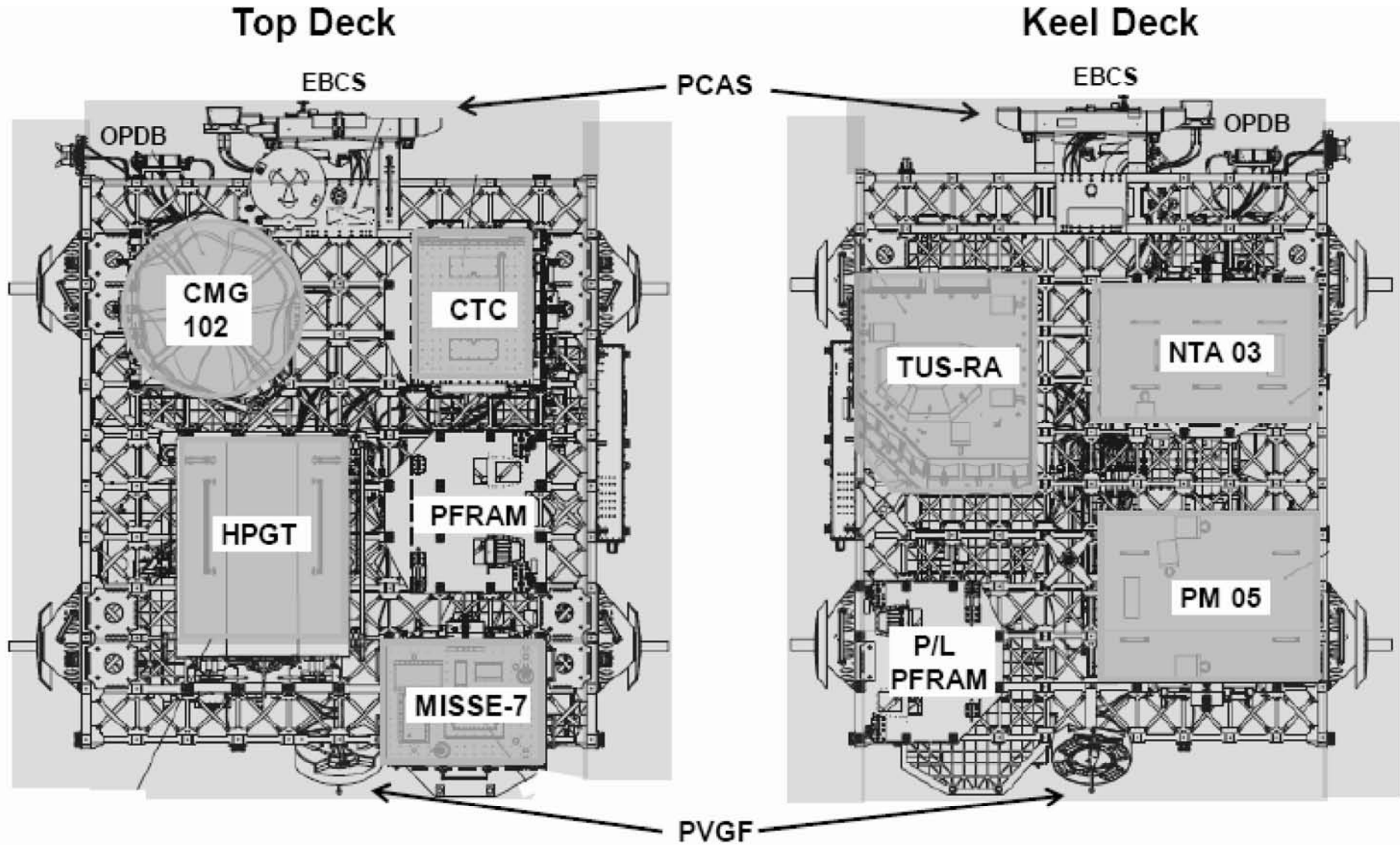



**ELC 1 AND 2 (Cont)**

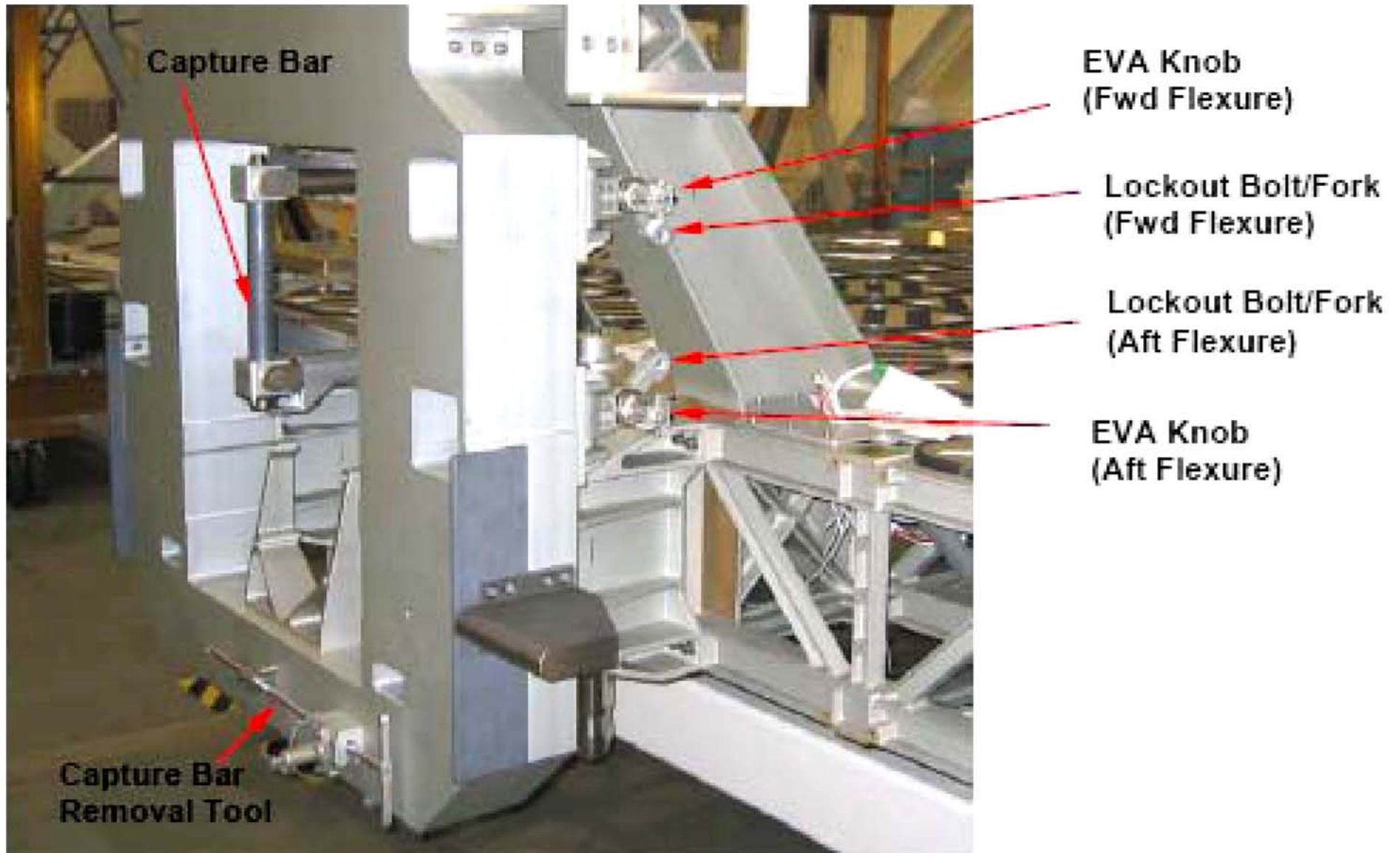

**ELC 1 AND 2 (Cont)**

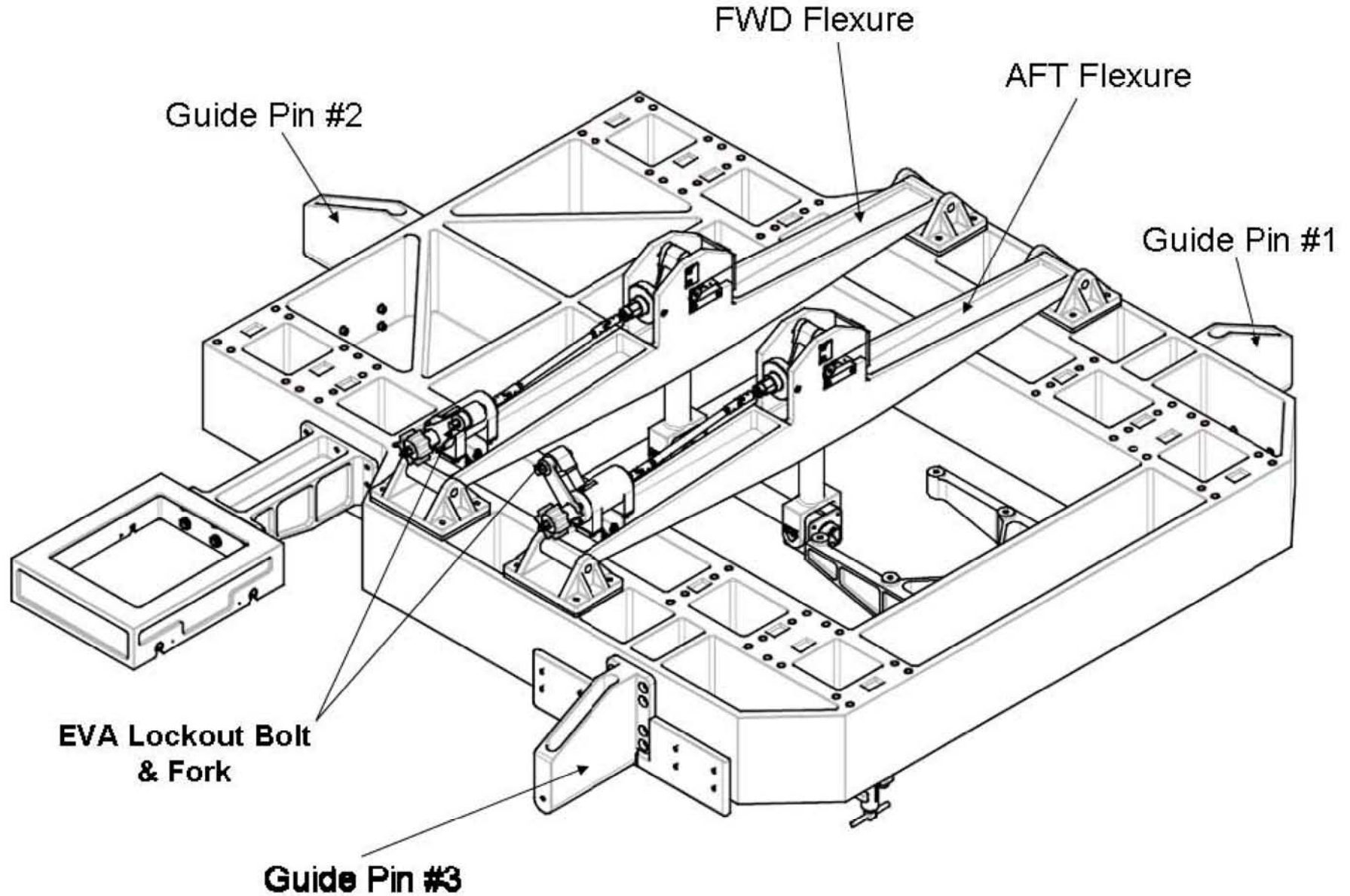

ELC 1 AND 2 (Cont)

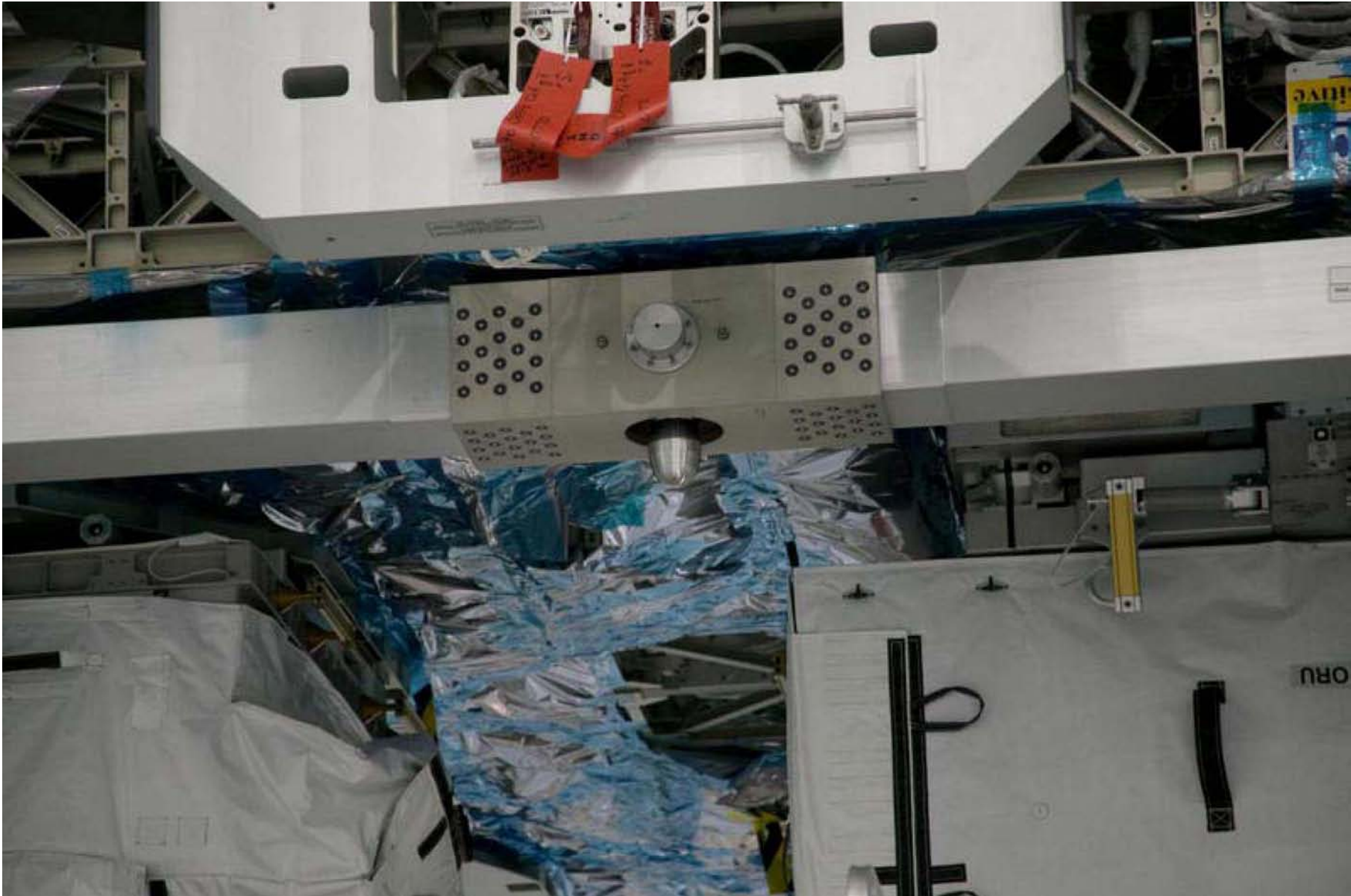

FS 18-55

EVA/129/FIN

MISC

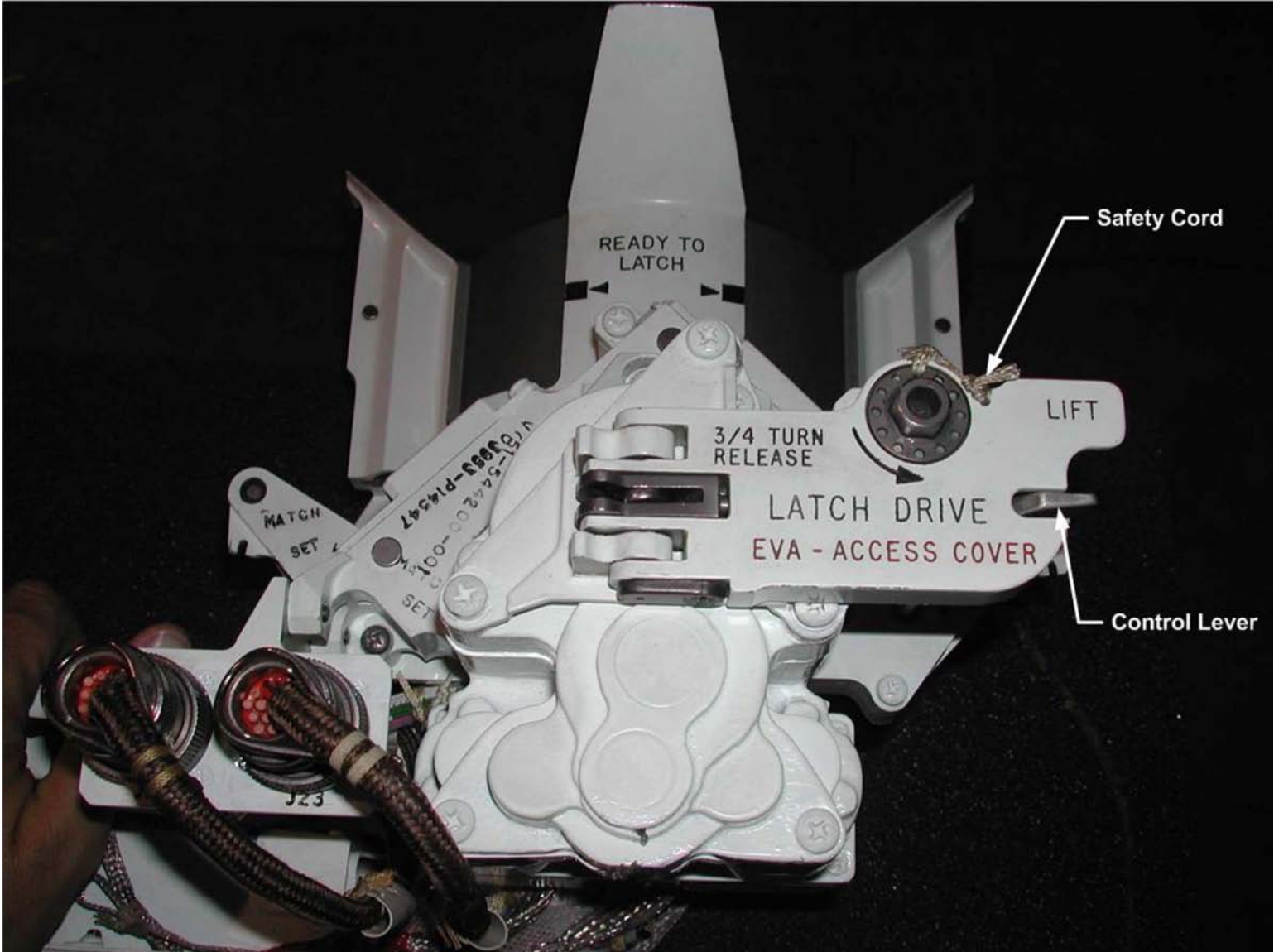

ROEU Latch Drive Interfaces

ROEU (Cont)



ROEU (Cont)

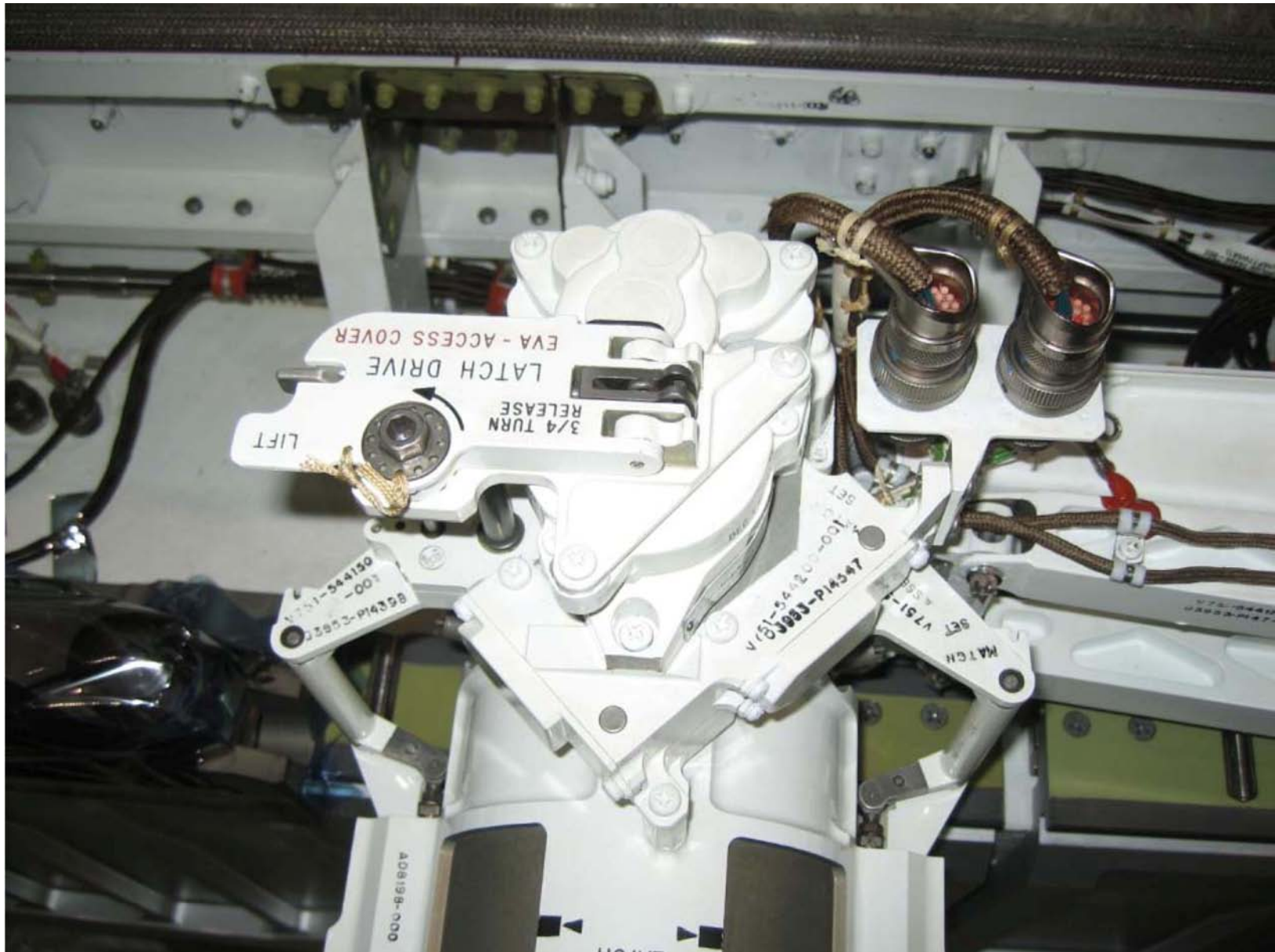

ROEU (Cont)

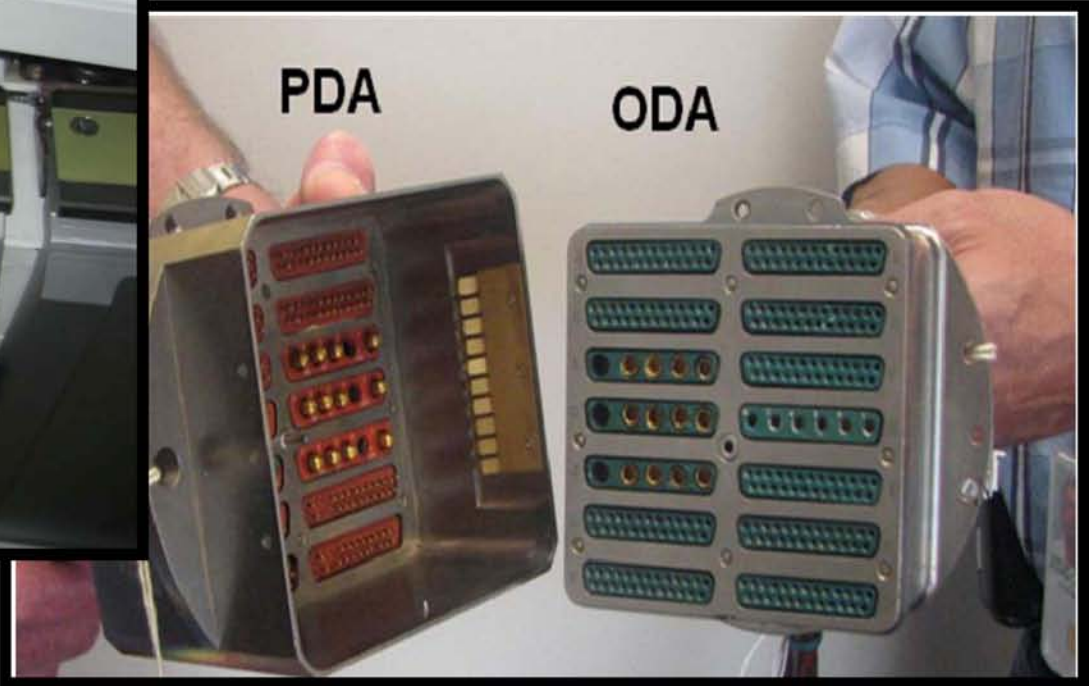

PRLA



FS 18-60

EVA/129/FIN





# EVA CHECKLIST

STS  
129