

STS-116 Integrated Delta Launch Site Flow Review

Presenter

Josh Krupnick

Date

08-10-06

Program Freeze Point

PRCB Presentation

S115116Q

STS-116 Integrated Delta Launch Site Flow Review

Presenter
Josh Krupnick
 Date
08-10-06

Baseline the STS-116 Mission Specific Requirements and Flow Plans.

The STS-116 Integrated Launch Site Requirements were established by PRCBD S115116NR1 dated 07-11-06. CR S115116P and the Associated Data Package were reviewed at the 06-19-06 FRWG.

| | | |
|--|-----------------------------------|----------------------|
| KSC Integration* | | MK-SIO |
| <u>Special Topic / Orbiter TPS*</u> | <u>Requesting Approval</u> | <u>USA-GO</u> |
| <u>Orbiter Engineering*</u> | <u>Requesting Approval</u> | <u>USA-OE</u> |
| Payload/Cargo Engineering | | USA-PI |
| Shuttle Processing* | | PH-B2 |
| | <u>Status in Backup</u> | |
| Flight Integration | | MO3/USA-PI |
| Flight Software | | USA-FSW |
| GFE FCE/EVA | | MV5/XA |
| SSME | | MP21 |
| ISS/Payload Operations | | UB-1 |

*Backup Material

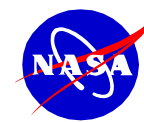

STS-116 DELTA LAUNCH SITE FLOW REVIEW

| |
|--|
| Presenter A. HOUTS-GILFRICHE |
| Date AUGUST 10, 2006 |

LAUNCH

12/14/06 NET
 39B/ MLP1
 CREW SIZE:6+1UP/6+1DOWN

CONFIGURATION

OV-103 (33)
 LP01;RP03
 ET-123
 BI-128
 RSRM-95
 (1) 2050 (2) 2054 (3) 2058
 OI-30
 RMS,ODS,OBSS

PAYLOAD

| | |
|---|----------------------------|
| ISS 12A.1-ITS P5, SPACEHAB SM, ICC(W/STP- H2 UTILIZATION P/L) | ISS 12A.1 RAMBO MAUI |
|---|----------------------------|

ORBIT

51.6 DEG
 122 NM
 DIRECT INSERTION
 DURATION: 11+(1)+2 DAYS

CONSUMABLES

| | |
|----------------|--------------------|
| CRYO TANK SETS | 5 (FULL) |
| GN2 TANKS | 6 (FULL) |
| FWD RCS | 1912# (2446# FULL) |
| AFT RCS | 4970# (FULL) |
| OMS | 24931# |

LANDING

| | |
|--------------------------------|--|
| SITE TAL ALT. TAL SCA | KSC ZARAGOZA MORON & ISTRES 905 |
|--------------------------------|--|



STS-116 DELTA LAUNCH SITE FLOW REVIEW

| |
|--|
| Presenter A. HOUTS-GILFRICHE |
| Date AUGUST 10, 2006 |

PERFORMANCE MARGIN

| | | |
|---|-------------|--------------------|
| • SIMULATION MARGIN (OCFEF116) | | +2917 |
| • WEIGHT CHANGES SINCE SIMULATION | | |
| • PAYLOAD | +180 | |
| • OPERATOR | -105 | |
| • ORBITER | +56 | |
| • SSME | -141 | |
| • NPC | +48 | |
| • CREW COMPARTMENT | -180 | |
| • MPS PROPELLANT | -512 | |
| • RECONSTR ASCENT PERFORM COLLECTOR | -66 | |
| TOTAL WEIGHT CHANGES | -720 | +720 |
| • OTHER PERFORMANCE PROJECTIONS | | |
| • PROTECTION FOR DOL DISPERSIONS | | -700 |
| • PARTIAL PROJ FOR MPS BGT GEN0603S | | +36 |
| • SRB M/P UPDATES | | -133 |
| • SRB BR / 0.85 MIL HIGHER THAN 0.3705 AVG | | +170 |
| • NEW ISP/THST FOR ENG SET 2050, 2054, 2058 | | +78 |
| • PROJ TO 5 MIN WINDOW INPLANE | | -600 |
| • PERFORMANCE CHANGES ADJUSTMENT | | <u>-50</u> |
| • CURRENT BASELINED APM (08/08/06) | | +2438 |
| • IPT PROJECTED CHANGES | | <u>-510</u> |
| • PROJ APM | | +1928 |

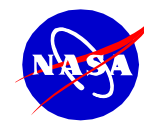

STS-116 DELTA LAUNCH SITE FLOW REVIEW

| |
|--|
| Presenter A. HOUTS-GILFRICHE |
| Date AUGUST 10, 2006 |

FLIGHT MASS PROPERTIES

CONT RTRN – Exceeds 233K NEOM**

**** A waiver is not required for Unplanned Payload Return downweight exceedances – Vol X Bk 1 Sec 3.3.1.1.9**

| CASE | TOUCHDOWN | | MACH 3.5 | |
|-----------|-----------------------|----------|-----------------------|----------|
| | WEIGHT pounds (LIMIT) | | X C.G. inches (LIMIT) | |
| NOMINAL | 225364 | (233000) | 1077.4 | (1075.2) |
| RTLS | 237796 | (245000) | 1077.6 | (1076.7) |
| TAL | 235684 | (244000) | 1077.4 | (1076.7) |
| AOA | 234227 | (242000) | 1077.6 | (1075.2) |
| CONT RTRN | 233777 | (233000) | 1077.5 | (1075.2) |

**NOTE: RTLS 25 SEC FRCS DUMP
 TAL 65 SEC FRCS DUMP
 2240 LBS. AFT FUS BALLAST**



STS-116 Delta Launch Site Flow Review

Presenter **JOSH KRUPNICK**

Date **08-10-2006**

Page **1**

- **STS-116 Orbiter/Ferry Mass Properties Have Been Reviewed by Space Shuttle Program Integration and Are Within Specified Limits**

| <u>Case</u> | <u>Ferry Weight (LB)</u> | <u>Center of Gravity (inch)</u> | | |
|---|--------------------------|---------------------------------|---------------|------------------|
| | | <u>X</u> | <u>Y</u> | <u>Z</u> |
| <u>Nominal - Orbiter c.g.</u> (SCA c.g.) (No CM Ballast, No Fluids Off-Loaded, No Payload Bay Opening) | 224378 | 1112.4 (1408.2) | -0.6 (N/A) | 373.4 (516.0) |
| <u>AOA - Orbiter c.g.</u> (SCA c.g.) (No Fluids Off-Loaded, No Payload Bay Opening) | 230356 | 1113.5 (1409.4) | -0.6 (N/A) | 374.8 (517.3) |
| <u>TAL - Orbiter c.g.</u> (SCA c.g.) (3 SSME's Removed, No Fluids Off-Loaded, No Payload Bay Opening, Max Weight 217000 LB) | 207032 | 1066.7 (1362.6) | -0.7 (N/A) | 374.0 (518.9) |

X c.g. Limits (Orbiter Coordinates)

Nominal = 1060.0 TO 1116.0
 AOA = 1060.0 TO 1116.0
 TAL = 1060.0 TO 1125.2

Z c.g. Limits (Orbiter Coordinates)

Nominal = 360.0 TO 380.0
 AOA = 360.0 TO 380.0
 TAL = 360.0 TO 380.0

Orbiter TPS BRI Hardening Plan (Action# 121-FRR-002)

Presenter

Greg Crews

Mike Stoner

Date

08/10/2006

Purpose

- The purpose of this briefing is to provide TPS hardening (BRI-18 Tile) implementation plan and rationale
 - Taking into account overall impacts, flight manifests and schedules, and Ground Ops resources (*Action# 121-FRR-002*)

Agenda

- Summarize TPS turnaround requirements
 - *To better understand the challenges / variables to TPS Pre-Planning*
- Additional work content competing for available TPS resources
 - *Risk Reduction and Hardening*
- Status Post-Columbia increased TPS resources / capability
- Overview of Fleet Work Content implementation plan
- BRI hardening priority plan

TPS Processing Background

- TPS turnaround requirements consist of:
 - Comprehensive post flight inspection of all components, and re-waterproofing (OMRS)
 - Removals for LRU replacement access (Windows, FRCS, Antennas, ADP, Engines, etc)
 - Deferred work, IFA's, Modifications and special Chits are mission specific
- Due to the high-volume nature of TPS, any process change can significantly affect the work content
- Significant increase in PRACA count post-Columbia
 - Average count for the 6 pre-Columbia flows was ~750 PR/DR's with 93 cavities
 - STS-121 count ~5000 PR/DR's and 352 cavities
 - STS-116 is at 1900 PR/DR's with post flight inspection at 90% complete
- Work content can be placed into Two major processing categories
 - Acreage area work – affects resources
 - Critical path area work – affects critical path schedule and vehicle configuration

***Many Variables / Challenges to TPS Pre-Planning
- Cavities are Only a Portion of Overall Work Content***

Additional Work Content Requiring TPS Resources

- In addition to the *Mandatory* turnaround requirements (OMRS, Deferred work, IFA's and LRU access), the following remaining *Risk Reduction and Hardening* effort is competing for available schedule and resources
 - Gap Filler replacements (~ 5500 per vehicle)
 - BRI Tile implementation - landing gear, LESS and windows (~550 tile per vehicle)
 - Lockbolt sampling (~25 – 100 removals)
 - Corrosion sampling (~200 removals)
 - Misc Modifications (Hub tile, Drain Hole, WLE soft goods, etc)
- Requires managing 'OMDP-type' work over multiple standard flows

Requires Detailed Prioritization and Partnering Between Orbiter and Ground Ops -- On-Going

Available TPS Resources - Increased Capability

- Additional TPS resources secured after post-Columbia (~35% increase)
 - *Plan to transition TPS Techs to Vehicle after OMM was aborted*
- TPS Organization formed to maximize fleet processing efficiency
- TPS resources recently further augmented - authorized by Gap Filler CR (additional ~33% increase)
- Additional resources available as they are trained
 - Gap filler training ECD – Sept 06
 - TPS Bonding ECD – early 07

~ 80% Increase in Post-Columbia TPS Workforce to Address Increased Workload and the Risk Reduction / Hardening Effort

Fleet TPS Work Content Implementation Plan

- **Individual-flow work content/priority to be partnered among Orbiter and Ground Ops**
 - Mandatory work content scope is matured after post flight inspections
 - Risk Reduction and Hardening will be prioritized and balanced with remaining/available schedule and resources
- **Final TPS work content will be baselined at the Delta Launch Site Flow Review**
 - Individual-flow work content must be balanced across the Fleet/Manifest
- **BRI Hardening implementation by prioritized areas - balanced with available schedule windows and resources**
 - Critical path considerations for landing gear areas
 - Resource and adjacent hardware configuration considerations for LESS and Window Carrier Panel areas

Plan Maximizes Risk Reduction and TPS Hardening

BRI Hardening Priority Plan (MLGD)

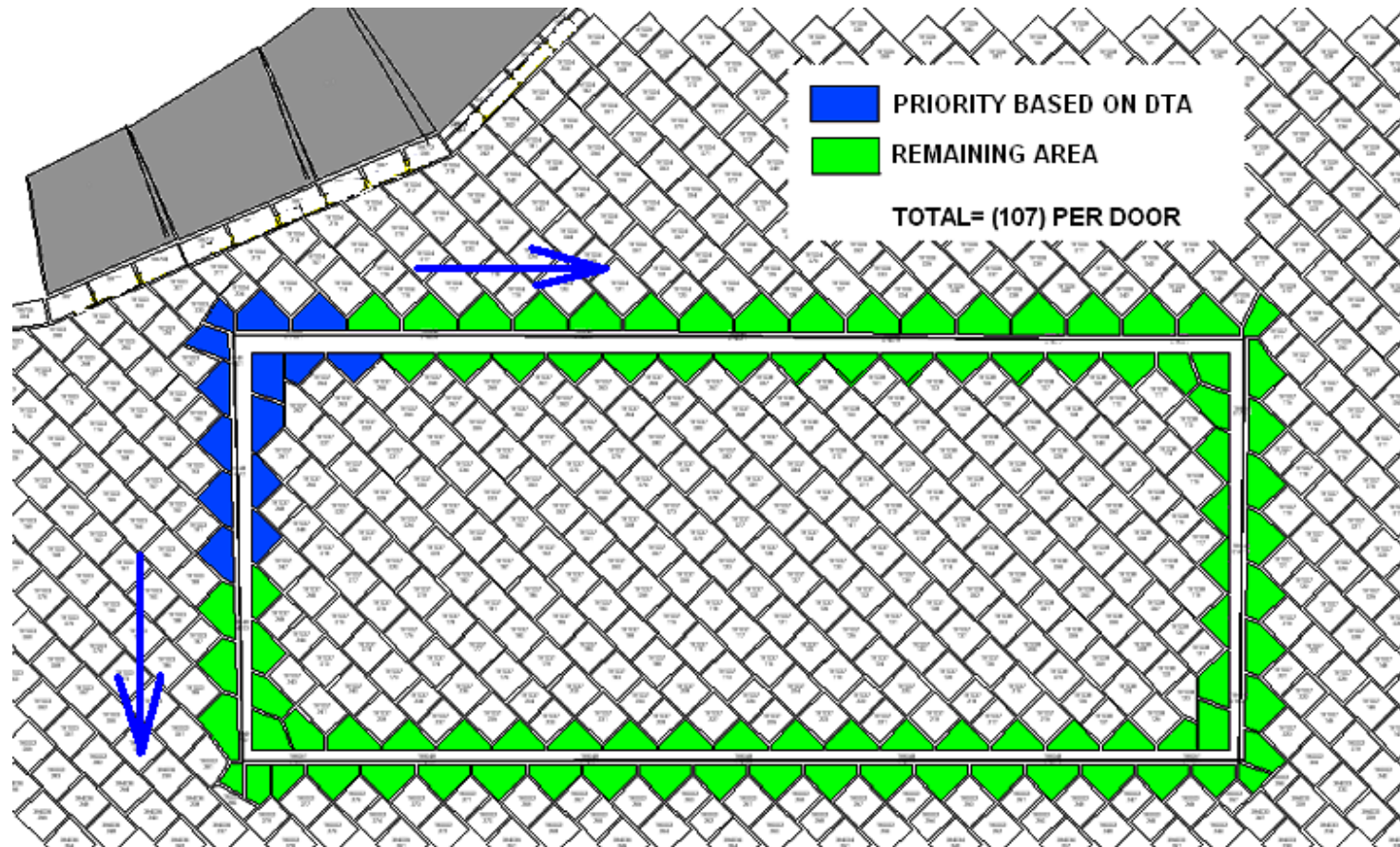



- **MLGD area to be worked from the FWD Outboard corner working Inboard and AFT (area most susceptible to debris impact)**

Current Status

- **OV-103 3-6 per side planned for STS-116**
- **OV-104 begin next flow**
- **OV-105 11 in-work and 4 potentials**

BRI Hardening Priority Plan (LESS)

 PRIORITY PANELS
 LESS (46) PER SIDE
TOTAL LESS= (92)

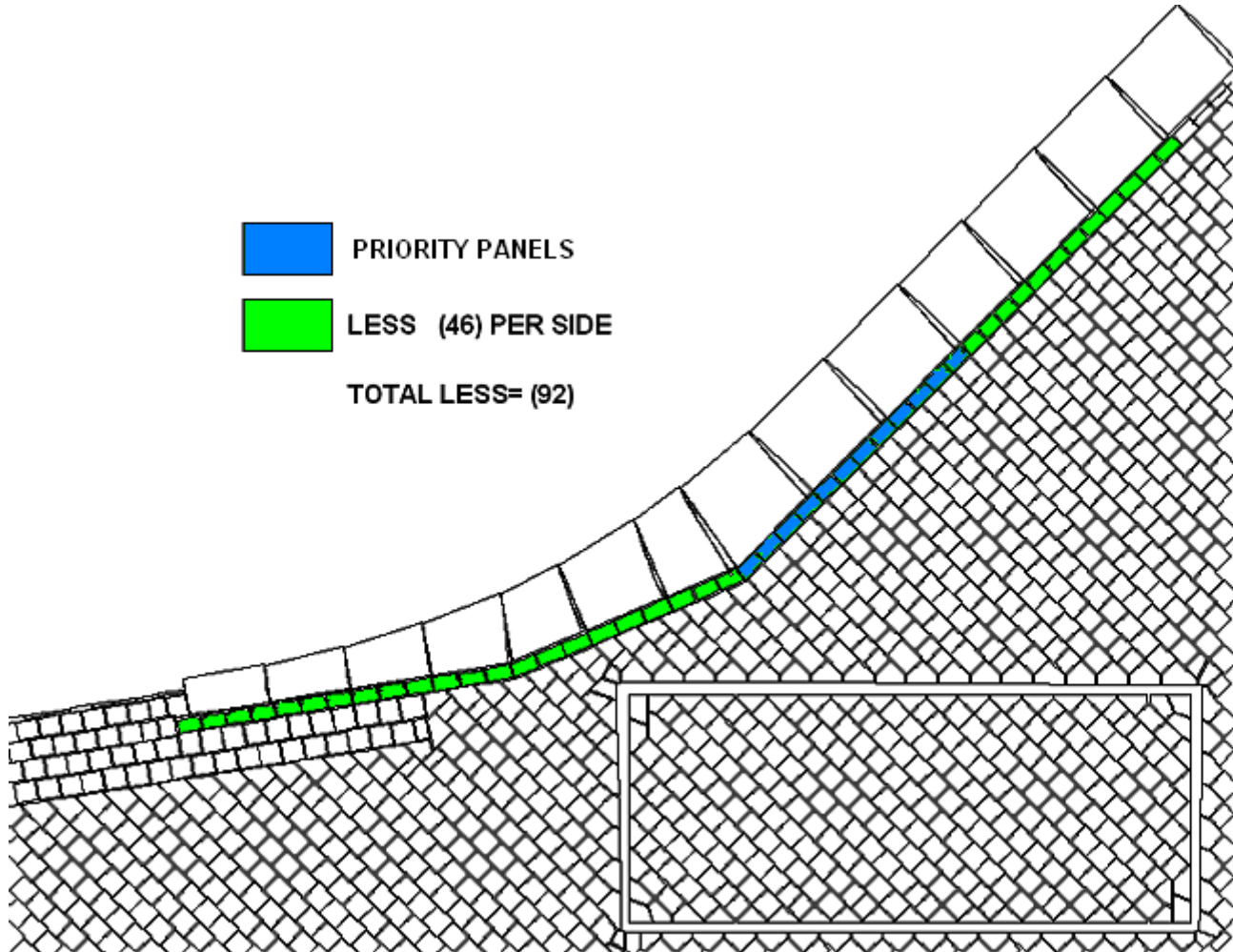

- Lower Wing LESS Carrier Panels (1 – 13)
 - Panels 8-10 as priority (hottest panels)

Current Status

- OV-103 currently has panels 8-10 both sides planned for STS-116 (24 total tile)
- OV-104 begin next flow
- OV-105 has 11 tile in-work

BRI Hardening Priority Plan (Windows)

- **Forward Window area (1 – 6)**

- **Windows 2-5 upper portion as priority (debris potential)**



PRIORITY BASED ON POTENTIAL DEBRIS



W1/W6= (22) W2/W5= (23) W3/W4= (18)

TOTAL WINDOWS= (126)

Current Status

- **OV-103 none planned for STS-116**
- **OV-104 begin next flow**
- **OV-105 has 11 tile in-work**

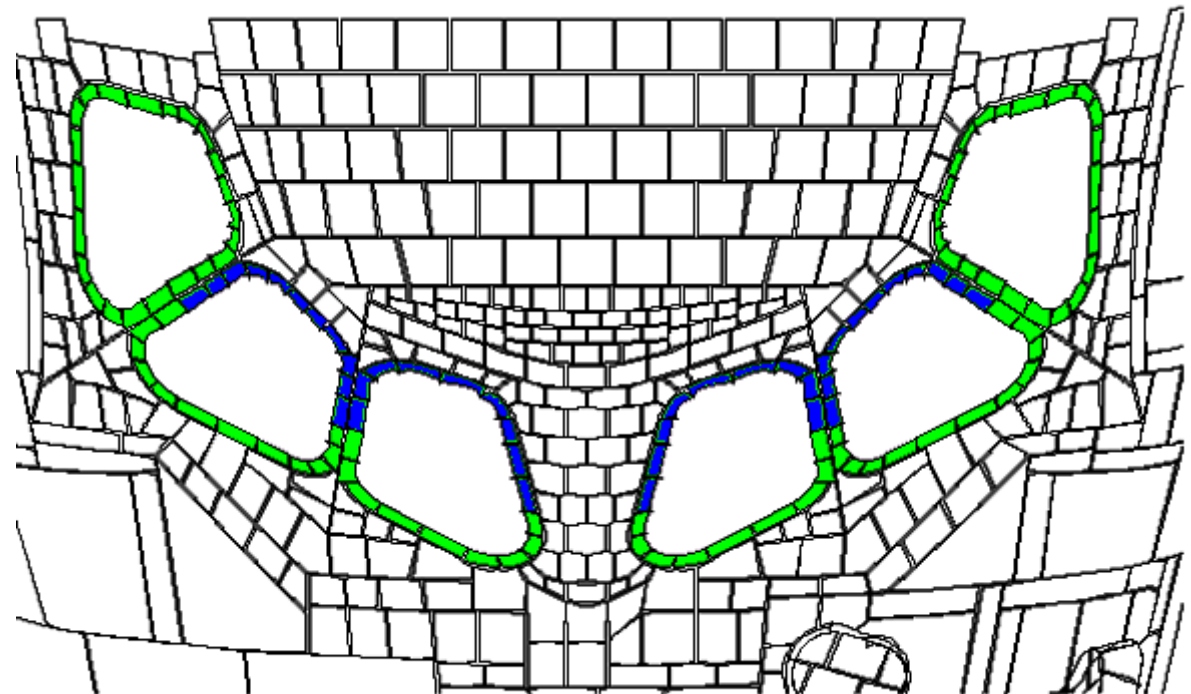

BRI Hardening Priority Plan (NLGD)

- NLGD Area to be worked as flight / processing damage dictates removal

Current Status

- OV-103 currently has 9 installed (1 planned for STS116)
- OV-104 currently has 14 installed
- OV-105 has 16 in-work

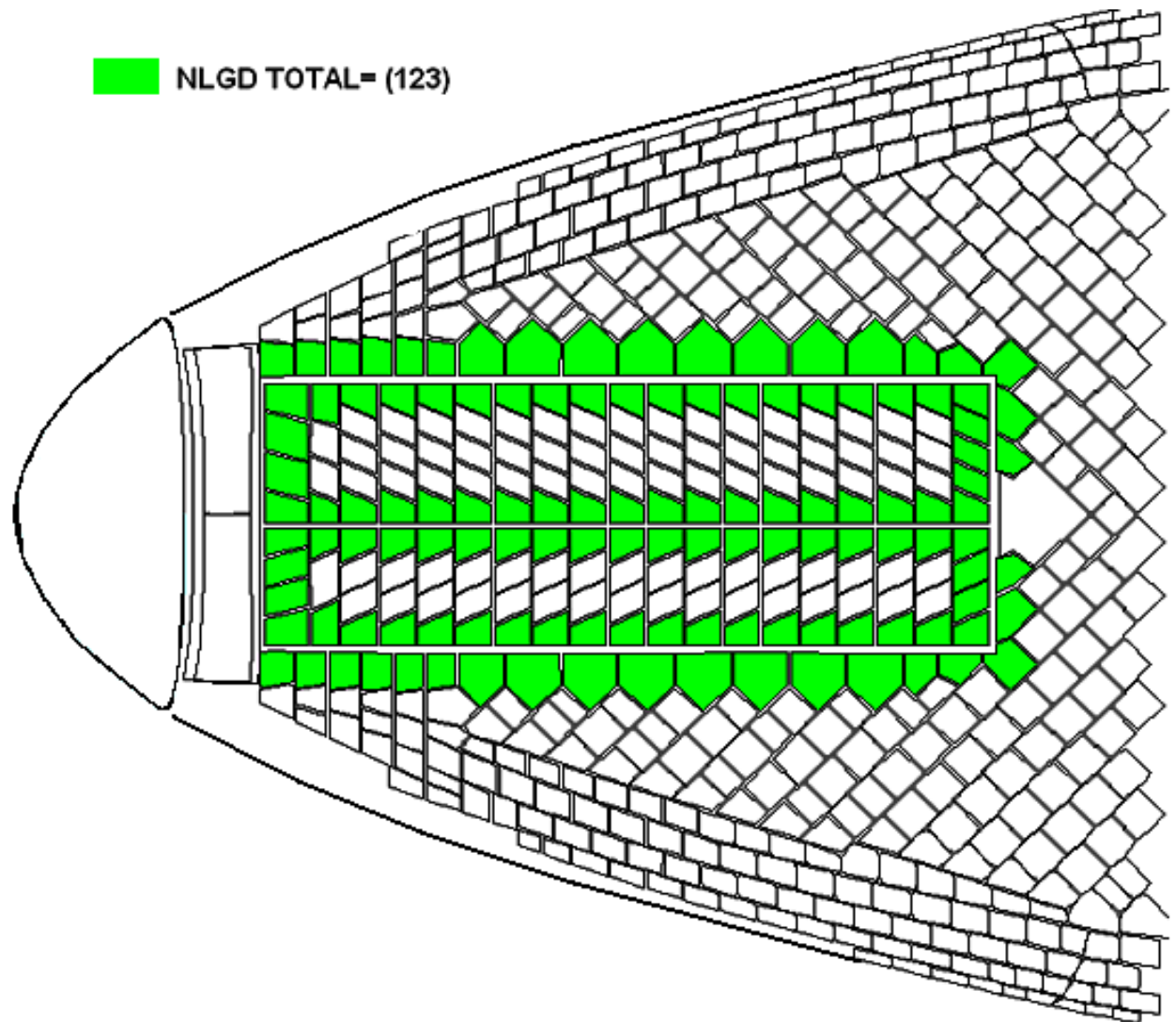

BRI Hardening Priority Plan

- Near-term BRI Plan

| Based on Manifest 06B-21 | | | Days in Flow | TPS Hardening (BRI-Tile) Included in Flt Damage | | | | Total |
|--------------------------|---------|--------|--------------|---|-----|------|-----|-------|
| STS | Vehicle | Flight | | MLG | NLG | LESS | WIN | |
| 121 | 103 | 32 | 253 | | 9 | | | 9 |
| 115 | 104 | 27 | 314 | | 14 | | | 14 |
| 116 | 103 | 33 | 110 | 6 | 1 | 24 | 3 | 34 |
| 117 | 104 | 28 | 110 | 6 | 2 | 12 | 4 | 24 |
| 118 | 105 | 20 | OMM | 11 | 16 | 11 | 11 | 49 |

- Approximately 450-550 prioritized BRI tile upgrades projected across the fleet by 2010
- Individual-flow work content must be balanced across the Fleet/Manifest
 - Risk Reduction and Hardening will be prioritized and balanced with remaining/available schedule and resources as post flight inspections are completed

Final TPS Work Content Will Be Partnered and Baseline'd at DLSFR

Recommendation

- **Recommend closing Action# 121-FRR-002 based on this Orbiter - Ground Operations partnered BRI Implementation Plan**

Back-Up

Management Planning Tool - Resource Demand Profile

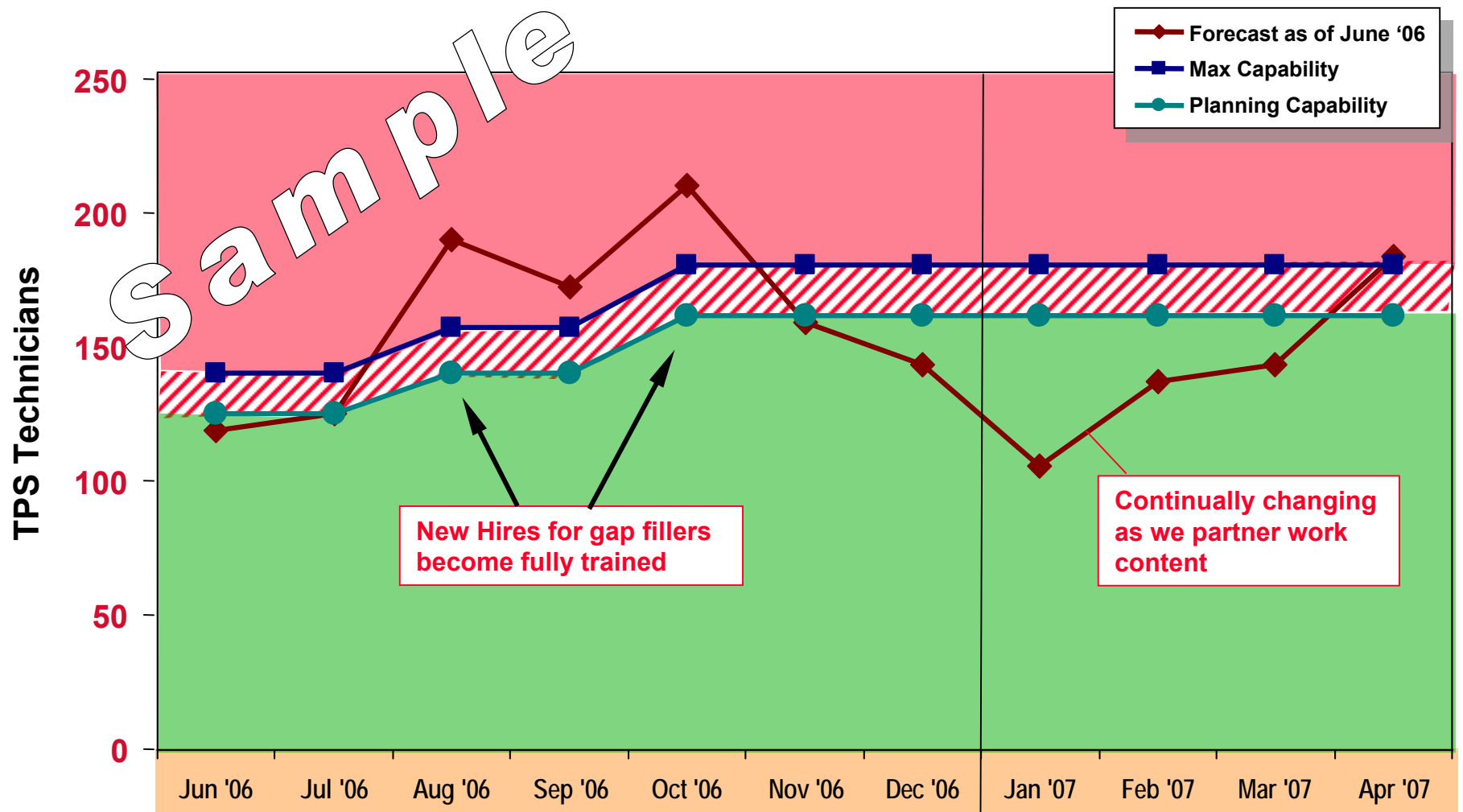

Planning Tool to Assess Work Across the Fleet / Manifest

STS-116 Partnered Priorities

- ***Current priority for STS-116***
 - ***Standard turnaround requirements (OMRS, IFA's, deferred work, etc)***
 - ***BRI Hardening - Main landing gear door (critical path driven)***
 - ***Gap Fillers ~800 per flow***
 - ***Lockbolts – Open midbody bay locations only***
 - ***BRI Hardening - LESS and window carrier panel tile (resource driven)***
 - ***Corrosion – targeted areas***
 - ***Misc Modifications (Hub tile, Drain Hole, WLE soft goods, etc)***

STS-116 Delta LSFR OV-103 FLIGHT 33 CONFIGURATION UPDATES

**Alan Ling
USA Orbiter Element**

August 10, 2006



8-10-06

22 of 128



STS-116 OV-103 Flt 33– LSFR Updates

- **Modifications To be baselined:**

- 1 Mod to be baselined as opportunity

- **Work content reduction**

- Revised OBSS Requirements
- RMS Configuration
 - 2 Modifications To Be Moved From Mandatory to Opportunity
- ASA & ATVC Removals

- **Updated Structures & TPS Requirements**

- **IVHM Configuration Waiver**

Authorization Requested for MECSLSI and CCCD Updates Due to STS-116 Orbiter Mods

- Incorporate updates to CCCD and V072-200195 (OV-103 Flight 33)

Backup

- Engineering, Hardware and Certification Status for Proposed Mods
- Mandatory and Opportunity Modification Details

Modification Updates

- Request the following modification be approved on an opportunity basis:
- **MCR 23471 Airlock Booster Fan Bypass Ducting**
Provides ducting to bypass booster fan allowing fan to be powered down.
Could allow for ~ 4.5 hours of cryo savings

Request update to the MECSLSI as shown:

Model MV0828A:

M072-643405-001 (WAS)

M072-643405-002 (IS)

Revised OBSS Requirements

- Orbiter has revisited the OBSS Turnaround Requirements and concluded that a subset of them can be deferred to Flt 34
- OBSS would not have to be returned to the Flight Crew Lab for checkout
- All work will be accomplished in the OPF transfer aisle
- Chit revision is in work to document changes

Revised OBSS Requirements



STS-121 Deleted IBA Turnaround Inspections

Generic inspections

- IBA ding map inspection
- IBA, ISA1, and ISA2 photo document survey
- ISA1 PTU angle recording
- Full Boom bumper layer inspection

STS-114 specific inspections

- IBA Boom internal bore scope inspection and video recording
- W6 Cable testing

Inspections moved to other groups

- Offline ISA1 and ISA2 Mounting Plate Assembly inspection -> NASA FCE
- Offline Grapple Fixture inspection -> MDA Brampton
- Offline Avionics Tray testing -> Superseded by IVT at the PAD

July 31, 2006

Space Missions

1



8-10-06

26 of 128



RMS Requirement Updates

Request authorization to not remove RMS s/n 303 during STS-116

- **On orbit data on DTO-849 indicated RMS performed nominally and was a stable platform during EVA's**
- **Orbiter's recommendation is to leave RMS s/n 303 installed for STS-116**
- **RMS will be r & r'd post STS-116**
- **Request authorization to update MECSLSI as shown:**
 - **V072-200195, Model MV0082A**
 - **For -003 Change M072-544502-033 to a -034**

Request The Following 2 Modifications be moved from mandatory to opportunity

- **MCR 19755 RMS Overcenter Stop Modification**
 - **For the STS-116 payload configuration, a high degree of confidence exists that the loads analysis will show positive margin**
- **MCR 19824 RMS MPM Pedestal Cover Flush Head Fastener Changeout**
- **A Configuration waiver will be processed and presented at a future Daily PRCB to document any modification not worked**

ASA & ATVC Removals

- Request authorization to not remove ASA's #2 & 4 and ATVC's #1 & 2
- Orbiter has reviewed the rationale and determined that there is a low likelihood for a smart short to occur
 - Avionics architecture design is robust to protect against random failures
 - Detailed hardware design includes layers of protection
 - Operational practices and controls minimize the potential for critical failures
 - Crit 1R2 for undetected null failure
 - Detectable during dynamic operations
 - Tested during pre-launch slew and OPS 8 aerosurface drive test (ADT)
 - Crit 1R3 for all other failures
- Revision to Chit J6106 is being processed to move the effectivity from Flt 33 to Flt 34

TPS / Structures Requirements

The following denotes the order to be worked

Mandatory

- In flight damage
- Deferred work items
 - Deferred work may be inspected and if acceptable deferred again

Prioritized Opportunity

1. BRI-18 Tile on the MLGD fwd outboard corners
2. Gapfillers

Area fwd of ET Door (approximately 165) *

* Change From LSFR

Previously pull tested areas will be r & r'd (approximately 340) *

Continue with Zones 2A, 2B and 2B' working forward to aft

3. Lockbolts (Chit J5897) *
 - Prioritized by ones in which bays are planned on being opened
4. Bri-18 Tile at the Lower LESS Carrier Panels
5. Corrosion Sampling (Chit J5930C)
6. Mod Work (Hub Tile, Bri NLGD & Other areas, WLE Sneak Flow, Horsecollar Gapfillers)

STS-116
ISS – 12A.1 P5, SPACEHAB, ICC
DELTA LAUNCH SITE FLOW REVIEW

PAYLOAD CARGO ENGINEERING STATUS

M. BARIDO/M. GERLACH

281.212.6072

08-10-2006

STS-116 LSFR

ENGINEERING FLIGHT PRODUCT STATUS

| <u>DRAWING NO.</u> | <u>TITLE</u> | <u>REV</u> | <u>EO</u> | <u>RELEASED</u> |
|--------------------|-------------------------------|------------|-----------|-----------------|
| • V072-200195 | MECSLSI | G | G01 | 06-01-2006 |
| • VA72-200195 | CARGO ARRANGEMENT DRAWING | G | G01 | 08-01-2006 |
| • VD72-200195 | AVIONICS INTERFACE DIAGRAM | C | C01 | 06-01-2006 |
| • VS72-200195 | INTEGRATED AVIONICS SCHEMATIC | C | C01 | 06-01-2006 |
| • VS70-540374 | RETENTION SCHEMATIC DIAGRAM | B | B01 | 07-12-2005 |

OPEN WORK

- V072-200195 MECSLSI – MINOR ORBITER UPDATES
& DLSFR UPDATES 08-17-2006

RESCUE FLIGHT STATUS

- STS-317 RECONFIGURATION ENGINEERING PRODUCTS WILL BE DEVELOPED BY THE ENGINEERING ORDER TO FOLLOW (EOTF) PROCESS.

STANDARDIZATION

- MISSION CONFIGURATION COMPLIES WITH ORBITER/PAYLOAD INTEGRATION STANDARDIZATION DOCUMENT NSTS 60523

STS-116 LSFR

PAYLOAD ICDs/PIRNs

ALL PAYLOAD-UNIQUE ICDs ARE BASELINED

PIRNs THAT IMPACT FLIGHT PRODUCTS

| <u>PIRN #</u> | <u>ICD/PAYLOAD</u> | <u>TITLE</u> | <u>ECD</u> |
|---------------|--------------------|------------------------------|------------|
| A05251 | ICD-A-21504-OOR | AVIONICS AND SOFTWARE UPDATE | 09-18-2006 |

ISSUES/CONCERNS

- NONE

STS-116 LSFR

OMRSD OPEN WORK

PAYLOAD OMRS (FILE II, VOL. 2 -POST MATE)

| <u>RCN</u> | <u>TITLE</u> | <u>RCN RELEASE</u> | <u>ECD</u> |
|------------|---|--------------------|------------|
| PP17097 R1 | OMRS P095 SPACEHAB WATER PUMP CHECKOUT | 06/16/2006A | 08/10/2006 |
| PP17105 R1 | OMRS P1504 ISS-12A1 SWAB SAMPLING AND STATIC BOND UPDATE | 06/29/2006A | 08/18/2006 |

PAYLOAD OMRS (FILE II, VOL.4 -PRE MATE)

| <u>RCN</u> | <u>TITLE</u> | <u>RCN RELEASE</u> | <u>ECD</u> |
|------------|-------------------------------------|--------------------|------------|
| PS16834 R3 | STS-116 MISSION UNIQUE LIST UPDATES | 07/10/2006 A | 08/04/2006 |

ISSUES/CONCERNS

- NONE

TGHR STATUS

OPEN WORK

| | <u>ECD</u> |
|----------------------------|------------|
| • CUSTOMER SUBMITTAL (L-4) | 08/14/2006 |
| • RELEASE FOR REVIEW (L-3) | 09/14/2006 |
| • BASELINE (L-2) | 10/16/2006 |

ISSUES/CONCERNS

- NONE

STS-116 LSFR

ANNEX 1 OPEN WORK

ITS-P5 –NSTS 21504- A01

- INTERIM WEIGHT UPDATE (L-4)
- FINAL WEIGHT SUBMITTAL (L-1)

CUSTOMER SUBMITTAL

07/24/2006A
10/30/2006

CR RELEASE

07/28/2006A
11/06/2006

CR BASELINE

08/14/2006
11/14/2006

ICC –NSTS 21448 – A01

- INTERIM WEIGHT SUBMITTAL (L-4)
- FINAL WEIGHT SUBMITTAL (L-1)

07/31/2006A
10/30/2006

08/01/2006A
11/06/2006

08/14/2006
11/14/2006

SPACEHAB –NSTS 21426 –A01

- INTERIM WEIGHT UPDATE (L-70D)
- FINAL WEIGHT UPDATE (L-1)

10/05/2006
10/30/2006

10/13/2006
11/06/2006

10/27/2006
11/14/2006

ISSUES/CONCERNS

- NONE

STS-116 LSFR

CARGO CLOSE CLEARANCE PROCESS

- **STANDARD CLOSE CLEARANCE PROCESS CALLS FOR A MEASUREMENT AFTER INSTALLATION IF:**
 - **STATIC IS CLOSER THAN 3”**
 - **DYNAMIC IS CLOSER THAN 1”**
 - **THE MISSION UNIQUE REQUEST IS WORKED VIA THE CHIT PROCESS**
(LAST FLIGHT WE DID THIS WAS STS-114)
- **THE FOLLOWING CLOSE CLEARANCE AREAS HAVE BEEN IDENTIFIED AND DOCUMENTED IN CHIT J6145:**
 - **ICC KYA TO MPM (STATIC 1.25, DYNAMIC ~.17") (OPF)**
 - **MPM TO LATCH (OPF)**
 - **REQUIRES THE MPM TO BE ROLLED IN AND OUT 3 TIMES**

STS-116 LSFR

HARDWARE

DELIVERY

- ALL HARDWARE DELIVERED

CERTIFICATION

- CERTIFICATION DOCUMENTATION UPDATES REQUIRED TO REFLECT DCR FINDINGS – ECD
9/7/2006

ISSUES/CONCERNS

- NONE

STS-116 Configuration Updates

Delta Launch Site Flow Review

Mike Storm
OV-103 Project Engineer
USA Ground Operations

Introduction

Configuration Waivers (Tech Orders):

- (1) M072-794500-004 IVHM Harness Installation Bay 13
- (2) M072-784633-014 Harness Installation-Interface Panel-MADS #3

Item (1) M072-794500-004 IVHM Harness Installation Bay 13

- Background
- M072-794500-004 IVHM Harness Installation Bay 13 called out by MECSLSI V072-200195
- During STS-114 processing this tech order configuration called for the removal of an un-used IVHM harness along with the routing hardware.
- At the time the tech order was made a requirement for flight 31, the bay 13 longeron had already been installed for flight.
- The harness was demated and stowed in place per MR and was deferred to a future flight at which time the bay 13 longeron will be removed.
- Since the bay 13 longeron was not removed this flight, a configuration waiver is needed for STS-116.
- Recommendation
- Approve Configuration Waiver for M072-794500-004

Item (2) M072-784633-014 Harness Installation-Interface Panel-MADS #3

- **Background**
- **M072-784633-014 Harness Installation-Interface Panel-MADS #3 called out by MECSLSI V072-200195**
- **During OMDP, the crossover bracket modification was successfully implemented at ALL FOUR locations with no technical issues by engineering defined by orbiter drawings as well as 3 tech orders (M072-794011, M072-794031, and M072-794051).**
- **The M072-784633-014 tech order was established to incorporate the crossover bracket modification at two of these locations (Xo863 and Xo750).**
- **At the Xo863 location, M072-784633-014 called for the removal of a clamp and six screws to reflect the change of harness mounting due to the new wire tray shape.**
- **TPS OEL-3-31-245 incorporated the electrical portion of this modification per the vehicle drawings as well as the three tank set harness tech orders. During STS-114 processing, the WAD was reviewed and it was determined that an error exists in the M072-784633 engineering.**
- **This tech order reflects harness routing at the Xo863 that does not reflect the as-built configuration on the orbiter, see pages 13 & 14.**
- **- continued -**

Item (2) M072-784633-014 Harness Installation-Interface Panel-MADS #3

- - continued -
- A one flight configuration waiver was processed and approved for STS-114 and STS-121.
- All hardware on this tech order is crit level 3.
- This tech order supports MADS wire routing, there were no observed wire routing violations noted during flight 31 midbody closeout and all MADS testing will be completed and verified.
- No technical issue with hardware, installation, or function of MADS.
- There was no access to this area this flow to perform wire routing as-built condition. A configuration waiver is needed for STS-116 for this tech order.
- Recommendation
- Approve Configuration Waiver for M072-784633-014

Item (2) M072-784633-014 Harness Installation-Interface Panel-MADS #3

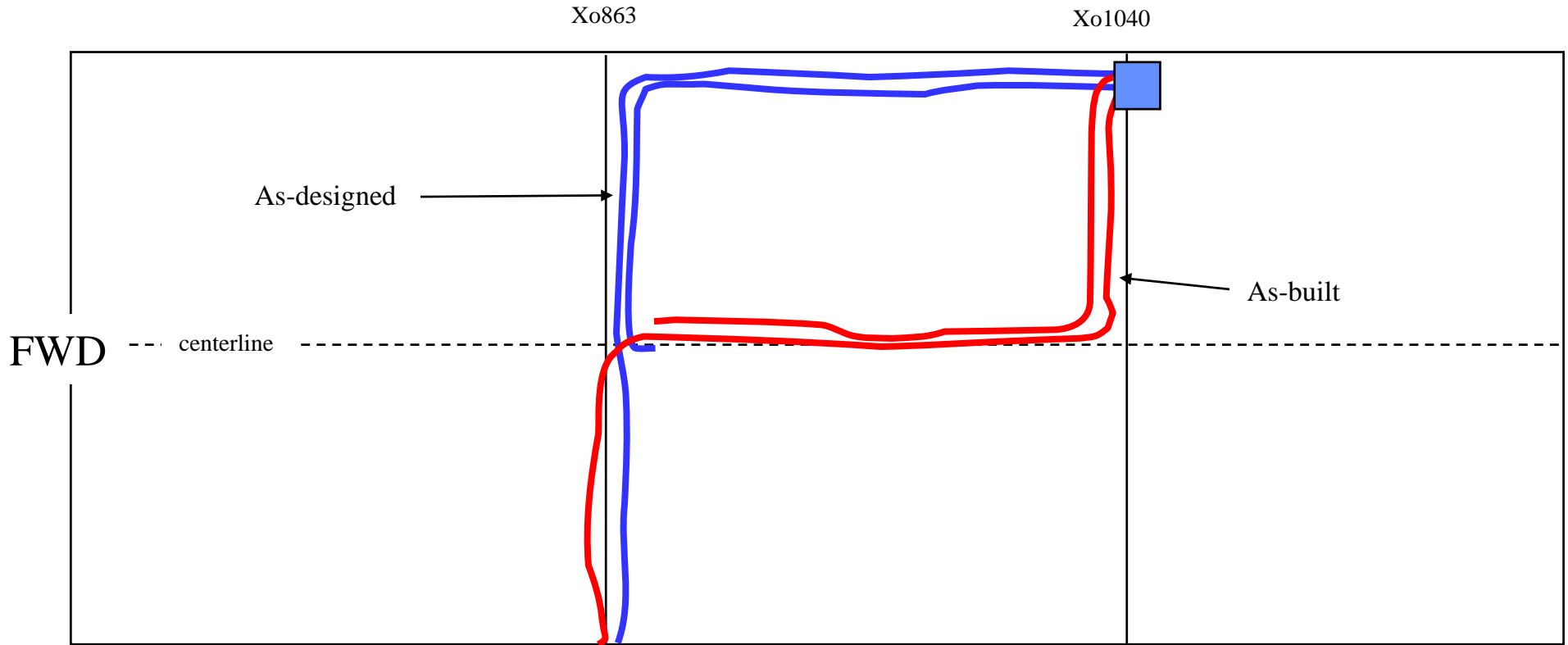

Item (2) M072-784633-014 Harness Installation-Interface Panel-MADS #3

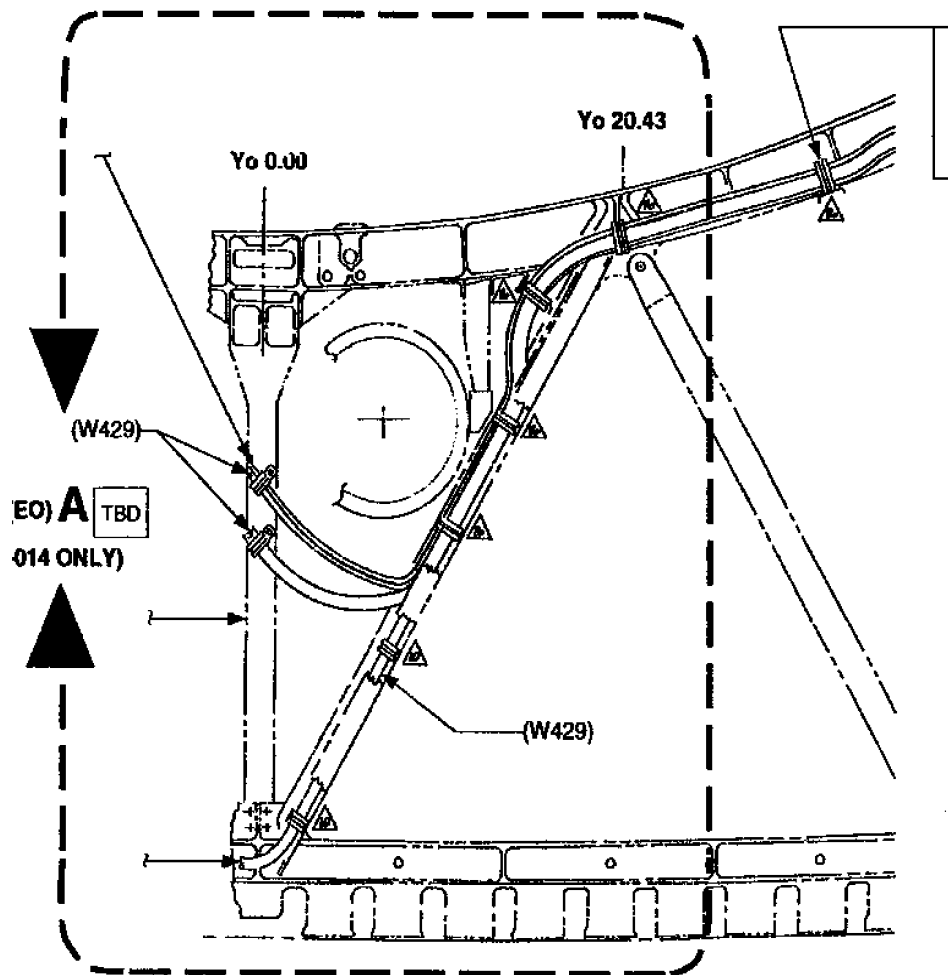

was

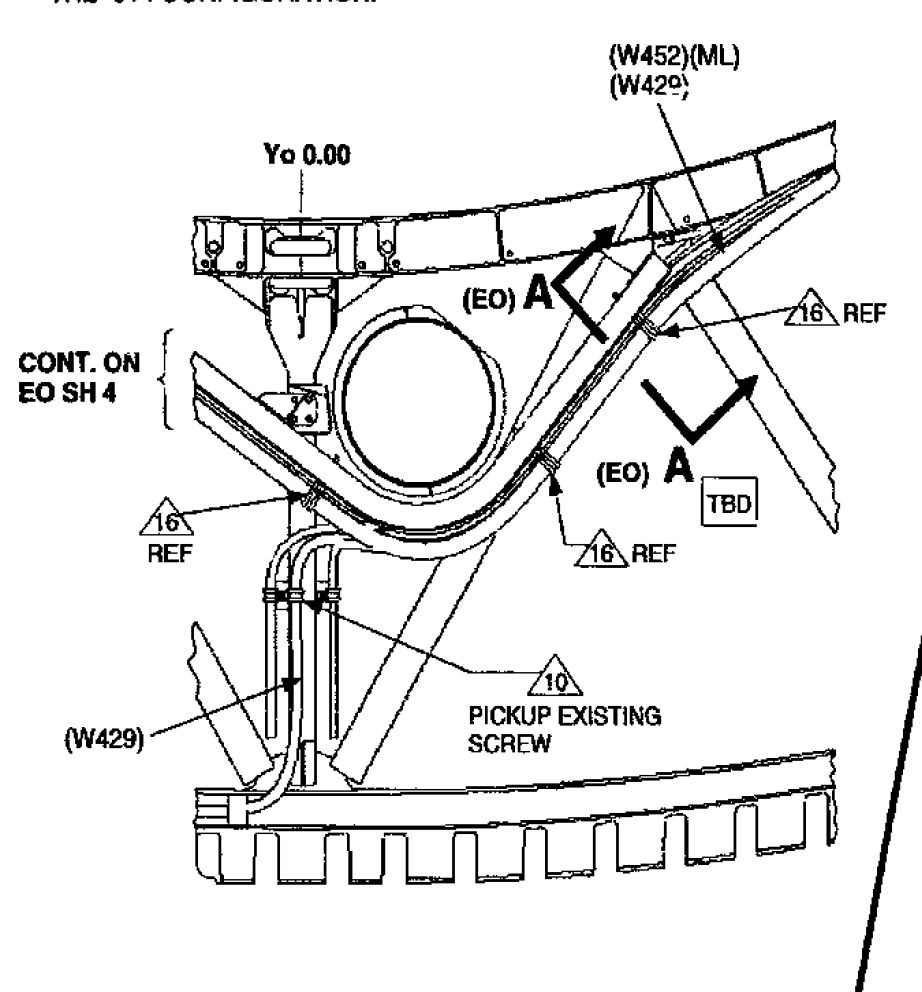

is

KSC Launch and Landing Project

STS-116

Delta Launch Site Flow Review

August 10, 2006

Agenda

- Multi Flow S.Stilson / NASA
- Flight Element Processing D. Perdomo / USA



Multi Flow

S.Stilson

Vehicle/TPS Manpower Allocation Priority

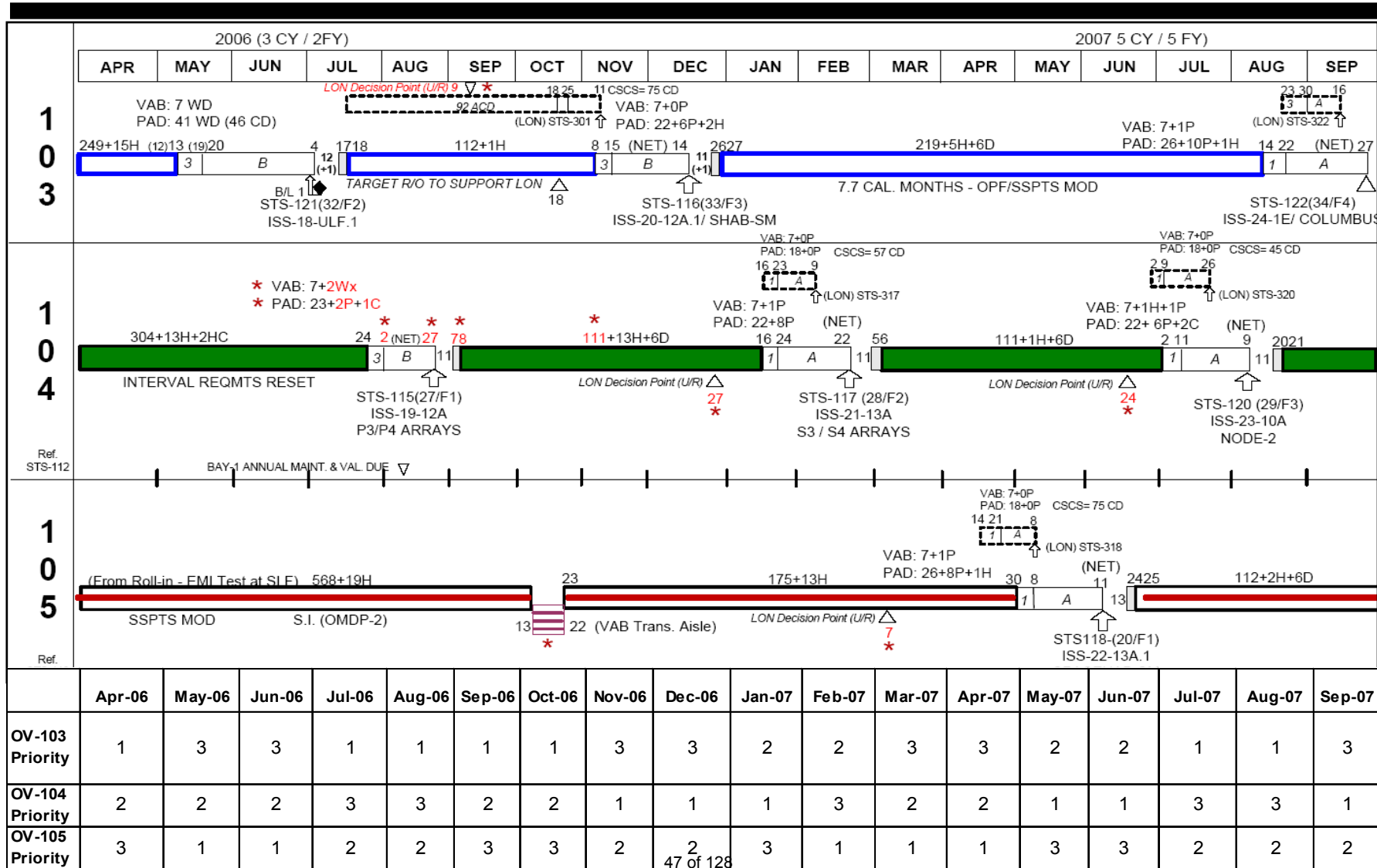

STS-116 LSFR

J. F. KENNEDY SPACE CENTER

STS-116 KSC Milestone Interface Chart

OPR: USA - J. HAZELTON, INTEG. OPS.
NASA - S. STILSON, PH-O

OV-103/33/ ISS-20-12A.1
CREW / DURATION: 7 / 11 + (1)
ET 123 / BI128 / RSRM 95 / MLP-1 / PAD-B / VAB HB3

SSP APPROVED MANIFEST (REF. CR #042013FP)
Status as of:
08/09/2006

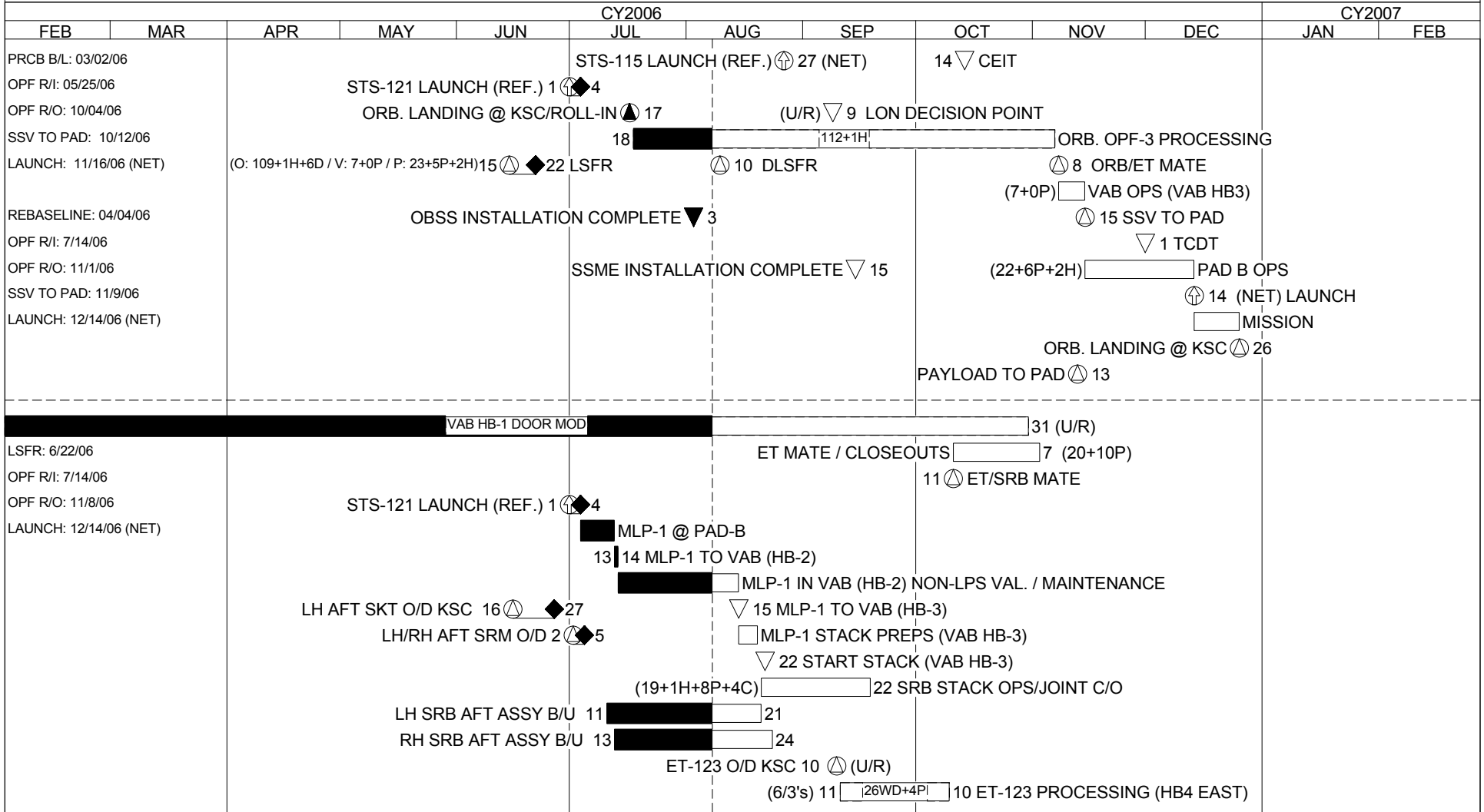

THREATS: 1. OPF FLOW PROCESSING TIMELINE
×2. TPS WORK CONTENT

NOTES: 1. TWENTIETH ISS/SSP FLIGHT

Flight Element Processing

D. Perdomo

Flight Element Processing Overview

- Milestone Summary To Be Presented
- Significant Processing Deltas To Be Presented
- LSFR/ Δ LSFR Comparison To Be Presented
- Issues and Concerns To Be Presented
- Stoplight Chart To Be Presented
- Backup Not Presented
 - Configuration/Facilities

| | | |
|------------|------------|---|
| STUDY ONLY | | NON-CONCUR |
| USA | NASA | This product should not be used for planning purpose or impact assessments. |
| On-Center | Off-Center | |

Creation Date:14-JUN-2006
Revision Date:26-JUL-2006
Revision :G

STS-116/OV-103 OPF FLOW MILESTONES
DOWN PAYLOAD:ISS-18-ULF.1/UP PAYLOAD:ISS-20-12A.1/SHAB

OPR:USA-
NASA-

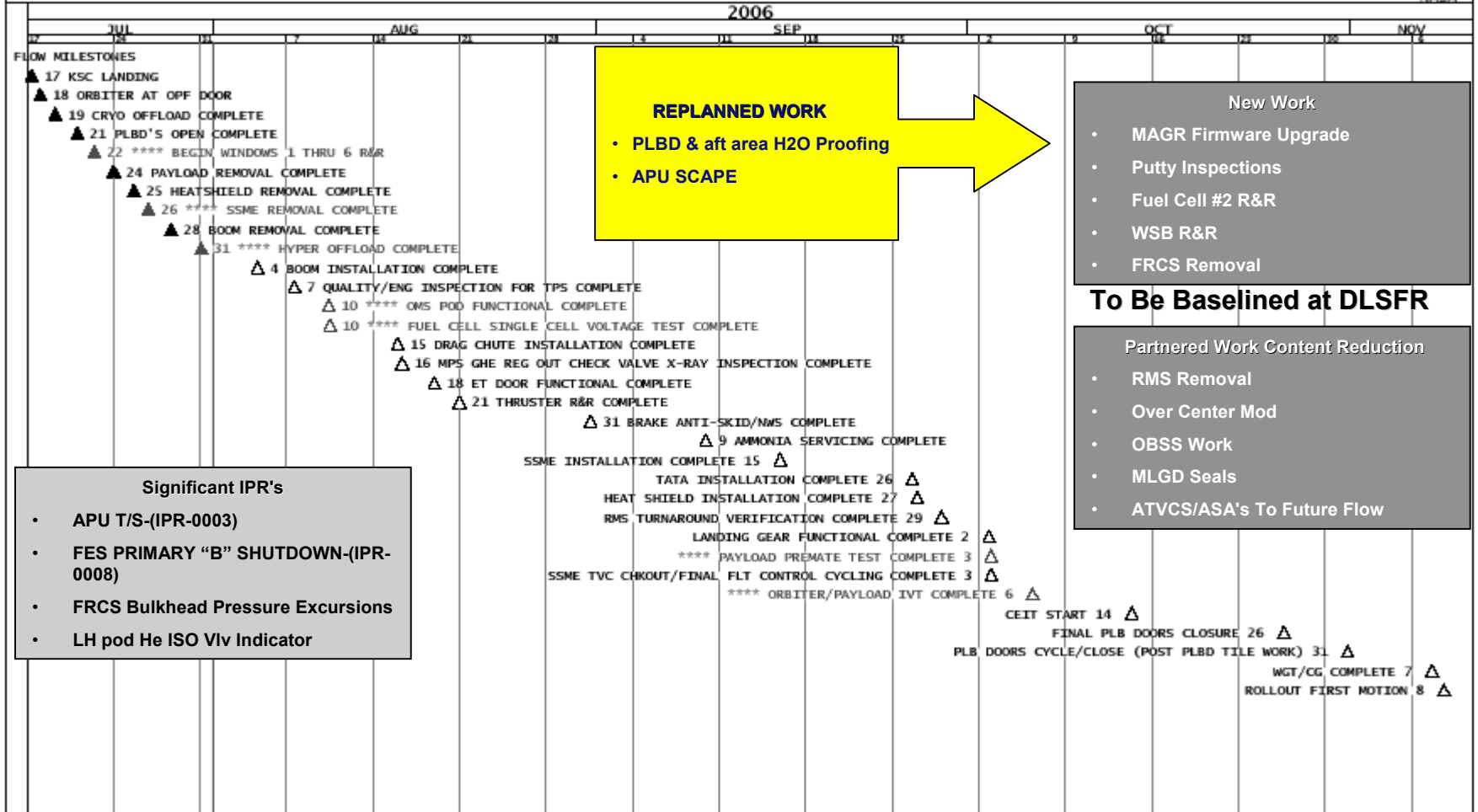

▲ PLAN/BASELINE ◆ DEVIATION FROM BASELINE ▲ ◆ ACTIVITY COMPLETED ▲ ACTIVITY CANCELED ▲ ▲ ACTIVITY DURATION **** SCHEDULE CHANGE

STATUS DATE: 1-AUG-2006;1 PLOT DATE: 1-AUG-2006, 11:47 am NETWORK: OPF116.571 CONTACT: B. COREY, J-8334 OPF BAY-3 EXE:CUSOPFSU.27

Significant Processing Deltas

- Processing Flow
 - Shifting Is Based on 7/3's
 - Overtime Required to Achieve Manifest Resources Allocation
 - No Contingency Days in Flow
- OBSS Removal / Installation
- RJD LRU'S R/R
- Fuel Cell #2 R&R

Significant Processing Deltas

- IPR-001 Thruster L5L Troubleshooting
 - Thruster R/R
- IPR-003 APU Drain T/S
 - Potential Fuel Off Load
 - Additional SCAPE operations not factored into schedule
- IPR-008 FES Primary B T/S
 - Potential FES R/R
- IPR-009 ECL Sensor T/S
 - Transducer R/R
- IPR-015 FRCS Pressure Excursion T/S
 - Potential FRCS R/R
- IPR-018/HYD-1310 HYDRAULIC PGME T/S
 - WSB/Controller R/R
- IPR-029 LH pod He isolation valve indicator
 - Potential Pod R/R

TPS Status

- **TPS Inspections 97% complete**
 - 108 cavities
 - 2051 total WADs
 - 364 closed WADs
 - 761 need engineering dispo
 - 1687 open WADs
- **Gap fillers**
 - Fwd of ET Doors – 35% complete
 - Priority 2A – 26% complete
 - Integrity test R/R (~300) – new requirement
 - Remaining priority areas not to exceed 800
- **Forecast capability = 117**
 - Increases to 130 w/ additional resources in Sept

TPS Cavity Count - LSFR/ Δ LSFR

| | LSFR | Δ LSFR |
|--|-----------|---------------|
| • Deferred Tile/ Fib For 1 Flight (Minimum) | 23 | 25 |
| • Less Carrier Panel Tile (Shaved Flt 32) | 10 | 0 |
| • Tile Estimate Of In-flight Tile Damage Resulting In Tile Removal/ Replacement | 60 | 30* |
| • Sub Nominal Bonds | 0 | 2* |
| • Operational Damage | 12 | 12* |
| • 800 Gap Fillers -Result In Tile Removal | 3 | 3* |
| • Radiometer | 1 | 0 |
| • BRI | | |
| • MLG | 6 | 6 |
| • LESS | 0 | 24 |
| • NLG (Flight Damage) | 0 | 1 |
| • Windows | 0 | 0 |
| • Lockbolts | 24 | 0 |
| • FIB | 0 | 46* |
| • Putty Repairs | 10 | 14* |
| • Window R&R | 6 | 3* |
| • Out of Tolerance S&G | <u>12</u> | <u>12*</u> |
| Totals | 167 | 178 |

Potential TPS Work

- **Potential R&Rs if estimates are lower than expected**
 - MLG BRI - 6
 - Lockbolts – 15

Issues and Concerns

- **TPS cavity count > capacity**
- **Work Content Growth**
 - IPR'S
 - Additional Chits And Mods
 - TPS
- **OMS pod thruster discrepancies**
 - Potential pod R/R
- **Potential FRCS R/R**
 - 4 to 6 weeks of TPS processing

STS-116/301 Stoplight

Program Milestone

Activity / Remarks

STS-116 LAUNCH

Issues/Critical Path

OV-103 OPF Overall

TPS Processing

R →

Launch on December 14 (Window extends to Dec. 26, 2006)

OPF Roll Over 11/8

R →

Working 7/3's (no contingency), additional requirements from Chits and RCNs

R →

High work content (BRI,G/F, Cavities) Potential growth to exceed capacity/putty repairs

ET/SRB Mate 10/11

G →

SRB Stacking to begin 8/22/06

SRB Stacking

Y →

ET-123 On Dock 9/10

ET Standalone C/O

Orbiter Mate 11/8

G →

ET/SRB Mate on 10/ 11, Orbiter Mate 11/8/06

ET/SRB Mate, Closeout

Launch NET 12/14

G →

Orbiter Mate/VAB Roll Out/Pad Ops; contingency held in the Pad flow

Integrated VAB/Pad Ops

LON

STS-317, ET-124 under supports 2 weeks (New ET-124 on dock date of 12/23/06)

STS-317, LON for STS-116

Potential Significant Growth

RJD Darlington Pair Failure

Y

Delivery dates, potential cold plate damage, R/R (3 RJDs)

APU Suspect Leak

U/R

Potential SCAPE Ops

FES Primary "B" Shutdown

Y

Potential FES change out; controller good.

GHe Isolation Valve

Y

Potential LPod removal to the HMF (IPR-029)

Work Content Growth

U/R

IFA's, IPR's, Post Flight Inspections, additional Chits/Mods

OMS Pod Thruster Discrepancies

Y

Potential multiple thruster R&R

Airlock Inner Hatch

G

Re-rig, rebond hatch guide, clarify crew procedures

FRCS Sensor

Y →

FRCS removal

G

Issue remains on schedule, 67% or better available Contingency Days remain in schedule

Y

Issue encountering concerns/problems which may cause an impact, 34-66% available Contingency Days remain in s

R

Issue may impact a specific Program milestone, 33% or less available Contingency Days remain in schedule

STS-116/301 Ground Operations Processing

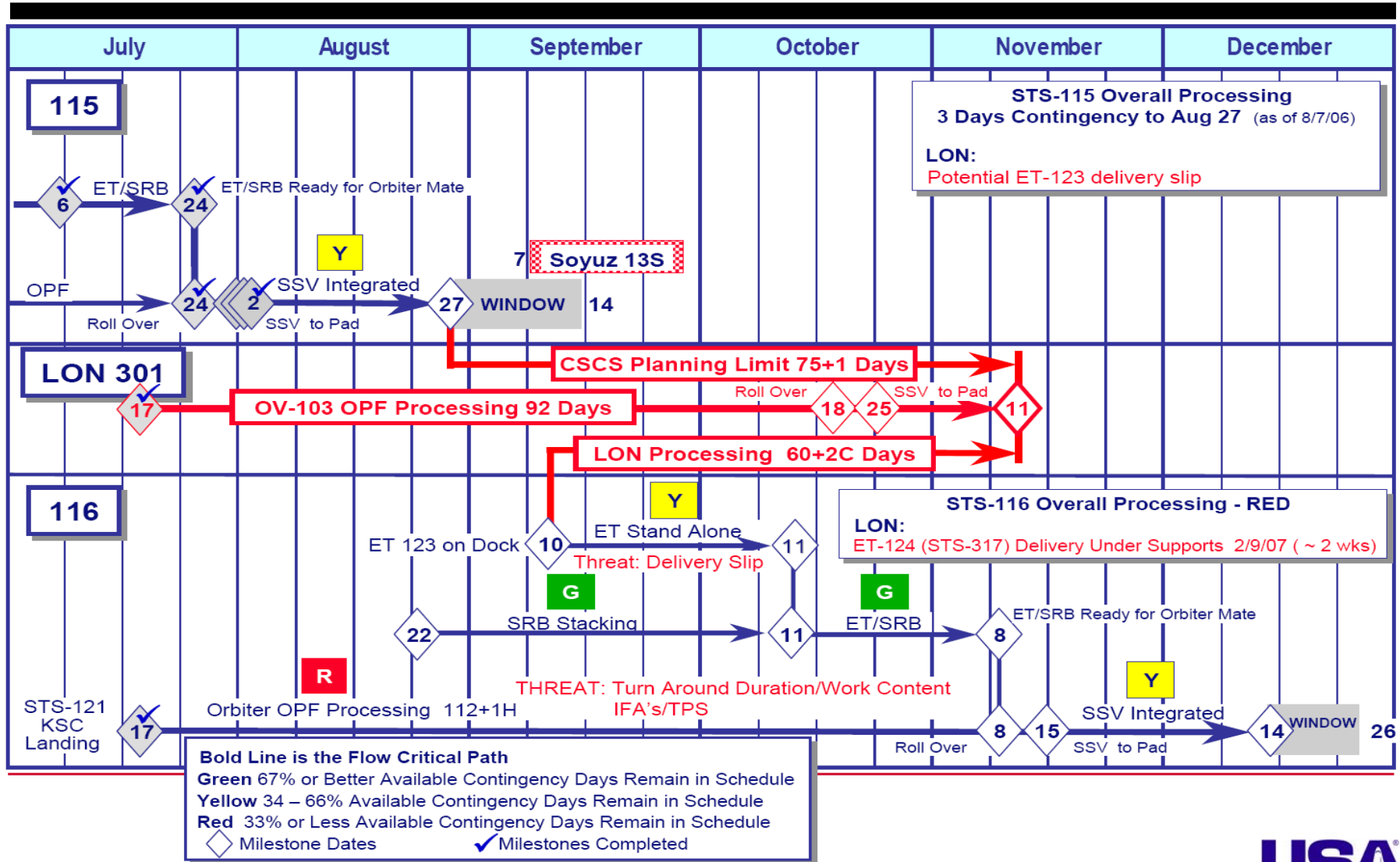

STATUS

OPR: USA - J. Taylor, INTEG FM (1-7420)
NASA S. Stilson, PH-O (1-9103)

USA

NASA

C

C

CONCUR

Creation Date: 31 MAR 06
Revision Date: 13 JUL 06
Revision: B-1

STS-116 / OV-103

Integrated Operations Assessment Summary

Payloads:ISS-20-12A.1 SPACEHAB-SM/P5 TRUSS (C/R) (VERT)

2006

NOVEMBER

DECEMBER

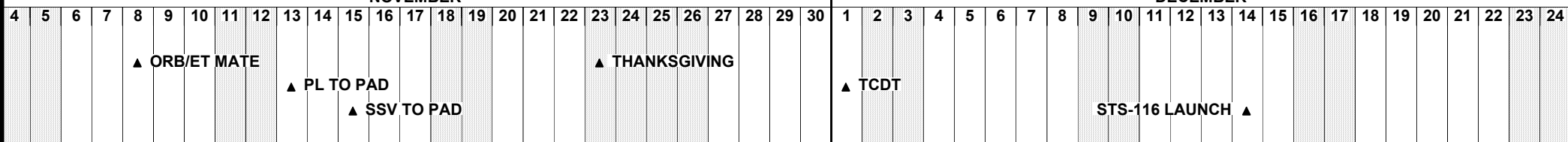

VAB HB-3 / MLP-1

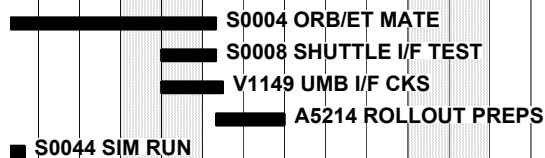

PAD B

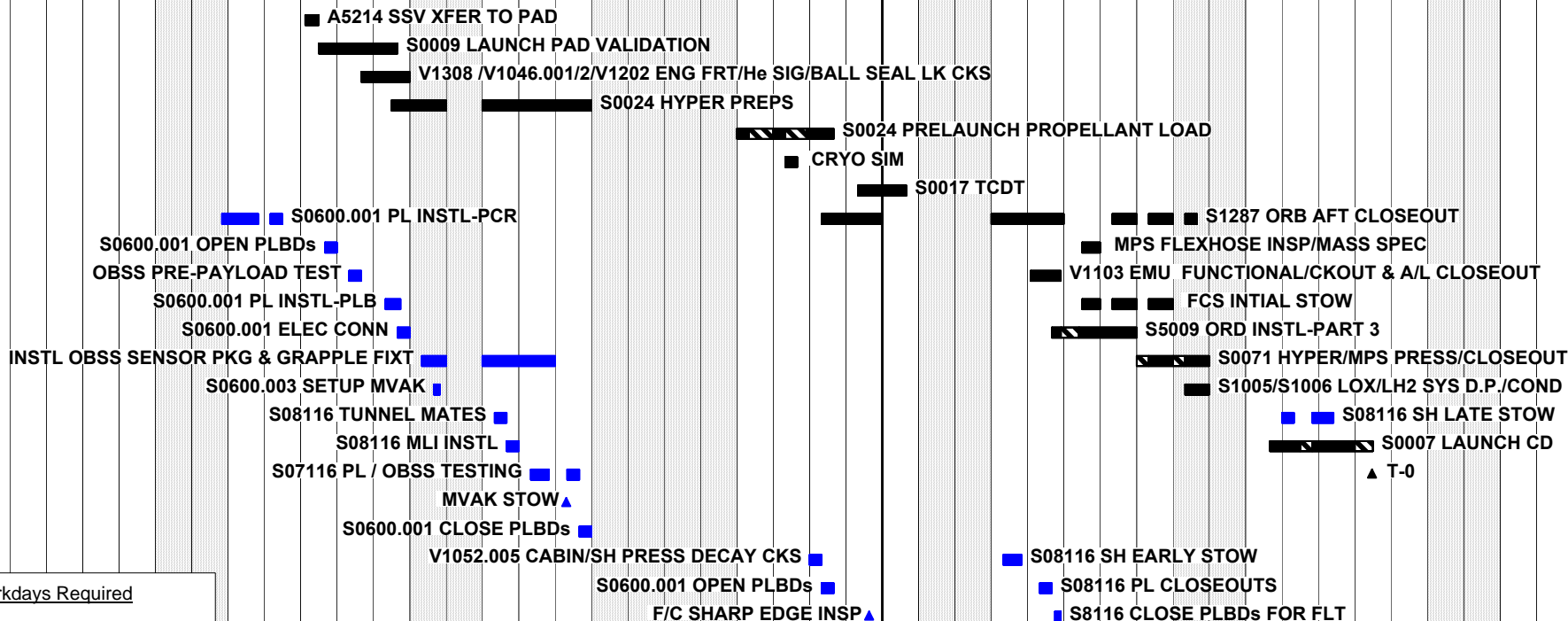

Workdays Required

7 VAB (0 P)

22 PAD (6 P/2 H)

HOLIDAY

PREMIUM DAYS

STS-116 Integrated Delta Launch Site Flow Review

Presenter

Josh Krupnick

Date

08-10-06

Backup Material

FRWG Presentation (With Minor Changes)



STS-116 Delta Launch Site Flow Review

| | | |
|-----------|---------------------|--|
| Presenter | Amy Houts-Gilfriche | |
| Date | 08-10-06 | |

SSP System Drawings

The Drawings Baseline Was Released By PRCB S115116NR1 on 07-11-06

- V072-000001-255 (Rev. UL01) Space Shuttle System (Rel. 03-21-06)
 - V072-200195-003 (Rev. G01) Mission Equipment Cargo Support (Rel. 06-01-06)
 - SGD32104439-301 (Rev. F) Crew Compartment Configuration (Rel. 07-10-06)
 - 302 Descent
 - V070-000001-003 Orbiter General Assembly
 - V070-4101000-017 SSME Installation
 - 10100-0061-166 Integrated SRB General Assembly (BI-128)
 - 80901000000-510 External Tank Assembly (ET-123)

- STS-116 LSRR + 18 days Mission Configuration Product Plan (MCP) was last published on 05-30-06 and will be republished at ORR -14 days on 10-20-06.



STS-116 Delta Launch Site Flow Review

| | | |
|-----------|---------------------|--|
| Presenter | Amy Houts-Gilfriche | |
| Date | 08-10-06 | |

SSP System Drawings (Cont'd)

Ferry Configuration

- V072-000001-256 (Rev. UN01) Space Shuttle System Drawing (Rel. 06-22-06)
 - V072-200195-004 (Rev. G01) Mission Equipment Cargo Support (Rel. 06-01-06)
 - SGD32104439-001 (Rev. F) Crew Compartment Configuration (Rel. 07-10-06)
 - V072-30055-027 (Rev. BL01) Ferry Flight Configuration (Rel. 06-21-06)

SCA 905



STS-116 Delta Launch Site Flow Review

| | | |
|-----------|---------------------|--|
| Presenter | Amy Houts-Gilfriche | |
| Date | 08-10-06 | |

SSP ICD Changes

- The Following ICD Changes, Program Designated for STS-116, are in the Review/Approval Cycle:

| <u>IRN#</u> | <u>Description</u> | <u>Status</u> |
|---|---|---------------|
| IC-3029/ICD-2-1D003 IC-3030/ICD-2-1A002 IC-3031/ICD-2-0A002 | Update ICD requirements for the replacement of the Water Spray Boiler Working Fluid from de-ionized water to PGME/de-ionized water for all three storage tanks. | ECD: 09/20/06 |



STS-116 Delta Launch Site Flow Review

| | | |
|-----------|---------------------|--|
| Presenter | Amy Houts-Gilfriche | |
| Date | 08-10-06 | |

SSP LCC Changes

- The Following LCC Open Work is currently designated as STS-116

Non-Mandatory:

| <u>LCN</u> | <u>Description</u> | <u>Status</u> |
|------------|--------------------------------------|---------------|
| 1198 | New LH2 ET/Orb Plate Gap Purge Rqmts | ECD: 11/17/06 |



| | | |
|--|---------------------------------------|------------------|
| STS-116 Delta Launch Site Flow Review | Presenter MK-SIO / A. Swift | |
| | Date 8-10-06 | Page 1 |

Mandatory RCNs:

| | | |
|-----------|-----------------------------------|--------------|
| MB17098 | B00 - SRB BORESCOPE FWD BSM DRAIN | 08/16/06 |
| KV16980R1 | V05 - MULTI UPDATES | 08/11/06 ECD |

Non-Mandatory Value Added RCNs:

| | | |
|-----------|--|----------------|
| SS17107 | S00 - PAYLOAD BAY DOOR/PCR CLEARANCE | 08/09/06 |
| OV17009R1 | V30 - CORROSION SAMPLING – GEN RQMT | 08/11/06 DAILY |
| OV16801R1 | V58 - FIG V58AC0.040_WSB GN2 TNK GRND SRVC | PRELIMINARY |
| OV17091 | V30 - RCM PATHFINDER FWD FUSELAGE | 8/31/06 ECD |
| KV17123 | V61 - O2/N2 FLEXHOSE INSPECTIONS | PRELIMINARY |
| OV17125 | V58 - HYD BELLOWS ACCUMULATOR GN2 PRESS | PRELIMINARY |

LW MAR

| | |
|-------------|--------------------|
| CDR | MARK POLANSKY |
| PLT | WILLIAM OEFELIN |
| M/S #1 | NICHOLAS PATRICK |
| M/S #2 | ROBERT CURBEAM |
| M/S #3 | CHRISTER FUGLESANG |
| M/S #4 | JOAN HIGGINBOTHAM |
| M/S #5 (UP) | SUNITA WILLIAMS |
| M/S #5 (DN) | THOMAS REITER |

MODULAR LOCKER LAYOUT ASCENT

| | | |
|-----------------------------|--------------------------------------|-----------------------------|
| 1622 PANTRY FOOD -308 | 1622 MF57A PANTRY FOOD -308 | 1622 PANTRY FOOD -302 |
|-----------------------------|--------------------------------------|-----------------------------|

| | | |
|---|--------------------------|---|
| MF43C 8039 -301 PRIME C/L CAMERA | MF57C TBD ISS RESERVE | MF71C 4033 -313 DC VACUUM CLEANER |
|---|--------------------------|---|

MIDDECK FORWARD

| | | | | |
|--|--|---|--|---|
| MF14E 2760 -306 FRESH FOOD FRESH FOOD | MF28E 5452 -324 IFM BREAKOUT BOX TURNBUCKLES AIR BOTTLES WWD FLT RMS KIT | MF43E 8720 -TBD BIOCIDE KIT/MNRL KIT SAMPLE-PURGE KIT US-RSA HOSES SDBIS-RENAL STONE LAT VIRUS/SLP SHORT MIDDORINE | MF57E TBD SODF RCC NOAX TUBES | MF71E 6020 -TBD G-SUITS |
| MF14G 2761 -308 FRESH FOOD MENU FOOD | 6300 MF28G 6250 -337 -345 IFM TOOLS 2163-302 2161-305 2162-306 | MF43G 7521 -317 SHUTTLE CSA-CP/ SUPA (12)/ CONDENSATE COLL/ INGRESS HARDWARE/ CWC | MF57G 6240 -311 ORBITER FDF SODF | MF71G 5473 -305 ORBITER FDF |
| MF14H 2763 -304 MENU FOOD MENU FOOD | MF28H 6684 -TBD MED KITS ALTIMETER | MF43H 1900 -308 CDR CLOTHING | MF57H 1902 -308 M/S #1 CLOTHING | MF71H 1904 -307 M/S #3 CLOTHING |
| MF14K 2764 -306 MENU FOOD MENU FOOD | MF28K 6231 -335 POST INSERTION | MF43K 6299 -311 COAS/BTA FLUOR LT/LT SHIELDS/DCS760 AUDIO DOSIMETER | MF57K TBD DOSIMETER IMAK SSK MAS MEDIA US-RSA TBD HCTB CREW CARE PKG TBD HCTB | MF71K TBD WATER SAMPLE COLLECTION KIT(3) CTB |
| MF14M 2765 -304 MENU FOOD MENU FOOD | MF28M TBD MENU FOOD HYGIENE | MF43M 1901 -305 PLT CLOTHING | MF57M 1903 -305 M/S #2 CLOTHING | MF71M 3005 -304 M/S #4 CLOTHING |
| MF14O 2766 -305 MENU FOOD MENU FOOD | MF28O 2762 -307 MENU FOOD MENU FOOD | MF43O TBD M/S #5 UP CLOTHING HYGIENE/ COMMUNITY PHK | MF57O TBD HYGIENE | MF71O TBD HYGIENE |

MIDDECK AFT

| | |
|---|---|
| MA9D TBD WVS CAM BAG TBD | MA16D 8076 -302 STS-2/ STS-6 ACCESS PGSC ACCESS. TBD |
| MA9F 8075 TBD STS-1/STS-3 | MA16F 1908 -309 CREW SUPPORT |
| MA9G 7996 -TBD STS-4/ STS-5/ ACCESS | MA16G 8076 -302 STS-7/STS-8/ STS-9/ PWR SPYS |
| 6066 MA9J 8719 -321 -302 COLOR PRINTER AND PAPER INK CARTRIDGES CTB | MA16J 7987 -TBD PCS CD CASE |
| 5962 MA9L 6269 -303 -307 PRINTER TRAYS IODINE REMOVAL 6256-303 | MA16L 6697 -317 HH LIDAR W/NIGHT SCOPE(TRAD) SSV/BPSMU's BPSMU BATT 2ND LIDAR |
| MA9N 7432-309 SOFT STWG BAGS PHKS 4980-311 BRKTS/CCK/RE-ENT LIGHT STICKS/JETSN BAGS 8071-308 RSTRNTS/RE-ENT FIBERSCOPE 8070-302 | MA16N TBD GFE TV CONTROLLER ULTRASONIC LEAK DET. |

NOT INSTALLED

VOL B
(MA73J)

NOT INSTALLED

VOL 3B
(MA73J)

QUICK DON MASKS(3)/
CABIN AIR CLEANER/
SPOTLIGHT/BATTS
PD100
LCD MON/DCS 760/
400 MM LENS

A16

35MM CAMERA BAG
DTV CAMERA BAG
PILOT HAND CNTRL

A17

CORE CC BAG
CC BAG #2 (ISS)
4 QUICK DON MASKS
HATCH TOOL

VOL D
(MD52C)

NOT INSTALLED

VOLUME F
(MD76M)

WET TRASH

VOLUME G
(MD80R)

CONT UCDS
WASTE MGMT

VOLUME H
(MD23R)

EVA ACCESS
(INBD)
EVA ACCESS
(OBD)

WMC
(MA82H)

TOWELS AND
RESUPPLY ITEMS
WMC DISPENSER
1st DAY CLOTH
1641-323

EXT AIRLOCK

2-EMUs
EXT A/L FLOOR
EMU BATTs (2)/ARMS
CCCs (4)/TETHERS
MINI WORKSTATION
EMU WATER PRCS KIT
LI-ION BATTs
EMU SERVICING KIT
SAFER HCM

MD CEIL (PORT 1) TBD

RSK-7
ACES

MD CEIL (PORT 2) TBD

IESL KIT

MD CEIL (STBD 1) TBD

RCC REPAIR KIT
EWA's
GEL BRUSH KIT's
B/U EVA HDRW/CVCG &
SIZING INSERTS
DIDB's/GLOVES

MD CEIL (STBD 2) TBD

DTV MUX & TOOLS
SPARE DSR-25 VTR
BACKUP C/L CAMERA

MD FLOOR (PORT 2) TBD

ISS RESERVE

MD FLOOR (PORT 1) TBD

EMPTY

MD FLOOR (STBD 2) TBD

* SPACEHAB DUCT
ERGOMETER SHOE BAG

MD FLOOR (STBD 1) TBD

2 MLE-IPT RESERVE
WATER SAMPLE COLL. KIT
ALSP
AMP

LIQH BOX (7435-101):
49 LIQH TOTAL + 1 ATCO
29 IN LIQH BOX
2 INSTALLED

SPACEHAB STOWAGE
18 LIQH
1 MLE CLOTHING: M/S #5 DN, ENTRY GARMENTS
1/2 MLE HYGIENE

WINDOW SHADE BAG - WINDOW SHADES
(5548-340)
IFM CABLES & HOSES (4259-337)
FILM CHANGE BAG (4828-303),
PANEL COVERS

L10A1: V10/AVIU/TAPES(6686-324)
L10A2: DTV
L11: PDIP 2
L11A2:A3 OIU PANELS
L12A1: SSP 1
L12A2: SSP 2
L12A3: PDIP 1
R12A1: VPU
R12A2: OPP/SPASP

* NOT APPROVED
L-24 LATE LOAD
TRANSFER HARDWARE
CARGO TRANSFER BAG
SWAP
HALF CARGO TRANSFER BAG

DWG NO. SGD32104439

CCFE: YVETTE CARMONA
(281) 483-3744

/USR/DWGS/LOCKER/STS116



STS-116 Delta Launch Site Flow Review

| | | |
|-----------|---------------------|--|
| Presenter | Amy Houts-Gilfriche | |
| Date | 08-10-06 | |

Modification Impact Report

- Mission Equipment Modifications and Orbiter Modifications analyzed for impacts to OMRSD, LCC, ICD, EMI, Software, and GSE.
- A total of 21 MCRs have been approved or are pending approval.
- Current MCR impact status:
 - No impacts for all six disciplines 13
 - One or more disciplines with impacts, documentation approved and/or pending approval 5



STS-116 Delta Launch Site Flow Review

| | | |
|-----------|---------------------|--|
| Presenter | Amy Houts-Gilfriche | |
| Date | 08-10-06 | |

Modification Impact Report (Cont'd)

- Possible impacts still under review 3
 - MCRs 18888, 19114, & 19343 are being reviewed for OMRSD impacts
 - MCR 19343 is being reviewed for GSE impacts

underlined MCRs have impacts in other disciplines



STS-116 Delta- LSFR

STS-301 LON LSFR

Flight Requirements Status

PRCB 8/10/06

Phyllis Grounds, MO3/Lead MIM
Frank Richmond, USA Flight Mgr.



| | | |
|-----------------------------------|---------------------------------|---------------|
| Flight Requirements Status | Presenter Frank Richmond | |
| | Date 8/7/06 | Page 2 |

- **Latest Revision: eFRD Revision 014, dated July 17, 2006**

- **No Open CRs**



| | | |
|--|----------------------------------|---------------|
| STS-116/12A.1 Requirements Status | Presenter Phyllis Grounds | |
| | Date 8/7/06 | Page 3 |

1. 12A.1 MIP (NSTS 21504)

- **Current version available on PILS: Revision B + Change 10, 6-27-06**
 - **Three open CR's, ECD 8/11/06:**
 - **21504-0051A Revise Table 4-3 Mated Attitude Requirements**
 - **21504-0053 SWAB Payload Requirements update,**
 - **21504-0054 Add the +(1) Energy Dependent Day**
 - **Pending MIP CR**
 - **Joint Mission Priorities updates**

2. Spacehab Single Module CIP (NSTS 21426), STS-116 Mission Unique Addendum

- **Current version available on PILS: Basic + Chg 1 – 55, 6/27-06**
 - **CR's in review: None**
- Pending CR's,**
Shuttle Booster Fan Bypass,
SSP Provided FCE GFE Table update.



STS-116/12A.1 Requirements Status-continued

Presenter

Date **8/7/06**

Page **4**

- **3. Integrated Cargo Carrier (ICC) Carrier Integration Plan (CIP) Addendum for STS-116 (NSTS 21448)**
 - **Current version avail. on PILS: CIP Basic, Chg 25, 3-29-06,**
 - **CRs in review: none**



| | | |
|--|--------------------|---------------|
| STS-116/12A.1 Requirements Status-continued | Presenter | |
| | Date 8/7/06 | Page 5 |

- **4. Payload Integration Plans**
 - **NSTS 21418 RMS Sideview Camera Integration Plan**
 - **Current Version avail on PILS: Basic-change 3 6/28/05**
 - **CR's in Review: None**

 - **NSTS 21516 Canister for All Payload Ejection/Internal Cargo Unit/Atmospheric Neutral Density Experiment (CAPE/ANDE)**
 - **Current Version avail on PILS: Basic-change 3, 6/1/06**
 - **CR's in Review: None**

 - **NSTS 21501 Microelectromechanical System-Based Pico-Satellite Inspector (MEPSI)**
 - **Current Version avail on PILS: Basic – change 8, 6/1/06**
 - **CR's in Review: None**

 - **NSTS 21526 Space Shuttle PICOSAT Launcher-5510 with STS-116 Addendum for RADAR Fence Transponder (RAFT)**
 - **Current Version avail on PILS: Basic – change 3, 6/1/06**
 - **CR's in Review: None**



| | | |
|---|--------------------|---------------|
| Launch On Need Crew Rescue Mission Integration Plan (MIP) Status | Presenter | |
| | Date 8/7/06 | Page 6 |

- **Launch On Need Crew Rescue (LONCR) Flight MIP, NSTS 21519, Rev. A Change 1, 7-25-05**
 - **No Open CR's under review.**
 - **CR's pending are TBD**



| | | |
|---|---------------------------------|---------------|
| STS-301 Flight Requirements Document | Presenter Frank Richmond | |
| | Date 8/7/06 | Page 7 |

- **Latest Revision: eFRD NSTS 17462-301, Revision 005, dated July 17, 2006**
- **Open CR's: none**



**STS-301 Requirements Summary
(Concluded)**

Presenter **Frank Richmond**

Date **8/7/06**

Page **8**

Payload Bay

- **Keel Yoke Assembly (KYA) to be removed**
- **Remove Aft Ballast excluding Boxes**
- **Install External Airlock Aft “B” Hatch**
- **Remove Tunnel Adapter Assembly (TAA) including Top “C” Hatch and Aft “D” Hatch**
- **Re-route EVA Safety Tethers currently routed to TAA**
- **Orbiter Docking System (ODS) changes to Configuration 1 from Configuration 3**
- **Install 2 Wireless Video System (WVS) Antennas at Xo = 1126**

Crew Compartment

- **LiOH quantity changes from 49 to 54 with all canisters stowed in middeck**
- **Middeck 5 MLE Stowage Bags change from 8 to 4 up/2 down**
- **Install Middeck Accommodations Rack (MAR)/LW**
- **Install Volume B**
- **Tools for Rendezvous & Docking (TRAD) changes to Conf. F from Conf. A**
- **Install LON Mission Kit (T.O. MO72-660932)-Recumbent Seat System**

STS-116/STS-301 Delta Launch Site Flow Review

Tom Stansel
Flight Software Element

PRCB 8/10/06

STS-116/STS-301 Delta LSFR (FSW)

- **STS-116/OV-103 is the Fourth Scheduled Flight of Operational Increment (OI) 30 Flight Software (FSW)**
- **STS-301 is the Rescue Mission for STS-115**
- **STS-116 Base 5 Products:**
 - **Shuttle Data Tape available in the field on August 21, 2006**
 - **Mass Memory available in the field on September 19, 2006**

STS-116/STS-301 Delta LSFR (FSW)

- **STS-301/OV-103 Deliveries (if needed) will consist of the STS-114 Base 3 SDT and Base 4 Mass Memory**
 - **Mandatory changes (including Flight Specific I-Loads) will be done post call-up**
 - **PRCB CR S063258A submitted to delete SSPTS FSW support requirement for STS-301**
 - **Approval pending**
- **Concern**
 - **No new concerns**
- **No FSW issues exist at this time that would impact launch site flow activities or flight.**

STS-116/STS-301 Delta LSFR (FSW) Backup

- **STS-116/OV-103 Flight Software Will Support the Following:**
 - ISS-12A.1
 - Orbiter Interface Unit (OIU)
 - Spacehab-Single Module (Shab-SM)
 - Sequential Still Video (SSV)
 - Orbiter Docking System (ODS)
 - Trajectory Control System (TCS)
 - Assembly Power Converter Units (APCUs)
 - Solid State Recorder (SSR)/Modular Memory Unit (MMU)
 - Orbiter Boom Sensor System (OBSS)
 - Remote Manipulator System (RMS)
 - ET Umbilical Well Digital Camera RTC Command Capability
 - Automatic Manifold Close for RCS Jet Failed- On
 - Space Test Program - H2 (STP- H2)
 - Improved MLG Wheel and Tire Assembly
 - Station-Shuttle Power Transfer System (SSPTS)

STS-116/STS-301 Delta LSFR (FSW) Backup

- STS-116 Base 5 will include the following Requirements for Primary Flight Software
 - DR 121191 - IPV Load/Store Problem on Discretes' Set/Resets may Cause Loss of Settings and Divergent Processing
 - DR 101072 - Immediate Moding Skipped
 - CR 92844A - Allow Uplink Change of AV Bay 3 Delta Pressure Parameter Scaling
 - CR 92871C - RCS Manifold Auto-Close for Failed-On Jet
 - CR 92872A - Make Cameras-Heater On Command Subject to RTC Moding
 - CR 92877A - RMS SPEC 94 Changes to Support Starboard Boom
 - CR 92879D - RMS Position Orientation Hold Select in Automatic Mode
 - CR 92887A - RCS Auto Manifold Close Enable/Disable via SPEC 23
 - CR 92889 - Remove Abort PE Engine-Out SSME Pitch Trim
 - CR 92894B - RMS Auto POHS MSID Change
 - CR 92899A - Correction CR to CR's 92871C and CR 92887A
 - CR 92900A - SPEC 23 Display Change for Auto-Manifold Close
 - CR 92909A - ET Camera Power Control Commands

STS-116/STS-301 Delta LSFR (FSW) Backup

- STS-116 Base 5 will include the following Requirements for Primary Flight Software (cont.)
 - CR 92920A - Eliminate Undesirable Roll Attitude Error Bias
 - CR 92922B - RCS Manifold Isolation Valve Close Command Timing Correction
 - CR 92950 - G/C Steer Roll Bias Ramp at PPD or MECO
 - SCR 93040A - Antenna Attitude Compensation Matrix Fix for DR 111696
 - SCR 93067A – SCR 93067A – Expand Effectivity of SCRs 92970B (SSPTS Computation and Display of Individual Fuel Cell Power) and 92982B (SSPTS Ground Uplink Commanding by RTC Moding) to include STS-116
- STS-116 Base 5 Patch implementation for Primary Flight Software
 - SCR 93028 - Expand Effectivity of SCR 92971D (RCO)
- STS-116 Base 5 Patch Implementation for Backup Flight Software
 - CR 92804A - Provide BFS Target Nz for Composite Display
 - CR 92889 - Remove Abort PE Engine-Out SSME Pitch Trim
 - CR 92909A - ET Camera Power Control Commands

BACKUP

- **Mod Record and MECSLSI Updates**
- **Engineering, Hardware and Certification Status**
- **Mandatory Mods - details**
- **Opportunity Mods - details**

Modification Records for STS-116 DLFSR Authorization

| MCR NO. | MCR TITLE | KIT/ MOD RECORD & DESCRIPTION | TECH ORDER IMPACT | REMARKS |
|-------------------------|--|--|---|---|
| Opportunity Mods | | | | |
| 23471 | <p><u>Booster Fan Bypass Duct for Spacehab</u> Airlock Booster Fan Bypass duct to be utilized for Cryo savings via power down of booster fan contributing to gaining an extra on-orbit day. Continued air flow exchange to the Spacehab to control humidity and CO2 requires the bypass duct to route cabin air around the non-operating fan. Bypass duct will be installed on-orbit by the crew and stowed in a middeck bag for launch and landing. This bypass duct will be installed with the Airlock Booster Fan Bypass previously established to provide conditioned air to the external airlock with the booster fan off (flown on STS-114 & STS-121). Should humidity and CO2 levels dictate, the booster fan and its ducting can be brought back on line, but with impact to the cryo savings.</p> | <p><u>023471.0002.0</u> - Adds airlock bypass duct for Spacehab missions.</p> | <p>M072-643405-002 (IS) -001 (WAS) MV0828A</p> | <p>MECSLSI Impact Note: Duct stowage configuration per CCCC to be addressed by Flight Crew Equipment.</p> |

Modification Records and MECSLSI Update Summary

Items Previously Baselined for STS-116

| MCR NO. | MCR TITLE | KIT/ MOD RECORD & DESCRIPTION | TECH ORDER IMPACT | REMARKS |
|-------------------------|--|---|---|--|
| Mandatory Mods | | | | |
| 19849 | New Seat 7 Recumbant Seat Kit (RSK) Rail Assembly Configuration The RSK 7 is being revised to remove the RSK 8 brackets in order to support the return of the Ergometer in the installed position and is required to avoid interference between the RSK 8 attach brackets and the Ergometer during stowage on return. | TCTIM0019849REF.0002.0 - RSK Seat 7 Config for Ergometer | M072-660865-010 (ADD) RSK Seat 7 Instl Model MV0865A | CCCD Mission Equipment item: M072-660865 D02 released 4/6/06 V865-000002 B01 released 4/7/06 |
| 19755 | RMS and OBSS MPM Guillotine Retention Fastener Mod Changes fasteners (4 ea per shoulder MPM and 3 ea for pedestal MPM) used to mount the wire harness guillotine with proper grip length fasteners to engage insert locking feature (OBSS and RMS). | 019755.0103.1 - Increase fastener length on MPM guillotine mounting bolts | M072-544501-087 (IS) -075 (WAS) MV0082A M072 -544505-013 (IS) -010 (WAS) MV0092A | MECSLSI Impact |
| Opportunity Mods | | | | |
| 17177 | ODS Vestibule Air Duct Strap Deletion Eliminates air duct retention strap from ODS vestibule duct which is no longer used or required. | TCTIM0017177REF.0002.0 - ODS Vestibule Air Duct Strap Deletion | M072-643406-005 (IS) -004 (was) ECLSS Duct - Ext Airlock Model MV0828A | MECSLSI Impact M072-634406 B05 rel'd 5/17/06 |
| 19546 | Inboard Elevon Tile Enhancement (Hub Tile Mod) Replaces 2 hub tiles on the inboard elevon area with a single, more robust tile / tile design (Attrition). | SUB-EO-19546.0103.0 - New Inbd Elevon Hub Tile (Substitution) | No Tech Order Impact | No MECSLSI Impact |
| 19735 | WLE Spar "Sneak Flow" Protection Implements partial deferral of remaining Non-RTF mandatory panels (1-4) | TCTIV1019735REF.0103.2 - Front Spar protect for sneak flow - Structures (Panels 1-4) TCTIV1919735REF.0103.2 - Front Spar protect for sneak flow - TPS/RCC (Panels 1-4) | No Tech Order Impact | No MECSLSI Impact |
| 19743 | BRI-18 TPS Hardening - MLG Door Implements TUFU-coated BRI tile on an attrition basis for the MLGD periphery tile locations. | SUB-EO-19743.0103.0 - MLGD TPS Hardening Substitution | No Tech Order Impact | No MECSLSI Impact |
| 19763 | Lower WLE Carrier Panel Horse Collar Gap Filler Redesign Implements partial deferral of remaining Non-RTF mandatory panels (1-4). | TCTIV1919763REF.0103.2 - WLE Horse Collar Redesign (Panels 1-4) | No Tech Order Impact | No MECSLSI Impact |
| 19755 | MPM Pyro Guillotine Cover Mod To Eliminate Interference Trim the OBSS and RMS Manipulator Positioning Mechanism (MPM) shoulder mechanism assembly guillotine cover (V082-544710) and cover bracket (V082-544705) and re-locate the bracket nutplate to eliminate interference between the lower outboard screw that attaches the guillotine cover and the MPM base directly above the deploy stop. | TCTIM0019755REF.0005.0 - RMS Shoulder MPM Cover Mod to eliminate interference. TCTIM0019755REF.0001.1 - OBSS Shoulder MPM Cover Mod to eliminate interference. | M072-544501-075 (IS) -063 (WAS) MV0082A M072 -544505-010 (IS) -007 (WAS) MV0092A | MECSLSI Impact M072-544501 D08 released 4/27/06 M072-544505 A08 released 4/27/06 |
| 19755 | RMS MPM Pedestal Over-Center Stops New Boeing stops to replace GFE stops on RMS MPMs (Shoulder, FWD, MID and AFT locations) due to potential that mission unique loads will exceed MPM over-center mechanism capability. | VK82-544010-003.0005.1 - OBSS MPM Pedestal Over-Center Stops | M072-544501-045 (IS) -027 (WAS) MODEL MV0082A | MECSLSI Impact |
| 19824 | MPM Pedestal Insulation Cover Fasteners Changes fasteners from a pan head screw/plain washer to a flush head screw/countersink washer to improve clearance between the PLBD Actuation Bellcrank and the RMS MPM Pedestal Insulation Cover at Xo911. | TCTIM0019824REF.0005.0 - Provide Improved Clearance with PLBD Bellcrank - RMS MPM Cover | M072-544501-063 (IS) -045 (WAS) MODEL MV0082A | MECSLSI Impact <i>Sequence issue if implemented prior to MCR 19755 RMS Over-Center Stop Mod</i> |

Modification Records and MECSLSI Update Summary

Items Previously Baselined for STS-116

| MCR NO. | MCR TITLE | KIT/ MOD RECORD & DESCRIPTION | TECH ORDER IMPACT | REMARKS |
|-------------------------|--|--|----------------------|---|
| Opportunity Mods | | | | |
| 19874 | BRI-18 TPS Hardening - Other Vehicle Areas Implements TUFF-coated BRI tile which is tougher than the current RCG-coated LI-2200 and FRCI-12 tiles. This MCR authorizes implementation on an attrition basis for the NLGD periphery, ET Door periphery, Window (1-6) carrier panels and lower LESS Carrier Panel locations. | SUB-EO-19874.0103.0 - NLG Door BRI-18 Hardening (SUBST) SUB-EO-19874.0103.1 - LESS Carrier Panel BRI-18 Hardening (SUBST) SUB-EO-19874.0103.2 - W1-6 Carrier Panel BRI-18 Hardening (SUBST) | No Tech Order Impact | No MECSLSI Impact |
| 23227 | Connector Saver Redesign Redesigned connector savers (ME414-0630) to reduce risk of inadvertent demate during use. Implementation at remaining unworked locations (OMS Pod and Ku-Band) as Opportunity. | VK70-795153-001.0103.1 - Vehicle Conn. Saver Redesign (Ku-Band) K598-430013-001.0011.1 & K598-430013-002.0011.1 - LP01 OMS Pod Conn. Saver Kits K598-430014-001.0023.1 & K598-430014-002.0023.1 - RP03 OMS Pod Conn. Saver Kits | No Tech Order Impact | No MECSLSI Impact |
| 23463 | Increase Torque on Window 7 Fasteners To CLASS II Increase in torque on overhead window 7 installation fasteners to preclude concern for window joint gapping. | TCTIV3123463REF.0103.0 - Increase Torque on Window 7 To CLASS II | No Tech Order Impact | No MECSLSI Impact |
| 19903 | Sky Genie Track Instl and AFD Overhead Closeout Panel Mod Changes the Sky Genie track installation fastener design to eliminate an interference / close proximity condition to wiring behind the overhead closeout panels. | TCTIV3319903REF.0103.0 - AFD Overhead Closeout Panel Mod VK70-660003-001.0103.0 - Sky Genie Track Instl Mod | No Tech Order Impact | No MECSLSI Impact Separate mod codes for the crew systems Sky Genie track work and the structures closeout panel work. |

Engineering, Hardware and Certification Status

| MCR NO. | MCR TITLE | Est. Engr Release (MM/DD/YY) | G.O. Engr Need (MM/DD/YY) | Est. Hdwe Delivery (MM/DD/YY) | G.O. Hdwe Need (MM/DD/YY) | MOD/CERT GO / NO-GO | CERT SUBMITTAL DATE | CERT APPROVAL DATE | CERTIFICATION CR / CAR (BOEING) | REMARKS |
|-------------------------|--|------------------------------|---------------------------|-------------------------------|---------------------------|---------------------|-------------------------------------|-------------------------------------|--|---|
| Mandatory Mods | | | | | | | | | | |
| 19849 | <u>New Seat 7 Recumbant Seat Kit (RSK) Rail Assembly Configuration</u> The RSK 7 is being revised to remove the RSK 8 brackets in order to support the return of the Ergometer in the installed position. This change is required to avoid interference between the RSK 8 attach brackets and the Ergometer during stowage for landing. The STS-116 crew is planning to have the one returning ISS crewmember's recumbent seat installed at the Seat 7 position. | Released | N/A | N/A (1) | N/A (1) | Go | 4/24/06 A | 5/21/06 A | CR 25-39129802-301B CAR 04-25-39129802-301B | OCRD S164974 authorizes STS-116 implementation. The STS-116 crew is planning to have the one returning ISS crewmember's recumbent seat installed at the Seat 7 position. (1) Hardware installed by tech order is delivered GFE CCCD Mission Equipment item: M072-660865-010 (ADD) (MV0865A) M072-660865 D02 rel'd 4/6/06 |
| 19755 | <u>MPM Guillotine Retention Fastener Mod</u> Fasteners (4 ea per shoulder MPM and 3 ea for pedestal MPM) used to mount the wire harness guillotine will be replaced with proper grip length fasteners to engage insert locking feature of the inserts. Resolves pre STS-121 issue where it was found that these fasteners are not of sufficient length and have minimal number (~2) of bolt threads engaged in the insert. | Released | N/A | N/A | N/A | Go | 7/11/06 A | 8/18/06 P | CAR 08-44-000002-001K | Corrective action resulting from pre STS-121 anomaly - affects both RMS & OBSS shoulder and pedestal MPMs. Note: These tech order configurations are built on top of the MPM Pyro Guillotine Cover Mod dash numbers. MECSLSI Mission Equipment Item M072-544501-087 (IS) , -075 (WAS) MV0082A M072 -544505-013 (IS), -010 (WAS) MV0092A |
| 23471 | <u>Booster Fan Bypass Duct for Spacehab</u> Airlock Booster Fan Bypass duct to be utilized for Cryo savings via power down of booster fan contributing to gaining an extra on-orbit day. To be installed on-orbit by the crew and stowed in a middeck bag for launch and landing. | 9/15/06 | TBD | 10/2/06 | 10/13/06 (10) | Go | 9/20/06 P | 11/1/06 P | CR 35-643500-002S CAR 17-35-643500-002S | OCRD S165114 app'd at 7/25/06 OCCB. (10) Hardware required for CEIT fitcheck scheduled for this date. MECSLSI Mission Equipment Item M072-643405-002 (IS) MV0828A M072-643405-001 (WAS) |
| Opportunity Mods | | | | | | | | | | |
| 17177 | <u>ODS Vestibule Air Duct Strap Deletion</u> Eliminates air duct retention strap from ODS vestibule duct which is no longer used or required. Strap was previously utilized for attaching the duct end in the ODS vestibule when the crew was present and to provide some mixing of air with ISS. To improve the air circulation with ISS, a new halo by-pass ducting configuration was developed which uses a T-handle clamp to attach the end of this duct to an ISS duct just below the Halo. With this configuration and the T-handle clamp, the velcro strap is not needed for duct securing. | Released | N/A | N/A | N/A | Go | N/A | N/A | N/A | OCRD S165051 approved for fleet - current plan for first effectivity is OV-104 STS-115. Tech order update removes existing strap - no new hardware. MECSLSI Mission Equipment item: M072-643406-005 (was -004) ECLSS DUCT-EXT AIRLOCK (MV0828A) |
| 19546 | <u>Inboard Elevation Tile Enhancement (Hub Tile Mod)</u> Replaces 2 hub tiles on the inboard elevation area with a single, more robust tile / tile design. | Released | N/A | N/A (4) | N/A | Go | 7/18/01 A | 9/26/01 A | CAR 25-07-190001-001U | (4) Parts to be fabricated at KSC |
| 19735 | <u>WLE Spar "Sneak Flow" Protection</u> Implements partial deferral of remaining Non-RTF mandatory panels (1-4) | Released | N/A | N/A (2) | N/A | Go | 10/6/04 A 10/6/04 A 10/6/04 A | 6/16/05 A 6/16/05 A 6/23/05 A | CR 08-199200-003T CAR 39-08-199200-003T CAR 146-05-100004-002J | (2) Hardware provided by KSC Back-Shop. |

Engineering, Hardware and Certification Status

| MCR NO. | MCR TITLE | Est. Engr Release (MM/DD/YY) | G.O. Engr Need (MM/DD/YY) | Est. Hdwe Delivery (MM/DD/YY) | G.O. Hdwe Need (MM/DD/YY) | MOD/CERT GO / NO-GO | CERT SUBMITTAL DATE | CERT APPROVAL DATE | CERTIFICATION CR / CAR (BOEING) | REMARKS |
|-------------------------|--|------------------------------|---------------------------|-------------------------------|---------------------------|---------------------|---|--|--|--|
| Opportunity Mods | | | | | | | | | | |
| 19743 | BRI-18 TPS Hardening - MLG Door Implements TUFU-coated BRI tile which is tougher than the current RCG-coated LI-2200 and FRCL-12 tiles. This MCR authorizes implementation on an attrition basis for the MLGD periphery tile locations. | Released | N/A | See Remarks (5) | See Remarks (5) | Go | 10/13/05 A 10/24/05 A 01/25/06 A 8/15/06 P | 5/03/06 A 5/03/06 A 5/03/06 A 9/26/06 P | CR 07-190001-001X CAR 28-07-190001-001X CAR 29-07-190001-001X CAR 30-07-190001-001X | (5) Current authorization provides 160 billets of BRI-18 material per vehicle & 50 containers of Tufu/Slurry under MCR 19743, which also will be used to cover attrition implementation under MCR 19874. As of July 2006, 320 of the 480 billets and 25 of the 50 containers of slurry have been delivered with remainder of deliverables to be shipped in increments thru September 2006. Will require billet allocation and final KSC backshop fabrication prioritization based on vehicle attrition needs. Certification noted is 2 mission limited cert. Full 17 mission cert to be submitted in August 2006 |
| 19763 | Lower WLE Carrier Panel Horse Collar Gap Filler Redesign Implements partial deferral of remaining Non-RTF mandatory panels (1-4) | Released | N/A | N/A (2) | N/A | Go | 10/6/04 A 10/6/04 A | 6/16/05 A 6/16/05 A | CR 08-199200-003T CAR 39-08-199200-003T | (2) Hardware provided by KSC Back-Shop. |
| 19755 | RMS MPM Pedestal Over-Center Stops New Boeing stops to replace GFE stops on RMS MPMs (Shoulder, FWD, MID and AFT locations) due to potential that mission unique loads will exceed MPM over-center mechanism capability | Released | N/A | Delivered | N/A | Go | 6/9/06 A | 6/13/06 A | CAR 08-44-000002-001K | The -003 replaces -001 stops. Requirement for new stops dependent upon flight specific loads analysis, completed late in the flow per loads analysis template. Due to sequencing issue, MCR 19824 needs to be worked with this mod. |
| 19755 | MPM Pyro Guillotine Cover Mod To Eliminate Interference Trims the OBSS and RMS Manipulator Positioning Mechanism (MPM) shoulder mechanism assembly guillotine cover and cover bracket and re-locates the bracket nutplate to eliminate interference between the lower outboard screw that attaches the guillotine cover and the MPM base directly above the deploy stop. The cover and cover bracket were trimmed and the bracket nutplate was re-located by MR for flight 32 (ref. PR MEQ-3-32-1596). | Released | N/A | N/A | N/A | Go | N/A | N/A | N/A | Note: Tech order sequence consideration - this tech order dash number will be built on top of MCR 19824 and MCR 19755 Over Center stop mod for the RMS side. MECSLSI Mission Equipment Item M072-544501-075 (IS) , -063 (WAS) MV0082A M072 -544505-010 (IS), -007 (WAS) MV0092A |
| 19824 | MPM Pedestal Insulation Cover Fasteners Changes fasteners from a pan head screw/plain washer to a flush head screw/countersink washer to improve clearance between the PLBD Actuation Bellcrank and the <u>RMS MPM</u> Pedestal Insulation Cover at Xo911 | Released | N/A | N/A (3) | N/A | Go | N/A | N/A | N/A | Engineering change at the tech order level. M072-544501 (RMS). Resequencing issue - new dash number built on top of OBSS/RMS over-center stop - needs to be worked with RMS over center stop mod to avoid resequence. (3) Parts (fasteners) available at KSC |

Engineering, Hardware and Certification Status

| MCR NO. | MCR TITLE | Est. Engr Release (MM/DD/YY) | G.O. Engr Need (MM/DD/YY) | Est. Hdwe Delivery (MM/DD/YY) | G.O. Hdwe Need (MM/DD/YY) | MOD/CERT GO / NO-GO | CERT SUBMITTAL DATE | CERT APPROVAL DATE | CERTIFICATION CR / CAR (BOEING) | REMARKS |
|-------------------------|--|------------------------------|---------------------------|-------------------------------|---------------------------|---------------------|-------------------------------------|------------------------------------|--|--|
| Opportunity Mods | | | | | | | | | | |
| 19874 | BRI-18 TPS Hardening - Other Vehicle Areas Implements TUF1-coated BRI tile which is tougher than the current RCG-coated LI-2200 and FRCI-12 tiles. This MCR authorizes implementation on an attrition basis for the NLGD periphery, ET Door periphery, Window (1-6) carrier panels and lower LESS Carrier Panel locations. | Released | N/A | See Remarks (5) | See Remarks (5) | Go | 3/06/06 A 3/06/06 A 8/15/06 P | 5/21/06 A 5/21/06 A 9/16/06P | CR 07-391001-001AB CAR 33-07-391001-001AB CAR 34-07-391001-001AB | NLG Door Portion of Mod (5) - Applies to all MCR 19874 material deliverables. Current authorization provides 160 billets of BRI-18 material per vehicle & 50 containers of Tufi/Slurry under MCR 19743, which also will be used to cover attrition implementation under MCR 19874. As of July 2006, 320 of the 480 billets and 25 of the 50 containers of slurry have been delivered with remainder of deliverables to be shipped in increments thru September 2006. Will require billet allocation and final KSC backshop fabrication prioritization based on vehicle attrition needs. Certification noted is 2 mission limited cert. Full 17 mission cert to be submitted in August 2006 |
| | | Released (6) | N/A | See Remarks (5) | See Remarks (5) | Go | 8/25/06 P | 10/6/06 P | CR 08-199200-003U CAR 40-08-199200-003U | Lower WLE Carrier Panel Portion of Mod (6) All 14 drawings including tree-up released. Cert submittal will cover full 17 flight certification - 'Go' implementation based on sequence of environment cycle testing completed - additional vehicle area specific analysis required prior to cert submittal. |
| | | Released (7) | N/A | See Remarks (5) | See Remarks (5) | Go | 9/8/06 P | 10/20/06 P | CR 07-391001-001AC CAR 35-07-391001-001AC | Window Carrier Panel Portion of Mod (7) All engineering released 7/28/06 due to ground ops request for re-prioritization. Cert submittal will cover full 17 flight certification - 'Go' implementation based on sequence of environment cycle testing completed - additional vehicle area specific analysis required prior to cert submittal. |
| | | 11/28/06 (8) | TBD | See Remarks (5) | See Remarks (5) | No Go (8) | ~12/21/06 P | ~1/12/07 P | CR 07-395001-001 W CAR 28-07-395001-001W | ET Door Perimeter Portion of Mod (Likely not ready for STS-116) (8) Requires build of 4 test arrays in support of ice impact testing at SWRI scheduled for Oct 2006. Effort approved at 5/17/06 OCCB - approved OCRD received 5/31/06. Engineering release consists of 2 working level drawings and 1 tree-up and will commence dependent upon testing results. |

Engineering, Hardware and Certification Status

| MCR NO. | MCR TITLE | Est. Engr Release (MM/DD/YY) | G.O. Engr Need (MM/DD/YY) | Est. Hdwe Delivery (MM/DD/YY) | G.O. Hdwe Need (MM/DD/YY) | MOD/CERT GO / NO-GO | CERT SUBMITTAL DATE | CERT APPROVAL DATE | CERTIFICATION CR / CAR (BOEING) | REMARKS |
|-------------------------|---|------------------------------|---------------------------|-------------------------------|---------------------------|---------------------|-------------------------------------|-------------------------------------|--|---|
| Opportunity Mods | | | | | | | | | | |
| 23227 | Connector Saver Redesign Redesigned connector savers (ME414-0630) provide proper interfacial seal and wavy washer engagement retention force to reduce risk of inadvertent demate during use. Implementation at remaining unworked locations (OMS Pod and Ku-Band) as Opportunity | Released | N/A | N/A | N/A | Go | 10/11/05 A 10/11/05 A | 3/17/06 A 3/17/06 A | CR 21-770000K CAR 08-21-770000K | |
| 23463 | Increase Torque on Window 7 Fasteners To Class 2 Increase in torque on overhead window 7 installation fasteners to preclude concern for window joint gapping based on updated stress analysis. Fasteners were brought up to the class 2 torque range by MR during the flight 32 flow. | Released | N/A | N/A | N/A | Go | 6/16/06 A | 8/8/06 P | CAR 27-07-390001-001N | Two flight cert dev covering CFD analysis updates and implementation of associated flight restrictions as well as window gapping analysis updates and fastener torque increase. Long term cert to be submitted upon completion of remaining certification analysis. |
| 19903 | Sky Genie Track Instl and AFD Overhead Closeout Panel Mod Mod changes the Sky Genie track installation fastener design from a screw / nutplate design to a stud design which will have the threaded stud installed in the reverse direction to eliminate an interference / close proximity condition of the screw shank & nutplate to wiring behind the closeout panels | Released | N/A | See Remarks (9) | See Remarks (9) | Go | 7/17/06 A 7/10/06 A 7/10/06 A | 8/28/06 P 8/28/06 P 8/28/06 P | CAR 146-04-331002H CR 25-660007-001R CAR 07-25-660007-001R | All engineering released on 7/10/06. (9) Doubler hardware fabrication at HDFF completed 7/6/06. ~ 3 week turnaround to mod existing vehicle tracks at HDFF upon receipt from KSC. OCCRD S165099 app'd at 6/13/06 OCCB. |



STS-116 Delta LSFR
Flight Crew Equipment/GFE

| | |
|--------------------------------------|--------|
| Presenter MV5/Bruce Sauser | |
| Date Aug. 1, 2006 | Page 1 |

Changes since LSFR

- No changes to Flight Crew Equipment (FCE) or Government Furnished Equipment (GFE) since the STS-116 LSFR.

Open certifications scheduled to be completed prior to OPF rollout

Tracking no other significant issues that may result in failure to deliver or complete certification of hardware

- KSC and JSC continue to partner need dates and delivery dates



EVA Status

STS-116/12A.1

Delta Launch Site Flow Review

XA/John Raines

Johnson Space Center

August 1, 2006

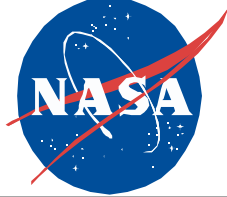

- **No PFR Sill Stack**

- **Bulkhead PFR, SED33105308-307**
 - Bulkhead PFR installation – Tech Order: M072-661568-029

- **Port TSA (Lightweight)**
 - Port LWTSAs installation – Tech Order: M072-660850-005
 - This T/O clarifies rigging instructions
 - Next revision of ESEL will reflect this change
 - Port LWTSAs Tools installation – Tech Order: M072-660853-002

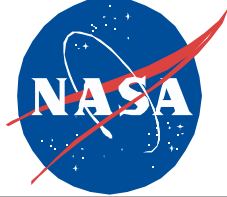

- **No Starboard TSA**

- **Port Slidewire**
 - Slidewire installation – Tech Order: M072-544700-016

- **Safety Tether Routing**
 - Tether Reel Box installation – Tech Order: M072-661618-002
 - Safety Tether Routing to Slidewire – Tech Order: M072-661618-015



Backup Chart STS-301 EVA Tools Status – STS-116 ΔLSFR

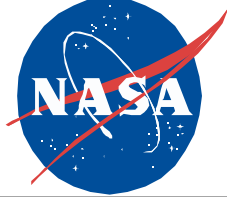

- **No PFR Sill Stack**

- **Bulkhead PFR, SED33105308-307**
 - Bulkhead PFR installation – Tech Order: M072-661568-029

- **Port TSA (Lightweight)**
 - Port LWTSA installation – Tech Order: M072-660850-005
 - Port LWTSA Tools installation – Tech Order: M072-660853-002
 - No Tile Repair Kit
 - First flight of this dash number is on STS-121

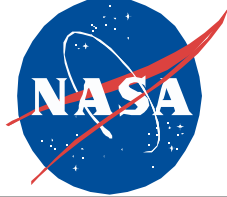

- **No Starboard TSA**

- **Port Slidewire**
 - Slidewire installation – Tech Order: M072-544700-016
 - Incorporation of new forward thermal cushion

- **Safety Tether Routing**
 - Tether Reel Box installation – Tech Order: M072-661618-003
 - Safety Tether Routing to Slidewire – Tech Order: M072-661618-014

Discovery STS-116
Delta Launch Site Flow Review
Space Shuttle Main Engine
10-August-2006

SSME- KSC
Greg Haile
(321) 861-4060

98 of 128



STS-116 Delta Launch Site Flow Review

SSME Allocations / Locations

ENGINES BASELINED
NO CHANGES

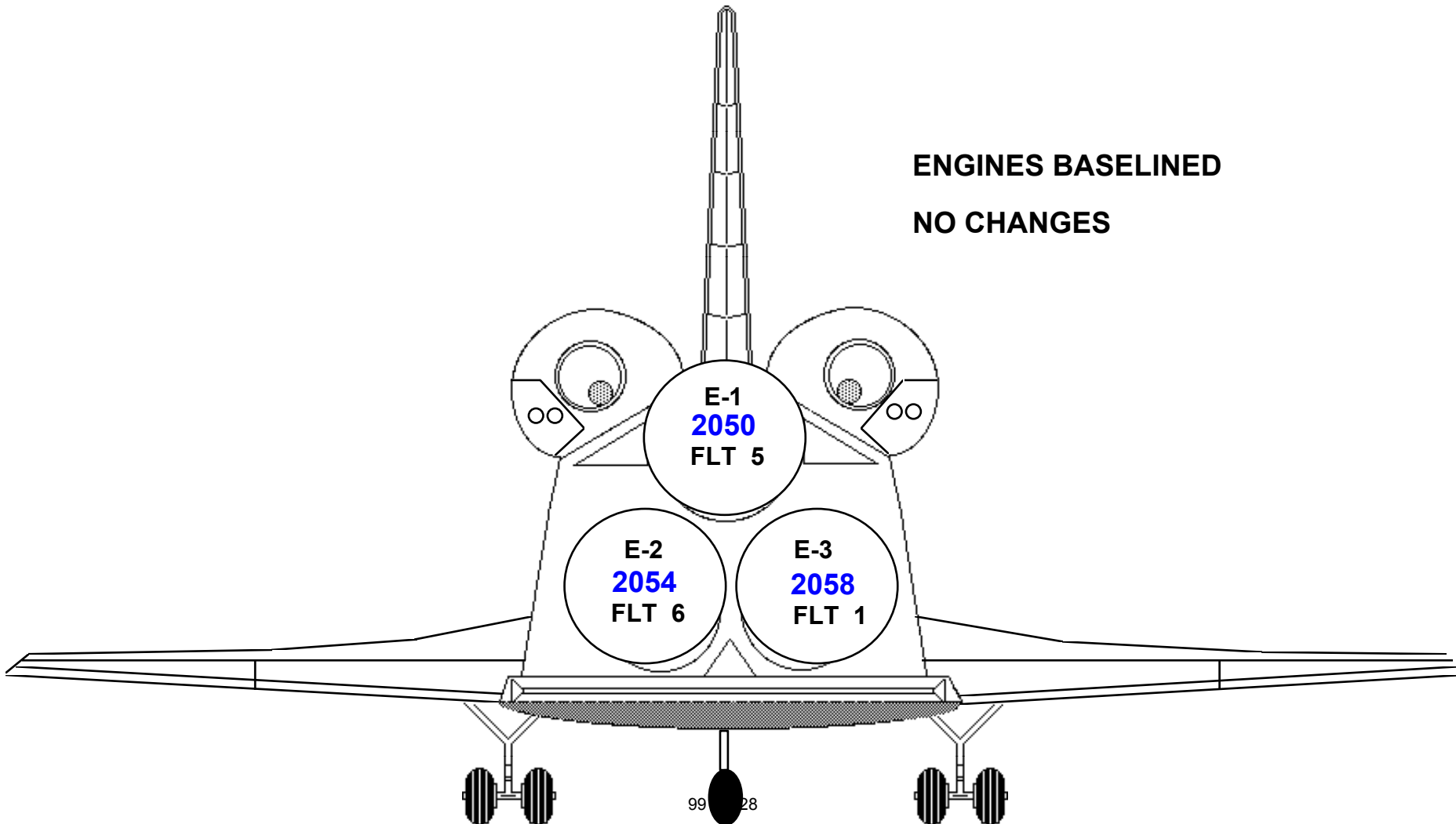



STS-116 Delta Launch Site Flow Review

SSME Planned Modifications

- Work authorized by Shuttle Project Action Request (SPAR) or Level II Change Request (CR)

| ECP | Kit No | Description | Weight Impact | SPAR No./ CR No. | Engine | Status |
|--------|-------------|-----------------------|---------------|----------------------------|--------------|--------------------|
| 1379 | 2R091522-10 | MFV Install | +0 LB | ME-0208 R02 | 2050 | Complete |
| 1414 | 2R091543-10 | HPFTP Mass Prop | +0 LB | ME-0208 R08 | 2050 | Complete |
| 1431 | 2R091545-10 | LAI Redesign | +0 LB | ME-0208 R17 | 2050 | Complete |
| 1439 | 2R091548-10 | HPFTP 1-Piece Sensor | +0 LB | ME-0208 R22 | 2050 | Complete |
| 1440R2 | 2R091544-10 | Frac Crit Bolts | +0 LB | ME-0208 R22 | 2050 | Complete |
| 1473 | 2R091567-10 | Incorp -19 Controller | +0 LB | ME-0208 R19 | 2050 | Complete |
| 1477 | 2R091569-10 | LAI Covers | +0 LB | ME-0208 R21 ME-0217 R01 | 2050 2054 | In-Work In-Work |
| 1491 | 2R091576-10 | Clamping Fasteners | +0 LB | ME-0208 R23 | 2050 | Complete |
| 1507 | 2R091599-10 | LAI Tape Req'ts | +0 LB | ME-0217 R02 ME-0219 B | 2054 2058 | In-Work In-Work |

100 of 128



STS-116 Delta Launch Site Flow Review

Rocketdyne Action Requests (RAR)

| RAR | Title | Engine(s) | SPARs / CRs | Status |
|----------|--|-----------|-------------|----------|
| KLO-1480 | Inspect HPFTP Speed Sensor RTV/LAI. | 2050 | ME-0208 B | Complete |
| KLO-1481 | Inspect LPFTP Kevlar Insulation. | 2050 | ME-0208 R01 | Complete |
| KLO-1488 | Ultrasonically Inspect Main Injector Row 13 LOX Posts | 2050 | ME-0208 R03 | Complete |
| KLO-1490 | Inspect LPOTP Inducer for ripples/waviness. | 2050 | ME-0208 R04 | Complete |
| KLO-1492 | Allocate LPOTP. | 2050 | ----- | Complete |
| KLO-1494 | Borescope Inspect Nozzle Aft Manifolds. (Unit 4026, currently installed on E2050, was installed on E2048 at time of inspection) | 2050 | ME-0205 R06 | Complete |
| KLO-1495 | Borescope Inspect Nozzle Heat-Shield Ring Interface Areas (ponyfoot). | 2050 | ME-0208 R05 | Complete |
| KLO-1498 | Inspect LPFTP & LPOTP Inlet Areas (BSTRA FOD issue). | 2050 | ME-0208 R06 | Complete |
| KLO-1499 | Borescope Inspect Nozzle Mixer Bowl. | 2050 | ME-0208 R07 | Complete |



STS-116 Delta Launch Site Flow Review

Rocketdyne Action Requests (RAR)

| RAR | Title | Engine(s) | SPARs / CRs | Status |
|------------------------|---|-----------|----------------------------|----------|
| KLO-1500 | Borescope Inspect Fuel Preburner Manifold. | 2050 | ME-0208 R07 | Complete |
| KLO-1503 | Baseline OMRSD 10-Start Leak Checks and LPFTP Disc Duct Ovality Checks. | 2050 | ME-0208 R09 | TBD |
| KLO-1511 | Photograph HPFTP LAI. | 2050 | ME-0208 R09 | Complete |
| KLO-1513 | Remove HPOTP & Ship to West Palm Beach. | 2050 | S060877P | Complete |
| KLO-1514 | Remove LPFTP Discharge Duct. | 2050 | S060878L | Complete |
| KLO-1515 | Remove Controller & Ship to Honeywell. | 2050 | S071807J | Complete |
| KLO-1520 | Inspect POGO Accumulator Lines. | 2050 | ME-0208 R11 | Complete |
| KLO-1526 KLO-1526R1 | X-Ray Nozzle (Braze Void issue). | 2050 | ME-0208 R12 ME-0208 R15 | Complete |
| KLO-1531 | Inspect Bolts at Joints N2.4, N8, N9, & O7.1. | 2050 | ME-0208 R13 | Complete |



STS-116 Delta Launch Site Flow Review

Rocketdyne Action Requests (RAR)

| RAR | Title | Engine(s) | SPARs / CRs | Status |
|------------------------|---|--------------|--------------------------|----------|
| KLO-1536 KLO-1536R1 | Borescope Inspect LPOTP Disc Ducts (weld issue). | 2050 | ME-0208 R14 | Complete |
| KLO-1537 | Weigh Engines. | 2050 | ME-0208 R16 | TBD |
| KLO-1543 | Inspect Gimbal Bushings. | 2050 | S060983P | Complete |
| KLO-1547 | Inspect HEX Inlet & Outlet. | 2050 | SR2753 | Complete |
| KLO-1551 | Inspect HPFTP Turbine Bellows Outer Heatshield & H-Ring (post STS-114). | 2054 | ----- | Complete |
| KLO-1552 | Dye Penetrant Inspect HPFTP Speed Sensor (post STS-114). | 2054 | ME-0217 B | Complete |
| KLO-1554 | Measure HPFTP LAI Thickness. | 2050 2054 | ME-0208 R20 ME-0217 B | Complete |
| KLO-1555 | Allocate HPOTP. | 2054 | ----- | Complete |
| KLO-1558 | Allocate HPOTP & LPOTP. | 2050 | ----- | Complete |
| KLO-1562 | Fit Check LAI Boots on Fuel System Ducts. | 2050 | ME-0208 R24 | Complete |
| KLO-1563 | Reallocate Controller from E2057 to E2054. | 2054 | ----- | Complete |

105 of 126

STS-116 Delta Launch Site Flow Review

ISS Mission 12A.1

- ITS P5 TRUSS
- SPACEHAB Single Module
- ICC
 - 3 Stacks of Service Module Debris Panels
 - SMDP Adapter
 - STP-H2 PICO Satellite Launcher
 - PFRAM

Deborah Hahn
Mission Manager
KSC ISS/Payload Processing
Aug 10, 2006



Payload Processing Milestone Summary

ISSUES and CONCERNS

- Aggressive pad schedule from payload arrival through closing P/L bay doors prior to Thanksgiving.

The KSC STS-116 ISS/Payload Processing Team is ready to process the 12A.1 Mission payload complement.



Payload Processing Milestones

PRE-SHUTTLE PLANNED INTEGRATION ACTIVITIES

Space Station Processing Facility

- ITS P5
 - Final P5 Assembly & Integration on-going through 09-11-06
 - P5 Closeouts 09-11-06
 - Final P5 Wt & CG and Transfer to Canister 10-31-06

- ICC delivery to SSPF 10-23-06
 - ICC transfer to Canister 10-25-06

- SPACEHAB Module delivery to SSPF 11-01-06
 - SPACEHAB Module transfer to Canister 11-02-06



Payload Processing Milestones

SHUTTLE PLANNED INTEGRATION ACTIVITIES

Orbiter Processing Facility

- APCU IVT 08-29-06 (U/R)
- Install ICC-KYA 09-28-06 (U/R)

PAD

- PAYLOAD TRANSFER TO PAD 11-13-06
- PAYLOAD INSTALLED INTO ORBITER 11-17-06
- SPACEHAB MODULE ORBITER IVT Start (2 days) 11-21-06
- SPACEHAB EARLY STOW (MVAK) 12-04-06
- SPACEHAB LATE STOW (MVAK) Start 12-12-06
- LAUNCH (N.E.T.) 12-14-06



BACK UP



Configuration / Facilities

- OV-103: Flight 33
- OMS Pods: LP01 / RP03
- ET: 123
- SRB: BI – 128
- SSME: 2050 (#1), 2054 (#2), 2058 (#3)
- Payload: Spacehab
- Flight Software: OI-30
- Firing Room: 3
- OPF Bay: 3
- MLP: 1
- VAB High Bay: 3
- Pad: B

| MCR/ECP | STAT | ITEM/KIT NUMBER | SEQ | DESCRIPTION / GENERAL REMARKS | PRCB | PRIOR |
|---------|-------------|-----------------|----------|---|--------------------------|-------------|
| ----- | SITE | TCTI NUMBER | EISN NO. | ----- | AUTHDATE | FLT |
| 017177 | PLND KSC | TCTIM0017177REF | 0002 000 | ODS VESTIBULE AIR DUCT STRAP DELETION ADDED PER V828-000002 F11, REPLACES 017177,0002,0. APP'D AT STS-116 LSRR- OPPORTUNITY MOD | S115116N 2006-06-06 | OPTY 033 |
| 019755 | AUTH KSC | TCTIM0019755REF | 0001 001 | MPM PYRO GUILLOTINE COVER MOD TO ELIM INTERFERENCE, MV0092A ADDED BY EDS I/F & V092-000002 A09. REPLACES 01975 5,0001,0- OPPORTUNITY MOD | S115116N 2006-06-06 | OPTY 033 |
| | AUTH KSC | TCTIM0019755REF | 0005 000 | MPM PYRO GUILLOTINE COVER MOD TO ELIM INTERFERENCE, MV0082A ADDED BY EDS I/F & V082-000002 E09. REPLACES 01975 5,0005,0- OPPORTUNITY MOD | S115116N 2006-06-06 | MAND 033 |
| | AUTH KSC | VK82-544010-003 | 0005 001 | OBSS MPM PEDESTAL OVER-CENTER STOPS ADDED PER EO V092-544254 NEW. (REPLACES VK82-5440 10-001, 0005,0). E/I 7 -1 KIT FLYING ON STS-114 | S115116N 2006-06-06 | MAND 033 |
| | AUTH KSC | 019755 | 0103 001 | INCREASE FASTENER LENGTH ON MPM GUILLOTINE MOUNTING BOLTS ADDED PER E. BURKE REQUEST FOR STS-116 LSFR. MAY BE MV0082A/MV0092A | S115116NR1 2006-07-11 | MAND 033 |
| 019760 | PLND JSC | TCTIM6619760REF | 0002 000 | RECUMBENT SEAT KIT (RSK) SEAT 8 RAIL ASSY ALIGNMENT ADDED PER V865-660002 NEW/PENDING VERIFICATION. POTENTIAL LON REQMT | S063027P 2004-05-13 | MAND 033 |
| 019824 | AUTH KSC | TCTIM0019824REF | 0005 000 | IMPROVED CLEARANCE W/PLBD BELLCRANK-RMS MPM COVER FASTENER ADDED PER EO V082-000002 E08. E/I 7 HDWE WAS PARTI ALLY MODIFIED & USED/FLOWN ON OV-103 OBSS MPM | S115116N 2006-06-06 | MAND 033 |
| 019849 | AUTH JSC | TCTIM0019849REF | 0002 000 | NEW SEAT 7 RAIL ASSY CONFIG W/ATTACH BRACKETS REMOVED ADDED PER SED39129808 B04 | S115116N 2006-06-06 | MAND 033 |

TOTAL MODS =

8

| MCR/ECP | STAT | ITEM/KIT NUMBER | SEQ | DESCRIPTION / GENERAL REMARKS | PRCB AUTHDATE | PRIO FLT |
|---------|------|-----------------|----------|---|---------------|----------|
| ----- | SITE | TCTI NUMBER | EISN NO. | ----- | ----- | ----- |
| | AUTH | J5338 | 0024 009 | OMS POD ACCESS DOOR INSPECTION | OMS-0034B | SCHD |
| | KSC | | SPAR | RP04-28 | 2000-07-21 | 028 |
| 023227 | AUTH | K598-430013-001 | 0011 001 | KIT-CONNECTOR SAVER REDESIGN, LP01 OMS POD, (W/W -002) | S115116N | OPTY |
| | KSC | NOT REQUIRED | | ADDED BY EDS I/F & V070-430007 B07. DEFERRED FROM STS-121, OV-103/32.OPPORTUNITY MOD | 2006-06-06 | 036 |
| | AUTH | K598-430013-002 | 0011 001 | MODIFICATION KIT - CONNECTOR PROTECTOR REDESIGN, (W/W -001) | S115116N | OPTY |
| | KSC | NOT REQUIRED | | ADDED BY EDS I/F & K598-430013 A01. OBTAIN PARTS F ROM VK70-795153. DEF'D FROM STS-121, 4/21/06 DAILY | 2006-06-06 | 036 |
| | DEFR | K598-430013-002 | 0011 000 | MODIFICATION KIT - CONNECTOR PROTECTOR REDESIGN | | OPTY |
| | KSC | NOT REQUIRED | | ADDED BY EDS I/F & K598-430013 A01. OBTAIN PARTS F ROM VK70-795153. DEF'D FROM STS-121, 4/21/06 DAILY | | 033 |
| | AUTH | K598-430014-001 | 0023 001 | KIT-CONNECTOR SAVER REDESIGN, RP03 OMS POD, (W/W -002) | S115116N | OPTY |
| | KSC | NOT REQUIRED | | ADDED BY EDS I/F & V070-430010 A93. DEFERRED FROM STS-121 PER 4/21/06 DAILY. | 2006-06-06 | 034 |
| | AUTH | K598-430014-002 | 0023 001 | MOD KIT CONNECTOR PROTECTOR REDESIGN, (W/W -001) | S115116N | OPTY |
| | KSC | NOT REQUIRED | | ADDED BY EDS I/F & K598-430014 A01. OBTAIN PARTS F ROM VK70-795153. DEF FROM STS-121 4/21/06 DAILY | 2006-06-06 | 034 |

TOTAL MODS = 6

| MCR/ECP | STAT SITE | ITEM/KIT NUMBER TCTI NUMBER | SEQ EISN NO. | DESCRIPTION / GENERAL REMARKS | PRCB AUTHDATE | PRIOR FLT |
|---------|--------------|--------------------------------|------------------|--|----------------------------|--------------|
| ----- | COMP KSC | J5636 | 0105 000 SPAR | MODAL IMPULSE GROUND TEST TO DETERMINE FLEXLINE CHARACTERIST ICS AND VALIDATE STRUCTURAL MODELS | ORB-0066 R16 2003-07-22 | MAND 020 |
| | PLND KSC | J5677A | 0105 000 SPAR | VENDOR NDE INSPECTION & BASELINING OF RCC CHIN PANEL ASSEMBLIES AND OV-104 NOSE CAP | ORB-0066R17 2003-11-06 | MAND 020 |
| | AUTH KSC | J5881A | 0103 000 SPAR | LOWER LESS ACCESS CARRIER PANEL POST FLT TORQUE CK VERIF | ORB-0075R10 2006-06-05 | MAND 033 |
| | AUTH KSC | J5883 | 0103 001 SPAR | HUB AND DRAIN HOLE TILE MANUAL DEFLECTION TEST | ORB-0075R01 2005-08-16 | MAND 033 |
| | AUTH KSC | J5884 | 0103 001 SPAR | THERMAL BARRIER FLOW PATH INSPECTIONS | ORB-0075R02 2005-08-16 | MAND 033 |
| | AUTH KSC | J5885 | 0103 001 SPAR | ARROWHEAD TILE INSPECTION | ORB-0075R03 2005-08-16 | MAND 033 |
| | AUTH KSC | J5897 | 0103 001 NSW | MID FUSELAGE SAMPLING AND FASTENER REPLACEMENT | S052923UZ 2005-06-09 | MAND 033 |
| | PLND KSC | J5906A | 0103 001 SPAR | STS-121 PAYLOAD CLOSE CLEARANCE REQUIREMENTS PER FRANK DILELLO: PERFORM POST FLT INSPNS. | ORB-0068R43 2006-03-10 | MAND 033 |
| | AUTH KSC | J5919B | 0103 001 SPAR | 0-GAUGE PROTECTION FOR OV-103 FLIGHT 32-35 AND OV-104 FLIGHT 27-30 | ORB-0075R06 2005-11-09 | MAND 033 |
| | AUTH KSC | J5925 | 0103 001 SPAR | OV-103 BODY FLAP (BF) POWER DRIVE UNIT (PDU) GEARBOX FLUID LEVEL INSPECTION | ORB-0075R05 2005-09-01 | MAND 033 |
| | AUTH KSC | J5930B | 0103 001 NSW | ORBITER STRUCTURE IML SURFACE CORROSION SAMPLING INSPECTION | S052923WQ 2006-02-10 | MAND 033 |
| | PLND KSC | J5959A | 0103 000 SPAR | RJD REMOVAL AND INSTALLATION ON OV-103 | ORB-0075R09 2006-06-05 | MAND 033 |
| | PLND KSC | J5988A | 0103 000 SPAR | SRMS WIRELESS STRAIN GAUGE INSTRUMENTATION SYSTEM (WSGIS) CHIT J5988A SUPPLEMNTS J5988 FOR ADD'L RMS WORK | ORB-0075 R08 2006-05-31 | MAND 033 |
| | PLND KSC | J6087 | 0103 000 SPAR | INSPECTION BOOM ASSEMBLY (IBA) POST FLIGHT INSPECTION | ORB-0075R07 2006-05-26 | MAND 033 |
| | AUTH KSC | J6103 | 0103 000 SPAR | POST FLIGHT VERNIER THRUSTER PC TUBE FLUSH | ORB-0075 R11 2006-06-20 | MAND 033 |
| | AUTH | J6104 | 0103 000 | POST FLIGHT AMES GAP FILLER VERIFICATION AND PULL TESTING | ORB-0075R25 | MAND |

| | | | | | | |
|------|--------|----------|---|--|-------------|------|
| KSC | | SPAR | | | 2006-08-01 | 033 |
| PLND | J6105A | 0103 000 | MPS GHE REG OUT CHECK VALVE X-RAY INSPECTION | | ORB-0075R22 | MAND |
| KSC | | SPAR | | | 2006-07-27 | 033 |
| AUTH | J6106 | 0103 000 | ASA #2 AND #4 AND ATVC #1 AND #2 R&R FOR OV-103, FLT 33 | | ORB-0075R24 | MAND |
| KSC | | SPAR | | | 2006-08-01 | 033 |

| MCR/ECP | STAT | ITEM/KIT NUMBER | SEQ | DESCRIPTION / GENERAL REMARKS | PRCB | PRIO |
|---------|-------------|---------------------------------|------------------|---|----------------------------|-------------|
| ----- | SITE | TCTI NUMBER | EISN NO. | ----- | AUTHDATE | FLT |
| | AUTH KSC | J6108 | 0103 000 SPAR | DIGITAL UMBILICAL CAMERA DATA CABLE TEST | ORB-0075R12 2006-06-28 | MAND 033 |
| | AUTH KSC | J6110 | 0103 000 SPAR | WSB PGME/WATER LOADING FOR STS-116 (OV-103 FLT 33) | ORB-0075R13 2006-06-28 | MAND 033 |
| | AUTH KSC | J6111 | 0103 000 SPAR | MC284-0469-0027 HYDRAULIC TVC ISOLATION VALVE X-RAYS | ORB-0075R14 2006-06-28 | MAND 033 |
| | PLND KSC | J6112A | 0103 000 SPAR | REMOVAL OF OV-103 WINDOWS THERMAL PANE 1 THROUGH 6 AND REPLA CE THEM WITH REFURBISHED WINDOW ASSEMBLIES FOR STS-116 | ORB-0075R19 2006-07-25 | MAND 033 |
| | PLND KSC | J6115 | 0103 000 SPAR | MICRO INSPECTION OF SMALL WIDTH AFRSI BLANKETS | ORB-0075R23 2006-07-27 | MAND 033 |
| | PLND KSC | J6117A | 0103 000 SPAR | INSPECTION OF PUTTY REPAIRS FOR POTENTIAL LOSS | ORB-0075R21 2006-07-26 | MAND 033 |
| | AUTH KSC | J6118 | 0103 000 SPAR | EXTERNAL TANK (ET) DOOR PAINT STRIPE POSTFLIGHT VERIFICATION | ORB-0075 R17 2006-07-19 | MAND 033 |
| | PLND KSC | J6120 | 0103 000 SPAR | POSTFLIGHT DAMAGE 3-D ACQUISITION | ORB-0075R18 2006-07-19 | MAND 033 |
| | PLND KSC | J6122A | 0103 000 SPAR | POSTFLIGHT THERMOGRAPHY INSPECTION ON RCC CHIT SUPERSEDES BASIC IN ENTIRETY. | ORB-0075R15 2006-07-10 | MAND 033 |
| | AUTH KSC | J6124A | 0103 000 SPAR | MAGR-S3S LINK-007 FIRMWARE UPGRADE | ORB-0075R16 2006-07-19 | MAND 033 |
| | PLND KSC | J6133 | 0103 000 SPAR | REMOVAL AND REPLACEMENT OF OV-103 GPC # 5 BBU | ORB-0075R20 2006-07-26 | MAND 033 |
| | PLND KSC | J6143 | 0103 000 SPAR | OV-103 RMS WRIST CAMERA REMOVAL | ORB-0075R26 2006-08-01 | MAND 033 |
| 011621 | AUTH KSC | TCTIV3511621REF NOT REQUIRED | 0103 002 | CORRECT GROUNDING STRAPS/FIBROUS BATT INSUL REQMTS - EOTF ADDED BY EDS I/F & V070-363200 C03 | S115116NR1 2006-07-11 | MAND 033 |
| 019476 | AUTH KSC | TCTIV1019476REF NOT REQUIRED | 0103 001 | IMPROVED MLG TIRE AND WHEEL ASSEMBLY ADDED BY EDS I/F & V070-656121 B03. V070-100001 M0 9 CHGD FROM FLT 33 TO 32 | S115116NR1 2006-07-11 | MAND 033 |
| 019735 | AUTH KSC | TCTIV1019735REF | 0103 002 | WLE FRONT SPAR PROT FOR SNEAK FLOW - STR (PNLS 1-4) SEE SEQ 0 FOR PANELS 5-13, SEQ 1 FOR PNLS 14-22 OV -103/32; PNLS 1-4 DEFERRED | S115116N 2006-06-06 | OPTY 033 |

| | | | | | | | |
|--------|------|-----------------|------|-----|---|------------|------|
| | AUTH | TCTIV1919735REF | 0103 | 002 | FRONT SPAR PROTECT FOR SNEAK FLOW (TPS/RCC), PNLs 1-4 | S115116N | OPTY |
| | KSC | | | | SEE SEQ 0 FOR PANELS 5-13, STS-114. PNLs 14-22 OV-103/32. | 2006-06-06 | 033 |
| | | | | | PNLS 1-4 DEFERRED - OPPORTUNITY MOD | | |
| 019763 | AUTH | TCTIV1919763REF | 0103 | 002 | WING LEADING EDGE HORSE COLLAR REDESIGN, (PNLS 1-4) | S115116N | |
| | KSC | | | | SEE SEQ 0 FOR PNLs 5-13, SEQ 1 FOR PNLs 14-22 OV-1 03/32. | 2006-06-06 | 033 |
| | | | | | PNLS 1-4 REMAINING- OPPORTUNITY MOD | | |

| MCR/ECP | STAT | ITEM/KIT NUMBER | SEQ | DESCRIPTION / GENERAL REMARKS | PRCB | PRIO |
|----------|------|-----------------|----------|--|------------|------|
| ----- | SITE | TCTI NUMBER | EISN NO. | ----- | AUTHDATE | FLT |
| 019903 | AUTH | TCTIV3319903REF | 0103 000 | SKY GENIE AFD OVERHEAD CLOSEOUT PANEL MOD | S115116NR1 | MAND |
| | KSC | NOT REQUIRED | | ADDED BY EDS I/F & V070-390392 B09 & M144566. REPL ACES 019903,0103,0 IN PART | 2006-07-11 | 033 |
| | AUTH | VK70-660003-001 | 0103 000 | SKY GENIE TRACK INSTL MOD | S115116NR1 | MAND |
| | JSC | | | RECORD BUILT PER MCR 19903. REPLACES 019903,0103,0 IN PART | 2006-07-11 | 033 |
| 023227R1 | AUTH | VK70-795153-001 | 0103 001 | CONNECTOR SAVER REDESIGN, (KU-BAND) | S115116N | OPTY |
| | KSC | | | ADDED PER R1 OF MCR. OBTAIN PARTS FROM K598-430013 , - 430014, VK70-795153 KITS. REPL 023227,0103,0 | 2006-06-06 | 033 |
| 023463 | AUTH | TCTIV3123463REF | 0103 000 | OVERHEAD WINDOW 7 FASTENER TORQUE INCREASE TO CLASS II | S115116M | MAND |
| | KSC | NOT REQUIRED | | ADDED BY EDS I/F & V070-390003 C09. REPLACES 02346 3,0103,0 MOD CONTR. | 2006-05-02 | 033 |

TOTAL MODS = 39

| MCR/ECP | STAT | ITEM/KIT NUMBER | SEQ | DESCRIPTION / GENERAL REMARKS | PRCB | PRIO |
|---------|-------------|-----------------|----------|--|----------|------|
| ----- | SITE | TCTI NUMBER | EISN NO. | ----- | AUTHDATE | FLT |
| 008750 | COMP KSC | TCTIM6308750REF | 0001 003 | PROVIDE FLEX DUCT WITH IMPROVED MAT'L - KEVLAR RUBBER BASE ADDED PER V727-634006 A05, (NOTE: MOVED OUT OF STS -107 PER D. AZAMA'S REPORT)(REMANIFTD FRM STS-116) | NOT REQD | 033 |
| 008806 | APPD KSC | K845-773008-001 | 0001 000 | SPACEHAB WIRE HARNESS ASSY ADDED PER V845-773954 NEW | NOT REQD | 033 |
| 008820 | APPD JSC | K845-773013-001 | 0001 000 | ADD'L HARDWARE TO SUPPORT OBSS/ISS INTEGRATION ADDED PER V845-774975 NEW MOVED FROM 116 TO 121 PER REMANIFEST D S063215 | NOT REQD | 033 |
| 008824 | COMP KSC | K845-774020-001 | 0001 000 | MOD KIT STP - H2 WIRING ADDED BY EDS I/F & V845-774973 NEW. MOD CODE CHGD FROM GN8 TO GOE PER KIT EO A01 | NOT REQD | 033 |

TOTAL MODS = 4

| MCR/ECP | STAT SITE | ITEM/KIT NUMBER TCTI NUMBER | SEQ EISN NO. | DESCRIPTION / GENERAL REMARKS | PRCB AUTHDATE | PRIO FLT |
|---------|--------------|--------------------------------|-----------------|---|-------------------------|-------------|
| | PLND KAS | B470ECP3789R000 | B128 000 | RSRM AFT SEGMENT STIFFENER RING FOAM APPLICATION TCTI | S170809R1 2005-06-30 | |
| | PLND KAS | CR S090912K | B128 000 | INC OF APPROVED SRB ENG TO MODIFY AFT BSM SUPPORT TPS CLOSE | S090912K 2006-05-10 | |
| | PLND KAS | FEC A-10352R1 | B128 000 | ASSEMBLED ETA STUB MOISTURE PROTECTION | S083852B 2006-07-11 | |
| | PLND KSC | H0850A | B128 000 NSW | REMOVAL OF TPS, FROTH-PAK AND PDL 1034-2.5 FROM SRB HW | S052923YA 2006-03-27 | MAND 033 |

TOTAL MODS = 4

| MCR/ECP | STAT | ITEM/KIT NUMBER | SEQ | DESCRIPTION / GENERAL REMARKS | PRCB | PRIO |
|------------|-------------|-----------------|------------------|---|--------------------------|-------------|
| ----- | SITE | TCTI NUMBER | EISN NO. | ----- | AUTHDATE | FLT |
| KLO-1480 | COMP KSC | KLO-1480 | 2050 000 SPAR | QNSPECT HPFTP SPEED SENSOR RTV/LAI SSME REMANIFEST, PER PRCBD S115116NR1 07/11/06 | ME-0208B 2002-12-17 | SCHD 005 |
| KLO-1481 | COMP KSC | KLO-1481 | 2050 000 SPAR | INSPECT LPFTP KEVLAR INSULATION SSME REMANIFEST, PER PRCBD S115116NR1 07/11/06 | ME-0208R01 2003-01-09 | SCHD 005 |
| KLO-1488 | COMP KSC | KLO-1488 | 2050 000 SPAR | ULTRASONICALLY INSPECT MAIN INJECTOR ROW 13 LOX POST SSME REMANIFEST PER PRCBD S115116NR1, 07/11/06 | ME-0208R03 2003-04-21 | MAND 005 |
| KLO-1490 | COMP KSC | KLO-1490 | 2050 000 SPAR | INSPECT EACH LPOTP INDUCER SSME REMANIFEST PER PRCBD S115116NR1, DTD 07/11/06 | ME-0208R04 2003-06-11 | MAND 005 |
| KLO-1495 | COMP KSC | KLO-1495 | 2050 000 SPAR | BOREScope INSPECT NOZZLE HEAT-SHIELD RING INTERFACE AREA SSME REMANIFEST, PER PRCBD S115116NR1 07/11/06 | ME-0208R05 2003-08-18 | SCHD 005 |
| KLO-1498 | COMP KSC | KLO-1498 | 2050 000 SPAR | PERFORM BASELINE INSPECTIONS OF EACH LPFTP & LPOTP INLET S/N'S B578875 & X201423 SSME REMANIFEST, PER PRCBD S115116NR1 07/11/06 | ME-0208R06 2003-10-02 | SCHD 005 |
| KLO-1499 | COMP KSC | KLO-1499 | 2050 000 SPAR | BOREScope INSPECT NOZZLE MIXER BOWL SSME REMANIFEST, PER PRCBD S115116NR1 07/11/06 | ME-0208R07 2003-11-13 | SCHD 005 |
| KLO-1500 | COMP KSC | KLO-1500 | 2050 000 SPAR | BOREScope INSPECT FUEL PREBURNER MANIFOLD SSME REMANIFEST, PER PRCBD S115116NR1 07/11/06 | ME-0208R07 2003-11-13 | SCHD 005 |
| KLO-1503 | COMP KSC | KLO-1503 | 2050 000 SPAR | BASELINE OMRSD 10-START LEAK CHECKS SSME REMANIFEST, PER PRCBD S115116NR1 07/11/06 | ME-0208R09 2003-12-12 | SCHD 005 |
| KLO-1511 | COMP KSC | KLO-1511 | 2050 000 SPAR | PHOTOGRAPH HPFTP LIQUID AIR INSULATION SSME REMANIFEST PER PRCBD S115116NR1 07/11/06 | ME-0208R10 2004-03-30 | SCHD 005 |
| KLO-1520 | COMP KSC | KLO-1520 | 2050 000 SPAR | INSPECT POGO ACCUMULATOR SUPPLY LINES SSME REMANIFEST PER PRCBD S115116NR1 07/11/06 | ME-0208R11 2004-09-21 | SCHD 005 |
| KLO-1526 | COMP KSC | KLO-1526 | 2050 000 SPAR | PERFORM X-RAYS OF THE NOZZLES ON ENGINES SSME REMANIFEST, PER PRCBD S063215, DTD 10/31/05 | ME-0208R12 2004-11-12 | SCHD 005 |
| KLO-1536R1 | COMP KSC | KLO-1526R1 | 2050 000 SPAR | PERFORM X-RAYS OF THE NOZZLE ON ENGINES SSME REMANIFEST, PER PRCBD S115116NR1 07/11/06 | ME-0208R15 2005-02-02 | SCHD 005 |
| KLO-1531 | COMP KSC | KLO-1531 | 2050 000 SPAR | INSPECT BOLTS AT JOINTS N2.4, N8, N9 & O7.1 SSME REMANIFEST PER PRCBD S115116NR1 07/11/06 | ME-0208R13 2004-12-21 | SCHD 005 |
| KLO-1536 | COMP KSC | KLO-1536 | 2050 000 SPAR | BOREScope INSPECT WELDS ON SELECTED LPOTP DISC DUCTS SSME REMANIFEST PER PRCBD S115116NR1 07/11/06 | ME-0208R14 2005-01-25 | SCHD 005 |

| | | | | | | |
|----------|-------------|----------|------------------|---|--------------------------|-------------|
| KLO-1537 | AUTH KSC | KLO-1537 | 2050 000 SPAR | WEIGH SELECTED ENGINES AT KSC SSME REMANIFEST, PER PRCBD S063215, DTD 10/31/05 | ME-0208R16 2005-02-23 | SCHD 005 |
| KLO-1552 | COMP KSC | KLO-1552 | 2054 000 SPAR | DYE PENETRANT INSPECT HPFTP SPEED SENSORS (POST STS-114) SSME REMANIFEST, PER PRCBD S115116NR1, 07/11/06 | ME-0217B 2005-09-12 | SCHD 006 |
| KLO-1554 | COMP KSC | KLO-1554 | 2050 000 SPAR | INSPECT LIQUID AIR INSULATION ON SELECTED HPFTP SSME REMANIFEST,PER PRCBD S115116NR1 07/11/06 | ME-0208R20 2005-09-12 | MAND 005 |

| MCR/ECP | STAT | ITEM/KIT NUMBER | SEQ | DESCRIPTION / GENERAL REMARKS | PRCB | PRIO |
|----------|-------------|-----------------|----------|--|--------------------------|-------------|
| ----- | SITE | TCTI NUMBER | EISN NO. | ----- | AUTHDATE | FLT |
| KLO-1554 | COMP KSC | KLO-1554 | 2054 000 | INSPECT LIQUID AIR INSULATION ON SELECTED HPFPTS SSME REMANIFEST, PER PRCBD S115116NR1, 07/11/06 | ME-0217B 2005-09-12 | SCHD 006 |
| | COMP KSC | KLO-1562 | 2050 000 | FIT CHECK LAI BOOTS ON ENGINE 2050 FUEL SYSTEM DUCTS SSME REMANIFEST PER PRCBD S115116NR1 07/11/06 | ME-0208R24 2006-05-16 | SCHD 005 |
| | AUTH KAR | RS007001-451 | 2050 001 | POSITION 1 OR 3 BLK II FLIGHT ENGINE NOZZLE CONFIGURATION ENGINE 2050 RE-ID PER PRCBD S060983T. SEQ 1 BECAUSE ENGINE WAS PREVIOUSLY -451 (STS-108) | S060983TR1 2006-06-06 | 005 |
| | AUTH KAR | RS007001-451 | 2058 000 | POSITION 1 OR 3 BLK II FLIGHT ENGINE NOZZLE CONFIGURATION SSME REMANIFEST, PER PRCBD S115116NR1 DTD 07/11/06 | ME-0219B 2006-05-11 | MAND 001 |
| 1379 | INC KAR | 2R091522-010 | 2050 000 | MAIN FUEL VALVE CAP TO HOUSING JOINT REDESIGN SSME REMANIFEST,PER PRCBD S0115116NR1 DTD 07/11/06 | ME-0208R02 2003-01-28 | SCHD 005 |
| 1414 | INC RKDN | 2R091543-010 | 2050 000 | UPDATE ENGINE ADP FOR REVISED HPFTP MASS CHARACTERIATICS SSME REMANIFEST PER PRCBD S0115116NR1, 07/11/06 | ME-0208R08 2003-12-09 | SCHD 005 |
| 1440R2 | AUTH KAR | 2R091544-030 | 2050 000 | BLOCK II HPFTP 2 PIECE INSPECTED SPEED SENSOR INC RECEIVED 07/10/06; AUTH DATE 05/11/06 SSME REMANIFEST PER PRCBD S115116NR1, 07/11/06 | ME-0208R22 2005-05-11 | 005 |
| | AUTH KAR | 2R091545-010 | 2050 000 | HPFTP BEARING COVER LAI REDESIGN SSME REMANIFEST PER PRCBD S115116NR1, DTD 07/11/06 | ME-0208R17 2005-04-28 | SCHD 005 |
| | PLND KAR | 2R091545-010 | 2058 000 | HPFTP BEARING COVER LAI REDESIGN SSME REMANIFEST, PER PRCBD S115116NR1 07/11/06 | ME-0219B 2006-05-11 | MAND 001 |
| 1439 | INC KAR | 2R091548-010 | 2050 000 | HPFTP SINGLE PIECE SPEED SENSOR RETROFIT INITIATED PER TCTI E41-01439-01 SSME REMANIFEST, PER PRCBD S115116NR1 DTD 07/11/06 | ME-0208R22 2005-05-11 | MAND 005 |
| 1473 | INC KAR | 2R091567-010 | 2050 000 | RETROFIT KIT SSME BLOCK II CONTROLLER RFI FILTER UPGRADE SSME REMANIFEST, PER PRCBD S0115116NR1, 07/11/06 | ME-0208R19 2005-08-17 | MAND 005 |
| 1477 | AUTH KAR | 2R091569-010 | 2050 000 | LIQUID AIR PROTECTIVE COVERS SSME REMANIFEST, PER PRCBD S115116NR1 DTD 07/11/06 | ME-0208R21 2006-04-26 | SCHD 005 |
| | INC KAR | 2R091569-010 | 2054 000 | LIQUID AIR PROTECTIVE COVERS SSME REMANIFEST, PER PRCBD S115116NR1 DTD 07/11/06 | ME-0217R01 2005-12-20 | SCHD 006 |
| | PLND KAR | 2R091569-010 | 2058 000 | LIQUID AIR PROTECTIVE COVERS SSME REMANIFEST, PER PRCBD S115116NR1 DTD 7/11/06 | ME-0219B 2006-05-11 | MAND 001 |
| 1465 | COMP | 2R091572-010 | 2054 001 | NOZZLE AFT MANIFOLD ABLATIVE RE-DESIGN (NOZZLE RE-ID ONLY) | S060983LR3 | |

| | | | | | | |
|------|------------|--------------|----------|--|--------------------------|-------------|
| | KAR | | | WAD TO BE DEFERRED FOR RE-ID (SEE SEQ 0 FOR ABLATIVE INSTALLATION FOR STS-114) | 2005-07-08 | 006 |
| 1491 | INC KAR | 2R091576-010 | 2050 000 | FASTENER MODIFICATIONS TO SMALL LINE CLAMPING PER TCTI E41-01491-01 SSME REMANIFEST PER PRCBD S115116NR1, 07/11/06 | ME-0208R23 2006-05-11 | MAND 005 |

| MCR/ECP | STAT SITE | ITEM/KIT NUMBER TCTI NUMBER | SEQ EISN NO. | DESCRIPTION / GENERAL REMARKS | PRCB AUTHDATE | PRIO FLT |
|---------|-------------|--------------------------------|-----------------|---|--------------------------|-------------|
| 1507 | AUTH KAR | 2R091599-010 | 2050 000 | AL TAPING REQUIREMENTS FOR LN2 PRESSURE TRANSDUCER COVERS SSME REMANIFEST PER PRCBD S115116NR1, DTD 07/11/06 | ME-0208R21 2006-04-26 | SCHD 005 |
| | INC KAR | 2R091599-010 | 2054 000 | AL TAPING REQUIREMENTS FOR LN2 PRESSURE TRANSDUCER COVERS SSME REMANIFEST, PER PRCBD S115116NR1 DTD 07/11/06 | ME-0217R02 2002-04-26 | MAND 006 |
| | PLND KAR | 2R091599-010 | 2058 000 | AL TAPING REQUIREMENTS FOR LN2 PRESSURE TRANSDUCER COVERS SSME REMANIFEST, PER PRCBD S115116NR1 DTD 07/11/06 | ME-0219B 2006-05-11 | MAND 001 |
| 1506 | INC KAR | 2R091600-010 | 2050 000 | NOZZLE AFT MANIFOLD ABLATIVE REMOVAL | S060983T 2006-05-24 | 005 |
| | INC KAR | 2R091600-020 | 2054 000 | NOZZLE AFT MANIFOLD ABLATIVE REMOVAL | S060983T 2006-05-24 | 006 |

TOTAL MODS = 39

Approved STS-116 OMRS Waivers and Exceptions

| WVR EXC | ELEMENT PROJECT | PRCBD NUMBER WAIVER# (STAT) (INITIAL STS) | ABSTRACT RAS REQUIREMENTS | STS EISN PAYLOAD | BEG END |
|------------|--------------------|---|---|------------------------|------------|
| E | OMS | S053296YK EK10327 (A) | OMRSD EXCEPTION REQUEST - RIGHT RC SOXIDIZER B-LEG PAD REGULATOR L OCKUPPRESSURE (EK10327) | 0023 | 032 040 |
| | | S053297WA EK10452 (A) | OMRSD EXCEPTION REQUEST - RRCS FUEL GHE TANK P1 TRANSDUCER ACCURA CY (EK10452) | 0023 | 032 039 |
| W | | S053296UM WK10299 (A) | OMRSD WAIVER REQUEST - RP03 TK302 DYNATUBE LEAK RATE (WK10299) | 0023 | 032 040 |
| | ORB | S053297NZ WK10415 (A) | OMRSD WAIVER REQUEST - MADS FDM CALIBRATION MANUAL MODE (WK10415) | 103 | 031 038 |

| +-----+-----+-----+-----+-----+-----+ | | | | | | | | | |
|---------------------------------------|---------|--------|--------|--------|-------|--|--|--|--|
| | Waivers | Except | Deviat | Cannib | Total | | | | |
| +-----+-----+-----+-----+-----+-----+ | | | | | | | | | |
| o Total Extracted | o 2 | o 2 | o 0 | o 0 | o 4 | | | | |
| +-----+-----+-----+-----+-----+-----+ | | | | | | | | | |

-
-
-
-
-
-
-
-
-
0

ACTIVE WAIVERS FOR
OV-103 (STS-116)

| Item # | Authority | Date | Waiver Description | Effectivity | Wad |
|--------|------------|----------|---|---|--|
| 47 | S052310A | 02/14/91 | Fly with FRSI instead of tile | OV-103, Flight 12 & Subs (flight by flight evaluation) | OK TO RETIRE S061954B MV 4-2 RTF-130 Briefing |
| 53 | S052428A | 03/27/91 | Allows specified flights to fly with interim TPS repair after each mission to minimize damage to surrounding tile during ferry flight | STS-37, STS-39, STS-40, STS-42 thru STS-999 | STAYS OPEN |
| 101 | S076972 | 11/19/91 | Permit the modified GPCs (AP101-S) Battery Back-up Unit to fly with annotated fastener improvements without rolling the LRU Part Number | STS-42, STS-44, STS-47 and STS-49 thru STS-999 | STAYS OPEN |
| 327 | S115114VR5 | 03/17/05 | Partial installation of M072-784633-014 (harness installation - interface panel - MADS #3). The M072-784663-014 Technical Order was established to incorporate the crossover bracket modification at locations X0863 and X0750. The dash number configuration for the Technical Order was not baselined until January 25, 2005 (PRCBD S115114VR2). This area was closed out before this time and would cause significant impact to verify configuration of this Technical Order dash number -014. ***** SEE NSTS 07700 VOLUME IV BOOK 2 FOR COMPLETE DETAILS ***** | OV-103, Flight 31 OV-103, Flight 32 WAIVER for STS-121 | INS-3-28-279 (installed Tech Order) |
| 328 | S115114WR1 | 04/07/05 | Partial installation of M072-794500-004, for Integrated Vehicle Health Monitoring (IVHM) harness installation, calls for the removal of the unused IVHM harness and routing hardware. This requirement was manifested after the Bay 13 Longerons Bridge installation was complete. With the installation of the bridge, the removal of the IVHM harness is no longer possible without the removal of the bridge. ***** SEE NSTS 07700 VOLUME IV BOOK 2 FOR COMPLETE DETAILS ***** | OV-103, Flight 31 OV-103, Flight 32 WAIVER for STS-121 | OEL-3-31-304 PTL OEL-3-31-4432 PTL |

ACTIVE WAIVERS FOR
OV-103 (STS-116)

| Item # | Authority | Date | Waiver Description | Effectivity | Wad |
|--------|-------------|----------|--|--------------------------------|--------------------------|
| 329 | S115114AM | 08/15/05 | <p>The following requirements are waived to allow OV-103, Flight 31 to fly (ferry) with the following out-of-configuration conditions:</p> <p>1) V070-391139-025 (blanket under window #1 removed for ferry flight)</p> <p>2) M072-421502-002 (did not perform acetone wipe prior to universal thruster plug assemblies - procedural omission)</p> <p>3) V070-753110-003 (camera mount will not be installed for ferry flight)</p> <p>***** SEE NSTS 07700 VOLUME IV BOOK 2 FOR COMPLETE DETAILS *****</p> | OV-103, Flight 31 | Ferry Flight from Dryden |
| 330 | S115114VR15 | 09/16/05 | <p>The following requirement is waived to allow OV-103 to ferry from DFRC to KSC with the following out-of-configuration condition:</p> <p>TCS blanket V070-362917-001 located at Door #44 NOT installed.</p> <p>***** SEE NSTS 07700 VOLUME IV BOOK 2 FOR COMPLETE DETAILS *****</p> | OV-103, Flight 31 Ferry Flight | Ferry Flight from Dryden |

ACTIVE WAIVERS FOR
OV-103 (STS-116)

| Item # | Authority | Date | Waiver Description | Effectivity | Wad |
|--------|-------------|----------|---|--------------------------------|--------------------------|
| 331 | S115114VR15 | 09/16/05 | <p>The following requirement is waived to allow OV-103 to ferry from DFRC to KSC with the following out-of-configuration condition:</p> <ol style="list-style-type: none">1) Two switches on Panel A15 will ferry without switch guards (P/N G070-700904-001). In lieu of switch guards at two locations, tape was installed.2) Eight GSE switch guards were left installed and not removed as required by Technical Order M072-710700-002 as called out in the ferry flight drawing.3) Three switch guards are not installed on Panel L4 for TACAN circuit breakers. The procedure does not include the switch guard installation. <p>***** SEE NSTS 07700 VOLUME IV BOOK 2 FOR COMPLETE DETAILS *****</p> | OV-103, Flight 31 Ferry Flight | Ferry Flight from Dryden |
| 332 | S115121TR8 | 05/04/06 | <p>The following requirement is waived to allow OV-103 to fly with the following out-of-configuration condition:</p> <p>M072-794500-004 IVHM harness installation Bay 13 called out by MECSLSI V072-200201 NOT removed from OV-103.</p> <p>During STS-114 processing this Tech Order configuration called for the removal of an un-used IVHM harness along with the routing hardware. At the time the Tech Order was made a requirement for Flight 31, the Bay 13 longeron had already been installed for flight. The harness was demated and stowed in place per MR and was deferred to a future flight at which time Bay 13 longeron will be removed since the Bay 13 longeron was not removed this flight, a configuration waiver is needed for STS-121.</p> | OV-103, Flight 32 | |

ACTIVE WAIVERS FOR
OV-103 (STS-116)

| Item # | Authority | Date | Waiver Description | Effectivity | Wad |
|--------|------------|----------|---|-------------------|-----|
| 333 | S115121TR8 | 05/04/06 | <p>The following requirement is waived to allow OV-103 to fly with the following out-of-configuration condition:</p> <p>Partial installation of M072-784633-014 (harness installation - interface panel - MADS#3). The M072-784633-014 Tech Order was established to incorporate the crossover bracket modification at locations X0863 and X0750. The dash number configuration for the Tech Order was not baselined until January 25, 2005 (PRCBD S115114VR2). This area was closed out before this time and would cause significant impact to verify configuration of this Tech Order dash number -014.</p> <p>***** SEE NSTS 07700 VOLUME IV BOOK 2 FOR COMPLETE DETAILS *****</p> | OV-103, Flight 32 | |