



SPACE SHUTTLE PROGRAM
Space Shuttle KSC Integration Office
NASA Kennedy Space Center, Florida



STS-131 Delta Launch Site Flow Review

Presenter **Steve Reilly**

Date **10-15-09**

Program Freeze Point

PRCB Presentation

S115131C



STS-131 Delta Launch Site Flow Review

Presenter **Steve Reilly**

Date **10-15-09**

Baseline the STS-131 Mission Specific Requirements and Flow Plans.

The STS-131 Integrated Launch Site Requirements were established by PRCBD S115131R1 dated 07-23-09. This CR and the Associated Data Package were reviewed at the 10-13-09 FRWG.

Flight Operation & Integration*

MO3/USA-PI

Orbiter Engineering*

Requesting Approval

USA-OE

Payload/Cargo Engineering*

USA-PI

SSME

Requesting Approval

MP21

Launch Vehicle Processing

PH-A

Status in BackUp

KSC Integration*

MK-SIO

Flight Software

USA-FSW

Orbiter GFE

MV5

EVA*

XA

KSC ISS and Payload Processing*

UB-R3

*Backup material included



STS-131 DELTA LAUNCH SITE FLOW REVIEW

Presenter

Ann M. Patterson

Date

15 Oct 2009

STS-131/19A

DELTA Launch Site Flow Review (LSFR)

Flight Requirements Status

PRCB 15 October 2009

Ann M. Patterson, STS-131 MIM

Frank Richmond, USA Flight Mgr.

Adam Richards/Boeing Mass Properties



STS-131 DELTA LAUNCH SITE FLOW REVIEW

Presenter

Ann M. Patterson

Date

15 Oct 2009

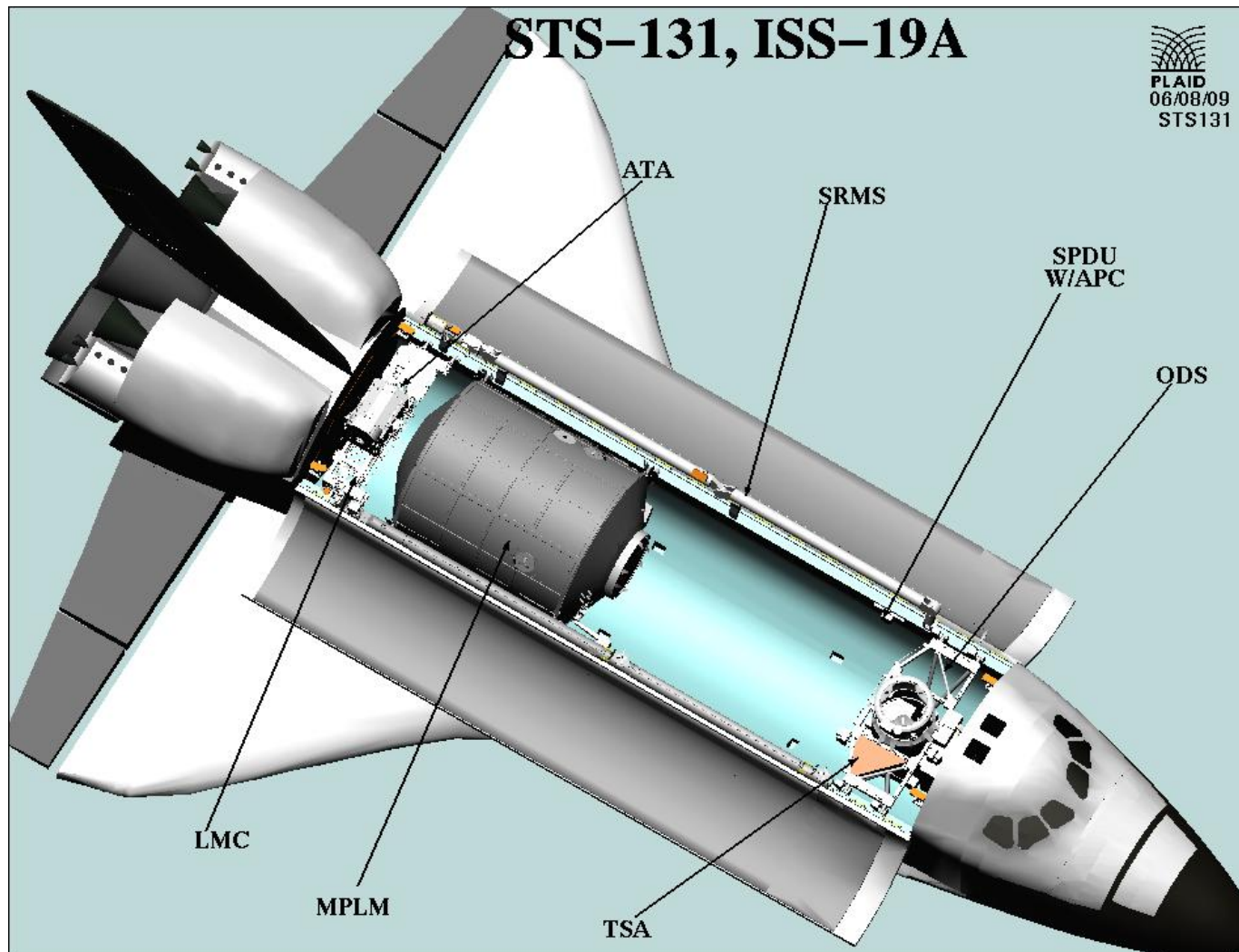



STS-131 DELTA LAUNCH SITE FLOW REVIEW

Presenter
Ann M. Patterson
Date
15 Oct 2009

Middeck Powered Payloads

- MERLIN- rear breather (18 CFM) ↑↓
- GLACIER – rear breather (36 CFM) ↑↓
- STL ↑↓
- AEM 1 & 2 ↑↓

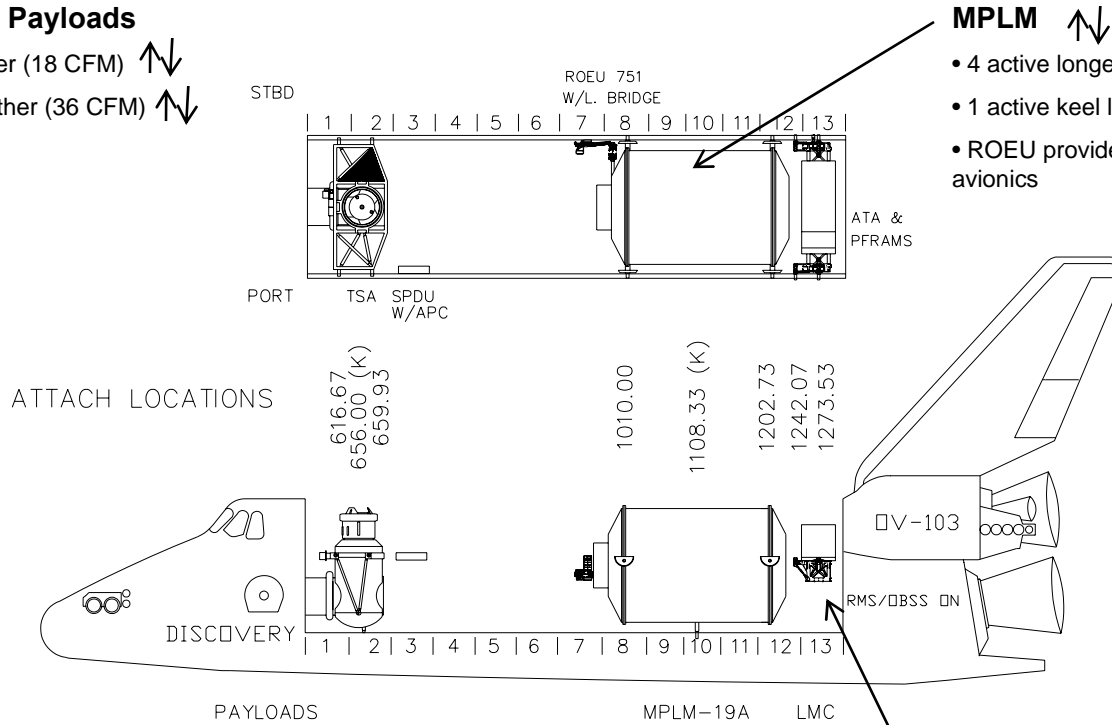

MPLM ↑↓

- 4 active longerons with aft primary
- 1 active keel latch with keel camera
- ROEU provides 28V heater power, 124V for MPLM avionics

LMC ↑↓

- 4 passive longeron latches with aft primary
- 28V heater power

•Note – SPDU supports OBSS



STS-131 DELTA LAUNCH SITE FLOW REVIEW

Presenter
Ann M. Patterson
Date
15 Oct 2009

LAUNCH

03/18/10
 39A/ MLP 3
 CREW SIZE: 7UP/7DN

CONFIGURATION

OV-103 (38)
 LP01;RP03
 ET-135
 BI-142
 RSRM-110
 PROPOSED SSME: (1) 2045 (2) 2060* (3) 2054*
 OI-34
 SRMS, ODS, OBSS, SSPTS

PAYLOAD

ISS-19A (MPLM, LMC)
 MAUI
 SEITE
 SIMPLEX
 RAMBO-2

ORBIT

51.6 DEG
 122 NM
 DIRECT INSERTION
 DURATION: 12 + 1 + 2 DAYS
 EVAs: 3 + 1

CONSUMABLES

CRYO TANK SETS	5 (OFFLOAD 605 lbs)
GN2 TANKS	6 (OFFLOAD 66 lbs)
FWD RCS	1912# (MIN)
AFT RCS	4970# (FULL)
OMS	22760# (FULL)

LANDING

SITE	KSC
TAL	ZARAGOZA
ALT. TAL	MORON & ISTRES
SCA	905

RESCUE FLIGHT FOR STS-130



STS-131 DELTA LAUNCH SITE FLOW REVIEW

Presenter
Ann M. Patterson
Date
15 Oct 2009

PERFORMANCE MARGIN

• SIMULATION MARGIN (OCFAF131)		+ 1677
• WEIGHT CHANGES SINCE SIMULATION		
• PAYLOAD	+ 13	
• OPERATOR	+ 6	
• ORBITER	+ 49	
• CREW COMPARTMENT	- 13	
TOTAL WEIGHT CHANGES	+ 55	- 55
• OTHER PERFORMANCE PROJECTIONS		
• PROTECTION FOR DOL DISPERSIONS		- 700
• SRB – M.P. UPDATES		- 257
• SRB – BR / 0.70 MIL HIGHER THAN 0.3705 AVG		+180
• PROJ TO 5 MIN WINDOW FROM INPLANE		- 600
• PERFORMANCE CHANGES ADJUSTMENT		+ 4
• CURRENT BASELINED APM (10/06/09)		+ 249
• IPT PROJECTIONS		
• REDUCE LMC TARE WEIGHT		+ 148
• INCREASE MPLM CONTROL WEIGHT		- 93
• REMOVE 1 N2 TANK (PRCB CR S072131B)		+ 58
• ADD TRIDAR REFLIGHT (PRCB CR S072131B)		- 59
• INCREASE MISSION DURATION TO 13+1 DAYS (PRCB CR S072131A)		- 128
• LOWER RNDZ ALT FROM 190 NM TO 188 NM		+ 232
• IPT PROJECTED APM		+ 407

VOLUME III: ASCENT PERFORMANCE MANAGER'S RESERVE GUIDELINE AT LSRR/LSFR IS 400 LBS



STS-131 DELTA LAUNCH SITE FLOW REVIEW

Presenter

Ann M. Patterson

Date

15 Oct 2009

FLIGHT MASS PROPERTIES

<u>CASE</u>	TOUCHDOWN	MACH 3.5
	<u>WEIGHT pounds (LIMIT)</u>	<u>X C.G. inches (LIMIT)</u>
NOMINAL	223810 (233000)	1088.7 (1075.2)
RTLS	238676 (245000)	1088.1 (1076.7)
TAL	237307 (244000)	1088.2 (1076.7)
AOA	233638 (242000)	1085.9 (1075.2)
CONT RTRN*	235414 (233000)	1088.1 (1075.2)

***CONT RTRN EXCEEDS 233K NEOM LIMIT (See Vol. X Bk. 1 Sec. 3.3.1.1.9)
(NO DOCK PLS CASE)**

**NOTE: RTLS INCLUDES 185 SEC ARCS & 25 SEC FRCS DUMPS
TAL INCLUDES 120 SEC ARCS & 65 SEC FRCS DUMPS
104 LBS AFT BALLAST (EMPTY BOXES)**

ESTIMATES BASED ON OCF131 AND MODIFIED FOR WEIGHT CHANGES THRU 10/06/09.

STS-131 Delta LSFR

OV 103 / FLT 38

Belinda Soublet

USA Orbiter Element

October 15, 2009



STS-131 OV 103/FLT 38 – Orbiter DLSFR Baseline

Modifications to be Baselined at DLSFR for OV 103 / FLT 38

- Two mandatory modifications to be baselined

Potential Modifications (Info Only)

Additional Requirements Being Tracked

- STR/TPS Priorities chart
- Chit Updates
- OV 103 OMDP Requirements Status
- APU 2 Wetted Life Extension/R&R Discussion

Authorization Requested for MECSLSI and CCCD Updates for STS-131 (OV 103 / FLT 38) Orbiter Mods

- Incorporate updates to CCCD and V072-200211 MECSLSI

Backup

- Opportunity Modifications (info only)
- STR/TPS Priorities backup data
- Previously Baselined Modifications (STS -131 LSRR/LSFR)
- Potential Modification Information
- OV 103 OMDP Red and Yellow Requirements
- Engineering, Hardware and Certification Status
- Mod Record and MECSLSI Updates

STS-131 DLSFR Proposed Mandatory Mod

- **TAD 30272 - Arrowhead Blanket Sleeving Redesign**

- Change Arrowhead Blanket configuration to preclude sleeving protuberance
 - Protrusion of the arrowhead blanket sleeving has occurred on several flights since RTF
 - Previously implemented sleeve stitching modification has not fully mitigated sleeving protrusions
- Alternate configurations were evaluated for redesign
 - Configuration chosen will replace sleeving with a gap filler bonded to the bearing plate and will increase the inside diameter of the arrowhead blanket cutout to compensate for the added gap filler

New Bonded Gap Filler



Current blanket with sleeving removed

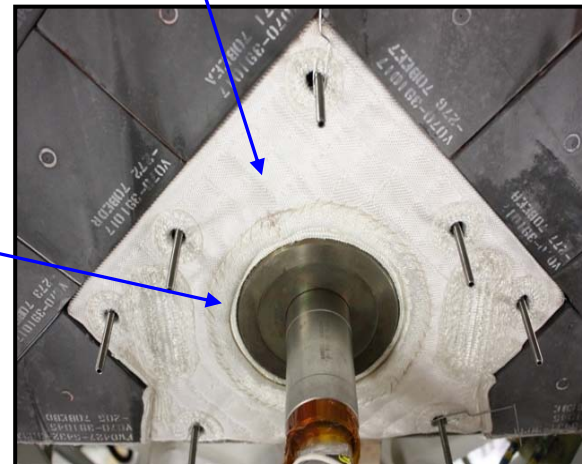

STS-131 DLSFR Proposed Mandatory Mod

- **MCR 30010 – Window Shield Bag Modification**

- Add Velcro™ to the window shield container bags to allow for temporary stowage of the shields and containers to existing Velcro locations on the flight deck in closer proximity to the windows
- Window shield container bags are used for protective in-flight storage of the flight deck window shields when removed for external viewing and photography and currently require stowage in the middeck
- Crew requested improvement for time-savings associated with the multiple short duration uses of the shield container bags on-orbit

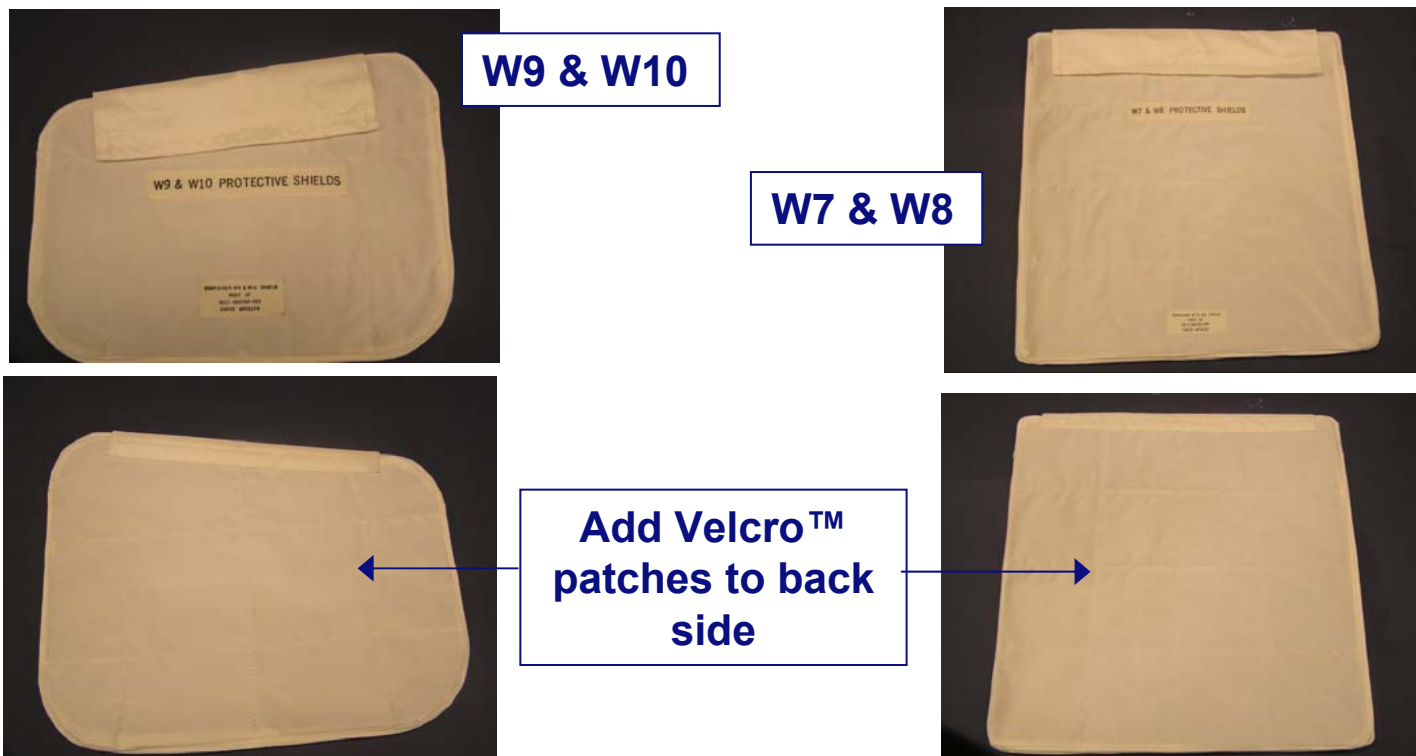

STS-131 Potential Mods (Info Only)

- **TAD 30091 BLT FE DTO Flight 3**

- Re-flight of protuberance tile and associated thermocouple instrumentation
- Protuberance tile instrumentation dropouts seen near the peak heating phase of entry (clear understanding of protuberance peak heating is required in order to step to higher protuberance)
 - Detail scan data did confirm no TPS tile damage
- IPT recommendation is to fly the previously flown (STS-128) 0.35” protuberance height tile
 - new protuberance tile will be installed (note – no mod required to be baselined for this re-flight)

- **TAD 30246 Catalytic Coating DTO Flight 2**

- Re-flight / re-application of catalytic coating applied to TPS in BLT DTO region of influence (flew first flight on STS-128)
- IPT plan is to recommend reducing the number of catalytic coated tiles from two (TC1 & TC3a tiles) to one (TC3a tile) and add an additional TC to the TC3a tile
 - Existing TC8a will be abandoned and its instrumentation channel will be used for new TC
 - IPT desire is to evaluate temperature effect of catalytic coating at different locations on the tile relative to position and footprint of the coating

- **IPT will present the STS-128 BLT and Catalytic Coating DTO flight results and STS-131 recommendation to OCCB 10/20/09 and PRCB 10/22/09**

STS-131 Potential Mods (Info Only)

- **TAD 30260 F3D/F4D Thruster Cover Redesign**
 - Redesign includes a change in cover geometry and overlapping reinforcements to reduce sudden inflation stress riser and reduce likelihood of remnant releasing beyond velocity certification limit
 - Modification concept has completed qual test and is qual test data is in final engineering evaluation
 - Plan is to bring CR forward to authorize fleet implementation, beginning with STS-129 at a near term PRCB/DPRCB

- **TAD 30274 Fuel Cell CPM Dedicated Power Feed – Study**
 - Intent of mod is to provide separate power feeds to the fuel cell CPM (cell performance monitor) and the fuel cell hydrogen flow meter
 - The fuel cell CPM and hydrogen flowmeter currently shares power source through a common MPCA fuse with the hydrogen flowmeter
 - Flowmeter failures have caused power circuit fuse to blow and also results in loss of power to fuel cell CPM
 - Plan is to present mod concept to OCCB 10/20/09 for approval to proceed to near term PRCB/DPRCB for authorization to baseline into the STS-131 flow

STR/TPS Priorities Current Vehicle Status

Priority Number	Total	OV-103	OV-104	OV-105
1. BRI-18 Tile - MLGD FWD O/B Corner	28	complete	complete	complete
2. BRI-18 Tile - MLGD FWD Edge	22	complete	complete	complete
3. BRI-18 Tile - MLGD O/B Side	18	complete	complete	complete
4. BRI-18 Tile - STR side of ET Doors	20	complete	complete	complete
5. BRI-18 Tile – LESS Carrier Panels 8-10 (103 & 104)	24	complete	complete	n/a
6. BRI-18 Tile – STR side of ET Doors I/B	8	complete	complete	complete
7. Inboard Elevon “Hub” Tile Mod	4	complete	2	complete
8. I/B Elevon 9lb/90 SIP	34	complete	complete	complete
9. O/B Elevon 9lb/90 SIP	6	complete	complete	complete
10. MLGD – Outboard Middle 1/3	24	0	0	3
11. ET Door remaining STR side	40	1	10	0
12. MLGD - Outboard AFT 1/3	24	0	0	1
13. Nose Area 9lb/90 SIP	14 (16 ^{OV103})	3	complete	0
14. Base Heat Shield 9lb/90 SIP	42	10	complete	complete
15. Body Flap Stub "Piano Key" tiles	40	1	14	0
16. Gap fillers in Subset 2B	5 Zones	2	1	0
17. Remaining BRI-18 - MLGD (top priority) / ET / LESS carrier panels / NLGD	MLGD 100	MLGD 0	MLGD 1	MLGD 0
	NLGD 123	NLGD 15	NLGD 19	NLGD 47
	LESS 68 (92 ^{OV-105})	LESS 7	LESS 5	LESS 19
	ET Door 28	ET Door 5	ET Door 2	ET Door 1
18. Mod work LESS internal	44 locations	40	complete	complete
20. Remaining Gap Fillers & Window BRI-18	124	3	2	19
Structural Corrosion Sampling Plan	See Special Chart			
2nd Subset Putty Repair Removals	11 / 6 / 5	complete	complete	complete



STS-131 Chits (OV-103 Flight 38)

- **Approved**

- J6116 Ames Gap Filler Removal and Replacement
- J6275A Orbiter Structure IML Surface Corrosion Sampling Inspection
- J6414A Rudder Speed Brake Thermal Tab Inspection
- J6482 STS-128 Payload Close Clearance Measurements
- J6505 Capture OV-103 Output Waveforms to Address Diode Concerns
- J6509 Removal of MPS GH2 Flow Control Valves post STS-128
- J6523A Optigo, Metris, and Z-Scan of BLT Protuberance Tile
- J6526 Evaluation of OMS Pod LI-900 tile installed on 0.090" SIP
- J6531 Metris Scan of OV -103 Lower Surface (OV-103, FLTS 37-39)
- J6533A Perform Borescope Inspection of MPS PV17 Ball Seal
- J6534 Putty Repair Tile Replacement for Risk Reduction
- J6539 OMS023 (RP03) Aged RTV
- J6543 ET Ferry Flight Door Attach Fitting Inspection
- J6545 X-Ray Inspection of MPS Helium Supply System Check Valves
- J6556 Micro-Inspection of thin LRSI Tiles
- J6557 Micro Inspection of Captive Gap Fillers
- J6558 Aft Stub Cracked Tile Inspection
- J6559 Upper Aft Stub Tile Inspection for In-Plane Cracks
- J6564 FRCS Manifold 5 Fuel & Ox Valve Cycle (File IX requirement)
- J6565 Removal of Nickel Plated Nuts on Inspection Boom Assembly (IBA) S/N 203
- J6567 L2D Thruster Flush (File IX requirement)

STS-131 Chits (OV-103 Flight 38) cont'd

- **Pending Approval**

- J6570 Calibration of OV-103 Vertical Tail Stinger Microphone and Drag Chute Door Pressure Transducer
- J6571 OV-103 Inspection for Large Steps on Lower Surface
- K6561A Ground Lightning Monitoring System (GLMS) Installation
- K6566 SSME Nozzle Purge Hot Wall Corrosion Prevention

- **Potential**

- JXXXX BLT DTO #3 Post-Flt Tempilabel Assessment

OV 103 OMDP Requirements Status

- **Phase 1 (Review of Requirements) is completed:**
 - 21 Red (not extendable)
 - 1 Yellow (in assessment)
 - 747 Green (extendable)
- **Ground Ops assessment results for red and yellow requirements:**
 - All 21 Red requirements are scheduled to be accomplished in the STS-131 flow
 - Any requirements not worked during STS-131 will be moved out to STS-133
 - Only Yellow requirement could possibly be worked in STS-131, if deemed necessary
 - APU wetted time extension; APU PRT will have results of WSTF testing in Dec. 2009
- **All Green requirements have been reviewed by a team from JSC Engineering, NASA, Boeing and USA Vehicle Managers**
 - Team looked at each requirement to determine if a sufficient rationale existed to extend
 - Rationale determined to be weak or unclear was flagged and sent back to the PRTs
- **Phase II (Management Review)**
 - Each PRT is going over their requirements and presenting their rationale for extension
 - Results will be summarized at an OCCB/OPOTT
 - Group Exception will be presented at a Noon Board/PRCB

APU 2 Wetted Life Extension/R&R Discussion

- Previously at STS 131 LSRR, it was addressed that R&R of APU 2 may be required this flow because of a 5-year OMRSD limitation on “wetted” time (time between installation in the Orbiter and removal for maintenance at the vendor)
- Presently we have 5 spare APUs
 - 4 planned removals required per the 5 year OMRSD limitation in 2010
 - At least 1 unplanned removal can be expected based on logistics projections (which has been a reliable/proven factor in asset availability/usage planning)
- Current APU wetted time limitation may result in as many as 5 missions with 0 spares (based on current FAWG)
 - Manifest slip or Program extension beyond 2010 will result in violation of the 5-year wetted time OMRSD limitation of additional APUs
 - Assumes no cannibalization
- The APU PRT is in work with a plan to extend the Time & Cycle requirement from 5 to 6 years
- To obtain the necessary rationale for extension a Disassembly and Inspection (D&I) of APU 401 (WSTF Fleet Leader) will be performed

APU 2 Wetted Life Extension/R&R Discussion cont'd

- Time frame for D&I/Extension results
 - Obtain preliminary results ~ Nov 20th (PRT working with HS to expedite scheduled 12/11 date)
 - If data is not acceptable, will initiate APU R&R
 - Final results / TIM scheduled for the week of Dec 14
 - If results are acceptable, an RCN will be processed to extend to 6 years
 - Will have adequate spares to fly to March 2011 on OV-103, 104 (OV-105 to 2012)
- Current assessment has APU removal starting on Nov 30 (If required)
 - Replacement APU will have the GGVM heater modification installed on the bench prior to installation as well as polysulfide application on a drain system fitting (MR) (can be done in the vehicle, preferred access if done on the bench)

APU PRT has high confidence that the D&I results will provide the necessary rationale for extension to 6 years

STS-131
ISS – 19A – MPLM LMC
△ Launch Site Flow Review

Payload Cargo Engineering Status

Michael Barido

281.212.6072

10-15-2009

STS-131 Δ LSFR

Engineering Flight Product Status

<u>Drawing</u>	<u>Title</u>	<u>Rev</u>	<u>EO</u>	<u>Released</u>		
• V072-200211	MECSLSI	A	A01	08/06/09		
• VA72-200211	Cargo Arrangement Drawing			A	A01	08/04/09
• VD72-200211	Avionics Interface Diagram			A	A01	08/04/09
• VS72-200211	Integrated Avionics Schematic			A	A01	08/04/09
• VS70-540413	Retention Schematic Diagram			NEW	-	05/13/09

Engineering Open Work

- Add Tridar, remove GN2 tank (S072131B, if approved 10/15) 10-29-2009

Standardization

- Mission Configuration does comply with Orbiter/Payload Integration Standardization Document NSTS 60523

STS-131 Δ LSFR

Cargo Close Clearance Process

- The following Close Clearance areas have been identified:
 - Aft Port Scuff plate to SRMS MPM
- A Chit will not be developed to take Close Clearance Measurements
 - Was measured on STS-128
 - Same vehicle, same MPLM, same Orbiter hardware

Discovery STS-131
Delta Launch Site Flow Review
Space Shuttle Main Engine

SSME - KSC
Paul Brzeski
(321) 861-4064



STS-131 Delta Launch Site Flow Review

SSME Allocations / Locations

Baseline for STS-131

- **ME-1: 2045** (last hot-fire STS-127)
- **ME-2: 2060** (last hot-fire STS-127)
- **ME-3: 2054** (last hot-fire STS-127)

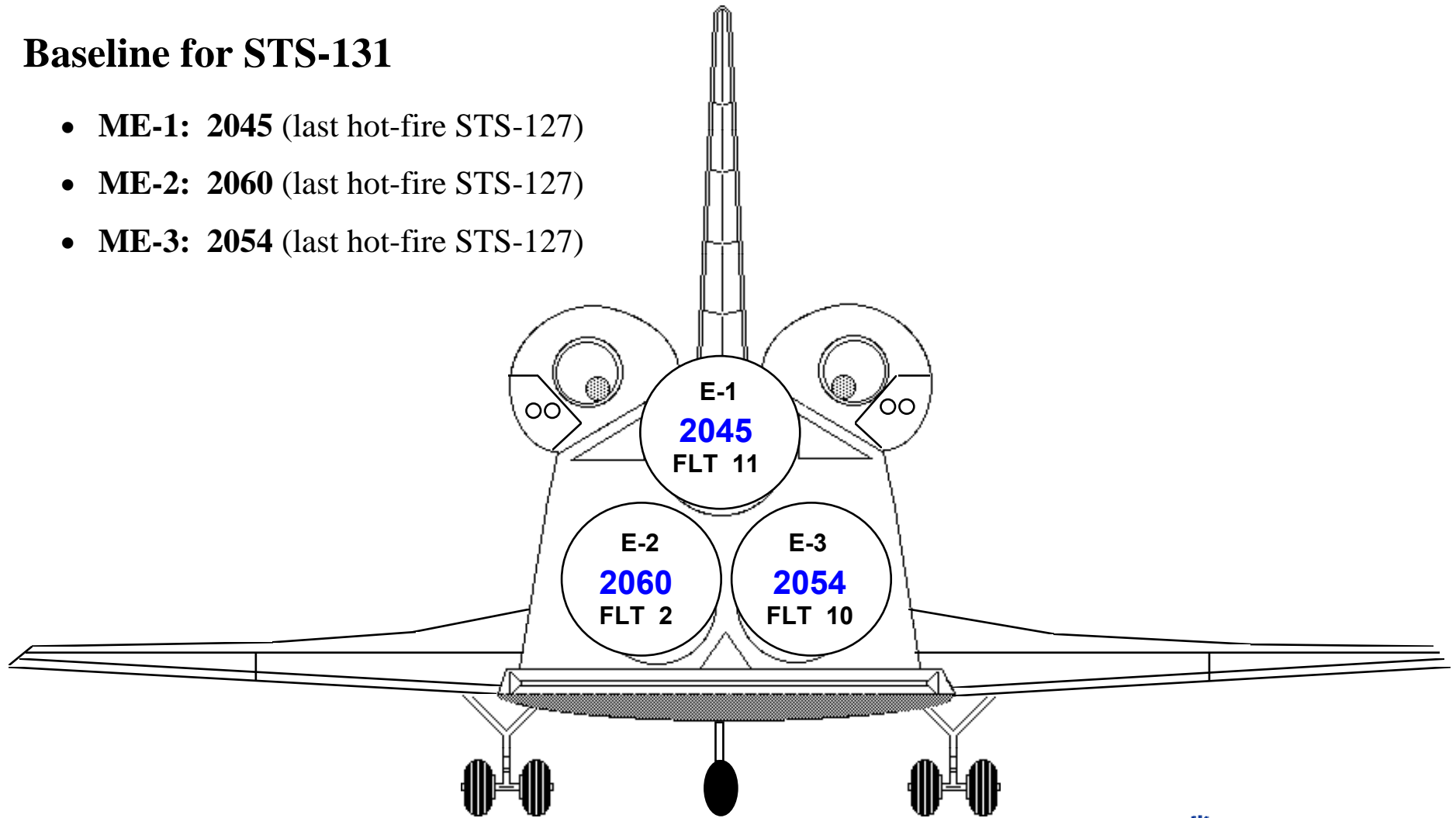



STS-131 Delta Launch Site Flow Review

SSME Planned Modifications

Mods authorized by Shuttle Project Action Request (SPAR) or Level II Change Request (CR)

ECP	Title	Engine(s)	Kit Drawing	Weight Impact	SPARs / CRs	Status
1537	Joint F2 (LPFTP-to-LPF Duct) Liquid Air Insulation Redesign, with Helium supply.	2045 2054	2R112833-010	+3.13 lbs	ME-0256 R01 ME-0255 R01	In-Work In-Work
1543	Joint F3 (LPF Duct-to-HPFTP) Liquid Air Insulation Redesign.	2045 2060 2054	2R112834-010	+0.37 lbs	ME-0256 R01 ME-0254 B ME-0255 B	In-Work In-Work In-Work
1544	Joint F5 (HPF Duct-to-MFV) Liquid Air Insulation Redesign.	2045 2060 2054	2R112835-010	-0.15 lbs	ME-0256 R01 ME-0254 B ME-0255 R03	In-Work In-Work In-Work
1556	Relocate G6 Accelerometer to Gimbal Bearing.	2045 2060 2054	2R112836-010 2R112836-020 2R112836-010	0 lbs	ME-0256 B ME-0254 R01 ME-0255 R02	Complete Complete Complete



STS-131 Delta Launch Site Flow Review

Rocketdyne Action Requests (RAR)

RAR	Title	Engine(s)	SPARs / CRs	Status
KLO-1640	Perform First Flight Inspections (post STS-127)	2060	ME-0254 B	Complete HPFTP 8125: Removed 25-Sep-09; reinstalled 7-Oct-2009. HPOTP 8312: Removed 29-Sep-09; reinstalled 8-Oct-2009.

KSC Launch and Landing Project

STS-131

DLSFR

October 15, 2009

Agenda

- Orbiter Multi Flow S.Stilson / NASA
- Milestone Interface Chart S. Stilson / NASA
- Flight Element Processing W.Bingham / USA



Multi Flow

S.Stilson

KSC ASSESSMENT / ORB MULTI-FLOW

SSP APPROVED MANIFEST

MANIFEST REF. 09B-9

1300 EDT, 9 OCT 2009

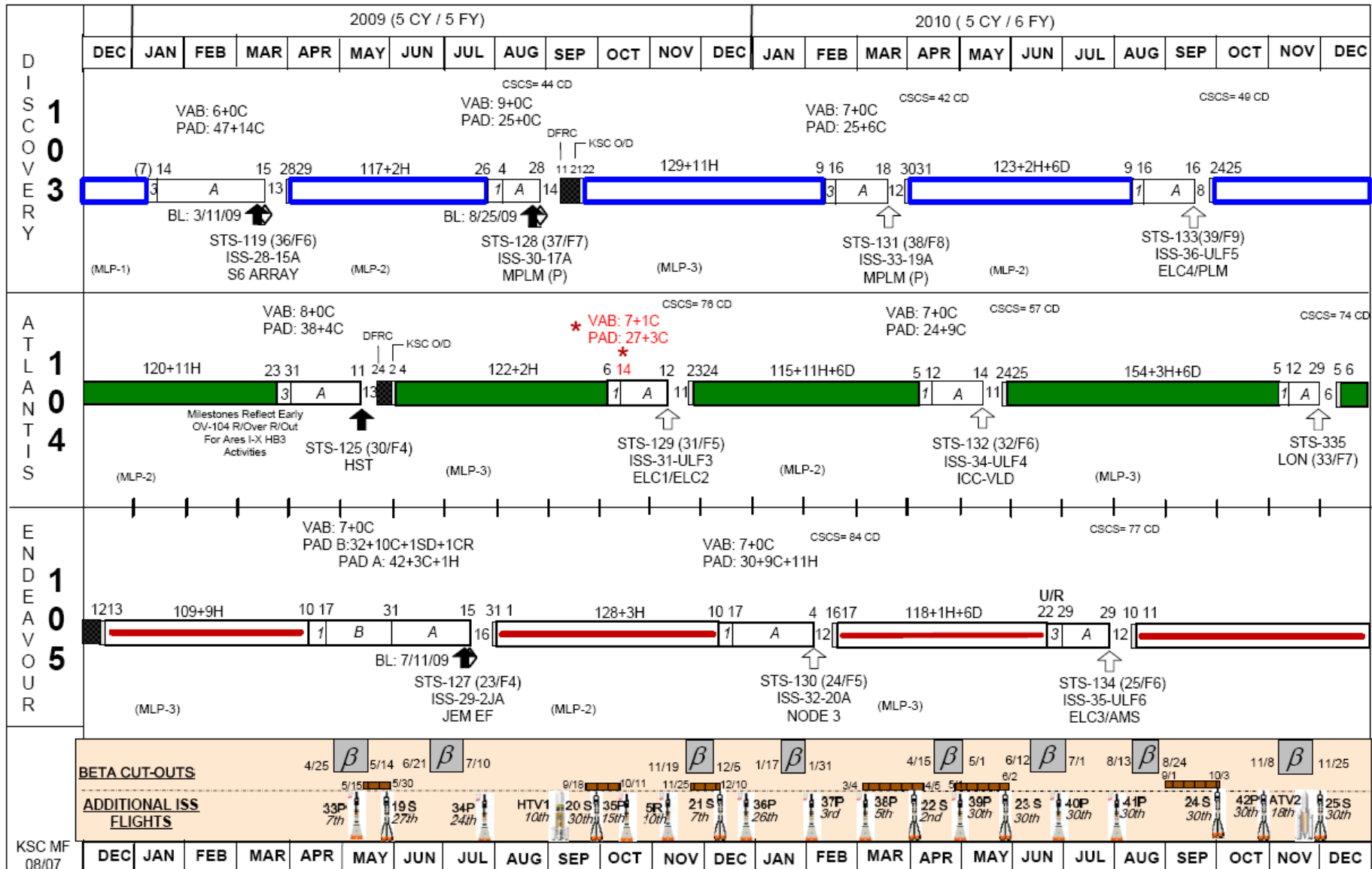

LEGEND
 H = HOLIDAY D = DRYDEN RESERVE C = PAD CONTINGENCY Wx = WEATHER OUTAGE [Green Box] = OPF-1 [Red Box] = OPF-2 [Blue Box] = OPF-3 [Hatched Box] = Vehicle out of service S = SOYUZ P = PROGRESS
 CR = CREW REST DAY [Hatched Box] = DFRC OPS [1/3] = VAB OPS [A/B] = PAD OPS △ = MILESTONE ↑ = LAUNCH ↓ = MATE CLOSEOUTS COMPLETE [Orange Box] = SOYUZ Cutout

Contact: S. Wierszalowski, USA Near-Term Manifest Planning (321)861-8701

STS-131 KSC Milestone Interface Chart

OPR: USA - R. GILLETTE, INTEG. OPS.
NASA - S. STILSON, PH-A

OV-103 / 38 / ISS-33-19A / MPLM
CREW / DURATION: 7 / 12
ET-135 / BI-142 / RSRM 110 / MLP-3 / PAD-A / VAB HB3

SSP APPROVED MANIFEST PRCB 2/5/09 (REF. S072131)
Status as of:
10/09/2009

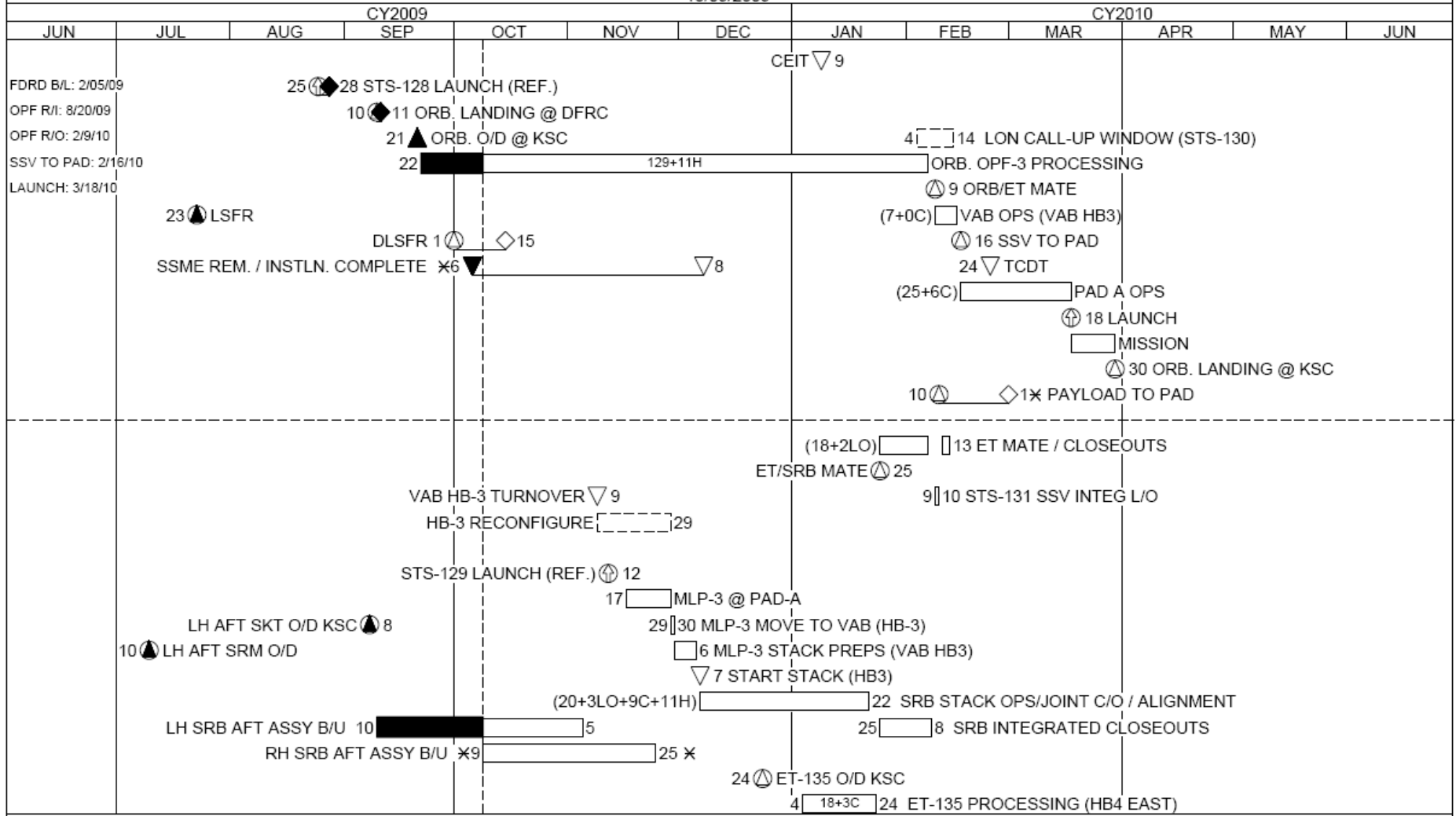

THREATS:

NOTES: 1. THIRTY-THIRD ISS/SSP FLIGHT

Flight Element Processing

W. Bingham

Flight Element Processing Overview

- **Milestone Summary** **To Be Presented**
- **Significant Processing Deltas** **To Be Presented**
- **TPS Status** **To Be Presented**
- **Issues and Concerns** **To Be Presented**

STATUS	
USA	NASA
C	C
<small>C=Concur</small>	<small>NC=Not-concur</small>

Creation Date:14-JUL-2009
Revision Date: 8-OCT-2009
Revision :L

STS-131/OV-103 OPF FLOW MILESTONES
DOWN PAYLOAD:ISS-30-17A / UP PAYLOAD:ISS-33-19A MPLM(P)

OPR:USA-BINGHAM, WAYNE W
NASA-STILSON, STEPHANIE S



Significant Processing Deltas

- Major Component Removal and Replacements
 - APU 2 (Time And Cycle) – (Potential)
 - MPS PV 9
 - MPS PV 12 Potential R/R
 - Fuel Cell 2
 - Panel A6
 - GN2 Tank - Removal Only
 - FRCS (Thruster R/R—F1D / F5R)
 - R/H RCC 22 (Discrepant Gap Filler)
- Mods
 - TAD 30231 Rudder Speed Inconel Thermal Barrier Redesign
 - TAD 30272 Arrowhead Blanket Sleeving Redesign
- Potential Mods
 - Fuel Cell Mod
 - BLT/Catalytic Coating

TPS Work Content (STS-131)

TPS Work Content (STS-131)

<u>Priority</u>	<u>Description</u>	<u>LSFR</u>	<u>DLSFR</u>
Mand	Deferred Tile/FIB for 1 Flight (Minimum) - B/F Inst	15	9 *3
Mand	In-Flight Tile/FIB Damage	*40	*40
Mand	Operation Damage (Estimate) - FRCS Tile Removal	*20	*20 *8
Mand	BLT Mod (1-Trip Tile/1-Cover Tile/Catalytic Coating)	2	5
Mand	Putty Repairs from Gind-Outs	*14	*14
Mand	Additional Putty Removals (Chits)	10	10
Mand	Corrosion Sampling (Chit J6275A)	5	5
Mandatory Total		106	114
Risk Reduction			
10	MLGD Outboard Middle 3 rd	24	24
15	Body-Flap Stub "Piano Key" Tile	18	18
Projected TPS Removals TOTAL (Estimate)		*Estimated Number	*148 *156

Issues and Concerns

- **Flow Control Valves - Hardware Deliverables**
- **APU 2 Removal and Replacement Extension Certification – Decision Date**
 - Preliminary Answer Due November 20th
- **MPS Fill and Drain Valve Actuators Hardware Deliverables**
- **A6 Panel Repair Duration (Power Down)**

STATUS		OPR: USA - J. Taylor, INTEG FM (1-7420) NASA - S. Stilson, PH-A (1-9103)	
USA	NASA	CONCUR	Creation Date: 10 MAR 09 Revision Date: 06 OCT 09 Revision: A-3
C	C		
C=Concur NC=Non-Concur			

STS-131 / OV-103

Integrated Operations Assessment Summary

Payloads: ISS-33-19A MPLM (VERT)

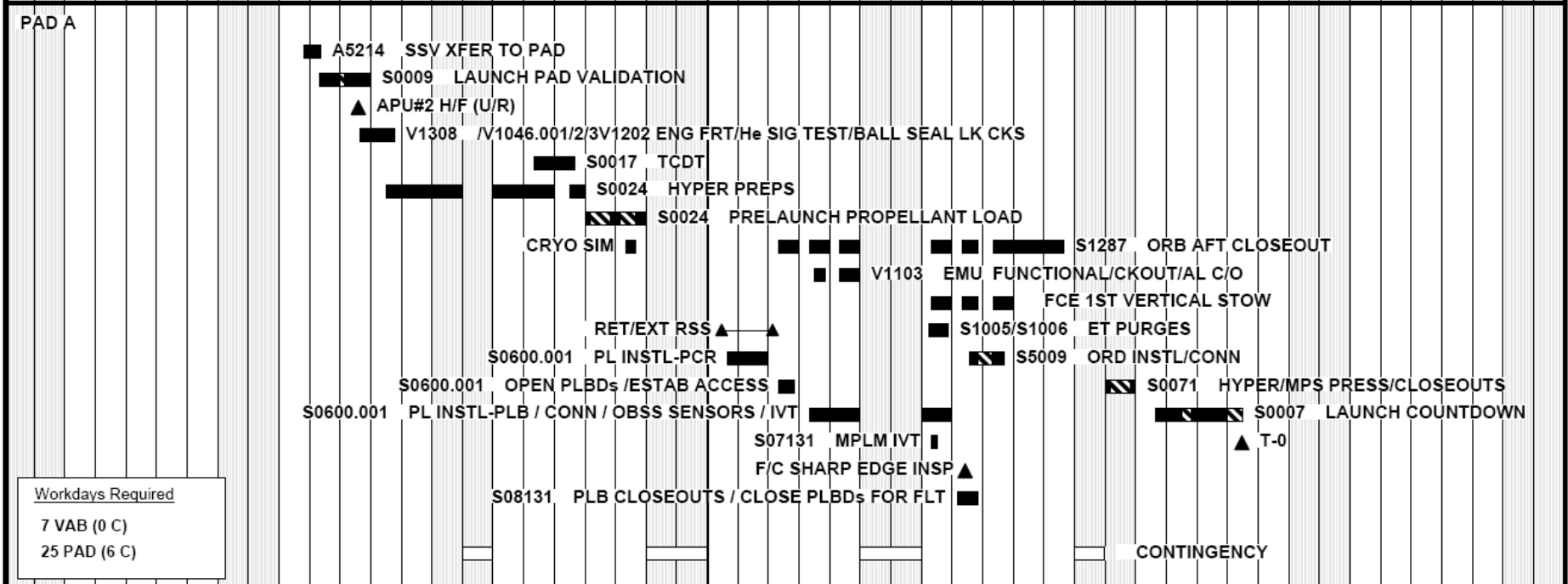
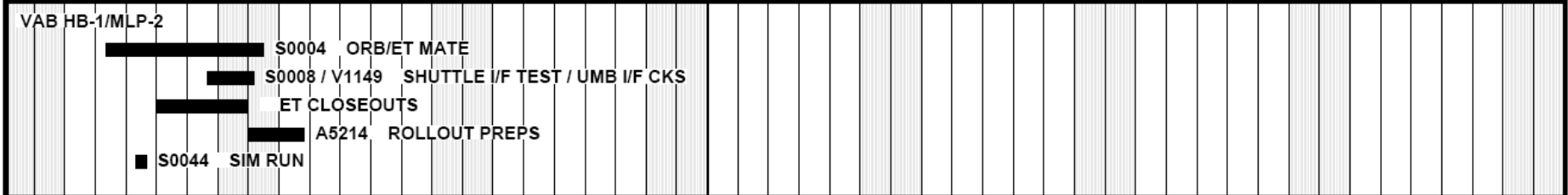
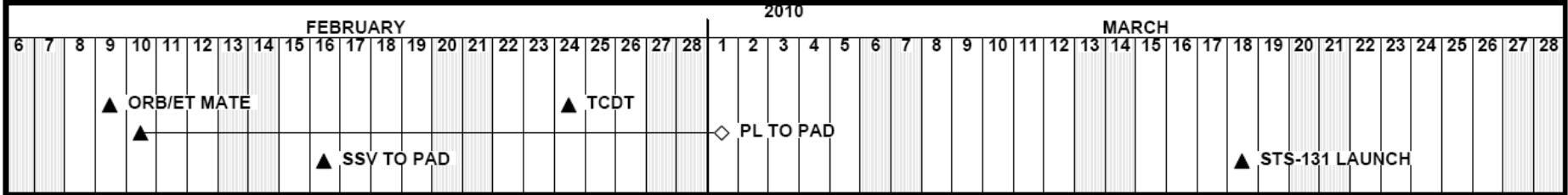



SPACE SHUTTLE PROGRAM
Space Shuttle KSC Integration Office
NASA Kennedy Space Center, Florida



STS-131 Delta Launch Site Flow Review

Presenter **Steve Reilly**

Date **10-15-09**

Backup Material

FRWG Presentation (With Minor Changes)



STS-131 DELTA LAUNCH SITE FLOW REVIEW

Presenter

Ann M. Patterson

Date

15 Oct 2009

Flight Operations and Integration (FO&I)

Flight Requirements:

FDRD

MIP, PIPs, CIP

FRD

Backup Charts



SPACE SHUTTLE PROGRAM
Space Shuttle Flight Operations and Integration Office
 NASA Johnson Space Center, Houston, TX



STS-131 DELTA LAUNCH SITE FLOW REVIEW

Presenter Ann M. Patterson
Date 15 Oct 2009

<u>Documentation</u>	<u>Status</u>	<u>ECD/Date</u>
----------------------	---------------	-----------------

FDRD – NSTS 07700, VOL III

- | | | |
|---------------|--|-------------------|
| - CR S072131A | Increase STS-131 Mission Duration
<i>(Out for review)</i> | JPRCB
2 Nov 09 |
| - CR S072131B | Remove 6 th GN2 Tank and Add TRIDAR
for STS-131
<i>(Out for review)</i> | PRCB
15 Oct 09 |

MIP – ISS 19A, Basic, Chg 1 (6/24/09)
NSTS 21553

- | | | |
|-----------------|--|-----------|
| - MIP21553-0003 | Add LWAPA, Delete SOLAR, Delete Contingency
Landing Case, Update Control Weights
<i>(Out for review)</i> | 15 Oct 09 |
| - MIP21553-0004 | Update Table 4-2a, Task Priorities
<i>(Out for review)</i> | 16 Oct 09 |
| - MIP21553-0005 | FPSR Update to Appendix E
<i>(Awaiting input from ISSP)</i> | TBD |

PIP – MAUI, Basic, Chg 2 (5/5/08)
NSTS 21530

No Open CRs



SPACE SHUTTLE PROGRAM
Space Shuttle Flight Operations and Integration Office
 NASA Johnson Space Center, Houston, TX



STS-131 DELTA LAUNCH SITE FLOW REVIEW

Presenter Ann M. Patterson
Date 15 Oct 2009

<u>Documentation</u>	<u>Status</u>	<u>ECD/Date</u>
----------------------	---------------	-----------------

PIP- SEITE, Basic, Chg 1 (9/4/08)

NSTS-21542 - PIP21542-0003	Update Attitude and Photo Requirements <i>(Out for Review)</i>	19 Oct 09
-------------------------------	---	-----------

PIP – SIMPLEX, Rev A (6/16/08)

NSTS 21327	No Open CRs	
------------	-------------	--

PIP – RAMBO-2, Basic (2/23/09)

NSTS 21556 - PIP21556-0002	Remove PLB Lighting Constraint <i>(Out for Review)</i>	19 Oct 09
-------------------------------	---	-----------

CIP – LMC (Lightweight Multipurpose Experiment Support Structure Carrier), Rev B, Change 16 (6/9/09)

NSTS 21494 - CIP21494-0031	Update control Weights in STS-131 LMC CIP Addendum <i>(Out for Review)</i>	19 Oct 09
-------------------------------	---	-----------

PIP – MPLM, ISS Multi-Purpose Logistics Module, Rev B, Change 3 (3/23/09)

NSTS 21499	No Open CRs	
------------	-------------	--



STS-131 DELTA LAUNCH SITE FLOW REVIEW

Presenter

Ann M. Patterson

Date

15 Oct 2009

- **STS-131 Latest FRD Revision**
 - **Revision 02, Dated, July 7, 2009 (<http://sspweb.jsc.nasa.gov/efrd>)**
- **Open CRs**
 - **FRD 17462-131-0011, Add One Hand Held LIDAR (HHL) to STS-131**
- **Closed CRs**
 - **FRD 17462-131-0009, Add DSO 640**
 - **FRD 17462-131-0010, Delete One N2 Tank**
- **Pending CRs**
 - **Increase STS-131 Mission Duration**
 - **Add TRIDAR to Mission**



STS-131 DELTA LAUNCH SITE FLOW REVIEW

Presenter

Ann M. Patterson

Date

15 Oct 2009

Payload Integration Services/Interfaces



MPLM

- **Services** - 124 VDC from PTU 1 via ROEU (on-orbit) (PTU 1 & 2 will be interconnected) (for MPLM internal components)
 - 28 VDC from Primary PL bus C via ROEU (for shell heaters)
 - OIU 1553 bus 2A and 2B via ROEU
- **Significant Support Hardware** – ROEU, SPAT, videospection camera, various harnesses and attach hardware
- **New 1st Flight** – None
- **Latch type** – Active, with 22” latch guides in all locations
 - Primary X₀ 1202.73, Secondary X₀1010.00, Keel X₀ 1108.33

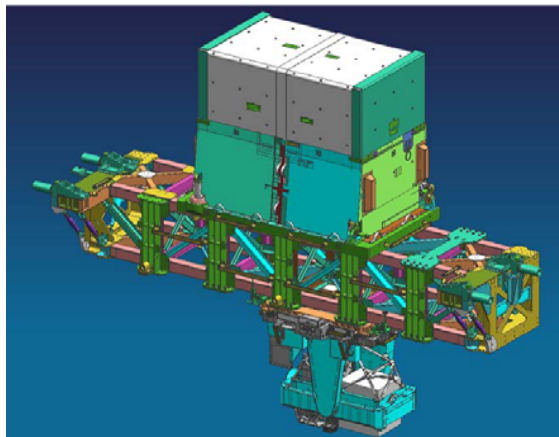

LMC

- **Services** - 28 VDC from aft PL bus C via LIP panel
- **Significant Support Hardware** – PAT box, harnesses and support hardware
- **New 1st Flight** – None
- **Latch type** – Passive
 - Primary X₀ 1273.53, Secondary X₀1242.07, No Keel (Y-lug)



STS-131 DELTA LAUNCH SITE FLOW REVIEW

Presenter

Ann M. Patterson

Date

15 Oct 2009

Payload Integration Services/Interfaces



OBSS (Configuration 4 LDRI/ITVC and LCS/IDC cameras)

•Services - 124 VDC from PTU 2 (for LCS/ID

- 28 VDC from MN A (for LDRI/ITVC)

- Ethernet line for LCS/IDS

- LDRI/ITVC video (VSU PL 2) and RCU CAM 4 Sync

- RSC (Config 2) camera video to VSU PL 3

•Significant Support Hardware – SPDU, PGSC, SPASP/OPP for SPEE relay control, RSC power and feed throughs

STS-131 DLSFR BACKUP

- **Opportunity Modifications (info only)**
- **STR/TPS Priorities backup data**
- **Previously Baselined Modifications (STS 131 LSRR/LSFR)**
- **Potential Modification Information**
- **OV 103 OMDP Red and Yellow Requirements**
- **Engineering, Hardware and Certification Status**
- **Mod Record and MECSLSI Updates**

STS-131 Opportunity Mods (Info Only)

- **19735 WLE Spar “Sneak Flow” Protection**
 - Increases RCC panel damage tolerance by adding a flow restrictor to limit allowable plume flow to 50% across the flow restrictor
 - Mod completed at all panel locations with the exception of RH panel 4 & LH panels 2-4.
- **19763 Lower WLE Carrier Panel Horse Collar Gap Filler Redesign, Panels 1-4**
 - Redesigns the lower WLE access carrier panel horse collar gap fillers with an enhanced design with additional sleeving
 - Mod completed at all panel locations with the exception of RH panel 4 & LH panels 2-4
- **23227 Connector Saver (ME414-0630) Redesign (OMS Pod, Ku Band)**
 - Connector Saver mod provides proper interfacial seal and wavy washer engagement retention force to reduce risk of inadvertent demate during use.
 - Only Left POD and KU band locations remain to be worked

STS-131 Risk Reduction ~ Percentages Shown

TPS Priorities

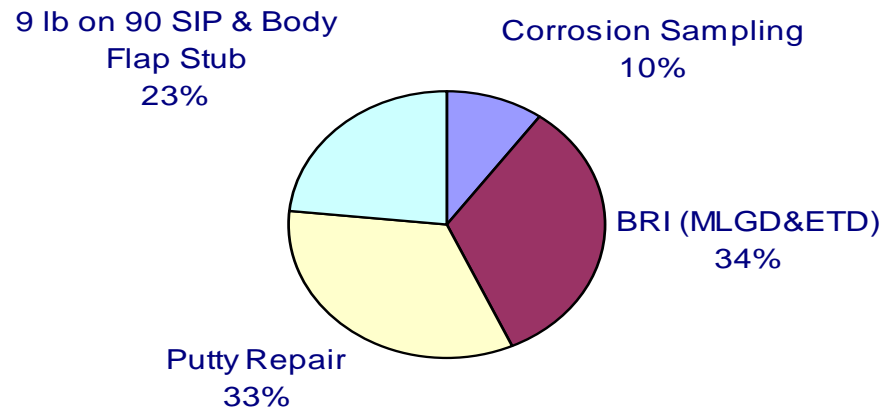

- Orbiter's expectations for the work areas are shown on the pie chart for STS-131
- Exact numbers are determined by the KSC Team based on vehicle configuration, access, and flow duration
 - Distribution provides data/risk reduction in all areas of the list
 - Does not allocate all the resources in one area

OV-103 STR/TPS Priorities

Mandatory

- **Flight damage, OMRS Rqmts/Chits, LRU access, & deferred work**
 - Corrosion Sampling (10% of total tile allocation) *Chit J6275A*
 - Putty repairs in RCC & Window DTA Zones (23% with 10 tile min.) *Chit Pending*
 - Continue G/F R & R on a best effort basis – zones 2B
 - Deferred work may be redeferred with acceptable inspection

Prioritized Opportunity

1 – 9 1 thru 9 complete on OV 103

10.MLGD – Outboard Middle 1/3 - (6 Door/6 STR) – None completed

**11.ET Door – Remaining STR side of door & leading edge on door – 40 tiles (24 STR/16 door) –
39 remaining**

12.MLGD – Outboard Aft (1/3 left) 6/door/6 STR)- 24 Tile – None completed

**13.Nose Area 9lb/90 SIP Upgrade to FRCI-12 – 14* Tiles (7/side) – (*103 16 tiles, thruster) – 13
remaining**

**14.Base Heat Shield Stinger 9lb/90 SIP Upgrade to AEBT-8 – 42 Tiles (32/stinger, 10/Box
Attach point) – 32 remaining**

OV-103 STR/TPS Priorities (cont)

15.Body Flap Stub “Piano Key” Upgrade to AETB-8 – 40 Tile – **39 remaining**

16.Gap fillers in Subset 2B (Line across MLGD edge) – **3 zones remaining**

17.BRI-18 Tile – Remaining MLGD (top priority)/ET Door/LESS carrier panels/NLGD

1. MLGD (Inboard forward edge working to AFT door edge) – **None Completed**
2. ET Door – **23 remaining**
3. LESS - panels 8, 9, 10, 7, 6, 5, 4, 3, 2, 1, 11, 12, 13 (in that order) – **61 tiles remaining**
4. NLGD (attrition – do leading edge first) – **108 tiles remaining**

18.Mod work (WLE sneak flow, WLE Horsecollar Gap Fillers) – **4 locations remaining**

19.MADS Instrumentation Failures (placeholder)

20.Remaining Gap Fillers & Window BRI-18 - **121 remaining**

Windows 2, 3, 4, & 5 Upper Carrier Panels (top priority)

Current Vehicle Status – Corrosion Under TPS

Special Chart

REGION	REMAINING WORK CONTENT			
	MINIMUM SAMPLE	OV-103 (Current Flight)	OV-104 (Current Flight)	OV-105 (Current Flight)

TILE (EACH SAMPLE SITE IS ONE TILE CAVITY)				
TILE - AFT FUSE BASE AND DOME HEAT SHIELDS	6	COMPLETE	COMPLETE	COMPLETE
TILE - AFT FUSE LOWER	7	COMPLETE	COMPLETE	COMPLETE
TILE - AFT FUSE SIDES	2	2	2	2
TILE - BODYFLAP LOWER SURFACE	3	3	3	COMPLETE
TILE - BODYFLAP SIDES AND UPPER SURFACE	3	1	3	COMPLETE
TILE - FWD FUSE LOWER	6	COMPLETE	COMPLETE	COMPLETE
TILE - FWD FUSE SIDES AND UPPER SURFACE	7	COMPLETE	COMPLETE	COMPLETE
TILE - LH IB ELEVON	3	COMPLETE	COMPLETE	COMPLETE
TILE - LH OB ELEVON	2	COMPLETE	COMPLETE	COMPLETE
TILE - LH WING	14	COMPLETE	COMPLETE	COMPLETE
TILE - MID FUSELAGE LOWER	21	COMPLETE	COMPLETE	COMPLETE
TILE - RH IB ELEVON	3	COMPLETE	COMPLETE	COMPLETE
TILE - RH OB ELEVON	2	COMPLETE	COMPLETE	COMPLETE
TILE - RH WING	14	COMPLETE	COMPLETE	COMPLETE
TILE - VERTICAL TAIL and RSB	4	COMPLETE	COMPLETE	COMPLETE

FLOW PLANNING KEY - REGION PRIORITY FOR LSRR / LSFR	
5	Priority Region - Number indicates remaining locations to be sampled
COMPLETE	Completed Region - No additional sampling required
3	Low Priority Region - Number Indicates remaining locations to be sampled

REGION	REMAINING WORK CONTENT			
	MINIMUM SAMPLE	OV-103 (Current Flight)	OV-104 (Current Flight)	OV-105 (Current Flight)

FRSI AND FIB (EACH SAMPLE SITE IS ONE FIB OR ONE 12" X 12" SECTION OF FRSI) - (12" x 24" for WINGS)				
RSI - AFT FUSE SIDES BHS and DHS	3	2	2	2
RSI - FWD FUSE SIDES AND UPPER SURFACE	9	COMPLETE	COMPLETE	COMPLETE
RSI - LH IB ELEVON	3	1	2	3
RSI - LH OB ELEVON	2	2	2	2
RSI - LH WING	12	10	COMPLETE	12
RSI - MID FUSELAGE SIDES	15	COMPLETE	1	COMPLETE
RSI - RH IB ELEVON	3	3	2	3
RSI - RH OB ELEVON	2	2	2	2
RSI - RH WING	12	10	COMPLETE	12
RSI - VERTICAL TAIL and RSB	11	COMPLETE	COMPLETE	COMPLETE

HEATSINK PERIMETER INSPECTIONS (EACH SAMPLE SITE IS ONE 2 LINEAR FOOT SECTION)				
HEATSINK PERIMETER - BODYFLAP	3	3	3	3
HEATSINK PERIMETER - LH OB ELEVON	1	1	1	COMPLETE
HEATSINK PERIMETER - LOWER FWD FUSELAGE	3	3	3	3
HEATSINK PERIMETER - RH IB ELEVON	2	2	2	1
HEATSINK PERIMETER - RH OB ELEVON	1	1	1	COMPLETE
HEATSINK PERIMETER - LH IB ELEVON	2	2	2	1



STS-119 Failure Aft Stub "Piano Key" Tile

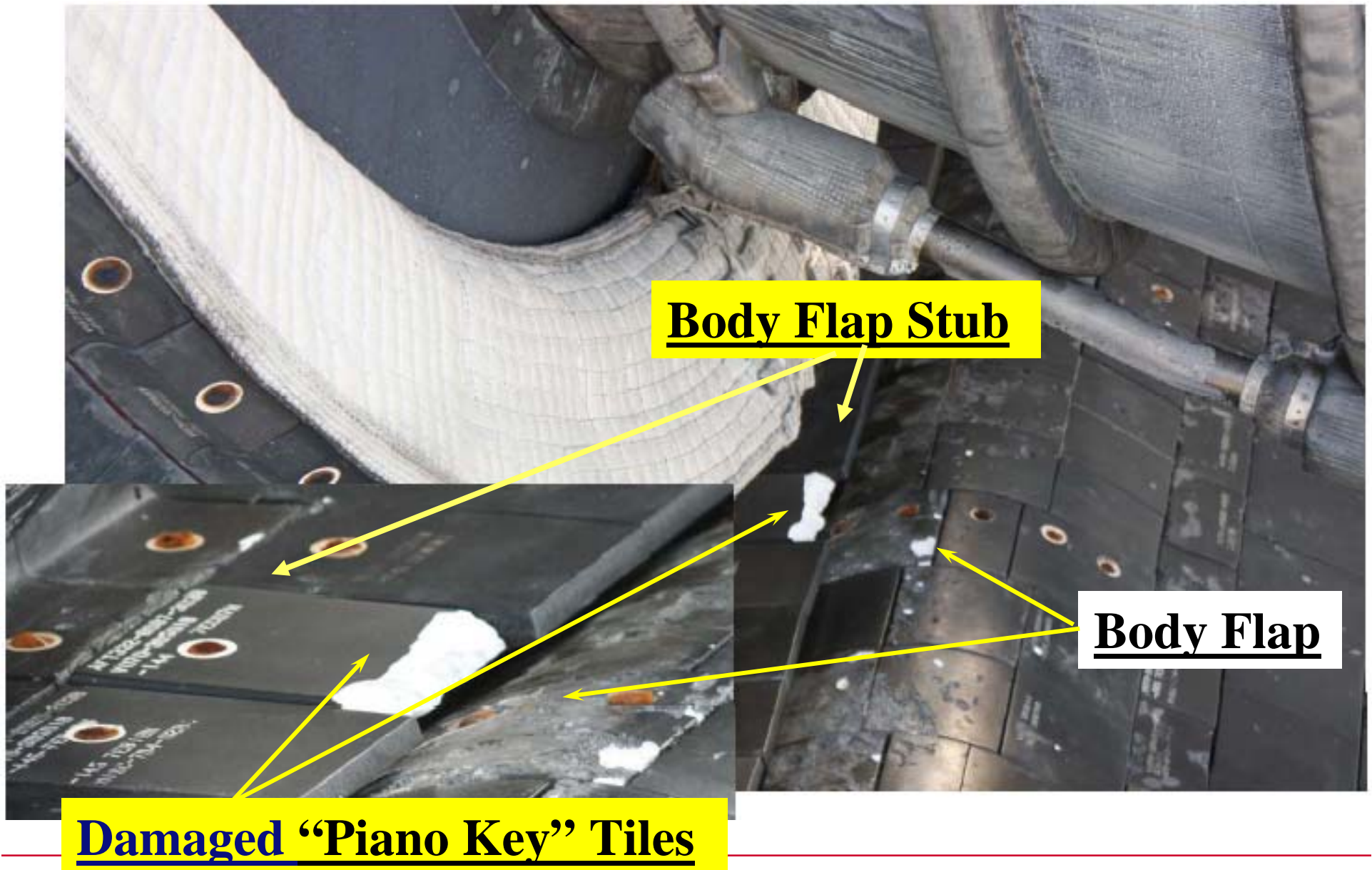

Body Flap Stub “Piano Key” Tile Upgrade

- **30261 Aft Stub Tile Upgrade (Attrition)**
 - Improves the damage resistance of these carrier panel tiles adjacent to the body flap
 - Several instances of damage historically seen attributed to ground processing collateral damage
 - 8 of these tiles at the centerline, determined to be most susceptible to handling damage, were previously upgraded to FRCI-12.
 - Flight experience has shown that these improved tiles have performed well to date and that recent tile damages have been to the remaining LI-900 tiles.
 - Due to the recent tile damages and success of the previous upgrade, the remaining LI-900 tiles along the aft stub will be upgraded to AETB-8 material having roughly twice the material strength

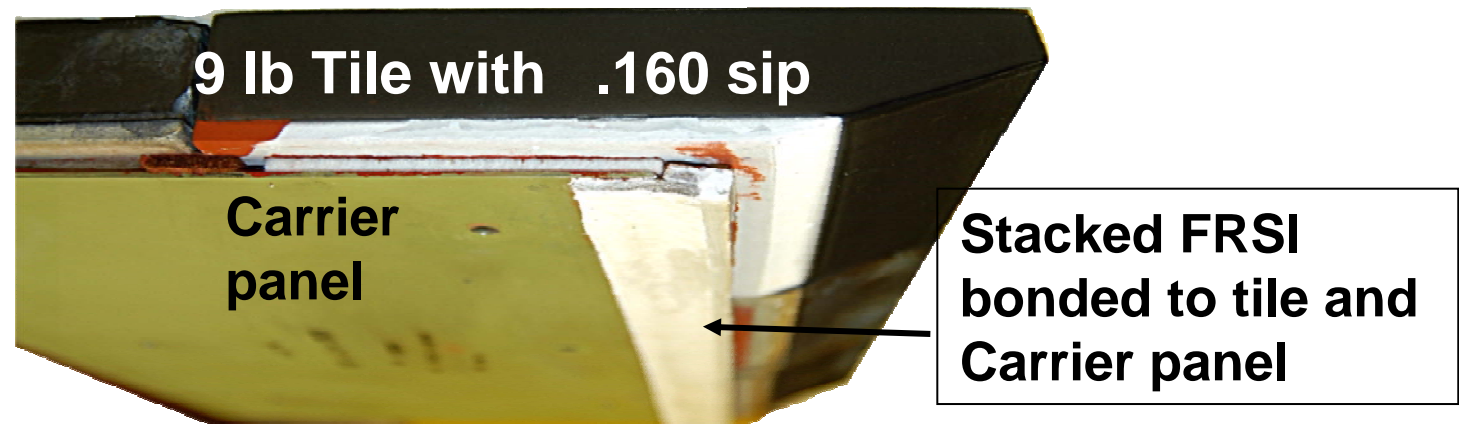

Previously Baselined Mod (STS 131 LSRR)

TAD 30231 – Rudder Speed Brake Inconel Thermal Barrier Redesign

- This mod provides redesigned Rudder Speed Brake (RSB) inconel thermal barrier tab attachments to improve strength and durability
 - Replaces all 60 tabs installed located around the RSB periphery, which provide thermal protection from SRB/SSME plume heating during ascent
 - Tabs are used to bridge the ~0.060” gap between the RSB spring clip seals
 - Missing tabs have been found post-flight on numerous occasions
 - Improved ground inspection procedures were implemented following STS-124 (tab loss seen on-orbit), but tabs still found missing post-flight
- The main features of the redesign include:
 - Improved primary fastening mechanism (spot welds) by increasing number and improving quality control (class “C” to “B”)
 - Shortened tab overlap (0.300”) with adjacent spring clip to reduce the moment arm and stress on the spot welds
 - Added secondary fastener by increasing tab length to allow for mechanical attachment using existing screws for spring clip

Previously Baselined Mod (STS 131 LSRR)

Rudder Speed Brake Spring Clip/Tab Locations

Original Design

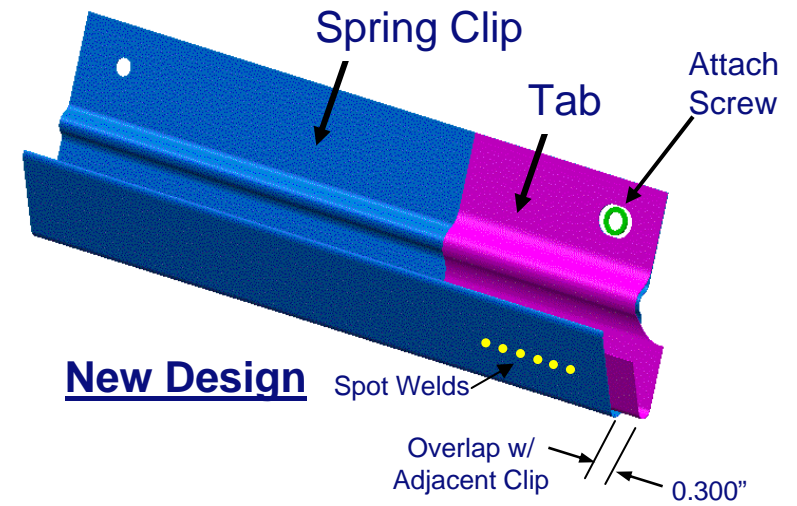
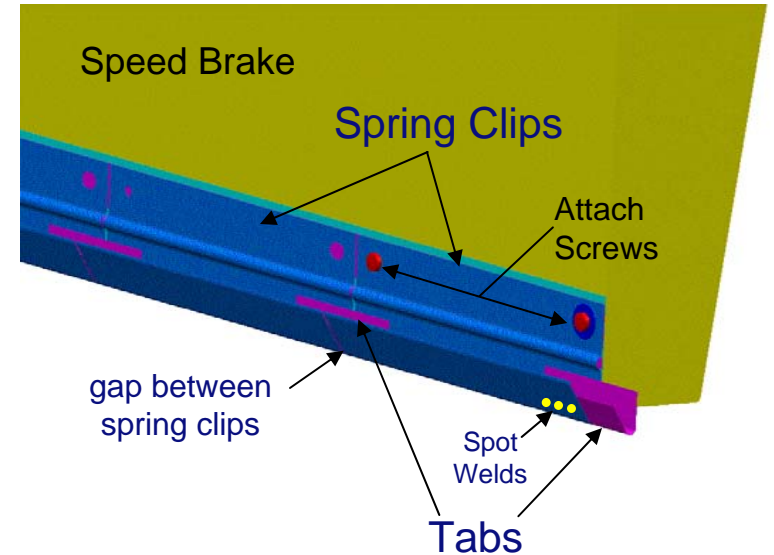
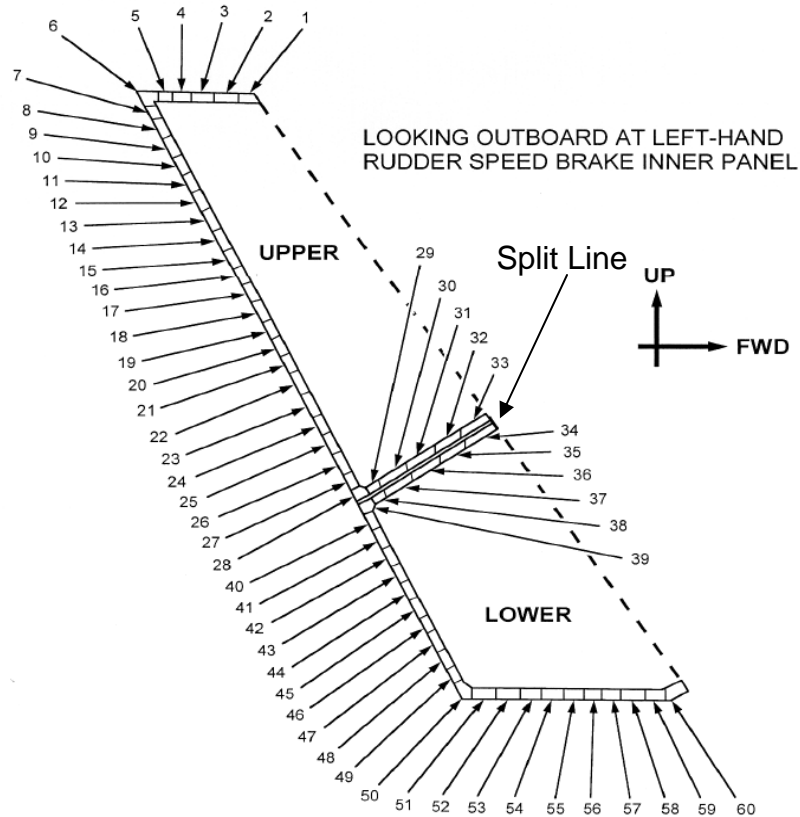

- **60 thermal spring clips are installed along the Rudder Speed Brake (RSB) periphery**

- Each spring clip is roughly 6-8 inches in length - Gap between spring clips is $0.060'' \pm 0.030''$
- **Tabs** located at the interface between adjacent spring clips to cover the gap

Previously Baselined Mission Kit Mod (STS 131 LSFR)

• STS-131 Starboard Lightweight Tool Stowage Assy Tray Mod

- Due to allocation of the two standard port lightweight TSAs to OV-104 and OV-105 and manifest delays, OV-103's STS-128 flight required use of the starboard LWT TSA for stowage of standard contingency tools.
- A new cushion was provided to stow the tools in the starboard TSA, however, a CEIT fitcheck issue resulted a 1-flight mod to reverse the forward tool tray installation and remove its handle.

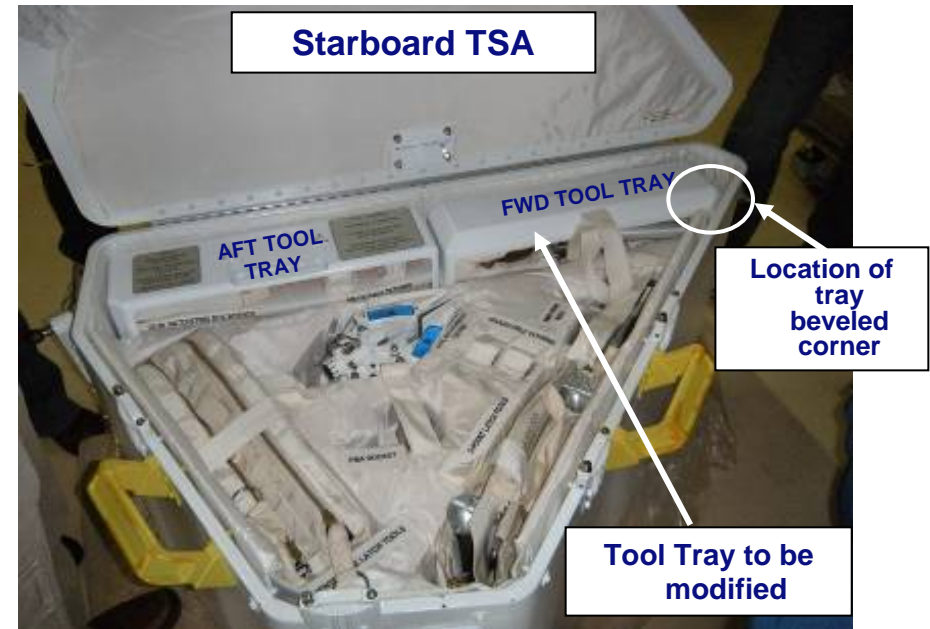

- Reversal to “upside-down” orientation was required to allow the tool tray’s beveled edge to align properly with the starboard TSA sidewall
- Reversing the tray put the tray handle on bottom in new orientation – handle was removed to allow tool tray to fit flush with the aft tray and allow TSA lid closure.
- For STS-131, the forward tool tray will receive a permanent mod which installs the handle on opposite end of the tray to facilitate use in the starboard TSA.

STS-131 BLT & Catalytic Coating DTO Overview Layout

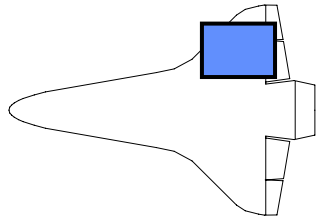
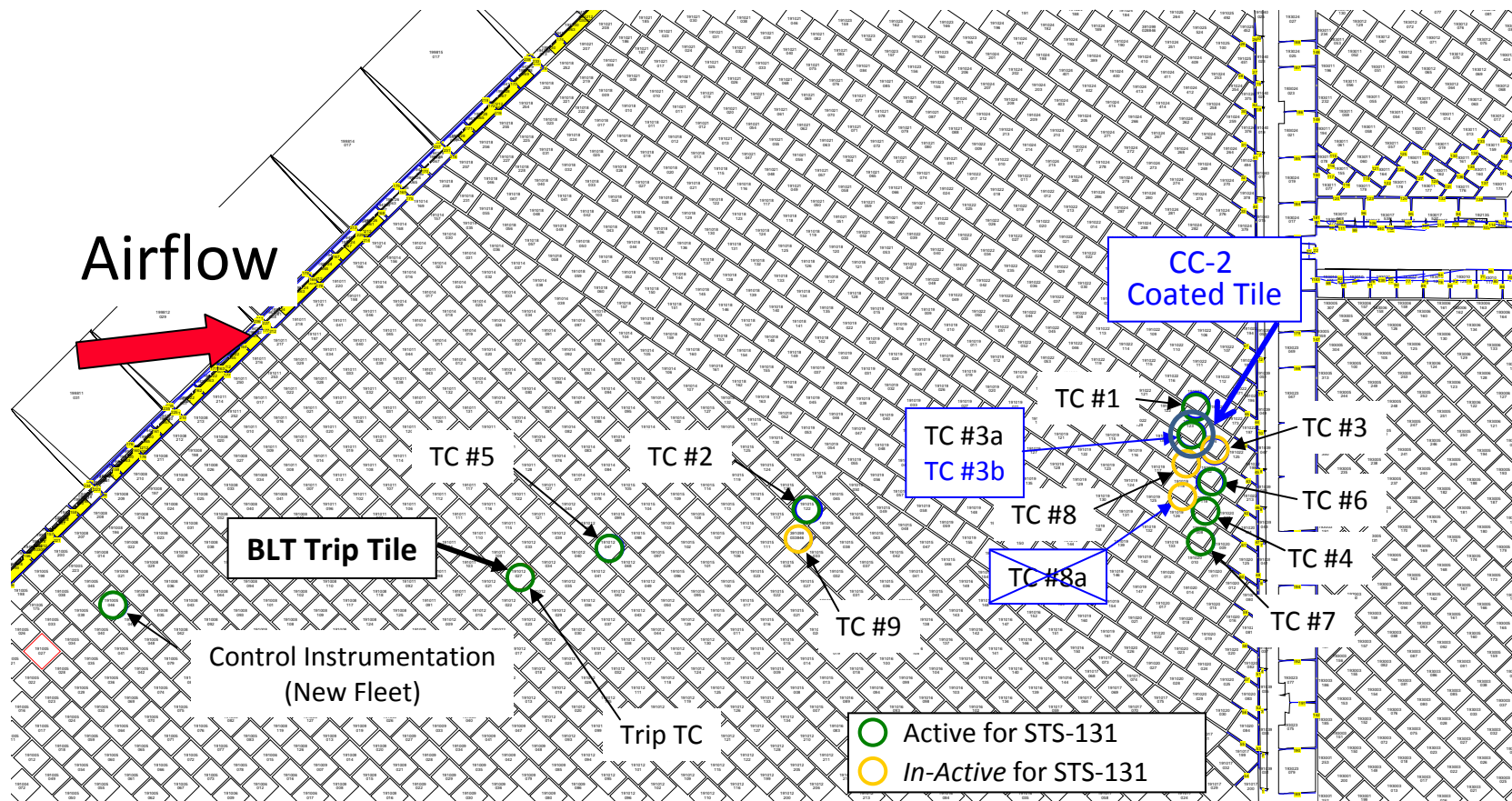
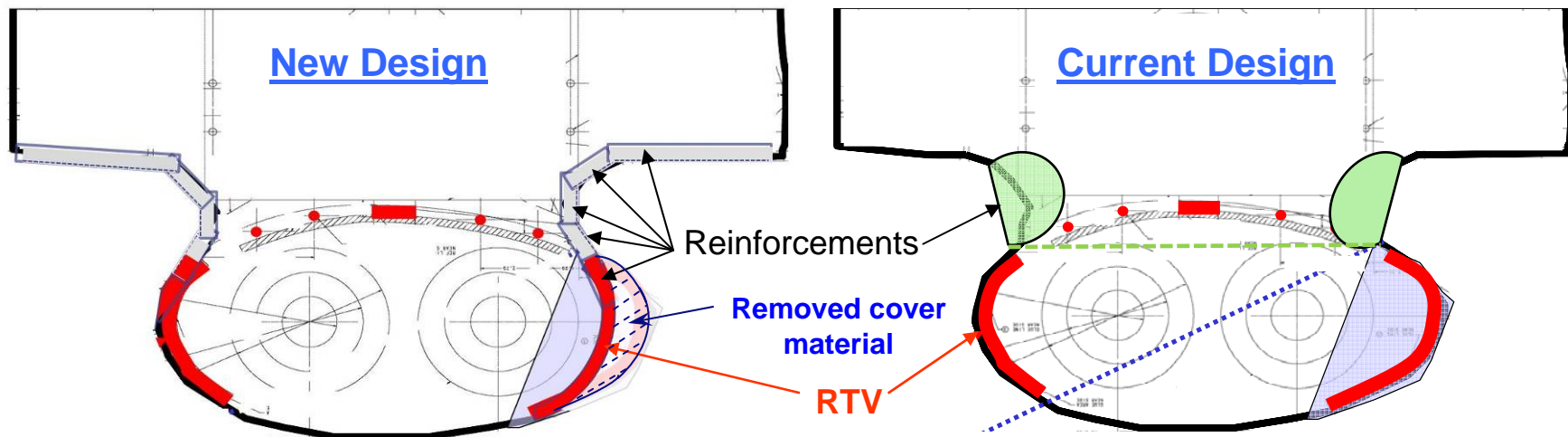

Diagram view:
Looking up at the lower surface of the orbiter.



STS-131 Redesigned F3D/F4D Thruster Tyvek Cover

- TAD 30270 Redesigned F3D/F4D Thruster Tyvek Cover
 - Modification to F3D/F4D Tyvek cover will reduce likelihood of remnant releasing beyond velocity certification limit
 - 10 out of 28 F3D/F4D covers have failed or released late in flight since RTF
 - Redesign includes a change in cover geometry and overlapping reinforcements to reduce sudden inflation stress riser
 - Cover geometry is smaller with remnant area trimmed off causing peeling force to be better aligned with adhesive edge (similar to other cover configurations)
 - Small continuous reinforcements are adhered to all leading edges which eliminates the 3 ply to single ply stress riser of the previous localized reinforcements
 - Mass is similar to previous down cover design (new design avg of 0.074 lbs vs previous design avg of 0.070 lbs - all other design features remain the same)



OV 103 OMDP Red and Yellow Requirements

- **List of 21 Red requirements**

HYD/WSB

- V58AJ0.011: MN PUMP EDV GRND SHORT CIRCUIT VERIF
- V58AJ0.012: MAIN PUMP EDV REDUNDANCY CHECK
- V58AJ0.020: CIRC PUMP ELECTRICAL VERIFICATION
- V58AJ0.023: CIRC PUMP APU CMD INHIBIT VERIF
- C00AD0.040002 (File II) SERIES RETRACT VALVES (LV25 & LV41)

PVD

- V05AN0.052: SIDE HATCH BARRIER CHECK VALVE INSP
- V05AN0.055: EMERGENCY CREW EGRESS CHECK VLV INSP
- V05AN0.060-B: VERTICAL STABILIZER PURGE DUCT CHECK VLV
- V05AN0.060-C: DRAG CHUTE PURGE DUCT CHECK VALVE
- V05AN0.065: OMS POD PURGE DUCT CHECK VALVE INSPECT
- V05AN0.070: 1307 BKHD CHECK VALVE INSPECTION
- V05AN0.110: DRAG CHUTE VENT CHECK VALVE INSP
- V05AR0.015: ORB COMPARTMENT STRUCT LEAKAGE TEST

OV 103 OMDP Red and Yellow Requirements cont'd

TPS

- V09AK0.036: ELEVON COVE INTERNAL INSPECTION
- V09AK0.037: ELEVON CENTER HINGE SEAL INSP
- V09AN0.013: PERIODIC POST FLT TPS RE-WTRPRF – ORB
- V09AT0.030: BODY FLAP/BODY FLAP END PLATES TPS
- V09AW0.020: HRSI/LRSI/FI SCREED/HEATSINK INSP
- V09AW0.030: ORBITER RTV BONDLINE SAMPLES
- V09AW0.040: OMS POD RTV BONDLINE SAMPLES

ATCS

- V61AY0.051: O2 PP SENSOR & CONT TEST - EMER MODE

● List of 1 Yellow requirement

APU

- C00AA0.090010: AUXILIARY POWER UNIT (APU) 5 YEAR WETTED LIFE R & R (APU 2 only, OV-103)

STS-131 DLSFR Mods for Baseline – Engineering, Hardware and Certification Status

MCR NO.	MCR TITLE	Est. Engr Release (MM/DD/YY)	G.O. Engr Need (MM/DD/YY)	Est. Hdwe Delivery (MM/DD/YY)	G.O. Hdwe Need (MM/DD/YY)	MOD/CERT GO / NO-GO	CERT SUBMITTAL DATE	CERT APPROVAL DATE (ESTIMATE)	CERTIFICATION CR / CAR (BOEING)
Mods for Authorization - STS-131 DLSFR									
30010 Teal	<u>Window Shield Bag Modification</u> Adds Velcro to the window shield container bags (windows 7 - 10) to allow for temporary stowage of the shields and containers to existing Velcro locations on the flight deck in closer proximity to the windows. Window shield container bags are used for protective in-flight storage of the flight deck window shields when removed for external viewing and photography and currently require stowage in the middeck. Crew requested improvement for time-savings associated with the multiple short duration uses of the shield container bags on-orbit	Released	N/A	10/29/09	TBD	Go	10/5/09 A	10/19/09 P	CR 25-660288-001B CAR 03-25-660288-001B
30272 Sharou	<u>Arrowhead Blanket Sleeving Redesign</u> Change Arrowhead Blanket configuration to preclude sleeving protrusion, which occurred on several flights since RTF, even with the stitching modification previously implented intended to mitigate sleeving protrusions. Configuration chosen will replace sleeving with a gap filler bonded to the bearing plate and will increase the inside diameter of the arrowhead blanket cutout to compensate for the added gap filler. An earlier configuration of the blanket had been bonded to the bearing plate, but was eliminated as a ground ops enhancement.	Released	N/A	N/A	N/A	Go	9/23/09A	10/2/09A	CR 07-391001-001AC CAR 36-07-391001-001AC

STS-131 DLSFR Mod Records for Baselineing

MCR NO.	MCR TITLE	KIT-MOD RECORD / TECH ORDER IMPACT DESCRIPTION	REMARKS
Mods for Authorization - STS-131 DLSFR			
30010 Teal	Window Shield Bag Modification Adds Velcro to the window shield container bags (windows 7 - 10) to allow for temporary stowage of the shields and containers to existing Velcro locations on the flight deck in closer proximity to the windows. Window shield container bags are used for protective in-flight storage of the flight deck window shields when removed for external viewing and photography and currently require stowage in the middeck. Crew requested improvement for time-savings associated with the multiple short duration uses of the shield container bags on-orbit	TCTIM6630010REF,0003,0 - Window Shield Bag Mod CCCD Impact: (Add) SED32105548-379 Window Shade Bag Contents (Remove) SED32105548-378 Window Shade Bag Contents SGD32104454 CCCD (Line Item 225) Model MV0611A	V611-660283 A01 window 7 & 8 shield stowage bag V611-660285 A01 window 9 & 10 shield stowage bag V611-661611 D03 end item SED32105548-379 installs/manifests shields in shade stowage container (installed by CCCD) Ref OCRD S165458
30272 Sharou	Arrowhead Blanket Sleeving Redesign Change Arrowhead Blanket configuration to preclude sleeving protrusion, which occurred on several flights since RTF, even with the stitching modification previously implented intended to mitigate sleeving protrusions. Configuration chosen will replace sleeving with a gap filler bonded to the bearing plate and will increase the inside diameter of the arrowhead blanket cutout to compensate for the added gap filler. An earlier configuration of the blanket had been bonded to the bearing plate, but was eliminated as a ground ops enhancement.	TCTIV3930272REF,0103,0 - Arrowhead Blanket Sleeving Redesign No Tech Order & MECSLSI Impact	Ref OCRD S165448

BACK-UP

STS-131 ΔLSFR

OMRSD

- **FII V2 Payload (Post-Mate)**

 - Baselined Files

 - P350 MPLM

 - P494 LMC

 - RCNs

 - PP17965

 - Payload Baseline (P553)

 - Baseline

 - 08/04/09A

- **FII V4 (Pre-Mate)**

 - RCNs

 - PS18038R1

 - Mission-Unique List

 - Baseline

 - 09/28/09A

 - PS18039R2

 - FIII MUL

 - 09/28/09A

 - PS18037R1

 - Adjacent Pin Test

 - 09/28/09A

- **FII V6 (Shuttle Experiments) – None**

- **Issues / Concerns**

 - None

STS-131 ΔLSFR

Annex 1: ISS-19A Annex 1

Activity

ECD

**Baselined
05/09/09A**

Post CIR Update

- CR Approval

10/30/09

L-1M Update

- Customer Submittal
- CR Approval
- Final weight log

02/02/10

02/18/10

03/05/10

STS-131 Δ LSFR

Annex 1: LMC CIP Annex 1

Activity

Baselined

ECD

04/20/09A

Post CIR Update

- **CR Approval**

10/30/09

L-1 M Update

- **Customer Submittal**
- **CR Approval**
- **Final weight log**

02/02/10

02/18/10

03/05/10

STS-131 ΔLSFR

Time-Critical Ground Handling Requirements

• Activity	<u>ECD</u>
• Customer Submittal (L-4M)	11/18/09
• Release for review (L-3M)	12/18/09
• Baseline (L-60 Days)	01/18/10

•Issues / Concerns

•None

STS-131 Δ LSFR

Payload ICDs/PIRNs

All Payload-Unique ICDs are baselined

PIRNS that impact Flight Products

<u>PIRN #</u>	<u>ICD/Payload</u>	<u>Title</u>	<u>ECD</u>
A0TBD	ICD-A-21494/LMC Update	Mechanical Figures	10-29-09
A0TBD	ICD-A-21350/MPLM	Extended Latch Guides	11-02-09

Issues/Concerns

- None

STS-131 Δ LSFR

Cargo Integration Hardware Status

Delivery Status

- All required CIH has been delivered
- No new hardware for this flight

Issues/Concerns

- None

STS-131

Delta Launch Site Flow Review

Flight Software Overview

Gail Sanders
USA FSW

FRWG 10/13/2009
PRCB 10/15/2009

STS-131 DLSFR (FSW)

- **STS-131/OV-103 Flight Software (FSW) Versions**
 - Fourth scheduled flight of Operational Increment (OI) 34 Flight Software (SASCB SCR 98107A documents PASS and BFS OI-34 content)
 - Second scheduled flight of MEDS IDP VI 07.01/MDUF VI 06.00 (SASCB SCR 98113 documents content)
 - Fifth scheduled flight of MAGRS-3S Link 613-996-008 Software (Link-008) (SASCB SCR 98115 documents content)
- **STS-131/OV-103 Flight Software Payload Support:**
 - ISS 19A
 - Orbiter Interface Unit (OIU)
 - Sequential Still Video (SSV)
 - Orbiter Docking System (ODS)
 - Trajectory Control System (TCS)
 - ISS Caution and Warning (ISSCW)
 - Multi-Purpose Logistics Module (MPLM)
 - Assembly Power Converter Units (APCUs) & Station to Shuttle Power Transfer System (SSPTS) (generic support for both configurations)
- **Major New Flight Software Support Items:**
 - None

STS-131 DLSFR (FSW)

- **STS-131 Source Changes/Edits for Primary Flight Software (Base)**
 - SCR 93211A Update of SSMEC Vehicle Data Table (VDT) for Enhanced Accelerometer Operations
 - SCR 93262A Film ET Camera
 - SCR 93267A Removal of the Set and Reset to False Cmds For the RCS Tank Iso Valves
 - DR 126366 SM GPC Failure to Send GCIL Commands
- **STS-131 Patch Implementation for Primary Flight Software**
 - None.
- **STS-131 Patch/Edit Implementation for Backup Flight Software (Base) (included on delivered Mass Memory)**
 - SCR 93282 Update PASS/BFS HUD Body Flap Warning Limit K-Loads
- **STS-131 Patch Implementation for Backup Flight Software**
 - None.

STS-131 DLSFR (FSW)

- Multifunction Electronic Display Subsystem (MEDS) IDP VI 07.01 Point Release
 - DR 121432A Corrupted DK Bus Message Causes IDP Software to Halt

STS-131 DLSFR (FSW)

- **Products**

- **STS-131/OV-103 Base delivery schedule (available to field)**
 - FPSB**
 - July 21, 2009 (A)**
 - August 7, 2009 (A)**
- **Shuttle Data Tape**
- **Mass Memory Unit**
- **An STS-131/OV103 ADTL SDT/Mass Memory will not be required**
- **MEDS IDP VI 07.01 Point Release – October 22, 2009**
 - **First Flight – STS-130**

- **Open Items**

- **None**

- **Concerns/Issues**

- **No issues or concerns with STS-131 at this time**

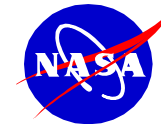

STS-131 DLSFR
Flight Crew Equipment/GFE

Presenter
MV6/Tom Goebel

Date
Oct.15, 2009

Page 1

STS-131 DLSFR

FCE/GFE Status

Tom Goebel
OV-103 Vehicle Manager, OPO
Johnson Space Center

BACKUP

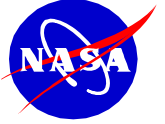

STS-131 DLSFR
Flight Crew Equipment/GFE

Presenter MV6/Tom Goebel	
Date Oct.15, 2009	Page 2

- **All GFE hardware need dates and delivery dates were partnered at CIR**
- **Tech orders and hardware list noted in following 2 charts**
- **No changes since STS-131 LSFR**



SPACE SHUTTLE PROGRAM
Space Shuttle Orbiter Project Office
 NASA Johnson Space Center, Houston, Texas



STS-131 DLSFR
Flight Crew Equipment/GFE

Presenter MV6/Tom Goebel	
Date Oct.15, 2009	Page 3

Tech Order numbers are identified for reference only. Report generated 10/9/2009.

Hardware	Tech Order	KSC Eng Need	Eng(TO) Release	In MEC	Cert O/C	KSC Need	JSC Planned	Comments	JSC Contact
A (port forward)	M072-750025-072	11/11/2009	1/7/2005	8/7/2009	C	12/23/2009	12/11/2009	OPF Installation Desirable. Camera from STS-129 (-510 Pan & Tilt Unit)	Randall Moore
B (port aft)	M072-750025-073	11/11/2009	1/7/2005	8/7/2009	C	12/23/2009	12/11/2009	OPF Instl for testing. Pad Installation. Camera from STS-129 (-510 Pan & Tilt Unit)	Randall Moore
C (starboard aft)	M072-750025-074	11/11/2009	1/7/2005	8/7/2009	C	12/23/2009	12/11/2009	OPF Instl for testing. Pad Installation. Camera from STS-129 (-510 Pan & Tilt Unit)	Randall Moore
D (starboard forward)	M072-750025-075	11/11/2009	1/7/2005	8/7/2009	C	12/23/2009	12/11/2009	OPF Installation Desirable. Camera from STS-129 (-510 Pan & Tilt Unit)	Randall Moore
Payload Ops camera	M072-340109-002	11/6/2009	11/15/2001	8/7/2009	C	12/7/2009	12/7/2009	OPF Installation Desirable. 4.8MM/68 degree HFOV @ 52 in. (from STS-127 keel).	Randall Moore
SRMS elbow camera	M072-544504-013	11/11/2009	3/3/2008	8/7/2009	C	12/23/2009	12/11/2009	OPF Instl for testing. Pad Instl for flight. Camera from STS-129 (-510 Pan & Tilt Unit)	Randall Moore
SRMS wrist camera	M072-544504-006	11/11/2009	3/3/2008	8/7/2009	C	12/28/2009	12/11/2009	OPF Installation Desirable. Camera from STS-129.	Randall Moore
Centerline Airlock Camera (stowed)	M072-660828-002, plus CCD stow	11/27/2009	3/17/1999	8/7/2009	C	12/28/2009	12/11/2009	OPF Installation mandatory for alignment. Units from STS-129.	Randall Moore
Lefthand Umbilical Camera (aft)	M072-705001-016	1/1/2010	10/28/2004	8/7/2009	C	2/2/2010	2/2/2010		Randall Moore
Righthand Umbilical Camera	M072-705001-028 M072-705001-027	1/1/2010	10/28/2004 10/28/2004	8/7/2009	C	2/2/2010	2/2/2010		Randall Moore
Digital Television (DTV)	M072-710570-007		11/15/2007		C			Installed Hardware.	Larry Schmidt
MCIU/RMS Situational Awareness Display (RSAD)	M072-710543-001		3/7/2000	8/7/2009	C			Installed Hardware.	Larry Schmidt
Tools for Rendezvous and Docking (TRAD)	M072-730021-019		7/20/2007	8/7/2009	C			Installed Hardware.	Larry Schmidt



SPACE SHUTTLE PROGRAM
Space Shuttle Orbiter Project Office
 NASA Johnson Space Center, Houston, Texas

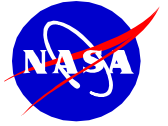

STS-131 DLSFR
Flight Crew Equipment/GFE

Presenter MV6/Tom Goebel	
Date Oct.15, 2009	Page 4

Tech Order numbers are identified for reference only. Report generated 10/9/2009.

Hardware	Tech Order	KSC Eng Need	Eng(TO) Release	In MEC	Cert O/C	KSC Need	JSC Planned	Comments	JSC Contact
Video Processing Unit (VPU)	M072-710338-007		3/2/2008		C			Installed Hardware.	Larry Schmidt
Wireless Video System (WVS)	M072-344828-001 mount M072-744007-001 UHF M072-744004-012 S-BAND M072-744004-013 S-BAND M072-744004-014 S-BAND M072-744004-016 S-BAND M072-744004-017 S-BAND M072-744004-018 S-BAND		8/24/2004 6/2/2004 3/21/2008 3/21/2008 3/21/2008 3/21/2008 3/21/2008 3/21/2008	8/7/2009	O			FRD CR Rev 15 REMOVES -15	Randall Moore
Space to Space Orbiter Radio (SSOR)	M072-344828-002 M072-740828-002 Harness		9/24/2004	8/7/2009	O				Larry Schmidt
RMS Sideview Camera (RSC)	M072-710281-002 M072-000416-006 camera	1/8/2010	11/24/2004	5/18/2009	C	2/9/2010	2/9/2010	Pad Installation. Same unit as STS-129. Camera requires repressurization.	Randall Moore
Wing Leading Edge (WLE) Instrumentation - Left Wing	M072-756111-007		8/21/2007	8/7/2009	C			Installed Hardware.	Micheal Wright
Wing Leading Edge (WLE) Instrumentation - Right Wing	M072-756111-008		8/21/2007	8/7/2009	C			Installed Hardware.	Micheal Wright
OBSS Sensor Package 1	M072-710282-008	11/9/2009	4/18/2008	8/7/2009	C	12/8/2009	12/8/2009	OPF Instl for testing. Pad Instl for flight.	Russell Yates
RMS-13 End Effector	M072-544502-036		5/27/2008	8/7/2009	C			Installed Hardware.	Kenneth Ruta
OBSS Sensor Package 2	M072-710282-006	9/11/2009	4/18/2008	8/7/2009	C	10/12/2009	10/12/2009	OPF Instl for testing. Pad Instl for flight.	Larry Schmidt



STS-131 Delta Launch Site Flow Review

Presenter **Kenneth Nowak**

Date **10-15-09**

Backup Material

- **SSP Systems Drawings** **Attachment 1**
- **SSP Authorized Modifications/Non-Standard Work** **Attachment 2**
- **SSP OMRS Waivers and Exceptions** **Attachment 3**
- **Launch Window** **Attachment 4**
- **Open Configuration Waivers** **Attachment 5**



STS-131 Delta Launch Site Flow Review

Presenter **Kenneth Nowak**

Date **10-15-09**

Overview

- **SSP System Drawings** **No Issues***
- **SSP Authorized Modifications/Non-Standard Work** **No Issues***
- **SSP OMRS Changes (RCNs)** **No Issues***

* Backup material included



STS-131 Delta Launch Site Flow Review	Presenter MK-SIO / A. Swift	
	Date 10-15-09	Page 1

Mandatory RCNs:

NONE

Non-Mandatory Value Added RCNs:

NONE

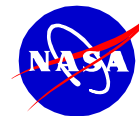

STS-131 Delta Launch Site Flow Review

Presenter **Kenneth Nowak**

Date **10-15-2009** Page **1**

- **STS-131 Orbiter/Ferry Mass Properties Have Been Reviewed by Space Shuttle Program Integration and Are Within Specified Limits**

<u>Case</u>	<u>Ferry Weight (lb)</u>	<u>Center of Gravity (inch)</u>		
		<u>X</u>	<u>Y</u>	<u>Z</u>
<u>Nominal - Orbiter c.g.</u> (SCA c.g.) (2066 lb Max CM Ballast + 1330 lbs CCD items, No Fluids Off-Loaded, No Payload Bay Opening)	226617	1113.7 (1409.5)	0.3 (N/A)	374.0 (516.5)
<u>AOA - Orbiter c.g.</u> (SCA c.g.) (2066 lb Max CM Ballast + 620 lbs CCD items, No Fluids Off-Loaded, No Payload Bay Opening)	233428	1113.7 (1409.5)	0.5 (N/A)	374.9 (517.4)
<u>TAL - Orbiter c.g.</u> (SCA c.g.) (3 SSME's Removed, No Fluids Off-Loaded, No Payload Bay Opening, Max Weight 217000 lb)	209903	1082.3 (1378.3)	0.6 (N/A)	376.6 (520.7)

X c.g. Limits (Orbiter Coordinates)

Nominal = 1060.0 TO 1116.0
 AOA = 1060.0 TO 1116.0
 TAL = 1060.0 TO 1123.2

Z c.g. Limits (Orbiter Coordinates)

Nominal = 360.0 TO 380.0
 AOA = 360.0 TO 380.0
 TAL = 360.0 TO 380.0



*Extravehicular
Activity
Office*

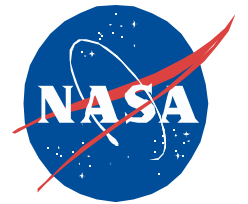

EVA Status

STS-131/Flight 19A Delta Launch Site Flight Review

**XA/Linda Thomas
Johnson Space Center
October 13, 2009**

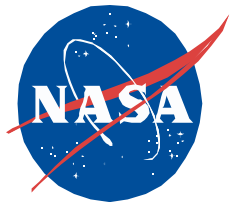

- **Bulkhead PFR – SED33105308-307**
 - Bulkhead PFR installation – Tech Order: M072-661568-029

- **Winches**
 - Forward Winch, SED33101570-327
 - Aft Winch removed

- **Stbd LWTSA**
 - Stbd LWTSA installation – Tech Order: M072-660858-001
 - Stbd LWTSA Tools installation – Tech Order: M072-660856-001

STS-131 Delta Launch Site Flow Review



J.F. KENNEDY SPACE CENTER

19A **STS-131** **MPLM/LMC**

KSC ISS & Spacecraft Processing
Joseph T. Delai, NASA, KSC Mission Manager
Mike Kinslow, Boeing, KSC Flow Manager

10/05/2009

Planned Processing Milestones



J.F. KENNEDY SPACE CENTER

PRE-SHUTTLE INTEGRATION ACTIVITIES

Space Station Processing Facility

- 19A
 - LMC/ORU Processing 10-02-09 to 01-15-10
 - MPLM Rack Integration 11-17-09 to 12-23-10
 - MPLM Internal/External Closeouts 01-26-10 to 02-16-10
 - SSPF Bay 1 late stow 02-16-10
 - Hatch Closure 02-17-10
 - Payload to Pad 03-01-10 (L-17)

10/05/2009

Planned Processing Milestones



J.F. KENNEDY SPACE CENTER

SHUTTLE INTEGRATION ACTIVITIES

PAD (U/R)

- Payload to Pad 03/01/10
- Payload installed into Orbiter U/R
- Payload IVT U/R
- Payload Closeouts U/R
- Launch 03/18/10

10/05/2009

KSC/ISS Processing Summary



J.F. KENNEDY SPACE CENTER

Watch Items:

- Critical path schedule due to 17A launch date and California landing.

The KSC STS-131/19A - ISS Mission Processing Team is ready to proceed with processing the STS-131 Mission payload complement.

10/05/2009



STS-131 Delta Launch Site Flow Review

Presenter **Kenneth Nowak**

Date **10-15-09**

SSP System Drawings

The Drawings Baseline Was Released By PRCB S115131A on 07-02-09

- **V072-000001-286** (Rev. WC) Space Shuttle System (Rel. 09-02-09)
 - **V072-200211-001** (Rev. A) Mission Equipment Cargo Support (Rel. 08-06-09)
 - **SGD32104454-301** (Rev. A) Crew Compartment Configuration (Rel. 09-25-09)
 - **-302** Descent
 - **V070-000001-003** Orbiter General Assembly
 - **V070-410100-017** SSME Installation
 - **10100-0061-179** Integrated SRB General Assembly (BI-142)
 - **80901000000-530** External Tank Assembly (ET-135)

- **STS-131 LSRR + 18 days Mission Configuration Product Plan (MCP) was last published on 07-06-09 and will be republished at ORR - 14 days on TBD.**



STS-131 Delta Launch Site Flow Review

Presenter **Kenneth Nowak**

Date **10-15-09**

SSP System Drawings – (Continued)

Ferry Configuration

- **V072-000001-287** (Rev. WB) Space Shuttle System Drawing (Rel. 07-06-09)
- **V072-200211-002** (Rev. A) Mission Equipment Cargo Support (Rel. 08-06-09)
- **SGD32104454-001** (Rev. A) Crew Compartment Configuration (Rel. 09-25-09)
- **V072-300055-027** (Rev. BU) Ferry Flight Configuration (Rel. 05-11-09)

SCA 905

CDR	ALAN POINDEXTER
PLT	JAMES DUTTON
M/S #1	RICHARD MASTRACCIO
M/S #2	DOROTHY METCALF-LINDENBURGER
M/S #3	STEPHANIE WILSON
M/S #4	NAOKO YAMAZAKI
M/S #5	CLAYTON ANDERSON

ASCENT MODULAR LOCKER LAYOUT

1622 -308 PANTRY FOOD	MF57A 1622 -308 PANTRY FOOD	1622 -302 PANTRY FOOD
------------------------------------	---	------------------------------------

LEADER:	KRIS ZAPALAC
DATE:	8-20-09
LAUNCH:	NET 3-18-10
FLIGHT:	STS-131/19A
VEHICLE:	OV-103
CREW:	7 PERSONS 13 + 1 + 2 DAYS
RQMTS:	NO RCRS, SLEEPING
	BAGS, EXT A/L, ERGOMETER, RMS, LW MAR

ML60B 6013 -309
PRIME C/L CAM GFE TV CNTRLR
ML60E 0695 -305
STS1=OCA STS2=WINDECOM STS3=KFX STS4=WORLDMAP STS5=RPOP STS6=RPOP2 STS7=WLES ACCESS PT ACCESSORIES
T-RAD
ML60M 6014 -312
B/U C/L CAM LEAK DETECTOR

MIDDECK FORWARD

MF14E 2760 -306 FRESH FOOD ● FRESH FOOD	MF28E/G GLACIER	MF43C 1382 -301 ⊗ SODF	MF57C 8965 -316 SHUTTLE CSA-CP SUPA (14) CONDENSATE HOSE CWC DOCKING KIT	MF71C 1903 -305 ISS HDWR
MF14G 2761 -308 MENU FOOD ● MENU FOOD	GLACIER (REAR BREATHER)	MF43E 5473 -305 M/S #2 CLOTHING	MF57E 1371 -301 CDR CLOTHING	MF71E 1901 -305 MERLIN (REAR BREATHER)
MF14H 2763 -304 MENU FOOD	MF28H 6684 -338 MED KITS ALTIMETER/ION LOCKER DR	6300 MF43G 6250 -347 -355 IFM TOOLS 2163-302 2161-305 2162-307 MULTIMETER	MF57G 8047 -304 DC VACUUM CLEANER CTB	MF71G 1908 -309 CREW SUPPORT
MF14K 2764 -306 MENU FOOD	MF28K 2768 -303 MENU FOOD FRED	MF43H 1902 -308 M/S #1 CLOTHING	MF57H 6231 -367 AEM MODULE 1	MF71H 1901 -305 PLT CLOTHING
VOL B 7436 (MA40/J) -319 HYGIENE NON EDO	MF14M 2765 -304 MENU FOOD	MF43M 1904 -307 M/S #3 CLOTHING	MF57K 0679 -301 ORBITER FDF	MF71K 1356 -301 POST INSERTION
VOL 3B 7425 (MA75/J) -326 QUICK DON MASKS(3) CABIN AIR CLEANER/ SPOTLIGHT(FLASHLIGHT) G1 CAMCDR/ FLASH D2X/400 MM/12-24MM LENS	MF14N 2766 -305 MENU FOOD	MF43N 1904 -307 M/S #3 CLOTHING	MF57M 3006 -304 M/S #5 CLOTHING	MF71M 1372 -301 MS#4 CLOTHING
A16 7490 -306 BOGEN ARMS CORE CAMERA BAG PGSC DESK PILOT HAND CONTROL	A17 7424 -304 CORE CC SYSTEM BAG DTV CAMERA BAG HATCH TOOL QUICK DON MASKS (4)	MF14O 2766 -305 MENU FOOD	MF28O 2767 -304 MENU FOOD	MF43O 1356 -301 SOMS RESUS ISS HRDWR (HCTB)
VOLUME D 7498 (MD52C) -301 NOT INSTALLED	VOLUME F 1403 (MD76M) -306 WET TRASH	MF43P 1904 -307 M/S #3 CLOTHING	MF57P 3006 -304 M/S #5 CLOTHING	MF71P 1372 -301 MS#4 CLOTHING
VOLUME G 1800 (MD80R) -346 CONT UCDS WASTE MGMT (2) CWC'S	VOLUME H 8068 (MA23R) -321 EVA ACCESS ⊗ EMU SERV. KIT (INBD)	MF43Q 1904 -307 M/S #3 CLOTHING	MF57Q 3006 -304 M/S #5 CLOTHING	MF71Q 1372 -301 MS#4 CLOTHING

MIDDECK AFT

MA9D 8737 -311 RCC NOAX TUBES ● DOUBLE COLD BAG	MA16D 5452 -329 ISS HARDWARE
MA9F 8723 -302 STOW-N-GO CTB	MA16F 1908 -309 IFM BREAKOUT BOX TURNBUCKELS AIR SAMPLERS WWD FILTERS
MA9G 0696 -305 STL	MA16G 6299 -321 COAS/BTA WORK LT/LT SHADES/D2XS
6066 MA9J 8719 -334 -309 COLOR PRINTER AND PAPER INK CARTRIDGES CTB (6066-334)	MA16J 1356 -301 ISS HARDWARE
5962 MA9L 6269 -303 -309 PRINTER TRAYS IODINE REMOVAL 6256-306	MA16L 1356 -301 PGSC ACCESS
MA9N 7432-311 SOFT STWG BAGS PHK'S (7) 4980-310 BRKTS/CK/RE-ENT 8071-308 LIGHT STICKS RSTRNTS/RE-ENT 8070-302 FIBERSCOPE	MA16N 6697 -337 HH LIDAR W/NIGHTSCOPE (TRAD)/SSV

MD CEIL (PORT 1) TBD	E
RCC REPAIR B/U DTV HARDWARE	
MD CEIL (PORT 2) TBD	F
ISS HARDWARE	
MD CEIL (STBD 1) TBD	G
ISS HARDWARE	
MD CEIL (STBD 2) TBD	H
ISS HARDWARE	
MD FLOOR (PORT 2) TBD	B
ISS HARDWARE	
MD FLOOR (PORT 1) TBD	A
ISS HARDWARE	
MD FLOOR (STBD 2) TBD	D
ISS HARDWARE	
MD FLOOR (STBD 1) TBD	C
ISS HARDWARE	

L10H BOX (7435-332): 31 L10H TOTAL + 1 ATCO 29 IN L10H BOX 2 INSTALLED 7 G-SUITS	C/D JSC (5077-309) P/D JSC (5075-310) C/D KSC (2186-304) P/D KSC (2187-304) CEIT KIT (2122-312) ISS LABEL (7518)	WINDOW SHADE BAG (5548-373) WINDOW SHADES IFM CABLES & HOSES (4259-345) PANEL COVERS	L10AI: MPC/AVIU/TAPES (6686-336) MPC POWER SUPPLY L10A2: DTV L11: PDIP 2 L11A2: A3 OIU PANELS L12A1: SSP 1 L12A2: SSP 2 L12A3: PDIP 1 R12A1: VPU
--	---	---	--

CTB	HLF	SGL
LAUNCH	37	9
RETURN	TBD	TBD

- * NOT APPROVED
- L-24 LATE LOAD
- ⊗ SWAP
- ⊗ TRANSFER HARDWARE
- CTB CARGO TRANSFER BAG
- HCTB HALF CARGO TRANSFER BAG

NOTE: LOCKER LAYOUTS ARE FOR REFERENCE ONLY & ARE NOT RELEASED DWGS. FOR RELEASED DRAWING, PLEASE REFER TO THE CREW COMPARTMENT CONFIGURATION DRAWING FOR THIS FLIGHT (SGD32104454)

Mission Duration = 12+1+2
 Inclination = 51.6°
 OMS2 ha/hp = 124 x 111 nmi.
 Target ha/hp = 194 x 186 nmi.

STS-131 OCF LAUNCH WINDOW

C. Osgood/USH-483L
 M. Jamroz/USH-483L
 March 13, 2009

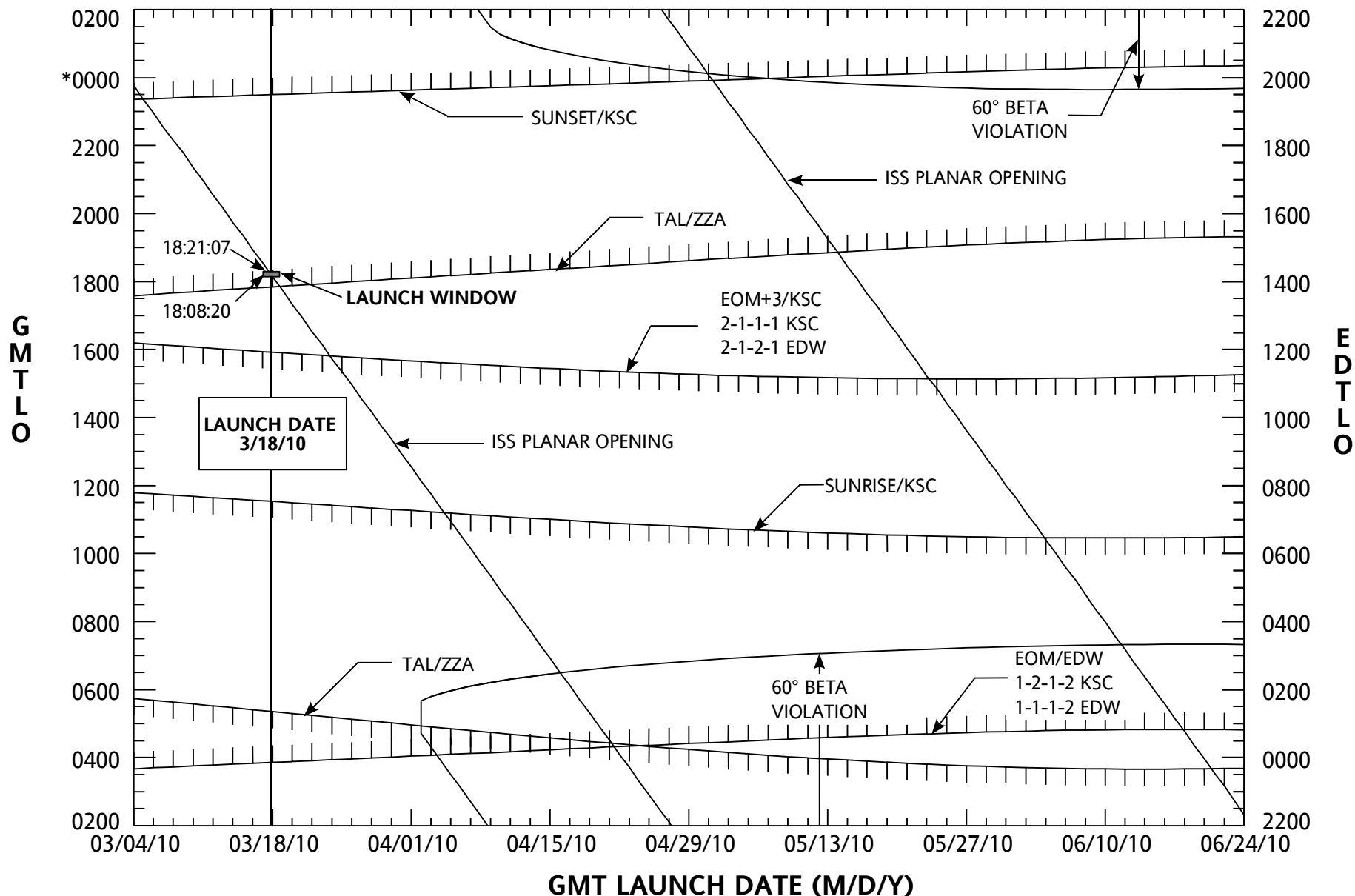

Note: EOM lighting lines, based on an OMS2 phase angle of 129 deg, are representative only.

The ISS beta angle ($|\beta| < 60^\circ$) for mated operation is beginning ~ 1/20:43:10 MET (FD3 Rendezvous) and ending ~ 10/15:06:00 MET.

* Indicates the dateline. Launch times above this point are on subsequent days from the date indicated on the corresponding date axis.



STS-131 Delta Launch Site Flow Review

Presenter **Kenneth Nowak**

Date **10-15-09**

Modification Impact Report

- **Mission Equipment Modifications and Orbiter Modifications analyzed for impacts to OMRSD, LCC, ICD, EMI, Software, and GSE.**
- **A total of 4 MCRs have been approved and/or pending mods**
- **Current MCR impact status:**
 - **No impacts for all six disciplines** **3**
 - **One or more disciplines with impacts, documentation approved and/or pending approval** **0**



STS-131 Delta Launch Site Flow Review

Presenter **Kenneth Nowak**

Date **10-15-09**

Modification Impact Report – (Continued)

- Possible impacts still under review
- MCR 30272 is being reviewed for OMRSD impacts

1

1MRCs REPT. 4650-1
PAGE NO. 1

SSP SUMMARY MOD ITEMS - PRCBD MOD BASE LINE STS-0131

MEQ

ECP-MCR/KIT SEQUENCE

RUN TIME

09:25 DATE 10/06/2009

PRCB	STAT	ITEM/KIT NUMBER	SEQ	
MCR/ECP	PRI0	TCTI NUMBER	EISN NO.	DESCRIPTION / GENERAL REMARKS
AUTHDATE	SITE			
	FLT			
030010	AUTH	030010	0103 004	STS-131 UNIQUE STBD LWTSa CUSHION/STORAGE TRAY CHANGE
S115131R1				
2009-08-05	KSC		CONTR	ADDED PER E. BURKE REQUEST FOR LSFR
	038			
TOTAL MODS =		1		

1MRCs REPT. 4650-1
PAGE NO. 2

SSP SUMMARY MOD ITEMS - PRCBD MOD BASE LINE STS-0131

OMS

ECP-MCR/KIT SEQUENCE

RUN TIME

09:25 DATE 10/06/2009

PRCB	STAT	ITEM/KIT NUMBER	SEQ	
MCR/ECP	PRI0	TCTI NUMBER	EISN NO.	DESCRIPTION / GENERAL REMARKS
AUTHDATE	SITE			
	FLT			
-----	----	-----	----	-----
S-J6539	AUTH	J6539	0023 000	OMS023 (RP03) AGED RTV
2009-08-28	MAND		SPAR	VEH/EFF'Y: OV-103 FLT 38 (RP03 FLT 39)
	KSC			
	039			
TOTAL MODS =		1		

1MRC5 REPT. 4650-1
 PAGE NO. 3

SSP SUMMARY MOD ITEMS - PRCBD MOD BASE LINE STS-0131

ORB

ECP-MCR/KIT SEQUENCE

RUN TIME

09:25 DATE 10/06/2009

PRCB	STAT	ITEM/KIT NUMBER	SEQ	
MCR/ECP	PRIO	TCTI NUMBER	EISN NO.	DESCRIPTION / GENERAL REMARKS
AUTHDATE	SITE			
	FLT			
S-J6275A	AUTH MAND KSC 038	J6275A	0103 003	ORBITER STRUCTURE IML SURFACE CORROSION SAMPLING INSPECTION CORROSION SAMPLING CAPABILITIES WILL BE PROJECTED AT LSFR, AND FINALIZED AT DLSFR FOR EACH FLOW.
2008-02-26				
S-J6414A	AUTH MAND KSC 038	J6414A	0103 000	RUDDER SPEED BRAKE THERMAL TAB INSPECTION
2008-12-19				
S-J6482	PLND MAND KSC 038	J6482	0103 001	STS-128 PAYLOAD CLOSE CLEARANCE MEASUREMENTS P/L CLOSE CLEARANCE MSRMNTS FOR STS-128 & STS-131 HAVE BEEN PLANNED FOR THEIR FLOWS. NO M/S IMPACTS.
2009-04-01				
S-J6505	AUTH MAND KSC 038	J6505	0103 000	CAPTURE OV-103 OUTPUT WAVEFORMS TO ADDRESS 1N3600 DIODE CONC ERNS
2009-05-20				
S-J6509	PLND MAND KSC 038	J6509	0103 000	REMOVAL OF MPS GH2 FLOW CONTROL VALVES FOLLOWING STS-125 (OV -104), STS-127 (OV-105), AND STS-128 (OV-103)
2009-05-12				
S-J6523A	AUTH MAND KSC 038	J6523A	0103 001	OPTIGO, METRIS AND Z-SCAN OF BLT PROTUBERANCE TILE SCAN OF BLT TPS WAS PART OF LSFR PKG. THIS SCAN RE QUEST IS
2009-06-10				

INTEG'D INTO CURRENT OPF PROCESSING PLAN

S-J6526	AUTH MAND KSC 038	J6526	0103 000	EVALUATION OF OMS POD LI-900 TILE INSTALLED ON 0.090" SIP
2009-07-01			SPAR	
S-J6531	AUTH MAND KSC 038	J6531	0103 001	METRIS SCAN OF OV-103 LOWER SURFACE
2009-06-26			SPAR	
S-J6533A	AUTH MAND KSC 038	J6533A	0103 000	PERFORM BORESCOPE INSPN OF MPS INBD RTLS DUMP VALVE (PV17)
2009-08-07			SPAR	BALL SEAL ON OV-104 (STS-129), OV-103 (STS-131), & OV-105 (STS-130)
S-J6534	AUTH MAND KSC 038	J6534	0103 000	PUTTY REPAIR TILE REPLACEMENT FOR RISK REDUCTION
2009-07-29			SPAR	EFFECTIVITY: OV-103, FLTS 38, & 39
S-J6543	AUTH MAND KSC 038	J6543	0103 001	ET FERRY FLIGHT DOOR ATTACH FITTING INSPECTION
2009-09-17			SPAR	NDE OF FERRY FLT DOOR ATTACH FITTINGS WILL ONLY BE REQ'D FOLLOWING A F/FLT BACK TO KSC. F/FLT ONLY.
S-J6545	AUTH MAND KSC 038	J6545	0103 000	X-RAY INSPECTION OF MPS HELIUM SUPPLY SYSTEM CHECK VALVES ON
2009-08-11			SPAR	OV-103 (STS-131) & OV-105 (STS-130)
S-J6556	AUTH MAND KSC 038	J6556	0103 000	MICRO-INSPECTION OF THIN LRSI TILES
2009-09-11			SPAR	INSPECTIONS WILL BE ACCOMPLISHED IN PARALLEL WITH SCHEDULED POST FLIGHT ORBITER RSI INSPECTION.
S-J6557	AUTH MAND	J6557	0103 000	MICRO INSPECTION OF CAPTIVE GAP FILLERS

2009-09-15	KSC 038	SPAR	INSPECTION OF THE IDENTIFIED GAP FILLERS IS INTEG-RATED INTO STS-130 & STS-131 PROCESSING FLOWS.
S-J6558	AUTH J6558 MAND	0103 000	AFT STUB CRACKED TILE INSPECTION
2009-09-15	KSC 038	SPAR	TILE INSPECTIONS WILL BE PERF'D IN PARALLEL WITH STS-130 & STS-131 PAD PROCESSING.

1MRCs REPT. 4650-1
PAGE NO. 4

SSP SUMMARY MOD ITEMS - PRCBD MOD BASE LINE STS-0131

ORB

ECP-MCR/KIT SEQUENCE

RUN TIME

09:25 DATE 10/06/2009

PRCB	STAT	ITEM/KIT NUMBER	SEQ	
MCR/ECP	PRIOR	TCTI NUMBER	EISN NO.	DESCRIPTION / GENERAL REMARKS
AUTHDATE	SITE			
	FLT			
S-J6559	AUTH	J6559	0103 000	UPPER AFT STUB TILE INSPECTION FOR IN-PLANE CRACKS
2009-10-01	MAND			
	KSC		SPAR	IT IS BELIEVED THAT IN-PLANE CRACKS STARTED AS MINOR
	038			DISREPARANCIES WHICH PROPAGATED. POST FLT INSP
030231	AUTH	TCTIV2930231REF	0103 000	RUDDER SPEED BRAKE INCONEL THERMAL BARRIER REDESIGN
S115131	KSC	NOT REQUIRED		ADDED BY EDS I/F & V070-298115 A07
2009-06-30	038			
TOTAL MODS =		17		

Approved STS-131 OMRS Waivers and Exceptions

WVR EXC	ELEMENT PROJECT	PRCBD NUMBER WAIVER# (STAT) (INITIAL STS)	ABSTRACT RAS REQUIREMENTS	EISN PAYLOAD	STS BEG END	
+	E	RCS	S053296YK EK10327 (A)	OMRSD EXCEPTION REQUEST - RIGHT RC SOXIDIZER B-LEG PAD REGULATOR L OCKUPPRESSURE (EK10327)	0023	032 040
			S053297WA EK10452 (A)	OMRSD EXCEPTION REQUEST - RRCS FUEL GHE TANK P1 TRANSDUCER ACCURA CY (EK10452)	0023	032 039
	W	ET	S053293FZ WK03850R1 (A) (STS-093)	L02/LH2 TANK PRESSURE MONITOR FOR MOVE	ET	099 999
		OMS	S053296UM WK10299 (A)	OMRSD WAIVER REQUEST - RP03 TK302 DYNATUBE LEAK RATE (WK10299)	0023	032 040
		ORB	S053297NZ WK10415 (A)	OMRSD WAIVER REQUEST - MADS FDM CALIBRATION MANUAL MODE (WK10415)	103	031 038
			S053298VM WK10557R1 (A)	OMRSD WAIVER REQUEST - FUEL CELL POWERPLANT 3 OXYGEN FLOWMETER LO WERLIMIT (WK10557R1)	103	033 042
			S053299BB WK10603 (A)	OMRSD WAIVER REQUEST - FORWARD OXYGEN REGULATOR LOCK UP PRESSURE(WK10603)	103	034 039
			S053299JU WK10653 (A)	OMRSD WAIVER REQUEST - WATER SPRAY BOILER #1 EXCEEDED 44 PSIA MAX	103	035 040

		IMUMLIMITATION (WK10653)		
	S053299MG WK10656 (A)	OMRSD WAIVER REQUEST - FUEL CELL POWERPLANT 3 HYDROGEN FLOWMETERL OWER LIMIT (WK10656)	103	035 038
RCS	S053298VTR1 WK10559 (A)	OMRSD WAIVER REQUEST - RIGHT RCS OXIDIZER B-LEG SECONDARY REGULAT ORLOCK UP HIGH (WK10559R1)	0023	035 043
SRB	S053293WA WK03886 (A) (STS-103)	LH FWD AND RH MID SRB JOINT TEMP SENSORS	BI	099 999

0
1

Date: 10/06/09 09:29

PCASS

Page: 2

FLIGHT-SPECIFIC

Approved STS-131 OMRS Waivers and Exceptions

	Waivers	Except	Deviat	Cannib	Total
Total Extracted	9	2	0	0	11

-
-
-
-
-
-
-
-
-
-
-
-