



**SPACE SHUTTLE PROGRAM**  
**Space Shuttle KSC Integration Office**  
NASA Kennedy Space Center, Florida



# STS-131 Launch Site Flow Review

Presenter **Kenneth Nowak**

Date **07-23-09**

## Program Freeze Point

## PRCB Presentation

## S115131B



# STS-131 Launch Site Flow Review

Presenter **Kenneth Nowak**

Date **07-23-09**

Baseline the STS-131 Mission Specific Requirements and Flow Plans. The STS-131 Integrated Launch Site Requirements were established by PRCBD S115131 dated 06-18-09. This CR and the Associated Data Package were reviewed at the 07-13-09 FRWG.

**Flight Operation & Integration\***

**Orbiter Engineering\***

**Payload/Cargo Engineering\***

**Launch Vehicle Processing**

**Requesting Approval**

**MO3/USA-PI**

**USA-OE**

**USA-PI**

**PH-A**

**Status in BackUp**

**KSC Integration**

**Flight Software**

**Orbiter GFE**

**EVA**

**KSC ISS and Payload Processing\***

**MK-SIO**

**USA-FSW**

**MV5**

**XA**

**UB-R3**

**SSME**

***Status at DLSFR***

**MP21**



**STS-131 LAUNCH SITE FLOW REVIEW**

Presenter
<b>Ann M. Patterson</b>
Date
<b>23 July 2009</b>

**STS-131/19A**

**Launch Site Flow Review (LSFR)**

**Flight Requirements Status**

**PRCB 23 July 2009**

**Ann M. Patterson, STS-131 MIM**  
**Frank Richmond, USA Flight Mgr.**  
**Adam Richards/Boeing Mass Properties**

## STS-131 LAUNCH SITE FLOW REVIEW

Presenter

**Ann M. Patterson**

Date

**23 July 2009**

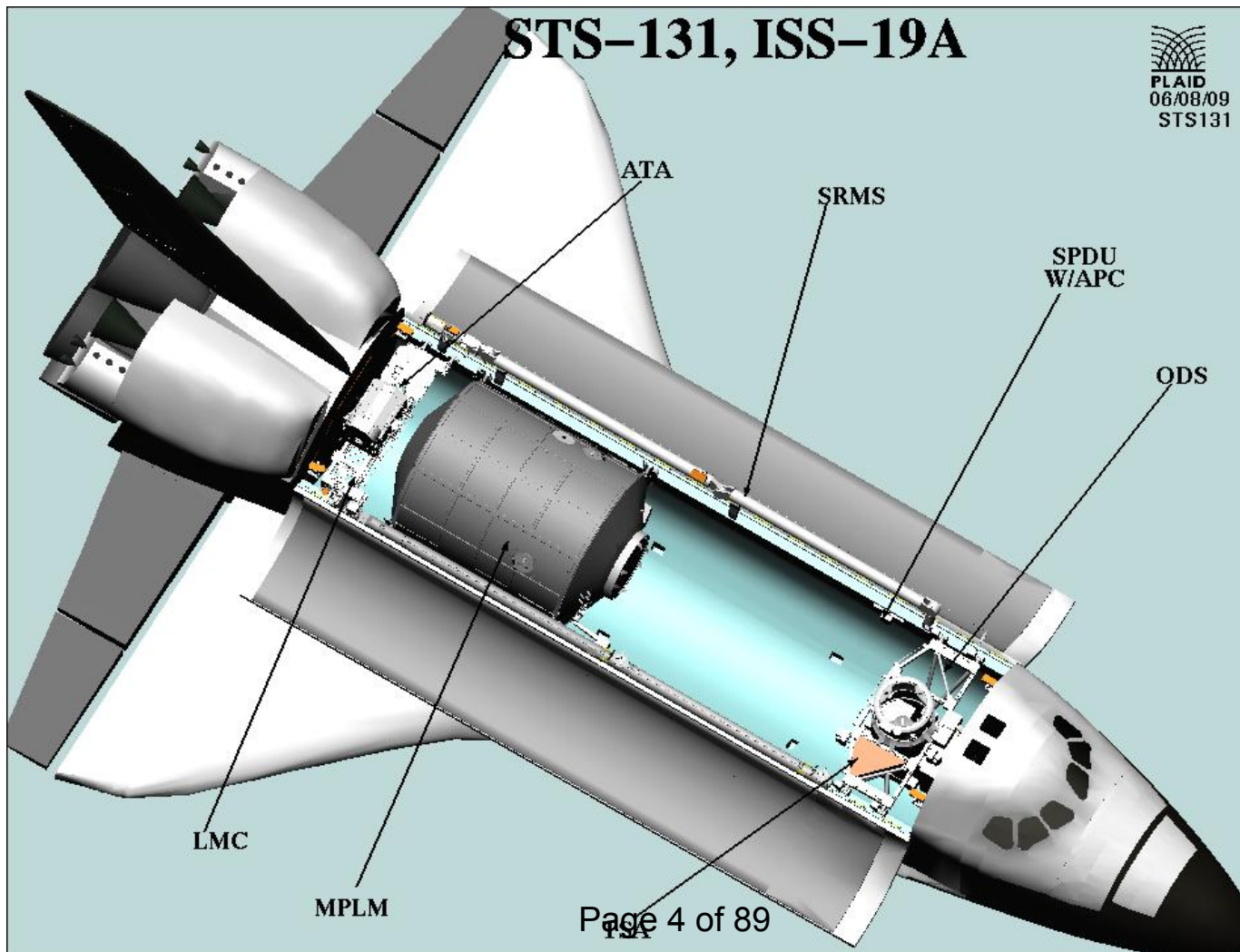



Presenter  
**Ann M. Patterson**

---

Date  
**23 July 2009**

## STS-131 LAUNCH SITE FLOW REVIEW

### Middeck Powered Payloads

- MERLIN– rear breather (18 CFM) ↕
- GLACIER – rear breather (36 CFM) ↕
- CGBA ↓
- STL ↕
- AEM 1 & 2 ↕

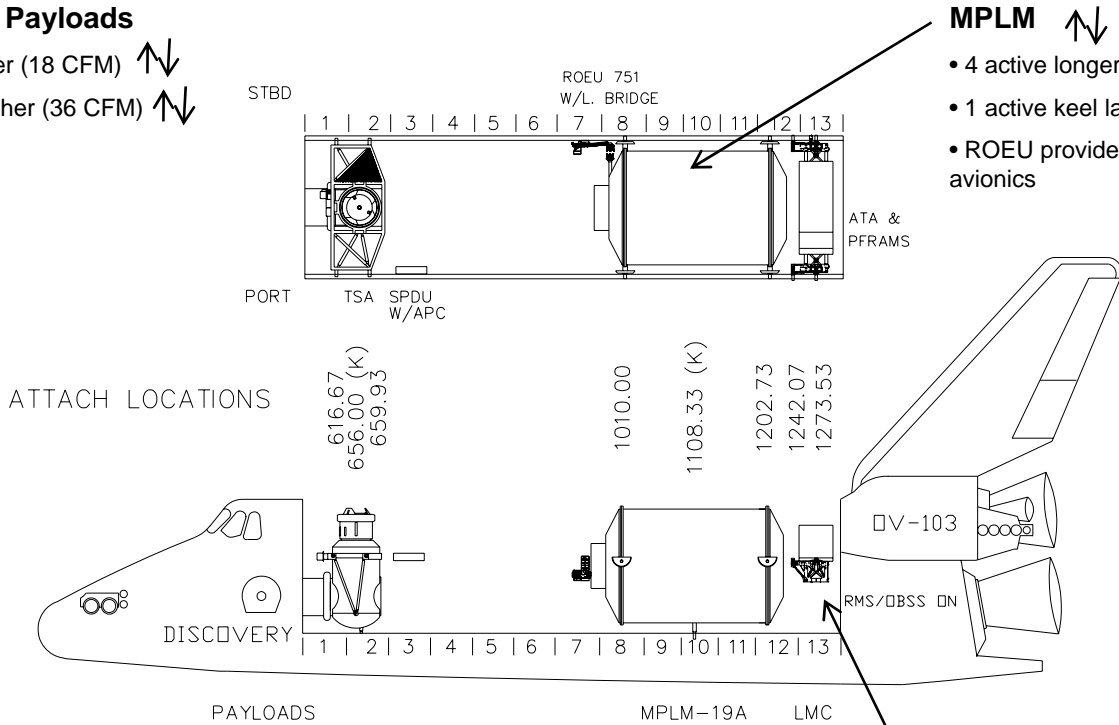

### MPLM ↕

- 4 active longerons with aft primary
- 1 active keel latch with keel camera
- ROEU provides 28V heater power, 124V for MPLM avionics

### LMC ↕

- 4 passive longeron latches with aft primary
- 28V heater power

•Note – SPDU supports OBSS



**STS-131 LAUNCH SITE FLOW REVIEW**

Presenter <b>Ann M. Patterson</b>
Date <b>23 July 2009</b>

**LAUNCH**

03/18/10  
 39A/ MLP 3  
 CREW SIZE: 7UP/7DN

**ORBIT**

51.6 DEG  
 122 NM  
 DIRECT INSERTION  
 DURATION: 12 + 1 + 2 DAYS

**CONFIGURATION**

OV-103(38)  
 LP01;RP03  
 ET-135  
 BI-142  
 RSRM-110  
 (1) TBD (2) TBD (3) TBD  
 OI-34  
 SRMS, ODS, OBSS, SSPTS

**CONSUMABLES**

CRYO TANK SETS	5 (OFFLOAD)
GN2 TANKS	6 (OFFLOAD)
FWD RCS	1912# (OFFLOAD)
AFT RCS	4970# (FULL)
OMS	22760# (FULL)

**PAYLOAD**

ISS-19A (MPLM, LMC)	ISS-19A MAUI SEITE SIMPLEX RAMBO-2
------------------------	------------------------------------------------

**LANDING**

SITE TAL ALT. TAL SCA	KSC ZARAGOZA MORON & ISTRES 905
--------------------------------	------------------------------------------



**STS-131 LAUNCH SITE FLOW REVIEW**

Presenter
<b>Ann M. Patterson</b>
Date
<b>23 July 2009</b>

**PERFORMANCE MARGIN**

• SIMULATION MARGIN (CIRAF131)		<b>+1709</b>
• WEIGHT CHANGES SINCE SIMULATION		
• PAYLOAD	- 204	
• OPERATOR	- 33	
• NPC	+65	
• CREW COMPARTMENT	+36	
• MPS PROP (NOT INERT)	+260	
• RECONSTRUCTED ASCENT PERF COLLECTOR	<u>- 94</u>	
TOTAL WEIGHT CHANGES	<b>+30</b>	<b>- 30</b>
• OTHER PERFORMANCE PROJECTIONS		
• PROTECTION FOR DOL DISPERSIONS		- 700
• USABLE IMPULSE FOR MPS BGT GEN0901S		- 17
• SRB – M.P. UPDATES		- 267
• SRB – BR / 0.70 MIL HIGHER THAN 0.3705 AVG		+140
• ISP/THST FOR GEN BLOCK 2 @ 104.5%		+6
• PROJ TO 5 MIN WINDOW FROM INPLANE		- 600
• PERFORMANCE CHANGES ADJUSTMENT		<u>+3</u>
• CURRENT BASELINED APM (07/14/09)		<b>+244</b>
• IPT PROJECTIONS		
• LOWER RNDZ ALT FROM 190 NM TO 188 NM		<u>+232</u>
• IPT PROJECTED APM		<b>+476</b>



**STS-131 LAUNCH SITE FLOW REVIEW**

Presenter <b>Ann M. Patterson</b>
Date <b>23 July 2009</b>

**FLIGHT MASS PROPERTIES**

<u>CASE</u>	<u>TOUCHDOWN WEIGHT pounds (LIMIT)</u>	<u>MACH 3.5 X C.G. inches (LIMIT)</u>
NOMINAL	223715 (233000)	1088.9 (1075.7)
RTLS	238666 (245000)	1088.4 (1077.2)
TAL	237283 (244000)	1088.5 (1077.2)
AOA	233576 (242000)	1086.2 (1075.7)
CONT RTRN*	235347 (233000)	1088.4 (1075.7)

\*CONT RTRN EXCEEDS 233K NEOM LIMIT (See Vol. X Bk. 1 Sec. 3.3.1.1.9)

**NOTE: RTLS INCLUDES 185 SEC ARCS & 25 SEC FRCS DUMPS  
 TAL INCLUDES 120 SEC ARCS & 65 SEC FRCS DUMPS  
 104 LBS AFT BALLAST (EMPTY BOXES)**

**ESTIMATES BASED ON CIRAF131 AND MODIFIED FOR WEIGHT CHANGES THRU 07/14/09.**



---

**STS-131 LSFR**

**OV 103 / FLT 38**

**Belinda Soublet**

**USA Orbiter Element**

**July 23, 2009**



# STS-131 OV 103/FLT 38 – Orbiter LSFR Baseline

---

## Modifications to be Baselined at LSFR for OV 103 / FLT 38

- One mandatory mission kit modification to be baselined

## Authorization Requested for MECSLSI and CCCD Updates for STS-131

### (OV 103 / FLT 38) Orbiter Mods

- Incorporate updates to CCCD and V072-200211 MECSLSI

## Backup

- Potential Modifications (info only)
- Opportunity Modifications (info only)
- STR/TPS Priorities
- Chit Updates
- Previously Baselined Modifications (STS 131 LSRR)
- Engineering, Hardware and Certification Status
- Mod Record and MECSLSI Updates

# STS-131 Mandatory Mission Kit Mod

## • STS-131 Starboard Lightweight Tool Stowage Assy Tray Mod

- Due to allocation of the two standard port lightweight TSAs to OV-104 and OV-105 and manifest delays, OV-103's STS-128 flight required use of the starboard LWT TSA for stowage of standard contingency tools.
- A new cushion was provided to stow the tools in the starboard TSA, however, a CEIT fitcheck issue resulted a 1-flight mod to reverse the forward tool tray installation and remove its handle.

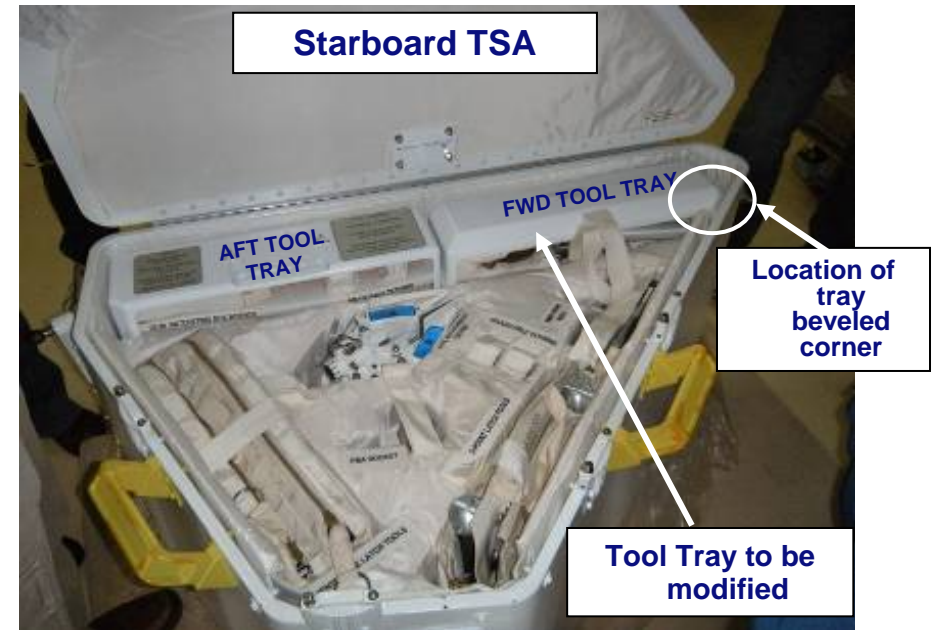

- Reversal to “upside-down” orientation was required to allow the tool tray’s beveled edge to align properly with the starboard TSA sidewall
- Reversing the tray put the tray handle on bottom in new orientation – handle was removed to allow tool tray to fit flush with the aft tray and allow TSA lid closure.
- For STS-131, the forward tool tray will receive a permanent mod which installs the handle on opposite end of the tray to facilitate use in the starboard TSA.

---

**STS-131  
ISS – 19A – MPLM LMC  
Launch Site Flow Review**

**Payload Cargo Engineering Status**

**Michael Barido**

**281.212.6072**

**07-23-2009**

# STS-131 LSFR

---

## Engineering Flight Product Status

<u>Drawing</u>	<u>Title</u>	<u>Rev</u>	<u>EO</u>	<u>Released</u>
• V072-200211	MECSLSI	NEW	-	05/12/09
• VA72-200211	Cargo Arrangement Drawing	NEW	-	05/13/09
• VD72-200211	Avionics Interface Diagram	NEW	-	05/15/09
• VS72-200211	Integrated Avionics Schematic	NEW	-	05/15/09
• VS70-540413	Retention Schematic Diagram	NEW	-	05/13/09

## Engineering Open Work

- FRED 08-07-09
  - MECSLSI update to include antenna and winch removal 08-07-09

## Standardization

- Mission Configuration does comply with Orbiter/Payload Integration Standardization Document NSTS 60523

---

# **KSC Launch and Landing Project**

## **STS-131**

### **LSFR**

**June 20, 2009**

# Agenda

---

- Orbiter Multi Flow S.Stilson / NASA
- Milestone Interface Chart S. Stilson / NASA
- Flight Element Processing W.Bingham / USA



---

# Multi Flow

**S.Stilson**



◆ KSC ASSESSMENT (SLIP or OPTION)

SSP APPROVED MANIFEST

\* DENOTES CHANGES TO BASELINE MANIFEST

MANIFEST REF. 09B-9

1000 EDT, 6 JUL 2009

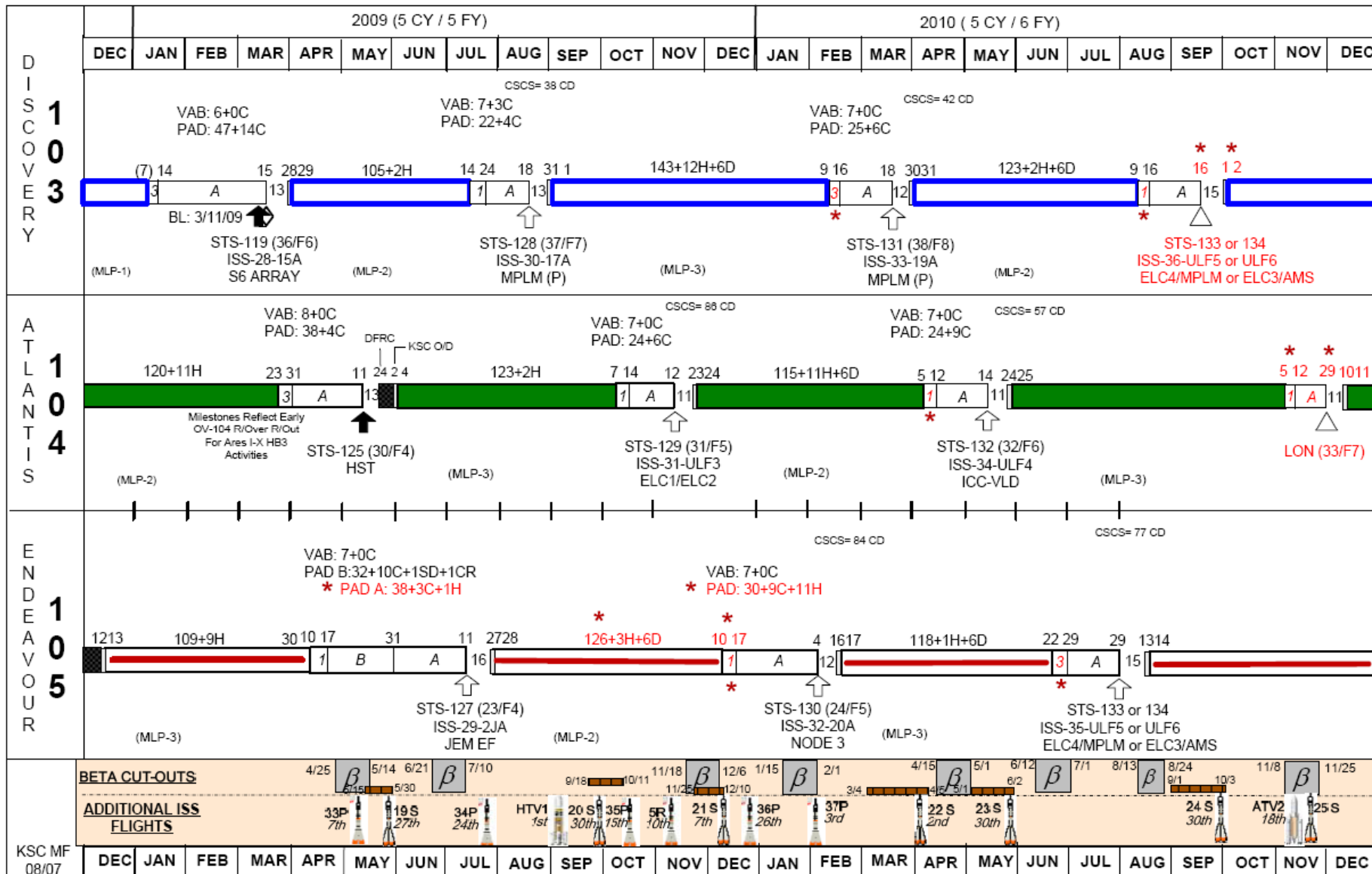

**LEGEND** H = HOLIDAY D = DRYDEN RESERVE C = PAD CONTINGENCY Wx = WEATHER OUTAGE OFF-1 OFF-2 OFF-3 Vehicle out of service S = SOYUZ P = PROGRESS  
 CR = CREW REST DAY DFRC OPS [1/3] VAB OPS [A/B] PAD OPS ▲ MILESTONE ▲ LAUNCH ▼ VAB TO VAB / START STACK / ET - SRB MATE / ET - MATE CLOSEOUTS COMPLETE  
 ■ = SOYUZ Cutout

# STS-131 KSC Milestone Interface Chart

OPR: USA - R. GILLETTE, INTEG. OPS.  
NASA - C. FORD, PH-0

OV-103 / 38 / ISS-33-19A / MPLM

CREW / DURATION: 7 / 12

ET-135 / BI-142 / RSRM 110 / MLP-3 / PAD-A / VAB HB3\*

SSP APPROVED MANIFEST PRCB 2/5/09 (REF. S072131)

Status as of:

07/06/2009

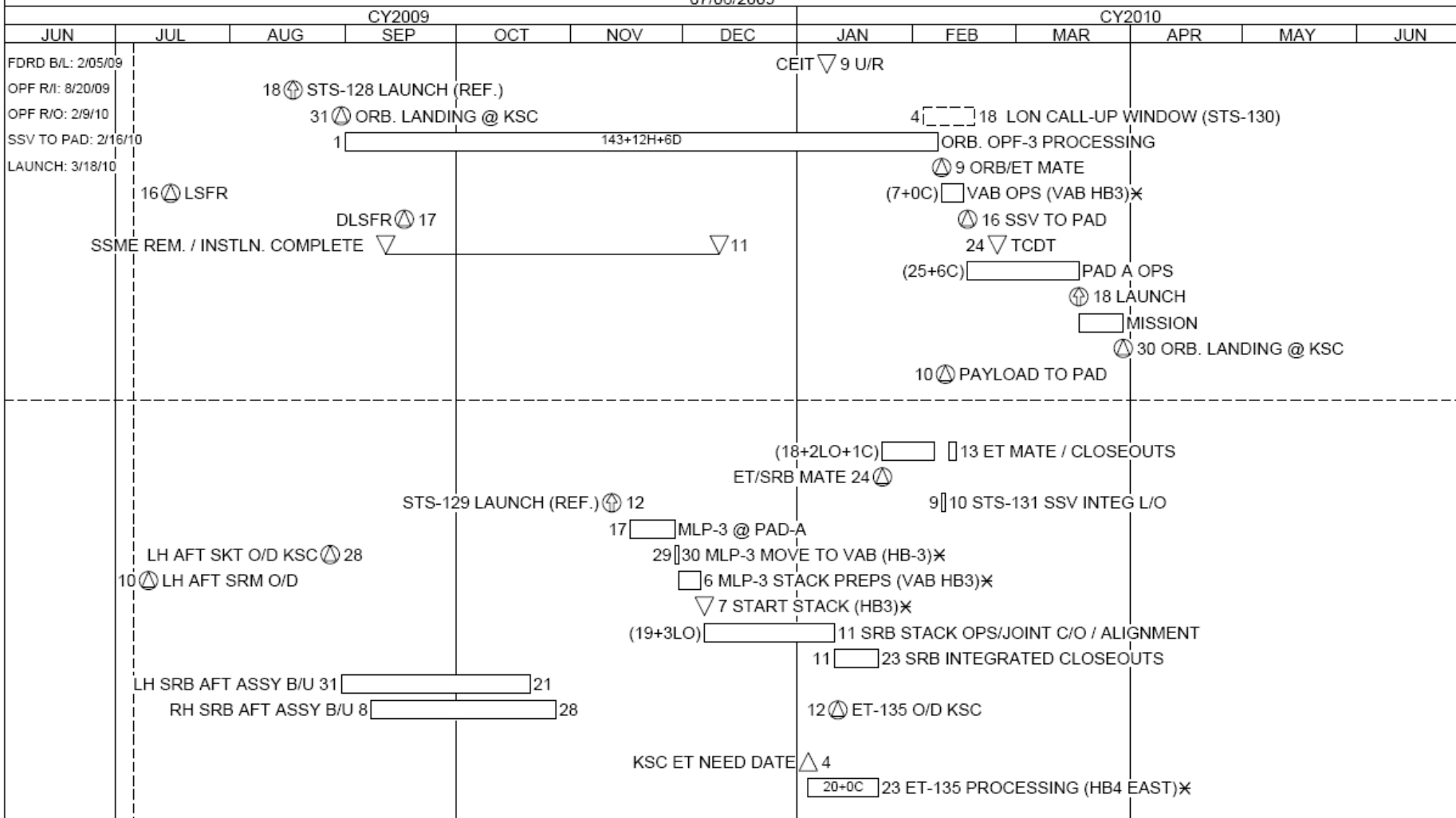

THREATS: 1. ET DELIVERY

NOTES: 1. THIRTY-THIRD ISS/SSP FLIGHT

---

# Flight Element Processing

**W. Bingham**

# Flight Element Processing Overview

---

- **Milestone Summary** **To Be Presented**
- **Significant Processing Deltas** **To Be Presented**
- **TPS Status** **To Be Presented**
- **Issues and Concerns** **To Be Presented**

**STATUS**

USA	NASA
C	C
C=CONCUR	NC=NOT-CONCUR

Creation Date:14-JUL-2009  
 Revision Date:14-JUL-2009  
 Revision :A

**STS-131/OV-103 OPF FLOW MILESTONES**  
 DOWN PAYLOAD: ISS-30-17A/ UP PAYLOAD: ISS-33-19A MPLM(P)

OPR:USA-BINGHAM, WAYNE W  
 NASA-STILSON, STEPHANIE S  
 2010



**Preliminary**

△ PLAN/BASELINE    ◇ DEVIATION FROM BASELINE    ▲ ◆ ACTIVITY COMPLETED    △ ACTIVITY CANCELED    △△ ACTIVITY DURATION \*\*\*\* SCHEDULE CHANGE

STATUS DATE: 14-JUL-2009:1    PLOT DATE: 14-JUL-2009, 12.29 pm    NETWORK: OPF131.280    CONTACT: R.C. SCHUBERT ,1-0951    OPF BAY-3    EXE:CUSOPFSU.27

# Significant Processing Deltas

---

- Major Components Removal / Replacements
  - APU 2 Removal And Replacement (Time And Cycle)
  - MPS PV 9/PV 12 Removal And Replacement (Time And Cycle)
  
- Mods
  - TAD 30231 Rudder Speed Inconel Thermal Barrier Redesign

# TPS Work Content (STS-131)

## Projected TPS Removals

<u>Priority</u>	<u>Description</u>	<u>LSFR</u>
Mand	Deferred Tile/ FIB For 1 Flight (Minimum)	15
Mand	In-Flight Tile/FIB Damage	*40
Mand	Operational Damage (Estimate)	*20
Mand	BLT Mod (1-Trip Tile/1-Cover Tile)	2
Mand	Putty Repairs from Grind-outs	*14
Mand	Additional Putty Removals (Chits)	10
Mand	Corrosion Sampling (Chit J6275A)	5

**Mandatory Total \*106**

### Risk Reduction:

10	MLGD Outboard Middle 3 <sup>rd</sup>	24
15	Body-Flap Stub "Piano Key" Tile	18

**Projected TPS Removals TOTAL (Estimate) \*148**

**Final TPS Work Content will be presented at the DLSFR**

**\*Based on Manifest 09B-1 OPF Flow 143 days**

**\* Estimated  
Number**

# Issues and Concerns

---

- **Flow Control Valves - Hardware Deliverables**
- **GFE - Hardware Deliverables**
- **Wave Form Output – Potential MDM R&R (Spares)**



**STATUS**

OPR: USA - J. Taylor, INTEG FM (1-7420)  
NASA - S. Stilson, PH-A (1-9103)

USA NASA

C C

**CONCUR**

Creation Date: 10 MAR 09  
Revision Date: 04 JUN 09  
Revision:

**STS-131 / OV-103**

**Integrated Operations Assessment Summary**

Payloads: ISS-33-19A MPLM (VERT)

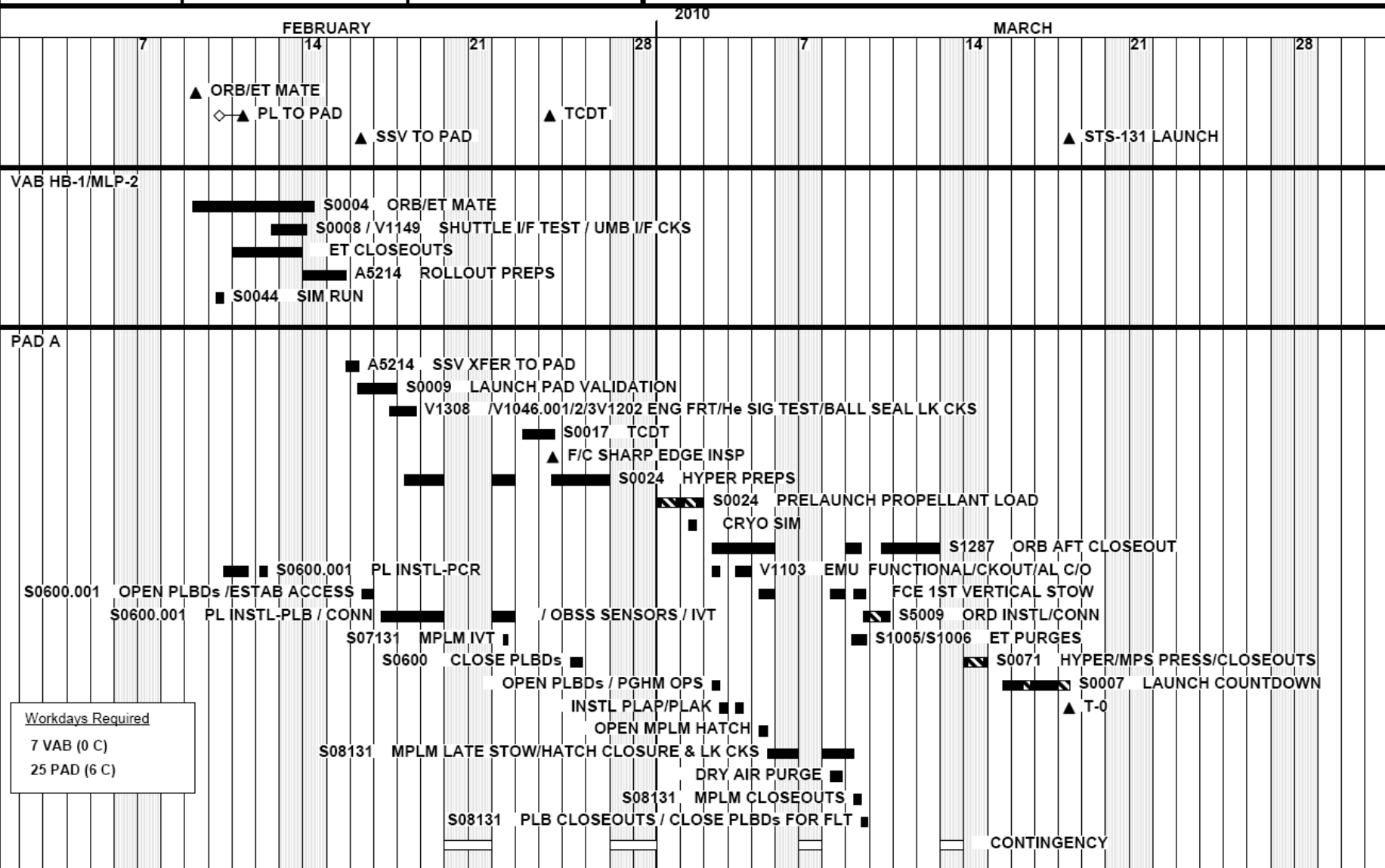

Workdays Required

7 VAB (0 C)  
25 PAD (6 C)



<b>STS-131 Launch Site Flow Review</b>	<b>Presenter</b> Kenneth Nowak
	<b>Date</b> 07-23-09

## **Backup Material**

### **FRWG Presentation (With Minor Changes)**



## STS-131 LAUNCH SITE FLOW REVIEW

Presenter

**Ann M. Patterson**

Date

**23 July 2009**

## Flight Operations and Integration (FO&I)

### Flight Requirements:

**MIP, PIPs, CIP**

**FDRD**

**FRD**

### Backup Charts



**STS-131 LAUNCH SITE FLOW REVIEW**

Presenter <b>Ann M. Patterson</b>
Date <b>23 July 2009</b>

<u>Documentation</u>	<u>Status</u>	<u>ECD/Date</u>
<u>MIP – ISS 19A, Basic, Chg 1 (6/24/09)</u> NSTS 21553	No Open CRs	
<u>PIP – MAUI, Basic, Chg 2 (5/5/08)</u> NSTS 21530	No Open CRs	
<u>PIP- SEITE, Basic, Chg 1 (9/4/08)</u> NSTS-21542	No Open CRs	
<u>PIP – SIMPLEX, Rev A (6/16/08)</u> NSTS 21327	No Open CRs	
<u>PIP – RAMBO-2, Basic (2/23/09)</u> NSTS 21556	No Open CRs	
<u>CI P – LMC (Lightweight Multipurpose Experiment Support Structure Carrier), Rev B, Change 16 (6/9/09)</u> NSTS 21494	No Open CRs	
<u>PIP – MPLM, ISS Multi-Purpose Logistics Module, Rev B, Change 3 (3/23/09)</u> NSTS 21499	No Open CRs	



## STS-131 LAUNCH SITE FLOW REVIEW

Presenter

**Ann M. Patterson**

Date

**23 July 2009**

- **STS-131 Latest FRD Revision**
  - **Revision 02, Dated, July 7, 2009 (<http://sspweb.jsc.nasa.gov/efrd>)**
- **Open CRs**
  - **None**
- **Closed CRs**
  - **None**
- **Pending CRs**
  - **None**



## STS-131 LAUNCH SITE FLOW REVIEW

Presenter
<b>Ann M. Patterson</b>
Date
<b>23 July 2009</b>

# Payload Integration Services/Interfaces



### MPLM

- **Services - 124 VDC from PTU 1 via ROEU (on-orbit) (PTU 1 & 2 will be interconnected) (for MPLM internal components)**
- 28 VDC from Primary PL bus C via ROEU (for shell heaters)
- OIU 1553 bus 2A and 2B via ROEU
- **Significant Support Hardware – ROEU, SPAT, videospection camera, various harnesses and attach hardware**
- **New 1<sup>st</sup> Flight – None**
- **Latch type – Active, with 22” latch guides in all locations**
- Primary X<sub>0</sub> 1202.73, Secondary X<sub>0</sub> 1010.00, Keel X<sub>0</sub> 1108.33

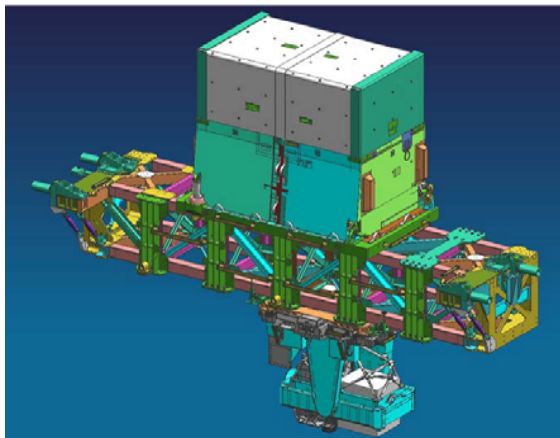

### LMC

- **Services - 28 VDC from aft PL bus C via LIP panel**
- **Significant Support Hardware – PAT box, harnesses and support hardware**
- **New 1<sup>st</sup> Flight – None**
- **Latch type – Passive**



## STS-131 LAUNCH SITE FLOW REVIEW

Presenter
<b>Ann M. Patterson</b>
Date
<b>23 July 2009</b>

# Payload Integration Services/Interfaces



**OBSS (Configuration 4 LDRI/ITVC and LCS/IDC cameras)**

- **Services - 124 VDC from PTU 2 (for LCS/ID**
  - 28 VDC from MN A (for LDRI/ITVC)
  - Ethernet line for LCS/IDS
  - LDRI/ITVC video (VSU PL 2) and RCU CAM 4 Sync
  - RSC (Config 2) camera video to VSU PL 3
- **Significant Support Hardware – SPDU, PGSC, SPASP/OPP for SPEE relay control, RSC power and feed throughs**

---

# STS-131 LSFR BACKUP

- **Potential Modifications (info only)**
- **Opportunity Modifications (info only)**
- **STR/TPS Priorities**
- **Chit Updates**
- **Previously Baselined Modifications (STS 131 LSRR)**
- **Engineering, Hardware and Certification Status**
- **Mod Record and MECSLSI Updates**



# STS-131 Potential Mods /Under Review (Info Only)

---

- **TAD 30091 BLT FE DTO Flight 3**

- Re-flight of protuberance tile and associated thermocouple instrumentation
- Potential for protuberance height increase from the 0.35” height being flown on STS-128 – pending further analysis, test and evaluation of STS-128 performance flight data

- **TAD 30246 Catalytic Coating DTO Flight 2**

- Re-flight of catalytic coating applied to two tiles in BLT DTO region of influence
- Catalytic coating DTO authorized for STS-128 as initial flight
- Would require production of new lot of catalytic coating (age life limited) and reapplication to selected tiles

- **TAD 30251 GH2 FCV Poppet Redesign**

- Poppet heat treat / material change under evaluation by Orbiter
- Recommendation pending completion of MPS & M&P PRTs study and OPO approval to proceed if viable option identified

- **TAD 30260 F3D/F4D Thruster Cover Redesign**

- Enhancement of the existing Tyvek rain cover design is being evaluated

# STS-131 Opportunity Mods (Info Only)

---

- **19735 WLE Spar “Sneak Flow” Protection**
  - Increases RCC panel damage tolerance by adding a flow restrictor to limit allowable plume flow to 50% across the flow restrictor
  - Mod completed at all panel locations with the exception of RH panel 4 & LH panels 2-4.
- **19763 Lower WLE Carrier Panel Horse Collar Gap Filler Redesign, Panels 1-4**
  - Redesigns the lower WLE access carrier panel horse collar gap fillers with an enhanced design with additional sleeving
  - Mod completed at all panel locations with the exception of RH panel 4 & LH panels 2-4
- **23227 Connector Saver (ME414-0630) Redesign (OMS Pod, Ku Band)**
  - Connector Saver mod provides proper interfacial seal and wavy washer engagement retention force to reduce risk of inadvertent demate during use.
  - Only Left POD and KU band locations remain to be worked

# STS-131 Risk Reduction ~ Percentages Shown

---

## TPS Priorities

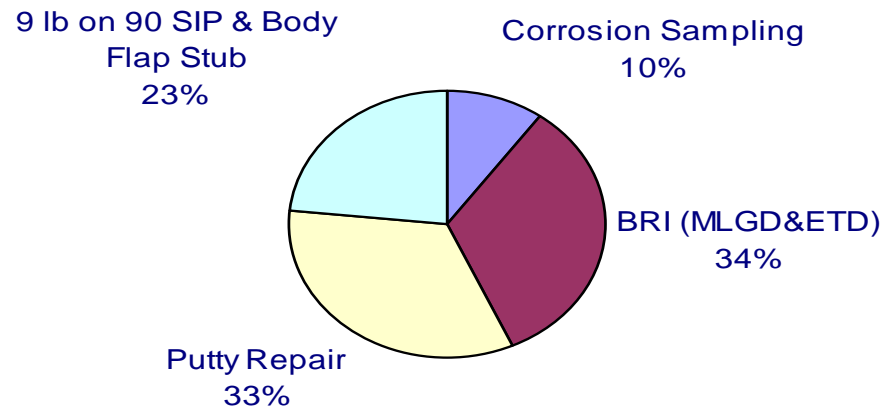

- Orbiter's expectations for the work areas are shown on the pie chart for STS-131
- Exact numbers are determined by the KSC Team based on vehicle configuration, access, and flow duration
  - Distribution provides data/risk reduction in all areas of the list
    - Does not allocate all the resources in one area

# OV-103 STR/TPS Priorities

---

## Mandatory

- **Flight damage, OMRS Rqmts/Chits, LRU access, & deferred work**
  - Corrosion Sampling (10% of total tile allocation) *Chit J6275A*
  - Putty repairs in RCC & Window DTA Zones (23% with 10 tile min.) *Chit Pending*
  - Continue G/F R & R on a best effort basis – zones 2B
  - Deferred work may be redeferred with acceptable inspection

## Prioritized Opportunity

1 – 9 1 thru 9 complete on OV 103

**10.MLGD – Outboard Middle 1/3 - (6 Door/6 STR) – None completed**

**11.ET Door – Remaining STR side of door & leading edge on door – 40 tiles (24 STR/16 door) –  
39 remaining**

**12.MLGD – Outboard Aft (1/3 left) 6/door/6 STR)- 24 Tile – None completed**

**13.Nose Area 9lb/90 SIP Upgrade to FRCI-12 – 14\* Tiles (7/side) – (\*103 16 tiles, thruster) – 13  
remaining**

**14.Base Heat Shield Stinger 9lb/90 SIP Upgrade to AEBT-8 – 42 Tiles (32/stinger, 10/Box  
Attach point) – 32 remaining**

# OV-103 STR/TPS Priorities (cont)

---

**15.**Body Flap Stub “Piano Key” Upgrade to AETB-8 – 40 Tile – **39 remaining**

**16.**Gap fillers in Subset 2B (Line across MLGD edge) – **3 zones remaining**

**17.**BRI-18 Tile – Remaining MLGD (top priority)/ET Door/LESS carrier panels/NLGD

1. MLGD (Inboard forward edge working to AFT door edge) – **None Completed**
2. ET Door – **23 remaining**
3. LESS - panels 8, 9, 10, 7, 6, 5, 4, 3, 2, 1, 11, 12, 13 (in that order) – **61 tiles remaining**
4. NLGD (attrition – do leading edge first) – **108 tiles remaining**

**18.**Mod work (WLE sneak flow, WLE Horsecollar Gap Fillers) – **4 locations remaining**

**19.**MADS Instrumentation Failures (placeholder)

**20.**Remaining Gap Fillers & Window BRI-18 - **121 remaining**

Windows 2, 3, 4, & 5 Upper Carrier Panels (top priority)

# STR/TPS Priorities Current Vehicle Status

Priority Number	Total	OV-103	OV-104	OV-105
1. BRI-18 Tile - MLGD FWD O/B Corner	28	complete	complete	complete
2. BRI-18 Tile - MLGD FWD Edge	22	complete	complete	complete
3. BRI-18 Tile - MLGD O/B Side	18	complete	complete	complete
4. BRI-18 Tile - STR side of ET Doors	20	complete	complete	complete
5. BRI-18 Tile – LESS Carrier Panels 8-10 (103 & 104)	24	complete	complete	n/a
6. BRI-18 Tile – STR side of ET Doors I/B	8	complete	complete	complete
7. Inboard Elevon “Hub” Tile Mod	4	complete	2	complete
8. I/B Elevon 9lb/90 SIP	34	complete	complete	complete
9. O/B Elevon 9lb/90 SIP	6	complete	complete	complete
10. MLGD – Outboard Middle 1/3	24	0	0	3
11. ET Door remaining STR side	40	1	10	0
12. MLGD - Outboard AFT 1/3	24	0	0	1
13. Nose Area 9lb/90 SIP	14 (16 <sup>OV103</sup> )	3	complete	0
14. Base Heat Shield 9lb/90 SIP	42	10	complete	complete
15. Body Flap Stub "Piano Key" tiles	40	1	14	0
16. Gap fillers in Subset 2B	5 Zones	2	1	0
17. Remaining BRI-18 - MLGD (top priority) / ET / LESS carrier panels / NLGD	MLGD 100	MLGD 0	MLGD 1	MLGD 0
	NLGD 123	NLGD 15	NLGD 19	NLGD 47
	LESS 68 (92 <sup>OV-105</sup> )	LESS 7	LESS 5	LESS 19
	ET Door 28	ET Door 5	ET Door 2	ET Door 1
18. Mod work LESS internal	44 locations	40	complete	complete
20. Remaining Gap Fillers & Window BRI-18	124	3	2	19
Structural Corrosion Sampling Plan	See Special Chart			
2nd Subset Putty Repair Removals	11 / 6 / 5	complete	complete	complete

# Current Vehicle Status – Corrosion Under TPS

## Special Chart

REGION	REMAINING WORK CONTENT			
	MINIMUM SAMPLE	OV-103 (Current Flight)	OV-104 (Current Flight)	OV-105 (Current Flight)

TILE ( EACH SAMPLE SITE IS ONE TILE CAVITY )				
REGION	MINIMUM SAMPLE	OV-103 (Current Flight)	OV-104 (Current Flight)	OV-105 (Current Flight)
TILE - AFT FUSE BASE AND DOME HEAT SHIELDS	6	COMPLETE	COMPLETE	COMPLETE
TILE - AFT FUSE LOWER	7	COMPLETE	COMPLETE	COMPLETE
TILE - AFT FUSE SIDES	2	2	2	2
TILE - BODYFLAP LOWER SURFACE	3	3	3	COMPLETE
TILE - BODYFLAP SIDES AND UPPER SURFACE	3	1	3	COMPLETE
TILE - FWD FUSE LOWER	6	COMPLETE	COMPLETE	COMPLETE
TILE - FWD FUSE SIDES AND UPPER SURFACE	7	COMPLETE	COMPLETE	COMPLETE
TILE - LH IB ELEVON	3	COMPLETE	COMPLETE	COMPLETE
TILE - LH OB ELEVON	2	COMPLETE	COMPLETE	COMPLETE
TILE - LH WING	14	COMPLETE	COMPLETE	COMPLETE
TILE - MID FUSELAGE LOWER	21	COMPLETE	COMPLETE	COMPLETE
TILE - RH IB ELEVON	3	COMPLETE	COMPLETE	COMPLETE
TILE - RH OB ELEVON	2	COMPLETE	COMPLETE	COMPLETE
TILE - RH WING	14	COMPLETE	COMPLETE	COMPLETE
TILE - VERTICAL TAIL and RSB	4	COMPLETE	COMPLETE	COMPLETE

FLOW PLANNING KEY - REGION PRIORITY FOR LSRR / LFSR	
5	Priority Region - Number indicates remaining locations to be sampled
COMPLETE	Completed Region - No additional sampling required
3	Low Priority Region - Number Indicates remaining locations to be sampled

REGION	REMAINING WORK CONTENT			
	MINIMUM SAMPLE	OV-103 (Current Flight)	OV-104 (Current Flight)	OV-105 (Current Flight)

FRSI AND FIB ( EACH SAMPLE SITE IS ONE FIB OR ONE 12" X 12" SECTION OF FRSI) - (12" x 24" for WINGS)				
REGION	MINIMUM SAMPLE	OV-103 (Current Flight)	OV-104 (Current Flight)	OV-105 (Current Flight)
RSI - AFT FUSE SIDES BHS and DHS	3	2	2	2
RSI - FWD FUSE SIDES AND UPPER SURFACE	9	COMPLETE	COMPLETE	COMPLETE
RSI - LH IB ELEVON	3	1	2	3
RSI - LH OB ELEVON	2	2	2	2
RSI - LH WING	12	10	COMPLETE	12
RSI - MID FUSELAGE SIDES	15	COMPLETE	1	COMPLETE
RSI - RH IB ELEVON	3	3	2	3
RSI - RH OB ELEVON	2	2	2	2
RSI - RH WING	12	10	COMPLETE	12
RSI - VERTICAL TAIL and RSB	11	COMPLETE	COMPLETE	COMPLETE

HEATSINK PERIMETER INSPECTIONS ( EACH SAMPLE SITE IS ONE 2 LINEAR FOOT SECTION)				
REGION	MINIMUM SAMPLE	OV-103 (Current Flight)	OV-104 (Current Flight)	OV-105 (Current Flight)
HEATSINK PERIMETER - BODYFLAP	3	3	3	3
HEATSINK PERIMETER - LH OB ELEVON	1	1	1	COMPLETE
HEATSINK PERIMETER - LOWER FWD FUSELAGE	3	3	3	3
HEATSINK PERIMETER - RH IB ELEVON	2	2	2	1
HEATSINK PERIMETER - RH OB ELEVON	1	1	1	COMPLETE
HEATSINK PERIMETER - LH IB ELEVON	2	2	2	1





# STS-119 Failure Aft Stub “Piano Key” Tile

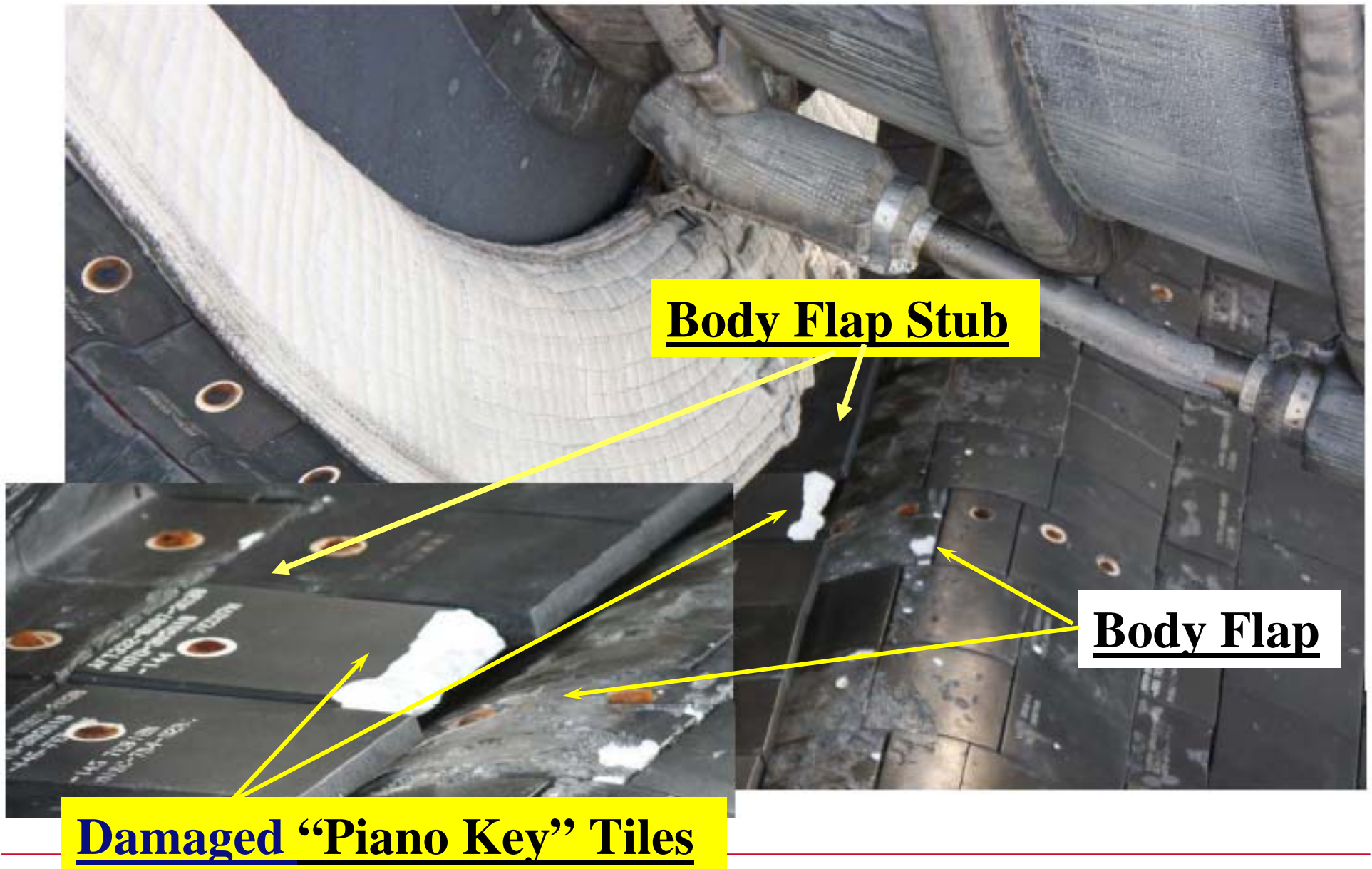





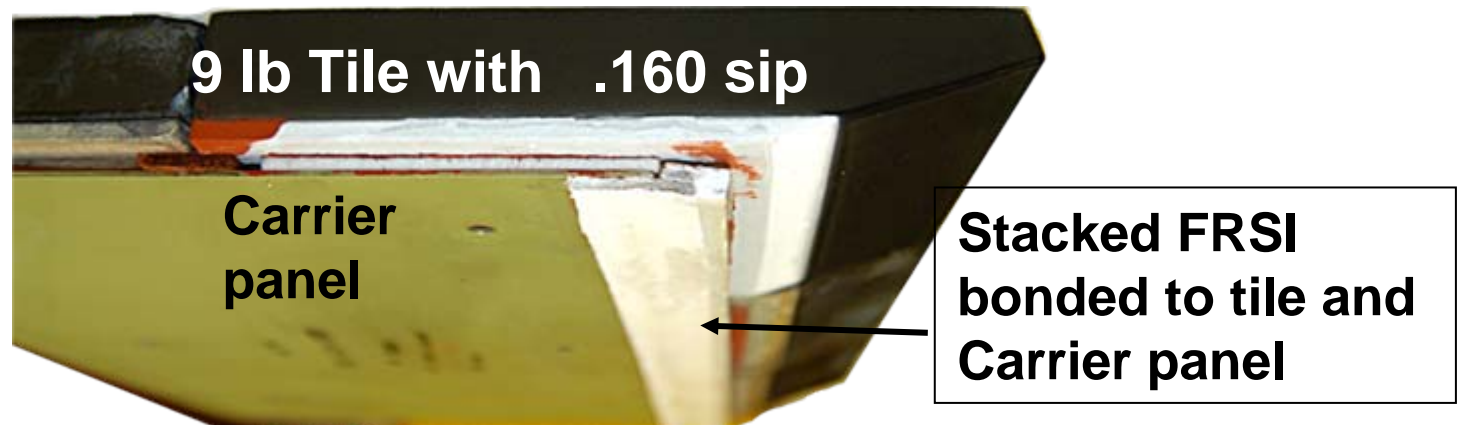

# Body Flap Stub “Piano Key” Tile Upgrade

- **30261 Aft Stub Tile Upgrade (Attrition)**
  - Improves the damage resistance of these carrier panel tiles adjacent to the body flap
    - Several instances of damage historically seen attributed to ground processing collateral damage
  - 8 of these tiles at the centerline, determined to be most susceptible to handling damage, were previously upgraded to FRCI-12.
    - Flight experience has shown that these improved tiles have performed well to date and that recent tile damages have been to the remaining LI-900 tiles.
  - Due to the recent tile damages and success of the previous upgrade, the remaining LI-900 tiles along the aft stub will be upgraded to AETB-8 material having roughly twice the material strength

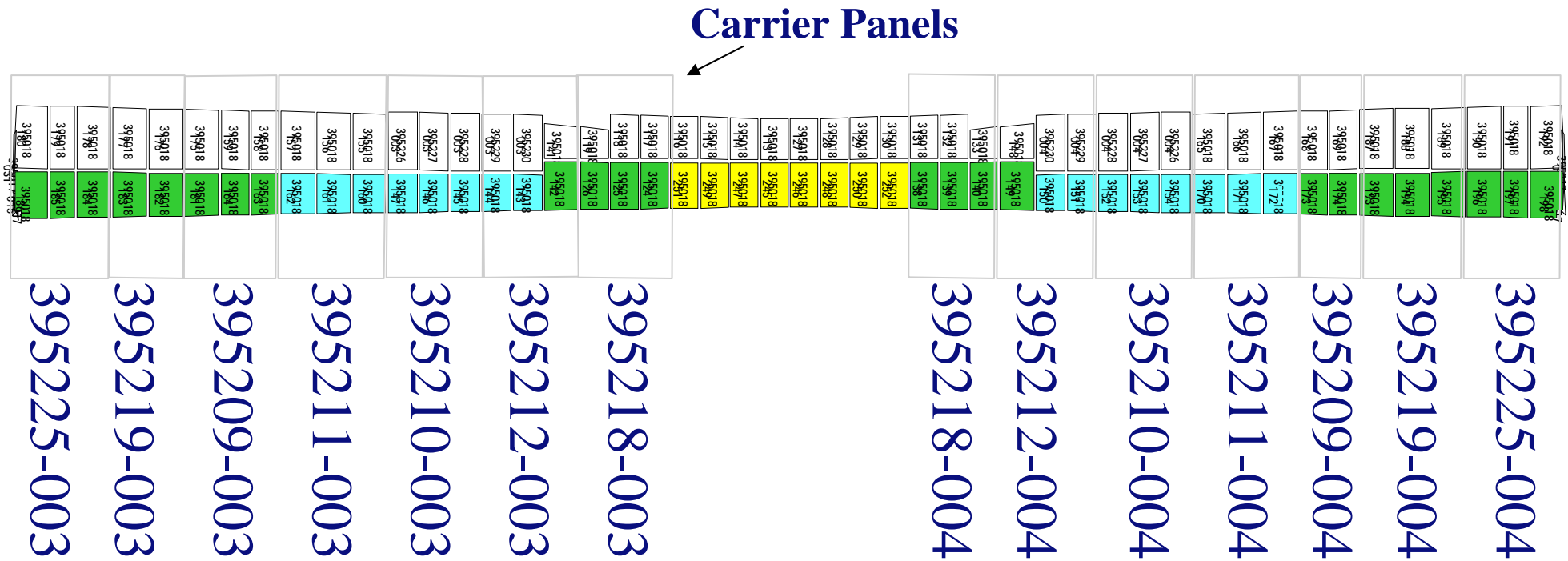

# Body Flap Stub “Piano Key” (PRT Map)



- Typically 3 tiles per Carrier Panel (exception 395219)
-  Highest Priority tiles, these should be done first
-  Remaining tiles can be done in any order
-  Stub tiles previously upgraded to FRCI-12

# STS-131 Chits (OV-103 Flight 38)

---

- **Approved or Pending Approval**

- J6275A Corrosion Sampling
- J6116 Ames Gap Filler Removal and Replacement
- J6414A Rudder Speed Brake Thermal Tab Inspection
- J6482 STS-128 Payload Close Clearance Measurements
- J6505 Capture OV-103 Output Waveforms to Address Diode Concerns
- J6509 Removal of MPS GH2 Flow Control Valves post STS-128
- J6523A Optigo, Metris, and Z-Scan of BLT Protuberance Tile
- J6526 Evaluation of OMS Pod LI-900 tile installed on 0.090” SIP
- J6531 Metris Scan of OV -103 Lower Surface (OV-103, FLTS 37-39)
- J6534 Putty Repair Tile Replacement for Risk Reduction

- **Potential**

- JXXXX BLT DTO #2 Post-Flt Tempilabel Assessment
- JXXXX MPS CV4 R&R to Inspect Poppet Condition
- JXXXX Aft Stub Tile Inspections
- JXXXX Gap Filler Micro Inspections
- JXXXX PLBD C/L Actuator R&R
- JXXXX Screed/RTV Sample for OMS 023
- KXXXX Cannibalization of Drag Chute Low Pass Filters from OV 105

# Previously Baselined Mod (STS 131 LSRR)

---

## TAD 30231 – Rudder Speed Brake Inconel Thermal Barrier Redesign

- This mod provides redesigned Rudder Speed Brake (RSB) inconel thermal barrier tab attachments to improve strength and durability
  - Replaces all 60 tabs installed located around the RSB periphery, which provide thermal protection from SRB/SSME plume heating during ascent
    - Tabs are used to bridge the ~0.060” gap between the RSB spring clip seals
  - Missing tabs have been found post-flight on numerous occasions
  - Improved ground inspection procedures were implemented following STS-124 (tab loss seen on-orbit), but tabs still found missing post-flight
- The main features of the redesign include:
  - Improved primary fastening mechanism (spot welds) by increasing number and improving quality control (class “C” to “B”)
  - Shortened tab overlap (0.300”) with adjacent spring clip to reduce the moment arm and stress on the spot welds
  - Added secondary fastener by increasing tab length to allow for mechanical attachment using existing screws for spring clip

# Previously Baselined Mod (STS 131 LSRR)

## Rudder Speed Brake Spring Clip/Tab Locations

## Original Design

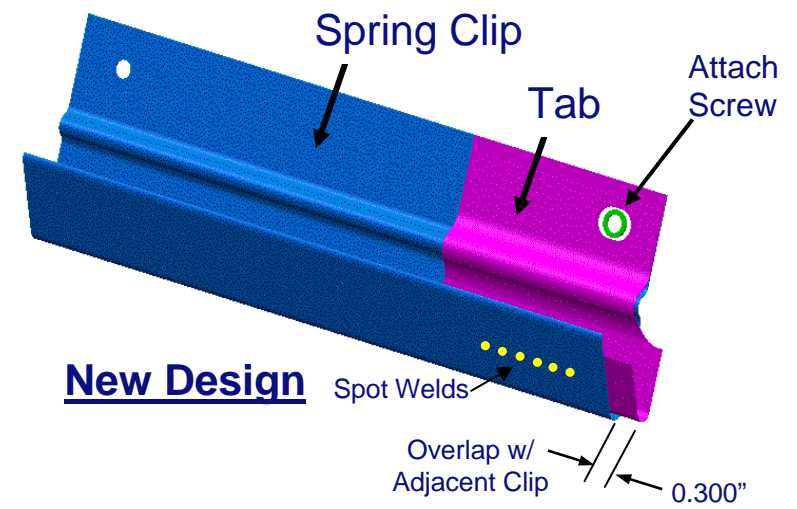
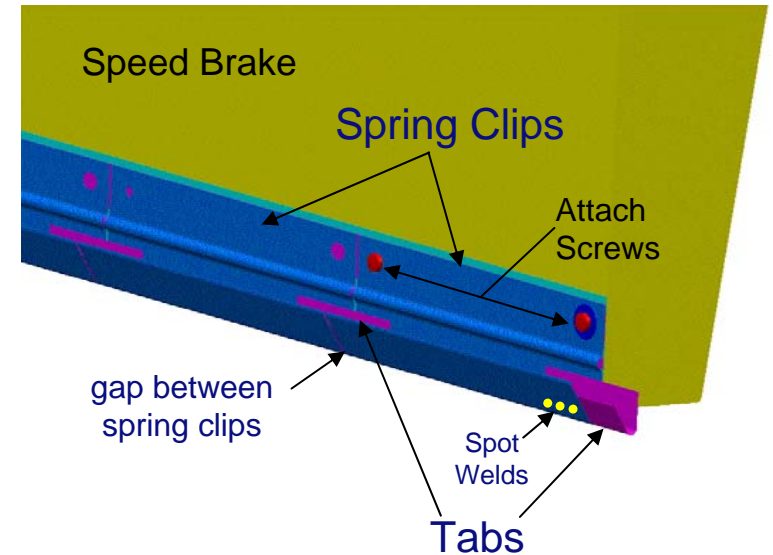
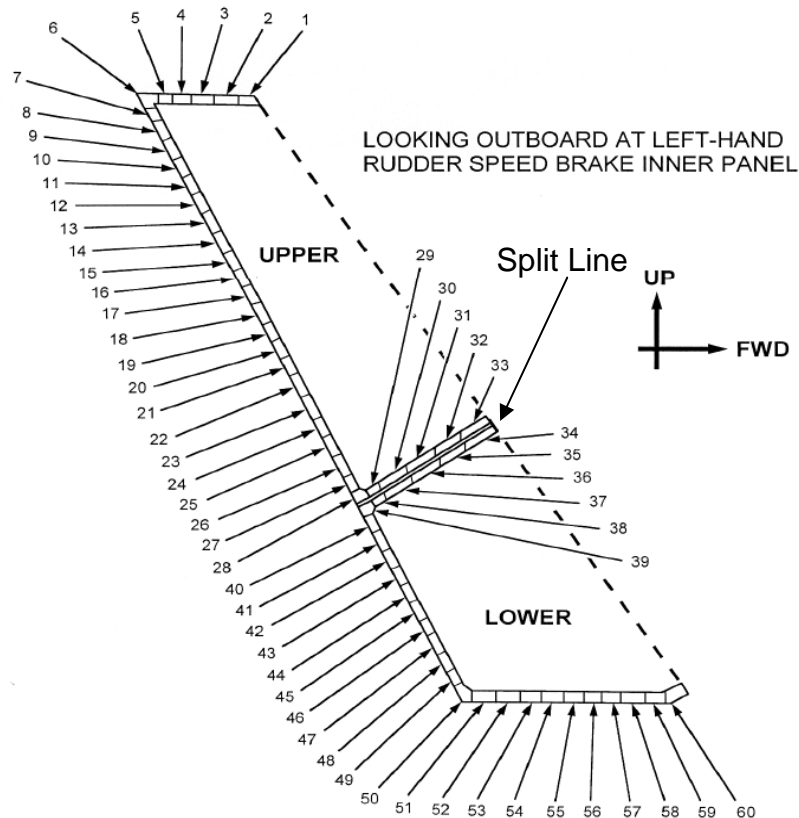

- **60 thermal spring clips are installed along the Rudder Speed Brake (RSB) periphery**

- Each spring clip is roughly 6-8 inches in length - Gap between spring clips is 0.060" ± 0.030"
- **Tabs** located at the interface between adjacent spring clips to cover the gap

# Engineering, Hardware and Certification Status

MCR NO.	MCR TITLE	Est. Engr Release (MM/DD/YY)	G.O. Engr Need (MM/DD/YY)	Est. Hdwe Delivery (MM/DD/YY)	G.O. Hdwe Need (MM/DD/YY)	MOD/CERT GO / NO-GO	CERT SUBMITTAL DATE	CERT APPROVAL DATE (ESTIMATE)	CERTIFICATION CR / CAR (BOEING)	REMARKS
<b>Mission Kit Mod for Authorization STS-131 LSFR</b>										
30010 Terry Teal	<b>Starboard LWT TSA Tool Tray Mod</b> Due to allocation of the two standard port lightweight TSAs to OV-104 and OV-105 and manifest delays, OV-103's STS-128 flight required use of the starboard LWT TSA for stowage of standard contingency tools. A new cushion was designed and fabricated to stow the tools in the starboard TSA, however, a CEIT fitcheck issue resulted a 1-flight mod to reverse the forward tool tray installation and remove the handle. Reversal to "upside-down" orientation was required to allow the tool tray's beveled edge to align properly w/ starboard TSA sidewall (mirror image of port TSA) and the handle (on bottom in new orientation) was removed to allow tool tray to fit flush with the aft tray and allow TSA lid closure. For STS-131, the forward tool tray will receive a permanent mod to the forward tool tray by installing the handle on opposite end of the tray to facilitate use in the starboard TSA.	11/18/09	TBD	11/20/09	TBD	Go	11/30/09	1/15/10	CR 25-849-660516-001Q CAR 17-25-849-660516-001Q	V849-660500 Assy Update required K849-000024-001,0006,0 New End Item Kit V849-000002 end item update required  Ref OCRD S165421

MCR NO.	MCR TITLE	Est. Engr Release (MM/DD/YY)	G.O. Engr Need (MM/DD/YY)	Est. Hdwe Delivery (MM/DD/YY)	G.O. Hdwe Need (MM/DD/YY)	MOD/CERT GO / NO-GO	CERT SUBMITTAL DATE	CERT APPROVAL DATE (ESTIMATE)	CERTIFICATION CR / CAR (BOEING)	REMARKS
<b>Previously Authorized Mod</b>										
30231 Hinkle	<b>Rudder Speed Brake Thermal Clip Redesgn</b> Installs redesigned Rudder Speed Brake inconel thermal barrier tabs to improve strength of the tab attachment to prevent tab loss during flight. Although improved pre-flight ground inspection procedures were implemented, missing tabs have been found post-flight. The redesign reduces the overhang of the tab, thus reducing the moment arm and stress to the spot welds, and provides a secondary mechanical fastener attachment - Tab lengthened to reach an existing spring tab attachment screw - Slides tab into spring by .70" (overhang reduced to .30") - Adds more spot welds and changes the spot weld from Class "C" to Class "B" (additional quality control to ensure weld conformance)	Released	N/A	8/20/09 (1)	TBD	Go	7/1/09 A  7/1/09 A	7/29/09 P  7/29/09 P	CR 07-290101-001S  CAR 20-07-290101-001S  External Insulation (RSB T/B)	(1) NSLD Fab - 3rd shipset delivery  <b>Authorized at STS-131 LSRR</b>



# Mod / MECSLSI Records for Baselineing

MCR NO.	MCR TITLE	KIT-MOD RECORD / TECH ORDER IMPACT DESCRIPTION	REMARKS
<b>Mission Kit Mod for Authorization STS-131 LSR</b>			
<b>30010</b> Terry Teal	<u>Starboard LWT TSA Tool Tray Mod</u>	<p><b>Placeholder 030010,0103,4</b> - STS-131 Unique Stbd LW TSA Cushion / Storage Tray Change</p> <p><b>Tech Order &amp; MECSLSI Impact:</b></p> <p>(Add) M072-660858-001 LW Stbd TSA Stowage Cushion-Tray Assy (new tech order)                      (Remove) M072-660856-001 LW Stbd TSA Stowage Cushion-Tray Assy                      Model MV0849A</p>	<p>V849-660500 Assy Update required                      K849-000024-001,0006,0 New End Item Kit                      V849-000002 end item update required</p> <p>Ref OCRD S165421</p>

## Cargo Engineering Backup



# STS-131 LSFR

---

## OMRSD

- **FII V2 Payload (Post-Mate)**

  - Baselined Files

    - P350 MPLM

    - P494 LMC

  - RCNs

    - PP17965

    - Payload Baseline (P553)

    - Baseline

    - 08/04/09

- **FII V4 (Pre-Mate)**

  - RCNs

    - DPS18038

    - Mission-Unique List

    - Baseline

    - 09/15/09

    - DPS18039

    - FIII MUL

    - 09/15/09

    - DPS18037

    - Adjacent Pin Test

    - 09/15/09

- **FII V6 (Shuttle Experiments) – None**

- **Issues / Concerns**

  - None

# STS-131 LSFR

---

## Annex 1: ISS-19A Annex 1

### Activity

### ECD

**Baselined  
05/09/09A**

### Post CIR Update

- CR Approval

**08/17/09**

### L-4M Update

- Customer submittal
- CR approval

**11/02/09**

**11/18/09**

### L-1M Update

- Customer Submittal
- CR Approval
- Final weight log

**02/02/10**

**02/18/10**

**03/05/10**

# STS-131 LSFR

---

## Annex 1: LMC CIP Annex 1

### Activity

**Baselined**

**ECD**

**04/20/09A**

### Post CIR Update

- CR Approval

**08/17/09**

### L-4 M Update

- Customer submittal
- CR approval

**11/02/09**

**11/18/09**

### L-1 M Update

- Customer Submittal
- CR Approval
- Final weight log

**02/02/10**

**02/18/10**

**03/05/10**

# STS-131 LSFR

---

## Time-Critical Ground Handling Requirements

<b>• Activity</b>	<b><u>ECD</u></b>
<b>• Customer Submittal (L-4M)</b>	<b>11/18/09</b>
<b>• Release for review (L-3M)</b>	<b>12/18/09</b>
<b>• Baseline (L-60 Days)</b>	<b>01/18/10</b>

### **•Issues / Concerns**

**•None**

# STS-131 LSFR

---

## Payload ICDs/PIRNs

All Payload-Unique ICDs are baselined

### PIRNS that impact Flight Products

<u>PIRN #</u>	<u>ICD/Payload</u>	<u>Title</u>	<u>ECD</u>
A0TBD	ICD-A-21494/LMC	Update Mech Figs	09-25-09
A0TBD	ICD-A-21350/MPLM	Extended Latch Guides	09-25-09

### Issues/Concerns

- None

# STS-131 LSFR

---

## Cargo Close Clearance Process

- The following Close Clearance areas have been identified:
  - Aft Port Scuff plate to SRMS MPM
- A Chit will not be developed to take Close Clearance Measurements
  - Will be measured on STS-128
  - Same vehicle, same MPLM, same Orbiter hardware

# STS-131 LSFR

---

## Cargo Integration Hardware Status

### Delivery Status

- All required CIH has been delivered
- No new hardware for this flight

### Issues/Concerns

- None



# STS-131 Launch Site Flow Review

Presenter **Kenneth Nowak**

Date **07-23-09**

## Overview

- **SSP System Drawings** **No Issues\***
- **SSP Authorized Modifications/Non Standard Work** **No Issues\***
- **SSP OMRS Changes (RCNs)** **To Be Presented**





<b>STS-131 Launch Site Flow Review</b>	<b>Presenter</b> MK-SIO / A. Swift	
	<b>Date</b> 07-23-09	<b>Page</b> 1

**Mandatory RCNs:**

**NONE**

**Non-Mandatory Value Added RCNs:**

**OV18009    V30 – OMS/FRCS/STR REQUIREMENTS CLARIFICATION    PRELIM**

---

# **STS-131 Launch Site Flow Review Flight Software Overview**

**Gail Sanders  
USA FSW**

**PRCB 07/23/09**

# STS-131 LSFR (FSW)

---

- **STS-131/OV-103 Flight Software (FSW) Versions**
  - Fourth scheduled flight of Operational Increment (OI) 34 Flight Software (SASCB SCR 98107A documents PASS and BFS OI-34 content)
  - Fourth scheduled flight of MEDS IDP VI 07.00/MDUF VI 06.00 (SASCB SCR 98113 documents content)
  - Fifth scheduled flight of MAGRS-3S Link 613-996-008 Software (Link-008) (SASCB SCR 98115 documents content)
- **STS-131/OV-103 Flight Software Payload Support:**
  - ISS 19A
  - Orbiter Interface Unit (OIU)
  - Sequential Still Video (SSV)
  - Orbiter Docking System (ODS)
  - Trajectory Control System (TCS)
  - ISS Caution and Warning (ISSCW)
  - Multi-Purpose Logistics Module (MPLM)
  - Assembly Power Converter Units (APCUs) & Station to Shuttle Power Transfer System (SSPTS) (generic support for both configurations)
- **Major New Flight Software Support Items:**
  - None

# STS-131 LSFR (FSW)

---

- **STS-131 Source Changes/Edits for Primary Flight Software (Base)**
  - **SCR 93211A Update of SSMEC Vehicle Data Table (VDT) for Enhanced Accelerometer Operations**
  - **SCR 93262A Film ET Camera**
  - **SCR 93267A Removal of the Set and Reset to False Cmds For the RCS Tank Iso Valves**
  - **DR 126366 SM GPC Failure to Send GCIL Commands**
- **STS-131 Patch Implementation for Primary Flight Software**
  - **None.**
- **STS-131 Patch/Edit Implementation for Backup Flight Software (Base) (included on delivered Mass Memory)**
  - **SCR 93282 Update PASS/BFS HUD Body Flap Warning Limit K-Loads**
- **STS-131 Patch Implementation for Backup Flight Software**
  - **None.**

# STS-131 LSFR (FSW)

---

- **Products**

- **STS-131/OV-103 Base delivery schedule (available to field)**

**FPSB**

- **Shuttle Data Tape**
- **Mass Memory Unit**

**July 24, 2009**

**August 10, 2009**

- **An STS-131/OV103 ADTL SDT/Mass Memory may be required**

- **Decision to generate these products will be made in September, 2009**

**FPSB**

- **ADTL Shuttle Data Tape**
- **ADTL Mass Memory Unit**

**December 2, 2009**

**December 16, 2009**

- **Open Items**

- **None**

- **Concerns/Issues**

- **No issues or concerns with STS-131 at this time**



**STS-131 LSFR**  
**Flight Crew Equipment/GFE**

Presenter <b>MV5/Kenneth Brown</b>	
Date July 23, 2009	Page 1

**STS-131 LSFR**  
**FCE/GFE Status**

**Kenneth Brown**  
**Manager, GFE & Flight Crew Equipment Office**  
**Johnson Space Center**

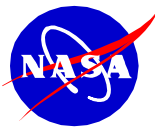

**STS-131 LSFR**  
**Flight Crew Equipment/GFE**

Presenter <b>MV5/Kenneth Brown</b>	
Date July 23, 2009	Page 2

- **All GFE hardware need dates and delivery dates were partnered at CIR**
- **Tech orders and hardware list noted in backup charts**
- **Changes since STS-128:**
  - **Starboard TSA only (lightweight TSA)**
  - **Remove aft bulkhead WVS and winch**
  - **Remove aft bulkhead handrails**
  - **Note: Due to 6 month Time and Cycle limit on videospection pressurization, GFE team is working with KSC GO team to assess keel camera installation. Delaying installation by 2 or 3 months would add margin for T&C expiration if launch slips.**



**STS-131 LSFR**  
**Flight Crew Equipment/GFE**

Presenter  
**MV5/Kenneth Brown**

Date  
July 23, 2009

Page 3

**BACKUP**



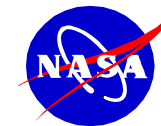

**STS-131 LSFR**  
**Flight Crew Equipment/GFE**

<b>Presenter</b> MV5/Kenneth Brown	
<b>Date</b> July 23, 2009	<b>Page</b> 4

Tech Order numbers are identified for reference only. Report generated Jun-10-2009

Hardware	Tech Order	KSC Eng Need	Eng(TO) Release	In MEC	Cert O/C	KSC Need	JSC Planned	Comments	JSC Contact
A (port forward)	M072-750025-072	11/11/09	1/7/05	5/18/09	C	12/23/09	12/11/09	Camera from STS-129 (-510 Pan & Tilt Unit). OPF	Randall Moore
B (port aft)	M072-750025-073	11/11/09	1/7/05	5/18/09	C	12/23/09	12/11/09	Camera from STS-129 (-510 Pan & Tilt Unit). OPF Instl for testing. Pad Installation.	Randall Moore
C (starboard aft)	M072-750025-074	11/11/09	1/7/05	5/18/09	C	12/23/09	12/11/09	Camera from STS-129 (-510 Pan & Tilt Unit). OPF Instl for testing. Pad Installation.	Randall Moore
D (starboard forward)	M072-750025-075	11/11/09	1/7/05	5/18/09	C	12/23/09	12/11/09	Camera from STS-129 (-510 Pan & Tilt Unit). OPF Installation Desirable	Randall Moore
Payload Ops camera	M072-340109-002	9/25/09	11/15/01	5/18/09	C	10/26/09	10/26/09	4.8MM/68 degree HFOV @ 52 in. (from STS-128 keel). JSC would prefer later delivery date to allow margin. OPF Installation desirable	Randall Moore
SRMS elbow camera	M072-544504-013	11/11/09	3/3/08	5/18/09	C	12/23/09	12/11/09	Camera from STS-129 (-510 Pan & Tilt Unit). OPF Instl for testing. Pad Instl for flight.	Randall Moore
SRMS wrist camera	M072-544504-006	11/11/09	3/3/08	5/18/09	C	12/28/09	12/11/09	Camera from STS-129. OPF Installation Desirable.	Randall Moore
Centerline Airlock Camera (stowed)	M072-660828-002, plus CCCC stow	11/27/09	3/17/99	5/18/09	C	12/28/09	12/11/09	Units from STS-129. OPF Installation mandatory for alignment.	Randall Moore
Lefthand Umbilical Camera (aft)	M072-705001-016	1/1/10	10/28/04	5/18/09	C	2/2/10	2/2/10	VAB installation mandatory.	Randall Moore
Righthand Umbilical Camera	M072-705001-028 M072-705001-027	1/1/10	10/28/04 10/28/04	5/18/09	C	2/2/10	2/2/10	VAB installation mandatory.	Randall Moore
Digital Television (DTV)	M072-710570-007		11/15/07		C			Installed Hardware	Larry Schmidt
MCIU/RMS Situational Awareness Display (RSAD)	M072-710543-001		3/7/00	5/18/09	C			Installed Hardware	Larry Schmidt
Tools for Rendezvous and Docking (TRAD)	M072-730021-019		7/20/07	5/18/09	C			Installed	Larry Schmidt

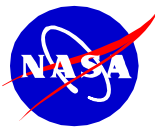

**STS-131 LSFR**  
**Flight Crew Equipment/GFE**

Presenter <b>MV5/Kenneth Brown</b>	
Date July 23, 2009	Page 5

Tech Order numbers are identified for reference only. Report generated Jun-10-2009

Hardware	Tech Order	KSC Eng Need	Eng(TO) Release	In MEC	Cert O/C	KSC Need	JSC Planned	Comments	JSC Contact
Tools Stowage Assembly (TSA)	M072-660850-006 M072-660856-XXX	11/27/09		5/18/09	O	12/28/09	12/28/09	Note: The configuration may switch to Lightweight Starboard. FRD CR Rev 4. Cushions and Liners will be delivered on 12/15/09 to support 1/9/10 CEIT. Need TSA Tools for CEIT	Anselmo Lozano
Video Processing Unit (VPU)	M072-710338-007		3/2/08		C			Installed	Larry Schmidt
Winches	V072-650007-084?				C			OPF Installtion Desirable Installed Hardware	
Wireless Video System (WVS)	M072-344828-001 mount M072-744007-001 UHF M072-744004-012 S-BAND M072-744004-013 S-BAND M072-744004-014 S-BAND M072-744004-015 S-BAND M072-744004-016 S-BAND M072-744004-017 S-BAND M072-744004-018 S-BAND		6/2/04	5/18/09	C			FRD CR Rev 15 REMOVES -15	Randall Moore
Space to Space Orbiter Radio (SSOR)	M072-344828-002		9/24/04	5/18/09	C				Larry Schmidt
RMS Sideview Camera (RSC)	M072-710281-002 M072-000416-006 camera	1/8/10	11/24/04	5/18/09	C	2/9/10	2/9/10	Same unit as STS-129. Camera requires repressurization. Pad Installation	Randall Moore
Wing Leading Edge (WLE) Instrumentation - Left Wing	M072-756111-007		8/21/07	5/18/09	C			Installed hardware	Micheal Wright
Wing Leading Edge (WLE) Instrumentation - Right Wing	M072-756111-008		8/21/07	5/18/09	C			Installed hardware	Micheal Wright
OBSS SENSOR PACKAGE 1 ** (OPF)	M072-710282-008	11/9/09	4/18/08	5/18/09	C	12/8/09	12/8/09	Unit from STS-129. OPF Instl for testing. Pad Instl for flight.	Russell Yates
RMS-13 End Effector	M072-544502-036			5/18/09	C			Installed	Kenneth Ruta
LCS, IDC, Mounting Plate & Wiring Harness -ISA2	M072-710282-006	9/11/09	4/18/08	5/18/09	C	10/12/09	10/12/09	OPF Instl for testing. Pad Instl for flight.	Larry Schmidt



# **EVA Status**

## **STS-131/Flight 19A Launch Site Flight Review**

**XA/Linda Thomas  
Johnson Space Center  
July 20, 2009**

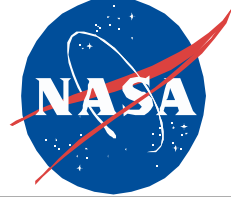

- **Bulkhead PFR – SED33105308-307**
  - Bulkhead PFR installation – Tech Order: M072-661568-029
  
- **Winches**
  - Forward Winch, SED33101570-327
  - Aft Winch removed
  
- **Stbd LWTSA**
  - Stbd LWTSA installation – Tech Order: M072-660850-006
  - Stbd LWTSA Tools installation – Tech Order: M072-660856-001



# STS-131 Launch Site Flow Review

Presenter **Kenneth Nowak**

Date **07-23-09**

## Backup Material

- **SSP Systems Drawings** Attachment 1
- **SSP Authorized Modifications/Non-Standard Work** Attachment 2
- **SSP OMRS Waivers and Exceptions** Attachment 3
- **Launch Window** Attachment 4
- **Open Configuration Waivers** Attachment 5

# STS-131 Launch Site Flow Review

---



J.F. KENNEDY SPACE CENTER

## **19A** **STS-131** **MPLM/LMC**

**KSC ISS & Spacecraft Processing**  
**Joseph T. Delai, NASA, KSC Mission Manager**  
**Edward Baglioni, Boeing, KSC Flow Manager**

# Planned Processing Milestones



J.F. KENNEDY SPACE CENTER

## PRE-SHUTTLE INTEGRATION ACTIVITIES

### Space Station Processing Facility (U/R)

- 19A
  - LMC/ORU Processing 09-21-09 to 11-18-09
  - MPLM Rack Integration 10-19-09 to 02-24-10
  - MPLM Internal/External Closeouts 01-26-10 to 02-12-10
  - Hatch Closure 02-15-10
  - MPLM/LMC ICD Walk down 02-19-10
  - Payload to Pad 03-01-10

# Planned Processing Milestones



J.F. KENNEDY SPACE CENTER

## SHUTTLE INTEGRATION ACTIVITIES

### PAD (U/R)

- Payload to Pad 03/01/10
- Payload installed into Orbiter 03/02/10
- Late Stow Operations/Hatch Closeouts 3/04/10-3/14/10
- Payload IVT 03/05/10
- Payload Closeouts 03/15/10
- Launch 03/18/10



# KSC/ISS Processing Summary

---



J.F. KENNEDY SPACE CENTER

## **Watch Items:**

- Possible new requirements for 19A weight reduction could delay the start of the nominal MPLM integration flow.

**The KSC STS-131/19A - ISS Mission Processing Team is ready to proceed with processing the STS-131 Mission payload complement.**



# STS-131 Launch Site Flow Review

Presenter **Kenneth Nowak**

Date **07-23-09**

## SSP System Drawings

The Drawings Baseline Was Released By PRCB S115131A on 07-02-09

- V072-000001-286 (Rev. WB) Space Shuttle System (Rel. 07-06-09)
  - V072-200211-001 (Rev. NEW) Mission Equipment Cargo Support (Rel. 05-12-09)
  - SGD32104454-301 (Rev. NC) Crew Compartment Configuration (Rel. TBD)
    - 302 Descent
  - V070-000001-003 Orbiter General Assembly
    - V070-410100-017 SSME Installation
  - 10100-0061-179 Integrated SRB General Assembly (BI-142)
  - 80901000000-530 External Tank Assembly (ET-135)
  
- STS-131 LSRR + 18 days Mission Configuration Product Plan (MCP) was last published on 07-06-2009 and will be republished at ORR - 14 days on TBD.



# STS-131 Launch Site Flow Review

Presenter **Kenneth Nowak**

Date **07-23-09**

## SSP System Drawings – (Continued)

### Ferry Configuration

- V072-000001-287 (Rev. WB) Space Shuttle System Drawing (Rel. 07-06-09)
  - V072-200211-002 (Rev. NEW) Mission Equipment Cargo Support (Rel. 05-12-09)
  - SGD321004454-001 (Rev. NC) Crew Compartment Configuration (Rel. TBD)
  - V072-300055-027 (Rev. BU) Ferry Flight Configuration (Rel. 05-11-09)

**SCA 905**

Mission Duration = 12+1+2  
 Inclination = 51.6°  
 OMS2 ha/hp = 124 x 111 nmi.  
 Target ha/hp = 194 x 186 nmi.

## STS-131 OCF LAUNCH WINDOW

C. Osgood/USH-483L  
 M. Jamroz/USH-483L  
 March 13, 2009

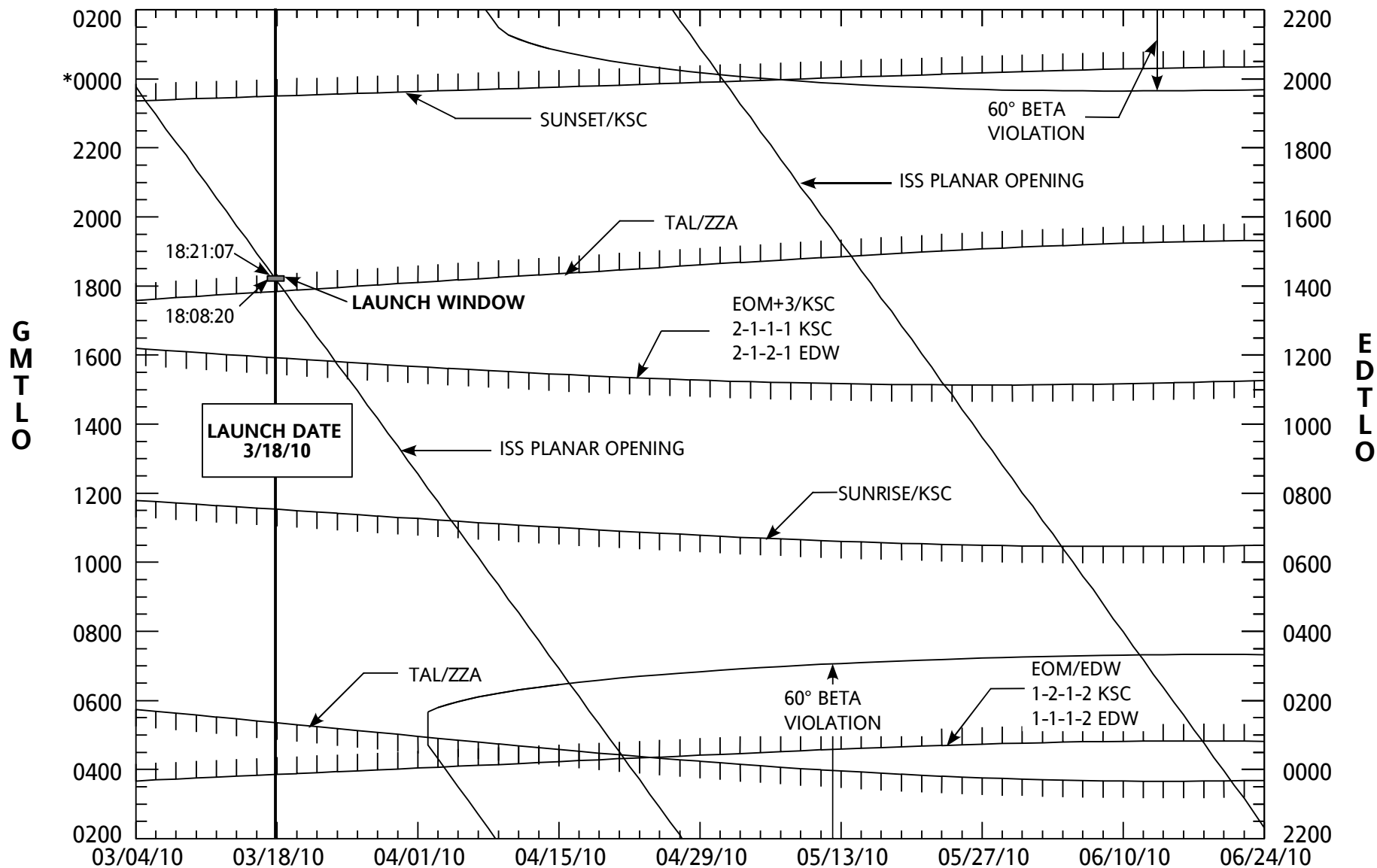

Note: EOM lighting lines, based on an OMS2 phase angle of 129 deg, are representative only.  
 The ISS beta angle ( $|\beta| < 60^\circ$ ) for mated operation is beginning ~ 1/20:43:10 MET (FD3 Rendezvous) and ending ~ 10/15:06:00 MET.  
 \* Indicates the dateline. Launch times above this point are on subsequent days from the date indicated on the corresponding date axis.



<h1>STS-131 Launch Site Flow Review</h1>	Presenter <b>Kenneth Nowak</b>	
	Date <b>07-23-09</b>	

## Modification Impact Report

- **Mission Equipment Modifications and Orbiter Modifications analyzed for impacts to OMRSD, LCC, ICD, EMI, Software, and GSE.**
- **A total of 2 MCRs have been approved and/or pending mods**
- **Current MCR impact status:**
- **No impacts for all six disciplines** 2

1MRC5 REPT. 4650-1  
 PAGE NO. 1

SSP SUMMARY MOD ITEMS - PRCBD MOD BASE LINE STS-0131

ORB

ECP-MCR/KIT SEQUENCE

RUN TIME

09:00 DATE 07/14/2009

PRCB	STAT	ITEM/KIT NUMBER	SEQ	
MCR/ECP	PRIO	TCTI NUMBER	EISN NO.	DESCRIPTION / GENERAL REMARKS
AUTHDATE	SITE			
	FLT			
S-J6275A	AUTH MAND KSC 038	J6275A	0103 003	ORBITER STRUCTURE IML SURFACE CORROSION SAMPLING INSPECTION  CORROSION SAMPLING CAPABILITIES WILL BE PROJECTED AT LSFR,  AND FINALIZED AT DLSFR FOR EACH FLOW.
2008-02-26				
S-J6482	AUTH MAND KSC 038	J6482	0103 001	STS-128 PAYLOAD CLOSE CLEARANCE MEASUREMENTS  P/L CLOSE CLEARANCE MSRMNTS FOR STS-128 & STS-131 HAVE BEEN  PLANNED FOR THEIR FLOWS. NO M/S IMPACTS.
2009-04-01				
S-J6505	AUTH MAND KSC 038	J6505	0103 000	CAPTURE OV-103 OUTPUT WAVEFORMS TO ADDRESS 1N3600 DIODE CONC  ERNS
2009-05-20				
S-J6509	AUTH MAND KSC 038	J6509	0103 000	REMOVAL OF MPS GH2 FLOW CONTROL VALVES FOLLOWING STS-125 (OV  -104), STS-127 (OV-105), AND STS-128 (OV-103)
2009-05-12				
S-J6523A	AUTH MAND KSC 038	J6523A	0103 001	OPTIGO, METRIS AND Z-SCAN OF BLT PROTUBERANCE TILE  SCAN OF BLT TPS WAS PART OF LSFR PKG. THIS SCAN RE QUEST IS  INTEG'D INTO CURRENT OPF PROCESSING PLAN
2009-06-10				
S-J6531	AUTH MAND	J6531	0103 001	METRIS SCAN OF OV-103 LOWER SURFACE

2009-06-26	KSC 038	SPAR	
030231 S115131	AUTH	TCTIV2930231REF 0103 000	RUDDER SPEED BRAKE INCONEL THERMAL BARRIER REDESIGN
2009-06-30	KSC 038	NOT REQUIRED	ADDED BY EDS I/F & V070-298115 A07
TOTAL MODS =		7	

Approved STS-131 OMRS Waivers and Exceptions

WVR EXC	ELEMENT PROJECT	PRCBD NUMBER WAIVER# (STAT) (INITIAL STS)	ABSTRACT RAS REQUIREMENTS	EISN PAYLOAD	STS BEG END
E	RCS	S053296YK EK10327 (A)	OMRSD EXCEPTION REQUEST - RIGHT RC SOXIDIZER B-LEG PAD REGULATOR L OCKUPPRESSURE (EK10327)	0023	032 040
		S053297WA EK10452 (A)	OMRSD EXCEPTION REQUEST - RRCS FUEL GHE TANK P1 TRANSDUCER ACCURA CY (EK10452)	0023	032 039
W	ET	S053293FZ WK03850R1 (A) (STS-093)	L02/LH2 TANK PRESSURE MONITOR FOR MOVE	ET	099 999
	OMS	S053296UM WK10299 (A)	OMRSD WAIVER REQUEST - RP03 TK302 DYNATUBE LEAK RATE (WK10299)	0023	032 040
	ORB	S053297NZ WK10415 (A)	OMRSD WAIVER REQUEST - MADS FDM CALIBRATION MANUAL MODE (WK10415)	103	031 038
		S053298VM WK10557R1 (A)	OMRSD WAIVER REQUEST - FUEL CELL POWERPLANT 3 OXYGEN FLOWMETER LO WERLIMIT (WK10557R1)	103	033 042
		S053299BB WK10603 (A)	OMRSD WAIVER REQUEST - FORWARD OXYGEN REGULATOR LOCK UP PRESSURE( WK10603)	103	034 039
		S053299JU WK10653 (A)	OMRSD WAIVER REQUEST - WATER SPRAY BOILER #1 EXCEEDED 44 PSIA MAX	103	035 040



IMUMLIMITATION (WK10653)

	S053299MG WK10656 (A)	OMRSD WAIVER REQUEST - FUEL CELL POWERPLANT 3 HYDROGEN FLOWMETERL OWER LIMIT (WK10656)	103	035 038
RCS	S053298VTR1 WK10559 (A)	OMRSD WAIVER REQUEST - RIGHT RCS OXIDIZER B-LEG SECONDARY REGULAT ORLOCK UP HIGH (WK10559R1)	0023	035 043
SRB	S053293WA WK03886 (A) (STS-103)	LH FWD AND RH MID SRB JOINT TEMP SENSORS	BI	099 999

Approved STS-131 OMRS Waivers and Exceptions

	◦ Waivers	◦ Except	◦ Deviat	◦ Cannib	◦ Total
◦ Total Extracted	9	2	0	0	11

ACTIVE WAIVERS FOR  
OV-103

Item #	Authority	Date	Waiver Description	Effectivity	Wad
47	S052310A	02/14/91	Fly with FRSI instead of tile	OV-103, Flight 12 & Subs (flight by flight evaluation)	<b>OK TO RETIRE</b> <b>S061954B MV 4-2</b> <b>RTF-130 Briefing</b>
53	S052428A	03/27/91	Allows specified flights to fly with interim TPS repair after each mission to minimize damage to surrounding tile during ferry flight	STS-37, STS-39, STS-40, STS-42 thru STS-999	<b>STAYS OPEN</b>
101	S076972	11/19/91	Permit the modified GPCs (AP101-S) Battery Back-up Unit to fly with annotated fastener improvements without rolling the LRU Part Number	STS-42, STS-44, STS-47 and STS-49 thru STS-999	<b>STAYS OPEN</b>
327	S115114VR5	03/17/05	Partial installation of M072-784633-014 (harness installation - interface panel - MADS #3). The M072-784663-014 Technical Order was established to incorporate the crossover bracket modification at locations X0863 and X0750. The dash number configuration for the Technical Order was not baselined until January 25, 2005 (PRCBD S115114VR2). This area was closed out before this time and would cause significant impact to verify configuration of this Technical Order dash number -014.	OV-103, Flight 31 OV-103, Flight 32 <b>WAIVER for STS-121</b>	INS-3-28-279 (installed Tech Order)
***** SEE NSTS 07700 VOLUME IV BOOK 2 FOR COMPLETE DETAILS *****					
328	S115114WR1	04/07/05	Partial installation of M072-794500-004, for Integrated Vehicle Health Monitoring (IVHM) harness installation, calls for the removal of the unused IVHM harness and routing hardware. This requirement was manifested after the Bay 13 Longerons Bridge installation was complete. With the installation of the bridge, the removal of the IVHM harness is no longer possible without the removal of the bridge.	OV-103, Flight 31 OV-103, Flight 32 <b>WAIVER for STS-121</b>	OEL-3-31-304 PTL OEL-3-31-4432 PTL
***** SEE NSTS 07700 VOLUME IV BOOK 2 FOR COMPLETE DETAILS *****					

ACTIVE WAIVERS FOR  
OV-103

Item #	Authority	Date	Waiver Description	Effectivity	Wad
329	S115114AM	08/15/05	<p>The following requirements are waived to allow OV-103, Flight 31 to fly (ferry) with the following out-of-configuration conditions:</p> <ol style="list-style-type: none"><li>1) V070-391139-025 (blanket under window #1 removed for ferry flight)</li><li>2) M072-421502-002 (did not perform acetone wipe prior to universal thruster plug assemblies - procedural omission)</li><li>3) V070-753110-003 (camera mount will not be installed for ferry flight)</li></ol> <p>***** SEE NSTS 07700 VOLUME IV BOOK 2 FOR COMPLETE DETAILS *****</p>	OV-103, Flight 31	Ferry Flight from Dryden
330	S115114VR15	09/16/05	<p>The following requirement is waived to allow OV-103 to ferry from DFRC to KSC with the following out-of-configuration condition:</p> <p>TCS blanket V070-362917-001 located at Door #44 NOT installed.</p> <p>***** SEE NSTS 07700 VOLUME IV BOOK 2 FOR COMPLETE DETAILS *****</p>	OV-103, Flight 31 Ferry Flight	Ferry Flight from Dryden

ACTIVE WAIVERS FOR  
OV-103

Item #	Authority	Date	Waiver Description	Effectivity	Wad
331	S115114VR15	09/16/05	<p>The following requirement is waived to allow OV-103 to ferry from DFRC to KSC with the following out-of-configuration condition:</p> <ol style="list-style-type: none"><li>1) Two switches on Panel A15 will ferry without switch guards (P/N G070-700904-001). In lieu of switch guards at two locations, tape was installed.</li><li>2) Eight GSE switch guards were left installed and not removed as required by Technical Order M072-710700-002 as called out in the ferry flight drawing.</li><li>3) Three switch guards are not installed on Panel L4 for TACAN circuit breakers. The procedure does not include the switch guard installation.</li></ol> <p>***** SEE NSTS 07700 VOLUME IV BOOK 2 FOR COMPLETE DETAILS *****</p>	OV-103, Flight 31 Ferry Flight	Ferry Flight from Dryden
332	S115121TR8	05/04/06	<p>The following requirement is waived to allow OV-103 to fly with the following out-of-configuration condition:</p> <p>M072-794500-004 IVHM harness installation Bay 13 called out by MECSLSI V072-200201 NOT removed from OV-103.</p> <p>During STS-114 processing this Tech Order configuration called for the removal of an un-used IVHM harness along with the routing hardware. At the time the Tech Order was made a requirement for Flight 31, the Bay 13 longeron had already been installed for flight. The harness was demated and stowed in place per MR and was deferred to a future flight at which time Bay 13 longeron will be removed since the Bay 13 longeron was not removed this flight, a configuration waiver is needed for STS-121.</p>	OV-103, Flight 32	

ACTIVE WAIVERS FOR  
OV-103

Item #	Authority	Date	Waiver Description	Effectivity	Wad
333	S115121TR8	05/04/06	<p>The following requirement is waived to allow OV-103 to fly with the following out-of-configuration condition:</p> <p>Partial installation of M072-784633-014 (harness installation - interface panel - MADS#3). The M072-784633-014 Tech Order was established to incorporate the crossover bracket modification at locations X0863 and X0750. The dash number configuration for the Tech Order was not baselined until January 25, 2005 (PRCBD S115114VR2). This area was closed out before this time and would cause significant impact to verify configuration of this Tech Order dash number -014.</p> <p>***** SEE NSTS 07700 VOLUME IV BOOK 2 FOR COMPLETE DETAILS *****</p>	OV-103, Flight 32	
335	S115116NR2	08/18/06	<p>The following requirement is waived to allow OV-103 to fly with the following out-of-configuration condition:</p> <p>M072-794500-004 IVHM harness installation Bay 13 called out by MECSLSI V072-200195 not removed from OV-103.</p> <p>During STS-114 processing, this Tech Order configuration called for the removal of an unused IVHM harness along with the routing hardware. At the time the Tech Order was made a requirement for Flight 31, the Bay 13 longeron had already been installed for flight. The harness was demated and stowed in place per MR and was deferred to a future flight at which time Bay 13 longeron will be removed since the Bay 13 longeron was not removed this flight, a configuration waiver is needed for STS-116.</p>	OV-103, Flight 33	

ACTIVE WAIVERS FOR  
OV-103

Item #	Authority	Date	Waiver Description	Effectivity	Wad
336	S115116NR2	08/18/06	<p>The following requirement is waived to allow OV-103 to fly with the following out-of-configuration condition:</p> <p>M072-794500-004 IVHM harness installation Bay 13 called out by MECSLSI V072-200201.</p> <p>During OMDP, the crossover bracket modification was successfully implemented at all four locations with no technical issues by engineering defined by Orbiter drawings as well as three Tech Orders (M072-794011, M072-794021 and M072-794051). The M072-784633-014 Tech Order was established to incorporate the crossover bracket modification at two locations (X0863 and X0750).</p> <p>At the X0863 location, M072-784633-014 called for the removal of a clamp and six screws to reflect the change harness mounting due to the new wire tray shape. TPS OEL-3-31-245 incorporated the electrical portion of this modification per the vehicle drawings as well as the three tank set harness Tech Orders. During STS-114 processing, the WAD was reviewed and it was determined that an error exists in the M072-784633 engineering. This Tech Order reflects harness routing at the X0863 that does not reflect the as-built configuration on the Orbiter. A one flight configuration waiver was processed and approved for STS-114 and STS-121. All hardware on this Tech Order supports MADS wire routing, there were no observed wire routing violations noted during Flight 31 midbody closeout and all MADS testing will be completed and verified. No technical issue with hardware, installation, or function of MADS. There was no access to this area this flow to perform wire routing as-designed condition. A configuration waiver is needed for STS-116 for this Tech Order.</p>	OV-103, Flight 33	

ACTIVE WAIVERS FOR  
OV-103

Item #	Authority	Date	Waiver Description	Effectivity	Wad
337	S115116NR4	10/27/06	<p>Tech Order M072-544501-087 - install, M072-544501-027 - remove, -087 configuration is for the new over-center stops being installed. Mission-unique loads will not require these new stops. Program decision was made to not remove the RMS.</p> <p>This configuration will incorporate the over-center stops mod, the change is to all four MPM locations. The new stops, replace existing GFE stops, incorporate a stronger design to address mission-unique loads that have a potential to exceed the current mechanism capability. The decision was made not to incorporate this mod during STS-116 flow due to the low potential for load exceedence. Since -087 established the over-center stops mod along with other mods that were completed for this flow,a configuration waiver is needed for STS-116. In addition the removal of the -027 from the previous mission was not completed.</p>	OV-103, Flight 33	
338	S115116NR4	10/27/06	<p>Tech Order M072-794021-026 install, M072-794021-019 remove, -026 configuration is for the new over-center stops being installed. The change is rerouting and retaping of the wire harnesses near the over-center stops to alleviate any interference. Program decision was made to not remove the RMS.</p> <p>This configuration would reroute and retape harnesses on the MPMs to support the over-center stops mod. Since -026 established a new configuration in support of the over-center stop mod and this was not worked this flight, a configuration waiver is needed for STS-116. In addition, the removal of the -019 from the previous mission was not completed.</p>	OV-103, Flight 33	



ACTIVE WAIVERS FOR  
OV-103

Item #	Authority	Date	Waiver Description	Effectivity	Wad
342	S115120DR3	09/12/07	<p>The following requirement is waived to allow OV-103 to fly with the following out-of-configuration condition:</p> <p>Tech Order M072-784633-015 harness installation - interface panel - MADS#3 called out by MECSLSI V070-200199 was established to re-route MADS harness in support of SSPTS at location X0863. There was no access to this area this flow to re-route harness to meet as-designed congiguration. At this time there is NO plan to ever open up this area again.</p>	OV-103, Flight 34 thru OV-103, Flight 999	
344	S071024MP	12/20/07	<p>During maintenance of an Advanced Master Events Controller (AMEC) it was discovered that the module cards are able to translate upward, away from connectors. The cards are retained by friction applied by wedge-locks. An assessment determined a 0.070 upward card translation, would result in card disengagement from connectors. The wedge-lock system can not assure the cards will not translate upwards. The AMEC vendor (Boeing Autonetics) is no longer on contract supporting SSP. A design proposal is to provide a secondary connector retention using the AMEC covers. The new design new lids will limit the upward translation to 0.055. The new design will reduce the milled section of the cover and add silicone pads to provide shock absorption. Due to the absence of the original vendor and no current alternate drawings available for the AMEC the modification is being requested via a program directed Material Review (MR).</p> <p>P/N MC450-0016-0029</p> <p>S/N U6F0002, U6F0003, U6F0004, U6F0006, U6F0007, U6F0009, U6F0010 and U6F0011</p> <p>***** SEE NSTS 07700 VOLUME IV BOOK 2 FOR COMPLETE DETAILS *****</p>	OV-103, Flight 35 OV-104, Flight 30 OV-105, Flight 21	