

---

# **STS-400 MOD FRR**

## **FLIGHT DESIGN AND DYNAMICS**

**April 14, 2009**

**Ray Moreno / 281-483-8040**

**Jennifer Mendeck / 281-483-8020**

# Table of Contents

---

## **USA Flight Design and Dynamics**

- X Mission Overview Summary
- X Significant Changes Since Design Baseline
- X Significant Mission Firsts and Unique Items
- X Deviations, Exceedances and Anomalies
- X Exceptions and Open Work

## **DM Flight Design and Dynamics (Trajectory Operations)**

- X Significant Mission Firsts and Unique Items
- X Issues and Concerns
- X Exceptions and Open Work

# Mission Overview Summary

---

<b>Launch Time, Date (GMT)</b>	<b>14:16:25, May 19, 2009</b>
<b>Launch Time, Date (EDT)</b>	<b>10:16:25, May 19, 2009</b>
<b>Window Duration</b>	<b>66 Minutes</b>
<b>Launch Pad</b>	<b>39B</b>
<b>Flight Duration</b>	<b>7+4+2 Days</b>
<b>Crew</b>	<b>4 up/ 11 down</b>
<b>Insertion Altitude</b>	<b>297 N. Mi.</b>
<b>Max Rendezvous Altitude</b>	<b>304 N. Mi.</b>
<b>Inclination</b>	<b>28.45°</b>
<b>First Stage Design Criteria</b>	<b>DOLILU II / Low Q</b>
<b>APM</b>	<b>18000+ lbs</b>

# Significant Requirements Changes Since Design Baseline

---

- **Launch Date** changed from August 14, 2008 to May 19, 2009
- **Non-standard I-Load patch designed and approved for August launch date**
  - Addressed RTLS 3<sup>rd</sup> peak heating and GRTLS flight control margin issues
- **Non-standard I-Load patch (400 patch2) designed and approved for Oct. launch date**
  - Based on STS-126 empty payload bay configuration
  - Improved RTLS 3<sup>rd</sup> peak heating and GRTLS flight control margins
- **Non-standard I-Load patch (400 patch3) designed and approved for May launch date**
  - Based on STS-127 empty payload bay configuration
  - Large increase in weight (~5000 lbm) and Xcg shift (~4” aft movement)
  - FDF updates have been provided for Flight support
  - Second set of rendezvous targeting I-Loads (OT2) were provided for additional flexibility for late callup rescue scenario
  - Plan to complete SAIL and Level 8 PASS SPF test case verification as part of the Comp Load Verification
- **AOA priorities have been updated to reflect EDW as prime**
  - DSCT28/Recovery Pre-bank charts and DATA09/FDF Inputs will be updated
- **MPS inventory update expected to be incorporated for Uplink cycle**

# Significant Mission Firsts and Unique Items

---

- **First Launch On Need (LON) for non-ISS mission**
  - First planned rendezvous with another Space Shuttle vehicle
  - STS-400 vehicle will approach and grapple the OBSS on the STS-125 vehicle (see backup)
- **Current plan is to conduct all close to launch activities through ~L-3 days**
  - Will be ready to launch within 7days of callup
- **STS-400 planned to launch from pad B**
  - OV-105 will remain at a Level 1 readiness on launch pad B
  - Additional data was delivered to protect launching from pad A
- **Abort boundary overlap**
  - Last RTLS overlaps PTA by 72 seconds
  - TAL site support not strictly required due to overlap
- **First flight to plan a nominal FD2 rendezvous**
  - FD3 and FD4 opportunities also an option
- **Inspection plans**
  - Early inspection and RPM will not be conducted
  - Post-release late inspection is planned

# Deviations, Exceedances and Anomalies

---

- **No Deviations or Exceedances were documented for STS-400**
- **Contingency Abort Black Zone (CABZ) assessment was not required, however an assessment was conducted**
  - Mass properties do not meet the CABZ assessment criteria of liftoff weight greater than 259,000 lbm and Xcg aft of 1115.0 in.
  - Latest liftoff weight = 242,442 lbs. and Xcg = 1124.4 in.
  - Larger 3EO black zones have been identified compared to ISS LON missions (back-up chart)
    - Provided final results to A/E Flight Director and IPT
    - No change to mission manifest

# Exceptions and Open Work

---

- **Exceptions**

- None

- **Standard Open Work**

- Open work tables for STS-400 are included in backup pages

- **STS-400 Non-standard Open Work**

- DSCT28 Redelivery 04/10/09
- DATA09 Redelivery 04/12/09
- MPS Inventory Incorporation 04/17/09
- GNAV INDAT Certification 05/01/09
- FSW Patch3 Verification 05/14/09

# Significant Mission Firsts And Unique Items

- **Launch Window**

- **May 19, 2009 planar window 13:45:48 to 14:47:37 GMT**
- **Launch window has FD2 and FD3 phase portions**
  - **Phase window is highly dependant on STS-125 actions prior to 400 callup**

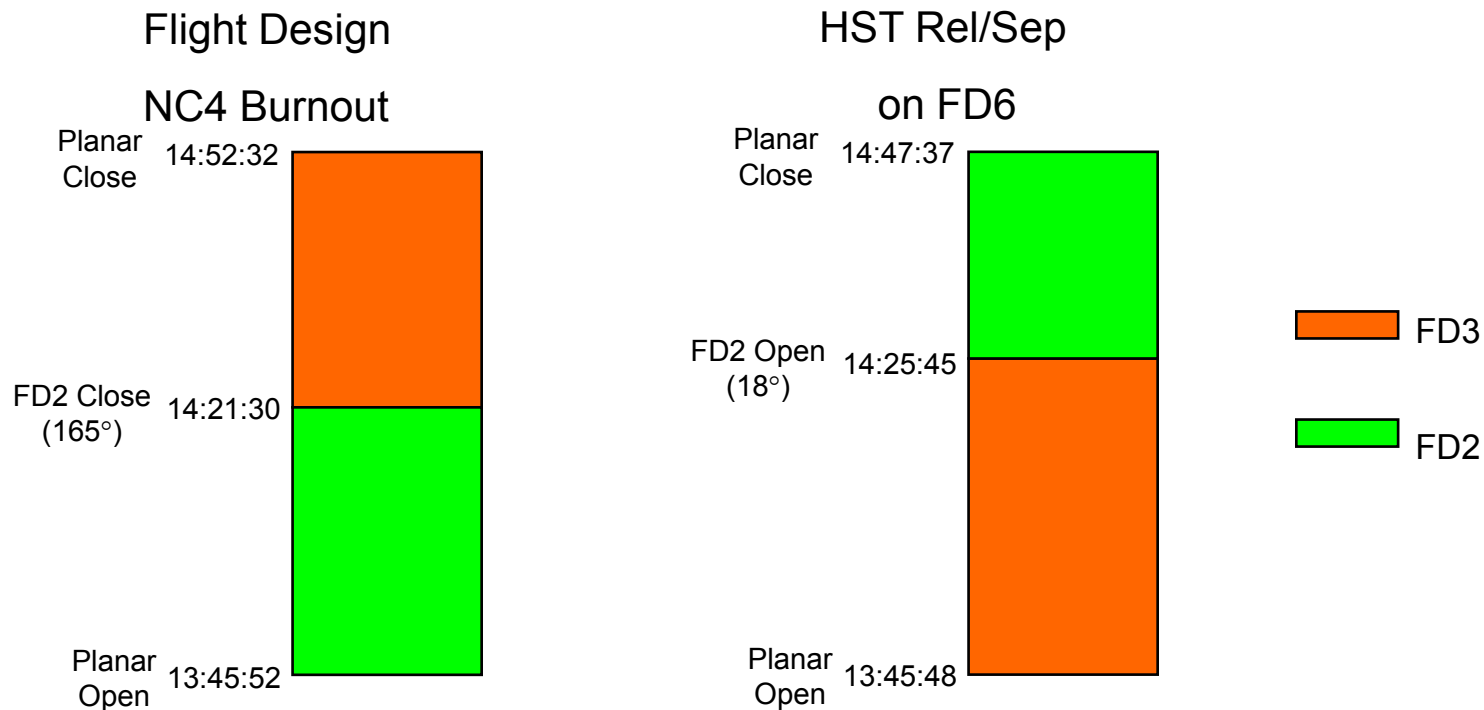



# Significant Mission Firsts And Unique Items

- **Launch Window**

- **Launch window has FD2 and FD3 phase portions**

- **Nominal (no retrograde burns) FD2 capability ~18°-165°**
- **Can use margin to increase FD2 capability to ~13°-227°**

## Example Launch Windows

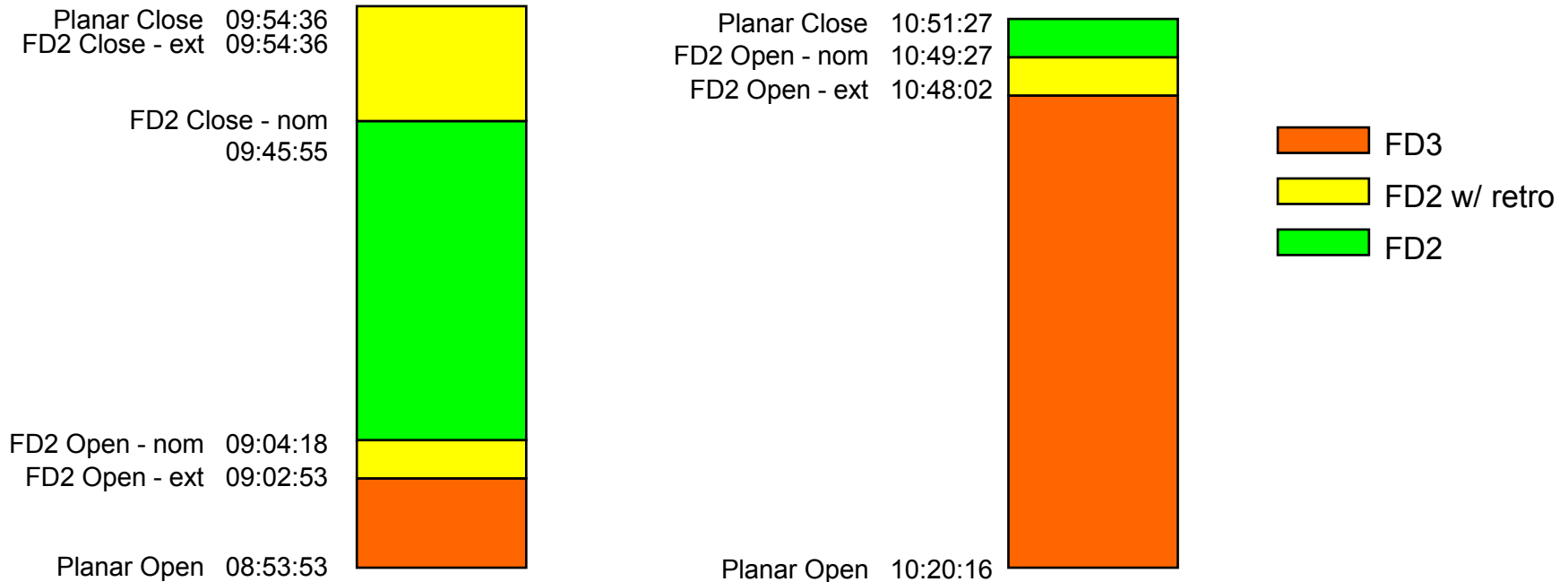

# Significant Mission Firsts And Unique Items

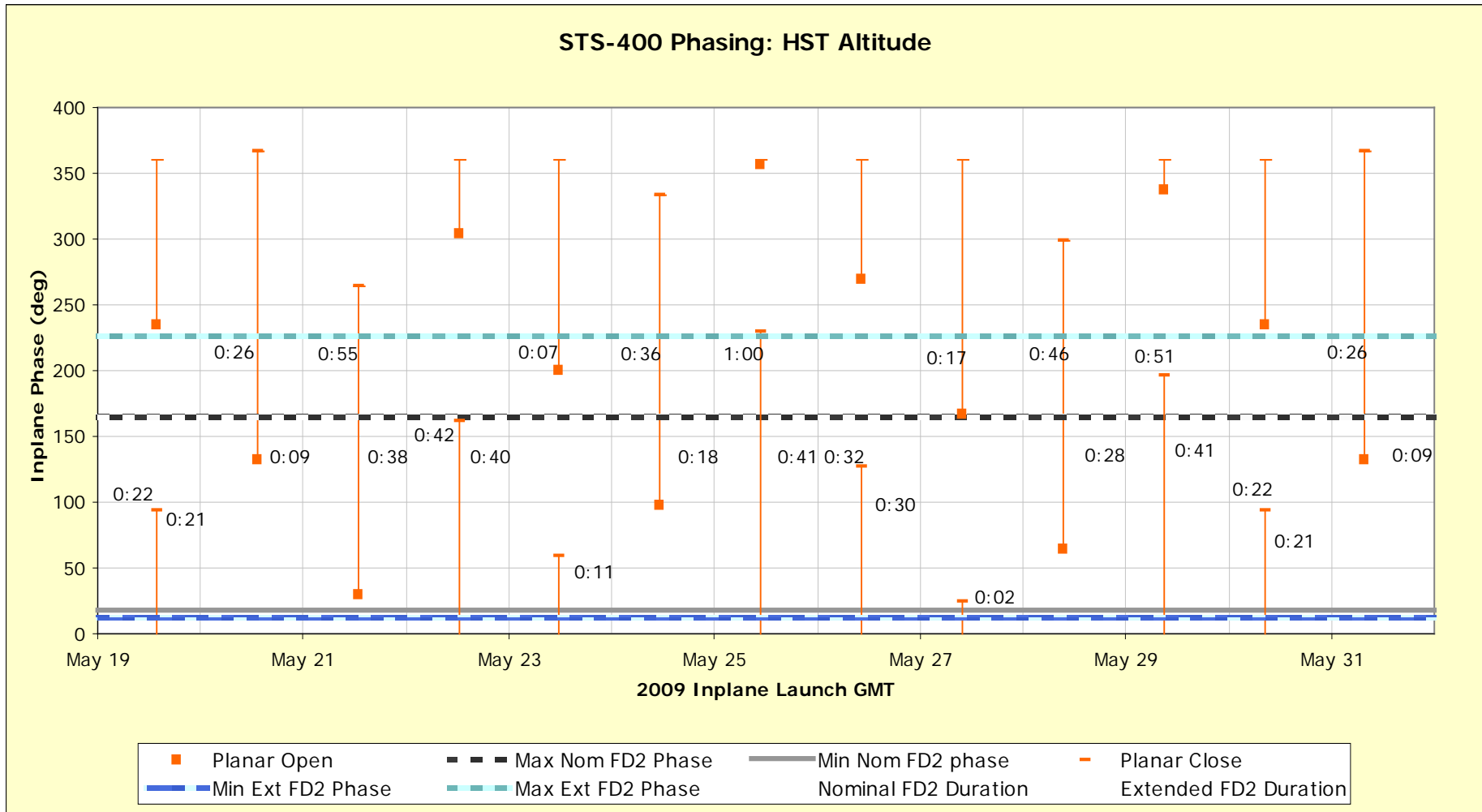

# Significant Mission Firsts and Unique Items

---

- **STS-125 orbit adjust will result in a highly elliptical orbit for late-callup rescue mission scenarios (300x160nmi)**
  - FDO and rendezvous team have developed a success oriented plan to support the earlier STS-125 Orbit adjust plan, if the Program accepts the risk trades
    - DM has expressed concerns regarding impacts to mission success
      - Increases prop requirements
      - Decreases FD2 launch opportunities
      - Decreases STS-125 Orbiter disposal opportunities
      - Increases work load on day of launch
      - Drastically reduces or eliminates propellant and trajectory margin available for contingencies
    - Plan discussed and approved at Ascent/Entry Flight Techniques #246
      - Ready to execute if required
  - Probability of executing the late callup has been assessed as extremely low (1/17000)
- **DragonSat and Ande-2 payloads**
  - DragonSat and Ande-2 deployable payloads will be in the payload bay if STS-400 launches
  - Deploy not in pre-flight plan
  - Real-time operations will be ready to support if opportunity occurs

# Issues and Concerns

---

- **LON call-up after STS-125 MMOD OA**

- DM concurred with the A/E FTP decision to tell the program we have a plan to execute the elliptical rendezvous, if required
- DM requests that the SSP be informed on the additional risks to the rescue mission should the late call-up occur

# Exceptions and Open Work

---

- **Exceptions**
  - None
- **Standard Open Work**
  - Open work tables for STS-400 are included in backup pages
- **Non-standard Open Work**
  - None

---

**Pending Completion of all Standard and Non-Standard  
Open Work The Flight Design and Dynamics Division  
will be prepared to support STS-400**

# Back-Up

---

- Flight Readiness Open Work
- Propellant Summary
- Launch Window
- Abort Regions
- Contingency Abort Black Zone Comparison
- Approach/Grapple/Separation plans

# STS-400 Flight Readiness Open Work

Item	Responsible	Due Date	Closed	Closure Rationale
<b>USA Flight Design Standard Open Work:</b>				
PROP37 SODB Volume II Amendment	PROP	-	08/27/08	Redelivery not planned
DATA43 FDD FRR Data Pack	FDM	04/09/09	04/07/09	Delivered
FSW Verification Test Results Review	Orbit	-	09/15/08	No new test results
RNDZ/FDO Phasing Plan Meeting	Orbit	04/20/09		
DATA45 FDD FSW PF Sign-off	FDM	04/20/09	04/09/09	Delivered
ONOR29B RNDZ Launch Target Data	Orbit	04/21/09		
FSW Verification Test Results Review	ADFD	04/21/09		
PROP06 OMRSD OMS/RCS	PROP	04/21/09	08/27/08	Redelivery not required
PROP07 Abort Propellant Dump Tagup	PROP	04/21/09		
ASCTU43 MPS Minimum Sigma Level	ADFD	04/21/09		
L-4 week LDO Database Freeze	ADFD	04/21/09		
PROP02 Mass Properties	PROP	04/24/09		
RNDZ08 RNDZ Phasing Limits	Orbit	04/24/09		
Prop Analyst & Flt Controller Tag-up	PROP	04/27/09		
ONOR37B Daily Planar/Phase Windows	Orbit	04/28/09		
ASCT04 Uplink APM	ADFD	04/28/09		



## STS-400 Flight Readiness Open Work - Continued

Work Item	Responsible	Due Date	Closed	Closure Rationale
<b>USA Flight Design Standard Open Work - Continued:</b>				
NAVO16B GPO COTM Data Pack	Navigation	04/28/09		
NAVO18B GPO/ONAV Ops Memo	Navigation	04/28/09		
LDO: L-3 week LDO Checkout/TCDDT Sim	ADFD	04/28/09		
ONOR27 Launch and Landing Data	Orbit	04/30/09		
C-Band tracking Scheduling Message	Navigation	04/30/09		
ASCT44 DOL Uplink I-loads	ADFD	05/04/09		
Dial Down Decision FIDP	FDM	N/R	N/R	OMS Assist is 0 seconds
ONOR29C RNDZ Launch Target Data	Orbit	05/11/09		
DSCT17 Landing Site Tables	ADFD	05/12/09		
PROP00A PROP/Ascent Abort Dump Tag-up	PROP	05/12/09		
RNDZ02 Target Drag Characteristics	Orbit	05/12/09		
PERA Pre-Flight Product	ADFD	05/12/09		
ASCT99 OMS Assist - ATO Update	ADFD	05/13/09		
ONOR37C Daily Planar/Phase Windows	Orbit	05/13/09		
PROP02A DOL Mass Properties Updates	PROP	05/14/09		
RNDZ09 Rendezvous COLA Plans	Orbit	05/14/09		
FSW Verification Test Results Review	ADFD	05/14/09		

## STS-400 Flight Readiness Open Work - Continued

Work Item	Responsible	Due Date	Closed	Closure Rationale
<b>USA Flight Design Standard Open Work - Continued:</b>				
PROP33 Ferry Data Package	PROP	05/14/09		
PROP34 MCC Data	PROP	05/14/09		
PROP31 ARD Data	PROP	05/14/09		
Pre-Launch Mass Properties Request	PROP	05/15/09		
Flight Annex	Navigation	05/16/09		
SRB & ET RTLS Impact Point Update Memo	ADFD	(L-3d)*		
ASCT42 Collision Avoidance Data	ADFD	(L-3d)*		
ASCT47 Final MCC Trajectory Inputs	ADFD	(L-3d)*		
DSCT66 Real-Time Support Files	ADFD	(L-3d)*		
Range Safety Launch Window Cutout	ADFD	(L-3d)*		
ASAB32B AME MCC Support Tables	ADFD	(L-2d)*		
L-2 day DOLILU System Checkout	ADFD	(L-2d)*		
DSCT05 Maximum Crossrange Capability	ADFD	(L-2d)*		
ASAB25 ARD Bias Tables	ADFD	(L-1d)*		

\* Will be performed after callup

## STS-400 Flight Readiness Open Work - Continued

Work Item	Responsible	Due Date	Closed	Closure Rationale
<b>USA Flight Design Non-Standard Open Work:</b>				
STS-400 TRS Initial Load Checkout	Nav	04/06/09	04/06/09	Completed
Contingency Abort Black Zone discussion	FDM	04/09/09	04/06/09	SSP concurred with no changes
DSCT28 Redelivery	ADFD	04/10/09		
DATA09 Redelivery	FDM	04/13/09		
MPS Inventory Incorporation	ADFD	04/17/09		
GNAV INDAT Certification	Nav	05/01/09		
FSW Patch3 Verification	ADFD	05/14/09		
Redelivery of ASCT21 Ascent limit lines (based on launch pad decision)	ADFD	(L-3d)*	04/02/09	Not required. Decision to remain on pad B.

\* Will be performed after callup

## STS-400 Flight Readiness Open Work - Continued

Item	Responsible	Due Date	Closed	Closure Rationale/Status
<b>Trajectory Operations Standard Open Work</b>				
Close to Launch Trajectory Data	OFDO	04/07/09		
TCDT Checkout in Ops Cert Mode	AE GPO	N/A		
Flight Load Checklist Complete	Nav	04/19/09		
Flight Load Checklist Complete	DOLILU	05/04/09		
Flight Load Checklist Complete	Entry Support	05/04/09		
Flight Load Checklist Complete	Orbit-RNDZ	05/04/09		
DOD Support Readiness	LSO	05/12/09		
Close to Launch Mass Properties	OFDO	*		
Flight Load Checklist Complete	RGPO	05/13/09		
Flight Load Checklist Complete	AE FDO	05/13/09		
Flight Load Checklist Complete	AE GPO	05/13/09		
Flight Load Checklist Complete	OFDO	05/13/09		
Flight Load Checklist Complete	LSO	05/13/09		

\* Will be performed after callup

# STS-400 Flight Readiness Open Work - Continued

Item	Responsible	Due Date	Closed	Closure Rationale/Status
<b>Trajectory Operations Standard Open Work</b>				
Real-time Data Transfer Schedule	OFDO	*		
Successful Completion of RNDZ Training	Instructor	05/05/09		
<b>Trajectory Operations Non-Standard Work:</b>				
None				

\* Will be performed after callup

# STS-400 Flight Readiness Open Work - Concluded

Item	Responsible	Due Date	Closed	Closure Rationale/Status
<b>DM Standard Open Work:</b>				
Orbiter Readiness Statement	FDRIB	04/29/09		
Range Safety Readiness Statement	FDRIB	05/01/09		

The Flight Design and Dynamics Division has performed a final review and determined all Division and USA FDD open work and/or actions for this mission are closed or acceptable rationale is provided for proceeding with the flight.

\_\_\_\_\_  
 Flight Design Manager  
 Date\_\_\_\_\_

\_\_\_\_\_  
 Chief, Flight Design Requirements and Integration Branch  
 Date\_\_\_\_\_

\_\_\_\_\_  
 Director, Flight Design and Dynamics Department  
 Date\_\_\_\_\_

\_\_\_\_\_  
 Chief, Flight Design and Dynamics Division  
 Date\_\_\_\_\_

## Propellant Summary

---

Propellant Summary	FRCS (lbm)	ARCS (lbm)	OMS (lbm)
Loadings	2446	4970	25063
FRR Design Margins **	772	223	1855

\*\* Assumptions: STS-400 ATL, FRR Cycle Trajectory Inputs, 304 nm RNDZ, 0 sec OMS Assist

Mission Duration = 7+4+2  
 Inclination = 28.45°  
 Target ha/hp = 304 x 298 nmi.

# STS-400 LDPR1 LAUNCH WINDOW

N. Wortham/USH-483L  
 P. Gentry/USH-483L  
 March 26, 2009

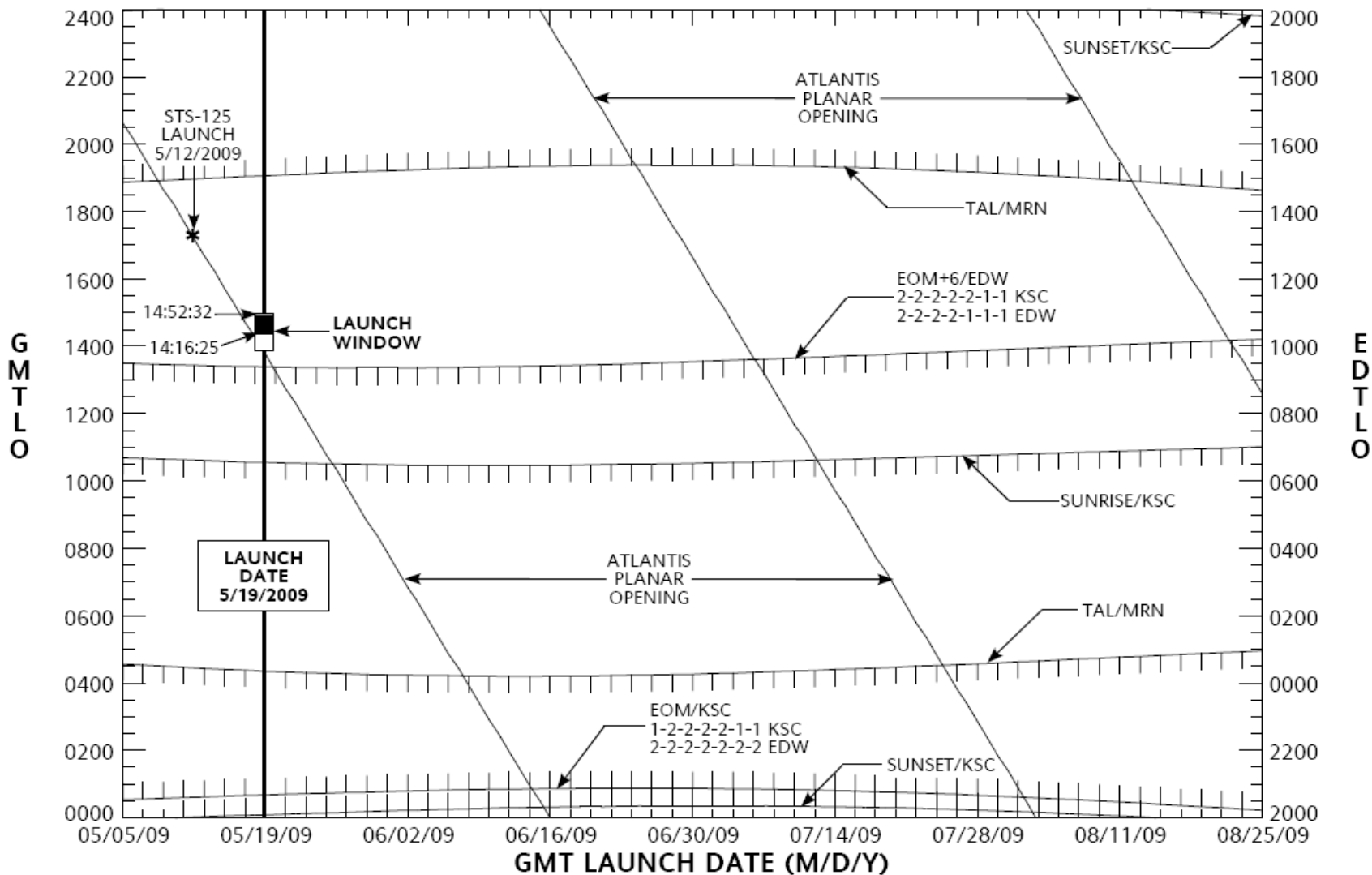

Note: EOM lighting lines, based on an OMS2 phase angle of 18 deg, are representative only.



Target State Vector  
 Source: STS-125 Post NC-4 vector  
 Received: 3/18/09  
 Target ha/hp = 304 x 298 nmi.

N. Wortham/USH-483L  
 P. Gentry/USH-483L  
 March 26, 2009

### STS-400 LDPR1 DAILY PLANAR/PASE WINDOWS

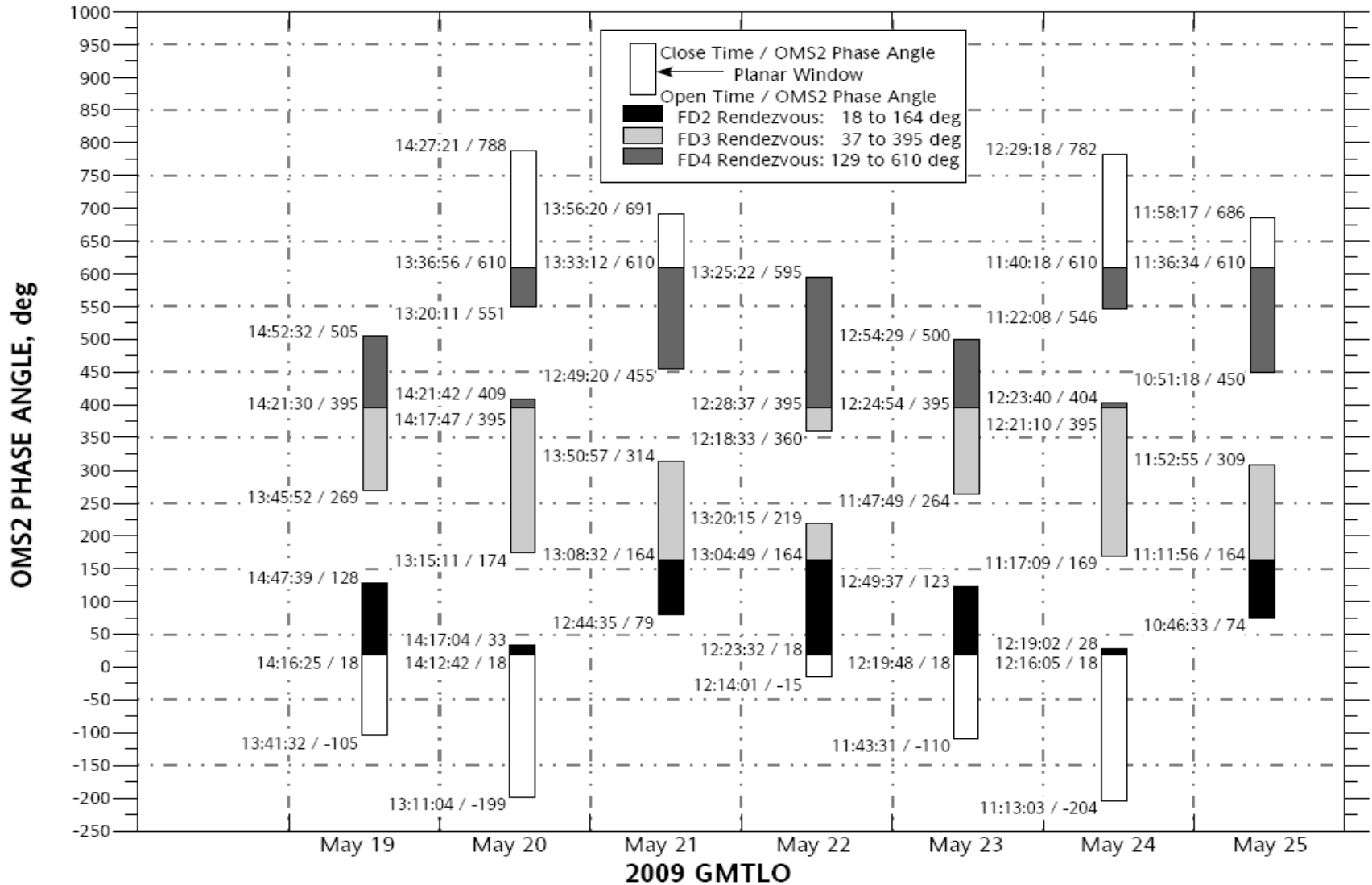

# STS-400 Launch Window

## STS-400 LDPR1 DIGITAL LAUNCH WINDOW

NOMINAL FLIGHT DURATION = 6:23:41 (D:H:M) MET

Date At Greenwich (M/D/Y)	WINDOW OPENINGS				WINDOW CLOSINGS			
	1 TAL/MRN SR-15 min GMT (H:M)	2 KSC Sunrise SR+3 min GMT (H:M)	3 EOM+6 EDW SR-10 min GMT (H:M)	4 Planar/ Phase Opening GMT (H:M:S)	5 KSC Sunset SS-3 min GMT (H:M)	6 EOM KSC SS+10 min GMT (H:M)	7 Planar/ Phase Closing GMT (H:M:S)	8 TAL/MRN SS+15 min GMT (H:M)
<b>05/19/2009</b>	<b>04:22</b>	<b>10:34</b>	<b>13:24</b>	<b>14:16:25</b>	<b>00:05</b>	<b>00:40</b>	<b>14:52:32</b>	<b>19:04</b>
05/20/2009	04:21	10:33	13:23	14:12:42	00:05	00:41	14:21:42	19:04
05/21/2009	04:20	10:33	13:23	12:44:35	00:06	00:41	13:50:57	19:05
05/22/2009	04:20	10:32	13:23	12:23:32	00:07	00:42	13:25:22	19:06
05/23/2009	04:19	10:32	13:23	12:19:48	00:07	00:42	12:54:29	19:07
05/24/2009	04:19	10:31	13:23	12:16:05	00:08	00:43	12:23:40	19:07
05/25/2009	04:18	10:31	13:22	10:46:33	00:08	00:43	11:52:55	19:08

The nominal Launch Window open and close times are shown in boxes

- 1 and 8 protect TAL landings
  - 2 and 5 protect daylight launch
  - 3 and 6 protect at least one daylight landing opportunities to KSC and EDW for each day from EOM through EOM+6 (based on a representative OMS2 phase angle of 18 deg)
  - 4 and 7 are based on the planar or phase window (FD2, FD3, and/or FD4 rendezvous) open and close for a 301 NM target altitude
- Planar window duration is 66 minutes

# STS-400 Abort Regions Chart

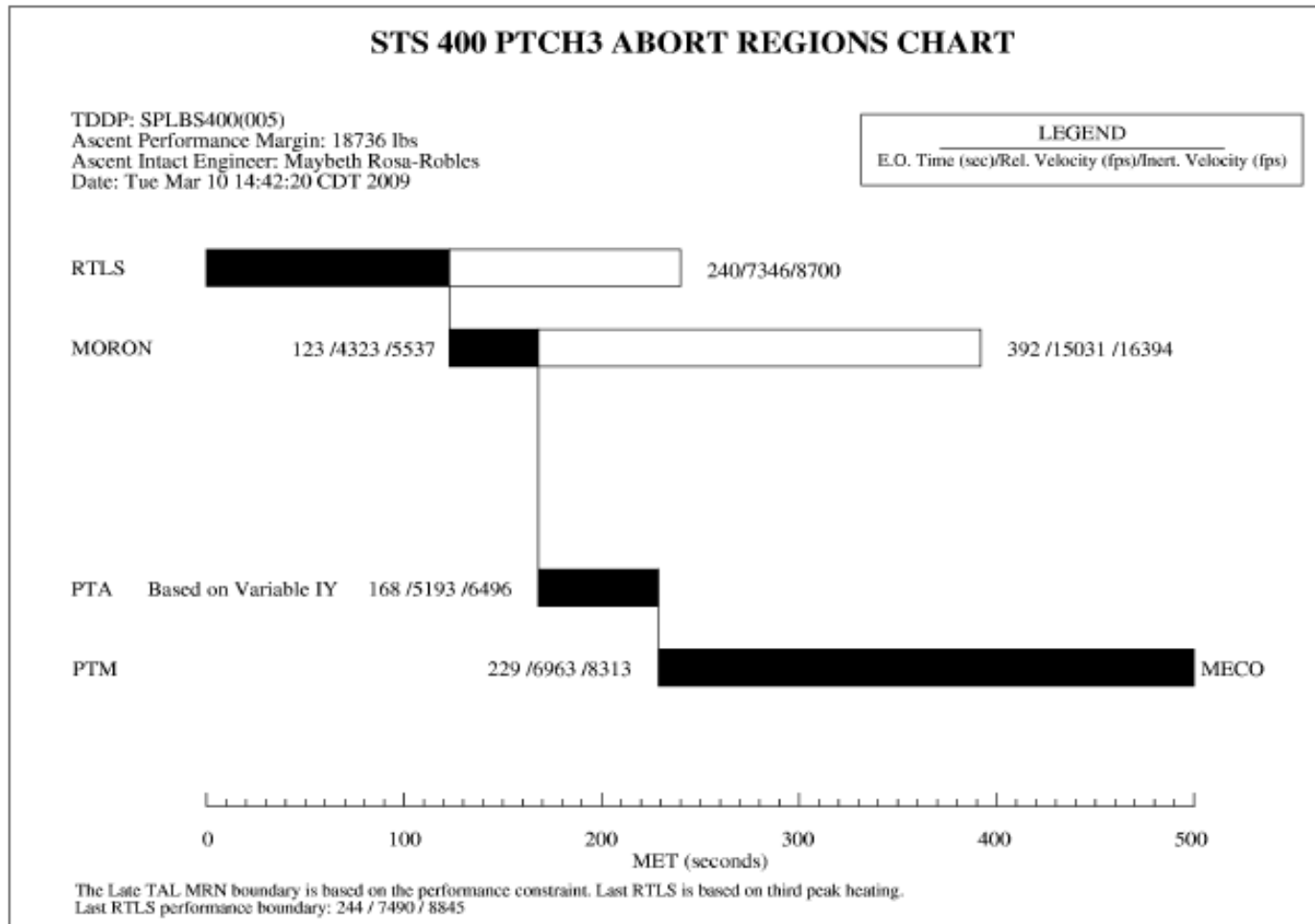

*Note: Due to inherent assumptions made in its creation, this chart may not accurately depict DOL conditions and intact abort boundary times.*

# STS-400 Contingency Abort Black Zone Comparison

CA Black Zones Comparison Chart  
STS 400 vs. STS 300

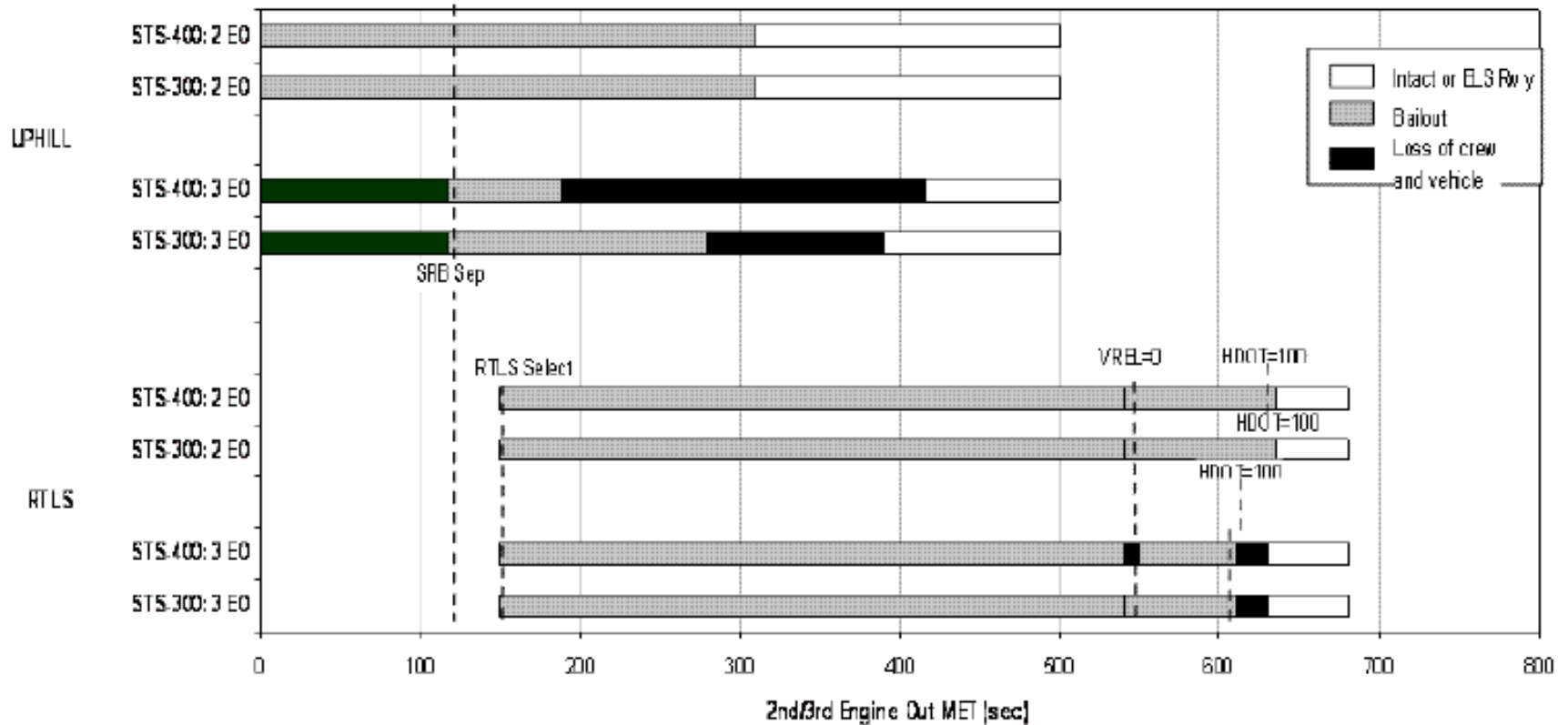

# STS-400 FRR

## ATLANTIS APPROACH DESIGN

W. Summa/USH-483L  
K. Wiuff/USH-483L

### ATLANTIS ORBITER CONFIGURATION FOR APPROACH

- Atlantis in LOWZ LVLH hold (+YVV -ZLV) with payload bay pointed down +Rbar and nose south

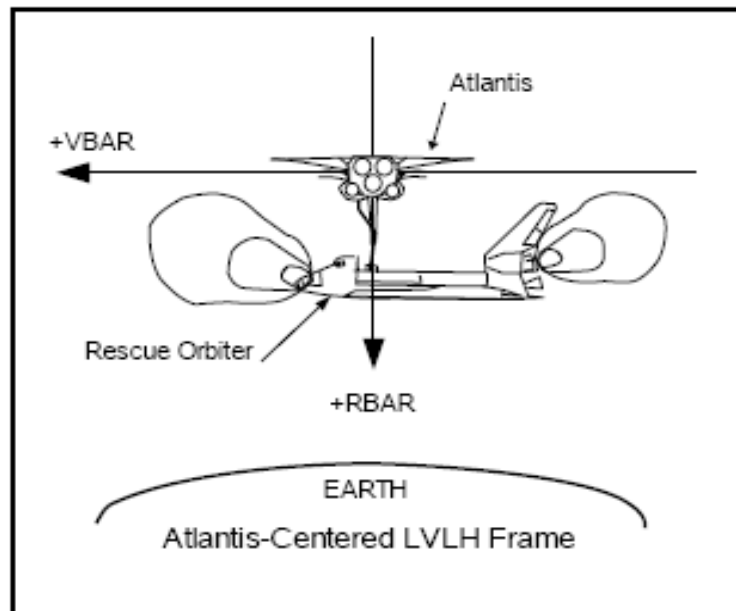

### APPROACH PROFILE

- LOWZ mode from 1000 ft. to grapple
- No Rbar Pitch Maneuver (RPM)
- Orbiter performs +Rbar approach to grapple range of approximately 44 ft. CG-CG in Orbiter Z
- Orbiters are at a 90 degree angle to each other to minimize plume impingement effects during final braking
- Rescue Orbiter grapples Atlantis using the forward grapple fixture on Atlantis' berthed Orbiter Boom Sensor System (OBSS)
  - OBSS is rolled out

# STS-400 FRR

W. Summa/USH-483L  
K. Wiuff/USH-483L

## TERMINAL PHASE AND +RBAR APPROACH

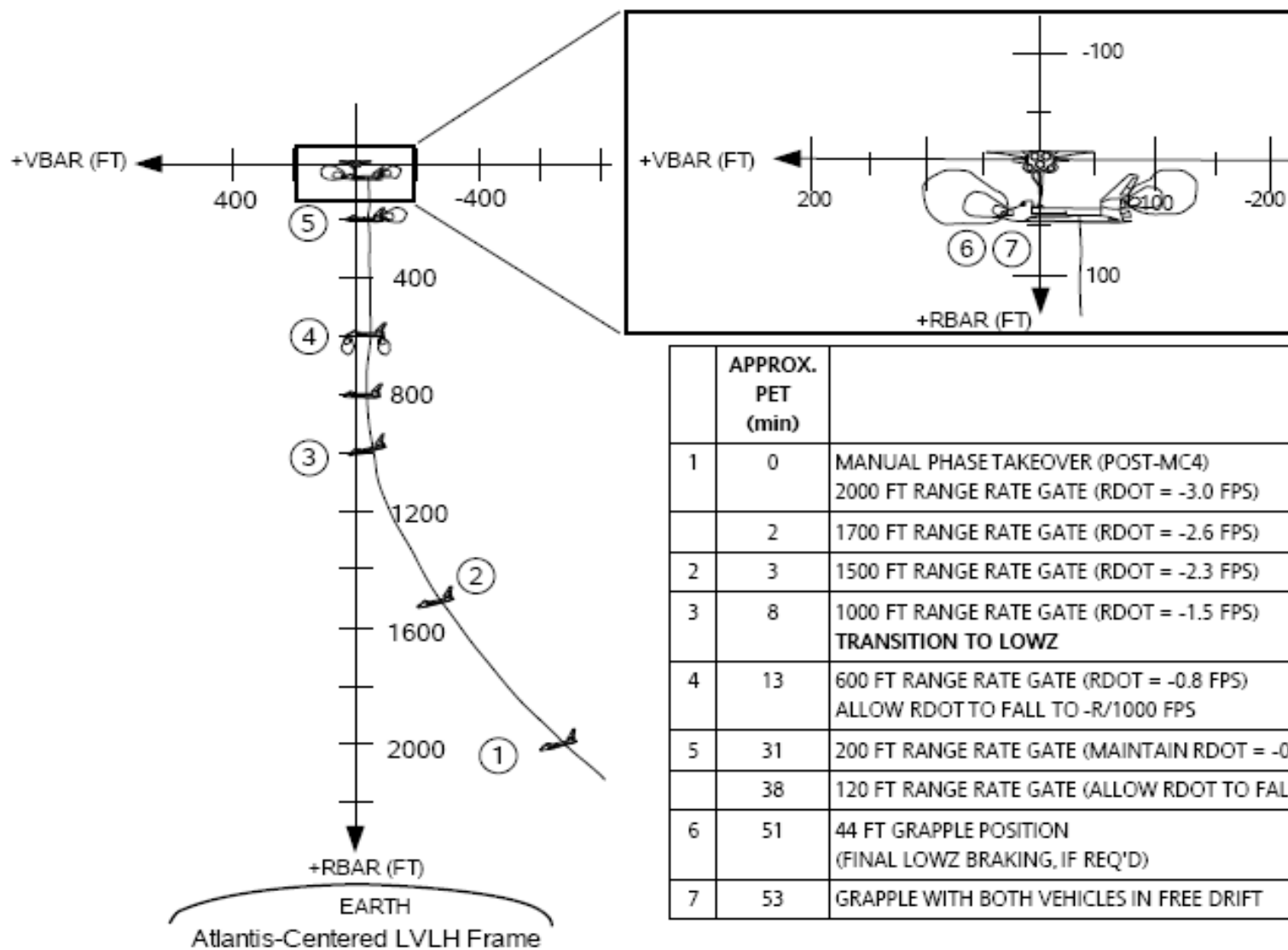

	APPROX. PET (min)	
1	0	MANUAL PHASE TAKEOVER (POST-MC4) 2000 FT RANGE RATE GATE (RDOT = -3.0 FPS)
	2	1700 FT RANGE RATE GATE (RDOT = -2.6 FPS)
2	3	1500 FT RANGE RATE GATE (RDOT = -2.3 FPS)
3	8	1000 FT RANGE RATE GATE (RDOT = -1.5 FPS) <b>TRANSITION TO LOWZ</b>
4	13	600 FT RANGE RATE GATE (RDOT = -0.8 FPS) ALLOW RDOT TO FALL TO -R/1000 FPS
5	31	200 FT RANGE RATE GATE (MAINTAIN RDOT = -0.2 FPS)
	38	120 FT RANGE RATE GATE (ALLOW RDOT TO FALL TO -0.1 FPS)
6	51	44 FT GRAPPLE POSITION (FINAL LOWZ BRAKING, IF REQ'D)
7	53	GRAPPLE WITH BOTH VEHICLES IN FREE DRIFT

## STS-400 FRR MATED CONFIGURATION

W. Summa/USH-483L  
K. Wiuff/USH-483L

### POST-GRAPPLE

- Rescue Orbiter nulls any rotational rates after grapple using ALT DAP
  - Verniers unable to control initial grapple configuration
- While in free drift, SRMS maneuvers Atlantis to nose-to-nose relative position needed for vernier attitude control
- Rescue Orbiter resumes control in ALT to maneuver stack to long-term mated gravity gradient/Torque Equilibrium attitude (TEA)
- Rescue Orbiter modes to vernier attitude control once in TEA

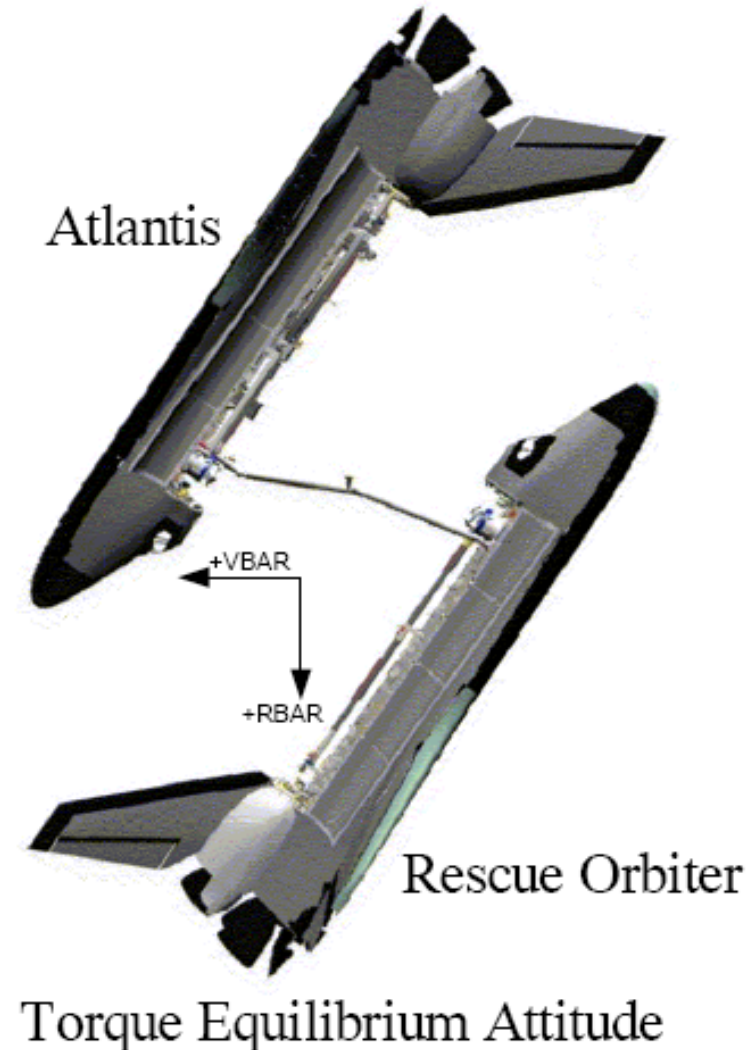

# STS-400 FRR

## ATLANTIS SEPARATION DESIGN

W. Summa/USH-483L  
K. Wiuff/USH-483L

### ATLANTIS CONFIGURATION FOR SEPARATION

- Atlantis in NORMZ LVLH hold (+ZVV +XLV) attitude for ungrapple
  - Atlantis LVLH PYR (270, 0, 180)
  - Atlantis must release in AUTO to allow subsequent commanding by the ground to deorbit into Pacific Ocean
    - OMS in ARM/PRESS
    - NORMZ/ALT/AUTO Earth track
      - 40 degree attitude and 5 degree/second rate deadbands in ALT to simulate free drift
      - Tail-only to avoid pluming Rescue Orbiter with Atlantis nose jets

### SEPARATION PROFILE

- Rescue Orbiter LVLH PYR (90, 0, 180)
- Ungrapple time of sunrise + 2 minutes chosen to ensure ungrapple and initial separation are in daylight
- Two burn -Vbar separation
  - Initial +Z NORMZ SEP1 burn of 0.2 fps retrograde to begin opening
  - Followed 5 minutes later by a 3 fps +Z NORMZ retrograde SEP2 final burn
  - Plume impingement on Atlantis is not a concern

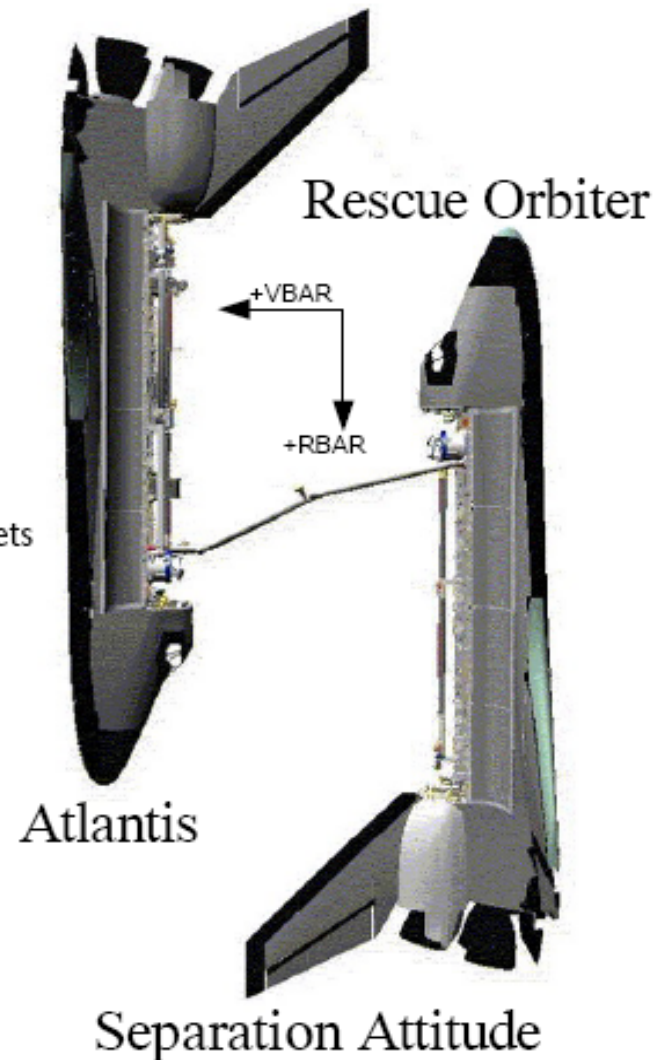



# STS-400 FRR

W. Summa/USH-483L

K. Wiuff/USH-483L

## UNGRAPPLE AND -VBAR SEPARATION

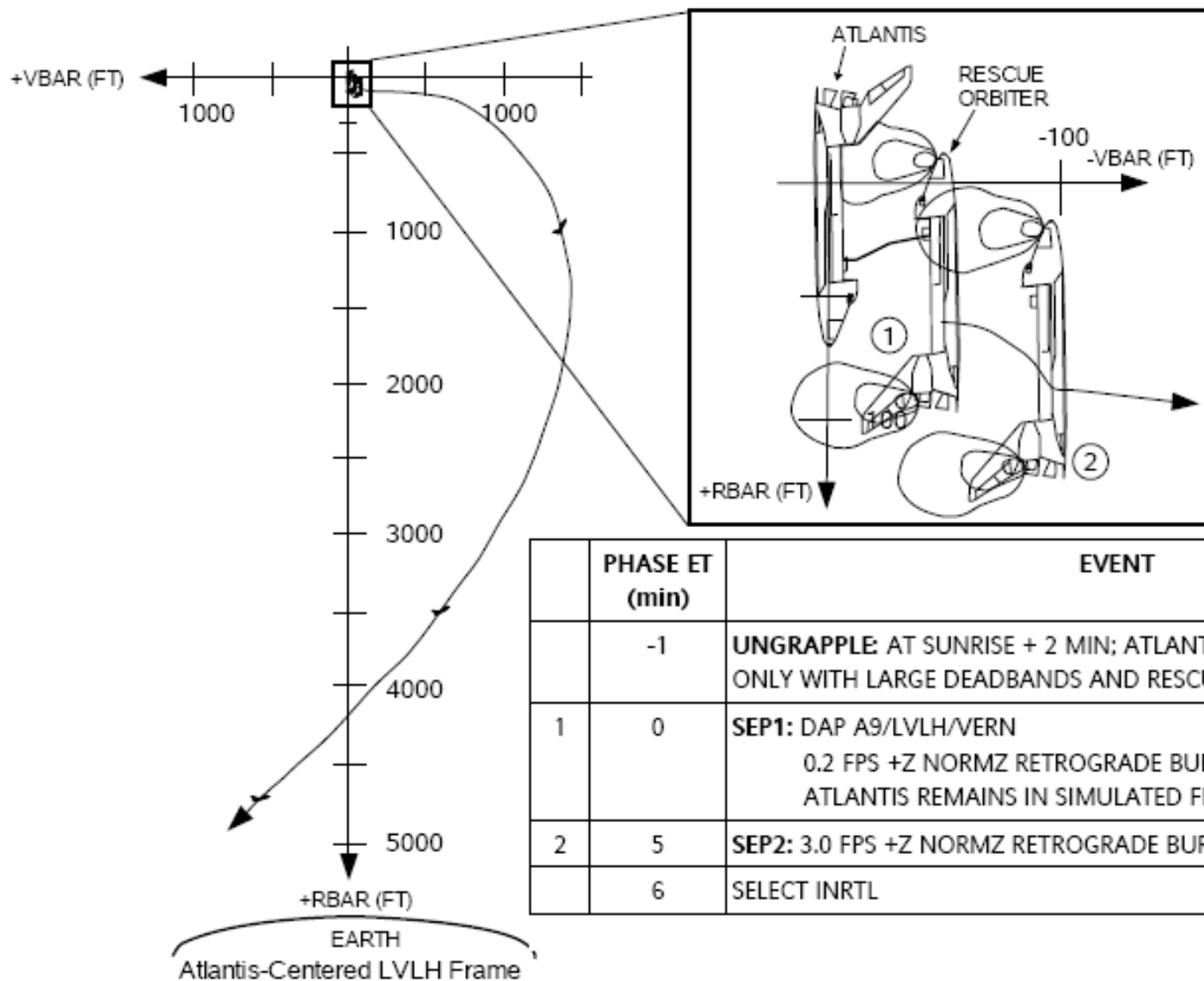

	PHASE ET (min)	EVENT
	-1	<b>UNGRAPPLE:</b> AT SUNRISE + 2 MIN; ATLANTIS IN AUTO/ALT TAIL ONLY WITH LARGE DEADBANDS AND RESCUE ORBITER IN FREE DRIFT
1	0	<b>SEP1:</b> DAP A9/LVLH/VERN 0.2 FPS +Z NORMZ RETROGRADE BURN ATLANTIS REMAINS IN SIMULATED FREE DRIFT
2	5	<b>SEP2:</b> 3.0 FPS +Z NORMZ RETROGRADE BURN
	6	SELECT INRTL