



SPACE SHUTTLE PROGRAM
Space Shuttle Systems Engineering and Integration Office
NASA Johnson Space Center, Houston, Texas



STS-130

Joint Shuttle/Station

Flight Readiness Review

MS/Travis Robinson
January 27, 2010



Pre-decisional. Internal Use Only.





Topics

Presenter	MS/Travis Robinson	
Date	01/27/10	Page 2

- **Systems Engineering & Integration**
 - STS-129 MEI Acoustics and Accelerometer Data Review
 - Integrated Debris Risk Summary
 - Imagery Status
 - Radar Status



Pre-decisional. Internal Use Only.

Presenter	
Date	1/27/10
Page 3	

MEI Acoustic Environment Validation

STS-129 MEI Acoustics and Accelerometer Data Review



Background

Presenter USA/Mark A. Miller

Date 1/27/10

Page 4

- **MEI Acoustics update incorporating flight experience was released on 9/29/09 by SICB for Orbiter assessment**
 - Orbiter initially identified structural mission life concerns at OMS/RCS base, but subsequently cleared their hardware to the new environments through analysis
- **Environment for OMS/RCS Base zone was based on Orbiter Base Heat Shield zone using the current Data Book approach**
 - There is no flight data or test data for the OMS/RCS Base area
- **11/5/09 PRCB approved new STS-129 instrumentation as a first step in a multi-flight data collection effort to validate the MEI Environment**
 - One tri-axial accelerometer on Left RCS Stinger structure
 - Four pressure transducers on Left TSM Inboard side



STS-129 Left TSM Pressure Transducers

- Four new pressure transducers were added to the inboard side of the Left TSM for STS-129
 - Similar distance to SSME noise source as vehicle area of interest (KSRP_105A)
- One of the transducers was capped to check for vibration effects (near KSRP_106A)

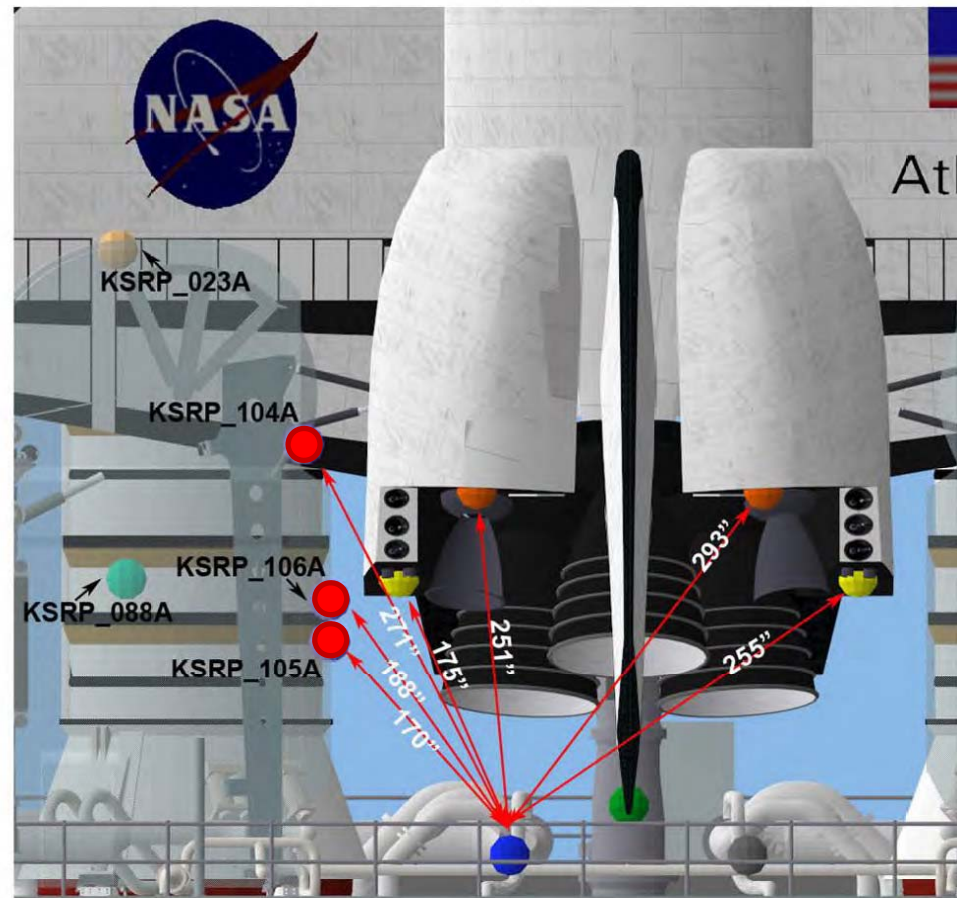

● New sensor



STS-129 Left TSM Acoustic Data

Presenter USA/Mark A. Miller

Date 1/27/10

Page 6

- The data was evaluated and appears reasonable
- Acoustics were within SE&I updated design levels used in Orbiter assessment
 - Based on KSRP_105A (Xo 1596) pressure transducer
 - KSRP_106A and KSRP_104A transducers recorded expected pressure decays with distances
- Orbiter area of interest for structural response is below 100 Hz

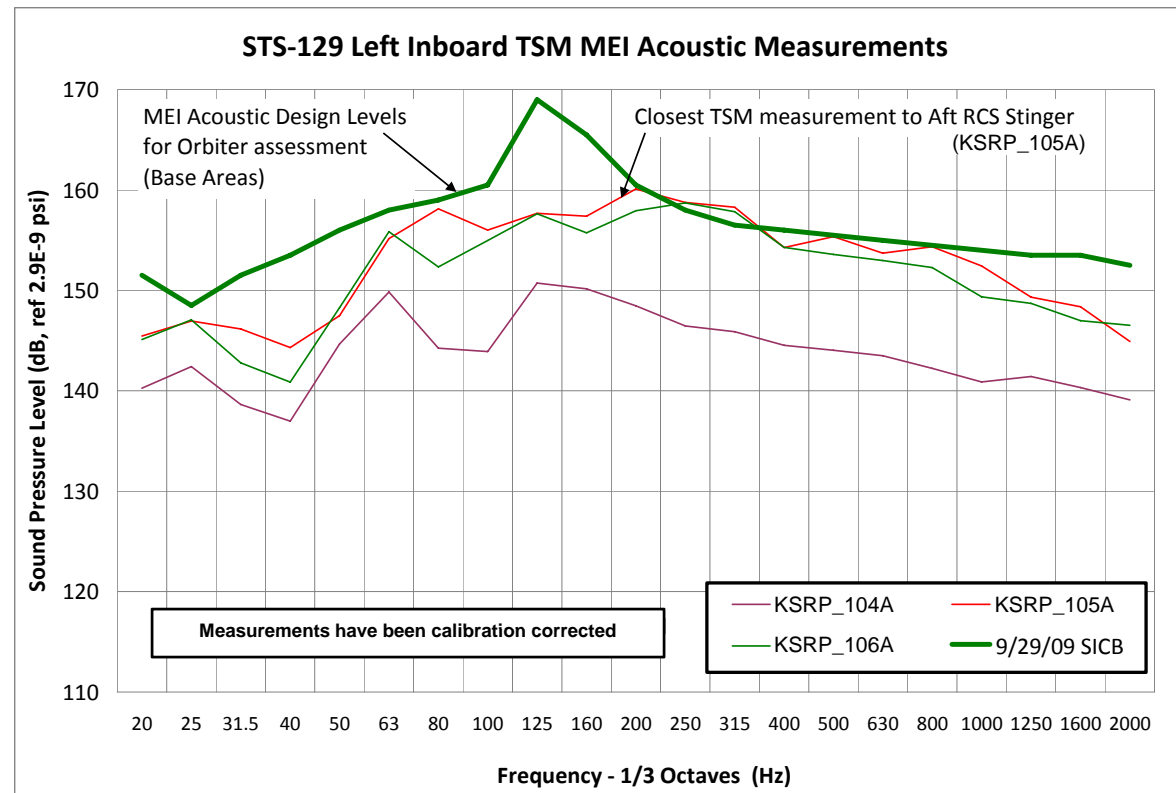



STS-129 (OV-104) Left RCS Stinger Tri-Axial Accelerometers

Presenter USA/Mark A. Miller

Date 1/27/10

Page 7

- One tri-axial accelerometer on Left RCS Stinger structure
 - V08D9701A, OMS-L POD QD PANEL VIB - X AXIS
 - V08D9702A, OMS-L POD QD PANEL VIB - Y AXIS
 - V08D9703A, OMS-L POD QD PANEL VIB - Z AXIS

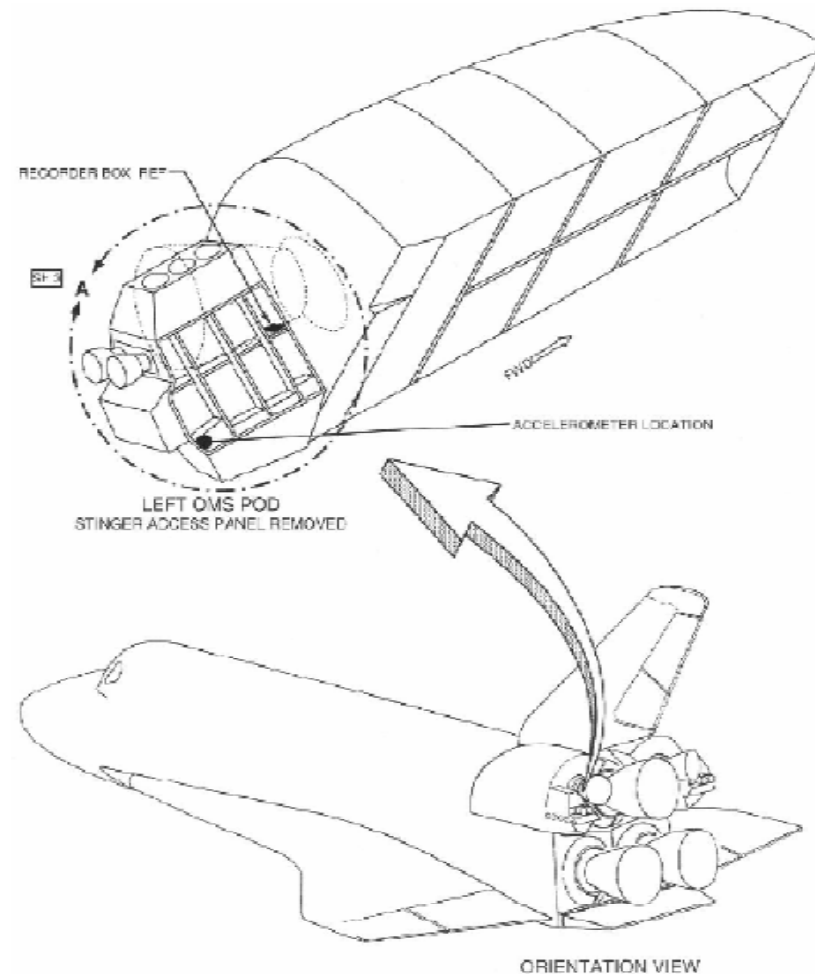



STS-129 Left RCS Stinger Accelerometer

Presenter USA/Mark A. Miller

Date 1/27/10

Page 8

- The data was evaluated and appears reasonable
- FEM predicted responses envelope the measured responses for frequencies of interest for structures (**<100 Hz**)

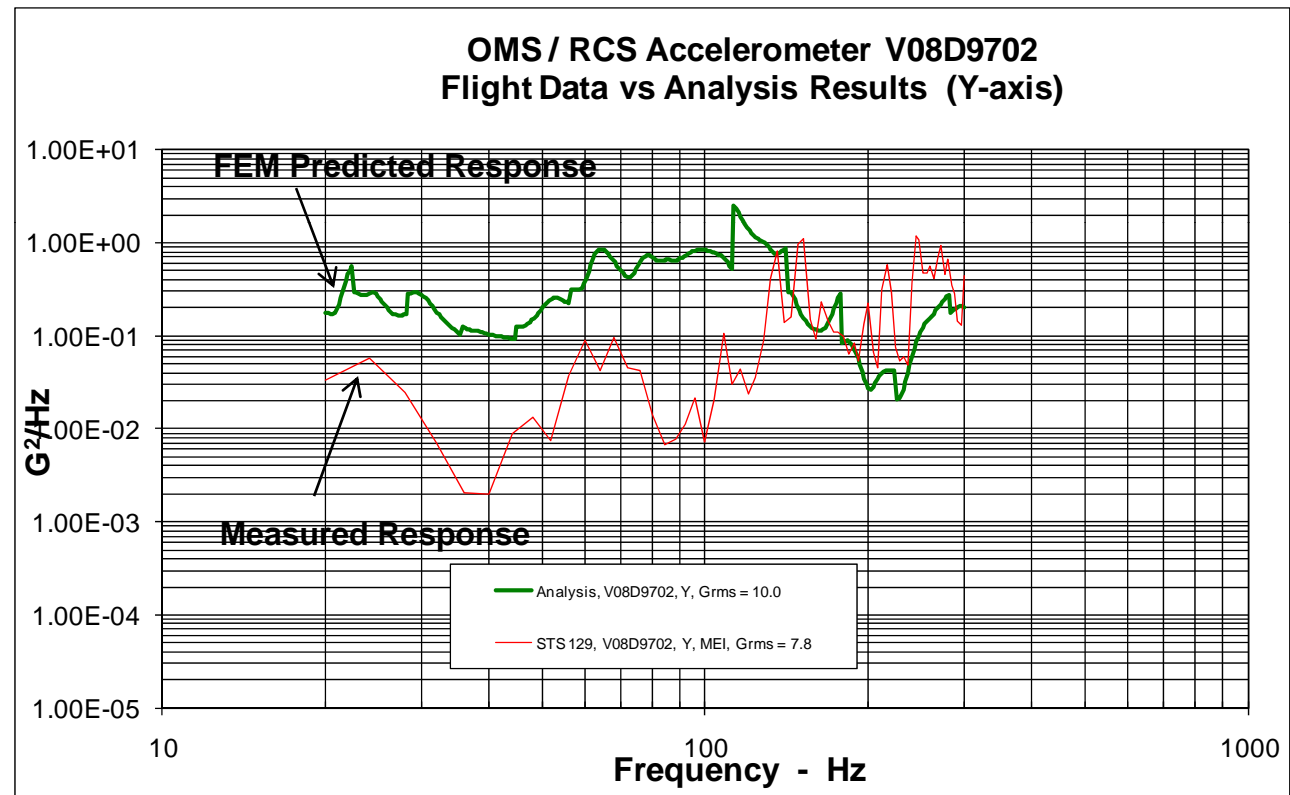



Summary and Forward Work

Presenter USA/Mark A. Miller

Date 1/27/10

Page 9

- **STS-129 data was evaluated for quality and appears to be reasonable**
- **TSM data compared well with predictions**
 - Spectral characteristics are similar to other Orbiter aft perimeter measurements (e.g. Upper Left Body Flap, Vertical Tail Stinger and Drag Chute Door)
- **FEM shows responses for STS-129 are enveloped by environment provided at the RCS stinger**
 - Loads and life analysis by Orbiter is still valid
- **Forward Work:**
 - Instrumentation plan for future flights presented to 12/10/09 PRCB
 - Similar sensor locations on LH2 TSM, 2 additional transducers on LO2 TSM
 - Two microphones and one accelerometer on RCS Stinger on OV-105 & -103
 - Add microphone on Base Heat Shield
 - Data from future flights with base heat shield microphone will help identify where STS-129 data falls within the historical distribution
 - Data from STS-129 and future flights will be used to reduce uncertainties and validate updated environments



**STS-130 (OV-105) MEI INSTRUMENTATION
 ON ORBITER AND TSMs**

Presenter USA/Mark A. Miller

Date 1/27/10

Page 10

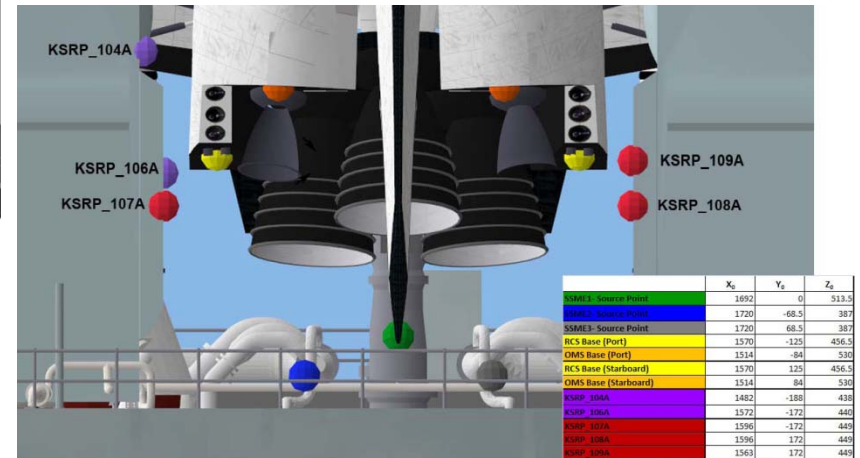
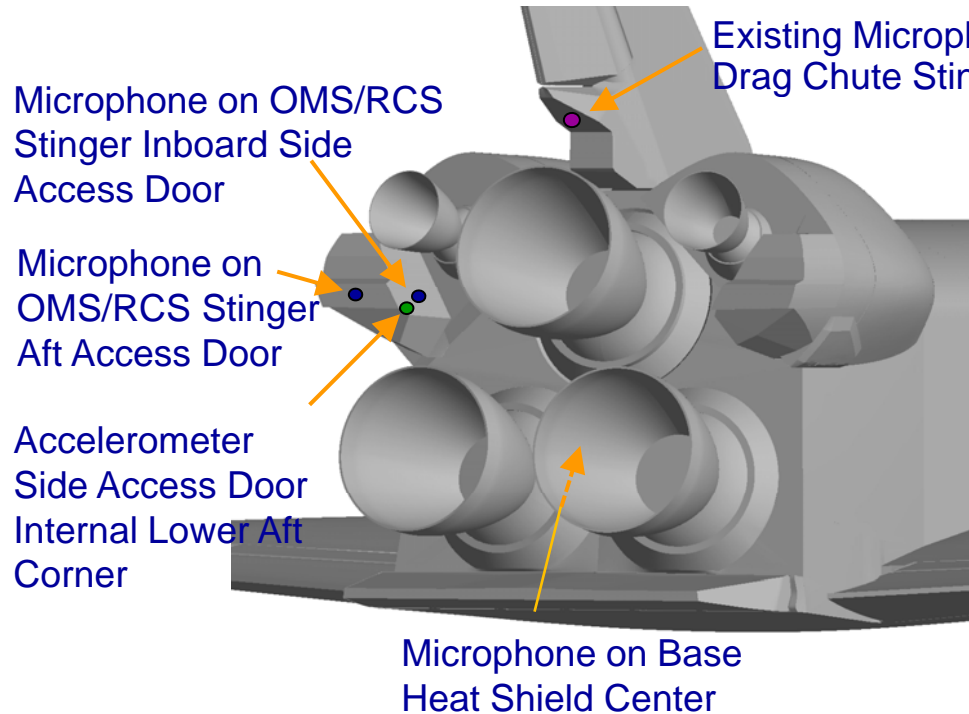



STS-130 Debris Risk Assessment Summary		Presenter MS/Travis Robinson
Date 1/27/10	Page 11	

(HAZARD SEVERITY LEVEL AND LIKELIHOOD OF OCCURRENCE WITH CONTROLS IN PLACE)

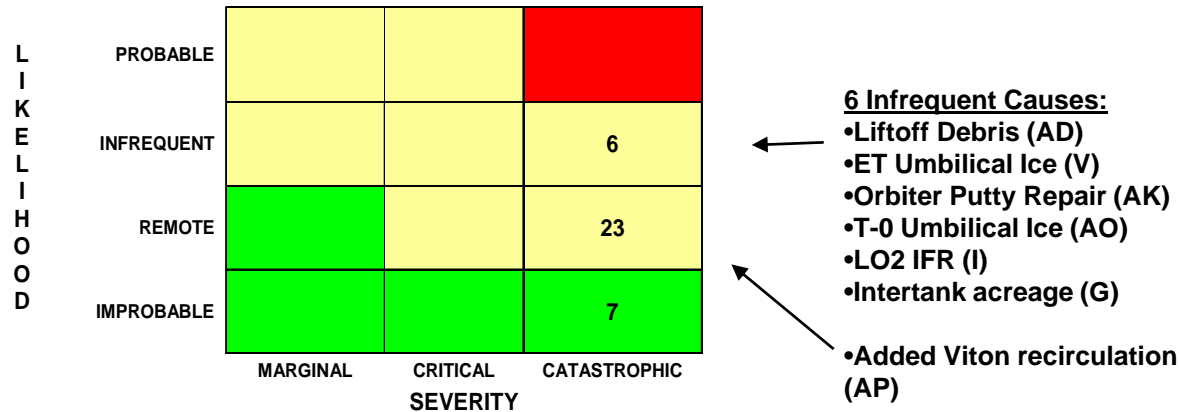

Debris Risk Assessment, 1/2010

Six IDBR-01 debris risks remain Infrequent/Catastrophic

-IDBR-01 has been updated for this flight to include Viton recirculation debris

- **Liftoff Debris** is expected to remain at this risk level for the life of the Program due to the diversity of potential Debris sources although rigorous controls have been implemented and continuous vigilance is policy.
- **ET Umbilical Ice:** Accepted Risk; Closely monitored during pre-launch
- **Putty Repair:** Windows zero impact allowable keeps any impact in the “catastrophic” category, forward work may be used to reduce the likelihood to “Remote”.
- **T-0 Umbilical Ice:** Accepted Risk; NSTS 08303 Updated to include 0.1 lbm allowable external ice
- **LOX IFR:** Implemented NDE of all IFR ramps to screen for large voids
- **ET Intertank Foam Loss:** Changed to Infrequent Catastrophic for STS-128
 - Continued Tensile Testing of ET high risk debris areas to mitigate risk





Issues & Integrated In Flight Anomalies

Presenter **MS/Travis Robinson**

Date **1/27/10**

Page 12r1

- **IIFA STS-128-I-002 Ice External to the LH2 T-0 Umbilical**
 - Closed with update to NSTS 08303
- **IIFA STS-127-I-004 ET TPS Loss at LO2 IFR 718**
 - Closed with 1/14/10 PRCB acceptance of NDE Inspection procedures
- **IIFA STS-128-I-006 Debris Observed on SSME**
 - SRB Viton, Closed for STS-130 but included due to related on-going work to review other possible sources of recirculation debris
 - DIG is currently analyzing 11 existing NSTS60559 items for potential recirculation impacts
 - Recirculation is a low velocity environment compared to the nominal for these debris source and it is expected it will be bounded with the existing risk
- **IIFA STS-129-I-003, "ET TPS Losses on -Z Intertank**
 - Closed, working with ET on foam breakup testing
- **IIFA STS-129-I-004, SRB Foam Cracks Near GN2 Purge Line**
 - DIG in concurrence with SRB plan to eliminate future cracks
 - Minimal/No ascent debris concern due to location and size



Orbiter Debris Impact summary		Presenter MS/Travis Robinson	
STS-129, OV-104		Date 1/27/10	Page 13

- TPS Hits w/damage > 1" = 14 (8 lower surface, 1 L OMS, 3 R OMS, 2 windows) (Total # of Hits = 88)
 - Prior to RTF Average for Lower Surface Hits >1" = 23; Since RTF = 14

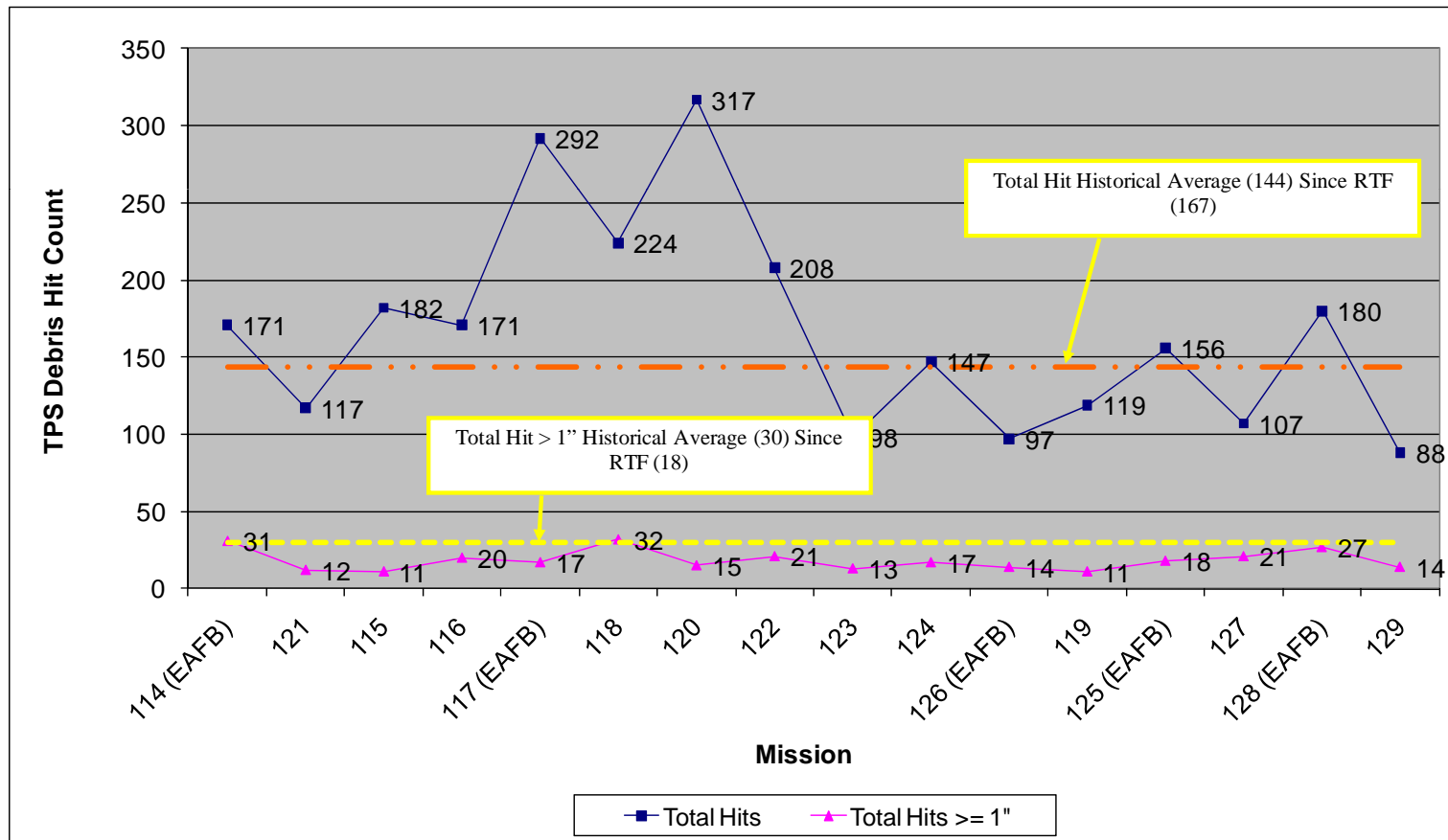

STS-129 elliptical volume Hits>1" = 1.498 in3; RTF Average = 2.603 in3
STS-129 Total elliptical volume ALL Hits = 1.785 in3; RTF Average = 3.761 in3





Putty Repair Debris Summary

Presenter MS/Travis Robinson

Date 1/27/10

Page 14

- **TPS putty repairs are listed as expected debris in NSTS 60559**
- **Putty Repair loss is listed as cause AK in IDBR-01 and carried as an Infrequent Catastrophic Risk primarily because Windows have zero capability for impacts**
 - The upper forward fuselage area is a relatively benign environment and we have never lost putty repairs forward of the windows
- **STS-129 experienced more losses than typical but types of losses still in family w/flight history**
 - Losses on bottom of vehicle – typically partial losses not whole putty repairs
 - All losses very small and attributed to same failure mechanism –adjacent contact
 - 5 losses larger than .0002 debris allowable: 2x.0003, .0005, .0006, & .0012
 - STS-129 loss represents NO increase in risk
- **OPO/TPS PRT continues risk reduction steps**
 - Allowable Repair filler volume was reduced to limit putty repair masses
 - Tile Undercut revised for new repairs
 - Process/tooling/Training enhanced
 - Tiles with large repairs are being removed in critical areas FWD of the RCC and windows
 - Inspections continue (Tactile Test & Minimum gap inspections) and Tiles to be removed are ranked by size/location/repair type
 - CHIT's will be initiated and a subset of tiles removed every flow until EOP

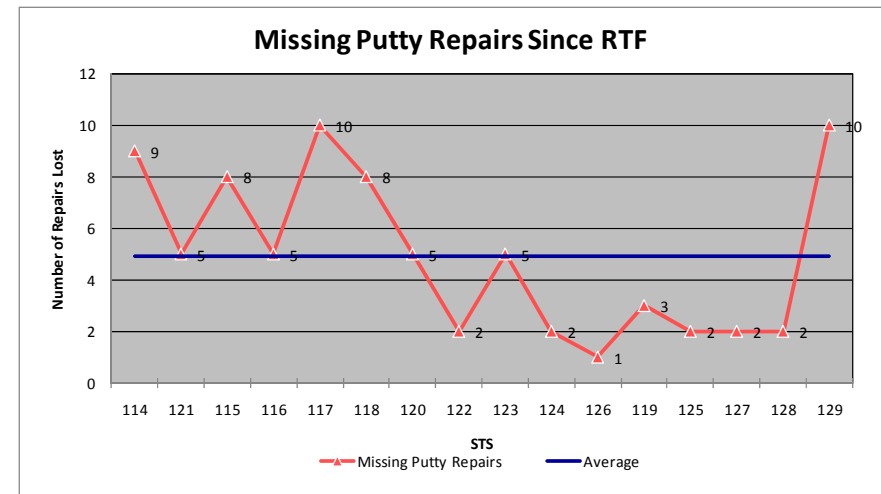



<h1>STS-129 Missing Putty Repairs</h1>		Presenter MS/Travis Robinson	
		Date 1/27/10	Page 15

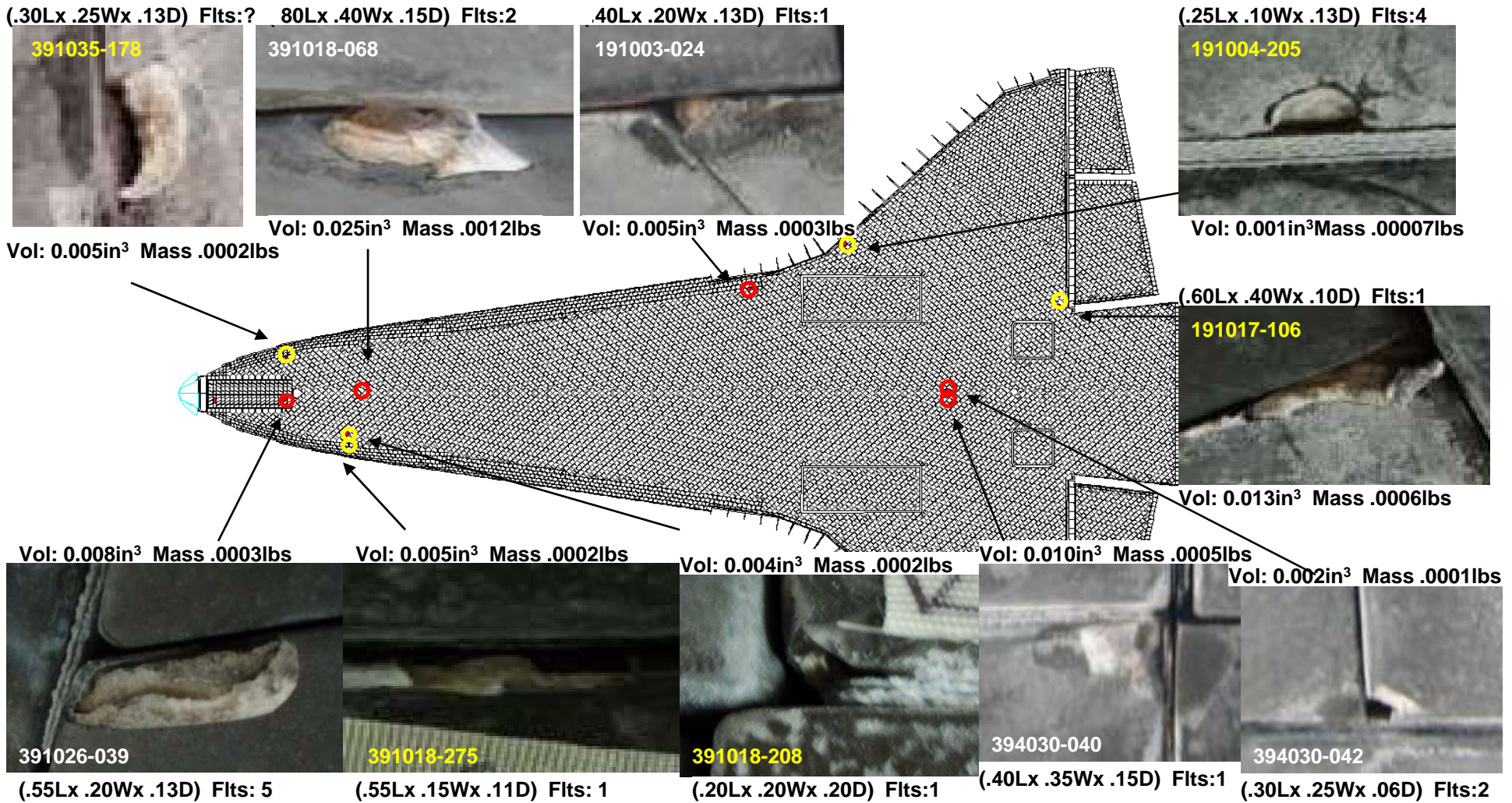



Imagery – ELVIS Hardware

Presenter	MS/Travis Robinson	
Date	1/27/10	Page 16

Enhanced Launch Vehicle Imaging System (ELVIS)

- ET LO2 Feedline Camera, SRB cameras, Digital ET TPS (umbilical) camera, crew handheld cameras, and ground network are on track for support with no open issues
- Minor anomalies from STS-129 have been dispositioned
 - DETTPS Flash anomalies
 - No flash recharge between 22nd and 23rd pictures – quantum board replaced
 - Thermostat short due to no heat shrink tubing – tubing applied
 - LH SRB Data Acquisition System recorder lost after water impact (394 sec) – unit refurbished at vendor
 - Crew Handheld HD Video downlink via OCA 48 Mbps not functional – crew training and in-vehicle checkout scheduled prior to launch

Ground Cameras

- Configured for nominal ISS trajectory

Imagery team is ready to support



Imagery – Orbiter Minicam

Presenter	MS/Travis Robinson	
Date	01/27/10	Page 17

Orbiter Minicam

- Sony XC-555 camera (NTSC 29.97 fps interlaced) with a 6mm lens was installed inboard of Window 4 on STS-129 to monitor ET LO2 IFR performance during ascent
- IFRs 514 – 676 observed in FOV, resolution capability of 2" @ 50' prior to image overexposure



Minicam view from STS-129



Imagery – Photo Targets

Presenter **MS/Travis Robinson**

Date **1/27/10**

Page **18**

Photogrammetry – “reliable measurement using imagery”

- Reference marks are essential for providing imagery-based trajectory analyses
 - Liftoff Debris(LOD) trajectory/location/size analysis
- Currently, IATs use known features on the SSV when performing requested LOD analyses
 - Time Consuming, Limited Accuracy, Points Move Over Time
- Improved reference marks on the MLP/FSS increase accuracy/improve efficiency
- Simulations performed to quantify errors in current methodology : ~13 feet vs 1.6 inches with optical targets
- Nineteen reference marks installed for STS-130
 - FSS: 8 photo targets
 - Each MLP: 11 photo targets
- Post-rollout survey of targets being worked

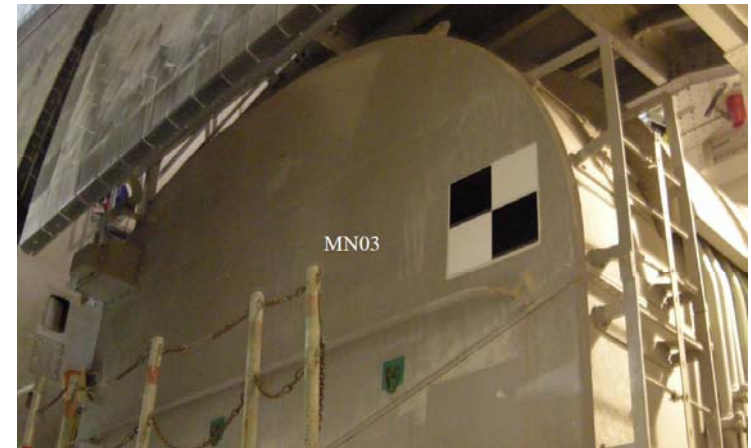

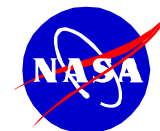

Debris Radar Configuration for STS-130:

Presenter MS/Travis Robinson

Date 1/27/10

Page 19

• **STS-130 NDR Configuration:**

- 1 MCR C-band radar
- 2 NASA X-band radars
 - NASA #1 on SRB vessel *Liberty Star*
 - NASA #2 *Co-located with MCR* (alternate mission location)
 - *Runnymede-Class ARMY LCU* not expected to be available due to Haitian Relief Efforts
- Operations will be the same as STS-129 except for alternate location of X4
 - Coverage of gap between the Orbiter and ET similar, but mirror image
 - Coverage of port side reduced to X3 only from down range
- Operational SRB tracking, following ASTT, by both X-bd radars
- NDR Readiness was reviewed on 01/15/10.
 - NDR-C1, NDR-X3, and NDR-X4 radars are GREEN
 - Facility and team are ready.





Pre-decisional. Internal Use Only.

Presenter MS/Travis Robinson	
Date 01/27/10	Page 20

Back-up charts



Pre-decisional. Internal Use Only.

Typical Orbiter Acoustic Sensor Installed

Presenter USA/Mark A. Miller

Date 1/27/10

Page 21





OV-103 & -105 Instrumentation (rear)

Presenter USA/Mark A. Miller

Date 1/27/10

Page 22

Microphone on OMS/RCS Stinger Inboard
Side Access Door

Existing Microphone on Drag Chute Stinger

Microphone on OMS/RCS
Stinger Aft Access Door

Approved Accelerometer
Side Access Door
Internal Lower Aft Corner
(same as installed on OV-104)

Microphone
Base Heatshield Center
(V08Y9686H)

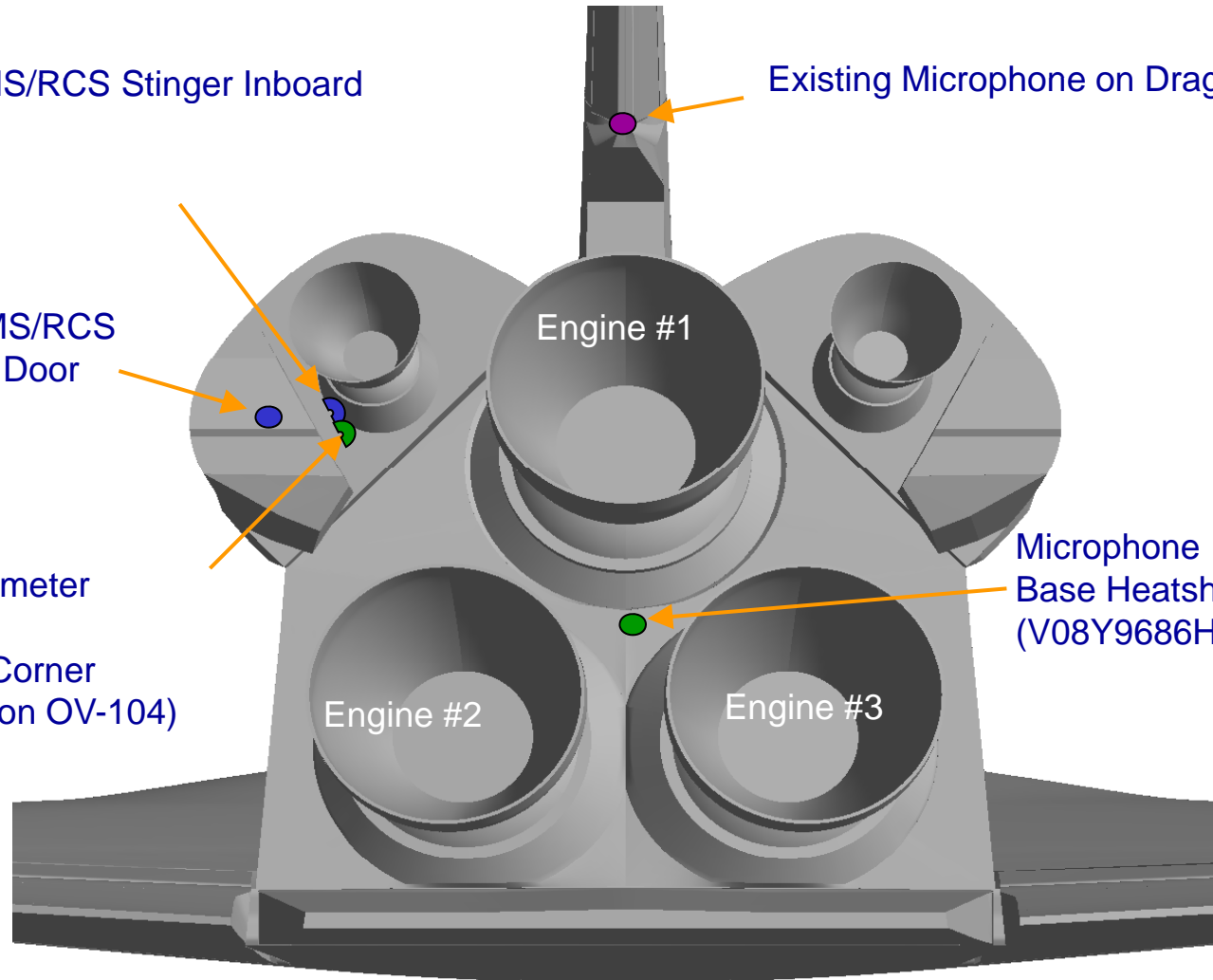



OV-103 & -105 Instrumentation (side)

Presenter USA/Mark A. Miller

Date 1/27/10

Page 23

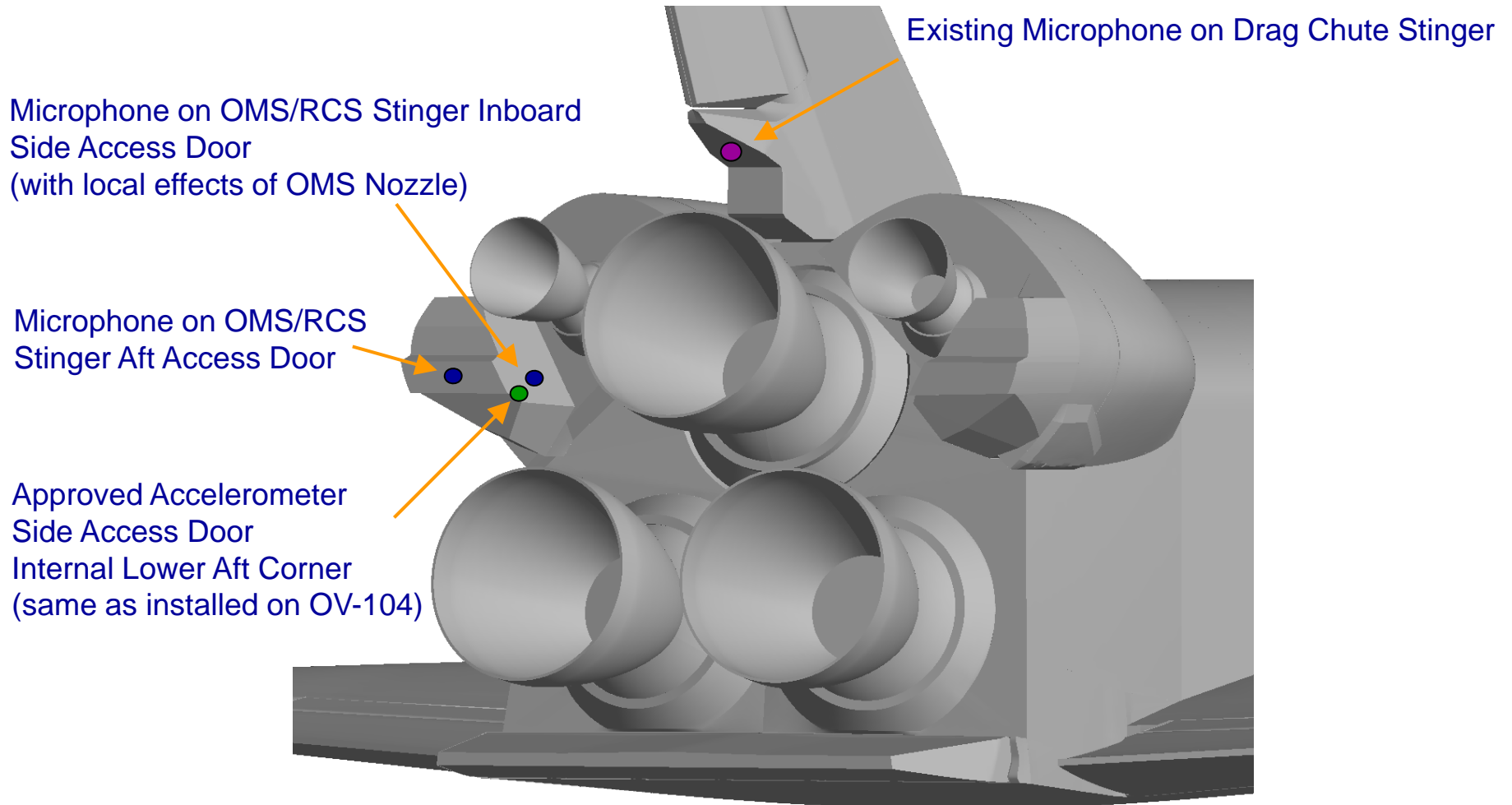



Pre-decisional. Internal Use Only.

Presenter	MS/Travis Robinson	
Date	1/27/10	Page 24

MEI Acoustics Environment and Assessment for Vertical Tail



Background

Presenter MS/Travis Robinson

Date 1/27/10

Page 25

- **MEI Acoustic and SSME IOP environment update incorporating flight experience were released by SICB on 09/29/09 for Orbiter assessment (PRCBD S052158EG)**
 - Open Work remained for the MEI Acoustic Vertical Tail zones
- **Orbiter evaluation cleared all OMS/RCS Base environment update concerns for STS-129 (11/12/09 PRCB)**
- **New STS-129 RCS Structure accelerometer and TSM inboard pressure sensors added for validation and uncertainty reduction**
 - STS-129 data was good and showed STS-129 MEI was enveloped by the updated environment assessed by Orbiter
- **Vertical Tail Stinger microphone calibration was completed and calibration correction curve developed (12/02/09 JALP)**
- **MEI Acoustic environment update and mission mix for Vertical Tail (12/9/09 JALP) approved 12/15/09 SICB for Orbiter assessment**
- **OPO CCB on Dec. 1 approved engineering for two microphones on port OMS/RCS stinger and one y-axis accelerometer using WLEIDS for STS-130**



Vertical Tail Acoustic Zone Updates

- Increases to lower tail zone over entire frequency range
 - 6 to 12dB
- Mid tail zone increased to updated lower tail values
- No Change to Tail Tip zone
- Mission mix for lower/mid zones provided

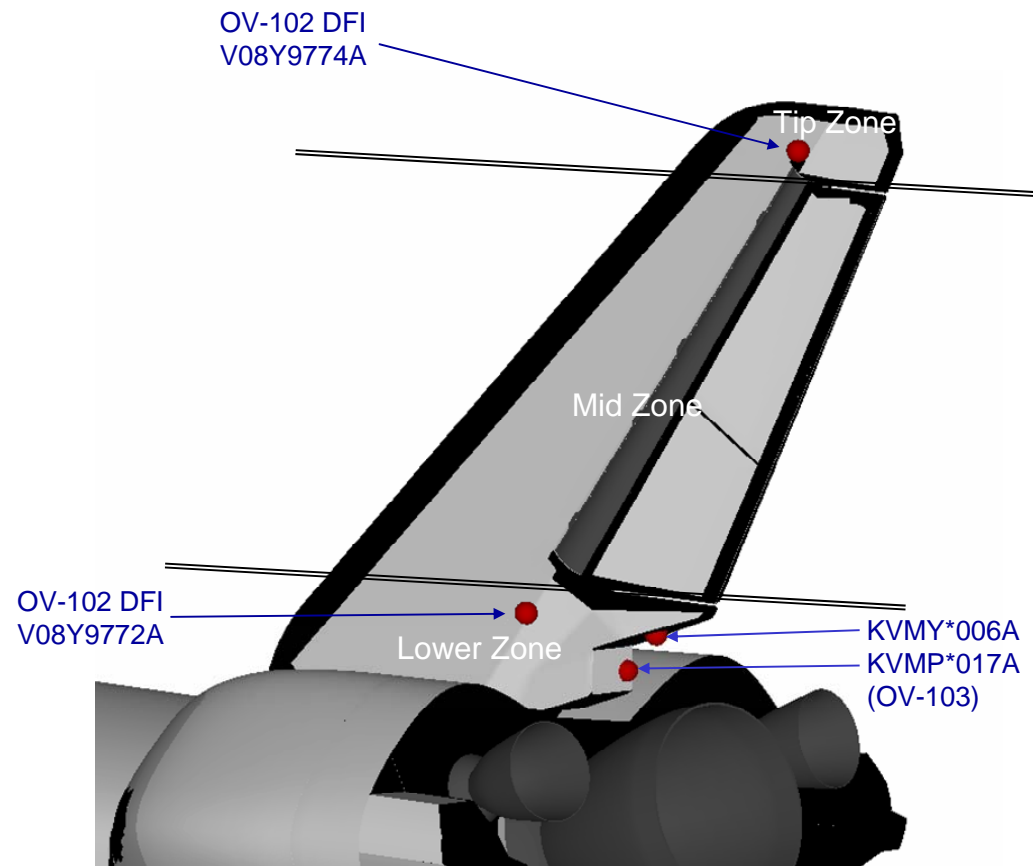



Updated Vertical Tail Lower Zone Design Environment with Calibration Correction Factors

Presenter MS/Travis Robinson

Date 1/27/10

Page 27

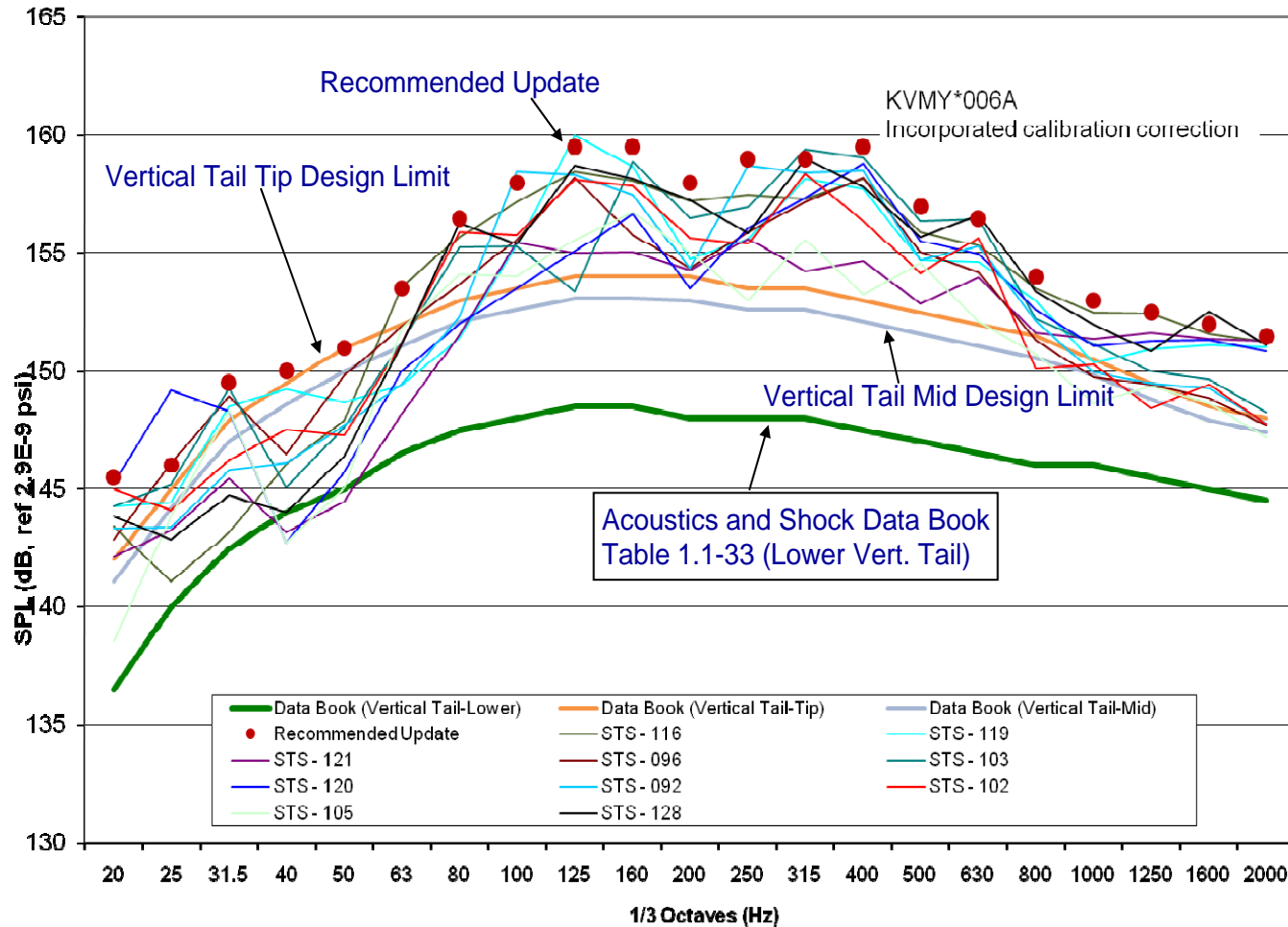



Original Vertical Tail Environment Differences

Presenter MS/Travis Robinson

Date 1/27/10

Page 28

- **Large exceedances of the Lower Vertical Tail zone appears to be caused by incorrect original Data Book environment**
 - Environment was based on a single set of questionable flight data from STS-1 (Vertical Tail Root)
 - Suspect MEI time history
 - Sensor completely failed later during ascent

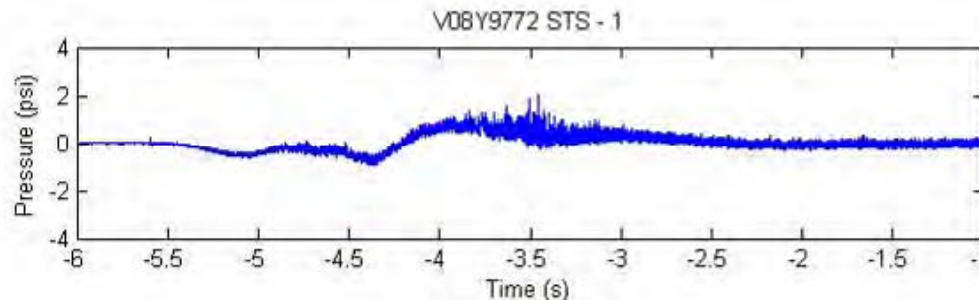

Failed sensor time history

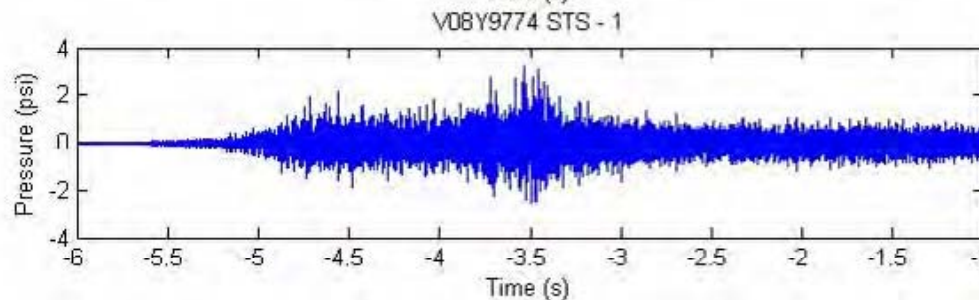

Typical time history



Vertical Tail Zone Mission Mix

Presenter MS/Travis Robinson

Date 1/27/10

Page 29

- Vertical Tail mission mix representative of lifetime exposure similar to OMS/RCS Base area mission mix released by 10/23/09 SICB for STS-129 assessment
 - Methodology consistent with current Data Book 50% mission ascent Aero-Acoustic fatigue approach
- Used data from 10 OV-103 flights for environment development

Vertical Tail Zone Mission Mix

Design Limit RMS P **0.692** psi = 1% of mission mix

Flight	RMS P (psi)	Max RMS P (psi)	
STS - 116	0.599	0.599	} = <u>49% of mission mix</u>
STS - 128	0.592	0.592	
STS - 092	0.587	0.587	
STS - 119	0.573	0.573	
STS - 103	0.569	0.569	
STS - 102	0.564	0.564	= <u>50% of mission mix</u>
STS - 096	0.523		
STS - 120	0.475		
STS - 105	0.461		
STS - 121	0.432		



Environment Forward Work

Presenter MS/Travis Robinson

Date 1/27/10

Page 30

- **Process data from STS-130 for environment verification**
 - Similar locations on LH2 TSM, 2 additional pressure transducers on LO2 TSM
 - Two microphones and one accelerometer on RCS Stinger
 - Base heat shield microphone
- **Instrumentation plan for future flights presented to 12/10/09 PRCB**
 - STS-131 should be the same as STS-130
- **Data from OVs with base heat shield microphone (including STS-130) will help identify where STS-129 (without mic) falls within the historical distribution**
- **Data from STS-130 and future flights will be used to continue validating updated environments**



Pre-decisional. Internal Use Only.

Presenter	MS/Travis Robinson	
Date	1/27/10	Page 31

Orbiter Summary



Background

Presenter MS/Travis Robinson

Date 1/27/10

Page 32

- **New environments for SSME Ignition Over Pressure (IOP) and Main Engine Ignition (MEI) Acoustics were presented and accepted at SICB Sept 29 as official assessment environments**
 - **Vertical Tail MEI environments were not included**
- **Vertical Tail MEI environments were presented at SICB Dec 15 as official assessment environments**
 - **Included both a design limit (DL) and the mission mix definition**
- **Increases to the Orbiter acoustic environments can affect structural responses including TPS/panel loads, and subsystem vibration levels, and primary structure fatigue life**
- **MEI experience on the Orbiter VT (including pad aborts and FRF + next flight):**
 - **41 MEI events on Vertical Tail fleet leader (OV-103)**
 - **26 MEI events on Drag Chute structure fleet leader (OV-105)**



TPS Assessment

Presenter MS/Travis Robinson

Date 1/27/10

Page 33

- For TPS, the tile acceleration environments were conservatively increased proportional to the acoustic Data Book updates
- All tiles have TFS >2.0 except for three regions:
 - Mid Leading Edge has TFS = 1.81
 - Very thick FRCI-12 tiles (t=3" to 4") that wrap around LE
 - Lower RSB LE has TFS = 1.62
 - LI-900 that has significant MEI and IOP stresses
 - Lower RSB close out region has TFS = 1.73
 - LI-900 that has large mechanical loads (> MEI and IOP)

FS > 1.4 For All TPS Locations

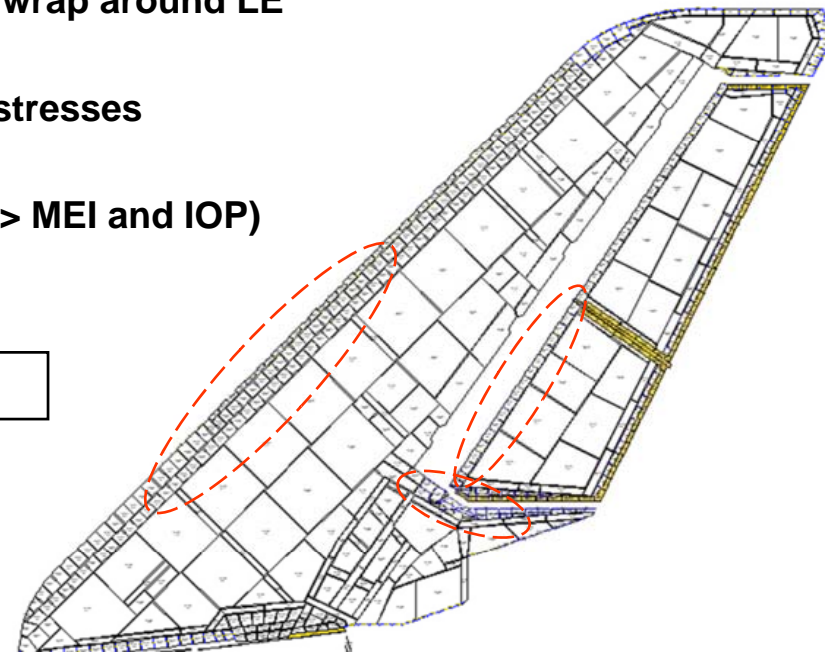



Vertical Tail Subsystems Are Not Affected By SE&I's Acoustic Environment Update

Presenter MS/Travis Robinson

Date 1/27/10

Page 34

- **Discussions with SE&I resulted in agreement that the actual acoustic environment has not changed significantly since STS-1**
- **VT vibration responses were developed from DFI accelerometer measurements**
 - Tail subsystems were part of 1988 NASA/Orbiter review that “grandfathered” existing hardware under the Orbiter Environment Spec (MF0004-014 Rev D)
- **VT subsystem hardware are primarily attached to stiff rear spar**
 - Power Drive Unit (hydraulic lines attached to PDU only), drive shafts/links, and Rudder/Speed Brake actuators
- **Actuators and other drive components were designed to carry large aerodynamic flight loads**
 - Subsystem random vibration loads are small in comparison
- **Some Drag Chute compartment items are attached to skins**
 - Mortar, pilot parachute, and door
- **Drag Chute hardware considered very low risk for exposure to 0.5 sec. MEI**
 - Hardware qual/certification environment included MEI loads (including GFE)
 - Attach/Jettison mechanism designed to 125,000 lb chute load (>> random vibs loads)
 - Drag chute compartment designed to react 15,000 lb mortar firing (> random vibs)
 - Mortar is not armed at Liftoff
 - Drag chute door pins redesigned using Inconel (vs. previous aluminum)



Acoustic Fatigue Analysis

Presenter MS/Travis Robinson

Date 1/27/10

Page 35

- **Acoustic fatigue report stresses were ratioed up to account for increase in acoustic environments**
 - **Different regions of tail required different ratios**
- **Fatigue analysis at increased Design Limit levels showed all but 4 parts exceeded the 50 mission requirement**
 - **Same reduced requirement as used for STS-129 MEI assessment**
- **Using the mission mix increased life on critical parts by factor of 4 to 6**
 - **Life exceeds 50 missions on all four critical parts when mission mix is considered**

Location	Part No.	Description	Load Factor	Original Life	Life at Design Limit	Mission Mix Life
Mid Fin	170D441425-11	Hinge #4 Right Fitting	1.97	429	38	163
Upper Fin	170D440602-21	Fin Tip Honeycomb Panel	1.2	244	39	187
Drag Chute	V070-220005	Panel - sidewall, fwd, middle	3.12	infinite	47	261
Drag Chute	V070-220038	Stinger Side Panel	3.12	infinite	8	51



Summary

Presenter MS/Travis Robinson

Date 1/27/10 Page 36

- SE&I provided an update to the Vertical Tail MEI acoustics environments for assessment
- TPS meets required FS of 1.4
 - Includes conservative MEI acceleration levels
- The VT/Drag Chute subsystems are low risk for exposure to MEI environment update
 - VT Vibration responses developed from DFI accelerometer measurements (includes MEI)
 - No calibration or processing concerns as with acoustic measurements
 - VT subsystem hardware are only attached to stiff rear spar (actuators, PDU)
 - Drag Chute subsystem design environment was MF004-014 Rev D (MEI)
 - Other very significant loads controlled subsystem design – mortar loads, chute loads
- Primary Structure Fatigue requires use of mission mix to provide adequate mission life
 - 42 missions on VT structure; 27 missions on drag chute structure (at end of Program)
 - Four parts do not meet life goal of 50 missions minimum using Design Limit environment (SF=4)
 - Using mission mix, all four exceed 50 missions
 - Use of VT mission mix provides relief of 4 to 6 times on mission life



MEI Instrumentation On Orbiter and TSM

Presenter MS/Travis Robinson

Date 1/27/10

Page 37

- **STS-130 MEI TSM Ground Instrumentation Modification**
 - Configuration approved at KSC ERB on 12/04/09
 - 3 sensors on LH2 TSM
 - 2 sensors on LOX TSM
 - Same type of IOP pressure transducers as STS-129
 - Drilling and installation performed in VAB
 - Drilling and tapping of holes completed on 12/10/09
 - Cable installation completed on 12/17/09
 - Transducer installation and testing planned for 01/18/10
 - ECD NLT 01/22/10
 - Procurement of Trig-Tek Microphone Calibrator in work
 - ETA mid Feb 2010 (8 week lead time)
 - Currently borrowing Langley's calibrator until end of Feb 2010



RTF Putty Repair Losses

Presenter	MS/Travis Robinson	
Date	1/27/10	Page 38

- 10 putty repairs liberated during STS-129 (identified post flight)
 - The masses were consistent with the masses provided in NSTS-60559

Mission	Vehicle	Losses	Mass Range (lbm)
STS-129	OV-104	10	0.00007 – 0.0012
STS-128	OV-103	2	0.0032 – 0.0097
STS-127	OV-105	2	0.0010 - 0.0013
STS-125	OV-104	2	0.0012 - 0.0045
STS-119	OV-103	3	0.0007 - 0.0036
STS-126	OV-105	1	0.0001 - 0.0047
STS-124	OV-103	2	0.0003 - 0.0021
STS-123	OV-105	5	0.0000 - 0.0061
STS-122	OV-104	2	0.0008 - 0.0026
STS-120	OV-103	5	0.0001 - 0.0120
STS-118	OV-105	8	0.0001 - 0.0019
STS-117	OV-104	10	0.0003 - 0.0010
STS-116	OV-103	5	0.0022 - 0.0059
STS-115	OV-104	8	0.0004 - 0.016
STS-121	OV-103	5	0.0029 - 0.0065
STS-114	OV-103	9	0.0045



RCC / Windows Putty Repair Debris Areas

Presenter MS/Travis Robinson

Date 1/27/10

Page 39

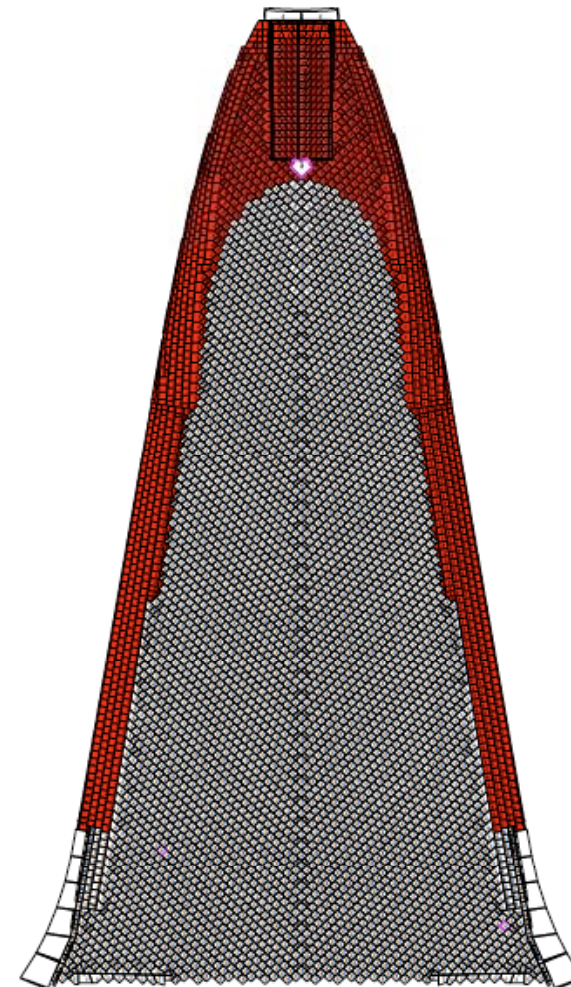
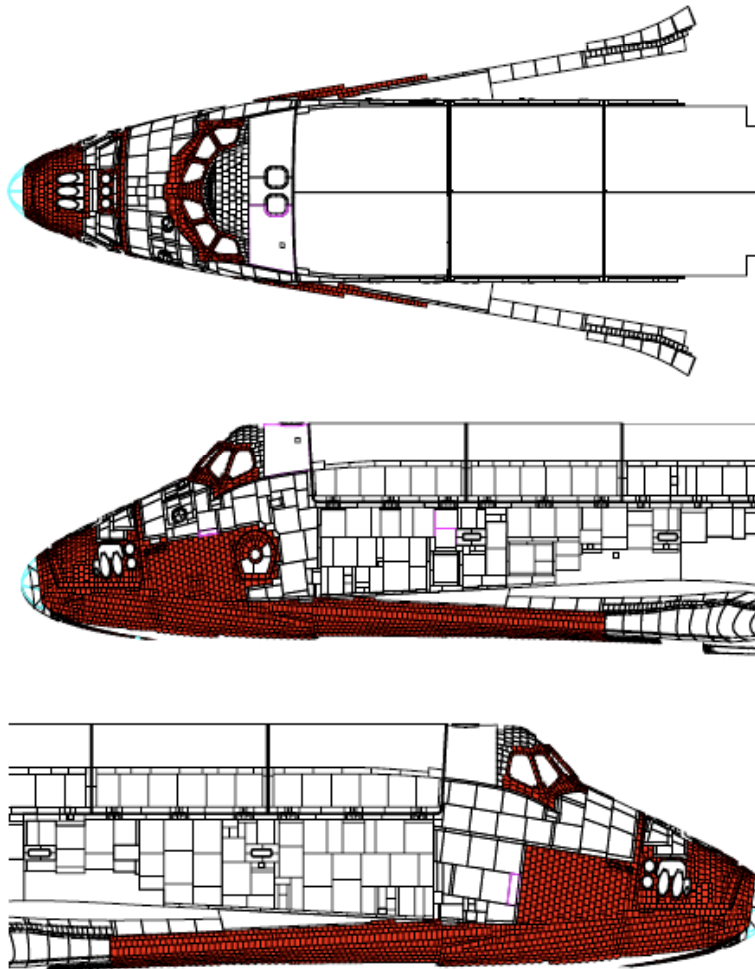



SPACE SHUTTLE PROGRAM

Space Shuttle Systems Engineering and Integration Office



Lower Surface Putty Repair Loss Locations Since RTF

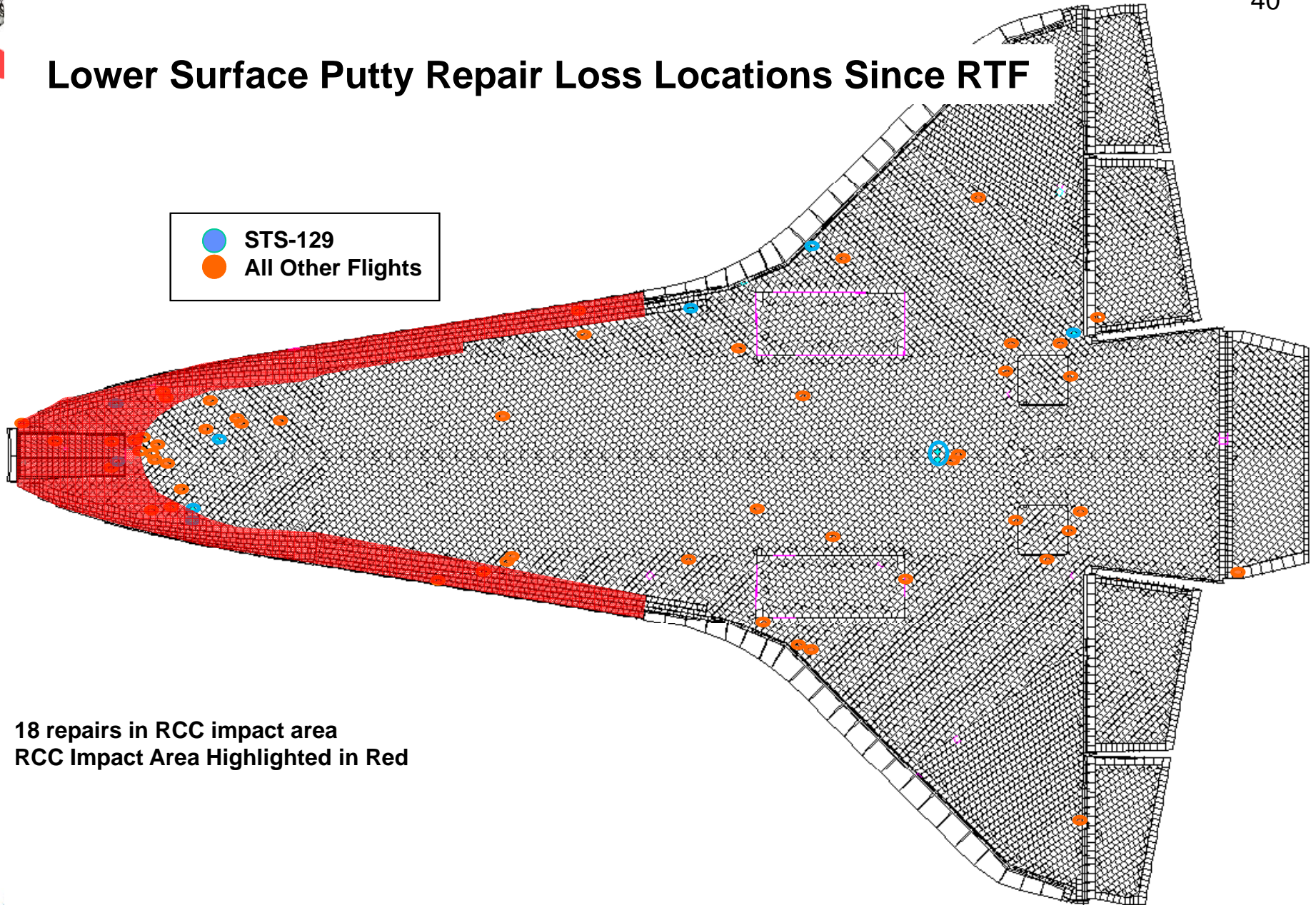
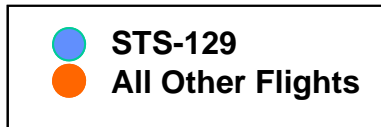

18 repairs in RCC impact area
RCC Impact Area Highlighted in Red



STS-127-I-004 ET TPS Loss at LO2 IFR 718	Presenter MS/Travis Robinson	
	Date 1/27/10	Page 41

- **ET/MAF Expanded Informal NDE Process to include prioritized LO2 IFR Ramps**
 - Includes all IFR's thru 553
- **ET/MAF expanded NDE capability in Bldg 420 to include Backscatter & Terahertz techniques**
- **Primary intent behind NDE recommendation at MAF IFR TIM was to “catch” large voids that could result in very large releases during ASTT**
 - SICB approval (10/13/09) of DIG recommended 0.01 lbm as NDE screening criteria
- **Current Engineering tool NDE capability with 90/95% confidence level for detecting smaller voids is acceptable – Certification not required**
 - POD studies show high confidence (90/95) in detecting >~0.5” voids at 8” depth
- **NDE will be performed prior to ET ship**
 - Low risk of very large void/divot based on flight history
 - Predictions are Conservative - There have been no releases of predicted divots to date
 - Probability of performing a repair for predicted divot at 0.01lbm is low
- **Minimizes Impacts to ET processing or schedule deliveries**
- **Accepts risk that if repair is required that it may have to be performed at KSC**
- **NSTS 60559 Vol II updated to document NDE process for LO2 IFRs**



Document Process for Assessment of TPS NDE Observations



• NDE Observation Assessment Approach

- Informal process developed by the ET Project and the SE&I directorate
- Implemented through the Debris Integration Group (DIG)
- Results of the assessment are reported at the appropriate milestone review in the COFR process

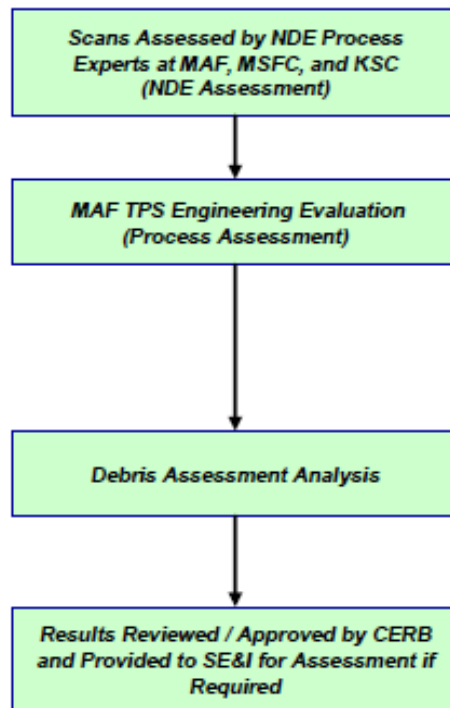

- *POD studies show high confidence (90/95) in detecting >~0.5" voids at 8" depth*
- *Indications > 0.9" x 0.4" are reported and provided for assessment*
- *Indications with spacing <0.4" are combined as single observations*

- *Process assessment performed to evaluate observations against known processing characteristic, part geometry and dissection data (RTF and V&V)*
- *Void-type indications sized & characterized as slot or cylinder based on aspect ratio of two largest dimensions*
- *Sizes compared to process performance data (RTF and verification and validation dissection data)*
- *Relative indication depth within ramp determined based on hardware configuration and experience with dissection data (distance to free surface)*

- *Conservative empirically derived divot / no-divot methodology used to assess release potential*
- *Maximum expected divot mass determined by placing defect at critical depth for divoting within specified depth range*
- *Mass calculated assuming conservative shape (conical frustum) with maximum material density*

- *Potential divot mass >NDE Screening Mass (0.01 lbm) provided to SE&I for Risk Assessment*
 - *SE&I will perform DTA/PRA for the specific location and potential divot identified*
 - *The ET Project will identify a repair option to mitigate the risk and identify risks associated with doing the candidate repair*
- *Data will be presented to the SSP Manager (thru SICB, Noon Board, or PRCB as appropriate) to consider with flight history on divot predictions in deciding whether to Repair or Use as Is.*



Integrated Hazard Report Changes Since STS-129

Presenter MS/Travis Robinson

Date 01/27/10

Page 43

•IDBR-01 ASCENT DEBRIS IMPACT TO SSV

- Flight Effectivity Update from STS-130 through STS-999
- No Change in Risk to overall report – remains Accepted Risk
- Added new cause, IDBR-01-AP “External Debris Impact to SSV due to SRB Viton Coated Nylon during ascent”
 - Introduced at STS-129 SSP FRR in Safety Issues Briefing
 - Added new cause as Remote/Catastrophic
 - Updated Appendix A IDBR-01 Fault Tree (Rev I)
- IDBR-01-I “External Debris Impact to the SSV During Ascent Due to ET Foam (PDL-1034/NCFI-26-007/BX-265) located at the LO2 Tank Ice/Frost Ramps and BX-265/BX-250/PDL-1034/NCFI-26-007 located on the LO2 Feedline Bellows PDL Drip Lip”
 - Added LO2 IFR NDE process to the verification section

•IMPS-01 CONTAMINATION IN THE INTEGRATED MPS H2 SYSTEM

- Flight Effectivity Update from STS-129 to STS-130

•IMPS-05 OVERPRESSURIZATION OF THE INTEGRATED MAIN PROPULSION SYSTEM HYDROGEN SYSTEM

- Flight Effectivity Update from STS-129 to STS-130



Integrated In-flight Anomalies(IFAs) Summary

Presenter MS/Travis Robinson

Date 01/27/10

Page 44

- **STS-129-I-001 “Unexpected Debris/Expected Debris Exceeding Mass Allowable Prior to Pad Clearance (Liftoff Debris)”**
 - Status – Dispositioned
- **STS-129-I-002 “Single Transient SRB I/O Error at Liftoff”**
 - Status – Dispositioned
- **STS-129-I-003 “ET TPS Losses on –Z Intertank”**
 - Status – Dispositioned
- **STS-129-I-004 “RH SRB Instafoam Cracks Near GN2 Purge Line”**
 - Status – Dispositioned



SPACE SHUTTLE PROGRAM

Space Shuttle Systems Engineering and Integration Office

NASA Johnson Space Center, Houston, Texas



Pre-decisional. Internal Use Only.

Presenter MS/Travis Robinson

Date 01/27/10

Page 45

Integrated Hazard Risk Matrix

Likelihood	Probable			
	Infrequent	2		13
	Remote	2	2	132
	Improbable	11	11	268
		Marginal	Critical	Catastrophic
		Severity		

Risk Summary
 21 of 38 IHR's are classified as Controlled Risk
 17 of 38 IHR's are classified as Accepted Risk
 * Previous Flight

Pre-decisional. Internal use Only.

Hazard Report #	Integrated Hazard Titles	Controlled					Accepted Risk					Total			
		Controlled Risk	remote-marginal	improbable-marginal	improbable-critical	improbable-catastrophic	Accepted Risk	probable-marginal	infrequent-marginal	remote-critical	remote-catastrophic		probable-critical	infrequent-critical	infrequent-catastrophic
"Accepted Risk" Hazard Reports															
IDBR-01	Ascent Debris Impact to SSV	7				7	29				23		6		
ICOM-01	Adverse Effects due to Intentional RF Environment	2				2	1			1					
IEME-01	Adverse Electromagnetic Effects (EME)	0					18			18					
IGNC-01	Ascent Trajectory Event Anomaly	13				13	1					1			
IMEO-01	Hazardous Environment in the Aft Compartment	0					4			1		3			
IMPS-01	Contamination in the Integrated MPS H2 System	0					2			1		1			
IMPS-02	Contamination in the Integrated MPS O2 System	0					1			1					
IMPS-03	Improper IMPS configuration during SSME Operation	11				11	3			3					
IMPS-04	Off-Nominal Purges	11				11	1			1					
IMPS-05	Over pressurization of the Integrated MPS H2 System	7				7	1			1					
IMPS-09	Hazardous Environment due to H2 External to SSV	4				4	6			5		1			
INEV-01	Exposure to Natural Environment Exceeds Capability of the Space Shuttle SSV Elements	17	1	1		15	45	1	1	42		1			
ISPR-04	SRB Hold Down Post (HDP) System Malfunction	1				1	1			1					
ISPR-05	SRB Umbilical System Malfunction	3				3	1			1					
ITHM-01	Exposure to Thermal Environment Exceed Capability of SSV	15	1	5	2	7	3	1	1	1					
IVLD-01	Exposure to Induced Environments Exceed Structural Capability of SSV	22				22	26			26					
ILIT-01	Adverse Effects of Lightning	0					6			6					
Accepted Risk Distribution Totals		(see next page)					149	0	2	2	132	0	0	13	0





Integrated Hazard Risk Matrix

"Controlled Risk" Hazard Reports																		
IARO-01	Aerodynamics Environment not per Specified Design	1			1	0												
IEPD-01	Inability to Power Critical Functions	8		3	5													
IFSI-01	ET/SRB System Interface Failure	6			6	0												
IFSI-02	ET/Orbiter System Interface Failure	10			10	0												
IFSI-03	SSME/Orbiter System Interface Failure	14			14	0												
IFSI-04	Outer Mold Line Configuration Error	3			3	0												
IFSW-01	Flight Software Generic Problems can cause loss of vehicle command and control	1			1	0												
IFSW-02	Erroneous Inputs to Flight Software can cause loss of vehicle command and control	9			9	0												
IMEO-02	Malfunction of Integrated Hydraulic System (Systems 1, 2 and 3)	4			4	0												
IMEO-03	SSME Nozzle/OMS Pod/ Body Flap Interference	2			2	0												
IMPS-06	Under pressurization of the Integrated MPS H2 System	7			7	0												
IMPS-07	Over pressurization of the Integrated MPS O2 System	7			7	0												
IMPS-08	Under pressurization of the Integrated MPS O2 System	7			7	0												
IMPS-12	Excessive O2 from ET/Orbiter/SSME External to SSV	7			7	0												
IMPS-15	LO2 Geyser Event during Cryo Loading	8			8	0												
IMPS-16	Loss of MPS He System	4			4	0												
IMPS-17	Inadvertent SSME Shutdown	3			3	0												
IPYR-01	Pyrotechnic System Malfunction	11			11	0												
ISPR-02	ET Vent Arm System (ETVAS) Umbilical System Malfunction	14			14	0												
ISPR-03	Tail Service Mast (TSM) T-0 Umbilical System Malfunction	40	5	6	29	0												
IVLD-02	System Instability Results In Structural Failure of SSV	13			13	0												
Controlled Risk Distribution Totals		292	2	11	11	268	149	0	2	2	132	0	0	13	0			



Integrated Hazard Risk Matrix Count Increase

Presenter	MS/Travis Robinson	
Date	01/27/10	Page 47

- **Infrequent Catastrophic**

- None

- **Remote Catastrophic**

- Added new cause, IDBR-01-AP “External Debris Impact to SSV due to SRB Viton Coated Nylon during ascent”

- Introduced at STS-129 SSP FRR in Safety Issues Briefing

- **Improbable Catastrophic**

- None



Integrated In Flight Anomalies (IIFAs)

Presenter MS/Travis Robinson

Date 01/27/10

Page 48

<p align="center"><u>IFA Number : Title</u></p> <p align="center">Description</p>	<p align="center">STS-130 Status and Rationale</p>
<p>▪ <u>STS-129-I-001: Unexpected Debris/Expected Debris Exceeding Mass Allowable Prior to Pad Clearance (Liftoff Debris)</u></p> <p>▪ Multiple pieces of debris were found on pad post-launch that include corrosion, liberated pad hardware, and foreign object debris or were captured in imagery observations</p>	<ul style="list-style-type: none"> • Risk Assessment indicates that given the proposed mitigations, observed debris poses no appreciable increase in risk. • Liftoff debris risk is currently characterized as infrequent, catastrophic due to significant uncertainties in controls and significant limitations in analysis. • Debris release has been mitigated for identified potential sources of critical debris by performing repairs and adding inspections for system-level components (e.g. MLP FIREX nozzles around the SSME Exhaust Hole; ETVAS cooling spray nozzles and plumbing; OIS electrical connector Dust Caps; and GVA hood knurled fasteners). Ongoing mitigations include FOD awareness, attrition-based hardware removal, routine inspections and monitoring for facility corrosion. <p>• Status - Dispositioned</p>



Integrated In Flight Anomalies (IIFAs)

Presenter MS/Travis Robinson	
Date 01/27/10	Page 49

<p align="center"><u>IFA Number : Title</u></p> <p align="center">Description</p>	<p align="center">STS-130 Status and Rationale</p>
<p>▪ <u>STS-129-I-002: Single Transient SRB I/O Error at Liftoff</u></p> <p>▪ During STS-129 liftoff, an SRB I/O error occurred on MDM LL2 (one of the two left SRB MDMs) via Launch Data Bus (LDB) 2.</p> <p>▪ Following the single transient error, SRB I/O operated nominally through SRB Separation.</p>	<ul style="list-style-type: none"> • From investigation, a single transient I/O error would be caused by the coincident timing of the disconnect of T-0 umbilical removing electrical power from the Data Bus Isolation Amplifier (DBIA) causing a short, less than 28 microsecond, noise burst on the LDB2. If the noise burst collides with a simultaneous transmission on the bus, an I/O error is recorded. • DPS system is designed to accommodate single I/O error. Nominal removal of the T-0 umbilical can generate only a single I/O error. • There is no effect on flight control or other flight systems, as the data is not used by the GPCs. • Status – Dispositioned



Integrated In Flight Anomalies (IIFAs)

Presenter MS/Travis Robinson

Date 01/27/10

Page 50

<p align="center"><u>IFA Number : Title</u></p> <p align="center">Description</p>	<p align="center">STS-130 Status and Rationale</p>
<p>▪ <u>STS-129-I-003: ET TPS Losses on -Z Intertank</u></p> <p>▪ Crew hand held camera imagery for ET-133 (STS-129) revealed eight thermal protection system (TPS) losses on the -Z side of the External Tank (ET) Intertank (IT).</p> <p>▪ The timing of release was indeterminate since ascent imagery of the -Z side of the ET was limited.</p> <p>▪ All of the losses were located outside of the critical debris zone and therefore did not pose a threat to the orbiter.</p>	<ul style="list-style-type: none"> • The proximate cause appears to be low bond adhesion of the TPS due to contamination. • The ET-133 (STS-129) losses were similar to those on ET-131 (STS-127) in that they also appeared to correlate with the location of the Michoud Assembly Facility (MAF) platforms used to clean the IT. The correlation was particularly noticeable for both ET-131 and ET-133 on the -Z side at the Xt-1057 platform level. • However, in the absence of a root cause or a conclusive correlation to tank processing, the ET will need to be cleared for each flight based on the bond adhesion tests conducted. • Bond Adhesion tests were performed on ET-134 (STS-130) and the results give some indication that there may be no gross TPS bond adhesion issues in the high-risk areas or at the +Z Xt-1057 level. • Status – Dispositioned



Integrated In Flight Anomalies (IIFAs)

Presenter MS/Travis Robinson	
Date 01/27/10	Page 51

<p align="center"><u>IFA Number : Title</u></p> <p align="center">Description</p>	<p align="center">STS-130 Status and Rationale</p>
<p>▪ <u>STS-129-I-004: RH SRB Froth Pak Cracks Near GN2 Purge Line</u></p> <p>▪ A crack in the right hand SRB Froth Pak foam near the GN2 Purge line was observed.</p> <p>▪ The ascent imagery was reviewed and it appears that the foam was still intact up to 66 seconds MET.</p>	<ul style="list-style-type: none"> • The investigation concluded that movement of a shop aid resulted in separation of the shop aid halves and allowed foam expansion into the GN2 purge probe area. • As a corrective action, position jacks were implemented to ensure the shop aid remains in place during foaming operations and reference marks were created to provide visual verification that the shop aid remains in place during foaming operations and assists in post-foaming inspections. • Additionally, Vaseline application to the shop aid seams has been implemented to mitigate foam intrusion and a tool has been designed to physically verify proper clearance between the foam and the GN2 purge probe. • For STS-130, the foam application with the enhanced shop aids and verifications will be performed no earlier than 1/18/10. Engineering presence is required during those foaming operations. • Status - Dispositioned



Integrated In Flight Anomalies (IIFAs)

Presenter MS/Travis Robinson	
Date 01/27/10	Page 52

<p align="center"><u>IFA Number : Title</u></p> <p align="center">Description</p>	<p align="center">STS-130 Status and Rationale</p>
<p>▪ <u>STS-128-I-001: LH2 PV-12 Inboard Fill and Drain valve did not indicate closed when commanded</u></p> <ul style="list-style-type: none"> • On 8/26 launch attempt, during transition to reduced fast fill, LH2 inboard fill & drain valve (PV12) position indicator did not indicate closed when valve was commanded closed. Violation of LCC MPS-04 • After ET de-tank, valve was cycled in ambient temperature conditions & closed indications were received • On 08/28/09 launch attempt, valve-closed indication was received 	<ul style="list-style-type: none"> ▪ Failure investigation to date shows no evidence of a systemic issue. ▪ Of all the possible failure causes, system contamination is the only integrated cause that has been identified. ▪ Root cause determination in work. However, the anomaly will be closed as unexplained with the most likely cause as contamination. ▪ Retaining the current LCC protection ensures the Fill and Drain valves are closed (in the appropriate configuration) for launch, which mitigates the hazard risks associated with this IIFA. ▪ Status - Dispositioned



Integrated In Flight Anomalies (IIFAs)

Presenter	MS/Travis Robinson	
Date	01/27/10	Page 53

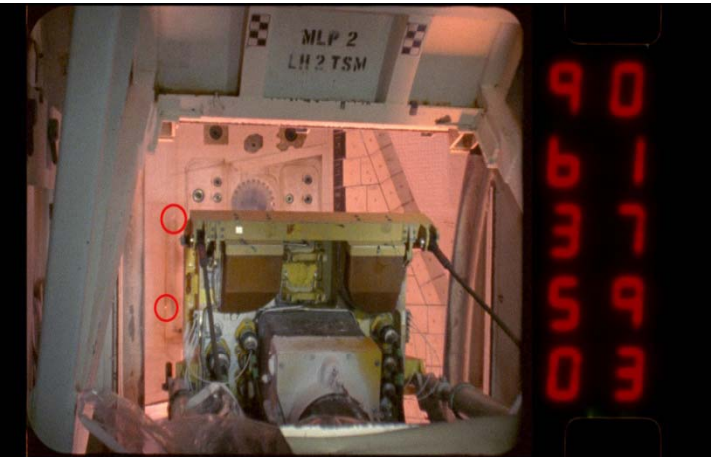
<p><u>IFA Number : Title</u></p> <p>Description</p>	<p>STS-130 Status and Rationale</p>
<p>▪<u>STS-128-I-002: Ice External to the LH2 T-0 Umbilical</u></p> <ul style="list-style-type: none"> •On 8/25 launch attempt, ice buildup was observed on –Z side of LH2 T-0 Umbilical, bridging over to Orbiter TPS. LCC ICE-01 waiver LW-114 approved. •On 8/28 launch attempt, ice observed bridging from the T-0 plate to Orbiter. LCC ICE-01 waiver LW-116 approved. 	<ul style="list-style-type: none"> •Ice/frost build-up outside peripheral seal on LH2 T-0 Umbilical seen on 3 flights since STS-126 •NSTS 08303 has been updated with acceptable definition of Ice/frost buildup on Orbiter at this interface •Umbilical seals inspected & verified integrity •The DTA results indicate credible transport to aft locations of orbiter downstream of T-0 umbilicals ▪Previous improvements to assist in detecting ice near umbilical or damage caused by ice liberation: <ul style="list-style-type: none"> ▪KSC Final Inspection Team (FIT) to use telescopic camera & heightened awareness during inspections ▪KSC IAT to expedite T-0 imagery review to reduce review time by ~1 day ▪JSC MOD implemented on-orbit inspections of aft fuselage and OMS pod area ▪STS-130 improvements include increased seal inspections and mitigations to reduce water intrusion ▪Status – Dispositioned

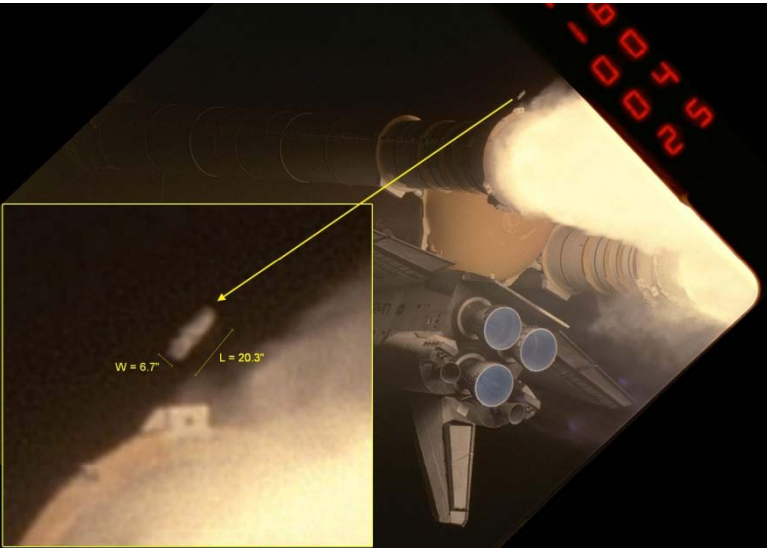

Integrated In Flight Anomalies (IIFAs)

<p align="center"><u>IFA Number : Title</u></p> <p align="center">Description</p>	<p align="center">STS-130 Status and Rationale</p>
<ul style="list-style-type: none"> ▪ <u>STS-128-I-005: Debris Observed Near RH SRB Aft Skirt HDP #4 Foot</u> ▪ Debris appears to be flexible fabric-like material, 68"x11", max of 2.29 lb ▪ Origination point not observed in videos 	<ul style="list-style-type: none"> ▪ SRB aft skirt viton coated nylon assemblies are the only credible source for this debris. ▪ Viton is an expected debris source, but this debris exceeds the 0.3 lbm allowable. ▪ Initial Debris Transport Analysis (DTA) indicates potential for Viton to impact to other elements. ▪ Added new cause, IDBR-01-AP "External Debris Impact to SSV due to SRB Viton Coated Nylon during ascent" to capture potential transport ▪ Status – Dispositioned



Integrated In Flight Anomalies (IIFAs)

Presenter	MS/Travis Robinson	
Date	01/27/10	Page 55

<p align="center"><u>IFA Number : Title</u></p> <p align="center">Description</p>	<p align="center">STS-130 Status and Rationale</p>
<ul style="list-style-type: none"> ▪ <u>STS-127-I-003: LH2 Leak at ET Ground Umbilical Carrier Plate (GUCP)</u> ▪ During first two launch attempts of ET-131/STS-127, hydrogen leak detectors 23 and 25 located at the ET/GUCP interface observed leakage exceeding Launch Commit Criteria (LCC) Haz-09 limit of 40,000 ppm, resulting in launch scrubs 	<ul style="list-style-type: none"> ▪ Failure also seen on STS-119 ▪ Changes implemented as a result of STS-119 and STS-127 failures <ul style="list-style-type: none"> ▪ Consistent method of flight seal inspection developed & put into place at MAF & KSC to ensure damaged seal could not be utilized ▪ Concentricity tool & tighter tolerance guide pins were developed to aid installation of the GUCP ▪ Two design changes implemented: washers added to GUCP feet to prevent lateral movement during external loading of hardware; and a 2-piece flight seal is to be used, which has greater resiliency & provides additional capability to compensate for misalignment Both changes will be used for remainder of flights ▪ Safety risk is mitigated through Leak Detectors 23 and 25 that monitor this interface for any hydrogen leaks ▪ Status - Dispositioned



Integrated In Flight Anomalies (IIFAs)

Presenter MS/Travis Robinson	
Date 01/27/10	Page 56

<p align="center"><u>IFA Number : Title</u></p> <p align="center">Description</p>	<p align="center">STS-130 Status and Rationale</p>
<p>▪ <u>STS-127-I-004: ET TPS Loss at LO2 IFR 718</u></p> <ul style="list-style-type: none"> • Divot seen on the LO2 Ice/Frost ramp (IFR) @ XT718 aft inboard corner. Estimated ~ 0.044 lbm • TPS debris was also observed from same ramp station on STS-125 	<p>After STS-127, SE&I changed the risk classification from “Remote, Catastrophic” to “Infrequent, Catastrophic” due to uncertainties in physics modeling of release mechanisms</p> <ul style="list-style-type: none"> • Based on the results of a TIM held on this topic, the following improvements were implemented <ul style="list-style-type: none"> • Increase level of NDE to include all horizontally poured LO2 IFRs • Audit design/process for improvements to reduce debris potential • ET Project performed NDE for STS-130/ET-134 IFRs with acceptable results • NSTS-60559, Volume II has been updated to document the ET Project’s NDE process. • IDBR-01 has been updated to reflect NSTS-60559 update. <p>▪ Status - Dispositioned</p>



Integrated In Flight Anomalies (IIFAs)

Presenter MS/Travis Robinson	
Date 01/27/10	Page 57

<p align="center"><u>IFA Number : Title</u></p> <p align="center">Description</p>	<p align="center">STS-130 Status and Rationale</p>
<p>▪ <u>STS-127-I-007: Layer of MCC-1 Missing on Aft Skirt Acreage</u></p> <p>• During STS-127 Post-flight assessment of SRB hardware, one incident of Marshall Convergent Coating (MCC-1) loss on LH Aft Skirt and two incidences of MCC-1 loss on RH Aft Skirt) were discovered</p>	<ul style="list-style-type: none"> • MCC-1 is not expected to liberate during ascent or post SRB Separation. It is classified as unexpected debris • All three liberations occurred in a recovery error overlap area, where spray application was interrupted and re-initiated. • Spray process interruptions due to mechanical problems or controlled parameter tolerance violations is most likely cause • For STS-129 through STS-131, the hardware does not have any overlap recovery areas and are not prone to the same failures as occurred on STS-127 • Status - Dispositioned

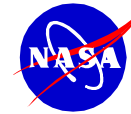

Integrated In Flight Anomalies (IIFAs)

Presenter MS/Travis Robinson

Date **01/27/10**

Page 58

<p align="center"><u>IFA Number : Title</u></p> <p align="center">Description</p>	<p align="center">STS-130 Status and Rationale</p>
<p>▪<u>STS-126-I-004: MPS GH2 Pressure Flow Control Valve open with no command</u></p> <p>▪During 2nd stage, there was uncommanded drop in SSME #2 hydrogen outlet pressure. Data was indicative of flow control valve (FCV) #2 not fully cycling to high flow position. Valves #1 & 3 compensated, no performance impact</p> <p>▪Post-flight inspection revealed an FCV hardware failure, with approximately 1/4 of the engine #2 FCV's poppet head missing. This resulted in the pressure drop seen in flight data</p>	<p>▪Poppet failures could cause ET venting causing a flammable atmosphere outside the ET, or poppet debris could puncture a line causing an explosive atmosphere in the aft compartment. The increase in risk due to these hazards has been documented in previous IIFA closures on this topic and accepted by the SSP</p> <p>▪Improved eddy current techniques and acceptance criteria have enhanced the ability to recognize & track growth in crack indications. This reduces the risk of a poppet piece liberating in one flight</p> <p>▪STS-130 poppets inspected to ensure no cracks present, using improved inspection capabilities</p> <p>▪Orbiter Project presented FCV closure to the 1/07/10 PRCB and has closed the open work in IMPS-01 and IMPS-05</p> <p>▪IMPS-01 and IMPS-05 will be updated prior to STS-131</p> <p>▪Status - Dispositioned</p>



Lighting Predicts 7 Feb – 31 Mar

Presenter	MS/Travis Robinson	
Date	1/27/10	Page 59

Launch

- Feb 7 – Mar 3: **DARK**
- Mar 4 – Mar 31: **DAYLIGHT**

ET Sep Imagery

- Feb 7 – Mar 4: **DARK****
- Mar 5 – Mar 31: **DAYLIGHT**

Handheld ET (post-pitcharound) Imagery

- Feb 7 – Feb 8: **DAYLIGHT, Non-Optimal**
- Feb 9 – Mar 6: **DARK**
- Mar 7: **DAYLIGHT, Non-Optimal**
- Mar 8 – Mar 31: **DAYLIGHT**

Post ET-Sep Mnvr

- Feb 7 – Feb 8: **Nominal +X, Nominal Pitch**
- Feb 9 – Mar 6: **Nominal +X**, No Pitch**
- Mar 7 – Mar 31: **Nominal +X, Nominal Pitch**

**For launch dates of Feb 9th – Mar 4th: MOD plans for a modified +X (20sec) vs. the nominal (11 sec) burn.

MOD, SE&I Agreements for Crew HH ET Photography

1. Pitch mnvr for handheld ET photography will not be attempted if nominal photography time is dark.
2. Pitch mnvr will not be performed "late"
3. Pitch mnvr and ET handheld photography will not be attempted on LON mission

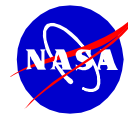

Lighting Predicts

Pre-decisional. Internal Use Only.

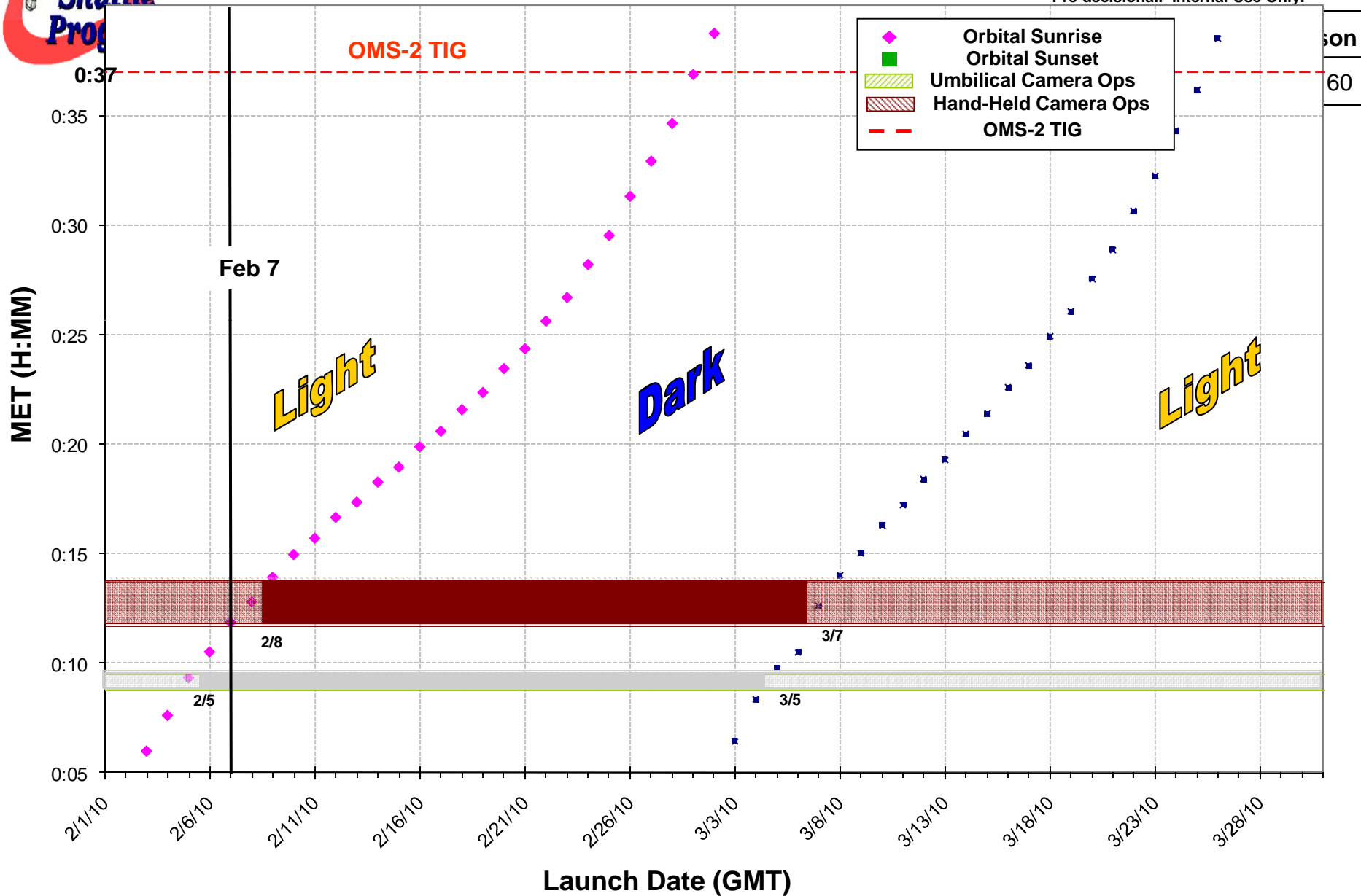



SPACE SHUTTLE PROGRAM
Space Shuttle Systems Engineering and Integration (SE&I)
 NASA Johnson Space Center, Houston, Texas



Pre-decisional. Internal Use Only.

Lighting Predicts (cont.)

Presenter	MS/Travis Robinson	
Date	1/27/10	Page 61

Launch Date (2010 GMT)	Launch	Umbilical Ops (8:46 - 9:30 MET)	Hand-Held Ops (11:43 - 13:43 MET)	Pitch-Up Maneuver
Feb 01 - Feb 04	DARK	DAYLIGHT	DAYLIGHT	Yes
Feb 05	DARK	Partly DAYLIGHT	DAYLIGHT	
Feb 06	DARK	DARK	DAYLIGHT	
Feb 07 - Feb 08	DARK	DARK	Partly DAYLIGHT	
Feb 09 - Mar 03	DARK	DARK	DARK	No
Mar 04	DAYLIGHT	DARK	DARK	
Mar 05 - Mar 06	DAYLIGHT	DAYLIGHT	DARK	Yes
Mar 07	DAYLIGHT	DAYLIGHT	Partly DAYLIGHT	
Mar 08 - Mar 31	DAYLIGHT	DAYLIGHT	DAYLIGHT	



STS-130 FLIGHT SOFTWARE SUMMARY

Presenter USA/John Magley

Date 01/27/10

Page 62

- **Third flight of PASS and BFS Operational Increment 34 (OI-34) and MEDS Multifunction Display Unit Function (MDUF) VI 6.00**
 - No logic changes from the STS-129 software system
- **First flight of MEDS Integrated Display Processor (IDP) VI 7.01**
 - Minor update corrected a condition (DR 121432) that could result in an IDP Halt in an unlikely operator error scenario where specific types of invalid data are broadcast on a DK bus
- **Fourth flight of MAGRS-3S Link 613-9966-008 GPS FSW**
 - No changes from STS-129 software



FSW READINESS SUMMARY

Presenter	USA/John Magley	
Date	01/27/10	Page 63

- **Integrated Avionics Verification (IAV) is complete**
 - A total of 16 cases were executed and analyzed in support of STS-130
 - Included testing of full flight system (PASS/BFS STS-130/OI-34 with flight-specific I-Loads; MEDS VI 7.01/6.00 (IDP/MDUF); MAGRS-3S Link 8; and SSME AD08/DA05 software)
- **SAIL facility will be in a condition of readiness for mission support**
- **Formal Software Readiness Review (SRR) was conducted on 12/17/09**
 - No known constraints
- **With the completion of planned open work, FSW will be ready to support STS-130 launch**



LAUNCH ON NEED STATUS

Presenter USA/John Magley

Date 01/27/10

Page 64

- In the event of call-up, the STS-131 flight software products would be flown on OV-103
 - OI-34 STS-131 Base Load and associated products
 - Flight specific I-Load patches for STS-131 (full payload bay)
 - OI-34 compatible MEDS IDP and MDUF software (VI 7.01/6.00)
 - MAGRS-3S Link 8
- Completion of the development and verification of flight-specific FSW products for STS-131 will be performed in time to support the 03/18/10 target launch date
- Formal Software Readiness Review to be conducted after call-up



STS-130 FLIGHT SOFTWARE FLIGHT READINESS STATEMENT

Presenter	USA/John Magley	
Date	01/27/10	Page 65

Full compliance with SPOC Flight Software CoFR requirements is documented in the STS-130 Software Readiness Review packages along with signed readiness statements and identification of open work.

Pending completion of standard open work and identified non-standard open work, Flight Software is ready to support flight.

Original signed by Patti A. French 01/08/10

Patti A. French **Date**
Associate Program Manager
USA Flight Software



STS-130 SYSTEM LEVEL WAIVERS

Presenter USA/John Magley

Date 01/27/10

Page 66

- No changes or waivers to NSTS 07700 Vol X impacting software for STS-130
- No new software-induced waivers to NSTS 07700 Vol X



Payload and General Support Computer Readiness – STS-130

Presenter MS/Travis Robinson	
Date 01/27/10	Page 67

Hardware and Software Summary

- STS-130 will be the seventeenth flight of the IBM ThinkPad A31p PGSC
 - **Six PGSC units** - None currently planned for ISS transfer
 - **New Software** – None
 - **Eleventh flight of the A31p Docking Station** (OCA and WinDecom)
 - **Ninth flight of Netgear Wireless Access Point.**
 - Note: No network issues observed during STS-129

IFA Summary

- OCA 48 Mbps High Data Rate initial failure (recovered for Late Inspection with backup cable)
 - **Primary cause was failed OCA cable**
 - Cable repaired (but not planned for flight manifest)
 - Broken Wire\Photos provided to RITF for analysis.
 - CR submitted for post-installation (in-vehicle) testing of OCA cable
 - DTV-MUX misconfiguration reoccurred – (enhanced training efforts undertaken)

PGSC Milestones

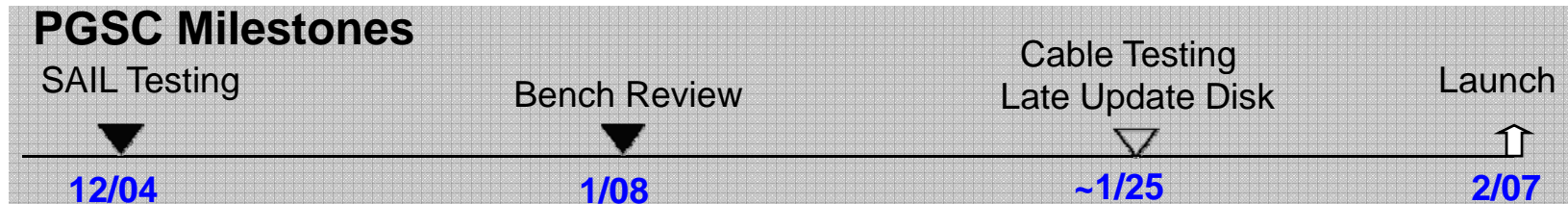



SPACE SHUTTLE PROGRAM
Space Shuttle Systems Engineering and Integration (SE&I)
NASA Johnson Space Center, Houston, Texas



Pre-decisional. Internal Use Only.

STS-129 Non Standard Open Work

Presenter MS/Travis Robinson

Date 01/27/10

Page 68

	ECD
Systems Safety -Disposition of CR S050425JV, IDBR-01, Ascent Debris Impact to SSV	01/26/10



Alternate/Dissenting Opinions

Presenter	MS/Travis Robinson	
Date	01/27/10	Page 69

- **Alternate/dissenting opinions were actively solicited at the SE&I STS-130 Pre-FRR.**
 - No dissenting opinions were identified.