

Flight Plan

STS-105/ISS-7A.1

(STS-105 FRR Trajectory)

**Mission Operations Directorate
Operations Division**

**Final
July 9, 2001**

For the latest working copy of the Flight Plan, visit
<https://mod.jsc.nasa.gov/do4/flightplan/fp.cfm?id=105>

EVENT	MET		CDT	
Launch	00	00:00	Thu	8/09/01 16:38
NC-1	00	03:33	Thu	8/09/01 20:11
NC-2	00	19:22	Fri	8/10/01 12:00
NC-3	01	02:11	Fri	8/10/01 18:49
NH	01	17:17	Sat	8/11/01 09:55
NC-4	01	18:02	Sat	8/11/01 10:40
Ti	01	19:36	Sat	8/11/01 12:14
Dock	01	21:56	Sat	8/11/01 14:34
EXP-3 Transferred	02	22:10	Sun	8/12/01 14:48
Reboost 1	03	21:20	Mon	8/13/01 13:58
Reboost 2	04	18:55	Tue	8/14/01 11:33
EVA 1	05	17:05	Wed	8/15/01 09:43
Reboost 3	06	15:36	Thu	8/16/01 08:14
EVA 2	07	17:05	Fri	8/17/01 09:43
MPLM Berth	08	22:50	Sat	8/18/01 15:28
Undock	09	18:16	Sun	8/19/01 10:54
Simplexat Deploy	09	21:12	Sun	8/19/01 13:50
OA Burn	09	22:31	Sun	8/19/01 15:09
D/O TIG	11	18:37	Tue	8/21/01 11:15
Landing	11	19:39	Tue	8/21/01 12:17

National Aeronautics and
Space Administration

Lyndon B. Johnson Space Center
Houston, Texas



Verify this is the correct version for the pending operation (training, simulation, or flight).
Electronic copies of FDF books are available. URL: <http://fltproc.jsc.nasa.gov/dfd>

MISSION OPERATIONS DIRECTORATE

STS-105 FLIGHT PLAN

FINAL
July 9, 2001

PREPARED BY:



Terry L. Clancy
Book Manager, Lead FAO

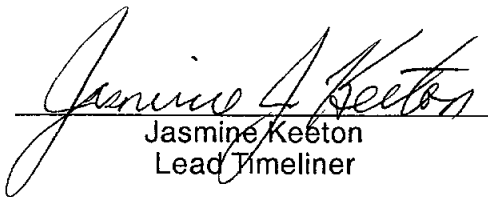

Jasmine Keeton
Lead Timeliner



Loi Nguyen
Lead RPE

APPROVED BY:



Linda DeLapp
Lead, Flight Planning
and Pointing Group

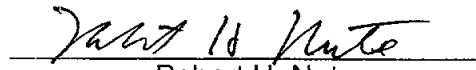

Robert H. Nute
Chief, Flight Planning Branch

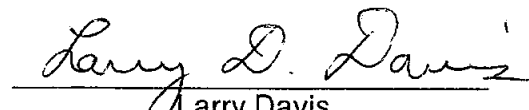

Larry Davis
Chief, Operations Division

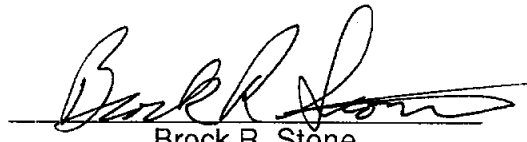

Brock R. Stone
Director of Operations

This document is under the configuration control of the Crew Procedures Control Board (CPCB). All proposed changes must be submitted on JSC Form 482 to DO3/FDF Manager.

Additional distribution of this book for official use must be requested in writing to DO3/FDF Manager. The request must include justification and requester's name, organization, position, and phone number. Contractor requests are made through the NASA or DOD organization supported. Deletions, reduction in quantity, or change of address may be submitted to DO3/FDF Management Office, 281-244-1184.

Incorporates the following:

482#: FLT PLN – 1982

AREAS OF TECHNICAL RESPONSIBILITY

Book Manager/Lead FAO	DO4/T. Clancy	281-483-5369
Lead Timeliner	DO4/J. Keeton	281-483-6882
Lead Pointer	DO4/B. Kelly	281-244-1141
Lead Ops Planner	DO4/J. Aldape	281-244-1113
Lead RPE	DO4/L. Nguyen	281-244-5432

FLIGHT PLAN
STS-105

LIST OF EFFECTIVE PAGES

FINAL 07/09/01

Sign Off	* 105/FIN	2-20A	105/FIN
ii	* 105/FIN	2-20B	105/FIN
iii	* 105/FIN	2-21A	105/FIN
iv	* 105/FIN	2-21B	105/FIN
v	* 105/FIN	2-22A	105/FIN
vi	* 105/FIN	2-22B	105/FIN
vii	* 105/FIN	2-23A	105/FIN
viii	* 105/FIN	2-23B	105/FIN
ix	* 105/FIN	2-24	105/FIN
x	* 105/FIN	2-25	105/FIN
1-1	105/FIN	2-26	105/FIN
1-2	105/FIN	2-27	105/FIN
1-3	105/FIN	2-28	105/FIN
1-4	105/FIN	3-1	105/FIN
2-1	105/FIN	3-2	105/FIN
2-2	105/FIN	3-3	105/FIN
2-3	105/FIN	3-4	105/FIN
2-4	105/FIN	3-5	105/FIN
2-5	105/FIN	3-6	105/FIN
2-6A	105/FIN	3-7	105/FIN
2-6B	105/FIN	3-8	105/FIN
2-7A	105/FIN	3-9	105/FIN
2-7B	105/FIN	3-10	105/FIN
2-8A	105/FIN	3-11	105/FIN
2-8B	105/FIN	3-12	105/FIN
2-9A	105/FIN	3-13	105/FIN
2-9B	105/FIN	3-14	105/FIN
2-10A	105/FIN	3-15	105/FIN
2-10B	105/FIN	3-16	105/FIN
2-11A	105/FIN	3-17	105/FIN
2-11B	105/FIN	3-18	105/FIN
2-12A	105/FIN	3-19	105/FIN
2-12B	105/FIN	3-20	105/FIN
2-13A	105/FIN	3-21	105/FIN
2-13B	105/FIN	3-22	105/FIN
2-14A	105/FIN	3-23	105/FIN
2-14B	105/FIN	3-24	105/FIN
2-15A	105/FIN	3-25	105/FIN
2-15B	105/FIN	3-26	105/FIN
2-16A	105/FIN	3-27	105/FIN
2-16B	105/FIN	3-28	105/FIN
2-17A	105/FIN	3-29	105/FIN
2-17B	105/FIN	3-30	105/FIN
2-18A	105/FIN	3-31	105/FIN
2-18B	105/FIN	3-32	105/FIN
2-19A	105/FIN	3-33	105/FIN
2-19B	105/FIN	3-34	105/FIN

* - Omit from flight book

3-35	105/FIN	3-89	105/FIN
3-36	105/FIN	3-90	105/FIN
3-37	105/FIN	3-91	105/FIN
3-38	105/FIN	3-92	105/FIN
3-39	105/FIN	3-93	105/FIN
3-40	105/FIN	3-94	105/FIN
3-41	105/FIN	3-95	105/FIN
3-42	105/FIN	3-96	105/FIN
3-43	105/FIN	3-97	105/FIN
3-44	105/FIN	3-98	105/FIN
3-45	105/FIN	3-99	105/FIN
3-46	105/FIN	3-100	105/FIN
3-47	105/FIN	3-101	105/FIN
3-48	105/FIN	3-102	105/FIN
3-49	105/FIN	3-103	105/FIN
3-50	105/FIN	3-104	105/FIN
3-51	105/FIN	3-105	105/FIN
3-52	105/FIN	3-106	105/FIN
3-53	105/FIN	3-107	105/FIN
3-54	105/FIN	3-108	105/FIN
3-55	105/FIN	3-109	105/FIN
3-56	105/FIN	3-110	105/FIN
3-57	105/FIN	3-111	105/FIN
3-58	105/FIN	3-112	105/FIN
3-59	105/FIN	3-113	105/FIN
3-60	105/FIN	3-114	105/FIN
3-61	105/FIN	3-115	105/FIN
3-62	105/FIN	3-116	105/FIN
3-63	105/FIN	3-117	105/FIN
3-64	105/FIN	3-118	105/FIN
3-65	105/FIN	3-119	105/FIN
3-66	105/FIN	3-120	105/FIN
3-67	105/FIN	3-121	105/FIN
3-68	105/FIN	3-122	105/FIN
3-69	105/FIN	3-123	105/FIN
3-70	105/FIN	3-124	105/FIN
3-71	105/FIN	3-125	105/FIN
3-72	105/FIN	3-126	105/FIN
3-73	105/FIN	3-127	105/FIN
3-74	105/FIN	3-128	105/FIN
3-75	105/FIN	3-129	105/FIN
3-76	105/FIN	3-130	105/FIN
3-77	105/FIN	3-131	105/FIN
3-78	105/FIN	3-132	105/FIN
3-79	105/FIN	3-133	105/FIN
3-80	105/FIN	3-134	105/FIN
3-81	105/FIN	3-135	105/FIN
3-82	105/FIN	3-136	105/FIN
3-83	105/FIN	3-137	105/FIN
3-84	105/FIN	3-138	105/FIN
3-85	105/FIN	3-139	105/FIN
3-86	105/FIN	3-140	105/FIN
3-87	105/FIN	3-141	105/FIN
3-88	105/FIN	3-142	105/FIN

4-1	105/FIN
4-2	105/FIN
4-3	105/FIN
4-4	105/FIN
4-5	105/FIN
4-6	105/FIN
4-7	105/FIN
4-8	105/FIN
5-i	* 105/FIN
5-ii	* 105/FIN
5-1	* 105/FIN
5-2	* 105/FIN
5-3	* 105/FIN
5-4	* 105/FIN
5-5	* 105/FIN
5-6	* 105/FIN
6-1	* 105/FIN
6-2	* 105/FIN
6-3	* 105/FIN
6-4	* 105/FIN
6-5	* 105/FIN
6-6	* 105/FIN
7-1	* 105/FIN
7-2	* 105/FIN
7-3	* 105/FIN
7-4	* 105/FIN
8-1	* 105/FIN
8-2	* 105/FIN
8-3	* 105/FIN
8-4	* 105/FIN
8-5	* 105/FIN
8-6	* 105/FIN
8-7	* 105/FIN
8-8	* 105/FIN
8-9	* 105/FIN
8-10	* 105/FIN
8-11	* 105/FIN
8-12	* 105/FIN
8-13	* 105/FIN
8-14	* 105/FIN
8-15	* 105/FIN
8-16	* 105/FIN
8-17	* 105/FIN
8-18	* 105/FIN
8-19	* 105/FIN
8-20	* 105/FIN

* - Omit from flight book

STS-105 FLIGHT PLAN FABRICATED ITEMS

<u>Title</u>	<u>Ref. Page</u>	<u>Item No.</u>
DAP A, DAP B TOC	8-2	FLT PLN-1a/105/O/A
(back)	8-2	FLT PLN-1b/105/O/A
DAP A	8-3	FLT PLN-2a/105/O/A
DAP A1	8-3	FLT PLN-2b/105/O/A
A1	8-3	FLT PLN-3a/105/O/A
DAP A2	8-3	FLT PLN-3b/105/O/A
A2	8-4	FLT PLN-4a/105/O/A
DAP A3	8-4	FLT PLN-4b/105/O/A
A3	8-4	FLT PLN-5a/105/O/A
DAP A4	8-4	FLT PLN-5b/105/O/A
A4	8-5	FLT PLN-6a/105/O/A
DAP A5	8-5	FLT PLN-6b/105/O/A
A5	8-5	FLT PLN-7a/105/O/A
DAP A6	8-5	FLT PLN-7b/105/O/A
A6	8-6	FLT PLN-8a/105/O/A
DAP A7	8-6	FLT PLN-8b/105/O/A
A7	8-6	FLT PLN-9a/105/O/A
DAP A8	8-6	FLT PLN-9b/105/O/A
A8	8-7	FLT PLN-10a/105/O/B
DAP A9	8-7	FLT PLN-10b/105/O/A
A9	8-7	FLT PLN-11a/105/O/B
DAP A10	8-7	FLT PLN-11b/105/O/A
A10	8-8	FLT PLN-12a/105/O/A
DAP A11	8-8	FLT PLN-12b/105/O/A
A11	8-8	FLT PLN-13a/105/O/B
DAP A12	8-8	FLT PLN-13b/105/O/A
A12	8-9	FLT PLN-14a/105/O/A
DAP A13	8-9	FLT PLN-14b/105/O/A
A13	8-9	FLT PLN-15a/105/O/A
DAP A14	8-9	FLT PLN-15b/105/O/A
A14	8-10	FLT PLN-16a/105/O/A
DAP A15	8-10	FLT PLN-16b/105/O/A
A15	8-10	FLT PLN-17a/105/O/B
(Blank)	8-10	FLT PLN-17b/105/O/A
DAP B	8-11	FLT PLN-18a/105/O/A
DAP B1	8-11	FLT PLN-18b/105/O/A
B1	8-11	FLT PLN-19a/105/O/A
DAP B2	8-11	FLT PLN-19b/105/O/A
B2	8-12	FLT PLN-20a/105/O/A
DAP B3	8-12	FLT PLN-20b/105/O/A
B3	8-12	FLT PLN-21a/105/O/A
DAP B4	8-12	FLT PLN-21b/105/O/A
B4	8-13	FLT PLN-22a/105/O/A
DAP B5	8-13	FLT PLN-22b/105/O/A
B5	8-13	FLT PLN-23a/105/O/A
DAP B6	8-13	FLT PLN-23b/105/O/A
B6	8-14	FLT PLN-24a/105/O/A
DAP B7	8-14	FLT PLN-24b/105/O/A
B7	8-14	FLT PLN-25a/105/O/A
DAP B8	8-14	FLT PLN-25b/105/O/A
B8	8-15	FLT PLN-26a/105/O/B
DAP B9	8-15	FLT PLN-26b/105/O/A
B9	8-15	FLT PLN-27a/105/O/B
DAP B10	8-15	FLT PLN-27b/105/O/A
B10	8-16	FLT PLN-28a/105/O/B
DAP B11	8-16	FLT PLN-28b/105/O/A
B11	8-16	FLT PLN-29a/105/O/B
DAP A12	8-16	FLT PLN-29b/105/O/A
B12	8-17	FLT PLN-30a/105/O/B

DAP B13	8-17	FLT PLN-30b/105/O/A
B13	8-17	FLT PLN-31a/105/O/A
DAP B14	8-17	FLT PLN-31b/105/O/A
B14	8-18	FLT PLN-32a/105/O/B
DAP B15	8-18	FLT PLN-32b/105/O/A
B15	8-18	FLT PLN-33a/105/O/B
(Blank)	8-18	FLT PLN-33b/105/O/A
UNIV PTG	8-19	FLT PLN-34/105/O/A

CONTENTS

PAGE

INTRODUCTION x

OVERVIEW TIMELINE 1-1

SUMMARY TIMELINE AND ISS SHORT TERM PLAN 2-1

DETAILED TIMELINE 3-1

STS-105 DAP TABLE 4-1

ATTITUDE TIMELINE 5-1

FLIGHT PLAN NOTES 6-1

STS-105 FLIGHT PLAN WALKTHROUGH (WITH RATIONALE) 7-1 |

DAP BOOK CONFIGURATION 8-1

INTRODUCTION

The STS-105 Flight Plan is the Flight Data File article that contains the on-orbit timeline. It does not contain the detailed timelines that are covered in the Ascent, Post Insertion, Deorbit Prep, and Entry Checklists. The detailed rendezvous and undocking timelines and procedures are contained in the Rendezvous Checklist. The detailed EVA task timelines and procedures are in the EVA Checklist.

This Flight Plan satisfies the mission requirements specified in the following documents:

- NSTS-07700 Vol III, Flight Definition and Requirements Document
- NSTS-17462-105, STS-105 Flight Requirements Document
- NSTS-37326, Shuttle Crew Scheduling Constraints

The timeline formats used in this Flight Plan are based on JSC-19933, Timeline Format Definitions and Standard Notes, Rev C, May 1990.

The Final STS-105 Flight Plan, as part of the Flight Data File, meets the specifications of the STS-105 Flight Initialization Data Pack, version 105base-ae.

The STS-105 Flight Plan is based on an FRR trajectory and a launch date of August 5, 2001 at 18:11 CDT. Orbiter inertial attitudes are expressed relative to a mean of 1950 (M50) reference frame.

NSTS-37326, Shuttle Crew Scheduling Constraints (SCSC), Rev A, July 2000, has been used to build the timelines contained in this Flight Plan.

The following SCSC Exceptions will be submitted if conflicts cannot be resolved:

- 105-1 Pre or Post Sleep < 2 hr minimum
- 105-2 Insufficient Off-duty time
- 105-3 Pre/Post Sleep < 5 hr aggregate

The Flight Plan and other related mission information are available on the following Space Shuttle Flight Planning web site:

<https://mod.jsc.nasa.gov/do4/flightplan/fp.cmf?id=105>

OVERVIEW TIMELINE

This Page Intentionally Blank

STS-105/ISS-7A.1 Overview Timeline – Launch on GMT August 9, 2001, 21:38

GMT	221/	10	11	12	13	14	15	16	17	18	19	20	21	22	23	222/0	1	2	3	4	5	6	7	8	9		
MET															0/0	1	2	3	4	5	6	7	8	9	10	11	12
FD1																ASC	PI	NC^		Pre Sleep							Sleep
ISS																				Pre Sleep							Sleep
Att																ASC				-ZLV -YVV							-ZLV -XVV
MET	0/12	13	14	15	16	17	18	19	20	21	22	23	1/0	1	2	3	4	5	6	7	8	9	10	11	12		
FD2			Sleep		Post Sleep																^NC-3 Pre Sleep					Sleep	
ISS				DPC																	Pre Sleep					Sleep	
Att																										-ZLV -XVV	
MET	1/12	13	14	15	16	17	18	19	20	21	22	23	2/0	1	2	3	4	5	6	7	8	9	10	11	12		
FD3				Post Sleep	Waste																Pre Sleep					Sleep	
ISS				PSA	DPC																Pre Sleep					Sleep	
Att				-ZLV -XVV	WASTE																					LVLH TEA, STS MNVRs, ISS in attitude control	
																											Ti at SS-28 minutes ^1/21:56 DOCK (2:21 post Ti)
MET	2/12	13	14	15	16	17	18	19	20	21	22	23	3/0	1	2	3	4	5	6	7	8	9	10	11	12		
FD4				Post Sleep																	Pre Sleep					Sleep	
ISS				PSA	DPC																Pre Sleep					Sleep	
Att																										LVLH TEA	
MET	3/12	13	14	15	16	17	18	19	20	21	22	23	4/0	1	2	3	4	5	6	7	8	9	10	11	12		
FD5				Post Sleep																	Pre Sleep					Sleep	
ISS				PSA	DPC																Pre Sleep					Sleep	
Att																										LVLH TEA	
MET	4/12	13	14	15	16	17	18	19	20	21	22	23	5/0	1	2	3	4	5	6	7	8	9	10	11	12		
FD6				Post Sleep																	Pre Sleep					Sleep	
ISS				PSA	DPC																Pre Sleep					Sleep	
Att																										LVLH TEA	
																											LVLH TEA ^Mask P/B ^10.2 PSI STS Depress
MET	5/12	13	14	15	16	17	18	19	20	21	22	23	6/0	1	2	3	4	5	6	7	8	9	10	11	12		
FD7				Post Sleep																	Pre Sleep					Sleep	
ISS				PSA	DPC																Pre Sleep					Sleep	
Att																										LVLH TEA	
																											^14.7 PSI STS Repress
MET	6/12	13	14	15	16	17	18	19	20	21	22	23	7/0	1	2	3	4	5	6	7	8	9	10	11	12		
FD8				Post Sleep																	Pre Sleep					Sleep	
ISS				Post Sleep	DPC																Pre Sleep					Sleep	
Att																										LVLH TEA	
																											^Mask P/B ^10.2 PSI STS Depress
MET	7/12	13	14	15	16	17	18	19	20	21	22	23	8/0	1	2	3	4	5	6	7	8	9	10	11	12		
FD9				Post Sleep																	Pre Sleep					Sleep	
ISS				Post	DPC																Pre Sleep					Sleep	
Att																										LVLH TEA	
																											^14.7 PSI STS Repress
MET	8/12	13	14	15	16	17	18	19	20	21	22	23	9/0	1	2	3	4	5	6	7	8	9	10	11	12		
FD10				Post Sleep																	Pre Sleep					Sleep	
ISS				Post Sleep	DPC																Pre Sleep					Sleep	
Att																										LVLH TEA	

STS-105/ISS-7A.1 Overview Timeline - Launch on GMT August 5, 2001, 23:11:02

MET	9/12	13	14	15	16	17	18	19	20	21	22	23	10/0	1	2	3	4	5	6	7	8	9	10	11	12
FD11	Post Sleep		Egress			UNDK/SEP		Cab Stow, L-1 Comm, Simplesat Deploy				Pre Sleep		Sleep										P/S	
ISS	Post Sleep	DPC	Egress			UNDK/SEP		P/L Act & Verif				DPC	Pre Sleep		Sleep										
Att	LVLH TEA					-ZLV -XVV				-ZSI		-ZLV -XVV													

^Undock at 18:16 ^Simplesat deploy at 9/21:12
(SR + 1 minutes) ^Orbit Adjust (OA) burn @ 9/22:31, -135 fps

MET	10/12	13	14	15	16	17	18	19	20	21	22	23	11/0	1	2	3	4	5	6	7	8	9	10	11	12
FD 12	P/S		FCS C/O, RCS H/F		OFF Duty/Exercise				D/O Brief, Pilot Ops, KU Ant Stow, OCA S-bd s/u				Pre Sleep		Sleep										P/S
Att	-ZLV -XVV																								

GMT 233/	10	11	12	13	14	15	16	17	18	19	20	21	22	23	224/0	1	2	3	4	5	6	7	8	9	
MET	11/12	13	14	15	16	17	18	19	20	21	22	23	12/0	1	2	3	4	5	6	7	8	9	10	11	12
FD 13	P/S		*	D/O Prep				Ldg	GMT 233/17:17																
Att	-ZLV -XVV		inu	-XSI		Comm																			

*MPLM Deact/ Recumb seats ^ D/O 11/18:37 KSC 185

SUMMARY TIMELINE AND ISS SHORT TERM PLAN

This Page Intentionally Blank

GMT 08/09/01
 FD1
 MET Day 000

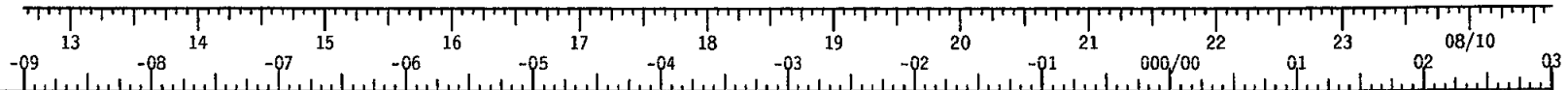

STS-105	CDR HOROWITZ		ASCENT	POST INSERTION	LD OAP D
	PLT STURCKOW		ASCENT	POST INSERTION	LD OAP D
	MS1 FORRESTER		ASCENT	POST INSERTION	PS GET CUP
	MS2 BARRY		ASCENT	POST INSERTION	HS EV ALC TICS ASUS/ CT#
	MS3 CULBERTSON		ASCENT	POST INSERTION	GI IN RS AT AL L
	MS4 DEZHUROV		ASCENT	POST INSERTION	SEE S/U
	MS5 TURIN		ASCENT	POST INSERTION	GI IN RS AT AL L
DAY/NIGHT					
ORBIT					
DAILY ORBIT					
TDRS	E -47.0 W -171.0				
ORB ATT			ASCENT	OMS-2	-ZLV -YVV
HEAT ACE					
NOTES					

LAUNCH

0
M
S
-
2

*ON-ORBIT II
 # HTRs - ON

GMT 08/10/01
 MET Day 000

GMT	01	02	03	04	05	06	07	08	09	10	11	12	13	14	15	
STS-105	CDR HOROWITZ	NC1 OMS BURN	M-NZ VLRV	GP PRDN	ELV PK	PRE SLEEP	PRE SLEEP									
	PLT STURCKOW	OMS BURN	M-NZ VLRV	GP PRDN	P/TV17 SETUP	PRE SLEEP	PRE SLEEP									
	MS1 FORRESTER	PS GET CUP		GAS GRP 1	P/TV17 SETUP	PRE SLEEP - GIRA										
	MS2 BARRY	LS CLROT PRT S/U	LAN S/U	RNDZ PGSC S/U	PRE SLEEP											
	MS3 CULBERTSON	GIRA INSTALL	MDDKN CK	PRE SLEEP												
	MS4 DEZHUROV		OS C/AU C	PRE SLEEP												
	MS5 TURIN	GIRA INSTALL	RE N A L	PRE SLEEP												
DAY/NIGHT																
ORBIT	3	4	5	6	7	8	9	10								
DAILY ORBIT	8	9	10	11	12	13	14	15								
TDRS	E -47.0															
	W -171.0															
ORB ATT	NC-1															
HEAT ACE																
NOTES																

*APCU 2 ACT
 *APCU 2 DEACT

RATE 16 -ZLV -XVV
 RATE 32

GMT 08/10/01
 FD2
 MET Day 000

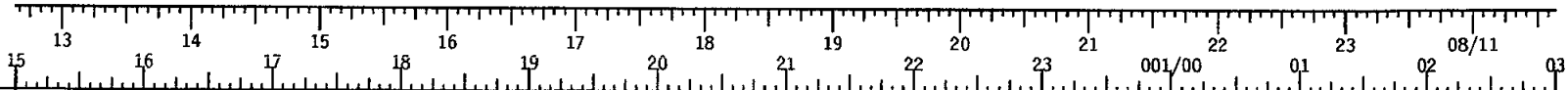

STS-105	CDR HOROWITZ	FD02		POST SLEEP	RNDZ TOOLS C/O	CRYO 02 S/USNR CK	OMS BURN	M-NZLV RV	RPMW S/UP	RMS C/O	RMS PLB SURVEY	RPMW S/UP	APCU 2	APCU 2	EXERCISE	MEAL	OFF DUTY	OMS BURN	M-NZLV RV	MP S/UP	PRE SLEEP
	PLT STURCKOW	POST SLEEP	RNDZ TOOLS S/U	RNDZ TOOLS C/O	PTV19 S/U (C/L CAM)	OMS BURN	M-NZLV RV	FCMS C/O	FILTER CLEANING	GAS GRP 2	PTV20 S/U (RNDZ)	FC*	MEAL	OFF DUTY	EXERCISE	OMS BURN	M-NZLV RV	MP S/UP	PRE SLEEP		
	MS1 FORRESTER	POST SLEEP - GIRA	RNDZ TOOLS C/O	RMSHT R	DOCK RING EXT	RPMW S/UP	RMS C/O	RMS PLB SURVEY	RPMW S/UP	MEAL	OFF DUTY	EXERCISE	OFF DUTY	PRE SLEEP - GIRA							
	MS2 BARRY	POST SLEEP	RNDZ TOOLS S/U	RNDZ TOOLS C/O	PTV19 S/U (C/L CAM)	DOCK RING EXT	PTV07 S/U (OSVS)	OSVS C/O	PCS S/U	MEAL	EXERCISE	OFF DUTY	PRE SLEEP								
	MS3 CULBERTSON	POST SLEEP	ERGO S/U	EXERCISE	H2O SETUP	HR ASST	HR MS3 SUBJECT	HR ASST	MDDK CK	MEAL	OFF DUTY	PRE SLEEP									
	MS4 DEZHUROV	POST SLEEP	ERGO S/U	DREAM TIME S/U	DREAM TIME OPS	HR S/U	HR MS4 SUBJECT	HR ASST	PO (PH T SR) V 1 0	HR F ST W	MEAL	OFF DUTY	PRE SLEEP								
	MS5 TURIN	POST SLEEP					*P/TV10 OPS (HR)	HR MS5 SUBJECT			MEAL	OFF DUTY	PRE SLEEP								
DAY/NIGHT	11		12		13		14		15		16		17		18						
DAILY ORBIT	16		1		2		3		4		5		6		7						
TDRS	E -47.0		W -171.0																		
ORB ATT			-ZLV -XVV								-ZLV -XVV										
HEAT ACE					RATE 8						RATE 32				RATE 16						
NOTES					^HTR ON		*P/TV10 S/U (HR)		*APCU 2 ACT		*APCU 2 DEACT		*PURGE-MANUAL		^HTR OFF						

GMT
MET

08/11/01
FD2
Day 001

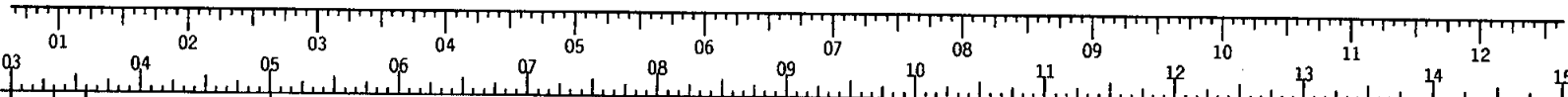

S T S - 1 0 5	CDR/RMS1 HOROWITZ	PS R L E E P P M C O C A	PRE SLEEP	SLEEP	FD03 POST SLEEP	EXERCISE					
	PLT/IV1 STURCKOW		PRE SLEEP	SLEEP	POST SLEEP						
	MS1/EV2 FORRESTER		PRE SLEEP - GIRA	SLEEP	POST SLEEP - GIRA						
	MS2/EV1 BARRY		PRE SLEEP	SLEEP	POST SLEEP						
E X P - 3	MS3 CULBERTSON		PRE SLEEP	SLEEP	POST SLEEP						
	MS4 DEZHUROV		PRE SLEEP	SLEEP	POST SLEEP						
	MS5 TURIN		PRE SLEEP	SLEEP	POST SLEEP						
DAY/NIGHT		[Timeline with shaded blocks]									
ORBIT		[Timeline with shaded blocks]									
DAILY ORBIT		19	20	21	22	23	24	25	26		
		8	9	10	11	12	13	14	15		
TDRS		[Timeline with horizontal bars]									
ORB ATT		[Timeline with horizontal bars]									
ISS ATT		[Timeline with horizontal bars]									
HEAT ACE		[Timeline with horizontal bars]									
		RATE 16		RATE 8		RATE 16		RATE 32			
							BIAS +XVV +ZLV		RATE 8		
NOTES											

MET Day 001 03 04 05 06 07 08 09 10 11 12 13 14 15
 GMT 08/11/01 01 02 03 04 05 06 07 08 09 10 11 12

EXP-2	USACHEV	PRE SLEEP	SLEEP										POST SLEEP	DPC	PREP WORK				
	VOSS	PRE SLEEP	SLEEP										POST SLEEP	DPC	PREP WORK				
	HELMS	PRE SLEEP	SLEEP										POST SLEEP	DPC	PREP WORK				
K	EXE-PKG U/L												EXE-PKG U/L						
S																			
SBD	SBD-KEY-CHG												SBD-KEY-CHG						
P	CPCG-H CRYSTAL GRWTH BONNER BALL CLCT EXPRS1 PWR/THERM EXPRS2 POWER EXPRS2 THERMAL MAMS NOM OPS SAMS OPS ICU/D1 SAMS OPS RTS/D1 SAMS OPS RTS/D2 MAMS COMMANDING 5												MAMS COMMANDING 5						
	MAMS STORED DATA D/L												MAMS STORED DATA D/L						
R																			
ISS	DAY/NIGHT	[Bar chart showing day/night cycle]																	
	ORBIT	19	20	21	22	23	24	25	26										
	DAILY ORBIT	8	9	10	11	12	13	14	15										
	ISS ATT														BIAS +XVV +ZLV				
ISS	TDRS	[Bar chart showing TDRS activity]																	
	S-BD	[Bar chart showing S-BD activity]																	
	GND														VHF	VHF	VHF	VHF	VHF
	NOTES																		

CPCG-H
BONNER
EXPRS1
EXPRS2
EXPRS2
MAMS A
SAMS C
SAMS C
SAMS C

MAMS COMM
MAMS STOP

ISS P/L

GMT
MET

08/11/01
FD3
Day 001

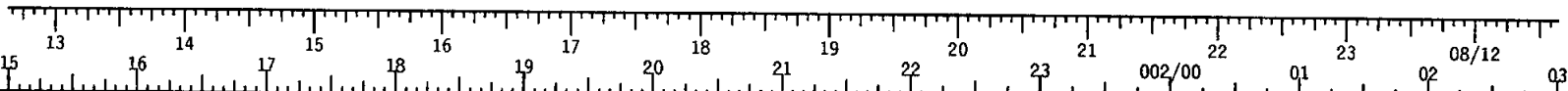

STS-105	CDR/RMS1 HOROWITZ	MWNA VSSRT E	WIAN SITTE E	IMAN PTM A	POST SLEEP	GPWR PRBU E	WAE RSM E		ISS RNDZ	APPROACH	MNV -XLV	GPWR PRBU E	HATCH OPEN	SHAN DK E	SFTY BRIEF	APCU 2 DEACT	RMS PGSC CNFG	PMC OCA	PRE SLEEP	
	PLT/IV1 STURCKOW	MWNA VSSRT E	WIAN SITTE E	IMAN PTM A	POST SLEEP	GPWR PRBU E	WAE RSM E		ISS RNDZ	APPROACH	PS T/US 21	GPWR PRBU E	PTV21 OPS (ISS)	SHAN DK E	SFTY BRIEF	POP /TV 16	MDDK XFER	VTR PB S/U	EXERCISE PRE SLEEP	
	MS1/EV2 FORRESTER				EXERCISE	PSG OLIS TEA P	MCI UI*		ISS RNDZ	APPROACH	LEAK CHECK	HRCC UN FG 1	HATCH OPEN	SHAN DK E	SFTY BRIEF	EMU RECON FIG BLOCK A			PRE SLEEP - GIRA	
	MS2/EV1 BARRY	POST SLEEP			EXERCISE				ISS RNDZ	APPROACH	AID US DS IO	ODS PREP INGRS	HATCH OPEN	SHAN DK E	SFTY BRIEF	EMU RECON FIG BLOCK A	XTF A E G R U P	POST RNDZ PGSC CNFG	XC FW E C R	PRE SLEEP
EXP-3	MS3 CULBERTSON	POST SLEEP		MDD K C K	EXERCISE			ISS RNDZ	APPROACH	LEAK CHECK	ODS PREP INGRS	HATCH OPEN	SHAN DK E	SFTY BRIEF	HIN 20 IT 1		MDD K C K	HT 2 O R A M L	R E N D P C	PRE SLEEP
	MS4 DEZHUROV	POST SLEEP			DREAM TIME S/U			DREAMTIME OPS	APPROACH			HATCH OPEN	SHAN DK E	SFTY BRIEF			R E N A L	PRE SLEEP	D P C	PRE SLEEP
	MS5 TURIN	POST SLEEP						ISS RNDZ	APPROACH			HATCH OPEN	SHAN DK E	SFTY BRIEF			XTF A E G R U P	PS R L E E P	D P C	PRE SLEEP
DAY/NIGHT		27		28		29		30		31		32		33		34				
ORBIT		1		2		3		4		5		6		7		8				
DAILY ORBIT		1		2		3		4		5		6		7		8				
TDRS		E -47.0 W -171.0																		
ORB ATT		-ZLV +YVV		NH		LVLH		RNDZ		RNDZ		VBAR		BIAS -XLV +ZVV						
ISS ATT		BIAS +XVV +ZLV						+XVV +ZLV						BIAS +ZLV +XVV						
HEAT ACE								RATE 8		HCU SW				RATE 8						
NOTES		*POST SLEEP @POST SLEEP - GIRA ^HTR ON		*FILTER CHECK										*STS TO CMG ATT H/O ^HTR OFF		*APCU 2 ACT *APCU 2 DEACT				

MET Day 001 15 16 17 18 19 20 21 22 23 002/00 01 02 03
 GMT 08/11/01 13 14 15 16 17 18 19 20 21 22 23 01 23 02 08/12 03

E X P - 2	USACHEV	ISS EXERCISE	AIR SMPL	ISS MEAL	PMA2 CFG	LEAK CHECK	HATCH OPEN	SFTY BRIEF	ISS EXERCISE	RPT PREP	PLN RVW	DPC PRE SLEEP
	VOSS	ISS EXERCISE		ISS MEAL			HATCH OPEN	SFTY BRIEF			PLN RVW	DPC PRE SLEEP
	HELMS	ISS EXERCISE		ISS MEAL			HATCH OPEN	SFTY BRIEF	ISS EXERCISE		PLN RVW	DPC PRE SLEEP

K	KUBD-ORB MASK-ENA	HRUBD-ORB MASK-ENA	
S	СЭП-АБ-FULL CHRГ СУДН-ОГНИ-LIGHTS ON C-COCB-CNTR CM-ФГБ C-COCB-CB-FEATHER C-COCB-CB-FEATHER C-COГБ-COMBINED MODE C-COГБ-COMBINED MODE СЭП-АБ-PART CHRГ	СЭП-АБ-FULL CHRГ СУДН-ОГНИ-LIGHTS ON СУДН-ОГНИ-LIGHTS ON СУДН-ОГНИ-LIGHTS ON C-COCB-CNTR CM-ФГБ C-COCB-CB-FEATHER C-COCB-CB-FEATHER C-COГБ-COMBINED MODE C-COГБ-COMBINED MODE СЭП-АБ-PART CHRГ	
S	UHF-1-ACT AUDIO-UHF OPS-CNFG ACS-ATT-CCDB-CHG ACS-ATT-CCDB-INC ACS-PRE-ARVL-CNFG ISS-PWR DWN & RCVRY PPS-P6 SA-FTHR ACS-PMA2-ARVL-CNFG AUDIO-DOCK OPS-CNFG ACS-POST-ARVL-CNFG PPS-SA-SUN-TRK ACS-POST DK-LK CK ACS-STC/CMG ATT-H/O C&DH-POST DOCK-CNFG UHF-1-DEACT AUDIO-UHF OPS-DCNFG ACS-MM-PREP & ACT VDS-VIDEO-CNFG MPLM-ENV-CHECK VDS-VIDEO-DCNFG	UHF-1-ACT AUDIO-UHF OPS-CNFG ACS-ATT-CCDB-CHG ACS-ATT-CCDB-INC ACS-PRE-ARVL-CNFG ISS-PWR DWN & RCVRY PPS-P6 SA-FTHR ACS-PMA2-ARVL-CNFG AUDIO-DOCK OPS-CNFG ACS-POST-ARVL-CNFG PPS-SA-SUN-TRK ACS-POST DK-LK CK ACS-STC/CMG ATT-H/O C&DH-POST DOCK-CNFG UHF-1-DEACT AUDIO-UHF OPS-DCNFG ACS-MM-PREP & ACT VDS-VIDEO-CNFG MPLM-ENV-CHECK VDS-VIDEO-DCNFG	
R	ISS MODE-PROX-XTION ISS MODE-STND-XTION	ISS MODE-PROX-XTION ISS MODE-STND-XTION	
M	ISS MODE-PROX-XTION ISS-COMM CNFG 1A-VFY MCC-M GO FOR TI ISS GO FOR TI STS GO FOR TI ISS-COMM CNFG 2A-VFY ISS MODE-STND-XTION MPLM-ENV-CHECK	ISS MODE-PROX-XTION ISS-COMM CNFG 1A-VFY MCC-M GO FOR TI ISS GO FOR TI STS GO FOR TI ISS-COMM CNFG 2A-VFY ISS MODE-STND-XTION MPLM-ENV-CHECK	

ISS	DAY/NIGHT	27	28	29	30	31	32	33	34
	ORBIT	1	2	3	4	5	6	7	8
ISS	DAILY ORBIT	1	2	3	4	5	6	7	8
	ISS ATT	BIAS +XVV +ZLV MNVR DCK ATT		+XVV +ZLV		+ZLV +XVV		BIAS +ZLV +XVV	
ISS	TDRS	KU							
	S-BD								
ISS	RS GND	VHF	VHF	VHF	VHF	VHF	VHF	VHF	VHF
	NOTES								

*ISS-COMM CNFG 1A-VFY
 @COMM CHK @WINDV OPS
 *COMM CHK
 VVDS-VIDEO-CNFG
 *STS TO CMG ATT H/O
 *HAND SHAKE
 *HAND SHAKE
 *ISS P/L CK
 @XFER TAGUP
 *STV16 OPS
 @HAND SHAKE

2-7B
 FLT PLN/105/FIN 07/09/01

GMT

08/12/01

FD3

MET

Day 002

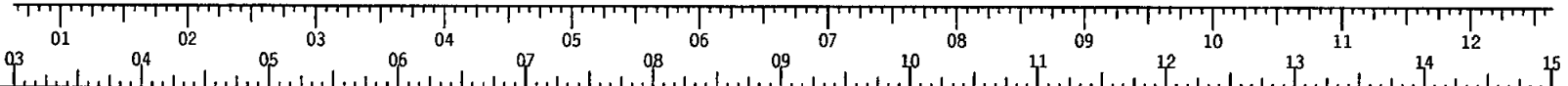

STS-105	CDR/RMS1 HOROWITZ	PRE SLEEP	SLEEP	FD04 POST SLEEP	POST SLEEP					
	PLT/IV1 STURCKOW	PRE SLEEP	SLEEP	POST SLEEP						
	MS1/EV2 FORRESTER	PRE SLEEP - GIRA	SLEEP	POST SLEEP - GIRA	RMSHTR	POST SLEEP - GIRA	MDDKCK			
	MS2/EV1 BARRY	PRE SLEEP	SLEEP	POST SLEEP				PS (OVSUS) 07		
EXP-3	MS3 CULBERTSON	PRE SLEEP	SLEEP	POST SLEEP	DPC	N1 CBM PREP FOR MAT	IP LE KP			
	MS4 DEZHUROV	PRE SLEEP	SLEEP	POST SLEEP	DPC	PW RO ER PK	*			
	MS5 TURIN	PRE SLEEP	SLEEP	POST SLEEP	DPC	PW RO ER PK	MDDK XFER			
DAY/NIGHT		[Bar chart showing day/night cycle]								
ORBIT		34	35	36	37	38	39	40	41	42
DAILY ORBIT		8	9	10	11	12	13	14	15	16
TDRS		[TDRS activity bars]								
ORB ATT		[ORB ATT activity bars]								
ISS ATT		[ISS ATT activity bars]								
HEAT ACE		RATE 32/TFL FOR 16		RATE 32		RATE 8				
NOTES		<p style="text-align: center;">2-8A</p> <p style="text-align: right;">FLT PLN/105/FIN 07/09/01</p>								

MANDOVI
APCU 2

MET Day 002 03 01 04 02 05 03 06 04 07 05 08 06 09 07 10 08 11 09 12 10 13 11 14 12 15
 GMT 08/12/01

EXP-2	USACHEV	PRE SLEEP	SLEEP	POST SLEEP	POST SLEEP	DPC	⊕	⬇
	VOSS	PRE SLEEP	SLEEP	POST SLEEP		DPC	PWR R E R E C K	ISS P/L Ⓢ
	HELMS	PRE SLEEP	SLEEP	POST SLEEP		DPC	PWR R E R E C K	

K EXE-PKG U/L
 S

SBD
 UHF-1-ACT
 AUDIO-UHF OPS-CNFG
 AUDIO-DOCK OPS-DCNFG
 C&DH-OIU 4.1C-LOAD
 SBD-KEY-CHG
 C&DH-OIU 4C-LOAD
 UHF-1-DEACT
 AUDIO-UHF OPS-DCNFG
 AUDIO-DOCK OPS-CNFG
 VDS-VIDEO-CNFG
 GNC-PPL UPDATE

ER1
 CPG-H CRYSTAL GRWTH
 EXPRS1 PWR/THERM
 MAMS NOM OPS
 SAMS OPS RTS/D1
 SAMS OPS RTS/D2
 MAMS COMMANDING 5

ER2
 MAMS STORED DATA D/L
 EXPRS2 POWER
 EXPRS2 THERMAL
 SAMS OPS ICU/D1

M/P
 BONNER BALL CLCT

M/C
 ISS-COMM CNFG 7A-VFY
 N1 CBM PREP FOR MATE
 ISS-COMM CNFG 2A-VFY

ISS	DAY/NIGHT	[Bar chart showing day/night cycle]									
	ORBIT	34	35	36	37	38	39	40	41	42	
	DAILY ORBIT	8	9	10	11	12	13	14	15	16	

ISS ATT
 BIAS +ZLV +XVV

ISS
 TDRS S-BD KU
 RS GND
 -VHF -VHF -VHF -VHF -VHF

NOTES
 2-8B
 FLT PLN/105/FIN 07/09/01
 Ⓢ ISS-COMM CNFG 2A-VFY Ⓢ MPLM EQ
 Ⓢ N1 CBM PREP
 Ⓢ HANDOV

GMT 08/12/01
 MET 08/13
 Day 002

STS-105	15	16	17	18	19	20	21	22	23	003/00	01	02	03
CDR/RMS1 HOROWITZ	RMWSUP	GRAPL	MPLM UNBTH	MPLM INSTALL	UNGRP	MEAL	DOSIMTR DEPLOY	DCPCG-V TRANSFER	APCF TRANSFER	PILOT OPS	EXERCISE	PRE SLEEP	PRE SLEEP
PLT/IV1 STURCKOW	PTV22 S/U (RMS)		EXERCISE			MEAL	MDDK XFER	CPCG-H TRANSFER		MDDK XFER		PRE SLEEP	
MS1/EV2 FORRESTER	RMWSUP	GRAPL	MPLM UNBTH	MPLM INSTALL	UNGRP	MEAL	MDDK XFER		EXERCISE	MDDK XFER		PRE SLEEP - GIRA	
MS2/EV1 BARRY			P/TV07 OPS (OSVS)			MEAL	DOSIMTR DEPLOY	EXERCISE		MDDK XFER		PRE SLEEP	PRE SLEEP
MS3 CULBERTSON	IELK INST & C/O				MEAL	IDERLYK	VEST PRESS	MPLM VEST/CNFG INGRS			ISS EXERCISE	PRE SLEEP	
MS4 DEZHUROV	HANDOVER		IPERLEP	IELK INST & C/O		MEAL	SOKOL LK CK	IDERLYK	MDDK XFER	MPLM ACT PART I	MA PCT M2	HANDOVER	RPT PREP
MS5 TURIN	MDDK XFER		SOKOL LK CK	MDDK XFER	IPERLEP	MEAL	IELK INST & C/O		APCF TRANSFER	AA PCT F	SOKOL LK CK	IDERLYK	HANDOVER
DAY/NIGHT	[Timeline]												
ORBIT	[Timeline]												
DAILY ORBIT	[Timeline]												
TDRS	[Timeline]												
ORB ATT	[Timeline]												
ISS ATT	[Timeline]												
HEAT ACE	[Timeline]												
NOTES	*PTV07 S/U (OSVS) *APCU 2 DEACT ^HTR OFF *DEMATE												

MET Day 002
 GMT 08/12/01

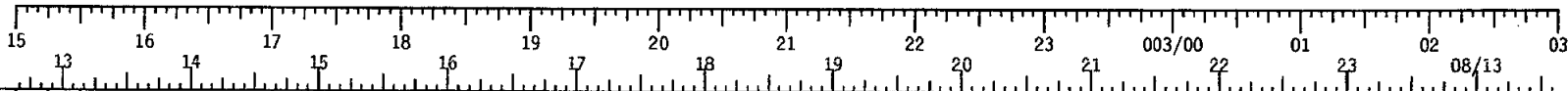

E X P - 2	USACHEV	*	ISS EXERCISE	IELK INST & C/O		ISS ET LO KW	MEAL	VEST PRESS	MPLM VEST/CNFG INGRS			ISS EXERCISE	DPC	PRE SLEEP
	VOSS		HANDOVER	ISS EXERCISE	MDDK XFER	⊕	MEAL	IELK INST & C/O	ISS ET LO KW	ISS EXERCISE	HANDOVER	PLN RVW	⊕	DPC PRE SLEEP
	HELMS		IELK INST & C/O	ISS ET LO KW	MDDK XFER	ISS EXERCISE	MEAL	MDDK XFER		ISS EXERCISE	HANDOVER	PLN RVW	DPC	PRE SLEEP

K
S

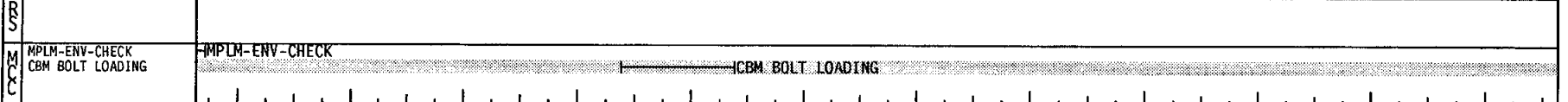
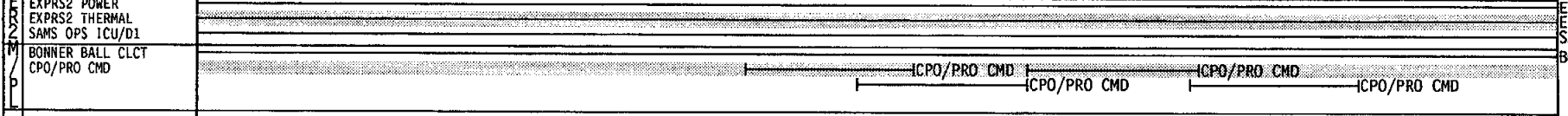
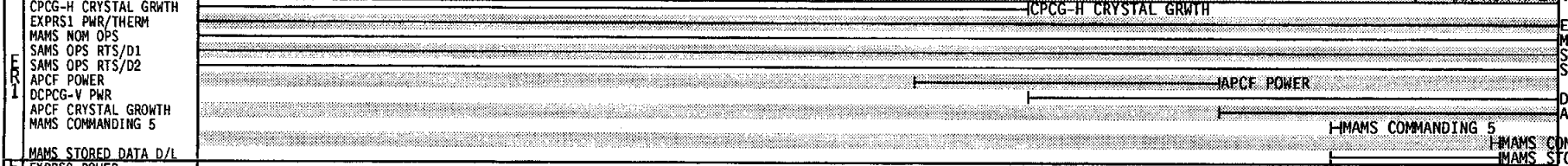
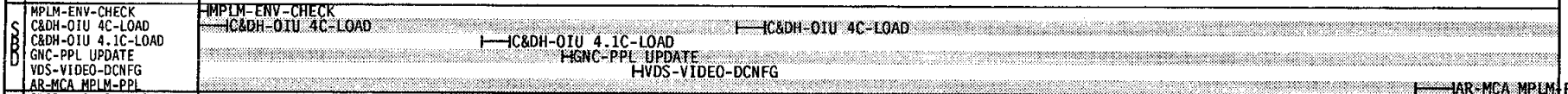

ISS	DAY/NIGHT	[Day/Night Cycle]								
	ORBIT	42	43	44	45	46	47	48	49	50
	DAILY ORBIT	16	1	2	3	4	5	6	7	8

ISS ATT BIAS +ZLV +XVV

ISS	TDRS	S-BD	[TDRS Activity]							
	RS GND	KU	[RS GND Activity]							

*MPLM EQUIP S/U ⊕NODE 1 NDR CBCS RMV -VHF -VHF -VHF -VHF -VHF ⊕XFER TAGUP

NOTES

2-9B

FLT PLN/105/FIN 07/09/01

PPL
EXPRS1
MAMS A
SAMS C
SAMS C
DCPCG-
APCF C
I-MAMS
COMMAND
I-MAMS
STORED
EXPRS2
EXPRS2
SAMS C
BONNER

GMT 08/13/01
 MET Day 003

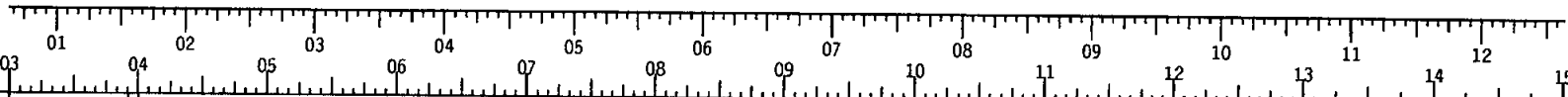

		FD05														
S T S - 1 0 5	CDR/RMS1 HOROWITZ	PRE SLEEP	SLEEP										POST SLEEP			
	PLT/IV1 STURCKOW	PRE SLEEP	SLEEP										POST SLEEP			
	MS1/EV2 FORRESTER	PRE SLEEP - GIRA	SLEEP										POST SLEEP - GIRA			
	MS2/EV1 BARRY	PRE SLEEP	SLEEP										POST SLEEP			
E X P - 2	MS3/IV2 VOSS	PRE SLEEP	SLEEP										POST SLEEP	DPC	PREP WORK	
	MS4 HELMS	PRE SLEEP	SLEEP										POST SLEEP	DPC	PREP WORK	M D K C K
	MS5 USACHEV	PRE SLEEP	SLEEP										POST SLEEP	DPC	PREP WORK	♦
DAY/NIGHT		[Shaded bars indicating day/night cycle]														
ORBIT		50	51	52	53	54	55	56	57	58						
DAILY ORBIT		8	9	10	11	12	13	14	15	1						
TDRS		[Timeline with E -47.0 and W -171.0 labels]														
ORB ATT		[Timeline with BIAS -XLV +ZVV label]														
ISS ATT		[Timeline with BIAS +ZLV +XVV label]														
HEAT ACE		[Timeline with RATE 8 label]														
NOTES		2-10A														

◆ MPLM I
 ⊕ MPLM I
 ♦ ISS EXE

MET Day 003

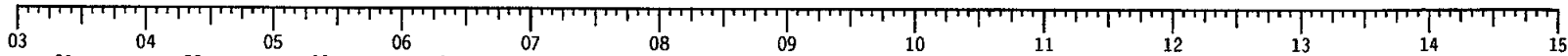

GMT 08/13/01

E X P - 3	CULBERTSON	PRE SLEEP	SLEEP										POST SLEEP	POST SLEEP	DPC	PREP WORK	ISS P/L CK	
		DEZHUROV		SLEEP										POST SLEEP		DPC	PREP WORK	⊕
		TURIN		SLEEP										POST SLEEP		DPC	PREP WORK	

KU EXE-PKG U/L I-EXE-PKG U/L

OPS AUDIO-DOCK OPS-DCNFG
 AUDIO-UHF OPS-CNFG
 UHF-1-ACT
 AR-MCA-PPL
 SBD-KEY-CHG
 UHF-1-DEACT
 AUDIO-UHF OPS-DCNFG
 AUDIO-DOCK OPS-CNFG

HAUDIO-DOCK OPS-DCNFG
 HAUDIO-UHF OPS-CNFG
 UHF-1-ACT

AR-MCA-PPL
 SBD-KEY-CHG

UHF-1-DEACT
 HAUDIO-UHF OPS-DCNFG
 HAUDIO-DOCK OPS-CNFG

FR1 EXPRS1 PWR/THERM
 MAMS NOM OPS
 SAMS OPS RTS/D1
 SAMS OPS RTS/D2
 DCPCG-V PWR
 APCF CRYSTAL GROWTH
 MAMS COMMANDING 5
 MAMS STORED DATA D/L

MAMS COMMANDING 5
 MAMS COMMANDING
 MAMS STORED DATA

FR2 EXPRS2 POWER
 EXPRS2 THERMAL
 SAMS OPS ICU/D1

FR3 BONNER BALL CLCT

FR4 ISS-COMM CNFG 7A-VFY
 ISS-COMM CNFG 2A-VFY

HISS-COMM CNFG 7A-VFY

HISS-COMM CNFG 2A-VFY

ISS	DAY/NIGHT	ORBIT	50	51	52	53	54	55	56	57	58
	DAILY ORBIT		8	9	10	11	12	13	14	15	1

ISS ATT BIAS +ZLV +XVV

ISS TDRS KU S-BD

RS GND -VHF -VHF -VHF -VHF -VHF -VHF

*ISS-COMM CNFG 2A-VFY ⊕TRANSFE

NOTES

2-10B

FLT PLN/105/FIN 07/09/01

EXPRS1
 MAMS A
 SAMS C
 SAMS C
 SAMS C
 DCPCG-
 APCF C

GMT
MET

08/13/01
EDS
Day 003

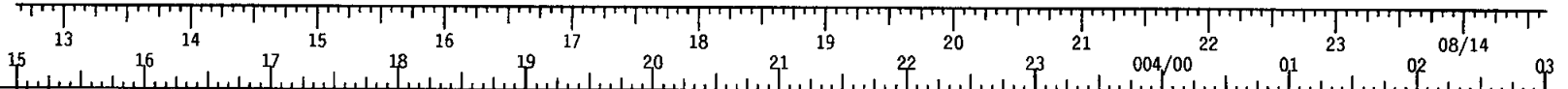

STS-105	CDR/RMS1 HOROWITZ	M C I U * A T T O R	TRANSFER			EXERCISE	MEAL	M N V R R B S T	REBOOST	M D U N V M R P	S I M O * X F E R	S I M O * M - N X L V R	A T T O R	PRE SLEEP	P M C D O C A	PRE SLEEP
	PLT/IV1 STURCKOW	TRANSFER			EXERCISE	TRANSFER	MEAL	TRANSFER				PRE SLEEP				
	MS1/EV2 FORRESTER	* EXERCISE	TRANSFER			MEAL	TRANSFER				PRE SLEEP - GIRA					
	MS2/EV1 BARRY	TRANSFER			EXERCISE	TRANSFER	MEAL	TRANSFER				PRE SLEEP				
EXP-2	MS3/IV2 VOSS	⊕ MPLM S/U FOR XFER	H I 2 N O I T 3	EXERCISE	H T 2 E O R M	HANDOVER	EXP4 RK XFER	MEAL	EXP5 RK XFER	ISS EXERCISE	TRANSFER	X C F W E C R	X T F A G E R U P	D P C	PRE SLEEP	
	MS4 HELMS	TRANSFER	ISS EXERCISE	HANDOVER		EXP4 RK XFER	MEAL	EXP5 RK XFER	EXERCISE	TRANSFER		M D D K C K	D P C	PRE SLEEP		
	MS5 USACHEV	ISS EXERCISE	HANDOVER			P E A V O E N T	HANDOVER	MEAL	HANDOVER			EXERCISE	D P C	PRE SLEEP		
DAY/NIGHT	[Day/Night Cycle]															
ORBIT	[Orbit Data]															
DAILY ORBIT	[Daily Orbit Data]															
TDRS	[TDRS Data]															
ORB ATT	[Orbit Att Data]															
ISS ATT	[ISS Att Data]															
HEAT ACE	[Heat Ace Data]															
NOTES	*MPLM INGR ⊕MPLM INGR *FILTER CHECK RATE 8 *CMG TO STS ATT H/O *SIMO INIT *STS TO CMG ATT H/O *SIMO TERM															

MET		Day 003		15		16		17		18		19		20		21		22		23		004/00		01		02		03	
GMT		08/13/01		13		14		15		16		17		18		19		20		21		22		23		08/14			
EXP-3	CULBERTSON	ISS EXERCISE		HANDOVER				* ⊕	HANDOVER		MEAL	HANDOVER				PLN RVW	PMCDPC	PRE SLEEP											
	DEZHUROV	TRANSFER		HANDOVER		EXP4 RK XFER		MEAL	EXP5 RK XFER		TRANSFER		RPT PREP	PLN RVW	PMCDPC	PRE SLEEP													
	TURIN	MPLM S/U FOR XFER	TRANSFER	HANDOVER		TRANSFER		MEAL	TRANSFER				PLN RVW	PMCDPC	PRE SLEEP														
SBD	ACS-CMG/STS ATT-H/O		HACS-CMG/STS ATT-H/O										PPS-P6 SA-FTHR		PPS-SA-SUN-TRK														
	PPS-P6 SA-FTHR																												
FRI	EXPRS1 PWR/THERM												MAMS COMMANDING 5		MAMS COMMANDING 5														
	MAMS NOM OPS																												
FRI	SAMS OPS RTS/D1												MAMS STORED DATA D/L		MAMS STORED DATA D/L														
	SAMS OPS RTS/D2																												
FRI	DCPCG-V PWR																												
	APCF CRYSTAL GROWTH																												
FRI	MAMS COMMANDING 5																												
	MAMS STORED DATA D/L																												
M/P	EXPRS2 POWER																												
	EXPRS2 THERMAL																												
M/P	SAMS OPS ICU/D1																												
	BONNER BALL CLCT																												
M/C	PPS-P6 SA-FTHR												PPS-P6 SA-FTHR		PPS-SA-SUN-TRK														
	PPS-SA-SUN-TRK																												
ISS	DAY/NIGHT		58		59		60		61		62		63		64		65												
	ORBIT		1		2		3		4		5		6		7		8												
ISS	DAILY ORBIT												REBOOST		BIAS +ZLV +XVV														
	ISS ATT																												
ISS	TDRS																												
	RS GND																												
ISS	KU																												
	S-BD																												
ISS	VHF																												
	NOTES												*PTV21 S/U (ISS)		*CMG TO STS ATT H/O														
												⊕RENAL		⊕RENAL															
												⊕XFER TAGUP		⊕RENAL															

EXPRS1
MAMS M
SAMS C
SAMS C
DCPCG-
APCF C

/L
EXPRS2
EXPRS2
SAMS C
BONNER

GMT

08/14/01

MET

FD5
Day 004

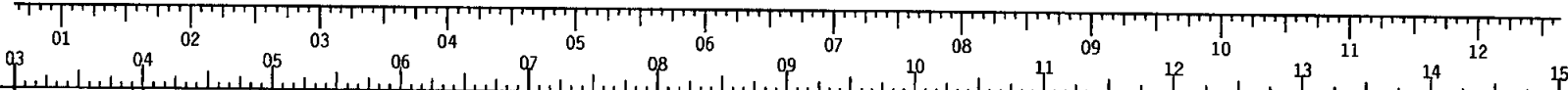

STS-105	CDR/RMS1 HOROWITZ	PRE SLEEP	SLEEP	FD06	POST SLEEP				
	PLT/IV1 STURCKOW	PRE SLEEP	SLEEP		POST SLEEP				
	MS1/EV2 FORRESTER	PRE SLEEP - GIRA	SLEEP		POST SLEEP - GIRA				
	MS2/EV1 BARRY	PRE SLEEP	SLEEP		POST SLEEP		+		
EXP-2	MS3/IV2 VOSS	PRE SLEEP	SLEEP		POST SLEEP	DPC	PREP WORK ⊕		
	MS4 HELMS	PRE SLEEP	SLEEP		POST SLEEP	DPC	PREP WORK ⊕ M D K C K		
	MS5 USACHEV	PRE SLEEP	SLEEP		POST SLEEP	DPC	PREP WORK ⊕		
DAY/NIGHT		[Bar chart showing day/night cycle]							
ORBIT		[Bar chart showing orbit data]							
DAILY ORBIT		66	67	68	69	70	71	72	73
TDRS		E -47.0	W -171.0	[Bar chart showing TDRS data]					
ORB ATT		[Bar chart showing orb att data]							
ISS ATT		[Bar chart showing iss att data]							
HEAT ACE		[Bar chart showing heat ace data]							
NOTES		BIAS -XLV +ZVV BIAS +ZLV +XVV RATE 8							

MET Day 004 03 01 04 02 05 03 06 04 07 05 08 06 09 07 10 08 11 09 12 10 13 11 14 12 15
 GMT 08/14/01

E X P - 3	CULBERTSON	PRE SLEEP	SLEEP										POST SLEEP	POST SLEEP	DPC	PREP WORK	⊕														
	DEZHUROV	PRE SLEEP	SLEEP										POST SLEEP		DPC	PREP WORK	♦														
	TURIN	PRE SLEEP	SLEEP										POST SLEEP		DPC	PREP WORK	⊗														
K S	EXE-PKG U/L		EXE-PKG U/L																												
	B S D	AUDIO-DOCK OPS-DCNFG AUDIO-UHF OPS-CNFG UHF-1-ACT SBD-KEY-CHG UHF-1-DEACT AUDIO-UHF OPS-DCNFG AUDIO-DOCK OPS-CNFG		AUDIO-DOCK OPS-DCNFG AUDIO-UHF OPS-CNFG UHF-1-ACT										SBD-KEY-CHG				UHF-1-DEACT AUDIO-UHF OPS-DCNFG AUDIO-DOCK OPS-CNFG													
E R I		EXPRS1 PWR/THERM MAMS NOM OPS SAMS OPS RTS/D1 SAMS OPS RTS/D2 DCPCG-V PWR APCF CRYSTAL GROWTH MAMS COMMANDING 5 MAMS STORED DATA D/L		MAMS COMMANDING 5 MAMS STORED DATA D/L																											
	E R 2	EXPRS2 POWER EXPRS2 THERMAL SAMS OPS ICU/D1																													
M P L		BONNER BALL CLCT																													
	R S																														
M C		ISS-COMM CNFG 7A-VFY ISS-COMM CNFG 2A-VFY		HISS-COMM CNFG 7A-VFY										HISS-COMM CNFG 2A-VFY																	
	I S S	DAY/NIGHT ORBIT		BIAS +ZLV +XVY																											
DAILY ORBIT		<table border="1"> <tr> <td>66</td><td>67</td><td>68</td><td>69</td><td>70</td><td>71</td><td>72</td><td>73</td> </tr> <tr> <td>9</td><td>10</td><td>11</td><td>12</td><td>13</td><td>14</td><td>15</td><td>16</td> </tr> </table>														66	67	68	69	70	71	72	73	9	10	11	12	13	14	15	16
66	67	68	69	70	71	72	73																								
9	10	11	12	13	14	15	16																								
I S S	ISS ATT																														
	TDRS	KU S-BD	<table border="1"> <tr> <td colspan="2">RS GND</td> <td colspan="2">VHF</td> <td colspan="2">VHF</td> <td colspan="2">VHF</td> <td colspan="2">VHF</td> <td colspan="2">VHF</td> </tr> </table>														RS GND		VHF		VHF		VHF		VHF		VHF				
RS GND		VHF		VHF		VHF		VHF		VHF																					
NOTES																															

EXPRS1
MAMS A
SAMS C
SAMS C
DCPCG-
APCF C

⊕ISS P/L
♦HANDOVE
⊗HANDOV

GMT 08/14/01
 MET [FD6] Day 004
 13 14 15 16 17 18 19 20 21 22 23 005/00 01 02 03
 08/15

STS-105	CDR/RMS1 HOROWITZ	MCIU*	TRANSFER	FILTER CLEAN INSPECT	EXERCISE	MNVR RBST	REBOOST	MEAL	TRANSFER	EVA PROC REVW	INGTRMS	PREP	IDOPRES	CNFG	PRE SLEEP		
	PLT/IV1 STURCKOW	TRANSFER	SXAFER	BXFER	EVA TOOL CONFG	A/L PREP	MDDK PREP	RC/REB/SAF	SAFER C/O	MEAL	EMU C/O	EVA PROC REVW	EXERCISE		PRE SLEEP		
	MS1/EV2 FORRESTER	EXERCISE		EVA TOOL CONFG	PGT C/O	A/L PREP	MDDK PREP	HELM*	RC/REB/SAF	SAFER C/O	MEAL	EMU C/O	EVA PROC REVW	AS/BNIT	PTV 18 S/U	HELM*	PRE SLEEP - GIRA
	MS2/EV1 BARRY	EXERCISE	SXAFER	BXFER	EVA TOOL CONFG	A/L PREP	MDDK PREP	HELM*	RC/REB/SAF	SAFER C/O	MEAL	EMU C/O	EVA PROC REVW	AS/BNIT	PTV 18 S/U	HELM*	PRE SLEEP
EXP-2	MS3/IV2 VOSS	HANDOVER		HI 20	HANDOVER	HT 20	ISS EXERCISE	MEAL		HI 20	EXERCISE	HT 20	XFER 2 CWC	XT FAGERUP		PRE SLEEP	
	MS4 HELMS	HANDOVER		ISS EXERCISE	PEAVOENT		HANDOVER	MEAL		TRANSFER		MDDKCK	DPC	EXERCISE		PRE SLEEP	
	MS5 USACHEV	HANDOVER		ISS EXERCISE	TRANSFER		HANDOVER	MEAL		TRANSFER		EXERCISE	DPC			PRE SLEEP	
DAY/NIGHT	[Timeline with shaded day/night periods]																
ORBIT	73	74	75	76	77	78	79	80	81								
DAILY ORBIT	16	1	2	3	4	5	6	7	8								
TDRS	[Timeline with TDRS events]																
ORB ATT	BIAS -XLV +ZVV																
ISS ATT	BIAS +ZLV +XVV																
HEAT ACE	RATE 8																
NOTES	*FILTER CHECK					*CMG TO STS ATT H/O *HELM BATT INIT *HELM BATT INIT					*STS TO CMG ATT H/O *HELM BATT TERM *HELM BATT TERM						

MET		Day 004		15		16		17		18		19		20		21		22		23		005/00		01		02		08/15		03	
GMT		08/14/01		13		14		15		16		17		18		19		20		21		22		23		01		02		03	
EXP-3	CULBERTSON	HANDOVER		ISS EXERCISE		⊕	♦	HANDOVER		MEAL		HR ASST		HR MS3 SUBJECT		HR ASST		DPC		⊙	PLN RVW		PMC SBD	PRE SLEEP							
	DEZHUROV	HANDOVER		HANDOVER		TRANSFER		MEAL		HR S/U		HR MS4 SUBJECT		HR ASST		Δ	▲	RPT PREP	DPC		PLN RVW		PMC SBD	PRE SLEEP							
	TURIN	HANDOVER		TRANSFER		HANDOVER		MEAL		•	P/TV10 OPS (HR)		HR MS5 SUBJECT		▽	DPC		PLN RVW		PMC SBD	PRE SLEEP										
K																															
S																															
ACS-CMG/STS ATT-H/O	HACS-CMG/STS ATT-H/O																														
EXP1	EXPRS1 PWR/THERM MAMS NOM OPS SAMS OPS RTS/D1 SAMS OPS RTS/D2 DCPCG-V PWR APCF CRYSTAL GROWTH MAMS COMMANDING 5																														
	MAMS STORED DATA D/L EXPRS2 POWER EXPRS2 THERMAL SAMS OPS ICU/D1 BONNER BALL CLCT																														
EXP2																															
MCC																															
ISS	DAY/NIGHT																														
	ORBIT		73	74	75	76	77	78	79	80	81																				
DAILY ORBIT		16	1	2	3	4	5	6	7	8																					
ISS ATT		BIAS +ZLV +XVV														REBOOST				BIAS +ZLV +XVV											
ISS	TDRS																														
	RS GND																														
ISS	KU S-BD																														
	VHF																														
NOTES	ISS P/L CK		⊕PTV21 S/U (ISS) ♦PAO EVENT *CMG TO STS ATT H/O														•P/TV10 S/U (HR)						▲HRF STW ⊙INTRM EGRSS ΔP/TV10 OPS (HR) VXFER TAGUP				▼RENAL ⊕RENAL ⊙RENAL				

EXPRS1
MAMS I
SAMS ()
SAMS ()
DCPCG-
APCF ()
MAMS COMMANDING 5
MAMS COMM
MAMS STORED
EXPRS2
EXPRS2
SAMS ()
BONNER

GMT 08/15/01
 MET [FD6] Day 005

		03 01 02 03 04 05 06 07 08 09 10 11 12 13 14 15																	
S T S - 1 0 5	CDR/RMS1 HOROWITZ	P R E P	S L E E P	PM C O C A	PRE S L E E P	SLEEP										FD07	POST SLEEP		1 0 . 2 *
	PLT/IV1 STURCKOW	PRE SLEEP		SLEEP										POST SLEEP	EVA PREP				
	MS1/EV2 FORRESTER	PRE SLEEP - GIRA		SLEEP										POST SLEEP - GIRA	EVA PREP				
	MS2/EV1 BARRY	PRE SLEEP		SLEEP										POST SLEEP	EVA PREP				
E X P - 2	MS3/IV2 VOSS	PRE SLEEP		SLEEP										POST SLEEP	EVA PREP				
	MS4 HELMS	PRE SLEEP		SLEEP										POST SLEEP	DPC	PREP WORK	M D D K C K		
	MS5 USACHEV	PRE SLEEP		SLEEP										POST SLEEP	DPC	PREP WORK			
DAY/NIGHT		[Day/Night Cycle]																	
ORBIT		81 82 83 84 85 86 87 88 89																	
DAILY ORBIT		8 9 10 11 12 13 14 15 1																	
TDRS		E -47.0 W -171.0																	
ORB ATT		BIAS -XLV +ZVV																	
ISS ATT		BIAS +ZLV +XVV																	
HEAT ACE		RATE 8																	
NOTES																			

MET Day 005 03 01 04 02 05 03 06 04 07 05 08 06 09 07 10 08 11 09 12 10 13 11 14 12 15
 GMT 08/15/01

EXP-3	CULBERTSON	PRE SLEEP	SLEEP											POST SLEEP	POST SLEEP	DPC	PREP WORK	⊕		
	DEZHUROV	PRE SLEEP	SLEEP											POST SLEEP		DPC	PREP WORK	♦		
	TURIN	PRE SLEEP	SLEEP											POST SLEEP		DPC	PREP WORK	⊗		
K	EXE-PKG U/L																F-EXE-PKG U/L			
	S																			
D	AUDIO-DOCK OPS-DCNFG AUDIO-UHF OPS-CNFG UHF-1-ACT	HAUDIO-DOCK OPS-DCNFG HAUDIO-UHF OPS-CNFG UHF-1-ACT															HSBD-KEY-CHG		HAUDIO-DOCK OPS-CNFG	
	SBD-KEY-CHG AUDIO-DOCK OPS-CNFG AR-MCA-OPS																			
E	EXPRS1 PWR/THERM MAMS NOM OPS SAMS OPS RTS/D1 SAMS OPS RTS/D2 DCPCG-V PWR APCF CRYSTAL GROWTH MAMS COMMANDING 5																HMAMS COMMANDING 5		HMAMS COMMANDING 5	
	MAMS STORED DATA D/L																HMAMS STORED DATA D/L		HMAMS STORED DATA D/L	
M	EXPRS2 POWER EXPRS2 THERMAL SAMS OPS ICU/D1																			
	BONNER BALL CLCT																			
R	ISS-COMM CNFG 7A-VFY ISS-COMM CNFG 4A-VFY	HISS-COMM CNFG 7A-VFY															HISS-COMM CNFG 4A-VFY			
	ISS	DAY/NIGHT																		
ISS	ORBIT	81	82	83	84	85	86	87	88	89										
	DAILY ORBIT	8	9	10	11	12	13	14	15	1										
ISS	ISS ATT	BIAS +ZLV +XVV																		
	TDRS S-BD	-VHF -VHF -VHF -VHF -VHF																		
ISS	RS GND																ISS-COMM CNFG 4A-VFY		VHF	
	NOTES																			

AR-MCA
EXPRS1
MAMS A
SAMS C
SAMS C
DCPCG-
APCF C

⊕ISS P/L
♦TRANSFE
⊗TRANSFE

GMT		08/15/01												08/16								
MET		Day 005												006/00								
		13	14	15	16	17	18	19	20	21	22	23	01	02	03							
STS-105	CDR/RMS1 HOROWITZ	WCS*	PMC A/G	EVA H1BT	RMS HTR	PTV23 S/U (EVA)	DPA A13	RMS RUP	RMS SUPPORT					RMS RDN	DPA A12	INN TRMS	1C NFG	PRE SLEEP	PMC OCA	PRE SLEEP		
	PLT/IV1 STURCKOW	EVA PREP	EMU PURGE P/B		DPA A13		EVA 1 SUPPORT EVA 1 (06:30)					REP RS	POST EVA W/H2O		HELM *	PRE SLEEP						
	MS1/EV2 FORRESTER	EVA PREP	EMU PURGE P/B		DPA A13		PREP /EVA	SORTIE SETUP		EVA 1			EVA CLEAN UP	PREP /EVA	POST EVA W/H2O		HELM BATT*	LIQH C/O	PRE SLEEP - GIRA			
	MS2/EV1 BARRY	EVA PREP	EMU PURGE P/B		DPA A13		PREP /EVA	SORTIE SETUP		EVA 1			EVA CLEAN UP	PREP /EVA	POST EVA W/H2O		HELM BATT*	LIQH C/O	PRE SLEEP			
EXP-2	MS3/IV2 VOSS	EVA PREP	EMU PURGE P/B		H2O INIT 6		14.7 REPRS	1C NFG	HT FORM	EXERCISE		MEAL	H2O INIT 7		EXERCISE	HT FORM	POST EVA W/H2O		XFA EGRUP	PRE SLEEP	DPC	PRE SLEEP
	MS4 HELMS	EXERCISE			RMS RUP		RMS SUPPORT					RMS RDN	EXERCISE		MDC CK	PRE SLEEP		DPC	PRE SLEEP			
	MS5 USACHEV	EXERCISE			14.7 REPRS		1C NFG	MEAL		EXERCISE			PRE SLEEP		DPC	PRE SLEEP						
DAY/NIGHT		[Day/Night Cycle]																				
ORBIT		89												90								
DAILY ORBIT		1												2								
TDRS		E -47.0												W -171.0								
ORB ATT		BIAS -XLV +ZVV												EVA1		BIAS +ZLV +XVV		BIAS -XLV +ZVV				
ISS ATT																						
HEAT ACE																						
NOTES		*WCS COMPACT OPS																*HELM BATT INIT *INIT *INIT				

MET Day 005 15 16 17 18 19 20 21 22 23 006/00 01 02 08/16 03
 GMT 08/15/01 13 14 15 16 17 18 19 20 21 22 23

EXP-3	CULBERTSON	TRANSFER	MEAL	TRANSFER	ISS EXERCISE	PMC SBD	⊕	PLN RVW	⊕DPC	PRE SLEEP	
	DEZHUROV	TRANSFER	MEAL	TRANSFER		PMC SBD	RPT PREP	PLN RVW	⊕DPC	PRE SLEEP	
	TURIN	TRANSFER	MEAL	TRANSFER		PMC SBD		PLN RVW	⊕DPC	PRE SLEEP	
K	KUBD-EVA MASK-ENA KUBD-EVA MASK-INH	HKUBD-EVA MASK-ENA								HKUBD-EVA MASK-INH	
S											
DB											
E	EXPRS1 PWR/THERM MAMS NOM OPS SAMS OPS RTS/D1 SAMS OPS RTS/D2 DCPCG-V PWR APCF CRYSTAL GROWTH MAMS COMMANDING 5										EXPRS1 MAMS A SAMS C SAMS C DCPCG- APCF C
	MAMS STORED DATA D/L									HMAMS COMMANDING 5 HMAMS COMMANDING 5 MAMS STORED DATA D/L	
N	EXPRS2 POWER EXPRS2 THERMAL SAMS OPS ICU/D1 BONNER BALL CLCT										EXPRS2 EXPRS2 SAMS C BONNER
R											
MCC											
ISS	DAY/NIGHT	[Bar chart showing day/night cycle]									
	ORBIT	89	90	91	92	93	94	95	96	97	
	DAILY ORBIT	1	2	3	4	5	6	7	8	9	
	ISS ATT	BIAS +ZLV +XVV									
ISS	TDRS	[Bar chart showing TDRS activity]									
	KU S-BD	[Bar chart showing KU S-BD activity]									
	RS GND	VHF	VHF	VHF	VHF	VHF	VHF	VHF	VHF	VHF	
	ISS P/L CK										
	NOTES										⊕INTRM INGRS ⊕RENAL ⊕RENAL ♥XFER TAGUP ΔRENAL

GMT 08/16/01
 MET [FD7] Day 006

		03 01 02 03 04 05 06 07 08 09 10 11 12 13 14 15														
S T S - 1 0 5	CDR/RMS1 HOROWITZ	PRE SLEEP	SLEEP										FD08 POST SLEEP			
	PLT/IV1 STURCKOW	PRE SLEEP	SLEEP										POST SLEEP			
	MS1/EV2 FORRESTER	PRE SLEEP - GIRA	SLEEP										POST SLEEP - GIRA			
	MS2/EV1 BARRY	PRE SLEEP	SLEEP										POST SLEEP			
E X P - 2	MS3/IV2 VOSS	PRE SLEEP	SLEEP										POST SLEEP	DPC	PREP WORK	♦
	MS4 HELMS	PRE SLEEP	SLEEP										POST SLEEP	DPC	PREP WORK	♦
	MS5 USACHEV	PRE SLEEP	SLEEP										POST SLEEP	DPC	PREP WORK	♦
DAY/NIGHT		[Shaded bars indicating day/night cycle]														
ORBIT		97 98 99 100 101 102 103 104														
DAILY ORBIT		9 10 11 12 13 14 15 1														
TDRS		E -47.0 W -171.0														
ORB ATT		BIAS -XLV +ZVV														
ISS ATT		BIAS +ZLV +XVV														
HEAT ACE		RATE 8														
NOTES		2-16A														

♦ HANDOVE
 @ ISS EX
 ♦ LOWER B

MET Day 006 03 04 05 06 07 08 09 10 11 12 13 14 15
 GMT 08/16/01 01 02 03 04 05 06 07 08 09 10 11 12

EXP-3	CULBERTSON	PRE SLEEP	SLEEP							POST SLEEP	POST SLEEP	DPC	PREP WORK	⊕							
	DEZHUROV	PRE SLEEP	SLEEP							POST SLEEP		DPC	PREP WORK	⊕							
	TURIN	PRE SLEEP	SLEEP							POST SLEEP		DPC	PREP WORK	⊕							
K	EXE-PKG U/L											EXE-PKG U/L									
DRS	AUDIO-DOCK OPS-DCNFG SBD-KEY-CHG UHF-1-DEACT AUDIO-UHF OPS-DCNFG AUDIO-DOCK OPS-CNFG											HAUDIO-DOCK OPS-DCNFG		HSBD-KEY-CHG		IUHF-1-DEACT HAUDIO-UHF OPS-DCNFG HAUDIO-DOCK OPS-CNFG					
M	EXPRS1 PWR/THERM MAMS NOM OPS SAMS OPS RTS/D1 SAMS OPS RTS/D2 DCPCG-V PWR APCF CRYSTAL GROWTH MAMS COMMANDING 5 MAMS STORED DATA D/L											MAMS COMMANDING 5		MAMS COMMANDING 5		MAMS STORED DATA D/L					
M	EXPRS2 POWER EXPRS2 THERMAL SAMS OPS ICU/D1 BONNER BALL CLCT																				
M	ISS-COMM CNFG 7A-VFY ISS-COMM CNFG 2A-VFY											HISS-COMM CNFG 7A-VFY		HISS-COMM CNFG 2A-VFY							
ISS	DAY/NIGHT	[Bar chart showing day/night cycle]																			
	ORBIT	97	98	99	100	101	102	103	104												
DAILY ORBIT	9	10	11	12	13	14	15	1													
ISS ATT	BIAS +ZLV +XVV																				
ISS	TDRS	[Bar chart showing TDRS activity]																			
	KU S-BD	[Bar chart showing KU S-BD activity]																			
RS GND	-VHF											-VHF		-VHF		-VHF		-VHF		-VHF	
NOTES																					

EXPRS1
MAMS M
SAMS C
SAMS C
DCPCG-
APCF C

⊕ISS P/L
⊕HANDOVE
⊕LOWER B

GMT 08/16/01
 MET [FDB] Day 006

STS-105	15	16	17	18	19	20	21	22	23	00	01	02	03									
CDR/RMS1 HOROWITZ	PS (T/V/S) 21	MNVR RBST	REBOOST	M D U V R P	S I M O *	XFER	S I M O *	M - N X I L L V R V	XFER	P O (T P I V S S) 21	MEAL	CREW CONF	CREW PHOTO	EXERCISE	EVA PROC REVW	XFER 2 CWC	I N G R S M S	P R E P	I D E P R E S S	C N F G	P M C O C A	PRE SLEEP
PLT/IV1 STURCKOW	TRANSFER				MDDK PREP	SAFER C/O	MEAL	CREW CONF	CREW PHOTO	EVA TOOL CONFG	EVA PROC REVW	EXERCISE		PRE SLEEP								
MS1/EV2 FORRESTER	TRANSFER		EXERCISE	TRANSFER		MDDK PREP	SAFER C/O	MEAL	CREW CONF	CREW PHOTO	EVA TOOL CONFG	EVA PROC REVW	EXERCISE		PTV 18 S/U	PT E / B R M	PRE SLEEP - GIRA					
MS2/EV1 BARRY	EXERCISE		TRANSFER			MDDK PREP	SAFER C/O	MEAL	CREW CONF	CREW PHOTO	EVA TOOL CONFG	EVA PROC REVW	EXERCISE		PTV 18 S/U	PT E / B R M	PRE SLEEP					
MS3/IV2 VOSS	HANDOVER		TRANSFER		ISS EXERCISE		MEAL	CREW CONF	CREW PHOTO	TRANSFER	HANDOVER		X T F A E G D P C	EXERCISE		PRE SLEEP						
MS4 HELMS	ISS EXERCISE		HANDOVER			TRANSFER		MEAL	CREW CONF	CREW PHOTO	TRANSFER		EXERCISE	D P C	PRE SLEEP							
MS5 USACHEV	LOWER BODY NEG PRESS	PE A V O E N T		HANDOVER			TRANSFER		MEAL	CREW CONF	CREW PHOTO	HANDOVER		D P C	PRE SLEEP	EXERCISE		PS R L E E P				
DAY/NIGHT	DAY		NIGHT		DAY		NIGHT		DAY		NIGHT		DAY		NIGHT		DAY		NIGHT		DAY	
ORBIT	105		106		107		108		109		110		111		112							
DAILY ORBIT	2		3		4		5		6		7		8		9							
TDRS	E -47.0		W -171.0																			
ORB ATT	REBOOST		REBOOST		REBOOST		REBOOST		REBOOST		REBOOST		REBOOST		REBOOST		REBOOST		REBOOST		REBOOST	
ISS ATT	BIAS -XLV +YVV		BIAS -XLV +YVV		BIAS -XLV +YVV		BIAS -XLV +YVV		BIAS -XLV +YVV		BIAS -XLV +YVV		BIAS -XLV +YVV		BIAS -XLV +YVV		BIAS -XLV +YVV		BIAS -XLV +YVV		BIAS -XLV +YVV	
HEAT ACE	BIAS +ZLV +YVV		BIAS +ZLV +YVV		BIAS +ZLV +YVV		BIAS +ZLV +YVV		BIAS +ZLV +YVV		BIAS +ZLV +YVV		BIAS +ZLV +YVV		BIAS +ZLV +YVV		BIAS +ZLV +YVV		BIAS +ZLV +YVV		BIAS +ZLV +YVV	
NOTES	*CMG TO STS ATT H/O				*SIMO INIT				*STS TO CMG ATT H/O				*TERM									
	*RCS REG RECONFIG				*SIMO TERM																	
	*HELM BATT TERM																					
	*HELM BATT TERM																					
					2-17A				FLT PLN/105/FIN				07/09/01									

MET Day 006 15 16 17 18 19 20 21 22 23 007/00 01 02 03
 GMT 08/16/01 13 14 15 16 17 18 19 20 21 22 23 01 23 02 08/17 03

E X P - 3	CULBERTSON	TRANSFER		HANDOVER		ISS EXERCISE	MEAL	CREW CONF	CREW PHOTO	HANDOVER		DPC ⊕	PLN RVW	PMC SBD	PRE SLEEP	
	DEZHUROV	HANDOVER		⊗	TRANSFER		MEAL	CREW CONF	CREW PHOTO	TRANSFER	HANDOVER	DPC	RPT PREP	PLN RVW	PMC SBD	PRE SLEEP
	TURIN	LOWER BODY NEG PRESS	TRANSFER	Δ	HANDOVER		TRANSFER	MEAL	CREW CONF	CREW PHOTO	TRANSFER		▲ DPC	PLN RVW	PMC SBD	PRE SLEEP
K S D	ACS-CMG/STS ATT-H/O PPS-P6 SA-FTHR PPS-SA-SUN-TRK	HACS-CMG/STS ATT-H/O PPS-P6 SA-FTHR PPS-SA-SUN-TRK														
	EXPRS1 PWR/THERM MAMS NOM OPS SAMS OPS RTS/D1 SAMS OPS RTS/D2 DCPCG-V PWR APCF CRYSTAL GROWTH MAMS COMMANDING 5 MAMS STORED DATA D/L															
E R 2 P S	EXPRS2 POWER EXPRS2 THERMAL SAMS OPS ICU/D1															
	BONNER BALL CLCT															
M C	PPS-P6 SA-FTHR PPS-SA-SUN-TRK	PPS-P6 SA-FTHR PPS-SA-SUN-TRK														
	ISS DAY/NIGHT ORBIT	105		106		107		108		109		110		111		112
ISS ATT		REBOOST		BIAS +ZLV +YVV		BIAS +ZLV +XVV										
ISS	TDRS KU S-BD															
	RS GND	VHF VHF VHF VHF														
NOTES		ISS P/L CK ⊗PAO EVENT ΔPAO EVENT *CMG TO STS ATT H/O										⊕INTRM EGRSS ▲XFER TAGUP		◆RENAL ♥RENAL φRENAL		

EXPRS1
MAMS N
SAMS C
SAMS C
DCPCG-
APCF C
MAMS COMMANDING 5
MAMS COMMANDING 5
MAMS STORED DATA
EXPRS2
EXPRS2
SAMS C
BONNER

GMT 08/17/01
 MET FDB Day 007

STS-105	CDR/RMS1 HOROWITZ	PRE SLEEP	SLEEP	FD09	POST SLEEP	POST SLEEP	PMC A/G	1 0 - 2 *	*
	PLT/IV1 STURCKOW	PRE SLEEP	SLEEP		POST SLEEP				EVA PREP
	MS1/EV2 FORRESTER	PRE SLEEP - GIRA	SLEEP		POST SLEEP - GIRA				EVA PREP
	MS2/EV1 BARRY	PRE SLEEP	SLEEP		POST SLEEP				EVA PREP
	MS3/IV2 VOSS	PRE SLEEP	SLEEP		POST SLEEP				EVA PREP
EXP-2	MS4 HELMS	PRE SLEEP	SLEEP		POST SLEEP	DPC	PREP WORK		M D K C K
	MS5 USACHEV	PRE SLEEP	SLEEP		POST SLEEP	DPC	PREP WORK		

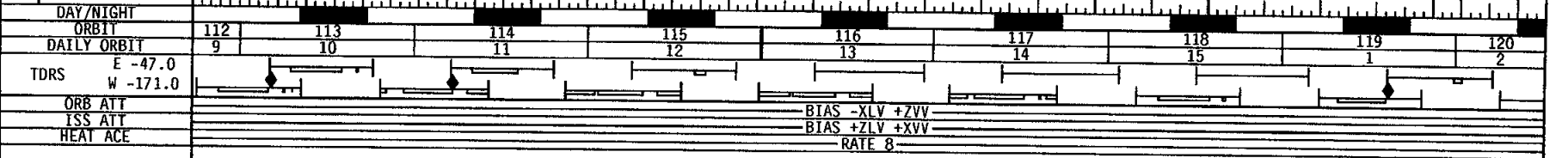

NOTES

2-18A

FLT PLN/105/FIN 07/09/01

*EXERCISE
 @EXERCISE
 *10.2 MAINT

MET Day 007 03 01 04 02 05 03 06 04 07 05 08 06 09 07 10 08 11 09 12 10 13 11 14 12 15
 GMT 08/17/01

EXP-3	CULBERTSON	PRE SLEEP	SLEEP										POST SLEEP	POST SLEEP	DPC	PREP WORK	⊕				
	DEZHUROV	PRE SLEEP	SLEEP										POST SLEEP		DPC	PREP WORK	⊕				
	TURIN	PRE SLEEP	SLEEP										POST SLEEP		DPC	PREP WORK	⊕				
K	EXE-PKG U/L		EXE-PKG U/L																		
	S																				
S		AUDIO-DOCK OPS-DCNFG AUDIO-UHF OPS-CNFG UHF-1-ACT SBD-KEY-CHG AUDIO-DOCK OPS-CNFG AR-MCA-OPS	HAUDIO-DOCK OPS-DCNFG HAUDIO-UHF OPS-CNFG UHF-1-ACT										SBD-KEY-CHG					HAUDIO-DOCK OPS-CNFG			
	1	EXPRS1 PWR/THERM MAMS NOM OPS SAMS OPS RTS/D1 SAMS OPS RTS/D2 DCPCG-V PWR APCF CRYSTAL GROWTH MAMS COMMANDING 5 MAMS STORED DATA D/L	MAMS COMMANDING 5																		
2		EXPRS2 POWER EXPRS2 THERMAL SAMS OPS ICU/D1	MAMS STORED DATA D/L																		
	P	BONNER BALL CLCT																			
S																					
	M	ISS-COMM CNFG 7A-VFY ISS-COMM CNFG 4A-VFY	HISS-COMM CNFG 7A-VFY										HISS-COMM CNFG 4A-VFY								
ISS		DAY/NIGHT	[Day/Night Bar]																		
	ORBIT	112	113	114	115	116	117	118	119	120											
DAILY ORBIT	9	10	11	12	13	14	15	1	2												
ISS ATT		BIAS +ZLV +XVV																			
ISS	TDRS	KU	[TDRS Data]																		
	S-BD		[S-BD Data]																		
RS GND		VHF VHF VHF VHF VHF VHF																			
NOTES		*ISS-COMM CNFG 4A-VFY ⊕ISS P/L †TRANSFE ⊗TRANSFE																			

GMT		08/17/01										08/18										
MET		Day 007										008/00										
		13	14	15	16	17	18	19	20	21	22	23	01	02	03							
STS-105	CDR/RMS1 HOROWITZ	EXERCISE	RMS HTR	PTV23 S/U (EVA)	PCS*	IN AH BT	REP M SR UP	RMS SUPPORT					REP M SR DN	REP M SR DN	IN N T R R M S	1 C N F 7 G	PRE S L E E P	PMC O C A	PRE S L E E P			
	PLT/IV1 STURCKOW	EVA PREP	EMU PURGE P/B		REP M SR UP	EVA 2 SUPPORT EVA 2 (6:30)					REP M SR DN	POST EVA W/H2O		HE L M *	PRE SLEEP							
	MS1/EV2 FORRESTER	EVA PREP	EMU PURGE P/B		DE P R S	EG R S	SORTIE SETUP		EVA 2			EVA CLEAN UP	IN G R E S E P	REP M SR DN	POST EVA W/H2O		PRE SLEEP - GIRA					
	MS2/EV1 BARRY	EVA PREP	EMU PURGE P/B		DE P R S	EG R S	SORTIE SETUP		EVA 2			EVA CLEAN UP	IN G R E S E P	REP M SR DN	POST EVA W/H2O		PRE SLEEP					
EXP-2	MS3/IV2 VOSS	EVA PREP	EMU PURGE P/B		HI N O I T 8	14.7 REPRS	1 C 4 N - 7 G	HT 2 O R M	EXERCISE		MEAL	HI N O I T 9	EXERCISE		HT 2 O R M	POST EVA W/H2O		X T F A E G R U P	PRE S L E E P	D P C	PRE S L E E P	
	MS4 HELMS	EXERCISE			REP M SR UP	RMS SUPPORT					REP M SR DN	EXERCISE		M D D K C K	PRE SLEEP		D P C	PRE S L E E P				
	MS5 USACHEV	EXERCISE			14.7 REPRS	1 C 4 N - 7 G	MEAL			EXERCISE			PRE SLEEP		D P C	PRE S L E E P						
DAY/NIGHT		ORBIT		DAILY ORBIT		TDRS		ORB ATT		ISS ATT		HEAT ACE		NOTES								
		120	121	122	123	124	125	126	127	128	E -47.0		W -171.0		BIAS -XLV +ZVV		EVA2		BIAS +ZLV +XVV		BIAS -XLV +ZVV	
		2	3	4	5	6	7	8	9	10												
		*PCS CONFIG										RATE 8										
												*HELM BATT INIT										

MET Day 007 15 16 17 18 19 20 21 22 23 008/00 01 02 03
 GMT 08/17/01 13 14 15 16 17 18 19 20 21 22 23 08/18

E X P - 3	CULBERTSON	TRANSFER	PMC SBD	ISS EXERCISE	MEAL	TRANSFER	CPA INSTALL	⊕	PLN RVW	⊙PC	PRE SLEEP	
	DEZHUROV	TRANSFER	PMC SBD	TRANSFER	MEAL	TRANSFER	CNFG MPLM RACS ENTRY	RPT PREP	PLN RVW	⊙PC	PRE SLEEP	
	TURIN	TRANSFER	PMC SBD	TRANSFER	MEAL	TRANSFER	CPA INSTALL		▼ PLN RVW	⊙PC	PRE SLEEP	
K	KUBD-EVA MASK-ENA KUBD-EVA MASK-INH	HKUBD-EVA MASK-ENA								HKUBD-EVA MASK-INH		
S												
S												
E I S P	EXPRS1 PWR/THERM MAMS NOM OPS SAMS OPS RTS/D1 SAMS OPS RTS/D2 DCPCG-V PWR APCF CRYSTAL GROWTH MAMS COMMANDING 5									MAMS COMMANDING 5		
	MAMS STORED DATA D/L									MAMS STORED DATA D/L		
S P	EXPRS2 POWER EXPRS2 THERMAL SAMS OPS ICU/D1											
	BONNER BALL CLCT											
S												
ISS	DAY/NIGHT											
	ORBIT	120	121	122	123	124	125	126	127	128		
	DAILY ORBIT	2	3	4	5	6	7	8	9	10		
	ISS ATT	BIAS +ZLV +XVV										
ISS	TDRS KU S-BD											
	RS GND	—VHF —VHF —VHF —VHF										
	ISS P/L CK									⊕INTRM INGRS ♦RENAL ⊙RENAL ▼XFER TAGUP ΔRENAL		
	NOTES											

EXPRS1
MAMS A
SAMS C
SAMS C
DCPCG-
APCF C

EXPRS2
EXPRS2
SAMS C
BONNER

GMT 08/18/01
 MET FD9 Day 008

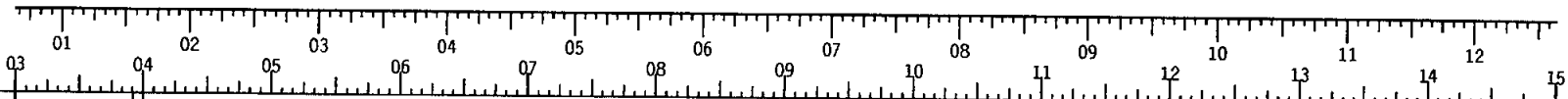

S T S - 1 0 5	CDR/RMS1 HOROWITZ	PRE SLEEP	SLEEP	FD10	POST SLEEP	EXERCISE				
	PLT/IV1 STURCKOW	PRE SLEEP	SLEEP		POST SLEEP					
	MS1/EV2 FORRESTER	PRE SLEEP - GIRA	SLEEP		POST SLEEP - GIRA					
	MS2/EV1 BARRY	PRE SLEEP	SLEEP		POST SLEEP					
E X P - 2	MS3/IV2 VOSS	PRE SLEEP	SLEEP		POST SLEEP	DPC PREP WORK *				
	MS4 HELMS	PRE SLEEP	SLEEP		POST SLEEP	DPC PREP WORK M D K C K				
	MS5 USACHEV	PRE SLEEP	SLEEP		POST SLEEP	DPC PREP WORK ⊕				
DAY/NIGHT		[Shaded bars indicating day/night cycle]								
ORBIT		128	129	130	131	132	133	134	135	12
DAILY ORBIT		10	11	12	13	14	15	16	1	2
TDRS		[Timeline with E -47.0, W -171.0 and various markers]								
ORB ATT		[Timeline with BIAS -XLV +ZVV]								
ISS ATT		[Timeline with BIAS +ZLV +XVV]								
HEAT ACE		[Timeline with RATE 8]								
NOTES										

*ISS EXE
 ⊕LOWER E

MET Day 008 03 01 04 02 05 03 06 04 07 05 08 06 09 07 10 08 11 09 12 10 13 11 14 12 15
 GMT 08/18/01

EXP-3	CULBERTSON	PRE SLEEP	SLEEP						POST SLEEP	POST SLEEP	DPC	PREP WORK	⊕
	DEZHUROV	PRE SLEEP	SLEEP						POST SLEEP		DPC	PREP WORK	
	TURIN	PRE SLEEP	SLEEP						POST SLEEP		DPC	PREP WORK	♦

K
S

AUDIO-DOCK OPS-DCNFG
 C&DH-OIU 4.1C-LOAD
 C&DH-OIU 4C-LOAD
 UHF-1-DEACT
 AUDIO-UHF OPS-DCNFG
 AUDIO-DOCK OPS-CNFG
 PPS-P6 SA-FTHR

HAUDIO-DOCK OPS-DCNFG

IC&DH-OIU 4.1C-LOAD

IC&DH-OIU 4C-LOAD

UHF-1-DEACT

AUDIO-UHF OPS-DCNFG

HAUDIO-DOCK OPS-CNFG

EXPRS1 PWR/THERM
 MAMS NOM OPS
 SAMS OPS RTS/D1
 SAMS OPS RTS/D2
 DPCPG-V PWR
 APCF CRYSTAL GROWTH
 MAMS COMMANDING 5
 MAMS STORED DATA D/L

MAMS COMMANDING 5

MAMS COMMANDING 5

MAMS STORED DATA

EXPRS2 POWER
 EXPRS2 THERMAL
 SAMS OPS ICU/D1

BONNER BALL CLCT

ISS-COMM CNFG 7A-VFY
 ISS-COMM CNFG 2A-VFY
 PPS-P6 SA-FTHR

HISS-COMM CNFG 7A-VFY

HISS-COMM CNFG 2A-VFY

ISS	DAY/NIGHT	[Bar chart showing day/night cycle]											
	ORBIT	128	129	130	131	132	133	134	135				
	DAILY ORBIT	10	11	12	13	14	15	16	1				

ISS ATT BIAS +ZLV +XVV

ISS TDRS KU S-BD
 RS GND

—VHF —VHF —VHF —VHF —VHF —VHF

NOTES

ISS P/L
LDNER B

ISS-COMM CNFG 2A-VFY

GMT 08/18/01
 MET [FD10] Day 008

GMT	13	14	15	16	17	18	19	20	21	22	23	009/00	01	02	08/19	03								
STS-105	CDR/RMS1 HOROWITZ	ATTN MNV R	SIMO *		SIMO *	MNVL R	RMSHT R	PILOT OPS	RP MRS UP	GRAPL	MEAL		MPLM UNINSTL	MPLM BERTH	RUN GRP	RP MRS RDN	APCU 2	RNDZ PGSC S/U	RNDZ TOOLS C/O	HL AUD B/O	PRE SLEEP	PMC OCA	PRE SLEEP	PRE SLEEP
	PLT/IV1 STURCKOW	PS T/V 21	(ISS) PTV21 OPS (ISS)		P/TV 24 S/U	P/TV 24 OPS			PS T/V 21	EXERCISE	MEAL						RNDZ TOOLS S/U	RNDZ TOOLS C/O					PRE SLEEP	
	MS1/EV2 FORRESTER	EMU RECONFG BLOCK C	SAFER C/O	SX AFER	POST EVA ENT PREP			EXERCISE		GRAPL	MEAL	PE AV OENT		MPLM UNINSTL	MPLM BERTH	RUN GRP	RP MRS RDN		RNDZ TOOLS C/O		IO LN LU M			PRE SLEEP - GIRA
	MS2/EV1 BARRY	EMU RECONFG BLOCK B	SAFER C/O	SX AFER	POST EVA ENT PREP		EXERCISE		SVLCS OPS S/U		MEAL	PE AV OENT	SOP VCS /U					RNDZ PGSC S/U	RNDZ TOOLS C/O		SP VLR CD SN			PRE SLEEP
	MS3/IV2 VOSS	ISS EXERCISE			TVIS MOTOR R&R			HANDOVER		H I 2 N O I T 1 0	MEAL	HT 2 O R M		HANDOVER				EXERCISE		XFER 3 CWC		DPC		PRE SLEEP
EXP-2	MS4 HELMS	ITCS LTL SMPL	ITCS MTL SMPL		ISS EXERCISE		HANDOVER			MEAL			HANDOVER					EXERCISE		M D D K C K	DPC		PRE SLEEP	
	MS5 USACHEV	LOWER BODY NEG PRESS	ME PL RMS	MD PE LA MC T	VESTIBULE CONFIG	VEST DEPRESS		CBCS S/U & C/O		MEAL		NODE 1 CBM DEMATE		HANDOVER					ISS EXERCISE			DPC		PRE SLEEP
DAY/NIGHT	ORBIT		ORBIT		ORBIT		ORBIT		ORBIT		ORBIT		ORBIT		ORBIT		ORBIT		ORBIT		ORBIT		ORBIT	
DAILY ORBIT	136		137		138		139		140		141		142		143									
TDRS	E -47.0		W -171.0																					
ORB ATT	BIAS -XLV +YVV		BIAS -ZLV +YVV																					
ISS ATT																								
HEAT ACE																								
NOTES	*CMG TO STS ATT H/O		*STS TO CMG ATT H/O		*SIMO INIT		*SIMO TERM				RATE 8		*MATE		*APCU 2 ACT		*APCU 2 DEACT		^HTR ON		^HTR OFF			

2-21A

FLT PLN/105/FIN 07/09/01

MET Day 008 15 16 17 18 19 20 21 22 23 009/00 01 02 03
 GMT 08/18/01 13 14 15 16 17 18 19 20 21 22 23 08/19

EXP-3	CULBERTSON	ISS EXERCISE	ME PGR LRS MS	⊕	VESTIBULE CONFIG	VEST DEPRESS	CBCS S/U & C/O	MEAL	NODE 1 CBM DEMATE	HANDOVER	⬠	Ⓜ	⬡	PLN RVW	PMCA SBD	DPC	PRE SLEEP
	DEZHUROV	ITCS LTL SMPL	ITCS MTL SMPL	▲	DREAMTIME OPS		HANDOVER	MEAL	HANDOVER			RPT PREP	PLN RVW	PMCA SBD	DPC	PRE SLEEP	
	TURIN	LOWER BODY NEG PRESS	TVIS MOTOR R&R		HANDOVER	MEAL	HANDOVER		PLN RVW	PMCA SBD	DPC	PRE SLEEP					

SBD	PPS-P6 SA-FTHR	PPS-P6 SA-FTHR																
	GNC-PPL UPDATE	GNC-PPL UPDATE																
	PPS-SA-SUN-TRK	PPS-SA-SUN-TRK																
	AR-MCA-PPL	AR-MCA-PPL																
	VDS-VIDEO-CNFG	VDS-VIDEO-CNFG																
FRI	C&DH-OIU 4.1C-LOAD	C&DH-OIU 4.1C-LOAD																
	C&DH-OIU 4C-LOAD	C&DH-OIU 4C-LOAD																
	VDS-VIDEO-DCNFG	VDS-VIDEO-DCNFG																
	MPLM-ENV-CHECK	MPLM-ENV-CHECK																
	EXPR1 PWR/THERM																	
FRI	MAMS NOM OPS																	
	SAMS OPS RTS/D1																	
	SAMS OPS RTS/D2																	
	DCPCG-V PWR																	
	APCF CRYSTAL GROWTH																	
FRI	MAMS COMMANDING 5																	
	MAMS STORED DATA D/L																	
	BTR OPERATION																	
	EXPR2 POWER																	
	EXPR2 THERMAL																	
M/P	SAMS OPS ICU/D1																	
	BONNER BALL CLCT																	
	CPO/PRO CMD																	
M/C	PPS-P6 SA-FTHR	PPS-P6 SA-FTHR																
	PPS-SA-SUN-TRK	PPS-SA-SUN-TRK																
	MPLM-ENV-CHECK	MPLM-ENV-CHECK																

ISS	DAY/NIGHT	[Day/Night Cycle]								
	ORBIT	136	137	138	139	140	141	142	143	
ISS	DAILY ORBIT	2	3	4	5	6	7	8	9	
	ISS ATT	BIAS -ZLV +YVV			BIAS +ZLV +XVV					
ISS	TDRS	[TDRS Schedule]								
	RS GND	[VHF Channels]								

ISS P/L CK @MPLM DEACT ▲DREAM TIME S/U

2-21B

FLT PLN/105/FIN 07/09/01

◆BTR 1 ACT ΔRENAL
 ◎BTR 2 XFER ◊RENAL
 ▼BTR 2 DEACT ●RENAL

EXPR1
MAMS A
SAMS C
SAMS C
DCPCG-
APCF C

BTR OF
EXPR2
EXPR2
SAMS C
BONNEF

GMT
MET

08/19/01
FD10
Day 009

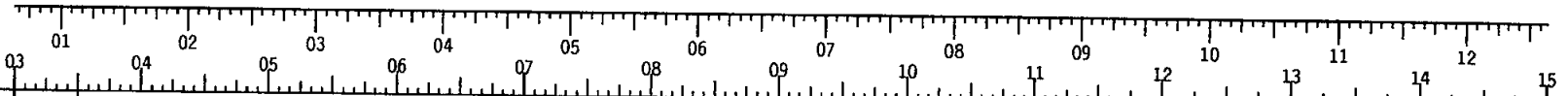

STS-105	Crew	Activity	Time (GMT)															
			03	04	05	06	07	08	09	10	11	12	13	14	15			
STS-105	CDR/RMS1 HOROWITZ	PRE SLEEP	SLEEP									FD11			POST SLEEP	*		
	PLT/IV1 STURCKOW	PRE SLEEP	SLEEP									FD11			POST SLEEP	P/TV 20 S/U		
	MS1/EV2 FORRESTER	PRE SLEEP - GIRA	ISS EXTERNAL SURVEY									FD11			POST SLEEP - GIRA	M C I U *		
	MS2/EV1 BARRY	PRE SLEEP	SLEEP									FD11			POST SLEEP			
EXP-2	MS3/IV2 VOSS	PRE SLEEP	SLEEP									FD11			POST SLEEP	DPC	PREP WORK	
	MS4 HELMS	PRE SLEEP	SLEEP									FD11			POST SLEEP	DPC	PREP WORK	M D D K C K
	MS5 USACHEV	PRE SLEEP	SLEEP									FD11			POST SLEEP	DPC	PREP WORK	
DAY/NIGHT			[Shaded bars indicating day/night cycle]															
ORBIT			143	144	145	146	147	148	149	150	151							
DAILY ORBIT			9	10	11	12	13	14	15	1	2							
TDRS			[Timeline with diamond markers and horizontal bars]															
ORB ATT			[Timeline with horizontal bars]															
ISS ATT			[Timeline with horizontal bars]															
HEAT ACE			[Timeline with horizontal bars]															
NOTES			BIAS -XLV +ZVV BIAS +ZLV +XVV RATE 8															

MET Day 009 03 04 05 06 07 08 09 10 11 12 13 14 15
 GMT 08/19/01 01 02 03 04 05 06 07 08 09 10 11 12

EXP-3	CULBERTSON	PRE SLEEP	SLEEP								POST SLEEP	POST SLEEP	DPC	PREP WORK	⊕
	DEZHUROV	PRE SLEEP	SLEEP									POST SLEEP	DPC	PREP WORK	
	TURIN	PRE SLEEP	SLEEP									POST SLEEP	DPC	PREP WORK	
K	EXE-PKG U/L	EXE-PKG U/L													
	C3N-AB-FULL CHRQ	C3N-AB-FULL CHRQ													
D	AUDIO-DOCK OPS-DCNFG AUDIO-UHF OPS-CNFG UHF-1-ACT	AUDIO-DOCK OPS-DCNFG AUDIO-UHF OPS-CNFG UHF-1-ACT													
	SBD-KEY-CHG AUDIO-DOCK OPS-CNFG GNC-MP-U/L	SBD-KEY-CHG						AUDIO-DOCK OPS-CNFG						GNC-MP-U/L	
M	ACG-ATT-CCDB-CHG	ACG-ATT-CCDB-CHG													
	EXPRS1 PWR/THERM MAMS NOM OPS SAMS OPS RTS/D1 SAMS OPS RTS/D2 DCPCG-V PWR APCF CRYSTAL GROWTH BTR OPERATION MAMS COMMANDING 5	MAMS COMMANDING 5													
M	MAMS STORED DATA D/L	MAMS STORED DATA D/L													
	EXPRS2 POWER EXPRS2 THERMAL SAMS OPS ICU/D1	MAMS STORED DATA D/L													
M	BONNER BALL CLCT	BONNER BALL CLCT													
	ISS MODE-PROX-XTION	ISS MODE-PROX-XTION													
M	ISS-COMM CNFG 7A-VFY ISS-COMM CNFG 3A-VFY ISS MODE-PROX-XTION	ISS-COMM CNFG 3A-VFY													
	ISS	DAY/NIGHT	BIAS +ZLV +XVV												
ISS	ORBIT	143	144	145	146	147	148	149	150	151					
	DAILY ORBIT	9	10	11	12	13	14	15	1	2					
ISS	TDRS	TDRS													
	RS GND	-VHF -VHF -VHF -VHF -VHF -VHF -VHF													
ISS	KU S-BD	ISS-COMM CNFG 3A-VFY													
	RS GND	ISS-COMM CNFG 3A-VFY													
NOTES															

HACS-A1
EXPRS1
MAMS N
SAMS C
SAMS C
DCPCG-
APCF C
BTR OF
MAMS COMMANDING 5
MAMS COMMANDING 5
MAMS STORED DATA D/L
EXPRS2
EXPRS2
SAMS C
BONNER
ISS P/L

GMT 08/19/01
 MET 08/19/01 Day 009

13 14 15 16 17 18 19 20 21 22 23 010/00 01 23 02 08/20 03

STS - 105	CDR/RMS1 HOROWITZ	* EGRS HATCH CLS	ODS VEST LK CK	GPWR PRUB	UNDOCK OPS	FLYAROUND	FMEN ZL SV	MEAL	MNZV SV RI	FES	CSAT BOW IN	PEAV OENT	OA OMS BURN	MNZV SV	L-1 COMM CHK	PILOT OPS	PFC	CABIN STOW	L-1 COMM CHK	PMC A/G	PRE SLEEP		
	PLT/IV1 STURCKOW	EGRS HATCH CLS	ODS VEST LK CK	P/TV19 C/L CMR	UNDOCK OPS	FLYAROUND	GPWR PRUB	PTV 08 NS/U	MEAL	P/TV 08 OPS	PSTE VTU 02	PEAV OENT	OA OMS BURN	PSEVT T OUR SPY	FILTER CLEANING			EXERCISE			PRE SLEEP	PFC	PRE SLEEP
	MS1/EV2 FORRESTER			FGIANS ALR P	P/TV19 C/L CMR	UNDOCK OPS	FLYAROUND	COMM*	MEAL	SSAT DPLY	RPMS RD N	PEAV OENT	IO LFLUM	CABIN STOW				EXERCISE			PRE SLEEP - GIRA	PFC	PRE SLEEP - GIRA
	MS2/EV1 BARRY		EXERCISE	GPWR PRUB	UNDOCK OPS	FLYAROUND	GPWR PRUB		MEAL	SSAT DPLY		PEAV OENT		CABIN STOW				PFC	CSAT BOW IN			PRE SLEEP	
	MS3/IV2 VOSS	EGRS HATCH CLS		EXERCISE	UNDOCK OPS	FLYAROUND			MEAL	CABIN STOW		PEAV OENT	CSAT BOW IN	PFC	EXERCISE	CABIN STOW						PRE SLEEP	
EXP - 2	MS4 HELMS		EXERCISE	UNDOCK OPS	FLYAROUND			MEAL	CABIN STOW		PEAV OENT	EXERCISE	CABIN STOW					MDDK CK	PFC		PRE SLEEP		
	MS5 USACHEV	EXERCISE		UNDOCK OPS	FLYAROUND			MEAL	CABIN STOW		PEAV OENT	CABIN STOW	PFC	EXERCISE							PRE SLEEP		
	DAY/NIGHT ORBIT	151	152	153	154	155	156	157	158	159													
DAILY ORBIT	2	3	4	5	6	7	8	9	10														
TDRS	E -47.0																						
ORB ATT	W -171.0																						
ISS ATT		BIAS -XLV +ZVV			TORF			+ZSI													-ZLV -XVV		
HEAT ACE		BIAS +ZLV +XVV																					
MTL																							
DFR																							
NOTES	*EXERCISE			*CMG TO STS ATT H/O ^HTR ON			2-23A		*FES DUMP INIT *COMM 1 STRING C/O (A)			*FES DUMP TERM	FLT PLN/105/FIN					*APCU 2 ACT *APCU 2 DEACT			07/09/01	^HTR OFF	

*** UNDOCK 9/18:16**

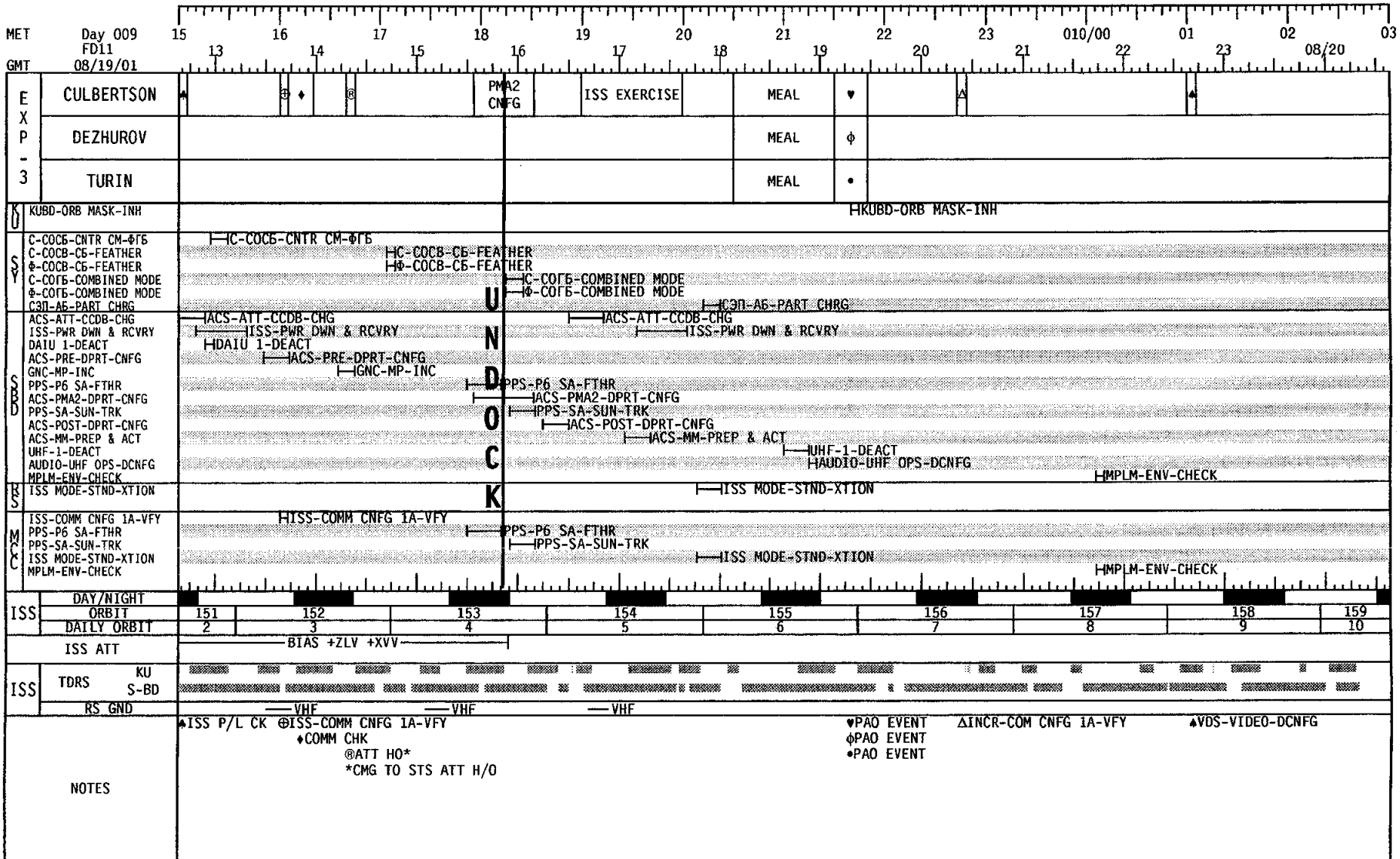

GMT

08/20/01

FD11

MET

Day 010

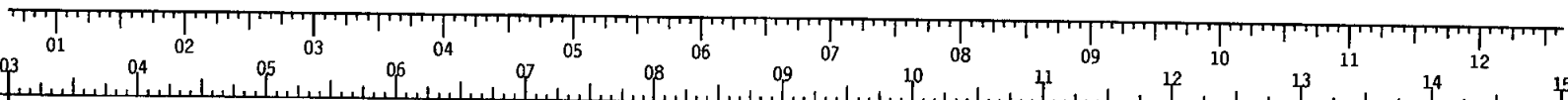

STS-105	CDR HOROWITZ	SLEEP										FD12	POST SLEEP	FCS C/O						
	PLT STURCKOW	SLEEP											POST SLEEP	FCS C/O						
	MS1 FORRESTER	SLEEP											POST SLEEP - GIRA	LAUNCH ENTRY SUIT CK						
	MS2 BARRY	SLEEP											POST SLEEP	POST SLEEP	FCS C/O					
	MS3 VOSS	SLEEP											POST SLEEP	LAUNCH ENTRY SUIT CK						
	MS4 HELMS	SLEEP											POST SLEEP	M D K C K LAUNCH ENTRY SUIT CK						
	MS5 USACHEV	SLEEP											POST SLEEP	LAUNCH ENTRY SUIT CK						
DAY/NIGHT	[Day/Night Cycle Diagram]																			
ORBIT	159	160	161	162	163	164	165	166	167											
DAILY ORBIT	10	11	12	13	14	15	16	1	2											
TDRS	E -47.0	[TDRS Schedule]																		
	W -171.0	[TDRS Schedule]																		
ORB ATT	[Orbit Attenuation]																			
HEAT ACE	[Heat Attenuation]																			
MIL	[MIL]																			
DFR	[DFR]																			
NOTES	2-24										FLT PLN/105/FIN					07/09/01				
	*APU HTR ACT																			

GMT 08/20/01
 MET [FD12] Day 010

STS-105	CDR HOROWITZ	FCS/O RCS/H/F	MMW PNA LVSS RTRT E	WI AN SI TT E	PILOT OPS	WT AE SR TM E	M N Z L V R V	OFF DUTY	MEAL	OFF DUTY	EXERCISE	A P O T E C U S S I O N S 2 2 *	D/O BRIEF	PRE SLEEP	PMC A/G			
	PLT STURCKOW	FCS/O RCS/H/F	PILOT SETUP		PILOT OPS			OFF DUTY	MEAL	OFF DUTY	S D S E V A C T	EXERCISE	D/O BRIEF	PRE SLEEP				
	MS1 FORRESTER		CABIN STOW	M C I U *		OFF DUTY		EXERCISE	MEAL	C O M M 2		OFF DUTY	R C M B N T S E A T S /U	D/O BRIEF	PRE SLEEP - GIRA			
	MS2 BARRY	FCS/O RCS/H/F	CABIN STOW		PILOT OPS	EXERCISE	PGSC STOW PART I		MEAL		OFF DUTY		K U S T O W	O C A S - B D S /U	D/O BRIEF	E R G O S T O W	O I U	PRE SLEEP
	MS3 VOSS				EXERCISE		OFF DUTY	P E A V O E N T	MEAL	EXERCISE	OFF DUTY		R C M B N T S E A T S /U	D/O BRIEF	E R G O S T O W	PRE SLEEP		
	MS4 HELMS		CABIN STOW		EXERCISE		OFF DUTY	C D P E C A G C - T H	P E A V O E N T	MEAL	OFF DUTY	EXERCISE	OFF DUTY	R C M B N T S E A T S /U	D/O BRIEF	M D D K C K	PRE SLEEP	
	MS5 USACHEV		CABIN STOW		EXERCISE			P S T E V T O U P	P E A V O E N T	MEAL	OFF DUTY	EXERCISE		R C M B N T S E A T S /U	D/O BRIEF	PRE SLEEP		

DAY/NIGHT	[Shaded bars indicating day/night cycle]											
ORBIT	167	168	169	170	171	172	173	174	175			
DAILY ORBIT	2	3	4	5	6	7	8	9	10			
TDRS	E -47.0											
	W -171.0											
ORB ATT												
HEAT ACE												
MIL												
DFR												
NOTES	^HTR ON *FILTER CHECK					*APCU 2 ACT ^HTR OFF *APCU 2 DEACT					2-25 FLT PLN/105/FIN 07/09/01	

GMT 08/21/01
 MET Day 011

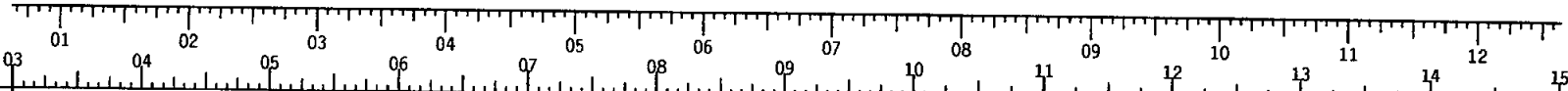

STS-105	CDR HOROWITZ	SLEEP	FD13	POST SLEEP	PMCA/G	GRWPRUP	IMU ALIGN/VERIF	M-NVSR	DERORBIT
	PLT STURCKOW	SLEEP	POST SLEEP	POST SLEEP	GRWPRUP	OSTACW	H20TK	DERORBIT	
	MS1 FORRESTER	SLEEP	POST SLEEP	POST SLEEP			GSTRORAW	DERORBIT	
	MS2 BARRY	SLEEP	POST SLEEP	POST SLEEP	PGSCSTOWPARTS II	SVH	ESTWCLRPRT	DERORBIT	
	MS3 VOSS	SLEEP	POST SLEEP	POST SLEEP			AIRSAM	DERORBIT	
	MS4 HELMS	SLEEP	POST SLEEP	POST SLEEP			TEFFC	MDKCK	DERORBIT
	MS5 USACHEV	SLEEP	POST SLEEP	POST SLEEP					DERORBIT
DAY/NIGHT	[Timeline with alternating light and dark bars]								
ORBIT	175	176	177	178	179	180	181	182	183
DAILY ORBIT	10	11	12	13	14	15	1	2	3
TDRS	[Timeline with diamond markers]								
ORB ATT	[Timeline with diamond markers]								
HEAT ACE	-ZLV -XV								
MIL	[Timeline with diamond markers]								
DFR	[Timeline with diamond markers]								
NOTES	2-26			^HTR ON			*DEACTIVATION # HTRS - OFF		
				FLT PLN/105/FIN			07/09/01		

GMT 08/21/01
 MET [FD13] Day 011

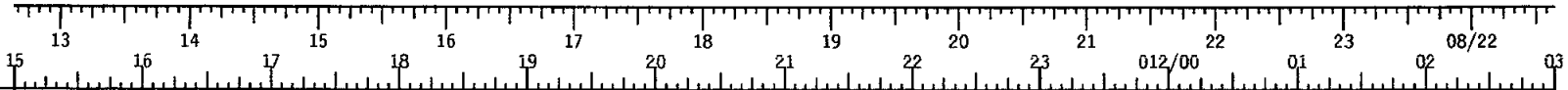

STS-105	CDR HOROWITZ	DEORBIT PREP		
	PLT STURCKOW	DEORBIT PREP		
	MS1 FORRESTER	DEORBIT PREP	D / O	K S C
	MS2 BARRY	DEORBIT PREP		L N D G
	MS3 VOSS	DEORBIT PREP	B U R N	
	MS4 HELMS	DEORBIT PREP		*GMT 233/17:17
	MS5 USACHEV	DEORBIT PREP		

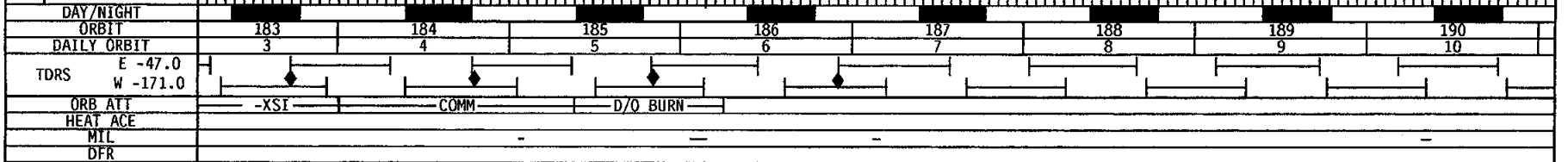

NOTES

D/O TIG 11/18:37
 KSC LNDG 11/19:39

2-27

FLT PLN/105/FIN 07/09/01

DETAILED TIMELINE

DETAILED
TIMELINE

DETAILED TIMELINE

STS-105 7A.1 (FD 01)

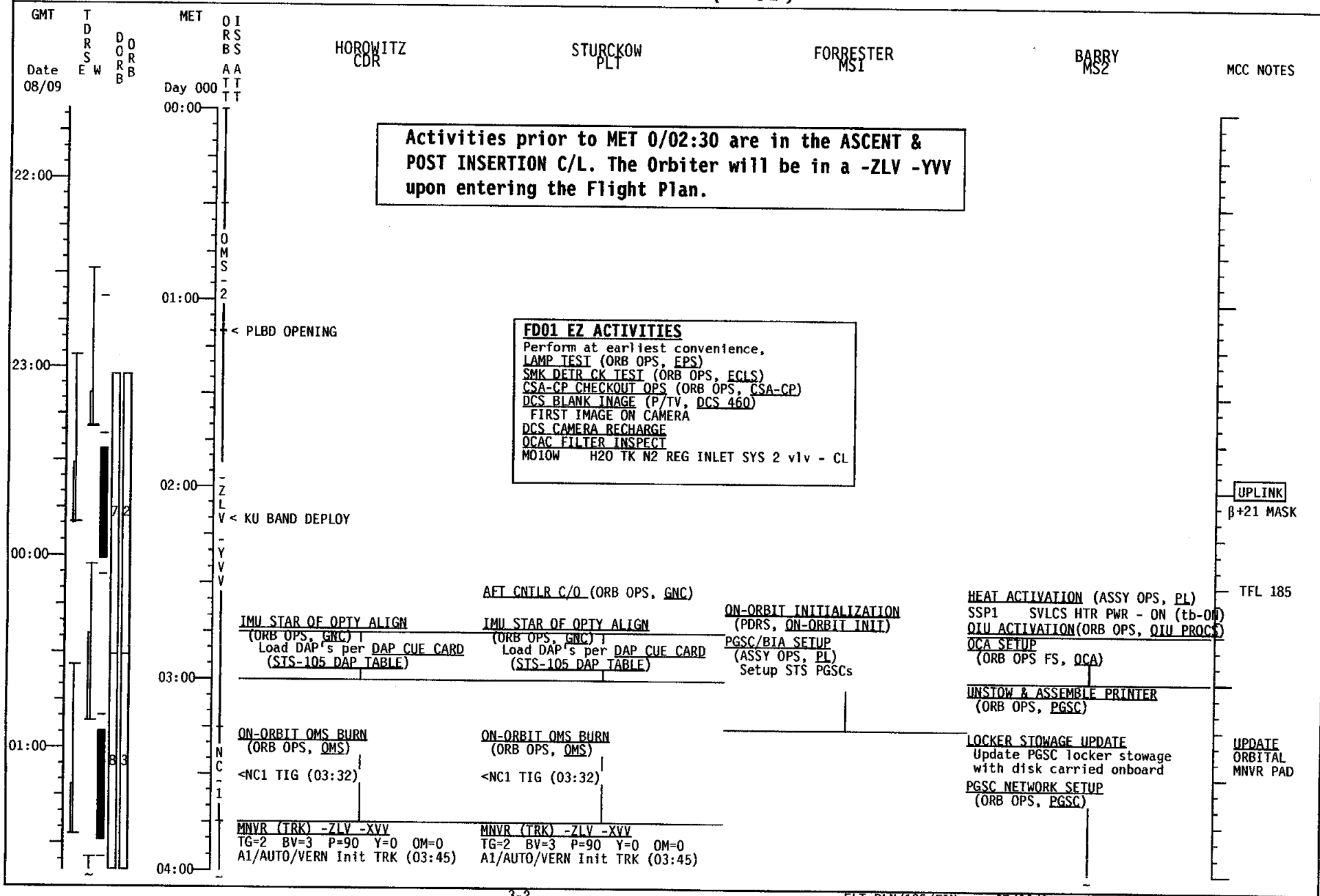

STS-105 7A.1 (FD 01)

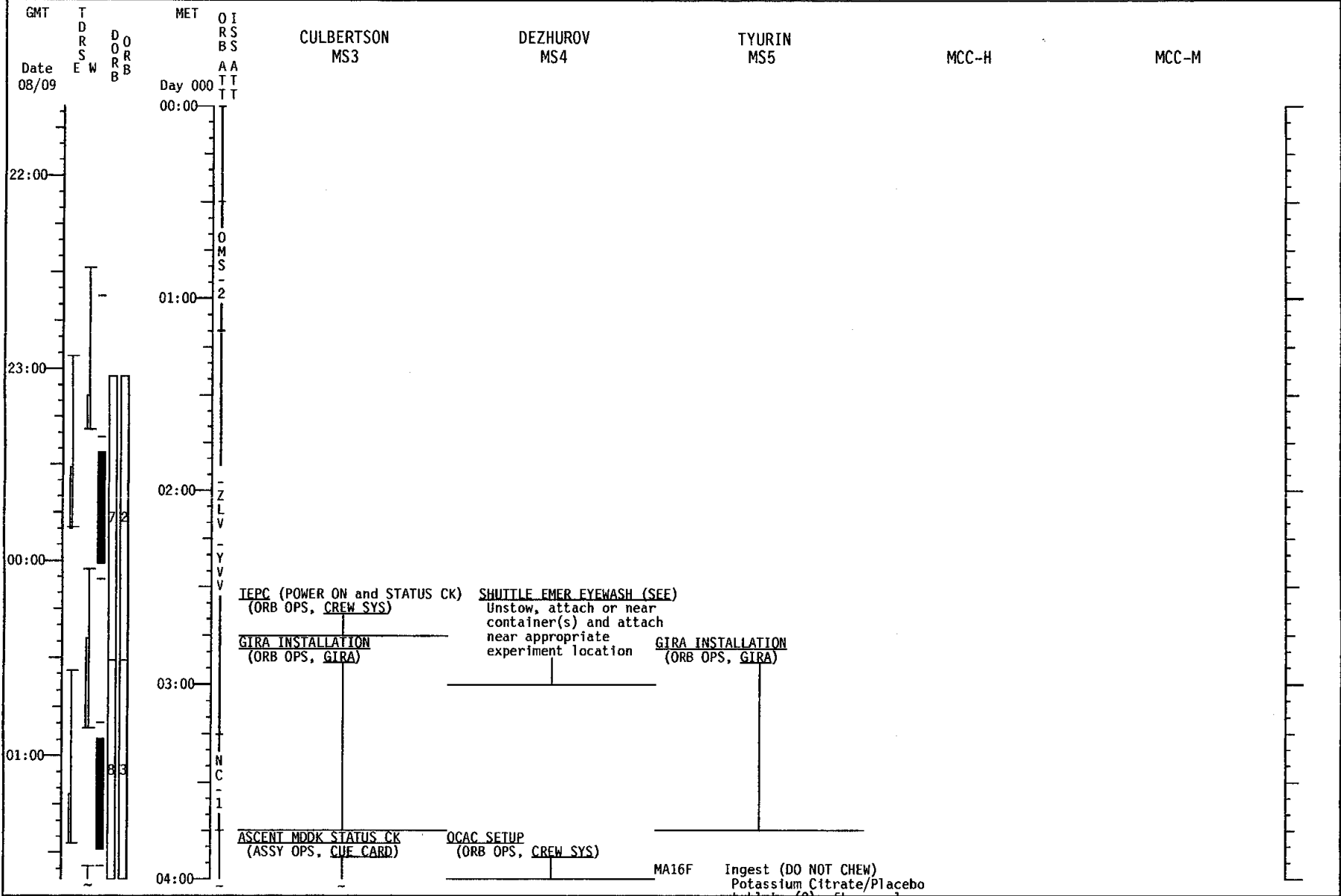

STS-105 7A.1 (FD 01)

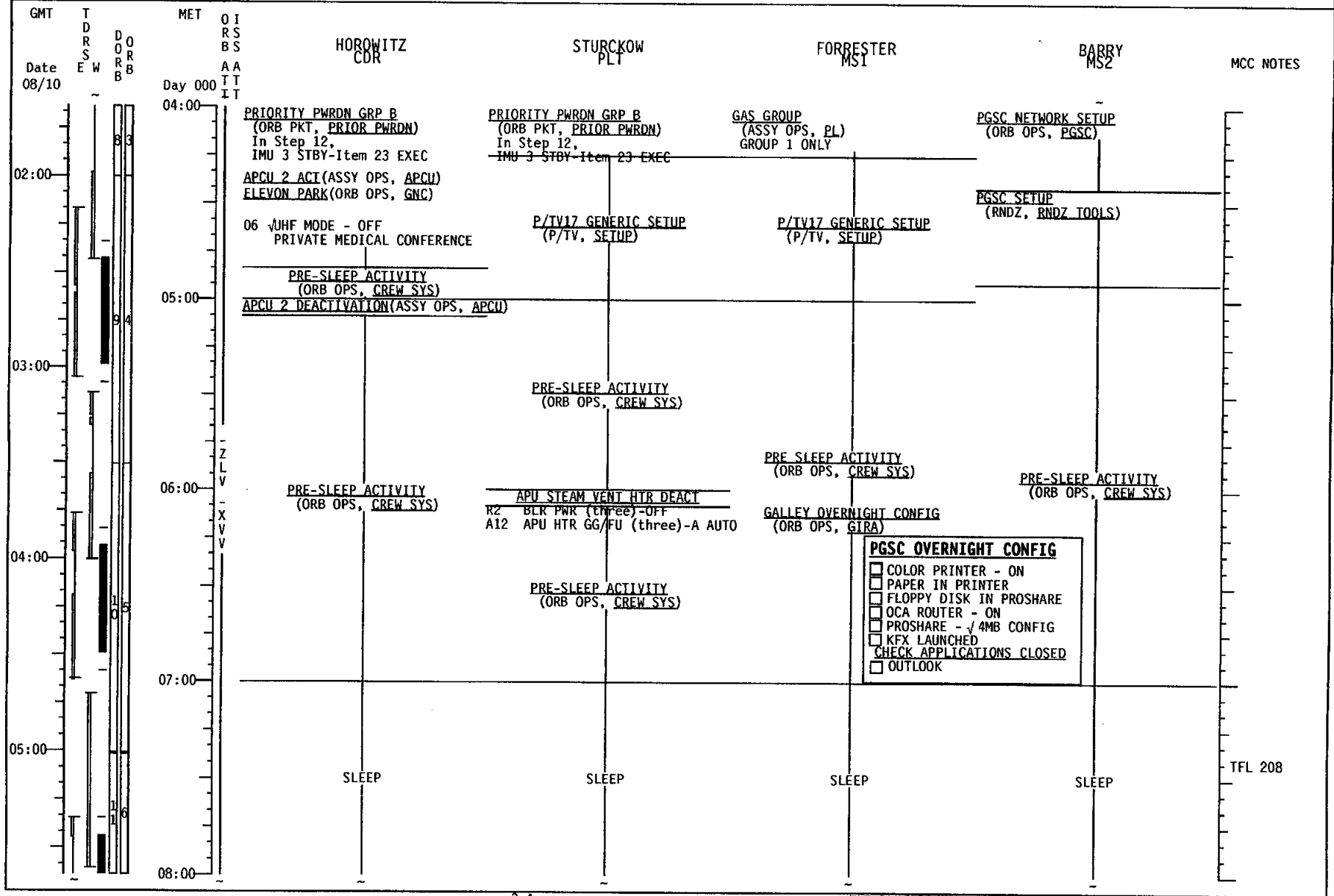

STS-105 7A.1 (FD 01)

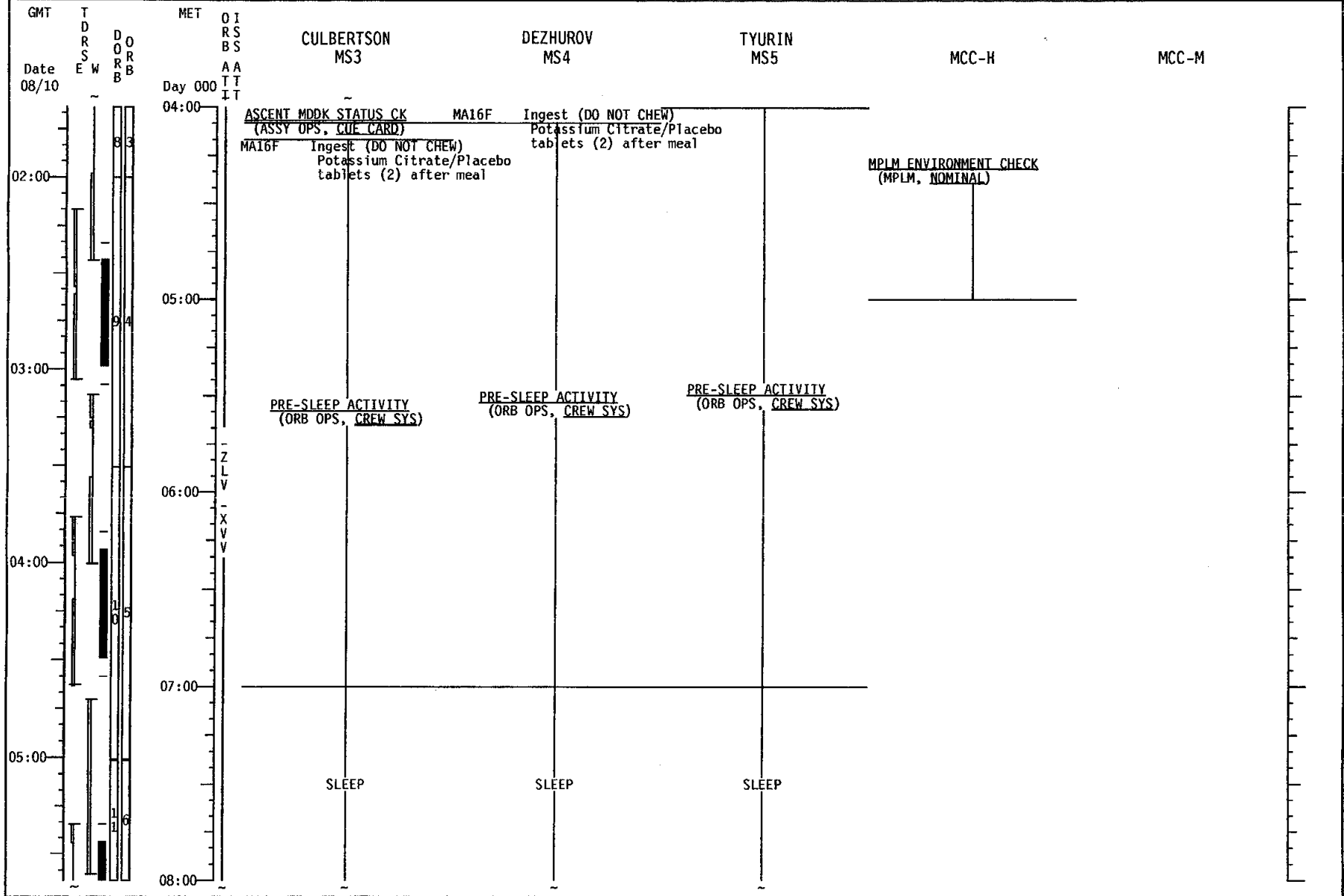

STS-105 7A.1 (FD 01)

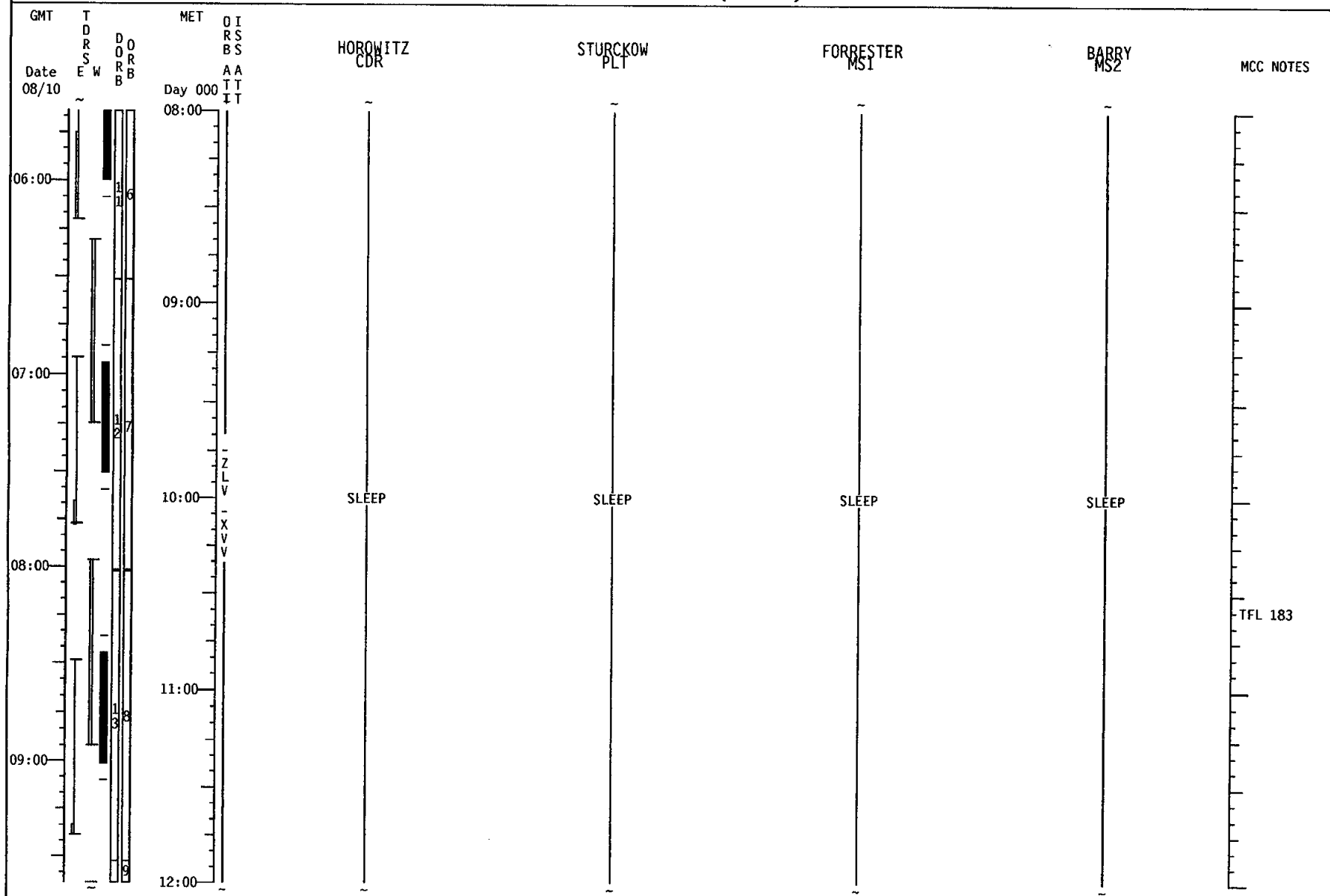

STS-105 7A.1 (FD 01)

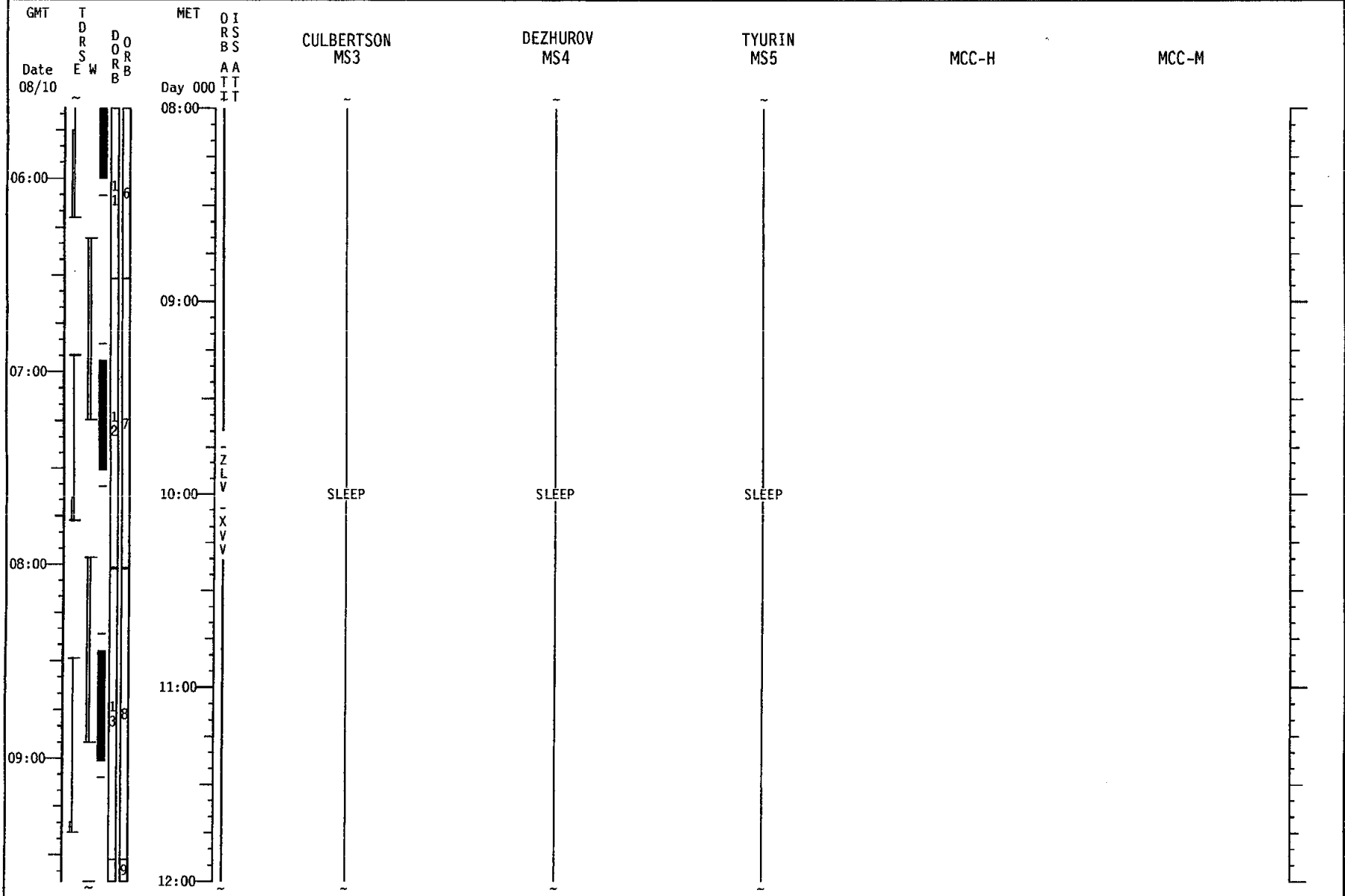

STS-105 7A.1 (FD 01)

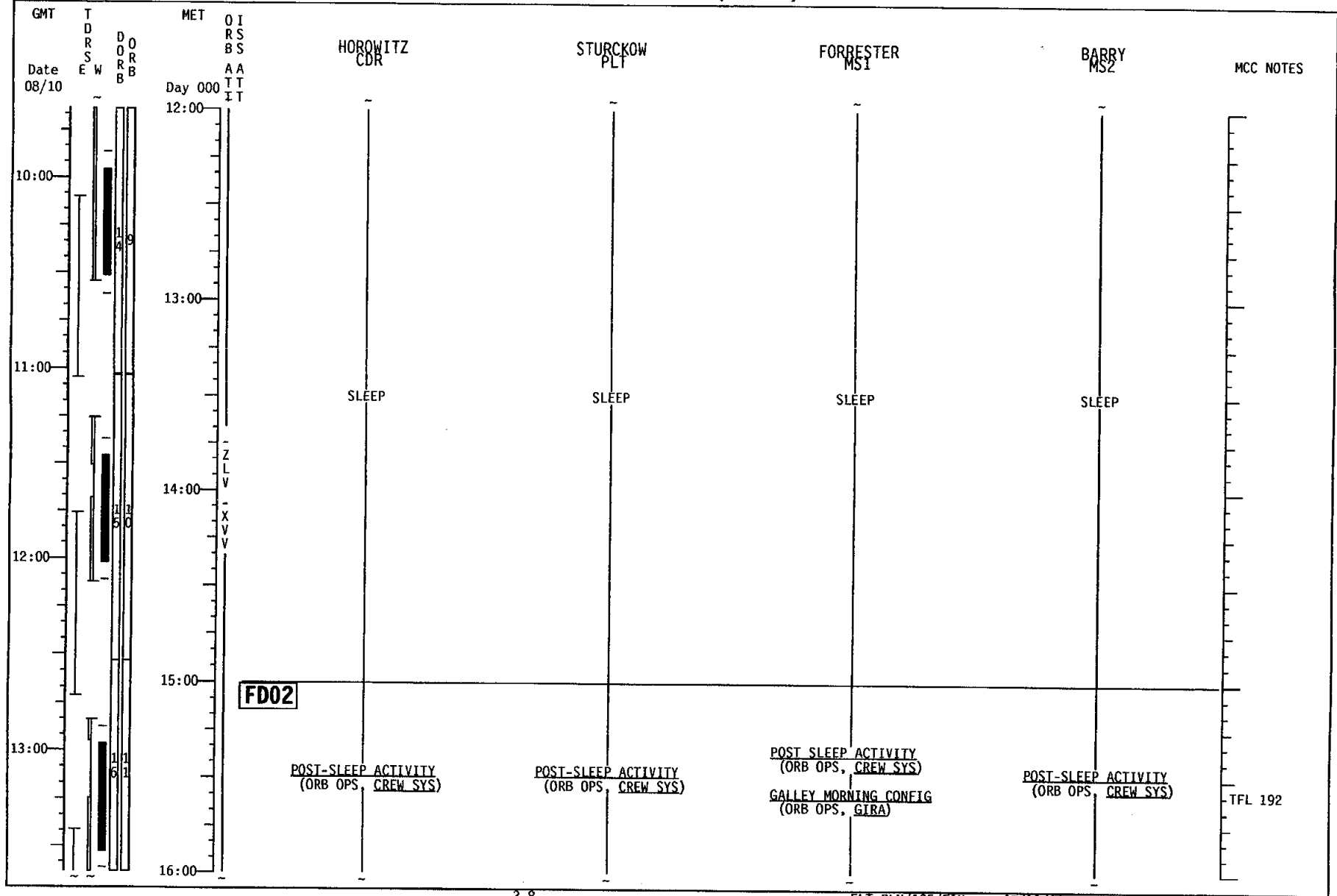

STS-105 7A.1 (FD 01)

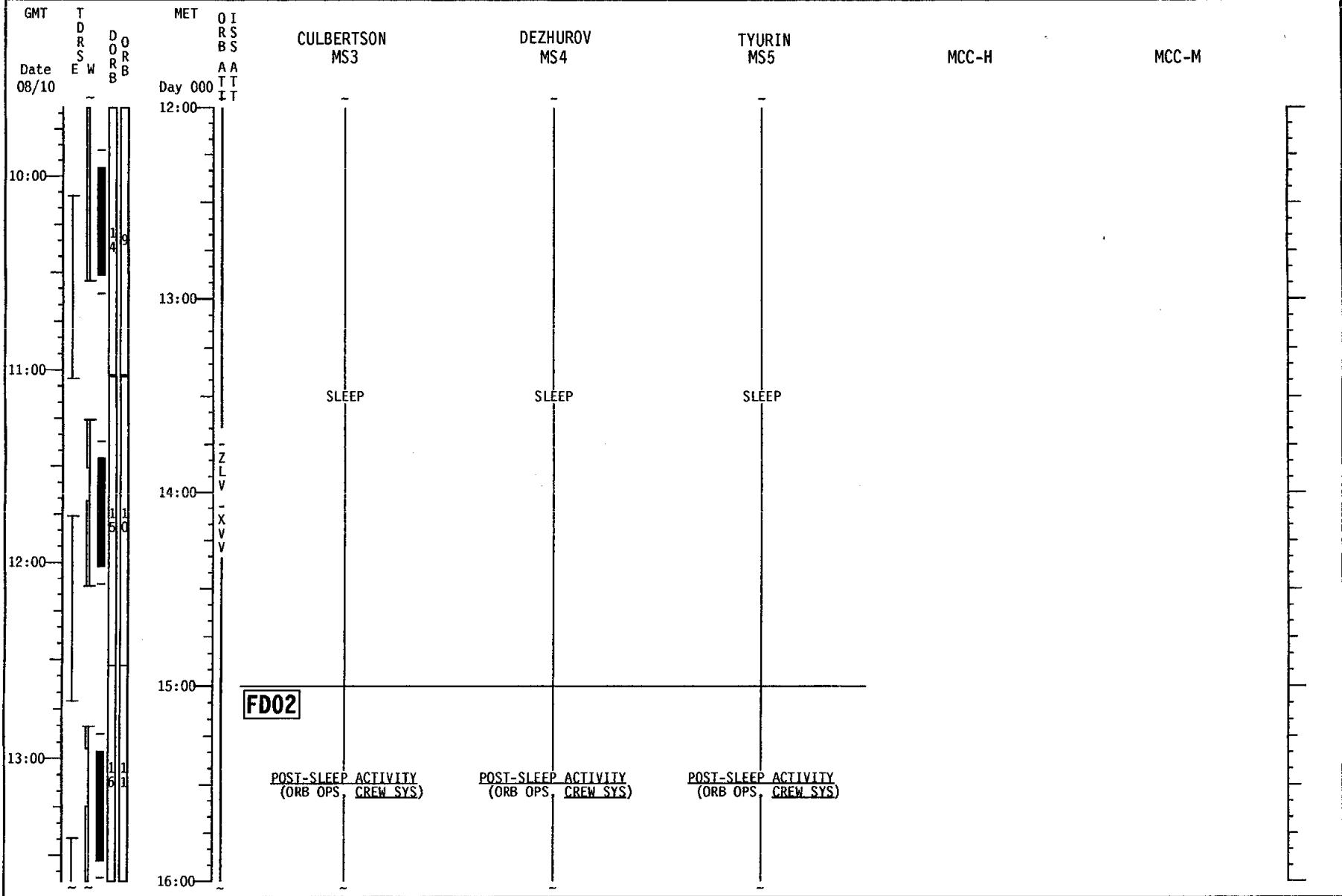

STS-105 7A.1 (FD 02)

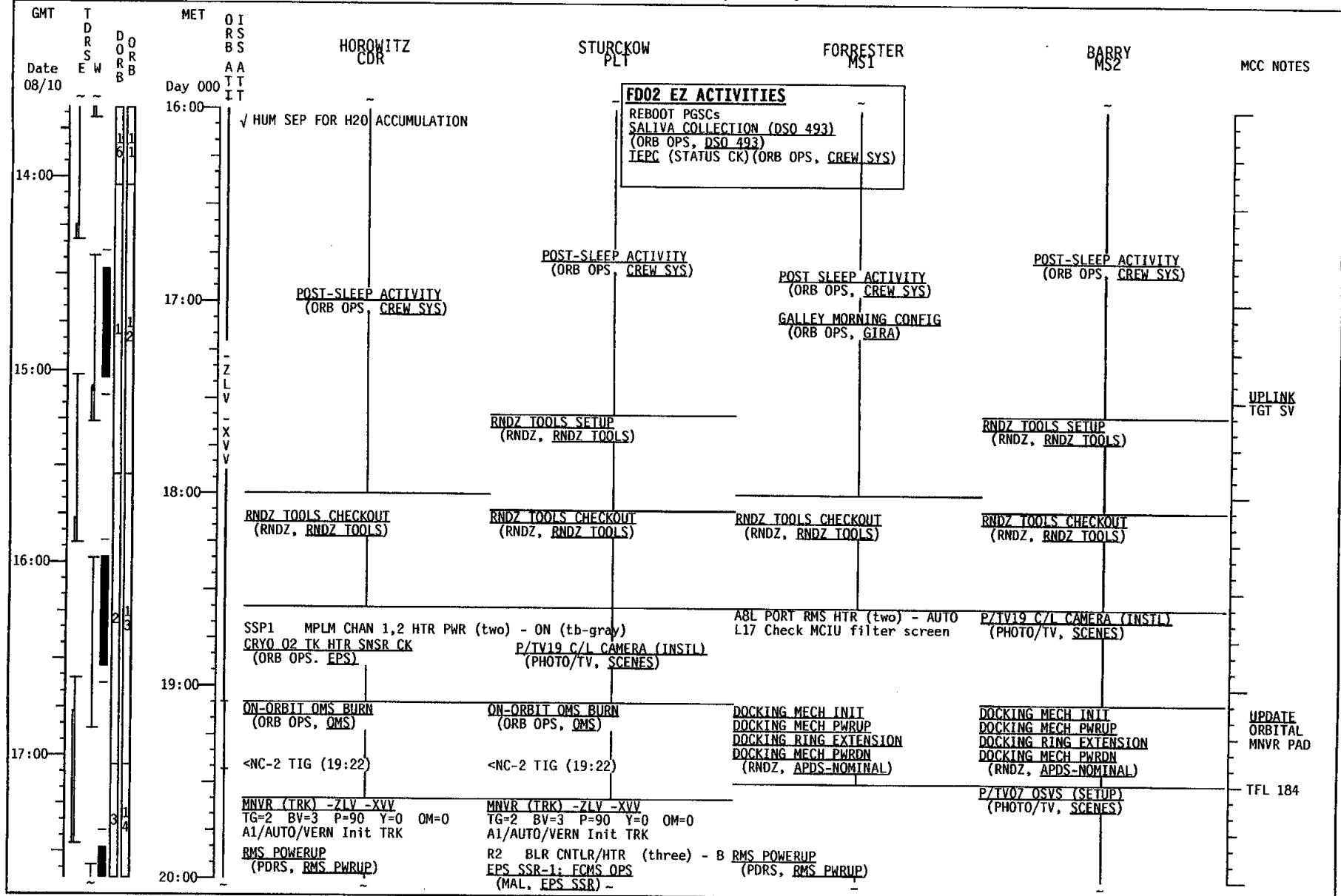

STS-105 7A.1 (FD 02)

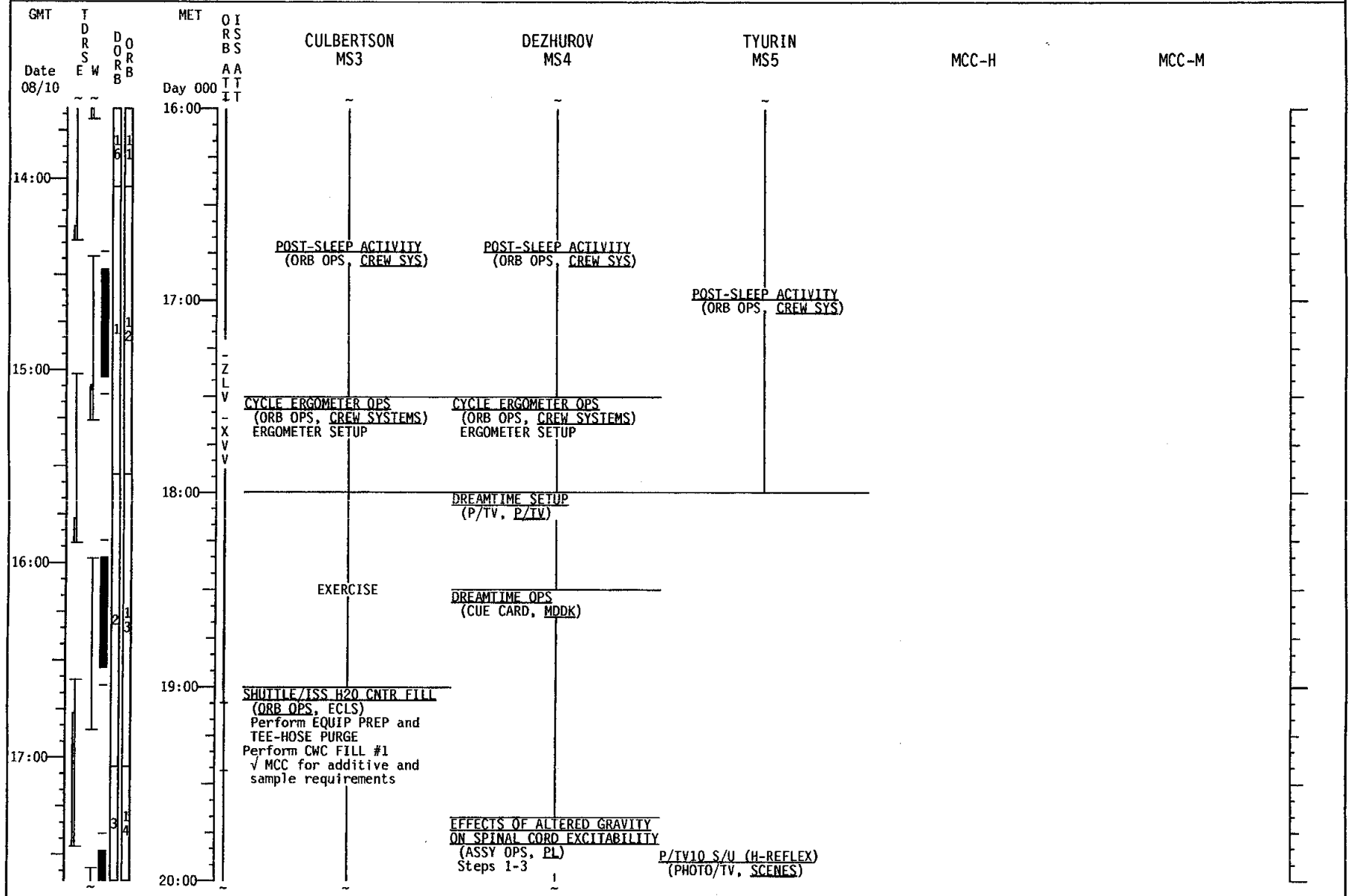

STS-105 7A.1 (FD 02)

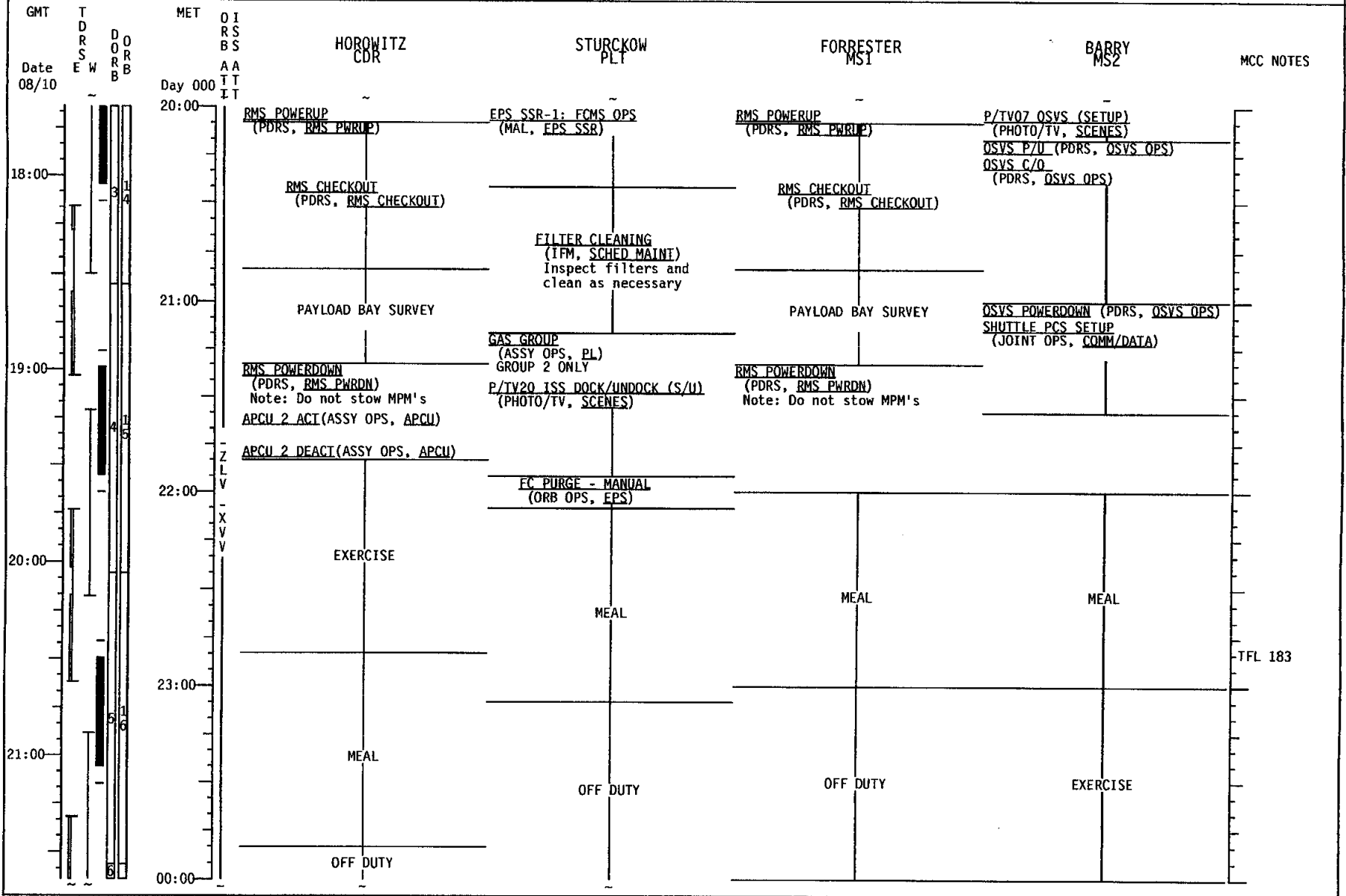

STS-105 7A.1 (FD 02)

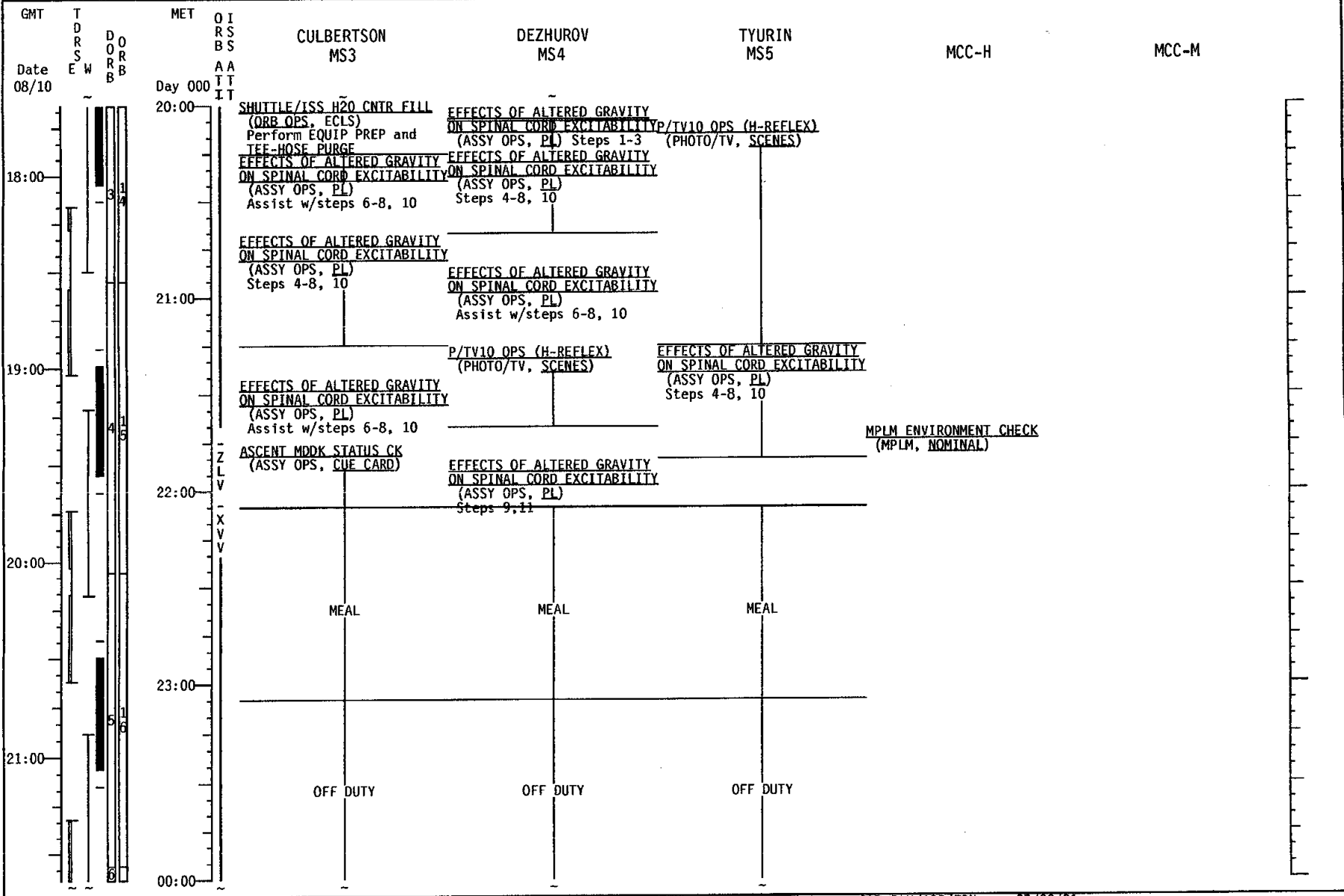

STS-105 7A.1 (FD 02)

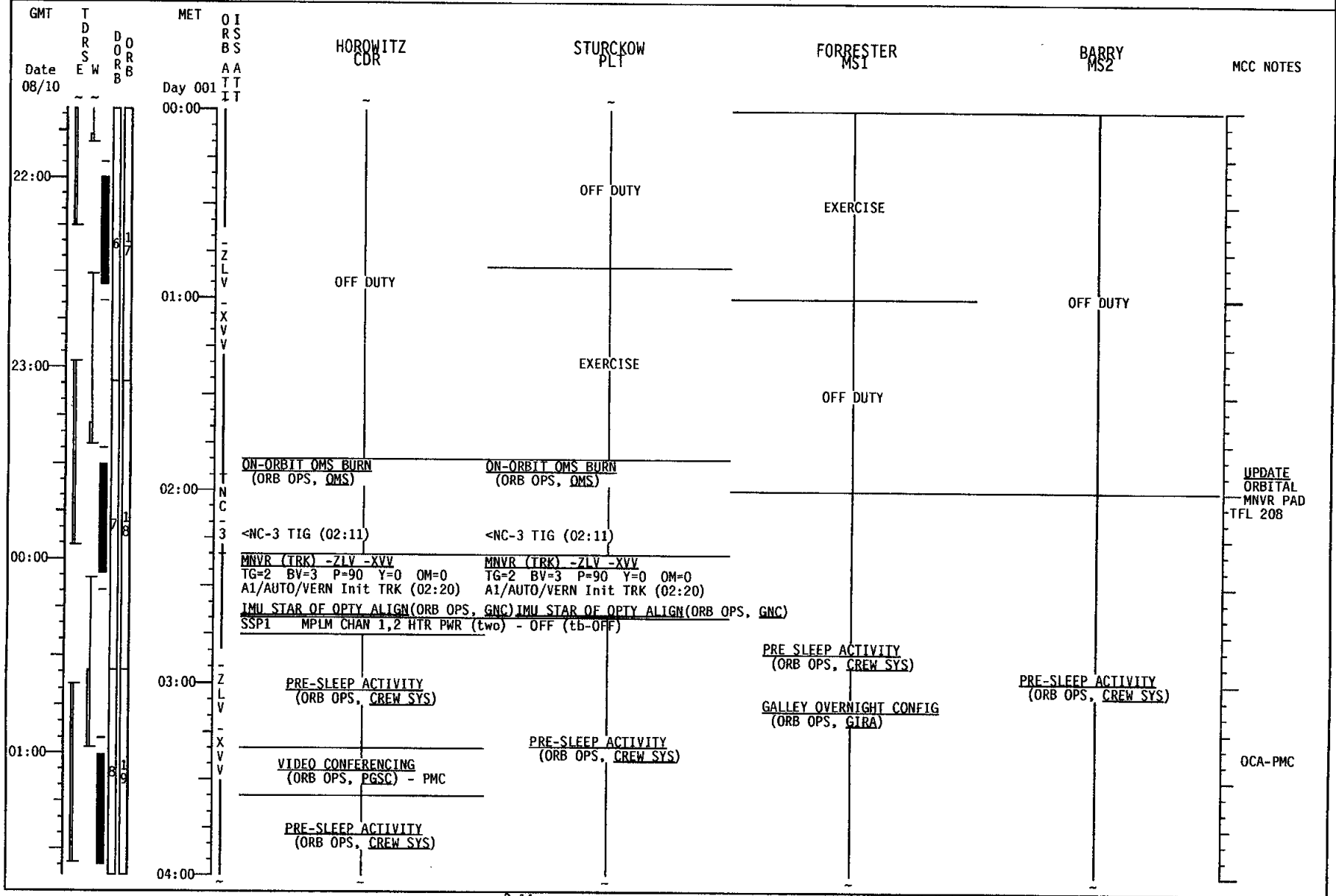

STS-105 7A.1 (FD 02)

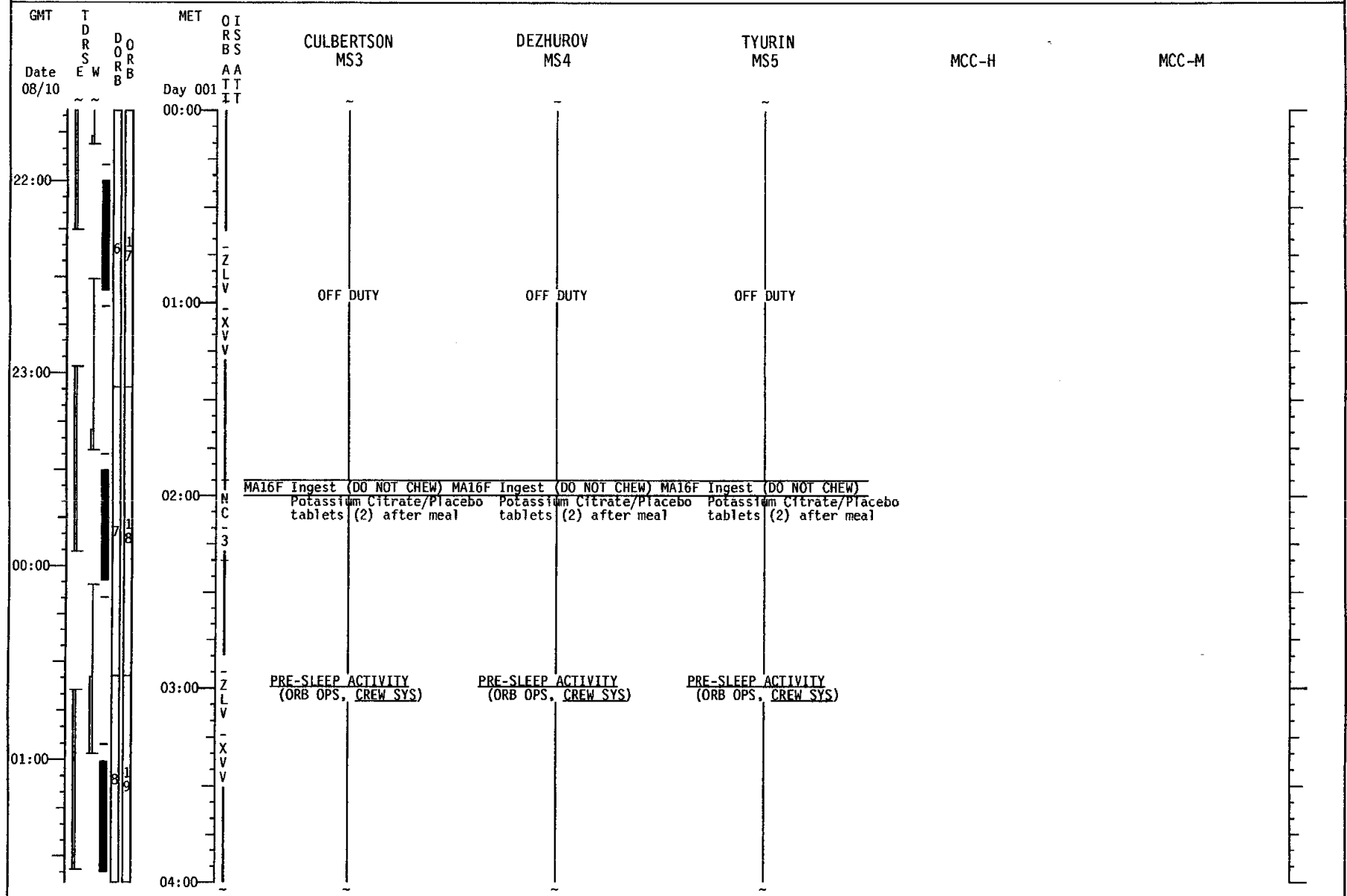

STS-105 7A.1 (FD 02)

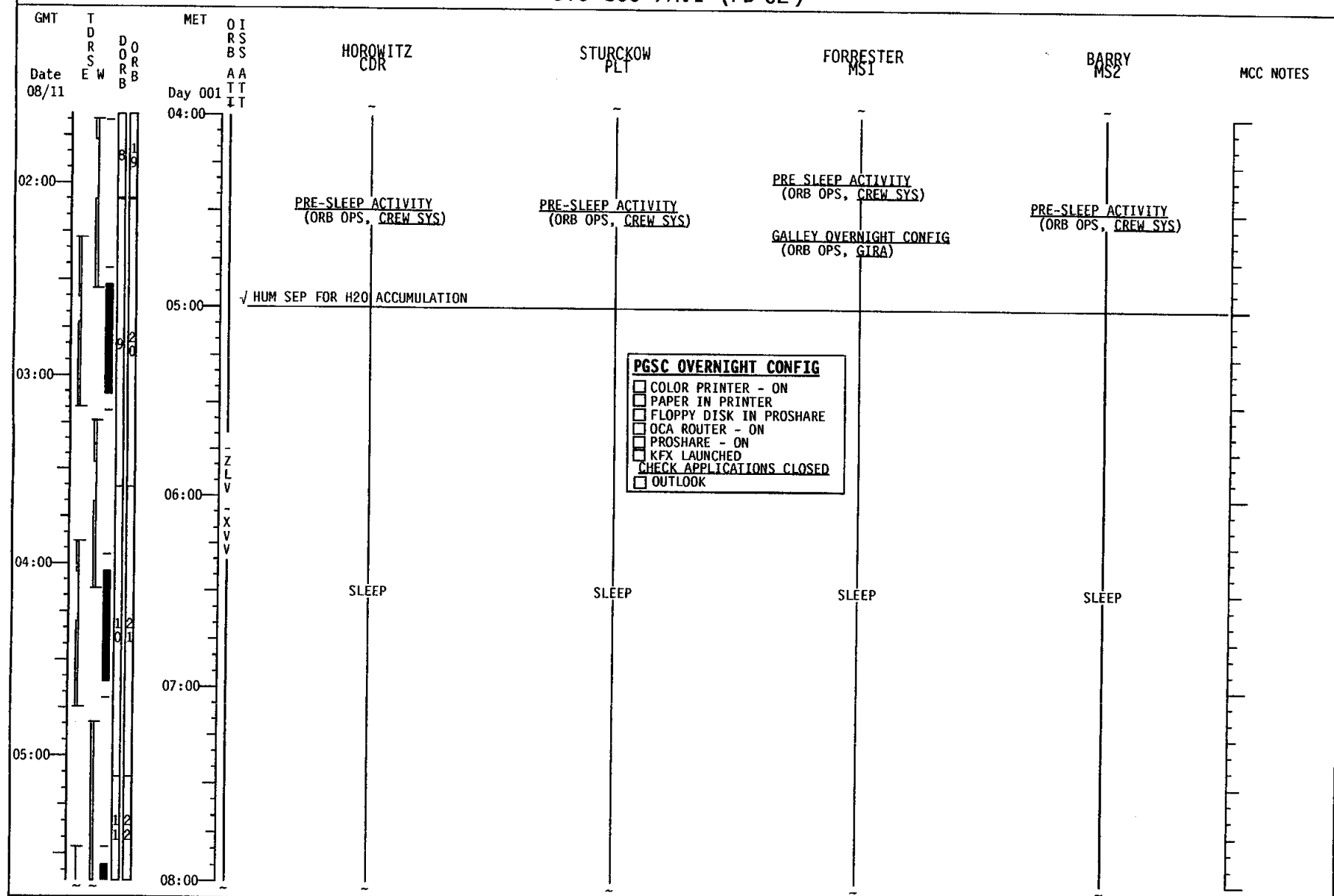

STS-105 7A.1 (FD 02)

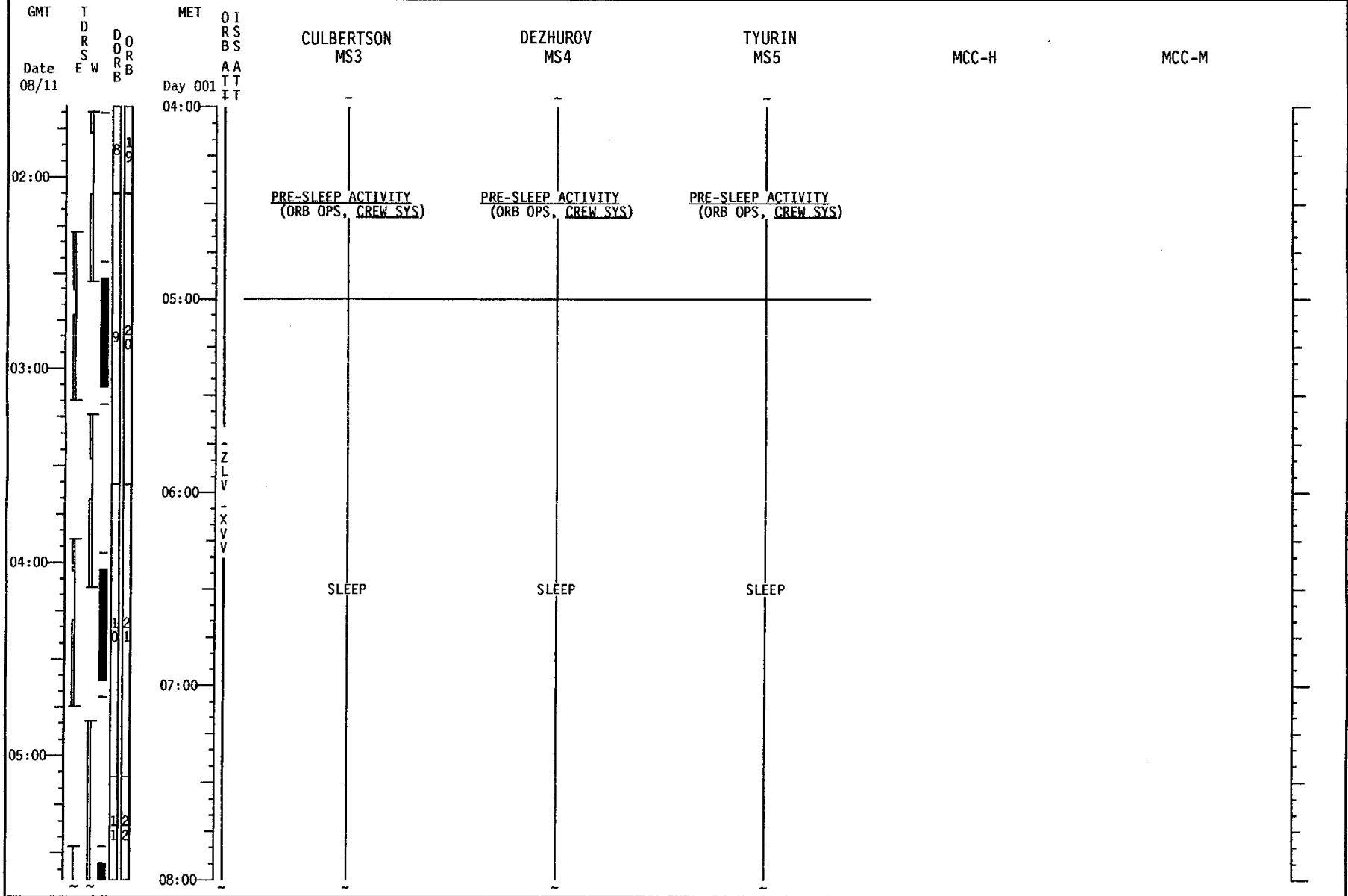

STS-105 7A.1 (FD 02)

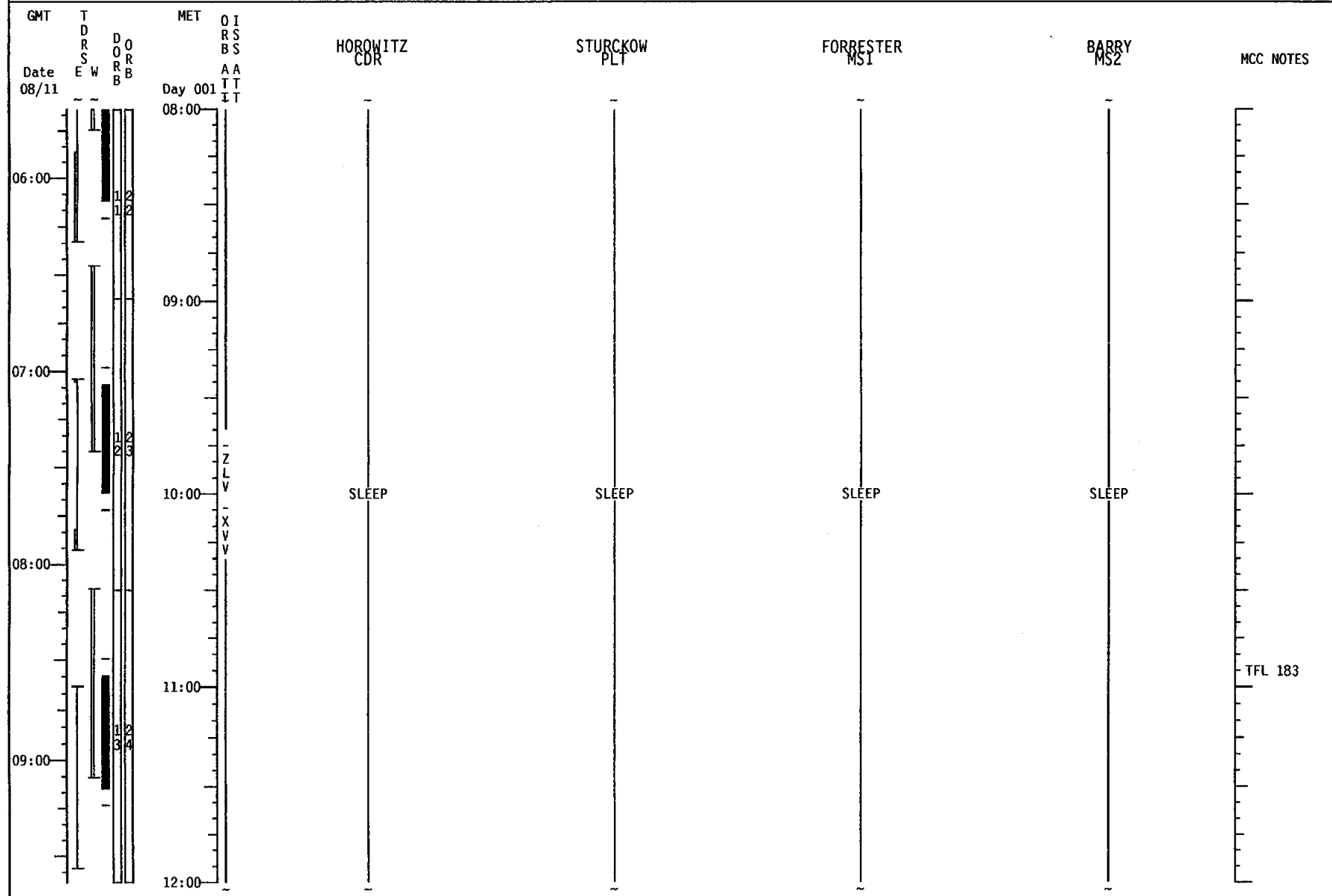

STS-105 7A.1 (FD 02)

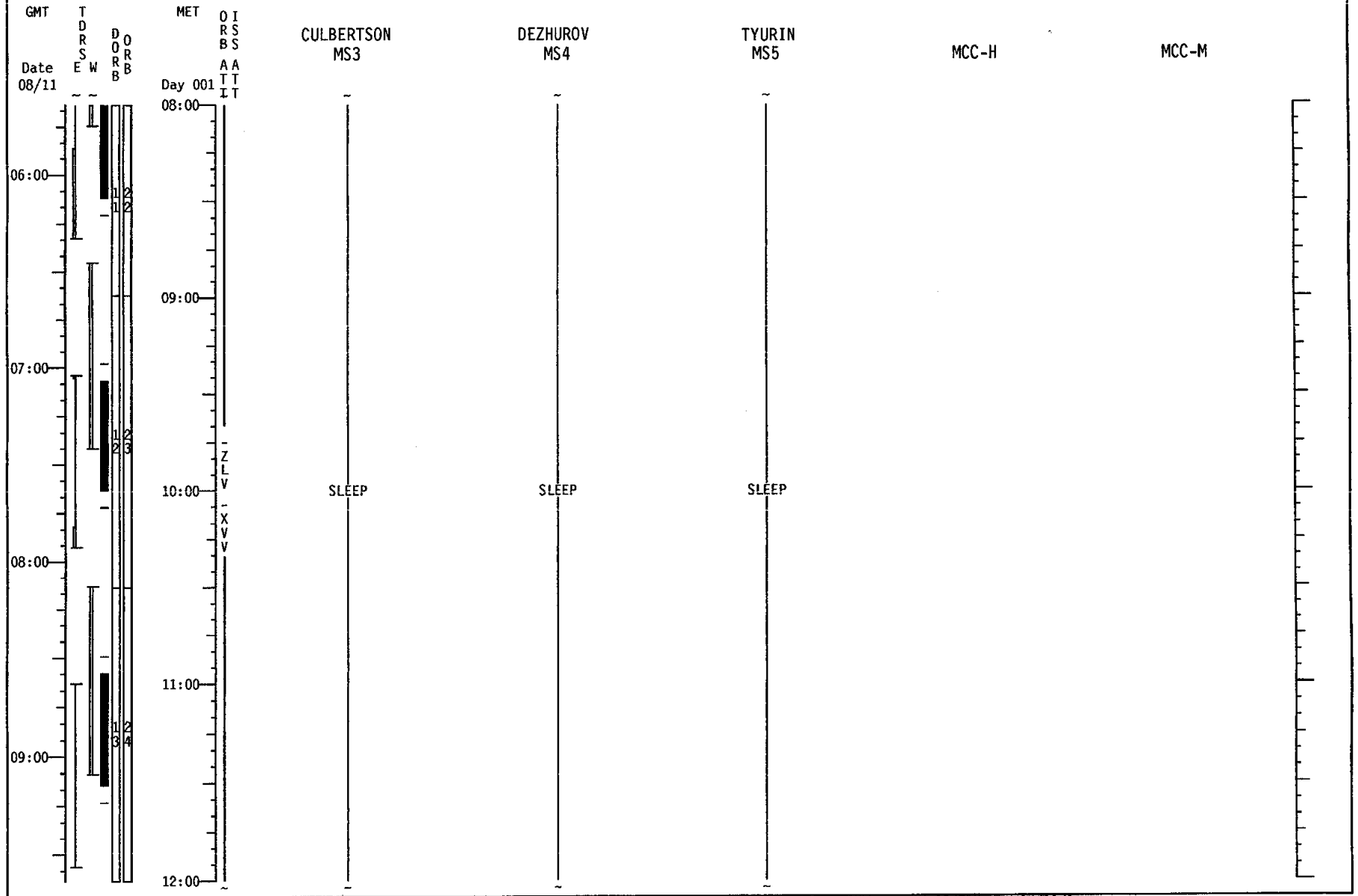

STS-105 7A.1 (FD 02)

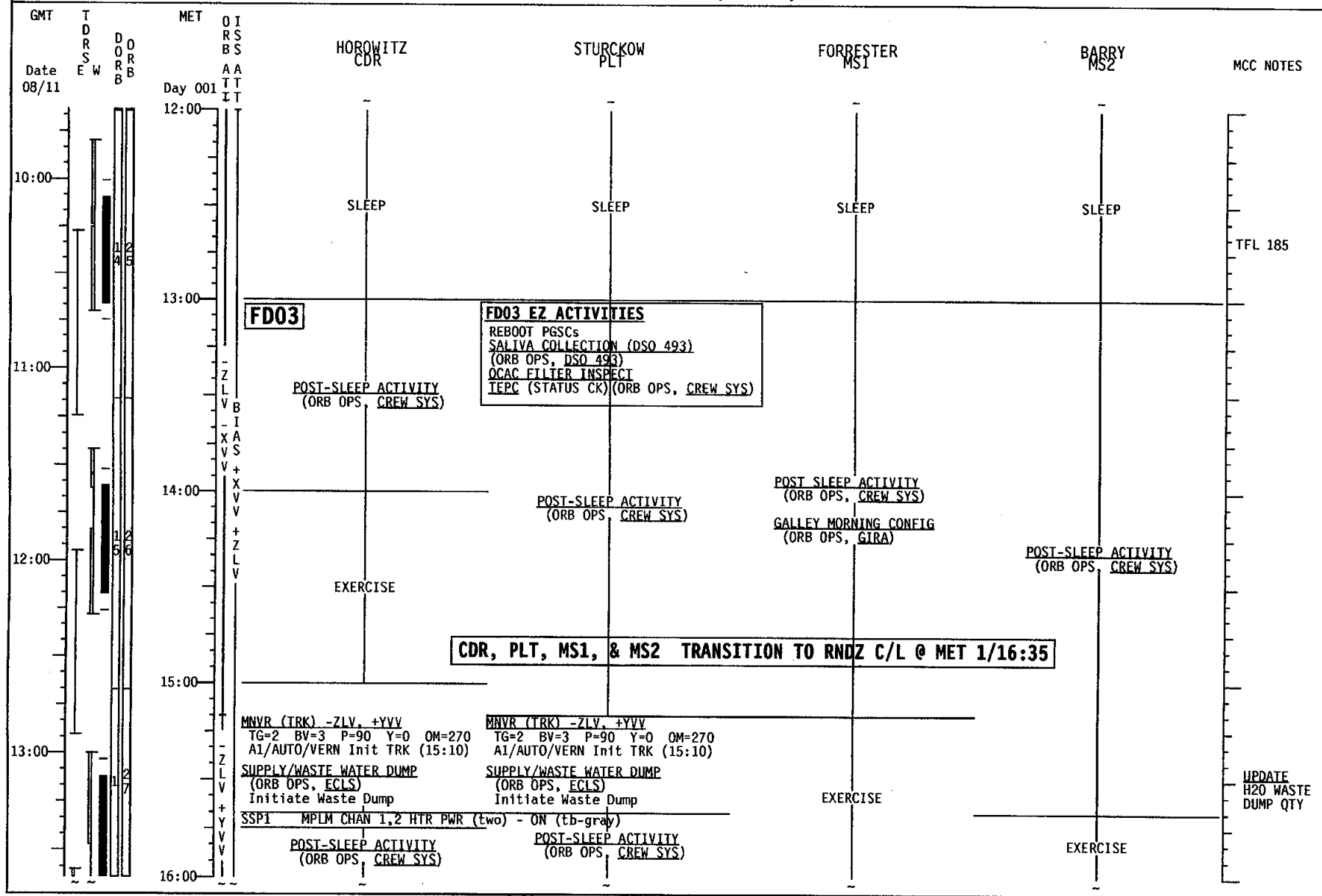

STS-105 7A.1 (FD 02)

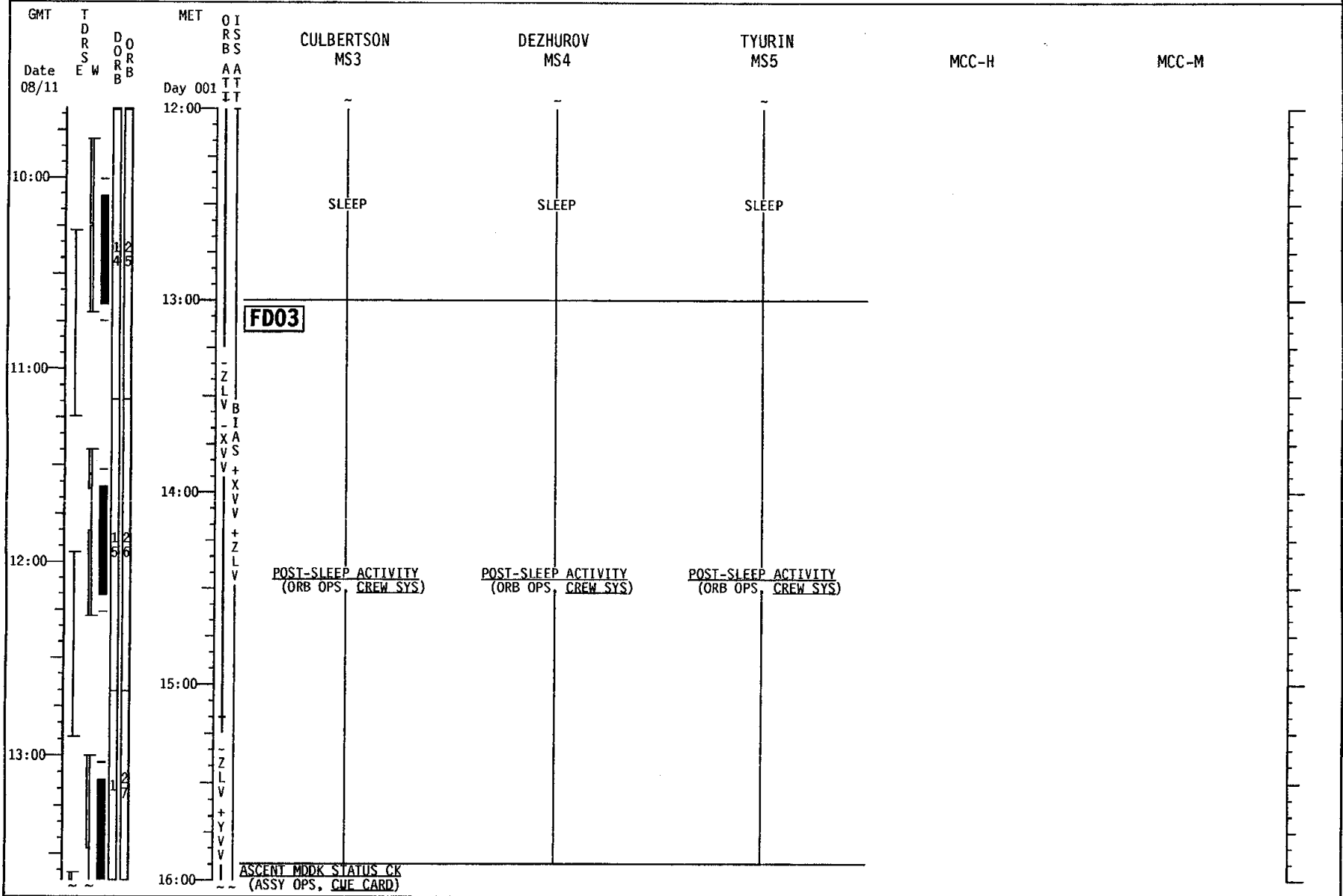

STS-105/7A.1 (FD 03)

PET Rel	GMT	T D R S E W	D O R B	MET	ORI RGS BSS ACA TMT IDI	HOROWITZ CDR/RMS1	STURCKOW PLT/IV1	FORRESTER MS1/EV2	BARRY MS2/EV1	MCC	MCC NOTES
	Date 08/11			Day 001							
02:00				16:00		POST-SLEEP ACTIVITY (ORB OPS, CREW SYS)	POST-SLEEP ACTIVITY (ORB OPS, CREW SYS)	EXERCISE			
					Z	PRIORITY PWUP GRP B (ORB PKT, PRIOR PWDRN)	PRIORITY PWUP GRP B (ORB PKT, PRIOR PWDRN)	POST SLEEP ACTIVITY (ORB OPS, CREW SYS)		EXERCISE	
14:00					V	Step 12: Recover IMU 3 Steps 9,6,& 5	Step 12: Recover IMU 3 Steps 9,6,& 5				
					+	Triple G2, NBAT 1233 (ORB OPS, ECLS)	Triple G2, NBAT 1233 (ORB OPS, ECLS)	GALLEY MORNING CONFIG (ORB OPS, GIRA)			
					V	Terminate Waste Dump	Terminate Waste Dump	L17 Check MCIU filter screen			
-02:00				17:00	N						
					H	NH 1/17:17					
					<						
					L						
					V						
					H						
-01:00				18:00	<	NC4 1/18:02					
					+	RENDEZVOUS (RNDZ, RNDZ T/L)	RENDEZVOUS (RNDZ, RNDZ T/L)	RENDEZVOUS (RNDZ, RNDZ T/L)	RENDEZVOUS (RNDZ, RNDZ T/L)		
					R						
					N						
					D						
					Z						
					V						
00:00				19:00							
					T	TI 1/19:35					
					<						
					R						
					N						
					D						
					Z						
					V						
01:00				20:00							

UPLINK
β-80° Only

TFL 211

STS-105 7A.1 (FD 03)

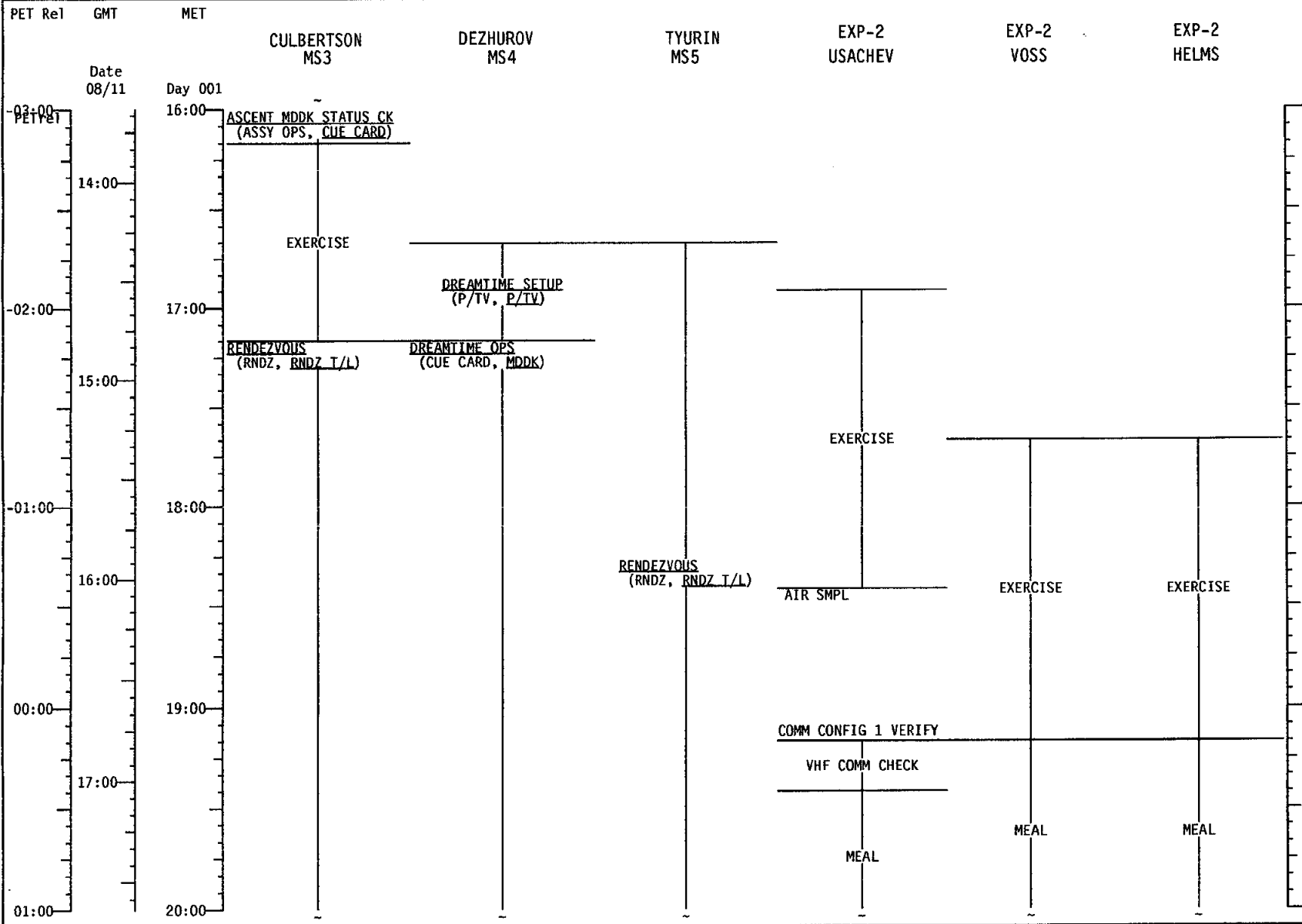

STS-105/7A.1 (FD 03)

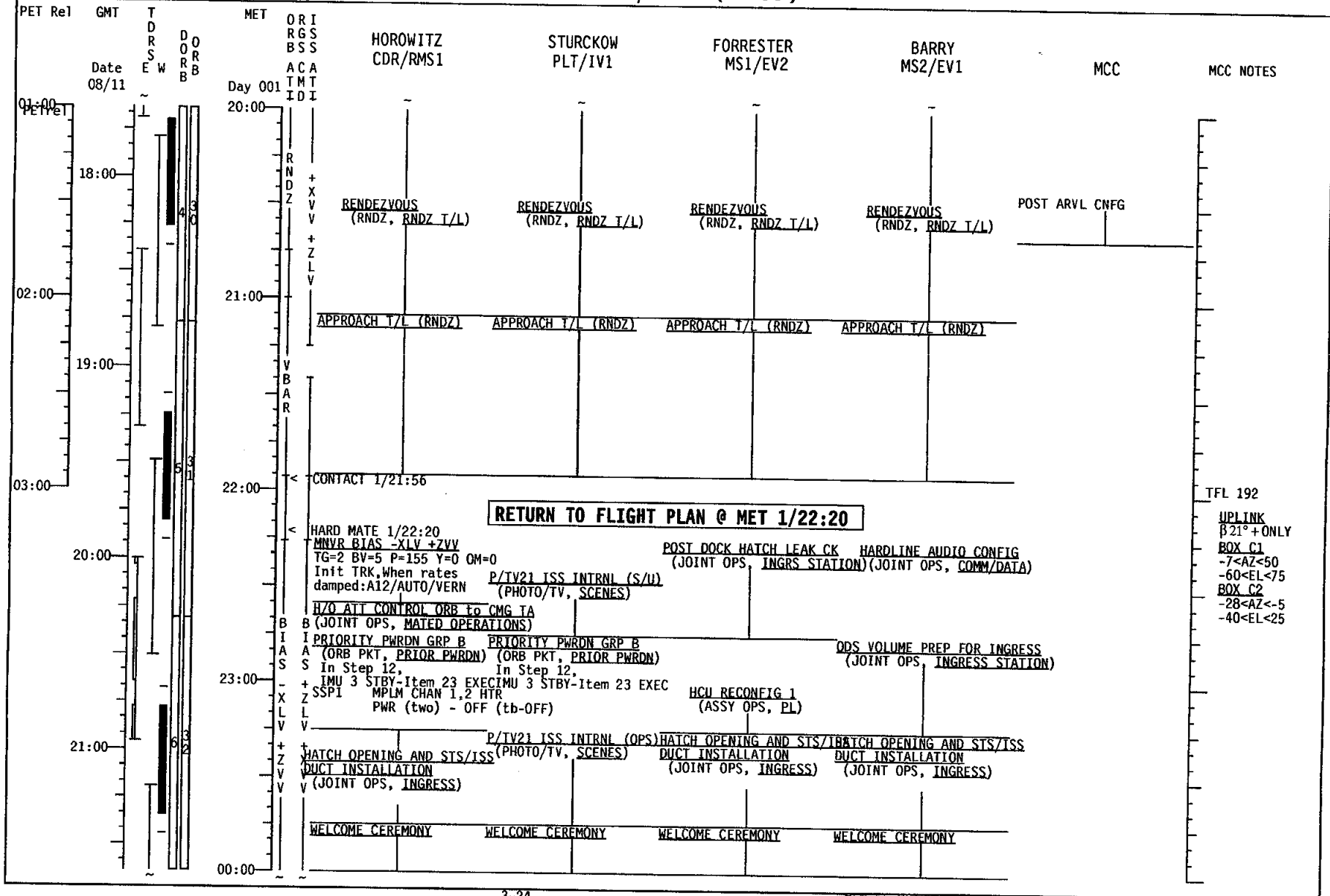

TFL 192
 UPLINK
 B21°+ ONLY
 BOX C1
 -7<AZ<50
 -60<EL<75
 BOX C2
 -28<AZ<-5
 -40<EL<25

STS-105 7A.1 (FD 03)

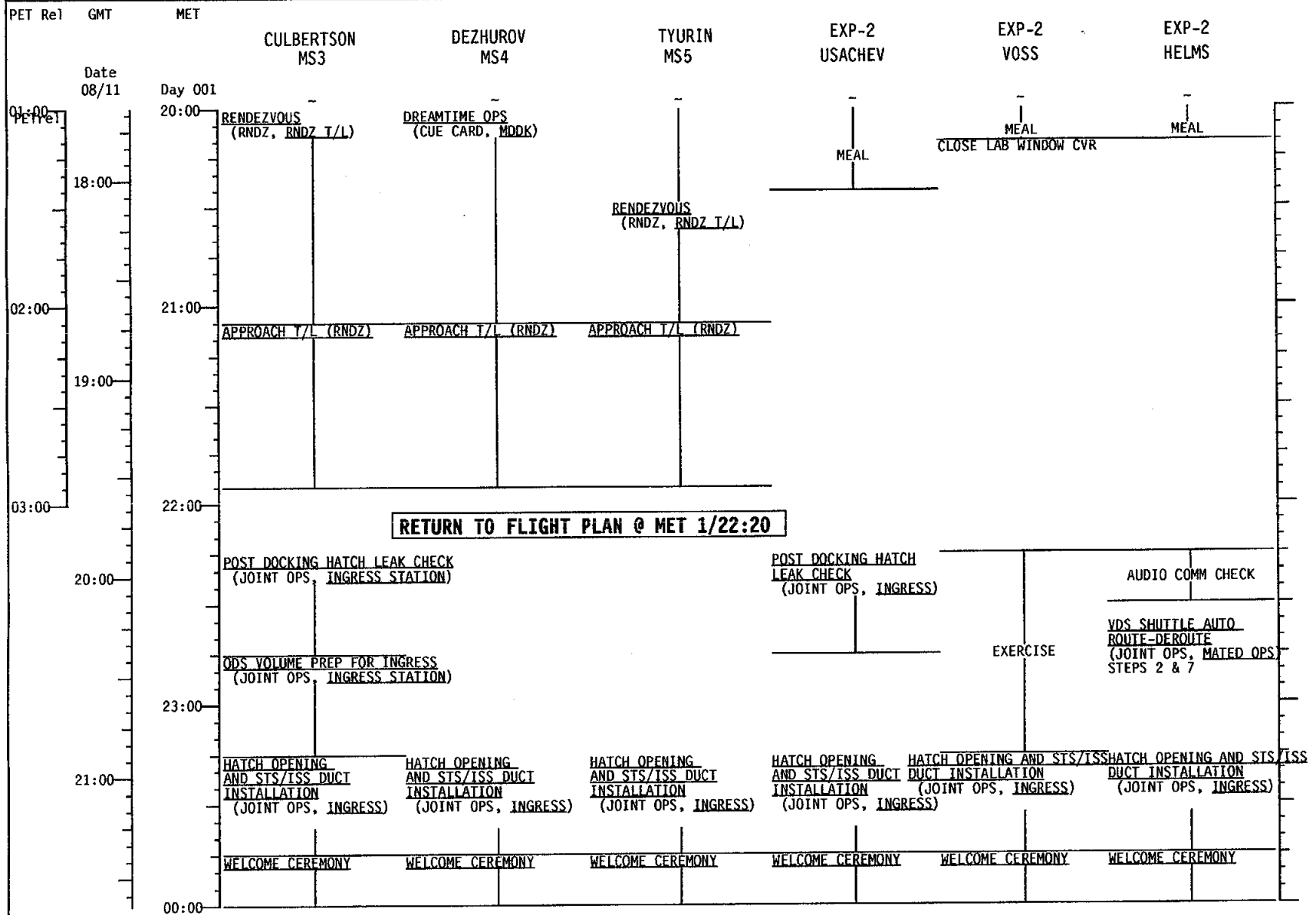

STS-105 7A.1 (FD 03)

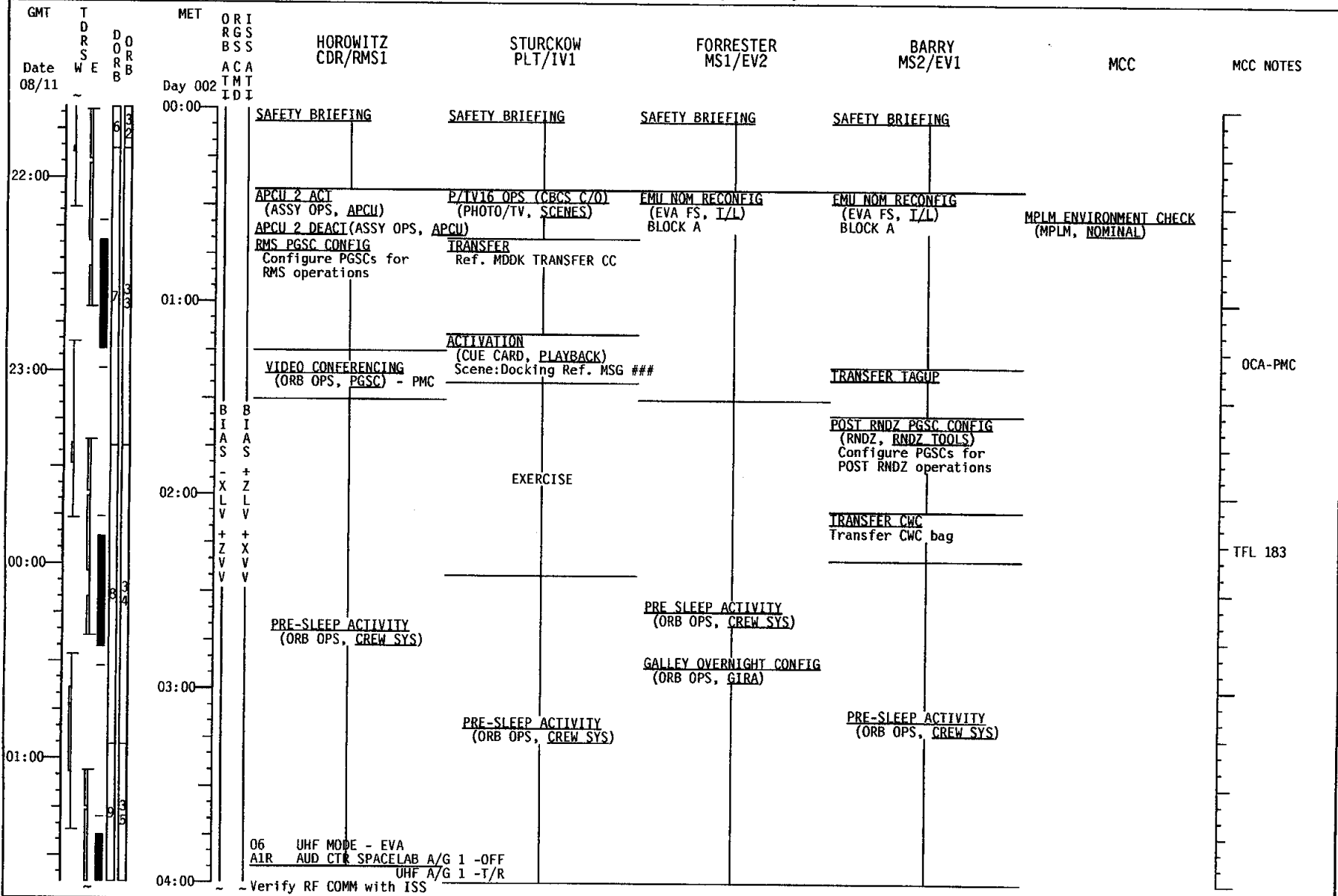

STS-105 7A.1 (FD 03)

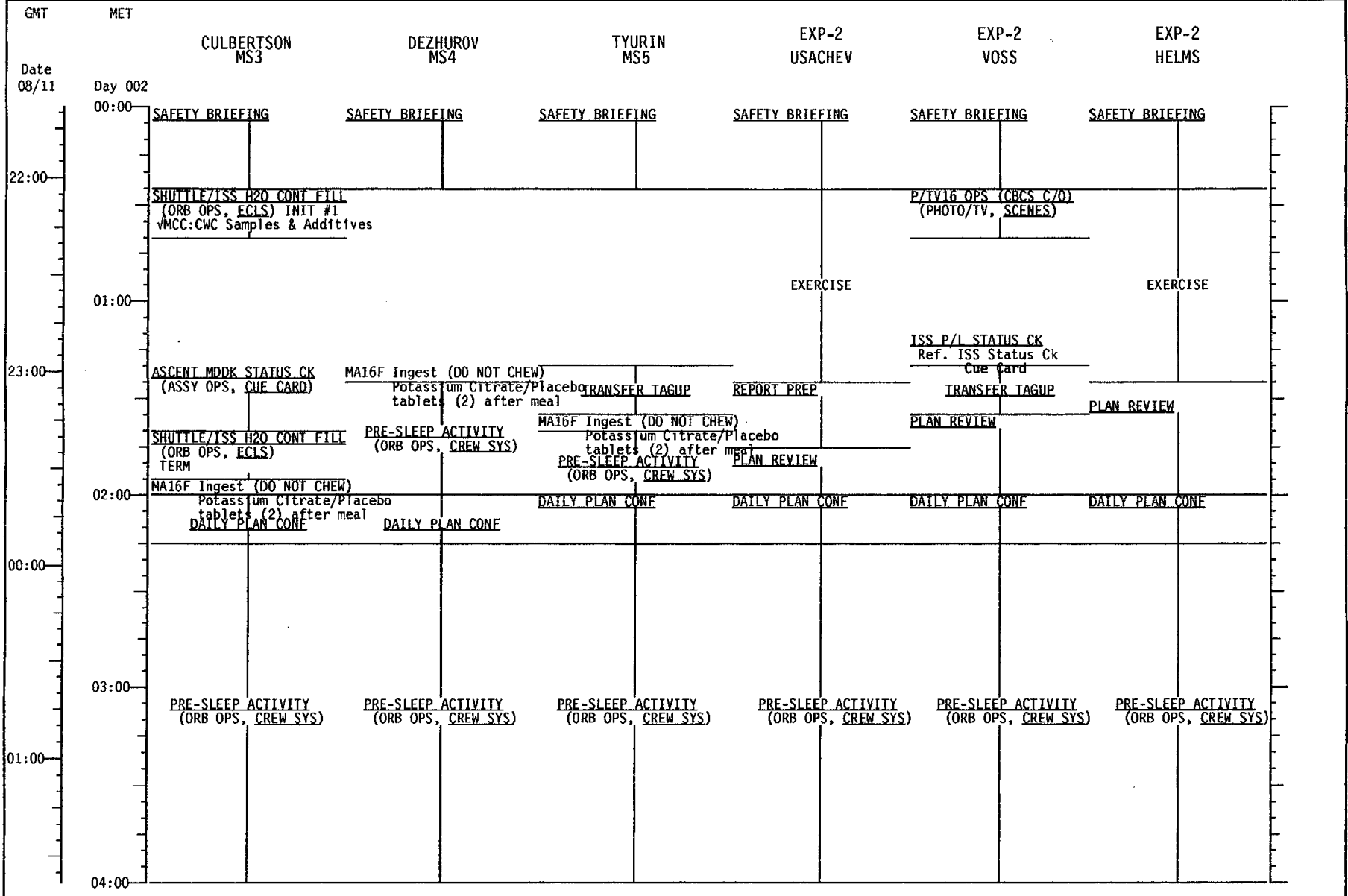

STS-105 7A.1 (FD 03)

GMT Date 08/12	T D R S W E	D O R B	MET Day 002	ORI RGS BSS ACA TMT ZDI	HOROWITZ CDR/RMS1	STURCKOW PLT/IV1	FORRESTER MS1/EV2	BARRY MS2/EV1	MCC	MCC NOTES
			04:00							
			05:00							
			06:00	B I A S + Z L V + X V V	SLEEP	SLEEP	SLEEP	SLEEP		TFL 208
			07:00							
			08:00							TFL 199

PGSC OVERNIGHT CONFIG

- COLOR PRINTER - ON
- PAPER IN PRINTER
- FLOPPY DISK IN PROSHARE
- OCA ROUTER - ON
- PROSHARE - ON
- KFX LAUNCHED
- CHECK APPLICATIONS CLOSED
- OUTLOOK

STS-105 7A.1 (FD 03)

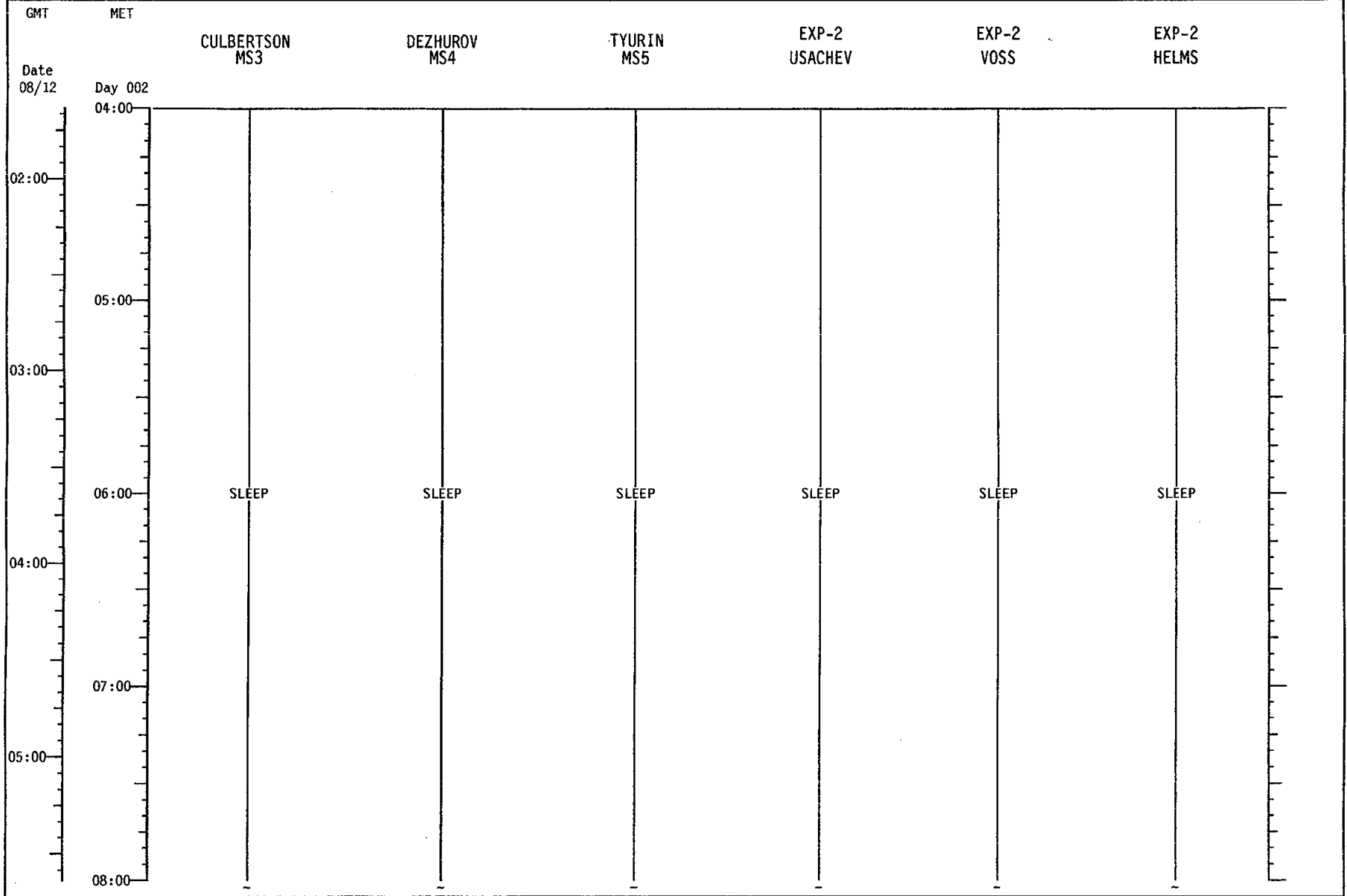

STS-105 7A.1 (FD 03)

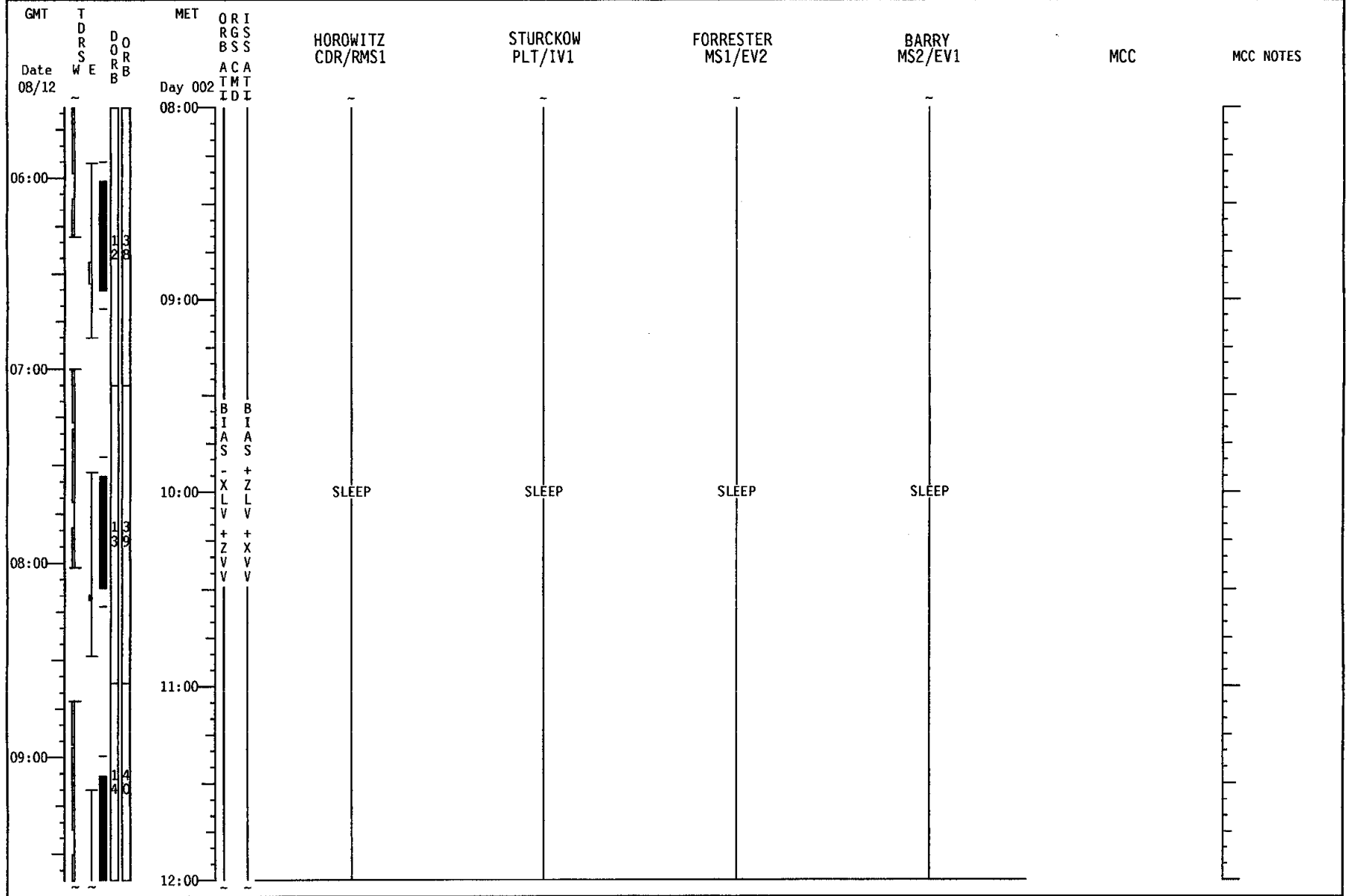

STS-105 7A.1 (FD 03)

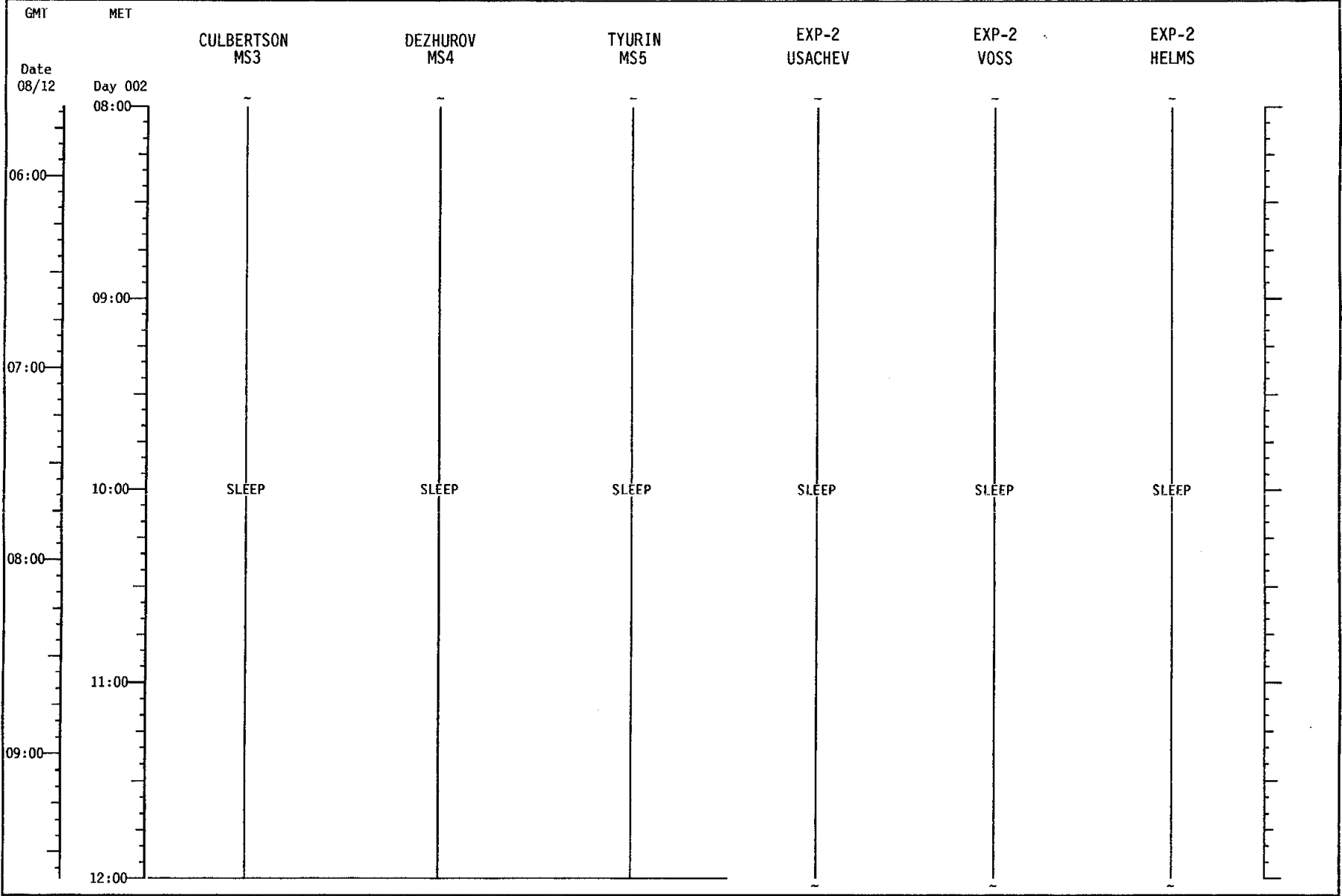

STS-105 7A.1 (FD 04)

GMT	TDRS W E	DORR B	MET	ORI RGS BSS	HOROWITZ CDR/RMS1	STURCKOW PLT/IV1	FORRESTER MS1/EV2	BARRY MS2/EV1	MCC	MCC NOTES
Date 08/12			Day 002	ACAI TMT IDI						
12:00					FD04		FD04 EZ ACTIVITIES REBOOT PGSCs SALIVA COLLECTION (DSO 493) (ORB OPS, DSO 493) QCAC FILTER INSPECT TEPC (STATUS CK)(ORB OPS, CREW SYS)			
11:00					POST-SLEEP ACTIVITY (ORB OPS, CREW SYS)					
10:00							POST SLEEP ACTIVITY (ORB OPS, CREW SYS)			
9:00					SSP1 MPLM CHAN 1,2 HTR PWR (two) - ON (tb-gray)		GALLEY MORNING CONFIG (ORB OPS, GIRA)			
8:00								POST-SLEEP ACTIVITY (ORB OPS, CREW SYS)		
7:00										
6:00					POST-SLEEP ACTIVITY (ORB OPS, CREW SYS)		ABL PORT RMS HTR (two) - AUTO L17 Check MCIU filter screen			
5:00										
4:00							POST SLEEP ACTIVITY (ORB OPS, CREW SYS)			
3:00					A1R AUD CTR SPACELAB A/G 1 -ON UHF A/G 1 -OFF		GALLEY MORNING CONFIG (ORB OPS, GIRA)	P/TV07 OSVS (SETUP) (PHOTO/TV, SCENES)		
2:00					O6 UHF MODE -OFF Verify H/L COMM with ISS APCU 2 ACT(ASSY OPS, APCU)		DESCENT MDDK STATUS CK (ASSY OPS, CUE CARD)			
1:00					RMS POWERUP (PDRS, RMS PWRUP)	P/TV22 RMS ASSY OPS (S/U)RMS POWERUP (PHOTO/TV, SCENES)	(PDRS, RMS PWRUP)			MPLM ENVIRONMENT CHECK (MPLM, NOMINAL)
12:00					APCU 2 DEACT(ASSY OPS, APCU) MPLM GRAPPLE IN BAY (PDRS, NOM MPLM INSTL OPS)		MPLM GRAPPLE IN BAY (PDRS, NOM MPLM INSTL OPS)	OSVS P/IL (PDRS, OSVS OPS)		TFL 185
11:00										
10:00								P/TV07 OSVS (OPS) (PHOTO/TV, SCENES)		
9:00										
8:00					SSP1 MPLM CHAN 1,2 HTR PWR (two) - OFF (tb-OFF)					

STS-105 7A.1 (FD 04)

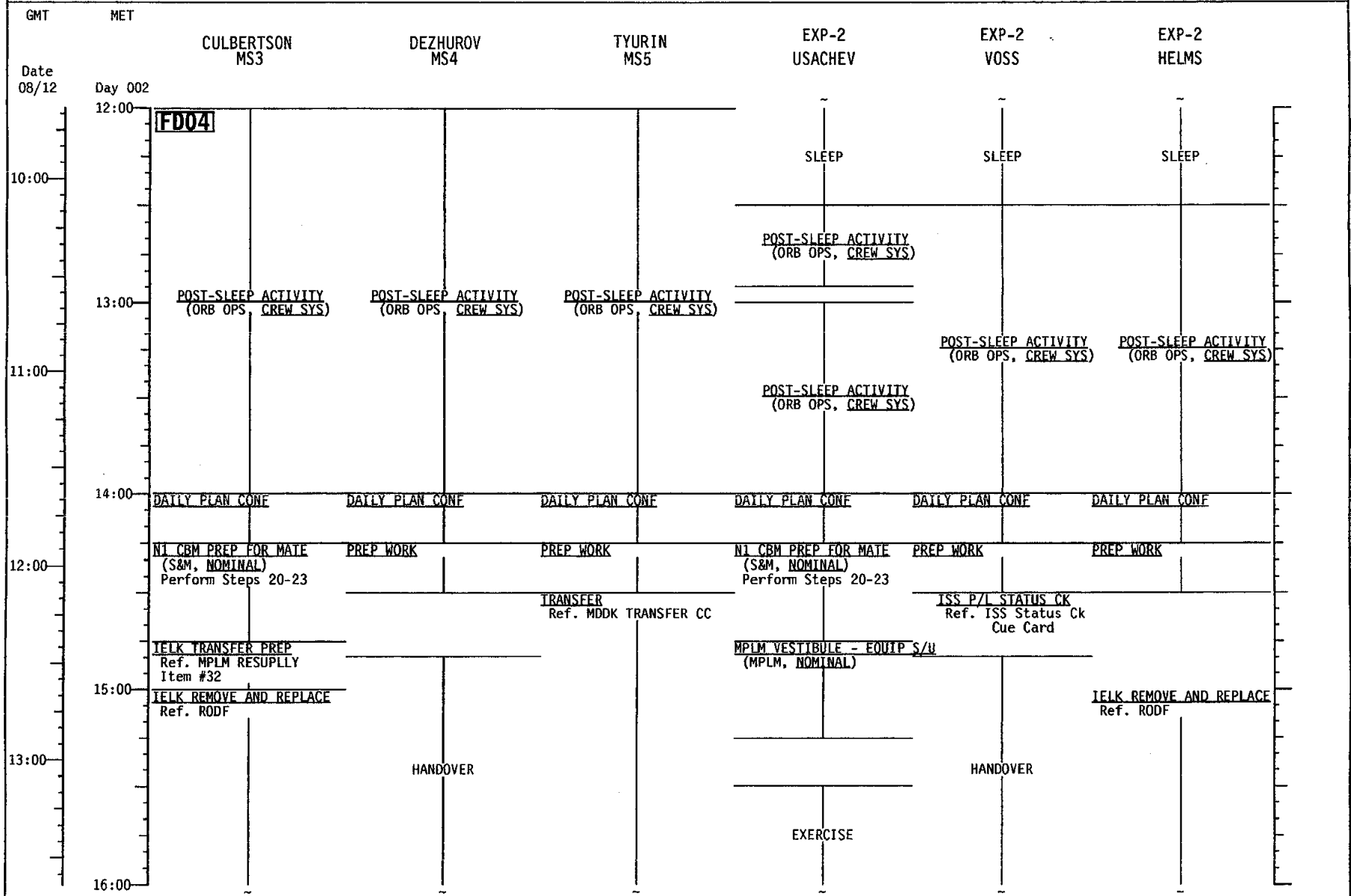

STS-105 7A.1 (FD 04)

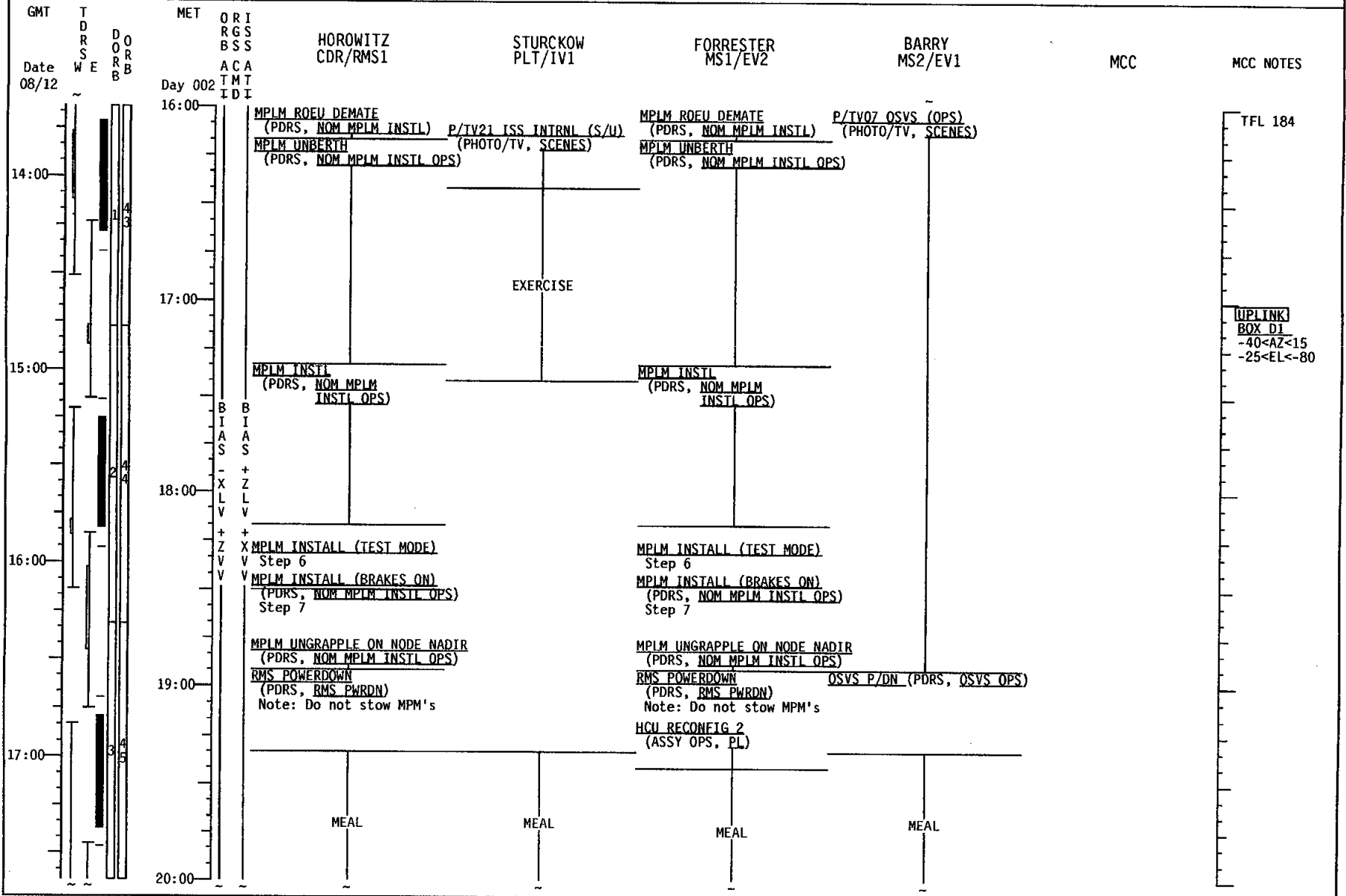

STS-105 7A.1 (FD 04)

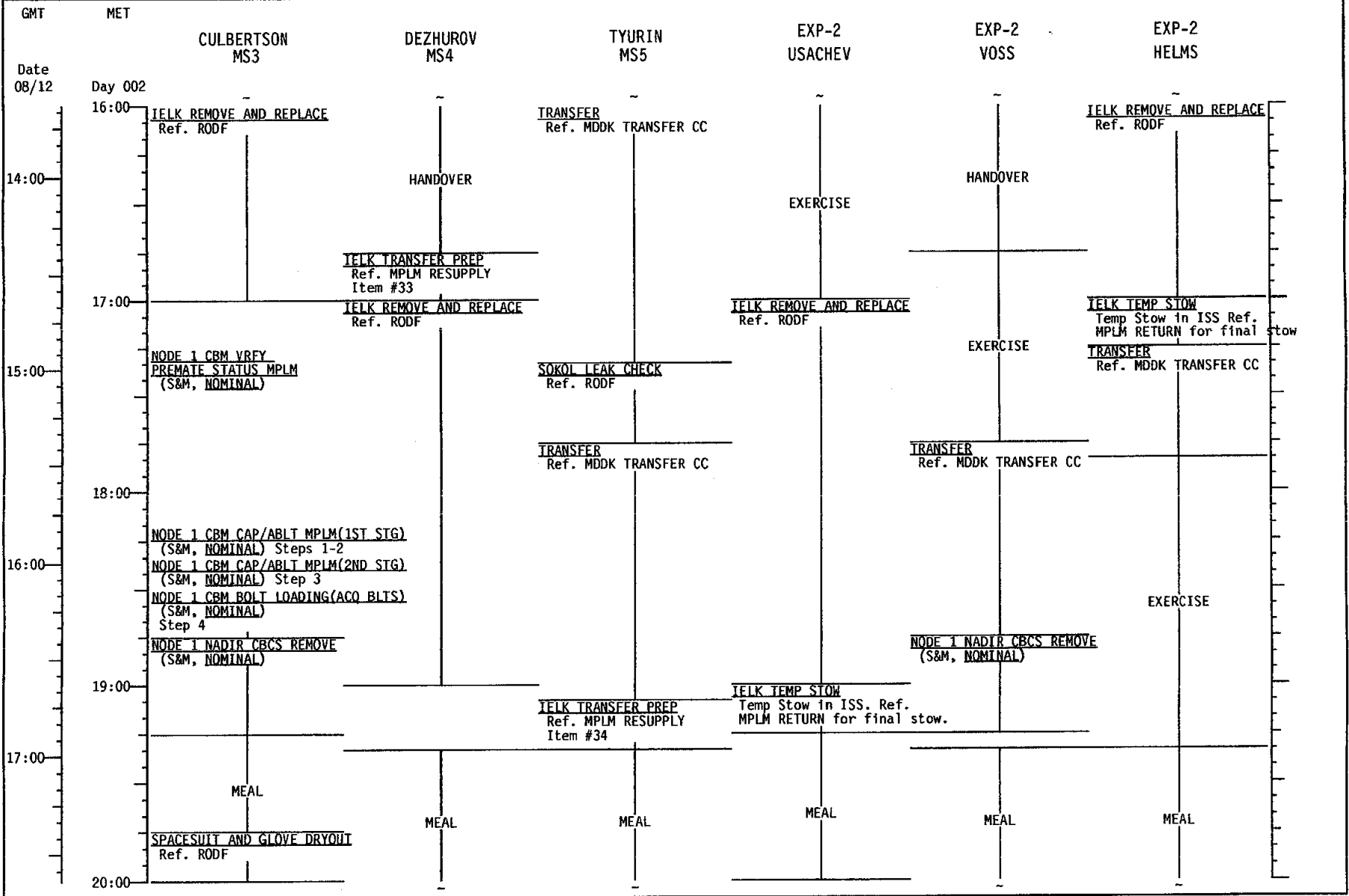

STS-105 7A.1 (FD 04)

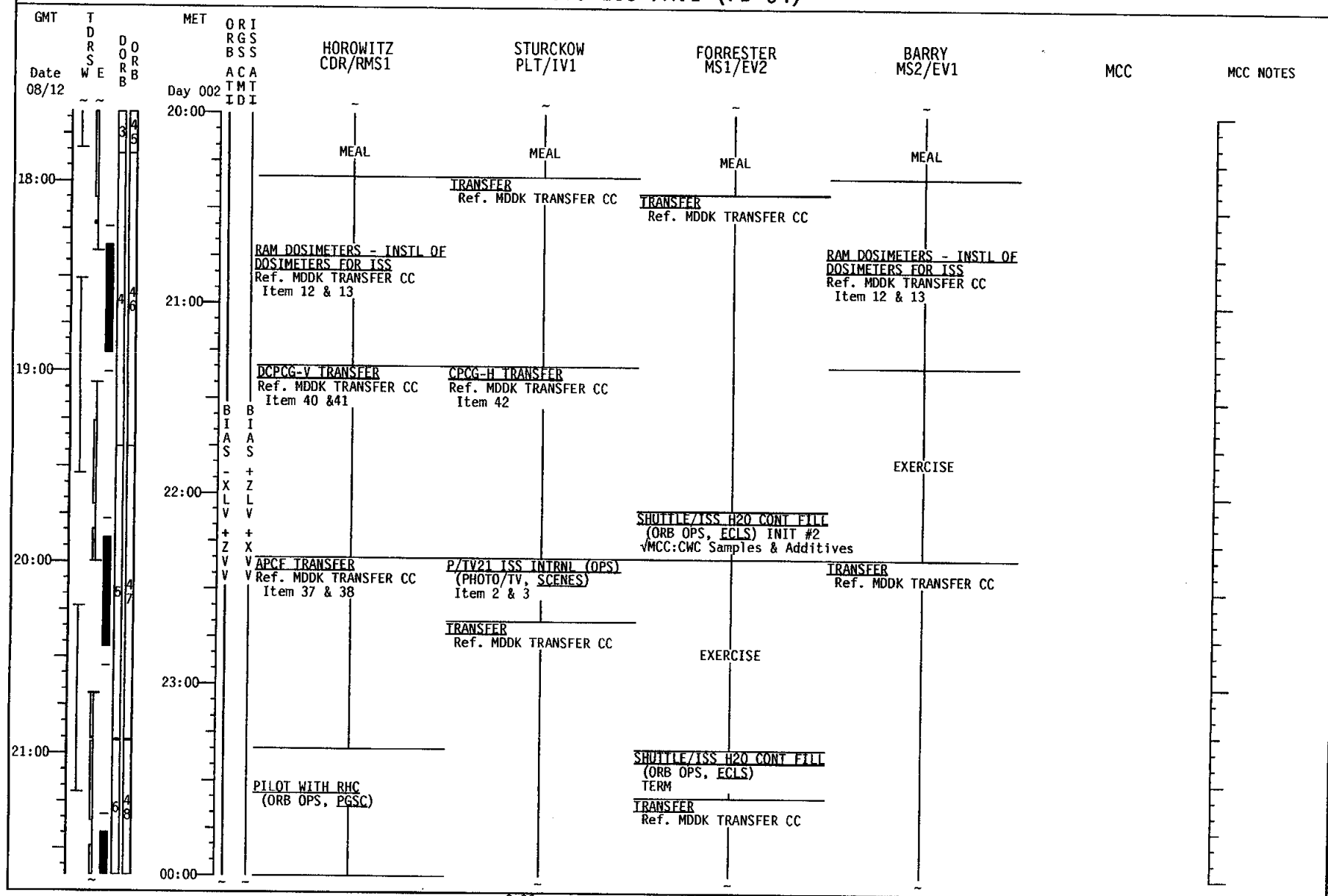

STS-105 7A.1 (FD 04)

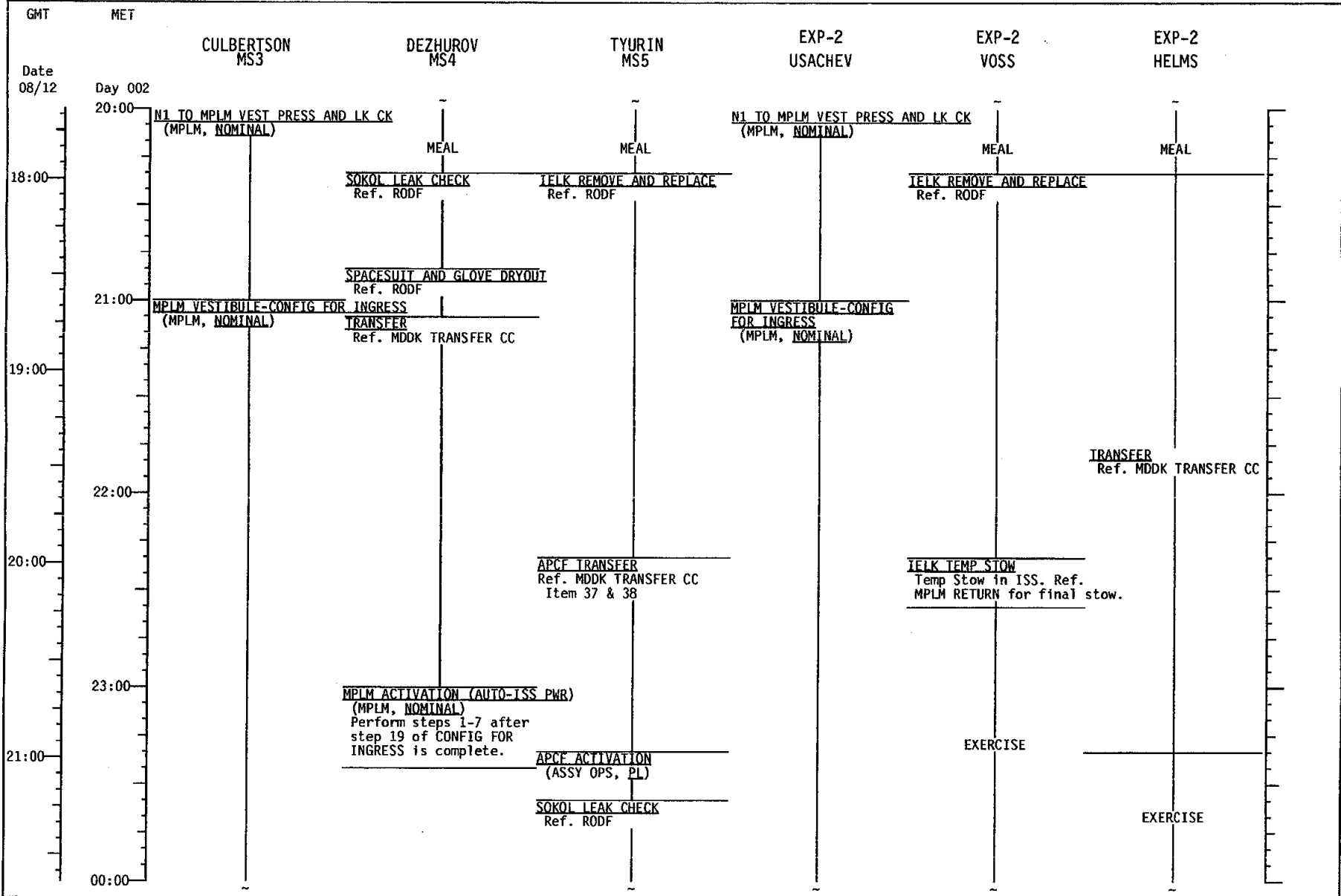

STS-105 7A.1 (FD 04)

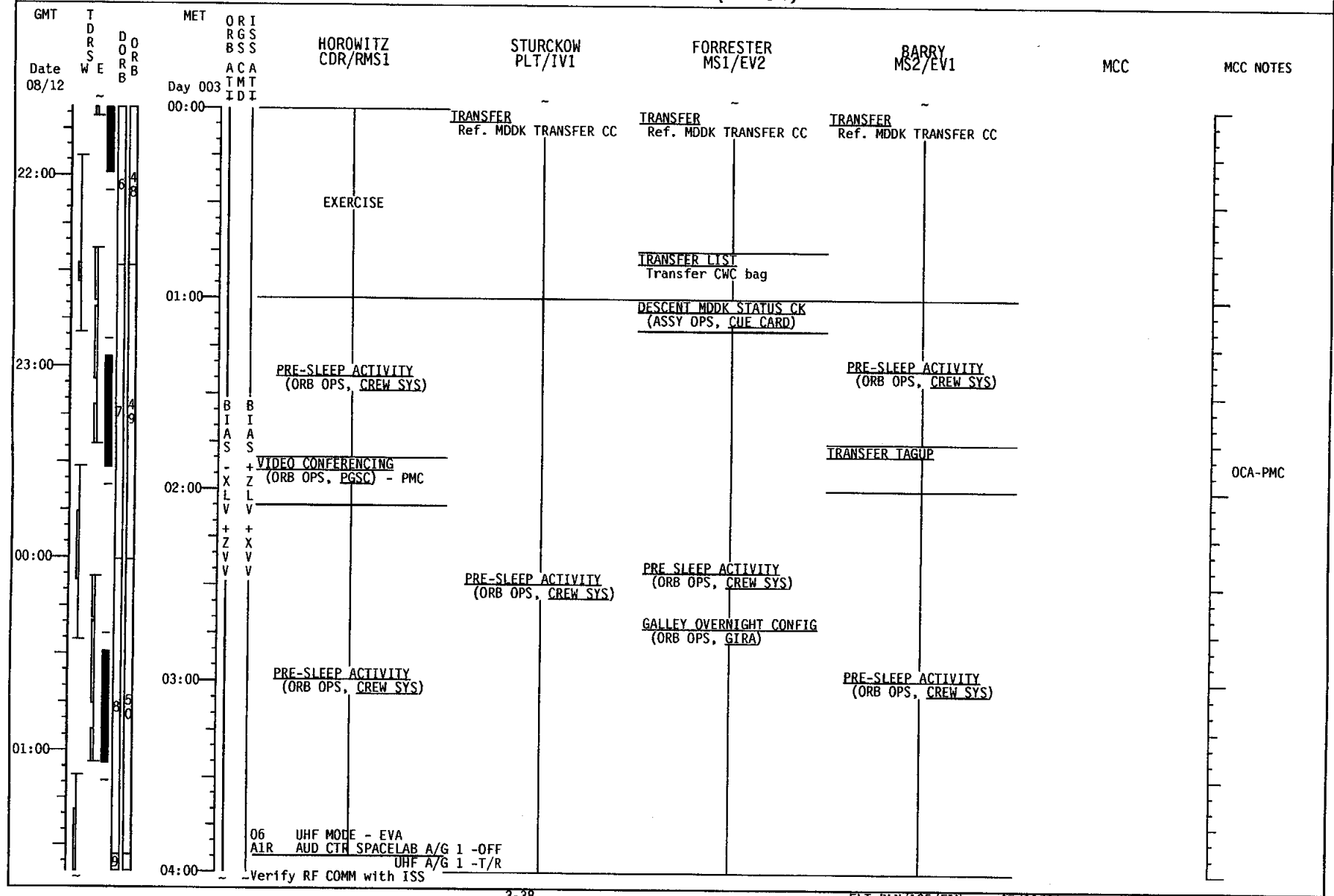

STS-105 7A.1 (FD 04)

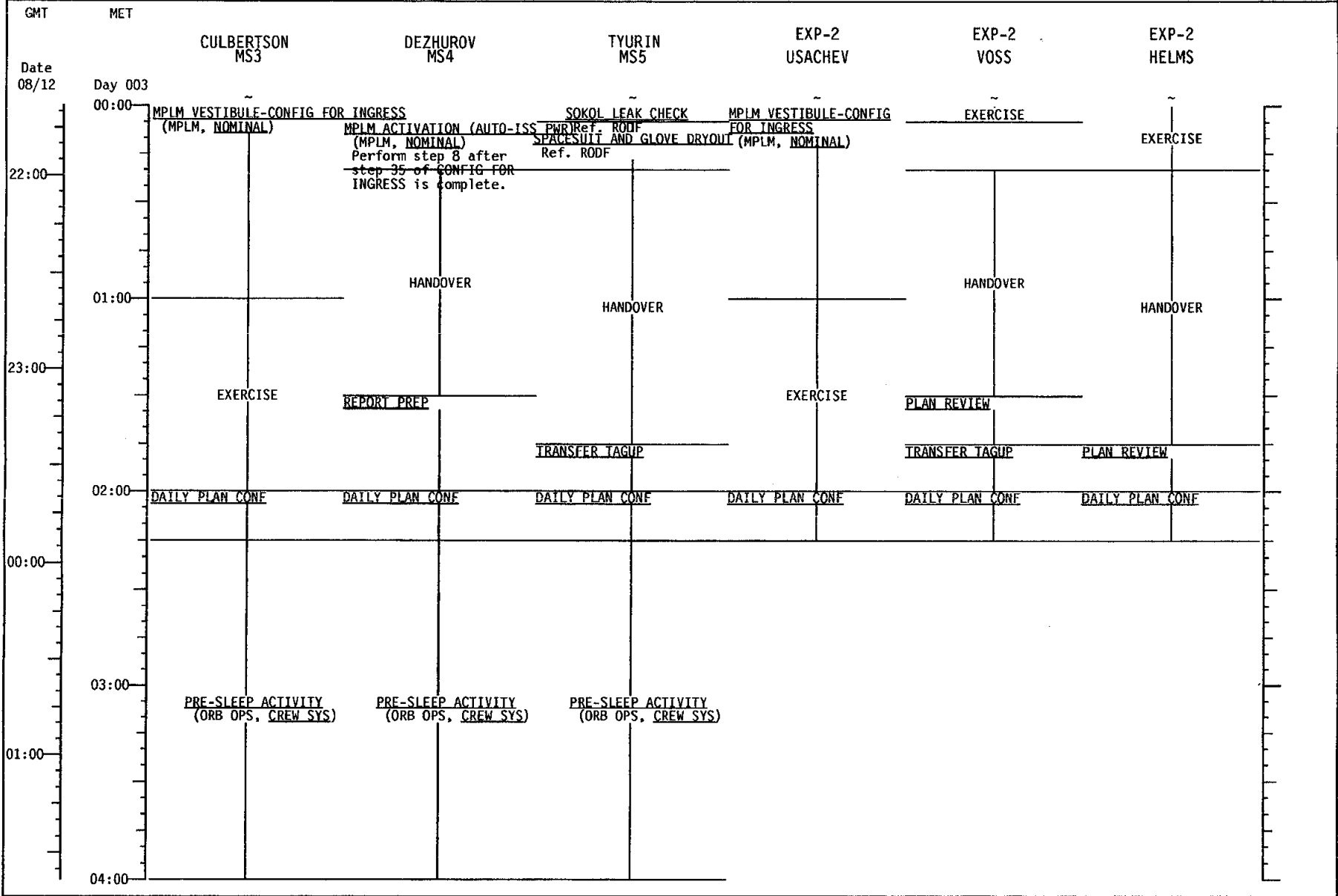

STS-105 7A.1 (FD 04)

GMT	TDRS W E	DORR B B	MET Day 003	ORIRGSS BSS ACA TMT IDI	HOROWITZ CDR/RMS1	STURCKOW PLT/IV1	FORRESTER MS1/EV2	BARRY MS2/EV1	MCC	MCC NOTES
Date 08/13										
04:00										
02:00										
03:00										
05:00										
06:00					SLEEP	SLEEP	SLEEP	SLEEP		
04:00										
07:00										
05:00										
08:00										

PGSC OVERNIGHT CONFIG

- COLOR PRINTER - ON
- PAPER IN PRINTER
- FLOPPY DISK IN PROSHARE
- OCA ROUTER - ON
- PROSHARE - ON
- KFX LAUNCHED
- CHECK APPLICATIONS CLOSED
- OUTLOOK

B I A S
 + Z L V
 - X L V
 + Z V V
 + X V V

STS-105 7A.1 (FD 04)

GMT	MET	VOSS MS3/IV2	HELMS MS4	USACHEV MS5	EXP-3 CULBERTSON	EXP-3 DEZHUROV	EXP-3 TYURIN
Date 08/13	Day 003						
04:00							
02:00							
05:00							
03:00							
06:00		SLEEP	SLEEP	SLEEP	SLEEP	SLEEP	SLEEP
04:00							
07:00							
05:00							
08:00							

STS-105 7A.1 (FD 04)

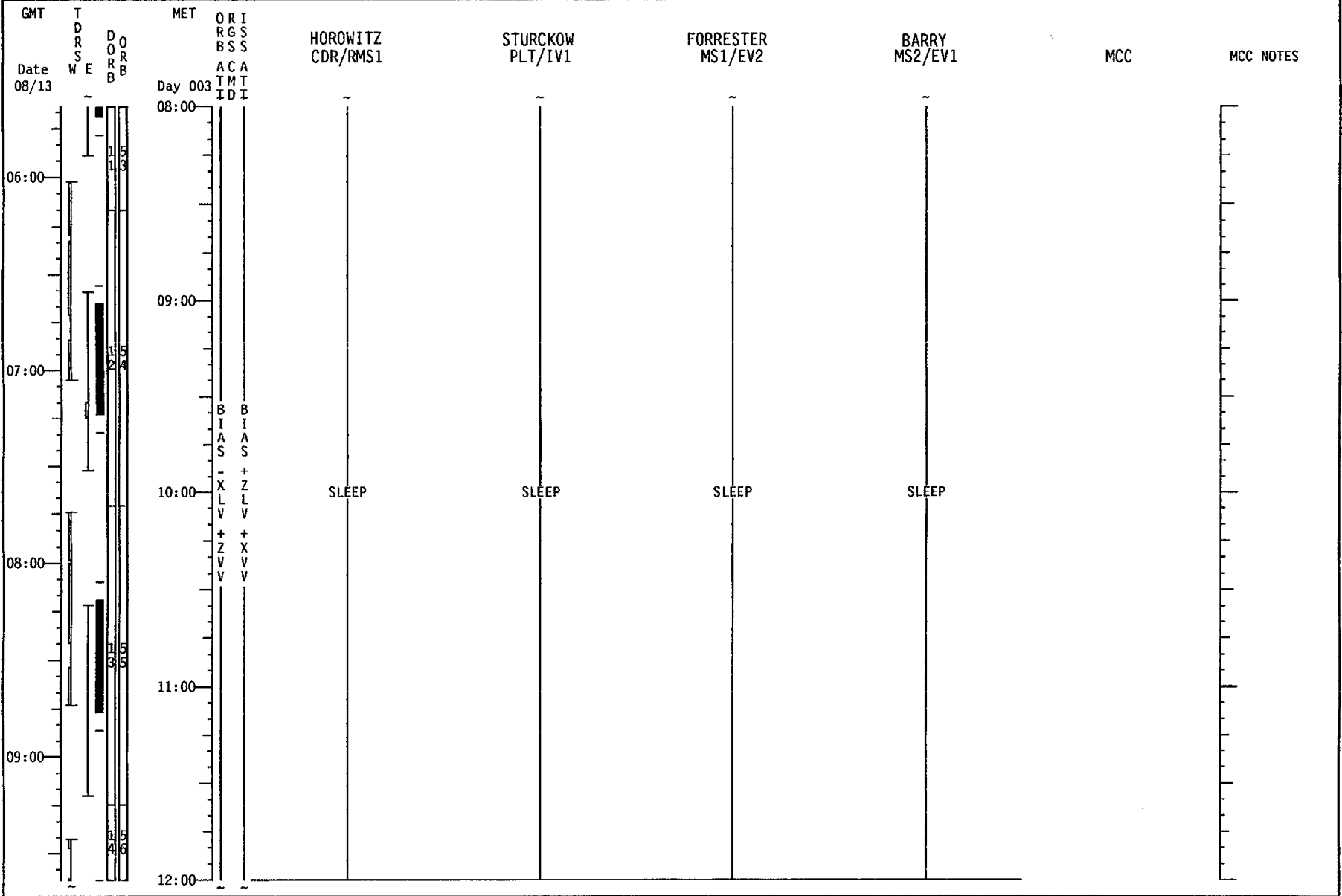

STS-105 7A.1 (FD 04)

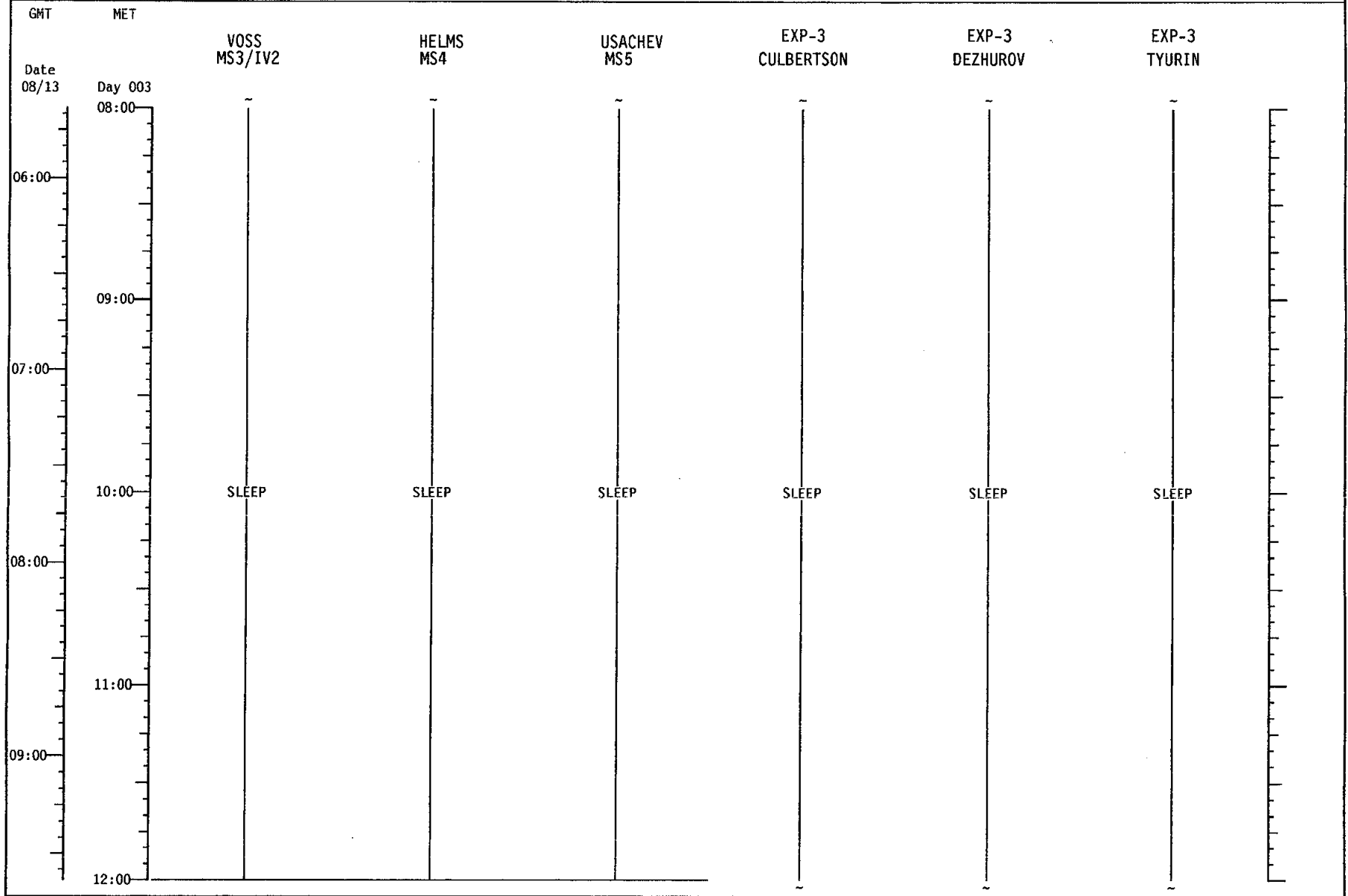

STS-105 7A.1 (FD 04)

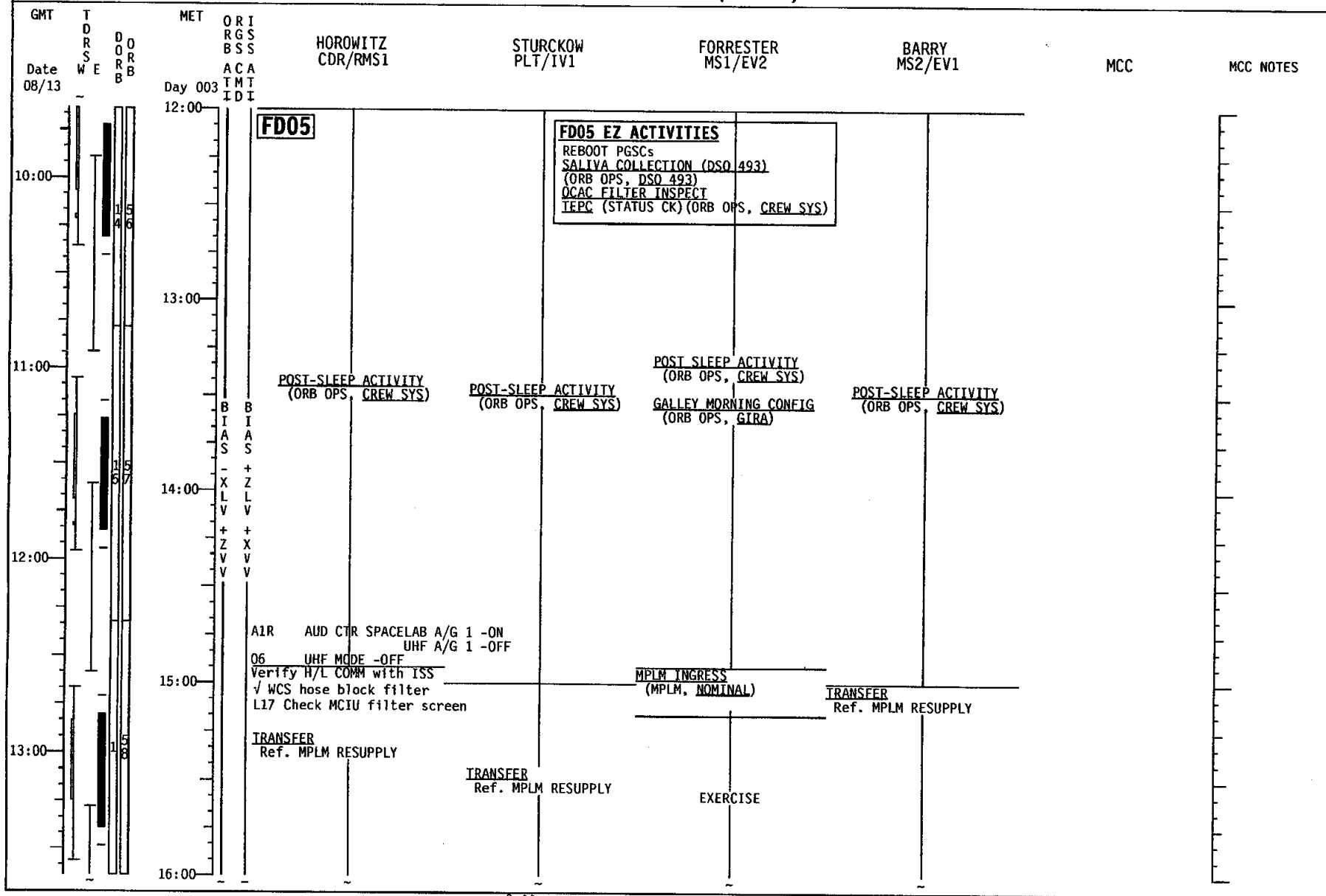

STS-105 7A.1 (FD 05)

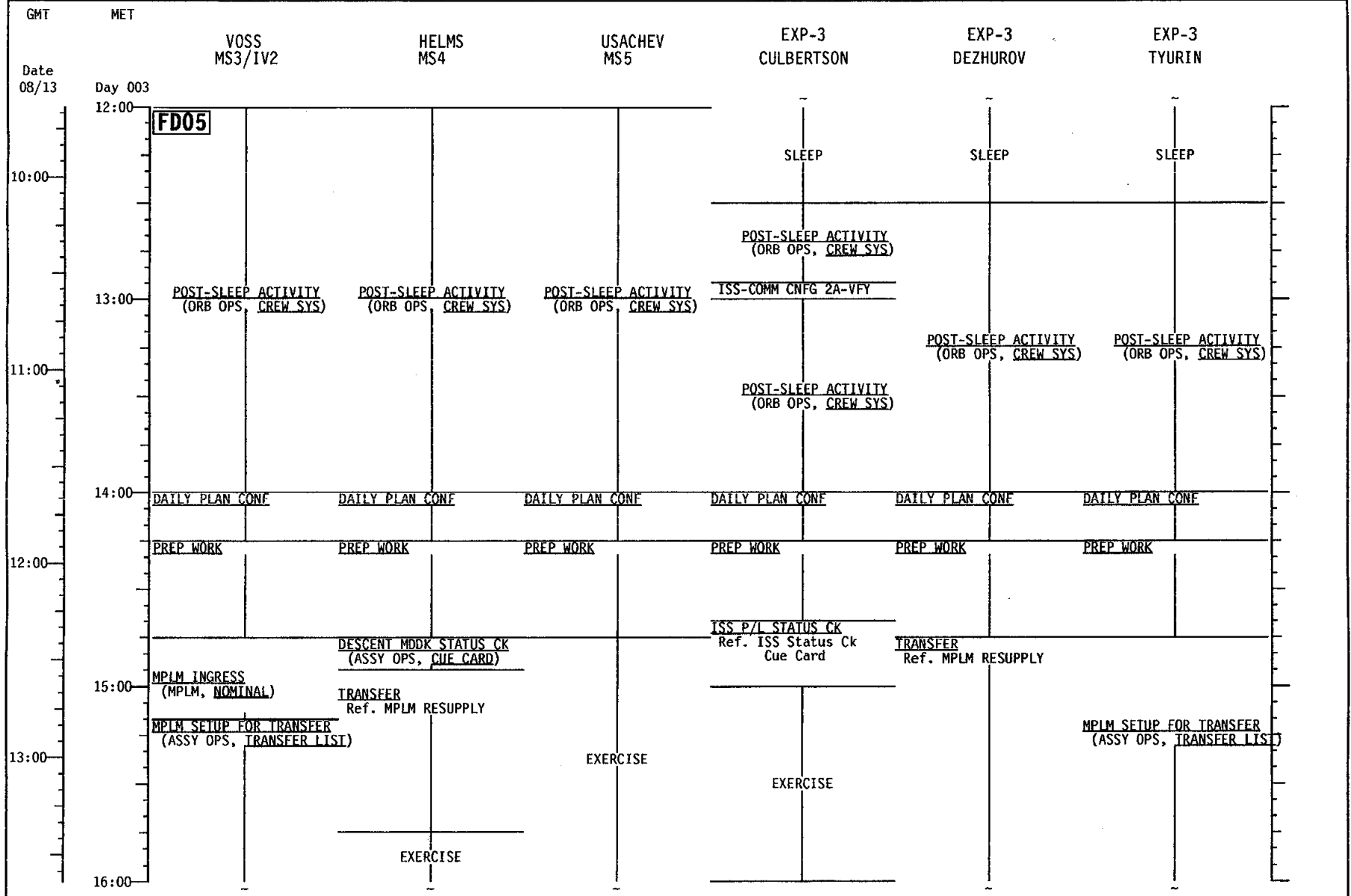

STS-105/7A.1 (FD 05)

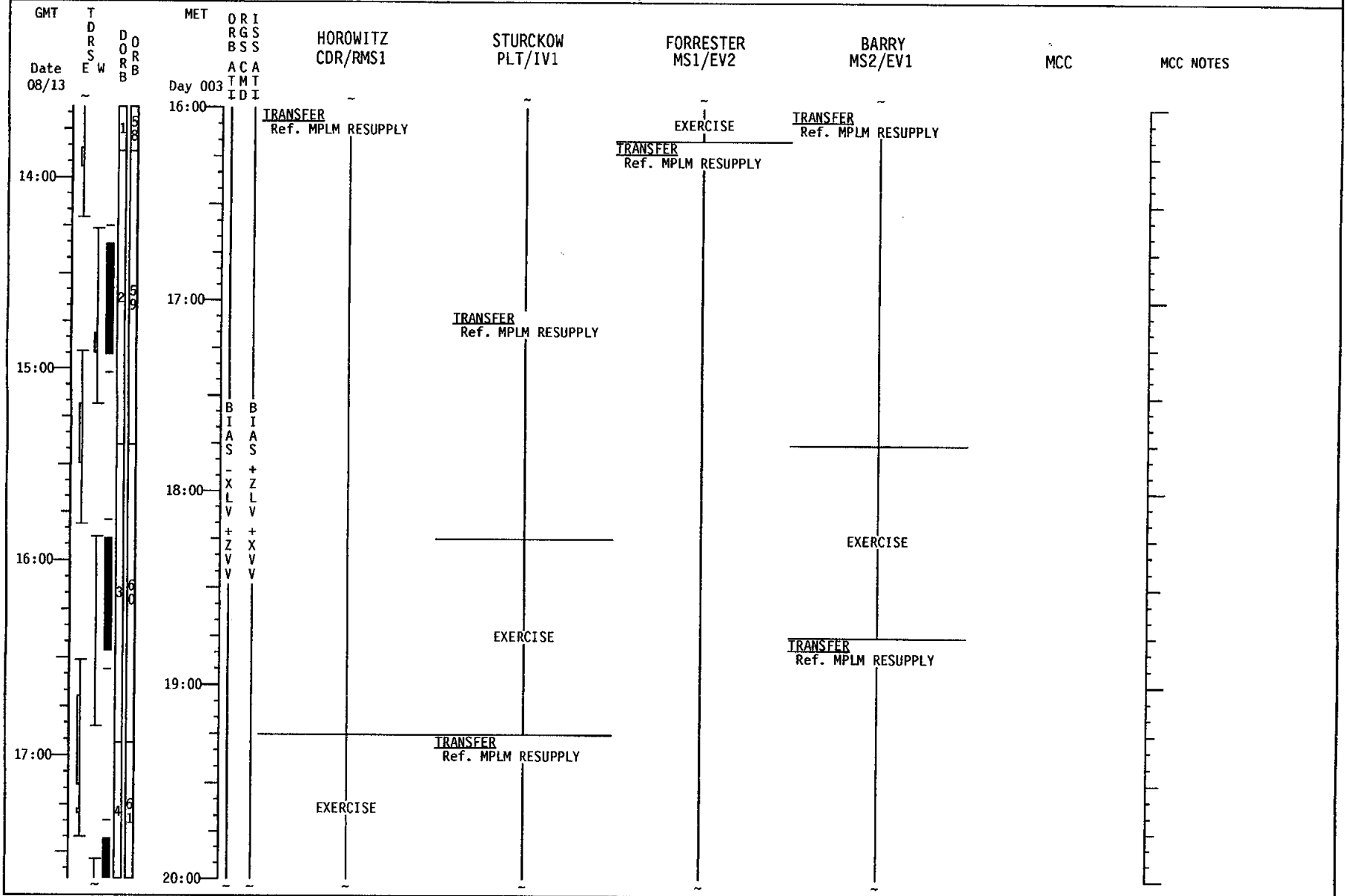

STS-105 7A.1 (FD 05)

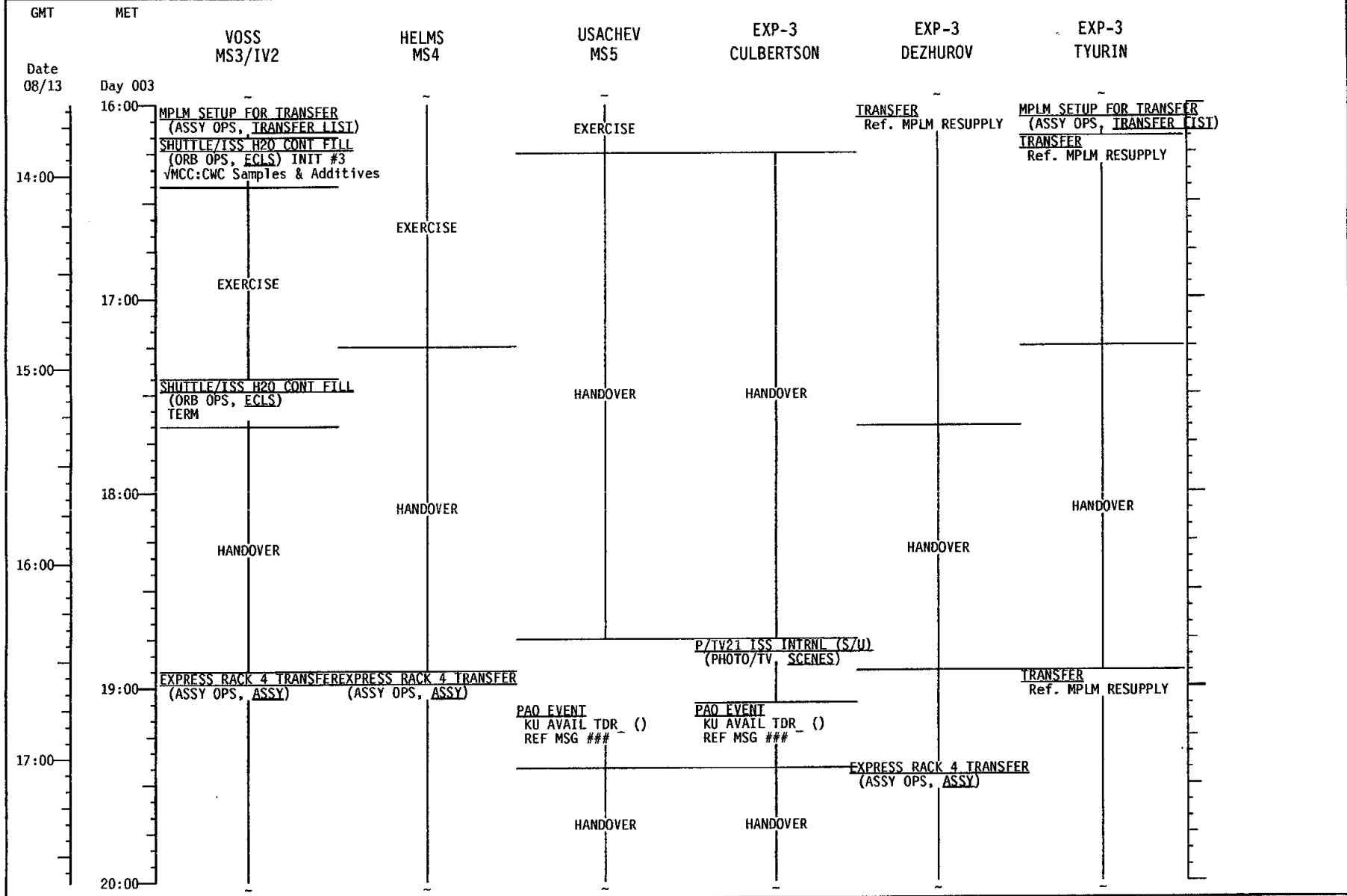

STS-105/7A.1 (FD 05)

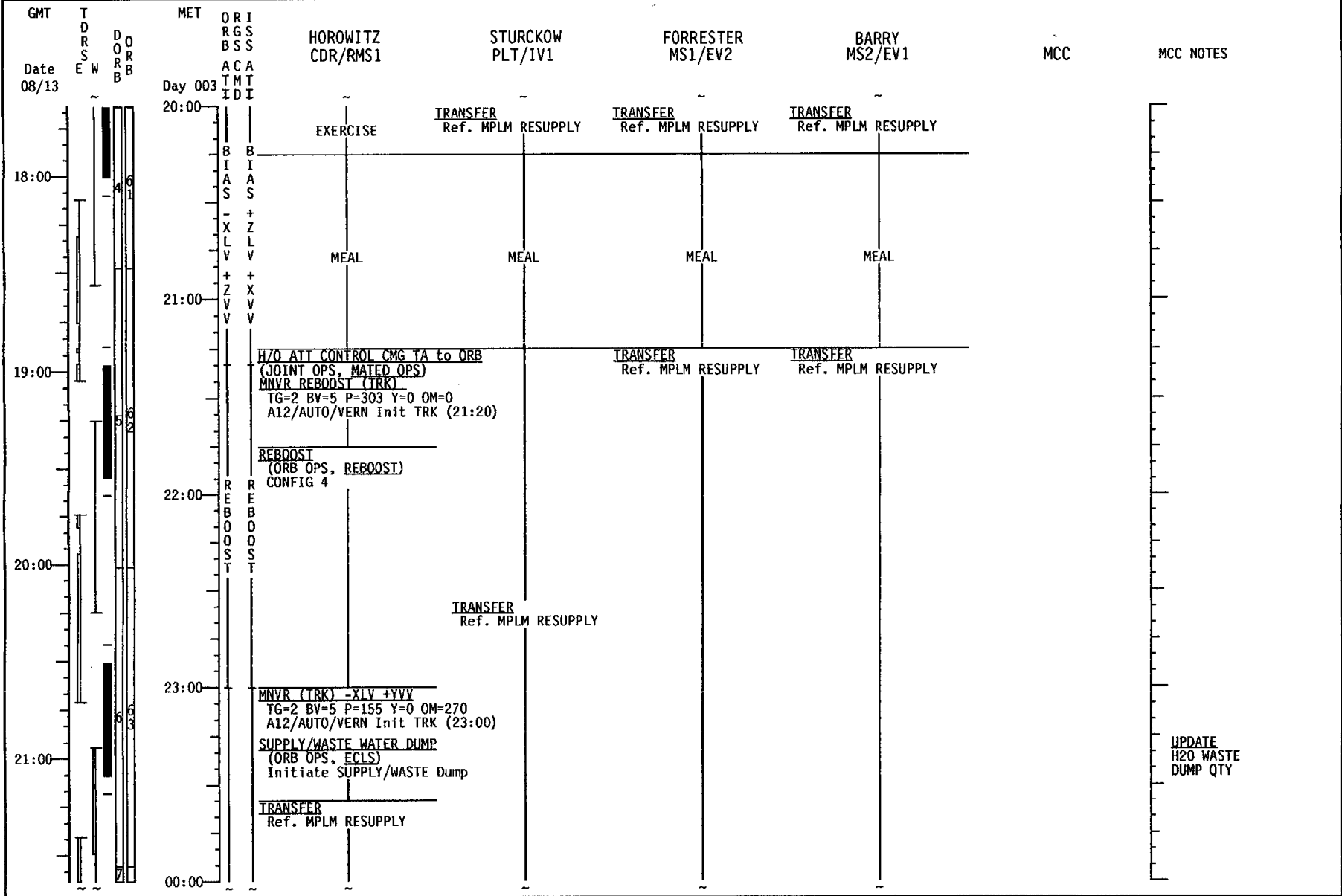

STS-105 7A.1 (FD 05)

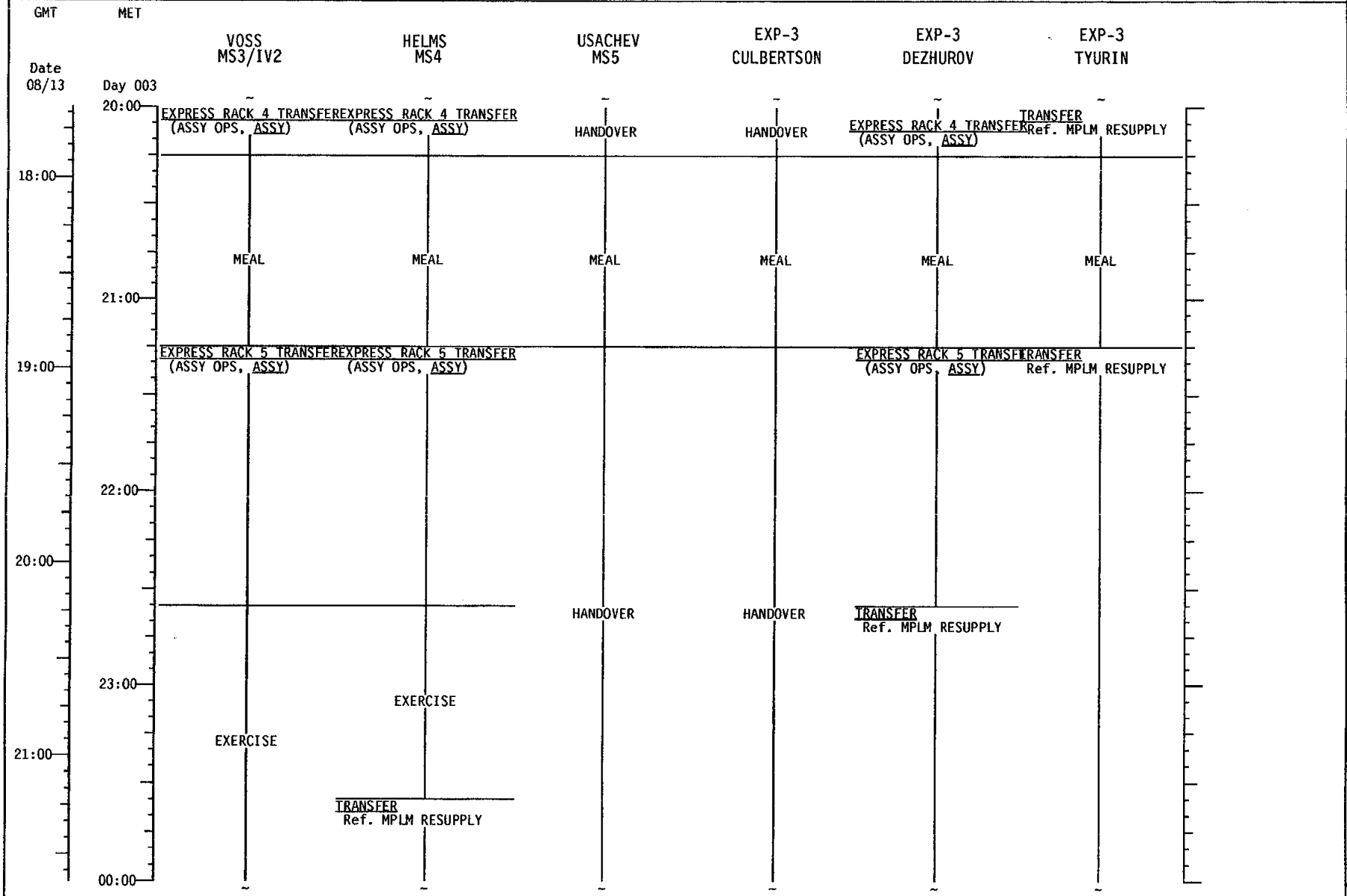

STS-105/7A.1 (FD 05)

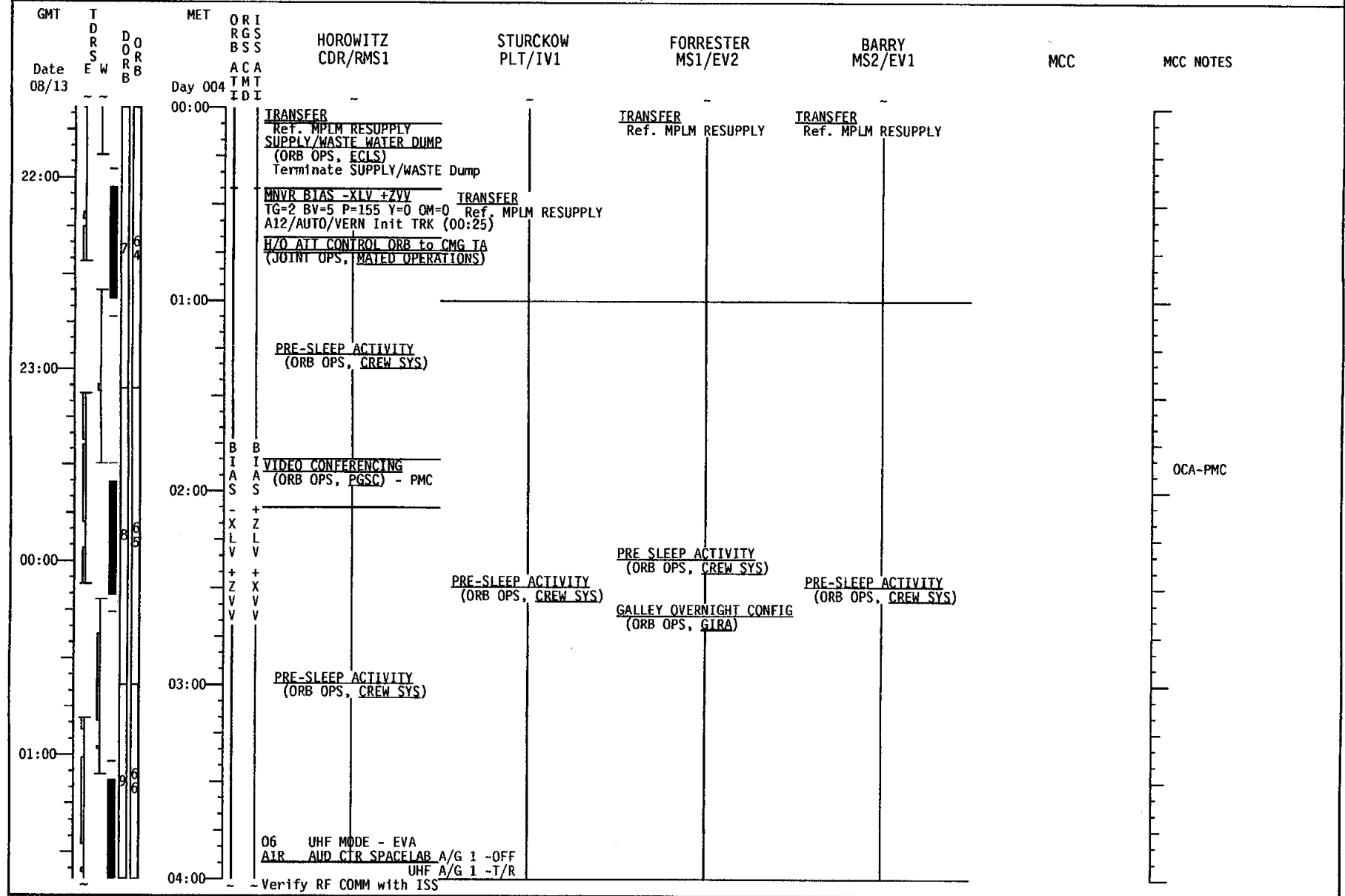

STS-105 7A.1 (FD 05)

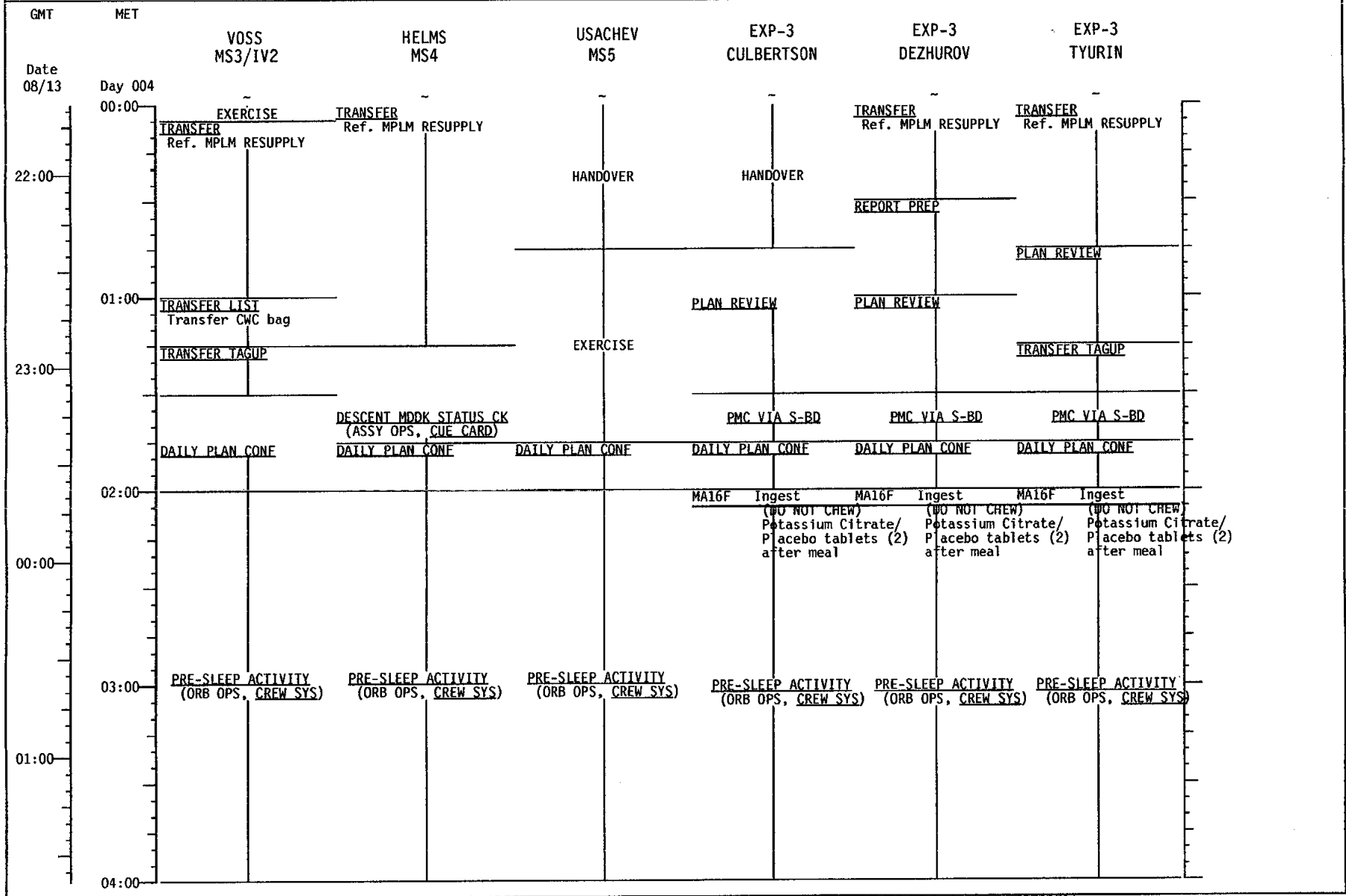

STS-105 7A.1 (FD 05)

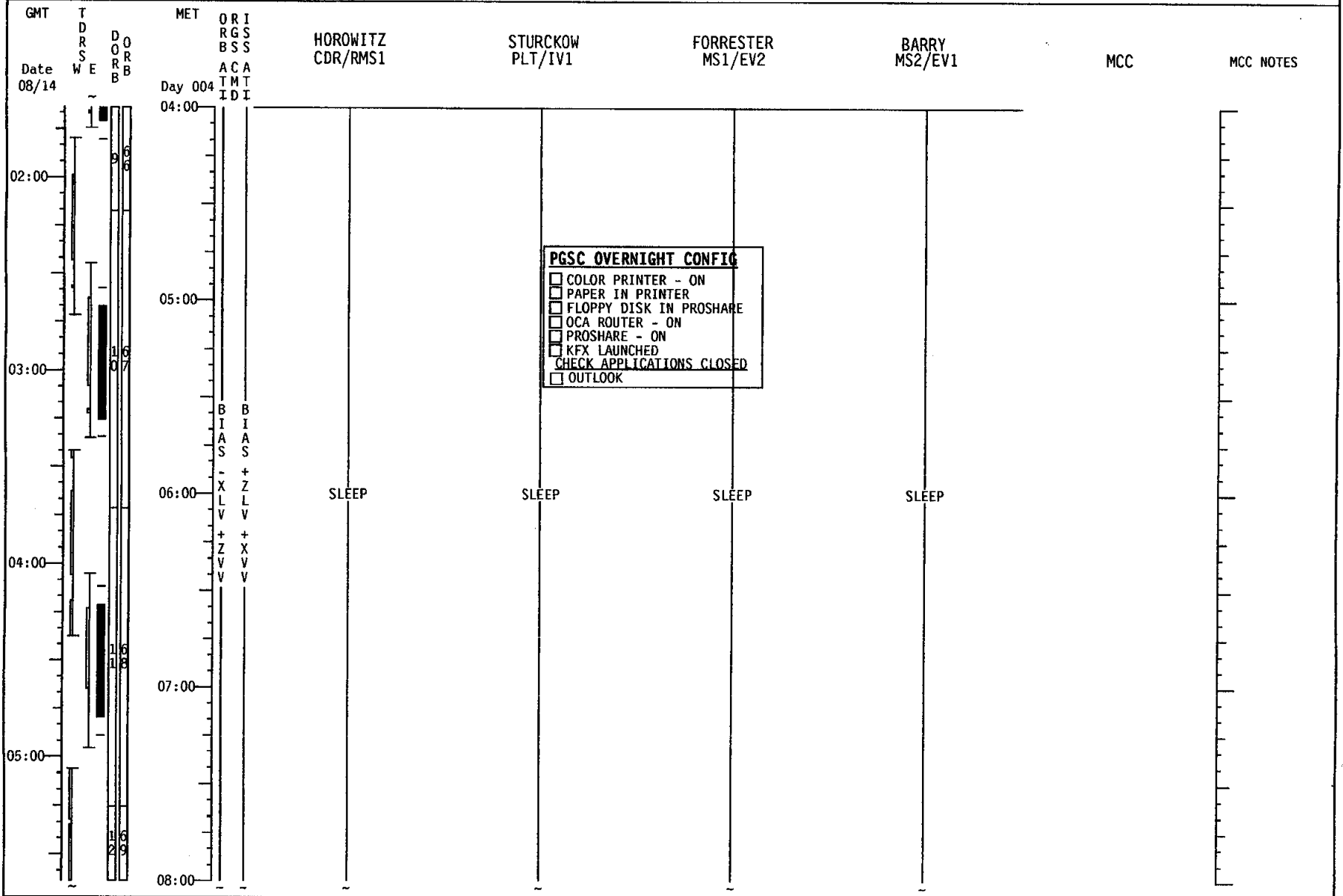

STS-105 7A.1 (FD 05)

GMT	MET	VOSS MS3/IV2	HELMS MS4	USACHEV MS5	EXP-3 CULBERTSON	EXP-3 DEZHUROV	EXP-3 TYURIN
Date 08/14	Day 004						
04:00							
02:00							
05:00							
03:00							
06:00		SLEEP	SLEEP	SLEEP	SLEEP	SLEEP	SLEEP
04:00							
07:00							
05:00							
08:00							

STS-105 7A.1 (FD 05)

GMT	TDRS W E	DORB R B	MET Day 004	ORIRGSS BSS ACA TMT IDI	HOROWITZ CDR/RMS1	STURCKOW PLT/IV1	FORRESTER MS1/EV2	BARRY MS2/EV1	MCC	MCC NOTES
Date 08/14			08:00 06:00 09:00 07:00 10:00 08:00 11:00 09:00 12:00	B B I I A A S S + Z L L V V + X V V V V		SLEEP	SLEEP	SLEEP	SLEEP	

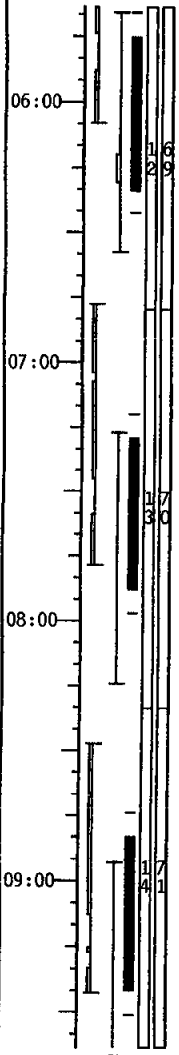

STS-105 7A.1 (FD 05)

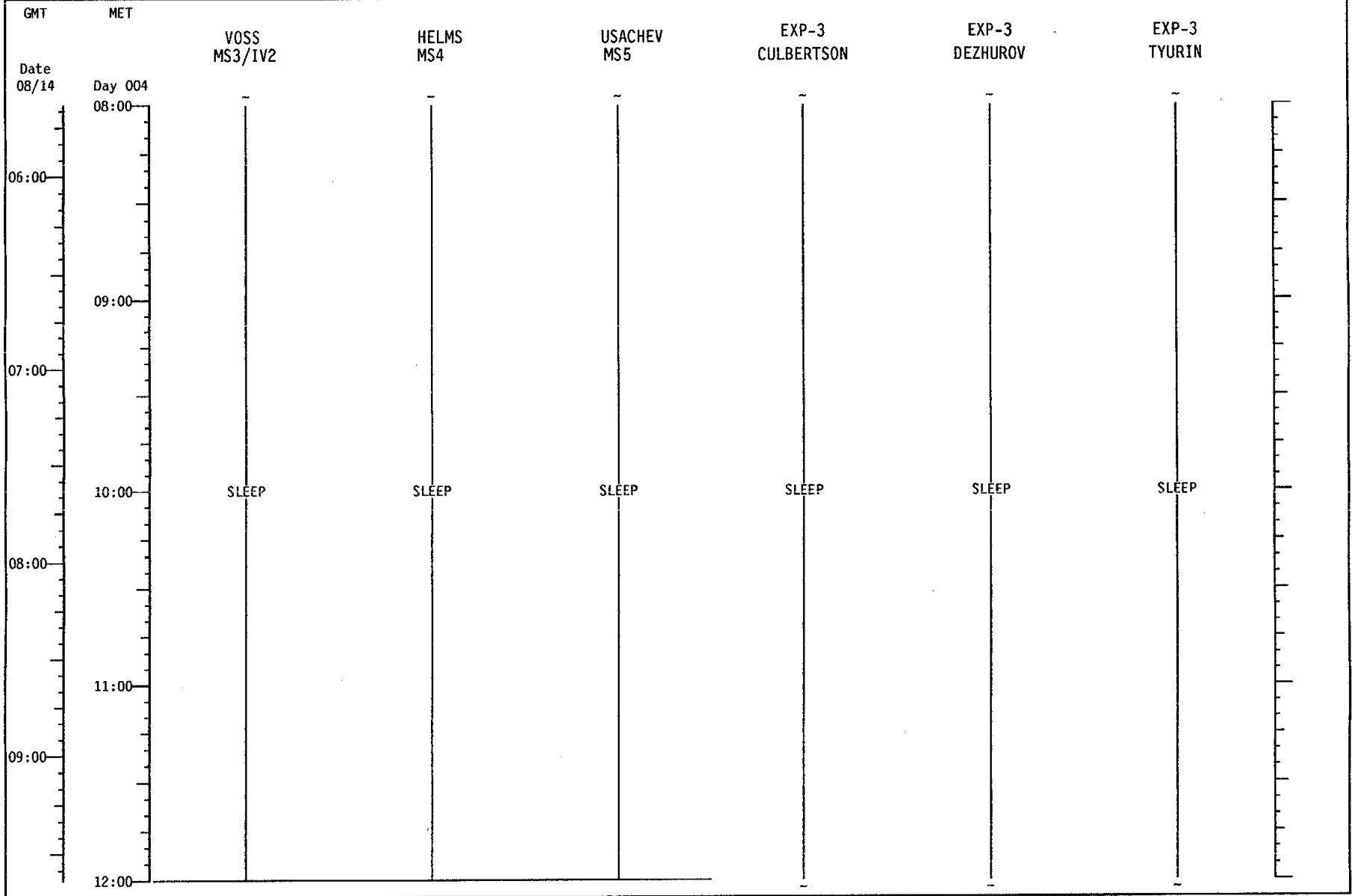

STS-105 7A.1 (FD 06)

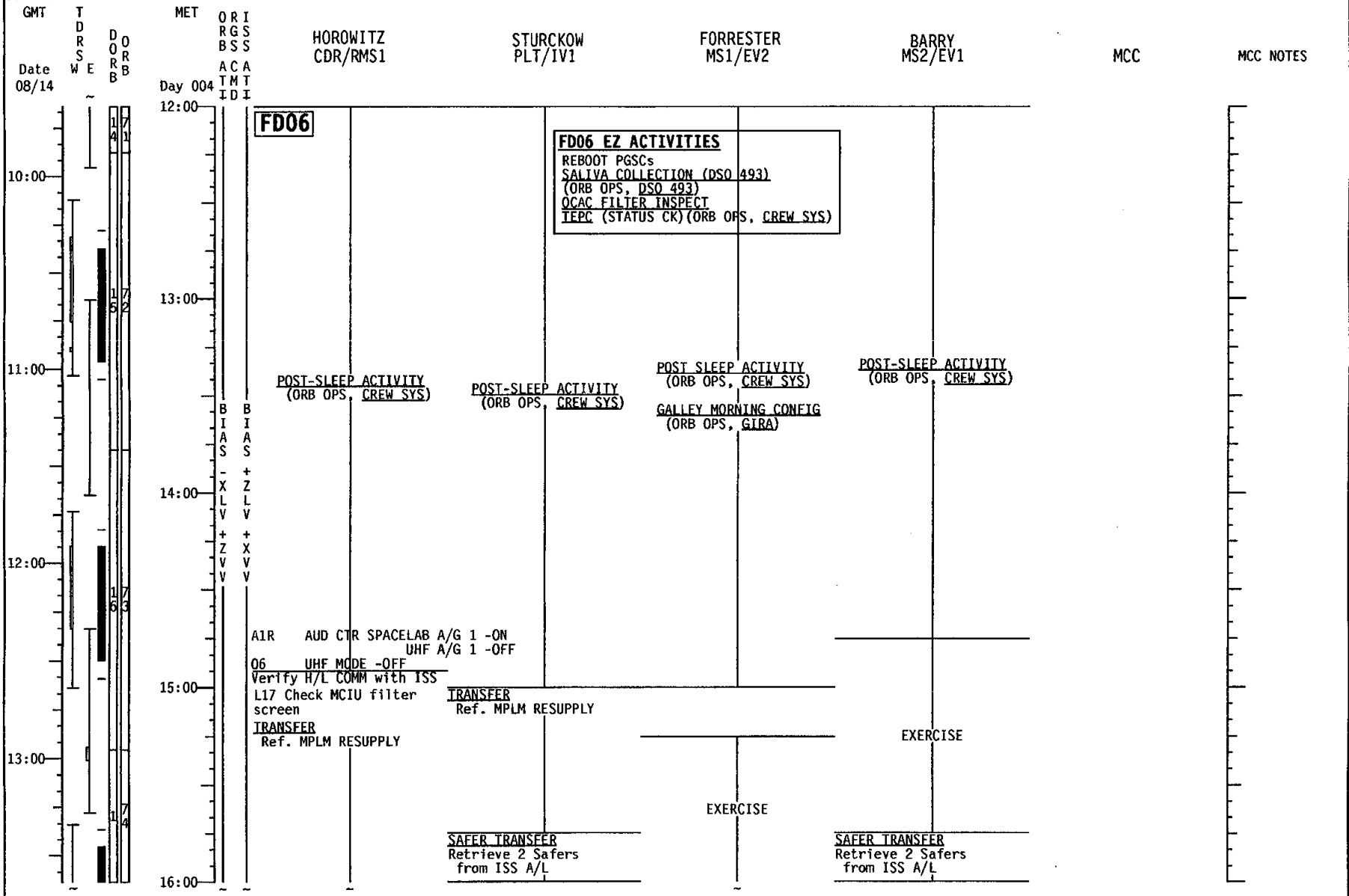

STS-105 7A.1 (FD 06)

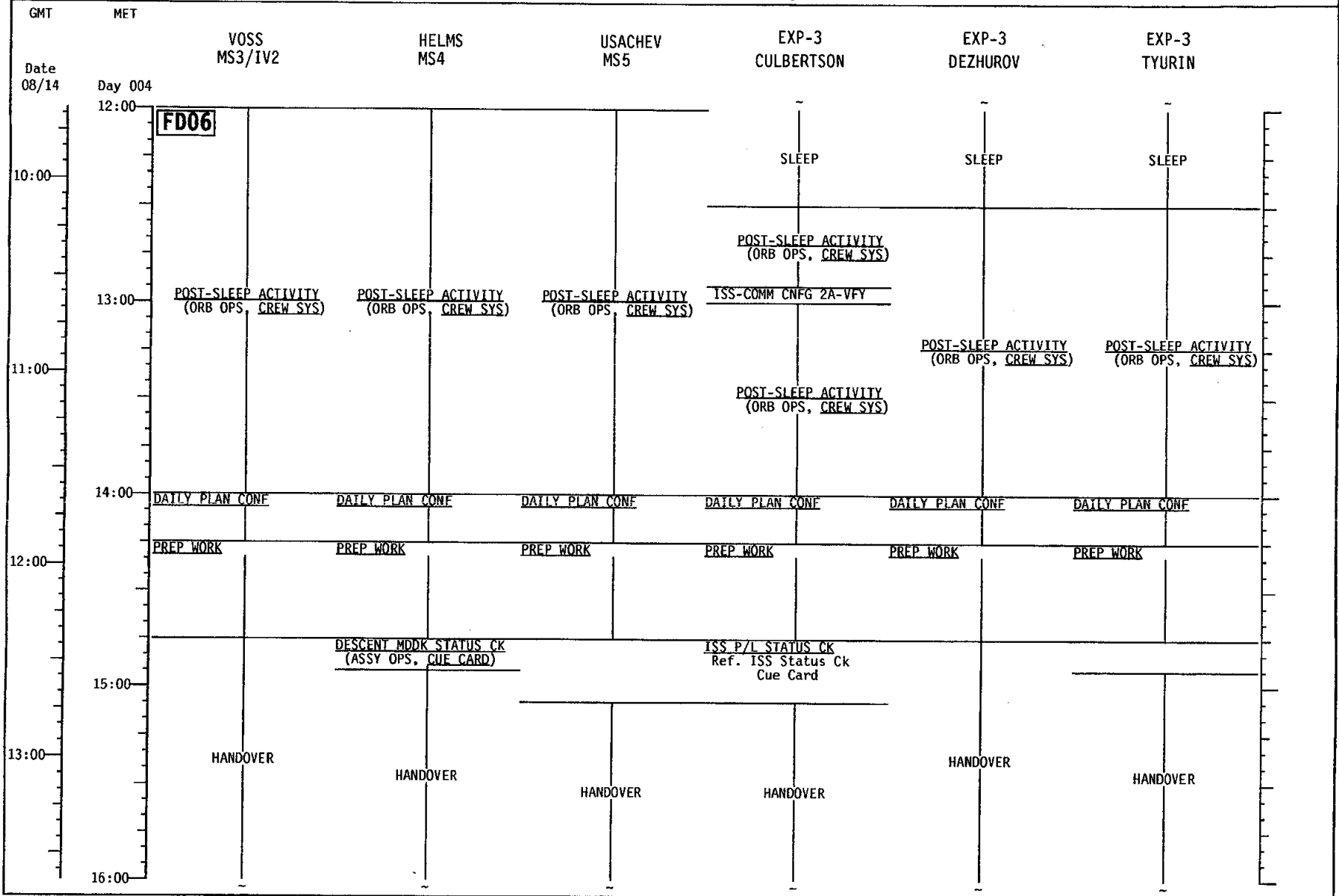

STS-105 7A.1 (FD 06)

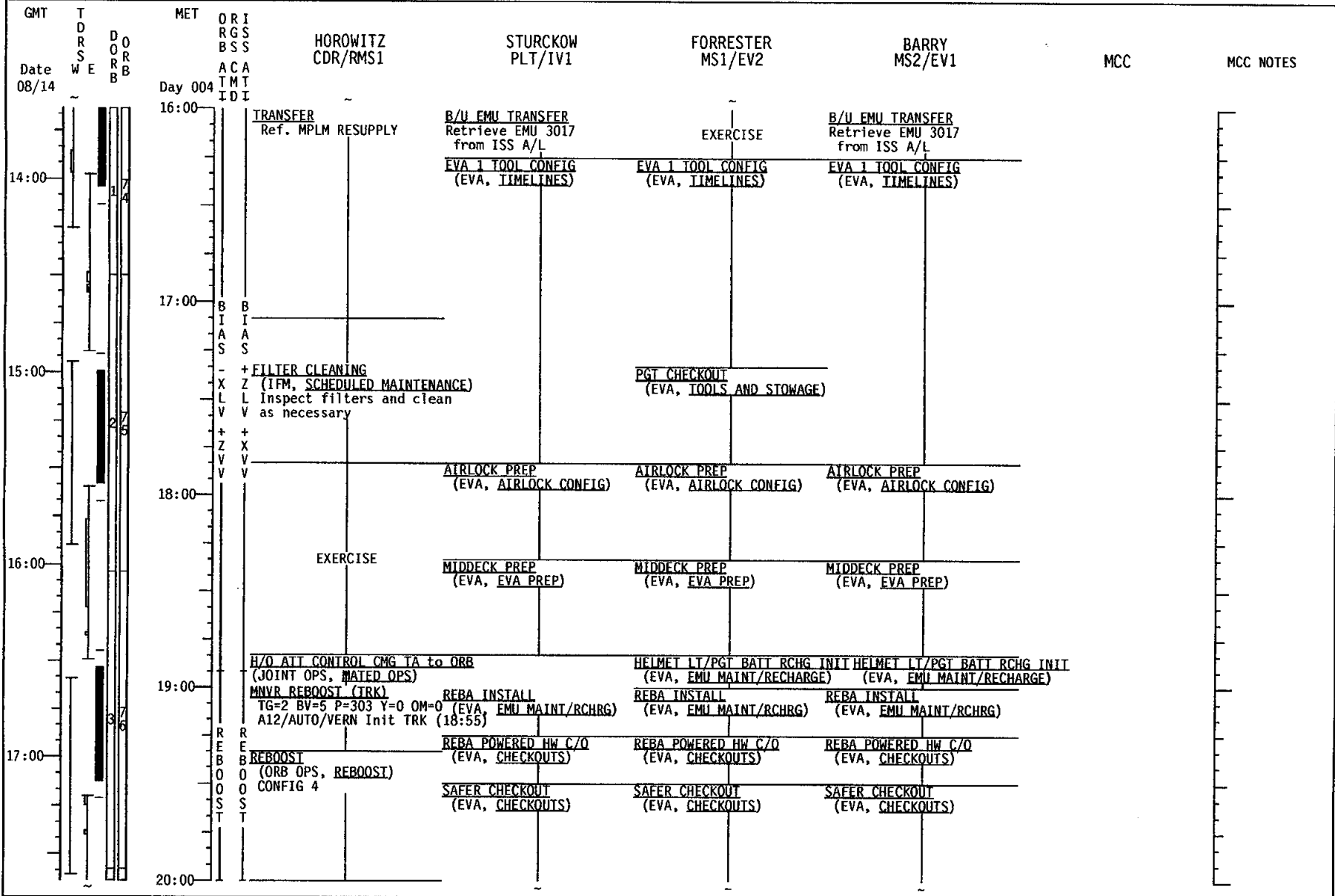

STS-105 7A.1 (FD 06)

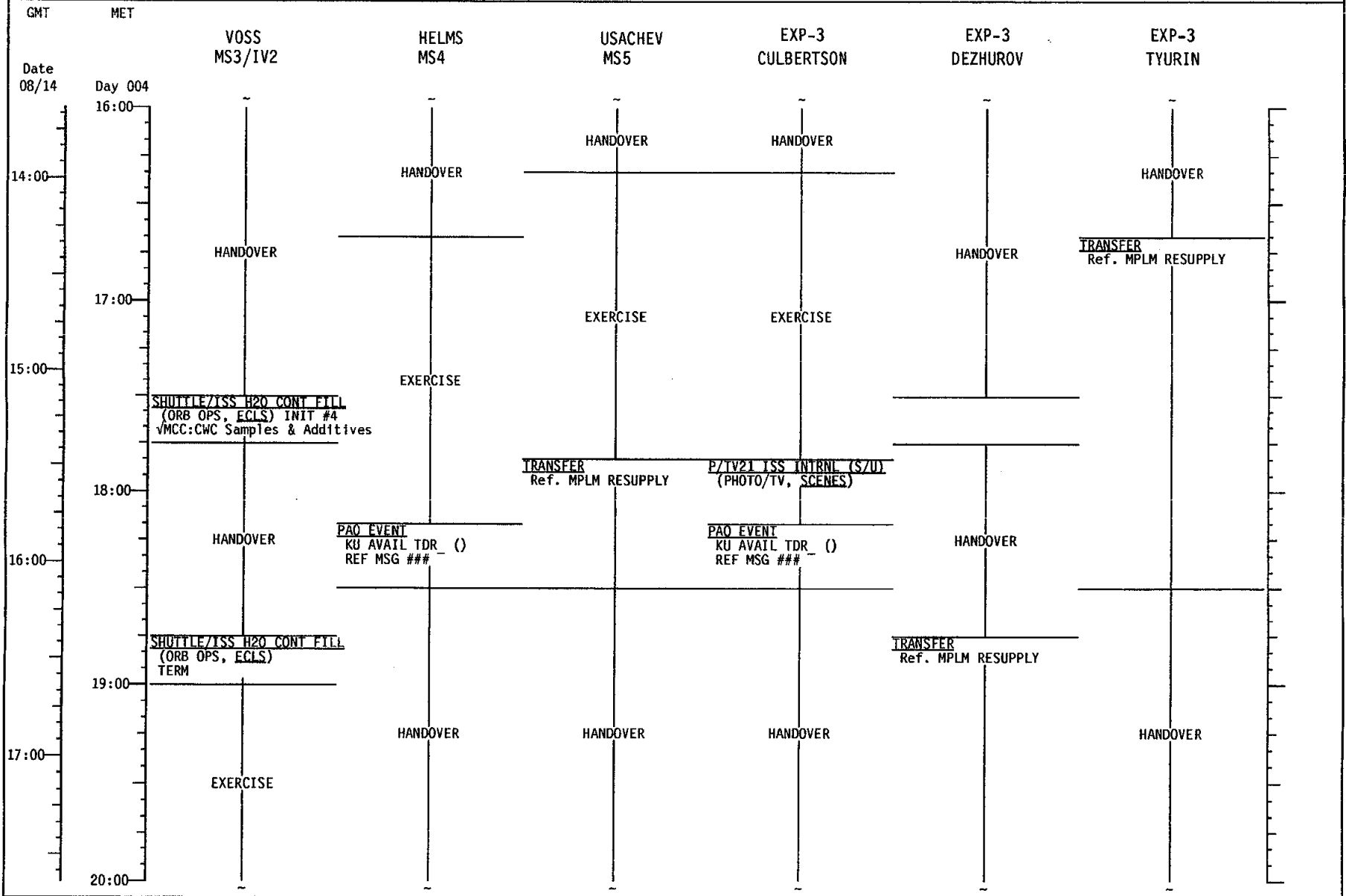

STS-105 7A.1 (FD 06)

GMT	TDRS W E	DORB	MET Day 004	ORIGSS BSS ACA TMT TDT	HOROWITZ CDR/RMS1	STURCKOW PLT/IV1	FORRESTER MS1/EV2	BARRY MS2/EV1	MCC	MCC NOTES					
Date 08/14			20:00	BIAS +ZLV +ZVV	MNV BIAS -XLV +ZVV					SAFER CHECKOUT (EVA, CHECKOUTS)					
					TG=2 BV=5 P=155 Y=0 OM=0 (EVA, CHECKOUTS)					SAFER CHECKOUT (EVA, CHECKOUTS)		SAFER CHECKOUT (EVA, CHECKOUTS)			
					A12/AUTO/VERN Init TRK (20:00)										
					H/O ATT CONTROL ORB to CMG TA (JOINT OPS, MATED OPERATIONS)										
					MEAL					MEAL		MEAL			
					MEAL					MEAL		MEAL			
					MEAL					MEAL		MEAL			
					MEAL					MEAL		MEAL			
					MEAL					MEAL		MEAL			
					MEAL					MEAL		MEAL			
18:00			21:00	BIAS +ZLV +ZVV	TRANSFER Ref. MPLM RESUPPLY					EMU CHECKOUTS (EVA, CHECKOUTS) Perform for 2 EMUs		EMU CHECKOUTS (EVA, CHECKOUTS) Perform for 2 EMUs			
					TRANSFER Ref. MPLM RESUPPLY					EMU CHECKOUTS (EVA, CHECKOUTS) Perform for 2 EMUs		EMU CHECKOUTS (EVA, CHECKOUTS) Perform for 2 EMUs		EMU CHECKOUTS (EVA, CHECKOUTS) Perform for 2 EMUs	
19:00			22:00	BIAS +ZLV +ZVV											
20:00			23:00	BIAS +ZLV +ZVV	EVA PROCEDURE REVIEW					EVA PROCEDURE REVIEW		EVA PROCEDURE REVIEW			
					EVA PROCEDURE REVIEW					EVA PROCEDURE REVIEW		EVA PROCEDURE REVIEW		EVA PROCEDURE REVIEW	
21:00			00:00	BIAS +ZLV +ZVV	EXERCISE					TAKE 1 ASPIRIN (325mg) MASK PREBREATHE INITIATE (EVA, 10.2 PSI CABIN)		TAKE 1 ASPIRIN (325mg) MASK PREBREATHE INITIATE (EVA, 10.2 PSI CABIN)			
					EXERCISE					TAKE 1 ASPIRIN (325mg) MASK PREBREATHE INITIATE (EVA, 10.2 PSI CABIN)		TAKE 1 ASPIRIN (325mg) MASK PREBREATHE INITIATE (EVA, 10.2 PSI CABIN)		TAKE 1 ASPIRIN (325mg) MASK PREBREATHE INITIATE (EVA, 10.2 PSI CABIN)	

STS-105 7A.1 (FD 06)

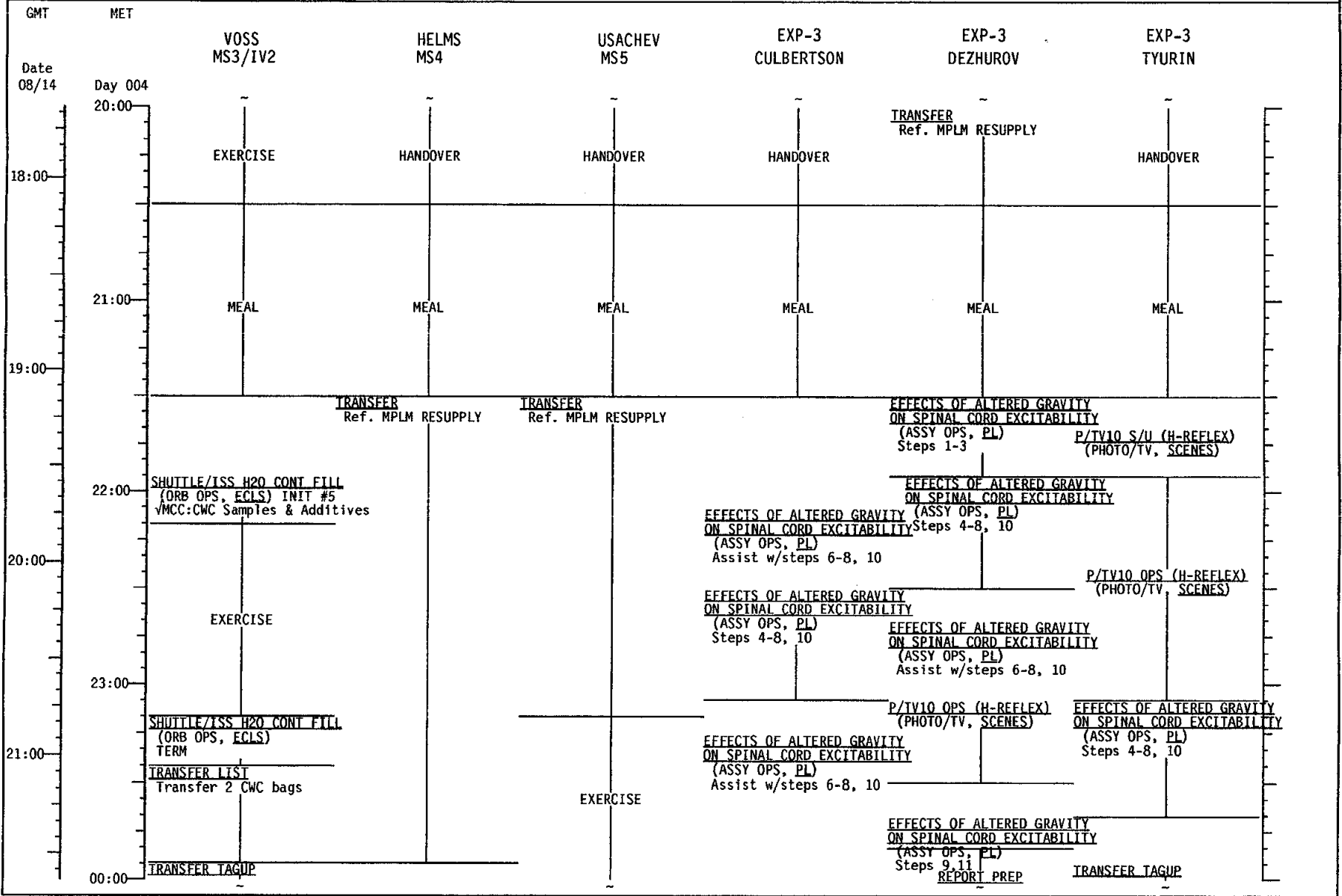

STS-105 7A.1 (FD 06)

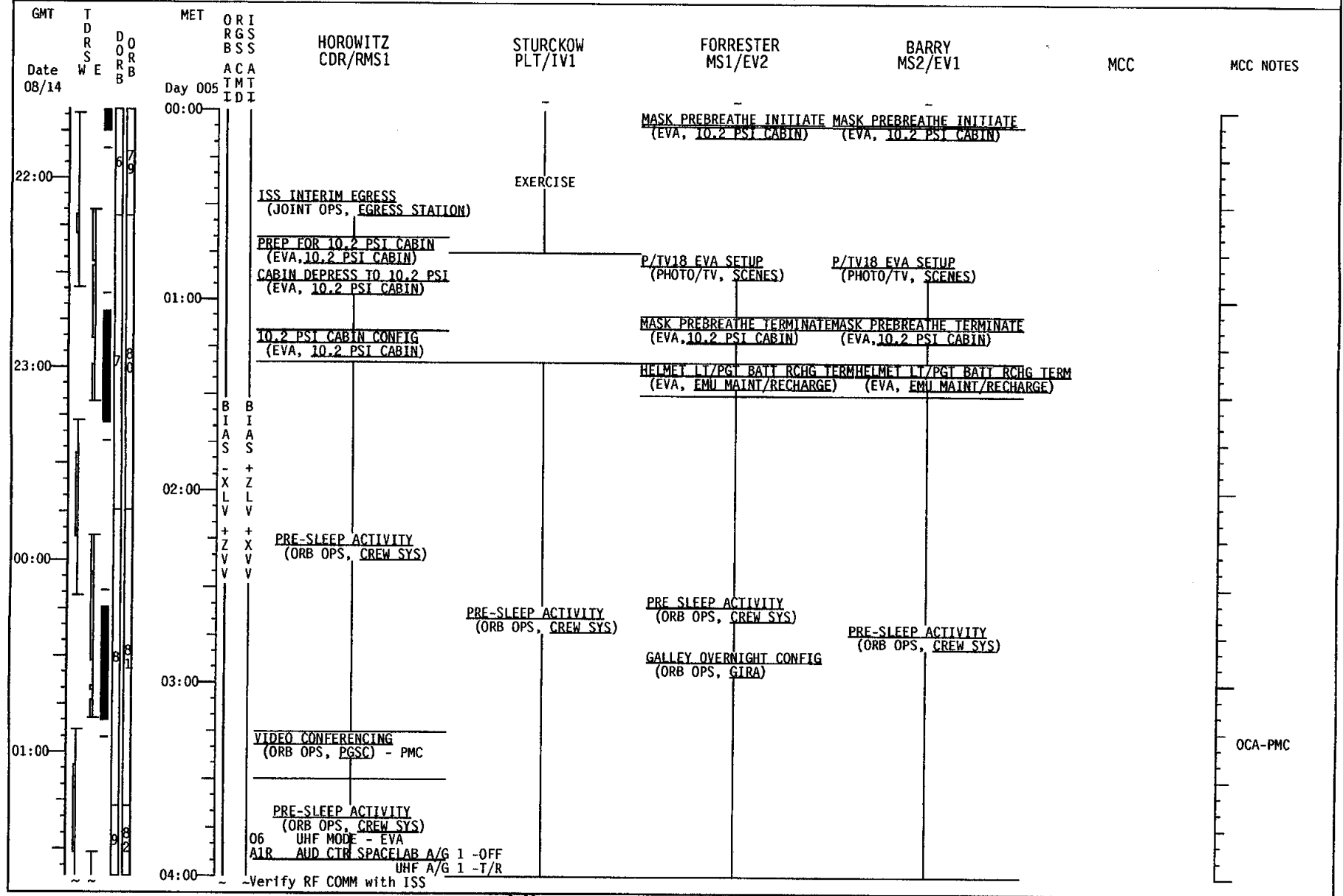

OCA-PMC

STS-105 7A.1 (FD 06)

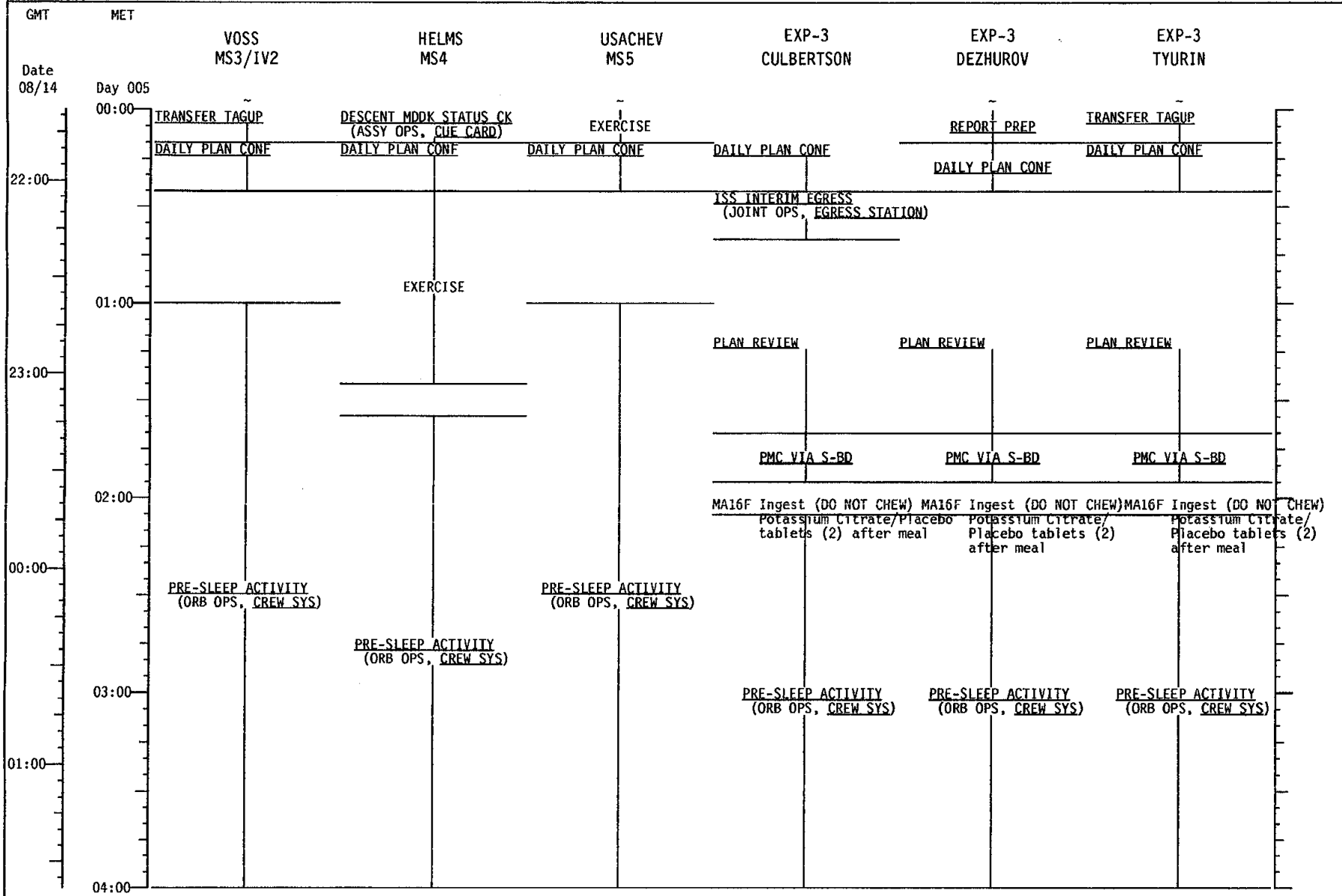

STS-105 7A.1 (FD 06)

GMT	TDRS WE	DORR B	MET	ORI	HOROWITZ CDR/RMS1	STURCKOW PLT/IV1	FORRESTER MS1/EV2	BARRY MS2/EV1	MCC	MCC NOTES
Date 08/15			Day 005	RGS BSS ACA TMT IDI						
04:00										
02:00										
03:00										
04:00										
05:00										
06:00				B I A S	SLEEP	SLEEP	SLEEP	SLEEP		
07:00				+ Z L V						
05:00				+ Z V V						
08:00				+ X V V						

PGSC OVERNIGHT CONFIG

- COLOR PRINTER - ON
- PAPER IN PRINTER
- FLOPPY DISK IN PROSHARE
- OCA ROUTER - ON
- PROSHARE - ON
- KFX LAUNCHED
- CHECK APPLICATIONS CLOSED
- OUTLOOK

STS-105 7A.1 (FD 06)

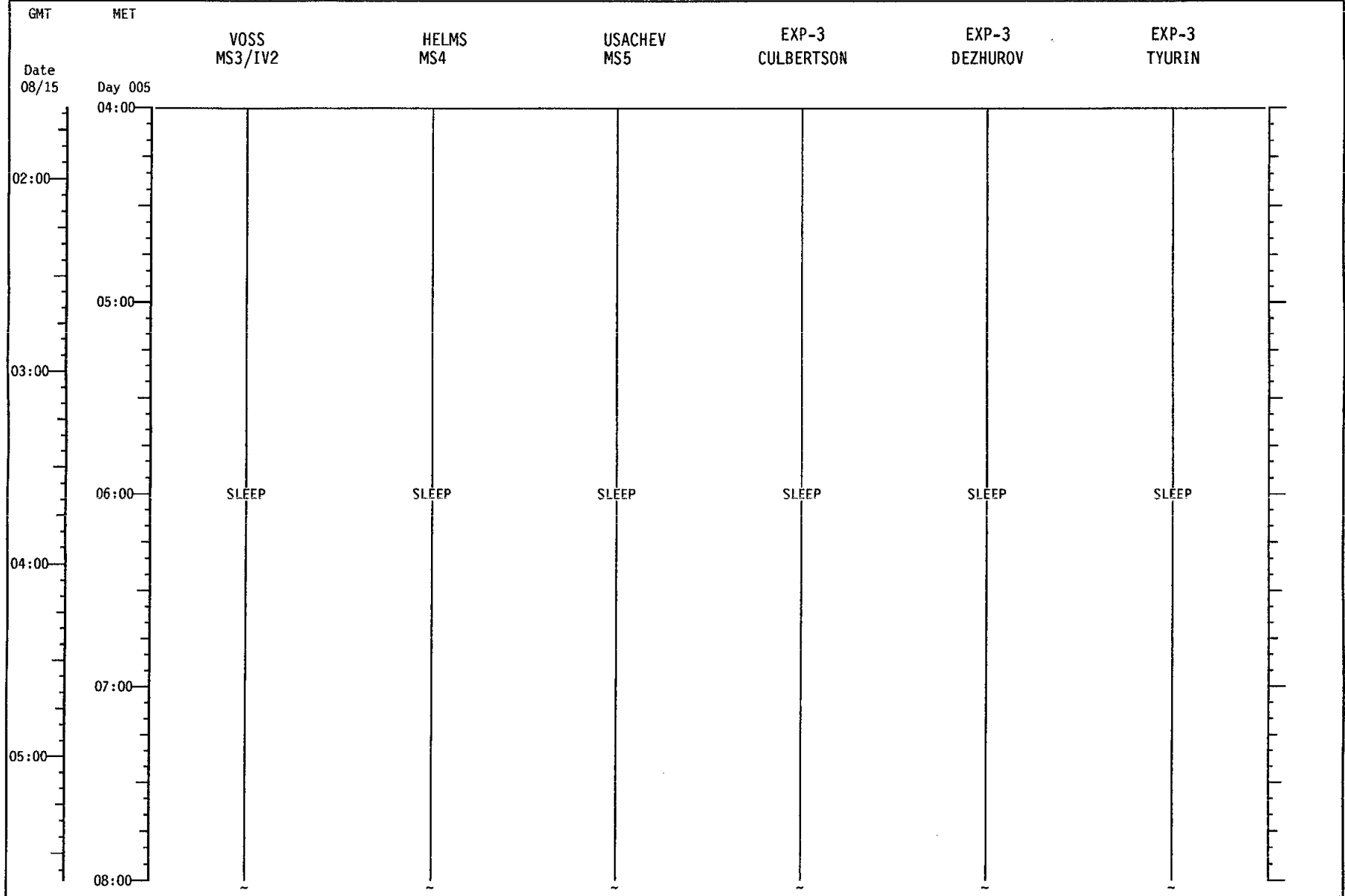

STS-105 7A.1 (FD 06)

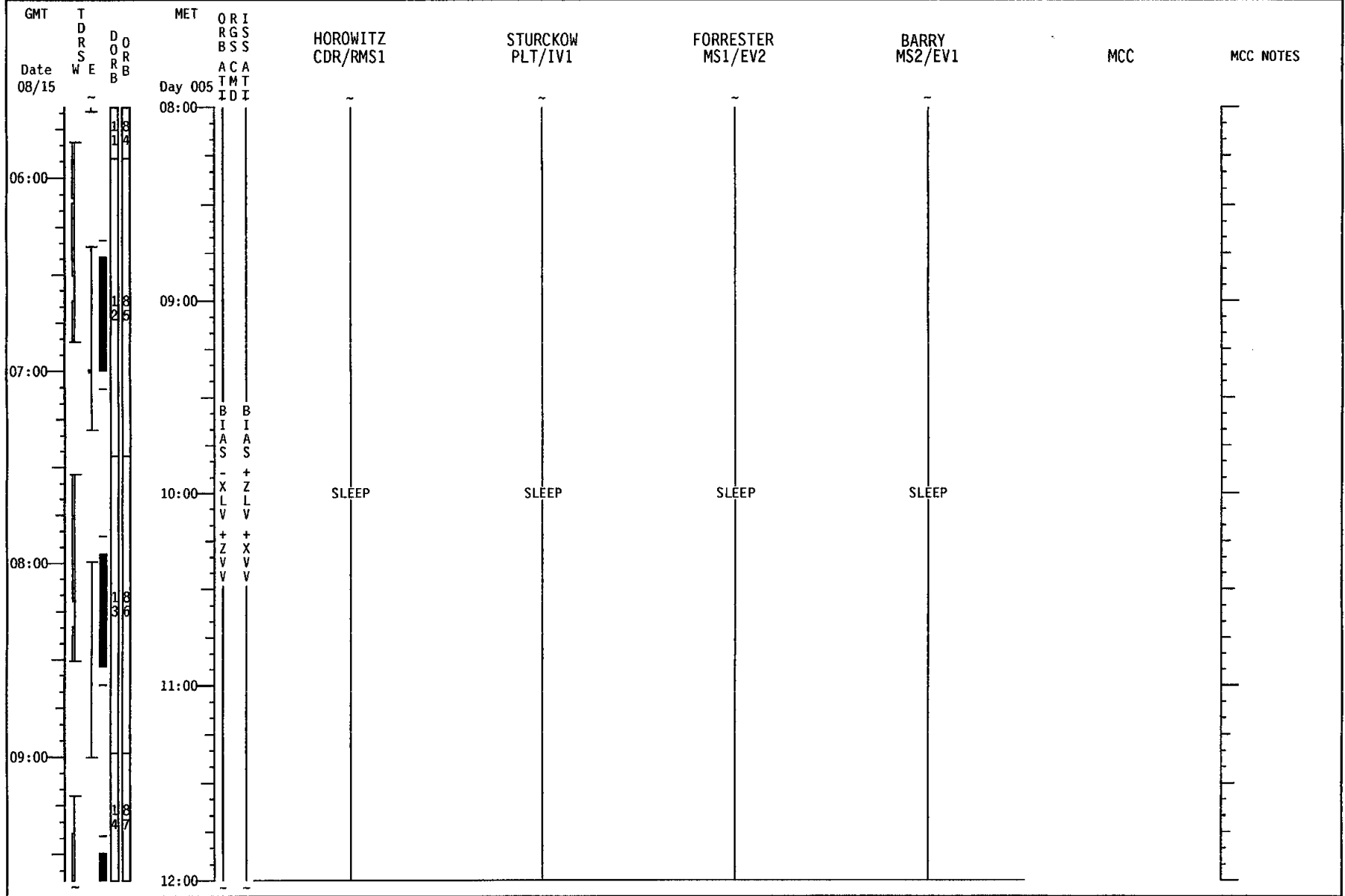

STS-105 7A.1 (FD 06)

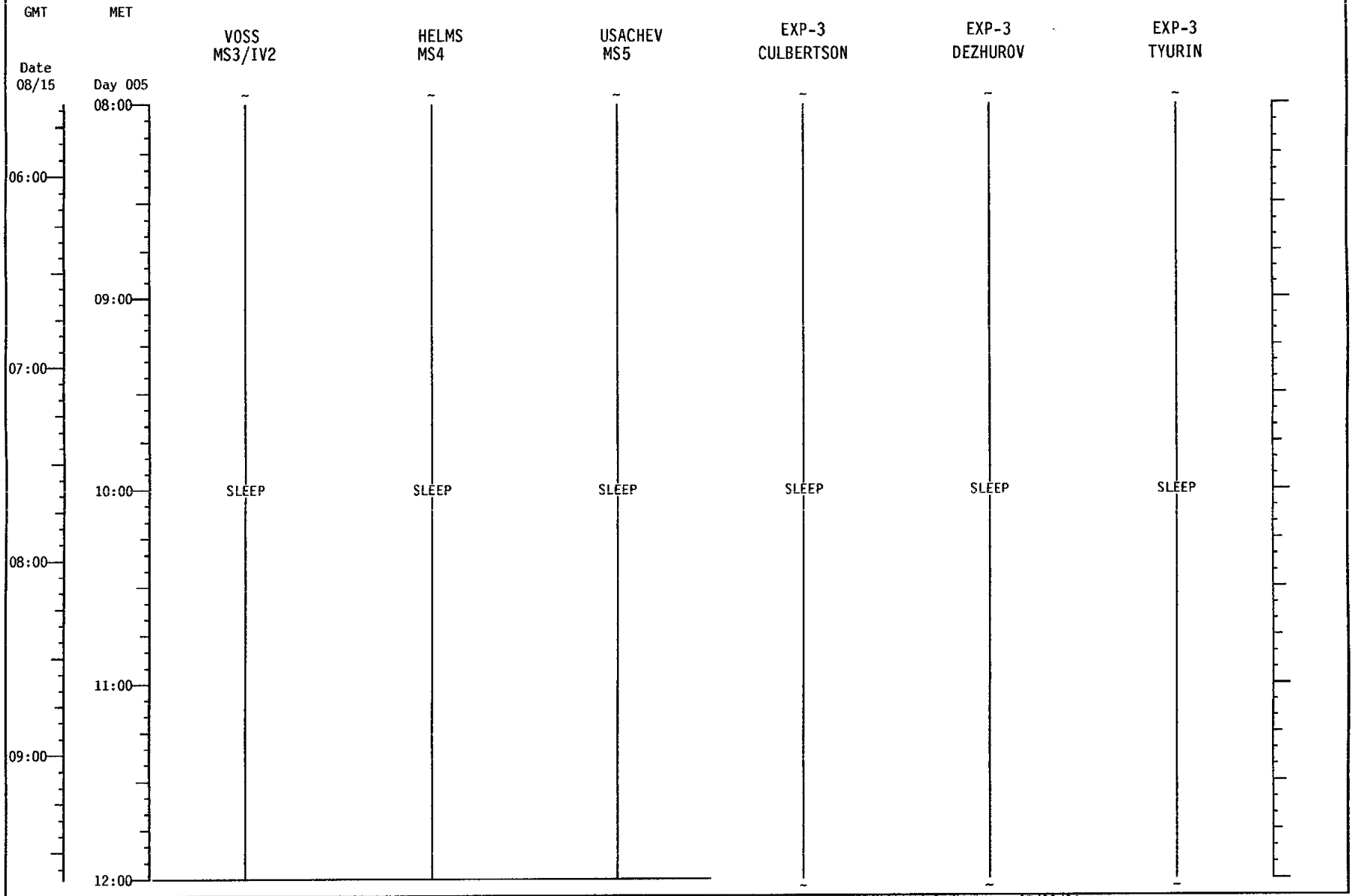

GMT

MET

Date
08/15

Day 005

VOSS
MS3/IV2

HELMS
MS4

USACHEV
MS5

EXP-3
CULBERTSON

EXP-3
DEZHUROV

EXP-3
TYURIN

08:00
06:00
09:00
07:00
10:00
08:00
11:00
09:00
12:00

SLEEP

SLEEP

SLEEP

SLEEP

SLEEP

SLEEP

STS-105 7A.1 (FD 07)

GMT	TDRS W E	DORB D O R B	MET	ORI RGS BSS ACA TMT IDI	HOROWITZ CDR/RMS1	STURCKOW PLT/IV1	FORRESTER MS1/EV2	BARRY MS2/EV1	MCC	MCC NOTES
Date 08/15			Day 005							
12:00					FD07		FD07 EZ ACTIVITIES REBOOT PGSCs SALIVA COLLECTION (DSO 493) (ORB OPS, DSO 493) QCAC FILTER INSPECT IEPC (STATUS CK) (ORB OPS, CREW SYS)			
10:00										
13:00					POST-SLEEP ACTIVITY (ORB OPS, CREW SYS)	POST-SLEEP ACTIVITY (ORB OPS, CREW SYS)	POST-SLEEP ACTIVITY (ORB OPS, CREW SYS)	POST-SLEEP ACTIVITY (ORB OPS, CREW SYS)		
11:00							GALLEY MORNING CONFIG (ORB OPS, GIRA)			
14:00						EVA PREP (EVA, EVA PREP)	EVA PREP (EVA, EVA PREP)	EVA PREP (EVA, EVA PREP)		
12:00										
15:00					A1R AUD CTR SPACELAB A/G 1 -ON UHF A/G 1 -OFF 06 UHF MODE -OFF Verify H/L COMM with ISS 10.2 PSI MAINTENANCE (EVA, 10.2 PSI CABIN) Perform Step 3 (N2) ONLY WCS COMPACTOR OPS (DUAL-VANE) (ORB OPS, CUE CARD) 06 UHF MODE - OFF PRIVATE MEDICAL CONFERENCE					
13:00						EMU PURGE/PREBREATHE (EVA, EVA PREP)	EMU PURGE/PREBREATHE (EVA, EVA PREP)	EMU PURGE/PREBREATHE (EVA, EVA PREP)		
16:00					EVAL INHIBIT PAD (EVA, EVAL) A8L PORT RMS HTR(two-AUTO) L17 Check MCIU filter					

screen

3-68

FLT PLN/105/FIN

07/09/01

STS-105 7A.1 (FD 07)

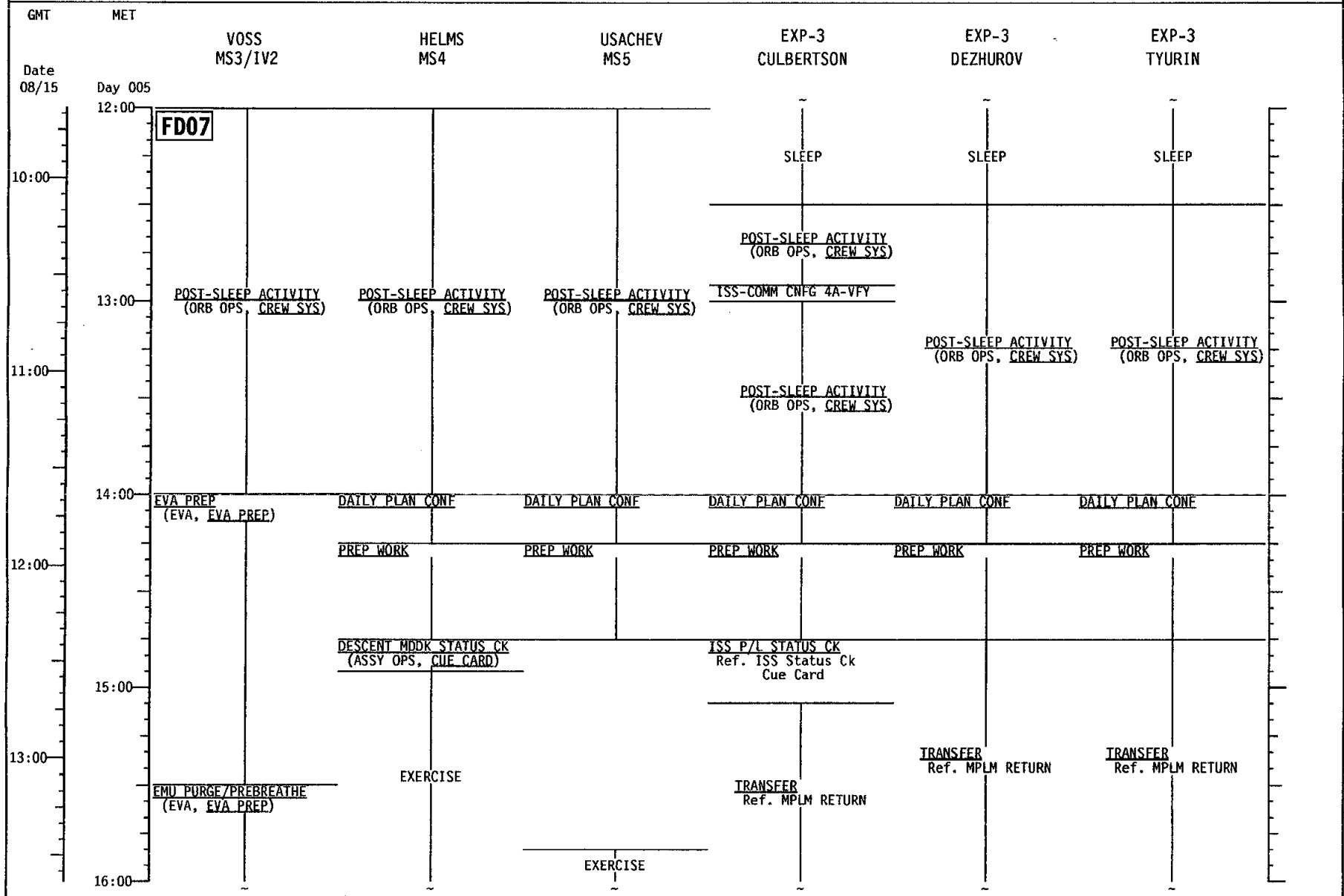

STS-105/7A.1 (FD 07)

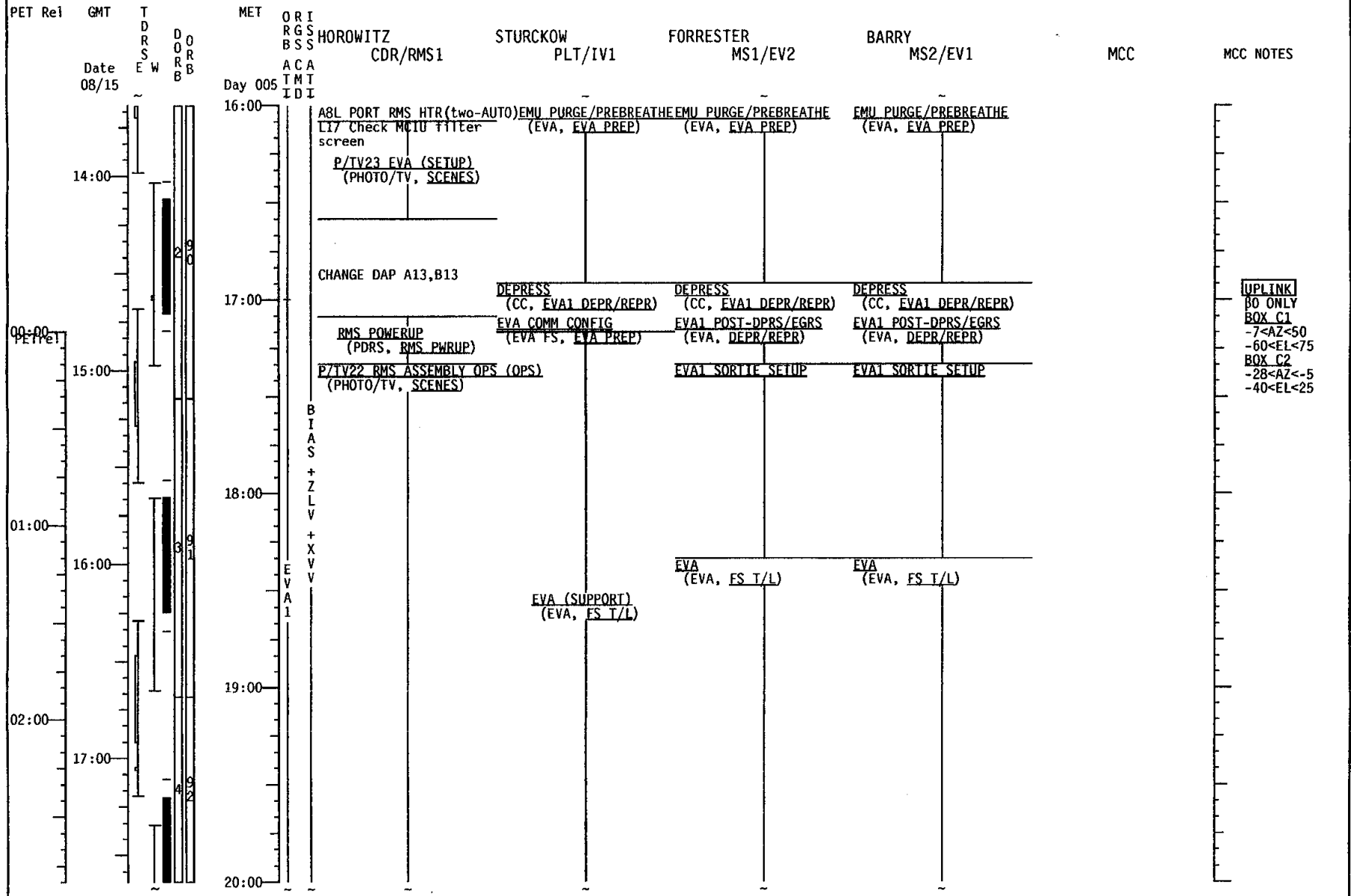

UPLINK
 BO ONLY
 BOX C1
 -7<AZ<50
 -60<EL<75
 BOX C2
 -28<AZ<-5
 -40<EL<25

STS-105 7A.1 (FD 07)

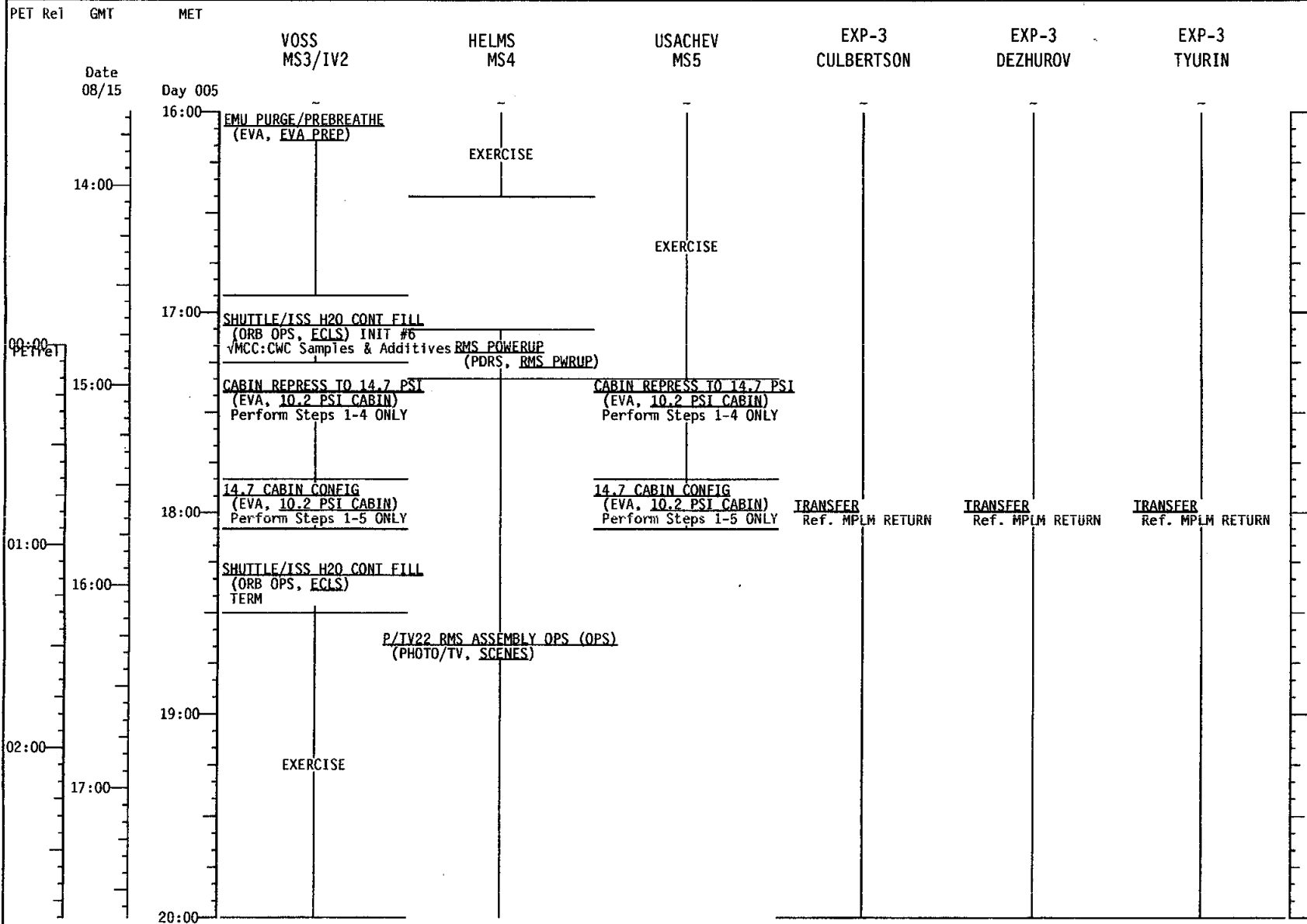

STS-105/7A.1 (FD 07)

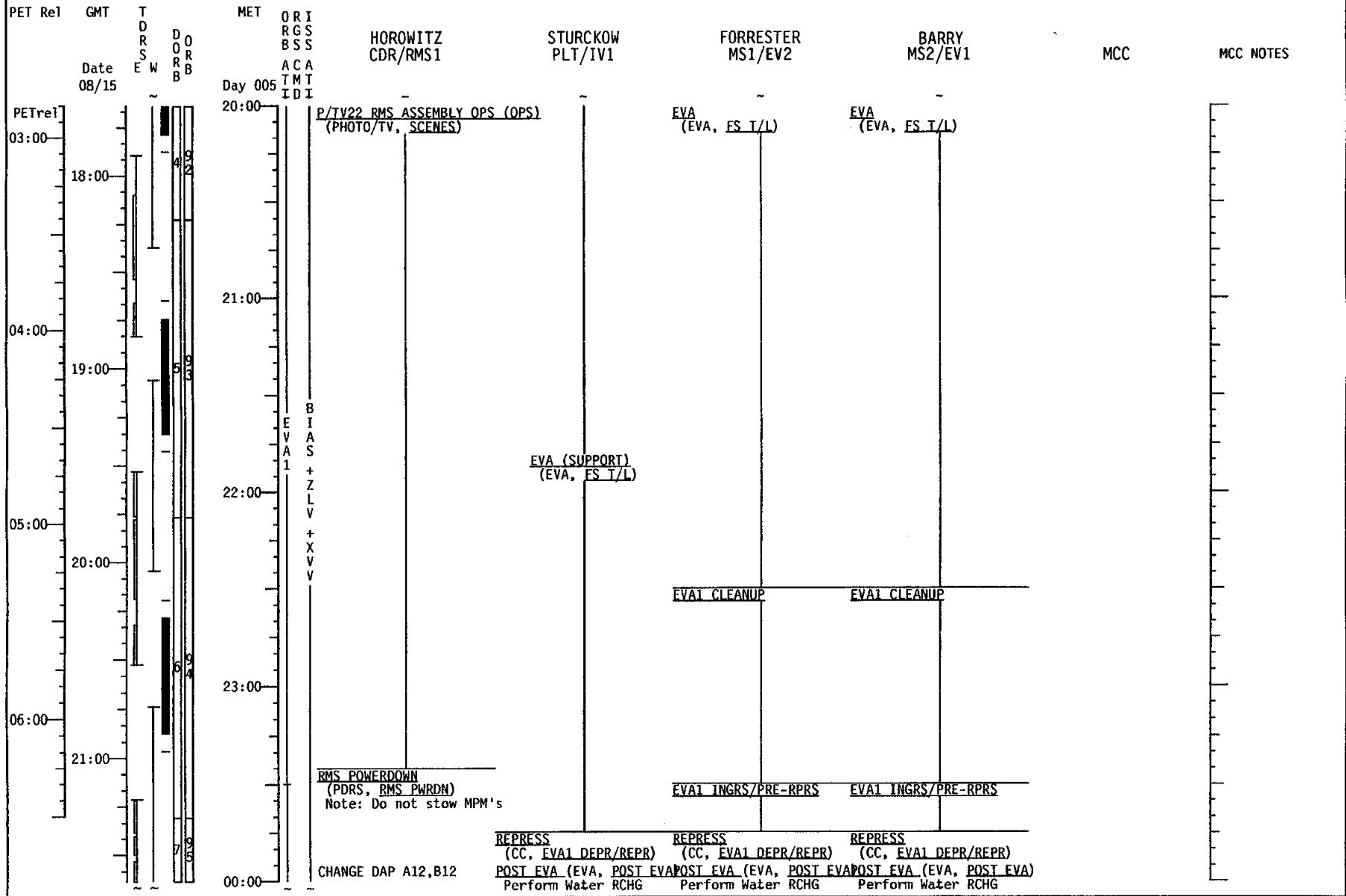

STS-105 7A.1 (FD 07)

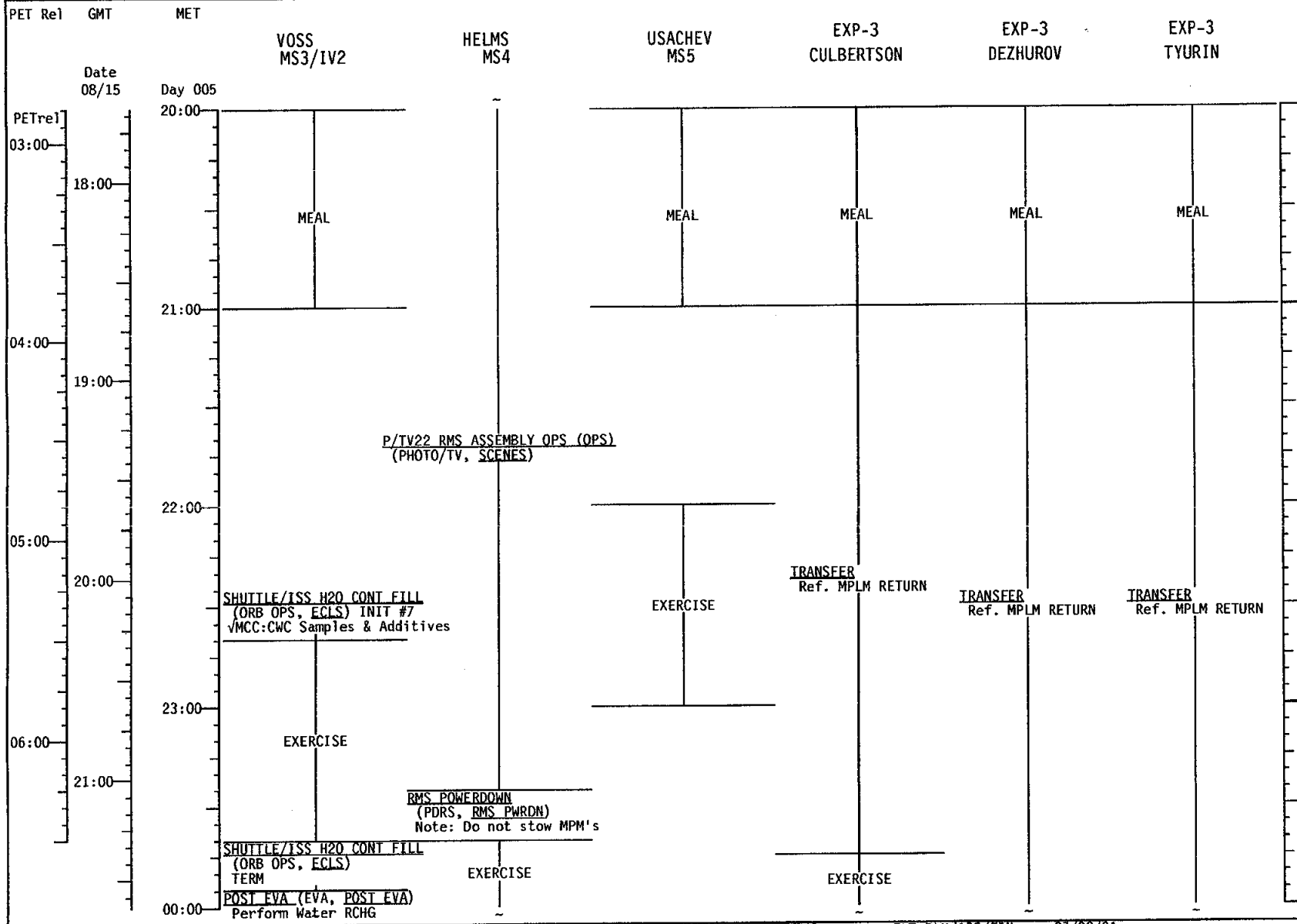

STS-105/7A.1 (FD 07)

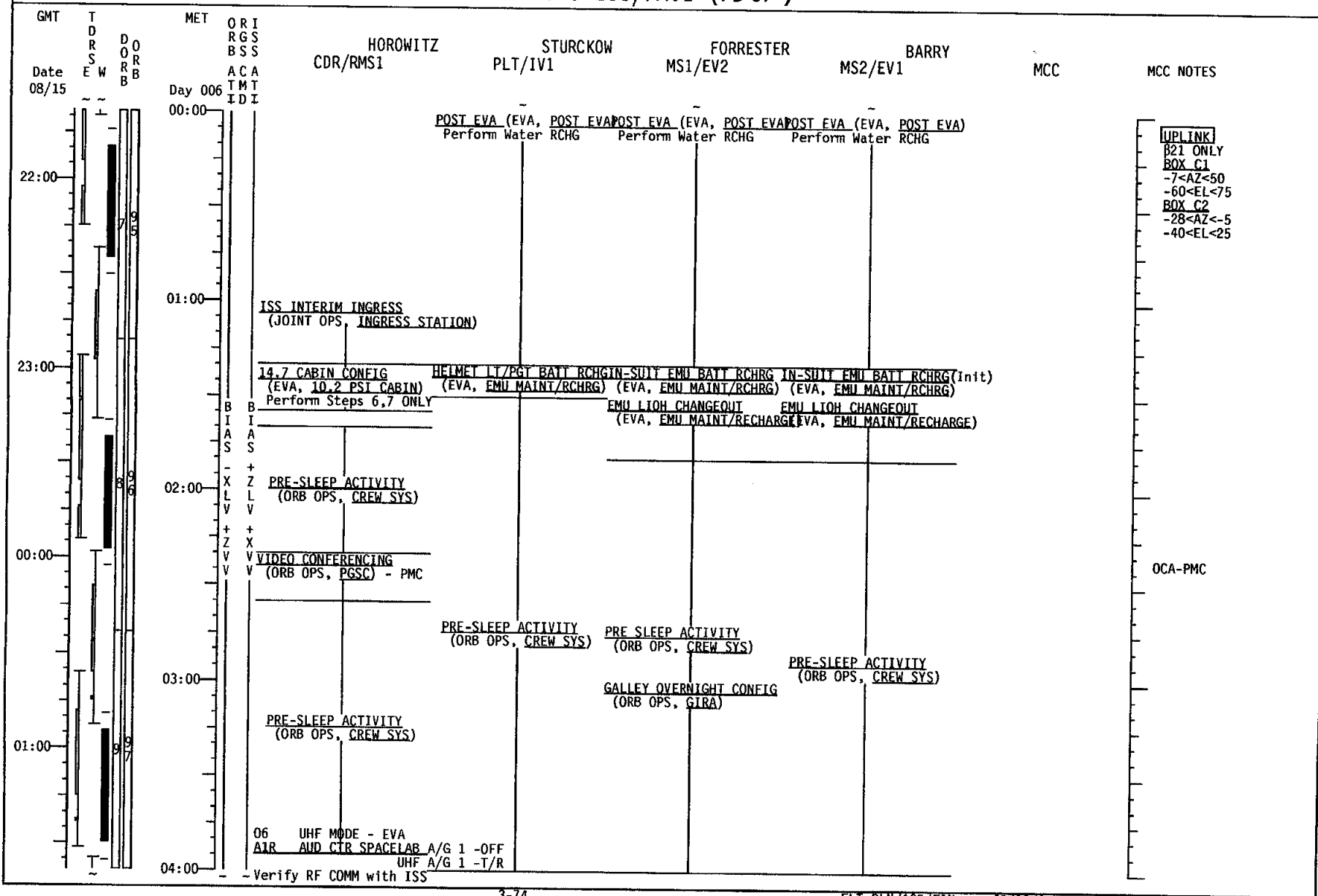

STS-105 7A.1 (FD 07)

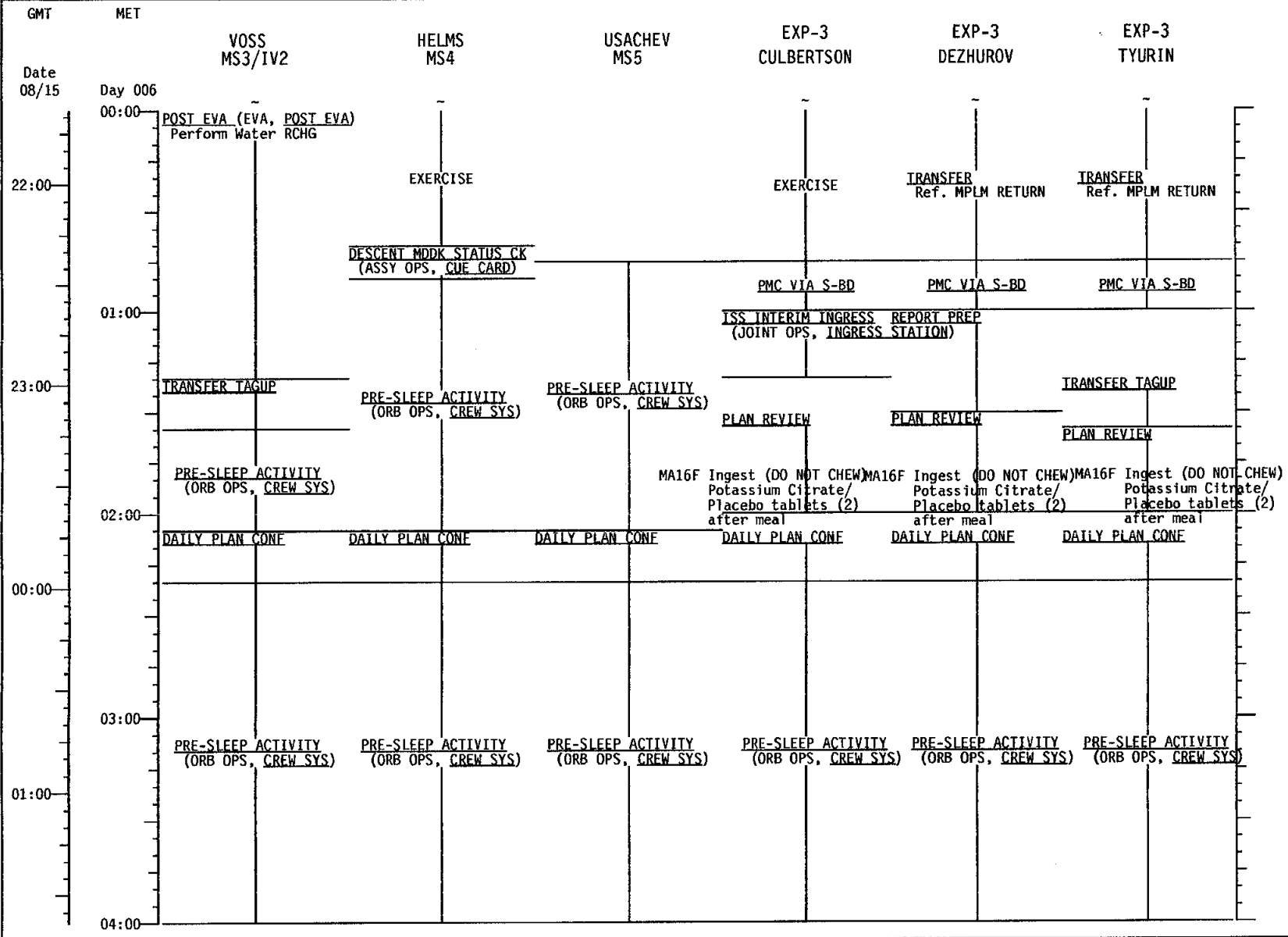

STS-105 7A.1 (FD 07)

GMT	TDRS W E	DORR B B	MET Day 006	ORI RGS BSS ACA TMT IDI	HOROWITZ CDR/RMS1	STURCKOW PLT/IV1	FORRESTER MS1/EV2	BARRY MS2/EV1	MCC	MCC NOTES
Date 08/16										
04:00										
02:00										
03:00										
04:00										
05:00										
06:00					SLEEP	SLEEP	SLEEP	SLEEP		
07:00										
05:00										
08:00										

PGSC OVERNIGHT CONFIG

- COLOR PRINTER - ON
- PAPER IN PRINTER
- FLOPPY DISK IN PROSHARE
- OCA ROUTER - ON
- PROSHARE - ON
- KFX LAUNCHED
- CHECK APPLICATIONS CLOSED
- OUTLOOK

STS-105 7A.1 (FD 07)

GMT	MET	VOSS MS3/IV2	HELMS MS4	USACHEV MS5	EXP-3 CULBERTSON	EXP-3 DEZHUROV	EXP-3 TYURIN
Date 08/16	Day 006						
04:00							
02:00							
05:00							
03:00							
06:00		SLEEP	SLEEP	SLEEP	SLEEP	SLEEP	SLEEP
04:00							
07:00							
05:00							
08:00							

STS-105 7A.1 (FD 07)

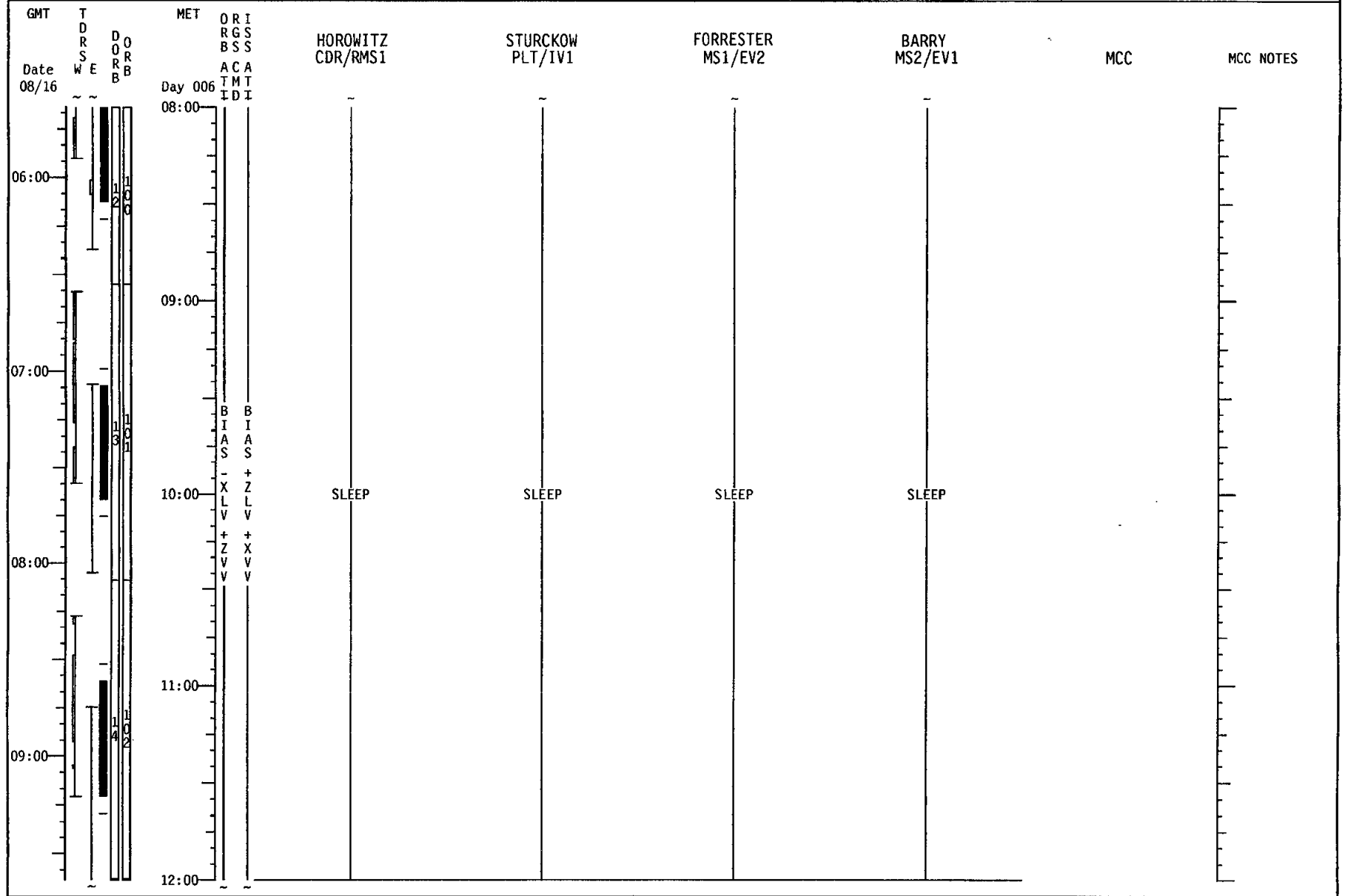

STS-105 7A.1 (FD 07)

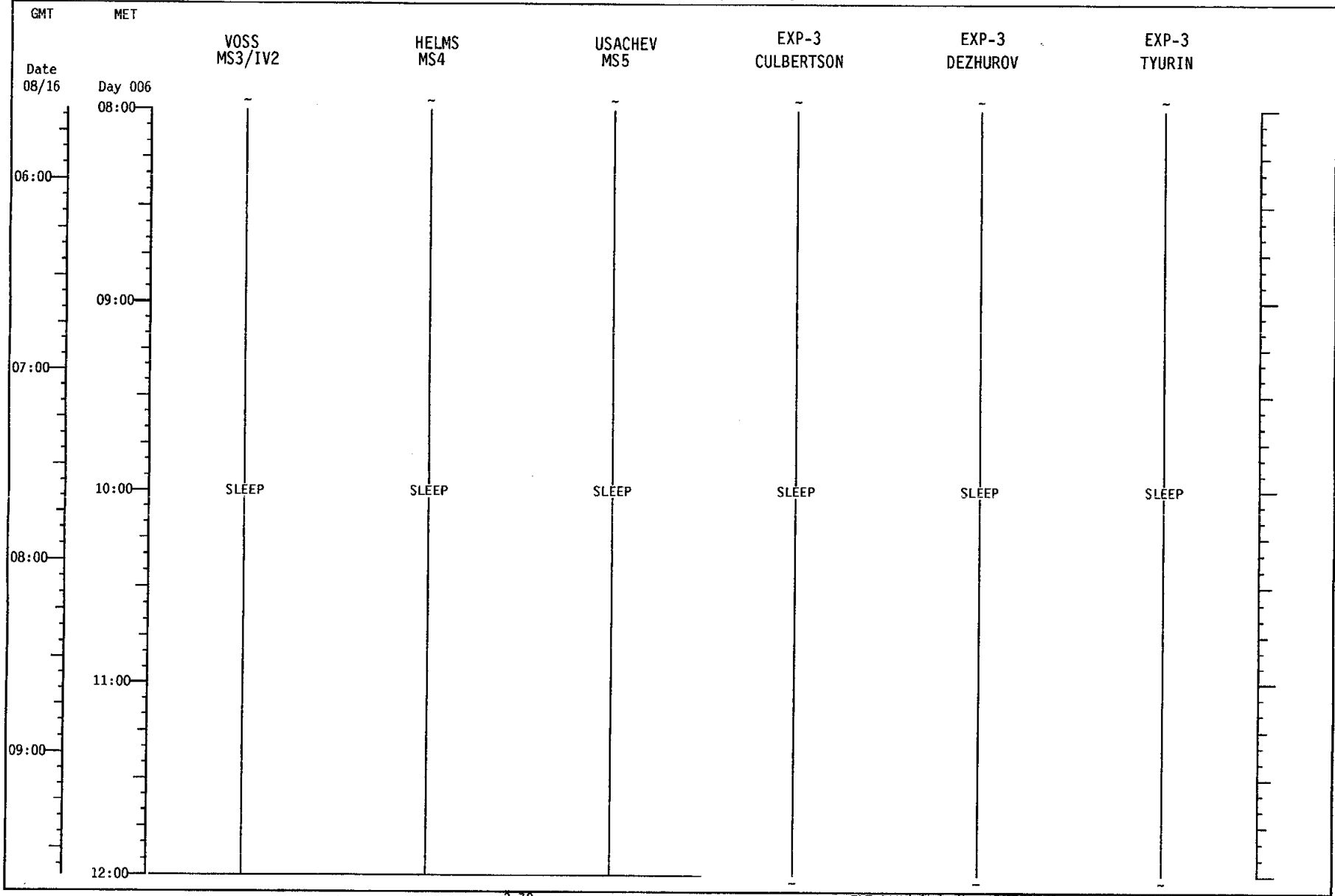

STS-105 7A.1 (FD 08)

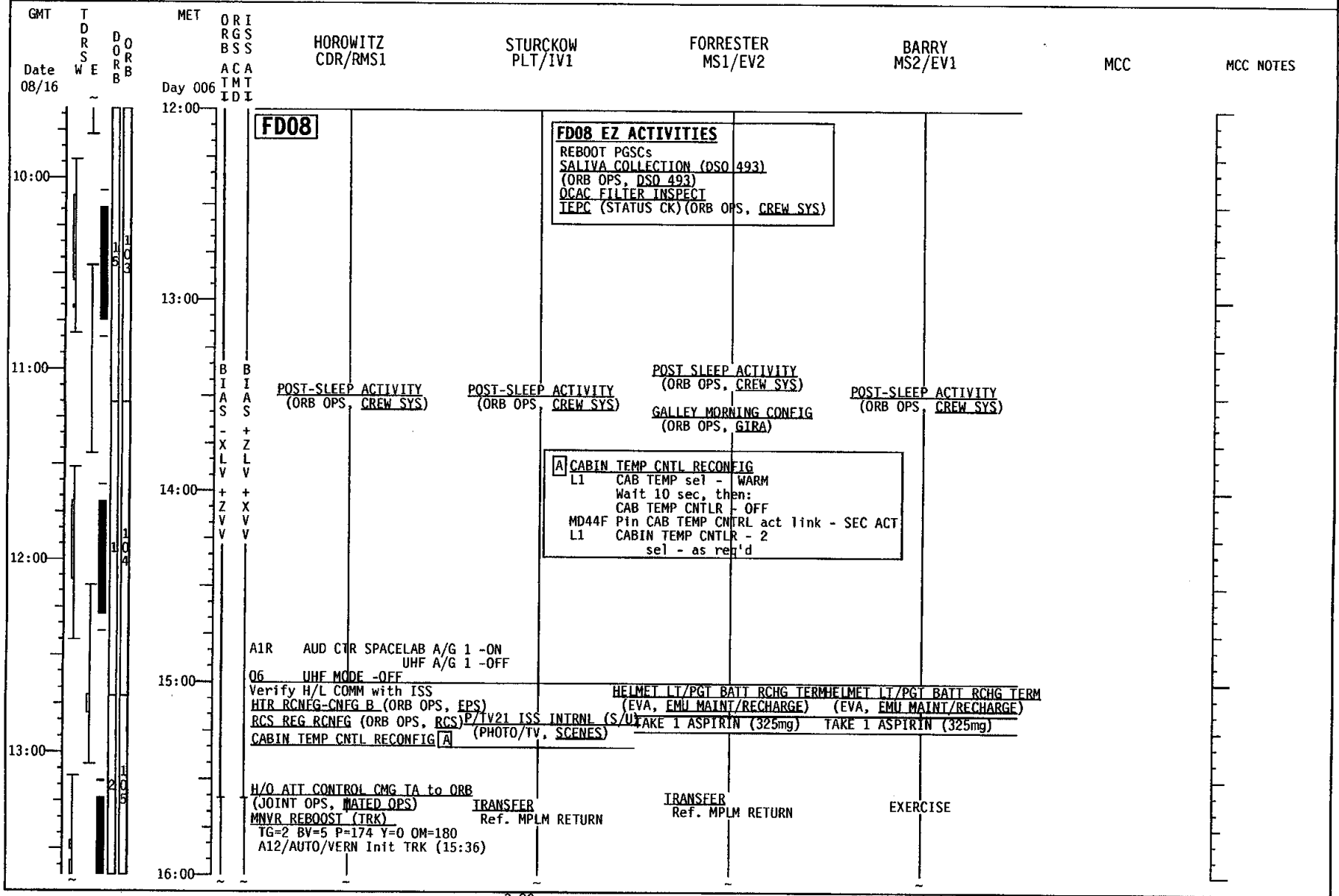

STS-105 7A.1 (FD 08)

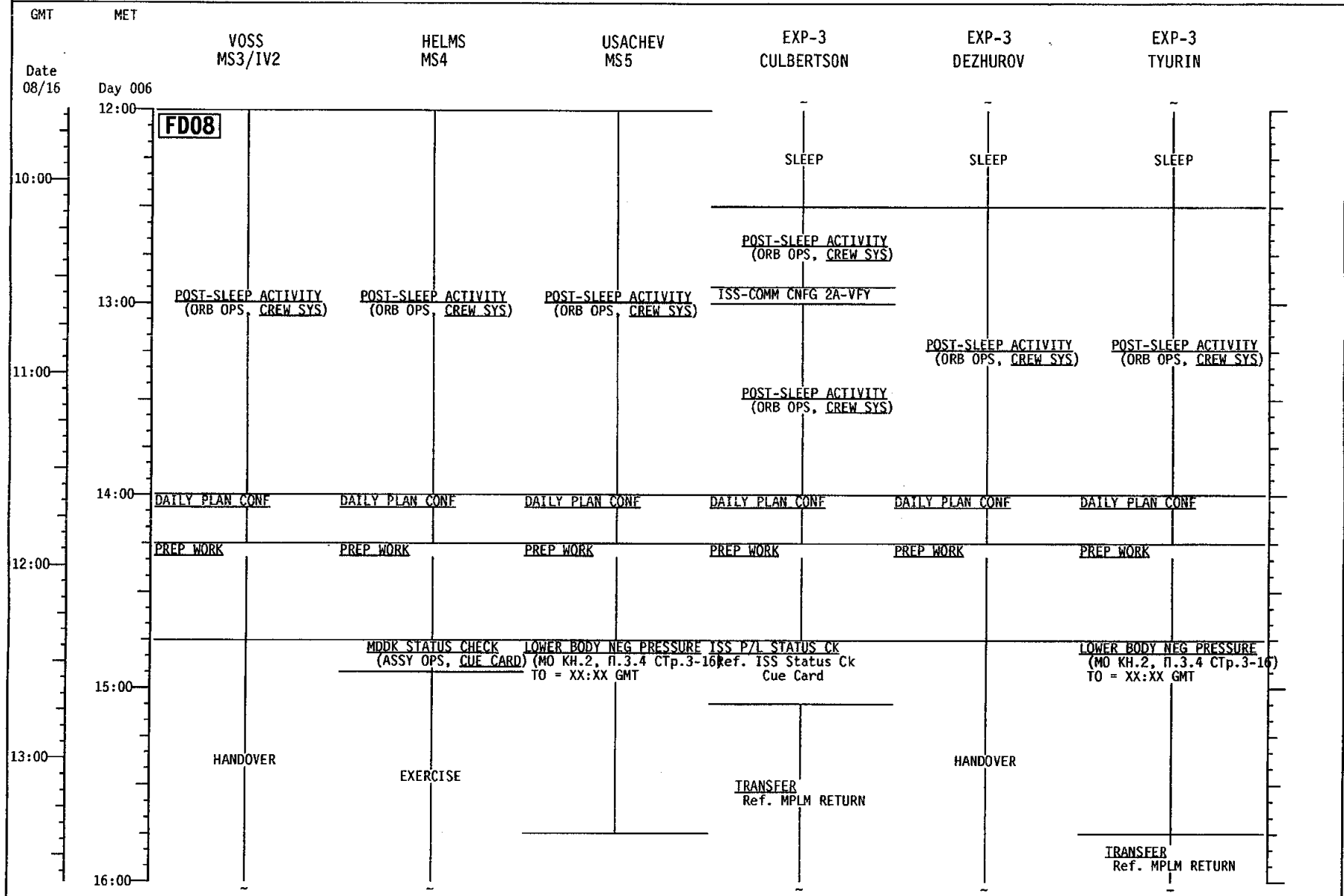

STS-105 7A.1 (FD 08)

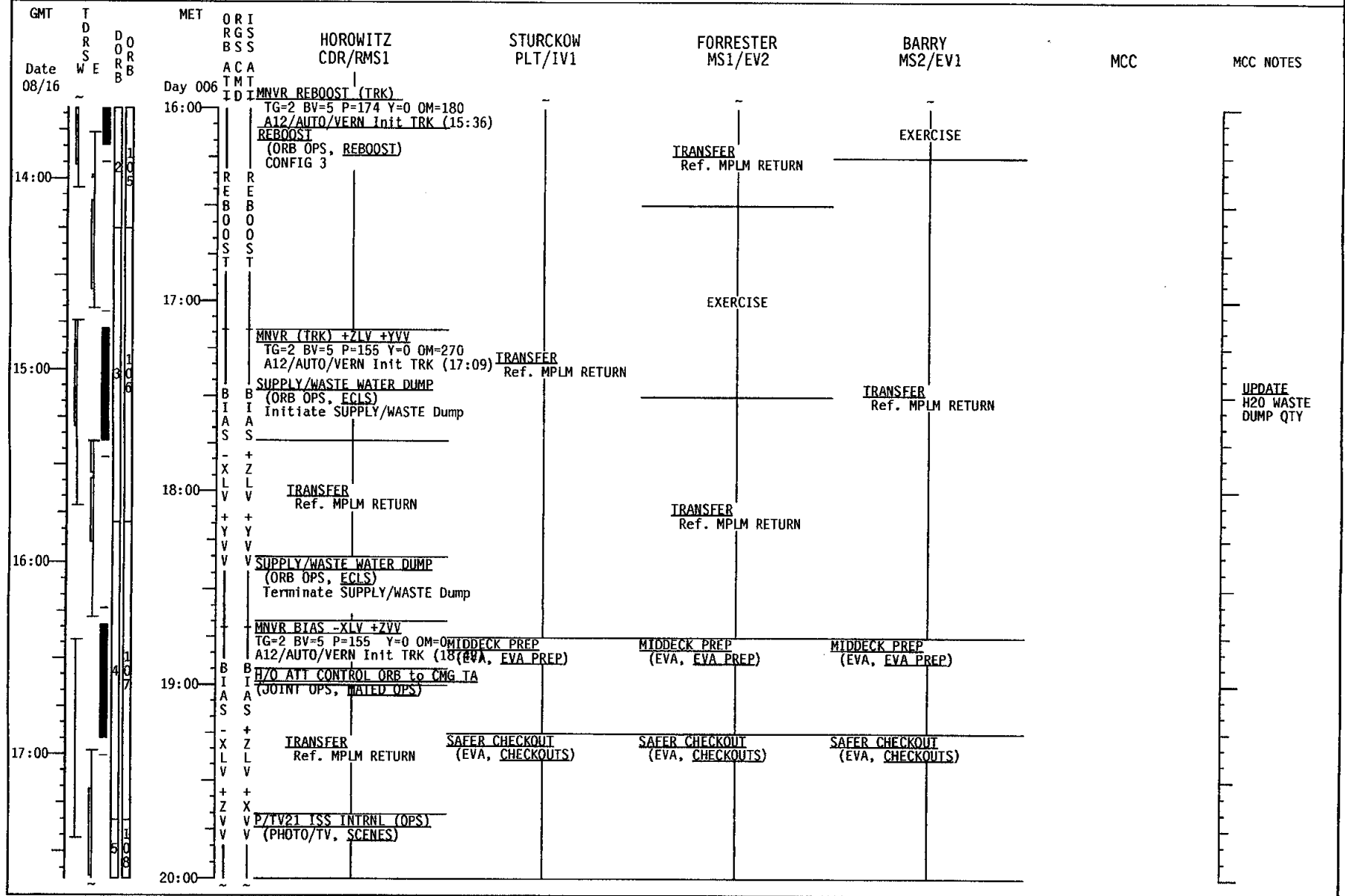

STS-105 7A.1 (FD 08)

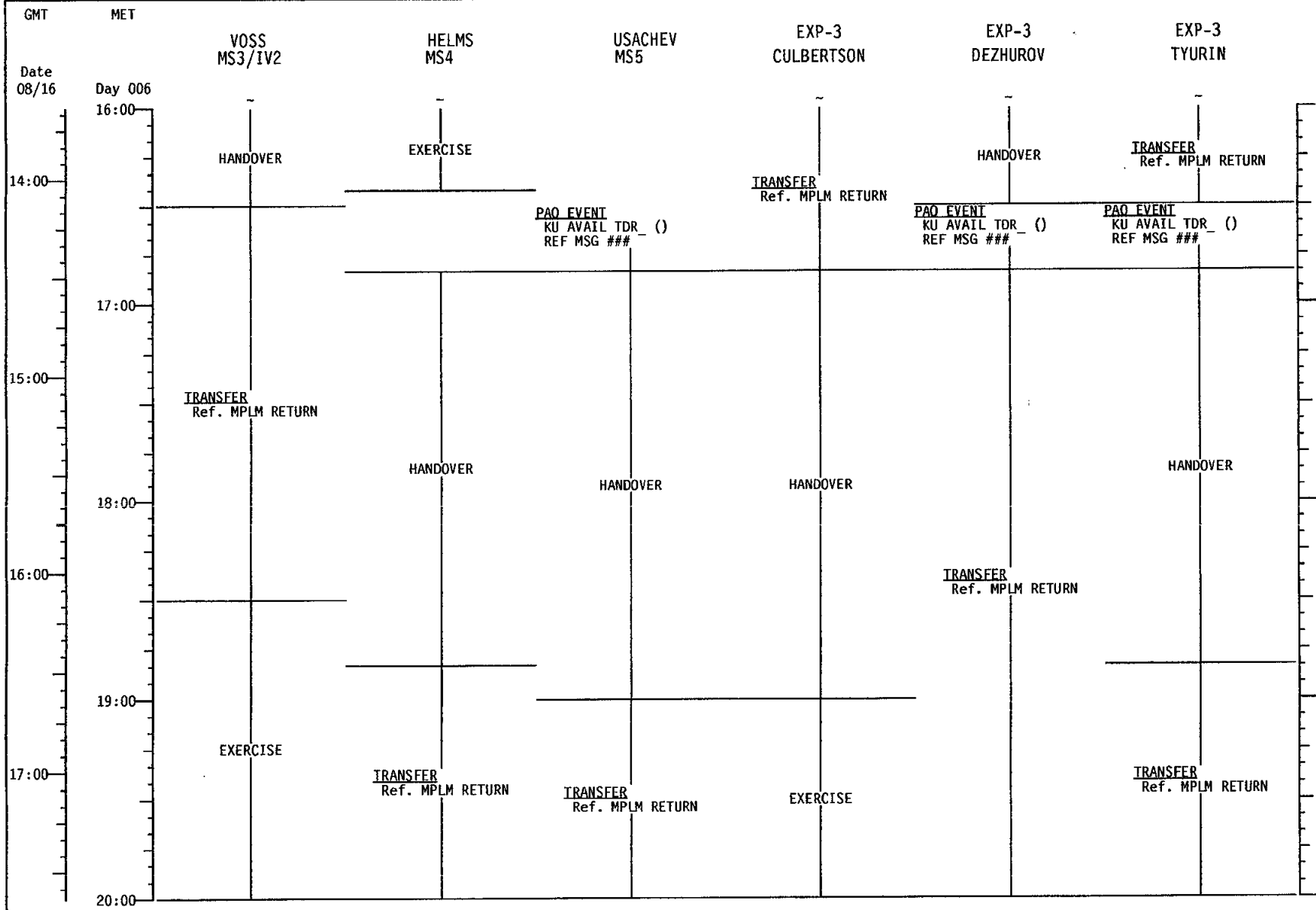

STS-105 7A.1 (FD 08)

GMT	TDRS W E	DORB	MET	ORIRGSS BSS	HOROWITZ CDR/RMS1	STURCKOW PLT/IV1	FORRESTER MS1/EV2	BARRY MS2/EV1	MCC	MCC NOTES
Date 08/16			Day 006	ACAIMT IDI						
18:00					MEAL	MEAL	MEAL	MEAL		
19:00					CREW CONF	CREW CONF	CREW CONF	CREW CONF		
20:00					CREW PHOTO	CREW PHOTO	CREW PHOTO	CREW PHOTO		
21:00										
22:00						EVA 2 TOOL CONFIG (EVA, TIMELINES)	EVA 2 TOOL CONFIG (EVA, TIMELINES)	EVA 2 TOOL CONFIG (EVA, TIMELINES)		
23:00					EXERCISE					
00:00					EVA 2 BRIEFING CARD (EVA, EVA 2 T/L)	EVA 2 BRIEFING CARD (EVA, EVA 2 T/L)	EVA 2 BRIEFING CARD (EVA, EVA 2 T/L)	EVA 2 BRIEFING CARD (EVA, EVA 2 T/L)		

STS-105 7A.1 (FD 08)

GMT	MET	VOSS MS3/IV2	HELMS MS4	USACHEV MS5	EXP-3 CULBERTSON	EXP-3 DEZHUROV	EXP-3 TYURIN
Date 08/16	Day 006						
18:00	20:00	MEAL	MEAL	MEAL	MEAL	MEAL	MEAL
19:00	21:00	CREW CONF	CREW CONF	CREW CONF	CREW CONF	CREW CONF	CREW CONF
		CREW PHOTO	CREW PHOTO	CREW PHOTO	CREW PHOTO	CREW PHOTO	CREW PHOTO
20:00	22:00	TRANSFER Ref. MPLM RETURN	TRANSFER Ref. MPLM RETURN			TRANSFER Ref. MPLM RETURN	
21:00	23:00	HANDOVER	EXERCISE	HANDOVER	HANDOVER	HANDOVER	TRANSFER Ref. MPLM RETURN
00:00							

STS-105 7A.1 (FD 08)

GMT	T D R S W E	D O R B	MET	O R I R G S B S S	H O R O W I T Z C D R / R M S 1	S T U R C K O W P L T / I V 1	F O R R E S T E R M S 1 / E V 2	B A R R Y M S 2 / E V 1	M C C	M C C N O T E S
Date 08/16			Day 007	ACA TMT IDI						
22:00			00:00		TRANSFER LIST Transfer 2 CMC bags					
						EXERCISE				
					ISS INTERIM EGRESS (JOINT OPS, EGRESS STATION)					
			01:00		PREP FOR 10.2 PSI CABIN (EVA, 10.2 PSI CABIN)					
					CABIN DEPRESS TO 10.2 PSI (EVA, 10.2 PSI CABIN)		P/TV18 EVA SETUP (PHOTO/TV, SCENES)	P/TV18 EVA SETUP (PHOTO/TV, SCENES)		
23:00					10.2 PSI CABIN CONFIG (EVA, 10.2 PSI CABIN)					
					VIDEO CONFERENCING (ORB OPS, PGSC) - PMC					
			02:00							
						PRE-SLEEP ACTIVITY (ORB OPS, CREW SYS)				
							PRE SLEEP ACTIVITY (ORB OPS, CREW SYS)			
00:00										
			03:00							
01:00										
			04:00							
					06 UHF MODE - EVA A1R AUD CTR SPACELAB A/G 1 -OFF UHF A/G 1 -T/R					
					-Verify RF COMM with ISS					

STS-105 7A.1 (FD 08)

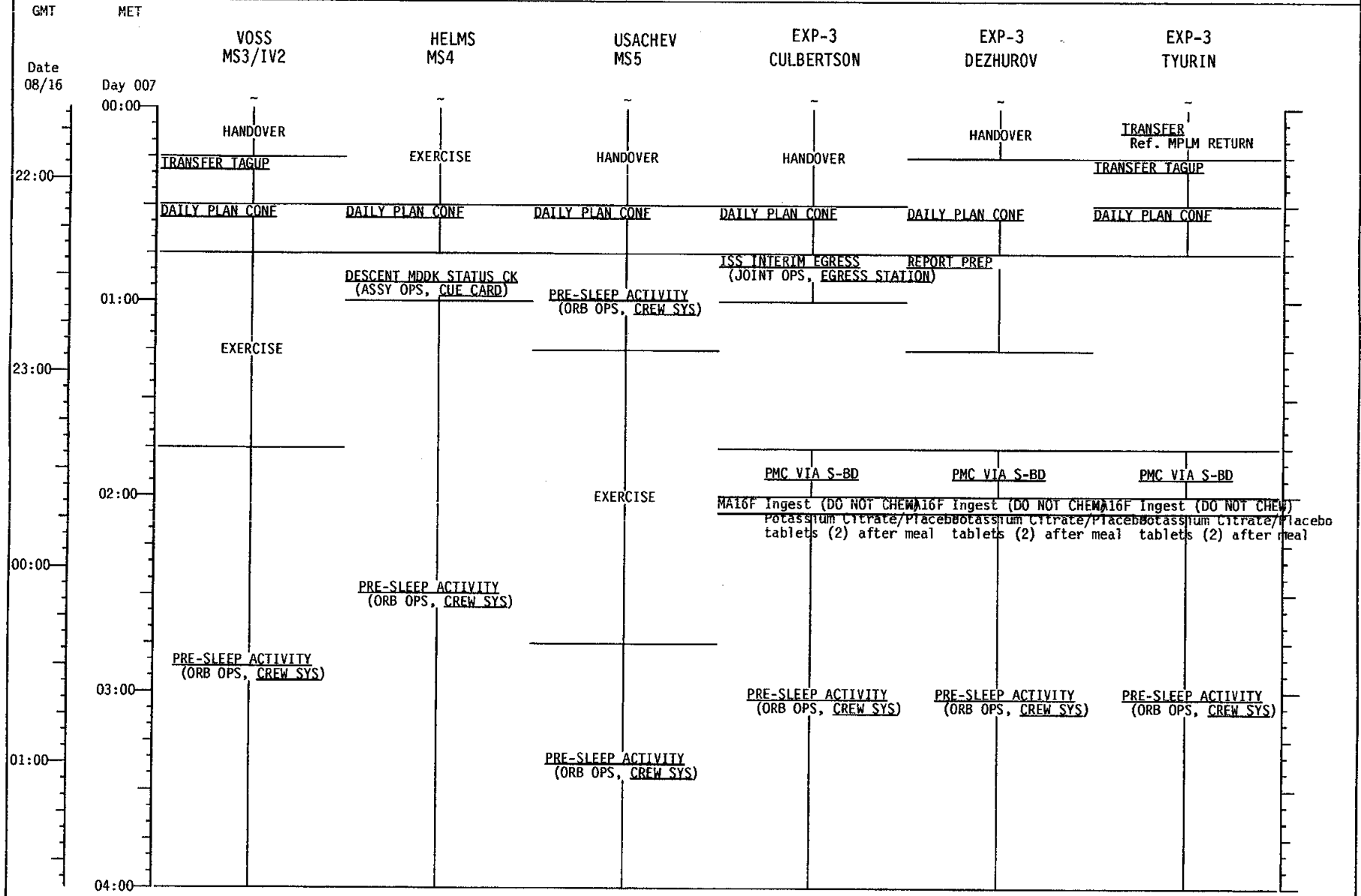

STS-105 7A.1 (FD 08)

GMT	TDRS W E	DORB B	MET Day 007	ORIRGSS BSS	HOROWITZ CDR/RMS1	STURCKOW PLT/IV1	FORRESTER MS1/EV2	BARRY MS2/EV1	MCC	MCC NOTES
Date 08/17			Day 007	ACATMT IDI						
04:00										
02:00										
03:00										
04:00										
05:00										
06:00					SLEEP	SLEEP	SLEEP	SLEEP		
07:00										
08:00										

P6SC OVERNIGHT CONFIG

- COLOR PRINTER - ON
- PAPER IN PRINTER
- FLOPPY DISK IN PROSHARE
- OCA ROUTER - ON
- PROSHARE - ON
- KFX LAUNCHED
- CHECK APPLICATIONS CLOSED
- OUTLOOK

STS-105 7A.1 (FD 08)

GMT	MET	VOSS MS3/IV2	HELMS MS4	USACHEV MS5	EXP-3 CULBERTSON	EXP-3 DEZHUROV	EXP-3 TYURIN
Date 08/17	Day 007						
04:00							
02:00							
05:00							
03:00							
06:00		SLEEP	SLEEP	SLEEP	SLEEP	SLEEP	SLEEP
04:00							
07:00							
05:00							
08:00							

STS-105 7A.1 (FD 08)

GMT Date 08/17	TDRS W E	DORB	MET Day 007	ORIRGSS BSS ACATMT IDI	HOROWITZ CDR/RMS1	STURCKOW PLT/IV1	FORRESTER MS1/EV2	BARRY MS2/EV1	MCC	MCC NOTES
06:00			08:00							
07:00			09:00							
08:00			10:00	BIAS +ZLV +XVV	SLEEP	SLEEP	SLEEP	SLEEP		
09:00			11:00							
12:00			12:00							

STS-105 7A.1 (FD 08)

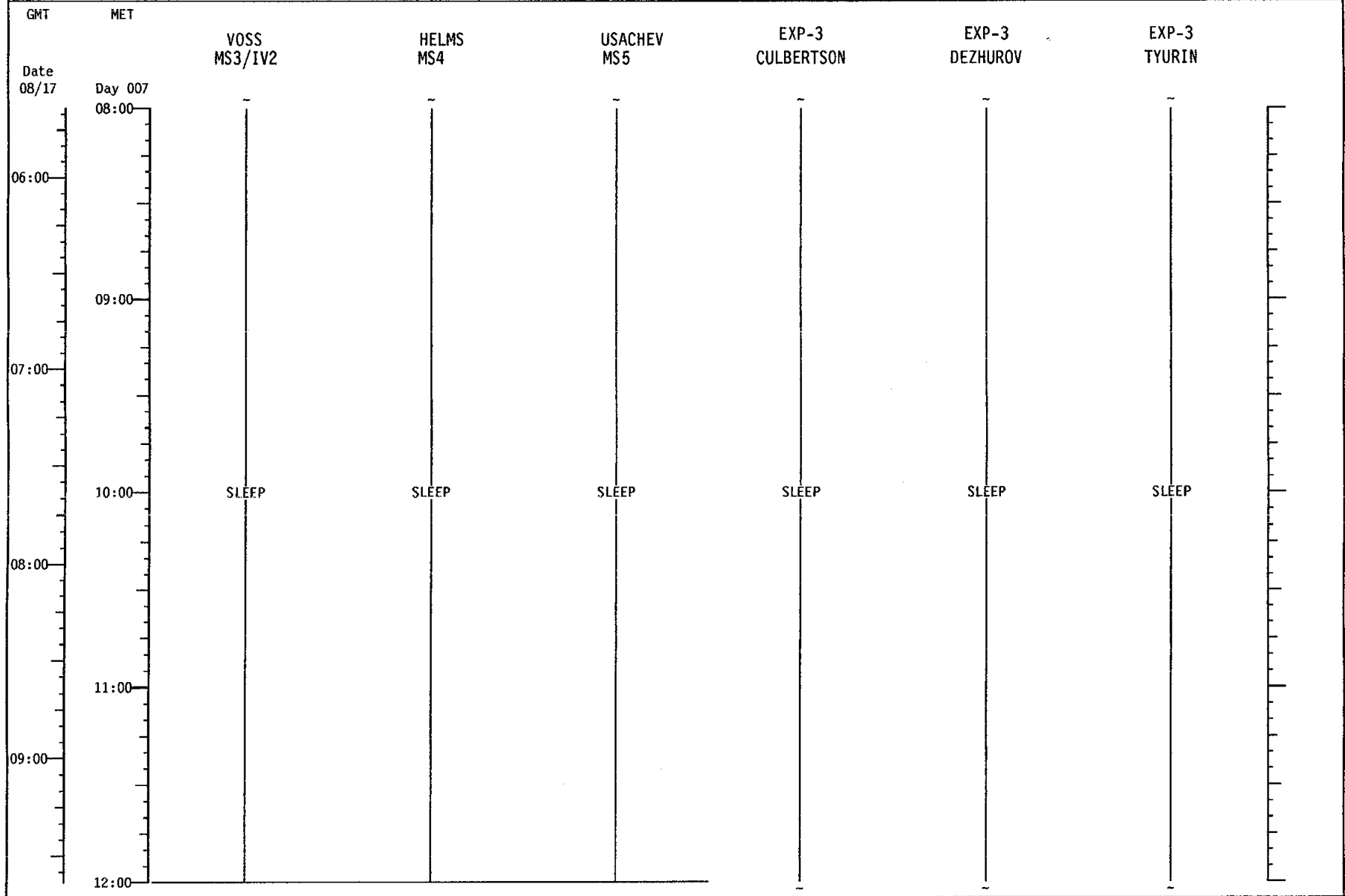

STS-105 7A.1 (FD 09)

GMT	T D R S W E	D O R B B	MET	ORI RGSS BSS	HOROWITZ CDR/RMS1	STURCKOW PLT/IV1	FORRESTER MS1/EV2	BARRY MS2/EV1	MCC	MCC NOTES
Date 08/17			Day 007	ACA TMT TDX						
12:00					FD09		FD09 EZ ACTIVITIES REBOOT PGSCs SALIVA COLLECTION (DSO 493) (ORB OPS, DSO 493) IEPC (STATUS CK) (ORB OPS, CREW SYS)			
13:00					POST-SLEEP ACTIVITY (ORB OPS, CREW SYS)	POST-SLEEP ACTIVITY (ORB OPS, CREW SYS)	POST-SLEEP ACTIVITY (ORB OPS, CREW SYS) GALLEY MORNING CONF (ORB OPS, GIRA)	POST-SLEEP ACTIVITY (ORB OPS, CREW SYS)		
14:00					POST-SLEEP ACTIVITY (ORB OPS, CREW SYS)	EVA PREP (EVA, EVA PREP)	EVA PREP (EVA, EVA PREP)	EVA PREP (EVA, EVA PREP)		
15:00					EXERCISE					
16:00					EMU PURGE/PREBREATHE (EVA, EVA PREP)	EMU PURGE/PREBREATHE (EVA, EVA PREP)	EMU PURGE/PREBREATHE (EVA, EVA PREP)			

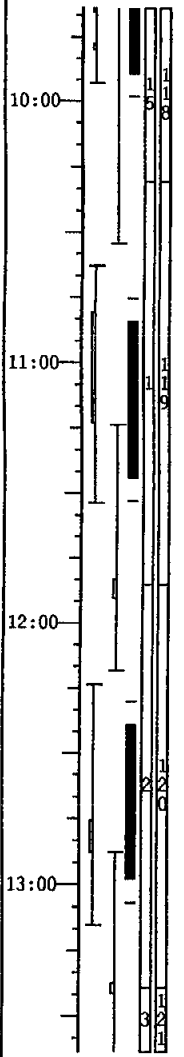

STS-105 7A.1 (FD 09)

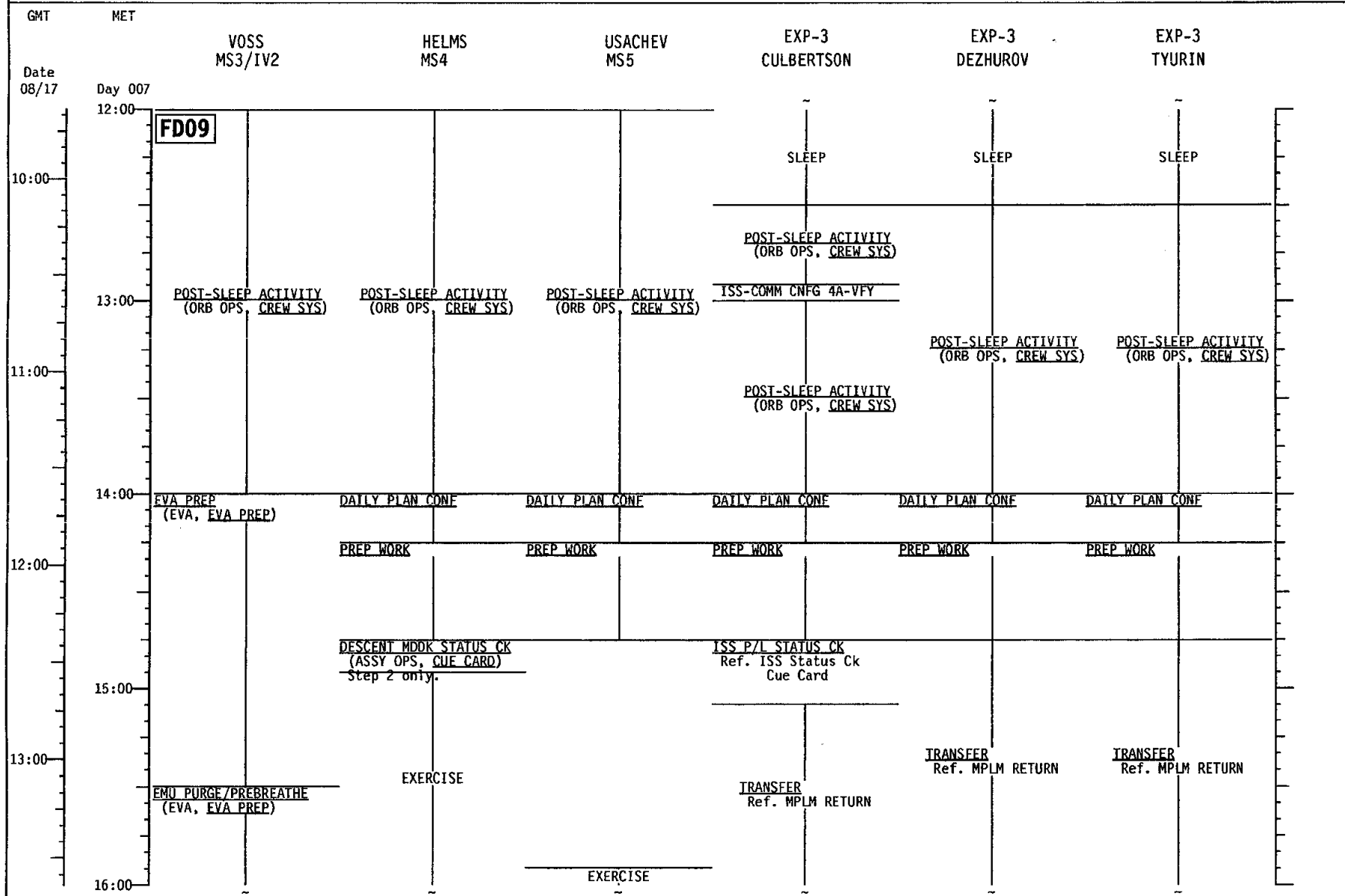

STS-105 7A.1 (FD 09)

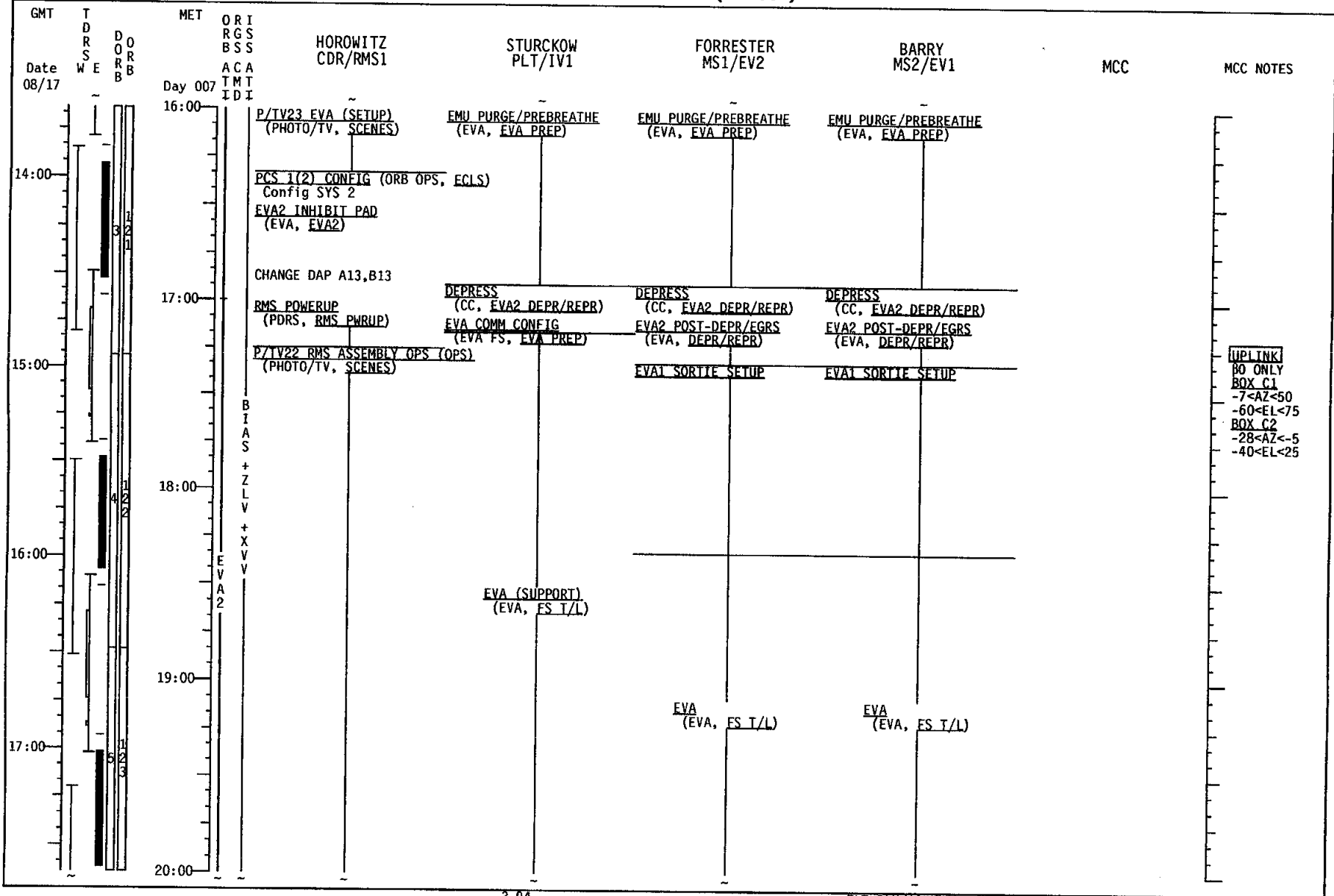

UPLINK
 BO ONLY
 BOX C1
 -7<AZ<50
 -60<EL<75
 BOX C2
 -28<AZ<-5
 -40<EL<25

STS-105 7A.1 (FD 09)

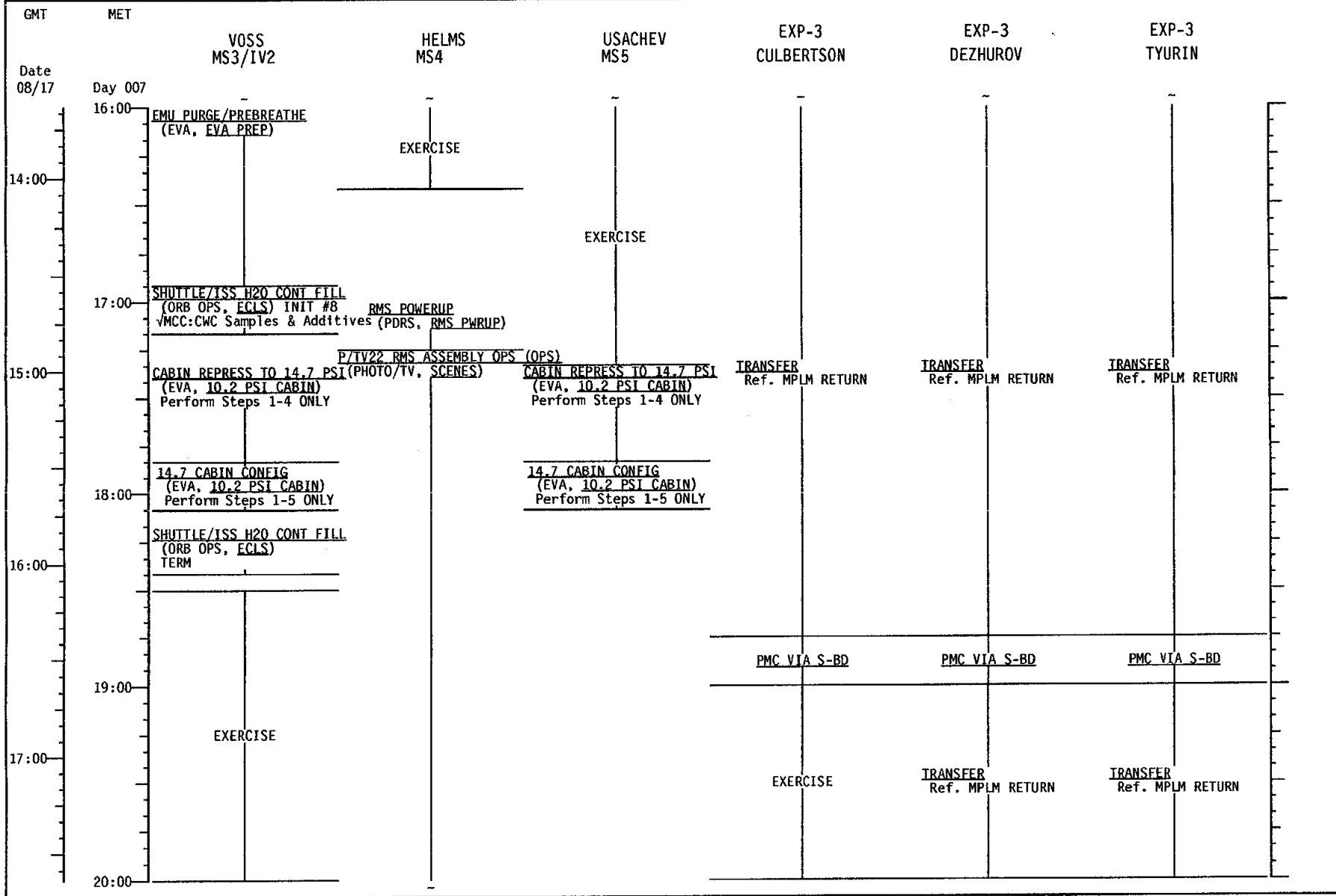

STS-105 7A.1 (FD 09)

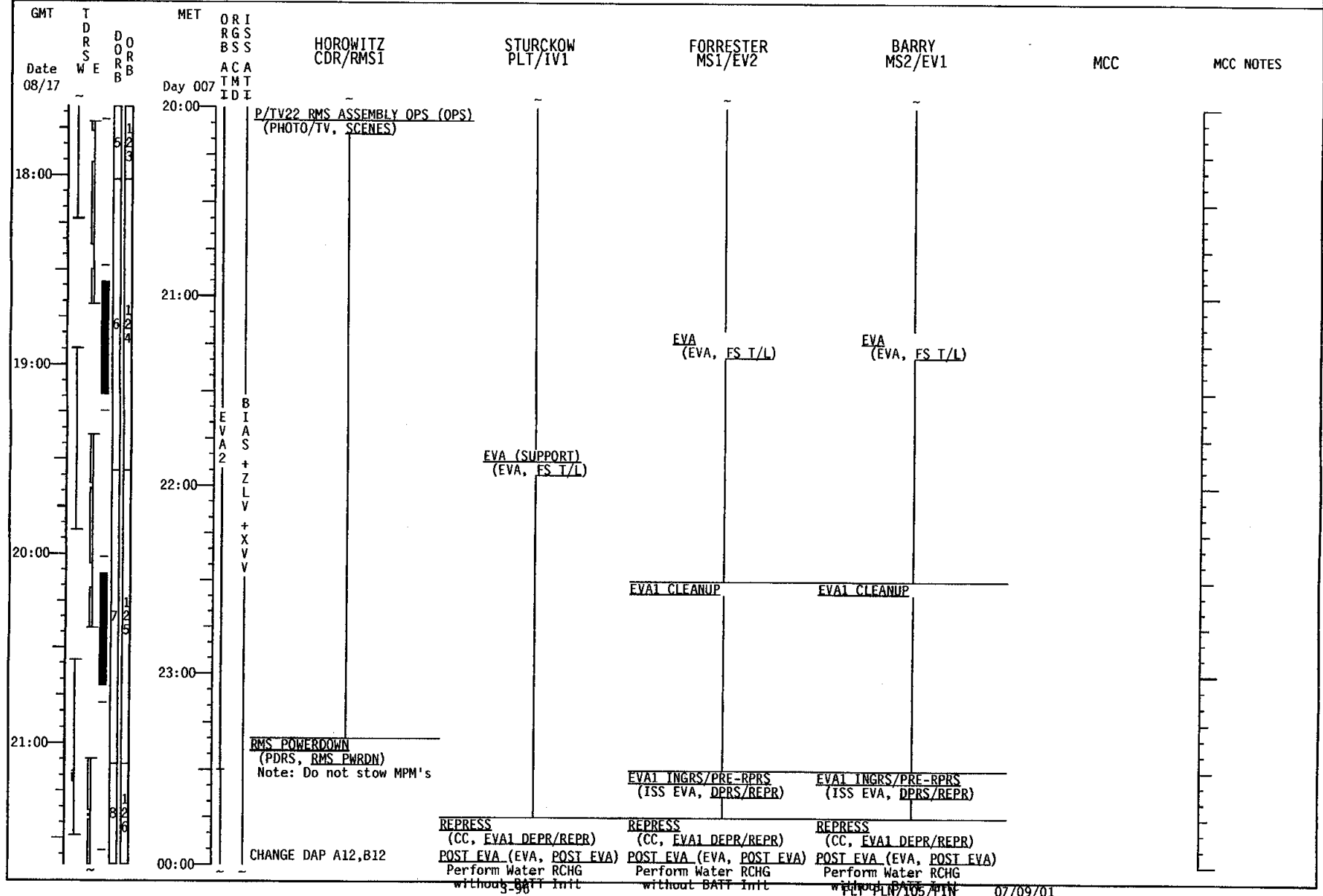

STS-105 7A.1 (FD 09)

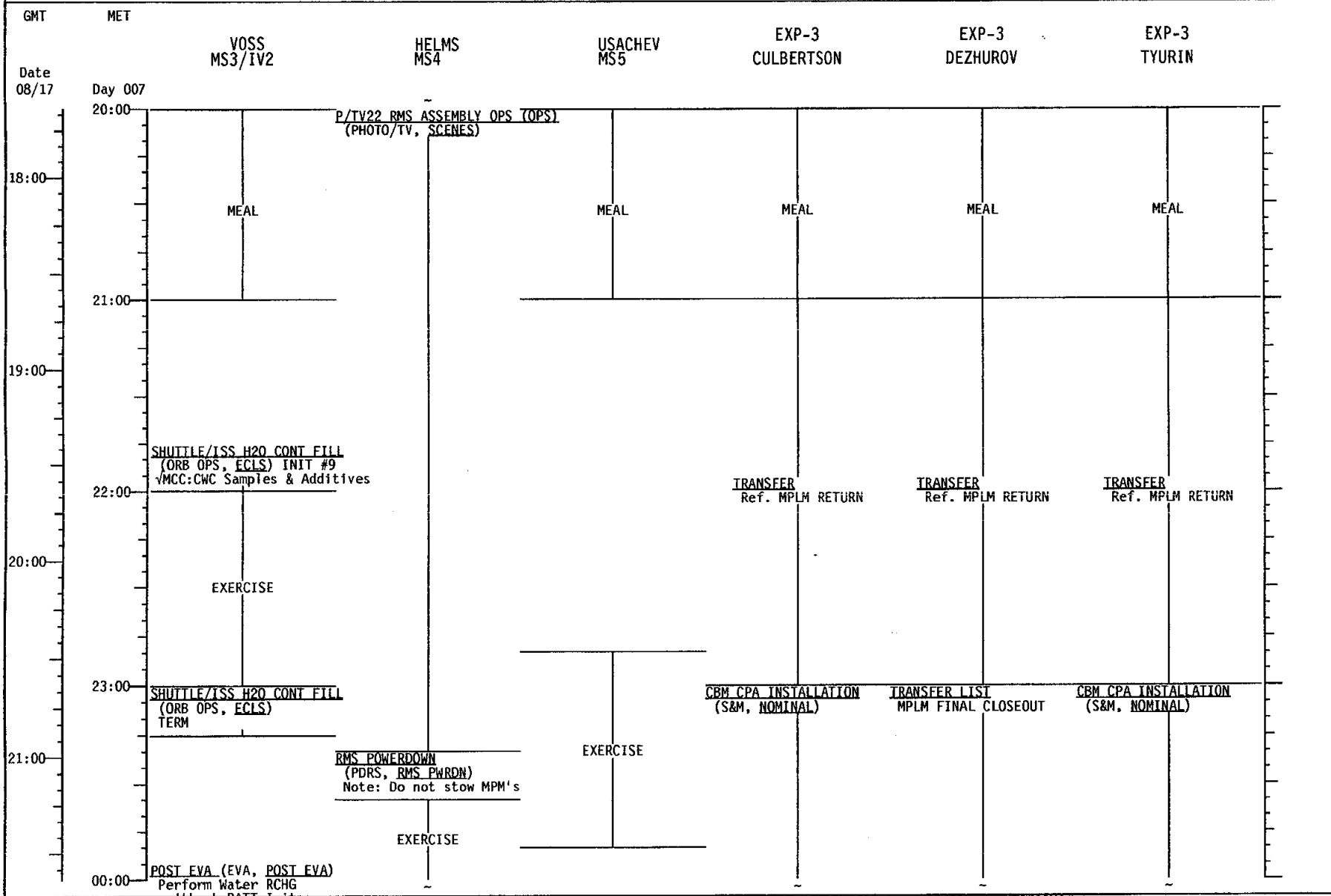

STS-105 7A.1 (FD 09)

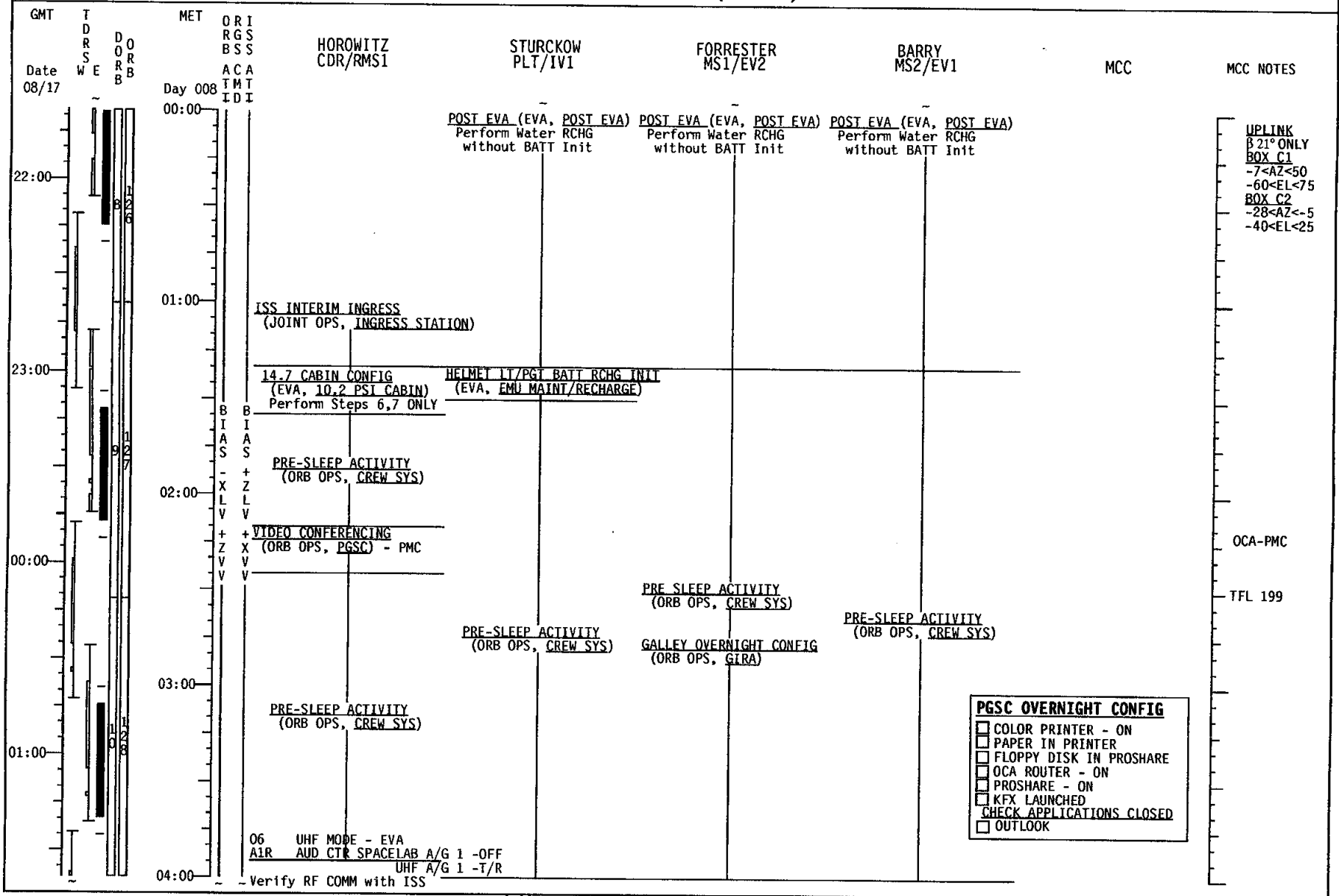

STS-105 7A.1 (FD 09)

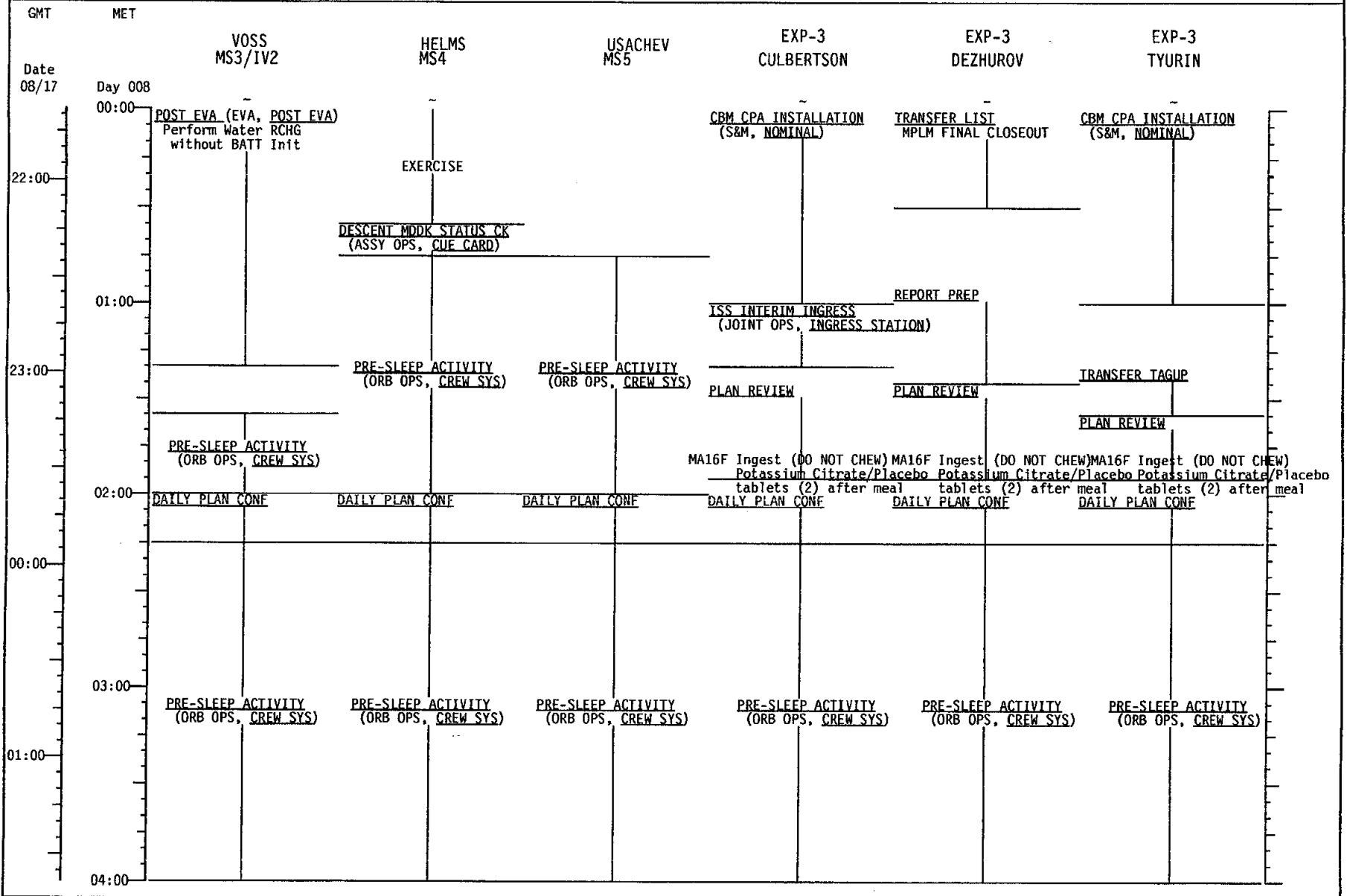

MA16F Ingest (DO NOT CHEW) MA16F Ingest (DO NOT CHEW) MA16F Ingest (DO NOT CHEW)
Potassium Citrate/Placebo Potassium Citrate/Placebo Potassium Citrate/Placebo
tablets (2) after meal tablets (2) after meal tablets (2) after meal

STS-105 7A.1 (FD 09)

GMT	T D R S S E W E	D O R B R B	MET	OR I R G S B S S A C A T M T I D I	HOROWITZ CDR/RMS1	STURCKOW PLT/IV1	FORRESTER MS1/EV2	BARRY MS2/EV1	MCC	MCC NOTES
Date 08/18			Day 008							
04:00										
02:00										
03:00										
04:00										
05:00										
06:00				B I A S + Z L V + X V V	SLEEP	SLEEP	SLEEP	SLEEP		
07:00										
08:00										

STS-105 7A.1 (FD 09)

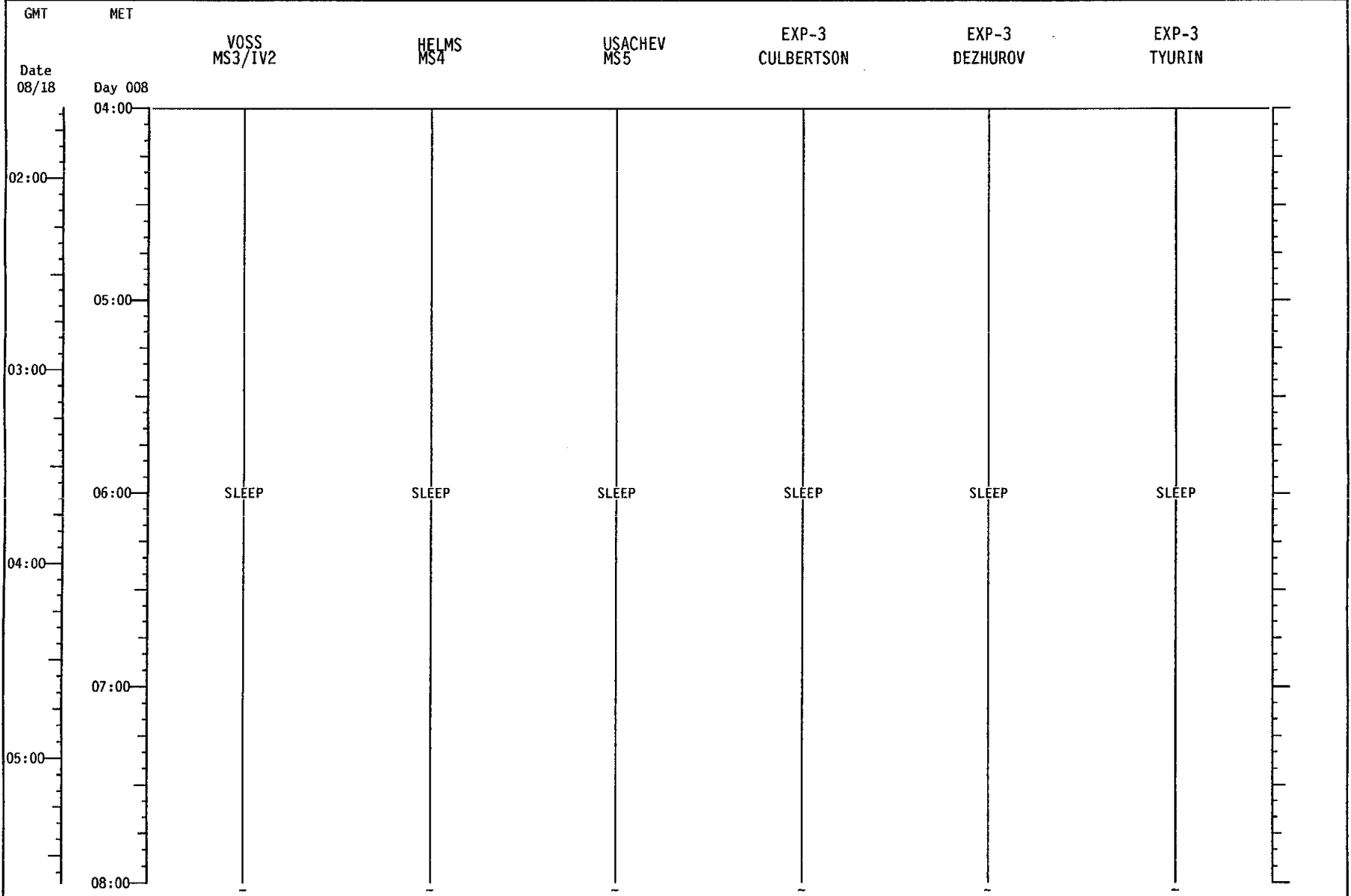

STS-105 7A.1 (FD 09)

GMT	T D R S W E	D O R B	MET	ORI RGS BSS ACA TMT IDI	HOROWITZ CDR/RMS1	STURCKOW PLT/IV1	FORRESTER MS1/EV2	BARRY MS2/EV1	MCC	MCC NOTES
Date 08/18			Day 008							
06:00										
07:00										
08:00										
09:00										
10:00				B I A S - X L V + Z V V	SLEEP	SLEEP	SLEEP	SLEEP		
11:00				B I A S + Z L V + X V V						
12:00										

STS-105 7A.1 (FD 09)

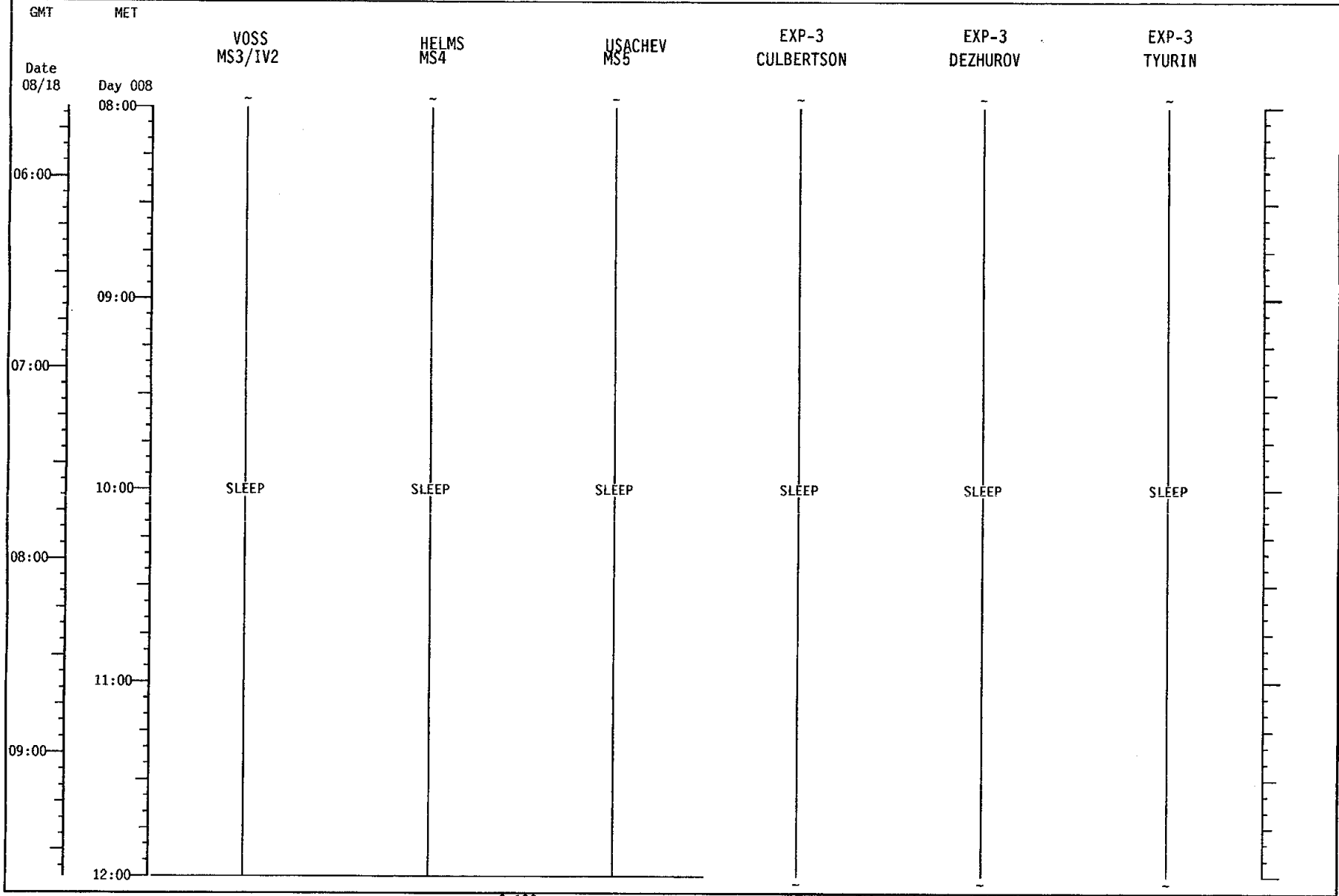

STS-105 7A.1 (FD 10)

GMT	T D R S W E	D O R B	MET	O R I R G S B S S	HOROWITZ CDR/RMS1	STURCKOW PLT/IV1	FORRESTER MS1/EV2	BARRY MS2/EV1	MCC	MCC NOTES
Date	08/18		Day	008						
12:00					FD10		FD10 EZ ACTIVITIES REBOOT PGSCs SALIVA COLLECTION (DSO 493) (ORB OPS, DSO 493) QCAC FILTER INSPECT TEPC (STATUS CK)(ORB OPS, CREW SYS)			
					POST-SLEEP ACTIVITY (ORB OPS, CREW SYS)					
13:00						POST-SLEEP ACTIVITY (ORB OPS, CREW SYS)		POST-SLEEP ACTIVITY (ORB OPS, CREW SYS)		
							GALLEY MORNING CONFIG (ORB OPS, GIRA)	POST-SLEEP ACTIVITY (ORB OPS, CREW SYS)		
14:00					LAIR AUD CTR SPACELAB A/G 1 -ON UHF A/G 1 -OFF 06 UHF MODE -OFF Verify H/L COMM with ISS					
					EXERCISE					
15:00							TAKE 1 ASPIRIN (325mg) EMU NOM RECONFIG (EVA FS, I/L) BLOCK C	TAKE 1 ASPIRIN (325mg) EMU NOM RECONFIG (EVA FS, I/L) BLOCK B		
					P/TV21 ISS INTRNL (S/U) (PHOTO/TV, SCENES)					
13:00					H/O ATT CONTROL CMG TA to ORB(JOINT OPS, MATED OPS)					
					MNVR (TRK) -XLV +YVV TG=2 BV=5 P=155 Y=0 OM=270 A12/AUTO/VERN Init TRK (15:27)					
					SUPPLY/WASTE WATER DUMP (ORB OPS, ECLS) Initiate SUPPLY/WASTE Dump	P/TV21 ISS INTRNL (OPS) (PHOTO/TV, SCENES) Item 8				
16:00										UPDATE H2O WASTE DUMP QTY

STS-105 7A.1 (FD 10)

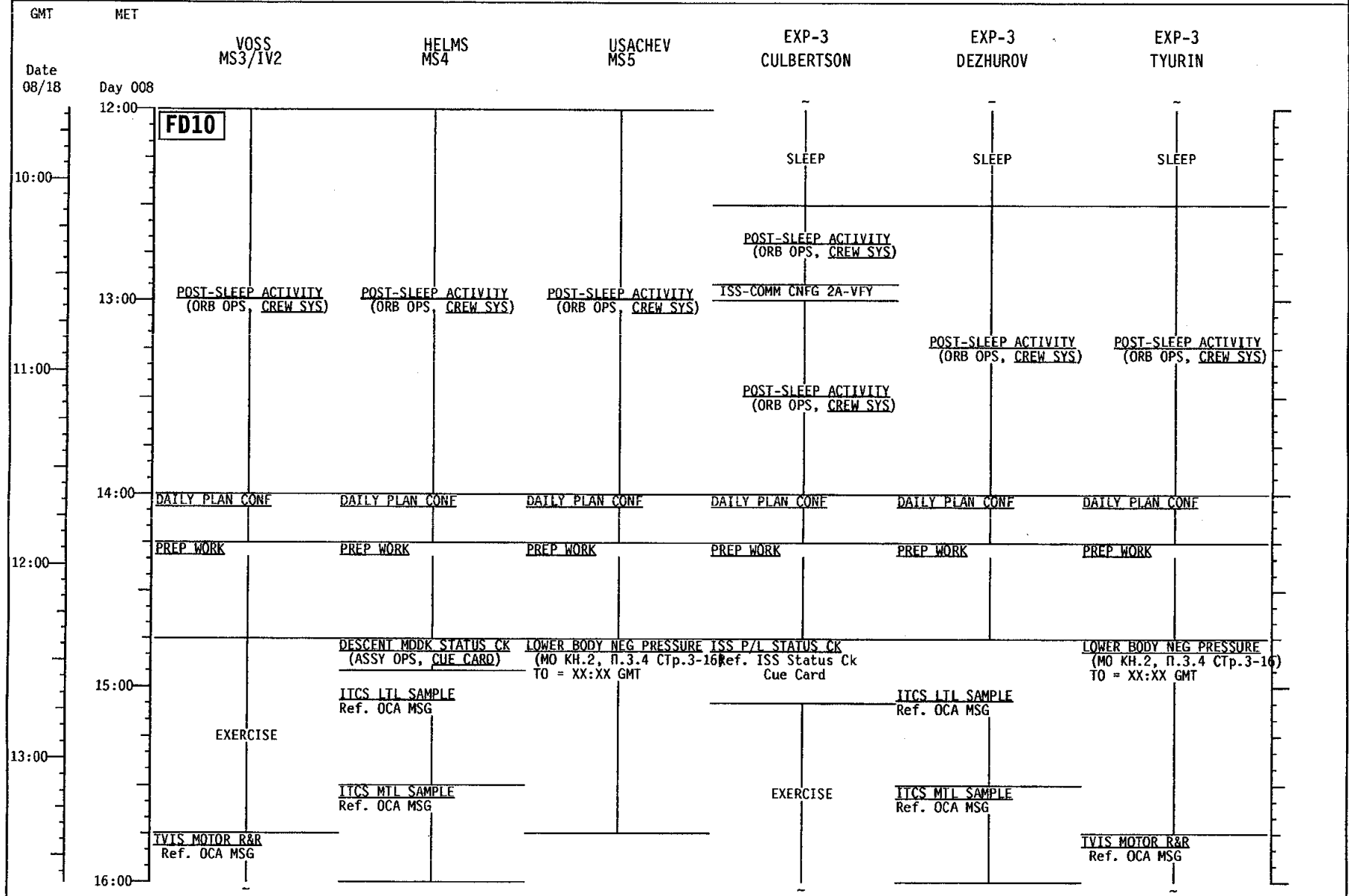

STS-105 7A.1 (FD 10)

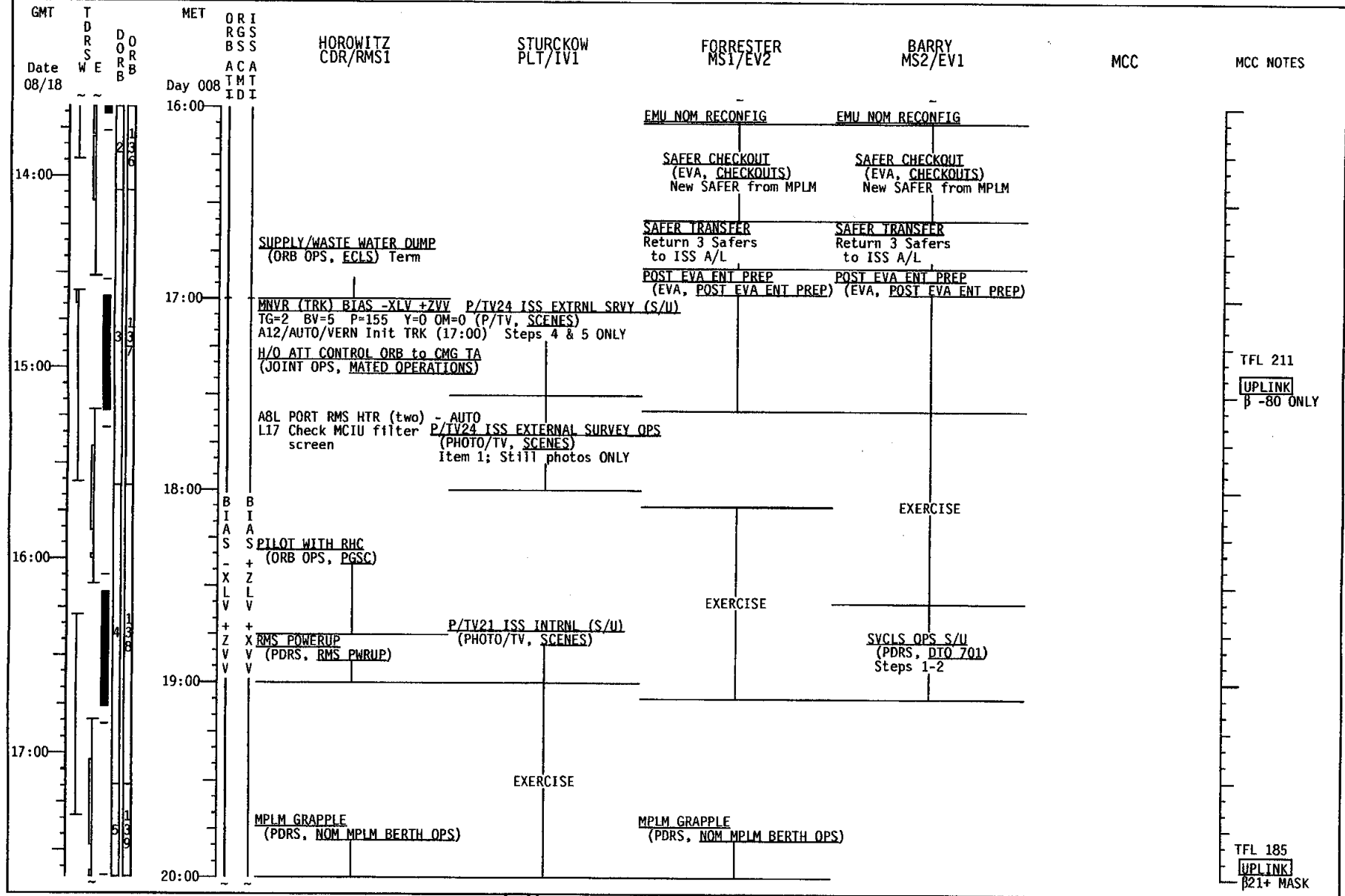

TFL 211
UPLINK
β -80 ONLY

TFL 185
UPLINK
β21+ MASK

STS-105 7A.1 (FD 10)

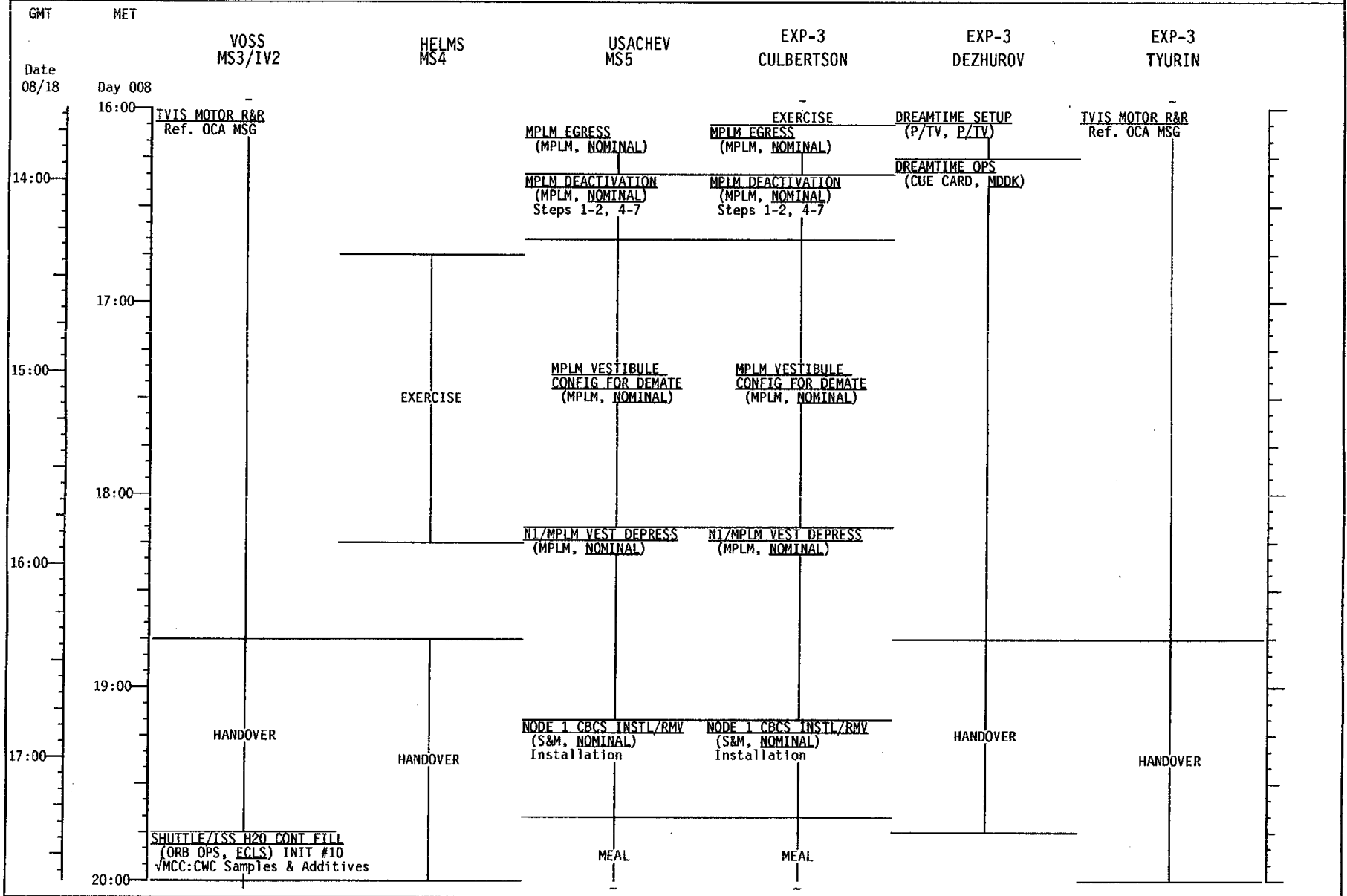

STS-105 7A.1 (FD10)

GMT	TDRS Date 08/18	MET Day 008	ORI RGS BSS ACA TMT IDZ	HOROWITZ CDR/RMS1	STURCKOW PLT/IV1	FORRESTER MS1/EV2	BARRY MS2/EV1	MCC	MCC NOTES
				MEAL	MEAL	MEAL	MEAL		
						PAO EVENT KU AVAIL TDR - () REF MSG ### - ()	PAO EVENT KU AVAIL TDR - () REF MSG ### - ()		
			+ Z X L V + Z X V V	+ MPLM UNINSTALL (PDRS, NOM MPLM BERTH OPS)		+ MPLM UNINSTALL (PDRS, NOM MPLM BERTH OPS)			
				MPLM BERTH (PDRS, NOM MPLM BERTH OPS)		MPLM BERTH (PDRS, NOM MPLM BERTH OPS)			
				ROEU MATE (PDRS, NOM MPLM BERTH OPS) MPLM UNGRAPPLE IN BAY (PDRS, NOM MPLM BERTH OPS) SSP1 MPLM CHAN 1,2 HTR PWR (two) - ON (tb-gray) RMS POWERDOWN (PDRS, RMS PWRDN) Note: Do not stow MPM's APCU 2 ACI (ASSY OPS, APCU)		ROEU MATE (PDRS, NOM MPLM BERTH OPS) MPLM UNGRAPPLE IN BAY (PDRS, NOM MPLM BERTH OPS) RMS POWERDOWN (PDRS, RMS PWRDN) Note: Do not stow MPM's			

STS-105 7A.1 (FD 10)

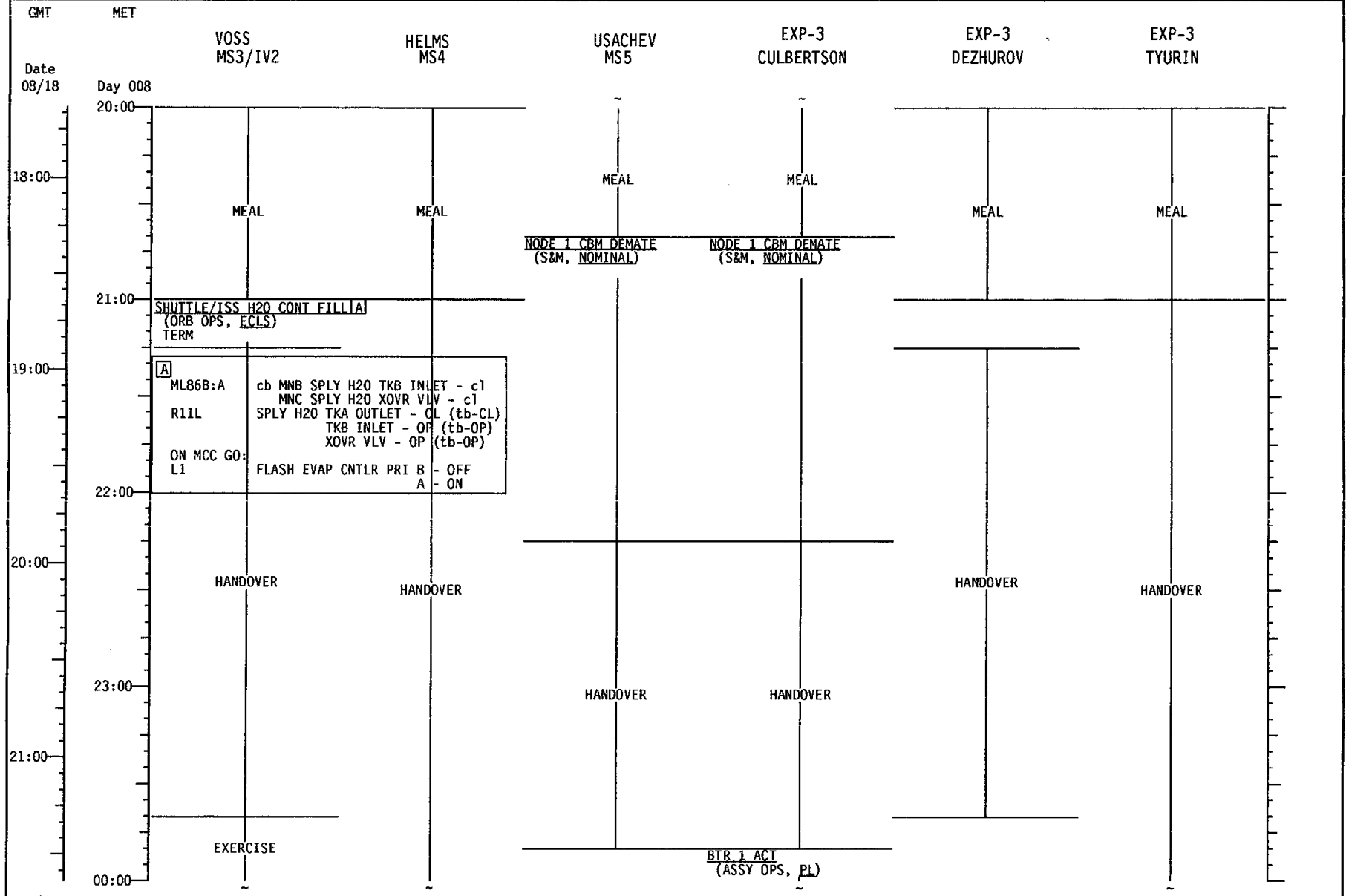

STS-105 7A.1 (FD 10)

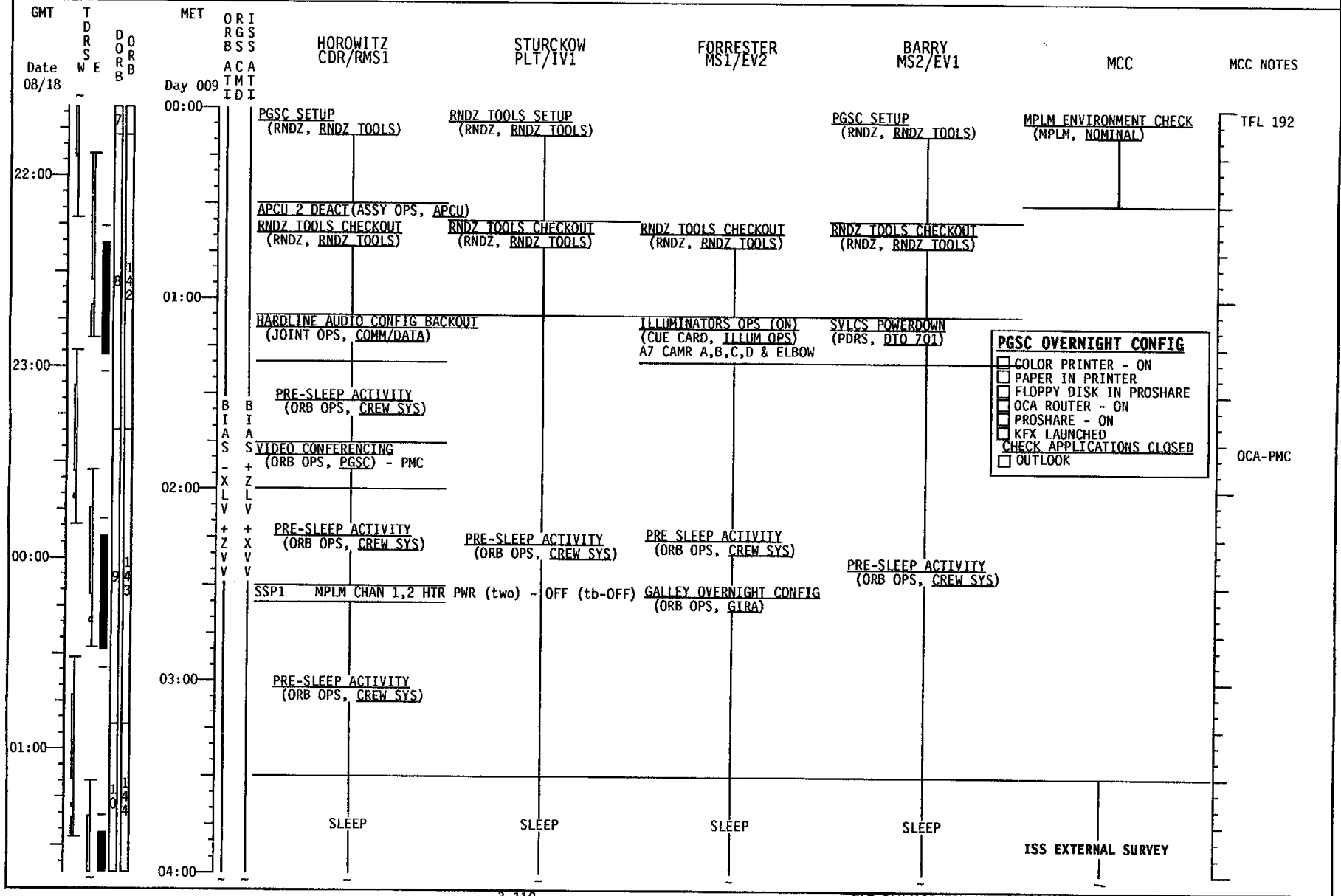

STS-105 7A.1 (FD 10)

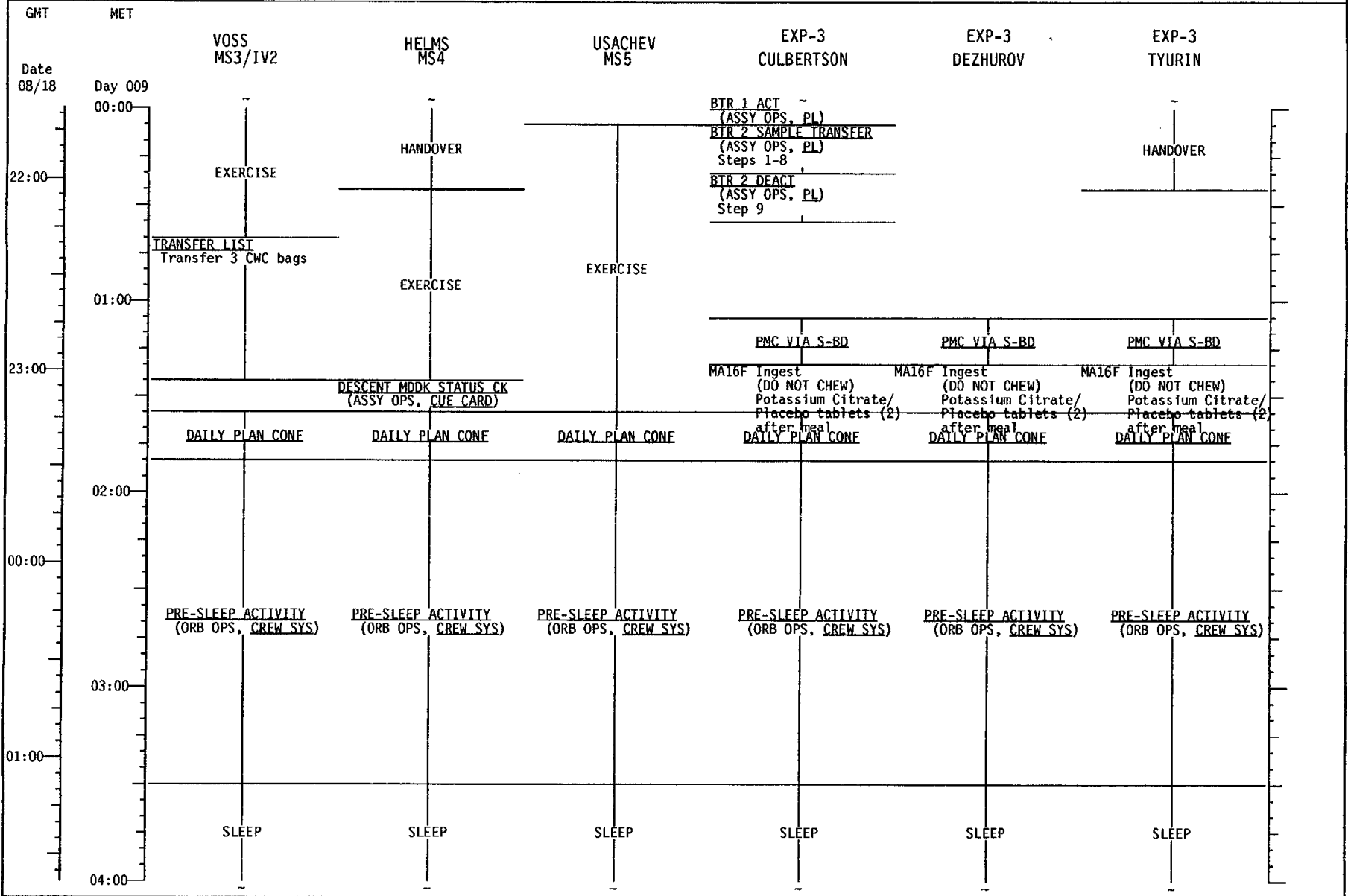

STS-105 7A.1 (FD 10)

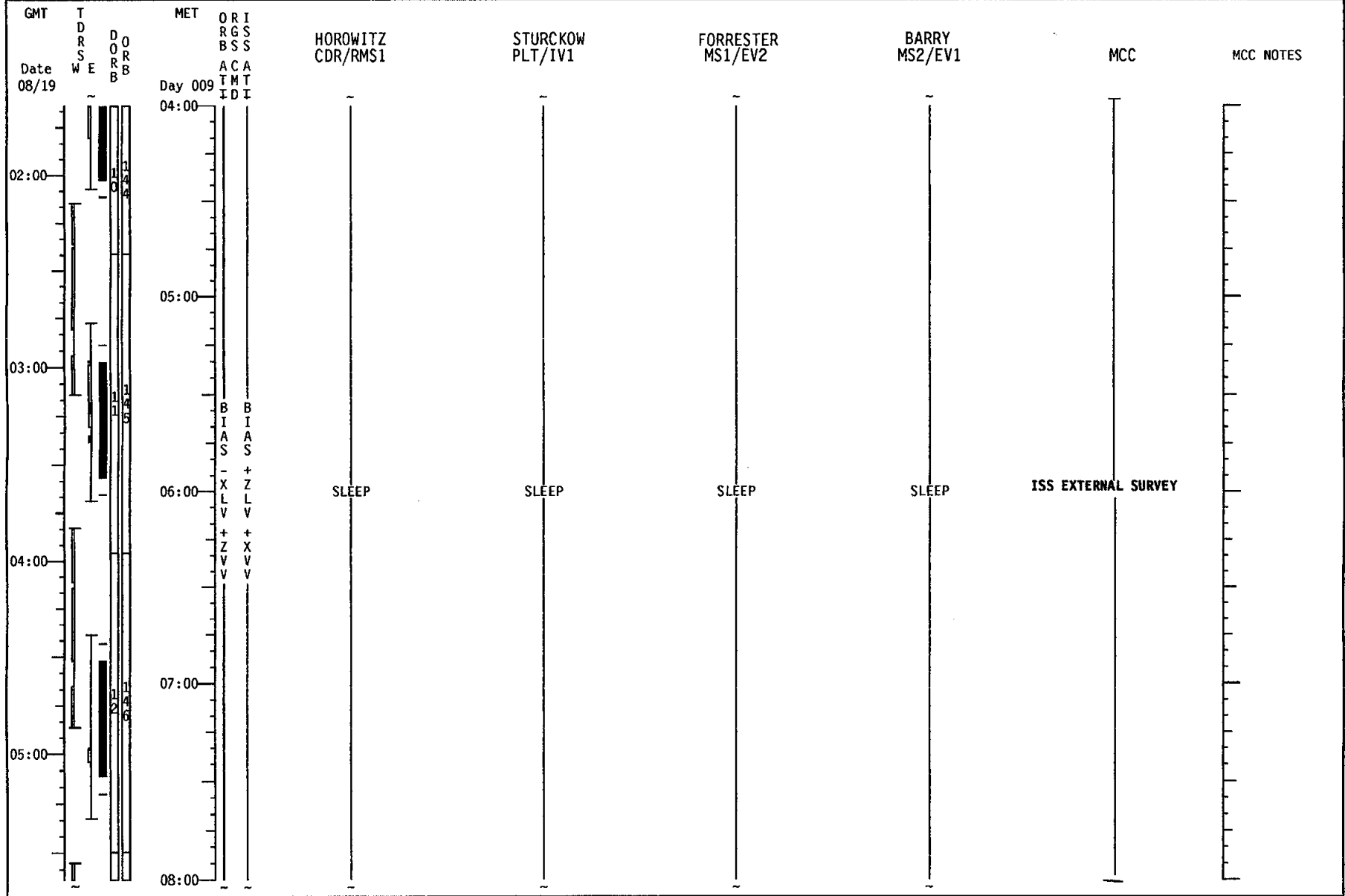

STS-105 7A.1 (FD 10)

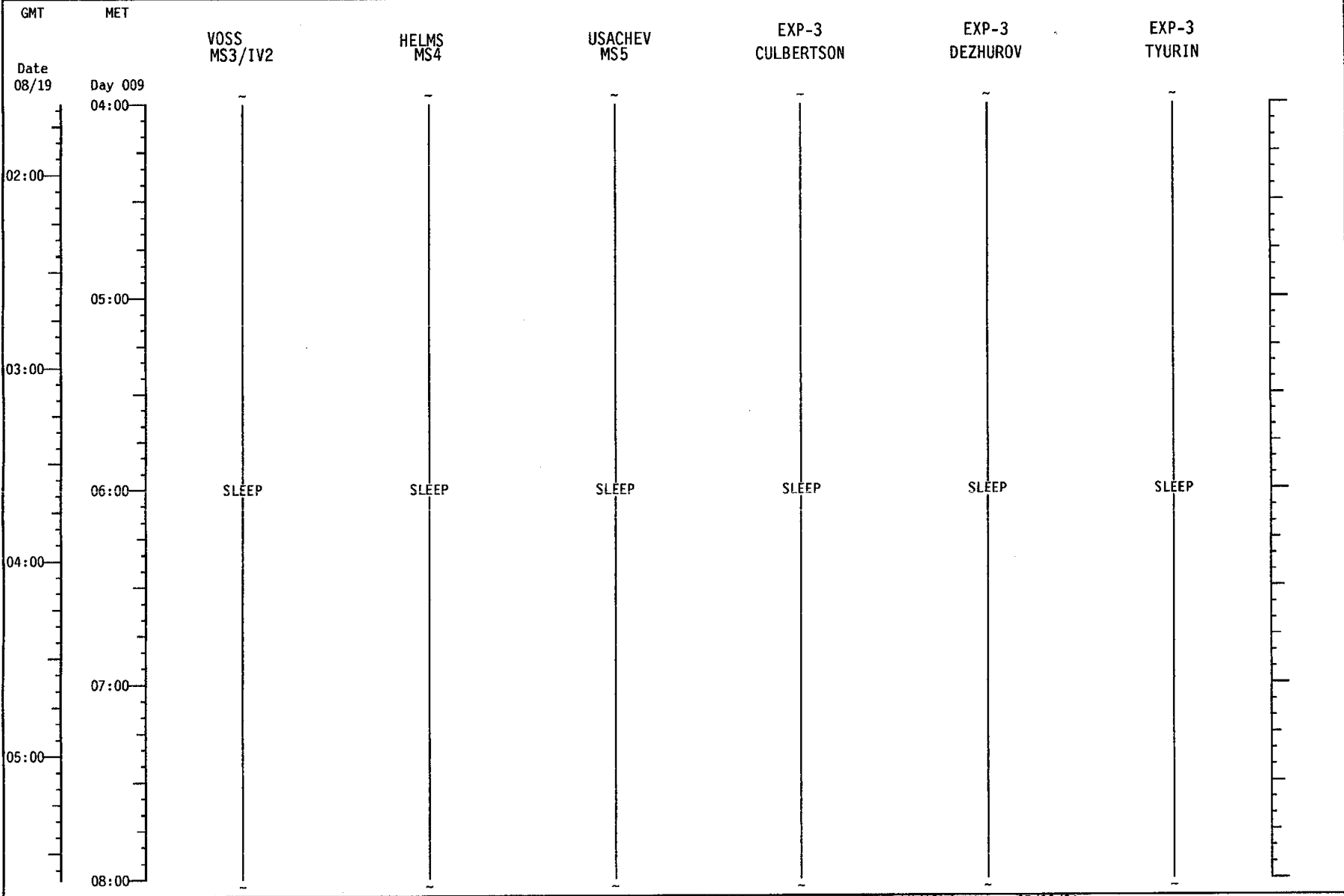

STS-105 7A.1 (FD 10)

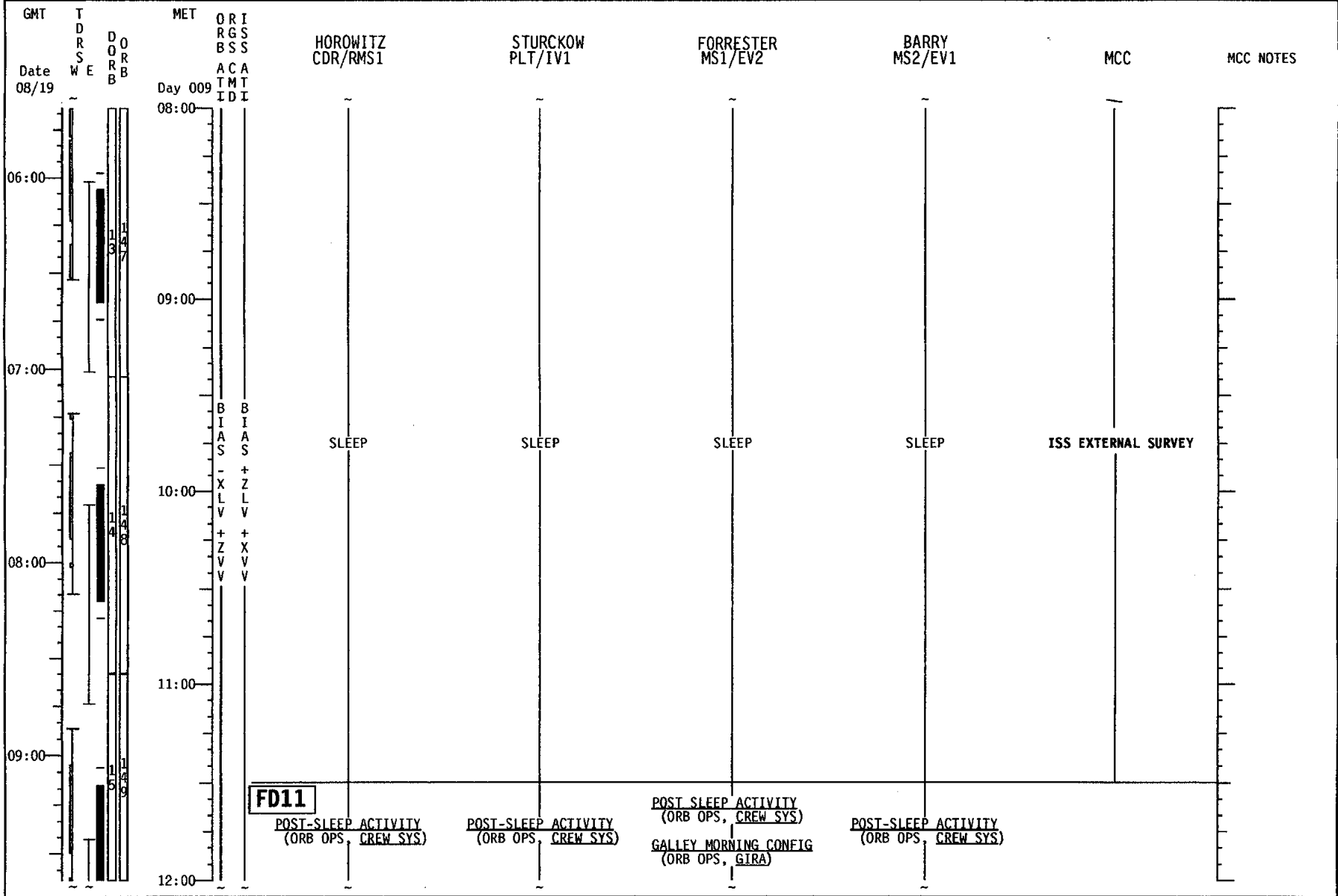

STS-105 7A.1 (FD 10)

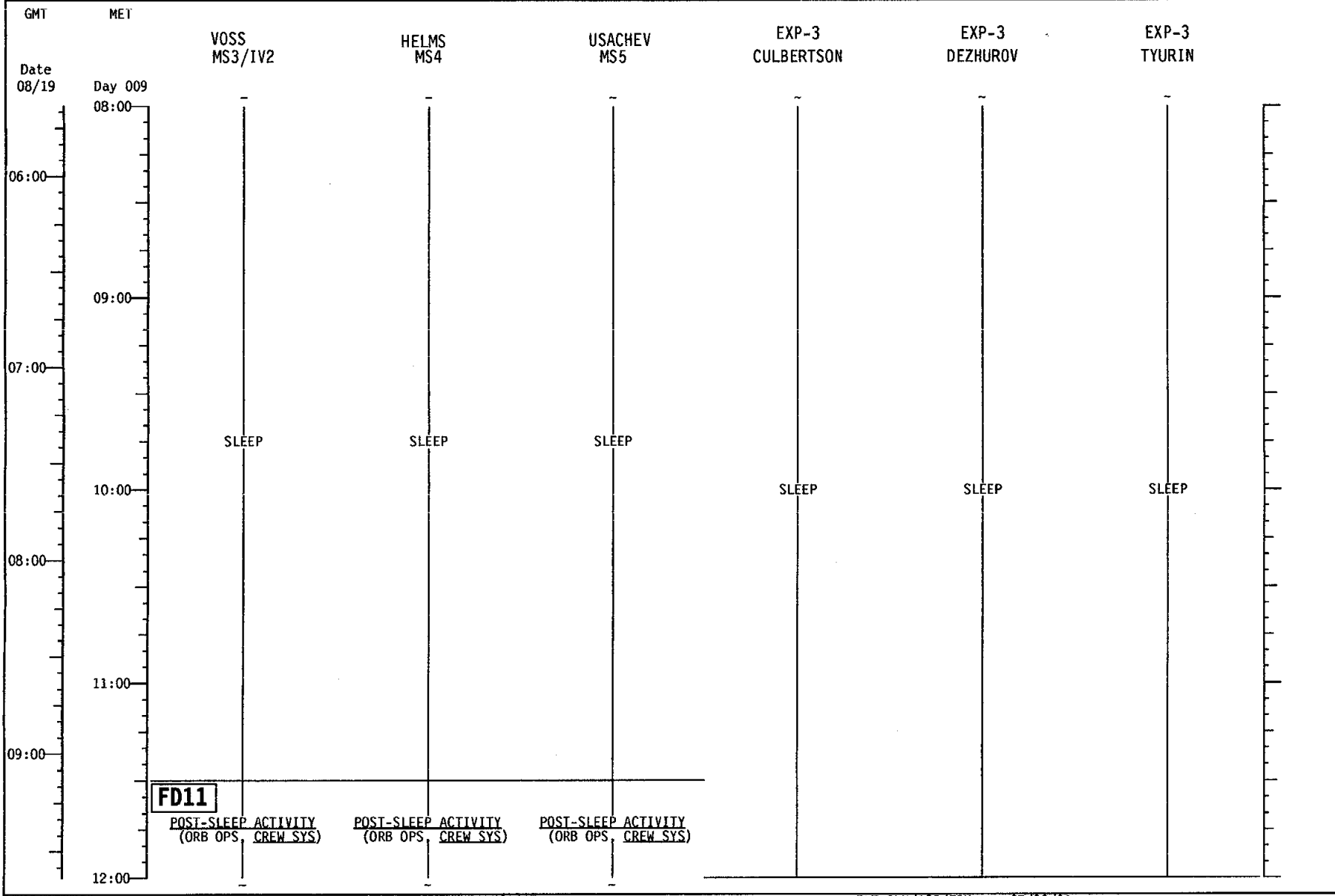

STS-105 7A.1 (FD11)

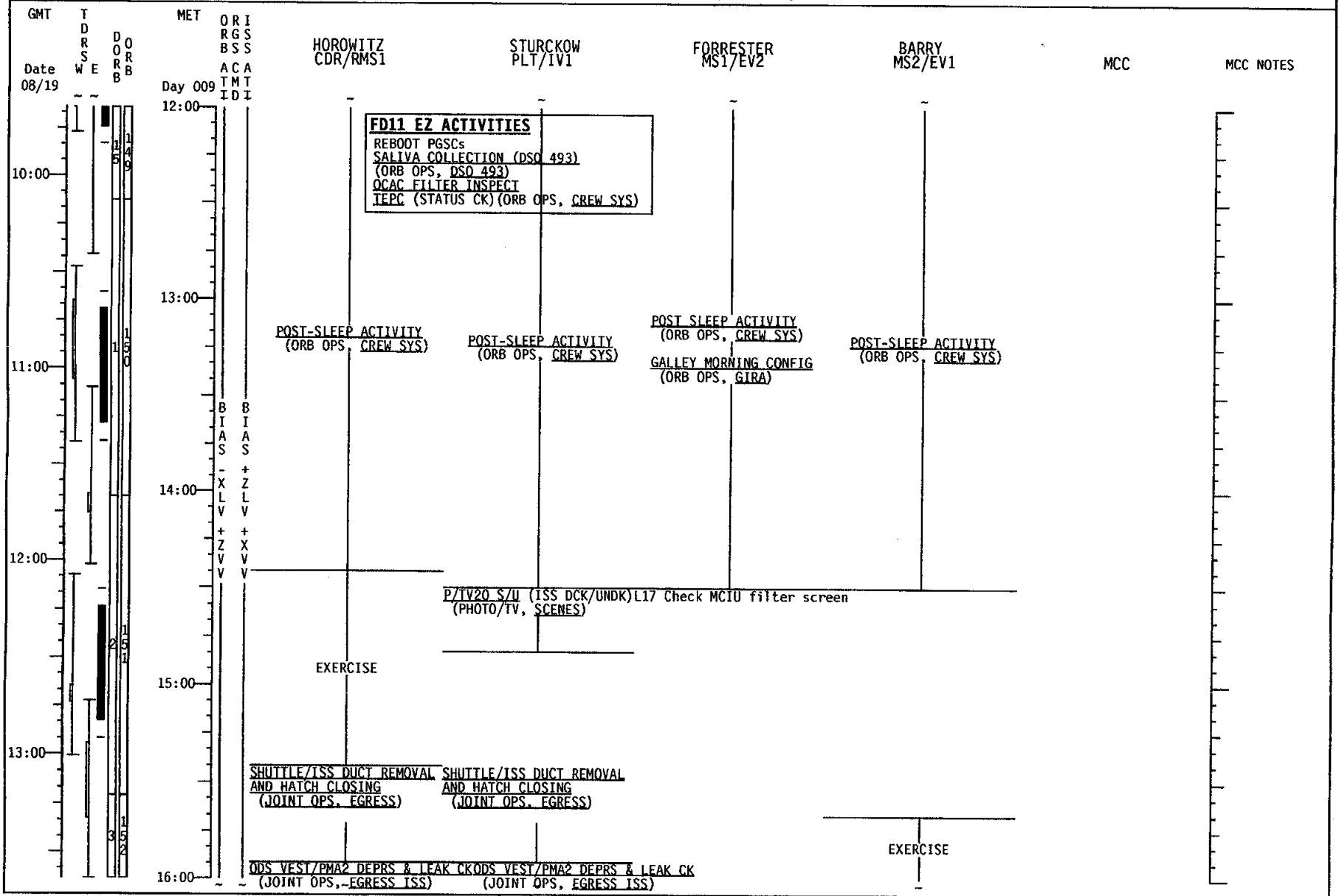

STS-105 7A.1 (FD11)

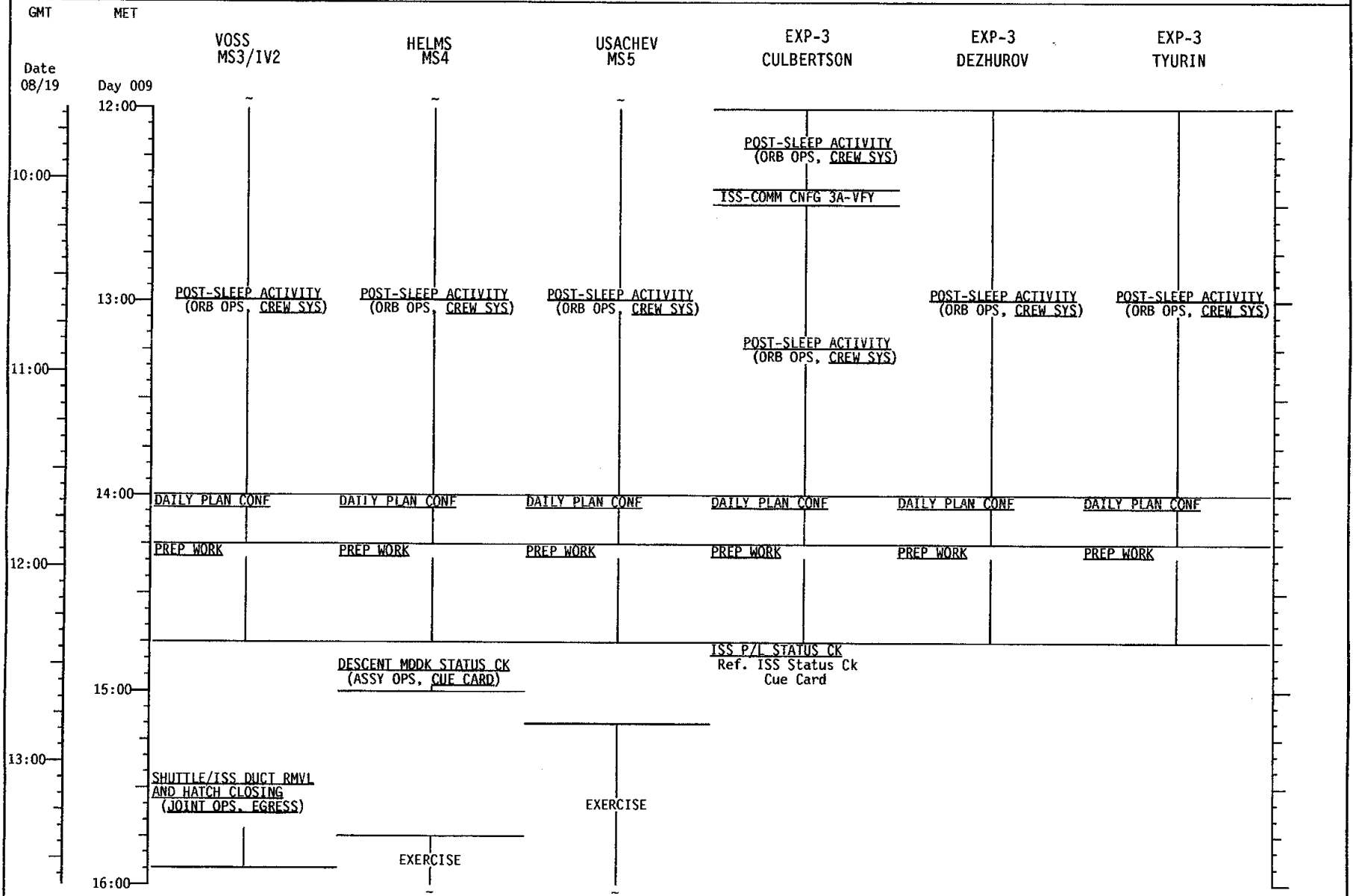

STS-105 7A.1 (FD11)

GMT	TDRS Date 08/19	MET Day 009	ORIGS BSS ACA TMT IDI	HOROWITZ CDR/RMS1	STURCKOW PLT/IV1	FORRESTER MS1/EV2	BARRY MS2/EV1	MCC	MCC NOTES
16:00				ODS VEST/PMA2 DEPRS & LEAK CK (JOINT OPS, EGRESS ISS)					
14:00					ODS VEST/PMA2 DEPRS & LEAK CK (JOINT OPS, EGRESS ISS)		EXERCISE		
						GAS GROUP (ASSY OPS, PL) GROUP 3 & 4			
				PRIORITY PWRUP GRP B (ORB PKT, PRIOR PWRDN) A Step 12: Recover IMU 3 S Steps 9,6, & 5	P/TV19 C/L CAMERA (INSTL) (PHOTO/TV, SCENES)	P/TV19 C/L CAMERA (INSTL) (PHOTO/TV, SCENES)	PRIORITY PWRUP GRP B (ORB PKT, PRIOR PWRDN) Step 12: Recover IMU 3 Steps 9,6, & 5		
17:00				+ SSP1 MPLM CHAN 1,2 HTR PWR (two) - ON (tb-gray) Z/H/O ATT CONTROL CMG TA to ORB L (JOINT OPS, MATED OPS)					
15:00				UNDOCK AND SEPARATION (RNDZ, UNDOCK & SEP T/L)	UNDOCK AND SEPARATION (RNDZ, UNDOCK & SEP T/L)	UNDOCK AND SEPARATION (RNDZ, UNDOCK & SEP T/L)	UNDOCK AND SEPARATION (RNDZ, UNDOCK & SEP T/L)		
18:00									
16:00				FLYAROUND (RNDZ, UNDOCK & SEP T/L)	FLYAROUND (RNDZ, UNDOCK & SEP T/L)	FLYAROUND (RNDZ, UNDOCK & SEP T/L)	FLYAROUND (RNDZ, UNDOCK & SEP T/L)		UPLINK β21° + MASK
19:00									
17:00				SPLY H2O DUMP W/FES (ORB OPS, ECLS) Step 1 MNVR (TRK) -ZLV BIAS +YVV TG=2 BV=3 P=90 Y=0 OM=290 A1/AUTO/YERN Init TRK (19:40)	PRIORITY PWRDN GRP B (ORB PKT, PRIOR PWRDN) In Step 12, IMU 3 STBY-Item 23 EXEC	COMM STRING 1 C/O (PT A) (ORB OPS, COMM/INST)	PRIORITY PWRDN GRP B (ORB PKT, PRIOR PWRDN) In Step 12, IMU 3 STBY-Item 23 EXEC		
20:00				MEAL	P/TV08 S/U (SSAT DPLY) (PHOTO/TV, SCENES)	MEAL	MEAL		

STS-105 7A.1 (FD11)

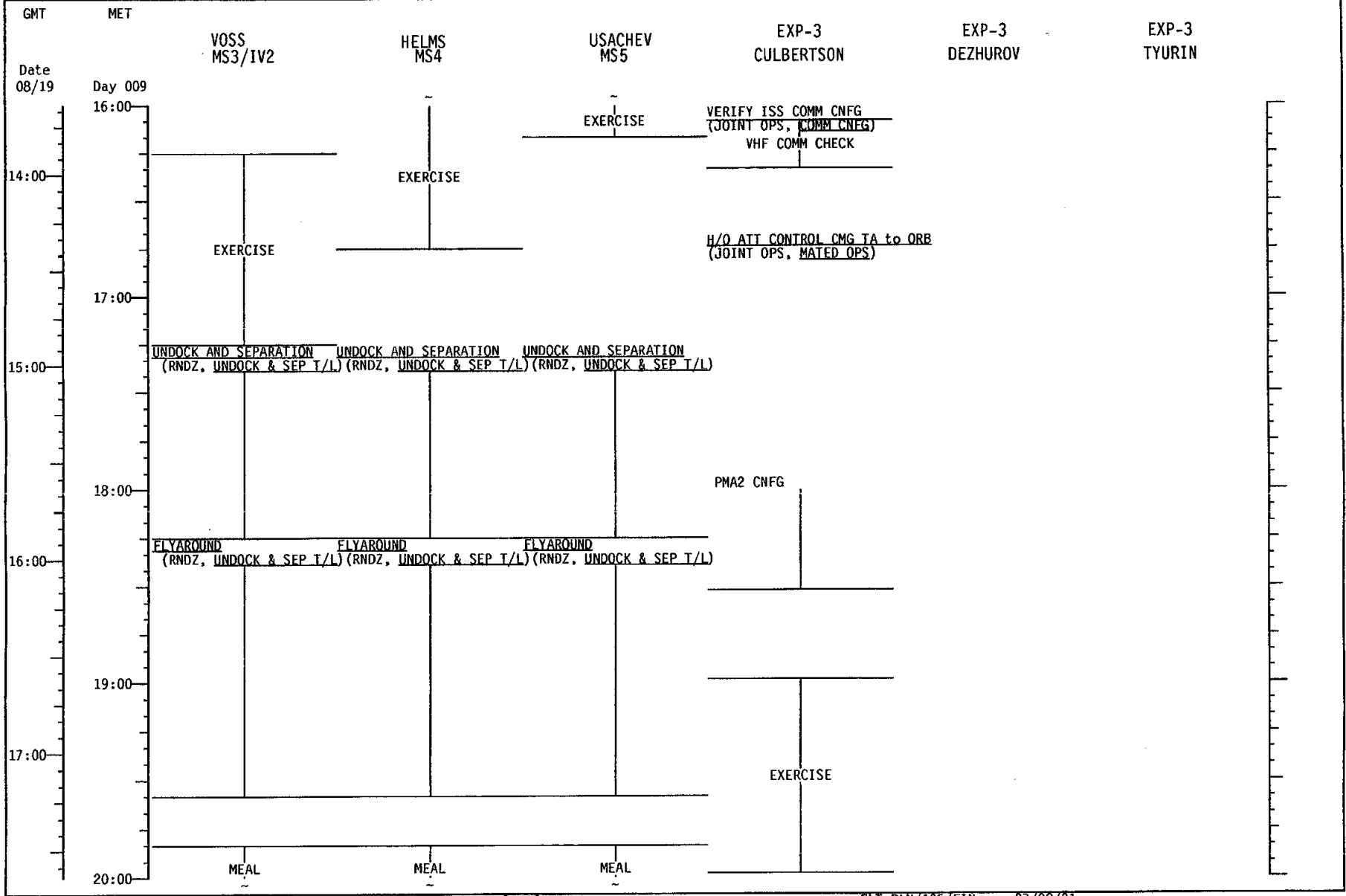

STS-105 7A.1 (FD 11)

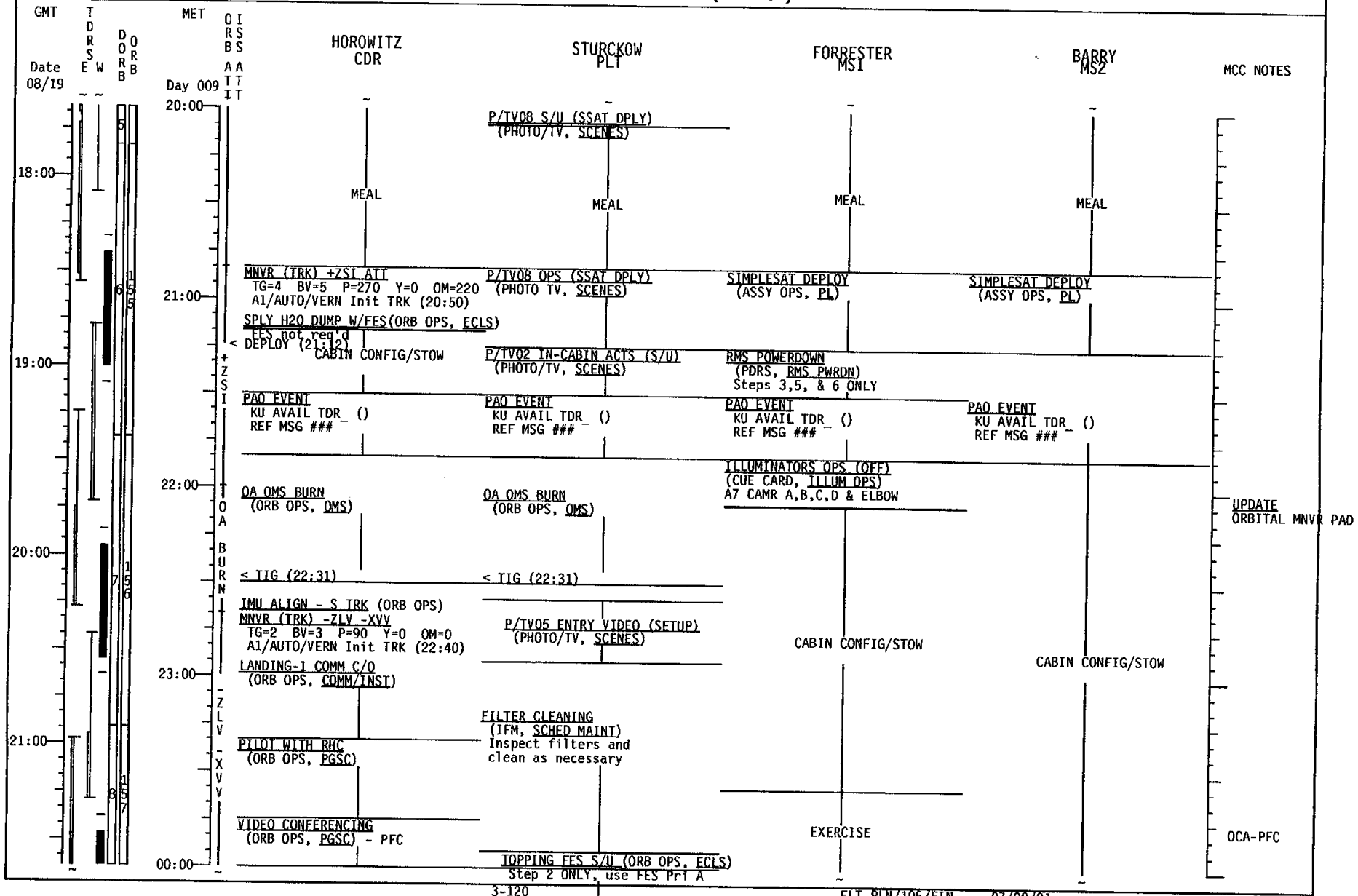

STS-105 7A.1 (FD 11)

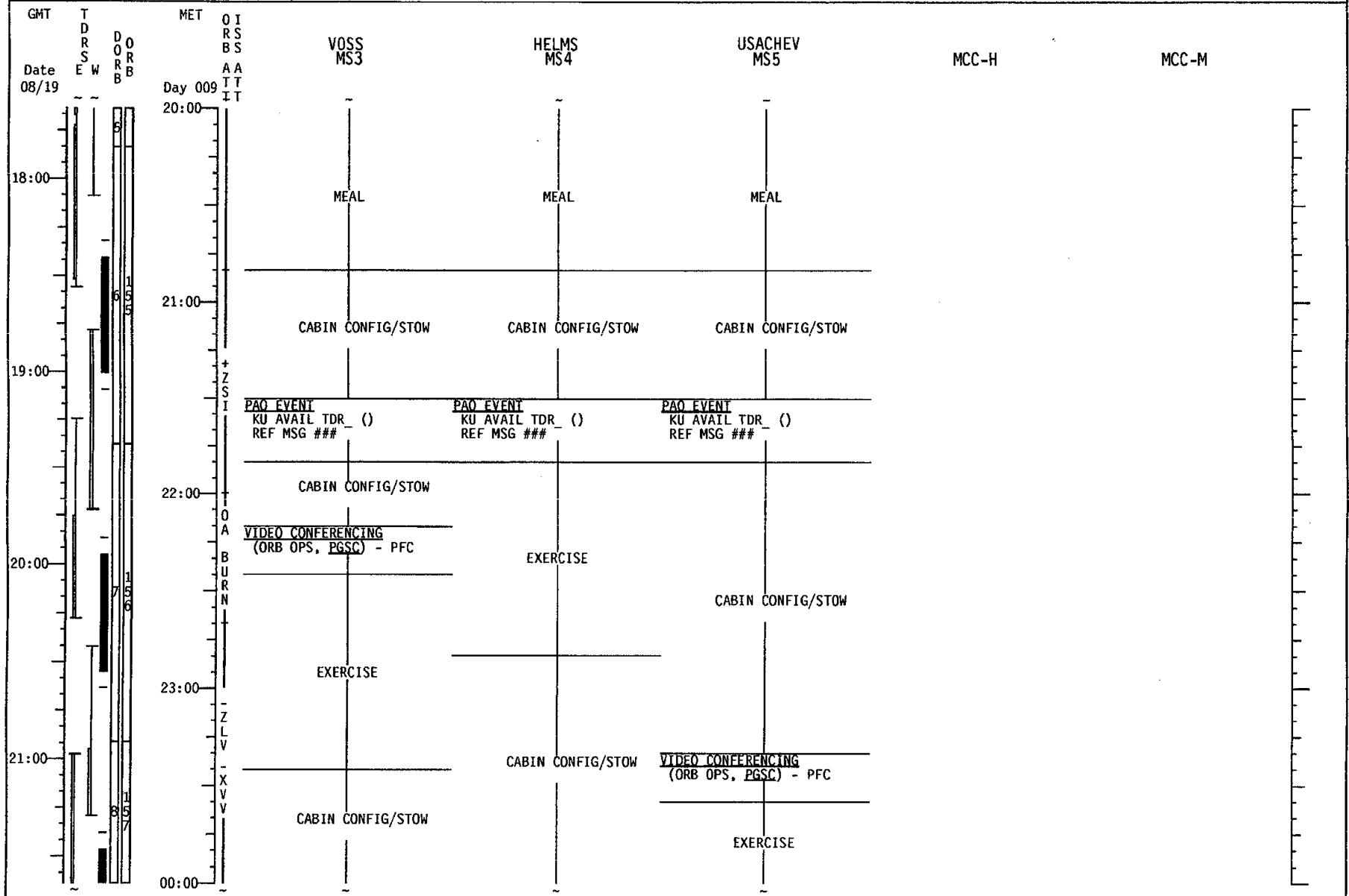

STS-105 7A.1 (FD 11)

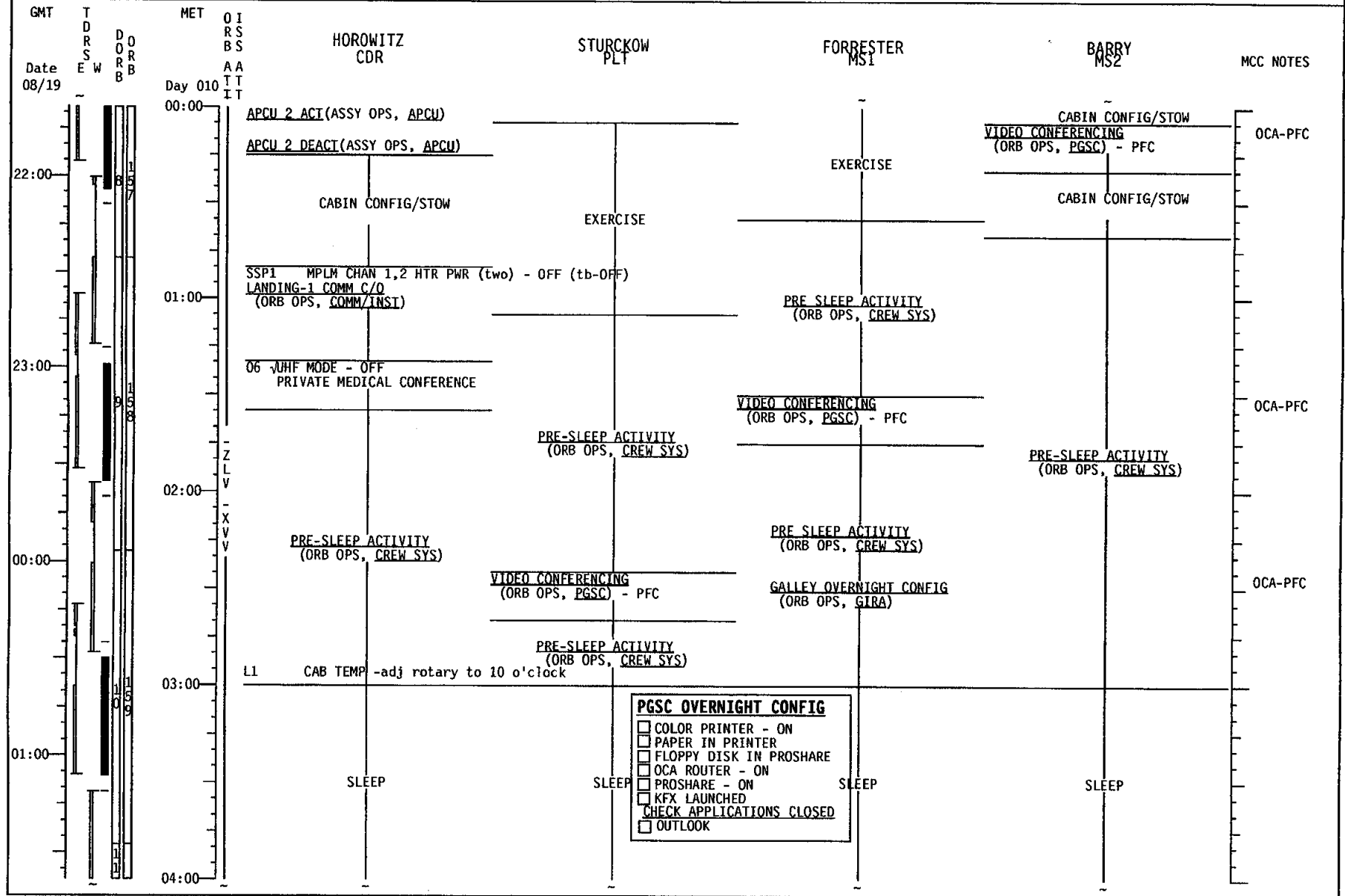

STS-105 7A.1 (FD 11)

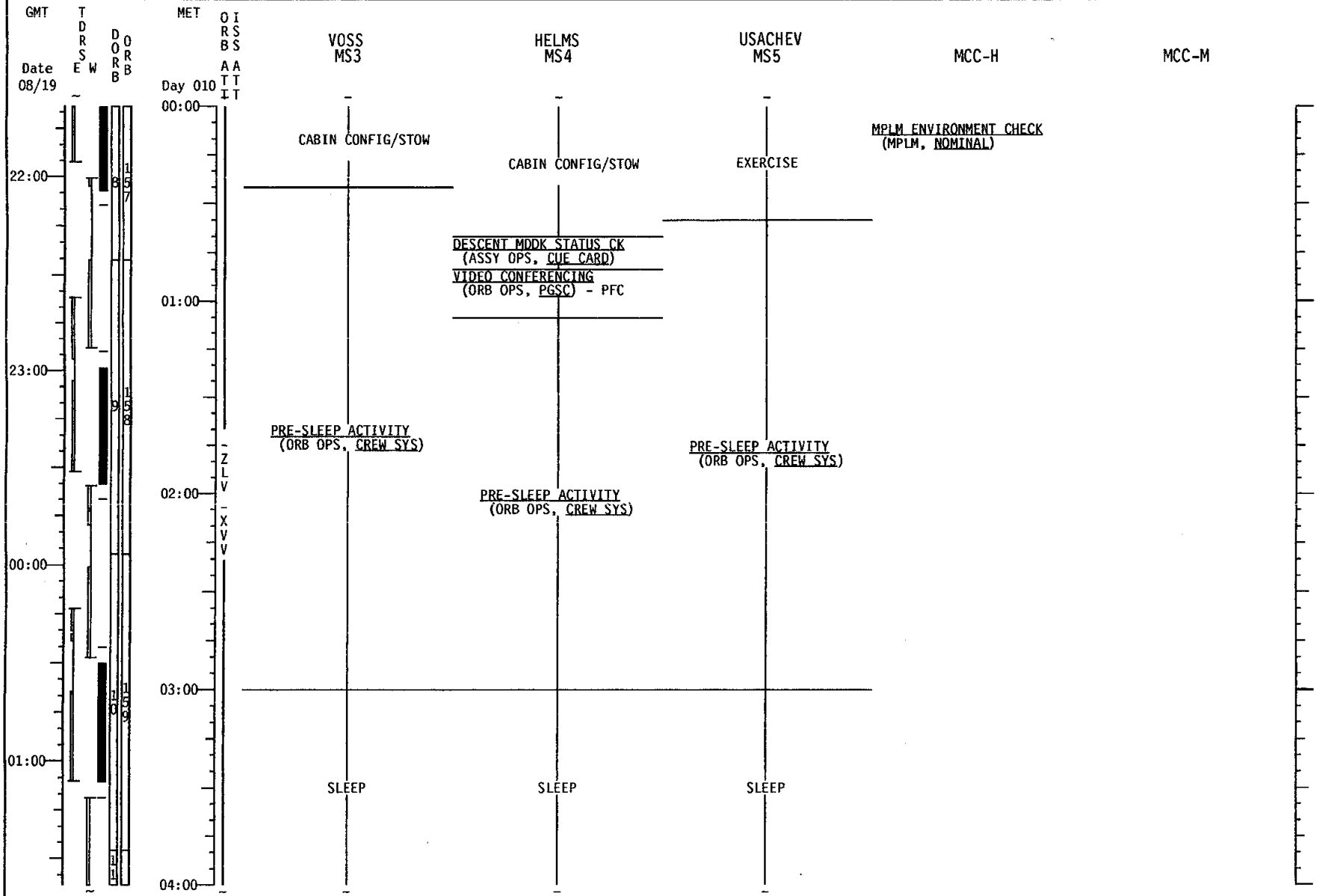

STS-105 7A.1 (FD 11)

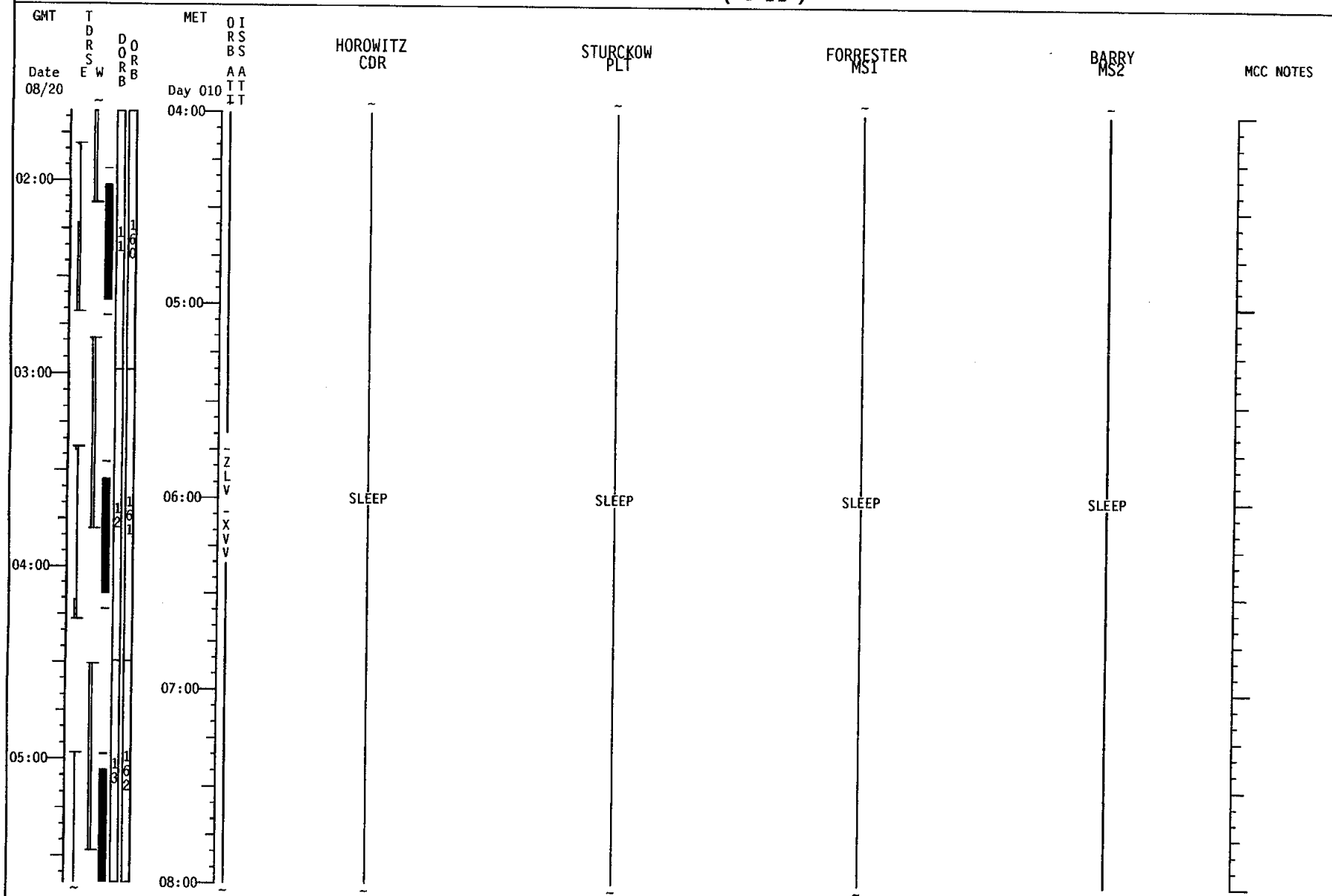

STS-105 7A.1 (FD 11)

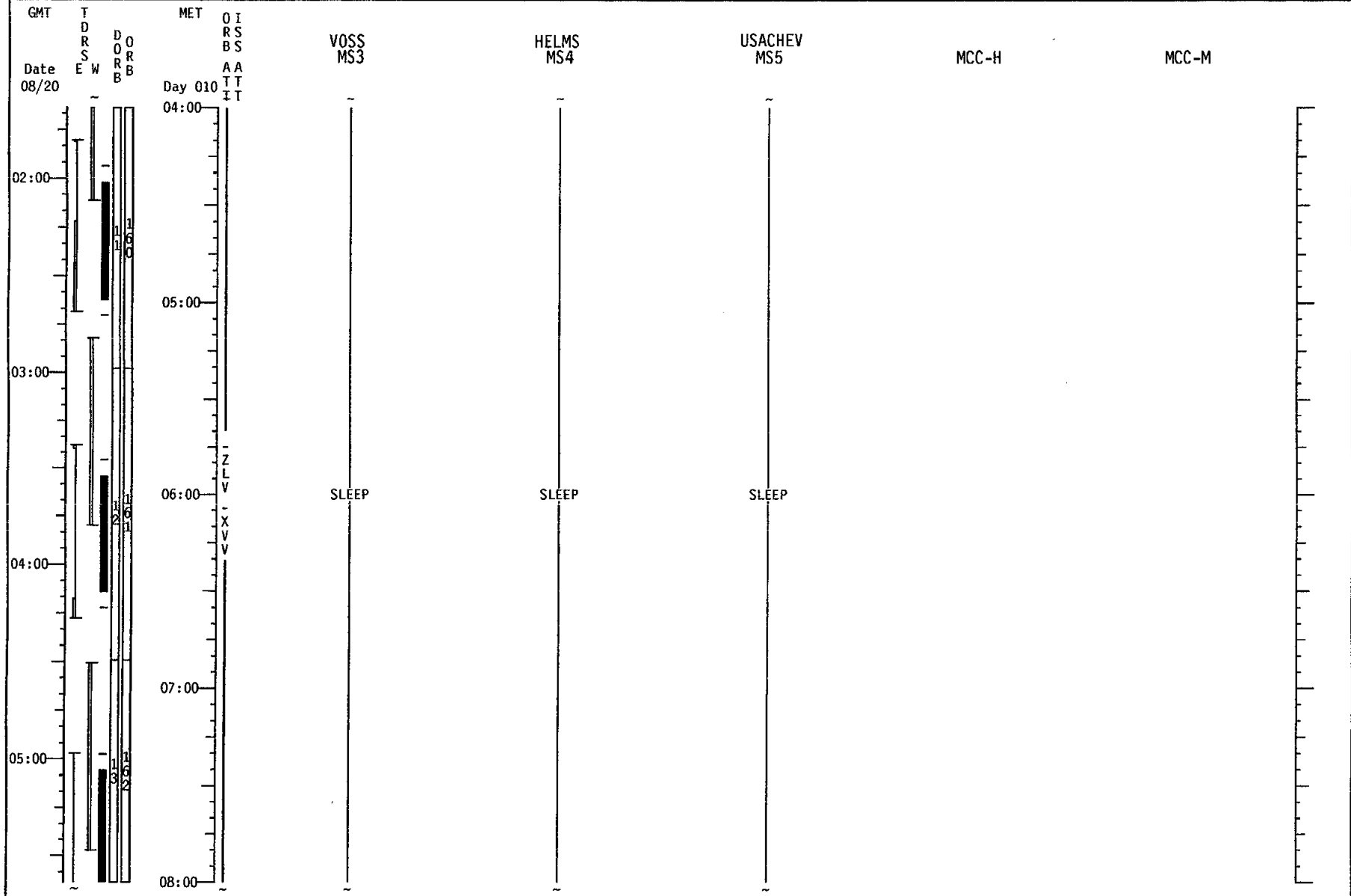

STS-105 7A.1 (FD 11)

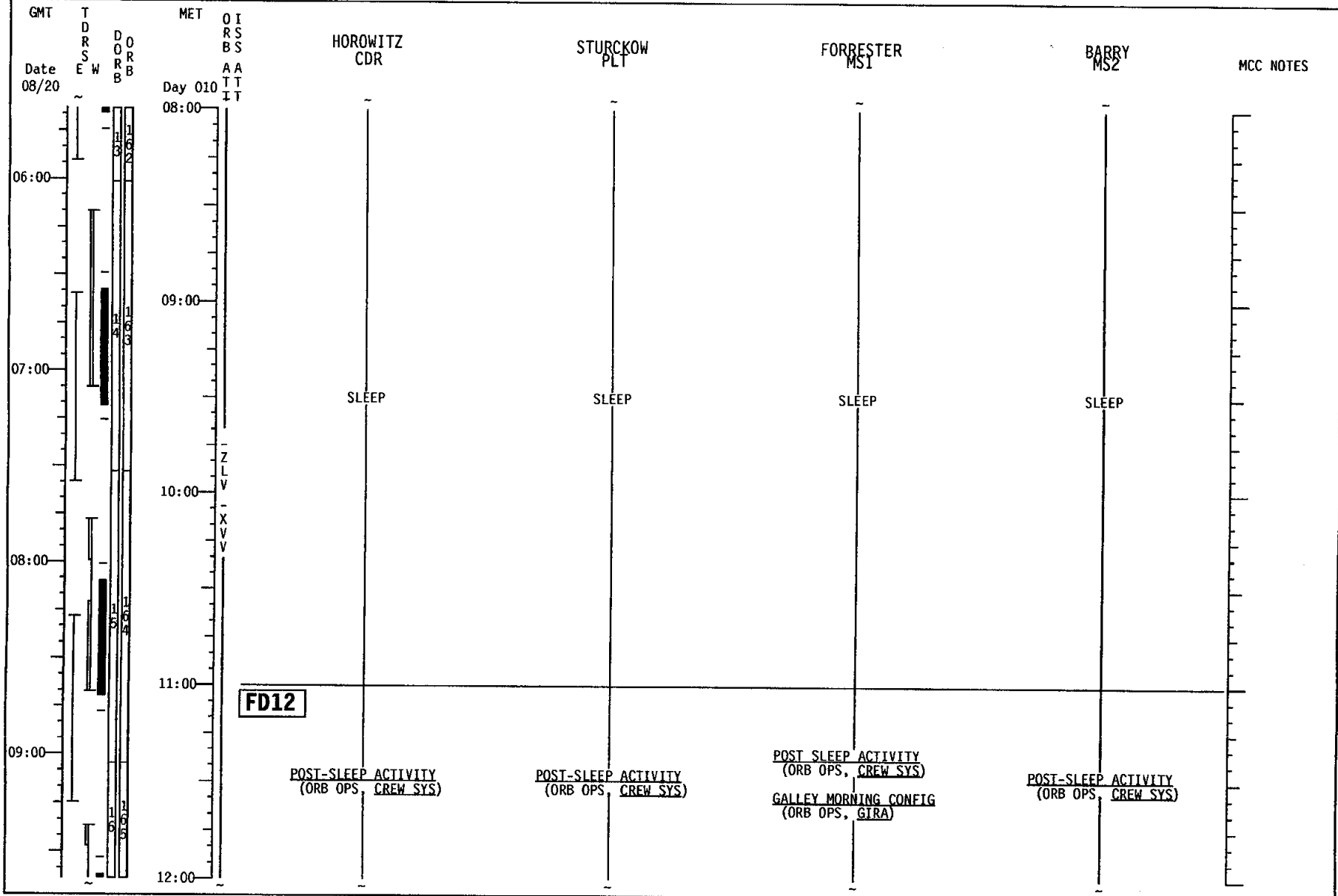

STS-105 7A.1 (FD 11)

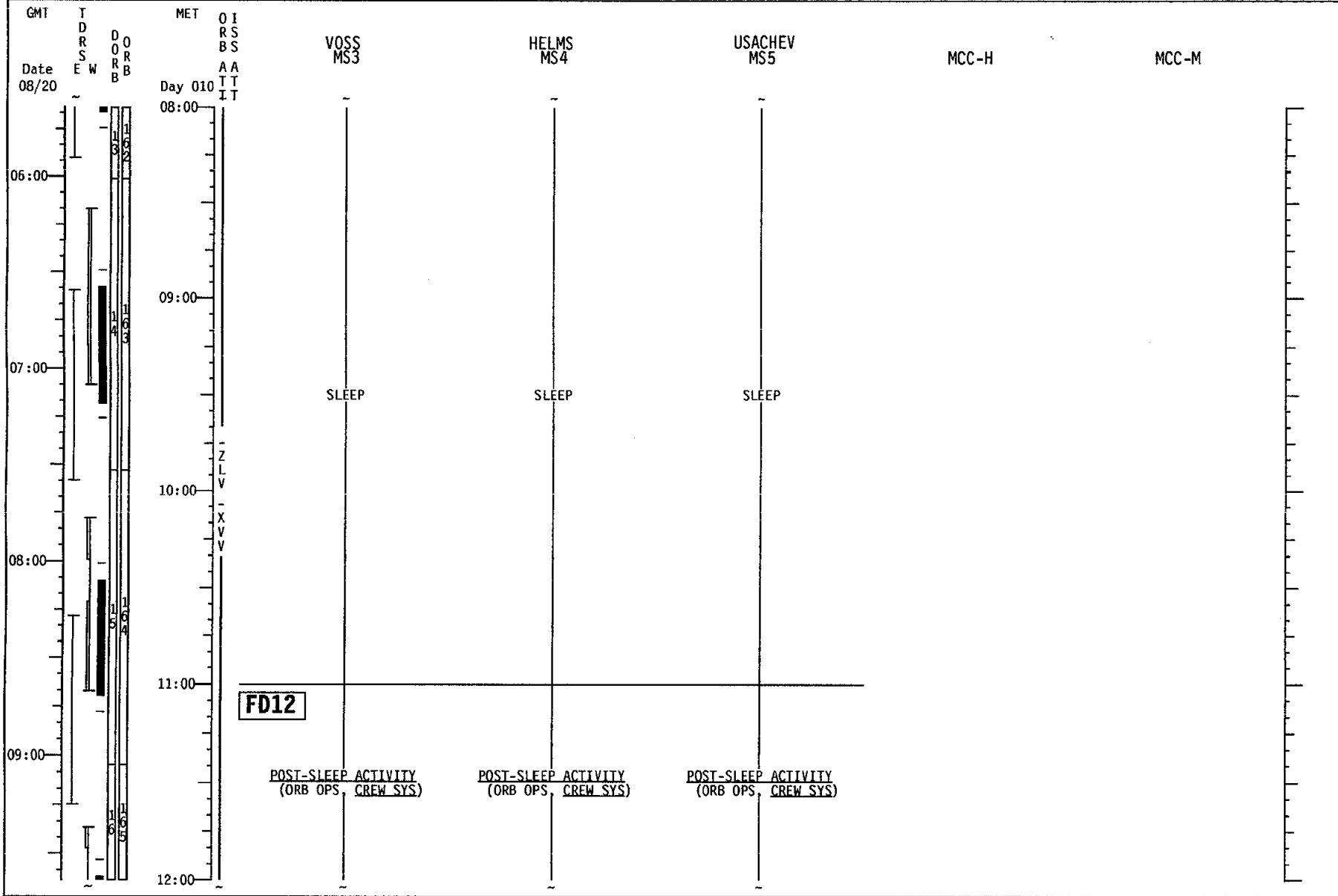

STS-105 7A.1 (FD 12)

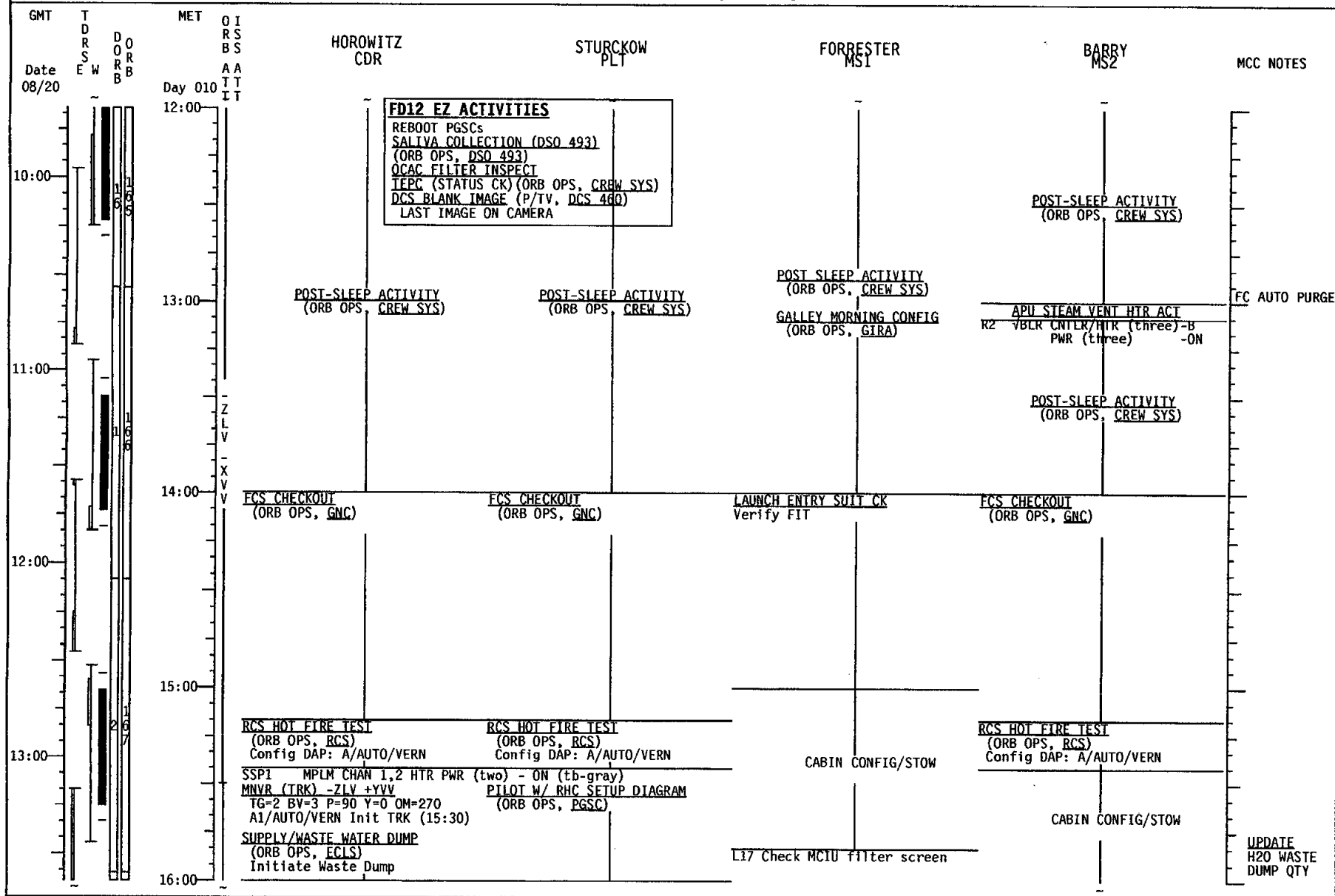

STS-105 7A.1 (FD 12)

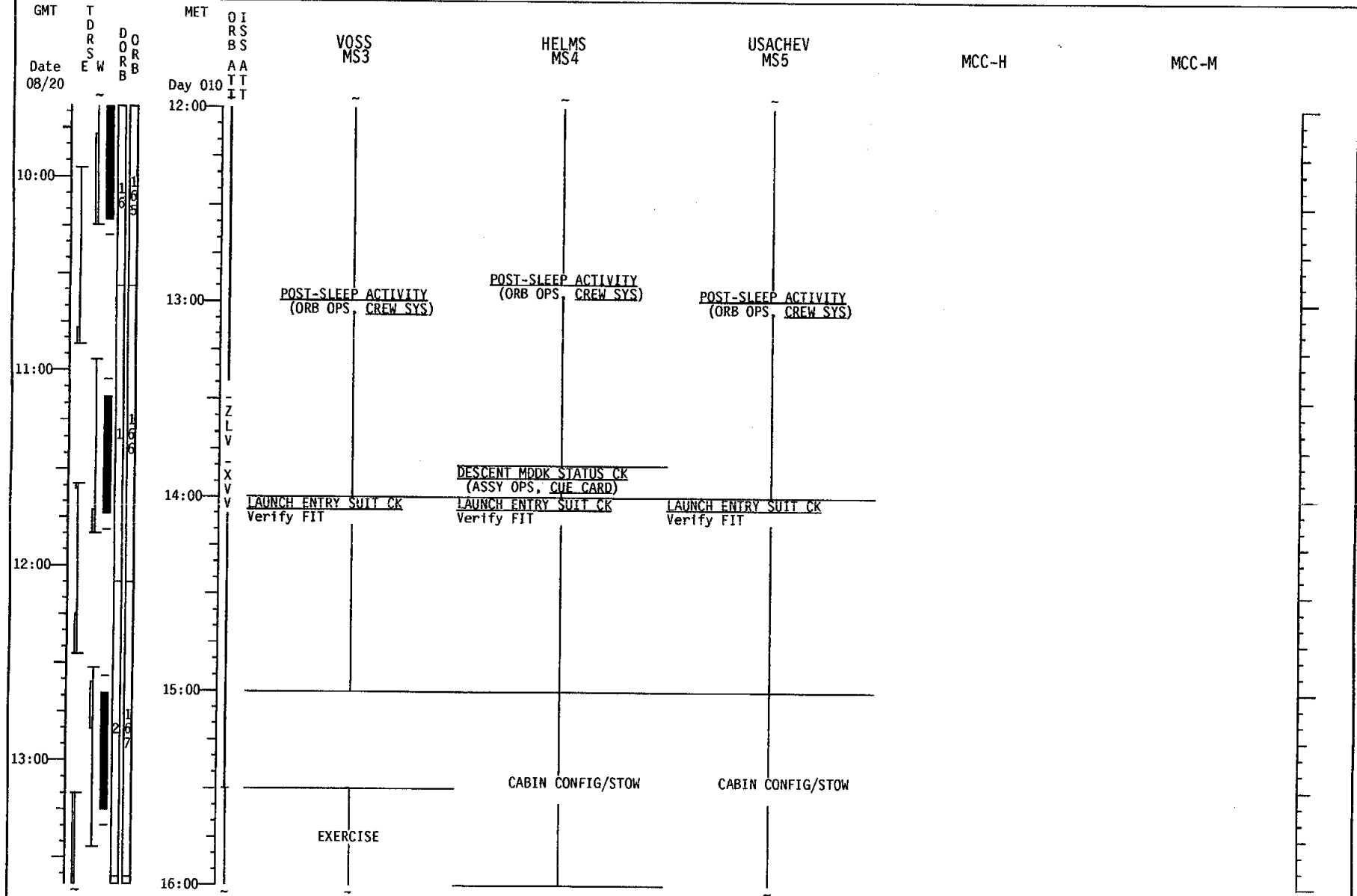

STS-105 7A.1 (FD 12)

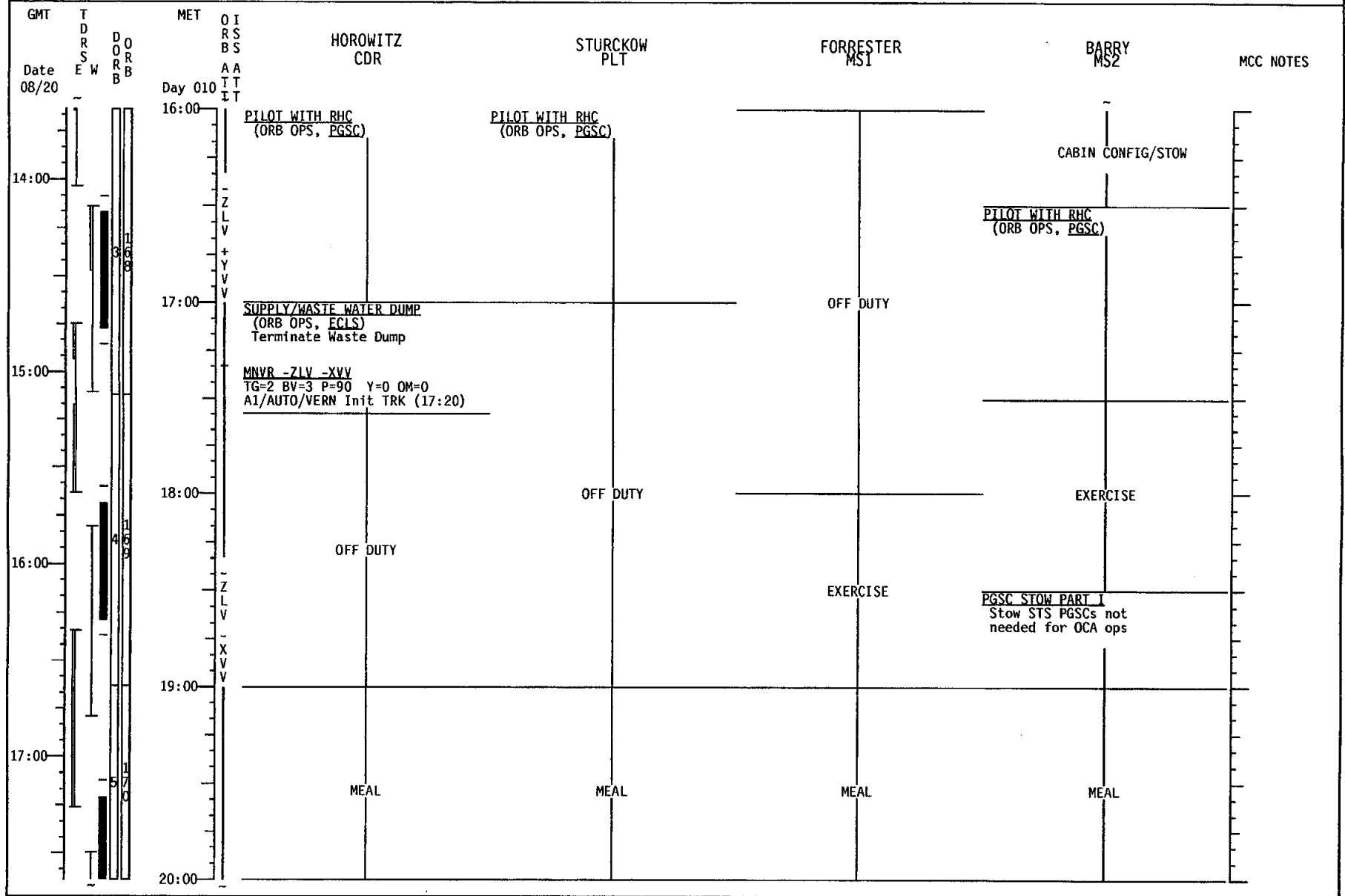

STS-105 7A.1 (FD 12)

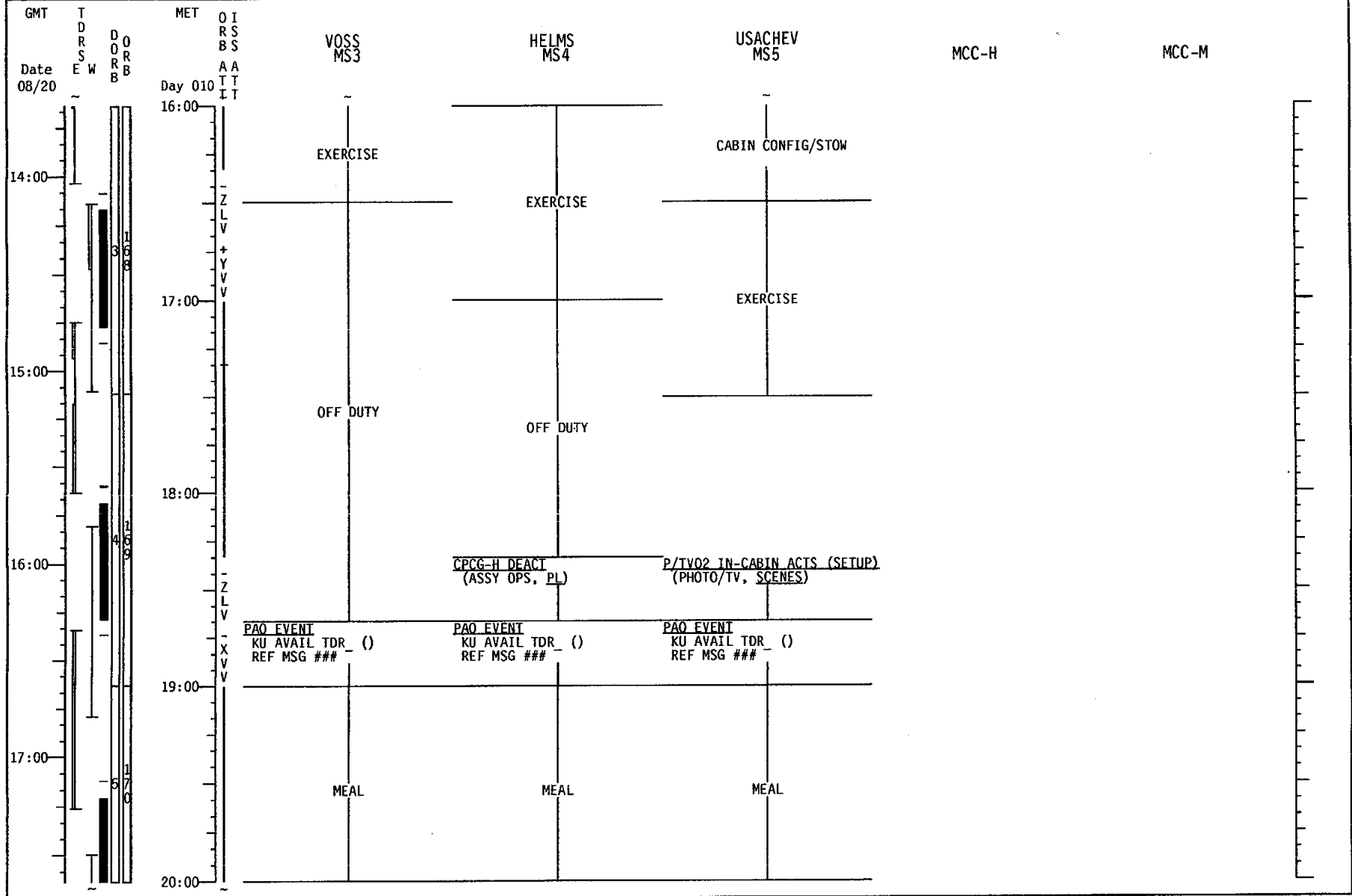

STS-105 7A.1 (FD 12)

GMT	TDRSEW	DORB	MET	OIRSBS	HOROWITZ CDR	STURCKOW PLT	FORRESTER MS1	BARRY MS2	MCC NOTES
Date 08/20			Day 010	AAIT					
18:00		570					COMM STRING 1 C/O (PART B) (ORB OPS, COMM/INST)		
19:00		671			OFF DUTY	OFF DUTY	OFF DUTY	OFF DUTY	
20:00		772	ZLV		EXERCISE				
21:00		873	XVV						
22:00						SSV DEACTIVATION (P/TV06, SSV)			
23:00					APCU 2 ACI (ASSY OPS, APCU)	EXERCISE	RECUMBENT SEAT KIT ATTACH (ORB OPS, RSK)	KU-BD ANT STOW (ORB OPS, COMM/INST)	
					OPS 2 GPS TEST (ORB OPS, GPS)			OCA S-BAND MODEM ACT (ORB OPS, PGSC)	
					APCU 2 DEACT (ASSY OPS, APCU)				
00:00					DEORBIT BRIEF	DEORBIT BRIEF	DEORBIT BRIEF	DEORBIT BRIEF	

STS-105 7A.1 (FD 12)

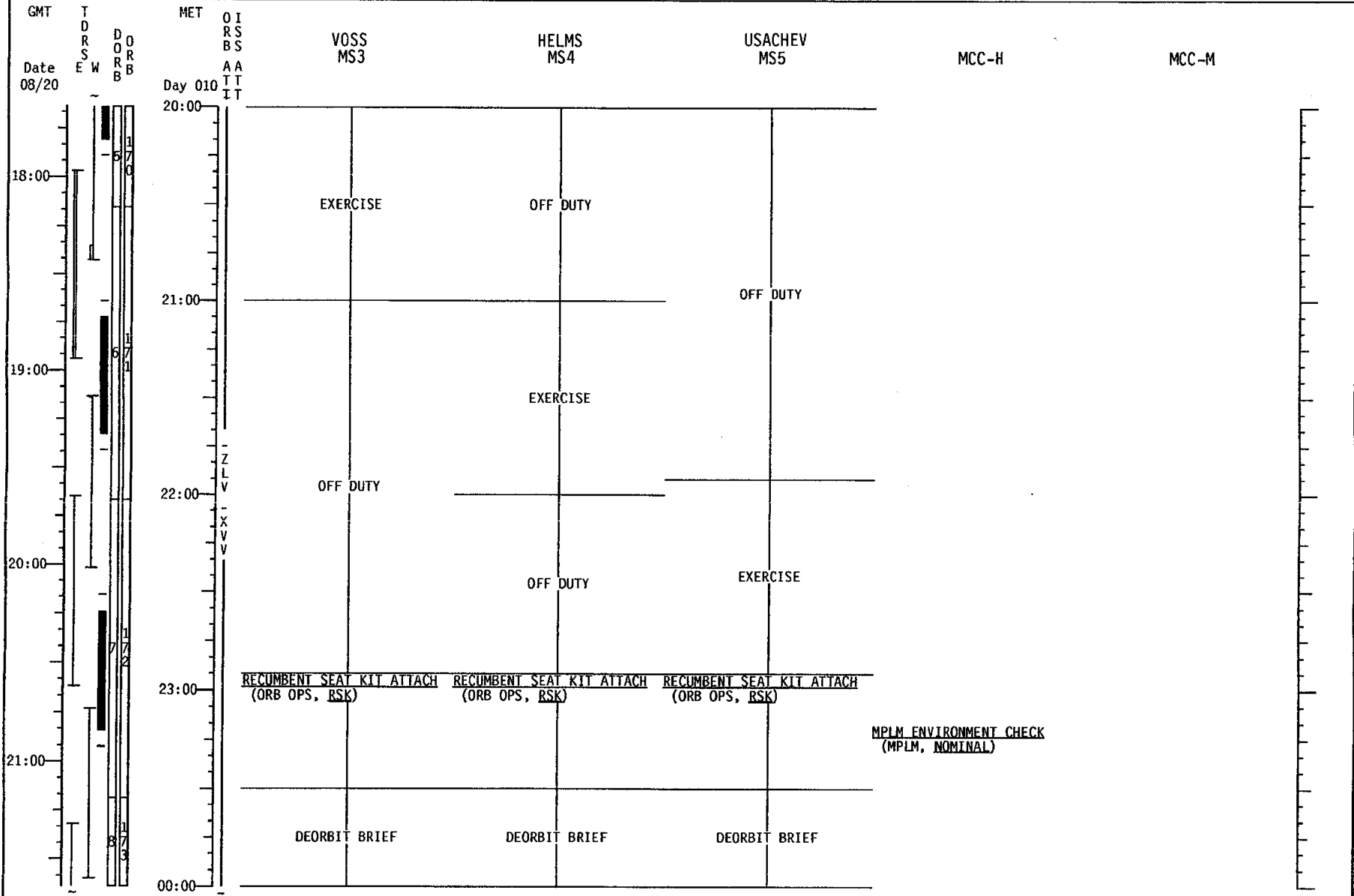

STS-105 7A.1 (FD 12)

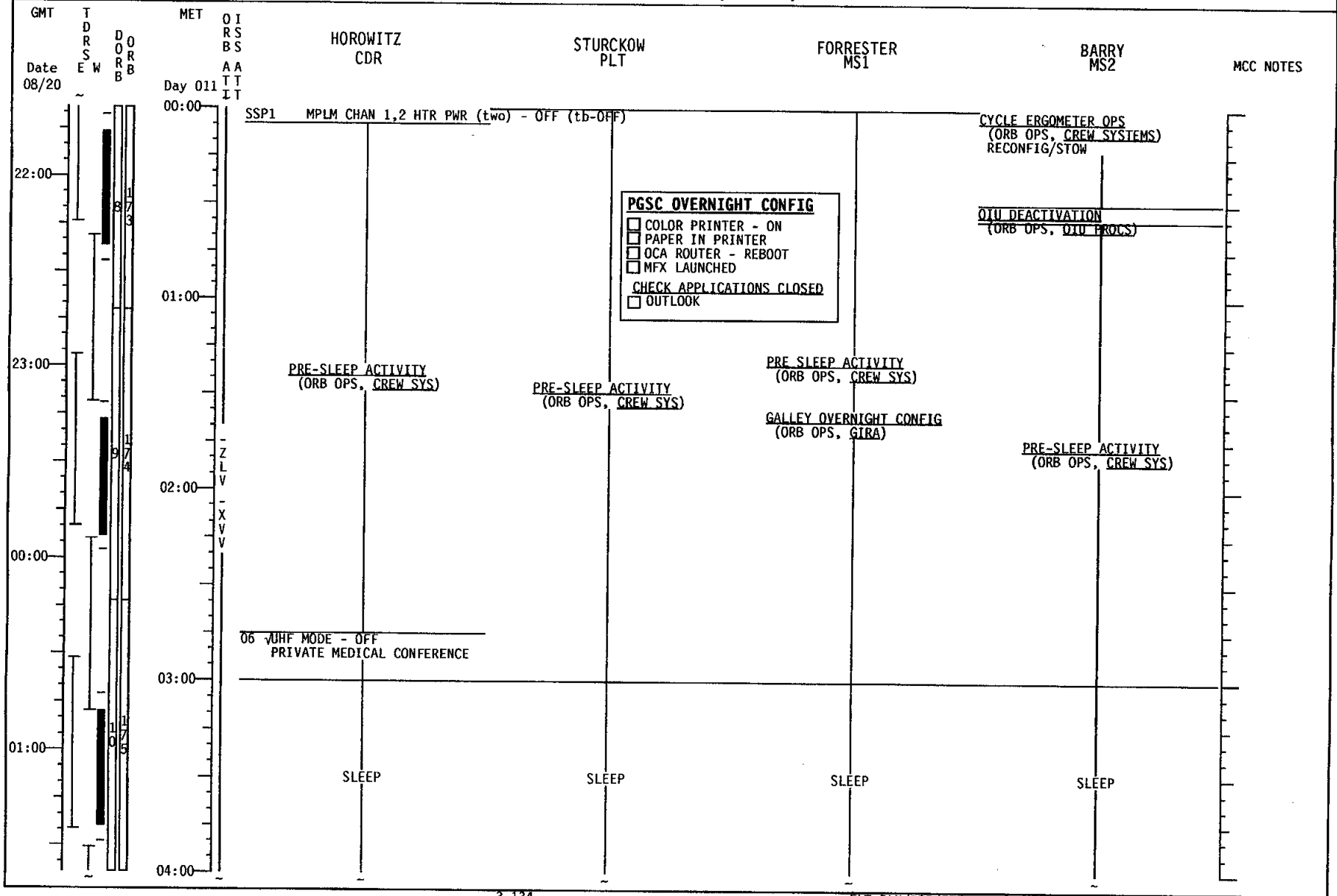

STS-105 7A.1 (FD 12)

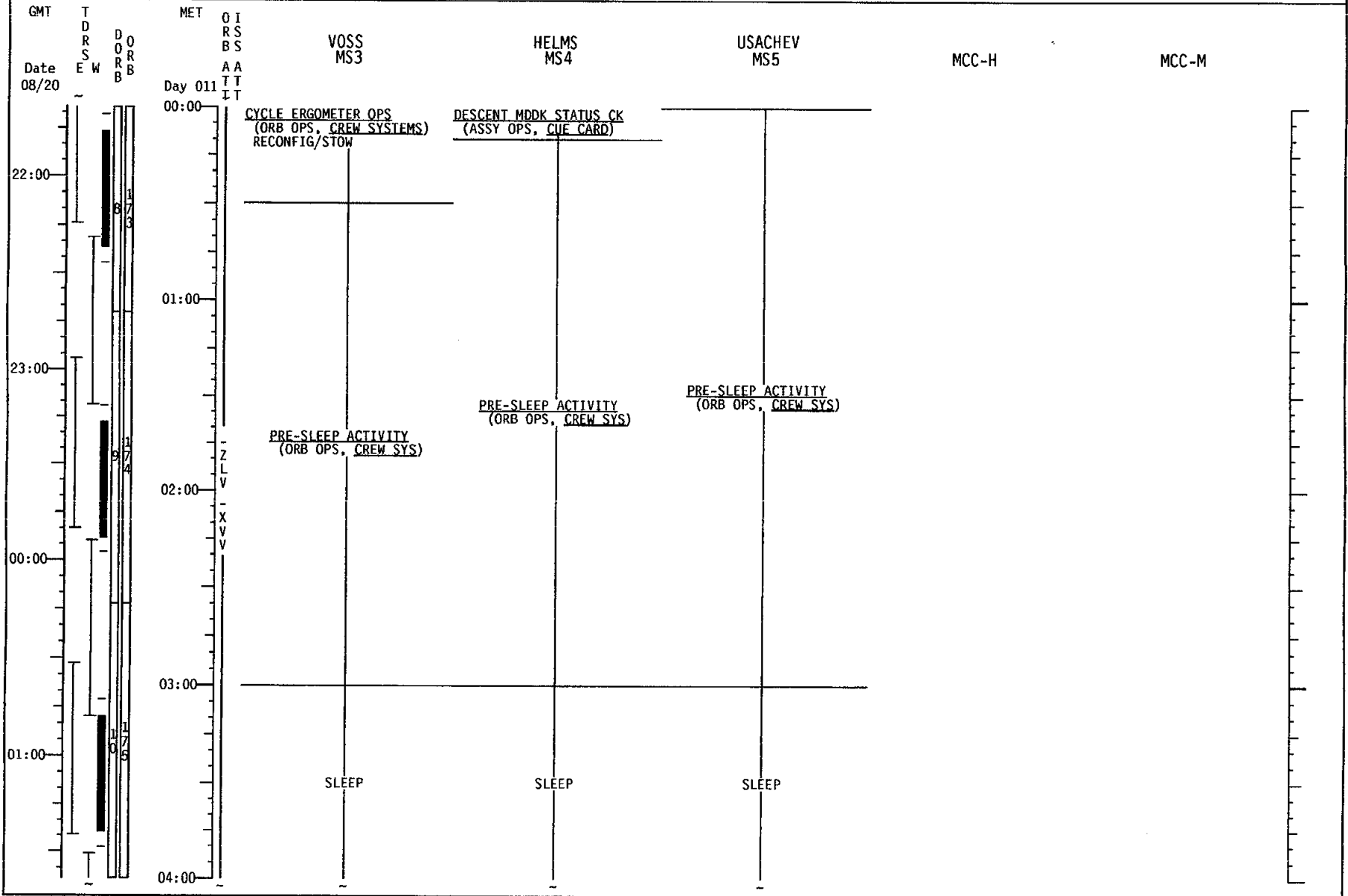

STS-105 7A.1 (FD 12)

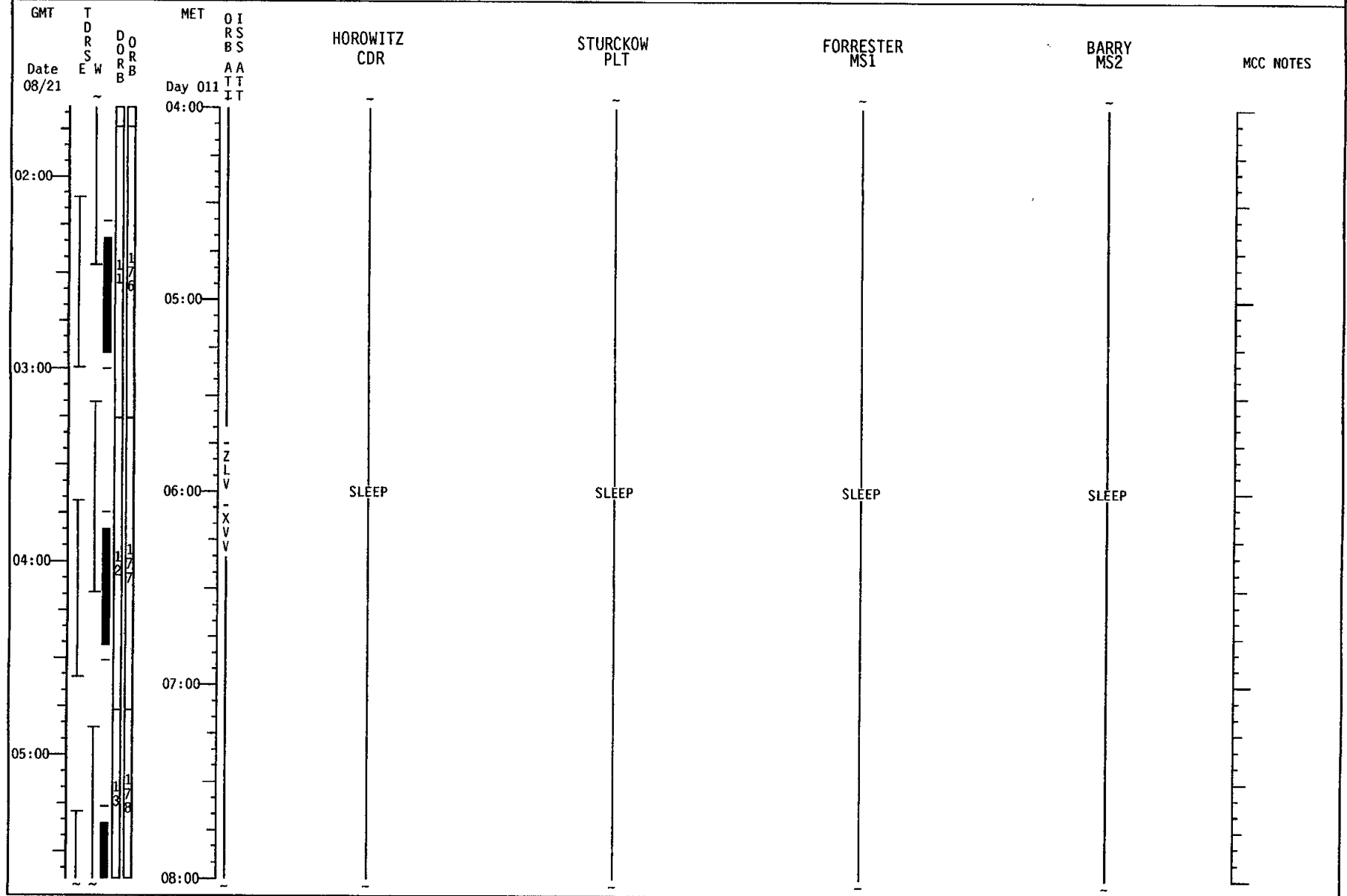

STS-105 7A.1 (FD 12)

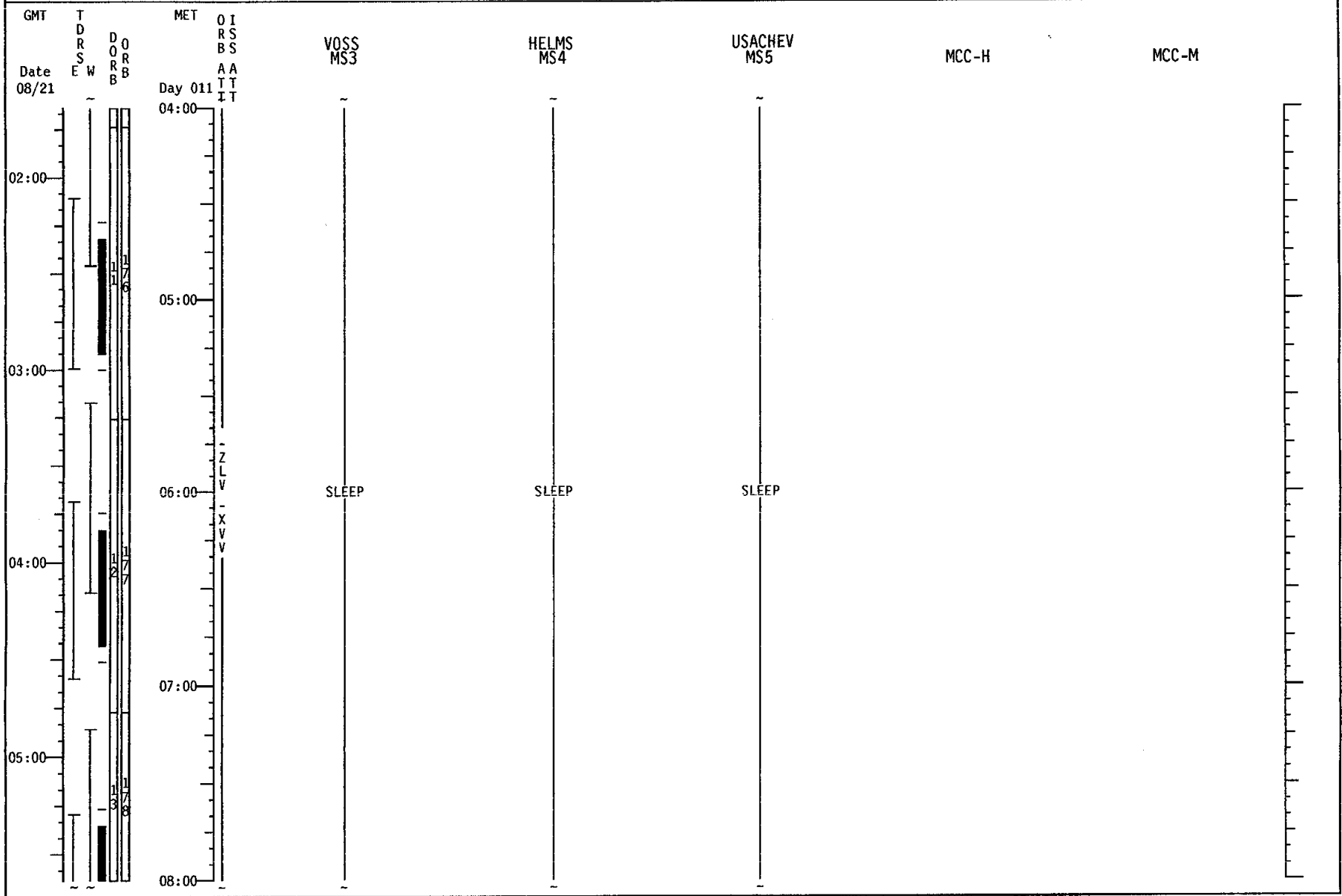

STS-105 7A.1 (FD 12)

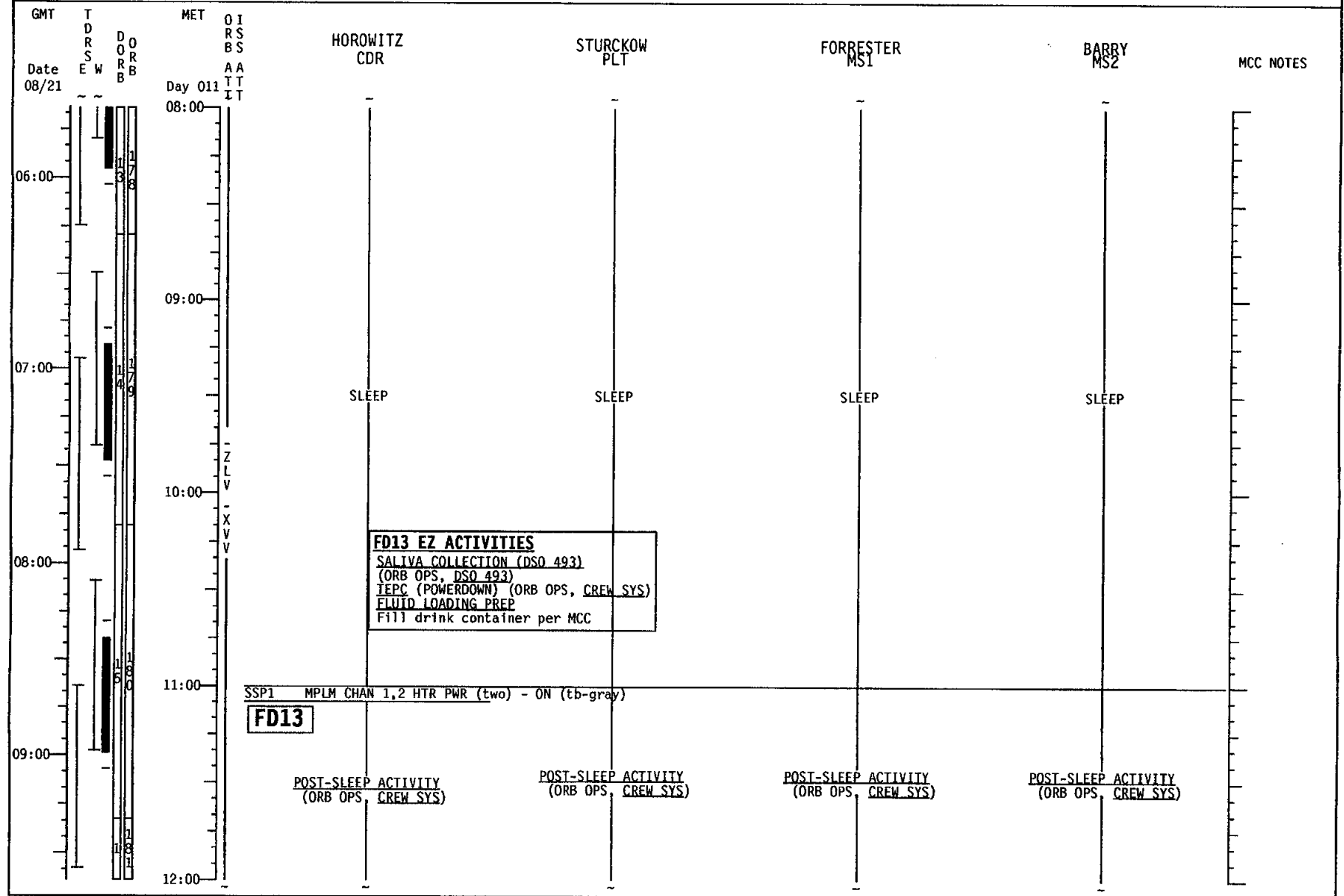

STS-105 7A.1 (FD 12)

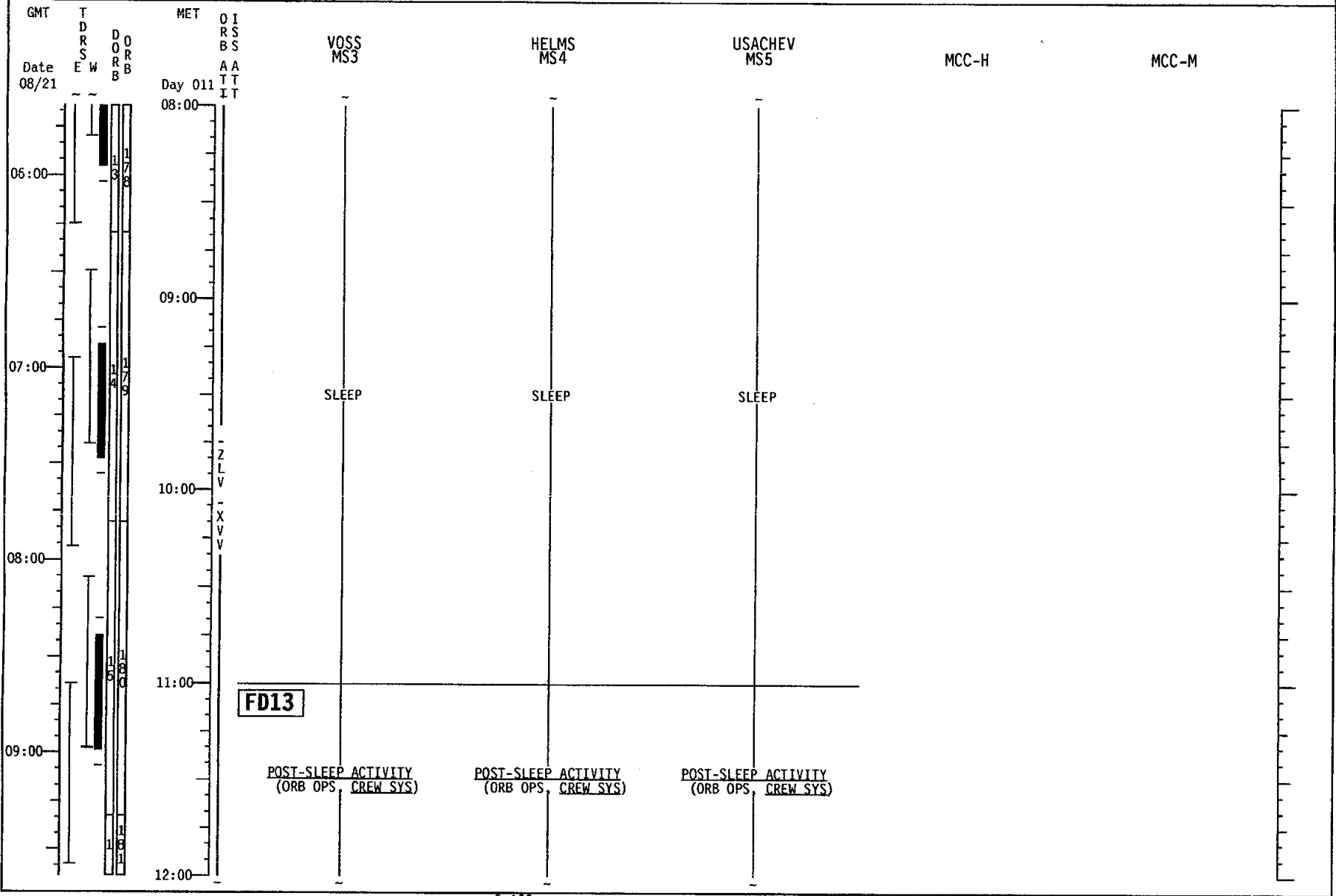

STS-105 7A.1 (FD 13)

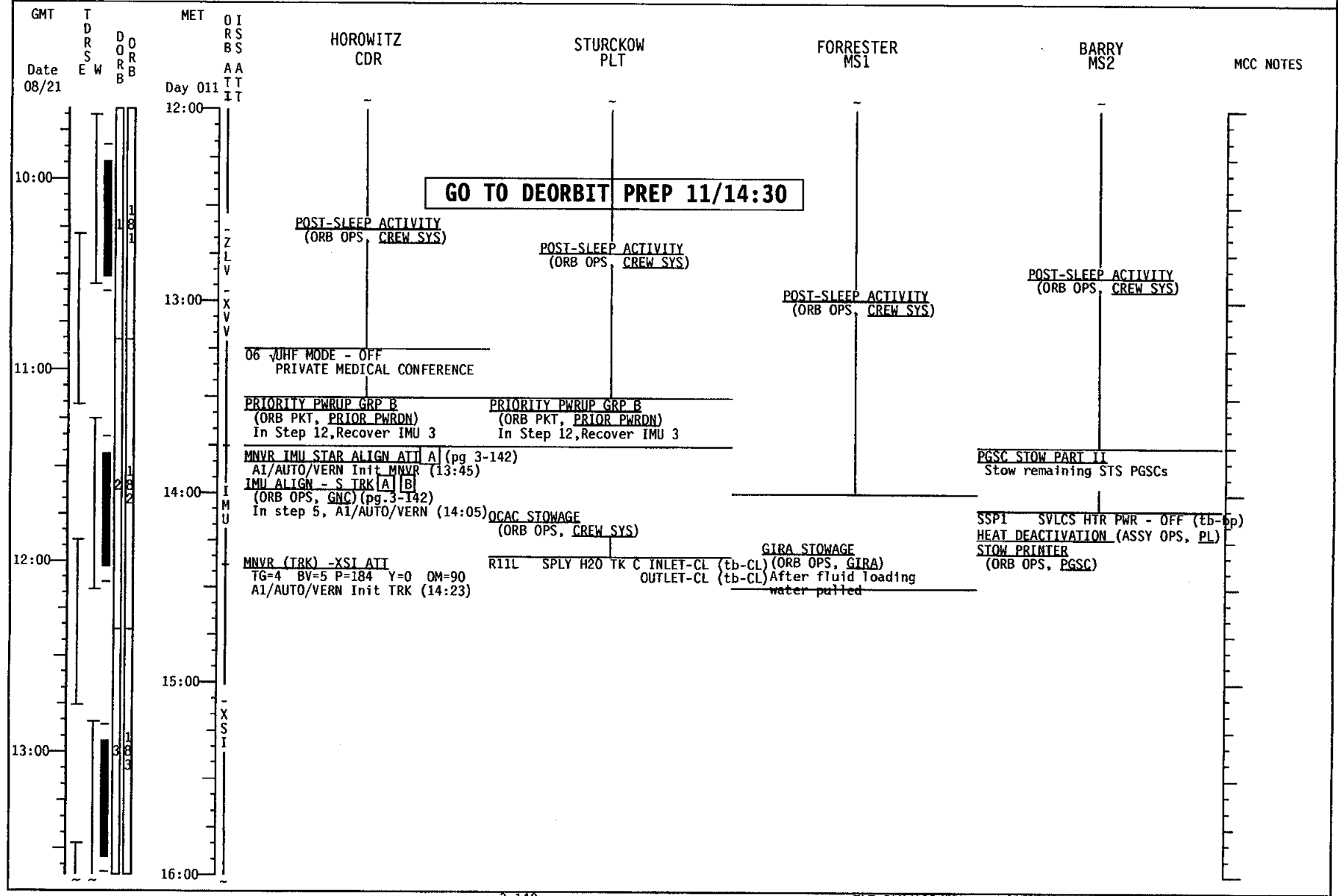

STS-105 7A.1 (FD 13)

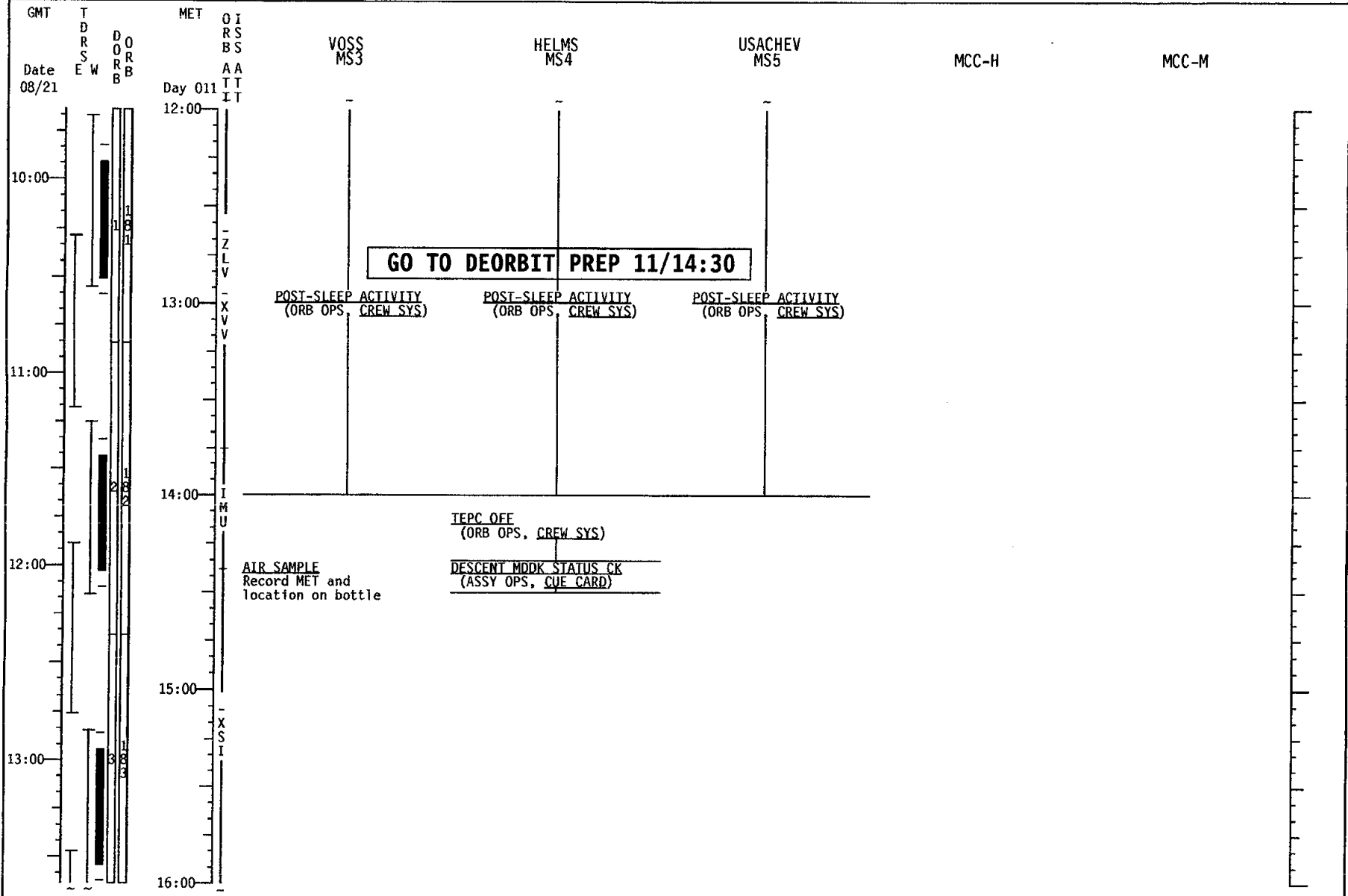

A	IMU STAR ALIGN		
ID: -Y: 43 RASALHAGUE			
MET (11/13:28 TO 11/14:16)			
-Z: 26 FOMALHAUT			
MET (11/13:48 TO 11/14:32)			
ANG DIFF: 883			
DUAL S TRKR ALIGNMENT		2nd ATTITUDE (SINGLE S TRKR)	
		-Z: 43	-Y: 26
R	348	R	261 74
P	302	P	292 313
Y	356	Y	7 6
REQD ID:			
-Y: ____, -Z: ____, ANG ERR ____, ____, ____,			
ANG: 1 2 3			
ΔX	{ } ____, ____, ____,	{ } ____, ____, ____,	{ } ____, ____, ____,
ΔY	{ } ____, ____, ____,	{ } ____, ____, ____,	{ } ____, ____, ____,
ΔZ	{ } ____, ____, ____,	{ } ____, ____, ____,	{ } ____, ____, ____,
EXECUTION TIME: __/__:__: MET			

B	IMU STAR VERIFICATION		
ID: -Y: 33 PEACOCK			
MET (11/13:48 TO 11/14:33)			
-Z: 59 SCHEAT			
MET (11/13:37 TO 11/14:23)			
ANG DIFF: 84.0			
DUAL S TRKR ALIGNMENT		2nd ATTITUDE (SINGLE S TRKR)	
		-Z: 33	-Y: 59
R	326	R	229 82
P	210	P	200 240
Y	290	Y	304 299
REQD ID:			
-Y: ____, -Z: ____, ANG ERR ____, ____, ____,			
ANG: 1 2 3			
ΔX	{ } ____, ____, ____,	{ } ____, ____, ____,	{ } ____, ____, ____,
ΔY	{ } ____, ____, ____,	{ } ____, ____, ____,	{ } ____, ____, ____,
ΔZ	{ } ____, ____, ____,	{ } ____, ____, ____,	{ } ____, ____, ____,
If any ΔX, ΔY, OR ΔZ > 0.1 Check MCC			
EXECUTION TIME: __/__:__: MET			

STS-105 DAP TABLE

STS-105
DAP TABLE

This Page Intentionally Blank

<u>DAP</u>	<u>PURPOSE</u>	<u>DAP</u>	<u>PURPOSE</u>
A1	- NOMINAL	B1	- OMS/RCS BURNS
A2	- PTC	B2	- LOSS OF VERN (TAIL ONLY)
A3	- GG	B3	- LOSS OF VERN (ALL)
A4	- PRE/POST DEPLOY	B4	- SSUS DEPLOY
A5	- LOSS OF VERN (ALL)	B5	- COAS/HUD CAL
A6	- LOSS OF VERN (TAIL ONLY)	B6	-
A7	- RNDZ	B7	- RNDZ
A8	- TERMINAL PHASE	B8	- TERMINAL PHASE
A9	- PROX OPS/FLYAROUND	B9	- PROX OPS/FLYAROUND
A10	- DOCKING	B10	- DOCKING
A11	- AUTO REBOOST	B11	-
A12	- VRCS MATED STACK	B12	- ALT MATED STACK AND RMS OPS
A13	- A/L DEPRESS ATTITUDE CONTROL	B13	- A/L DEPRESS RATE DAMPING
A14	-	B14	-
A15	- PRCS (DTO 257)	B15	-

DAPs FOR MATED OPS ARE BASED ON ANALYSIS FROM
GNC, PDRS, AND DRAPER LABS

UNIV PTG	
TGT ID	= 1 Orbiting Vehicle = 2 Earth ctr = 3 Earth tgt Input LAT (± 90) LON (± 180 , + = Earth) ALT (-3444.0 to 20000.0 nm)
	= 4 Sun ctr = 5 Celestial tgt Input RA (0-359.99) DEC (± 90) = 11-110 Nav Stars
BODY VECT	= 1 +X* = 2 -X* = 3 -Z* = 4 -Y Star Tracker* = 5 Optional Input P (0-359.99) Y (270-359.99, 0-90)
* input OM	→ OM (0-359.99)
MON AXIS	= 1 +X = 2 -X

CNTL ACC = 0 UNLOADED RMS
= 1 VRCS MATED CONTROL
= 2 ALT PRCS MATED CONTROL
= 3 A/L DEPRESS VRCS MATED CONTROL
= 4 A/L DEPRESS ALT PRCS MATED CONTROL
= 5-9 NOT USED

STS-105 DAP A1 THROUGH A8 CONFIGURATIONS

	ITEM #	A1	A2	A3	A4	A5	A6	A7	A8
PRI									
ROT RATE	10(50)	0.2000	0.4000	0.2000	0.5000	0.2000	0.2000	0.2000	0.0500
ATT DB	11(51)	5.00	1.00	0.30	3.00	5.00	5.00	2.00	2.00
RATE DB	12(52)	0.20	0.20	0.20	0.20	0.20	0.20	0.20	0.20
ROT PLS	13(53)	0.100	0.100	0.100	0.100	0.100	0.100	0.100	0.100
COMP	14(54)	.000	.000	.000	.000	.000	.000	.000	.000
P OPTION	15(55)	ALL	ALL	ALL	ALL	ALL	TAIL	ALL	ALL
Y OPTION	16(56)	ALL	ALL	TAIL	ALL	ALL	TAIL	ALL	ALL
TRAN PLS	17(57)	0.100	0.100	0.100	0.100	0.100	0.100	0.100	0.100
ALT									
RATE DB	18(58)	0.200	0.200	0.070	0.200	0.070	0.070	0.100	0.100
JET OPT	19(59)	ALL	ALL	ALL	ALL	ALL	TAIL	ALL	ALL
# JETS	20(60)	2	2	1	2	1	1	2	2
ON TIME	21(61)	0.08	0.08	0.08	0.08	0.08	0.08	0.08	0.08
DELAY	22(62)	0.00	0.00	0.00	0.00	0.00	0.00	0.00	0.00
VERN									
ROT RATE	23(63)	0.2000	0.4000	0.0080	0.2000	0.0500	0.0500	0.0160	0.0500
ATT DB	24(64)	1.000	1.000	0.070	1.000	1.000	1.000	1.000	1.000
RATE DB	25(65)	.020	.020	.010	.020	.020	.020	.020	.020
ROT PLS	26(66)	0.010	0.010	0.010	0.010	0.010	0.010	0.010	0.050
COMP	27(67)	.000	.000	.000	.000	.000	.000	.000	.000
CNTL ACC	28(68)	0	0	0	0	0	0	0	0
PURPOSE		NOMINAL	PTC	GG	PRE/POST DEPLOY	LOSS OF VERN (ALL)	LOSS OF VERN (TAIL ONLY)	RNDZ	TERMINAL PHASE

STS-105 DAP A9 THROUGH A15 CONFIGURATIONS

	ITEM #	A9	A10	A11	A12	A13	A14	A15
PRI								
ROT RATE	10(50)	0.1300	0.0500	0.1000	0.1000	0.1000	0.2000	0.1000
ATT DB	11(51)	1.00	0.50	10.00	5.00	5.00	5.00	40.00
RATE DB	12(52)	0.10	0.10	0.20	0.20	0.20	0.20	0.20
ROT PLS	13(53)	0.100	0.100	0.100	0.040	0.040	0.100	0.003
COMP	14(54)	.000	.000	.000	.000	.000	.000	.000
P OPTION	15(55)	TAIL	TAIL	TAIL	TAIL	TAIL	ALL	TAIL
Y OPTION	16(56)	TAIL	TAIL	TAIL	TAIL	TAIL	ALL	TAIL
TRAN PLS	17(57)	0.050	0.050	0.100	0.010	0.010	0.100	0.100
ALT								
RATE DB	18(58)	0.100	0.100	0.070	0.070	0.070	0.200	0.200
JET OPT	19(59)	TAIL	TAIL	TAIL	TAIL	TAIL	ALL	TAIL
# JETS	20(60)	2	2	3	3	3	2	2
ON TIME	21(61)	0.08	0.08	0.08	0.08	0.08	0.08	0.08
DELAY	22(62)	0.00	0.00	11.60	11.04	11.04	0.00	0.00
VERN								
ROT RATE	23(63)	0.1300	0.0500	0.1000	0.1000	0.1000	0.2000	0.0200
ATT DB	24(64)	1.000	0.500	5.000	3.000	3.000	1.000	5.000
RATE DB	25(65)	.020	.020	.050	.050	.080	.020	.050
ROT PLS	26(66)	0.050	0.050	0.010	0.002	0.002	0.010	0.001
COMP	27(67)	.000	.000	.000	.000	.000	.000	.000
CNTL ACC	28(68)	0	0	1,2*	1	3,4**	0	7
PURPOSE		PROX OPS/ FLYAROUND	DOCKING	AUTO REBOOST	VRCS MATED STACK	A/L DEPRESS ATTITUDE CONTROL		

BOLD-ITALIC indicate a change from the I-load

*1 For VERN, 2 for ALT

**3 For VERN, 4 for ALT

STS-105 DAP B1 THROUGH B8 CONFIGURATIONS

	ITEM #	B1	B2	B3	B4	B5	B6	B7	B8
PRI									
ROT RATE	30(50)	0.5000	0.2000	0.2000	0.2000	0.2000	0.5000	0.5000	0.0500
ATT DB	31(51)	3.00	3.00	3.00	0.30	3.00	3.00	2.00	2.00
RATE DB	32(52)	0.20	0.20	0.20	0.20	0.20	0.20	0.20	0.20
ROT PLS	33(53)	0.040	0.040	0.040	0.040	0.040	0.040	0.040	0.040
COMP	34(54)	.000	.000	.000	.000	.000	.000	.000	.000
P OPTION	35(55)	ALL	TAIL	ALL	TAIL	TAIL	ALL	ALL	ALL
Y OPTION	36(56)	ALL	TAIL	ALL	TAIL	TAIL	ALL	ALL	ALL
TRAN PLS	37(57)	0.100	0.020	0.020	0.020	0.020	0.020	0.050	0.050
ALT									
RATE DB	38(58)	0.200	0.070	0.070	0.100	0.200	0.200	0.100	0.100
JET OPT	39(59)	ALL	TAIL	ALL	ALL	ALL	ALL	ALL	ALL
# JETS	40(60)	2	1	1	2	2	2	2	2
ON TIME	41(61)	0.08	0.08	0.08	0.08	0.08	0.08	0.08	0.08
DELAY	42(62)	0.00	0.00	0.00	0.00	0.00	0.00	0.00	0.00
VERN									
ROT RATE	43(63)	0.2000	0.2000	0.2000	0.0080	0.0160	0.2000	0.2000	0.0500
ATT DB	44(64)	1.000	1.000	1.000	0.100	0.033	1.000	1.000	1.000
RATE DB	45(65)	.020	.020	.020	.010	.020	.020	.020	.020
ROT PLS	46(66)	0.002	0.002	0.002	0.002	0.002	0.002	0.002	0.020
COMP	47(67)	.000	.000	.000	.000	.000	.000	.000	.000
CNTL ACC	48(68)	0	0	0	0	0	0	0	0
PURPOSE		OMS/RCS BURNS	LOSS OF VERN (TAIL ONLY)	LOSS OF VERN (ALL)	SSUS DEPLOY	COAS/HUD CAL		RNDZ	TERMINAL PHASE

STS-105 B9 THROUGH B15 DAP CONFIGURATIONS

	ITEM #	B9	B10	B11	B12	B13	B14	B15
PRI								
ROT RATE	30(50)	0.1300	0.0500	0.5000	0.1000	0.1000	0.5000	0.1000
ATT DB	31(51)	1.00	0.50	3.00	5.00	40.00	3.00	40.00
RATE DB	32(52)	0.10	0.10	0.20	0.20	0.20	0.20	0.20
ROT PLS	33(53)	0.040	0.040	0.040	0.040	0.040	0.040	0.003
COMP	34(54)	.000	.000	.000	.000	.000	.000	.000
P OPTION	35(55)	TAIL	TAIL	ALL	TAIL	TAIL	ALL	TAIL
Y OPTION	36(56)	TAIL	TAIL	ALL	TAIL	TAIL	ALL	TAIL
TRAN PLS	37(57)	0.010	0.010	0.020	0.010	0.010	0.020	0.010
ALT								
RATE DB	38(58)	0.100	0.100	0.200	0.070	0.070	0.200	0.200
JET OPT	39(59)	TAIL	TAIL	ALL	TAIL	TAIL	ALL	TAIL
# JETS	40(60)	2	2	2	3	3	2	2
ON TIME	41(61)	0.08	0.08	0.08	0.08	0.08	0.08	0.08
DELAY	42(62)	0.00	0.00	0.00	11.04	11.04	0.00	0.00
VERN								
ROT RATE	43(63)	0.1300	0.0500	0.2000	0.1000	0.1000	0.2000	0.2000
ATT DB	44(64)	1.000	0.500	1.000	3.000	40.000	1.000	5.000
RATE DB	45(65)	.020	.020	.020	.050	.050	.020	.050
ROT PLS	46(66)	0.020	0.020	0.002	0.002	0.002	0.002	0.001
COMP	47(67)	.000	.000	.000	.000	.000	.000	.000
CNTL ACC	48(68)	0	0	0	2	3,4*	0	7
PURPOSE		PROX OPS/ FLYAROUND	DOCKING		ALT MATED STACK AND RMS OPS	A/L DEPRESS RATE DAMPING		

BOLD-ITALIC indicate a change from I-load or prior flight DAP configuration

*3 for VERN, 4 for ALT

This Page Intentionally Blank

The sections following this divider page will not be included in flight copies.

This Page Intentionally Blank

ATTITUDE TIMELINE

ATTITUDE
TIMELINE

Attitude Timeline

MET/GMT	MNVR OPTION		DAP	E/S	REF ATT/REMARKS	EVENT
1 000/00:30:00 MET 221/22:08:12 GMT	INRTL R= 48.00 MNVR P=131.00 Y=344.00	TRN AUTO ALT	RATE 0.5000 DB AT 3.50 DB RT 0.200	SUN R 355 P 85	LVLH R= 0.00 P=16.000 Y= 0.00 AT TIG	OMS-2 Att TIG 0/0:38:16
2 000/01:10:00 MET 21:11 221/22:48:12 GMT 59:23	TGT=2 BV=3 P= 90.00 Y= 0.00 OM= 90.00	A1 AUTO ALT	RATE 0.2000 DB AT 5.00 DB RT 0.200	EARTH R 0 P 90	LVLH R= 0.00 P=180.00 Y=270.00	PLB Opening and SOPA -ZLV -YVV
3 000/03:15:00 MET 28:15 222/00:53:12 GMT 01:06:27	INRTL R=317.00 MNVR P=220.00 Y=347.00	A1 AUTO VERN	RATE 0.2000 DB AT 1.000 DB RT 0.020	SUN R 151 P 55	LVLH R=180 P=344 Y= 0.00 AT TIG	NC-1 Posigrade Heads Down TIG:0/3:32:53
4 000/03:45:00 MET 58:41 222/01:23:12 GMT 36:53	TGT=2 BV=3 P= 90.00 Y= 0.00 OM= 0.00	A1 AUTO VERN	RATE 0.2000 DB AT 1.000 DB RT 0.020	EARTH R 360 P 90	LVLH R= 0.00 P=180.00 Y= 0.00	-ZLV -XVV
5 000/19:05:00 MET 19:46 222/16:43:12 GMT 57:58	INRTL R=354.00 MNVR P=103.00 Y= 38.00	A1 AUTO VERN	RATE 0.2000 DB AT 1.000 DB RT 0.020	SUN R 41 P 72		NC-2 TIG 00/19:22:24
6 000/19:26:00 MET 40:43 222/17:04:12 GMT 18:55	TGT=2 BV=3 P= 90.00 Y= 0.00 OM= 0.00	A1 AUTO VERN	RATE 0.2000 DB AT 1.000 DB RT 0.020	EARTH R 0 P 90	LVLH R= 0.00 P=180.00 Y= 0.00	-ZLV -XVV
7 000/19:35:57 MET 222/17:14:09 GMT	NPC Multi axis					
8 001/01:55:00 MET 02:05:55 222/23:33:12 GMT 44:07	INRTL R=201.00 MNVR P= 65.00 Y= 33.00	A1 AUTO VERN	RATE 0.2000 DB AT 1.000 DB RT 0.020	SUN R 215 P 97	LVLH R= 0.00 P=16.000 Y= 0.00 AT TIG	NC3 Burn TIG:1/02:11:00 HEADS UP STARS
9 001/02:20:00 MET 30:39 222/23:58:12 GMT 223/00:08:51	TGT=2 BV=3 P= 90.00 Y= 0.00 OM= 0.00	A1 AUTO VERN	RATE 0.2000 DB AT 1.000 DB RT 0.020	EARTH R 0 P 90	LVLH R= 0.00 P=180.00 Y= 0.00	-ZLV -XVV
10 001/15:10:00 MET 17:30 223/12:48:12 GMT 55:42	TGT=2 BV=5 P= 90.00 Y= 0.00 OM=270.00	A1 AUTO VERN	RATE 0.2000 DB AT 1.000 DB RT 0.020	EARTH R 360 P 90	LVLH R= 0.00 P=180.00 Y= 90.00	Waste dump -ZLV +YVV
11 001/16:55:00 MET 17:05:46 223/14:33:12 GMT 43:58	INRTL R=206.00 MNVR P= 60.00 Y= 31.00	A1 AUTO VERN	RATE 0.2000 DB AT 1.000 DB RT 0.020	SUN R 212 P 102	LVLH R= 0.00 P=16.000 Y= 0.00 AT TIG	NH Burn Att TIG:1/17:17:30 HEADS UP
12 001/17:20:00 MET 223/14:58:12 GMT		A1 LVLH VERN	RATE 0.2000 DB AT 1.000 DB RT 0.020	EARTH R 181 P 116	LVLH R=359.37 HOLD P= 26.36 Y=359.74	LVLH between Burns

*** ALL ATTITUDES IN MEAN OF 1950 ***
*** PYR EULER SEQUENCE ***

ATTITUDE
TIMELINE

Attitude Timeline

MET/GMT	MNVR OPTION	DAP	E/S	REF ATT/REMARKS	EVENT
13					
001/18:00:00 MET	INRTL R=152.00	A1 RATE 0.2000	SUN	LVLH R= 0.00	NC4 Burn
01:38	MNVR P=238.00	AUTO DB AT 1.000	R 328	P=16.000	TIG:1/18:02:22
223/15:38:12 GMT	Y=330.00	VERN DB RT 0.020	P 77	Y= 0.00	HEADS UP
39:50				AT TIG	STARS
14					
001/18:05:00 MET	TGT=2	B7 RATE 0.5000	EARTH	LVLH R= 0.00	Rendezvous
08:52	BV=1	AUTO DB AT 2.00	R 139	P=270.00	+XLV -ZVV
223/15:43:12 GMT	P= 0.00	ALT DB RT 0.100	P 0	Y= 0.00	
47:04	Y= 0.00			OM= 0.00	
15					
001/18:16:30 MET	TGT=2	A7 RATE 0.0070	EARTH	LVLH R= 0.00	-Z Traget Track
42:41	BV=5	AUTO DB AT 1.000	R 180	P=281.00	
223/15:54:42 GMT	P=349.00	VERN DB RT 0.020	P 11	Y= 0.00	
16:20:53	Y= 0.00			OM= 0.00	
16					
001/18:43:30 MET	TGT=2	A7 RATE 0.0090			-Z Traget Track
	BV=5	AUTO DB AT 1.000			
223/16:21:42 GMT	P=328.00	VERN DB RT 0.020			
	Y= 0.00				
	OM= 0.00				
17					
001/19:15:00 MET	*** MNVR INTERRUPT ***	A7 RATE 0.2000	SUN	LVLH R= 0.00	TI Burn Att
11	INRTL R=154.00	AUTO DB AT 2.00	R 329	P=16.000	TIG:01/19:35:30
223/16:53:12 GMT	MNVR P=242.00	ALT DB RT 0.100	P 79	Y= 0.00	
23	Y=329.00			AT TIG	
18					
001/19:34:30 MET	TGT=2	B7 RATE 0.5000	EARTH	LVLH R= 0.00	-Z Traget Track
37:54	BV=5	AUTO DB AT 2.00	R 153	P=270.00	
223/17:12:42 GMT	P= 0.00	ALT DB RT 0.100	P 0	Y= 0.00	
16:06	Y= 0.00			OM= 0.00	
19					
001/19:39:30 MET	TGT=2	A7 RATE 0.0190	EARTH	LVLH R= 0.00	-Z Traget Track
20:45:17	BV=5	AUTO DB AT 1.000	R 180	P=345.00	
223/17:17:42 GMT	P=285.00	VERN DB RT 0.020	P 75	Y= 0.00	
18:23:29	Y= 0.00			OM= 0.00	
20					
001/20:45:30 MET	TGT=2	A8 RATE 0.0500	EARTH	LVLH R= 0.00	+ZLV +XVV
50:30	BV=5	AUTO DB AT 1.000	R 180	P= 0.00	Establish Rbar
223/18:23:42 GMT	P=270.00	VERN DB RT 0.020	P 90	Y= 0.00	
28:42	Y= 0.00			OM= 0.00	
21					
001/21:00:00 MET	TGT=2	A9 RATE 0.1300	EARTH	LVLH R= 0.00	-XLV +ZVV
11:32	BV=5	AUTO DB AT 1.000	R 20	P= 90.00	TORVA to Vbar
223/18:38:12 GMT	P=180.00	VERN DB RT 0.020	P 180	Y= 0.00	
49:44	Y= 0.00			OM= 0.00	
22					
001/21:56:00 MET					DOCKING
223/19:34:12 GMT					
23					
001/22:16:00 MET	TGT=2	A12 RATE 0.1000	EARTH	LVLH R= 0.00	LVLH TEA
20:10	BV=5	AUTO DB AT 3.000	R 0	P=115.00	BIAS -XLV +ZVV
223/19:54:12 GMT	P=155.00	VERN DB RT 0.050	P 155	Y= 0.00	ISS LVLH YPR
58:22	Y= 0.00			OM= 0.00	(0,25,0)
24					
003/21:20:00 MET	TGT=2	A12 RATE 0.1000	EARTH	LVLH R= 0.00	Reboost confg 4
44:40	BV=5	AUTO DB AT 3.000	R 180	P=327.00	
225/18:58:12 GMT	P=303.00	VERN DB RT 0.050	P 57	Y= 0.00	
19:22:52	Y= 0.00			OM= 0.00	

*** ALL ATTITUDES IN MEAN OF 1950 ***
 *** PYR EULER SEQUENCE ***

Attitude Timeline

MET/GMT	MNVR OPTION	DAP	E/S	REF ATT/REMARKS	EVENT
25 003/23:00:00 MET 26:15 225/20:38:12 GMT 21:04:27	TGT=2 BV=5 P=155.00 Y= 0.00 OM=270.00	A12 RATE 0.1000 AUTO DB AT 3.000 VERN DB RT 0.050	EARTH R 360 P 155	LVLH R= 90.00 P= 90.00 Y= 25.00	WASTE DUMP Bias -XLV +YVV ISS LVLH YPR (270,25,0)
26 004/00:25:00 MET 40:00 225/22:03:12 GMT 18:12	TGT=2 BV=5 P=155.00 Y= 0.00 OM= 0.00	A12 RATE 0.1000 AUTO DB AT 3.000 VERN DB RT 0.050	EARTH R 360 P 155	LVLH R= 0.00 P=115.00 Y= 0.00	TEA Bias -XLV +ZVV ISS LVLH YPR (0,25,0)
27 004/18:55:00 MET 19:19:40 226/16:33:12 GMT 57:52	TGT=2 BV=5 P=303.00 Y= 0.00 OM= 0.00 SUN SET 18:53	A12 RATE 0.1000 AUTO DB AT 3.000 VERN DB RT 0.050	EARTH R 180 P 57	LVLH R= 0.00 P=327.00 Y= 0.00	Reboost confg 4
28 004/20:00:00 MET 24:40 226/17:38:12 GMT 18:02:52	TGT=2 BV=5 P=155.00 Y= 0.00 OM= 0.00	A12 RATE 0.1000 AUTO DB AT 3.000 VERN DB RT 0.050	EARTH R 360 P 155	LVLH R= 0.00 P=115.00 Y= 0.00	TEA Bias -XLV +ZVV ISS LVLH YPR (0,25,0)
29 005/17:00:00 MET 227/14:38:12 GMT				DAPS to A13/B13 on depress	EVA 1 5/17:00:00 to 5/23:45:00
30 006/15:36:00 MET 16:06:00 228/13:14:12 GMT 44:12	TGT=2 BV=5 P=174.00 Y= 0.00 OM=180.00	A12 RATE 0.1000 AUTO DB AT 3.000 VERN DB RT 0.050	EARTH R 0 P 174	LVLH R=180.00 P= 84.00 Y= 0.00	Reboost confg 3
31 006/17:09:00 MET 24:16 228/14:47:12 GMT 15:02:28	TGT=2 BV=5 P=155.00 Y= 0.00 OM=270.00	A12 RATE 0.1000 AUTO DB AT 3.000 VERN DB RT 0.050	EARTH R 360 P 155	LVLH R= 90.00 P= 90.00 Y= 25.00	Dump Att Bias -XLV +YVV ISS LVLH YPR (270,25,0)
32 006/18:42:00 MET 57:00 228/16:20:12 GMT 35:12	TGT=2 BV=5 P=155.00 Y= 0.00 OM= 0.00	A12 RATE 0.1000 AUTO DB AT 3.000 VERN DB RT 0.050	EARTH R 0 P 155	LVLH R= 0.00 P=115.00 Y= 0.00	LVLH TEA Bias -XLV +ZVV ISS LVLH YPR (0,25,0)
33 007/17:00:00 MET 229/14:38:12 GMT				DAPS to A13/B13 on depress	EVA 2 7/17:00:00 to 7/23:45:00
34 008/15:27:00 MET 42:00 230/13:05:12 GMT 20:12	TGT=2 BV=5 P=155.00 Y= 0.00 OM=270.00 SUN SET 15:02	A12 RATE 0.1000 AUTO DB AT 3.000 VERN DB RT 0.050	EARTH R 0 P 155	LVLH R= 90.00 P= 90.00 Y= 25.00	Dump Att Bias -XLV +YVV ISS LVLH YPR (270,25,0)
35 008/17:00:00 MET 15:00 230/14:38:12 GMT 53:12	TGT=2 BV=5 P=155.00 Y= 0.00 OM= 0.00	A12 RATE 0.1000 AUTO DB AT 3.000 VERN DB RT 0.050	EARTH R 0 P 155	LVLH R= 0.00 P=115.00 Y= 0.00	LVLH TEA Bias -XLV +ZVV ISS LVLH YPR (0,25,0)
36 009/18:16:33 MET 231/15:54:45 GMT				LVLH R=0 P=115 Y=0	Free Drift For Undoocking ISS LVLH YPR (0,25,0)

*** ALL ATTITUDES IN MEAN OF 1950 ***
*** PYR EULER SEQUENCE ***

Attitude Timeline

MET/GMT	MNVR OPTION	DAP	E/S	REF ATT/REMARKS	EVENT	
37 009/18:21:00 MET 231/15:59:12 GMT	TGT=2 BV=5 P=155.00 Y= 0.00 OM= 0.00	A9 AUTO DB AT 1.000 VERN DB RT 0.020	RATE 0.1300 DB AT 1.000 RT 0.020	EARTH R 0 P 155	LVLH R= 0.00 P=115.00 Y= 0.00	POST UNDOCK TEA
38 009/18:36:00 MET 231/16:14:12 GMT	TGT=2 BV=5 P= 90.00 Y= 0.00 OM= 0.00	A9 AUTO DB AT 1.000 VERN DB RT 0.020	RATE 0.1300 DB AT 1.000 RT 0.020			Fly Around Start
39 009/18:42:00 MET 231/16:20:12 GMT	*** MNVR INTERRUPT *** TGT=2 BV=5 P= 0.00 Y= 0.00 OM= 0.00	A9 AUTO DB AT 1.000 VERN DB RT 0.020	RATE 0.1300 DB AT 1.000 RT 0.020			Fly Around PRIOR TO -Rbar
40 009/18:55:00 MET 231/16:33:12 GMT	*** MNVR INTERRUPT *** TGT=2 BV=5 P=270.00 Y= 0.00 OM= 0.00	A9 AUTO DB AT 1.000 VERN DB RT 0.020	RATE 0.1300 DB AT 1.000 RT 0.020			Fly Around PRIOR TO -VBAR
41 009/19:04:00 MET 231/16:42:12 GMT	*** MNVR INTERRUPT *** TGT=2 BV=5 P=180.00 Y= 0.00 OM= 0.00	A9 AUTO DB AT 1.000 VERN DB RT 0.020	RATE 0.1300 DB AT 1.000 RT 0.020			Fly Around PRIOR TO Rbar
42 009/19:16:00 MET 30:29 231/16:54:12 GMT 17:08:41	*** MNVR INTERRUPT *** TGT=2 BV=5 P= 90.00 Y= 0.00 OM= 0.00	A9 AUTO DB AT 1.000 VERN DB RT 0.020	RATE 0.1300 DB AT 1.000 RT 0.020	EARTH R 0 P 90	LVLH R= 0.00 P=180.00 Y= 0.00	Fly Around PRIOR TO Vbar
43 009/19:36:33 MET 231/17:14:45 GMT				LVLH R=0 P=180 Y=0	FINAL SEP (undock +75min)	
44 009/19:40:00 MET 45:50 231/17:18:12 GMT 24:02	TGT=2 BV=3 P= 90.00 Y= 0.00 OM=290.00	A1 AUTO DB AT 1.000 VERN DB RT 0.020	RATE 0.2000 DB AT 1.000 RT 0.020	EARTH R 360 P 90	LVLH R= 0.00 P=180.00 Y= 70.00	-ZLV BIAS +YV
45 009/20:50:00 MET 21:04:25 231/18:28:12 GMT 42:37	TGT=4 BV=5 P=270.00 Y= 0.00 OM=220.00 desire to deploy at open	A1 AUTO DB AT 1.000 VERN DB RT 0.020	RATE 0.2000 DB AT 1.000 RT 0.020	SUN R 180 P 90	INRTL R=328.86 P=279.87 Y=351.53	+ZSI SSAT Deploy window 09/21:12:08 to 09/21:42
46 009/22:00:00 MET 12:04 231/19:38:12 GMT 50:16	INRTL R=241.00 MNVR P= 50.00 Y= 9.00	A7 AUTO DB AT 2.00 ALT DB RT 0.100	RATE 0.2000 DB AT 2.00 RT 0.100	SUN R 170 P 128	LVLH R= 0.00 P=16.000 Y= 0.00 AT TIG	SEP Burn att TIG:09/22:31:00
47 009/22:40:00 MET 50:45 231/20:18:12 GMT 28:57	TGT=2 BV=3 P= 90.00 Y= 0.00 OM= 0.00	A1 AUTO DB AT 1.000 VERN DB RT 0.020	RATE 0.2000 DB AT 1.000 RT 0.020	EARTH R 0 P 90	LVLH R= 0.00 P=180.00 Y= 0.00	-ZLV -XV
48 010/15:30:00 MET 37:30 232/13:08:12 GMT 15:42	TGT=2 BV=3 P= 90.00 Y= 0.00 OM=270.00	A1 AUTO DB AT 1.000 VERN DB RT 0.020	RATE 0.2000 DB AT 1.000 RT 0.020	EARTH R 0 P 90	LVLH R= 0.00 P=180.00 Y= 90.00	Waste Dump -ZLV +YV

*** ALL ATTITUDES IN MEAN OF 1950 ***
*** PYR RULER SEQUENCE ***

Attitude Timeline

MET/GMT	MNVR OPTION	DA	E/S	REF ATT/REMARKS	EVENT
49 010/17:20:00 MET 27:30 232/14:58:12 GMT 15:05:42	TGT=2 BV=3 P= 90.00 Y= 0.00 OM= 0.00	A1 AUTO VERN RATE 0.2000 DB AT 1.000 DB RT 0.020	EARTH R 0 P 90	LVLH R= 0.00 P=180.00 Y= 0.00	-ZLV -XVV
50 011/13:45:00 MET 55:40 233/11:23:12 GMT 33:52	INRTL R=348.00 MNVR P=302.00 Y=356.00	A1 AUTO VERN RATE 0.2000 DB AT 1.000 DB RT 0.020	SUN R 163 P 108	-Y:43 -Z:26 PAIR AOS 13:48 LOS 14:16	IMU -Y: 13:28-14:16 -Z: 13:48-14:32
51 011/14:05:00 MET 13:11 233/11:43:12 GMT 51:23	INRTL R=326.00 MNVR P=210.00 Y=290.00	A1 AUTO VERN RATE 0.2000 DB AT 1.000 DB RT 0.020	SUN R 138 P 100	-Y:59 -Z:33 PAIR AOS 13:48 LOS 14:23	VERIF -Y: 13:37-14:23 -Z: 13:48-14:33
52 011/14:23:00 MET 29:35 233/12:01:12 GMT 07:47	TGT=4 RA= 149.970 BV=5 DEC= 12.246N P=184.00 Y= 0.00 OM= 90.00	A1 AUTO VERN RATE 0.2000 DB AT 1.000 DB RT 0.020	SUN R 180 P 176	INRTL R=144.67 P= 17.82 Y=328.35	-XSI Rad Cold Soak
53 011/16:15:00 MET 26:21 233/13:53:12 GMT 14:04:33	INRTL R=294.00 MNVR P= 48.00 Y=336.00	A1 AUTO VERN RATE 0.2000 DB AT 1.000 DB RT 0.020	SUN R 83 P 149		Comm Attitude
54 011/18:20:00 MET 30:56 233/15:58:12 GMT 16:09:08	INRTL R=113.00 MNVR P=238.00 Y=335.00	A1 AUTO VERN RATE 0.2000 DB AT 1.000 DB RT 0.020	SUN R 18 P 69	LVLH R= 0.00 P=196.00 Y= 0.00 AT TIG	D/O Burn Att TIG 18:37

*** ALL ATTITUDES IN MEAN OF 1950 ***
*** PYR EULER SEQUENCE ***

FLIGHT PLAN NOTES

FLIGHT PLAN NOTES
(CONSTRAINTS AND GUIDELINES)

A. FLIGHT DESCRIPTION

Orbiter: OV103/Discovery
 Inclination: 51.6°
 Insertion Altitude: 127 nm
 ISS RNDZ Altitude: 210 nm
 Duration: 12 + 0 + 2 days

B. SHUTTLE AND STATION CREW

CDR	- Scott "Doc" Horowitz	ISS (up)	- Vladimir Dezhurov
PLT	- Rick "CJ" Sturckow	ISS (up)	- Mikhail Tyurin
MS1	- Patrick Forrester	ISS (down)	- Yuri Usachev
MS2	- Dan Barry	ISS (down)	- Jim Voss
ISS (up)	- Frank Culbertson	ISS (down)	- Susan Helms

C. MAJOR EVENTS

<u>MAJOR EVENT</u>	<u>MET</u>	<u>CDT DATE</u>	<u>CDT</u>	<u>GMT</u>	<u>V (FPS)</u>	<u>HP/HA (nm)</u>
Launch	00/00:00	08/09/01	16:38	221/21:38	—	—/—
OMS-2	00/00:38	08/09/01	17:16	221/22:16	96.2	190/125
NC1	00/03:33	08/09/01	20:11	222/01:11	186.5	190/125
NC2	00/19:22	08/10/01	12:00	222/17:00	8	189/190
NC3	01/02:11	08/10/01	18:49	222/23:49	37.6	211/129
NH	01/17:17	08/11/01	09:55	223/14:55	0	210/129
NC4	01/18:02	08/11/01	10:40	223/15:40	136	212/203
TI	01/19:36	08/11/01	12:14	223/17:14	8.8	215/206
Dock	01/21:56	08/11/01	14:34	223/19:34	—	212
Ingress	01/23:45	08/11/01	16:23	223/21:23	—	212
MPLM Install	02/15:20	08/12/01	07:58	224/12:58	—	212
Incr 3 Transferred	02/22:10	08/12/01	14:48	224/19:48	—	212
Reboost 1	03/21:20	08/13/01	13:58	225/18:58	6.8	217/210
Reboost 2	04/18:55	08/14/01	11:33	226/16:33	3.4	217/211
Interim Egress 1	05/00:45	08/14/01	17:23	226/22:23	—	217/211
EVA 1	05/17:05	08/15/01	09:43	227/14:43	—	217/211
Reboost 3	06/15:36	08/16/01	08:14	228/13:14	11.3	218/215
Interim Egress 2	07/00:45	08/16/01	17:23	228/22:23	—	218/215
EVA 2	07/17:05	08/17/01	09:43	229/14:43	—	218/215
MPLM Egress	08/16:05	08/18/01	08:43	230/13:43	—	218/215
MPLM Berth	08/22:50	08/18/01	15:28	230/19:28	—	218/215
Egress	09/15:00	08/19/01	07:38	231/12:38	—	218/215
Undock	09/18:16	08/19/01	10:54	231/15:54	3	218/214
Simplexat Deploy	09/21:12	08/19/01	13:50	231/18:50	—	218/214
OA Burn	09/22:31	08/19/01	15:09	231/20:09	135	217/139
D/O TIG	11/18:37	08/21/01	11:15	233/16:15	205	—/—
Landing	11/19:39	08/21/01	12:17	233/17:17	—	—/—

D. LANDING OPPORTUNITIES

		<u>Landing Orbit No.</u>	<u>Site</u>	<u>Local Time</u>	<u>MET</u>
Nominal	Primary	185	KSC	Aug 21 13:17	11/19:39
	1 Rev Late	186	KSC	Aug 21 14:52	11/21:14
1 Day Late	Primary	200	KSC	Aug 22 12:00	12/18:22
	1 Rev Late	201	KSC	Aug 22 13:35	12/19:57
2 Day Late	Primary	216	KSC	Aug 23 12:18	13/18:40
	1 Rev Late	217	KSC	Aug 23 13:53	13/20:15

E. COMMUNICATIONS

Shuttle

TDRS Support: East (47° W), West (171° W), Z (85° E)
 Contingency GSTDN: MLX, BDA, (BDX*), and WLP
 Contingency RTS: DGS, GTS, HTS, MIL, BDA, OTS, VTS, and NHS

UHF capability*

Lead time for site callup – GSTDN – 2 hr, RTS – 4 hr

ISS

TDRS Support: East (41° W), West (174° W), Z (85° E)

ISS

TDRS Support: East (47° W), West (171° W), Z (85° E)
 Russian RTS*: DJS, PPK, ULD, SHK, and USK

*The five Russian Remote Tracking Sites (RTSs) represent the available Regul SM Command Sites. The AOS/LOS of the sites are integrated into a single band on summary timeline tab data, but are displayed individually on the ISS detailed timeline pages.

F. PAYLOADS

1. LAUNCH PACKAGE (LP) 7A.1

The main purpose of Mission 7A.1 is to outfit the ISS and perform the second ISS crew rotation of the Expedition 2 and 3 crews. No new permanent modules will be delivered. Two EXPRESS racks will be transferred to ISS. In addition to these two racks, there are five Resupply Stowage Racks (RSRs) and six Resupply Stowage Platforms (RSPs) filled with logistics and supplies requiring transfer to ISS. All these racks are launched within a pressurized Multi Purpose Logistics Module (MPLM) located in the orbiter bay.

For external Orbital Replacement Units (ORUs) requiring Extravehicular Activity (EVA) installation externally on the ISS, there is an unpressurized Integrated Cargo Carrier (ICC), which will be used to secure the hardware during launch and on orbit until EVA operations begin. The ICC used during Mission 7A.1 will contain the External Ammonia Servicer (EAS), Materials International Space Station Experiment (MISSE), and Passive Experiment Containers (PECs). All planned EVA tasks can be accomplished within two EVAs.

The orbiter middeck will be used to stow equipment required for crew rotation, MPLM activation and ingress hardware, and some additional supporting equipment for HRF and Dreamtime. Additionally, there are powered and unpowered middeck locker experiments that will be transferred to ISS.

The orbiter will dock to PMA2 of the ISS, with the tail pointed down toward Earth and the belly pointed in the velocity vector. At high Sun beta angles, it is necessary to fly in an

X-axis perpendicular to the orbit plane (XPOP) reference plane. Ingress is planned immediately after docking, and middeck transfer and ISS crew handover will commence.

2. HITCHHIKER EXPERIMENTS ADVANCING TECHNOLOGY (HEAT)

HEAT is a collection of Get Away Special (GAS) canisters all under the direction of Goddard Space Flight Center. It consists of the following experiments:

a. Advanced Carrier Equipment (ACE) Avionics System

The ACE Avionics System has been designed to replace the HH Avionics. This project is managed by NASA/GSFC. ACE will require a Ku interface and a Payload Signal Processor (PSP) interface. A standard (8 kbps) PDI interface from the orbiter is required, although a selectable (8, 16, 32 kbps) PDI is highly desired. Activation and status of the ACE avionics shall be through the Standard Switch Panel.

b. SimpleSAT

SimpleSAT is an engineering satellite designed to evaluate the use of inexpensive commercial hardware of spacecraft. It is expected that SimpleSAT will demonstrate GPS attitude control and fine pointing control while in free-flyer Low Earth Orbit (LEO).

c. Student Experiment Module (SEM)

SEM is housed in a sealed, extended 5 cubic-foot canister mounted in the aft position of the port adapter beam. The SEM will contain up to 10 small enclosed modules, each containing a separate, passive experiment designed and constructed by students.

d. G-774

The objective of this experiment is to increase the understanding of smoldering combustion in a long-term microgravity environment. This experiment will focus on one-dimensional smoldering polyurethane foam.

3. GAS CANISTER G-780 PAYLOAD

The GAS G-780 payload is sponsored by Mayo High School, Rochester, Minnesota. The objective of the G-780 experiment is to investigate cell growth in microgravity. The experiment utilizes six growing chambers containing various seed types.

G. DETAILED TEST OBJECTIVES (DTOs)

1. SPACE VISION LASER CAMERA SYSTEM (SVLCS) (DTO 701)

This DTO will demonstrate the SVS Laser Sensor capability to enhance the target tracking capability of the SVS, thereby expanding its operational envelope and improving its robustness.

2. MAGR GPS (DTO 700-14)

The purpose of this DTO is to demonstrate the performance and operation of the GPS during the orbiter on-orbit phase, utilizing a modified military GPS receiver processor and the existing orbiter GPS antennas.

H. DETAILED SUPPLEMENTAL OBJECTIVES (DSOs)

1. SPACEFLIGHT AND IMMUNE FUNCTION (DSO 498)

This project will characterize the effects of space flight on selected immune elements that are important in maintaining an effective defense against infectious agents.

The following activities are performed pre/post flight only:

2. INDIVIDUAL SUSCEPTIBILITY TO POST SPACEFLIGHT ORTHOSTATIC INTOLERANCE (DSO 496)

This DSO will address this hypothesis by performing a flight related study, designed to elucidate preflight and postflight differences in susceptible and non-susceptible astronauts.

3. PHARMACOKINETICS AND CONTRIBUTING PHYSIOLOGIC CHANGES DURING SPACE FLIGHT (DSO 632B)

Determine changes in the GI function and physiology and examine the pharmacokinetics of orally administered pharmaceutical probe acetaminophen.

4. SPATIAL REORIENTATION FOLLOWING SPACE FLIGHT (DSO 635)

Examine adaptive changes in the spatial reference frame and the fragility of the adaptive process and the feasibility of driving state changes in central vestibular processing via discordant sensory stimuli.

This Page Intentionally Blank

STS-105 FLIGHT PLAN WALKTHROUGH (WITH RATIONALE)

|

STS-105 FLIGHT PLAN WALKTHROUGH (WITH RATIONALE)

FLIGHT PLAN
WALKTHROUGH

Flight Day 1

- Standard FD01 activities.
- Setups completed for PGSCs (OCA, RF network, BIA for GAS)
- The crew will set up all generic P/TV equipment, in addition to the SSV.
- Secondary payloads are activated and science data is taken for G-774 post NC1 burn/mnvr back to overnight attitude.
- HEAT ACE Ku low rate databases will begin after launch data dump is complete. OCA and PDIP panel will need to be selected for High Data Rate (Ch. 3 Ku).
- The crew goes to be sleep 7 hr after launch to support docking on FD03 and the nominal EOM landing time with a 5 hr sleep shift over the mission.
- APCU 2 is activated to support the MPLM Environment Checks. APCU 1 and 2 output relays are closed and the APCU 2 converter is powered on. With the APCU 1 output relay closed and the OIU activated, the ground team can partially activate the MPLM to monitor the MPLM environment for 30 min. The MPLM data will be monitored as much as possible during the flight depending on which TFL is loaded (not all TFLs contain the MPLM data).

Flight Day 2

- Checkouts include RMS, OSVS, and RNDZ tools, as well as setup of Ergometer.
- Setup of the Contingency Water Container (CWC) equipment. Filling begins on FD03.
- The first H-Reflex runs are performed on this day for all three Increment 3 crewmembers. A subject run can start anytime after Setup is complete. An assisting crewmember is not required the first 10 min and the last 5 min of a subject run. Photo/TV documentation is desired and scheduled.
- The crew will sleep shift 2 hr earlier to minimize ISS crew sleep shifting and to support EOM deorbit opportunities.
- On ISS, the CBCS (centerline camera) is installed on the Node Nadir hatch window in preparation for the MPLM install. Note: This can be done anytime before the MPLM Install on FD04.

Flight Day 3

- The first waste dump will be performed on the morning of this day. FDO would like this dump to be scheduled as close to the first rendezvous burn as possible to minimize trajectory dispersions.
- Docking is not required to occur over a Russian Ground Site; therefore, stationkeeping to dock over ground sites will not be done. This would impact crew total day and crew handover/transfer activities unnecessarily. Stationkeeping burns an additional 60 lb each of propellant in the FRCS and ARCS. The approach will be recorded using the High Definition Television Camera, Dreamtime.
- After docking, a leak check will be performed on the ODS. Hardline audio is established.
- The stack will stay in free drift until the hard mate is completed. The shuttle will then maneuver the stack into the nominal docking attitude once the rates have damped. Once in attitude, attitude control will be handed over to ISS. ISS will maintain attitude control during the entire docked timeframe using the Lab CMGs. However, it is assumed that if shuttle has the prop, they will perform any maneuvers that may be required.
- A short STS-to-ISS CBCS checkout will be performed both by STS (P/TV 16 OPS) and by ISS.
- RMS PGSC Config scheduled after docking gives the RMS operators some additional time to adjust the location of any PGSC for the docked/RMS timeframe.
- After the first hatch opening and welcome ceremonies, documented by Dreamtime, transfer and handover time are priority one. A crewmember is not considered transferred until the IELK Installation and Checkout is completed and the AMP and ALSP Drug Pack are transferred for that crewmember.
- The transfer tagup is an opportunity for the loadmaster (MS2) to coordinate with fellow crewmembers (including someone on ISS), and call down results to MCC (A/G comm is made available for the last 5 min of the activity). An Excel file will be transferred via OCA for MS2 to fill out and return on FD03 and FD04 for Middeck transfer.
- The shuttle crew transfers two CWC bags that were filled.

- EV crewmember will perform the first block in EMU Nominal Reconfiguration to prepare for EVA checkouts on FD06. This involves transferring the XL suit and retrieving the L for MS2.

Flight Day 4

- First thing in post-sleep, the ground is going to perform some CBM operations to check out the nadir CBMs. This is in preparation for the MPLM transfer. The RMS will grapple the MPLM and start the MPLM Install PDRS procedure.
- Just prior to unberth, the MPLM environment is checked via OIU and the Remotely Operated Electrical Umbilical (ROEU) is disconnected. Once ROEU disconnect is complete, the MPLM can be unberthed from the payload bay and installed onto the ISS. MS1 is prime and CDR is backup for the MPLM RMS activities. ISS CDR-3 performs CBM ops from the AFD before installing his IELK. He will return to the AFD to complete the CBM ops.
- On ISS, the MPLM Ingress Setup activity can be completed any time prior to Vestibule Pressurization.
- After the MPLM is installed, the CBCS Camera can be removed from the Node Nadir hatch window. MPLM Vestibule Pressurization and MPLM Vestibule Config For Ingress can then be performed.
- MPLM Activation, Part 1, can begin after step 9 of Config for Ingress, and must be completed prior to step 23. After step 35, MPLM Activation, Part 2, can begin. The ISS crews will remove the four CBM CPAs.
- IELK Prep is an activity to prepare the IELK for transfer to ISS. This consists of unstowing it from any temp stow location and removing it from the bag, etc.
- The Expedition 2 and 3 teams are getting as much handover as possible on this day while still meeting the exercise requirements. For the returning Increment 2 crew, they are supposed to exercise twice a day. One and one half hr of aerobic exercise plus 1 hr of resistive exercise on ISS.
- Shuttle crew transfers items on middeck including the powered middeck payloads APCF, DCPCG-V, and CPCG-H. APCF transfer requires ground commanding, and since the crew is a backup we will need an ISS crewmember to supervise. CGBA, now failed and unpowered, is required to be transferred since APCG will reside in its current location on ISS. The CDR and MS2 will deploy new dosimeters in ISS.

Flight Day 5

- MPLM Ingress followed by transfers in ISS.
- Reboost and STS H2O SIMO Dump in the afternoon.

Flight Day 6

- The shuttle crewmembers will assemble one EMU from parts on ISS. The crew will then check out the two EMUs. A third EMU from ISS will be staged on STS in case of suit failure.
- The EV crewmembers begin a 100% O2 Mask Prebreathe 45 min prior to Orbiter 10.2 depress. The hatches are closed between the Lab and the ODS.
- The increment 3 ISS crew is completing the second run of the HRF experiment. The requirement is to perform on FD06 \pm 2 days.
- Reboost in the afternoon.

Flight Day 7

- EVA 1 (EAS/MISSE).
- ISS continues unloading/packing MPLM.

Flight Day 8

- Reboost and STS H2O SIMO Dump in the morning.
- Lower Body Negative Pressure activity for Usachev (first of two). Afternoon exercise via TVIS.
- On ISS, the crew will be transferring most of the system racks and installing them in the Lab. They are timed to be transferred in order of packing. The rack transfers are scheduled for two ISS crewmembers. A third crewmember is scheduled to help with the rack, but will only be useful as a spotter when the rack is being moved between modules.
- MPLM transfer/packing continues in ISS.

- A crew conference is scheduled post meal.
- Shuttle crew prepares for EVA 2. The EV crewmembers begin a 100% O2 Mask prebreathe 45 min prior to Orbiter 10.2 depress. The hatches are closed between the Lab and the ODS.

Flight Day 9

- EVA 2 (S0 cables).
- MPLM transfer/packing continues in ISS.
- CBM CPAs are installed for checkout and MPLM racks are configured for entry.

Flight Day 10

- Lower Body Negative Pressure activity for Usachev (second of two. Afternoon exercise via TVIS.
- The ISS crew will egress the MPLM and set up the CBCS.
- Once MPLM Deactivation, Vestibule Config for Demate, and Vestibule Depress are completed, the shuttle crew can transfer the MPLM back to the shuttle payload bay. The procedure is similar to the MPLM Install Procedure on, but in reverse.
- For the other ISS crewmembers not involved in the MPLM activities, crew handover time is the top priority for this day.
- EV crewmembers resize and configure suits for STS and ISS, and check out the new SAFER.
- TVIS Motor R&R will involve Voss and Tyurin for 3 hr.

Flight Day 11

- Following the Egress, a leak check of the ODS vestibule is performed, the ODS Centerline Camera is reinstalled, and the crew transitions to the Undock rendezvous checklist.
- Following Undocking, a one rev flyaround is scheduled before final sep from ISS. Undock is scheduled for SR plus one minute to allow for lighting during undock/flyaround.
- STS crew begins cabin stow and deploys Simplesat prior to entering presleep.

Flight Day 12

- FCS Checkout, RCS Hot Fire, Post EVA Entry Prep, L-1 Comm checks, and a Launch Entry Suit check for EXP-2 are completed before Off Duty. PFCs will occur during Off Duty and Presleep.
- All PGSCs other than those required for OCA MFX ops on FD12 will be stowed.
- The recumbent seat setup is partially performed in preparation for landing.
- The day will finish with a crew Deorbit Prep Briefing.

Flight Day 13

- The crew performs last of the stowage activities before transitioning to the Deorbit Prep book.
- PGSC stow part two stows any remaining PGSC equipment used for OCA MFX operations.
- The recumbent seat setup is finished after the final LiOH changeout at the end of Post Sleep.

Generic Planning Guidelines

- Twenty hr of handover are scheduled for the ISS CDRs. Since some information is needed to be transferred between non-CDRs, extra time is needed. All others have 16 hr of handover scheduled.
- Each EXP-2 crewmember receives 2.5 hr of exercise if possible.
- Both expedition crews will participate in the daily planning conferences and work preps.

DAP BOOK CONFIGURATION

DAP BOOK
CONFIGURATION



TOP



<u>DAP</u>	<u>PURPOSE</u>	<u>DAP</u>	<u>PURPOSE</u>
A1	- NOMINAL	B1	- OMS/RCS BURNS
A2	- PTC	B2	- LOSS OF VERN (TAIL ONLY)
A3	- GG	B3	- LOSS OF VERN (ALL)
A4	- PRE/POST DEPLOY	B4	- SSUS DEPLOY
A5	- LOSS OF VERN (ALL)	B5	- COAS/HUD CAL
A6	- LOSS OF VERN (TAIL)	B6	-
A7	- RNDZ	B7	- RNDZ
A8	- TERMINAL PHASE	B8	- TERMINAL PHASE
A9	- PROX OPS/FLYAROUND	B9	- PROX OPS/FLYAROUND
A10	- DOCKING	B10	- DOCKING
A11	- AUTO REBOOST	B11	-
A12	- VRCS MATED STACK	B12	- ALT MATED STACK AND RMS OPS
A13	- A/L DEPRESS ATTITUDE CONTROL	B13	- A/L DEPRESS RATE DAMPING
A14	-	B14	-
A15	- PRCS (DTO 257)	B15	-

- CNTL ACC = 0 UNLOADED RMS
- = 1 VRCS MATED CONTROL
- = 2 ALT PRCS MATED CONTROL
- = 3 A/L DEPRESS VRCS MATED CONTROL
- = 4 A/L DEPRESS ALT PRCS MATED CONTROL
- = 5-9 NOT USED

DAP BOOK
CONFIGURATION



FLT PLN-1a/105/O/A

TOP



FLT PLN-1b/105/O/A



(reduced copy)



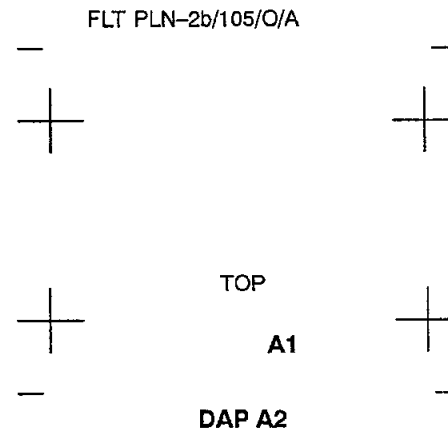
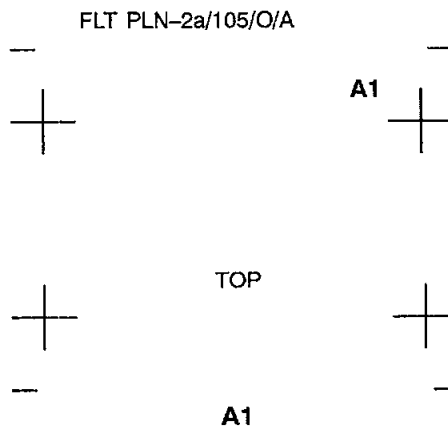
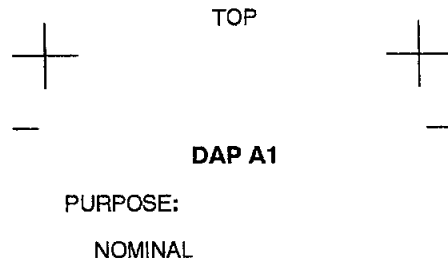

DAP A 0 1	1	PRI
0.2 0 0 0	10/50	ROT RATE
- 5.0 0	11/51	ATT DB
0.2 0	12/52	RATE DB
0.1 0 0	13/53	ROT PLS
.0 0 0	14/54	COMP
ALL	15/55	P OPTION
ALL	16/56	Y OPTION
0.1 0 0	17/57	TRAN PLS
		ALT
0.2 0 0	18/58	RATE DB
ALL	19/59	JET OPT
2	20/60	#JETS
0.0 8	21/61	ON TIME
- 0.0 0	22/62	DELAY
		VERN
0.2 0 0 0	23/63	ROT RATE
- 1.0 0 0	24/64	ATT DB
.0 2 0	25/65	RATE DB
0.0 1 0	26/66	ROT PLS
.0 0 0	27/67	COMP
0	28/68	CNTL ACC

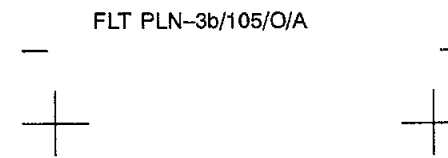
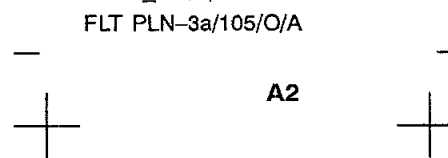



DAP A 0 2 1 PRI
 0.4 0 0 0 10/50 ROT RATE
 - 1.0 0 11/51 ATT DB
 0.2 0 12/52 RATE DB
 0.1 0 0 13/53 ROT PLS
 .0 0 0 14/54 COMP
 ALL 15/55 P OPTION
 ALL 16/56 Y OPTION
 0.1 0 0 17/57 TRAN PLS
 ALT
 0.2 0 0 18/58 RATE DB
 ALL 19/59 JET OPT
 2 20/60 #JETS
 0.0 8 21/61 ON TIME
 - 0.0 0 22/62 DELAY
 VERN
 0.4 0 0 0 23/63 ROT RATE
 - 1.0 0 0 24/64 ATT DB
 .0 2 0 25/65 RATE DB
 0.0 1 0 26/66 ROT PLS
 .0 0 0 27/67 COMP
 0 28/68 CNTL ACC
 FLT PLN-4a/105/O/A

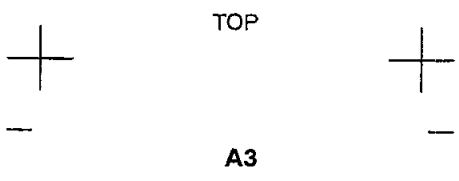
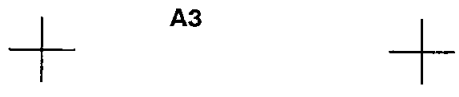

DAP A 0 3 1 PRI
 0.2 0 0 0 10/50 ROT RATE
 - 0.3 0 11/51 ATT DB
 0.2 0 12/52 RATE DB
 0.1 0 0 13/53 ROT PLS
 .0 0 0 14/54 COMP
 ALL 15/55 P OPTION
 TAIL 16/56 Y OPTION
 0.1 0 0 17/57 TRAN PLS
 ALT
 0.0 7 0 18/58 RATE DB
 ALL 19/59 JET OPT
 1 20/60 #JETS
 - 0.0 8 21/61 ON TIME
 - 0.0 0 22/62 DELAY
 VERN
 0.0 0 8 0 23/63 ROT RATE
 - 0.0 7 0 24/64 ATT DB
 .0 1 0 25/65 RATE DB
 0.0 1 0 26/66 ROT PLS
 .0 0 0 27/67 COMP
 0 28/68 CNTL ACC
 FLT PLN-5a/105/O/A

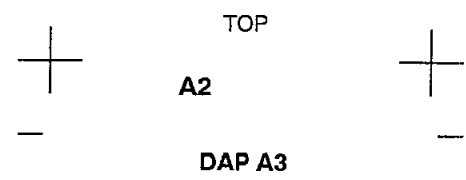

PURPOSE:
 GG

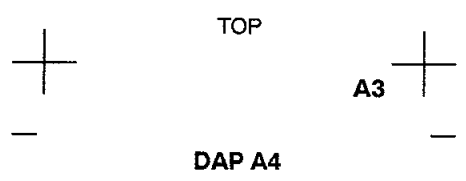
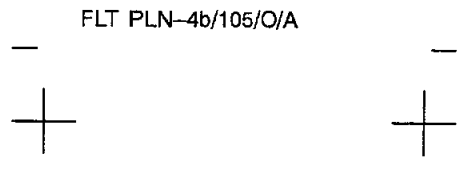

PRE/POST DEPLOY

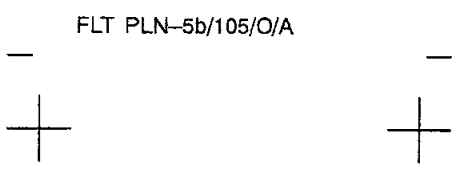

(reduced copy)



TOP

A4

DAP A 0 4	1	PRI
0.5 0 0 0	10/50	ROT RATE
- 3.0 0	11/51	ATT DB
0.2 0	12/52	RATE DB
0.1 0 0	13/53	ROT PLS
.0 0 0	14/54	COMP
ALL	15/55	P OPTION
ALL	16/56	Y OPTION
0.1 0 0	17/57	TRAN PLS
		ALT
0.2 0 0	18/58	RATE DB
ALL	19/59	JET OPT
2	20/60	#JETS
0.0 8	21/61	ON TIME
- 0.0 0	22/62	DELAY
		VERN
0.2 0 0 0	23/63	ROT RATE
- 1.0 0 0	24/64	ATT DB
.0 2 0	25/65	RATE DB
0.0 1 0	26/66	ROT PLS
.0 0 0	27/67	COMP
0	28/68	CNTL ACC

FLT PLN-6a/105/O/A



A5



TOP

A4

DAP A5

PURPOSE:
LOSS OF VERN (ALL)

FLT PLN-6b/105/O/A

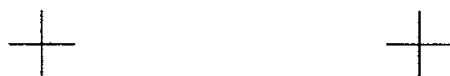

TOP

A5

DAP A6

PURPOSE:
LOSS OF VERN (TAIL ONLY)

DAP A 0 5	1	PRI
0.2 0 0 0	10/50	ROT RATE
- 5.0 0	11/51	ATT DB
0.2 0	12/52	RATE DB
0.1 0 0	13/53	ROT PLS
.0 0 0	14/54	COMP
ALL	15/55	P OPTION
ALL	16/56	Y OPTION
0.1 0 0	17/57	TRAN PLS
		ALT
0.0 7 0	18/58	RATE DB
ALL	19/59	JET OPT
1	20/60	#JETS
0.0 8	21/61	ON TIME
- 0.0 0	22/62	DELAY
		VERN
0.0 5 0 0	23/63	ROT RATE
- 1.0 0 0	24/64	ATT DB
.0 2 0	25/65	RATE DB
0.0 1 0	26/66	ROT PLS
.0 0 0	27/67	COMP
0	28/68	CNTL ACC

FLT PLN-7a/105/O/A



A6



FLT PLN-7b/105/O/A

(reduced copy)

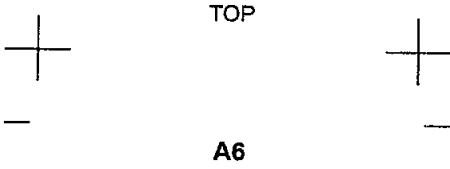

A6

DAP A 0 6	1	PRI
0.2 0 0 0	10/50	ROT RATE
- 5.0 0	11/51	ATT DB
0.2 0	12/52	RATE DB
0.1 0 0	13/53	ROT PLS
.0 0 0	14/54	COMP
TAIL	15/55	P OPTION
TAIL	16/56	Y OPTION
0.1 0 0	17/57	TRAN PLS
		ALT
0.0 7 0	18/58	RATE DB
TAIL	19/59	JET OPT
1	20/60	#JETS
0.0 8	21/61	ON TIME
0 0.0 0	22/62	DELAY
		VERN
0.0 5 0 0	23/63	ROT RATE
- 1.0 0 0	24/64	ATT DB
.0 2 0	25/65	RATE DB
0.0 1 0	26/66	ROT PLS
.0 0 0	27/67	COMP
0	28/68	CNTL ACC

FLT PLN-8a/105/O/A



DAP A7

PURPOSE:
RENDEZVOUS

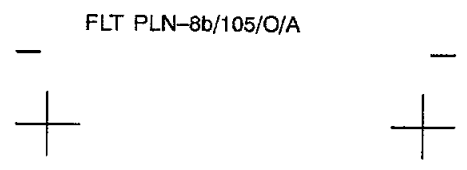

A7

DAP A 0 7	1	PRI
0.2 0 0 0	10/50	ROT RATE
- 2.0 0	11/51	ATT DB
0.2 0	12/52	RATE DB
0.1 0 0	13/53	ROT PLS
.0 0 0	14/54	COMP
ALL	15/55	P OPTION
ALL	16/56	Y OPTION
0.1 0 0	17/57	TRAN PLS
		ALT
0.1 0 0	18/58	RATE DB
ALL	19/59	JET OPT
2	20/60	#JETS
0.0 8	21/61	ON TIME
- 0.0 0	22/62	DELAY
		VERN
0.0 1 6 0	23/63	ROT RATE
- 1.0 0 0	24/64	ATT DB
.0 2 0	25/65	RATE DB
0.0 1 0	26/66	ROT PLS
.0 0 0	27/67	COMP
0	28/68	CNTL ACC

FLT PLN-9a/105/O/A

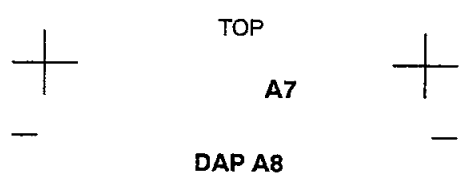

DAP A8

PURPOSE:
TERMINAL PHASE

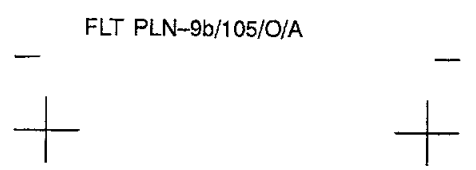
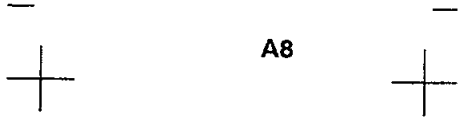

(reduced copy)



TOP



A8

DAP A 0 8	1	PRI
0.0 5 0 0	10/50	ROT RATE
- 2.0 0	11/51	ATT DB
0.2 0	12/52	RATE DB
0.1 0 0	13/53	ROT PLS
0.0 0 0	14/54	COMP
ALL	15/55	P OPTION
ALL	16/56	Y OPTION
0.1 0 0	17/57	TRAN PLS
		ALT
0.1 0 0	18/58	RATE DB
ALL	19/59	JET OPT
2	20/60	#JETS
0.0 8	21/61	ON TIME
0.0 0 0	22/62	DELAY
		VERN
0.0 5 0 0	23/63	ROT RATE
- 1.0 0 0	24/64	ATT DB
0.2 0	25/65	RATE DB
0.0 5 0	26/66	ROT PLS
0.0 0 0	27/67	COMP
0	28/68	CNTL ACC

FLT PLN-10a/105/O/B

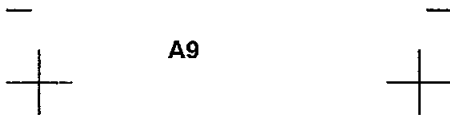

A9



A9

DAP A 0 9	1	PRI
0.1 3 0 0	10/50	ROT RATE
- 1.0 0	11/51	ATT DB
0.1 0	12/52	RATE DB
0.1 0 0	13/53	ROT PLS
0.0 0 0	14/54	COMP
TAIL	15/55	P OPTION
TAIL	16/56	Y OPTION
0.0 5 0	17/57	TRAN PLS
		ALT
0.1 0 0	18/58	RATE DB
TAIL	19/59	JET OPT
2	20/60	#JETS
0.0 8	21/61	ON TIME
0.0 0	22/62	DELAY
		VERN
0.1 3 0 0	23/63	ROT RATE
- 1.0 0 0	24/64	ATT DB
0.2 0	25/65	RATE DB
0.0 5 0	26/66	ROT PLS
0.0 0 0	27/67	COMP
0	28/68	CNTL ACC

FLT PLN-11a/105/O/B



A10

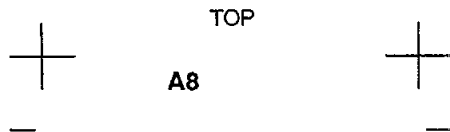

TOP

A8

DAP A9

PURPOSE:
PROX OPS/FLY AROUND

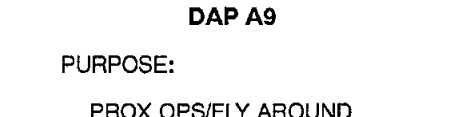

FLT PLN-10b/105/O/A



TOP

A9

DAP A10

PURPOSE:
DOCKING

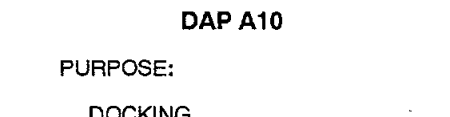

FLT PLN-11b/105/O/A



(reduced copy)

TOP
 +
 -
A10

DAP A 1 0	1	PRI
0.0 5 0 0	10/50	ROT RATE
0.5 0	11/51	ATT DB
0.1 0	12/52	RATE DB
0.1 0 0	13/53	ROT PLS
.0 0 0	14/54	COMP
TAIL	15/55	P OPTION
TAIL	16/56	Y OPTION
0.0 5 0	17/57	TRAN PLS
		ALT
0.1 0 0	18/58	RATE DB
TAIL	19/59	JET OPT
2	20/60	#JETS
0.0 8	21/61	ON TIME
0.0 0	22/62	DELAY
		VERN
0.0 5 0 0	23/63	ROT RATE
- 0.5 0 0	24/64	ATT DB
.0 2 0	25/65	RATE DB
0.0 5 0	26/66	ROT PLS
.0 0 0	27/67	COMP
0	28/68	CNTL ACC

FLT PLN-12a/105/O/A

+
 -
A11

TOP
 +
 -
A11

DAP A 1 1	1	PRI
0.1 0 0 0	10/50	ROT RATE
1 0.0 0	11/51	ATT DB
0.2 0	12/52	RATE DB
0.1 0 0	13/53	ROT PLS
.0 0 0	14/54	COMP
TAIL	15/55	P OPTION
TAIL	16/56	Y OPTION
0.1 0 0	17/57	TRAN PLS
		ALT
0.0 7 0	18/58	RATE DB
TAIL	19/59	JET OPT
3	20/60	#JETS
0.0 8	21/61	ON TIME
1 1.6 0	22/62	DELAY
		VERN
0.1 0 0 0	23/63	ROT RATE
- 5.0 0 0	24/64	ATT DB
.0 5 0	25/65	RATE DB
0.0 1 0	26/66	ROT PLS
.0 0 0	27/67	COMP
1.2	28/68	CNTL ACC

FLT PLN-13a/105/O/B

+
 -
A12

TOP
 +
 -
A10
DAP A11

PURPOSE:
 MATED STACK (MNVR &
 HOLD)

FLT PLN-12b/105/O/A

+
 -

TOP
 +
 -
A11
DAP A12

PURPOSE:
 VRCS MATED STACK

FLT PLN-13b/105/O/A

+
 -

(reduced copy)



TOP

A12

DAP A 1 2	1	PRI
0.1 0 0 0	10/50	ROT RATE
- 5.0 0	11/51	ATT DB
0.2 0	12/52	RATE DB
0.0 4 0	13/53	ROT PLS
.0 0 0	14/54	COMP
TAIL	15/55	P OPTION
TAIL	16/56	Y OPTION
0.0 1 0	17/57	TRAN PLS
		ALT
0.0 7 0	18/58	RATE DB
TAIL	19/59	JET OPT
3	20/60	#JETS
0.0 8	21/61	ON TIME
1 1.0 4	22/62	DELAY
		VERN
0.1 0 0 0	23/63	ROT RATE
- 3.0 0 0	24/64	ATT DB
.0 5 0	25/65	RATE DB
0.0 0 2	26/66	ROT PLS
.0 0 0	27/67	COMP
1	28/68	CNTL ACC

FLT PLN-14a/105/O/A

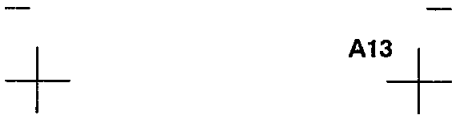

A13



TOP

A13

DAP A 1 3	1	PRI
0.1 0 0 0	10/50	ROT RATE
- 5.0 0	11/51	ATT DB
0.2 0	12/52	RATE DB
0.0 4 0	13/53	ROT PLS
.0 0 0	14/54	COMP
TAIL	15/55	P OPTION
TAIL	16/56	Y OPTION
0.0 1 0	17/57	TRAN PLS
		ALT
0.0 7 0	18/58	RATE DB
TAIL	19/59	JET OPT
3	20/60	#JETS
0.0 8	21/61	ON TIME
1 1.0 4	22/62	DELAY
		VERN
0.1 0 0 0	23/63	ROT RATE
- 3.0 0 0	24/64	ATT DB
.0 8 0	25/65	RATE DB
0.0 0 2	26/66	ROT PLS
.0 0 0	27/67	COMP
3.4	28/68	CNTL ACC

FLT PLN-15a/105/O/A

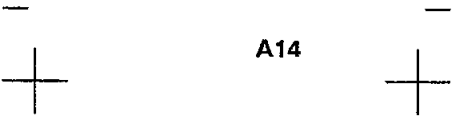

A14



TOP

A12

DAP A13

PURPOSE:

A/L DEPRESS ATTITUDE
CONTROL

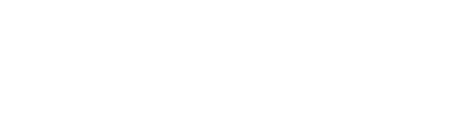

FLT PLN-14b/105/O/A



TOP

A13

DAP A14

PURPOSE:



FLT PLN-15b/105/O/A



(reduced copy)

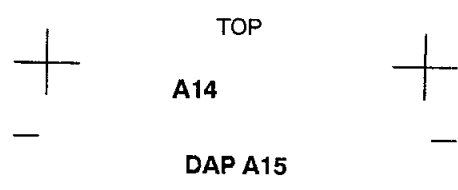

DAP A 1 4 1 PRI
 0.2 0 0 0 10/50 ROT RATE
 - 5.0 0 11/51 ATT DB
 0.2 0 12/52 RATE DB
 0.1 0 0 13/53 ROT PLS
 .0 0 0 14/54 COMP
 ALL 15/55 P OPTION
 ALL 16/56 Y OPTION
 0.1 0 0 17/57 TRAN PLS
 ALT
 0.2 0 0 18/58 RATE DB
 ALL 19/59 JET OPT
 2 20/60 #JETS
 0.0 8 21/61 ON TIME
 0.0 0 22/62 DELAY
 VERN
 0.2 0 0 0 23/63 ROT RATE
 - 1.0 0 0 24/64 ATT DB
 .0 2 0 25/65 RATE DB
 0.0 1 0 26/66 ROT PLS
 .0 0 0 27/67 COMP
 0 28/68 CNTL ACC
 FLT PLN-16a/105/O/A

PURPOSE:

FLT PLN-16b/105/O/A

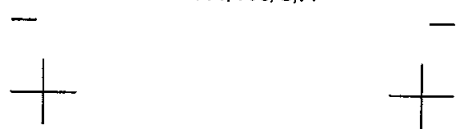
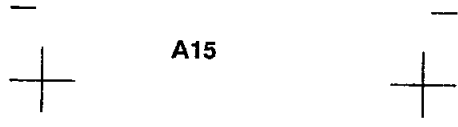

DAP A 1 5 1 PRI
 0.1 0 0 0 10/50 ROT RATE
 4 0.0 0 11/51 ATT DB
 0.2 0 12/52 RATE DB
 0.0 0 3 13/53 ROT PLS
 .0 0 0 14/54 COMP
 TAIL 15/55 P OPTION
 TAIL 16/56 Y OPTION
 0.1 0 0 17/57 TRAN PLS
 ALT
 0.2 0 0 18/58 RATE DB
 TAIL 19/59 JET OPT
 2 20/60 #JETS
 0.0 8 21/61 ON TIME
 0.0 0 22/62 DELAY
 VERN
 0.0 2 0 0 23/63 ROT RATE
 - 5.0 0 0 24/64 ATT DB
 .0 5 0 25/65 RATE DB
 0.0 0 1 26/66 ROT PLS
 .0 0 0 27/67 COMP
 7 28/68 CNTL ACC
 FLT PLN-17a/105/O/B

FLT PLN-17b/105/O/A

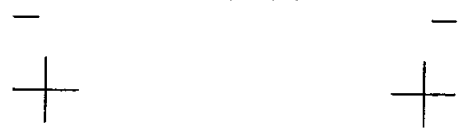

(reduced copy)

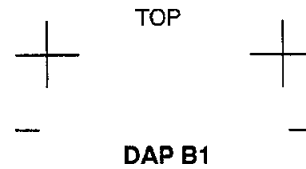
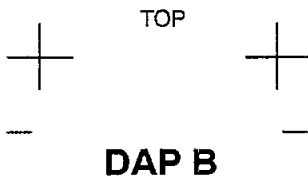

PURPOSE:
OMS/RCS BURNS

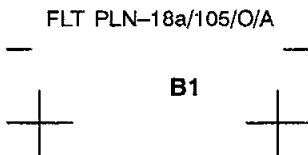

2	DAP B 0 1
30/50	0.5 0 0 0
31/51	- 3.0 0
32/52	0.2 0
33/53	0.0 4 0
34/54	.0 0 0
35/55	ALL
36/56	ALL
37/57	0.1 0 0

38/58	0.2 0 0
39/59	ALL
40/60	2
41/61	0.0 8
42/62	- 0.0 0

43/63	0.2 0 0 0
44/64	- 1.0 0 0
45/65	.0 2 0
46/66	0.0 0 2
47/67	.0 0 0
48/68	0

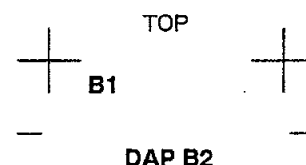
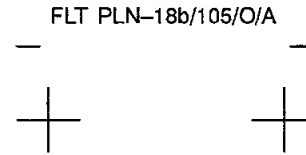
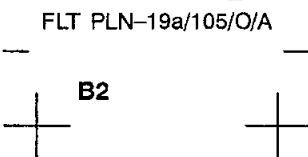

PURPOSE:
LOSS OF VERN
(TAIL ONLY)

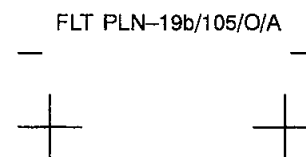

(reduced copy)



2	DAP B 0 2
30/50	0.2 0 0 0
31/51	- 3.0 0
32/52	0.2 0
33/53	0.0 4 0
34/54	.0 0 0
35/55	TAIL
36/56	TAIL
37/57	0.0 2 0
38/58	0.0 7 0
39/59	TAIL
40/60	1
41/61	0.0 8
42/62	- 0.0 0
43/63	0.2 0 0 0
44/64	- 1.0 0 0
45/65	.0 2 0
46/66	0.0 0 2
47/67	.0 0 0
48/68	0

FLT PLN-20a/105/O/A

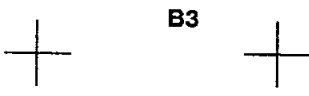

2	DAP B 0 3
30/50	0.2 0 0 0
31/51	- 3.0 0
32/52	0.2 0
33/53	0.0 4 0
34/54	.0 0 0
35/55	ALL
36/56	ALL
37/57	0.0 2 0
38/58	0.0 7 0
39/59	ALL
40/60	1
41/61	0.0 8
42/62	- 0.0 0
43/63	0.2 0 0 0
44/64	- 1.0 0 0
45/65	.0 2 0
46/66	0.0 0 2
47/67	.0 0 0
48/68	0

FLT PLN-21a/105/O/A

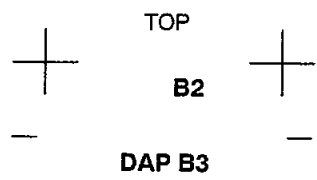

PURPOSE:
LOSS OF VERN
(ALL)

FLT PLN-20b/105/O/A

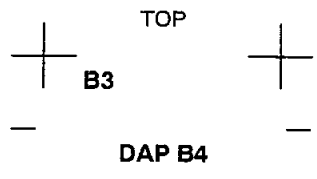

PURPOSE:
SSUS DEPLOY

FLT PLN-21b/105/O/A



(reduced copy)



B4

2/4	DAP B 0 4
30/50	0.2 0 0 0
31/51	- 0.3 0
32/52	0.2 0
33/53	0.0 4 0
34/54	.0 0 0
35/55	TAIL
36/56	TAIL
37/57	0.0 2 0
38/58	0.1 0 0
39/59	ALL
40/50	2
41/61	0.0 8
42/62	- 0.0 0
43/63	0.0 0 8 0
44/64	- 0.1 0 0
45/65	.0 1 0
46/66	0.0 0 2
47/67	.0 0 0
48/68	0

FLT PLN-22a/105/O/A

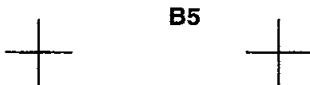

B5



B5

2	DAP B 0 5
30/50	0.2 0 0 0
31/51	- 3.0 0
32/52	0.2 0
33/53	0.0 4 0
34/54	.0 0 0
35/55	TAIL
36/56	TAIL
37/57	0.0 2 0
38/58	0.2 0 0
39/59	ALL
40/60	2
41/61	0.0 8
42/62	- 0.0 0
43/63	0.0 1 6 0
44/64	- 0.0 3 3
45/65	.0 2 0
46/66	0.0 0 2
47/67	.0 0 0
48/68	0

FLT PLN-23a/105/O/A



B6



B4

DAP B5

PURPOSE:
COAS/HUD CAL

FLT PLN-22b/105/O/A



B5

DAP B6

PURPOSE:

FLT PLN-23b/105/O/A



(reduced copy)



B6

2/4	DAP B 0 6
30/50	0.5 0 0 0
31/51	- 3.0 0
32/52	0.2 0
33/53	0.0 4 0
34/54	.0 0 0
35/55	ALL
36/56	ALL
37/57	0.0 2 0
38/58	0.2 0 0
39/59	ALL
40/60	2
41/61	0.0 8
42/62	- 0.0 0
43/63	0.2 0 0 0
44/64	- 1.0 0 0
45/65	.0 2 0
46/66	0.0 0 2
47/67	.0 0 0
48/68	0

FLT PLN-24a/105/O/A

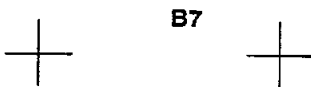

B7

2/4	DAP B 0 7
30/50	0.5 0 0 0
31/51	- 2.0 0
32/52	0.2 0
33/53	0.0 4 0
34/54	.0 0 0
35/55	ALL
36/56	ALL
37/57	0.0 5 0
38/58	0.1 0 0
39/59	ALL
40/60	2
41/61	0.0 8
42/62	- 0.0 0
43/63	0.2 0 0 0
44/64	- 1.0 0 0
45/65	.0 2 0
46/66	0.0 0 2
47/67	.0 0 0
48/68	0

FLT PLN-25a/105/O/A

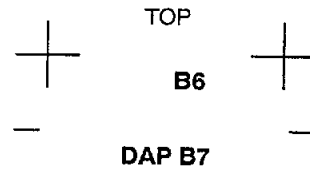
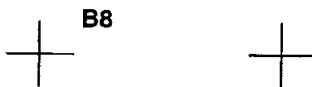

DAP B7
PURPOSE:
RENDEZVOUS

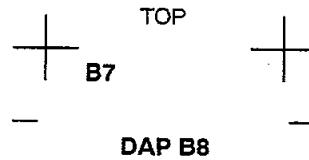
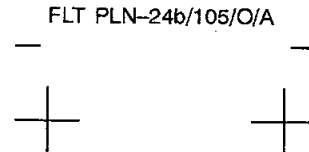

DAP B8
PURPOSE:
TERMINAL PHASE

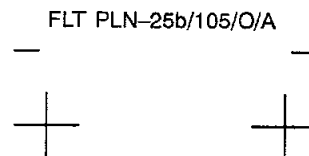

FLT PLN-25b/105/O/A

(reduced copy)



B8

2/4	DAP B 0 8
30/50	<u>0.0 5 0 0</u>
31/51	<u>- 2.0 0</u>
32/52	<u>0.2 0</u>
33/53	<u>0.0 4 0</u>
34/54	<u>.0 0 0</u>
35/55	ALL
36/56	ALL
37/57	<u>0.0 5 0</u>
38/58	<u>0.1 0 0</u>
39/59	ALL
40/60	2
41/61	<u>0.0 8</u>
42/62	<u>0.0 0</u>
43/63	<u>0.0 5 0 0</u>
44/64	<u>- 1.0 0 0</u>
45/65	<u>.0 2 0</u>
46/66	<u>0.0 2 0</u>
47/67	<u>.0 0 0</u>
48/68	<u>0</u>

FLT PLN-26a/105/O/B

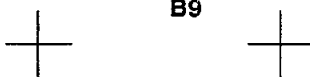

B9



B9

2/4	DAP B 0 9
30/50	<u>0.1 3 0 0</u>
31/51	<u>- 1.0 0</u>
32/52	<u>0.1 0</u>
33/53	<u>0.0 4 0</u>
34/54	<u>.0 0 0</u>
35/55	TAIL
36/56	TAIL
37/57	<u>0.0 1 0</u>
38/58	<u>0.1 0 0</u>
39/59	TAIL
40/60	2
41/61	<u>0.0 8</u>
42/62	<u>0.0 0</u>
43/63	<u>0.1 3 0 0</u>
44/64	<u>- 1.0 0 0</u>
45/65	<u>.0 2 0</u>
46/66	<u>0.0 2 0</u>
47/67	<u>.0 0 0</u>
48/68	<u>0</u>

FLT PLN-27a/105/O/B

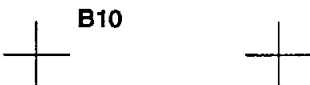

B10

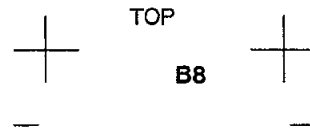

B8

DAP B9

PURPOSE:
PROX OPS/
FLY AROUND

FLT PLN-26b/105/O/A

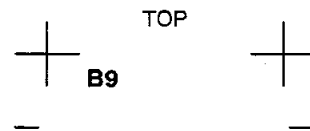

B9

B9

DAP B10

PURPOSE:
DOCKING

FLT PLN-27b/105/O/A



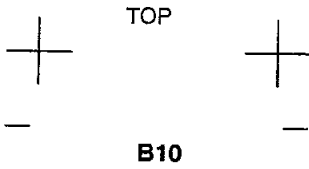

2/4	DAP B 1 0
30/50	<u>0.0 5 0 0</u>
31/51	<u>- 0.5 0</u>
32/52	<u>0.1 0</u>
33/53	<u>0.0 4 0</u>
34/54	<u>.0 0 0</u>
35/55	TAIL
36/56	TAIL
37/57	<u>0.0 1 0</u>
38/58	<u>0.1 0 0</u>
39/59	TAIL
40/60	2
41/61	<u>0.0 8</u>
42/62	<u>0.0 0</u>
43/63	<u>0.0 5 0 0</u>
44/64	<u>- 0.5 0 0</u>
45/65	<u>.0 2 0</u>
46/66	<u>0.0 2 0</u>
47/67	<u>.0 0 0</u>
48/68	<u>0</u>

FLT PLN-28a/105/O/B

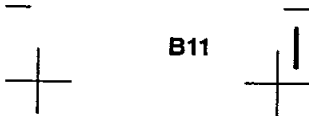

2/4	DAP B 1 1
30/50	<u>0.5 0 0 0</u>
31/51	<u>3.0 0</u>
32/52	<u>0.2 0</u>
33/53	<u>0.0 4 0</u>
34/54	<u>.0 0 0</u>
35/55	ALL
36/56	ALL
37/57	<u>0.0 2 0</u>
38/58	<u>0.2 0 0</u>
39/59	ALL
40/60	2
41/61	<u>0.0 8</u>
42/62	<u>0.0 0</u>
43/63	<u>0.2 0 0 0</u>
44/64	<u>- 1.0 0 0</u>
45/65	<u>.0 2 0</u>
46/66	<u>0.0 0 2</u>
47/67	<u>.0 0 0</u>
48/68	<u>0</u>

FLT PLN-29a/105/O/B

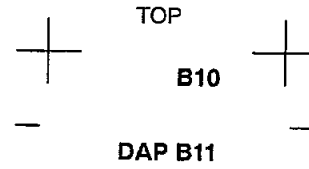
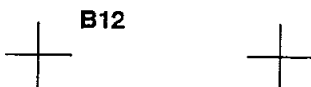

PURPOSE:

FLT PLN-28b/105/O/A

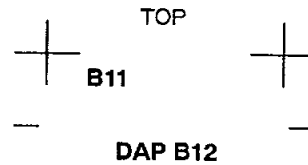

PURPOSE:

ALT MATED STACK
AND RMS OPS

FLT PLN-29b/105/O/A



(reduced copy)



TOP

B12

2/4	DAP B 1 2
30/50	0.1 0 0 0
31/51	5.0 0
32/52	0.2 0
33/53	0.0 4 0
34/54	.0 0 0
35/55	TAIL
36/56	TAIL
37/57	0.0 1 0
38/58	0.0 7 0
39/59	TAIL
40/60	3
41/61	0.0 8
42/62	1 1.0 4
43/63	0.1 0 0 0
44/64	- 3.0 0 0
45/65	.0 5 0
46/66	0.0 0 2
47/67	.0 0 0
48/68	2

FLT PLN-30a/105/O/B

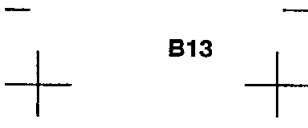

B13



TOP

B13

2/4	DAP B 1 3
30/50	0.1 0 0 0
31/51	4 0.0 0
32/52	0.2 0
33/53	0.0 4 0
34/54	.0 0 0
35/55	TAIL
36/56	TAIL
37/57	0.0 1 0
38/58	0.0 7 0
39/59	TAIL
40/60	3
41/61	0.0 8
42/62	1 1.0 4
43/63	0.1 0 0 0
44/64	4 0.0 0 0
45/65	.0 5 0
46/66	0.0 0 2
47/67	.0 0 0
48/68	3,4

FLT PLN-31a/105/O/A

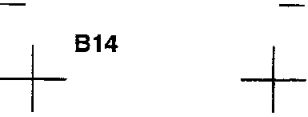

B14

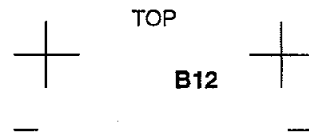

TOP

B12

DAP B13

PURPOSE:

A/L DEPRESS
RATE DAMPING

FLT PLN-30b/105/O/A

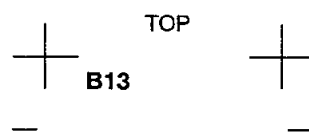

TOP

B13

DAP B14

PURPOSE:

FLT PLN-31b/105/O/A



(reduced copy)



2/4	DAP B 1 4
30/50	0.5 0 0 0
31/51	3.0 0
32/52	0.2 0
33/53	0.0 4 0
34/54	.0 0 0
35/55	ALL
36/56	ALL
37/57	0.0 2 0
38/58	0.2 0 0
39/59	ALL
40/60	2
41/61	0.0 8
42/62	0.0 0
43/63	0.2 0 0 0
44/64	1.0 0 0
45/65	.0 2 0
46/66	0.0 0 2
47/67	.0 0 0
48/68	0

FLT PLN-32a/105/O/B

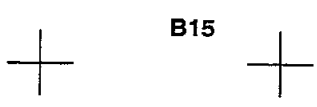

2/4	DAP B 1 5
30/50	0.1 0 0 0
31/51	4.0 0 0
32/52	0.2 0
33/53	0.0 0 3
34/54	.0 0 0
35/55	TAIL
36/56	TAIL
37/57	0.0 1 0
38/58	0.2 0 0
39/59	TAIL
40/60	2
41/61	0.0 8
42/62	- 0.0 0
43/63	0.2 0 0 0
44/64	- 5.0 0 0
45/65	.0 5 0
46/66	0.0 0 1
47/67	.0 0 0
48/68	7

FLT PLN-33a/105/O/B

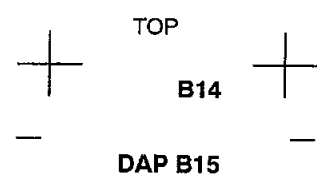

PURPOSE:

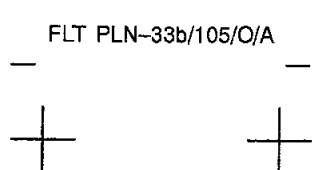
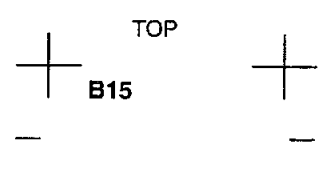
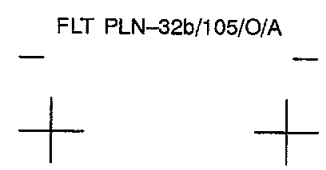

(reduced copy)

TOP

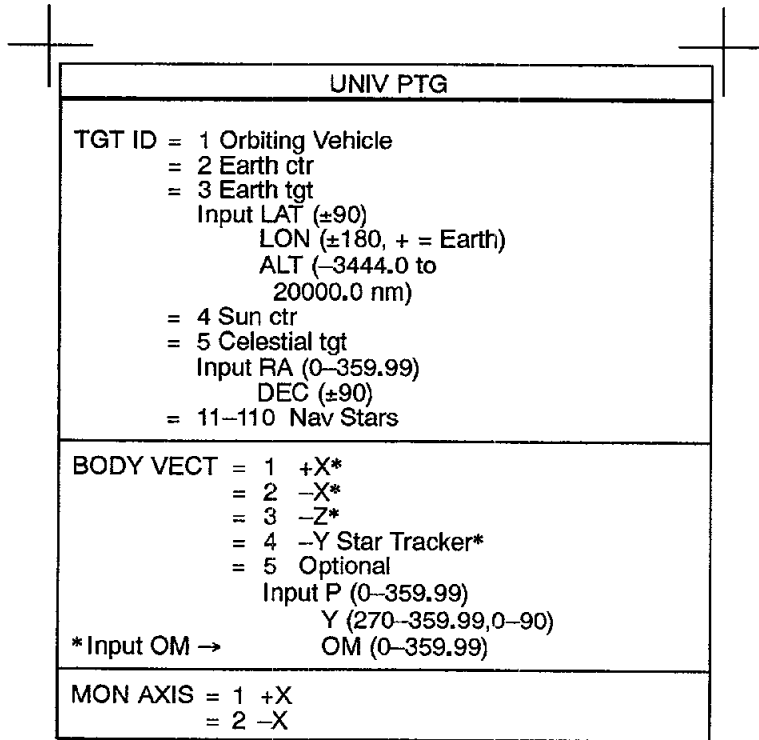

FLT PLN-34/105/O/A

FLT PLN-34/105/O/A is mounted on the back of the DAP Book

This Page Intentionally Blank

FLIGHT DATA FILE
Distribution
105 FLT PLN FS FIN

** JSC **

AP/LEAD PAO
CB/CHIEF, ASTRONAUT OFF.
CB/FLIGHT CREW (7)
DA2/STONE, B.R.
DA8/LEAD ISS FD (4)
DA8/LEAD STS FD (4)
DA82/ACTION CENTER
DF23/LEAD CATO (3)
DF24/INCO FDF REP (4)
DF25/LEAD DPS (3)
DF25/LEAD ODIN (3)
DF52/LEAD MMACS (3)
DF53/LEAD OSO (3)
DF62/LEAD GNC (3)
DF63/LEAD PROP (3)
DF64/ADCO (3)
DF72/LEAD EECOM
DF73/LEAD EGIL
DF74/LEAD PHALCON
DF74/PHALCON LIBRARY (2)
DF83/LEAD ECLSS (3)
DF84/LEAD THOR (3)
DM3/LEAD RNDZ (3)
DM3/LEAD TOPO (3)
DM32/LEAD FIDO
DO13/HSG-H LIBRARY (3)
DO13/HSG-M LIBRARY (2)
DO13/HSG-MTLO
DO13/MSR LIBRARY (2)
DO13/TTI LIBRARY (2)
DO35/RODGERS, M.
DO353/FDF MNGR/RESERVE (15)
DO4/FAO TEAM (30)
DO4/LEAD FAO (15)
DO4/LEAD OPS PLANNER (6)
DO4/NUTE, R.H.
DO4/POINTING (3)
DO4/SHUTTLE FLT PLANNING (3)
DO44/CLANCY, T.
DO45/LIBRARY (2)
DO5/LEAD ACO/PLO (6)
DT32/TEAM LEAD
DT34/CONTROL PROP

DT35/DPS/NAV LIBRARY (3)
DT36/SHUTTLE SYSTEMS
DT37/CARGO SYSTEMS
DT37/SHUTTLE COMMUNICATIONS
DX22/LEAD PDRS (4)
DX22/LEAD ROBO
DX25/RMS TRAINING GROUP (3)
DX32/LEAD EVA (3)
DX32/PERSON, S.
DX34/PHOTO/TV
GP23/STIC (3)
MER/30 LIBRARY
MT3/IPT
NC62/MORAN, S. (2)
OM2/CONSOLE SUPPORT (2)
OV/LEAD ISS GC
OV/LEAD SHUTTLE GC
SD24/SURGEON (3)
ZRI/USAF TECHNICAL LIBRARY (3)

** JSC OFFSITE **

BOEING-HOUSTON
13100 SPACE CENTER BLVD.
HOUSTON, TX 77059
HS-22/FLIGHT/STAGE MANAGER
HS-22/OPERATIONS LEAD

HERNANDEZ ENGINEERING, INC.
SUITE 206
17629 EL CAMINO REAL
HOUSTON, TX 77058
CARABELOS, L.

** POUCH MAIL **

NASA KSC
KSC/KSC TECH LIBRARY-D (2)
TA-E-A/CREW QUARTERS
XA-E1/GRINTER, K.

** U.S. MAIL **

BOEING-HUNTINGTON BEACH
5301 BOLSA AVENUE
HUNTINGTON BEACH, CA 92647
HO19-F754/GOOSSENS, M.H.

BOEING-CALIFORNIA
5301 BOLSA AVE. BLDG 17-7
7D-45 HUNTINGTON BEACH
CA 92647-2099
HO17-D415/MUHAR, M.M.
HO17-D416/GARAY, L.
HO17-D307/WARD, J.
HO19-E7522/FERGUS, E.M.

Total 208
(07/16/01 - FERNANCA)

NOTE

* FOR CHANGES *
* IN DISTRIBUTION *
* OR ADDRESS CORRECTIONS *
* CONTACT THE *
* PROCEDURES MANAGEMENT *
* OFFICE AT MAILCODE D035 *
* OR (281) 244-1184 *
