

# Flight Plan

## STS-114 / LF-1

(STS-114 OCFR2\_RevD Cycle Trajectory)

### Mission Operations Directorate Operations Division

For the latest working copy of the Flight Plan, visit  
<http://mod.jsc.nasa.gov/do4/flightplan/main/fp.cfm?id=114>

### Basic, Rev A November 19, 2004

EVENT	MET		CENTRAL		GMT
Launch	0/00:00	Sun	9/12/04	18:22	256/23:22
OBSS Survey	0/17:15	Mon	9/13/04	11:37	257/16:37
Docking	1/19:58	Tue	9/14/04	14:20	258/19:20
OBSS Handoff	1/23:00	Tue	9/14/04	17:22	258/22:22
MPLM Install	2/14:00	Wed	9/15/04	08:22	259/13:22
OBSS Survey	2/19:45	Wed	9/15/04	14:07	259/19:07
EVA 1	3/18:00	Thu	9/16/04	12:22	260/17:22
EVA 2	5/18:00	Sat	9/18/04	12:22	262/17:22
EVA 3	7/18:00	Mon	9/20/04	12:22	264/17:22
MPLM Uninstall	8/20:30	Tue	9/21/04	14:52	265/19:52
OBSS Handoff	8/23:00	Tue	9/21/04	17:22	265/22:22
Undocking	9/17:15	Wed	9/22/04	11:37	266/16:37
Deorbit Burn	11/17:53	Fri	9/24/04	12:15	268/17:15
Landing	11/18:56	Fri	9/24/04	13:18	268/18:18

National Aeronautics and  
Space Administration

Lyndon B. Johnson Space Center  
Houston, Texas



Verify this is the correct version for the pending operation (training, simulation or flight).  
Electronic copies of FDF books are available. URL: <http://mod.jsc.nasa.gov/do3/FDF/index.html>



MISSION OPERATIONS DIRECTORATE

**FLIGHT PLAN  
STS-114**

BASIC, REVISION A  
November 19, 2004

PREPARED BY:

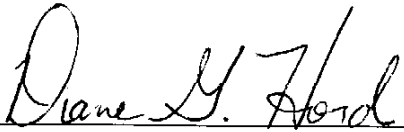
  
\_\_\_\_\_  
Diane G. Hord  
Book Manager, Lead FAO

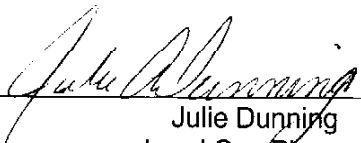
  
\_\_\_\_\_  
Julie Dunning  
Lead Ops Planner

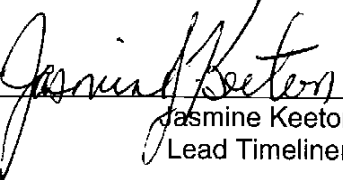
  
\_\_\_\_\_  
Jasmine Keeton  
Lead Timeliner

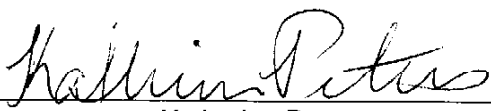
  
\_\_\_\_\_  
Katherine Peters  
Lead RPE

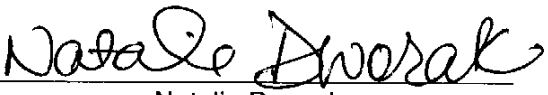
  
\_\_\_\_\_  
Natalie Dworak  
Lead Pointer

APPROVED BY:

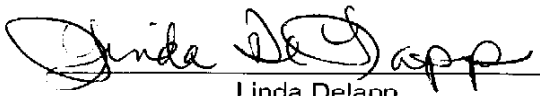
  
\_\_\_\_\_  
Linda Delapp  
Lead, Shuttle Flight Planning  
and Pointing Group

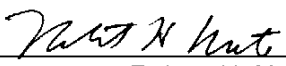
  
\_\_\_\_\_  
Robert H. Nute  
Chief, Flight Planning Branch

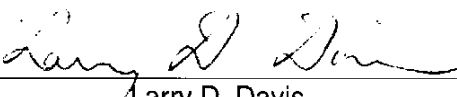
  
\_\_\_\_\_  
Larry D. Davis  
Chief, Operations Division

*(Deferred until Final)*  
\_\_\_\_\_  
G. Allen Flynt  
Director, Mission Operations

This document is under the configuration control of the Crew Procedures Control Board (CPCB). Except for Discrepancy Notices (DN) approved at the flight operations review (FOR), all proposed changes must be submitted via FDF Workflow Crew Procedure Change Request (CR) to DO3/FDF Manager.

Additional distribution of this book, for official use only, may be requested in writing to DO3/FDF Manager. The request must include justification and requester's name, organization, position, and phone number. Contractor requests are made through the NASA or DOD organization supported. Deletions, reduction in quantity, or change of address may be submitted to DO3/FDF Management Office, 281-244-1184.

Incorporates the following:
482#: FLT PLN-2022

AREAS OF TECHNICAL RESPONSIBILITY

Book Manager/Lead FAO	DO4/D. Hord	281-244-0294
Lead Timeliner	DO4/J. Keeton	281-483-6882
Lead Pointer	DO4/N. Dworak	281-244-0955
Lead Ops Planner	DO4/J. Dunning	281-483-4360
Lead RPE	DO4/K. Peters	281-483-5735

FLIGHT PLAN  
STS-114

**LIST OF EFFECTIVE PAGES**

BASIC	10/07/02
FINAL	01/28/03
BAS A	11/19/04

Sign Off .....	*	114/BAS A	2-20B .....	114/BAS A
ii .....	*	114/BAS A	2-21A .....	114/BAS A
iii .....	*	114/BAS A	2-21B .....	114/BAS A
iv .....	*	114/BAS A	2-22A .....	114/BAS A
v .....	*	114/BAS A	2-22B .....	114/BAS A
vi .....	*	114/BAS A	2-23 .....	114/BAS A
vii .....	*	114/BAS A	2-24 .....	114/BAS A
viii .....	*	114/BAS A	2-25 .....	114/BAS A
1-1 .....		114/BAS A	2-26 .....	114/BAS A
1-2 .....		114/BAS A	2-27 .....	114/BAS A
1-3 .....		114/BAS A	3-1 .....	114/BAS A
1-4 .....		114/BAS A	3-2 .....	114/BAS A
2-1 .....		114/BAS A	3-3 .....	114/BAS A
2-2 .....		114/BAS A	3-4 .....	114/BAS A
2-3 .....		114/BAS A	3-5 .....	114/BAS A
2-4 .....		114/BAS A	3-6 .....	114/BAS A
2-5 .....		114/BAS A	3-7 .....	114/BAS A
2-6A .....		114/BAS A	3-8 .....	114/BAS A
2-6B .....		114/BAS A	3-9 .....	114/BAS A
2-7A .....		114/BAS A	3-10 .....	114/BAS A
2-7B .....		114/BAS A	3-11 .....	114/BAS A
2-8A .....		114/BAS A	3-12 .....	114/BAS A
2-8B .....		114/BAS A	3-13 .....	114/BAS A
2-9A .....		114/BAS A	3-14 .....	114/BAS A
2-9B .....		114/BAS A	3-15 .....	114/BAS A
2-10A .....		114/BAS A	3-16 .....	114/BAS A
2-10B .....		114/BAS A	3-17 .....	114/BAS A
2-11A .....		114/BAS A	3-18 .....	114/BAS A
2-11B .....		114/BAS A	3-19 .....	114/BAS A
2-12A .....		114/BAS A	3-20 .....	114/BAS A
2-12B .....		114/BAS A	3-21 .....	114/BAS A
2-13A .....		114/BAS A	3-22 .....	114/BAS A
2-13B .....		114/BAS A	3-23 .....	114/BAS A
2-14A .....		114/BAS A	3-24 .....	114/BAS A
2-14B .....		114/BAS A	3-25 .....	114/BAS A
2-15A .....		114/BAS A	3-26 .....	114/BAS A
2-15B .....		114/BAS A	3-27 .....	114/BAS A
2-16A .....		114/BAS A	3-28 .....	114/BAS A
2-16B .....		114/BAS A	3-29 .....	114/BAS A
2-17A .....		114/BAS A	3-30 .....	114/BAS A
2-17B .....		114/BAS A	3-31 .....	114/BAS A
2-18A .....		114/BAS A	3-32 .....	114/BAS A
2-18B .....		114/BAS A	3-33 .....	114/BAS A
2-19A .....		114/BAS A	3-34 .....	114/BAS A
2-19B .....		114/BAS A	3-35 .....	114/BAS A
2-20A .....		114/BAS A	3-36 .....	114/BAS A

\* – Omit from flight book

3-37 .....	114/BAS A	3-91 .....	114/BAS A
3-38 .....	114/BAS A	3-92 .....	114/BAS A
3-39 .....	114/BAS A	3-93 .....	114/BAS A
3-40 .....	114/BAS A	3-94 .....	114/BAS A
3-41 .....	114/BAS A	3-95 .....	114/BAS A
3-42 .....	114/BAS A	3-96 .....	114/BAS A
3-43 .....	114/BAS A	3-97 .....	114/BAS A
3-44 .....	114/BAS A	3-98 .....	114/BAS A
3-45 .....	114/BAS A	3-99 .....	114/BAS A
3-46 .....	114/BAS A	3-100 .....	114/BAS A
3-47 .....	114/BAS A	3-101 .....	114/BAS A
3-48 .....	114/BAS A	3-102 .....	114/BAS A
3-49 .....	114/BAS A	3-103 .....	114/BAS A
3-50 .....	114/BAS A	3-104 .....	114/BAS A
3-51 .....	114/BAS A	3-105 .....	114/BAS A
3-52 .....	114/BAS A	3-106 .....	114/BAS A
3-53 .....	114/BAS A	3-107 .....	114/BAS A
3-54 .....	114/BAS A	3-108 .....	114/BAS A
3-55 .....	114/BAS A	3-109 .....	114/BAS A
3-56 .....	114/BAS A	3-110 .....	114/BAS A
3-57 .....	114/BAS A	3-111 .....	114/BAS A
3-58 .....	114/BAS A	3-112 .....	114/BAS A
3-59 .....	114/BAS A	3-113 .....	114/BAS A
3-60 .....	114/BAS A	3-114 .....	114/BAS A
3-61 .....	114/BAS A	3-115 .....	114/BAS A
3-62 .....	114/BAS A	3-116 .....	114/BAS A
3-63 .....	114/BAS A	3-117 .....	114/BAS A
3-64 .....	114/BAS A	3-118 .....	114/BAS A
3-65 .....	114/BAS A	3-119 .....	114/BAS A
3-66 .....	114/BAS A	3-120 .....	114/BAS A
3-67 .....	114/BAS A	3-121 .....	114/BAS A
3-68 .....	114/BAS A	3-122 .....	114/BAS A
3-69 .....	114/BAS A	3-123 .....	114/BAS A
3-70 .....	114/BAS A	3-124 .....	114/BAS A
3-71 .....	114/BAS A	3-125 .....	114/BAS A
3-72 .....	114/BAS A	3-126 .....	114/BAS A
3-73 .....	114/BAS A	3-127 .....	114/BAS A
3-74 .....	114/BAS A	3-128 .....	114/BAS A
3-75 .....	114/BAS A	3-129 .....	114/BAS A
3-76 .....	114/BAS A	3-130 .....	114/BAS A
3-77 .....	114/BAS A	3-131 .....	114/BAS A
3-78 .....	114/BAS A	3-132 .....	114/BAS A
3-79 .....	114/BAS A	3-133 .....	114/BAS A
3-80 .....	114/BAS A	3-134 .....	114/BAS A
3-81 .....	114/BAS A	3-135 .....	114/BAS A
3-82 .....	114/BAS A	3-136 .....	114/BAS A
3-83 .....	114/BAS A	3-137 .....	114/BAS A
3-84 .....	114/BAS A	3-138 .....	114/BAS A
3-85 .....	114/BAS A	3-139 .....	114/BAS A
3-86 .....	114/BAS A	3-140 .....	114/BAS A
3-87 .....	114/BAS A	3-141 .....	114/BAS A
3-88 .....	114/BAS A	3-142 .....	114/BAS A
3-89 .....	114/BAS A	4-i .....	* 114/BAS A
3-90 .....	114/BAS A	4-ii .....	* 114/BAS A

\* – Omit from flight book

4-1.....	*	114/BAS A
4-2.....	*	114/BAS A
4-3.....	*	114/BAS A
4-4.....	*	114/BAS A
4-5.....	*	114/BAS A
4-6.....	*	114/BAS A
4-7.....	*	114/BAS A
4-8.....	*	114/BAS A
5-1.....	*	114/BAS A
5-2.....	*	114/BAS A
5-3.....	*	114/BAS A
5-4.....	*	114/BAS A
5-5.....	*	114/BAS A
5-6.....	*	114/BAS A
6-1.....	*	114/BAS A
6-2.....	*	114/BAS A
6-3.....	*	114/BAS A
6-4.....	*	114/BAS A
6-5.....	*	114/BAS A
6-6.....	*	114/BAS A
6-7.....	*	114/BAS A
6-8.....	*	114/BAS A
6-9.....	*	114/BAS A
6-10.....	*	114/BAS A

\* – Omit from flight book

This Page Intentionally Blank



CONTENTS

PAGE

INTRODUCTION ..... viii

OVERVIEW TIMELINE ..... 1-1

SUMMARY TIMELINE AND ISS SHORT TERM PLAN ..... 2-1

DETAILED TIMELINE ..... 3-1

ATTITUDE TIMELINE ..... 4-1

FLIGHT PLAN NOTES ..... 5-1

FLIGHT PLAN WALKTHROUGH ..... 6-1

## INTRODUCTION

The STS-114 Flight Plan is the Flight Data File article that contains the on-orbit timeline. It does not contain the detailed timelines that are covered in the Ascent, Post Insertion, Deorbit Prep, and Entry Checklists. The detailed rendezvous and undocking timelines and procedures are contained in the Rendezvous Checklist. The detailed EVA task timelines and procedures are contained in the EVA Checklist.

This Flight Plan satisfies the mission requirements specified in the following documents:

NSTS-07700 Vol III, Flight Definition and Requirements Document

NSTS-17462-114, STS-114 Flight Requirements Document

NSTS-37326, Shuttle Crew Scheduling Constraints

The STS-114 Basic A Flight Plan is based on a launch date of September 12, 2004 at 18:22 CDT (23:22 GMT). Orbiter inertial attitudes are expressed relative to a mean of 1950 (M50) reference frame. |

The Flight Plan and other related mission information are available on the following Space Shuttle Flight Planning web site:

<http://mod.jsc.nasa.gov/do4/flightplan/main/fp.cfm?id=114> |

OVERVIEW TIMELINE

This Page Intentionally Blank

# STS-114 (LF1) OVERVIEW TIMELINE

MET	0/-12	-11	-10	-9	-8	-7	-6	-5	-4	-3	-2	-1	0	1	2	3	4	5	6	7	8	9	10	11	12	
STS													ASC	PI	RMS c/o, LAN s/u	Pre-Sleep	Sleep									
ATT													ASC	-ZLV +YVW			OMS	-ZLV -XVW								
													^OMS2			^NC1										
MET	0/12	13	14	15	16	17	18	19	20	21	22	23	1/0	1	2	3	4	5	6	7	8	9	10	11	12	
STS	Sleep	F02 Post Sleep		Graphic Unbrkth	PTV, Rndz tools s/u		Meal	EMU c/o, tools		Beath. Ungrainpt		Pre-Sleep		Sleep												
ATT	-ZLV -XVW		OMS	Bias -ZLV (Survey)								RCS	OMS	-ZLV -XVW												
													^NC2			^NPC ^NC3										
MET	1/12	13	14	15	16	17	18	19	20	21	22	23	2/0	1	2	3	4	5	6	7	8	9	10	11	12	
STS	F03 Post Sleep		RMS Survey	Rndz			Approach, Dock, Leak Cks		Hatch Open	Boom h/o		Pre-Sleep		Sleep												
ISS	Post Sleep	Post Sleep	Post Sleep	Rndz			Pitch mnvr P/TV		Hatch Open	Boom h/o		Pre-Sleep		Sleep												
ATT	-ZLV -XVW		-ZLV +YVW	Rndz			Bias -XLV +ZVW																			
													^NH^		^NC4		^Ti		^Docking							
MET	2/12	13	14	15	16	17	18	19	20	21	22	23	3/0	1	2	3	4	5	6	7	8	9	10	11	12	
STS	F04 Post Sleep		MPLM Install			Meal	SSRMS w/o	OBSS Survey		EVA Rvw	Pre-Sleep		Sleep													
ISS	Post Sleep	Post Sleep	EVA tool prep		Meal	MPLM Vest, Act, Ingress			EVA Rvw	Pre-Sleep		Sleep														
ATT	Bias -XLV +ZVW																									
MET	3/12	13	14	15	16	17	18	19	20	21	22	23	4/0	1	2	3	4	5	6	7	8	9	10	11	12	
STS	PS	EVA Prep/EMU Purge/DPRS			DTO TILE REPAIR (6.30)						Post EVA	Pre-Sleep		Sleep												
ISS	Post Sleep	EVA Support											Pre-Sleep		Sleep											
ATT	Bias -XLV +ZVW																									
MET	4/12	13	14	15	16	17	18	19	20	21	22	23	5/0	1	2	3	4	5	6	7	8	9	10	11	12	
STS	F06 Post Sleep		EVA tool prep, CWC/PWR dump			Meal	Transfer, CWC fill		EVA Rvw	Pre-Sleep		Sleep														
ISS	Post Sleep	Post Sleep	Transfer						EVA Rvw	Pre-Sleep		Sleep														
ATT	Bias -XLV +ZVW																									
MET	5/12	13	14	15	16	17	18	19	20	21	22	23	6/0	1	2	3	4	5	6	7	8	9	10	11	12	
STS	PS	EVA Prep/EMU Purge/DPRS			CMG R&R (6.30)						Post EVA	Pre-Sleep		Sleep												
ISS	Post Sleep	EVA Support											Pre-Sleep		Sleep											
ATT	Bias -XLV +ZVW																									
MET	6/12	13	14	15	16	17	18	19	20	21	22	23	7/0	1	2	3	4	5	6	7	8	9	10	11	12	
STS	F08 Post Sleep		EVA tool prep, PWR fill			Crew Conf	Meal	Xfer	Off Duty	EVA Rvw	Pre-Sleep		Sleep													
ISS	Post Sleep	Post Sleep	Transfer			Crew Conf	Meal	Xfer	Off Duty	EVA Rvw	Pre-Sleep		Sleep													
ATT	Bias -XLV +ZVW																									
MET	7/12	13	14	15	16	17	18	19	20	21	22	23	8/0	1	2	3	4	5	6	7	8	9	10	11	12	
STS	PS	EVA Prep/EMU Purge/DPRS			ESP2/MISSE 5 Install (6.30)						Post EVA	Pre-Sleep		Sleep												
ISS	Post Sleep	EVA Support											Pre-Sleep		Sleep											
ATT	Bias -XLV +ZVW																									
MET	8/12	13	14	15	16	17	18	19	20	21	22	23	9/0	1	2	3	4	5	6	7	8	9	10	11	12	
STS	F010 Post Sleep		Post EVA EMU config			Meal	MPLM Uninstall		Boom h/o		Pre-Sleep		Sleep													
ISS	Post Sleep	Post Sleep	MPLM Egress, Deact, Vest			Meal	MDDK Xfer				Pre-Sleep		Sleep													
ATT	Bias -XLV +ZVW																									

## STS-114 (LF1) OVERVIEW TIMELINE (Concluded)

MET	9/12	13	14	15	16	17	18	19	20	21	22	23	10/0	1	2	3	4	5	6	7	8	9	10	11	12
STS	FD11 Post Sleep		Egress/Undock					Meal	Off Duty					Pre-Sleep		Sleep									
ISS	Post Sleep		Egress/Undock																						
ATT	Bias -XLV +ZVV					Undock/Sep			-ZLV +YVV					-ZLV -XW											
<b>^Undock</b>																									
MET	10/12	13	14	15	16	17	18	19	20	21	22	23	11/0	1	2	3	4	5	6	7	8	9	10	11	12
STS	FD12 Post Sleep		FCS o/o, RCS HF		Pilot	EVA Stow	Meal	Meal	Cabin Stow			Pre-Sleep		Sleep								PS			
ATT	-ZLV -XVV																								
MET	11/12	13	14	15	16	17	18	19	20	21	22	23	12/0	1	2	3	4	5	6	7	8	9	10	11	12
STS	FD13 Post Sleep		Deorbit Prep					Entry																	
ATT	-ZLV	IMU	-XSI	Comm	Ent																				

SUMMARY TIMELINE AND ISS SHORT TERM PLAN

This Page Intentionally Blank



GMT 09/12/04 (256)

MET Day 000

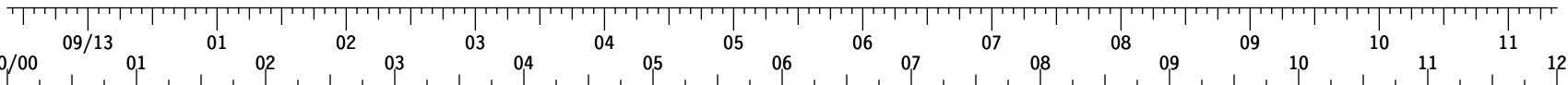

STS-114	CDR COLLINS	ASCENT	POST INSERTION	APU OFF	PRE SLEEP	APU ON	WSB DTO/ELEV PK	PMC A/G	PSLEEP	NC1	OMS BURN	MZLV	GRPRDN	PSLEEP	MNVR	SLEEP
	PLT KELLY	ASCENT	POST INSERTION	RMS INIT	RMW SUP	PRE SLEEP	WSB DTO/ELEV PK	PRE SLEEP	OMS BURN	APU OFF	GRPRDN	PSLEEP				SLEEP
	MS1 NOGUCHI	ASCENT	POST INSERTION	P/TV01 SETUP		HVD HIDE/O			PRE SLEEP - GIRA							SLEEP
	MS2 ROBINSON	ASCENT	POST INSERTION	PGSC S/U PT1					PRE SLEEP							SLEEP
	MS3 THOMAS	ASCENT	POST INSERTION	GIRA INSTALL	RMS C/O	RMW SRDN			PRE SLEEP							SLEEP
	MS4 LAWRENCE	ASCENT	POST INSERTION	P/TV01 SETUP		TEPTUP	SO S/AUC	SEE S/U		PRE SLEEP	WR AETN CA HL					SLEEP
	MS5 CAMARDA	ASCENT	POST INSERTION	PGSC S/U PT1		RMS C/O	RMW SRDN		PRE SLEEP		WATCH					SLEEP

DAY/NIGHT	[Timeline bars]														
ORBIT	[Timeline bars]														
TDRS	E -47.0	[Timeline bars]													
	W -171.0	[Timeline bars]													
	Z -275.0	[Timeline bars]													
ORB ATT		-ZLV +YVV BIASED		*ACT	*DEACT		NC-1		-ZLV -XVV BIASED		INTRL		-ZLV -XVV		
NOTES	-----  MPLM ENV CK														

GMT 09/13/04 (257)

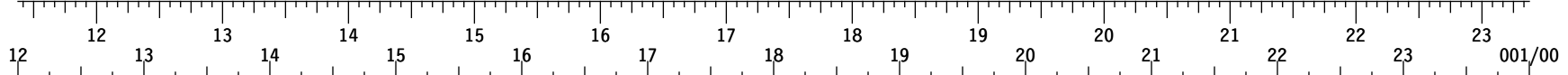

MET Day 000

STS-114	CDR COLLINS	SLEEP	FD02 POST SLEEP	NC2 OMS BURN	M-NZ VLRV	POST SLEEP	FC*	FILTER CLEANING	APCU 11*	PLD OAP	AFT C/O	APCU*	EXERCISE	CRYO 02 SNSR CK	M-NZ VLRV	DOCK RING EXT	MEAL	MSB	H2O CWC SETUP	PRE SLEEP		
	PLT KELLY	SLEEP	POST SLEEP	OMS BURN		POST SLEEP		OBSS UNBERTH		OBSS SURVEY				OBSS SURVEY		MEAL		OBSS SURVEY				
	MS1 NOGUCHI	SLEEP	POST SLEEP - GIRA				C/L CMR INSTL	ERGO S/U	P/TV01 SETUP				PGT C/O	EMSH ITAP	CIPAA C/O	MEAL		EMU C/O PREP	A/ L*	EMU C/O		
	MS2 ROBINSON	SLEEP	POST SLEEP					ERGO S/U	PGSC S/U PT2		RNDZ TOOLS C/O PT1			PGT C/O	EMSH ITAP	CIPAA C/O	MEAL		EMU C/O PREP		EMU C/O	
	MS3 THOMAS	SLEEP	POST SLEEP				RMS C/O		OBSS UNBERTH	OBSS SURVEY				MEAL	OBSS SURVEY	OBSS SURVEY						
	MS4 LAWRENCE	SLEEP	POST SLEEP				C/L CMR INSTL	SSV S/U	P/TV01 SETUP		RNDZ TOOLS C/O PT1				DOCK RING EXT	MEAL		MDDK XFER PREP	EMU C/O	MDDK XFER PREP		
	MS5 CAMARDA	SLEEP	POST SLEEP				RMS C/O		OBSS UNBERTH	OBSS SURVEY				OBSS SURVEY		MEAL	OBSS SURVEY					

DAY/NIGHT

ORBIT



ORB ATT -ZLV -XVV NC-2 -ZLV -YV BIASED

NOTES \*ACT \*DEACT \*FAN ACT  
 \*PURGE-MANUAL LDRI SURVEY: | STBD WING | | NOSE CAP | | PORT WING |  
 | MPLM PRESSURE CK

GMT 09/13/04 (257)

MET Day 001

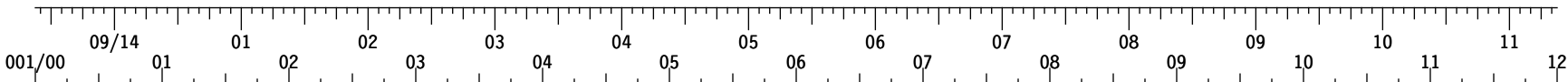

STS-114	CDR COLLINS	M-Z N-V L-R V	P-S R-L E-E P	PAO A/G	NPC RCS BURN	PRE SLEEP	PMC OCA	C-M G-H T-R	P-S R-L E-E P	NC3 RCS BURN	M-Z N-V L-R V	PRE SLEEP	MNVR			SLEEP	
	PLT KELLY	FCMS C/O	PAO A/G	RCS BURN	PRE SLEEP	RCS BURN	PRE SLEEP				SLEEP						
	MS1 NOGUCHI	EVA PREP FOR XFER			A / L *	PRE SLEEP - GIRA						SLEEP					
	MS2 ROBINSON	EVA PREP FOR XFER			PRE SLEEP						SLEEP						
	MS3 THOMAS	O-S B-U S-R S-V E-Y	OBSS BERTH	PRE SLEEP						SLEEP							
	MS4 LAWRENCE	VTR PB	PRE SLEEP	VTR PB	PRE SLEEP	RE N A L						SLEEP					
	MS5 CAMARDA	O-S B-U S-R S-V E-Y	OBSS BERTH	PRE SLEEP						SLEEP							

DAY/NIGHT	ORBIT	17	18	19	20	21	22	23	24	25
-----------	-------	----	----	----	----	----	----	----	----	----

TDRS	E -47.0	W -171.0	Z -275.0
------	---------	----------	----------

ORB ATT	-ZLV +YV BIASED	NC-3	-ZLV -XV	INTRL	-ZLV -XV
---------	-----------------	------	----------	-------	----------

NOTES

\*FAN BYPASS

GMT 09/14/04 (258)

MET Day 001

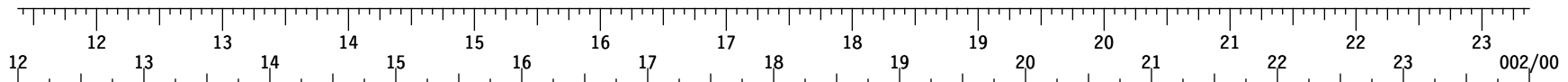

STS-114	CDR COLLINS	+YVV POST SLEEP	FD03 SIMO INIT	POST SLEEP	SIMO TERM	POST	GP RR UP	NH	NC4	TI	ISS RNDZ	APPROACH W/RPM	MNVR -XLV	ATHO*	GP RR DN	HATCH OPEN	SFTY BRIEF	AC CWN IT	EXERCISE
	PLT KELLY	POST SLEEP		EXERCISE			GP RR UP				ISS RNDZ	APPROACH W/RPM	MNVR -XLV		GP RR DN	HATCH OPEN	SFTY BRIEF	OBSS GRPL	OBSS UNBRTH *
	MS1 NOGUCHI	POST SLEEP - GIRA			EXERCISE	EMU RMVL	ISS RNDZ	P/TV02 S/U	PTV02 OPS					PS // TU V 0 4	PO P /T S V 0 4	PS // TU V 0 5	N SFTY BRIEF	POST RNDZ PGSC CNFG	EVA TOOL XFER
	MS2 ROBINSON	POST SLEEP		EXERCISE	RNDZ TOOLS C/O PT2	ISS RNDZ	EMU RMVL	ISS RNDZ			APPROACH W/RPM		PCS S/U	HATCH OPEN	SFTY BRIEF	POST RNDZ PGSC CNFG	EVA TOOL XFER		
	MS3 THOMAS	POST SLEEP	TILE INSPECT	POST SLEEP	ISS RNDZ	EXERCISE	ISS RNDZ	APPROACH W/RPM		LEAK CHECK	API R N L E G P R S	HATCH OPEN	SFTY BRIEF	⊕	OBSS UNBTH CAMR				
	MS4 LAWRENCE	POST SLEEP	TILE INSPECT	POST SLEEP	CS OE NT DU P	EXERCISE	ISS RNDZ	APPROACH W/RPM		LEAK CHECK	API R N L E G P R S	HATCH OPEN	SFTY BRIEF	OBSS GRPL	OBSS UNBRTH *				
MS5 CAMARDA	POST SLEEP	TILE INSPECT	POST SLEEP	EXERCISE	ISS RNDZ			APPROACH W/RPM		A I U S D S I O	PCS S/U	HATCH OPEN	SFTY BRIEF	Ⓢ	OBSS UNBTH CAMR				
ISS	ISS CDR KRIKALEV	SLEEP	POSTSLEEP-ISS	DPC	PREP WORK	AIR SMPL	EXERCISE TVIS	VERFY	COX MNT	ISS MEAL	DO FILM	DOCK-FILM		LEAK CHECK	ASK MP 1 M	HATCH OPEN	SFTY BRIEF	MDDK XFER	♣
	FE-1 PHILLIPS	SLEEP	POSTSLEEP-ISS	DPC	PREP WORK	RMS	EXERCISE RED	VERFY	C N F G	WDW CL	ISS MEAL	DI OM CE R	RBAR-FILM	PMA2 ARVL	LEAK CHECK		HATCH OPEN	SFTY BRIEF	SSRMS SUPPORT

DAY/NIGHT																			
ORBIT	25	26	27	28	29	30	31	32	33										
TDRS	E -47.0																		
	W -171.0																		
	Z -275.0																		
ORB ATT		+ZLV +YVV BIASED			RNDZ					DOCK	FREE					BIAS -XLV +ZVV			

NOTES

2-6A

\*ACT

♣OBSS MNVR

ⓈOBSS H/O FROM SSRMS

♣OBSS MNVR

ⓈOBSS H/O FROM SSRMS

♣A/L CCAA A

▼C&T-DAIU-VOICE-CK

ΔA/L CCAA ACT

FLT PLN/114/BAS A \*STS TO RS

**\*DOCK 1/19:58**

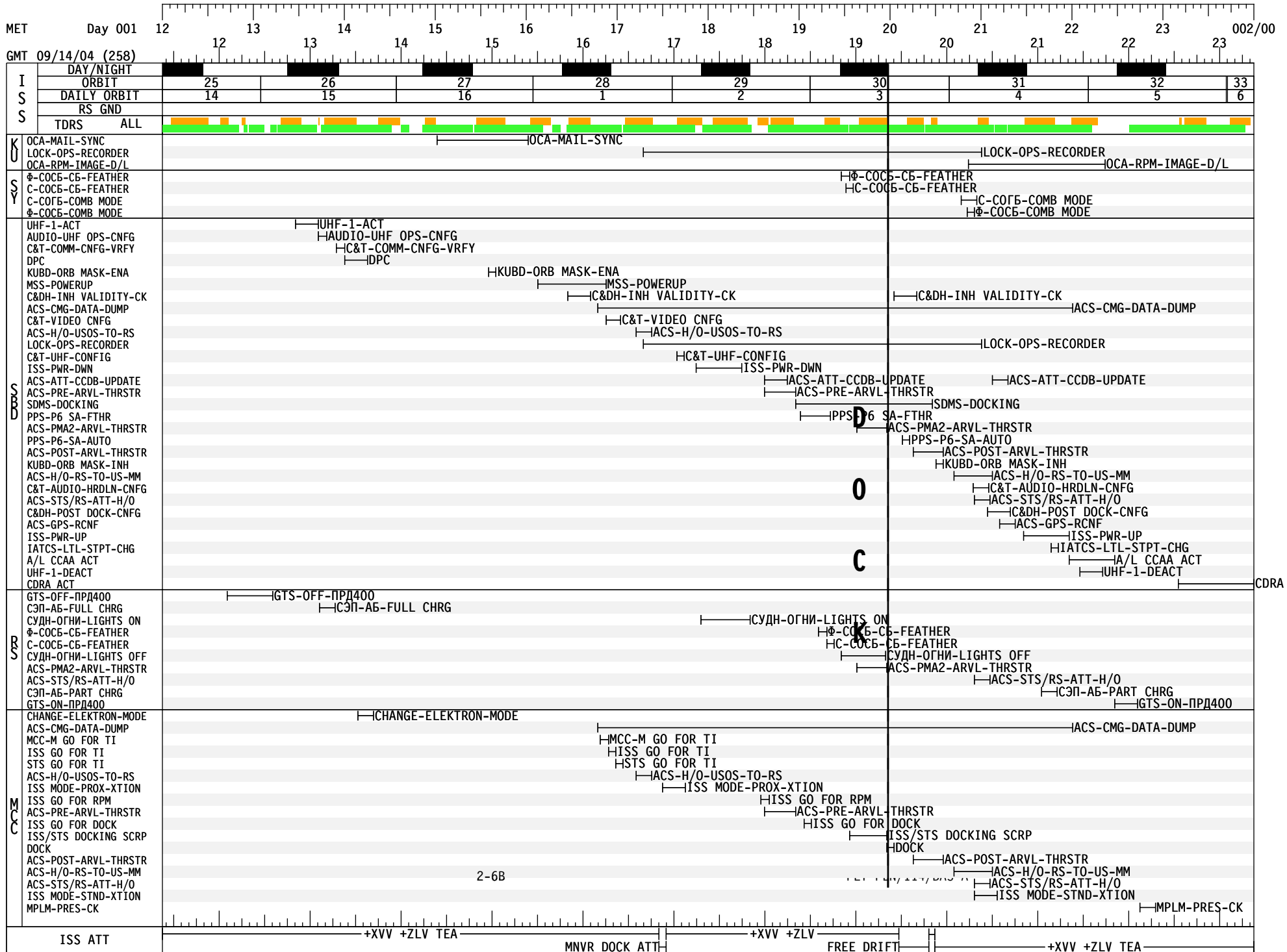

GMT 09/14/04 (258)

MET Day 002

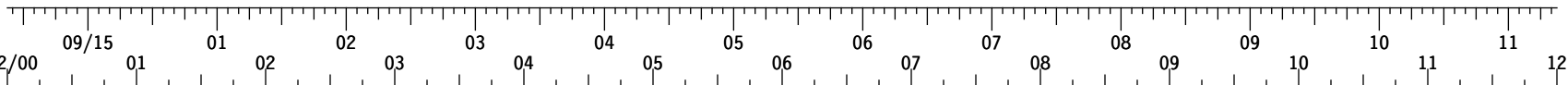

S T S - 1 1 4	CDR COLLINS	*CTW EFC RUC MLR	PXC CFW EFC MLR	VTR S/U	VTR PB	PRE SLEEP	PMC OCA	PRE SLEEP	SLEEP
	PLT KELLY	⊕	OH B/S S	PRE SLEEP	MNVR TO ACBM INSPT	PRE SLEEP			SLEEP
	MS1 NOGUCHI	EVA TOOL XFER		PTV06 S/U MPLM		PRE SLEEP - GIRA			SLEEP
	MS2 ROBINSON	EVA TOOL XFER				PRE SLEEP			SLEEP
	MS3 THOMAS	OUC BNA SBM STR H	♦	OBSS H/O FROM SSRMS		PRE SLEEP			SLEEP
	MS4 LAWRENCE	⊗	OH B/S S	PRE SLEEP	MNVR TO ACBM INSPT	PRE SLEEP	REN AL		SLEEP
	MS5 CAMARDA	OUC BNA SBM STR H	♥	OBSS H/O FROM SSRMS		PRE SLEEP			SLEEP
I S S	ISS CDR KRIKALEV	VELO + HC	DPC	AIR SMPL		PRE SLEEP			SLEEP
	FE-1 PHILLIPS	SSRMS SUPPORT	DPC	Δ	PREP WORK	PRE SLEEP			SLEEP

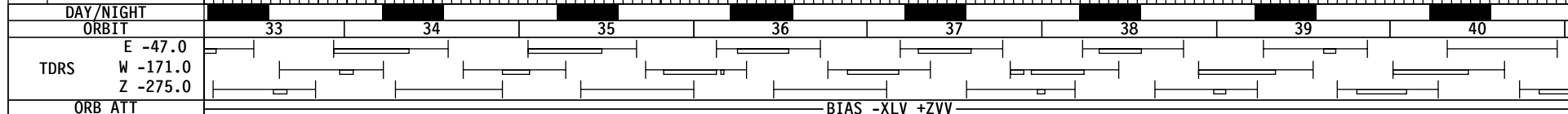

NOTES

- \*EXERCISE ΔDAILY PLN RVW
- ⊕OBSS MNVR TO HANDOFF
- ♦OBSS H/O FROM SSRMS 2-7A
- ⊗OBSS MNVR TO HANDOFF
- ♥OBSS H/O FROM SSRMS
- \*DEACT

FLT PLN/114/BAS A

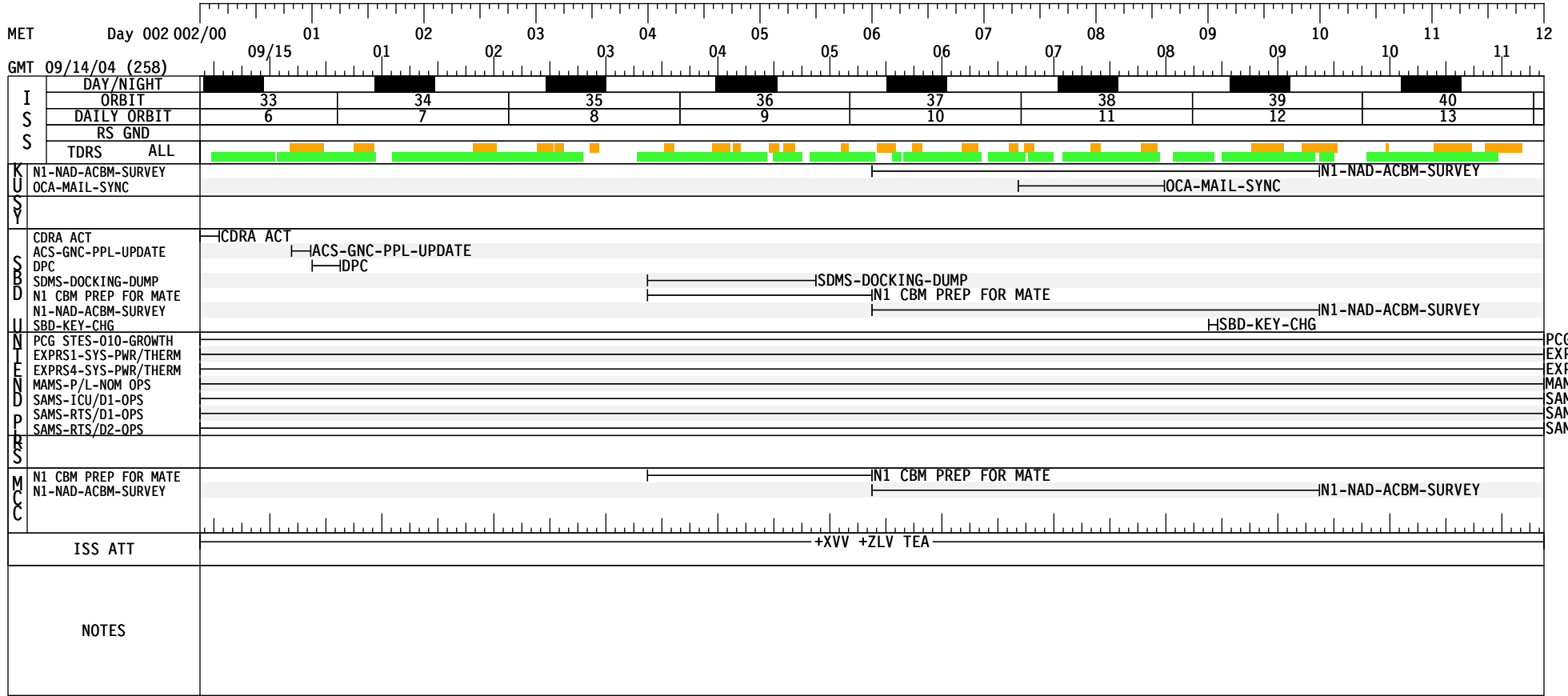

GMT 09/15/04 (259)

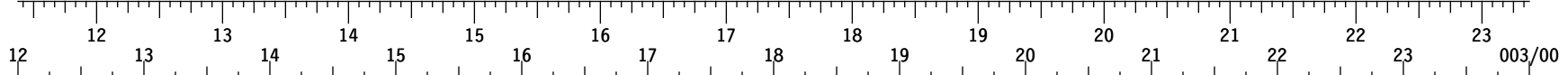

MET Day 002

STS - 114	CDR COLLINS	FD04 POST SLEEP	POST SLEEP	POST SLEEP	CINWICIT 2	PCB M*	CTWCRM	CINWICIT 3	MEAL	CTWCRM	PAO A/G	XFER 2 CWC	OBSS SURVEY				EVA PROC REVW						
	PLT KELLY	POST SLEEP	MPLM INSTL GRPL	MPLM UNBTH	MPLM INSTL	MPLM INSTL	M E A L	MEAL	BRAKE	UNGRP	MBS GRAPPLE	LAB UNGRPL	MNVR TO SRVY SPT	OBSS SURVEY				EVA PROC REVW					
	MS1 NOGUCHI	POST SLEEP - GIRA			CEVIS	EMU XFER & RCFG	EMU TO A/L I/F CK	VERIF	ECVAMRSTG	CBM 1ST STG	CBM 2ND STG/ ABOLTS	MEAL		EXERCISE		MDDK XFER	E LK PREP	EVA TOOL CONFG	RH/BWA	CIPAA PRE/HEAT	XSF AFE R	EVA PROC REVW	
	MS2 ROBINSON	POST SLEEP			CEVIS	EMU XFER & RCFG	EMU TO A/L I/F CK	VERIF	ECVAMRSTG	CBM 1ST STG	CBM 2ND STG/ ABOLTS	MEAL		PAO A/G	EXERCISE		MDDK XFER	E LK PREP	EVA TOOL CONFG	RH/BWA	CIPAA PRE/HEAT	XSF AFE R	EVA PROC REVW
	MS3 THOMAS	POST SLEEP			PRLA	EMU XFER & RCFG	EMU TO A/L I/F CK	N2 XFER		STS 02 P/B CONFIG		MEAL		DOUG RVW	OBSS SURVEY		E LK PREP	EVA TOOL CONFG	EXERCISE		EVA PROC REVW		
	MS4 LAWRENCE	POST SLEEP			MPLM INSTL GRPL	MPLM UNBTH	MPLM INSTL	MPLM INSTL	M E A L	MEAL	BRAKE	UNGRP	MDDK XFER	VEST PRESS		MPLM VEST				MIPN/LG LRM	MS/ULM	EVA PROC REVW	
	MS5 CAMARDA	POST SLEEP		EXERCISE	PRLA	POST SLEEP		N2 XFER		MDDK XFER	N1 NDR CBCS RMV	MEAL		DOUG RVW	OBSS SURVEY				EVA PROC REVW				
ISS	ISS CDR KRIKALEV	SLEEP	POST SLEEP	PWRORK	DPC	PWRORK	MPLM EQUIP S/U	VELO + HC	COX MNT	MEAL		VEST PRESS		MPLM VEST				MIPN/LG LRM	MS/ULM	EVA REVW			
	FE-1 PHILLIPS	SLEEP	POST SLEEP	DPS WOLPNT	*DPC	CEVIS	EMU XFER & RCFG	EMU TO A/L I/F CK	N2 XFER		STS 02 P/B CONFIG		MBS GRAPPLE	LAB UNGRPL	MNVR TO SRVY SPT	MEAL		E LK PREP	EVA TOOL CONFG	EXERCISE TVIS		EVA REVW	
DAY/NIGHT ORBIT		41		42		43		44		45		46		47		48							
TDRS		E -47.0		W -171.0		Z -275.0																	
ORB ATT		BIAS -XLV +ZVV																					
NOTES		*ACT *CBCS P/U *DEACT				*INSPECT				2-8A				FLT PLN/114/BAS A									



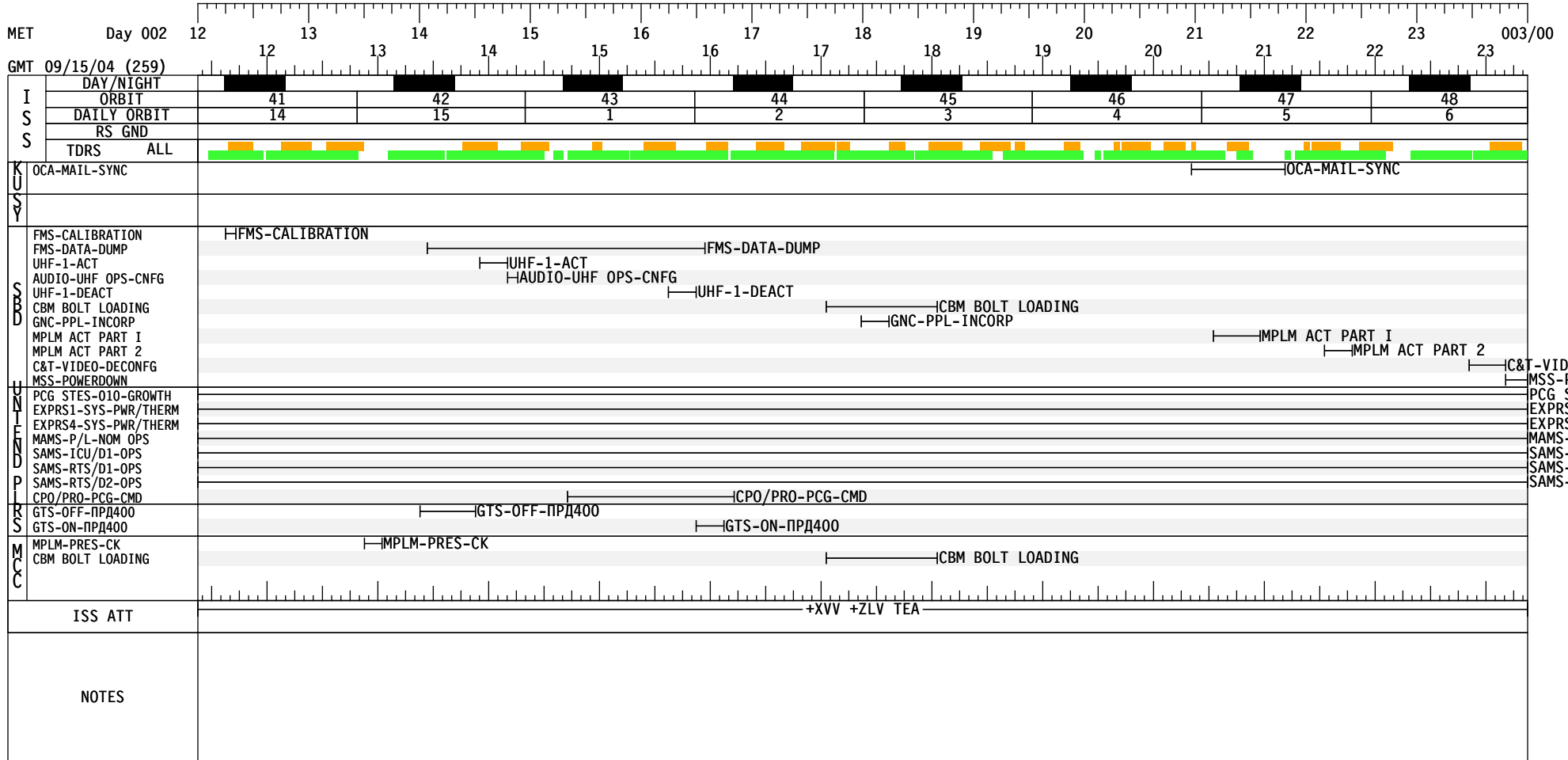

GMT 09/15/04 (259)

MET Day 003

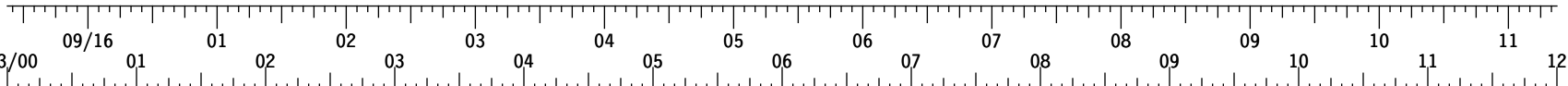

S T S - 1 1 4	CDR COLLINS	EVA PROC REVW	PRE SLEEP	EXERCISE	PRE SLEEP	PMC OCA	PRE SLEEP	SLEEP			
	PLT KELLY	EVA PROC REVW	PRE SLEEP					SLEEP			
	MS1 NOGUCHI	EVA PROC REVW	SAFER C/O	PRE SLEEP - GIRA				SLEEP			
	MS2 ROBINSON	EVA PROC REVW	SAFER C/O	PRE SLEEP				SLEEP			
	MS3 THOMAS	EVA PROC REVW	PRE SLEEP					SLEEP			
	MS4 LAWRENCE	EVA PROC REVW	PRE SLEEP					SLEEP			
	MS5 CAMARDA	EVA PROC REVW	PRE SLEEP	XTFA EGRUP	XTFA EGRUP	XCFA EGRUP	PRE SLEEP	SLEEP			
I S S	ISS CDR KRIKALEV	EVA REVW	PREP WORK	PS LEE EP	DPC	XTFA EGRUP	PRE SLEEP	SLEEP			
	FE-1 PHILLIPS	EVA REVW			DPC		PRE SLEEP	SLEEP			
DAY/NIGHT		ORBIT		49	50	51	52	53	54	55	56
TDRS		E -47.0	W -171.0	Z -275.0							
ORB ATT		BIAS -XLV +ZVV									
NOTES		2-9A					FLT PLN/114/BAS A				

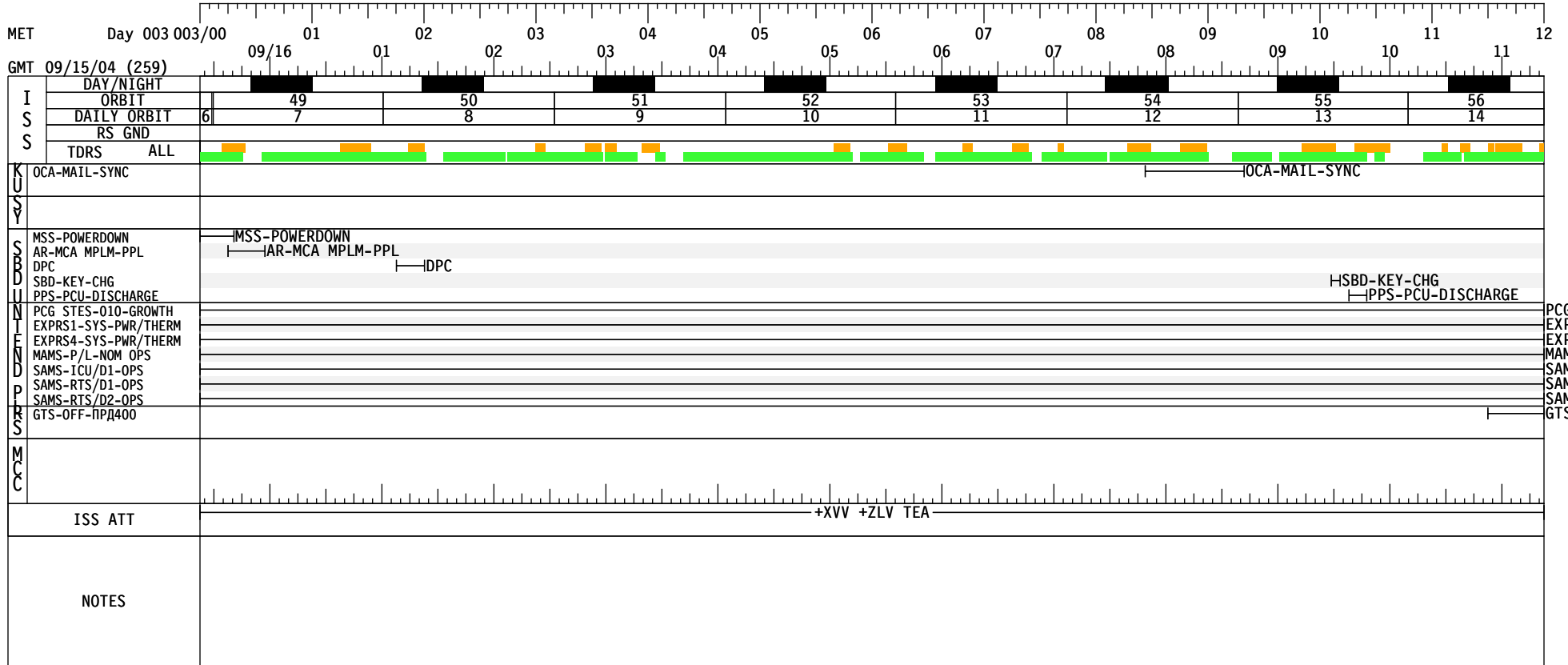

GMT 09/16/04 (260)

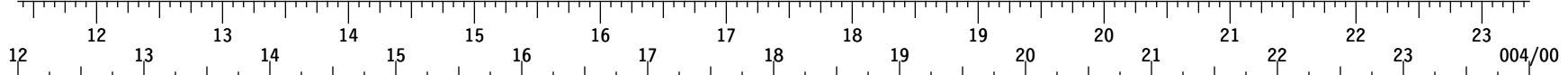

MET Day 003

STS-114	CDR COLLINS	POST SLEEP	PMCM A/GU	POST SLEEP		EVN A H 1 B T		CINW C I T 4	EXERCISE	CTW E C R M	MEAL	CINW C I T 5	CTW E C R M	XFER 2 CWC	FILTER CLEAN INSPECT		
	PLT KELLY	POST SLEEP		POST SLEEP	COM M *	EXERCISE	LAB GRAPPLE	MBS UNGRPL	DES T V E T O A U P	SSMRS SUPPORT							
	MS1 NOGUCHI	POST SLEEP - GIRA	CIP A A *	CEVIS	STS P/B 02 EVA PREP	EP M U R G E	EMU P/B	C/L DPRS	EGRS /SETUP	PAYLOAD BAY SETUP	<b>EVA 1 (06:30)</b>		TPS SAMPLE REPAIR	PAYLOAD BAY CLEANUP	C/U & INGR		
	MS2 ROBINSON	POST SLEEP	CIP A A *	CEVIS	STS P/B 02 EVA PREP	EP M U R G E	EMU P/B	C/L DPRS	EGRS /SETUP	PAYLOAD BAY SETUP	TPS SAMPLE REPAIR		PAYLOAD BAY CLEANUP	C/U & INGR			
	MS3 THOMAS	POST SLEEP	LEH		STS P/B 02 EVA PREP	EP M U R G E	EMU P/B	C/L DPRS	IVA SUPPORT								
	MS4 LAWRENCE	POST SLEEP		EXERCISE	XFER REVIEW	P/TV07 EVA S/U	LAB GRAPPLE	MBS UNGRPL	DES T V E T O A U P	SSMRS SUPPORT							
	MS5 CAMARDA	POST SLEEP			XFER REVIEW	TRANSFER		EXERCISE	TRANSFER		MEAL	TRANSFER					
ISS	ISS CDR KRIKALEV	SLEEP	POST SLEEP	DPC	PREP WORK	XFER REVIEW	VELO + HC	COX MNT	TRANSFER			MEAL	TRANSFER		♣	⊕	
	FE-1 PHILLIPS	SLEEP	POST SLEEP	LEH	STS P/B 02 EVA PREP	EP M U R G E	EMU P/B	C/L DPRS	POST SLEEP	EXERCISE TVIS	MEAL	♦	EXERCISE RED				
DAY/NIGHT ORBIT		56	57	58	59	60	61	62	63	64							
TDRS		E -47.0															
		W -171.0															
		Z -275.0															
ORB ATT		BIAS -XLV +ZVV															
NOTES		*TERM		*CONFIG		2-10A		FLT PLN/114/BAS A				♣C&T-CMM-CNFG-VRFY-2B				♣CFO-ACY-MI-Φ-B-R&R ⊕EXERCISE TV	

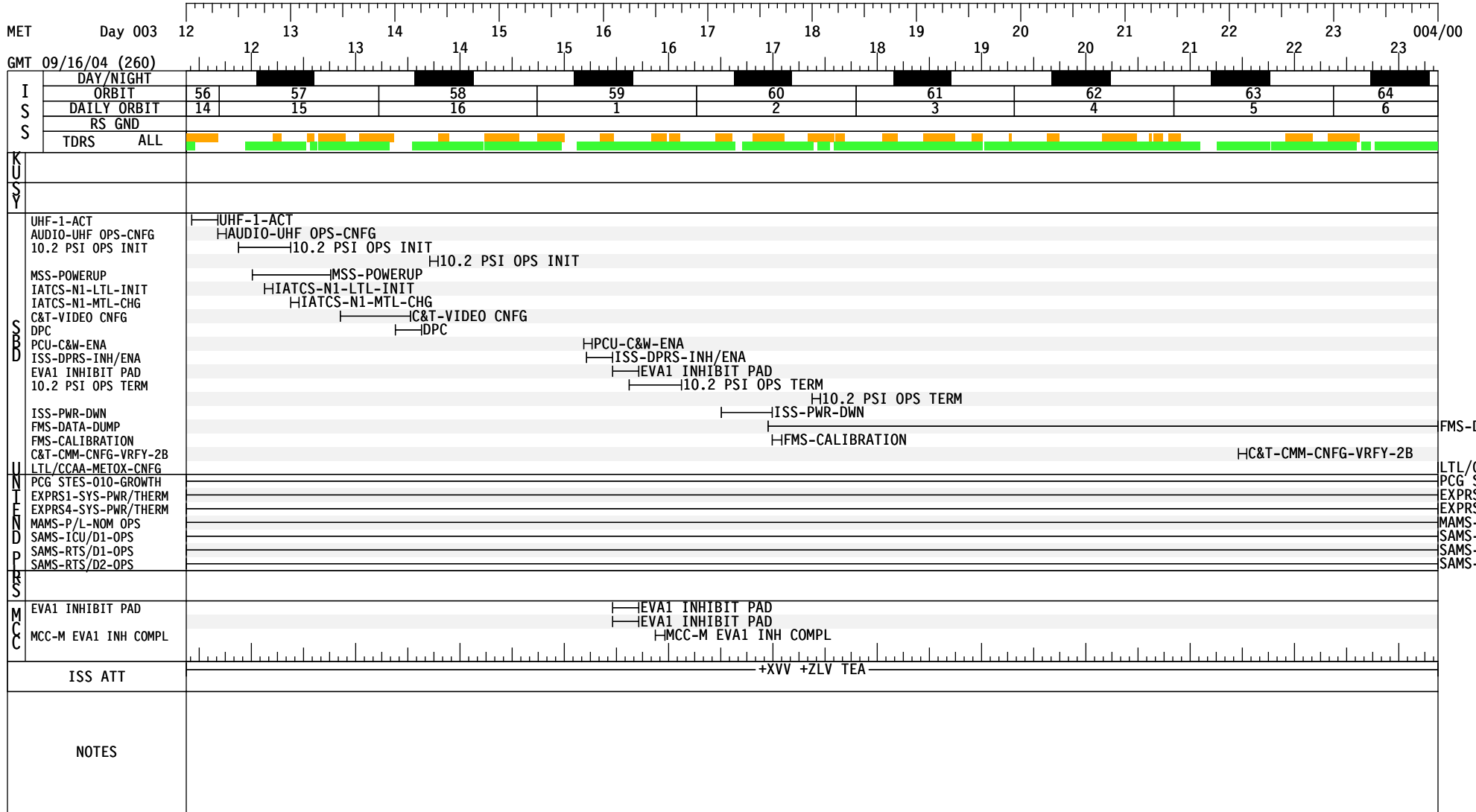

GMT 09/16/04 (260)

FDS 004/00  
MET Day 004

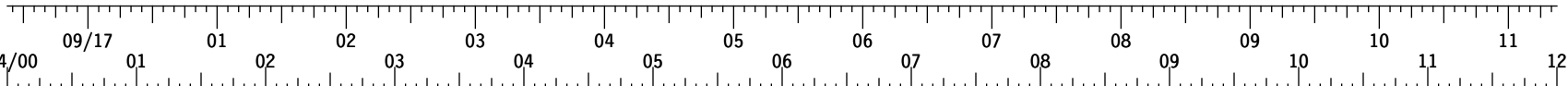

S T S - 1 1 4	CDR COLLINS		PWR FILL	PRE SLEEP	PMC OCA	PRE SLEEP	SLEEP				
	PLT KELLY	CMG R&R EVA S/U	COMM*	PRE SLEEP			SLEEP				
	MS1 NOGUCHI	C/U & INGR	CR/P/LS	POST EVA W/O H2O & W/MTX	PRE SLEEP - GIRA		SLEEP				
	MS2 ROBINSON	C/U & INGR	CR/P/LS	POST EVA W/O H2O & W/MTX	PRE SLEEP		SLEEP				
	MS3 THOMAS	IVA SUPPORT	CR/P/LS	POST EVA W/O H2O & W/MTX	L/M/EMU BATT	B S A - I	PRE SLEEP	SLEEP			
	MS4 LAWRENCE	CMG R&R EVA S/U	PRE SLEEP		XTFAEGRUP	XCFAELL	PRE SLEEP	SLEEP			
	MS5 CAMARDA	*	PRE SLEEP		XTFAEGRUP	XCFAELL	PRE SLEEP	SLEEP			
I S S	ISS CDR KRIKALEV	EXERCISE TVIS	PREP WORK	DPC	PSRLEEPP	XTFAEGRUP	PRE SLEEP	SLEEP			
	FE-1 PHILLIPS		CR/P/LS	POST EVA W/O H2O	L/M/EMU BATT	B S A - I	PRE SLEEP	SLEEP			
DAY/NIGHT ORBIT		64	65	66	67	68	69	70	71	72	
TDRS		E -47.0	[Timeline bars for E -47.0]								
		W -171.0	[Timeline bars for W -171.0]								
		Z -275.0	[Timeline bars for Z -275.0]								
ORB ATT		BIAS -XLV +ZVV									
NOTES		*TRANSFER *DECONFIG 2-11A FLT PLN/114/BAS A									

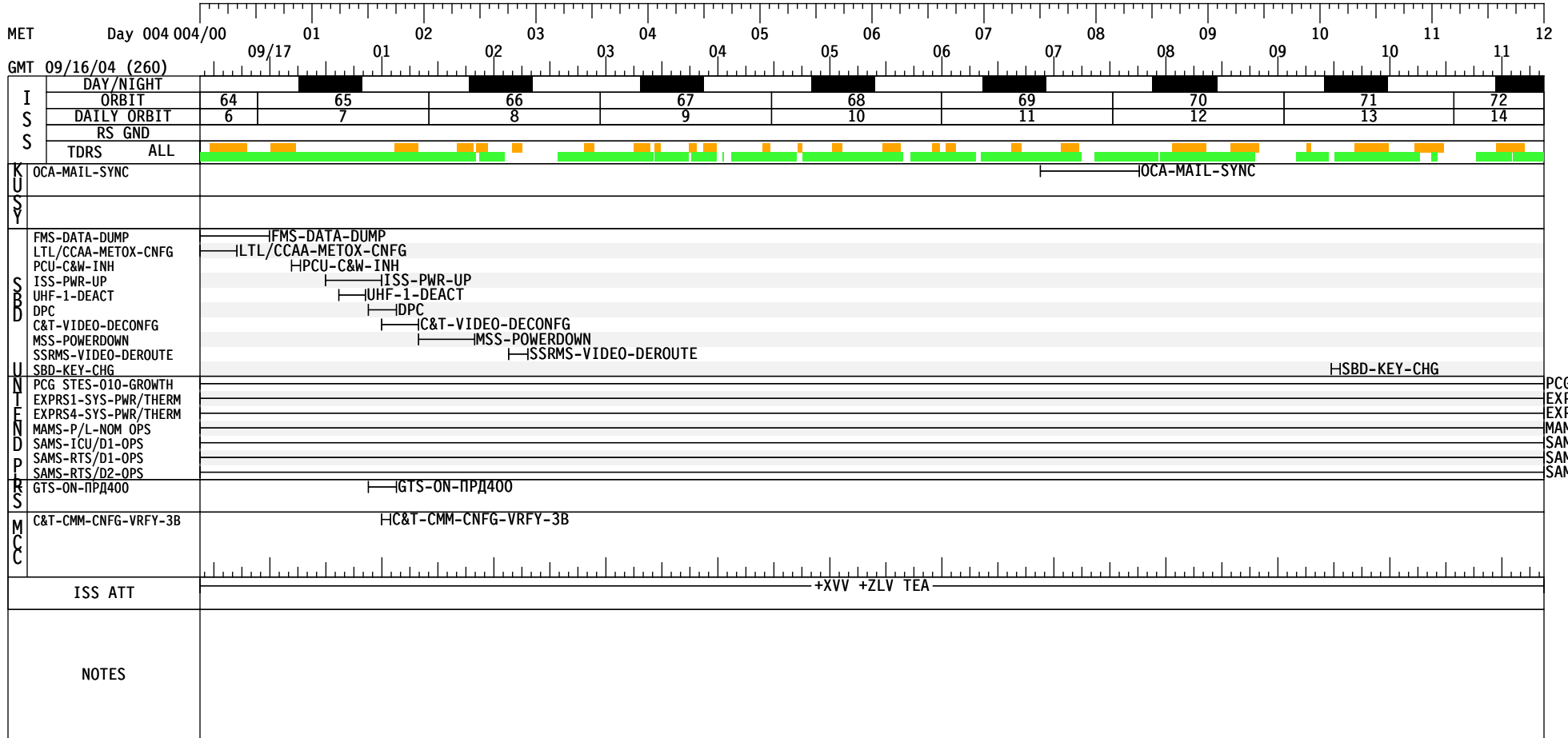

GMT 09/17/04 (261)

MET Day 004

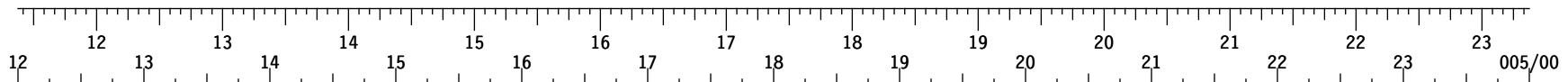

S T S - 1 1 4	CDR COLLINS	FD06 POST SLEEP	POST SLEEP	ATT HO*	CWC VENT/PWR DUMP		CHAB TRIN	CRCS *K	WCC	ATT HO*	CIN T 6	CC/O ND	PE AV E N T	CT WE CR M	CIN T 7	MEAL	CT WE CR M	XFER 2 CWC	PWR FILL	EXERCISE	PE AV E N T	ERE AV W
	PLT KELLY	POST SLEEP	EXERCISE	POST SLEEP	CWC VENT/PWR DUMP			TRANSFER			PE AV E N T	TRANSFER		MEAL	TRANSFER				ERE AV W			
	MS1 NOGUCHI	POST SLEEP - GIRA			AS PR N	EMU H2O RCHG	TPS EVA TOOL/XFER		ME TO X	E LK PREP	EC VA M R	EVA TOOL CFG		MEAL	TRANSFER			PE AV E N T	ERE AV W			
	MS2 ROBINSON	POST SLEEP	EXERCISE	AS PR N	EMU H2O RCHG	TPS EVA TOOL/XFER		E LK PREP	EC VA M R	EVA TOOL CFG		MEAL	TRANSFER			PE AV E N T	ERE AV W					
	MS3 THOMAS	POST SLEEP			TRANSFER			E LK PREP	EVA TOOL CFG		MEAL	TRANSFER			ERE AV W							
	MS4 LAWRENCE	POST SLEEP	XFER REVIEW		TRANSFER		EXERCISE	PA O S/ U	TRANSFER		MEAL	TRANSFER			ERE AV W							
	MS5 CAMARDA	POST SLEEP	XFER REVIEW		WB LA ET ST	TRANSFER		EXERCISE	PE AV E N T	TRANSFER		MEAL	TRANSFER			ERE AV W						
I S S	ISS CDR KRIKALEV	SLEEP	POST SLEEP	DPC P R O E R P K	XFER R E V I E W	TRANSFER			EXERCISE TVIS		MEAL	TRANSFER		VELO + HC	PE AV E N T	ERE AV W						
	FE-1 PHILLIPS	SLEEP	POST SLEEP	DPC P R E P W O R K	*	TRANSFER			EXERCISE RED		MEAL	⊕	TRANSFER		EXERCISE TVIS	ERE AV W						

DAY/NIGHT																					
ORBIT	72	73	74	75	76	77	78	79	80												

TDRS	E -47.0	W -171.0	Z -275.0																		
ORB ATT	BIAS -XLV +ZVV																				

NOTES	*LAB CWC FILL				*REG RCNFG				⊕COX-MNT													
	*CMG TO STS				*STS TO RS																	
	2-12A				*TERM				FLT PLN/114/BAS A													



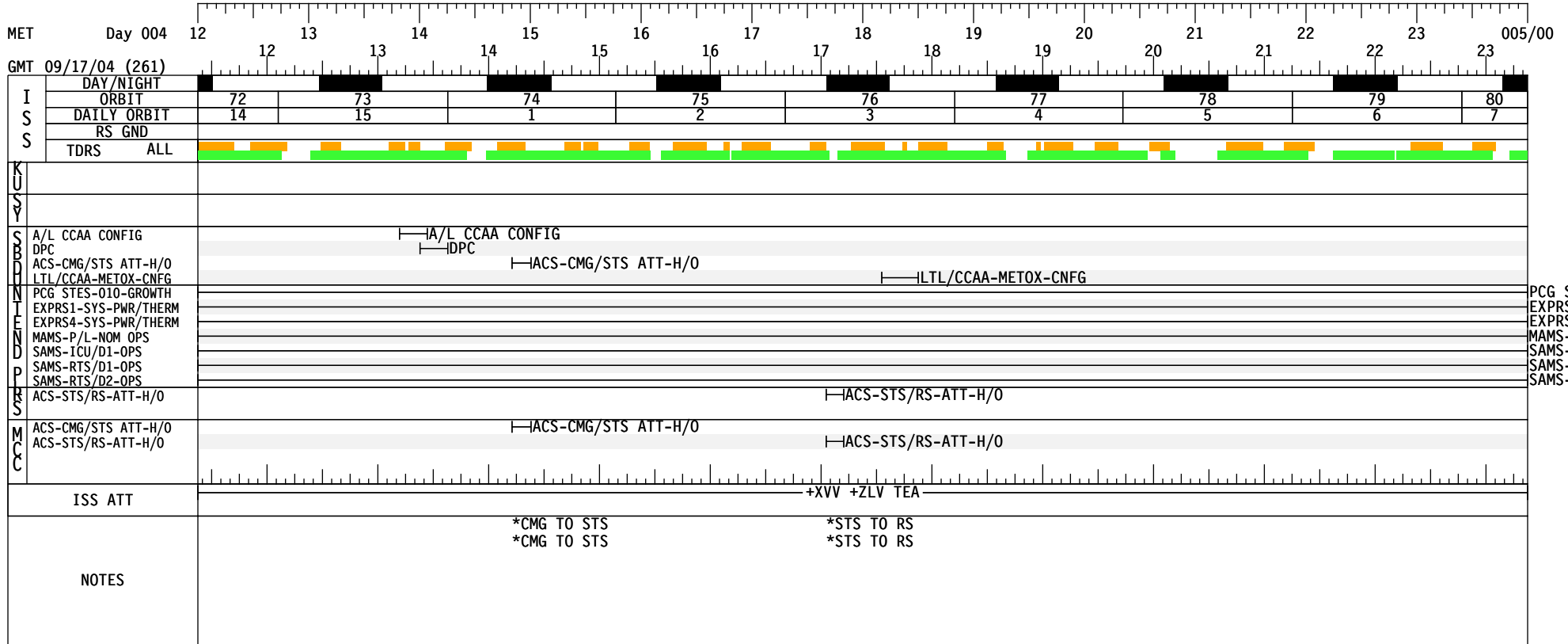

GMT 09/17/04 (261)

MET Day 005

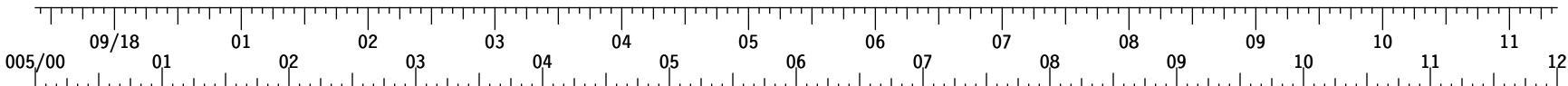

S T S - 1 1 4	CDR COLLINS	EVA REVW	PRE SLEEP		PMC OCA	PRE SLEEP	SLEEP					
	PLT KELLY	EVA REVW	PRE SLEEP				SLEEP					
	MS1 NOGUCHI	EVA REVW	EXERCISE	PRE SLEEP - GIRA			SLEEP					
	MS2 ROBINSON	EVA REVW	PRE SLEEP				SLEEP					
	MS3 THOMAS	EVA REVW	PRE SLEEP	EXERCISE	PRE SLEEP		SLEEP					
	MS4 LAWRENCE	EVA REVW	PRE SLEEP	XT F A G E R U P	XC F A L L	PRE SLEEP	RE N A L	SLEEP				
	MS5 CAMARDA	EVA REVW	PRE SLEEP	XT F A G E R U P	XC F A L L	PRE SLEEP	SLEEP					
I S S	ISS CDR KRIKALEV	EVA REVW	PREP WORK	PS R L E E P	DPC	XT F A G E R U P	PRE SLEEP	SLEEP				
	FE-1 PHILLIPS	EVA REVW	PREP WORK		DPC	PRE SLEEP		SLEEP				
DAY/NIGHT		ORBIT		80	81	82	83	84	85	86	87	88
TDRS		E -47.0	[Timeline bars for TDRS parameters]									
		W -171.0	[Timeline bars for TDRS parameters]									
		Z -275.0	[Timeline bars for TDRS parameters]									
ORB ATT		BIAS -XLV +ZVV										
NOTES		2-13A					FLT PLN/114/BAS A					

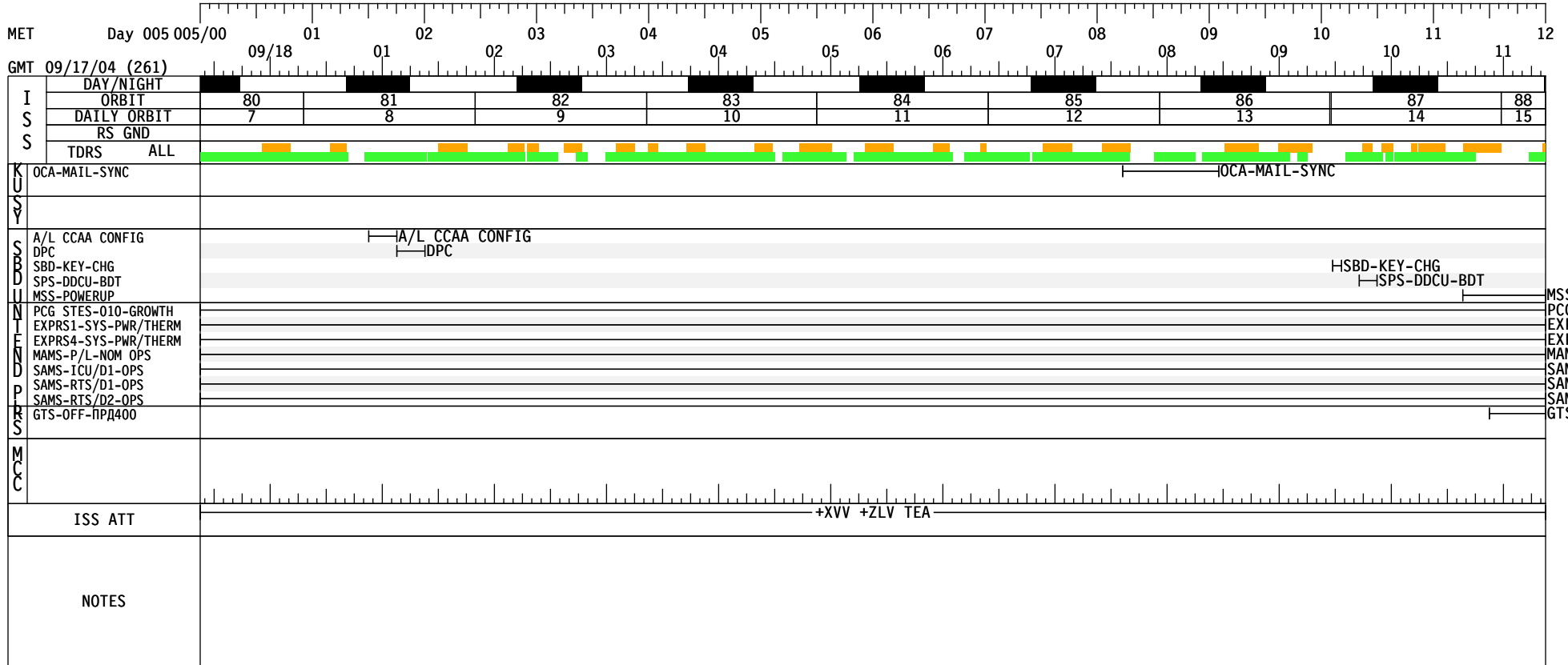

GMT 09/18/04 (262)

MET Day 005

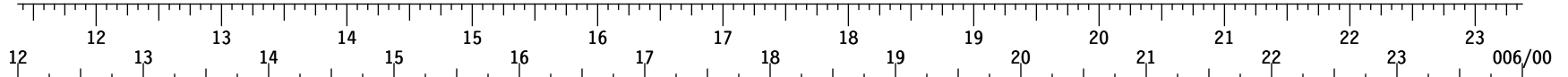

STS-114	CDR COLLINS	POST SLEEP	PMCM A/GU	POST SLEEP	ATT HO*	WANSITTE	WASRME	ATT HO*	EINVAH2T	CINWIT 8	EXERCISE	CTWERM	MEAL	CINWIT 9	CMGCK		
	PLT KELLY	POST SLEEP	COMM*	EXERCISE	WANSITTE	WASRME	TRANSFER	EVA SSRMS SUPPORT						ESP2 EVA SETUP			
	MS1 NOGUCHI	POST SLEEP - GIRA	CEVIS	STS P/B 02 EVA PREP	EMURGE	EMU P/B	C/L DPRS	EGRS /SETUP	EVA 2 (6:30)						C/U & INGR		
	MS2 ROBINSON	POST SLEEP	CEVIS	STS P/B 02 EVA PREP	EMURGE	EMU P/B	C/L DPRS	EGRS /SETUP	EVA2 CMG R&R						C/U & INGR		
	MS3 THOMAS	POST SLEEP	LEH	STS P/B 02 EVA PREP	EMURGE	EMU P/B	C/L DPRS	IVA SUPPORT									
	MS4 LAWRENCE	POST SLEEP	XFER REVIEW	EXERCISE	P/TV07 EVA S/U	TRANSFER	EVA SSRMS SUPPORT						ESP2 EVA SETUP				
	MS5 CAMARDA	POST SLEEP	XFER REVIEW	TRANSFER			EXERCISE	MEAL	TRANSFER								
ISS	ISS CDR KRIKALEV	SLEEP	POSTSLEEP-ISS	PREP WORK	XFER REVIEW	DPC	TRANSFER			COX MNT	VELO + HC	MEAL	TRANSFER		EXERCISE TVIS		
	FE-1 PHILLIPS	SLEEP	LEH	STS P/B 02 EVA PREP	EMURGE	EMU P/B	C/L DPRS	⊕	EXERCISE TVIS	MEAL	EXERCISE RED						
DAY/NIGHT ORBIT		88	89	90	91	92	93	94	95	96							
TDRS		E -47.0															
		W -171.0															
		Z -275.0															
ORB ATT		BIAS -XLV +ZVV															
NOTES		*POSTSLEEP-ISS*CONFIG			*CMG TO STS		*STS TO RS		⊕POSTSLEEP-ISS								
		♦C&T-CMM-CNFG-VRFY-2B			2-14A		FLT PLN/114/BAS A										

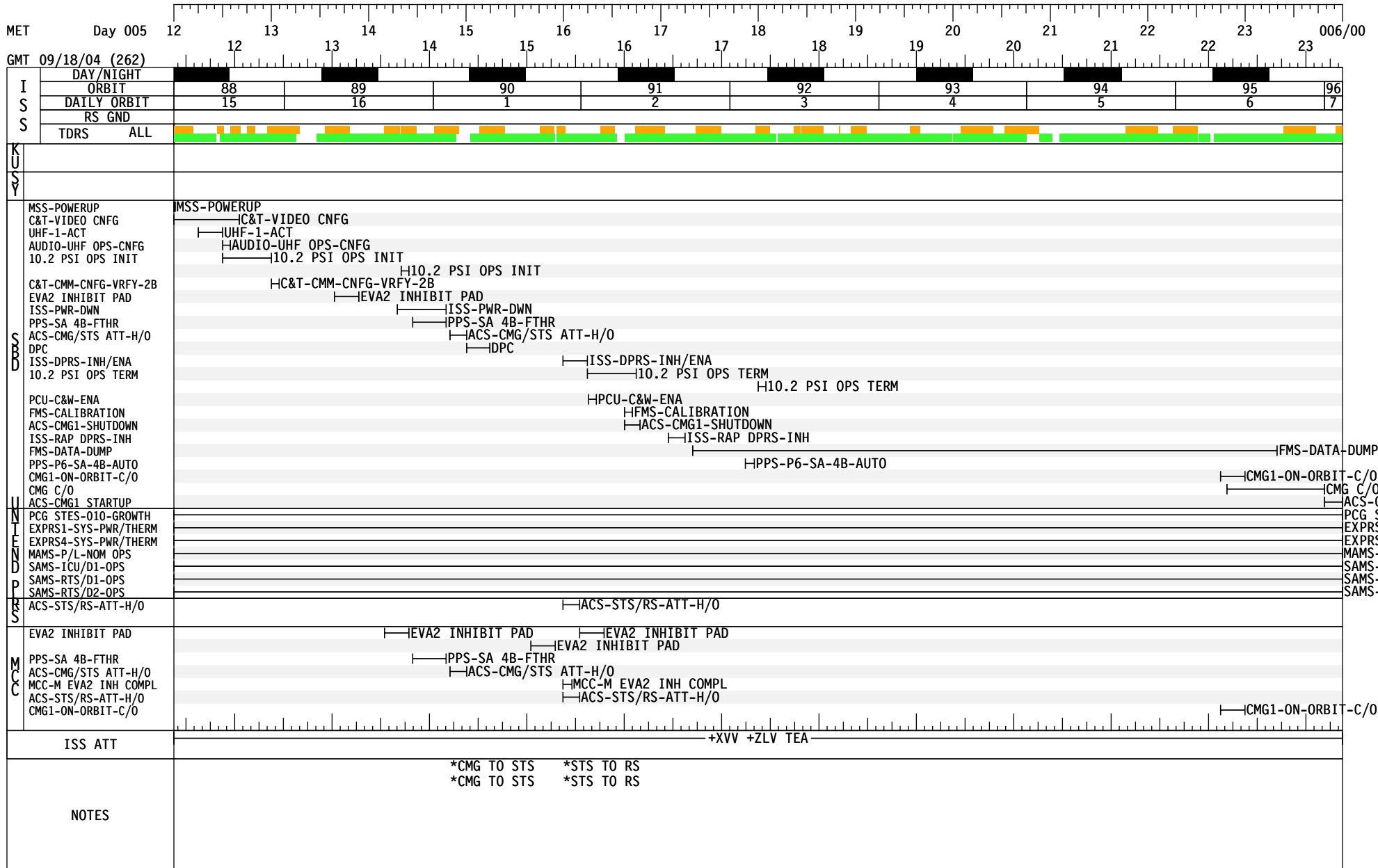

GMT 09/18/04 (262)

MET Day 006

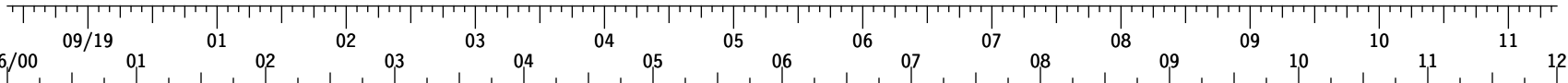

S T S - 1 1 4	CDR COLLINS	CT WE CRM	XFER 2 CWC	PRE SLEEP	PMC OCA	PRE SLEEP	SLEEP		
	PLT KELLY	<del>EVA</del>	COMM*	PRE SLEEP			SLEEP		
	MS1 NOGUCHI	C/U &INGR	CR P/LRS	POST EVA W/O H2O W/METOX	PRE SLEEP - GIRA		SLEEP		
	MS2 ROBINSON	C/U &INGR	CR P/LRS	POST EVA W/O H2O W/METOX	PRE SLEEP		SLEEP		
	MS3 THOMAS	*	CR P/LRS	POST EVA W/O H2O W/METOX	PRE SLEEP		SLEEP		
	MS4 LAWRENCE			PRE SLEEP	X T F A E G R U P	X C F A E L R L	PRE SLEEP	SLEEP	
	MS5 CAMARDA	⊕		PRE SLEEP	X T F A E G R U P	X C F A E L R L	PRE SLEEP	SLEEP	
I S S	ISS CDR KRIKALEV	♦	DAILY PLN RVW	PREP WORK	X T F A E G R U P	DPC	PRESLEEP-ISS	SLEEP	
	FE-1 PHILLIPS	®	CR P/LRS	POST EVA W/O H2O			PRESLEEP-ISS	SLEEP	
DAY/NIGHT									
ORBIT		96	97	98	99	100	101	102	103
TDRS		E -47.0							
		W -171.0							
		Z -275.0							
ORB ATT						BIAS -XLV +ZVV			
NOTES		*IVA SUPPORT		♥C&T-CMM-CNFG-VRFY-3B					
		⊕TRANSFER							
		♦EXERCISE TVIS		2-15A				FLT PLN/114/BAS A	
		®EXERCISE RED							
		*OBECONFIG							

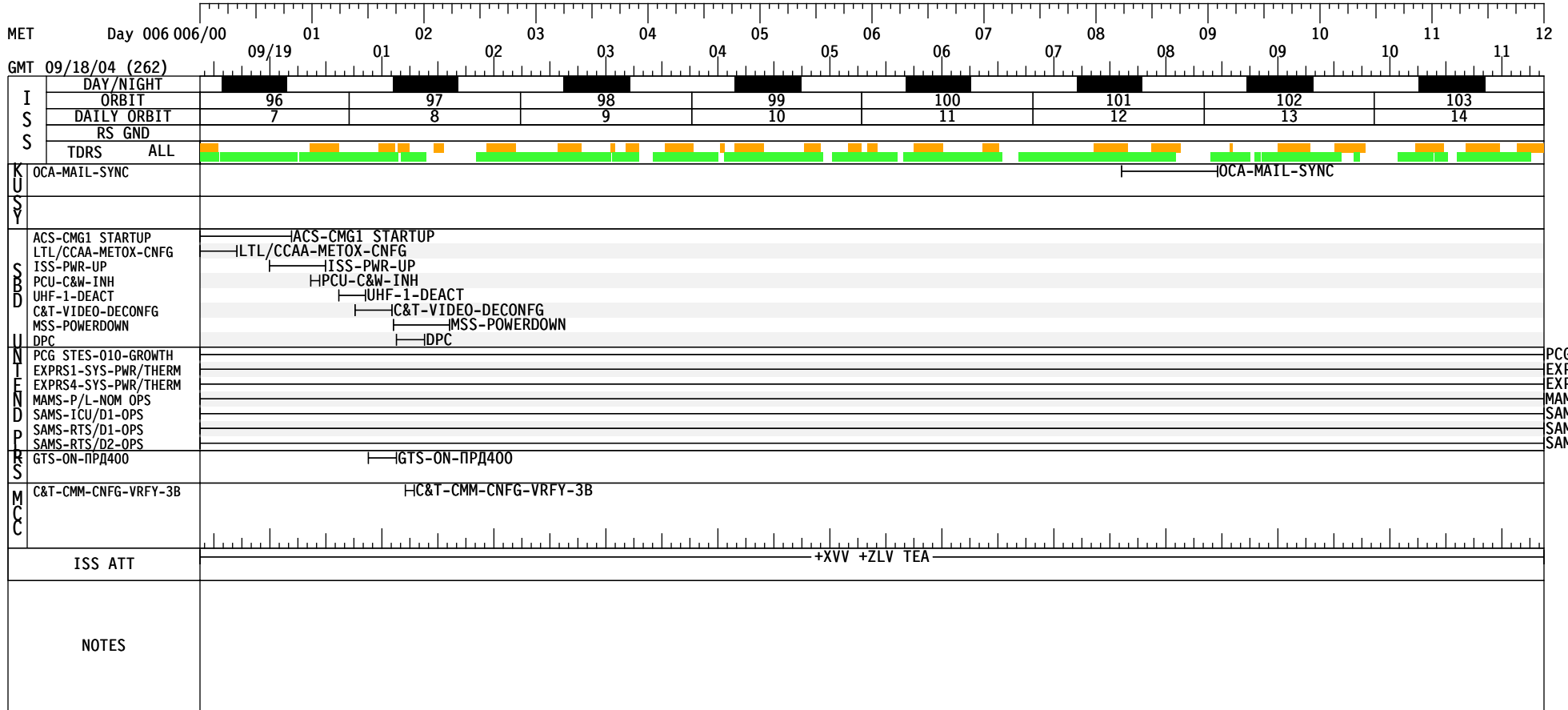

PCG STES  
EXPRS1-SY  
EXPRS4-SY  
MAMS-P/L  
SAMS-ICU  
SAMS-RTS  
SAMS-RTS

GMT 09/19/04 (263)

MET Day 006

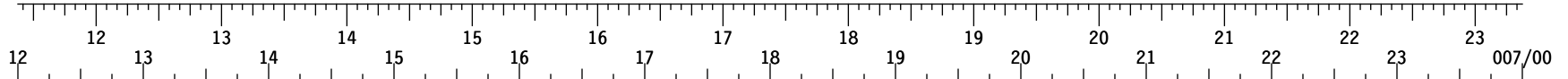

S T S - 1 1 4	CDR COLLINS	POST SLEEP	POST SLEEP	PWR FILL	PWR FILL	PWR FILL	CIN W C I T 1 0	EXERCISE	CT W E C R M	X C F W R E C M	FILTER CLEANING	CP R H E O W T O	CREW CONF	JOINT MEAL	JAXA PAO	OFF DUTY			
	PLT KELLY	POST SLEEP	EXERCISE	POST SLEEP	TRANSFER						CP R H E O W T O	CREW CONF	JOINT MEAL	OFF DUTY					
	MS1 NOGUCHI	POST SLEEP - GIRA			AS P R N	EMU H2O RCHG	E LK PREP	EC VA M R	EVA TOOL CONFG	M E T O X	X F E R	PAO S/U	CP R H E O W T O	CREW CONF	JOINT MEAL	JAXA PAO	OFF DUTY		
	MS2 ROBINSON	POST SLEEP	EXERCISE	AS P R N	EMU H2O RCHG	E LK PREP	EC VA M R	EVA TOOL CONFG	TRANSFER		CP R H E O W T O	CREW CONF	JOINT MEAL	OFF DUTY					
	MS3 THOMAS	POST SLEEP			L/M/ EMU BATT	E LK PREP	EVA TOOL CONFG		TRANSFER		CP R H E O W T O	CREW CONF	JOINT MEAL	OFF DUTY					
	MS4 LAWRENCE	POST SLEEP	XFER REVIEW	EXERCISE	TRANSFER						CP R H E O W T O	CREW CONF	JOINT MEAL	OFF DUTY					
	MS5 CAMARDA	POST SLEEP	XFER REVIEW	TRANSFER						EXERCISE	CP R H E O W T O	CREW CONF	JOINT MEAL	OFF DUTY					
I S S	ISS CDR KRIKALEV	SLEEP	POSTSLEEP-ISS	DPC P R O E R P K	XFER REVIEW	EXERCISE TVIS		TRANSFER			CP R H E O W T O	CREW CONF	JOINT MEAL	*COX MNT	FILE DWNLD	⊕ R P E S A V E M E N T	VELO + HC		
	FE-1 PHILLIPS	SLEEP	POSTSLEEP-ISS	DPC P R E P W O R K	♦	L/M/ EMU BATT	EXERCISE RED		TRANSFER			CP R H E O W T O	CREW CONF	JOINT MEAL	ECLSS DTO		EXERCISE TVIS		
DAY/NIGHT		ORBIT		104		105		106		107		108		109		110		111	
TDRS		E -47.0		W -171.0		Z -275.0													
ORB ATT		BIAS -XLV +ZVV																	
NOTES		♦HRF1-PC HD-INSTL						*TERM						♦CBO-CPBK-БРПК-INSPECT					⊕PAO S/U
		2-16A						FLT PLN/114/BAS A											



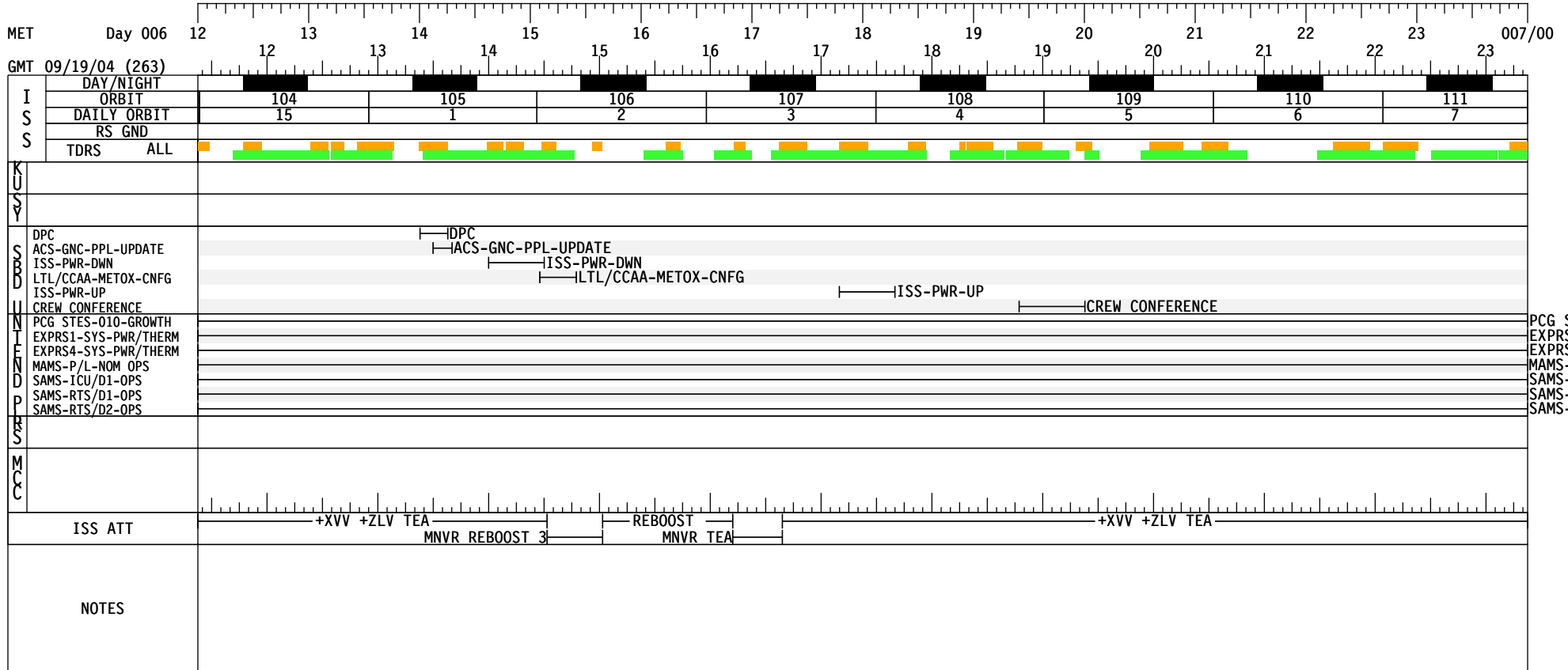

GMT 09/19/04 (263)

MET Day 007

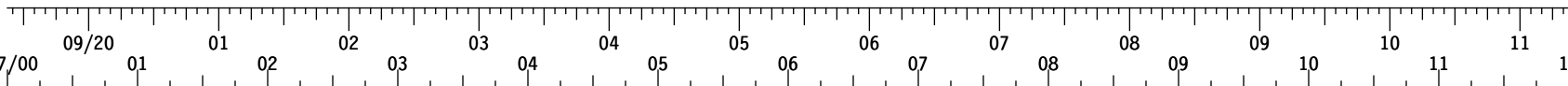

S T S - 1 1 4	CDR COLLINS	EVA REVW	I O L N L U M	PRE SLEEP	PMC OCA	PRE SLEEP	ISS EXTERNAL SURVEY					SLEEP	
	PLT KELLY	EVA REVW		PRE SLEEP								SLEEP	
	MS1 NOGUCHI	EVA REVW		EXERCISE		PRE SLEEP - GIRA						SLEEP	
	MS2 ROBINSON	EVA REVW				PRE SLEEP						SLEEP	
	MS3 THOMAS	EVA REVW		PRE SLEEP	EXERCISE		PRE SLEEP					SLEEP	
	MS4 LAWRENCE	EVA REVW		PRE SLEEP	X T F A E G R U P	X C F A F E L R L	PRE SLEEP	R E N A L					SLEEP
	MS5 CAMARDA	EVA REVW		PRE SLEEP	X T F A E G R U P	X C F A F E L R L	PRE SLEEP						SLEEP
I S S	ISS CDR KRIKALEV	EVA REVW	* DAILY PLN RVW	DPC	X T F A E G R U P	PRESLEEP-ISS						SLEEP	
	FE-1 PHILLIPS	EVA REVW	P W R O R E R P K	DAILY PLN RVW	DPC	PRESLEEP-ISS						SLEEP	
DAY/NIGHT													
ORBIT													
TDRS													
ORB ATT		BIAS -XLV +ZVV											
NOTES		*PRESLEEP-ISS  2-17A  FLT PLN/114/BAS A											

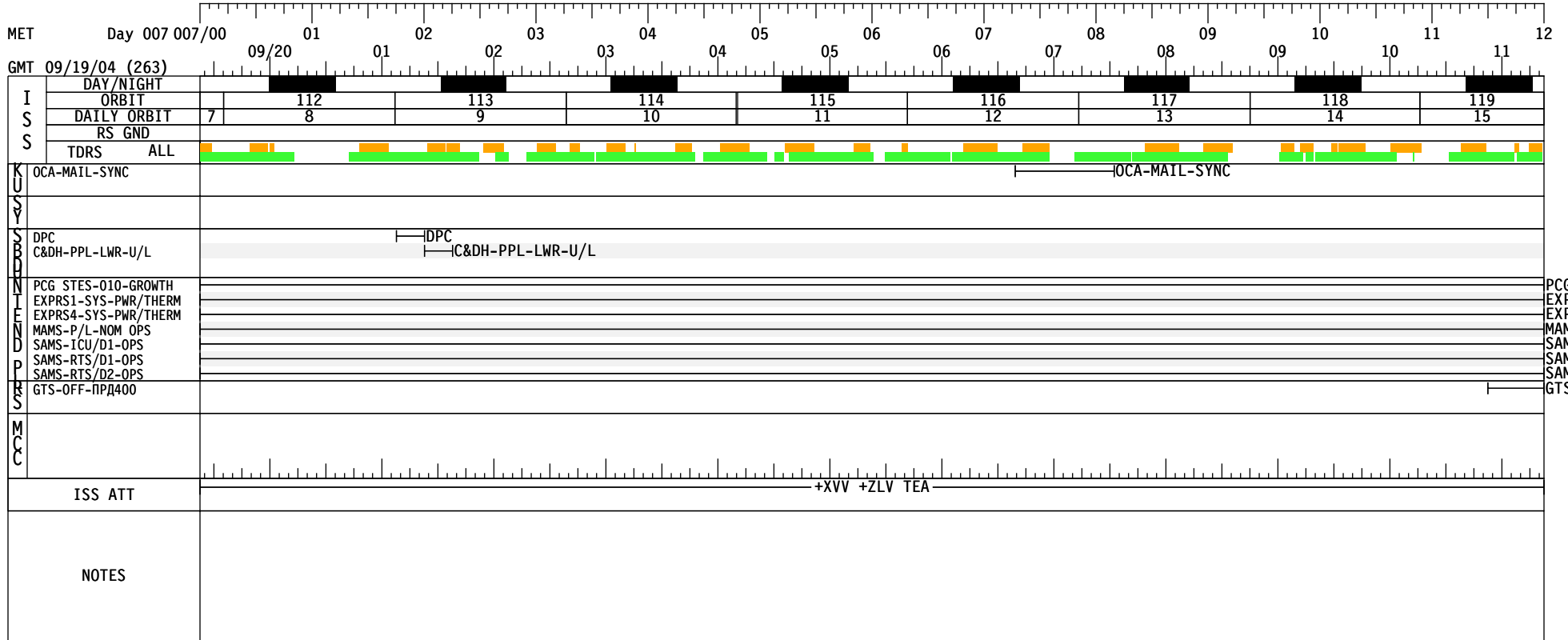

PCG STES-  
EXPRS1-S  
EXPRS4-S  
MAMS-P/L  
SAMS-ICU  
SAMS-RTS  
SAMS-RTS  
GTS-OFF-I

GMT 09/20/04 (264)

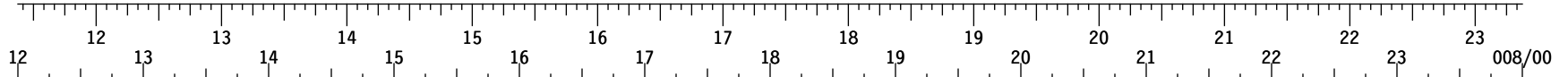

STS - 1 1 4	<b>FD09</b> CDR COLLINS	POST SLEEP	PMCM A/GU	POST SLEEP	OFFLUM	ATTNHO*	CONDIT	EVN3BT	CTOERDM	ATTNHO*	CINWCT11	EXERCISE	CTWERM	CINWCT12	MEAL	CTWERM	XFER 2 CWC	PRLA	
	PLT KELLY	POST SLEEP	COMM*	POST SLEEP	CONDIT	TRANSFER	CTOERDM	EXERCISE	EVA ESPAD INSTALL	SSRMS ESP2 GRPL	ESP2 UNBRTH	SSRMS ESP2 INSTALL	EUNPGRPL	MNVR TO MATED MPLM	MGRPLMPL				
	MS1 NOGUCHI	POST SLEEP - GIRA	CEVIS	STS P/B 02 EVA PREP	EMURGE	EMU P/B	C/L DPRS	EGRS /SETUP	PRIMARY CABLE ROUTNG	MISSE 1&2 RETRIEVAL	MISSE 5 INSTALL	SECONDARY CABLE ROUT	ESP2 INSTALL	ESP2 FRGF RMV	<b>EVA 3 (6:30)</b>				
	MS2 ROBINSON	POST SLEEP	CEVIS	STS P/B 02 EVA PREP	EMURGE	EMU P/B	C/L DPRS	EGRS /SETUP	ESPAD INSTALL	MISSE 5 INSTALL	SECONDARY CABLE ROUT	ESP2 INSTALL							
	MS3 THOMAS	POST SLEEP	LEH	STS P/B 02 EVA PREP	EMURGE	EMU P/B	C/L DPRS	IVA SUPPORT											
	MS4 LAWRENCE	POST SLEEP	XFER REVIEW	EXERCISE	P/TV07 EVA S/U	XFER	EVA ESPAD INSTALL	SSRMS ESP2 GRPL	ESP2 UNBRTH	SSRMS ESP2 INSTALL	EUNPGRPL	MNVR TO MATED MPLM	MGRPLMPL						
	MS5 CAMARDA	POST SLEEP	XFER REVIEW	TRANSFER	EXERCISE	TRANSFER	MEAL	CPA INSTALL	PRLA	CPA INSTALL	TRANSFER								
	ISS	ISS CDR KRIKALEV	SLEEP	POSTSLEEP-ISS	PREP WORK	DPC	XFER REVIEW	*EXERCISE TVIS	TRANSFER	MEAL	COX MNT	CPA INSTALL	TRANSFER						
		FE-1 PHILLIPS	SLEEP	POST SLEEP	LEH	STS P/B 02 EVA PREP	EMURGE	EMU P/B	C/L DPRS	POST SLEEP	MEAL	EXERCISE TVIS							
	DAY/NIGHT ORBIT		119	120	121	122	123	124	125	126	127								
TDRS		E -47.0	W -171.0	Z -275.0															
ORB ATT		BIAS -XLV +ZVV																	
NOTES		*CONFIG *C&T-CMM-CNFG-VRFY-2B *CMG TO STS *STS TO RS 2-18A													FLT PLN/114/BAS A				

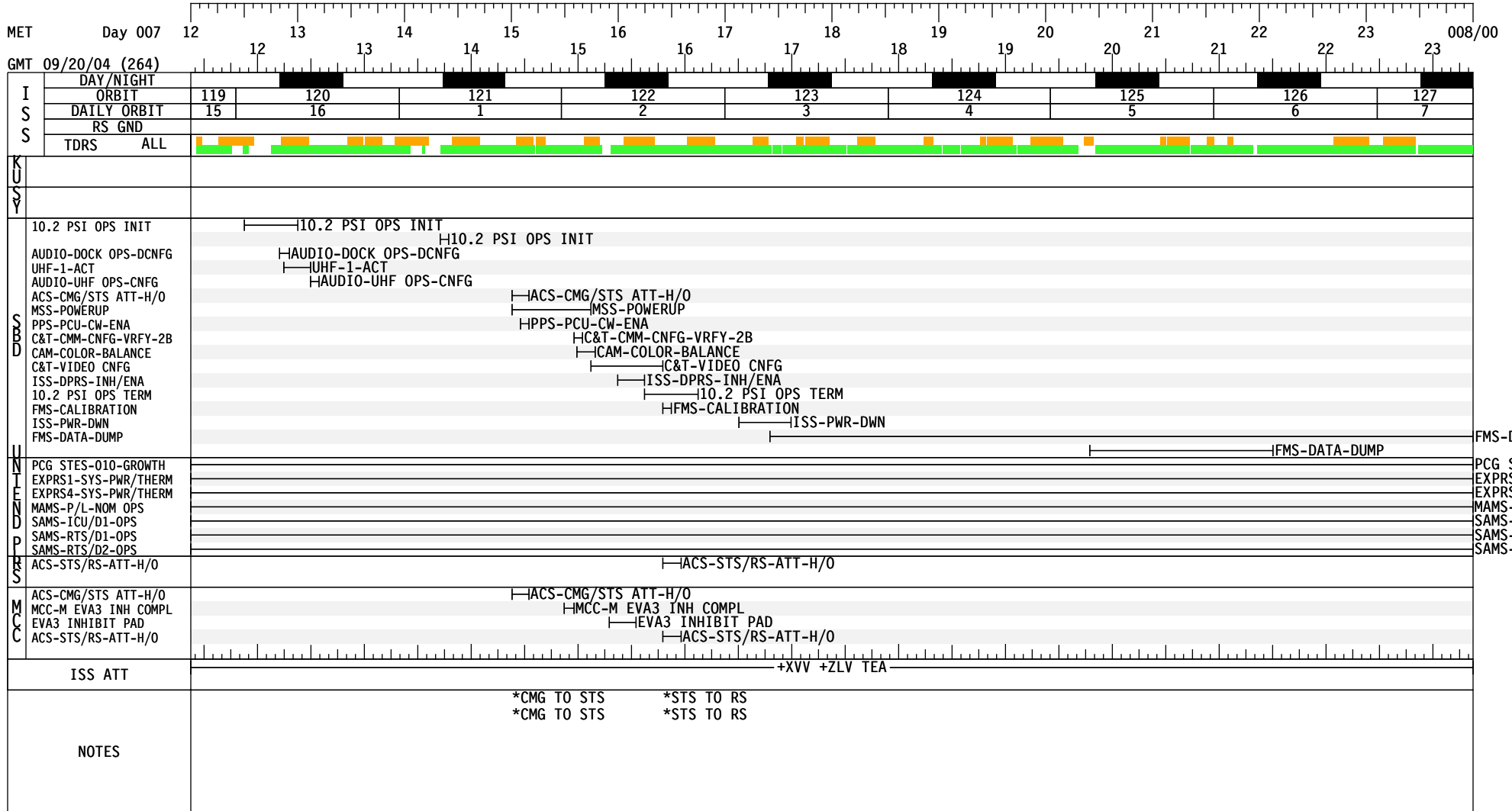

GMT 09/20/04 (264)

MET Day 008

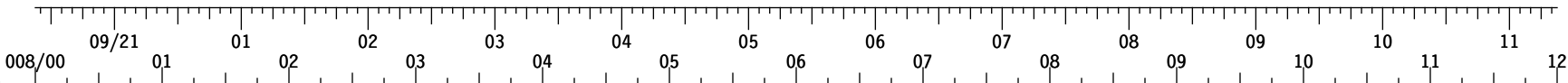

S T S - 1 1 4	CDR COLLINS		I O L N L U M	P C S *	PRE SLEEP	PMC OCA	PRE SLEEP	ISS EXTERNAL SURVEY							SLEEP	
	PLT KELLY	CNFG MPLM RACKS		XFER	C O M M *	W C S	PRE SLEEP								SLEEP	
	MS1 NOGUCHI	C/U &INGR	C R / P L R S		POST EVA W/H2O & MTX		PRE SLEEP - GIRA								SLEEP	
	MS2 ROBINSON	C/U &INGR	C R / P L R S		POST EVA W/H2O & MTX		PRE SLEEP								SLEEP	
	MS3 THOMAS	*	C R / P L R S		POST EVA W/H2O & MTX		PRE SLEEP								SLEEP	
	MS4 LAWRENCE	CNFG MPLM RACKS		POST EVA XFER	PRE SLEEP	X T F A G E R U P	X C F A L L	PRE SLEEP	R E N A L						SLEEP	
	MS5 CAMARDA	TRANSFER		PRE SLEEP	X T F A G E R U P	X C F A L L	PRE SLEEP								SLEEP	
I S S	ISS CDR KRIKALEV	VELO + HC		PREP WORK	D P C	P R E	X T F A G E R U P	PRE SLEEP-ISS							SLEEP	
	FE-1 PHILLIPS		C R / P L R S		POST EVA W/H2O & MTX	*	PRE SLEEP-ISS								SLEEP	
DAY/NIGHT		[Timeline with shaded day/night blocks]														
ORBIT		127	128		129		130		131		132		133		134	135
TDRS		E -47.0	[Timeline with TDRS signal blocks]													
		W -171.0	[Timeline with TDRS signal blocks]													
		Z -275.0	[Timeline with TDRS signal blocks]													
ORB ATT		BIAS -XLV +ZVV														
NOTES		*IVA SUPPORT      ♦C&T-CMM-CNFG-VRFY-3B ⊕TRANSFER *CNFG    *DECONFIG 2-19A FLT PLN/114/BAS A														

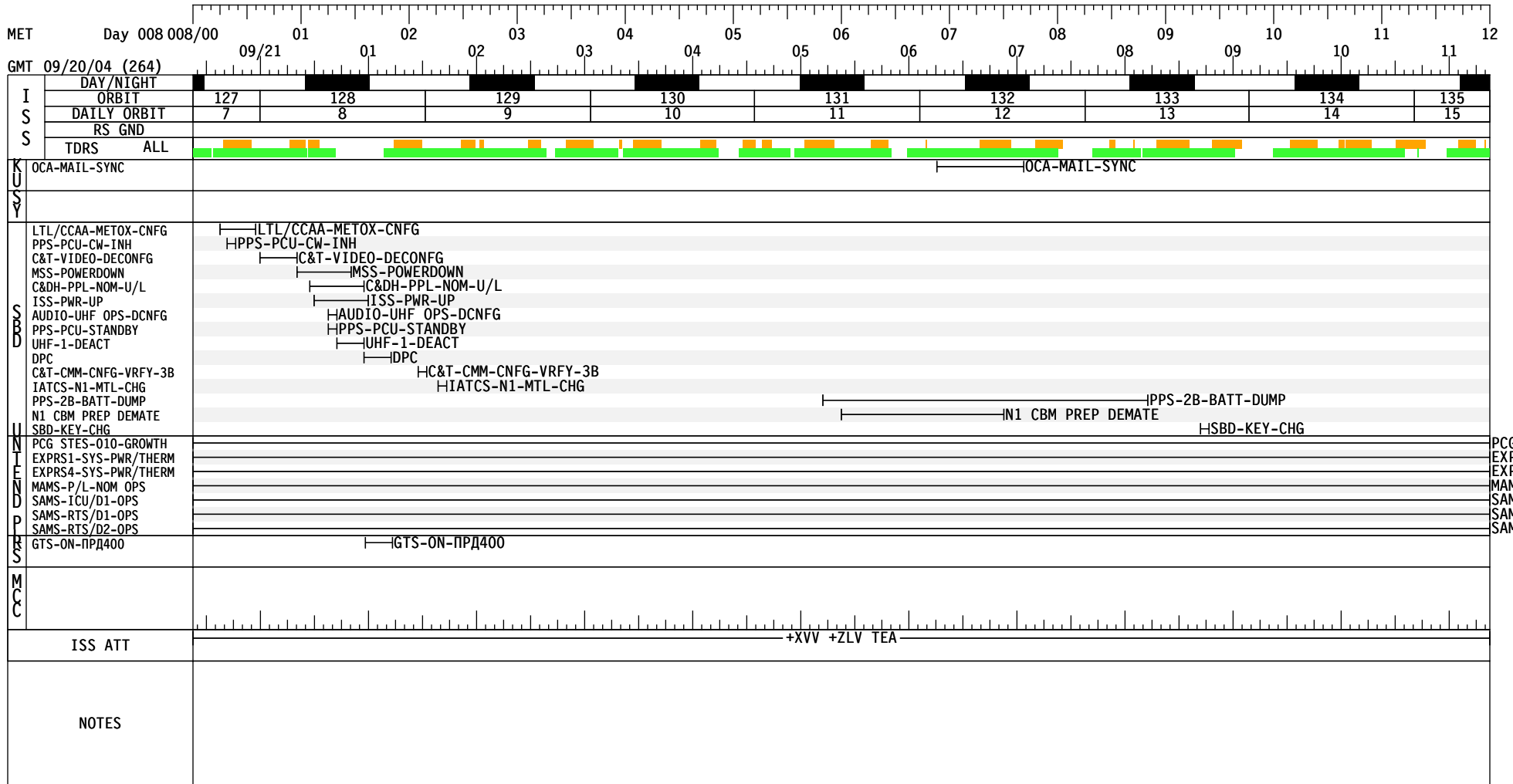

PCG STES  
 EXPRS1-SY  
 EXPRS4-SY  
 MAMS-P/L  
 SAMS-ICU  
 SAMS-RTS  
 SAMS-RTS

GMT 09/21/04 (265)

MET Day 008

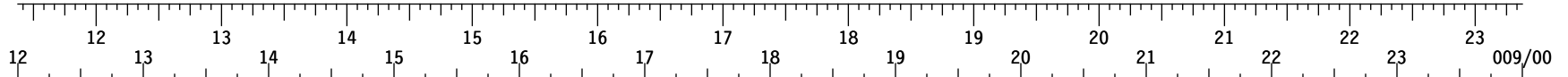

S T S - 1 1 4	CDR COLLINS	FD10 POST SLEEP	POST SLEEP	EXERCISE		CIN CIT 13	PAO S/U	PE AV E N T	CT WE CR M	PWR FILL	PWR FILL	PWR FILL	CIN CIT 14	MEAL	CT WE CR M	XFER 2 CWC	HC N 2 O F G		AP CU IL *	AP CU IL *
	PLT KELLY	POST SLEEP	MPLM CLEANUP	POST SLEEP	IO LF LF UM	MDDK XFER	PE AV E N T	EXERCISE	MDDK XFER	MEAL	MPLM UNINSTL	MPLM BERTH	MPLM UNGRPL	MNVR OBSS GRPL H/O		OG BR SP SL	OBSS MNVR TO CLR UHF			
	MS1 NOGUCHI	POST SLEEP - GIRA			AS PR N	EMU C/O	EX MF UR	POST EVA EMU XFER	ME TO X	EVA TOOL STOW	NODE 1 CBM DEMATE	MEAL	MDDK XFER		EXERCISE					
	MS2 ROBINSON	POST SLEEP			AS PR N	EMU C/O	EX MF UR	POST EVA EMU XFER	EVA TOOL STOW	NODE 1 CBM DEMATE	MEAL	RNDZ TOOLS C/O PT1		MDDK XFER						
	MS3 THOMAS	POST SLEEP		EXERCISE	POST EVA EMU XFER			EVA TOOL STOW	MEAL	O2 TRDWN	PR LA	N2 TERM	OBSS H/O FROM SRMS	OBSS BERTH CAMR						
	MS4 LAWRENCE	POST SLEEP	MPLM CLEANUP	XC FA ELL	POST SLEEP	PCG-STES 10 TRANSFER	EXERCISE	MDDK XFER	PTV06 S/U MPLM	MEAL	MPLM UNINSTL	MPLM BERTH	MPLM UNGRPL	MNVR OBSS GRPL H/O	OG BR SP SL	OBSS MNVR TO CLR UHF				
	MS5 CAMARDA	POST SLEEP			D W P N T	M D P E L A M C T	VESTIBULE CONFIG		VEST DEPRESS		MEAL	MDDK XFER	PR LA	RNDZ TOOLS C/O PT1	OBSS H/O FROM SRMS	OBSS BERTH CAMR				
I S S	ISS CDR KRIKALEV	SLEEP	POST SLEEP-ISS	PREP WORK	DPC	M E P G L R M S	M D P E L A M C T	VESTIBULE CONFIG		VEST DEPRESS		MEAL	COX MNT	MDDK XFER	EXERCISE TVIS	VELO + HC				
	FE-1 PHILLIPS	SLEEP	POST SLEEP-ISS	PREP WORK	DPC	EXERCISE TVIS	PCG-STES 10 TRANSFER	PE AV E N T	POST EVA EMU XFER	EVA TOOL STOW	MEAL	O2 TRDWN	LAB CWC FILL	N2 TERM	EXERCISE RED					

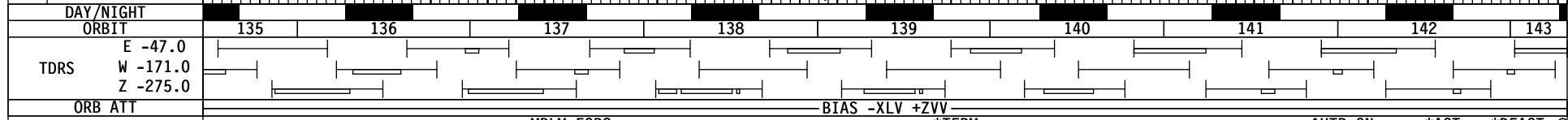

BIAS -XLV +ZVV

\*MPLM EGRS \*TERM ^HTR ON \*ACT \*DEACT @DAILY PLN

NOTES 2-20A FLT PLN/114/BAS A



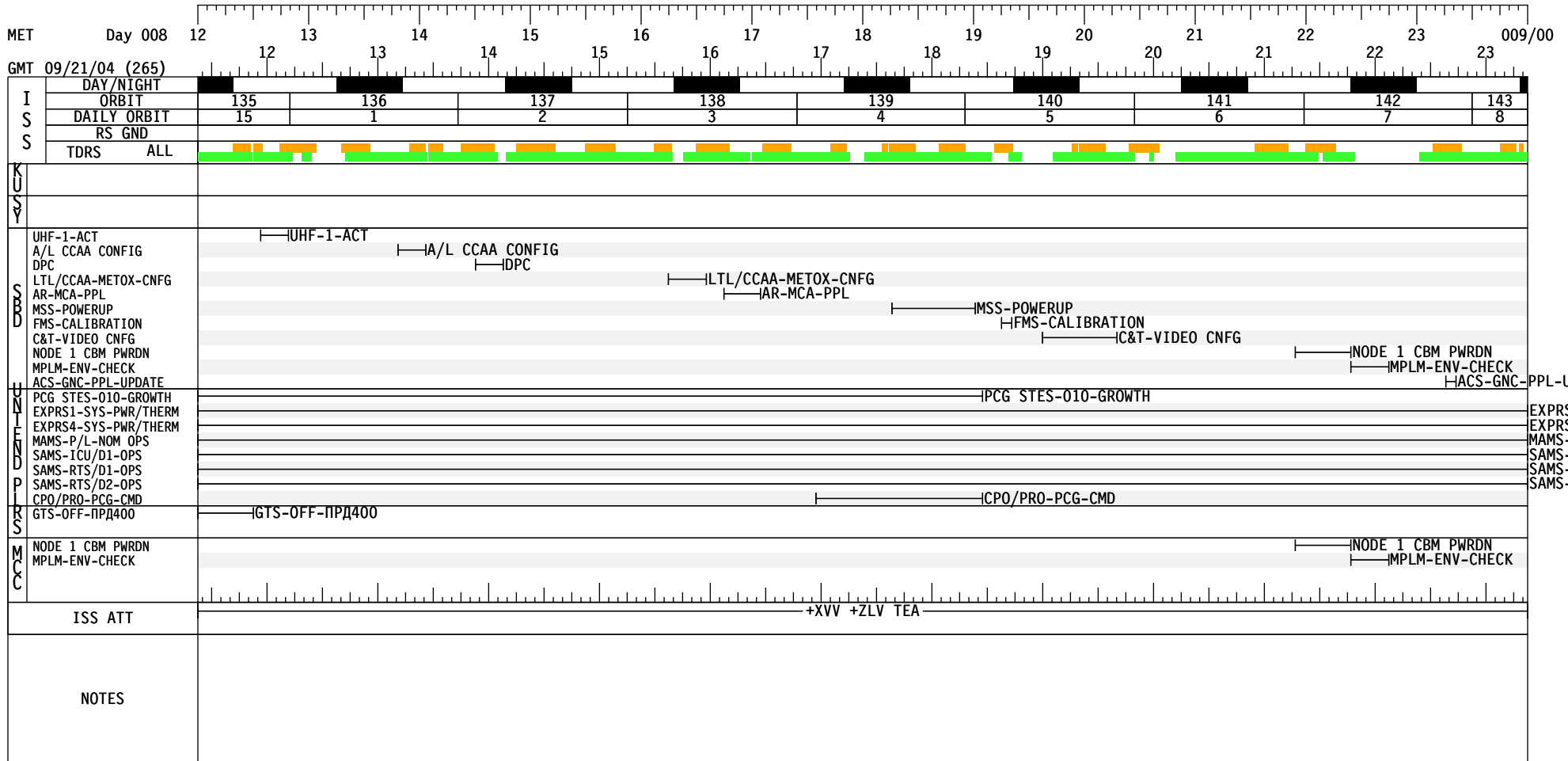

GMT 09/21/04 (265)

MET Day 009

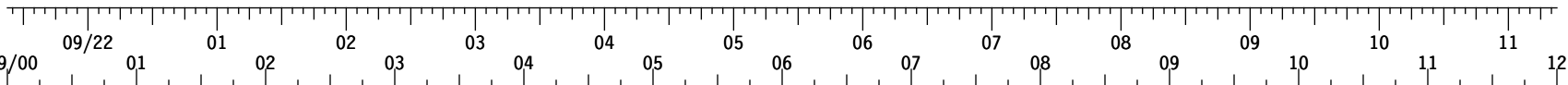

S T S - 1 1 4	CDR COLLINS		I O L N L U M	PRE SLEEP		M P L L M M	PRE SLEEP	PMC OCA	PRE SLEEP	ISS EXTERNAL SURVEY					SLEEP		
	PLT KELLY	⊕	OBSS BERTH	OBSS UNGRPL	PRE SLEEP					SLEEP							
	MS1 NOGUCHI	P S // T U V 0 4	P S // T U V 0 8	P/TV08 OPS	PRE SLEEP - GIRA					SLEEP							
	MS2 ROBINSON	EXERCISE			PRE SLEEP					SLEEP							
	MS3 THOMAS	OBSS BERTH CAMR			R P M W S R D N	PRE SLEEP					SLEEP						
	MS4 LAWRENCE	⊕	OBSS BERTH	O U B N S G S R P L	PRE SLEEP	X T F A E G R U P	X C F A E L R	PRE SLEEP	R E N A L	SLEEP							
	MS5 CAMARDA	OBSS BERTH CAMR			M D D K	PRE SLEEP					SLEEP						
I S S	ISS CDR KRIKALEV	VELO + HC	DAILY PLN RVW	PREP WORK	DPC	⊕	X T F A E G R U P	PRE SLEEP					SLEEP				
	FE-1 PHILLIPS	DAILY PLN RVW	PREP WORK	OBSS UNGRPL	DPC	PRESLEEP-ISS					SLEEP						
DAY/NIGHT		[Timeline with shaded sleep periods]															
ORBIT		143	144		145		146		147		148		149		150	151	
TDRS		E -47.0	[Timeline with shaded TDRS periods]														
		W -171.0	[Timeline with shaded TDRS periods]														
		Z -275.0	[Timeline with shaded TDRS periods]														
ORB ATT		BIAS -XLV +ZVV															
NOTES		⊕OBSS MNVR TO CLR UHF    ⊕PRE SLEEP ⊕OBSS MNVR TO CLR UHF ^HTR OFF 2-21A FLT PLN/114/BAS A															

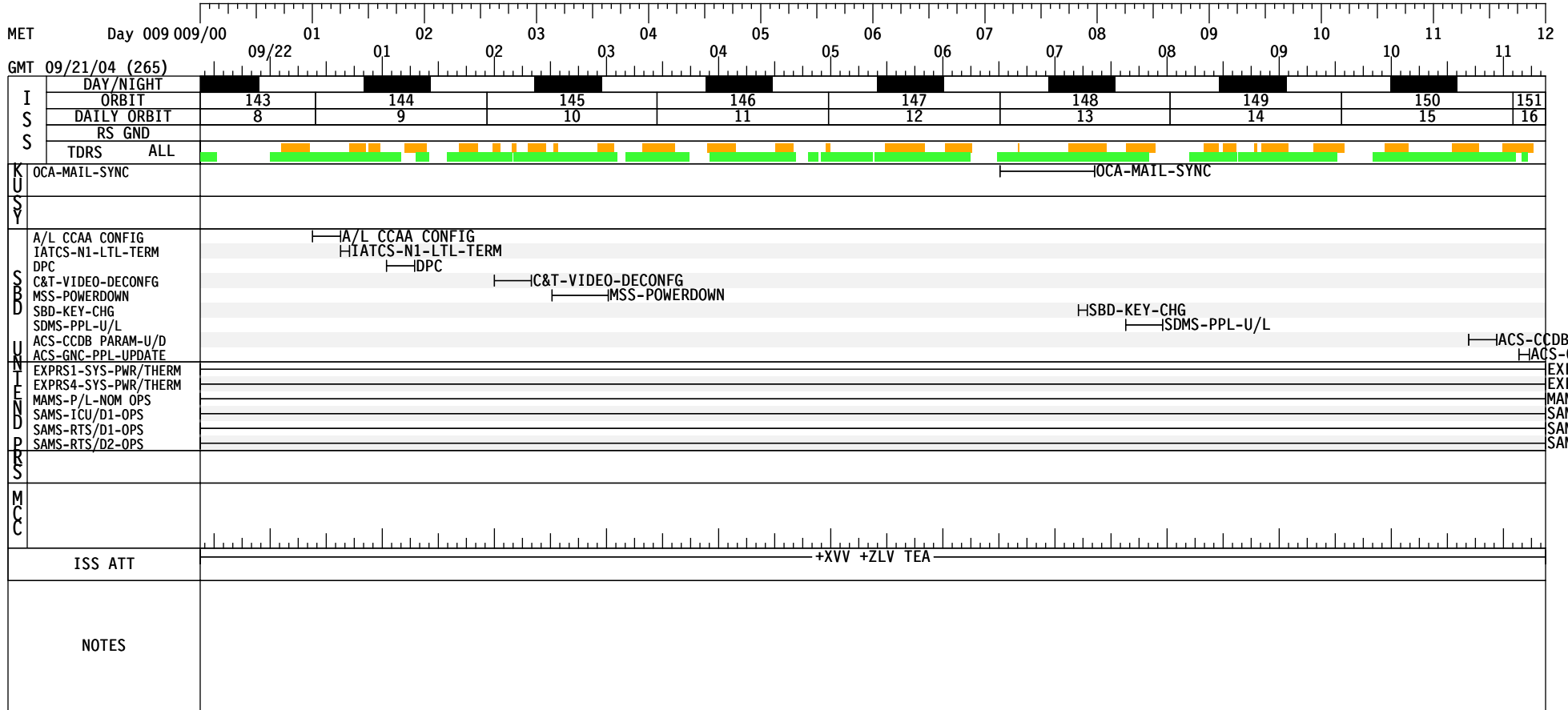

GMT 09/22/04 (266)

MET Day 009

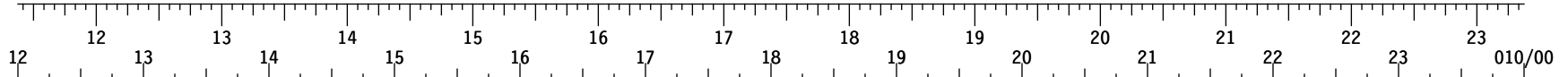

STS - 1 1 4	CDR COLLINS	FD11	POST SLEEP	POST SLEEP	FWA REL	EGRS HATCH CLS		GP RPR UP	MP LHO*	MUN VDR CK	SEP-1 SEP-2	UNDOCK OPS	GP RPR UP	MEAL	OFF DUTY	EXERCISE	OFF DUTY	CT OEN RDM	
	PLT KELLY		POST SLEEP		FWA REL	EGRS HATCH CLS		GP RPR UP				UNDOCK OPS	IO LFL UM	MEAL	EXERCISE	OFF DUTY	CT OEN RDM	OFF DUTY	
	MS1 NOGUCHI		POST SLEEP - GIRA		FWA REL	P/TVO4 EGRS OPS	SMP/TVO3 S/U		C/L CMR INSTL			P/T OPS	RMV C/L CMR	MEAL	OFF DUTY	EXERCISE	OFF DUTY		
	MS2 ROBINSON		POST SLEEP		FWA REL	RNDZ TOOLS C/O PT2						UNDOCK OPS		MEAL	OFF DUTY				
	MS3 THOMAS		POST SLEEP		FWA REL		ODS VEST LK CK					UNDOCK OPS	MS PT MOW	MEAL	OFF DUTY		PFC	OFF DUTY	
	MS4 LAWRENCE		POST SLEEP		FWA REL		ODS VEST LK CK		C/L CMR INSTL			UNDOCK OPS	VTR S/U	MEAL	OFF DUTY	PFC	EXERCISE	OFF DUTY	
	MS5 CAMARDA		POST SLEEP		M DREL KEL	RNDZ TOOLS C/O PT2	HL AUD B/O					UNDOCK OPS	A/ L*	MEAL	OFF DUTY	PFC	OFF DUTY		
ISS	ISS CDR KRIKALEV	SLEEP	POSTSLEEP	PW ROER PK	DPC	FWA REL							MEAL						
	FE-1 PHILLIPS	SLEEP	POSTSLEEP	PW ROER PK	DPC	FWA REL	EGRS HATCH CLS						MEAL	PMA2-DEPRESS		EXERCISE TVIS			

DAY/NIGHT

ORBIT

E -47.0

W -171.0

Z -275.0

ORB ATT

\*SALIVA

NOTES

\*ACT \*DEACT \*COMM 1 STRING C/O \*FAN BYPASS

\*UNDOCK 9/17:15

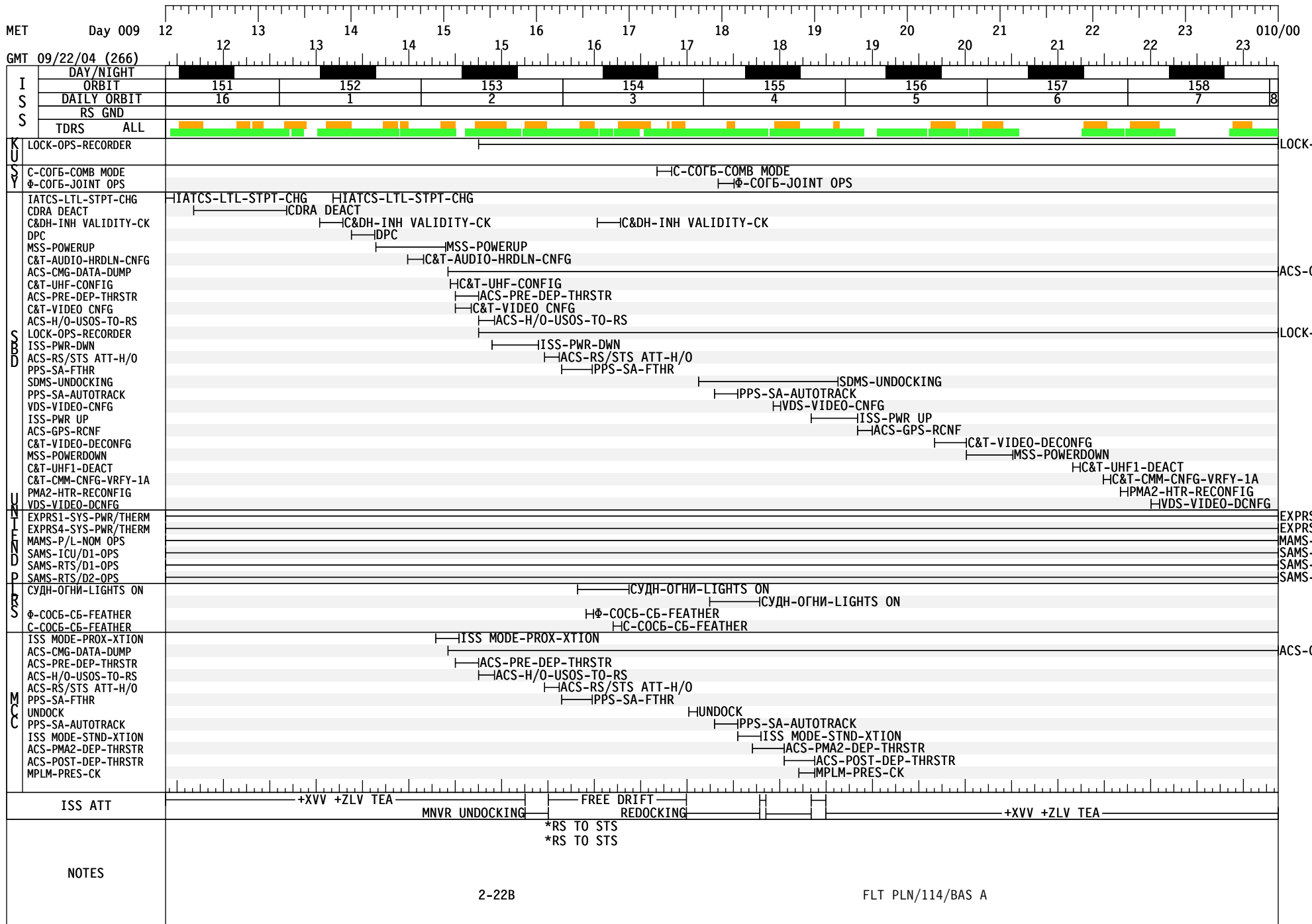

GMT 09/22/04 (266)

FD11

MET Day 010

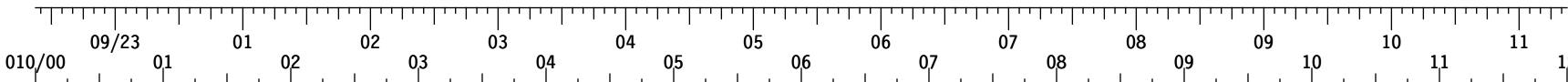

STS-114	CDR COLLINS	M-NZ V-LR V	OFF DUTY	PFC	OFF DUTY	PRE SLEEP	PMC OCA	PRE SLEEP	SLEEP		
	PLT KELLY		OFF DUTY		M P L M ^	PRE SLEEP	PFC	PRE SLEEP	SLEEP		
	MS1 NOGUCHI		OFF DUTY		PFC	PRE SLEEP - GIRA			SLEEP		
	MS2 ROBINSON		*PFC	OFF DUTY		PRE SLEEP			SLEEP		
	MS3 THOMAS		OD FU FT Y	EXERCISE		PRE SLEEP			SLEEP		
	MS4 LAWRENCE			OFF DUTY				R E N A L	PRE SLEEP	SLEEP	
	MS5 CAMARDA			OFF DUTY		K D D M			PRE SLEEP	SLEEP	
DAY/NIGHT		ORBIT		159	160	161	162	163	164	165	166
TDRS		E -47.0	W -171.0	Z -275.0							
MIL											
DFR											
ORB ATT		-ZLV -XVV									
NOTES		*OFF DUTY ^HTR OFF									
		2-23					FLT PLN/114/BAS A				

GMT 09/23/04 (267)

MET Day 010

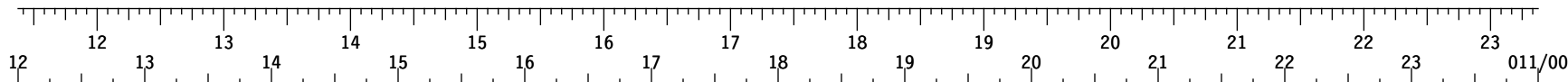

STS-114	CDR COLLINS	FD12 POST SLEEP	POST SLEEP	FCS C/O	RCS H/F	ELEVON PSN	PILOT OPS	EXERCISE	CABIN STOW	FL TOE RAS D	D/O BRIEF	PEAVO ENT	MEAL	WSSH COMM CK	M-NZLV	CABIN STOW	FE S*	CS AT BOW N	L-1 COMM CHK	HUD CAL	M-NZLV
	PLT KELLY	POST SLEEP	POST SLEEP	FCS C/O	RCS H/F	ELEVON PSN	PILOT OPS	CABIN STOW	EXERCISE		D/O BRIEF	PEAVO ENT	MEAL	CABIN STOW			MI NMV R	IMU	HM DV R	HUD CAL	M-NZLV
	MS1 NOGUCHI	POST SLEEP - GIRA		FILTER CLEANING	CABIN STOW	EXERCISE	PAO S/U	EVA H/W STOW	POST EVA ENT PREP	D/O BRIEF	PEAVO ENT	MEAL	EVS NI TDU REYO	CABIN STOW			ERGO STOW				
	MS2 ROBINSON	POST SLEEP		FCS C/O	RCS H/F	PILOT SETUP	PILOT OPS	EVA H/W STOW	POST EVA ENT PREP	D/O BRIEF	PEAVO ENT	MEAL	CABIN STOW	EXERCISE	PGSC STOW PART I						
	MS3 THOMAS	POST SLEEP		CABIN STOW	EXERCISE	CABIN STOW			D/O BRIEF	PEAVO ENT	MEAL	COMM*	CABIN STOW		ERGO STOW						
	MS4 LAWRENCE	POST SLEEP		CABIN STOW			EXERCISE	CABIN STOW	D/O BRIEF	PEAVO ENT	MEAL	CABIN STOW									
	MS5 CAMARDA	POST SLEEP		EXERCISE	CABIN STOW				D/O BRIEF	PEAVO ENT	MEAL	CABIN STOW									

DAY/NIGHT	[Timeline bars for Day/Night]																				
ORBIT	[Timeline bars for Orbit]																				
TDRS	[Timeline bars for TDRS]																				
MIL	[Timeline bars for MIL]																				
DFR	[Timeline bars for DFR]																				
ORB ATT	[Timeline bars for ORB ATT]																				
NOTES	^HTR ON      *DEACT      *INIT      +ZLV      -ZLV -XVV      *TERM *ACT      *DEACT  -----  MPLM PRESSURE CK      *COMM STRING 2 C/O 2-24 FLT PLN/114/BAS A																				

GMT 09/23/04 (267)

MET Day 011

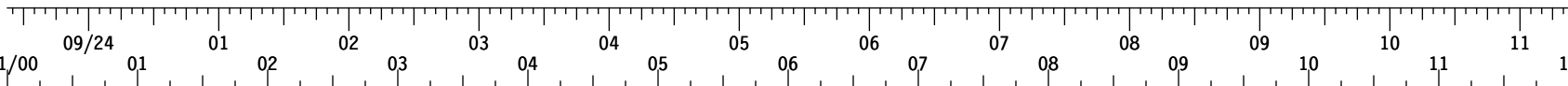

STS-114	CDR COLLINS	PRE SLEEP	L-1 COMM CHK	PRE SLEEP	PMC A/G	PRE SLEEP	SLEEP	FD13	POST SLEEP	
	PLT KELLY	KU STOW	ENT RY*	PRE SLEEP		MP L M X	SLEEP	SAL I V A	POST SLEEP	
	MS1 NOGUCHI	S D S E V A C T		PRE SLEEP - GIRA			SLEEP		POST SLEEP - GIRA	
	MS2 ROBINSON	OCA S-BD S/U		PRE SLEEP			SLEEP		POST SLEEP	
	MS3 THOMAS			PRE SLEEP			SLEEP		POST SLEEP	
	MS4 LAWRENCE	CABIN STOW		PRE SLEEP		R E N A L	SLEEP	SAL I V A	POST SLEEP	
	MS5 CAMARDA	WLES STW	M D D K	PRE SLEEP			SLEEP	SAL I V A	POST SLEEP	
DAY/NIGHT		[Timeline with shaded blocks]								
ORBIT		[Timeline with shaded blocks]								
TDRS		[Timeline with shaded blocks]								
MIL		[Timeline with shaded blocks]								
DFR		[Timeline with shaded blocks]								
ORB ATT		[Timeline with shaded blocks]								
NOTES		*CONFIG ^HTR OFF -ZLV -XVV								
		2-25				FLT PLN/114/BAS A				



GMT 09/24/04 (268)

MET Day 011

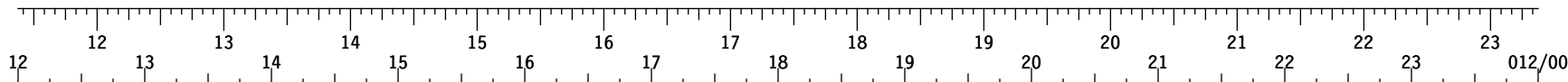

STS-114	CDR COLLINS	POST SLEEP	M P L P M C M A / G B	G P R W P R U B P	IMU ALIGN /VERIF	M- N X V S I	DEORBIT PREP		
	PLT KELLY	POST SLEEP		G P R W P R U B P	POST SLEEP		DEORBIT PREP		
	MS1 NOGUCHI	POST SLEEP - GIRA				G S I T R O A W	DEORBIT PREP	D / O	K S C
	MS2 ROBINSON	POST SLEEP		P G S C S T O W P A R T I I	CL R P R T S T W		DEORBIT PREP		L
	MS3 THOMAS	POST SLEEP		F M K S T W	O S T A O C W		DEORBIT PREP	B U R N	N D G
	MS4 LAWRENCE	POST SLEEP		M A T C H	T O E P F C		DEORBIT PREP		*
	MS5 CAMARDA	POST SLEEP		M A T C H	A I R S A M P		DEORBIT PREP		

DAY/NIGHT	[Shaded bars indicating day/night cycle]									
ORBIT	182	183	184	185	186	187	188	189	190	
TDRS	E -47.0									
	W -171.0									
	Z -275.0									
MIL										
DFR										
ORB ATT	-ZLV	-XVV	VERIF		-XSI		COMM		D/O BURN	
NOTES	^HTR ON				D/O TIG 11/17:53			*KSC LNDG 11/18:56		
	2-26				FLT PLN/114/BAS A					

This Page Intentionally Blank

DETAILED TIMELINE

DETAILED  
TIMELINE

# STS-114 LF1 (FD01)

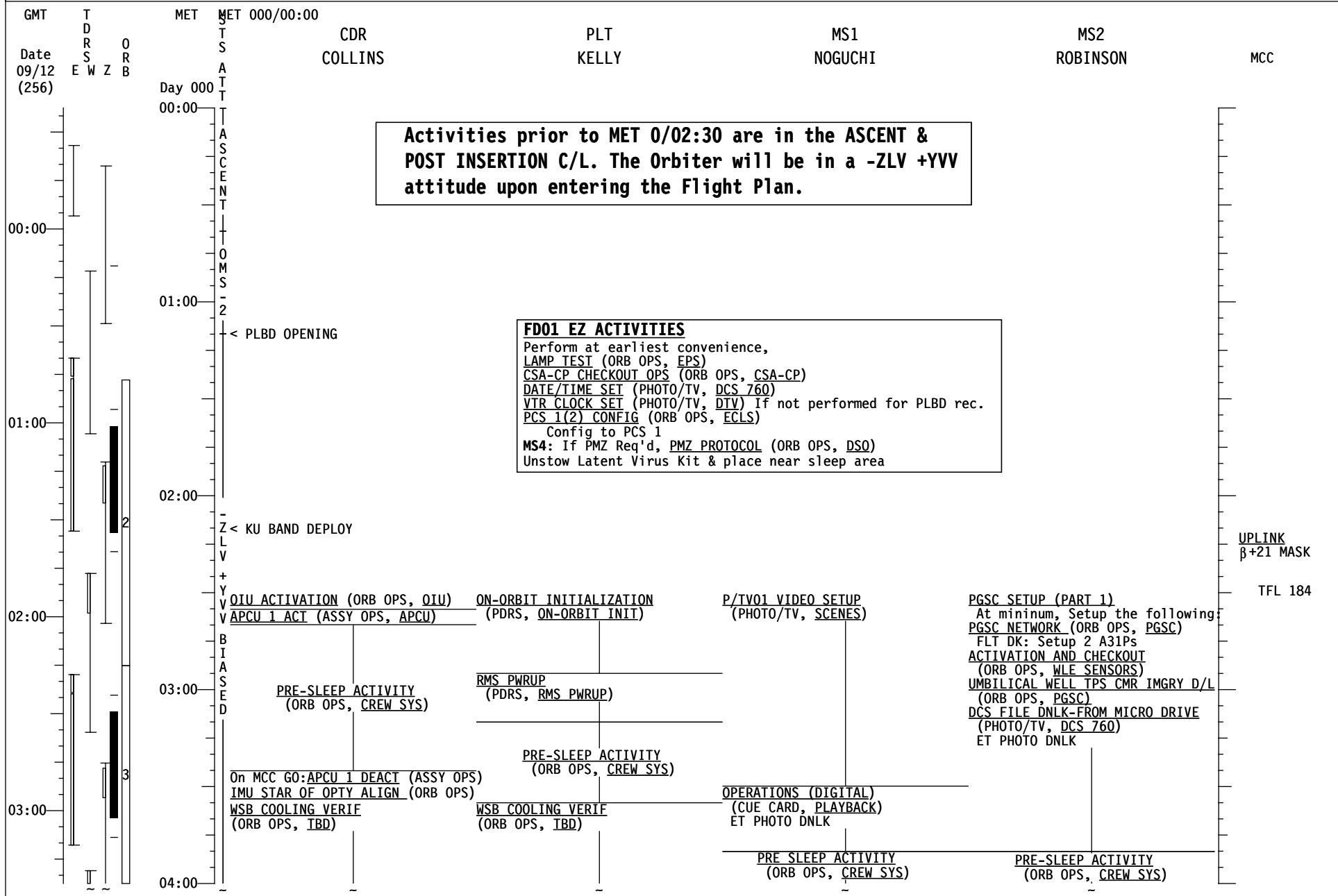

# STS-114 LF1 (FD 01)

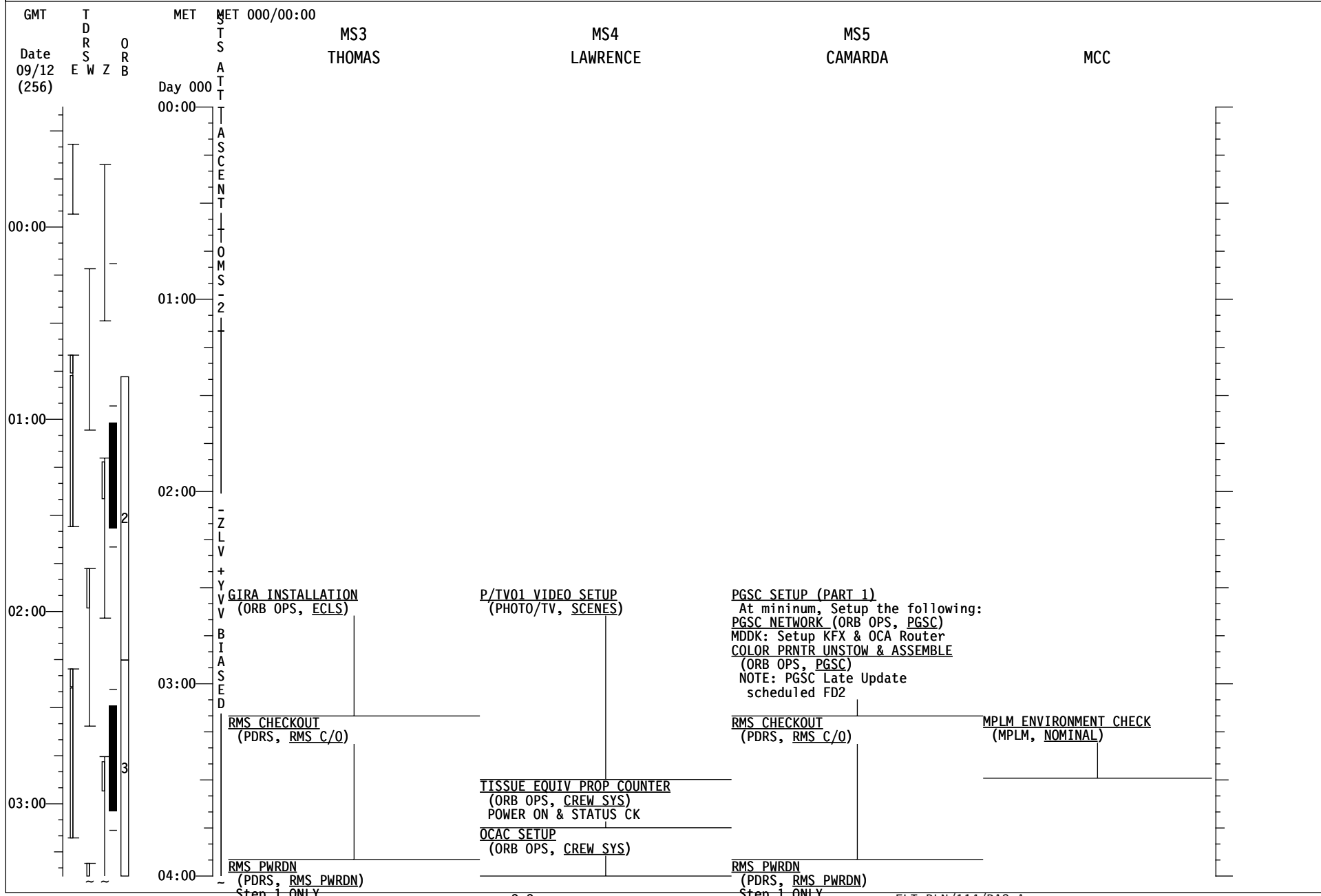

# STS-114 LF1 (FD01)

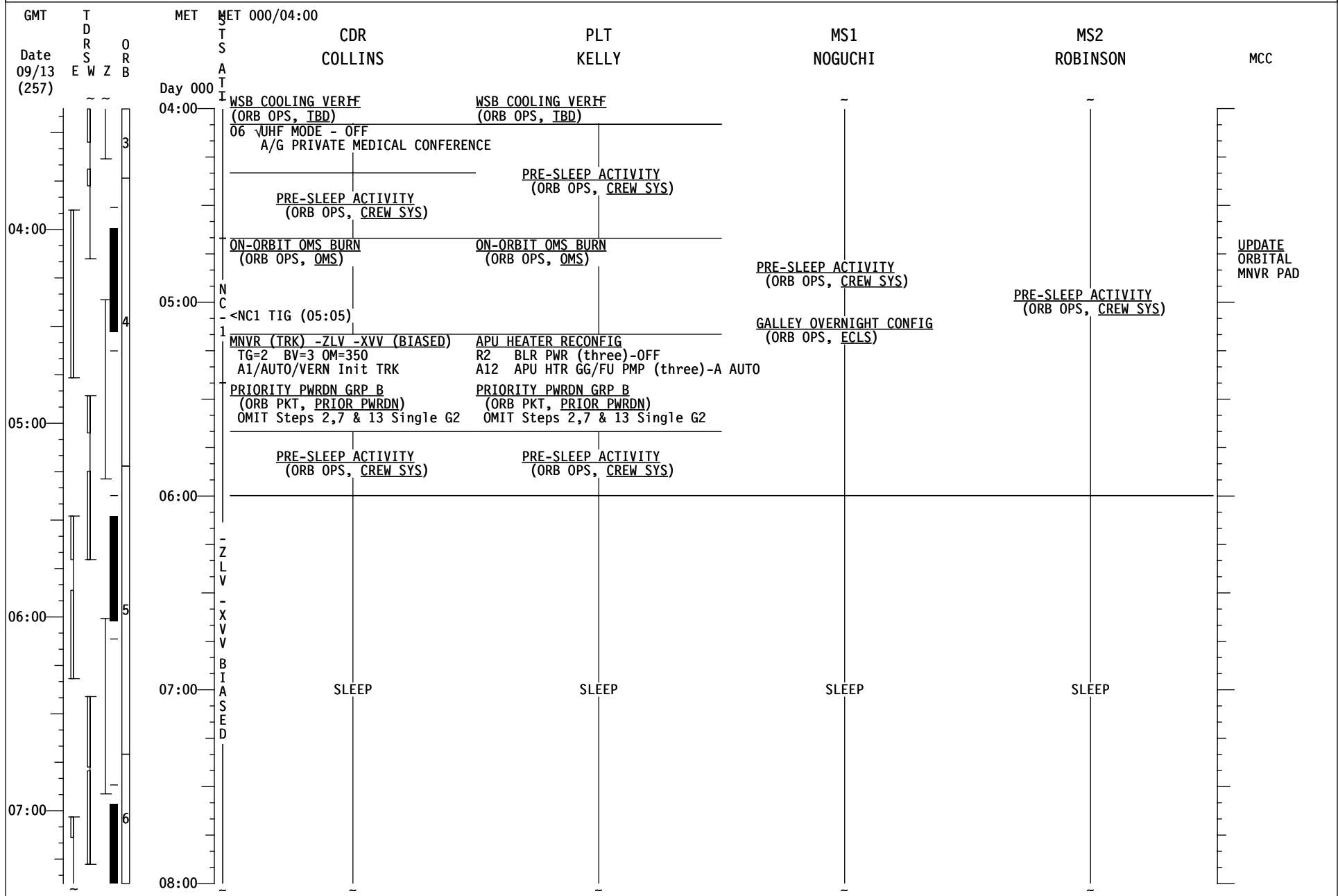

# STS-114 LF1 (FD 01)

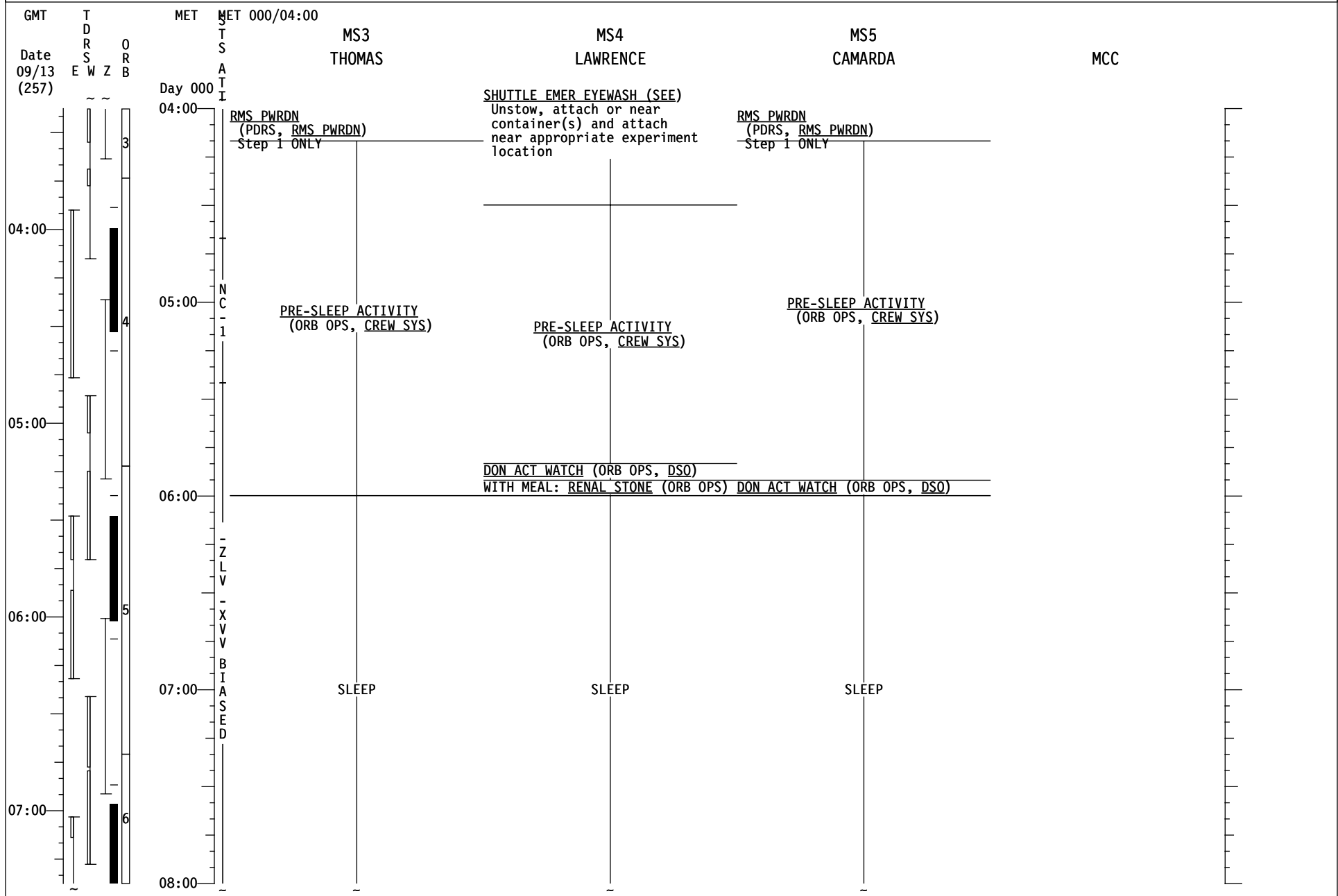

# STS-114 LF1 (FD01)

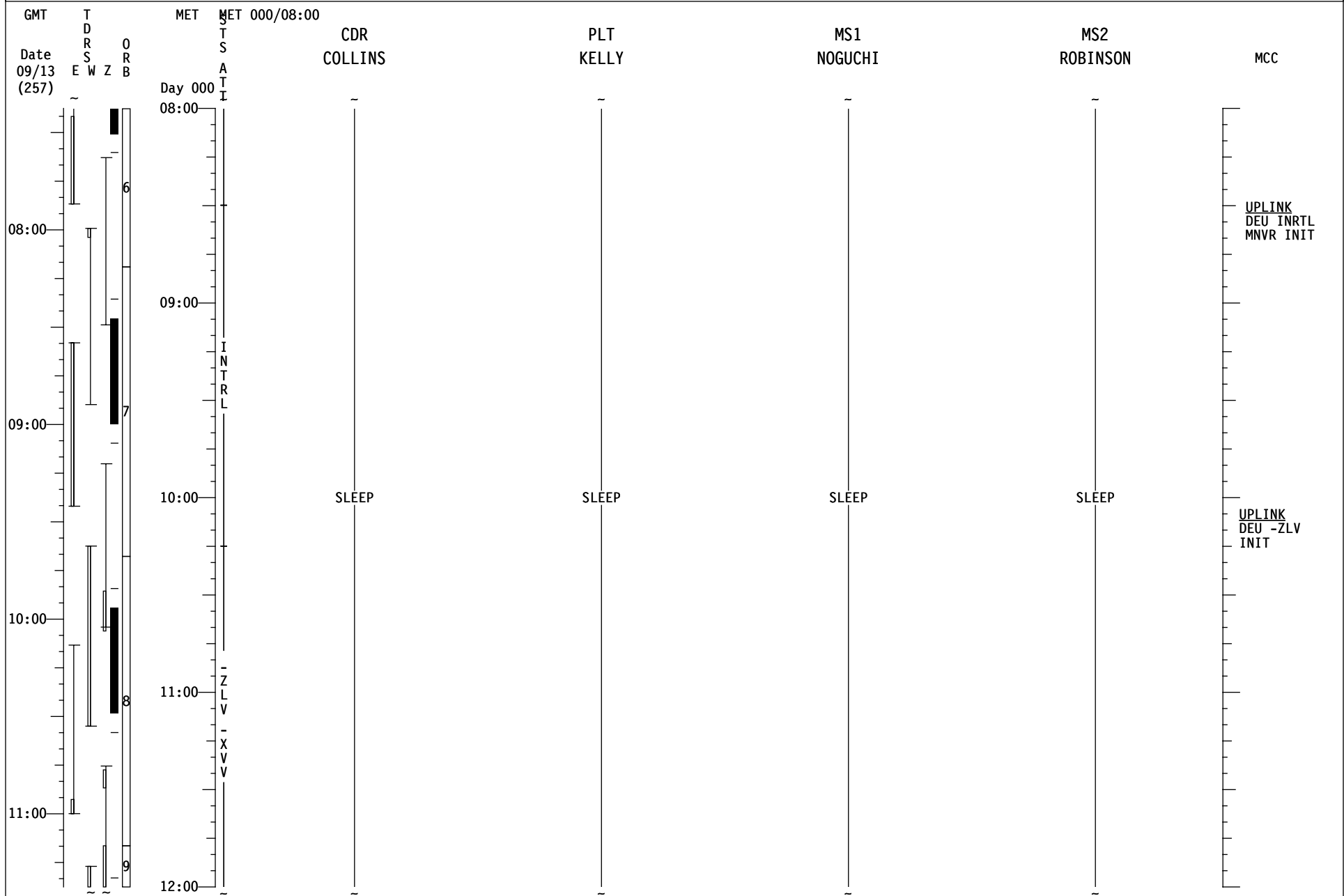



# STS-114 LF1 (FD 01)

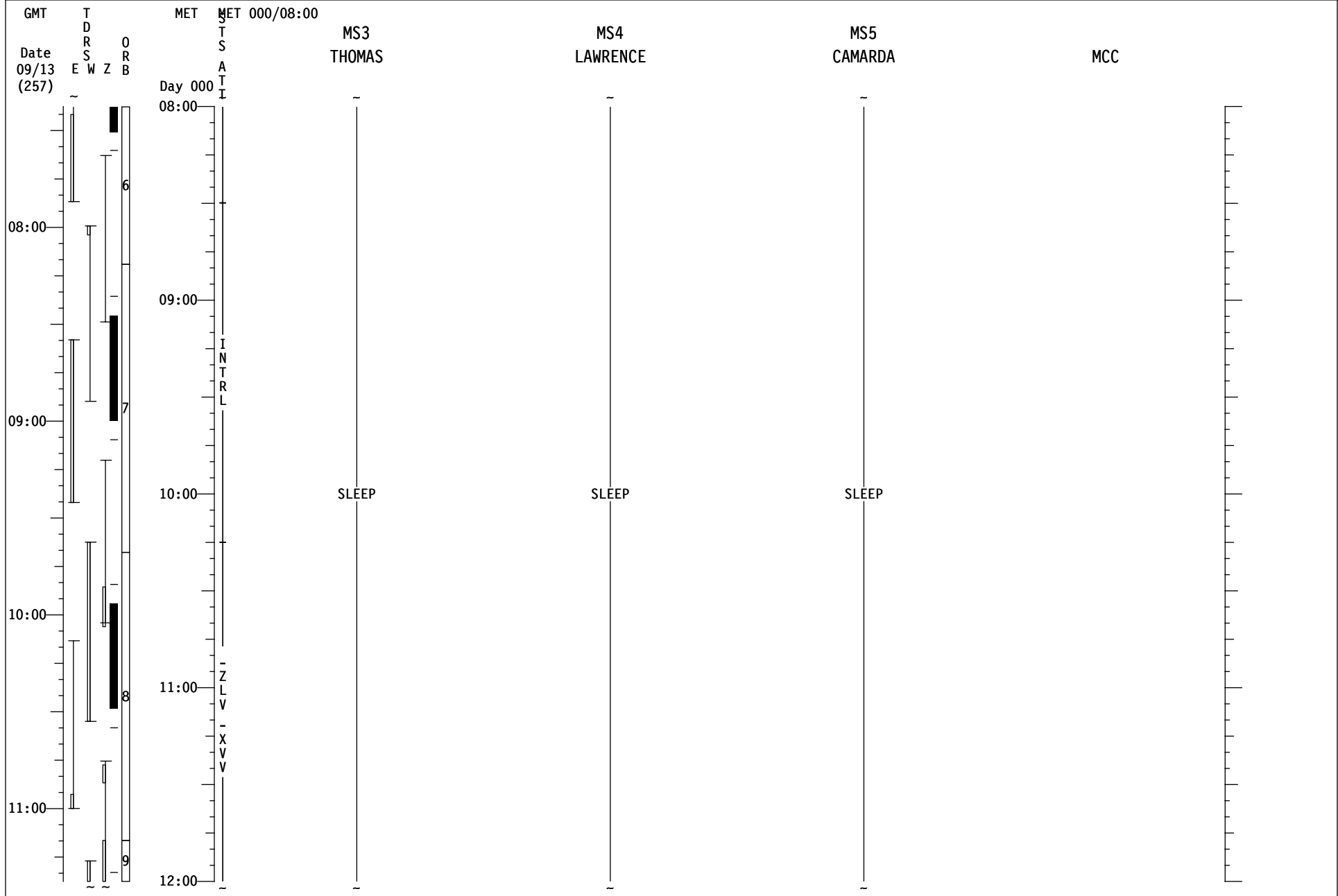

# STS-114 LF1 (FD02)

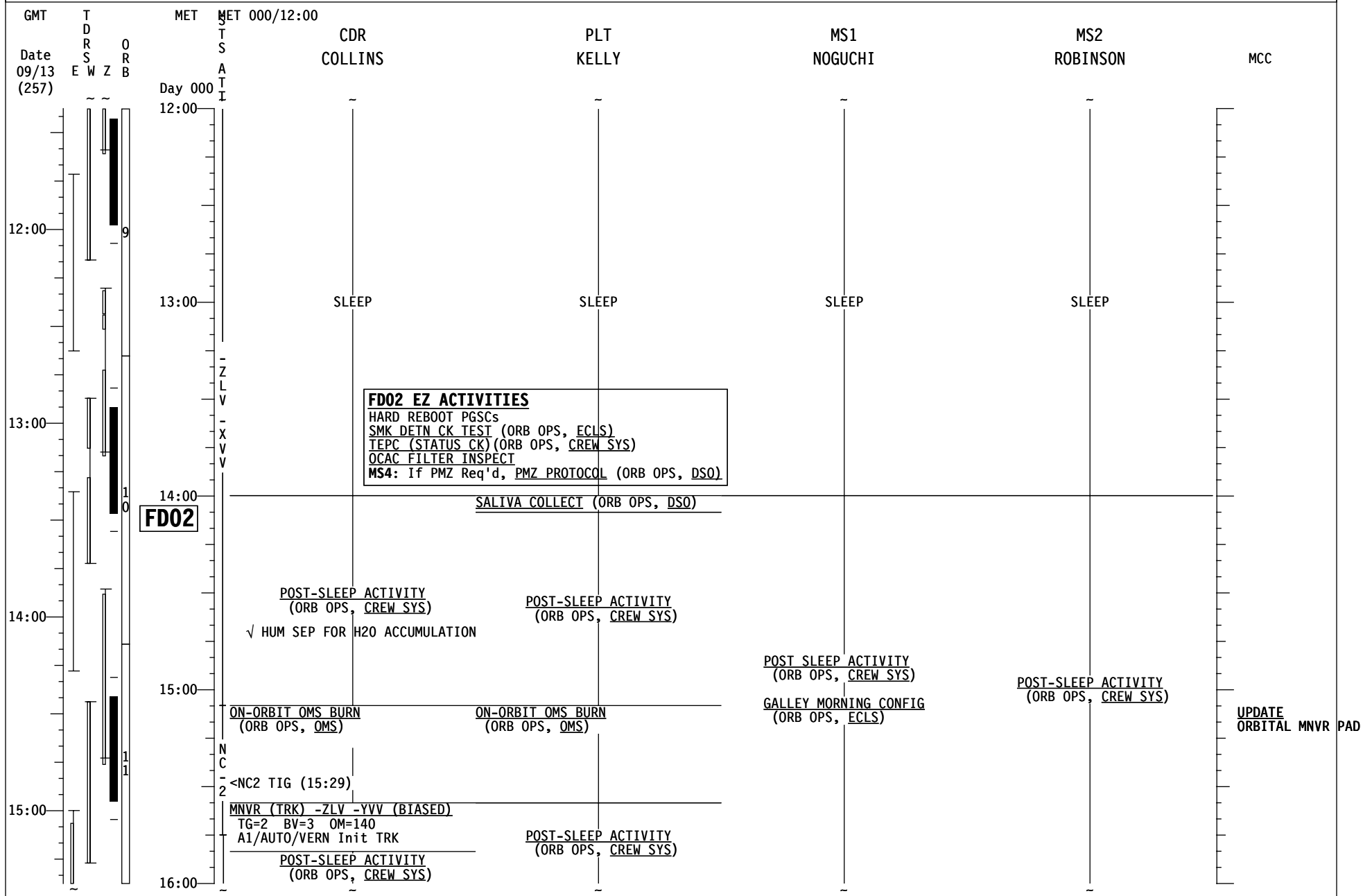

# STS-114 LF1 (FD02)

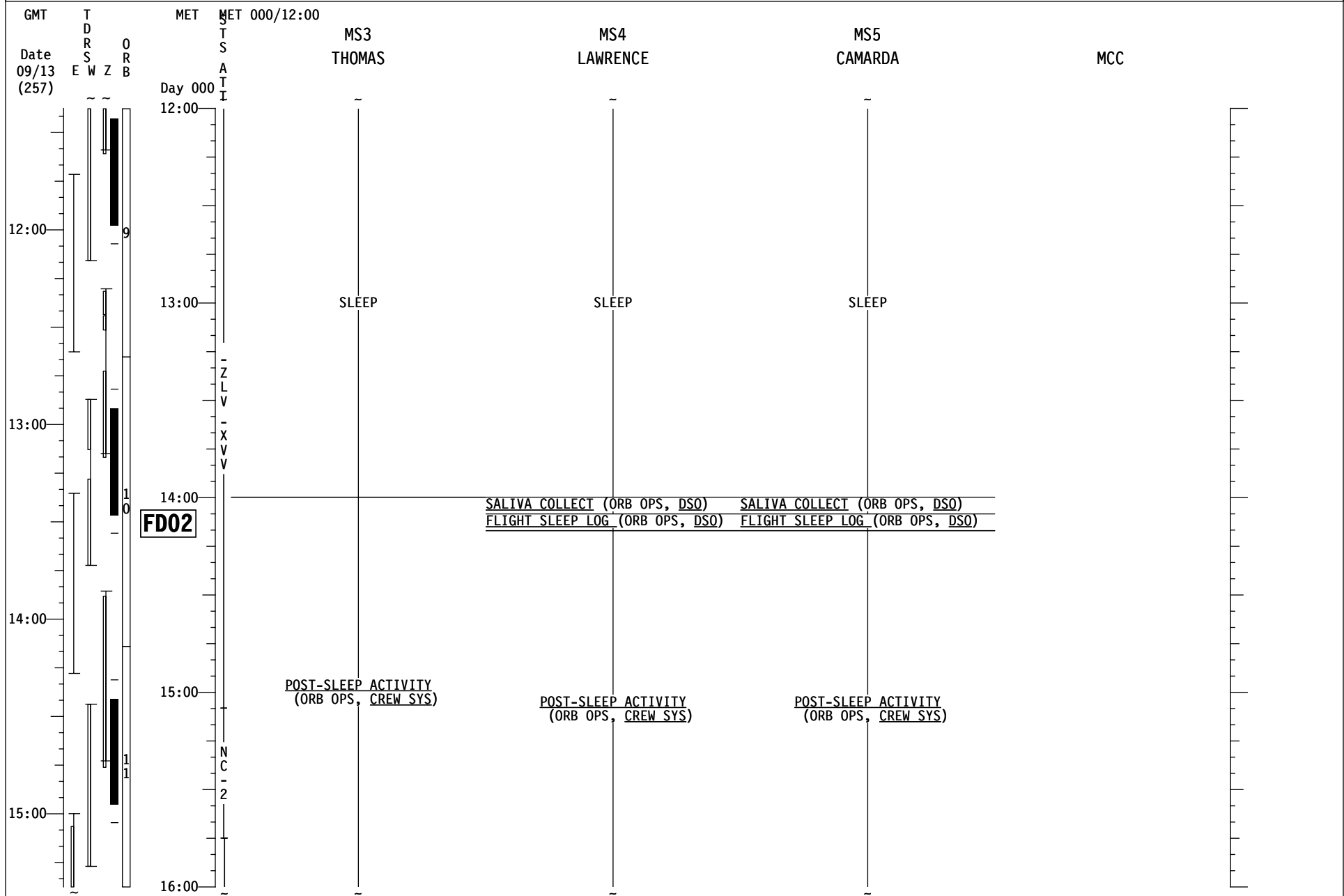

# STS-114 LF1 (FD02)

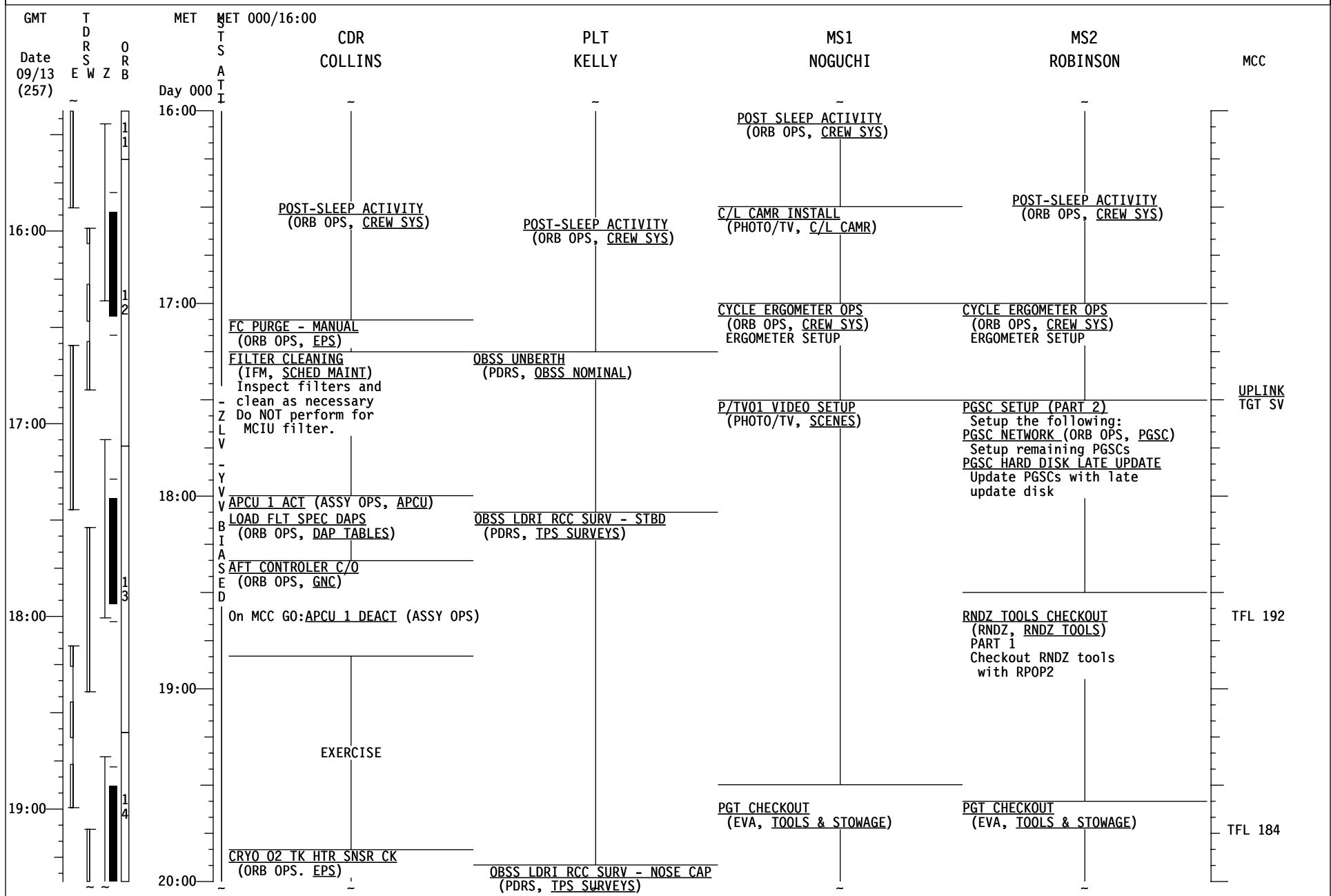

# STS-114 LF1 (FD02 )

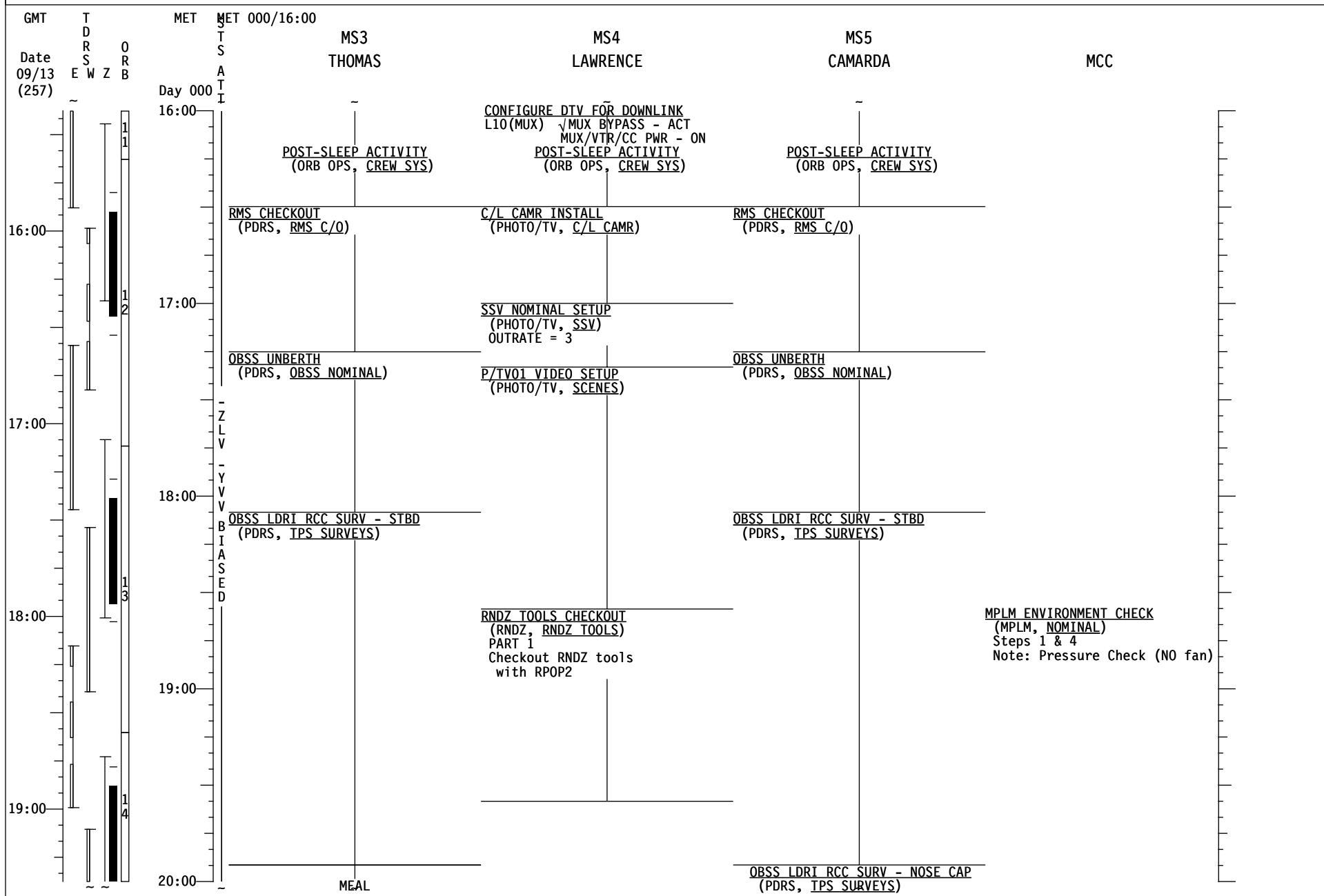

# STS-114 LF1 (FD02)

GMT	TDRS ORB	MET	MET 000/20:00	CDR COLLINS	PLT KELLY	MS1 NOGUCHI	MS2 ROBINSON	MCC	
Date 09/13 (257)	E W Z B	Day 000	I	20:00	CRYO 02 TK HTR SNSR CK (ORB OPS, EPS)	OBSS LDRI RCC SURV - NOSE CAP (PDRS, TPS SURVEYS)	PGT CHECKOUT (EVA, TOOLS & STOWAGE)	PGT CHECKOUT (EVA, TOOLS & STOWAGE)	
				20:00	MNVR (TRK) -ZLV -YVV (BIASED) TG=2 BV=3 OM=110 A1/AUTO/VERN Init TRK on MCC GO		EMITTANCE WASH APPLICATOR PREP (EVA, TPS REPAIR PREP)	EMITTANCE WASH APPLICATOR PREP (EVA, TPS REPAIR PREP)	
				DOCKING MECH INIT DOCKING MECH PWRUP After STBD SURV complete: DOCKING RING EXTENSION DOCKING MECH PWRDN (RNDZ, APDS-NOMINAL)			CIPAA CHECKOUT (EVA, TPS REPAIR PREP)	CIPAA CHECKOUT (EVA, TPS REPAIR PREP)	
				MEAL	MEAL	MEAL	MEAL		
				22:00	R2 BLR CNTLR/HTR (three) - B	OBSS LDRI RCC SURV - PORT (PDRS, TPS SURVEYS)	EMU CHECKOUT PREP (EVA, AIRLOCK CONFIG)	EMU CHECKOUT PREP (EVA, AIRLOCK CONFIG)	
				22:00	E SHUTTLE/ISS H2O CONT FILL (ORB OPS, ECLS) Perform EQUIP PREP and WATER TRANSFER HOSE PURGE		A/L FAN ACT & ODS VOL PREP (RNDZ, APDS-NOMINAL) Steps 1-5		
				22:00			EMU CHECKOUT (EVA, CHECKOUTS)	EMU CHECKOUT (EVA, CHECKOUTS)	
				23:00	PRE-SLEEP ACTIVITY (ORB OPS, CREW SYS)				
				00:00					



# STS-114 LF1 (FD02)

GMT	TDRS Date 09/13 (257)	MET	MET 001/00:00	CDR COLLINS	PLT KELLY	MS1 NOGUCHI	MS2 ROBINSON	MCC
		Day 001	00:00	MNVR (TRK) -ZLV +YVV (BIASED) TG=2 BV=3 OM=295 A1/AUTO/VERN Init TRK on MCC GO	FC MONITORING SYS (FCMS) OPS (ORB OPS, EPS)	EVA PREP FOR ISS TRANSFER (EVA, AIRLOCK CONFIG)	EVA PREP FOR ISS TRANSFER (EVA, AIRLOCK CONFIG)	
				PRE-SLEEP ACTIVITY (ORB OPS, CREW SYS)				
			00:00	PAO VOICE CHECK/EVENT (A/G) REF MSG ###	PAO VOICE CHECK/EVENT (A/G) REF MSG ###			
				ON-ORBIT MULTI-AXIS RCS BURN (ORB OPS, RCS)	ON-ORBIT MULTI-AXIS RCS BURN (ORB OPS, RCS)			
			01:00	Y< NPC TIG (01:08)				
				PRE-SLEEP ACTIVITY (ORB OPS, CREW SYS) √ HUM SEP FOR H2O ACCUMULATION		AIRLOCK FAN BYPASS (RNDZ, APDS-NOMINAL)		
			01:00	VIDEO CONFERENCING (ORB OPS, PGSC) - PMC	PRE-SLEEP ACTIVITY (ORB OPS, CREW SYS)			OCA-PMC
			02:00	CMG HTR: R1 PL AFT MNC - ON				
				PRE-SLEEP ACTIVITY (ORB OPS, CREW SYS)				
				ON-ORBIT +X RCS BURN (ORB OPS, RCS)	ON-ORBIT +X RCS BURN (ORB OPS, RCS)			
			02:00	NC-3 TIG (02:40)	< NC-3 TIG (02:40)	PRE-SLEEP ACTIVITY (ORB OPS, CREW SYS)	PRE-SLEEP ACTIVITY (ORB OPS, CREW SYS)	
			03:00	MNVR (TRK) -ZLV -XVV TG=2 BV=3 OM=0 A1/AUTO/VERN Init TRK		GALLEY OVERNIGHT CONFIG (ORB OPS, ECLS)		
				PRE-SLEEP ACTIVITY (ORB OPS, CREW SYS)	PRE-SLEEP ACTIVITY (ORB OPS, CREW SYS)			
			03:00					
			04:00					



# STS-114 LF1 (FD02)

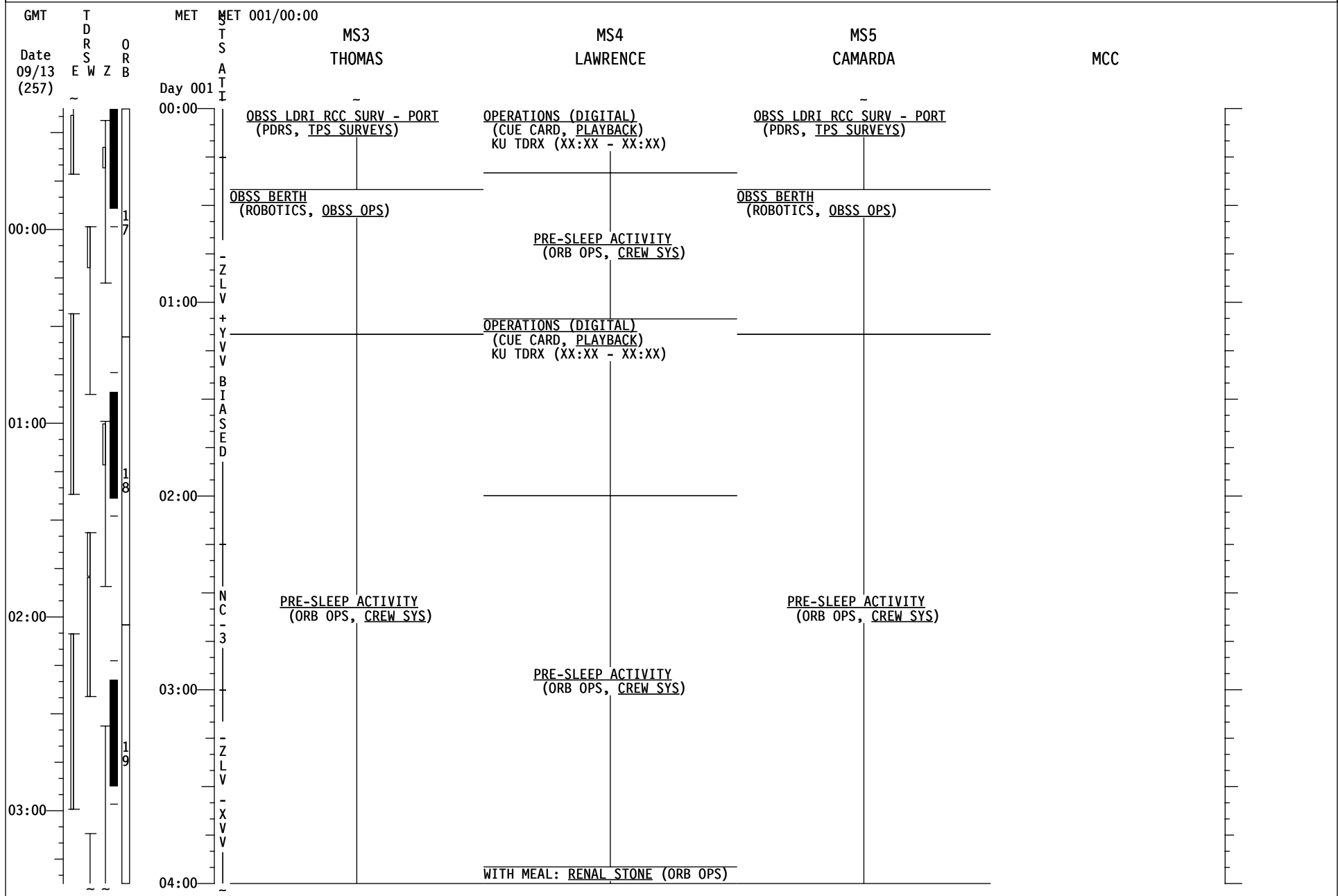

# STS-114 LF1 (FD02)

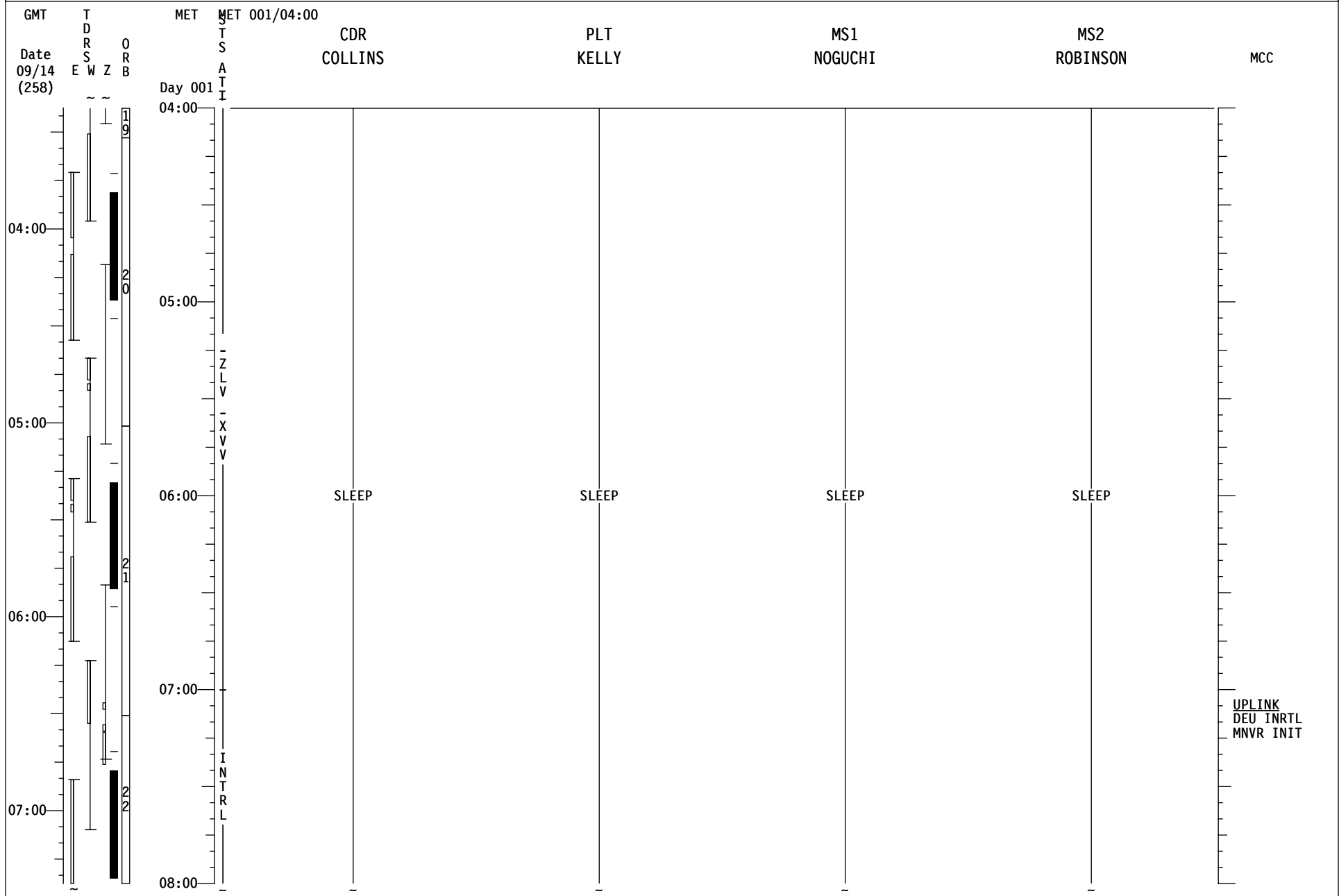

# STS-114 LF1 (FD02 )

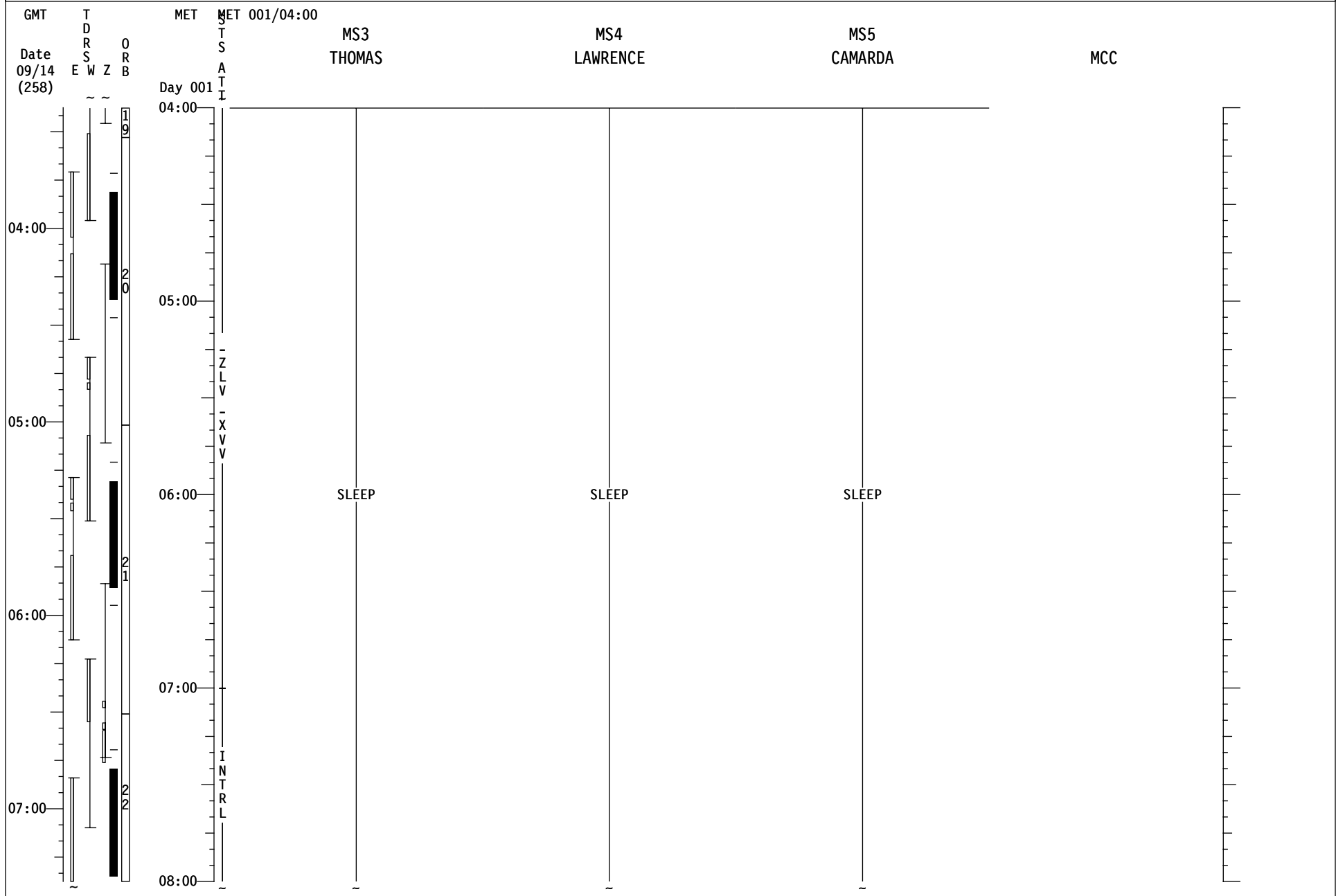

# STS-114 LF1 (FD02)

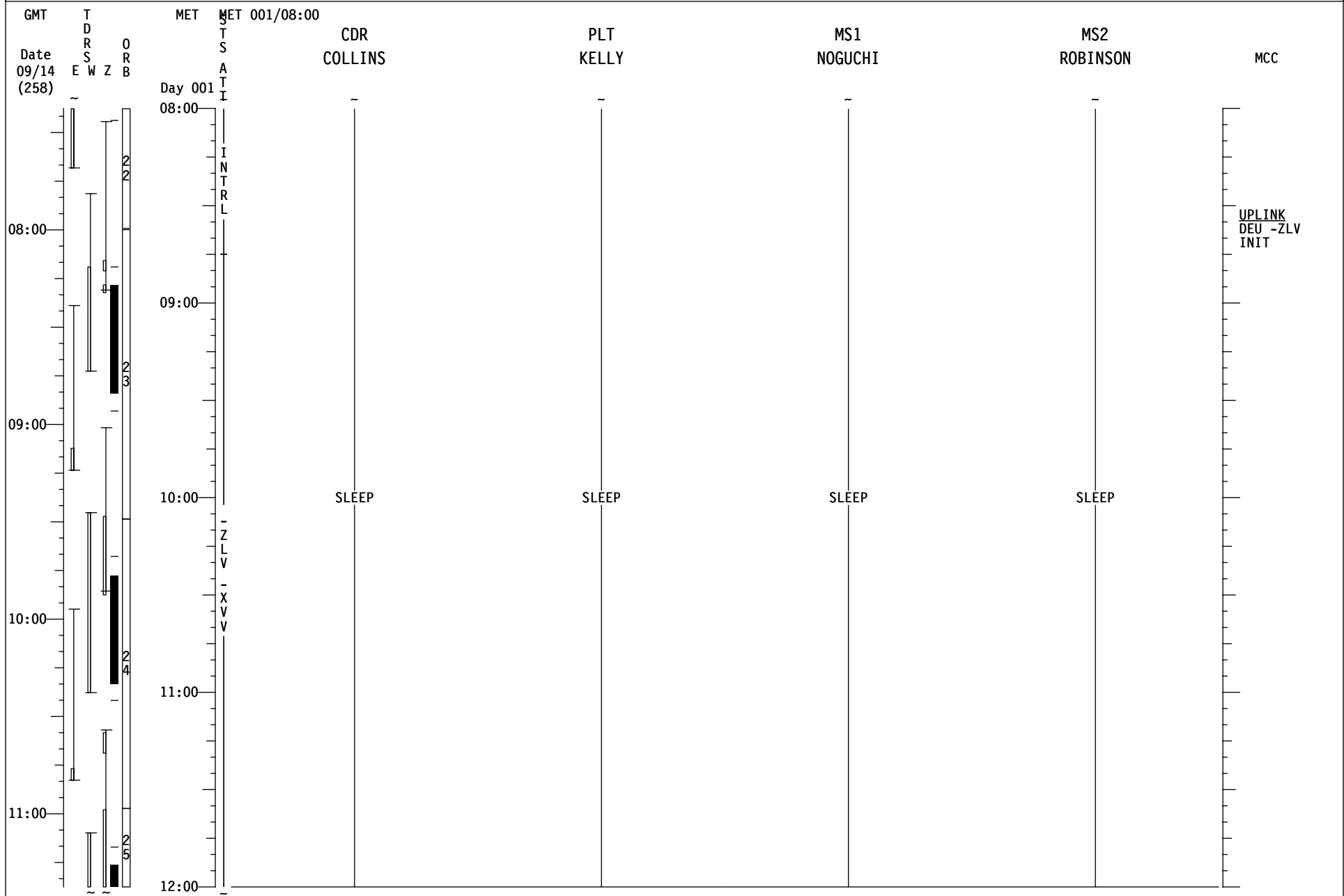

# STS-114 LF1 (FD02 )

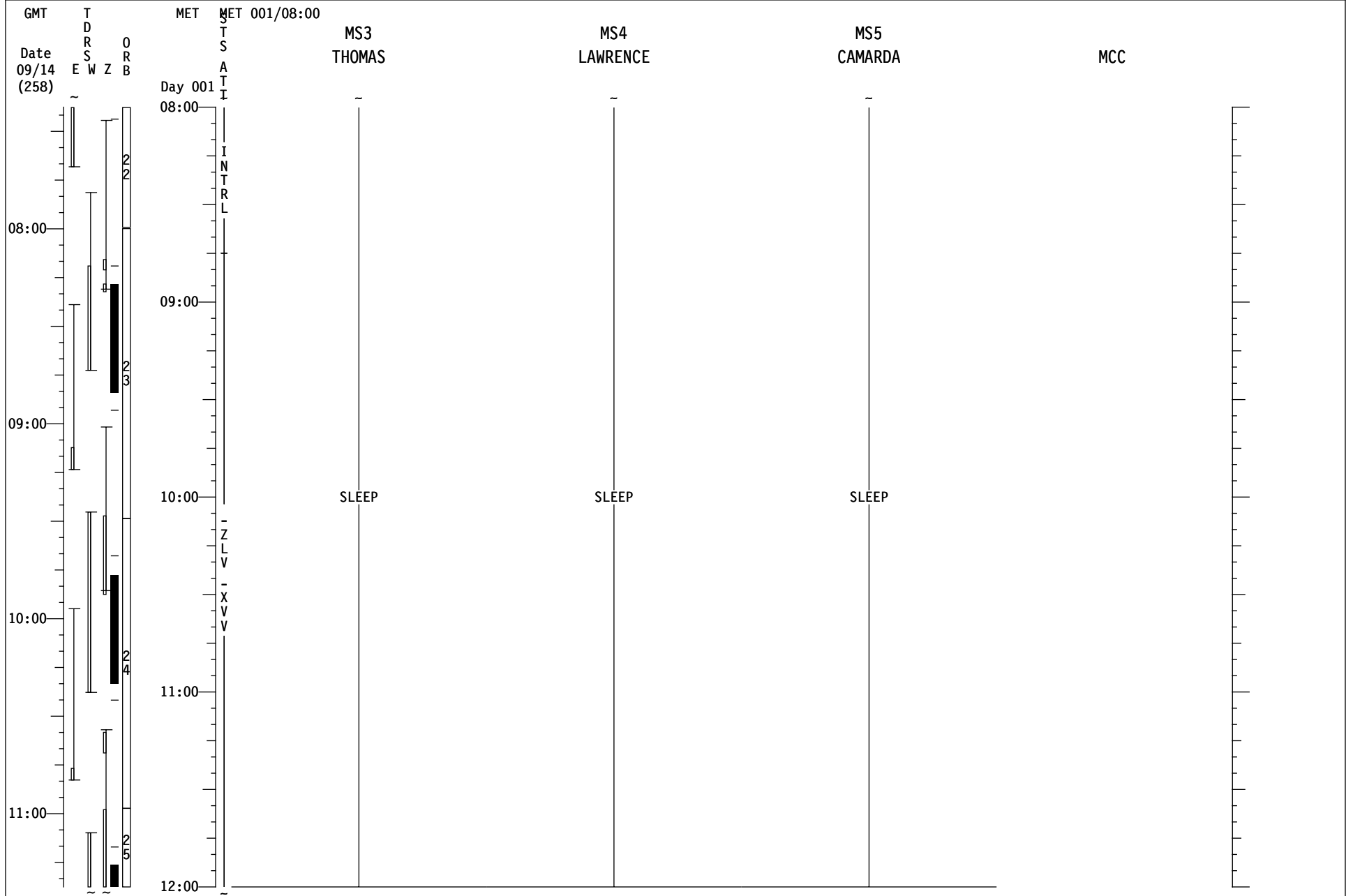

# STS-114 LF1 (FD03)

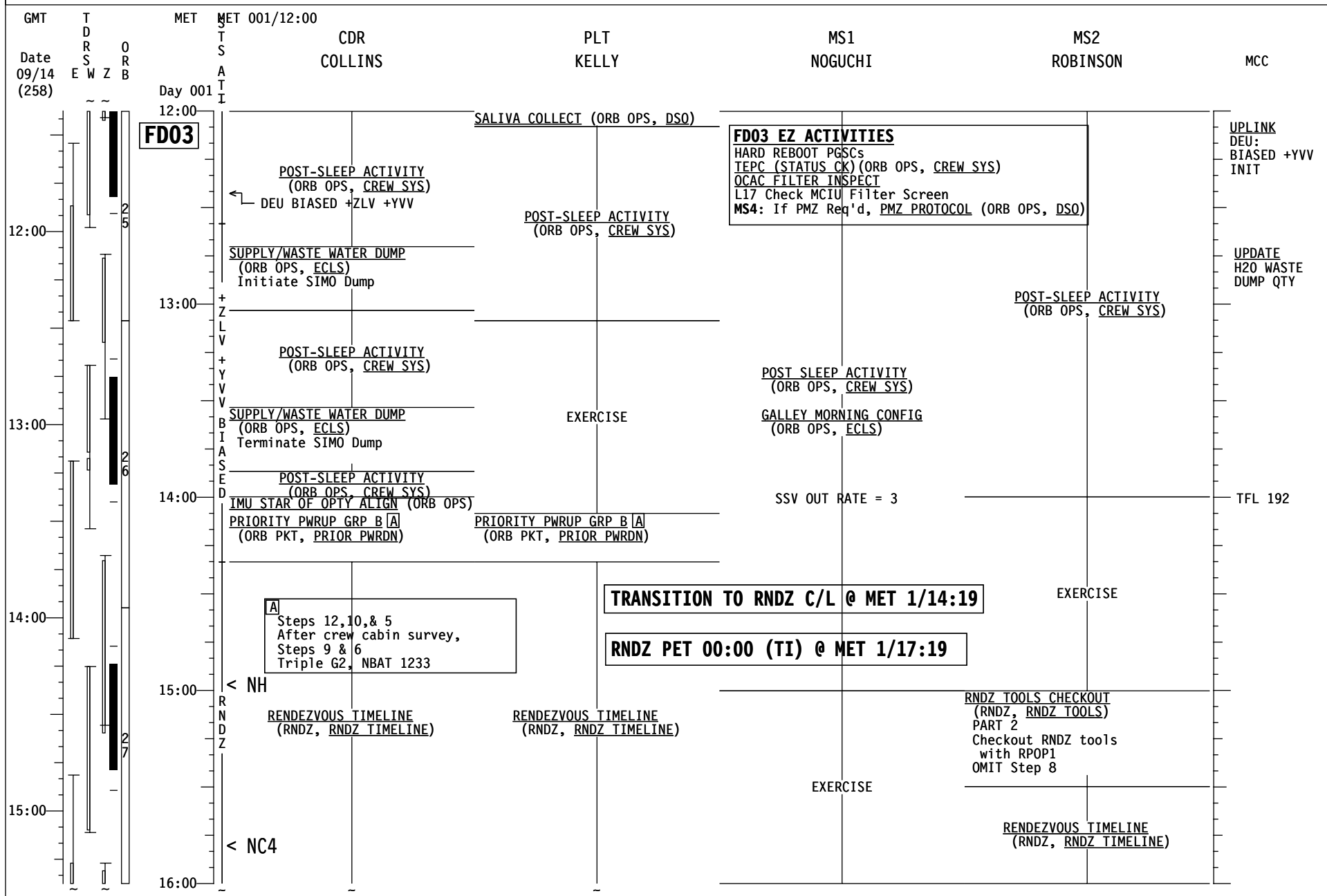

# STS-114 LF1 (FD03)

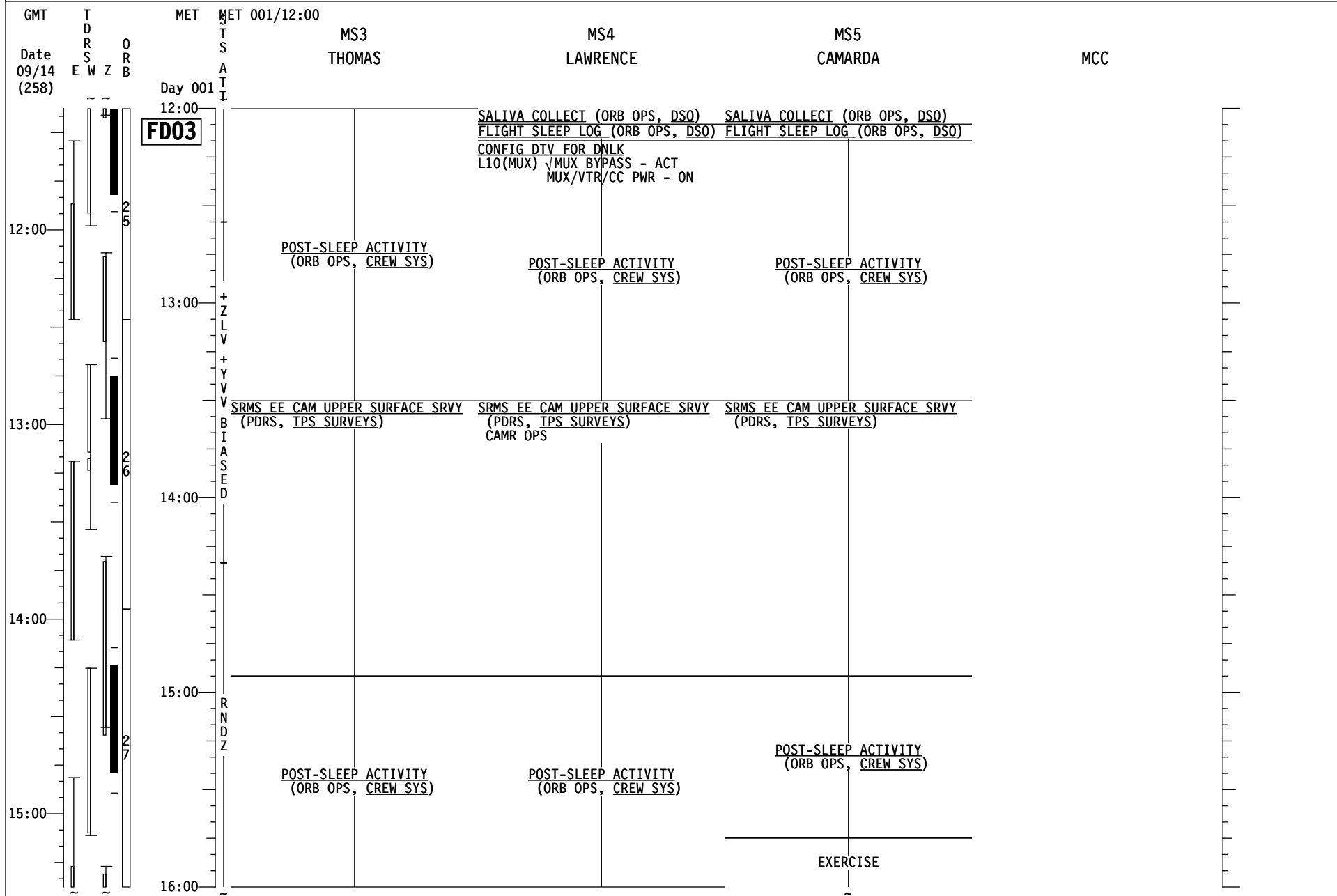

# STS-114 LF1 (FD 03)

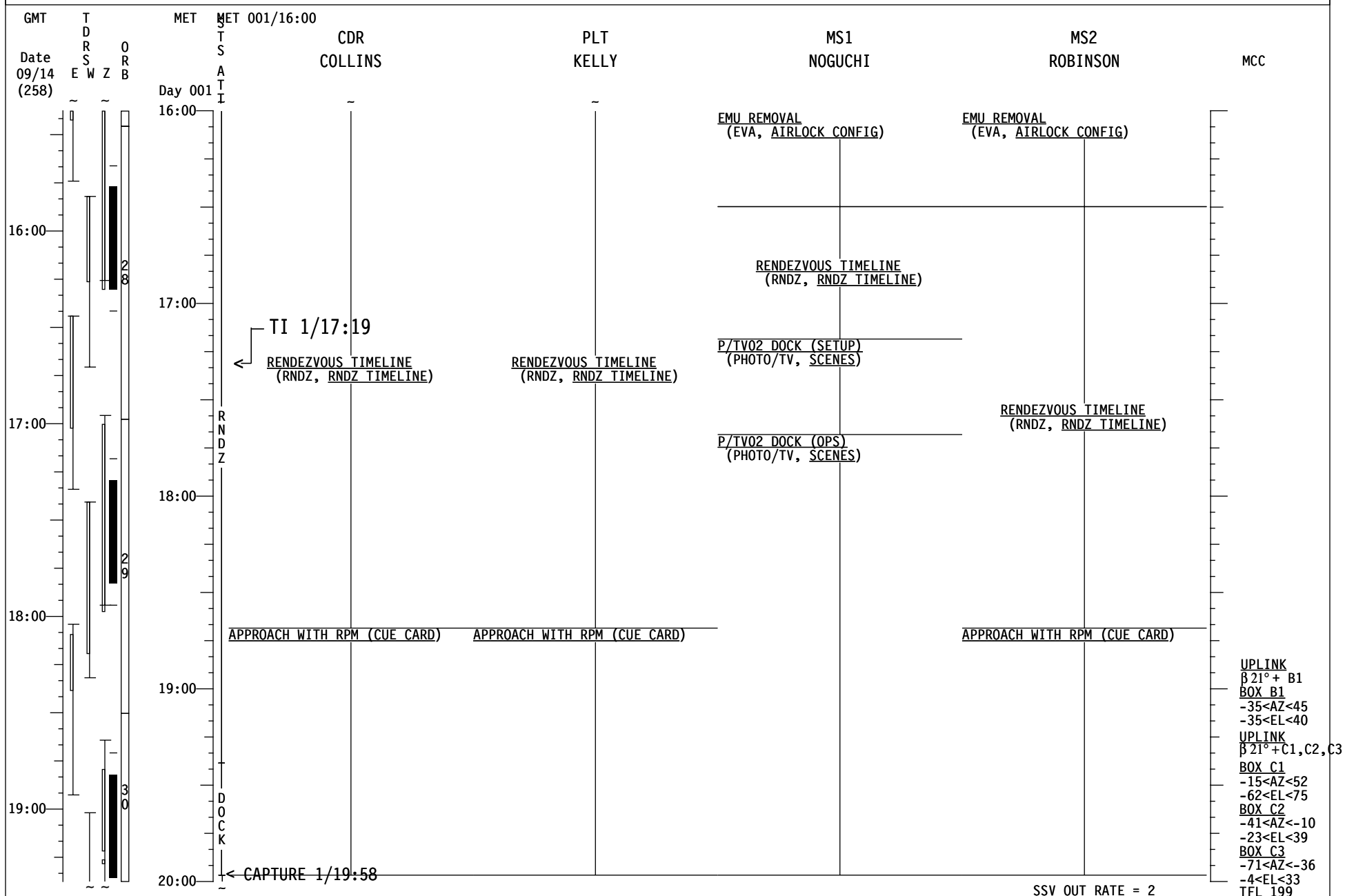



# STS-114 LF1 (FD 03)

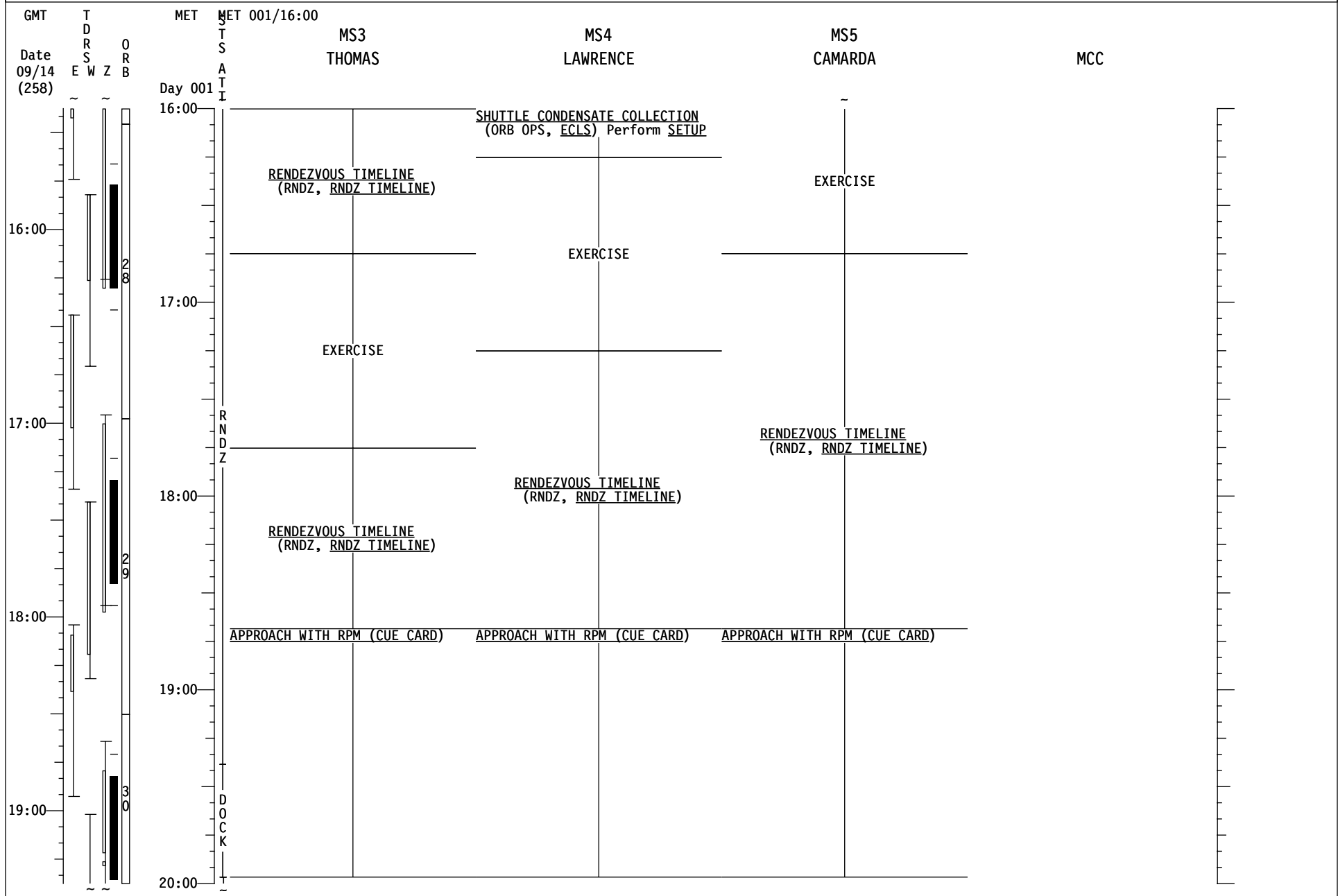

# STS-114 LF1 (FD 03)

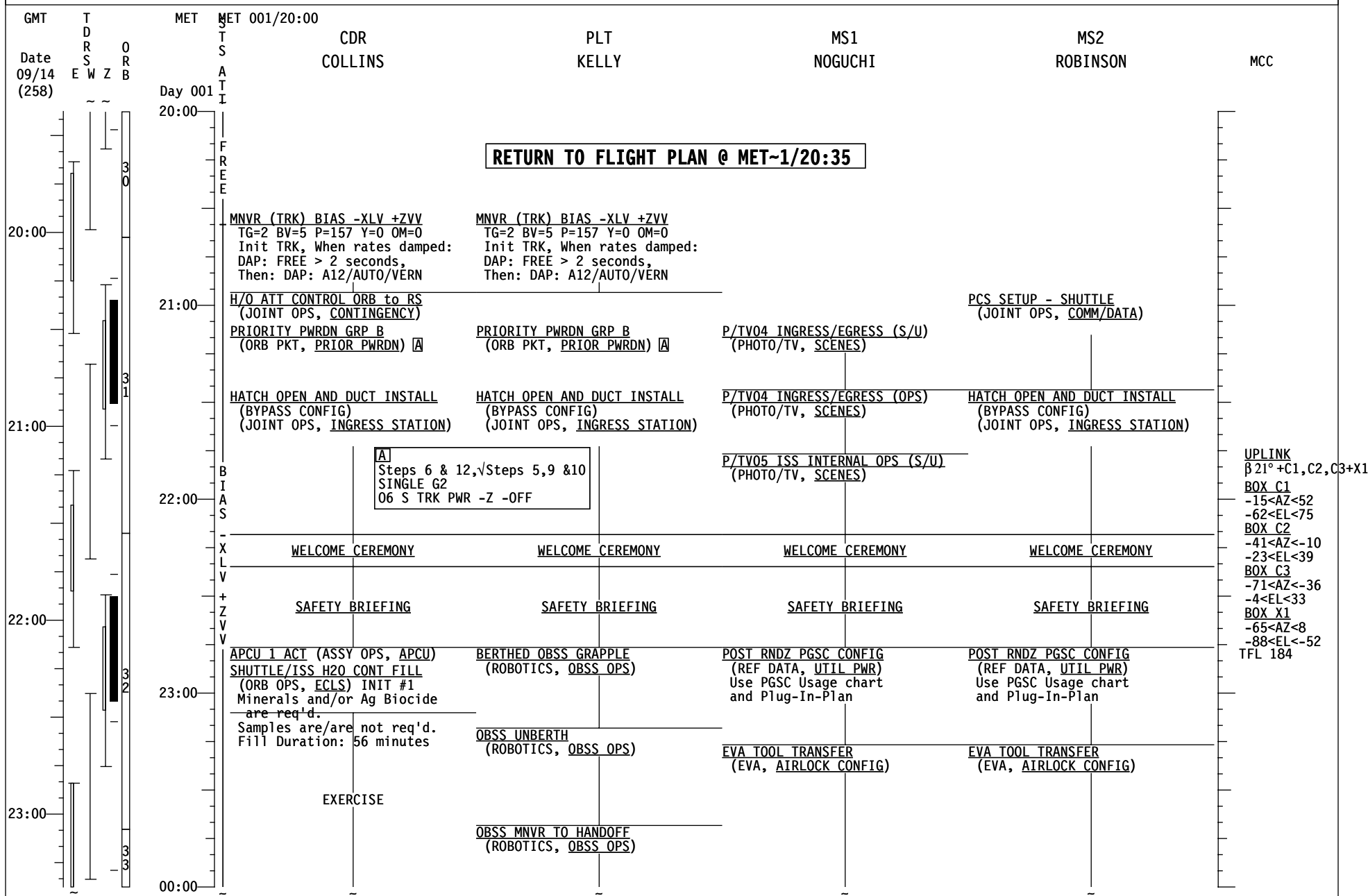

# STS-114 LF1 (FD 03)

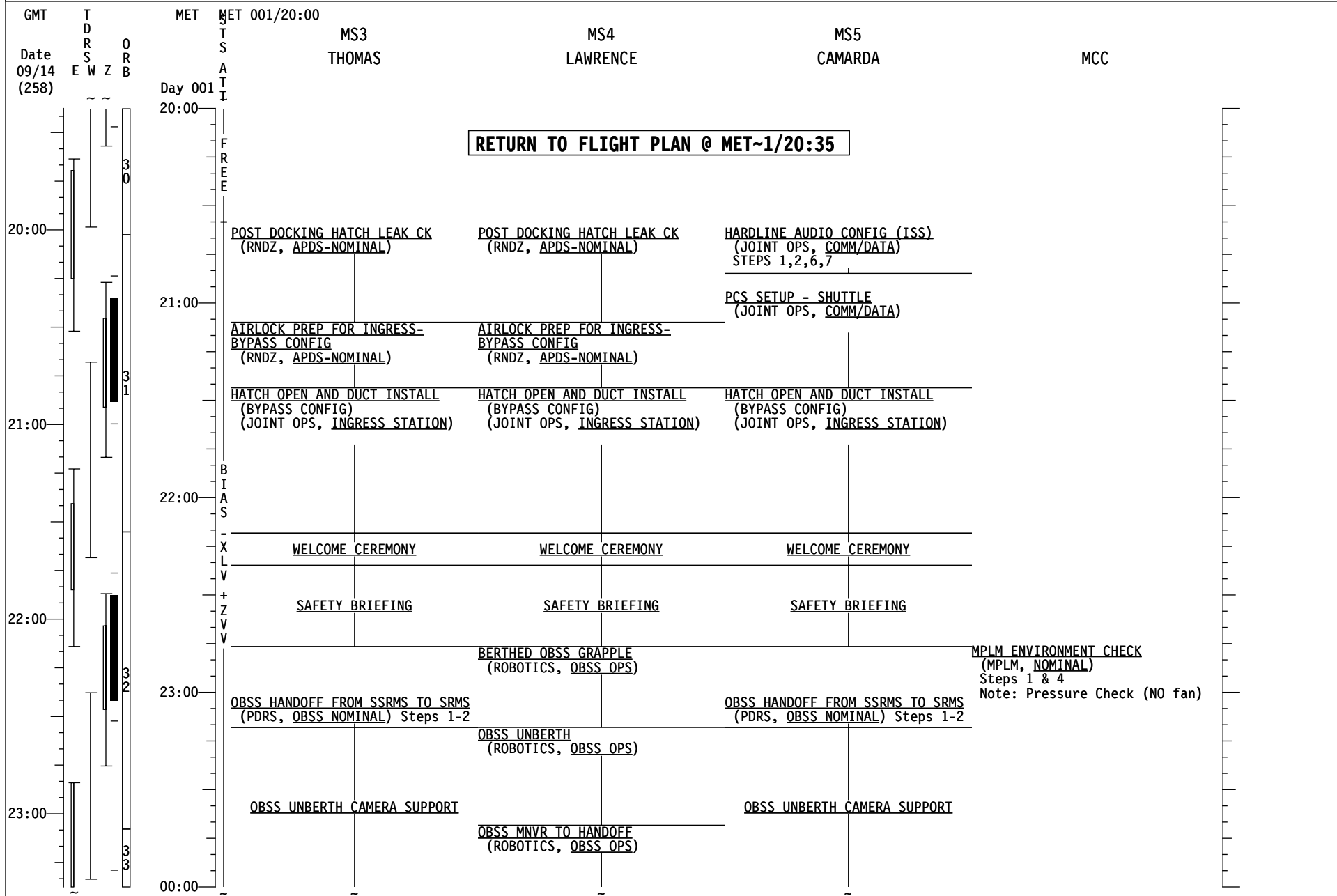

# STS-114 LF1 (FD 03)

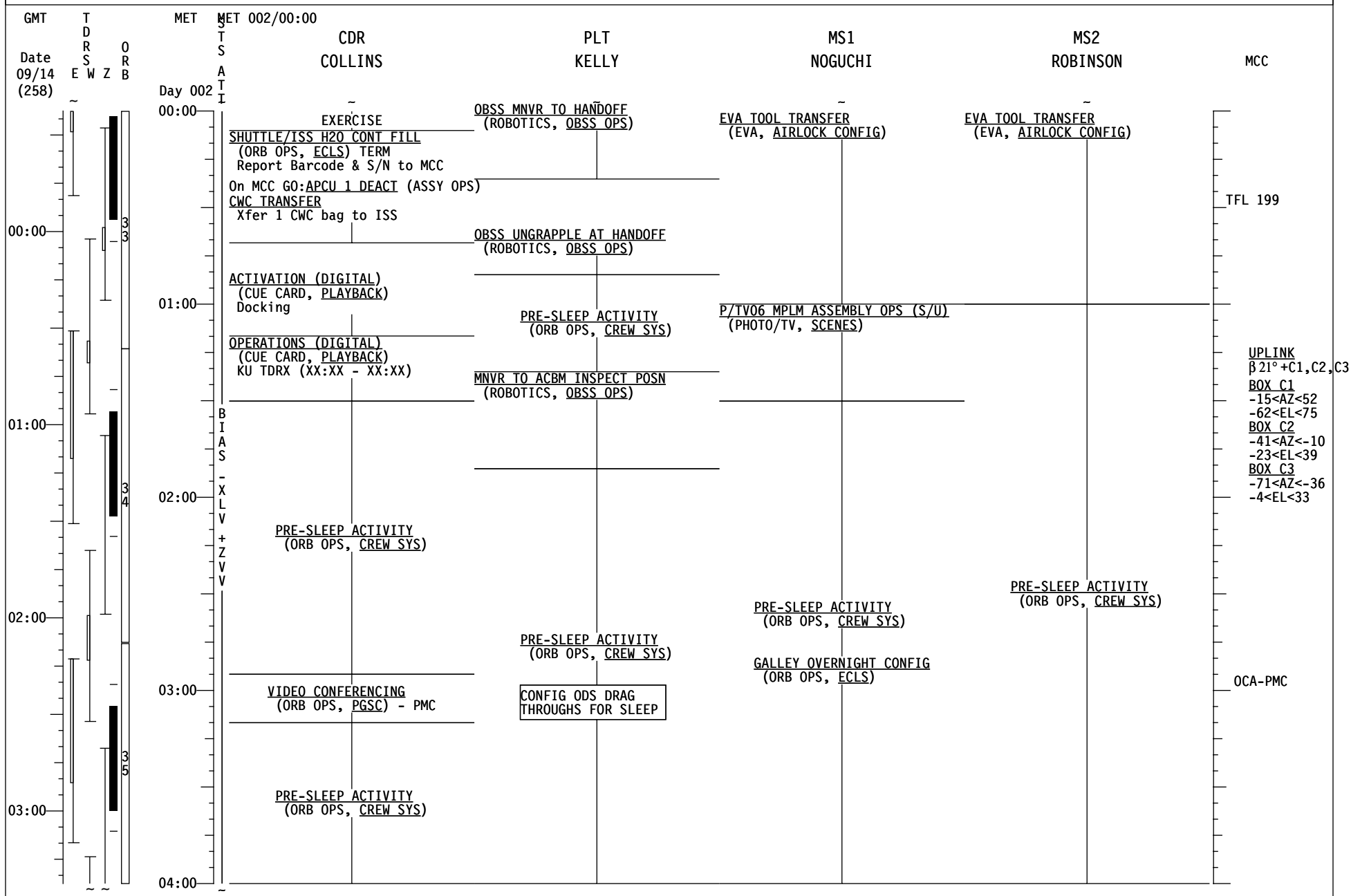

# STS-114 LF1 (FD 03)

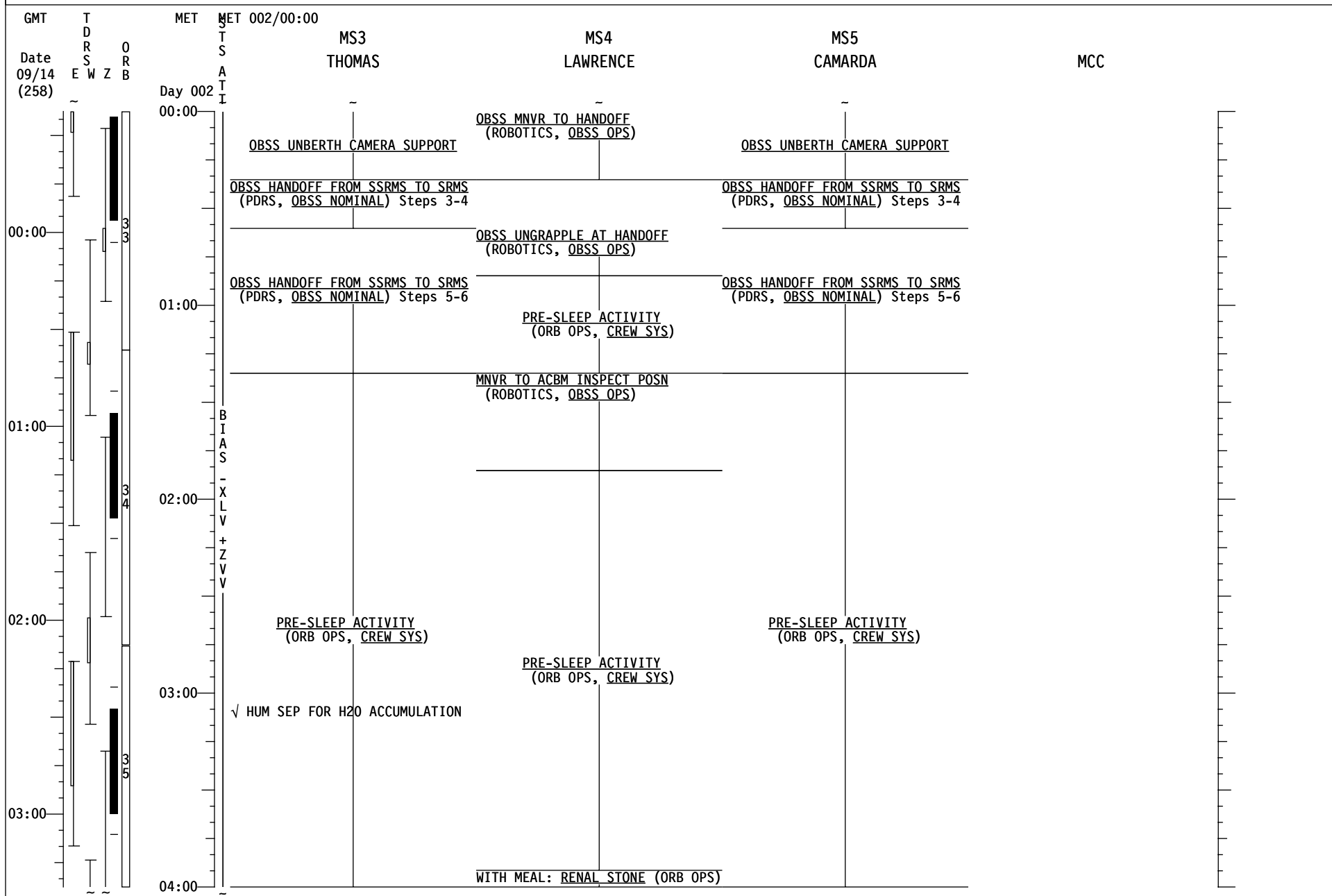

# STS-114 LF1 (FD 03)

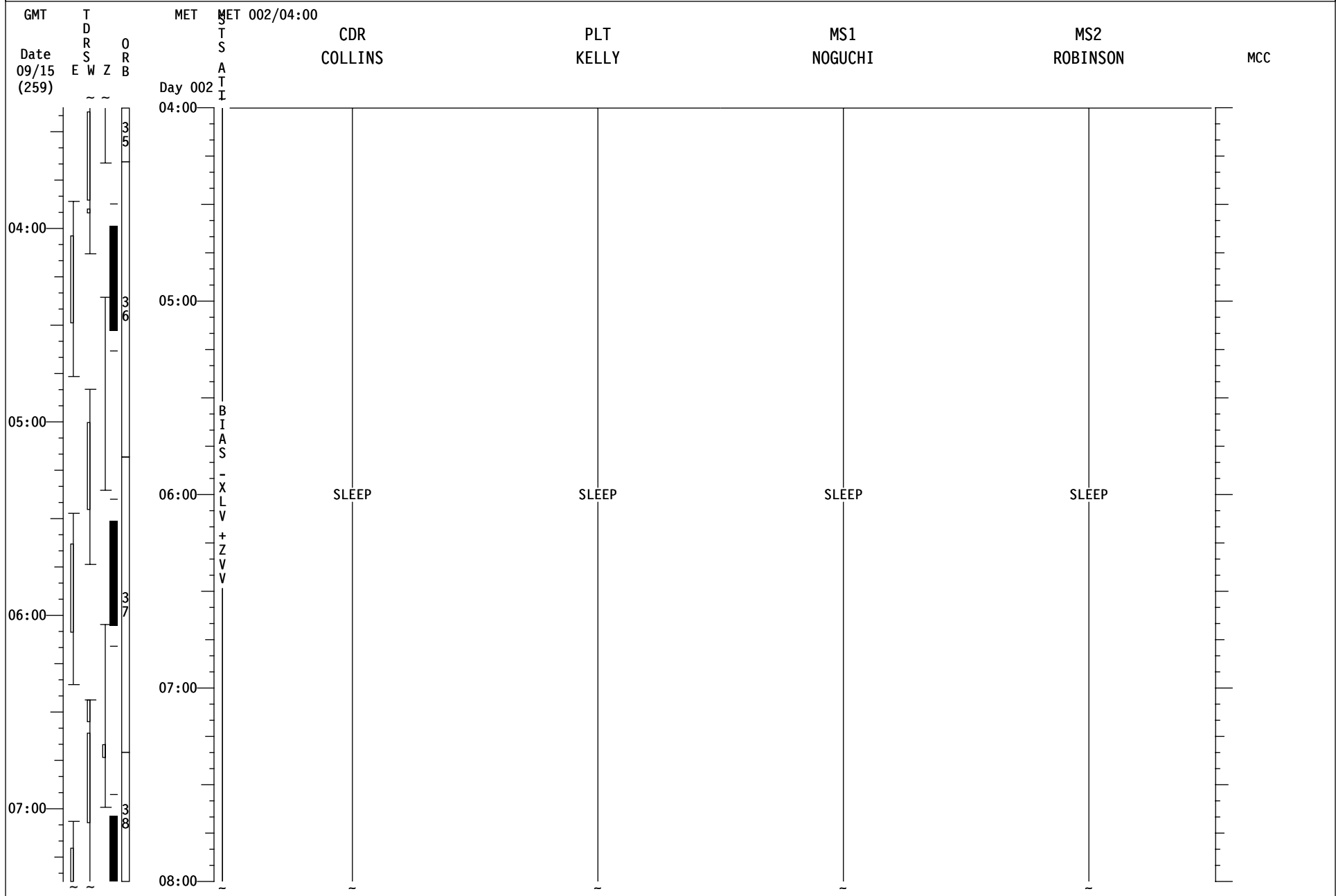

# STS-114 LF1 (FD 03)

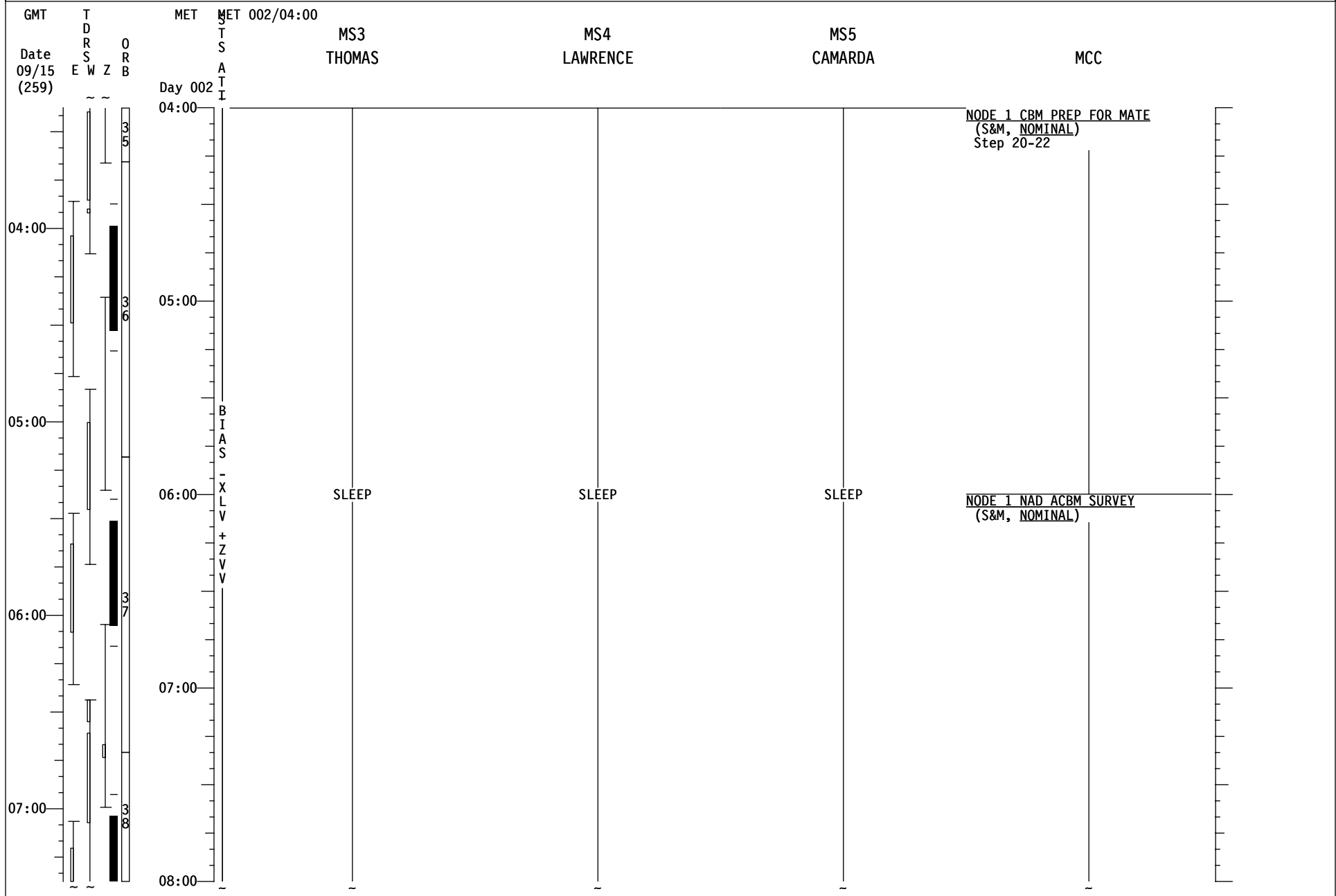

# STS-114 LF1 (FD 03)

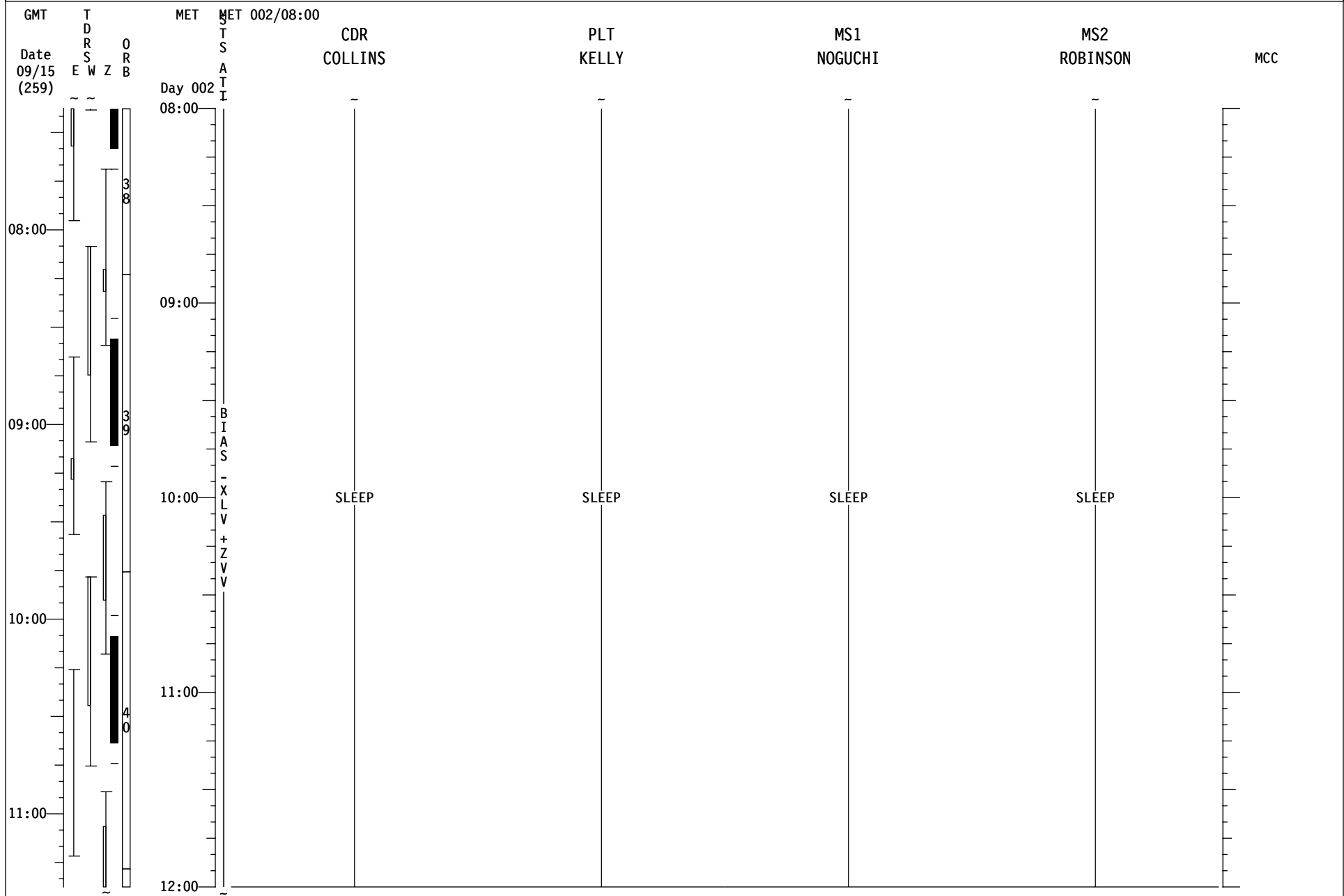



# STS-114 LF1 (FD 03)

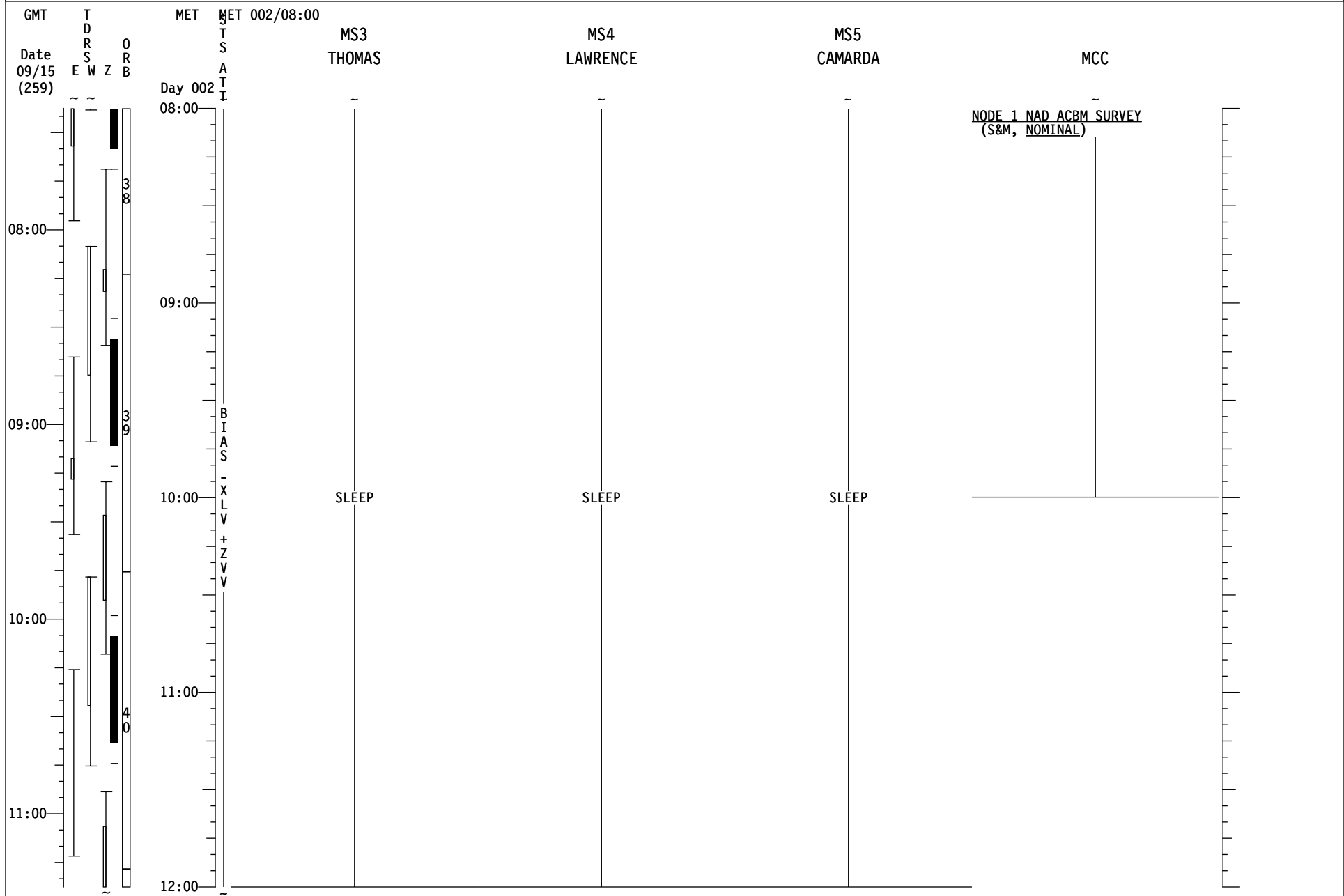

# STS-114 LF1 (FD 04)

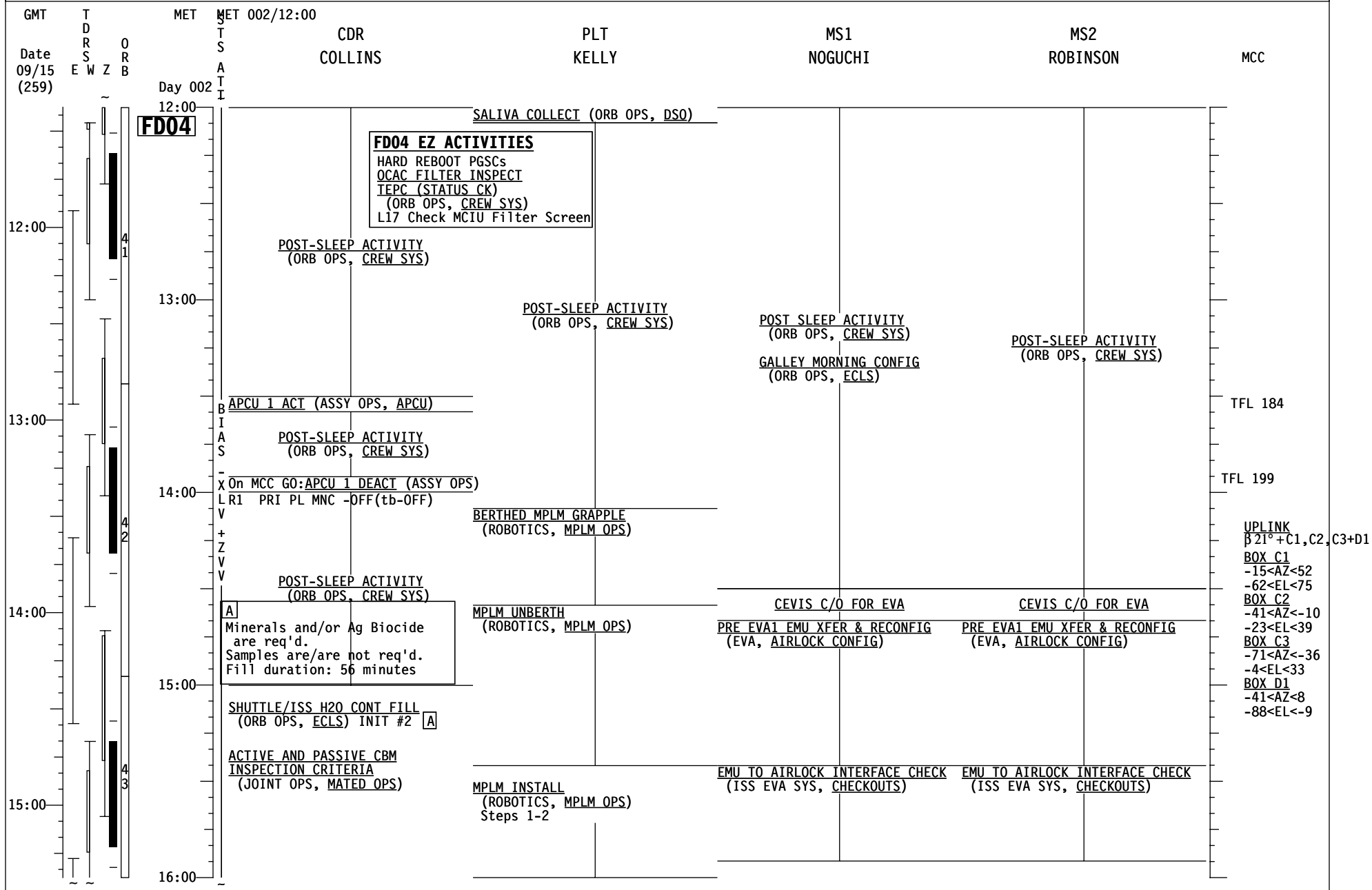

# STS-114 LF1 (FD 04)

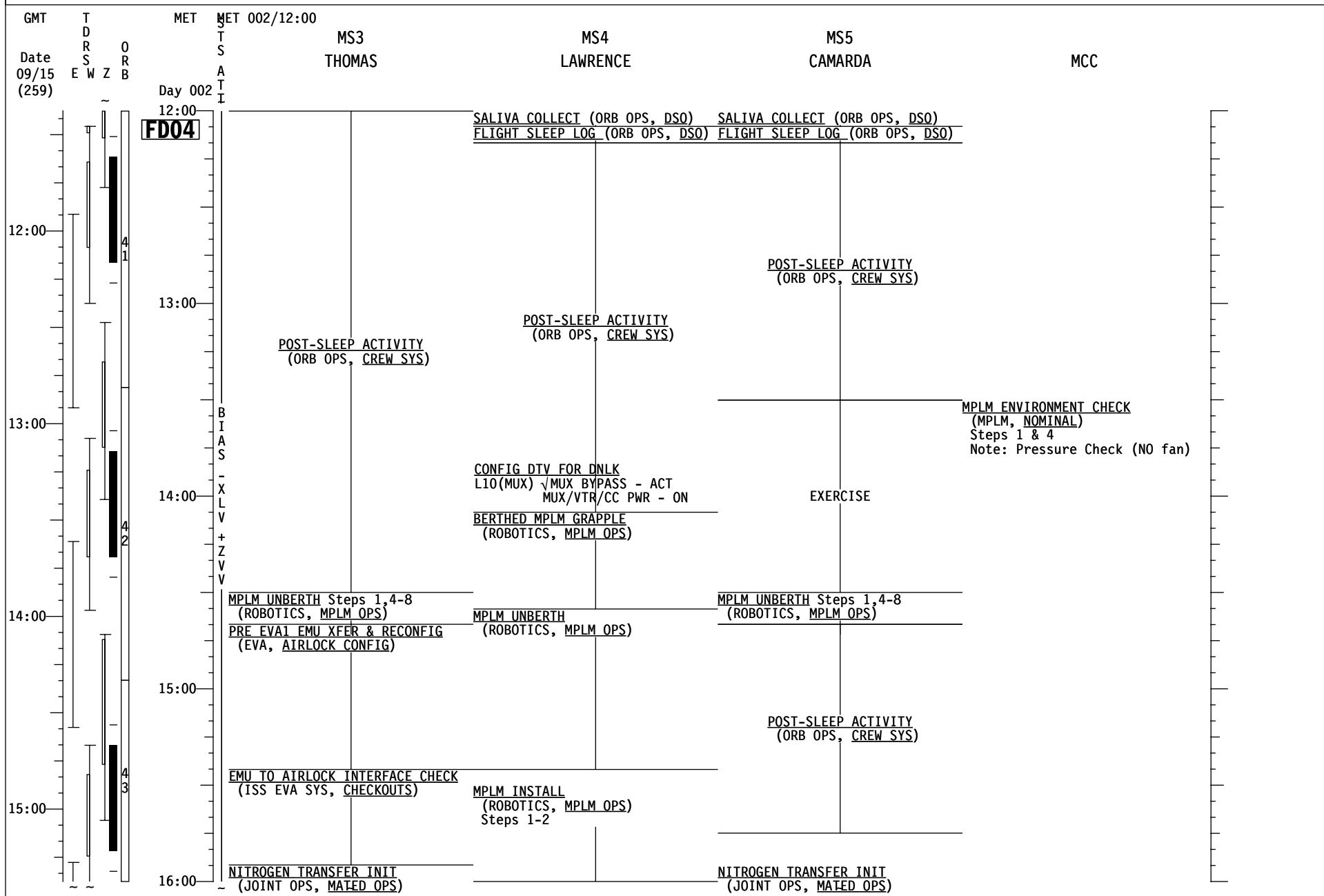

# STS-114 LF1 (FD 04)

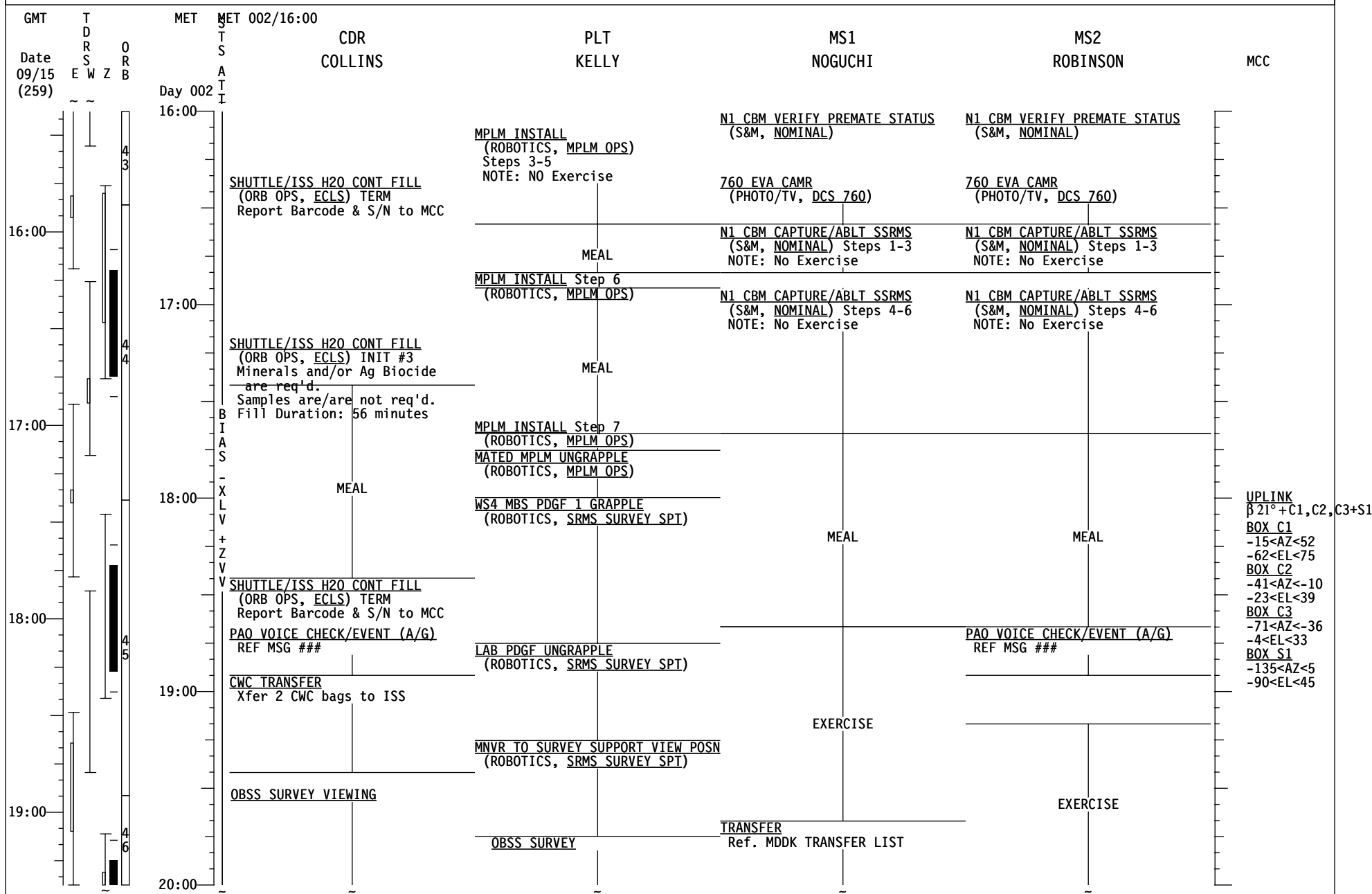

# STS-114 LF1 (FD04)

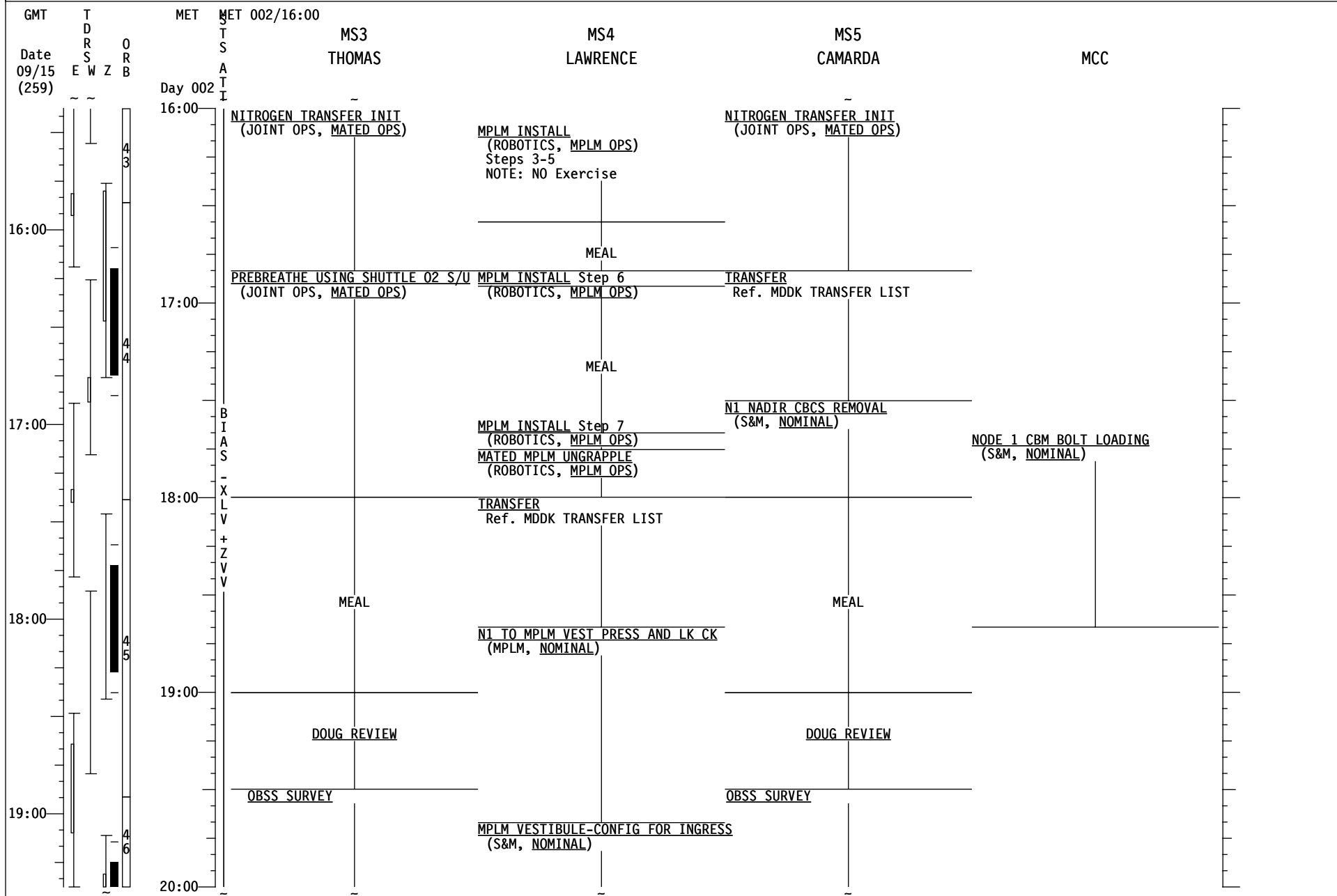

# STS-114 LF1 (FD04 )

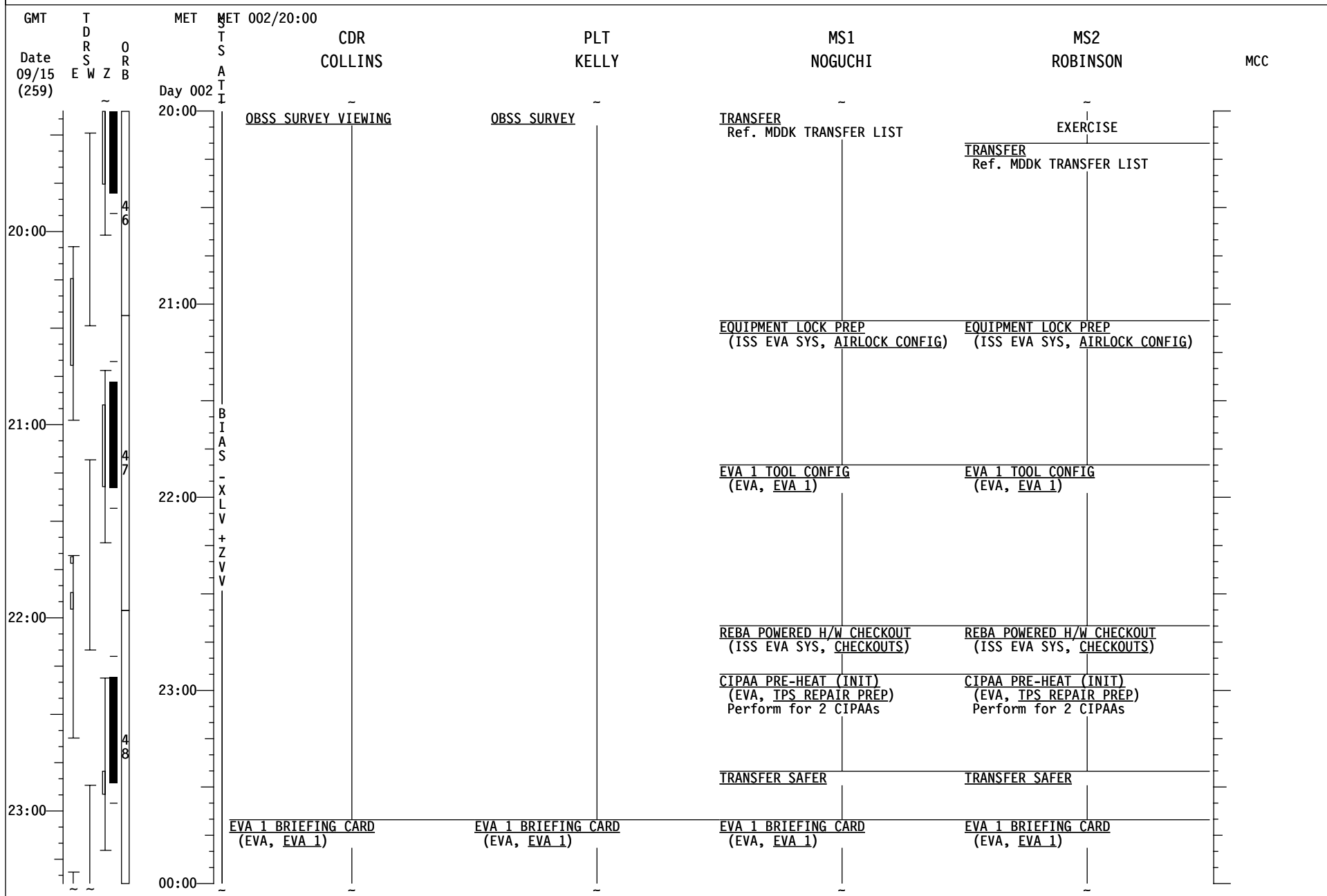

# STS-114 LF1 (FD 04)

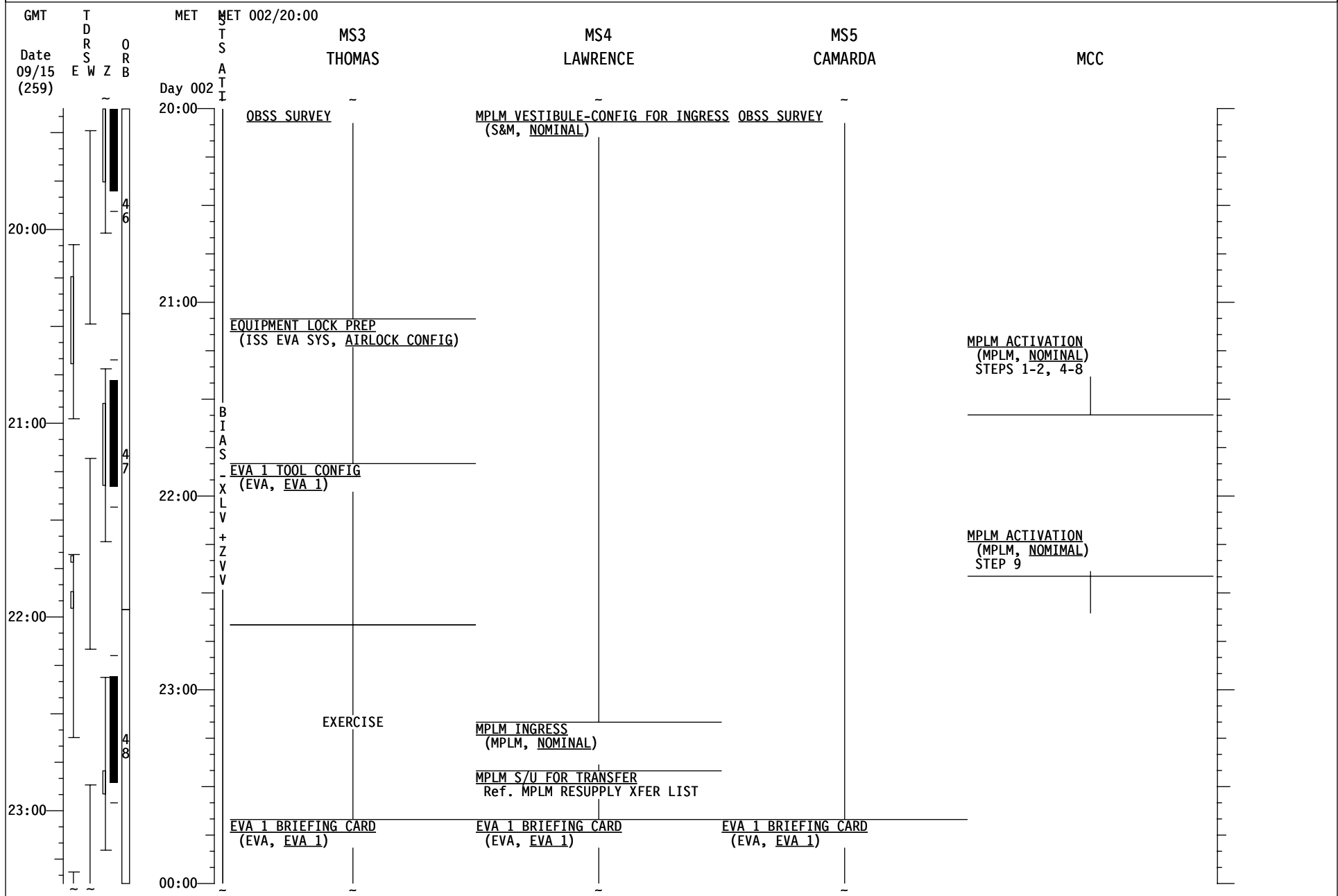

# STS-114 LF1 (FD04)

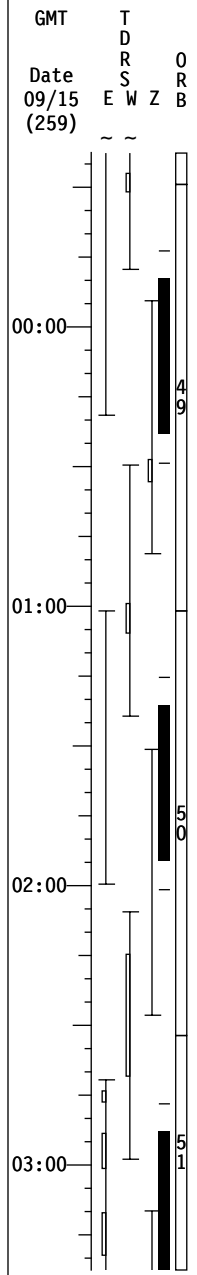
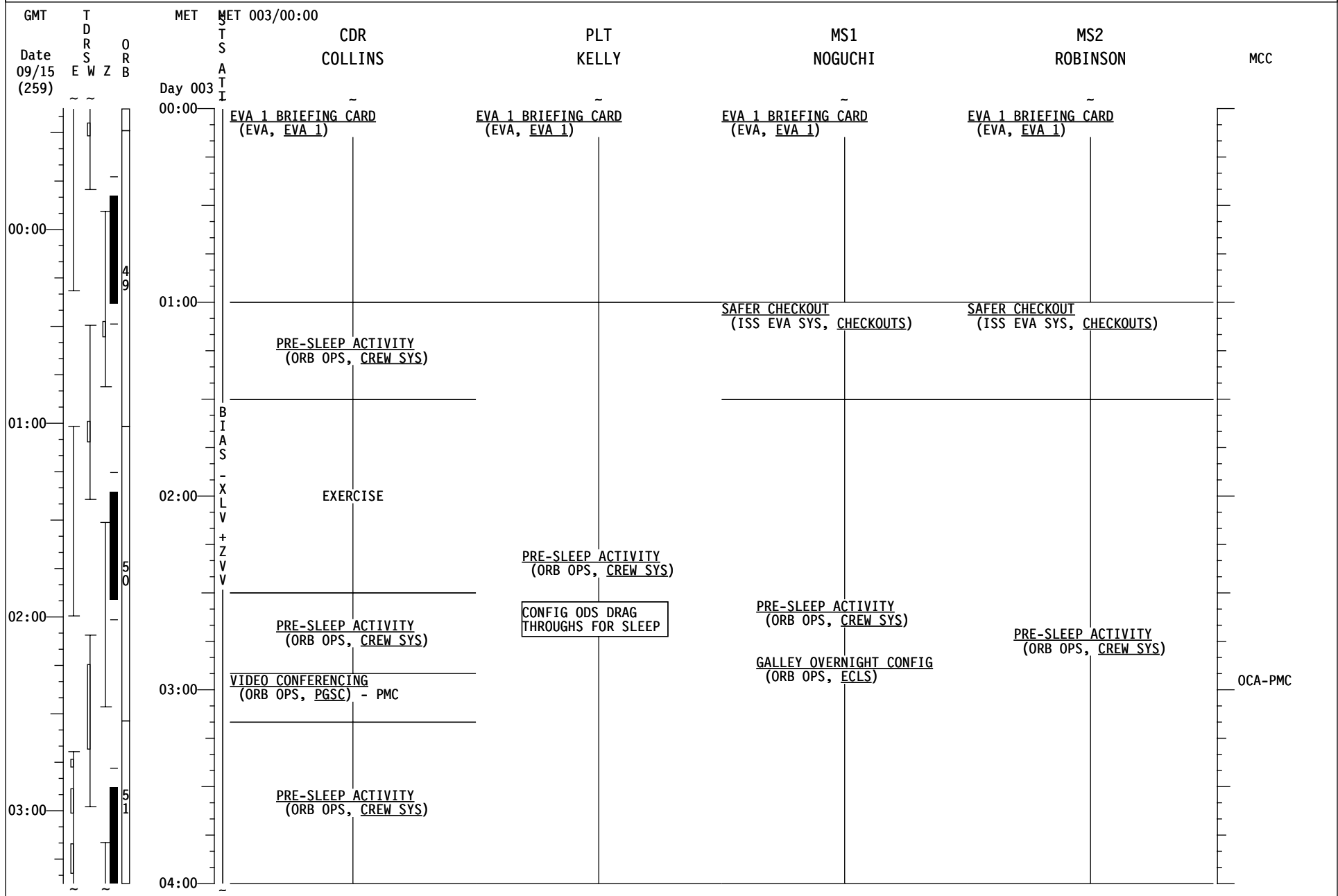



# STS-114 LF1 (FD04)

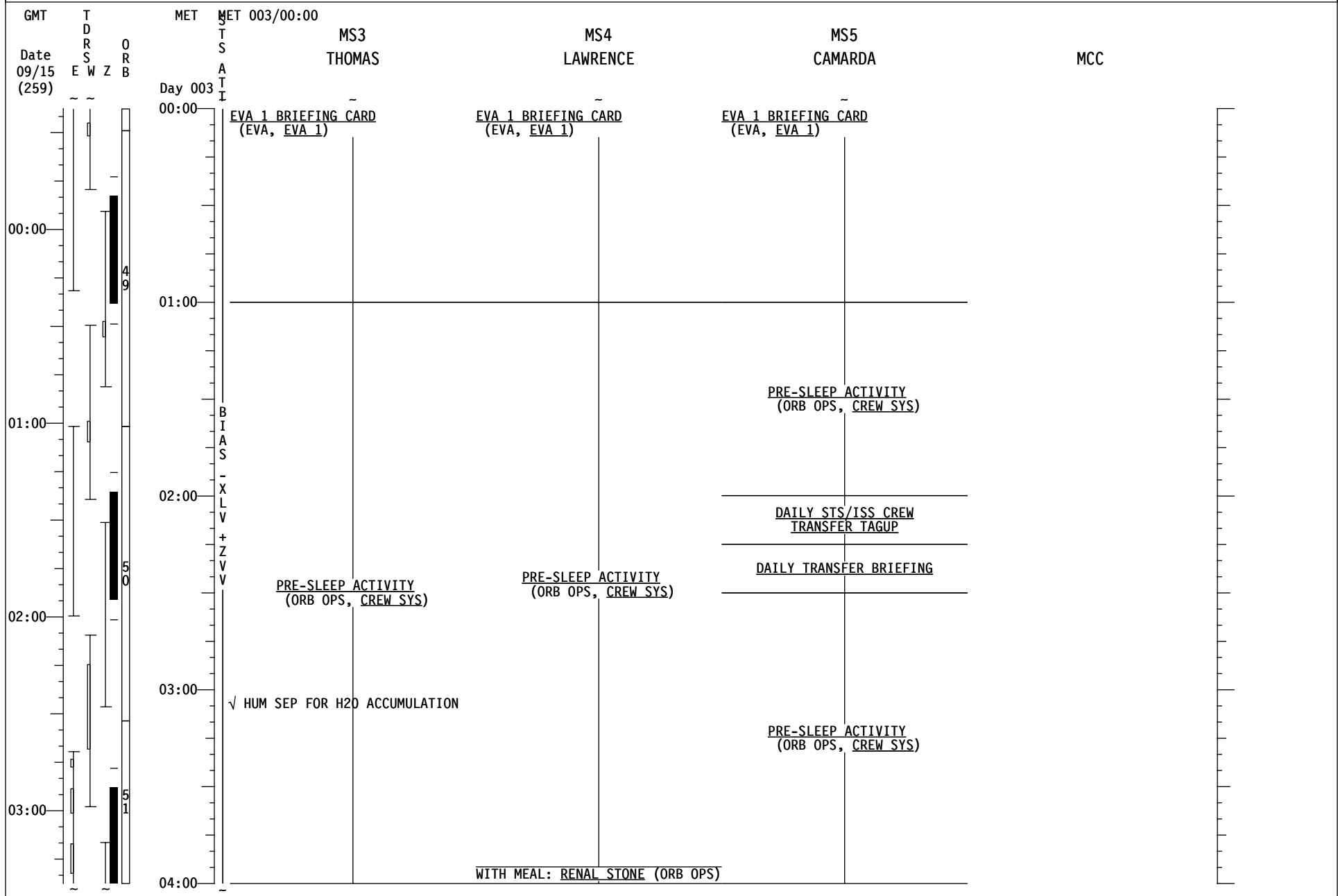

# STS-114 LF1 (FD 04)

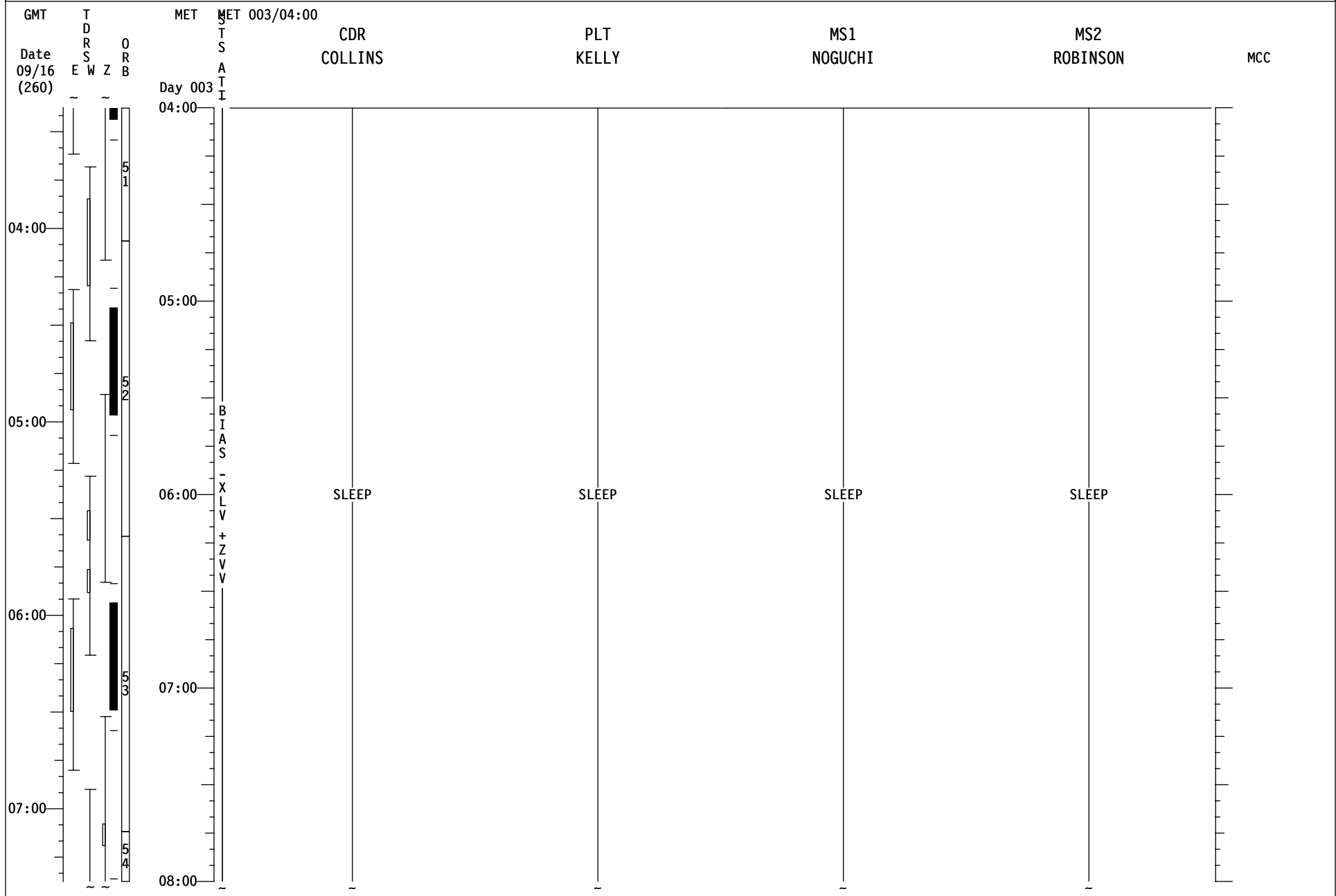

# STS-114 LF1 (FD 04)

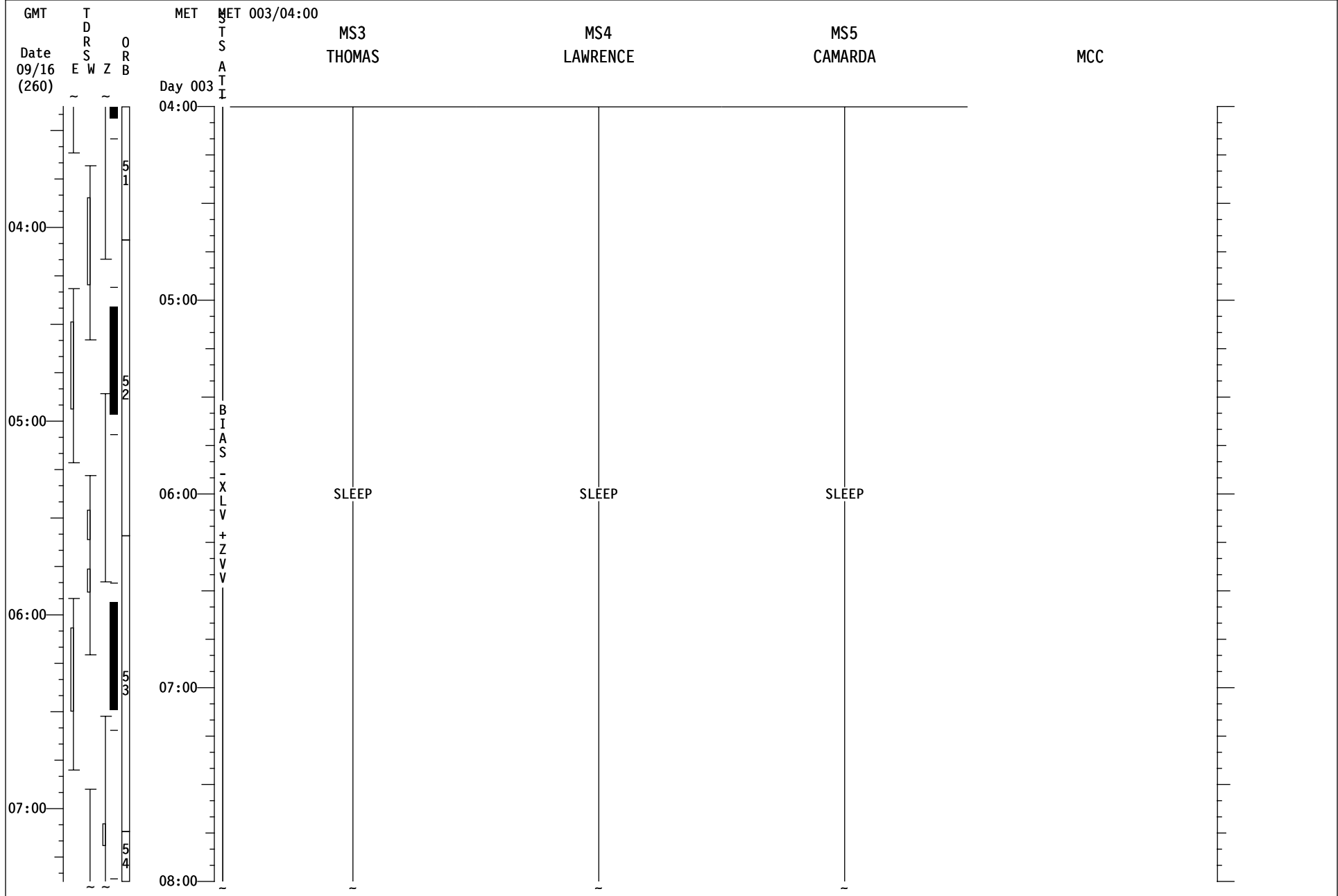

# STS-114 LF1 (FD 04)

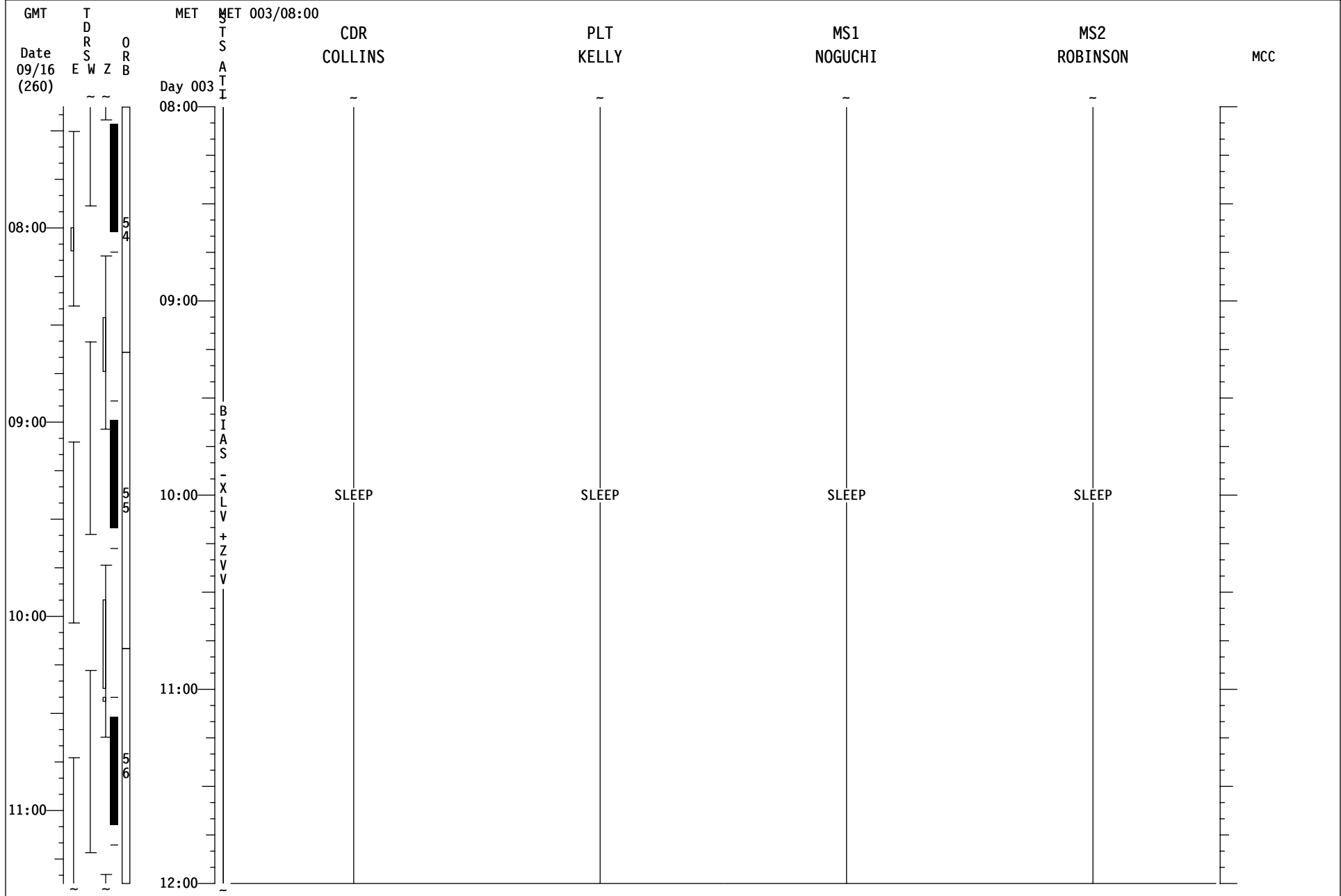

# STS-114 LF1 (FD 04)

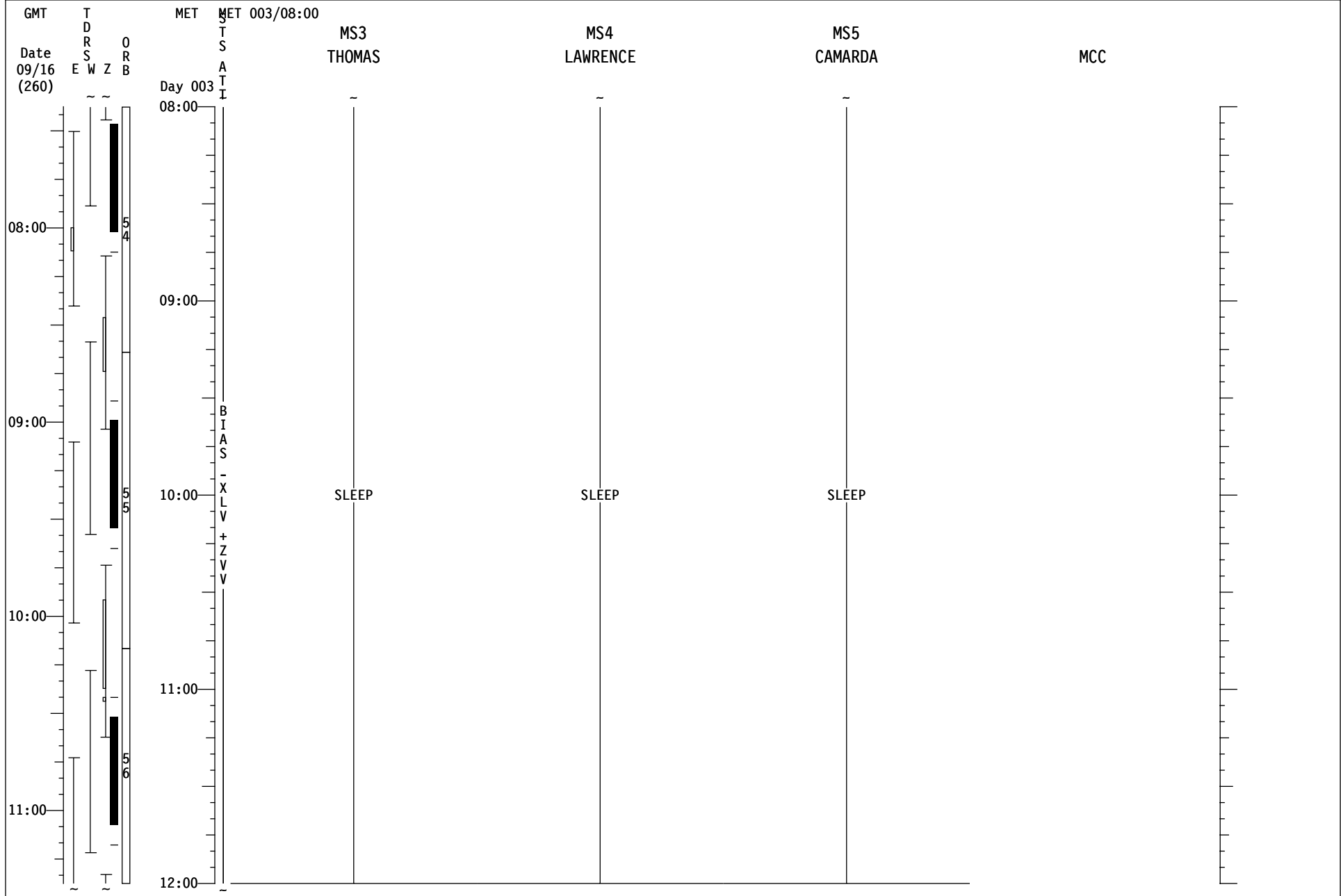

# STS-114 LF1 (FD 05)

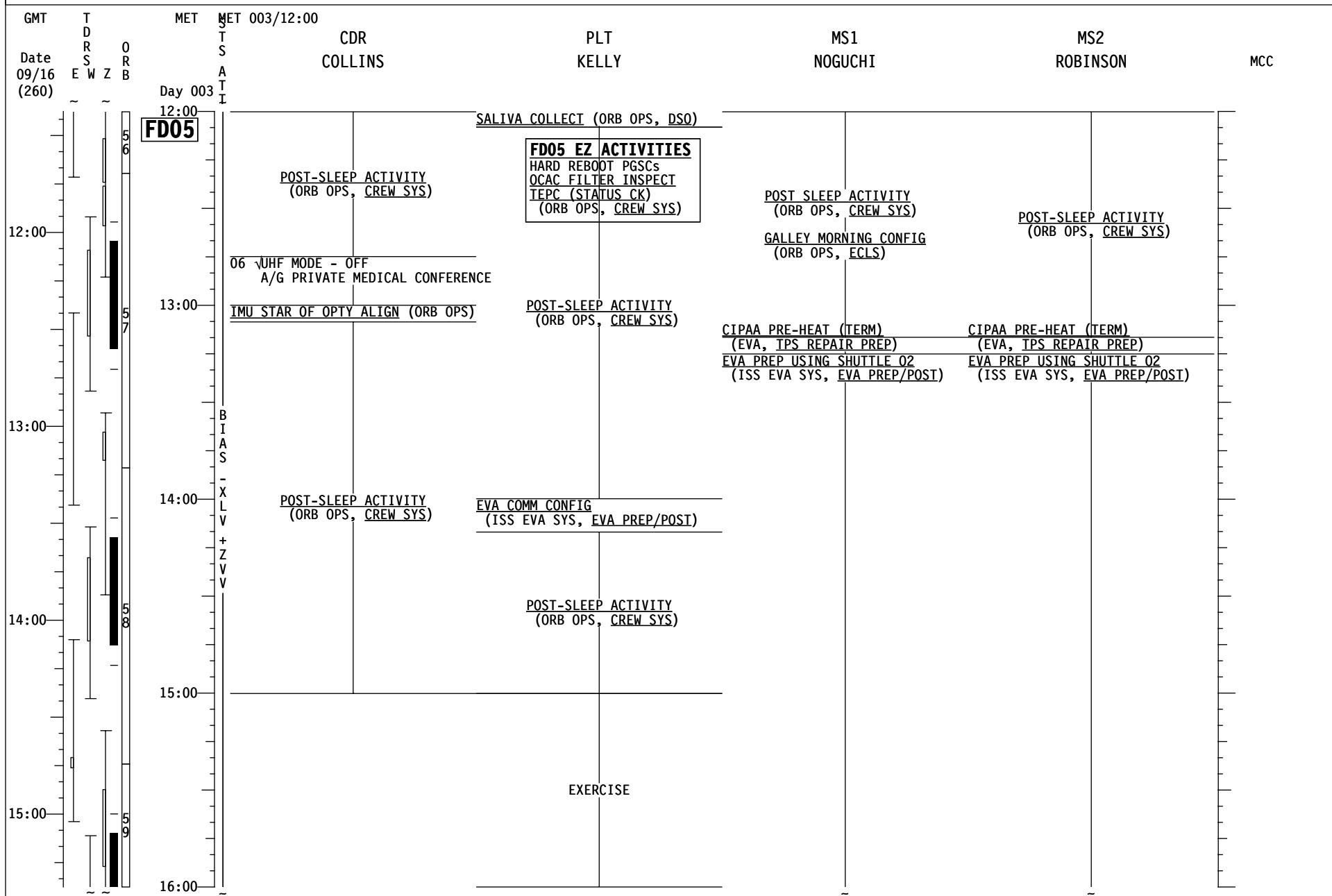

# STS-114 LF1 (FD 05)

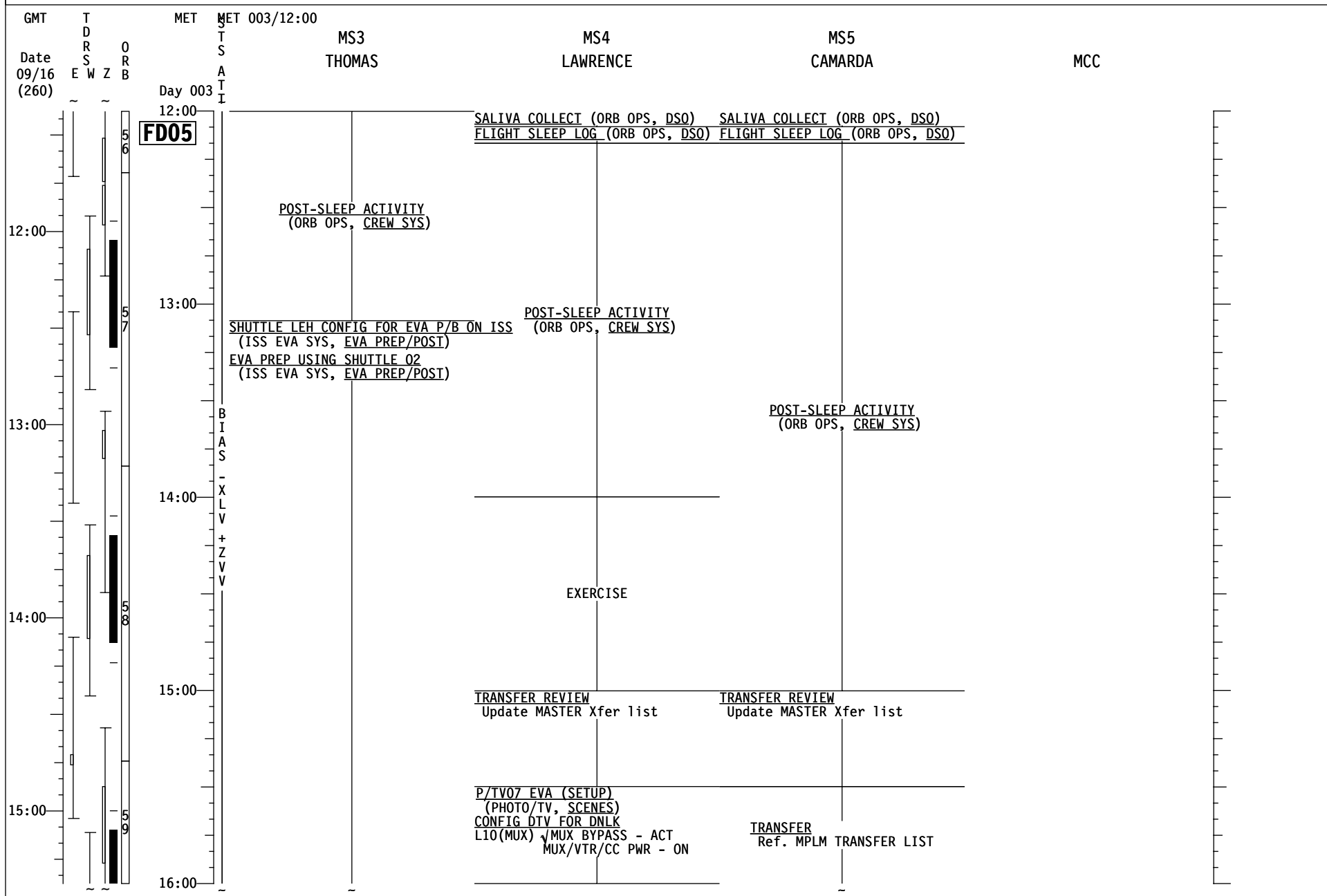

# STS-114 LF1 (FD 05)

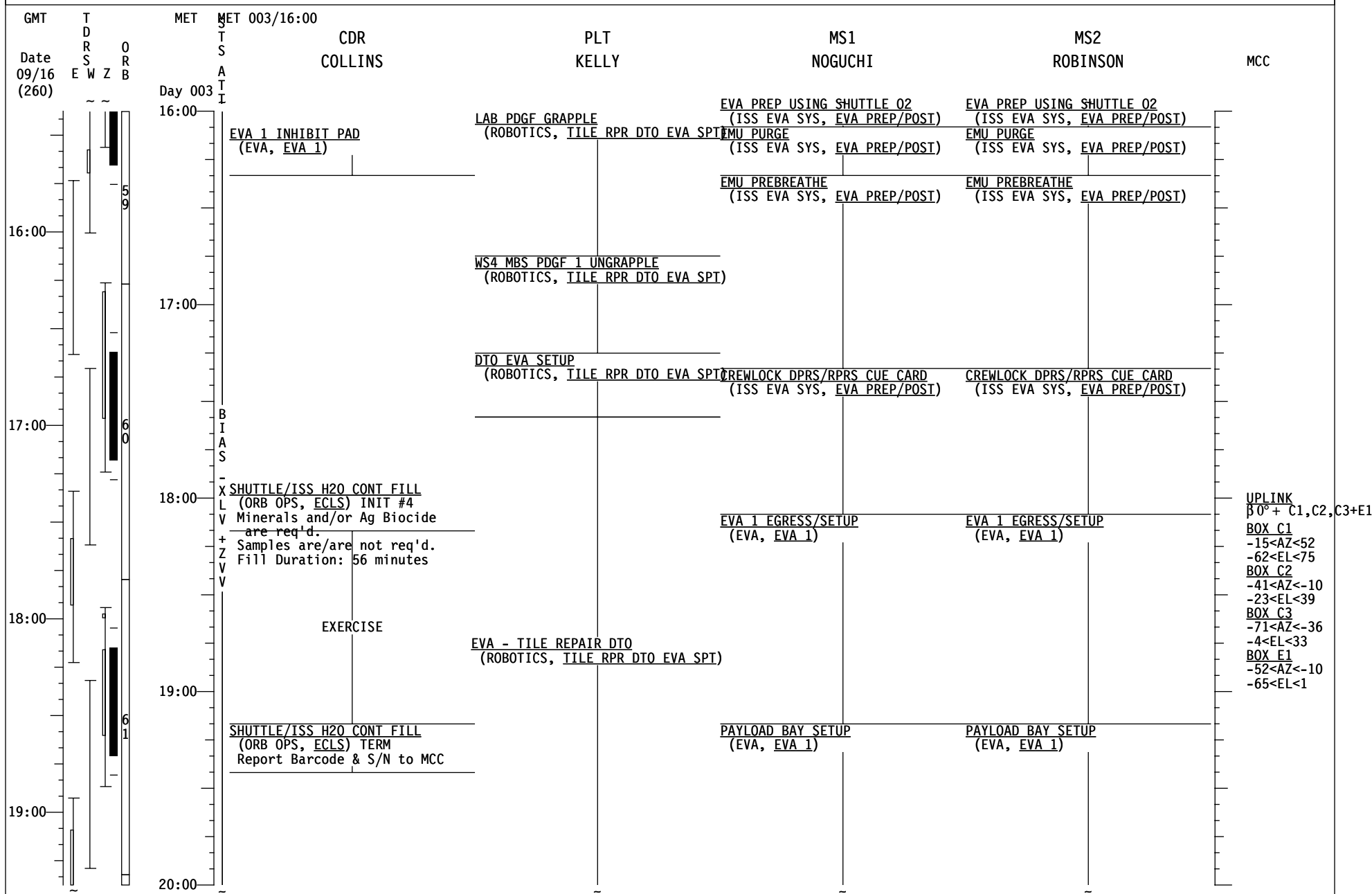



# STS-114 LF1 (FD 05)

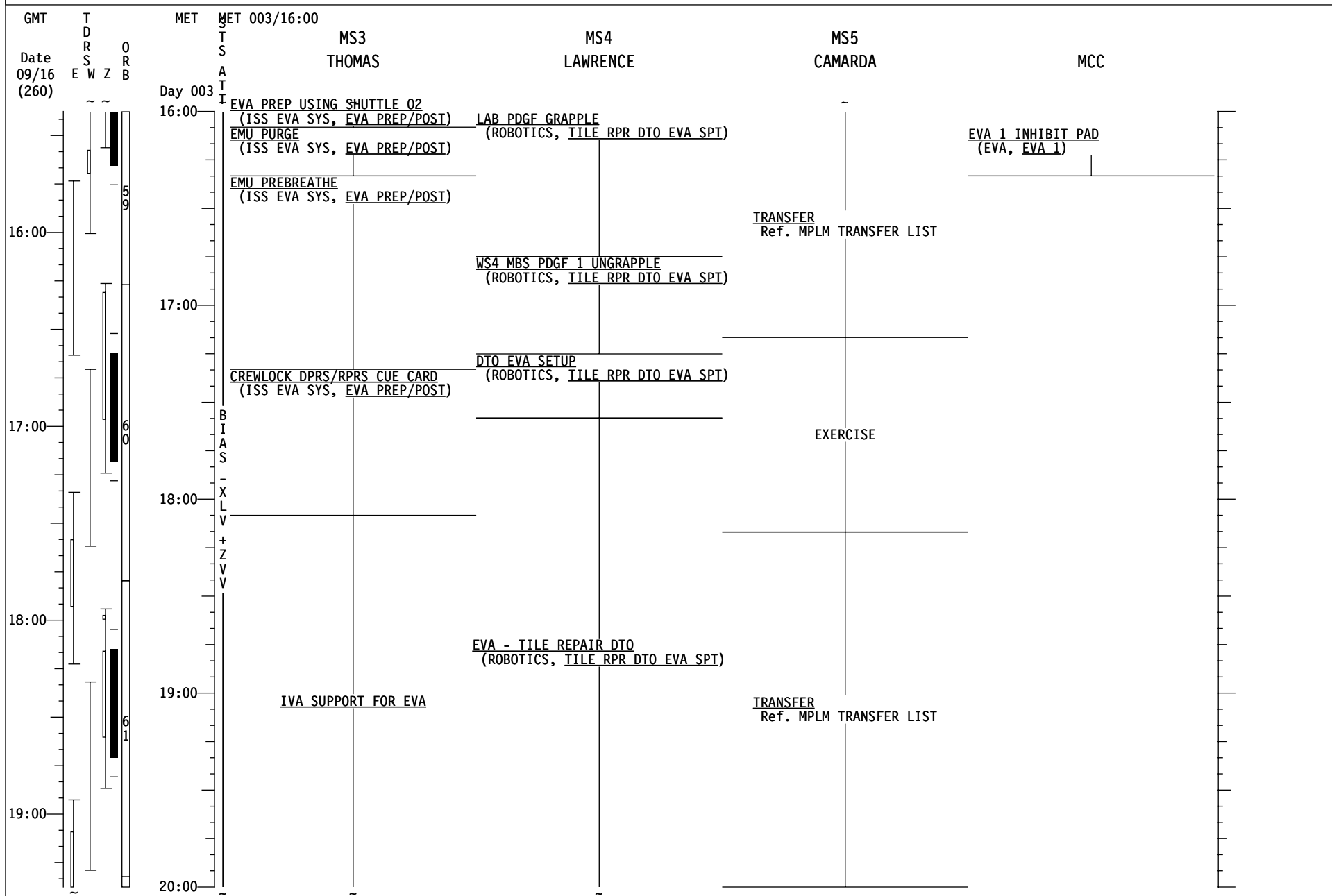

# STS-114 LF1 (FD 05)

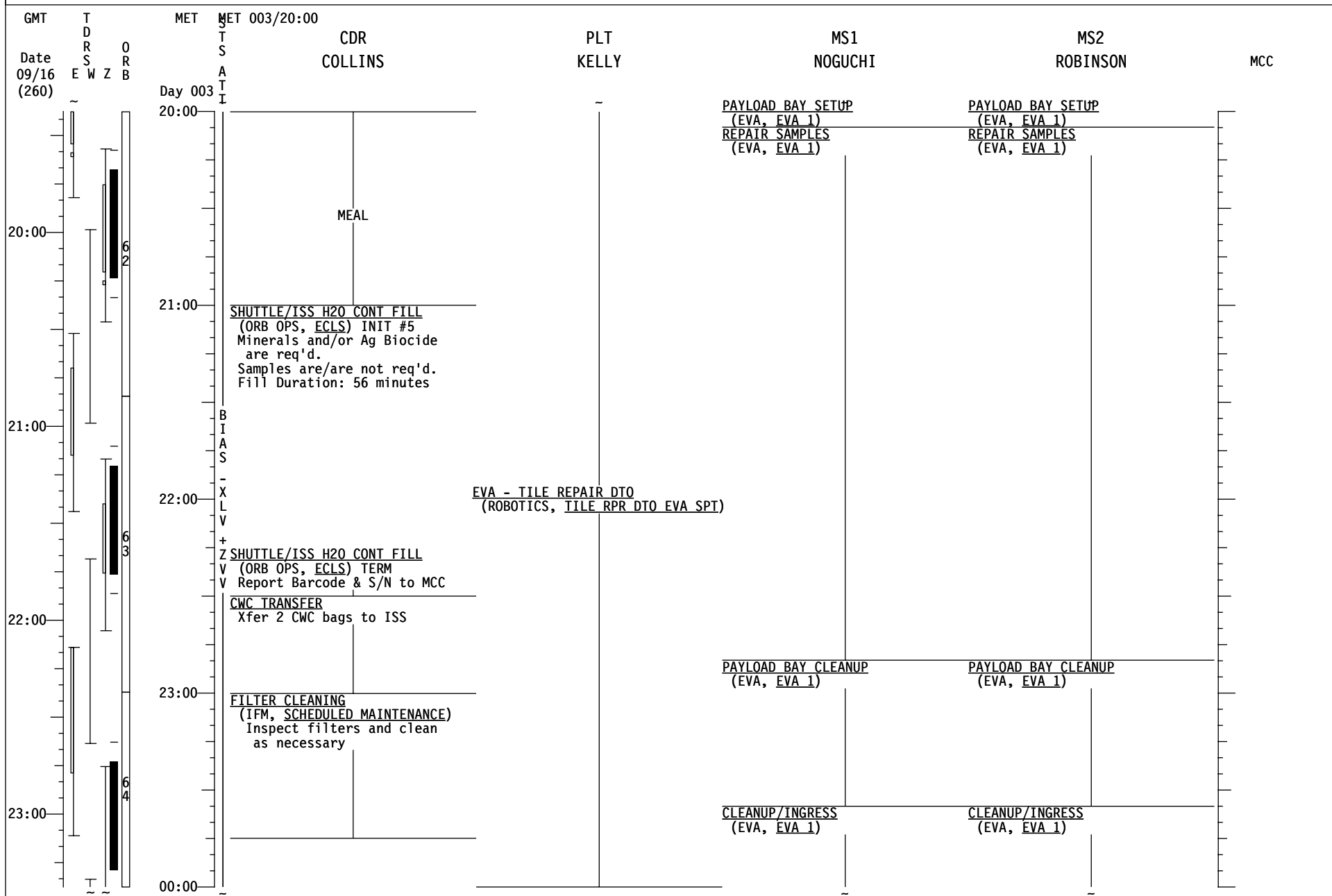

# STS-114 LF1 (FD 05)

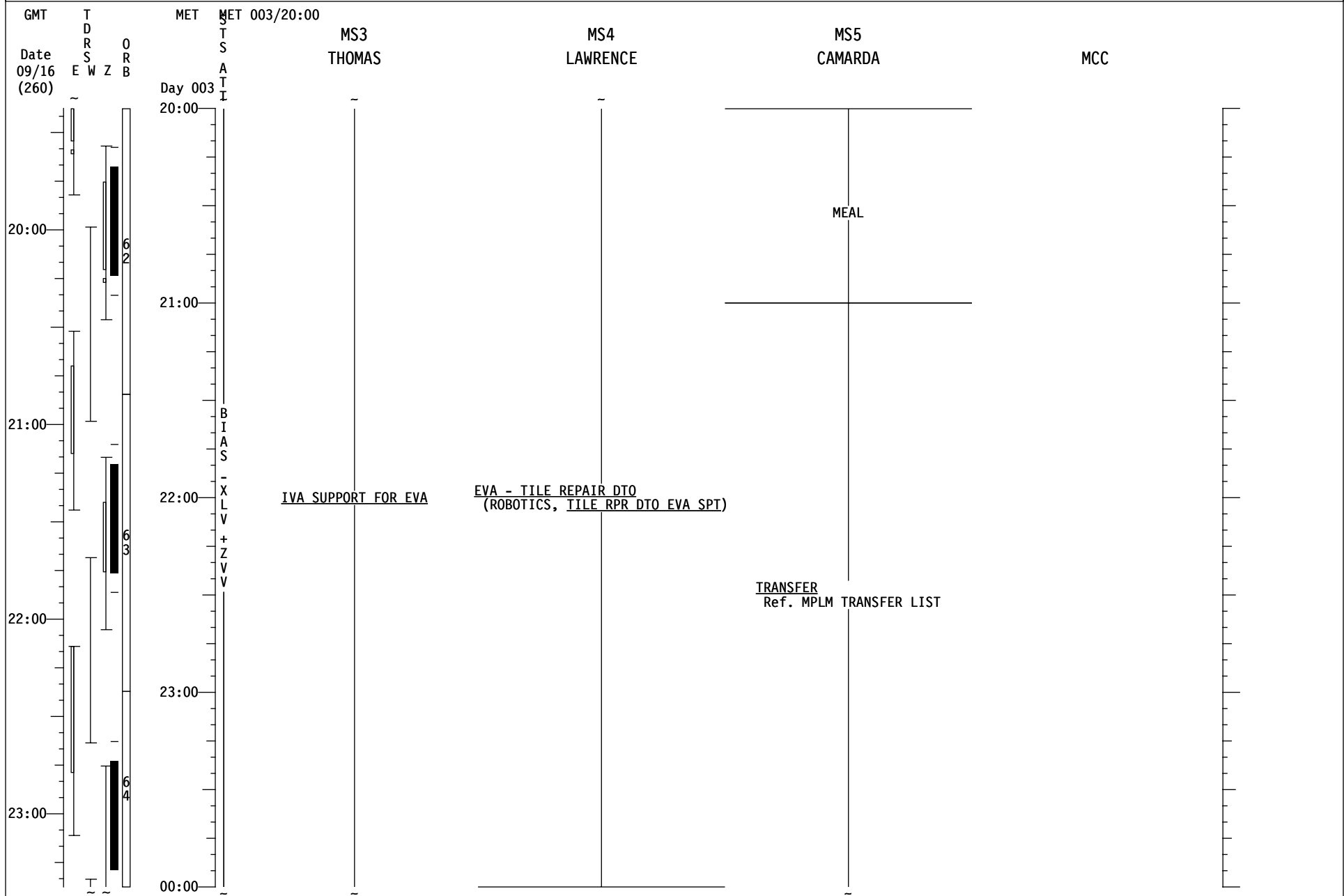

# STS-114 LF1 (FD 05)

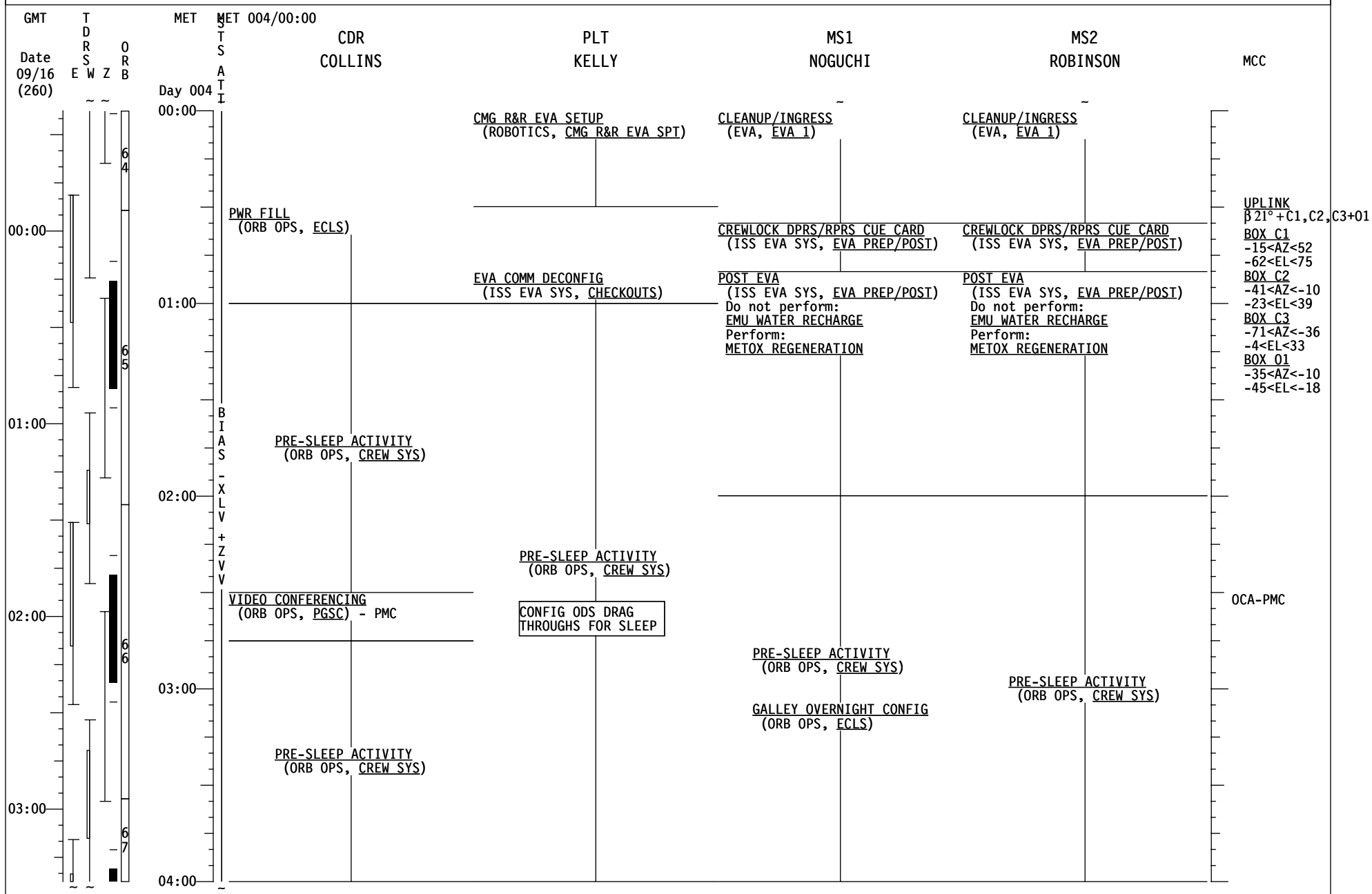

# STS-114 LF1 (FD 05)

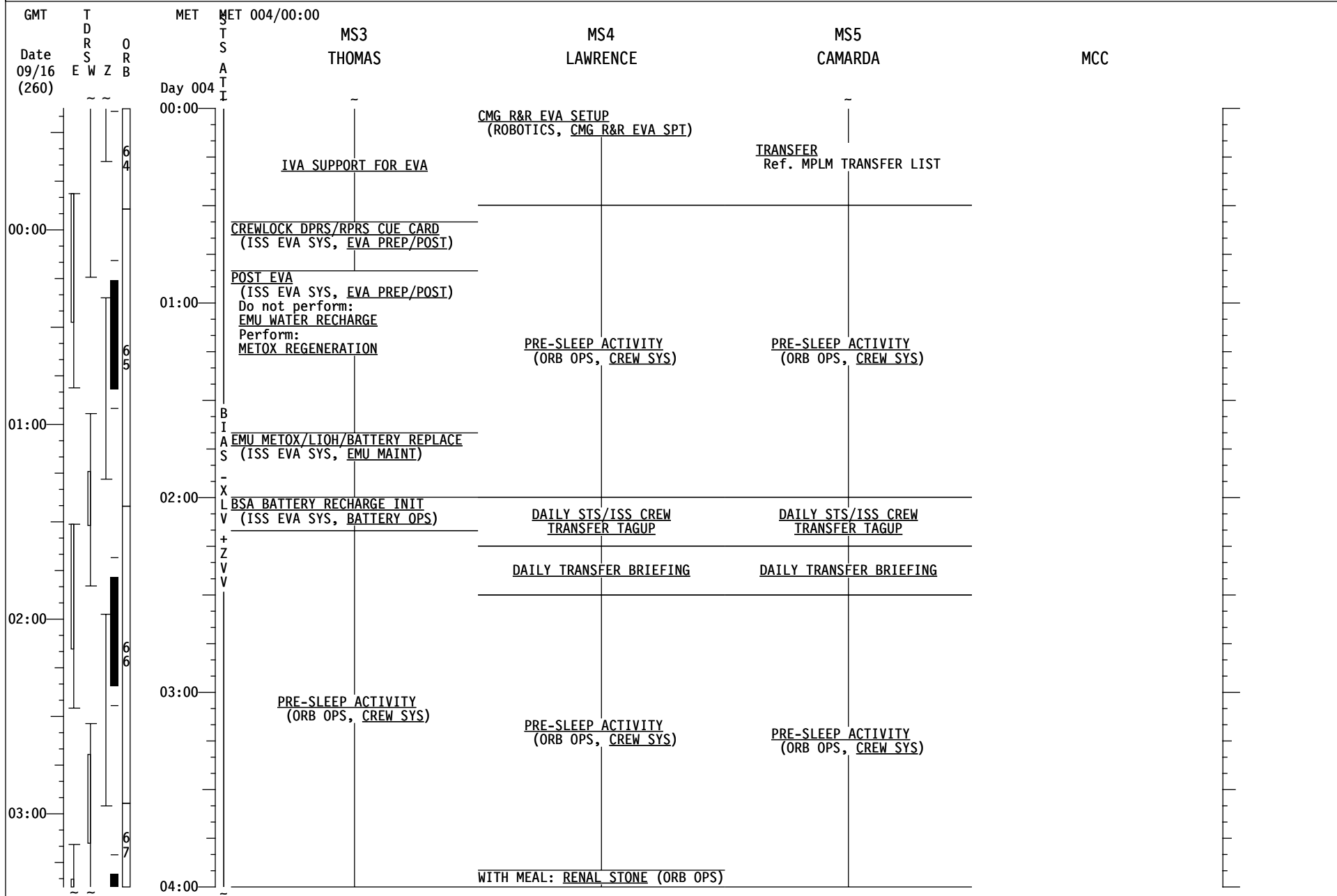



# STS-114 LF1 (FD 05)

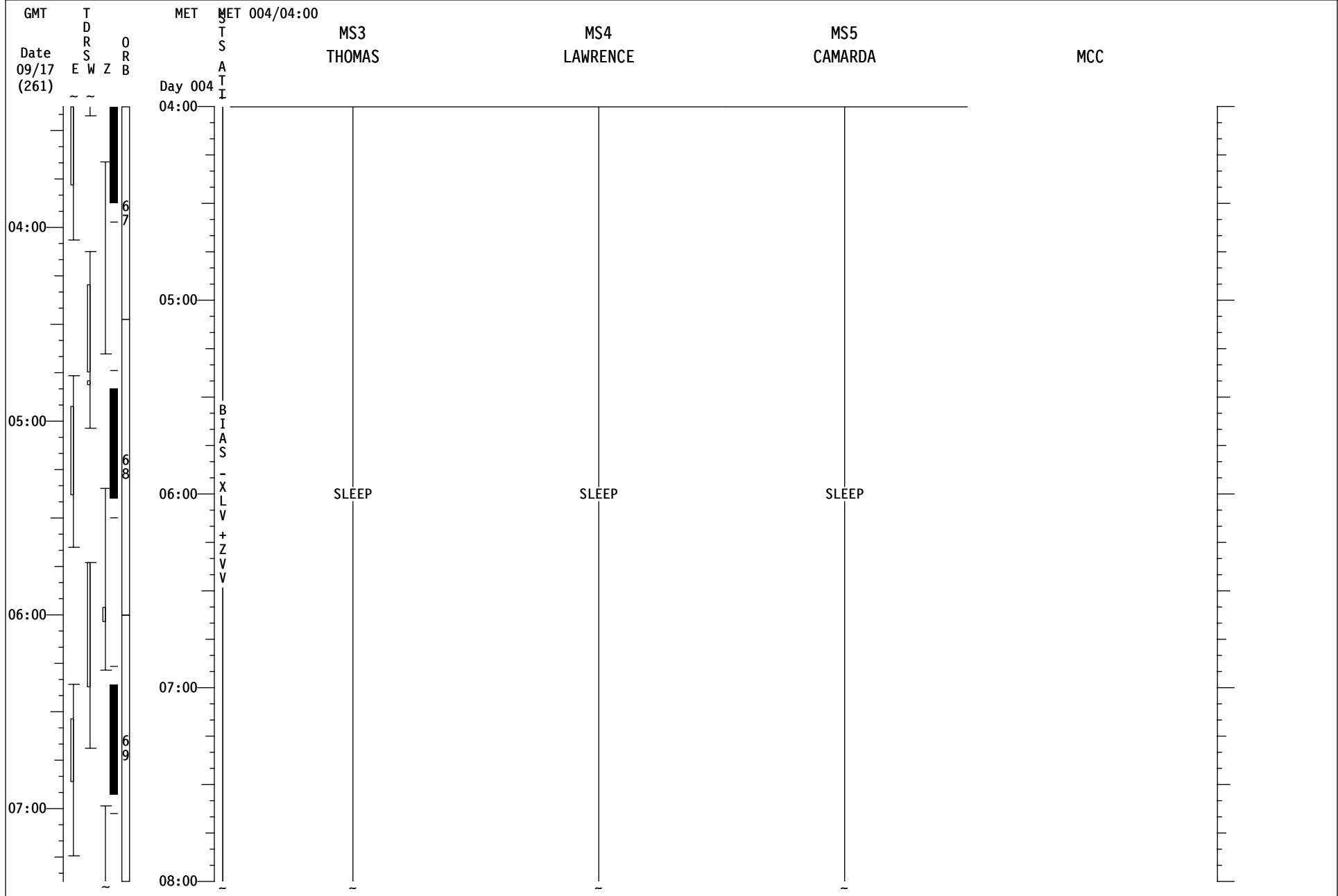

# STS-114 LF1 (FD 05)

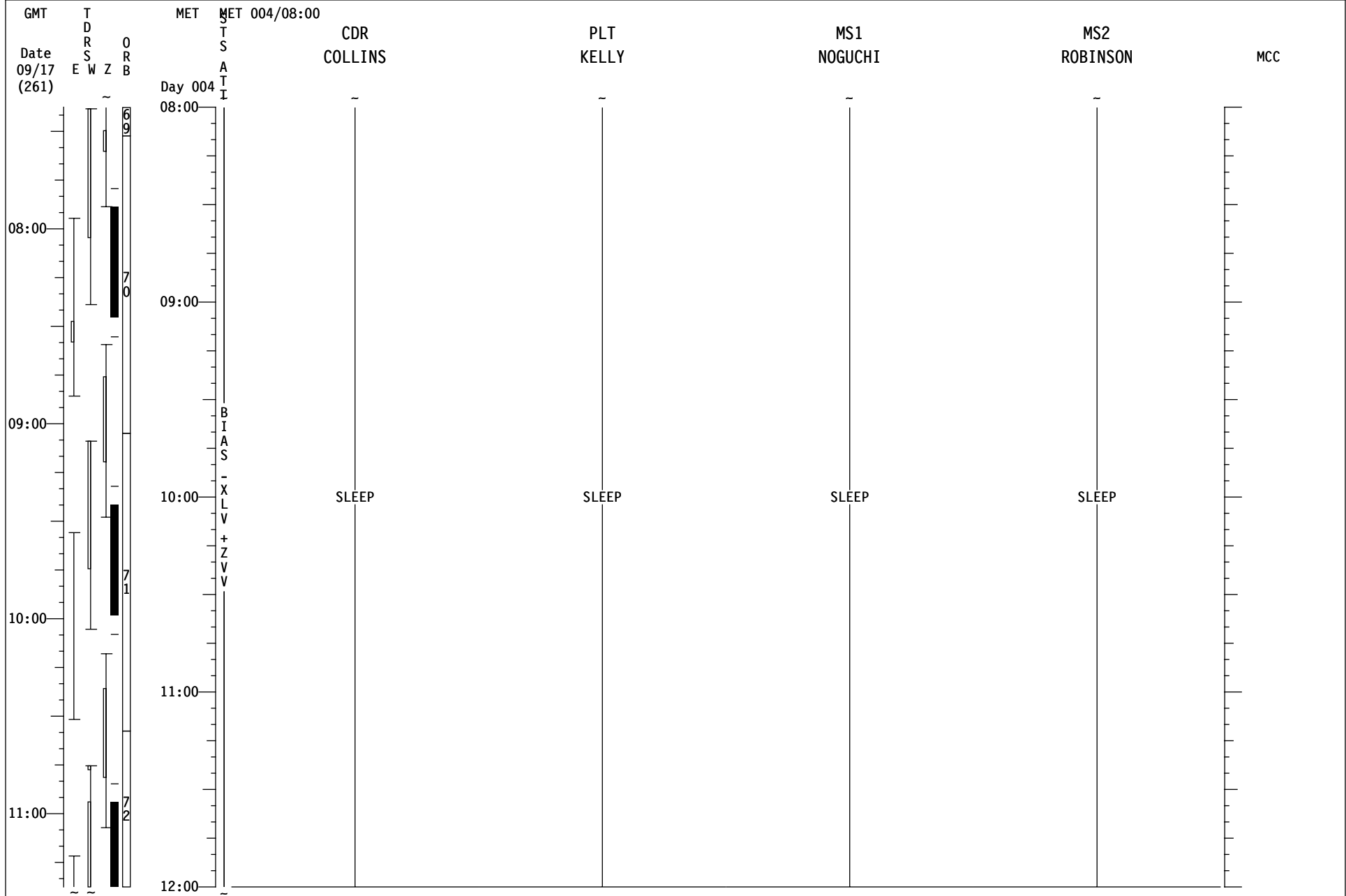



# STS-114 LF1 (FD 05)

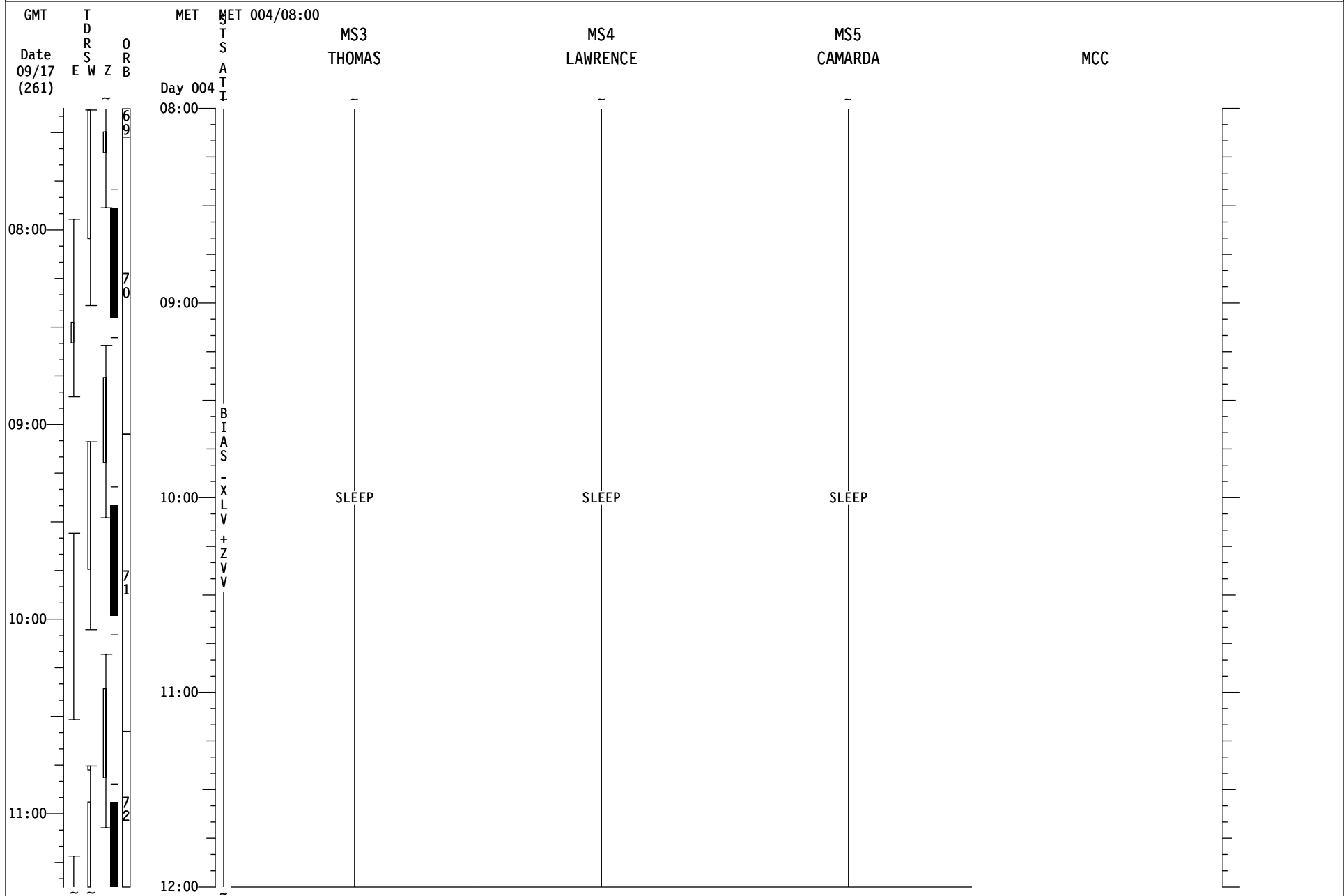

# STS-114 LF1 (FD 06)

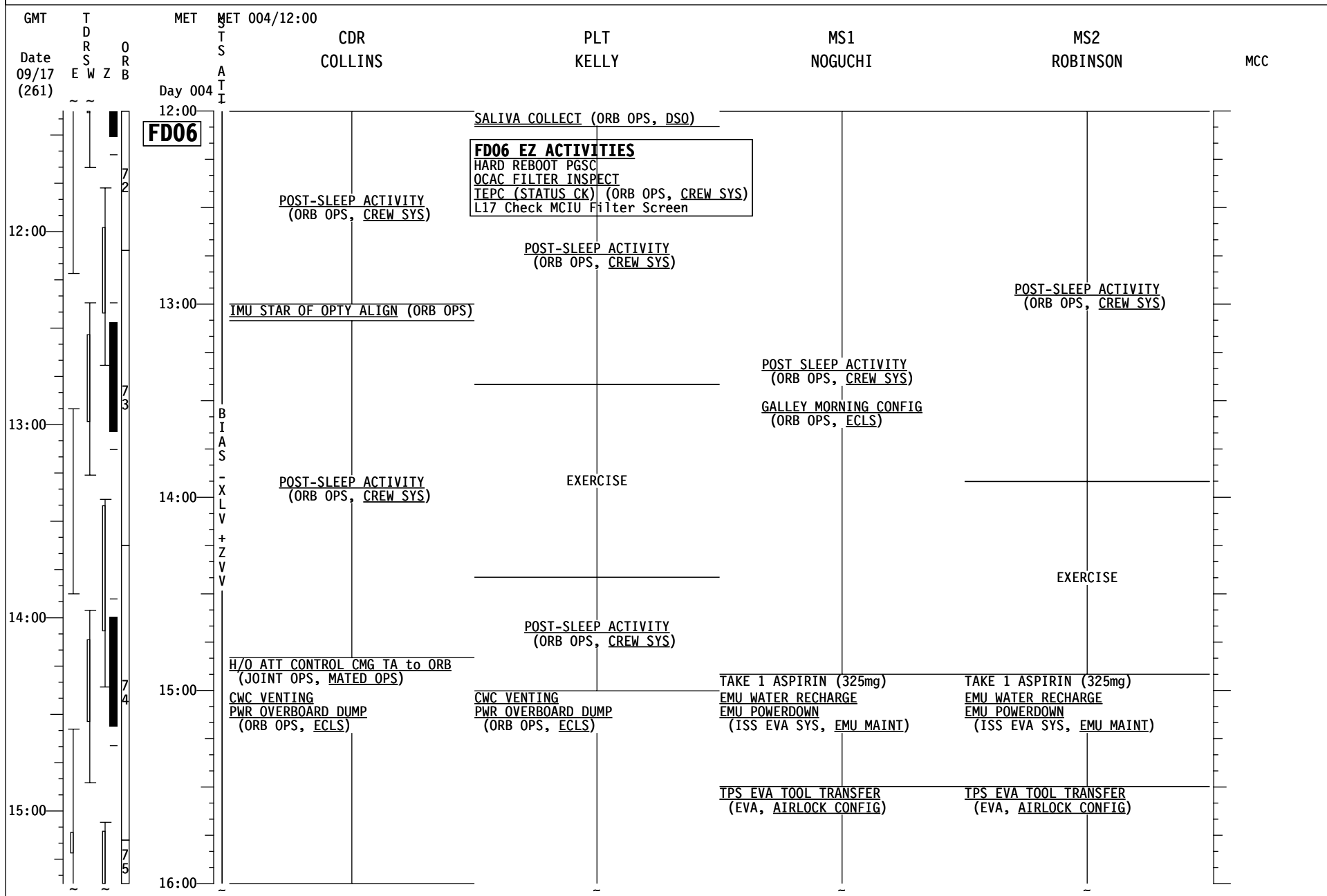

# STS-114 LF1 (FD 06)

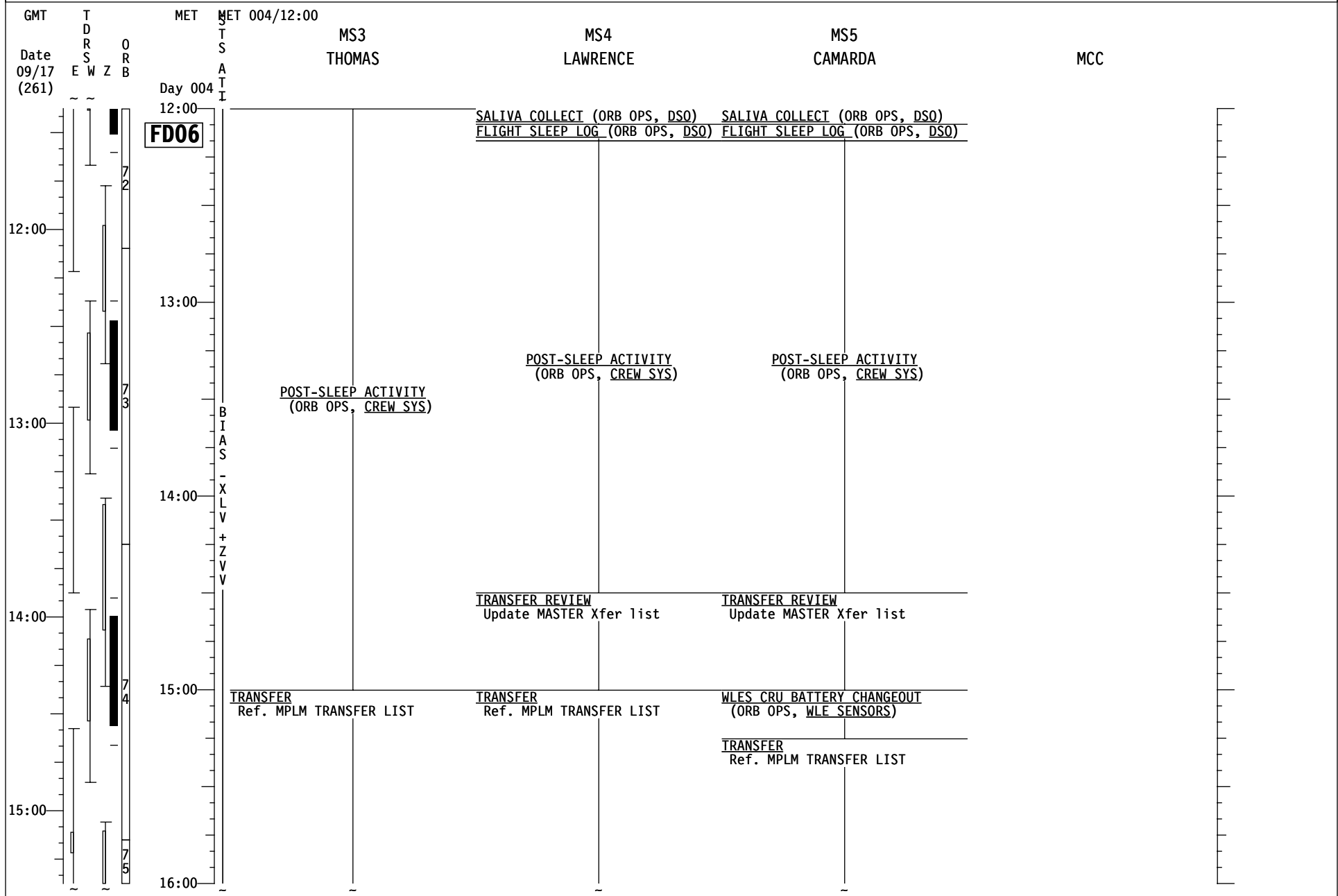

# STS-114 LF1 (FD 06)

GMT	T D R S O E W Z B Date 09/17 (261)	MET Day 004	MET 004/16:00 S A T I	CDR COLLINS	PLT KELLY	MS1 NOGUCHI	MS2 ROBINSON	MCC
16:00					CWC VENTING PWR OVERBOARD DUMP (ORB OPS, ECLS)	TPS EVA TOOL TRANSFER (EVA, AIRLOCK CONFIG)	TPS EVA TOOL TRANSFER (EVA, AIRLOCK CONFIG)	
17:00				HTR RCNFG-CNFG B (ORB OPS, EPS) CABIN TEMP CNTL RECONFIG 2(1) (ORB OPS, ECLS) RCS REG RCNFG (ORB OPS, RCS) √ WCS hose block filter		METOX REGENERATION TERM (ISS EVA SYS, EMU MAINT)		
17:00				AH/O ATT CONTROL ORB to RS S (JOINT OPS, CONTINGENCY)	TRANSFER Ref. MPLM TRANSFER LIST	EQUIPMENT LOCK PREP (ISS EVA SYS, AIRLOCK CONFIG)	EQUIPMENT LOCK PREP (ISS EVA SYS, AIRLOCK CONFIG)	
18:00				SHUTTLE/ISS H2O CONT FILL (ORB OPS, ECLS) INIT #6 Minerals and/or Ag Biocide are req'd. Samples are/are not req'd. Fill Duration: 56 minutes		760 EVA CAMR (PHOTO/TV, DCS 760)	760 EVA CAMR (PHOTO/TV, DCS 760)	
18:00				SHUTTLE CONDENSATE COLLECTION (ORB OPS, ECLS) CHANGEOUT, STEPS 1-6		EVA 2 TOOL CONFIG (EVA, EVA 2)	EVA 2 TOOL CONFIG (EVA, EVA 2)	
19:00				PUBLIC AFFAIRS EVENT KU AVAIL TDRS XX:XX-XX:XX REF MSG ###	PUBLIC AFFAIRS EVENT			
19:00				SHUTTLE/ISS H2O CONT FILL (ORB OPS, ECLS) TERM Report Barcode & S/N to MCC	TRANSFER Ref. MPLM TRANSFER LIST			
19:00				SHUTTLE/ISS H2O CONT FILL [A] (ORB OPS, ECLS) INIT #7	[A] Minerals and/or Ag Biocide are req'd. Samples are/are not req'd. Fill Duration: 56 minutes.			
20:00								

# STS-114 LF1 (FD 06)

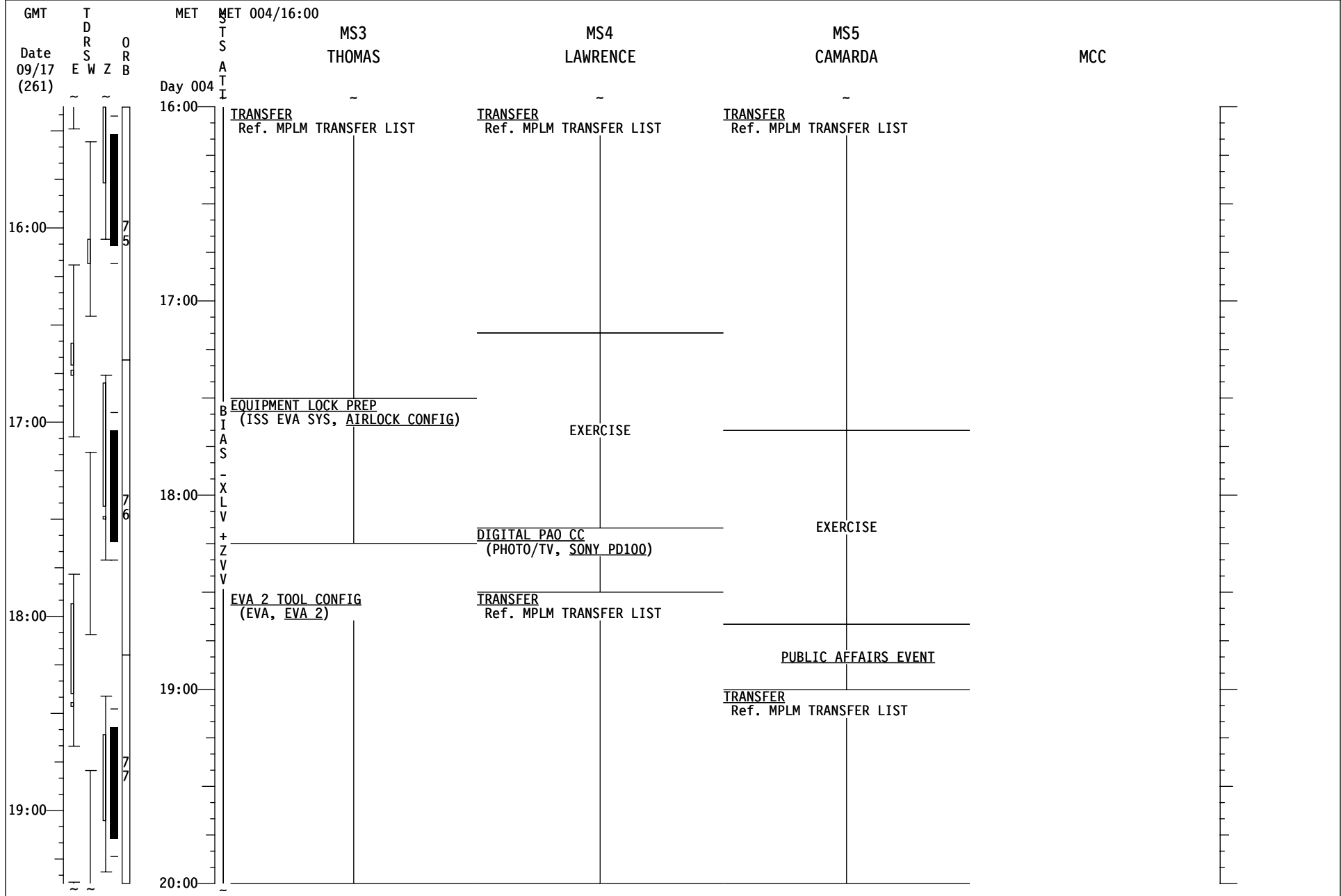

# STS-114 LF1 (FD 06)

GMT	TDRS E W Z	ORB	MET	MET 004/20:00	CDR COLLINS	PLT KELLY	MS1 NOGUCHI	MS2 ROBINSON	MCC
Date 09/17 (261)			Day 004	20:00					
				20:00	MEAL	MEAL	MEAL	MEAL	
				21:00	<u>SHUTTLE/ISS H2O CONT FILL</u> (ORB OPS, ECLS) TERM Report Barcode & S/N to MCC  <u>CWC TRANSFER</u> Xfer 2 CWC bags to ISS	<u>TRANSFER</u> Ref. MPLM TRANSFER LIST	<u>TRANSFER</u> Ref. MPLM TRANSFER LIST	<u>TRANSFER</u> Ref. MPLM TRANSFER LIST	
				21:00	B I A S PWR FILL (ORB OPS, ECLS)				
				22:00					
				22:00	EXERCISE				
				23:00					
				23:00	<u>PUBLIC AFFAIRS EVENT</u> REF MSG ###		<u>PUBLIC AFFAIRS EVENT</u> KU AVAIL TDRS XX:XX-XX:XX REF MSG ###	<u>PUBLIC AFFAIRS EVENT</u> KU AVAIL TDRS XX:XX-XX:XX REF MSG ###	
				00:00	<u>EVA 2 BRIEFING CARD</u> (EVA, EVA 2)	<u>EVA 2 BRIEFING CARD</u> (EVA, EVA 2)	<u>EVA 2 BRIEFING CARD</u> (EVA, EVA 2)	<u>EVA 2 BRIEFING CARD</u> (EVA, EVA 2)	

# STS-114 LF1 (FD 06)

GMT	T D R S O E W Z B	MET MET 004/20:00	S T S A T I	MS3 THOMAS	MS4 LAWRENCE	MS5 CAMARDA	MCC
Date 09/17 (261)		Day 004					
20:00	77			MEAL	MEAL	MEAL	
21:00	78			<u>TRANSFER</u> Ref. MPLM TRANSFER LIST	<u>TRANSFER</u> Ref. MPLM TRANSFER LIST	<u>TRANSFER</u> Ref. MPLM TRANSFER LIST	
22:00	79		B I A S - X L V + Z V V				
23:00	80						
00:00				<u>EVA 2 BRIEFING CARD</u> (EVA, EVA 2)	<u>EVA 2 BRIEFING CARD</u> (EVA, EVA 2)	<u>EVA 2 BRIEFING CARD</u> (EVA, EVA 2)	

# STS-114 LF1 (FD 06)

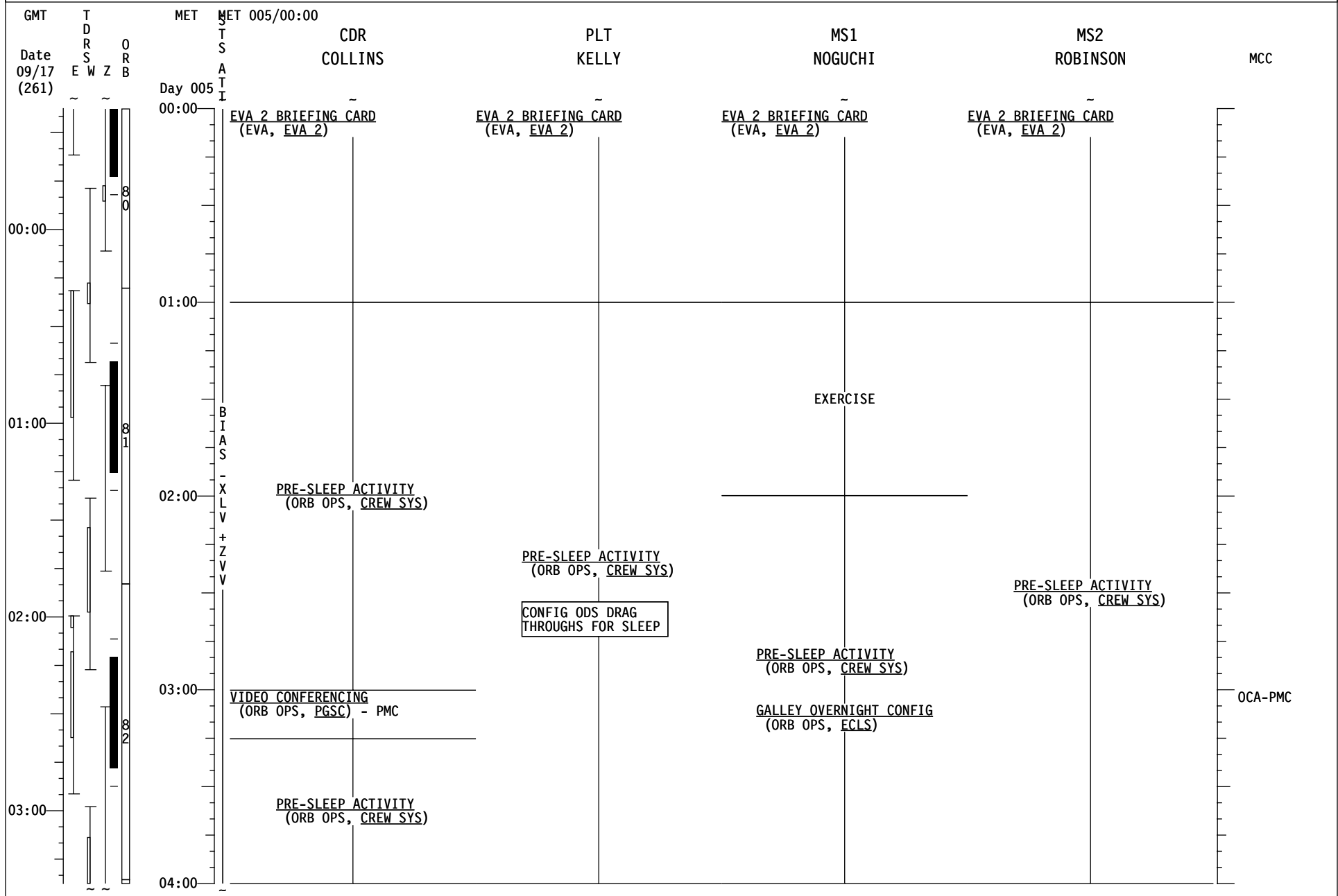



# STS-114 LF1 (FD 06)

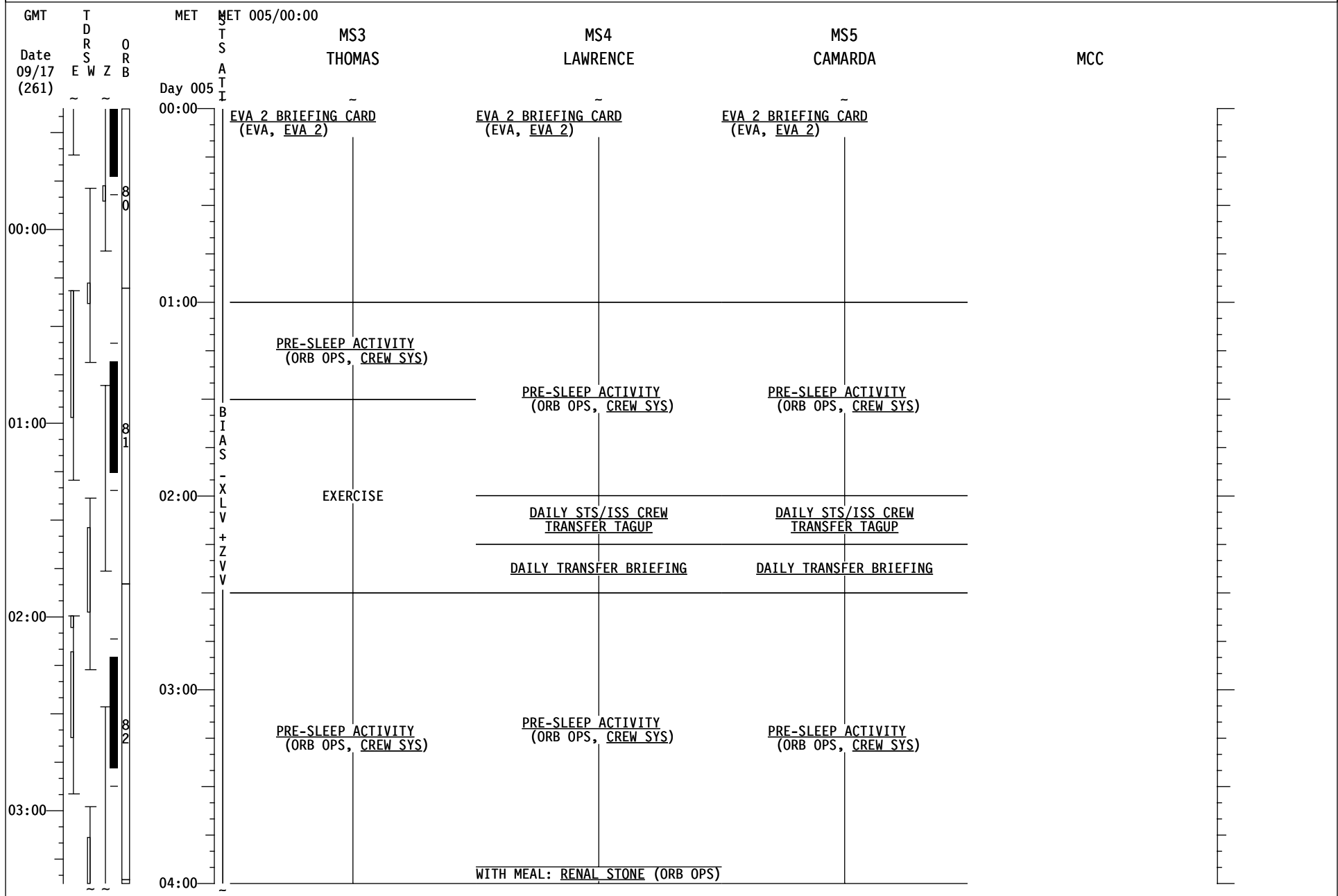

# STS-114 LF1 (FD 06)

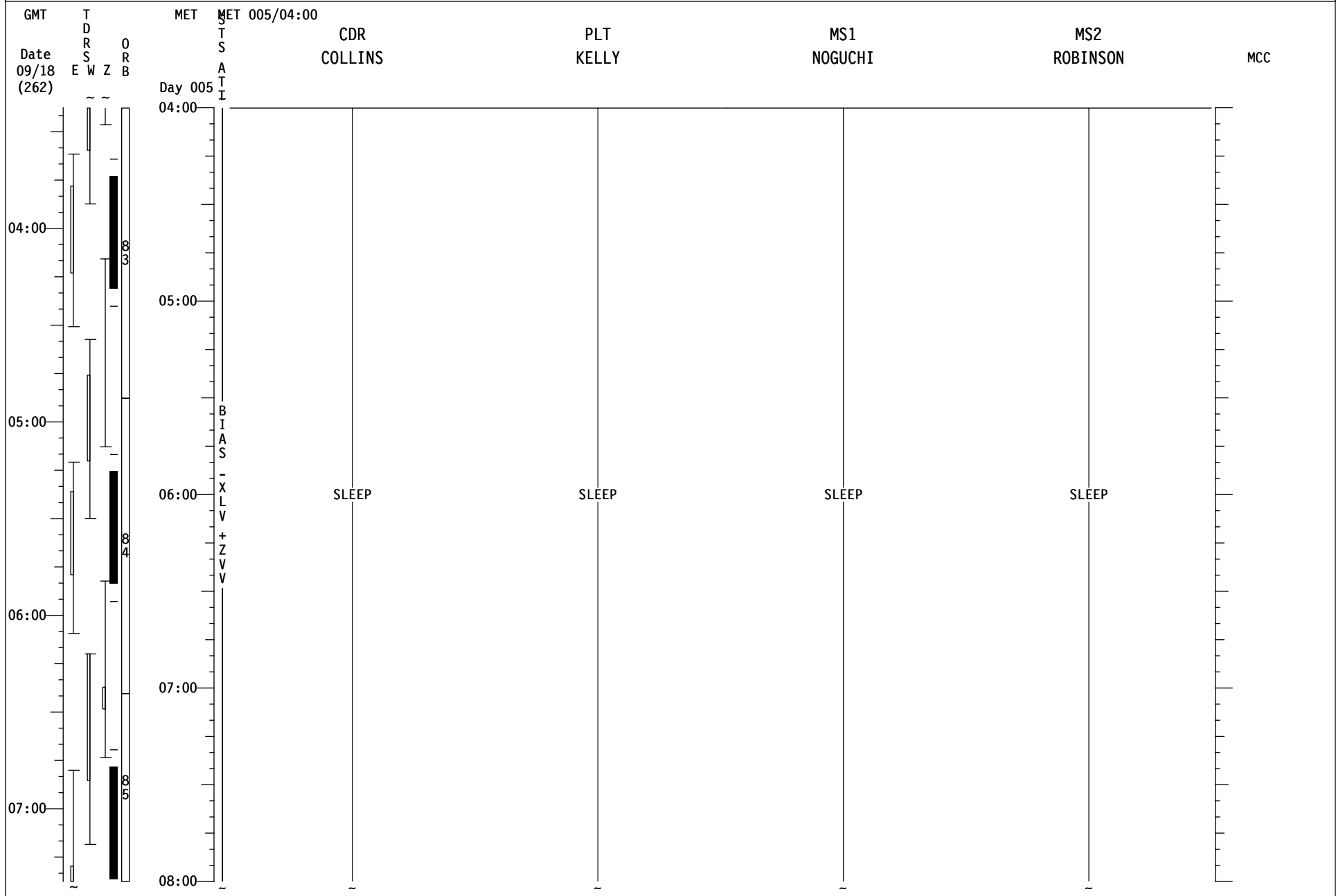



# STS-114 LF1 (FD 06)

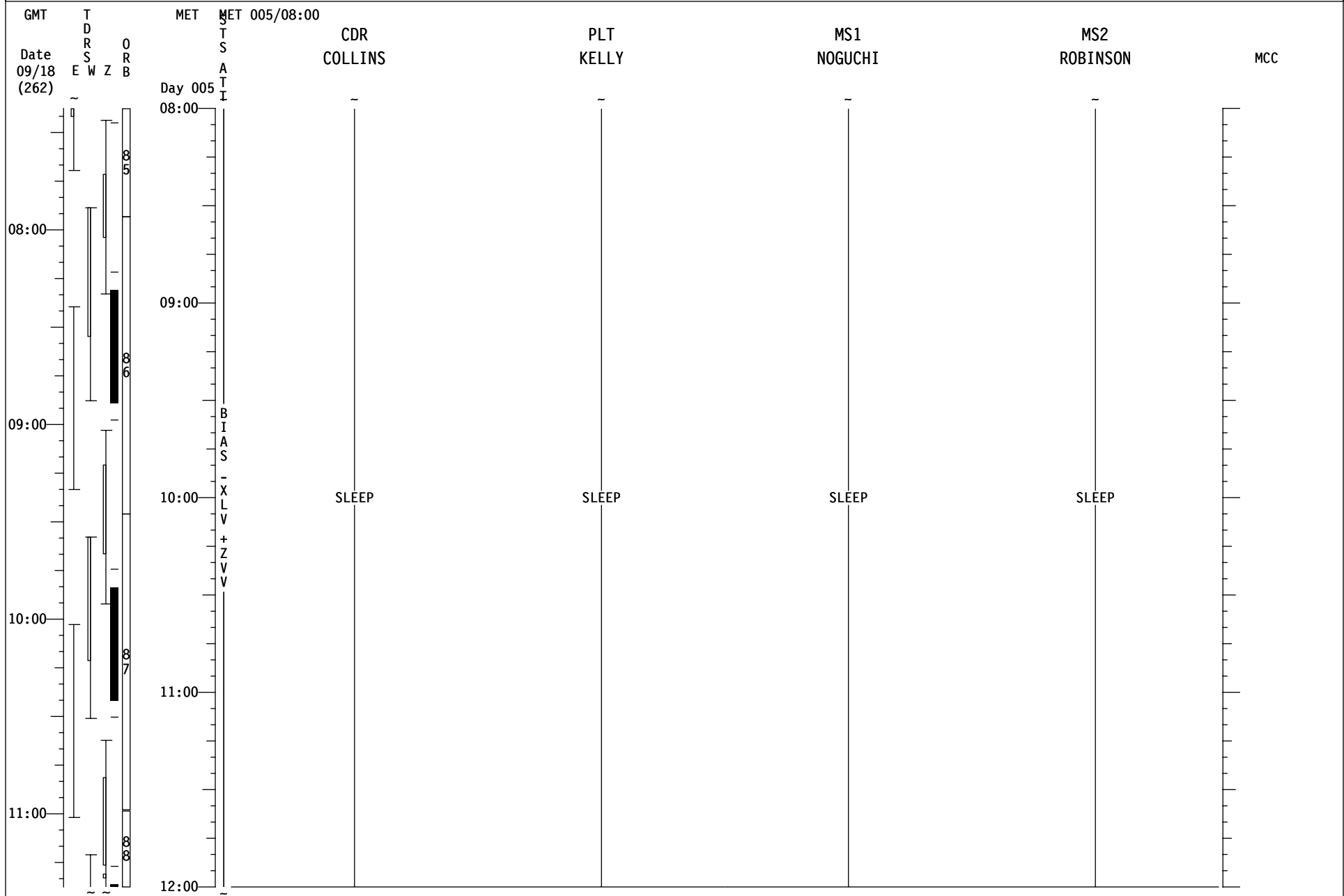

# STS-114 LF1 (FD 06)

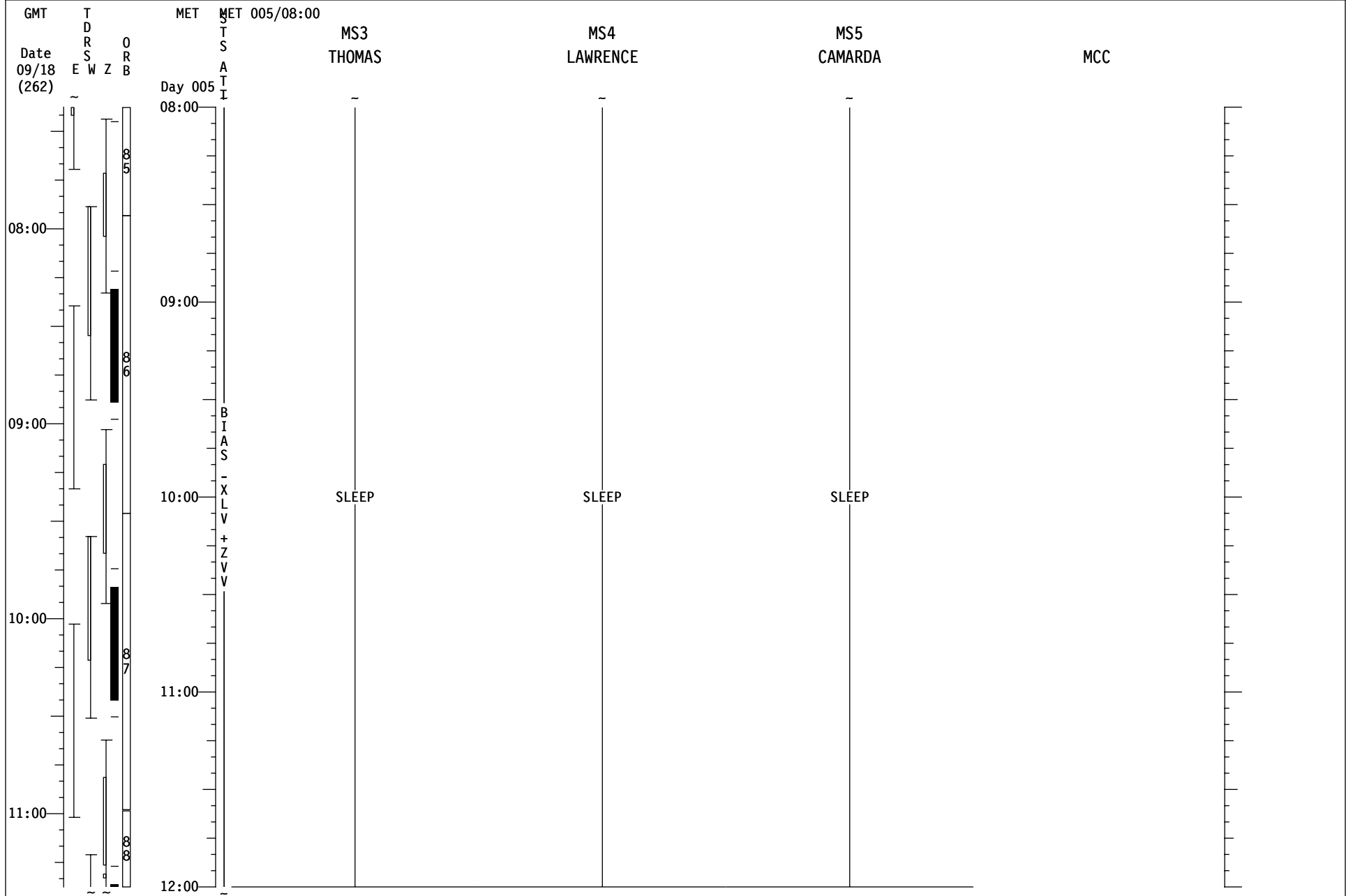

# STS-114 LF1 (FD 07)

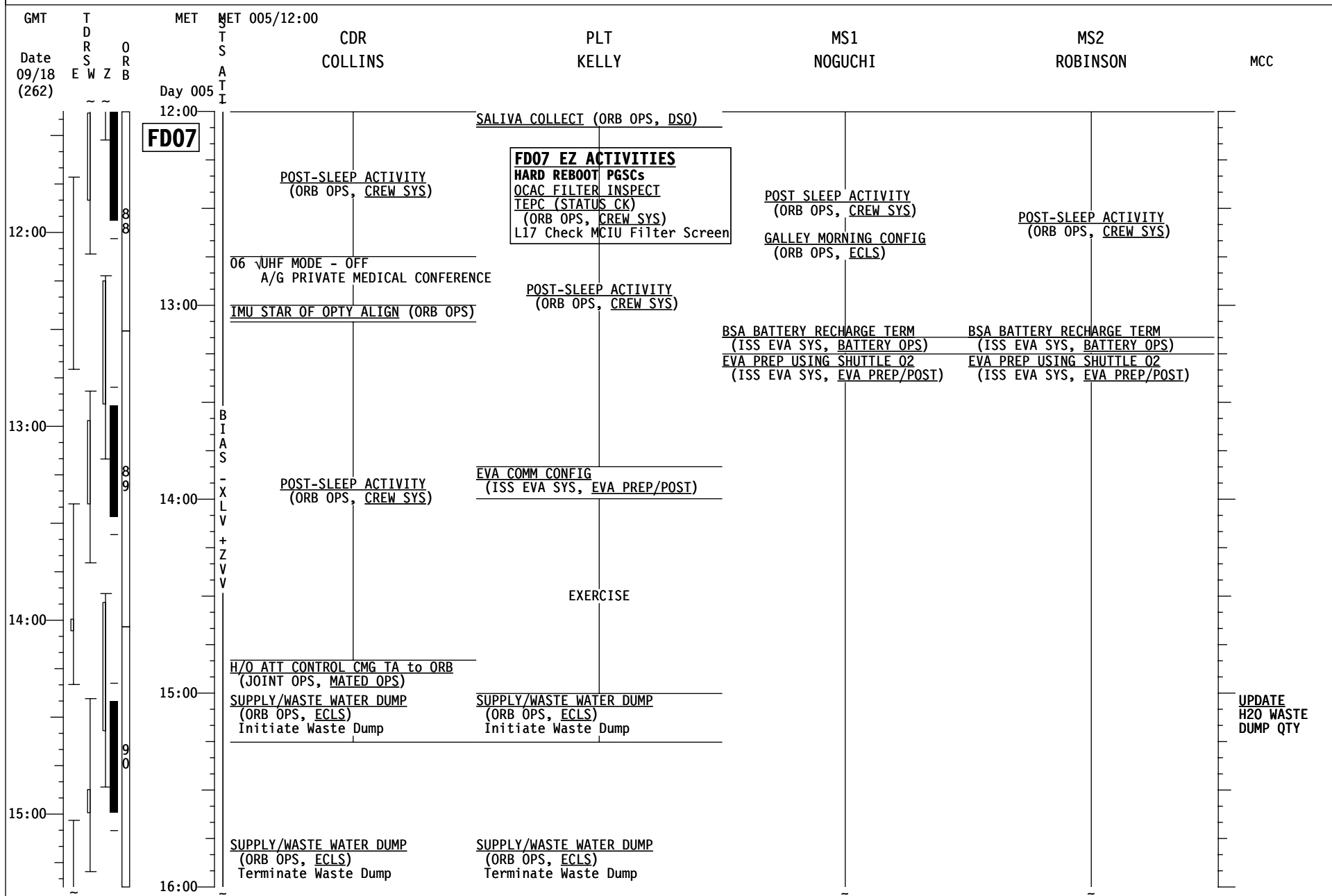

# STS-114 LF1 (FD 07)

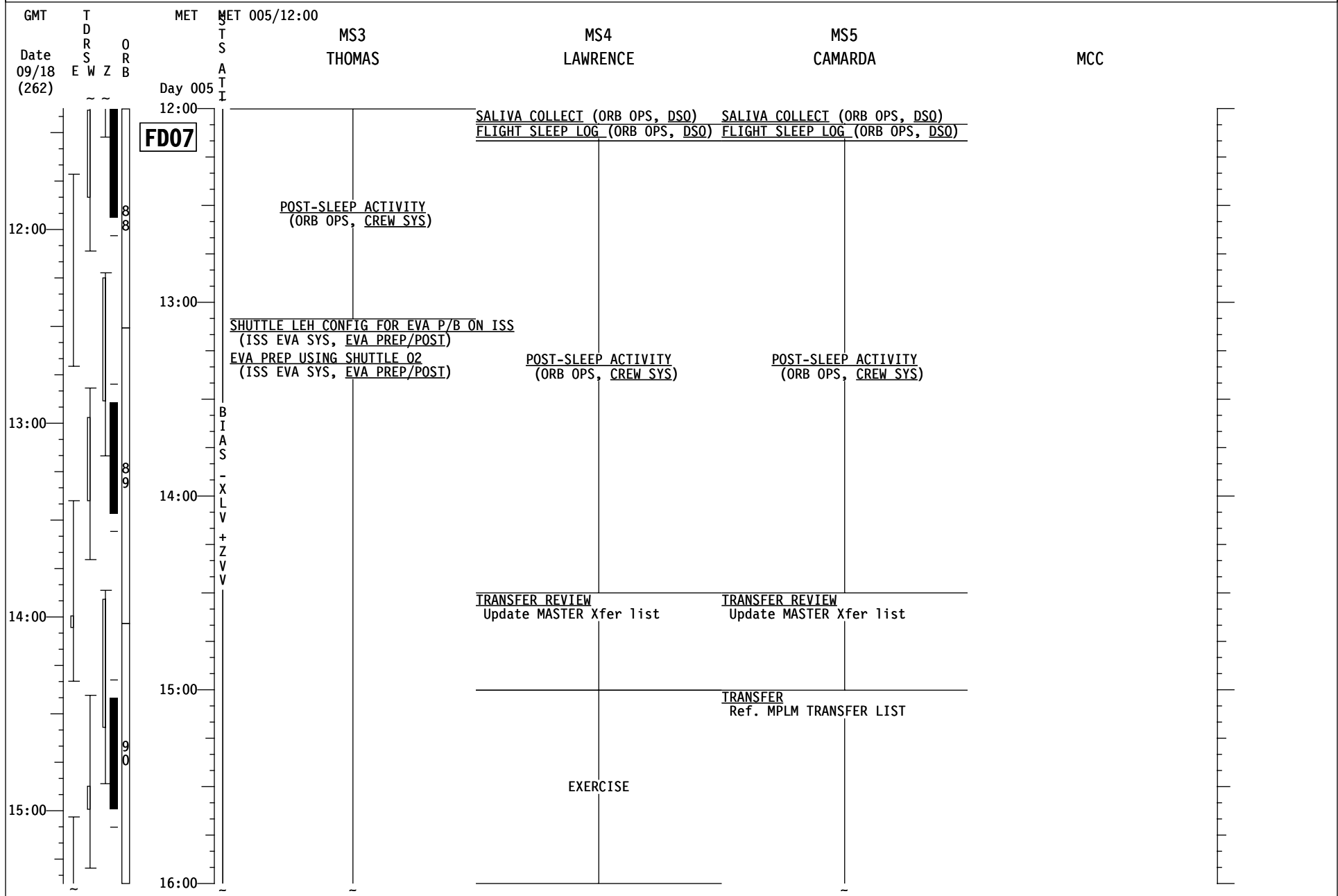

**FD07**

# STS-114 LF1 (FD 07)

GMT	TDRS Date 09/18 (262)	MET	MET 005/16:00 S A T I	CDR COLLINS	PLT KELLY	MS1 NOGUCHI	MS2 ROBINSON	MCC
16:00	90	Day 005	H/O ATT CONTROL ORB to RS (JOINT OPS, CONTINGENCY) EVA 2 INHIBIT PAD (EVA, EVA 2)		TRANSFER Ref. MPLM TRANSFER LIST	EVA PREP USING SHUTTLE O2 (ISS EVA SYS, EVA PREP/POST) EMU PURGE (ISS EVA SYS, EVA PREP/POST) EMU PREBREATHE (ISS EVA SYS, EVA PREP/POST)	EVA PREP USING SHUTTLE O2 (ISS EVA SYS, EVA PREP/POST) EMU PURGE (ISS EVA SYS, EVA PREP/POST) EMU PREBREATHE (ISS EVA SYS, EVA PREP/POST)	
17:00	91							UPLINK B0+ C1,C2,C3+E2 BOX C1 -15<AZ<52 -62<EL<75 BOX C2 -41<AZ<-10 -23<EL<39 BOX C3 -71<AZ<-36 -4<EL<33 BOX E2 -68<AZ<-10 -67<EL<4
17:00						CREWLOCK DPRS/RPRS CUE CARD (ISS EVA SYS, EVA PREP/POST)	CREWLOCK DPRS/RPRS CUE CARD (ISS EVA SYS, EVA PREP/POST)	
18:00	92		+ SHUTTLE/ISS H2O CONT FILL Z (ORB OPS, ECLS) INIT #8 V Minerals and/or Ag Biocide V are req'd. Samples are/are not req'd. Fill Duration: 56 minutes		EVA - CMG R&R (ROBOTICS, CMG R&R EVA SPT)	EVA 2 EGRESS/SETUP (EVA, EVA 2)	EVA 2 EGRESS/SETUP (EVA, EVA 2)	
19:00			EXERCISE					
19:00	93		SHUTTLE/ISS H2O CONT FILL (ORB OPS, ECLS) TERM Report Barcode & S/N to MCC			CMG R&R (EVA, EVA 2)	CMG R&R (EVA, EVA 2)	
20:00								



# STS-114 LF1 (FD 07)

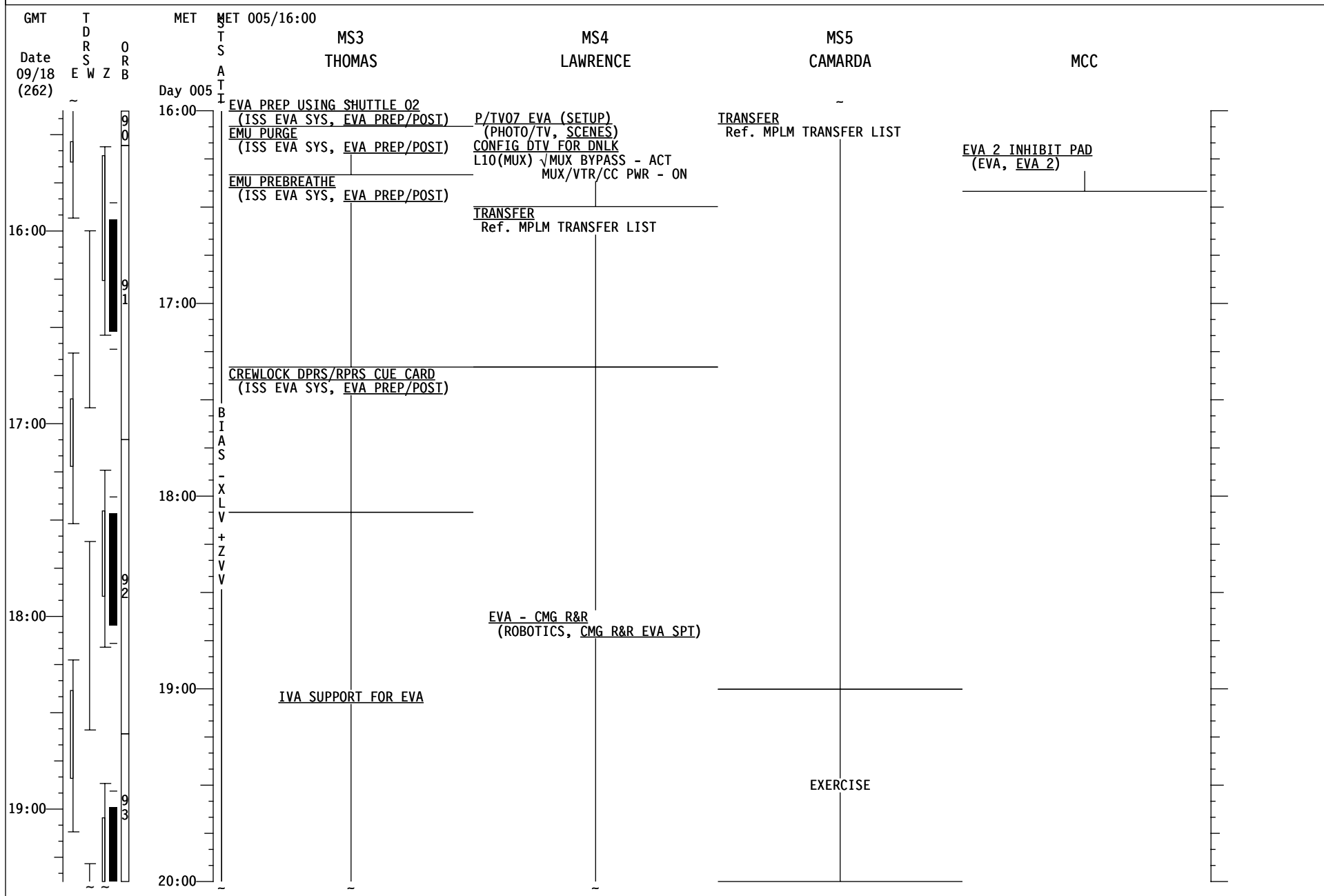

# STS-114 LF1 (FD 07)

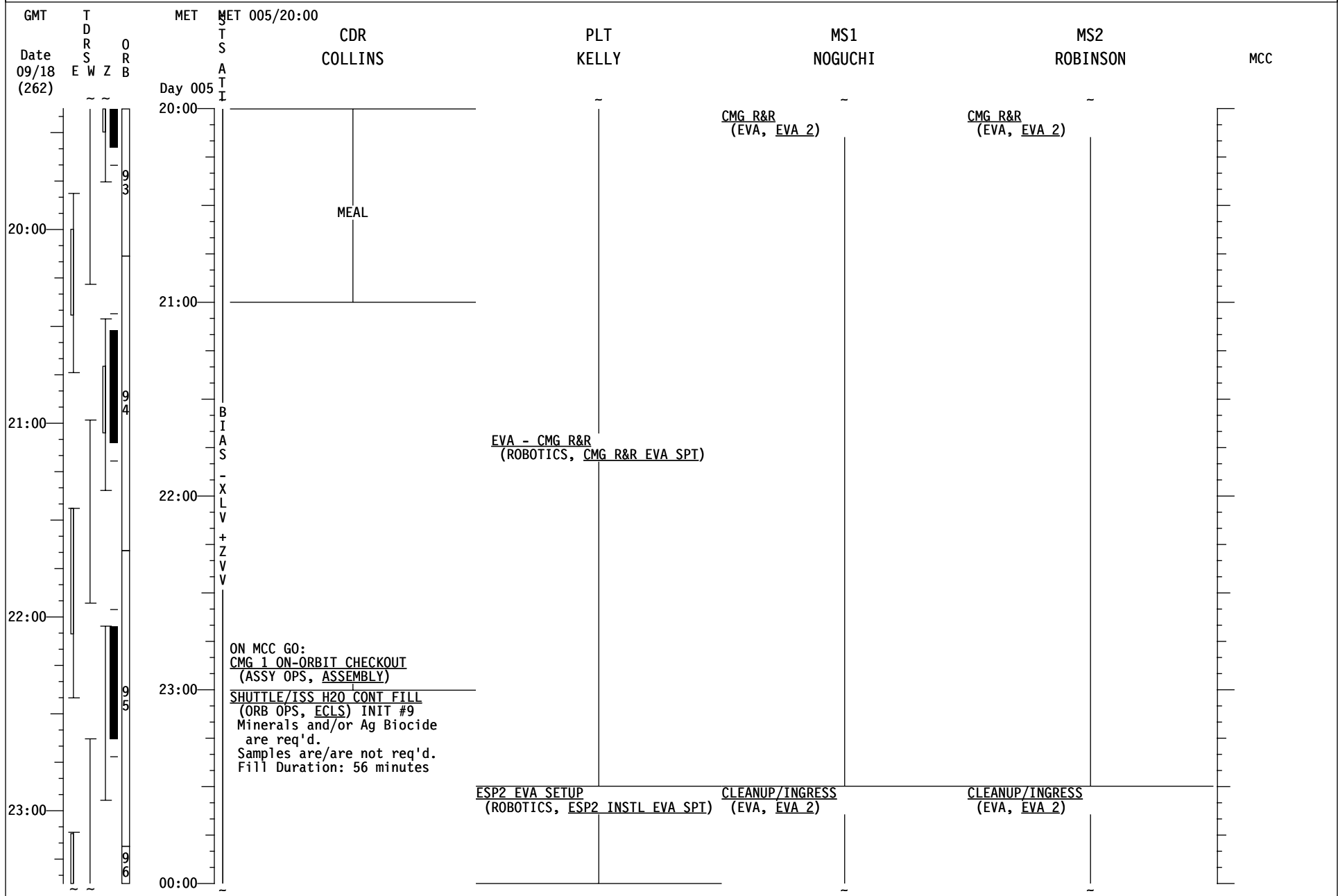

# STS-114 LF1 (FD 07)

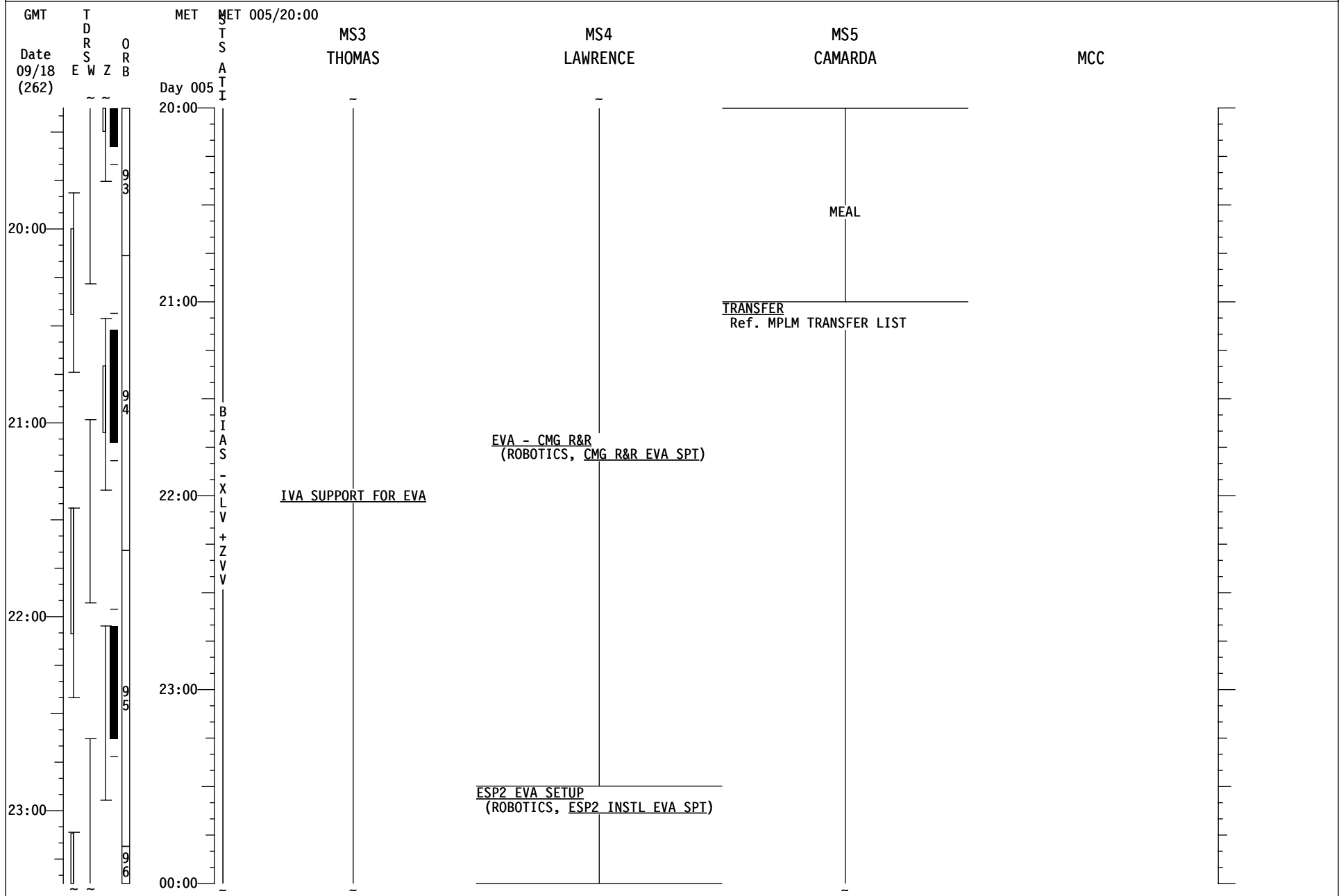

# STS-114 LF1 (FD 07)

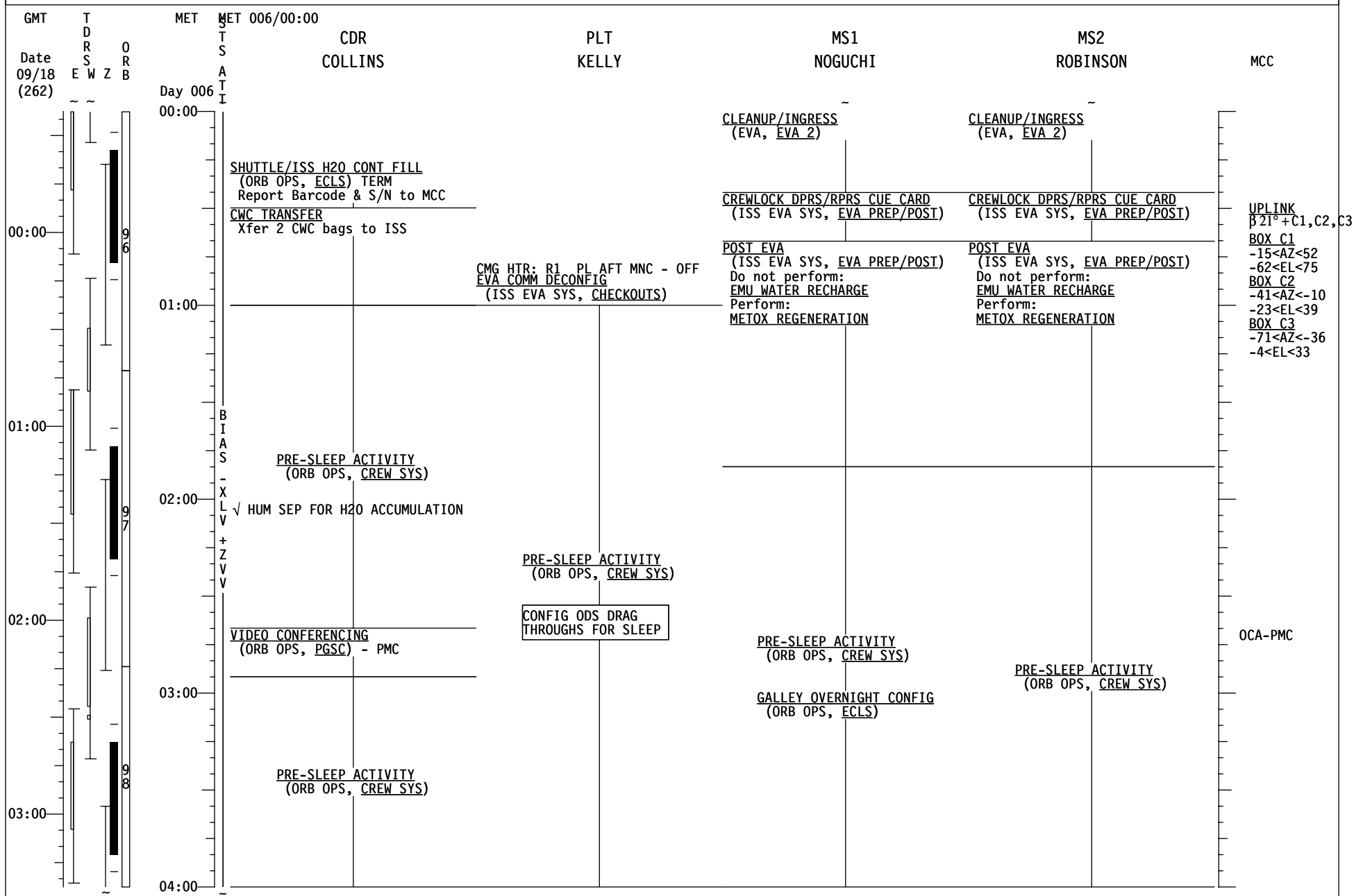

# STS-114 LF1 (FD 07)

GMT	T D R S O E W Z B	MET	MET 006/00:00	MS3 THOMAS	MS4 LAWRENCE	MS5 CAMARDA	MCC
		Day 006	00:00			TRANSFER Ref. MPLM TRANSFER LIST	
			00:00	IVA SUPPORT FOR EVA			
			00:00	CREWLOCK DPRS/RPRS CUE CARD (ISS EVA SYS, EVA PREP/POST)			
			01:00	POST EVA (ISS EVA SYS, EVA PREP/POST) Do not perform: EMU WATER RECHARGE Perform: METOX REGENERATION	PRE-SLEEP ACTIVITY (ORB OPS, CREW SYS)	PRE-SLEEP ACTIVITY (ORB OPS, CREW SYS)	
			01:00		DAILY STS/ISS CREW TRANSFER TAGUP	DAILY STS/ISS CREW TRANSFER TAGUP	
			02:00		DAILY TRANSFER BRIEFING	DAILY TRANSFER BRIEFING	
			03:00	PRE-SLEEP ACTIVITY (ORB OPS, CREW SYS)	PRE-SLEEP ACTIVITY (ORB OPS, CREW SYS)	PRE-SLEEP ACTIVITY (ORB OPS, CREW SYS)	
			04:00		WITH MEAL: RENAL STONE (ORB OPS)		

# STS-114 LF1 (FD 07)

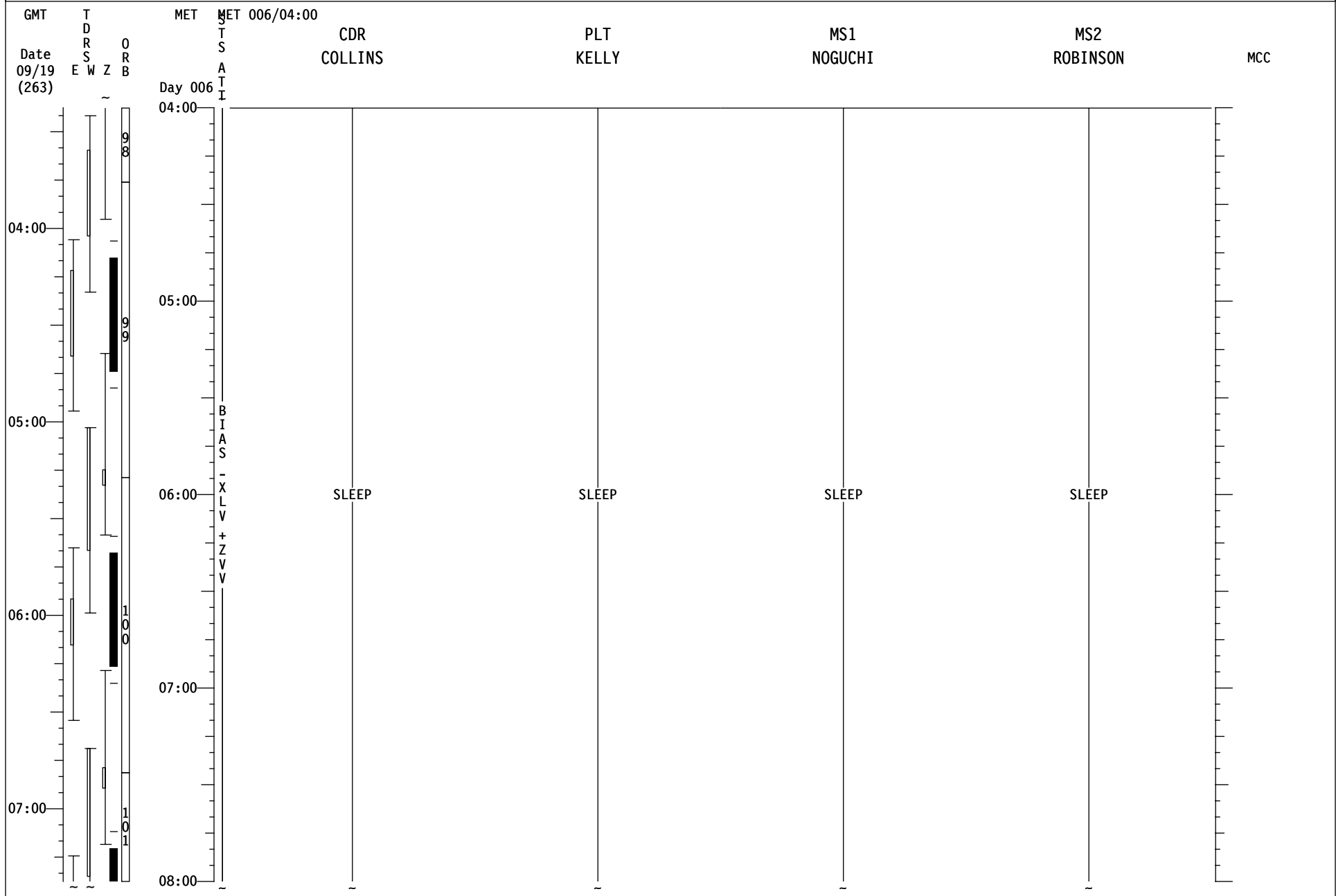



# STS-114 LF1 (FD 07)

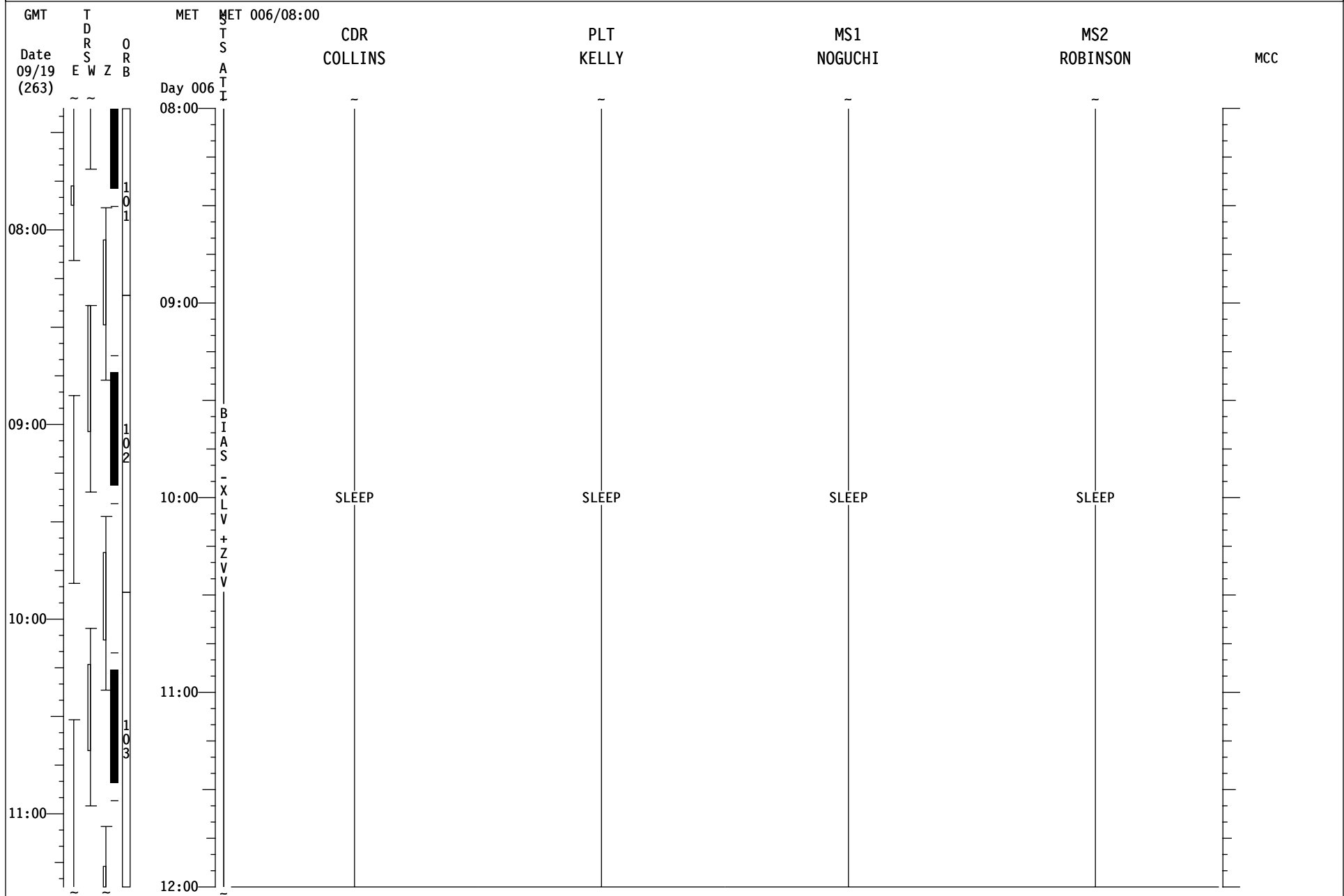



# STS-114 LF1 (FD 07)

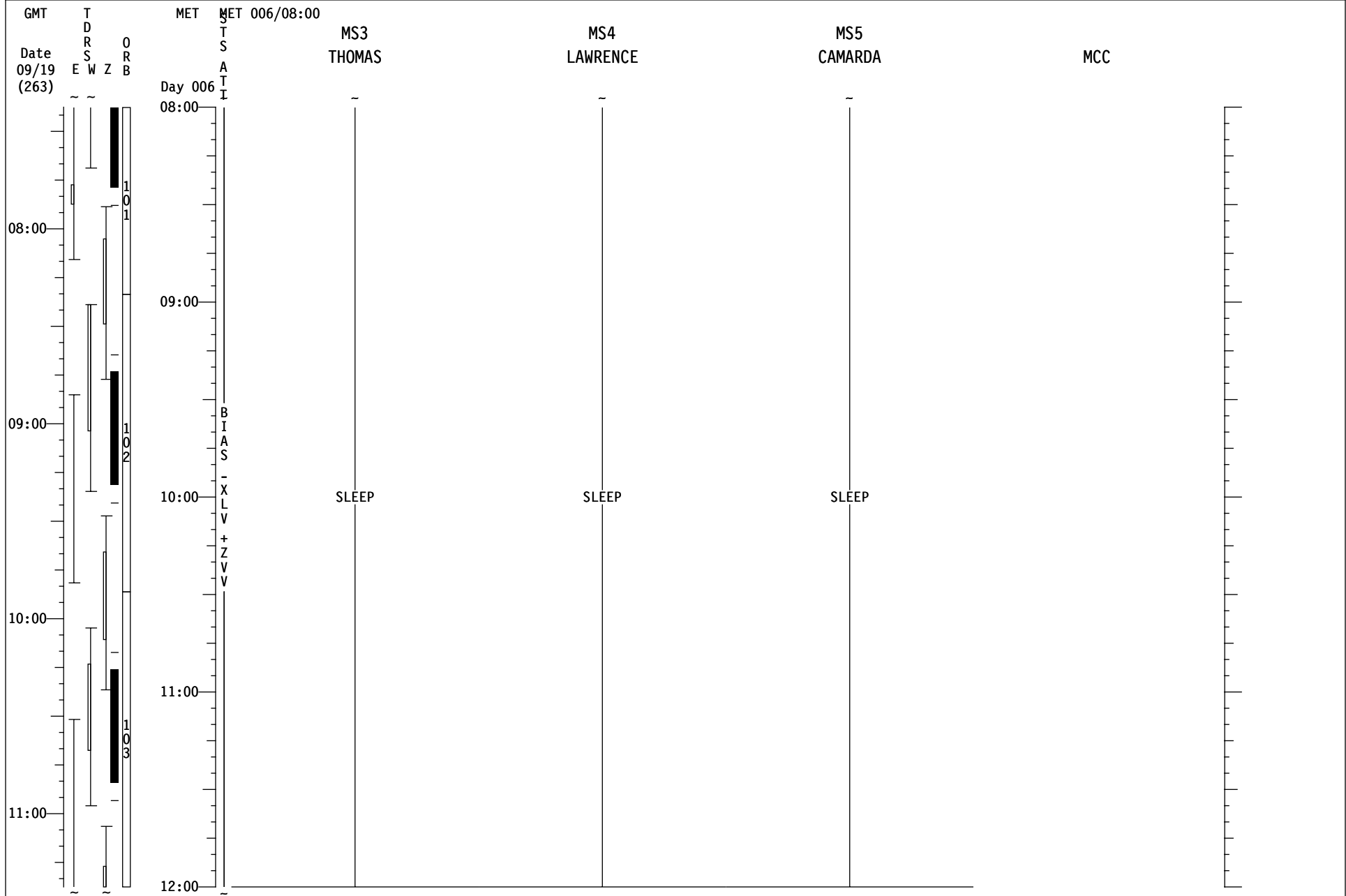

# STS-114 LF1 (FD 08)

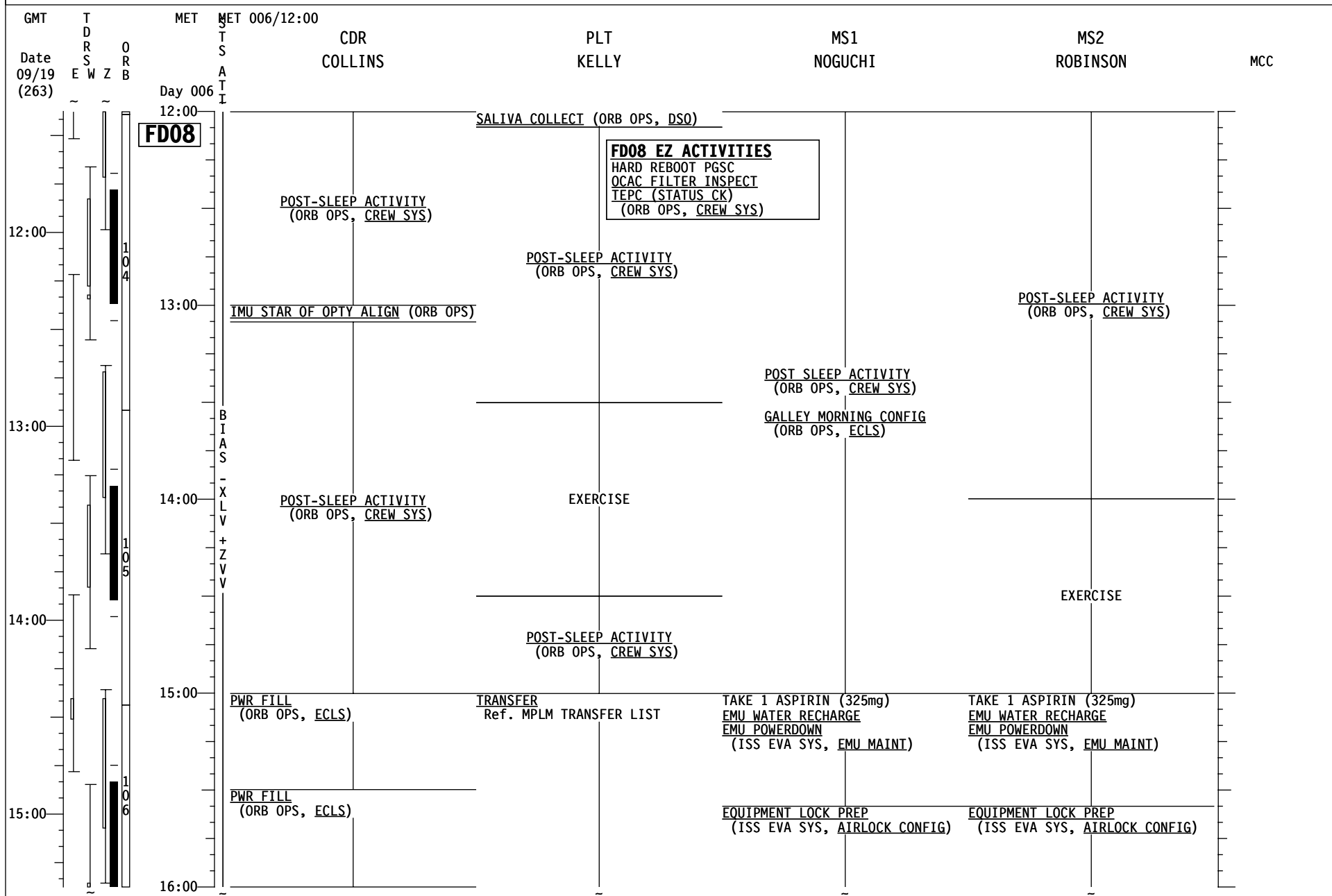

# STS-114 LF1 (FD 08)

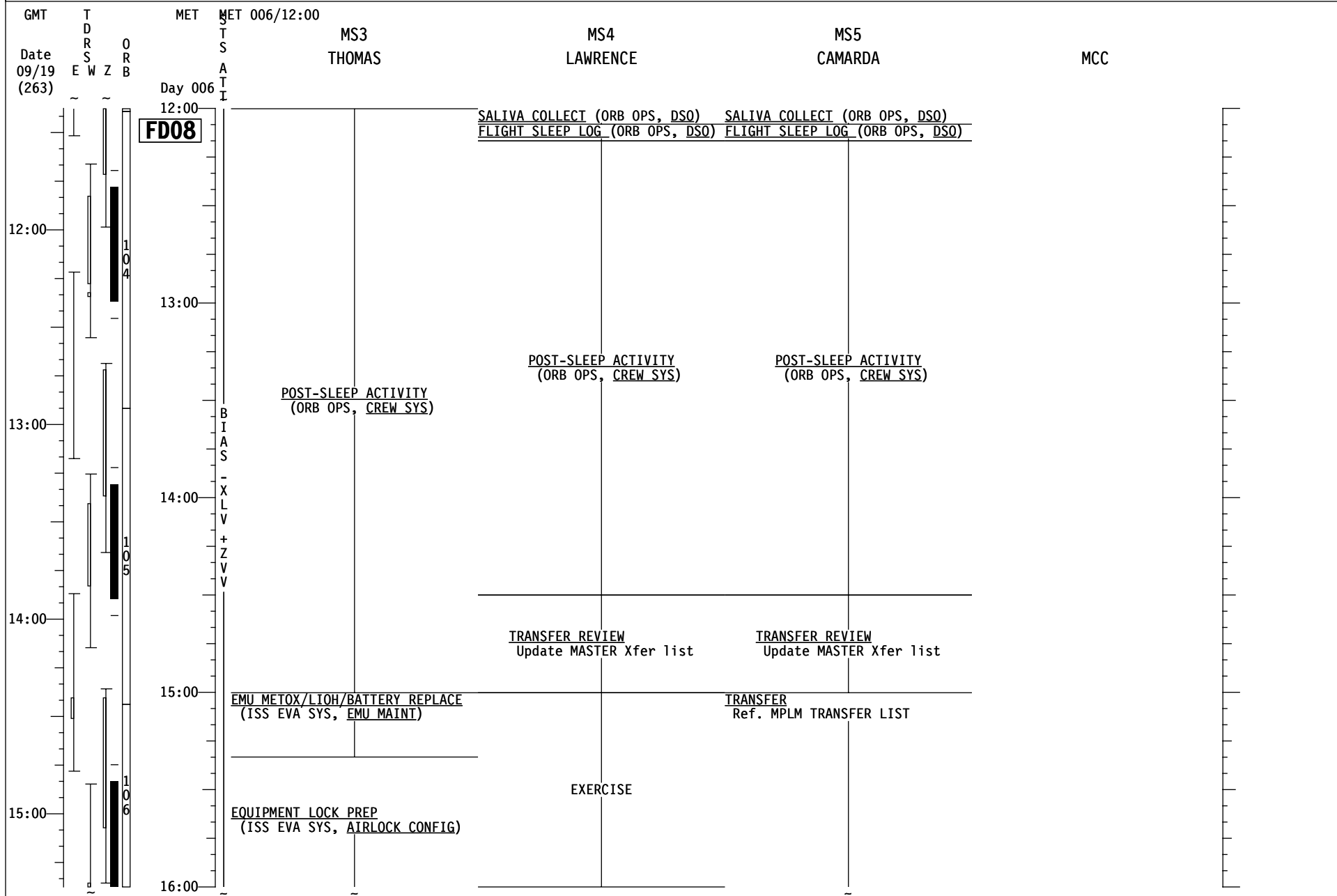

# STS-114 LF1 (FD 08)

GMT	T D R S O E W Z B	MET	MET 006/16:00	CDR COLLINS	PLT KELLY	MS1 NOGUCHI	MS2 ROBINSON	MCC
Date 09/19 (263)	~ ~ ~ ~ ~ ~ ~ ~ ~ ~	Day 006	16:00	PWR FILL (ORB OPS, ECLS)	TRANSFER Ref. MPLM TRANSFER LIST	EQUIPMENT LOCK PREP (ISS EVA SYS, AIRLOCK CONFIG)	EQUIPMENT LOCK PREP (ISS EVA SYS, AIRLOCK CONFIG)	
			16:00	SHUTTLE/ISS H2O CONT FILL (ORB OPS, ECLS) INIT #10 Minerals and/or Ag Biocide are req'd. Samples are/are not req'd. Fill Duration: 56 minutes		760 EVA CAMR (PHOTO/TV, DCS 760)	760 EVA CAMR (PHOTO/TV, DCS 760)	
			17:00	EXERCISE				
			17:00	SHUTTLE/ISS H2O CONT FILL (ORB OPS, ECLS) TERM Report Barcode & S/N to MCC				
			18:00	CWC TRANSFER Xfer 1 CWC bag to ISS		METOX REGENERATION TERM (ISS EVA SYS, EMU MAINT)	TRANSFER Ref. MPLM TRANSFER LIST	
			18:00	FILTER CLEANING (IFM, SCHED MAINT) Inspect filters and clean as necessary		TRANSFER Ref. MPLM TRANSFER LIST		
			19:00			DIGITAL PAO CC (PHOTO/TV, SONY PD100)		
			19:00	CREW PHOTO	CREW PHOTO	CREW PHOTO	CREW PHOTO	
			19:00	CREW CONFERENCE Ref. MSG ###	CREW CONFERENCE Ref. MSG ###	CREW CONFERENCE Ref. MSG ###	CREW CONFERENCE Ref. MSG ###	
			20:00					

# STS-114 LF1 (FD 08)

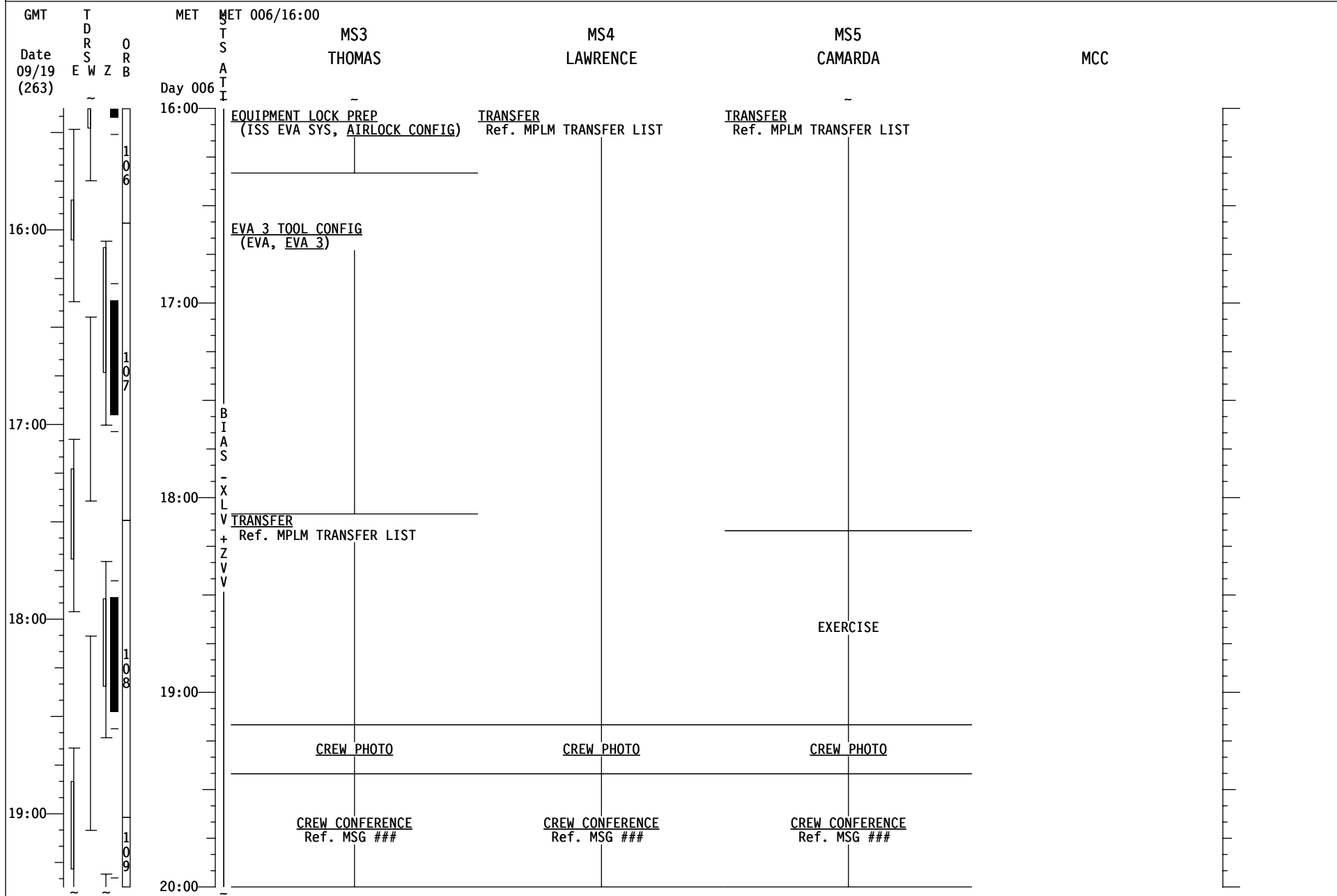

# STS-114 LF1 (FD 08)

GMT	TDRS E W Z	ORB	MET Day 006	MET 006/20:00 S A T I	CDR COLLINS	PLT KELLY	MS1 NOGUCHI	MS2 ROBINSON	MCC
20:00					MEAL	MEAL	MEAL	MEAL	
21:00					<u>PUBLIC AFFAIRS EVENT (JAXA)</u> KU AVAIL TDRS XX:XX-XX:XX REF MSG ###		<u>PUBLIC AFFAIRS EVENT (JAXA)</u> KU AVAIL TDRS XX:XX-XX:XX REF MSG ###		
22:00					OFF DUTY	OFF DUTY	OFF DUTY	OFF DUTY	
23:00									
00:00									

# STS-114 LF1 (FD 08)

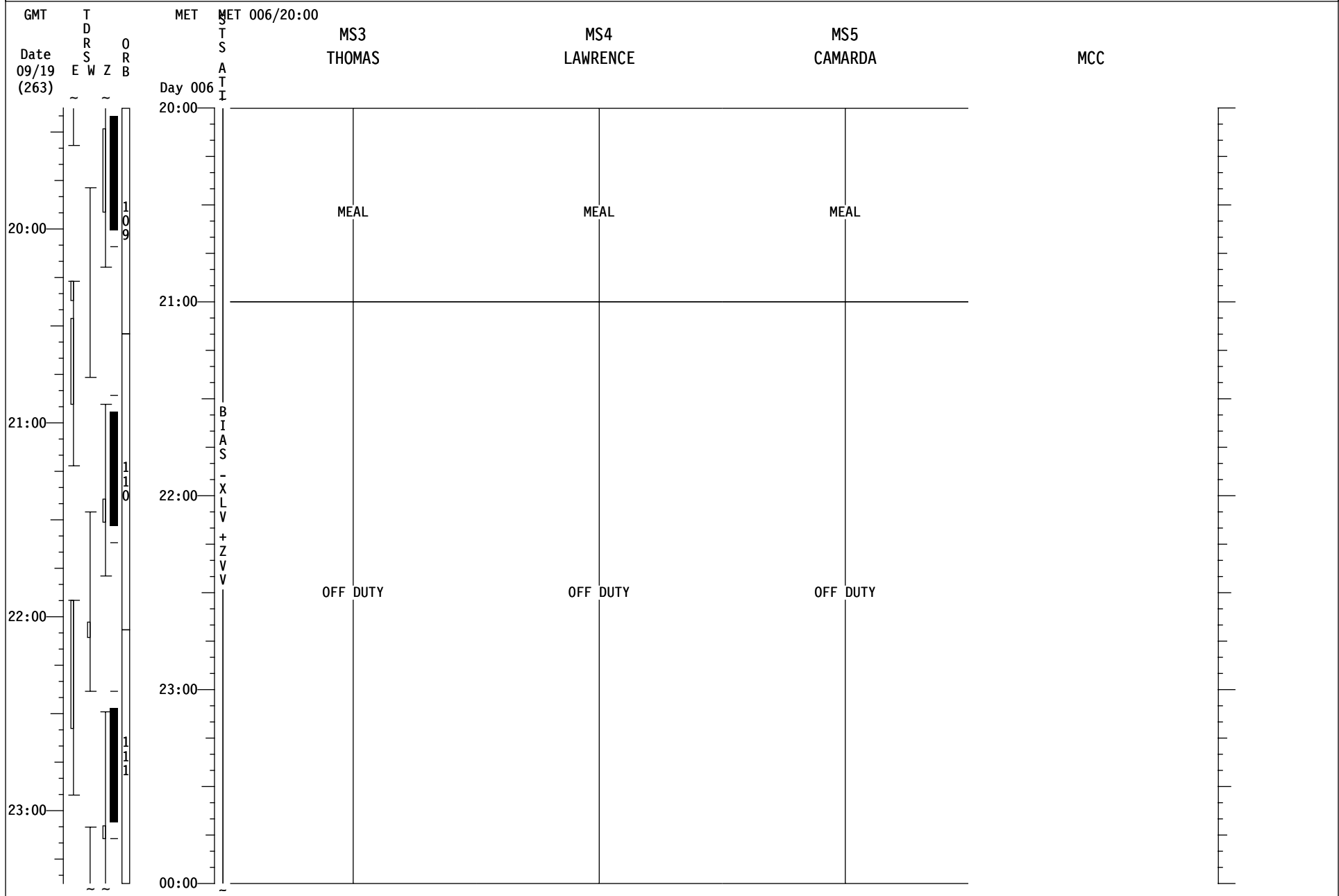

# STS-114 LF1 (FD 08)

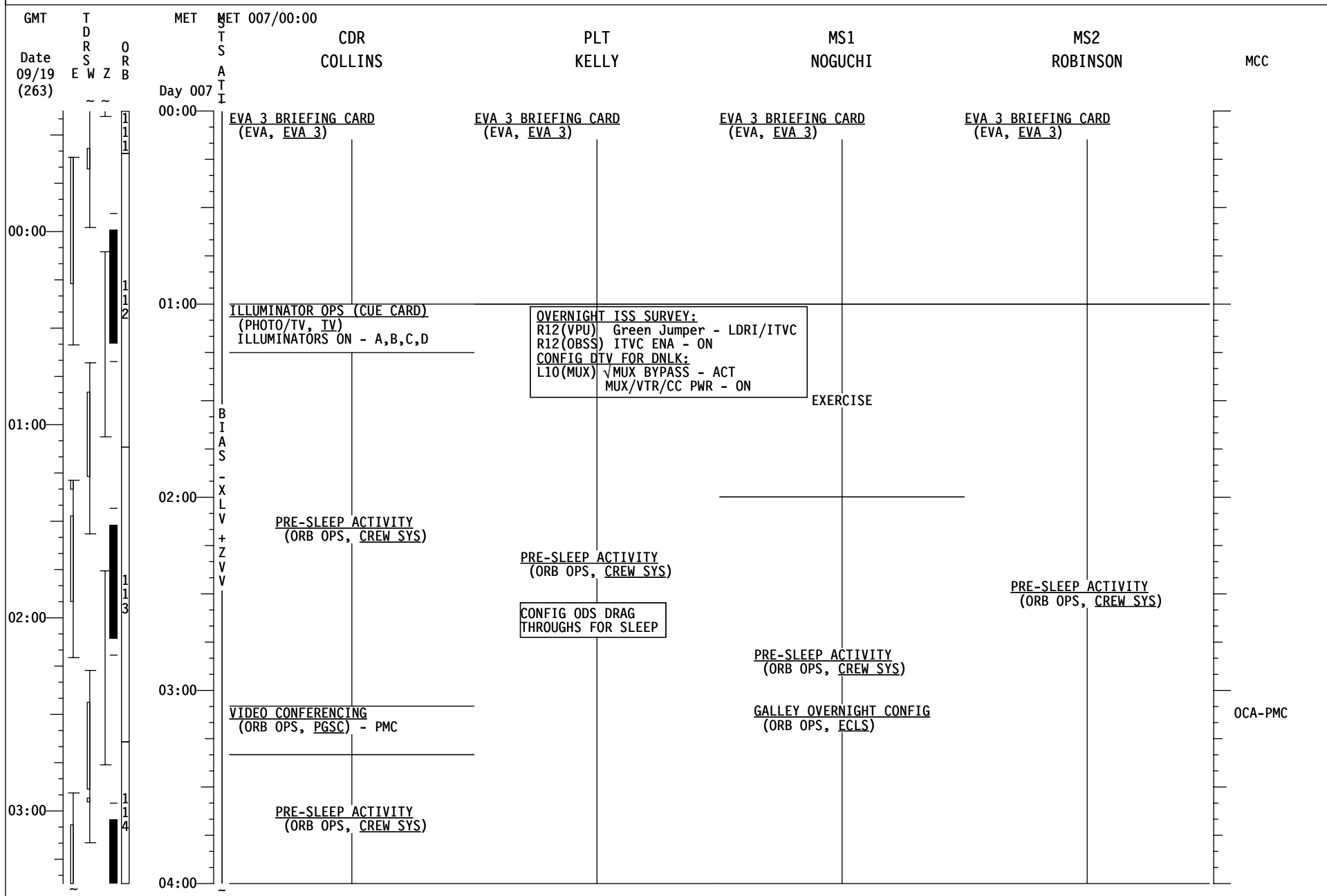



# STS-114 LF1 (FD 08)

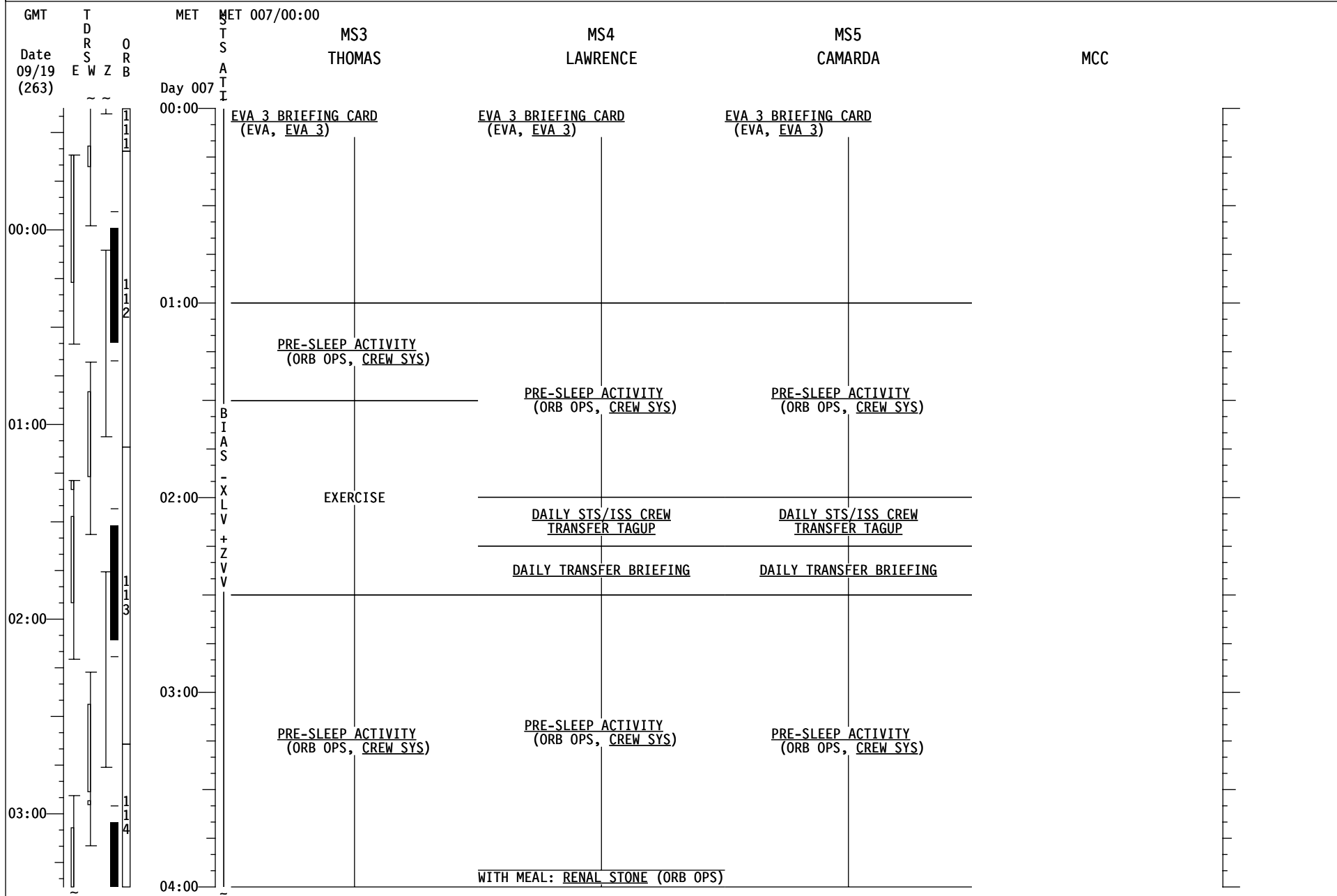

# STS-114 LF1 (FD 08)

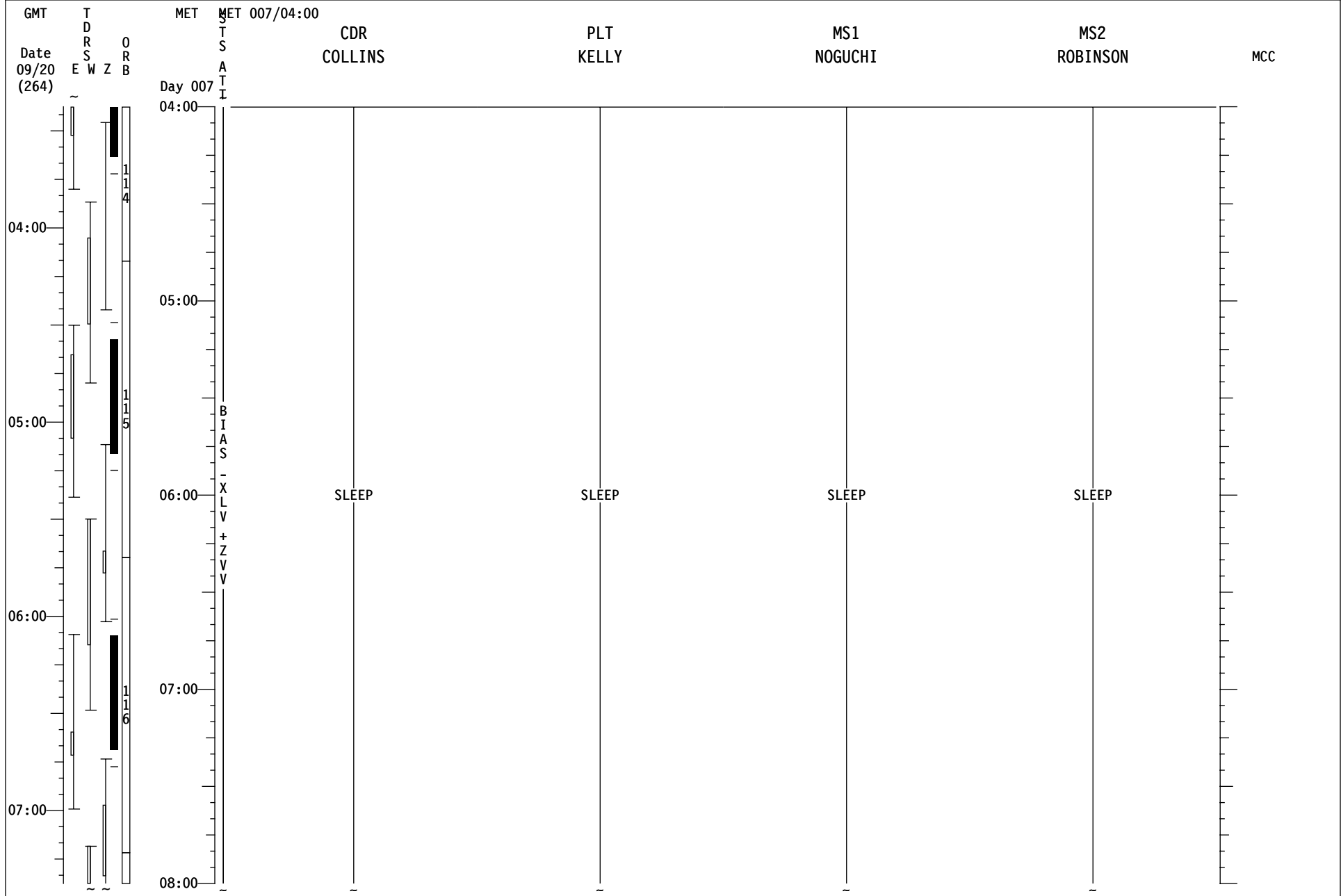

# STS-114 LF1 (FD 08)

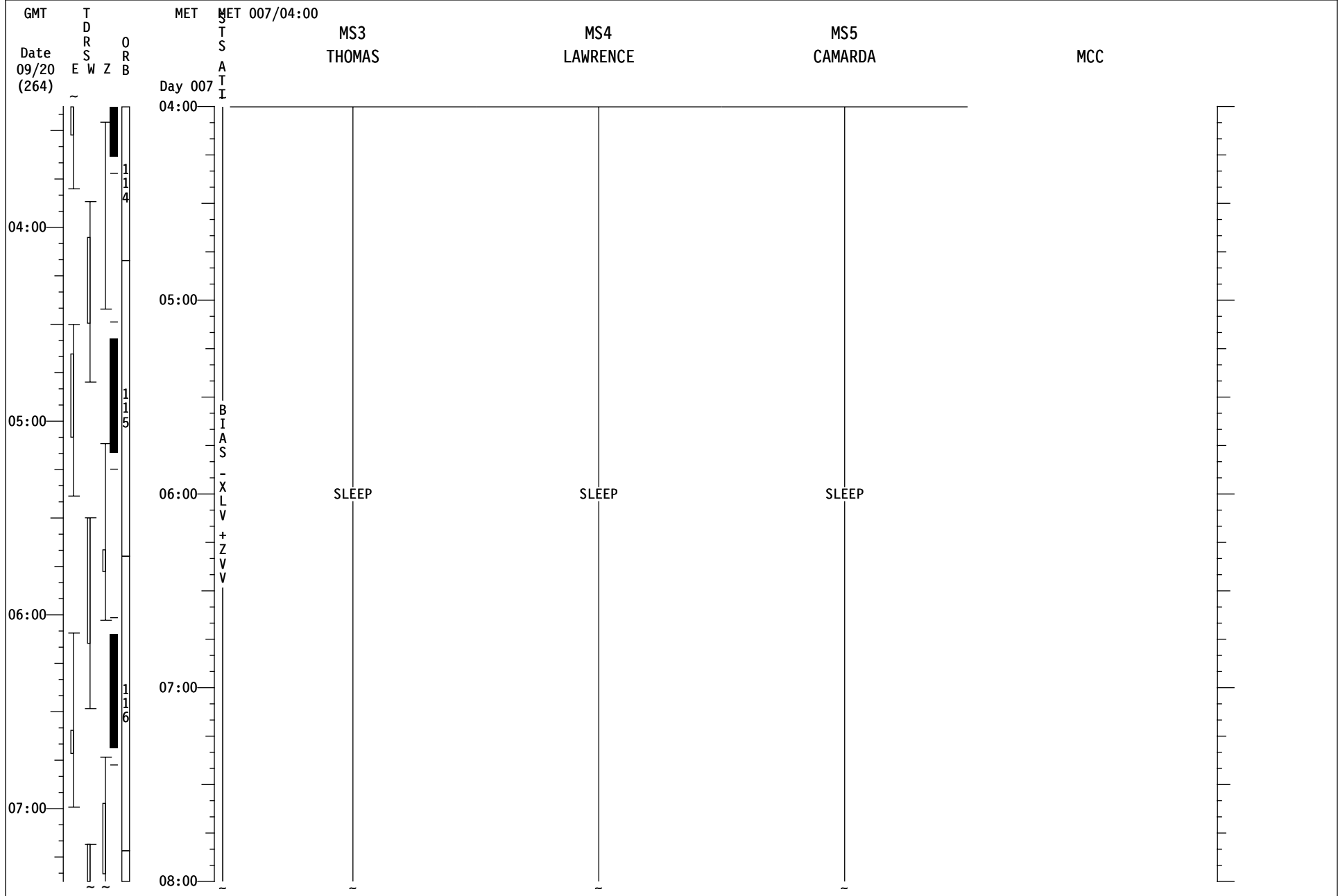

# STS-114 LF1 (FD 08)

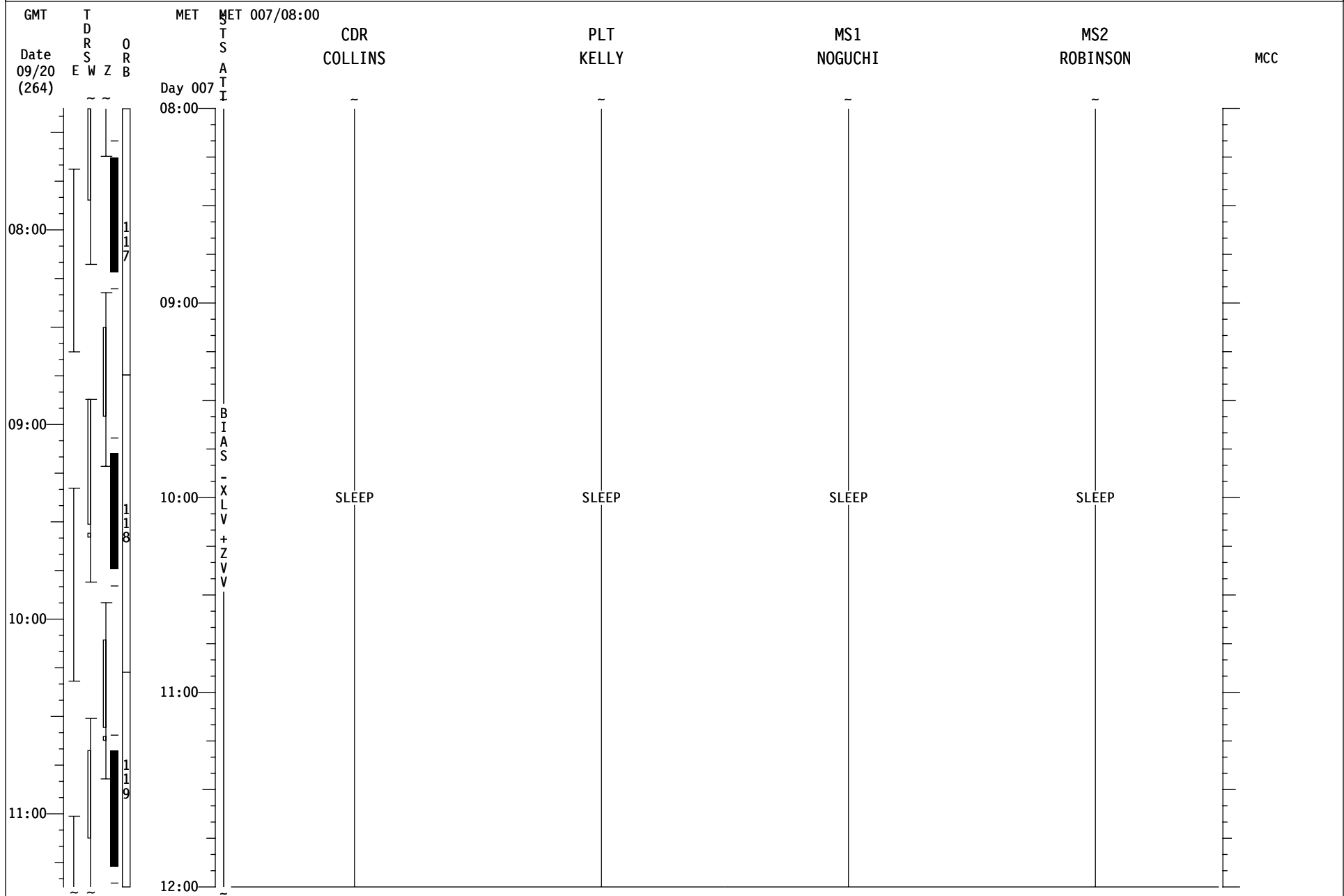

# STS-114 LF1 (FD 08)

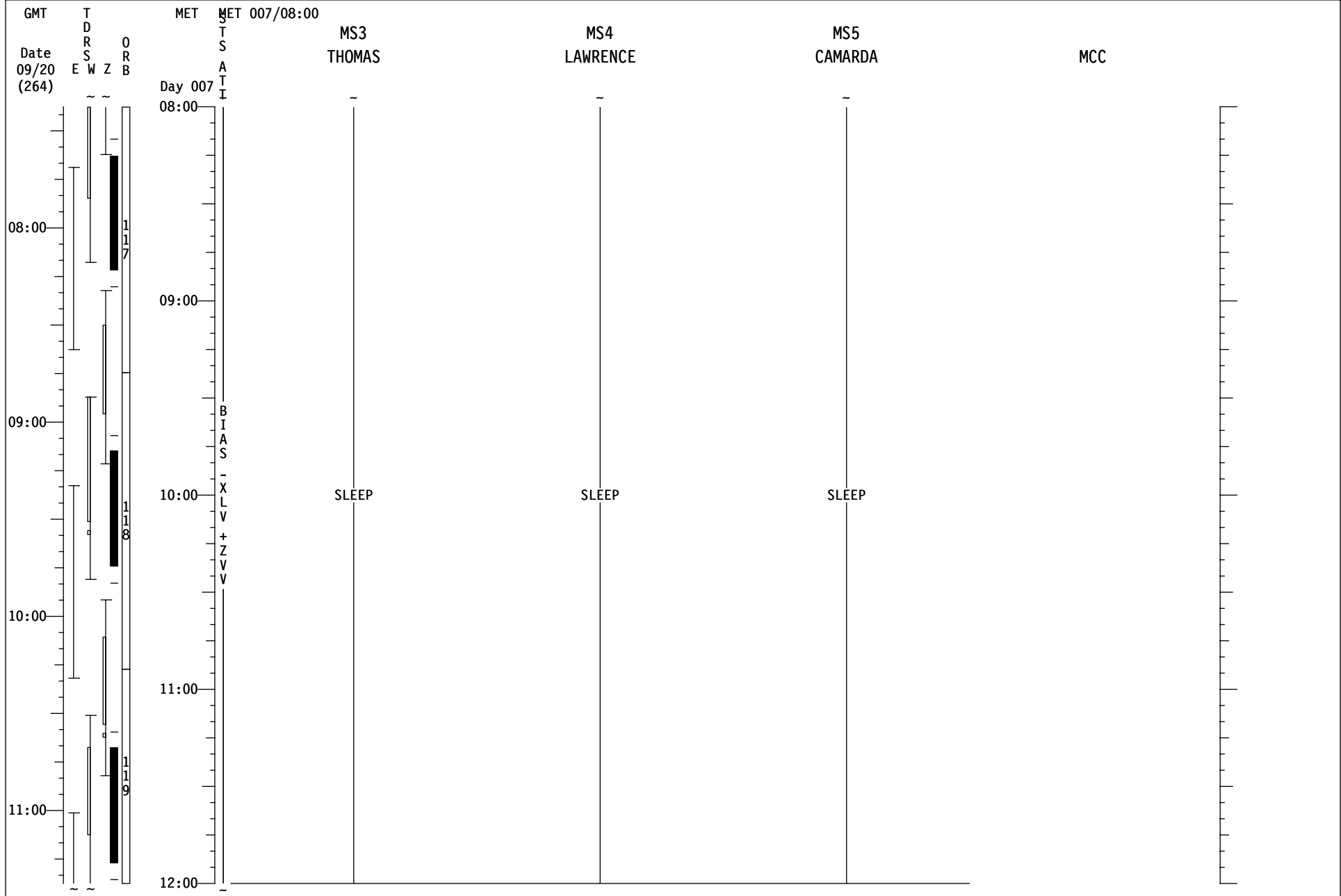

# STS-114 LF1 (FD 09)

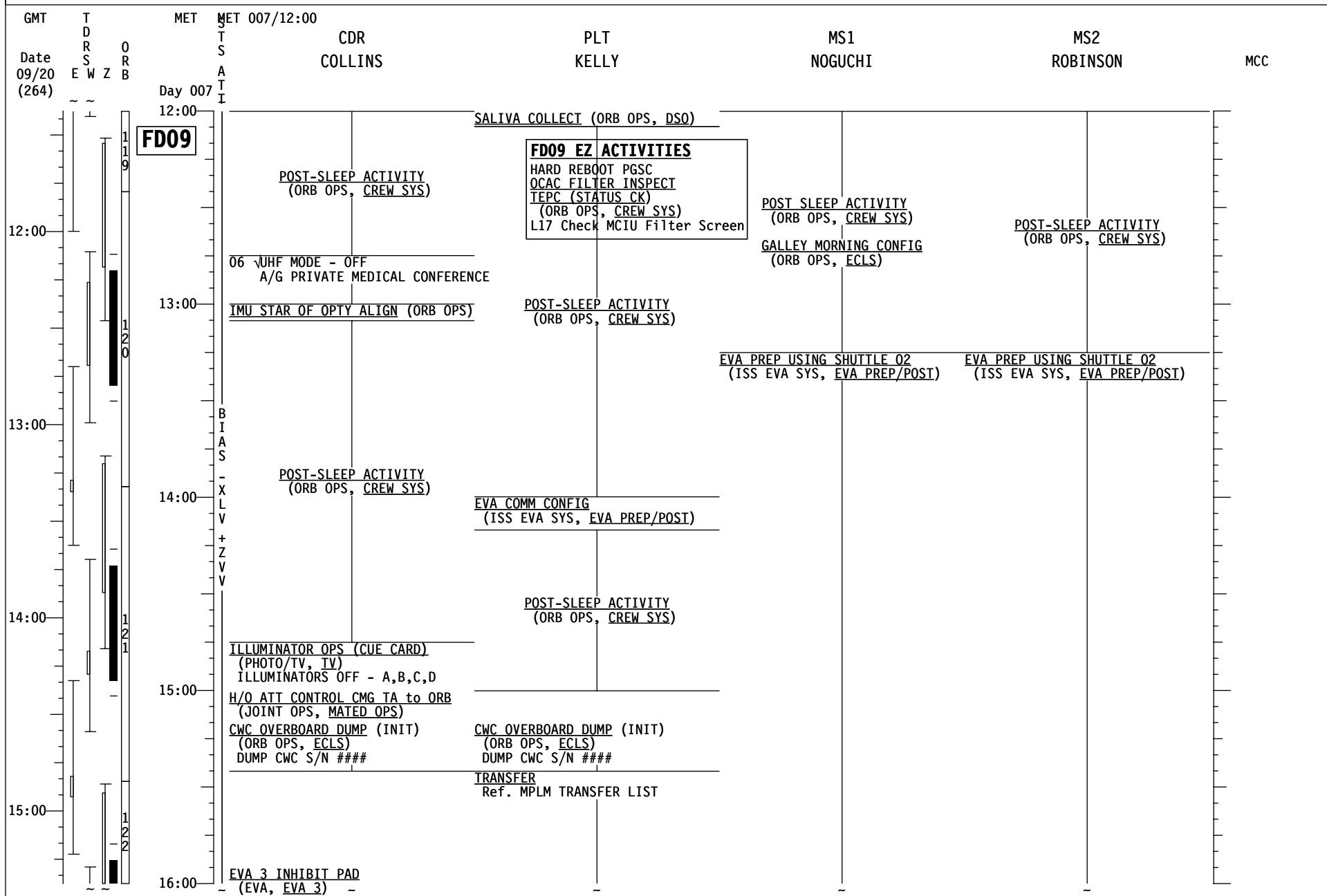

# STS-114 LF1 (FD 09)

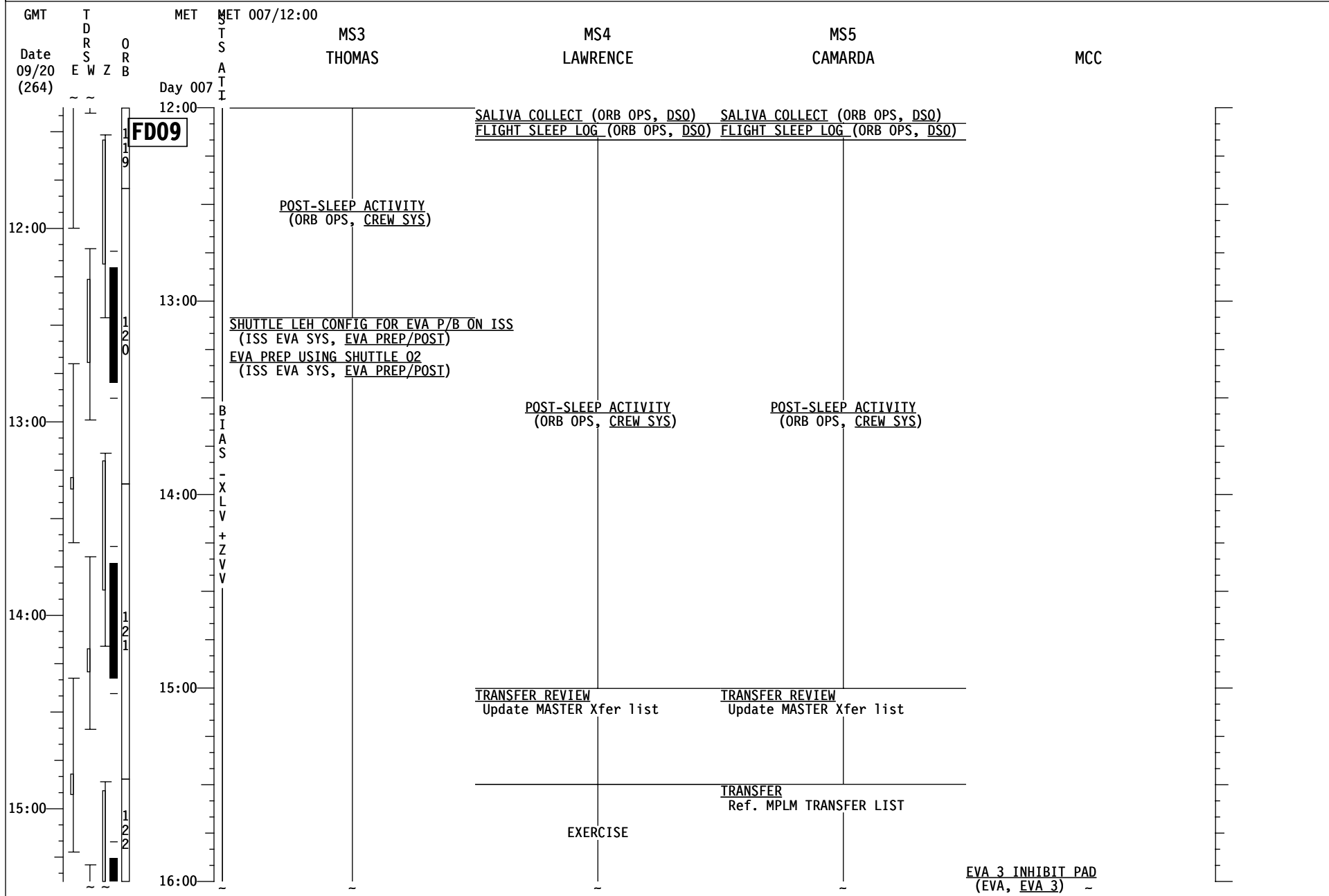

# STS-114 LF1 (FD 09)

GMT	TDRS E W Z	MET	MET 007/16:00 S A T I	CDR COLLINS	PLT KELLY	MS1 NOGUCHI	MS2 ROBINSON	MCC
16:00	122	Day 007	I	EVA 3 INHIBIT PAD (EVA, EVA 3)	TRANSFER Ref. MPLM TRANSFER LIST	EVA PREP USING SHUTTLE 02 (ISS EVA SYS, EVA PREP/POST)	EVA PREP USING SHUTTLE 02 (ISS EVA SYS, EVA PREP/POST)	
				CWC OVERBOARD DUMP (TERM) (ORB OPS, ECLS)	CWC OVERBOARD DUMP (TERM) (ORB OPS, ECLS)	EMU PURGE (ISS EVA SYS, EVA PREP/POST)	EMU PURGE (ISS EVA SYS, EVA PREP/POST)	
17:00	122			H/O ATT CONTROL ORB to RS (JOINT OPS, CONTINGENCY)		EMU PREBREATHE (ISS EVA SYS, EVA PREP/POST)	EMU PREBREATHE (ISS EVA SYS, EVA PREP/POST)	
				SHUTTLE/ISS H2O CONT FILL (ORB OPS, ECLS) INIT #11 Minerals and/or Ag Biocide are req'd. Samples are/are not req'd. Fill Duration: 56 minutes	EXERCISE			
17:00	123			EXERCISE	EVA - ESPAD INSTALL (ROBOTICS, ESP2 INSTL EVA SPT)	CREWLOCK DPRS/RPRS CUE CARD (ISS EVA SYS, EVA PREP/POST)	CREWLOCK DPRS/RPRS CUE CARD (ISS EVA SYS, EVA PREP/POST)	UPLINK β 21°+C1,C2,C3+E3 BOX C1 -15<AZ<52 -62<EL<75 BOX C2 -41<AZ<-10 -23<EL<39 BOX C3 -71<AZ<-36 -4<EL<33 BOX E3 -49<AZ<9 -89<EL<4
18:00	123			SHUTTLE/ISS H2O CONT FILL (ORB OPS, ECLS) TERM Report Barcode & S/N to MCC		EVA 3 EGRESS/SETUP (EVA, EVA 3)	EVA 3 EGRESS/SETUP (EVA, EVA 3)	
19:00	124			SHUTTLE/ISS H2O CONT FILL (ORB OPS, ECLS) INIT #12 Minerals and/or Ag Biocide are req'd. Samples are/are not req'd. Fill Duration: 56 minutes		PRIMARY CABLE ROUTING (EVA, EVA 3)	ESPAD INSTALL (EVA, EVA 3)	
				MEAL				
20:00						MISSE 1 & 2 RETRIEVAL (EVA, EVA 3)		



# STS-114 LF1 (FD 09)

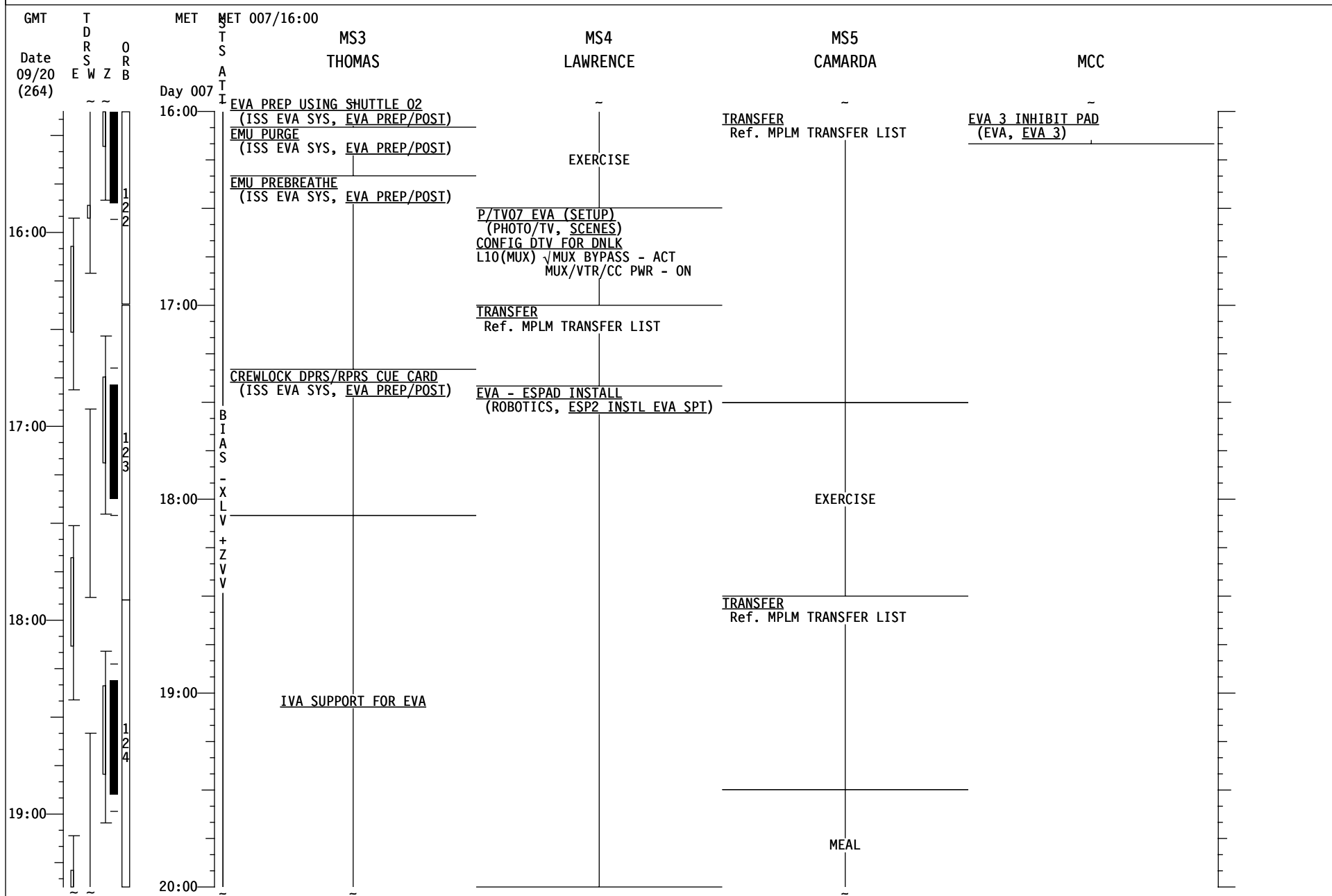

# STS-114 LF1 (FD 09)

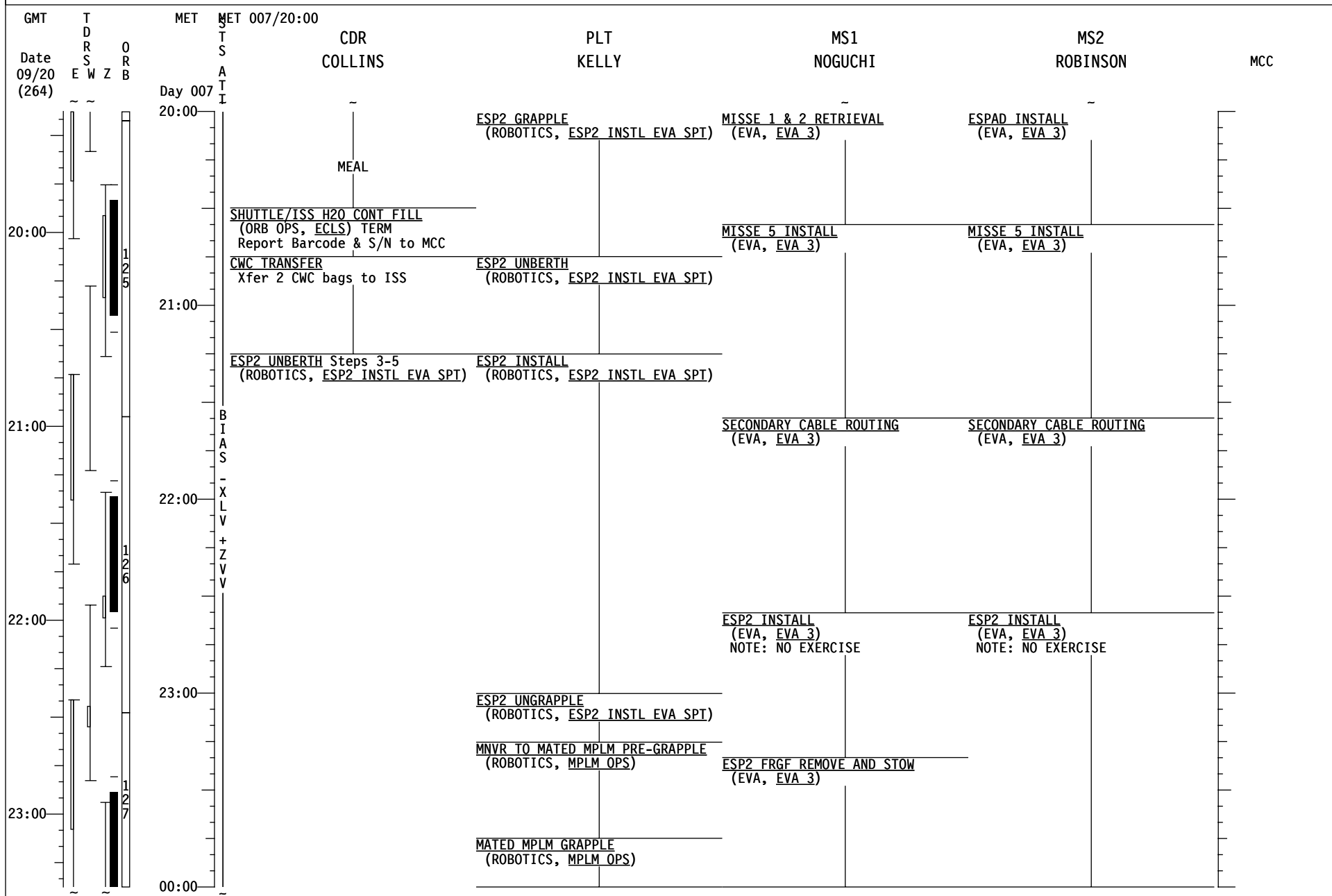

# STS-114 LF1 (FD 09)

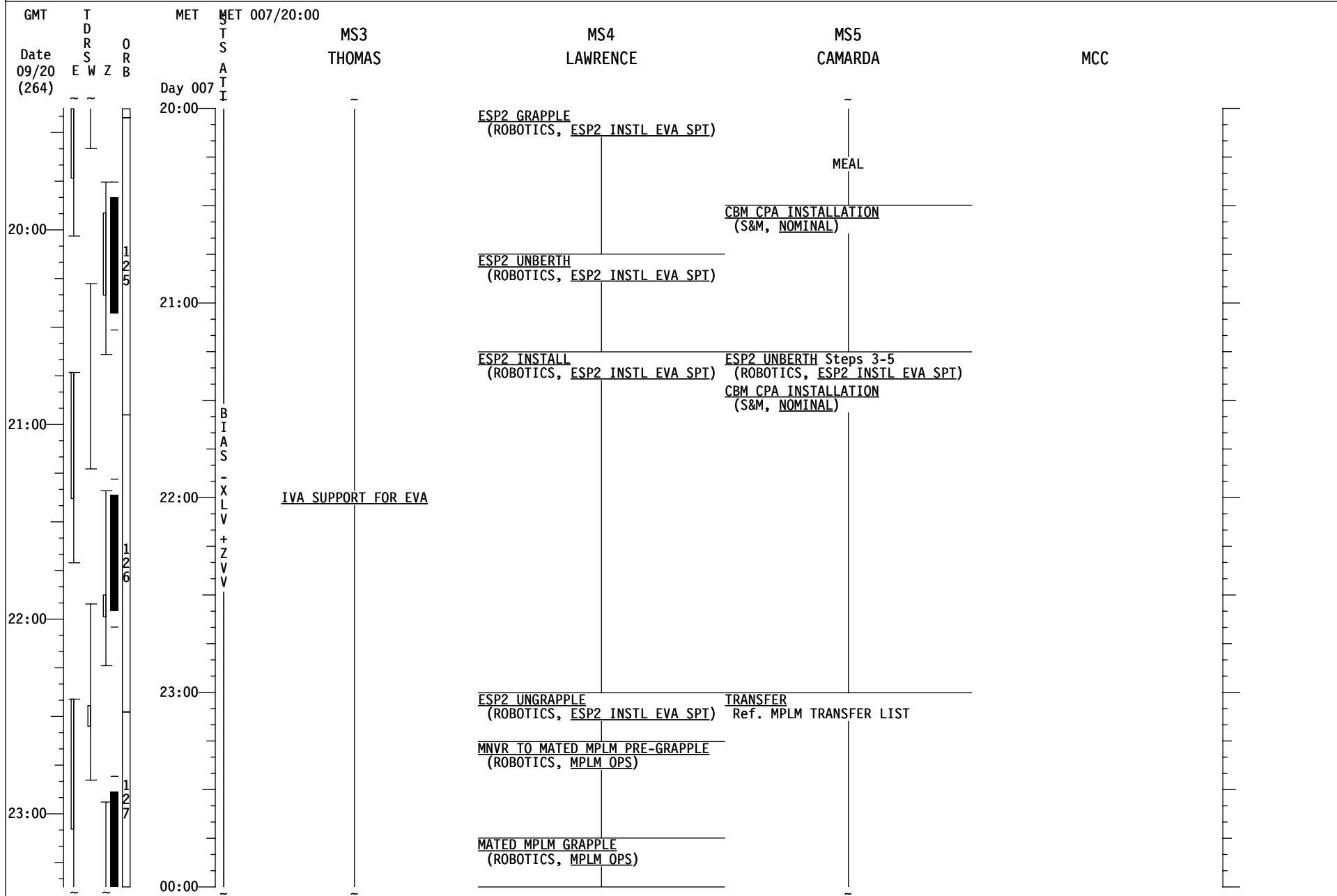

# STS-114 LF1 (FD 09)

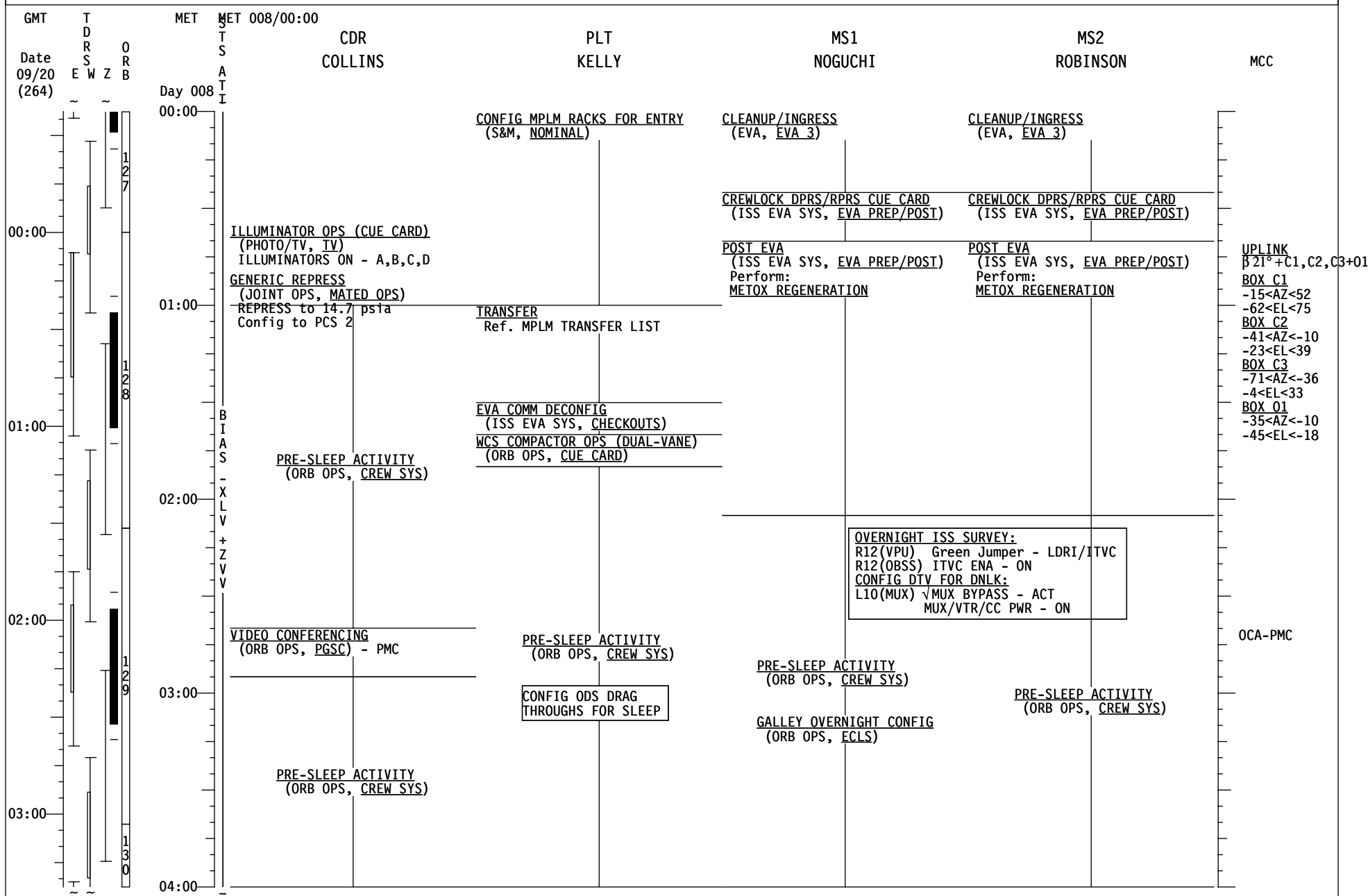

# STS-114 LF1 (FD 09)

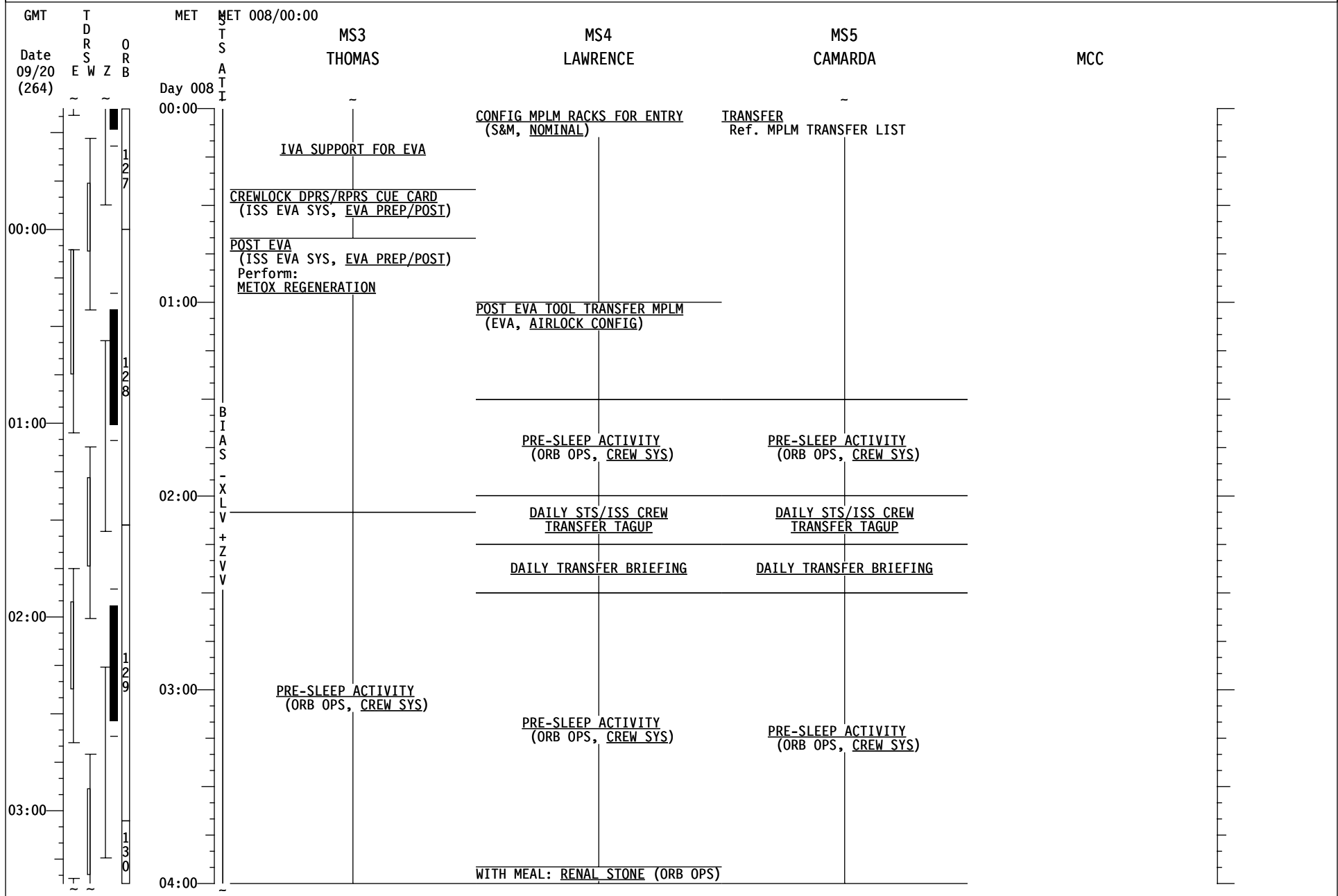

# STS-114 LF1 (FD 09)

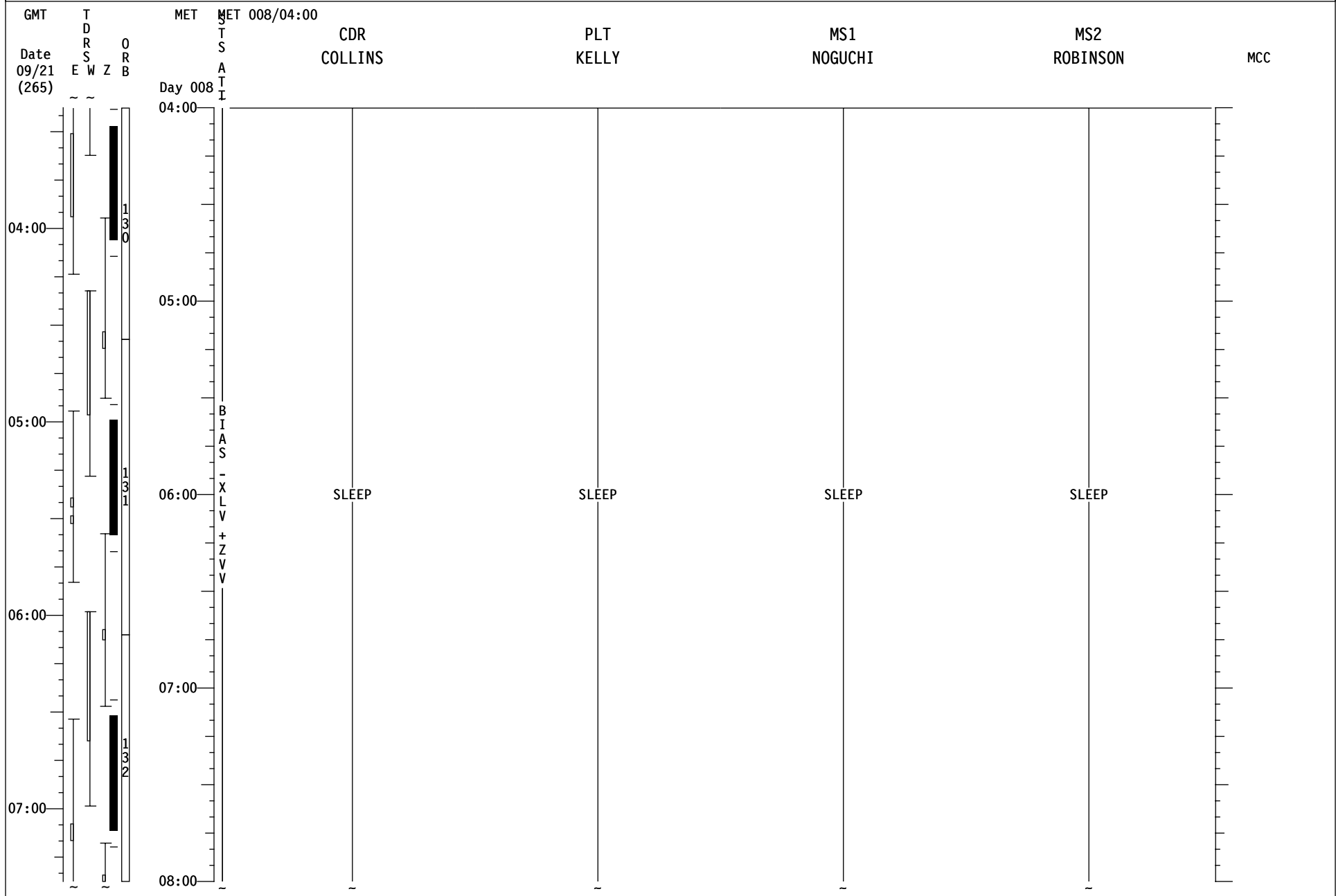

# STS-114 LF1 (FD 09)

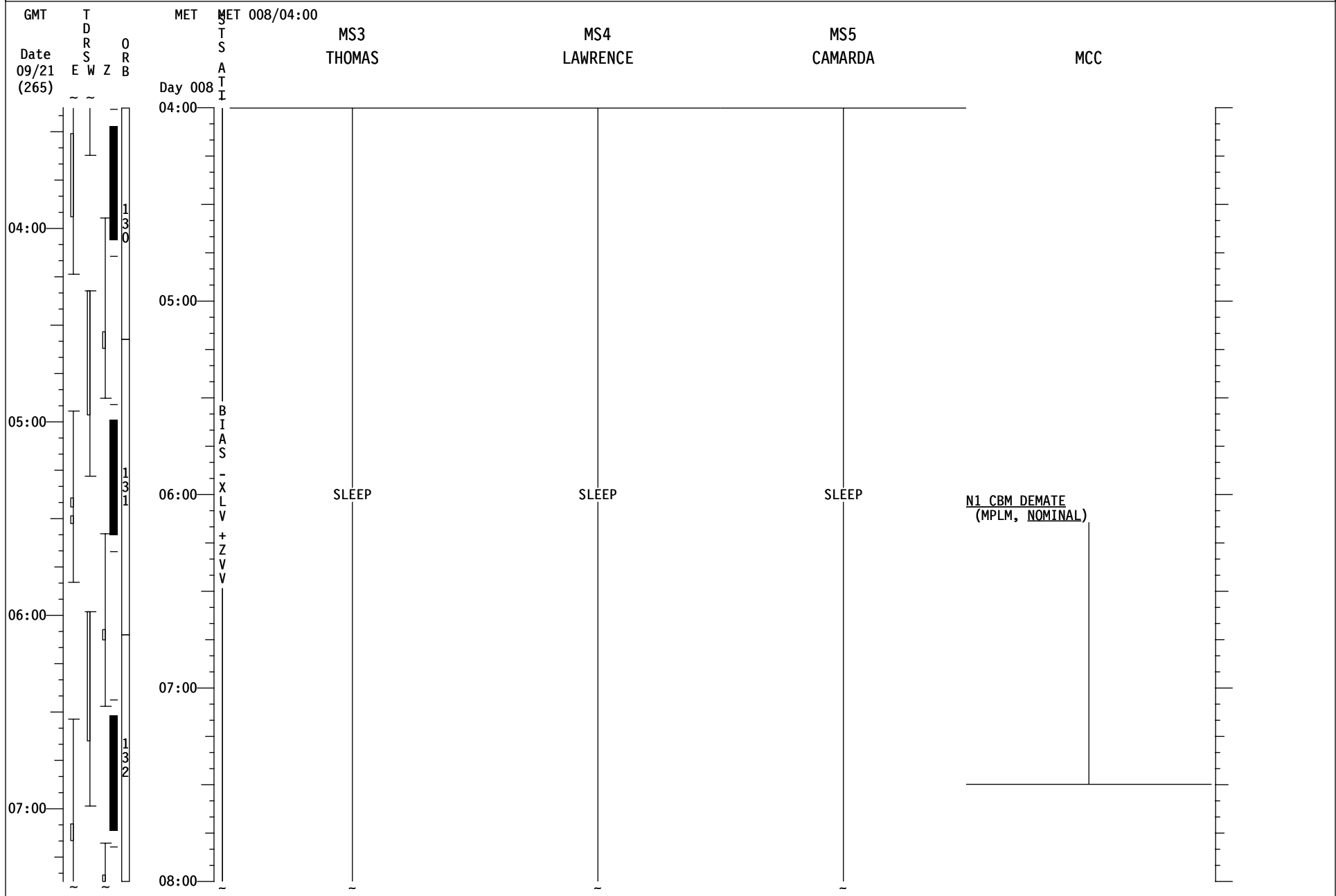

# STS-114 LF1 (FD 09)

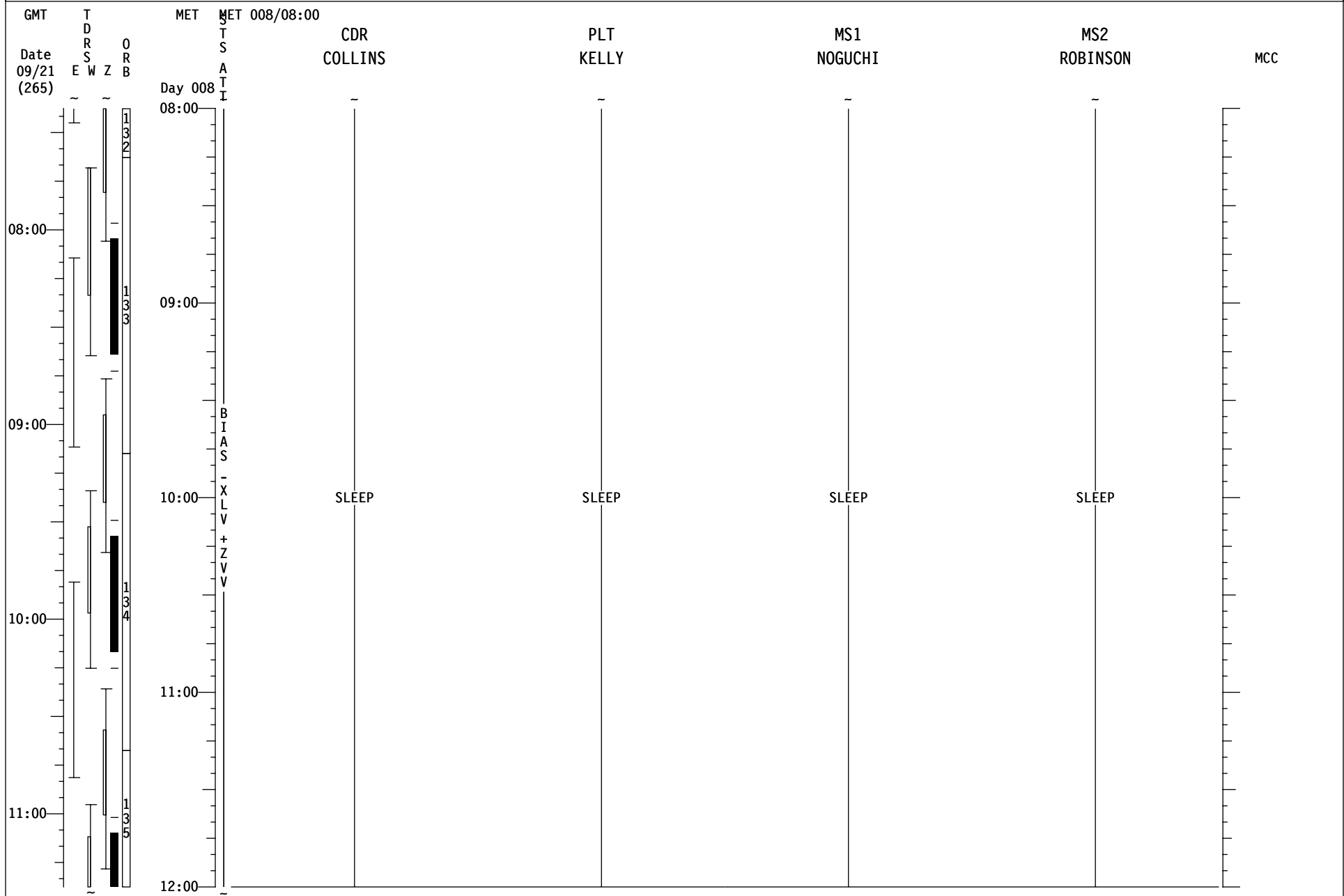



# STS-114 LF1 (FD 09)

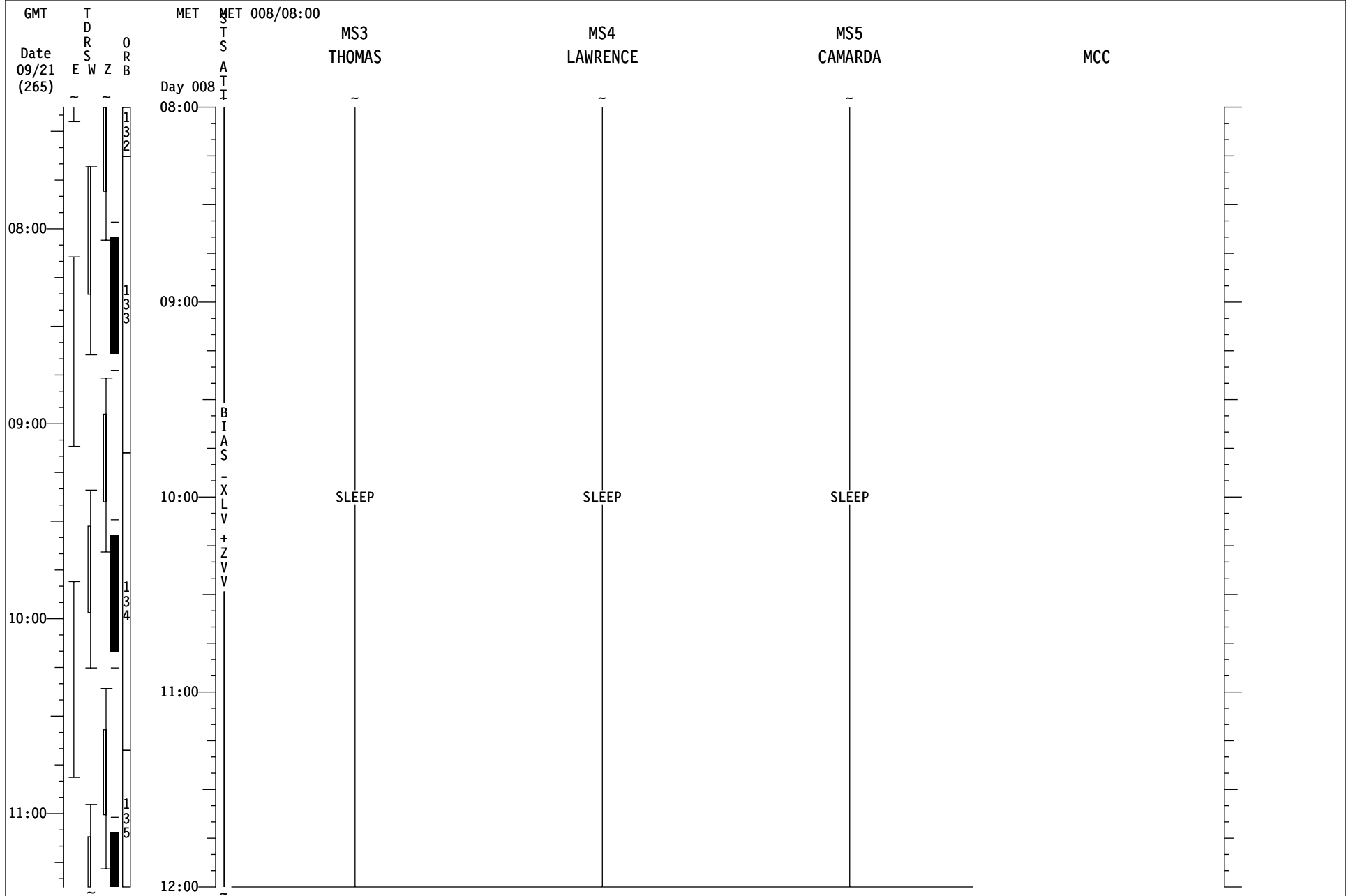

# STS-114 LF1 (FD 10)

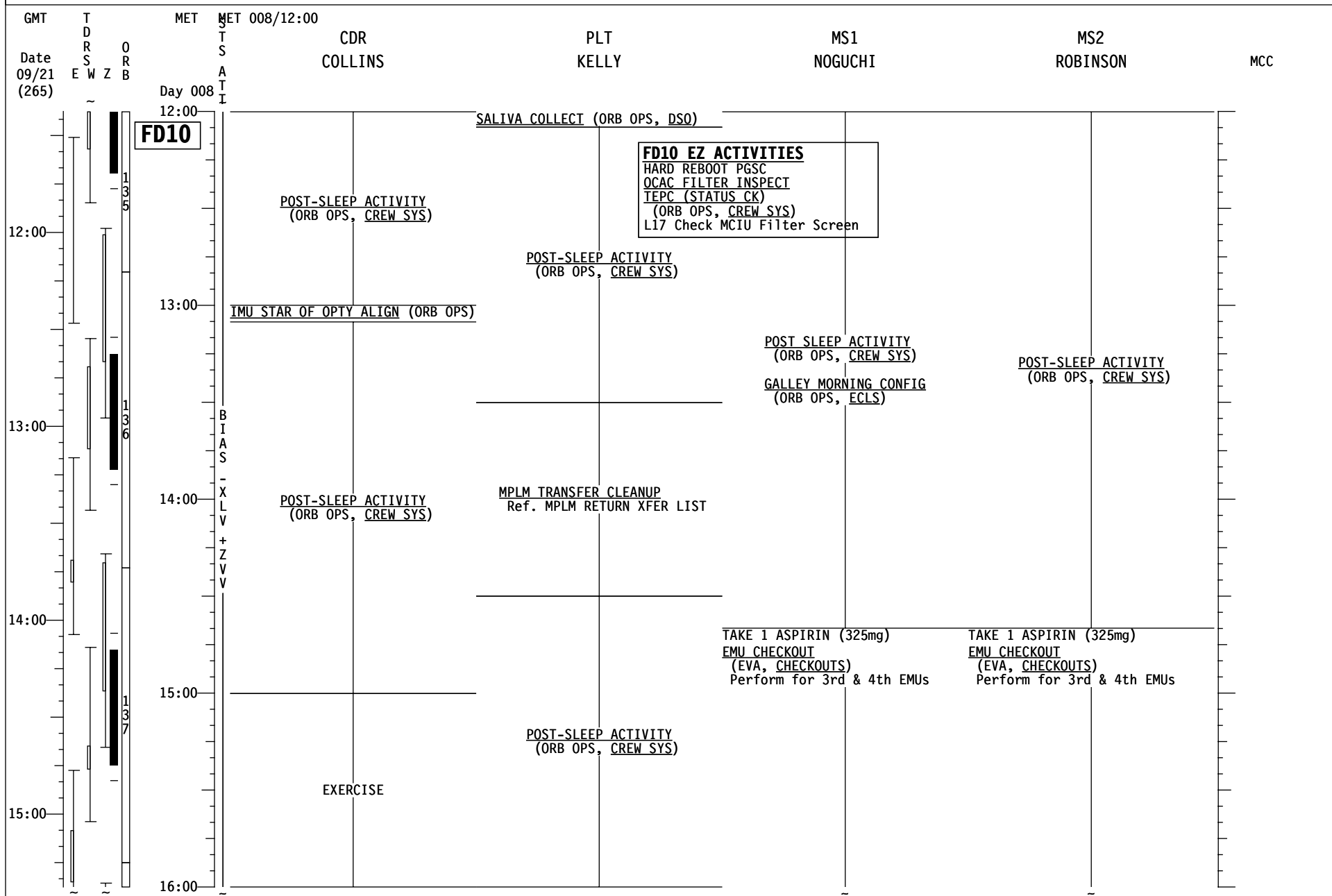

# STS-114 LF1 (FD 10)

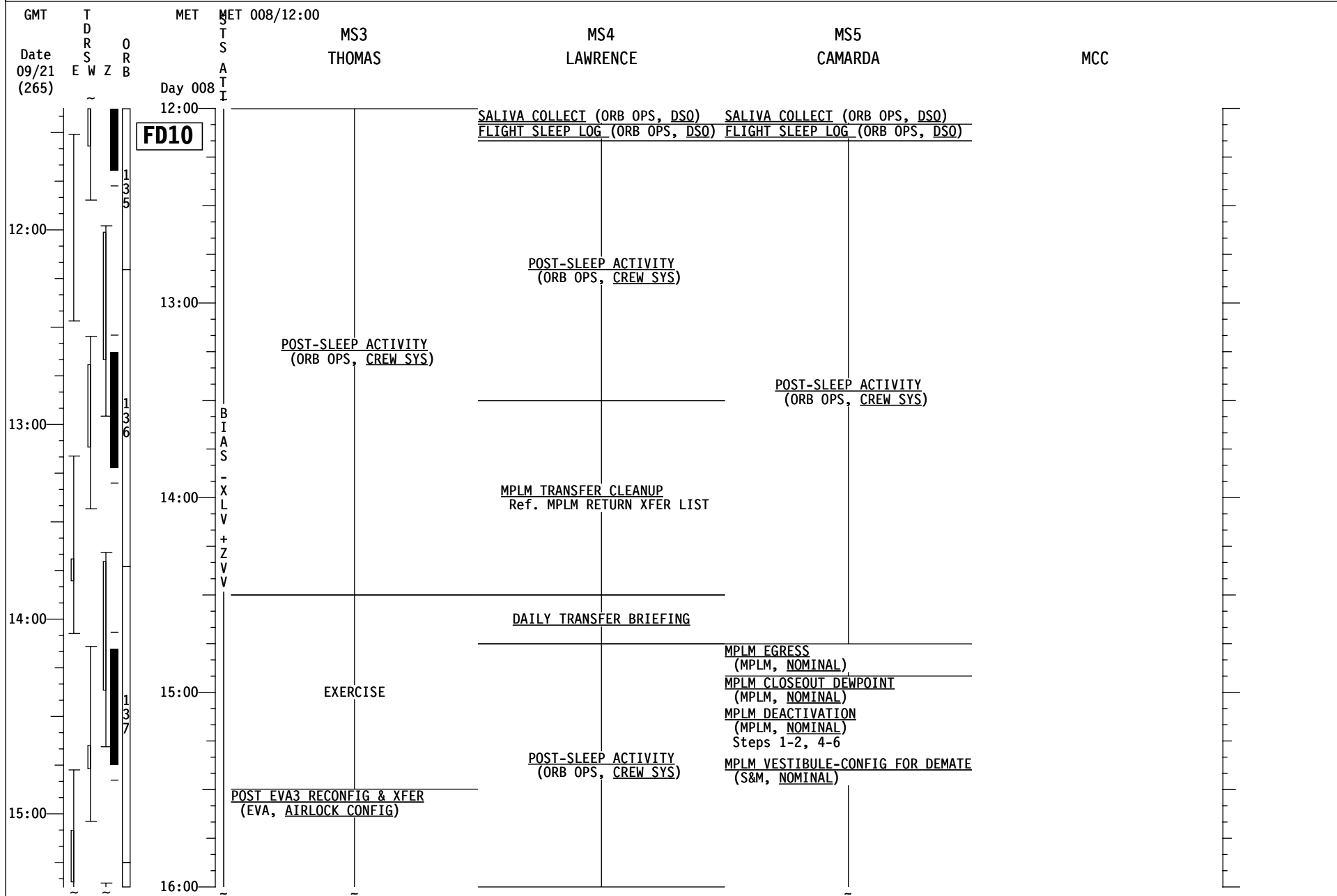

# STS-114 LF1 (FD 10)

GMT	T D R S O E W Z B	MET MET 008/16:00 Day 008	CDR COLLINS	PLT KELLY	MS1 NOGUCHI	MS2 ROBINSON	MCC
16:00				ILLUMINATOR OPS (CUE CARD) (PHOTO/TV, TV) ILLUMINATORS OFF - A,B,C,D	EMU CHECKOUT (EVA, CHECKOUTS) Perform for 3rd & 4th EMUs	EMU CHECKOUT (EVA, CHECKOUTS) Perform for 3rd & 4th EMUs	
				TRANSFER Ref. MDDK TRANSFER LIST	EMU TRANSFER TO ISS	EMU TRANSFER TO ISS	
16:00			SHUTTLE/ISS H2O CONT FILL (ORB OPS, ECLS) INIT #13 Minerals and/or Ag Biocide are req'd. Samples are/are not req'd. Fill Duration: 56 minutes DIGITAL PAO CC (PHOTO/TV, SONY PD100)		POST EVA3 RECONFIG & XFER (EVA, AIRLOCK CONFIG)	POST EVA3 RECONFIG & XFER (EVA, AIRLOCK CONFIG)	
			PUBLIC AFFAIRS EVENT KU AVAIL TDRS XX:XX-XX:XX REF MSG ###	PUBLIC AFFAIRS EVENT KU AVAIL TDRS XX:XX-XX:XX REF MSG ###			
17:00							
			SHUTTLE/ISS H2O CONT FILL (ORB OPS, ECLS) TERM Report Barcode & S/N to MCC	EXERCISE			
			PWR FILL (ORB OPS, ECLS)				
18:00					METOX REGENERATION TERM (ISS EVA SYS, EMU MAINT)		
			PWR FILL (ORB OPS, ECLS)	TRANSFER Ref. MDDK TRANSFER LIST	EVA TOOL STOW (EVA, AIRLOCK CONFIG)	EVA TOOL STOW (EVA, AIRLOCK CONFIG)	
19:00			PWR FILL (ORB OPS, ECLS)				
			SHUTTLE/ISS H2O CONT FILL (ORB OPS, ECLS) INIT #14 Minerals and/or Ag Biocide are req'd. Samples are/are not req'd. Fill Duration: 56 minutes	MEAL	NODE 1 CBM DEMATE (S&M, NOMINAL) NOTE : NO Exercise	NODE 1 CBM DEMATE (S&M, NOMINAL) NOTE : NO Exercise	UPLINK β 21° +C1,C2,C3+D1 BOX C1 -15<AZ<52 -62<EL<75 BOX C2 -41<AZ<-10 -23<EL<39 BOX C3 -71<AZ<-36 -4<EL<33 BOX D1 -41<AZ<8 -88<EL<-9
20:00							

# STS-114 LF1 (FD 10)

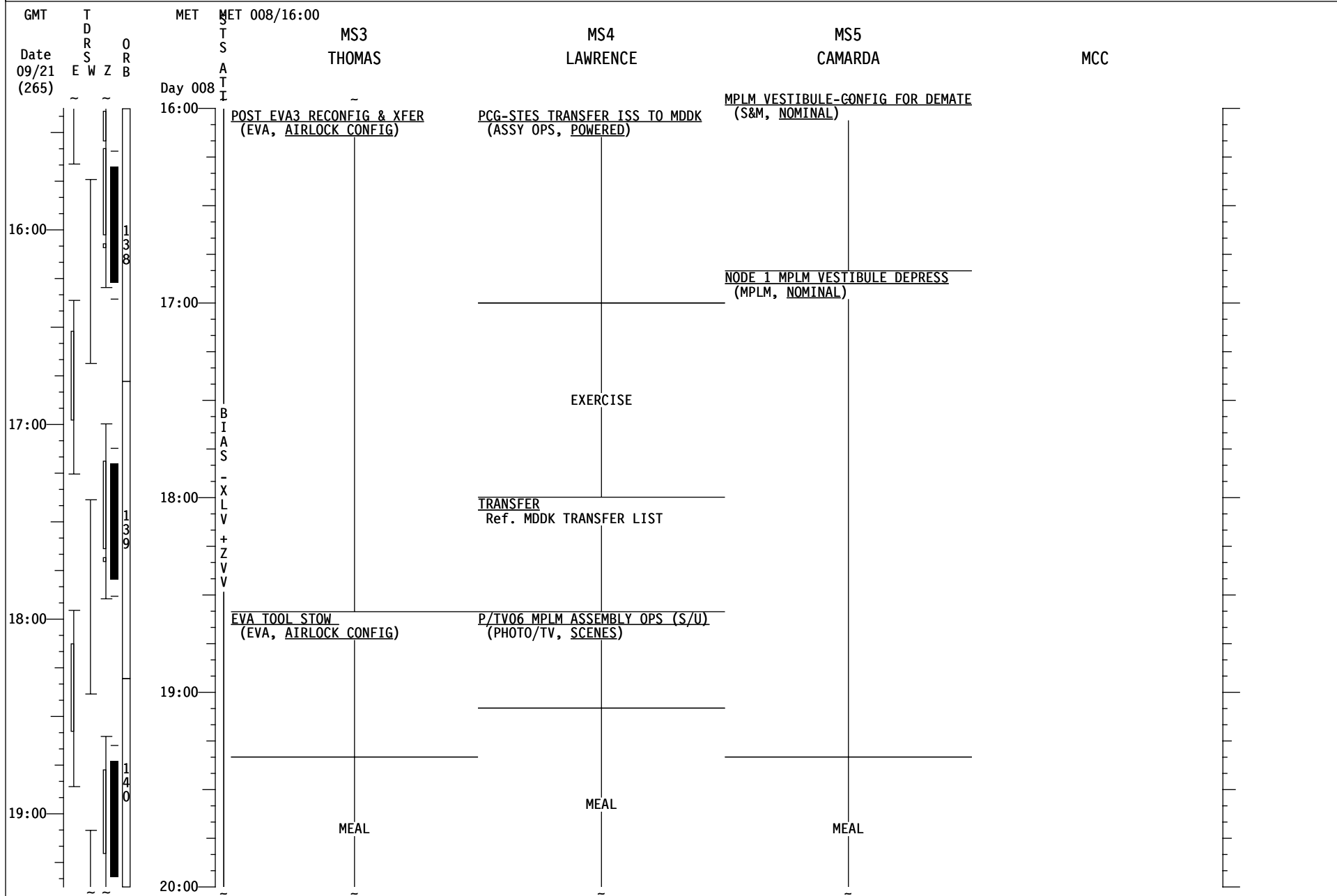

# STS-114 LF1 (FD 10)

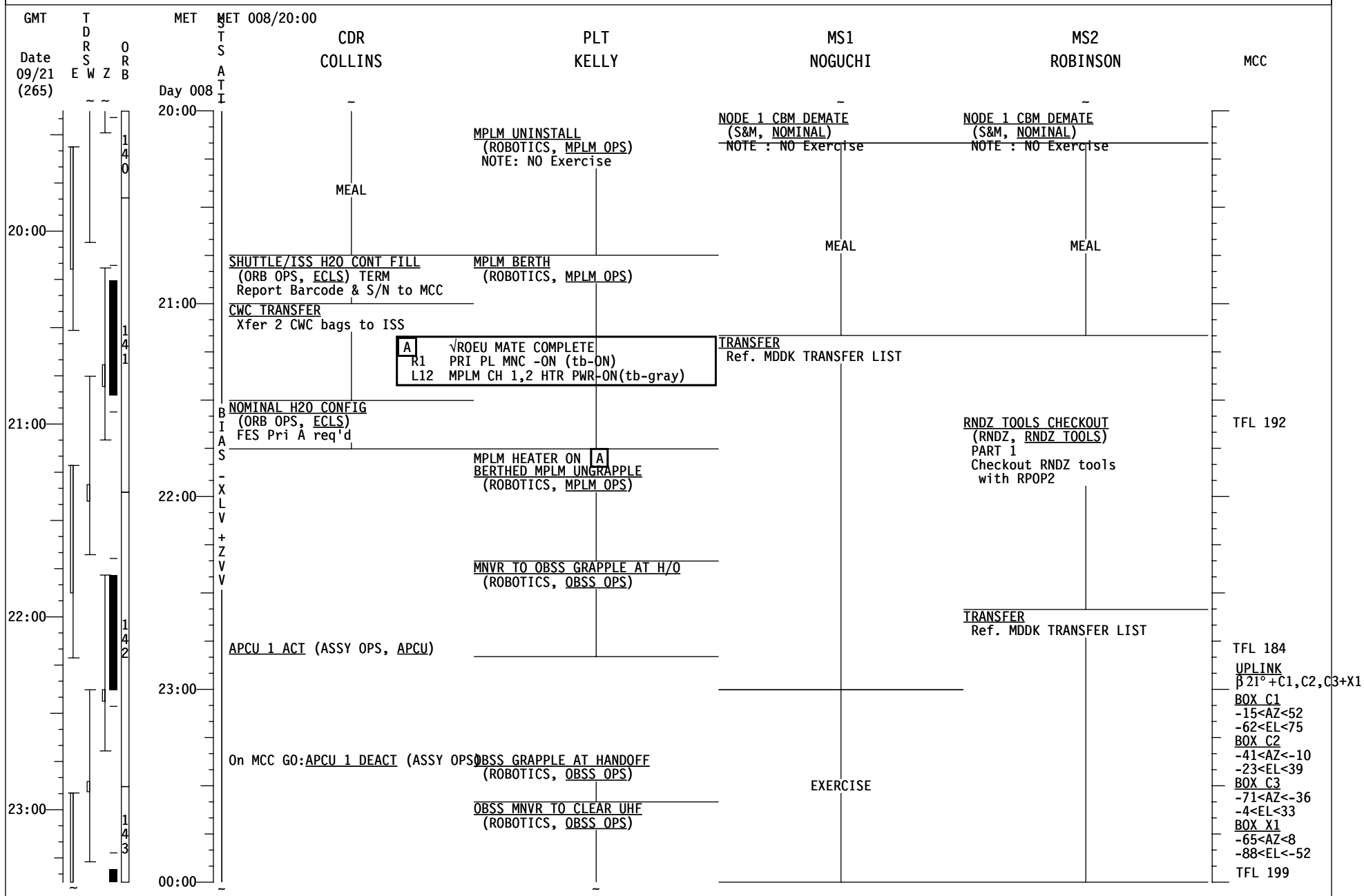

# STS-114 LF1 (FD 10)

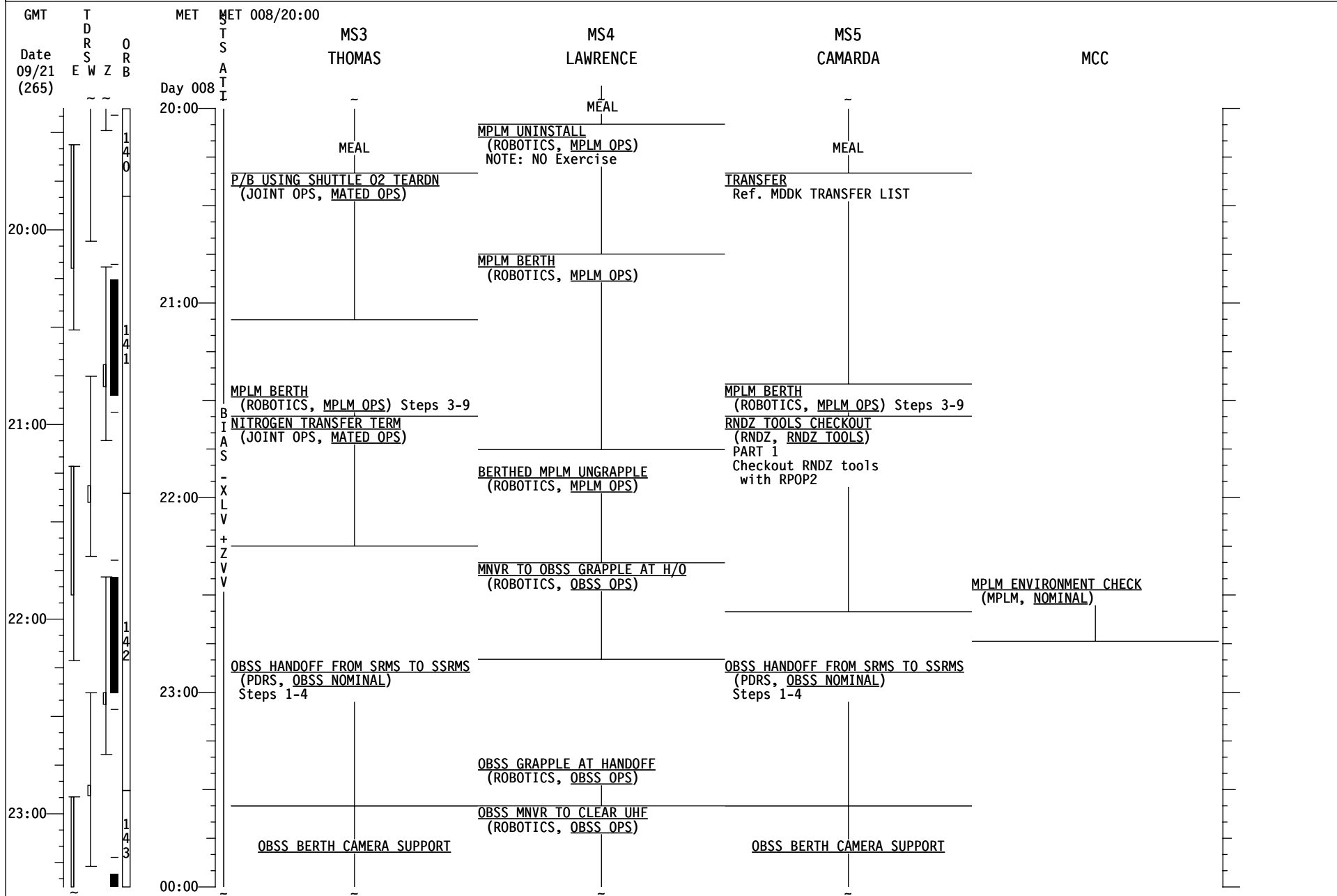

# STS-114 LF1 (FD 10)

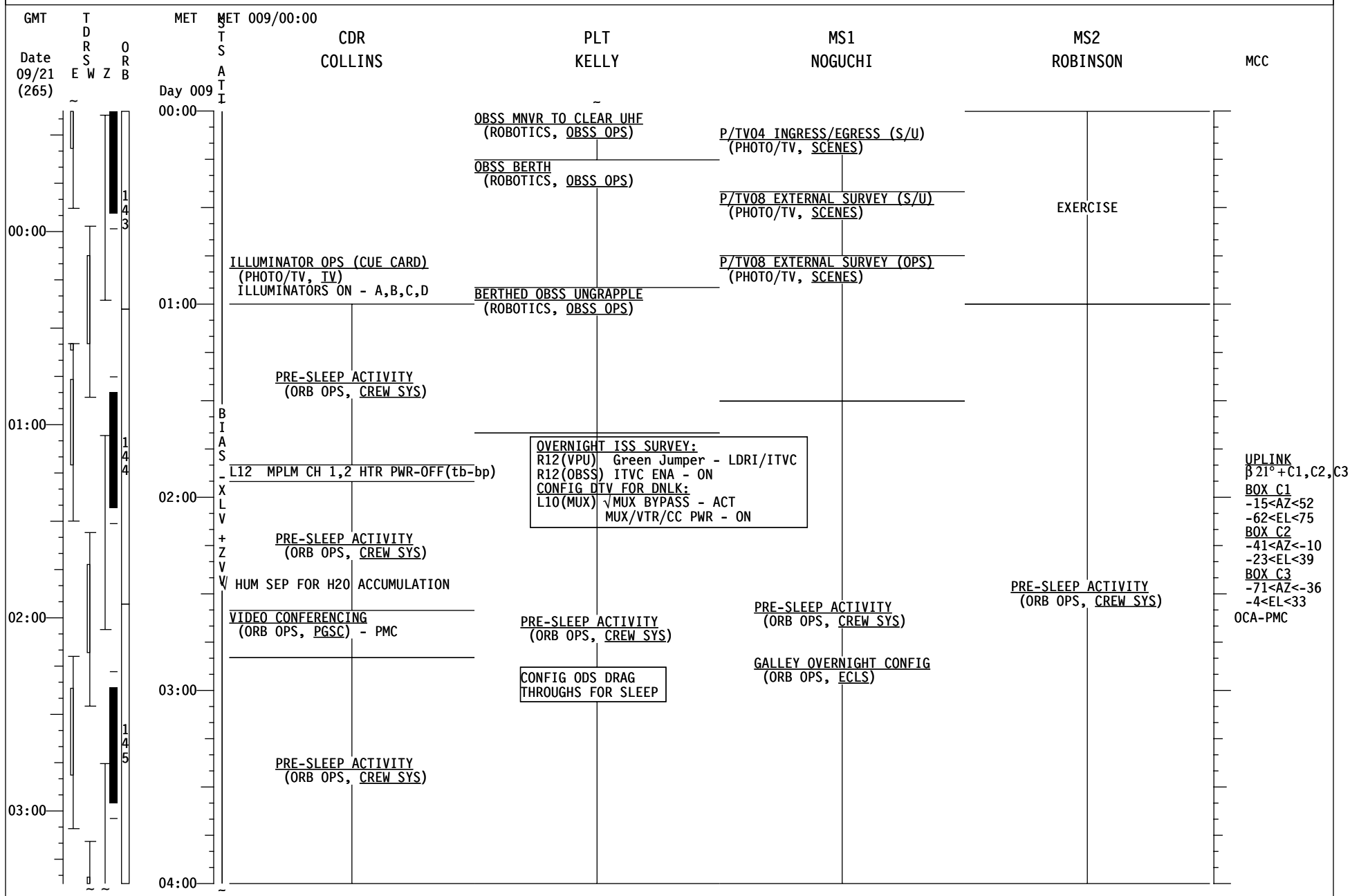

UPLINK  
β 21° + C1, C2, C3  
BOX C1  
-15<AZ<52  
-62<EL<75  
BOX C2  
-41<AZ<-10  
-23<EL<39  
BOX C3  
-71<AZ<-36  
-4<EL<33  
OCA-PMC



# STS-114 LF1 (FD 10)

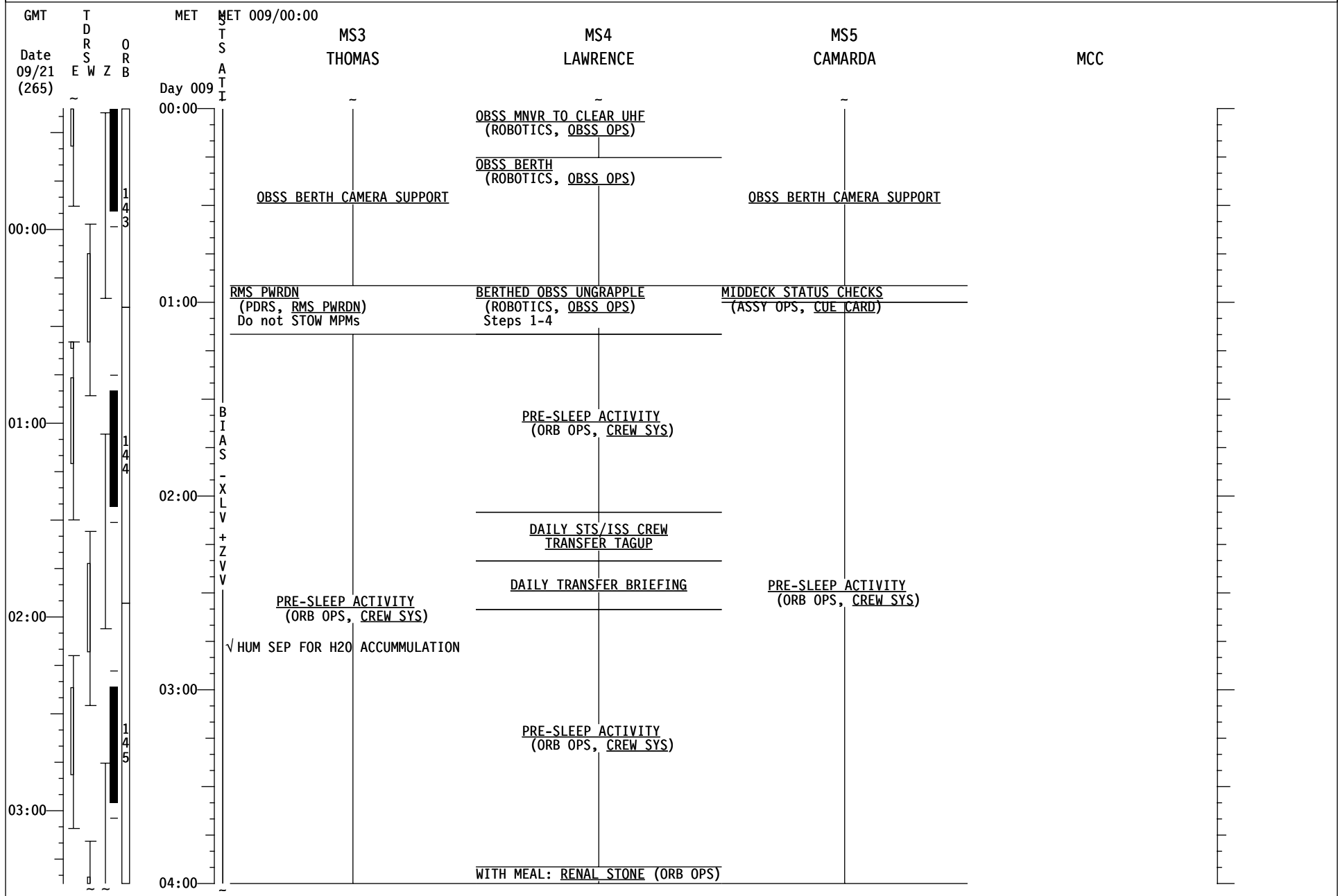

# STS-114 LF1 (FD 10)

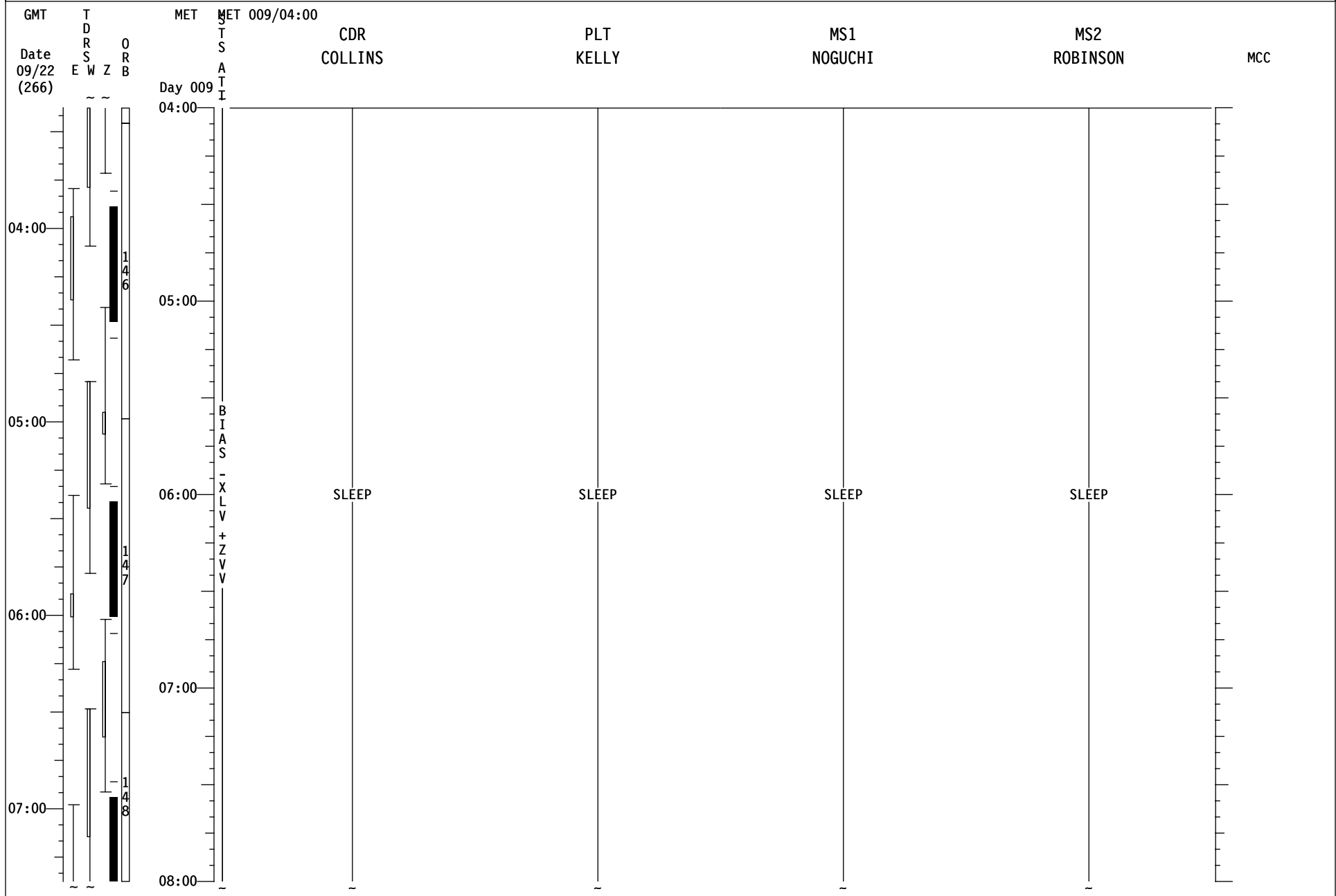

# STS-114 LF1 (FD 10)

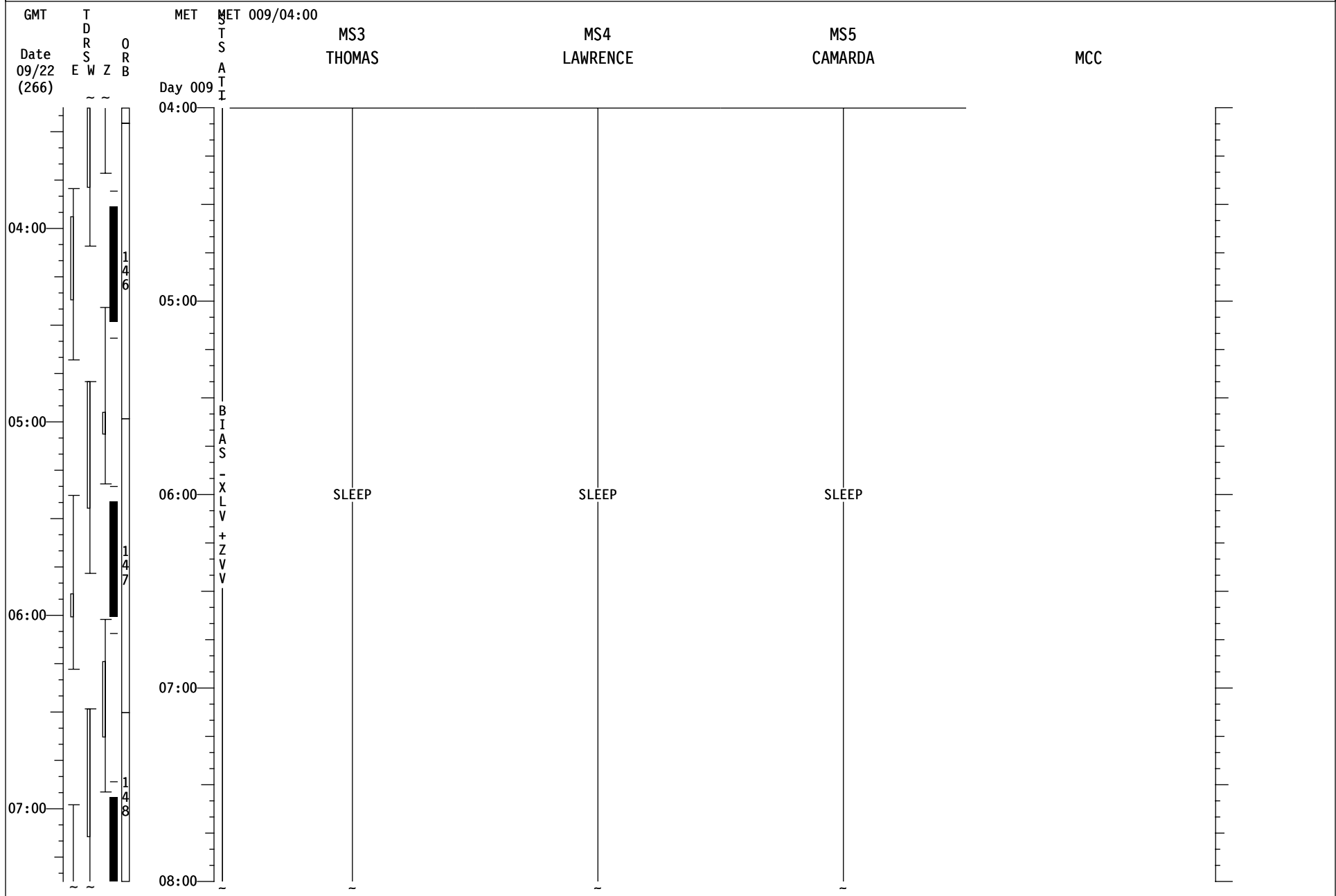

# STS-114 LF1 (FD 10)

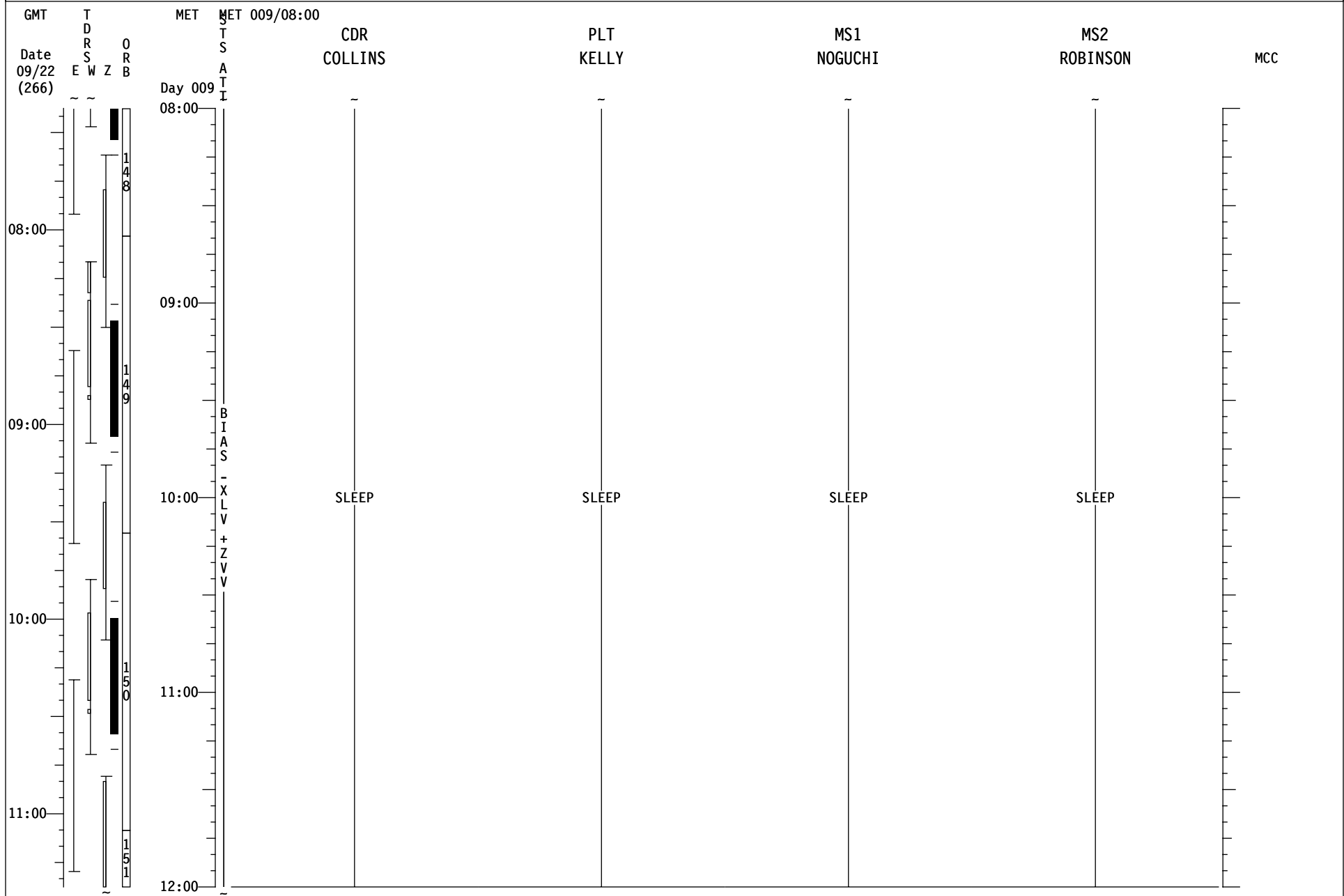

# STS-114 LF1 (FD 10)

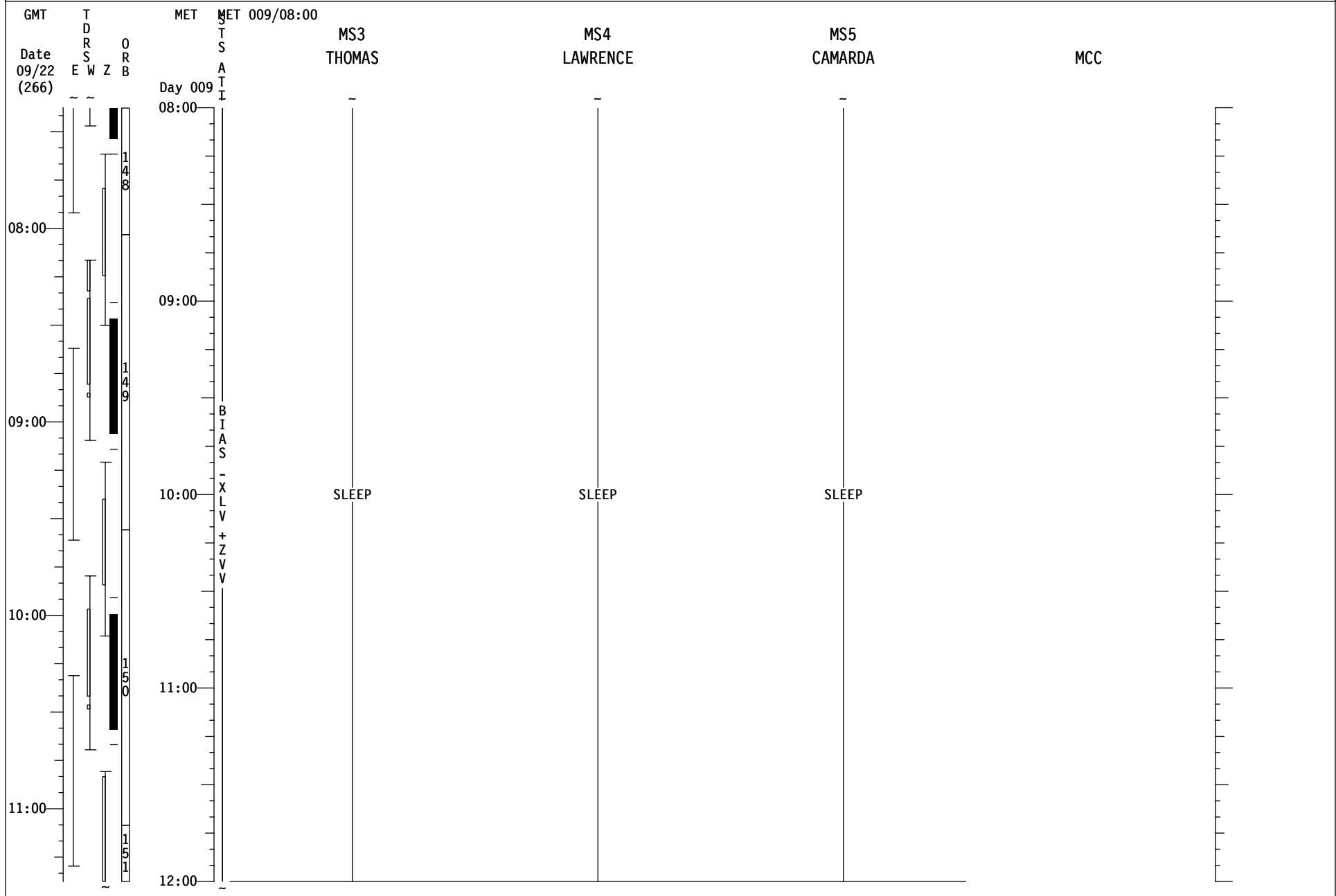

# STS-114 LF1 (FD 11)

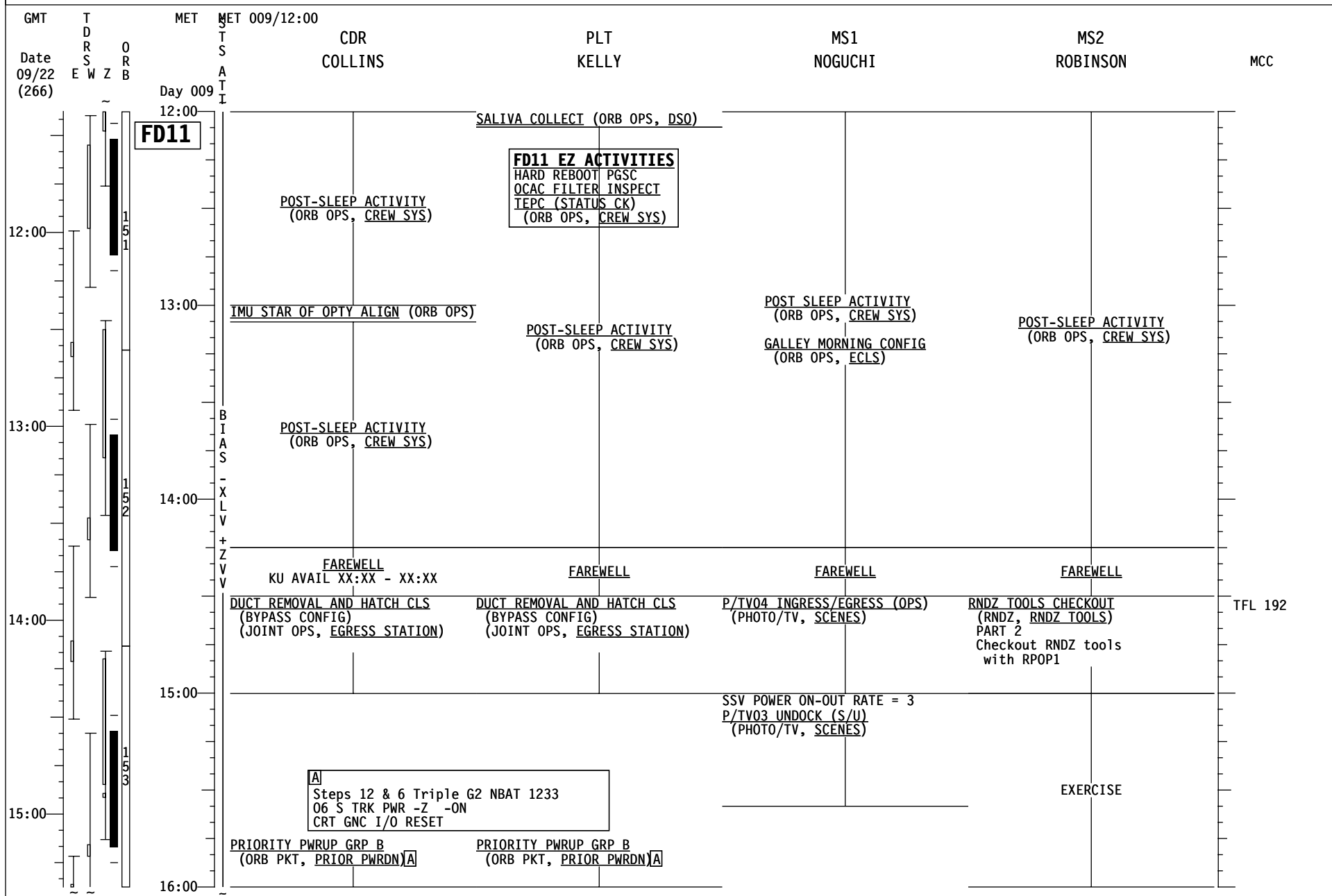

# STS-114 LF1 (FD 11)

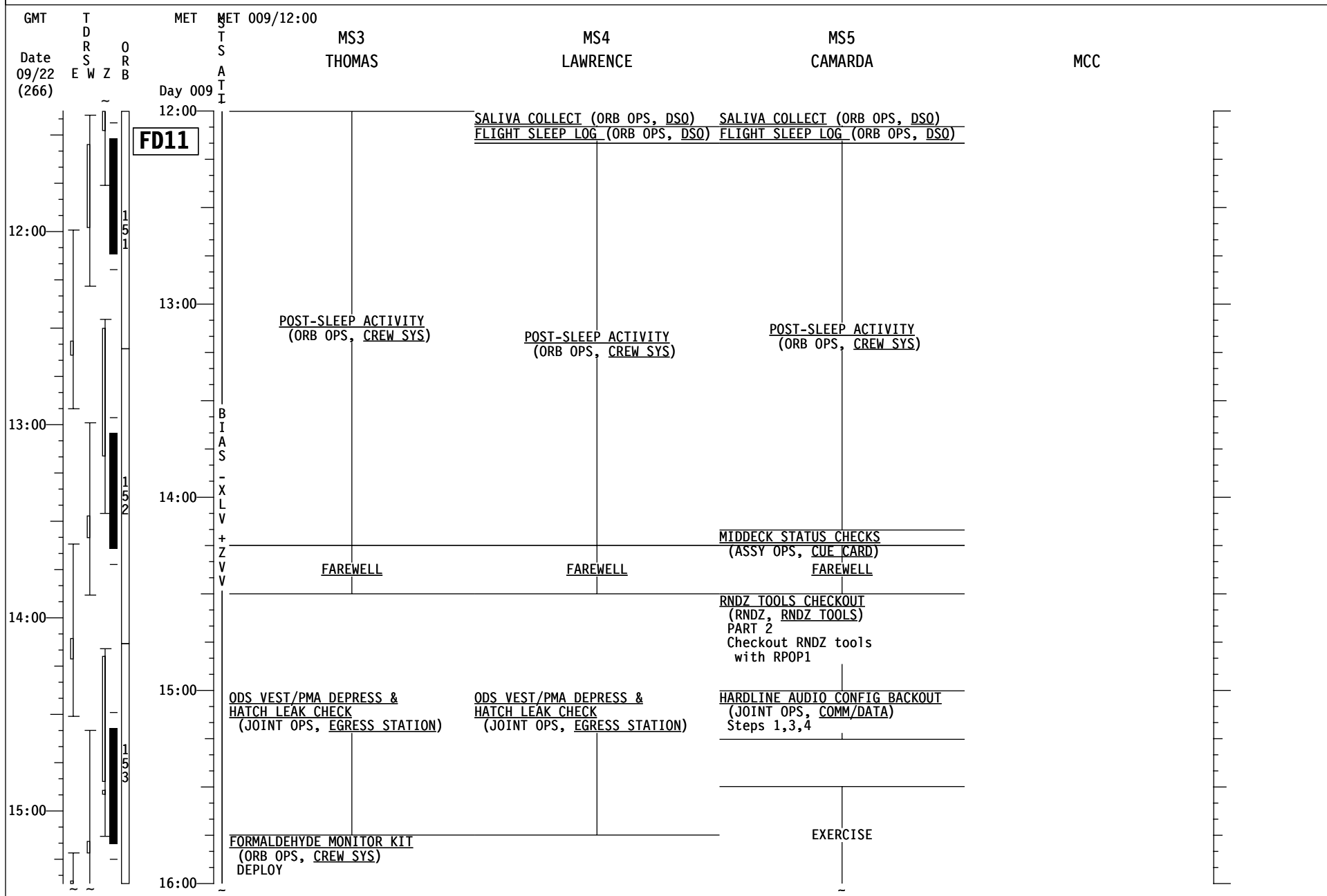

# STS-114 LF1 (FD 11)

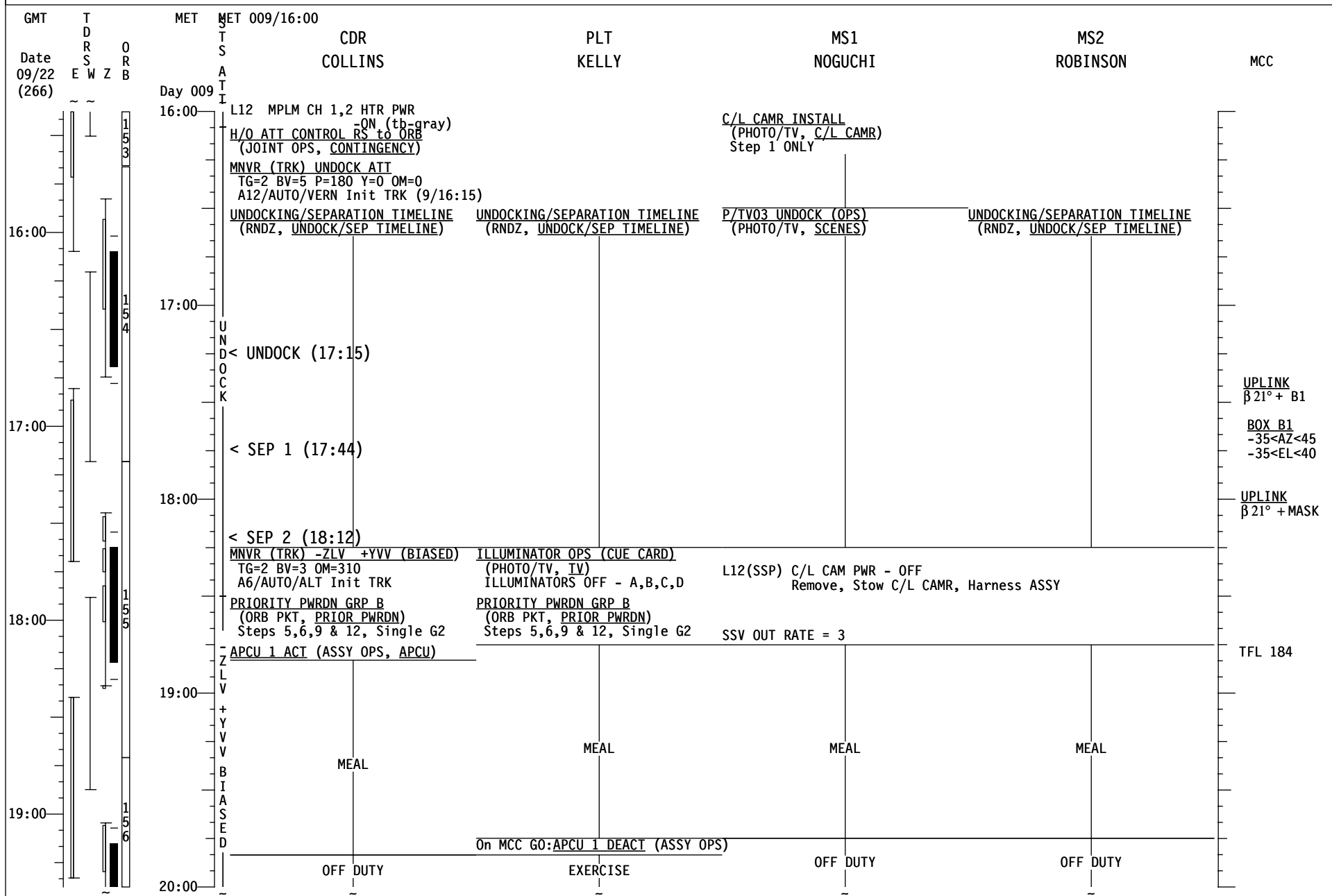



# STS-114 LF1 (FD 11)

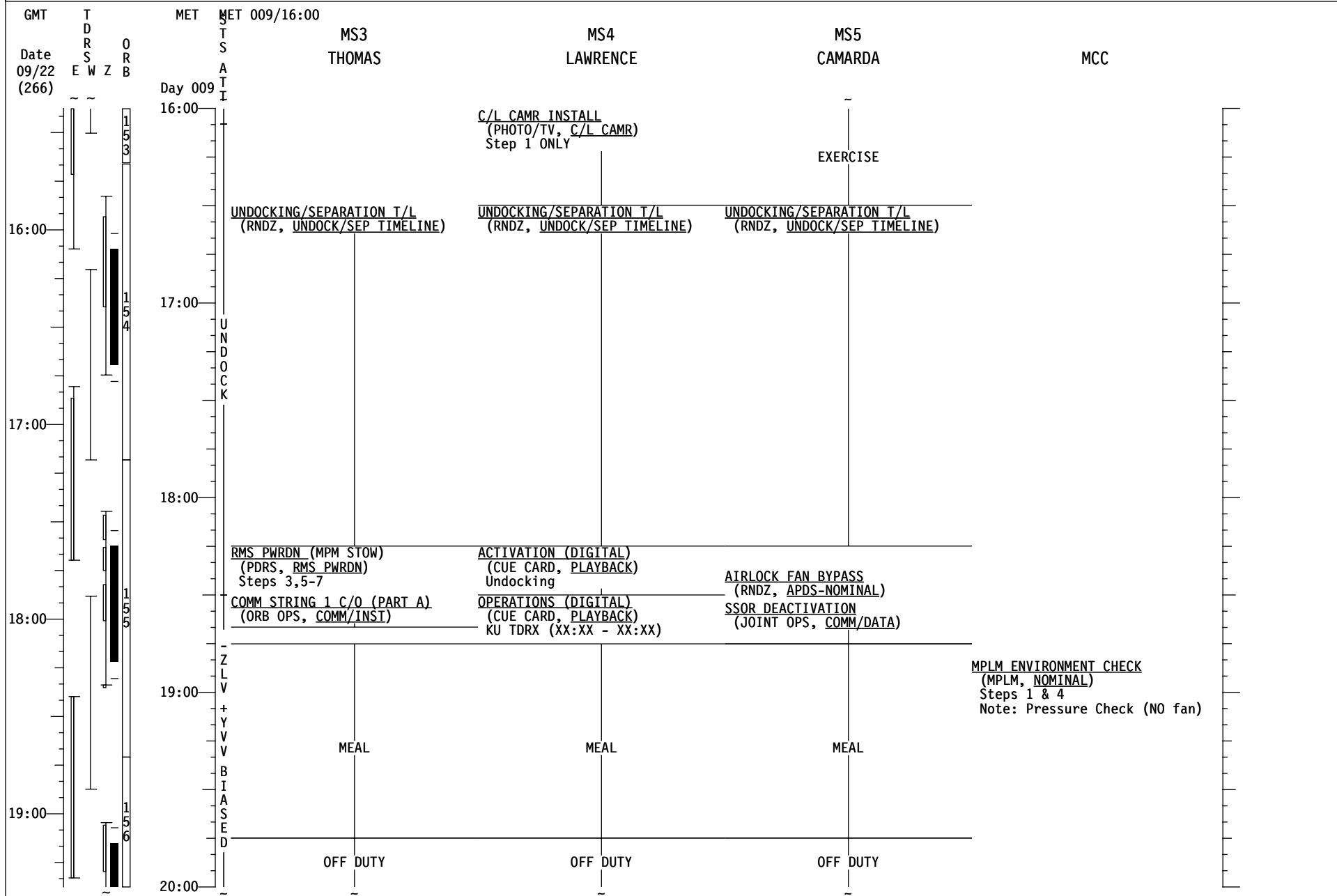

# STS-114 LF1 (FD11)

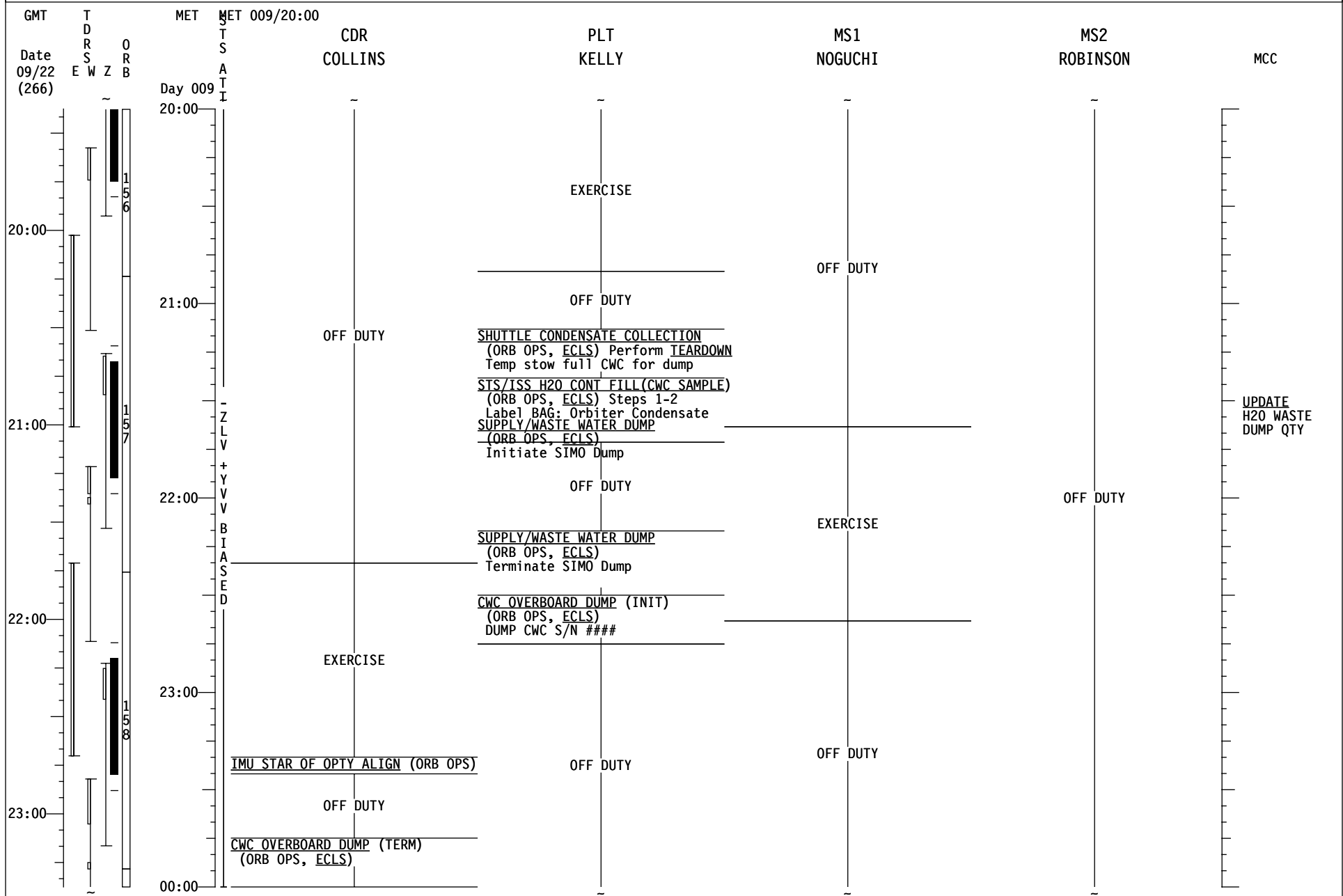

# STS-114 LF1 (FD 11)

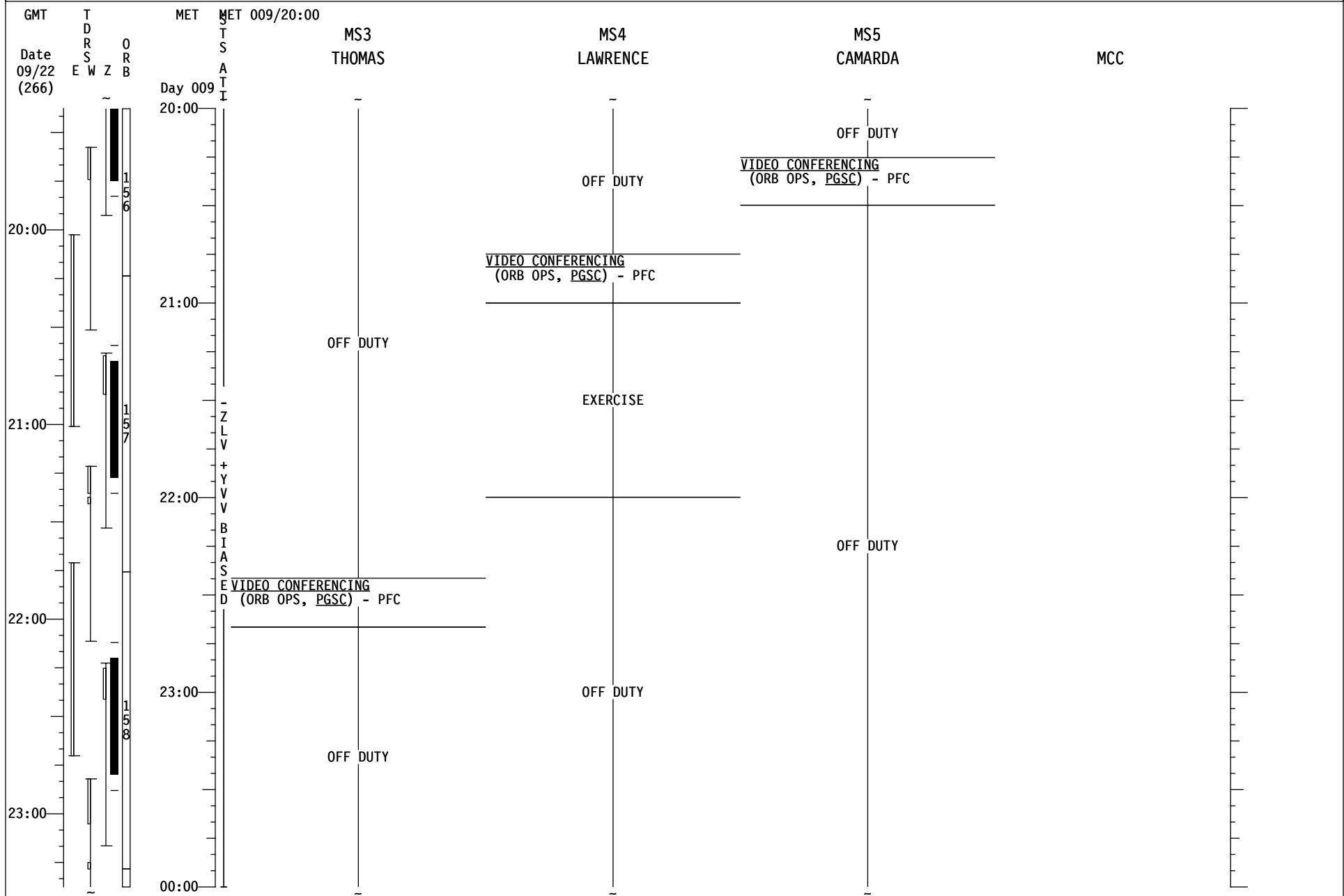

# STS-114 LF1 (FD11)

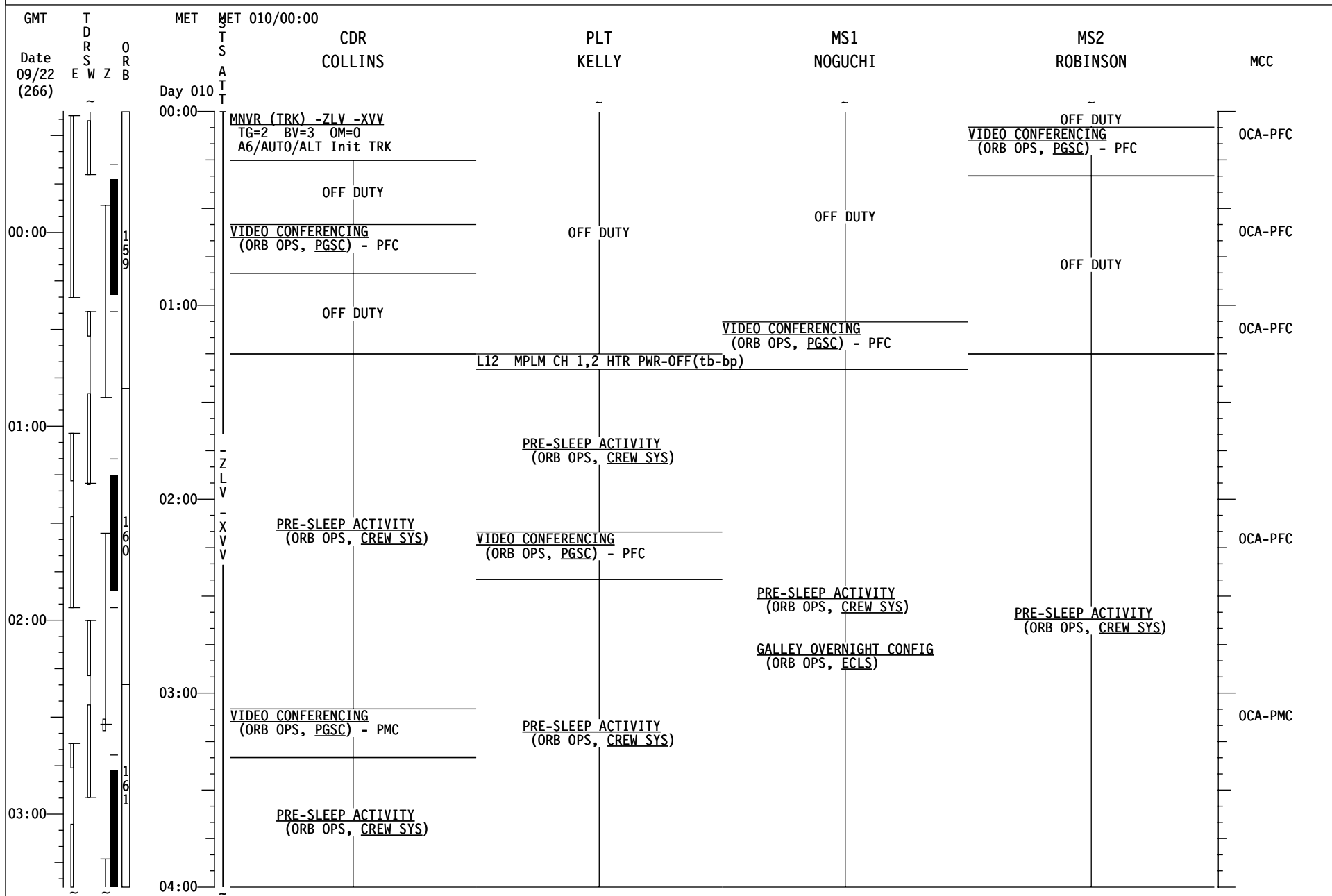

# STS-114 LF1 (FD 11)

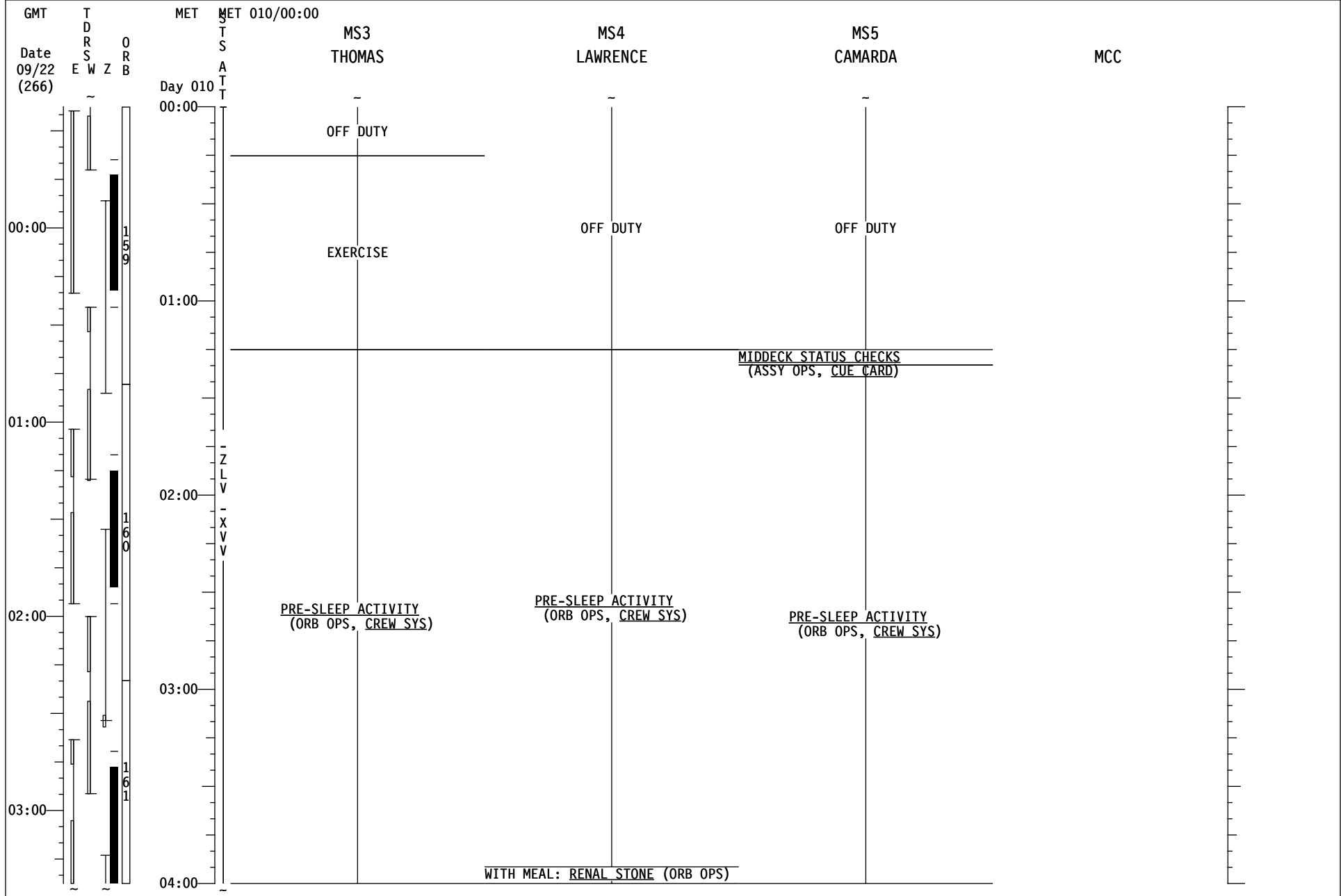

# STS-114 LF1 (FD 11)

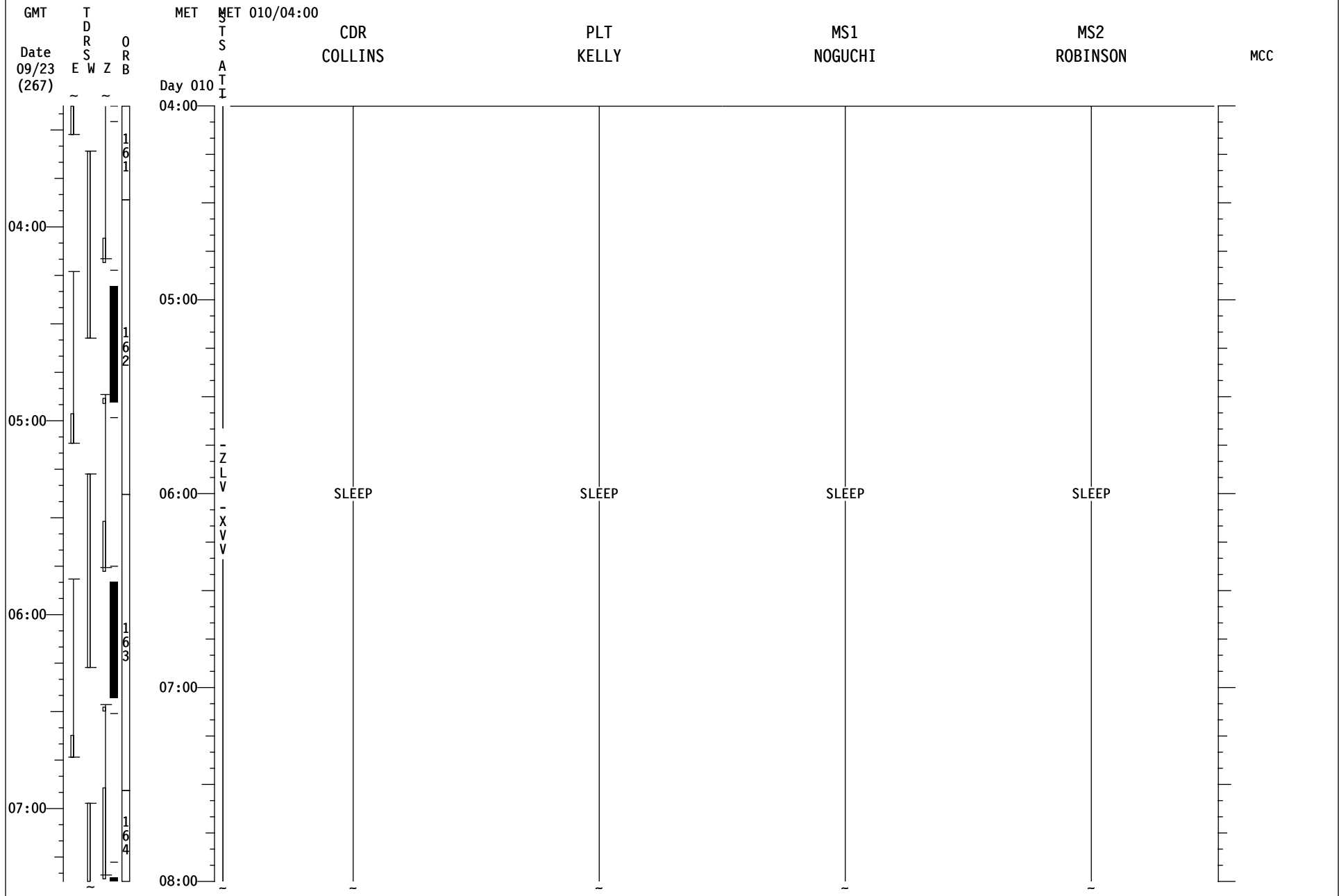

# STS-114 LF1 (FD 11)

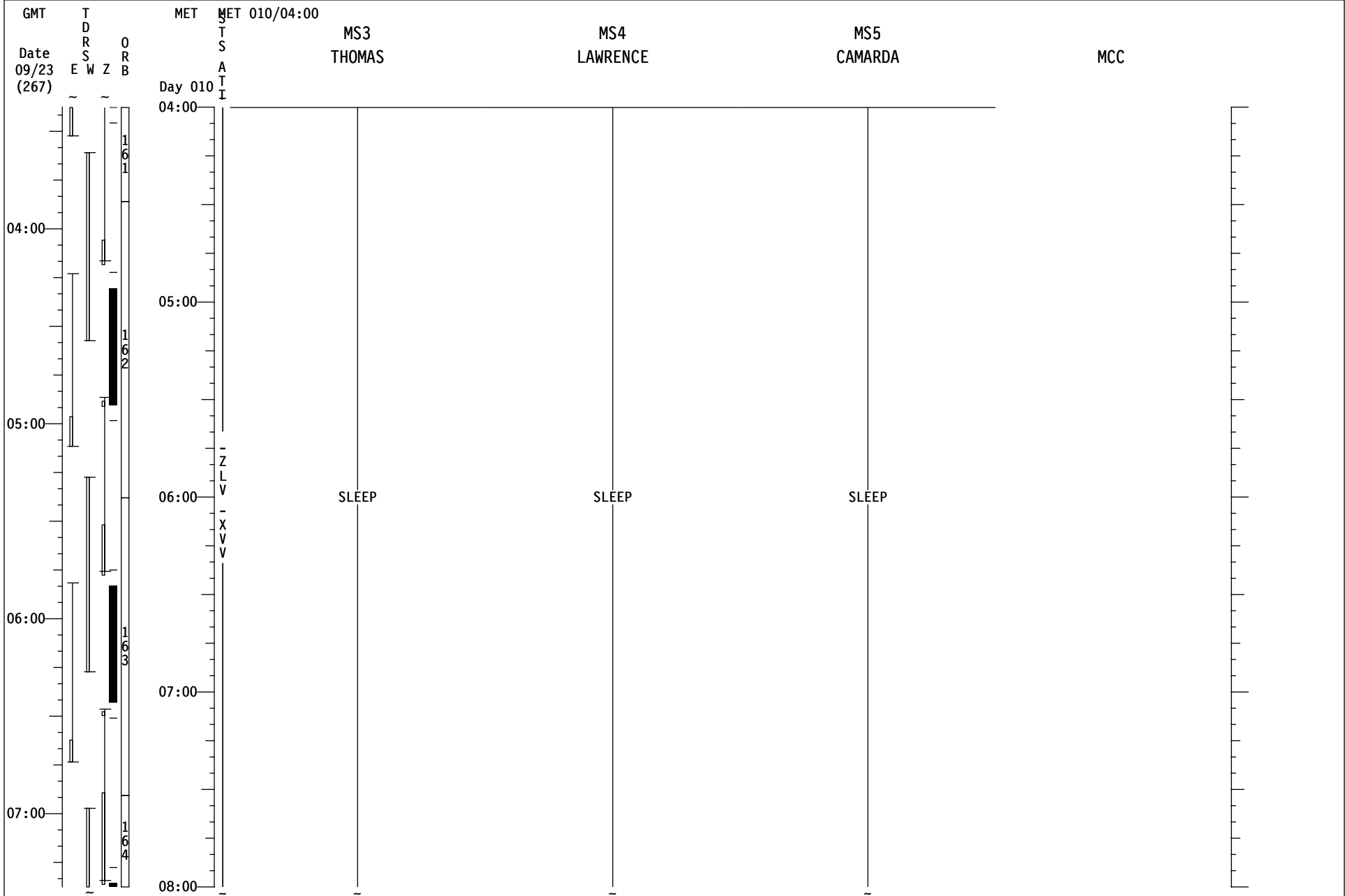

# STS-114 LF1 (FD11)

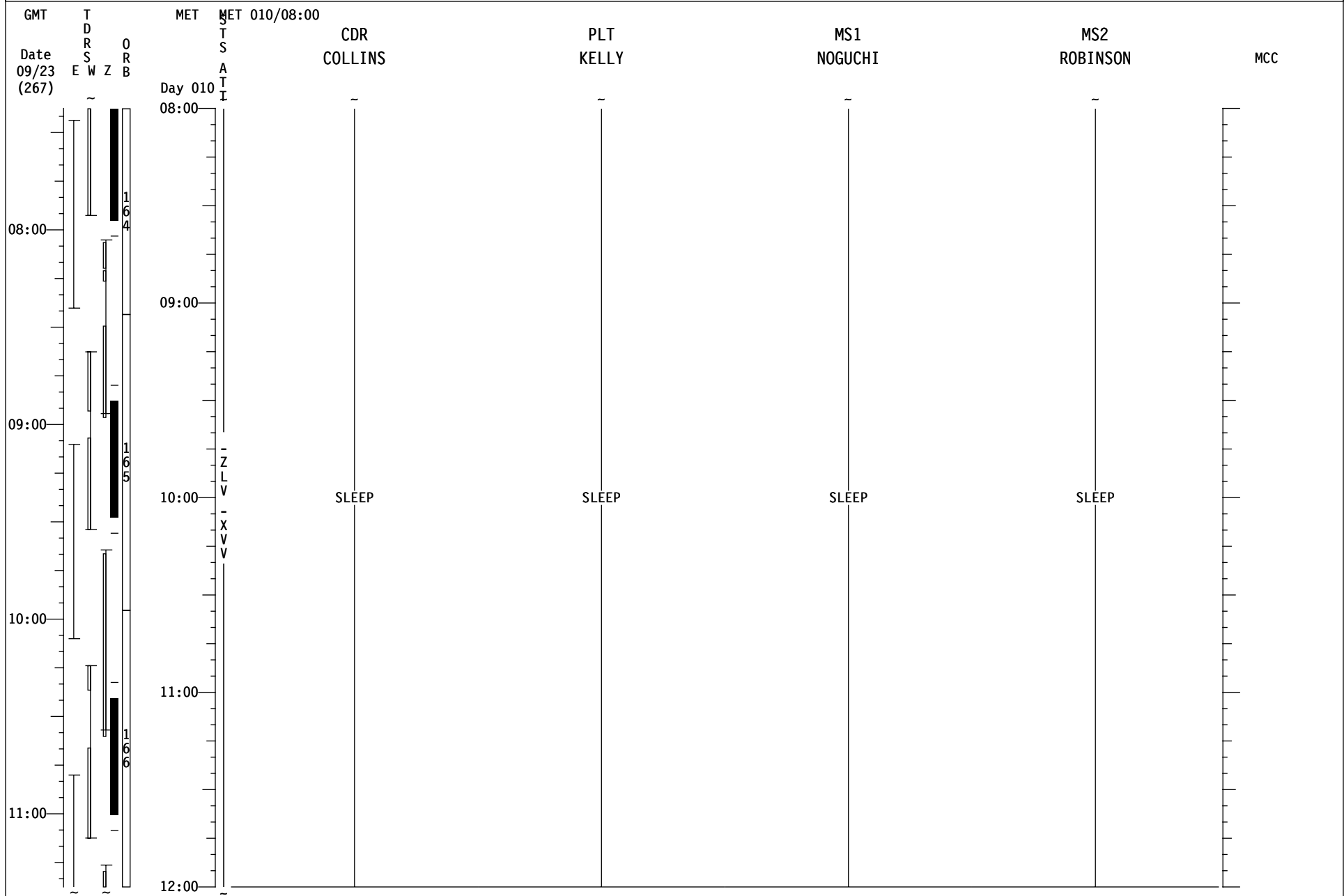



# STS-114 LF1 (FD 11)

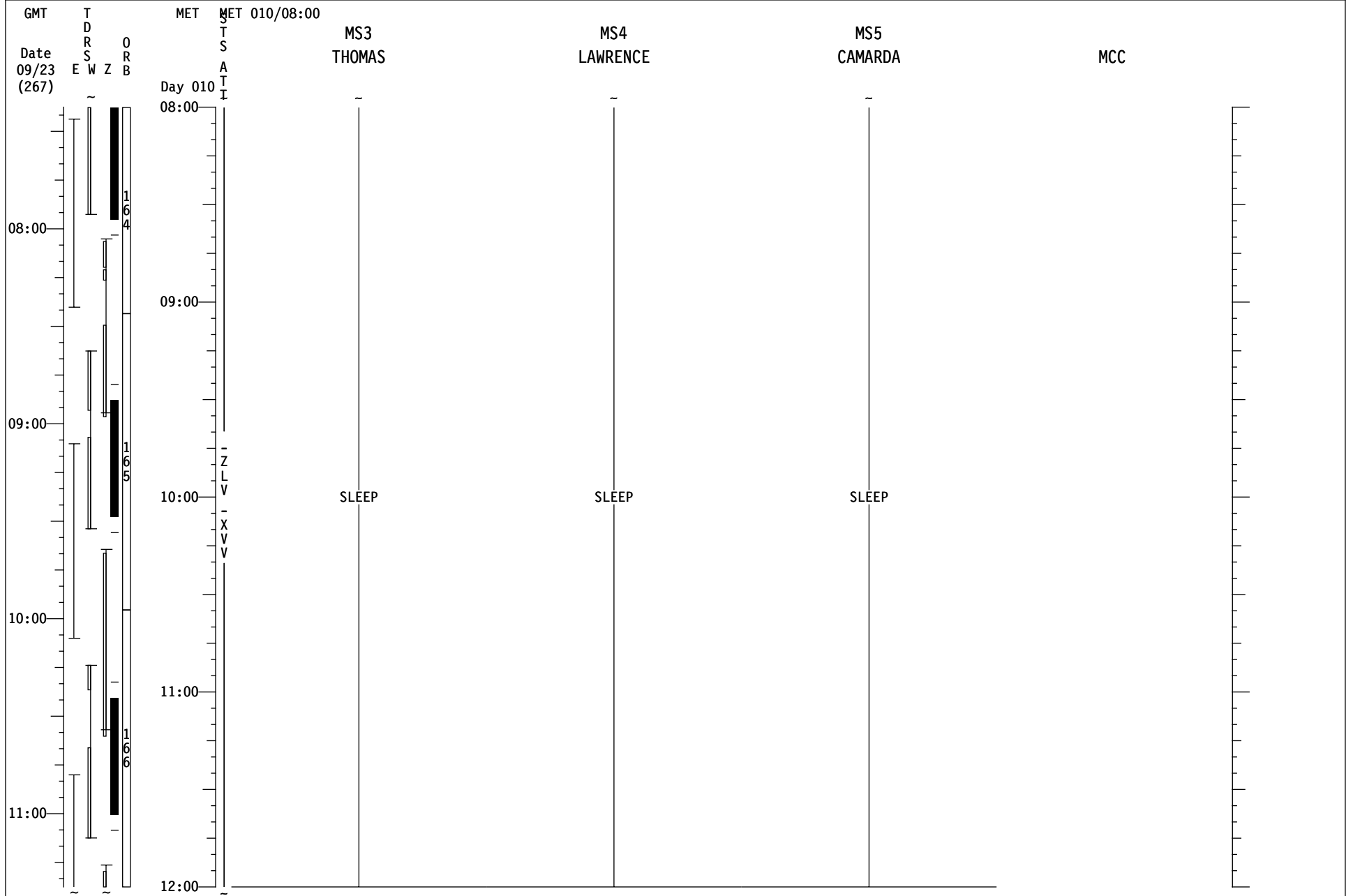

# STS-114 LF1 (FD12)

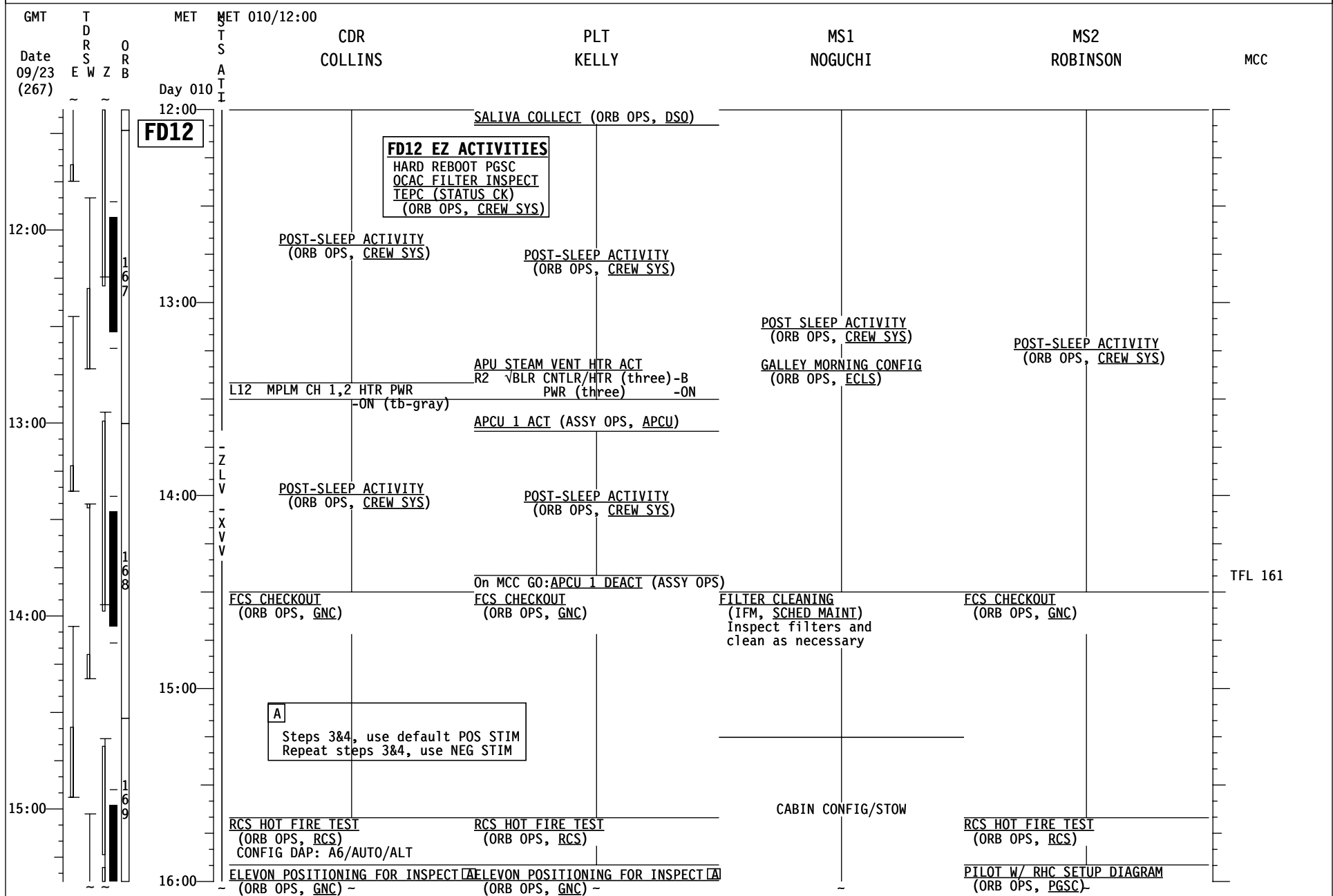

# STS-114 LF1 (FD 12)

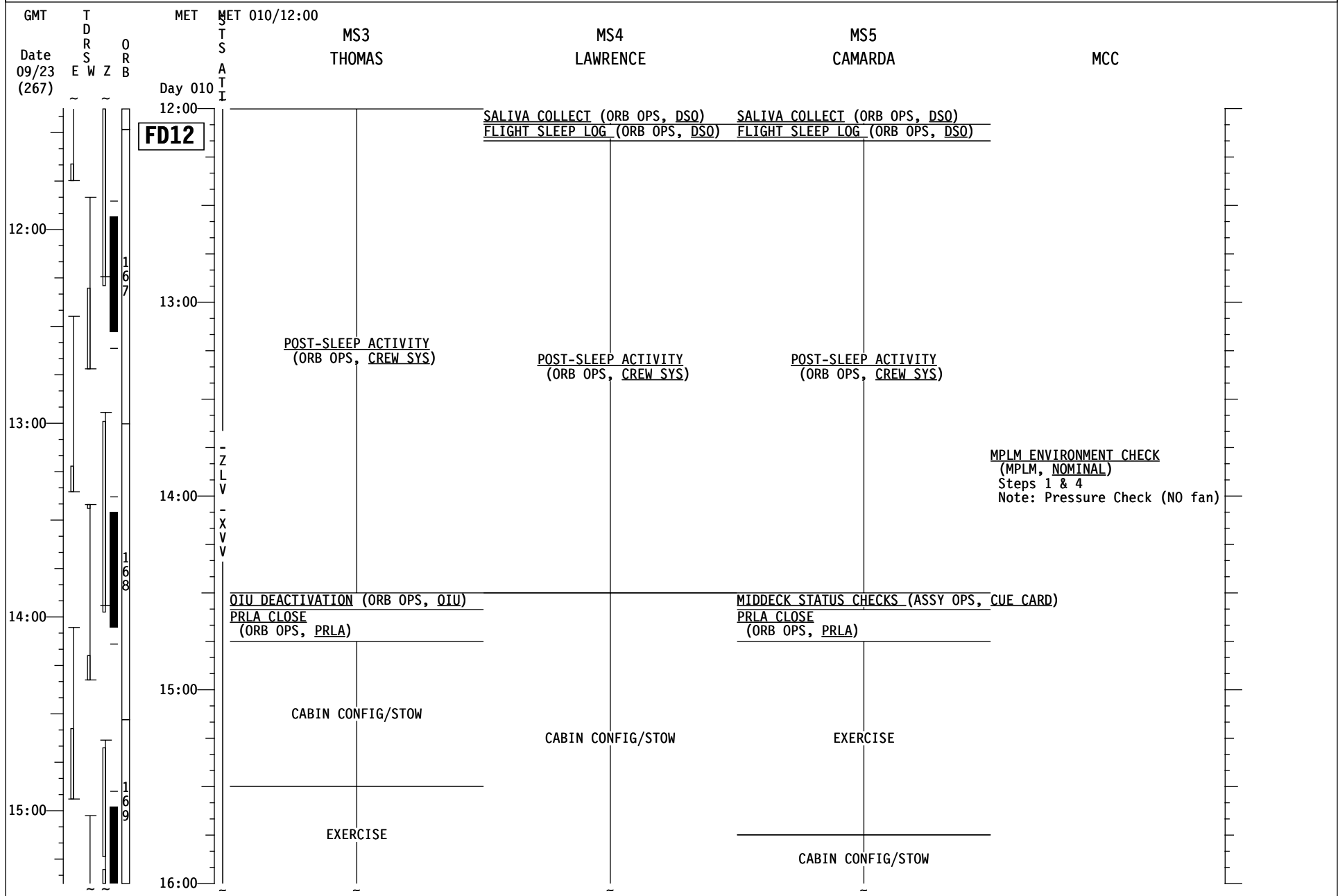

# STS-114 LF1 (FD12)

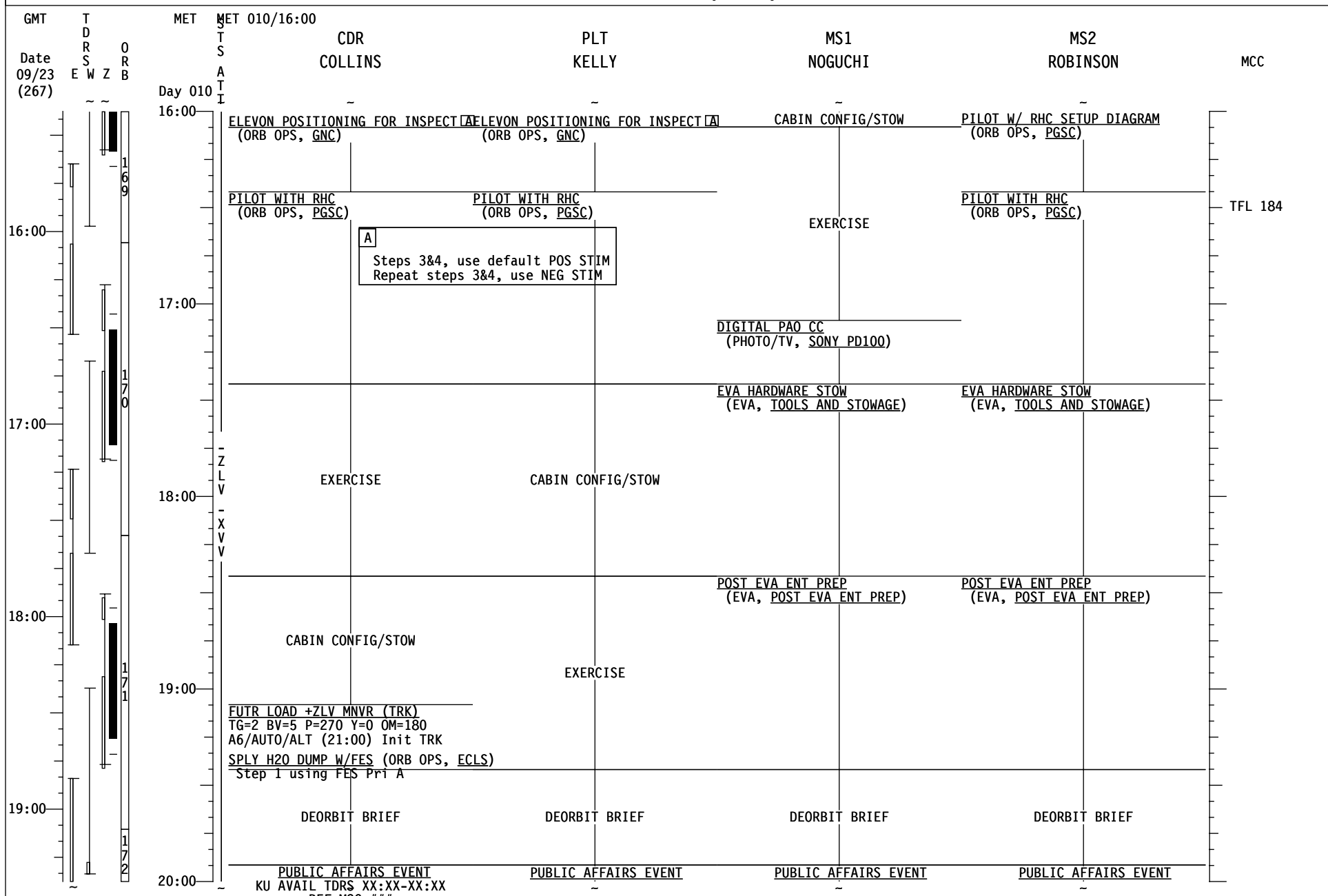

REF MSG ###

# STS-114 LF1 (FD 12)

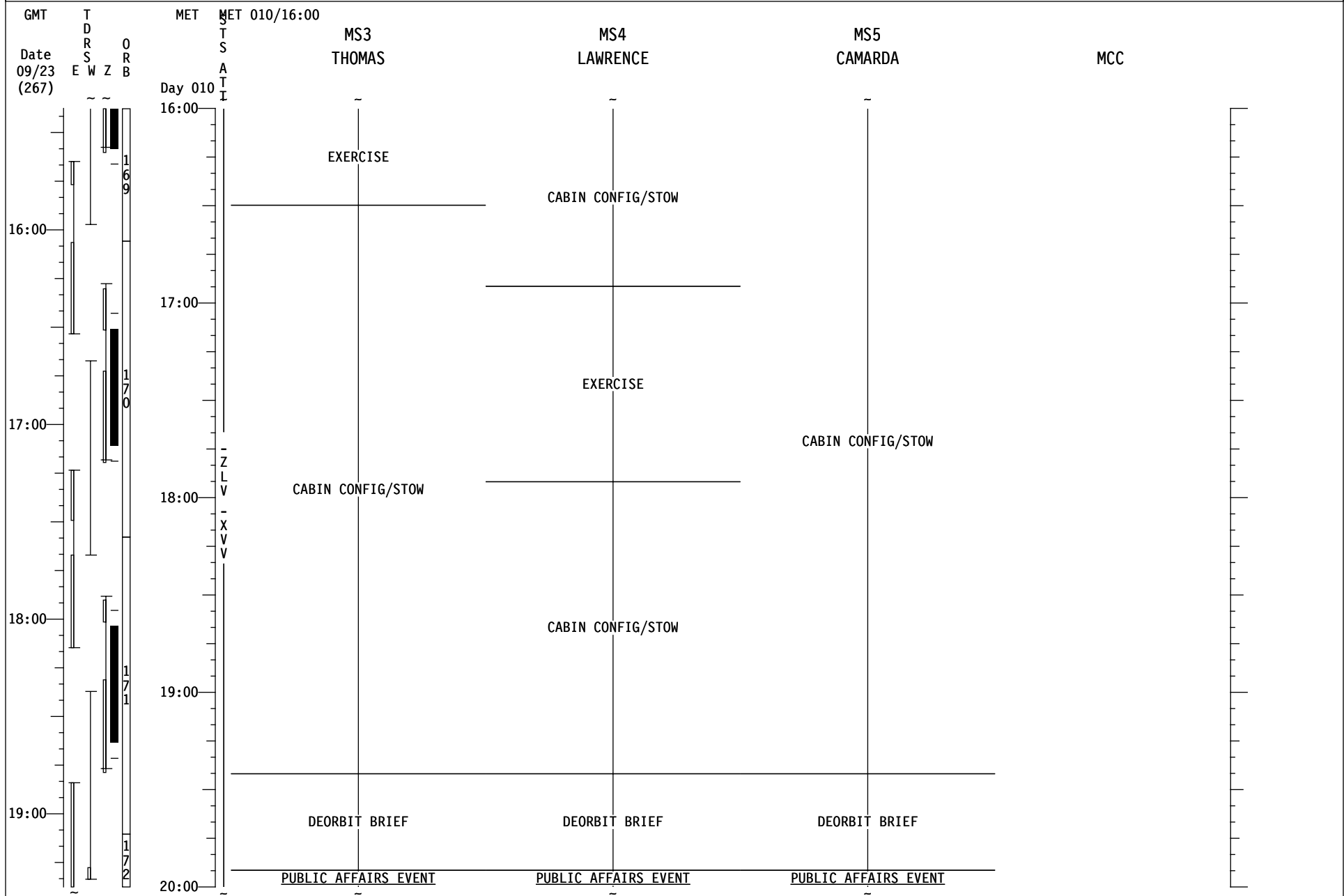

# STS-114 LF1 (FD 12)

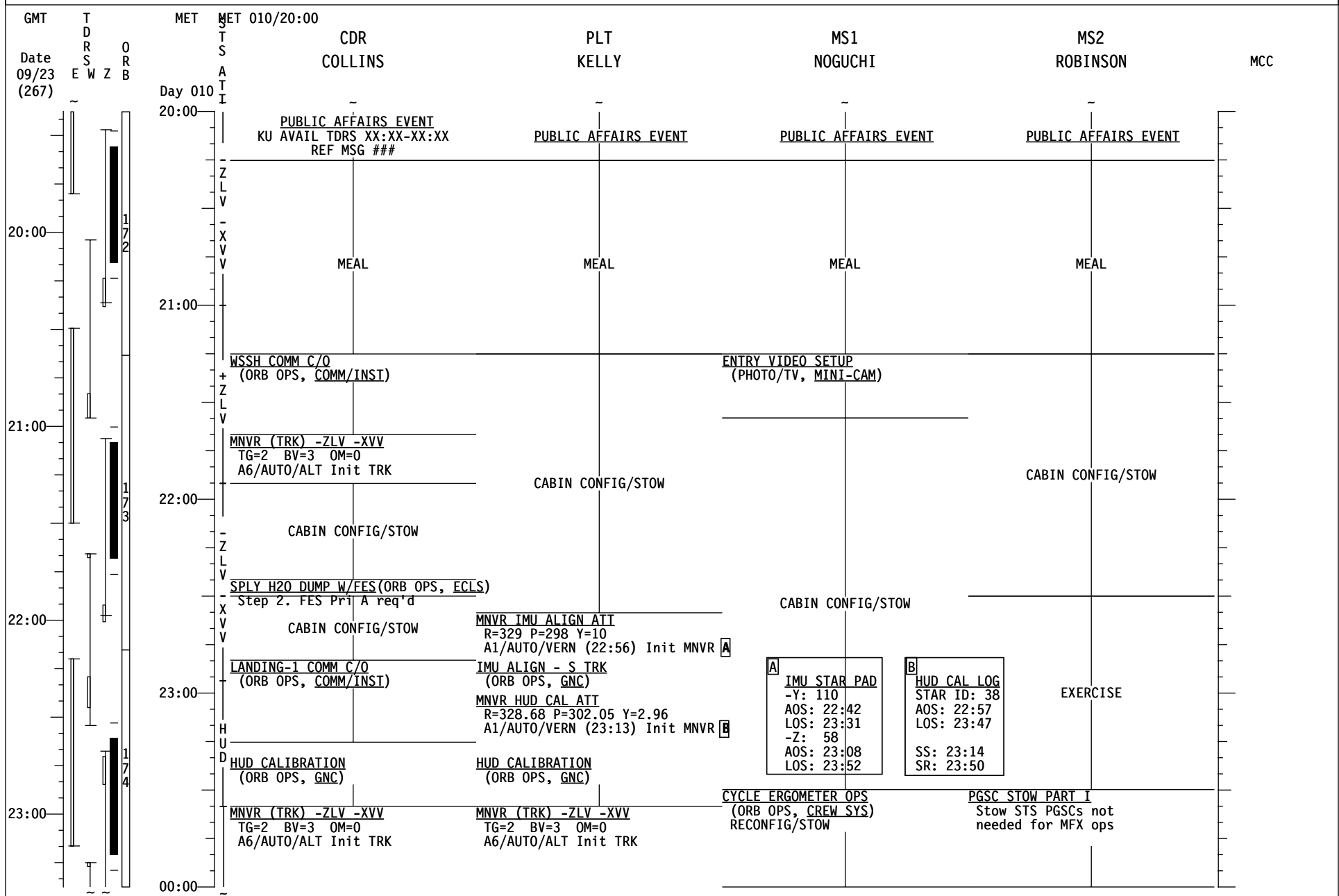

# STS-114 LF1 (FD 12)

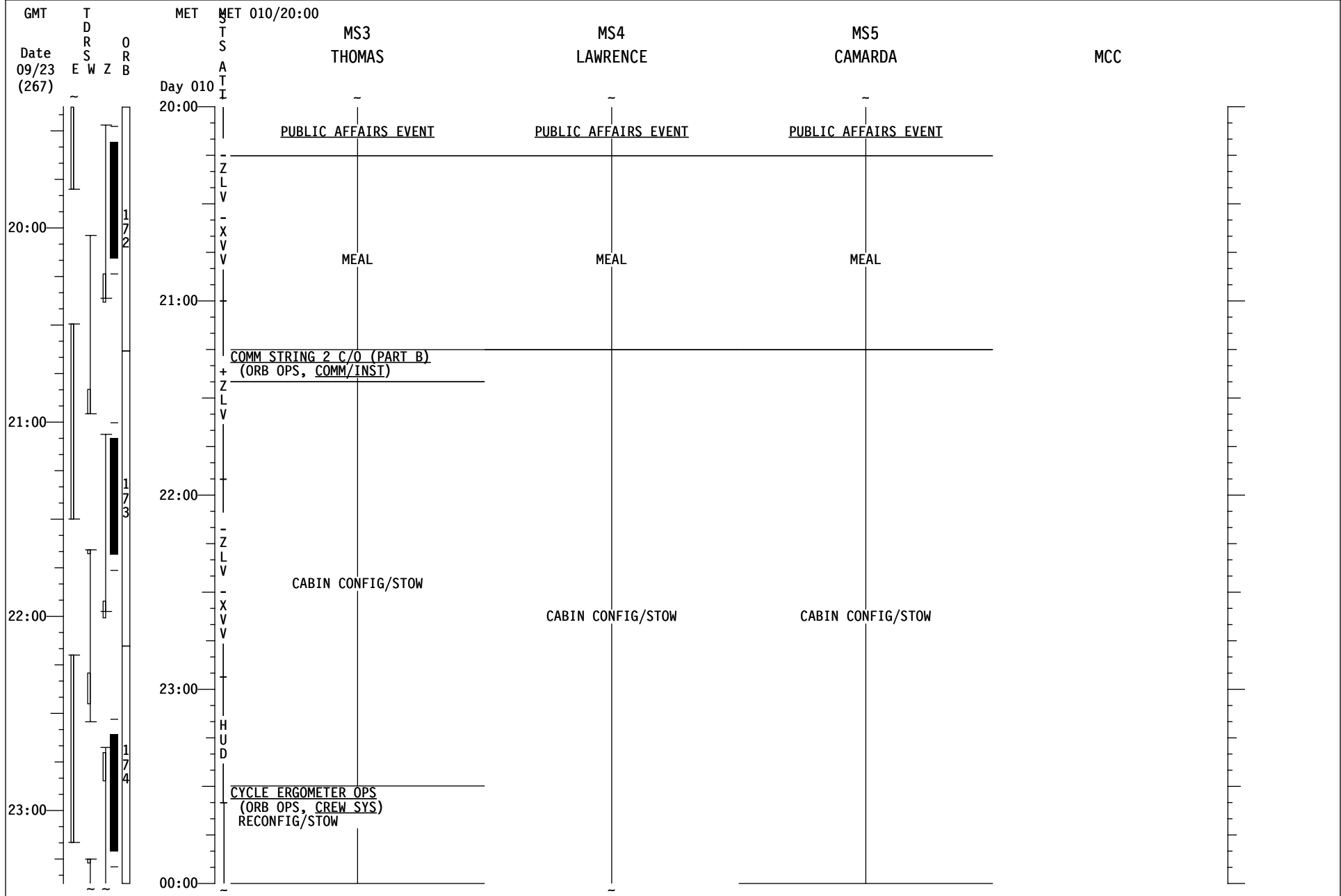

# STS-114 LF1 (FD 12)

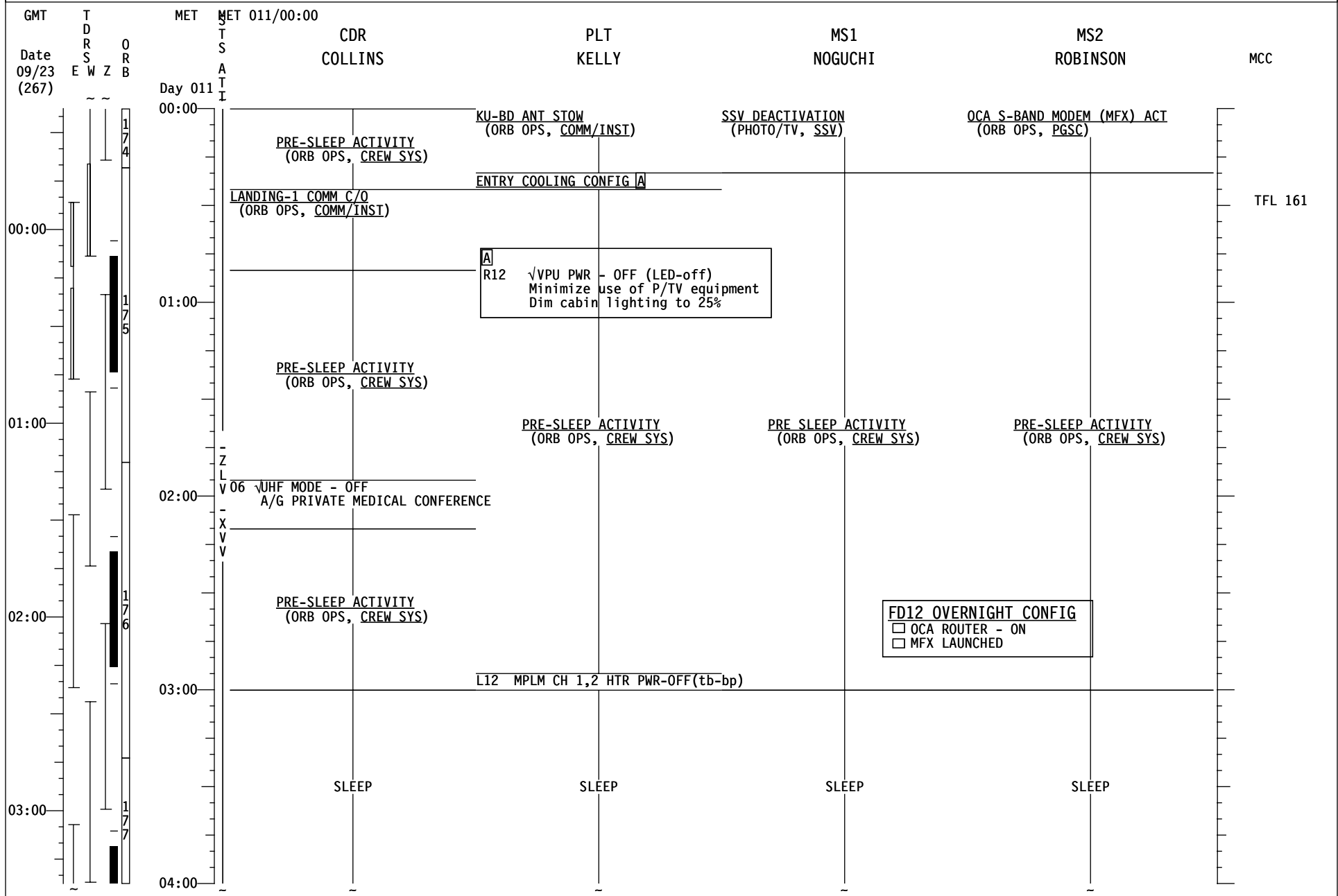



# STS-114 LF1 (FD 12)

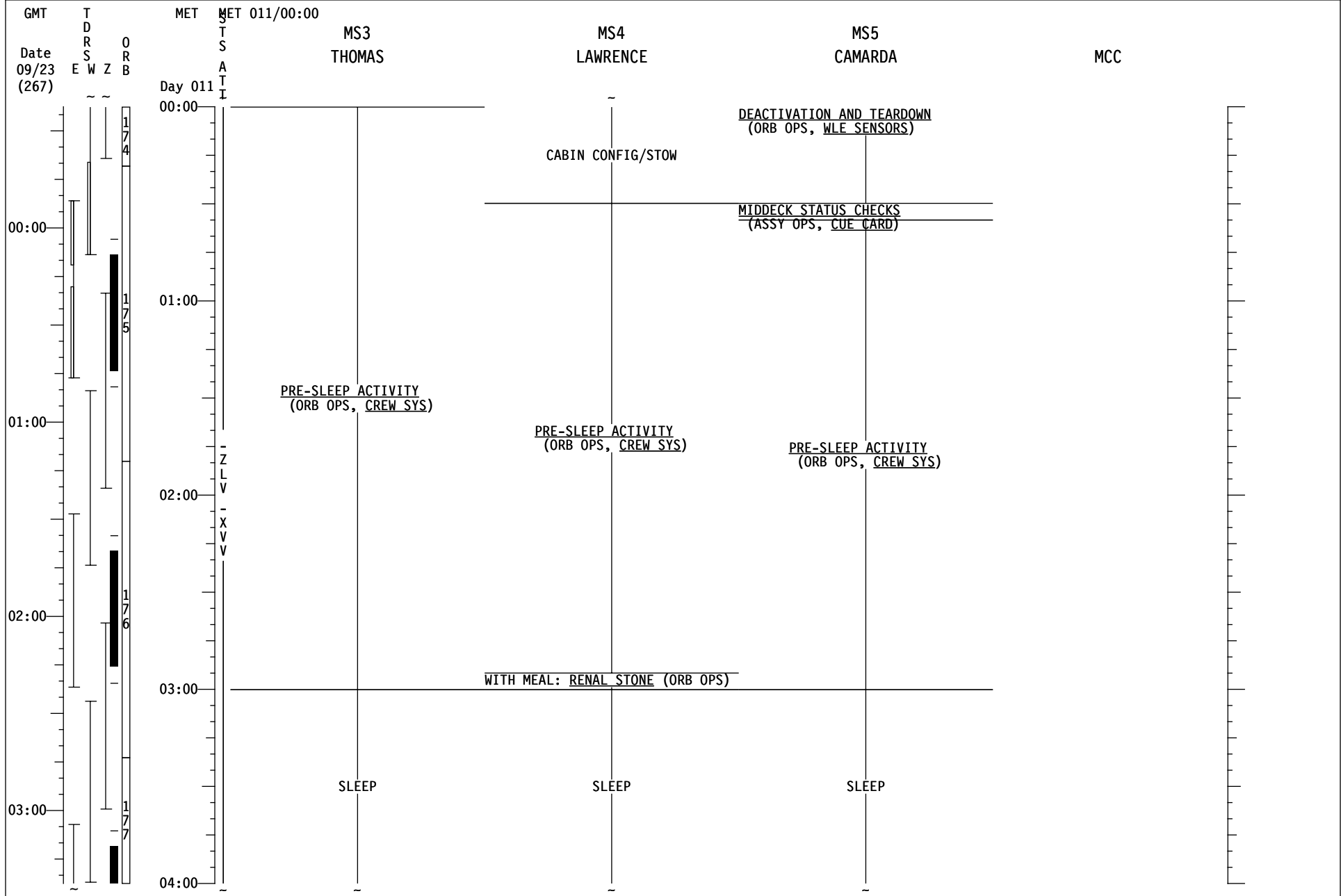

# STS-114 LF1 (FD 12)

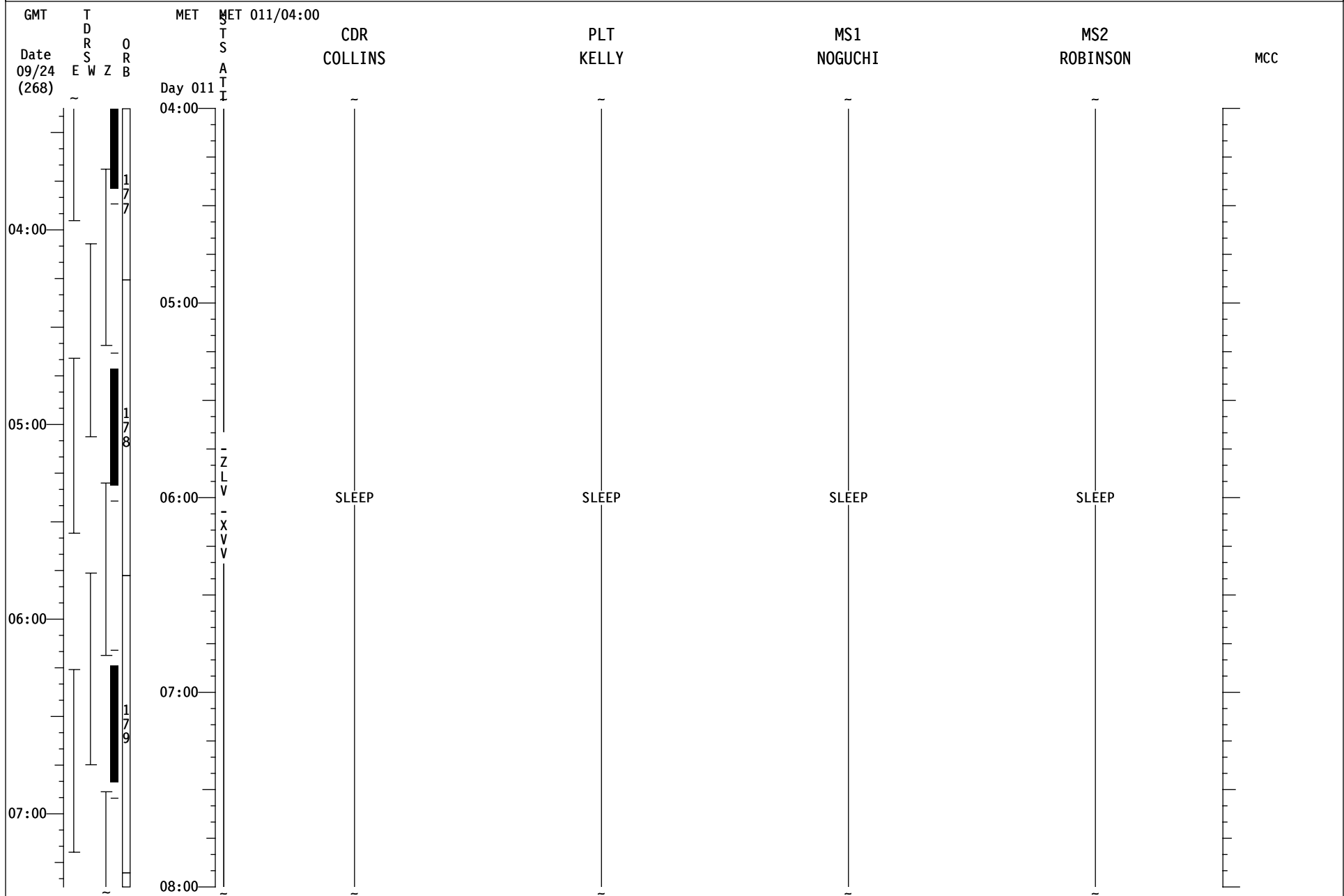

# STS-114 LF1 (FD 12)

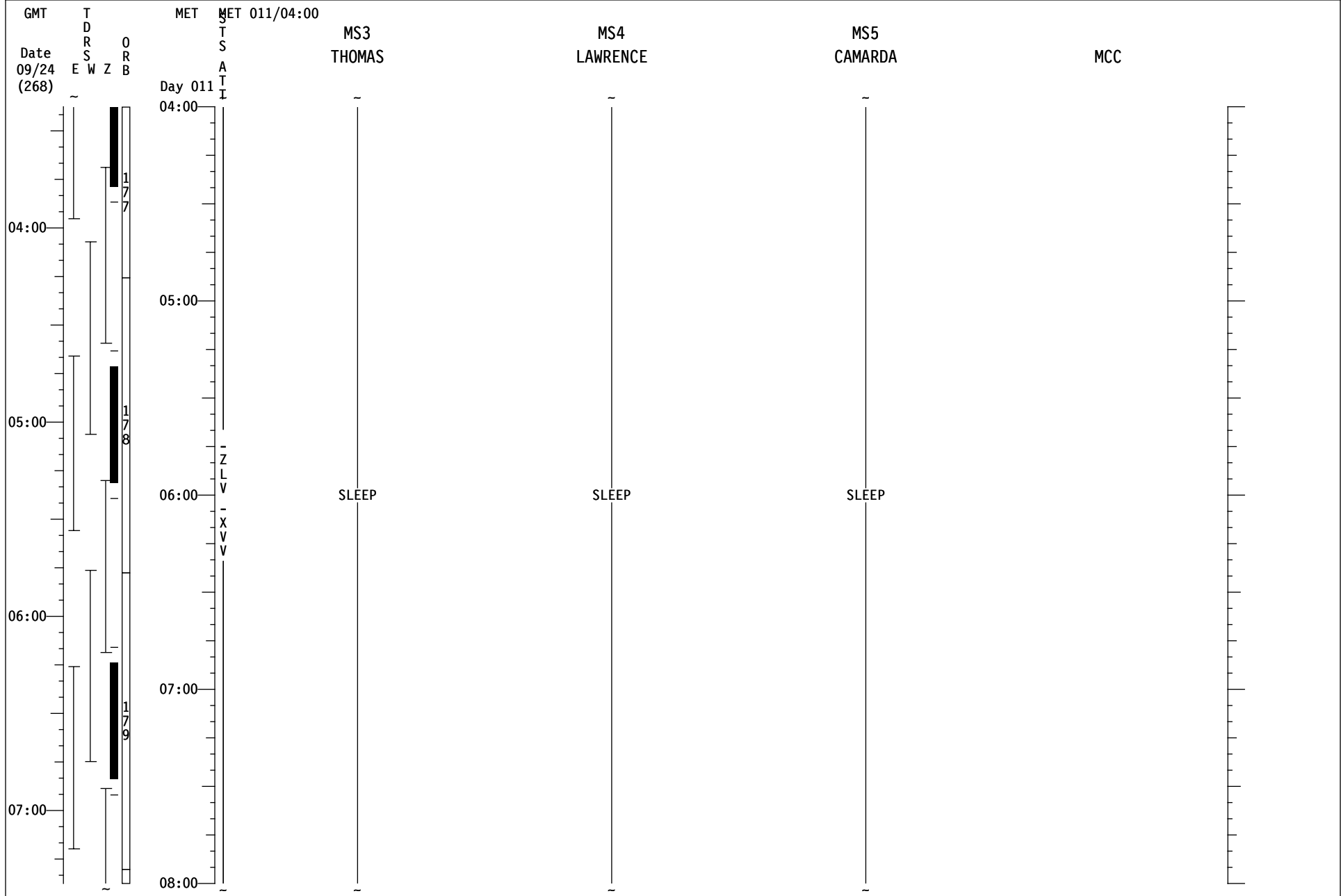

# STS-114 LF1 (FD13)

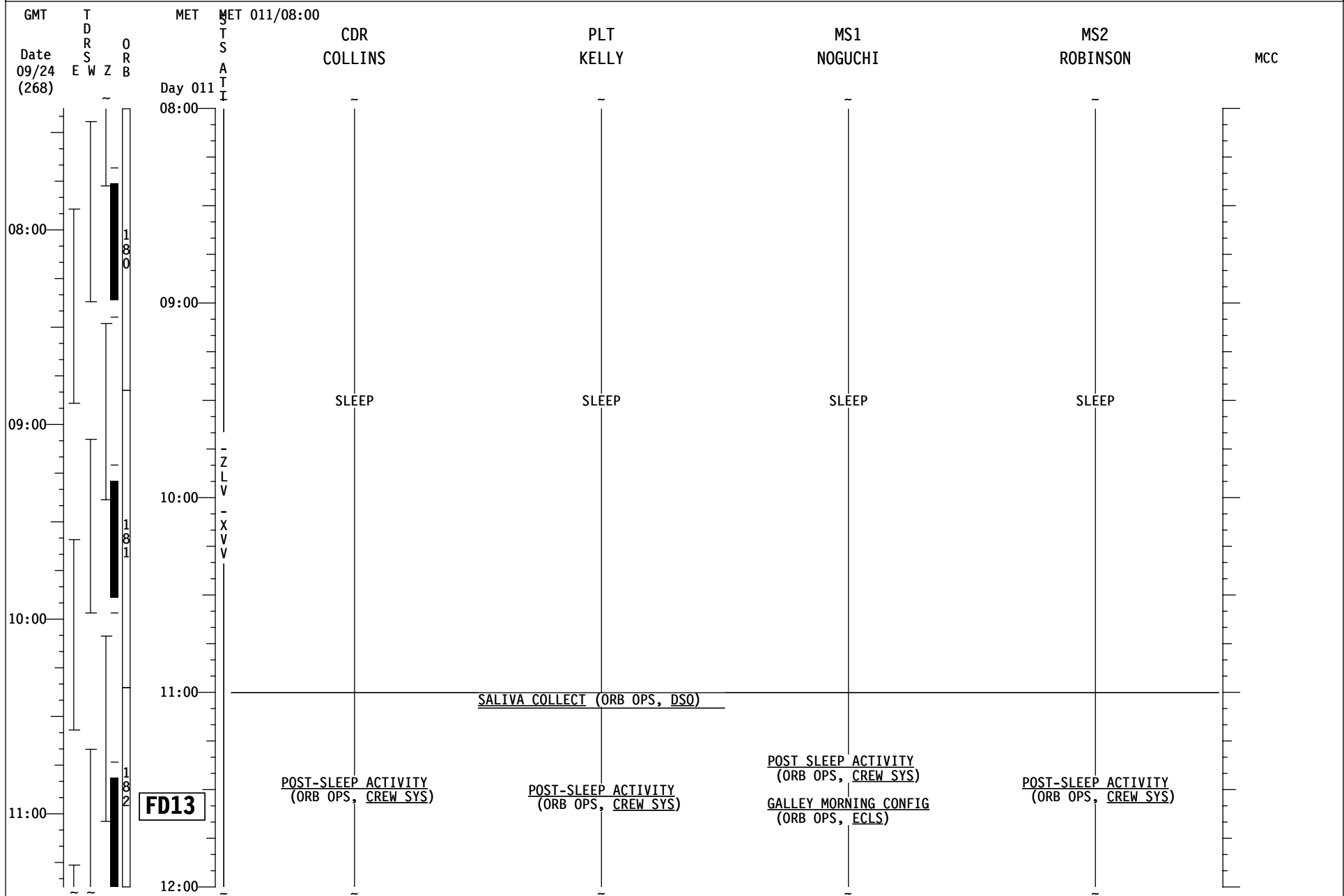

**FD13**

# STS-114 LF1 (FD 13)

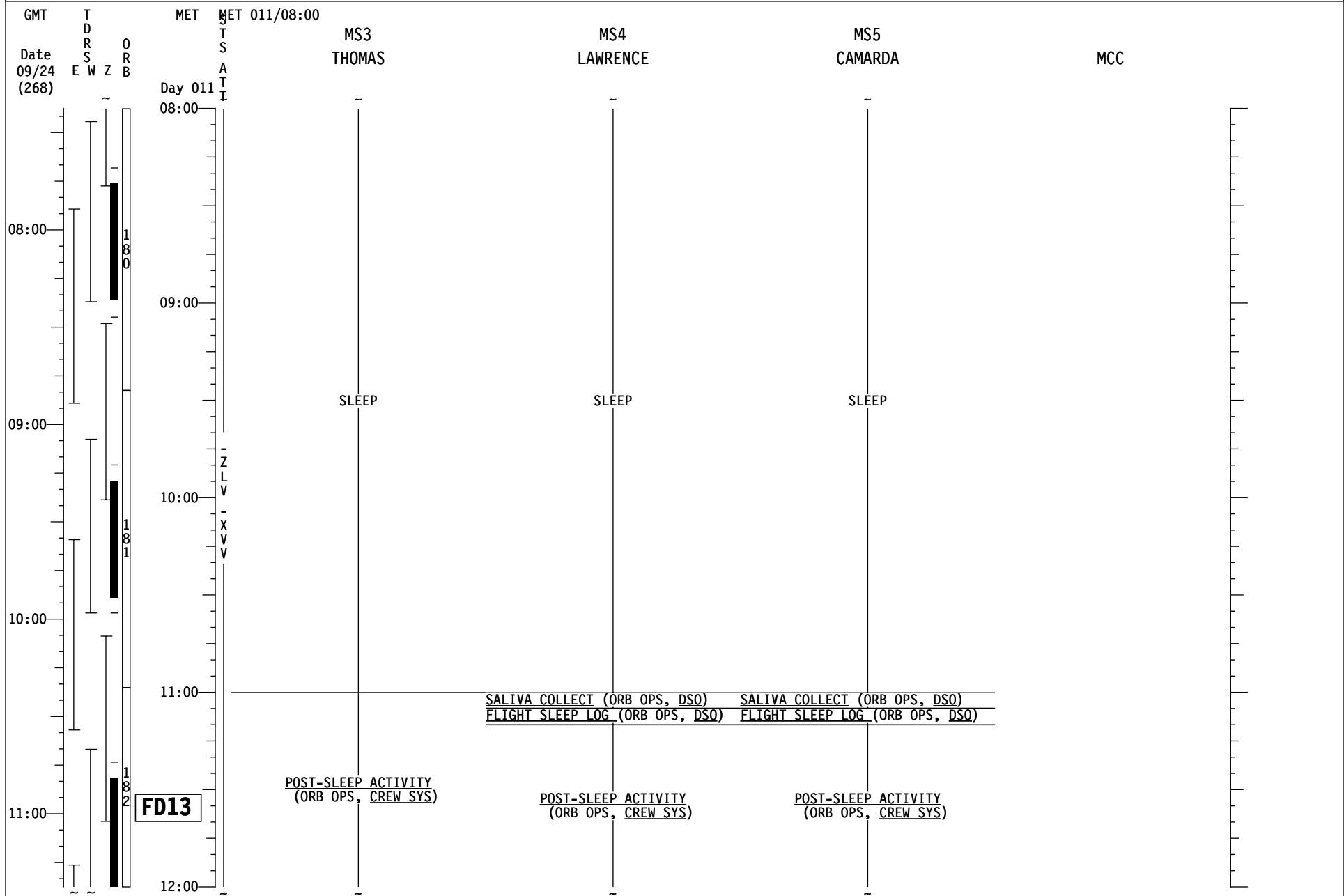

# STS-114 LF1 (FD 13)

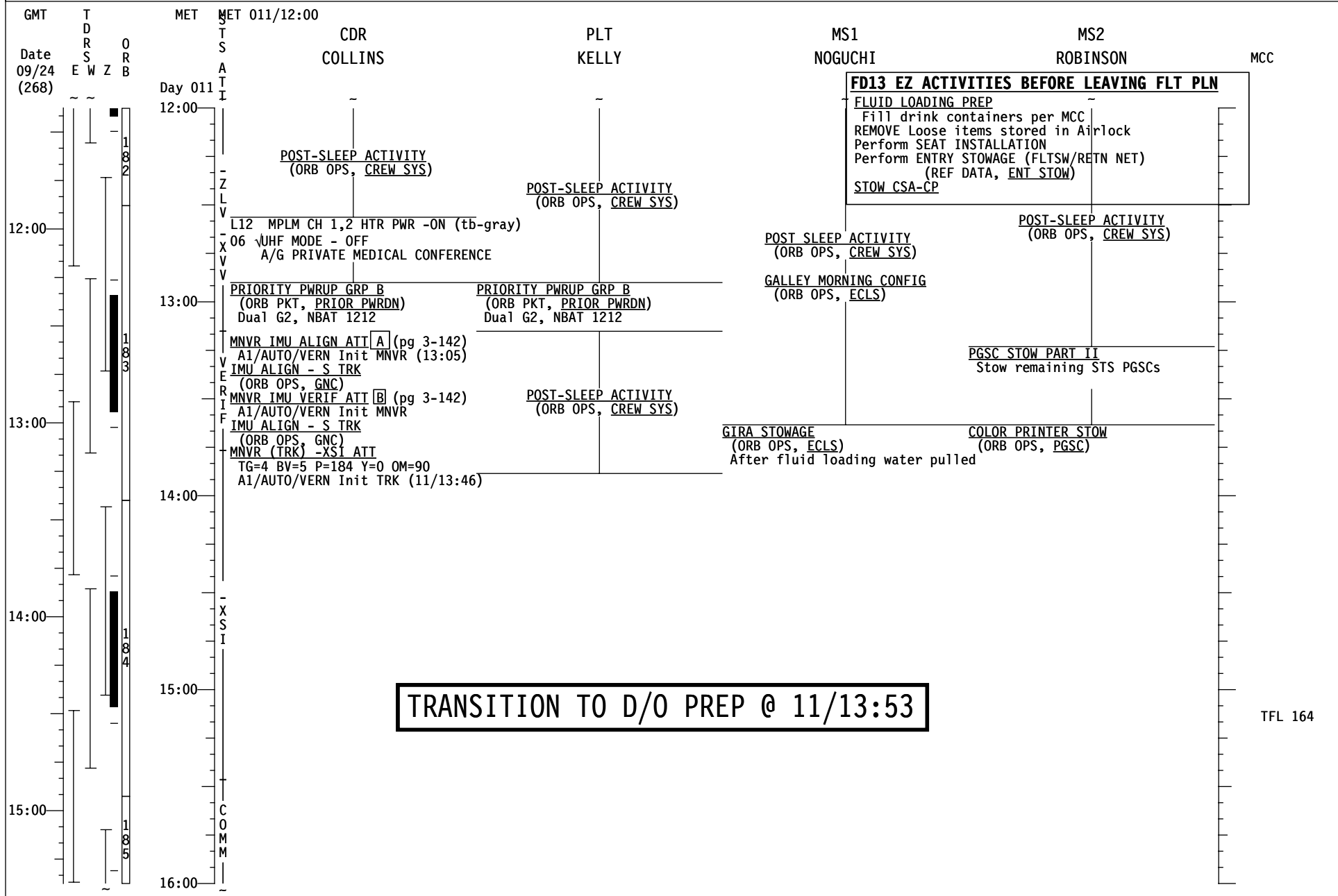

# STS-114 LF1 (FD 13)

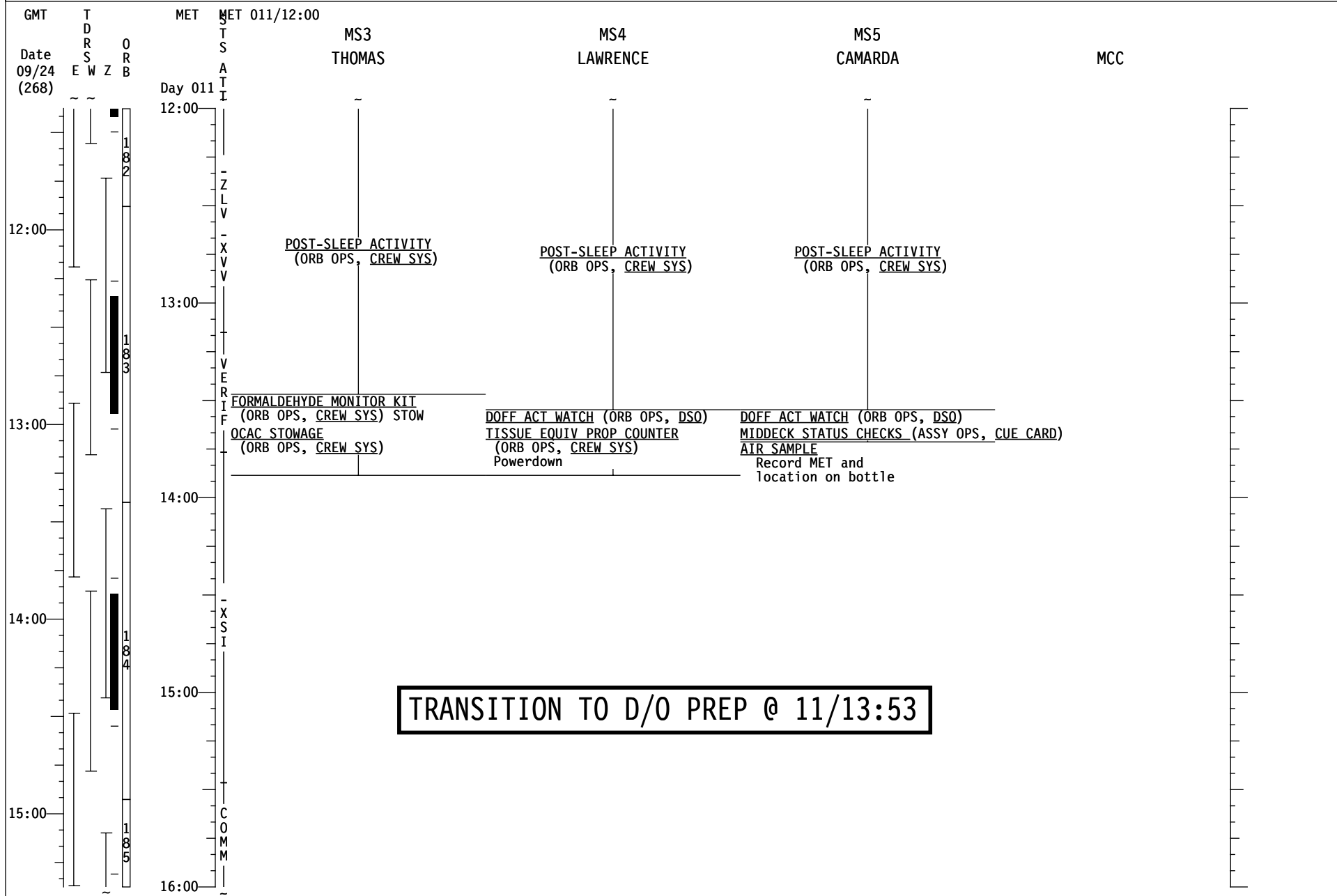

<b>A</b>	<b>IMU STAR ALIGN</b>		
ID: -Y: 13 RIGEL MET (11/13:07 TO 11/13:57)			
-Z: 95 BETA GRUIS MET (11/12:58 TO 11/13:47)			
ANG DIFF: 89.4			
<u>DUAL S TRKR</u>		<u>2nd ATTITUDE</u>	
<u>ALIGNMENT</u>		<u>(SINGLE S TRKR)</u>	
		-Z: 13	-Y: 95
R	195	R	105 284
P	134	P	148 128
Y	13	Y	8 359
REQD ID:			
-Y: ____, -Z: ____, ANG ERR ____, ____, __			
ANG:                    1                    2                    3			
$\Delta X$	{ } ____, ____, __	{ } ____, ____, __	{ } ____, ____, __
$\Delta Y$	{ } ____, ____, __	{ } ____, ____, __	{ } ____, ____, __
$\Delta Z$	{ } ____, ____, __	{ } ____, ____, __	{ } ____, ____, __
EXECUTION TIME: __/__:__:__ MET			

<b>B</b>	<b>IMU STAR VERIFICATION</b>		
ID: -Y: 93 ICEN MET (11/13:29 TO 11/14:18)			
-Z: 21 PROCYON MET (11/13:20 TO 11/14:11)			
ANG DIFF: 89.4			
<u>DUAL S TRKR</u>		<u>2nd ATTITUDE</u>	
<u>ALIGNMENT</u>		<u>(SINGLE S TRKR)</u>	
		-Z: 93	-Y: 21
R	71	R	346 162
P	68	P	56 59
Y	17	Y	8 29
REQD ID:			
-Y: ____, -Z: ____, ANG ERR ____, ____, __			
ANG:                    1                    2                    3			
$\Delta X$	{ } ____, ____, __	{ } ____, ____, __	{ } ____, ____, __
$\Delta Y$	{ } ____, ____, __	{ } ____, ____, __	{ } ____, ____, __
$\Delta Z$	{ } ____, ____, __	{ } ____, ____, __	{ } ____, ____, __
<b>If any <math>\Delta X</math>, <math>\Delta Y</math>, OR <math>\Delta Z</math> &gt; 0.1 Check MCC</b>			
EXECUTION TIME: __/__:__:__ MET			



The sections following this divider page will not be included in flight copies.

This Page Intentionally Blank

ATTITUDE TIMELINE

ATTITUDE  
TIMELINE

This Page Intentionally Blank

Attitude Timeline

MET/GMT	ORBITER		REF ATT/REMARKS	EVENT
	MNVR OPTION	DAP E/S/ $\beta$		
1 000/00:30:00 M  256/23:52:33 G	M50 (CALC) INRTL R = 122.00 MNVR P = 111.00 PYR Y = 40.00  MNVR TRN/AUTO/PRI HOLD (same)	RATE 0.5000 DB AT 3.50 DB RT 0.20  SUN R 234 P 71 $\beta = 49$	+X PYR R = 359.73 P = 16.03 Y = 0.04  LVLH 000/00:38:15 M 257/00:00:48 G	OMS-2 Posi Heads Up  TIG 00:38  DV= 95.7
2 000/01:00:00 M  257/00:22:33 G				STS-114 Launch Sept 12, 2004  GMTLO: 256/23:22:33
3 000/01:12:00 M 17:27  257/00:34:33 G 40:00	LVLH TRACK TGT = 2 P = 90.00 BV = 3 Y = 0.00 OM = 300.00  MNVR A1/AUTO/VERN HOLD (same)	RATE 0.2000 DB AT 1.000 DB RT 0.020  EARTH R 0 P 90 $\beta = 49$	LVLH R= 0.00 P=180.00 Y= 60.00	Biased -ZLV +YVV PLBD Opening  SOPA @ 3:30
4 000/04:50:00 M 05:01:48  257/04:12:33 G 24:21	M50 (CALC) INRTL R = 122.00 MNVR P = 113.00 PYR Y = 37.00  MNVR A1/AUTO/VERN HOLD (same)	RATE 0.2000 DB AT 1.000 DB RT 0.020  SUN R 234 P 69 $\beta = 49$	+X PYR R = 0.23 P = 15.91 Y = 0.00  LVLH 000/05:05:00 M 257/04:27:33 G	NC-1 Posi Heads Up OMS TIG 05:05  DV= 89.1
5 000/05:10:00 M 22:00  257/04:32:33 G 44:33	LVLH TRACK TGT = 2 P = 90.00 BV = 3 Y = 0.00 OM = 350.00  MNVR A1/AUTO/VERN HOLD (same)	RATE 0.2000 DB AT 1.000 DB RT 0.020  EARTH R 0 P 90 $\beta = 49$	LVLH R= 0.00 P=180.00 Y= 10.00	-ZLV -XVV  (tweaked for Ku)
6 000/08:30:00 M 42:57  257/07:52:33 G 08:05:30	INRTL R = 0.00 MNVR P = 0.00 Y = 0.00  MNVR A1/AUTO/VERN HOLD (same)	RATE 0.2000 DB AT 1.000 DB RT 0.020  SUN R 113 P 170 $\beta = 48$		INRTL HOLD ONE ORBIT DEU
7 000/10:15:00 M 29:32  257/09:37:33 G 52:05	LVLH TRACK TGT = 2 P = 90.00 BV = 3 Y = 0.00 OM = 0.00  MNVR A1/AUTO/VERN HOLD (same)	RATE 0.2000 DB AT 1.000 DB RT 0.020  EARTH R 0 P 90 $\beta = 48$	LVLH R= 0.00 P=180.00 Y= 0.00	-ZLV -XVV
8 000/15:10:00 M 19:46  257/14:32:33 G 42:19	M50 (CALC) INRTL R = 122.00 MNVR P = 116.00 PYR Y = 40.00  MNVR A1/AUTO/VERN HOLD (same)	RATE 0.2000 DB AT 1.000 DB RT 0.020  SUN R 230 P 67 $\beta = 47$	+X PYR R = 0.41 P = 16.35 Y = 355.80  LVLH 000/15:29:34 M 257/14:52:07 G	NC-2 Posi Head Up OMS - Right TIG 15:29  DV= 8
9 000/15:35:00 M 48:51  257/14:57:33 G 15:11:24	LVLH TRACK TGT = 2 P = 90.00 BV = 3 Y = 0.00 OM = 140.00  MNVR A1/AUTO/VERN HOLD (same)	RATE 0.2000 DB AT 1.000 DB RT 0.020  EARTH R 0 P 90 $\beta = 47$	LVLH R=180.00 P= 0.00 Y=320.00	Biased -ZLV -YVV  Biased for Ku for Calibration and 1st Scan
10 000/20:10:00 M 12:30  257/19:32:33 G 35:03	LVLH TRACK TGT = 2 P = 90.00 BV = 3 Y = 0.00 OM = 110.00  MNVR A1/AUTO/VERN HOLD (same)	RATE 0.2000 DB AT 1.000 DB RT 0.020  EARTH R 0 P 90 $\beta = 47$	LVLH R=180.00 P= 0.00 Y=290.00	Biased -ZLV -YVV  Biased for Ku for 2nd and 3rd Scans

ALL ORBITER DATA IN  
MEAN OF 1950 AND PYR EULER SEQUENCE

Attitude Timeline

MET/GMT	ORBITER		REF ATT/REMARKS	EVENT
	MNVR OPTION	DAP E/S/ $\beta$		
11 001/00:00:00 M 14:35 257/23:22:33 G 37:08	LVLH TRACK TGT = 2 P = 90.00 BV = 3 Y = 0.00 OM = 295.00 MNVR A1/AUTO/VERN HOLD (same)	RATE 0.2000 DB AT 1.000 DB RT 0.020 EARTH R 0 P 90 $\beta = 46$	LVLH R= 0.00 P=180.00 Y= 65.00	Biased -ZLV +YVV Biased for Ku for down-link
12 001/01:08:00 M 258/00:30:33 G				NPC Multi-Axis TIG 01:08 DV= .7
13 001/02:25:00 M 36:57 258/01:47:33 G 59:30	M50 (CALC) INRTL R = 234.00 MNVR P = 292.00 PYR Y = 324.00 MNVR A1/AUTO/VERN HOLD (same)	RATE 0.2000 DB AT 1.000 DB RT 0.020 SUN R 310 P 110 $\beta = 46$	+X PYR R = 360.00 P = 15.96 Y = 359.98 LVLH 001/02:39:51 M 258/02:02:24 G	NC-3 +X RCS Posi Heads Up TIG 02:39 DV= 3
14 001/02:45:00 M 56:57 258/02:07:33 G 19:30	LVLH TRACK TGT = 2 P = 90.00 BV = 3 Y = 0.00 OM = 0.00 MNVR A1/AUTO/VERN HOLD (same)	RATE 0.2000 DB AT 1.000 DB RT 0.020 EARTH R 0 P 90 $\beta = 46$	LVLH R= 0.00 P=180.00 Y= 0.00	-ZLV -XVV
15 001/07:00:00 M 14:26 258/06:22:33 G 36:59	INRTL R = 0.00 MNVR P = 0.00 Y = 0.00 MNVR A1/AUTO/VERN HOLD (same)	RATE 0.2000 DB AT 1.000 DB RT 0.020 SUN R 113 P 171 $\beta = 45$		INRTL HOLD ONE ORBIT DEU
16 001/08:45:00 M 57:59 258/08:07:33 G 20:32	LVLH TRACK TGT = 2 P = 90.00 BV = 3 Y = 0.00 OM = 0.00 MNVR A1/AUTO/VERN HOLD (same)	RATE 0.2000 DB AT 1.000 DB RT 0.020 EARTH R 0 P 90 $\beta = 45$	LVLH R= 0.00 P=180.00 Y= 0.00	-ZLV -XVV
17 001/12:25:00 M 37:40 258/11:47:33 G 12:00:13	LVLH TRACK TGT = 2 P = 310.00 BV = 5 Y = 0.00 OM = 270.00 MNVR A1/AUTO/VERN HOLD (same)	RATE 0.2000 DB AT 1.000 DB RT 0.020 EARTH R 180 P 50 $\beta = 44$	LVLH R=270.00 P=270.00 Y=310.00	Biased +ZLV +YVV Simo Dump SOPA @ 14:00 Inspection 1/13:50-14:50 (Ku optimized for Inspection)
18 001/14:45:00 M 52:28 258/14:07:33 G 15:01	M50 (CALC) INRTL R = 226.00 MNVR P = 349.00 PYR Y = 43.00 MNVR A1/AUTO/VERN HOLD (same)	RATE 0.2000 DB AT 1.000 DB RT 0.020 SUN R 242 P 127 $\beta = 44$	+X PYR R = 359.41 P = 16.00 Y = 359.82 LVLH 001/14:58:08 M 258/14:20:41 G	NH Posi Heads Up OMS TIG 14:58 DV= 110
19 001/15:03:00 M 258/14:25:33 G		RATE 0.2000 DB AT 2.00 DB RT 0.100 EARTH R 181 P 126 $\beta = 44$	LVLH R=359.42 HOLD P= 35.68 Y=359.80	LVLH HOLD between burns
20 001/15:42:00 M 45:20 258/15:04:33 G 07:53	M50 (CALC) INRTL R = 147.00 MNVR P = 187.00 PYR Y = 307.00 MNVR A7/AUTO/ALT HOLD (same)	RATE 0.2000 DB AT 2.00 DB RT 0.100 SUN R 307 P 61 $\beta = 44$	+X PYR R = 0.16 P = 15.62 Y = 0.21 LVLH 001/15:47:06 M 258/15:09:39 G	NC-4 Posi Head Up OMS TIG 15:47 DV= 88.3

ALL ORBITER DATA IN  
MEAN OF 1950 AND PYR EULER SEQUENCE

Attitude Timeline

MET/GMT	ORBITER		REF ATT/REMARKS	EVENT
	MNVR OPTION	DAP E/S/ $\beta$		
21 001/16:00:00 M 05:11  258/15:22:33 G 27:44	EPH TARGET TGT = 1 P = 90.00 BV = 3 Y = 0.00 OM = 0.00  MNVR B7/AUTO/ALT HOLD A7/AUTO/VERN	RATE 0.5000 DB AT 2.00 DB RT 0.100  $\beta = 44$	LVLH R=359.93 P=271.99 Y= 0.00  TGT VIDFILE: 114SIM_ISS VID #: 1	-Z TGT TRK
22 001/17:10:00 M 15:01  258/16:32:33 G 37:34	M50 (CALC) INRTL R = 153.00 MNVR P = 194.00 PYR Y = 312.00  MNVR A7/AUTO/ALT HOLD (same)	RATE 0.2000 DB AT 2.00 DB RT 0.100  SUN R 310 P 57 $\beta = 43$	+X PYR R = 0.70 P = 16.29 Y = 353.90  LVLH 001/17:19:04 M 258/16:41:37 G	TI Posi Head Up OMS - Left TIG 17:19  DV= 8.9
23 001/17:35:00 M 40:29  258/16:57:33 G 17:03:02	EPH TARGET TGT = 1 P = 90.00 BV = 3 Y = 0.00 OM = 0.00  MNVR B7/AUTO/ALT HOLD A7/AUTO/VERN	RATE 0.5000 DB AT 2.00 DB RT 0.100  $\beta = 43$	LVLH R=359.79 P=276.29 Y= 0.00  TGT VIDFILE: 114SIM_ISS VID #: 1	-Z TGT TRK
24 001/18:40:00 M 54:23  258/18:02:33 G 16:56	LVLH TRACK TGT = 2 P = 270.00 BV = 5 Y = 0.00 OM = 0.00  MNVR A8/AUTO/VERN HOLD A7/AUTO/VERN	RATE 0.0500 DB AT 1.000 DB RT 0.020  EARTH R 180 P 90 $\beta = 43$	LVLH R= 0.00 P= 0.00 Y= 0.00	+ZLV +XVV  Establish RBAR
25 001/18:57:00 M 59:00  258/18:19:33 G 21:33	LVLH TRACK TGT = 2 P = 180.00 BV = 5 Y = 0.00 OM = 0.00  MNVR A9/AUTO/PRI HOLD (same)	RATE 0.7500 DB AT 1.00 DB RT 0.10  EARTH R 90 P 180 $\beta = 43$	LVLH R= 0.00 P= 90.00 Y= 0.00	RPM MNVR
26 001/18:59:00 M 19:01:00  258/18:21:33 G 23:33	LVLH TRACK TGT = 2 P = 90.00 BV = 5 Y = 0.00 OM = 0.00  MNVR A9/AUTO/PRI HOLD (same)	RATE 0.7500 DB AT 1.00 DB RT 0.10  EARTH R 0 P 90 $\beta = 43$	LVLH R= 0.00 P=180.00 Y= 0.00	RPM MNVR
27 001/19:01:00 M 03:00  258/18:23:33 G 25:33	LVLH TRACK TGT = 2 P = 0.00 BV = 5 Y = 0.00 OM = 0.00  MNVR A9/AUTO/PRI HOLD (same)	RATE 0.7500 DB AT 1.00 DB RT 0.10  EARTH R 307 P 0 $\beta = 43$	LVLH R= 0.00 P=270.00 Y= 0.00	RPM MNVR
28 001/19:03:00 M 05:00  258/18:25:33 G 27:33	LVLH TRACK TGT = 2 P = 270.00 BV = 5 Y = 0.00 OM = 0.00  MNVR A9/AUTO/PRI HOLD (same)	RATE 0.7500 DB AT 1.00 DB RT 0.10  EARTH R 180 P 90 $\beta = 43$	LVLH R= 0.00 P= 0.00 Y= 0.00	RPM MNVR
29 001/19:08:00 M 19:40  258/18:30:33 G 42:13	LVLH TRACK TGT = 2 P = 179.00 BV = 5 Y = 0.00 OM = 0.00  MNVR A9/AUTO/PRI HOLD (same)	RATE 0.1300 DB AT 1.00 DB RT 0.10  EARTH R 0 P 179 $\beta = 43$	LVLH R= 0.00 P= 91.00 Y= 0.00	-XLV +ZVV TORVA  Transition from +RBar to +VBar
30 001/19:58:00 M  258/19:20:33 G	FREE DRIFT  Config DAP: A12 for Att. Cntrl			DOCKING 01/19:58  ISS (0,0,0)

ALL ORBITER DATA IN  
MEAN OF 1950 AND PYR EULER SEQUENCE

Attitude Timeline

MET/GMT	ORBITER		REF ATT/REMARKS	EVENT
	MNVR OPTION	DAP E/S/ $\beta$		
31 001/20:35:00 M 38:40 258/19:57:33 G 20:01:13	COE (CALC) TGT = 2 P = 157.00 BV = 5 Y = 0.00 OM = 0.00 MNVR A12/AUTO/VERN HOLD (same)	RATE 0.1000 DB AT 3.000 DB RT 0.050 EARTH R 0 P 157 $\beta = 43$	ISS YPR R = 0.00 P = 23.00 Y = 0.00 LVLH 001/20:35:00 M 258/19:57:33 G	BIAS -XLV +ZVV Approx ISS TEA ISS (0,23,0) ORB R = 0.00 LVLH P = 113.00 Y = 0.00
32 009/16:15:00 M 18:50 266/15:37:33 G 41:23	LVLH TRACK TGT = 2 P = 180.00 BV = 5 Y = 0.00 OM = 0.00 MNVR A12/AUTO/VERN HOLD (same)	RATE 0.1000 DB AT 3.000 DB RT 0.050 EARTH R 36 P 180 $\beta = 7$	LVLH R= 0.00 P= 90.00 Y= 0.00	-XLV +ZVV Prep for Undock ISS (0,0,0) Note:BV=5 keeps w RNDZ/Flyaround
33 009/17:15:00 M 266/16:37:33 G	FREE DRIFT for Undocking			UNDOCK 09/17:15
34 009/17:44:00 M 266/17:06:33 G				SEP 1 9/17:44 DV = 1.5
35 009/17:50:00 M 266/17:12:33 G	LVLH FREE ROTATION ROTR ABOUT +Y AXIS RATE=0.130 MNVR A9/LVLH/VERN HOLD (same)	RATE 0.1300 DB AT 1.000 DB RT 0.020 $\beta = 7$	LVLH R= 0.00 P= 90.00 Y= 0.00	1/4 "FLY AROUND"
36 009/18:01:33 M 266/17:24:06 G	HOLD A9/LVLH/VERN	RATE 0.1300 DB AT 1.000 DB RT 0.020 EARTH R 0 P 90 $\beta = 7$	LVLH R= 0.00 HOLD P=180.09 Y= 0.00	LVLH HOLD FINAL SEP: TIG: 18:12
37 009/18:15:00 M 19:10 266/17:37:33 G 41:43	LVLH TRACK TGT = 2 P = 90.00 BV = 3 Y = 0.00 OM = 310.00 MNVR A6/AUTO/ALT HOLD (same)	RATE 0.2000 DB AT 5.00 DB RT 0.070 EARTH R 0 P 90 $\beta = 6$	LVLH R= 0.00 P=180.00 Y= 50.00	-ZLV +YVV post sep for: Simo Dump Init: 21:30
38 010/00:00:00 M 04:10 266/23:22:33 G 26:43	LVLH TRACK TGT = 2 P = 90.00 BV = 3 Y = 0.00 OM = 0.00 MNVR A6/AUTO/ALT HOLD (same)	RATE 0.2000 DB AT 5.00 DB RT 0.070 EARTH R 0 P 90 $\beta = 5$	LVLH R= 0.00 P=180.00 Y= 0.00	-ZLV -XVV
39 010/15:00:00 M 267/14:22:33 G	HOLD A6/INRT/VERN	RATE 0.0500 DB AT 1.000 DB RT 0.020 SUN R 183 P 124 $\beta = 2$	INRTL R=202.06 HOLD P= 48.45 Y= 32.41	FCS C/O
40 010/15:10:00 M 13:17 267/14:32:33 G 35:50	LVLH TRACK TGT = 2 P = 90.00 BV = 3 Y = 0.00 OM = 0.00 MNVR A6/AUTO/ALT HOLD (same)	RATE 0.2000 DB AT 5.00 DB RT 0.070 EARTH R 0 P 90 $\beta = 2$	LVLH R= 0.00 P=180.00 Y= 0.00	-ZLV -XVV

ALL ORBITER DATA IN  
MEAN OF 1950 AND PYR EULER SEQUENCE



Attitude Timeline

MET/GMT	ORBITER		REF ATT/REMARKS	EVENT
	MNVR OPTION	DAP E/S/ $\beta$		
41 010/15:40:00 M  267/15:02:33 G	HOLD A6/INRT/VERN	RATE 0.0500 DB AT 1.000 DB RT 0.020  SUN R 355 P 33 $\beta = 2$	INRTL R=147.45 HOLD P=205.98 Y=338.14	RCS H/F
42 010/15:55:00 M 59:55  267/15:17:33 G 22:28	LVLH TRACK TGT = 2 P = 90.00 BV = 3 Y = 0.00 OM = 0.00  MNVR A6/AUTO/ALT HOLD (same)	RATE 0.2000 DB AT 5.00 DB RT 0.070  EARTH R 0 P 90 $\beta = 2$	LVLH R= 0.00 P=180.00 Y= 0.00	-ZLV -XVV
43 010/21:00:00 M 15:00  267/20:22:33 G 37:33	LVLH TRACK TGT = 2 P = 270.00 BV = 5 Y = 0.00 OM = 180.00  MNVR A6/AUTO/ALT HOLD (same)	RATE 0.2000 DB AT 5.00 DB RT 0.070  EARTH R 180 P 90 $\beta = 1$	LVLH R=180.00 P=180.00 Y= 0.00	+ZLV -XVV for WSSH UHF Comm Check
44 010/21:40:00 M 55:00  267/21:02:33 G 17:33	LVLH TRACK TGT = 2 P = 90.00 BV = 3 Y = 0.00 OM = 0.00  MNVR A6/AUTO/ALT HOLD (same)	RATE 0.2000 DB AT 5.00 DB RT 0.070  EARTH R 0 P 90 $\beta = 1$	LVLH R= 0.00 P=180.00 Y= 0.00	-ZLV -XVV
45 010/22:56:00 M 23:07:53  267/22:18:33 G 30:26	INRTL R = 329.00 MNVR P = 298.00 Y = 10.00  MNVR A1/AUTO/VERN HOLD (same)	RATE 0.2000 DB AT 1.000 DB RT 0.020  SUN R 206 P 118 $\beta = 1$	-Y: 110 ZETA HERCULES 22:42 - 23:31  -Z: 58 DENEBA ALGEIDI 23:08 - 23:52	IMU ALIGN  -Y: 110 -Z: 58 PAIR AOS: 23:08 PAIR LOS: 23:31
46 010/23:13:00 M 41  267/22:35:33 G 36:14	INRTL R = 328.68 MNVR P = 302.05 Y = 2.96  MNVR A1/AUTO/VERN HOLD (same)	RATE 0.2000 DB AT 1.000 DB RT 0.020  SUN R 210 P 122 $\beta = 0$	ID: 38 NAVI 22:57 - 23:47	HUD CAL  STAR ID: 38  SUNSET: 23:14 SUNRISE: 23:50
47 010/23:25:00 M 37:48  267/22:47:33 G 23:00:21	LVLH TRACK TGT = 2 P = 90.00 BV = 3 Y = 0.00 OM = 0.00  MNVR A6/AUTO/ALT HOLD (same)	RATE 0.2000 DB AT 5.00 DB RT 0.070  EARTH R 0 P 90 $\beta = 0$	LVLH R= 0.00 P=180.00 Y= 0.00	-ZLV -XVV
48 011/13:05:00 M 13:48  268/12:27:33 G 36:21	INRTL R = 195.00 MNVR P = 134.00 Y = 13.00  MNVR A1/AUTO/VERN HOLD (same)	RATE 0.2000 DB AT 1.000 DB RT 0.020  SUN R 151 P 47 $\beta = -1$	-Y: 13 RIGEL 13:07 - 13:57  -Z: 95 BETA GRUIS 12:58 - 13:47	IMU ALIGN  -Y: 13 -Z: 95 PAIR AOS: 13:07 PAIR LOS: 13:47
49 011/13:19:00 M 31:24  268/12:41:33 G 53:57	INRTL R = 71.00 MNVR P = 68.00 Y = 17.00  MNVR A1/AUTO/VERN HOLD (same)	RATE 0.2000 DB AT 1.000 DB RT 0.020  SUN R 295 P 111 $\beta = -1$	-Y: 93 ICEN 13:29 - 14:18  -Z: 21 PROCYON 13:20 - 14:11	VERIFICATION  -Y: 93 -Z: 21 PAIR AOS: 13:29 PAIR LOS: 14:11
50 011/13:46:00 M 52:46  268/13:08:33 G 15:19	TGT= 4 BV = 5 P = 184.00 Y = 0.00 OM = 90.00  MNVR A1/AUTO/VERN HOLD (same)	RATE 0.2000 DB AT 1.000 DB RT 0.020  SUN R 180 P 176 $\beta = -2$	INRTL R=128.41 P= 2.06 Y=357.84  RA= 180.976 DEC= -0.423S	-XSI

ALL ORBITER DATA IN  
MEAN OF 1950 AND PYR EULER SEQUENCE

Attitude Timeline

MET/GMT	ORBITER		REF ATT/REMARKS	EVENT
	MNVR OPTION	DAP E/S/ $\beta$		
51 011/15:28:00 M 39:48  268/14:50:33 G 15:02:21	INRTL R = 269.00 MNVR P = 30.00 Y = 1.00  MNVR A1/AUTO/VERN HOLD (same)	RATE 0.2000 DB AT 1.000 DB RT 0.020  SUN R 91 P 150 $\beta = -2$		COMM
52 011/17:30:00 M 34:03  268/16:52:33 G 56:36	M50 (CALC) INRTL R = 174.00 MNVR P = 262.00 PYR Y = 322.00  MNVR TRN/AUTO/PRI HOLD (same)	RATE 0.5000 DB AT 3.50 DB RT 0.20  SUN R 2 P 83 $\beta = -2$	+X PYR R = 0.65 P = 196.26 Y = 0.10  LVLH 011/17:53:00 M 268/17:15:33 G	D/O BURN Retro Head Down Dual OMS  KSC TIG 11/17:53 DV = 186

FLIGHT PLAN NOTES

## FLIGHT PLAN NOTES

### A. FLIGHT DESCRIPTION

Orbiter: OV-103 Discovery  
 Launch Window: 10 minutes  
 Inclination: 51.6°  
 Insertion/Rndz Altitude: 122/190 nautical miles  
 Duration: 12 + 0 + 2 days

### B. SHUTTLE CREW

CDR – Eileen Collins	MS3 – Andrew Thomas
PLT – James Kelly	MS4 – Wendy Lawrence
MS1 – Soichi Noguchi	MS5 – Charles Camarda
MS2 – Steve Robinson	

### C. MAJOR EVENTS

<u>EVENT</u>	<u>FD</u>	<u>MET</u>	<u>DATE</u>	<u>CDT</u>	<u>GMT</u>
Launch	1	0/00:00	9/12/2004	18:22	256/23:22
OMS-2	1	0/00:38	9/12/2004	19:00	257/00:00
NC-1	1	0/03:35	9/12/2004	21:57	257/02:57
NC-2	2	0/15:29	9/13/2004	9:52	257/14:52
OBSS Survey	2	0/17:15	9/13/2004	11:37	257/16:37
NPC	2	1/01:08	9/13/2004	19:30	258/00:30
NC-3	2	1/02:40	9/13/2004	21:02	258/02:02
NH	3	1/14:58	9/14/2004	9:20	258/14:20
NC-4	3	1/15:47	9/14/2004	10:09	258/15:09
Ti	3	1/17:19	9/14/2004	11:41	258/16:41
MC-4	3	1/18:36	9/14/2004	12:58	258/17:58
Docking	3	1/19:58	9/14/2004	14:20	258/19:20
ISS Ingress	3	1/22:10	9/14/2004	16:32	258/21:32
OBSS Handoff	3	1/23:00	9/14/2004	17:22	258/22:22
MPLM Install	4	2/14:00	9/15/2004	8:22	259/13:22
OBSS Survey	4	2/19:45	9/15/2004	14:07	259/19:07
EVA 1	5	3/18:00	9/16/2004	12:22	260/17:22
EVA 2	7	5/18:00	9/18/2004	12:22	262/17:22
EVA 3	9	7/18:00	9/20/2004	12:22	264/17:22
MPLM Uninstall	10	8/20:30	9/21/2004	14:52	265/19:52
OBSS Handoff	10	8/23:00	9/21/2004	17:22	265/22:22
ISS Egress	11	9/14:15	9/22/2004	8:37	266/13:37
Undocking	11	9/17:15	9/22/2004	11:37	266/16:37
Sep-1	11	9/17:44	9/22/2004	12:06	266/17:06
Sep-2	11	9/18:12	9/22/2004	12:34	266/17:34
Deorbit Burn	13	11/17:53	9/24/2004	12:15	268/17:15
Landing	13	11/18:56	9/24/2004	13:18	268/18:18

#### D. LANDING OPPORTUNITIES

		<u>Landing</u>		<u>CST</u>	<u>MET</u>
		<u>Orbit</u>	<u>Site</u>		
Nominal	Primary	186	KSC	Sep 24/13:15	11/17:53
	1 Rev Late	187	KSC	Sep 24/14:51	11/19:29
EOM +1	Primary	202	KSC	Sep 25/13:41	12/18:19
	1 Rev Late	203	EDW	Sep 25/12:11	12/19:49
EOM +2	Primary	217	KSC	Sep 26/12:31	13/17:09
	1 Rev Late	218	KSC	Sep 26/14:07	13/18:45

#### E. COMMUNICATIONS

The Summary Timeline contains several data bands for ground site and TDRS events. The TDRS band reflects the three prime TDRS satellites that will be used for orbiter coverage (East, West, and Z) and their longitudinal positions. Ku-band coverage is shown as unshaded bars.

TDRS-Z currently does not have the capability for DTV, therefore can not be used for critical damage detection. Nor is TDRS-Z considered acceptable for PAO events. OCA downlink is limited to 2 Mbps on TDRS-Z.

Prime TDRS Support: East (aka 'Spare'): -47°, West (aka '171'): -171°, Z: -275°  
 Backup TDRS Support: East: -41°, West: -174°  
 U.S. Ground Sites: MIL, DFR, WLP

#### F. MAJOR PAYLOADS

##### 1. LOGISTICS FLIGHT 1 (LF1) LAUNCH PACKAGE (LP)

The ISS LF1 LP consists of the MPLM, the External Stowage Platform (ESP)-2, the Lightweight Multi-Purpose Experiment Structure Carrier (LMC), two Assembly Power Converter Units (APCUs), and ISSP equipment and supplies in the orbiter crew compartment.

The MPLM Cargo Element (CE) is a pressurized module that will carry to orbit one payload rack, seven Resupply Stowage Platforms (RSPs), and four Resupply Stowage Racks (RSRs). The payload rack is the Human Research Facility (HRF)-2 rack. For LF1, the MPLM is configured in its passive configuration.

The ESP-2 consists of the Unpressurized Cargo Pallet (UCP) and the Keel Yoke Assembly (KYA). The UCP will be installed on the ISS, while the KYA will be returned in the orbiter payload bay. The UCP will carry to orbit four Video Stanchion Support Assemblies (VSSAs) and three Orbital Replacement Units (ORUs): the Utility Transfer Assembly (UTA), the Flex Hose Rotary Coupler (FHRC), and the Main Bus Switching Unit (MBSU). An EVA-removable cable harness is used to provide 120 Vdc of electrical power to the ESP-2 heaters while installed in the orbiter payload bay. The starboard Tool Stowage Assembly (TSA) contains ESP-2 primary and secondary power cables.

The LMC is a cross-bay carrier located in Bay 13. Its launch configuration will include a replacement ISS Control Moment Gyro (CMG)-1, and hardware associated with DTO 848 Orbiter Thermal Protection System (TPS) Repair Techniques.

Cargo/payload items will be carried in the orbiter crew compartment including EVA tools and equipment, and other ISS mission-unique support hardware.

The ISS LF1 Return Complement (RC) in the cargo bay consists of the MPLM with seven RSPs, four RSRs, the ESP-2 KYA, the LMC, and two APCUs.

The LMC return configuration will carry the failed CMG unit and the DTO 848 hardware. The starboard TSA will return the ESP-2 Flight Releasable Grapple Fixture (FRGF).

Cargo/payload items will also be returned in the orbiter crew compartment, including a utilization payload, EVA tools and equipment, and other ISS mission-unique support hardware. The only ISS middeck utilization return experiment for LF1 is Protein Crystal Growth-Single Thermal Enclosure System (PCG-STES)-10. PCG-STES-10 is powered during descent.

## 2. MAJOR MISSION OBJECTIVES

A combination of EVA, robotics, and IVA activities will be performed to accomplish the following major LF1 mission objectives:

- a. Inspect all orbiter Reinforced Carbon-Carbon (RCC) using the Orbiter Boom Sensor System (OBSS) attached to the SRMS, and downlink sensor data to the ground for evaluation.
- b. Inspect all orbiter tile using ISS imagery during the rendezvous Rbar Pitch Maneuver (RPM) and the SRMS end effector camera.
- c. Perform three scheduled EVAs to accomplish DTO 848 objectives, remove and replace CMG-1, install ESP-2, and install the Material International Space Station Experiment (MISSE)-5 and retrieve MISSEs 1 and 2.
- d. Transfer MPLM logistics and experiment hardware.
- e. Transfer middeck logistics and experiment hardware.

## G. STATION DEVELOPMENT TEST OBJECTIVE (SDTO)

### 1. SDTO 12004-U: SHUTTLE BOOSTER FAN BYPASS

The purpose of this SDTO is to increase shuttle on-orbit cryo margin by bypassing and deactivating the shuttle booster fan (airlock fan) whenever possible on orbit. The booster fan will not be activated in post insertion and will remain deactivated for most of the mission. It will however be activated for APDS docking ring extension, docking, and undocking to provide cooling to the powered docking avionics and to prevent condensation on the ODS hatch window. The fan will also be activated when the crew is working in the airlock (such as during EMU checkout) to provide good airflow. While docked, sufficient air circulation will be achieved through use of the Lab forward IMV fan so that CO<sub>2</sub> levels on both the ISS and shuttle can be controlled during the day by the ISS. During the overnight period, additional remediation may be required to control CO<sub>2</sub> levels in the shuttle. A real-time call may instruct the crew to replace LiOH on the middeck to supplement the CO<sub>2</sub> removal provided by the ISS, or to reconfigure the duct and turn on the booster fan overnight. Acceptable flow rate through the IMV fan and proper CO<sub>2</sub> levels on the shuttle throughout the docked timeframe must be confirmed on-orbit to prove this cryo reduction method a success.

## H. ON-ORBIT DETAILED TEST OBJECTIVES (DTOs)

### 1. DTO 848: ORBITER THERMAL PROTECTION SYSTEM (TPS) REPAIR TECHNIQUES

The purpose of this DTO is to perform an on-orbit EVA demonstration of the tools and techniques developed to repair damaged orbiter TPS tiles and RCC; however, effective RCC repair techniques have not been developed to date. Tile samples will be mounted into the TPS Sample Box Assembly (SBA) and onto the upper surface of the LMC. The EVA crew will translate to the DTO worksite on the LMC, open the SBA protective cover, and use EVA tools such as the CIPAA and Emittance Wash Applicator to repair damaged tile samples. The SSRMS will be used to position EV crewmembers at the worksite. Tile repair objectives include: 1) demonstrate adhesion of ablative repair material using various application techniques and repair depths, 2) perform repairs to be evaluated post flight, 3) demonstrate that tile repair can be accomplished without significant voids in the ablator material, 4) demonstrate that recommended techniques are effective given environmental factors, and 5) evaluate ablator material hardness after it has cured. RCC repair hardware and techniques may also be evaluated if viable methods are developed in time. MV/Orbiter Project Office is responsible for the design and development of this DTO.

### 2. DTO 850: WATER SPRAY BOILER COOLING WITH WATER/PGME ANTIFREEZE

The purpose of this DTO is confirm ground test results for Water Spray Boiler (WSB) capability post APU shutdown and confirm that coolant usage is within predictions. A special antifreeze of water and propylene glycol monomethyl ether (PGME) mixture will be loaded into WSB 3 only. All three APUs will be shut down per the nominal Post Insertion timeline and allowed to cool. Then APU 3 will be restarted in OPS 8 and allowed to heat until the WSB is commanded to spray. The APU 3 will be restarted while it is still warm but has not cooled below its normal restart limits, thus the restart will be a real-time call based on temperatures. APU 3 is projected to cool to the restart limits around MET 0/03:45 based on previous flight data. After cooling capability has been verified, APU 3 will be shut down again.

## I. ON-ORBIT DETAILED SUPPLEMENTAL OBJECTIVES (DSOs)

### 1. DSO 490B: BIOAVAILABILITY AND PERFORMANCE EFFECTS OF PROMETHAZINE DURING SPACE FLIGHT

The purpose of this DSO is to evaluate Promethazine (PMZ) as an aid for space motion sickness. All participants will don an Actilight watch as soon as possible on orbit, and will record sleep times at wakeup. If motion sickness occurs during the first three days, participants will collect a saliva sample, take PMZ, and complete a series of saliva samples and logs.

### 2. DSO 493: MONITORING LATENT VIRUS REACTIVATION AND SHEDDING IN ASTRONAUTS

The objective of this DSO is to determine the frequency of induced reactivation of latent viruses, latent virus shedding, and clinical disease after exposure to the physical, physiological, and psychological stressors associated with space flight. Participants will collect a saliva sample and complete a log entry at wakeup.

3. DSO 633B: RENAL STONE RISK DURING SPACE FLIGHT, ASSESSMENT AND COUNTERMEASURE VALIDATION

The purpose of this DSO is to quantify the risk of renal stone formation associated with space flight, evaluate the effects of dietary intake on the urinary biochemistry, and determine the effects of potassium citrate as a countermeasure in reducing the potential for renal stone formation. Participants will ingest a potassium citrate (Kcit) pill with each evening meal.

4. DSO 634: SLEEP/WAKE ACTIGRAPHY AND LIGHT EXPOSURE DURING SPACE FLIGHT

The objective of this DSO is to monitor sleep/wake activity and light exposure patterns obtained in flight, to better understand and develop countermeasures for insomnia common in space flight. Participants will don an Actilight watch as soon as possible on orbit, and will wear it continuously throughout the mission on their non-dominant wrists outside of their clothing/sleeve. A common Actilight watch is used for DSO 490B. Subjects will also complete a sleep log within 15 min of wakeup every morning.



FLIGHT PLAN WALKTHROUGH

## FLIGHT PLAN WALKTHROUGH

**Station Activities Performed Prior to Shuttle Docking**

- Prepacking
- LF-1 timeline review
- RPM photography training
- SSRMS checkouts and move from MBS to Lab PDGF
- ITCS sampling
- VDS routing
- Node 1 nadir CBM checkout
- Airlock prep for EVA ops, EMU battery recharge, METOX regen, Safer checkout, and EVA tool config
- CBCS install and checkout
- PMA prep for docking

**Generic Activities/Constraints**

- Daily log entries for DSOs 490B and 634 and saliva samples for DSO 493 are collected every morning at wakeup. A renal stone pill for DSO 633B is ingested with every evening meal.
- A total of 14 CWCs and 8 PWRs are filled and transferred to ISS. CWCs and PWRs cannot be filled at the same time since EECOM would not be able to tell how much water is in each. PWR fills cannot occur during supply nozzle dumps.
- An estimated 90 man-hr are required for MPLM generic transfer, and TBD hr for middeck transfer. Powered payload, EVA equipment, and water bag transfers are scheduled separately from generic transfer. MS4 (loadmaster), MS5 (b/u loadmaster), and ISS CDR will perform a transfer review every docked morning to review the latest uplinked transfer list. A transfer tagup between crewmembers and a transfer call to MCC are scheduled for MS4 and/or MS5 and ISS CDR every docked day starting 2 hr prior to sleep. HRF-2 rack transfer and RSP rotation are not scheduled, per crew request.
- All nominal EVAs are performed using the ISS airlock and the CEVIS exercise prebreathe protocol. The shuttle crew is prime for all SSRMS and EVA tasks. MS1 and MS2 are EVs, MS3 is IV, ISS FE-1 is IV2, and PLT and MS4 are SSRMS operators. MS5 will perform any SRMS tweaks for camera views if necessary although none are scheduled.
- The SRMS is used for OBSS operations and EVA camera views. The SSRMS is used for MPLM operations, OBSS survey camera views, and EVA robotics operations. SSRMS operators are PLT and MS4 and SRMS operators are MS3 and MS5. PLT, MS3, and MS5 are prime for OBSS/SRMS survey operations.
- Water dumps can and will be performed in the docked attitude as long as the centerline of the dump nozzle is aft of the LVLH Y-Z plane (retrograde). The shuttle will hold attitude control during all dump events.
- TFLs:
  - TFL 192 is required for TCS during rndz tool c/o, rendezvous, and undocking. SSV Outrate = 3.
  - TFL 184 is required for MPLM environmental checks and is the default while undocked. SSV Outrate = 3.
  - TLF 199 is used while docked. SSV Outrate = 2.
  - TFL 161 is required for FCS C/O.
- Matrix aligns are required during the docked period because there are no stack maneuvers scheduled for stars of opportunity.
- If reboost is added back to the mission, schedule both CDR and PLT for the first 20 min of procedure, then only one for the rest.
- Post undocked maneuvers and attitude hold periods are performed in ALT DAP to save forward prop.

## **Flight Day 1**

- MS5 will set up the middeck PGSCs (Kfx, router, color printer), and MS2 will set up the flight deck PGSCs (2 A31Ps) for ET umbilical photos and WLES sensor data. The crew will download the ET photos and WLES data to the A31Ps as soon as possible so OCA can downlink them for quick ground processing. The crew will also load ET handheld camera still photos to the Kfx machine for downlink. The remainder of the network setup is scheduled on FD2.
- MS1 will downlink the ET handheld camera video during Ku coverage.
- The PI, NC-1, and post burn -ZLV attitudes are biased to improve Ku for quick downlink of ET photos and video and WLES sensor data.
- Two hours of P/TV01 setup are completed. This activity sets up all photo/tv equipment needed for the FD2 OBSS survey.
- APCU 1 and OIU are activated so MCC can perform an MPLM environmental check. The FD1 check is a full check with fan activation.
- The RMS init includes deployment of both port and starboard MPMs. RMS C/O is scheduled on FD1 to allow more OBSS survey time on FD2. The RMS C/O on FD2 will be deleted real-time if accomplished on FD1. The RMS will remain in precradle overnight, thus only step 1 is scheduled for the powerdown.
- WSB DTO is performed by starting APU 3 when the APU is at a good temperature per real time call (~3:45 MET). Elevon park is also included in this procedure since both require Ops 8. NC-1 was moved late to accommodate the Ops 8 transition.
- Actilight watches are donned for DSOs 634 and 490B.

## **Flight Day 2**

- All starboard wing, nose cap, and port wing RCC are surveyed with the OBSS. Three crew are required continuously during the survey with two performing OBSS/SRMS ops and one monitoring the LDRI and situational awareness cameras. When the three primary crew (PLT, MS3, MS5) are taking a break, MS4 will assist with camera ops. Only two crew are required during unberthing and berthing (non laser ops). The survey is scheduled to continue through the night passes due to time constraints, but the crew may elect to pause if the nighttime visuals are not sufficient. The survey attitude requires no sun within 20 degrees normal to the RCC surface to avoid sun glint. An LDRI 3D calibration during OBSS unberth requires real-time Ku to evaluate laser accuracy. Real-time Ku is not required during the flat-field calibration during the maneuver to the first survey. Each 90-minute surface scan requires as much real-time Ku as possible to downlink DTV. Biased -ZLV attitudes are scheduled to maximize Ku. These maneuvers are scheduled to occur during SRMS repositioning and should be delayed if necessary until the survey is complete. Replay of survey data not obtained real-time will occur in presleep after the crew cues up the tapes using LOS times provided by INCO. The presleep burn attitudes are also biased for Ku. Note: TDRS Z does not have the capability for DTV, thus cannot be used to downlink critical damage data.
- RMS C/O will be deleted real time if accomplished on FD1.
- The RMS will remain in precradle overnight, thus no powerdown is required (the precradle step is in the OBSS berth procedure).
- Two EMUs, two PGTs, three CIPAAAs, and one Emittance Wash Applicator are checked out. MS4 will perform the EMU comm check with the EV crew. During the EVA prep for transfer procedure, the crew will pack EMUs 1/2 and EVA tools for transfer to ISS, and remove and pack EMUs 3/4 batteries for use during EVA 2. One safer is in the middeck, but is checked out on FD4 at the same time as the safer in the MPLM.
- Manual FC purge is scheduled early to avoid survey because of possible contamination on the LDRI.
- PGSCs are set up if not completed on FD1.
- APCU 1 is activated so MCC can perform an MPLM environmental check (pressure check only).
- Rendezvous prep activities are performed including centerline camera install, rendezvous tool checkout part 1, ODS ring extension, and rendezvous burns. Centerline camera install

is required prior to survey because the same monitor is used for the camr crosshair check as for LDRI video. The rndz tool checkout is divided into two parts such that on FD2 the tools are checked out with the RPOP2 machine since RSAD will be running continuously on the prime RPOP machine during survey. Rndz tool checkout must be decoupled with APCU on for MPLM checks due to a TFL conflict. Due to clearances, docking ring extension cannot be performed until the starboard survey is complete. NC2 is scheduled early in post sleep and NPC/NC3 are scheduled late to avoid the survey.

- The airlock fan is turned off for the mission to save cryo per SDTO 12004-U. It is activated before ODS ring extension to provide cooling to docking avionics, and will remain activated during EMU checkout to provide airflow to the crew while they're working in the airlock.
- P/TV01 setup is completed.
- Middeck transfer prep is scheduled to prepare items for transfer to ISS.
- CWC fill equipment is set up so that fills can begin immediately after docking.
- An A/G only PAO event is scheduled because all available Ku is needed for downlink of LDRI data.
- The CMG heater is activated by 1/02:00 MET for thermal protection.
- Sleep begins at MET 1/04:00, two hours earlier than on launch day, to shift the crew for an early docking and set up the sleep cycle to support EOM landing.

### **Flight Day 3**

- A simo water dump is performed to minimize the amount of waste water dumped during the docked mission. The maneuver for the dump is uplinked via DEU.
- An SRMS end effector survey of upper tile surfaces is performed. Real-time Ku is required to downlink survey video, therefore the retrograde water dump attitude is +YVV, with a pitch bias to maximize Ku. Replay of any survey data not obtained real-time will occur as soon as possible before the Ku is taken to radar mode. The SRMS must be precradled prior to NH (called out in survey procedure), and will remain precradled through docking.
- Rendezvous tool checkout part 2 is performed after the SRMS survey to configure the prime RPOP machine from RSAD to RPOP operations.
- The condensate collection hardware is setup and collection is initiated. This also minimizes waste dumps during the docked mission.
- The two EMUs are removed from the shuttle airlock and temp stowed prior to docking to facilitate PMA access/transfers after docking.
- As part of the rendezvous procedures, the crew will perform a 360° Rbar pitch maneuver while the ISS crew takes digital photos of the lower and upper tile surfaces. The ISS crew will load these photos onto the network so that ISS OCA can downlink them as soon as Ku is regained after docking.
- The shuttle will dock with the ISS. After docking, leak checks are performed on the PMA and ODS, the ODS is prepared for ingress (centerline camera removed and ducting prepared), and hatches are opened. All crew will participate in a 25-minute safety briefing. The airlock fan is bypassed and deactivated as part of the post docking procedures.
- The shuttle will maneuver the stack to the nominal docked TEA attitude (STS biased -XLV +ZVV) after rates are damped. Once in attitude, the crew will perform attitude control handover from shuttle to RS, and MCC will perform handover from RS to CMGs.
- The PGSC network is reconfigured from the rendezvous configuration to the EVA configuration, and the PCS is set up to monitor ISS status.
- APCU 1 is activated so MCC can perform an MPLM environmental check (pressure check only).
- EVA tools (such as the CIPAAAs) to be used during the TPS DTO EVA are transferred to ISS.
- The OBSS is unberthed by the SSRMS and handoff from the SSRMS to the SRMS is completed. Two SRMS crew and two SSRMS crew are required for this entire operation. ISS FE-1 will provide SSRMS support since this is the first use of the SSRMS by the shuttle crew. During SSRMS unberth of the OBSS and maneuver to handoff position, the SRMS cameras will provide clearance monitoring. After handoff is complete, the SSRMS is maneuvered to a position for an overnight MCC commanded petal deploy and seal

inspection on the Node 1 nadir ACBM. The SRMS/OBSS will remain deployed and powered for the entire docked mission.

- One CWC is filled.
- P/TV06 is set up for MPLM operations the next day.

#### **Flight Day 4**

- APCU 1 is activated so MCC can perform an MPLM environmental check (pressure check only) prior to MPLM unberth.
- The ROEU is disconnected, the PRLAs unlatched, and the MPLM unberthed from the payload bay using the SSRMS and installed onto ISS Node 1 nadir. During MPLM install and in the low hover position, the CDR will use the PLB cameras to perform a PCBM seal inspection.
- CBMs are closed after MPLM installation is complete. No exercise is allowed from the start of MPLM installation until bolts are acquired. The 1-hr CBM bolt loading must be completed by MCC before the vestibule can be pressurized. The CBCS is removed and the equipment needed for vestibule config is set up.
- MS4 and ISS CDR will continue with vestibule depress, vestibule config for ingress, MPLM activation parts I and II, MPLM ingress, and MPLM setup. One safer stowed in MPLM is transferred and checked out at the same time as the one stowed in the middeck.
- A placeholder is scheduled for docked OBSS survey. This may be used to complete the nominal FD2 RCC survey if it runs long, or to perform a focused inspection on areas where tile or RCC damage is suspected. The SSRMS must be based on the MBS for situational awareness views, so PLT and ISS FE-1 will perform a walkoff of the SSRMS to the MBS and will maneuver the SSRMS to a viewing position prior to the survey. MS3 is one of the three prime survey crewmembers but he is also IV. Therefore, CDR is scheduled as a third person to assist with video routing while MS3 performs EVA prep activities.
- Several activities are scheduled throughout the day for the EVs and IVs to prepare the EMUs and airlock equipment for EVA 1. The shuttle O2 system is configured for use during EVA prep prebreathe. The two EVs will familiarize themselves with CEVIS as used during EVA prep prebreathe. The EMUs are transferred to the ISS airlock and reconfigured as necessary with parts from ISS. An EMU to airlock interface check is performed, the EVA still camera is set up, the equipment lock and EVA tools are configured, the REBA hardware is checked out, and CIPAA preheat is initiated. CIPAA preheat init must occur on FD4 but no later than 11 hr prior to the EVA. An ~1.5 hr EVA procedure review is conducted between all crewmembers involved with the EVA, including the CDR, EVs, IVs, and SSRMS and SRMS operators.
- N2 transfer from the shuttle to the ISS airlock tanks is initiated.
- Two CWCs are filled.
- MDDK transfer is performed.
- An A/G only PAO event is scheduled because all available Ku is needed for downlink of LDRI data.

#### **Flight Day 5**

- PLT's comm config is required 4 hr prior to the end of crewlock depress.
- EVs will terminate CIPAA preheat prior to EVA Prep.
- EVA 1 specific tasks include:
  - Tile samples are contained in a Sample Box Assembly (SBA) on the upper surface of the LMC. The EV crew will translate to the DTO worksite, open the SBA protective cover, prime the tile samples, and use 2 CIPAAAs and various repair methods to repair the damaged tile samples.
- The crew will perform an SSRMS walkoff from the MBS to the Lab PDGF prior to egress. They will utilize the SSRMS based on the Lab PDGF for EV worksite access. The SSRMS is maneuvered to the EVA 2 position after all EVA tasks are complete.
- Post EVA: H2O recharge is delayed until the following day to maximize presleep. The EMU batteries are removed and replaced with batteries taken from EMUs 3/4 on FD2. The

METOX is replaced with LiOH, and METOX regeneration is initiated. BSA and EMU battery charging is initiated.

- Two CWCs and one PWR are filled. This PWR fill is required prior to EMU H2O recharge on FD6.
- MPLM transfer continues.

### **Flight Day 6**

- EMU water recharge and METOX regen termination are performed. METOX term is required  $\geq 14$  hr after init (after 16:00 MET). TPS EVA tool transfer and stow is required to get the CIPAAAs and other TPS equipment cleaned and stowed back in the middeck.
- The crew will prepare for EVA 2 with equipment lock prep, still camera set up, and EVA tool config. At least 1.5 hr for three crewmembers are required for EVA tool config. A 1-hr (or more) EVA procedure review is conducted between all crewmembers involved with the EVA including the CDR, EVs, IVs, and SSRMS and SRMS operators (all except ISS CDR).
- Several partially full CWCs and expired PWRs from ISS are vented from the shuttle. The CWCs bags are dumped out the supply nozzle and the PWRs out the waste nozzle. Two crew are required for the first hour and only one is required for the remainder of the procedure. The crew will perform attitude control handover from CMGs to shuttle before the dump and back to RS after the dump. Then MCC will perform control handover from RS to CMGs. The PWR dumps are required before the third PWR is filled (currently scheduled for FD8) since the same PWR will be filled. There are no constraints on when the CWC dumps occur.
- The shuttle condensate bag is swapped. This is required no later than FD6.
- Two CWCs and one PWR are filled.
- MPLM transfer continues.
- WLES requires a battery changeout mid-mission.
- Shuttle mid-mission reconfigurations are completed.
- One Russian and two U.S. PAO events are scheduled using shuttle assets.

### **Flight Day 7**

- PLT's comm config is required 4 hr prior to the end of crewlock depress.
- EVs will terminate BSA battery charging prior to EVA Prep.
- A wastewater dump is performed. The crew will perform attitude control handover from CMGs to shuttle before the dump and back to RS after the dump. Then MCC will perform control handover from RS to CMGs.
- EVA 2 specific tasks include:
  - A complete R&R of CMG-1 is performed. The failed CMG is removed from the Z1 truss and replaced with a spare CMG, which is launched on a Lightweight MPRESS Carrier (LMC) in the PLB. The failed CMG is returned on the LMC.
  - MCC will unpower the CMG electronics assembly prior to the R&R (included in inhibits). After three of the connectors are mated, MCC will power up the electronics assembly and the crew will perform a CMG aliveness check.
- The crew will utilize the SSRMS based on the Lab PDGF for EV worksite access. The SSRMS is maneuvered to the EVA 3 position after all EVA tasks are complete.
- Post-EVA: H2O recharge and EMU METOX/LiOH/battery replacement are delayed until the following day to maximize presleep. METOX regeneration is initiated on a stowed canister.
- Two CWCs are filled.
- MPLM transfer continues.
- The heater is turned off for the old CMG in the PLB.

### **Flight Day 8**

- EMU water recharge and METOX regen termination are performed. METOX term is required  $\geq 14$  hr after init (after 16:00 MET). EMU batteries are replaced with the ones charged after EVA 1, and LiOH is replaced with METOX.

- The crew will prepare for EVA 3 with equipment lock prep, still camera set up, and EVA tool config. At least 1.5 hr for three crewmembers are required for EVA tool config. A 1-hr EVA procedure review is conducted between all crewmembers involved with the EVA including the CDR, EVs, IVs, and SSRMS and SRMS operators (all except ISS CDR).
- The joint crew news conference, crew photo, and a JAXA event for MS1 are scheduled using shuttle assets. The JAXA event is highly desired during daylight hours in Japan (GMT + 9 hr).
- A joint crew meal is scheduled per crew request.
- One CWC and three PWRs are filled.
- MPLM transfer continues.
- Three hours of off duty are scheduled for the shuttle crew, with the remainder scheduled post undock. Off duty is not required for the ISS crew but they will not perform any joint activities during this time period.
- Illuminators are activated, OBSS ITVC is enabled, and DTV is configured for downlink prior to crew sleep for ground controlled video overnight.

### **Flight Day 9**

- Illuminators are deactivated.
- PLT's comm config is required 4 hr prior to the end of crewlock depress.
- A dump of one of the shuttle condensate bags is performed through the waste nozzle. The crew will perform attitude control handover from CMGs to shuttle before the dump and back to RS after the dump. Then MCC will perform control handover from RS to CMGs.
- EVA 3 specific tasks include:
  - The ESP Attachment Device (ESPAD) is installed on the ISS airlock, the ESP-2 is berthed to the ESPAD, and the power cables are connected. CDR/MS5 will unlatch the PRLAs prior to ESP-2 unberthing from the PLB. After ESP-2 install is complete, MCC will power up and checkout the ESP heaters. ESP-2 contains critical spares.
  - The MISSE Payload Experiment Carriers (PECs) 1 and 2 are removed from the ISS airlock and replaced with PEC 5.
  - The FRGF is removed from ESP-2 and stowed in the starboard TSA for return.
- The crew will utilize the SSRMS based on the Lab PDGF for EV worksite access and to install the ESP-2. The SSRMS will grapple the MPLM after all EVA tasks are complete.
- No exercise is allowed during ESP-2 installation until hard capture.
- All post EVA activities are performed including H2O recharge. METOX regeneration is initiated on a stowed canister.
- Two CWCs are filled.
- The CBM CPA installation occurs at the end of the day, allowing MCC to do a complete checkout overnight in preparation for the MPLM uninstall on FD10. After the CPAs are installed the crew will only be able to transfer smaller MPLM items.
- MPLM transfer concludes. Due to cg limitations, a percentage of the MPLM return items cannot be brought back if the ESP-2 is still in the PLB. Therefore, a few hours of transfer are scheduled after ESP-2 install to allow the crew time to stow these items in the MPLM. MS4 specifically is scheduled to stow EVA hardware in the MPLM.
- The MPLM racks are configured for entry.
- Generic repress is performed to repress the cabin to 14.7 psi.
- Illuminators are activated, OBSS ITVC is enabled, and DTV is configured for downlink prior to crew sleep for ground controlled video overnight.

### **Flight Day 10**

- Illuminators are deactivated.
- EMUs 3 and 4 are checked out and transferred to ISS. EMU resize and reconfig is performed to leave usable EMUs 3/4 and parts of EMUs 1/2 onboard ISS, and to transfer EMUs 1/2 back to shuttle. The crew will clean up the airlock and stow tools during EVA tool stow.

- METOX regen termination is performed. METOX term is required  $\geq 14$  hr after init (after 16:00 MET).
- MPLM cleanup and transfer call will occur before egress. This is the final time to transfer any last minute items to/from the MPLM. MS5 and ISS CDR will perform MPLM egress, deactivation, vestibule configuration, and vestibule depress. Note that a different shuttle crewmember will perform MPLM vestibule ops on FD10 as on FD4 to avoid SCSC exceptions.
- After vestibule depress, the crew will perform Node 1 nadir CBM demate, and uninstall and reberth the MPLM in the PLB using the SSRMS. No exercise is allowed during CBM demate and MPLM uninstall. The MPLM heaters are turned on for about 4 hr. APCU 1 is activated so MCC can perform a full environmental check.
- The OBSS handoff from the SRMS to the SSRMS is completed and the SSRMS will reberth the OBSS in the PLB. Two SRMS crew and two SSRMS crew are required for this entire operation. During SSRMS maneuvering after OBSS grapple and during reberthing, the SRMS cameras will provide clearance monitoring. After the OBSS is reberthed, the SSRMS is maneuvered to an undock viewing position and the SRMS is powered down.
- The PCG-STES 10 powered payload is transferred from ISS to the shuttle middeck. Two crewmembers are required for one hr each. A status check is performed every morning and evening after the payload is transferred to shuttle.
- Two CWCs and three PWRs are filled.
- The shuttle O2 prebreathe equipment is torn down.
- N2 transfer from the shuttle to the ISS airlock tanks is terminated.
- MDDK transfer concludes.
- Rendezvous tool checkout is completed to support undock. The checkout is divided into two parts such that on FD10 the tools are checked out with the RPOP2 machine since RSAD will be running continuously on the prime RPOP machine during MPLM berthing. Rndz tool c/o must be decoupled with APCU on for MPLM checks due to a TFL conflict.
- One U.S. PAO event is scheduled using shuttle assets.
- P/TV08 ISS external survey is performed over a daylight pass.
- Illuminators are activated, OBSS ITVC is enabled, and DTV is configured for downlink prior to crew sleep for ground controlled video overnight.

### **Flight Day 11**

- A PCG-STES 10 status check is performed in the morning and evening.
- The crew will close the hatch between vehicles, perform an ODS leak check, and install the centerline camera.
- Rendezvous tool checkout part 2 is performed to configure the prime RPOP machine from RSAD to RPOP operations.
- MPLM heaters are activated for ~9 hr.
- The formaldehyde monitoring kit (FMK) deploy is performed. It must be stowed after 48 hr.
- MCC will perform handover of attitude control from CMGs to RS. Then the crew will perform handover from RS to shuttle and maneuver to undock attitude.
- Undocking is performed at sunrise minus 5 minutes. Flyaround is low on the priority list and was not scheduled in order to allow sufficient transfer time by maximizing post undock off duty.
- The starboard and port MPMs are stowed.
- Illuminators are deactivated.
- APCU 1 is activated so MCC can perform an MPLM environmental check (pressure check only).
- The centerline camera is removed from the ODS.
- The airlock fan is deactivated.
- The comm system is switched to comm string 1 to check out that string.
- A maneuver to -ZLV +YVV attitude is performed soon after undocking and a simo and condensate bag dump is performed later in the day once ISS is out of range for dump particle recontact.



- Approximately 4 to 5 hr of off-duty is scheduled for all crewmembers.
- PFCs are scheduled for each crewmember during off duty.

### **Flight Day 12**

- A PCG-STES 10 status check is performed in the morning and evening.
- APCU 1 is activated so MCC can perform an MPLM environmental check (pressure check only). Once this last MPLM check is complete, the OIU is deactivated.
- Standard day before entry activities are performed: FCS checkout, RCS hotfire, PILOT ops, deorbit briefing, L-1 comm checks, cabin stow, entry video setup, SSV deact, ergometer stow, Ku stow, PGSC stow, and MFX setup.
- A procedure to position the elevons for inspection is performed anytime after undocking.
- MPLM heaters are activated for ~13 hr.
- The PRLAs that were unlatched during ESP-2 unberth are closed.
- One U.S. PAO event is scheduled for all crewmembers.
- EVA hardware stow and post EVA entry prep are performed.
- A FES dump is performed for 3 hr.
- A dedicated IMU alignment and HUD calibration are performed during a night pass. This is required since the HUD has been removed and reinstalled in the vehicle.
- The WLES A31P and equipment is stowed.
- The comm system is switched back to comm string 2 after 24 hr.

### **Flight Day 13**

- Standard entry day activities are performed: IMU align, GIRA stow, TEPC stow, air sample, OCAC stow, PGSC and printer stow, group B powerup, and mnvr to -XSI.
- The MPLM heaters are activated. They are deactivated in D/O prep.
- The DSO actilight watches are stowed after final log.
- The formaldehyde monitoring kit (FMK) stow is performed after 48 hr of deployment.
- A PCG-STES 10 status check is performed.
- Deorbit prep and landing at KSC.

This Page Intentionally Blank



**FLIGHT PLAN**

**STS  
114**