

# Flight Plan

## STS-120/10A

(OCFR1 RevA Flight Cycle Trajectory)

### Mission Operations Directorate Operations Division

#### Basic

For the latest working copy of the Flight Plan, visit  
<http://mod.jsc.nasa.gov/do4/flightplan/main/fp.cfm?id=120>

April 27, 2007

EVENT	FD	MET	LOCAL DATE	CDT	GMT
Launch	1	0/00:00	8/09/2007	17:16	221/22:16
OBSS Survey	2	0/18:00	8/10/2007	11:16	222/16:16
Ti	3	1/17:22	8/11/2007	10:38	223/15:38
Docking	3	1/20:17	8/11/2007	13:33	223/18:33
EVA 1	4	2/17:45	8/12/2007	11:01	224/16:01
EVA 2	6	4/17:15	8/14/2007	10:31	226/15:31
P6 Handoff	7	5/14:30	8/15/2007	07:46	227/12:46
EVA 3	8	6/16:45	8/16/2007	10:01	228.15:01
P6 SAW Deploy	8	6/23:25	8/16/2007	16:41	228/21:41
Undocking	10	8/14:42	8/18/2007	07:58	230/12:58
Landing	12	10/19:32	8/20/2007	12:48	232/17:48

National Aeronautics and  
Space Administration

Lyndon B. Johnson Space Center  
Houston, Texas



Verify this is the correct version for the pending operation (training, simulation or flight).  
Electronic copies of FDF books are available. URL: <http://mod.jsc.nasa.gov/do3/FDF/index.html>



## MISSION OPERATIONS DIRECTORATE

FLIGHT PLAN  
STS-120BASIC  
April 27, 2007

PREPARED BY:



---

 Diane Hord  
Book Manager, Lead FAO





---

 Patrick White  
Lead Timeliner





---

 Aaron McDonald  
Lead Ops Planner



---

 Rudy Gonzalez  
Lead RPE



---

 for Marcos Stocco  
Lead Pointer

APPROVED BY:



---

 Linda DeLapp  
Lead, Flight Planning Group



---

 Debbie Stapleton  
Chief, Flight Planning Branch



---

 Michael Hess  
Chief, Operations Division

---

 (Deferred until Final)  
G. Allen Flynt  
Director of Operations

This document is under the configuration control of the Crew Procedures Control Board (CPCB). Except for Discrepancy Notices (DN) approved at the flight operations review (FOR), all proposed changes must be submitted via FDF Workflow Crew Procedure Change Request (CR) to DO3/FDF Manager.

Additional distribution of this book, for official use only, may be requested in writing to DO3/PMO Administrator. The request must include justification and requester's name, organization, position, and phone number. Contractor requests are made through the NASA or DOD organization supported. Deletions, reduction in quantity, or change of address may be submitted to DO3/FDF Management Office, 281-244-1184.

Incorporates the following:
482#: FLT PLN-2042

AREAS OF TECHNICAL RESPONSIBILITY

Book Manager/Lead FAO	DO4/D. Hord	281-244-0294
Lead Timeliner	DO4/P. White	281-244-1190
Lead Pointer	DO4/M. Stocco	281-244-1023
Lead Ops Planner	DO4/A. McDonald	281-483-5958
Lead RPE	DO4/R. Gonzalez	281-244-1099

FLIGHT PLAN  
STS-120

**LIST OF EFFECTIVE PAGES**

BASIC 04/27/07

Sign Off .....	*	120/BAS	3-1 .....	120/BAS
ii.....	*	120/BAS	3-2 .....	120/BAS
iii.....	*	120/BAS	3-3 .....	120/BAS
iv.....	*	120/BAS	3-4 .....	120/BAS
v .....	*	120/BAS	3-5 .....	120/BAS
vi.....	*	120/BAS	3-6 .....	120/BAS
1-1 .....		120/BAS	3-7 .....	120/BAS
1-2 .....		120/BAS	3-8 .....	120/BAS
1-3 .....		120/BAS	3-9 .....	120/BAS
1-4 .....		120/BAS	3-10 .....	120/BAS
2-1 .....		120/BAS	3-11 .....	120/BAS
2-2 .....		120/BAS	3-12 .....	120/BAS
2-3 .....		120/BAS	3-13 .....	120/BAS
2-4 .....		120/BAS	3-14 .....	120/BAS
2-5 .....		120/BAS	3-15 .....	120/BAS
2-6 .....		120/BAS	3-16 .....	120/BAS
2-7 .....		120/BAS	3-17 .....	120/BAS
2-8 .....		120/BAS	3-18 .....	120/BAS
2-9 .....		120/BAS	3-19 .....	120/BAS
2-10 .....		120/BAS	3-20 .....	120/BAS
2-11 .....		120/BAS	3-21 .....	120/BAS
2-12 .....		120/BAS	3-22 .....	120/BAS
2-13 .....		120/BAS	3-23 .....	120/BAS
2-14 .....		120/BAS	3-24 .....	120/BAS
2-15 .....		120/BAS	3-25 .....	120/BAS
2-16 .....		120/BAS	3-26 .....	120/BAS
2-17 .....		120/BAS	3-27 .....	120/BAS
2-18 .....		120/BAS	3-28 .....	120/BAS
2-19 .....		120/BAS	3-29 .....	120/BAS
2-20 .....		120/BAS	3-30 .....	120/BAS
2-21 .....		120/BAS	3-31 .....	120/BAS
2-22 .....		120/BAS	3-32 .....	120/BAS
2-23 .....		120/BAS	3-33 .....	120/BAS
2-24 .....		120/BAS	3-34 .....	120/BAS
2-25 .....		120/BAS	3-35 .....	120/BAS
2-26 .....		120/BAS	3-36 .....	120/BAS
2-27 .....		120/BAS	3-37 .....	120/BAS
2-28 .....		120/BAS	3-38 .....	120/BAS
2-29 .....		120/BAS	3-39 .....	120/BAS
2-30 .....		120/BAS	3-40 .....	120/BAS
2-31 .....		120/BAS	3-41 .....	120/BAS
2-32 .....		120/BAS	3-42 .....	120/BAS
2-33 .....		120/BAS	3-43 .....	120/BAS
2-34 .....		120/BAS	3-44 .....	120/BAS
2-35 .....		120/BAS	3-45 .....	120/BAS
2-36 .....		120/BAS	3-46 .....	120/BAS
2-37 .....		120/BAS	3-47 .....	120/BAS
2-38 .....		120/BAS	3-48 .....	120/BAS
2-39 .....		120/BAS	3-49 .....	120/BAS
2-40 .....		120/BAS	3-50 .....	120/BAS

\* – Omit from flight book

3-51	120/BAS	3-108	120/BAS
3-52	120/BAS	3-109	120/BAS
3-53	120/BAS	3-110	120/BAS
3-54	120/BAS	3-111	120/BAS
3-55	120/BAS	3-112	120/BAS
3-56	120/BAS	3-113	120/BAS
3-57	120/BAS	3-114	120/BAS
3-58	120/BAS	3-115	120/BAS
3-59	120/BAS	3-116	120/BAS
3-60	120/BAS	3-117	120/BAS
3-61	120/BAS	3-118	120/BAS
3-62	120/BAS	3-119	120/BAS
3-63	120/BAS	3-120	120/BAS
3-64	120/BAS	3-121	120/BAS
3-65	120/BAS	3-122	120/BAS
3-66	120/BAS	3-123	120/BAS
3-67	120/BAS	3-124	120/BAS
3-68	120/BAS	3-125	120/BAS
3-69	120/BAS	3-126	120/BAS
3-70	120/BAS	3-127	120/BAS
3-71	120/BAS	3-128	120/BAS
3-72	120/BAS	3-129	120/BAS
3-73	120/BAS	3-130	120/BAS
3-74	120/BAS	4-i	* 120/BAS
3-75	120/BAS	4-ii	* 120/BAS
3-76	120/BAS	4-1	* 120/BAS
3-77	120/BAS	4-2	* 120/BAS
3-78	120/BAS	4-3	* 120/BAS
3-79	120/BAS	4-4	* 120/BAS
3-80	120/BAS	4-5	* 120/BAS
3-81	120/BAS	4-6	* 120/BAS
3-82	120/BAS	4-7	* 120/BAS
3-83	120/BAS	4-8	* 120/BAS
3-84	120/BAS	5-1	* 120/BAS
3-85	120/BAS	5-2	* 120/BAS
3-86	120/BAS	5-3	* 120/BAS
3-87	120/BAS	5-4	* 120/BAS
3-88	120/BAS	5-5	* 120/BAS
3-89	120/BAS	5-6	* 120/BAS
3-90	120/BAS	6-1	* 120/BAS
3-91	120/BAS	6-2	* 120/BAS
3-92	120/BAS	6-3	* 120/BAS
3-93	120/BAS	6-4	* 120/BAS
3-94	120/BAS	6-5	* 120/BAS
3-95	120/BAS	6-6	* 120/BAS
3-96	120/BAS	6-7	* 120/BAS
3-97	120/BAS	6-8	* 120/BAS
3-98	120/BAS		
3-99	120/BAS		
3-100	120/BAS		
3-101	120/BAS		
3-102	120/BAS		
3-103	120/BAS		
3-104	120/BAS		
3-105	120/BAS		
3-106	120/BAS		
3-107	120/BAS		

\* – Omit from flight book

CONTENTS

PAGE

INTRODUCTION ..... vi

OVERVIEW TIMELINE ..... 1-1

SUMMARY TIMELINE AND ISS SHORT TERM PLAN ..... 2-1

DETAILED TIMELINE ..... 3-1

ATTITUDE TIMELINE ..... 4-1

FLIGHT PLAN NOTES ..... 5-1

KU BAND ANTENNA MASKING PLAN ..... 6-1

## INTRODUCTION

The STS-120 Flight Plan is the Flight Data File article that contains the on-orbit timeline. It does not contain the detailed timelines that are covered in the Ascent, Post Insertion, Deorbit Prep, and Entry Checklists. The detailed rendezvous and undocking timelines and procedures are contained in the Rendezvous Checklist. The detailed EVA task timelines and procedures are contained in the EVA Checklist.

This Flight Plan satisfies the mission requirements specified in the following documents:

- NSTS-07700 Vol III, Flight Definition and Requirements Document
- NSTS-17462-120, STS-120 Flight Requirements Document
- NSTS-37326, Shuttle Crew Scheduling Constraints
- NSTS-21504, ISS 10A Mission Integration Plan

The timeline formats used in this Flight Plan are based on JSC-19933, Timeline Format Definitions and Standard Notes, Rev C, May 1990.

The STS-120 Flight Plan is based on a launch date of August 9, 2007 at 22:16 GMT (17:16 CDT). Orbiter inertial attitudes are expressed relative to a mean of 1950 (M50) reference frame.

The following SCSC Exceptions have been submitted in order to meet Category 1 objectives:

None

The Flight Plan and other related mission information are available on the following Space Shuttle Flight Planning web site:

<http://mod.jsc.nasa.gov/do4/flightplan/main/fp.cfm?id=120>



OVERVIEW TIMELINE

This Page Intentionally Blank

# STS-120/10A Overview Timeline (11+1+2)

MET														00/0	1	2	3	4	5	6	7	8	9	10	11	12
<b>FD01</b>	STS											ASC	PI	Setups	PSA	Sleep										
	Orb Att											ASC	-ZLV +YVV	-ZLV -XVV												
		^OMS 2												^NC1												
<b>FD02</b>	STS	PSA		Rndz Prep, EMU C/O, OBSS Unberth, Surveys, Berth										PSA		Sleep										
	Orb Att	-ZLV -XVV				Survey				-ZLV -XVV		Comm	-ZLV -XVV													
		^NC2												^NC3												
<b>FD03</b>	STS	PSA		Rendezvous										Ingress	OBSS Unberth & Handoff	EVA Proc Rvw	PSA		Sleep							
	ISS	PSA		Rendezvous													PSA		Sleep							
	Orb Att	-ZLV -XVV		-ZLV +YVV		Rendezvous										BIAS -XLV -ZVV										
		^NH ^NC4 ^Ti												^Docking 1/20:17												
<b>FD04</b>	STS	PSA		EVA Prep				EVA 1 - N2 install, SASA retrieve, SSU shroud					Post EVA	N2 Vest	PSA	Sleep										
	ISS	PSA						SSRMS						N2 Vest	N2 OF	PSA	Sleep									
	Orb Att	BIAS -XLV -ZVV																								
		MET 2/12												03/0												
<b>FD05</b>	STS	PSA		Focused Inspect (if reqd)				Meal	OBSS Handoff & Berth				EVA Proc Rvw	PSA		Sleep										
	ISS	PSA		Xfer, Node 2 Ingrs				N2 Init						PSA		Sleep										
	Orb Att	BIAS -XLV -ZVV																								
		MET 3/12												04/0												
<b>FD06</b>	STS	PSA		EVA Prep				EVA 2 - P6 detach, RPCM R&R, N2 PDGF					Post EVA	PSA		Sleep										
	ISS	PSA		SSRMS W/O MBS				SSRMS						PSA		Sleep										
	Orb Att	BIAS -XLV		H2O Dmp		BIAS -XLV -ZVV																				
		MET 4/12												05/0												
<b>FD07</b>	STS	PSA		O2 Init	Off Duty				Meal	N2 Term	O2 Term	EVA tools	EVA Proc Rvw	PSA		Sleep										
	ISS	PSA		P6 h/o SRMS, H/O					Xfer, H/O, P6 h/o SSRMS						PSA		Sleep									
	Orb Att	BIAS -XLV -ZVV																								
		MET 5/12												06/0												
		MT xlate WS8																								
<b>FD08</b>	STS	PSA		EVA Prep				EVA 3 - P6 install, MBSU relocate					Post EVA	PSA		Sleep										
	ISS	PSA						SSRMS					P6 SAW Dply	PSA		Sleep										
	Orb Att	BIAS -XLV -ZVV																								
		MET 6/12												07/0												
<b>FD09</b>	STS	PSA		Post EVA Reconfig, Xfer, H2O Dump				Meal	Crew Conf	Off Duty		Hatch	ODS Leak Check	PSA		Sleep										
	ISS	PSA												PSA		Sleep										
	Orb Att	BIAS -XLV -ZVV		H2O Dump		BIAS -XLV -ZVV																				
		MET 7/12												08/0												
<b>FD10</b>	STS	PSA		Undk	Flyaround Sep	Meal	H2O Dump		OBSS Unberth, LI, Berth				PSA		Sleep											
	ISS	PSA											PSA		PSA											
	Orb Att	BIAS -XLV		Undock/Sep		-ZLV +YVV		Survey				-ZLV -XVV														
		Undock 8/14:42^												^Sep2 16:25												
<b>FD11</b>	STS	PSA		FCS C/O	Cabin Stow	D/O Brief	Meal	Cond Dump	Cabin Stow	Ku	PSA		Sleep													
	Orb Att	-ZLV -XVV				-ZLV +YVV				-ZLV -XVV																
			MET 9/12												10/0											
<b>FD12</b>	STS	PSA		D/O Prep				KSC																		
	Orb Att	-ZLV -XVV		-XSI		COMM		ENT																		
		MET 10/12												11/0												

^D/O TIG 10/18:29

This Page Intentionally Blank

SUMMARY TIMELINE AND ISS SHORT TERM PLAN

**SUMMARY  
TIMELINE**

GMT 08/09/07 (221)

MET Day 000

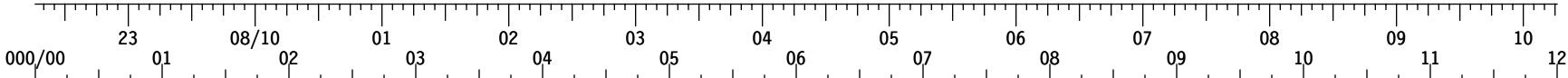

STS - 120	<b>FD01</b> CDR MELROY	ASCENT	POST INSERTION	LOAD DAPS AFT CO	OMS BURN NC1 Δ	--ZLV EV PK	PRE SLEEP	PMC A/G	PRE SLEEP	WATCH	SLEEP
	<b>R1</b> PLT ZAMKA	ASCENT	POST INSERTION	RMS* RMRUP	OMS BURN	GPWR PRDN	RMS C/O	TEPCON	PRE SLEEP	WATCH	SLEEP
	<b>MS1</b> PARAZYNSKI	ASCENT	POST INSERTION	PGSC SETUP			WLESACT	PRE SLEEP	WATCH	SLEEP	
	<b>R2</b> MS2 WILSON	ASCENT	POST INSERTION	P/TVO1 VIDEO SETUP	GPWR PRDN	RMS C/O	RMS	PRE SLEEP	WATCH	SLEEP	
	<b>MS3</b> WHEELock	ASCENT	POST INSERTION	GIRA INSTALL	SEE SETUP	UMB WELL D/L	HVD HID LEO	ETPHOTO	PRE SLEEP	WATCH	SLEEP
	<b>MS4</b> NESPOLI	ASCENT	POST INSERTION	PGSC SETUP			OS CE AT CU P	PRE SLEEP	WATCH	SLEEP	
	<b>MS5</b> TANI	ASCENT	POST INSERTION	FRED SETUP	PRE SLEEP			WATCH	SLEEP		

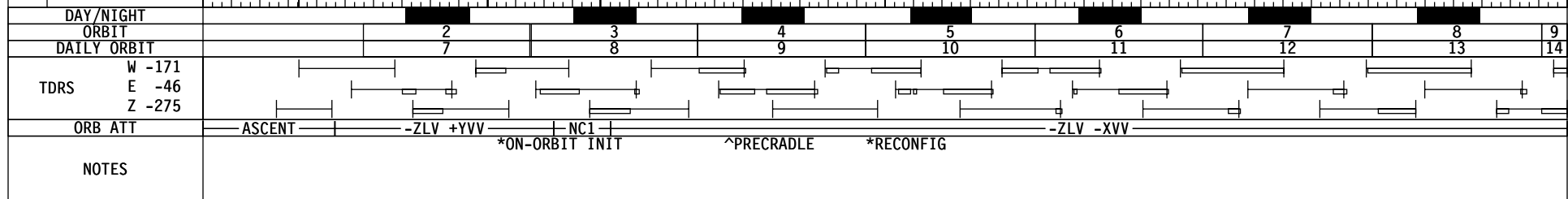

GMT 08/10/07 (222)

MET Day 000

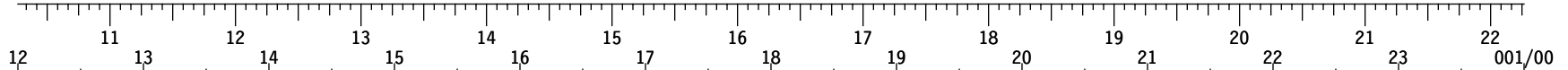

STS - 120	<b>FD02</b> <b>R3</b> CDR MELROY	SLEEP	POST SLEEP	OMS BURN	CRYO 02 SENSOR CK	NOSE SURVEY	PORT WING SRVY	MEAL	FCMS	HTR	CABIT
	<b>R2</b> PLT ZAMKA	SLEEP	POST SLEEP	OMS BURN	P/TV01 VIDEO SETUP	EXERCISE	NOSE CAP SURVEY	PORT WING SRVY	OBSS BERTH	MEAL	FCMS OPS
	<b>R2, R1</b> MS1 PARAZYNSKI	SLEEP	POST SLEEP	OBSS UNBERTH	STBD WING SRVY	EMU C/O PREP	MEAL	EMU C/O	EMU & EVA XFER PREP		
	<b>R2, R1</b> MS2 WILSON	SLEEP	POST SLEEP	P/TV01 VIDEO SETUP	STBD WING SRVY	NOSE CAP SURVEY	PORT WING SRVY	OBSS BERTH	RPMWSDN#	MEAL	OMS POD SURV
	<b>MS3</b> WHELOCK	SLEEP	POST SLEEP	ERG SETUP	TRANSFER PREP	EMU C/O PREP	MEAL	EMU C/O	EMU & EVA XFER PREP		
	<b>R1, R2</b> MS4 NESPOLI	SLEEP	POST SLEEP	OBSS UNBERTH	STBD WING SRVY	NOSE CAP SURVEY	EMU C/O COMM	MEAL	UNSTOW	SAFER C/O	EXERCISE
	<b>MS5</b> TANI	SLEEP	POST SLEEP	ERG SETUP	EXERCISE		MEAL	EMU C/O	EMU & EVA XFER PREP		

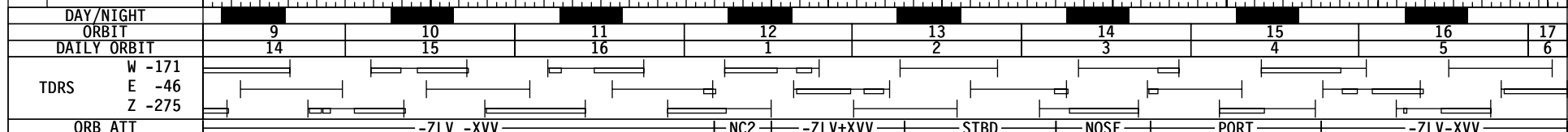

NOTES

\*MANUAL PURGE  
\*CNTLR SWAP  
# PRECRADLE



GMT 08/10/07 (222)

MET Day 001

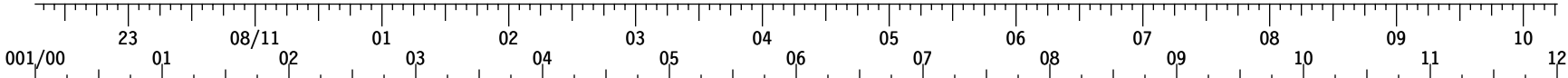

S T S - 1 2 0	<b>FD02</b>	CWC S/U	EXERCISE	PRE SLEEP	NC3Δ RCS BURN	FUT - - Z X L V V V R	PRE SLEEP	PMC A/G	PRE SLEEP	SLEEP									
	PLT ZAMKA	FILTER CLEANING		PRE SLEEP	RCS BURN		PRE SLEEP			SLEEP									
	MS1 PARAZYNSKI	RNDZ TOOLS C/O	HHL C/O	EXERCISE			PRE SLEEP			SLEEP									
	MS2 WILSON	C/L CAMR INST	ODS RING EXT				PRE SLEEP			SLEEP									
	MS3 WHEELock	C/L CAMR INST	ODS RING EXT				PRE SLEEP			SLEEP									
	MS4 NESPOLI	RNDZ TOOLS C/O	LDRI PLBK		C D M		PRE SLEEP			SLEEP									
	MS5 TANI				U N I S T O N		PRE SLEEP			SLEEP									
DAY/NIGHT		17		18		19		20		21		22		23		24		25	
ORBIT		6		7		8		9		10		11		12		13		14	
DAILY ORBIT		6		7		8		9		10		11		12		13		14	
TDRS		W -171		E -46		Z -275													
ORB ATT		-ZLV-XVV		NC3								-ZLV -XVV							
NOTES																			

GMT 08/11/07 (223)

MET Day 001

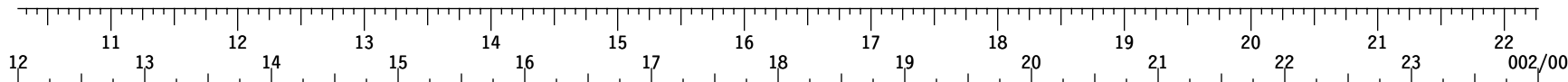

S T S - 1 2 0	<b>FD03 R2</b> CDR MELROY	SLEEP	POST SLEEP	IR R P U B P	ΔNH	ΔNC4	ΔT1	ISS RNDZ OPS	ΔRPM	APPROACH T/L	HATCH LEAK CK	ODS PREP	HATCH OPEN	SFTY BRF	OBSS	UBNERTH							
	<b>R1</b> PLT ZAMKA	SLEEP	POST SLEEP	IR R P U B P				ISS RNDZ OPS		APPROACH T/L	MNVR TEA	P/TV04 S/U	P/TV04 OPS	SFTY BRF	OBSS	UBNERTH							
	<b>MS1</b> PARAZYNSKI	SLEEP	POST SLEEP					ISS RNDZ OPS		APPROACH T/L	POST RNDZ PGSC CNFG	PCS SETUP - STS		SFTY BRF		EMU EVA TOOL XFR	*						
	<b>M1</b> MS2 WILSON	SLEEP	POST SLEEP	WI A N S I T E	POST SLEEP	WT A E S R T M E		POST SLEEP	COND CWC S/U	M C I U *	EXERCISE			APPROACH T/L	HATCH LEAK CK	ODS PREP	HATCH OPEN	SFTY BRF	OBSS GRPL	UBNERTH	MNVR		
	<b>MS3</b> WHEELLOCK	SLEEP	POST SLEEP					POST SLEEP	C N F G *	MDDK PREP	EMU RMVL	OIU ACT		EXERCISE			APPROACH T/L	SFTY BRF		EMU EVA TOOL XFR	⊕		
	<b>MS4</b> NESPOLI	SLEEP	POST SLEEP					POST SLEEP	C D M		ISS RNDZ OPS				APPROACH T/L	SFTY BRF	C I W C I T # 1						
U P	<b>FE-2</b> TANI	SLEEP	POST SLEEP					POST SLEEP	MDDK PREP	EMU RMVL			P/TV02 S/U	P/TV02 DOCK OPS*			P L Y B K		P/TV05 S/U	SFTY BRF	IELK INST & C/O		
E X P 1 6	<b>ISS</b> CDR WHITSON	SLEEP (8.5)	POST SLEEP	PREP WORK	DPC			EXERCISE CEVIS		EXERCISE RED		EVA DCS CNFG	MIDDAY-MEAL	DOCK	VIDE				HATCH OPEN	SFTY BRF	EMU EVA TOOL XFR	*	
	<b>FE-1</b> MALENCHENKO	SLEEP (8.5)	POST SLEEP	PREP WORK	DPC			EXERCISE TVIS		EXERCISE VELO		I S W I U S	MIDDAY-MEAL	PMA2 CFG				AK 1M SMPL	HATCH OPEN	SFTY BRF	IELK INST & C/O		
D N	<b>M2</b> FE-2 ANDERSON	SLEEP (8.5)	POST SLEEP	PREP WORK	DPC			VRFY P/TV S/U	COX MNT	IMS EDIT	EXERCISE CEVIS	EXERCISE RED	MIDDAY-MEAL	P C M A G 2				HATCH LK CK-ISS		SFTY BRF	OBSS GRPL	UBNERTH	MNVR

DOCKING

HARDMATE

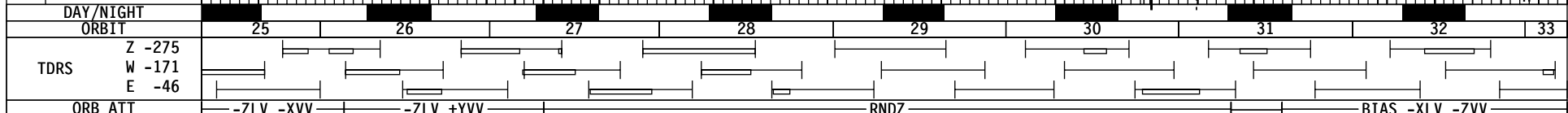

NOTES

\*FILTER CK  
\*GALLEY OVERNIGHT  
\*GALLEY MORNING

\*DOCKING (01/20:17)

⊕E/L PREP  
⊕E/L PREP

CT 08/11/07 (223)

MET Day 001  
FD03  
GMT 08/11/07 (223)

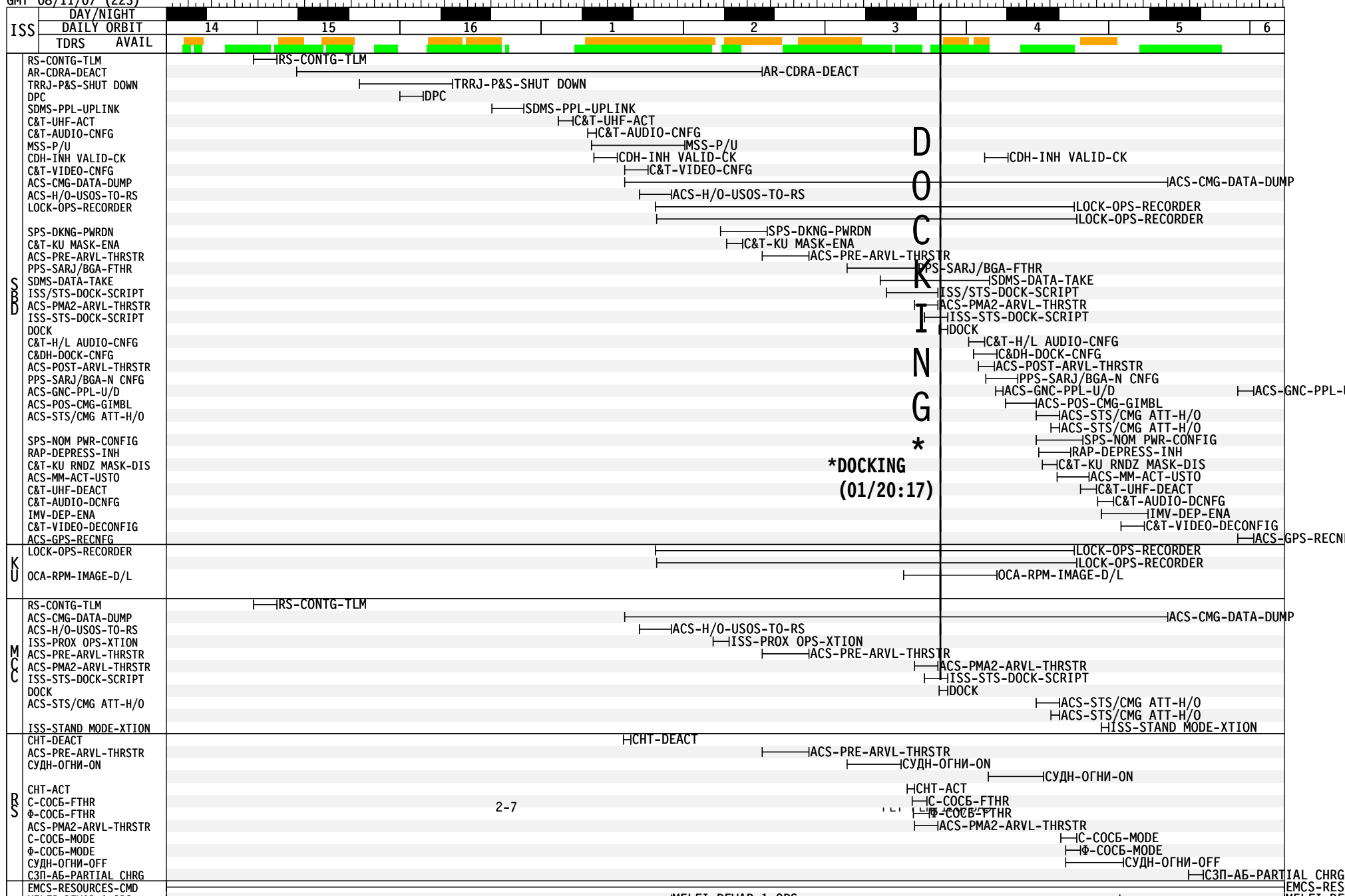
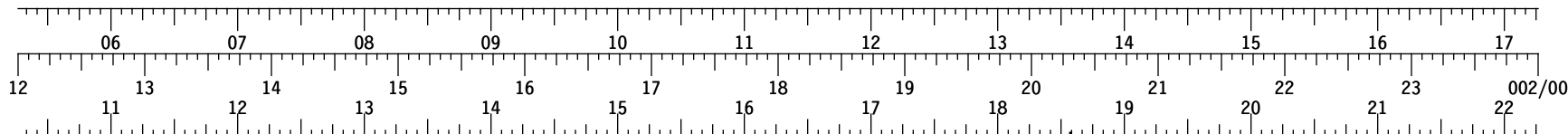

\*DOCKING  
(01/20:17)

IAL CHRГ  
EMCS-RES

GMT 08/11/07 (223)

MET Day 002

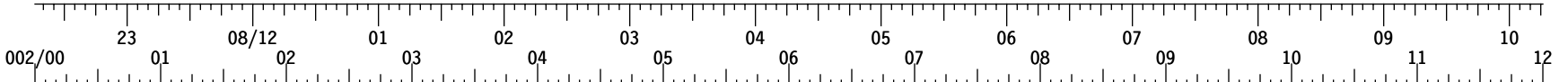

S T S - 1 2 0	FD03 R2 CDR MELROY		GRA P L		N2 V I E W	C X F E R	EVA P R O C E D U R E R E V I E W	P S R L E E P M C E A / G	PRE SLEEP	SLEEP	
	R1 PLT ZAMKA		GRA P L		N2 V I E W	S O F T W A R E	EVA P R O C E D U R E R E V I E W		PRE SLEEP	SLEEP	
	MS1 PARAZYNSKI	E/L P R E P	R E B O A	R C / B O A			EVA P R O C E D U R E R E V I E W	P R E S L E E P	M A S K P B / T O O L C O N F I G	P R E S L E E P	SLEEP (A/L)
	M1 MS2 WILSON	M N V R		U N G R P		R O B O E V A 1 S / U	EVA P R O C E D U R E R E V I E W		PRE SLEEP		SLEEP
	MS3 WHEELLOCK	E/L P R E P	R E B O A	R C / B O A			EVA P R O C E D U R E R E V I E W	P R E S L E E P	M A S K P B / T O O L C O N F I G	P R E S L E E P	SLEEP (A/L)
	MS4 NESPOLI	C T W E R M		02 P/B C O N F I G			EVA P R O C E D U R E R E V I E W	P R E S L E E P	M A S K P B / T O O L C O N F I G	P R E S L E E P	SLEEP
U P	FE-2 TANI	I E L K I N S T & C / O	S L O K O K	I E L K		P R E S L E E P	EVA P R O C E D U R E R E V I E W	P M C	PRE SLEEP	SLEEP (8.5)	
E X P 1 6	ISS CDR WHITSON	E/L P R E P	02 P/B C O N F I G	P W R O T E R P K	P S R L E E P	EVA P R O C E D U R E R E V I E W		PRE SLEEP		SLEEP (8.5)	
	FE-1 MALENCHENKO	I E L K I N S T & C / O	S L O K O K	I E L K	P S R L E E P	EVA P R O C E D U R E R E V I E W		PRE SLEEP		SLEEP (8.5)	
D N	M2 FE-2 ANDERSON	M N V R	P W R O T E R P K	U N G R P	P S R L E E P	R O B O E V A 1 S / U	EVA P R O C E D U R E R E V I E W		PRE SLEEP	SLEEP (8.5)	
DAY/NIGHT		ORBIT		Z -275		W -171		E -46		ORB ATT	
		33		34		35		36		37	
		38		39		40		41			
										BIAS -XLV -ZVV	
NOTES		<p>*INSTALL No Exercise while both arms grappled</p> <p>NO EX</p>									

CT 08/11/07 (223)

MET Day 002 002/00

FD03

GMT 08/11/07 (223)

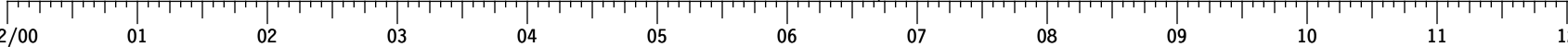
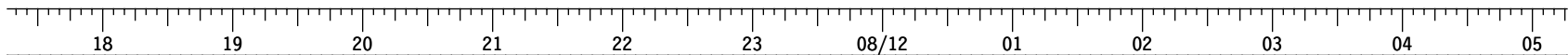

ISS	DAY/NIGHT	Timeline																																	
	DAILY ORBIT	6	7	8	9	10	11	12	13	14	15	16	17	18	19	20	21	22	23	01	02	03	04	05	06	07	08	09	10	11	12	13	14		
	TDRS AVAIL	[Color-coded availability bars]																																	
DBS	SDMS-DATA-DUMP	[Timeline bar]																																	
	IATCS-MTL FLOW-ADJST	[Timeline bar]																																	
	C&T-AUDIO-CNFG	[Timeline bar]																																	
	MSS-P/D	[Timeline bar]																																	
	EVA-10.2 PSI OP-INIT	[Timeline bar]																																	
	PMC	[Timeline bar]																																	
	ACS-A/L O2-PREP	[Timeline bar]																																	
	THC-A/L CCAA-SPD CHG	[Timeline bar]																																	
	NIP-CBM PREP-MATE	[Timeline bar]																																	
	AR-MCA WARN-CNFG	[Timeline bar]																																	
EVA-A/L CAMPOUT-CNFG	[Timeline bar]																																		
ACS-AUTO H/O RS-ENA	[Timeline bar]																																		
N1-PORT ACBM-INSPECT	[Timeline bar]																																		
CK	N1-PORT ACBM-INSPECT	[Timeline bar]																																	
	N1-PORT ACBM-INSPECT	[Timeline bar]																																	
CC	NO-EXERCISE	[Timeline bar]																																	
	NIP-CBM PREP-MATE	[Timeline bar]																																	
	ACS-AUTO H/O RS-ENA	[Timeline bar]																																	
	N1-PORT ACBM-INSPECT	[Timeline bar]																																	
PL	EMCS-RESOURCES-CMD	[Timeline bar]																																	
	ALTEA-DOSI-OPS	[Timeline bar]																																	
	CGBA5-PL-RES TRACK	[Timeline bar]																																	
	EXPRS3-SYS-PWR/THERM	[Timeline bar]																																	
	EXPRS4-SYS-PWR/THERM	[Timeline bar]																																	
	MULT-RUN-PART2	[Timeline bar]																																	
	MELFI-DEWAR 1-OPS	[Timeline bar]																																	
	MELFI-DEWAR 2-OPS	[Timeline bar]																																	
	MELFI-DEWAR 3-OPS	[Timeline bar]																																	
	MELFI-DEWAR 4-OPS	[Timeline bar]																																	
MELFI-DEWAR-COOLDN	[Timeline bar]																																		
SS	ISS ATT	[Timeline bar]																																	
	NOTES	[Timeline bar]																																	

\*PWRDN

-XVV +ZLV TEA

GMT 08/12/07 (224)

003/00

MET Day 002

		12	13	14	15	16	17	18	19	20	21	22	23	24			
S T S - 1 2 0	<b>FD04 R3</b> CDR MELROY	SLEEP	POST SLEEP	POST SLEEP	POST SLEEP	EXERCISE	EXERCISE	MEAL	MEAL	MEAL	MEAL	MEAL	MEAL	MEAL			
	<b>R3</b> PLT ZAMKA	SLEEP	POST SLEEP	POST SLEEP	POST SLEEP	EXERCISE	EXERCISE	P/TV07 EVA OPS	P/TV07 EVA OPS	P/TV07 EVA OPS	P/TV07 EVA OPS	P/TV07 EVA OPS	P/TV07 EVA OPS	VERIF			
	<b>EV1</b> MS1 PARAZYNSKI	SLEEP (A/L)	POST SLEEP	HYGN BREAK/ PREBRTHE	CAMPOUT EVA PREP	EMU PBRTHE	C/L DPRS	P/TV07 EVA OPS	SASA RETRV	NODE PREP UBRTH	SASA STOW	PREP FOR UNBRTH	DISCONN Z1/P6 FLUID	SHRD	SSU		
	<b>M1,M2</b> MS2 WILSON	SLEEP	POST SLEEP	POST SLEEP	POST SLEEP	EXERCISE	EXERCISE	EXERCISE	SASA STOW	SASA STOW	SASA STOW	MEAL	N2 GRPL	N2 UNBERTH/INSTALL	N2 UNBERTH/INSTALL		
	<b>EV2</b> MS3 WHEELLOCK	SLEEP (A/L)	POST SLEEP	HYGN BREAK/ PREBRTHE	CAMPOUT EVA PREP	EMU PBRTHE	C/L DPRS	P/TV07 EVA OPS	SASA RETRV	SASA STOW	SASA STOW	PREP FOR UNBRTH	PREP FOR UNBRTH	AFT RAD SHROUD	SSU		
	<b>IV</b> MS4 NESPOLI	SLEEP	POST SLEEP	HYG BRK/ HATCH CLS	CAMPOUT EVA PREP	EMU PBRTHE	C/L DPRS	P/TV07 EVA OPS	IV SUPPORT	IV SUPPORT	IV SUPPORT	IV SUPPORT	IV SUPPORT	IV SUPPORT	IV SUPPORT		
	<b>M3</b> FE-2 DN ANDERSON	SLEEP (8.5)	POST SLEEP	PREP WORK	DPC	EXERCISE TVIS	EXERCISE RED	EXERCISE RED	SASA STOW	SASA STOW	SASA STOW	MIDDAY-MEAL	MIDDAY-MEAL	N2 GRPL	N2 UNBERTH/INSTALL	VERIF	
E X P 1 6	<b>IV2</b> ISS CDR WHITSON	SLEEP (8.5)	POST SLEEP	HYG BRK/ HATCH CLS	CAMPOUT EVA PREP	EMU PBRTHE	C/L DPRS	P/TV07 EVA OPS	EXERCISE TVIS	MIDDAY-MEAL	MIDDAY-MEAL	MIDDAY-MEAL	EXERCISE RED	EXERCISE RED			
	<b>FE-1</b> MALENCHENKO	SLEEP (8.5)	POST SLEEP	PREP WORK	DPC	SD OR Y OL	N1/ LAB JMPR	EXERCISE TVIS	SS OT KO WL	D A T A	MIDDAY-MEAL	MIDDAY-MEAL	GL O M E D I T	S T O W	COX MNT	VELO	
U P	<b>M2,M1</b> FE-2 UP TANI	SLEEP (8.5)	POST SLEEP	PREP WORK	DPC	ADAPTATION	ADAPTATION	ADAPTATION	SASA STOW	SASA STOW	SASA STOW	MIDDAY-MEAL	ADAPT	N2 GRPL	N2 UNBERTH/INSTALL		
DAY/NIGHT		41		42		43		44		45		46		47		48	
ORBIT		41		42		43		44		45		46		47		48	
TDRS		W -171		E -46		Z -275											
ORB ATT																	
NOTES				*HTR ACT		*CBCS P/U		*FILTER CK		BIAS -XLV -ZVV							

CT 08/12/07 (224)

MET Day 002

FD04

GMT 08/12/07 (224)

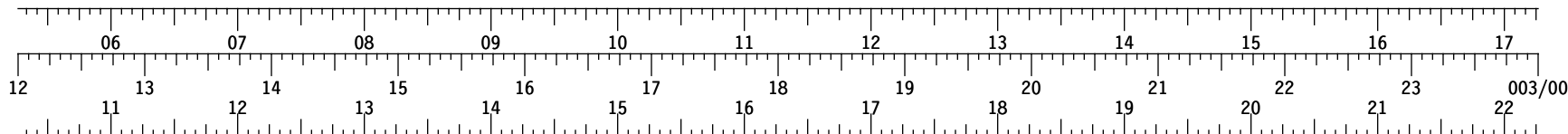

ISS	DAY/NIGHT	06 07 08 09 10 11 12 13 14 15 16 17					
	DAILY ORBIT	14 15 1 2 3 4 5 6					
	TDRS AVAIL	[Green bars indicating TDRS availability]					
S B D	C&T-VIDEO-CNFG	----- ----- ----- ----- ----- -----					
	VDS-WETA-ACT	----- ----- ----- ----- ----- -----					
	ACS-AUTO H/O RS-INH	----- ----- ----- ----- ----- -----					
	MSS-P/U	----- ----- ----- ----- ----- -----					
	C&T-UHF-ACT	----- ----- ----- ----- ----- -----					
	EVA-HYG BRK/PREBRTHE	----- ----- ----- ----- ----- -----					
	C&T-AUDIO-CNFG	----- ----- ----- ----- ----- -----					
	DPC	----- ----- ----- ----- ----- -----					
	RWS-CAUTION-RE-ENABL	----- ----- ----- ----- ----- -----					
	PPS-PCU-DISCHARGE	----- ----- ----- ----- ----- -----					
K U	ACS-AUTO H/O RS-INH	----- ----- ----- ----- ----- -----					
	ACS-CMG-DATA-DUMP	----- ----- ----- ----- ----- -----					
	N2-AFT PCBM-INSPT	----- ----- ----- ----- ----- -----					
	LOCK-OPS-RECORDER	----- ----- ----- ----- ----- -----					
	ACS-AUTO H/O RS-INH	----- ----- ----- ----- ----- -----					
	ACS-CMG-DATA-DUMP	----- ----- ----- ----- ----- -----					
	N2-AFT PCBM-INSPT	----- ----- ----- ----- ----- -----					
	ALTEA-DOSI-OPS	----- ----- ----- ----- ----- -----					
	CGBA5-PL-RES TRACK	----- ----- ----- ----- ----- -----					
	EMCS-RESOURCES-CMD	----- ----- ----- ----- ----- -----					
P L	EXPRES3-SYS-PWR/THERM	----- ----- ----- ----- ----- -----					
	EXPRES4-SYS-PWR/THERM	----- ----- ----- ----- ----- -----					
	MELFI-DEWAR 1-OPS	----- ----- ----- ----- ----- -----					
	MELFI-DEWAR 2-OPS	----- ----- ----- ----- ----- -----					
	MELFI-DEWAR 3-OPS	----- ----- ----- ----- ----- -----					
	MELFI-DEWAR 4-OPS	----- ----- ----- ----- ----- -----					
	MULT-RUN-PART2	----- ----- ----- ----- ----- -----					
	PRO-MULT-FILE-CMD	----- ----- ----- ----- ----- -----					
	MULT-FILEUP-CMD	----- ----- ----- ----- ----- -----					
	HRF-PC1 & UOP-TRK	----- ----- ----- ----- ----- -----					
S Y	PMDIS-A31P & UOP-TRK	----- ----- ----- ----- ----- -----					
	CGBA5-PARAM-CMD	----- ----- ----- ----- ----- -----					
	ISS ATT	-XVV +ZLV TEA					
	ISS ATT	MNVR TO POST INSTALL					
	NOTES	2-11					
	NOTES	FLT PLN/120/BAS					

ALTEA-DOSI-OPS  
 CGBA5-PL-RES TRACK  
 EMCS-RESOURCES-CMD  
 EXPRES3-SYS-PWR/THERM  
 EXPRES4-SYS-PWR/THERM  
 MELFI-DEWAR 1-OPS  
 MELFI-DEWAR 2-OPS  
 MELFI-DEWAR 3-OPS  
 MELFI-DEWAR 4-OPS  
 MULT-RUN-PART2  
 PRO-MULT-FILE-CMD  
 MULT-FILEUP-CMD  
 HRF-PC1 & UOP-TRK  
 PMDIS-A31P & UOP-TRK  
 CGBA5-PARAM-CMD

IACS-CMG-DATA-DUMP  
 IACS-AH-MNVR-USTO  
 ILOCK-OPS-RECORDER  
 IACS-MM-ACT-USTO  
 IN2-AFT PCBM-INSPT  
 IACS-GNC-PPL-U/D  
 EPS-P4 SA

IACS-GNC-PPL-U/D  
 EPS-P4 SA

GMT 08/12/07 (224)

MET Day 003

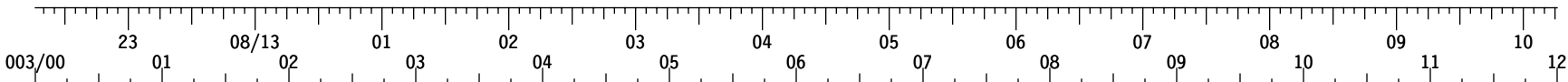

STS-120	FD04	MUNDRAT	CXFCER	IMU	WVS	PRE SLEEP	PMC A/G	PRE SLEEP	SLEEP				
	PLT ZAMKA		CBM 1ST STG	CBM 2ND STG *	PRE SLEEP	N 1/2 VEST LEAK CK	PRE SLEEP	SLEEP					
	MS1 PARAZYNSKI	SSU	INGRS	PREPRS	POST EVA W/H2O	PRE SLEEP	SLEEP						
	MS2 WILSON	N2NSTL	BRAKE	UNGRP	PRE SLEEP	SLEEP							
	MS3 WHEELLOCK	SSU	INGRS	PREPRS	POST EVA W/H2O	PRE SLEEP	SLEEP						
	MS4 NESPOLI	*	INGRS	PREPRS	POST EVA W/H2O	CDM	PRE SLEEP	SLEEP					
	FE-2 DN ANDERSON	N2NSTL	CBM 1ST STG	CBM 2ND STG *	PREP WORK	PRE SLEEP	N 1/2 VEST LEAK CK	PRE SLEEP	SLEEP (8.5)				
EXP 16	ISS CDR WHITSON		PREPRS	POST EVA W/H2O	D/BSA INIT	PW	PRE SLEEP	N2 VEST OUTFT	PRE SLEEP	SLEEP (8.5)			
	FE-1 MALENCHENKO	VELO	EXER	CBCS RMVL	PWORK	DPC	PREP WORK	PRE SLEEP	SLEEP (8.5)				
UP	FE-2 UP TANI	N2NSTL	ADAPT	BRAKE	UNGRP	PMC	PWORK	DPC	PWORK	PRE SLEEP	N2 VEST OUTFT	PRE SLEEP	SLEEP (8.5)
DAY/NIGHT		[Day/Night bar]											
ORBIT		[Orbit bar]											
TDRS		[TDRS bar]											
ORB ATT		[ORB ATT bar]											
NOTES		*IV SUPPORT *AND A BOLTS No Exercise from 1st Stage Capture to A-Bolts complete. NO EX [ ]											





GMT 08/13/07 (225)

MET Day 003

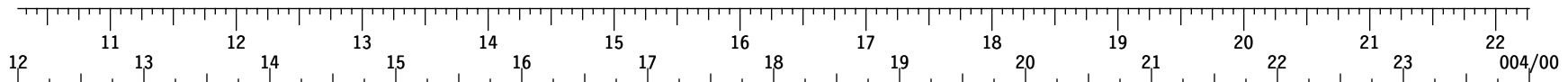

S T S - 1 2 0	FD05 R3, R2 CDR MELROY	SLEEP	POST SLEEP	PEAV OENT	FI RVW	OBSS FOCUSED INSPECT	C I W N M C I # U 4	MEAL	C T W E R C # M 4	MNVR OBSS H/O	U N G L P	C I W N C I # 5	B E R T H	P C R E A D L		
	R1 PLT ZAMKA	SLEEP	POST SLEEP	P/TV 05 S/U	PEAV OENT	FI RVW	OBSS FOCUSED INSPECT	N2 XFER INIT	MEAL	MNVR OBSS H/O	U N G L P		B E R T H	P C R E A D L		
	MS1 PARAZYNSKI	SLEEP	POST SLEEP		PEAV OENT		TRANSFER	EMU BATT INIT	EMU SWAP	EXERCISE	MEAL		METX BATT	E/L PREP	EVA TOOL CONFIG	
	M2, R2 MS2 WILSON	SLEEP	POST SLEEP		SSRMS MNVR FI	FI RVW	OBSS FOCUSED INSPECT			MEAL	MNVR OBSS PRE-G		G R A P P L	LOW HVR	B E R T H	U G R A P P L
	M1 MS3 WHEELock	SLEEP	POST SLEEP		SSRMS MNVR FI		TRANSFER			MEAL	MNVR OBSS PRE-G		G R A P P L	LOW HVR	B E R T H	U G R A P P L
	MS4 NESPOLI	SLEEP	POST SLEEP		C D M	PEAV OENT *	N2 INGRS & S/U		EXERCISE		MEAL	EMU R E S I Z E	METX BATT	E/L PREP	EVA TOOL CONFIG	
	FE-2 DN ANDERSON	SLEEP (8.5)	POST SLEEP	PREP WORK	DPC	PEAV OENT	EXERCISE RED	EXERCISE TVIS		HANDOVER	MIDDAY-MEAL				PREP WORK	*
E X P 1 6	ISS CDR WHITSON	SLEEP (8.5)	POST SLEEP	PREP WORK	DPC	N2 VEST OUTFIT	N2 INGRS & S/U	D C S		EXERCISE RED	MIDDAY-MEAL		BSA TERM	EXERCISE CEVIS	P W R O E R P K	
	FE-1 MALENCHENKO	SLEEP (8.5)	POST SLEEP	PREP WORK	DPC	IMS EDIT	TRANSFER		EXERCISE VELO	N2 XFER INIT	MIDDAY-MEAL		COX MNT	EXER TVIS		
U P	FE-2 UP TANI	SLEEP (8.5)	POST SLEEP	PREP WORK	DPC	N2 VEST OUTFIT	ADAPTATION		EMU SWAP	HANDOVER	MIDDAY-MEAL	EMU R E S I Z E	R C / B O A	E/L PREP	EVA TOOL CONFIG	P M C



ORB ATT: \*FILTER CK, BIAS -XLV -ZVV

NOTES: No Exercise while both arms grappled

CT 08/13/07 (225)

MET Day 003

FD05

GMT 08/13/07 (225)

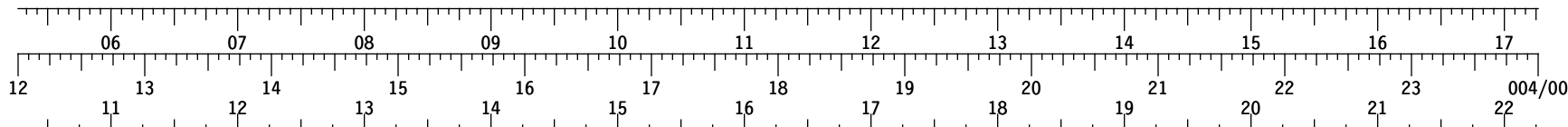

ISS		DAY/NIGHT
		DAILY ORBIT
		TDRS AVAIL
S B D	MSS-P/U	ISS
	ACS-AUTO H/O RS-INH	ISS
K U	DPC	ISS
	PMC	ISS
M C	ACS-AUTO H/O RS-INH	ISS
	NO-EXERCISE	ISS
P L	ALTEA-DOSI-OPS	ISS
	CGBA5-PL-RES TRACK	ISS
S Y	EMCS-RESOURCES-CMD	ISS
	EXPRS3-SYS-PWR/THERM	ISS
ISS ATT	EXPRS4-SYS-PWR/THERM	ISS
	MELFI-DEWAR 1-OPS	ISS
NOTES	MELFI-DEWAR 2-OPS	ISS
	MELFI-DEWAR 3-OPS	ISS
	MELFI-DEWAR 4-OPS	ISS
	MULT-RUN-PART2	ISS
	PRO-MULT-FILE-CMD	ISS
	MULT-FILEUP-CMD	ISS
	CGBA5-PARAM-CMD	ISS

ALTEA-DOS  
 CGBA5-PL-  
 EMCS-RES  
 EXPRS3-SY  
 EXPRS4-SY  
 MELFI-DEW  
 MELFI-DEW  
 MELFI-DEW  
 MELFI-DEW  
 MULT-RUN

GMT 08/13/07 (225)

MET Day 004

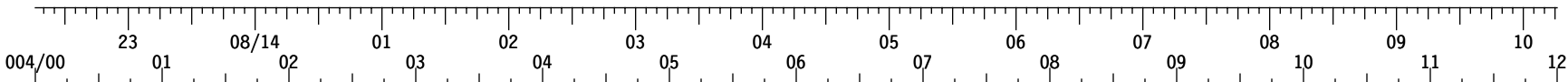

S T S - 1 2 0	FD05	CDR MELROY	CT WE CR #5	CX WE CE R	EVA PROCEDURE REVIEW	PRE SLEEP	PMC A/G	PRE SLEEP	SLEEP
		PLT ZAMKA	PRE SLEEP	R P R S *	EVA PROCEDURE REVIEW	R P R S *		PRE SLEEP	SLEEP
		MS1 PARAZYNSKI	PRE SLEEP		EVA PROCEDURE REVIEW	PRE SLEEP	MASK PB/TOOL CONFIG	PRE SLEEP	SLEEP (A/L)
		MS2 WILSON	PDGF3 GRPL		EVA PROCEDURE REVIEW		PRE SLEEP		SLEEP
		MS3 WHELOCK	PDGF3 GRPL		EVA PROCEDURE REVIEW	X B F R E I R E F	PRE SLEEP		SLEEP
		MS4 NESPOLI	PRE SLEEP		EVA PROCEDURE REVIEW	PRE SLEEP	MASK PB/TOOL CONFIG	PRE SLEEP	SLEEP
		FE-2 DN ANDERSON	* PREP WORK	DPC	EVA PROCEDURE REVIEW		PRE SLEEP		SLEEP (8.5)
E X P 1 6		ISS CDR WHITSON	PREP WORK	DPC	EVA PROCEDURE REVIEW		PRE SLEEP	SLEEP (8.5)	
		FE-1 MALENCHENKO	EXER TVIS	EX PREP WORK	DPC	EVA PROCEDURE REVIEW		PRE SLEEP	SLEEP (8.5)
U P		FE-2 UP TANI	P M C	PRE SLEEP	EVA PROCEDURE REVIEW	PRE SLEEP	MASK PB/TOOL CONFIG	SLEEP (A/L)	
DAY/NIGHT		[Timeline with day/night indicators]							
ORBIT		[Timeline with orbit parameters]							
TDRS		[Timeline with TDRS parameters]							
ORB ATT		[Timeline with orbit attachment parameters]							
NOTES		*L10H RPLC *N2 TERM *N2 INIT							

CT 08/13/07 (225)

MET Day 004 004/00  
**FD05**  
 GMT 08/13/07 (225)

		18 19 20 21 22 23 08/14 01 02 03 04 05													
		01 02 03 04 05 06 07 08 09 10 11 12													
		23 08/14 01 02 03 04 05 06 07 08 09 10													
ISS	DAY/NIGHT	[Bar chart showing day/night cycle]													
	DAILY ORBIT	[Bar chart showing orbit data]													
		TDRS	[Bar chart showing TDRS availability]												
DBS	PMC	----- ----- ----- ----- ----- ----- ----- ----- ----- ----- ----- ----- ----- -----													
	TRRJ-LP A-SHTDN	----- ----- ----- ----- ----- ----- ----- ----- ----- ----- ----- ----- ----- -----													
	DPC	----- ----- ----- ----- ----- ----- ----- ----- ----- ----- ----- ----- ----- -----													
	SSRMS-BASE-CHANGE	----- ----- ----- ----- ----- ----- ----- ----- ----- ----- ----- ----- ----- -----													
	C&T-UHF-ACT	----- ----- ----- ----- ----- ----- ----- ----- ----- ----- ----- ----- ----- -----													
	EVA-10.2 PSI OP-INIT	----- ----- ----- ----- ----- ----- ----- ----- ----- ----- ----- ----- ----- -----													
	C&T-AUDIO-CNFG	----- ----- ----- ----- ----- ----- ----- ----- ----- ----- ----- ----- ----- -----													
	ACS-AUTO H/O RS-ENA	----- ----- ----- ----- ----- ----- ----- ----- ----- ----- ----- ----- ----- -----													
	MSS-P/D	----- ----- ----- ----- ----- ----- ----- ----- ----- ----- ----- ----- ----- -----													
	EVA-A/L CAMPOUT-CNFG	----- ----- ----- ----- ----- ----- ----- ----- ----- ----- ----- ----- ----- -----													
N2-CBM PETAL-CAPTURE	----- ----- ----- ----- ----- ----- ----- ----- ----- ----- ----- ----- ----- -----														
K															
M	ACS-AUTO H/O RS-ENA	----- ----- ----- ----- ----- ----- ----- ----- ----- ----- ----- ----- ----- -----													
	N2-CBM PETAL-CAPTURE	----- ----- ----- ----- ----- ----- ----- ----- ----- ----- ----- ----- ----- -----													
R															
P	ALTEA-DOSI-OPS	----- ----- ----- ----- ----- ----- ----- ----- ----- ----- ----- ----- ----- -----													
	CGBA5-PL-RES TRACK	----- ----- ----- ----- ----- ----- ----- ----- ----- ----- ----- ----- ----- -----													
	EMCS-RESOURCES-CMD	----- ----- ----- ----- ----- ----- ----- ----- ----- ----- ----- ----- ----- -----													
	EXPRS3-SYS-PWR/THERM	----- ----- ----- ----- ----- ----- ----- ----- ----- ----- ----- ----- ----- -----													
	EXPRS4-SYS-PWR/THERM	----- ----- ----- ----- ----- ----- ----- ----- ----- ----- ----- ----- ----- -----													
	MELFI-DEWAR 1-OPS	----- ----- ----- ----- ----- ----- ----- ----- ----- ----- ----- ----- ----- -----													
	MELFI-DEWAR 2-OPS	----- ----- ----- ----- ----- ----- ----- ----- ----- ----- ----- ----- ----- -----													
	MELFI-DEWAR 3-OPS	----- ----- ----- ----- ----- ----- ----- ----- ----- ----- ----- ----- ----- -----													
	MELFI-DEWAR 4-OPS	----- ----- ----- ----- ----- ----- ----- ----- ----- ----- ----- ----- ----- -----													
	MULT-RUN-PART2	----- ----- ----- ----- ----- ----- ----- ----- ----- ----- ----- ----- ----- -----													
S															
ISS ATT		-----XV +ZLV TEA-----													
NOTES		*PWRDN													



CT 08/14/07 (226)

MET Day 004

FD06

GMT 08/14/07 (226)

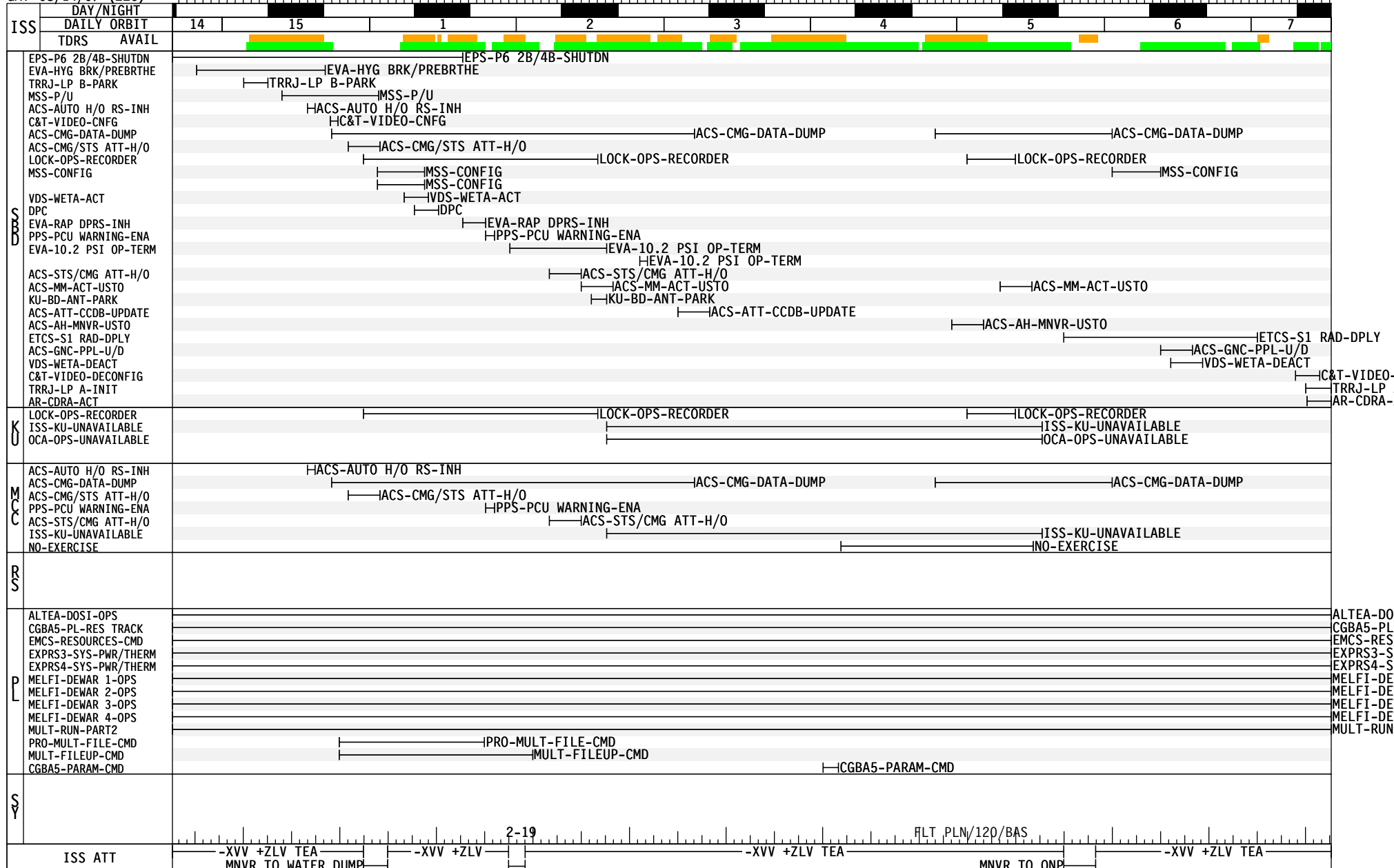
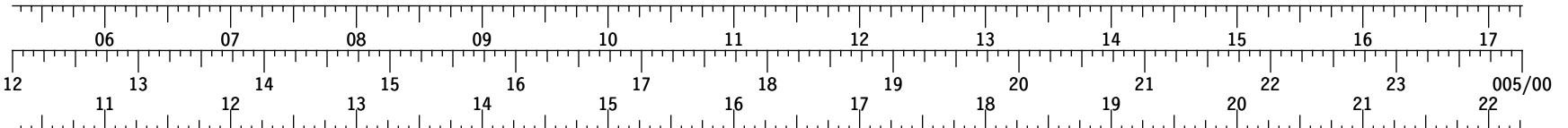

ETCS-S1 RAD-DPLY

C&T-VIDEO-

TRRJ-LP A

AR-CDRA-A

ALTEA-DOSI-OPS

CGBA5-PL-RES TRACK

EMCS-RESOURCES-CMD

EXPRS3-SYS-PWR/THERM

EXPRS4-SYS-PWR/THERM

MELFI-DEWAR 1-OPS

MELFI-DEWAR 2-OPS

MELFI-DEWAR 3-OPS

MELFI-DEWAR 4-OPS

MULT-RUN-PART2

PRO-MULT-FILE-CMD

MULT-FILEUP-CMD

CGBA5-PARAM-CMD

2-19

FLT PLN/120/BAS

-XVV +ZLV TEA  
MNVR TO WATER DUMP

-XVV +ZLV TEA

MNVR TO ONP

-XVV +ZLV TEA

GMT 08/14/07 (226)

MET Day 005

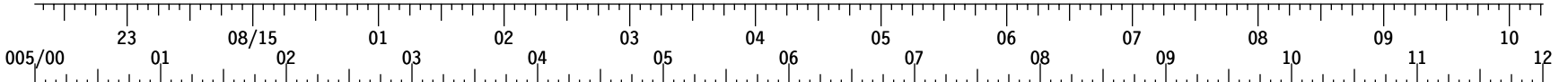

S T S - 1 2 0	FD06	CDR MELROY	CT WE CR #6	CX WF CES R	IM FM SU	PRE SLEEP	PMC OCA	PRE SLEEP	SLEEP	
	PLT ZAMKA	MCS*	FILTER INSPECT			PRE SLEEP		SLEEP		
	MS1 PARAZYNSKI	R P R S	POST EVA W/H2O, METOX			PRE SLEEP		SLEEP		
	MS2 WILSON		TRANSFER	X B F R I E E F		PRE SLEEP		SLEEP		
	MS3 WHEELock		TRANSFER	E M U *		PRE SLEEP		SLEEP		
	MS4 NESPOLI	R P R S	POST EVA W/H2O, METOX		C D M	PRE SLEEP		SLEEP		
	FE-2 DN ANDERSON		EXER CISE TVIS	PREP WORK	DPC	PREP WORK	PRE SLEEP	SLEEP (8.5)		
E X P 1 6	ISS CDR WHITSON	R P R S	POST EVA W/H2O, METOX		D L	PRE SLEEP	SLEEP (8.5)			
	FE-1 MALENCHENKO		PW	DPC	BSA INIT	PW	PRE SLEEP	SLEEP (8.5)		
U P	FE-2 UP TANI	R P R S	POST EVA W/H2O, METOX			PRE SLEEP	SLEEP (8.5)			
DAY/NIGHT		[Timeline with alternating black and white bars]								
ORBIT		[Timeline with alternating black and white bars]								
TDRS		[Timeline with horizontal bars]								
ORB ATT		[Timeline with horizontal bars]								
NOTES		*HTR DEACT *FILTER CK *BATT TERM								



CT 08/14/07 (226)

MET Day 005 005/00

**FD06**

GMT 08/14/07 (226)

		18	19	20	21	22	23	08/15	01	02	03	04	05
ISS	DAY/NIGHT	[Night/Day Cycle]											
	DAILY ORBIT	[Orbit Data]											
	TDRS	[TDRS Data]											
	AVAIL	[Availability Data]											
DBS	TRRJ-LP A-INIT	-----											
	AR-CDRA-ACT	-----											
	PPS-PCU WARNING-INH	-----											
	PMC	-----											
	TRRJ-LP A-AUTO	-----											
	TRRJ-LP B-AUTO	-----											
	DPC	-----											
	MT-XLATE PATH-SURVEY	-----											
	C&T-AUDIO-DCNFG	-----											
	C&T-UHF-DEACT	-----											
	MSS-P/D	-----											
	TCS-SFU-WARMUP	-----											
ACS-AUTO H/O RS-ENA	-----												
K													
MCC	PPS-PCU WARNING-INH	-----											
	ACS-AUTO H/O RS-ENA	-----											
RS													
PL	ALTEA-DOSI-OPS	-----											
	CGBA5-PL-RES TRACK	-----											
	EMCS-RESOURCES-CMD	-----											
	EXPRS3-SYS-PWR/THERM	-----											
	EXPRS4-SYS-PWR/THERM	-----											
	MELFI-DEWAR 1-OPS	-----											
	MELFI-DEWAR 2-OPS	-----											
	MELFI-DEWAR 3-OPS	-----											
	MELFI-DEWAR 4-OPS	-----											
	MULT-RUN-PART2	-----											
SY													
ISS ATT		-XVV +ZLV TEA											
NOTES		*PWRDN											

GMT 08/15/07 (227)

MET Day 005

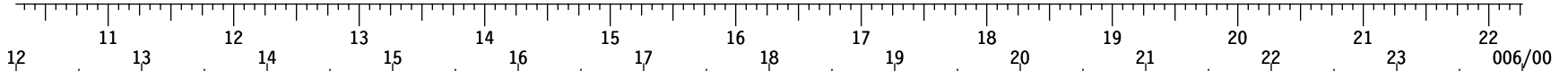

STS-120	<b>FD07</b> CDR MELROY	POST SLEEP	02 RECONFIG TO XFER	02 INT	PFC OCA	OFF DUTY	MEAL	N2 XFER TERM	EXERCISE	COND CWC/O	CTWCR#8	CXWFER	PSLEEP				
	<b>R1</b> PLT ZAMKA	POST SLEEP	PSS//TURMS 6	P6 GRAPL	ODUFTY	PFC OCA	OFF DUTY	MEAL	MCIU	CIN#7	02 TRM	02 RECONFIG TO P/B	CTWCR#7	CIN#8	P/TV6 S/U SSRMS	P/TV05 S/U	P6 UNGL
	<b>MS1</b> PARAZYNSKI	POST SLEEP	OFF DUTY	PFC OCA	OFF DUTY	MEAL	EXERCISE	EMU BATT INIT	METX BATT	E/L PREP	EVA TOOL CONFIG	PRE SLEEP					
	<b>R2</b> MS2 WILSON	POST SLEEP	P6 GRAPL	OFF DUTY	PFC OCA	OFF DUTY	MEAL	TRANSFER	P6 UNGL								
	<b>MS3</b> WHEELock	POST SLEEP	OFF DUTY	PFC OCA	OFF DUTY	MEAL	EMU SWAP	EXERCISE	METX BATT	E/L PREP	EVA TOOL CONFIG	PRE SLEEP					
	<b>MS4</b> NESPOLI	POST SLEEP	OFF DUTY	PFC OCA	OFF DUTY	OFF DUTY	MEAL	EMU SWAP	METX*	EXERCISE	EVA TOOL CONFIG	PRE SLEEP					
	<b>M2</b> FE-2 DN ANDERSON	POST SLEEP	PREP WORK	DPC	PUNGRP	MNVR SSRMS MT TRANS	EXERCISE CEVIS	HANDOVER	MIDDAY-MEAL	HANDOVER	EXERCISE TVIS	P6 GRAPPLE FROM SRMS	PREP WORK				
EXP 16	<b>ISS CDR</b> WHITSON	POST SLEEP	PREP WORK	02 RECONFIG TO XFER	02 INT	EXERCISE CEVIS	EXERCISE RED	DCS	MIDDAY-MEAL	N2 XFER TERM	02 TRM	02 RECONFIG TO P/B	RSR KBAR	BSA TERM	EXER	PREP WORK	
	<b>FE-1</b> MALENCHENKO	POST SLEEP	PREP WORK	DPC	IMS EDIT	EXERCISE VELO	EXERCISE TVIS	COX MNT	MIDDAY-MEAL	TRANSFER	PREP WORK						
UP	<b>M1</b> FE-2 UP TANI	POST SLEEP	PREP WORK	DPC	ADAPT	PUNGRP	MNVR SSRMS MT TRANS	STAT	HANDOVER	MIDDAY-MEAL	HANDOVER	PMC	P6 GRAPPLE FROM SRMS	PREP WORK			



ORB ATT	BIAS -XLV -ZVV											
NOTES	*IMMN-FE2 LIQUID-CLCT	No Exercise S1 PVR Deploy while both arms grappled	No Exercise while both arms grappled	No STS Ergometer MT Demate through MT Xlate WS8	No Exercise S1 PVR Deploy	*TERM	*N2 INIT	*N2 TERM	No Exercise while both arms grappled			

CT 08/15/07 (227)

MET Day 005

FD07

GMT 08/15/07 (227)

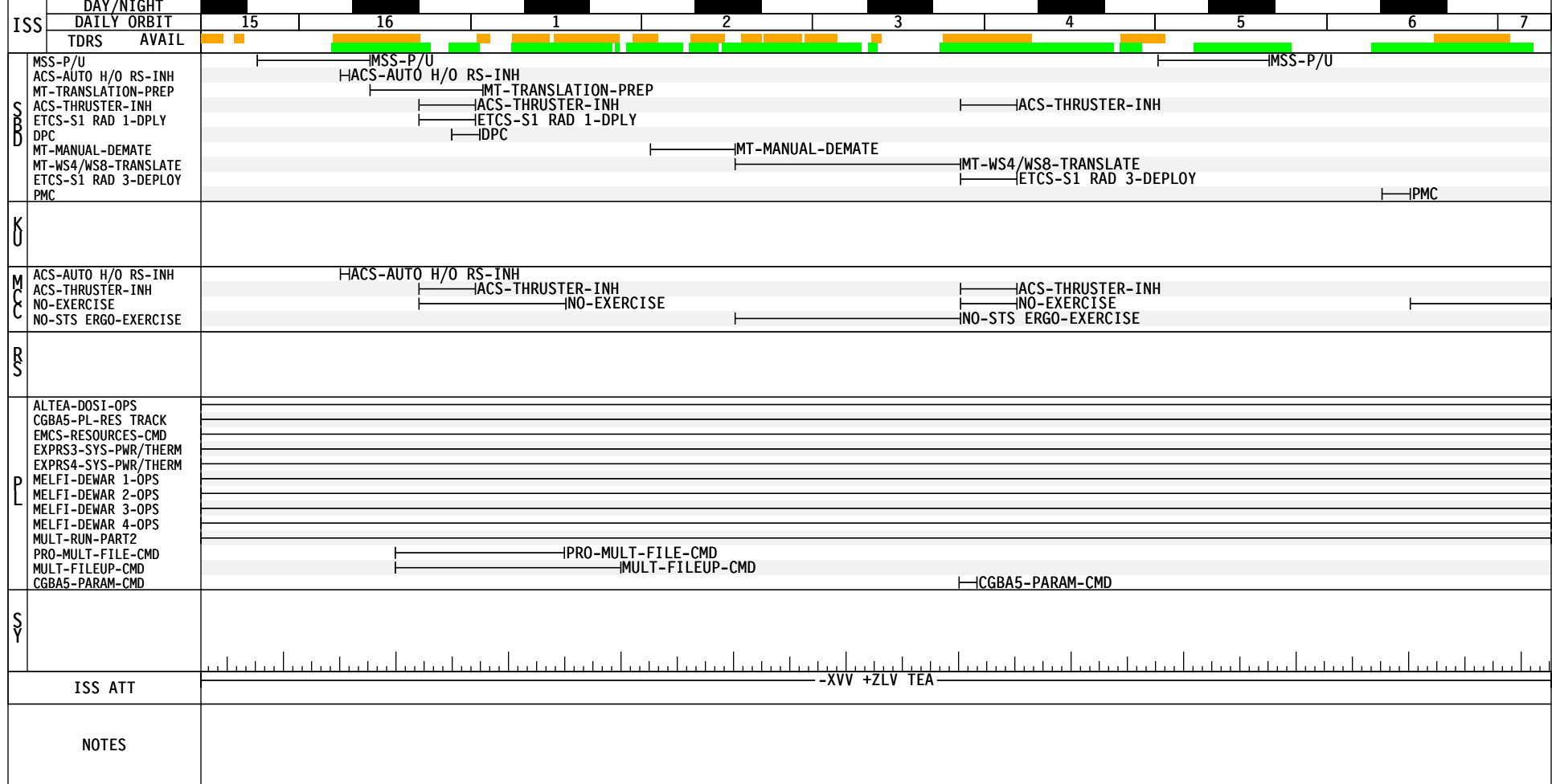

GMT 08/15/07 (227)

MET Day 006

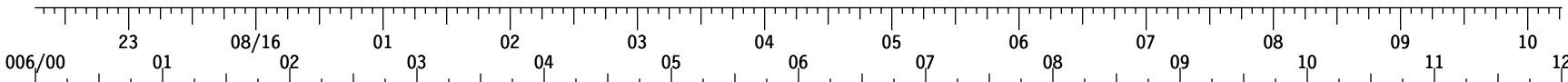

S T S - 1 2 0	FD07	CDR MELROY	EVA PROCEDURE REVIEW	PE AV O E N T	PRE SLEEP	PMC A/G	PRE SLEEP	SLEEP	ISS EXTERNAL SURVEY	
		PLT ZAMKA	EVA PROCEDURE REVIEW	PE AV O E N T	PRE SLEEP		PRE SLEEP	SLEEP		
		MS1 PARAZYNSKI	EVA PROCEDURE REVIEW		PRE SLEEP		MASK PB/TOOL CONFIG	PRE SLEEP	SLEEP (A/L)	
		MS2 WILSON	EVA PROCEDURE REVIEW	PE AV O E N T	X B F R E E R E F		PRE SLEEP		SLEEP	
		MS3 WHEELLOCK	EVA PROCEDURE REVIEW		PRE SLEEP		MASK PB/TOOL CONFIG	PRE SLEEP	SLEEP (A/L)	
		MS4 NESPOLI	EVA PROCEDURE REVIEW		PRE SLEEP		MASK PB/TOOL CONFIG	PRE SLEEP	SLEEP	
		FE-2 DN ANDERSON	EVA PROCEDURE REVIEW	PE AV O E N T	P R P W K		PRE SLEEP		SLEEP (8.5)	
E X P 1 6		ISS CDR WHITSON	EVA PROCEDURE REVIEW	DPC	P R O E R P K		PRE SLEEP		SLEEP (8.5)	
		FE-1 MALENCHENKO	EVA PROCEDURE REVIEW	DPC	P R O E R P K		PRE SLEEP		SLEEP (8.5)	
U P		FE-2 UP TANI	EVA PROCEDURE REVIEW	PE AV O E N T	P R P W K		PRE SLEEP		SLEEP (8.5)	
DAY/NIGHT		[Bar chart showing day/night cycle]								
ORBIT		96   97   98   99   100   101   102   103   104								
TDRS		W -171 E -46 Z -275 [Bar chart showing TDRS events]								
ORB ATT		BIAS -XLV -ZVV								
NOTES										

CT 08/15/07 (227)

MET Day 006 006/00

FD07

GMT 08/15/07 (227)

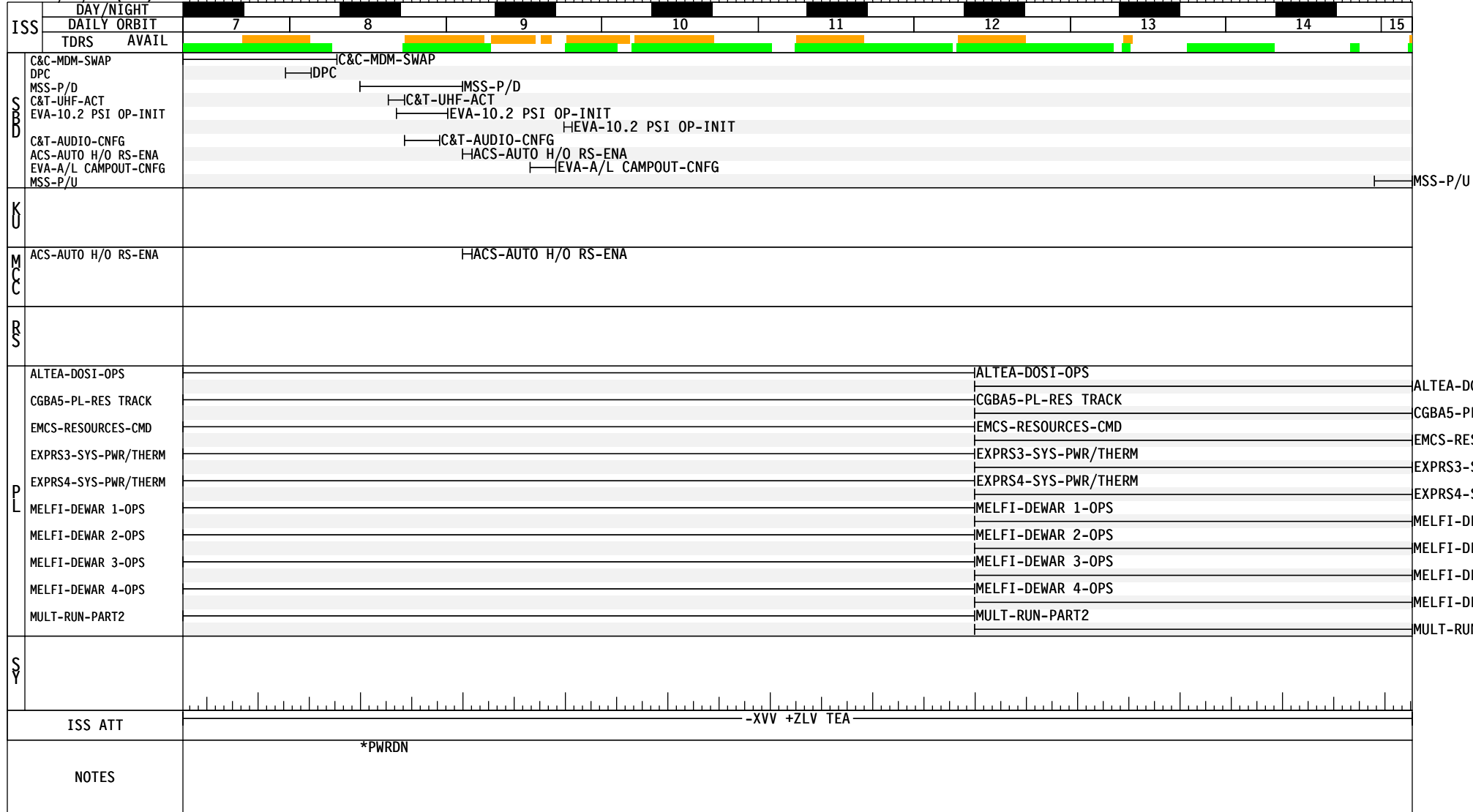



CT 08/16/07 (228)

MET Day 006

FD08

GMT 08/16/07 (228)

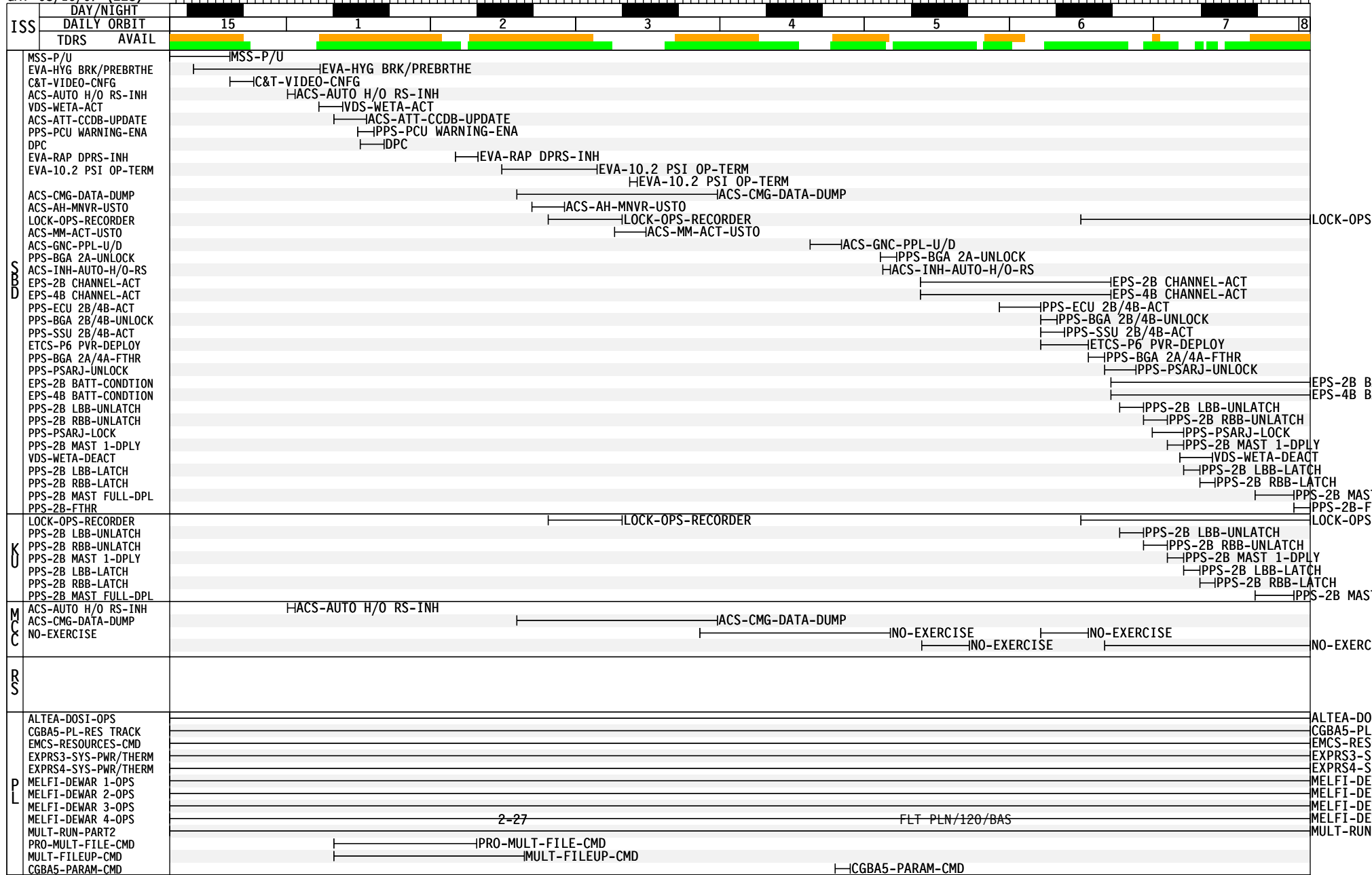
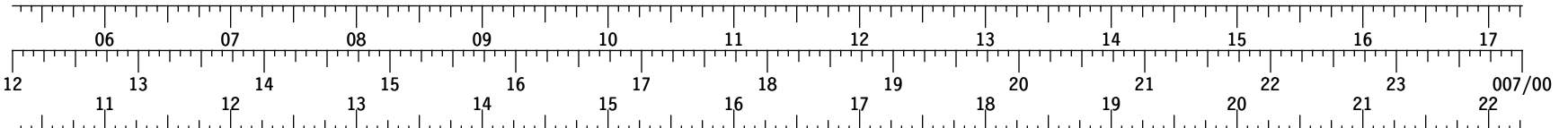

2-27

FLT PLN/120/BAS

PRO-MULT-FILE-CMD

MULT-FILEUP-CMD

CGBA5-PARAM-CMD

GMT 08/16/07 (228)

MET Day 007

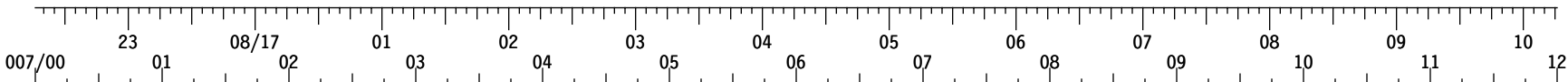

S T S - 1 2 0	FD08	CDR MELROY	COM 1	W 1	SM 1	PRE SLEEP	4B 100%	PRE SLEEP	PMC A/G	PRE SLEEP	ISS EXTERNAL SURVEY						
	PLT ZAMKA	CT 1	WE 1	CR 1	MX 1	PRE SLEEP	4B 100%	RP MWRSDN		PRE SLEEP	SLEEP						
	MS1 PARAZYNSKI	POST EVA W/H2O METOX				PRE SLEEP				SLEEP							
	MS2 WILSON			PRE SLEEP	4B 100%	PRE SLEEP		SLEEP									
	MS3 WHEELLOCK	POST EVA W/H2O METOX				PRE SLEEP				SLEEP							
	MS4 NESPOLI	POST EVA W/H2O METOX		EM	CD	PRE SLEEP				SLEEP							
	FE-2 DN ANDERSON	AB	PREP WORK	PRE SLEEP	4B 100%	PRE SLEEP		SLEEP (8.5)									
E X P 1 6	ISS CDR WHITSON	POST EVA W/H2O METOX		D	DPC	PW	R	O	R	PRE SLEEP	SLEEP (8.5)						
	FE-1 MALENCHENKO	D	EX	PREP WORK	DPC	PW	R	O	R	PRE SLEEP	SLEEP (8.5)						
U P	FE-2 UP TANI	PW	PMC	PREP WORK	PRE SLEEP	4B 100%	PRE SLEEP		SLEEP (8.5)								
DAY/NIGHT ORBIT		112		113		114		115		116		117		118		119	
TDRS		W -171	E -46	Z -275	[Timeline bars for TDRS]												
ORB ATT		*HTR DEACT										BIAS -XLV -ZVV					
NOTES		*BATT TERM No Exercise during SAW Deploy															



CT 08/16/07 (228)

MET Day 007 007/00

FD08  
GMT 08/16/07 (228)

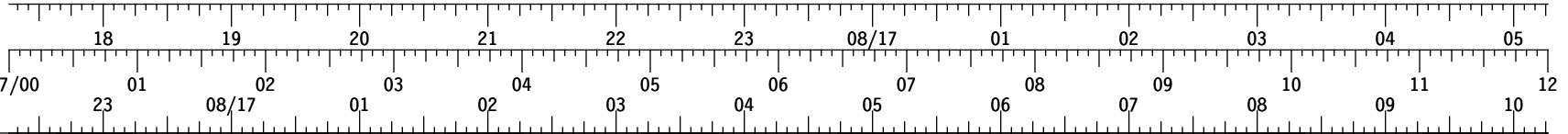

ISS	DAY/NIGHT	DAILY ORBIT	TDRS	AVAIL
S	LOCK-OPS-RECORDER			LOCK-OPS-RECORDER
	EPS-2B BATT-CONDITION			EPS-2B BATT-CONDITION
	EPS-4B BATT-CONDITION			EPS-4B BATT-CONDITION
	PPS-2B-FTHR			PPS-2B-FTHR
	PPS-4B LBB-UNLATCH			PPS-4B LBB-UNLATCH
	PPS-4B RBB-UNLATCH			PPS-4B RBB-UNLATCH
	PMC			PMC
	C&T-VIDEO-DECONFIG			C&T-VIDEO-DECONFIG
	PPS-4B MAST 1-DPLY			PPS-4B MAST 1-DPLY
	DPC			DPC
	PPS-4B LBB-LATCH			PPS-4B LBB-LATCH
	PPS-4B RBB-LATCH			PPS-4B RBB-LATCH
	PPS-4B MAST FULL-DPL			PPS-4B MAST FULL-DPL
	PPS-4B-FTHR			PPS-4B-FTHR
	PPS-ECU 2B-PWR SWAP			PPS-ECU 2B-PWR SWAP
PPS-PSARJ-AUTO			PPS-PSARJ-AUTO	
PPS-BGA-AUTO			PPS-BGA-AUTO	
EPS-2B2 BATT-CHARGE				EPS-2B2 BATT-CHARGE
EPS-4B2 BATT-CHARGE				EPS-4B2 BATT-CHARGE
ACS-AUTO H/O RS-ENA				ACS-AUTO H/O RS-ENA
C&T-AUDIO-DCNFG				C&T-AUDIO-DCNFG
PPS-PCU WARNING-INH				PPS-PCU WARNING-INH
C&T-UHF-DEACT				C&T-UHF-DEACT
MSS-P/D				MSS-P/D
K	LOCK-OPS-RECORDER			LOCK-OPS-RECORDER
	PPS-4B LBB-UNLATCH			PPS-4B LBB-UNLATCH
	PPS-4B RBB-UNLATCH			PPS-4B RBB-UNLATCH
	PPS-4B MAST 1-DPLY			PPS-4B MAST 1-DPLY
	PPS-4B LBB-LATCH			PPS-4B LBB-LATCH
	PPS-4B RBB-LATCH			PPS-4B RBB-LATCH
PPS-4B MAST FULL-DPL			PPS-4B MAST FULL-DPL	
M	NO-EXERCISE			NO-EXERCISE
	ACS-AUTO H/O RS-ENA			ACS-AUTO H/O RS-ENA
P	ALTEA-DOSI-OPS			ALTEA-DOSI-OPS
	CGBA5-PL-RES TRACK			CGBA5-PL-RES TRACK
	EMCS-RESOURCES-CMD			EMCS-RESOURCES-CMD
	EXPRS3-SYS-PWR/THERM			EXPRS3-SYS-PWR/THERM
	EXPRS4-SYS-PWR/THERM			EXPRS4-SYS-PWR/THERM
	MELFI-DEWAR 1-OPS			MELFI-DEWAR 1-OPS
	MELFI-DEWAR 2-OPS			MELFI-DEWAR 2-OPS
	MELFI-DEWAR 3-OPS			MELFI-DEWAR 3-OPS
MELFI-DEWAR 4-OPS			MELFI-DEWAR 4-OPS	
MULT-RUN-PART2			MULT-RUN-PART2	
S			2-29	FLT PLN/120/BAS

ISS ATT -XVV +ZLV TEA \*PWRDN

GMT 08/17/07 (229)

MET Day 007

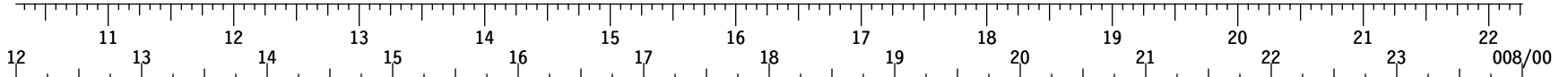

S T S - 1 2 0	FD09	POST SLEEP		PEAV OEN T	CIN CIT I	MCI I U*	I M U	CT W C R 1 M 1	EXERCISE	02 SYS TEARDOWN	MEAL	CREW CONF	OFF DUTY		BYE	HATCH CLOSE	H O A T T	ODS LEAK CHECK			
	PLT ZAMKA	POST SLEEP		R P R S T *	H O A T T	M D U M P	S I M O I N I T	S I M O T E R M	M T E A R	H O A T T	C X F E R	P / T V 0 4 S /	P / T V 0 5 S /	MEAL	CREW CONF	OFF DUTY		BYE	R P R S T *	P / T V 0 4 O P S	EXERCISE
	MS1 PARAZYNSKI	POST SLEEP		R E B A *	E M U R C N F G & X F E R			X F E R	U N S T W	B O L S T O W	MEAL	CREW CONF	OFF DUTY		BYE	R N D Z T O O L S C /		*			
	MS2 WILSON	POST SLEEP		P / T V 0 5 S /	P / T V 0 8 E X T S U R V	EXERCISE		T R A N S F E R		X B F R E E F	MEAL	CREW CONF	OFF DUTY		BYE	HATCH CLOSE	ODS LEAK CHECK				
	MS3 WHEELLOCK	POST SLEEP		R E B A *	E M U R C N F G & X F E R			EXERCISE		MEAL	CREW CONF	OFF DUTY		BYE							
	MS4 NESPOLI	POST SLEEP		C D M	P E A V E N T	EXERCISE		T R A N S F E R		MEAL	CREW CONF	OFF DUTY		BYE	R N D Z T O O L S C /						
	FE-2 DN ANDERSON	POST SLEEP	P R E P W O R K	D P C	H A N D O V E R				EXERCISE T V I S		M I D D A Y - M E A L	CREW CONF	C G B A	H A N D O V E R	H A N D O V E R	BYE	EXERCISE				
E X P 1 6	ISS CDR WHITSON	POST SLEEP	P R E P W O R K	D P C	N 2 A V R A C K			D C B 1 P A C K	0 2 S Y S T E A R D O W N	M I D D A Y - M E A L	CREW CONF	D C B 2 P A C K	EXERCISE C E V I S		BYE	EXERCISE R E D					
	FE-1 MALENCHENKO	POST SLEEP	P R E P W O R K	D P C	N 2 A V R A C K			EXERCISE R E D		M I D D A Y - M E A L	CREW CONF	I M S E D I T	C O X M N T	EXERCISE V E L O		BYE	HATCH CLOSE	P R E P W O R K			
U P	FE-2 UP TANI	POST SLEEP	P R E P W O R K	D P C	H A N D O V E R				EXERCISE R E D		M I D D A Y - M E A L	CREW CONF	M E T X *	H A N D O V E R	H A N D O V E R	BYE	EXERCISE C E V I S		P M C P W		



NOTES \*N2 INIT \*FILTER CK \*Removal \*INIT \*N2 TERM \*EXERCISE

CT 08/17/07 (229)

MET Day 007

FD09

GMT 08/17/07 (229)

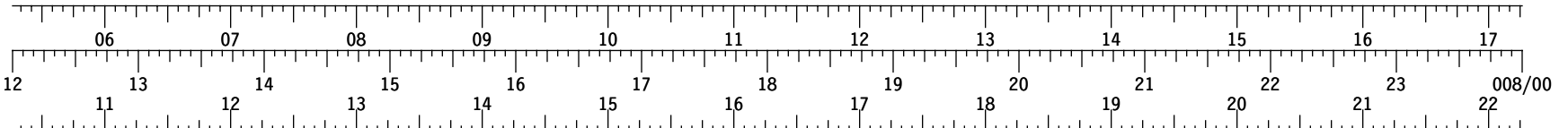

ISS		DAY/NIGHT	DAILY ORBIT	TDRS	AVAIL
S B D	EPS-2B2 BATT-CHARGE		16		
	EPS-4B2 BATT-CHARGE		1		
K	ACS-AUTO H/O RS-INH		2		
	DPC		3		
M C C	EPS-2B1 BATT-CHARGE		4		
	EPS-4B1 BATT-CHARGE		5		
R S	PPS-SARJ ODEG-POSN		6		
	ACS-CMG-DATA-DUMP		7		
P L	ACS-CMG/STS ATT-H/O				
	LOCK-OPS-RECORDER				
S	ACS-CMG/STS ATT-H/O				
	LOCK-OPS-RECORDER				
ISS ATT					
NOTES					

GMT 08/17/07 (229)

MET Day 008

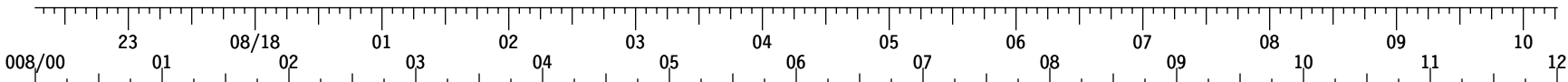

S T S - 1 2 0	FD09	HO A T T	PRE SLEEP	PMC A/G	PRE SLEEP	ISS EXTERNAL SURVEY				LOG	POST SLEEP
	CDR MELROY										
	PLT ZAMKA	COM M 2	PRE SLEEP							LOG	POST SLEEP
	MS1 PARAZYNSKI	⊕	PRE SLEEP							LOG	POST SLEEP
	MS2 WILSON		PRE SLEEP							LOG	POST SLEEP
	MS3 WHEELLOCK		PRE SLEEP							LOG	POST SLEEP
	MS4 NESPOLI		PRE SLEEP							LOG	POST SLEEP
FE-2 DN ANDERSON		PRE SLEEP									POST SLEEP
E X P 1 6	ISS CDR WHITSON	♦DPCPW	PRE SLEEP						SLEEP (8.5)		POST SLEEP
	FE-1 MALENCHENKO	EX ER ♦DPCPW	PRE SLEEP						SLEEP (8.5)		POST SLEEP
U P	FE-2 UP TANI	P W ♦DPC	PRE SLEEP	⊗	♥				SLEEP (8.5)		POST SLEEP
DAY/NIGHT		[Bar chart showing day/night cycle]									
ORBIT		[Bar chart showing orbit parameters]									
TDRS		[Bar chart showing TDRS events]									
ORB ATT		[Bar chart showing orbit attention]									
NOTES		♦EXERCISE @IMMN-FE2 DRY-CLCT ⊕EXERCISE ♥IMMN-SALIVA H/W-STOW ♦EXERCISE RED									

CT 08/17/07 (229)

MET Day 008 008/00

FD09  
GMT 08/17/07 (229)

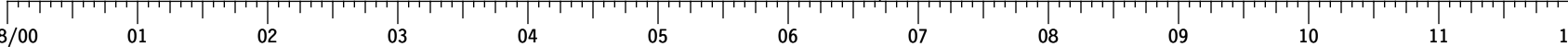
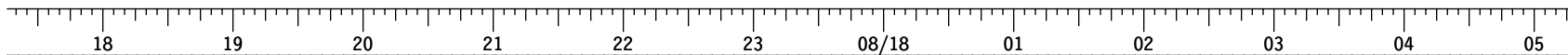

ISS	DAY/NIGHT	
	DAILY ORBIT	TDRS AVAIL
	7   8   9   10   11   12   13   14   15	

OPS	EPS-2B1 BATT-CHARGE		EPS-2B1 BATT-CHARGE
	EPS-4B1 BATT-CHARGE		EPS-4B1 BATT-CHARGE
	ACS-CMG-DATA-DUMP	ACS-CMG-DATA-DUMP	
	LOCK-OPS-RECORDER	LOCK-OPS-RECORDER	
	DPC	DPC	
	ACS-STG/CMG ATT-H/O	ACS-STG/CMG ATT-H/O	
	ACS-MM-ACT-USTO	ACS-MM-ACT-USTO	
	C&T-VIDEO-CNFG		C&T-VIDEO-CNFG
	ACS-ATT-CCDB-UPDATE		ACS-ATT-CCDB-UPDATE
	ACS-GNC-PPL-U/D		ACS-GNC-PPL-U/D
	SDMS-PPL-UPLINK		SDMS-PPL-UPLINK
	C&T-H/L AUDIO-CNFG		C&T-H/L AUDIO-CNFG
	PPS-P4 BGA-LOCK		PPS-P4 BGA-LOCK
	CDH-INH VALID-CK		CDH-INH VALID-CK
	SPS-PWRDOWN		SPS-PWRDOWN
ACS-AUTO H/O RS-INH		ACS-AUTO H/O RS-INH	
HATCH-CLOSE		HATCH-CLOSE	
IATCS-LTL STPT-CHNG		IATCS-LTL STPT-CHNG	
LOCK-OPS-RECORDER	LOCK-OPS-RECORDER		

KU	LOCK-OPS-RECORDER	LOCK-OPS-RECORDER	
----	-------------------	-------------------	--

MC	ACS-CMG-DATA-DUMP	ACS-CMG-DATA-DUMP	
	ACS-STG/CMG ATT-H/O	ACS-STG/CMG ATT-H/O	
	SPS-PWRDOWN		SPS-PWRDOWN
	ACS-AUTO H/O RS-INH		ACS-AUTO H/O RS-INH

RS			
----	--	--	--

PL	EMCS-RESOURCES-CMD		EMCS-RESOURCES-CMD	EMCS-RESOURCES-CMD
	EXPRS3-SYS-PWR/THERM		EXPRS3-SYS-PWR/THERM	EXPRS3-SYS-PWR/THERM
	EXPRS4-SYS-PWR/THERM		EXPRS4-SYS-PWR/THERM	EXPRS4-SYS-PWR/THERM
	MELFI-DEWAR 1-OPS		MELFI-DEWAR 1-OPS	MELFI-DEWAR 1-OPS
	MELFI-DEWAR 2-OPS		MELFI-DEWAR 2-OPS	MELFI-DEWAR 2-OPS
	MELFI-DEWAR 3-OPS		MELFI-DEWAR 3-OPS	MELFI-DEWAR 3-OPS
	MELFI-DEWAR 4-OPS		MELFI-DEWAR 4-OPS	MELFI-DEWAR 4-OPS
	MULT-RUN-PART2		MULT-RUN-PART2	MULT-RUN-PART2
	ALTEA-CNSM-DATA REC		ALTEA-CNSM-DATA REC	ALTEA-CNSM-DATA REC
	MELFI-DEWAR-CMD		MELFI-DEWAR-CMD	MELFI-DEWAR-CMD
MELFI-RACK-OPS		MELFI-RACK-OPS	MELFI-RACK-OPS	

S			
---	--	--	--

ISS ATT -XVV +ZLV TEA

NOTES 2-33 FLT PLN/120/BAS

GMT 08/18/07 (230)

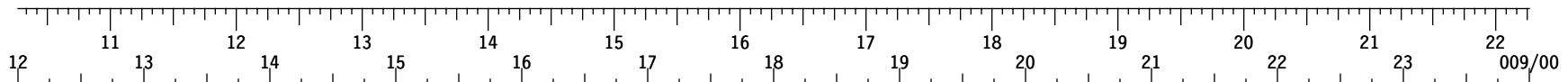

MET	Day 008	12	13	14	15	16	17	18	19	20	21	22	23	09/00			
STS-120	<b>FD10 R3</b> CDR MELROY	POST SLEEP	GP RWR UP BUP	MU NN VD RK	UNDOCK OPS	SEP1 FLYAROUND/SEP	SEP2 MNU VNR RPR BPN	MEAL	R SC	MS NT V RD	MN NO V RE	MP NO V RT	PORT WING SRVY	-Z X L V V	I M U	EXERCISE	
	<b>R2, R1</b> PLT ZAMKA	POST SLEEP	GP RWR UP BUP	C/L CAMR INST	UNDOCK OPS	FLYAROUND/SEP	CT O N D	SIMO INIT	MEAL	SIMO TERM	EXERCISE	NOSE CAP SURVEY	PORT WING SRVY	OBSS BERTH	R P M W S D N		
	<b>R1</b> MS1 PARAZYNSKI	POST SLEEP		R P M W S R U P	UNDOCK OPS	FLYAROUND/SEP	POST UNDK PGSC CNFG		MEAL	OBSS UNBERTH	STBD WING SRVY	POST ISS EVA ENT PRP	EVA STOW				
	<b>R2, R1</b> MS2 WILSON	POST SLEEP		C/L CAMR INST	UNDOCK OPS	FLYAROUND/SEP	M C I U *	GP RWR UP BPN	MEAL	EXERCISE	STBD WING SRVY	NOSE CAP SURVEY	PORT WING SRVY	OBSS BERTH	R P M W S D N *	FRED STOW	
	<b>MS3</b> WHEELOCK	POST SLEEP		P/T V03 S/U		P/T V03 UNDOCK OPS	UNDK PLBK	P D E T A V C T	MEAL	O I U *		EXERCISE	POST ISS EVA ENT PRP	EVA STOW			
	<b>R2, R1</b> MS4 NESPOLI	POST SLEEP		U A N U D D K I O	UNDOCK OPS	FLYAROUND/SEP	S D S E O A R C T		MEAL	OBSS UNBERTH	STBD WING SRVY	NOSE CAP SURVEY	EXERCISE		LDRI PLBK	C D M	
	<b>FE-2 DN</b> ANDERSON	POST SLEEP			UNDOCK OPS	* FLYAROUND/SEP	EMU RE- PLACE		MEAL			EXERCISE					
EXP 16	<b>ISS CDR</b> WHITSON	POST SLEEP	PREP WORK	DPC	SSRMS MT TRANS		EXERCISE TVIS		MIDDAY-MEAL				EXERCISE RED			E R W E R S	P W R O P E R P K
	<b>FE-1</b> MALENCHENKO	POST SLEEP	PREP WORK	DPC			EXERCISE VELO		MIDDAY-MEAL		IMS EDIT	C D R A	EXERCISE TVIS	COX MNT			P W R O P E R P K
UP	<b>FE-2 UP</b> TANI	POST SLEEP	PREP WORK	DPC	SSRMS MT TRANS	PMA2 CNFG	EXERCISE RED		MIDDAY-MEAL				EXERCISE CEVIS		M E T X *	P M C	P W R O P E R P K
DAY/NIGHT																	
ORBIT		135	136		137		138		139		140		141		142		143
TDRS		W -171															
		E -46															
		Z -275															
ORB ATT		BIAS	-XLV	-ZVV			-XLV	+ZVV	FLYAROUND								
NOTES					*CONFIG ISS UNMATED OPS		*UNDOCK (8/14:42)		*FILTER CK			*REG RCNFG *DEACT					*Stow MPMS *PWRDN *TERM

CT 08/18/07 (230)

MET Day 008

FD10

GMT 08/18/07 (230)

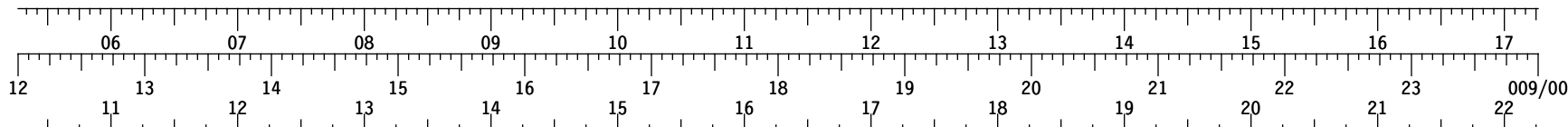

ISS	DAY/NIGHT	[Day/Night Cycle]								
	DAILY ORBIT	15	1	2	3	4	5	6	7	8
	TDRS AVAIL	[TDRS Availability Bars]								

DPC	EPS-2B1 BATT-CHARGE	[Timeline]							
	EPS-4B1 BATT-CHARGE	[Timeline]							
	SPS-PWRDOWN	[Timeline]							
	HATCH-CLOSE	[Timeline]							
	IATCS-LTL STPT-CHNG	[Timeline]							
	C&T-H/L AUDIO-BCKOUT	[Timeline]							
	LOCK-OPS-RECORDER	[Timeline]							
	DPC	[Timeline]							
	ACS-CMG-DATA-DUMP	[Timeline]							
	ACS-CMG/STS ATT-H/O	[Timeline]							
DPS	ACS-PRE DPRT-THRSTR	[Timeline]							
	THC-A/L CCAA-C&W-CFG	[Timeline]							
	ACS-GNC-PPL-U/D	[Timeline]							
	EPS-2B3 BATT-CHARGE	[Timeline]							
	EPS-4B3 BATT-CHARGE	[Timeline]							
	CDH-INH VALID-CK	[Timeline]							
	KU-BD-ANT-PARK	[Timeline]							
	SDMS-DATA-TAKE	[Timeline]							
	ACS-PMA2-DPRT-THRSTR	[Timeline]							
	C&DH-UNDOCK-CNFG	[Timeline]							
UNDOCK	C&T-VTR-RECORD	[Timeline]							
	UNDOCK	[Timeline]							
	ACS-POST DPRT-THRSTR	[Timeline]							
	AR-CDRA-DEACT	[Timeline]							
	PPS-SARJ/BGA-AUTOTRK	[Timeline]							
	KU-BD-ANT-UNPARK	[Timeline]							
	SPS-PWRUP	[Timeline]							
	TRRJ-P&S-TO AUTO	[Timeline]							
	PMA2-DEPRESS	[Timeline]							
	THC-IMV VLV-C/O	[Timeline]							
*UNDOCK	TRRJ-P&S-SHUT DOWN	[Timeline]							
	ACS-H/O-RS-TO-US-MM	[Timeline]							
	C&T-RS-US COM-CNFG	[Timeline]							
	C&T-UHF-DEACT	[Timeline]							
	C&T-AUDIO-DCNFG	[Timeline]							
	ACS-GPS-RECNG	[Timeline]							
	IATCS-PMA2 HTR-RCNFG	[Timeline]							
	SDMS-DATA-DUMP	[Timeline]							
	IPMC	[Timeline]							
	PMC	[Timeline]							

KU	LOCK-OPS-RECORDER	[Timeline]							
		[Timeline]							

MCC	SPS-PWRDOWN	[Timeline]							
	ISS-PROX OPS-XTION	[Timeline]							
	ACS-CMG-DATA-DUMP	[Timeline]							
	ACS-CMG/STS ATT-H/O	[Timeline]							
	ACS-PRE DPRT-THRSTR	[Timeline]							
	ACS-PMA2-DPRT-THRSTR	[Timeline]							
	UNDOCK	[Timeline]							
	ACS-POST DPRT-THRSTR	[Timeline]							
	ISS-STAND MODE-XTION	[Timeline]							
	SPS-PWRUP	[Timeline]							
RS	ACS-H/O-RS-TO-US-MM	[Timeline]							
		[Timeline]							

RS	ACS-PRE DPRT-THRSTR	[Timeline]							
	ACS-PMA2-DPRT-THRSTR	[Timeline]							

PL	EMCS-RESOURCES-CMD	[Timeline]							
	EXPRS3-SYS-PWR/THERM	[Timeline]							
	EXPRS4-SYS-PWR/THERM	[Timeline]							
	MULT-RUN-PART2	[Timeline]							
	MELFI-RACK-OPS	[Timeline]							
PRO-MULT-FILE-CMD	[Timeline]								
MULT-FILEUP-CMD	[Timeline]								
ALTEA-DOSI-OPS	[Timeline]								
MELFI-DEWAR 1-OPS	[Timeline]								

EPS-2B3 E

EPS-4B3 E

EMCS-RESO

EXPRS3-SY

EXPRS4-SY

MULT-RUN-

ALTEA-DOS

MELFI-D





GMT 08/19/07 (231)

MET Day 009

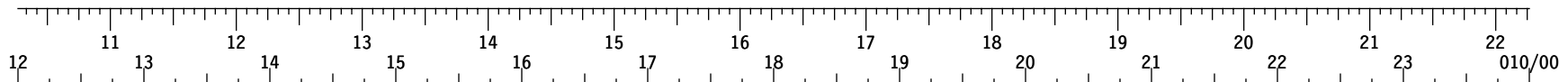

STS-120	<b>FD11</b>	POST SLEEP	I M U	FCS C/O	RCS H/F	CABIN STOW	EXERCISE	CABIN STOW	D/O BRIEF	PEAVO EN T	MEAL	CABIN STOW	LC-1 M M	CABIN STOW	LC-1 M M	CABIN STOW	PILOT OPS	
	PLT ZAMKA	POST SLEEP	W B *	POST SLEEP	FCS C/O	RCS H/F	CABIN STOW	EXERCISE	D/O BRIEF	PEAVO EN T	MEAL	M D C D N U W U V M R P C M P	CABIN STOW	C D W U C M P	- - Z X L V V	PILOT OPS		
	MS1 PARAZYNSKI	POST SLEEP		CABIN STOW		EXERCISE	CABIN STOW	U N S T W	B O L P S T O D	D/O BRIEF	PEAVO EN T	MEAL	ERG STOW	LAUNCH ENTRY SUIT CK	RCMBNT SEAT S/U	CABIN STOW	W D L E A S C T	P S R T N O T W R
	MS2 WILSON	POST SLEEP		FCS C/O	RCS H/F	CABIN STOW	EXERCISE	CABIN STOW	PAO P/TV S/U	D/O BRIEF	PEAVO EN T	MEAL		CABIN STOW			PILOT OPS	
	MS3 WHEELLOCK	POST SLEEP		CABIN STOW		EXERCISE	CABIN STOW			D/O BRIEF	PEAVO EN T	MEAL	ERG STOW	LAUNCH ENTRY SUIT CK	RCMBNT SEAT S/U	CABIN STOW		
	MS4 NESPOLI	POST SLEEP	C D M	EXERCISE		CABIN STOW		S A L V A	E V N I T D R E Y O	B D L R O A O W D	D/O BRIEF	PEAVO EN T	MEAL	S D S E V A C T		S A L V A	CABIN STOW	
	MS5 ANDERSON	POST SLEEP		CABIN STOW		EXERCISE	CABIN STOW			D/O BRIEF	PEAVO EN T	MEAL		CABIN STOW				

DAY/NIGHT	151		152		153		154		155		156		157		158		159
ORBIT	16		1		2		3		4		5		6		7		8
DAILY ORBIT	16		1		2		3		4		5		6		7		8
TDRS	W -171	E -46		Z -275													
ORB ATT	-ZLV -XVV																
GND	-MLA -MLA -WSS -MLA -WSS -MLA -WSS -MLA -DFR -WSS -DFR																

\*HEATER ACT

NOTES



GMT 08/20/07 (232)

MET Day 010

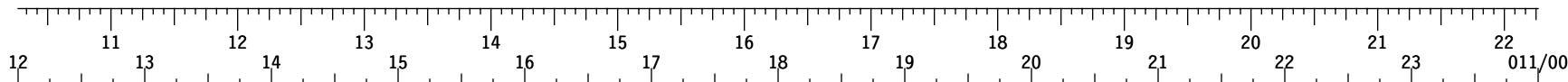

STS-120	<b>FD12</b> CDR MELROY	POST SLEEP	PMCA/G	PSL OL SE TE PH	MG AR TP CB	GP WR RU UP	IMU ALIGN & VERIF	-X S I	DEORBIT PREP	D E O R B I T  L A N D I N G  * # *
	PLT ZAMKA	POST SLEEP			MG AR TP CB	GP WR RU UP		TE P C	DEORBIT PREP	
	MS1 PARAZYNSKI	POST SLEEP						WA IT CH	DEORBIT PREP	
	MS2 WILSON	POST SLEEP						WA IT CH	DEORBIT PREP	
	MS3 WHEELLOCK	POST SLEEP					GS IT RO AW	WA IT CH	DEORBIT PREP	
	MS4 NESPOLI	POST SLEEP					OS CT AO CW	WA IT CH	DEORBIT PREP	
	MS5 ANDERSON	POST SLEEP							DEORBIT PREP	

DAY/NIGHT

ORBIT 167 168 169 170 171 172 173 174 175

DAILY ORBIT 1 2 3 4 5 6 7 8 9



ORB ATT -ZLV -XVV -IMU -XSI -COMM -ENTRY -MLA

GND -WSS -MLA -DFR

NOTES \*DEORBIT TIG # SBDI 1503 (Midodrine) (10/18:29) \*LANDING (10/19:32)

This Page Intentionally Blank

DETAILED TIMELINE

DETAILED  
TIMELINE

# STS-120 FD01

GMT	TDRS W E Z	DORB	MET Day 000	STS ASCENT	CDR MELROY	R1 PLT ZAMKA	MS1 PARAZYNSKI	Notes
23:00			00:00	ASCENT	<div style="border: 1px solid black; padding: 5px; margin: 5px auto; width: 80%;">           ACTIVITIES PRIOR TO 00/02:30 ARE IN THE ASCENT AND POST INSERTION CHECKLISTS. THE ORBITER SHOULD BE IN A -ZLV +YVV ATTITUDE UPON ENTERING THE FLIGHT PLAN         </div>			
			01:00		<div style="border: 1px solid black; padding: 5px;"> <b>FD01 EZ ACTIVITES</b>            PCS 1(2) CONFIG (ORB OPS, ECLS)            Config Sys with 1            14.7 CAB REG INLET SYS 1,2 VLV - CL            SMK DETN CHECK TEST (ORB OPS, ECLS)            LAMP TEST (ORB OPS, EPS)            CSA-CP BATTERY CHANGEOUT (ORB OPS, CSA-CP)            CSA-CP CHECKOUT (ORB OPS, CSA-CP)            DATE/TIME SET (PHOTO/TV, DCS 760)            VTR CLOCK SET (PHOTO/TV, DTV)            if not performed for PLBD rec         </div>			
			02:00	-ZLV +YVV	POST INSERTION	POST INSERTION	POST INSERTION	
			02:30			A SSP1 APCU1,2 OUTPUT RLY (two)-CL (tb-bp) CONV - ON (two) (tb-grey) vtb OUTPUT RLY (two) -grey	UPLINK β21 + Mask	
01:00			03:00		DAP A(B) CONFIG (ORB OPS, DAP TABLES) Load Flight Specific A&B DAPS	NODE 2 HEATER ACT A ON-ORBIT INITIALIZATION (PDRS, ON-ORBIT INIT)	PGSC NETWORK SETUP OCA SETUP COLOR PRINTER UNSTOW & ASSEMBLE (ORB OPS, PGSC) PGSC HARD DISK LATE UPDATE Update all network PGSCs with late update disk.	UPLINK β21 + Mask +Box A1
			03:30		IMU STAR OF OPPTY ALIGN (ORB OPS, GNC) AFT CONTROLLER C/O (ORB OPS, GNC)	RMS PWRUP (PDRS, RMS PWRUP)		
			04:00	DESCENT	ON-ORBIT OMS BURN (ORB OPS, OMS)	ON-ORBIT OMS BURN (ORB OPS, OMS)		UPDATE ORBITAL MNVR PAD
			04:30		< NC1 TIG (03:35) MNVR (TRK) -ZLV -XVV TG=2 BV=3 OM=0 A1/AUTO/VERN Init TRK	PRIORITY PWRDN GRP B (ORB PKT, PRIOR PWRDN) Omit Steps 3,7,13 In Step 6, Single G2 In Step 12, IMU 3 STBY-ITEM 23 EXEC		
			05:00		ELEVON PARK, GNC 201 (ORB OPS, GNC)	RMS CHECKOUT (PDRS, RMS C/O)		

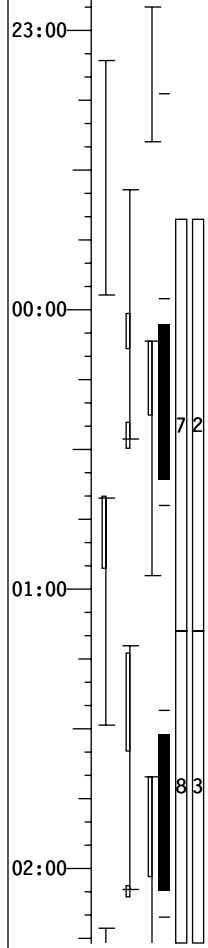

# STS-120 FD01

GMT	TDRS W E Z	DORB	MET Day 000	STS A T T	R2 MS2 WILSON	MS3 WHEELOCK	MS4 NESPOLI	MS5 TANI	Notes
23:00			00:00	ASC E N T					
00:00			01:00		POST INSERTION	POST INSERTION	POST INSERTION	POST INSERTION	
01:00			02:00	Z L V + Y V V	P/TVO1 VIDEO SETUP (PHOTO/TV, SCENES)	GIRA INSTALLATION (ORB OPS, ECLS)	PGSC NETWORK SETUP OCA SETUP COLOR PRINTER UNSTOW & ASSEMBLE (ORB OPS, PGSC) PGSC HARD DISK LATE UPDATE Update all network PGSCs with late update disk.	FRED SETUP (ORB OPS, FRED)	
02:00			03:00	N C 1	PRIORITY PWRDN GRP B (ORB PKT, PRIOR PWRDN) Omit Steps 3,7,13 In Step 6, Single G2 In Step 12, IMU 3 STBY-ITEM 23	SHUTTLE EMER EYEWASH (SEE) Unstow, attach on or near galley. Fill one drink container. Label "FOR EYE RINSE ONLY", and attach on or near galley.		PRE-SLEEP ACTIVITY (ORB OPS, CREW SYS)	
04:00			04:00		RMS CHECKOUT (PDRS, RMS C/O)	EXEC			

# STS-120 FD01

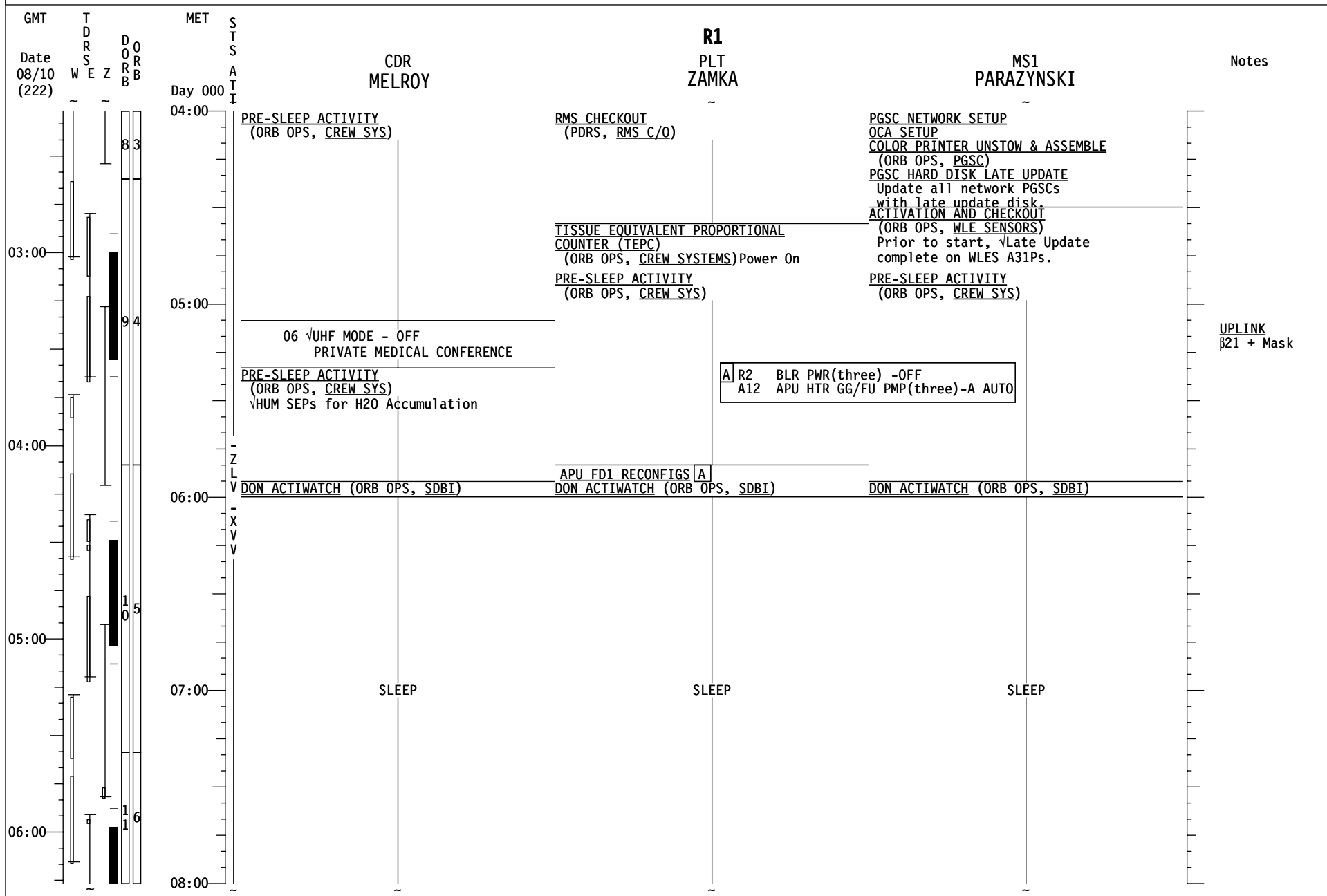



# STS-120 FD01

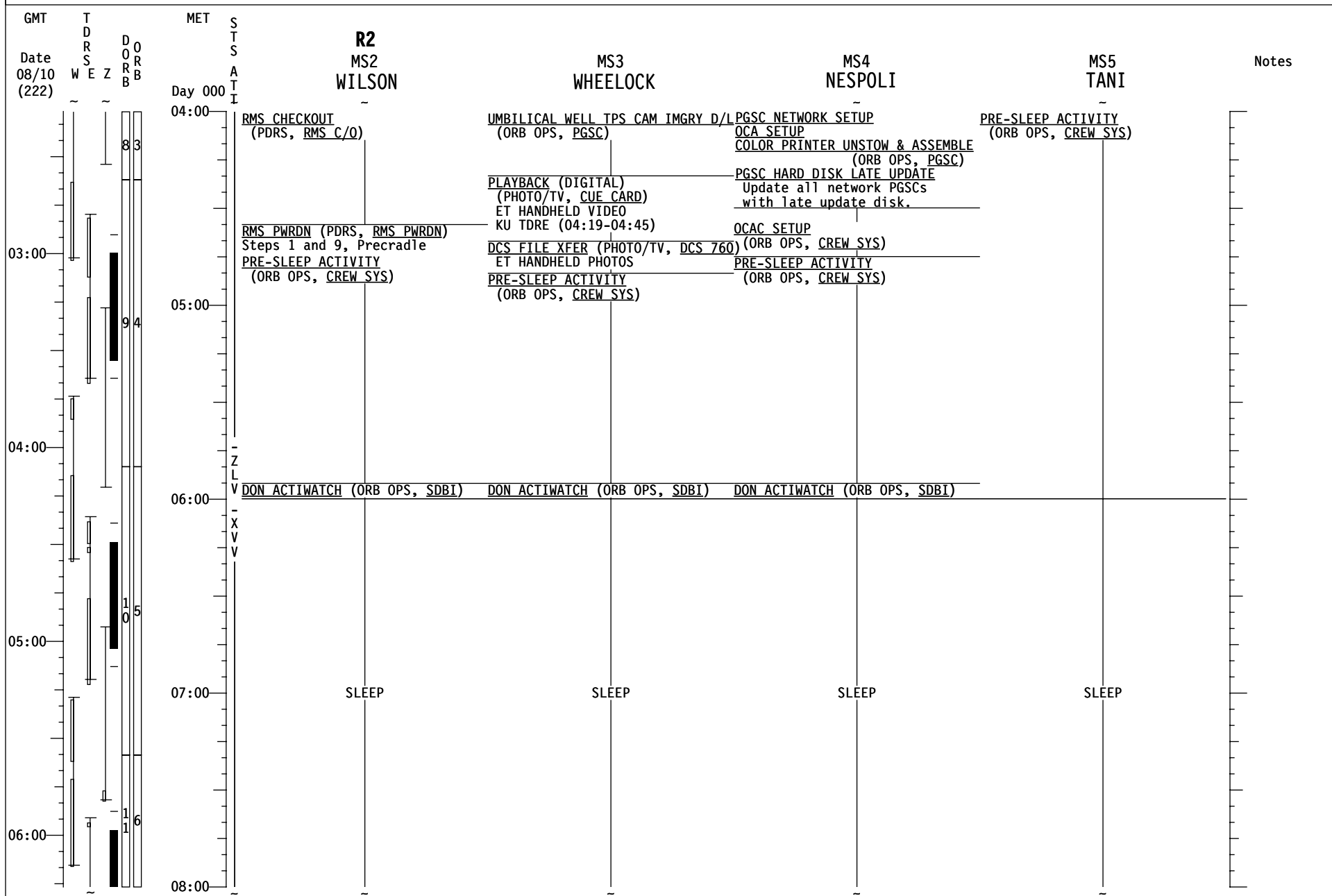

# STS-120 FD01

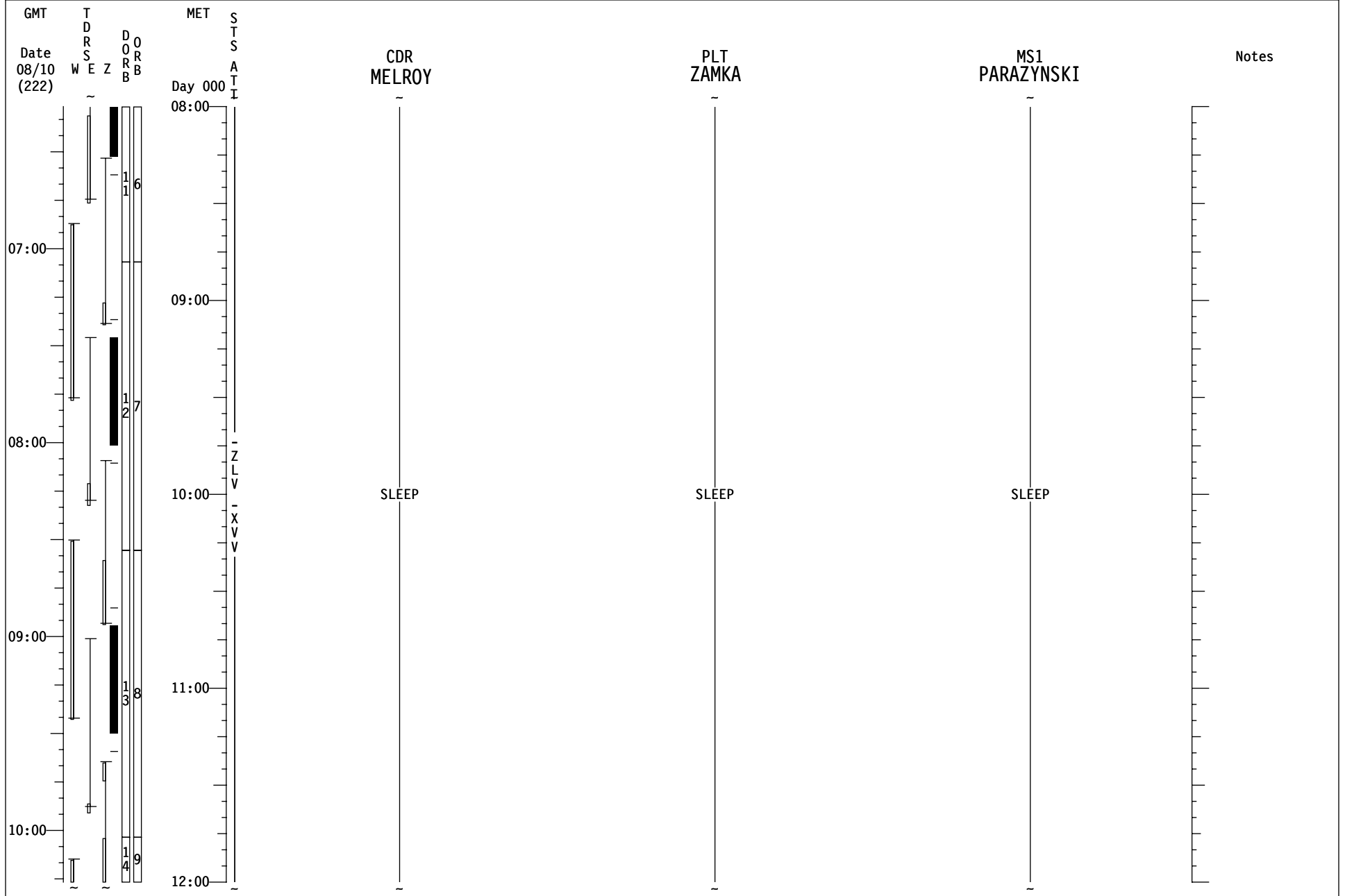

# STS-120 FD01

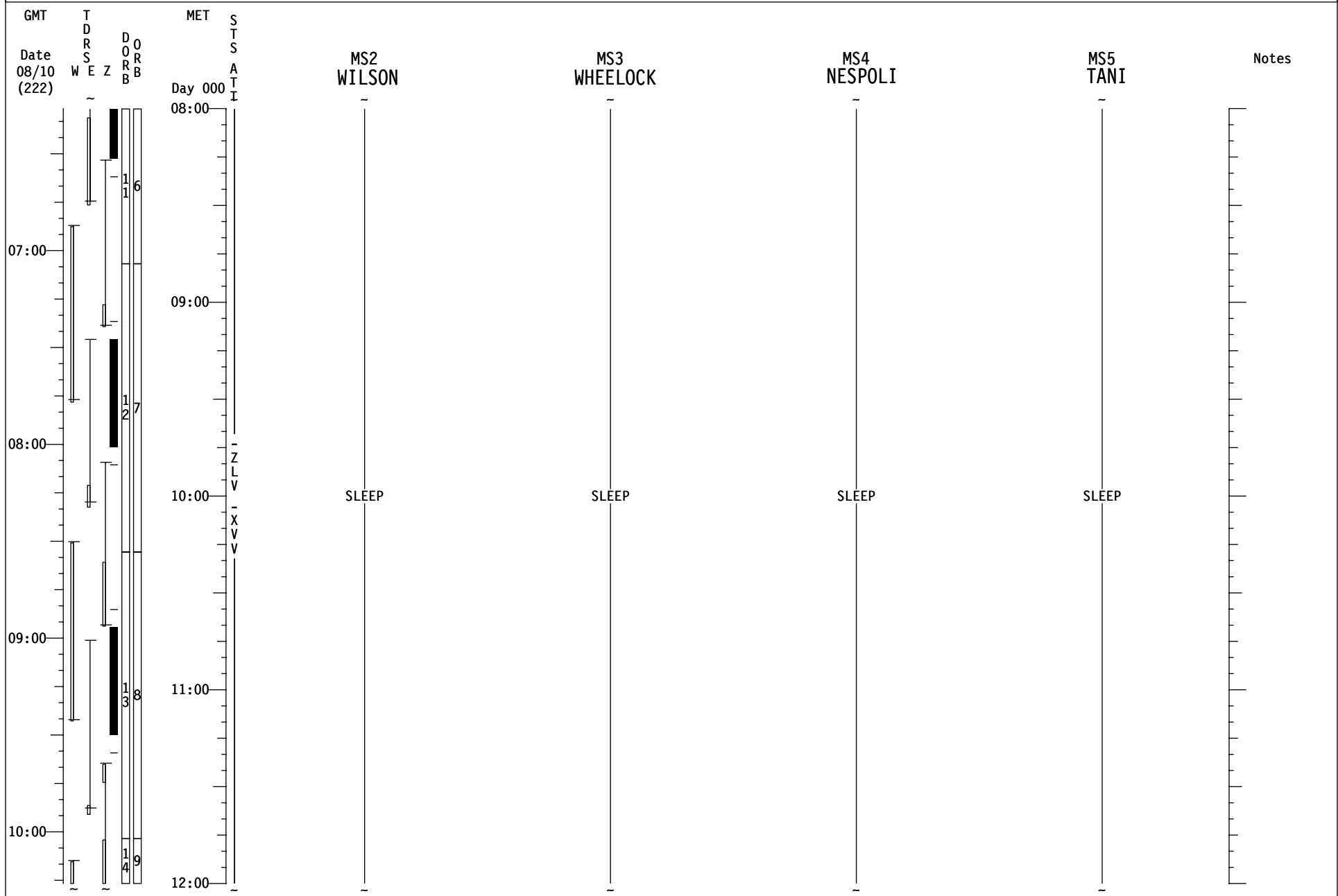

# STS-120 FD02

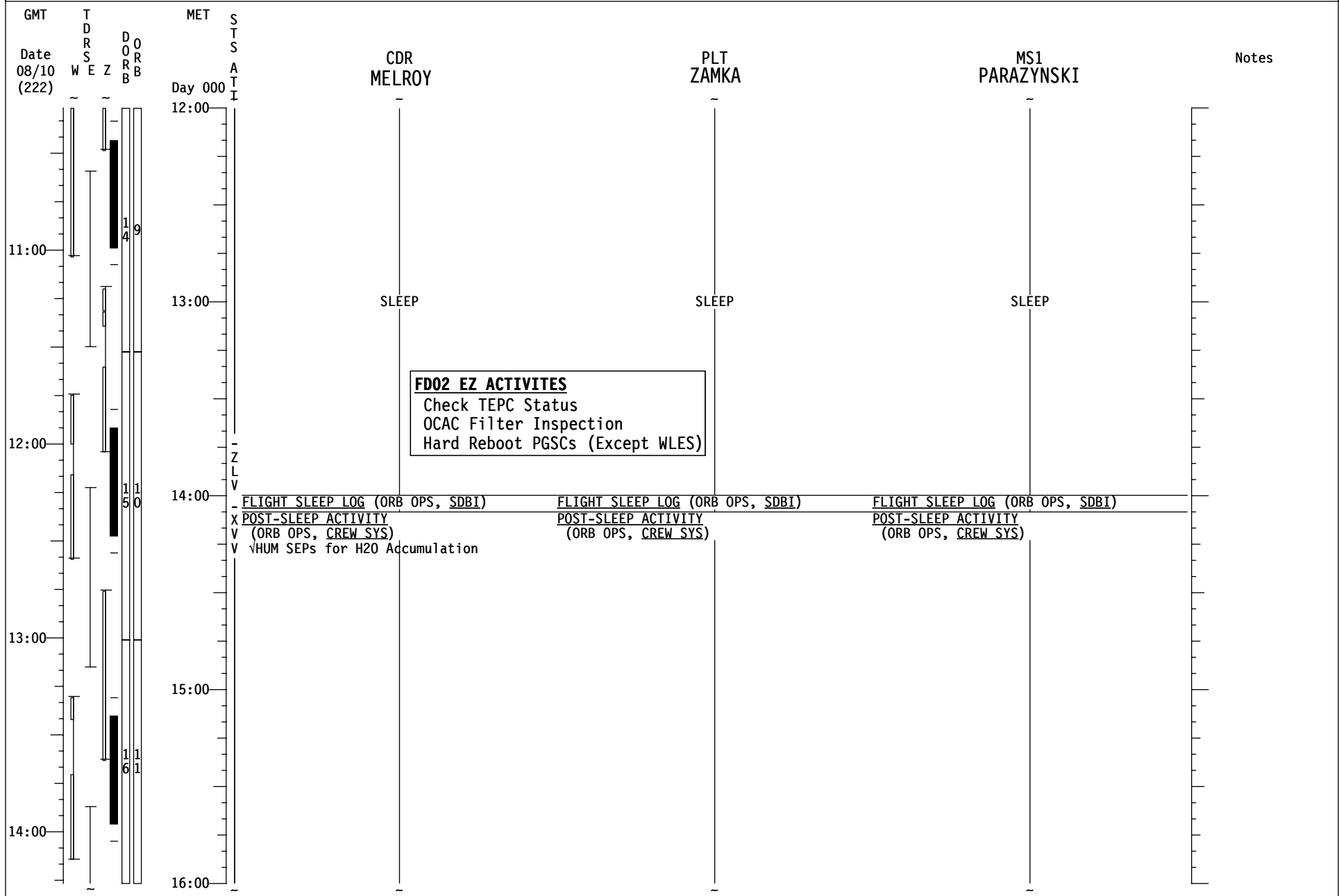

# STS-120 FD02

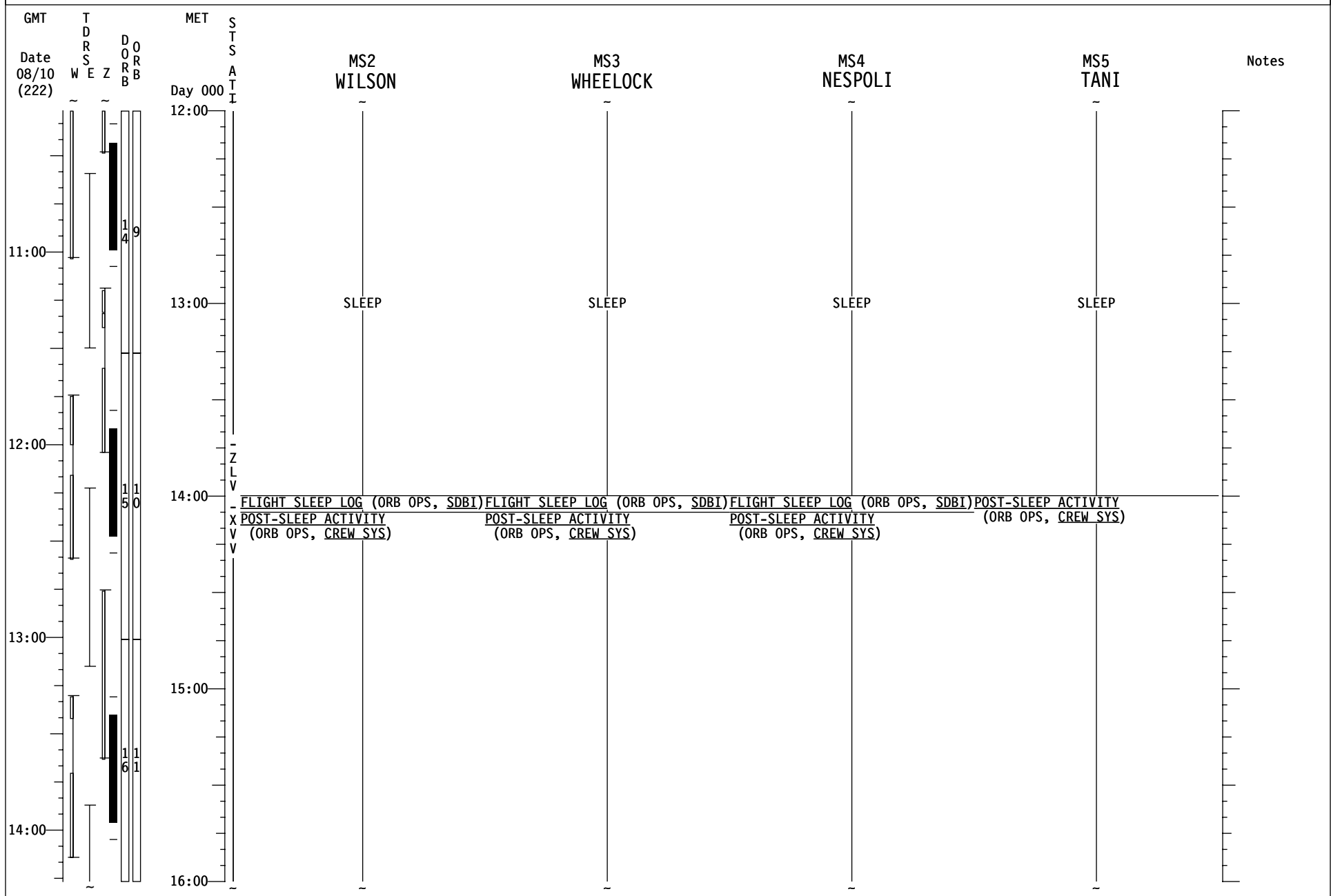

# STS-120 FD02

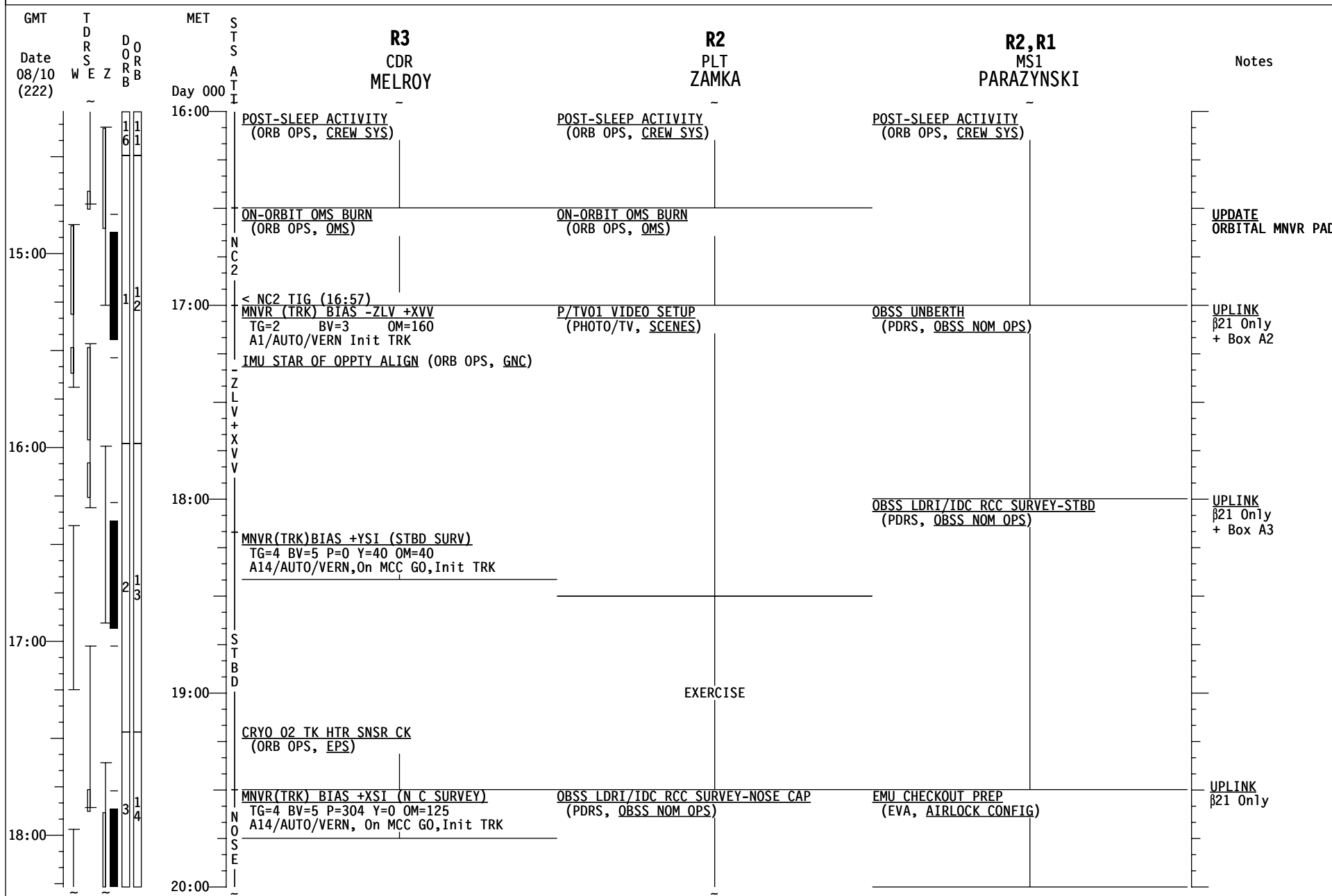

# STS-120 FD02

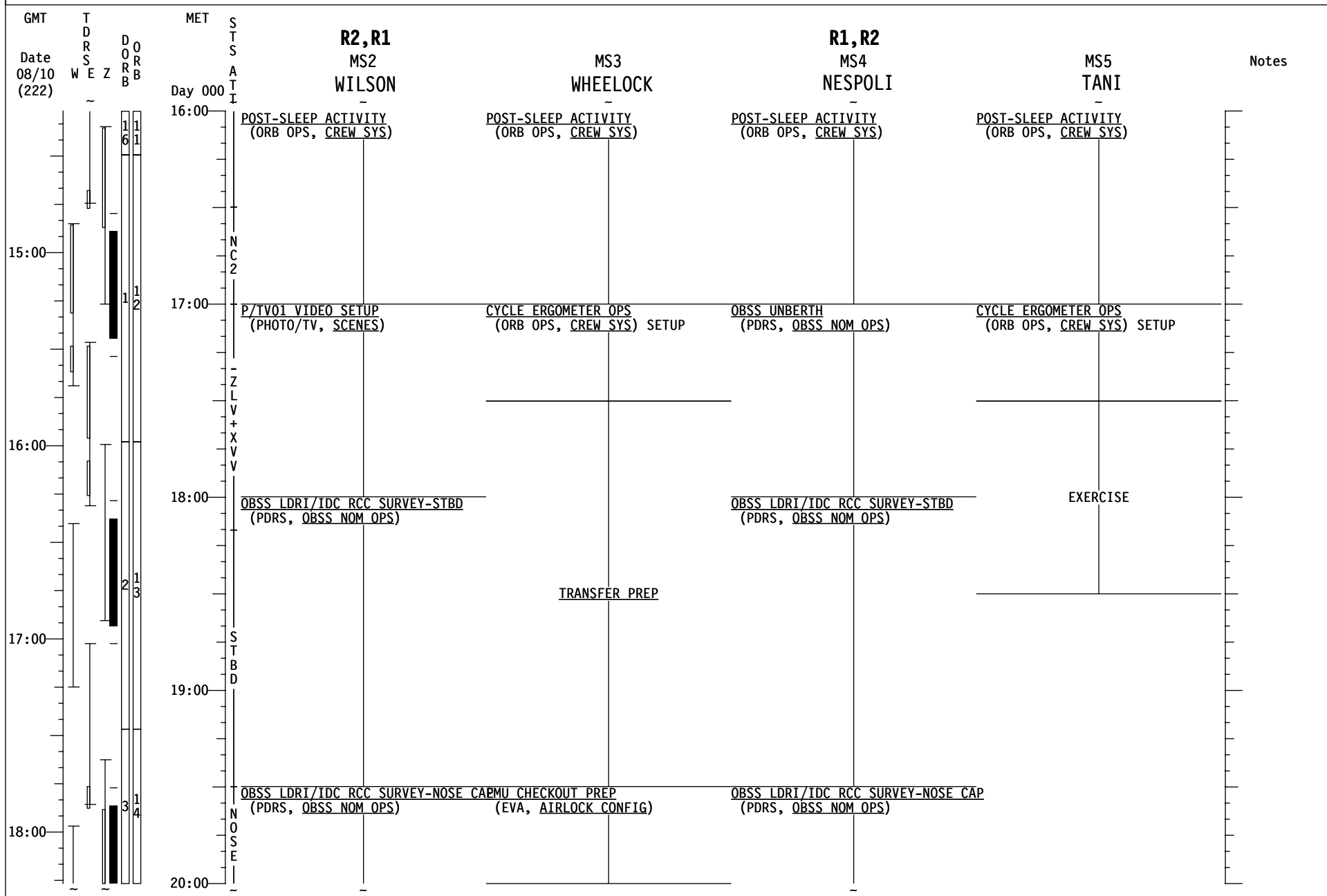

# STS-120 FD02

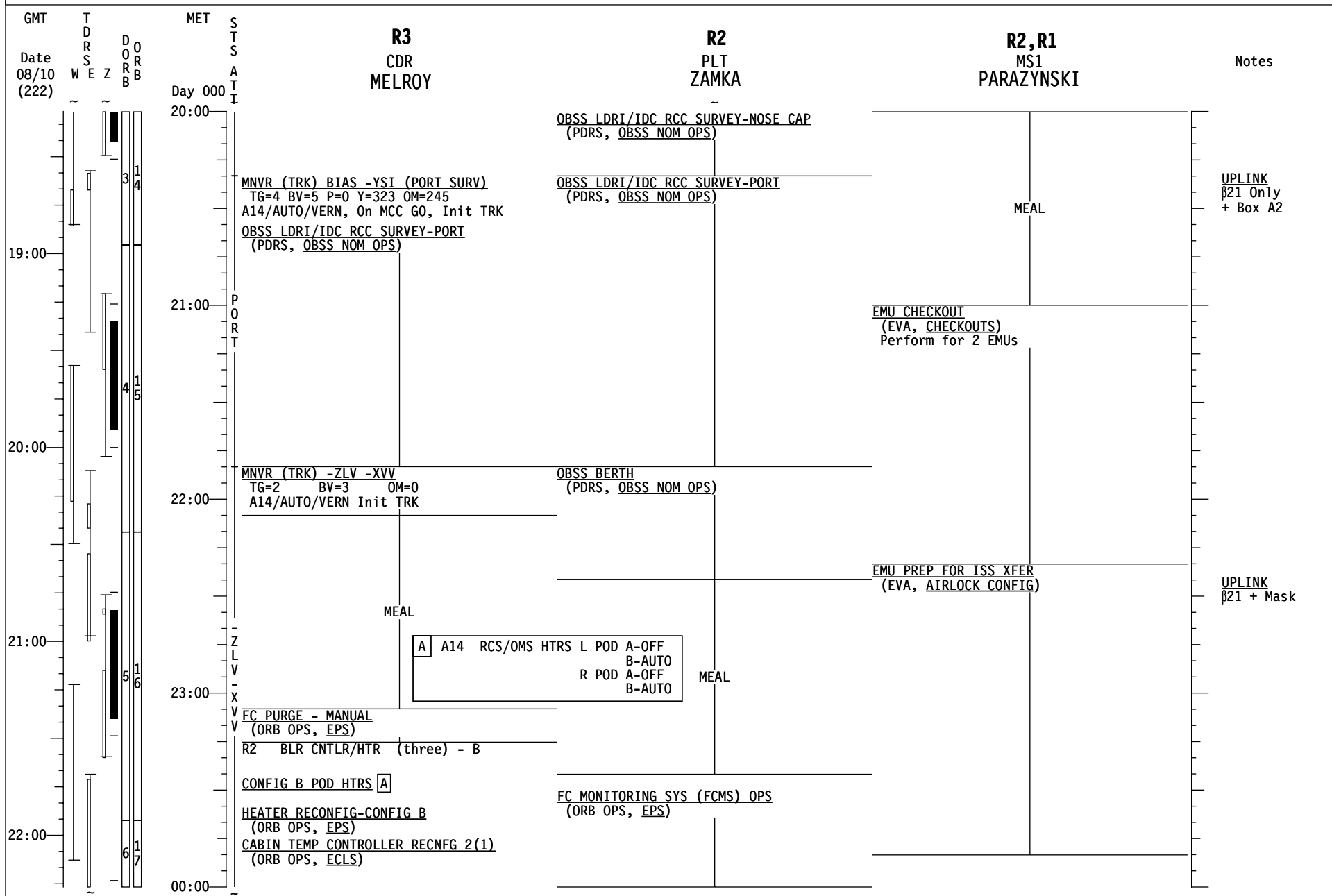



# STS-120 FD02

GMT	T D R S E Z W E Z	D O R B D O R B	MET Day 000	S T S A T T I	R2, R1 MS2 WILSON	MS3 WHEELLOCK	R1, R2 MS4 NESPOLI	MS5 TANI	Notes
19:00					OBSS LDRI/IDC RCC SURVEY-NOSE CAP (PDRS, OBSS NOM OPS)		OBSS LDRI/IDC RCC SURVEY-NOSE CAP (PDRS, OBSS NOM OPS)		
					OBSS LDRI/IDC RCC SURVEY-PORT (PDRS, OBSS NOM OPS)	MEAL		MEAL	
20:00									
				P O R T		EMU CHECKOUT (EVA, CHECKOUTS) Perform for 2 EMUs	EMU CHECKOUT (EVA, CHECKOUTS) Comm Check	EMU CHECKOUT (EVA, CHECKOUTS) Perform for 2 EMUs	
21:00									
					OBSS BERTH (PDRS, OBSS NOM OPS)		MEAL		
22:00									
					RMS PWRDN (PDRS, RMS PWRDN) Steps 1 and 9, Precradle	EMU PREP FOR ISS XFER (EVA, AIRLOCK CONFIG)	S/U FOR SALIVA SAMPLE COLLECT (ORB OPS, SDBI) SAFER CHECKOUT (EVA, CHECKOUTS)	EMU PREP FOR ISS XFER (EVA, AIRLOCK CONFIG)	
23:00				Z L V X V V	MEAL				
22:00							EXERCISE		
00:00					P/TV08 EXTERNAL SRVY (S/U) (P/TV, SCENES) Step 1-Sunlit OMS POD P/TV08 EXTERNAL SRVY (OPS) (P/TV, SCENES) ITEM 1				

# STS-120 FD02

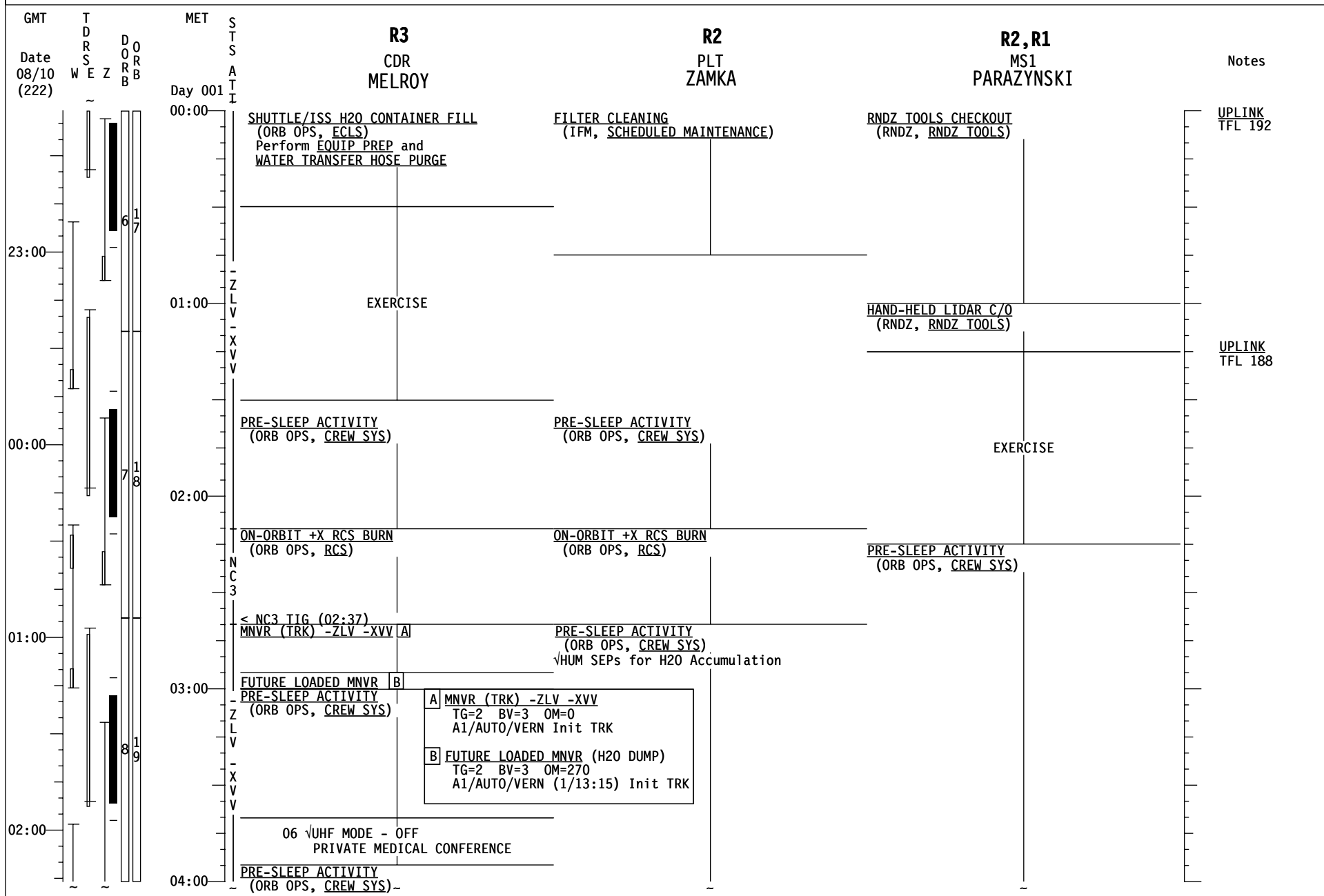



# STS-120 FD02

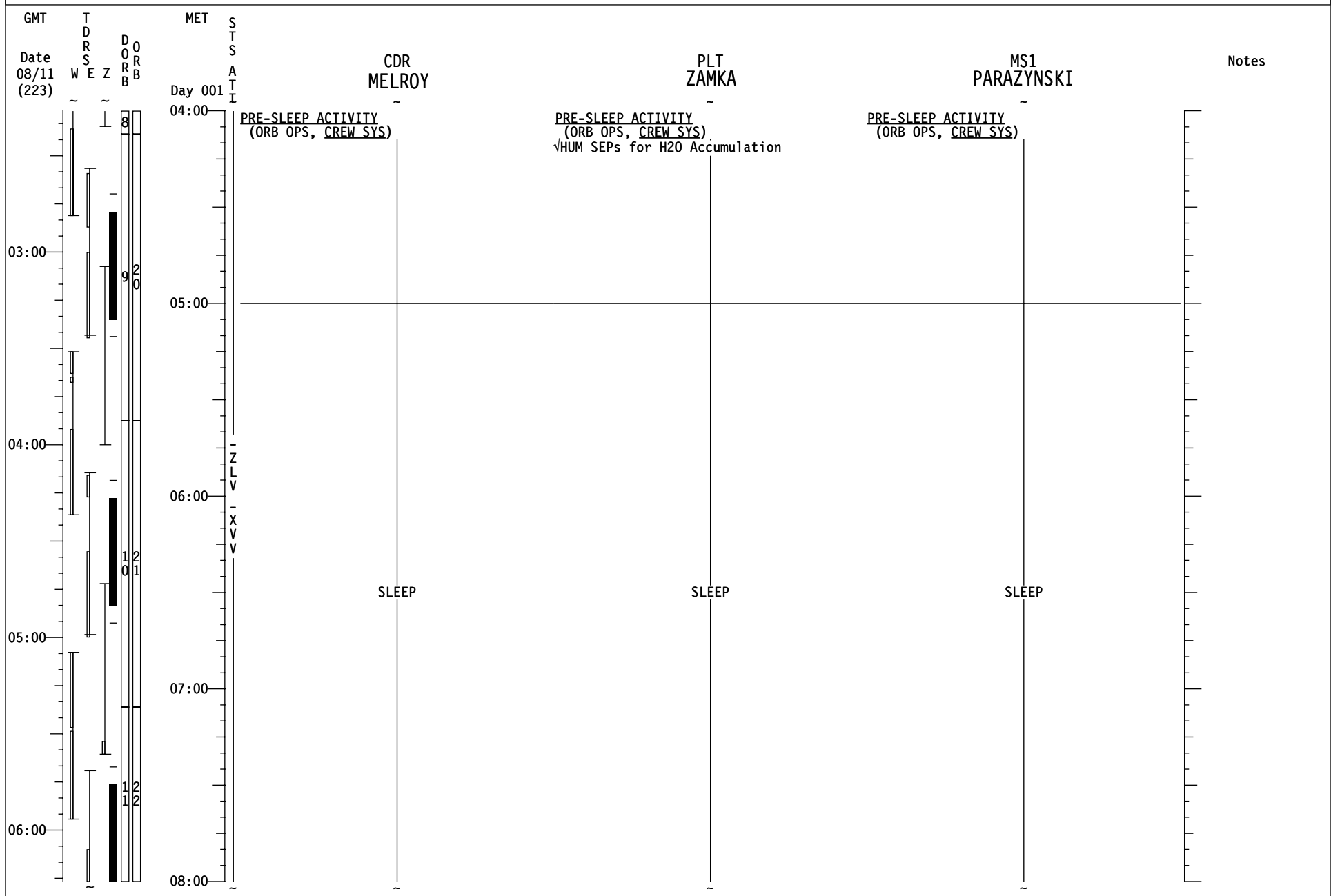

# STS-120 FD02

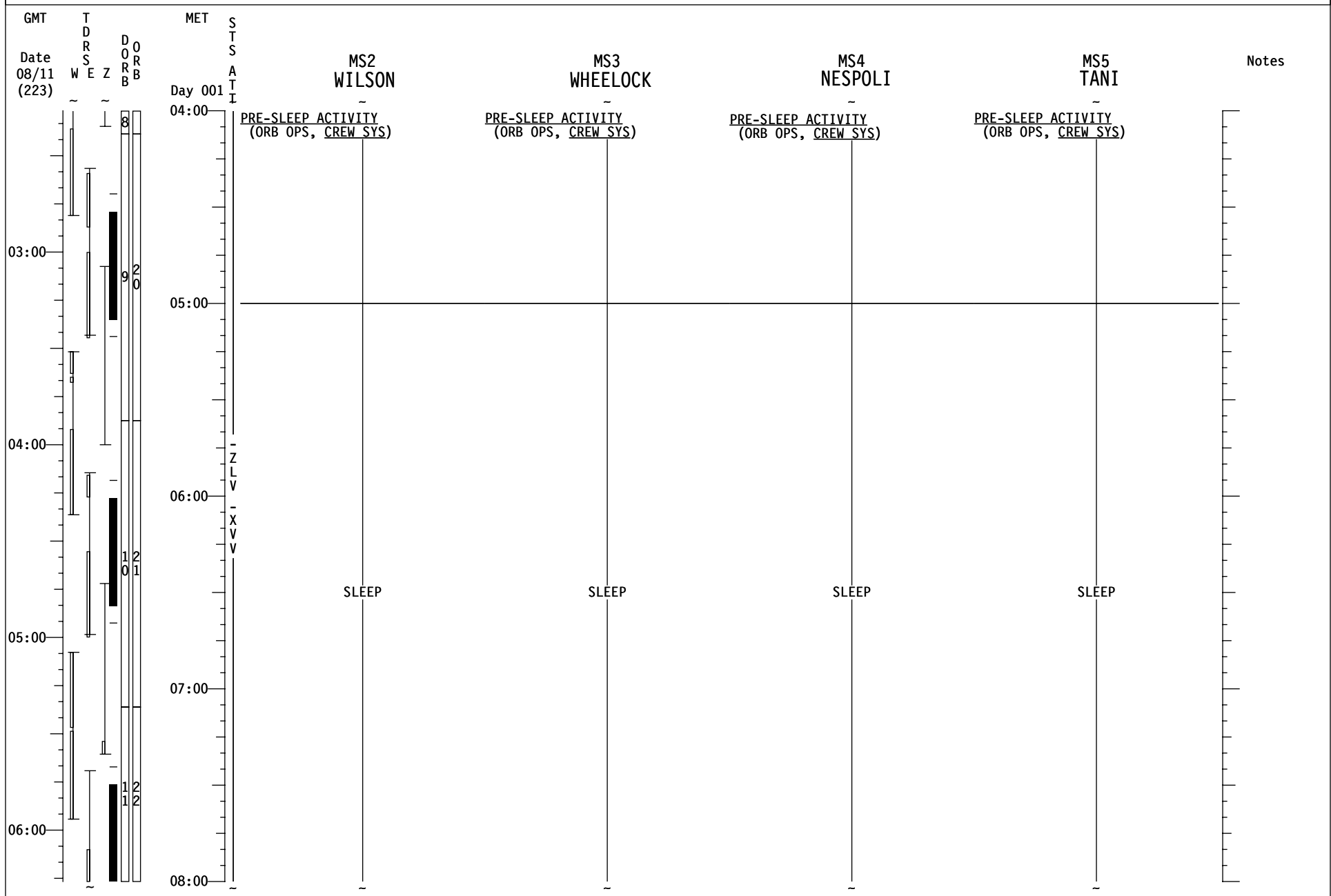



# STS-120 FD02

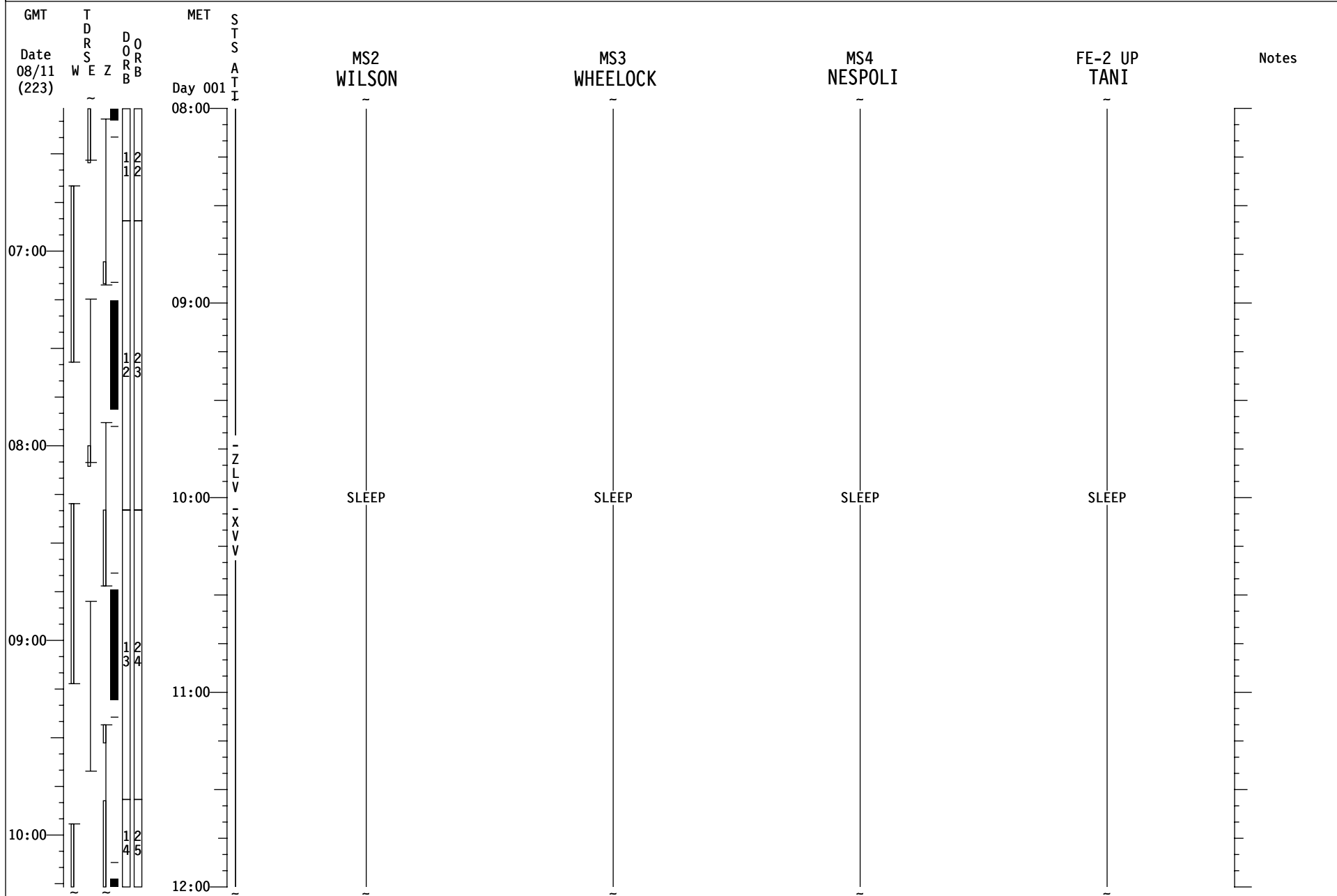

# STS-120 FD03

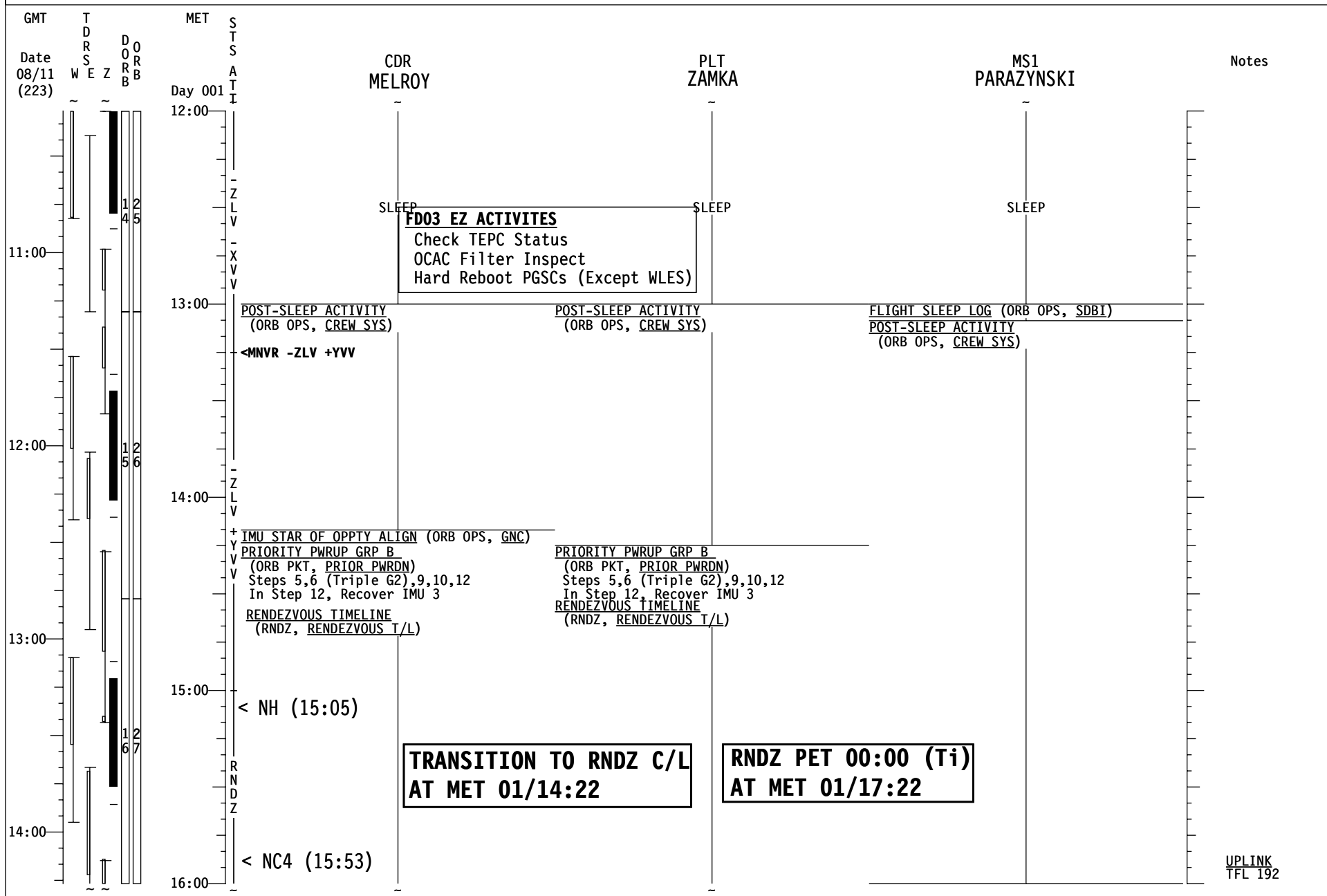



# STS-120 FD03

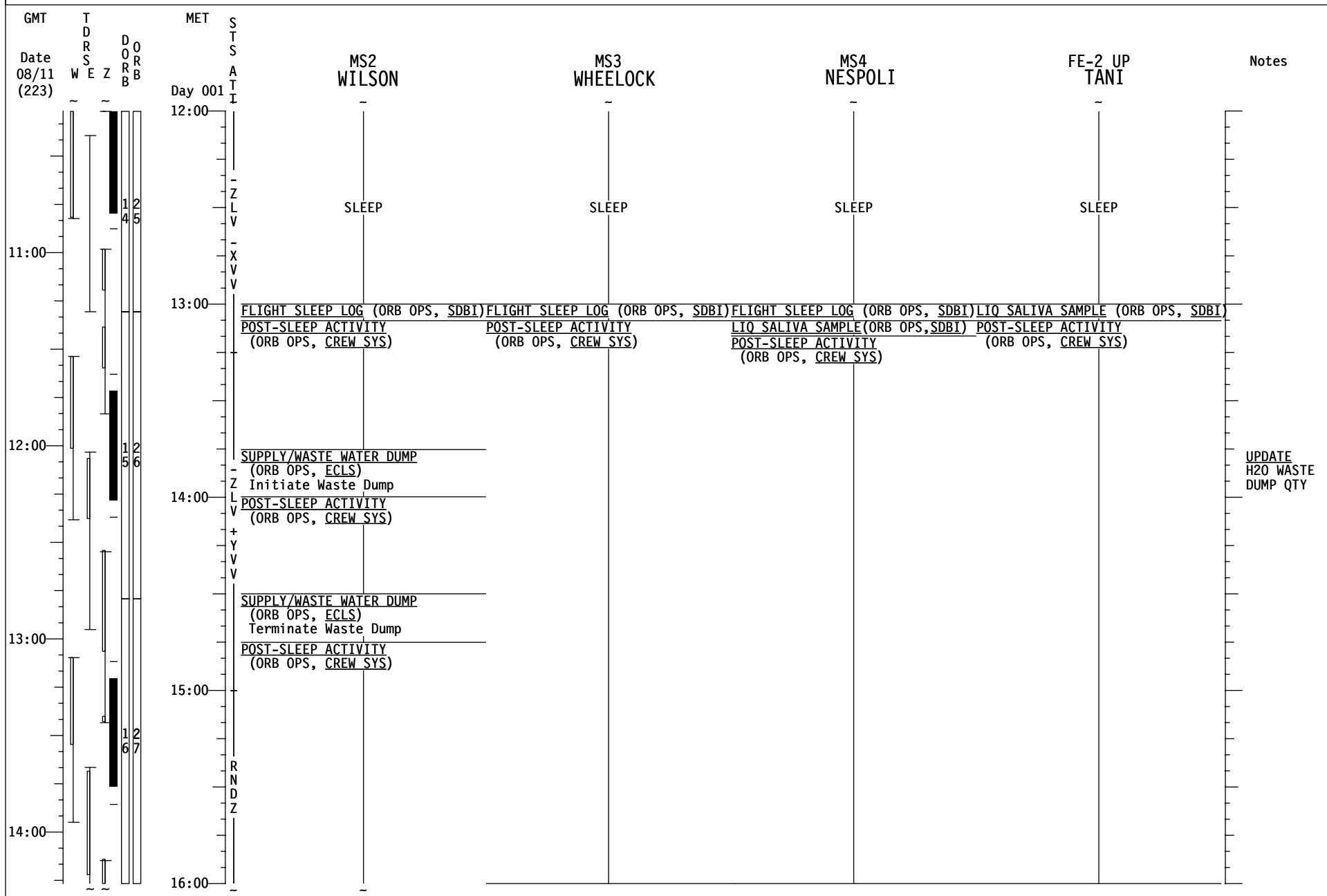

UPDATE H2O WASTE DUMP QTY

# STS-120 FD03

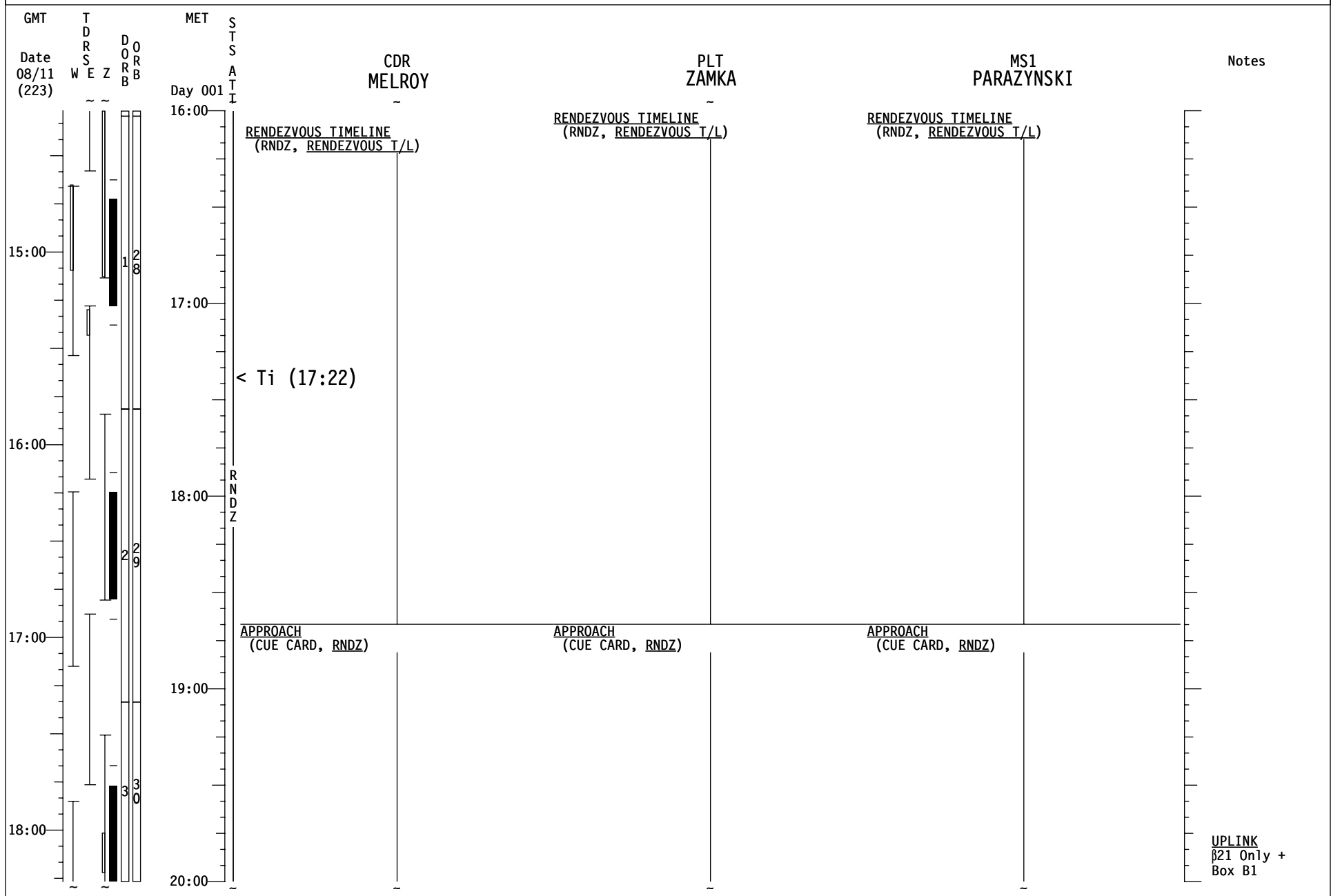

# STS-120 FD03

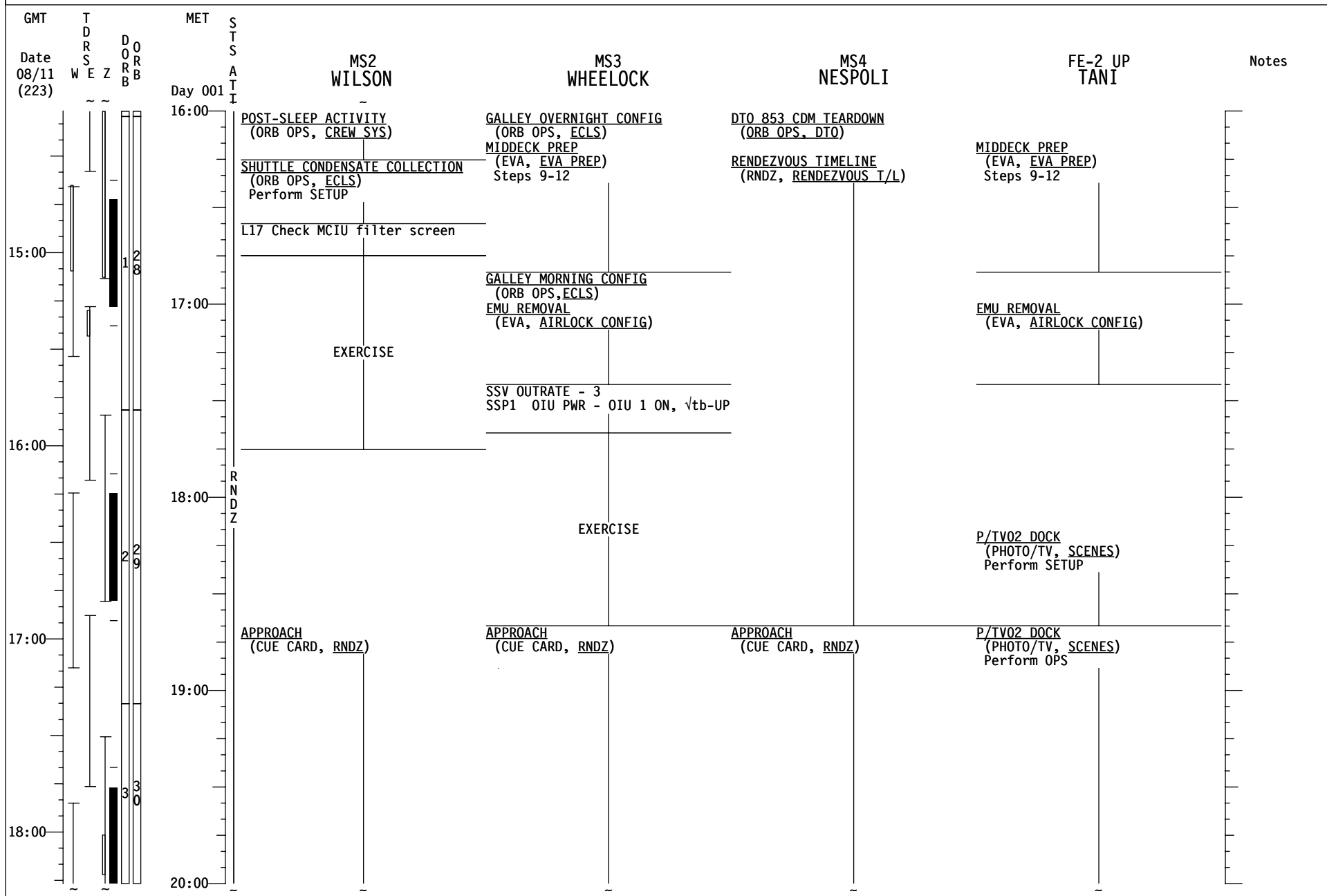

# STS-120 FD03

GMT	TDRS Z	DORB	MET	STS	R2 CDR MELROY	R1 PLT ZAMKA	MS1 PARAZYNSKI	Notes
Date 08/11 (223)	W	E	Day 001	DAY				
19:00			20:00	APPROACH	APPROACH (CUE CARD, RNDZ)	APPROACH (CUE CARD, RNDZ)	APPROACH (CUE CARD, RNDZ)	
				<b>&lt; DOCKING (21:17)</b>				
				<div style="border: 1px solid black; padding: 5px; display: inline-block;">                     A Note time of DAP:AUTO,MET 1/___:___                      At 10 &amp; 20 min after AUTO,                      DAP:FREE&gt;2 sec, then DAP:AUTO                 </div>				UPLINK β21 Only + Box C1,C2,C3
				<b>RETURN TO FLIGHT PLAN</b>				
			21:00	POST DOCKING HATCH LEAK CHECK (RNDZ, APDS)	MNVR BIAS -XLV -ZVV (TEA) TG=2 BV=5 P=162 Y=357 OM=180 Init TRK then DAP:FREE>2 sec DAP: A12/AUTO/VERN [A]	POST RNDZ PGSC CONFIG Configure PGSCs per EVA/RMS Usage Chart		UPLINK TFL 184
				A/L PREP FOR INGRS-BYPASS CONFG (RNDZ, APDS)	PRIORITY PWRDN GRP B (ORB PKT, PRIOR PWRDN) Steps 6(Single G2),12(IMU 3 STBY-ITEM 23 EXEC) 06 S TRK PWR-Z-OFF H/O ATT CNTRL ORB TO ISS	JOINT OPS: 6.107 PCS SETUP-SHUTTLE		
			20:00	JOINT OPS: 2.106 HATCH OPEN AND DUCT INSTALL (BYPASS CONFG) Steps 2-11, Verify MCC-H complete with Step 1	On MCC Go, DAP: FREE P/TV04 INGRESS/EGRESS (PHOTO/TV, SCENES) Perform SETUP			
			22:00		SSV OUTFRATE - 2 P/TV04 INGRESS/EGRESS (PHOTO/TV, SCENES) Perform Ops			
				WELCOME				
			21:00	SAFETY BRIEF				
				WELCOME				
			23:00			POST-DOCKING EVA TRANSFER/RECONFIG (EVA, AIRLOCK CONFG) Ref: PRE EVA 1 TOOL CONFG (EVA, TIMELINES)		UPLINK β0 Only + Box C1,C2,C3,D1
				OBSS HANDOFF FROM SSRMS TO SRMS (PDRS, OBSS HANDOFF) Steps 1-2	OBSS HANDOFF FROM SSRMS TO SRMS (PDRS, OBSS HANDOFF) Steps 1-2			
				OBSS HANDOFF FROM SSRMS TO SRMS (PDRS, OBSS HANDOFF) Steps 3-5	OBSS HANDOFF FROM SSRMS TO SRMS (PDRS, OBSS HANDOFF) Steps 3-5			
			22:00			EVA SYS: 1.305 EQUIPMENT LOCK PREP REF: 120 CONSUMABLES TRACKING CC (EVA) FLY PEN/120/BAS		
			00:00					

# STS-120 FD03

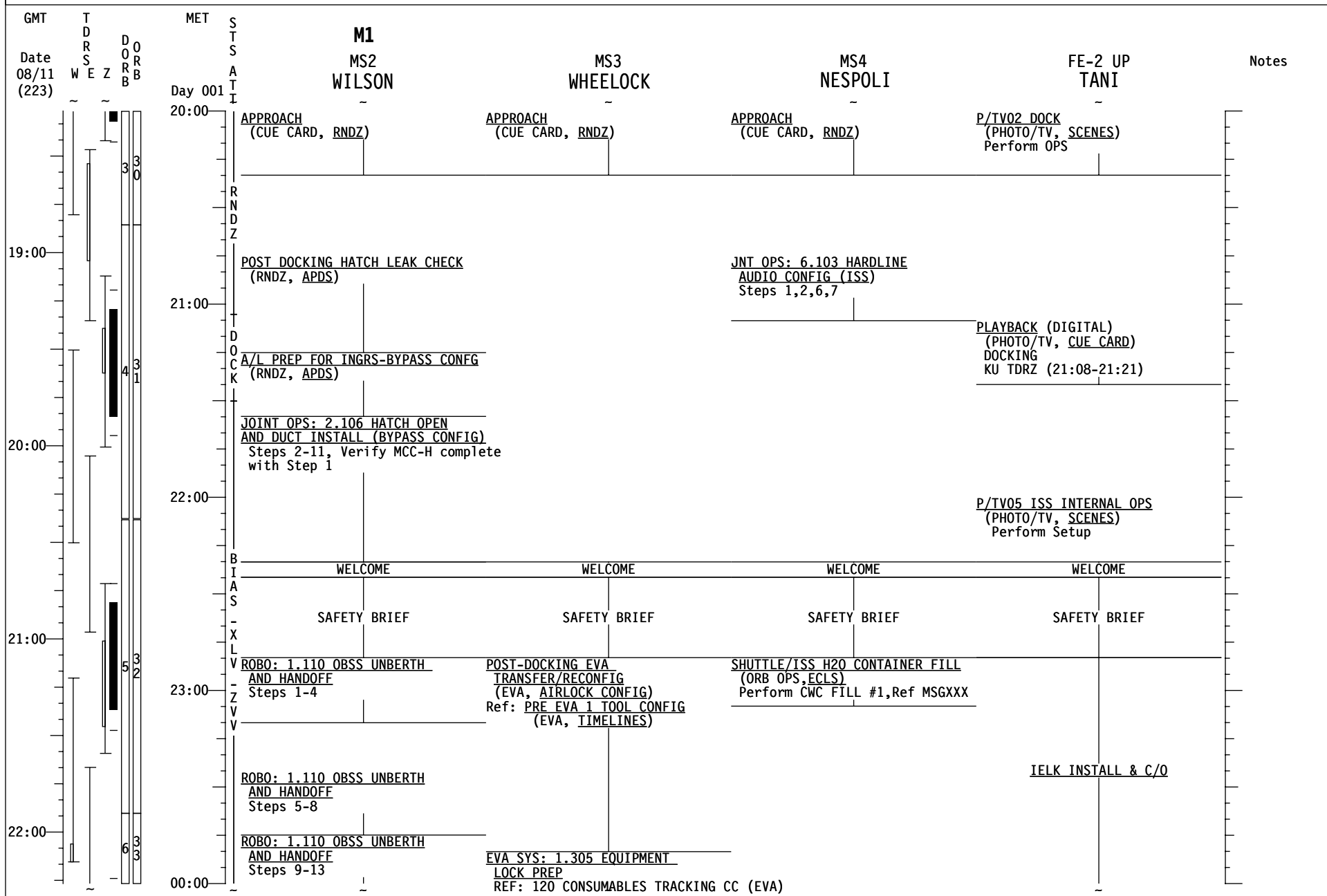

# STS-120 FD03

GMT	T D R S E Z	D O R B	MET	S T S	R2 CDR MELROY	R1 PLT ZAMKA	MS1 PARAZYNSKI	Notes
Date 08/11 (223)	W	E	Day 002	A T I				
23:00		6 3	00:00				<u>EVA SYS: 1.305 EQUIPMENT LOCK PREP</u> REF: 120 CONSUMABLES TRACKING CC (EVA)	No Exercise When both arms grappled
					<u>OBSS HANDOFF FROM SSRMS TO SRMS</u> (PDRS, OBSS HANDOFF) Steps 6-7	<u>OBSS HANDOFF FROM SSRMS TO SRMS</u> (PDRS, OBSS HANDOFF) Steps 6-7	<u>EVA SYS: 1.307 REBA INSTALL</u>	
							<u>EVA SYS: 1.403 REBA POWERED</u> <u>HARDWARE CHECKOUT</u>	
			01:00		<u>OBSS HANDOFF FROM SSRMS TO SRMS</u> (PDRS, OBSS HANDOFF) Steps 8-9	<u>OBSS HANDOFF FROM SSRMS TO SRMS</u> (PDRS, OBSS HANDOFF) Steps 8-9	<u>PRE-SLEEP ACTIVITY</u> (ORB OPS, CREW SYS)	
00:00		7 4			<u>CWC TRANSFER</u> Transfer CWC(s) to ISS	<u>SODF TRANSFER</u> REF MSG XXX		
			02:00		<u>EVA PROCEDURE REVIEW</u> REF: EVA 1 PREBRIEF (EVA, TIMELINES)	<u>EVA PROCEDURE REVIEW</u> REF: EVA 1 PREBRIEF (EVA, TIMELINES)	<u>EVA PROCEDURE REVIEW</u> REF: EVA 1 PREBRIEF (EVA, TIMELINES)	
			03:00		<u>PRE-SLEEP ACTIVITY</u> (ORB OPS, CREW SYS)	<u>PRE-SLEEP ACTIVITY</u> (ORB OPS, CREW SYS)	<u>PRE-SLEEP ACTIVITY</u> (ORB OPS, CREW SYS)	
		8 5			06 UHF MODE - OFF PRIVATE MEDICAL CONFERENCE			
02:00					<u>PRE-SLEEP ACTIVITY</u> (ORB OPS, CREW SYS)		<u>EVA SYS: 2.305 10.2 PSIA CAMPOUT</u> <u>MASK PREBREATHE</u>	
							REF: <u>PRE EVA 1 TOOL CONFIG</u> (EVA, TIMELINES)	
							REF: <u>120 CONSUMABLES TRACKING CC (EVA)</u>	
04:00								<u>UPLINK</u> β21 Only + Box C1,C2,C3

# STS-120 FD03

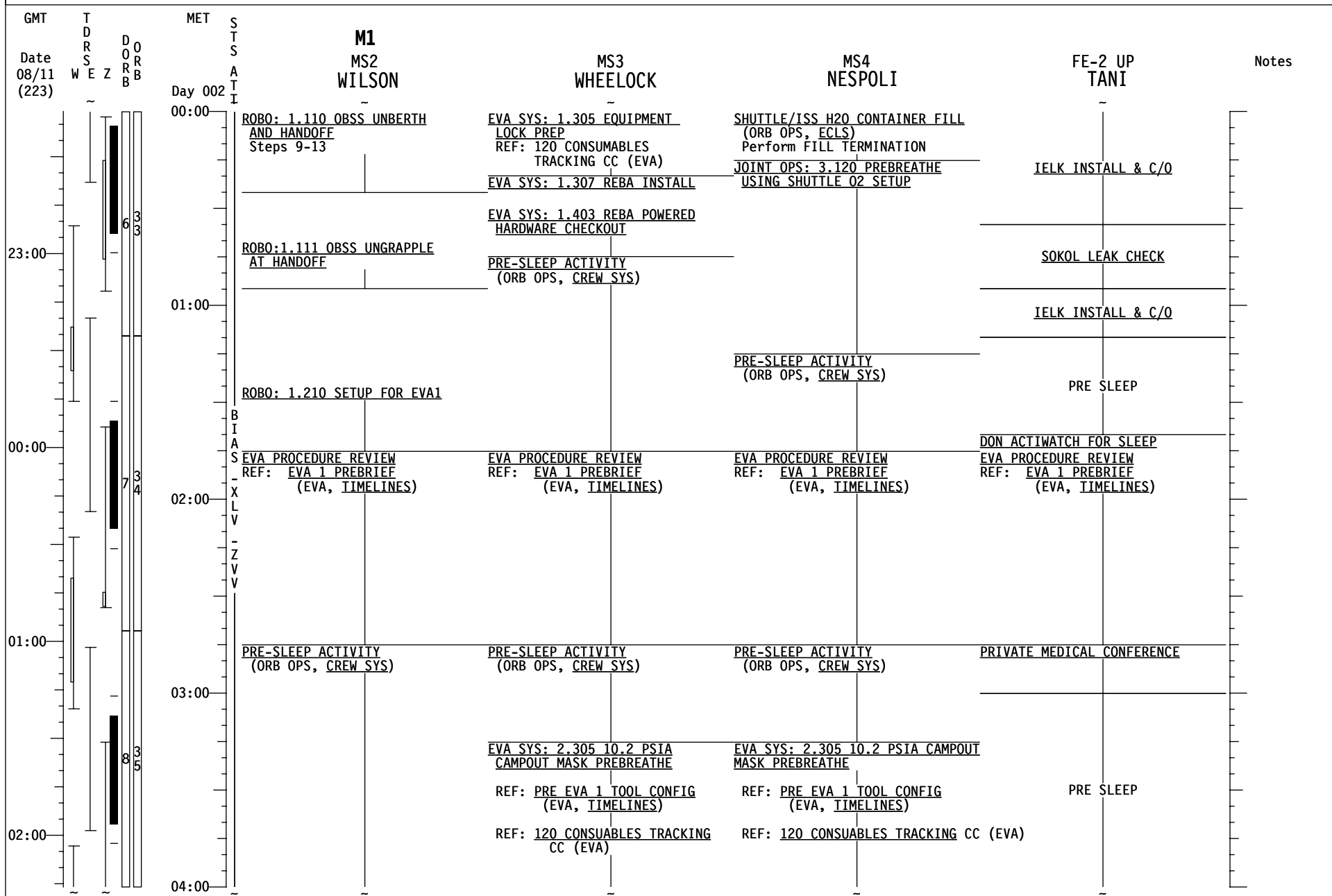

# STS-120 FD03

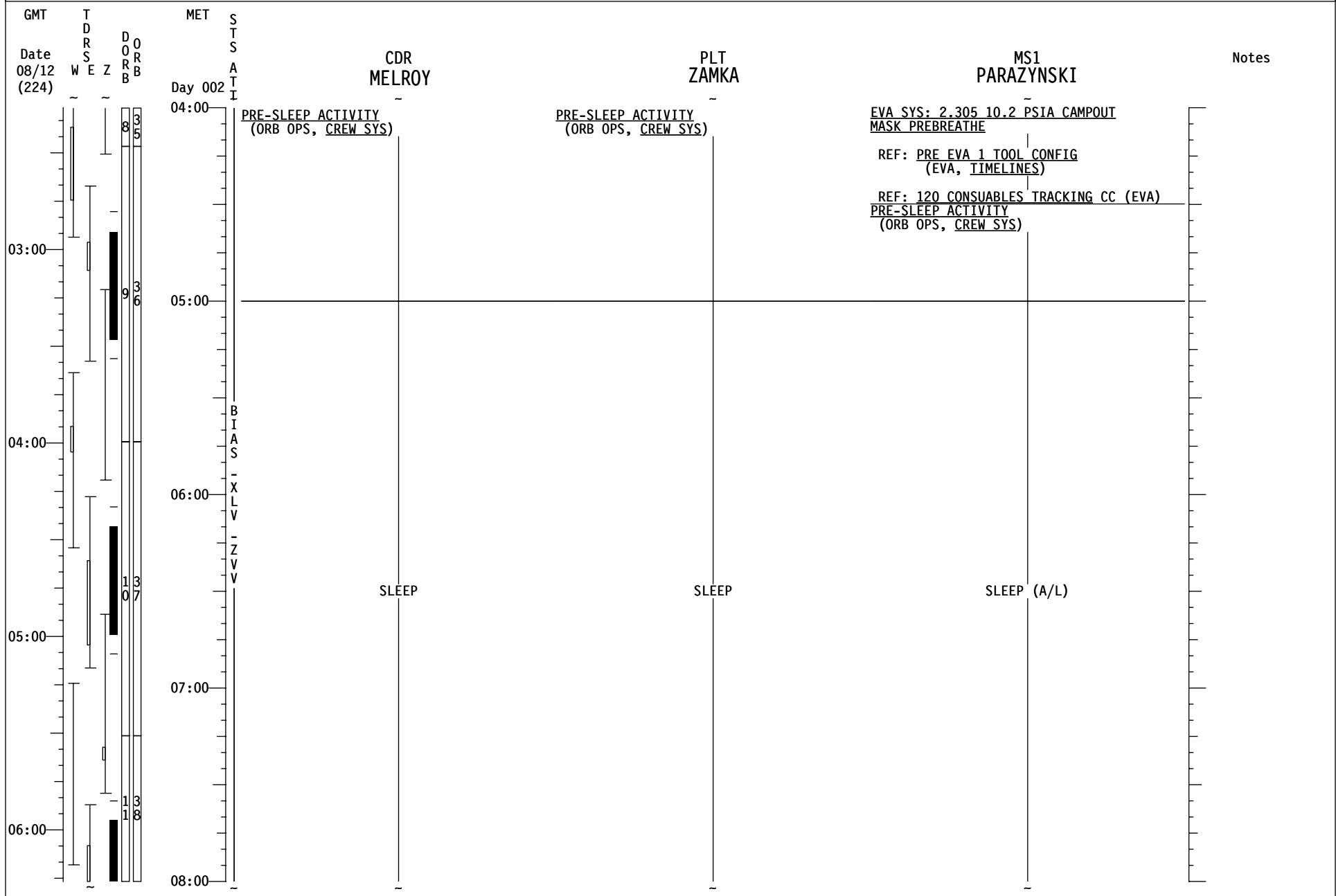



# STS-120 FD03

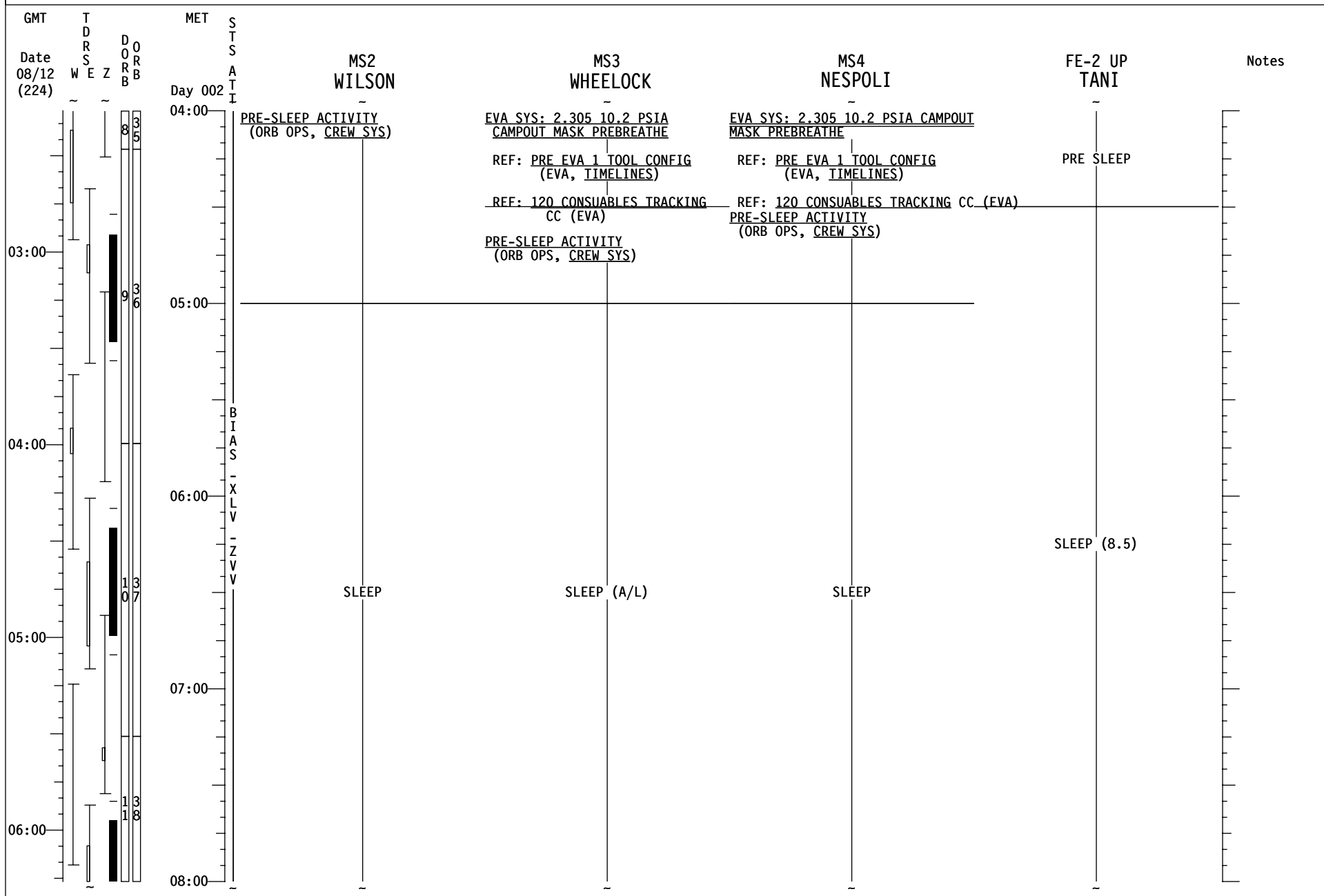

# STS-120 FD03

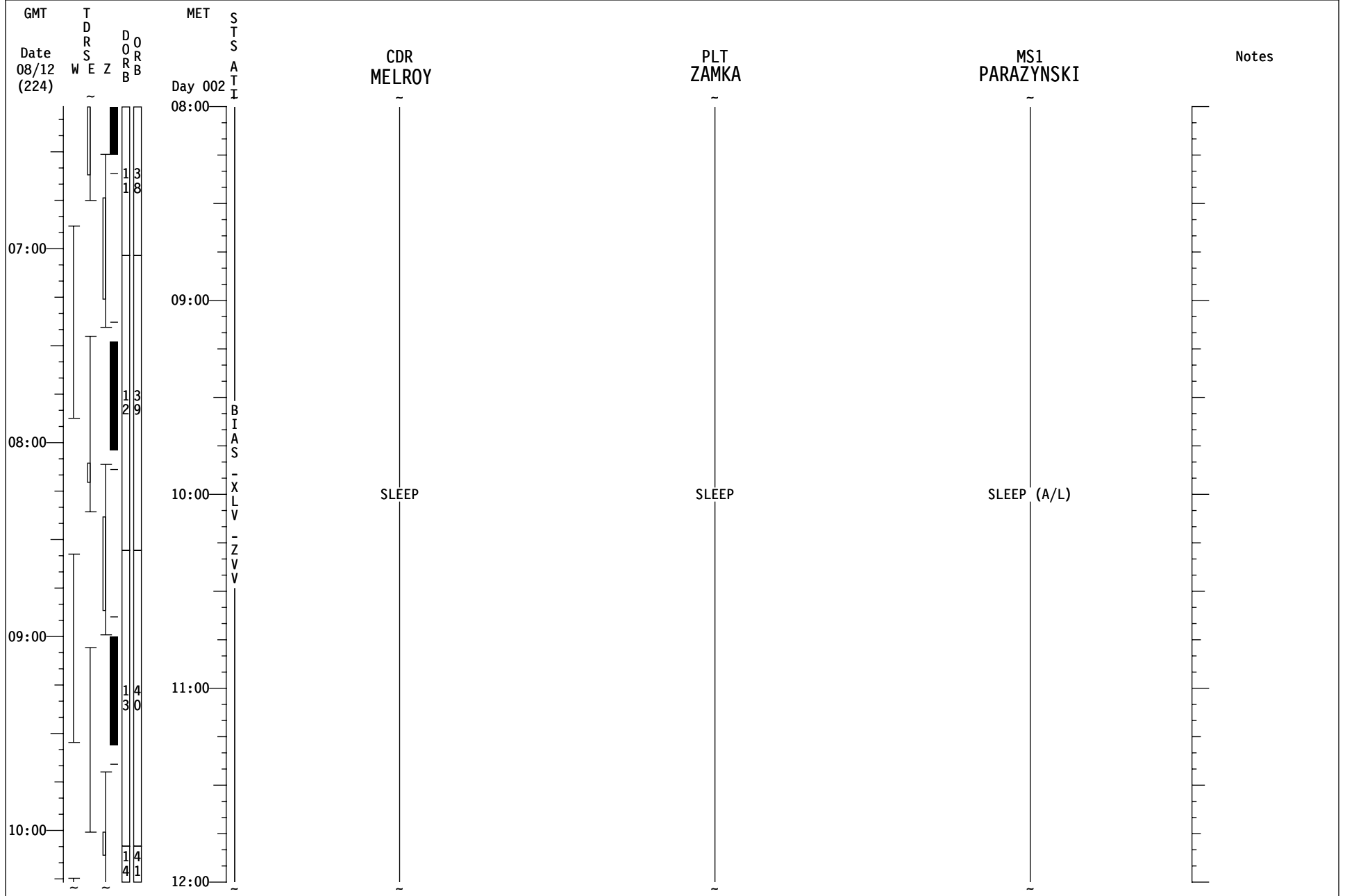

# STS-120 FD03

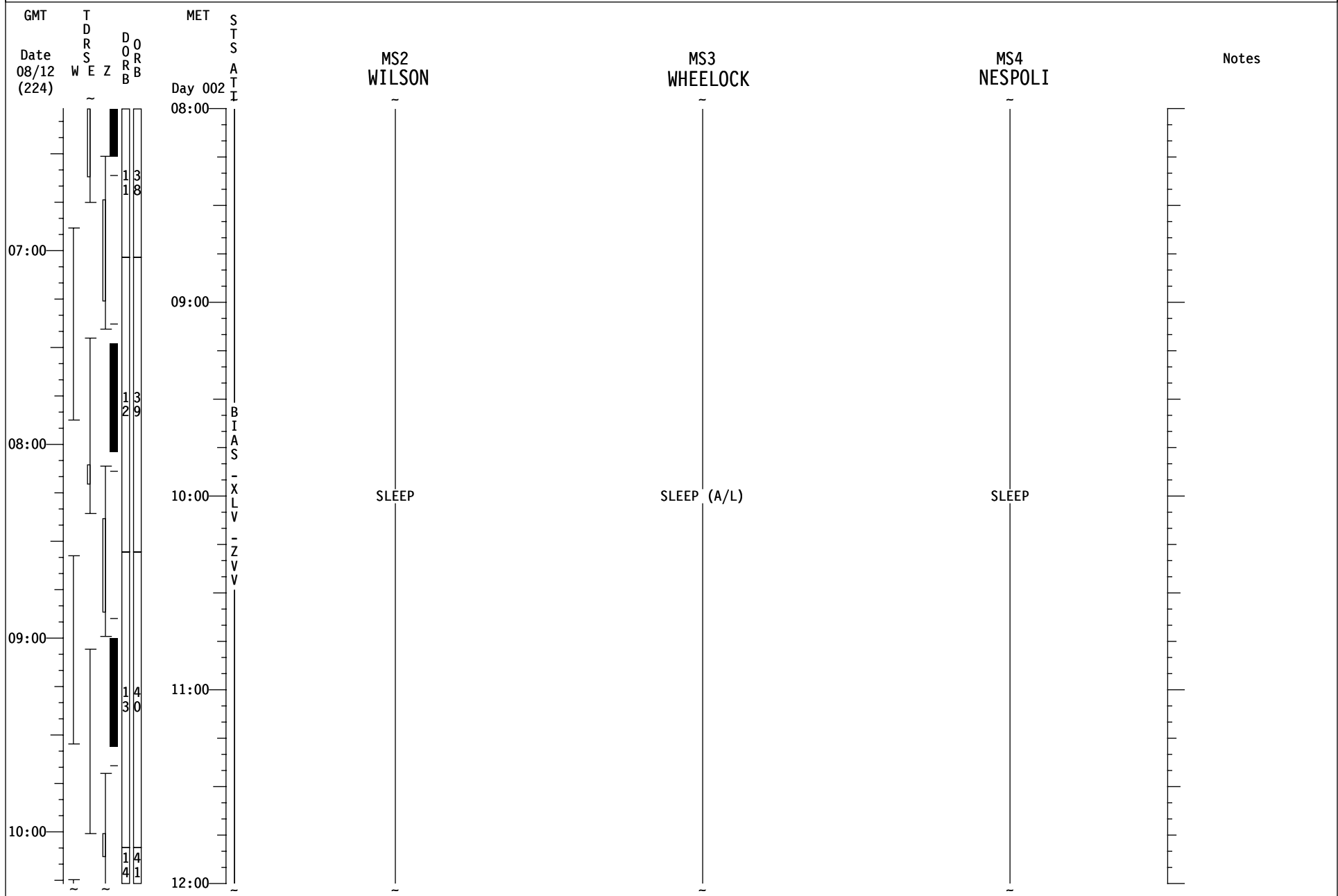

# STS-120 FD04

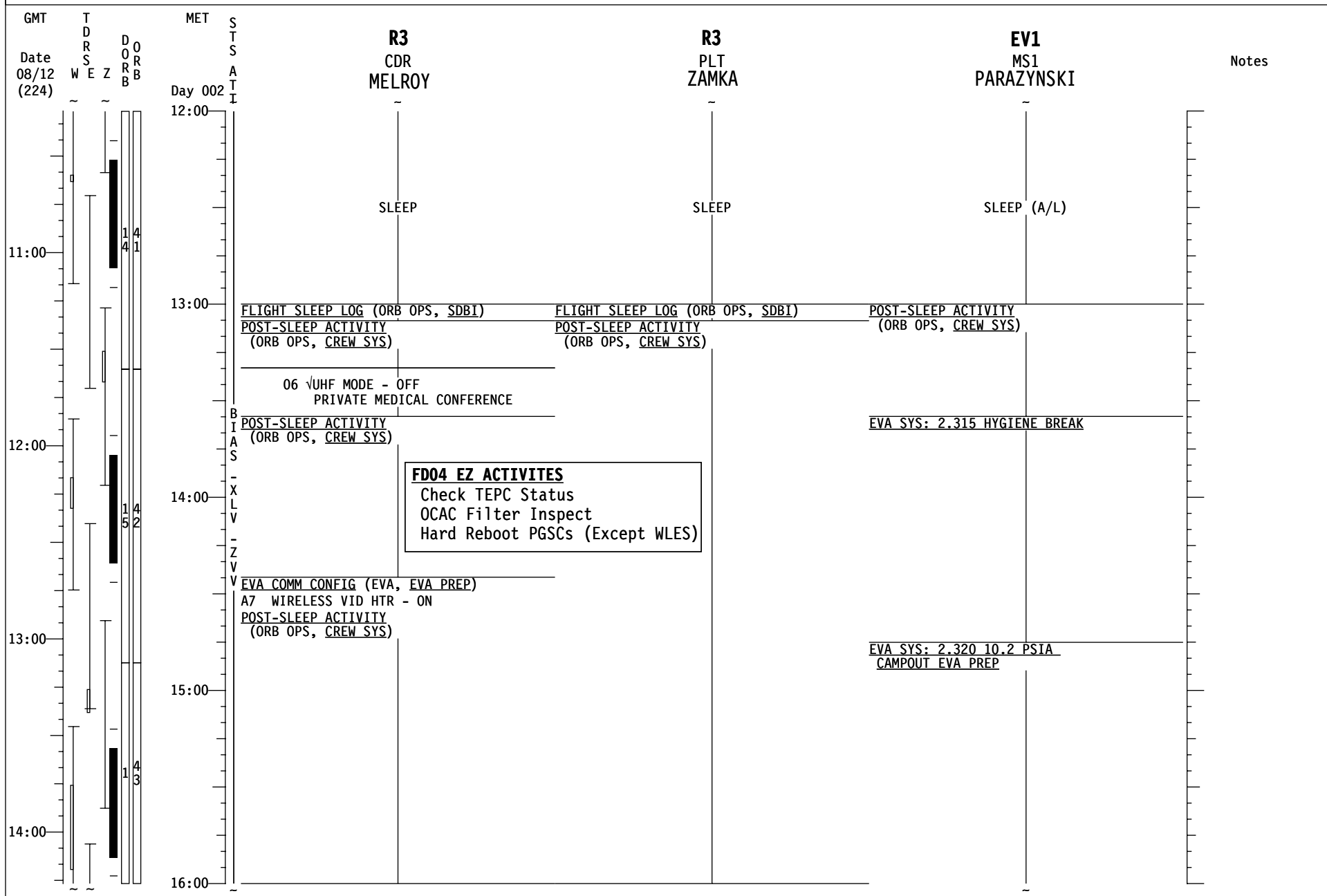

# STS-120 FD04

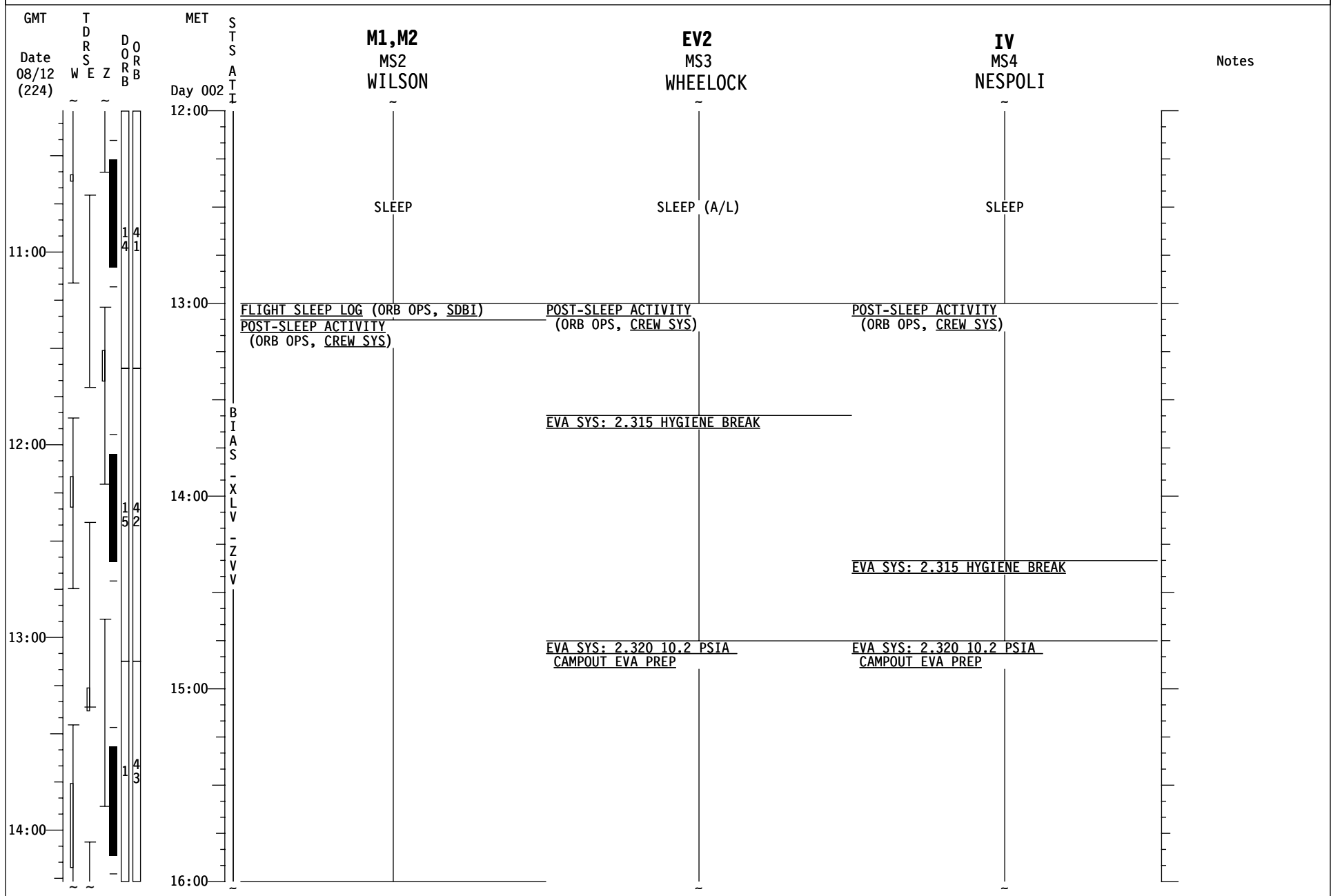

# STS-120 FD04

GMT	TDRS W E Z	DORB 1 3 2 4 3 5 4 6	MET Day 002	STS A T I	R3 CDR MELROY	R3 PLT ZAMKA	EV1 MS1 PARAZYNSKI	Notes
16:00					<u>EVA1 INHIBIT PAD</u> (EVA, TIMELINES)	L17 Check MCIU filter screen	<u>EVA SYS: 2.320 10.2 PSIA</u> <u>CAMPOUT EVA PREP</u>	
					<u>SHUTTLE/ISS H2O CONTAINER FILL</u> (ORB OPS, ECLS) Perform CWC FILL #2, Ref MSGXXX	<u>PODF: 2.003 PMDIS EXPERIMENT OPERATION</u>	<u>EVA SYS: 1.220 EMU PURGE</u>	
15:00						<u>PODF: 2.006 BURNING A CD W/PMDIS DATA</u> <u>P/TV07 EVA</u> (PHOTO/TV, SCENES) Perform SETUP	<u>EVA SYS: 1.225 EMU PREBREATHE</u>	
17:00					EXERCISE			<u>UPLINK</u> BO Only + Box C1,C2,C3,E1
						EXERCISE	<u>EVA SYS: CREWLOCK DEPRESS (CC)</u>	
16:00					<u>SHUTTLE/ISS H2O CONTAINER FILL</u> (ORB OPS, ECLS) Perform FILL TERMINATION		<u>EVA SYS: CREWLOCK POST DEPRESS (CC)</u>	
						<u>P/TV07 EVA</u> (PHOTO/TV, SCENES) Perform OPS	<u>EVA 1 A/L EGRESS AND SETUP</u>	
18:00							<u>SASA RETRIEVE</u>	
17:00							<u>NODE 2 PREP FOR UNBERTH</u>	
19:00							<u>SASA STOW</u>	
18:00					<u>SHUTTLE/ISS H2O CONTAINER FILL</u> (ORB OPS, ECLS) Perform CWC FILL #3, Ref MSGXXX			
20:00								

# STS-120 FD04

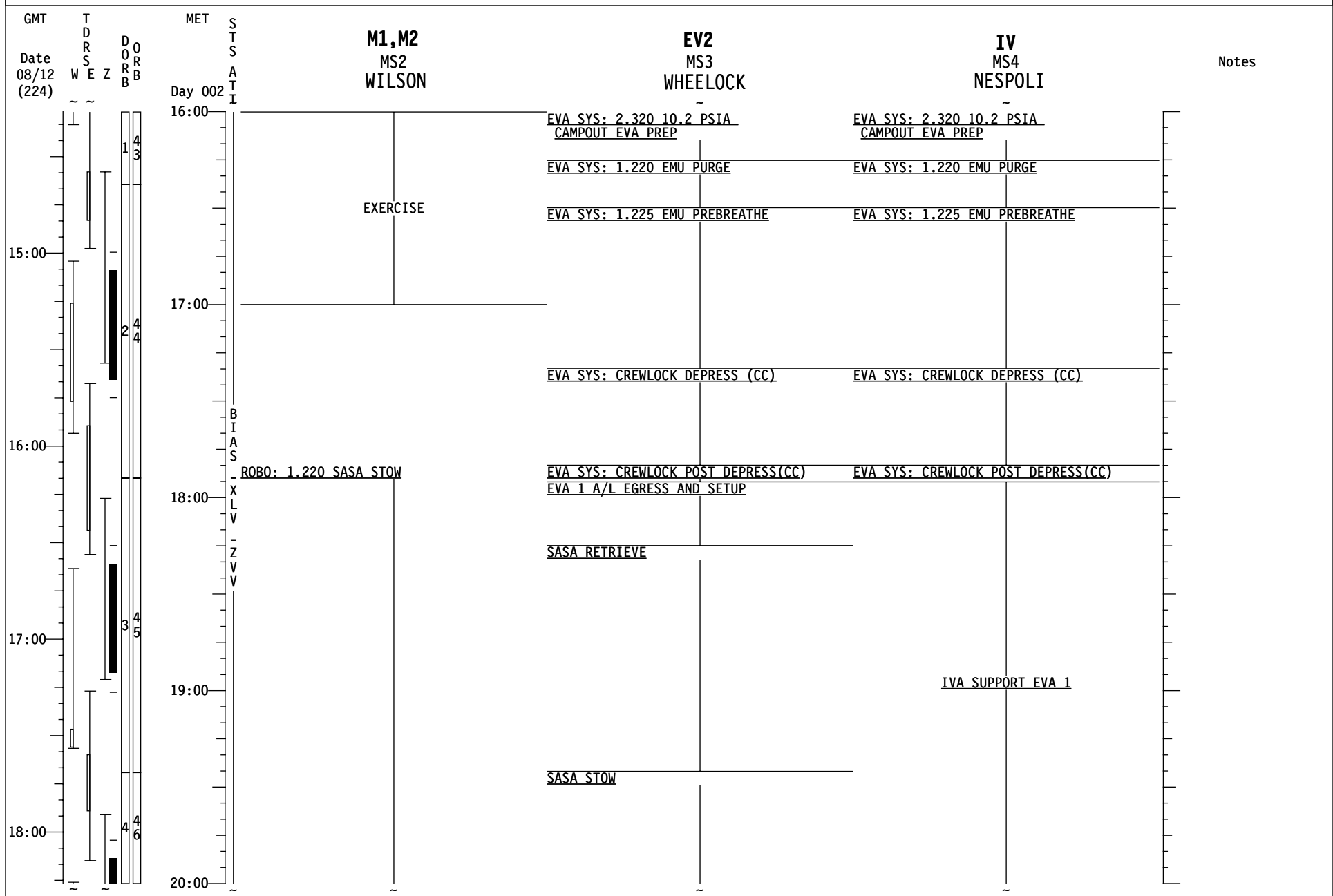

# STS-120 FD04

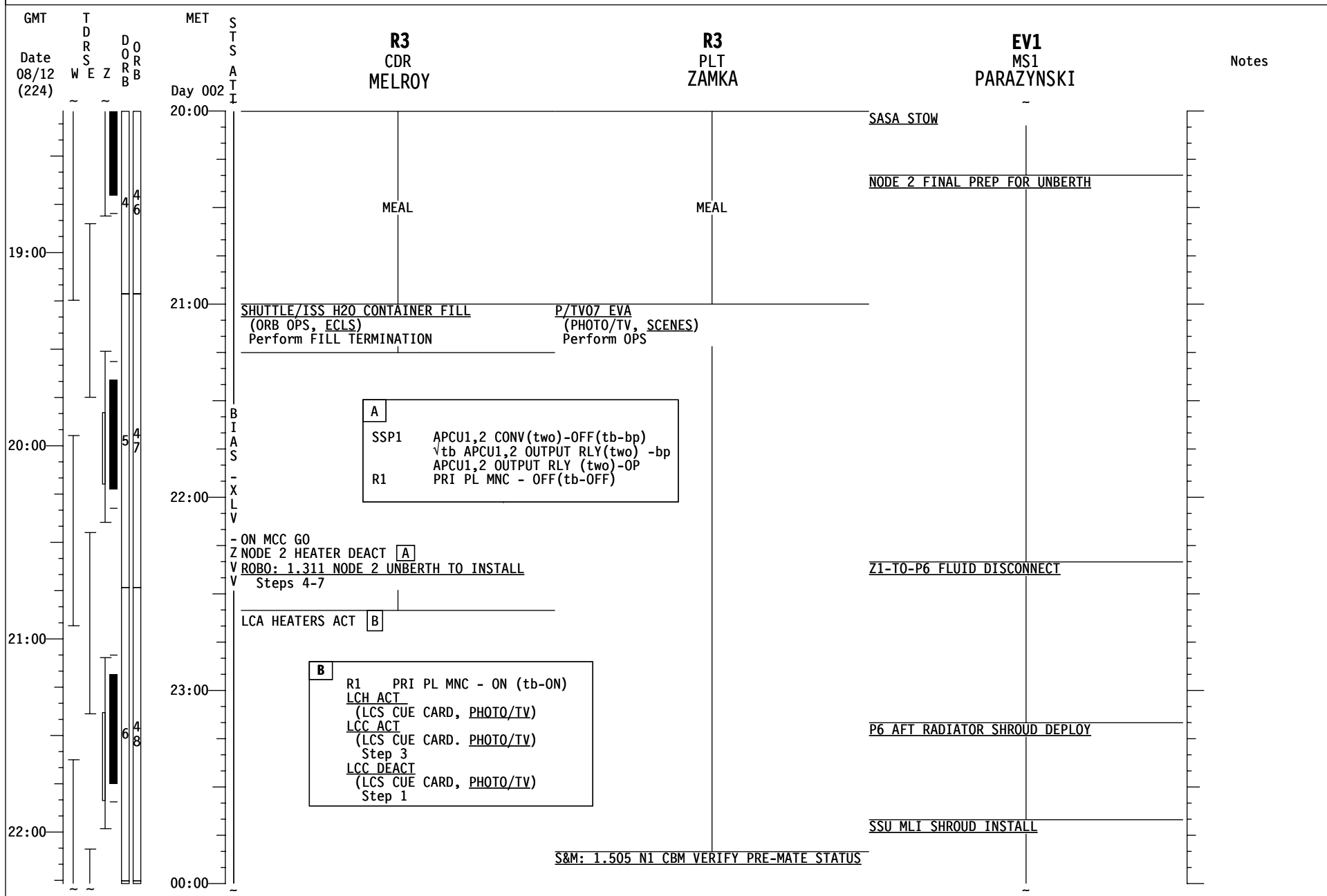



# STS-120 FD04

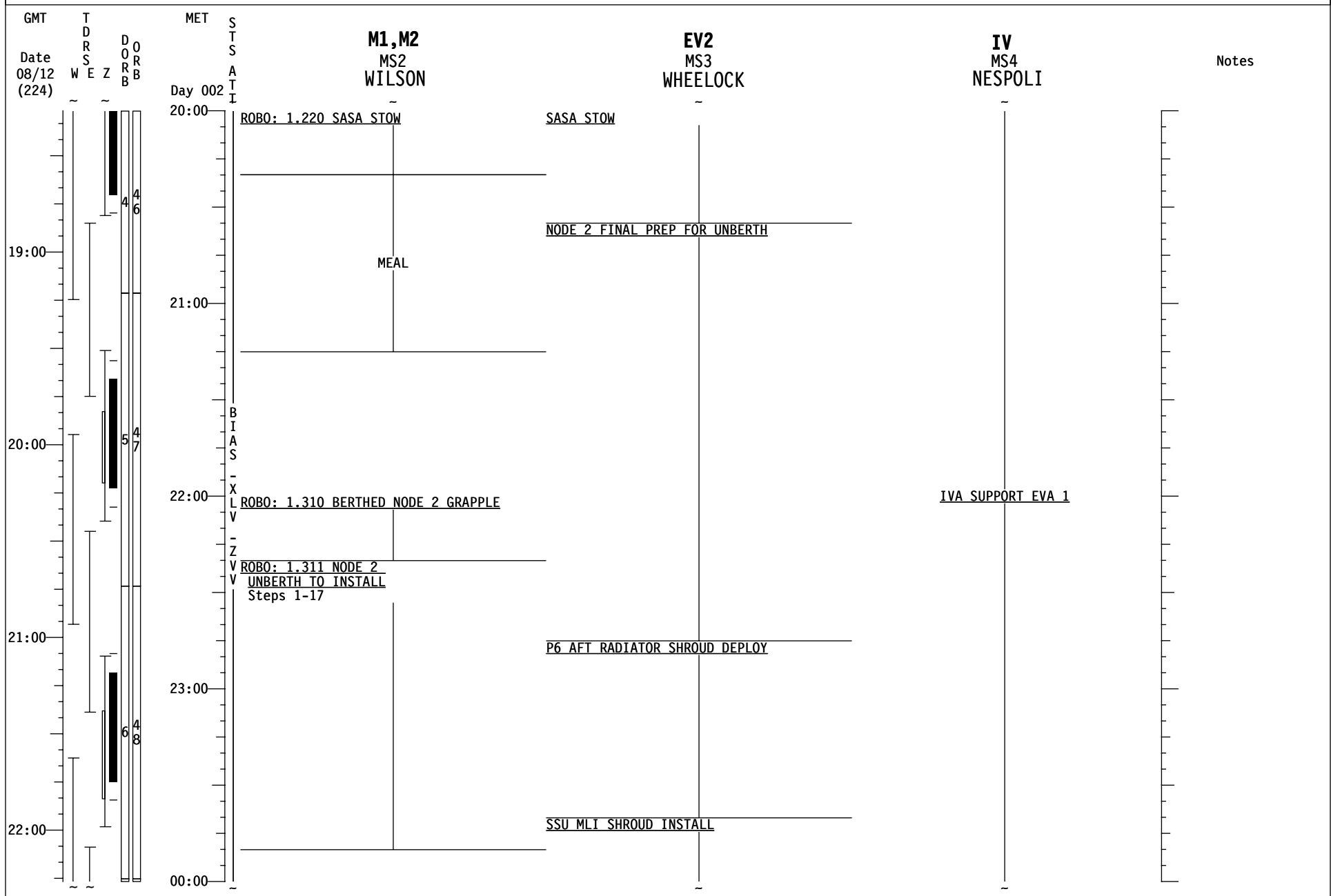

# STS-120 FD04

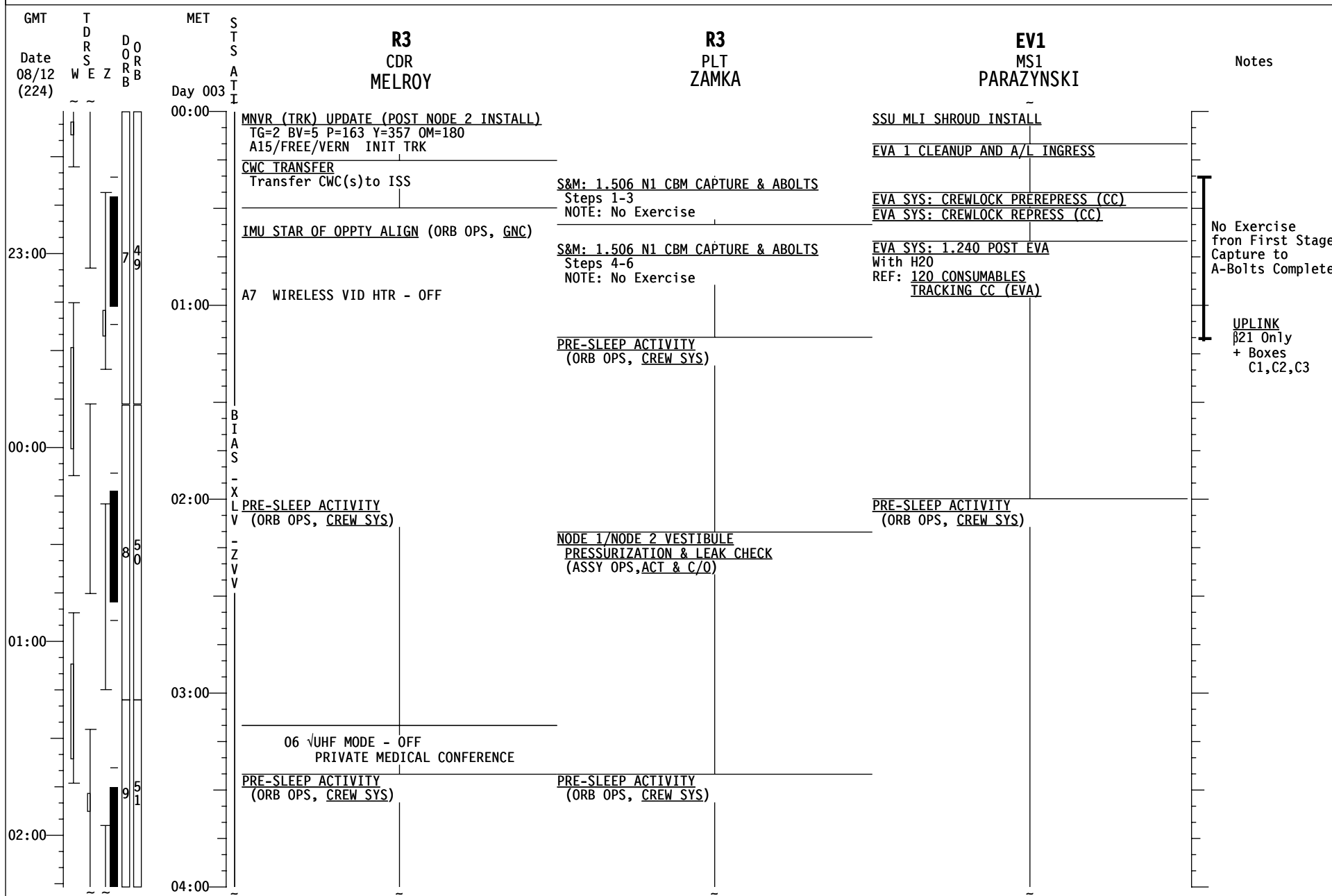

# STS-120 FD04

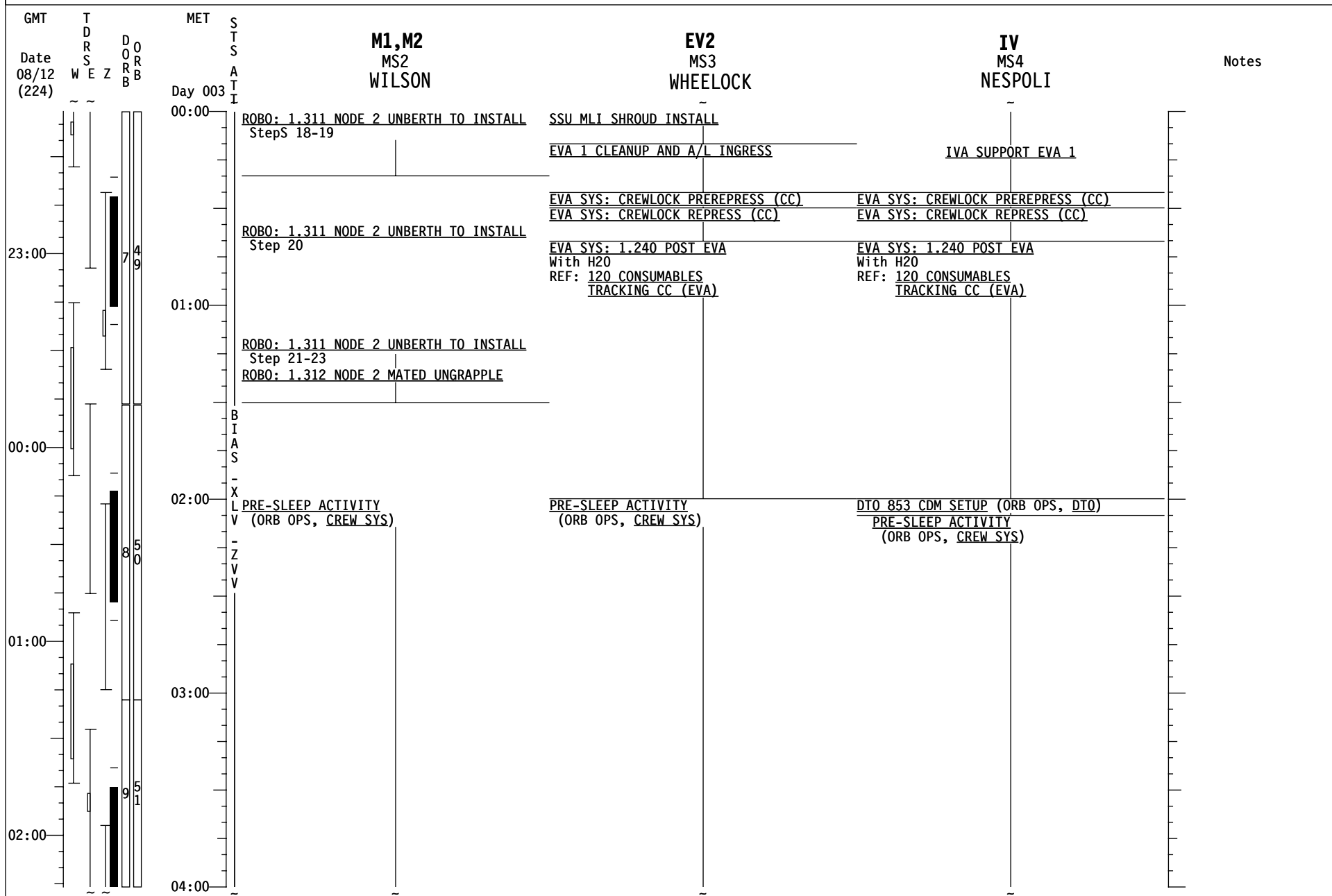

# STS-120 FD04

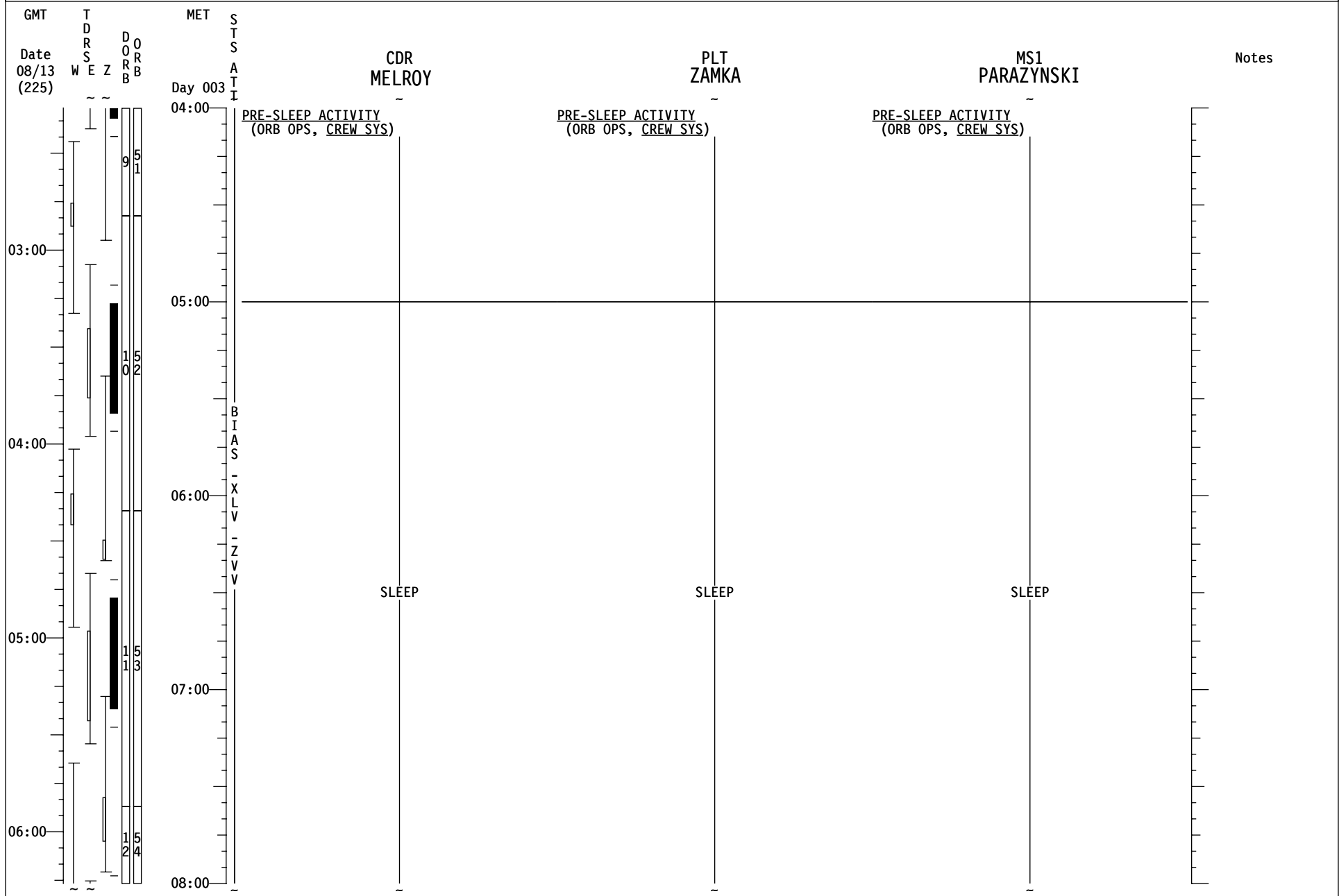

# STS-120 FD04

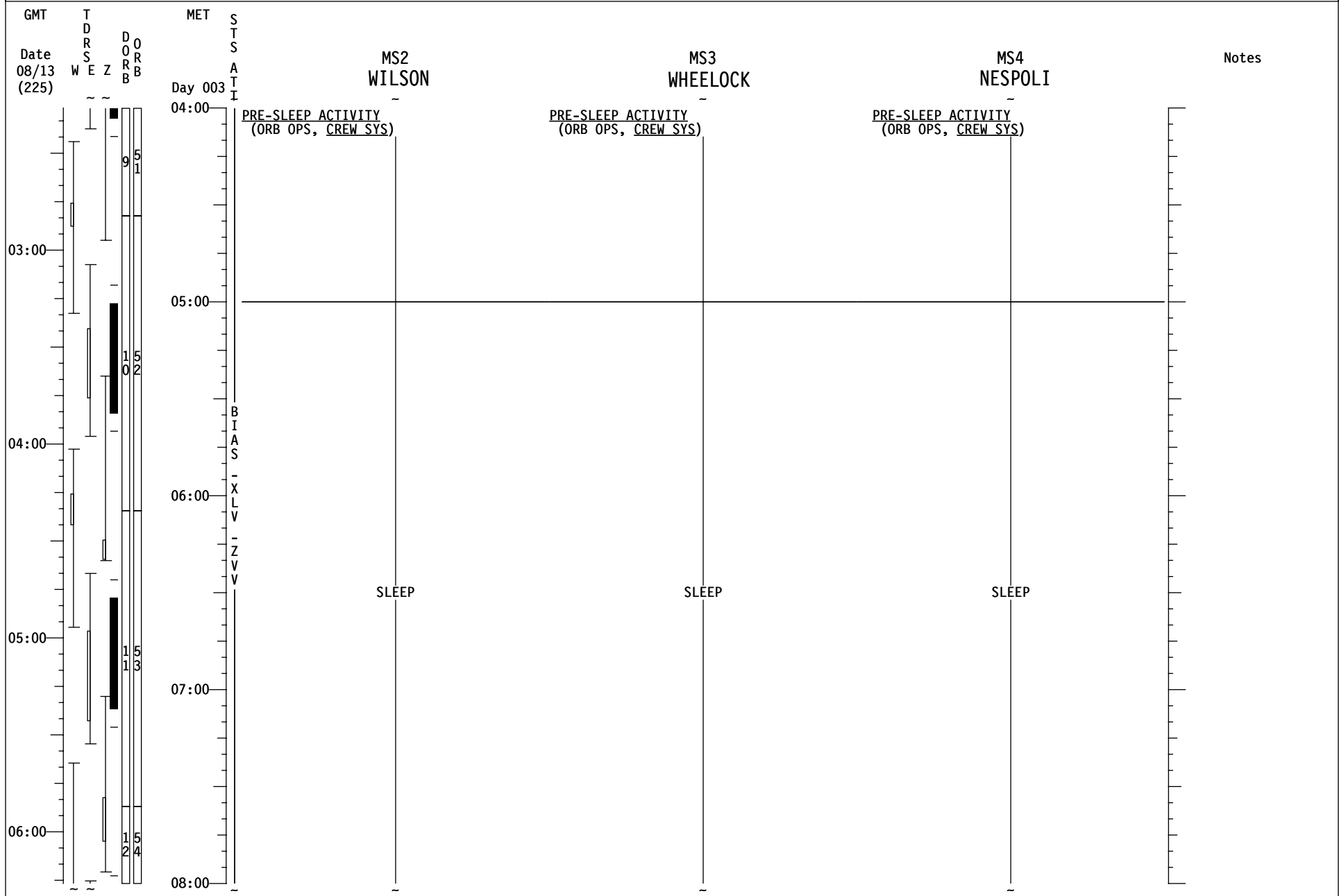

# STS-120 FD04

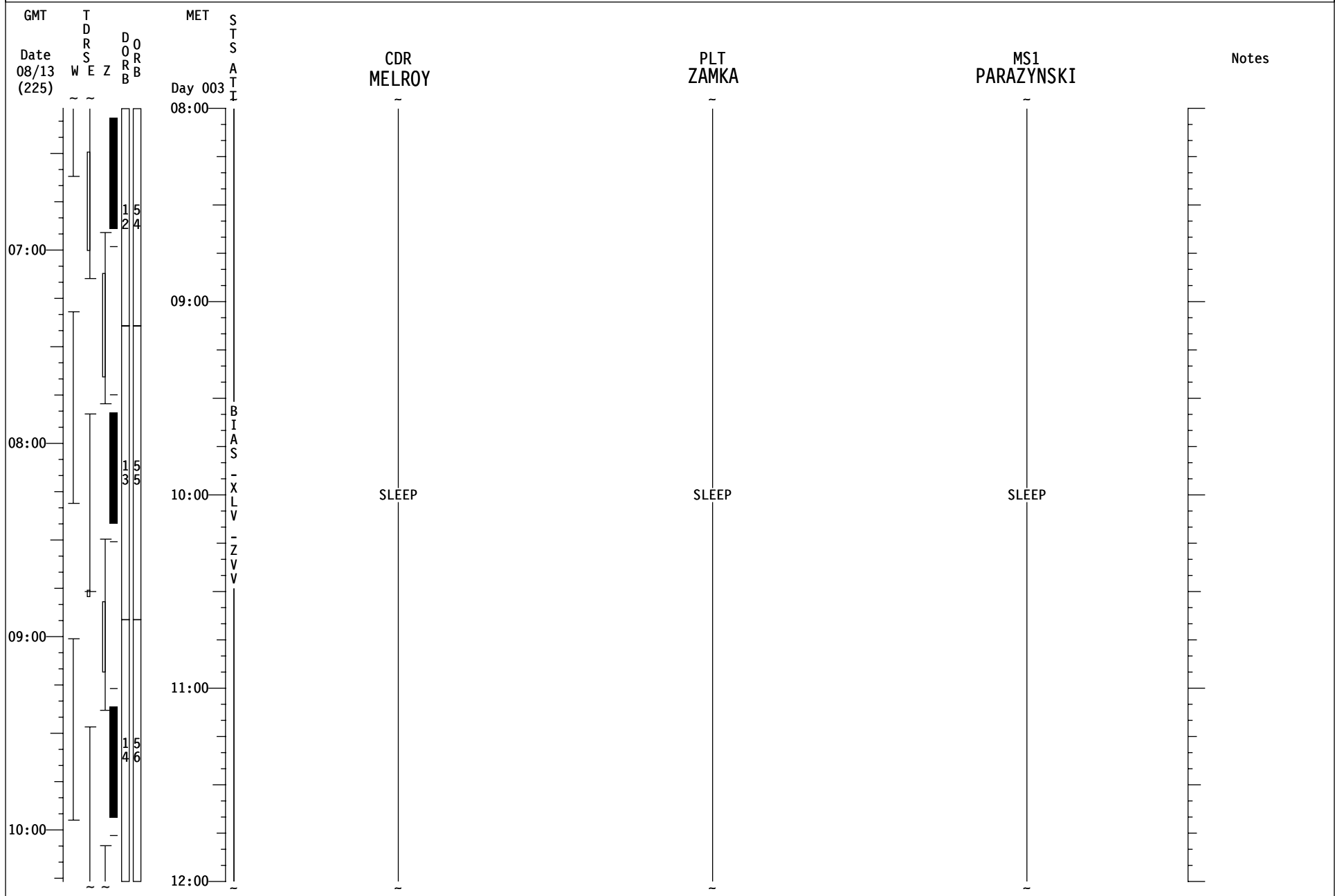

# STS-120 FD 04

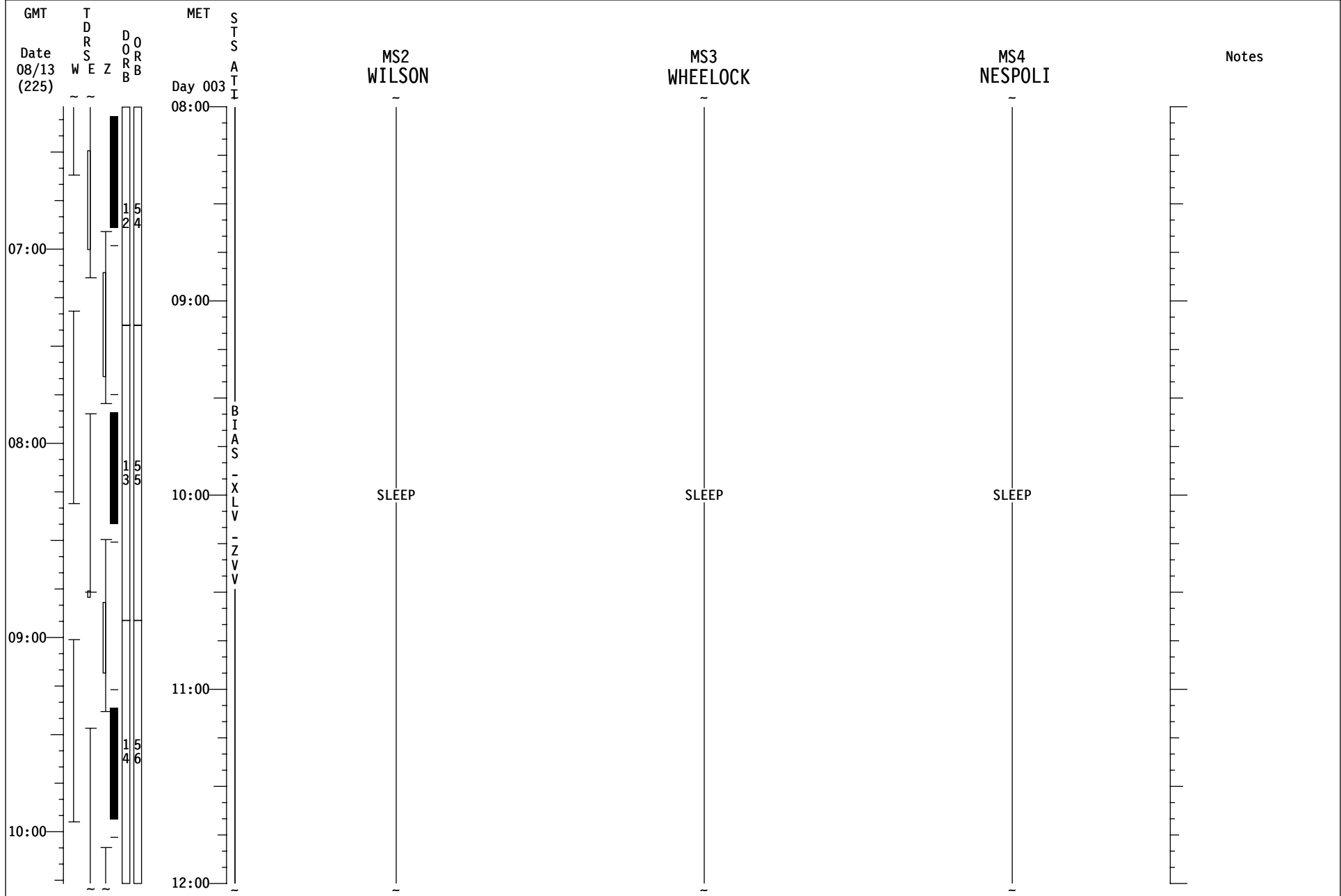

# STS-120 FD05

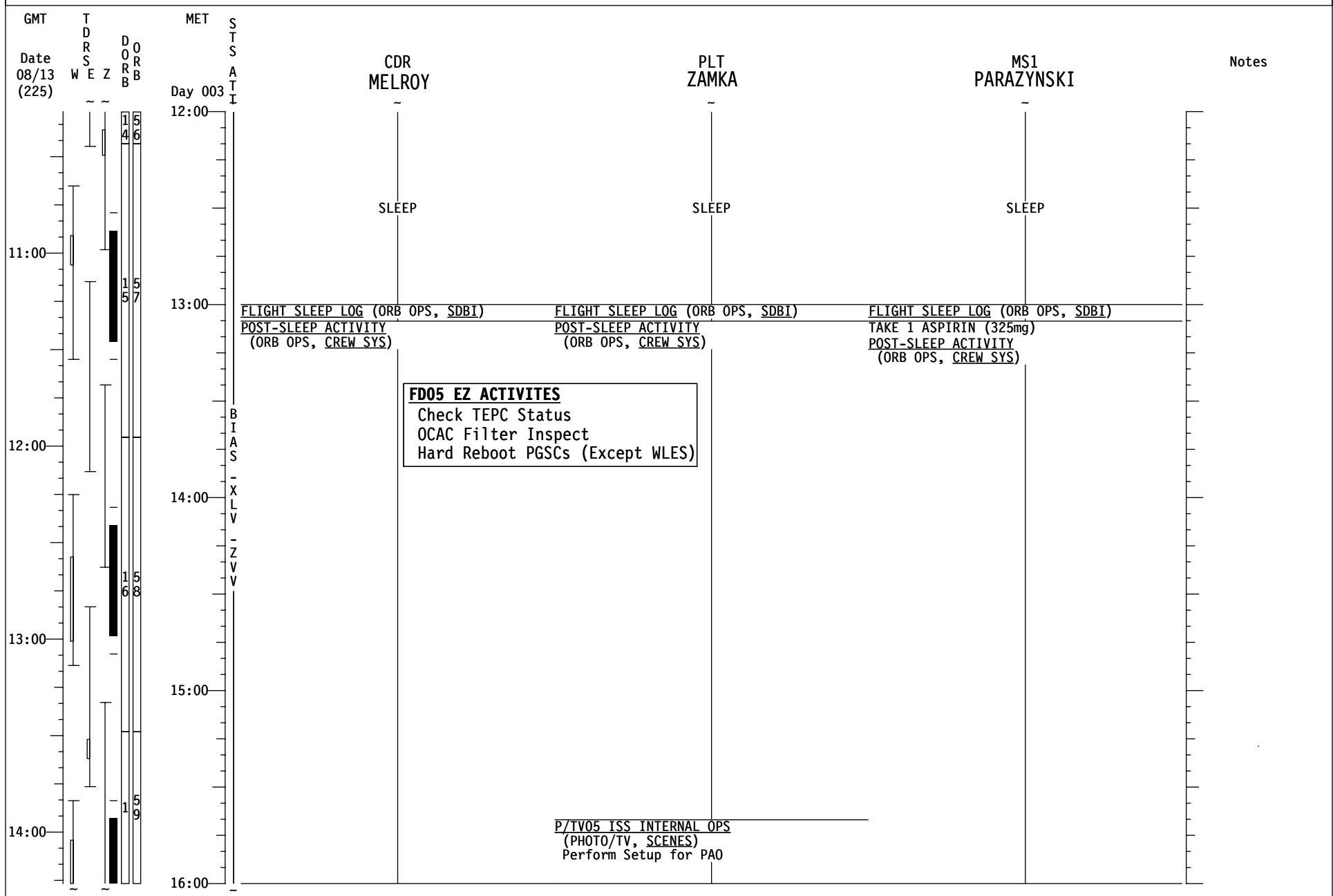



# STS-120 FD05

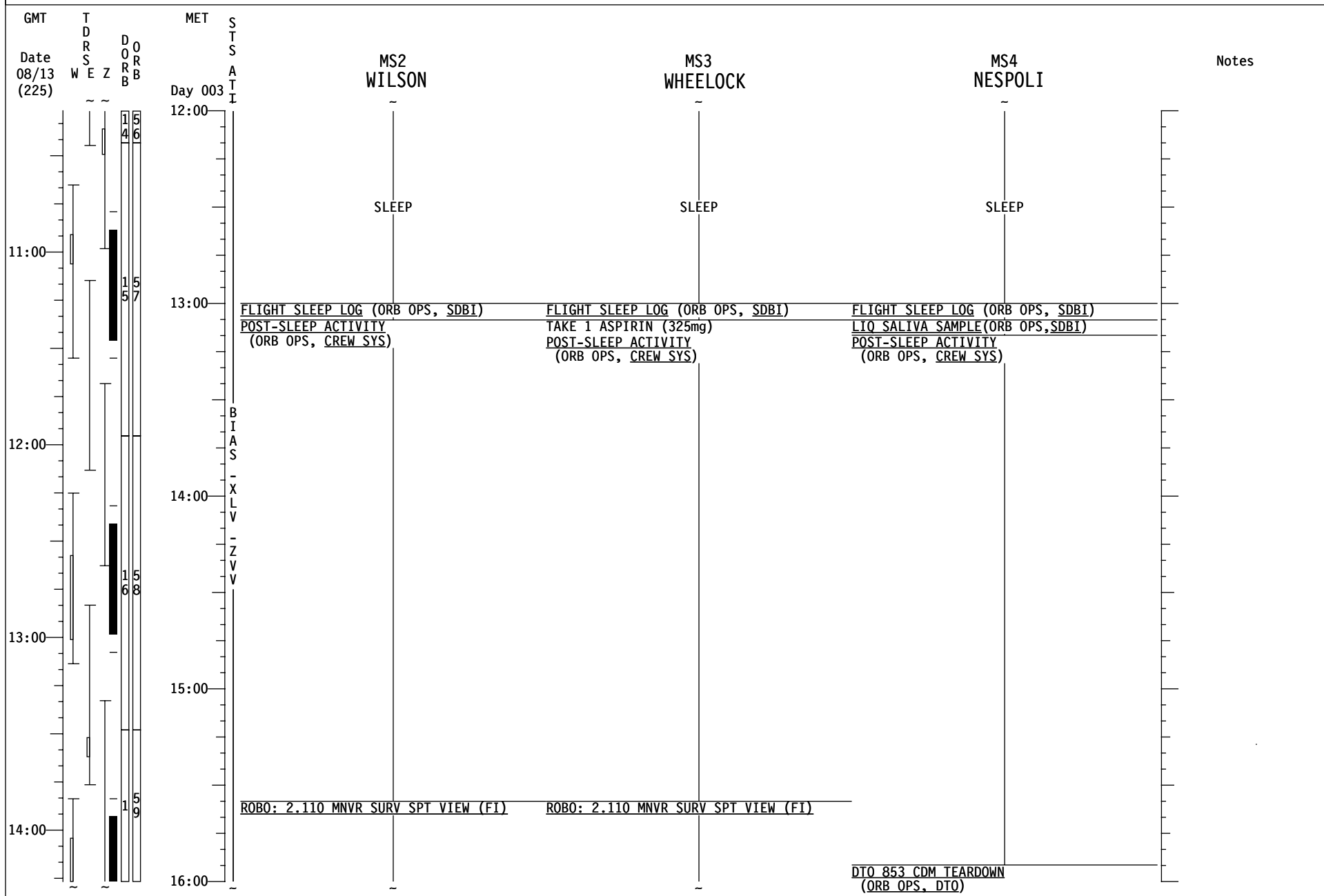

# STS-120 FD05

GMT	T D R S E Z	D O R B	MET	S T S	R3, R2 CDR MELROY	R1 PLT ZAMKA	MS1 PARAZYNSKI	Notes
Date 08/13 (225)	W E Z	D O R B	Day 003	A T I				
16:00		159			<u>PUBLIC AFFAIRS EVENT</u> KU: XX:XX-XX:XX, TDRX	<u>PUBLIC AFFAIRS EVENT</u> KU: XX:XX-XX:XX, TDRX	<u>PUBLIC AFFAIRS EVENT</u> KU: XX:XX-XX:XX, TDRX	
					<u>FOCUSED INSPECTION DOUG REVIEW</u> REF MSG XXX	<u>FOCUSED INSPECTION DOUG REVIEW</u> REF MSG XXX		
15:00					<u>OBSS FOCUSED INSPECTION</u>	<u>OBSS FOCUSED INSPECTION</u>		
16:00		260		B I A S			<u>TRANSFER</u> REF MSG XXX	
				X L V				
17:00				Z V V			<u>EVA SYS: 1.625 EMU BATTERY RECHARGE</u> <u>FROM PSA UTILITY OUTLET</u> Init	
							<u>EMU SWAP</u> (EVA, AIRLOCK CONFIG)	
18:00		361						
					<u>IMU STAR OF OPPTY ALIGN (ORB OPS, GNC)</u>	<u>JNT OPS: 3.102 NITROGEN TRANSFER INIT</u>	<u>EXERCISE</u>	
		462			<u>SHUTTLE/ISS H2O CONTAINER FILL</u> (ORB OPS, ECLS)			
20:00					Perform CWC FILL #4, Ref MSGXXX			

# STS-120 FD05

GMT	TDRS WSEZ	DORB	MET Day 003	STS A T I	M2, R2 MS2 WILSON	M1 MS3 WHEELLOCK	MS4 NESPOLI	Notes
16:00		159			ROBO: 2.110 MNVR SURV SPT VIEW (FI)	ROBO: 2.110 MNVR SURV SPT VIEW (FI)	PUBLIC AFFAIRS EVENT KU: XX:XX-XX:XX, TDRX	
					FOCUSED INSPECTION DOUG REVIEW REF MSG XXX		L17 Check MCIU filter screen	
15:00					OBSS FOCUSED INSPECTION		NODE 2 FIRST INGRESS AND SETUP (ASSY OPS, NODE 2)	
16:00		260		B I A S				
				X L V		TRANSFER REF MSG XXX		
17:00		361		Z V V			EXERCISE	
18:00		462						
20:00								

# STS-120 FD05

GMT	TDRS W E Z	DORB D O R B	MET Day 003	STS A T I	R3, R2 CDR MELROY	R1 PLT ZAMKA	MS1 PARAZYNSKI	Notes
19:00		4 6 2 2	20:00		SHUTTLE/ISS H2O CONTAINER FILL (ORB OPS, ECLS) Perform CWC FILL #4, Ref MSGXXX	JNT OPS: 3.102 NITROGEN TRANSFER INIT	EXERCISE	
					MEAL			
			21:00		SHUTTLE/ISS H2O CONTAINER FILL (ORB OPS, ECLS) Perform FILL TERMINATION	MEAL	MEAL	UPLINK β21 Only + Boxes C1, C2, C3, D1
			20:00	B I A S	OBSS HANDOFF FROM SRMS TO SSRMS (PDRS, OBSS HANDOFF) Steps 1-2	OBSS HANDOFF FROM SRMS TO SSRMS (PDRS, OBSS HANDOFF) Steps 1-2		
			22:00	X L V			EVA SYS: 1.515 EMU METOX/LIOH BATTERY REPLACEMENT Install METOX Canisters	No Exercise while both arms grappled.
		5 6 3 3		V	OBSS HANDOFF FROM SRMS TO SSRMS (PDRS, OBSS HANDOFF) Steps 3-6	OBSS HANDOFF FROM SRMS TO SSRMS (PDRS, OBSS HANDOFF) Steps 3-6	EVA SYS: 1.305 EQUIPMENT LOCK PREP REF: 120 CONSUMABLES TRACKING CC (EVA)	
21:00			23:00	Z V	SHUTTLE/ISS H2O CONTAINER FILL (ORB OPS, ECLS) Perform CWC FILL #5, Ref MSGXXX		PRE EVA 2 TOOL CONFIG (EVA, TIMELINES)	
					OBSS HANDOFF FROM SRMS TO SSRMS (PDRS, OBSS HANDOFF) Steps 7-9	OBSS HANDOFF FROM SRMS TO SSRMS (PDRS, OBSS HANDOFF) Steps 7-9		
22:00		6 6 4 4			OBSS HANDOFF FROM SRMS TO SSRMS (PDRS, OBSS HANDOFF) Perform Step 10	OBSS HANDOFF FROM SRMS TO SSRMS (PDRS, OBSS HANDOFF) Perform Step 10		
00:00								

# STS-120 FD05

GMT	T D R S E Z	D O R B B	MET	S T S A T I	M2, R2 MS2 WILSON	M1 MS3 WHEELLOCK	MS4 NESPOLI	Notes
Date 08/13 (225)			Day 003					
19:00		4 6	20:00		MEAL	TRANSFER REF MSG XXX		
			21:00			MEAL	MEAL	
					<u>ROBO: 2.120 MNVR TO OBSS HANDOFF PRE-GRAPPLE (FI)</u>	<u>ROBO: 2.120 MNVR TO OBSS HANDOFF PRE-GRAPPLE (FI)</u>		
			20:00	B I A S			<u>EVA SYS:1.550 EMU RESIZE</u>	
		5 6	22:00	X L V	<u>ROBO: 1.121 OBSS GRAPPLE AND BERTH Steps 1-3</u>	<u>ROBO: 1.121 OBSS GRAPPLE AND BERTH Steps 1-3</u>	<u>EVA SYS: 1.515 EMU METOX/LIOH BATTERY REPLACEMENT Install METOX Canisters</u>	
			21:00	Z V V	<u>ROBO: 1.121 OBSS GRAPPLE AND BERTH Steps 4-6</u>	<u>ROBO: 1.121 OBSS GRAPPLE AND BERTH Steps 4-6</u>	<u>EVA SYS: 1.305 EQUIPMENT LOCK PREP REF: 120 CONSUMABLES TRACKING CC (EVA)</u>	
			23:00				<u>PRE EVA 2 TOOL CONFIG (EVA, TIMELINES)</u>	
		6 6			<u>ROBO: 1.121 OBSS GRAPPLE AND BERTH Steps 7-11</u>	<u>ROBO: 1.121 OBSS GRAPPLE AND BERTH Steps 7-11</u>		
22:00					<u>ROBO: 1.122 BERTHED OBSS UNGRAPPLE</u>	<u>ROBO: 1.122 BERTHED OBSS UNGRAPPLE</u>		
			00:00					

# STS-120 FD05

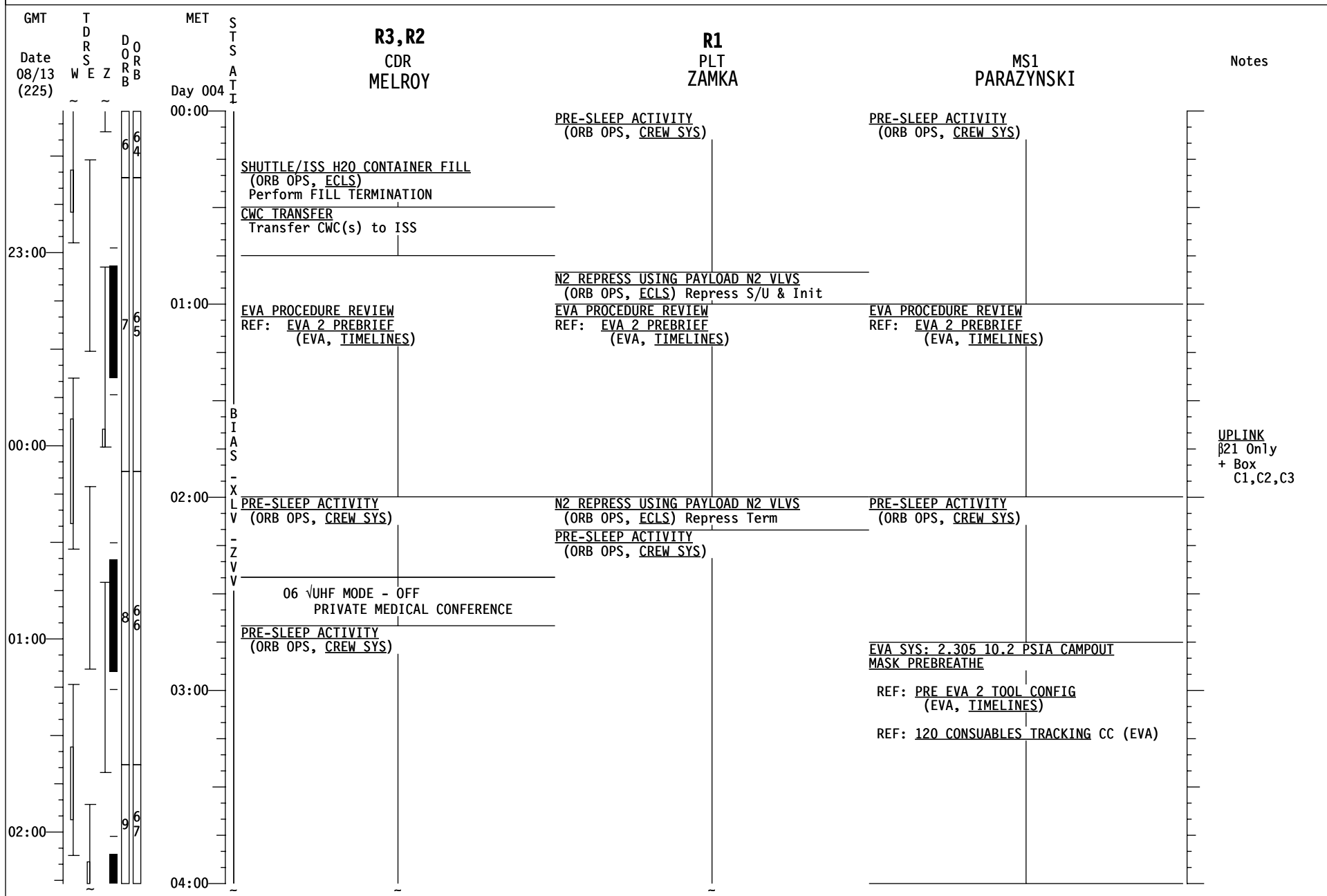

UPLINK  
β21 Only  
+ Box  
C1,C2,C3

# STS-120 FD05

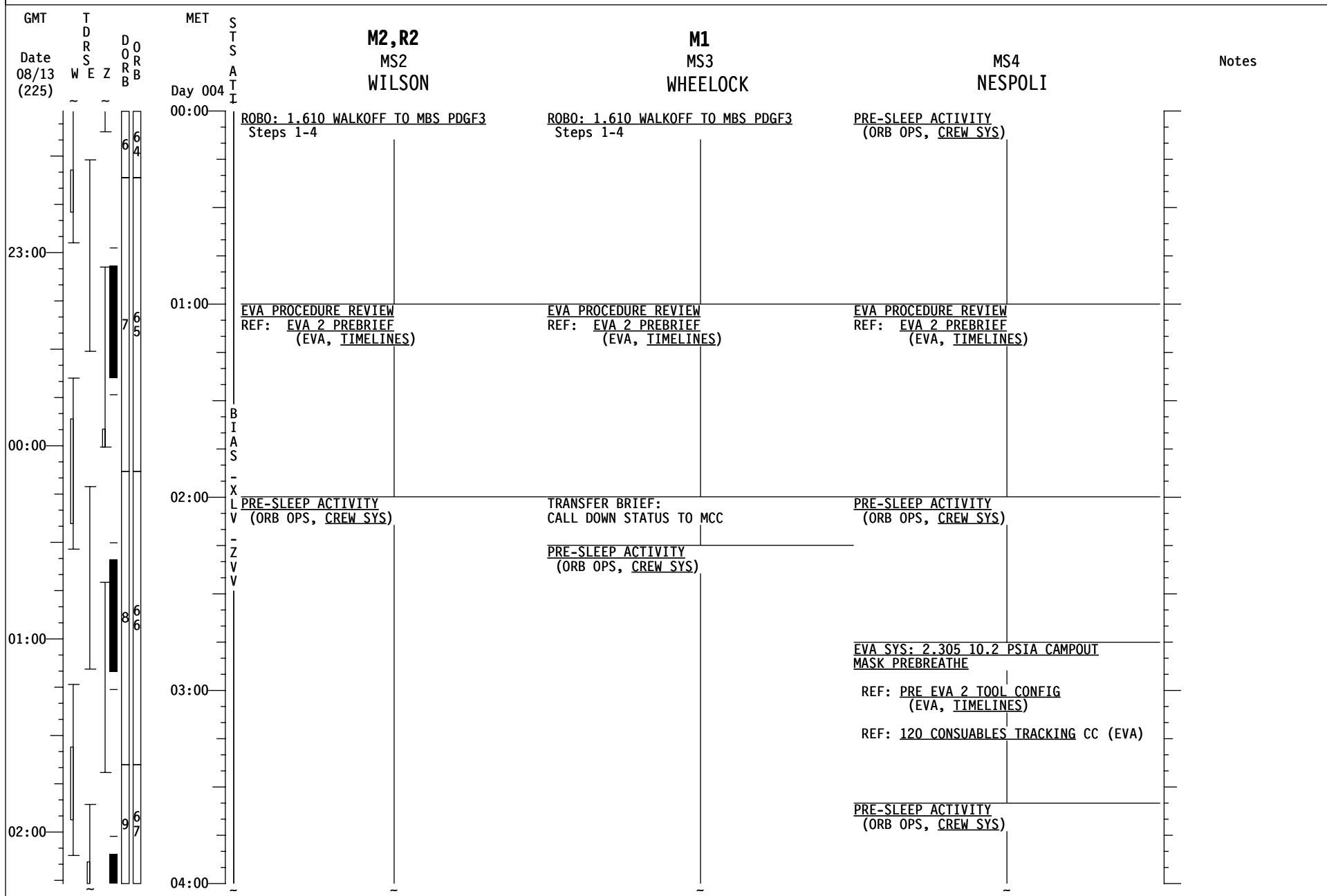

# STS-120 FD05

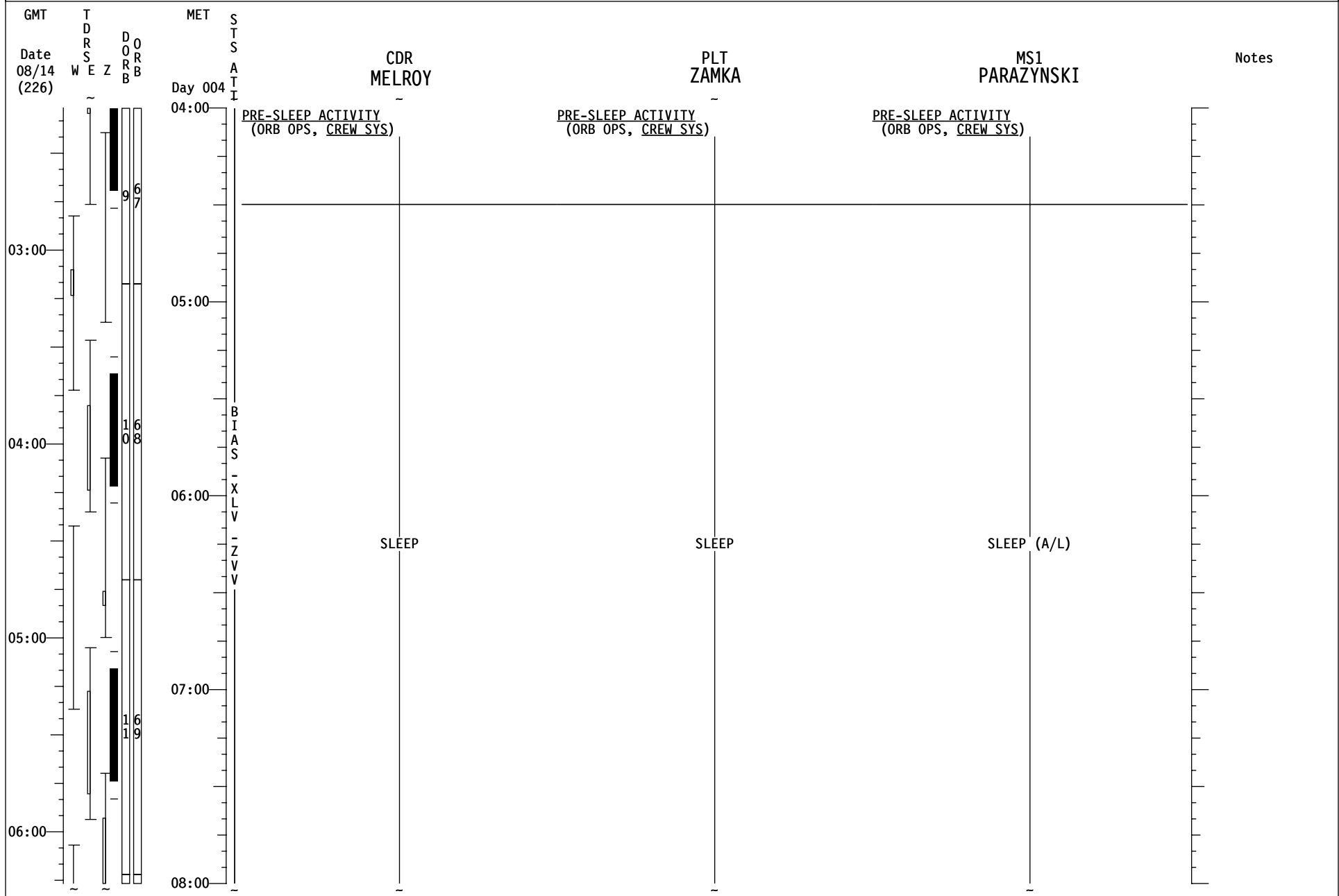



# STS-120 FD05

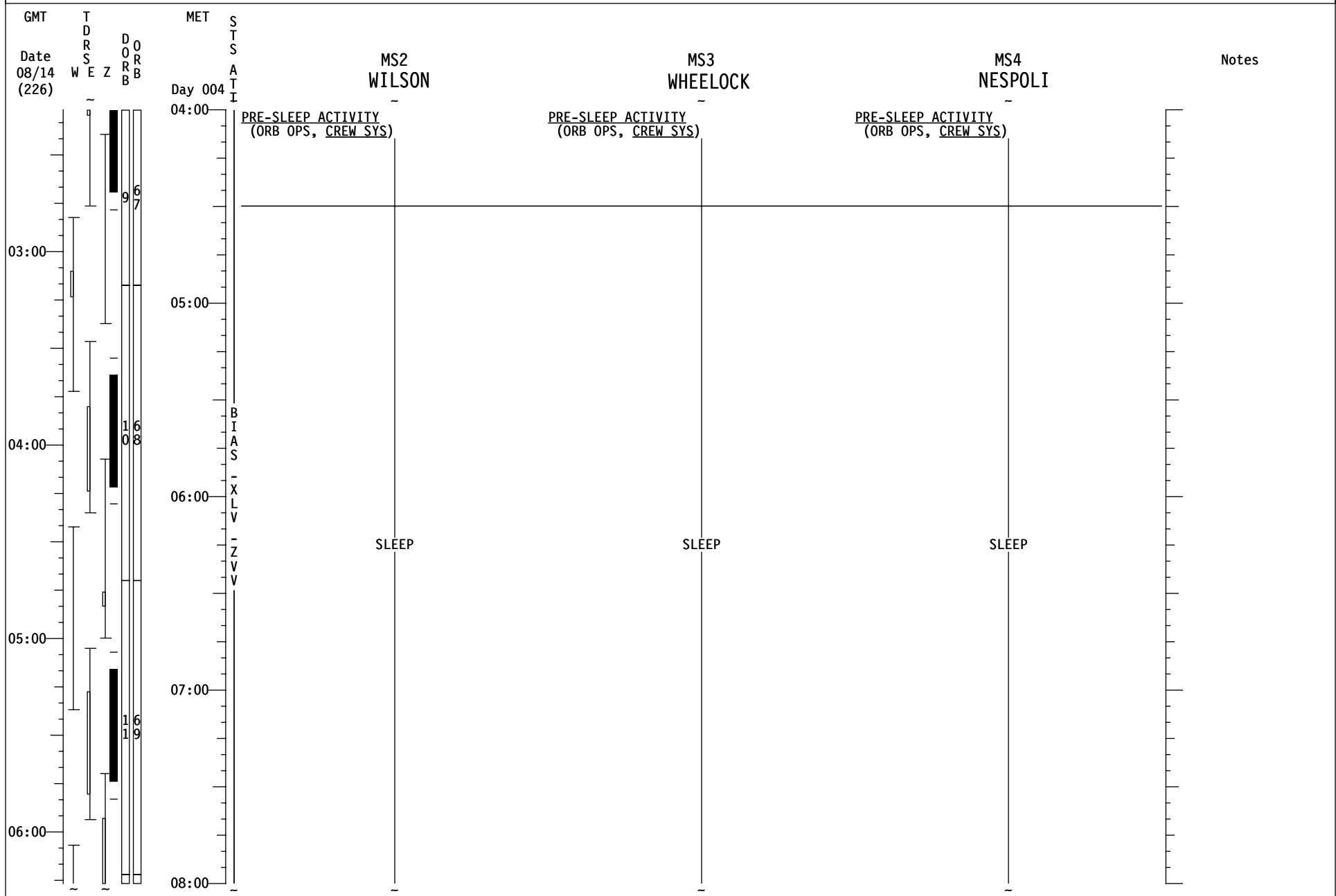

# STS-120 FD05

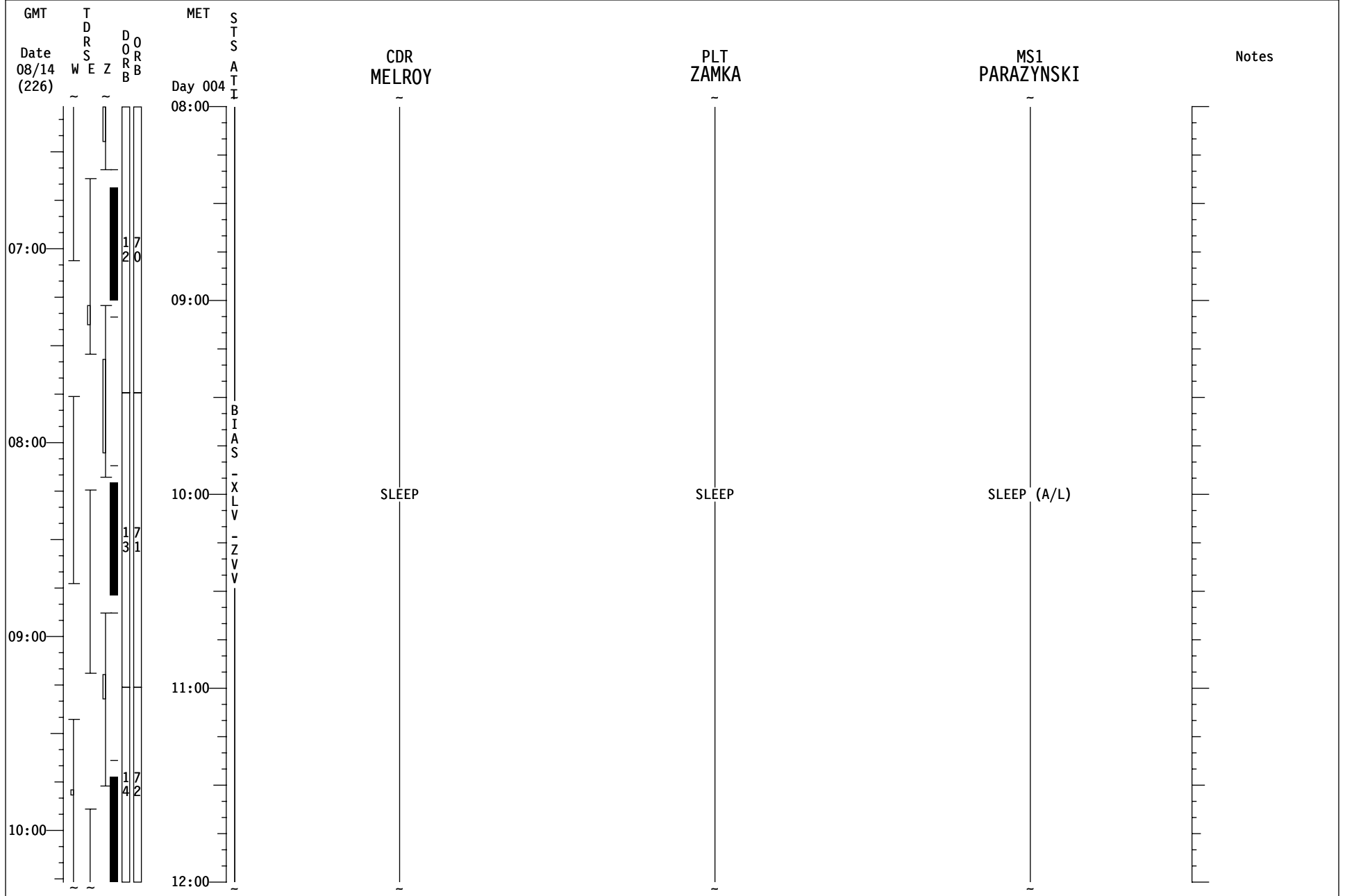



# STS-120 FD06

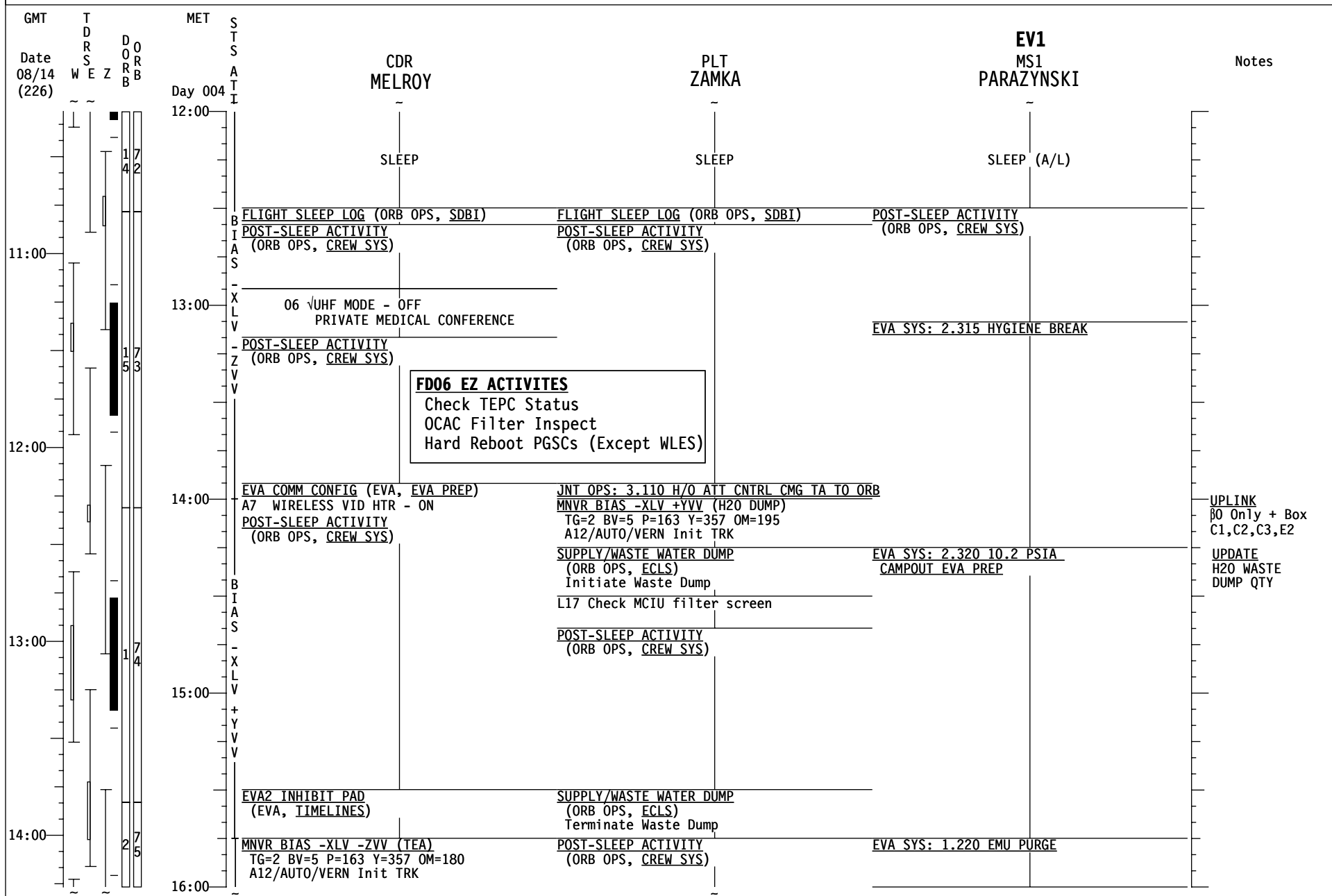

# STS-120 FD06

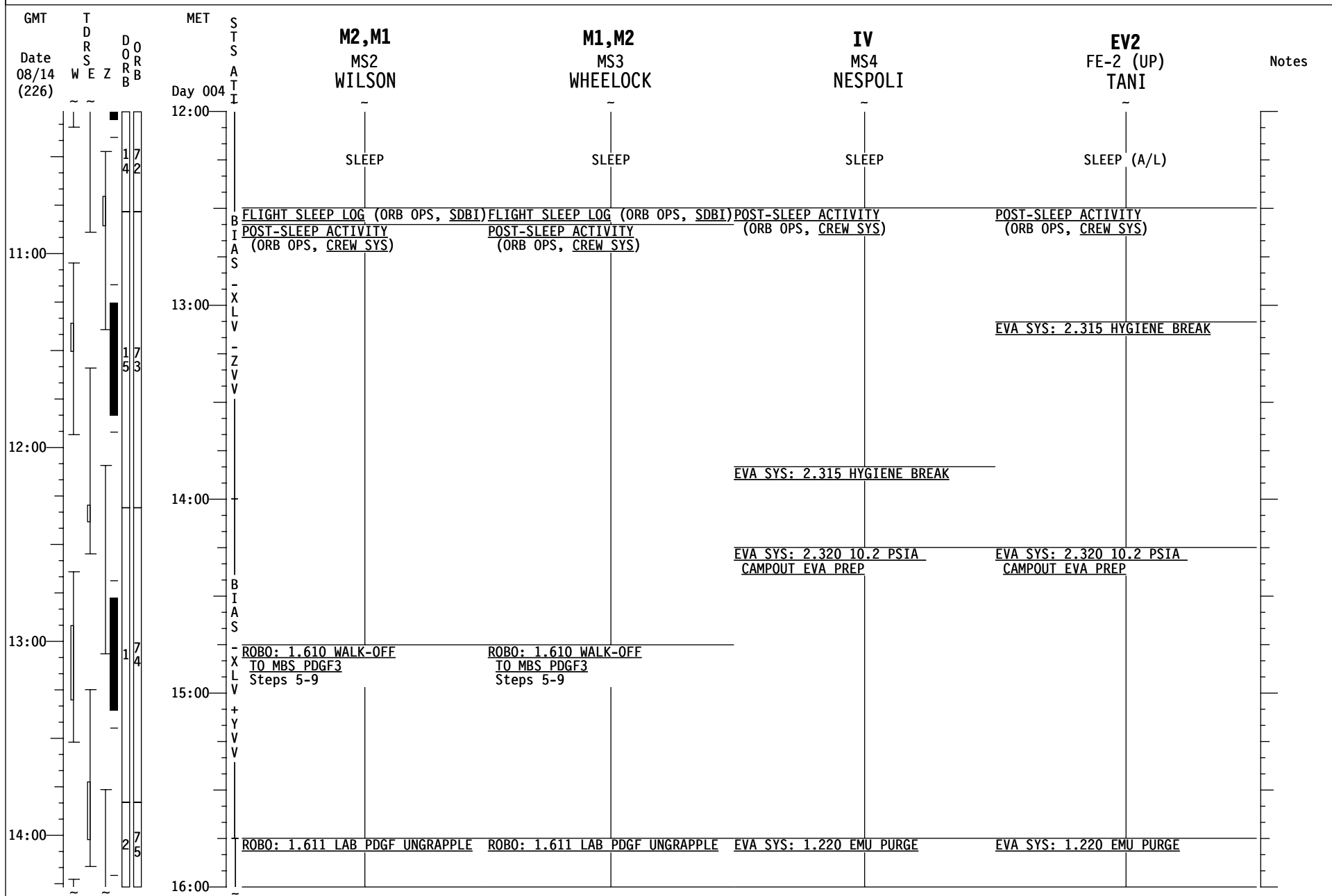

# STS-120 FD06

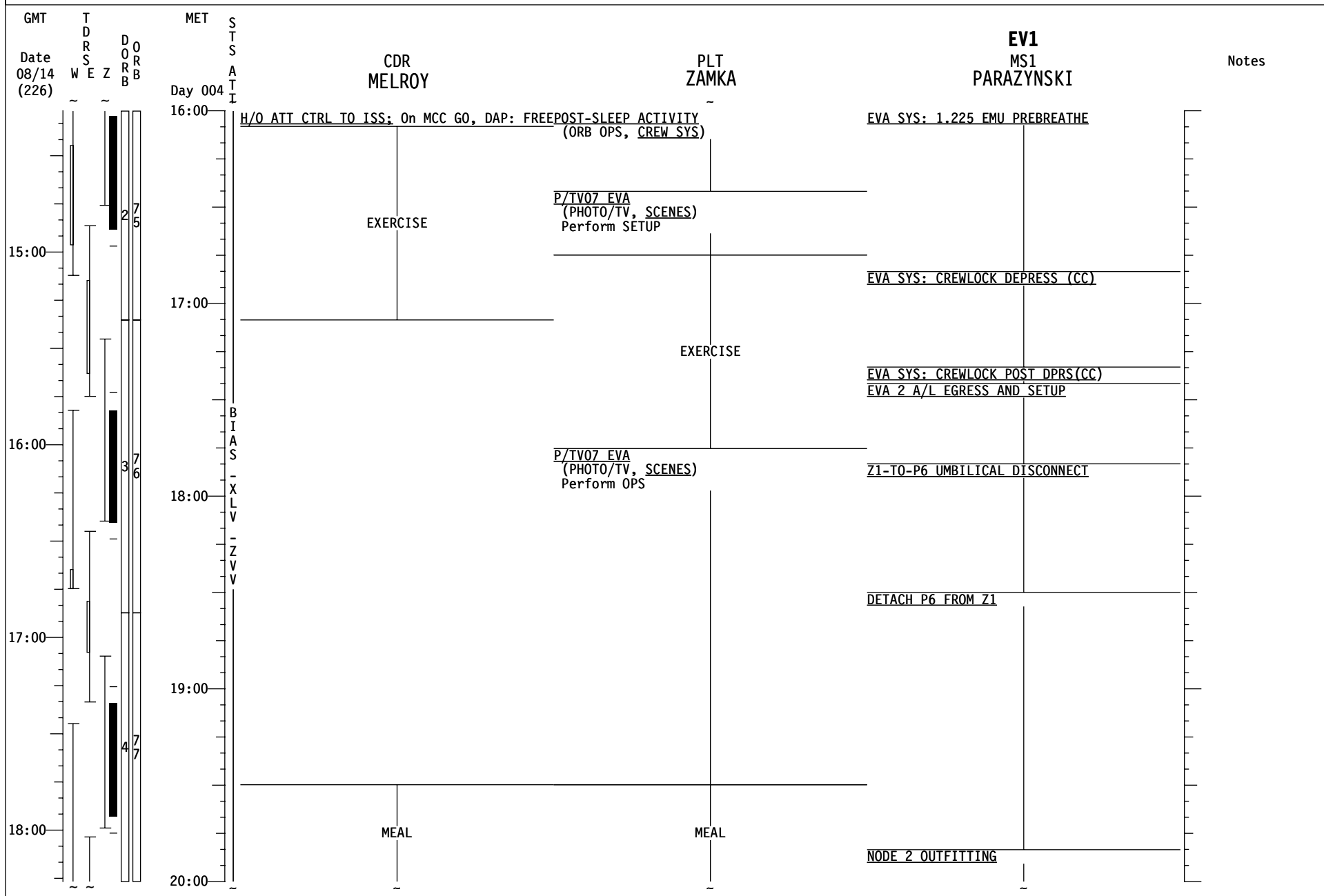

# STS-120 FD06

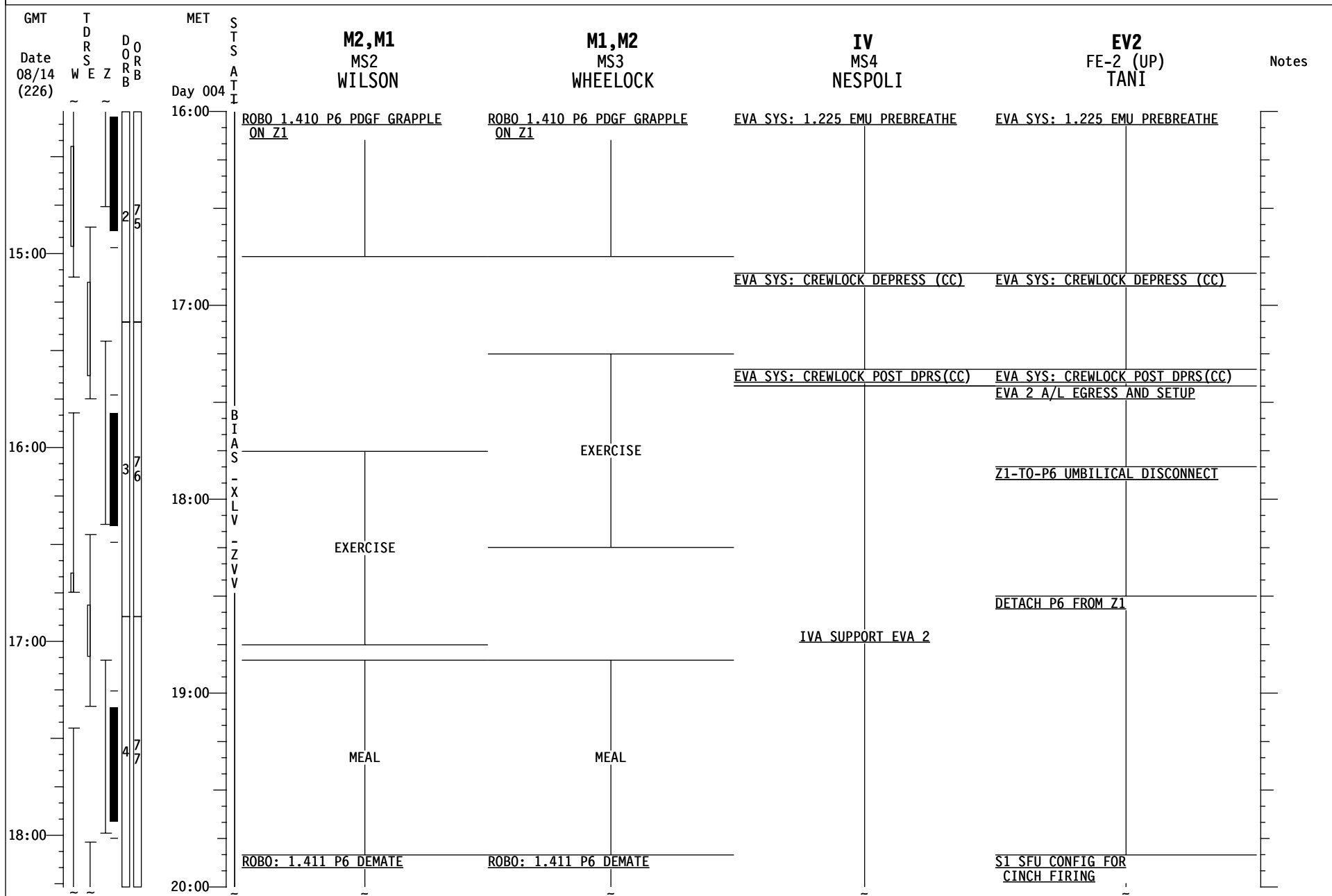

# STS-120 FD06

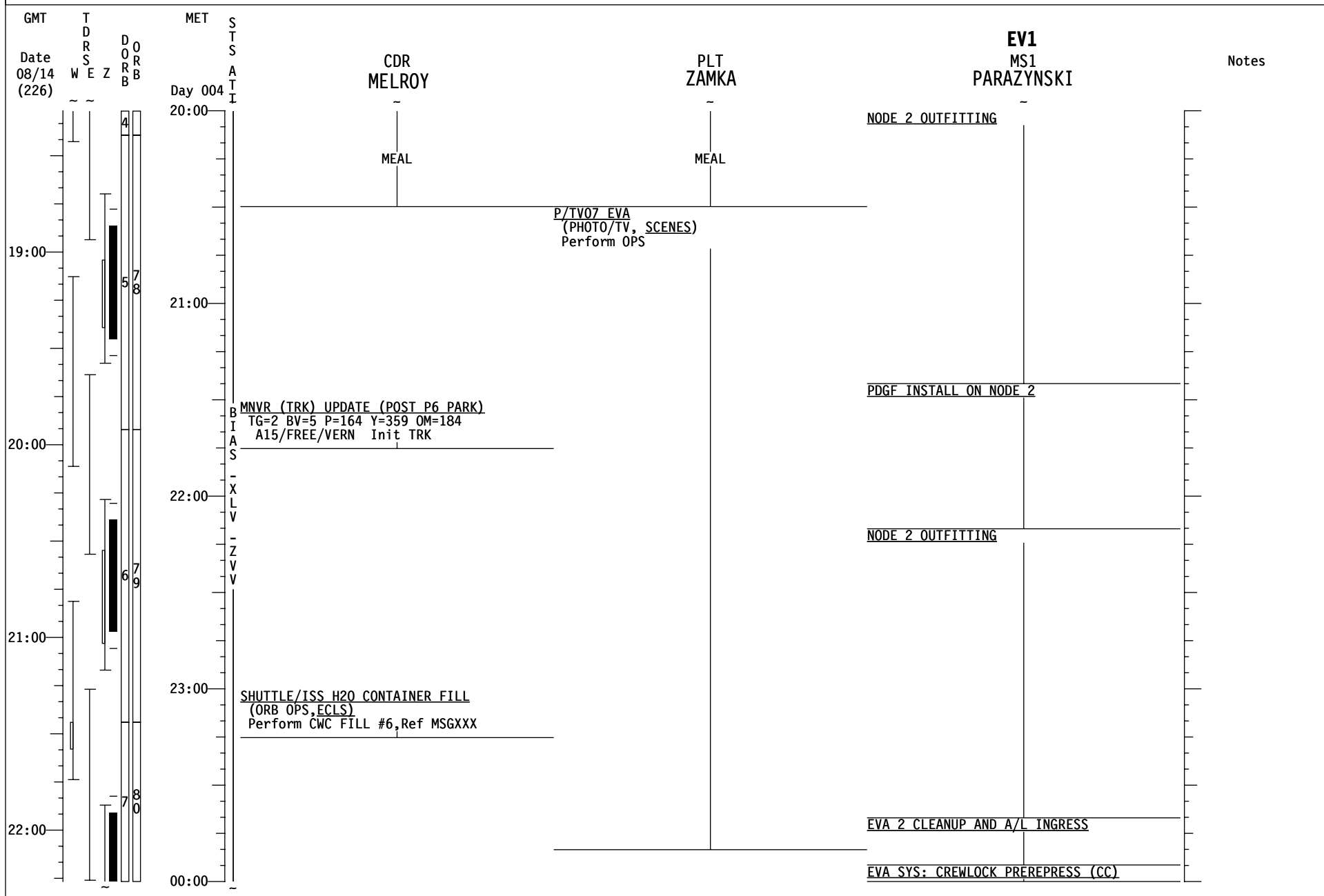



# STS-120 FD06

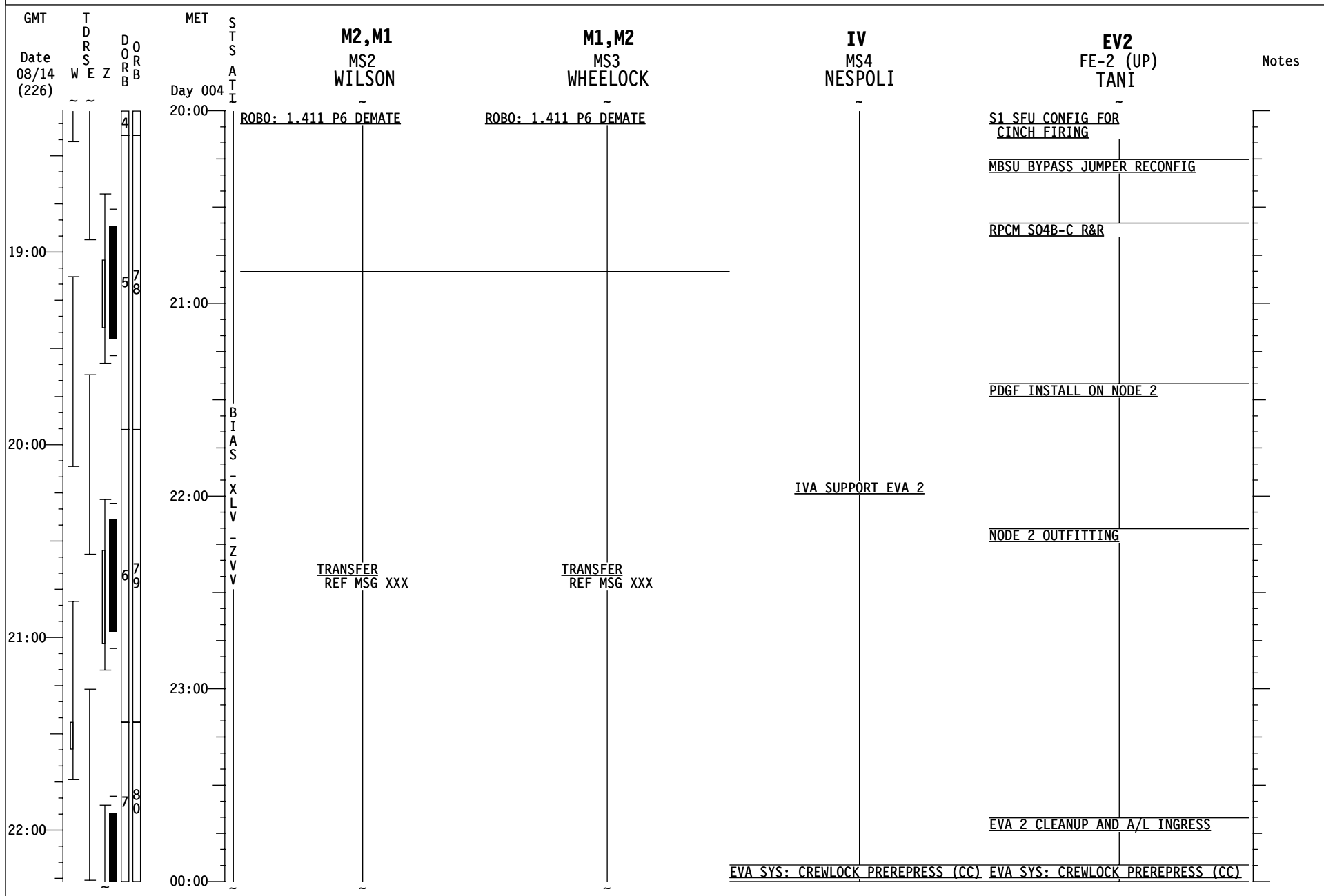

# STS-120 FD06

GMT	T D R S E Z	D O R R B	MET	S T S	CDR MELROY	PLT ZAMKA	EVA1 MS1 PARAZYNSKI	Notes
Date 08/14 (226)			Day 005	A T I				
			00:00			WCS CRADLE - AUTO INHIBIT Inspect hose block filter, change if req'd WCS CRADLE - AUTO	EVA SYS: CREWLOCK PREREPRESS (CC)	
					SHUTTLE/ISS H2O CONTAINER FILL (ORB OPS, ECLS) Perform FILL TERMINATION	FILTER CLEANING (IFM, SCHEDULED MAINTENANCE) Inspect filters and clean as necessary	EVA SYS: 1.240 POST EVA With H2O & METOX REF: 120 CONSUMABLES TRACKING CC (EVA)	
			23:00		CWC TRANSFER Transfer CWC(s) to ISS			
					A7 WIRELESS VID HTR - OFF IMU STAR OF OPPTY ALIGN (ORB OPS, GNC)			
			01:00		PRE-SLEEP ACTIVITY (ORB OPS, CREW SYS)	PRE-SLEEP ACTIVITY (ORB OPS, CREW SYS)		
			00:00	B I A S				UPLINK β21 ONLY + Box C1,C2,C3,C5
					NETMEETING VIDEO CONF (ORB OPS, PGSC) 06 VHF MODE - OFF Use A/G 2 for comm & KFX PGSC during PMC			
			01:00		PRE-SLEEP ACTIVITY (ORB OPS, CREW SYS)		PRE-SLEEP ACTIVITY (ORB OPS, CREW SYS)	
			03:00					
			02:00					
			04:00					

# STS-120 FD06

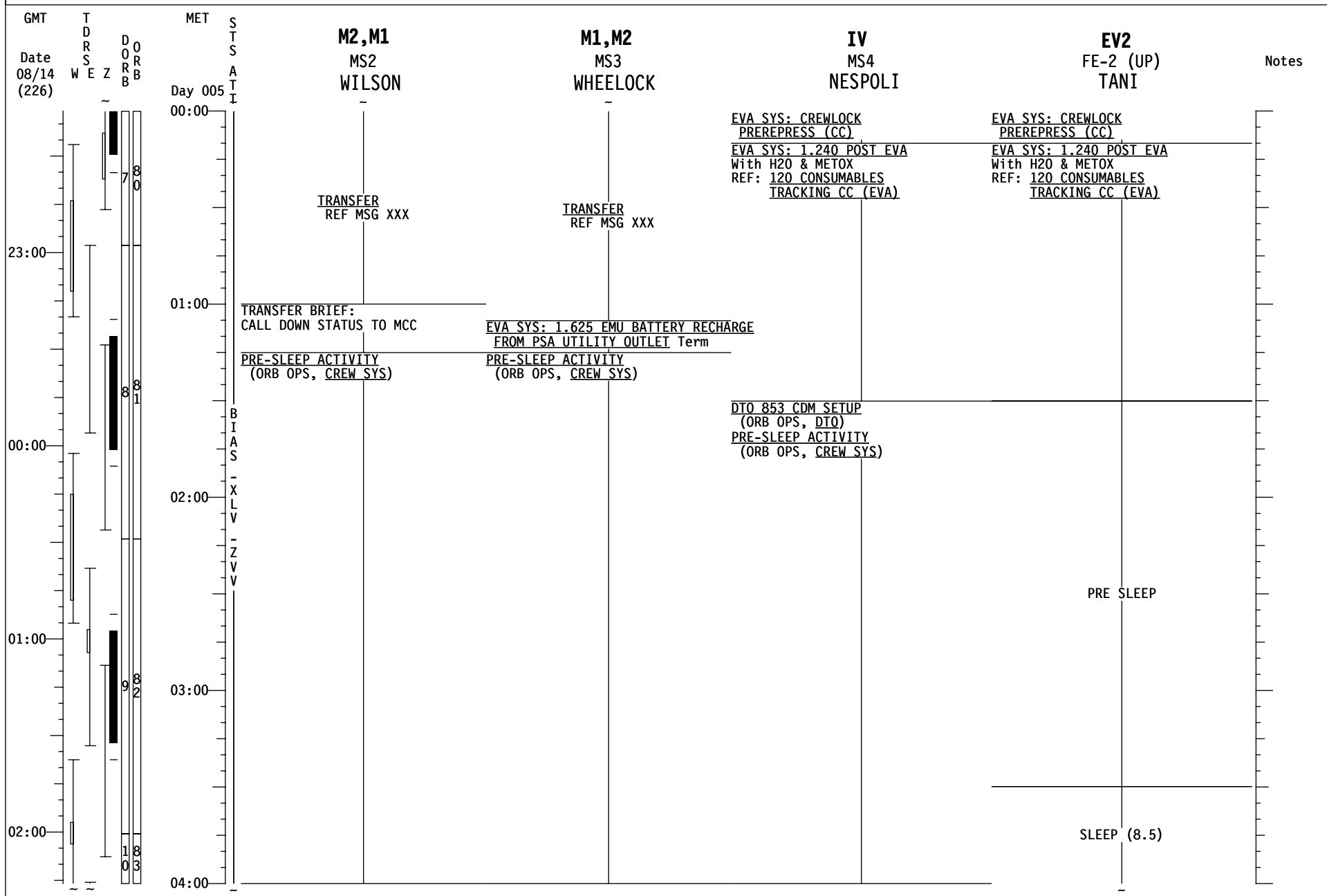

# STS-120 FD06

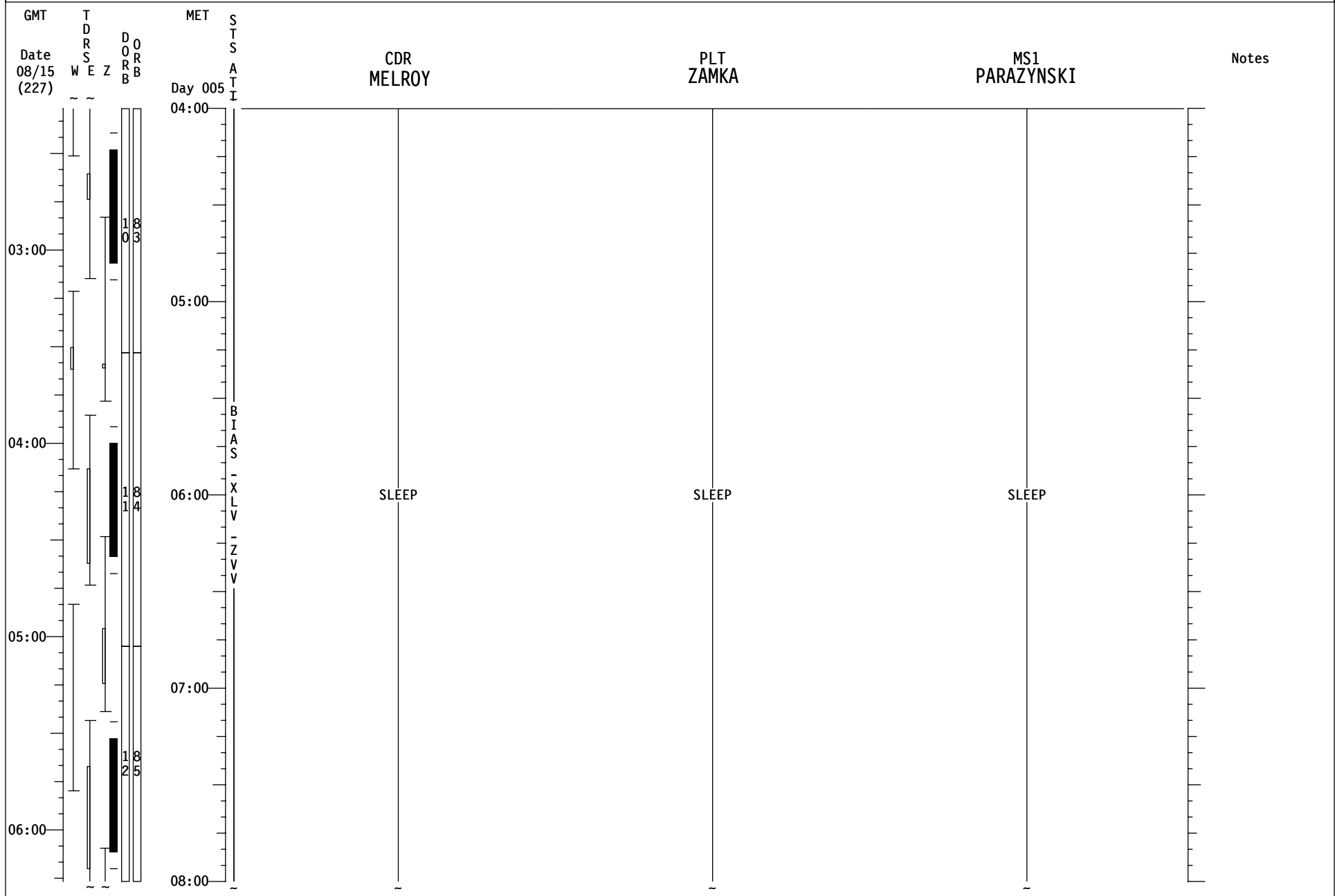

# STS-120 FD06

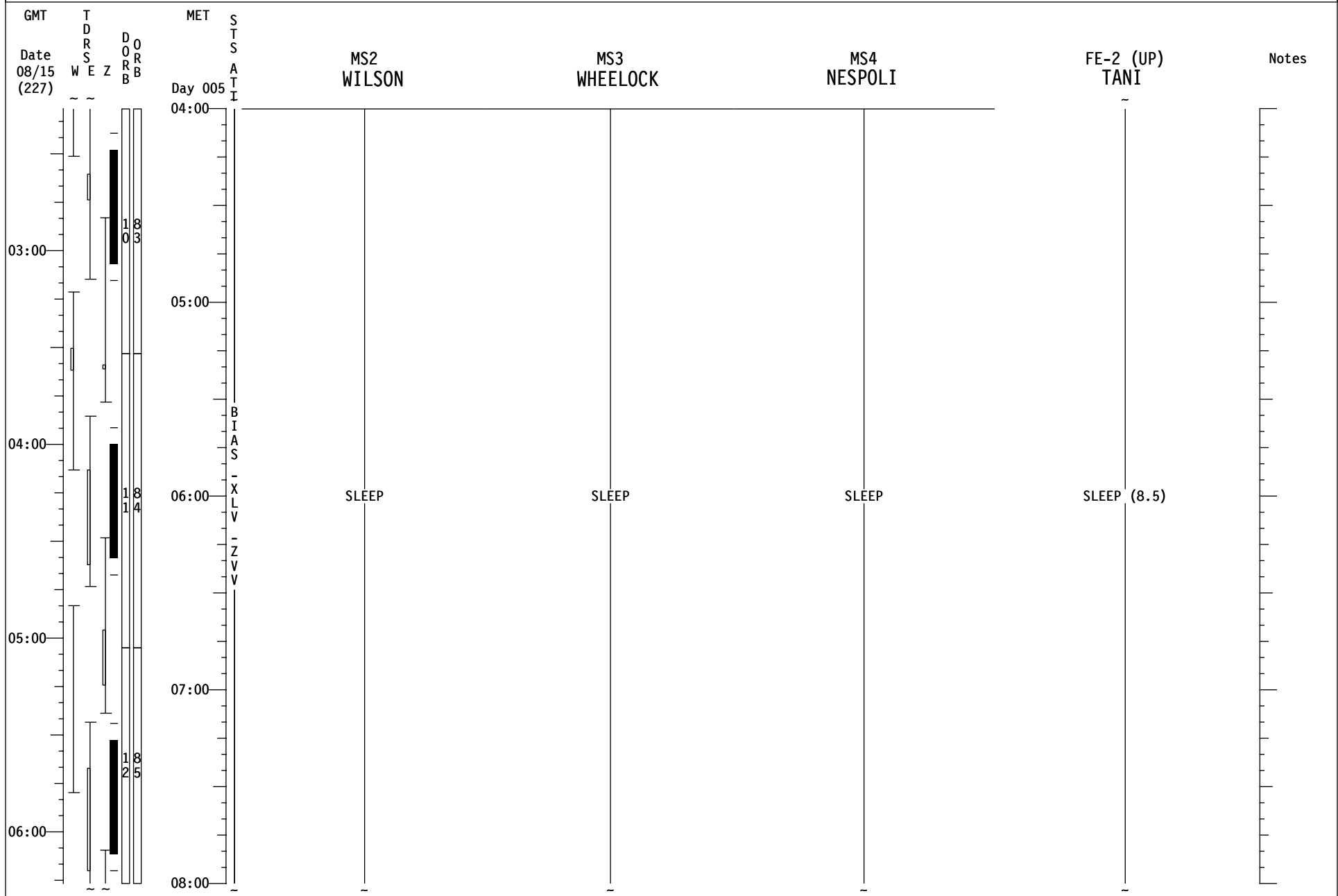

# STS-120 FD06

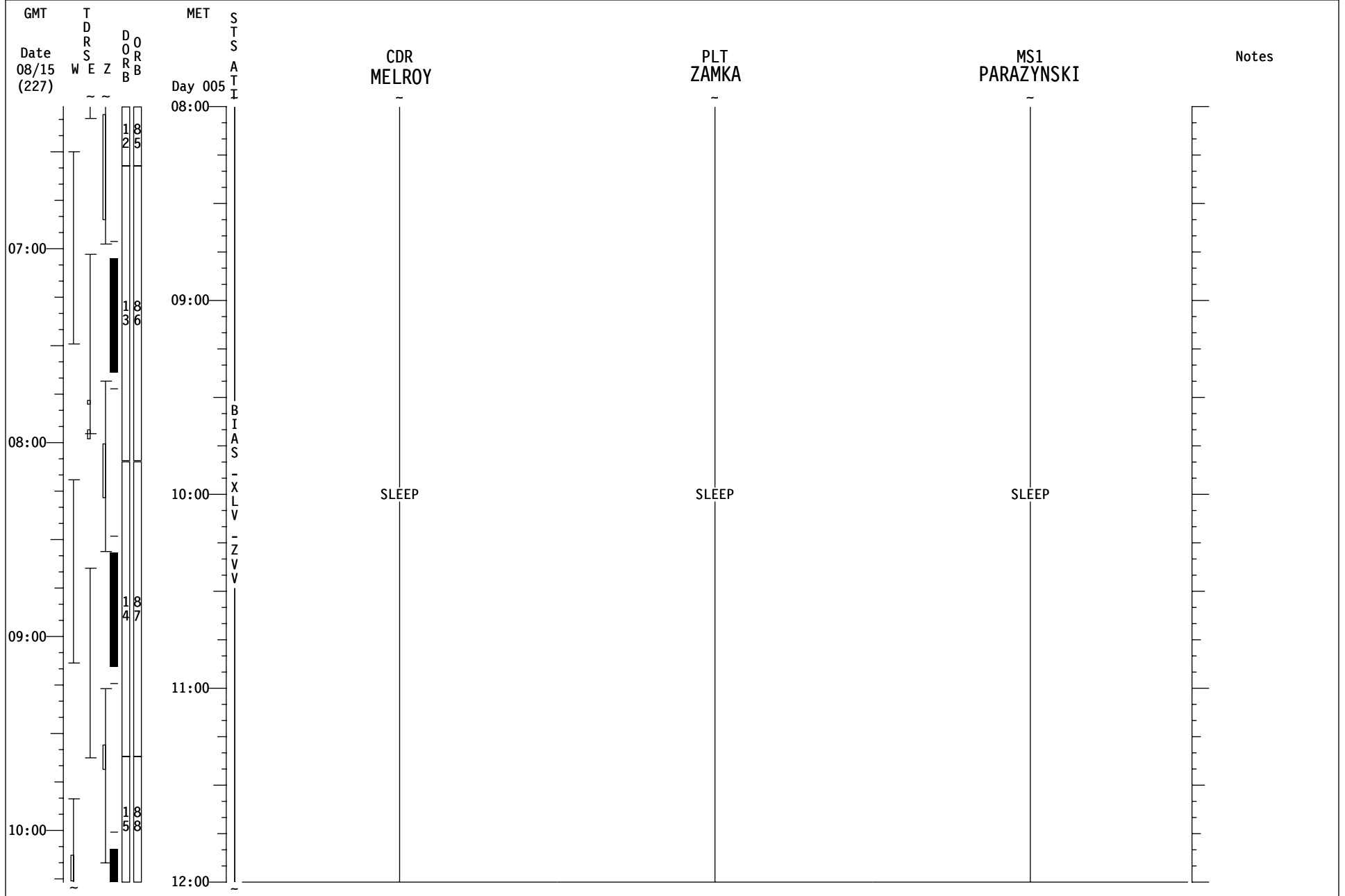

# STS-120 FD06

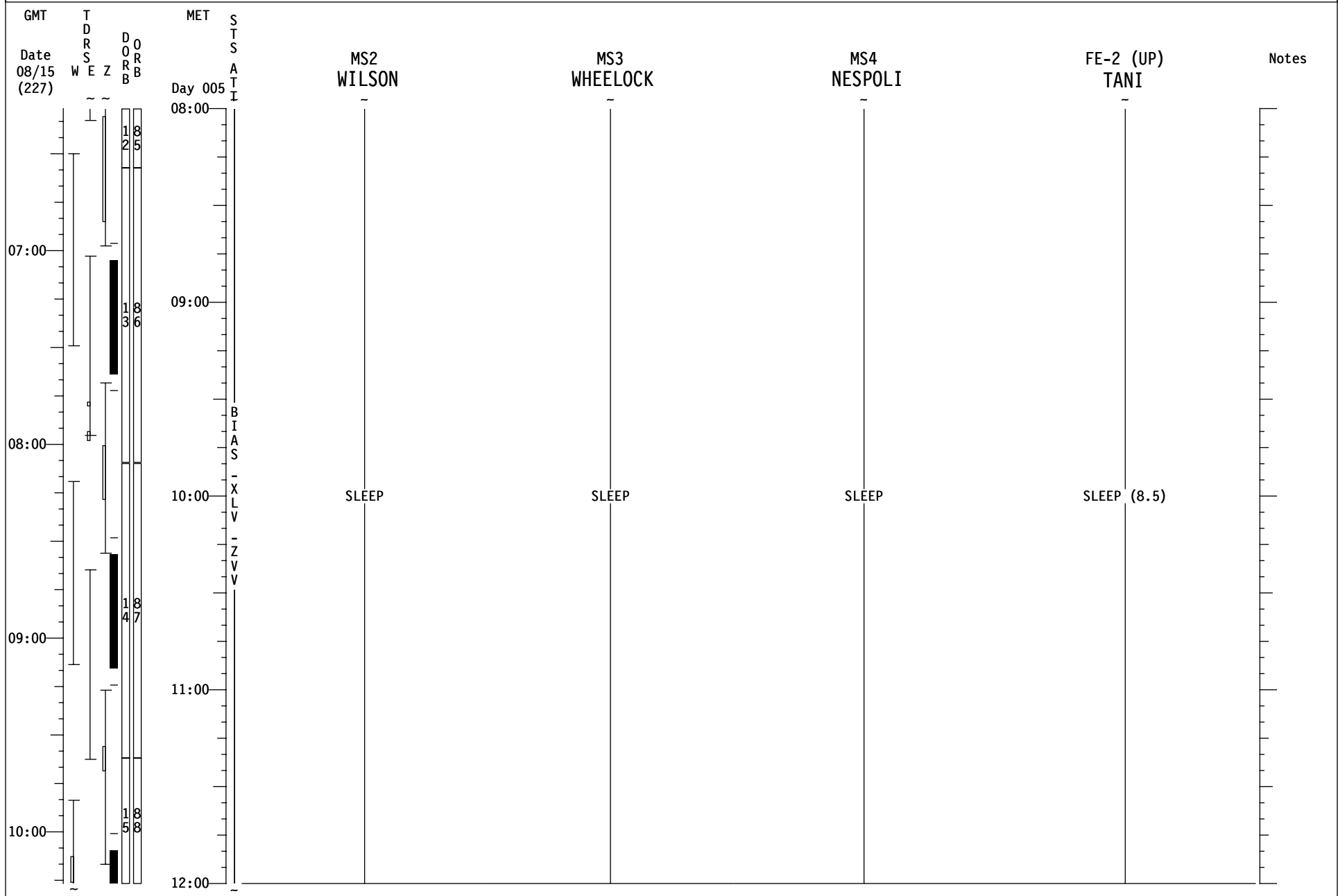

# STS-120 FD07

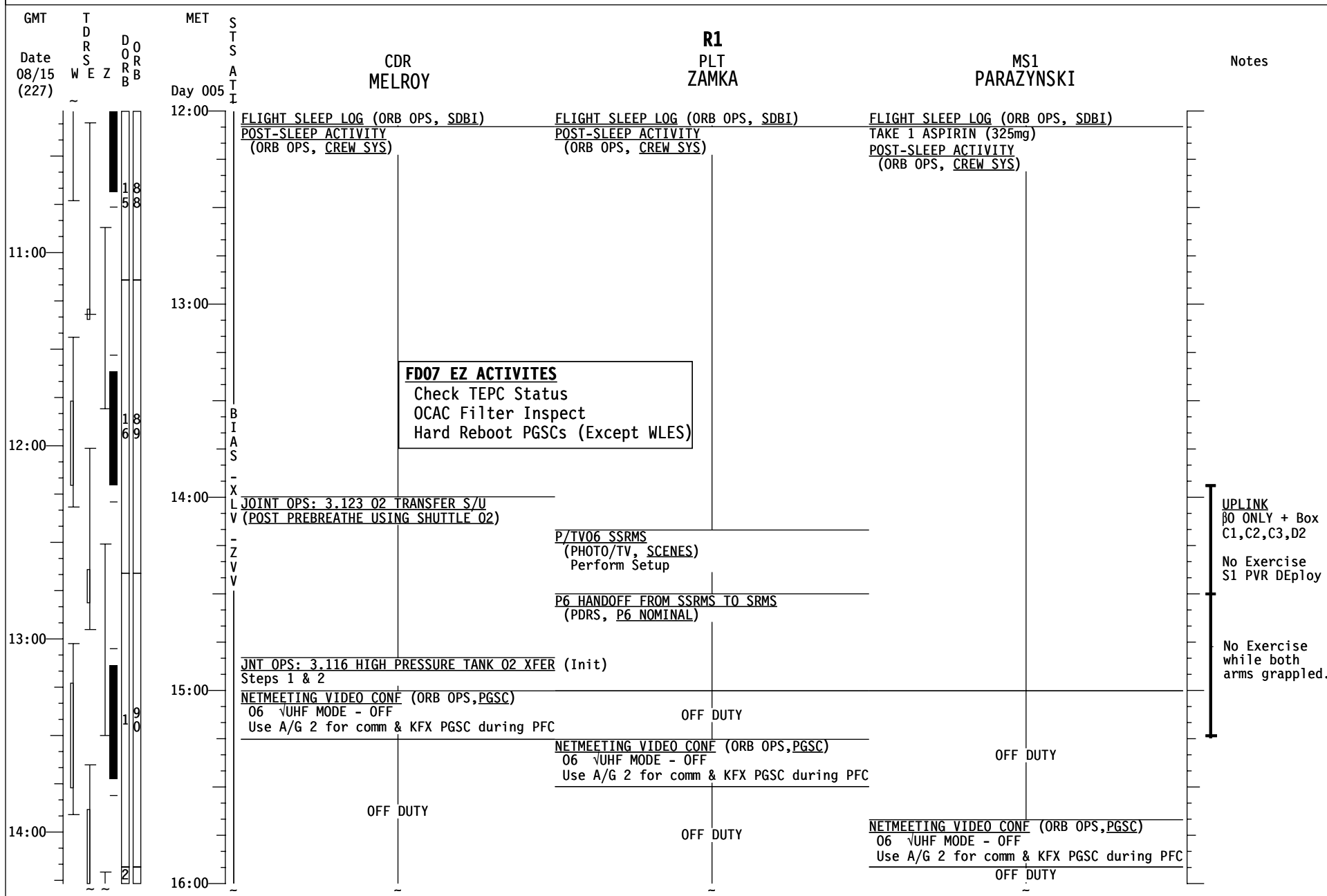

**UPLINK**  
 80 ONLY + Box  
 C1,C2,C3,D2  
 No Exercise  
 S1 PVR DEploy  
 No Exercise  
 while both  
 arms grappled.





# STS-120 FD07

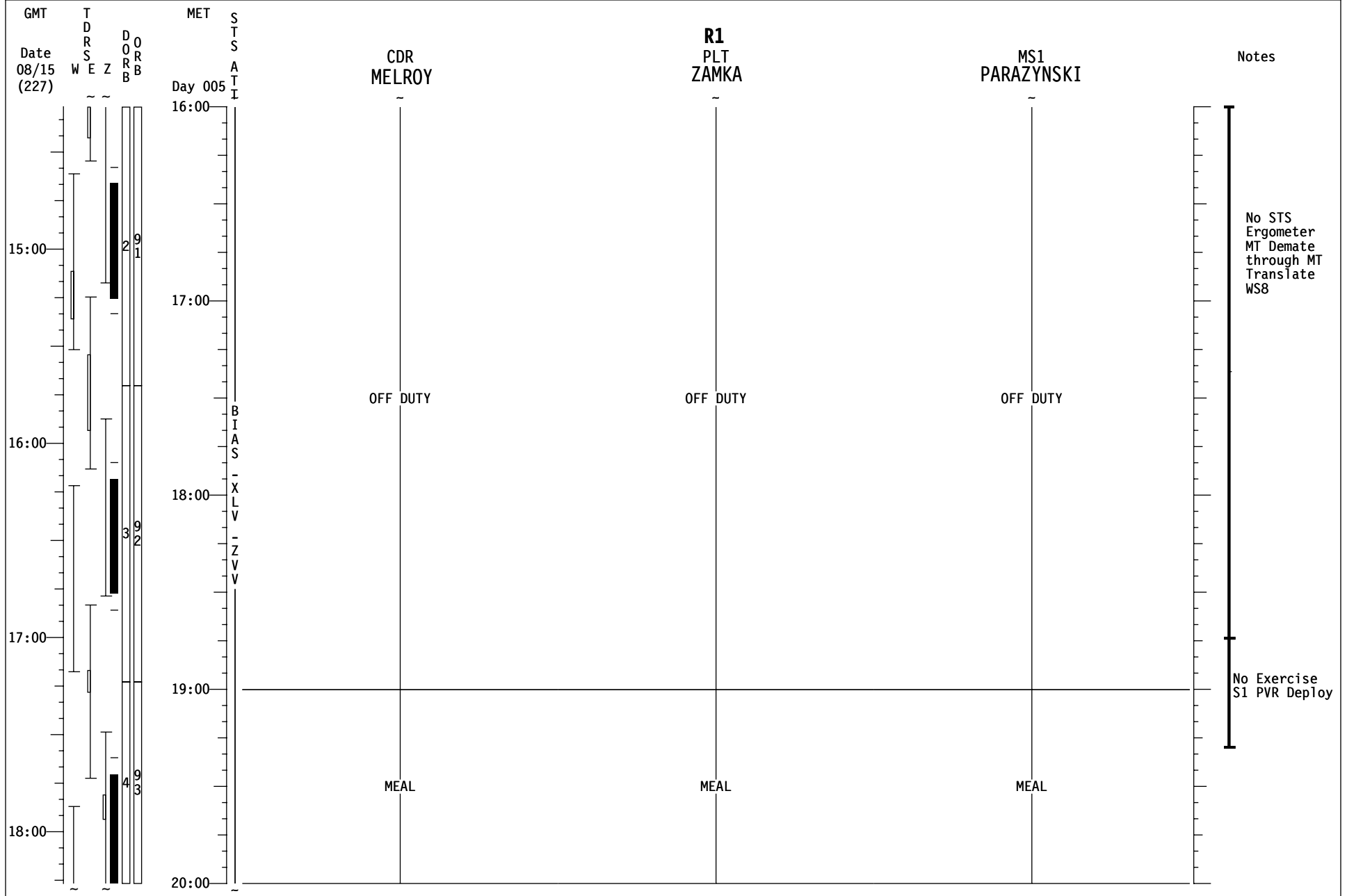



# STS-120 FD07

GMT	T D R S E Z	D O R B	MET	S T S	C D R	R 1	M S 1	Notes
Date 08/15 (227)	W	E	Day 005	A T I	MELROY	PLT ZAMKA	PARAZYNSKI	
19:00		4 9 3	20:00		<u>IMU STAR OF OPPTY ALIGN</u> (ORB OPS, GNC) <u>JOINT OPS: 3.103 NITROGEN</u> <u>TRANSFER TERM</u>	L17 Check MCIU filter screen		
						<u>SHUTTLE/ISS H2O CONTAINER FILL</u> (ORB OPS, ECLS) Perform CWC FILL #7, Ref MSGXXX	EXERCISE	
			21:00			<u>JOINT OPS: 3.116 HIGH PRESSURE</u> <u>TANK O2 XFER (TERM) Step 3</u> <u>JOINT OPS: 3.121 PREBREATHE USING SHUTTLE</u> <u>O2 SETUP (POST O2 TRANSFER)</u>	<u>EVA SYS: 1.625 EMU BATTERY RECHARGE</u> <u>FROM PSA UTILITY OUTLET</u> Init	
		5 9 4			<u>N2 REPRESS USING PAYLOAD N2 VLVS</u> (ORB OPS, ECLS) Repress S/U & Init			
20:00				B I A S		<u>SHUTTLE/ISS H2O CONTAINER FILL</u> (ORB OPS, ECLS) Perform FILL TERMINATION	<u>EVA SYS: 1.515 EMU METOX/LIOH</u> <u>BATTERY REPLACEMENT</u> Install METOX Canisters	
			22:00	X L V	EXERCISE	<u>SHUTTLE/ISS H2O CONTAINER FILL</u> (ORB OPS, ECLS) Perform CWC FILL #8, Ref MSGXXX	<u>EVA SYS: 1.305 EQUIPMENT</u> <u>LOCK PREP</u> REF: 120 CONSUMABLES TRACKING CC (EVA)	
				Z V V		<u>P/TV06 SSRMS</u> (PHOTO/TV, SCENES) Perform Setup	<u>PRE EVA 3 TOOL CONFIG</u> (EVA, TIMELINES)	
21:00		6 9 5			<u>N2 REPRESS USING PAYLOAD N2 VLVS</u> (ORB OPS, ECLS) Repress Term			
			23:00		<u>SHUTTLE CONDENSATE COLLECTION</u> (ORB OPS, ECLS) Perform CHANGEOUT			
					<u>SHUTTLE/ISS H2O CONTAINER FILL</u> (ORB OPS, ECLS) Perform FILL TERMINATION	<u>P/TV05 ISS INTERNAL OPS</u> (PHOTO/TV, SCENES) Perform Setup for PAO		
					<u>CWC TRANSFER</u> Transfer CWC(s) to ISS	<u>P6 HANDOFF FROM SRMS TO SSRMS</u> (PDRS, P6 NOMINAL)	<u>PRE-SLEEP ACTIVITY</u> (ORB OPS, CREW SYS)	
22:00		7 9 6			<u>PRE-SLEEP ACTIVITY</u> (ORB OPS, CREW SYS)			
00:00								No Exercise While both arms grappled.

# STS-120 FD07

GMT	TDRS WSEZ	DORB ORB	MET Day 005	STS ATTI	R2 MS2 WILSON	MS3 WHEELLOCK	MS4 NESPOLI	M1 FE-2 (UP) TANI	Notes
19:00		493				EMU SWAP (EVA, AIRLOCK CONFIG)	EMU SWAP (EVA, AIRLOCK CONFIG)		
							EVA SYS: 1.510 METOX REGENERATION Perform TERMINATE		
						EXERCISE		HANDOVER	
		594					EXERCISE		
20:00					TRANSFER REF MSG XXX	EVA SYS: 1.515 EMU METOX/LIOH BATTERY REPLACEMENT Install METOX Canisters			
						EVA SYS: 1.305 EQUIPMENT LOCK PREP REF: 120 CONSUMABLES TRACKING CC (EVA)			
						PRE EVA 3 TOOL CONFIG (EVA, TIMELINES)	PRE EVA 3 TOOL CONFIG (EVA, TIMELINES)		
							DRY SALIVA SAMPLE(ORB OPS,SDBI)		
21:00		695						PRIVATE MED CONF ISS	
								ROBO: 1.413 P6 GRAPPLE FROM SRMS-WS8	
						PRE-SLEEP ACTIVITY (ORB OPS, CREW SYS)	PRE-SLEEP ACTIVITY (ORB OPS, CREW SYS)		
					P6 HANDOFF FROM SRMS TO SSRMS (PDRS, P6 NOMINAL)				
22:00		796						PREP WORK	
00:00									

# STS-120 FD07

GMT	TDRS W E Z	DORB D O R B	MET Day 006	STS A T I	CDR MELROY	PLT ZAMKA	MS1 PARAZYNSKI	Notes
00:00					<u>EVA PROCEDURE REVIEW</u> REF: <u>EVA 3 PREBRIEF</u> (EVA, TIMELINES)	<u>EVA PROCEDURE REVIEW</u> REF: <u>EVA 3 PREBRIEF</u> (EVA, TIMELINES)	<u>EVA PROCEDURE REVIEW</u> REF: <u>EVA 3 PREBRIEF</u> (EVA, TIMELINES)	<u>UPLINK</u> β21 Only + Box C4,C2,C3,D3
01:00					<u>PUBLIC AFFAIRS EVENT</u> KU: XX:XX-XX:XX, TDRX	<u>PUBLIC AFFAIRS EVENT</u> KU: XX:XX-XX:XX, TDRX	<u>PRE-SLEEP ACTIVITY</u> (ORB OPS, CREW SYS)	
02:00					<u>PRE-SLEEP ACTIVITY</u> (ORB OPS, CREW SYS)	<u>PRE-SLEEP ACTIVITY</u> (ORB OPS, CREW SYS)		
02:00					06 UHF MODE - OFF PRIVATE MEDICAL CONFERENCE			
03:00					<u>PRE-SLEEP ACTIVITY</u> (ORB OPS, CREW SYS)		<u>EVA SYS: 2.305 10.2 PSIA CAMPOUT</u> <u>MASK PREBREATHE</u>  REF: <u>PRE EVA 3 TOOL CONFIG</u> (EVA, TIMELINES)  REF: <u>120 CONSUABLES TRACKING CC (EVA)</u>	
04:00							<u>PRE-SLEEP ACTIVITY</u> (ORB OPS, CREW SYS)	

# STS-120 FD07

GMT	TDRS WSEZ	DORB	MET Day 006	STS A T I	MS2 WILSON	MS3 WHEELOCK	MS4 NESPOLI	Notes
08/15 (227)								
23:00		796	00:00		<u>EVA PROCEDURE REVIEW</u> REF: <u>EVA 3 PREBRIEF</u> (EVA, TIMELINES)	<u>EVA PROCEDURE REVIEW</u> REF: <u>EVA 3 PREBRIEF</u> (EVA, TIMELINES)	<u>EVA PROCEDURE REVIEW</u> REF: <u>EVA 3 PREBRIEF</u> (EVA, TIMELINES)	
			01:00		<u>PUBLIC AFFAIRS EVENT</u> KU: XX:XX-XX:XX, TDRX	<u>PRE-SLEEP ACTIVITY</u> (ORB OPS, CREW SYS)	<u>PRE-SLEEP ACTIVITY</u> (ORB OPS, CREW SYS)	
			00:00		TRANSFER BRIEF: CALL DOWN STATUS TO MCC			
		897			<u>PRE-SLEEP ACTIVITY</u> (ORB OPS, CREW SYS)			
			02:00			<u>EVA SYS: 2.305 10.2 PSIA CAMPOUT</u> <u>MASK PREBREATHE</u>	<u>EVA SYS: 2.305 10.2 PSIA CAMPOUT</u> <u>MASK PREBREATHE</u>	
					REF: <u>PRE EVA 3 TOOL CONFIG</u> (EVA, TIMELINES)	REF: <u>PRE EVA 3 TOOL CONFIG</u> (EVA, TIMELINES)		
01:00					REF: <u>120 CONSUABLES TRACKING CC (EVA)</u>	REF: <u>120 CONSUABLES TRACKING CC (EVA)</u>		
			03:00				<u>PRE-SLEEP ACTIVITY</u> (ORB OPS, CREW SYS)	
		998						
02:00					<u>PRE-SLEEP ACTIVITY</u> (ORB OPS, CREW SYS)			
			04:00				<u>DRY SALIVA SAMPLE (ORB OPS, SDBI)</u>	

# STS-120 FD07

GMT	TDRSEZ	DORB	MET	STS	CDR MELROY	PLT ZAMKA	MS1 PARAZYNSKI	Notes
Date 08/16 (228)			Day 006	ATTI				
03:00		1909						
04:00				BIAS				
05:00		1100		XLV	SLEEP	SLEEP	SLEEP (A/L)	
06:00		1201		ZVV				
07:00								
08:00								



# STS-120 FD07

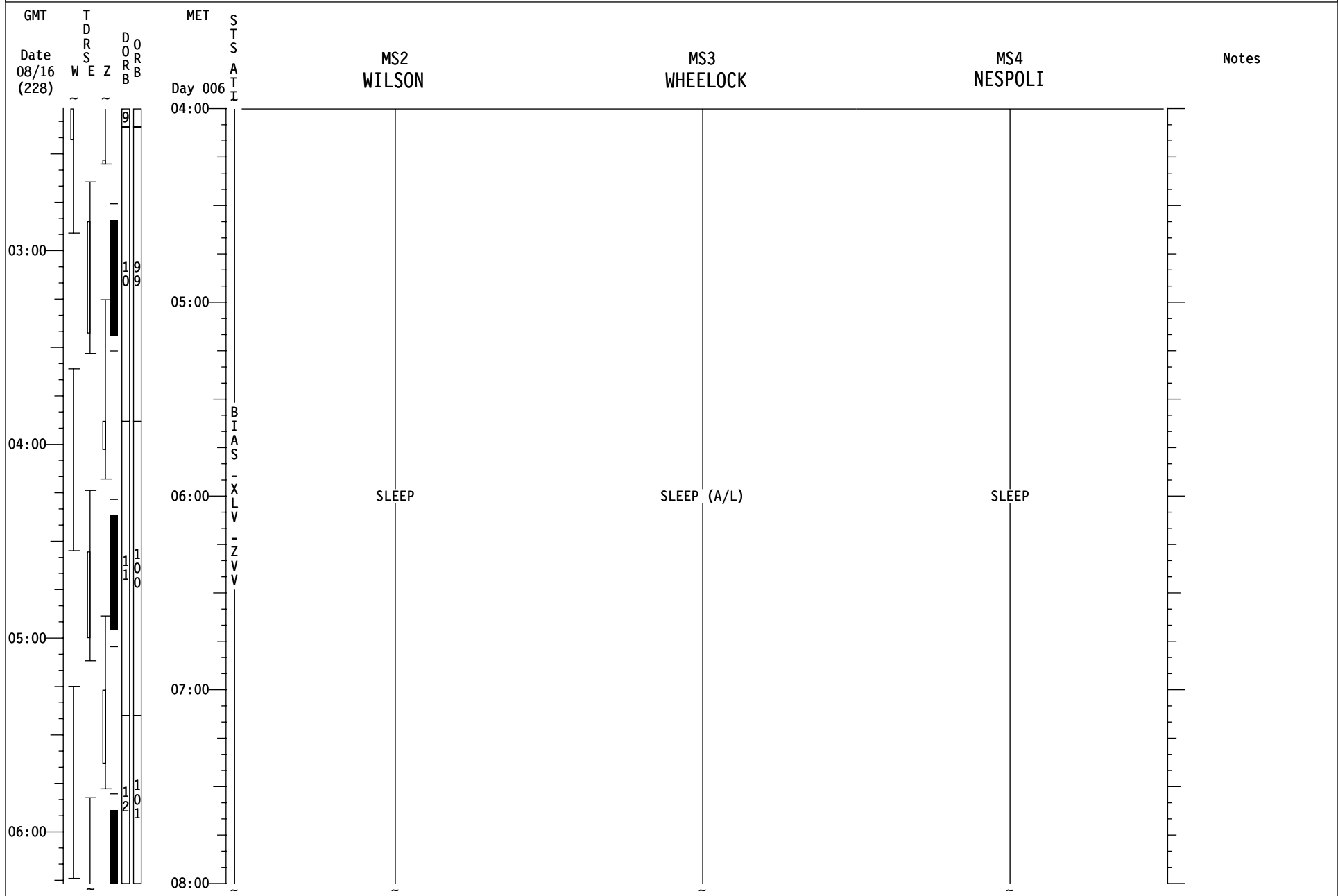



# STS-120 FD07

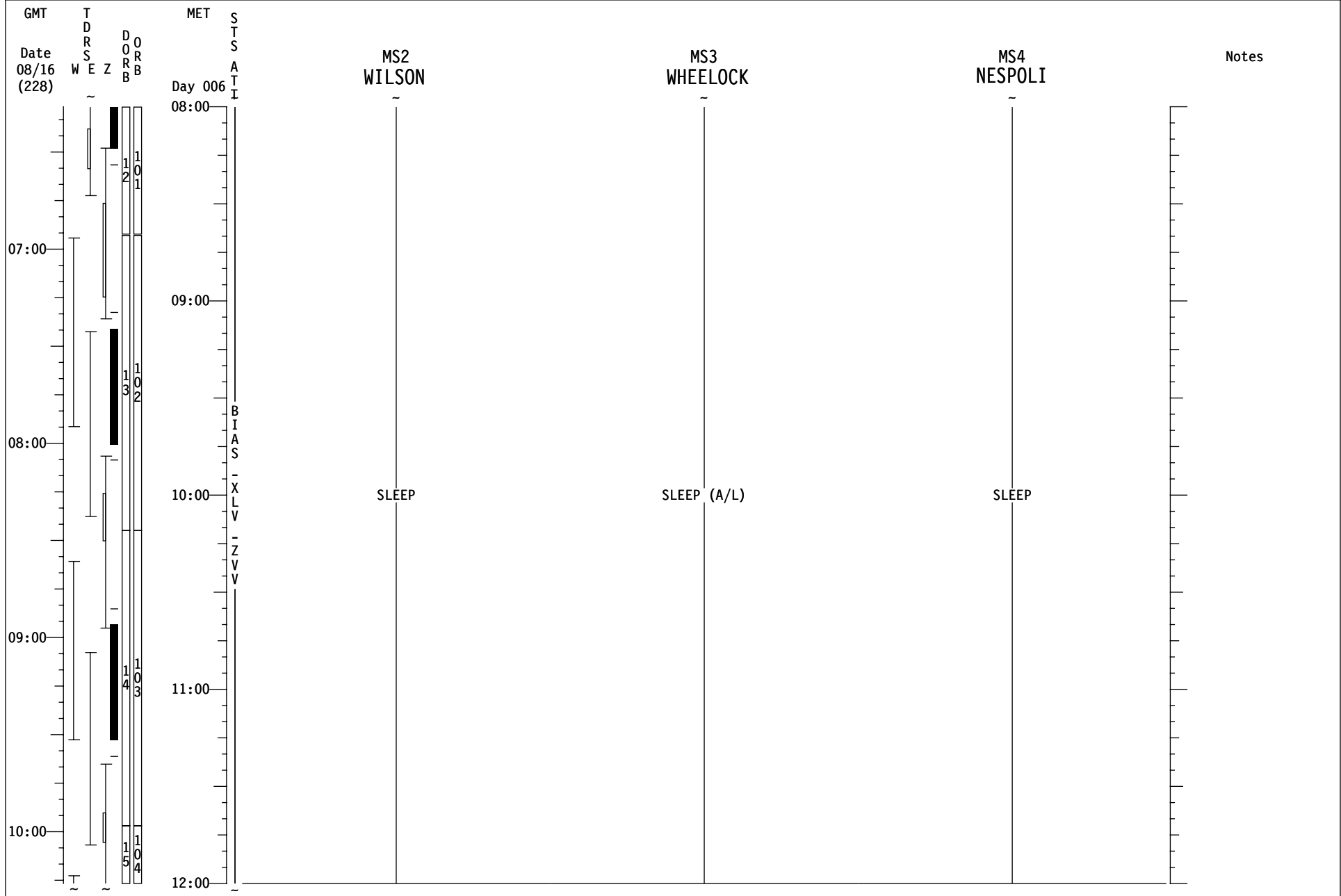



# STS-120 FD08

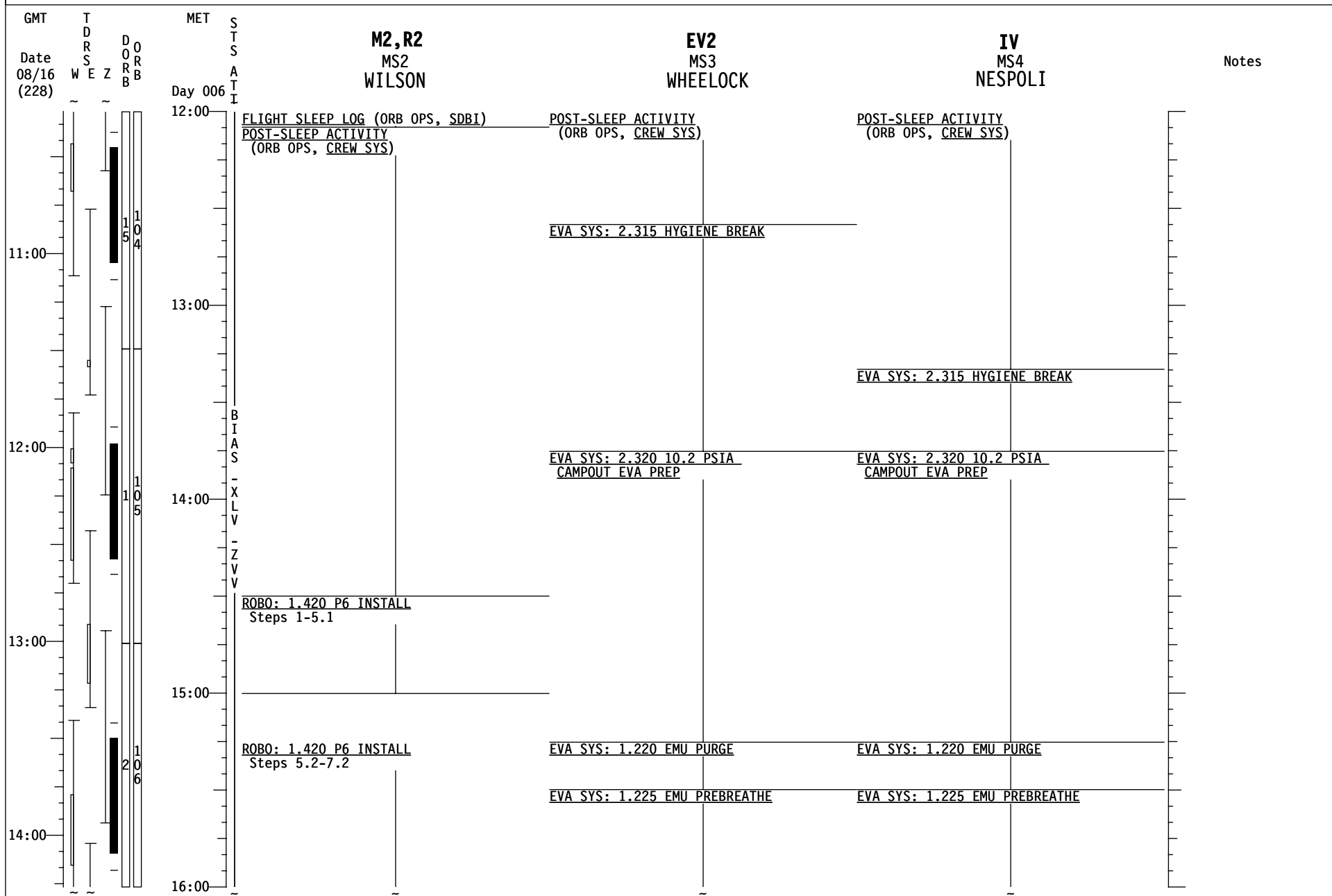

# STS-120 FD08

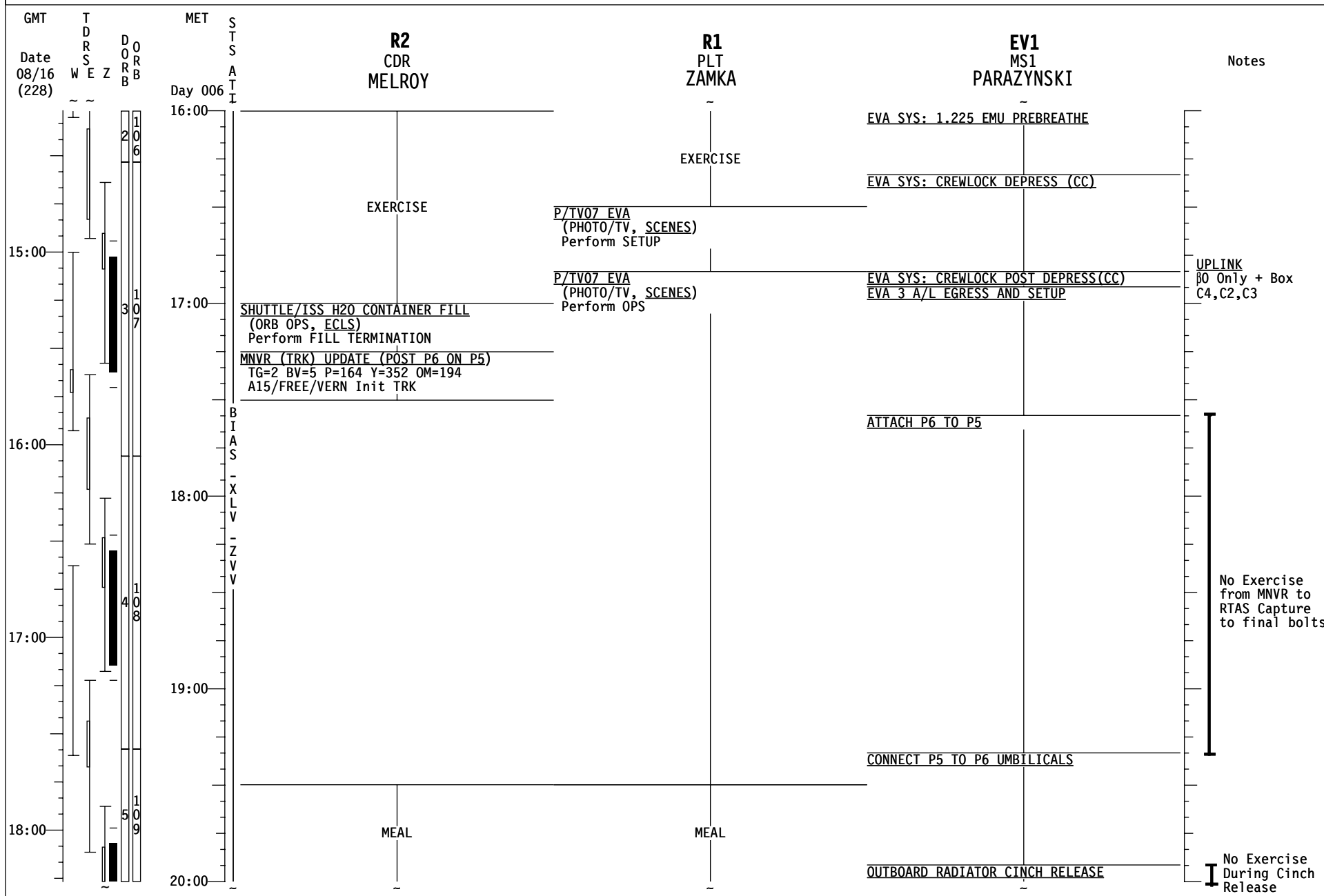

# STS-120 FD08

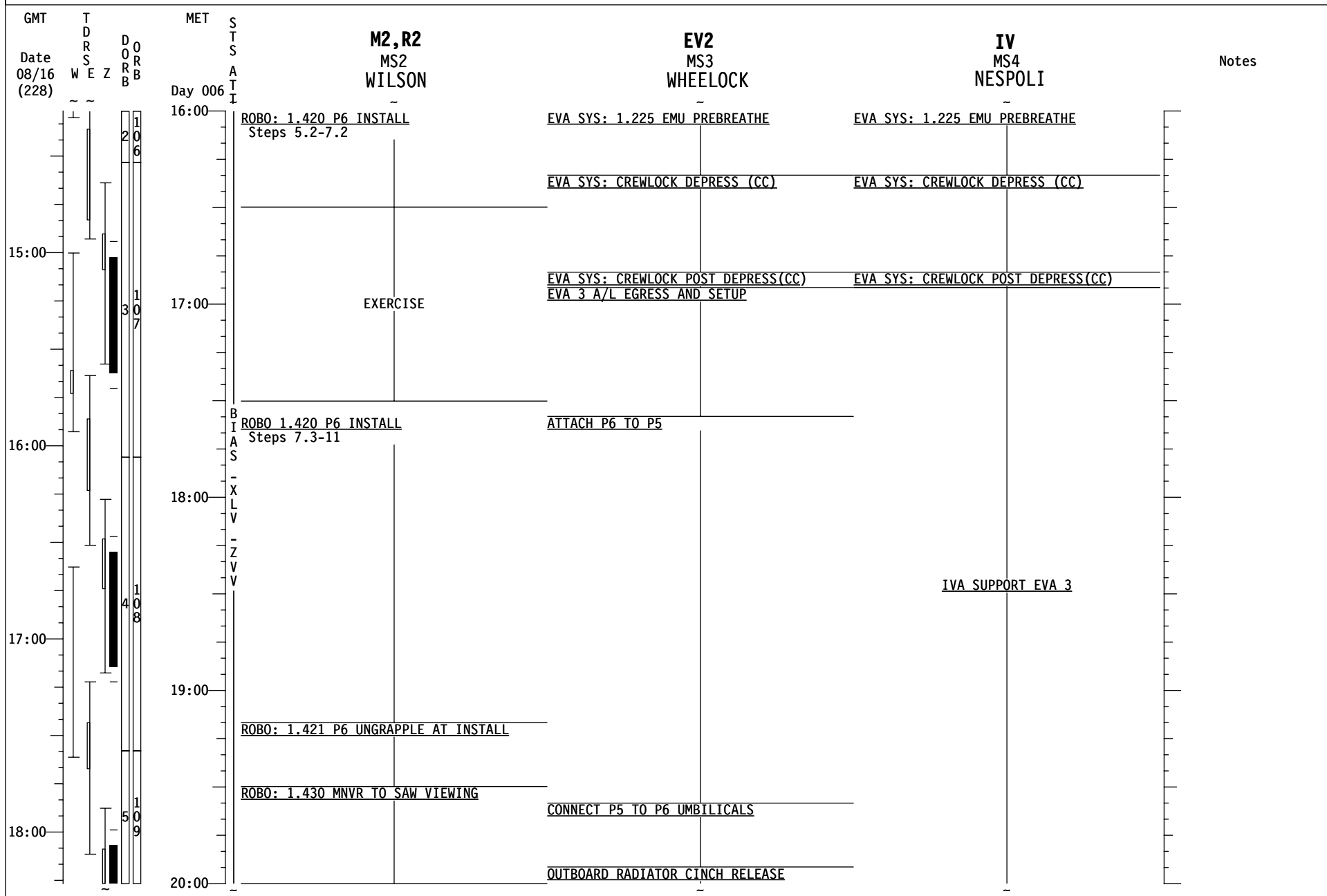

# STS-120 FD08

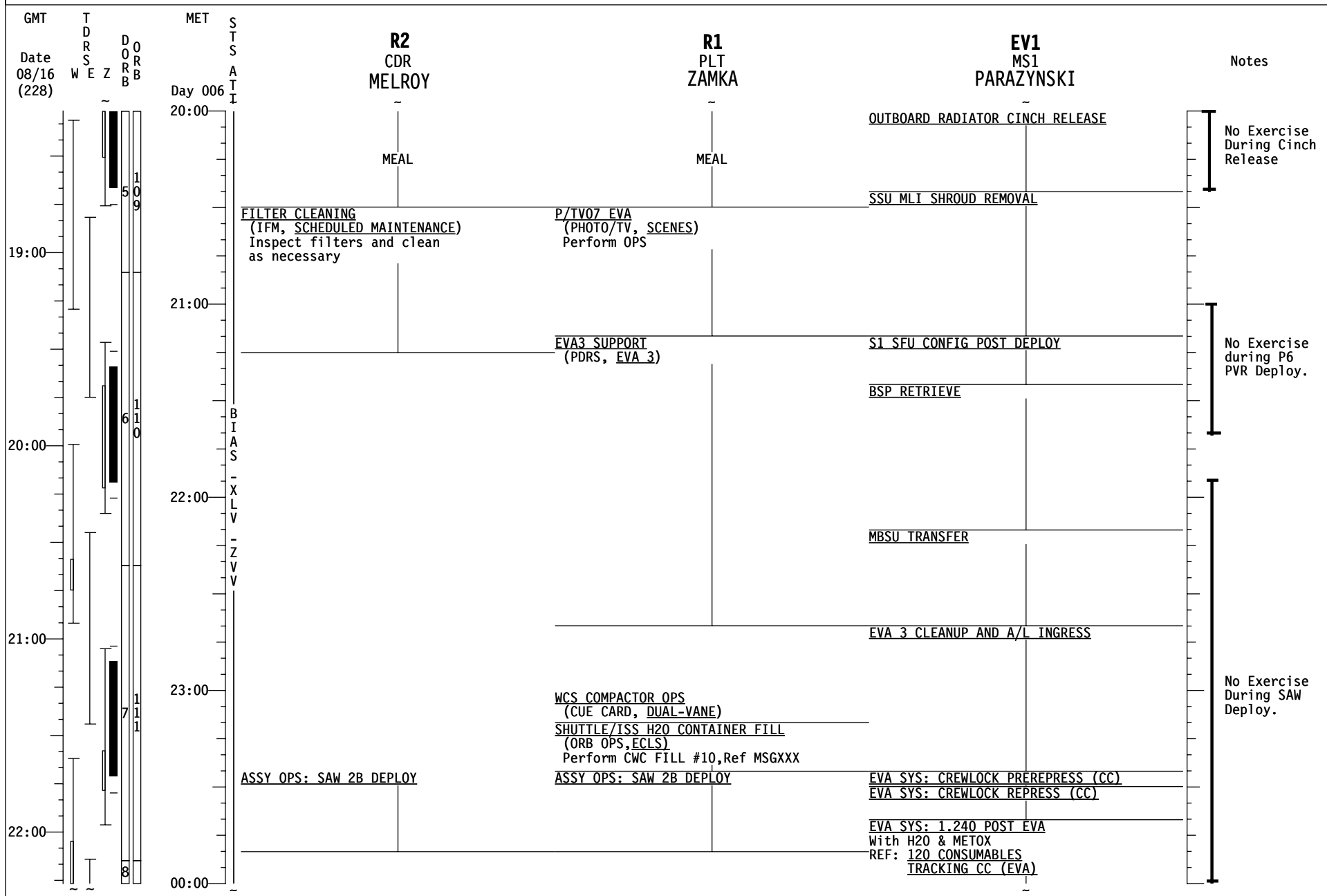









# STS-120 FD08

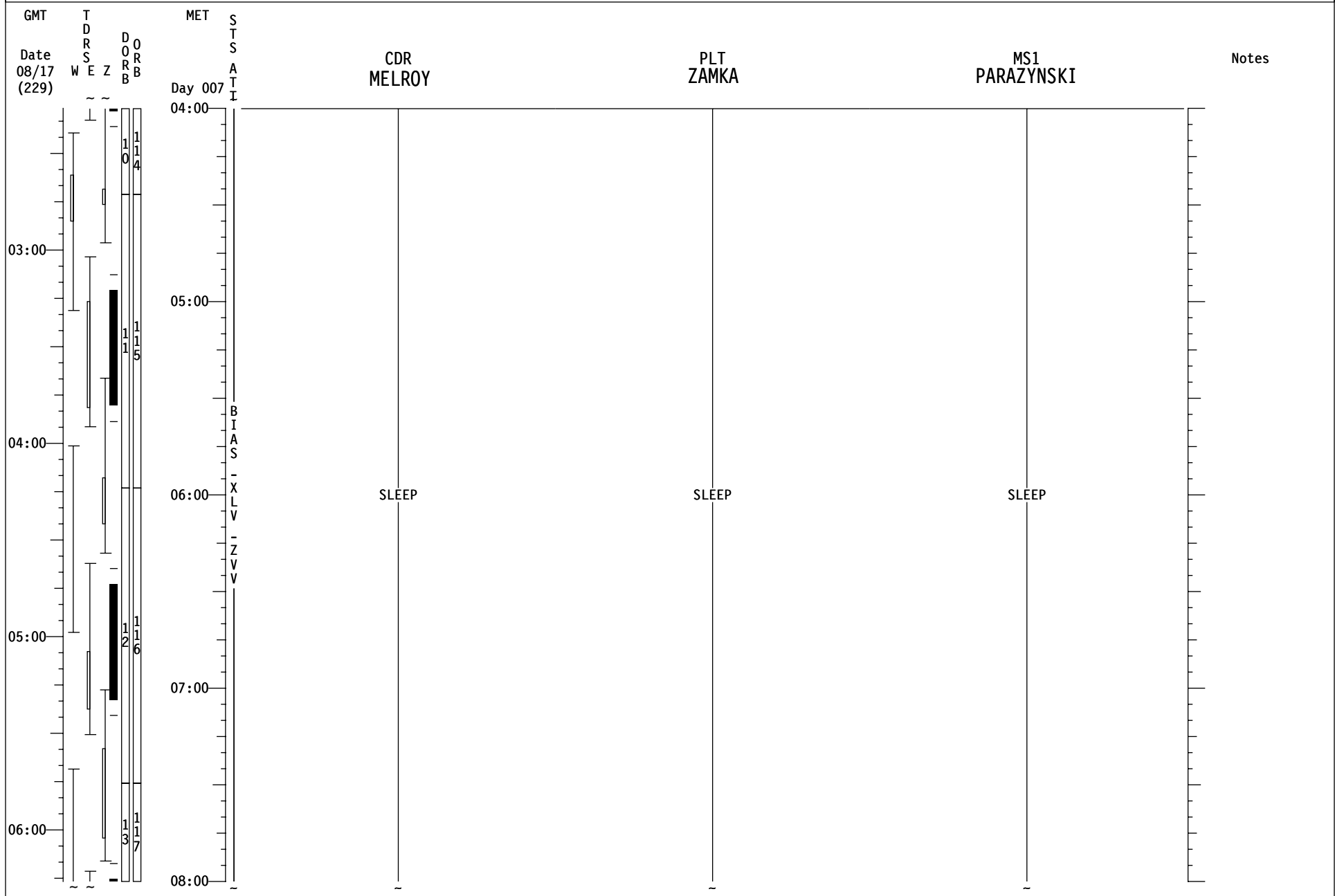

# STS-120 FD08

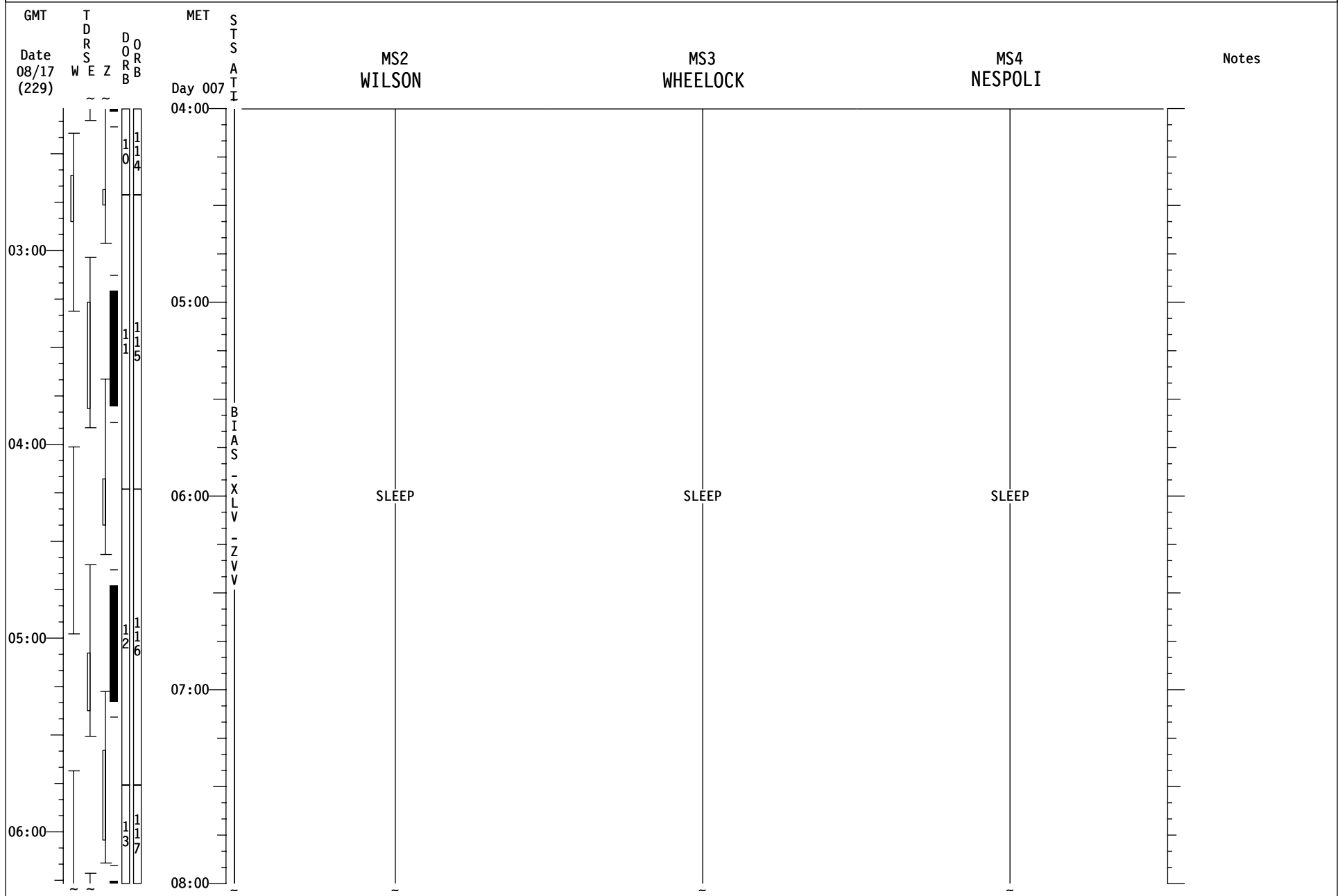

# STS-120 FD08

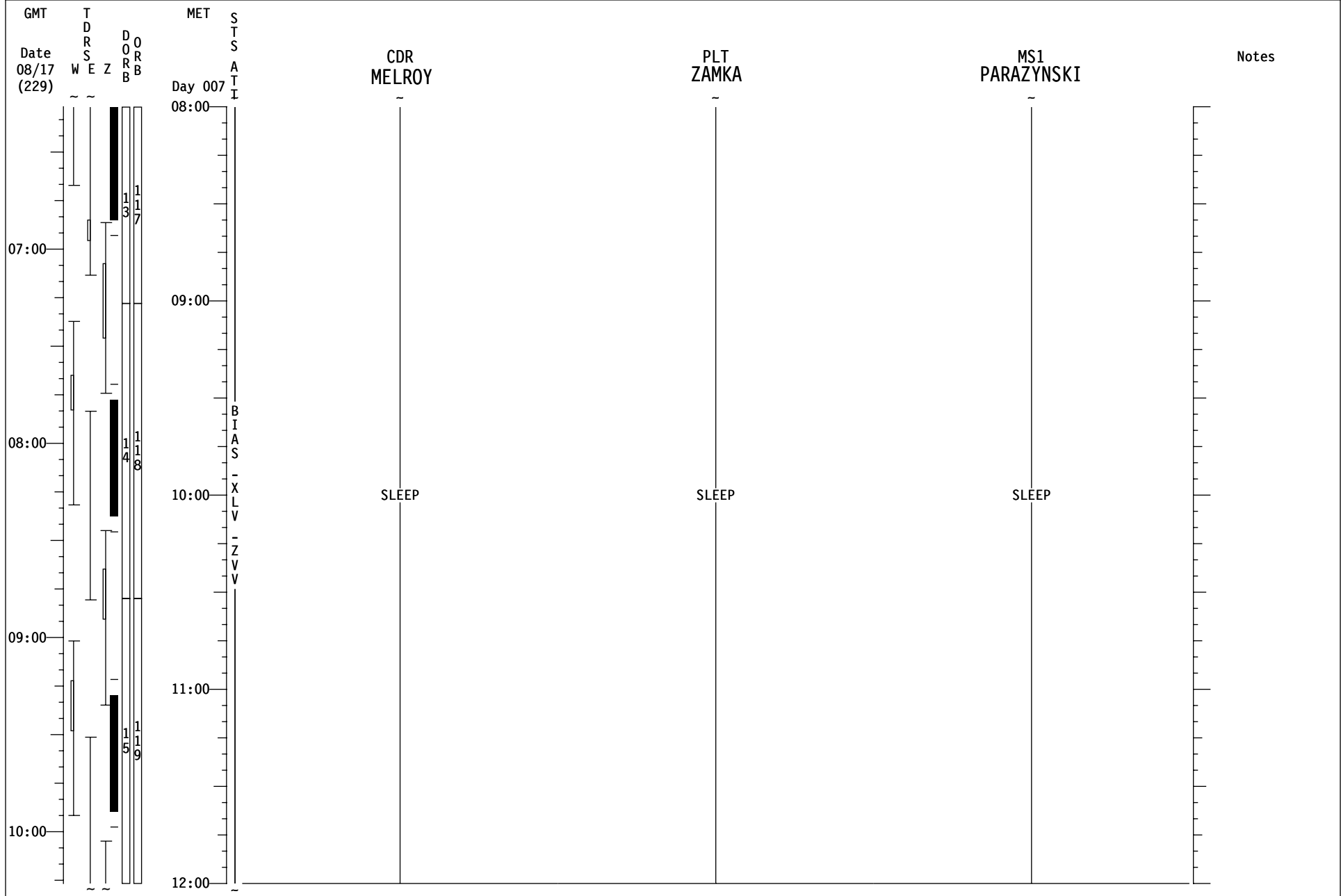

# STS-120 FD08

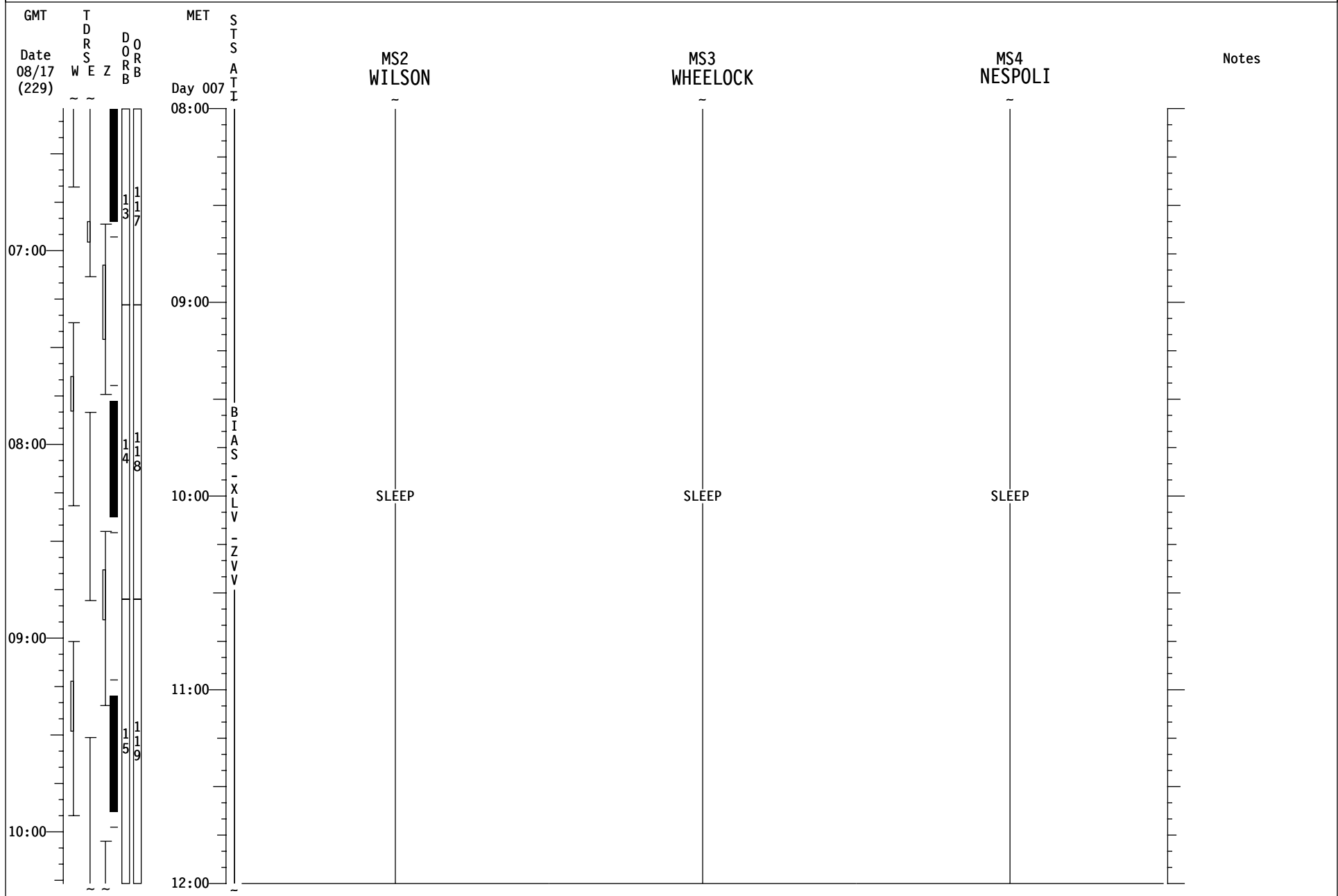

# STS-120 FD09

GMT	TDRS W E Z	DORB	MET Day 007	STS A T T I	CDR MELROY	PLT ZAMKA	MS1 PARAZYNSKI	Notes
12:00					<u>FLIGHT SLEEP LOG (ORB OPS, SDBI)</u> <u>POST-SLEEP ACTIVITY (ORB OPS, CREW SYS)</u>	<u>FLIGHT SLEEP LOG (ORB OPS, SDBI)</u> <u>POST-SLEEP ACTIVITY (ORB OPS, CREW SYS)</u>	<u>FLIGHT SLEEP LOG (ORB OPS, SDBI)</u> TAKE 1 ASPIRIN (325mg) <u>POST-SLEEP ACTIVITY (ORB OPS, CREW SYS)</u>	
11:00					<b>FD09 EZ ACTIVITES</b> Check TEPC Status OCAC Filter Inspect Hard Reboot PGSCs (Except WLES)			
13:00								
12:00								
14:00								
13:00								
15:00					<u>PUBLIC AFFAIRS EVENT</u> KU: XX:XX-XX:XX, TDRX	<u>N2 REPRESS USING PAYLOAD N2 VLVS</u> (ORB OPS, ECLS) Repress S/U & Init <u>JNT OPS: 3.110 H/O ATT CNTRL</u> <u>CMG TA TO ORB</u>	<u>EVA SYS: 1.307 REBA REMOVAL</u>	
14:00					<u>SHUTTLE/ISS H2O CONTAINER FILL</u> (ORB OPS, ECLS) Perform CWC FILL #11, Ref MSGXXX L17 Check MCIU filter screen	<u>MNVR BIAS -XLV +YVV (H2O DUMP)</u> TG=2 BV=5 P=163 Y=357 OM=195 A12/AUTO/VERN Init TRK <u>SUPPLY/WASTE WATER DUMP</u> (ORB OPS, ECLS) Initiate Supply/Waste Dump	<u>POST EVA TRANSFER &amp; RECONFIG</u> (EVA, AIRLOCK CONFIG)	
16:00								





# STS-120 FD09

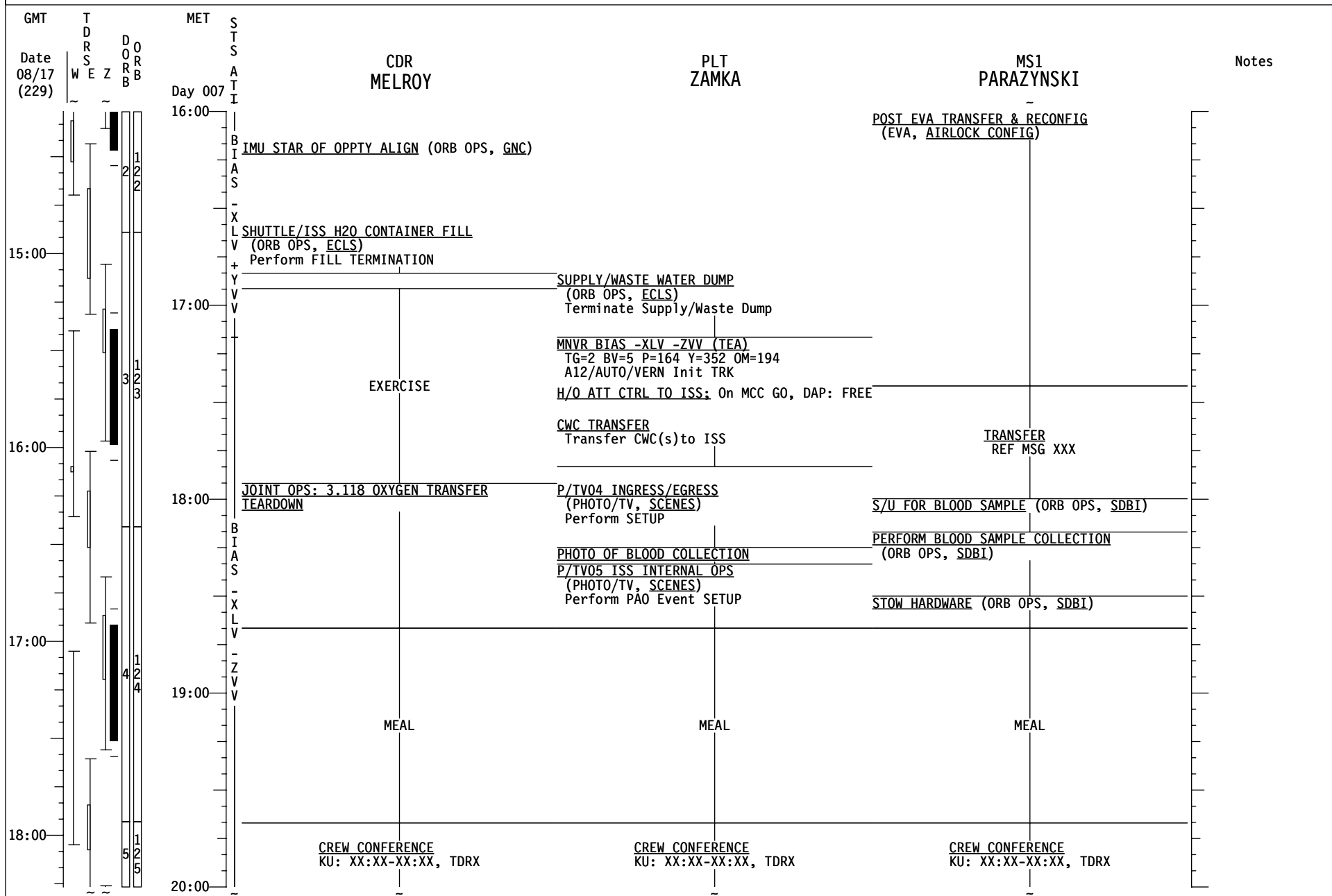

# STS-120 FD09

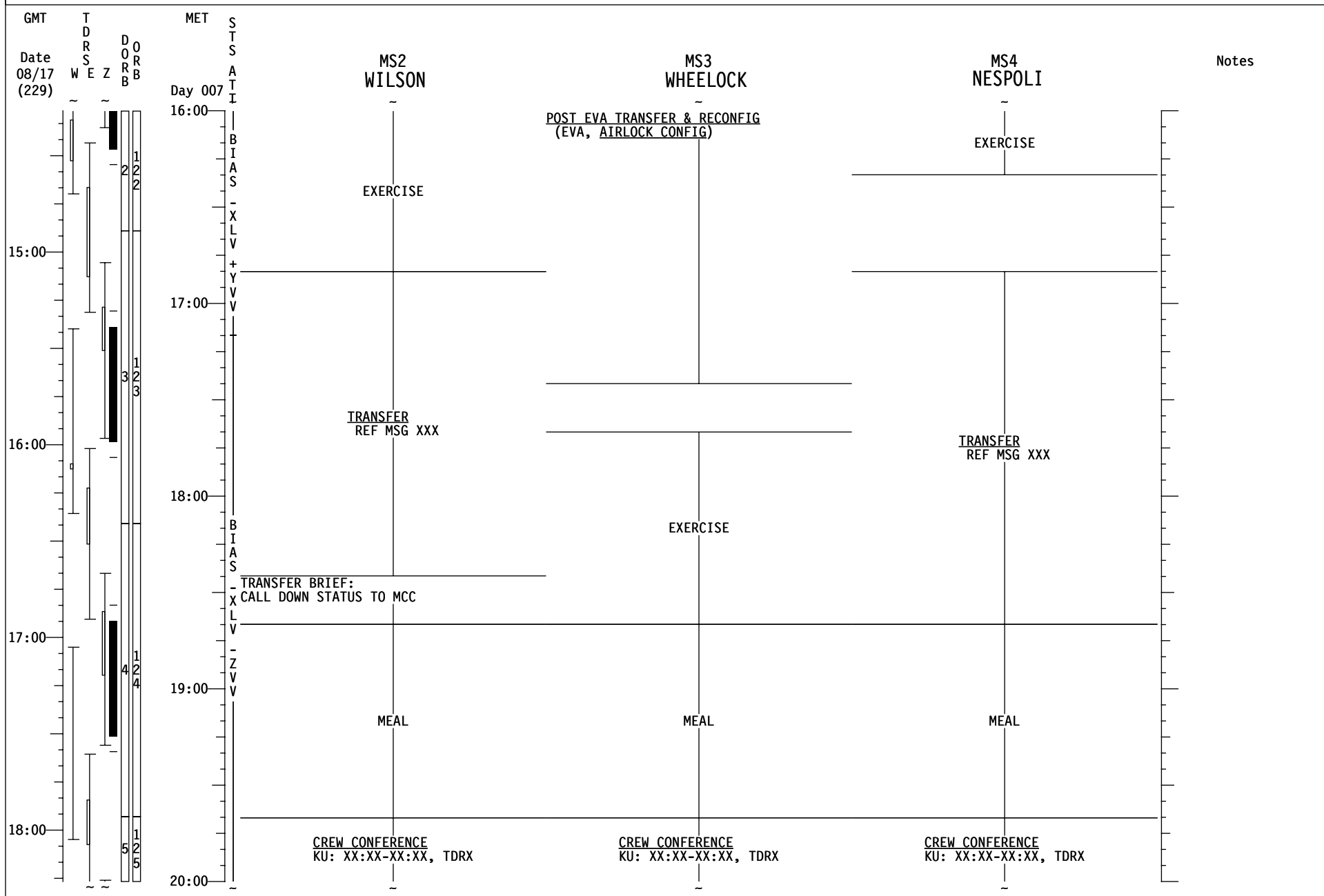

# STS-120 FD09

GMT	TDRS W E Z	DORB	MET Day 007	STS A T I	CDR MELROY	PLT ZAMKA	MS1 PARAZYNSKI	Notes
19:00		5			CREW CONFERENCE KU: XX:XX-XX:XX, TDRX	CREW CONFERENCE KU: XX:XX-XX:XX, TDRX	CREW CONFERENCE KU: XX:XX-XX:XX, TDRX	
20:00		6			OFF DUTY	OFF DUTY	OFF DUTY	
21:00		7			JNT OPS: 4.103 DUCT REMOVAL AND HATCH CLOSE (BYPASS CONFIG)	N2 REPRESS USING PAYLOAD N2 VLVS (ORB OPS, ECLS) Repress Term P/TV04 INGRESS/EGRESS (PHOTO/TV, SCENES) Perform Ops	RNDZ TOOLS CHECKOUT (RNDZ, RNDZ TOOLS)	UPLINK TFL 192
22:00					JNT OPS: 3.110 H/O ATT CNTRL CMG TA TO ORB	EXERCISE	EXERCISE	UPLINK TFL 188
23:00					JNT OPS: 4.104 ODS VEST/PMA DPRS AND HATCH LEAK CHECK			
00:00								

# STS-120 FD09

GMT	T D R S E Z	D O R R B	MET	S T S	MS2 WILSON	MS3 WHEELLOCK	MS4 NESPOLI	Notes
Date 08/17 (229)	W	E	Day 007	A				
			20:00	T	~	~	~	
					<u>CREW CONFERENCE</u> KU: XX:XX-XX:XX, TDRX	<u>CREW CONFERENCE</u> KU: XX:XX-XX:XX, TDRX	<u>CREW CONFERENCE</u> KU: XX:XX-XX:XX, TDRX	
19:00								
			21:00		OFF DUTY	OFF DUTY	OFF DUTY	
20:00								
			22:00					
					FAREWELL	FAREWELL	FAREWELL	
					<u>JNT OPS: 4.103 DUCT REMOVAL AND HATCH CLOSE (BYPASS CONFIG)</u>		<u>RNDZ TOOLS CHECKOUT (RNDZ, RNDZ TOOLS)</u>	
21:00								
			23:00					
					<u>JNT OPS: 4.104 ODS VEST/PMA DPRS AND HATCH LEAK CHECK</u>			
22:00								
			00:00					

# STS-120 FD09

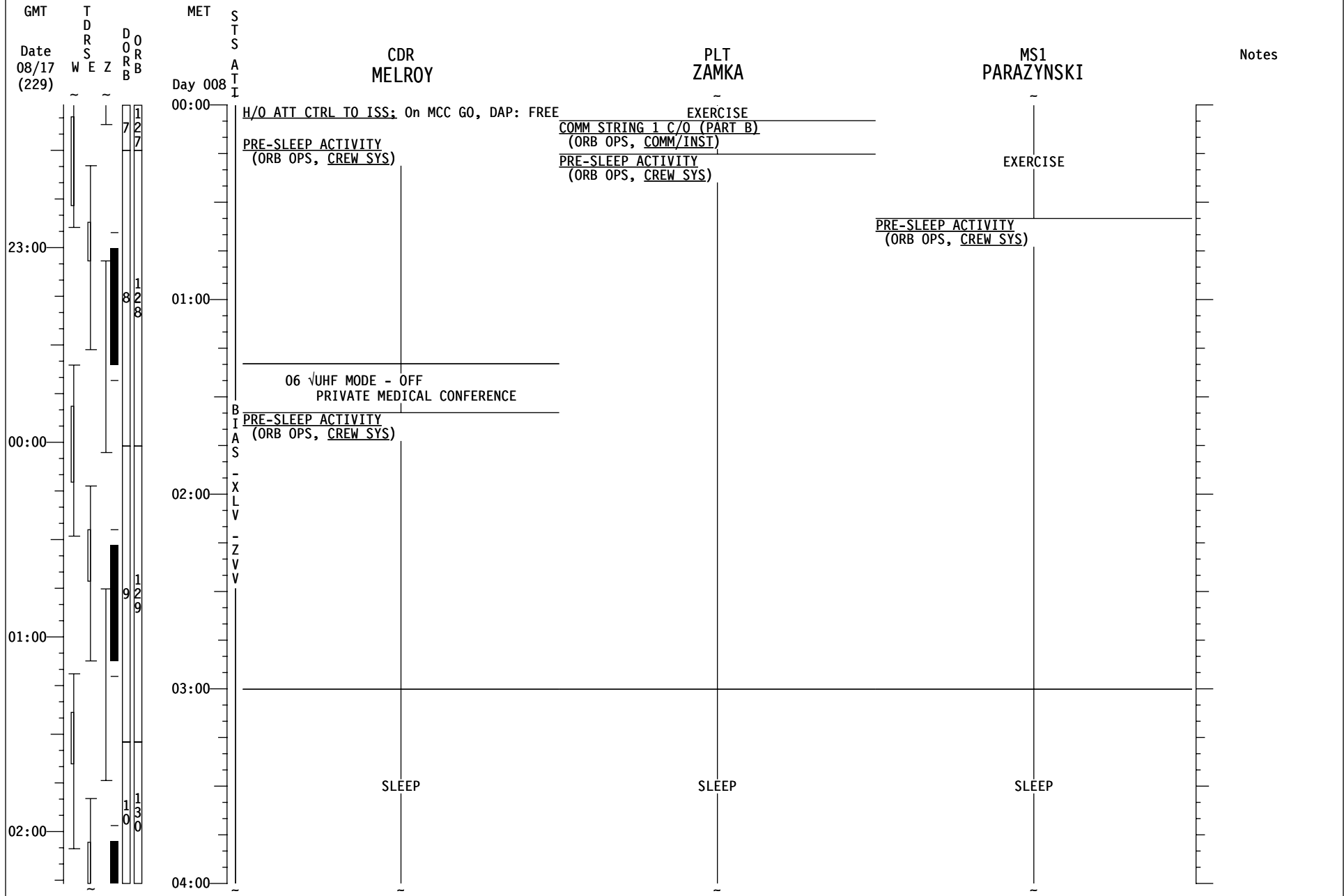

# STS-120 FD09

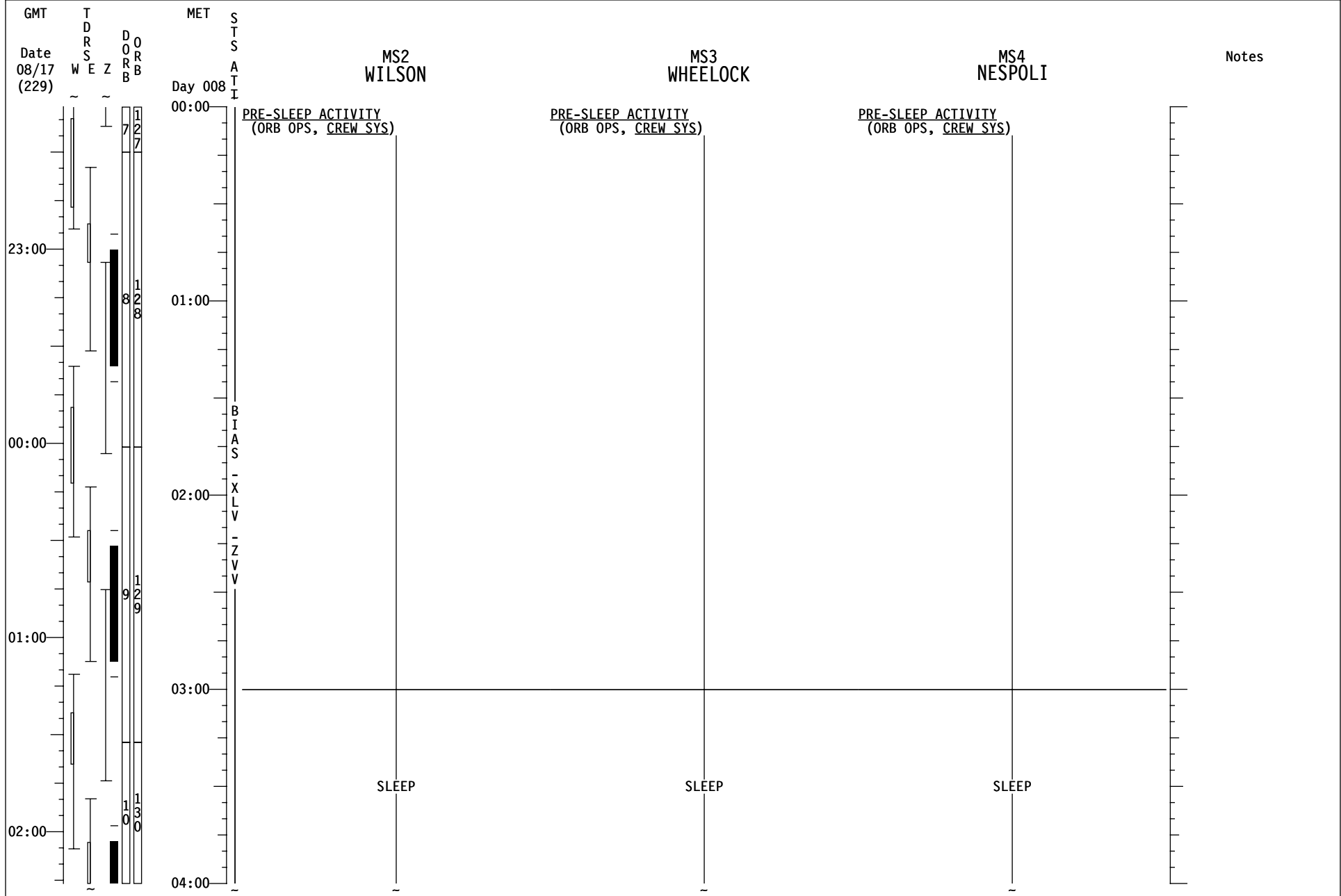







# STS-120 FD10

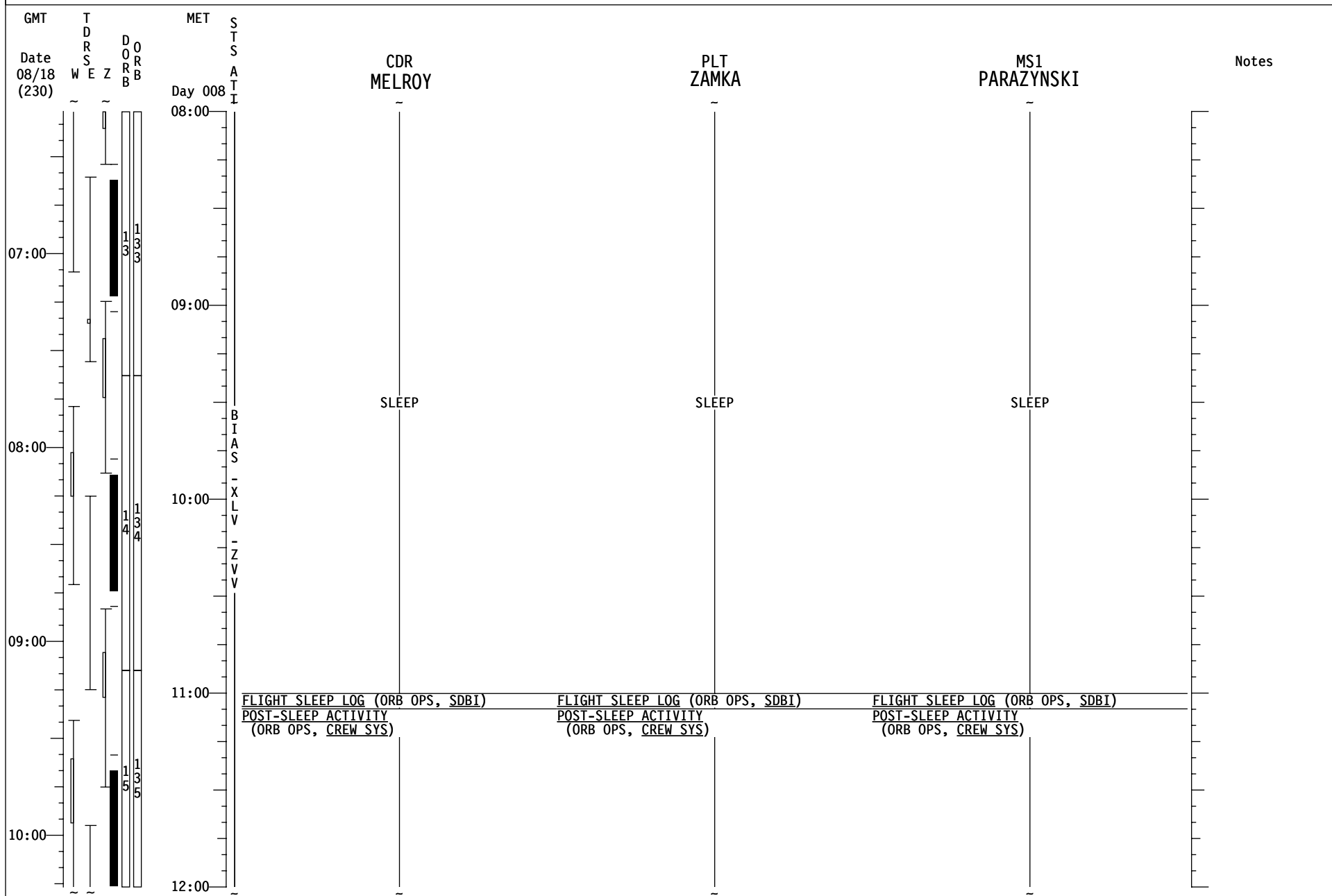

# STS-120 FD10

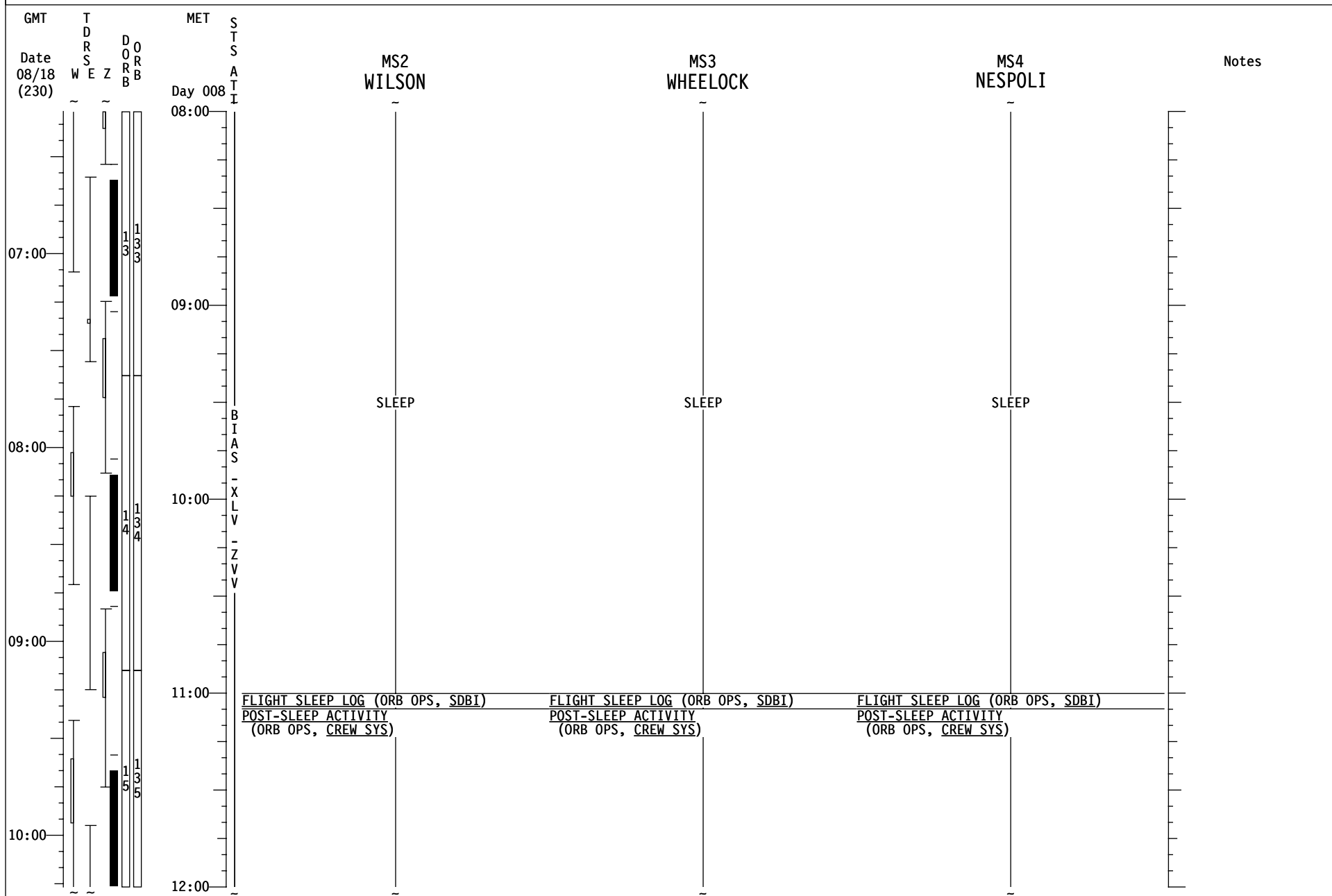

# STS-120 FD 10

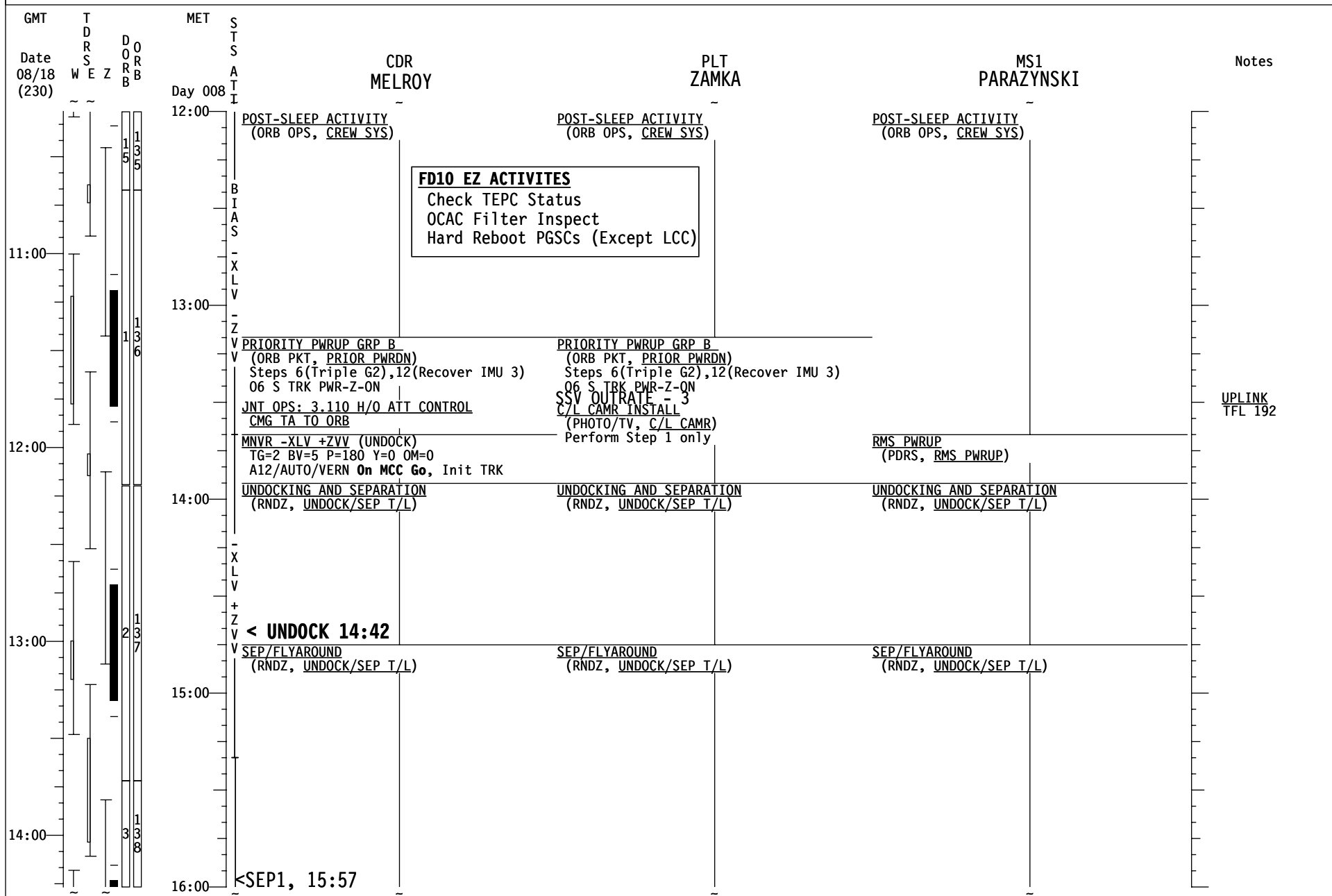

UPLINK  
TFL 192

# STS-120 FD10

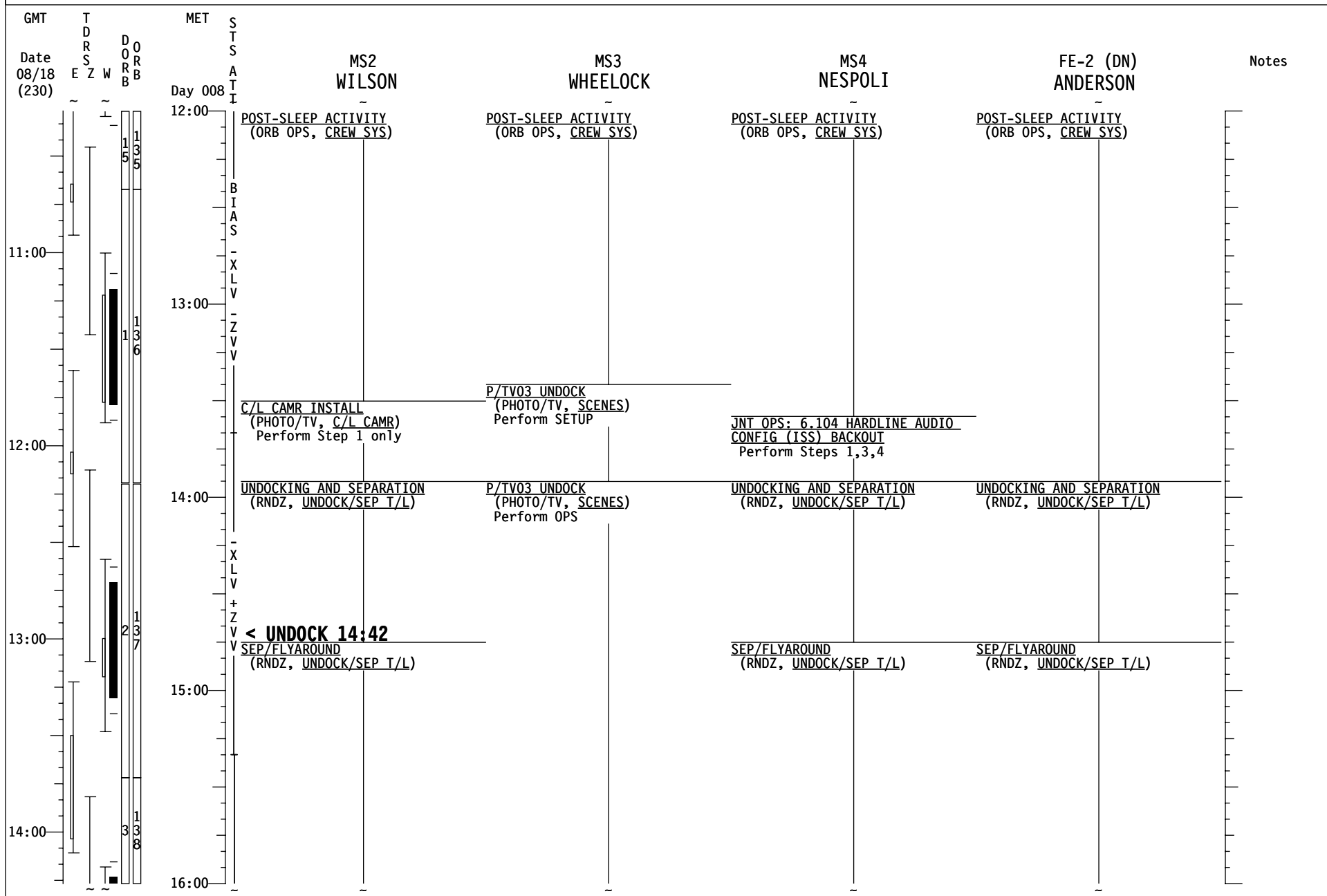

# STS-120 FD 10

GMT	TDRS W E Z	DORB D O R B	MET Day 008	S T S A T I	R3 CDR MELROY	R2, R1 PLT ZAMKA	R1 MS1 PARAZYNSKI	Notes
16:00					SEP/FLYAROUND (RNDZ, UNDOCK/SEP T/L)	SEP/FLYAROUND (RNDZ, UNDOCK/SEP T/L)	SEP/FLYAROUND (RNDZ, UNDOCK/SEP T/L)	
					<SEP2, 16:25			
15:00					MNVR -ZLV +YVV (H2O DUMP) TG=2 BV=3 OM=270 A14/AUTO/VERN Init TRK	SHUTTLE CONDENSATE COLLECTION (ORB OPS, ECLS) Perform TEARDOWN	POST UNDOCK PGSC CONFIG Configure PGSCs	UPLINK β21 Only + Box B1
17:00					PRIORITY PWRDN GRP B (ORB PKT, PRIOR PWRDN) Steps 5,6 (Single G2),9,10,12 (IMU 3 STBY-ITEM 23 EXEC)	SUPPLY/WASTE WATER DUMP (ORB OPS, ECLS) Initiate Supply/Waste Dump		UPLINK TFL 188
16:00					MEAL	MEAL	MEAL	UPLINK β21 + MASK
18:00								UPLINK β21 Only + Box A2
17:00					RCS REG RCNFG (ORB OPS, RCS)	SUPPLY/WASTE WATER DUMP (ORB OPS, ECLS) Terminate Supply/Waste Dump	OBSS UNBERTH (PDRS, OBSS NOM OPS)	
19:00						EXERCISE		UPLINK β21 Only + Box A3
18:00					MNVR (TRK) BIAS +YSI (STBD SURV) TG=4 BV=5 P=0 Y=40 OM=54 A14/AUTO/VERN, On MCC Go, Init TRK		OBSS LDRI/IDC RCC SURVEY-STBD (PDRS, OBSS NOM OPS)	
20:00								

# STS-120 FD10

GMT	T D R S Z W	D O R B	MET	S T S A T I	R2, R1 MS2 WILSON	MS3 WHEELLOCK	R2, R1 MS4 NESPOLI	FE-2 (DN) ANDERSON	Notes
Date 08/18 (230)			Day 008						
16:00					SEP/FLYAROUND (RNDZ, UNDOCK/SEP T/L)	P/TV03 UNDOCK (PHOTO/TV, SCENES) Perform OPS	SEP/FLYAROUND (RNDZ, UNDOCK/SEP T/L)	SEP/FLYAROUND (RNDZ, UNDOCK/SEP T/L)	
15:00					L17 Check MCIU filter screen	PLAYBACK (DIGITAL) (PHOTO/TV, CUE CARD) UNDOCK KU TDRE (16:35-17:03)		EMU INSTALLATION (EVA, AIRLOCK CONFIG)	
17:00					PRIORITY PWRDN GRP B (ORB PKT, PRIOR PWRDN) Steps 5,6 (Single G2),9,10,12 (IMU 3 STBY-ITEM 23 EXEC)	P/TV03 UNDOCK (PHOTO/TV, SCENES) Deact	JNT OPS: 6.106 SSOR DEACTIVATION		
16:00					MEAL	MEAL	MEAL	MEAL	
18:00						SSV OUTFRATE - 4 SSP1 OIU PWR - OIU 1 OFF, vtb-bp (PDRS, QBSS NOM OPS) Expect S62 BCE BYP PSP1 msg.	OBSS UNBERTH		
17:00					EXERCISE				
19:00					OBSS LDRI/IDC RCC SURVEY-STBD (PDRS, QBSS NOM OPS)		OBSS LDRI/IDC RCC SURVEY-STBD (PDRS, QBSS NOM OPS)		
18:00									
20:00						EXERCISE			

# STS-120 FD 10

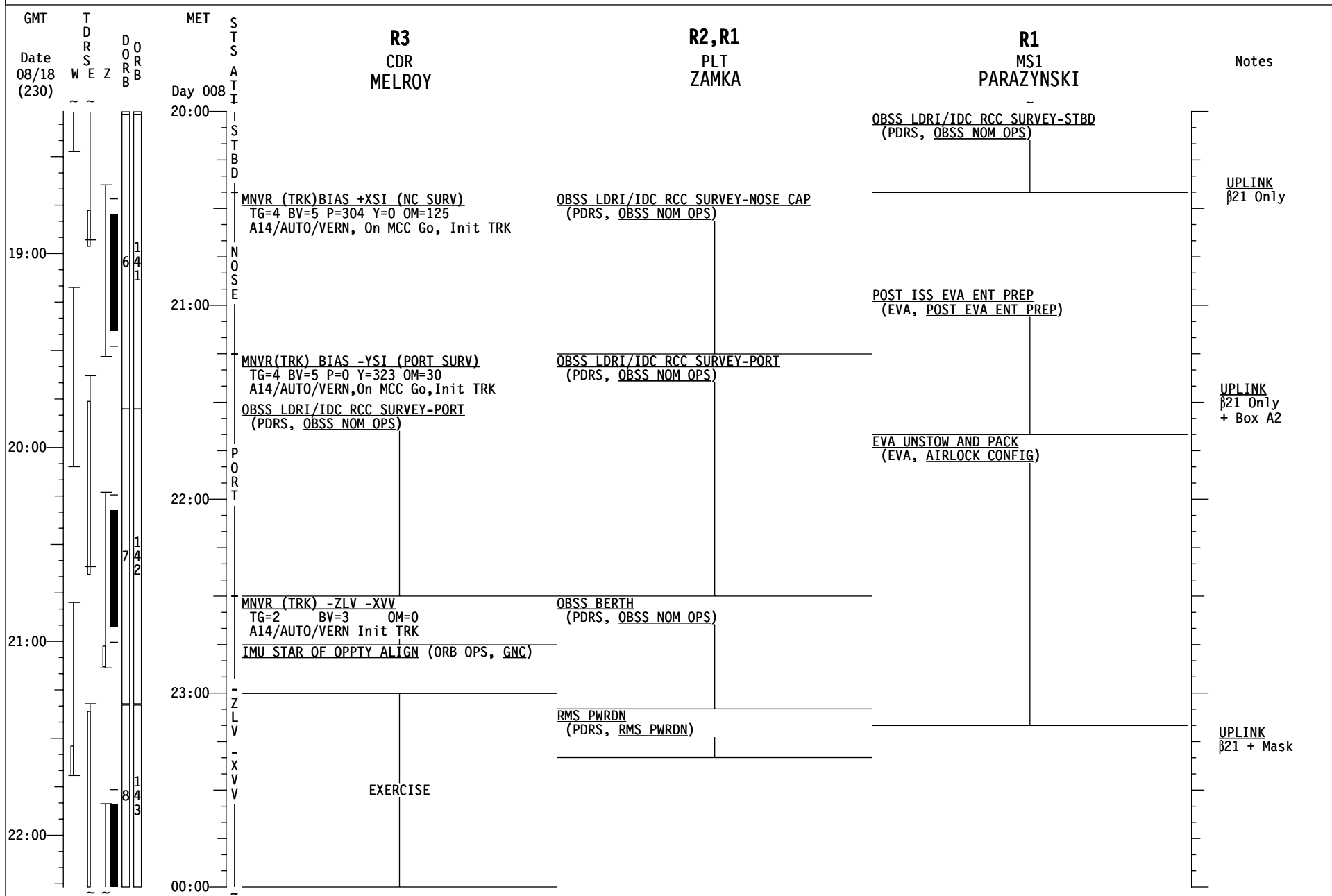



# STS-120 FD 10

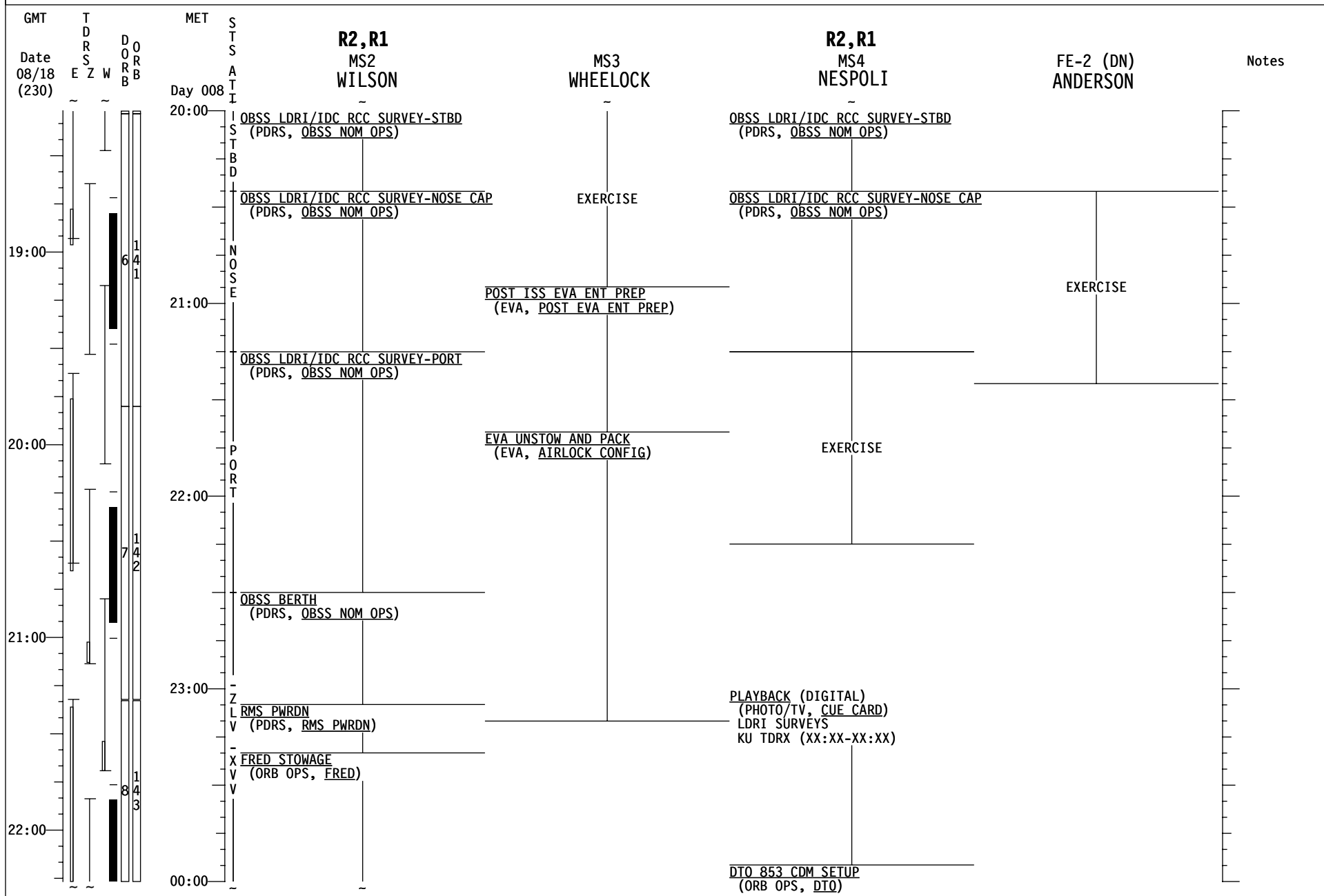

# STS-120 FD 10

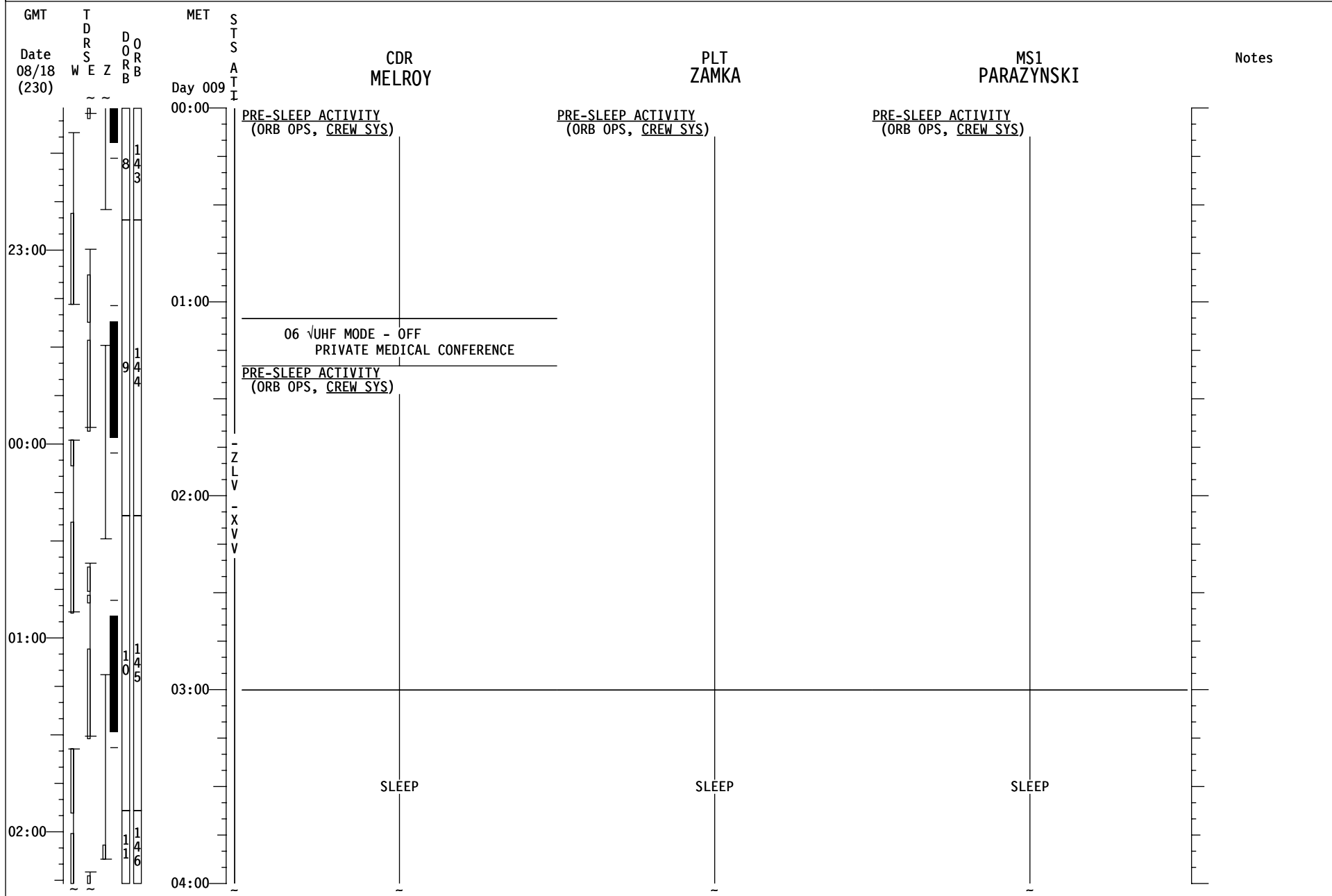

# STS-120 FD 10

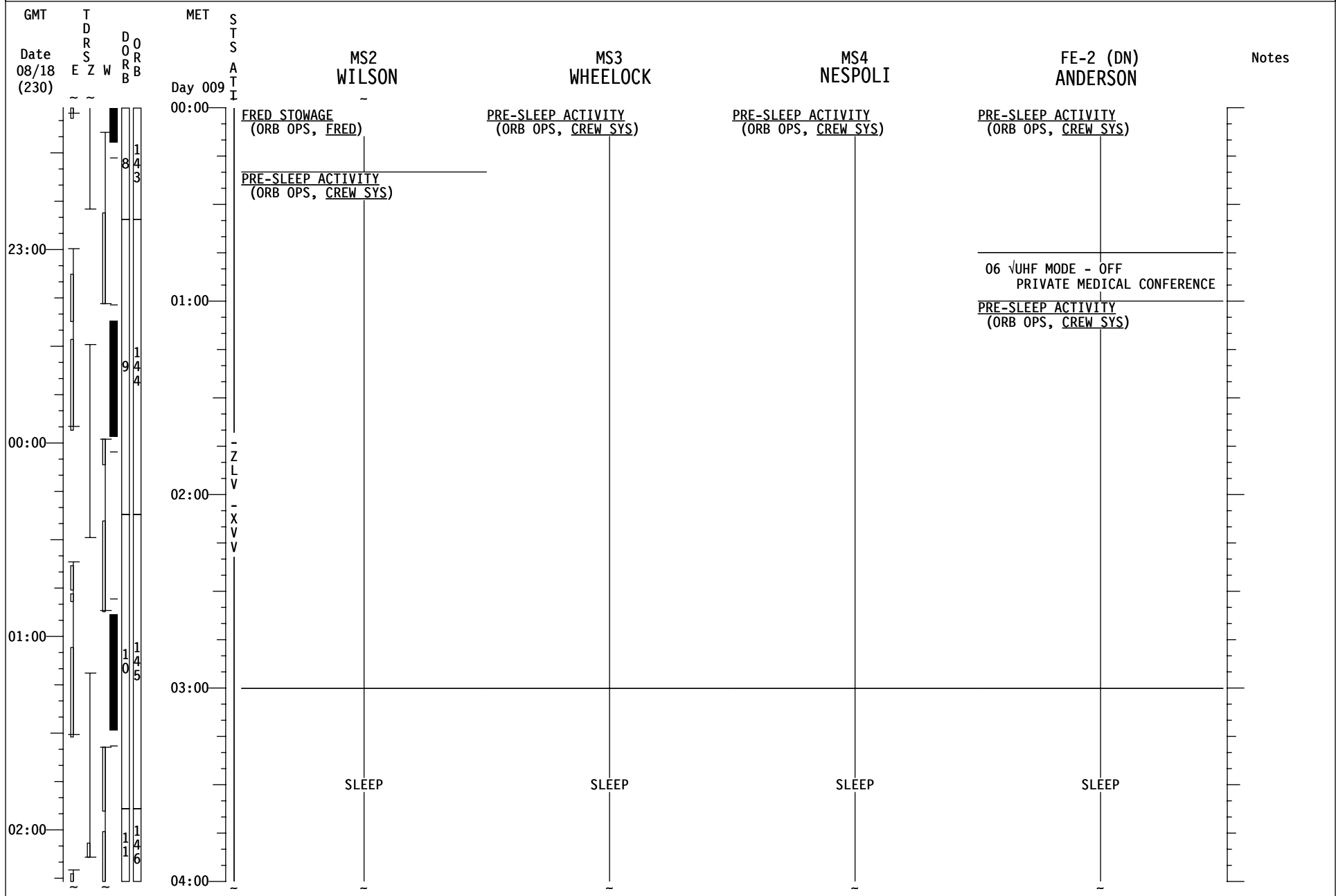

# STS-120 FD 10

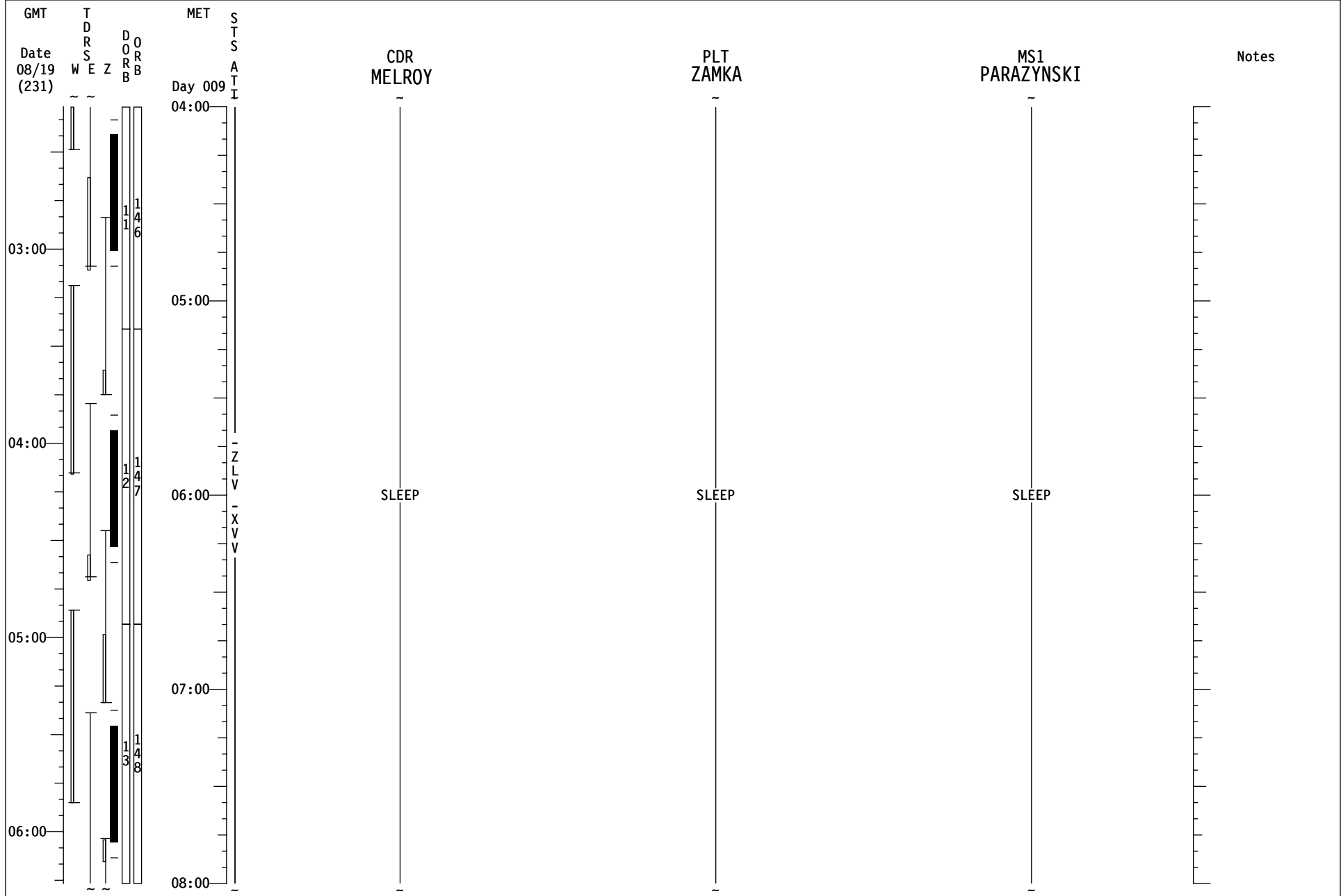

# STS-120 FD 10

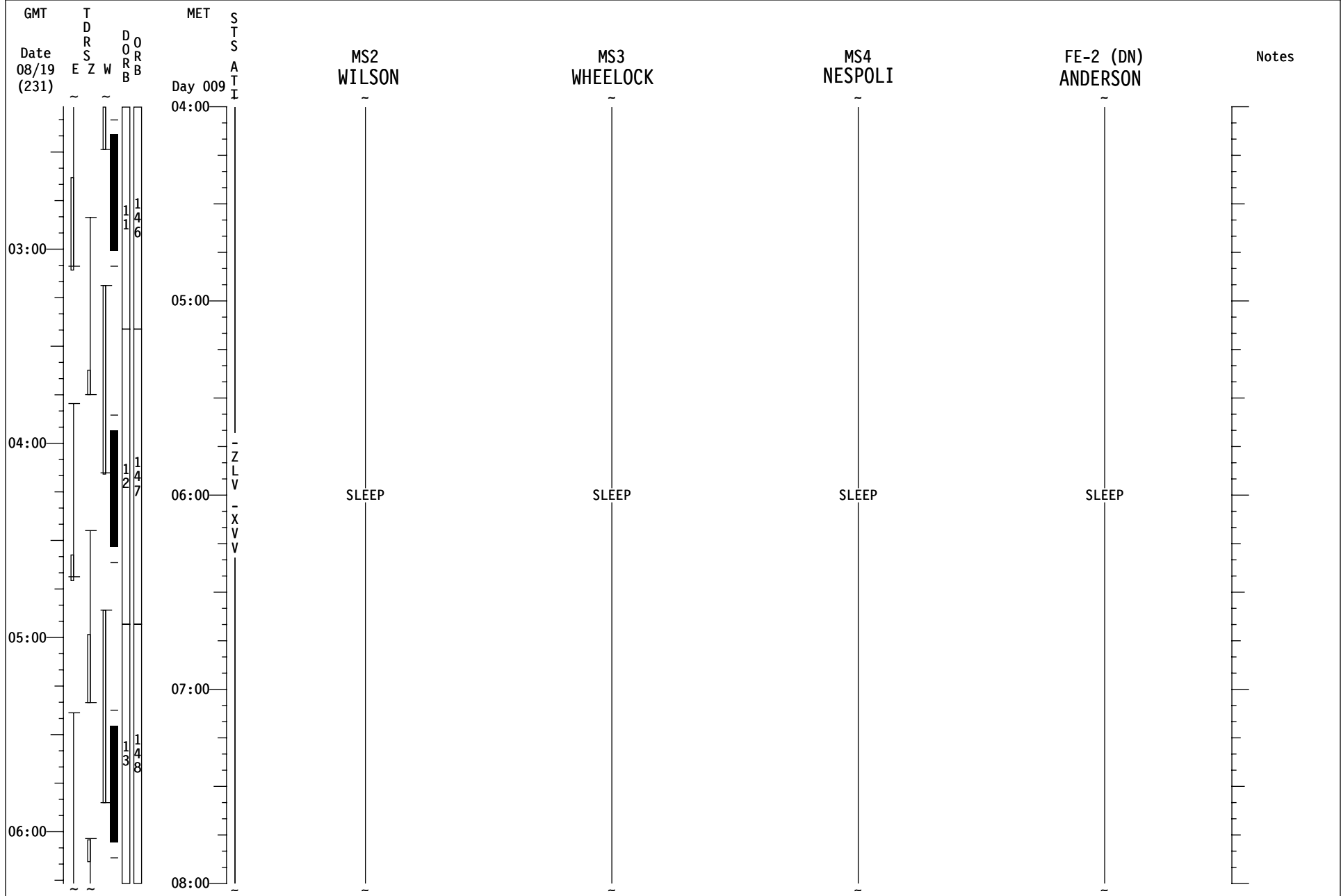

# STS-120 FD 11

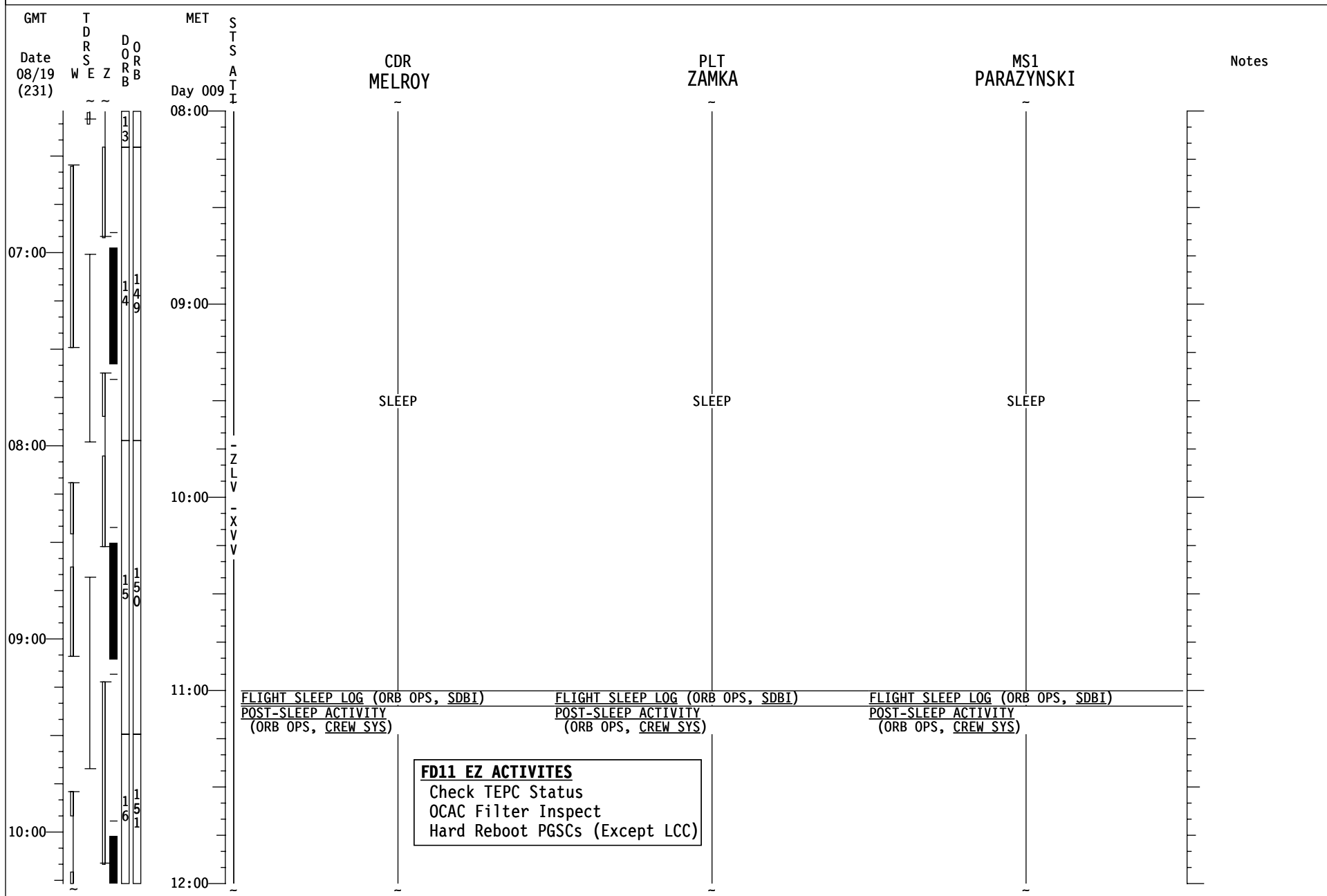



# STS-120 FD 11

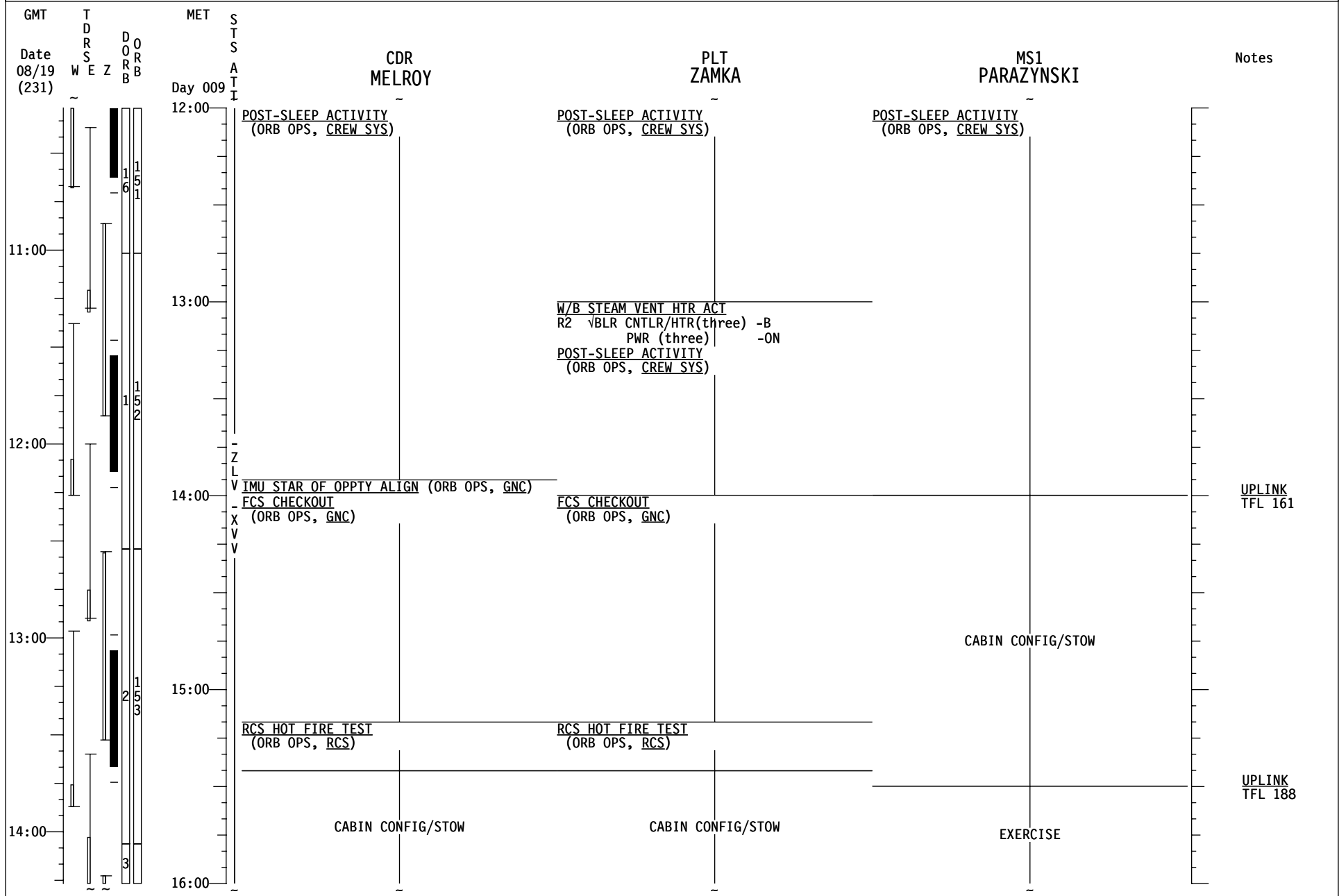



# STS-120 FD 11

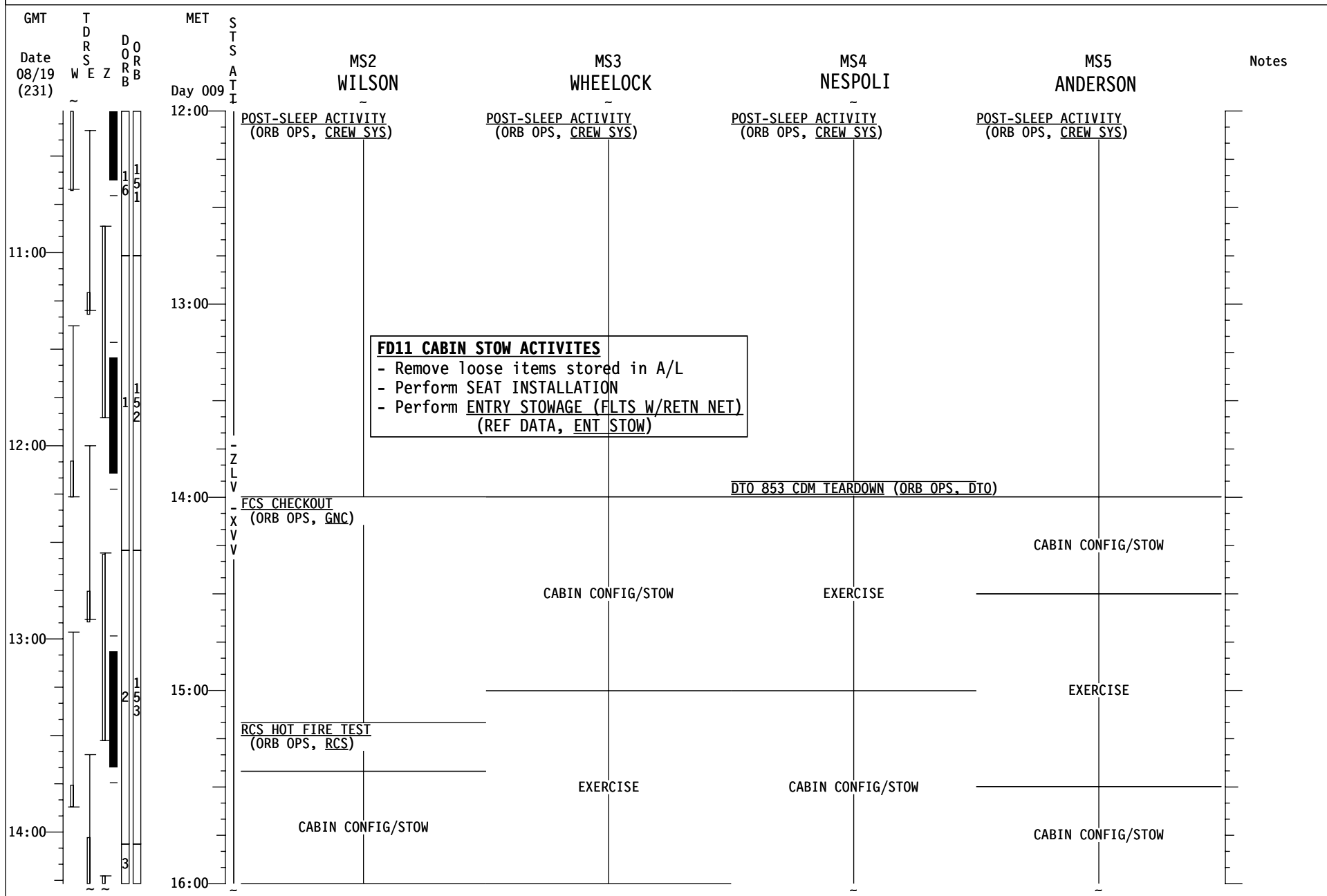

# STS-120 FD 11

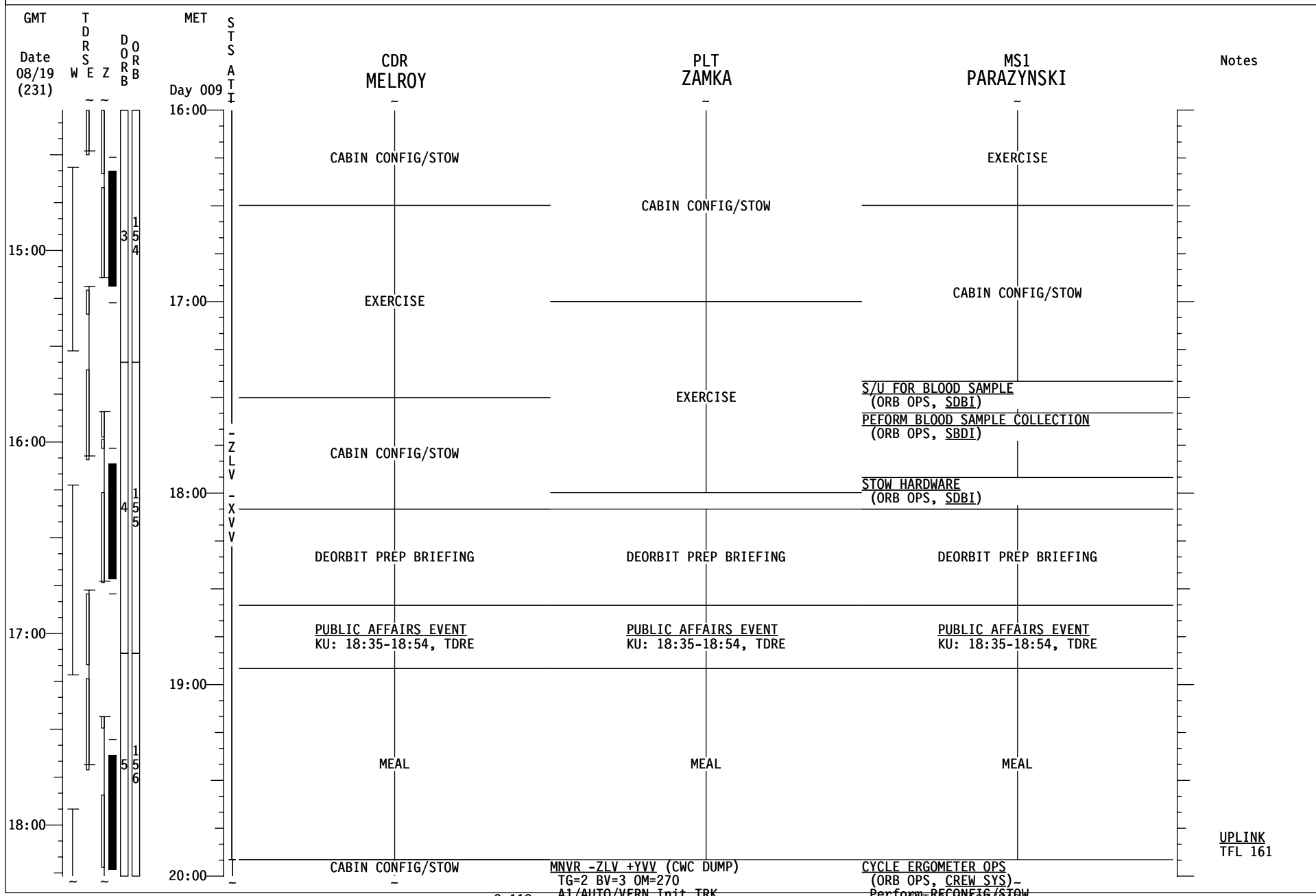



# STS-120 FD11

GMT	TDRSZ	DORB	MET	STS	CDR MELROY	PLT ZAMKA	MS1 PARAZYNSKI	Notes
Date 08/19 (231)	W E Z	DORB	Day 009	STATI				
19:00		1556	20:00		CABIN CONFIG/STOW	MNVR -ZLV +YVV (CWC DUMP) TG=2 BV=3 OM=270 A1/AUTO/VERN Init TRK CWC OVERBOARD DUMP (ORB OPS, ECLS)	CYCLE ERGOMETER OPS (ORB OPS, CREW SYS) Perform RECONFIG/STOW	
					LANDING-1 COMM C/O (ORB OPS, COMM/INST) MLA AOS: LOS:		LAUNCH ENTRY SUIT CHECK Verify Fit	
		1567	21:00	ZLV	CABIN CONFIG/STOW	CABIN CONFIG/STOW	RECUMBANT SEAT KIT (RSK) INSTALL (ORB OPS, CUE CARD)	
				+YVV				
20:00			22:00		LANDING-1 COMM C/O (ORB OPS, COMM/INST) MLA AOS: LOS:	CWC OVERBOARD DUMP (ORB OPS, ECLS)		
		1578			CABIN CONFIG/STOW	MNVR (TRK) -ZLV -XVV TG=2 BV=3 OM=0 A1/AUTO/VERN Init TRK	CABIN CONFIG/STOW	
21:00			23:00	ZLV	PILOT WITH RHC (ORB OPS, PGSC)	PILOT WITH RHC (ORB OPS, PGSC)		
				-XVV			DEACTIVATION AND TEARDOWN (ORB OPS, WLE SENSORS)	
22:00		1589					COLOR PRINTER STOW (ORB OPS, PGSC)	
			00:00					



# STS-120 FD 11

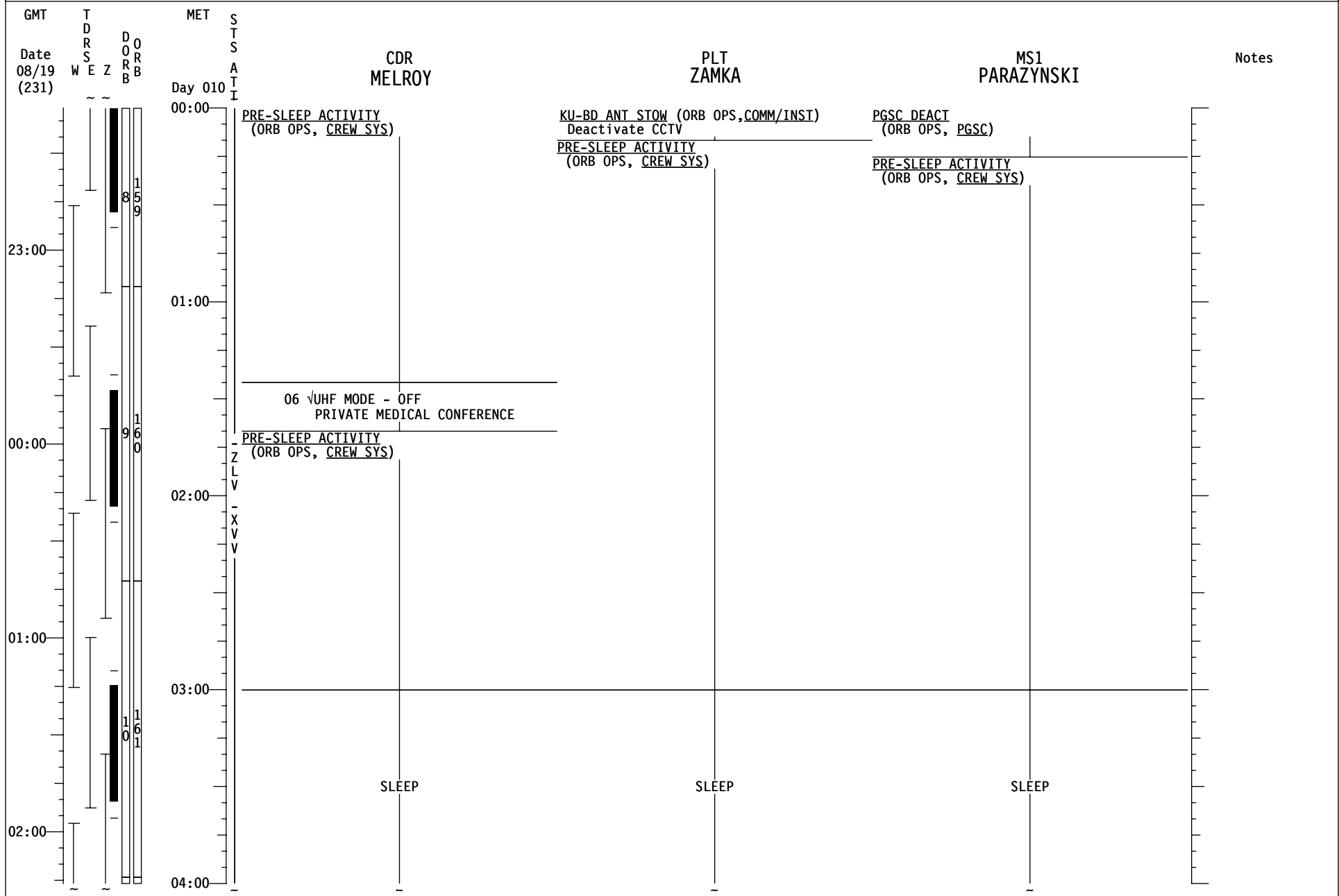

# STS-120 FD11

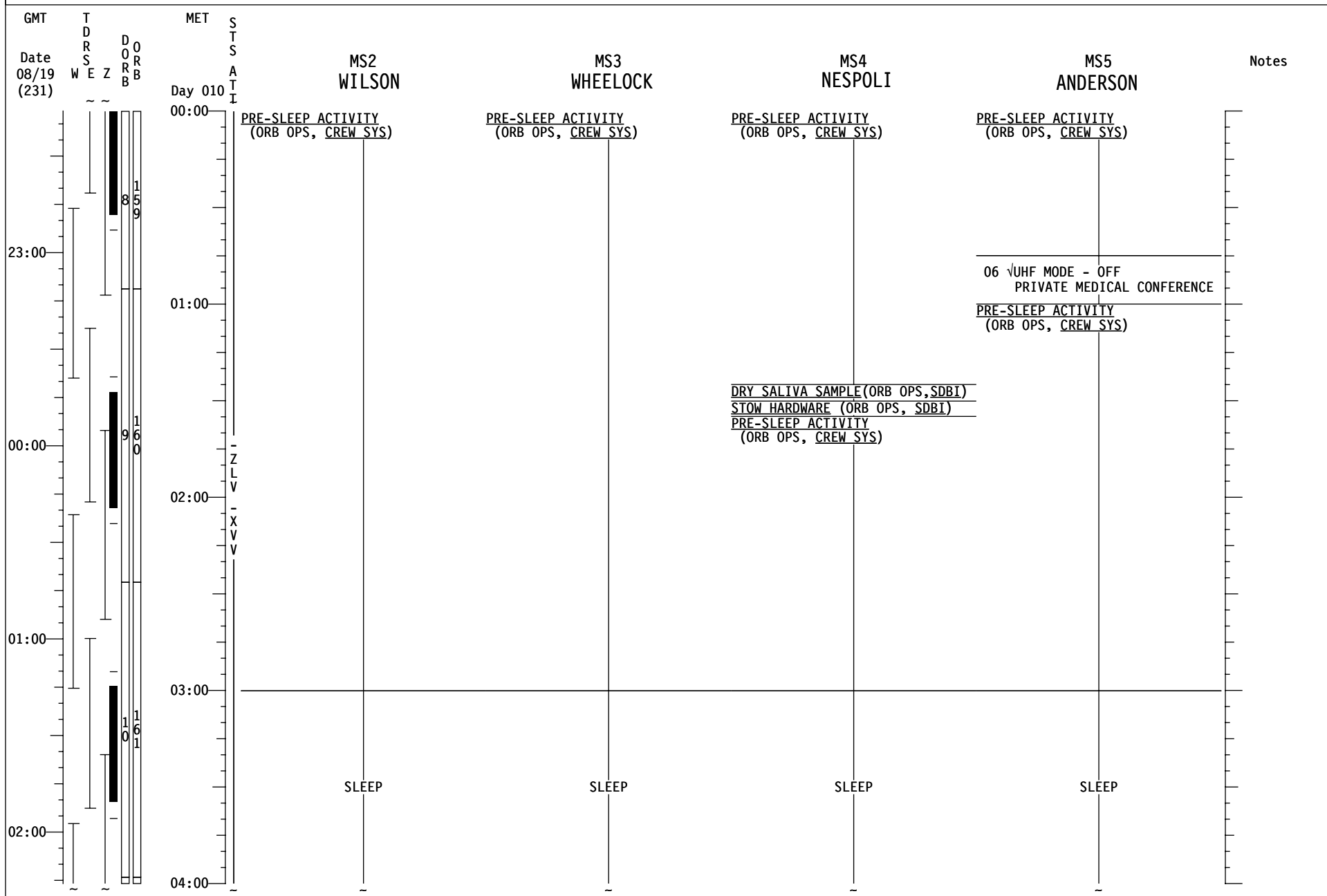

# STS-120 FD11

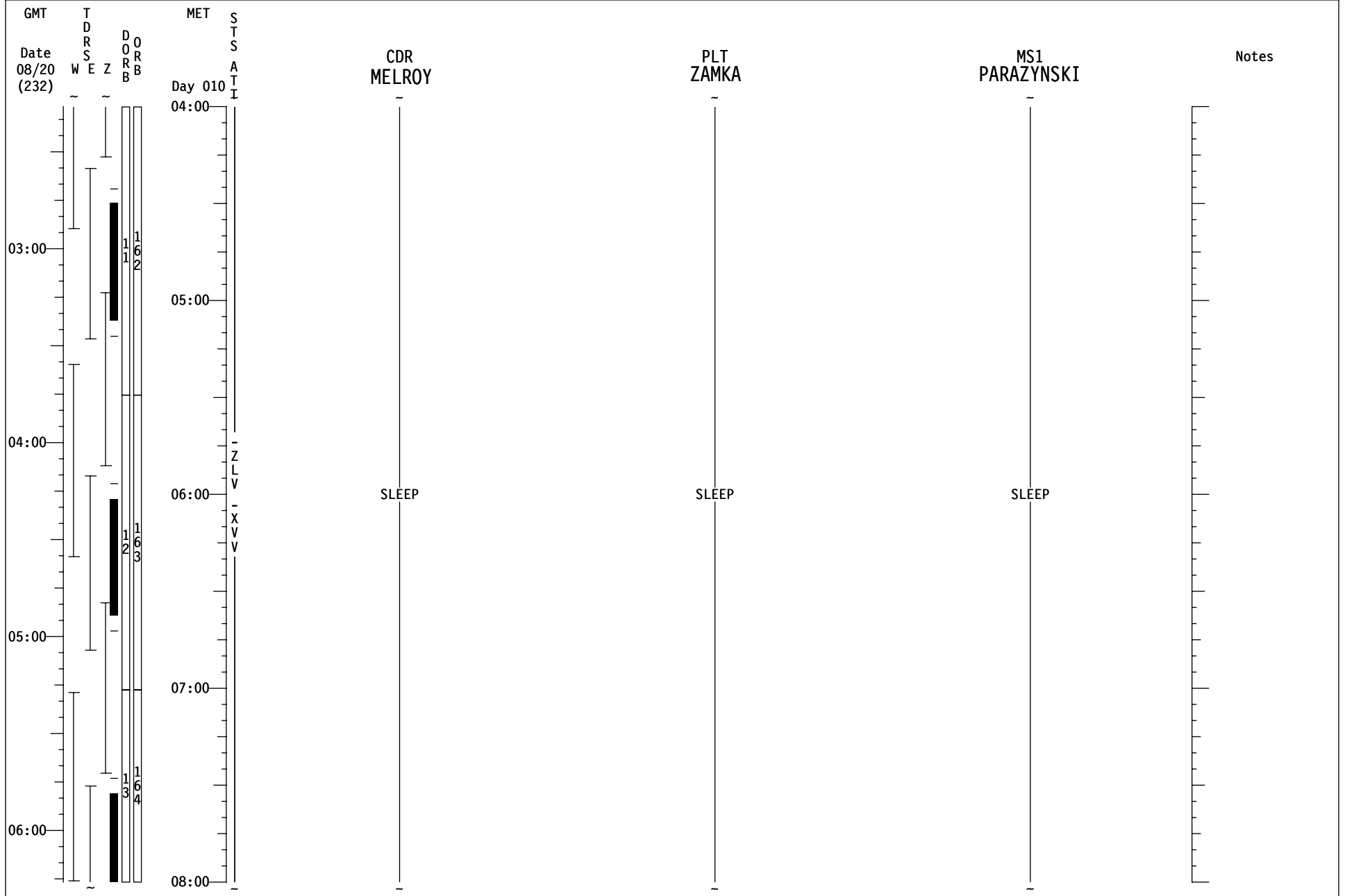







# STS-120 FD12

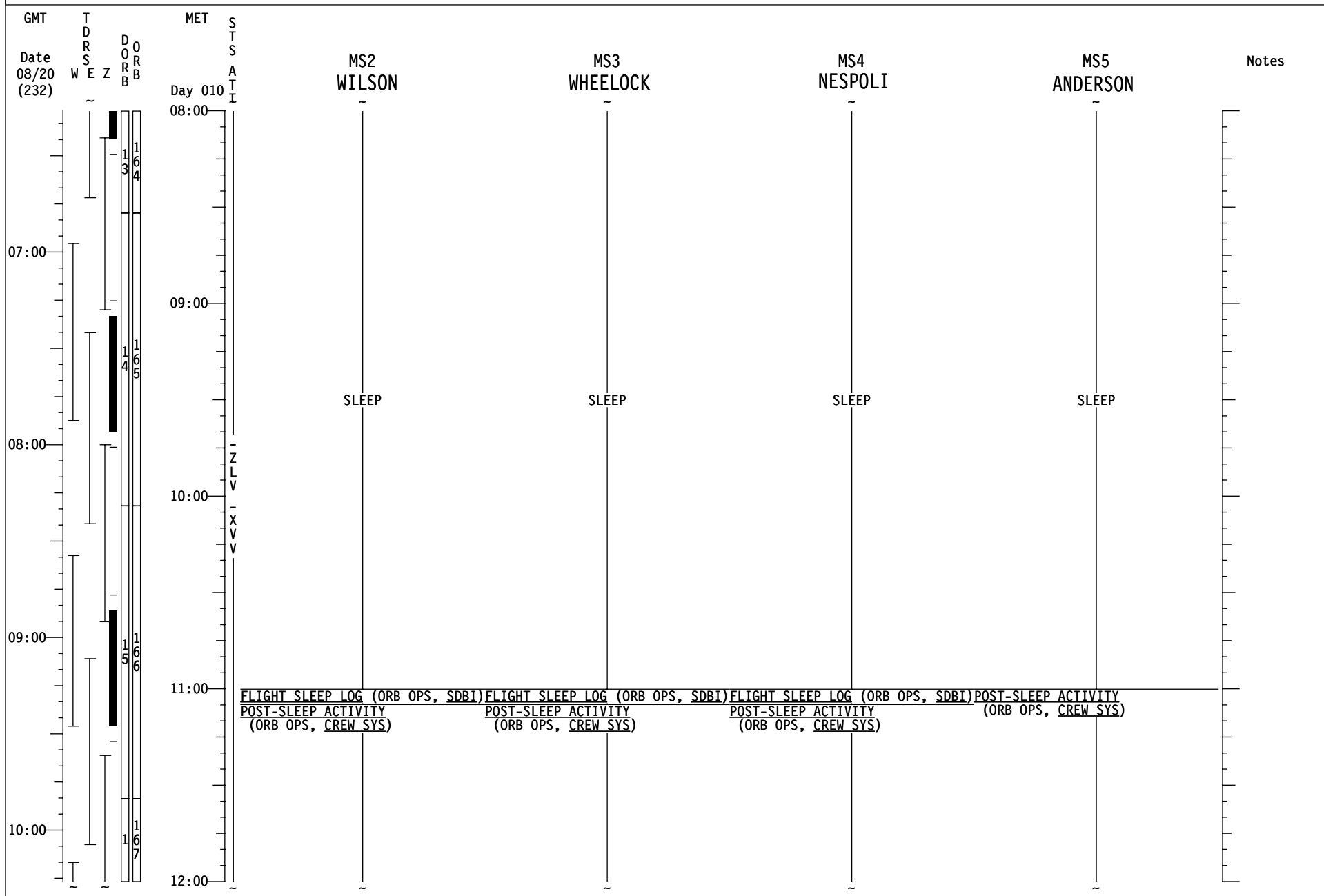

# STS-120 FD12

GMT	T D R S E Z	D O R B	MET	S T S	CDR MELROY	PLT ZAMKA	MS1 PARAZYNSKI	Notes
Date 08/20 (232)	W E Z	D O R B	Day 010	A T I				
12:00					POST-SLEEP ACTIVITY (ORB OPS, CREW SYS)	POST-SLEEP ACTIVITY (ORB OPS, CREW SYS)	POST-SLEEP ACTIVITY (ORB OPS, CREW SYS)	
11:00		167			06 UHF MODE - OFF PRIVATE MEDICAL CONFERENCE			
13:00					POST-SLEEP ACTIVITY (ORB OPS, CREW SYS)			
12:00		268			DOFF ACTIWATCH (ORB OPS, SDBI) PRIORITY PWRUP GRP B (ORB PKT, PRIOR PWRDN) In Step 6, Dual G2 In Step 12, Recover IMU 3	DOFF ACTIWATCH (ORB OPS, SDBI) PRIORITY PWRUP GRP B (ORB PKT, PRIOR PWRDN) In Step 6, Dual G2 In Step 12, Recover IMU 3		
14:00					MNVR IMU STAR ALIGN ATT A (pg.3-130) A1/AUTO/VERN (13:40) Init MNVR IMU ALIGN - S TRK (ORB OPS, GNC)			
					MNVR IMU VERIF ATT B (pg.3-130) A1/AUTO/VERN (13:55) Init MNVR IMU ALIGN - S TRK (ORB OPS, GNC) Step 5			
13:00					MNVR (TRK) -XSI ATT TG=4 BV=5 P=184 Y=0 OM=270 A1/AUTO/VERN (14:10) Init TRK	TISSUE EQUIVALENT PROPORTIONAL COUNTER (TEPC) (ORB OPS, CREW SYSTEMS) Perform POWERDOWN	AIR SAMPLE; Rcd MET and loc. on bottle DOFF ACTIWATCH (ORB OPS, SDBI)	
					<b>GO TO DEORBIT PREP AT 10/14:29</b>			
15:00		369			DEORBIT PREP	DEORBIT PREP	DEORBIT PREP	
14:00								
16:00								

# STS-120 FD12

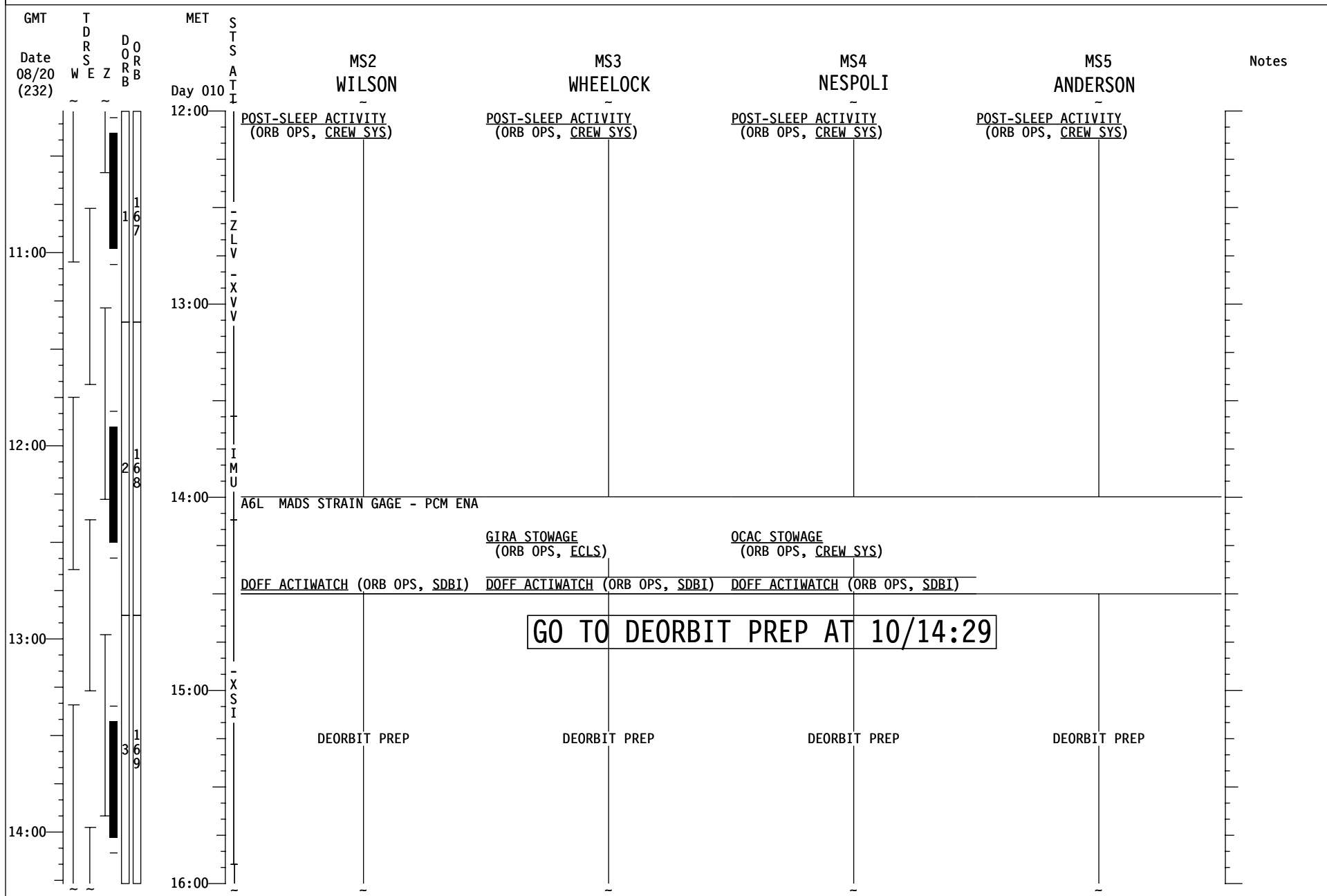

<b>A</b>	<u>IMU STAR ALIGN PAD</u>		
ID: -Y: 27, DENEK MET (10/13:19 TO 10/14:08)			
-Z: 30, ANTARES MET (10/13:24 TO 10/14:14)			
ANG DIFF: 91.7			
DUAL S TRKR ALIGNMENT		2nd ATTITUDE (SINGLE S TRKR) -Z: 27 -Y:30	
R 304	R 215	35	
P 27	P 27	42	
Y 350	Y 5	349	
REQD ID:			
-Y: ____, -Z: ____, ANG ERR ____, ____, __			
ANG:	1	2	3
$\Delta X$	( ) ____, ____, ( ) ____, ____, ( ) ____, ____,		
$\Delta Y$	( ) ____, ____, ( ) ____, ____, ( ) ____, ____,		
$\Delta Z$	( ) ____, ____, ( ) ____, ____, ( ) ____, ____,		
EXECUTION TIME: ____/____:____:____MET			

<b>B</b>	<u>IMU VERIFICATION STAR ALIGN PAD</u>		
ID: -Y: 35, NUNKI MET (10/13:31 TO 10/14:15)			
-Z: 57, ACAMAR MET (10/13:48 TO 10/14:36)			
ANG DIFF: 93.6			
DUAL S TRKR ALIGNMENT		2nd ATTITUDE (SINGLE S TRKR) -Z: 35 -Y: 57	
R 33	R 299	122	
P 341	P 316	332	
Y 346	Y 347	1	
REQD ID:			
-Y: ____, -Z: ____, ANG ERR ____, ____, __			
ANG:	1	2	3
$\Delta X$	( ) ____, ____, ( ) ____, ____, ( ) ____, ____,		
$\Delta Y$	( ) ____, ____, ( ) ____, ____, ( ) ____, ____,		
$\Delta Z$	( ) ____, ____, ( ) ____, ____, ( ) ____, ____,		
<b>If any <math>\Delta X</math>, <math>\Delta Y</math>, OR <math>\Delta Z</math> &gt; 0.1 Check MCC</b>			
EXECUTION TIME: ____/____:____:____MET			

The sections following this divider page will not be included in flight copies.

This Page Intentionally Blank



ATTITUDE TIMELINE

This Page Intentionally Blank

Attitude Timeline

MET/GMT	ORBITER		REF ATT/REMARKS	EVENT
	MNVR OPTION	DAP E/S/ $\beta$		
1 000/00:39:00 M  221/22:55:15 G	M50 (CALC) INRTL R = 184.00 MNVR P = 75.00 PYR Y = 39.00  MNVR TRN/AUTO/PRI HOLD (same)	RATE 0.5000 DB AT 3.50 DB RT 0.20  SUN R 227 P 87 $\beta = 47$	+X PYR R = 0.43 P = 11.71 Y = 359.87  LVLH 000/00:39:00 M 221/22:55:15 G	OMS-2 Posigrade Heads Up TIG 0/00:39:00 dv=96.8 fps GMTL: Aug 9,2007 GMTL:221/22:16:15
2 000/01:12:00 M 19:55  221/23:28:15 G 36:10	LVLH TRACK TGT = 2 P = 90.00 BV = 3 Y = 0.00 OM = 270.00  MNVR A5/AUTO/ALT HOLD (same)	RATE 0.2000 DB AT 5.00 DB RT 0.070  EARTH R 0 P 90 $\beta = 47$	LVLH R= 0.00 P=180.00 Y= 90.00	-ZLV +YVV PLBD Opening
3 000/03:15:00 M 25:06  222/01:31:15 G 41:21	M50 (CALC) INRTL R = 348.00 MNVR P = 101.00 PYR Y = 37.00  MNVR B1/AUTO/VERN HOLD (same)	RATE 0.2000 DB AT 1.000 DB RT 0.020  SUN R 50 P 74 $\beta = 47$	+X PYR R = 180.09 P = 347.94 Y = 0.25  LVLH 000/03:34:52 M 222/01:51:07 G	NC-1 Posigrade Heads Down TIG 0/03:35 dv=76.4 fps
4 000/03:40:00 M 54:59  222/01:56:15 G 02:11:14	LVLH TRACK TGT = 2 P = 90.00 BV = 3 Y = 0.00 OM = 0.00  MNVR A1/AUTO/VERN HOLD (same)	RATE 0.2000 DB AT 1.000 DB RT 0.020  EARTH R 0 P 90 $\beta = 46$	LVLH R= 0.00 P=180.00 Y= 0.00	-ZLV -XVV
5 000/16:30:00 M 45:00  222/14:46:15 G 15:01:15	M50 (CALC) INRTL R = 351.00 MNVR P = 100.00 PYR Y = 38.00  MNVR B1/AUTO/VERN HOLD (same)	RATE 0.2000 DB AT 1.000 DB RT 0.020  SUN R 46 P 74 $\beta = 44$	+X PYR R = 180.11 P = 348.39 Y = 359.61  LVLH 000/16:56:53 M 222/15:13:08 G	NC-2 Posigrade Heads Down TIG 0/16:57 dv=8.0 fps
6 000/17:00:00 M 01:38  222/15:16:15 G 17:53	LVLH TRACK TGT = 2 P = 90.00 BV = 5 Y = 0.00 OM = 160.00  MNVR A1/AUTO/VERN HOLD A14/AUTO/VERN	RATE 0.2000 DB AT 1.000 DB RT 0.020  EARTH R 0 P 90 $\beta = 44$	LVLH R=180.00 P= 0.00 Y=340.00	Bias -ZLV +XVV OBSS Unberth and Survey
7 000/18:00:00 M 07:15  222/16:16:15 G 23:30	TGT= 4 BV = 5 P = 0.00 Y = 40.00 OM = 40.00  MNVR A14/AUTO/VERN HOLD (same)	RATE 0.2000 DB AT 3.000 DB RT 0.200  SUN R 90 P 40 $\beta = 44$	INRTL R=138.59 P=233.54 Y= 76.05  RA= 139.317 DEC= 15.785N	BIAS +YSI STBD Wing Survey
8 000/19:30:00 M 39:58  222/17:46:15 G 56:13	TGT= 4 BV = 5 P = 304.00 Y = 0.00 OM = 125.00  MNVR A14/AUTO/VERN HOLD A14/AUTO/ALT	RATE 0.2000 DB AT 3.000 DB RT 0.200  SUN R 180 P 56 $\beta = 43$	INRTL R=256.59 P=186.12 Y=344.42  RA= 139.377 DEC= 15.767N	BIAS +YSI Nose Cap Survey
9 000/20:20:00 M 32:12  222/18:36:15 G 48:27	TGT= 4 BV = 5 P = 0.00 Y = 323.00 OM = 245.00  MNVR A14/AUTO/VERN HOLD (same)	RATE 0.2000 DB AT 3.000 DB RT 0.200  SUN R 270 P 37 $\beta = 43$	INRTL R= 38.34 P=171.77 Y= 73.04  RA= 139.410 DEC= 15.757N	BIAS -YSI PORT Wing Survey
10 000/20:46:27 M  222/19:02:42 G				NPC Multi-Axis  TIG 0/20:46:27 dv=1.4 fps

Attitude Timeline

MET/GMT	ORBITER		REF ATT/REMARKS	EVENT
	MNVR OPTION	DAP E/S/ $\beta$		
11 000/21:55:00 M 22:02:33  222/20:11:15 G 18:48	LVLH TRACK TGT = 2 P = 90.00 BV = 3 Y = 0.00 OM = 0.00  MNVR A14/AUTO/VERN HOLD A1/AUTO/VERN	RATE 0.2000 DB AT 3.000 DB RT 0.200  EARTH R 0 P 90 $\beta = 43$	LVLH R= 0.00 P=180.00 Y= 0.00	-ZLV -XVV OBSS Berth
12 001/02:10:00 M 25:00  223/00:26:15 G 41:15	M50 (CALC) INRTL R = 8.00 MNVR P = 281.00 PYR Y = 322.00  MNVR B1/AUTO/VERN HOLD (same)	RATE 0.2000 DB AT 1.000 DB RT 0.020  SUN R 136 P 107 $\beta = 42$	+X PYR R = 179.99 P = 348.24 Y = 0.32 LVLH 001/02:36:53 M 223/00:53:08 G	NC-3 Posigrade Heads Down TIG 1/02:37 dv=3.0 fps
13 001/02:40:00 M 54:58  223/00:56:15 G 01:11:13	LVLH TRACK TGT = 2 P = 90.00 BV = 3 Y = 0.00 OM = 0.00  MNVR A1/AUTO/VERN HOLD (same)	RATE 0.2000 DB AT 1.000 DB RT 0.020  EARTH R 0 P 90 $\beta = 42$	LVLH R= 0.00 P=180.00 Y= 0.00	-ZLV -XVV
14 001/13:15:00 M 22:30  223/11:31:15 G 38:45	LVLH TRACK TGT = 2 P = 90.00 BV = 3 Y = 0.00 OM = 270.00  MNVR A1/AUTO/VERN HOLD (same)	RATE 0.2000 DB AT 1.000 DB RT 0.020  EARTH R 0 P 90 $\beta = 39$	LVLH R= 0.00 P=180.00 Y= 90.00	-ZLV +YVV Simo Dump Future Load
15 001/15:05:06 M   223/13:21:21 G				NH Placeholder  TIG 1/15:05:06 dv=98.3
16 001/15:35:00 M 46:43  223/13:51:15 G 14:02:58	M50 (CALC) INRTL R = 149.00 MNVR P = 216.00 PYR Y = 336.00  MNVR A7/AUTO/ALT HOLD (same)	RATE 0.2000 DB AT 2.00 DB RT 0.100  SUN R 315 P 64 $\beta = 39$	+X PYR R = 359.92 P = 12.27 Y = 0.02 LVLH 001/15:52:33 M 223/14:08:48 G	NC-4 Posigrade Heads Up TIG 1/15:52 dv=91.0 fps
17 001/15:55:00 M 58:44  223/14:11:15 G 14:59	LVLH TRACK TGT = 2 P = 0.00 BV = 5 Y = 0.00 OM = 0.00  MNVR B7/AUTO/ALT HOLD A7/AUTO/VERN	RATE 0.5000 DB AT 2.00 DB RT 0.100  EARTH R 263 P 0 $\beta = 39$	LVLH R= 0.00 P=270.00 Y= 0.00	-Z Target Track Sunset 16:27
18 001/16:00:00 M 50:00  223/14:16:15 G 15:06:15	LVLH TRACK TGT = 2 P = 339.00 BV = 5 Y = 0.00 OM = 0.00  MNVR A7/AUTO/VERN HOLD (same)	RATE 0.0070 DB AT 1.000 DB RT 0.020  EARTH R 180 P 21 $\beta = 39$	LVLH R= 0.00 P=291.00 Y= 0.00	-Z Target Track
19 001/16:50:00 M 17:08:31  223/15:06:15 G 24:46	LVLH TRACK TGT = 2 P = 349.00 BV = 5 Y = 0.00 OM = 0.00  MNVR A7/AUTO/VERN HOLD (same)	RATE 0.0090 DB AT 1.000 DB RT 0.020  EARTH R 180 P 11 $\beta = 39$	LVLH R= 0.00 P=281.00 Y= 0.00	-Z Target Track
20 001/17:09:00 M 12:13  223/15:25:15 G 28:28	M50 (CALC) INRTL R = 147.00 MNVR P = 211.00 PYR Y = 339.00  MNVR A7/AUTO/ALT HOLD (same)	RATE 0.2000 DB AT 2.00 DB RT 0.100  SUN R 313 P 60 $\beta = 39$	+X PYR R = 359.99 P = 12.38 Y = 0.12 LVLH 001/17:22:26 M 223/15:38:41 G	Ti Posigrade Heads Up TIG 1/17:22 dv=9.0 fps

ALL ORBITER DATA IN  
MEAN OF 1950 AND PYR EULER SEQUENCE

Attitude Timeline

MET/GMT	ORBITER		REF ATT/REMARKS	EVENT
	MNVR OPTION	DAP E/S/ $\beta$		
21 001/17:30:00 M 34:20 223/15:46:15 G 50:35	LVLH TRACK TGT = 2 P = 358.00 BV = 5 Y = 0.00 OM = 0.00 MNVR B7/AUTO/ALT HOLD A7/AUTO/VERN	RATE 0.5000 DB AT 2.00 DB RT 0.100 EARTH R 180 P 2 $\beta = 39$	LVLH R= 0.00 P=272.00 Y= 0.00	-Z Target Track
22 001/17:35:00 M 18:46:26 223/15:51:15 G 17:02:41	LVLH TRACK TGT = 2 P = 310.00 BV = 5 Y = 0.00 OM = 0.00 MNVR A7/AUTO/VERN HOLD (same)	RATE 0.0112 DB AT 1.000 DB RT 0.020 EARTH R 180 P 50 $\beta = 39$	LVLH R= 0.00 P=320.00 Y= 0.00	-Z Target Track
23 001/18:47:00 M 19:00:20 223/17:03:15 G 16:35	LVLH TRACK TGT = 2 P = 270.00 BV = 5 Y = 0.00 OM = 0.00 MNVR A8/AUTO/VERN HOLD A9/AUTO/VERN	RATE 0.0500 DB AT 1.000 DB RT 0.020 EARTH R 180 P 90 $\beta = 38$	LVLH R= 0.00 P= 0.00 Y= 0.00	Establish RBAR Ti +01:18
24 001/19:05:00 M 07:00 223/17:21:15 G 23:15	COE (CALC) TGT = 2 P = 180.00 BV = 5 Y = 0.00 OM = 0.00 MNVR A9/AUTO/ALT HOLD A9/AUTO/VERN	RATE 0.7500 DB AT 2.00 DB RT 0.100 EARTH R 39 P 180 $\beta = 38$	+X PYR R = 0.00 P = 90.00 Y = 0.00 LVLH 001/19:05:00 M 223/17:21:15 G	RPM ORB R = 0.00 LVLH P = 90.00 Y = 0.00
25 001/19:07:00 M 09:00 223/17:23:15 G 25:15	COE (CALC) TGT = 2 P = 90.00 BV = 5 Y = 0.00 OM = 0.00 MNVR A9/AUTO/ALT HOLD A9/AUTO/VERN	RATE 0.7500 DB AT 2.00 DB RT 0.100 EARTH R 0 P 90 $\beta = 38$	+X PYR R = 0.00 P = 180.00 Y = 0.00 LVLH 001/19:07:00 M 223/17:23:15 G	RPM ORB R = 0.00 LVLH P = 180.00 Y = 0.00
26 001/19:09:00 M 11:00 223/17:25:15 G 27:15	COE (CALC) TGT = 2 P = 0.00 BV = 5 Y = 0.00 OM = 0.00 MNVR A9/AUTO/ALT HOLD A9/AUTO/VERN	RATE 0.7500 DB AT 2.00 DB RT 0.100 EARTH R 180 P 0 $\beta = 38$	+X PYR R = 0.00 P = 270.00 Y = 0.00 LVLH 001/19:09:00 M 223/17:25:15 G	RPM ORB R = 0.00 LVLH P = 270.00 Y = 0.00
27 001/19:11:00 M 13:00 223/17:27:15 G 29:15	COE (CALC) TGT = 2 P = 270.00 BV = 5 Y = 0.00 OM = 0.00 MNVR A9/AUTO/ALT HOLD A9/AUTO/VERN	RATE 0.7500 DB AT 2.00 DB RT 0.100 EARTH R 180 P 90 $\beta = 38$	+X PYR R = 0.00 P = 0.00 Y = 0.00 LVLH 001/19:11:00 M 223/17:27:15 G	RPM ORB R = 0.00 LVLH P = 0.00 Y = 0.00
28 001/19:18:00 M 29:40 223/17:34:15 G 45:55	LVLH TRACK TGT = 2 P = 179.00 BV = 5 Y = 0.00 OM = 0.00 MNVR A9/AUTO/ALT HOLD A9/AUTO/VERN	RATE 0.1300 DB AT 2.00 DB RT 0.100 EARTH R 0 P 179 $\beta = 38$	LVLH R= 0.00 P= 91.00 Y= 0.00	TORVA
29 001/20:17:00 M 223/18:33:15 G				Docking 1/20:17
30 001/20:45:00 M 21:14:56 223/19:01:15 G 31:11	COE (CALC) TGT = 2 P = 162.00 BV = 5 Y = 357.00 OM = 180.00 MNVR A12/AUTO/VERN HOLD A12/FREE/VERN	RATE 0.1000 DB AT 3.000 DB RT 0.050 EARTH R 350 P 162 $\beta = 38$	ISS YPR R = 356.85 P = 17.97 Y = 179.03 LVLH 001/20:45:00 M 223/19:01:15 G	Bias -XLV -ZVV Mated TEA Pre N2 Install (ORB CNTRL) ORB R = 180.93 LVLH P = 71.98 Y = 2.85

ALL ORBITER DATA IN  
MEAN OF 1950 AND PYR EULER SEQUENCE

Attitude Timeline

MET/GMT	ORBITER		REF ATT/REMARKS	EVENT
	MNVR OPTION	DAP E/S/ $\beta$		
31 002/23:18:45 M 19:35  224/21:35:00 G 50	COE (CALC) TGT = 2 P = 163.00 BV = 5 Y = 357.00 OM = 180.00  MNVR A15/FREE/VERN HOLD (same)	RATE 0.0200 DB AT 3.000 DB RT 0.080  EARTH R 350 P 163 $\beta = 33$	ISS YPR R = 356.86 P = 16.98 Y = 179.08  LVLH 002/23:18:45 M 224/21:35:00 G	Bias -XLV -ZVV Mated TEA Post N2 Install (ISS CNTRL) ORB R = 180.88 LVLH P = 72.98 Y = 2.87
32 004/14:00:00 M 02:30  226/12:16:15 G 18:45	COE (CALC) TGT = 2 P = 163.00 BV = 5 Y = 357.00 OM = 195.00  MNVR A12/AUTO/VERN HOLD (same)	RATE 0.1000 DB AT 3.000 DB RT 0.050  EARTH R 350 P 163 $\beta = 25$	ISS YPR R = 356.86 P = 16.98 Y = 194.08  LVLH 004/14:00:00 M 226/12:16:15 G	Bias -XLV +YVV Simo Dump  (ORB CNTRL) ORB R = 166.44 LVLH P = 74.24 Y = 7.12
33 004/15:45:00 M 47:30  226/14:01:15 G 03:45	COE (CALC) TGT = 2 P = 163.00 BV = 5 Y = 357.00 OM = 180.00  MNVR A12/AUTO/VERN HOLD A15/FREE/VERN	RATE 0.1000 DB AT 3.000 DB RT 0.050  EARTH R 350 P 163 $\beta = 24$	ISS YPR R = 356.86 P = 16.98 Y = 179.08  LVLH 004/15:45:00 M 226/14:01:15 G	Bias -XLV -ZVV Mated TEA Post Dump Return (ORB CNTRL) ORB R = 180.88 LVLH P = 72.98 Y = 2.87
34 004/21:13:45 M 17:36  226/19:30:00 G 33:51	COE (CALC) TGT = 2 P = 164.00 BV = 5 Y = 359.00 OM = 184.00  MNVR A15/FREE/VERN HOLD (same)	RATE 0.0200 DB AT 3.000 DB RT 0.080  EARTH R 356 P 164 $\beta = 23$	ISS YPR R = 358.96 P = 16.00 Y = 183.71  LVLH 004/21:13:45 M 226/19:30:00 G	Bias -XLV -ZVV Mated TEA P6 Overnite Park (ISS CNTRL) ORB R = 176.43 LVLH P = 74.10 Y = 2.06
35 006/16:15:00 M 25:10  228/14:31:15 G 41:25	COE (CALC) TGT = 2 P = 164.00 BV = 5 Y = 352.00 OM = 194.00  MNVR A15/FREE/VERN HOLD (same)	RATE 0.0200 DB AT 3.000 DB RT 0.080  EARTH R 333 P 162 $\beta = 14$	ISS YPR R = 351.68 P = 15.84 Y = 191.71  LVLH 006/16:15:00 M 228/14:31:15 G	Bias -XLV -ZVV Mated TEA Post P6 on P5 (ISS CNTRL) ORB R = 168.51 LVLH P = 76.13 Y = 11.33
36 006/22:00:00 M   228/20:16:15 G				P6 Outboard SAW Deploy 2B, 4B (In LVLH Att.) 6/22:00-7/00:30
37 008/13:40:00 M 14:07:53  230/11:56:15 G 12:24:08	COE (CALC) TGT = 2 P = 180.00 BV = 5 Y = 0.00 OM = 0.00  MNVR A12/AUTO/VERN HOLD (same)	RATE 0.1000 DB AT 3.000 DB RT 0.050  EARTH R 304 P 180 $\beta = 5$	ISS YPR R = 0.00 P = 0.00 Y = 0.00  LVLH 008/13:40:00 M 230/11:56:15 G	-XLV +ZVV Mnvr To Undock  (ORB CNTRL) ORB R = 0.00 LVLH P = 90.00 Y = 0.00
38 008/14:42:00 M   230/12:58:15 G				Undock 8/14:42
39 008/15:22:00 M 33:32  230/13:38:15 G 49:47	LVLH TRACK TGT = 2 P = 90.00 BV = 5 Y = 0.00 OM = 0.00  MNVR A9/AUTO/VERN HOLD (same)	RATE 0.1300 DB AT 1.000 DB RT 0.020  EARTH R 0 P 90 $\beta = 5$	LVLH R= 0.00 P=180.00 Y= 0.00	TORF -RBAR
40 008/15:33:33 M 45:05  230/13:49:48 G 14:01:20	LVLH TRACK TGT = 2 P = 0.00 BV = 5 Y = 0.00 OM = 0.00  MNVR A9/AUTO/VERN HOLD (same)	RATE 0.1300 DB AT 1.000 DB RT 0.020  EARTH R 270 P 0 $\beta = 5$	LVLH R= 0.00 P=270.00 Y= 0.00	TORF -VBAR

ALL ORBITER DATA IN  
MEAN OF 1950 AND PYR EULER SEQUENCE

Attitude Timeline

MET/GMT	ORBITER		REF ATT/REMARKS	EVENT
	MNVR OPTION	DAP E/S/ $\beta$		
41 008/15:45:06 M 56:38 230/14:01:21 G 12:53	LVLH TRACK TGT = 2 P = 270.00 BV = 5 Y = 0.00 OM = 0.00 MNVR A9/AUTO/VERN HOLD (same)	RATE 0.1300 DB AT 1.000 DB RT 0.020 EARTH R 180 P 90 $\beta = 5$	LVLH R= 0.00 P= 0.00 Y= 0.00	TORF +RBAR SEP-1 TIG 15:57
42 008/15:59:00 M 16:10:32 230/14:15:15 G 26:47	LVLH TRACK TGT = 2 P = 180.00 BV = 5 Y = 0.00 OM = 0.00 MNVR A9/AUTO/VERN HOLD (same)	RATE 0.1300 DB AT 1.000 DB RT 0.020 EARTH R 0 P 180 $\beta = 4$	LVLH R= 0.00 P= 90.00 Y= 0.00	TORF +VBAR
43 008/16:10:33 M 22:05 230/14:26:48 G 38:20	LVLH TRACK TGT = 2 P = 90.00 BV = 5 Y = 0.00 OM = 0.00 MNVR A9/AUTO/VERN HOLD A14/AUTO/VERN	RATE 0.1300 DB AT 1.000 DB RT 0.020 EARTH R 0 P 90 $\beta = 4$	LVLH R= 0.00 P=180.00 Y= 0.00	TORF -RBAR SEP-2 TIG 16:25 OBSS Unberth
44 008/16:35:00 M 42:30 230/14:51:15 G 58:45	LVLH TRACK TGT = 2 P = 90.00 BV = 3 Y = 0.00 OM = 270.00 MNVR A14/AUTO/VERN HOLD (same)	RATE 0.2000 DB AT 3.000 DB RT 0.200 EARTH R 0 P 90 $\beta = 4$	LVLH R= 0.00 P=180.00 Y= 90.00	-ZLV +YVV Simo Dump
45 008/19:10:00 M 23:53 230/17:26:15 G 40:08	TGT= 4 BV = 5 P = 0.00 Y = 40.00 OM = 54.00 MNVR A14/AUTO/VERN HOLD (same)	RATE 0.2000 DB AT 3.000 DB RT 0.200 SUN R 90 P 40 $\beta = 4$	INRTL R=199.40 P=181.19 Y= 71.32 RA= 146.892 DEC= 13.327N	BIAS +YSI STBD Wing Survey
46 008/20:25:00 M 34:04 230/18:41:15 G 50:19	TGT= 4 BV = 5 P = 304.00 Y = 0.00 OM = 125.00 MNVR A14/AUTO/VERN HOLD A14/AUTO/ALT	RATE 0.2000 DB AT 3.000 DB RT 0.200 SUN R 180 P 56 $\beta = 4$	INRTL R=259.10 P=185.11 Y=337.00 RA= 146.941 DEC= 13.310N	BIAS +XSI Nose Cap Survey
47 008/21:15:00 M 22:55 230/19:31:15 G 39:10	TGT= 4 BV = 5 P = 0.00 Y = 323.00 OM = 30.00 MNVR A14/AUTO/VERN HOLD (same)	RATE 0.2000 DB AT 3.000 DB RT 0.200 SUN R 270 P 37 $\beta = 3$	INRTL R=165.73 P=185.67 Y=356.29 RA= 146.973 DEC= 13.299N	BIAS -YSI PORT Wing Survey
48 008/22:30:00 M 39:51 230/20:46:15 G 56:06	LVLH TRACK TGT = 2 P = 90.00 BV = 3 Y = 0.00 OM = 0.00 MNVR A14/AUTO/VERN HOLD A1/AUTO/VERN	RATE 0.2000 DB AT 3.000 DB RT 0.200 EARTH R 0 P 90 $\beta = 3$	LVLH R= 0.00 P=180.00 Y= 0.00	-ZLV -XVV (OBSS Berth)
49 009/19:55:00 M 20:02:30 231/18:11:15 G 18:45	LVLH TRACK TGT = 2 P = 90.00 BV = 3 Y = 0.00 OM = 270.00 MNVR A1/AUTO/VERN HOLD (same)	RATE 0.2000 DB AT 1.000 DB RT 0.020 EARTH R 0 P 90 $\beta = 0$	LVLH R= 0.00 P=180.00 Y= 90.00	-ZLV +YVV CWC Dump
50 009/22:25:00 M 32:30 231/20:41:15 G 48:45	LVLH TRACK TGT = 2 P = 90.00 BV = 3 Y = 0.00 OM = 0.00 MNVR A1/AUTO/VERN HOLD (same)	RATE 0.2000 DB AT 1.000 DB RT 0.020 EARTH R 0 P 90 $\beta = -1$	LVLH R= 0.00 P=180.00 Y= 0.00	-ZLV -XVV

ALL ORBITER DATA IN  
MEAN OF 1950 AND PYR EULER SEQUENCE

Attitude Timeline

MET/GMT	ORBITER		REF ATT/REMARKS	EVENT
	MNVR OPTION	DAP E/S/ $\beta$		
51 010/13:35:00 M 48:26  232/11:51:15 G 12:04:41	INRTL R = 304.00 MNVR P = 27.00 Y = 350.00  MNVR A1/AUTO/VERN HOLD (same)	RATE 0.2000 DB AT 1.000 DB RT 0.020  SUN R 119 P 157 $\beta = -4$	-Y:27 Deneb 13:19-14:08 -Z:30 Antares 13:24-14:14	IMU Align  Pair AOS 13:24 Pair LOS 14:08
52 010/13:55:00 M 14:03:52  232/12:11:15 G 20:07	INRTL R = 33.00 MNVR P = 341.00 Y = 346.00  MNVR A1/AUTO/VERN HOLD (same)	RATE 0.2000 DB AT 1.000 DB RT 0.020  SUN R 113 P 145 $\beta = -4$	-Y:35 Nunki 13:31-14:15 -Z:57 Acamar 13:48-14:36	IMU Verif  Pair AOS 13:48 Pair LOS 14:15 Planar Sep 70.4
53 010/14:10:00 M 17:40  232/12:26:15 G 33:55	TGT= 4 BV = 5 P = 184.00 Y = 0.00 OM = 270.00  MNVR A1/AUTO/VERN HOLD (same)	RATE 0.2000 DB AT 1.000 DB RT 0.020  SUN R 180 P 176 $\beta = -4$	INRTL R=316.71 P= 11.47 Y=332.12  RA= 148.559 DEC= 12.747N	-XSI
54 010/16:00:00 M 11:40  232/14:16:15 G 27:55	M50 (CALC) INRTL R = 80.00 MNVR P = 340.00 PYR Y = 330.00  MNVR A1/AUTO/VERN HOLD (same)	RATE 0.2000 DB AT 1.000 DB RT 0.020  SUN R 90 P 150 $\beta = -4$	+Y PYR R = 359.96 P = 359.70 Y = 29.95 TCWIN 010/16:00:00 M 232/14:16:15 G	Comm Attitude
55 010/18:10:00 M 14:10  232/16:26:15 G 30:25	M50 (CALC) INRTL R = 126.00 MNVR P = 242.00 PYR Y = 333.00  MNVR TRN/AUTO/PRI HOLD (same)	RATE 0.5000 DB AT 3.50 DB RT 0.20  SUN R 5 P 73 $\beta = -5$	+X PYR R = 359.92 P = 191.59 Y = 359.87 LVLH 010/18:29:00 M 232/16:45:15 G	Deorbit Burn Orb 171 KSC EOM TIG 18:29



FLIGHT PLAN NOTES

## FLIGHT PLAN NOTES

### A. FLIGHT DESCRIPTION

Orbiter: OV-103 Discovery  
 Launch Window: 10 minutes  
 Inclination: 51.6°  
 Insertion Altitude: 124x85 nautical miles  
 Rendezvous Altitude: 187x182 nautical miles  
 Duration: 11+1+2

### B. SHUTTLE AND STATION CREW

CDR	– Pam Melroy	E16 FE-2 (up)	– Dan Tani
PLT	– George Zamka	E15 FE-2 (dn)	– Clay Anderson
MS1	– Scott Parazynski	E16 ISS CDR	– Peggy Whitson
MS2	– Stephanie Wilson	E16 FE-1	– Yuri Malenchenko
MS3	– Doug Wheelock		
MS4	– Paolo Nespoli		

### C. MAJOR EVENTS

<u>EVENT</u>	<u>FD</u>	<u>MET</u>	<u>GMT</u>	<u>CDT</u>
Launch	01	00/00:00	221/22:16	17:16 (8/09/07)
OMS-2	01	00/00:38	221/22:54	17:54 (8/09/07)
NC-1	01	00/03:35	222/01:51	20:51 (8/09/07)
NC-2	02	00/16:57	222/15:13	10:13 (8/10/07)
OBSS Survey	02	00/18:00	222/16:16	11:16 (8/10/07)
NPC	02	00/20:46	222/19:02	14:02 (8/10/07)
NC-3	02	01/02:37	223/00:53	19:53 (8/10/07)
NH	03	01/15:05	223/13:21	08:21 (8/11/07)
NC-4	03	01/15:52	223/14:08	09:08 (8/11/07)
Ti	03	01/17:22	223/15:38	10:38 (8/11/07)
Docking	03	01/20:17	223/18:33	13:33 (8/11/07)
OBSS Handoff	03	01/22:50	223/21:06	16:06 (8/11/07)
EVA 1	04	02/17:45	224/16:01	11:01 (8/12/07)
Node 2 Ingress	05	03/16:00	225/14:16	09:16 (8/13/07)
OBSS Handoff	05	03/21:00	225/19:16	14:16 (8/13/07)
EVA 2	06	04/17:15	226/15:31	10:31 (8/14/07)
P6 Handoff SRMS	07	05/14:30	227/12:46	07:46 (8/15/07)
P6 Handoff SSRMS	07	05/22:45	227/21:01	16:01 (8/15/07)
EVA 3	08	06/16:45	228/15:01	10:01 (8/16/07)
P6 2B SAW Deploy	08	06/23:25	228/21:41	16:41 (8/16/07)
P6 4B SAW Deploy	08	07/01:00	228/23:16	18:16 (8/16/07)
Hatch Closure	09	07/22:30	229/20:46	15:46 (8/17/07)
Undocking	10	08/14:42	230/12:58	07:58 (8/18/07)
Sep-1	10	08/15:57	230/14:13	09:13 (8/18/07)
Sep-2	10	08/16:25	230/14:41	09:41 (8/18/07)
OBSS Late Survey	10	08/19:10	230/17:26	12:26 (8/18/07)
Deorbit	12	10/18:29	232/16:45	11:45 (8/20/07)
Landing	12	10/19:32	232/17:48	12:48 (8/20/07)

FLIGHT PLAN NOTES

#### D. LANDING OPPORTUNITIES

		<u>Landing Orbit #</u>	<u>Site</u>	<u>TIG MET</u>	<u>Landing MET</u>	<u>Landing GMT</u>	<u>Landing CDT</u>
Nominal	Primary	171	KSC	10/18:29	10/19:32	232/17:48	12:48, 8/20/07
	1 Rev	172	KSC	10/20:05	10/21:07	232/19:23	14:23, 8/20/07
	Late Weather Alt	173	EDW	10/21:35	10/22:37	232/20:53	15:53, 8/20/07
EOM +1	Primary	186	KSC	11/17:16	11/18:19	233/16:35	11:35, 8/21/07
	1 Rev	187	KSC	11/18:52	11/19:54	233/18:10	13:10, 8/21/07
	Late Weather Alt	188	EDW	11/20:22	11/21:24	233/19:41	14:40, 8/21/07
EOM +2	Primary	202	KSC	12/17:39	12/18:41	234/16:58	11:57, 8/22/07
	1 Rev	203	KSC	12/19:15	12/20:17	234/18:33	13:33, 8/22/07
	Late Weather Alt	204	EDW	12/20:44	12/21:47	234/20:03	15:03, 8/22/07

#### E. COMMUNICATIONS

The Summary Timeline contains several databands for ground site and TDRS events. The TDRS band reflects the three TDRS satellites that will be used for orbiter coverage (East, West, and Z) and their longitudinal positions. The data shown contain Ku-band coverage (unshaded bars) as well as TDRS SHO schedule (solid bars). The SHO schedule depicts early, normal, and midpass handovers and closed or extended Z satellite coverage.

The GND band contains the AOS/LOS of the U.S. ground sites used for the L-1 Comm Checks and for deorbit and landing comm. MLA and DFA are for Kennedy Space Center and Edwards Air Force Base respectively, and WSS is for White Sands Space Harbor (which is needed on wave-off opportunities only).

TDRS Z currently does not have the capability for DTV, and therefore cannot be used for critical damage detection. TDRS Z is not desirable for PAO events, however the events can be scheduled on TDRS Z. OCA downlink is limited to 2Mbps on TDRS Z.

Prime TDRS Support: East (LON: -46° W), West (LON: -171° W), Z (LON: -275° W)

B/U TDRS Support: East (LON: -41° W), West (LON: -174° W)

Ground Sites: MLA, WLP, WSS, AGO, DFR

Contingency RTS: DGS, GTS, HTS, OTS, CTS, VTS, NHS

## F. PAYLOADS

### LAUNCH PACKAGE (LP) 10A

The 10A LP consists of the ISS Node 2, a sidewall-mounted Power and Data Grapple Fixture (PDGF), a sidewall-mounted Main Bus Switching Unit (MBSU), and a sidewall-mounted S-band Antenna Support Assembly (SASA) Flight Support Equipment (FSE) in the cargo bay. The PDGF is mounted using an Increased Capability Adaptive Payload Carrier (ICAPC), and the MBSU and SASA FSE are mounted using Small Payload Accommodations (SPAs) beams. The Node 2 module contains four avionics system racks capable of initial activation of Node 2, two Resupply Stowage Racks (RSRs), and two empty zero-g stowage racks.

The LP also consists of ISS equipment, supplies, crew rotation equipment, and ISS utilization middeck payloads in the orbiter crew compartment.

The Return Complement (RC) consists of middeck return items, including the Baseband Signal Processor (BSP), crew rotation equipment, and ISS utilization payloads. The RC also consists of cargo bay hardware including the failed SASA.

Node 2 is installed on the Node 1 port Active Common Berthing Mechanism (ACBM) and shell heaters are activated. Node 2 EV and IV outfitting tasks are completed including installation of the PDGF onto Node 2. The P6 truss is relocated from Z1 to P5 and its SAWs and PVR deployed. The failed SASA and BSP are retrieved from Z1 and returned by the shuttle. A spare MBSU is installed on ESP-2. S1 radiator panels are deployed. The S0 4BC Remote Power Control Mechanism (RPCM) is replaced. E15 and E16 FE-2 crewmembers are rotated and crew rotation equipment is transferred.

## G. SECONDARY PAYLOADS

### 1. Perceptual Motor Deficits In Space (PMDIS)

The PMDIS objective is to determine if perceptual motor performance deficits observed in earlier missions are due to postural instability or represent central nervous system deficits. The equipment used is a laptop computer with touch screen, joystick, and reaction switches; mounted on a lap-table tray. PMDIS allows crewmembers to respond to visual stimuli and measures their response accuracy.

The equipment is set up in the Lab prior to docking. After docking, and no later than 96 hours after launch, a shuttle crewmember will complete a data session and an ISS crewmember will stow the hardware to be returned on shuttle.

### 2. Ram Burn Observation (RAMBO) - payload of opportunity

RAMBO requires state vector information to determine whether data take opportunities are available. The payload does not require dedicated orbiter burns.

### 3. Maui Analysis of Upper Atmospheric Injections (MAUI) - payload of opportunity

MAUI requires state vector information to determine whether data take opportunities are available. The payload may request dedicated OMS, RCS, or VRCS burns if appropriate overflight opportunities exist and if propellant and crew time are available.

## H. ON ORBIT SHORT DURATION BIOASTRONAUTICS INVESTIGATIONS (SDBI'S)

### 1. Bioavailability and Performance Effects of Promethazine During Space Flight (SDBI 1490B)

PMZ is the anti-motion sickness medication of choice for treating SMS during shuttle missions. However, there are side effects with PMZ use that could impact crew performance. The objective of this SDBI is to establish a dose/response relationship to PMZ, estimate bioavailability of PMZ from the various routes of drug administration, and compare and contrast the effects of flight related variables and PMZ administration on sleep quality and efficiency.

All participants will don an Actiwatch monitor as soon as possible on orbit and wear it throughout the mission. Participants will also complete a sleep log each morning at wakeup. If the participant experiences SMS, he/she will take PMZ and collect saliva samples at various time intervals. This SDBI shares the Actiwatch and logbook with SDBI 1634.

### 2. Test of Midodrine as a Countermeasure Against Postflight Orthostatic Hypotension (SDBI 1503-S)

This study is designed to evaluate a new pharmacological countermeasure for protection from postflight orthostatic hypotension. This experiment will measure the efficacy of midodrine in reducing the incidence and/or severity of orthostatic hypotension in returning astronauts.

Participants will ingest a 10-mg midodrine pill between deorbit TIG and landing.

### 3. Sleep-Wake Actigraphy and Light Exposure During Space Flight (SDBI 1634)

The success and effectiveness of manned space flight depends on the ability of crew members to maintain a high level of cognitive performance and vigilance while operating and monitoring sophisticated instrumentation. Astronauts however commonly experience sleep disruption and misalignment of circadian phase during space flight, conditions associated with insomnia and associated impairment of alertness and cognitive performance. This experiment will use state-of-the-art technology to monitor sleep-wake activity and light exposure patterns obtained in-flight. This data will help explain the effects of space flight on sleep as well as aid in the development of effective countermeasures for both short and long-duration spaceflight.

All participants will don an Actiwatch monitor as soon as possible on orbit and wear it throughout the mission. Participants will also complete a sleep log each morning at wakeup. This SDBI shares the Actiwatch and logbook with SDBI 1490B.

### 4. Validation of Procedures for Monitoring Immune Function (Integrated Immune) (SDBI 1900)

There is evidence to suggest that space flight leads to immune system dysregulation. This may be a result of microgravity, confinement, physiological stress, radiation, environment, or other mission related factors. The purpose of this SDBI is to assess the clinical risks resulting from adverse effects of spaceflight on the human immune system, and to validate a flight-compatible immune monitoring strategy. This data is required so that appropriate countermeasures can be validated.

Participants will supply saliva and blood samples. Liquid saliva samples are collected every other day at wakeup. A shuttle crewmember will collect dry saliva samples throughout a day as early as possible in the mission and again on EOM-1. An ISS crewmember will collect dry saliva samples throughout a day as late as possible in the docked mission. An ISS crewmember will give a blood sample as late as possible prior to undock, and a shuttle crewmember will give a blood sample on EOM-1. Both blood samples will be drawn by a shuttle crewmember.

## I. STATION DEVELOPMENT TEST OBJECTIVE (SDTO)

### ISS Structural Life Validation and Extension (SDTO 13005-U)

The objective of this SDTO is to accurately determine ISS structural life usage, to expand ISS operations, and to increase the life of the structure. Structural life estimates are based on worst case loading conditions using finite element models of structures and forcing function estimations. It is desirable to reduce this conservatism through post-flight reconstructions using correlated models, validated forcing functions, measured ISS response data, and actual on orbit loading conditions. This reconstruction requires actual or educated estimates of input (forcing function) and actual output (sensor measurements) of the ISS response.

The specific test involves IWIS data takes during Node 2 Installation.

## J. ON ORBIT DETAILED TEST OBJECTIVE (DTO)

### In-Flight Evaluation for Areas of CO<sub>2</sub> Concentration (DTO 853)

The purpose of this DTO is to evaluate CO<sub>2</sub> levels at mission specific times and in suspect areas of the orbiter where the potential exists for elevated CO<sub>2</sub> levels. Data sample locations are dependent upon crew sleep and high-activity periods, as these are times when CO<sub>2</sub> symptoms have been reported by previous crews and CO<sub>2</sub> peaks have been experienced. Data will be used to identify 'hot spots' in the orbiter and engineering evaluations will be made to fine tune air exchange analyses and determine if configuration changes are necessary to optimize airflow.

CO<sub>2</sub> levels are recorded using the Carbon Dioxide Monitor (CDM), a portable handheld device designed to monitor and quantify CO<sub>2</sub> concentrations. The CDM is setup in pre-sleep and deactivated in post-sleep, so that data takes occur during five sleep periods when the shuttle crew is sleeping in the middeck.

KU BAND ANTENNA MASKING PLAN

KU BAND ANT  
MASKING

## KU BAND ANTENNA MASKING PLAN

APPROX. MET (ALL TIMES APPROXIMATE)	MODE	EVENT	DESCRIPTION
000/01:45:00	Beta 21 + Mask	Ku-band deploy	Standard mode used for Orbiter with all payloads within PLB envelope  SRMS ON-ORBIT INIT
000/04:00:00	Beta 21 + Mask with box:  A1: $26 \leq AZ \leq 110$ $-90 \leq EL \leq -30$	SRMS Power-up	Protects the SRMS during C/O operations  RMS PWRUP RMS C/O PRECRDL
000/04:15:00	Beta 0 Only	RMS C/O	Standby for the crew designated SRMS trajectories if the position goes Starboard
000/05:05:00	Beta 21 + Mask	Post Pre-cradle	Unmated, standard mode used for Orbiter with all payloads within PLB envelope
000/17:00:00	Beta 21 Only with box:  A2: $-90 \leq AZ \leq 110$ $-90 \leq EL \leq 0$	OBSS Unberth through Flat Field Positions	Protects the SRMS during OBSS Unberth and initial survey operations  OBSS UNBERTH FLAT FIELD
000/18:00:00	Beta 21 Only with box:  A3: $-132 \leq AZ \leq 80$ $-90 \leq EL \leq 60$	OBSS STBD Survey	Protects SRMS during survey operations  OBSS STBD SURVEY
000/19:30:00	Beta 12 Only:	Nose Cap Survey	Protects SRMS during survey operations  NOSE CAP SURVEY  NOTE: Do not initiate until SRMS in NOSE CAPE ACAS Start
000/21:20:00	Beta 21 Only with box:  A2: $-90 \leq AZ \leq 110$ $-90 \leq EL \leq 0$	Port Wing Survey and OBSS Berth	Protects SRMS during survey operations  OBSS PORT SURVEY OBSS BERTH
000/23:25:00	Beta 21 + Mask	SRMS Post Pre-cradle	SRMS back in Pre-Cradle Posn. Standard mode used for Orbiter with all payloads within PLB envelope

KU BAND ANT  
MASKING



APPROX. MET (ALL TIMES APPROXIMATE)	MODE	EVENT	DESCRIPTION
001/19:45:00	Beta 21 Only with box:  B1: $-35 \leq AZ \leq 45$ $-35 \leq EL \leq 40$	RNDZ at 765 ft	Post MC-2 to protect the ISS Ku-band antenna
001/20:00:00	Beta 21 Only with box:  C1: $-13 \leq AZ \leq 46$ $-66 \leq EL \leq 75$  C2: $-37 \leq AZ \leq -8$ $-28 \leq EL \leq 44$  C3: $-83 \leq AZ \leq -32$ $-13 \leq EL \leq 39$	ISS at 105 ft	Protects the ISS Ku-band antenna, ISS structure during approach, ISS structure while mated  SRMS @ Pre-Cradle Posn SSRMS @ Docked Viewing Posn
001/22:30:00	Beta 0 Only with box:  C1: $-13 \leq AZ \leq 46$ $-66 \leq EL \leq 75$  C2: $-37 \leq AZ \leq -8$ $-28 \leq EL \leq 44$  C3: $-83 \leq AZ \leq -32$ $-13 \leq EL \leq 39$  D1: $-76 \leq AZ \leq -13$ $-85 \leq EL \leq -45$	OBSS operations	Protects ISS structure while mated, and for use during OBSS Unberth and H/O procedures  1.110 OBSS Unberth & H/O 1.111 OBSS Ungrapple @ H/O OBSS H/O f/m SSRMS to SRMS
002/01:30:00	Beta 21 Only with box:  C1: $-13 \leq AZ \leq 46$ $-66 \leq EL \leq 75$  C2: $-37 \leq AZ \leq -8$ $-28 \leq EL \leq 44$  C3: $-83 \leq AZ \leq -32$ $-13 \leq EL \leq 39$	OBSS operations completed	Protects ISS structure while mated, and for OBSS on SRMS in H/O Posn  SSRMS @ OBSS Grapple Backoff Posn

APPROX. MET (ALL TIMES APPROXIMATE)	MODE	EVENT	DESCRIPTION
002/18:00:00	Beta 0 Only with box:  C1: $-13 \leq AZ \leq 46$ $-66 \leq EL \leq 75$  C2: $-37 \leq AZ \leq -8$ $-28 \leq EL \leq 44$  C3: $-83 \leq AZ \leq -32$ $-13 \leq EL \leq 39$  E1: $-45 \leq AZ \leq 125$ $-66 \leq EL \leq 62$	EVA#1 and SSRMS through SASA retrieve & stow, Node2 Unberth and Install	Protects ISS structure, EVA operations, and SSRMS operations for EVA support and for Node2 Install  1.210 Setup for EVA#1 1.220 SASA Retrieve and Stow 1.310 Berthed Node2 Grapple 1.311 Node2 Unberth to Install 1.312 Node2 Mated Ungrapple 1.120 MNVR to OBSS H/O Pre-Grapple SRMS @ Node2 Viewing Posn
003/01:00:00	Beta 21 Only with box:  C1: $-13 \leq AZ \leq 46$ $-66 \leq EL \leq 75$  C2: $-37 \leq AZ \leq -8$ $-28 \leq EL \leq 44$  C3: $-83 \leq AZ \leq -32$ $-13 \leq EL \leq 39$	EVA#1 operations concluded	Protects ISS structure, and MT/SSRMS operations while mated  SRMS @ Node2 Viewing Posn SSRMS @ OBSS H/O Pre-Grapple Posn
003/16:00:00	Beta 0 Only with boxes TBD	Focused Inspection	Standby for the Focused Inspection trajectories if the positions are beyond current masking
003/20:00:00	Beta 21 Only with box:  C1: $-13 \leq AZ \leq 46$ $-66 \leq EL \leq 75$  C2: $-37 \leq AZ \leq -8$ $-28 \leq EL \leq 44$  C3: $-83 \leq AZ \leq -32$ $-13 \leq EL \leq 39$	Focused Inspection operations concluded	Protects ISS structure, and MT/SSRMS operations while mated

APPROX. MET (ALL TIMES APPROXIMATE)	MODE	EVENT	DESCRIPTION
003/21:00:00	Beta 0 Only with box:  C1: $-13 \leq AZ \leq 46$ $-66 \leq EL \leq 75$  C2: $-37 \leq AZ \leq -8$ $-28 \leq EL \leq 44$  C3: $-83 \leq AZ \leq -32$ $-13 \leq EL \leq 39$  D1: $-76 \leq AZ \leq -13$ $-85 \leq EL \leq -45$	OBSS operations	Protects ISS structure while mated, and for use during OBSS H/O and Berth procedures  1.121 OBSS Grapple & Berth 1.122 Berthed OBSS Ungrapple
004/01:00:00	Beta 21 Only with box:  C1: $-13 \leq AZ \leq 46$ $-66 \leq EL \leq 75$  C2: $-37 \leq AZ \leq -8$ $-28 \leq EL \leq 44$  C3: $-83 \leq AZ \leq -32$ $-13 \leq EL \leq 39$	OBSS operations completed	Protects ISS structure while mated  SRMS @ Pre-Cradle Posn SSRMS @ OBSS Grapple Backoff Posn
004/14:00:00	Beta 0 Only with box:  C1: $-13 \leq AZ \leq 46$ $-66 \leq EL \leq 75$  C2: $-37 \leq AZ \leq -8$ $-28 \leq EL \leq 44$  C3: $-83 \leq AZ \leq -32$ $-13 \leq EL \leq 39$  E2: $-30 \leq AZ \leq 70$ $-30 \leq EL \leq 80$	SSRMS Walkoff and EVA#2 and P6 Detach Operations	Protects ISS structure, EVA2 operations, and SSRMS Walkoff from MBS  1.610 SSRMS Walkoff to MBS PDGF3 1.611 Lab PDGF Ungrapple
005/01:00:00	Beta 21 Only with box:  C1: $-13 \leq AZ \leq 46$ $-66 \leq EL \leq 75$  C2: $-37 \leq AZ \leq -8$ $-28 \leq EL \leq 44$  C3: $-83 \leq AZ \leq -32$ $-13 \leq EL \leq 39$  C5: $-13 \leq AZ \leq 53$ $10 \leq EL \leq 52$	EVA Crewmembers Ingress	Protects ISS structure while mated, SSRMS attached to MBS at WS#4, P6 Detached but still remains on Z1

APPROX. MET (ALL TIMES APPROXIMATE)	MODE	EVENT	DESCRIPTION
005/14:00:00	Beta 0 Only with box:  C1: -13 ≤ AZ ≤ 46 -66 ≤ EL ≤ 75  C2: -37 ≤ AZ ≤ -8 -28 ≤ EL ≤ 44  C3: -83 ≤ AZ ≤ -32 -13 ≤ EL ≤ 39  D2: -126 ≤ AZ ≤ 6 -89 ≤ EL ≤ -52	SSRMS-SRMS H/O of P6, MT Xlate to WS#8, SRMS-SSRMS H/O,P6 to Overnite Park	Protects ISS structure, P6 through H/O's, Xlate to Overnight Park Posn. Also protects MT/MBS through Xlate to worksite #8  P6 H/O f/m SSRMS-SRMS H/O P6 H/O f/m SRMS-SSRMS H/O P6 Install Viewing 1.410 through 1.41
006/00:00:00	Beta 21 Only with box:  C4: -13 ≤ AZ ≤ 46 -66 ≤ EL ≤ 40  C2: -37 ≤ AZ ≤ -8 -28 ≤ EL ≤ 44  C3: -83 ≤ AZ ≤ -32 -13 ≤ EL ≤ 39  D3: -92 ≤ AZ ≤ -8 -57 ≤ EL ≤ 64	SRMS-SSRMS H/O completed, P6 in Overnite Park, MT at WS#8	Protects ISS structure, P6 in Overnight Park Posn. Also protects MT/MBS at worksite #8  SRMS @ P6 Install Viewing Posn SSRMS @ Overnight Park w/ P6
006/17:00:00	Beta 0 Only with box:  C4: -13 ≤ AZ ≤ 46 -66 ≤ EL ≤ 40  C2: -37 ≤ AZ ≤ -8 -28 ≤ EL ≤ 44  C3: -83 ≤ AZ ≤ -32 -13 ≤ EL ≤ 39	EVA#3, MBSU Ops	Protects ISS structure while mated and for use during EVA#3, MBSU operations, and P6 Install to P5  EVA#3 Support MBSU Relocate 1.420 P6 Install 1.421 P6 Ungrapple & Install 1.430 MNVR to SAW Deploy Viewing MBSU Relocate
007/00:00:00	Beta 21 Only with box:  C4: -13 ≤ AZ ≤ 46 -66 ≤ EL ≤ 40  C2: -37 ≤ AZ ≤ -8 -28 ≤ EL ≤ 44  C3: -83 ≤ AZ ≤ -32 -13 ≤ EL ≤ 39	EVA Crewmembers Ingress, P6 relocated	Protects ISS structure and SSRMS while mated, MT at Worksite #8, and P6 is installed on P5  SRMS @ Pre-Cradle Posn SSRMS @ SAW Viewing Posn
008/16:30:00	Beta 21 Only with box:  B1: -35 ≤ AZ ≤ 45 -35 ≤ EL ≤ 40	ISS Range > 105 ft.	Protects the ISS Ku-band antenna

<b>APPROX. MET (ALL TIMES APPROXIMATE)</b>	<b>MODE</b>	<b>EVENT</b>	<b>DESCRIPTION</b>
008/17:00:00	Beta 21 + Mask	ISS Range > 765 ft.	Unmated
008/19:00:00	Beta 21 Only with box: A2: $-90 \leq AZ \leq 110$ $-90 \leq EL \leq 0$	OBSS Unberth	Protects the SRMS during survey operations  OBSS UNBERTH
008/20:00:00	Beta 21 Only with box: A3: $-132 \leq AZ \leq 80$ $-90 \leq EL \leq 60$	OBSS STBD Survey	Protects SRMS during survey operations  OBSS STBD SURVEY
008/21:30:00	Beta 12 Only	Nose Cap Survey	Protects SRMS during survey operations  NOSE CAP SURVEY  Note: Do not initiate until SRMS in NOSE CAPE ACAS Start
008/23:20:00	Beta 21 Only with box: A2: $-90 \leq AZ \leq 110$ $-90 \leq EL \leq 0$	Port Wing Survey	Protects SRMS during survey operations  OBSS PORT SURVEY OBSS BERTH
009/01:25:00	Beta 21 + Mask	Post OBSS Berth	Unmated
009/23:30:00		Ku-band Stow	

This Page Intentionally Blank



**FLIGHT PLAN**

**STS  
120**