

Flight Plan

STS-121 / ULF-1.1

(STS-121 FRRR3 Trajectory)

Mission Operations Directorate Operations Division

Final
May 12, 2006

GMT Launch Date: Saturday, July 1, 2006

GMT Launch Time: 182/19:43:39

For the latest working copy of the Flight Plan, visit
<http://mod.jsc.nasa.gov/do4/flightplan/fp.cfm?id=121>

National Aeronautics and
Space Administration

Lyndon B. Johnson Space Center
Houston, Texas



Verify this is the correct version for the pending operation (training, simulation or flight).
Electronic copies of FDF books are available. URL: <http://mod.jsc.nasa.gov/do3/FDF/index.html>

MISSION OPERATIONS DIRECTORATE

**FLIGHT PLAN
STS-121**

FINAL
May 12, 2006

PREPARED BY:



Terry L. Clancy
Book Manager, Lead FAO



Mark Grethen
Lead Ops Planner



Jaime Marshik
Lead Timeliner



Karen Wells
Lead RPE



Karen Watts
Lead Pointer

APPROVED BY:



Linda DeLapp
Lead, Flight Planning
and Pointing Group



Debbie D. Stapleton
Chief, Flight Planning Branch

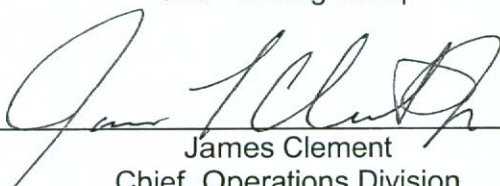

James Clement
Chief, Operations Division



G. Allen Flynt
Director, Mission Operations

This document is under the configuration control of the Crew Procedures Control Board (CPCB). All proposed changes must be submitted on FDF Workflow Crew Procedure Change Request (CR) to DO3/FDF Manager.

Additional distribution of this book for official use must be requested in writing to DO3/FDF Manager. The request must include justification and requester's name, organization, position, and phone number. Contractor requests are made through the NASA or DOD organization supported. Deletions, reduction in quantity, or change of address may be submitted to DO3/FDF Management Office, 281-244-1184.

Incorporates the following:		
482#:	FLT PLN-2028	ORB OPS-2163 ORB OPS-2169

AREAS OF TECHNICAL RESPONSIBILITY

Book Manager/Lead FAO	DO4/T. Clancy	281-483-5369
Lead Timeliner	DO4/J. Marshik	281-483-8796
Lead Pointer	DO4/K. Watts	281-244-5368
Lead Ops Planner	DO4/M. Grethen	281-244-1102
Lead RPE	DO4/K. Wells	281-244-0288

FLIGHT PLAN
STS-121

LIST OF EFFECTIVE PAGES

	FINAL	05/12/06	
Sign Off	* 121/FIN	2-37	121/FIN
ii.....	* 121/FIN	2-38	121/FIN
iii.....	* 121/FIN	2-39	121/FIN
iv.....	* 121/FIN	2-40	121/FIN
v	* 121/FIN	2-41	121/FIN
vi.....	* 121/FIN	2-42	121/FIN
vii.....	* 121/FIN	2-43	121/FIN
viii.....	* 121/FIN	2-44	121/FIN
1-1	121/FIN	3-1	121/FIN
1-2.....	121/FIN	3-2	121/FIN
1-3.....	121/FIN	3-3	121/FIN
1-4.....	121/FIN	3-4	121/FIN
2-1	121/FIN	3-5	121/FIN
2-2.....	121/FIN	3-6	121/FIN
2-3.....	121/FIN	3-7	121/FIN
2-4.....	121/FIN	3-8	121/FIN
2-5.....	121/FIN	3-9	121/FIN
2-6.....	121/FIN	3-10	121/FIN
2-7.....	121/FIN	3-11	121/FIN
2-8.....	121/FIN	3-12	121/FIN
2-9.....	121/FIN	3-13	121/FIN
2-10.....	121/FIN	3-14	121/FIN
2-11.....	121/FIN	3-15	121/FIN
2-12.....	121/FIN	3-16	121/FIN
2-13.....	121/FIN	3-17	121/FIN
2-14.....	121/FIN	3-18	121/FIN
2-15.....	121/FIN	3-19	121/FIN
2-16.....	121/FIN	3-20	121/FIN
2-17.....	121/FIN	3-21	121/FIN
2-18.....	121/FIN	3-22	121/FIN
2-19.....	121/FIN	3-23	121/FIN
2-20.....	121/FIN	3-24	121/FIN
2-21.....	121/FIN	3-25	121/FIN
2-22.....	121/FIN	3-26	121/FIN
2-23.....	121/FIN	3-27	121/FIN
2-24.....	121/FIN	3-28	121/FIN
2-25.....	121/FIN	3-29	121/FIN
2-26.....	121/FIN	3-30	121/FIN
2-27.....	121/FIN	3-31	121/FIN
2-28.....	121/FIN	3-32	121/FIN
2-29.....	121/FIN	3-33	121/FIN
2-30.....	121/FIN	3-34	121/FIN
2-31.....	121/FIN	3-35	121/FIN
2-32.....	121/FIN	3-36	121/FIN
2-33.....	121/FIN	3-37	121/FIN
2-34.....	121/FIN	3-38	121/FIN
2-35.....	121/FIN	3-39	121/FIN
2-36.....	121/FIN	3-40	121/FIN

* – Omit from flight book

3-41	121/FIN	3-95	121/FIN
3-42	121/FIN	3-96	121/FIN
3-43	121/FIN	3-97	121/FIN
3-44	121/FIN	3-98	121/FIN
3-45	121/FIN	3-99	121/FIN
3-46	121/FIN	3-100	121/FIN
3-47	121/FIN	3-101	121/FIN
3-48	121/FIN	3-102	121/FIN
3-49	121/FIN	3-103	121/FIN
3-50	121/FIN	3-104	121/FIN
3-51	121/FIN	3-105	121/FIN
3-52	121/FIN	3-106	121/FIN
3-53	121/FIN	3-107	121/FIN
3-54	121/FIN	3-108	121/FIN
3-55	121/FIN	3-109	121/FIN
3-56	121/FIN	3-110	121/FIN
3-57	121/FIN	3-111	121/FIN
3-58	121/FIN	3-112	121/FIN
3-59	121/FIN	3-113	121/FIN
3-60	121/FIN	3-114	121/FIN
3-61	121/FIN	3-115	121/FIN
3-62	121/FIN	3-116	121/FIN
3-63	121/FIN	3-117	121/FIN
3-64	121/FIN	3-118	121/FIN
3-65	121/FIN	3-119	121/FIN
3-66	121/FIN	3-120	121/FIN
3-67	121/FIN	3-121	121/FIN
3-68	121/FIN	3-122	121/FIN
3-69	121/FIN	3-123	121/FIN
3-70	121/FIN	3-124	121/FIN
3-71	121/FIN	3-125	121/FIN
3-72	121/FIN	3-126	121/FIN
3-73	121/FIN	3-127	121/FIN
3-74	121/FIN	3-128	121/FIN
3-75	121/FIN	3-129	121/FIN
3-76	121/FIN	3-130	121/FIN
3-77	121/FIN	3-131	121/FIN
3-78	121/FIN	3-132	121/FIN
3-79	121/FIN	3-133	121/FIN
3-80	121/FIN	3-134	121/FIN
3-81	121/FIN	3-133	121/FIN
3-82	121/FIN	3-136	121/FIN
3-83	121/FIN	3-137	121/FIN
3-84	121/FIN	3-138	121/FIN
3-85	121/FIN	3-139	121/FIN
3-86	121/FIN	3-140	121/FIN
3-87	121/FIN	3-141	121/FIN
3-88	121/FIN	3-142	121/FIN
3-89	121/FIN	3-143	121/FIN
3-90	121/FIN	3-144	121/FIN
3-91	121/FIN	4-i.....*	121/FIN
3-92	121/FIN	4-ii.....*	121/FIN
3-93	121/FIN	4-1	* 121/FIN
3-94	121/FIN	4-2	* 121/FIN

* – Omit from flight book

4-3.....	*	121/FIN
4-4.....	*	121/FIN
4-5.....	*	121/FIN
4-6.....	*	121/FIN
4-7.....	*	121/FIN
4-8.....	*	121/FIN
5-1.....	*	121/FIN
5-2.....	*	121/FIN
5-3.....	*	121/FIN
5-4.....	*	121/FIN
5-5.....	*	121/FIN
5-6.....	*	121/FIN
5-7.....	*	121/FIN
5-8.....	*	121/FIN
6-1.....	*	121/FIN
6-2.....	*	121/FIN
6-3.....	*	121/FIN
6-4.....	*	121/FIN
6-5.....	*	121/FIN
6-6.....	*	121/FIN
6-7.....	*	121/FIN
6-8.....	*	121/FIN

* – Omit from flight book

This Page Intentionally Blank

CONTENTS

PAGE

INTRODUCTION viii

OVERVIEW TIMELINE 1-1

SUMMARY TIMELINE 2-1

DETAILED TIMELINE 3-1

ATTITUDE TIMELINE 4-1

FLIGHT PLAN NOTES 5-1

FLIGHT PLAN WALKTHROUGH WITH RATIONALE 6-1

INTRODUCTION

The STS-121 Flight Plan is the Flight Data File article that contains the on-orbit timeline. It does not contain the detailed timelines that are covered in the Ascent, Post Insertion, Deorbit Prep, and Entry Checklists. The detailed rendezvous and undocking timelines and procedures are contained in the Rendezvous Checklist. The detailed Extra-Vehicular Activity (EVA) task timelines and procedures are contained in the EVA Checklist.

This Flight Plan satisfies the mission requirements specified in the following documents:

- NSTS-07700 Vol III, Flight Definition and Requirements Document
- NSTS-17462-121, STS-121 Flight Requirements Document
- NSTS-37326, Shuttle Crew Scheduling Constraints

The timeline formats used in the Flight Plan are based on JSC-19933, Timeline Format Definitions and Standard Notes, Rev C, May 1990.

The STS-121 Final Flight Plan is based on a launch date of Saturday, July 1, 2006, at 14:44 PM CDT (182/19:43:39 GMT). Orbiter inertial attitudes are expressed relative to a mean of 1950 (M50) reference frame.

The following SCSC Exceptions have been submitted in order to meet Category 1 objectives:

- 2.3.1.1(c) Pre-sleep violation due to 10 minute mandatory activity incursion into last hour and half of pre-sleep on FD10 for PLT and MS4.

The Flight Plan and other related mission information are available on the following Space Shuttle Flight Planning web site:

<http://mod.jsc.nasa.gov/do4/flightplan/fp.cfm?id=121>

OVERVIEW TIMELINE

This Page Intentionally Blank

OVERVIEW TIMELINE

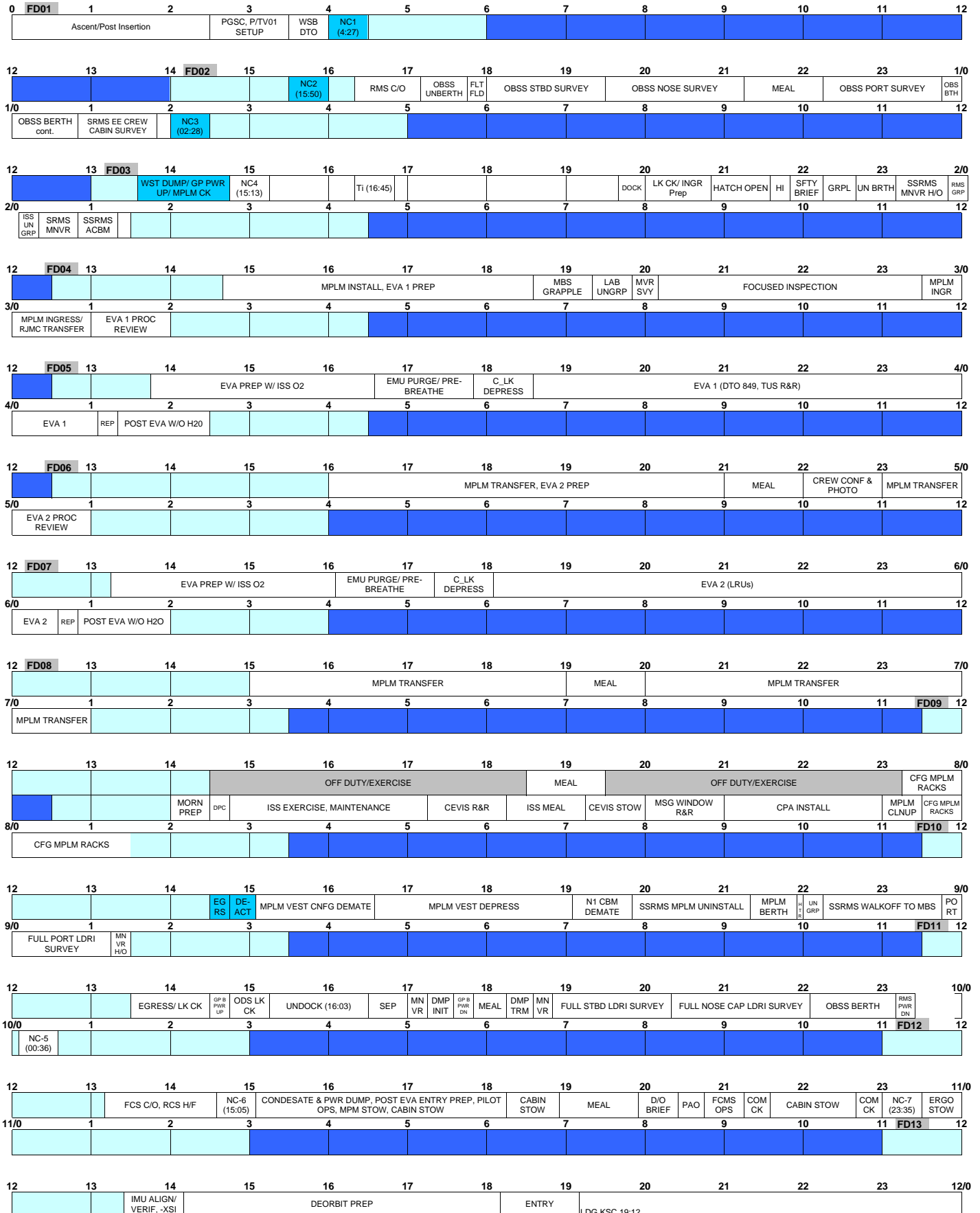

*LDG KSC (EOM + 1) 12/17:57

This Page Intentionally Blank

SUMMARY TIMELINE

This Page Intentionally Blank

GMT 07/01/06 (182)

MET Day 000

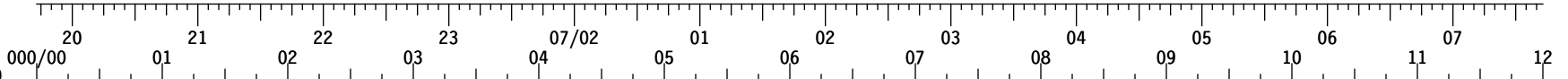

STS-121	FD01	OMS2		AFTIC/O	LDAPS	PRE SLEEP	WSB DTO/ELEV PK	OMS BURN	NC1	M-NZLV	GPRDN	PRE SLEEP	PMCTA/GCH		MNVR	SLEEP
	CDR LINDSEY	ASCENT	POST INSERTION													
	PLT KELLY	ASCENT	POST INSERTION	OIU	LDAPS	PRE SLEEP	WSB DTO/ELEV PK	OMS BURN		A-U	GPRDN	PRE SLEEP				SLEEP
	MS1 FOSSUM	ASCENT	POST INSERTION			P/TV01 SETUP	WSB DTO/ELEV PK		CC/AO	HVID	D/L	PRE SLEEP				SLEEP
	MS2 NOWAK	ASCENT	POST INSERTION	OSCEATCUP					TEPCON			PRE SLEEP				SLEEP
	MS3 WILSON	ASCENT	POST INSERTION	RMS-I		P/TV01 SETUP		RPMSRUP				FRED SETUP	PRE SLEEP			SLEEP
	MS4 SELLERS	ASCENT	POST INSERTION			PGSC SETUP		WLES/S/U	UMB WELL/D/L		SSV TUP		PRE SLEEP			SLEEP
FE-2 REITER	ASCENT	POST INSERTION			GIRA INSTALL		SEE SETUP				PRE SLEEP				SLEEP	
STS	DAY/NIGHT	[Timeline with shaded day/night blocks]														
	ORBIT	[Timeline with orbit segments]														
STS	TDRS	W -171	[Timeline with TDRS segments]													
		E - 46	[Timeline with TDRS segments]													
	Z -275	[Timeline with TDRS segments]														
ORB ATT	LAUNCH	[Timeline with orbital events]														
NOTES		*ACT *DEACT *RECONFIG														
		^ACT ^DEACT														
		MPLM ENV CK														

GMT 07/02/06 (183)

MET Day 000

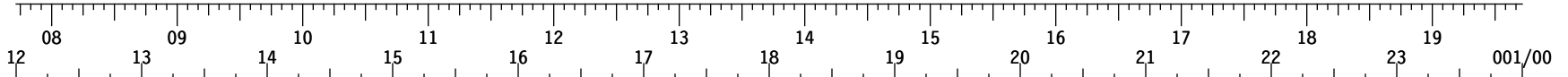

STS-121	FD02 CDR LINDSEY	SLEEP	POST SLEEP	NC2 OMS BURN	RHC CTAL SRBM *BT	POST SLEEP	OBSS UNBRT	FLI LA ET LD	MIN N V R T L	OBSS SURVEY - STBD	MIN N V R T L	OBSS SURVEY - NOSE	MEAL	MIN N V R T L	OBSS SURVEY - PORT		
	PLT KELLY	SLEEP	POST SLEEP	OMS BURN	M - N Z V L R V	POST SLEEP	FC P R G *	P/TV01 VIDEO SETUP			OBSS SURVEY - NOSE			MEAL	EMU C/O (2 EMUS)		
	MS1 FOSSUM	SLEEP	POST SLEEP			C/L CMR INSTL		OBSS UNBRT	FLI LA ET LD	OBSS SURVEY - STBD			ERG SETUP	MEAL	FILTER CLEANING	EMU C/O PREP	EMU C/O (2 EMUS)
	MS2 NOWAK	SLEEP	POST SLEEP			RMS C/O		OBSS UNBRT	FLI LA ET LD	OBSS SURVEY - STBD			MEAL		DOCK RING EXT	OBSS SURVEY - PORT	OB B S R S T H
	MS3 WILSON	SLEEP	POST SLEEP			RMS C/O		MDDK XFER PREP			OMS POD	OBSS SURVEY - NOSE		MEAL		OBSS SURVEY - PORT	OB B S R S T H
	MS4 SELLERS	SLEEP	POST SLEEP			C/L CMR INSTL		PGSC SETUP (PART II)		P/TV01 VIDEO SETUP			MEAL		DOCK RING EXT	EMU C/O PREP	EMU C/O (2 EMUS)
	FE-2 REITER	SLEEP	POST SLEEP			MDDK XFER PREP			ERG SETUP			MEAL		H2O CWC SETUP			

STS	DAY/NIGHT	[Timeline showing day/night cycles]															
	ORBIT	9 10 11 12 13 14 15 16															
	TDRS	W -171 E - 46 Z -275															

ORB ATT	-ZLV -YVV NC2 BIAS -ZLV -YVV INRTL INRTL INRTL															
NOTES	*REG RCNFG *MANUAL *CNTLR SWAP ^ACT ^DEACT LDRI-STBD WING LDRI-NOSE CAP LDRI-PORT WING MPLM PRESS CK															

GMT 07/02/06 (183)

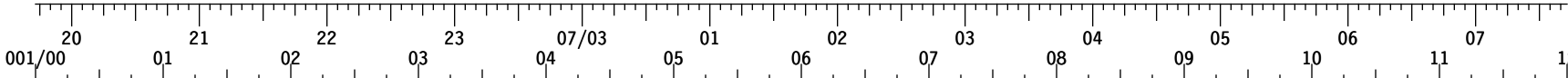

MET Day 001

S T S - 1 2 1	FD02		M N Z L V R	PRE SLEEP	NC3 RCS BURN	M I N N V R T L	F M U N V R	PRE SLEEP	PMC A/G	^ - Y V V	PRE SLEEP		M N V R	SLEEP				
	PLT KELLY			PRE SLEEP		RNDZ TOOLS C/O					PRE SLEEP			SLEEP				
	MS1 FOSSUM			SRMS SURVEY	VTR PB						PRE SLEEP			SLEEP				
	MS2 NOWAK	OBSS BERTH		SRMS SURVEY							PRE SLEEP			SLEEP				
	MS3 WILSON	OBSS BERTH		SRMS SURVEY							PRE SLEEP			SLEEP				
	MS4 SELLERS			PRE SLEEP	PGSC RCNFG	RNDZ TOOLS C/O					PRE SLEEP			SLEEP				
	FE-2 REITER			C T W E C R M 1							PRE SLEEP			SLEEP				
S T S	DAY/NIGHT																	
	ORBIT			17		18		19		20		21		22		23		24
	TDRS	W -171																
		E - 46																
		Z -275																
	ORB ATT			INRTL		-ZLV -XVV		NC3		INRTL		-ZLV -YVV		INRTL		-ZLV -YVV		
	NOTES																	

GMT 07/03/06 (184)

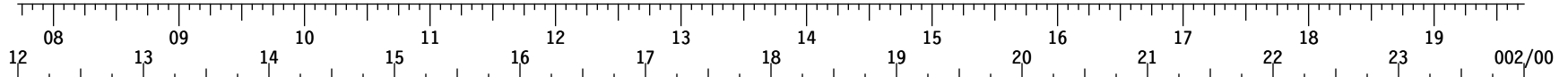

STS-121	FD03 CDR LINDSEY	SLEEP	POST SLEEP	ISS RNDZ OPS				APPROACH	MNVR -XLV	GPRBNDN	ATT*	HATCH OPEN	SHANDKE	SFTY BRIEF	BPU SMIUO	PTPVS06	OBSS UNBTH CAMR					
	PLT KELLY	SLEEP	POST SLEEP	ISS RNDZ OPS				APPROACH	LEAK CK	ODS PREP FOR INGR		HATCH OPEN	SHANDKE	SFTY BRIEF	EMU PREP FOR XFER		ROOBA LK CK & C/O I					
	MS1 FOSSUM	SLEEP	POST SLEEP		ERMUUVL	EXERCISE	DRHARGU*	APPROACH		P/TV 04 S/U	P/TV 04 OPS INGR/EGR	SHANDKE	SFTY BRIEF	BPU SMIUO	PTPVS06	OBSS UNBTH CAMR						
	MS2 NOWAK	SLEEP	POST SLEEP	ISS RNDZ OPS				APPROACH	DAOUCKIO	GPRBNDN		HATCH OPEN	SHANDKE	SFTY BRIEF	OBSS GRPL	OBSS UNBRT	SSRMS OBSS MNVR H/O					
	MS3 WILSON	SLEEP	POST SLEEP		EXERCISE		ISS RNDZ OPS	APPROACH	LEAK CK	ODS PREP FOR INGR		HATCH OPEN	SHANDKE	SFTY BRIEF	OBSS GRPL	OBSS UNBRT	SSRMS OBSS MNVR H/O					
	MS4 SELLERS	SLEEP	POST SLEEP		EXERCISE	ERMUUVL	P/TV02 DOCK S/U	P/TV02 OPS				POST RNDZ PGSC CNFG	SHANDKE	SFTY BRIEF	EMU PREP FOR XFER		RWS CBL S/U					
ISS	ISS CDR	SLEEP	POST SLEEP	MORN PREP WK	DPC	H20	WONDS	VELO + HC	P/TV RPM CNFG VRFY	MIDDAY-MEAL	V4 IOIOM	4 F OIOLM	DOCK VIDEO	LEAK CK	ASKM1PL	HATCH OPEN	SHANDKE	SFTY BRIEF	TK TRNSF	IELK INST & C/O FE2		
	FE-1	SLEEP	POST SLEEP	MORN PREP WK	DPC	PSTUR	CDOM	RED	P/TV RPM CNFG VRFY	MIDDAY-MEAL	T8 IOIOM	8 F OIOLM	RBDL	LEAK CK		HATCH OPEN	SHANDKE	SFTY BRIEF	IMS	OBSS GRPL	COX	ROOBA LK CK & C/O I
	FE-2 Reiter	SLEEP	POST SLEEP		FIT	COND CWC S/U	CINCI T2	XFER RVW		CTWCRM2						HATCH OPEN	SHANDKE	SFTY BRIEF	IELK RMVL	IELK INST & C/O FE2		

DOCK *



ORB ATT	-ZLV -YVV			RNDZ									BIAS -XLV -ZVV		
NOTES		*ACT *DEACT ^ACT		♦MSS-RWS CABLE-CNCT		*QD INSTL		@CCAA ACT				▼CTTC-ST5-DK-CONFIG *STS TO CMG		♦OBSS H/O FROM SSRMS	⊕OBSS H/O FROM SSRMS

***DOCK 001/19:40**

STS-121/ULF 1.1 JOINT MISSION STP

MET Day 001 12 13 14 15 16 17 18 19 20 21 22 23 002/00

GMT 07/03/06 (184)

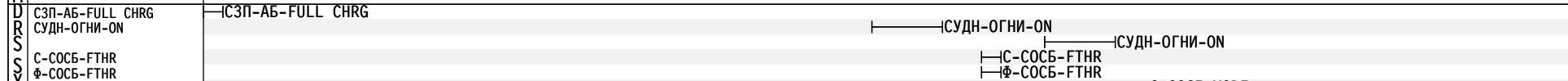
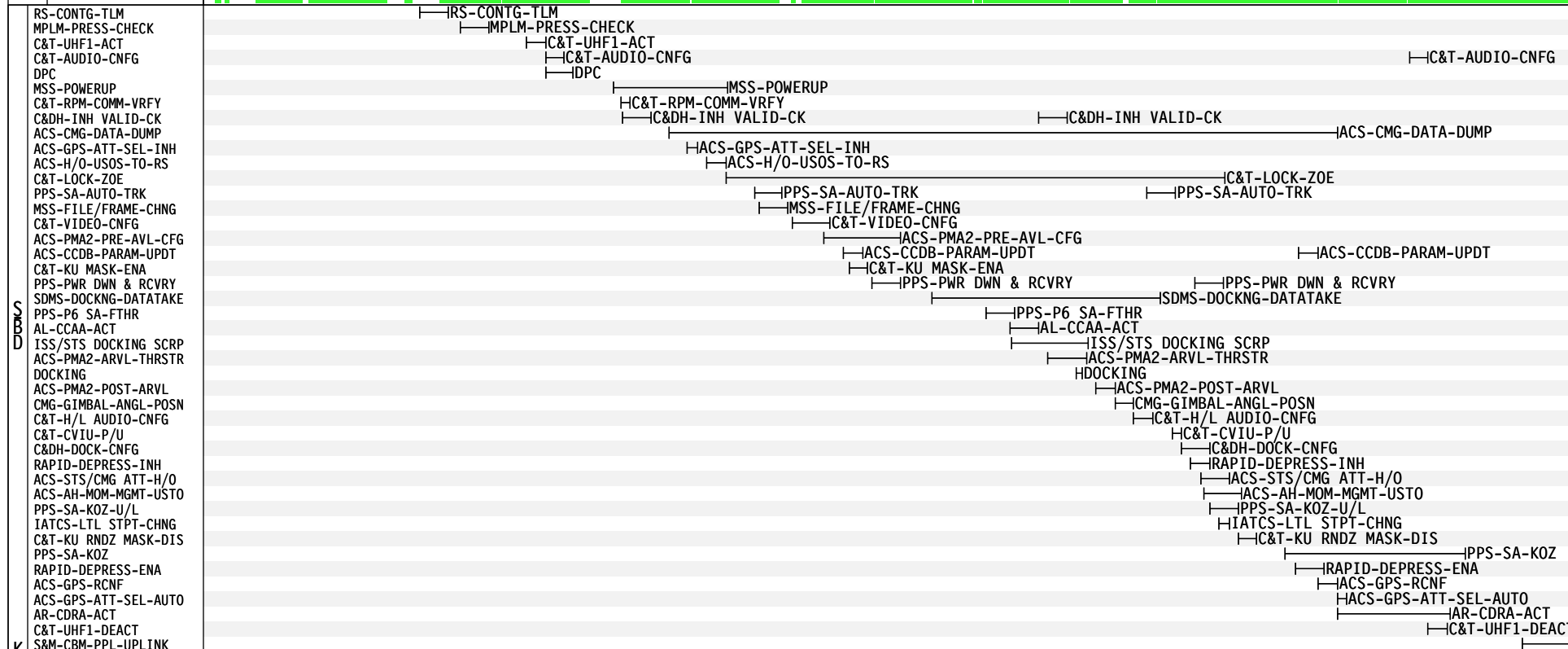

GMT 07/03/06 (184)

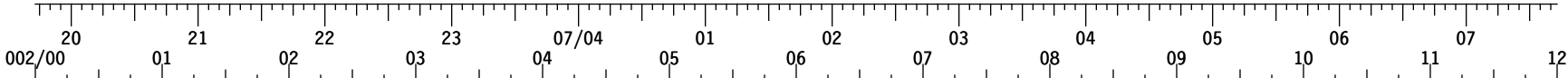

MET Day 002

S T S - 1 2 1	FD03 CDR LINDSEY	* O H B / S O S	OBSS H/O FROM SSRMS	X B F R E I R E F	CWC XFER (2)	PRE SLEEP	PMC A/G	PRE SLEEP	SLEEP	
	PLT KELLY	ROOBA LK CK & C/O I	VTR S/U	VTR PB		PRE SLEEP		SLEEP		
	MS1 FOSSUM	⊕ O H B / S O S	OBSS H/O FROM SSRMS	EVA TOOL XFER		PRE SLEEP		SLEEP		
	MS2 NOWAK	♦ U H N / G O R P		MNVR ACBM INSPT		PRE SLEEP		SLEEP		
	MS3 WILSON	Ⓢ U H N / G O R P		MNVR ACBM INSPT		PRE SLEEP		SLEEP		
	MS4 SELLERS	MDDK XFER	EVA TOOL XFER			PRE SLEEP		SLEEP		
I S S	ISS CDR	♥ S L O K C O K L	S D O R K O L	PREP WK	DPC	PREP WK	PRE SLEEP	G D R Y PRE SLEEP	S P S R L S O O P S R L S O O P S R L S O O P S R L S O O P	
	FE-1	ROOBA LK CK & C/O I		PREP WK	DPC	PREP WK	PRE SLEEP-ISS		SLEEP	
	FE-2 Reiter	♥ S L O K C O K L		PMC X B F R E I R E F	P R E P W K	DPC	PREP WK	PRE SLEEP-ISS	SLEEP	
S T S	DAY/NIGHT ORBIT	32	33	34	35	36	37	38	39	40
	TDRS	W -171 E - 46 Z -275	[Timeline bars showing activity for W, E, Z across days 32-40]							
ORB ATT		BIAS -XLV -ZVV								

NOTES

- *OBSS UNBTH CAMR
- ⊕OBSS UNBTH CAMR
- ♦SSRMS OBSS MNVR H/O
- ⓈSSRMS OBSS MNVR H/O
- ♥IELK INST & C/O FE2

*STATUS CK

ROOBA LEAK CHECK

STS-121/ULF 1.1 JOINT MISSION STP

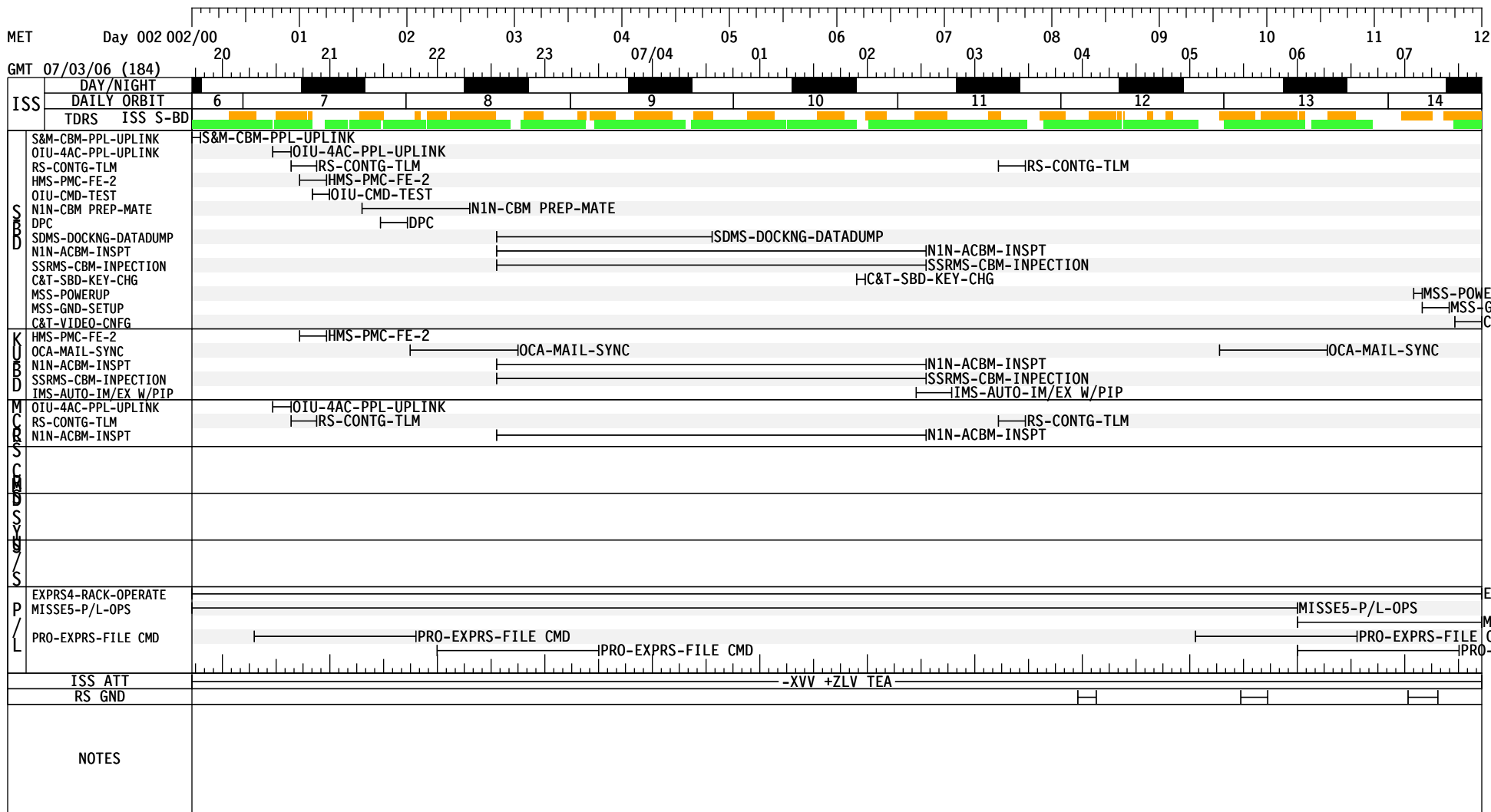

NO EXERCISE

GMT 07/04/06 (185)

MET Day 002

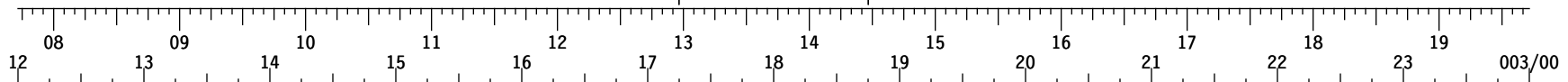

STSS-121	Personnel	08	09	10	11	12	13	14	15	16	17	18	19	20	21	22	23	003/00
S T S - 1 2 1	FD04 CDR LINDSEY	SLEEP	POST SLEEP	POST SLEEP	POST SLEEP	EXERCISE	N2 XFER INIT	MEAL	MPLM VEST PRESS	MPLM VEST INGRS CNFG	MPLM ACT1	MPLM VEST INGRS CNFG	MPLM VEST INGRS CNFG					
	PLT KELLY	SLEEP	POST SLEEP	PTV06 OPS	EXERCISE	PTV06 OPS	PAO A/G	MEAL	CWC XFER (2)	OBSS TPS SURVEY								
	MS1 FOSSUM	SLEEP	POST SLEEP	PTV06 OPS	P/B	P/B	CBM 2ND STG & ABOLTS	MEAL	EMU XFER & RCFG	RH E/BWA	ROOBA LK CK & C/O II	E_LK PREP	ROOBA P/B TEST	EVA TOOL CNFG				
	MS2 NOWAK	SLEEP	POST SLEEP	MPLM INSTL GRPL	MPLM UNBTH	MPLM INSTL	MPLM INSTL	MEAL	MBS GRAPPLE	LAB UNGRPL	MNVR SRVY SUPT	OBSS TPS SURVEY				LAB GRAPPLE	EXERCISE	
	MS3 WILSON	SLEEP	POST SLEEP	MPLM INSTL GRPL	MPLM UNBTH	MPLM INSTL	MPLM INSTL	MEAL	EXERCISE	DOUG RVW	OBSS TPS SURVEY				LAB GRAPPLE			
	MS4 SELLERS	SLEEP	POST SLEEP	PTV06 OPS	P/B	P/B	CBM 2ND STG & ABOLTS	MEAL	EMU XFER & RCFG	RH E/BWA	ROOBA LK CK & C/O II	E_LK PREP	ROOBA P/B TEST	EVA TOOL CNFG				
I S S	ISS CDR	SLEEP	POST SLEEP	P/B	H/O	ETD-CDR	PMC	MIDDAY-MEAL	CBCS CAMRA RMV	ACY MΠ Φ B MNT	IMS	TVIS	VELO + HC	CBO 3 EDB FILL	COX			
	FE-1	SLEEP	POST SLEEP	MORN PREP WK	DPC	MPLM UNBTH	MPLM INSTL	MPLM INSTL	N2 XFER INIT	MEAL	MBS GRAPPLE	LAB UNGRPL	MNVR SRVY SUPT	RED	ROOBA LK CK & C/O II	E_LK PREP	ROOBA P/B TEST	TVIS
	FE-2 Reiter	SLEEP	POST SLEEP	MORN PREP WK	DPC	H/O	XRFVWR	MPLM VEST EQUIP S/U	MIDDAY-MEAL	MPLM VEST PRESS	MPLM VEST INGRS CNFG	MPLM VEST INGRS CNFG	MPLM VEST INGRS CNFG	MPLM VEST INGRS CNFG	MPLM VEST INGRS CNFG	MPLM VEST INGRS CNFG	MPLM VEST INGRS CNFG	MPLM VEST INGRS CNFG
S T S	DAY/NIGHT ORBIT	40	41	42	43	44	45	46	47	48								
	TDRS W -171 E - 46 Z -275	[Timeline bars indicating TDRS activity]																
ORB ATT		BIAS -XLV -ZVV																
NOTES	*ACT *DEACT ^OFF ^POWERUP *INSPECT MPLM PRESS CK																	
	*DCS 760 W																	

STS-121/ULF 1.1 JOINT MISSION STP

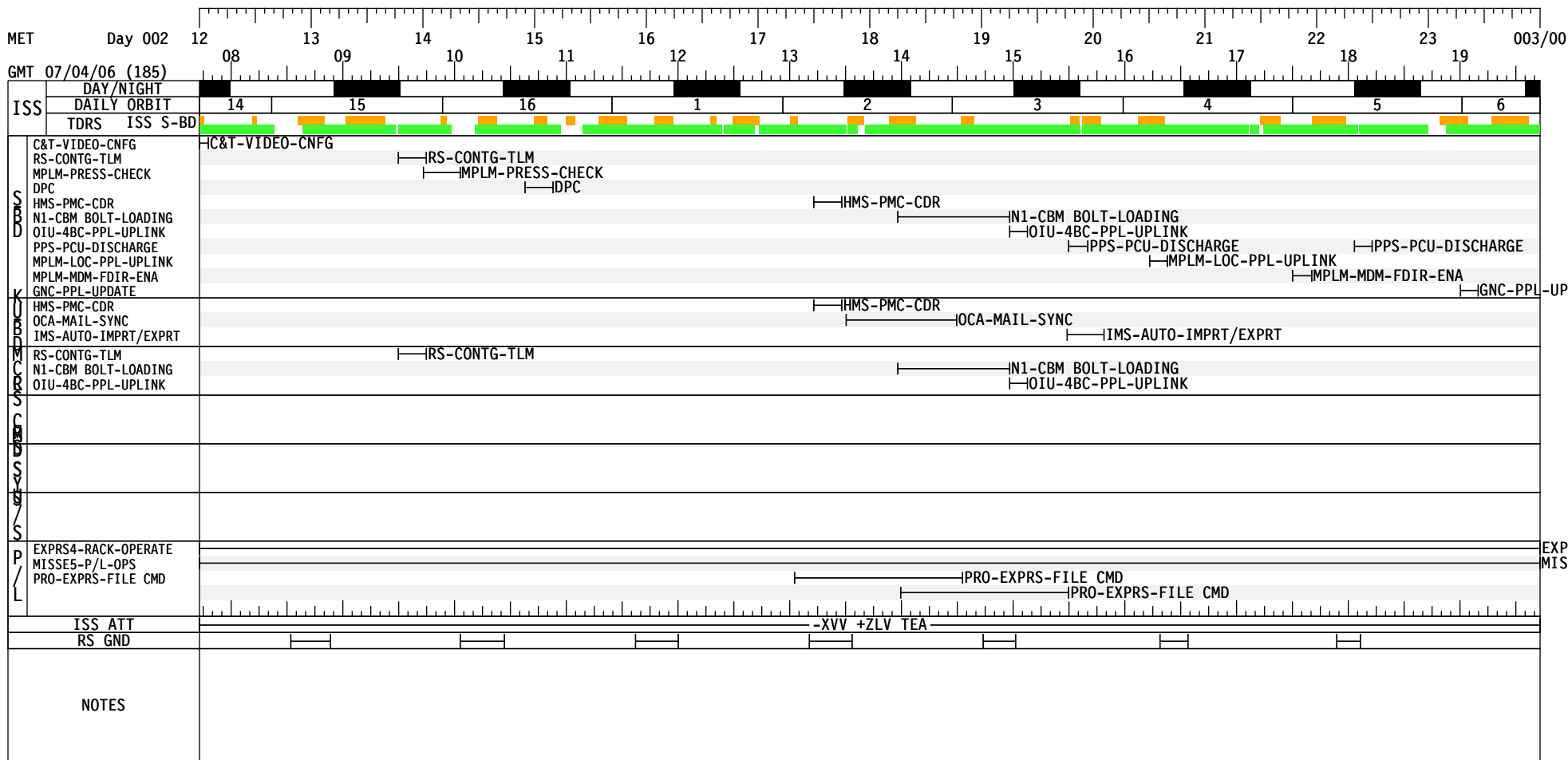

GMT 07/04/06 (185)

MET Day 003

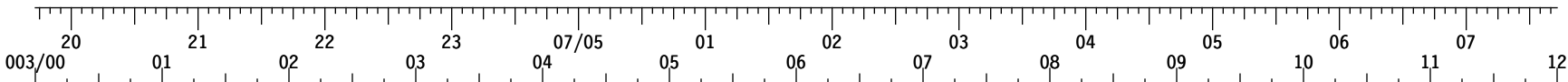

S T S - 1 2 1	FD04 CDR LINDSEY	PO T V S 0 5	X F A T I O N R E G U L A T I O N R E G U L A T I O N	PRE SLP	EVA 1 PROC RVW	PRE SLEEP	PMC OCA	PRE SLEEP	SLEEP
	PLT KELLY	*760 S/U	B X F A T I O N R E G U L A T I O N	RJMC XFER	EVA 1 PROC RVW	PRE SLEEP		PRE SLEEP	SLEEP
	MS1 FOSSUM	DCS 760 w/ FLASH	E X F A T I O N R E G U L A T I O N	RJMC XFER	EVA 1 PROC RVW	PRE SLEEP		PRE SLEEP	SLEEP
	MS2 NOWAK	EXER CISE		PRE SLEEP	EVA 1 PROC RVW	PRE SLEEP		PRE SLEEP	SLEEP
	MS3 WILSON	M S P / L U M	X F A T I O N R E G U L A T I O N	PRE SLEEP	EVA 1 PROC RVW	PRE SLEEP		PRE SLEEP	SLEEP
	MS4 SELLERS	EXERCISE			EVA 1 PROC RVW	PRE SLEEP		PRE SLEEP	SLEEP
I S S	ISS CDR	C O M	EVE PREP WK	S / U P R E P	EVA 1 PROC RVW	PAO DPC		PRE SLEEP-ISS	SLEEP
	FE-1	TVIS		D S R L M S P R E P	EVA 1 PROC RVW	PAO DPC		PRE SLEEP-ISS	SLEEP
	FE-2 Reiter	M S P / L U M	X F A T I O N R E G U L A T I O N	B X F A T I O N R E G U L A T I O N	PRE SLEEP	PMC EVE PREP WK	PAO DPC	PRE SLEEP-ISS	SLEEP



ORB ATT

*PRE SLEEP ^DEACT *STATUS CK BIAS -XLV -ZVV

NOTES

STS-121/ULF 1.1 JOINT MISSION STP

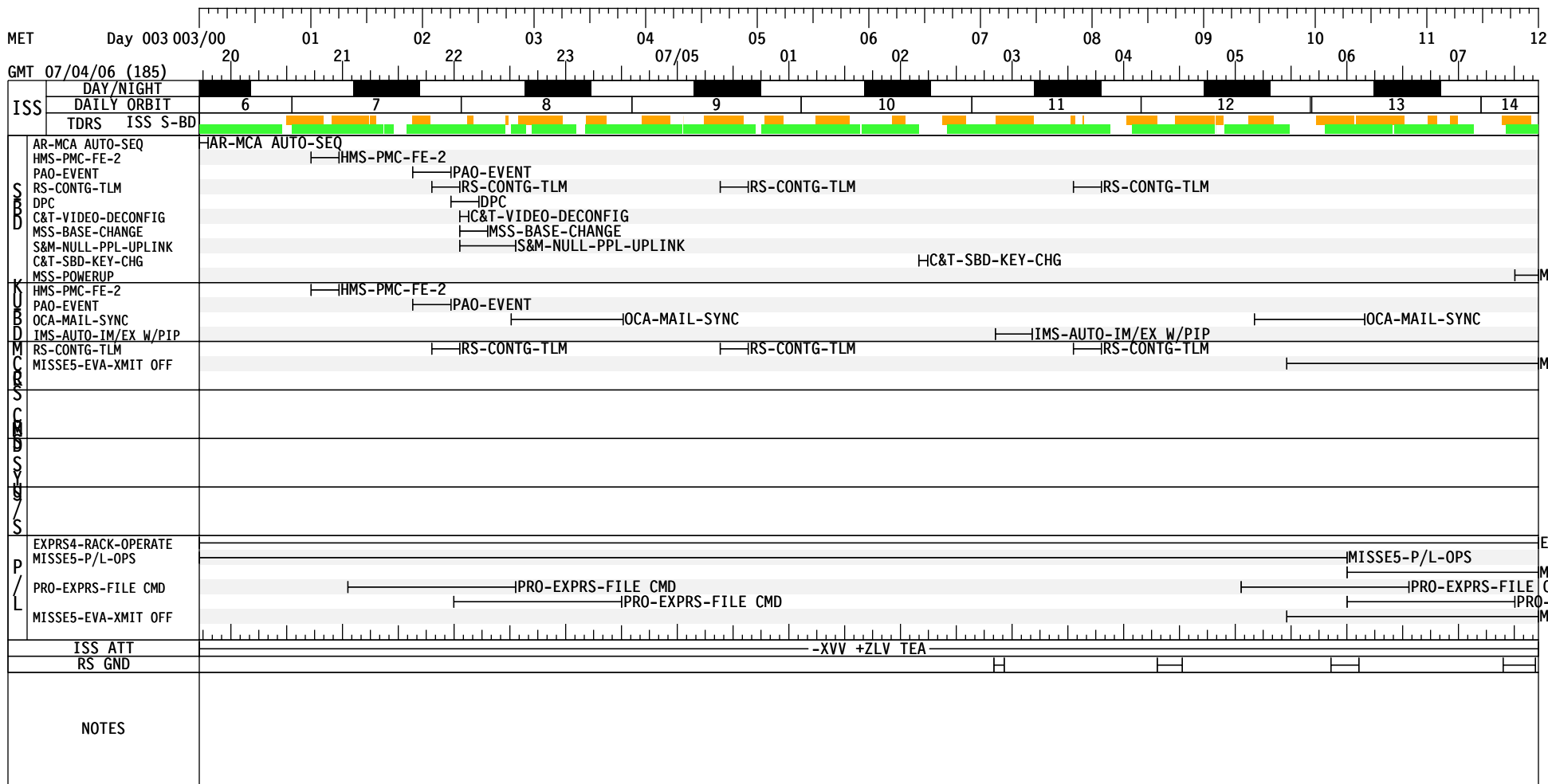

GMT 07/05/06 (186)

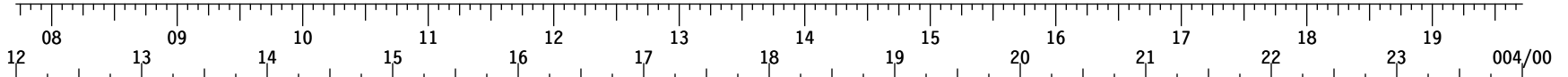

MET Day 003		12	13	14	15	16	17	18	19	20	21	22	23	19	004/00										
STS-121	FD05 CDR LINDSEY	SLEEP	POST SLEEP	PMCA/G	POST SLEEP	MNVR DUMP	WINSIT	P/TV 07 S/U	WS/GUIS	INAHBT	PTAESR	MNVR-XLV	ATTI*	CINWCT5	EXERCISE	CTWRM5	P/TV 07 EVA	MEAL	ANTC	CINWCT6	P/TV 07 EVA	CTWRM6	CWC XFER (2)	P/TV 07 EVA	
	PLT KELLY	SLEEP	POST SLEEP	EVA PREP W/ ISS 02				EMURGE	EMU PREBREATHE	C_LK DPRS	EVA 1 IVA SUPPORT														
	MS1 FOSSUM	SLEEP	POST SLEEP	EVA PREP W/ ISS 02				EMURGE	EMU PREBREATHE	C_LK DPRS	PDESPRRS	ZEN IUA R&R	TOOL SETUP	OBSS S/U-PART I	1 EV POSN 1 EVAL	OBSS S/U PT II	2 EV POSN 3 EVAL	2 EV P1 PUSH EVAL	OBSS CLNUP						
	MS2 NOWAK	SLEEP	POST SLEEP	POST SLEEP			EXERCISE	MPLM XFER	MUNBSGRP	EVA 1 RMS SUPPORT															
	MS3 WILSON	SLEEP	POST SLEEP	EVA PREP W/ ISS 02				EMURGE	EMU PREBREATHE	MUNBSGRP	EVA 1 RMS SUPPORT														
	MS4 SELLERS	SLEEP	POST SLEEP	EVA PREP W/ ISS 02				EMURGE	EMU PREBREATHE	C_LK DPRS	PDESPRRS	ZEN IUA R&R	TOOL SETUP	OBSS S/U-PART I	1 EV POSN 1 EVAL	OBSS S/U PT II	2 EV POSN 3 EVAL	2 EV P1 PUSH EVAL	OBSS CLNUP						
ISS	ISS CDR	SLEEP	POST SLEEP	MORN PREP WK	COMM	DPC	COX	TVIS	MPLM XFER			MIDDAY-MEAL	MELFI XFER	OGS XFER	MPLM XFER										
	FE-1	SLEEP	POST SLEEP	EVA PREP W/ ISS 02				EMURGE	EMU PREBREATHE	C_LK DPRS	MIDDAY-MEAL	MPLM XFER	TVIS	RED											
	FE-2 Reiter	SLEEP	POST SLEEP	PWKREP	XRVFEW	DPC	*	MPLM XFER			MIDDAY-MEAL	MELFI XFER	OGS XFER	MPLM XFER											
STS	DAY/NIGHT ORBIT	56	57	58	59	60	61	62	63	64															
	TDRS W -171 E - 46 Z -275	[Timeline bars for TDRS]																							
ORB ATT		BIAS -XLV -ZVV				BIAS -XLV +YVV				BIAS -XLV -ZVV															
NOTES		*CMG TO STS				*PMC-БРАСЛЕТ-FE-2				*STS TO CMG				^IWIF ACT											

STS-121/ULF 1.1 JOINT MISSION STP

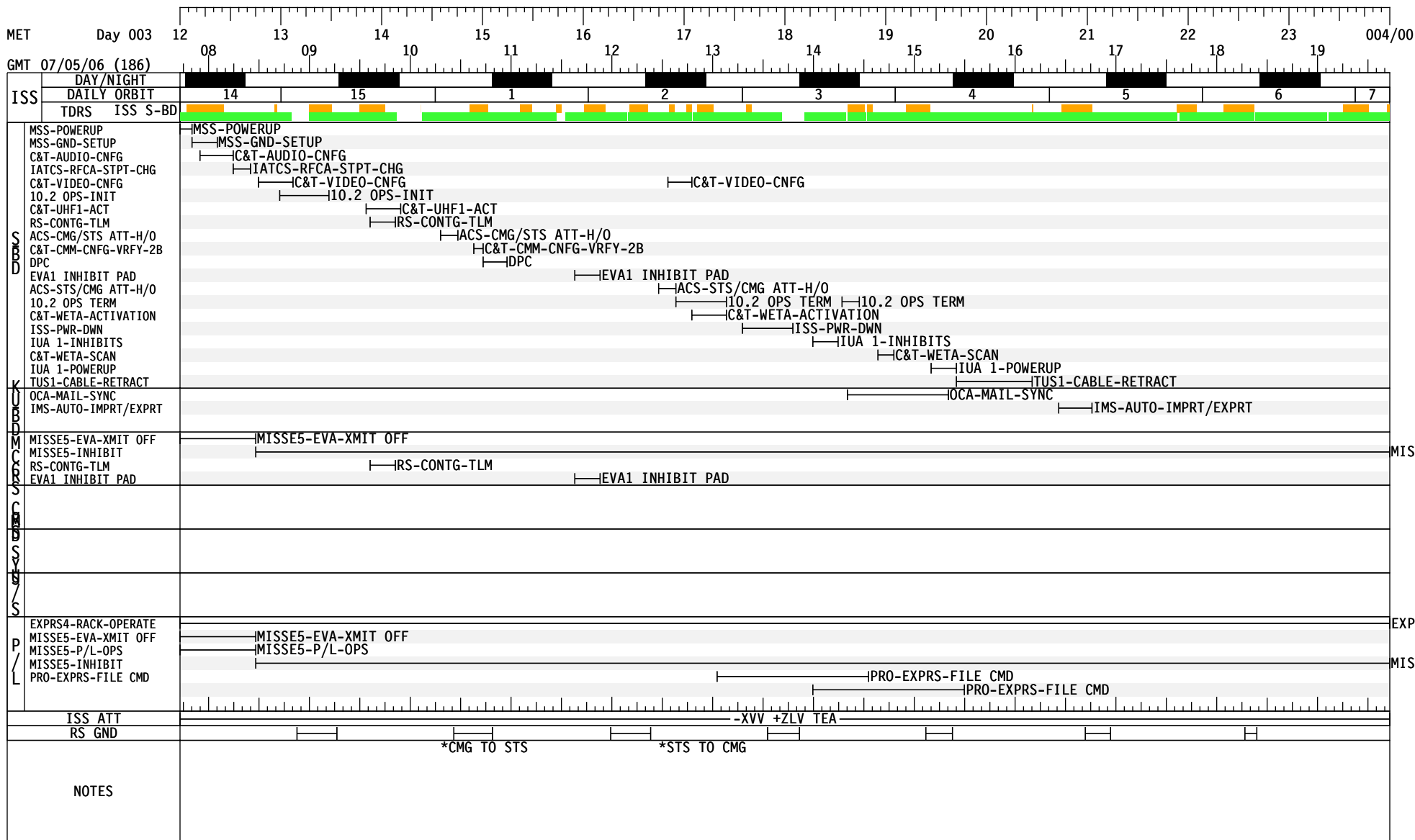

GMT 07/05/06 (186)

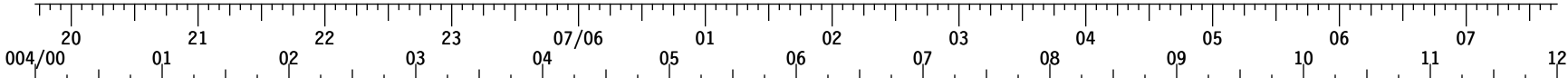

S T S - 1 2 1	FD05 CDR LINDSEY	P/TV 07 EVA	X T I F A D E G R U I P	C R P T R K S	D C N F G	PRE SLEEP	PMC OCA	PRE SLEEP	SLEEP
	PLT KELLY	EVA 1 IVA SUPPORT		C R P T R K S		POST EVA W/O H2O		PRE SLEEP	SLEEP
	MS1 FOSSUM	TOOL CLNUP	A I N L G R S	C R P T R K S		POST EVA W/O H2O		PRE SLEEP	SLEEP
	MS2 NOWAK	*				PRE SLEEP		PRE SLEEP	SLEEP
	MS3 WILSON	⊕	EXERCISE			PRE SLEEP		PRE SLEEP	SLEEP
	MS4 SELLERS	TOOL CLNUP	A I N L G R S	C R P T R K S		POST EVA W/O H2O		PRE SLEEP	SLEEP
I S S	ISS CDR	MPLM XFER	VELO + HC	DPC	PREP WK	C O M M		PRE SLEEP-ISS	SLEEP
	FE-1	RED	EVE PREP WK	C R P T R K S		POST EVA W/O H2O	B S A - I	PRE SLEEP-ISS	SLEEP
	FE-2 Reiter	MPLM XFER	X T I F A D E G R U I P	B F R E I R E F	EVE PREP WK	DPC	P W K R E P PMC	PRE SLEEP-ISS	SLEEP

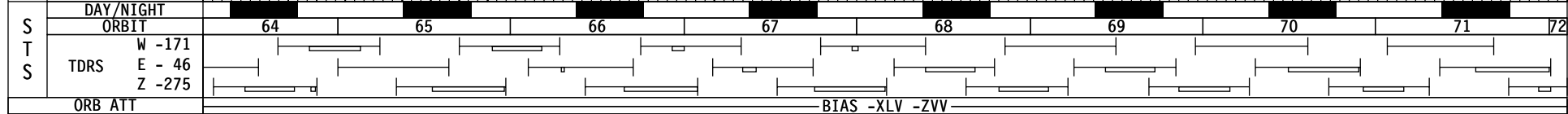

NOTES	*EVA 1 RMS SUPPORT ⊕EVA 1 RMS SUPPORT *STATUS CK
-------	--

STS-121/ULF 1.1 JOINT MISSION STP

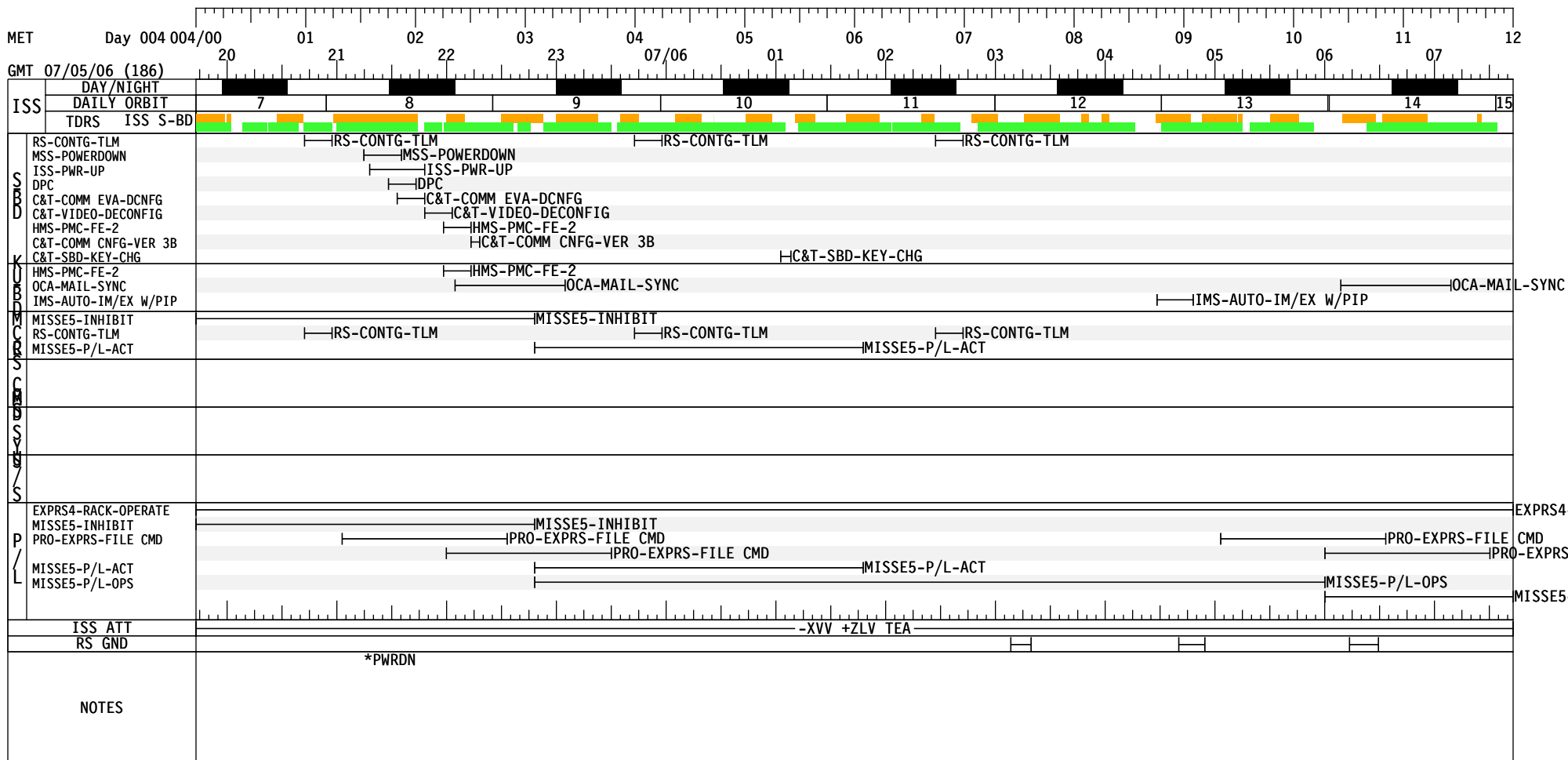

GMT 07/06/06 (187)

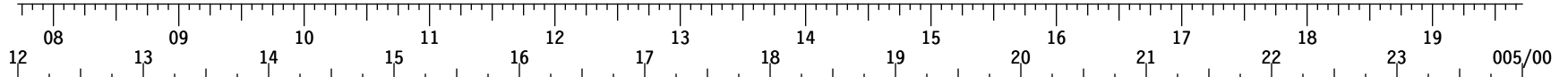

S T S - 1 2 1	FD06 CDR LINDSEY	SLEEP	POST SLEEP	SAFER	MDDK XFER	CIN 7	MDDK XFER	CTW 7	CIN 8	EXERCISE	CTW 8	CWC XFER (2)	MEAL	CREW CONF	CPH 0	LIQH TRANSFER	MPLM XFER	XTFA 0	
	PLT KELLY	SLEEP	POST SLEEP	WCS	FLTR CLN - INSPECT		EXERCISE	EXM 7	MPLM XFER	CKM	MPLM XFER	SAFER C/O	MEAL	CREW CONF	CPH 0	MPLM XFER			
	MS1 FOSSUM	SLEEP	POST SLEEP	MBT / ^	EMU H20 RCHRG	E_LK PREP	EVA TOOLS MGMT		EMU C/O	EMU *	BSA - T		MEAL	CREW CONF	CPH 0	EXERCISE	MPLM XFER		
	MS2 NOWAK	SLEEP	POST SLEEP			EXERCISE	MPLM XFER					MEAL	CREW CONF	CPH 0	MPLM XFER				
	MS3 WILSON	SLEEP	POST SLEEP			MPLM XFER					P/TV 05 S/U	EXERCISE	MEAL	CREW CONF	CPH 0	MPLM XFER	XTFA 0	MXPF 0	
	MS4 SELLERS	SLEEP	POST SLEEP	DCS 760 T/D	EMU H20 RCHRG	E_LK PREP	EVA TOOLS MGMT		EMU C/O	EMU *	760 S/U		MEAL	CREW CONF	CPH 0	MDDK XFER	EXERCISE		
I S S	ISS CDR	SLEEP	POST SLEEP	PWK EP	DPC	MPLM XFER					TVIS	MIDDAY-MEAL	CREW CONF	CPH 0	MPLM XFER	VELO + HC			
	FE-1	SLEEP	POST SLEEP	PWK EP	DPCLAB1S6	CCAA HX XFER	CWC FILL	MPLM XFER	EXM 7	CEVIS	SAFER C/O	MIDDAY-MEAL	CREW CONF	CPH 0	MPLM XFER	RED			
	FE-2 Reiter	SLEEP	POST SLEEP	XRF EW	DPCLAB1S6	CCAA HX XFER	MPLM XFER					MIDDAY-MEAL	CREW CONF	CPH 0	MPLM XFER	XTFA 0	XBFR 0		

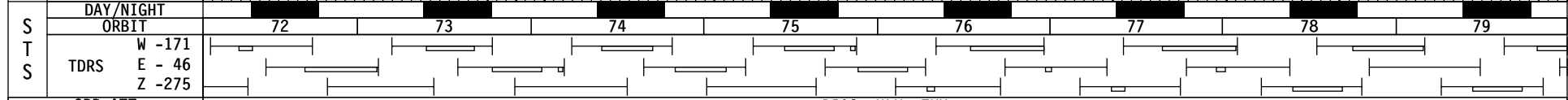

S T S	ORB ATT	BIAS -XLV -ZVV																
	NOTES	^CRADLE ^INSTALL *BATT CHRG *SWAP																

STS-121/ULF 1.1 JOINT MISSION STP

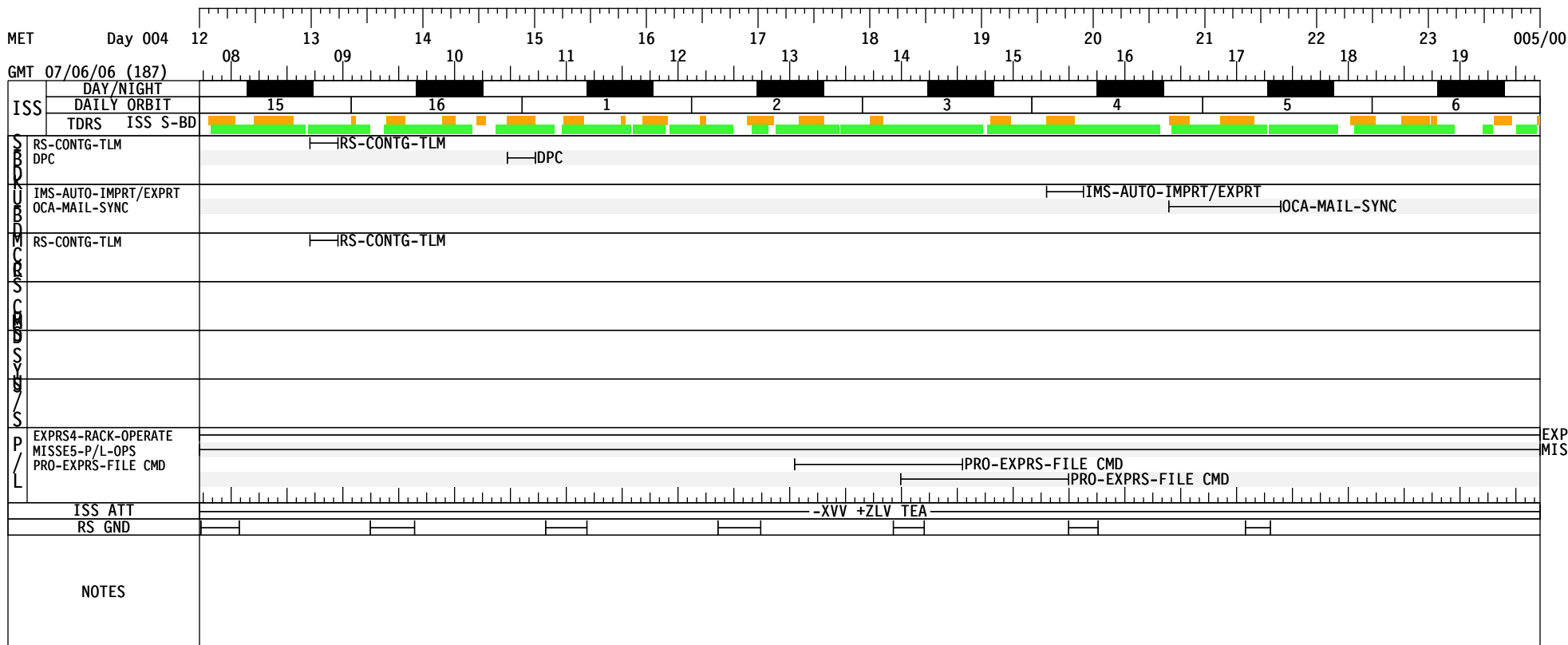

EXPRS4-RA
MISSE5-P

GMT 07/06/06 (187)

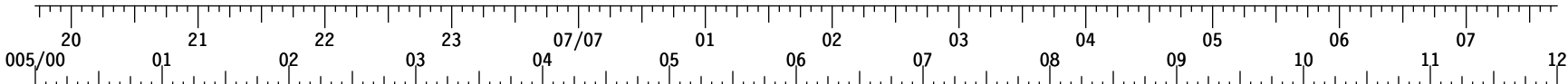

MET Day 005

S T S - 1 2 1	FD06		EVA 2 PROC RVW		PRE SLEEP		PMC OCA		PRE SLEEP		SLEEP	
	CDR LINDSEY											
	PLT KELLY		EVA 2 PROC RVW		PRE SLEEP						SLEEP	
	MS1 FOSSUM		EVA 2 PROC RVW		PRE SLEEP						SLEEP	
	MS2 NOWAK		EVA 2 PROC RVW		PRE SLEEP						SLEEP	
	MS3 WILSON		EVA 2 PROC RVW		PRE SLEEP						SLEEP	
MS4 SELLERS		EVA 2 PROC RVW		PRE SLEEP						SLEEP		
I S S	ISS CDR		EVA 2 PROC RVW		PWRKREP		DPC COX		PRE SLEEP-ISS		SLEEP	
	FE-1		REIMS		JRNLEVEPREP WK		DPC		EVEPREP WK		PRE SLEEP-ISS	
	FE-2 Reiter		PMC		EVEPREP WK		DPC		EVEPREP WK		PRE SLEEP-ISS	
S T S	DAY/NIGHT ORBIT		80		81		82		83		84	
	W -171											
	TDRS E - 46											
Z -275												
ORB ATT								BIAS -XLV -ZVV				
NOTES				*STATUS CK								

STS-121/ULF 1.1 JOINT MISSION STP

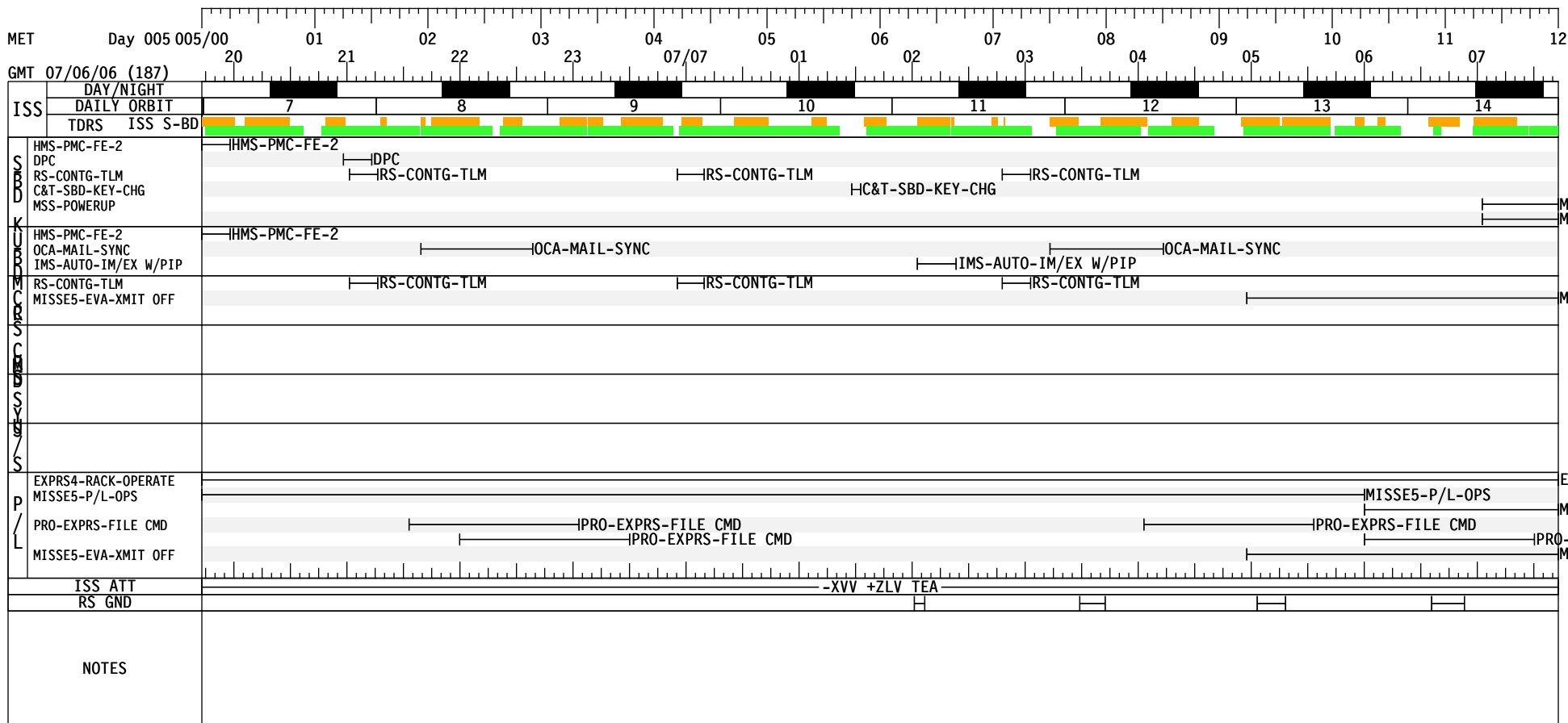

GMT 07/07/06 (188)

MET Day 005

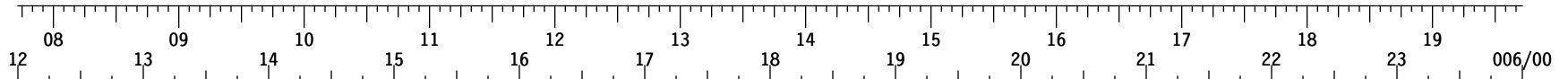

S T S - 1 2 1	FD07 CDR LINDSEY	POST SLEEP	PMC A/G	POST SLEEP	C/O N/D	C I W I T U	I O I U ^	P I N A D I O I U ^	P/TV 07 S/U	C T W E C R M 9	PWR 1	PWR 2	PWR XFER (2)	P/TV 07 EVA	MEAL	P/TV 07 EVA	C I W N C I 1 0	EXERCISE	C T W R C M 1 0	CWC XFER (2)	P/TV 07 EVA				
	PLT KELLY	POST SLEEP	E M U - T	EVA PREP W/ ISS 02				E P M U R G E	EMU PREBREATHE	C_LK DPRS						EVA 2 IVA SUPPORT									
	MS1 FOSSUM	POST SLEEP		EVA PREP W/ ISS 02				E P M U R G E	EMU PREBREATHE	C_LK DPRS	E G R S	A P F R S/U	P M *	F G B ^	P R M T R V L	A P F R R C N F G & T U S S/U	T U S *	P U M M O D U L E I N S T A L L				NADIR TUS R&R	T U S C B L R O U T E		
	MS2 NOWAK	POST SLEEP		EXERCISE					M P L M X F E R		D O U G S/U	P M P R E G R P L			P M G R P L	M N V R P M T O E S P - 2	P M U N G R P L	T U S R M V L	M N V R T O I C C	T U S S W A P	M N V R T O S O	T U S I N S T L	M P N A V R R K	M N V R ^	*
	MS3 WILSON	POST SLEEP		EVA PREP W/ ISS 02				E P M U R G E	EMU PREBREATHE	C_LK DPRS	P M P R E G R P L				P M G R P L	M N V R P M T O E S P - 2	P M U N G R P L	T U S R M V L	M N V R T O I C C	T U S S W A P	M N V R T O S O	T U S I N S T L	M P N A V R R K	M N V R ^	⊕
	MS4 SELLERS	POST SLEEP		EVA PREP W/ ISS 02				E P M U R G E	EMU PREBREATHE	C_LK DPRS	E G R S	F G B R T R V L			F G B ^	P R M T R V L	N A D I R I U A R & R	T U S *	P U M M O D U L E I N S T A L L				NADIR TUS R&R	T U S C B L R O U T E	
I S S	ISS CDR	SLEEP	POST SLEEP	MORN PREP WK	D P C	C I T O A E M H S M K T		VELO + HC		M P L M X F E R				MIDDAY-MEAL								M P L M X F E R	T V I S		
	FE-1	SLEEP	POST SLEEP	MORN PREP WK	D P C		I M S	RED		T V I S		M P L M X F E R		MIDDAY-MEAL								M P L M X F E R			
	FE-2 Reiter	SLEEP	POST SLEEP	MORN PREP WK	D P C	X R V E W R		V + E L C		M P L M X F E R				MIDDAY-MEAL								M P L M X F E R			
S T S	DAY/NIGHT ORBIT	87	88	89	90	91	92	93	94	95															
	TDRS W -171 E - 46 Z -275	[Timeline bars for TDRS]																							
ORB ATT													BIAS -XLV -ZVV												

NOTES

^ACT

*SETUP
^INSTL

*CABLE
RETRACT

*MNV R MATE
⊕MNV R MATE
^MPLM
VIEW

STS-121/ULF 1.1 JOINT MISSION STP

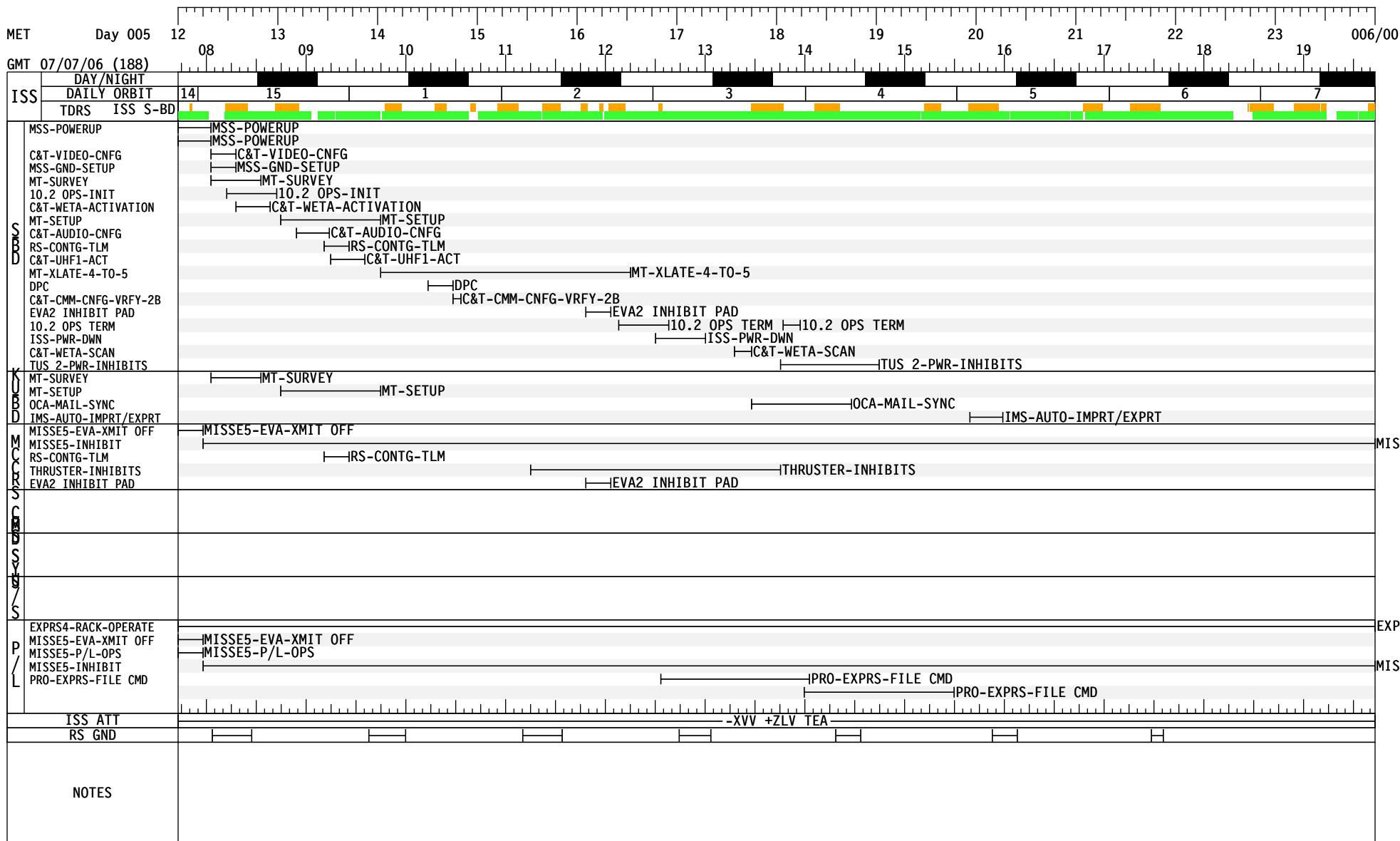

GMT 07/07/06 (188)

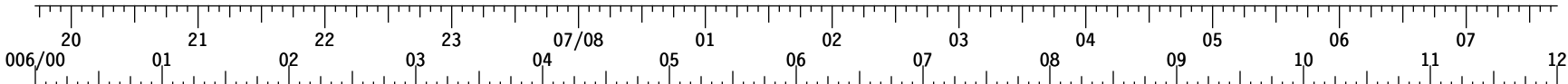

MET Day 006

S T S - 1 2 1	FD07 CDR LINDSEY	P/TV 07 EVA	OTU ^	D C N F G	X T L F A D E G R I T P	PRE SLEEP	PMC OCA	PRE SLEEP	SLEEP
	PLT KELLY	EVA 2 IVA SUPPORT	CRP TRK			POST EVA W/O H2O		PRE SLEEP	SLEEP
	MS1 FOSSUM	T C R I A I N S L U L G R S T E	CRP TRK			POST EVA W/O H2O		PRE SLEEP	SLEEP
	MS2 NOWAK	MNVR MATE MPLM				PRE SLEEP			SLEEP
	MS3 WILSON	MNVR MATE MPLM	CRP TRK			POST EVA W/O H2O	B S A - I	PRE SLEEP	SLEEP
	MS4 SELLERS	T C R I A I N S L U L G R S T E	CRP TRK			POST EVA W/O H2O		PRE SLEEP	SLEEP
I S S	ISS CDR	TVIS			PREP WK	DPC	COM M	PRE SLEEP-ISS	SLEEP
	FE-1	MPLM XFER		COX	P W R K E P	DPC		PRE SLEEP-ISS	SLEEP
	FE-2 Reiter	MPLM XFER		X T L F A D E G R I T P	B F R E I P M C	DPC		PRE SLEEP-ISS	SLEEP

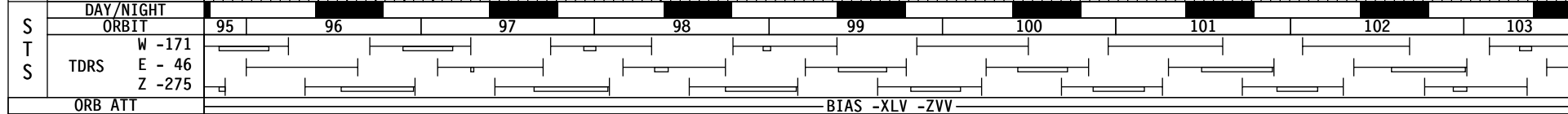

NOTES

^DEACT *STATUS CK

BIAS -XLV -ZVV

STS-121/ULF 1.1 JOINT MISSION STP

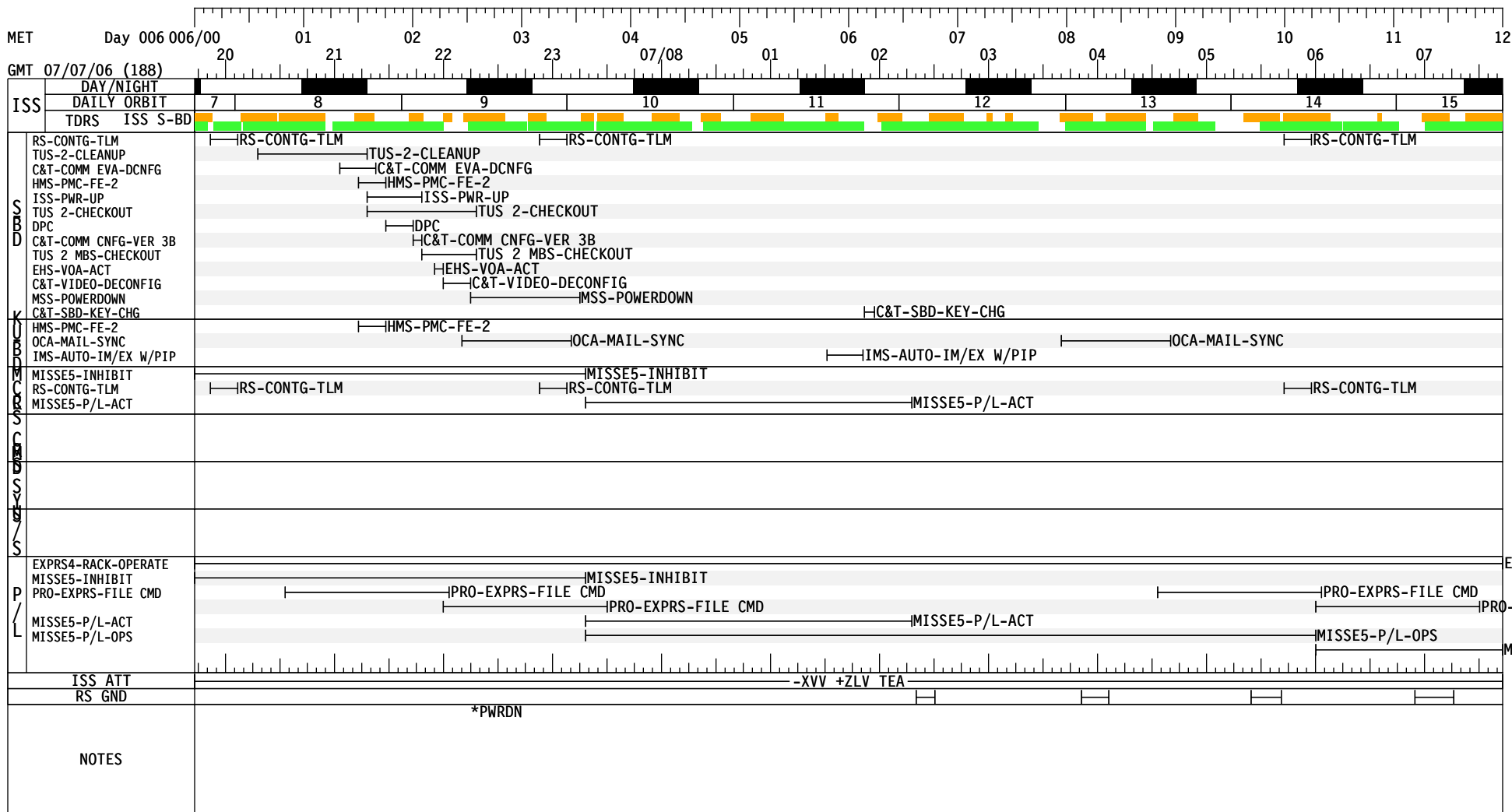

GMT 07/08/06 (189)

MET Day 006

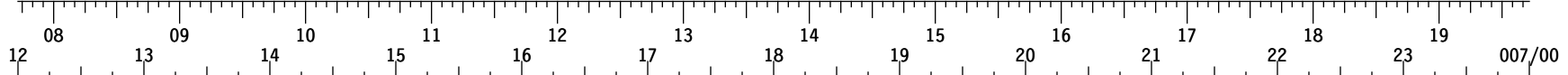

STS	CDR	PLT	MS1	MS2	MS3	MS4	ISS CDR	FE-1	FE-2	DAY/NIGHT	ORBIT	TDRS	ORB ATT	NOTES
STS-121	FD08 LINDSEY		POST SLEEP											
ISS			SLEEP	POST SLEEP	PWK RKEP	DPC								
			SLEEP	POST SLEEP	PWK RKEP	DPC								
			SLEEP	POST SLEEP	XRF FEWR	DPC								
STS														
BIAS -XLV -ZVV BIAS -XLV +YVV BIAS -XLV -ZVV *CMG TO STS *STS TO CMG *COMPACT *BATT CHRG ^INSTALL														

STS-121/ULF 1.1 JOINT MISSION STP

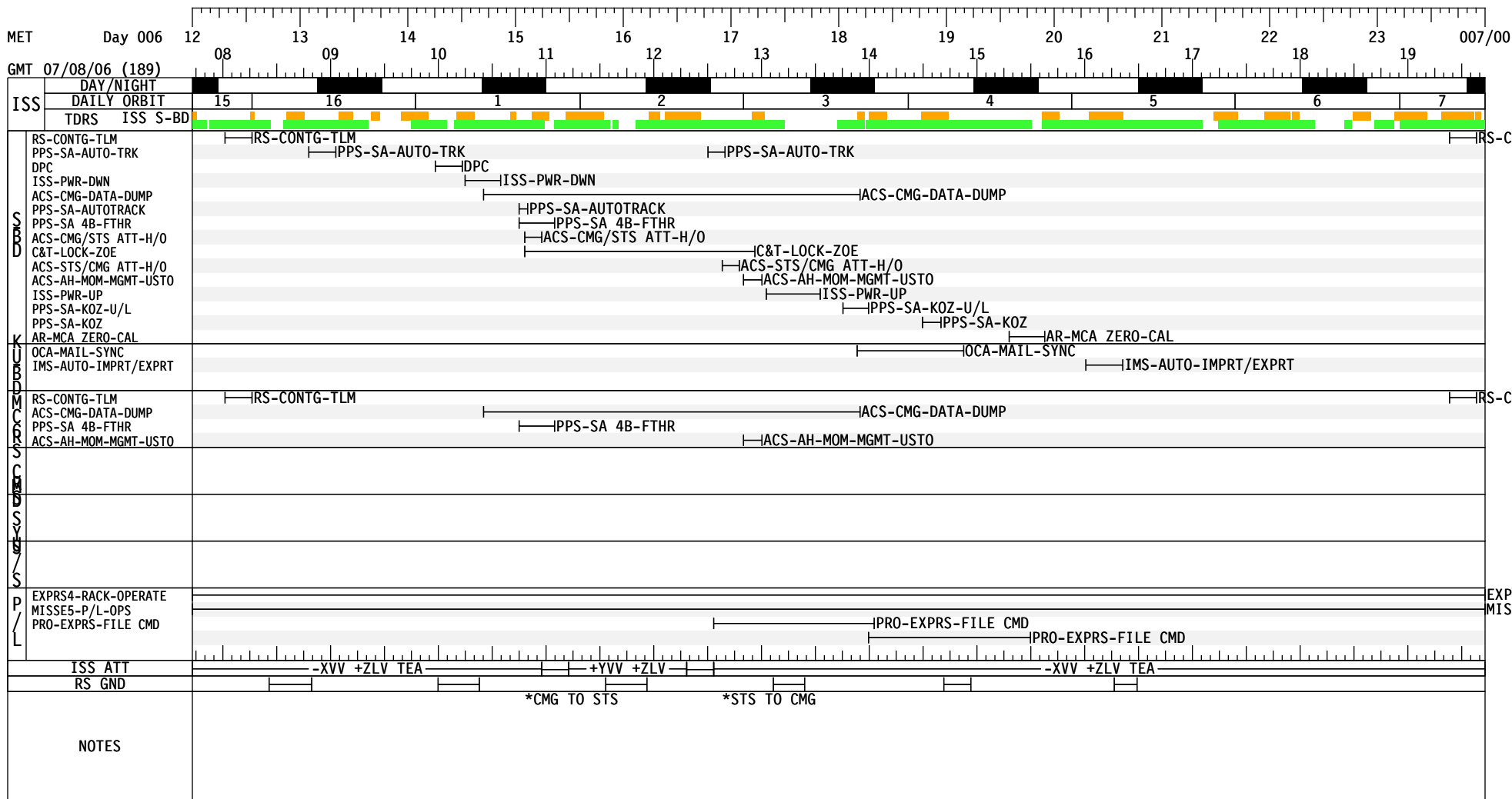

GMT 07/08/06 (189)

MET Day 007

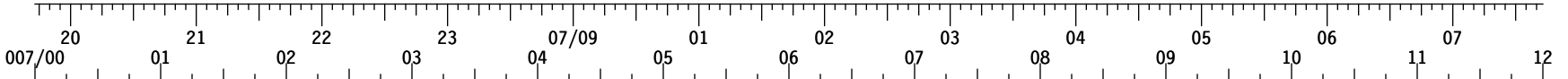

S T S - 1 2 1	FD08	MPLM XFER	PRE SLEEP	PMC OCA	PRE SLEEP	SLEEP	POST SLEEP
	CDR LINDSEY						
	PLT KELLY	PWR 3	PRE SLEEP			SLEEP	POST SLEEP
	MS1 FOSSUM	MPLM XFER	PRE SLEEP			SLEEP	POST SLEEP
	MS2 NOWAK	MPLM XFER	PRE SLEEP			SLEEP	POST SLEEP
	MS3 WILSON	MXPFLEMR	PRE SLEEP			SLEEP	POST SLEEP
MS4 SELLERS	MXDFDKR	PRE SLEEP			SLEEP	POST SLEEP	
I S S	ISS CDR	VELO + HC	PREP WK	PRE SLEEP-ISS		SLEEP	
	FE-1	MXPFLEMR	PREP WK	PRE SLEEP-ISS		SLEEP	
	FE-2 Reiter	MXPFLEMR	PREP WK	PRE SLEEP-ISS		SLEEP	
S T S	DAY/NIGHT						
	ORBIT	111	112	113	114	115	116
	TDRS	W -171	E - 46	Z -275			
ORB ATT		BIAS -XLV -ZVV					
NOTES	*STATUS CK *CNFG FOR DOWNLINK						

STS-121/ULF 1.1 JOINT MISSION STP

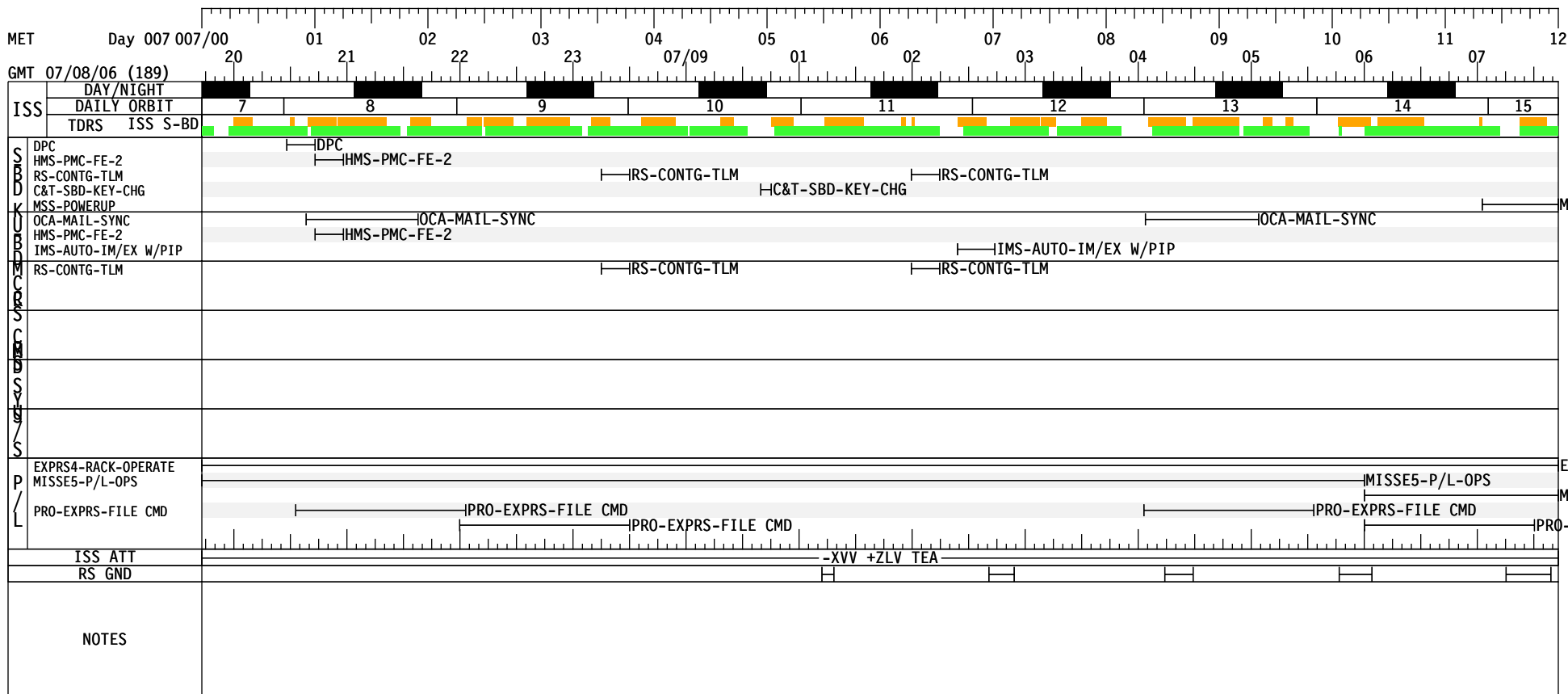

GMT 07/09/06 (190)

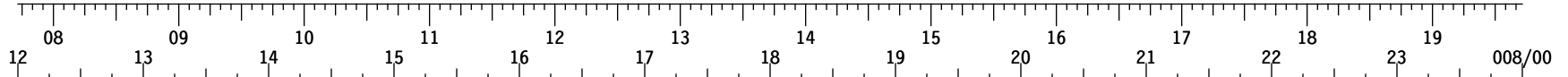

MET Day 007		12	13	14	15	16	17	18	19	20	21	22	23	19	008/00							
STS-121	FD09 CDR LINDSEY	POST SLEEP			EXERCISE		OFF DUTY					PFC OCA	MEAL		OFF DUTY			MPLM CLNUP	♣			
	PLT KELLY	POST SLEEP			ILLUM	OFF DUTY				PFC OCA	EXERCISE		OFF DUTY		MEAL		OFF DUTY			PWR 4	⊕	
	MS1 FOSSUM	POST SLEEP				OFF DUTY			PFC OCA	EXERCISE		OFF DUTY		MEAL		OFF DUTY				PEAVONT		
	MS2 NOWAK	POST SLEEP				OFF DUTY			PFC OCA	EXERCISE		OFF DUTY		MEAL		OFF DUTY				PEAVONT		
	MS3 WILSON	POST SLEEP				OFF DUTY		PFC OCA	EXERCISE		OFF DUTY			MEAL		OFF DUTY			P/TV 05 S/U	♦		
	MS4 SELLERS	POST SLEEP				OFF DUTY		PFC OCA	EXERCISE		OFF DUTY			MEAL		OFF DUTY				PRNTR SWAP		
ISS	ISS CDR	POST SLEEP		MORN PREP WK		DPC	TVIS				COX	IMS	S/U	PREP	PAO	MIDDAY-MEAL		PAO	VELO + HC		TVIS*	CUL QUEST
	FE-1	POST SLEEP		MORN PREP WK	DPC	RED				TVIS			PREP	PAO	MIDDAY-MEAL		PAO	CPA INST			DWNLD	PRNTR SWAP
	FE-2 Reiter	POST SLEEP		MORN PREP WK	DPC	ETD-EXE1_FE2				COX	IMS	S/U	PREP	PAO	MIDDAY-MEAL		PAO	CPA INST			DWNLD	V+ E H L C PMC
STS	DAY/NIGHT ORBIT	119		120		121		122		123		124		125		126		127				
	TDRS	W -171		E - 46		Z -275																
ORB ATT																BIAS -XLV -ZVV						
NOTES																						

♣CNFG MPLM
⊕PWR XFER
♦CNFG MPLM
*WKLY-MNT

STS-121/ULF 1.1 JOINT MISSION STP

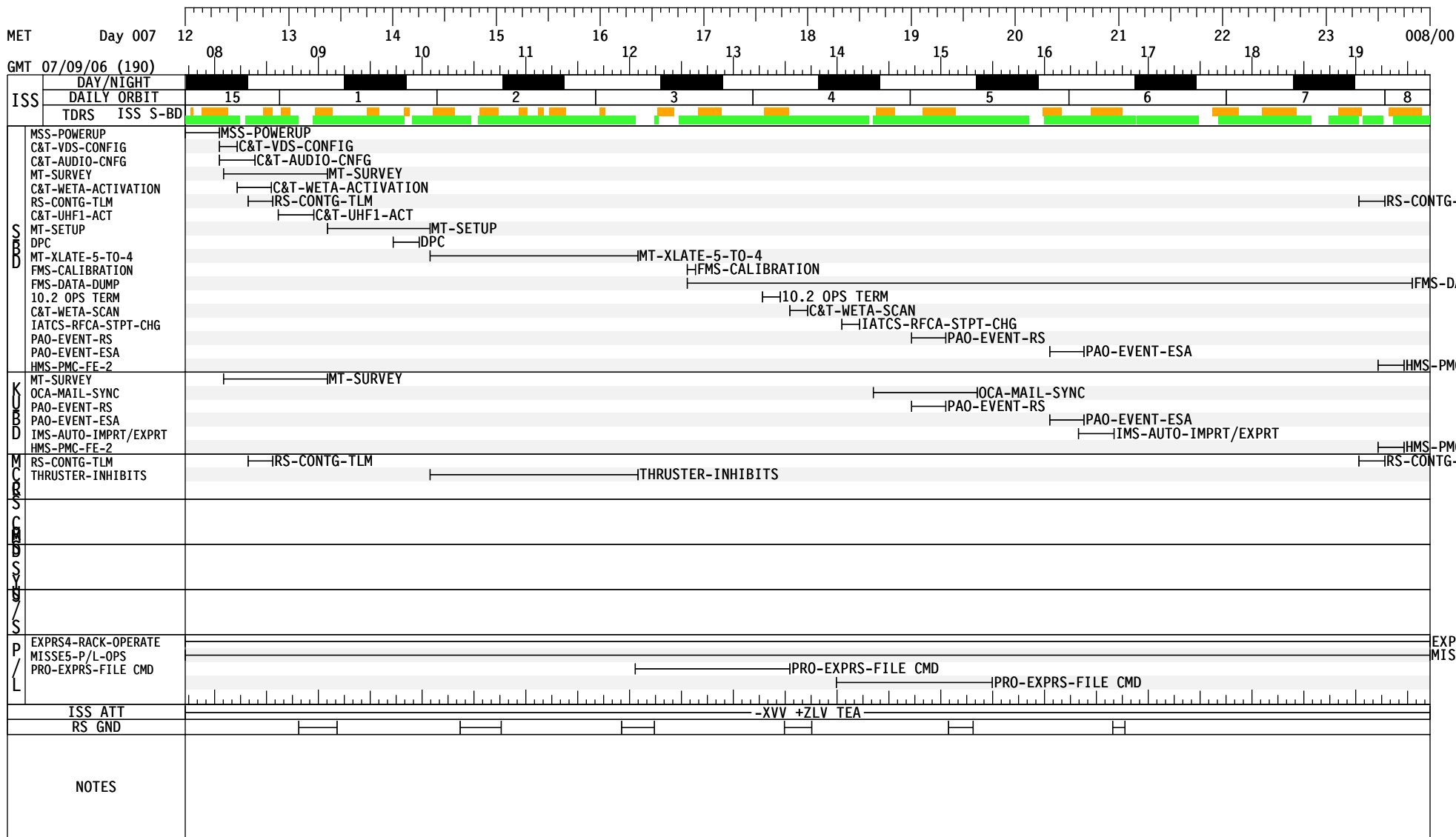

GMT 07/09/06 (190)

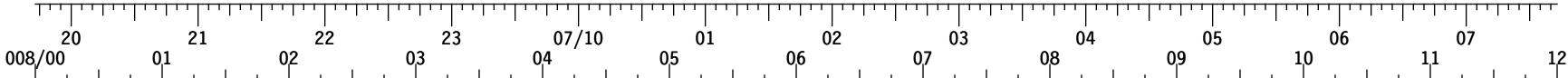

MET Day 008

S T S - 1 2 1	FD09 CDR LINDSEY	CNFG MPLM RACKS	PRE SLEEP	PMC OCA	PRE SLEEP	SLEEP	POST SLEEP			
	PLT KELLY	* C D L I D * U R L I V * M	PRE SLEEP			SLEEP	D S O S T S L E E P			
	MS1 FOSSUM		PRE SLEEP			SLEEP	A P S O L S E T E P			
	MS2 NOWAK		PRE SLEEP			SLEEP	POST SLEEP			
	MS3 WILSON	CNFG MPLM RACKS	PRE SLEEP			SLEEP	POST SLEEP			
	MS4 SELLERS	A31P XFER	PRE SLEEP			SLEEP	A P S O L S E T E P			
I S S	ISS CDR	C O U L E S T	EVE PREP WK	DPC	EVE PREP WK	PRE SLEEP-ISS	SLEEP			
	FE-1	J R N L	EVE PREP WK	DPC	EVE PREP WK	PRE SLEEP-ISS	SLEEP			
	FE-2 Reiter	VELO + HC	DPC	EVE PREP WK		PRE SLEEP-ISS	SLEEP			
S T S	DAY/NIGHT ORBIT									
	TDRS	W -171						E - 46		
		Z -275								
	ORB ATT	BIAS -XLV -ZVV								
	NOTES	*PWR XFER ⊕PRNTR SWAP ^ACT *STATUS CK *CNFG FOR DOWNLINK								

STS-121/ULF 1.1 JOINT MISSION STP

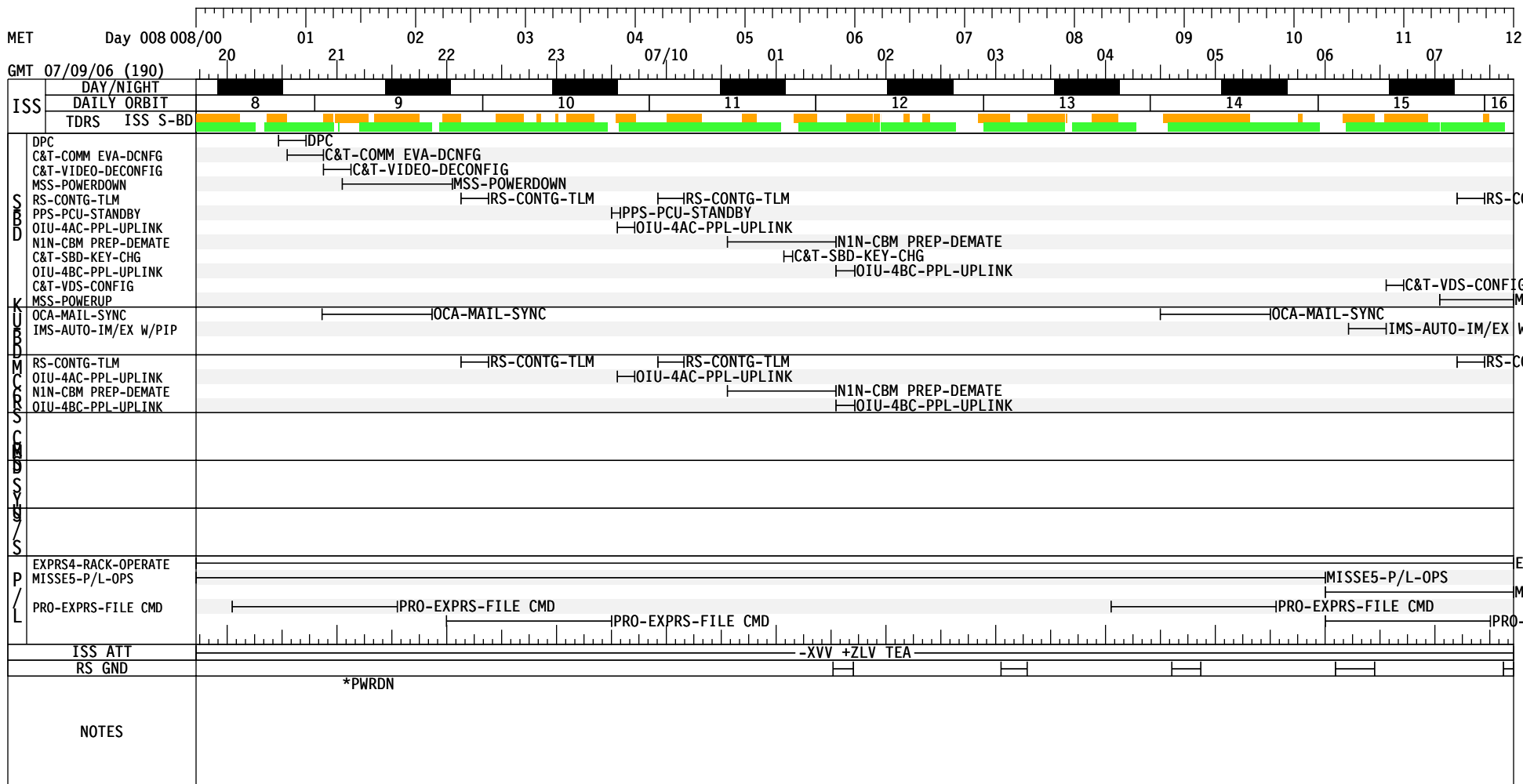

NO EXERCISE

GMT 07/10/06 (191)

MET Day 008

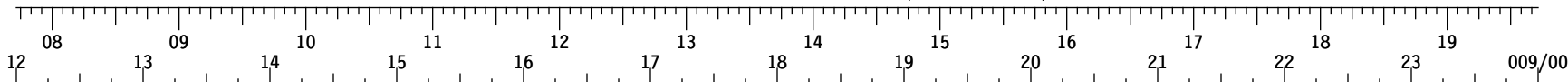

S T S - 1 2 1	FD10 CDR LINDSEY	POST SLEEP	MEGLRMS	MDPELA PLACT	MPLM VEST CNFG DMATE	MPLM VEST DEPRESS	MADS	MEAL	NAU DAIR	IMU	02 TRDWN	EXERCISE	HC 2N 0FG	MDDK XFER	OBS SRVY PORT						
	PLT KELLY	POST SLEEP	DCOX	POST SLEEP	ILLUM	PTV06 S/U MPLM	MDDK XFER	CIN WC 14	EXERCISE	CTWR CM 14	CX WC	EM VAP 06	PTV VS	MEAL	CIN WC 15	MDDK XFER	CTWR CM 15	CX WC	EVA TOOLS MGMT	AP CU *	XT FA EG RU P
	MS1 FOSSUM	POST SLEEP	PO TV S 05	PE AV O E N T	EXERCISE	EMU RCFG & XFER	MEAL	N1 CBM DEMATE	PTV06 OPS	KCA E M L	PTV06 OPS	P R L A	M P L M *	PTV06 OPS	P/TV 04 S/U						
	MS2 NOWAK	POST SLEEP	PE AV O E N T	DOUG S/U	EXERCISE	MDDK XFER	MEAL	SG SR RA M P S L	MPLM UNINSTL	MPLM BERTH	M U P N L G R P	MBS GRAPPLE	LAB UNGRP	MNV ROBSS SRVY SUPT PORT							
	MS3 WILSON	POST SLEEP	PE AV O E N T	MDDK XFER	PTV08 S/U	PTV08 OPS	EXERCISE	MEAL	SG SR RA M P S L	MPLM UNINSTL	MPLM BERTH	M U P N L G R P	MBS GRAPPLE	LAB UNGRP	MNV ROBSS SRVY SUPT PORT						
	MS4 SELLERS	POST SLEEP	PE AV O E N T	760 FLASH CAMR T/D	C A M R *	EMU RCFG & XFER	MEAL	N1 CBM DEMATE	PTV06 OPS	KCA E M L	PTV06 OPS	P R L A	EVA TOOLS MGMT	PRE SLEEP							
I S S	ISS CDR	POST SLEEP	MORN PREP WK	DPC	PRE P R E P	MDDK XFER	TVIS	COX	MIDDAY-MEAL	IMS	MDDK XFER	VELO + HC									
	FE-1	POST SLEEP	MORN PREP WK	DPC	S/ U P R E P	MDDK XFER	CWC FILL	RED	MIDDAY-MEAL	IATCS SMPL	02 TRDWN	MDDK XFER	TVIS								
	FE-2 Reiter	POST SLEEP	X R F V E R	DPC	ME P G L R M S	MDPELA PLACT	MPLM VEST CNFG DMATE	MPLM VEST DEPRESS	MIDDAY-MEAL	I S A M T P C L S	MDDK XFER	VELO + HC	MDDK XFER	PMC	XT FA EG RU P						

S T S	DAY/NIGHT	135	136	137	138	139	140	141	142
	ORBIT								
	TDRS	W -171	E - 46	Z -275					

ORB ATT *CONFIG *DCS 760 T/D BIAS -XLV -ZVV *HTR *CNFG FOR LAND *HTR ACT *ACT

NOTES	
-------	--

MPLM
PRESS
CHECK

STS-121/ULF 1.1 JOINT MISSION STP

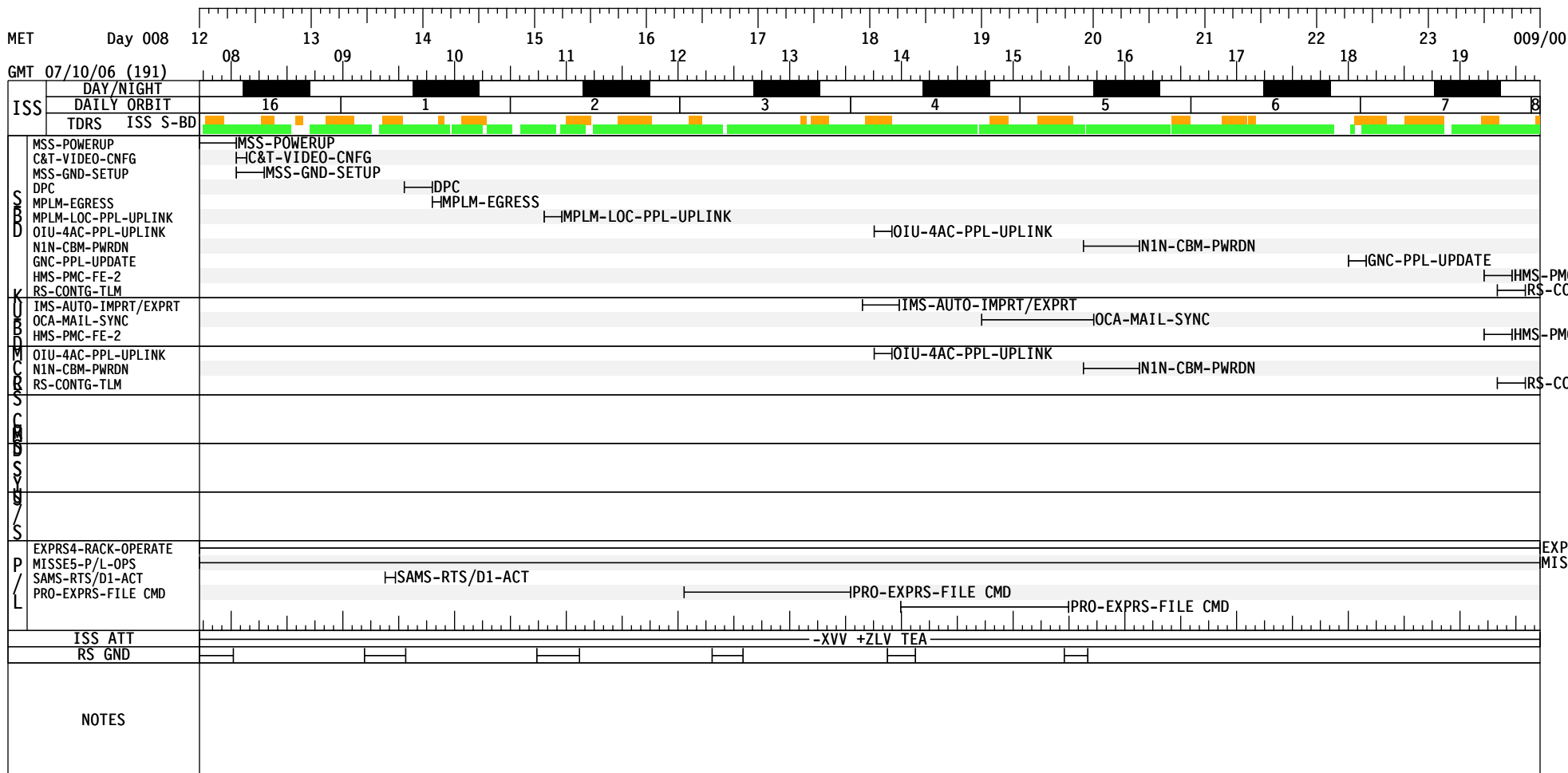

GMT 07/10/06 (191)

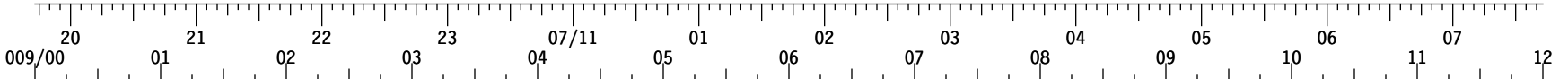

MET Day 009

S T S - 1 2 1	FD10 CDR LINDSEY	OBSS SRVY PORT	PRE SLEEP	PMC A/G	PRE SLEEP	SLEEP	POST SLEEP		
	PLT KELLY	PRE SLEEP	RNDZ TOOLS C/O	PRE SLEEP	SLEEP	POST SLEEP			
	MS1 FOSSUM	PRE SLEEP			SLEEP	POST SLEEP			
	MS2 NOWAK	OBSS SRVY PORT	PRE SLEEP			SLEEP	POST SLEEP		
	MS3 WILSON	OBSS SRVY PORT	PRE SLEEP			SLEEP	POST SLEEP		
	MS4 SELLERS	PRE SLEEP	RNDZ TOOLS C/O	PRE SLEEP	SLEEP	POST SLEEP			
I S S	ISS CDR	V+ E H L C	EVE PREP WK	DPC	EVE PREP WK	PRE SLEEP-ISS	SLEEP	POST SLEEP	
	FE-1	T V I S	P W R K	J R N L	DPC	EVE PREP WK	PRE SLEEP-ISS	SLEEP	POST SLEEP
	FE-2 Reiter	X B F R E I R E F	EVE PREP WK	DPC	EVE PREP WK	PRE SLEEP-ISS	SLEEP	POST SLEEP	
S T S	DAY/NIGHT	[Timeline bars for Day/Night]							
	ORBIT	143 144 145 146 147 148 149 150							
	TDRS	W -171 E - 46 Z -275							
	ORB ATT	BIAS -XLV -ZVV							
	NOTES	*DEACT ^DEACT							

STS-121/ULF 1.1 JOINT MISSION STP

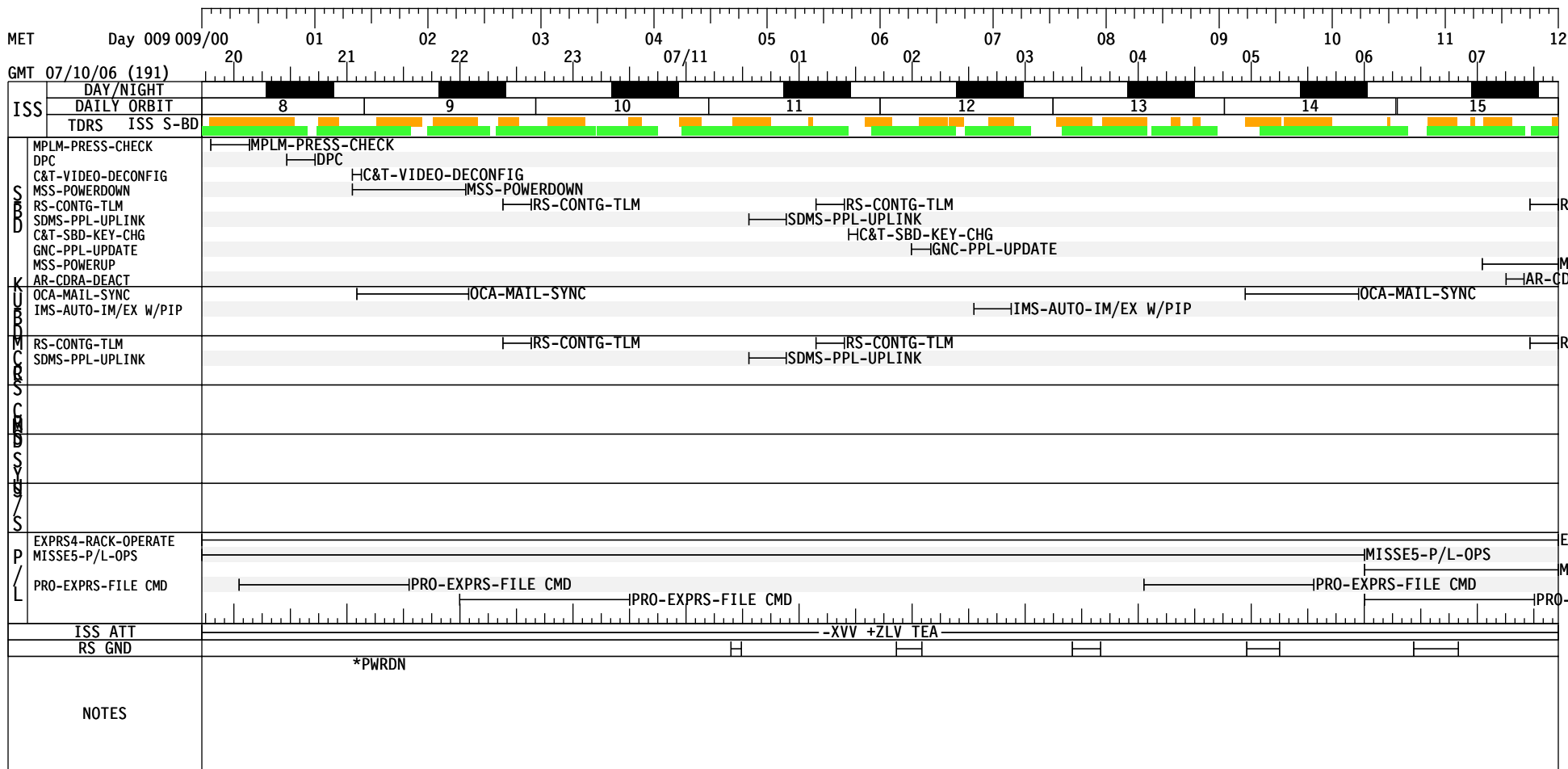

GMT 07/11/06 (192)

MET Day 009

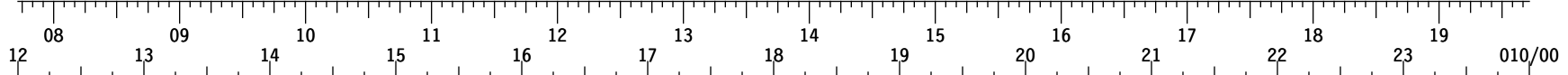

STS - 1 2 1	FD11 CDR LINDSEY	POST SLEEP	FW A R L E L	EGRS HATCH CLS	A T T *	G P R P U B	H L A U D B /	M U N N V R K	UNDOCK OPS	SEP	S E P	M D U N V M R P	C I M U ^	G P R P B D N	MEAL	M I N V R T L	OBSS SURVEY - STBD	M I N V R T L	OBSS SURVEY - NOSE	PRE SLEEP	M - N Z V L R V	P S R L E E P
	PLT KELLY	POST SLEEP	FW A R L E L	EGRS HATCH CLS		G P R P U B			UNDOCK OPS	SEP	S E P	C O M M 1	S I M O I N I T	G P R P B D N	MEAL			OBSS SURVEY - NOSE		EXERCISE	PRE SLEEP	
	MS1 FOSSUM	POST SLEEP	FW A R L E L			C/L C M R I N S T L			UNDOCK OPS	SEP	S E P		S E A R C T	MEAL		OBSS SURVEY - STBD	EXERCISE	EMU H/W S T O W	POST EVA ENT PREP	P D T E V A O C 3 T		
	MS2 NOWAK	POST SLEEP	FW A R L E L	L I M O K *			ODS VEST L K C K		UNDOCK OPS	SEP	S E P			MEAL	M S N R V R Y	OBSS SURVEY - STBD		EXERCISE		OBSS BERTH	R P M S R D N	
	MS3 WILSON	POST SLEEP	FW A R L E L	P/TV 04 O P S E G R			ODS VEST L K C K		UNDOCK OPS	SEP	S E P			MEAL	M S N R V R Y	EXERCISE		OBSS SURVEY - NOSE		OBSS BERTH	R P M S R D N	
	MS4 SELLERS	POST SLEEP	FW A R L E L	P/TV 04 O P S E G R	S S V R 3	C/L C M R I N S T L	P/TV03 S/U		P/TV03 OPS	SEP	S E P	P O S T U N D K P G S C C N F G		MEAL	FILTER C L E A N I N G		EXERCISE		EMU H/W S T O W	POST EVA ENT PREP	P D T E V A O C 3 T	V T R V T R S /U P B
ISS	ISS CDR	POST SLEEP	D P C	FW A R L E L		PM							TVIS	MIDDAY-MEAL		C B O 3 E D B F I L L			VELO + HC		*	
	FE-1	POST SLEEP	D P C	FW A R L E L	EGRS HATCH CLS			DEP T R S T R		RED		P M A 2 - D E P R E S S	MIDDAY-MEAL	P M A 2 D P R S	C O M M S	P M A 2 F F O D P R S		TVIS			*	
	FE-2 Reiter	POST SLEEP	D P C	FW A R L E L									MIDDAY-MEAL					COX		VELO + HC	*	

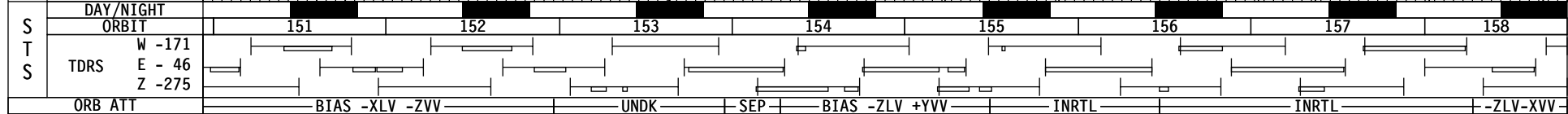

NOTES

*CMG TO STS
*DEPLOY

*UNDOCK 09/16:04

^TEARDOWN ^ACT ^DEACT
^ACT ^DEACT

MPLM PRESS CK

*PRE SLEEP

STS-121/ULF 1.1 JOINT MISSION STP

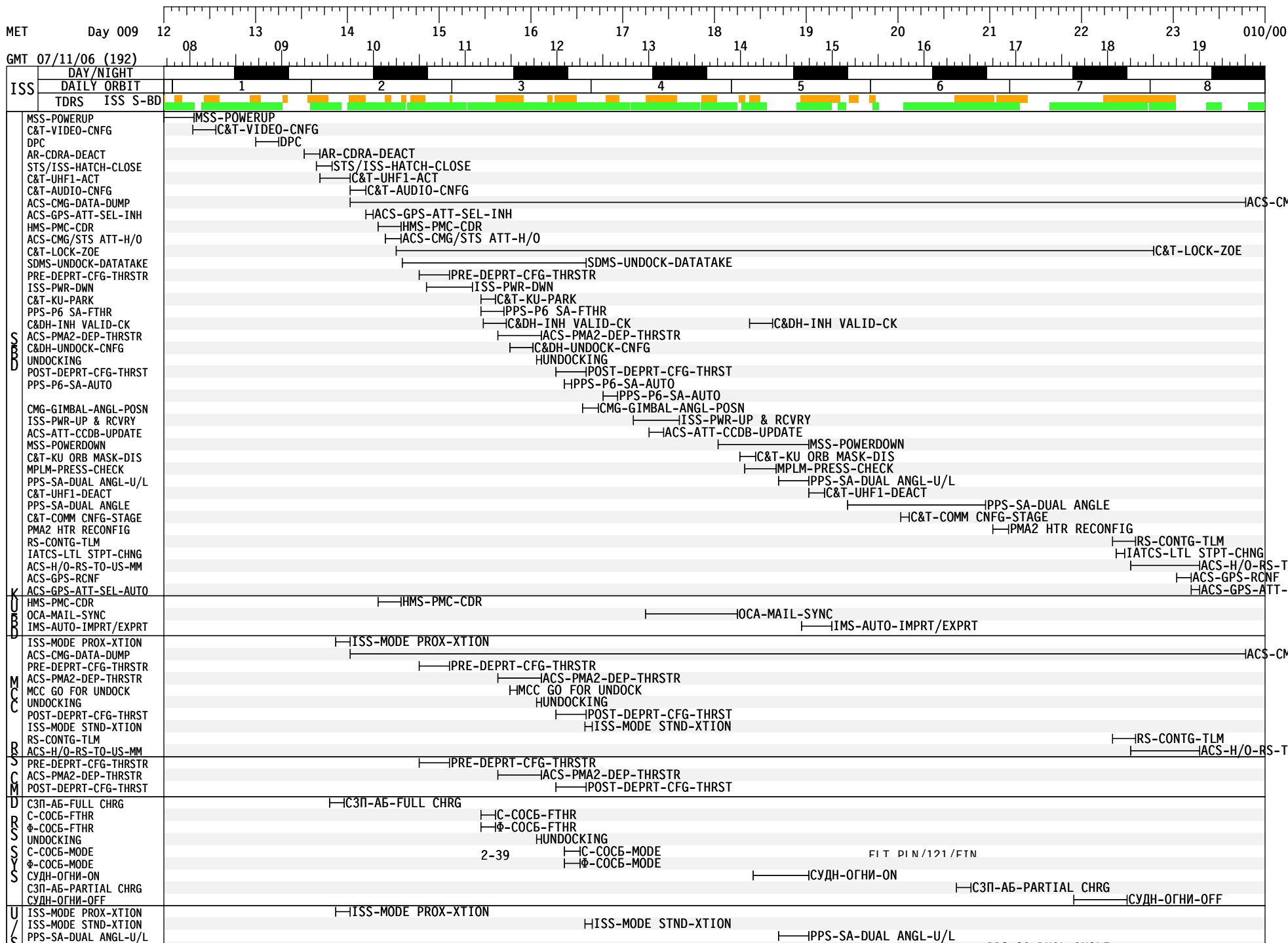

GMT 07/11/06 (192)

MET Day 010

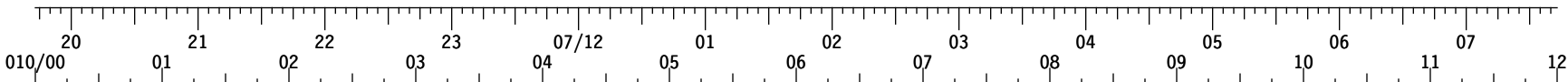

STS-121	FD11	PS R L E E P	NC5^ RCS BURN	PRE SLEEP	PMC OCA	PRE SLEEP	SLEEP	POST SLEEP		
	CDR LINDSEY									
	PLT KELLY	PS R L E E P	RCS BURN	PRE SLEEP			SLEEP	POST SLEEP		
	MS1 FOSSUM			PRE SLEEP			SLEEP	POST SLEEP		
	MS2 NOWAK			PRE SLEEP			SLEEP	POST SLEEP		
	MS3 WILSON			PRE SLEEP			SLEEP	POST SLEEP		
MS4 SELLERS			PRE SLEEP			SLEEP	POST SLEEP			
STS	DAY/NIGHT	[Timeline with alternating black and white bars]								
	ORBIT	158	159	160	161	162	163	164	165	166
	TDRS	W -171	E - 46	Z -275						
ORB ATT		NC5					-ZLV -XVV			
STS	GND		-DFR	-MIL -DFR	-MIL -DFR	-MIL -WHS -DFR	-WHS -DFR			
	NOTES									

GMT 07/12/06 (193)

MET Day 010

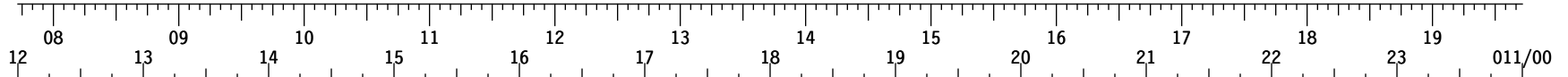

STS-121	FD12	POST SLEEP	FCS C/O	RFCS HOT	NC6	RCS BURN	MNU V R P	CION I D T	DUMP PWR (2)	CTO E N R S * D M	PILOT OPS	CABIN STOW	MEAL	F S * D/O BRIEF	L-1 COMM CHK	PEAV O E N T	CABIN STOW	M+Z L V L-1 COMM CHK	M-Z L V	EXERCISE	NC7	E N T R Y * RCS BURN		
	PLT KELLY	POST SLEEP	FCS C/O	RFCS HOT	OP U *	POST SLEEP	AP C I U *		EXERCISE	C I O N I D T	PILOT OPS	CTO E N R D M	SIMO INIT	MEAL	SIMO TERM	D/O BRIEF	PEAV O E N T	FCMS OPS	CABIN STOW	RCS BURN	KU STOW			
	MS1 FOSSUM	POST SLEEP		RCC DTO TOOL CLN/STW			CABIN STOW		EXERCISE		CABIN STOW		MEAL	D/O BRIEF		PEAV O E N T	ENTRY VIDEO S/U		CABIN STOW		ERG STOW			
	MS2 NOWAK	POST SLEEP	FCS C/O	RFCS HOT		POST SLEEP	PILOT SETUP		CABIN STOW		PILOT OPS		CABIN STOW		MEAL	D/O BRIEF		PEAV O E N T	EXERCISE		CABIN STOW		ERG STOW	KU STOW
	MS3 WILSON	POST SLEEP					CABIN STOW		EXERCISE		CABIN STOW		MEAL	D/O BRIEF	PAO S/U		PEAV O E N T	COM M 2				CABIN STOW		
	MS4 SELLERS	POST SLEEP		RCC DTO TOOL CLN/STW			CABIN STOW		EXERCISE				MEAL	D/O BRIEF	W T S / G D I S		PEAV O E N T	WLES STOW				CABIN STOW		PGSC STOW PART I

STS	DAY/NIGHT	[Shaded bars indicating day/night cycle]											
	ORBIT	166	167	168	169	170	171	172	173	174			
	TDRS	W -171	E - 46	Z -275	[Timeline bars for TDRS events]								

ORB ATT	-ZLV -XVV	-NC6	-ZLV +YVV	-MIL -WHS	+ZLV-XVV	-MIL -WHS -DFR	-ZLV -XVV	NC7
---------	-----------	------	-----------	-----------	----------	----------------	-----------	-----

STS	GND	*HEATER ACT	*ACT ^ACT	*DEACT ^DEACT	*INIT	*TERM	*COOLING CNFG
-----	-----	-------------	-----------	---------------	-------	-------	---------------

NOTES	MPLM PRESS CK						
-------	---------------	--	--	--	--	--	--

GMT 07/12/06 (193) 20 21 22 23 07/13 04 05 06 07 08 09 10 11 07 12
 MET Day 011 011/00 01 02 03 04 05 06 07 08 09 10 11 12

S T S - 1 2 1	FD12	CDR LINDSEY	PRE SLEEP	PMC A/G	PRE SLEEP	SLEEP	POST SLEEP
		PLT KELLY	PRE SLEEP			SLEEP	POST SLEEP
		MS1 FOSSUM	PRE SLEEP			SLEEP	POST SLEEP
		MS2 NOWAK	PRE SLEEP			SLEEP	POST SLEEP
		MS3 WILSON	PRE SLEEP			SLEEP	POST SLEEP
		MS4 SELLERS	PRE SLEEP			SLEEP	POST SLEEP

S T S	DAY/NIGHT	[Bar chart showing day/night cycle]									
	ORBIT	174	175	176	177	178	179	180	181	182	
	TDRS	W -171	E - 46	Z -275	[TDRS coverage bars]						

ORB ATT				-ZLV -XVV		
STS	GND	-DFR	-MIL -DFR	-MIL -WHS -DFR	MIL -WHS -DFR	-DFR

NOTES

GMT 07/13/06 (194)

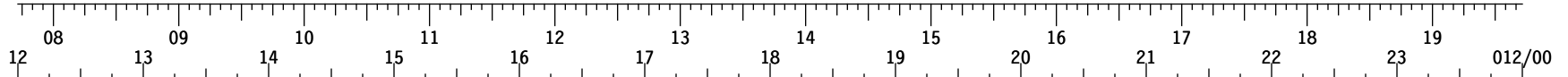

STS-121	FD13	CDR LINDSEY	POST SLEEP	PMCA/G	GPWRUP	I/MLVUEGRNIF	WATTCHE	DEORBIT PREP		
		PLT KELLY	POST SLEEP	WATTCHE	GPWRUP	I/MLVUEGRNIF	TRXSKI	DEORBIT PREP		
		MS1 FOSSUM	POST SLEEP			GSTRORAW	SAMPL	DEORBIT PREP		
		MS2 NOWAK	POST SLEEP	WATTCHE	WATTCHE	WATTCHE	WATTCHE	DEORBIT PREP		
		MS3 WILSON	POST SLEEP					DEORBIT PREP		
		MS4 SELLERS	POST SLEEP	WATTCHE	WATTCHE	WATTCHE	WATTCHE	DEORBIT PREP		
STS	DAY/NIGHT	[Bar chart showing day/night cycle]								
	ORBIT	182	183	184	185	186	187	188	189	190
STS	TDRS	[Timeline bars for TDRS W, E, Z]								
	ORB ATT	[Timeline bars for -ZLV, -XVV, IMU, -XSI, COMM, -MIL, -WHS, -DFR]								
	GND	[Timeline bars for -MIL, -WHS, -DFR, -WHS, -DFR]								
NOTES	<p style="text-align: center;">^D/O TIG 11/18:07</p> <div style="border: 1px solid black; padding: 5px; display: inline-block;">*KSC LAND 11/19:12</div>									

This Page Intentionally Blank

DETAILED TIMELINE

DETAILED
TIMELINE

STS-121/ULF 1.1 (FD 01)

GMT	TDRS ORB	MET	ORBIT	CDR LINDSEY	PLT KELLY	MS2 NOWAK	MCC	NOTES
Date 07/01 (182)	W E Z B	Day 000	00:00					
20:00			L A U N C H					
21:00				POST INSERTION	POST INSERTION	POST INSERTION		UPLINK β21°+MASK
22:00			B I A S					
				AFT CONTROLLER C/O (ORB OPS, GNC)	SSPI OIU PWR - OIU 1 ON (tb-UP)	OCAC SETUP (ORB OPS, CREW SYS)		TFL 184
				IMU STAR OF OPTY ALIGN (ORB OPS, GNC)	ON MCC GO: APCU ACT (ASSY OPS, APCU) APCU 1	PGSC SETUP At minimum, set up WLES, DOUG & LCS A31Ps per PGSC Usage Chart.	MPLM: 1.101 MPLM ENVIRONMENT CK	
				LOAD DAPS (ORB OPS, DAP TABLE)	LOAD DAPS (ORB OPS, DAP TABLE)	PGSC NETWORK (ORB OPS, PGSC)		
23:00			V V	PRE-SLEEP ACTIVITY (ORB OPS, CREW SYS)	PRE-SLEEP ACTIVITY (ORB OPS, CREW SYS)			TFL 161
				ON MCC GO: APCU DEACT (ASSY OPS, APCU) APCU 1	SSPI OIU PWR - OFF (tb-bp)			
				W/B COOLING VERIF (DTO 850) (ORB OPS, DTO)	W/B COOLING VERIF (DTO 850) (ORB OPS, DTO)			
04:00						TEPC (POWER ON) (ORB OPS, CREW SYS)		TFL 184

FD01 EZ ACTIVITIES
 PCS 1(2) CONFIG (ORB OPS, ECLS)
 Configure to PCS 1
 L17 Check MCIU Filter Screen
 SMK DETN CK TEST (ORB OPS, ECLS)
 MS2: If PMZ req'd, PMZ PROTOCOL (ORB OPS, DS0s)
 Unstow Latent Virus Kit & place near sleep area

STS-121/ULF 1.1 (FD 01)

GMT	TDRS WSEZ	MET Day 000	ORBIT ATT	MS1 FOSSUM	MS3 WILSON	MS4 SELLERS	FE-2/MS5 REITER	NOTES
07/01 (182)		00:00	L A U N C H					
20:00								
21:00				P O S T I N S E R T I O N	P O S T I N S E R T I O N	P O S T I N S E R T I O N	P O S T I N S E R T I O N	
22:00			B I A S	P/TVO1 VIDEO SETUP (PHOTO/TV, SCENES)	ON-ORBIT INITIALIZATION (PDRS, ON-ORBIT INIT) P/TVO1 VIDEO SETUP (PHOTO/TV, SCENES)	PGSC SETUP (MDDK) At minimum, set up KFX & OCA Router per PGSC Usage Chart. PGSC NETWORK (ORB OPS, PGSC) COLOR PRNTR UNSTOW & ASSMBLE (ORB OPS, PGSC) DCS FILE DNK (FROM MICRO DRIVE) (PHOTO/TV, DCS 760) DOWNLINK ET STILL PHOTOS	GIRA INSTALLATION (ORB OPS, ECLS)	
23:00			Z L V - Y V V	W/B COOLING VERIF (DTO 850) (ORB OPS, DTO)	RMS PWRUP (PDRS, RMS PWRUP)	ACTIVATION AND CHECKOUT (ORB OPS, WLE SENSORS)	SHUTTLE EMER EYEWASH (SEE) Unstow, attach on or near galley Fill one drink container & label For SEE Use Only	
04:00				FRED SETUP (ORB OPS, FRED)	UMBILICAL WELL TPS CAMR IMGRY D/L (ORB OPS, PGSC)			

STS-121/ULF 1.1 (FD 01)

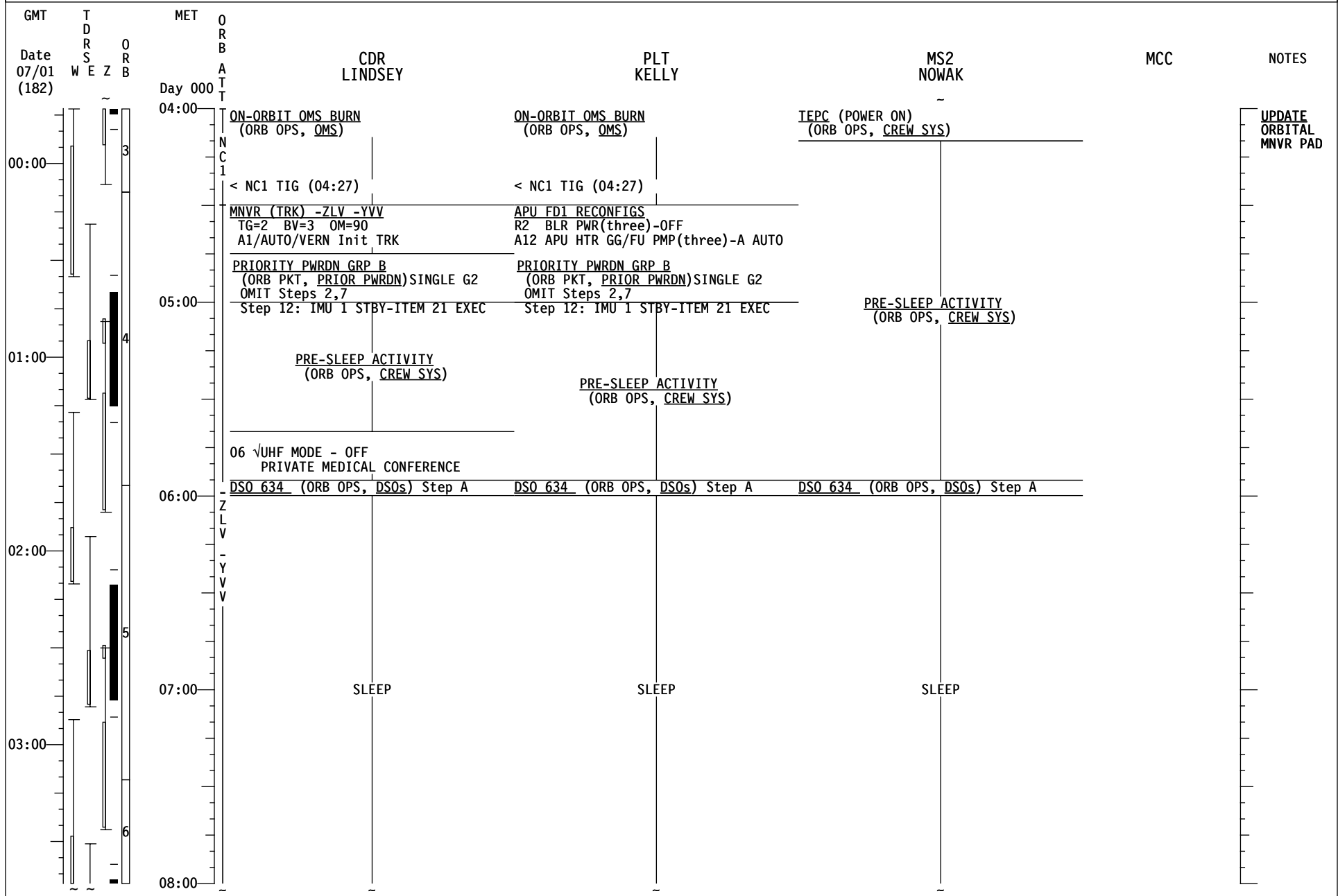

STS-121/ULF 1.1 (FD 01)

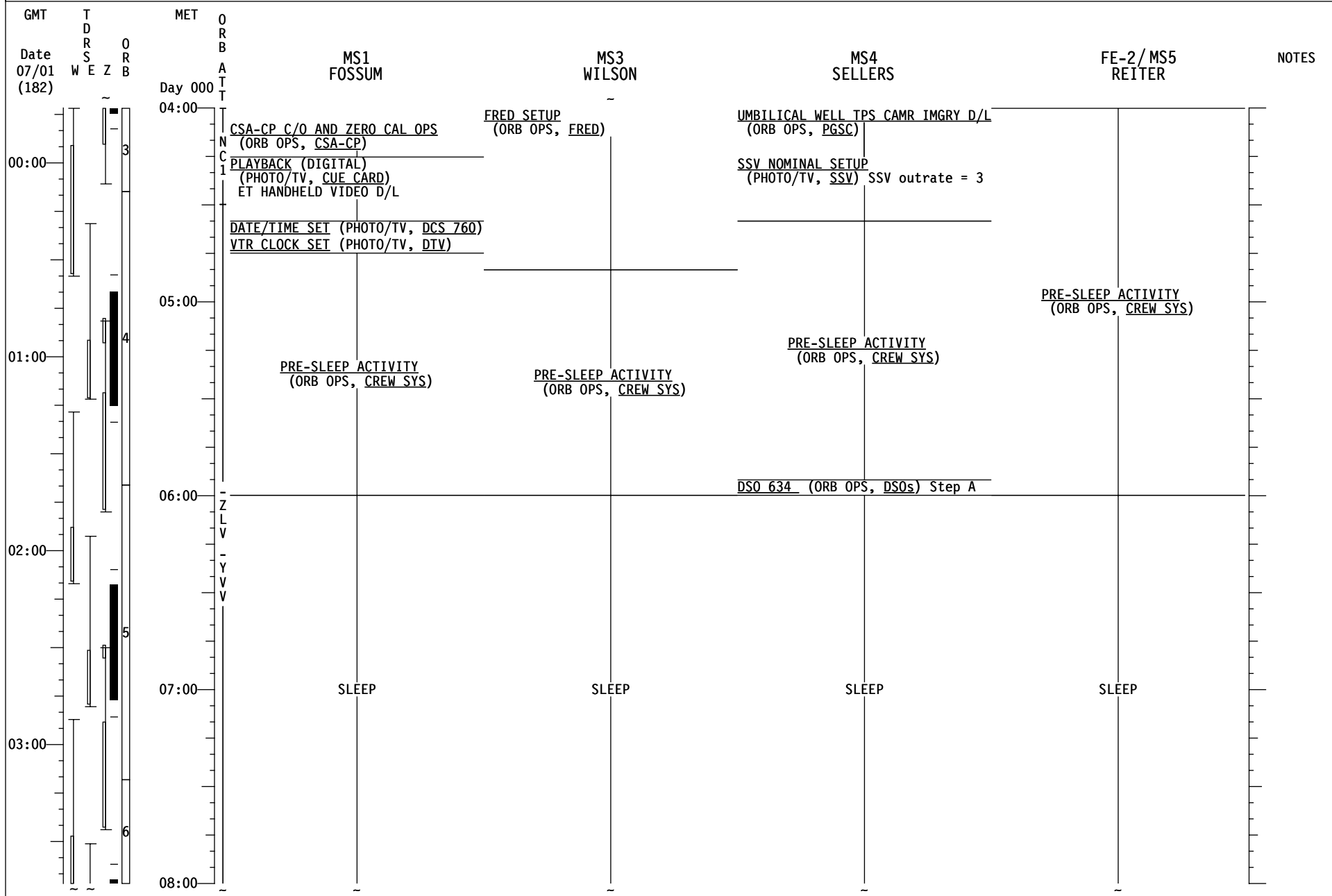

STS-121/ULF 1.1 (FD 01)

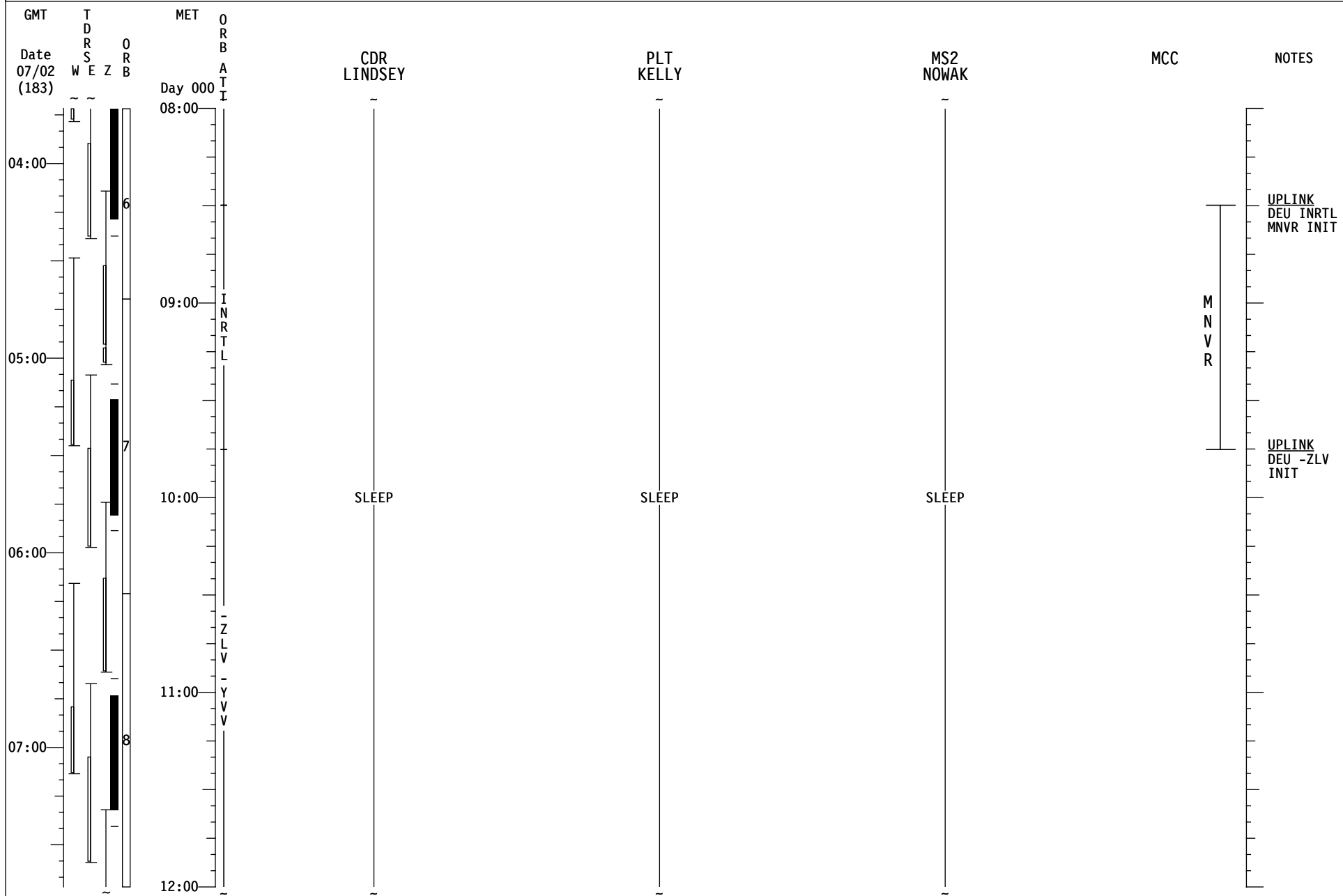

STS-121/ULF 1.1 (FD 01)

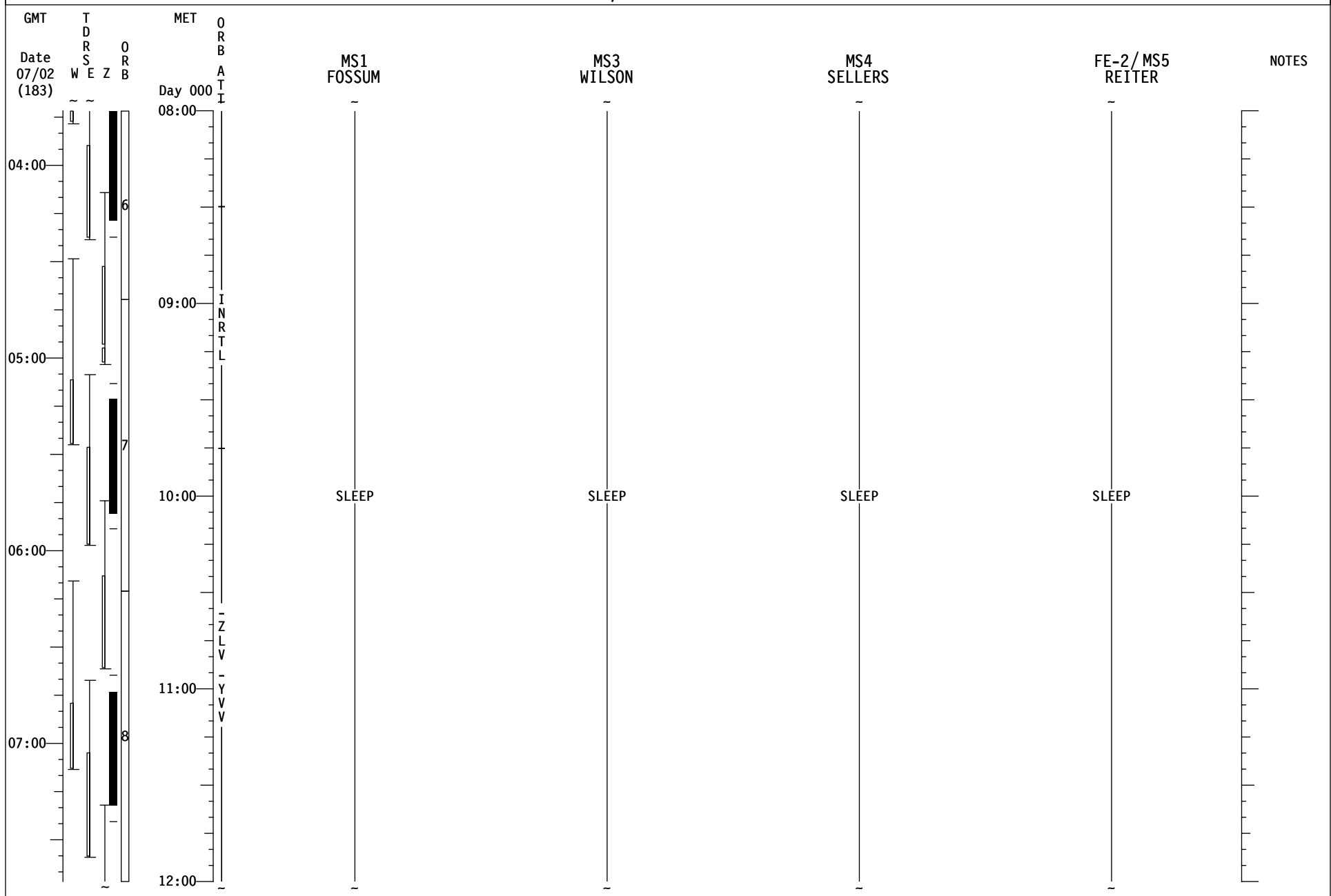

STS-121/ULF 1.1 (FD 02)

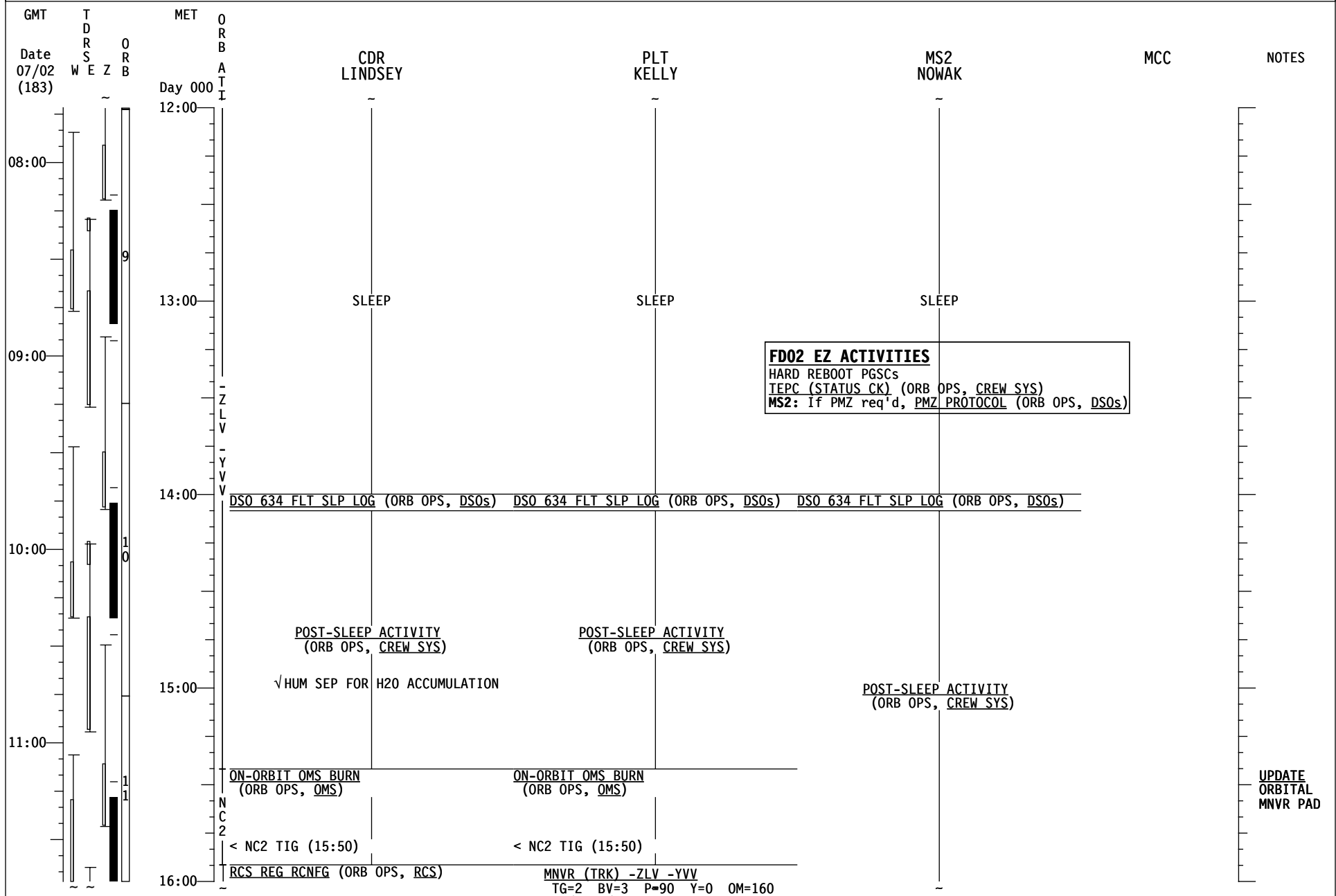

FD02 EZ ACTIVITIES
 HARD REBOOT PGSCs
 TEPC (STATUS CK) (ORB OPS, CREW SYS)
 MS2: If PMZ req'd, PMZ PROTOCOL (ORB OPS, DSOs)

UPDATE
ORBITAL
MNVR PAD

STS-121/ULF 1.1 (FD 02)

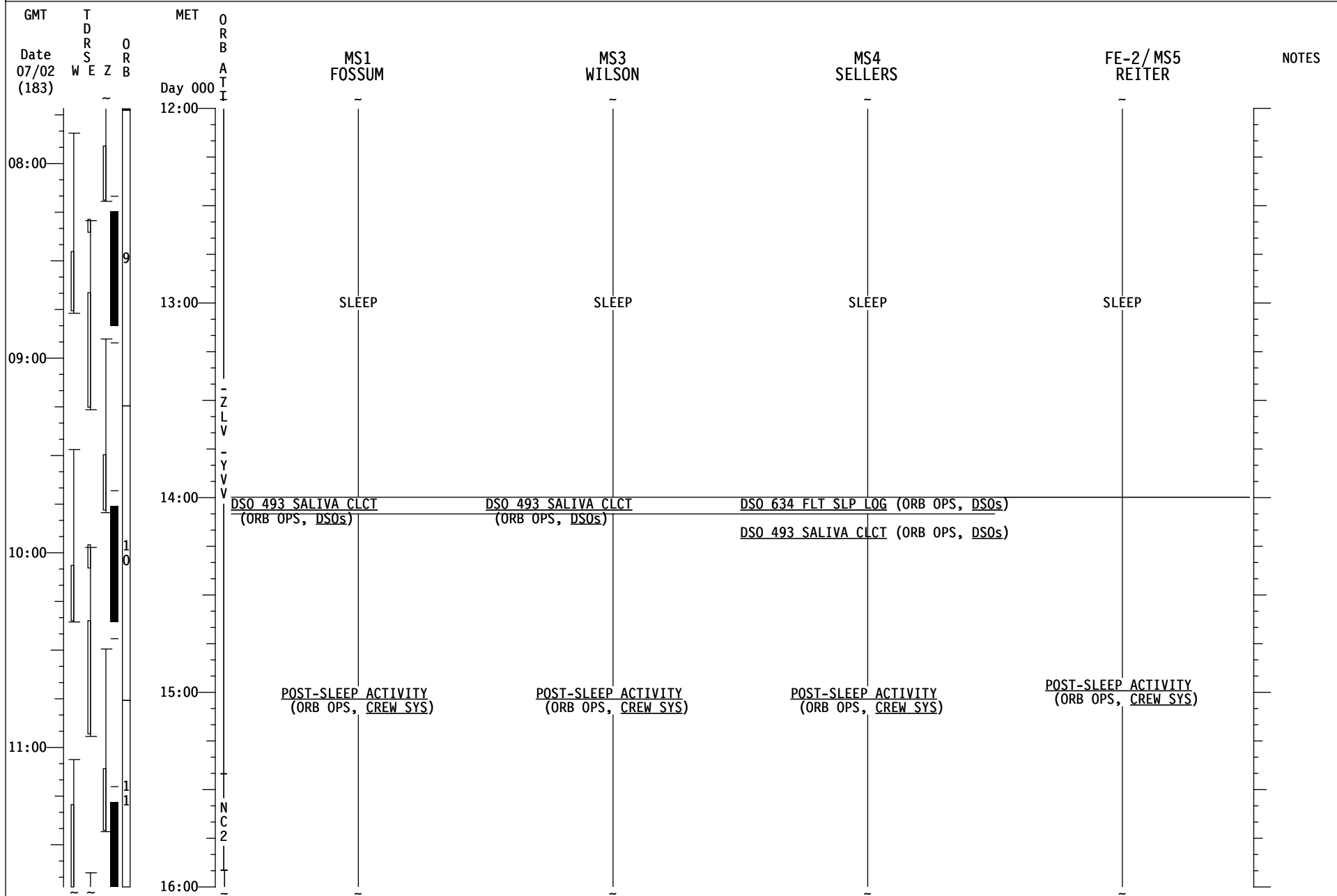

STS-121/ULF 1.1 (FD 02)

GMT	TDRS W E Z	ORB O R B	MET Day 000	CDR LINDSEY	PLT KELLY	MS2 NOWAK	MCC	NOTES
12:00	~	1	16:00	HTR RCNFG-CNFG B (ORB OPS, EPS) CABIN TEMP CONTROLLER REC NFG 2(1) (ORB OPS, ECLS) IMU STAR OF OPTY ALIGN (ORB OPS, GNC)	MNVR (TRK) -ZLV -YVY TG=2 BV=3 P=90 Y=0 OM=160 A1/AUTO/VERN Init TRK	POST-SLEEP ACTIVITY (ORB OPS, CREW SYS)		UPLINK B21°+MASK+ BOX A1 26<AZ<110 -90<EL<-30
				POST-SLEEP ACTIVITY (ORB OPS, CREW SYS)	POST-SLEEP ACTIVITY (ORB OPS, CREW SYS)	RMS CHECKOUT (PDRS, RMS C/O)		
				OBSS UNBERTH (PDRS, NOMINAL)	FC PURGE - MANUAL (ORB OPS, EPS)	OBSS UNBERTH (PDRS, NOMINAL)		UPLINK B21°+MASK+ BOX A2 -27<AZ<110 -90<EL<0 BOX A3 -81<AZ<110 -67<EL<-10
				P/TVO1 VIDEO SETUP (PHOTO/TV, SCENES) Prior to start, verify Late Update Complete	OBSS ITVC/LDRI FLAT FIELD (PDRS, NOMINAL)	OBSS ITVC/LDRI FLAT FIELD (PDRS, NOMINAL)		
13:00	~	2	17:00	MNVR STBD SURVEY TG=4 BV=5 P=0 Y=49 OM=110 A1/AUTO/VERN/ Init TRK on MCC GO OBSS LDRI RCC SRVY.- STBD (PDRS, SURVEYS)	SSP1 OIU PWR - OIU 1 ON (tb-UP)	OBSS LDRI RCC SRVY - STBD (PDRS, SURVEYS)		UPLINK B21°+MASK+ BOX A4 -122<AZ<110 -90<EL<45
				ON MCC GO: SSP1 APCU 1 OUTPUT RLY - CL (tb-gray) CRYO 02 TK HTR SNSR CK (ORB OPS, EPS)				
14:00	~	3	18:00	MNVR NOSE CAP SURVEY TG=4 BV=5 P=320 Y=0 OM=257 A/AUTO/VERN/ Init TRK on MCC GO OBSS LDRI RCC SRVY.- NOSE CAP (PDRS, SURVEYS)	ON MCC GO: SSP1 APCU 1 OUTPUT RLY - OP (tb-bp) SSP1 OIU PWR - OFF (tb-bp)			
15:00	~	4	19:00				MPLM: 1.101 MPLM ENVIRONMENT CHECK Steps 1 & 4 PRESS CK (NO fan)	UPLINK B21°+MASK+ BOX A5 -32<AZ<110 -50<EL<30
20:00								

STS-121/ULF 1.1 (FD 02)

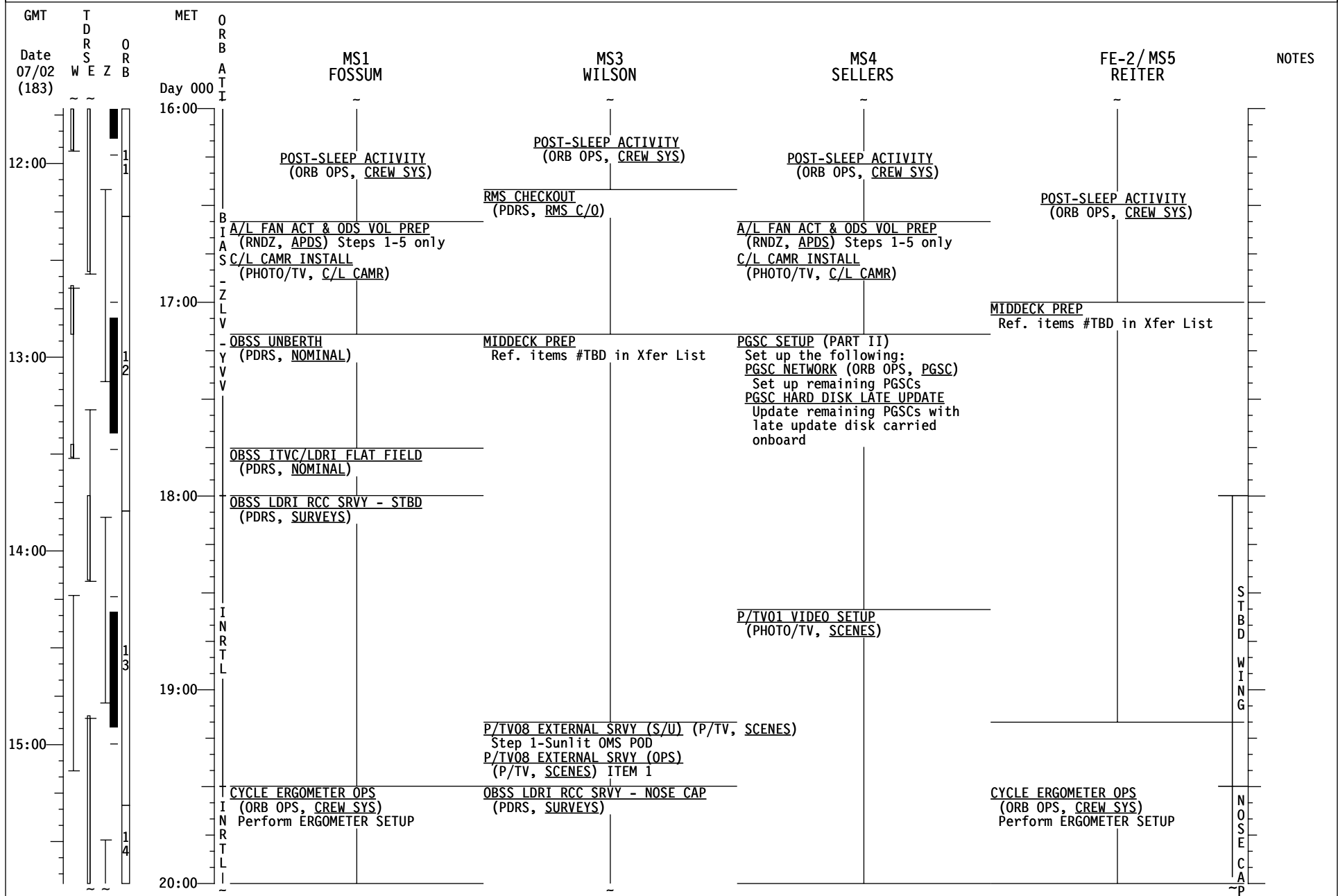

STS-121/ULF 1.1 (FD 02)

GMT	TDRS W E Z	ORB O R B	MET Day 000	ORBIT A T I	CDR LINDSEY	PLT KELLY	MS2 NOWAK	MCC	NOTES
07/02 (183)									
16:00									
17:00									
18:00									
19:00									
00:00									

GMT	TDRS W E Z	ORB O R B	MET Day 000	ORBIT A T I	CDR LINDSEY	PLT KELLY	MS2 NOWAK	MCC	NOTES
20:00					<u>OBSS LDRI RCC SRVY - NOSE CAP</u> (PDRS, SURVEYS)	<u>OBSS LDRI RCC SRVY - NOSE CAP</u> (PDRS, SURVEYS)			
21:00							MEAL		
22:00					MEAL	MEAL			
23:00									
					<u>MNVR PORT SURVEY</u> TG=4 BV=5 P=0 Y=334 OM=306 A/AUTO/VERN/ Init TRK on MCC GO	<u>EMU CHECKOUT</u> (EVA, CHECKOUTS) Perform for 2 EMUs Upon completion, stow SCOFs in EMU Mesh Transfer Bag	<u>OBSS LDRI RCC SRVY - PORT</u> (PDRS, SURVEYS)		<u>UPLINK</u> B21+MASK+ BOX A2 -27<AZ<110 -90<EL<0
					<u>OBSS LDRI RCC SRVY - PORT</u> (PDRS, SURVEYS)	Post EMU C/O: <u>A/L FAN BYPASS</u> (RNDZ, APDS)			
							<u>OBSS BERTH</u> (PDRS, NOMINAL)		

STS-121/ULF 1.1 (FD 02)

GMT	TDRS W E Z	MET Day 000	ORB A T I	MS1 FOSSUM	MS3 WILSON	MS4 SELLERS	FE-2 / MS5 REITER	NOTES
07/02 (183)	~							
16:00				MEAL	OBSS LDRI RCC SRVY - NOSE CAP (PDRS, SURVEYS)			N O S E C A P
17:00				FILTER CLEANING (IFM, SCHEDULED MAINTENANCE)				
18:00				EMU CHECKOUT PREP (EVA, A/L CONFIG) Only need SCOFs from Vol. H INBD bag	MEAL	DOCKING MECH INITIALIZATION DOCKING MECH POWERUP DOCKING RING EXTENSION DOCKING MECH POWERDOWN (RNDZ, APDS)	MEAL	
19:00				EMU CHECKOUT (EVA, CHECKOUTS) Perform for 2 EMUs Upon completion, stow SCOFs in EMU Mesh Transfer Bag Post EMU C/O: A/L FAN BYPASS (RNDZ, APDS)	OBSS LDRI RCC SRVY - PORT (PDRS, SURVEYS)	EMU CHECKOUT (EVA, CHECKOUTS) Perform for 2 EMUs Upon completion, stow SCOFs in EMU Mesh Transfer Bag Post EMU C/O: A/L FAN BYPASS (RNDZ, APDS)	SHUTTLE/ISS H2O CONT FILL (ORB OPS, ECLS) Perform EQUIP PREP and WATER TRANSFER HOSE PURGE, then CWC FILL #1 - INIT REF MSG XXX	P O R T W I N G
00:00					OBSS BERTH (PDRS, NOMINAL)			

STS-121/ULF 1.1 (FD 02)

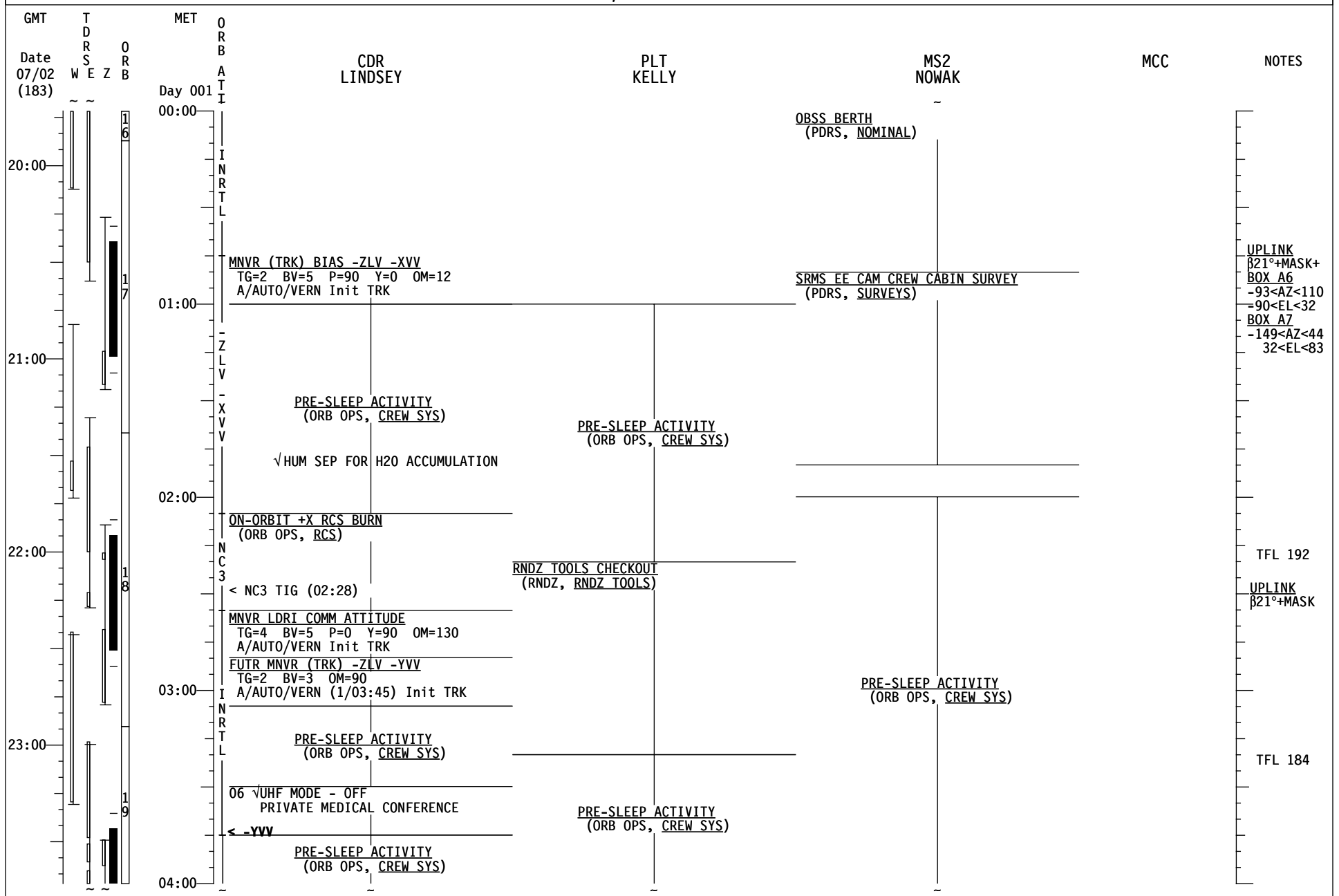

STS-121/ULF 1.1 (FD 02)

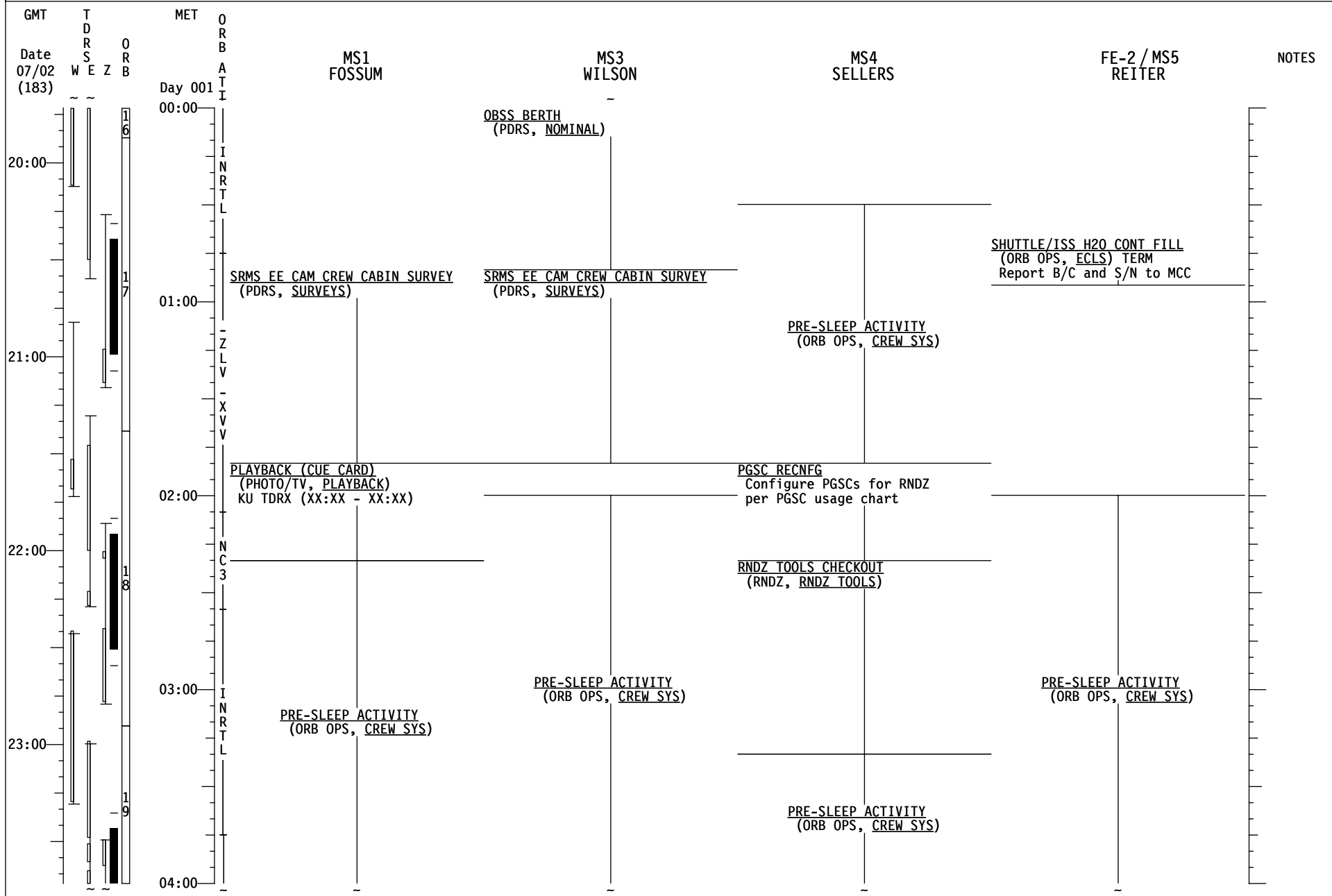

STS-121/ULF 1.1 (FD 02)

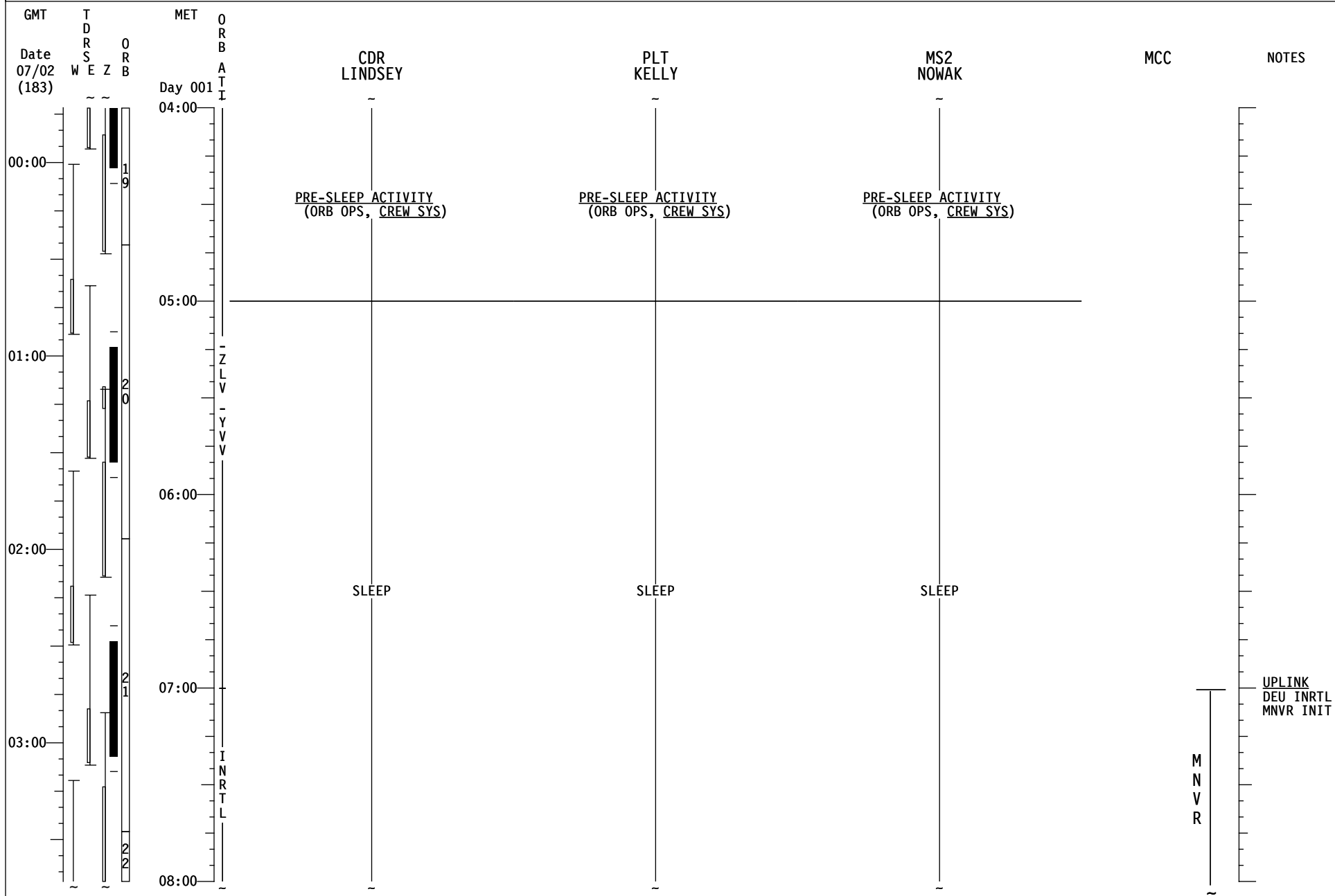

STS-121/ULF 1.1 (FD 02)

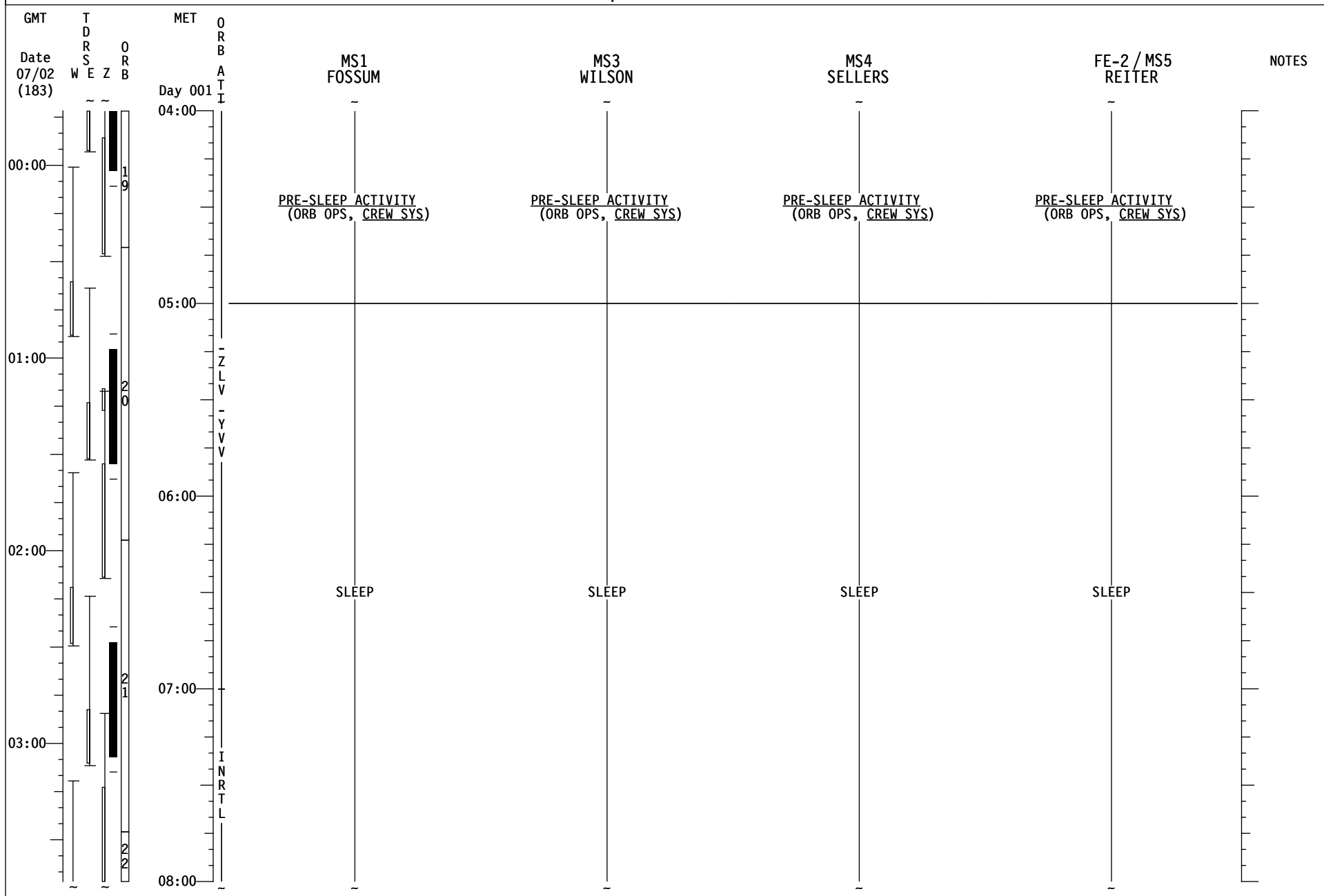

STS-121/ULF 1.1 (FD 02)

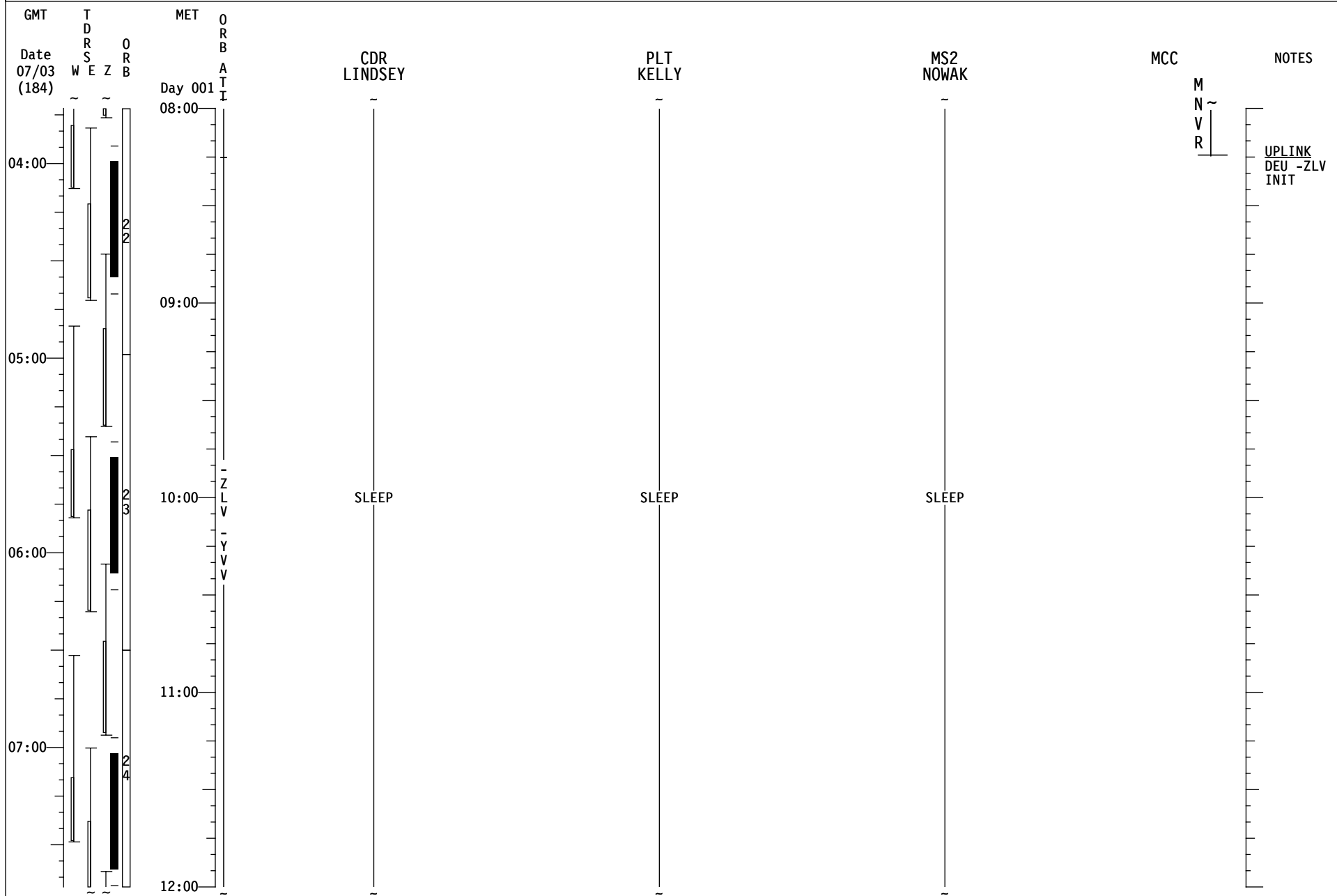

STS-121/ULF 1.1 (FD 02)

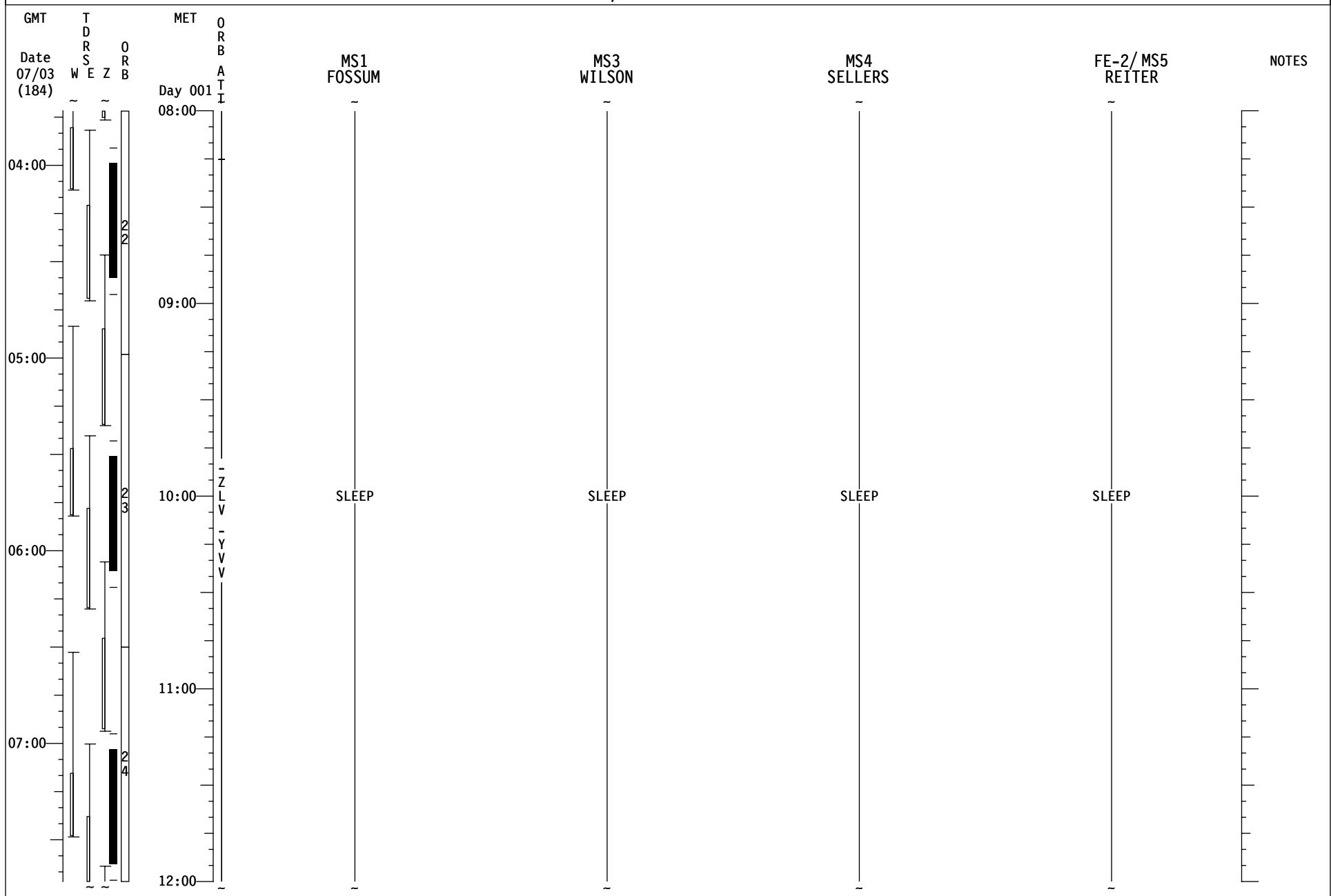

STS-121/ULF 1.1 (FD 03)

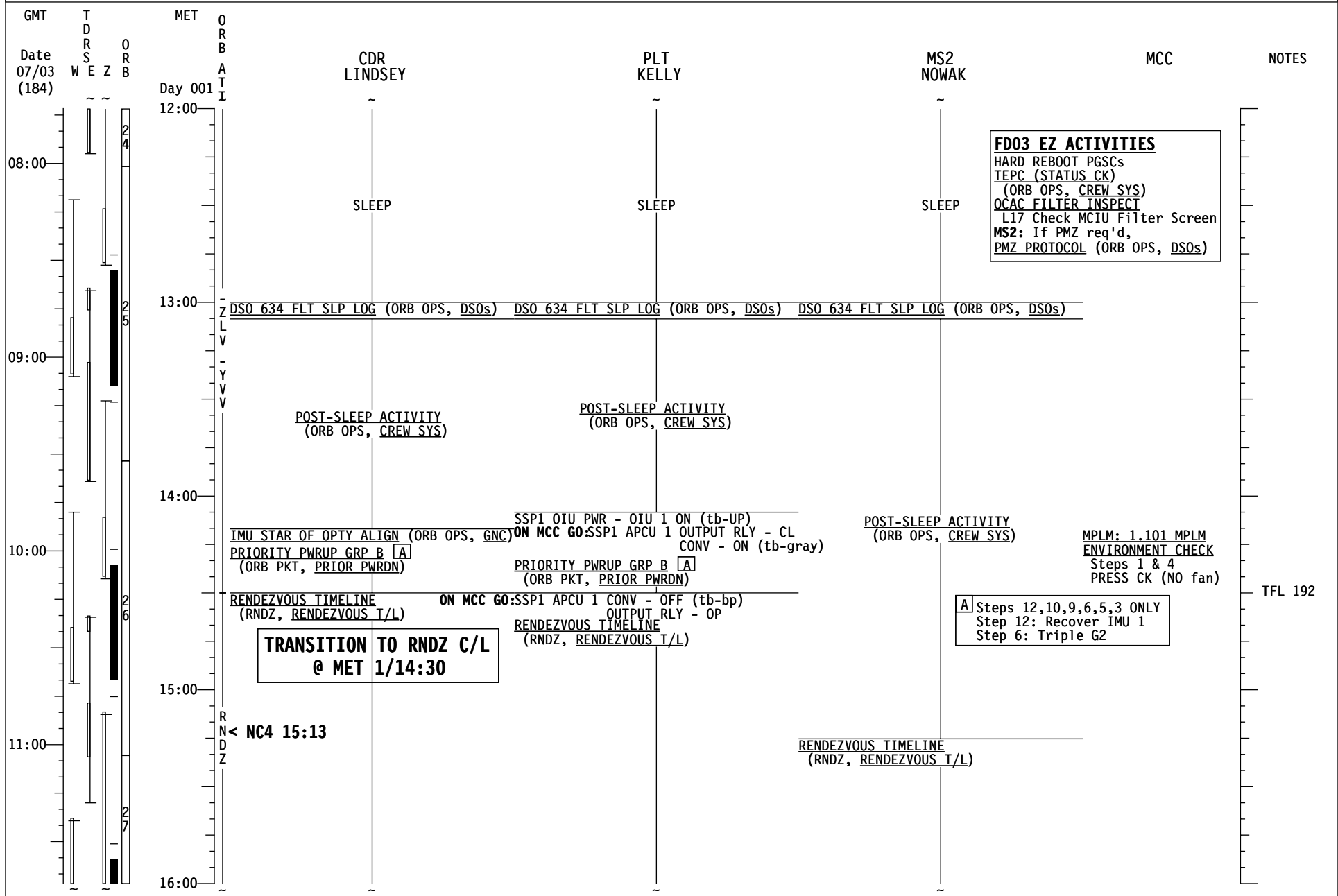

STS-121/ULF 1.1 (FD 03)

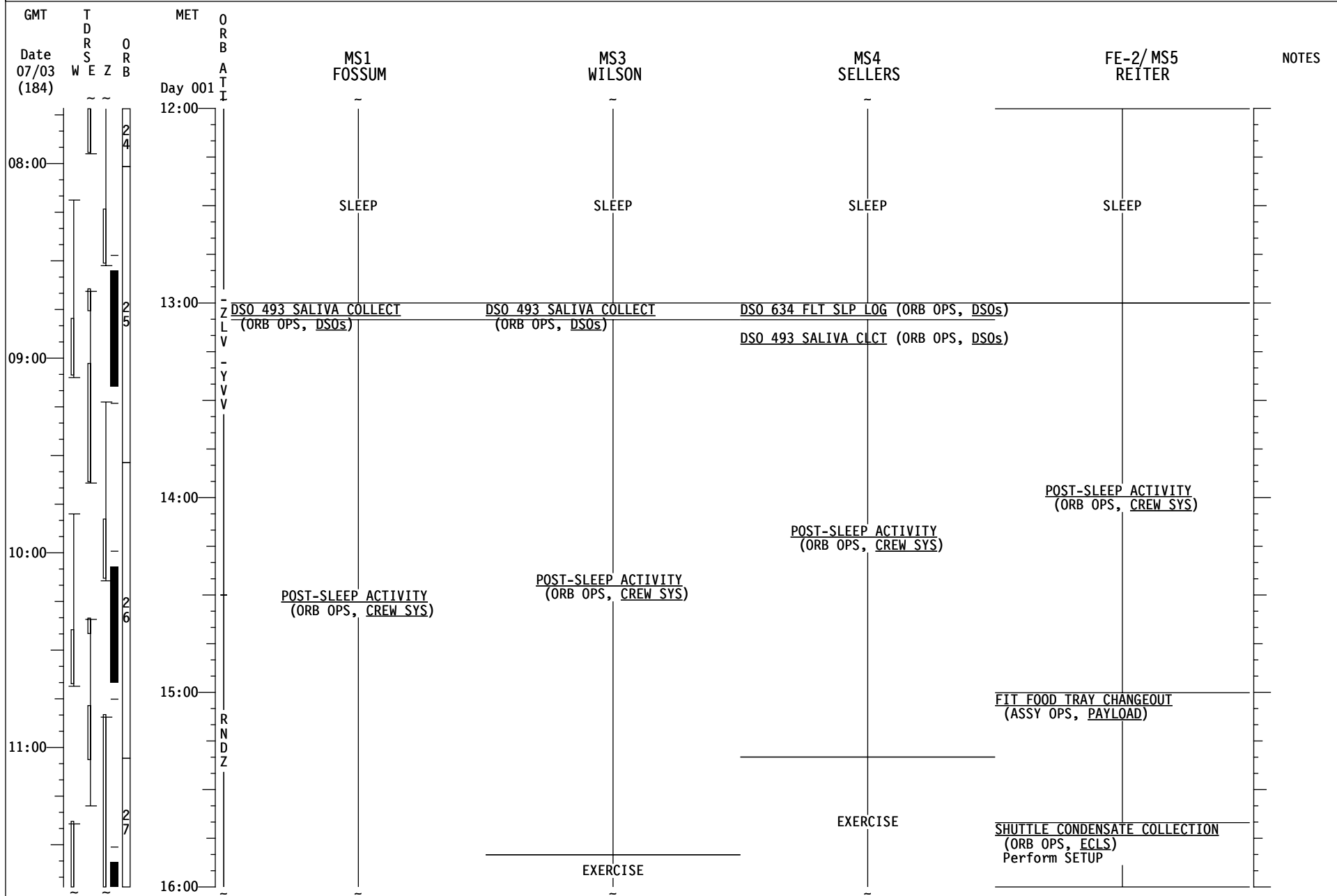

STS-121/ULF 1.1 (FD 03)

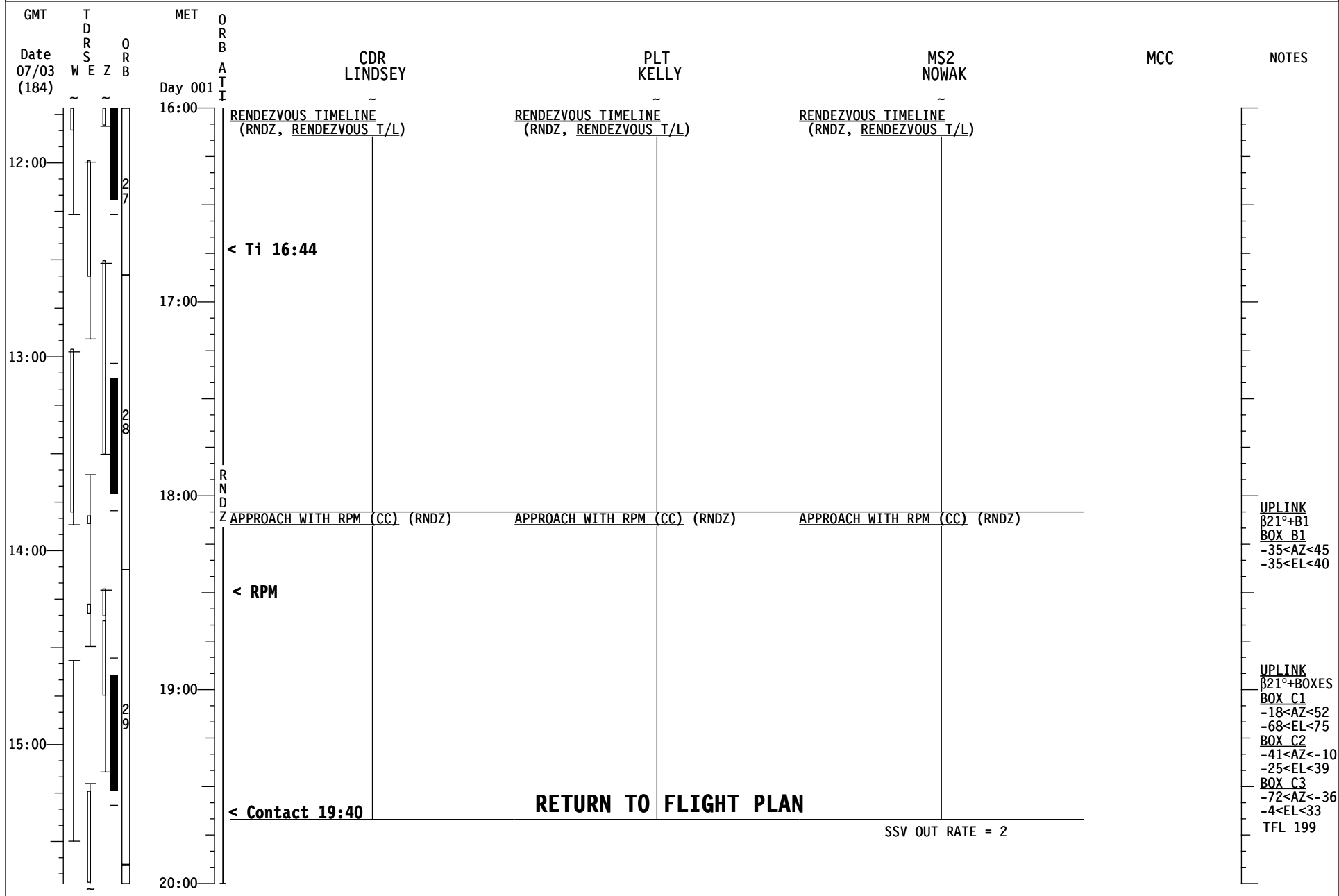

STS-121/ULF 1.1 (FD 03)

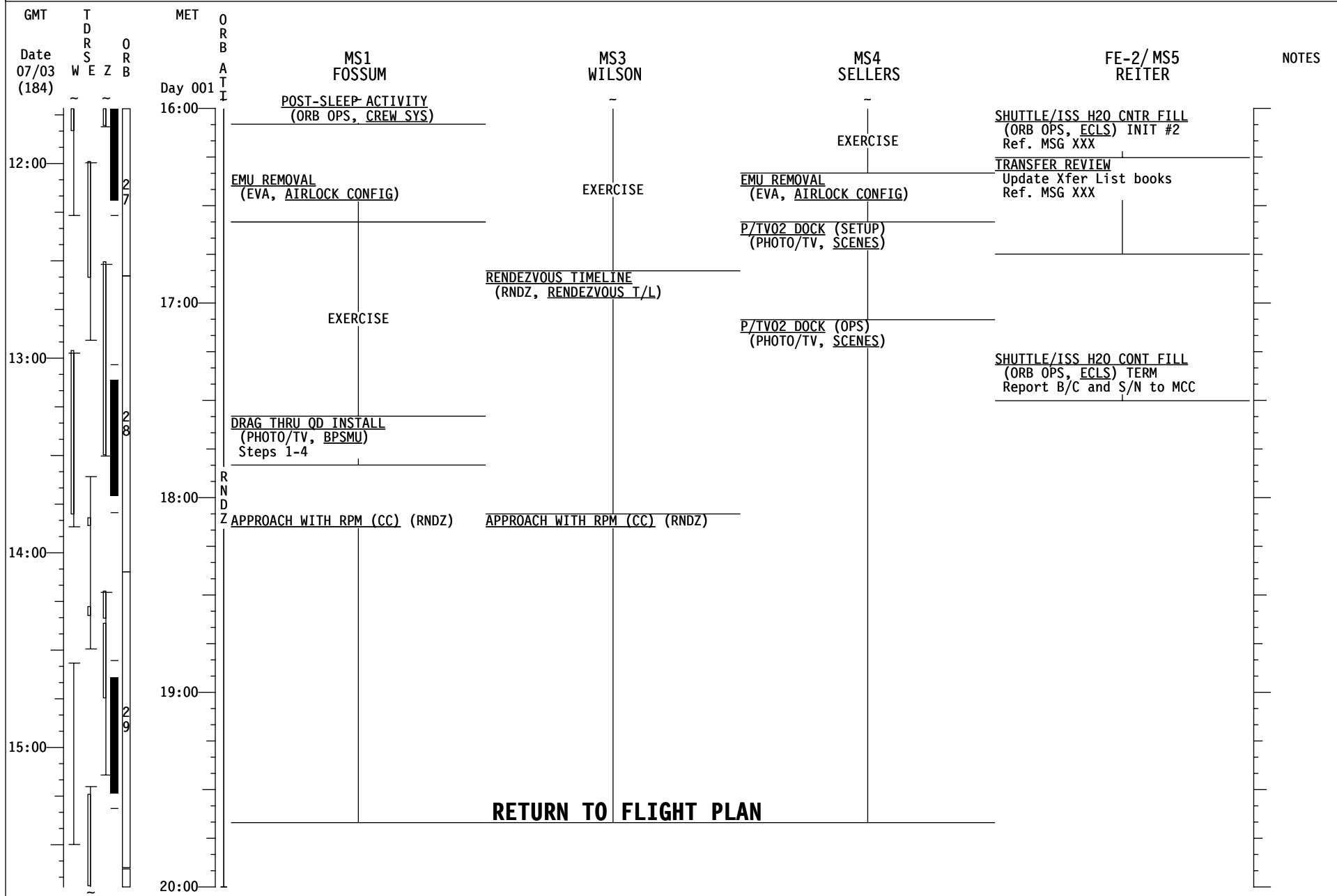

STS-121/ULF 1.1 (FD 03)

GMT	TDRS W E Z	ORB O R B	MET Day 001	ORBIT A T	CDR LINDSEY	PLT KELLY	MS2 NOWAK	MCC	NOTES
16:00				20:00	<p>When rates damped from DAP:LVLH (RNDZ C/L): MNYR (TRK) BIAS -XLV -ZVV TG=2 BV=5 P=157 Y=0 OM=178 Init TRK when DAP:FREE >2 sec DAP:A12/AUTO/VERN Note time of DAP:AUTO, MET 1/___:___ At 10 & 20 min after AUTO, DAP:FREE >2 sec, then DAP:AUTO</p>	<p>POST DOCKING HATCH LEAK CHECK (RNDZ, APDS)</p>			<div style="border: 1px solid black; padding: 2px;"> A Steps 6,12 ONLY Step 6: Single G2 Step 12: IMU 1 STBY - ITEM 21 EXEC 06 S TRK PWR -Z - OFF </div>
					<p>PRIORITY PWRDN GRP B [A] (ORB PKT, PRIOR PWRDN)</p>	<p>A/L PREP FOR INGRESS - BYPASS CONFIG (RNDZ, APDS)</p>	<p>PRIORITY PWRDN GRP B [A] (ORB PKT, PRIOR PWRDN)</p>		
					<p>JNT OPS: 3.111 H/O ATTITUDE CONTROL ORBITER TO CMG TA</p>	<p>JNT OPS: 2.106 HATCH OPEN AND DUCT INSTALL (BYPASS CONFIG)</p>	<p>JNT OPS: 2.106 HATCH OPEN AND DUCT INSTALL (BYPASS CONFIG)</p>		
					<p>JNT OPS: 2.106 HATCH OPEN AND DUCT INSTALL (BYPASS CONFIG)</p>				
					<p>WELCOME</p>	<p>WELCOME</p>	<p>WELCOME</p>		
					<p>SAFETY BRIEFING</p>	<p>SAFETY BRIEFING</p>	<p>SAFETY BRIEFING</p>		
					<p>Z BPSMU AUDIO ONLY (PHOTO/TV, BPSMU)</p>	<p>EMU PREP FOR ISS TRANSFER (EVA, A/L CONFIG)</p>			
					<p>P/TV06 SSRMS ASSY OPS (NON-EVA) (PHOTO/TV, SCENES) OPS</p>		<p>ROBO: 1.110 BERTHED OBSS GRAPPLE</p>		
					<p>OBSS HANDOFF FROM SSRMS TO SRMS (PDRS, NOMINAL) Steps 1-2</p>		<p>ROBO: 1.111 OBSS UNBERTH</p>		
					<p>OBSS H/O FROM SSRMS TO SRMS (PDRS, NOMINAL) Steps 3-5</p>				
						<p>ROOBA PURGE/LEAK CK/SETUP FOR P/B USING SIS 02 (ASSY OPS, ISS) Steps 1-9</p>	<p>ROBO: 1.112 OBSS MNYR TO HANDOFF</p>		
19:00									
18:00									<p>UPLINK B21+BOXES BOX C1 -18<AZ<52 -68<EL<75 BOX C2 -41<AZ<-10 -25<EL<39 BOX C3 -72<AZ<-36 -4<EL<33 BOX D2 -120<AZ<6 -89<EL<-45</p>
17:00									
16:00									

STS-121/ULF 1.1 (FD 03)

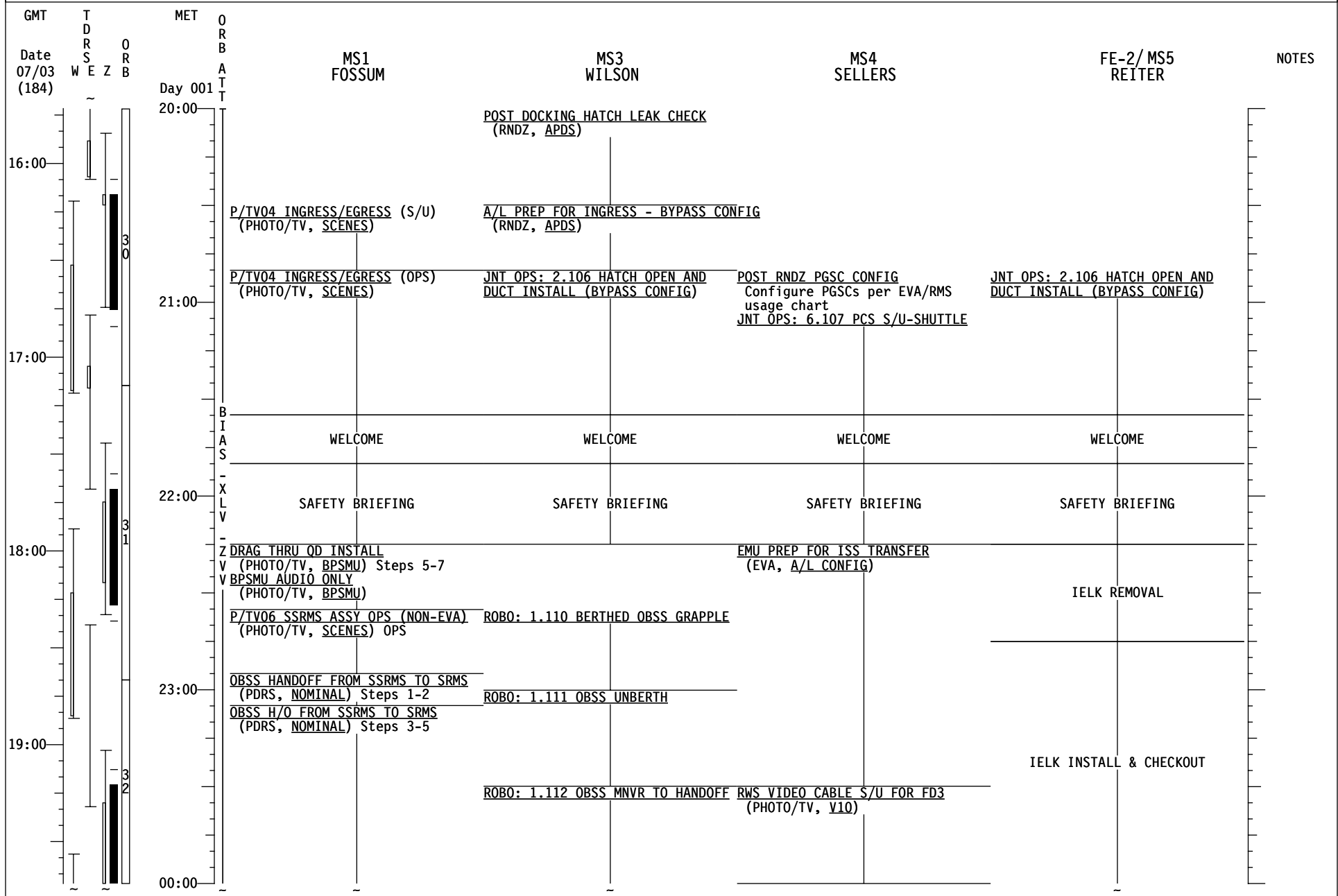

STS-121/ULF 1.1 (FD 03)

GMT	TDRS W E Z	MET Day 002	ORB A T I	CDR LINDSEY	PLT KELLY	MS2 NOWAK	MCC	NOTES
20:00				OBSS H/O FROM SSRMS TO SRMS (PDRS, NOMINAL) Steps 3-5	ROOBA PURGE/LEAK CK/SETUP FOR P/B USING STS 02 (ASSY OPS, ISS) Steps 1-9	ROBO: 1.112 OBSS MNVR TO HANDOFF		
				OBSS H/O FROM SSRMS TO SRMS (PDRS, NOMINAL) Steps 6-7			ROBO: 1.113 OBSS UNGRAPPLE AT HANDOFF	
				OBSS H/O FROM SSRMS TO SRMS (PDRS, NOMINAL) Steps 8-9				
21:00				TRANSFER BRIEF Call down status to MCC	ACTIVATION (CUE CARD) (PHOTO/TV, PLAYBACK)	ROBO: 1.114 MANEUVER TO ACBM INSPECT POSITION		
				CWC TRANSFER Transfer 2 CWCs to ISS	PLAYBACK (CUE CARD) (PHOTO/TV, PLAYBACK) KU TDRX (XX:XX - XX:XX)			UPLINK B21+BOXES BOX C1 -18<AZ<52 -68<EL<75 BOX C2 -41<AZ<-10 -25<EL<39 BOX C3 -72<AZ<-36 -4<EL<33
22:00				L R12 (VPU) GREEN JMPR-LDRI/ITVC V R12 (OBSS) ITVC ENA - ON				
				PRE-SLEEP ACTIVITY (ORB OPS, CREW SYS)				
				√ HUM SEP FOR H2O ACCUMULATION				
				06 √ UHF MODE - OFF PRIVATE MEDICAL CONFERENCE	PRE-SLEEP ACTIVITY (ORB OPS, CREW SYS)	PRE-SLEEP ACTIVITY (ORB OPS, CREW SYS)		
23:00							ROOBA LEAK CHECK	
				PRE-SLEEP ACTIVITY (ORB OPS, CREW SYS)				
04:00								

**NOTE: SLEEP SHIFT 30 MIN EARLIER
WAKEUP @ MET 2/12:30**

STS-121/ULF 1.1 (FD 03)

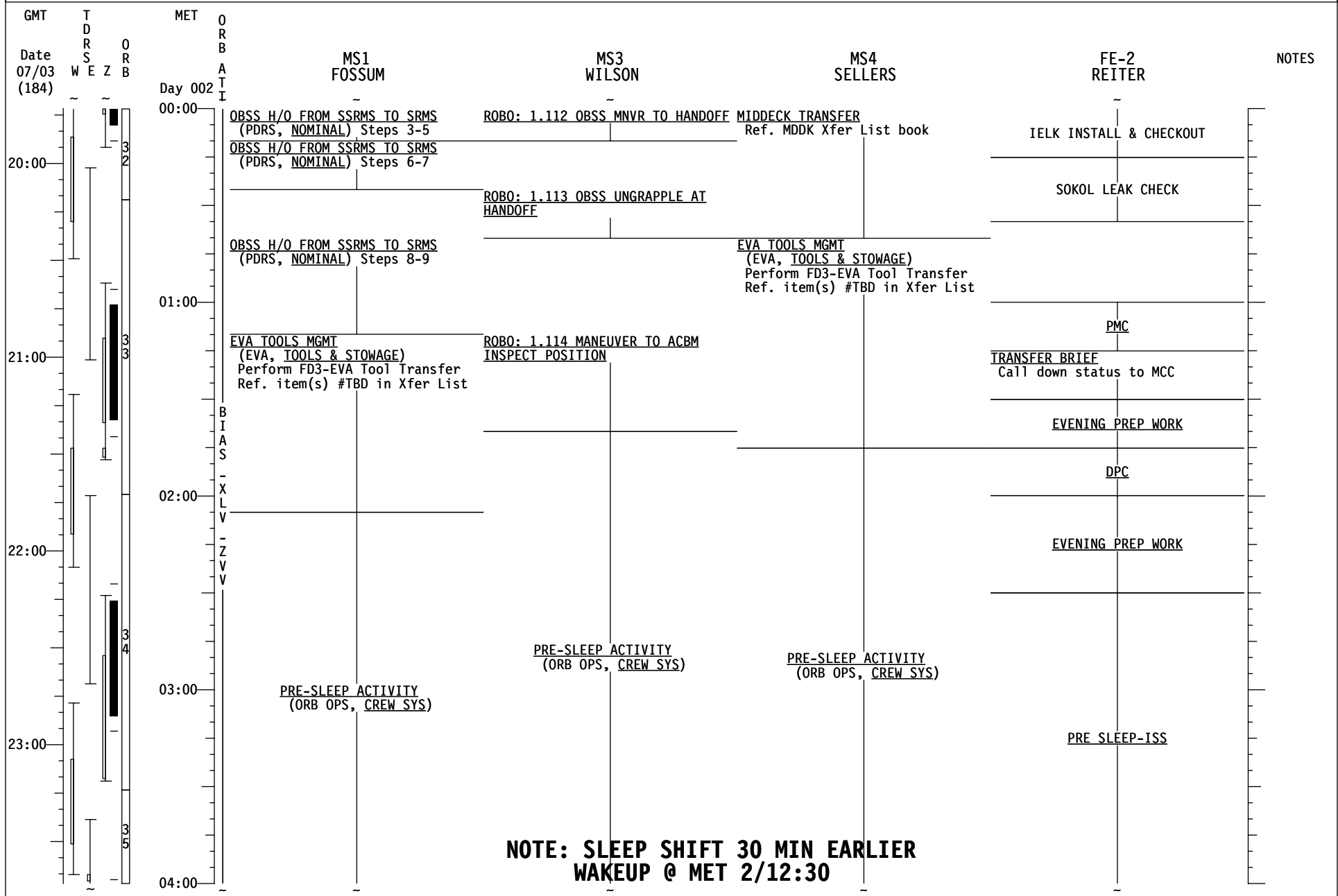

**NOTE: SLEEP SHIFT 30 MIN EARLIER
WAKEUP @ MET 2/12:30**

STS-121/ULF 1.1 (FD 03)

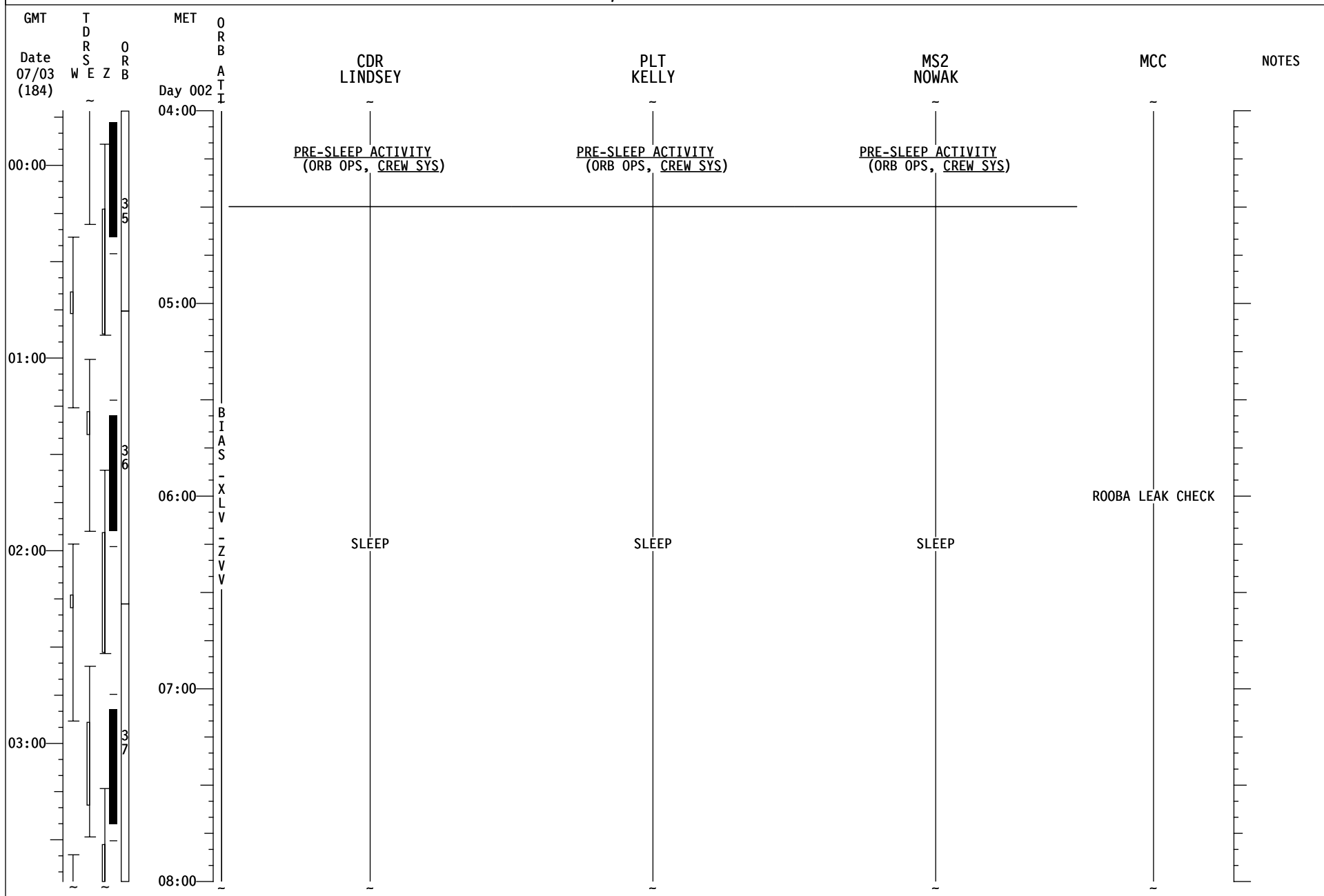

STS-121/ULF 1.1 (FD 03)

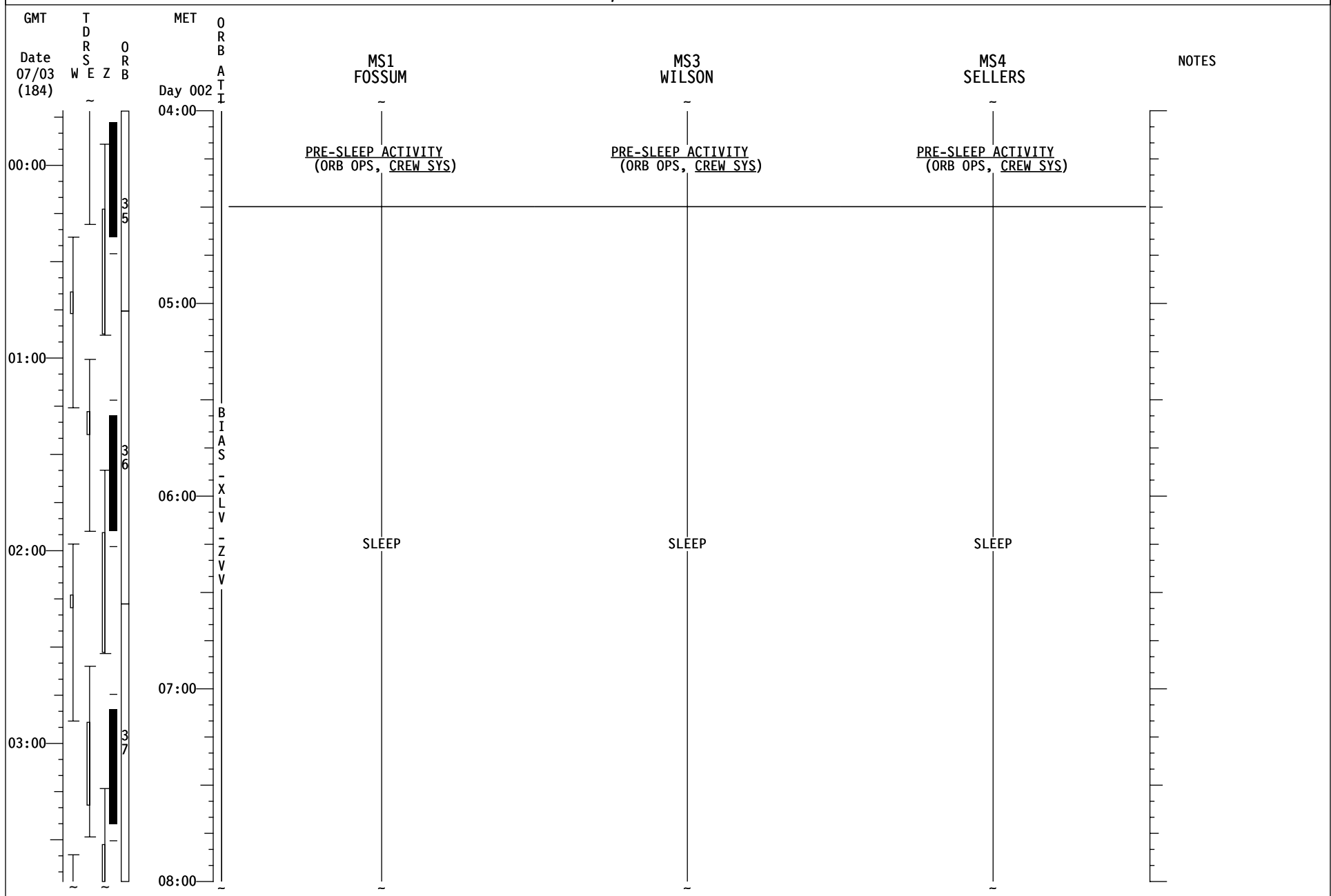

STS-121/ULF 1.1 (FD 03)

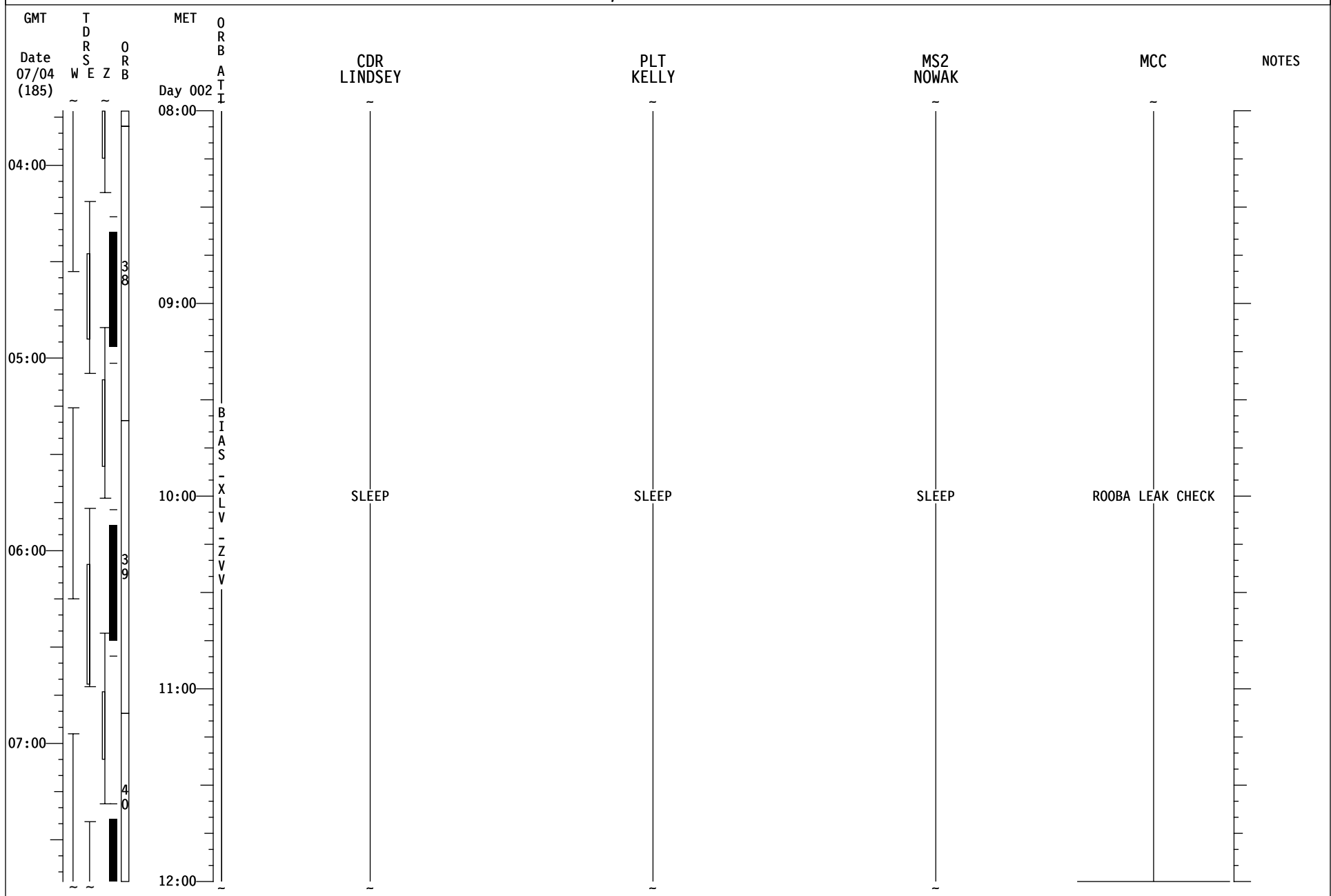

STS-121/ULF 1.1 (FD 03)

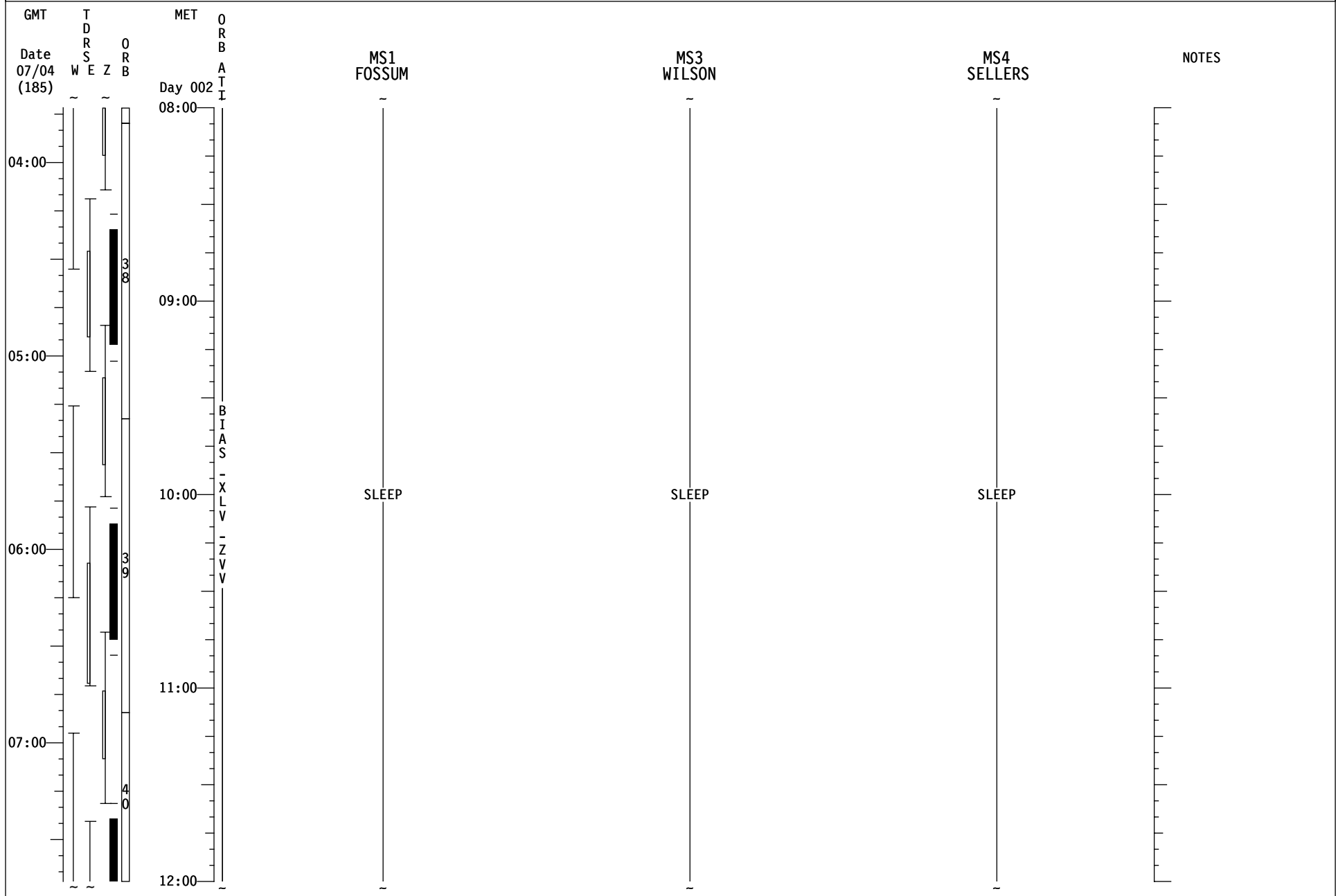

STS-121/ULF 1.1 (FD 04)

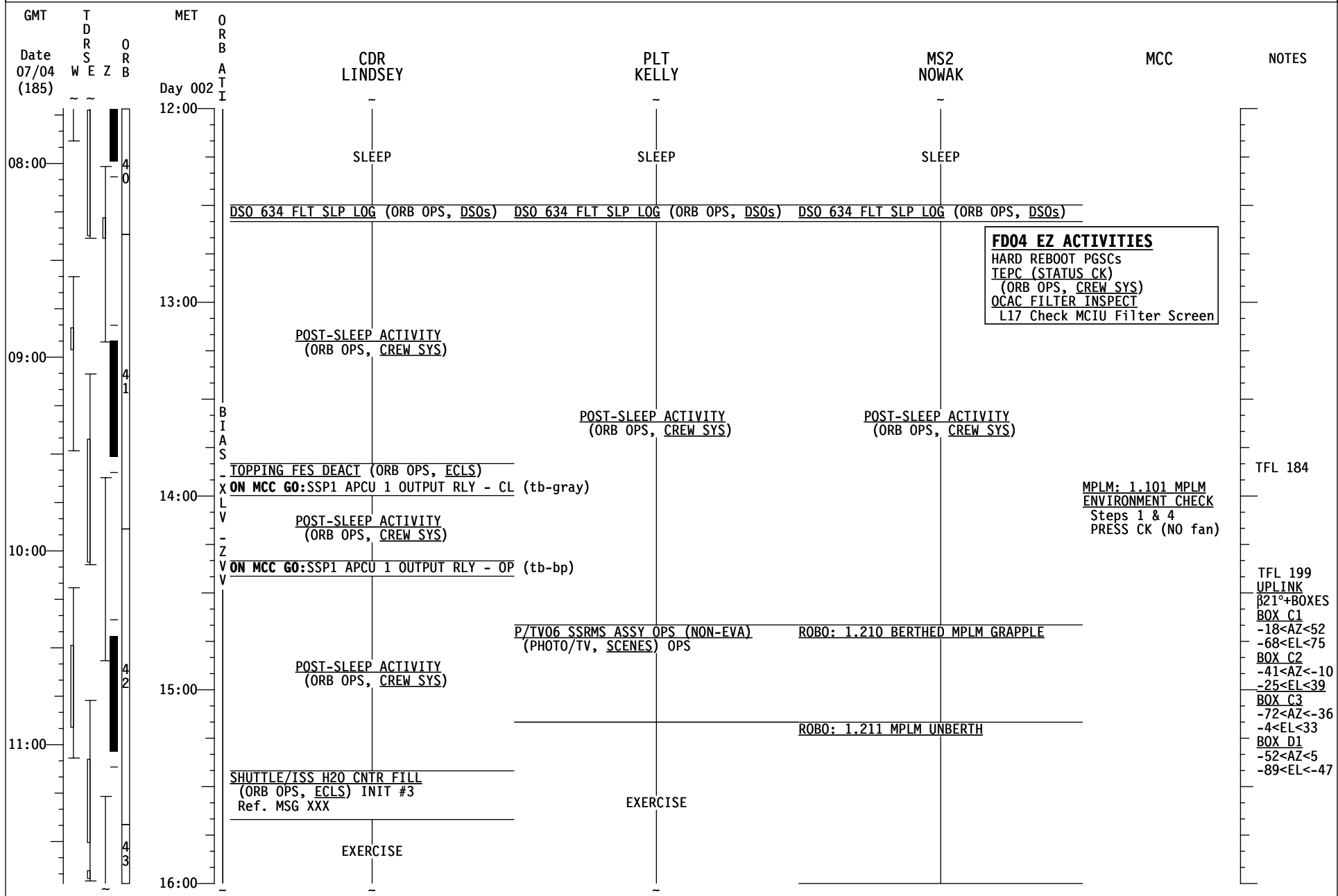

MPLM: 1.101 MPLM ENVIRONMENT CHECK Steps 1 & 4 PRESS CK (NO fan)

TFL 184

TFL 199 UPLINK β21+BOXES BOX C1 -18<AZ<-52 -68<EL<75 BOX C2 -41<AZ<-10 -25<EL<39 BOX C3 -72<AZ<-36 -4<EL<33 BOX D1 -52<AZ<5 -89<EL<-47

STS-121/ULF 1.1 (FD 04)

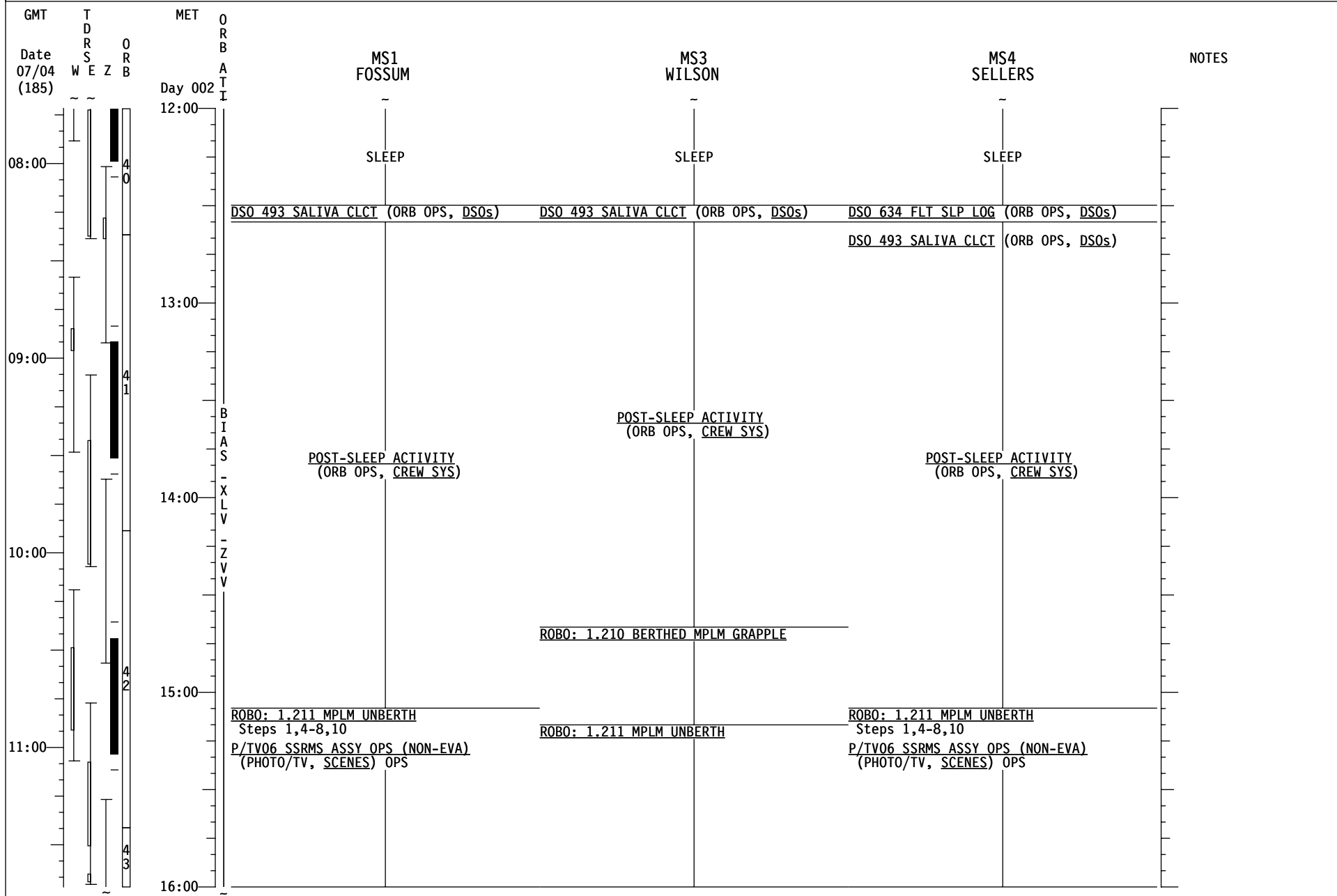

STS-121/ULF 1.1 (FD 04)

GMT	TDRS W E Z	MET Day 002	ORBIT A T I	CDR LINDSEY	PLT KELLY	MS2 NOWAK	MCC	NOTES
16:00				EXERCISE	EXERCISE P/TV06 SSRMS ASSY OPS (NON-EVA) (PHOTO/TV, SCENES) OPS	ROBO: 1.212 MPLM INSTALL Steps 1-4		
12:00								
17:00				SHUTTLE/ISS H2O CONT FILL (ORB OPS, ECLS) TERM Report B/C and S/N to MCC		ROBO: 1.212 MPLM INSTALL Steps 5-7 NO EXERCISE during Steps 7-9		
13:00				SHUTTLE/ISS H2O CNTR FILL (ORB OPS, ECLS) INIT #4 Ref. MSG XXX				
				JNT OPS: 3.102 NITROGEN TRANSFER INIT		MEAL		
						ROBO: 1.212 MPLM INSTALL Step 8		
18:00					PUBLIC AFFAIRS EVENT A/G Ref MSG XXX	MEAL		
14:00				SHUTTLE/ISS H2O CONT FILL (ORB OPS, ECLS) TERM Report B/C and S/N to MCC		ROBO: 1.212 MPLM INSTALL Step 9 ROBO: 1.213 MATED MPLM UNGRAPPLE		
				MEAL		ROBO: 1.310 WS4 MBS PDGF 1 GRAPPLE		
					MEAL		S&M: 1.507 NODE 1 CBM BOLT LOADING	
19:00				C3 MSTR MADS PWR - OFF MPLM: 1.102 N1 TO MPLM VESTIBULE PRESS AND LEAK CHECK		ROBO: 1.311 LAB PDGF UNGRAPPLE		
15:00					MED OPS: 2.1.825 CEVIS-CONTINGENCY CONTROLLER OPS CWC TRANSFER Transfer 2 CWCs to ISS			TFL 188
20:00						ROBO: 1.312 MNVR TO SURVEY SUPPORT VIEWING POSN Steps 1-3, 4 as req'd		

A	UPLINK B21°+BOXES BOX C1 -18<AZ<52 -68<EL<75 BOX F1 -92<AZ<5 -82<EL<4 BOX F2 -129<AZ<10 -10<EL<42
---	---

A

STS-121/ULF 1.1 (FD 04)

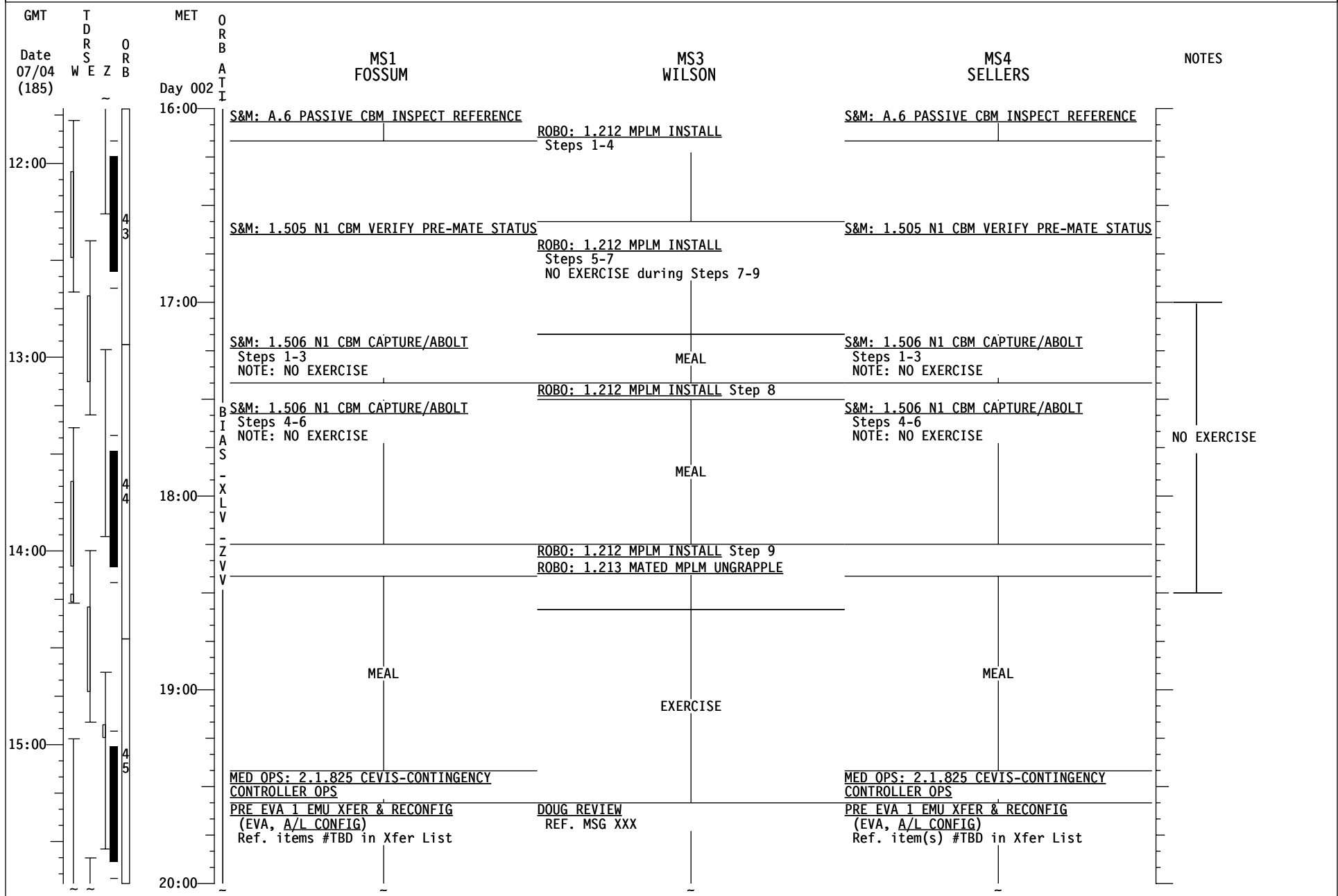

STS-121/ULF 1.1 (FD 04)

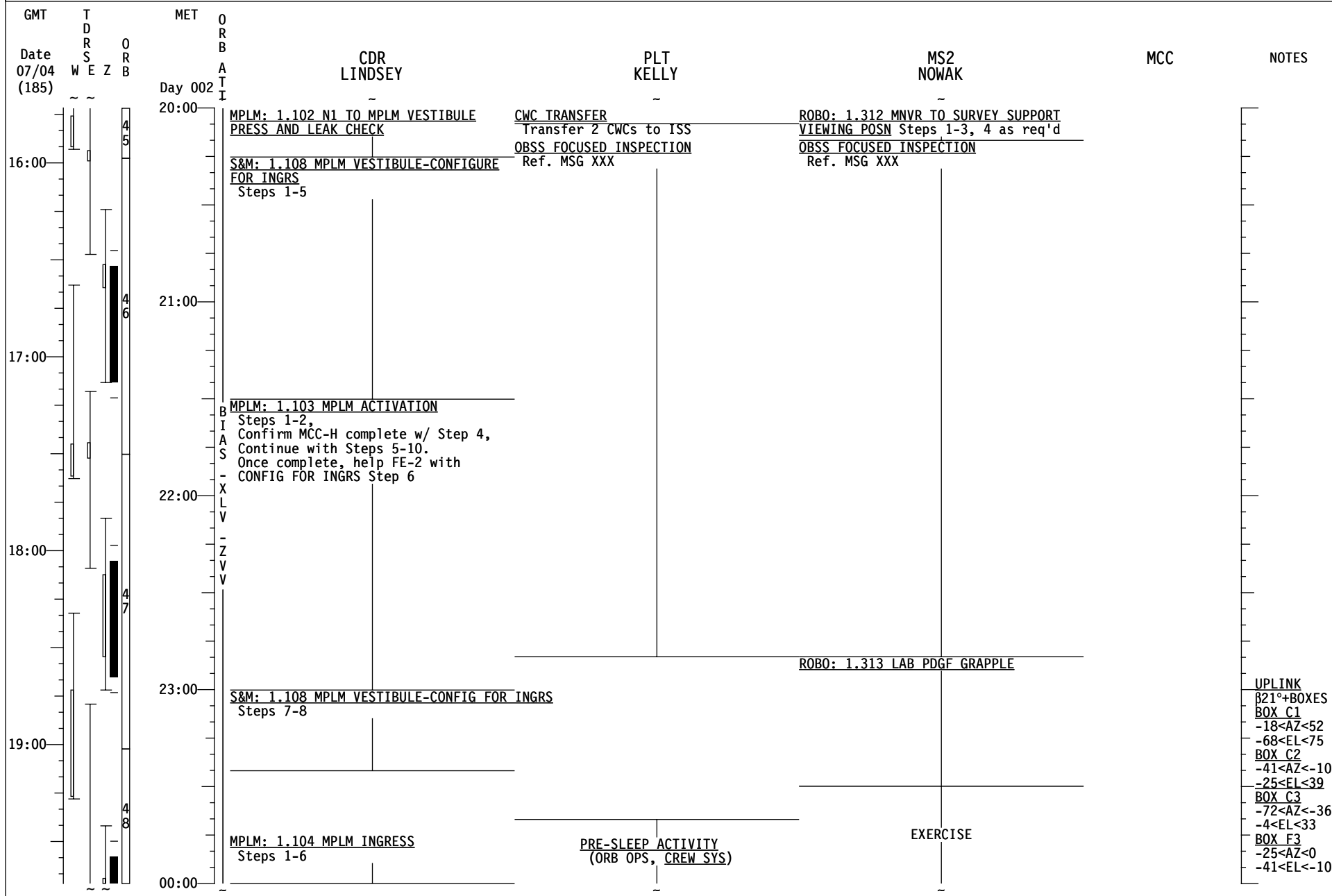

UPLINK
 821°+BOXES
 BOX C1
 -18<AZ<52
 -68<EL<75
 BOX C2
 -41<AZ<-10
 -25<EL<39
 BOX C3
 -72<AZ<-36
 -4<EL<33
 BOX F3
 -25<AZ<0
 -41<EL<-10

STS-121/ULF 1.1 (FD 04)

GMT	T D R S E Z	MET	O R B	MS1 FOSSUM	MS3 WILSON	MS4 SELLERS	NOTES
Date 07/04 (185)	W E Z	Day 002	A T I				
16:00	4 5	20:00		<u>PRE EVA 1 EMU XFER & RECONFIG</u> (EVA, A/L CONFIG) Ref. items #TBD in Xfer List	<u>DOUG REVIEW</u> REF. MSG XXX <u>OBSS FOCUSED INSPECTION</u> Ref. MSG XXX	<u>PRE EVA 1 EMU XFER & RECONFIG</u> (EVA, A/L CONFIG) Ref. item(s) #TBD in Xfer List	
17:00	4 6	21:00		<u>EVA SYS: 1.403 REBA POWERED HARDWARE CHECKOUT</u>		<u>EVA SYS: 1.403 REBA POWERED HARDWARE CHECKOUT</u>	
				<u>ROOBA PURGE/LEAK CK/SETUP FOR P/B USING STS 02</u> (ASSY OPS, ISS) Steps 10-13		<u>ROOBA PURGE/LEAK CK/SETUP FOR P/B USING STS 02</u> (ASSY OPS, ISS) Steps 10-13	
18:00	4 7	22:00		<u>EVA SYS: 1.305 EQUIPMENT LOCK PREP</u> Refer to STS-121 CONSUMABLES TRACKING CUE CARD for EHIP Batts. EHIP Batts to be installed are in EMU Systems Mesh Transfer Bag		<u>EVA SYS: 1.305 EQUIPMENT LOCK PREP</u> Refer to STS-121 CONSUMABLES TRACKING CUE CARD for EHIP Batts. EHIP Batts to be installed are in EMU Systems Mesh Transfer Bag	
				<u>EVA SYS: 1.215 EVA PREP</u> Steps 4,6-7,10,22-25 <u>EVA SYS: 1.225 EMU PREBREATHE</u> Steps 4,6 <u>EVA SYS: 1.305 EQUIPMENT LOCK PREP</u> Steps 28-30	<u>ROBO: 1.313 LAB PDGF GRAPPLE</u>	<u>EVA SYS: 1.215 EVA PREP</u> Steps 4,6-7,10,22-25 <u>EVA SYS: 1.225 EMU PREBREATHE</u> Steps 4,6 <u>EVA SYS: 1.305 EQUIPMENT LOCK PREP</u> Steps 28-30	
19:00	4 8	23:00		<u>EVA 1 TOOL CONFIG</u> (EVA, EVA 1)		<u>EVA 1 TOOL CONFIG</u> (EVA, EVA 1)	
00:00				<u>760 EVA - CAMR W/FLASH</u> (PHOTO/TV, DCS 760 -EVA)			

STS-121/ULF 1.1 (FD 04)

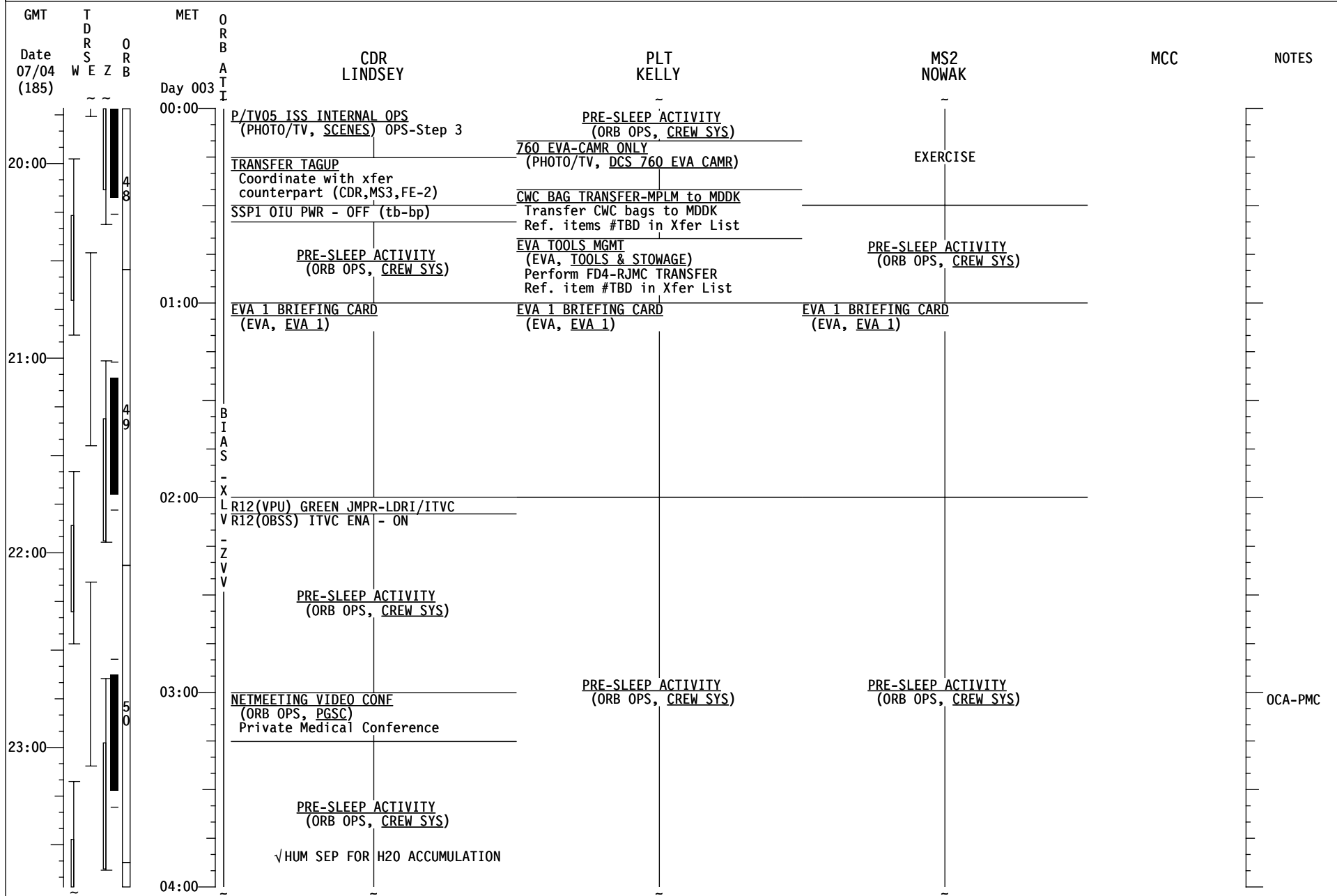

STS-121/ULF 1.1 (FD 04)

GMT	T D R S E Z	MET	O R B	MS1 FOSSUM	MS3 WILSON	MS4 SELLERS	NOTES
Date 07/04 (185)	W E Z	Day 003	A T I				
20:00	48	00:00		<u>760 EVA - CAMR W/FLASH</u> (PHOTO/TV, DCS 760 EVA)	<u>MPLM SETUP FOR TRANSFER</u> Ref. items #TBD in MPLM Resupply Xfer List		
				<u>ERCA XFER</u> Ref. item #TBD in Xfer List	<u>TRANSFER TAGUP</u> Coordinate with xfer counterpart (CDR,MS3,FE-2)	EXERCISE	
				<u>EVA TOOLS MGMT</u> (EVA, TOOLS & STOWAGE) Perform FD4-RJMC TRANSFER Ref. item #TBD in Xfer List	<u>PRE-SLEEP ACTIVITY</u> (ORB OPS, CREW SYS)		
21:00	49	01:00		<u>EVA 1 BRIEFING CARD</u> (EVA, EVA 1)	<u>EVA 1 BRIEFING CARD</u> (EVA, EVA 1)	<u>EVA 1 BRIEFING CARD</u> (EVA, EVA 1)	
22:00		02:00	B I A S				
			X L V				
23:00	50	03:00	Z V V	<u>PRE-SLEEP ACTIVITY</u> (ORB OPS, CREW SYS)	<u>PRE-SLEEP ACTIVITY</u> (ORB OPS, CREW SYS)	<u>PRE-SLEEP ACTIVITY</u> (ORB OPS, CREW SYS)	
04:00							

STS-121/ULF 1.1 (FD 04)

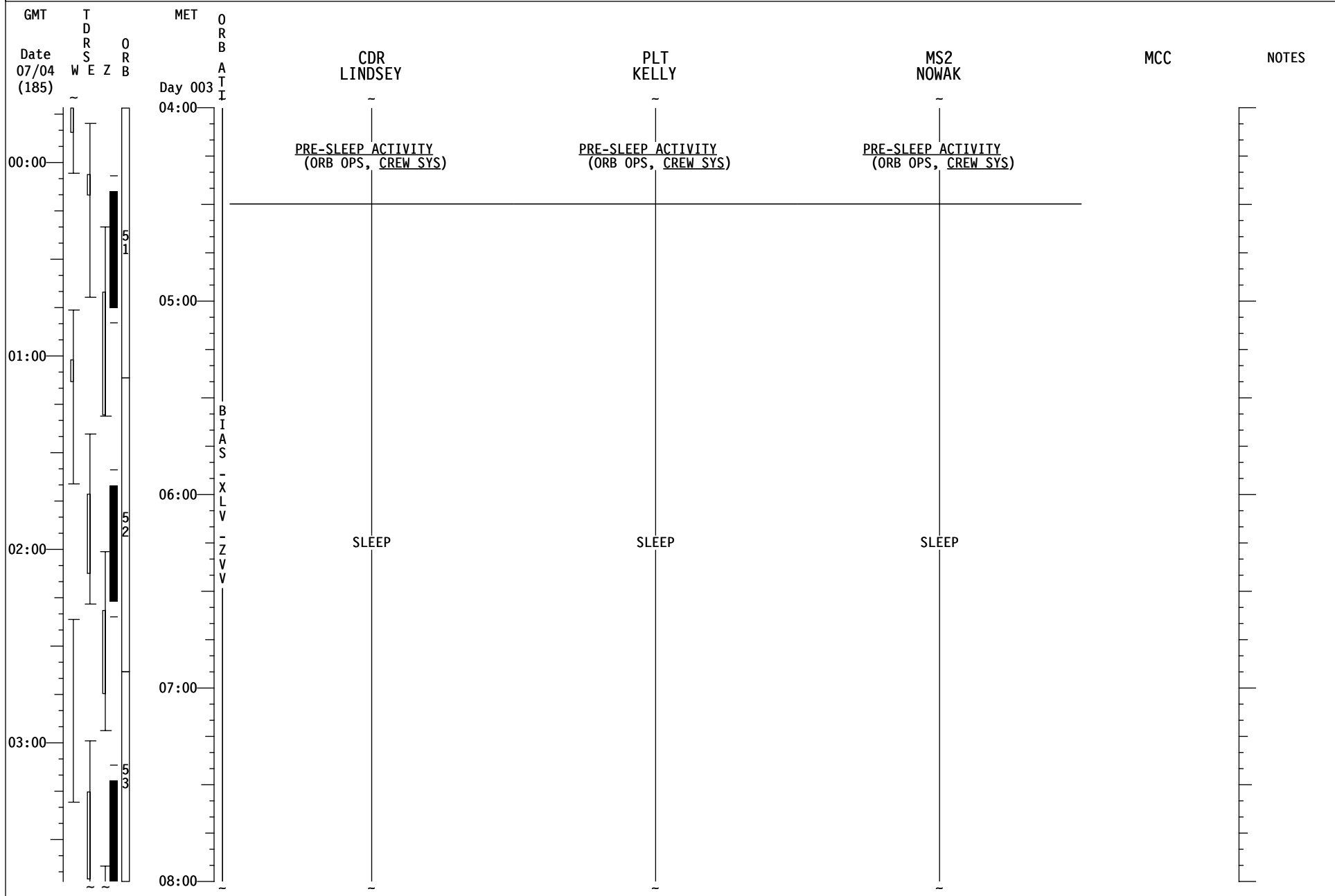

STS-121/ULF 1.1 (FD 04)

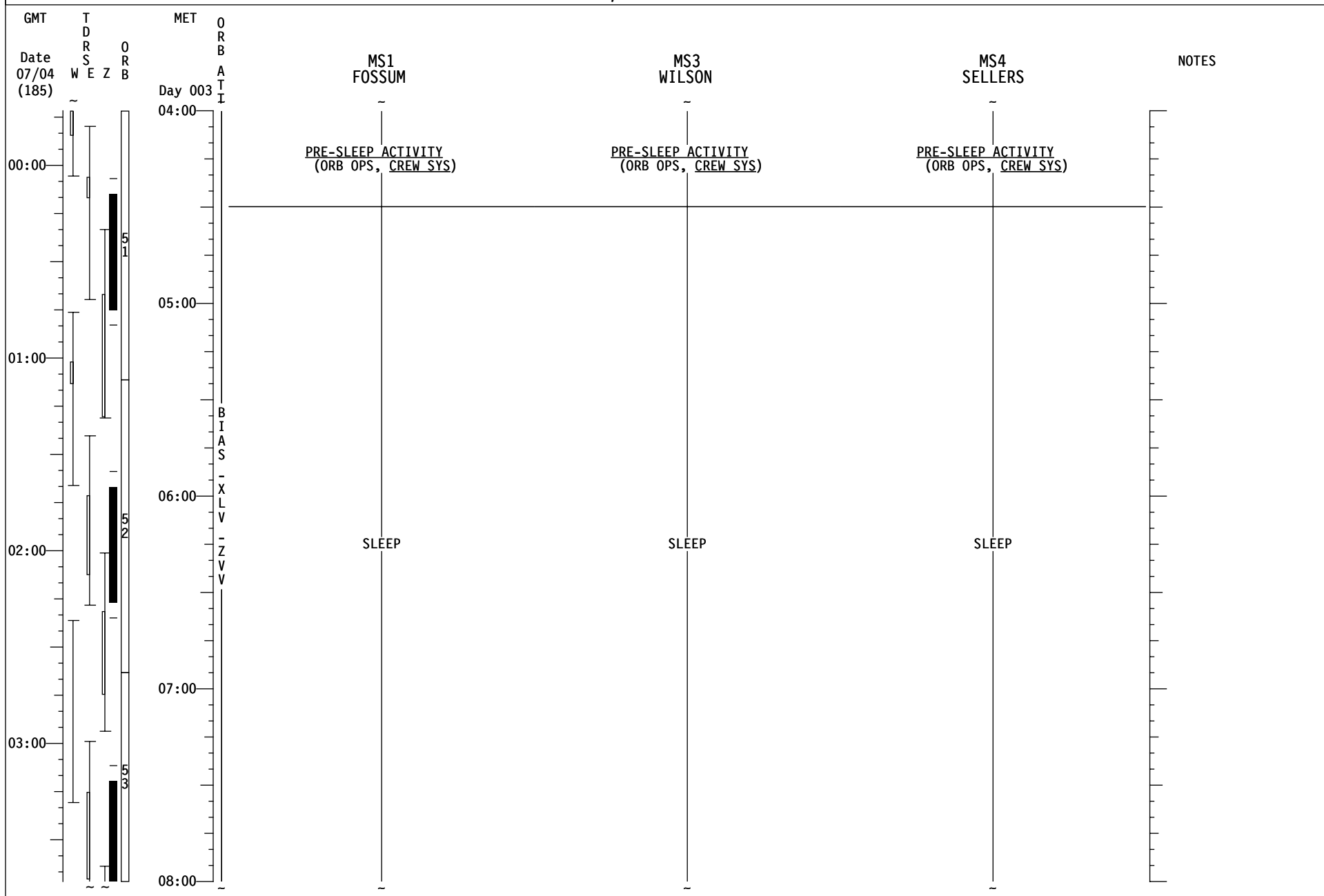

STS-121/ULF 1.1 (FD 04)

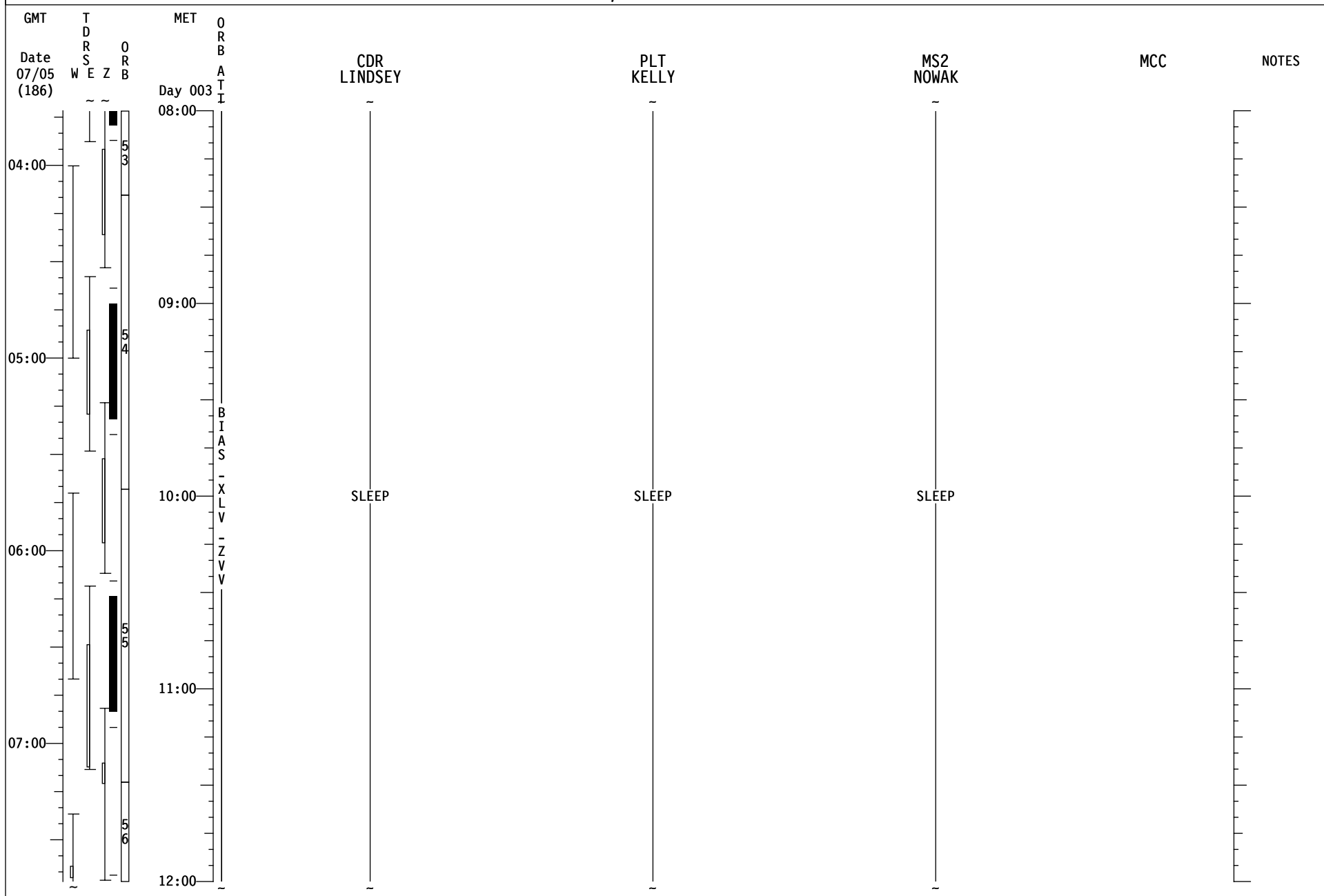

STS-121/ULF 1.1 (FD 04)

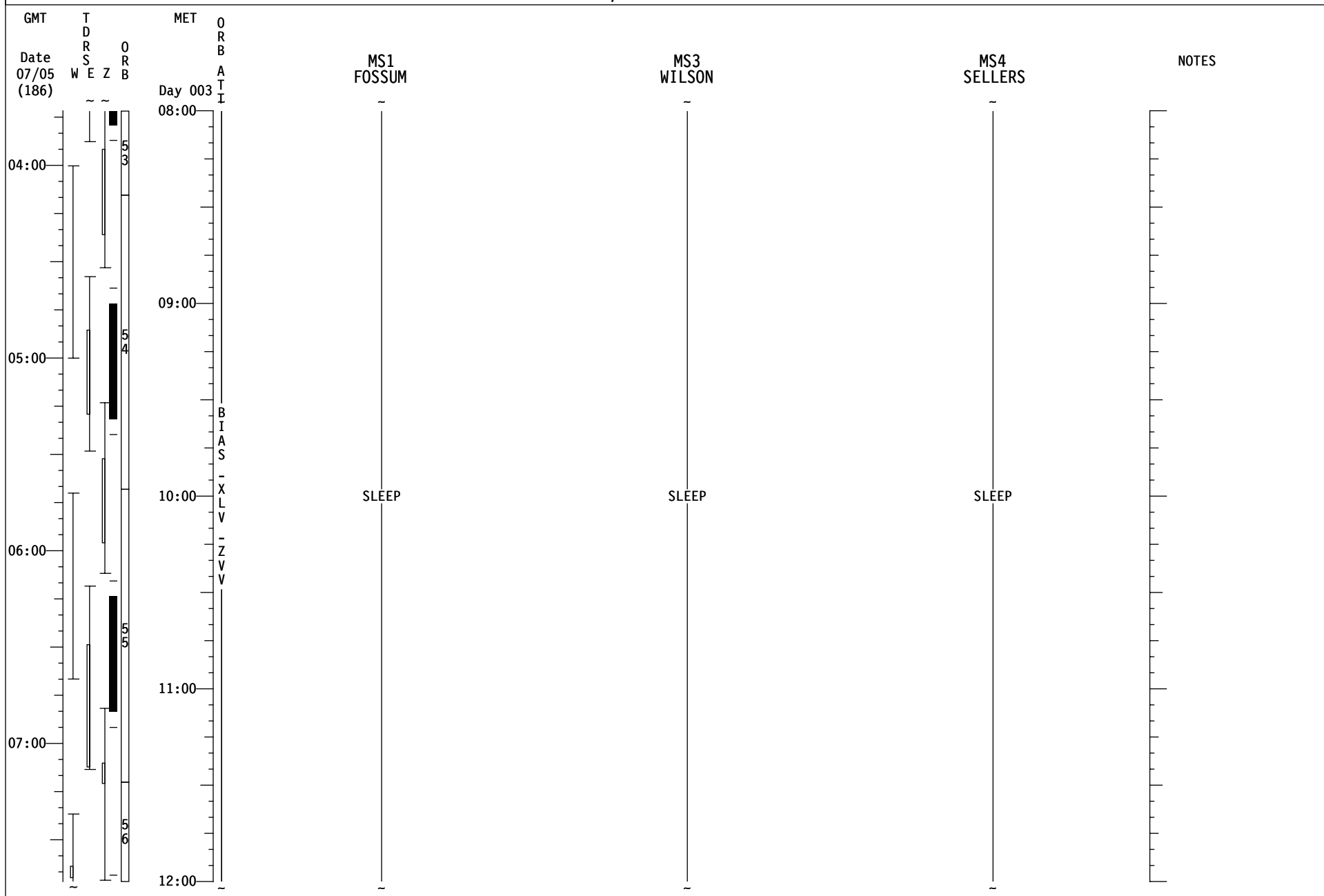

STS-121/ULF 1.1 (FD 05)

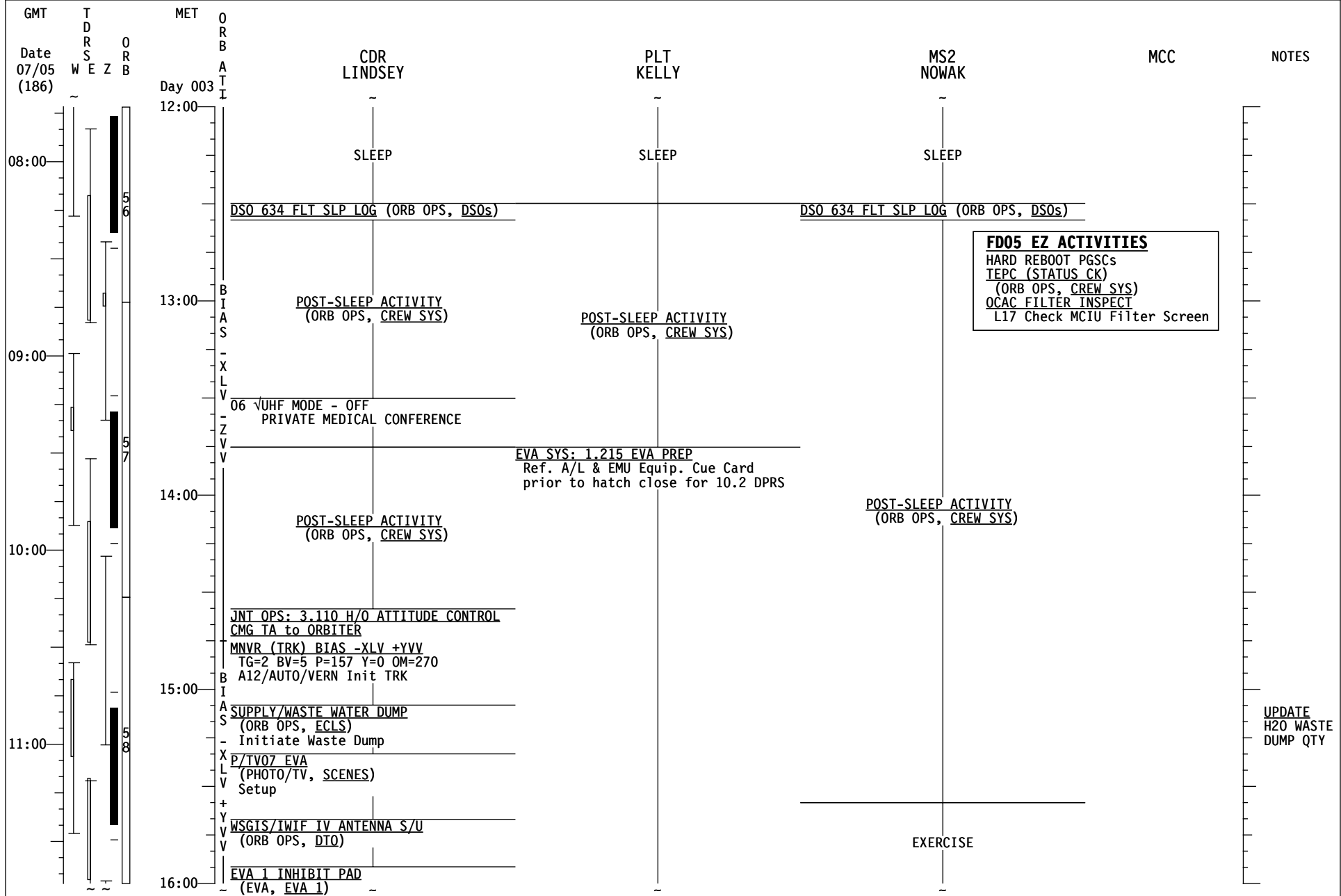

FD05 EZ ACTIVITIES
 HARD REBOOT PGSCs
 TEPC (STATUS CK)
 (ORB OPS, CREW SYS)
 OCAC FILTER INSPECT
 L17 Check MCIU Filter Screen

STS-121/ULF 1.1 (FD 05)

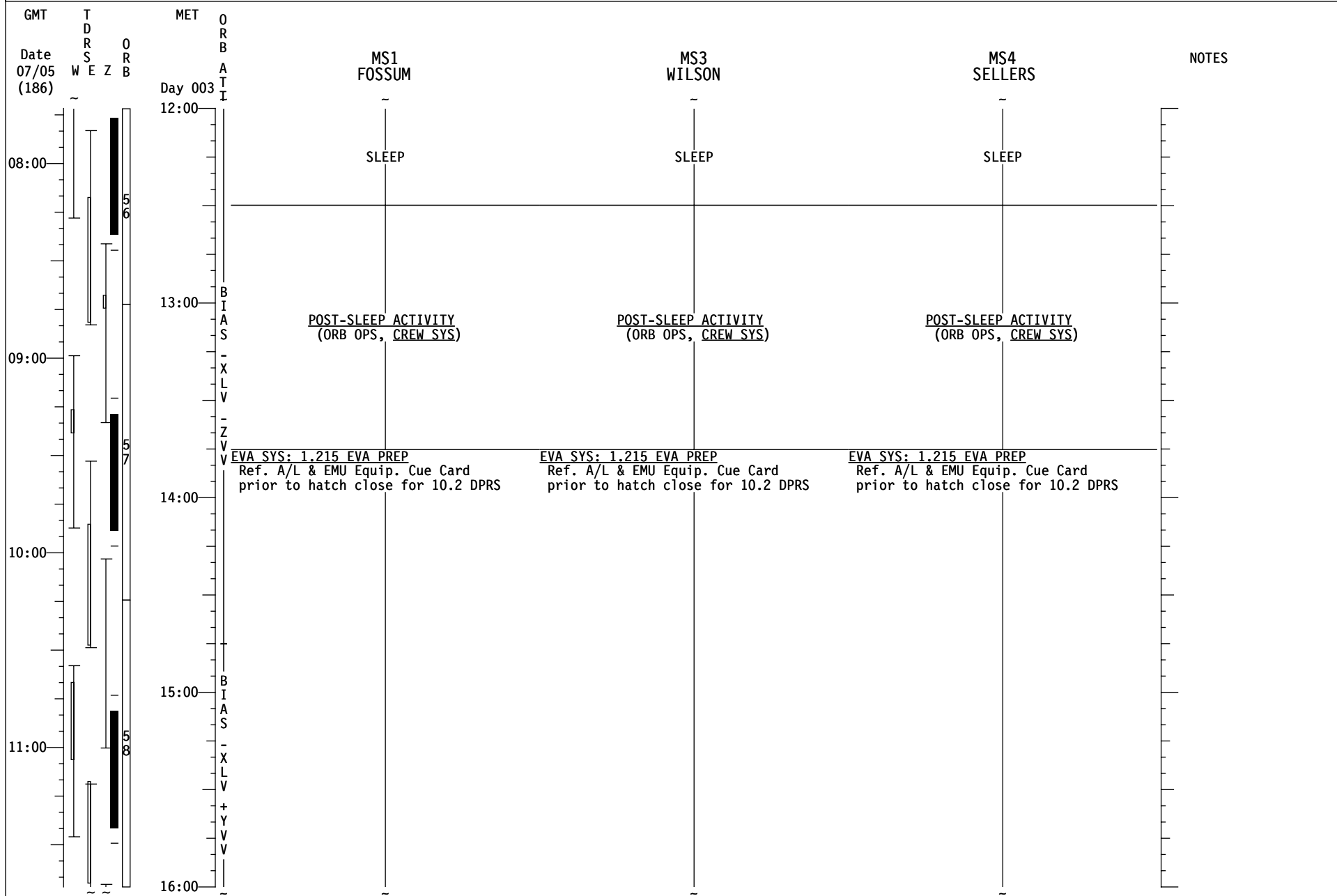

STS-121/ULF 1.1 (FD 05)

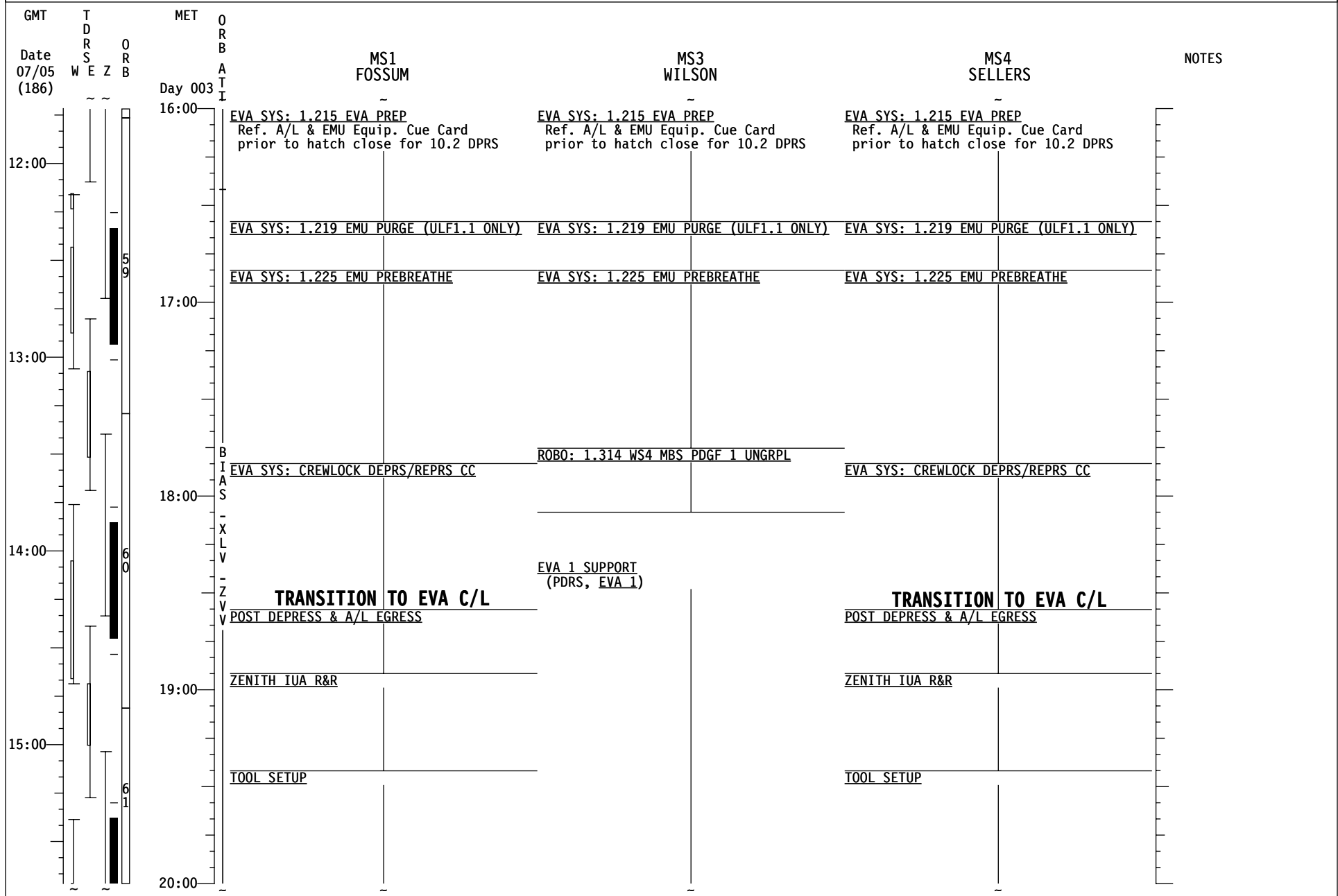

STS-121/ULF 1.1 (FD 05)

GMT	T D R S E Z	O R B	MET	O R B	A T I	CDR LINDSEY	PLT KELLY	MS2 NOWAK	MCC	NOTES
Date 07/05 (186)	W E Z	6 1	Day 003	20:00		MEAL				
						On EVA IV GO: WSGIS/IWIF ACT (ORB OPS, DTQ)				
						SHUTTLE/ISS H2O CNTR FILL (ORB OPS, ECLS) INIT #6 Ref. MSG XXX				
						P/TV07 EVA (PHOTO/TV, SCENES)				
				21:00						
		6 2								
						SHUTTLE/ISS H2O CONT FILL (ORB OPS, ECLS) TERM Report B/C and S/N to MCC				
						X CWC TRANSFER L Transfer 2 CWCs to ISS				
				22:00						
						P/TV07 EVA (PHOTO/TV, SCENES)				
				23:00						
		6 3								
		6 4		00:00						

STS-121/ULF 1.1 (FD 05)

GMT	TDRS W E Z	ORB O R B	MET Day 003	ORBIT A T I	MS1 FOSSUM	MS3 WILSON	MS4 SELLERS	NOTES
16:00					TOOL SETUP OBSS SETUP - PART I	EVA 1 SUPPORT (PDRS, EVA 1)	TOOL SETUP OBSS SETUP - PART I	
17:00					ONE EV POSN 1 LOAD EVAL		ONE EV POSN 1 LOAD EVAL	
18:00					OBSS SETUP - PART II		OBSS SETUP - PART II	
19:00					TWO EV POSN 3 LOAD EVAL		TWO EV POSN 3 LOAD EVAL	
					TWO EV P1 PUSH LOAD EVAL		TWO EV P1 PUSH LOAD EVAL	
					OBSS CLEANUP		OBSS CLEANUP	
00:00								

STS-121/ULF 1.1 (FD 05)

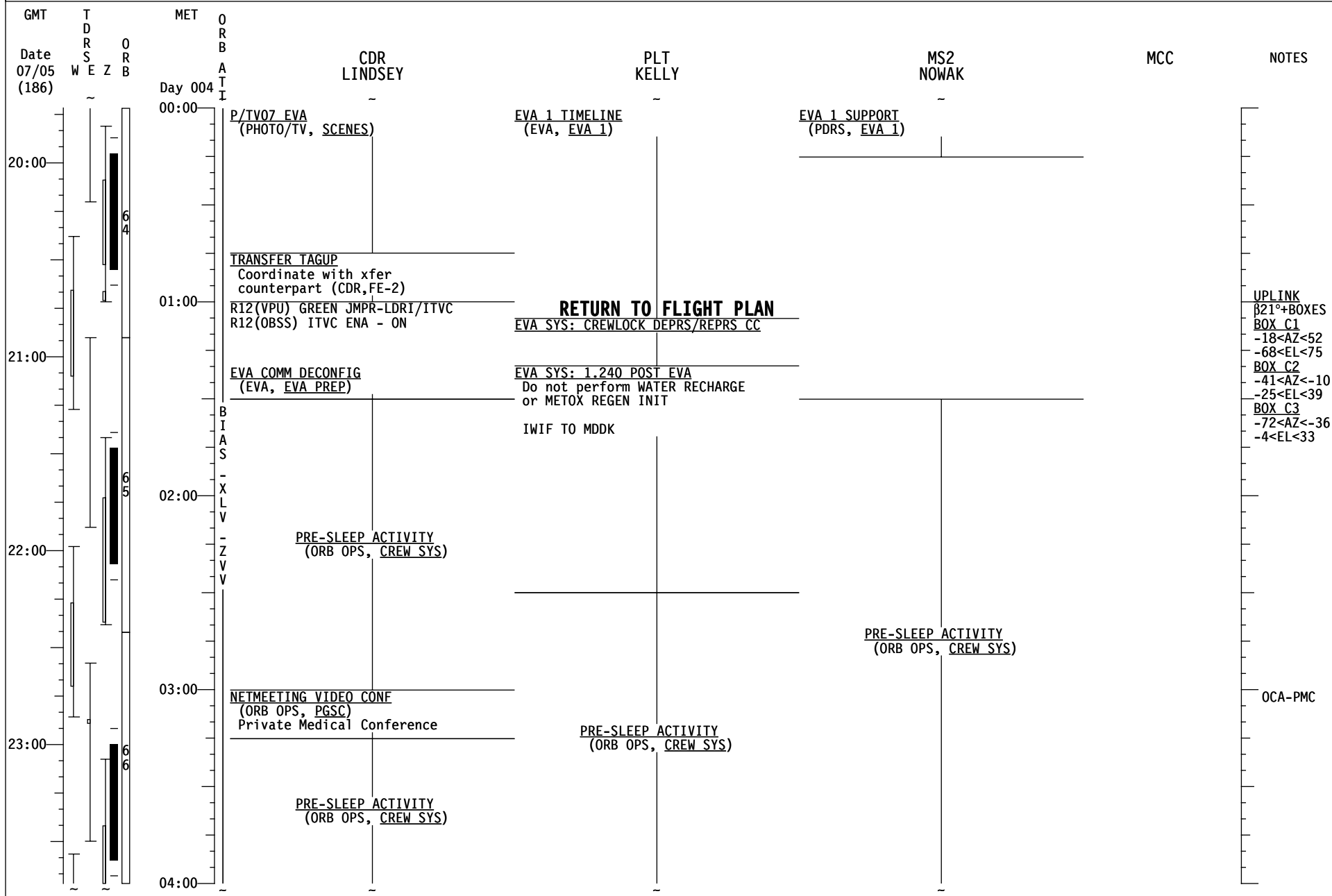

STS-121/ULF 1.1 (FD 05)

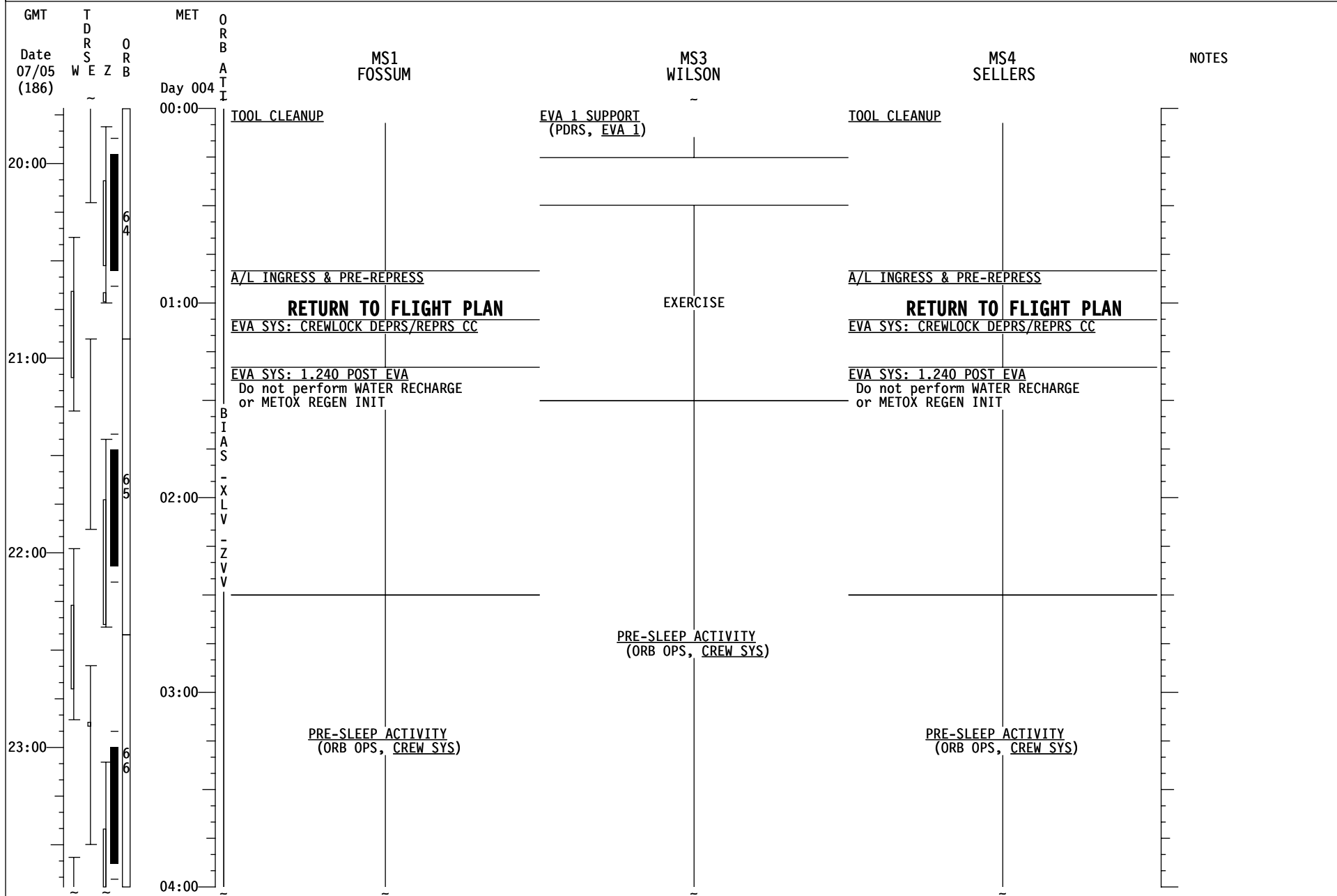

STS-121/ULF 1.1 (FD 05)

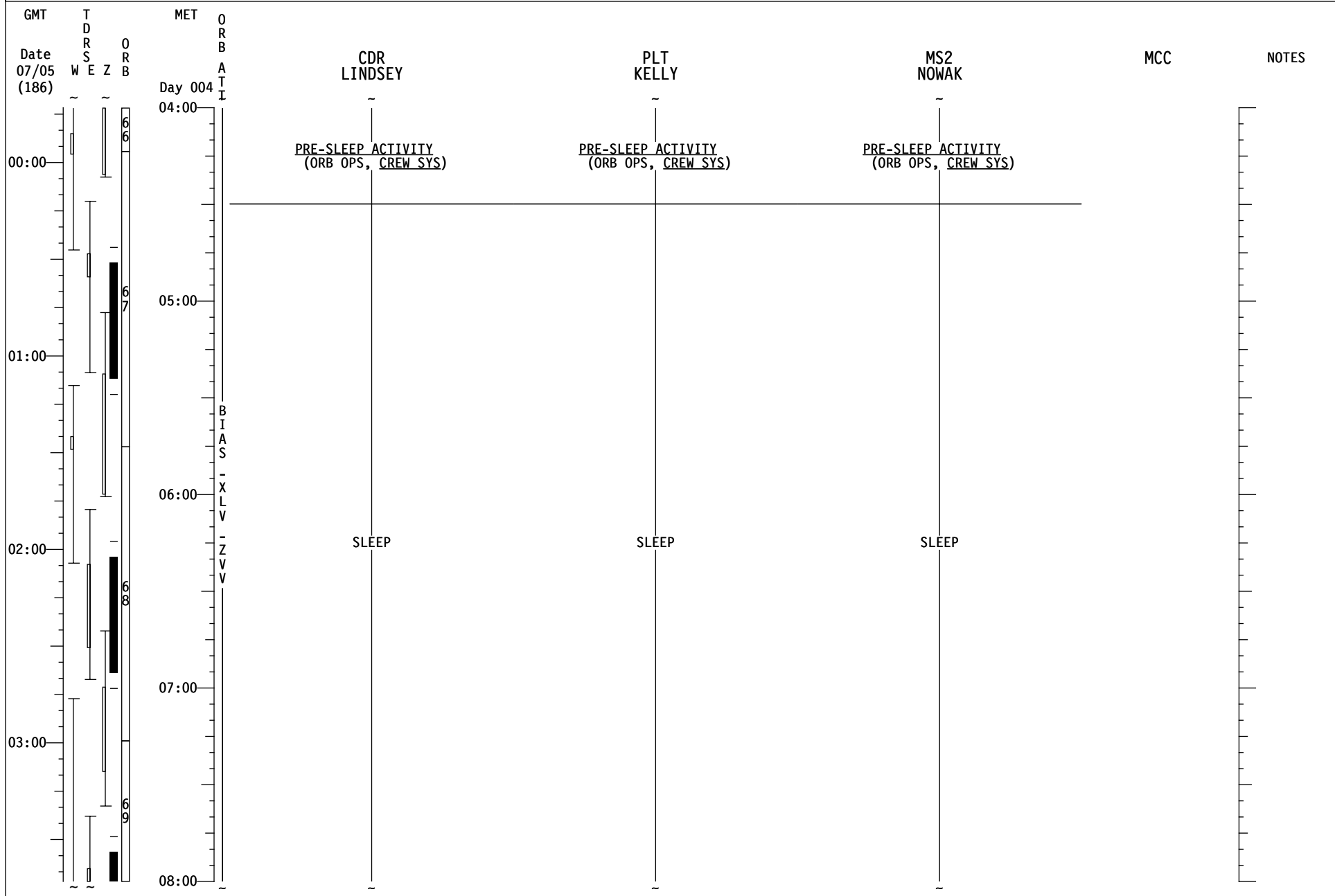

STS-121/ULF 1.1 (FD 05)

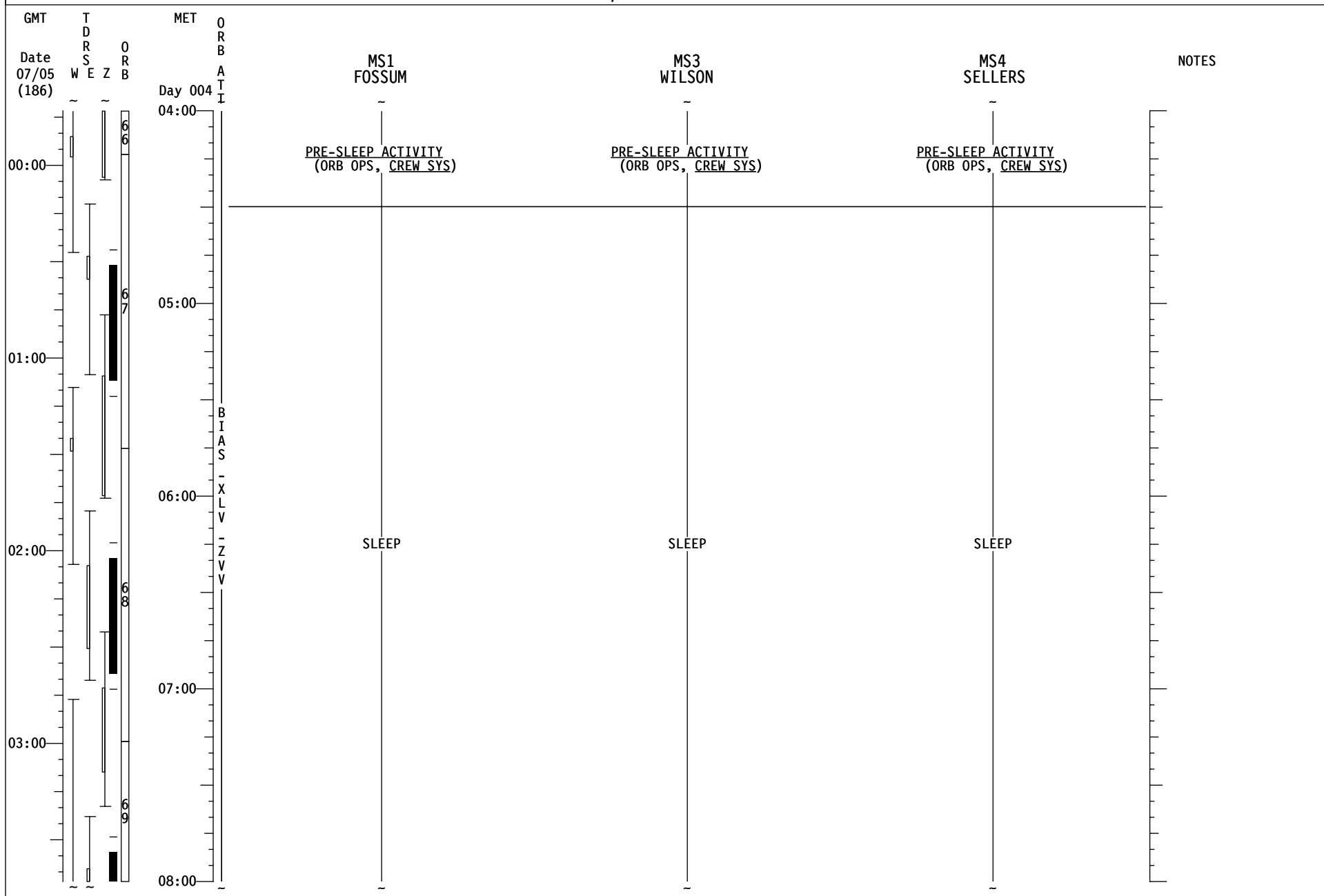

STS-121/ULF 1.1 (FD 05)

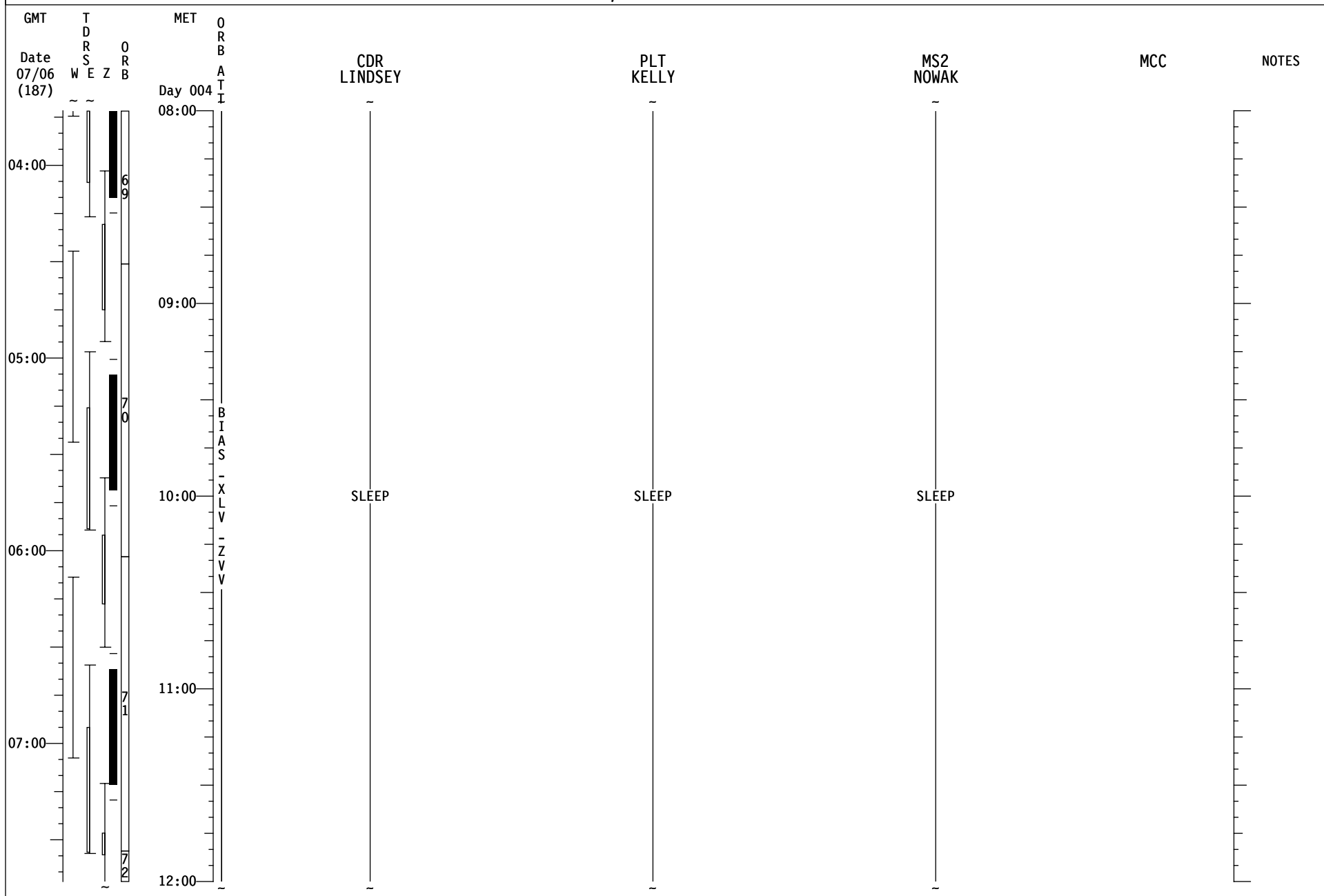

STS-121/ULF 1.1 (FD 06)

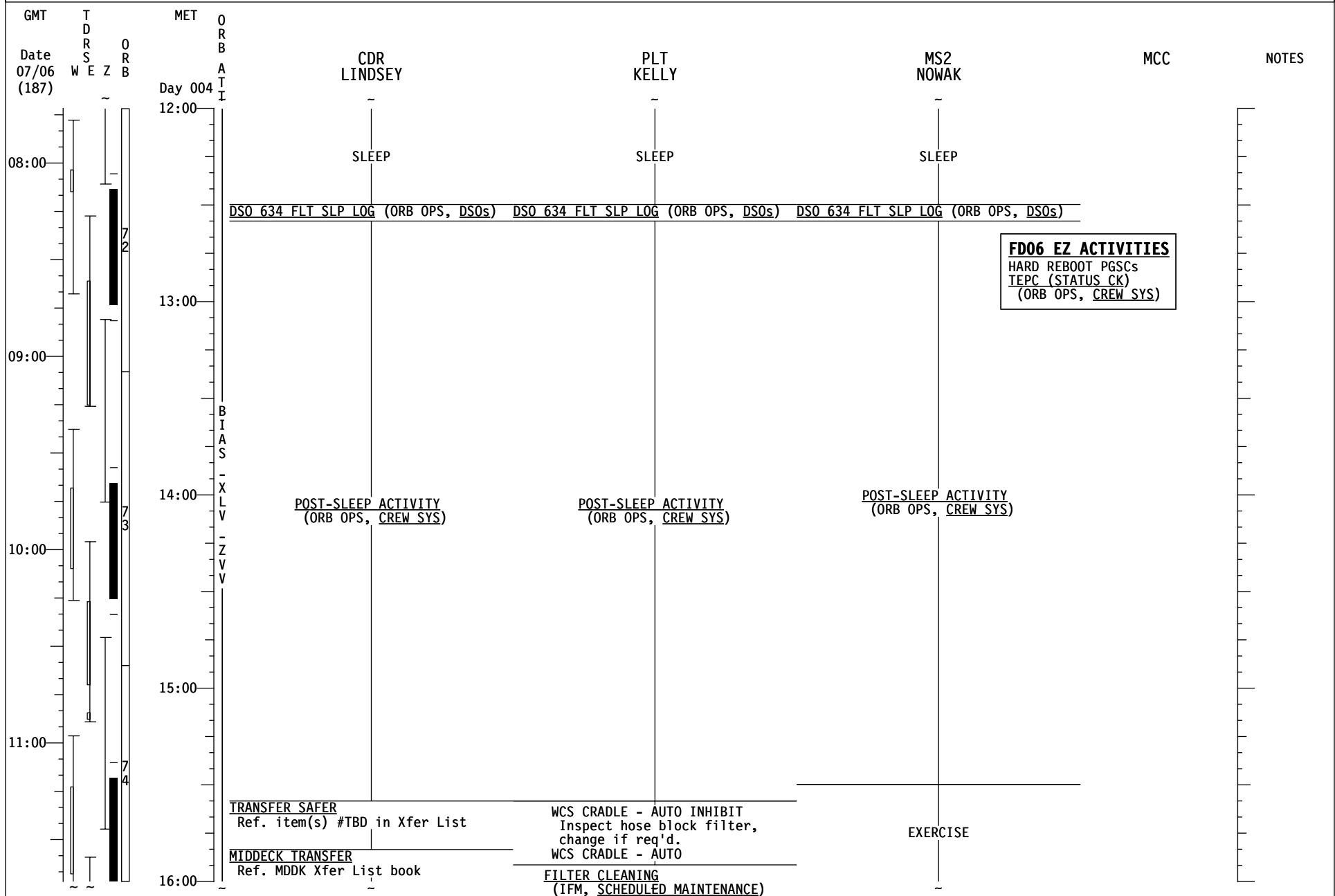

STS-121/ULF 1.1 (FD 06)

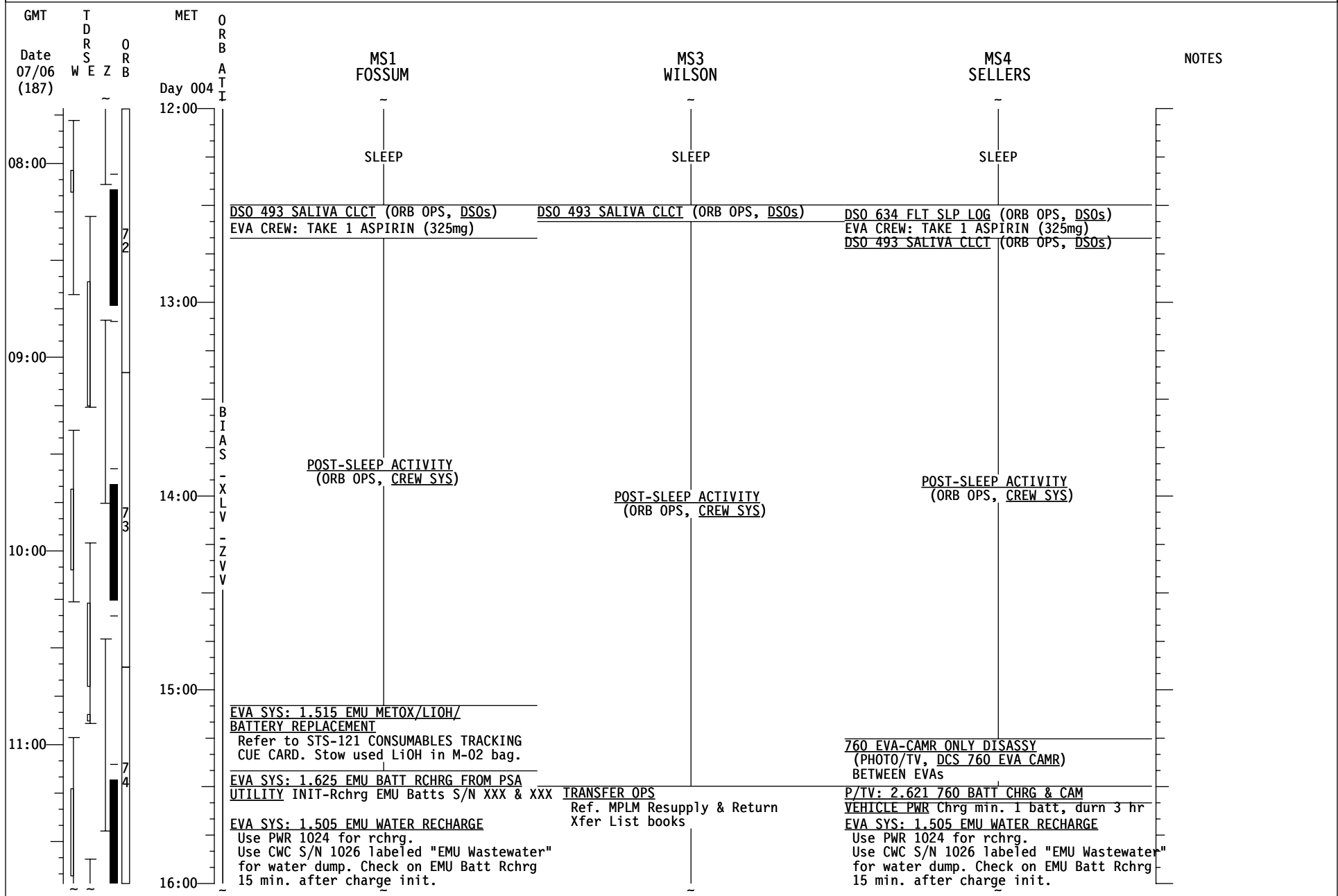

STS-121/ULF 1.1 (FD 06)

GMT	T D R S E Z	MET	O R B	CDR LINDSEY	PLT KELLY	MS2 NOWAK	MCC	NOTES
Date 07/06 (187)	W E Z	Day 004	ORB A T I					
12:00				<u>MIDDECK TRANSFER</u> Ref. MDDK Xfer List book	<u>FILTER CLEANING</u> (IFM, SCHEDULED MAINTENANCE) Inspt filters & clean as necessary	EXERCISE		
				<u>SHUTTLE/ISS H2O CNTR FILL</u> (ORB OPS, ECLS) INIT #7 Ref. MSG XXX		<u>TRANSFER OPS</u> Ref. MPLM Resupply & Return Xfer List books		
				<u>MIDDECK TRANSFER</u> Ref. MDDK Xfer List book				
13:00					EXERCISE			
				<u>SHUTTLE/ISS H2O CONT FILL</u> (ORB OPS, ECLS) TERM Report B/C and S/N to MCC	<u>EMU TRANSFER TO ISS</u> Transfer EMU 3008 to AFT EDDA Ref. Transfer List #TBD			
				<u>SHUTTLE/ISS H2O CNTR FILL</u> (ORB OPS, ECLS) INIT #8 Ref. MSG XXX	<u>TRANSFER OPS</u> Ref. MPLM Resupply & Return Xfer List books			
14:00					<u>EVA SYS: 1.412 EMU CHECKOUT W/O LEAK CK</u> Use REI Comm Cap from EMU Mesh Transfer Bag and EV-1 LCVG.			
				EXERCISE	<u>TRANSFER OPS</u> Ref. MPLM Resupply & Return Xfer List books			
15:00				<u>SHUTTLE/ISS H2O CONT FILL</u> (ORB OPS, ECLS) TERM Report B/C and S/N to MCC				
				<u>CWC TRANSFER</u> Transfer 2 CWCs to ISS	<u>EVA SYS: 1.430 SAFER CHECKOUT</u>			
20:00								

STS-121/ULF 1.1 (FD 06)

GMT	T D R S O W E Z B	MET	O R B A T I	MS1 FOSSUM	MS3 WILSON	MS4 SELLERS	NOTES
Date 07/06 (187)		Day 004					
12:00		16:00		<u>EVA SYS: 1.505 EMU WATER RECHARGE</u> Use PWR 1024 for rchrg. Use CWC S/N 1026 labeled "EMU Wastewater" for water dump. Check on EMU Batt Rchrg 15 min. after charge init.	<u>TRANSFER OPS</u> Ref. MPLM Resupply & Return Xfer List books	<u>EVA SYS: 1.505 EMU WATER RECHARGE</u> Use PWR 1024 for rchrg. Use CWC S/N 1026 labeled "EMU Wastewater" for water dump. Check on EMU Batt Rchrg 15 min. after charge init.	
				<u>EVA SYS: 1.305 EQUIPMENT LOCK PREP</u> Refer to STS-121 CONSUMABLES TRACKING CUE CARD for EHIP Batts. EHIP Batts are in M-02 bag.		<u>EVA SYS: 1.305 EQUIPMENT LOCK PREP</u> Refer to STS-121 CONSUMABLES TRACKING CUE CARD for EHIP Batts. EHIP Batts are in M-02 bag.	
13:00		17:00		<u>EVA TOOLS MGMT</u> (EVA, TOOLS & STOWAGE) Perform FD6-EVA 1 Tool Dcnfg		<u>EVA TOOLS MGMT</u> (EVA, TOOLS & STOWAGE) Perform FD6-EVA 1 Tool Dcnfg	
14:00		18:00					
15:00		19:00		<u>EVA SYS: 1.412 EMU CHECKOUT W/O LEAK CK</u> Use REI Comm Cap from EMU Mesh Transfer Bag and EV-1 LCVG.	<u>P/TV05 ISS INTERNAL OPS (HC)</u> (PHOTO/TV, SCENES) SETUP	<u>EVA SYS: 1.412 EMU CHECKOUT W/O LEAK CK</u> Use REI Comm Cap from EMU Mesh Transfer Bag and EV-1 LCVG.	
				<u>EMU SWAP</u> Instl EMU 3006 on AFT EDDA	EXERCISE	<u>EMU SWAP</u> Instl EMU 3006 on AFT EDDA	
		20:00		<u>EVA SYS: 1.605 BSA BATTERY RECHARGE</u> TERMINATE		<u>760 EVA-CAMR ONLY</u> (PHOTO/TV, DCS 760 EVA CAMR)	

STS-121/ULF 1.1 (FD 06)

GMT	TDRS W E Z	MET Day 004	ORBIT A T I	CDR LINDSEY	PLT KELLY	MS2 NOWAK	MCC	NOTES
16:00				MEAL	MEAL	MEAL		
17:00				CREW CONFERENCE KU AVAIL: XX:XX - XX:XX, TDRX REF: MSG XXX	CREW CONFERENCE KU AVAIL: XX:XX - XX:XX, TDRX REF: MSG XXX	CREW CONFERENCE KU AVAIL: XX:XX - XX:XX, TDRX REF: MSG XXX		
18:00				CREW PHOTO	CREW PHOTO	CREW PHOTO		
19:00				<u>CO2 ABSORBER REPLACEMENT CUE CARD</u> (ORB OPS, CUE CARD CONFIG) Ref. item(s) #TBD in Transfer List	<u>TRANSFER OPS</u> Ref. MPLM Resupply & Return Xfer List books	<u>TRANSFER OPS</u> Ref. MPLM Resupply & Return Xfer List books		
20:00								
21:00								
22:00								
23:00				<u>TRANSFER OPS</u> Ref. MPLM Resupply & Return Xfer List books				
00:00				<u>TRANSFER TAGUP</u> Coordinate with xfer counterpart (CDR,MS3,FE-2)				

STS-121/ULF 1.1 (FD 06)

GMT	TDRS W E Z	MET Day 004	ORBIT A T I	MS1 FOSSUM	MS3 WILSON	MS4 SELLERS	NOTES
16:00				MEAL	MEAL	MEAL	
17:00				CREW CONFERENCE KU AVAIL: XX:XX - XX:XX, TDRX REF: MSG XXX	CREW CONFERENCE KU AVAIL: XX:XX - XX:XX, TDRX REF: MSG XXX	CREW CONFERENCE KU AVAIL: XX:XX - XX:XX, TDRX REF: MSG XXX	
18:00				CREW PHOTO	CREW PHOTO	CREW PHOTO	
19:00				EXERCISE	TRANSFER OPS Ref. MPLM Resupply & Return Xfer List books	MIDDECK TRANSFER Ref. MDDK Xfer List book	
20:00				TRANSFER OPS Ref. MPLM Resupply & Return Xfer List books	TRANSFER TAGUP Coordinate with xfer counterpart (CDR,MS3,FE-2)	EXERCISE	
21:00					TRANSFER OPS Ref. MPLM Resupply & Return Xfer List books		
22:00							
23:00							
00:00							

STS-121/ULF 1.1 (FD 06)

GMT	T D R S E Z	O R B	MET	O R B A T I	CDR LINDSEY	PLT KELLY	MS2 NOWAK	MCC	NOTES
Date 07/06 (187)	W E Z	O R B	Day 005						
20:00			00:00		<u>EVA 2 BRIEFING CARD</u> (EVA, EVA 2)	<u>EVA 2 BRIEFING CARD</u> (EVA, EVA 2)	<u>EVA 2 BRIEFING CARD</u> (EVA, EVA 2)		
21:00			01:00		R12(VPU) GREEN JMPR-LDRI/ITVC R12(OBSS) ITVC ENA - ON				
22:00			02:00	B I A S - X L L V - Z V V V	<u>PRE-SLEEP ACTIVITY</u> (ORB OPS, CREW SYS)				
23:00			03:00		<u>NETMEETING VIDEO CONF</u> (ORB OPS, PGSC) Private Medical Conference	<u>PRE-SLEEP ACTIVITY</u> (ORB OPS, CREW SYS)	<u>PRE-SLEEP ACTIVITY</u> (ORB OPS, CREW SYS)		OCA-PMC
04:00			04:00		<u>PRE-SLEEP ACTIVITY</u> (ORB OPS, CREW SYS)				
					NOTE: SLEEP SHIFT 30 MIN EARLIER WAKEUP @ MET 5/12:00				

STS-121/ULF 1.1 (FD 06)

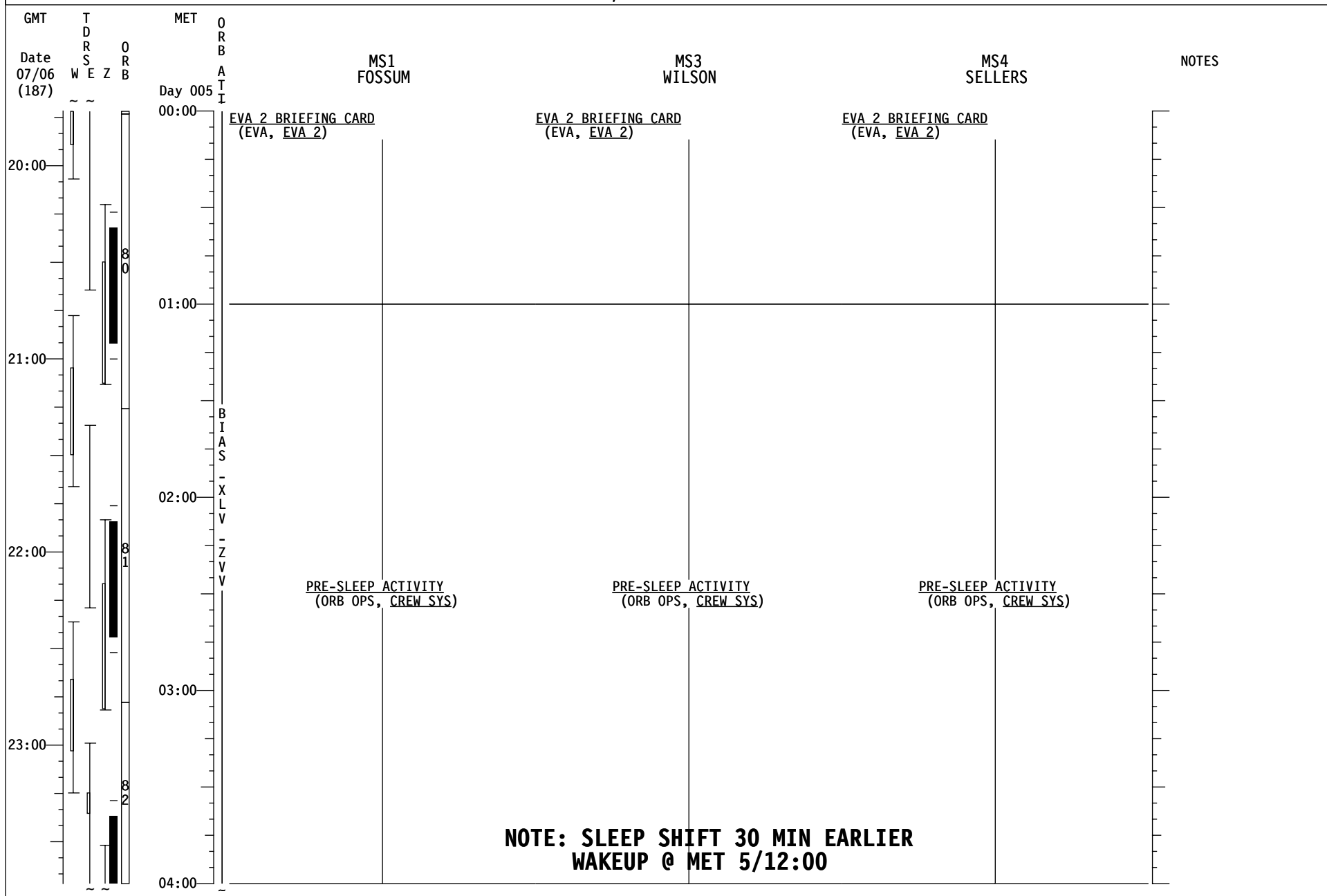

STS-121/ULF 1.1 (FD 06)

GMT	T D R S E Z	MET	O R B	CDR LINDSEY	PLT KELLY	MS2 NOWAK	MCC	NOTES
Date 07/06 (187)	W E Z	Day 005	A T I					
00:00	~	04:00						
01:00	~	05:00						
02:00	~	06:00	B I A S - X L V - Z V V	SLEEP	SLEEP	SLEEP		
03:00	~	07:00						
08:00	~	08:00						

STS-121/ULF 1.1 (FD 06)

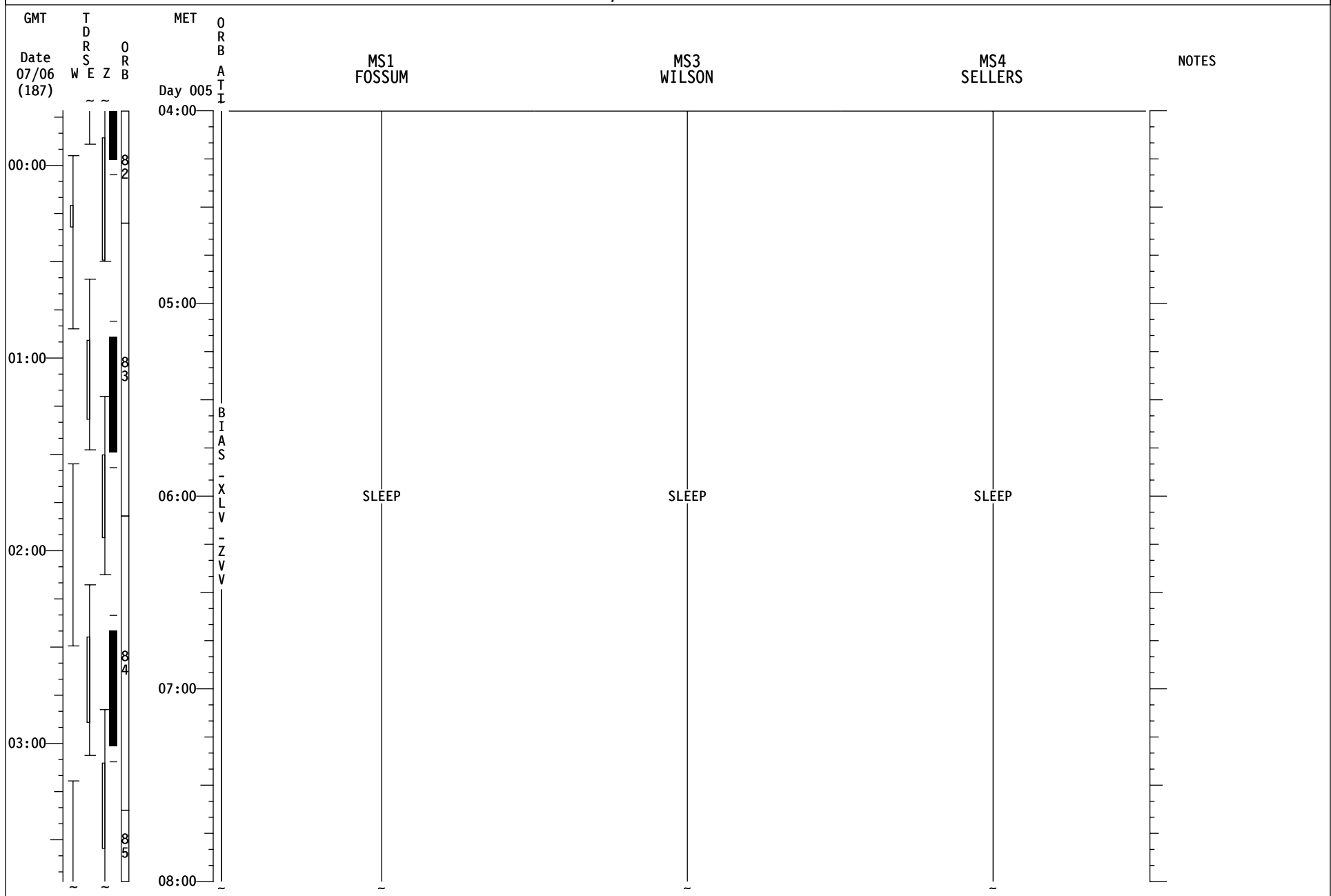

STS-121/ULF 1.1 (FD 06)

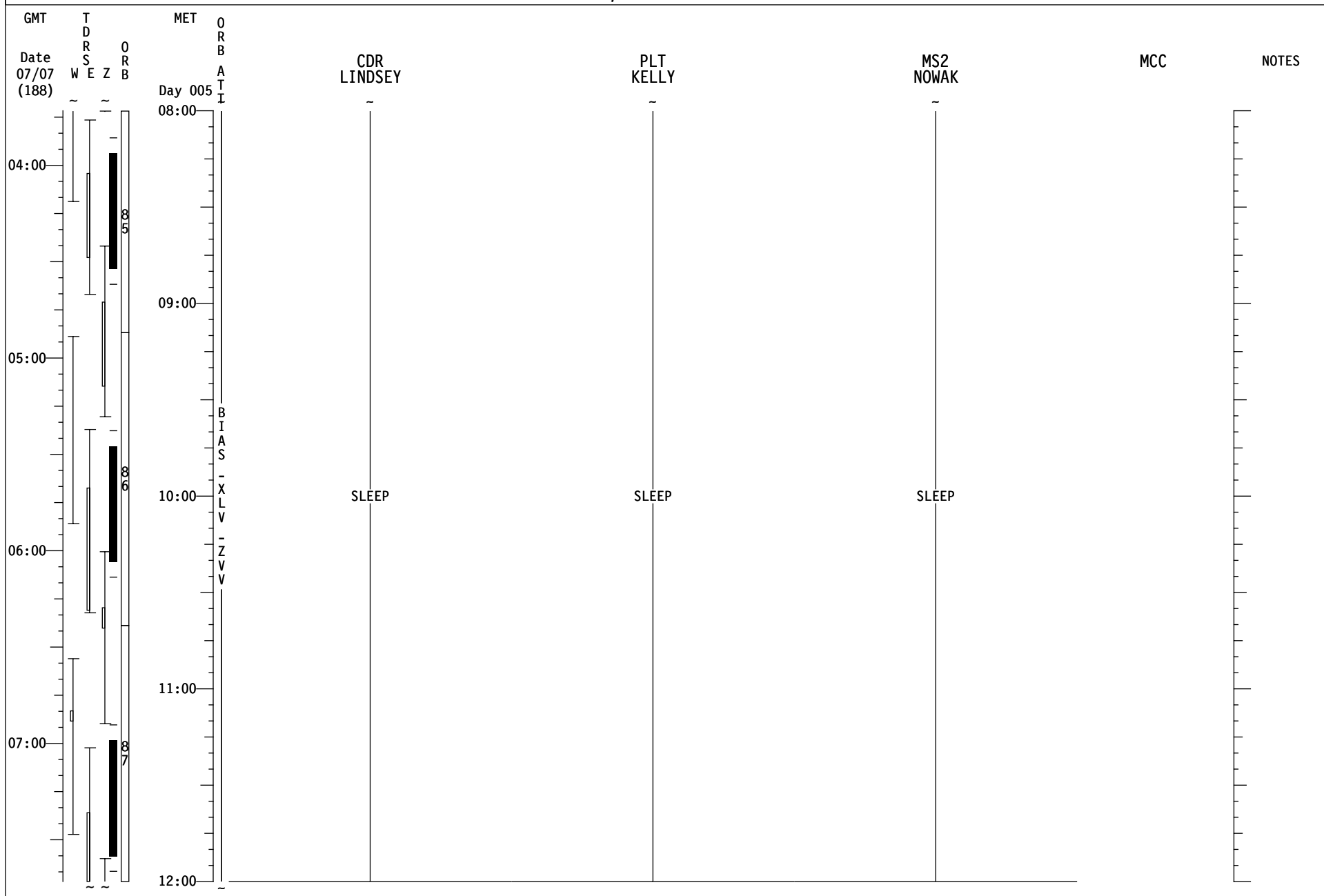

STS-121/ULF 1.1 (FD 06)

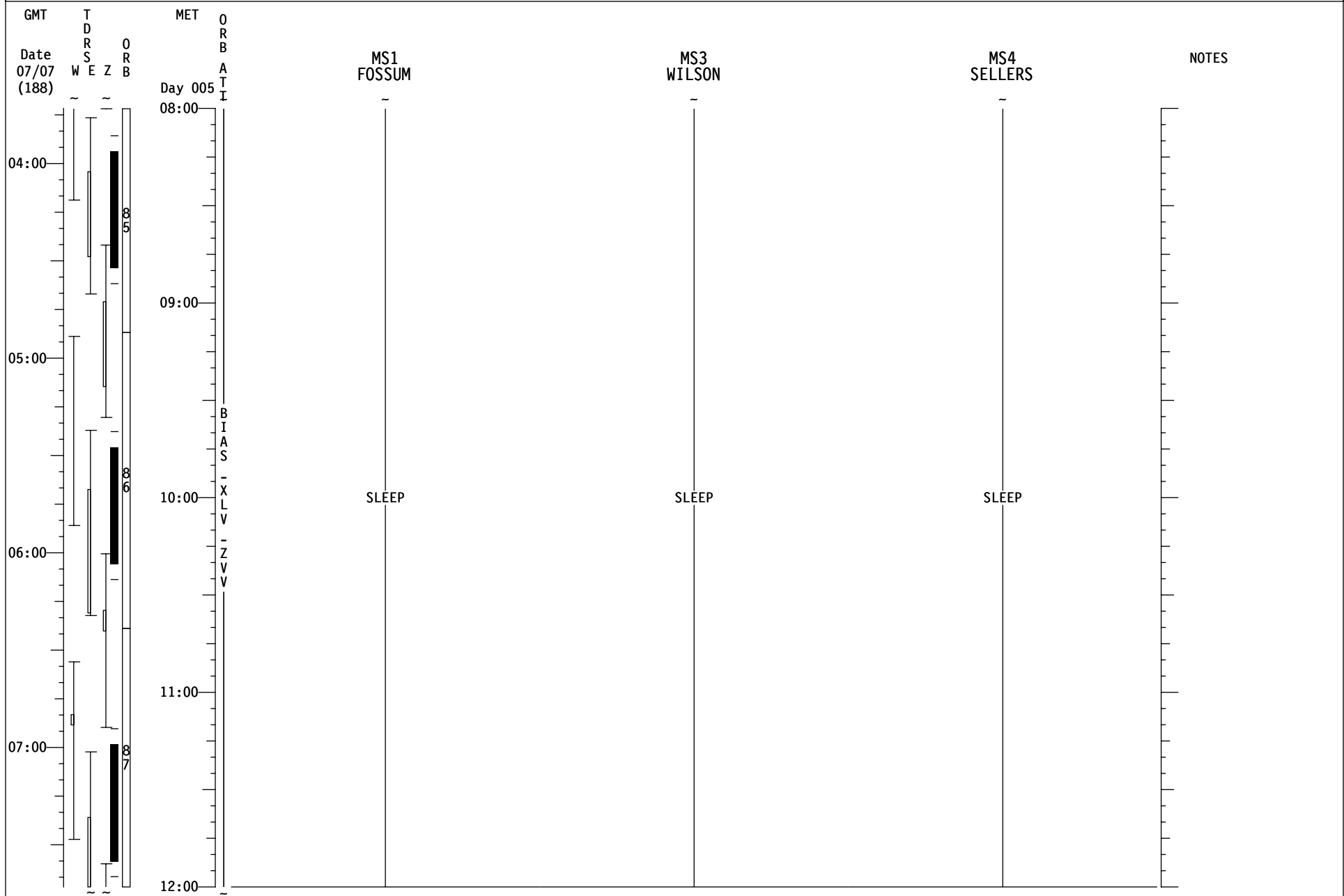

STS-121/ULF 1.1 (FD 07)

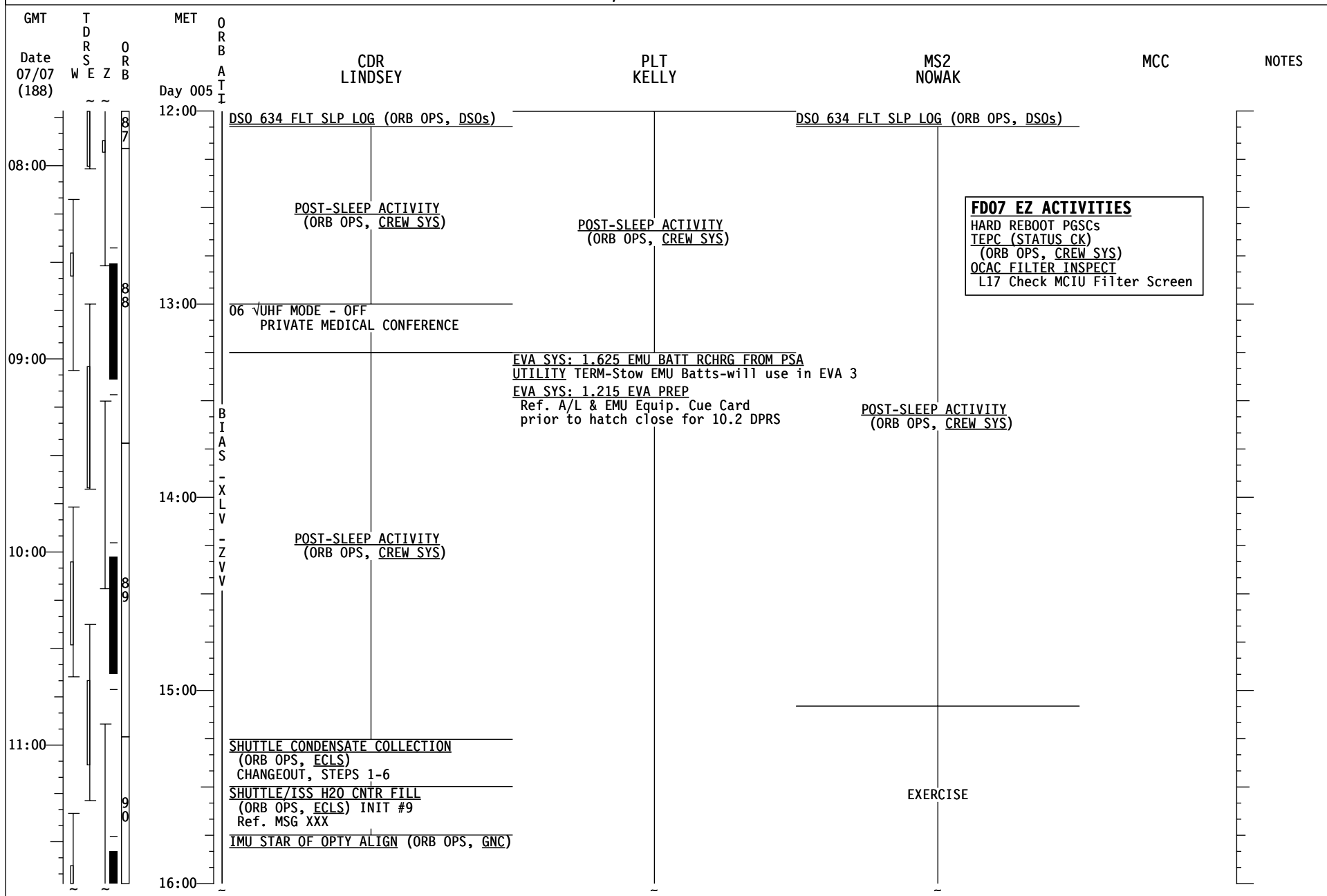

STS-121/ULF 1.1 (FD 07)

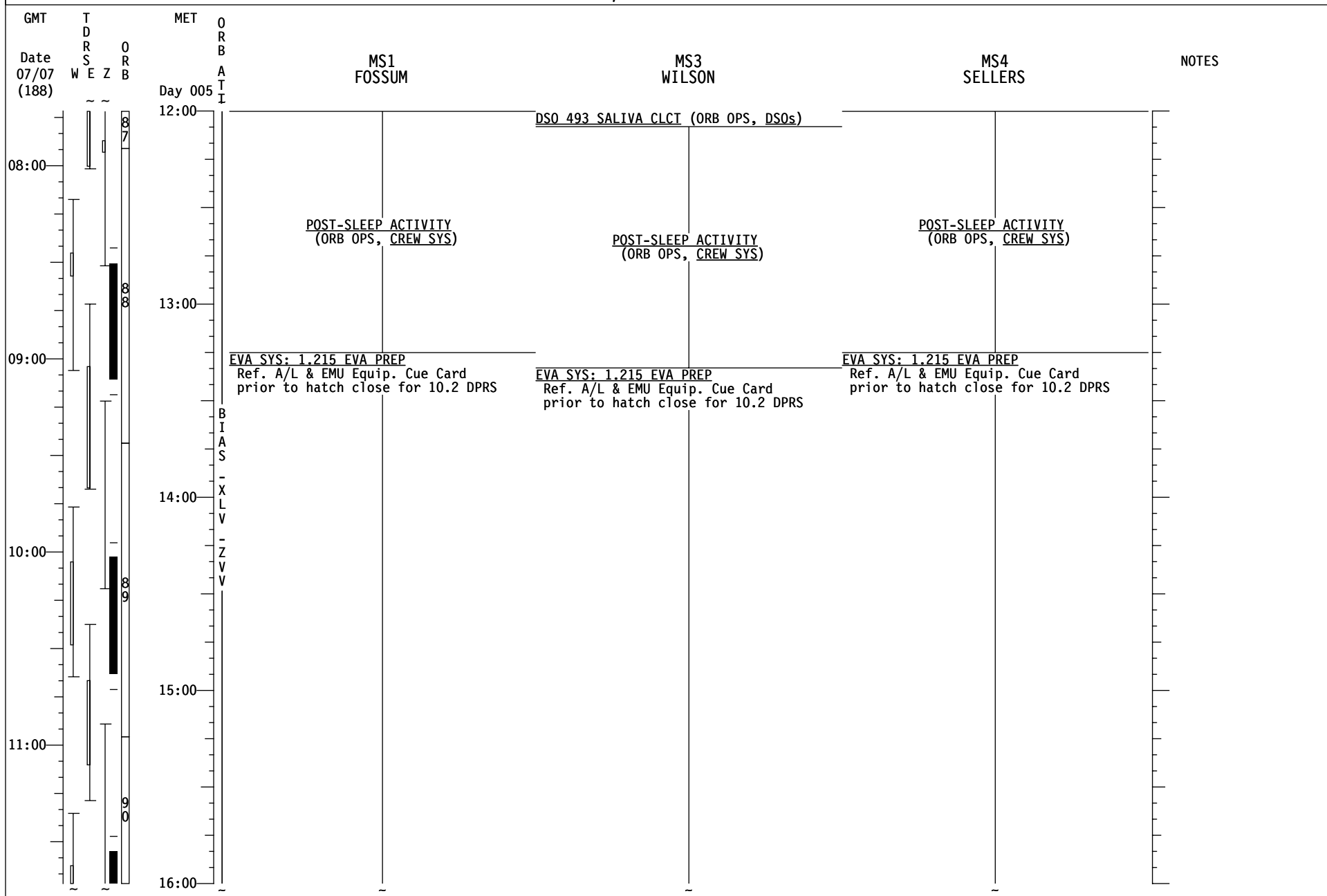

STS-121/ULF 1.1 (FD 07)

GMT	T D R S E Z	MET	O R B	CDR LINDSEY	PLT KELLY	MS2 NOWAK	MCC	NOTES
Date 07/07 (188)	W E Z B	Day 005	A T I					
16:00				SSP1 OIU PWR - OIU 1 ON (tb-UP) EVA 2 INHIBIT PAD (EVA, EVA 2)	EVA SYS: 1.215 EVA PREP Ref. A/L & EMU Equip. Cue Card prior to hatch close for 10.2 DPRS	EXERCISE		
12:00				P/TV07 EVA (PHOTO/TV, SCENES) Setup	EVA SYS: 1.225 EMU PREBREATHE	TRANSFER OPS Ref. MPLM Resupply & Return Xfer List books		
17:00				SHUTTLE/ISS H2O CONT FILL (ORB OPS, ECLS) TERM Report B/C and S/N to MCC				
13:00				PWR FILL (ORB OPS, ECLS) INIT #1 Ref. MSG XXX	EVA SYS: CREWLOCK DEPRS/REPRS CC			
18:00				PWR FILL (ORB OPS, ECLS) INIT #2 Ref. MSG XXX		POC: 1.301 DOUG STARTUP PROCEDURE Step 1 - Ref. MSG XXX		
14:00				PWR TRANSFER Transfer 2 PWRs to ISS	TRANSITION TO EVA C/L EVA 2 TIMELINE (EVA, EVA 2)	ROBO: 1.411 MNVR TO PUMP MODULE PRE-GRAPPLE		UPLINK BO+BOXES BOX C1 -18<AZ<52 -68<EL<75 BOX C2 -41<AZ<-10 -25<EL<39 BOX C3 -72<AZ<-36 -4<EL<33 BOX E2 -66<AZ<5 -75<EL<-1
15:00				P/TV07 EVA (PHOTO/TV, SCENES)				
19:00				MEAL		ROBO: 1.412 PUMP MODULE GRAPPLE		
20:00				P/TV07 EVA (PHOTO/TV, SCENES)		ROBO: 1.413 MNVR PUMP MODULE TO ESP-2		

STS-121/ULF 1.1 (FD 07)

GMT	T D R S E Z	MET	O R B	MS1 FOSSUM	MS3 WILSON	MS4 SELLERS	NOTES
Date 07/07 (188)	W E Z	Day 005	A T I	EVA SYS: 1.215 EVA PREP Ref. A/L & EMU Equip. Cue Card prior to hatch close for 10.2 DPRS EVA SYS: 1.219 EMU PURGE (ULF1.1 ONLY)	EVA SYS: 1.215 EVA PREP Ref. A/L & EMU Equip. Cue Card prior to hatch close for 10.2 DPRS EVA SYS: 1.219 EMU PURGE (ULF1.1 ONLY)	EVA SYS: 1.215 EVA PREP Ref. A/L & EMU Equip. Cue Card prior to hatch close for 10.2 DPRS EVA SYS: 1.219 EMU PURGE (ULF1.1 ONLY)	
12:00				EVA SYS: 1.225 EMU PREBREATHE	EVA SYS: 1.225 EMU PREBREATHE	EVA SYS: 1.225 EMU PREBREATHE	
13:00				EVA SYS: CREWLOCK DEPRS/REPRS CC	EVA SYS: CREWLOCK DEPRS/REPRS CC	EVA SYS: CREWLOCK DEPRS/REPRS CC	
14:00				TRANSITION TO EVA C/L V POST DEPRESS & A/L EGRESS	ROBO: 1.411 MNVR TO PUMP MODULE PRE-GRAPPLE	TRANSITION TO EVA C/L POST DEPRESS & A/L EGRESS	
				V APFR SETUP		FGB RETRIEVAL	
				PUMP MODULE SETUP			
				FGB INSTALL		FGB INSTALL	
15:00				PUMP MODULE RETRIEVAL	ROBO: 1.412 PUMP MODULE GRAPPLE	PUMP MODULE RETRIEVAL	
				APFR RECONFIG & TUS S/U	ROBO: 1.413 MNVR PUMP MODULE TO ESP-2	NADIR IUA R&R	
20:00							

STS-121/ULF 1.1 (FD 07)

GMT	TDRS W E Z	ORB O R B	MET Day 005	ORBIT O R B A T I	CDR LINDSEY	PLT KELLY	MS2 NOWAK	MCC	NOTES
16:00									
					P/TV07 EVA (PHOTO/TV, SCENES)	EVA 2 TIMELINE (EVA, EVA 2)	ROBO: 1.413 MNVR PUMP MODULE TO ESP-2		
							ROBO: 1.414 PUMP MODULE UNGRAPPLE		
							ROBO: 1.415 TUS RMVL AT S0 TRUSS		
17:00					SHUTTLE/ISS H2O CNTR FILL (ORB OPS, ECLS) INIT #10 Ref. MSG XXX		ROBO: 1.416 MNVR TO ICC		
							ROBO: 1.417 TUS H/O AT ICC		
18:00					EXERCISE		ROBO: 1.418 MNVR TO S0 TRUSS		
					SHUTTLE/ISS H2O CONT FILL (ORB OPS, ECLS) TERM Report B/C and S/N to MCC		ROBO: 1.419 TUS INSTL AT S0 TRUSS		
					CWC TRANSFER Transfer 2 CWCs to ISS		ROBO: 1.420 MNVR TO EVA 2 PARK POSN		
19:00					P/TV07 EVA (PHOTO/TV, SCENES)		OBSS MNVR FROM EVA-2 VIEW TO MPLM VIEW (PDRS, NOMINAL)		
							ROBO: 1.220 MNVR TO MATED MPLM PRE-GRAPPLE S/U		
00:00									

STS-121/ULF 1.1 (FD 07)

GMT	T D R S E Z	MET	O R B	MS1 FOSSUM	MS3 WILSON	MS4 SELLERS	NOTES
Date 07/07 (188)	W E Z	Day 005	A T I				
16:00				<u>NADIR TUS CABLE RETRACT</u>	<u>ROBO: 1.413 MNVR PUMP MODULE TO ESP-2</u>	<u>NADIR TUS CABLE RETRACT</u>	
				<u>PUMP MODULE INSTALL</u>	<u>ROBO: 1.414 PUMP MODULE UNGRAPPLE</u>	<u>PUMP MODULE INSTALL</u>	
					<u>ROBO: 1.415 TUS RMVL AT S0 TRUSS</u>		
				<u>NADIR TUS R&R</u>		<u>NADIR TUS R&R</u>	
17:00					<u>ROBO: 1.416 MNVR TO ICC</u>		
					<u>ROBO: 1.417 TUS H/O AT ICC</u>		
18:00					<u>ROBO: 1.418 MNVR TO S0 TRUSS</u>		
					<u>ROBO: 1.419 TUS INSTL AT S0 TRUSS</u>		
19:00					<u>ROBO: 1.420 MNVR TO EVA 2 PARK POSN</u>		
				<u>TUS CABLE ROUTING</u>	<u>OBSS MNVR FROM EVA-2 VIEW TO MPLM VIEW (PDRS, NOMINAL)</u>	<u>TUS CABLE ROUTING</u>	
00:00					<u>ROBO: 1.220 MNVR TO MATED MPLM PRE-GRAPPLE S/U</u>		

STS-121/ULF 1.1 (FD 07)

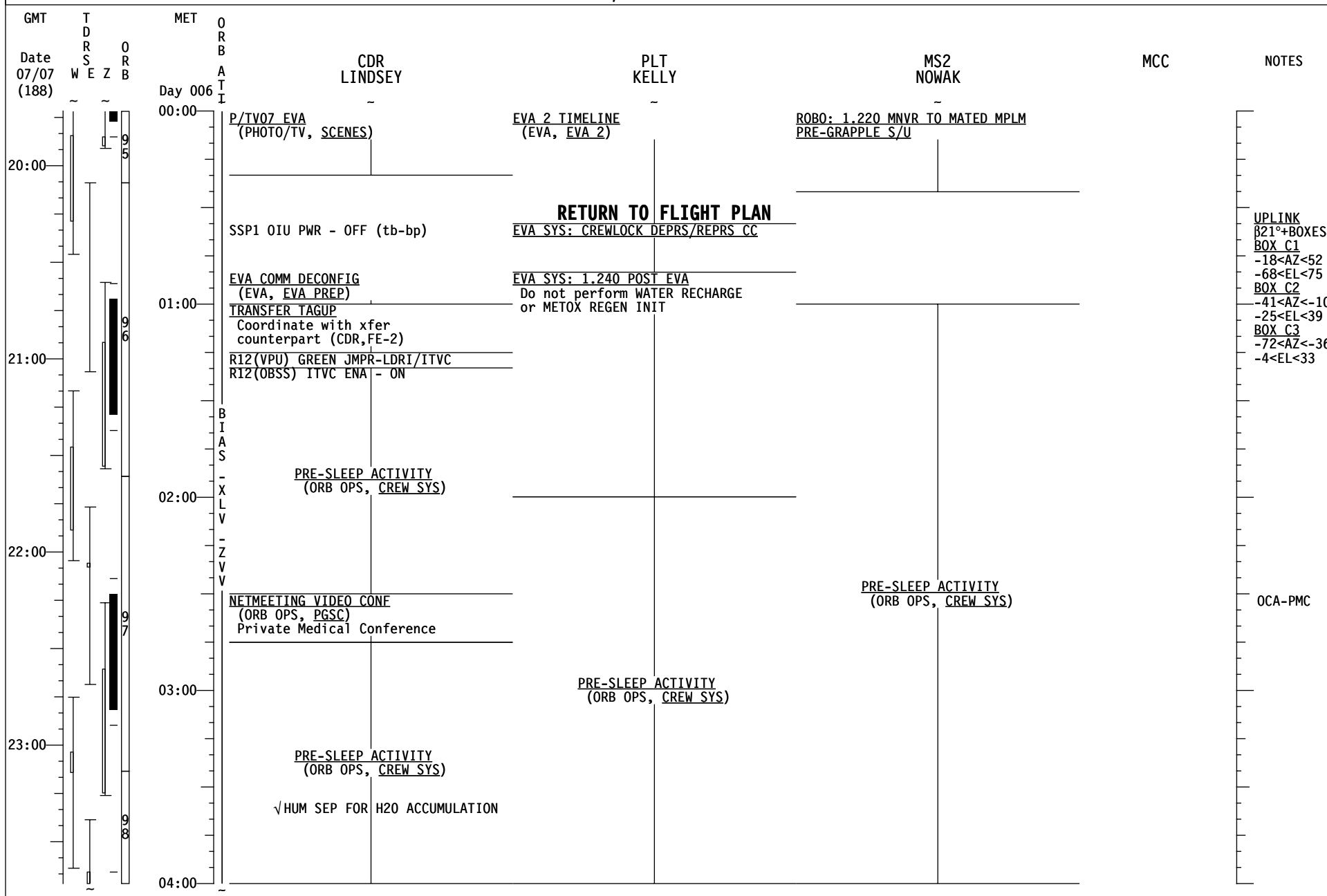

STS-121/ULF 1.1 (FD 07)

GMT	T D R S E Z	O R B	MET	O R B	MS1 FOSSUM	MS3 WILSON	MS4 SELLERS	NOTES
Date 07/07 (188)	W E Z	O R B	Day 006	A T I				
20:00		95	00:00		TUS CABLE ROUTING	ROBO: 1.220 MNVR TO MATED MPLM PRE-GRAPPLE S/U	TUS CABLE ROUTING	
					A/L INGRESS & PRE-REPRESS		A/L INGRESS & PRE-REPRESS	
					RETURN TO FLIGHT PLAN EVA SYS: CREWLOCK DEPRS/REPRS CC	RETURN TO FLIGHT PLAN EVA SYS: CREWLOCK DEPRS/REPRS CC	RETURN TO FLIGHT PLAN EVA SYS: CREWLOCK DEPRS/REPRS CC	
			01:00		EVA SYS: 1.240 POST EVA Do not perform WATER RECHARGE or METOX REGEN INIT	EVA SYS: 1.240 POST EVA Do not perform WATER RECHARGE or METOX REGEN INIT	EVA SYS: 1.240 POST EVA Do not perform WATER RECHARGE or METOX REGEN INIT	
21:00		96						
						EVA SYS: 1.605 BSA BATTERY RECHARGE INIT - CNFG Batts in BSA per STS-121 LOGISTICS CC (Post EVA 2 Batt Rchrg). Remove from BSA any Batts not being charged and stow in M-02 bag.		
22:00			02:00					
					PRE-SLEEP ACTIVITY (ORB OPS, CREW SYS)	PRE-SLEEP ACTIVITY (ORB OPS, CREW SYS)	PRE-SLEEP ACTIVITY (ORB OPS, CREW SYS)	
23:00		97						
			03:00					
			04:00					

STS-121/ULF 1.1 (FD 07)

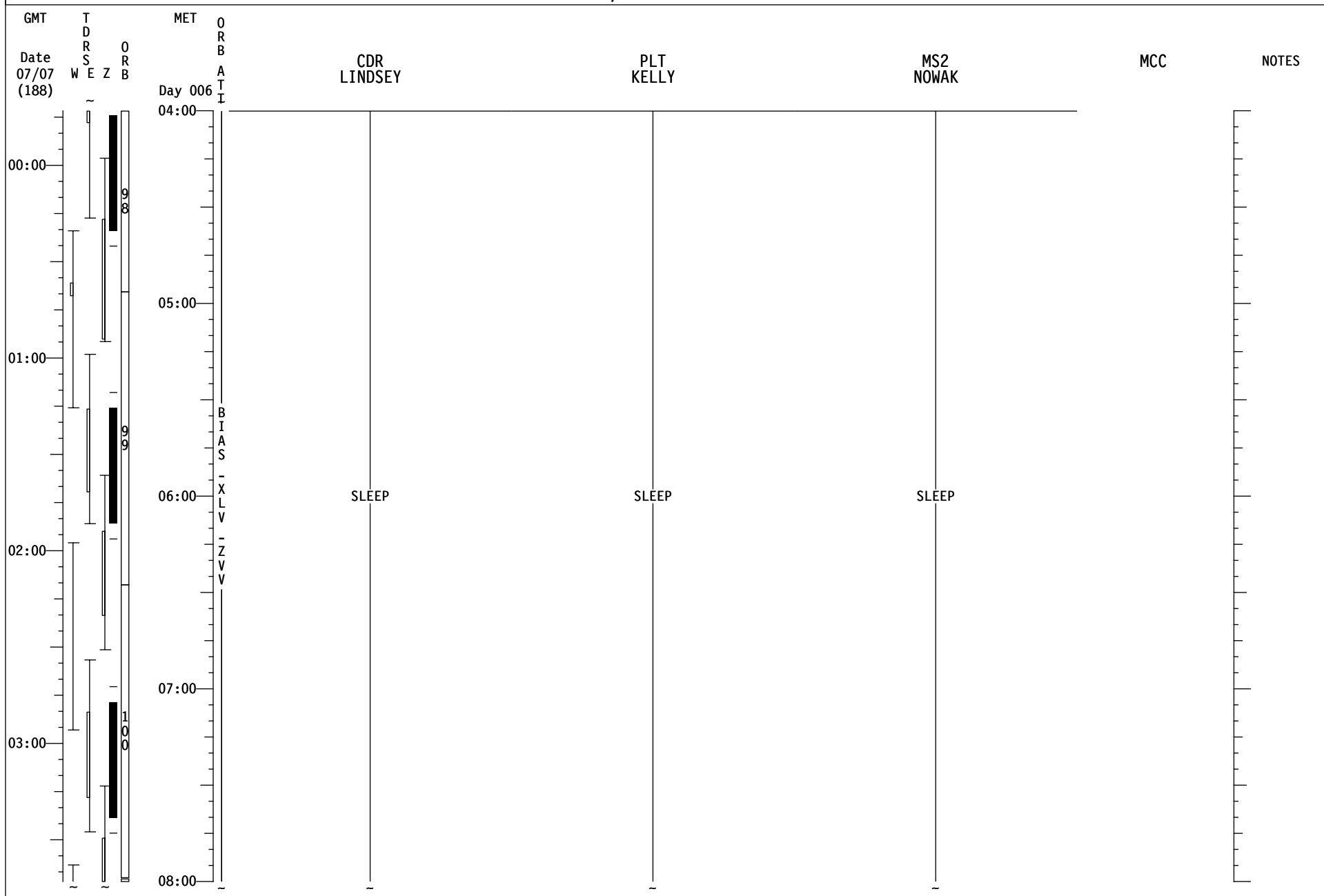

STS-121/ULF 1.1 (FD 07)

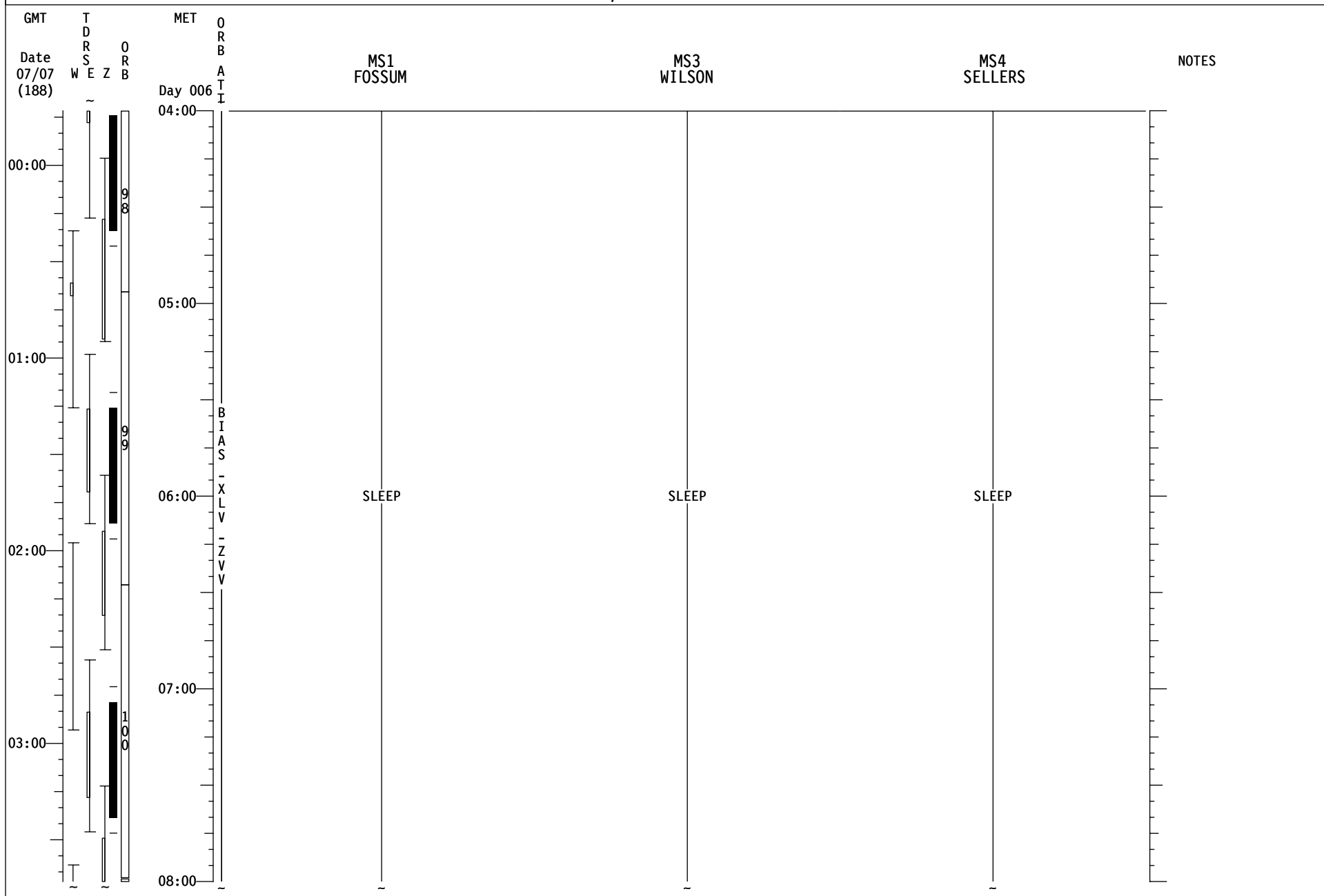

STS-121/ULF 1.1 (FD 07)

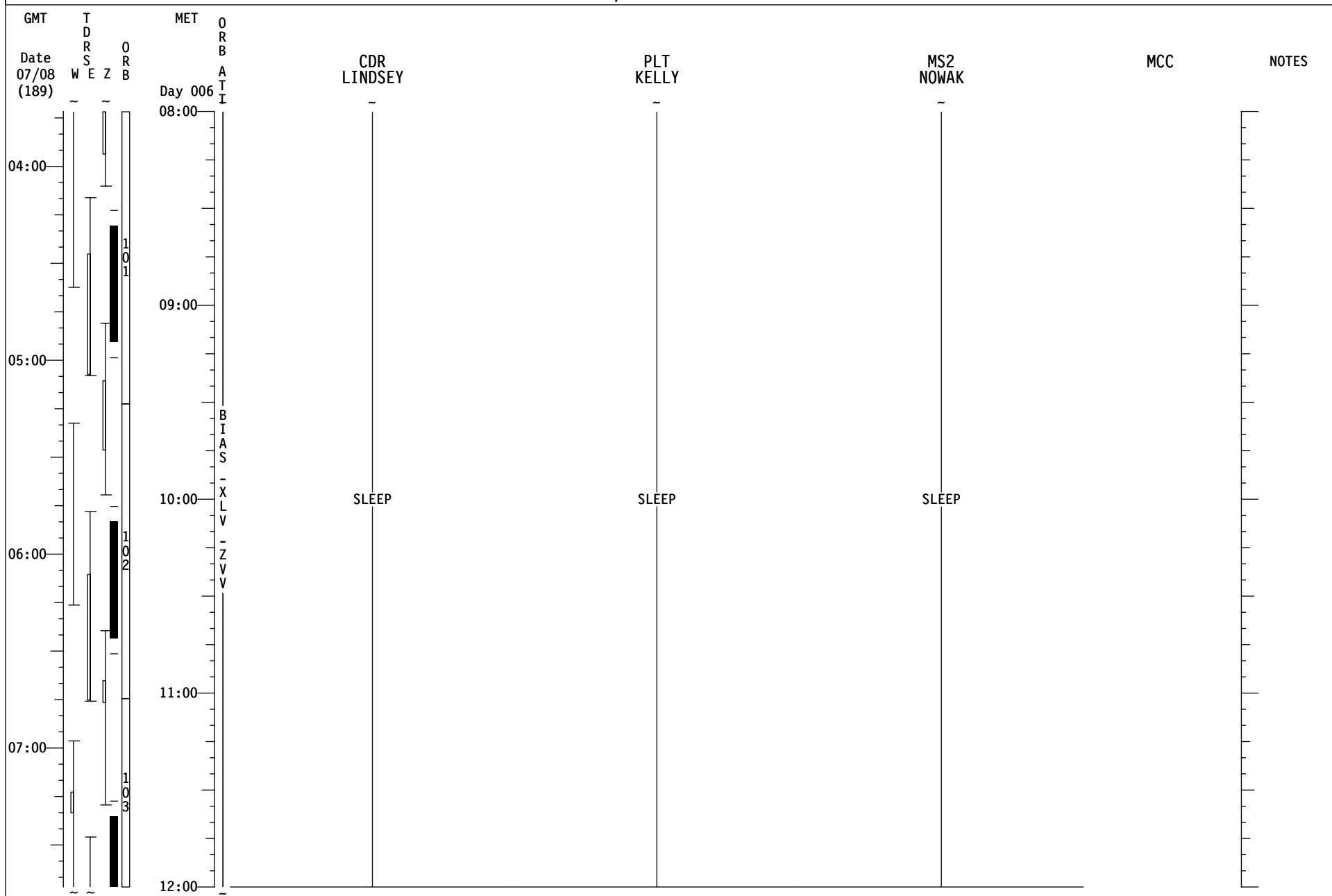

STS-121/ULF 1.1 (FD 07)

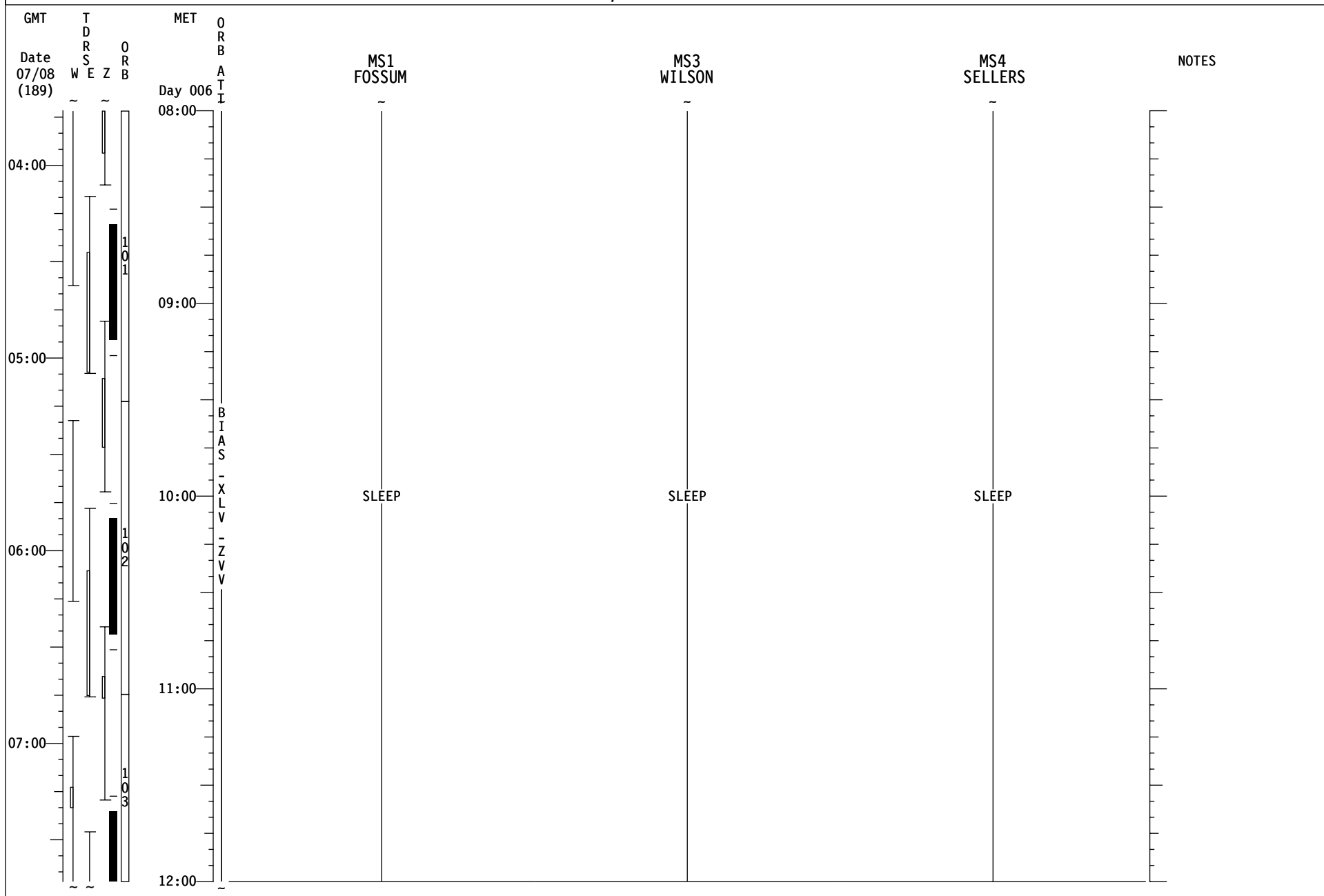

STS-121/ULF 1.1 (FD 08)

GMT	TDRS W E Z	MET Day 006	ORB A T I	CDR LINDSEY	PLT KELLY	MS2 NOWAK	MCC	NOTES
08:00	103	12:00		DSO 634 FLT SLP LOG (ORB OPS, DS0s)	DSO 634 FLT SLP LOG (ORB OPS, DS0s)	DSO 634 FLT SLP LOG (ORB OPS, DS0s)		
09:00	104	13:00	BIAS	POST-SLEEP ACTIVITY (ORB OPS, CREW SYS)	POST-SLEEP ACTIVITY (ORB OPS, CREW SYS)	POST-SLEEP ACTIVITY (ORB OPS, CREW SYS)		
10:00	105	14:00	XLV					
11:00	106	15:00	ZVV	JNT OPS: 3.110 H/O ATTITUDE CONTROL CMG TA to ORBITER MNVR (TRK) BIAS -XLV +YVV TG=2 BV=5 P=157 Y=0 OM=270 A12/AUTO/VERN Init TRK	SHUTTLE/ISS H2O CNTR FILL (ORB OPS, ECLS) INIT #11 Ref. MSG XXX 760 EVA-CAMR ONLY DISASSY (PHOTO/TV, DCS 760 EVA CAMR) BETWEEN EVAS			
				SUPPLY/WASTE WATER DUMP (ORB OPS, ECLS) Initiate Waste Dump	P/TV: 2.621 760 BATT CHRG & CAM VEHICLE PWR Chrg min. 1 batt, durn 3 hr MIDDECK TRANSFER Ref. MDDK Xfer List book	EXERCISE		
16:00				PWR DUMP - SUPPLY LINE (ORB OPS, ECLS) Ref. MSG XXX				UPDATE H2O WASTE DUMP QTY

FD08 EZ ACTIVITIES
 HARD REBOOT PGSCs
 TEPC (STATUS CK)
 (ORB OPS, CREW SYS)
 OCAC FILTER INSPECT
 L17 Check MCIU Filter Screen

STS-121/ULF 1.1 (FD 08)

GMT	T D R S E Z	MET	O R B	MS1 FOSSUM	MS3 WILSON	MS4 SELLERS	NOTES
Date 07/08 (189)	W E Z	Day 006	A T I				
08:00	103	12:00		<u>DSO 493 SALIVA CLCT (ORB OPS, DSOs)</u> EVA CREW: TAKE 1 ASPIRIN (325mg)	<u>DSO 493 SALIVA CLCT (ORB OPS, DSOs)</u>	<u>DSO 634 FLT SLP LOG (ORB OPS, DSOs)</u> EVA CREW: TAKE 1 ASPIRIN (325mg) <u>DSO 493 SALIVA CLCT (ORB OPS, DSOs)</u>	
09:00	104	13:00	B I A S	<u>POST-SLEEP ACTIVITY (ORB OPS, CREW SYS)</u>	<u>POST-SLEEP ACTIVITY (ORB OPS, CREW SYS)</u>	<u>POST-SLEEP ACTIVITY (ORB OPS, CREW SYS)</u>	
10:00		14:00	X L V				
11:00	105	15:00	Z V V	<u>EVA SYS: 1.505 EMU WATER RECHARGE</u> Use PWR 1024 first, then 1023 for recharge. Use CWC S/N 1026 labeled "EMU Wastewater" for Water Dump.	<u>TRANSFER OPS</u> Ref. MPLM Resupply & Return Xfer List books	<u>EVA SYS: 1.505 EMU WATER RECHARGE</u> Use PWR 1024 first, then 1023 for recharge. Use CWC S/N 1026 labeled "EMU Wastewater" for Water Dump.	
16:00	106	16:00		<u>EVA SYS: 1.515 EMU METOX/LIOH/ BATTERY REPLACEMENT</u> Refer to STS-121 CONSUMABLES TRACKING CUE CARD. Stow used LiOHs in M-02 bag.		<u>EXERCISE</u>	

Refer to STS-121 CONSUMABLES TRACKING CUE CARD. Stow used LiOHs in M-02 bag.

FLT PLN/121/FIN

STS-121/ULF 1.1 (FD 08)

GMT	TDRS W E Z	MET Day 006	ORB A T I	CDR LINDSEY	PLT KELLY	MS2 NOWAK	MCC	NOTES
16:00				<u>PWR DUMP - SUPPLY LINE</u> (ORB OPS, ECLS) Ref. MSG XXX	<u>MIDDECK TRANSFER</u> Ref. MDDK Xfer List book	<u>EXERCISE</u>		
12:00				<u>SUPPLY/WASTE WATER DUMP</u> (ORB OPS, ECLS) Terminate Waste Dump	<u>SHUTTLE/ISS H2O CONT FILL</u> (ORB OPS, ECLS) TERM Report B/C and S/N to MCC	<u>TRANSFER OPS</u> Ref. MPLM Resupply & Return Xfer List books		
				<u>MNVR (TRK) BIAS -XLV -ZVV</u> TG=2 BV=5 P=157 Y=0 OM=178 A12/AUTO/VERN Init TRK	<u>CWC TRANSFER</u> Transfer 1 CWC to ISS			
17:00				<u>JNT OPS: 3.111 H/O ATTITUDE CONTROL</u> <u>ORBITER TO CMG TA</u> <u>IMU STAR OF OPTY ALIGN (ORB OPS, GNC)</u>	<u>MIDDECK TRANSFER</u> Ref. MDDK Xfer List book			
13:00						<u>MIDDECK TRANSFER</u> Ref. MDDK Xfer List book		
18:00				<u>EXERCISE</u>				
14:00				<u>JNT OPS: 3.103 NITROGEN TRANSFER TERM</u>				
19:00					<u>PUBLIC AFFAIRS EVENT</u> KU AVAIL: XX:XX-XX:XX Ref: MSG XXX	<u>PUBLIC AFFAIRS EVENT</u> KU AVAIL: XX:XX-XX:XX Ref: MSG XXX		
15:00				<u>MEAL</u>	<u>MEAL</u>	<u>MEAL</u>		
20:00								

STS-121/ULF 1.1 (FD 08)

GMT	T D R S E Z	MET	O R B	MS1 FOSSUM	MS3 WILSON	MS4 SELLERS	NOTES
Date 07/08 (189)	W E Z	Day 006	A T I				
16:00				<u>EVA SYS: 1.515 EMU METOX/LIOH/</u> <u>BATTERY REPLACEMENT</u> Refer to STS-121 CONSUMABLES TRACKING CUE CARD. Stow used LiOHs in M-02 bag.	<u>TRANSFER OPS</u> Ref. MPLM Resupply & Return Xfer List books		
12:00				EXERCISE		EXERCISE	
17:00						<u>TRANSFER OPS</u> Ref. MPLM Resupply & Return Xfer List books	
13:00				<u>TRANSFER OPS</u> Ref. MPLM Resupply & Return Xfer List books			
18:00			B I A S				
14:00			X L V		<u>P/TV05 ISS INTERNAL OPS (HC)</u> (PHOTO/TV, SCENES) SETUP		
19:00			Z V V	<u>PUBLIC AFFAIRS EVENT</u> KU AVAIL: XX:XX-XX:XX Ref: MSG XXX	<u>PUBLIC AFFAIRS EVENT</u> KU AVAIL: XX:XX-XX:XX Ref: MSG XXX	<u>PUBLIC AFFAIRS EVENT</u> KU AVAIL: XX:XX-XX:XX Ref: MSG XXX	
15:00				MEAL	MEAL	MEAL	
20:00							

STS-121/ULF 1.1 (FD 08)

GMT	T D R S E Z	MET	O R B	CDR LINDSEY	PLT KELLY	MS2 NOWAK	MCC	NOTES
Date 07/08 (189)	W E Z	Day 006	A T I					
16:00		20:00		<u>TRANSFER OPS</u> Ref. MPLM Resupply & Return Xfer List books	<u>WCS COMPACTOR OPS (DUAL-VANE)</u> (CUE CARD) <u>SHUTTLE/ISS H2O CNTR FILL</u> (ORB OPS, ECLS) INIT #12 Ref. MSG XXX <u>MIDDECK TRANSFER</u> Ref. MDDK Xfer List book	<u>MIDDECK TRANSFER</u> Ref. MDDK Xfer List book		
17:00		21:00						
18:00		22:00	B I A S		<u>SHUTTLE/ISS H2O CONT FILL</u> (ORB OPS, ECLS) TERM Report B/C and S/N to MCC <u>SHUTTLE/ISS H2O CNTR FILL</u> (ORB OPS, ECLS) INIT #13 Ref. MSG XXX	<u>TRANSFER OPS</u> Ref. MPLM Resupply & Return Xfer List books		
19:00		23:00	X L V		EXERCISE			
			Z V V		<u>SHUTTLE/ISS H2O CONT FILL</u> (ORB OPS, ECLS) TERM Report B/C and S/N to MCC <u>CWC TRANSFER</u> Transfer 2 CWCs to ISS			
		00:00			<u>PWR FILL</u> (ORB OPS, ECLS) INIT #3 Ref. MSG XXX			

STS-121/ULF 1.1 (FD 08)

GMT	T D R S E Z	MET	O R B	MS1 FOSSUM	MS3 WILSON	MS4 SELLERS	NOTES
Date 07/08 (189)	W E Z	Day 006	A T I				
16:00		20:00		<u>EVA SYS: 1.605 BSA BATTERY RECHARGE</u> TERM - Stow HL Batts in M-02 Bag. HL Batt S/N 1015 for EVA IR CAM SETUP.	<u>TRANSFER OPS</u> Ref. MPLM Resupply & Return Xfer List books	<u>MIDDECK TRANSFER</u> Ref. MDDK Xfer List book	
				<u>TRANSFER OPS</u> Ref. MPLM Resupply & Return Xfer List books			
17:00		21:00					
			B I A S				
18:00		22:00	X L V				
			Z V V				
19:00		23:00			EXERCISE		
		00:00			<u>TRANSFER OPS</u> Ref. MPLM Resupply & Return Xfer List books		

STS-121/ULF 1.1 (FD 08)

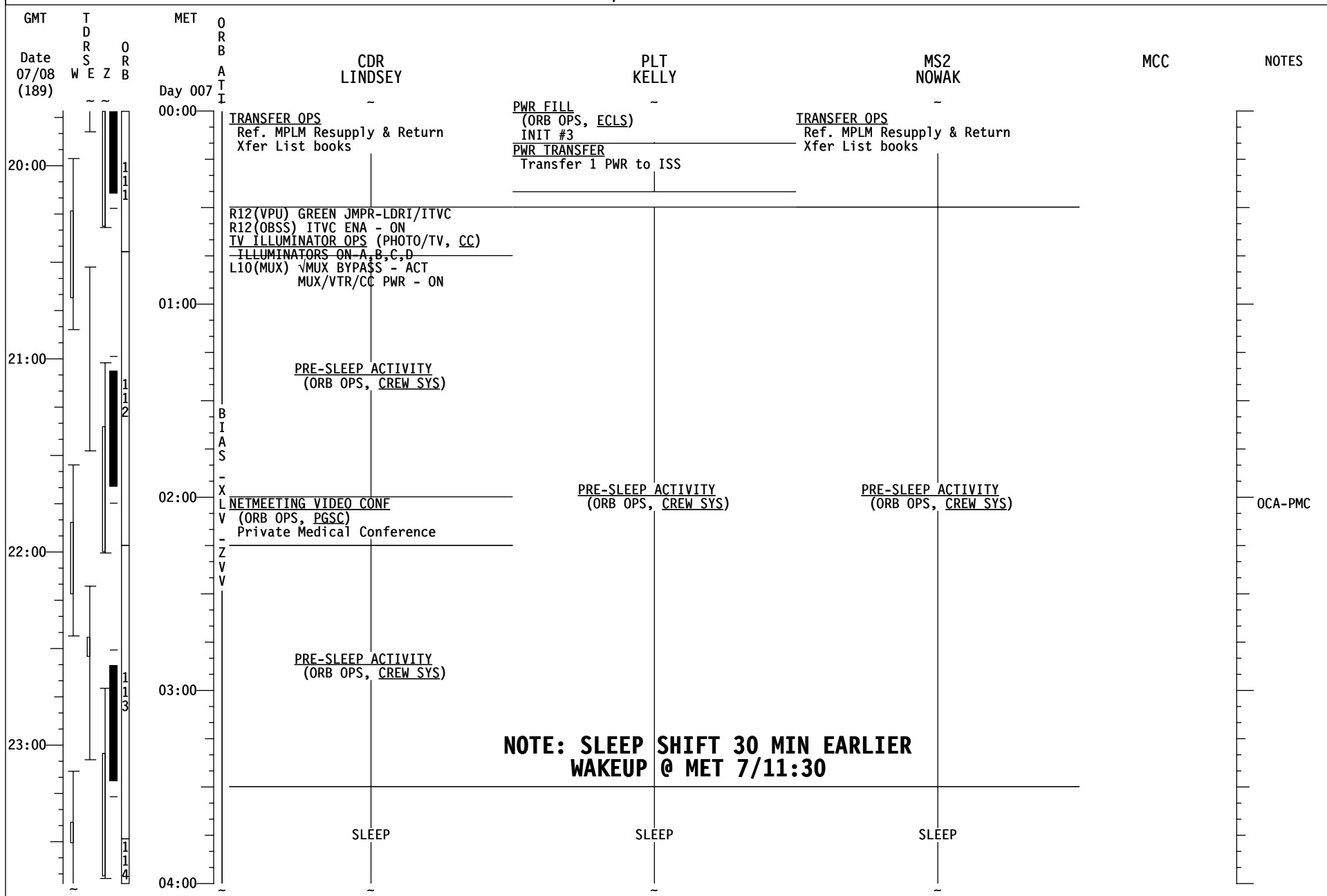

STS-121/ULF 1.1 (FD 08)

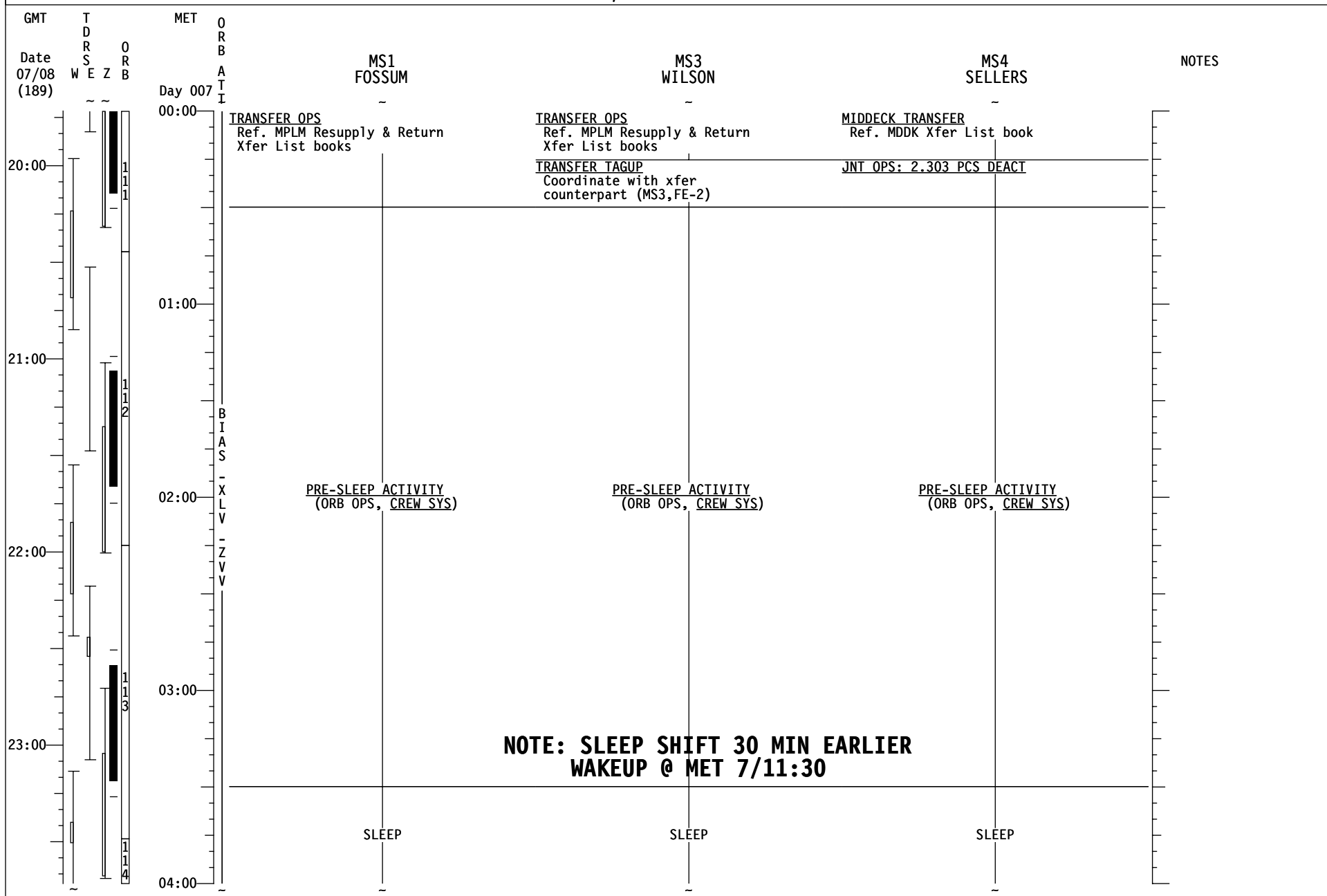

STS-121/ULF 1.1 (FD 08)

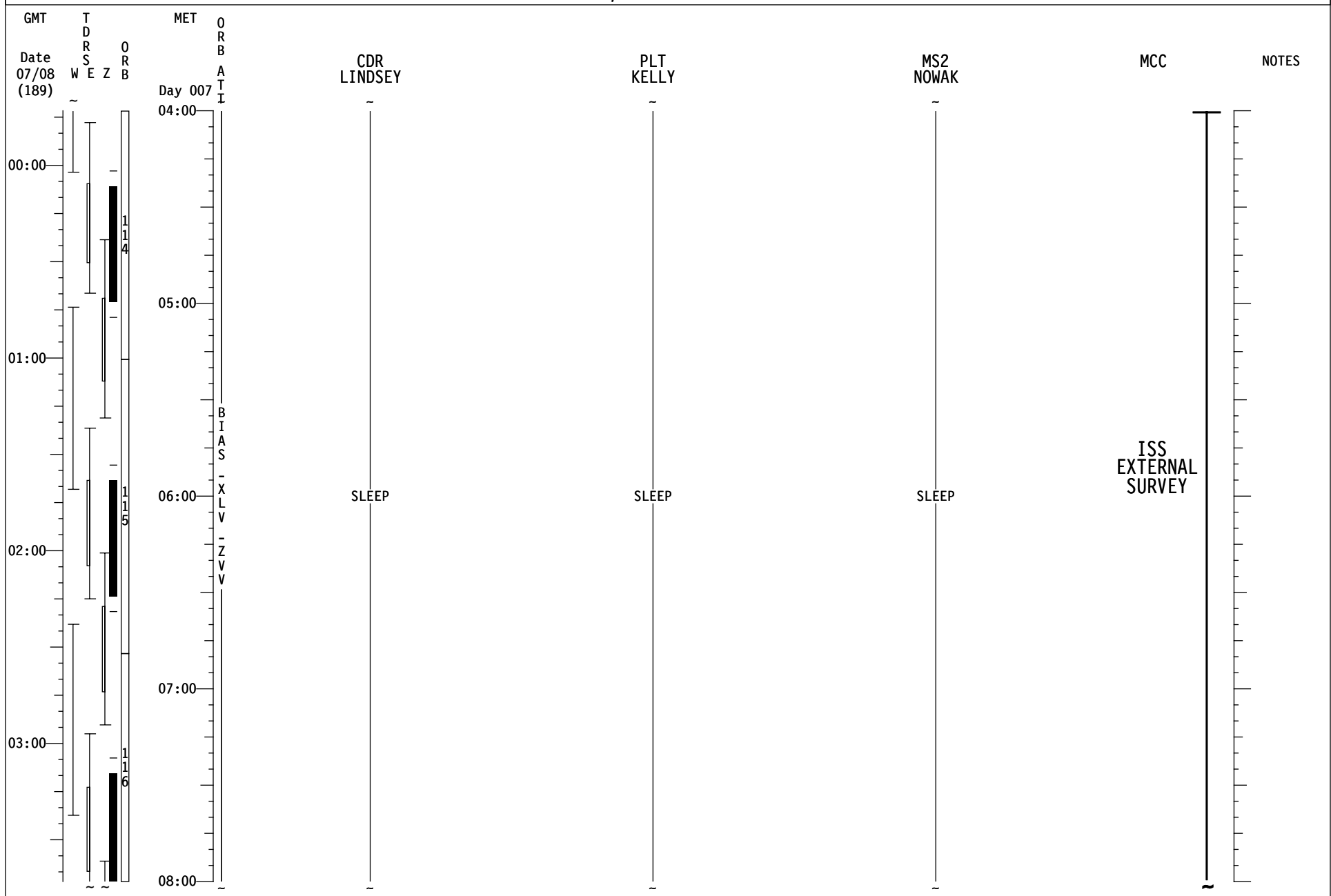

STS-121/ULF 1.1 (FD 08)

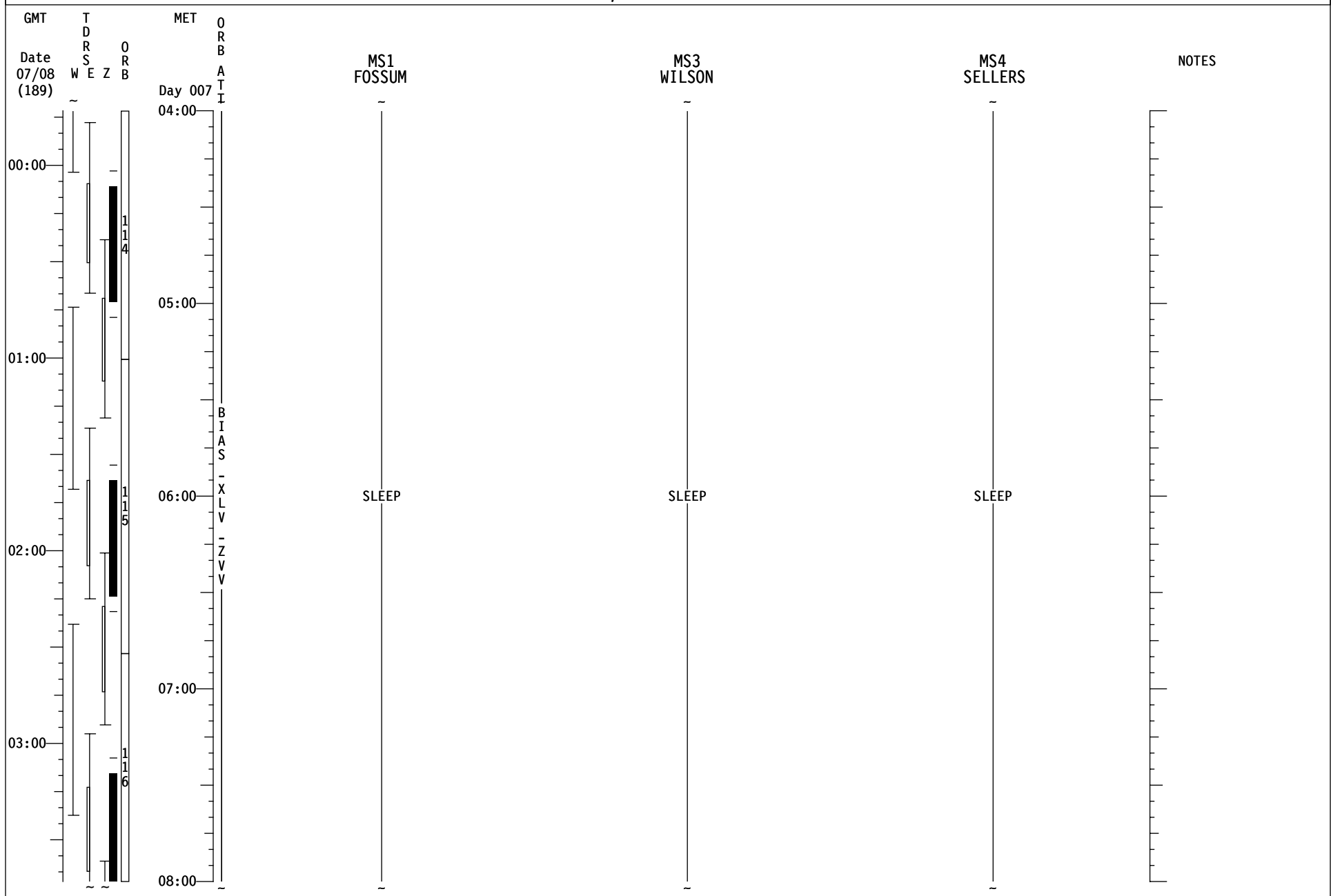

STS-121/ULF 1.1 (FD 09)

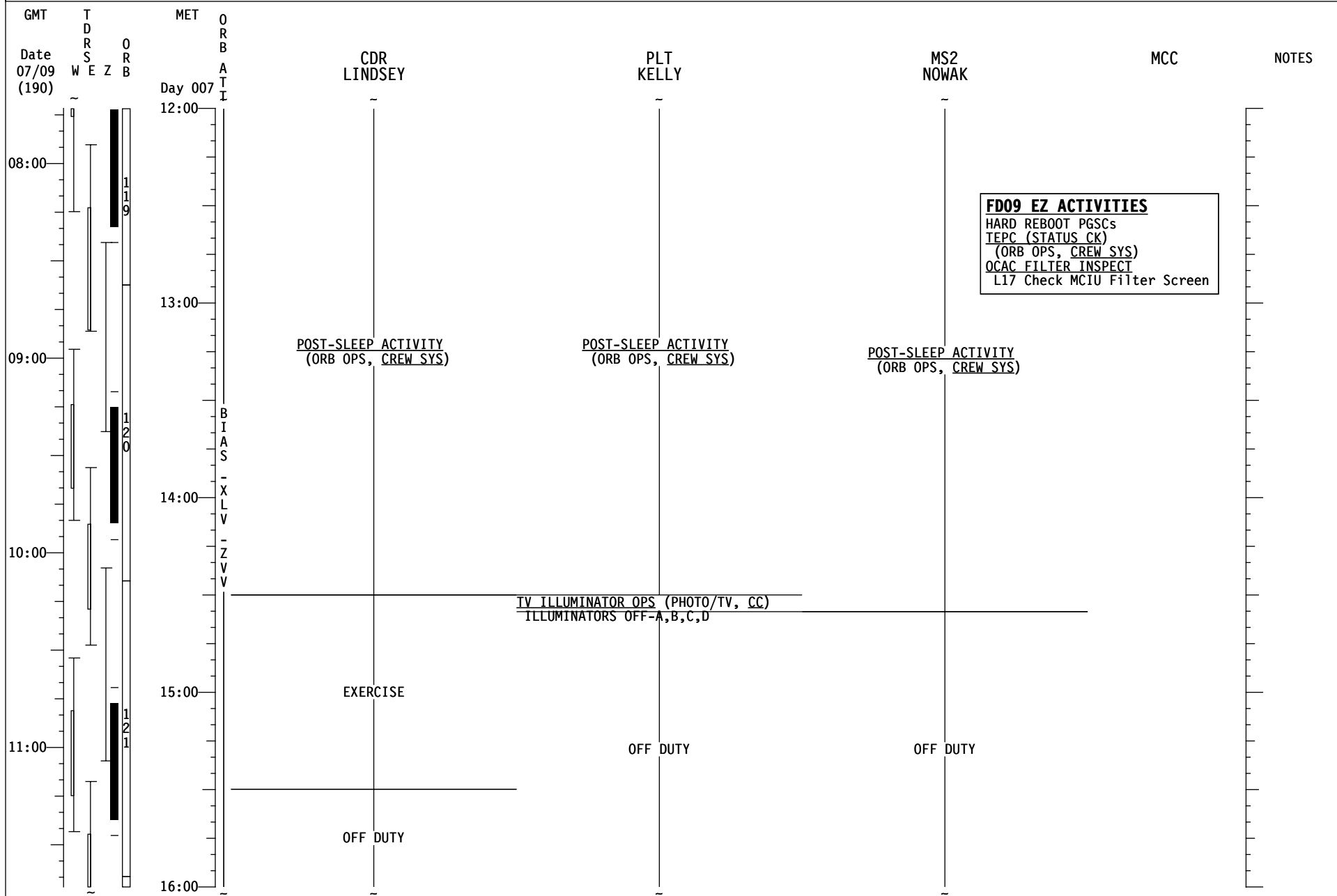

STS-121/ULF 1.1 (FD 09)

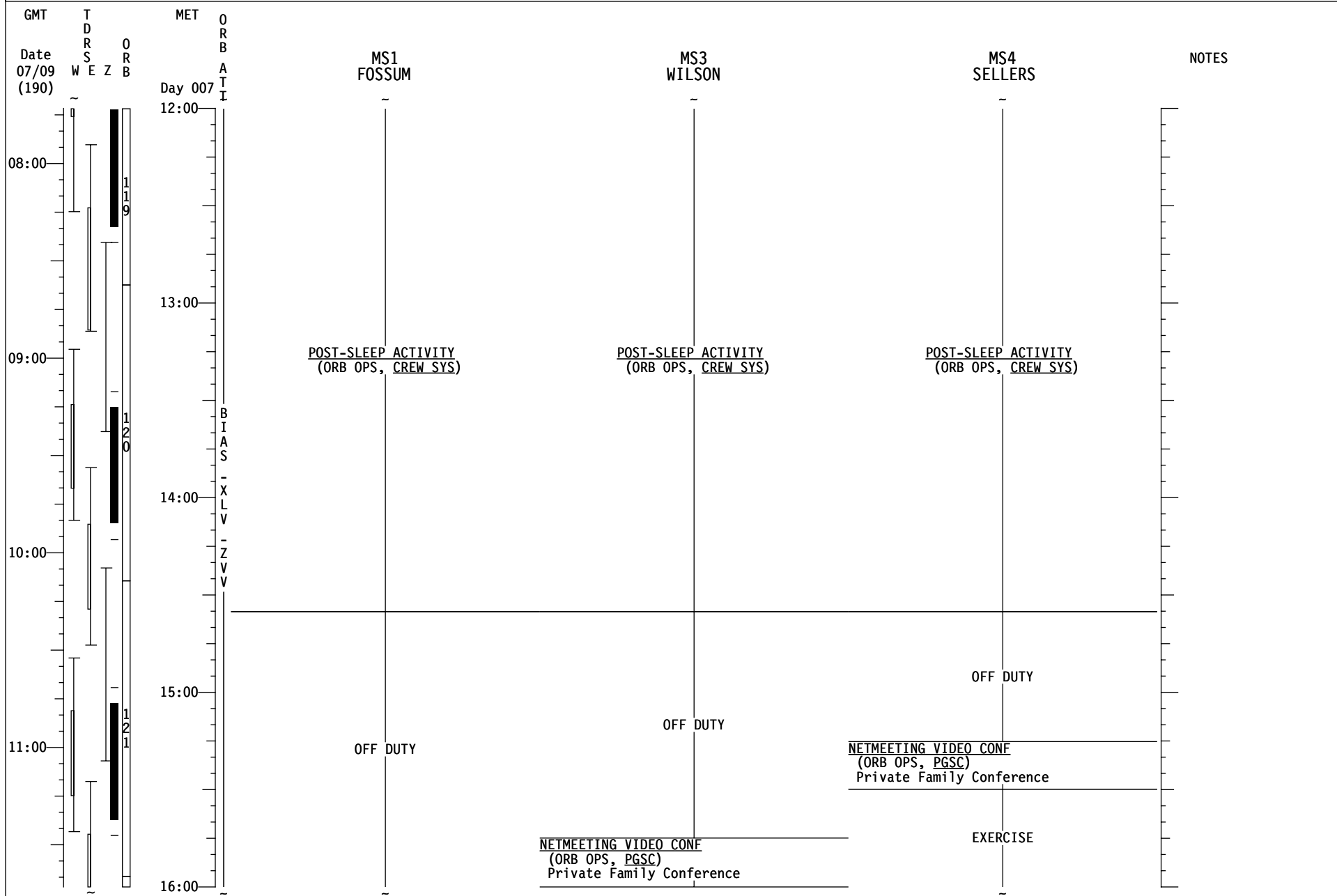

STS-121/ULF 1.1 (FD 09)

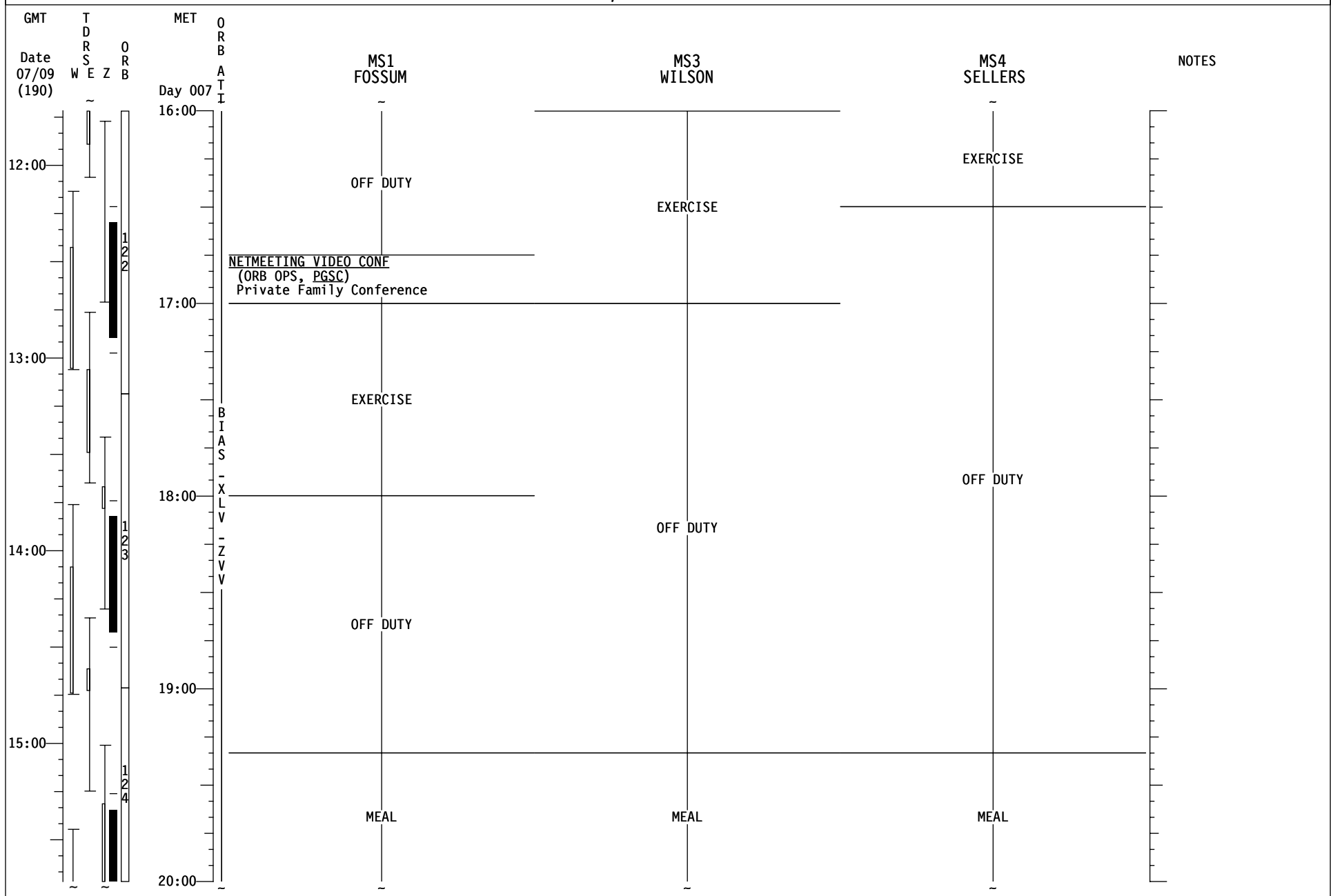

STS-121/ULF 1.1 (FD 09)

GMT	T D R S E Z	O R B	MET	O R B	CDR LINDSEY	PLT KELLY	MS2 NOWAK	MCC	NOTES
Date 07/09 (190)	W E Z	O R B	Day 007	O R B					
16:00		124	20:00	A T I	MEAL	MEAL	MEAL		
17:00		152	21:00	B I A S	OFF DUTY	OFF DUTY	OFF DUTY		
18:00		155	22:00	X L V					
19:00		166	23:00	Z V V					
		127	00:00						
					<u>MPLM CLEANUP</u> Ref. items #TBD in MPLM Return Xfer List	<u>PWR FILL</u> (ORB OPS, ECLS) INIT #4 Ref. MSG XXX			
					<u>S&M: 1.260 CONFIG MPLM RACKS FOR ENTRY</u>	<u>PWR TRANSFER</u> Transfer 1 PWR to ISS	<u>PUBLIC AFFAIRS EVENT</u> KU AVAIL: XX:XX-XX:XX Ref: MSG XXX		

STS-121/ULF 1.1 (FD 09)

GMT	T D R S E Z	MET	O R B	MS1 FOSSUM	MS3 WILSON	MS4 SELLERS	NOTES
Date 07/09 (190)	W E Z	Day 007	A T I				
16:00				MEAL	MEAL	MEAL	
17:00							
18:00				OFF DUTY	OFF DUTY	OFF DUTY	
19:00							
							<u>P/TV05 ISS INTERNAL OPS (HC)</u> (PHOTO/TV, SCENES) SETUP
							<u>ISS & STS PRINTER EXCHANGE</u> (ASSY OPS, TRANSFER) Steps B,C,D Ref. item(s) #TBD in Xfer List
00:00				<u>PUBLIC AFFAIRS EVENT</u> KU AVAIL: XX:XX-XX:XX Ref: MSG XXX	<u>S&M: 1.260 CONFIG MPLM RACKS</u> <u>FOR ENTRY</u>		

STS-121/ULF 1.1 (FD 09)

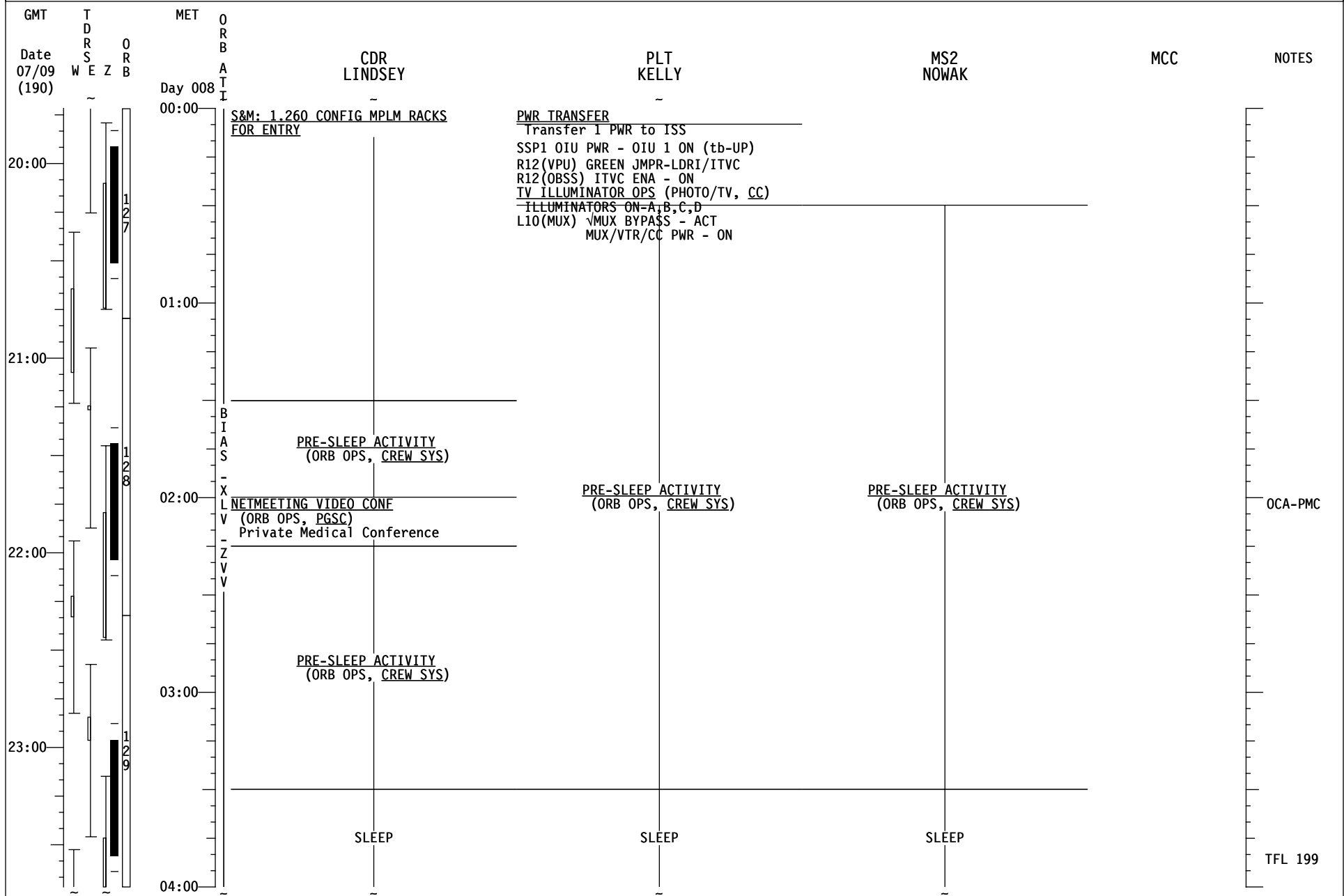

STS-121/ULF 1.1 (FD 09)

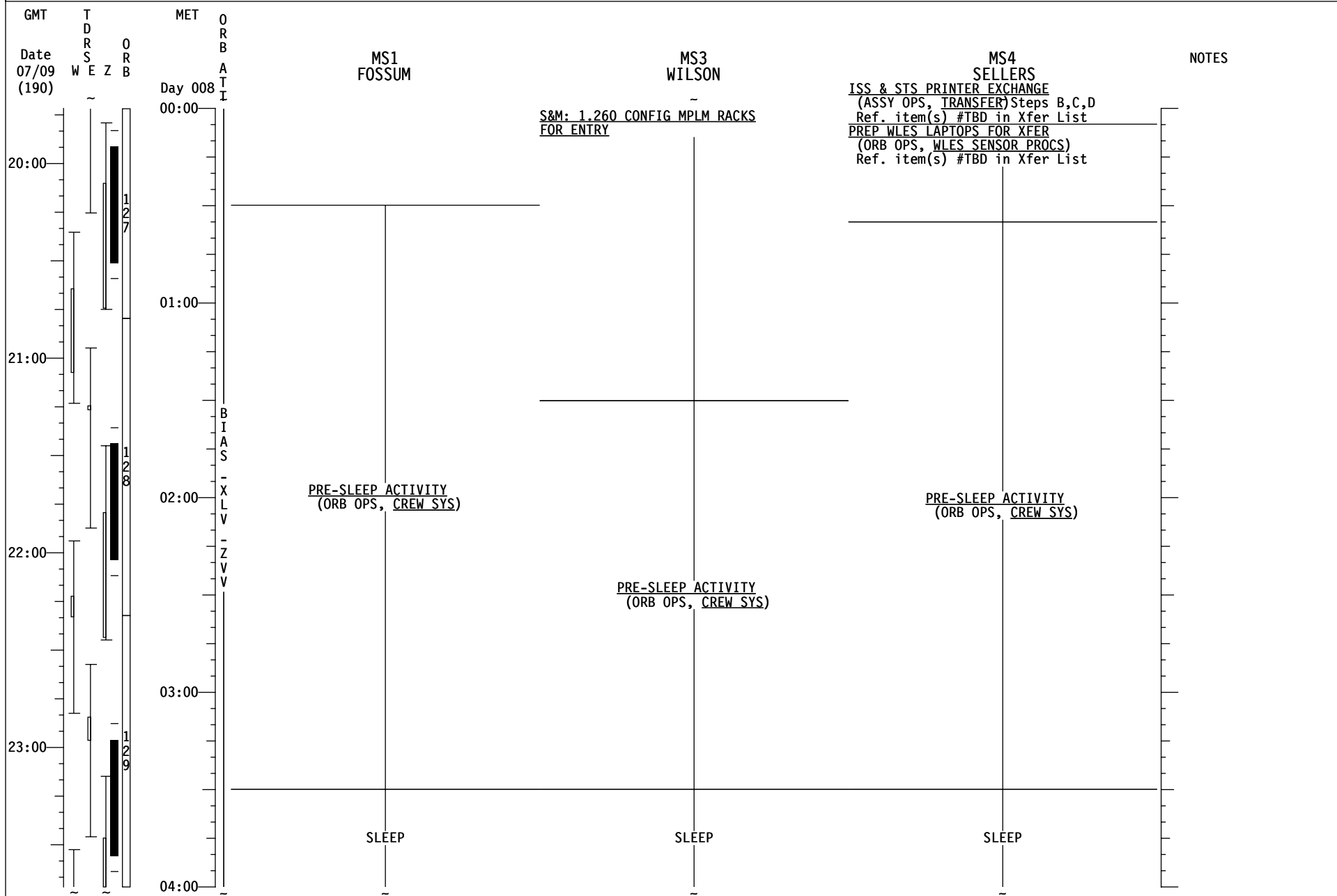

STS-121/ULF 1.1 (FD 09)

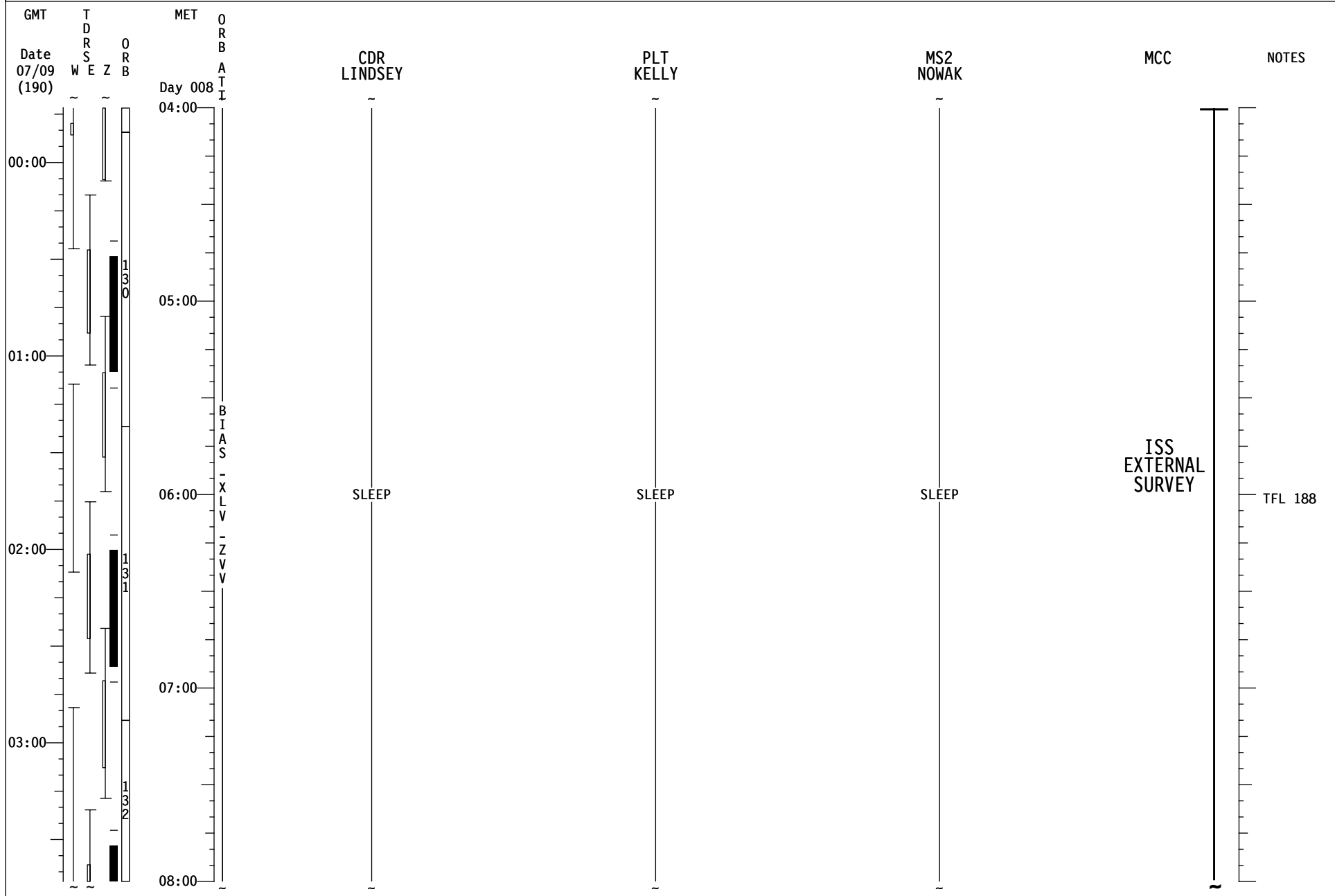

STS-121/ULF 1.1 (FD 09)

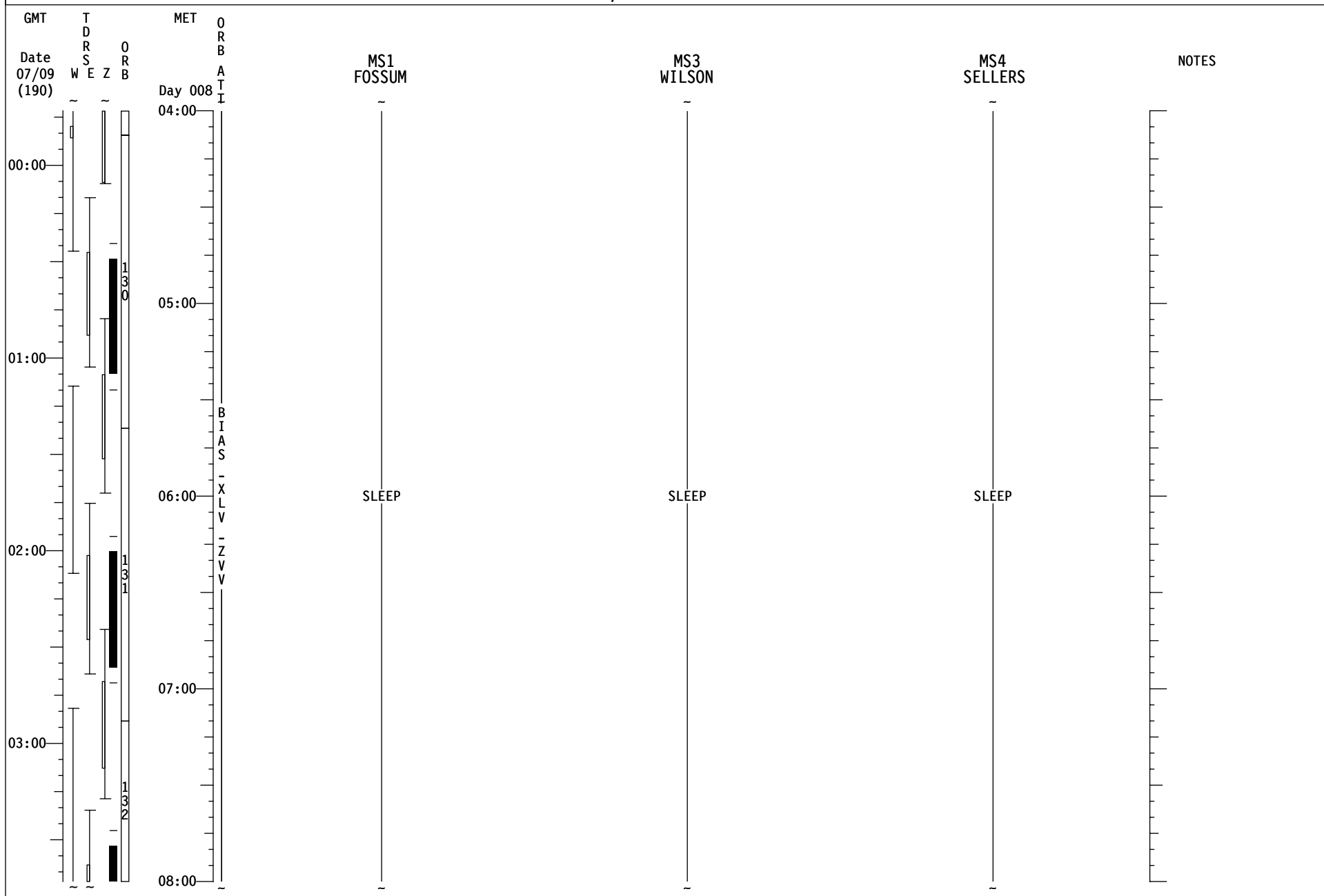

STS-121/ULF 1.1 (FD 09)

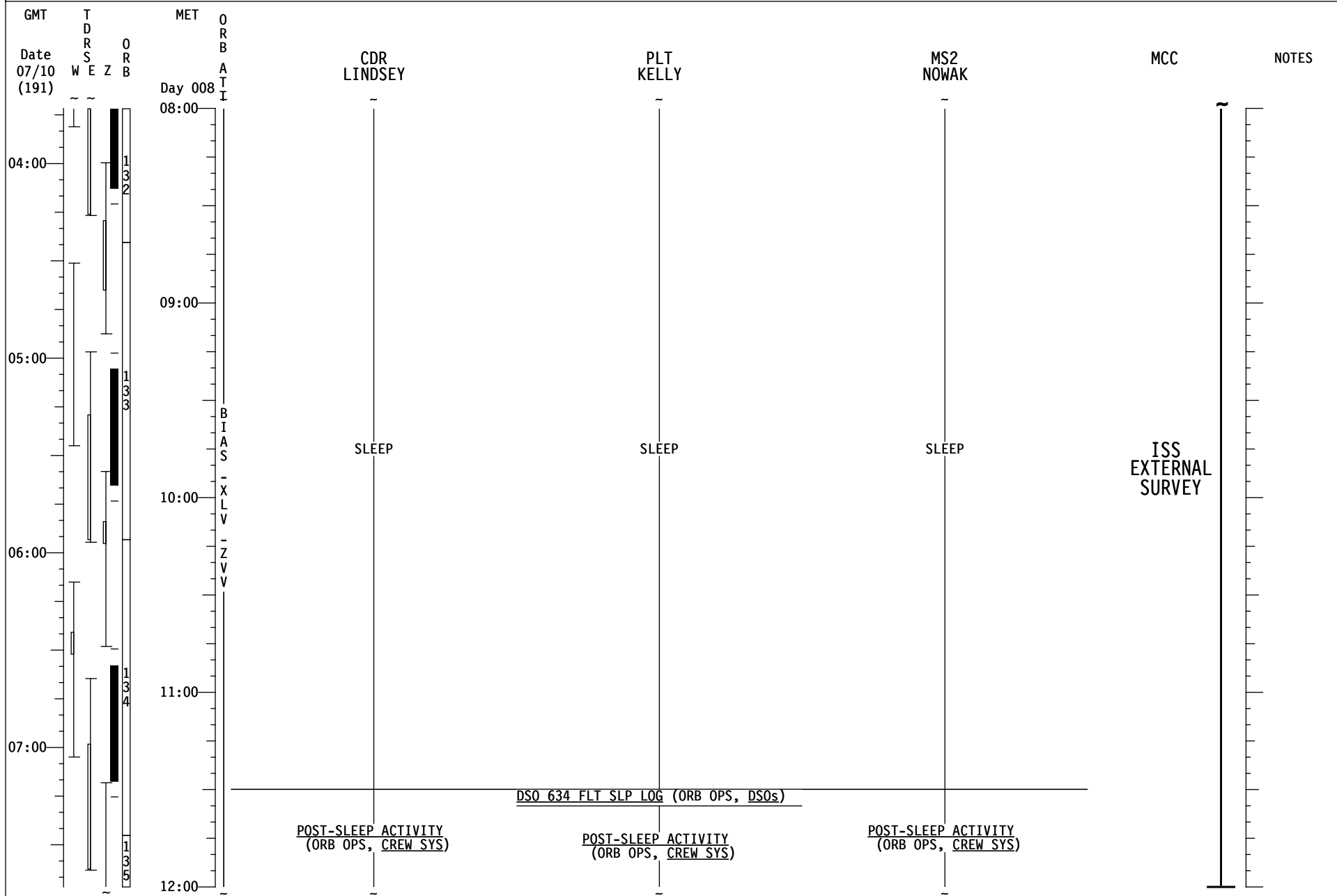

STS-121/ULF 1.1 (FD 09)

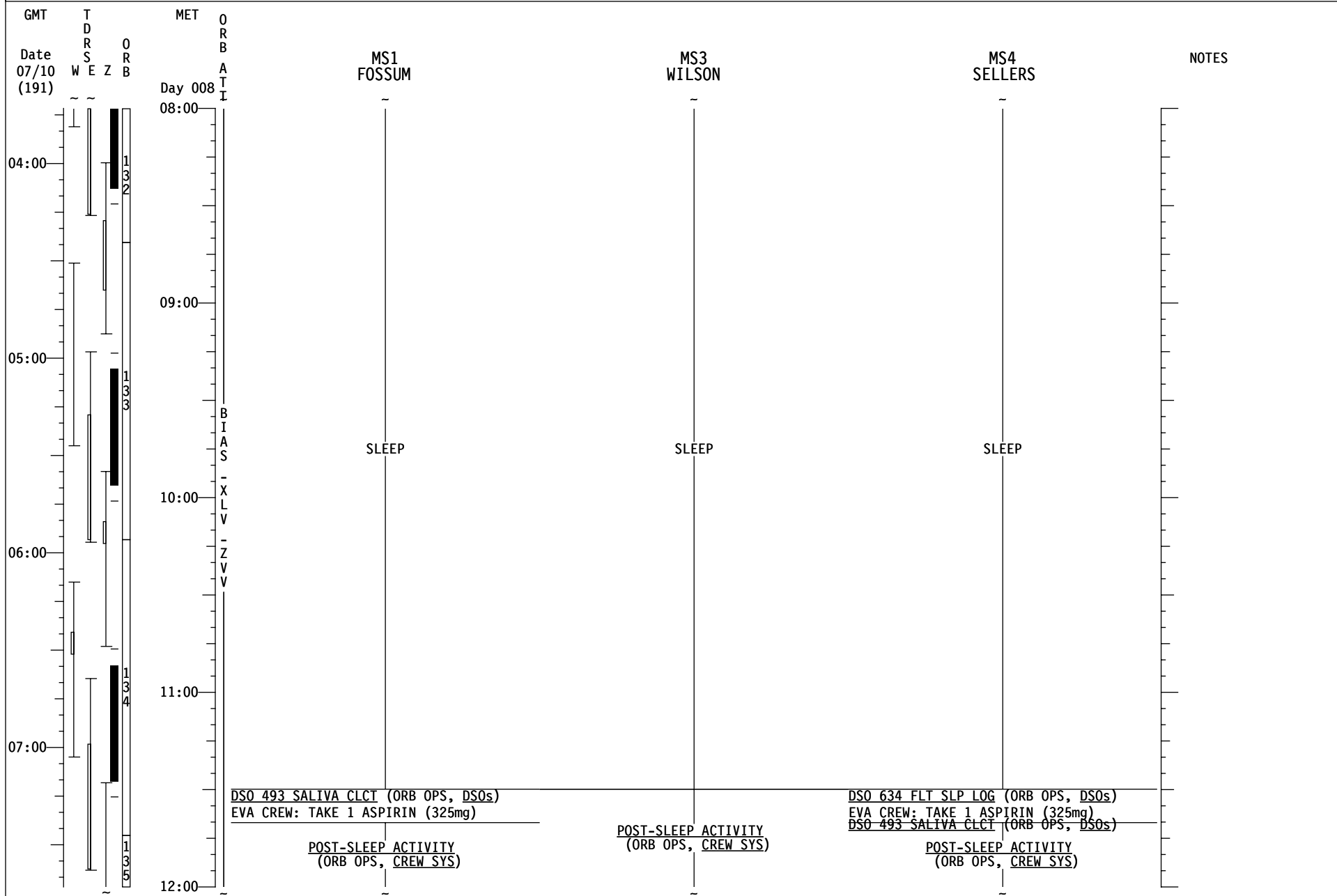

STS-121/ULF 1.1 (FD 10)

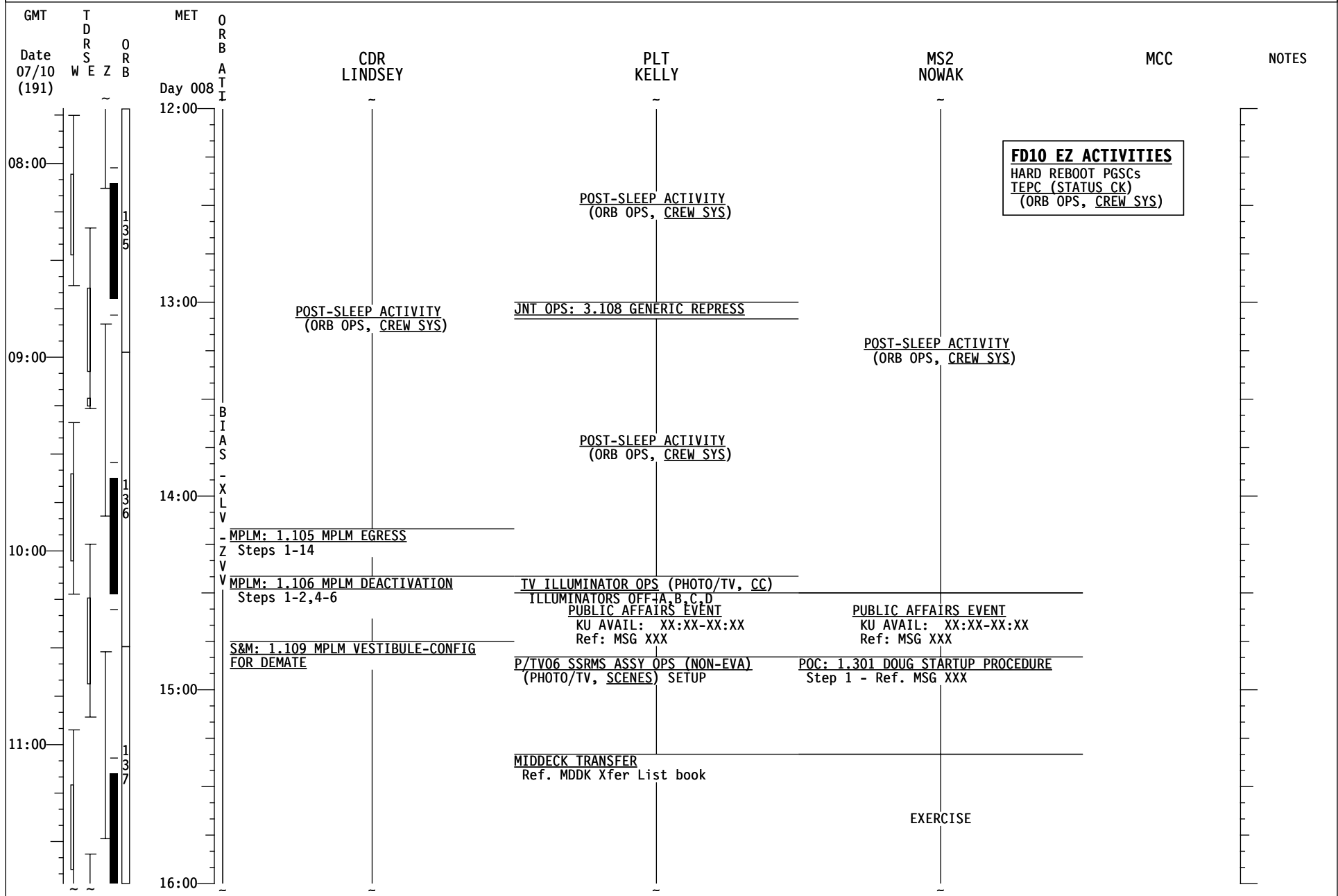

FD10 EZ ACTIVITIES
 HARD REBOOT PGSCs
 TEPC (STATUS CK)
 (ORB OPS, CREW SYS)

STS-121/ULF 1.1 (FD 10)

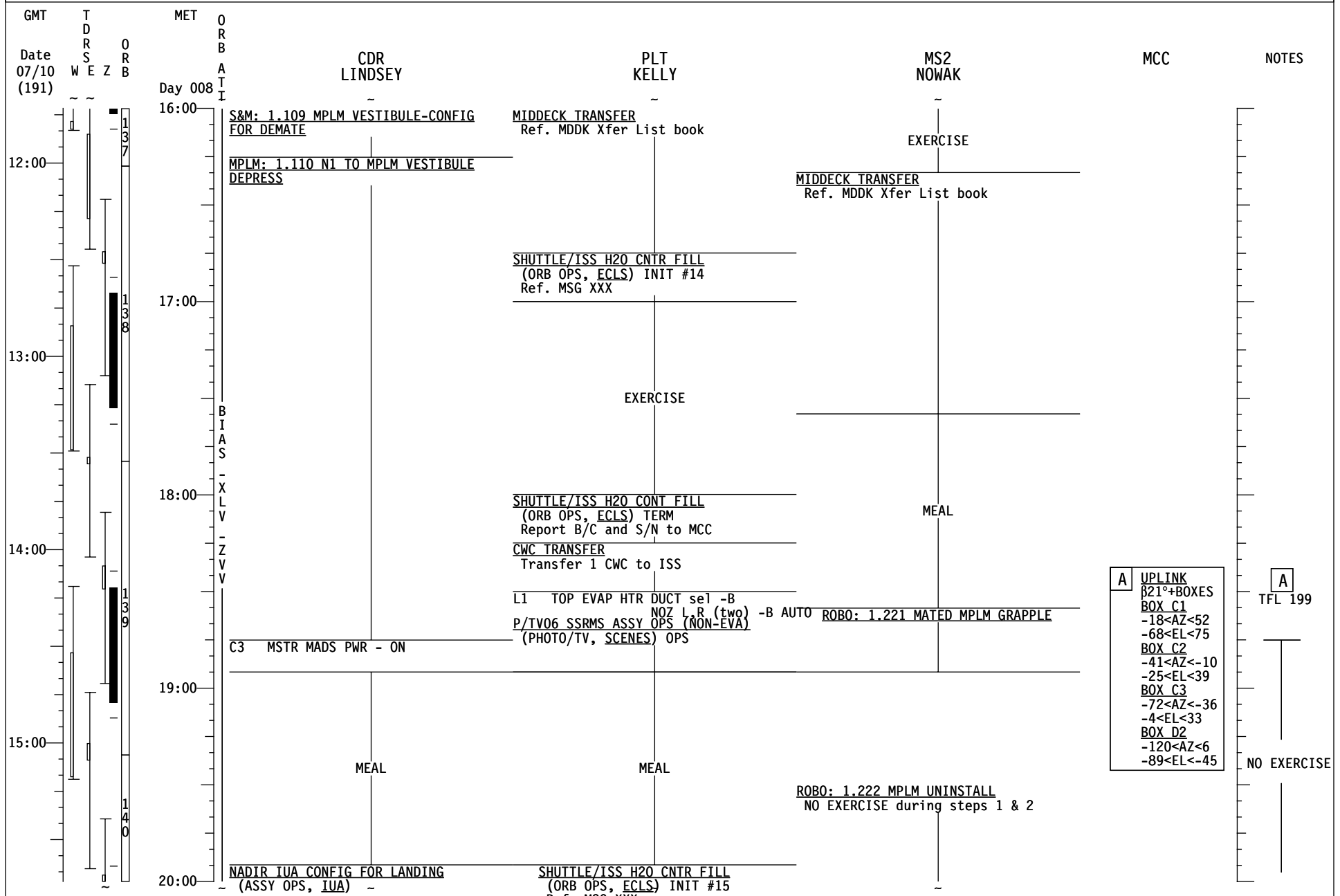

- A** UPLINK

 - 821°+BOXES
 - BOX C1
 - 18<AZ<52
 - 68<EL<75
 - BOX C2
 - 41<AZ<-10
 - 25<EL<39
 - BOX C3
 - 72<AZ<-36
 - 4<EL<33
 - BOX D2
 - 120<AZ<6
 - 89<EL<-45

A

TFL 199

NO EXERCISE

STS-121/ULF 1.1 (FD 10)

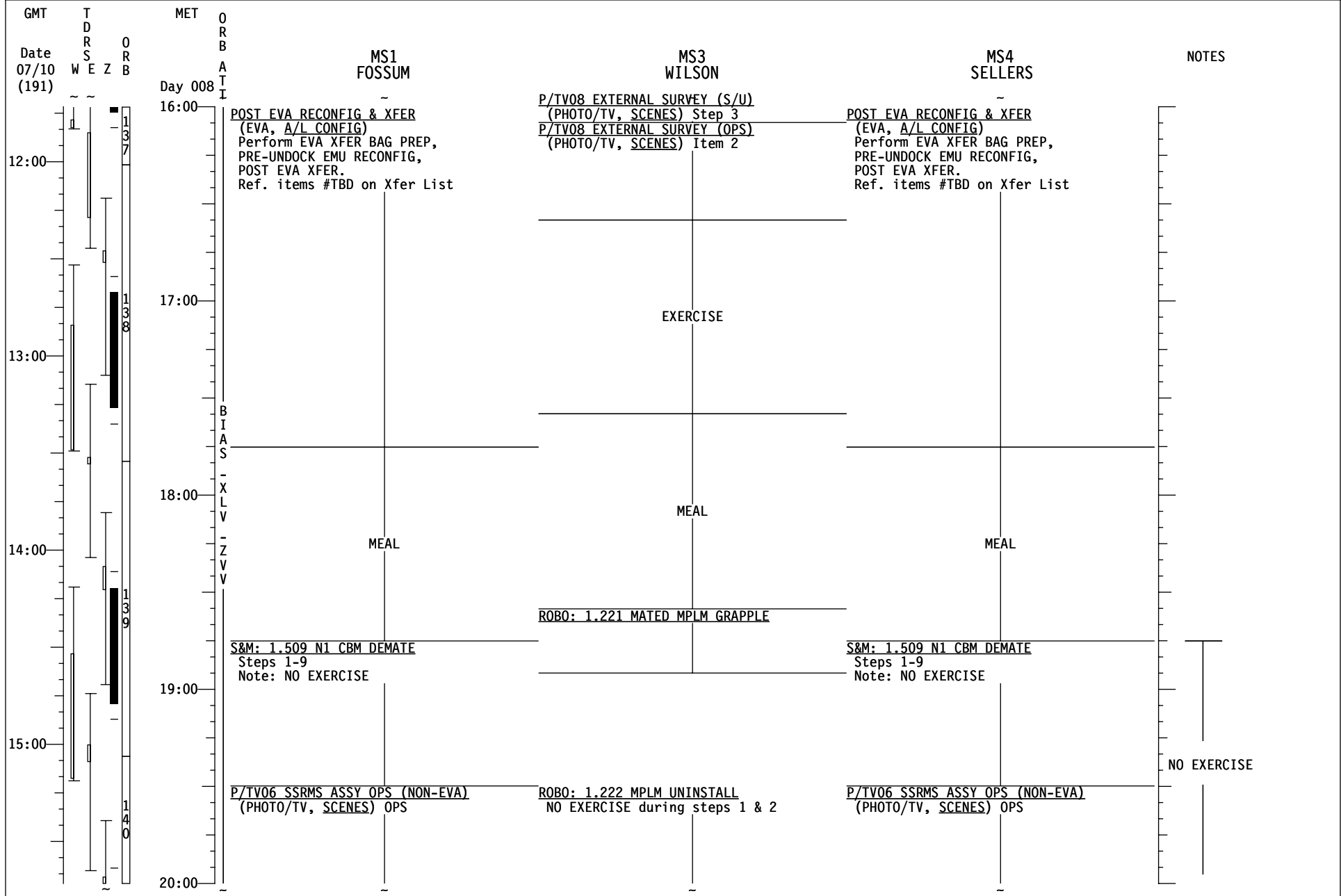

STS-121/ULF 1.1 (FD 10)

GMT	TDRS W E Z	MET Day 008	ORB A T I	CDR LINDSEY	PLT KELLY	MS2 NOWAK	MCC	NOTES
16:00		20:00		<u>NADIR IUA CONFIG FOR LANDING</u> (ASSY OPS, IUA)	<u>SHUTTLE/ISS H2O CNTR FILL</u> (ORB OPS, ECLS) INIT #15 Ref. MSG XXX	<u>ROBO: 1.222 MPLM UNINSTALL</u> NO EXERCISE during steps 1 & 2		NO EXERCISE
				<u>IMU STAR OF OPTY ALIGN</u> (ORB OPS, GNC)	Ref. MDDK Xfer List book			
				<u>JNT OPS: 3.122 P/B USING</u> <u>SHUTTLE 02 TEARDOWN</u>				
		21:00				<u>ROBO: 1.223 MPLM BERTH</u>		
					<u>SHUTTLE/ISS H2O CONT FILL</u> (ORB OPS, ECLS) TERM Report B/C and S/N to MCC			
					<u>CWC TRANSFER</u> Transfer 1 CWC to ISS			
					<u>EVA TOOLS MGMT</u> (EVA, TOOLS & STOWAGE) Perform FD10-EVA 3 Tool Dcnfg Ref. item(s) #TBD in Xfer List	<u>ROBO: 1.224 BERTHED MPLM UNGRAPPLE</u>		
		22:00		EXERCISE		<u>ROBO: 1.315 FD10 WALKOFF TO</u> <u>MBS PDGF 1</u>		UPLINK B21°+BOXES BOX C1 -18<AZ<52 -68<EL<75 BOX F1 -92<AZ<5 -82<EL<4 BOX F2 -129<AZ<10 -10<EL<42
					<u>NOMINAL H2O CONFIG</u> (ORB OPS, ECLS) FES Pri A req'd			
				<u>MIDDECK TRANSFER</u> Ref. MDDK Xfer List book		<u>ROBO: 1.311 LAB PDGF UNGRAPPLE</u>		
		23:00				<u>ROBO: 1.312 MNVR TO SURVEY SUPPORT</u> <u>VIEWING POSN</u> Steps 1-3,5		
19:00				<u>OBSS LDRI RCC SRVY - PORT</u> (PDRS, SURVEYS)	<u>TRANSFER TAGUP</u> Coordinate with xfer counterpart (PLT,FE-2)	<u>OBSS LDRI RCC SRVY - PORT</u> (PDRS, SURVEYS)	<u>MPLM: 1.101 MPLM</u> <u>ENVIRONMENT CHECK</u> Steps 1 & 4 PRESS CK (NO fan)	TFL 184
00:00								

STS-121/ULF 1.1 (FD 10)

GMT	T D R S W E Z	MET	O R B	MS1 FOSSUM	MS3 WILSON	MS4 SELLERS	NOTES
Date 07/10 (191)	W E Z	Day 008	A T I				
16:00				P/TV06 SSRMS ASSY OPS (NON-EVA) (PHOTO/TV, SCENES) OPS	ROBO: 1.222 MPLM UNINSTALL NO EXERCISE during steps 1 & 2	P/TV06 SSRMS ASSY OPS (NON-EVA) (PHOTO/TV, SCENES) OPS	NO EXERCISE
				ROBO: 1.222 MPLM UNINSTALL (KEEL CAM) Step 5 only		ROBO: 1.222 MPLM UNINSTALL (KEEL CAM) Step 5 only	
				P/TV06 SSRMS ASSY OPS (NON-EVA) (PHOTO/TV, SCENES) OPS	ROBO: 1.223 MPLM BERTH	P/TV06 SSRMS ASSY OPS (NON-EVA) (PHOTO/TV, SCENES) OPS	
17:00				ROBO: 1.223 MPLM BERTH Steps 4-10		ROBO: 1.223 MPLM BERTH Steps 4-10	
				B I A S P/TV06 SSRMS ASSY OPS (NON-EVA) (PHOTO/TV, SCENES) OPS	ROBO: 1.224 BERTHED MPLM UNGRAPPLE	EVA TOOLS MGMT (EVA, TOOLS & STOWAGE) Perform FD10-EVA 3 Tool Dcnfg Ref. item(s) #TBD in Xfer List	
				SSP1 MPLM CH 1 HTR PWR - ON (tb-gray) 2 HTR PWR - ON (tb-gray)			
18:00					ROBO: 1.315 FD10 WALKOFF TO MBS PDGF 1		
					ROBO: 1.311 LAB PDGF UNGRAPPLE		
					ROBO: 1.312 MNVR TO SURVEY SUPPORT VIEWING POSN Steps 1-3,5		
19:00							
				P/TV04 INGRESS/EGRESS (S/U) (PHOTO/TV, SCENES)	OBSS LDRI RCC SRVY - PORT (PDRS, SURVEYS)	PRE-SLEEP ACTIVITY (ORB OPS, CREW SYS)	
00:00							

STS-121/ULF 1.1 (FD 10)

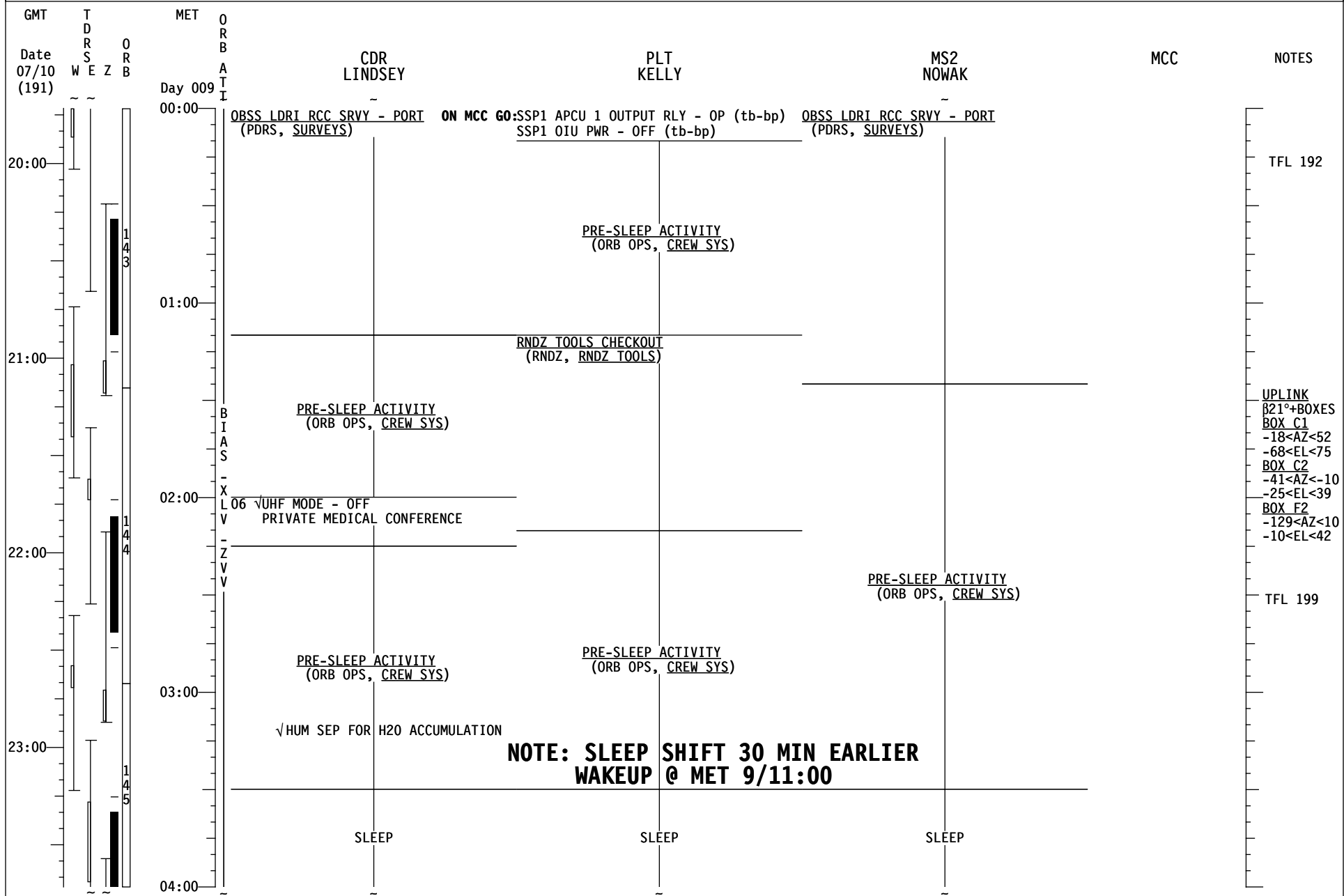

STS-121/ULF 1.1 (FD 10)

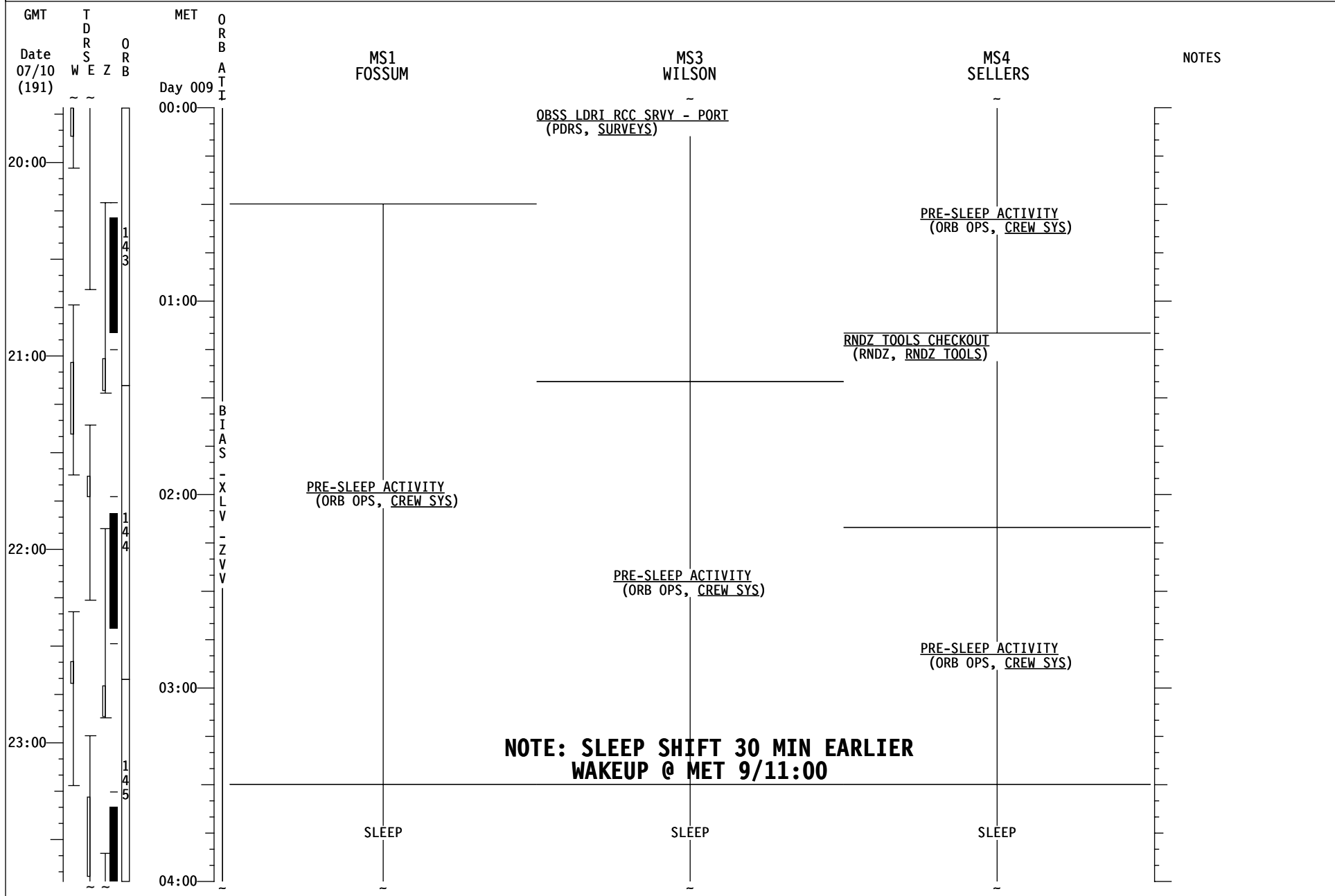

STS-121/ULF 1.1 (FD 10)

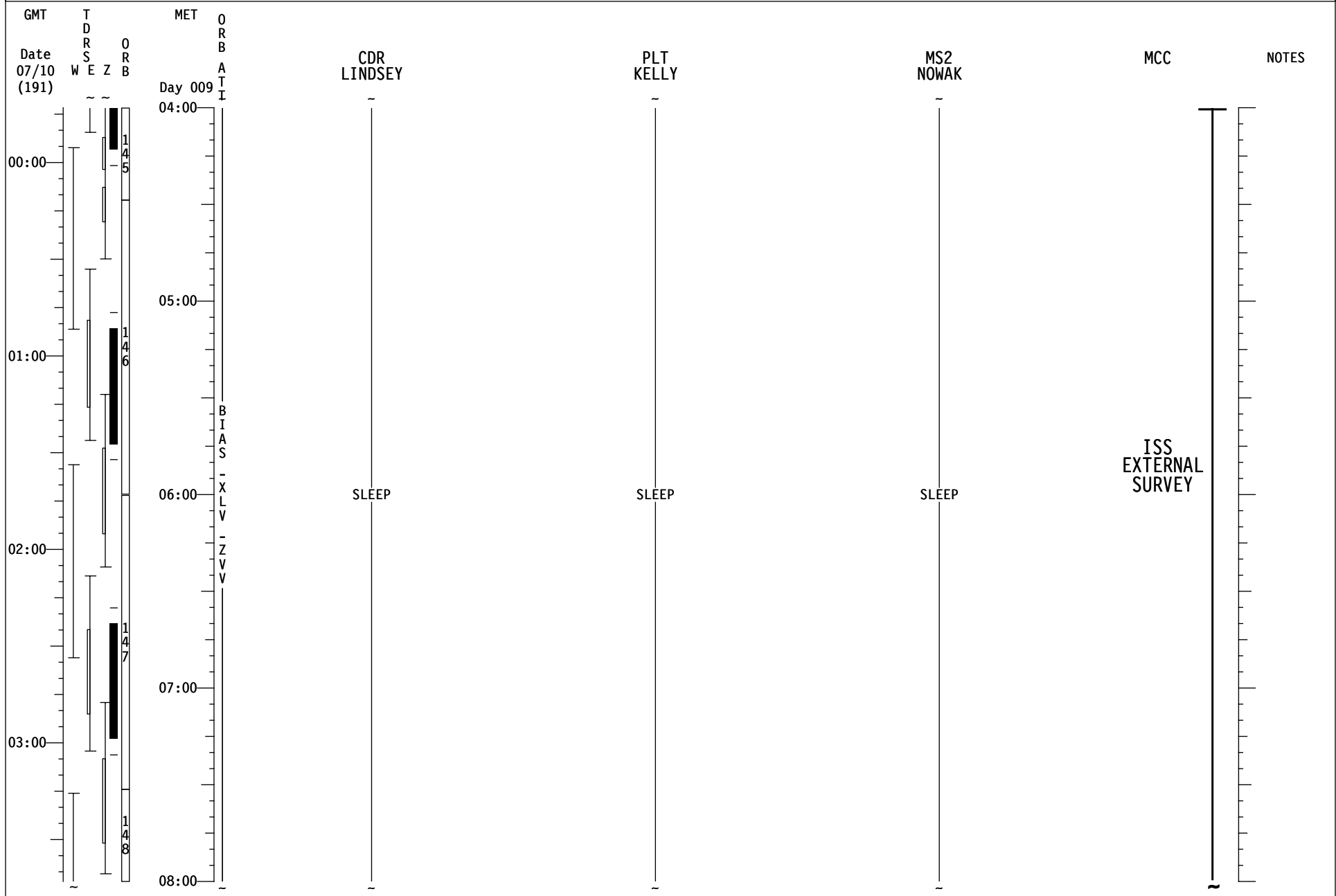

STS-121/ULF 1.1 (FD 10)

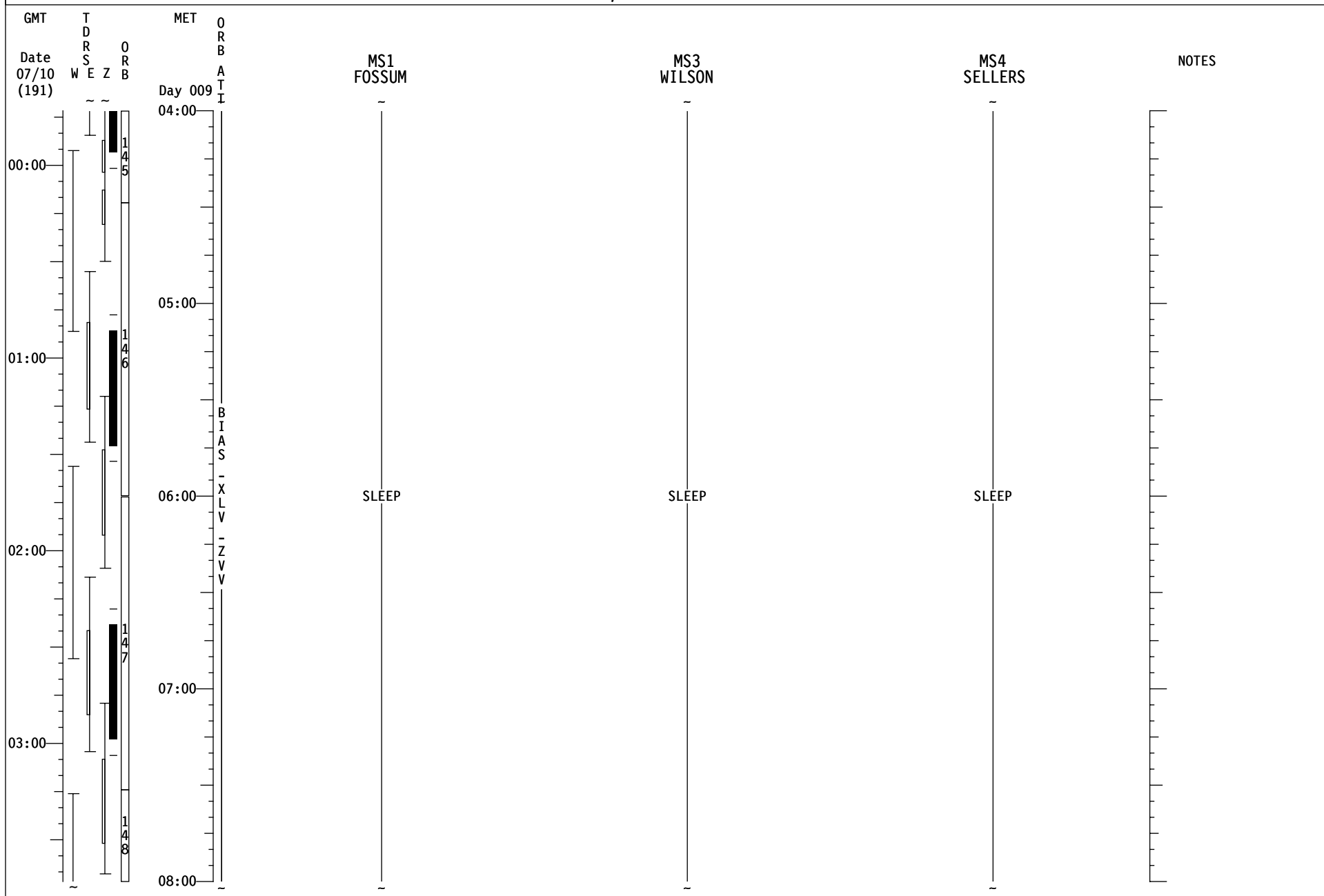

STS-121/ULF 1.1 (FD 10)

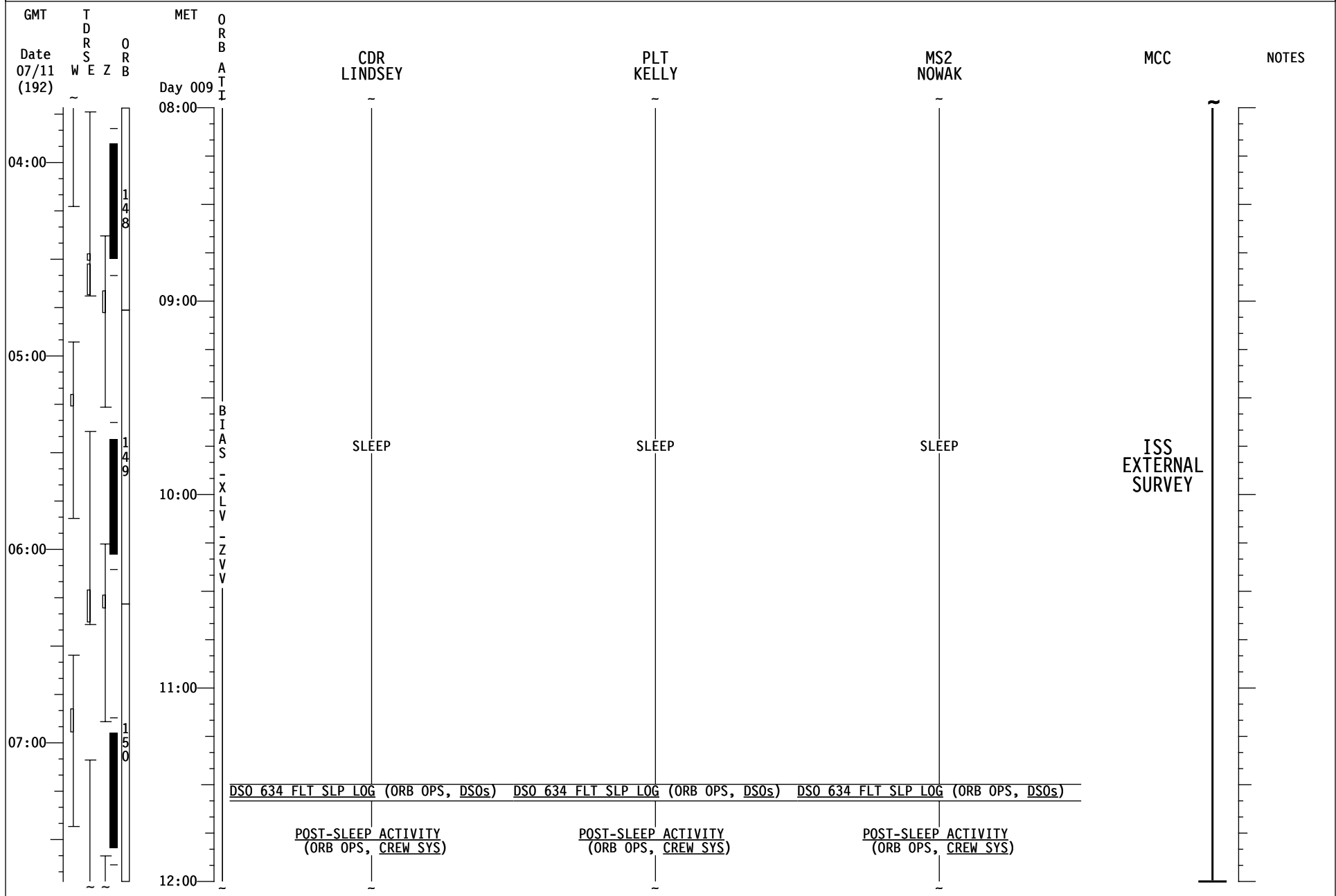

STS-121/ULF 1.1 (FD 10)

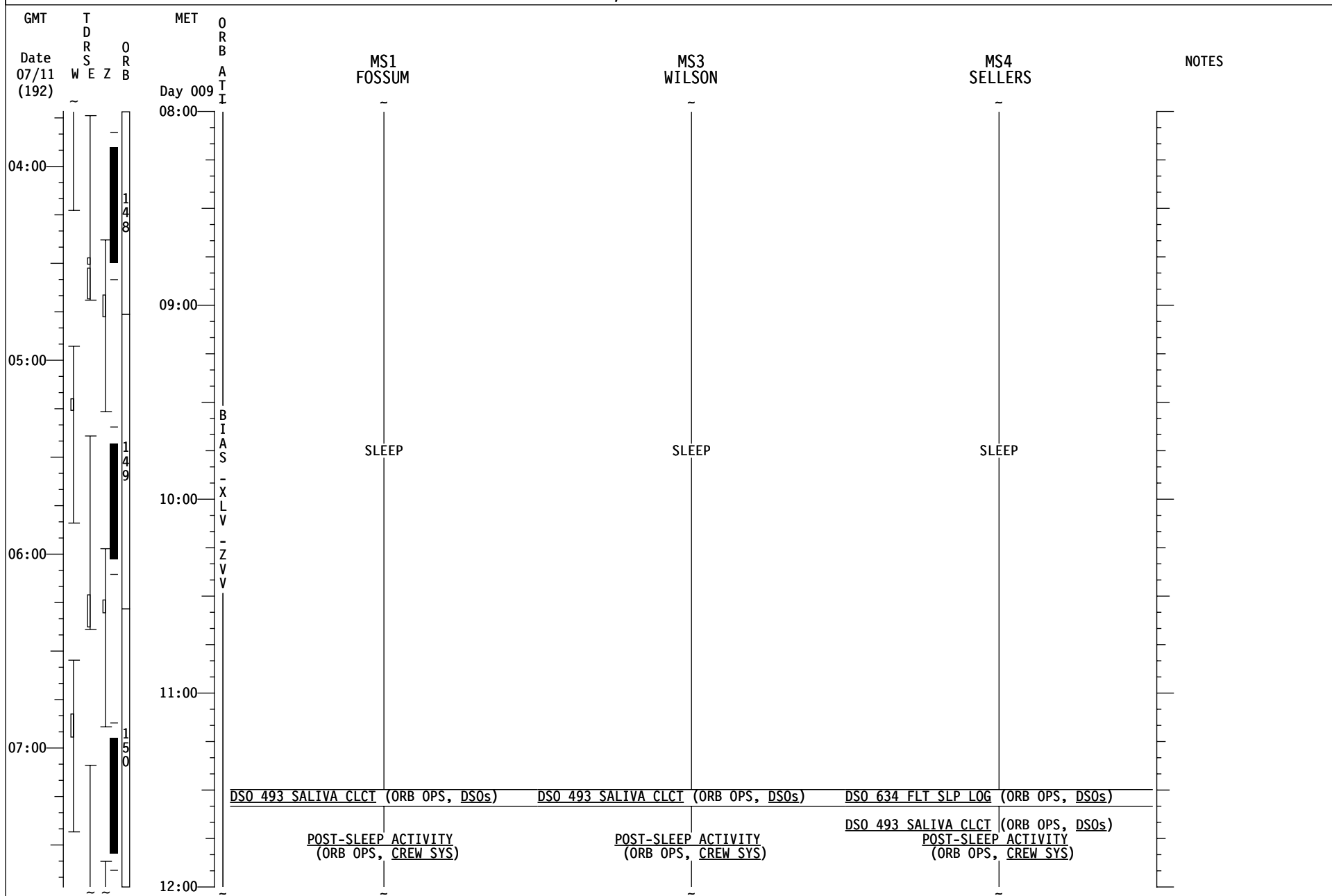

STS-121/ULF 1.1 (FD 11)

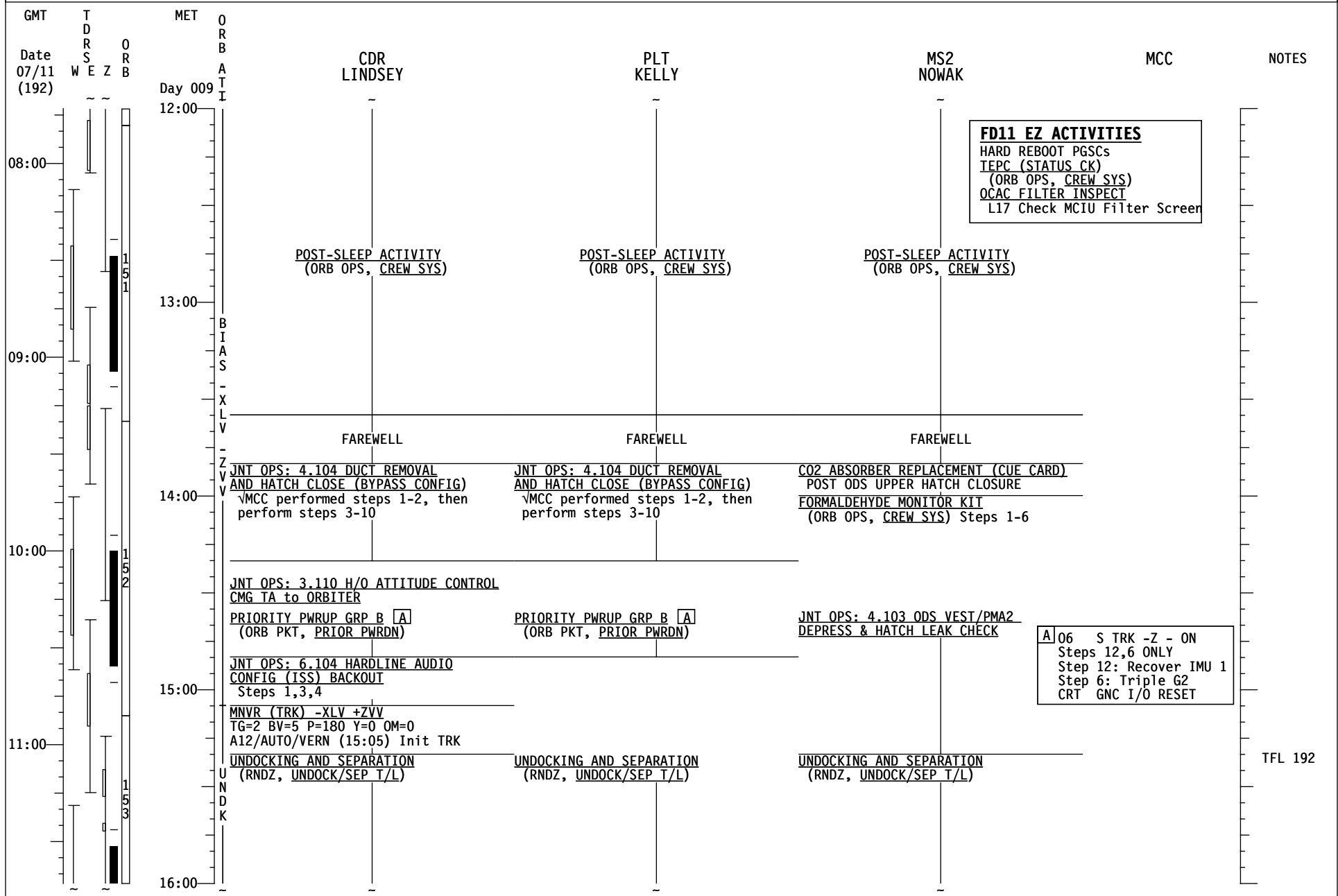

FD11 EZ ACTIVITIES
 HARD REBOOT PGSCs
 TEPC (STATUS CK)
 (ORB OPS, CREW SYS)
 QCAC FILTER INSPECT
 L17 Check MCIU Filter Screen

STS-121/ULF 1.1 (FD 11)

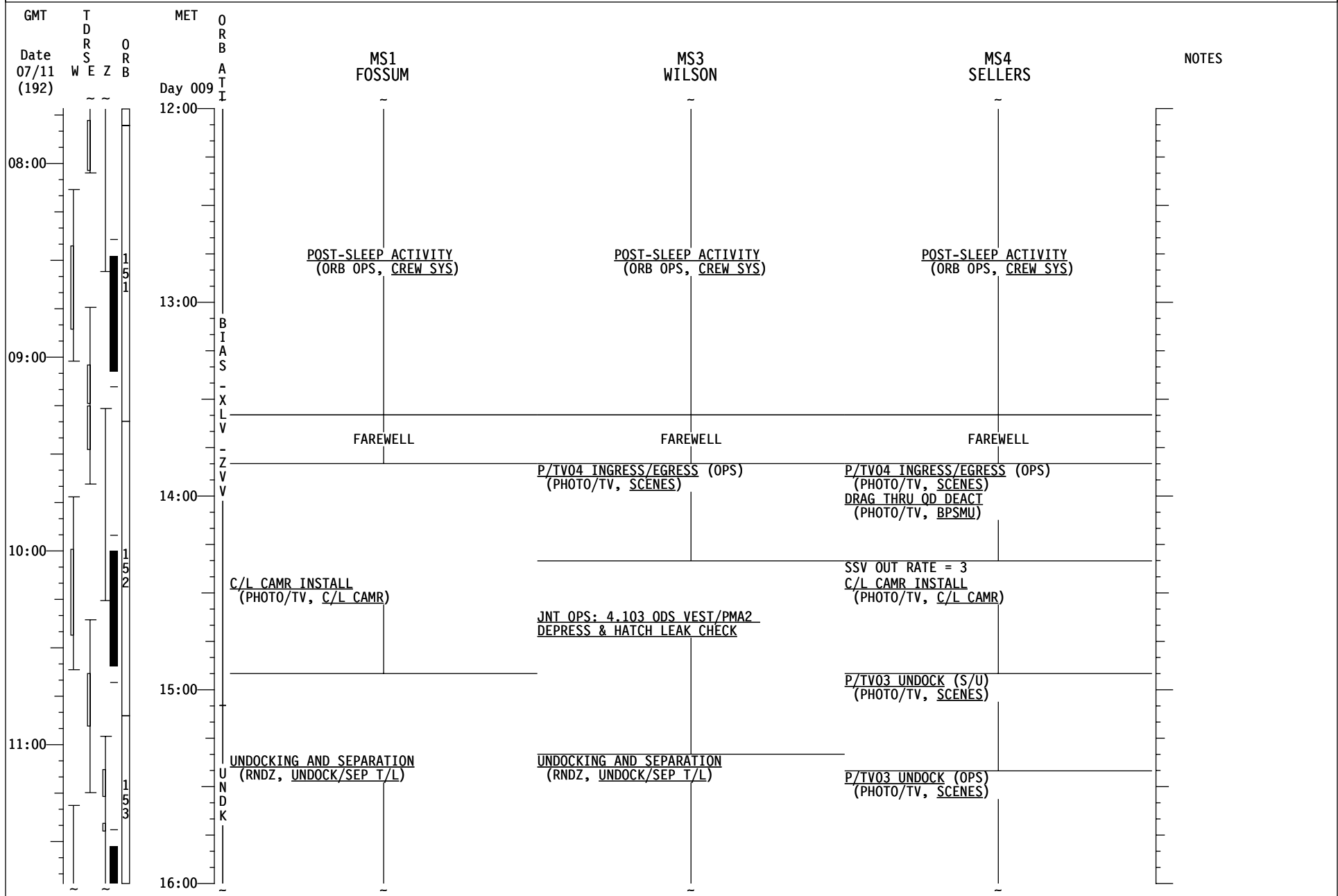

STS-121/ULF 1.1 (FD 11)

GMT	TDRS WSEZ	ORB ORZ	MET Day 009	ORBIT CDR LINDSEY	PLT KELLY	MS2 NOWAK	MCC	NOTES
16:00				<u>UNDOCKING AND SEPARATION</u> (RNDZ, UNDOCK/SEP T/L)	<u>UNDOCKING AND SEPARATION</u> (RNDZ, UNDOCK/SEP T/L)	<u>UNDOCKING AND SEPARATION</u> (RNDZ, UNDOCK/SEP T/L)		UPLINK B21°+B1 BOX B1 -35<AZ<45 -35<EL<40
17:00				<u>SEP/FLYAROUND</u> (RNDZ, UNDOCK/SEP T/L)	<u>SEP/FLYAROUND</u> (RNDZ, UNDOCK/SEP T/L)	<u>SEP/FLYAROUND</u> (RNDZ, UNDOCK/SEP T/L)		UPLINK B21°+MASK
17:00				< PHYSICAL SEP CONFIG DAP A1,B1 MNV R BIAS (TRK) -ZLV +YVV TG=2 BV=5 P=90 Y=0 OM=310 A1/AUTO/VERN Init TRK SHUTTLE CONDENSATE COLLECTION (ORB OPS, ECLS) TEARDOWN	RETURN TO FLIGHT PLAN			
17:00				IMU STAR OF OPY ALIGN (ORB OPS, GNC)	SUPPLY/WASTE WATER DUMP (ORB OPS, ECLS) Init Supply/Waste Dump			
18:00				PRIORITY PWRDN GRP B [A] (ORB PKT, PRIOR PWRDN)	PRIORITY PWRDN GRP B [A] (ORB PKT, PRIOR PWRDN)			
18:00					SSP1 OIU PWR - OIU 1 ON (tb-UP) ON MCC GO: SSP1 APCU 1 OUTPUT RLY - CL CONV ON (tb-gray) SUPPLY/WASTE WATER DUMP (ORB OPS, ECLS) Terminate Supply/Waste Dump	MEAL		TFL 184
18:00							MPLM: 1.101 MPLM ENVIRONMENT CHECK Steps 1 & 4 PRESS CK (NO fan)	
19:00				MNV R STBD SURVEY TG=4 BV=5 P=0 Y=49 OM=140 A1/AUTO/VERN/ Init TRK on MCC GO	SSP1 OIU PWR - OFF (tb-bp)	OBSS MNVR HO TO STBD SRVY (PDRS, NOMINAL)		UPLINK B21°+MASK+ BOX A4 -122<AZ<110 -90<EL<45
19:00				OBSS LDRI RCC SRVY.- STBD (PDRS, SURVEYS)	SSP1 OIU PWR - OFF (tb-bp) OUTPUT RLY - OP	OBSS LDRI RCC SRVY - STBD (PDRS, SURVEYS)		
20:00								

A] Steps 2,5,6,9,10,12 ONLY
Step 6: Single G2
Step 12: IMU 1 STBY - ITEM 21 EXEC

STS-121/ULF 1.1 (FD 11)

GMT	TDRS WSEZ	ORB ORB	MET Day 009	ORBIT ATTI	MS1 FOSSUM	MS3 WILSON	MS4 SELLERS	NOTES
16:00				UNDOCK	UNDOCKING AND SEPARATION (RNDZ, UNDOCK/SEP T/L)	UNDOCKING AND SEPARATION (RNDZ, UNDOCK/SEP T/L)	P/TV03 UNDOCK (OPS) (PHOTO/TV, SCENES)	
17:00				SEP	SEP/FLYAROUND (RNDZ, UNDOCK/SEP T/L)	SEP/FLYAROUND (RNDZ, UNDOCK/SEP T/L)	SEP/FLYAROUND (RNDZ, UNDOCK/SEP T/L)	
17:00					RETURN TO FLIGHT PLAN			
13:00				BIAS	JNT OPS: 6.106 SSOR DEACTIVATION		JNT OPS: 2.303 PCS DEACT POST UNDK PGSC CONFIG Configure PGSCs as needed	
18:00				ZLV +YVV	MEAL	MEAL	MEAL	
19:00				INRTL	OBSS LDRI RCC SRVY - STBD (PDRS, SURVEYS)	OBSS MNVR HO TO STBD SRVY (PDRS, NOMINAL)	FILTER CLEANING (IFM, SCHEDULED MAINTENANCE)	
20:00						EXERCISE	EXERCISE	

STS-121/ULF 1.1 (FD 11)

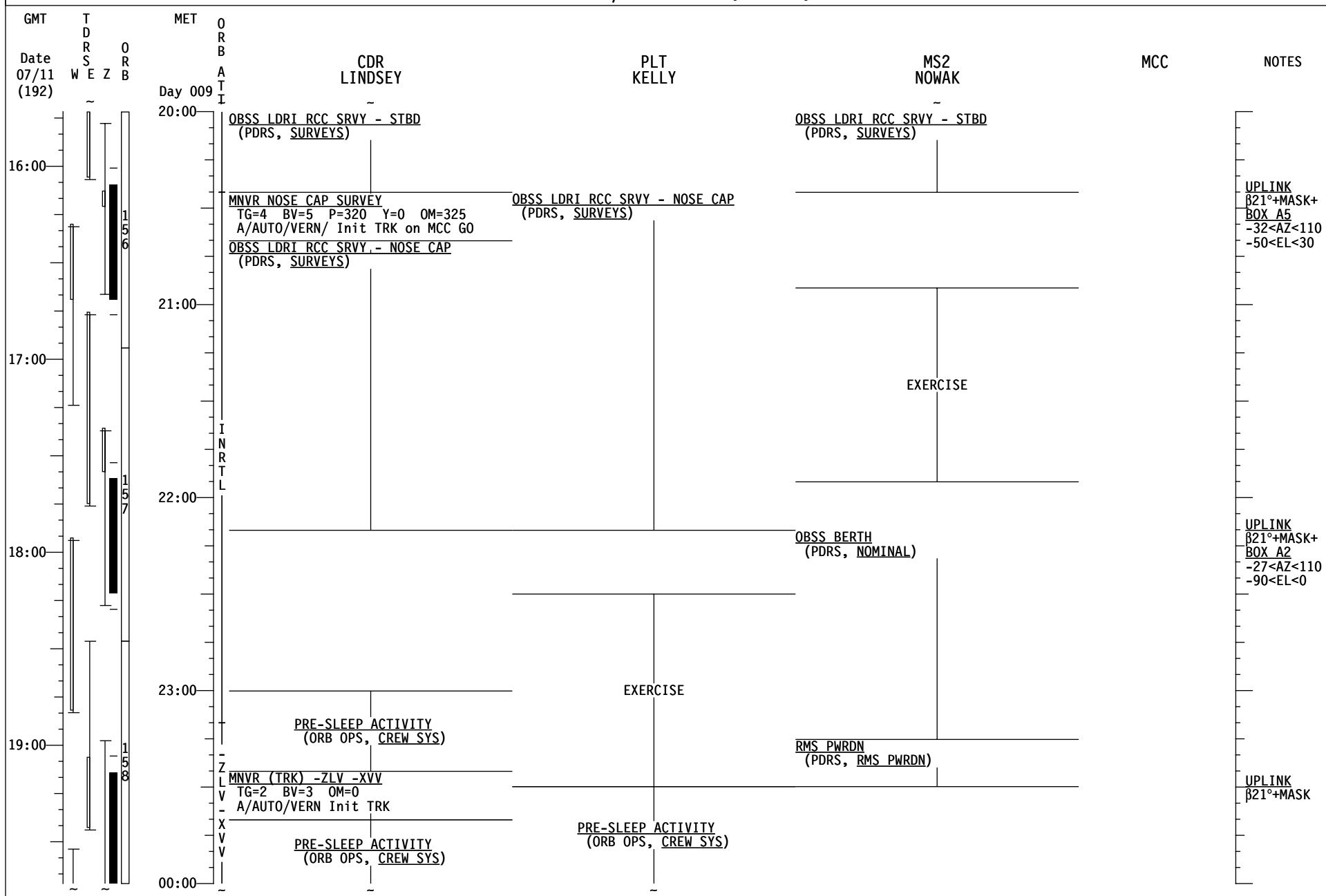

STS-121/ULF 1.1 (FD 11)

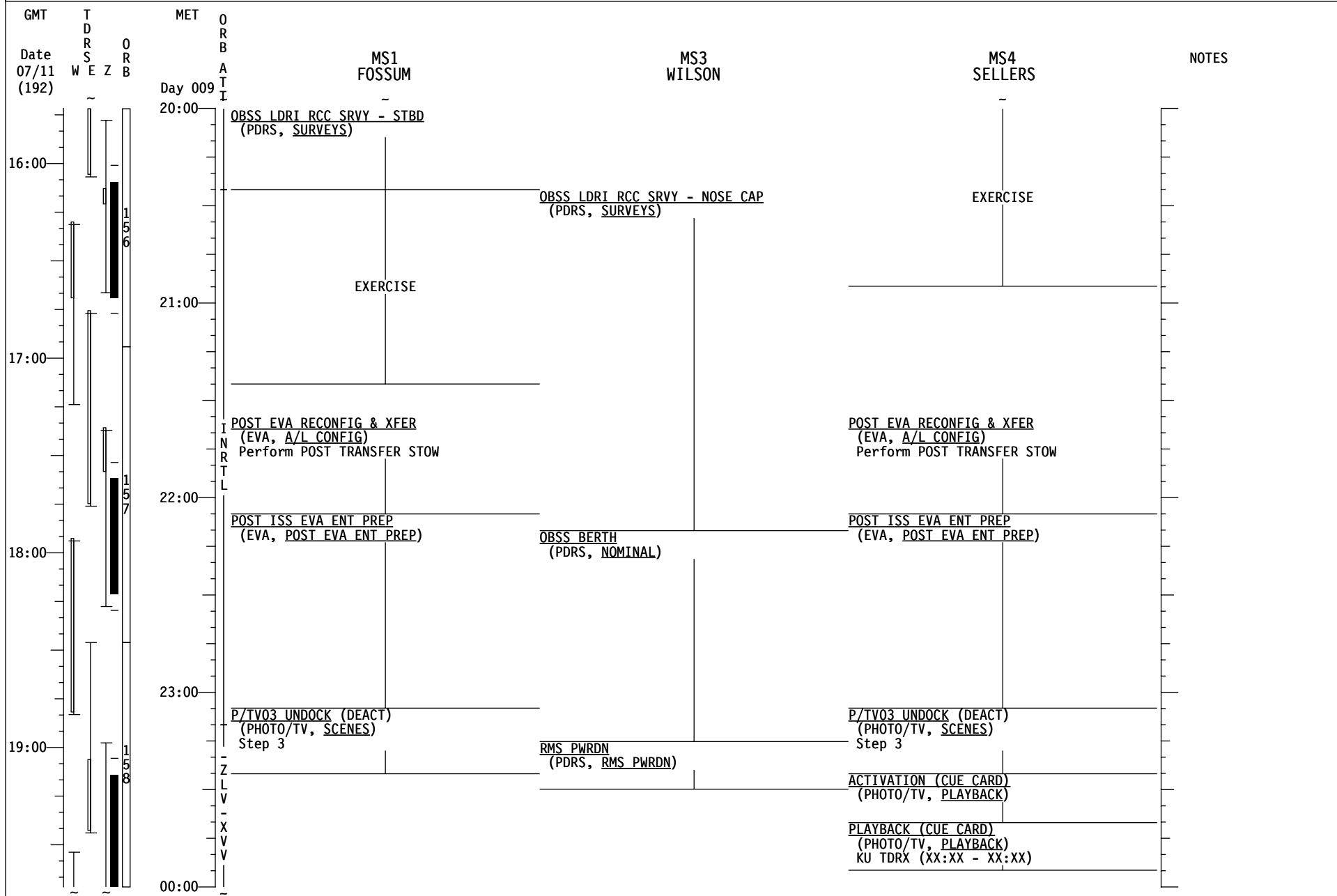

STS-121/ULF 1.1 (FD 11)

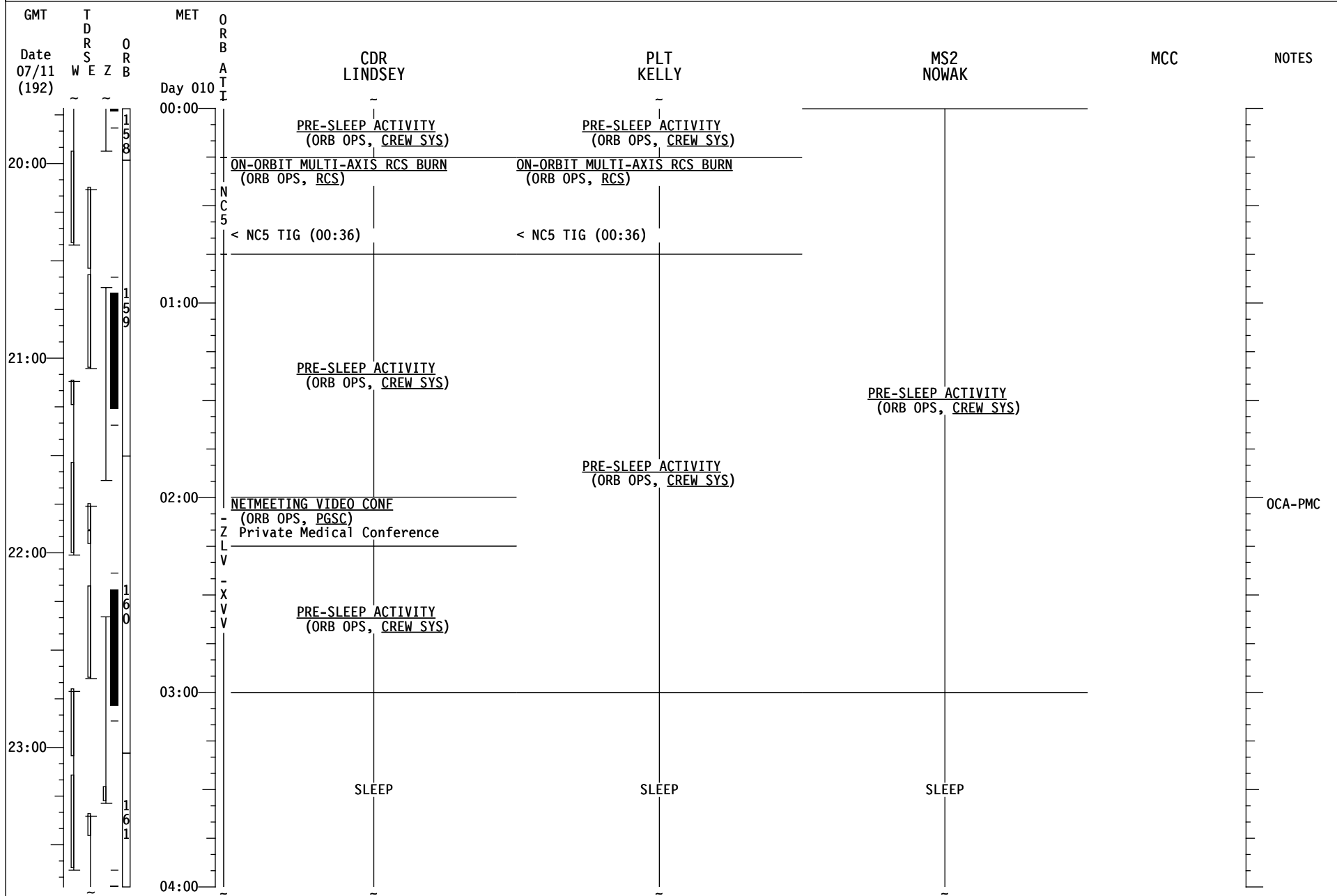

STS-121/ULF 1.1 (FD 11)

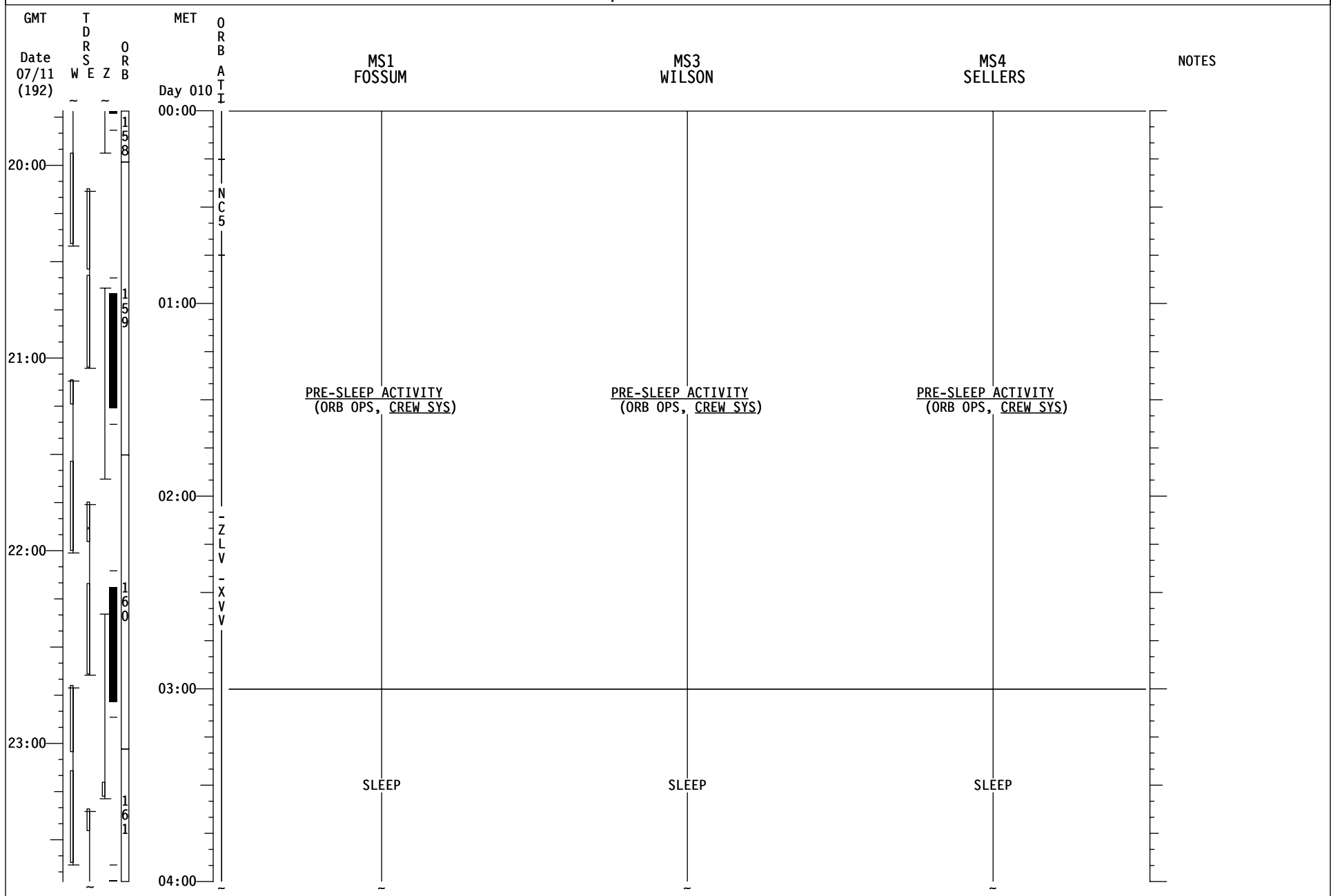

STS-121/ULF 1.1 (FD 11)

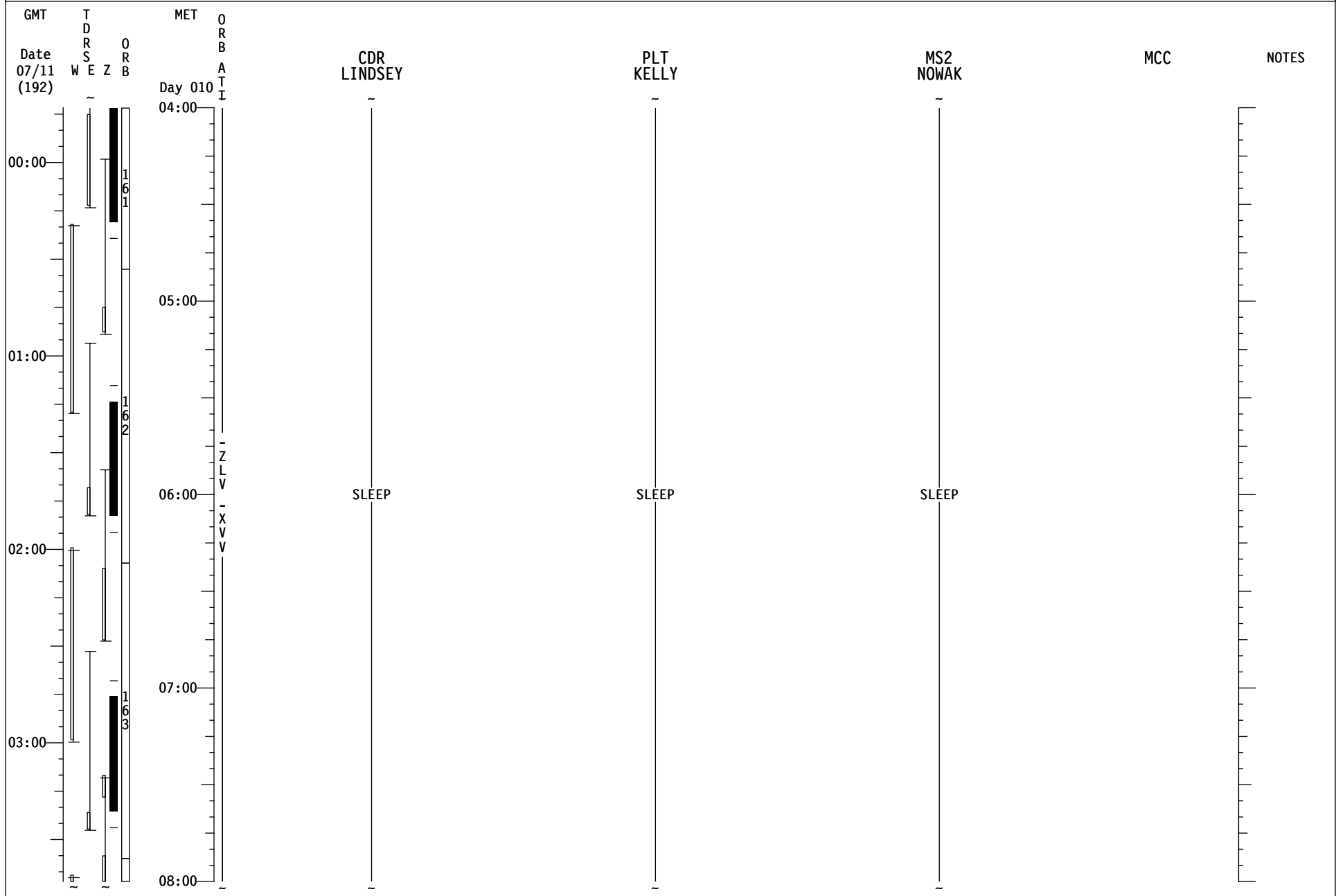

STS-121/ULF 1.1 (FD 11)

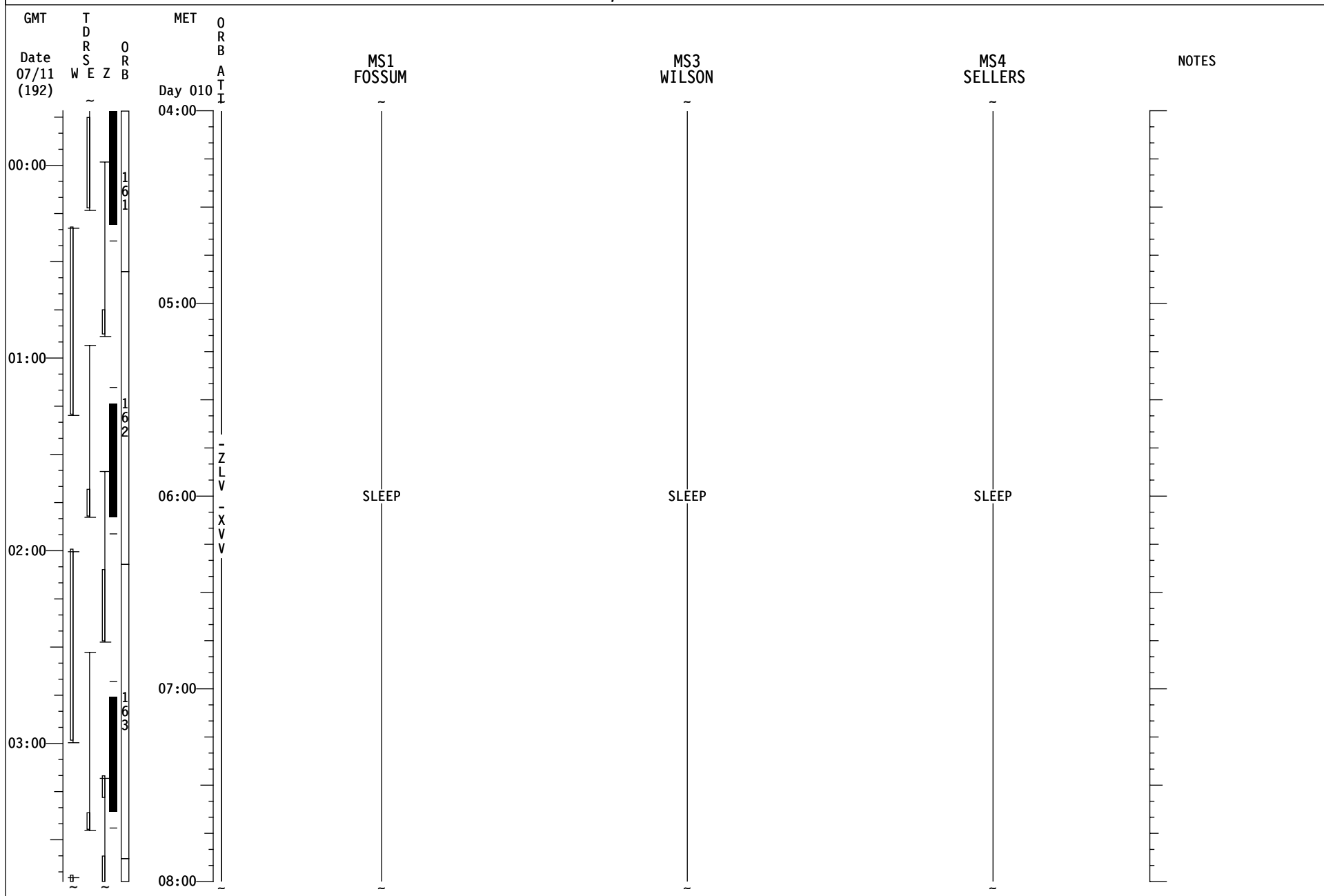

STS-121/ULF 1.1 (FD 11)

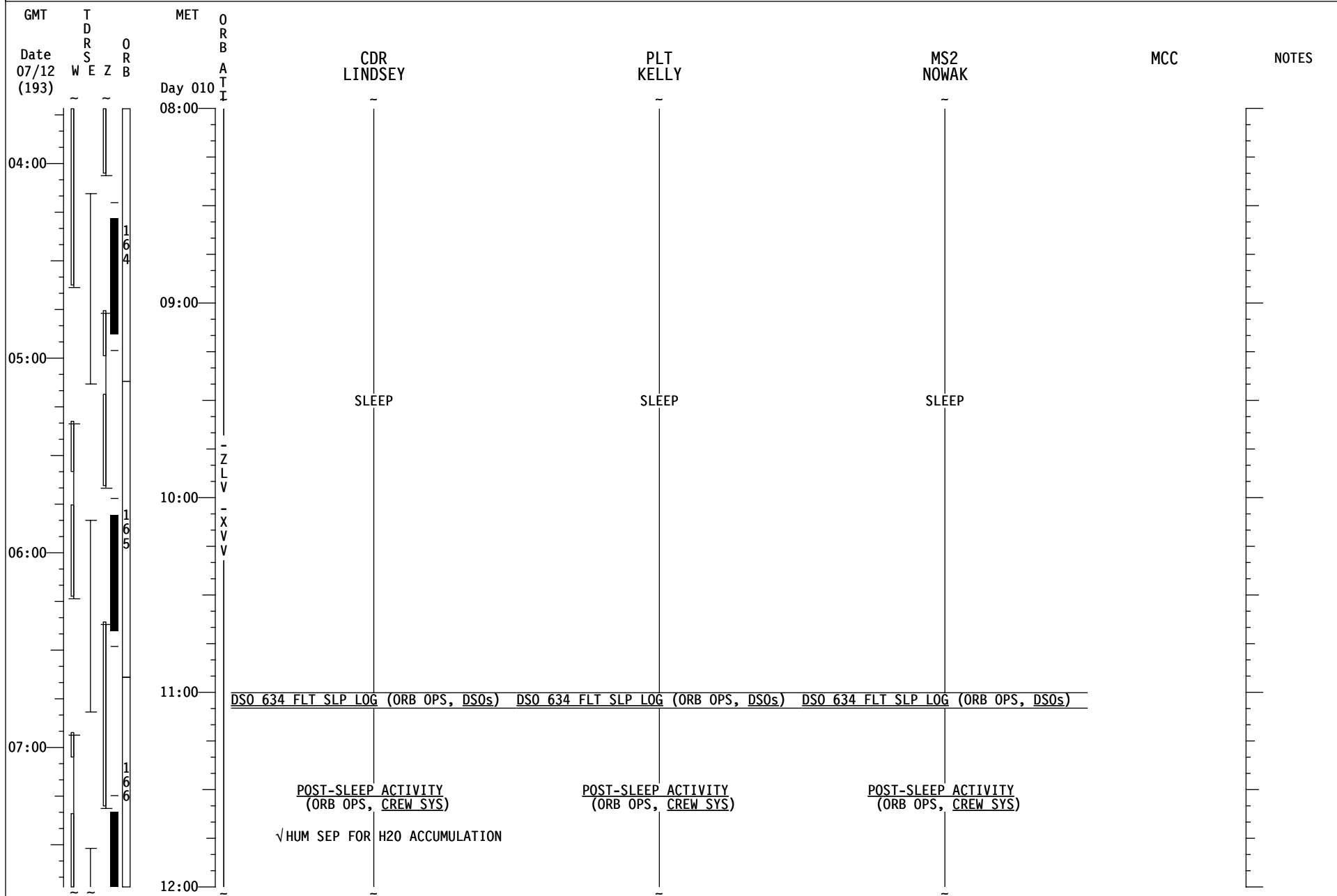

STS-121/ULF 1.1 (FD 12)

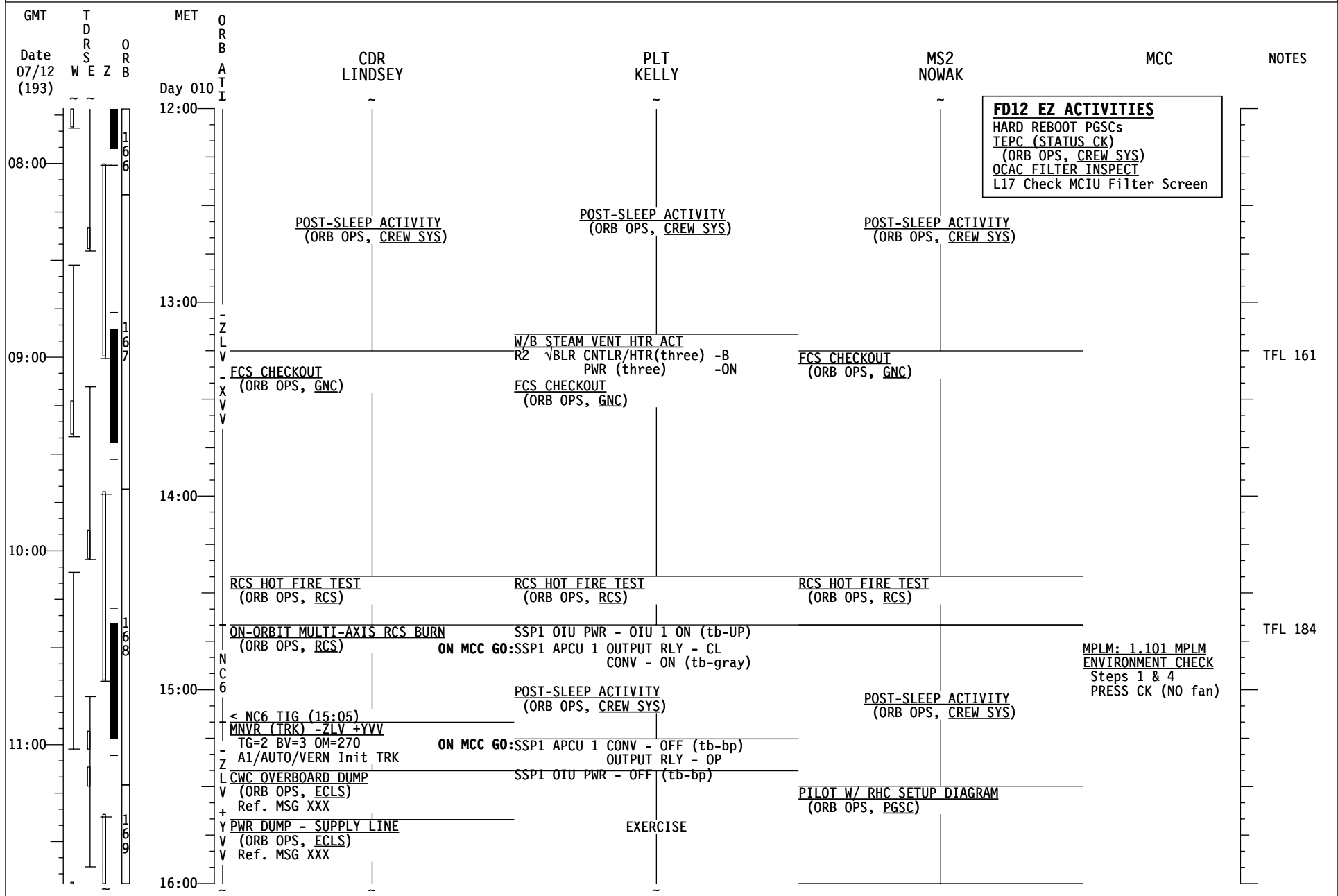

FD12 EZ ACTIVITIES
 HARD REBOOT PGSCs
 TEPC (STATUS CK)
 (ORB OPS, CREW SYS)
 OCAC FILTER INSPECT
 L17 Check MCIU Filter Screen

STS-121/ULF 1.1 (FD 12)

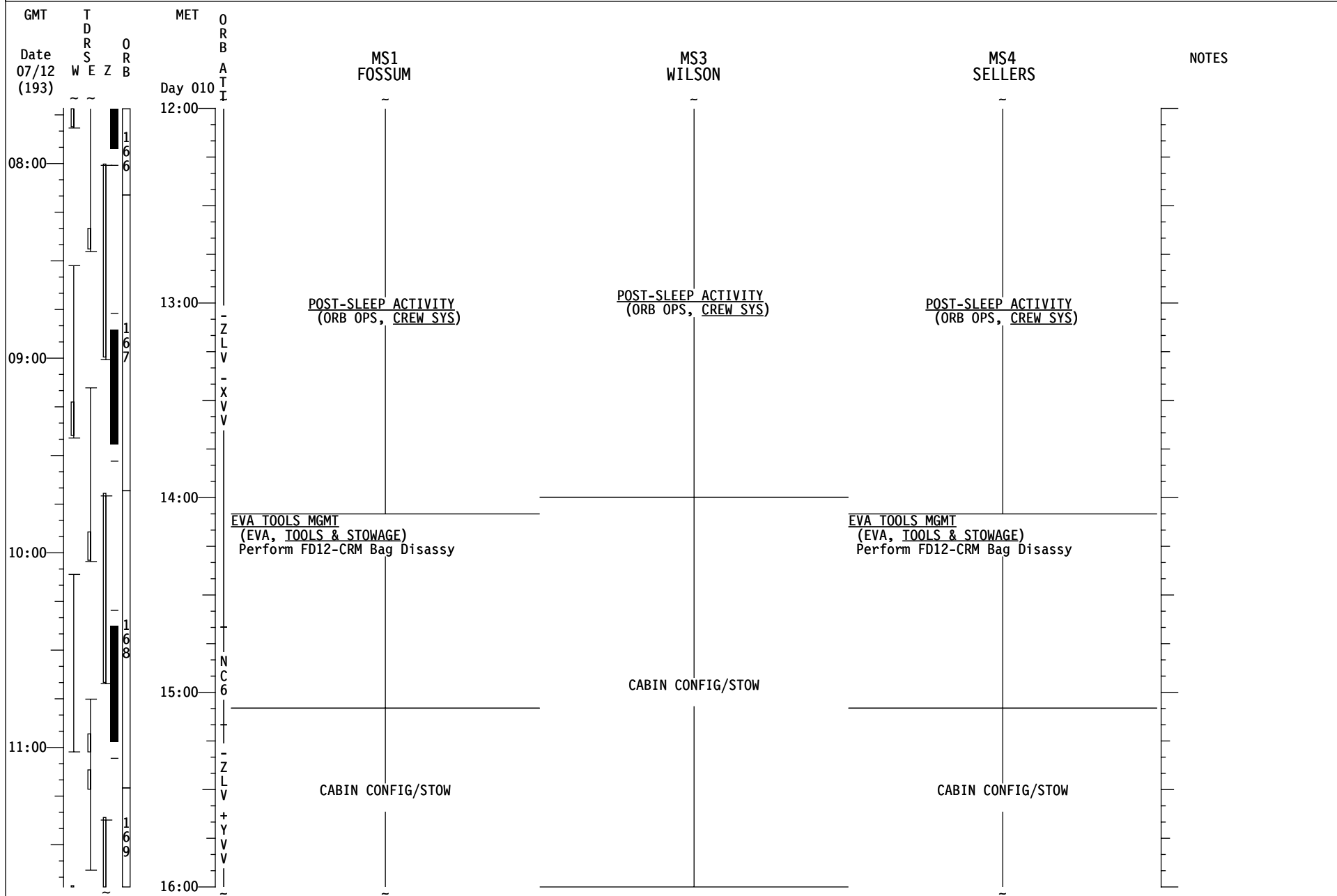

STS-121/ULF 1.1 (FD 12)

GMT	T D R S E Z	MET	O R B A T I	CDR LINDSEY	PLT KELLY	MS2 NOWAK	MCC	NOTES
Date 07/12 (193)	W E Z B	Day 010	16:00					
				<u>PWR DUMP - SUPPLY LINE</u> (ORB OPS, ECLS) Ref. MSG XXX	EXERCISE			
12:00				<u>CWC OVERBOARD DUMP (TERM)</u> (ORB OPS, ECLS)		CABIN CONFIG/STOW		
				<u>SPLY H2O DUMP W/FES (ORB OPS, ECLS)</u> Step 1 using FES Pri B	<u>CWC OVERBOARD DUMP</u> (ORB OPS, ECLS) Ref. MSG XXX			
			17:00	<u>PILOT WITH RHC</u> (ORB OPS, PGSC)	<u>PILOT WITH RHC</u> (ORB OPS, PGSC)	<u>PILOT WITH RHC</u> (ORB OPS, PGSC)		
13:00								
					<u>CWC OVERBOARD DUMP (TERM)</u> (ORB OPS, ECLS)			
			18:00	CABIN CONFIG/STOW	<u>SUPPLY/WASTE WATER DUMP</u> (ORB OPS, ECLS) Initiate Supply/Waste Dump	CABIN CONFIG/STOW		
14:00								
					MEAL			
			19:00	MEAL		MEAL		
15:00					<u>SUPPLY/WASTE WATER DUMP</u> (ORB OPS, ECLS) Terminate Supply/Waste Dump			
				<u>SPLY H2O DUMP W/FES (ORB OPS, ECLS)</u> Step 2. FES Pri B req'd				
			20:00	DEORBIT PREP BRIEFING	DEORBIT PREP BRIEFING	DEORBIT PREP BRIEFING		

STS-121/ULF 1.1 (FD 12)

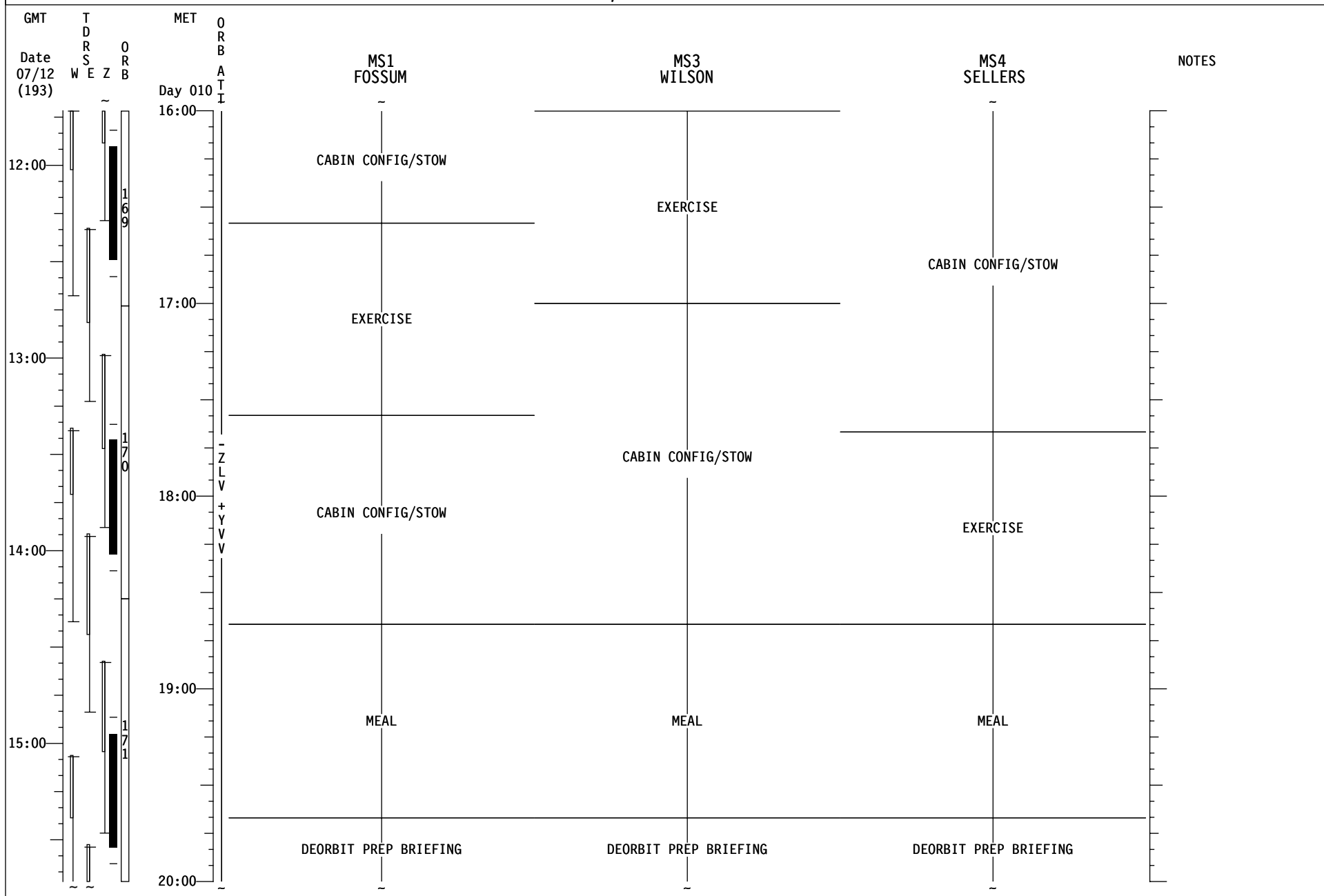

STS-121/ULF 1.1 (FD 12)

GMT	T D R S E Z	MET	O R B	CDR LINDSEY	PLT KELLY	MS2 NOWAK	MCC	NOTES
Date 07/12 (193)	W E Z	Day 010	ORB AT I					
16:00		20:00		DEORBIT PREP BRIEFING	DEORBIT PREP BRIEFING	DEORBIT PREP BRIEFING		
			Z L V	LANDING-1 COMM C/O (ORB OPS, COMM/INST)				
			+ Y V V	PUBLIC AFFAIRS EVENT KU AVAIL: XX:XX-XX:XX Ref: MSG XXX	PUBLIC AFFAIRS EVENT KU AVAIL: XX:XX-XX:XX Ref: MSG XXX	PUBLIC AFFAIRS EVENT KU AVAIL: XX:XX-XX:XX Ref: MSG XXX		
					FC MONITORING SYS (FCMS) OPS (ORB OPS, EPS)			
17:00		21:00		CABIN CONFIG/STOW				
			+ Z L V	MNVR (TRK) +ZLV -XVV TG=2 BV=5 P=270 Y=0 OM=180 A1/AUTO/VERN Init TRK		EXERCISE		
			- X V V	LANDING-1 COMM C/O (ORB OPS, COMM/INST)				
				MNVR (TRK) -ZLV -XVV TG=2 BV=3 OM=0 A/AUTO/VERN Init TRK				
18:00		22:00			CABIN CONFIG/STOW			
			- Z L V			CABIN CONFIG/STOW		
			- X V V	EXERCISE				
19:00		23:00						
			N C 7	ON-ORBIT MULTI-AXIS RCS BURN (ORB OPS, RCS)	ON-ORBIT MULTI-AXIS RCS BURN (ORB OPS, RCS)	CYCLE ERGOMETER OPS (ORB OPS, CREW SYS) Perform RECONFIG/STOW		
				< NC7 TIG (23:35) ENTRY COOLING CONFIG R12 VVPU PWR - OFF(LED-off) Minimize use of P/TV equipment Dim cabin lighting to 25%	< NC7 TIG (23:35)			
					KU-BD ANT STOW (ORB OPS, COMM/INST) Deactivate CCTV	KU-BD ANT STOW (ORB OPS, COMM/INST) Deactivate CCTV		
00:00								

STS-121/ULF 1.1 (FD 12)

GMT	T D R S E Z	O R B	MET	O R B	MS1 FOSSUM	MS3 WILSON	MS4 SELLERS	NOTES
Date 07/12 (193)	W E Z	O R B	Day 010	A T I				
16:00					DEORBIT PREP BRIEFING	DEORBIT PREP BRIEFING	DEORBIT PREP BRIEFING	
						ANALOG PAO CC (PHOTO/TV, SONY PD100)	WSGIS/IWIF IV ANTENNA T/D (ORB OPS, DTO)	
					PUBLIC AFFAIRS EVENT KU AVAIL: XX:XX-XX:XX Ref: MSG XXX	PUBLIC AFFAIRS EVENT KU AVAIL: XX:XX-XX:XX Ref: MSG XXX	PUBLIC AFFAIRS EVENT KU AVAIL: XX:XX-XX:XX Ref: MSG XXX	
					ENTRY VIDEO SETUP (PHOTO/TV, MINI-CAM)	COMM STRING 1 C/O (PART B) (ORB OPS, COMM/INST)	DEACT AND TEARDOWN (ORB OPS, WLE SENSORS)	
17:00								
18:00					CABIN CONFIG/STOW	CABIN CONFIG/STOW	CABIN CONFIG/STOW	
19:00					CYCLE ERGOMETER OPS (ORB OPS, CREW SYS) Perform RECONFIG/STOW		PGSC DEACT (ORB OPS, PGSC) Stow all STS PGSCs except for OCA router and worldmap	
							SSV DEACTIVATION (PHOTO/TV, SSV)	TFL 161
00:00								

STS-121/ULF 1.1 (FD 12)

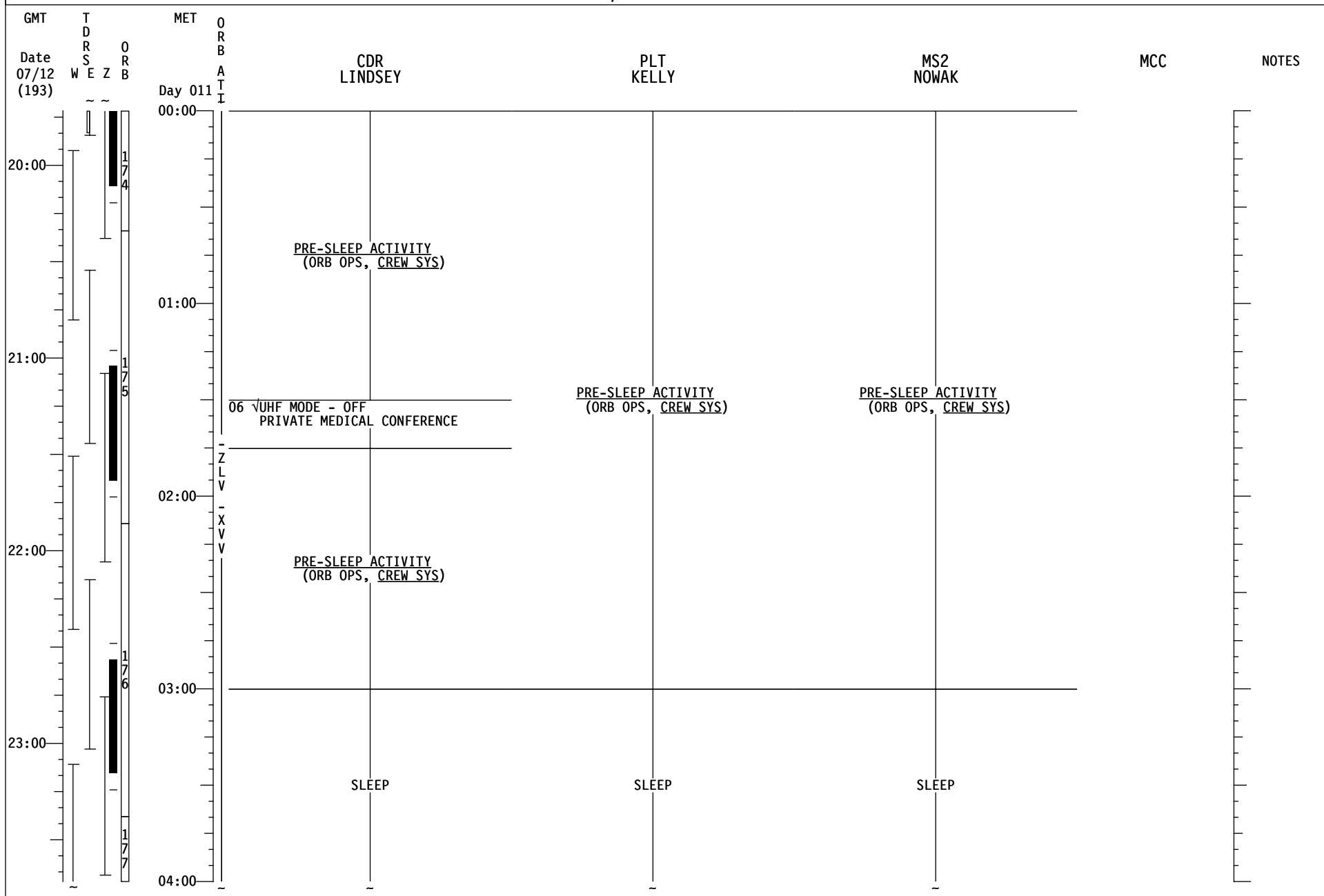

STS-121/ULF 1.1 (FD 12)

GMT	T D R S E Z	MET	O R B	MS1 FOSSUM	MS3 WILSON	MS4 SELLERS	NOTES
Date 07/12 (193)	W E Z	Day 011	A T I				
20:00	174	00:00					
21:00	175	01:00		<u>PRE-SLEEP ACTIVITY</u> (ORB OPS, CREW SYS)	<u>PRE-SLEEP ACTIVITY</u> (ORB OPS, CREW SYS)	<u>PRE-SLEEP ACTIVITY</u> (ORB OPS, CREW SYS)	
22:00		02:00	Z L V				
23:00	176	03:00	X V V				
				SLEEP	SLEEP	SLEEP	
04:00	177						

STS-121/ULF 1.1 (FD 12)

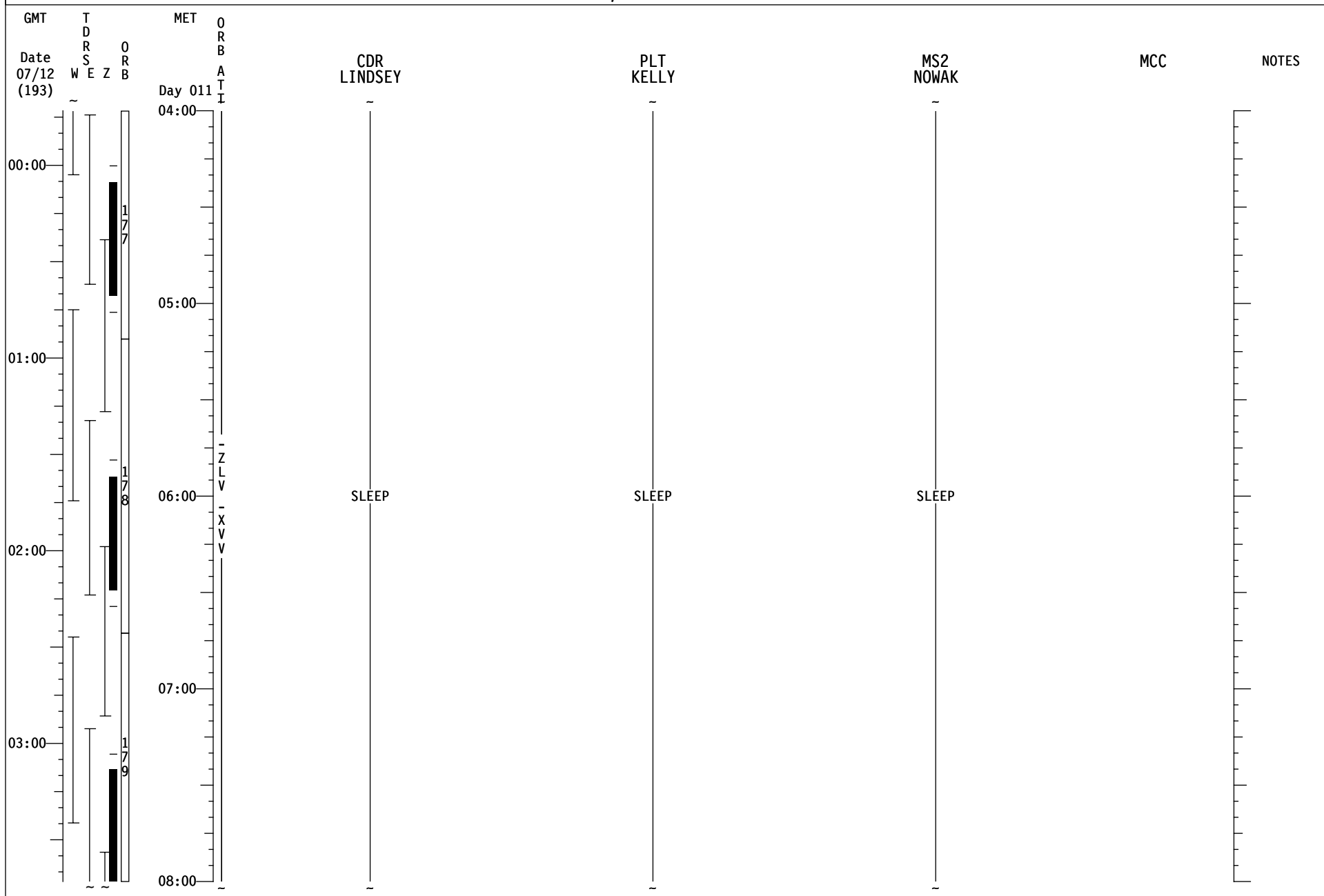

STS-121/ULF 1.1 (FD 12)

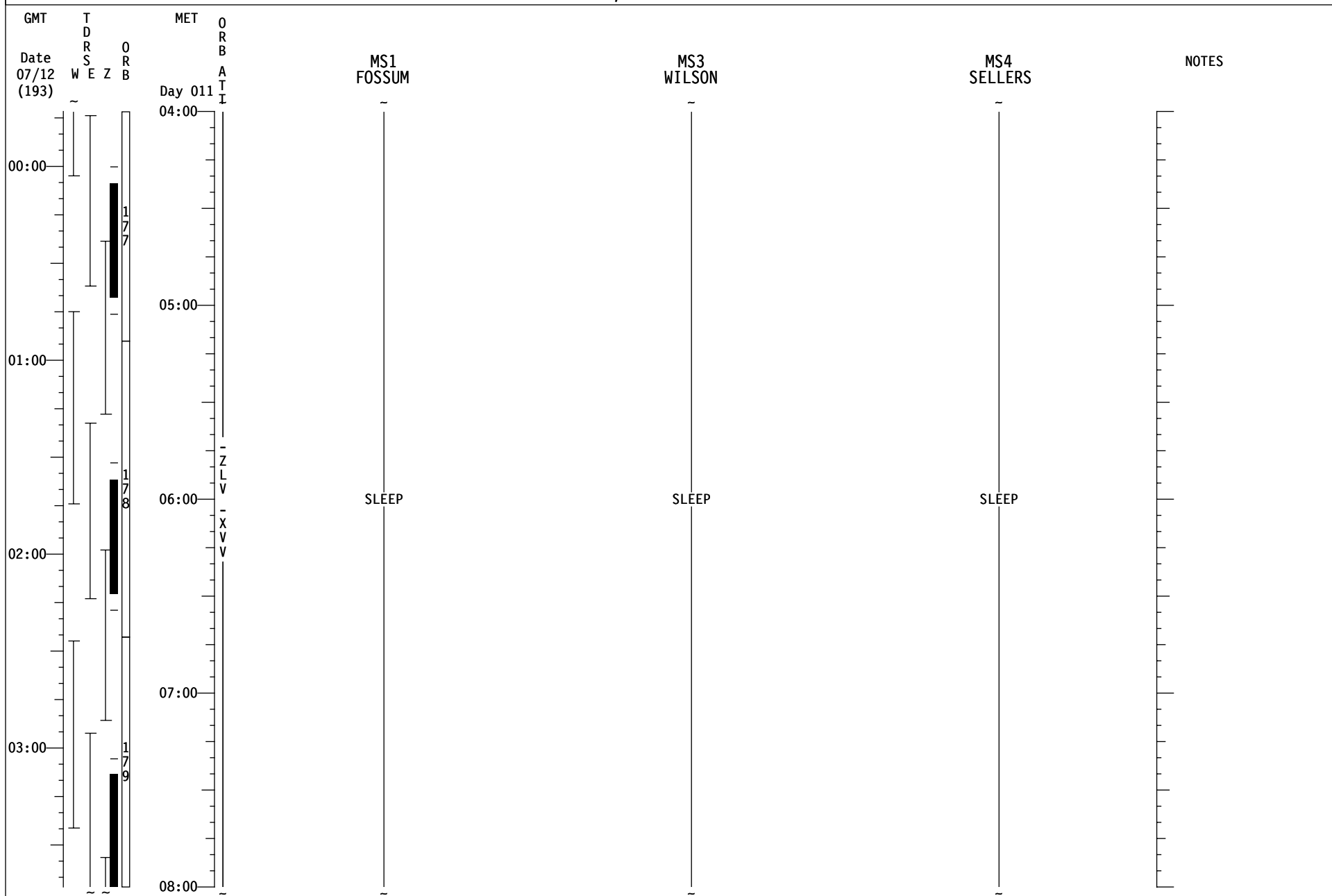

STS-121/ULF 1.1 (FD 12)

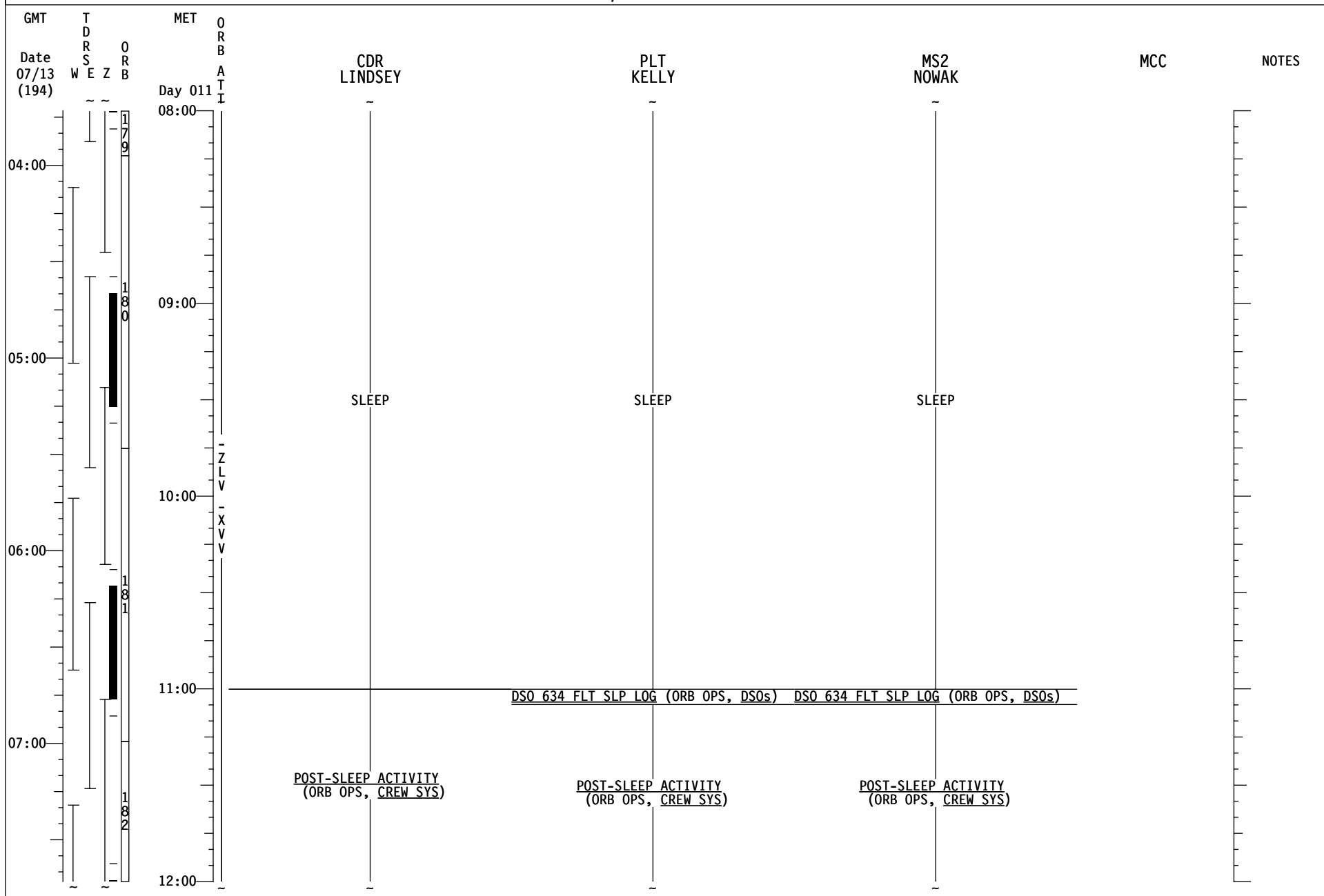

STS-121/ULF 1.1 (FD 12)

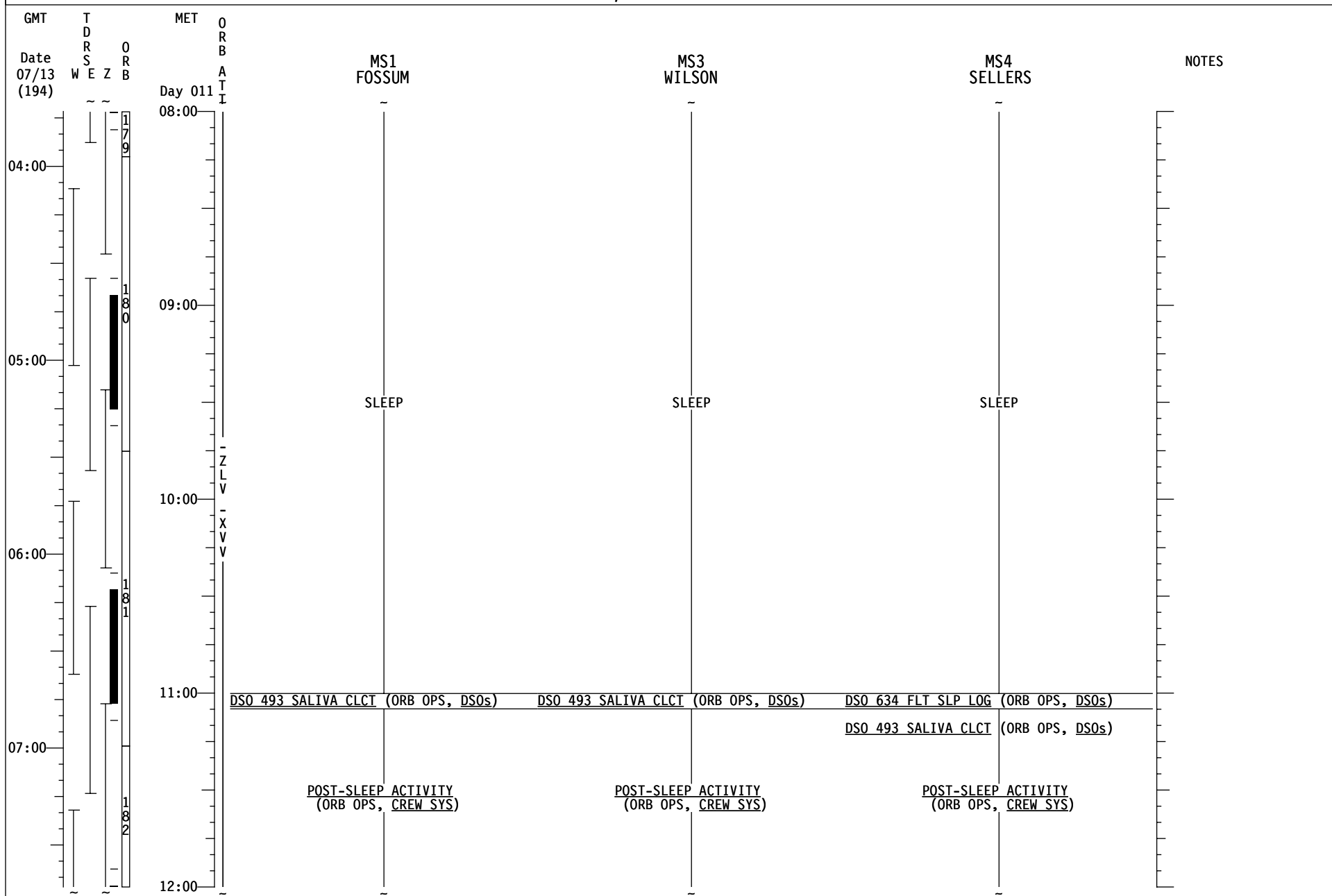

STS-121/ULF 1.1 (FD 13)

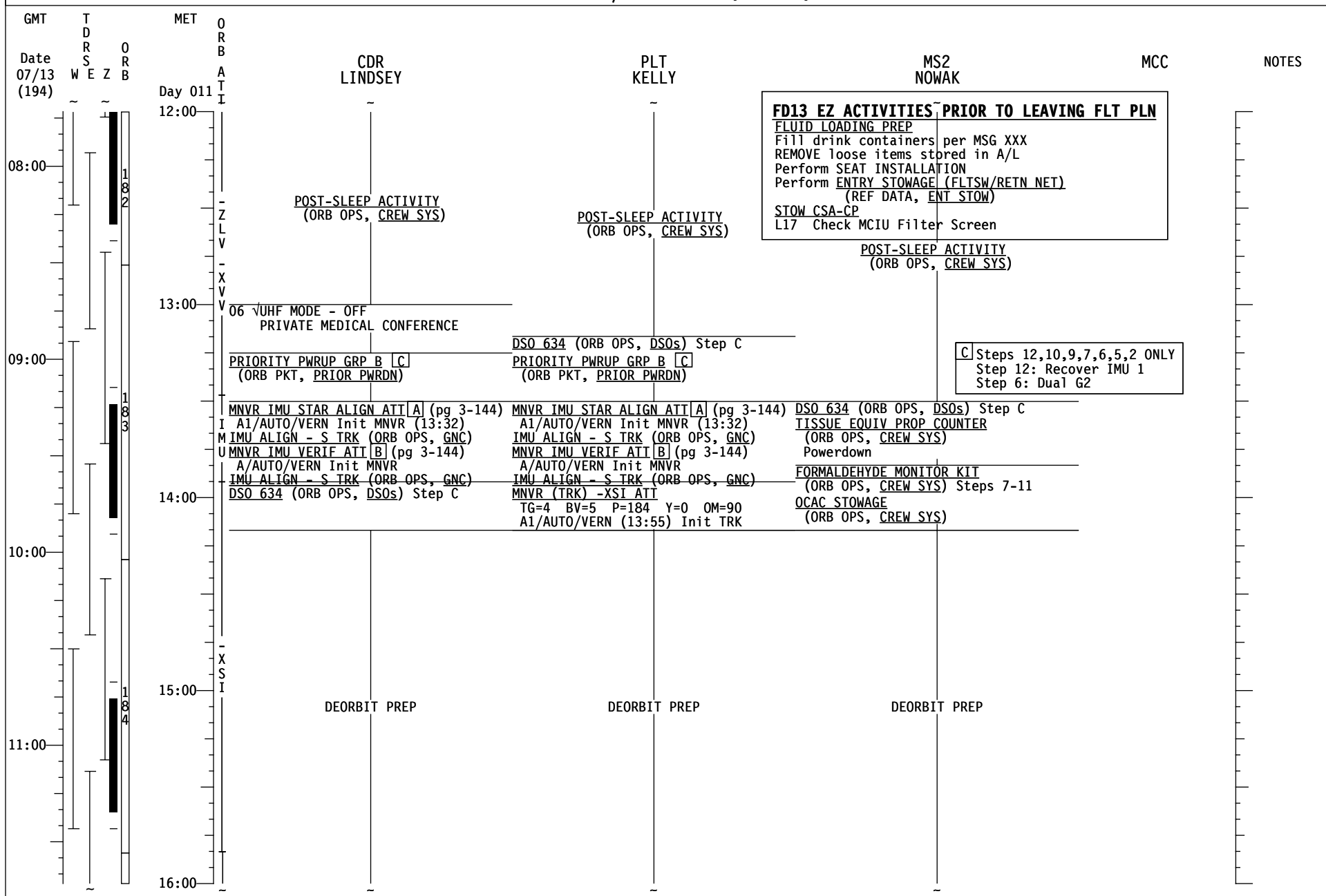

STS-121/ULF 1.1 (FD 13)

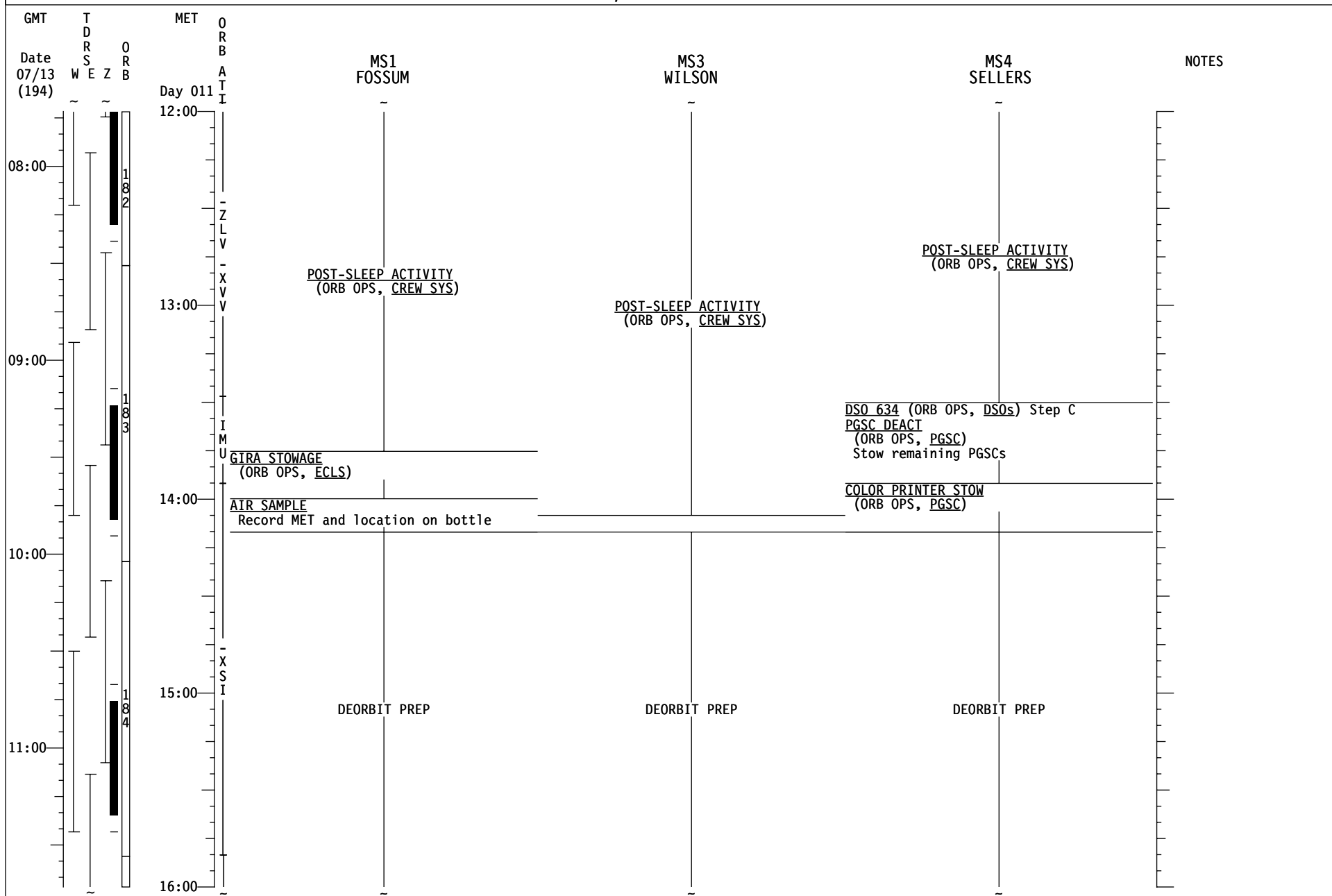

STS-121/ULF 1.1 (FD 13)

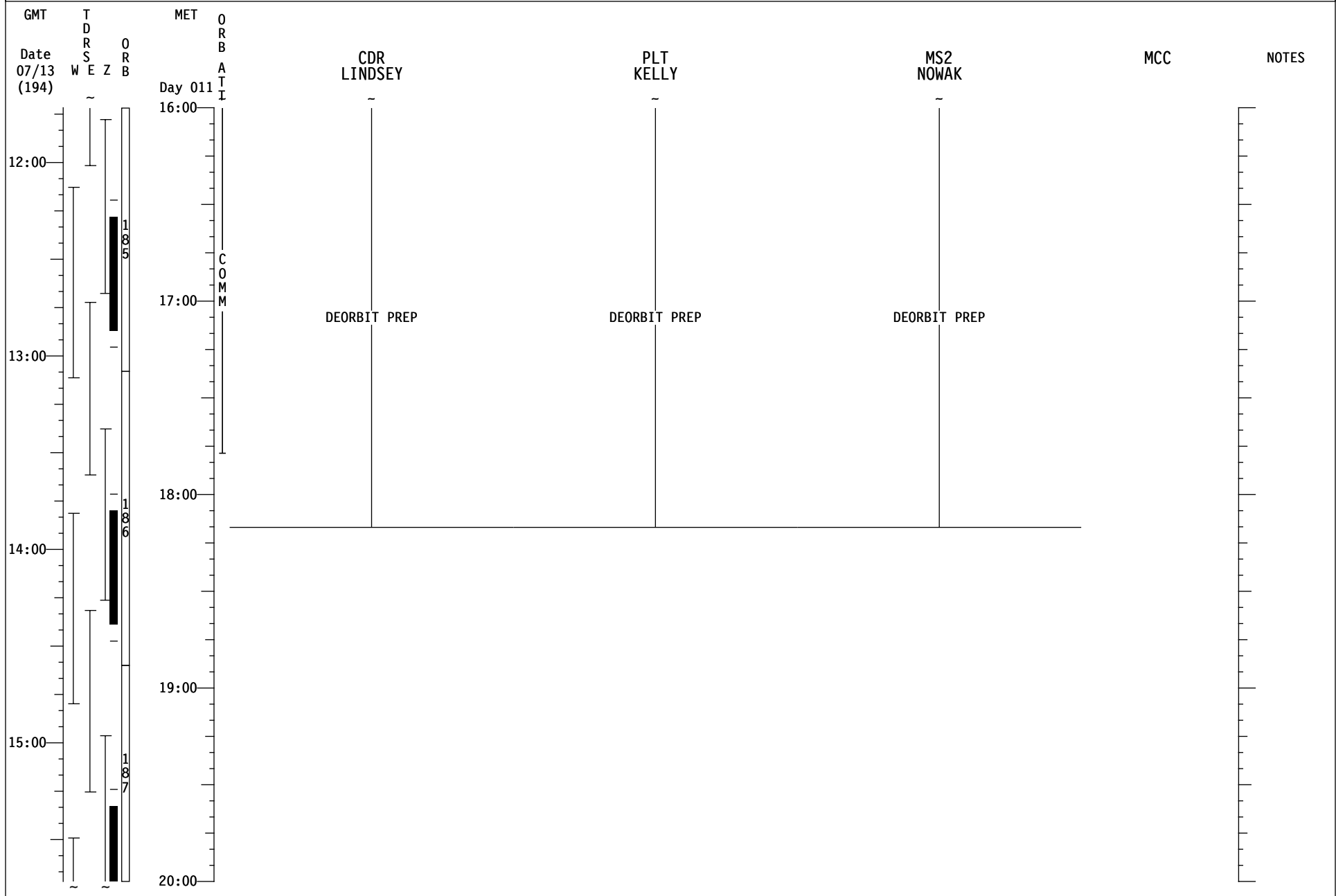

STS-121/ULF 1.1 (FD 13)

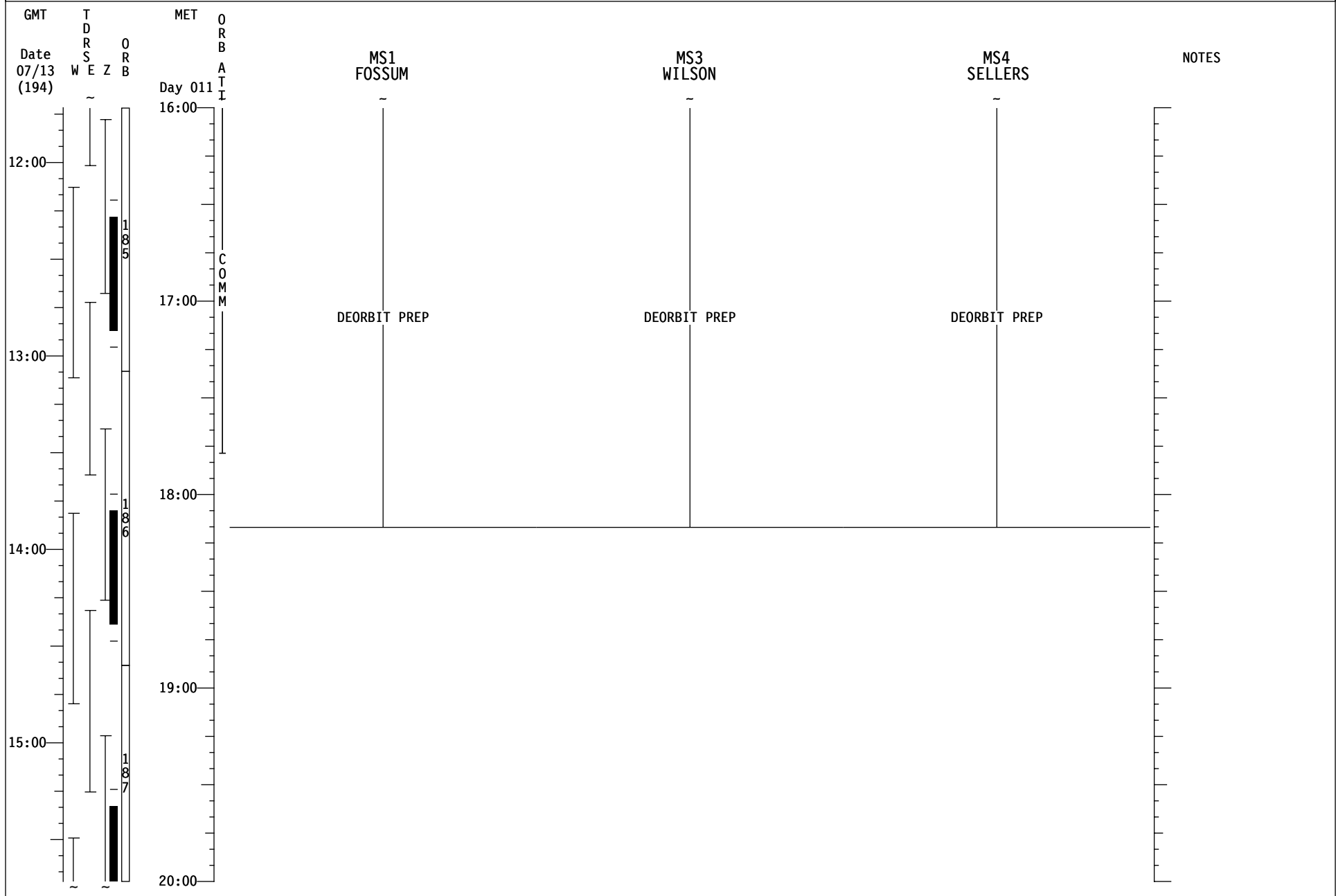

A	IMU STAR ALIGN		
	ID: -Y: 60 ENIF MET: (11/13:31 to 11/14:19)		
-Z: 16 ACHERNAR MET: (11/13:37 to 11/14:25)			
ANG DIFF: 82.2			
DUAL S TRKR ALIGNMENT		2nd ATTITUDE (SINGLE S TRKR) -Z: 60 -Y: 16	
R 19 P 322 Y 42	R 308 P 303 Y 43	97 330 55	
REQD ID:			
-Y: ____, -Z: ____, ANG ERR ____, ____, ____,			
ANG: 1 2 3			
ΔX { } ____, ____, ____, { } ____, ____, ____, { } ____, ____, ____,			
ΔY { } ____, ____, ____, { } ____, ____, ____, { } ____, ____, ____,			
ΔZ { } ____, ____, ____, { } ____, ____, ____, { } ____, ____, ____,			
EXECUTION TIME: __/__:__: MET			

B	IMU STAR VERIFICATION		
	ID: -Y: 77 ALGENIB MET: (11/13:45 to 11/14:35)		
-Z: 33 PEACOCK MET: (11/13:31 to 11/14:15)			
ANG DIFF: 86.0			
DUAL S TRKR ALIGNMENT		2nd ATTITUDE (SINGLE S TRKR) -Z: 77 -Y: 33	
R 283 P 58 Y 61	R 181 P 75 Y 50	350 80 52	
REQD ID:			
-Y: ____, -Z: ____, ANG ERR ____, ____, ____,			
ANG: 1 2 3			
ΔX { } ____, ____, ____, { } ____, ____, ____, { } ____, ____, ____,			
ΔY { } ____, ____, ____, { } ____, ____, ____, { } ____, ____, ____,			
ΔZ { } ____, ____, ____, { } ____, ____, ____, { } ____, ____, ____,			
If any ΔX, ΔY, or ΔZ > 0.1 Check MCC EXECUTION TIME: __/__:__: MET			

The sections following this divider page will not be included in flight copies.

This Page Intentionally Blank

ATTITUDE TIMELINE

This Page Intentionally Blank

Attitude Timeline

MET/GMT	ORBITER		REF ATT/REMARKS	EVENT
	MNVR OPTION	DAP E/S/ β		
1 000/01:00:00 M 182/20:43:39 G				STS-121 Launch July 1, 2006 GMTLO: 182/19:43:39
2 000/01:12:00 M 19:28 182/20:55:39 G 21:03:07	LVLH TRACK TGT = 2 P = 90.00 BV = 5 Y = 7.00 OM = 85.00 MNVR A1/AUTO/VERN HOLD (same)	RATE 0.2000 DB AT 1.000 DB RT 0.020 EARTH R 7 P 90 $\beta = 22$	LVLH R=353.00 P=180.00 Y=275.00	Biased -ZLV -YVV PLBD Opening
3 000/04:07:00 M 17:47 182/23:50:39 G 183/00:01:26	M50 (CALC) INRTL R = 105.98 MNVR P = 231.67 PYR Y = 354.69 MNVR A1/AUTO/VERN HOLD (same)	RATE 0.2000 DB AT 1.000 DB RT 0.020 SUN R 337 P 71 $\beta = 21$	+X PYR R = 0.00 P = 16.00 Y = 0.00 LVLH 000/04:27:23 M 183/00:11:02 G	NC-1 OMS TIG 4:27:23 DV= 94.4
4 000/04:30:00 M 43:27 183/00:13:39 G 27:06	LVLH TRACK TGT = 2 P = 90.00 BV = 3 Y = 0.00 OM = 90.00 MNVR A1/AUTO/VERN HOLD (same)	RATE 0.2000 DB AT 1.000 DB RT 0.020 EARTH R 0 P 90 $\beta = 21$	LVLH R= 0.00 P=180.00 Y=270.00	-ZLV -YVV WLES Battery Life Extension Overnight Att
5 000/15:30:00 M 41:22 183/11:13:39 G 25:01	M50 (CALC) INRTL R = 255.90 MNVR P = 52.06 PYR Y = 5.95 MNVR A1/AUTO/VERN HOLD (same)	RATE 0.2000 DB AT 1.000 DB RT 0.020 SUN R 201 P 108 $\beta = 19$	+X PYR R = 0.00 P = 16.00 Y = 0.00 LVLH 000/15:50:00 M 183/11:33:39 G	NC-2 OMS TIG 15:50 DV= 13.8
6 000/15:55:00 M 16:09:29 183/11:38:39 G 53:08	LVLH TRACK TGT = 2 P = 90.00 BV = 5 Y = 0.00 OM = 160.00 MNVR A1/AUTO/VERN HOLD (same)	RATE 0.2000 DB AT 1.000 DB RT 0.020 EARTH R 0 P 90 $\beta = 19$	LVLH R=180.00 P= 0.00 Y=340.00	Biased -ZLV +XVV
7 000/18:00:00 M 10:34 183/13:43:39 G 54:13	TGT= 4 BV = 5 P = 0.00 Y = 49.00 OM = 110.00 MNVR A1/AUTO/VERN HOLD (same)	RATE 0.2000 DB AT 1.000 DB RT 0.020 SUN R 90 P 49 $\beta = 19$	INRTL R=348.28 P= 87.65 Y= 65.40 RA= 100.620 DEC= 23.087N	STBD WING LDRI Survey
8 000/19:30:00 M 43:59 183/15:13:39 G 27:38	TGT= 4 BV = 5 P = 320.00 Y = 0.00 OM = 257.00 MNVR A1/AUTO/VERN HOLD (same)	RATE 0.2000 DB AT 1.000 DB RT 0.020 SUN R 180 P 40 $\beta = 18$	INRTL R=299.56 P=294.37 Y= 36.28 RA= 100.684 DEC= 23.082N	NOSECAP LDRI Survey
9 000/21:10:43 M 183/16:54:22 G				NPC MultiAxis TIG=21:10:43 DV=1.5
10 000/22:15:00 M 21:07 183/17:58:39 G 18:04:46	TGT= 4 BV = 5 P = 0.00 Y = 334.00 OM = 306.00 MNVR A1/AUTO/VERN HOLD (same)	RATE 0.2000 DB AT 1.000 DB RT 0.020 SUN R 270 P 26 $\beta = 18$	INRTL R=105.50 P=165.66 Y= 78.14 RA= 100.803 DEC= 23.074N	PORT WING LDRI Survey

ALL ORBITER DATA IN
MEAN OF 1950 AND PYR EULER SEQUENCE

Attitude Timeline

MET/GMT	ORBITER		REF ATT/REMARKS	EVENT
	MNVR OPTION	DAP E/S/ β		
11 001/00:45:00 M 51:49 183/20:28:39 G 35:28	LVLH TRACK TGT = 2 P = 90.00 BV = 5 Y = 0.00 OM = 12.00 MNVR A1/AUTO/VERN HOLD (same)	RATE 0.2000 DB AT 1.000 DB RT 0.020 EARTH R 0 P 90 $\beta = 17$	LVLH R= 0.00 P=180.00 Y=348.00	Biased -ZLV -XVV SRMS Survey
12 001/02:08:00 M 17:08 183/21:51:39 G 22:00:47	M50 (CALC) INRTL R = 257.00 MNVR P = 54.00 PYR Y = 13.00 MNVR A1/AUTO/VERN HOLD (same)	RATE 0.2000 DB AT 1.000 DB RT 0.020 SUN R 198 P 102 $\beta = 17$	+X PYR R = 359.62 P = 9.73 Y = 0.21 LVLH 001/02:28:21 M 183/22:12:00 G	NC-3 +X RCS TIG 1/02:28:21 DV=3
13 001/02:30:00 M 42:01 183/22:13:39 G 25:40	TGT= 4 BV = 5 P = 0.00 Y = 90.00 OM = 130.00 MNVR A1/AUTO/VERN HOLD (same)	RATE 0.2000 DB AT 1.000 DB RT 0.020 SUN R 90 P 90 $\beta = 17$	INRTL R=338.00 P=185.08 Y=346.95 RA= 100.986 DEC= 23.061N	LDRI Comm
14 001/03:45:00 M 57:11 183/23:28:39 G 40:50	LVLH TRACK TGT = 2 P = 90.00 BV = 3 Y = 0.00 OM = 90.00 MNVR A1/AUTO/VERN HOLD (same)	RATE 0.2000 DB AT 1.000 DB RT 0.020 EARTH R 0 P 90 $\beta = 17$	LVLH R= 0.00 P=180.00 Y=270.00	-ZLV -YVV WLES Battery Life Extension
15 001/14:28:34 M 184/10:12:13 G				NH Placeholder TIG 14:28:34 DV = 0
16 001/14:53:00 M 15:04:02 184/10:36:39 G 47:41	M50 (CALC) INRTL R = 101.35 MNVR P = 226.04 PYR Y = 27.03 MNVR A7/AUTO/ALT HOLD (same)	RATE 0.2000 DB AT 2.00 DB RT 0.100 SUN R 336 P 39 $\beta = 15$	+X PYR R = 0.00 P = 10.00 Y = 0.00 LVLH 001/15:13:16 M 184/10:56:55 G	NC-4 +X RCS TIG 15:13:16 DV= 7
17 001/15:20:00 M 24:11 184/11:03:39 G 07:50	EPH TARGET TGT = 1 P = 90.00 BV = 3 Y = 0.00 OM = 0.00 MNVR B7/AUTO/ALT HOLD A7/AUTO/VERN	RATE 0.5000 DB AT 2.00 DB RT 0.100 $\beta = 14$	LVLH R= 0.05 P=271.75 Y= 0.00 TGT VIDFILE: JUL1 VID #: 12	-Z TGT TRK
18 001/16:24:00 M 12 184/12:07:39 G 51	M50 (CALC) INRTL R = 102.00 MNVR P = 225.00 PYR Y = 32.00 MNVR A7/AUTO/ALT HOLD (same)	RATE 0.2000 DB AT 2.00 DB RT 0.100 SUN R 333 P 35 $\beta = 14$	+X PYR R = 0.34 P = 15.53 Y = 0.06 LVLH 001/16:44:39 M 184/12:28:18 G	TI OMS TIG 16:44:39 DV= 8.9
19 001/16:50:00 M 54:03 184/12:33:39 G 37:42	EPH TARGET TGT = 1 P = 90.00 BV = 3 Y = 0.00 OM = 0.00 MNVR B7/AUTO/ALT HOLD A7/AUTO/VERN	RATE 0.5000 DB AT 2.00 DB RT 0.100 $\beta = 14$	LVLH R= 0.68 P=277.14 Y= 0.00 TGT VIDFILE: JUL1 VID #: 12	-Z TGT TRK
20 001/18:03:00 M 10:13 184/13:46:39 G 53:52	LVLH TRACK TGT = 2 P = 270.00 BV = 5 Y = 0.00 OM = 0.00 MNVR A7/AUTO/ALT HOLD (same)	RATE 0.2000 DB AT 2.00 DB RT 0.100 EARTH R 180 P 90 $\beta = 14$	LVLH R= 0.00 P= 0.00 Y= 0.00	+ZLV +XVV Establish RBAR

ALL ORBITER DATA IN
MEAN OF 1950 AND PYR EULER SEQUENCE

Attitude Timeline

MET/GMT	ORBITER		REF ATT/REMARKS	EVENT
	MNVR OPTION	DAP E/S/ β		
21 001/18:30:53 M 184/14:14:32 G	LVLH FREE ROTATION ROTR ABOUT +Y AXIS RATE=0.750 MNVR A9/LVLH/PRI HOLD (same)	RATE 0.7500 DB AT 1.00 DB RT 0.10 $\beta = 14$	LVLH R= 0.00 P= 0.00 Y= 0.00	RPM
22 001/18:39:00 M 50:00 184/14:22:39 G 33:39	LVLH TRACK TGT = 2 P = 179.00 BV = 5 Y = 0.00 OM = 0.00 MNVR A9/AUTO/PRI HOLD (same)	RATE 0.1300 DB AT 1.00 DB RT 0.10 EARTH R 0 P 179 $\beta = 14$	LVLH R= 0.00 P= 91.00 Y= 0.00	-XLV +ZVV TORVA Transition from +RBar to +VBar
23 001/19:40:00 M 184/15:23:39 G	FREE DRIFT Config DAP: A12 for Att. Cntrl		ISS YPR R = 0.00 P = 0.00 Y = 0.00	DOCKING 01/19:40:00
24 001/20:00:00 M 29:40 184/15:43:39 G 16:13:19	COE (CALC) TGT = 2 P = 157.00 BV = 5 Y = 0.00 OM = 178.00 MNVR A12/AUTO/VERN HOLD (same)	RATE 0.1000 DB AT 3.000 DB RT 0.050 EARTH R 0 P 157 $\beta = 68$	ISS YPR R = 0.00 P = 23.00 Y = 178.00 LVLH 001/20:00:00 M 184/15:43:39 G	BIAS -XLV -ZVV ORB R = 181.84 LVLH P = 67.01 Y = 359.22
25 003/14:45:00 M 15:00:20 186/10:28:39 G 43:59	COE (CALC) TGT = 2 P = 157.00 BV = 5 Y = 0.00 OM = 270.00 MNVR A12/AUTO/VERN HOLD (same)	RATE 0.1000 DB AT 3.000 DB RT 0.050 EARTH R 0 P 157 $\beta = 5$	ISS YPR R = 0.00 P = 23.00 Y = 270.00 LVLH 003/14:45:00 M 186/10:28:39 G	Bias -XLV +YVV STS Waste Dump ORB R = 90.00 LVLH P = 90.00 Y = 23.00
26 003/16:25:00 M 40:20 186/12:08:39 G 23:59	COE (CALC) TGT = 2 P = 157.00 BV = 5 Y = 0.00 OM = 178.00 MNVR A12/AUTO/VERN HOLD (same)	RATE 0.1000 DB AT 3.000 DB RT 0.050 EARTH R 0 P 157 $\beta = 5$	ISS YPR R = 0.00 P = 23.00 Y = 178.00 LVLH 003/16:25:00 M 186/12:08:39 G	BIAS -XLV -ZVV ORB R = 181.84 LVLH P = 67.01 Y = 359.22
27 006/15:15:00 M 30:20 189/10:58:39 G 11:13:59	COE (CALC) TGT = 2 P = 157.00 BV = 5 Y = 0.00 OM = 270.00 MNVR A12/AUTO/VERN HOLD (same)	RATE 0.1000 DB AT 3.000 DB RT 0.050 EARTH R 0 P 157 $\beta = -6$	ISS YPR R = 0.00 P = 23.00 Y = 270.00 LVLH 006/15:15:00 M 189/10:58:39 G	Bias -XLV +YVV STS Waste Dump ORB R = 90.00 LVLH P = 90.00 Y = 23.00
28 006/16:35:00 M 50:20 189/12:18:39 G 33:59	COE (CALC) TGT = 2 P = 157.00 BV = 5 Y = 0.00 OM = 178.00 MNVR A12/AUTO/VERN HOLD (same)	RATE 0.1000 DB AT 3.000 DB RT 0.050 EARTH R 0 P 157 $\beta = -7$	ISS YPR R = 0.00 P = 23.00 Y = 178.00 LVLH 006/16:35:00 M 189/12:18:39 G	BIAS -XLV -ZVV ORB R = 181.84 LVLH P = 67.01 Y = 359.22
29 009/15:05:00 M 34:40 192/10:48:39 G 11:18:19	COE (CALC) TGT = 2 P = 180.00 BV = 5 Y = 0.00 OM = 0.00 MNVR A12/AUTO/VERN HOLD (same)	RATE 0.1000 DB AT 3.000 DB RT 0.050 EARTH R 108 P 180 $\beta = -17$	ISS YPR R = 0.00 P = 0.00 Y = 0.00 LVLH 009/15:00:00 M 192/10:43:39 G	-XLV +ZVV Prep for Undock ORB R = 0.00 LVLH P = 90.00 Y = 0.00
30 009/16:01:00 M 192/11:44:39 G	FREE DRIFT for Undocking			UNDOCK 009/16:04

ALL ORBITER DATA IN
MEAN OF 1950 AND PYR EULER SEQUENCE

Attitude Timeline

MET/GMT	ORBITER		REF ATT/REMARKS	EVENT
	MNVR OPTION	DAP E/S/ β		
31 009/16:32:30 M 192/12:16:09 G				SEP 1 TIG: 9/16:33 DV = 1.6
32 009/16:33:30 M 45:02 192/12:17:09 G 28:41	LVLH TRACK TGT = 2 P = 90.00 BV = 5 Y = 0.00 OM = 0.00 MNVR A9/AUTO/VERN HOLD (same)	RATE 0.1300 DB AT 1.000 DB RT 0.020 EARTH R 0 P 90 $\beta = -18$	LVLH R= 0.00 P=180.00 Y= 0.00	Post SEP 1
33 009/16:53:00 M 54:03 192/12:36:39 G 37:42	M50 (CALC) INRTL R = 319.00 MNVR P = 3.00 PYR Y = 60.00 MNVR B7/AUTO/ALT HOLD A7/INRT/PRI	RATE 0.5000 DB AT 2.00 DB RT 0.100 SUN R 157 P 54 $\beta = -18$	+X PYR R = 359.73 P = 179.91 Y = 359.79 LVLH 009/17:01:00 M 192/12:44:39 G	SEP 2 TIG: 9/17:01 DV = 1 Retro Heads Down
34 009/17:05:00 M 09:22 192/12:48:39 G 53:01	LVLH TRACK TGT = 2 P = 90.00 BV = 5 Y = 0.00 OM = 310.00 MNVR A1/AUTO/VERN HOLD (same)	RATE 0.2000 DB AT 1.000 DB RT 0.020 EARTH R 0 P 90 $\beta = -18$	LVLH R= 0.00 P=180.00 Y= 50.00	Biased -ZLV +YVV
35 009/18:55:00 M 19:09:55 192/14:38:39 G 53:34	TGT= 4 BV = 5 P = 0.00 Y = 49.00 OM = 140.00 MNVR A1/AUTO/VERN HOLD (same)	RATE 0.2000 DB AT 1.000 DB RT 0.020 SUN R 90 P 49 $\beta = -18$	INRTL R=323.49 P=116.04 Y= 60.23 RA= 109.904 DEC= 22.185N	STBD WING LDRI Survey
36 009/20:25:00 M 38:17 192/16:08:39 G 21:56	TGT= 4 BV = 5 P = 320.00 Y = 0.00 OM = 325.00 MNVR A1/AUTO/VERN HOLD (same)	RATE 0.2000 DB AT 1.000 DB RT 0.020 SUN R 180 P 40 $\beta = -18$	INRTL R=320.00 P=319.50 Y= 61.35 RA= 109.968 DEC= 22.177N	NOSECAP LDRI Survey
37 009/23:25:00 M 30:31 192/19:08:39 G 14:10	LVLH TRACK TGT = 2 P = 90.00 BV = 3 Y = 0.00 OM = 0.00 MNVR A1/AUTO/VERN HOLD (same)	RATE 0.2000 DB AT 1.000 DB RT 0.020 EARTH R 0 P 90 $\beta = -19$	LVLH R= 0.00 P=180.00 Y= 0.00	-ZLV -XVV Overnight Att
38 010/00:18:00 M 192/20:01:39 G				NC-5 Multiaxis TIG 00:38:00 DV= 0.7
39 010/13:40:00 M 193/09:23:39 G		RATE 0.2000 DB AT 1.000 DB RT 0.020 SUN R 35 P 142 $\beta = -20$	INRTL R= 0.85 HOLD P=137.86 Y=295.35	FCS C/O
40 010/13:45:00 M 46:38 193/09:28:39 G 30:17	LVLH TRACK TGT = 2 P = 90.00 BV = 3 Y = 0.00 OM = 0.00 MNVR A1/AUTO/VERN HOLD (same)	RATE 0.2000 DB AT 1.000 DB RT 0.020 EARTH R 0 P 90 $\beta = -20$	LVLH R= 0.00 P=180.00 Y= 0.00	-ZLV -XVV Return to att. post FCS C/O

ALL ORBITER DATA IN
MEAN OF 1950 AND PYR EULER SEQUENCE

Attitude Timeline

MET/GMT	ORBITER		REF ATT/REMARKS	EVENT
	MNVR OPTION	DAP E/S/ β		
41 010/14:25:00 M 193/10:08:39 G	HOLD A1/INRT/VERN	RATE 0.2000 DB AT 1.000 DB RT 0.020 SUN R 147 P 40 $\beta = -20$	INRTL R=353.55 HOLD P=324.02 Y= 64.36	RCS Hotfire
42 010/14:40:00 M 44:56 193/10:23:39 G 28:35	LVLH TRACK TGT = 2 P = 90.00 BV = 3 Y = 0.00 OM = 0.00 MNVR A1/AUTO/VERN HOLD (same)	RATE 0.2000 DB AT 1.000 DB RT 0.020 EARTH R 0 P 90 $\beta = -20$	LVLH R= 0.00 P=180.00 Y= 0.00	-ZLV -XVV Return to att. post RCS Hotfire
43 010/14:46:00 M 193/10:29:39 G				NC-6 Multiaxis TIG 15:06:00 DV= 0.9
44 010/15:10:00 M 17:30 193/10:53:39 G 11:01:09	LVLH TRACK TGT = 2 P = 90.00 BV = 3 Y = 0.00 OM = 270.00 MNVR A1/AUTO/VERN HOLD (same)	RATE 0.2000 DB AT 1.000 DB RT 0.020 EARTH R 0 P 90 $\beta = -20$	LVLH R= 0.00 P=180.00 Y= 90.00	-ZLV +YVV Cond. Dump
45 010/21:20:00 M 35:00 193/17:03:39 G 18:39	LVLH TRACK TGT = 2 P = 270.00 BV = 5 Y = 0.00 OM = 180.00 MNVR A1/AUTO/VERN HOLD (same)	RATE 0.2000 DB AT 1.000 DB RT 0.020 EARTH R 180 P 90 $\beta = -21$	LVLH R=180.00 P=180.00 Y= 0.00	+ZLV -XVV WSSH Comm Check AOS: 21:40 LOS: 21:49 Max. El: 88.97
46 010/21:55:00 M 22:10:00 193/17:38:39 G 53:39	LVLH TRACK TGT = 2 P = 90.00 BV = 3 Y = 0.00 OM = 0.00 MNVR A1/AUTO/VERN HOLD (same)	RATE 0.2000 DB AT 1.000 DB RT 0.020 EARTH R 0 P 90 $\beta = -21$	LVLH R= 0.00 P=180.00 Y= 0.00	-ZLV -XVV Overnight Att
47 010/23:55:00 M 193/19:38:39 G				NC-7 Placeholder TIG: 23:55
48 011/13:32:00 M 37:43 194/09:15:39 G 21:22	INRTL R = 19.00 MNVR P = 322.00 Y = 42.00 MNVR A1/AUTO/VERN HOLD (same)	RATE 0.2000 DB AT 1.000 DB RT 0.020 SUN R 108 P 57 $\beta = -23$	-Y Star: 60 ENIF 13:31 - 14:19 -Z Star: 16 ACHERNAR 13:37 - 14:25	IMU ALIGN -Y: 60 -Z: 16 PAIR AOS: 13:37 PAIR LOS: 14:19
49 011/13:45:00 M 49:51 194/09:28:39 G 33:30	INRTL R = 283.00 MNVR P = 58.00 Y = 61.00 MNVR A1/AUTO/VERN HOLD (same)	RATE 0.2000 DB AT 1.000 DB RT 0.020 SUN R 161 P 59 $\beta = -23$	-Y Star: 77 ALGENIB 13:45 - 14:35 -Z Star: 33 PEACOCK 13:31 - 14:15	IMU VERIF -Y: 77 -Z: 33 PAIR AOS: 13:45 PAIR LOS: 14:15
50 011/13:55:00 M 14:06:10 194/09:38:39 G 49:49	TGT= 4 BV = 5 P = 184.00 Y = 0.00 OM = 90.00 MNVR A1/AUTO/VERN HOLD (same)	RATE 0.2000 DB AT 1.000 DB RT 0.020 SUN R 180 P 176 $\beta = -23$	INRTL R=203.81 P= 54.64 Y=301.91 RA= 111.728 DEC= 21.943N	-XSI IN ATT @ TIG - 4 HR

ALL ORBITER DATA IN
MEAN OF 1950 AND PYR EULER SEQUENCE

Attitude Timeline

MET/GMT	ORBITER		REF ATT/REMARKS	EVENT
	MNVR OPTION	DAP E/S/ β		
51 011/15:56:00 M 16:05:42 194/11:39:39 G 49:21	M50 (CALC) INRTL R = 333.00 MNVR P = 74.00 PYR Y = 325.00 MNVR A1/AUTO/VERN HOLD (same)	RATE 0.2000 DB AT 1.000 DB RT 0.020 SUN R 90 P 150 $\beta = -23$	+Y PYR R = 0.08 P = 0.22 Y = 30.01 TCSUM 011/15:37:00 M 194/11:20:39 G	COMM
52 011/17:47:00 M 52:54 194/13:30:39 G 36:33	M50 (CALC) INRTL R = 53.00 MNVR P = 249.00 PYR Y = 35.00 MNVR TRN/AUTO/PRI HOLD (same)	RATE 0.5000 DB AT 3.50 DB RT 0.20 SUN R 61 P 28 $\beta = -24$	+X PYR R = 0.64 P = 195.76 Y = 359.54 LVLH 011/18:07:00 M 194/13:50:39 G	D/O BURN Retro Head Down Dual OMS KSC TIG 11/18:07

FLIGHT PLAN NOTES

FLIGHT PLAN NOTES

A. FLIGHT DESCRIPTION

Orbiter: OV-103 Discovery
 Launch Window: 10 minutes
 Inclination: 51.6°
 Insertion / Rndz Altitude: 122 / 185 nautical miles
 Duration: 12 + (1) + 2 days

B. SHUTTLE CREW

CDR – Steve Lindsey	MS3 – Stephanie Wilson
PLT – Mark Kelly	MS4 – Piers Sellers
MS1 –Mike Fossum	MS5 – Thomas Reiter (ISS UP Augmentation)
MS2 – Lisa Nowak	

C. MAJOR EVENTS

<u>EVENT</u>	<u>FD</u>	<u>MET</u>	<u>DATE</u>	<u>CDT</u>	<u>GMT</u>
Launch	1	0/00:00	7/1/06	14:43	182/19:43
OBSS Survey	2	0/18:00	7/2/06	8:43	183/13:43
Ti	3	1/16:45	7/3/06	7:28	184/12:28
DOCK	3	1/19:40	7/3/06	10:03	184/15:03
OBSS Handoff	3	2/00:20	7/3/06	14:63	184/20:03
MPLM Installed on ISS (1 st string bolts)	4	2/17:25	7/4/06	08:08	185/13:08
MPLM Ingress	4	2/23:45	7/4/06	14:28	185/19:28
EVA #1	5	3/18:20	7/5/06	09:03	186/14:03
Crew Conference	6	4/21:00	7/6/06	11:43	187/16:43
EVA #2	7	5/18:05	7/7/06	08:48	188/13:43
MPLM Egress	10	8/14:10	7/10/06	04:53	191/09:53
MPLM Berthed in Shuttle	10	8/21:40	7/10/06	12:23	191/17:23
OBSS Port Survey	10	8/23:40	7/10/06	14:23	191/19:23
ISS Egress	11	9/13:50	7/11/06	04:33	192/09:33
Undock	11	9/16:04	7/11/06	06:47	192/11:47
OBSS Survey STBD/Nose	11	9/18:55	7/11/06	09:38	192/14:38
OBSS Berthed	11	9/23:15	7/11/06	13:58	192/18:58
D/O TIG KSC 187	13	11/18:07	7/13/06	08:50	194/13:50

FLIGHT PLAN NOTES

D. LANDING OPPORTUNITIES

		<u>Landing</u>		<u>CDT</u>	<u>MET</u>
		<u>Orbit</u>	<u>Site</u>		
Nominal	Primary	187	KSC	Thur Jul 13/09:56 AM	11/19:12
	1 Rev Late	188	KSC	Thur Jul 13/11:31 PM	11/20:48
EOM +1	Primary	202	KSC	Fri Jul 14/08:44 AM	12/18:00
	1 Rev Late	203	KSC	Fri Jul 14/10:19 AM	12/19:35
EOM +2	Primary	218	KSC	Sat Jul 15/09:07 AM	13/18:23
	1 Rev Late	219	KSC	Sat Jul 15/10:42 AM	13/19:58

E. COMMUNICATIONS

The Summary Timeline contains several data bands for ground site and TDRS events. The TDRS band reflects the three prime TDRS satellites that will be used for orbiter coverage (East, West, and Z) and their longitudinal positions. Ku-band coverage is shown as unshaded bars.

TDRS-Z currently does not have the capability for DTV, therefore can not be used for critical damage detection. Nor is TDRS-Z considered acceptable for PAO events. OCA downlink is limited to 2 Mbps on TDRS-Z.

Prime TDRS Support: TDRS 46(LON: - 46° W), TDRS 171(LON: -171° W),
TDRS 275(LON -275° W)

Backup TDRS Support: TDRS 41 (LON: -41° W), TDRS 174(LON: -174° W)

U.S. Ground Sites: MIL, DFR, WLP

F. MAJOR PAYLOADS

1. UTILITY LOGISTICS FLIGHT 1.1 (ULF1.1) LAUNCH PACKAGE (LP)

The LP consists of a Multi-Purpose Logistics Module (MPLM), an Integrated Cargo Carrier (ICC), a Lightweight Multipurpose Experiment Support Structure Carrier (LMC), two Assembly Power Converter Units (APCUs), and ISS equipment and supplies in the Orbiter crew compartment.

The ICC is an Orbiter cross-bay logistics cargo carrier, on orbit stowage/EVA work platform, and active science support platform. It spans bays 5 through 7. The ICC will be used to transport the Early Ammonia Thermal Control (EATC) Pump Module (PM) assembly, the Trailing Umbilical System (TUS) Reel Assembly (RA), and two Fixed Grapple Bars (FGBs). The two FGBs will be installed on the FGB Flight Support Equipment (FSE) attached to the ICC.

The Trailing Umbilical System (TUS) Reel Assembly (RA) will be transferred from the ICC to the ISS and the replaced TUS RA will be returned on the ICC.

The MPLM is a pressurized module that will transport (3) International Standard Payload Racks, (ISPRs), (5) Resupply/Return Stowage Platforms (RSPs), and (3) Resupply Stowage Racks (RSRs). The MPLM is used to transfer logistics and utilization items to and from the ISS and will be in the passive configuration.

The Ram Burn Observation (RAMBO) payload will be flown as a Payload of Opportunity. The RAMBO payload does not require any dedicated Orbital Maneuvering System (OMS) burn but does require state vectors. Also, the Maui Analysis of Upper-

Atmospheric Injections (MAUI) payload will be flown as a payload of opportunity and does not require any dedicated burns.

The LMC Cargo Element (CE) is a cross-bay carrier located in bay 13 and will carry the Orbiter Thermal Protection System (TPS) Repair Techniques Development Test Objective (DTO).

Cargo/payload items will be carried in the Orbiter crew compartment including EVA tools and equipment, and other ISS mission-unique support hardware.

Cargo/payload items will also be returned in the Orbiter crew compartment, including a utilization payload, EVA tools and equipment, and other ISS mission-unique support hardware. Unpowered Payloads Human Research Facility (HRF) Renal Stone, European Modular Cultivation System (EMCS) experiment containers, Passive Observation for Experimental Microbial Systems (POEMS) (10 containers (UP), 5 containers (DOWN)), and Fungal Pathogenesis, Tumorigenesis, and Effects of Host Immunity in Space (FIT) Food Tray Changeout.

2. MAJOR MISSION OBJECTIVES

A combination of EVA, robotics, and IVA activities will be performed to accomplish the following major ULF1.1 mission objectives:

- a. Inspect all Orbiter Reinforced Carbon-Carbon (RCC) using the Orbiter Boom Sensor System (OBSS) attached to the SRMS, and downlink sensor data to the ground for evaluation.
- b. Inspect all Orbiter tile using ISS imagery during the rendezvous Rbar Pitch Maneuver (RPM) and the SRMS end effector camera.
- c. Perform two scheduled EVAs and one unscheduled EVA to accomplish DTO 848, DTO 849, DTO 851, and DTO 852. Install the PM on the External Stowage Platform 2 (ESP 2) and two FGBs on the ISS. Remove and replace the Zenith and Nadir Interface Umbilical Assembly (IUA) and the Trailing Umbilical System Reel Assembly (TUS RA).
- d. Transfer MPLM logistics and experiment hardware.
- e. Transfer middeck logistics and experiment hardware.
- f. Augment ISS crew.

G. STATION DEVELOPMENT TEST OBJECTIVE (SDTO)

1. SDTO 12004-U: SHUTTLE BOOSTER FAN BYPASS

The purpose of this SDTO is to increase Shuttle on-orbit cryo margin by bypassing and deactivating the Shuttle booster fan (airlock fan) whenever possible on-orbit. The booster fan will not be activated in post insertion and will remain deactivated for most of the mission. It will however be activated for APDS docking ring extension, docking, and undocking to provide cooling to the powered docking avionics and to prevent condensation on the ODS hatch window. The fan will also be activated when the crew is working in the airlock (such as during EMU checkout) to provide good airflow. While docked, sufficient air circulation will be achieved through use of the Lab forward IMV fan so that CO₂ levels on both the ISS and Shuttle can be controlled during the day by the ISS. During the overnight period, additional remediation may be required to control CO₂

levels in the Shuttle. A real-time call may instruct the crew to replace LiOH on the middeck to supplement the CO₂ removal provided by the ISS, or to reconfigure the duct and turn on the booster fan overnight. Acceptable flow rate through the IMV fan and proper CO₂ levels on the Shuttle throughout the docked timeframe must be confirmed on-orbit to prove this cryo reduction method a success.

H. ON-ORBIT DETAILED TEST OBJECTIVES (DTOs)

1. DTO 848: ORBITER THERMAL PROTECTION SYSTEM (TPS) REPAIR TECHNIQUES

The purpose of this DTO is to perform an on-orbit EVA demonstration of the tools and techniques developed to repair damaged Orbiter TPS tiles and RCC; however effective RCC repair techniques have not been developed to date. Tile samples will be mounted into the TPS Sample Box Assembly (SBA) and onto the upper surface of the LMC. The EVA crew will translate to the DTO worksite on the LMC, open the SBA protective cover, and use EVA tools such as the CIPAA and Emittance Wash Applicator to repair damaged tile samples. The SSRMS will be used to position EV crewmembers at the worksite. Tile repair objectives include: 1) demonstrate adhesion of ablative repair material using various application techniques and repair depths, 2) perform repairs to be evaluated post flight, 3) demonstrate that tile repair can be accomplished without significant voids in the ablator material, 4) demonstrate that recommended techniques are effective given environmental factors, and 5) evaluate ablator material hardness after it has cured. RCC repair hardware and techniques may also be evaluated if viable methods are developed in time. MV/Orbiter Project Office is responsible for the design and development of this DTO.

2. DTO 849: OBSS/SRMS LOADS CHARACTERIZATION WITH EVA CREWMEMBER

The objective of the DTO is to characterize the loads and boom motion/deflection that are caused by an EV crewmember located at the end of the OBSS/SRMS. The measured EVA induced loads and boom tip deflections will be used to validate the 3 DOF Simulator, and to develop load-minimizing techniques, worksite stability requirements and associated hardware in order to accomplish EVA inspection and repair of the Thermal Protection System.

Loads data and deflection measurements will be made with an EVA crewmember simulating typical EVA operations that envelope the loads expected to be imparted on the system for all boom-based operations. Data will be taken at several different SRMS positions to envelope the range of SRMS stiffness, from the weaker SRMS positions to the more sturdy positions. The EVA loads will be measured during all operations using EVA DTO hardware (Instrumented Worksite Interface - I-WIF), and the system dynamic response monitored and recorded.

3. DTO 850: WATER SPRAY BOILER COOLING WITH WATER/PGME ANTIFREEZE

The purpose of this DTO is confirm ground test results for Water Spray Boiler (WSB) capability post APU shutdown and confirm that coolant usage is within predictions. A special antifreeze of water and propylene glycol monomethyl ether (PGME) mixture will be loaded into WSB 3 only. All three APUs will be shut down per the nominal Post Insertion timeline and allowed to cool. Then APU 3 will be restarted in OPS 8 and allowed to heat until the WSB is commanded to spray. The APU 3 will be restarted while it is still warm but has not cooled below its normal restart limits, thus the restart will be a real-time call based on temperatures. APU 3 is projected to cool to the restart limits around MET 0/03:45 based on previous flight data. After cooling capability has been verified, APU 3 will be shut down again.

4. DTO 851: EXTRAVEHICULAR ACTIVITY (EVA) INFRARED (IR) CAMERA

The purpose of this DTO is to test the application of an IR camera for on-orbit RCC inspection by the EVA crewmember. Ground testing and analysis will provide a baseline inspection technique and an initial characterization of the IR camera performance. However, on-orbit testing is required to validate the EVA inspection/damage detection techniques and characterize expected flight performance.

Specific objectives of the DTO are to:

1. Measure the surface temperature profile of the WLE RCC under on-orbit solar heating. This will provide the data necessary to update ground thermal models and refine the inspection/damage detection technique.
2. Compare IR imagery of an RCC test article with known damage taken on-orbit to ground imagery of the same RCC test article. This will enable analysts to characterize the expected flight performance of the EVA IR camera based on ground test results.

These objectives will be accomplished by having an EVA crewmember image both a WLE RCC panel and an RCC test article with known damage.

The priorities for the above test objectives are: 1) WLE imagery; and 2) Damaged sample imagery. A third priority would be to image RCC repair DTO samples (if flown) both before and after repair attempts.

5. DTO 852: SRMS ON-ORBIT LOADS, HEAVY PAYLOADS

The objective of the DTO is to characterize the loads that are induced into the SRMS system during “non-typical” loaded SRMS operations and to correlate these SRMS loads to math models. “Non-typical” operations can be defined as operations that fall outside the current historical operational dataset for the SRMS. These operations include but are not limited to heavy payload maneuvering and interaction with a vehicle’s motion control system, payloads that do not meet current SRMS requirements or new operational techniques that include EVA worksite stabilization at the end of the grappled OBSS. The loads being used for STS-121 will be the EVA induced loading from DTO 849. The data will be downloaded from the WSGIS computer and downlinked via OCA for processing.

I. ON-ORBIT DETAILED SUPPLEMENTAL OBJECTIVES (DSOs)

1. DSO 490B: BIOAVAILABILITY AND PERFORMANCE EFFECTS OF PROMETHAZINE DURING SPACE FLIGHT

The purpose of this DSO is to evaluate Promethazine (PMZ) as an aid for space motion sickness. All participants will don an Actilight watch as soon as possible on orbit, and will record sleep times at wakeup. If motion sickness occurs during the first three days, participants will collect a saliva sample, take PMZ, and complete a series of saliva samples and logs.

2. DSO 493: MONITORING LATENT VIRUS REACTIVATION AND SHEDDING IN ASTRONAUTS

The objective of this DSO is to determine the frequency of induced reactivation of latent viruses, latent virus shedding, and clinical disease after exposure to the physical, physiological, and psychological stressors associated with space flight. Participants will collect a saliva sample and complete a log entry at wakeup.

3. DSO 633B: RENAL STONE RISK DURING SPACE FLIGHT, ASSESSMENT AND COUNTERMEASURE VALIDATION

The purpose of this DSO is to quantify the risk of renal stone formation associated with space flight, evaluate the effects of dietary intake on the urinary biochemistry, and determine the effects of potassium citrate as a countermeasure in reducing the potential for renal stone formation. Participants will ingest a potassium citrate (Kcit) pill with each evening meal.

4. DSO 634: SLEEP/WAKE ACTIGRAPHY AND LIGHT EXPOSURE DURING SPACE FLIGHT

The objective of this DSO is to monitor sleep-wake activity and light exposure patterns obtained in-flight, to better understand and develop countermeasures for insomnia common in space flight. Participants will don an Actilight watch as soon as possible on orbit, and will wear it continuously throughout the mission on their non-dominant wrists outside of their clothing/sleeve. A common Actilight watch is used for DSO 490B. Subjects will also complete a sleep log within 15 minutes of wakeup every morning.

This Page Intentionally Blank

FLIGHT PLAN WALKTHROUGH WITH RATIONALE

FLIGHT PLAN WALKTHROUGH

Station Activities Performed Prior to Shuttle Docking

- Prepacking
- ULF1.1 timeline review
- RPM photography training
- SSRMS checkout & move from MBS to Lab PDGF
- ITCS sampling
- VDS routing
- Node 1 nadir CBM checkout
- Airlock prep for EVA ops, EMU battery recharge, METOX regen, Safer checkout, and EVA tool configuration
- CBCS install and checkout
- PMA prep for docking

Generic Activities/Constraints

- Daily log entries for DSO 634 and saliva samples for DSO 493 are collected every morning at wakeup.
- A total of 15 CWCs and 4 PWRs are filled and transferred to ISS. CWCs and PWRs can not be filled at the same time since EECOM would not be able to tell how much water is in each. PWR fills can not occur during supply nozzle dumps.
- An estimated ~98 man-hours are required for MPLM generic transfer, and 30 hours for middeck transfer. Powered payload, EVA equipment, and water bag transfers are scheduled separately from generic transfer. MS3 (loadmaster), FE-2 (b/u loadmaster), and/or STS CDR will perform a transfer review every docked morning to review the latest uplinked transfer list. A transfer tagup between crewmembers and a transfer call to MCC are scheduled for MS4, FE-2 and/or STS CDR every docked day starting approximately 3 hours prior to sleep.
- All nominal EVAs are performed using the ISS airlock and the CEVIS exercise prebreathe protocol. The Shuttle crew is prime for all SSRMS and EVA tasks. MS1 and MS4 are EV2 and EV1, respectfully, PLT is IV1, ISS FE-1 is IV2, and MS2 and MS3 are SSRMS operators. CDR will perform any SRMS tweaks for camera views if necessary although none are scheduled.
- The SRMS is used for OBSS operations and EVA camera views. The SSRMS is used for MPLM operations, OBSS survey camera views, and EVA robotics operations. SSRMS operators are MS2 and MS3 and SRMS operators are CDR and MS1. CDR, MS1, MS2, and MS3 are prime for OBSS/SRMS survey operations.
- Water dumps will be performed in the nominal +YVV docked attitude. The Shuttle will maneuver the stack to the dump attitude and hold attitude control during all dump events. Three hours is the maximum excursion time from docked attitude for water dumps.
- TFLs:
 - TFL 192 is required for TCS during rndz tool c/o, rendezvous, and undocking. SSV Outrate = 3.
 - TFL 184 is required for MPLM environmental checks and is the default while undocked. SSV Outrate = 3.
 - TLF 199 is used while docked. SSV Outrate = 2.
 - TFL 161 is required for FCS C/O.
- Matrix aligns are required during the docked period because there are no stack maneuvers scheduled for stars of opportunity.

Flight Day 1

- Setup will be completed for the KFX PGSC, router, color printer, and the three A31Ps for WLES sensor data, ET Umbilical Photos (DOUG machine), and LCS. The crew will download the ET photos and WLES data to the A31Ps as soon as possible so OCA can downlink them for ground processing. The crew will also load ET handheld camera still photos to the KFX machine for downlink. The remainder of the network setup is scheduled on FD2.
- The ET handheld camera video will be downlinked during Ku coverage.
- Almost two hours of P/TV01 setup is completed. This activity sets up all photo/TV equipment needed for the FD2 OBSS survey. SSV setup is performed for still video of FD01 activities. A TFL conflict exists between SSV Setup and the WSB DTO. This may cause SSV to be delayed.
- APCU 1 and OIU are momentarily activated so MCC can perform an MPLM environmental check. The FD1 check is a full check with fan activation.
- The RMS powerup includes deployment of both port and starboard MPMs (RMS and OBSS respectfully).
- WSB DTO is performed by starting APU 3 when the APU is at a good temperature per real time call (~3:30 MET). Elevon park is also included in this procedure since both require Ops 8. NC-1 was moved late to accommodate the Ops 8 transition.
- FRED setup is performed to provide operational relief to the SRMS operators.
- Actilight watches are donned for DSO 634 just prior to the first sleep period.

Flight Day 2

- RMS C/O must be performed prior to beginning the OBSS surveys. RMS powerup is not required as the arm was powered overnight.
- Manual FC purge is scheduled early to avoid survey because of possible contamination on the LDRI.
- PGSCs are set up if not completed on FD1.
- APCU 1 is momentarily activated so MCC can perform an MPLM environmental check (pressure check only).
- All starboard wing, nose cap, and port wing RCC are surveyed with the OBSS LDRI. Scans of the starboard wing and nose cap may not be performed while docked so these are scheduled first in the timeline. Three crewmembers are required continuously during the survey with two performing OBSS/SRMS ops and one monitoring the LDRI and situational awareness cameras. Only two crewmembers are required during unberthing and berthing (non laser ops). The survey is scheduled to continue through the night passes due to time constraints, but the crew may elect to pause if the night time visuals are not sufficient.
 - The LDRI survey attitude requires no sun within +/- 10 degrees of the laser FOV. Real-time Ku is required during the LDRI 3D calibration in OBSS unberth and during LDRI mode changes in Flat Fields. Each 90-minute surface scan requires as much real-time Ku as possible to downlink DTV. Inertial attitudes are scheduled to maximize Ku and to optimize LDRI sun avoidance. Specifically, the wing attitudes put the sun on the wing in the X-Y plane ~60 degrees from the nose, and the nose cap attitude puts the sun on the nose pitched down 30 degrees to avoid sun in the crew's eyes. All maneuvers are scheduled to occur during SRMS/OBSS repositioning. If maneuvers are required during the survey, the scanning will be paused during maneuver init and term. VERN/ALT attitude hold is acceptable for LDRI. A special DAP (A14) is loaded in Unberth and used during the survey. Nose jets are disabled during the nose cap survey and ALT/tail only is selected per the procedure.
 - Replay of survey data not obtained real-time is scheduled prior to presleep. INCO will provide LOS times in order to help the crew cue the tapes. A dedicated maneuver may be required in order to get enough LDRI downlink time. Note: TDRS Z does not have the capability for DTV, thus can not be used to downlink critical damage data.
 - LCS notes: LSC will be used as a backup to LDRI. LCS has no lighting constraints and requires OCA downlink of data instead of video downlink. LCS requires masking from

Ku radiation during surveys due to data degradation. LCS also requires certain S-band antennas be inhibited during data takes but this is handled by the procedure.

- ISIS Digital Camera (IDC) notes: The ISIS Digital Camera is capable of snapping single frame, highly detailed photos from the end of the boom. These photos can then be downlinked via OCA. The camera requires either direct sunlight or Earth-shine lighting. No nominal operations are planned.
- SRMS end effector survey of the crew cabin is performed. Real-time Ku is desired to downlink survey video. The SRMS must be in pre-cradle prior to NC-3 and will remain in pre-cradle through docking.
- The OMS pod tiles are surveyed with digital pictures from the AFD windows. Daylight, and either -ZLV or an inertial attitude that puts the sun on the OMS pos is required for good lighting.
- The airlock fan is turned off for the mission to save cryogenic consumables per SDTO 12004-U. It is activated before ODS ring extension to provide cooling to docking avionics, and will remain activated during EMU checkout(c/o) to provide airflow to the crew while they're working in the airlock. Airlock fan is turned off after EMU checkout is complete.
- Rendezvous prep activities are performed including centerline camera install, rendezvous tool checkout, ODS ring extension, and rendezvous burns. Centerline camera install will be performed prior to survey because the same monitor is used for the camera cross hair check as for LDRI video. Rendezvous tool checkout must be performed after the OBSS surveys are complete due to the fact that RSAD will be running continuously on the prime RPOP machine. Rndz tool c/o must be decoupled with APCU on for MPLM checks due to a TFL conflict. NC2 is scheduled early in post sleep and NC3 is scheduled late to avoid the survey.
- P/TV01 setup is completed.
- Middeck transfer prep is scheduled to prepare items for transfer to ISS.
- CWC fill equipment is set up and one bag is filled.
- Sleep begins at MET 1/05:00, two hours earlier than on launch day, to shift the crew for an early docking and set up the sleep cycle to support EOM landing.

Flight Day 3

- CDR and PLT begin the rendezvous sequence after the minimum post sleep.
- APCU 1 is momentarily activated so MCC can perform an MPLM environmental check (pressure check only).
- FIT food tray change out will be performed. No other actions are required for this payload.
- The condensate collection hardware is setup and a collection is initiated. Two bags will be collected during the docked timeframe and will be discharged overboard on end-of-mission - 1 day.
- One CWC is filled and 2 CWC bags are transferred.
- The two EMUs are removed from the Shuttle airlock and temp stowed prior to docking to facilitate PMA access/transfers after docking.
- As part of the rendezvous procedures, the crew will perform a 360° Rbar pitch maneuver while the ISS crew takes digital photos of the lower and upper tile surfaces. The ISS crew will load these photos onto the network so that ISS OCA can downlink them as soon as Ku is available.
- After docking, the Shuttle will maneuver the stack to the docked TEA attitude (STS biased - XLV -ZVV) after rates are damped. Ten minutes into the maneuver, the DAP will be moded to FREE for at least 2 seconds then back to AUTO. This will again be performed after an additional ten minutes. DRAPER analysis indicates this will prevent the jets from excessive firings. Once in attitude, the crew will perform attitude control handover from Shuttle to US CMG TA.
- After docking, leak checks are performed on the PMA and ODS, the ODS is prepared for ingress (centerline camera removed and ducting prepared), and hatches are opened. STS and ISS crewmembers will participate in a 25-minute safety briefing. The airlock fan is bypassed and deactivated as part of the post docking procedures.

- The STS PGSC network is reconfigured from the rendezvous configuration to the EVA/RMS configuration to support OBSS and SRMS operations.
- During the EVA prep for transfer procedure, the crew will pack the two EMUs and EVA tools for transfer to ISS.
- EVA tools are transferred to ISS.
- The OBSS is unberthed by the SSRMS and handed off from the SSRMS to the SRMS. Two SRMS crew and two SSRMS crew are required for this entire operation. ISS FE-1 will provide SSRMS support during the OBSS ungrapple since this is the first use of the SSRMS by the Shuttle crew. During SSRMS unberth of the OBSS and maneuver to handoff position, the SRMS cameras will provide clearance monitoring. After handoff is complete, the SSRMS is maneuvered to a position for an overnight MCC commanded petal deploy and seal inspection on the Node 1 Nadir ACBM. The SRMS/OBSS will remain deployed and powered for the entire docked mission.
- Augmentation is complete once the IELK is installed and checked out. A SOKOL leak check is scheduled to complete the IELK installation.
- The connections for ROOBA are performed and a gross leak check for overnight is initiated (Part 1).

Flight Day 4

- APCU 1 is momentarily activated so MCC can perform an MPLM environmental check (pressure check only) prior to MPLM unberth.
- Once the SSRMS grapples the MPLM, the ROEU is disconnected, the PRLAs unlatched, and the MPLM is unberthed from the payload bay and installed onto ISS Node 1 Nadir port. MS1 and MS4 will provide camera views (P/TV06) to the SSRMS operators until they are needed for the PCMB inspection. During MPLM install and in the low hover position, MS1 and MS4 will use the PLB cameras to perform a PCBM seal inspection. MS1 and MS4 will transition to the ISS Lab for the Node 1 CBM Verify Pre-mate Status while the PLT will continue P/TV06 operations for the SSRMS operators.
- CBMs are closed after MPLM installation is complete. No exercise is allowed once the MPLM is moved from Pre-Install position until 12 bolts are acquired. The one hour CBM bolt loading must be completed by MCC before the vestibule can be pressurized. The CBCS is removed and the equipment needed for vestibule configuration is set up.
- STS CDR and FE-2 will continue with vestibule press, vestibule configuration for ingress, MPLM activation parts I and II, MPLM ingress, and MPLM setup. Once the CDR is finished with Activation, he will join FE-2 in the removal of the CPAs.
- Two hours and forty minutes of OBSS survey is scheduled as a placeholder in the afternoon. This may be used to complete the nominal FD2 RCC survey if it runs long, or to perform a focused inspection on areas where tile or RCC damage is suspected. The SSRMS will be based on the MBS for situational awareness views. After MPLM ungrapple, MS2 and ISS FE-1 will setup the SSRMS for use in Survey situational awareness by performing an SSRMS walkoff from the lab to the MBS (MBS GRAPPLE) and then maneuvering the SSRMS to a viewing position prior to the survey. Due to the TUS failure on ISS, the SSRMS will grapple the Lab after survey operations to provide a redundant power path.
- Several activities are scheduled throughout the day for the EVs and IVs to prepare the EMUs and airlock equipment for EVA 1. The two EVs will familiarize themselves with CEVIS Exercise equipment as it is used during the ISS EVA prep prebreathe protocol. The EMUs are transferred to the ISS airlock and reconfigured as necessary with parts from ISS. Two DCS 760s are set up, one with flash and one without. The equipment lock and EVA tools are configured. The REBA hardware is checked out. ROOBA leak check and checkout part 2 and the ROOBA P/B test are performed. A one hour EVA procedure review is conducted between all crewmembers involved with the EVA including the CDR, EVs, IVs, and SSRMS and SRMS operators (all except ISS FE-2).
- RJMC is transferred from the MPLM to the A/L in preparation for EVA2
- N2 transfer from the Shuttle to the ISS airlock tanks is initiated.
- Two CWCs are filled.

- MDDK transfer is performed as available.
- A midday shuttle PAO event is scheduled on A/G only because all available Ku is needed for downlink of LDRI data. An ISS PAO event is scheduled on the three ISS crewmembers just prior to the DPC.
- SOKOL Dry and SOKOL glove stow activities are scheduled but may be removed if deemed unnecessary by the Russian Planners.

Flight Day 5

- Stack is maneuvered to the dump attitude by shuttle and a Waste Water dump is performed. After the dump the stack is maneuvered back to the TEA attitude and control is returned to ISS.
- EVA PREP is performed using ISS O2.
- Prior to the beginning of the EVA, the SSRMS will ungrapple the MBS in order to support camera views of the EVA.
- EVA1 tasks include: DTO 849 OBSS/SRMS loads characterization with EVA crewmember.
- Post EVA H2O recharge is delayed until the following day to maximize presleep. BSA battery charging is initiated.
- Two CWCs are filled and transferred to the ISS.
- MPLM transfer continues by ISS crewmembers. Based on crew input, this will not begin until EVA prep is complete.
- The MELFI rack transfer is scheduled separately from MPLM transfers and are performed by two ISS crewmembers.

Flight Day 6

- EMU water recharge is performed. EMU METOX/LiOH/Battery replacement procedure is performed with LiOH being installed into the EMUs. The crew will prepare for EVA 2 with equipment lock prep, 760-electronic still camera set up, and EVA tool configuration. BSA battery charging is terminated. A one-hour EVA procedure review is conducted between all crewmembers involved with the EVA including the CDR, EVs, IVs, and SSRMS and SRMS operators (all except ISS FE-2).
- The SAFER that was brought in the MPLM is checked out for the ISS.
- The 3rd EMU containing the advanced C&W is transferred from STS to ISS and checked out.
- Two CWCs are filled and transferred to the ISS.
- MPLM transfer continues.
- The CDR is managing the onboard ISS LiOH with multiple transfers and swaps.
- The crew conference and photo are scheduled using Shuttle assets.
- The Lab1S6 CCAA heat exchanger is transferred.

Flight Day 7

- EVA crewmembers start into EVA PREP using ISS O2.
- DOUG setup is scheduled prior to EVA 2 Robotic activities.
- EVA 2 specific tasks include ORU transfer and TUS R&R.
- The crew will utilize the SSRMS based on the Lab PDGF for EV worksite access. The SSRMS is maneuvered to the MPLM viewing position after all EVA tasks are complete.
- Post EVA: H2O recharge and EMU METOX/LiOH/battery replacement are delayed until the following day to maximize presleep.
- Two CWCs and two PWRs are filled. The condensate bag is changed out on Shuttle.
- MPLM transfer continues on a non-Lab/SSRMS interference basis.

Flight Day 8

- Wastewater and PWR dumps are performed. The crew will perform attitude control handover from CMGs to Shuttle before the dump and back to CMGs after the dump.
- A US PAO event is scheduled using Shuttle assets.
- Two CWCs and one PWR are filled.

- EMU water recharge is performed. EMU METOX/LiOH/Battery replacement procedure is performed with LiOH being installed into the EMUs.
- MPLM and Middeck transfer continues. 3 computers are transferred from Shuttle to ISS (PCS, WLES, and RPOP2). The LCC laptop is configured with the WLES antenna so that data can still be retrieved.
- N2 transfer from the Shuttle to the ISS airlock tanks is terminated.

Flight Day 9

- Six hours and forty-five minutes of off duty are scheduled for the Shuttle crew. PFCs are scheduled for each crewmember during off duty. Off duty is not required for the ISS crew.
- ISS housekeeping items and two ISS PAO events are performed during this time.
- ISS crew performs CEVIS R&R which removes the parts of the current exercise machine and places them in the MPLM for return.
- The ISS crew will perform CPA install.
- The MPLM Cleanup is performed by the two STS loadmasters and racks are configured for entry. All MPLM transfer is complete at this point.
- A Printer swap is performed by an ISS and STS crewmember that also involves a verification of a working Shuttle printer after the swap has occurred
- STS PAO event occurs in the late afternoon.
- PWR fills and xfers occur prior to Pre-sleep.

Flight Day 10

- STS CDR and FE-2 will perform MPLM egress, deactivation, vestibule configuration, and vestibule depress.
- Between the PLT, MS1, and MS4, the EMUs are reconfigured for return to the shuttle. EVA tool management is completed. The 760 flash is removed from the camera and stowed.
- Morning PAO event occurs for all crewmembers except CDR and FE-2.
- DOUG is once again setup in preparation for MPLM Uninstall Robotic activities.
- After vestibule depress, the STS crew will perform Node 1 Nadir CBM demate, and uninstall and reberth the MPLM in the PLB using the SSRMS. No exercise is allowed during CBM demate and MPLM uninstall. The MPLM heater logic is activated. After MPLM is berthed, APCU 1 is momentarily activated so MCC can perform a pressure check.
- Once again, the SSRMS is relocated to the MBS. Following an SSRMS maneuver to support survey viewing, the OBSS is again used to scan the Port wing for Late Inspection requirements. Due to ISS structural interference, no other scans are possible, at this time. Following the LDRI scan, the OBSS is maneuvered to the previous OBSS handoff position in preparation for undock.
- Two CWCs and one PWR are filled and transferred.
- MDDK transfer concludes.
- P/TV08 ISS external survey is performed over a daylight pass.
- Rendezvous tool checkout is completed following the robotics operations. It must be decoupled with APCU on for MPLM checks due to a TFL conflict.

Flight Day 11

- The crew will close the hatch between vehicles, install the centerline camera, and perform an ODS leak check.
- The formaldehyde monitoring kit (FMK) deploy is performed. It must be stowed after 48 hours.
- The crew will perform handover of attitude control from CMGs to STS and maneuver to undock attitude.
- There is no flyaround due to time constraints resulting from the addition of Late Inspection.
- Illuminators are deactivated.
- APCU 1 is momentarily activated so MCC can perform an MPLM environmental check (pressure check only).
- The centerline camera is removed from the ODS (P/TV03).

- A maneuver to -ZLV +YVV attitude is performed soon after undocking and a simultaneous supply and waste dump is performed once ISS is out of range for dump particle re-contact
- The communication system string 1 check out.
- The maneuver to a sun avoidance inertial attitude protects the LDRI sensor during the Starboard and Nose Cap surveys. Following the surveys, the OBSS is berthed.
- The starboard and port MPMs are stowed RMS is power downed.
- The EV crewmembers prep the middeck for entry with EMU Hardware Stow and Post EVA Entry Prep.
- MS4 reconfigures the PGSC network for post-undocking operations.
- The RCS NC-5 burn sets up the re-rendezvous forty nautical mile station keeping (football).

Flight Day 12

- Following FCS checkout and RCS hot-fire, NC-6 cleans up the re-rendezvous “football” with a small RCS burn.
- APCU 1 and OIU are momentarily activated so MCC can perform an MPLM environmental check (pressure check only). Once this last MPLM check is complete, the OIU is deactivated.
- Standard day before entry activities are performed: PILOT ops, de-orbit briefing, L-1 communication checks, cabin stow, entry video setup, SSV deactivation, ergo meter stow, Ku stow, PGSC stow, and MFX setup (may be deleted) and MPM stow.
- One U.S. PAO event is scheduled for all crewmembers.
- Condensate dumps for two bags and a simultaneous supply and waste dump are performed.
- A FES dump is performed for 2.5 hours.
- RCC DTO tools are stowed.
- The WLES (LCC) A31P laptop and equipment is stowed. The WSGIS antenna is torn down and stowed.
- The communication system is switched back to communication string 2 after 24 hours.
- The Entry Video is configured.
- The Fuel Cell Monitoring System data will be retrieved and downlinked via OCA.
- NC-7 burn placeholder is scheduled in case Re-rendezvous to station is required. If NC-7 not required this will be replaced by an Orbit-Adjust burn to optimize landing opportunities.

Flight Day 13

- Standard entry day activities are performed: IMU align, GIRA stow, TEPC stow, air sample, OCAC stow, PGSC and printer stow (if required), group B powerup, and mnvr to -XSI.
- The DSO actilight watches are stowed after final log.
- The formaldehyde monitoring kit (FMK) stow is performed after 48 hours of deployment.
- Deorbit prep and landing at KSC.



FLIGHT PLAN

STS
121