

Flight Plan

STS-60

(Rotated FRR Cycle Trajectory)

Mission Operations Directorate
Operations Division

Final
December 14, 1993

<u>EVENT</u>	<u>CST</u>		
Launch	06:14	Thur	Jan 27
WSF Release	10:04	Sat	Jan 29
WSF Grapple	14:14	Mon	Jan 31
ODERACS Deploy	08:59	Wed	Feb 02
BREMSAT Deploy	13:53	Wed	Feb 02
KSC Landing	11:46	Fri	Feb 04

National Aeronautics and
Space Administration

Lyndon B. Johnson Space Center
Houston, Texas

BRANCH CHIEF
S. NUTE
DC4
BOND



MISSION OPERATIONS DIRECTORATE

STS-60 FLIGHT PLAN

FINAL
December 14, 1993

PREPARED BY:



John M. Curry
Book Manager

APPROVED BY:

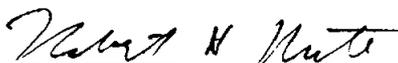
Ben E. Ferguson
Head, Flight Planning and
Operations Section

Robert H. Nute
Chief, Space Shuttle Flight
Planning Branch

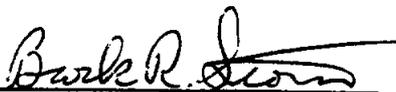
Earl W. Thompson
Chief, Operations Division

Brock R. Stone
Assistant Director,
Space Shuttle Program

Operatecar

This document is under the configuration control of the Crew Procedures Control Board (CPCB). All proposed changes must be submitted on JSC Form 482 to DO4/FDF Manager.

Additional distribution of this book for official use must be requested in writing to DO4/FDF Manager. The request must include justification and requester's name, organization, position, and phone number. Contractor requests are made through the NASA or DOD organization supported. Deletions, reduction in quantity, or change of address may be submitted to DO4/FDF distribution manager, (713) 244-7893.

Incorporates the following:			
482#:	FLT PLN-1574A	FLT PLN-1584	MULTI-940A
	FLT PLN-1579	FLT PLN-1585	MULTI-936
	FLT PLN-1580	FLT PLN-1586	
	FLT PLN-1582	FLT PLN-1587	
	FLT PLN-1583		Exemptions: #54, #55

AREAS OF TECHNICAL RESPONSIBILITY

Book Manager/Lead FAO	DO4/J. Curry	244-7936
Lead Timeliner	DO4/S. Greene	244-7712
Lead Pointer	DO4/C. McKenna	244-7863

3-77 60/FIN
 3-78 60/FIN
 3-79 60/FIN
 3-80 60/FIN
 3-81 60/FIN
 3-82 60/FIN
 3-83 60/FIN
 3-84 60/FIN
 3-85 60/FIN
 3-86 60/FIN
 3-87 60/FIN
 3-88 60/FIN
 4-1 60/FIN
 4-2 60/FIN
 4-3 60/FIN
 4-4 60/FIN
 4-5 60/FIN
 4-6 60/FIN
 4-7 60/FIN
 4-8 60/FIN
 4-9 60/FIN
 4-10 60/FIN
 5-1 * 60/FIN
 5-2 * 60/FIN
 5-3 * 60/FIN
 5-4 * 60/FIN
 5-5 * 60/FIN
 5-6 * 60/FIN
 5-7 * 60/FIN
 5-8 * 60/FIN
 6-1 * 60/FIN
 6-2 * 60/FIN
 6-3 * 60/FIN
 6-4 * 60/FIN
 6-5 * 60/FIN
 6-6 * 60/FIN
 6-7 * 60/FIN
 6-8 * 60/FIN
 6-9 * 60/FIN
 6-10 * 60/FIN
 6-11 * 60/FIN
 6-12 * 60/FIN
 6-13 * 60/FIN
 6-14 * 60/FIN
 6-15 * 60/FIN
 6-16 * 60/FIN
 6-17 * 60/FIN
 6-18 * 60/FIN
 6-19 * 60/FIN
 6-20 * 60/FIN
 7-1 * 60/FIN
 7-2 * 60/FIN
 7-3 * 60/FIN
 7-4 * 60/FIN
 7-5 * 60/FIN
 7-6 * 60/FIN

7-7 * 60/FIN
 7-8 * 60/FIN

(*) - Omit from flight book

This Page Intentionally Blank

<u>CONTENTS</u>	<u>PAGE</u>
INTRODUCTION	viii
STS-60 OVERVIEW	1-1
SUMMARY TIMELINE	2-1
DETAILED TIMELINE	3-1
CONTINGENCY TIMELINES	4-1
MINIMUM DURATION FLIGHT (MDF) TIMELINE	4-2
WSF 1-DAY LATE DEPLOY/RETRIEVE TIMELINE	4-4
WSF NO DEPLOY TIMELINE	4-8
ATTITUDE TIMELINE	5-1
STS-60 DAP BOOK	6-1
STS-60 FLIGHT PLAN NOTES	7-1

INTRODUCTION

The STS-60 Flight Plan is the Flight Data File article that contains the on-orbit timeline. It does not contain the detailed timelines that are covered in the Ascent, Post Insertion, Rendezvous, Deorbit Prep, and Entry Checklists. The detailed rendezvous timelines and procedures are in the Rendezvous Checklist. For continuity, the entire flight is shown in the summary level timeline.

This on-orbit timeline satisfies the objectives specified in the Flight Definition and Requirements Directive and the requirements of the STS-60 Flight Requirements Document. The Flight Plan, as part of the Flight Data File, meets the specifications of the STS-60 Flight Initialization Data Pack.

The flight profile used for this Flight Plan is for a launch date of January 27, 1994 at 06:14 CST. Orbiter inertial attitudes are expressed relative to a Mean of 1950 (M50) reference frame.

JSC-22359, Crew Scheduling Constraints (Appendix K, CPMP), Basic, Rev B, January 1992, has been used to build the timelines contained in this Flight Plan. Two Appendix K exemptions are approved for this flight. Exemption #55 allows blood draws and peripheral venous pressure measurements during postsleep on Flight Days 2 and 7. This is required by DSO 202, Joint U.S./Russian Metabolic Investigations. Exemption #54 allows a work day longer than 8 hours, no exercise, and a short meal during the rendezvous and plume impingement experiment on Flight Day 5 so long as a no later than grapple time (corresponding to wakeup +13 hours) is defined. This is required to accomplish the Wake Shield Facility Plume Impingement Investigation (two orbits of additional proximity operations prior to WSF capture).

STS-60 OVERVIEW

SUMMARY TIMELINE

This Page Intentionally Blank

GMT (D:H:M)	MET (D:H:M)	CST (D:H:M)	FD/ DOY	BETA	MOON	HOUSTON DATE	FLIGHT	EDITION	PUB. DATE		
034:12:14/ 035:00:14	007:00:00/ 007:12:00	034:06:14/ 034:18:14	08/034 CST	-43.7		FEBRUARY 3, 1994	STS-60	FINAL	12/14/93		
CST :034 FD :08 MET :007	0 1 2 3 4 5 6 7 8 9 10 11 12										
CDR BOLDEN	FCS C/O	URRNSAL	EXERCISE	MEAL	SAREX STOW	CABIN STOW	PRE SLEEP	PRE SLEEP			
PLT REIGHTLER	FCS C/O	EXERCISE	VHM SUBJ	MEAL	VHM OPER	CABIN STOW	PRE SLEEP				
MS1 DAVIS	VHM SUBJ	OKN SUBJ	VHM OPER	OKN OPER	VHM OPER	OKN OPER	MEAL	EXERCISE	MODULE TRDN	CABIN STOW	PRE SLEEP
MS2 SEGA	FCS C/O	VHM SUBJ	OKN SUBJ	EXERCISE	MEAL	PSU VOV4	ERGOMETER STOW	CABIN STOW	CABIN STOW	PRE SLEEP	
MS3 CHANG-DIAZ	EXERCISE	CGBA TERM	ASC-3 DEACT	MEAL	SEF OPAQ DEACT	MODULE TRDN	CABIN STOW	PRE SLEEP			
MS4 KRIKALEV	OKN OPER	EXERCISE	PAO EVENT	MEAL	VHM SUBJ	OKN SUBJ	CABIN STOW	PRE SLEEP			
DAY/NIGHT	[Day/Night Cycle Diagram]										
ORBIT	111 112 113 114 115 116 117 118										
TDRS	[TDRS Cycle Diagram]										
ATTITUDE	-ZLV +YVV -ZSI -ZLV +YVV -ZLV +YVV -ZLV +YVV										
CAPL	NO DTA - APU HTR RECONFIG @-ZLV, +YVV @SIDNEY, ME -ZLV 6.0 KU-BD STOW @-ZLV, +YVV -ZLV 13.0										
NOTES:	<ul style="list-style-type: none"> o APU HTR RECONFIG o -ZLV, +YVV @SIDNEY, ME o SAREX PWRDN o DTO 623 CABIN AIR MONITORING o KU-BD STOW @-ZLV, +YVV 										

GMT (D:H:M)	MET (D:H:M)	CST (D:H:M)	FD/ DOY	BETA	MOON	HOUSTON DATE	FLIGHT	EDITION	PUB. DATE
035:00:14 / 035:12:14	007:12:00 / 008:00:00	034:18:14 / 035:06:14	09/034 CST	-41.4		FEBRUARY 3, 1994	STS-60	FINAL	12/14/93

CST :034 19 20 21 22 23 0 CST:035 1 2 3 4 5 6 MET:008
 FD 08 12 13 14 15 16 17 18 19 20 21 22 23 0
 MET :007

CDR BOLDEN PLT REIGHTLER MS1 DAVIS MS2 SEGA MS3 CHANG-DIAZ MS4 KRIKALEV	PRE SLEEP	SLEEP	POST SLEEP	POST SLEEP	POST SLEEP	POST SLEEP	POST SLEEP	POST SLEEP	POST SLEEP	POST SLEEP
	URN/SAL	URN/SAL	URN/SAL	URN/SAL	URN/SAL	URN/SAL	URN/SAL	URN/SAL	URN/SAL	URN/SAL
	DSO 326									
	PGSS WRA RPLN LP UBEL P YE									
	CREW DSK									
	SAMS DEAC									

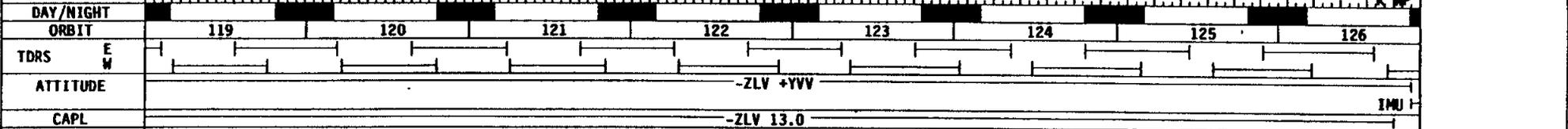

NOTES: ▲ INDICATES GND COMMANDED ACTIVITY ▲ FC PURGE ◎ DSO 326 WINDOW IMPACT OBS
▲ S HAB FIN DEACT
▲ S HAB FIN DEACT

This Page Intentionally Blank

DETAILED TIMELINE

**DETAILED
TIMELINE**

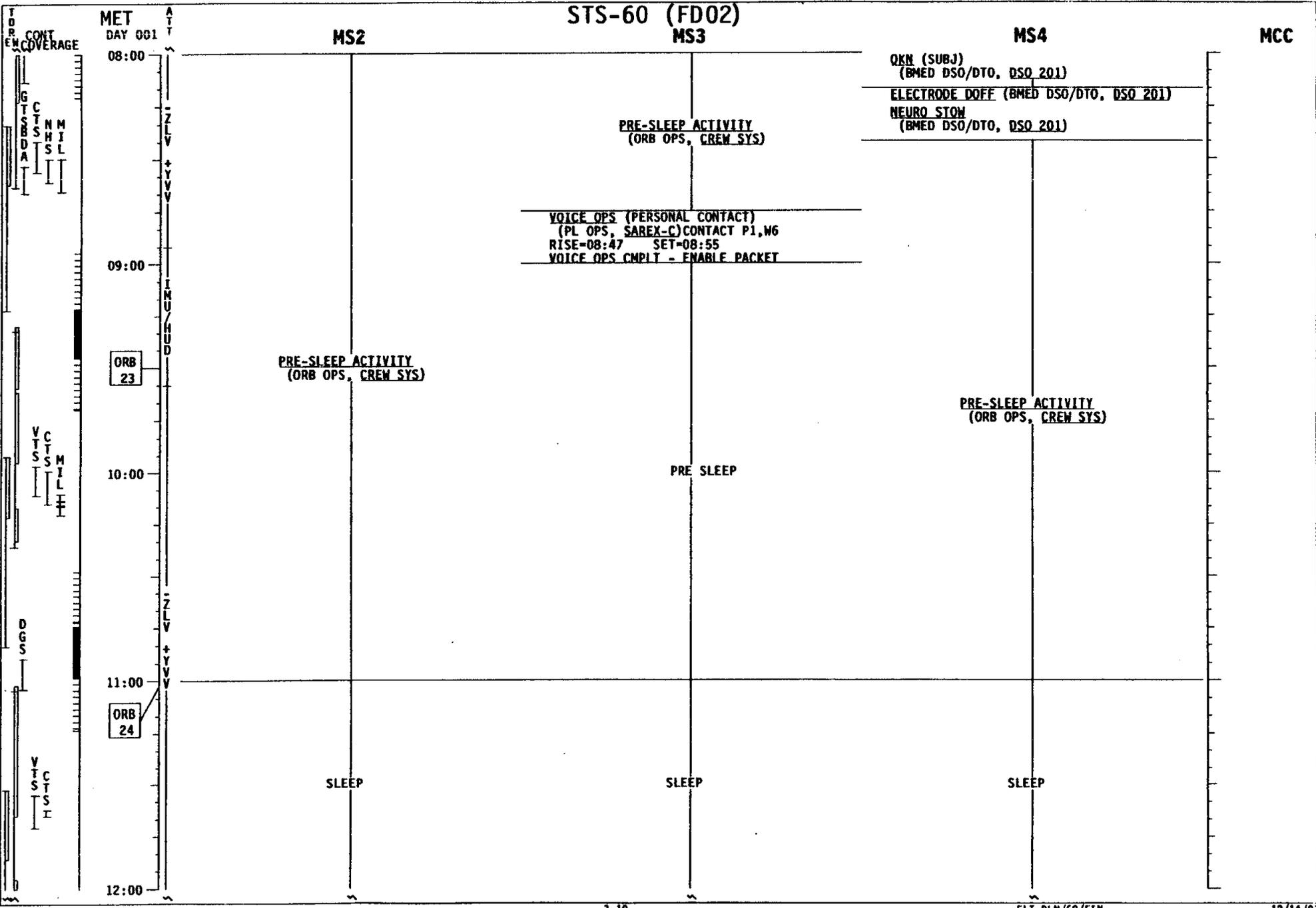

STS-60 (FD02)

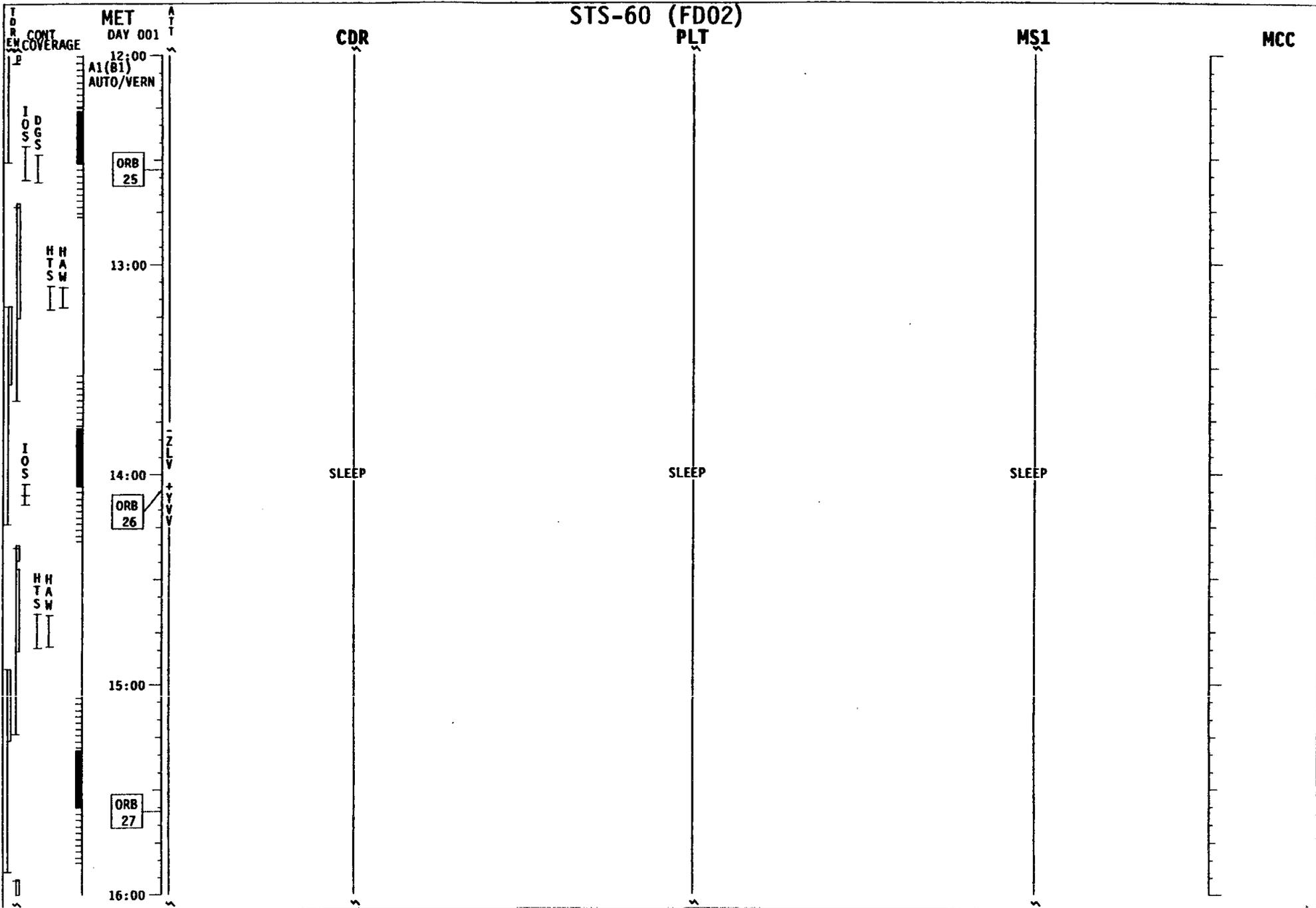

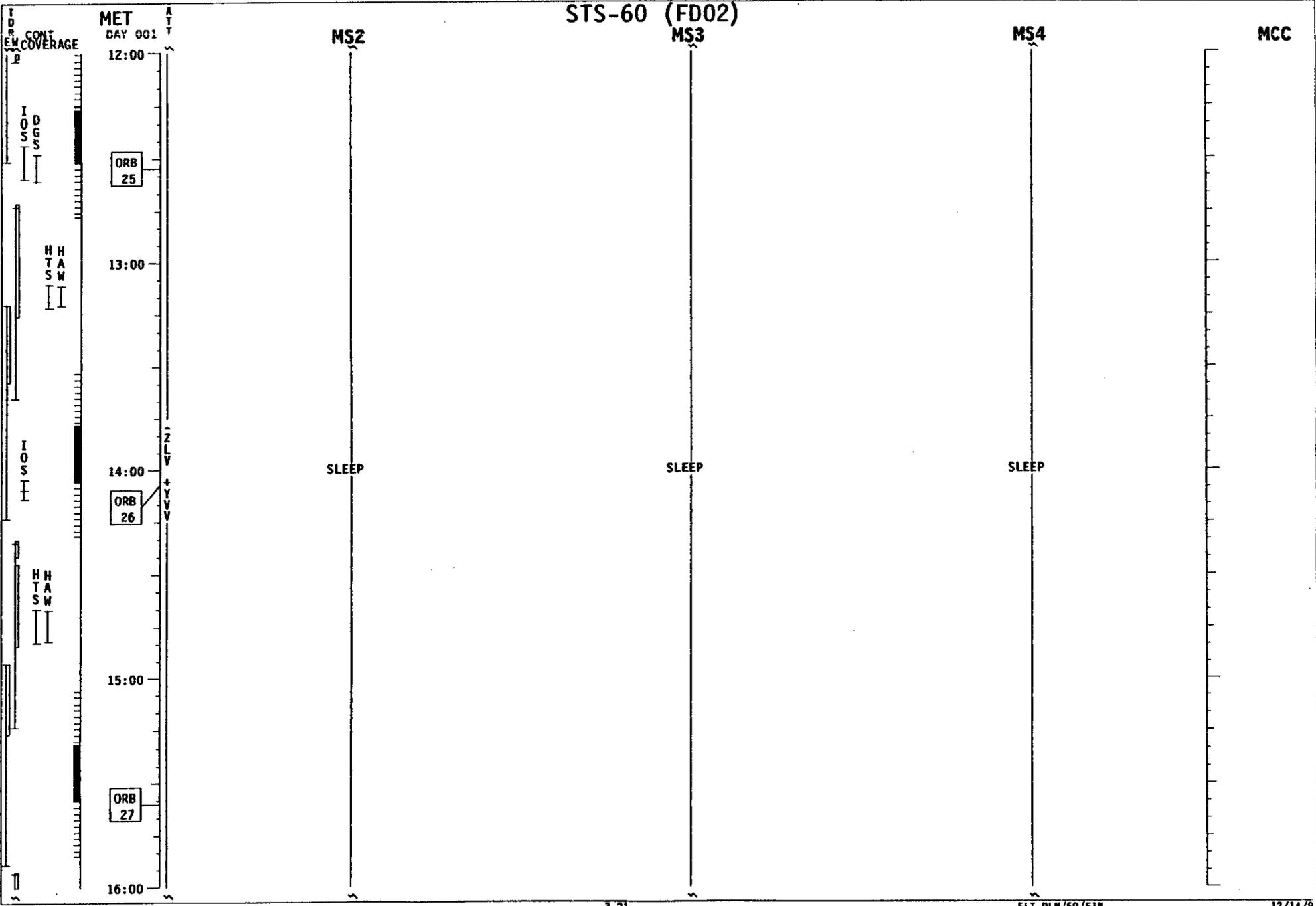

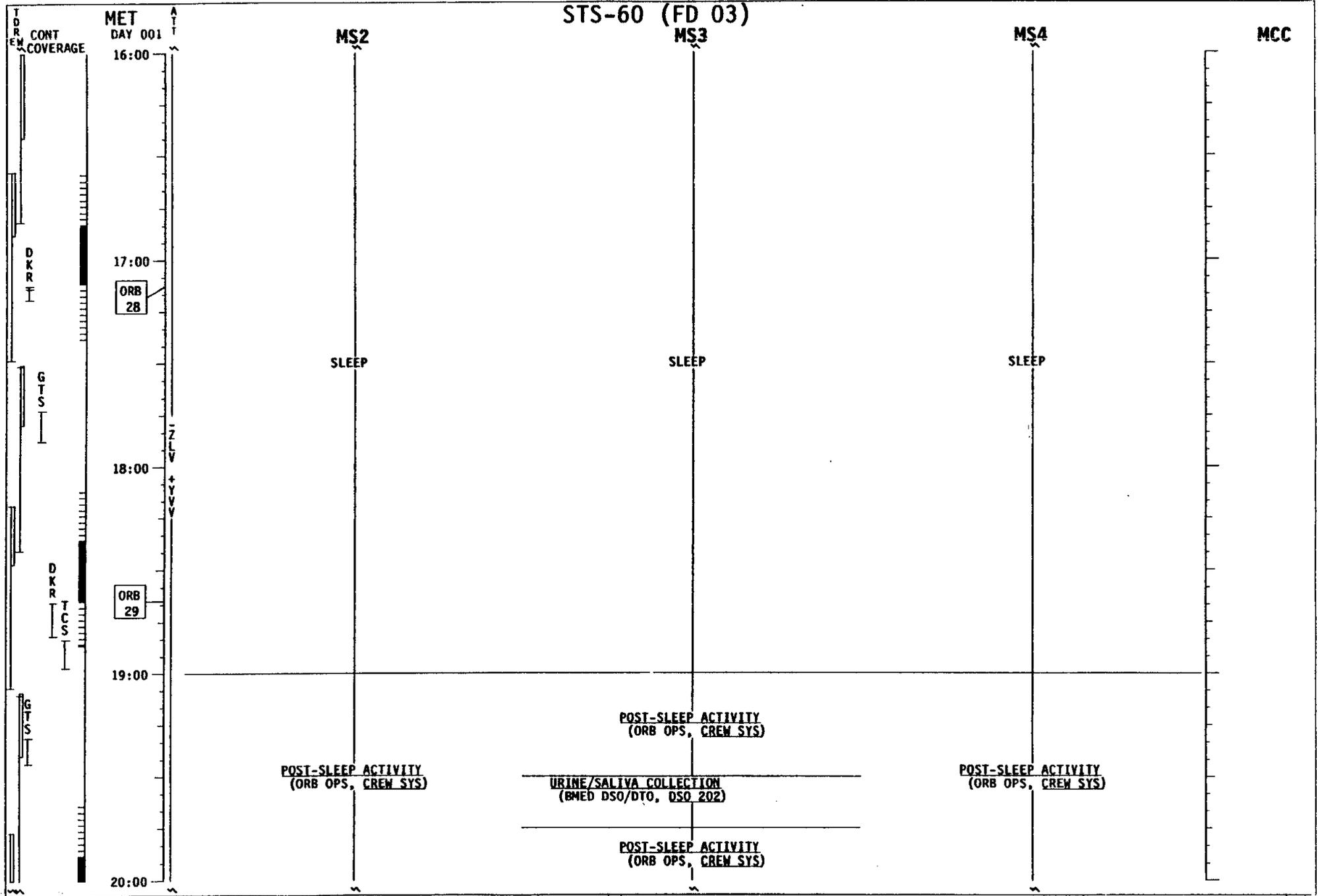

STS-60 (FD 03)

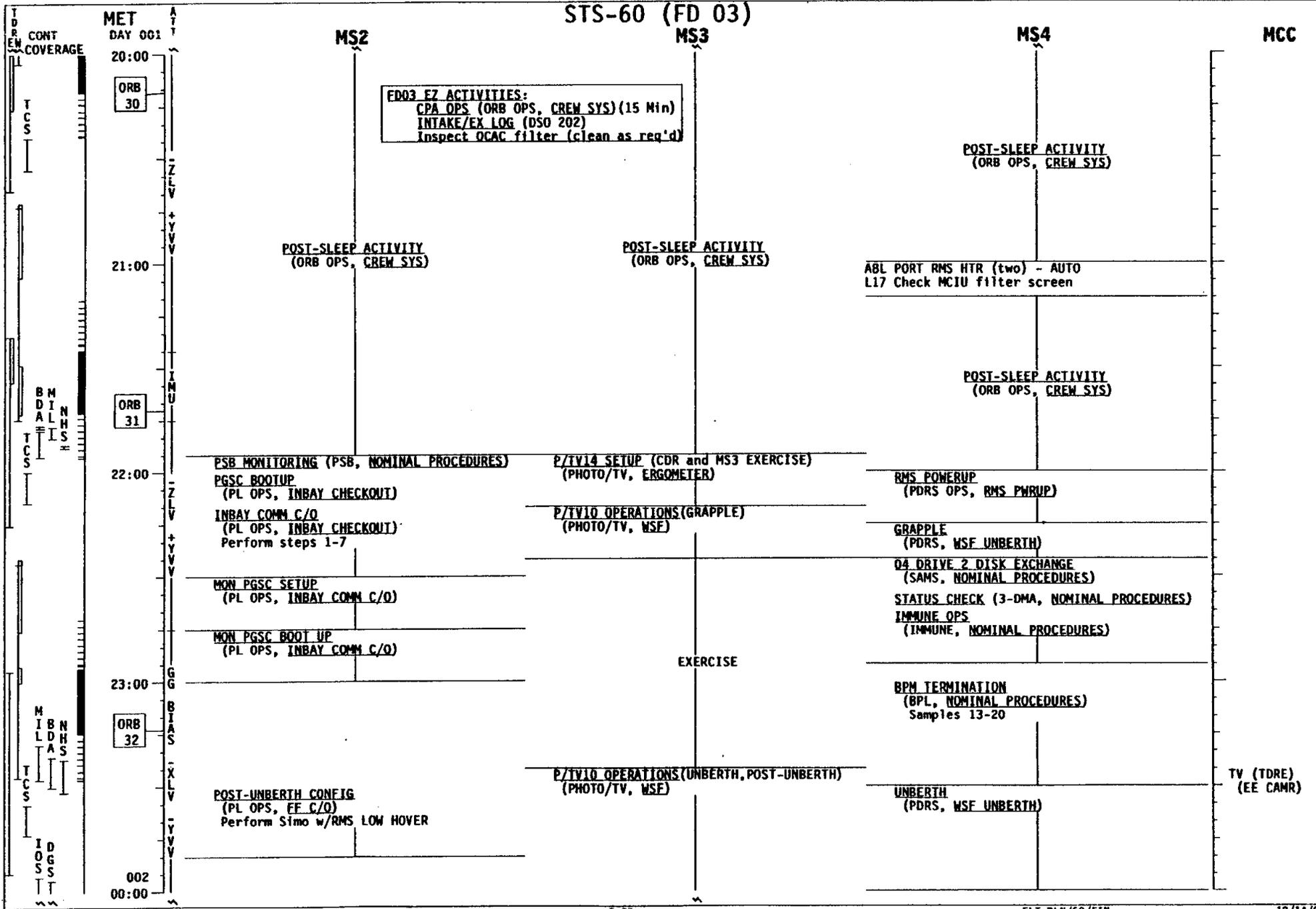

FD03 E7 ACTIVITIES:
 CPA OPS (ORB OPS, CREW SYS) (15 Min)
 INTAKE/EX LOG (DSO 202)
 Inspect OCAC filter (clean as req'd)

STS-60 (FD 03)

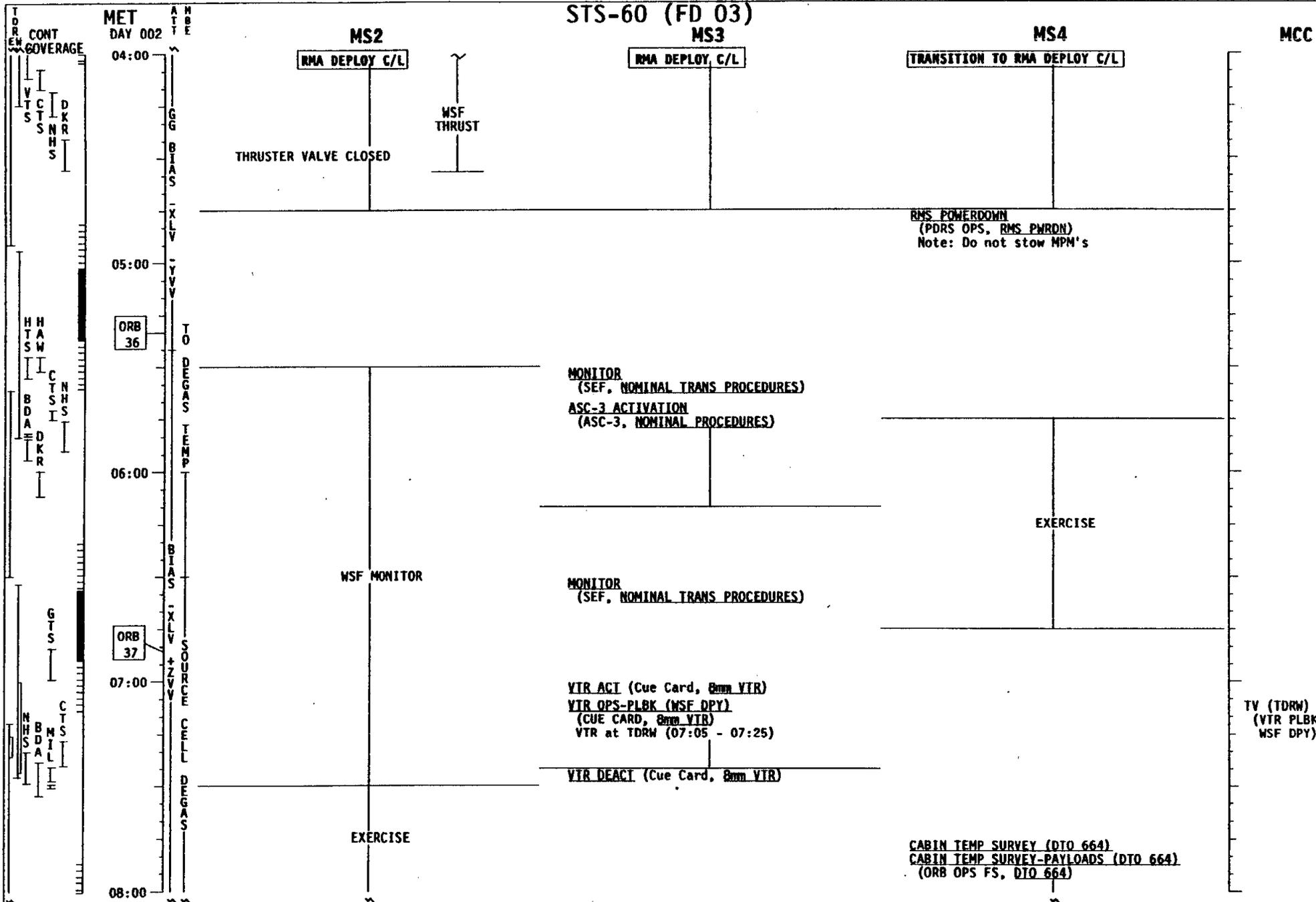

STS-60 (FD 03)

PLT

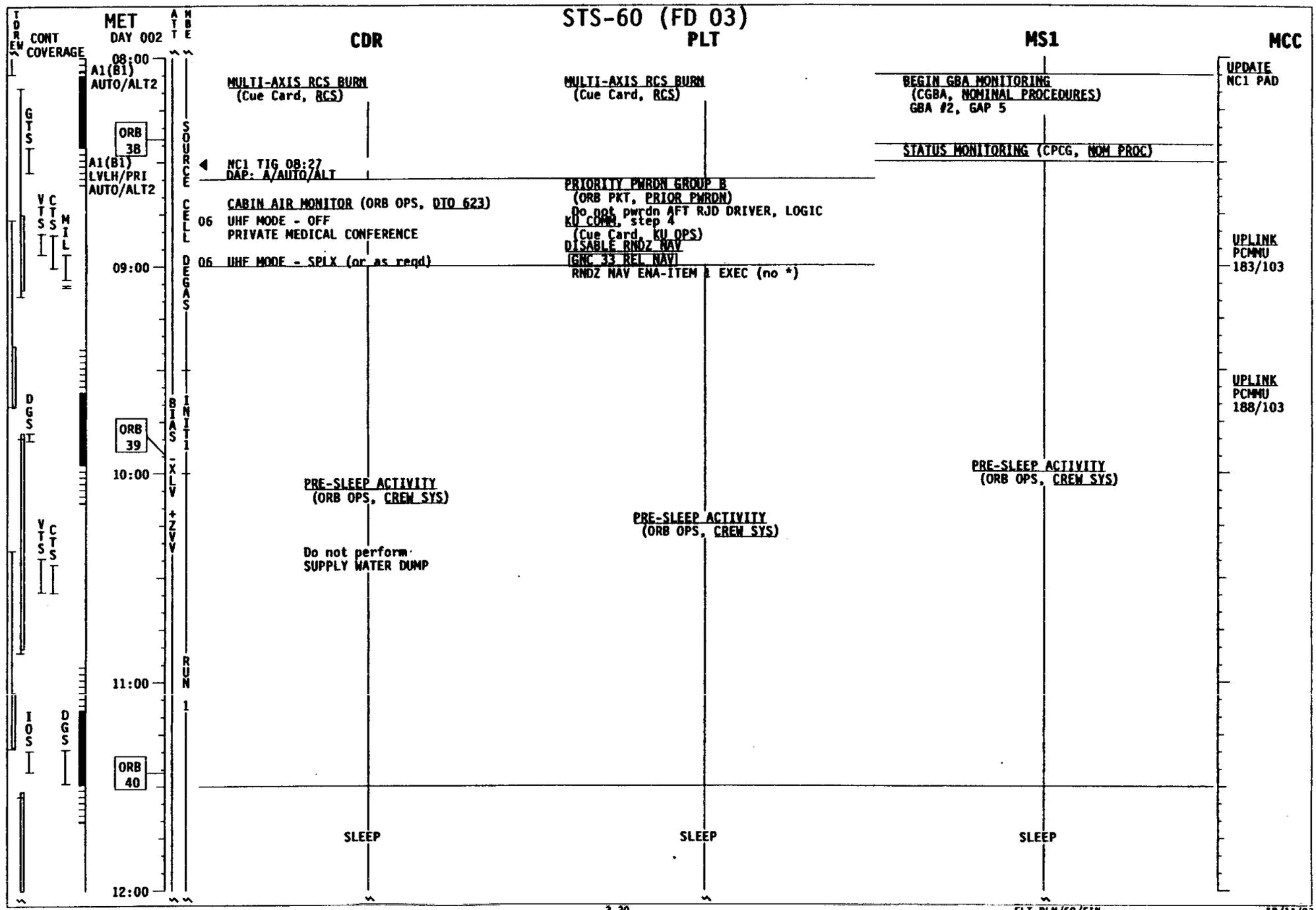

STS-60 (FD 04)

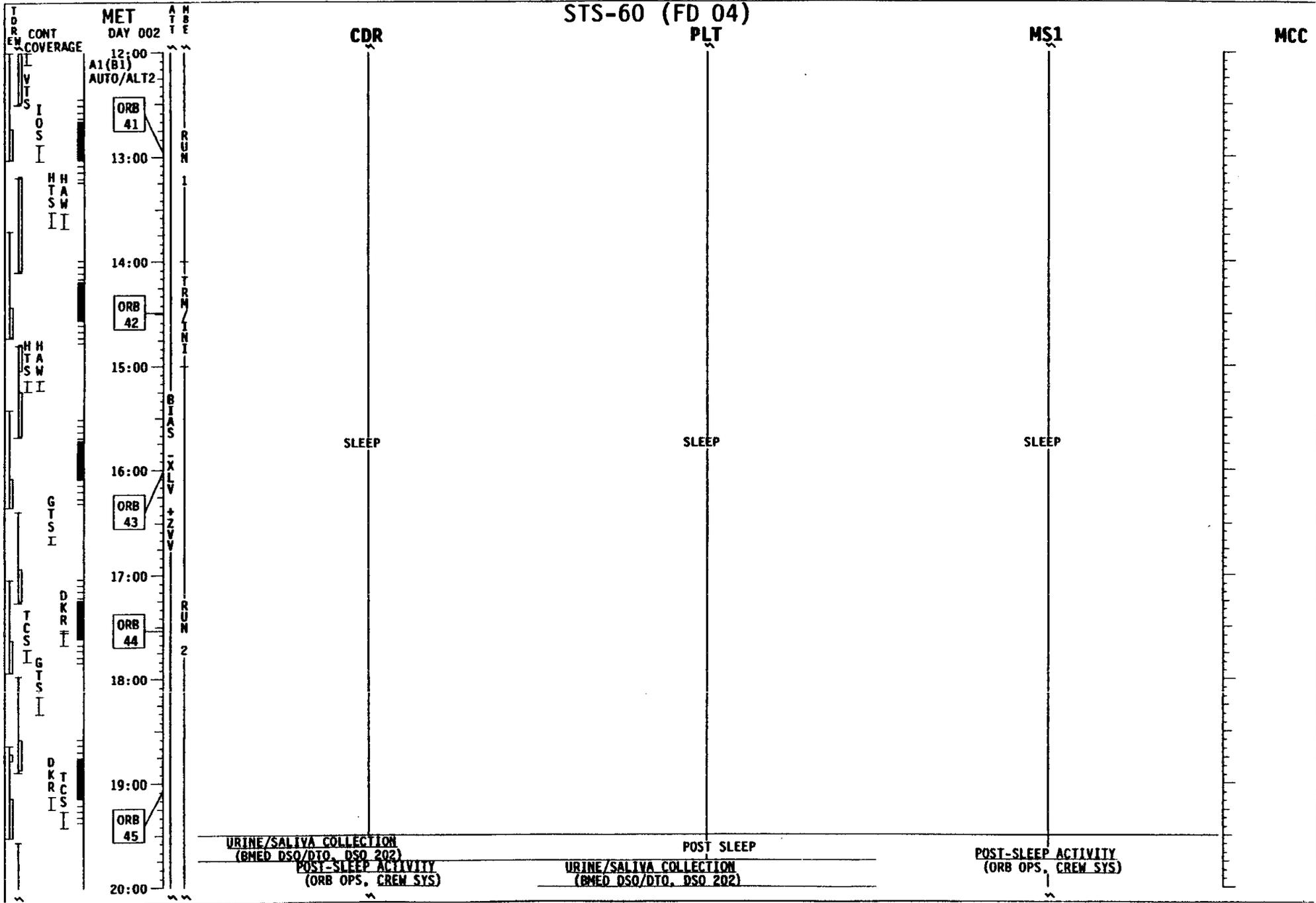

STS-60 (FD 04)

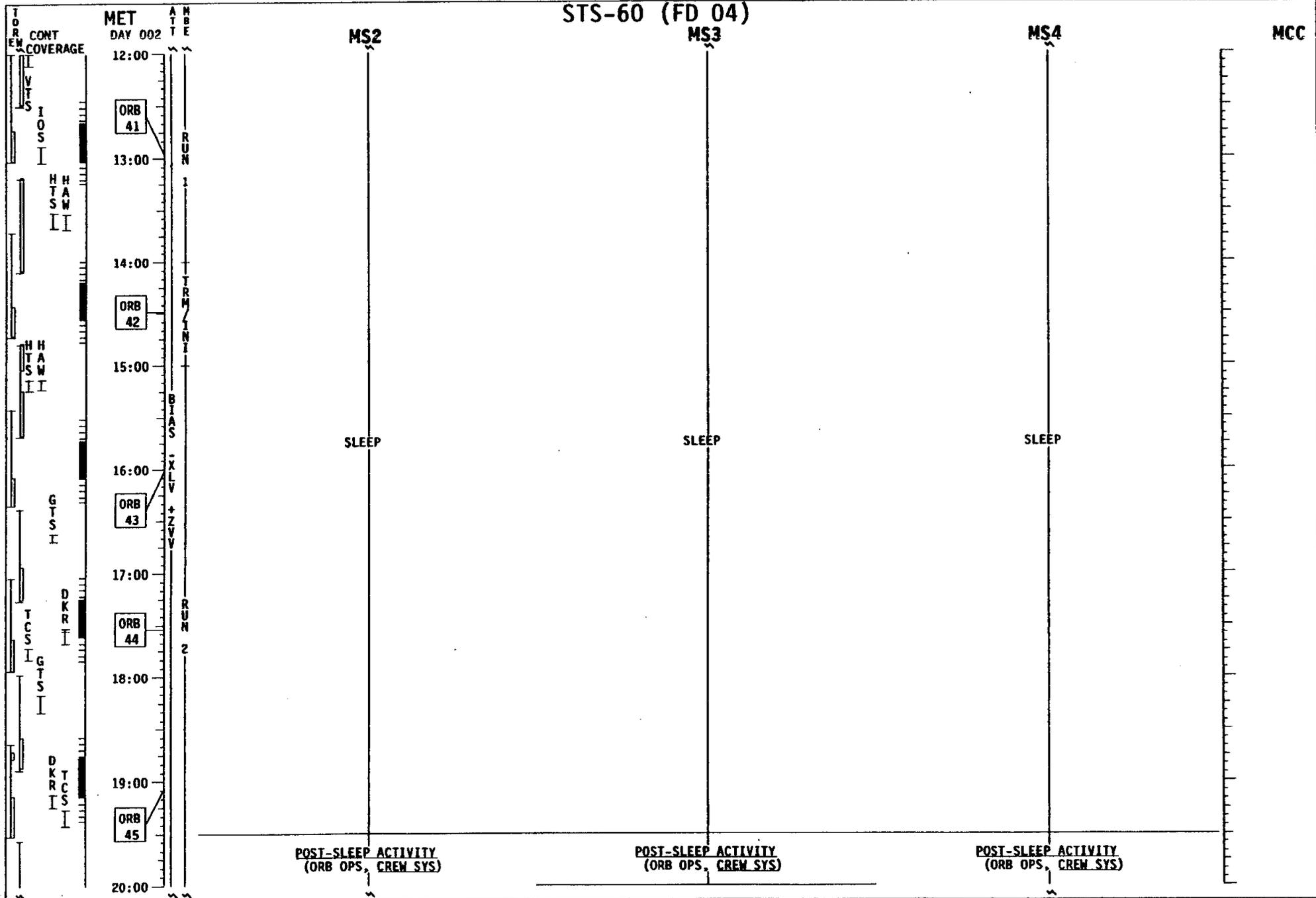

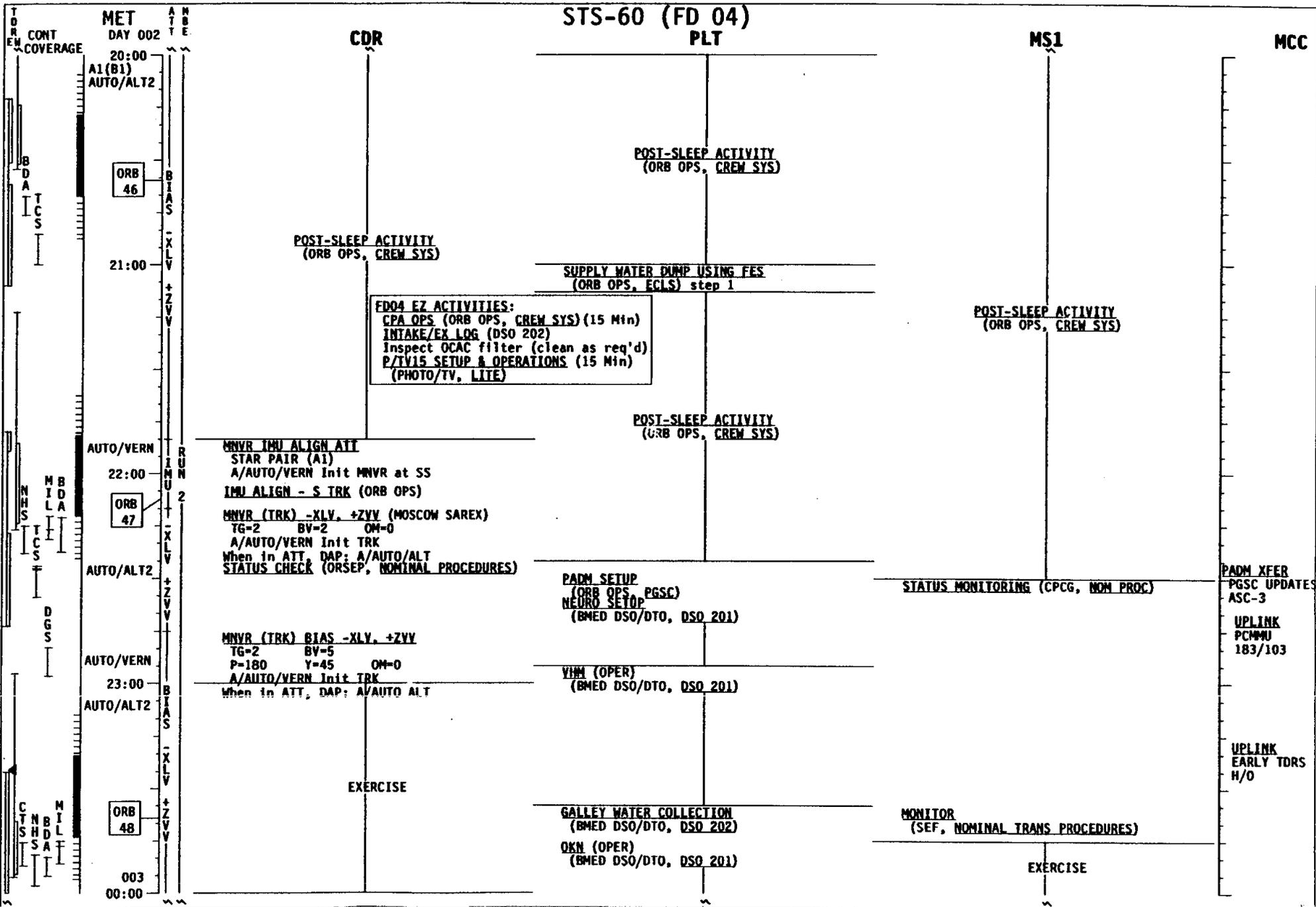

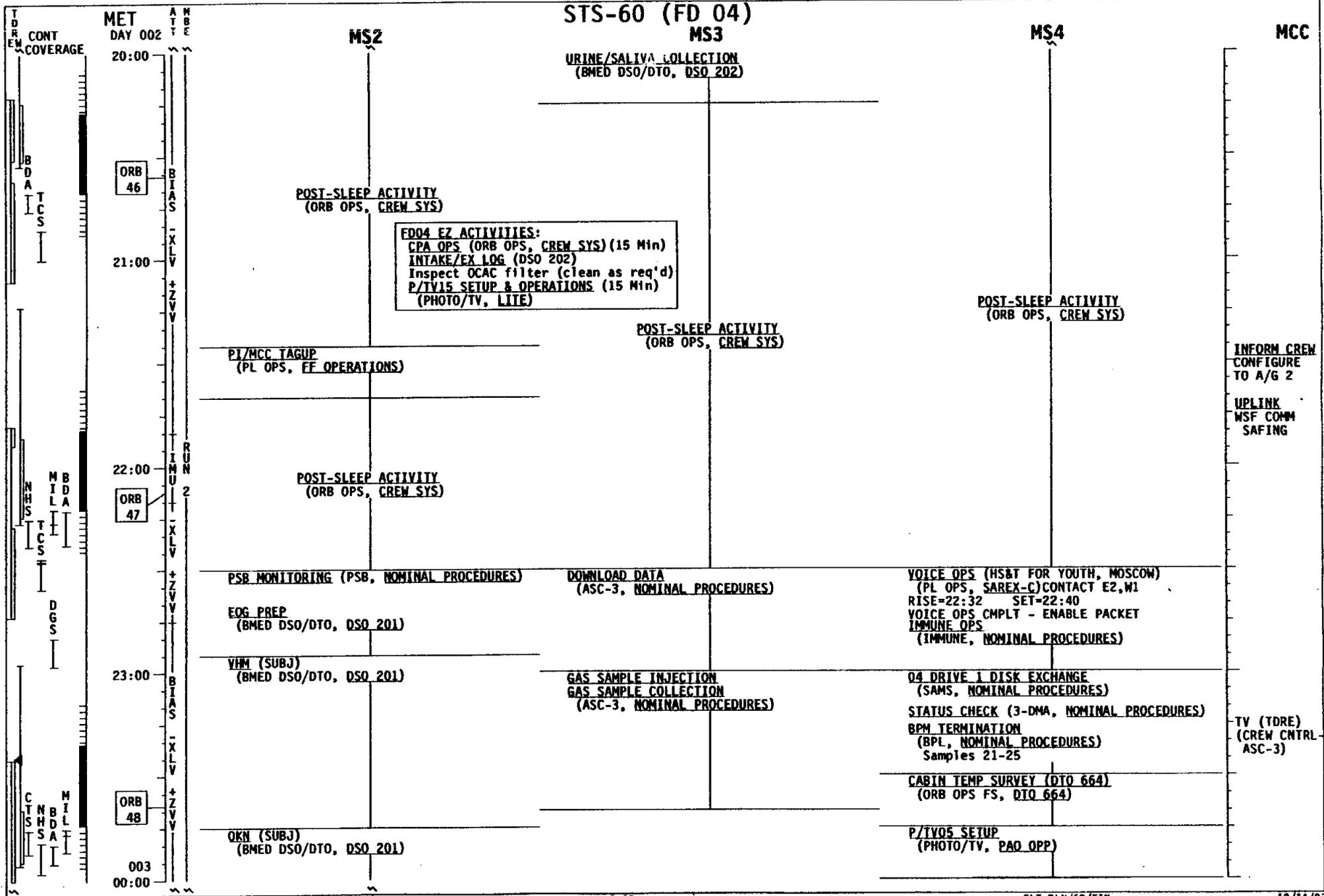

MET DAY 003		STS-60 (FD 04)		MS1	MCC
00:00 A1(B1) AUTO/ALT2 01:00 ORB 49 A1(B1) LVLH/PRI A1(B1) AUTO/ALT2 02:00 ORB 50 03:00 04:00	TDR EN CONT COVERAGE I TO GGS S S S C T S H S T C S I O S H T S M V T S H S T C S I D S K R I	CDR PAO VOICE CHECK/EVENT TV at TDRE	PLT QKN (OPER) (BMED DSO/DTO, DSO 201) EGG CARD CHANGE (BMED DSO/DTO, DSO 201) AUTONOMIC & GASTRIC FUNC DBRE (BMED DSO/DTO, DSO 201) WINDOW IMPACT OBSERVATIONS (ORB OPS FS, DSO 326)	EXERCISE	
		MULTI-AXIS RCS BURN (Cue Card, RCS) NC2 TIG 01:14	MULTI-AXIS RCS BURN (Cue Card, RCS)	YHM (OPER) (BMED DSO/DTO, DSO 201)	UPDATE NC2 PAD
		SUPPLY WATER DUMP USING FES (ORB OPS, ECLS) Perform Step 2 w/FES not req SUPPLY WATER DUMP USING FES (ORB OPS, ECLS) step 1	EXERCISE	QKN (OPER) (BMED DSO/DTO, DSO 201)	UPLINK CERL-1 ACT
		PCS 1(2) CONEIG (ORB OPS, ECLS) Config SYS 2	HEATER RECONEIG-Config B (ORB OPS, EPS) PCS 1(2) CONEIG (ORB OPS, ECLS) Config SYS 2		
		MEAL	MEAL	MEAL	

STS-60 (FD 04)
MS3

▲=GROUND COMMANDED ACTIVITY
MS2

MS4

MCC

MET DAY 003
00:00
01:00
02:00
03:00
04:00

DR EW
CONT COVERAGE
I O G S S
T C S S
V T S
C T S H S
I O S
H A S W T S
H T S W T S
N H S
T C S R I

A M B E
R U N
2
T E R M / I N I T
B I A S
X L V
+ Z V V
R U N
3

00:00	OKN (SUBJ) (BMED DSO/DTO, DSO 201)	CERL ACT (PL OPS, CERL)	PAO VOICE CHECK/EVENT TV at TORE
	ELECTRODE DOFF (BMED DSO/DTO, DSO 201)	TERMINATE SAMPLE PROCESSING (CGBA, NOMINAL PROCEDURES) GAP 10,29-31	
	P/TV10 OPERATIONS (MBE SYS C/O) (PHOTO/TV, WSE)		EOG PREP (BMED DSO/DTO, DSO 201)
01:00	TERM RUN 2 (MONITOR) ▲	MONITOR (SEF, NOMINAL TRANS PROCEDURES) GAS SAMPLE COLLECTION (ASC-3, NOMINAL PROCEDURES)	VHM (SUBJ) (BMED DSO/DTO, DSO 201)
	INIT RUN 3 (MONITOR) ▲		OKN (SUBJ) (BMED DSO/DTO, DSO 201)
02:00	P/TV04 OPERATIONS (MEAL, FILTER CLEANING) (PHOTO/TV, MIDDECK)	TUBE ALIGNMENT EXPERIMENT OPERATIONS (3-DMA, NOMINAL PROCEDURES)	ELECTRODE DOFF (BMED DSO/DTO, DSO 201) FILTER CLEANING (IFM, SCHEDULED MAINTENANCE) Inspect filters and clean as necessary Do not perform during VHM or OKN OPS
03:00	MEAL	MONITOR (SEF, NOMINAL TRANS PROCEDURES)	MEAL
04:00	MEAL		MEAL

UPLINK
CERL-1 ACT

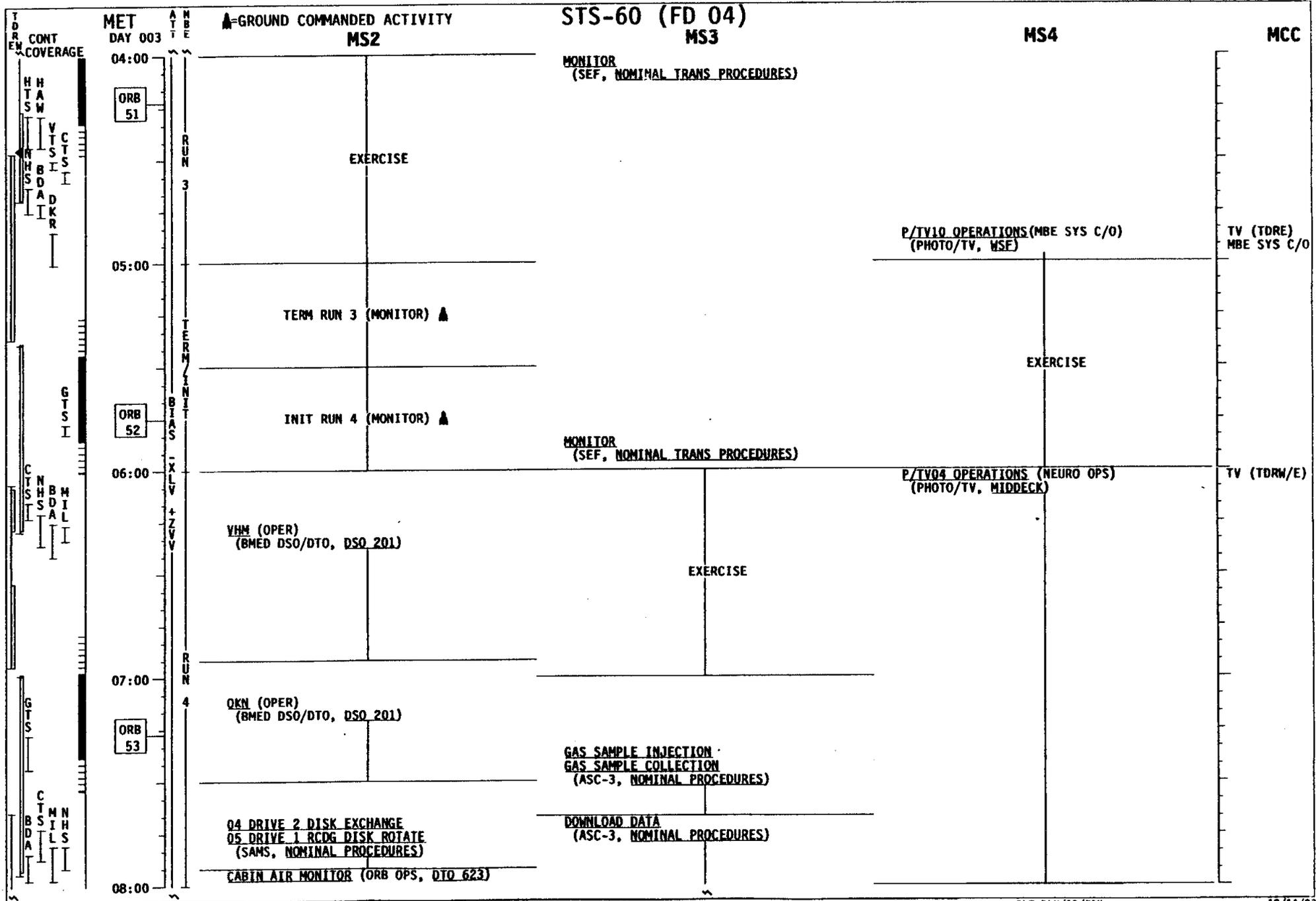

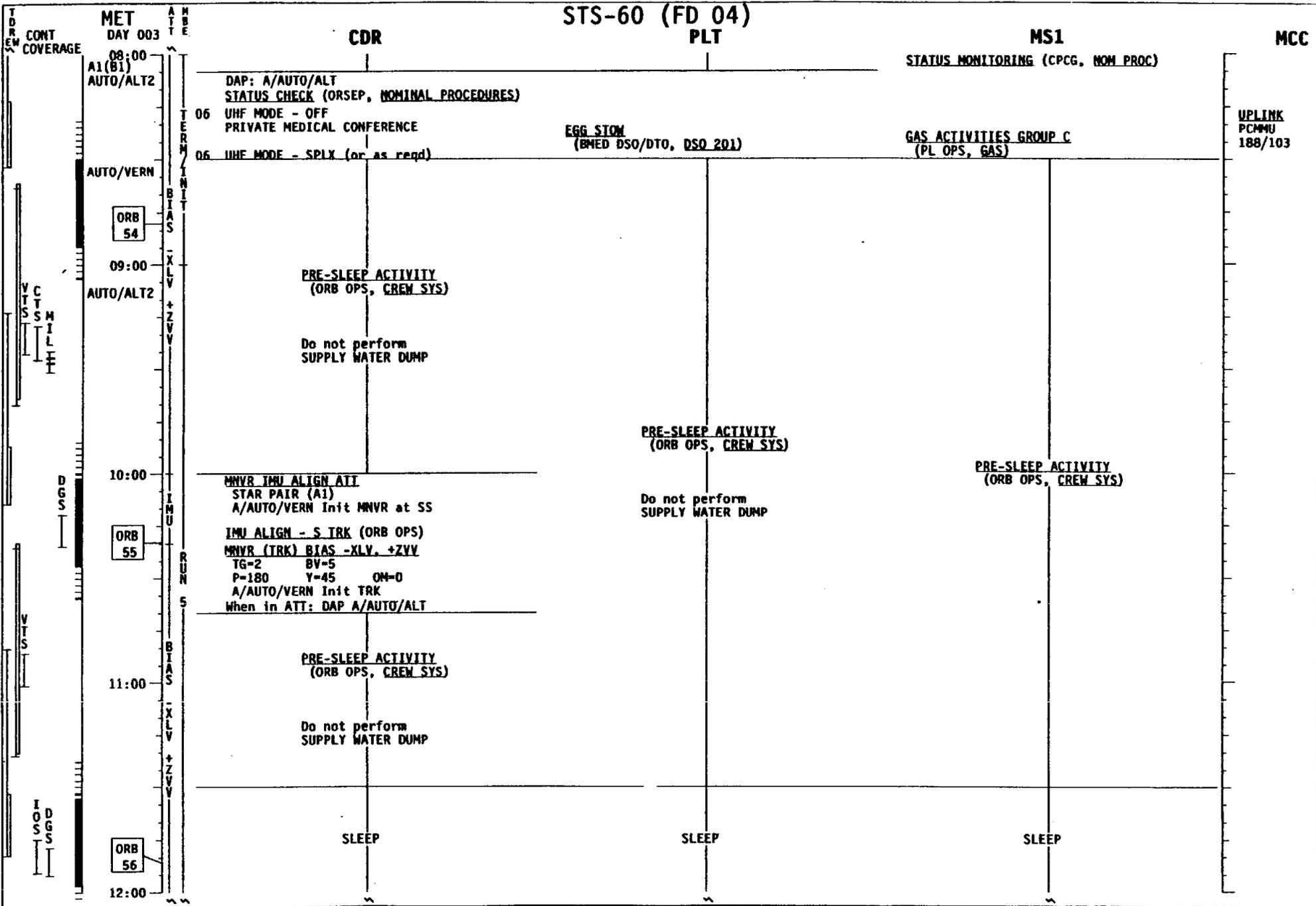

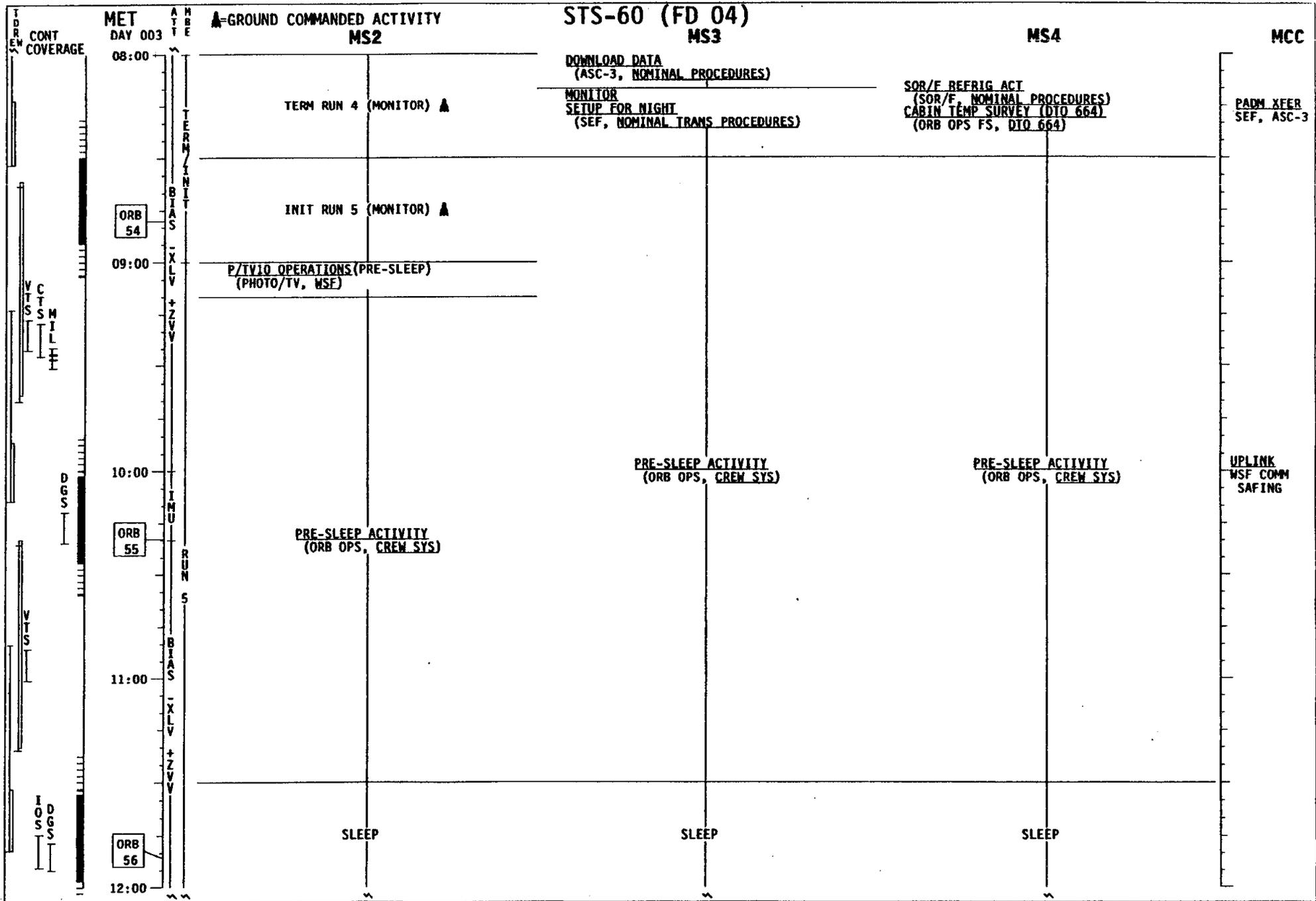

STS-60 (FD 05)

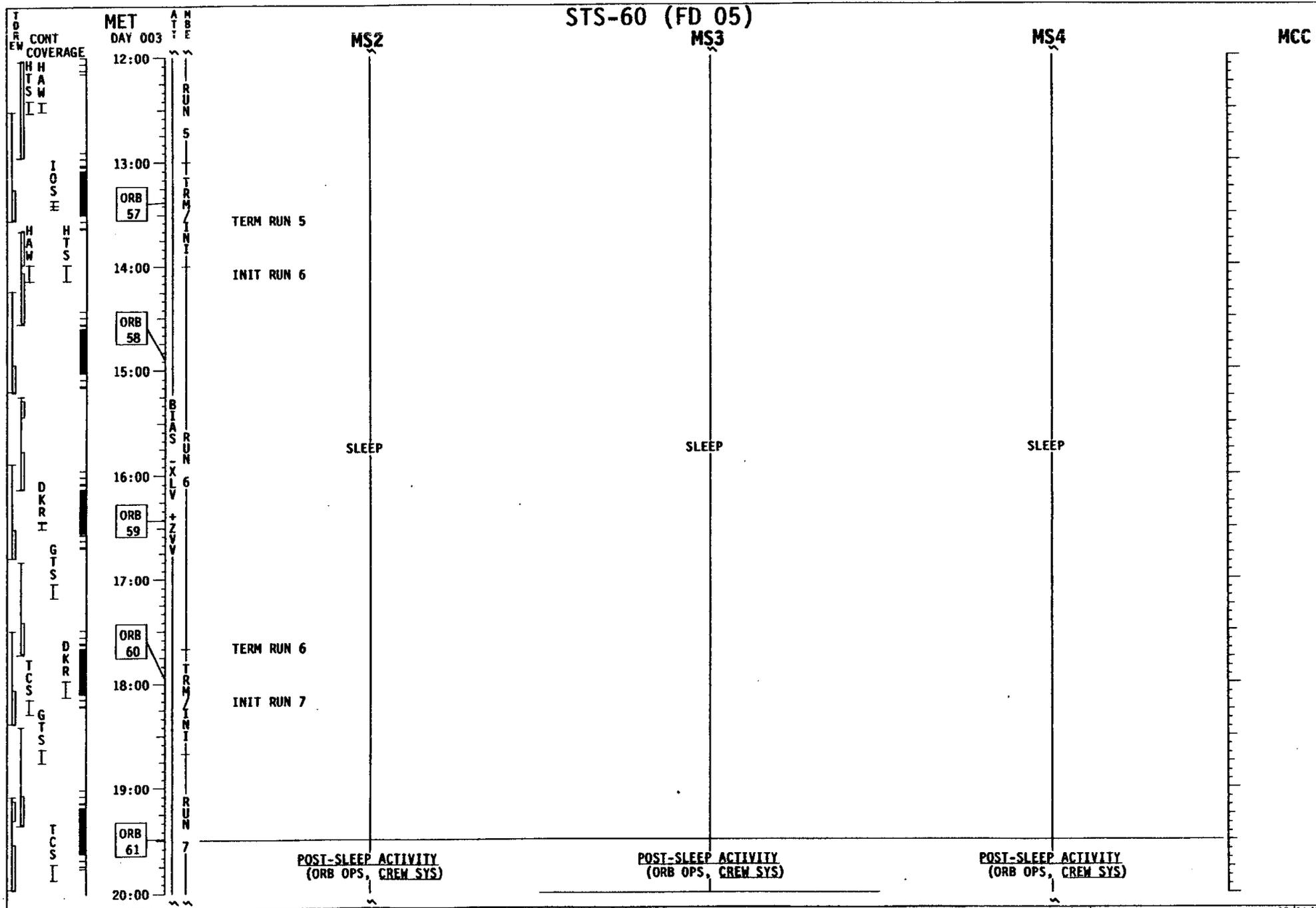

STS-60 (FD 05)

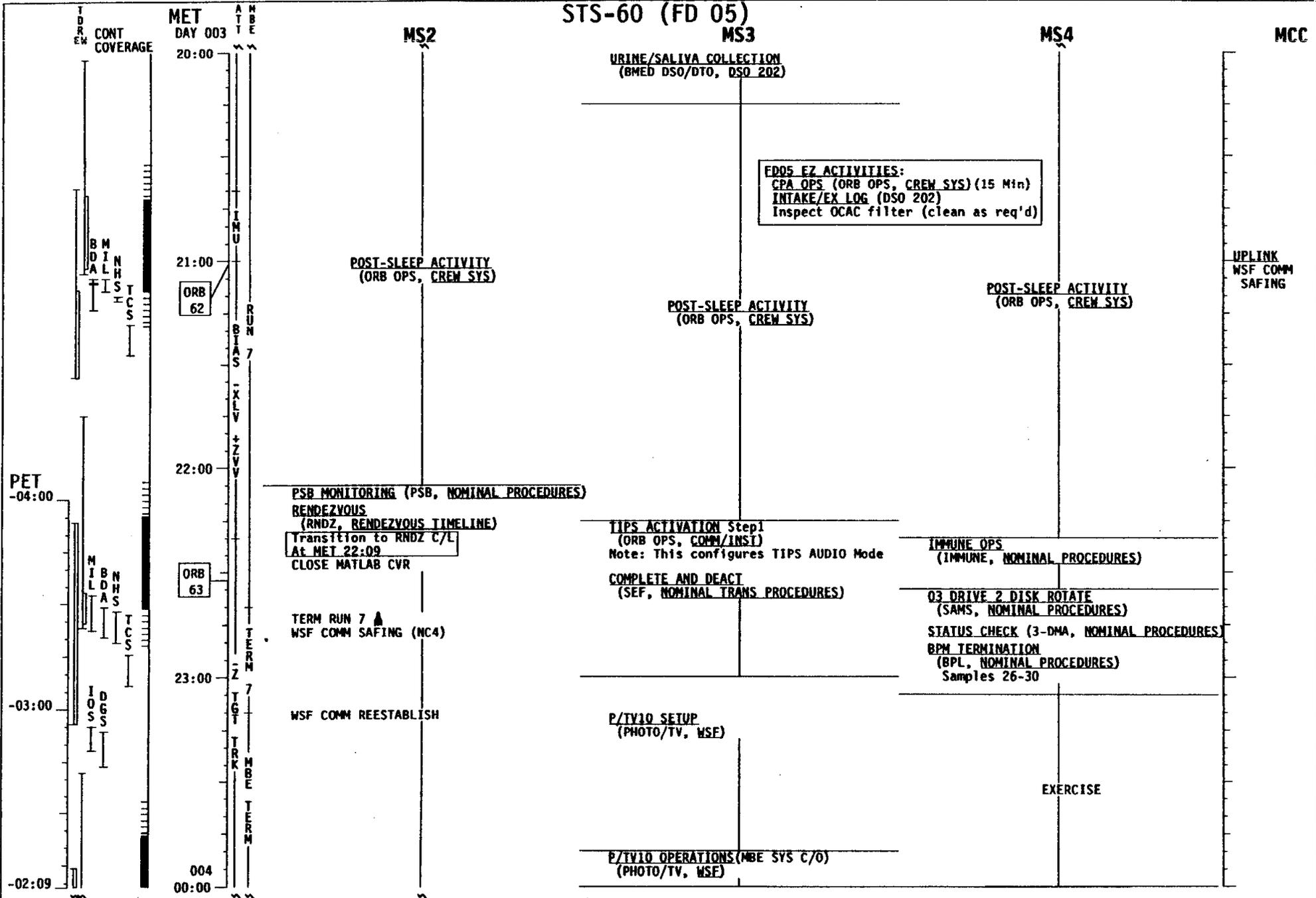

STS-60 (FD 05)

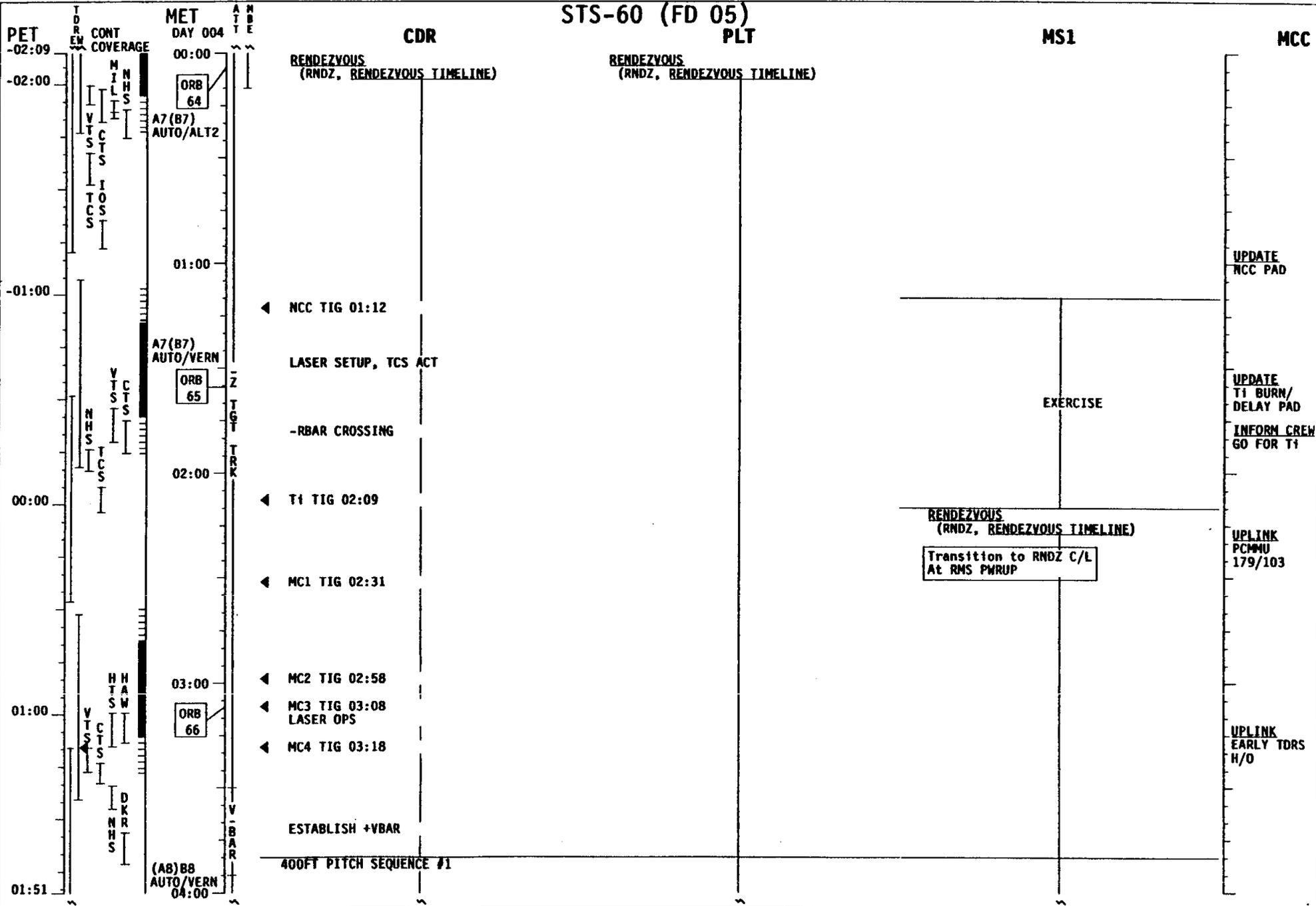

STS-60 (FD 05)

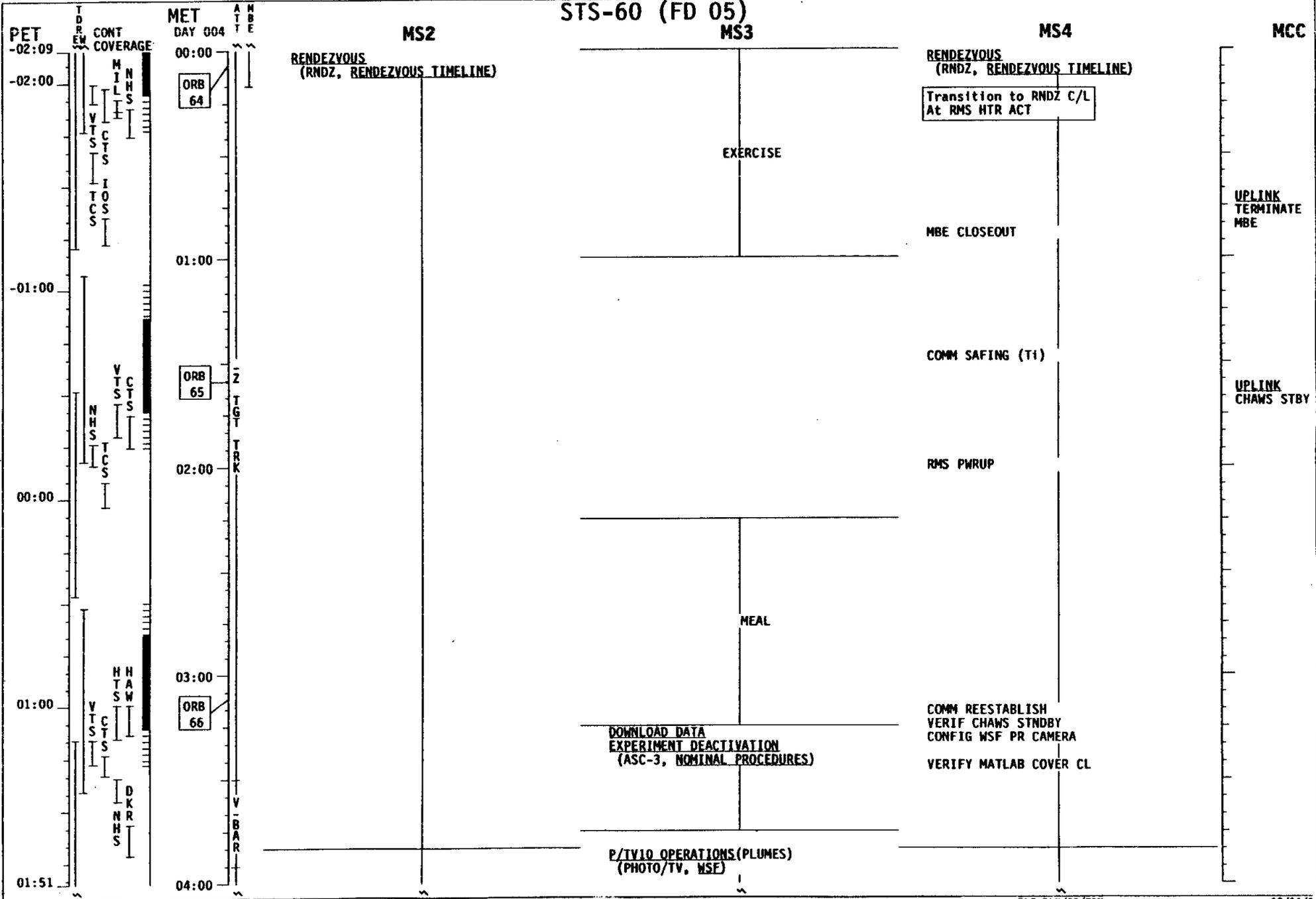

STS-60 (FD 05)

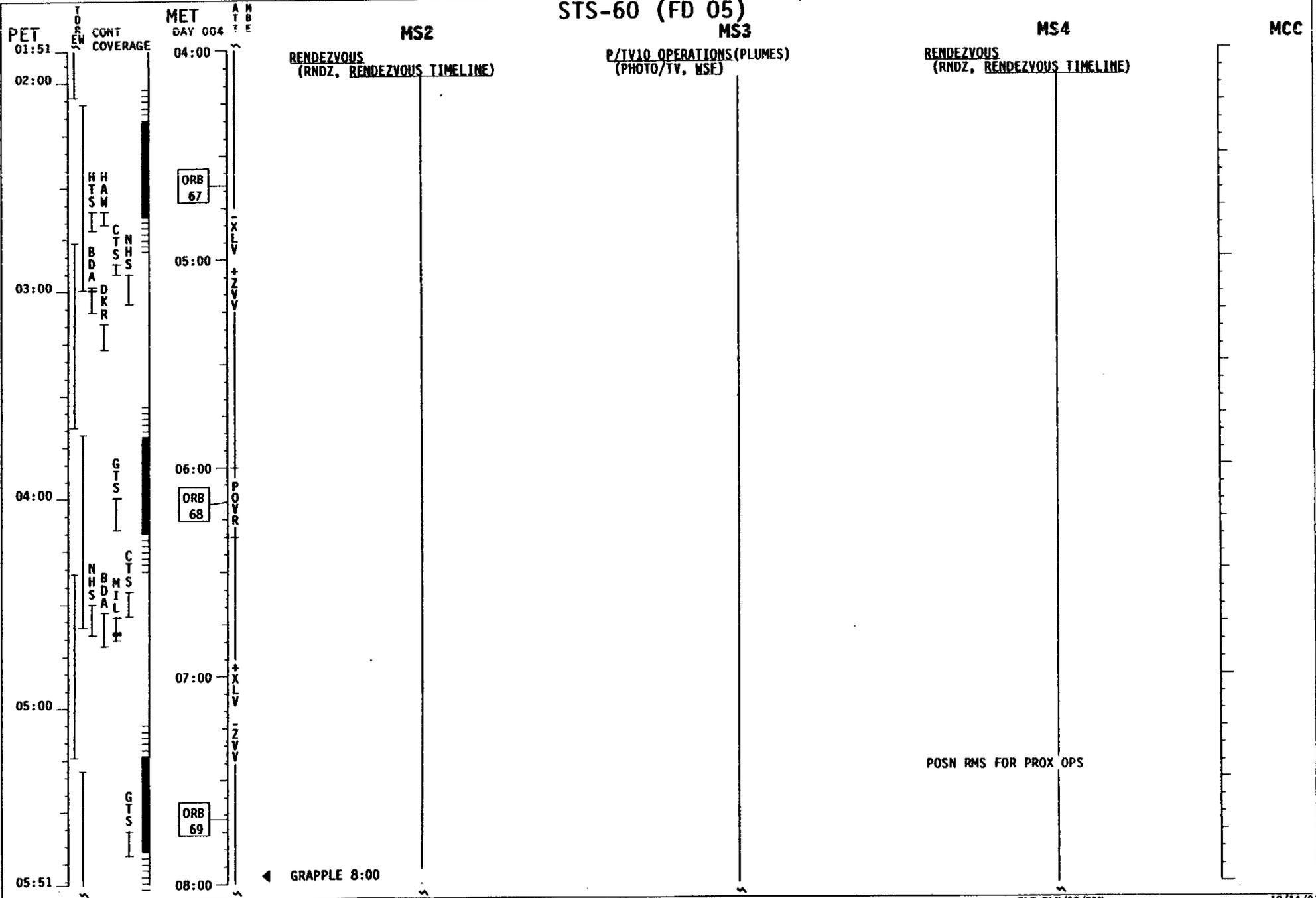

STS-60 (FD 05)

PET
05:51
06:00
06:30

MET
DAY 004
08:00
(A9)89
AUTO/VERN

DR EM
M I L I
V T C T S
D G S S I
V T C T S
D G S S I
V T S

CONT COVERAGE

ORB 70
ORB 71

11:00
A9(B9)
AUTO/VERN

12:00

CDR

RENDEZVOUS
(RNDZ, RENDEZVOUS TIMELINE)
DISA R NAV, MNVR -ZLV, +YVY
LASER STOW

GRAPPLE NO LATER THAN
4/08:30

PRE-SLEEP ACTIVITY
(ORB OPS, CREW SYS)

Do not perform
SUPPLY WATER DUMP

PRE-SLEEP ACTIVITY
(ORB OPS, CREW SYS)

PRE-SLEEP ACTIVITY
(ORB OPS, CREW SYS)

PRE-SLEEP ACTIVITY
(ORB OPS, CREW SYS)

PLT

RENDEZVOUS
(RNDZ, RENDEZVOUS TIMELINE)

When in att:
SUPPLY/WASTE WATER DUMP
(ORB OPS, ECLS) Init Waste Dump
Dump Tank to 5%
PRIORITY PWRDN GROUP B
(ORB PKT, PRIOR PWRDN)

PRE-SLEEP ACTIVITY
(ORB OPS, CREW SYS)

Do not perform
SUPPLY WATER DUMP

SUPPLY/WASTE WATER DUMP
(ORB OPS, ECLS) Term Waste Dump

06 UHF MODE - OFF
PRIVATE MEDICAL CONFERENCE

06 UHF MODE - SPLX (or as reqd)
MNVR IMU ALIGN ATT
STAR PAIR (A1)
B/AUTO/VERN Init MNVR at SS

IMU ALIGN - S TRK (ORB OPS)
MNVR (TRK) BIAS -XLY, -YVY
TG-2 BV-2 ON-90
B/AUTO/VERN Init TRK
When in ATT, DAP A/AUTO/VERN

PRE-SLEEP ACTIVITY
(ORB OPS, CREW SYS)

SUPPLY WATER DUMP USING FES
(ORB OPS, ECLS) Perform Step 2 w/FES reqd

PRE-SLEEP ACTIVITY
(ORB OPS, CREW SYS)

MS1

RENDEZVOUS
(RNDZ, RENDEZVOUS TIMELINE)

STATUS MONITORING (CPCG, NOM PROC)
STATUS CHECK (ORSEP, NOMINAL PROCEDURES)
CABIN AIR MONITOR (ORB OPS, DTD 623)

PRE-SLEEP ACTIVITY
(ORB OPS, CREW SYS)

MCC

UPLINK
KU-COMM
β only 10°

UPLINK
PCMMU
188/103

STS-60 (FD 05)

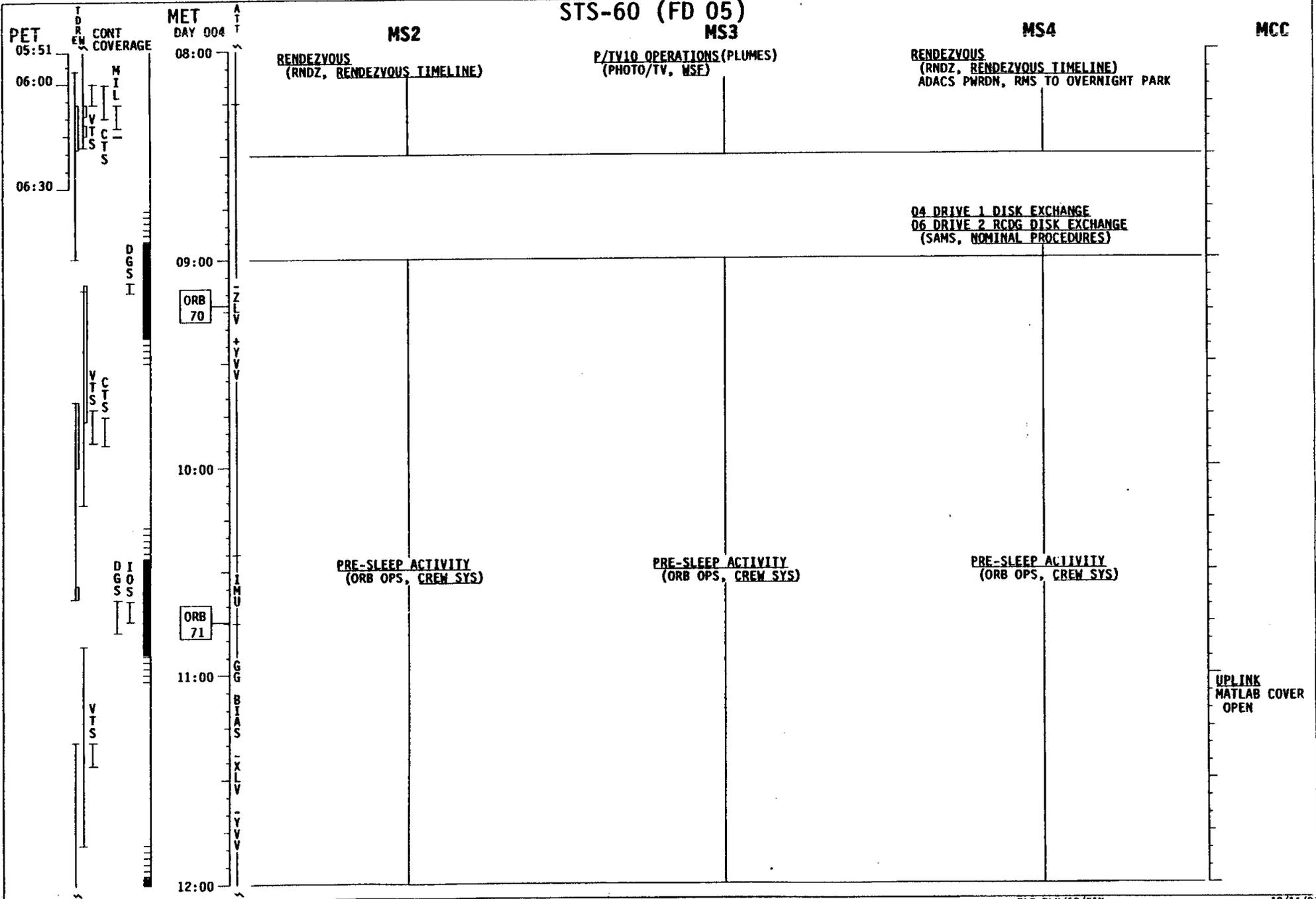

STS-60 (FD05)

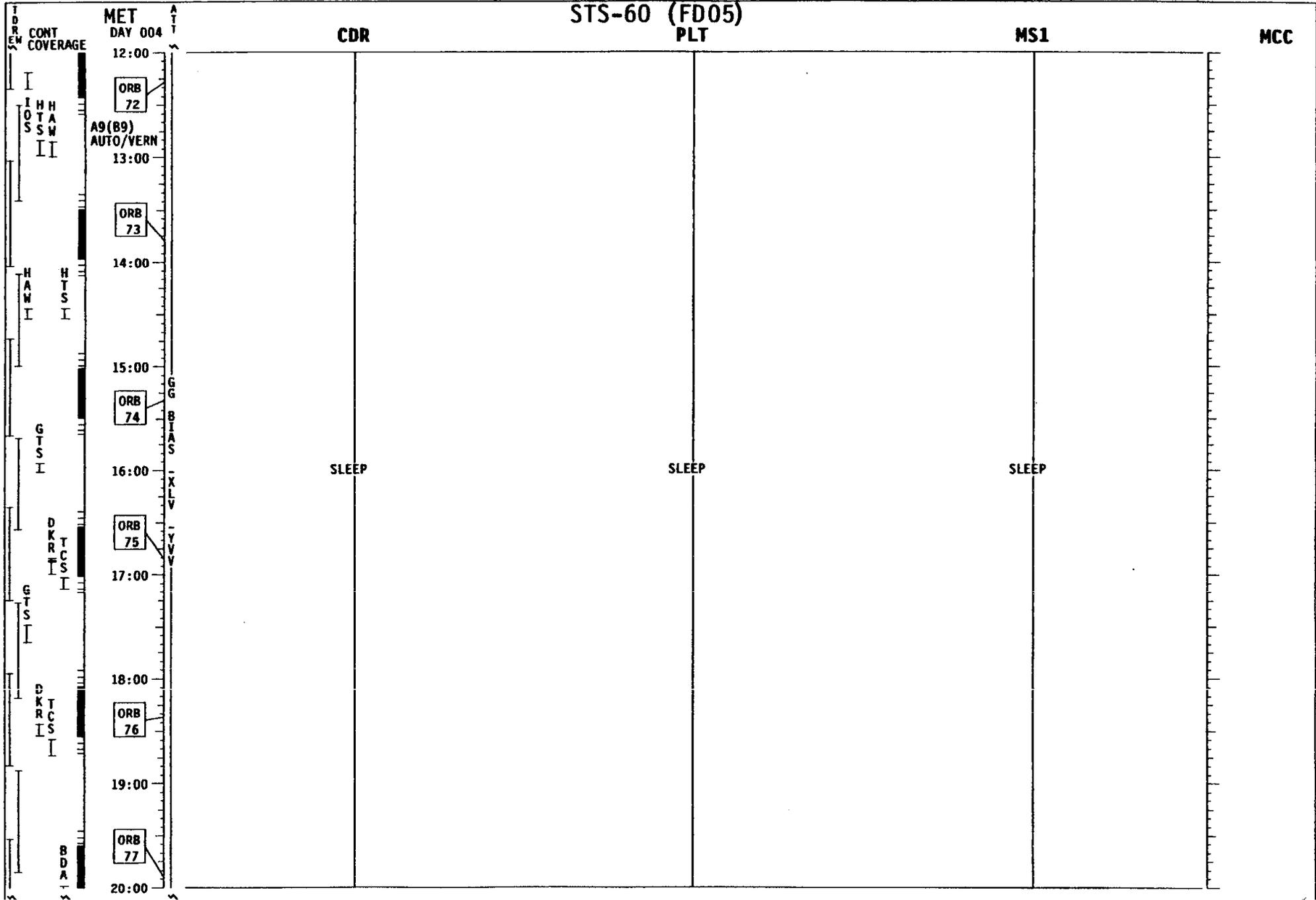

STS-60 (FD05)

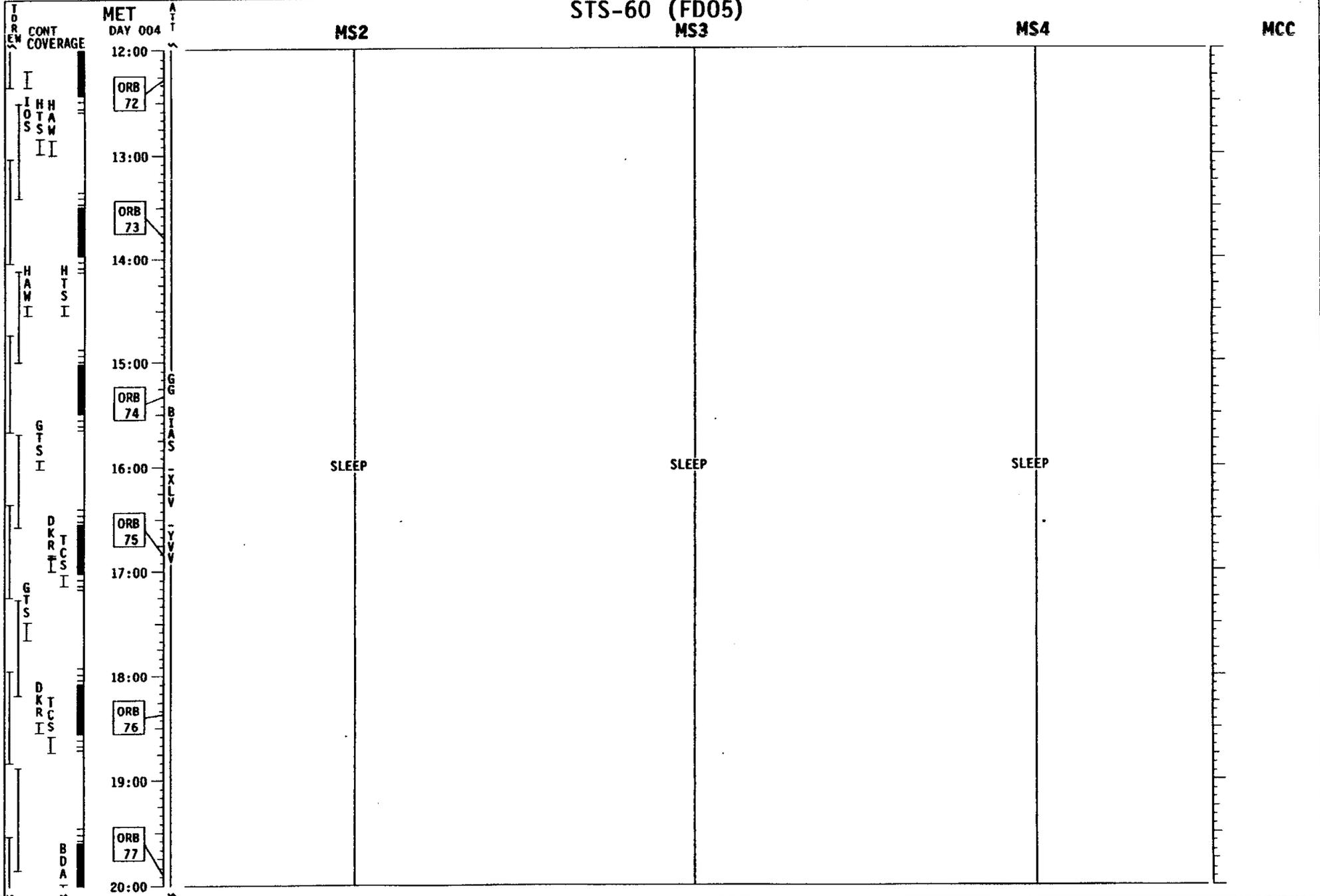

STS-60 (FD 06)
PLT

MS1

MCC

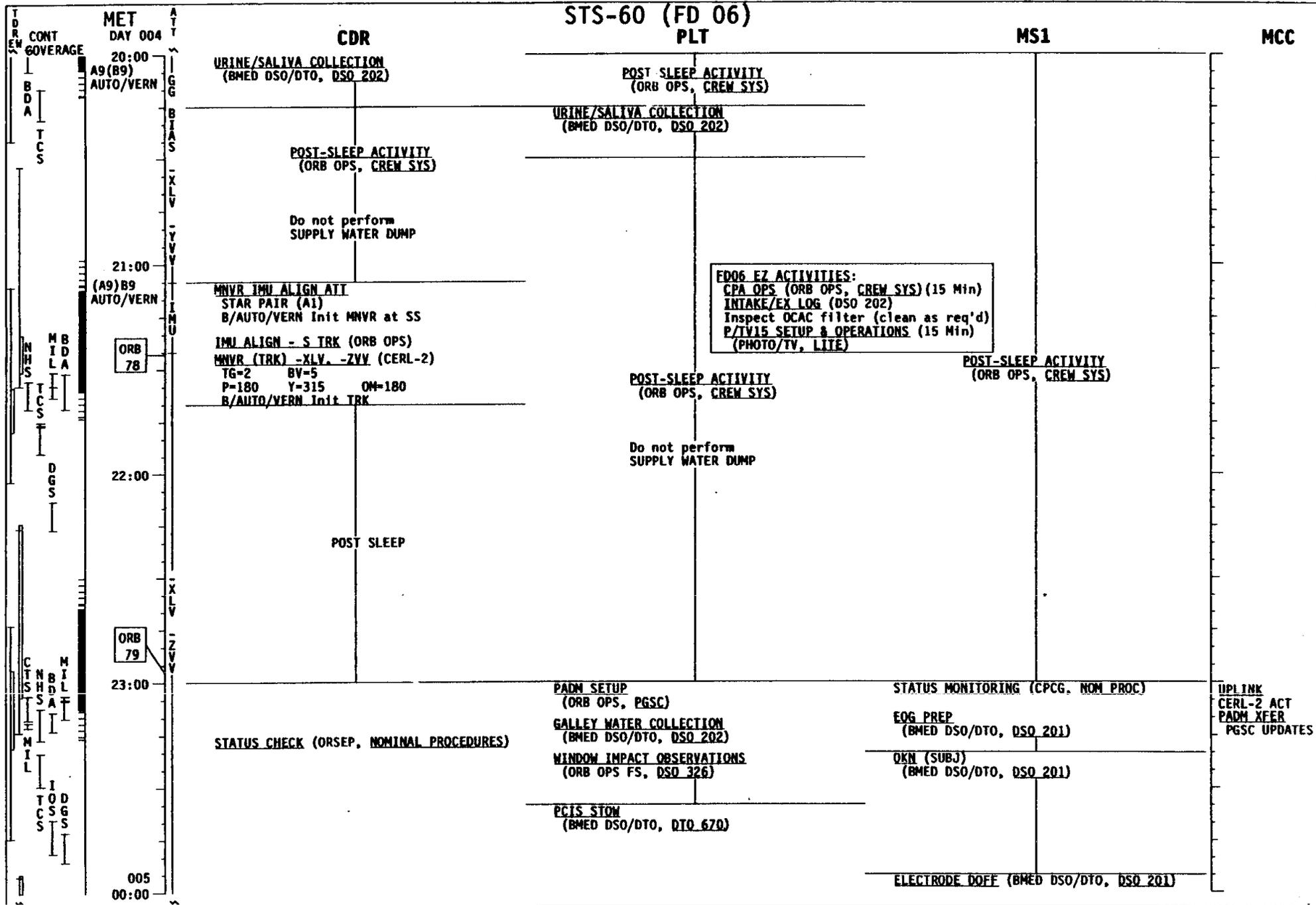

STS-60 (FD 06)

MET
DAY 004

MS2

MS3

MS4

MCC

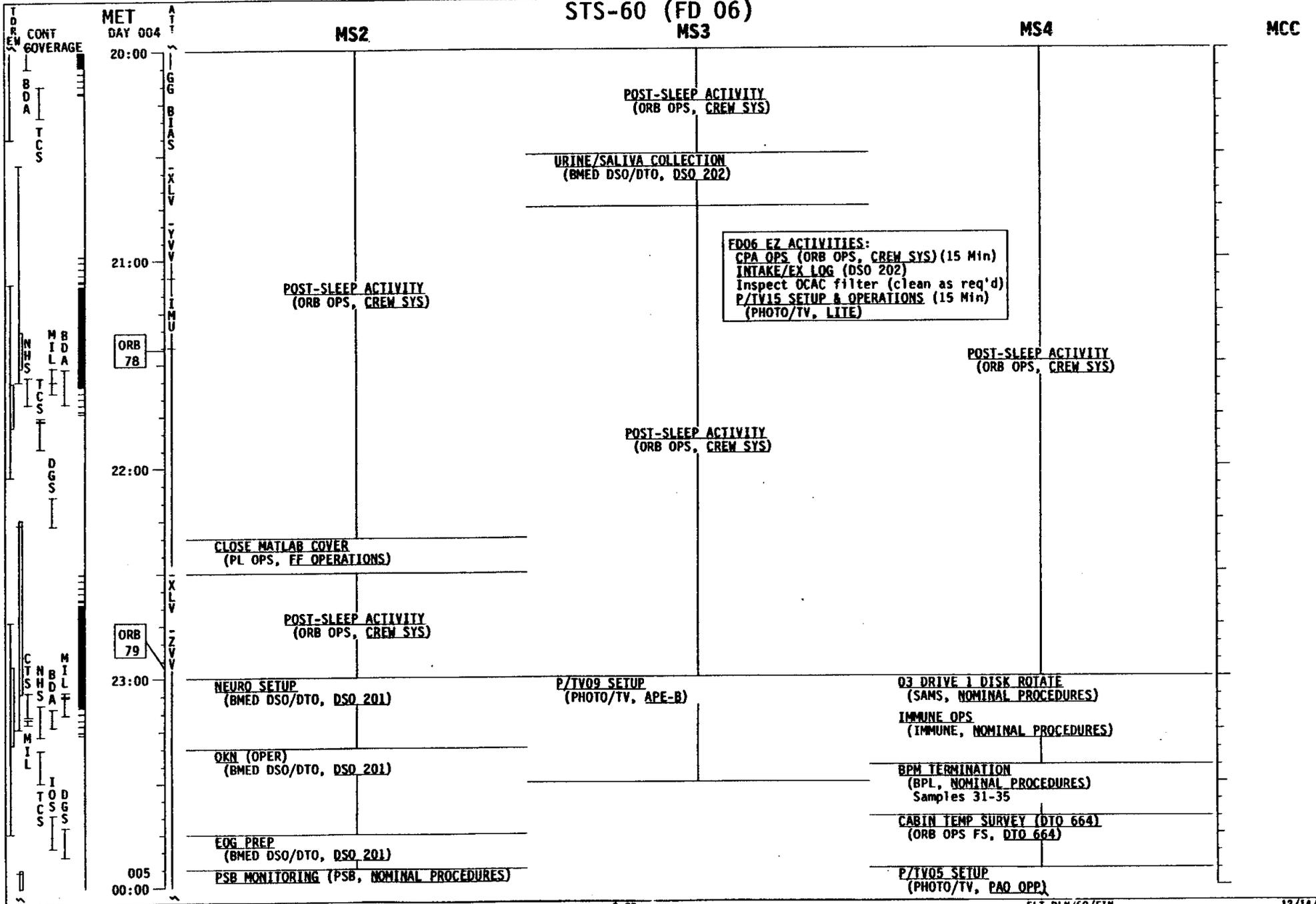

TDR
EM

CONT COVERAGE

VTS
CTS
NHS
TCS

IOS

H
T
S
W
T
S
C
T
S
N
H
S
T
C
S
C
R
R

H
T
S
W
T
S
V
T
S
C
T
S
N
H
S
T

MET DAY 005

00:00
(A9)89
AUTO/VERN

01:00

02:00

03:00

04:00

CDR

SR/SS TIMES		
ORB 80	SS-01:42	
81	SR-02:11	SS-03:13
82	SR-03:43	SS-04:45
83	SR-05:14	

← **MNVR (TRK) BIAS -XLV,-YV (CHAWS N1 POSN1)**
 TG-2 BV-5
 P-180 Y-30 OM-90
 B/AUTO/VERN(01:34) Init TRK
 NIGHT OPS 1
 (PL OPS, CHAWS)

DAYLIGHT OPS
 (PL OPS, CHAWS)
 CHAWS DAYLIGHT PASS #1
 Note: MNVR to CHAWS PITCHOVER POSN 1 MLT 03:09

PITCHOVER TEST
 (PL OPS, CHAWS)

LOAD FUTURE START:
MNVR (TRK) BIAS +XLV,-YV (CHAWS N2 POSN1)
 TG-2 BV-5
 P-0 Y-320 OM-90
 B/AUTO/VERN (04:40) Init TRK

STS-60 (FD 06) PLT

OXM (OPER)
 (BMED DSO/DTO, DSO 201)

TERMINATE SAMPLE PROCESSING
 (CGBA, NOMINAL PROCEDURES)
 GAP 12,35-37,7,21

EXERCISE

EXERCISE

MS1

PAO VOICE CHECK/EVENT
 TV at TDRW

EXERCISE

RMS/CHAWS MONITOR

OUTER COVER CLOSING
 (SH OPS, VIEWPORT)

MEAL

MEAL

MCC

TV (TDRW)
PAO EVENT

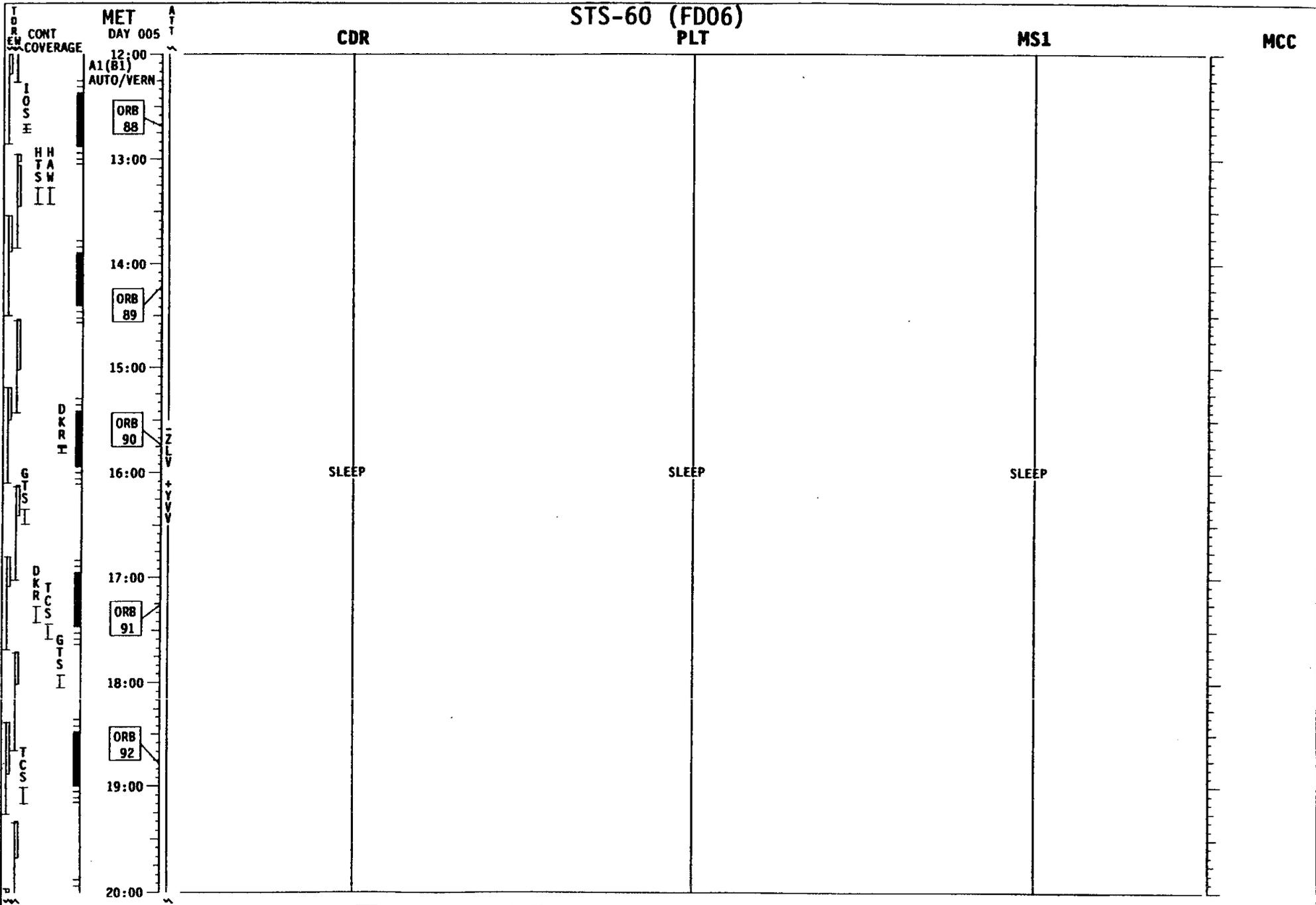

STS-60 (FD06)

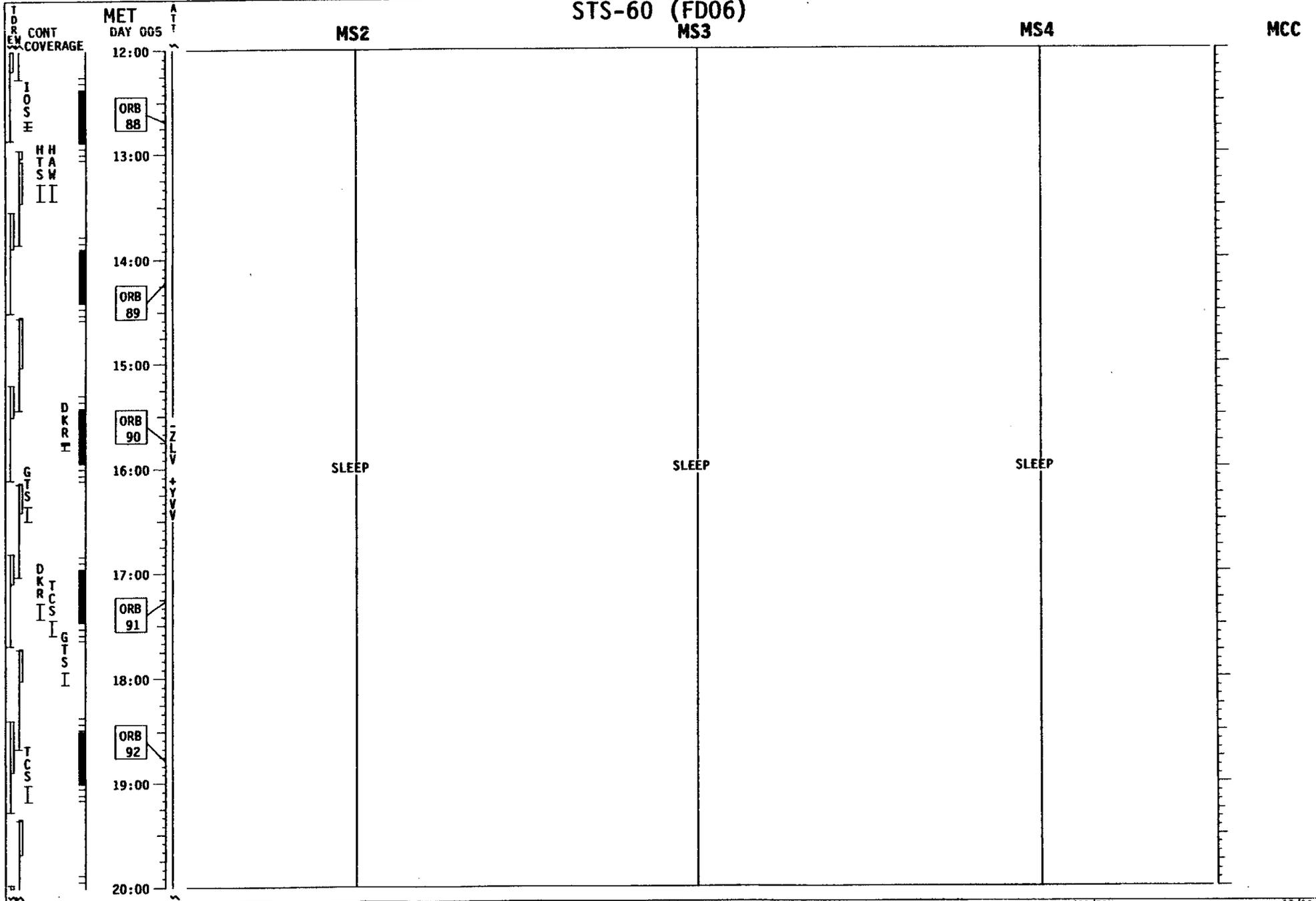

STS-60 (FD 07)

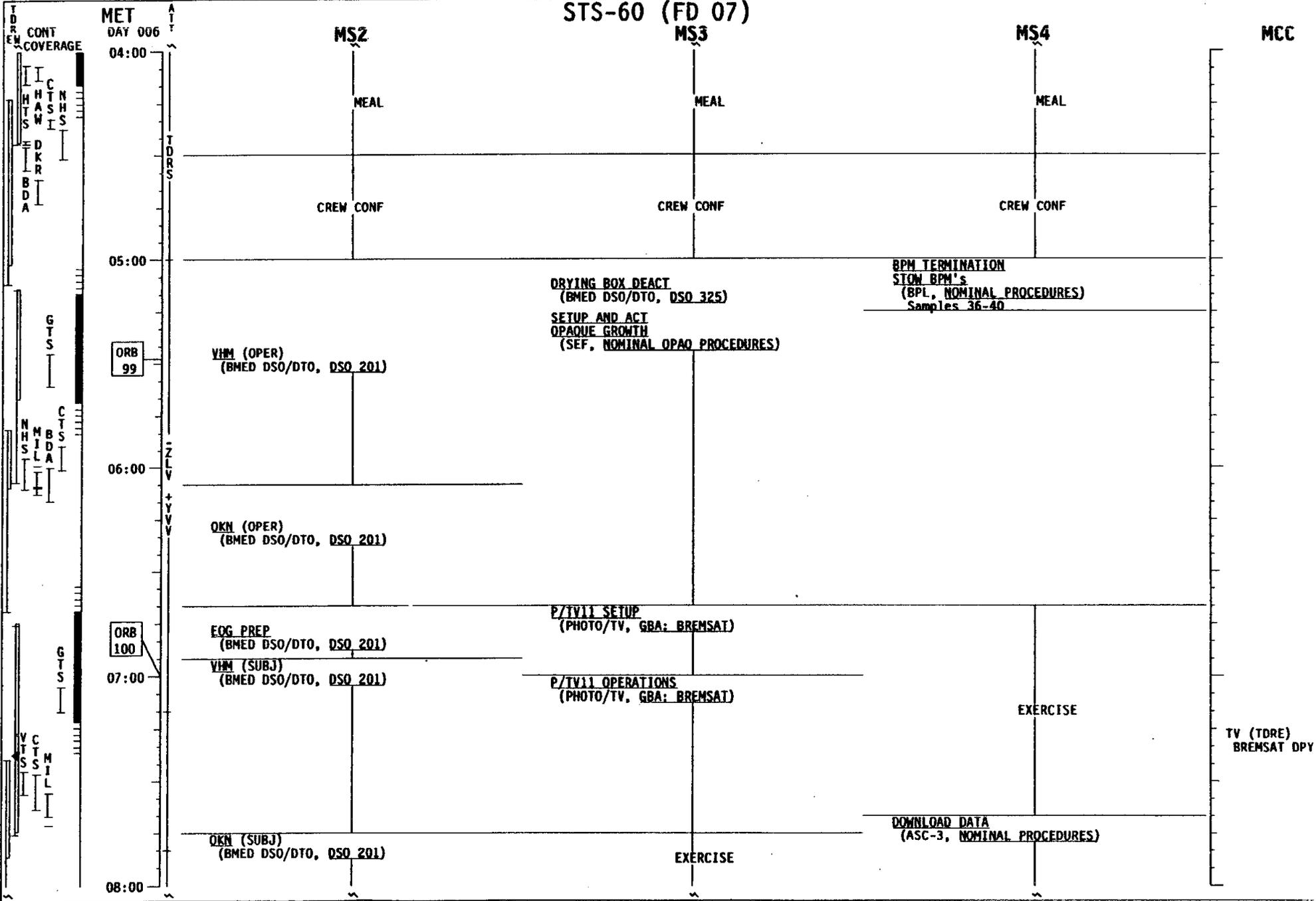

STS-60 (FD 07)
PLT

MS1

MCC

MET

DAY 006

TDR CONT COVERAGE
DGS
VTS
IOS
DGS
VTS
IOS

08:00
A1(B1)
AUTO/VERN

ORB
101

09:00

10:00

ORB
102

11:00

ORB
103

12:00

CDR

OXM (OPER)
(BMED DSO/DTO, DSO 201)

PRIORITY PWRDN GROUP B
(ORB PKT, PRIOR PWRDN)

CABIN TEMP SURVEY (DTO 664)
CABIN TEMP SURVEY-PAYLOADS (DTO 664)
(ORB OPS FS, DTO 664)

GN2 FREEZER/SAMPLE COOLER
(BMED DSO/DTO, DSO 202)

STATUS MONITORING (CPCG, NOM PROC)
STATUS CHECK (ORSEP, NOMINAL PROCEDURES)

PRE-SLEEP ACTIVITY
(ORB OPS, CREW SYS)

Do not perform
SUPPLY WATER DUMP

06 UHF MODE - OFF
PRIVATE MEDICAL CONFERENCE

06 UHF MODE - SPLX (or as reqd)
MNVR IMU ALIGN ATT
STAR PAIR (A1)
A/AUTO/VERN Init MNVR at SS

IMU ALIGN - S TRK (ORB OPS)
MNVR (TRK) -ZLV, +YVV
TG=2 BV=3 OM=270
A/AUTO/VERN Init TRK

REMINDER: Stow Urine and Blood
Samples in GN2 Freezer
prior to SLEEP

PRE-SLEEP ACTIVITY
(ORB OPS, CREW SYS)

Do not perform
SUPPLY WATER DUMP

PRE-SLEEP ACTIVITY
(ORB OPS, CREW SYS)

PRE-SLEEP ACTIVITY
(ORB OPS, CREW SYS)

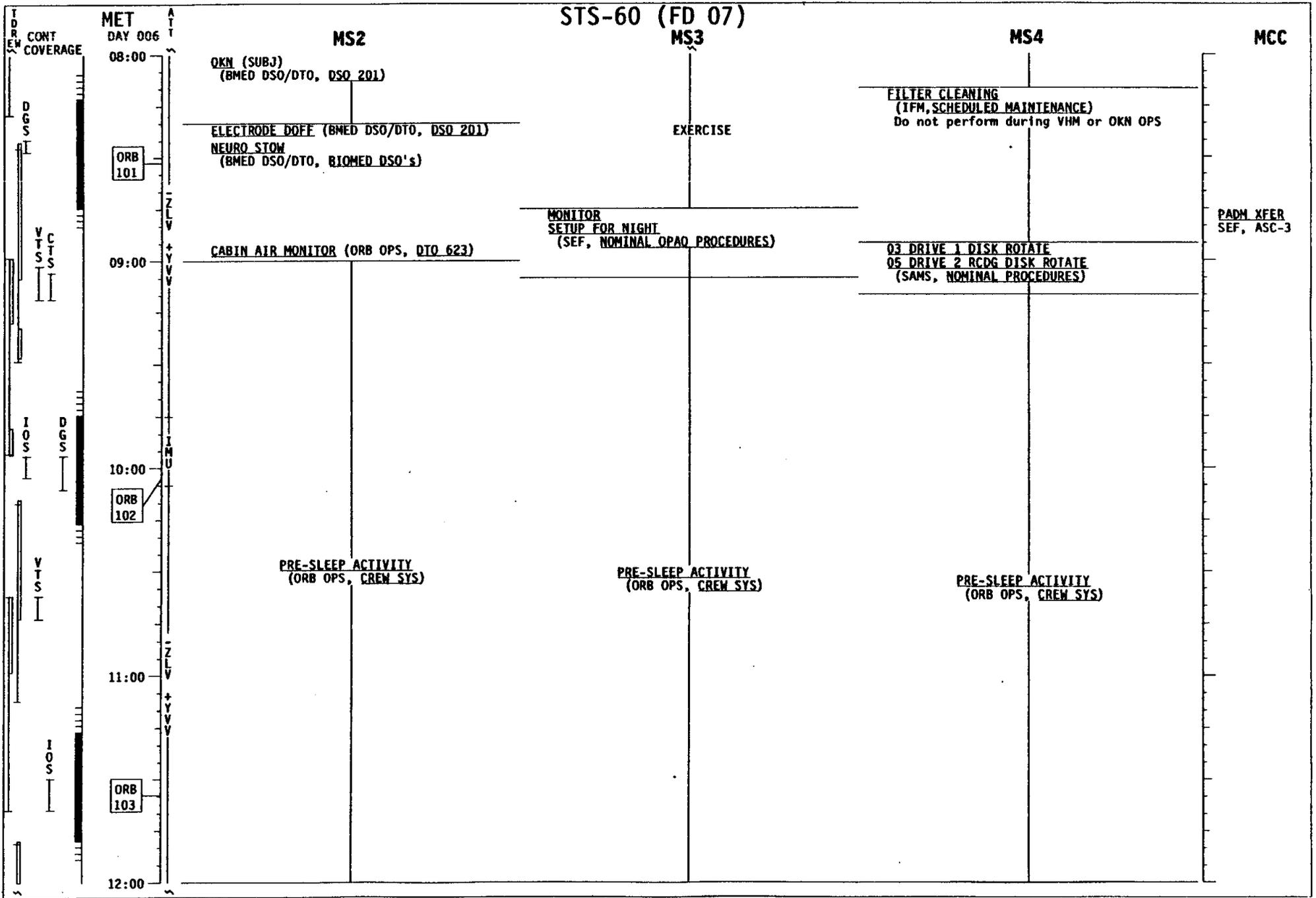

STS-60 (FD07)
PLT

CDR

MS1

MCC

CONT COVERAGE
MET DAY 006
A1(B1)
AUTO/VERN

12:00
13:00
14:00
15:00
16:00
17:00
18:00
19:00
20:00

HTASW
HTASW
GTSI
DKRCS
GTSI
DKRCS
BDACS

ORB 104
ORB 105
ORB 106
ORB 107
ORB 108

TT
Z
V
W
Y
V
W

SLEEP

SLEEP

SLEEP

STS-60 (FD07)

MS3

MS2

MS4

MCC

MET DAY 006

TDR CONT
EM COVERAGE

HTSW
HTSW
HTSW

HTSW
HTSW
HTSW

GTSI
GTSI
GTSI

DKRCS
DKRCS
DKRCS
DKRCS

BDACI
BDACI
BDACI

12:00

13:00 ORB 104

14:00 ORB 105

15:00

16:00 ORB 106

17:00

18:00 ORB 107

19:00 ORB 108

20:00

SLEEP

SLEEP

SLEEP

MCC

**STS-60 (FD 08)
PLT**

MS1

MCC

TD R EM
CONT COVERAGE
MB N I L A S
D G S
MC B I T N H S
D L A S
I O D G S
V T C S
T C S

MET DAY 006
20:00 A1(B1) AUTO/VERN
ORB 109
21:00
22:00 A1(B1) INRTL/VERN
ORB 110
23:00
A1(B1) INRTL/VERN
ORB 111
007
00:00

CDR

URINE/SALIVA COLLECTION
(BMED DSO/DTO, DSO 202)

DLW INGESTION (BMED DSO/DTO, DSO 202)

POST SLEEP

SUPPLY/WASTE WATER DUMP
(ORB OPS, ECLS) Init Waste Dump
Dump Tank to 5%

POST-SLEEP ACTIVITY
(ORB OPS, CREW SYS)

SUPPLY/WASTE WATER DUMP
(ORB OPS, ECLS)
Terminate Waste Dump

MNVR IMU ALIGN ATT
STAR PAIR (A1)
A/AUTO/VERN Init MNVR at SS
IMU ALIGN - S TRK (ORB OPS)
MNVR (TRK) -ZLV, +YVV
TG=2 BV=3 OM=270
A/AUTO/VERN Init TRK

POST SLEEP

PADM SETUP
(ORB OPS, PGSC)

SALIVA COLLECTION (BMED DSO/DTO, DSO 202)
RCS HOT FIRE TEST
(ORB OPS, RCS)

Config DAP: A/AUTO/VERN
ECS CHECKOUT
(ORB OPS, GNC)

PLT

POST-SLEEP ACTIVITY
(ORB OPS, CREW SYS)

SUPPLY WATER DUMP USING FES
(ORB OPS, ECLS) step 1

URINE/SALIVA COLLECTION
(BMED DSO/DTO, DSO 202)

POST-SLEEP ACTIVITY
(ORB OPS, CREW SYS)

POST-SLEEP ACTIVITY
(ORB OPS, CREW SYS)

APU STEAM VENT HTR ACT
R2 JBLR CNTLR/HTR(three) -B
PWR (three) -ON
SUPPLY WATER DUMP USING FES
(ORB OPS, ECLS) Perform Step 2 w/FES reqd
WINDOW IMPACT OBSERVATIONS
(ORB OPS FS, DSO 326)

GALLEY WATER COLLECTION
(BMED DSO/DTO, DSO 202)
SALIVA COLLECTION (BMED DSO/DTO, DSO 202)

RCS HOT FIRE TEST
(ORB OPS, RCS)

Config DAP: A/AUTO/VERN
ECS CHECKOUT
(ORB OPS, GNC)

MS1

POST-SLEEP ACTIVITY
(ORB OPS, CREW SYS)

EDOB EZ ACTIVITIES:
CPA OPS (ORB OPS, CREW SYS) (15 Min)
INTAKE/EX LOG (DSO 202)
Inspect OCAC filter (clean as req'd)
P/TVIS SETUP & OPERATIONS (15 Min)
(PHOTO/TV, LIFE)

STATUS MONITORING (CPCG, NOM PROC)
DEACT CPCG #1 PWRBK LS PGM
(CPCG, NOM PROC) Step 1
EOG PREP
(BMED DSO/DTO, DSO 201)

VHM (SUBJ)
(BMED DSO/DTO, DSO 201)

MCC

PADM KEYS
PGSC UPDATES
ASC-3

UPLINK
PCM4U
161/103

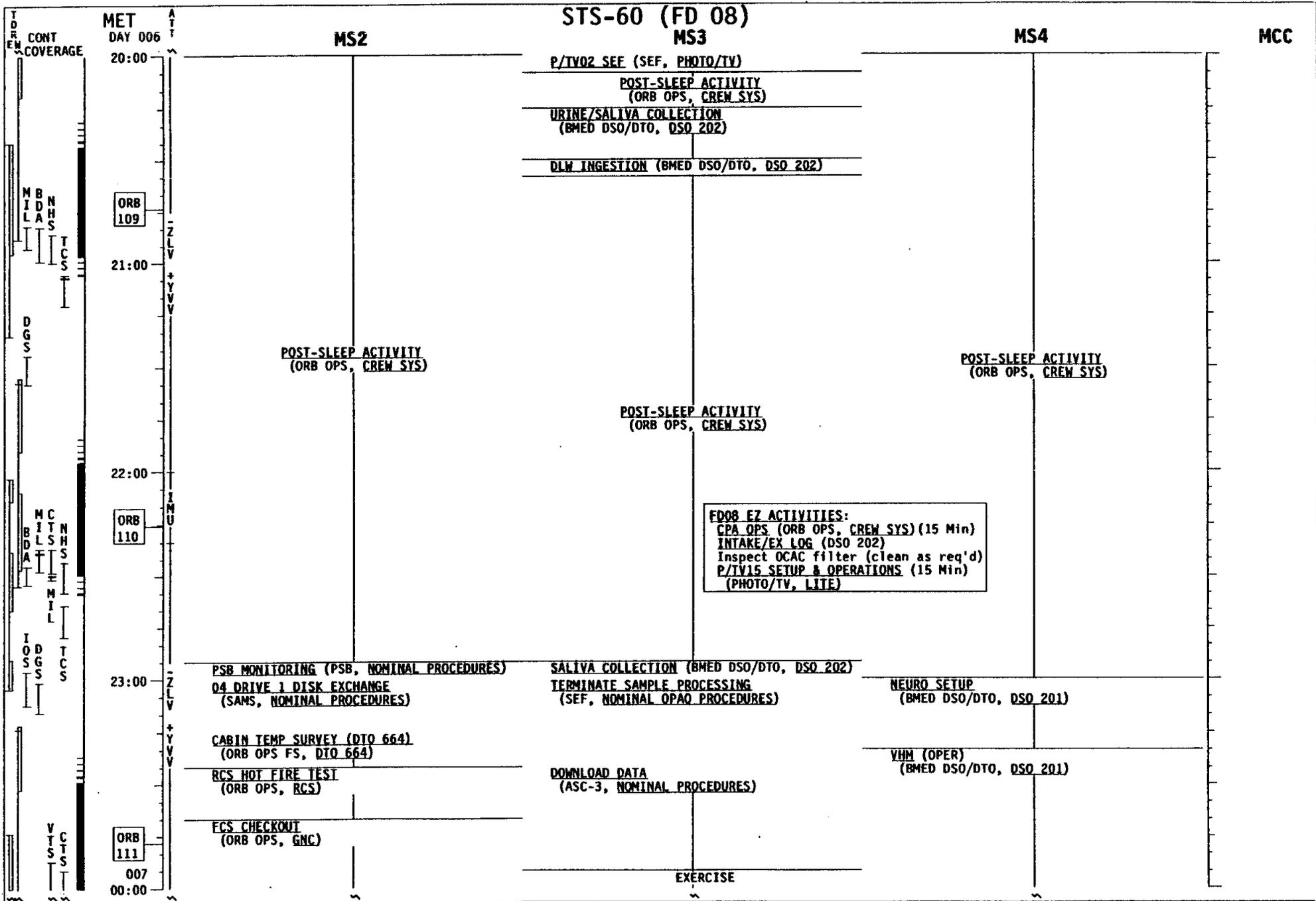

STS-60 (FD 08)

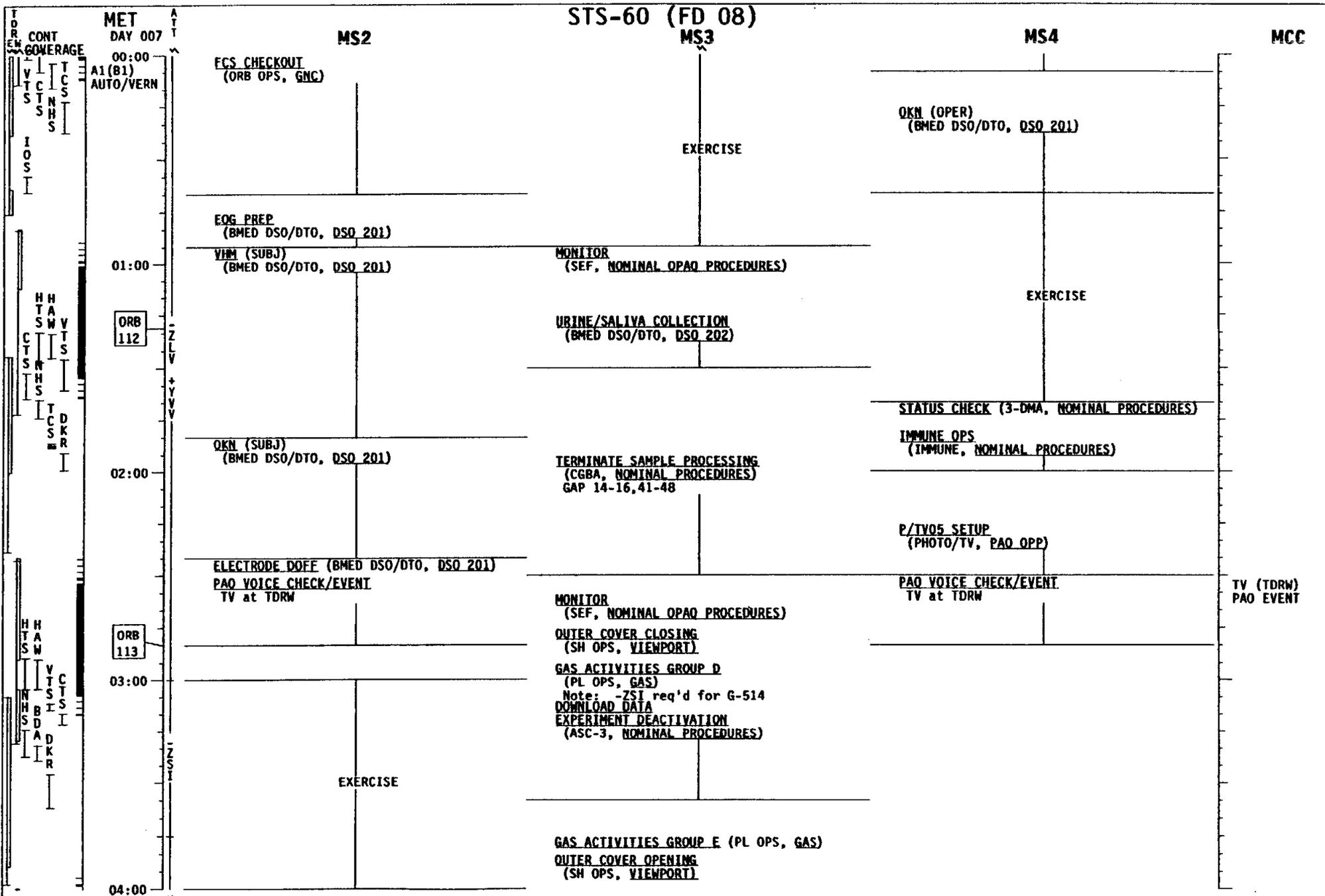

STS-60 (FD 08)

	A T		
	CDR	PLT	MS1
MET DAY 007 04:00 A1(B1) AUTO/VERN	MEAL	MEAL	MEAL
05:00 VOICE OPS (JAMES BEAN SCHOOL, SIDNEY, ME) (PL OPS, SAREX-C) CONTACT E5, M6 RISE=04:49 SET=04:58 VOICE OPS CMPLT - ENABLE PACKET		YHM (OPER) (BMED DSO/DTO, DSO 201)	EXERCISE
06:00 SAREX PWDRM (PL OPS, SAREX-C) SAREX STOW (PL OPS, SAREX-C)			
06:00 CABIN AIR MONITOR (ORB OPS, DTO 623) Perform step 3		STOWAGE (BMED DSO/DTO, DSO 200)	MODULE TEARDOWN (SH EH, MODULE TEARDOWN)
DEACTIVATE (ORSEP, NOMINAL PROCEDURES)		OKN (OPER) (BMED DSO/DTO, DSO 201)	
07:00 CABIN CONFIG/STOW	CABIN CONFIG/STOW	CABIN CONFIG/STOW	CABIN CONFIG/STOW
08:00			

TOR EM CONT COVERAGE
 GTS
 CTN
 N M S
 H I L
 B D A
 V T S
 N M S
 H I L
 V T S
 B D A
 V T S
 N M S
 H I L
 V T S
 B D A

ORB 114

ORB 115

ORB 116

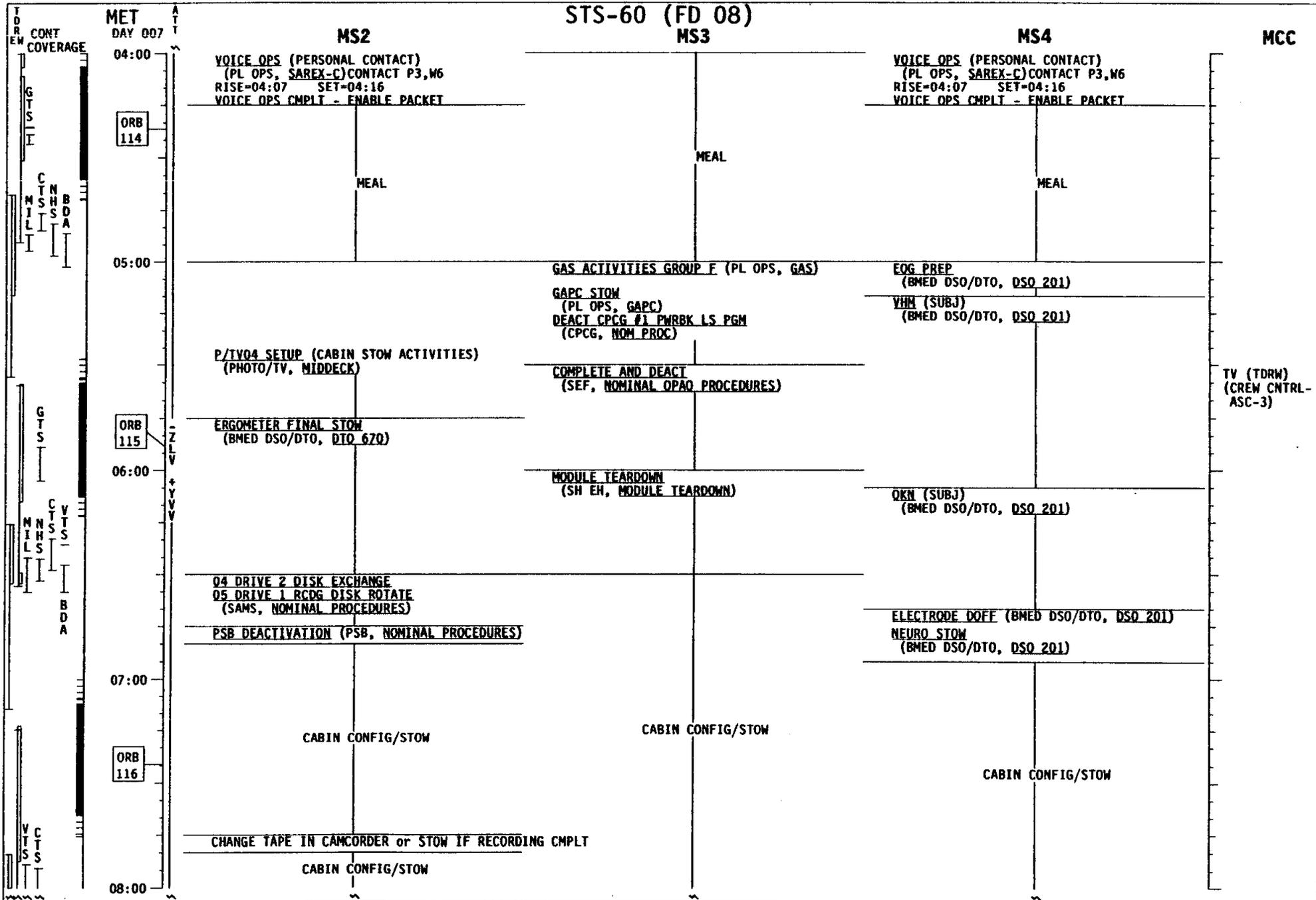

STS-60 (FD 08)

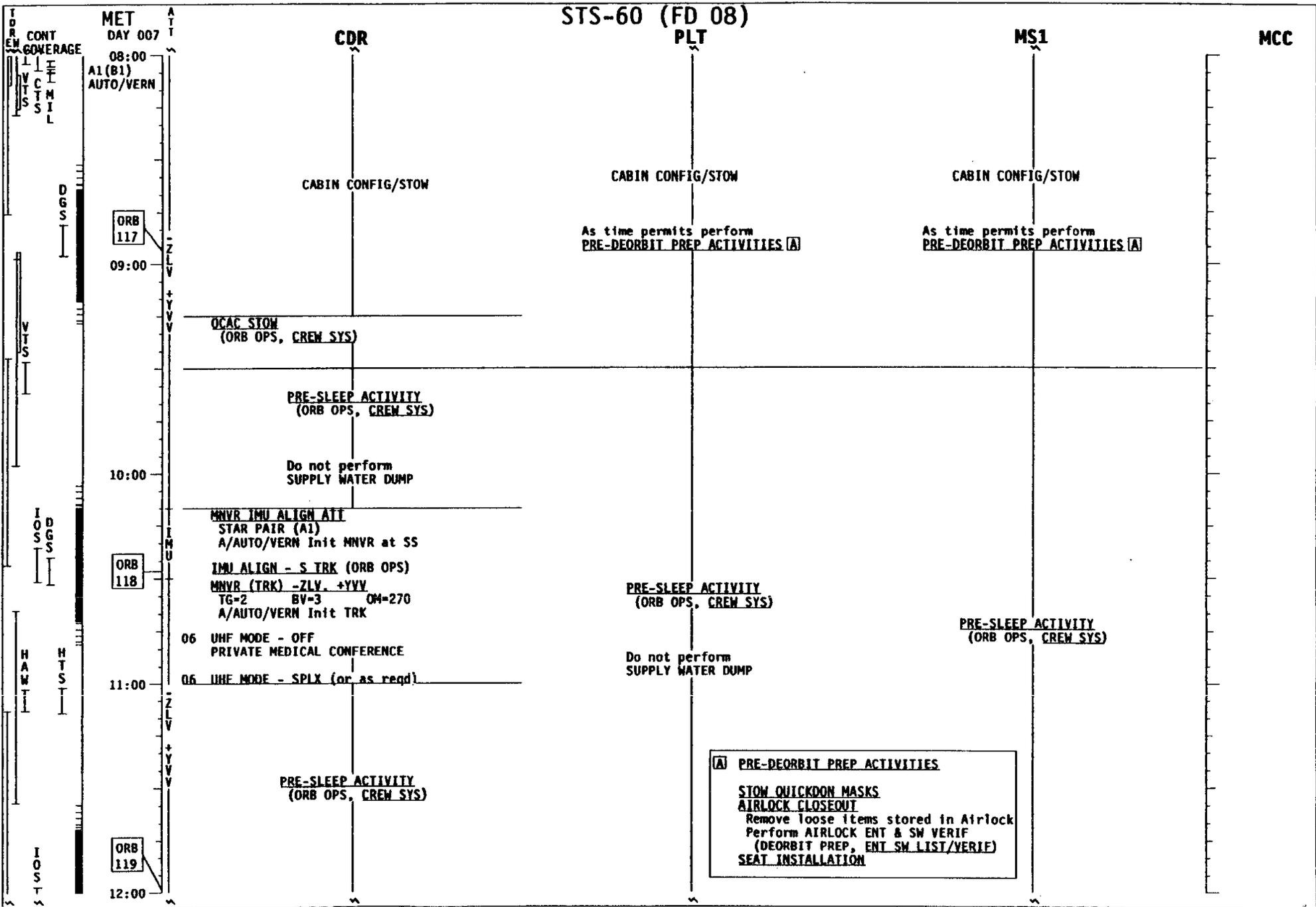

STS-60 (FD 08)

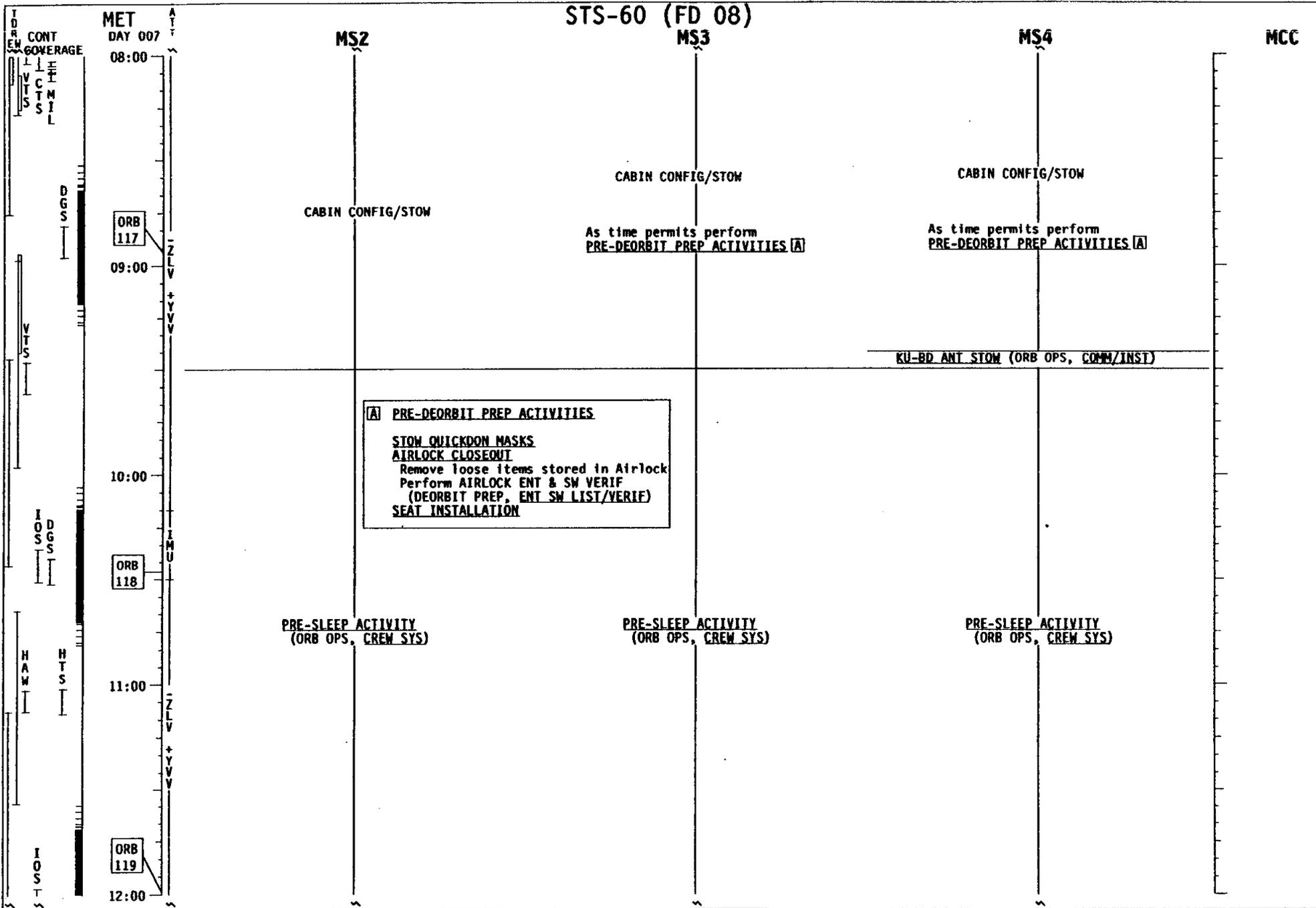

STS-60 (FD08)

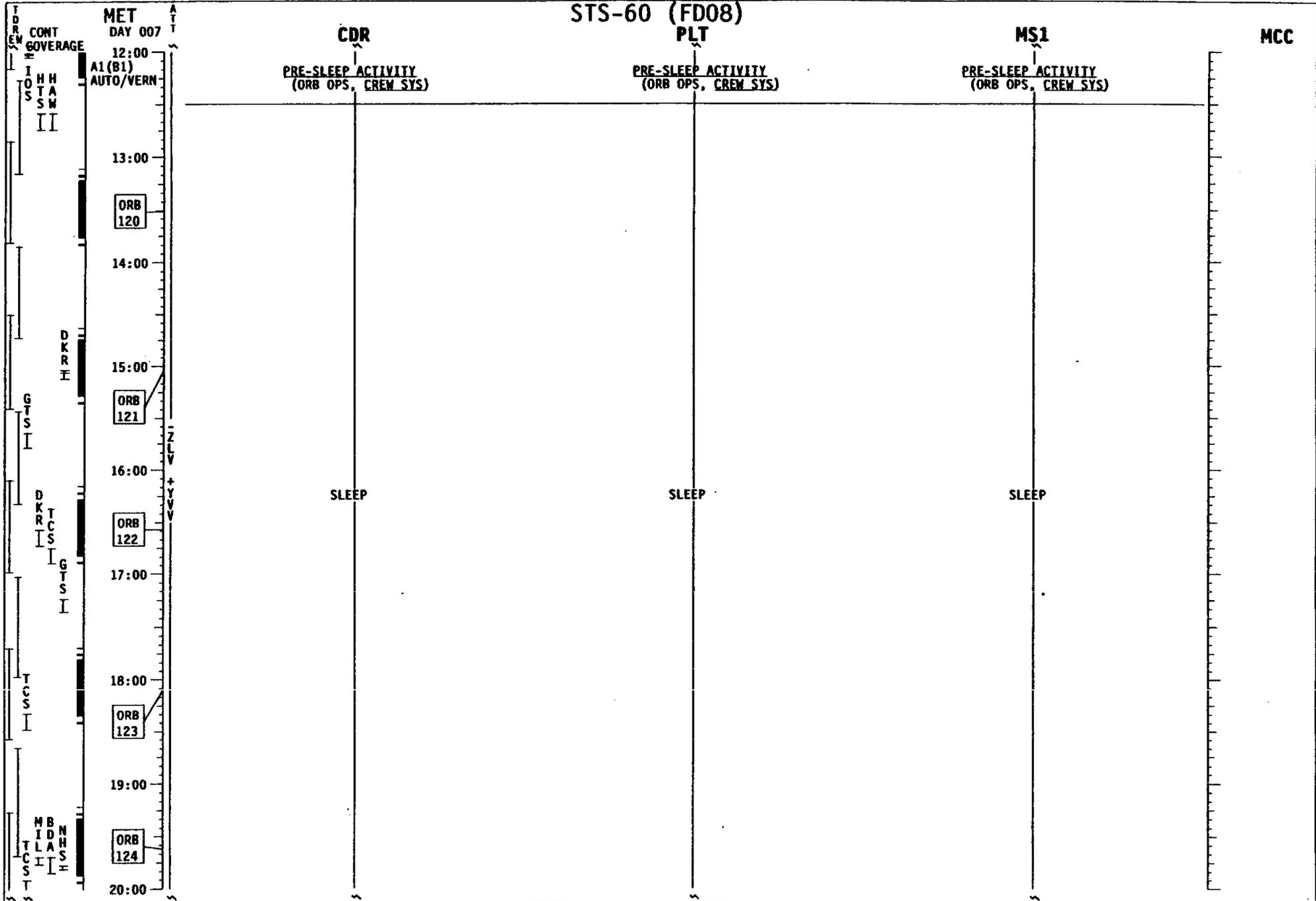

STS-60 (FD08)

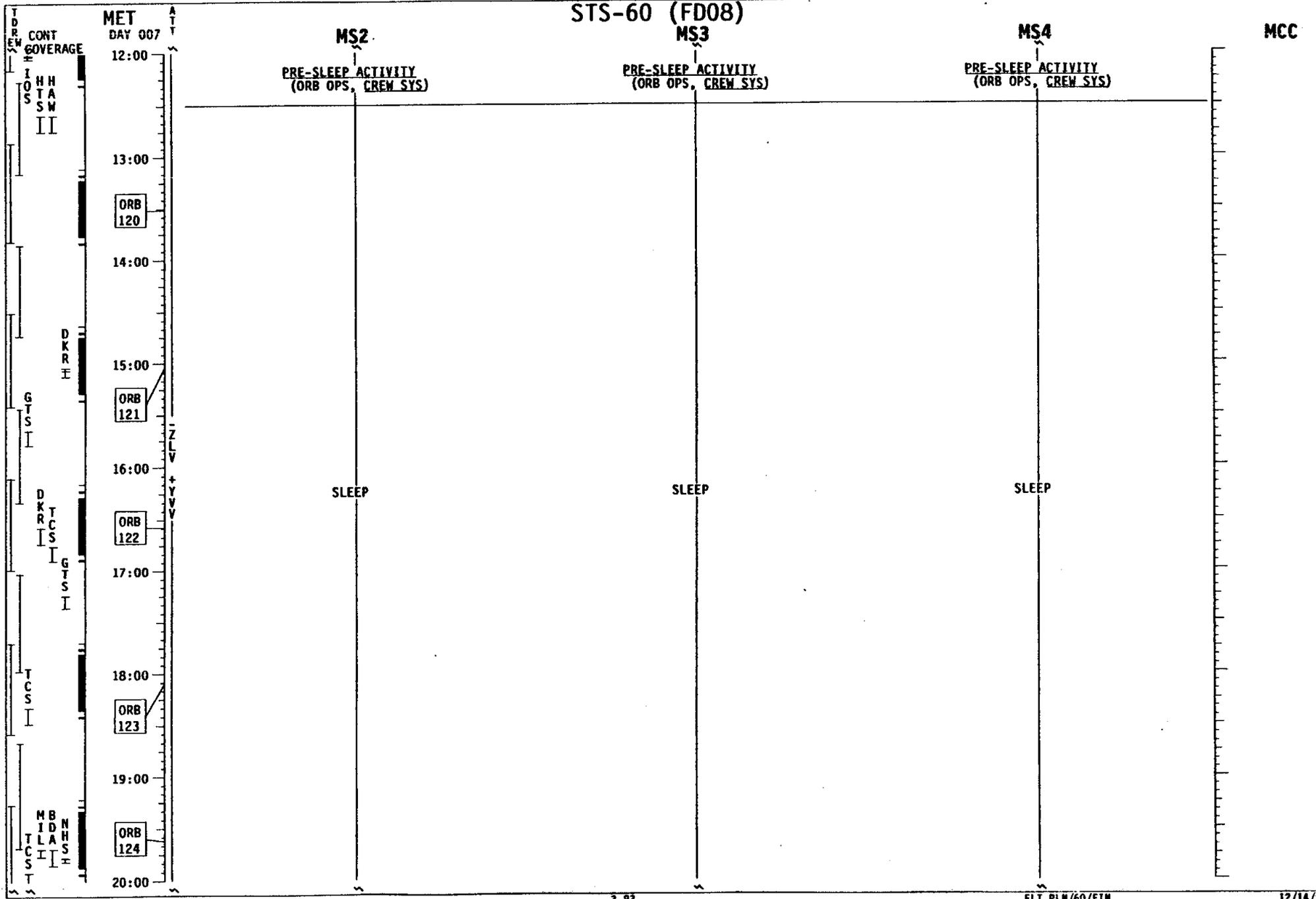

STS-60 (FD 09)

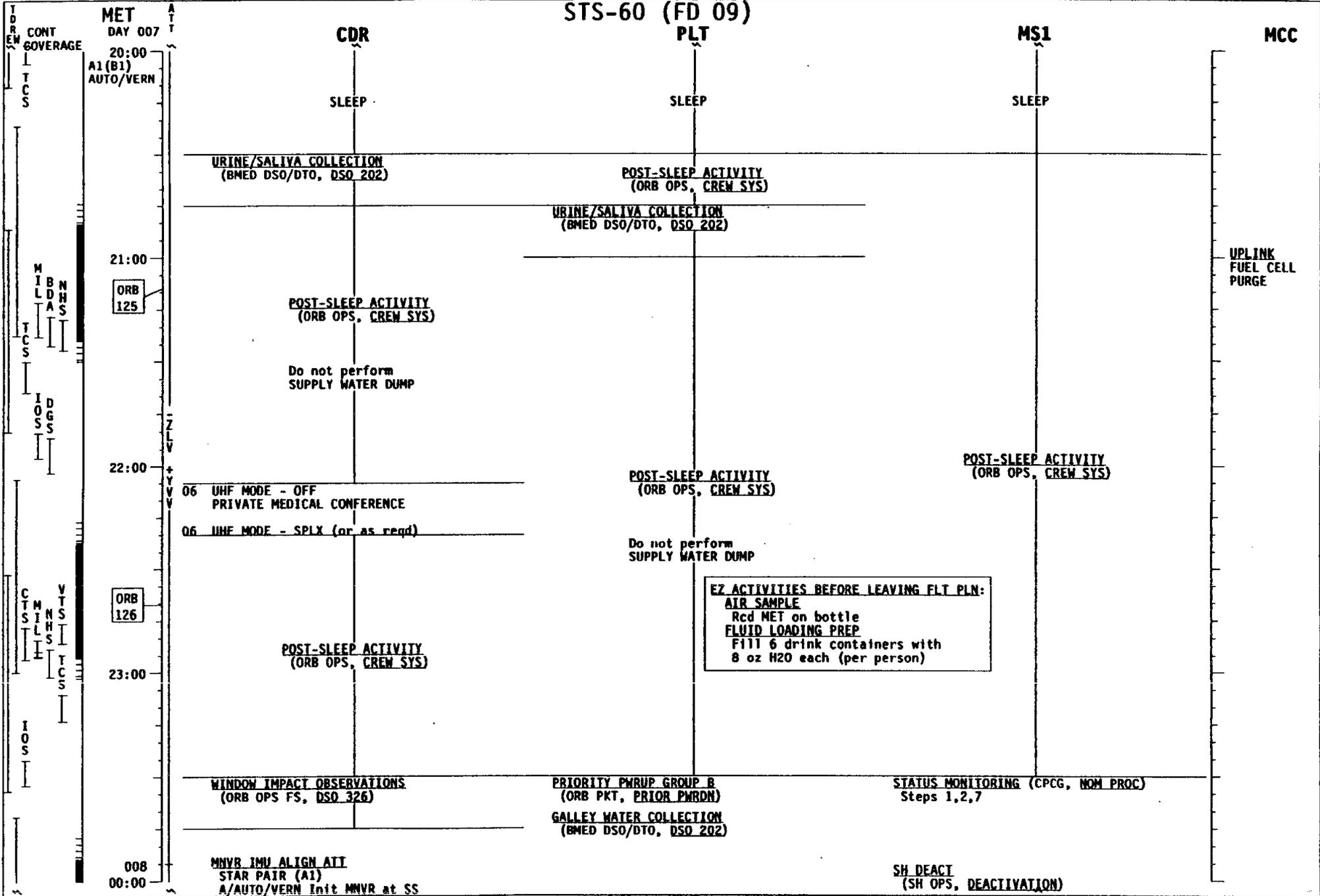

STS-60 (FD 09)

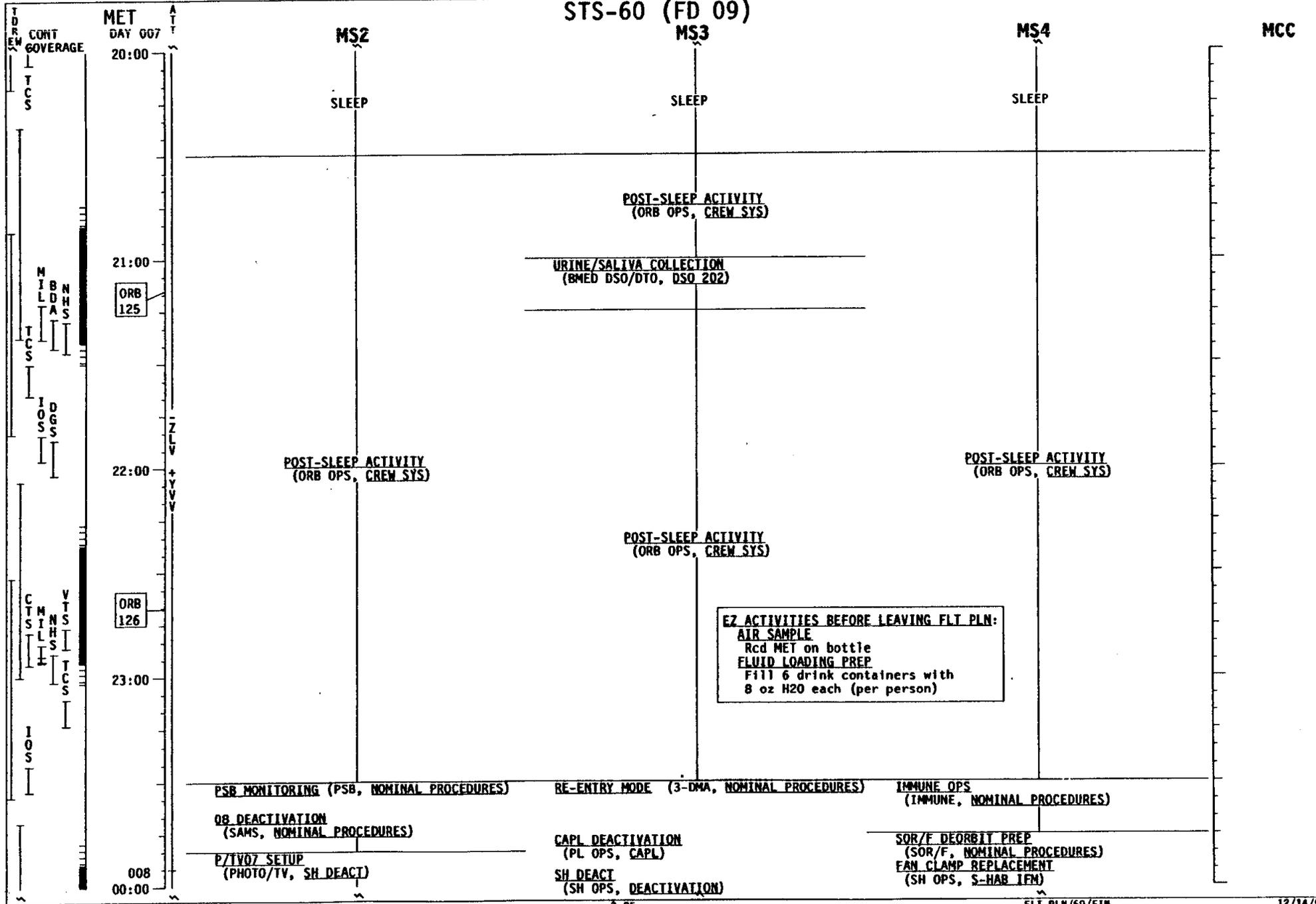

STS-60 (FD 09)
PLT

MS1

MCC

CDR

CABIN TEMP SURVEY (DIO 664)
(ORB OPS FS, DIO 664)

SH DEACT
(SH OPS, DEACTIVATION)

UPDATE
CRT TIMER
SETUP PAD

MNVR IMU ALIGN ATT
STAR PAIR (A1)
A/AUTO/VERN Init MNVR at SS
IMU ALIGN - S TRK (ORB OPS)
MNVR (TRK) - XSI
TG-4 BV-5
P-184 Y-0 OM-90
A/AUTO/VERN Init TRK

DEORBIT PREP (AT LES DOWNING)
(BMEC DSO/DIO, DSO 201)

GO TO DEORBIT PREP AT 8/00:28 MET

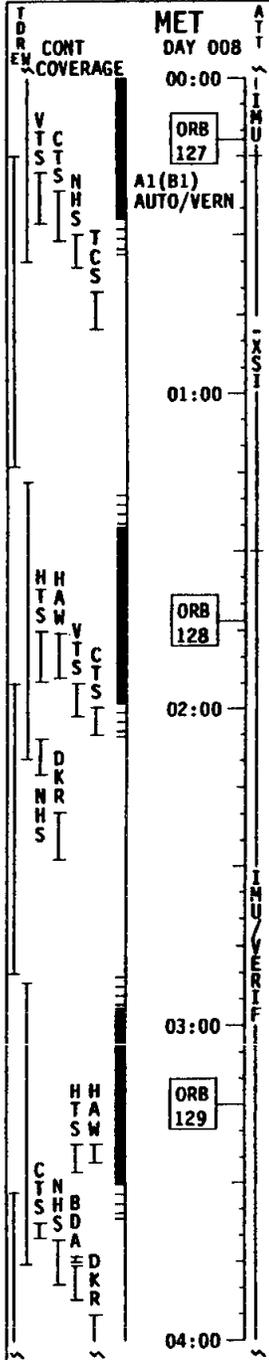

STS-60 (FD 09)
MS3

MS4

MCC

MET
DAY 008

00:00
ORB
127

01:00

ORB
128

02:00

03:00

ORB
129

04:00

TDR EN
CONT
COVERAGE

ATY
IMU

LXST

IMU
VERIF

V
T
S
T
S
N
H
S
T
C
S

H
T
S
A
M
V
T
S
T
S

D
K
R
R
N
H
S

H
T
S
A
M
N
H
S
D
K
R

P/TVO7 OPERATIONS
(PHOTO/TV, SH DEACT)

SH DEACT
(SH OPS, DEACTIVATION)

FAN CLAMP REPLACEMENT
(SH OPS, S-HAB IEM)

GO TO DEORBIT PREP AT 8/00:28 MET

This Page Intentionally Blank

CONTINGENCY TIMELINES

MINIMUM DURATION FLIGHT (MDF) TIMELINE 4-2
WSF 1-DAY LATE DEPLOY/RETRIEVE TIMELINE 4-4
WSF NO DEPLOY TIMELINE 4-8

**CONTINGENCY
TIMELINES**

CONTINGENCY TIMELINES

MINIMUM DURATION FLIGHT (MDF) TIMELINE

The timeline assumes an MDF is declared no later than 0/23:30 MET and is designed to allow WSF to accomplish their mission success MBE growth objectives while deployed. The orbiter must be maneuvered to the WSF deploy attitude and all contamination sources (with the exception of the SEF transparent vacuum vent valve) must be isolated by 0/23:30 MET to support WSF unberth at 1/00:35 MET. The nominal timeline may be used up to the point of MDF declaration.

WSF

WSF release is scheduled on orbit 19 (\approx 1/03:45 MET) with grapple on orbit 35 (\approx 2/03:45 MET) for a total of 23.5 hours free flight time. An ORB 19 release assumes WSF ram cleaning is one orbit and WSF unberth occurs 30 min after the initiation of the GG attitude. The Plume Impingement test and CHAWS operations will not be performed.

SPACEHAB

Spacehab venting may occur during the WSF mission after Release +2 hours (1/05:30 MET). The SEF transparent vent valve will be allowed open anytime during the mission so long as it only equalizes the SEF vacuum (no real venting). The 16 hours of Spacehab Category 1 objectives will be scheduled per FR A6.5-1.

JOINT SCIENCE

High priority Joint Science operations such as the FD1 and 2 metabolics and FD1 VHM will be protected to the extent possible. Other Joint Science desires such as FD2 VHM and any FD3 activities will be scheduled as time permits.

COB

ODERACS and BREMSAT deploy are scheduled as time permits post WSF retrieval on FD3 (orbits 36/37) with no consideration for overflight constraints. CAPL operations will continue throughout the third flight day.

FLIGHT: STS-60 EDITION: MDF PUB. DATE: 12/14/93

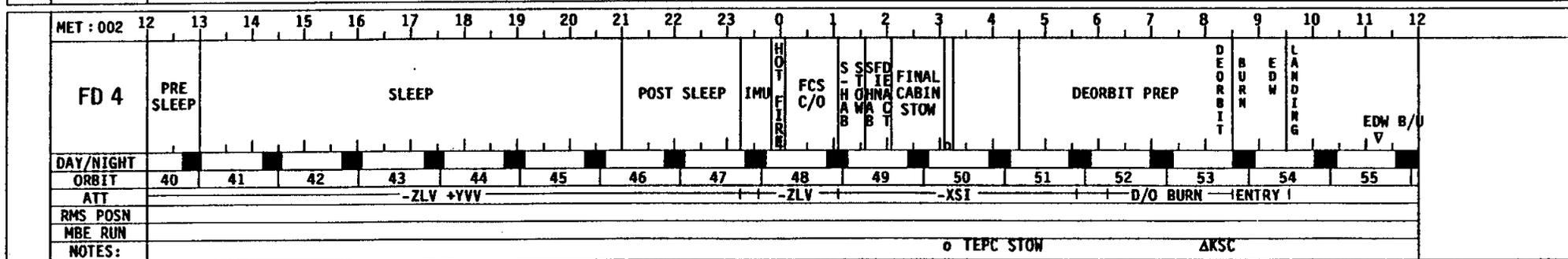
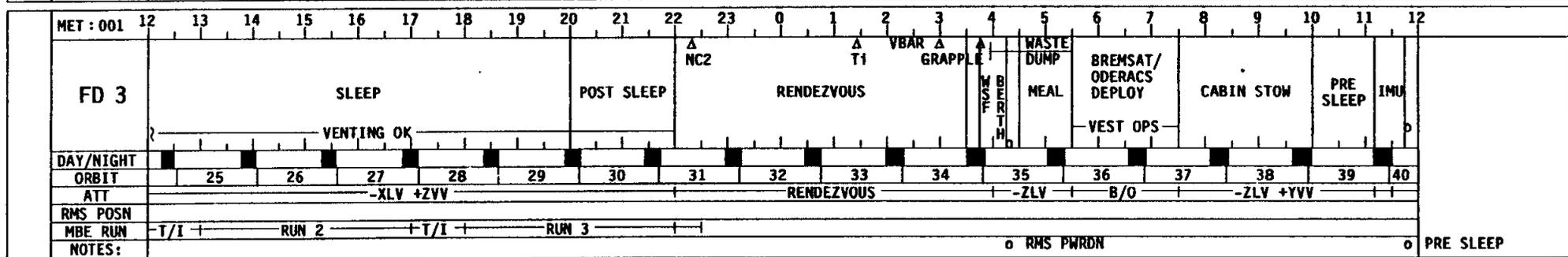
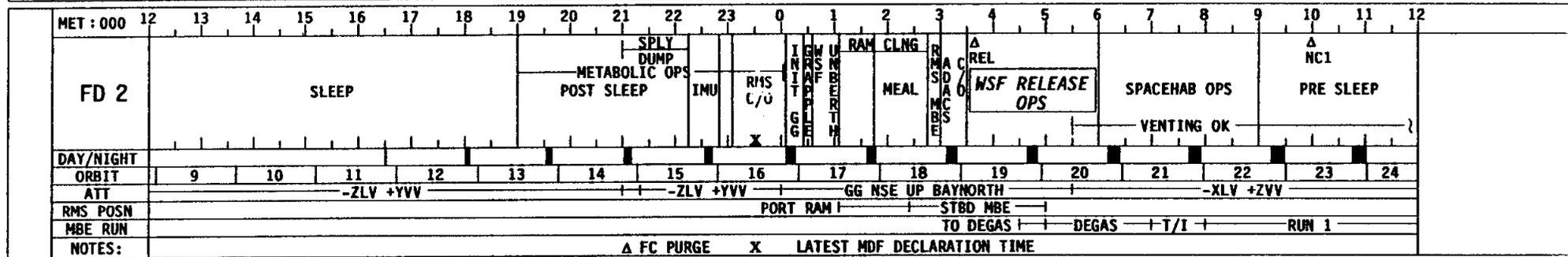
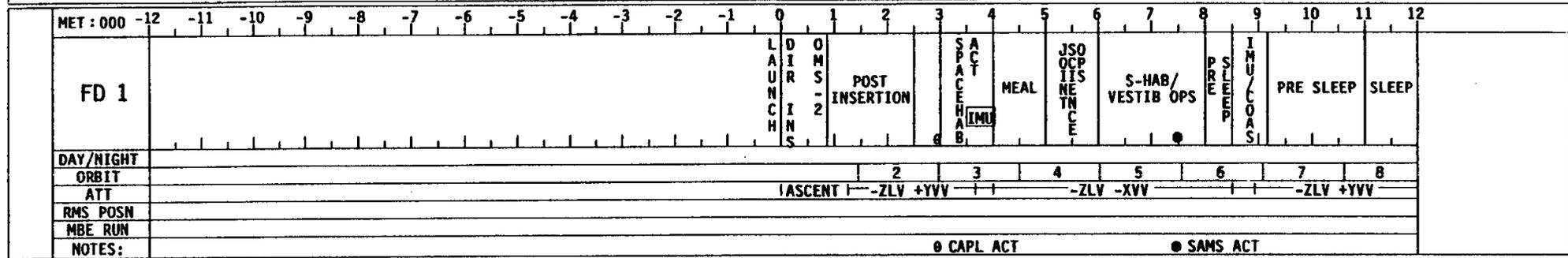

WSF 1-DAY LATE DEPLOY/RETRIEVE TIMELINE

This timeline assumes a nominal mission until a failure causes a deploy wave-off until Flight Day 4. Two days of WSF deployed operations are preserved. Attempts will be made to minimize impact to the nominal Flight Plan. ODERACS deploy occurs one orbit later than nominally scheduled (Orbit 98) due to CHAWS operations so a separation burn is required. The timeline returns to nominal after ODERACS deploy on Flight Day 7. If WSF battery margins preclude 48 hours of deployed operations, Rendezvous will be scheduled FD5 and the timeline returns to normal at that point. The timeline uses the Rotated FRR trajectory.

FLIGHT: STS-60 **EDITION:** WSF ONE DAY LATE **PUB. DATE:** 12/14/93

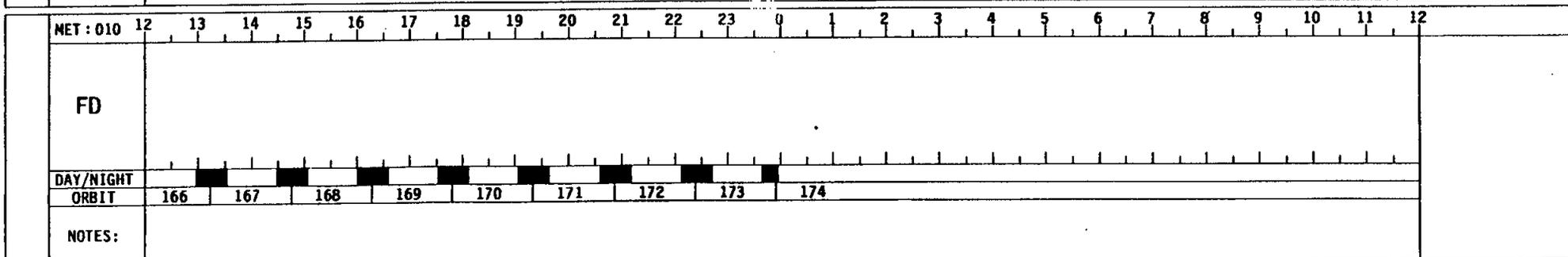
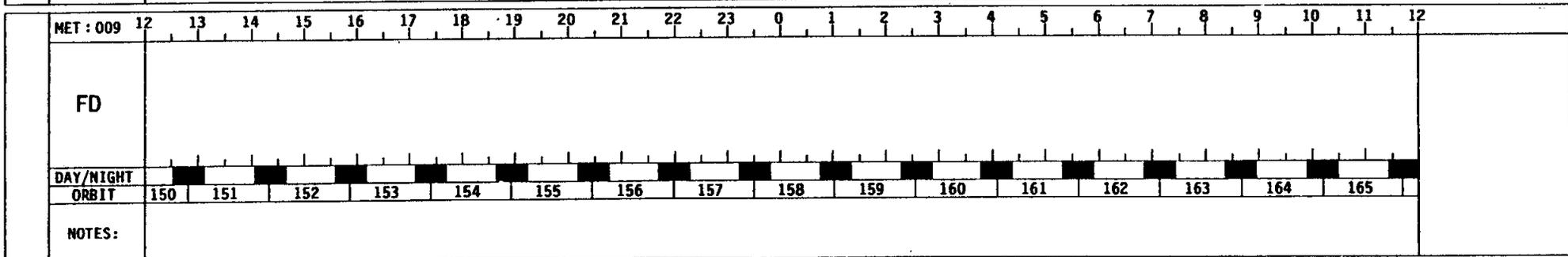
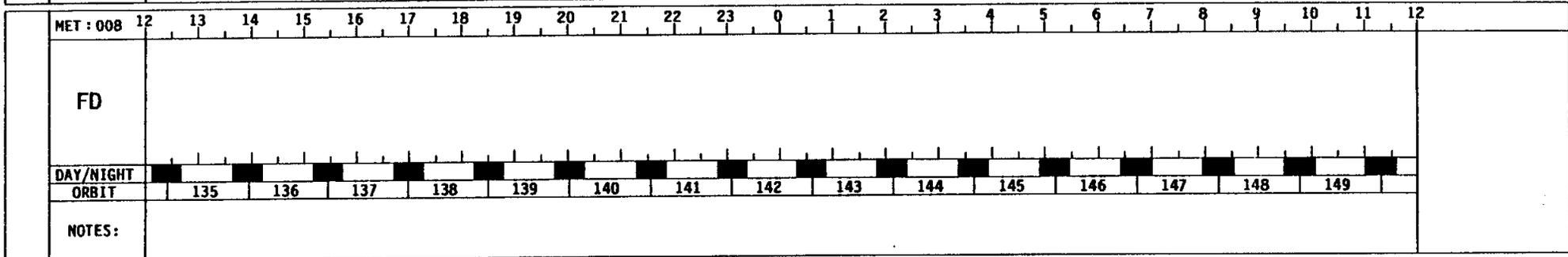
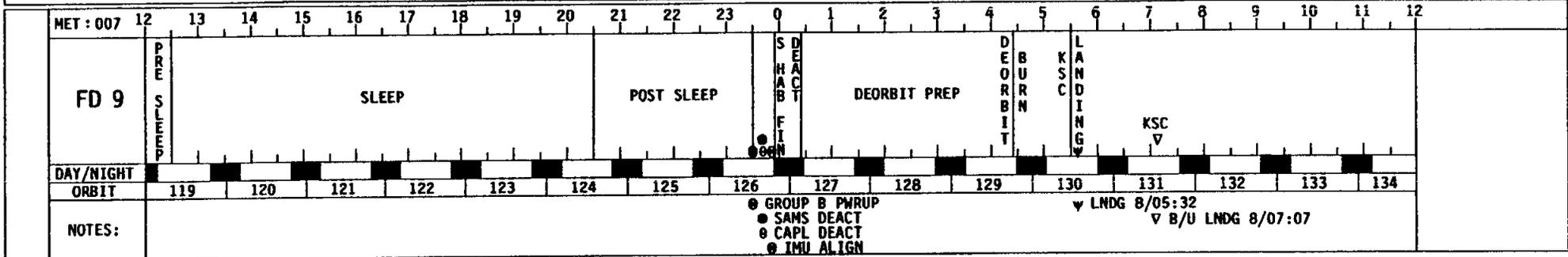

WSF NO DEPLOY TIMELINE

This timeline assumes a nominal mission until a failure prevents WSF from being deployed; therefore, all WSF MBE growth runs must be done on the RMS. The WSF will be re-berthed each morning to allow for 6 hours of orbiter/Spacehab venting as required each day. The timeline returns to nominal prior to WSF CHAWS operations on Flight Day 6. The timeline uses the Rotated FRR trajectory.

FLIGHT: STS-60 EDITION: WSF NO DEPLOY PUB. DATE: 12/14/93

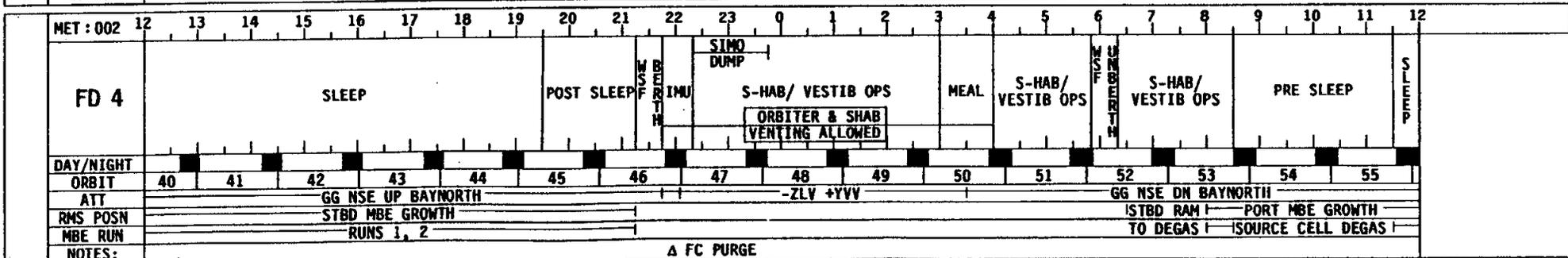
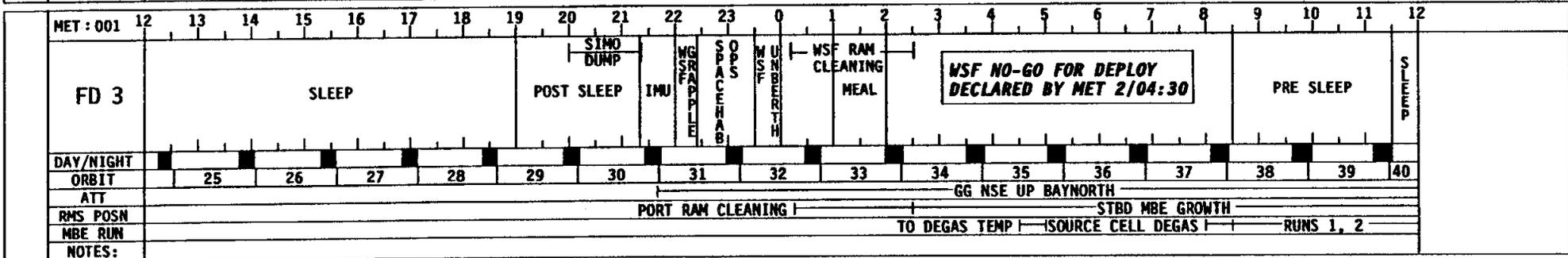
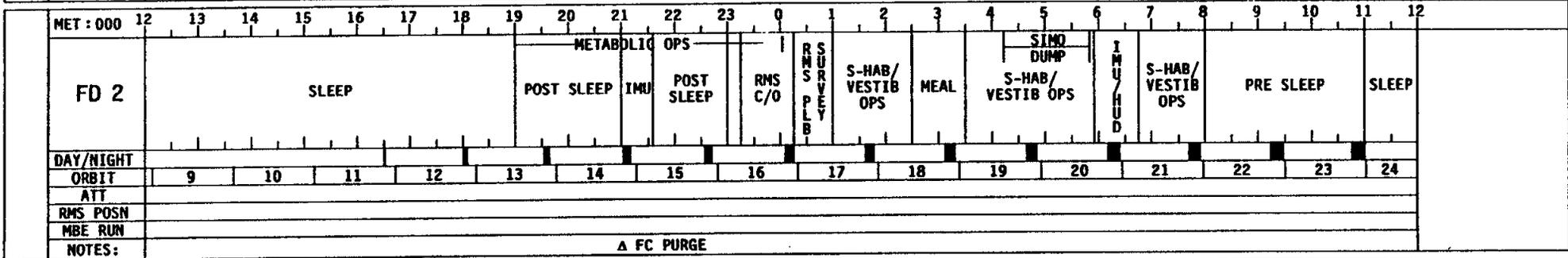
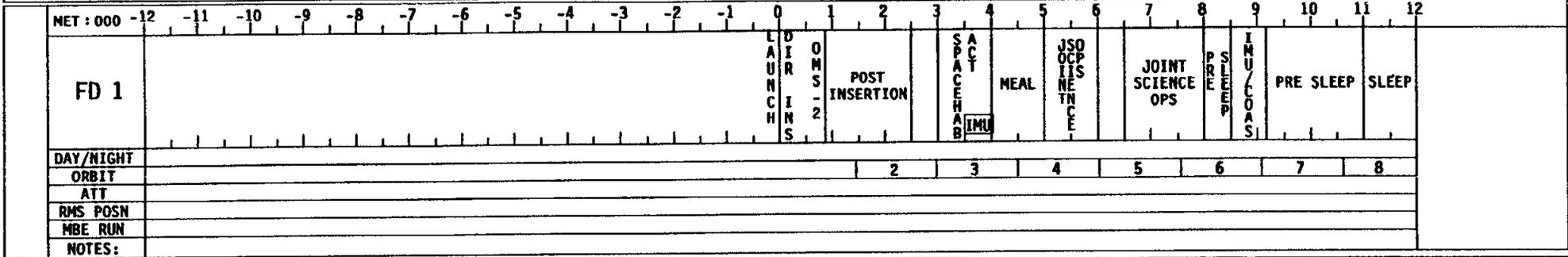

The sections following this divider page will not be included in flight copies.

ATTITUDE TIMELINE

Attitude Timeline

MET/GMT	MNVR OPTION	DAP	E/ZS	REF ATT/REMARKS	EVENT	
1 007/23:55:00 MET 008/00:08:32 035/12:09:00 GMT 22:32 (MNVR AT SS)	INRTL R= 81.00 MNVR P= 40.00 Y= 25.00	A1 AUTO VERN	DSC 0.200 DB AT 1.00 DB RT 0.02	SUN R 174 P 68	STAR PAIR A1 -Y: 17 -Z: 21	IMU ALIGN
2 008/00:15:00 MET 26:51 035/12:29:00 GMT 40:51	TGT=4 RA= 317.314 BV=5 DEC= -16.383S P=184.00 Y= 0.00 OM= 90.00	A1 AUTO VERN	DSC 0.200 DB AT 1.00 DB RT 0.02	SUN R 180 P 176	INRTL R= 48.19 P=198.29 Y= 37.65	-XSI
3 008/01:30:00 MET 36:31 035/13:44:00 GMT 50:31	INRTL R= 12.00 MNVR P=146.00 Y= 29.00	A1 AUTO PRI	DSC 0.200 DB AT 5.00 DB RT 0.20	SUN R 198 P 134	ALIGN STAR PAIR -Y: 48 -Z: 44	D/O IMU ALIGN
4 008/01:50:00 MET 52:30 035/14:04:00 GMT 06:30	INRTL R= 43.00 MNVR P=200.00 Y=354.00	B1 AUTO PRI	DSC 0.500 DB AT 3.00 DB RT 0.20	SUN R 225 P 133	VERIF STAR PAIR -Y: 14 -Z: 18	D/O IMU VERIF
5 008/02:01:00 MET 05:14 035/14:15:00 GMT 19:14	INRTL R=330.00 MNVR P= 45.00 Y=307.00	B1 AUTO PRI	DSC 0.500 DB AT 3.00 DB RT 0.20	SUN R 181 P 20		COMM ATT COLD SOAK ATT
6 008/04:13:00 MET 17:35 035/16:27:00 GMT 31:35	INRTL R=206.00 MNVR P= 22.00 Y= 34.00 TIG 8/04:28	TRN AUTO PRI	DSC 0.500 DB AT 3.50 DB RT 0.30	SUN R 64 P 74		D/O BURN

*** ALL ATTITUDES IN MEAN OF 1950 ***
*** PYR EULER SEQUENCE ***

STS-60 DAP BOOK

DAP A CONFIGURATIONS

	ITEM #	A1*	A2	A3	A4	A5	A6	A7	A8	A9
TRANSLATION										
PULSE ft/sec	1	0.10	0.10	0.10	0.10		0.10	0.10	0.05	0.05
ROTATION										
DSC RT NORM °/sec	2	0.200	0.400	0.200	0.500		0.200	0.200	0.200	0.100
VERN °/sec	3	0.200	0.400	0.008	0.200		0.200	0.200	0.200	0.200
PULSE NORM °/sec	4	0.10	0.10	0.10	0.10		0.10	0.10	0.10	0.04
VERN °/sec	5	0.010	0.010	0.010	0.010		0.010	0.010	0.010	0.01
COMP NORM °/sec	6	.00	.00	.00	.00		.00	.00	.00	.00
VERN °/sec	7	.000	.000	.000	.000		.000	.000	.000	.000
DEADBAND										
ATT NORM (deg)	8	5.00	1.00	1.00	3.00		5.00	2.00	2.00	40.00
VERN (deg)	9	1.000	1.000	0.070	1.000		1.000	1.000	1.000	40.000
RATE NORM °/sec	10	0.20	0.20	0.20	0.20		0.20	0.20	0.20	0.20
VERN °/sec	11	.020	.020	.010	.020		.020	.020	.020	.040
JET OPT										
P	12	1	1	1	1		3	1 or 3	1	1 or 3
Y	13	1	1	3	1		3	1 or 3	1	1 or 3
CNTL ACCEL	14	0	0	0	0		0	0	0	0-4

*I-LOADED OPS-2 DAP Configuration

DAP B CONFIGURATIONS

	ITEM #	B1*	B2	B3	B4	B5	B6	B7	B8	B9
<u>TRANSLATION</u>										
PULSE ft/sec	15	0.10	0.10	0.10	0.10	0.10		0.05	0.01	0.01
<u>ROTATION</u>										
DSC RT NORM °/sec	16	0.500	0.200	0.200	0.200	0.200		0.500	0.200	0.100
VERN °/sec	17	0.200	0.200	0.200	0.008	0.016		0.200	0.200	0.200
PULSE NORM °/sec	18	0.04	0.04	0.04	0.04	0.04		0.04	0.04	0.04
VERN °/sec	19	0.002	0.002	0.002	0.002	0.002		0.002	0.002	0.002
COMP NORM °/sec	20	.00	.00	.00	.00	.00		.00	.00	.00
VERN °/sec	21	.000	.000	.000	.000	.000		.000	.000	.000
<u>DEADBAND</u>										
ATT NORM (deg)	22	3.00	3.00	3.00	0.30	3.00		2.00	2.00	3.00
VERN (deg)	23	1.000	1.000	1.000	0.100	0.033		1.000	1.000	3.000
RATE NORM °/sec	24	0.20	0.20	0.20	0.20	0.20		0.20	0.20	0.20
VERN °/sec	25	.020	.020	.020	.010	.020		.020	.020	.040
<u>JET OPT</u>										
P	26	1	3	1	3	3		1 or 3	1	1 or 3
Y	27	1	3	1	3	3		1 or 3	1	1 or 3
CNTL ACCEL	28	0	0	0	0	0		0	0	0 - 4

*I-LOADED OPS-2 DAP Configuration except TRANSLATION PULSE (I-LOAD is 0.02 ft/sec)

ALT DAP CONFIGURATIONS

	ITEM #	ALT1*	ALT2	ALT3
RATE DEADBAND	32	0.200	0.070	0.100
JET OPTION	33	1	1 or 3	1 or 3
NUMBER OF JETS	34	2	1	2
ON TIME	35	0.08	0.08	0.08
DELAY	36	0.00	0.00	**

*I-LOADED OPS-2 DAP Configuration

**DELAY: 5.3 WSF Hover
6.0 WSF CHAWS
6.7 WSF Release
WSF Overnight Park
8.0 WSF Ram Cleaning
WSF MBE C/O



DAP A

FLT PLN-2a/60/O/A



A1



DAP A1



A1



PURPOSE:

NOMINAL
IMU ALIGN
LOSS OF VERN
(NOSE & TAIL)

0.10	1	TRANSLATION PULSE
0.200	2	ROTATION DSC RT NORM
0.200	3	VERN
0.10	4	PULSE NORM
0.010	5	VERN
.00	6	COMP NORM
.000	7	VERN
DEADBAND		
-5.00	8	ATT NORM
-1.000	9	VERN
0.20	10	RATE NORM
.020	11	VERN
1	12	JET OPT P
1	13	Y
0	14	CNTL ACCEL

FLT PLN-2b/60/O/A

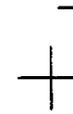

FLT PLN-3a/60/O/A



A2

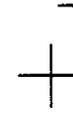



A5

DAP A6

PURPOSE:
LOSS OF VERN
(TAIL ONLY)

- 0.10 1 TRANSLATION PULSE
- 0.200 2 ROTATION DSC RT NORM
- 0.200 3 VERN
- 0.10 4 PULSE NORM
- 0.010 5 VERN
- .00 6 COMP NORM
- .000 7 VERN

- 5.00 8 DEADBAND ATT NORM
- 1.000 9 VERN
- 0.20 10 RATE NORM
- .020 11 VERN

- 3 12 JET OPT P
- 3 13 Y
- 0 14 CNTL ACCEL

FLT PLN-7b/60/O/A

FLT PLN-8a/60/O/A



A7



A6

DAP A7

PURPOSE:
RENDEZVOUS

- 0.10 1 TRANSLATION PULSE
- 0.200 2 ROTATION DSC RT NORM
- 0.200 3 VERN
- 0.10 4 PULSE NORM
- 0.010 5 VERN
- .00 6 COMP NORM
- .000 7 VERN

- 2.00 8 DEADBAND ATT NORM
- 1.000 9 VERN
- 0.20 10 RATE NORM
- .020 11 VERN

- 1 or 3 12 JET OPT P
- 1 or 3 13 Y
- 0 14 CNTL ACCEL

FLT PLN-8b/60/O/A

FLT PLN-9a/60/O/A



A8

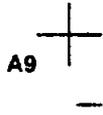

DAP B

FLT PLN-11b/60/O/A

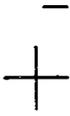

FLT PLN-12a/60/O/A



B1



DAP B1

B1

PURPOSE:
NOMINAL
PRCS IMU ALIGN
OMS & RCS
BURNS

15	0.10*
16	0.500
17	0.200
18	0.04
19	0.002
20	.00
21	.000
22	-.300
23	-1.000
24	0.20
25	.020
26	1
27	1
28	0

* Not I-LOAD

FLT PLN-12b/60/O/A



FLT PLN-13a/60/O/B

B2



+
B1

+

+

+

DAP B2

B2

PURPOSE:

LOSS OF VERN
(TAIL ONLY)

15	0.10
16	0.200
17	0.200
18	0.04
19	0.002
20	.00
21	-0.00
22	-3.00
23	-1.000
24	0.20
25	-0.20
26	3
27	3
28	0

FLT PLN-13b/60/O/A

FLT PLN-14a/60/O/B

+

+

+

B3

+

+

B2

+

+

+

DAP B3

B3

PURPOSE:

LOSS OF VERN
(NOSE & TAIL)
GG MNVR

15	0.10
16	0.200
17	0.200
18	0.04
19	0.002
20	.00
21	-0.00
22	-3.00
23	-1.000
24	0.20
25	-0.20
26	1
27	1
28	0

FLT PLN-14b/60/O/A

FLT PLN-15a/60/O/B

+

+

+

B4

+

+ B3 +

+ +

DAP B4
 PURPOSE:
 SSUS DEPLOY

B4

15	0.1 0
16	0.2 0 0
17	0.0 0 8
18	0.0 4
19	0.0 0 2
20	.0 0
21	.0 0 0
22	_.3 0
23	-.1 0 0
24	0.2 0
25	.0 1 0
26	3
27	3
28	0

FLT PLN-15b/60/O/A

FLT PLN-16a/60/O/B

+ +

+ B5 +

+ B4 +

+ +

DAP B5
 PURPOSE:
 COAS CAL

B5

15	0.1 0
16	0.2 0 0
17	0.0 1 6
18	0.0 4
19	0.0 0 2
20	.0 0
21	.0 0 0
22	_.3 0 0
23	-.0 0 3 3
24	0.2 0
25	.0 2 0
26	3
27	3
28	0

FLT PLN-16b/60/O/A

FLT PLN-17a/60/O/B

+ +

+ B6 +



DAP B6

PURPOSE:
(Blank)



B6

15 -----
 16 -----
 17 -----
 18 -----
 19 -----
 20 -----
 21 -----

 22 -----
 23 -----

 24 -----
 25 -----

 26 -
 27 -

 28 -

FLT PLN-17b/60/O/A

FLT PLN-18a/60/O/A



DAP B7

PURPOSE:
RENDEZVOUS

B7

15 0.0 5
 16 0.5 0 0
 17 0.2 0 0
 18 0.0 4
 19 0.0 0 2
 20 .0 0
 21 .0 0 0

 22 .2 0 0
 23 - 1.0 0 0

 24 0.2 0
 25 .0 2 0

 26 1 or 3
 27 1 or 3

 28 0

FLT PLN-18b/60/O/A

FLT PLN-19a/60/O/A



+ B7 +

DAP B8

PURPOSE:
PROX OPS

+ B8 +

15	0.01
16	0.200
17	0.200
18	0.04
19	0.002
20	.00
21	.000
22	-2.00
23	-1.000
24	0.20
25	.020
26	1
27	1
28	0

FLT PLN-19b/60/O/A

FLT PLN-20a/60/O/A

+ +

+ B9 +

+ B8 +

+ +

DAP B9

PURPOSE:
RMS/WSF OPS

B9

15	0.01
16	0.100
17	0.200
18	0.04
19	0.002
20	.00
21	.000
22	-3.00
23	-3.000
24	0.20
25	.040
26	1 or 3
27	1 or 3
28	0-4

FLT PLN-20b/60/O/B

FLT PLN-21a/60/O/B

+ +

+ +

+

B9

+

+

DAP PURPOSE

+

ALT1 - NOMINAL
I-LOAD

ALT2 - LOSS OF
VERNS

ALT3 - RMS/WSF
OPS

FLT PLN-22a/60/O/A

+

ALT1

+

FLT PLN-21b/60/O/A

+

+

+

DAP ALT1

+

PURPOSE:
NOMINAL I-LOAD

FLT PLN-22b/60/O/A

+

+

+

ALT1

+

RATE DB	
32	0.200
JET OPT	
33	1
# JETS	
34	2
ON TIME	
35	-0.08
DELAY	
36	-0.00

FLT PLN-23a/60/O/A

+

ALT2

+

+ DAP ALT2 +

PURPOSE:
LOSS OF VERNIS

FLT PLN-23b/60/O/A

+ ALT2 +

RATE DB
32 0.0 7 0
JET OPT
33 1 or 3
JETS
34 1
ON TIME
35 - 0.0 8
DELAY
36 - 0.0 0

FLT PLN-24a/60/O/A

+ ALT1 +

+ ALT3 +

+ DAP ALT3 +

PURPOSE:
RMS/WSF OPS

FLT PLN-24b/60/O/A

+ ALT3 +

RATE DB
32 0.1 0 0
JET OPT
33 1 or 3
JETS
34 2
ON TIME
35 - 0.0 8
DELAY
36 ** (see back)

FLT PLN-25a/60/O/B

+ ALT2 +

+ ** +



****DELAY: WSF**

- 5.3 Hover
- 6.0 CHAWS
- 6.7 Release
- O-Night Park
- 8.0 Ram Clean
- MBE C/O

FLT PLN-25b/60/O/B



ALT3



UNIV PTG			
TGT ID = 1	Orbiting Vehicle		
= 2	Earth ctr		
= 3	Earth tgt		
	Input LAT (± 90)		
	LON (± 180 , + = East)		
	ALT (-3444.0 to 20000.0 nm)		
= 4	Sun ctr		
= 5	Celestial tgt		
	Input RA (0-359.99)		
	DEC (± 90)		
= 11-110	Nav Stars		
BODY VECT = 1	+X*		
= 2	-X*		
= 3	-Z*		
= 4	-Y Star Tracker*		
= 5	Optional		
	Input P (0-359.99)		
	Y (270-359.99, 0-90)		
* input OM →	OM (0-359.99)		
MON AXIS = 1	+X		
2	-X		
CNTL ACCEL = 0	Orbiter Alone		
= 1	WSF Hover		
= 2	WSF Ram Cleaning		
= 3	WSF MBE C/O		
= 4	WSF Release, Overnight Park, CHAWS		
PRI JET OPT = 1	Normal	ALT JET OPT = 1	Normal
= 2	Nose only	= 2	Illegal entry
= 3	Tail only	= 3	Tail only

FLT PLN-26a/60/O/B

This DAP Book Page Intentionally Blank

FLT PLN-26b/60/O/A

This Page Intentionally Blank

**STS-60
FLIGHT PLAN NOTES**

**FLT PLN
NOTES**

**FLIGHT PLAN NOTES
(CONSTRAINTS AND GUIDELINES)**

A. FLIGHT DESCRIPTION

Orbiter: DISCOVERY (OV103)
 Inclination: 57.0°
 Insertion Altitude: 190 x 190 nm
 Duration: 8 + 2 days

B. MAJOR EVENTS

<u>EVENT</u>	<u>MET</u>	<u>DATE</u>	<u>CST</u>	<u>DV (fps)</u>	<u>HA/HP (nmi)</u>
Launch	00/00:00	01/27/94	27/06:14	--	--
OMS-2	00/00:45	01/27/94	27/06:59	267.2	191/189
WSF Release	02/03:50	01/29/94	29/10:04	0.0	191/189
WSF Thrust*	02/03:51	01/29/94	29/10:05	~1.9	--
NC-1	02/08:27	01/29/94	29/13:41	0.6	190/189
NC-2	03/01:14	01/30/94	30/07:28	0.5	190/189
NPC	03/07:00	01/30/94	30/13:14	0.0	190/189
NC-3	03/08:00	01/30/94	30/14:14	0.3	190/189
NC-4	03/23:06	01/31/94	31/05:20	8.7	195/191
NH-1	03/23:52	01/31/94	31/06:06	0.2	195/191
NCC	04/01:12	01/31/94	31/07:26	0.0	195/191
Ti	04/02:09	01/31/94	31/08:23	12.0	191/188
WSF Grapple	04/08:00	01/31/94	31/14:14	0.0	191/189
ORBIT ADJUST** (if reqd)	05/07:45	02/01/94	01/13:59	TBD	191/183
ODERACS Release	06/02:45	02/02/94	02/08:59	0.0	191/189
BREMSAT Release	06/07:39	02/02/94	02/13:53	0.0	191/189
Deorbit	08/04:28	02/04/94	04/10:42	335.4	--
Landing	08/05:32	02/04/94	04/11:46	--	--

*WSF provides a ~1.9 fps posigrade separation thrust over a ~35 min period using a 2 oz N₂ thruster. This thruster is designed to place WSF 40 nm behind the orbiter at NC-2.

**ORBIT ADJUST burn is only a possibility. If reqd, it will be designed to lower the shuttle's orbit prior to ODERACS deploy and reduce ODERACS orbital lifetime.

C. LANDING OPPORTUNITIES ARE:

		<u>Landing Orbit</u> <u>No.</u>	<u>Site</u>	<u>Local Time</u>
Nominal	Primary	130	KSC	12:46 EST
	1 Rev late	131	KSC	14:21 EST
	Weather Alt	131	EDW	11:14 PST
1 Day Late	Primary	146	KSC	13:13 EST
	Weather Alt			
	(1 Rev late)	147	EDW	11:41 PST
	Weather Alt (2 Rev late)	148	EDW	13:16 PST
2 Days Late	Primary	161	KSC	12:04 EST
	1 Rev late	162	KSC	13:39 EST
	Weather Alt	162	EDW	10:32 PST

D. CREW

CDR - Charlie Bolden
 PLT - Ken Reightler
 MS1 - Jan Davis
 MS2 - Ron Sega
 MS3 - Franklin Chang-Diaz
 MS4 - Sergei Krikalev

E. COMMUNICATIONS

TDRS Support: East (41° W), West (174° W)
 Backup TV Support: GDS(GDX), MIL(MLX)
 Contingency GSTDN: MIL(MLX), BDA(BDX), DKR, DFR, and GDS(GDX)
 Contingency RTS: HST, GTS, VTS, IOS, CTS, OTS, DGS, and NHS
 Lead time for site call-up: GSTDN - 2 hr, RTS - 4 hr

F. PAYLOADS

1. Wake Shield Facility (WSF) - 1

The WSF payload consists of an RMS-deployable Free Flyer experiment platform, a cross-bay carrier structure and two "smart" canisters mounted on the carrier. The WSF is controlled by either the crew using a PGSC or the ground using the WSF-provided communications link. While deployed, the free flyer creates a wake which provides a high vacuum environment essential to Molecular Beam Epitaxy (MBE) and Chemical Beam Epitaxy (CBE) thin film growth. During Free Flight, WSF uses processing equipment to grow GaAs and GaAsSi thin films within this vacuum wake. The WSF MBE growths are extremely sensitive to contamination so they are planned (7 total) when the orbiter is 40 nm away from WSF to minimize contamination concerns.

The orbiter is maneuvered to a controlled free drift attitude (i.e., tail down gravity gradient with a 60° deadband) 30 min prior to unberth where it remains during RMS "ram cleaning", WSF systems checkout, and for several hours after release. Following release, the free flyer separates from the orbiter using a 2 oz. cold gas thruster. The free flyer remains deployed for approximately 48 hours. During this time, the ground controls the growth of up to seven thin films via orbiter-carrier-free flyer link. Prior to retrieval, after all WSF MBE science is complete, a plume impingement investigation is performed, with the orbiter firing RCS jets on the +Vbar and -Vbar in an effort to improve current

orbiter plume models. The free flyer measures accelerations, plume pressures, and constituents. The orbiter records free flyer data on the ops recorders and video data on the CCTV system. Post-retrieval, WSF is moved to an "overnight park" position designed to provide additional data for the Charge Hazards and Wake Studies (CHAWS) experiment and the CASE Western University materials Laboratory (i.e., MAT-LAB) experiment. The following flight day, the RMS is moved to a CHAWS position and the orbiter is maneuvered to various attitudes relative to the velocity vector to support the CHAWS experiments study of plasma flows in Earth orbit.

2. Spacehab - 2

STS-60 is the second in a series of flights for the Spacehab. The Spacehab is a pressurized module installed in the forward section of the orbiter payload bay, and is crew-accessible from the middeck via airlock/tunnel adapter. Payloads are primarily mounted in middeck-type lockers (up to 50) or in a limited number of Spacelab-type racks. The Spacehab subsystems require orbiter resources which include DC and AC power, cooling via the Freon Heat Exchanger, atmosphere makeup (O₂ and N₂), humidity control, and CO₂ scrubbing.

For mission 2 (STS-60), Spacehab will support 11 payloads including six in the middeck. The cargo is primarily microgravity-oriented with emphasis on material and life science.

The following is a list of the Spacehab - 2 experiments:

ECLIPSE	-	Equipment for Controlled Liquid Phase Sintering Experiment
SEF	-	Space Experiment Facility
PSB	-	Penn State Biomodule
IMMUNE	-	Animal Enclosure Modules (AEM), rodents
ASC-3	-	Astroculture-3
CGBA	-	Commercial Generic Bioprocessing Apparatus
CPCG	-	Commercial Protein Crystal Growth
3-DMA	-	Three-Dimensional Microgravity Accelerometer
BPL	-	Bioserve Pilot Laboratory
ORSEP	-	Organic Separation
SAMS	-	Space Acceleration Measurement System
SOR/F	-	Spacelab Orbiter Refrigerator/Freezer

3. Orbital Debris Radar Calibration Spheres (ODERACS)

This experiment will eject six spheres ranging in size from two to six inches in diameter from a GAS can located on the starboard-aft portion of the PLB. The spheres will be observed, tracked, and recorded by ground-based radars and optical telescopes, enabling calibration of these imaging facilities and data analysis systems. In addition, the radar signatures of the spheres with their known physical properties will be compared to signatures detected from current orbital debris.

4. Bremen Satellite Experiment (BREMSAT)

BREMSAT will execute and obtain data from six experiments during three major flight phases: ascent through BREMSAT deployment, BREMSAT orbit, and BREMSAT reentry. Before deployment, BREMSAT will study thermal conductivity of solutions and residual accelerations. During the orbital phase, experiments include: micro meteorite/dust flow, atomic oxygen, and gas-surface interaction. During reentry, pressure/temperature and residual accelerations will be measured for as long as possible prior to atmospheric burnout.

5. Joint U.S./ Russian Investigations

a. DSO 200, Radiobiological Effects

The purpose of this DSO is to: compare NASA and the Institute for Biomedical Problems space flight dosimeter calibration techniques, correlate the independent simultaneous space radiation exposure measurements and calculations made by the two space programs, and assess the radiobiological effects of high charge/high energy particles on actively metabolizing biological samples.

Passive dosimeters will be mounted in the crew compartment and worn by crew members throughout the mission. The Tissue Equivalent Proportional Counter (TEPC) will be deployed on Flight Day 1 and stowed prior to return. Seed containers and Active Autonomous Dosimeter will be affixed to the TEPC for the duration of the mission.

b. DSO 201, Sensory Motor Investigation

DSO 201 is intended to: enhance the understanding of adaptation to space flight and readaptation postflight; correlate the postflight recovery of postural equilibrium control, head and gaze stability, and readaptation changes in vestibular function; and examine the relationship between voluntary oculomotor performance and passive vestibulo-ocular responses following space flight.

On-orbit investigation protocols are: Voluntary Head Movements (VHM), Optokinetic Nystagmus (OKN), and electrogastrography (EGG) monitoring of autonomic and Gastric Function.

Since VHM and OKN data are both recorded on the "superpocket" data recorder, all VHM and OKN sessions must be performed serially.

c. DSO 202, Metabolic

Fluid and electrolyte balance in the body is regulated by several systems, any or all of which are potentially responsible for the microgravity-induced changes in total body water, extracellular fluid volume, and plasma volume; fluid/electrolyte regulatory hormones; and energy expenditure.

Metabolic activities include bromide and/or doubly labeled water ingestion, taking blood samples, measuring peripheral venous pressure using a catheter, and collecting urine and saliva samples. Metabolic samples will be stored in passive gaseous nitrogen freezers.

d. DSO 204, Visual Observations From Space

The purpose of this DSO is to visually observe Earth features using remote imaging and recording. A modified set of optical equipment is being manifested for these observations, as well as for studies of the solar terminator and the stars. This investigation can be accomplished in concert with ongoing Earth observations.

6. Capillary Pumped Loop/GAS Bridge Assembly (CAPL/GBA)

The CAPL/GBA consists of the CAPL experiment mounted to the top of the GBA and up to six GAS experiment canisters mounted in standard side-mount positions on the GBA.

The CAPL experiment will study the behavior of a full-scale capillary pumped loop heat transfer system in the microgravity environment. A unique feature of the CAPL is that all the pumping is done by capillary forces, with no mechanical moving parts. The CAPL is a prototype of the thermal control system planned for use on the Earth Observing System (EOS) platform.

The six gas cans mounted on the GBA consist of the following:

- a. ODERACS (see PAYLOADS, reference 3)
 - b. BREMSAT (see PAYLOADS, reference 4)
 - c. The G-071 experiment consists of a pellet of a low-melting-point metal alloy that will be melted under zero-G conditions. When the experiment container is cooled, the pellet should form a perfect sphere.
 - d. The G-514 payload consists of two experiments: the Orbiter Stability Experiment (OSE) will measure the high-frequency vibrations that may be present in the orbiter structure during routine in-flight operations. The second experiment will evaluate fogging of photographic emulsions due to energetic particles.
 - e. The G-536 experiment will determine the effects of heat flux and liquid subcooling on nucleate pool boiling in a long-term reduced-gravity environment.
 - f. The G-557 experiment will give an on-orbit demonstration of a two-phase capillary pumped loop (CPL), a two-phase vapor quality sensor (VQS), and a two-phase multichannel condenser profile (CP) and to compare data on CPL behavior in microgravity with analytical predictions resulting from modeling and terrestrial performance.
7. Shuttle Amateur Radio Experiment - II (SAREX-II) (Config C)

SAREX-II consists of a Ham radio capable of two-way communication with amateur radio stations within orbiter line of sight (LOS). Communications occur through an antenna mounted in either window 1 or 6. Configuration C allows radio operation in a Robot mode for the majority of the flight with intermittent voice operations performed by the crew.

8. Auroral Photography Experiment (APE) - B

The objective of this experiment is to photograph and record the spectra of the following aurora phenomena: shuttle glow, thruster emissions, aurora effects on the orbiter, aurora and airglow layer. Aurora and airglow will be the only opportunities available on STS-60. APE-B will also be used during the night CHAWS runs to investigate Shuttle glow phenomenon on the WSF Langmuir Probe.

G. ON-ORBIT DTOs:

1. DTO 623, Cabin Air Monitoring

This DTO will use the solid sorbent sampler to continuously sample the orbiter atmosphere throughout the flight.

2. DTO 656, PGSC Single Event Upset Monitoring

The purpose of this DTO is to determine the susceptibility of the Payload and General Support Computer's random access memory (RAM) to single event upset caused by cosmic radiation.

3. DTO 664, Cabin Temperature Survey

The purpose of this DTO is to compile a temperature profile of the crew cabin in a variety of orbiter attitudes and configurations and to correlate the cabin temperature sensor reading with the cabin temperature profile during on-orbit operations.

4. DTO 670, Evaluation of the Passive Cycle Isolation System (PCIS)

The purpose of this DTO is to compare the magnitude and frequency of the vibrations of the ergometer using the PCIS to those using the hard mount, as well as to evaluate the ease of set up and stowage of the PCIS, the impact on the performance of exercise activities, and the impact on crew habitation in the middeck.

5. DTO 700-2, Laser Range and Range Rate Device

The purpose of this DTO is to demonstrate the capability to provide the orbiter crew with range and range rate data for rendezvous, proximity operations, and deploy operation. The DTO will assess the usefulness of the data to assist the pilot in achieving the desired trajectory conditions. The hardware consists of two handheld, in-cabin laser range and range rate devices.

6. DTO 700-7, Payload Bay Rendezvous Laser Data Comparison

This DTO will provide a more accurate assessment of the laser as a rendezvous and proximity operations guidance aid. This will provide orbiter attitude information to the laser software in real time, thereby increasing the accuracy of the Payload Bay Laser navigation (DTO 700-5).

H. ON-ORBIT DSOs:

1. DSO 325, Dried Blood Method for In-Flight Storage

This DSO will examine the effects of space flight on the passive absorption of blood plasma onto a paper filter. Protocol 1 will have the crew draw blood from a subject and prepare several dried blood samples as well as some frozen control samples for analysis on the ground.

2. DSO 326, Orbiter Window Inspection

This DSO will visually document window abrasions made by orbital debris. The crew will check the windows once a day for new abrasions and will record their findings in a log.

3. DSO 901, Documentary Television

The purpose of DSO 901 is to provide live television or VTR dumps of crew activities, orbiter operations, payload deployment/retrieval operations, Earth views, rendezvous and proximity operations. The broadcast is accomplished using operational air-to-ground and/or operational intercom audio VTR recording when live television is not possible.

4. DSO 902, Documentary Motion Picture

The purpose of DSO 902 is to provide documentary and public affair motion picture photography of the orbiter's basic capabilities and key flight objectives. Documentation shall include launch, crew activities, payload deployment/retrieval, landing, and unscheduled activities of special interest.

5. DSO 903, Documentary Still Photography

The purpose of DSO 903 is to provide still photography of crew activities, orbiter operations, payload deployment/retrieval and operations, Earth views, and unscheduled items of interest.

SPACE INDUSTRIES INC.
101 COURAGEOUS DRIVE
LEAGUE CITY, TX 77573
BONNER, T., JR (10)

** PRIORITY MAIL **

NASA GSFC
530/MORSE, G.
542.2/HENRY, D.G.
553.3/GLADE, M. (2)
740/DUNKER, C. (3)
740.3/KNAPP, D. (2)

NASA HEADQUARTERS
HE/MANN, B.J.(JEANNIE)
HE/PERRY, C.F. (2)
PH/MC CULLA, J.W.
PT/SNAFER, R.
SB/STEMART, D.F., MD (2)
SM-B/EDMOND, H.R.

NASA KSC
CV-PSD-1/HACKEY, A.J.
F264/WUNTER, R.
F266/MC INTYRE, S.
LSO-215/KELLY, T.E.
LSO-247/HOOPER, J. (2)
PA-P18/GRINTER, K.
SPAR-1/RISDON, J.
TP-TMS-A/CREW QUARTERS
TP-TMS-B/VITT OFFICE
TP-VPD-1/SOLMASH, S. (2)
LIBRARY-D

NASA MSFC
CA01/TAYLOR, J.B. (2)
CN22D/TECH DOC REPOSITORY
CT21/LIVINGSTON, J.
E002/MELTON, T. (2)
E022/PDF NGR (2)
E042/BRANCH CHIEF
E043/BRANCH CHIEF
E061/CHIEF DATA MGMT
ES44/HILL, C.K.
NTI/MARSHAL OPERATIONS

FALCON AIR FORCE BASE
SPACE COMMAND
50055-005L
FALCON, CO 80912-5000
LAUNCH OPERATIONS OFF

ROCKWELL INTERNATIONAL DOWNEY
SPACE SYSTEMS DIVISION
12214 LAKEWOOD BOULEVARD
DOWNEY, CA 90241
841-2,AC85/TAYLOR, B.N.
FA43/SMITH, C.U. (28)
FB13/FRANK, G.

** U.S. MAIL **

MCDONNELL DOUGLAS-MUNTSVILLE
609 DISCOVERY DRIVE
MUNTSVILLE, AL 35806
21A1/SPACELAB LIBRARY
23B1/FRENCH, A.L.
32C2/KIRBY, J. (8)
32C2/SPACENAB
MS5C/TRU/ANDERS, B.

ALLIED/BENDIX AEROSPACE
OAG SUITE 450
10210 GREENBELT RD
SEABROOK, MD 20706
BEADLING, R. (5)

CANADIAN ASTRONAUT PROGRAM
CANADIAN SPACE AGENCY
6767 ROUTE DE L'AEROPORT
SAINT-HUBERT, QUEBEC
J3Y 8Y9
CANADA
AIKENHEAD, B.A.

DRAPER LABORATORIES
555 TECHNOLOGY SQUARE
CAMBRIDGE, MA 02139-3539
MS4A/LARSON, R.A.
MS4C/TURNBALL, J.
KACHMAR, P.

GTE GOVERNMENT SYSTEMS CORP-MN
P O BOX 235
LAS CRUCES, NM 88004
GC/GOMEZ, M.

HAMILTON STANDARD
BRADLEY FIELD RD.
WINDSOR LOCKS, CT 06096
1A-2-X65/RUEL, S.D.

HONEYWELL AVIONICS DIVISION
13350 US HWY 19N
CLEARWATER, FL 34624-7290
MS737-5/MC GUIRE, G.M.

INTERMETRICS, INC.-CA
5312 BOLSA AVE
MUNTINGTON BEACH, CA 92649
KOEHLER, K.

INTERMETRICS, INC.-WA
1750 112TH AVE NE
SUITE D-151
BELLEVUE, WA 98004
NIKKEL, G.

NASA GSFC-AL
117 JETPLEX CIRCLE
SUITE C-7
MADISON, AL 35758
442/OLSON, K.

ONITRON, INC.
6411 IVY LANE, SUITE 600
GREENBELT, MD 20770
COLE, S. (3)

ROCKWELL INTERNATIONAL CORP.
ROCKETDYNE DIVISION
6633 CANOGA AVENUE
CANOGA PARK, CA 91303
055-LA38/CONNOR, T.J.

SPAR AEROSPACE
9445 AIRPORT ROAD
BRAMPTON, ONTARIO
CANADA L6B4J3
WOODLAND, C. (2)

TELEDYNE BROWN ENGINEERING
CUMMINGS RESEARCH PARK
300 SPARKMAN DRIVE, NW
P. O. BOX 070007
MUNTSVILLE, AL 35807-7007
MS 172/GILCHRIST, M.

UNIVERSITY OF HOUSTON
SPACE VACUUM EPITAXY CENTER
SCIENCE AND RESEARCH ONE
ROOM 724
4800 CALHOUN ROAD
HOUSTON, TX 77024-5507
COMBS, M.
IGNATIEV, A., DR.
STERLING, M., DR. (6)

Total 421
(12/14/93 - NCANADA)

NOTE
* FOR CHANGES *
* IN DISTRIBUTION *
* OR ADDRESS CORRECTIONS *
* CONTACT THE PDF MANAGEMENT *
* OFFICE AT (713) 244-7893 *
* OR MAIL TO *
* DO46/DISTRIBUTION MANAGER, *
* HELEN CANADA *